

DEE'S DECAD OF SHAPES
AND
PLATO'S NUMBER

© 2010 by Jim Egan. All Rights reserved.

ISBN_10:

ISBN-13:

LCCN:

Published by
Cosmopolite Press
153 Mill Street
Newport, Rhode Island 02840

Visit
johndeetower.com
for more information.

Printed in the United States of America

DEE'S DECAD OF SHAPES
AND
PLATO'S NUMBER

BY
JIM EGAN

COSMOPOLITE PRESS
NEWPORT, RHODE ISLAND



"CITIZEN OF THE WORLD"
(COSMOPOLITE, IS A WORD COINED
BY JOHN DEE, FROM THE GREEK
WORDS COSMOS MEANING "WORLD"
AND POLITĒS MEANING "CITIZEN")



Dedication

To Plato for his pursuit of
“Truth, Goodness, and Beauty”
and for writing a mathematical riddle
for Dee and me to figure out.

Table of Contents

page

- 1 “Intertransformability” of the 5 Platonic Solids
- 15 The hidden geometric solids on the Title page of the *Monas Hieroglyphica*
- 65 Renewed enthusiasm for the Platonic and Archimedean solids in the Renaissance
- 87 Brief Biography of Plato
- 91 Plato’s Number(s) in Republic 8:546
- 101 An even closer look at Plato’s Number(s) in Republic 8:546
- 129 Plato shows his love of 360, 2520, and 12-ness in the Ideal City of “The Laws”
- 153 Dee plants more clues about Plato’s Number

“INTERTRANSFORMABILITY” OF THE 5 PLATONIC SOLIDS

Of all the polyhedra, only 5 have the stuff required to be considered “regular polyhedra” or Platonic solids:

Rule 1. The faces must be all the same shape and be “regular” polygons
(all the polygon’s angles must be identical).

Rule 2. The same number of edges must meet at each vertex.

Rule 3. All its edges must be the same length.

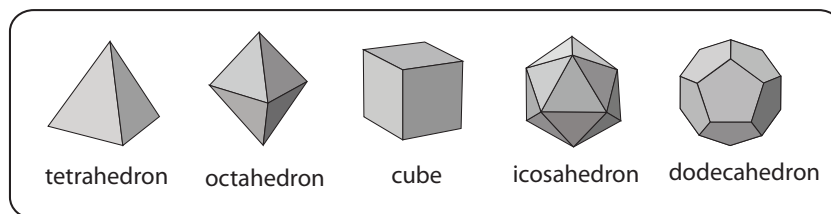

The 5 Platonic solids

These five may all look like different animals, but they are all closely interrelated. Bucky and Dee were both fascinated by what Bucky calls their “intertransformability.”

The most obvious interconnection is that the tetrahedron, the octahedron, and the icosahedron all have triangular faces. Bucky demonstrated how a flexible-elbowed cuboctahedron “jitterbugs” into all of these shapes. But jitterbugging is only a taste of how all the Platonic solids are interrelated.

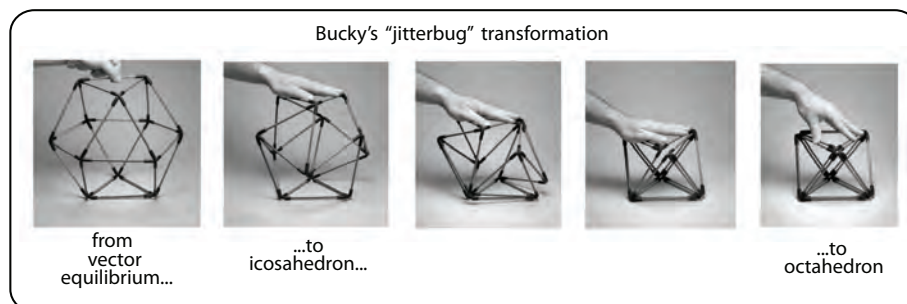

The best way to explore their intertransformabilities is by studying their various “truncations” and “stellations.” Let’s start with the “truncations.”

Truncations

Truncation simply means slicing off all the corner tips of a given polyhedron by the same amount. You can use a sword, machete, chainsaw, or if it’s a cheese polyhedron, a cheese knife.

When a polyhedron is truncated so much that it transforms into a different regular or irregular polyhedron is said to be “degenerately truncated,” a term coined by Bucky’s associate Arthur Loeb. Generally, this means slicing away the corners until the choppings meet up at the midpoints of the edges.

To clarify this visually, I’ll demonstrate the “degenerate truncations” of the 5 Platonic solids, one at a time. (One mustn’t cut corners when exploring cutting corners.)

Starting with a tetrahedron, I have sliced a little bit off the corners, then sliced off a little bit more, and finally, when the slicings meet up (at mid-edge), it has morphed into an octahedron!

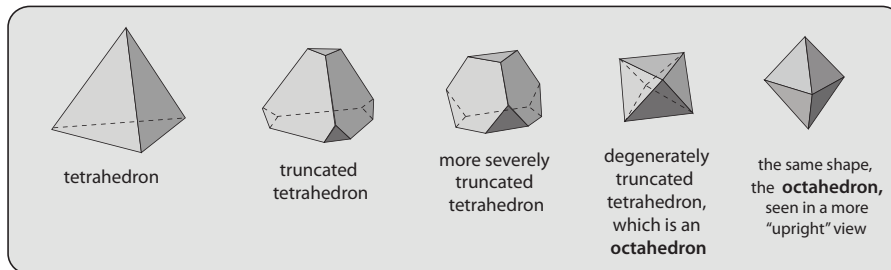

A “degenerately truncated” cube transforms into a cuboctahedron.

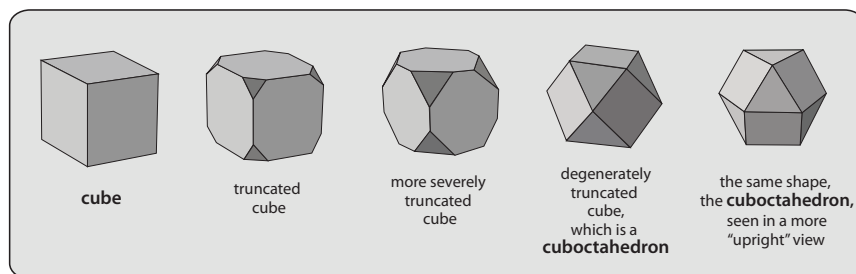

And curiously, a “degenerately truncated” octahedron also transforms into a cuboctahedron.

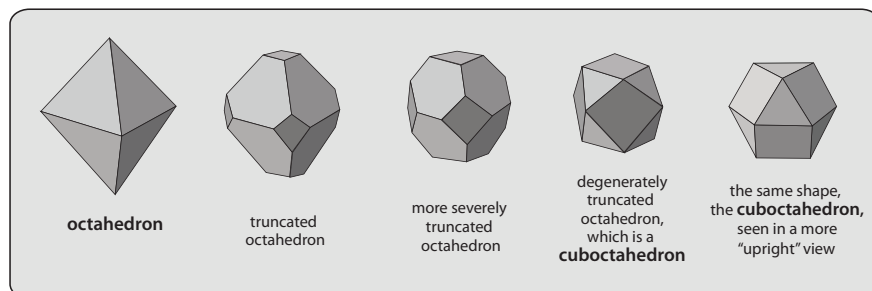

A “degenerately truncated” dodecahedron morphs into an icosidodecahedron.

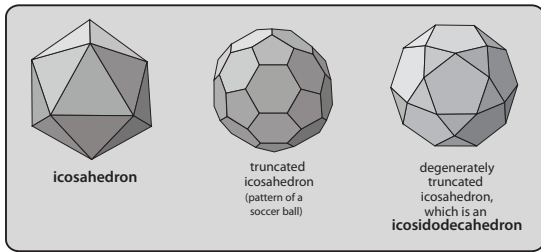

For simplicity, I have not shown all the stages, but one interesting stage you will recognize is the “soccer ball shape,” whose faces are a symmetrical mix of pentagons and hexagons. This helps you sense how truncation leads towards sphericity.)

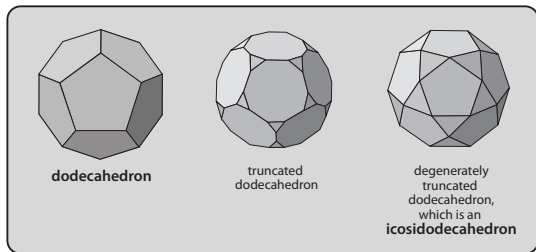

And, perhaps not surprisingly, a dodecahedron is also “degenerately truncates” into an icosidodecahedron.

Now we’re starting to get a feel for “intertransformability.” Let’s look at “stellations.”

Stellations

A stellation is kind of like the opposite of truncation. Instead of “chopping off corners,” a small pyramid is “added” to each face. (The number of sides on the pyramid, of course, depends upon the number of vertices the face has.)

Loeb’s “degenerate stellation” simply means the pyramid is raised so high that some of its faces become “coplanar” (come to be on the same plane) and a new shape is formed.

For example, if all the faces of a tetrahedron are raised up a little bit as pyramids, then raised a little more, then raised a little more, eventually the sides of adjoining pyramids are on the same plane and cube suddenly appears. (These raised pyramids are not raised high enough to become full tetrahedra– they are little bit squatter.)

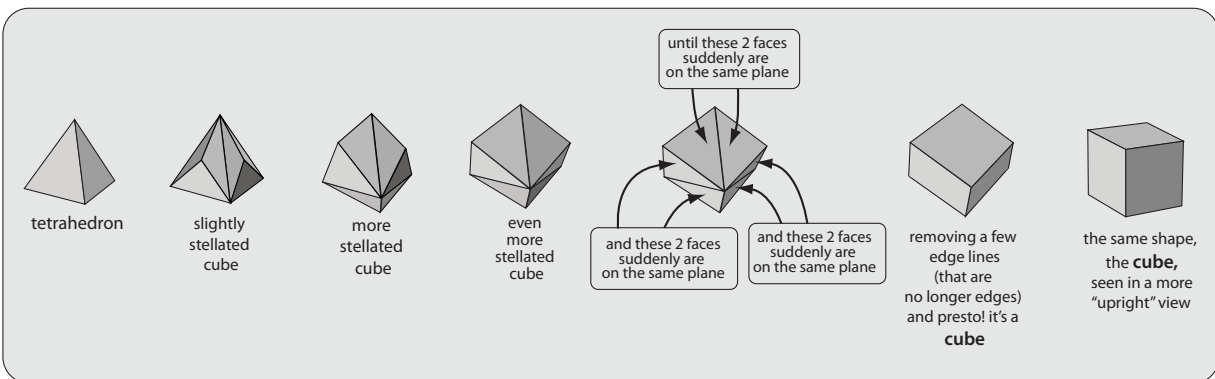

If the eight faces of an octahedron are raised up as little pyramids, then raised some more, then raised some more, the final “degenerately stellated” form is rhombic dodecahedron. (This shape has 12 equal-sized rhombic or diamond-shaped faces and we’ll take a more in-depth look at it momentarily)

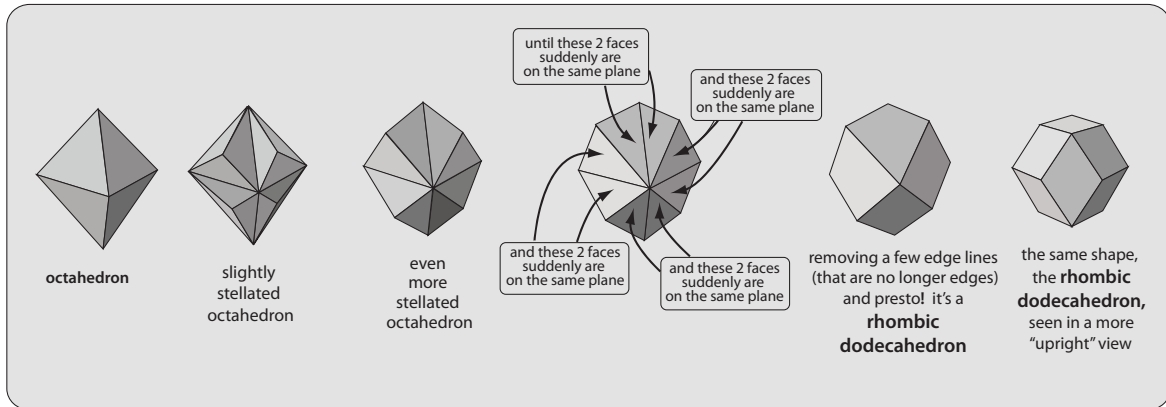

When a cube is “degenerately stellated” it also forms a rhombic dodecahedron!

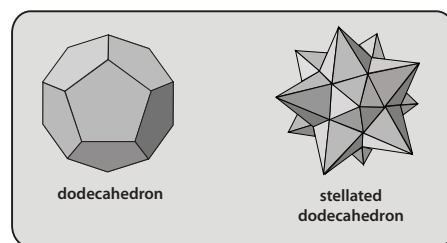
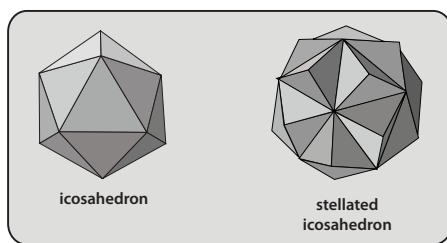
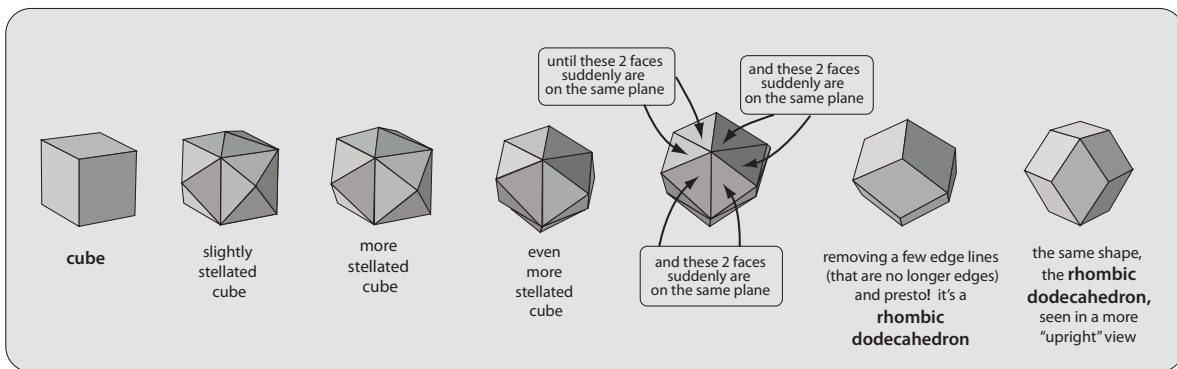

The icosahedron and a dodecahedron only stellate into spiky clusters like these. The “spiky-ness” depends on how tall the pyramids are made.



Paolo Uccello's mosaic of a stellated dodecahedron dating from around 1430

As proof that Renaissanceers were excited about all this, here is a mosaic of a stellated dodecahedron on the floor of the cathedral of San Marco in Venice. It was made around 1430 by Paolo Uccello. This mathematician and artist was one of the first Italian painters to explore the use of perspective.

Here's a summary of the degenerate truncations and degenerate stellations of the 5 Platonic solids.

It's obvious that there is an important relationship between the cuboctahedron and the rhombic dodecahedron.

	the shape's degenerate truncation	the shape's degenerate stellation
tetrahedron	octahedron	cube
octahedron	cuboctahedron	rhombic dodecahedron
cube	cuboctahedron	rhombic dodecahedron
icosahedron	icosidodecahedron	stellated icosahedron
dodecahedron	icosidodecahedron	stellated dodecahedron

The rhombic dodecahedron

Let's explore the intriguing rhombic dodecahedron a little deeper. Its 12 diamond-shaped faces are made from 24 edges that are the same length.

Then why is it not considered a Platonic solid? Because it doesn't conform to either "rule 1" or "rule 2."

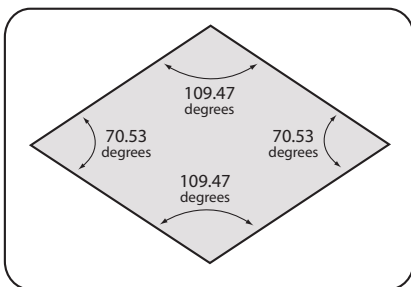

While its faces are all equal-sized, they are not "regular" polygons. Each face has two acute angles are 109.47 degrees each and two obtuse angles are 70.53 degrees each.

It fails meet the requirement of "Rule 2" because at some of its vertices are the meeting points of 3 edges and some are the meeting points of 4 edges.

A deeper look “intertransformabilities”

Let’s take a closer look at the pyramids involved in the preceding truncations and stellations.

What is the shape of the pyramids
sliced off by the cube and the octahedron,
 before they each morph into a cuboctahedron?

What is the shape of a pyramids
added to the faces of the cube and the octahedron,
 before they each morph into a rhombic dodecahedron?

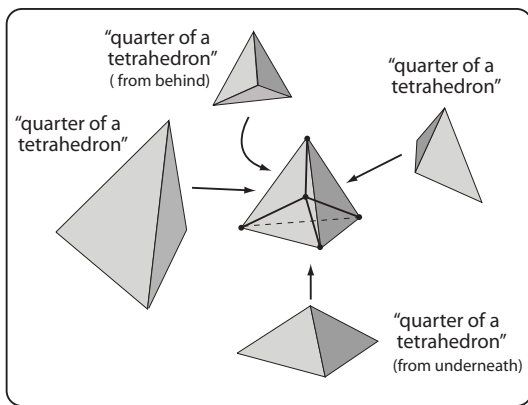

dividing a tetrahedron into four
 “quarter of a tetrahedron” pyramids

One answer can be found by finding the exact centerpoint of a tetrahedron and making lines out to the various vertices. In other words, by splitting the whole tetrahedron into four flat-tish pyramid shapes, each one being a **“quarter of a tetrahedron.”**

The other answer can be found by finding the exact centerpoint of a cube and making lines out to all its various vertices. In other words, by splitting the whole cube into 6 pyramid shapes, each one being **“one eighth of a cube.”**

Let’s see how these shapes are involved in the truncations and stellations of some of the Platonic solids.

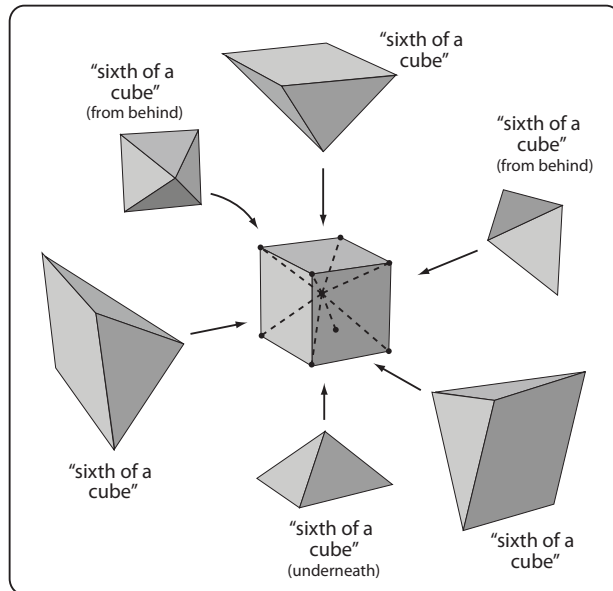

dividing a cube into six
 “sixth of a cube” pyramids

When a “one eighth of a cube” pyramid is **sliced off** each of the 6 corners of an octahedron, it to morphs into a cuboctahedron.

slicing “sixth of a cube” pyramids off of an octahedron

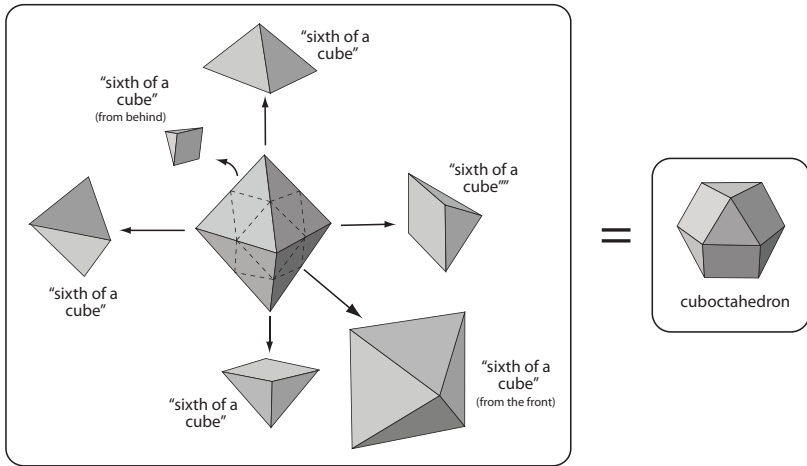

When a “quarter of a tetrahedron” pyramid is **sliced off** each of the 8 corners of a cube, it to morphs into a cuboctahedron.

slicing “quarter of a tetrahedron” pyramids off of a cube

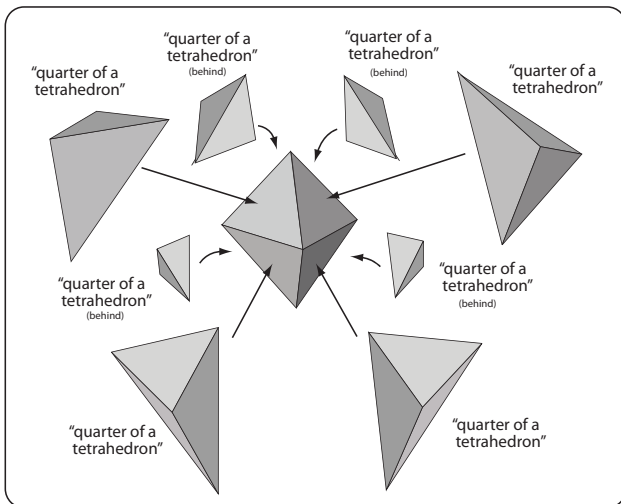
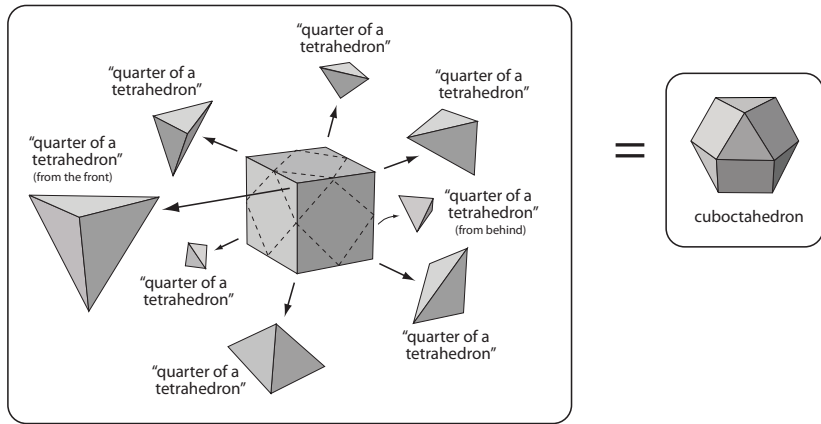

adding “quarter of a tetrahedron” pyramids to the faces of an octahedron

When a “ quarter of a tetrahedron” pyramid is **added to** each of the 8 faces of an octahedron, it morphs into a rhombic dodecahedron.

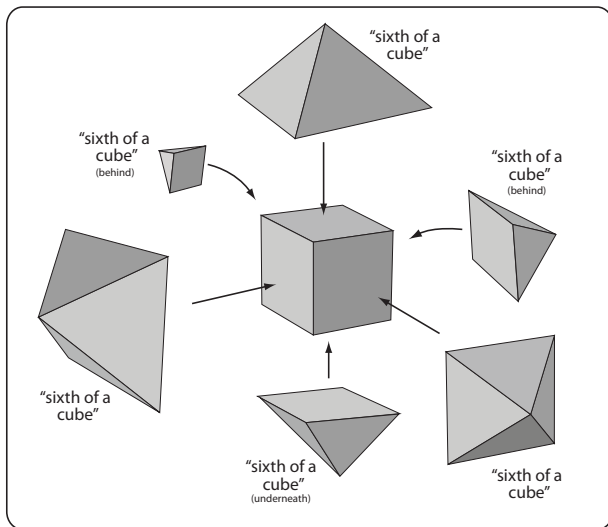

adding "sixth of a cube" pyramids to the faces of a cube

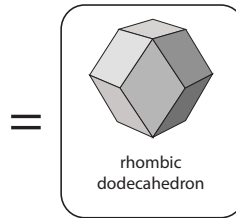

When a "one eighth of a cube" pyramid is added to each of the 6 faces of a cube, it morphs into a rhombic dodecahedron.

As we are dealing in pyramids made by subdividing a tetrahedron and a cube, this provides more insight into the amazing "intertransformability" of the Platonic solids.

And it also hints at the close relationship between the cuboctahedron and the rhombic dodecahedron.

They don't really look related. One has 14 faces comprised of triangles and squares; and the other has 12 diamond-shape faces. But these two shapes aren't just friends, they are like twins or inside-out versions of each other.

In short, they are "duals." The vertices of one shape correspond to the faces centerpoint of the other. (Amy Edmundson, *A Fuller Explanation*, pp. 47-53, 137-140, 180-185)

Duals

The 12 vertices of the cuboctahedron correspond to the centerpoints of the 12 faces of the rhombic dodecahedron.

And conversely, the 14 vertices of the rhombic dodecahedron correspond to the center points of the 14 faces of the cuboctahedron (even though some are triangles and some are squares).

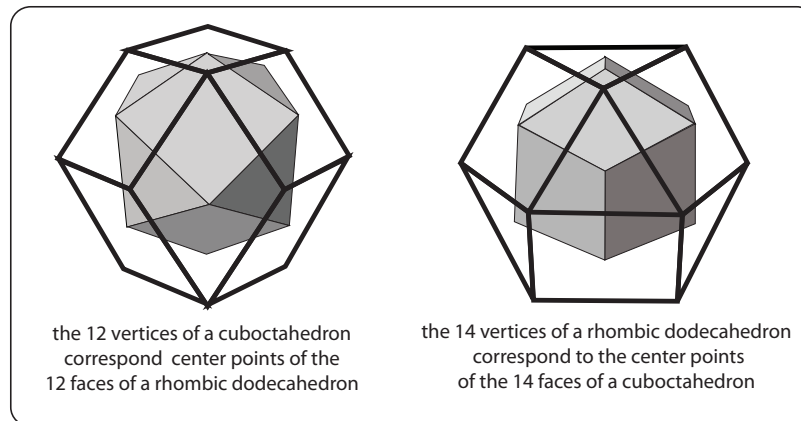

the cuboctahedron and the rhombic dodecahedron are duals

If the shapes are made to be approximately the same size, they “embrace” each other nicely.

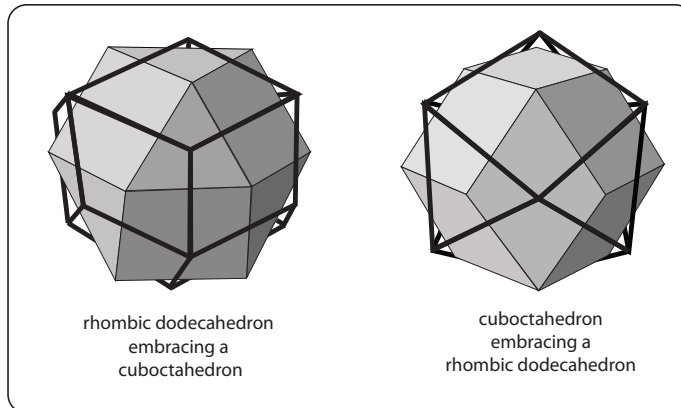

A even more vivid display of this duality can be seen by studying the cubotahedral shape of the closest-packing-of-spheres. We’ve seen how connecting the centerpoints of the 12 outer spheres makes a cuboctahedron.

Let’s turn our attention to the interstices (*inter* means “between” and *sistere* means to stand) that “stand between” the 12 outer spheres. They come in two flavors. Some are surrounded by 3 of the outer spheres and some are surrounded by 4 outer spheres.

Connecting the centerpoints of all the all the interstices makes a rhombic dodecahedron!

Now it’s easy to see how the rhombic dodecahedron is sort of a “reflection” of the triangular groupings and the square groupings of the cuboctahedron of spheres.

The two different kinds of vertices of the rhombic dodecahedron (where 3 edges meet and where 4 edges meet) are a “reflection” of the two different kinds of faces of a cuboctahedron (triangular and square).

In *Synergetics II*, Bucky expresses it another way: “The midpoints of the 12 diamond faces of the rhombic dodecahedron’s 12 faces are congruent with the points of tangency of the 12 surrounding spheres.” (Fuller, *Synergetics II*, 987.326, p. 345)

In the 12-around-1
closest packing of spheres
arrangement...

...connecting the center points
of the 12 outer spheres
forms a cuboctahedron.

... and connecting the center points of the
interstices (the areas between the spheres)
forms a rhombic dodecahedron.

Balloons and Pomegranates

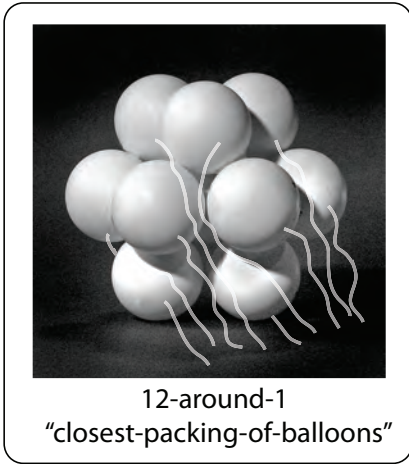

Another way to see the duality of these two shapes is with balloons.

Imagine 13 spherical balloons (with air hoses attached) clustered in a "closest-packing-of-balloons" arrangement.

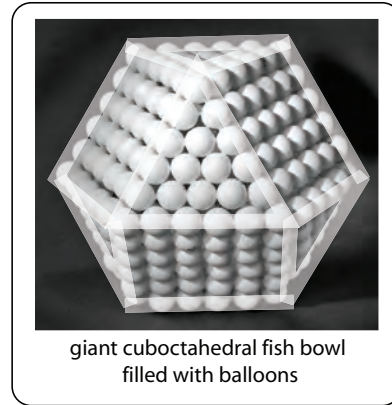

Then imagine this cluster in the middle of a giant cuboctahedral-shaped fish bowl of several hundred more balloons (all with air hoses).

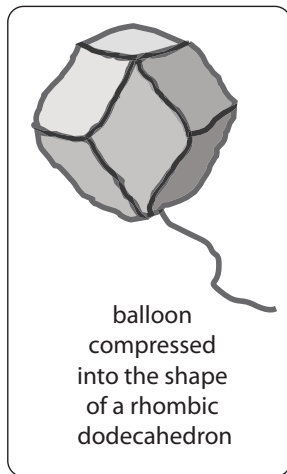

If we inflate all the balloons simultaneously, the only places they can expand is into the interstices between them. Eventually each balloons will have 12 flat faces where it meets its neighbors. All the inner balloons (including the original 13) will be shaped like rhombic dodecahedra!

Johannes Kepler in his 1611 treatise, *On the six-cornered Snowflake*, uses the example of the shape of a pomegranate seeds which expand inside a relatively hard outer rind.

“ Thus in the closest pack in three dimensions,
the triangular pattern cannot exist without the square, and vice versa.

It is therefore obvious that the loculi [cells or seeds]
of the pomegranate are squeezed into the shape of a solid rhomboid;
the demands of their matter coincide with the proportions of their growth.
The globular loculi opposite each other do not persist in pushing face to face,
but are displaced and slip aside into the spaces left between
three and four others in the confronting plane”

(Kepler, translated by Colin Hardie, p.17)

(Kepler's example is rather conceptual. One can observe flat faces on pomegrante seeds, but it's not that easy to find a seed in the shape of a perfect rhombic dodecahedron. Inside a pomegrante are also what Kepler calls "peduncles" that take food to the seeds and the seeds are not perfectly close-packed to start with.)

These examples reveal another noteworthy characteristic of the rhombic dodecahedron. It's an "all-space filling" shape. there aren't many shapes that can make this claim. Of the Platonic solids, only the cube is an "all space" filler. You could fill a square warehouse with thousands of Rubik's cubes and there would be no interstices between them.

Shapes hidden in Bucky's "Space Frame"

Another way to see the interrelationship between the cuboctahedron and the rhombic dodecahedron is in Bucky's "Isotropic Vector Matrix" or what has come to be called Space Frame in the engineering trade.

Recall that the essence of Space Frame is Bucky's "octet truss," the combination of a tetrahedron and an octahedron.

When tetrahedra and half octahedra are connected in a row, they form linear structure used for tall or radio transmitting towers. When several rows are added together to make a layer, they become the plane structure used for the ceilings of auditoriums. When several layers are added together, it becomes Space Frame.

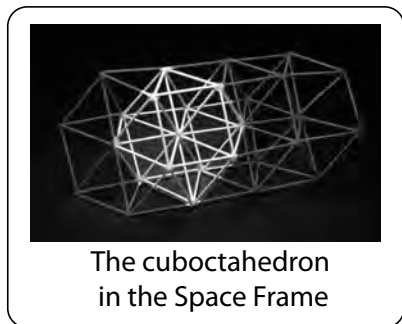
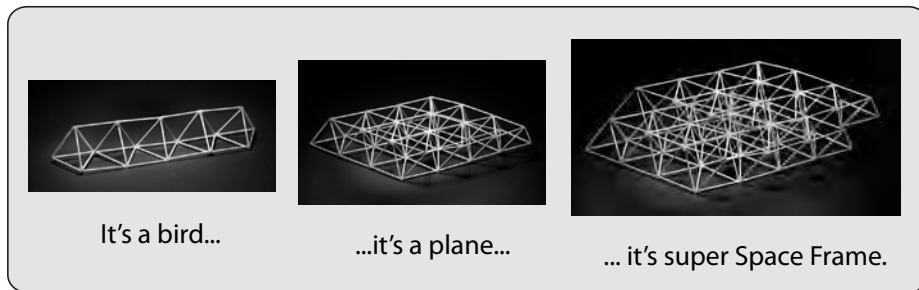
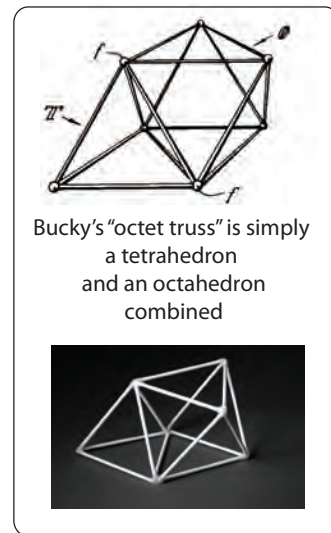

Each of its innermost juncture points has 12 radiating vectors, so it's pretty easy to visualize the cuboctahedrons in the Space Frame. (But cuboctahedrons are not "all space fillers." They require small octahedra to fill in the gaps created when they pack together.)

The cube is an “all space filler.” And the rhombic dodecahedron is an all space filler.” However, neither of them is easily discernable in the Space Frame. They can both be found, but we need to make some new interconnections to locate them. (This is easier to explain than to illustrate.)

Simply connect the centerpoints of all the **octahedra** and these new lines make **cubes** that are “all space filling.”

In other words, each of the octahedrons’ centerpoints is a meeting place for the corners of 8 different cubes. In this way, Space Frame can be seen as dozens of rows and columns of cubes (the warehouse of Rubik’s cubes).

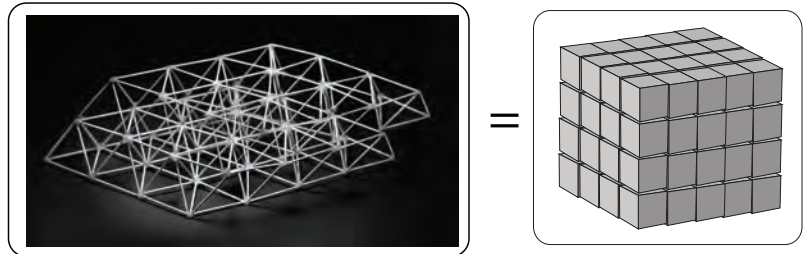

Let’s return to the Space Frame, only this time let’s connect the center points of all the **tetrahedra**. Guess what shape results? You guessed it, dozens of “all space filling” **rhombic dodecahedra!**

This one is easier to visualize. Remember that an octahedron needed a “quarter of a tetrahedron” pyramid on each of its 8 faces in order to stellate into a rhombic dodecahedron.

In the process of connecting the centerpoints of the tetrahedron we have actually cut each tetrahedron into four flat pyramids, exactly the pieces required.

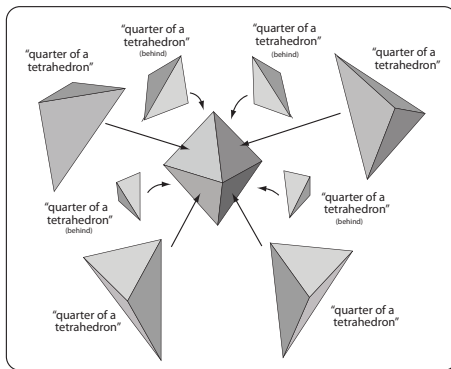

adding “quarter of a tetrahedron” pyramids to the faces of an octahedron

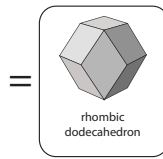

Conveniently, all the faces of all the octahedra in the Space Frame face neighboring tetrahedra.

If these octahedra “borrows” a “quarter of a tetrahedron” pyramid from each of its 12 neighbors, it makes a rhombic dodecahedron. And since all the “quarterered tetrahedra” get used up, the rhombic dodecahedra are filling “all space.”

In this illustration of rhombic dodecahedra filling “all space,” I’ve left a liile air between the sapes only to avoid visual confusion. They all actually fit snug as a bug in a rug.

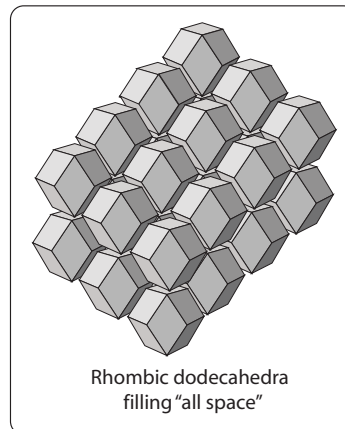

By recognizing the “invisible grid “ connecting the centerpoints of all the tetrahedra, the Space Frame can be seen as an array of all space filling rhombic dodecahedra.

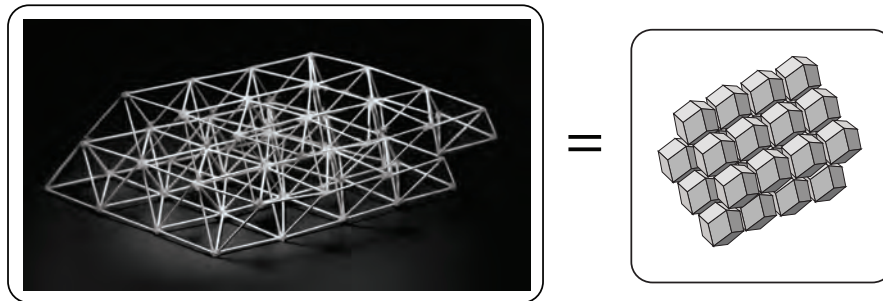

To summarize, Space Frame is a treasury of intertransformability:

the Space Frame itself is made from the octet truss, which is a combination of a tetrahedron and an octahedron

the cuboctahedron, with its 12 radiating vectors, can be seen at each internal junction point

interconnecting all the center points of all the octahedra makes an array of “all space filling” cubes

interconnecting all the center points of all the tetrahedra makes an array of “all space filling” rhombic dodecahedra

But what about the 3-D shapes? Surely the geometer Dee would leave them out of his grand blueprint of the Universe! He mentions point, line and circle, but there is no mention of a cube, octahedron, icosahedron, or dodecahedron. (The only one of the 5 Platonic solids Dee mentions in the text is the tetrahedron– in reference to how vision works, in his advice to Opticians in his Letter to Maximillian.)

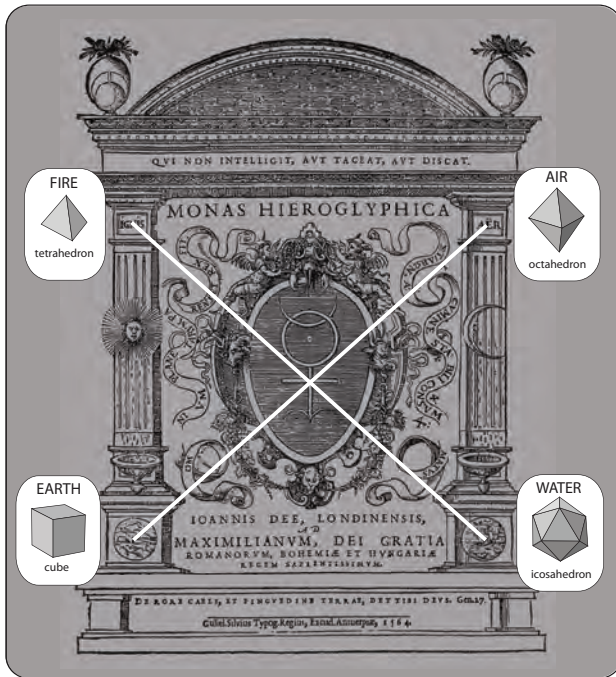

On the Title page, there is an obvious reference to four of the regular solids. Dee was such a Plato enthusiast, surely he intended to the 4 Elements shown to represent four of the regular solids (as per Timaeus 55)

When the Title page has been “restored” (the emblem moved up to fit more harmoniously in the square theater between the columns), lines connecting these elements intersect at the center point of the cross on the Monas symbol.

Plato also writes about the “fifth” regular solid, which “God used to paint the Universe.” This figure is obviously important in Dee’s cosmos. Where is it to be positioned?

The most obvious place is on that central point, making an arrangement like the five dots on the face of a die.

This whole pattern suggests that Dee is interested in the **interrelationships** between these 5 regular solids.

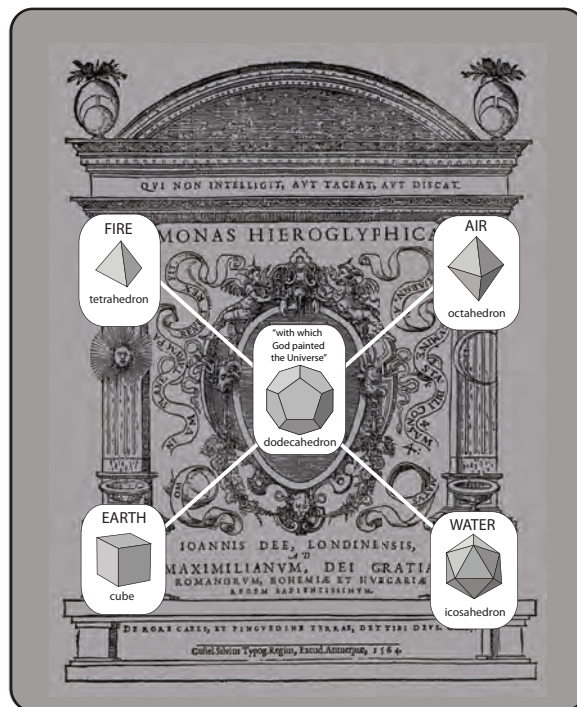

The most obvious inter relationship is that these shapes naturally “pair up” as duals of each other. The octahedron and the cube are duals. The 8 vertices of an octahedron correspond with the center points of the 8 faces of the cube.

And conversely the 6 vertices of the cube correspond with the center points of the 6 faces of the octahedron.

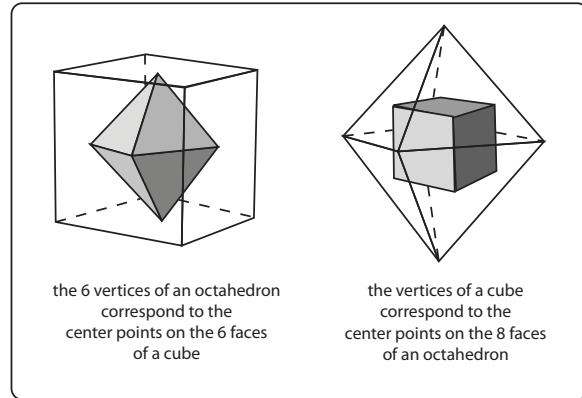

The icosahedron and dodecahedron are also duals. The 20 vertices of the icosahedron correspond to the center points of the 20 faces of the dodecahedron.

And conversely, the 12 vertices of the dodecahedron correspond to the center points of the 12 faces of the icosahedron.

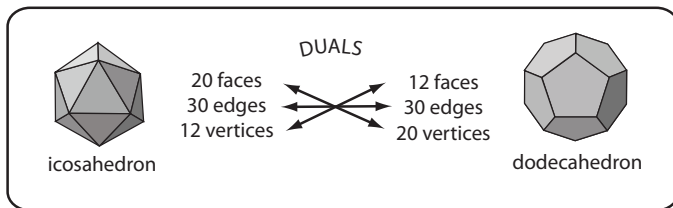
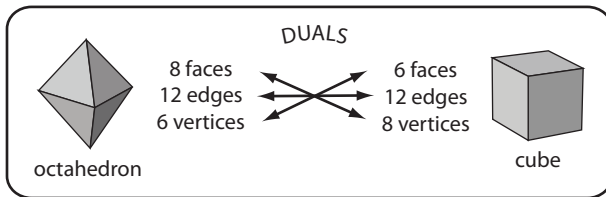
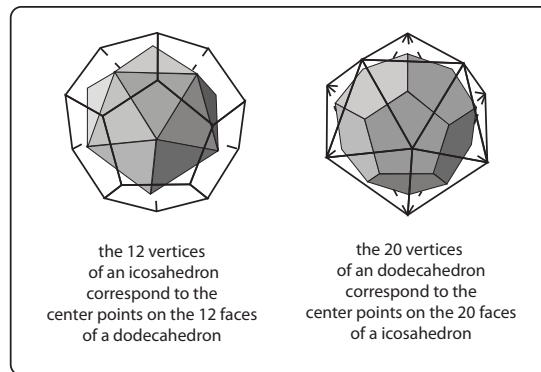

Looking at the number of vertices, edges, and faces helps portray this relationship between the octahedron and the cube as a “union of opposites.”

The same goes for the relationship between the icosahedron and the dodecahedron.

Fortunately we now have a sign to express this “union of opposites”—the retrocity symbol.

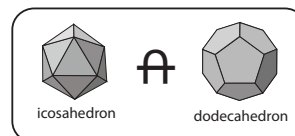
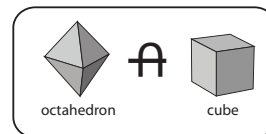

There's no doubt Dee also wants the reader to explore the intersection of an octahedron and cube, the cuboctahedron.

When all of the pointy star-tips of this octahedron-cube compound are removed, what remains is just what is common to both. And this is the shape of a **cuboctahedron**.

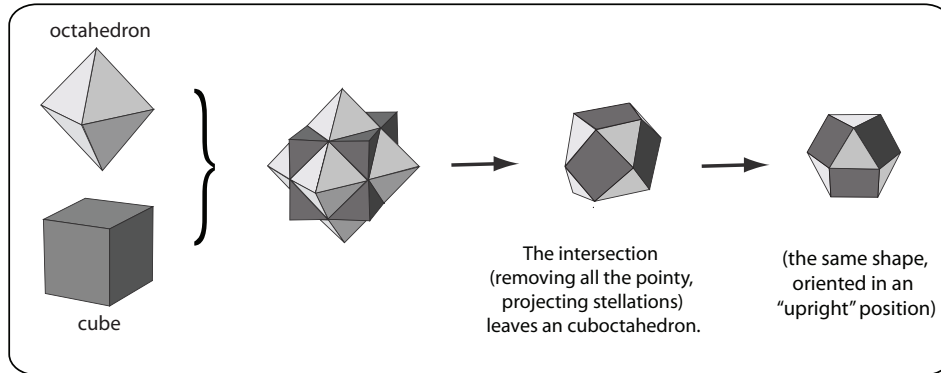

Dee gave makes cryptic references to the cuboctahedron throughout the Monas: The spheres of the eagle's eggs and scarab-beetle's dung balls loose will close-pack in cuboctahedral shape. He makes several references to the numbers 12 and 13 (the 12-around-1 arrangement) as well is the 24 (edges of a cuboctahedron and 25 (great circles of a cuboctahedron). He has even hidden in 8 triangles and the 6 squares (quaternaries) in the graphic design on his "Thus the World Was Created" chart.

It's apparent Dee was aware of the cuboctahedron, as he owned copies of Luca Pacioli's 1509 *The Divine Proportion* and Albrecht Dürer's 1525 *Art of Painting*, where this shape is illustrated. Dee also owned Geralmo Cardano's 1550 *On the Subtleties of Nature*, which describes the 12-around-1, closest-packing-of spheres arrangement.

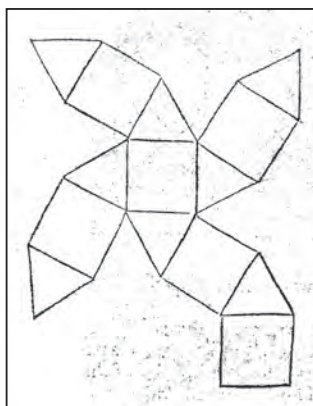

Flussas' net of the cuboctahedron

But more convincing is the fact that Dee and Henry Billingsley appended Flussas' *Brief Treatise* to their 1570 translation of Euclid's *Elements*.

In that treatise, Flussas provides all the geometry to find the cuboctahedron as the intersection of an octahedron and a cube.

Flussas actually calls the cuboctahedron an "exothadron" This is an abbreviated form of "hexoctahedron (the "hex" referring to the six-sided cube).

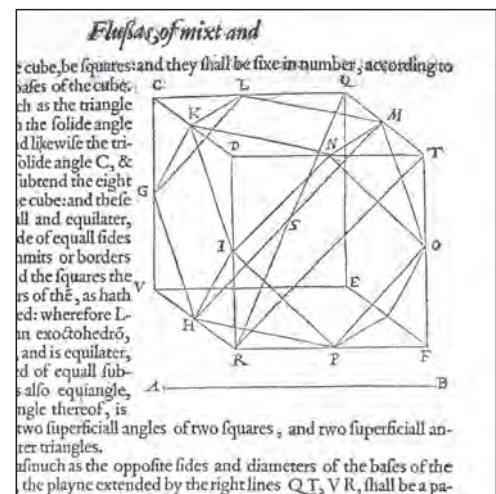

Flussas derives the cuboctahedron using the midpoints the edges of a cube

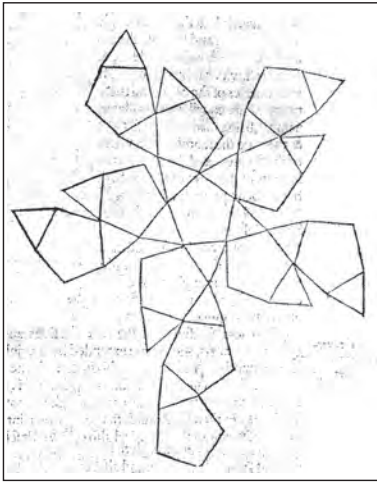

Flussas' net of the icosidodecahedron

Flussas also describes in detail the intersection of an icosahedron and a dodecahedron, resulting in an **icosidodecahedron**.

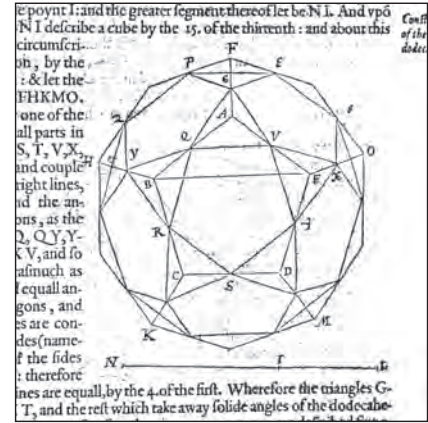

Flussas explains the construction of the icosidodecahedron

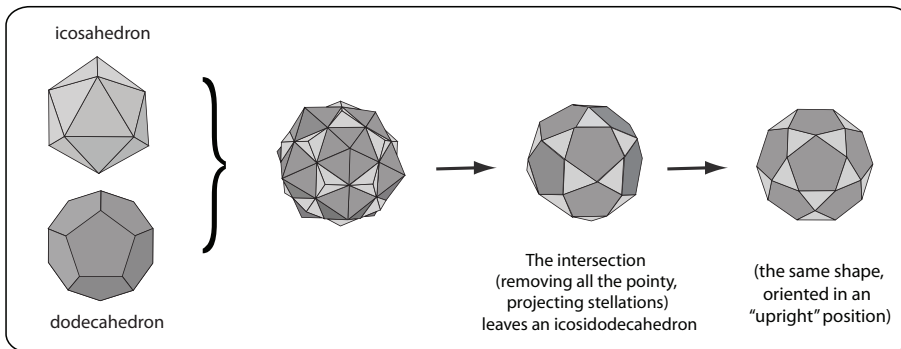

When all of the pointy star-tips of the icosahedron-dodecahedron compound are removed, what remains is just what is common to both of them—an **icosidodecahedron**.

As these two "intersection" shapes are so intimately interconnected with the regular polyhedra, it seems like they belong on the Title page as well.

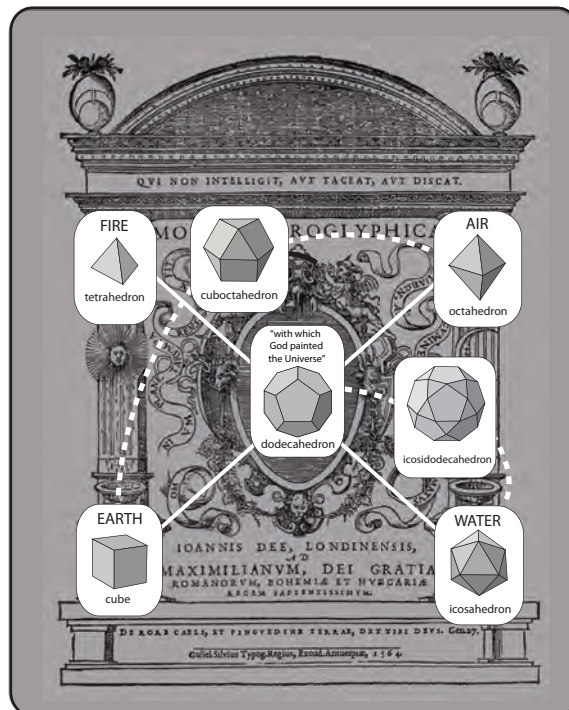

The tetrahedron appears sadly left out of all his interaction. But it mustn't be neglected, as it is the simplest and most basic of all Nature's polyhedra.

The reason it is "alone" is that it is a "self dual." The 4 vertices of an "inverted" tetrahedron correspond to the centerpoints of the 4 faces of an "upright" tetrahedron. The converse holds true as well.

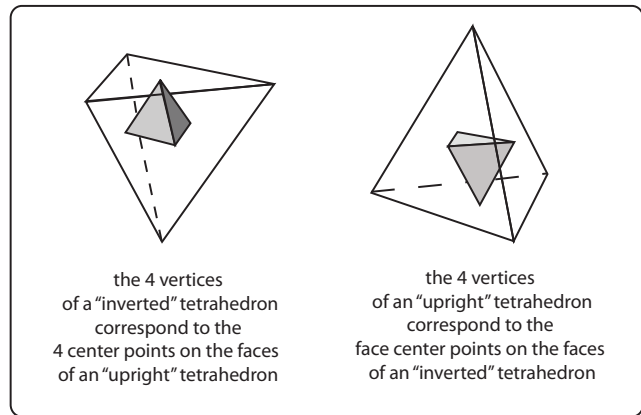

A tetrahedron is like a palindrome, it reflects itself.

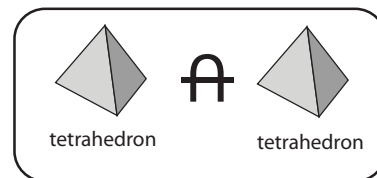
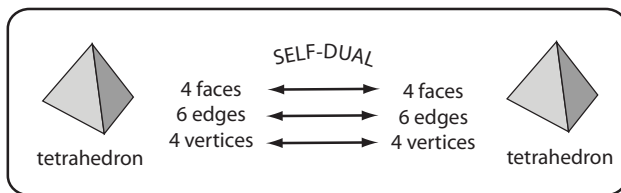

The intersection of an "upright" tetrahedron and "inverted" tetrahedron forms what is called a "stella octangula" or an "eight-pointed star."

When the 8, pointy, star-tips are removed, what's left of the original two tetrahedra is the shape of an octahedron. (The tetrahedron is related to the rest of the happy family of regular solids after all!)

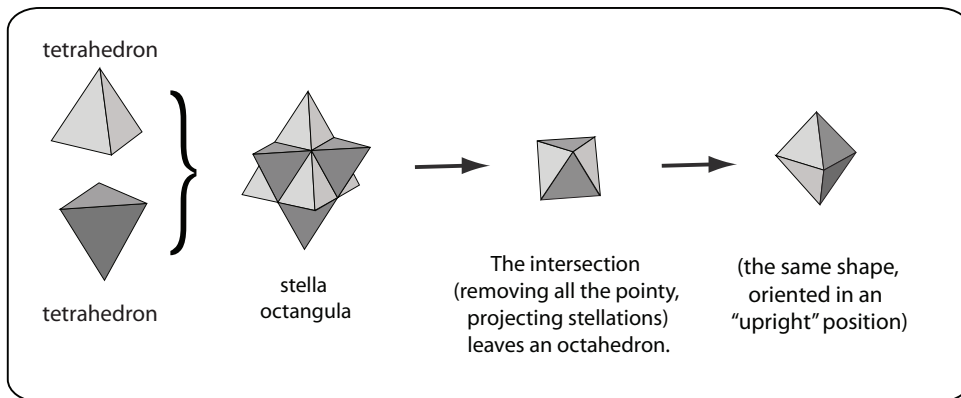

Luca Pacioli and Leonardo da Vinci depicted a "stella octangula" in the 1509 *The Divine Proportion*. They called it an "octaedron elevatus," meaning an octahedron whose sides have been "elevated" or "stellated."

This "stellated octahedron" has an important interconnection with the cuboctahedron. Can you figure out what that is?

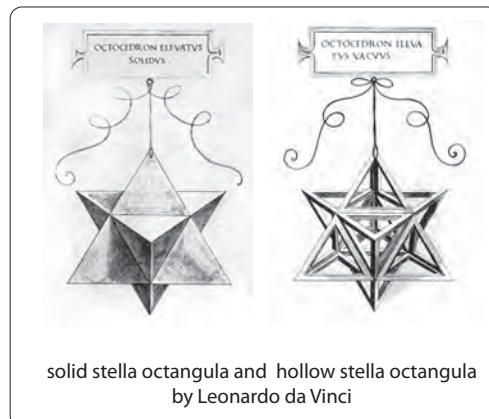

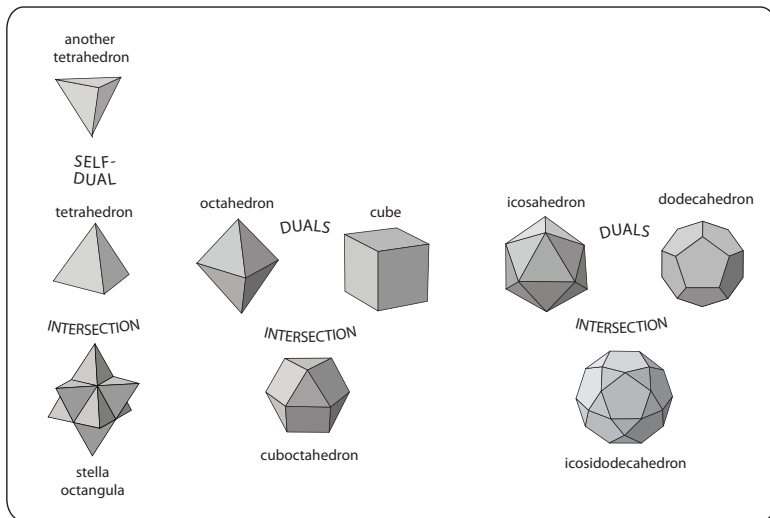

This brings the tally up to 8 shapes.

But what about the duals of the three “intersection shapes”?

The dual of the cuboctahedron is the **rhombic dodecahedron**. We saw earlier how this shape is the “degenerate stellation” of the cube and also of the cube.

It’s also formed by connecting the “interstices” in the closest packing of spheres arrangement.

The dual of the icosidodecahedron is the **rhombic triacontahedron**. This name might sound daunting at first sight, but its easy to grasp.

“**Triaconta-**” means “30”, “**hedron**” means “sides,” and **rhombic** means diamond-shaped. It’s a shape with 30 equal-sized diamond-shaped faces.

Like the tetrahedron from which it is born, the stella octangula is a self-dual, so it doesn’t add another shape to our growing list.

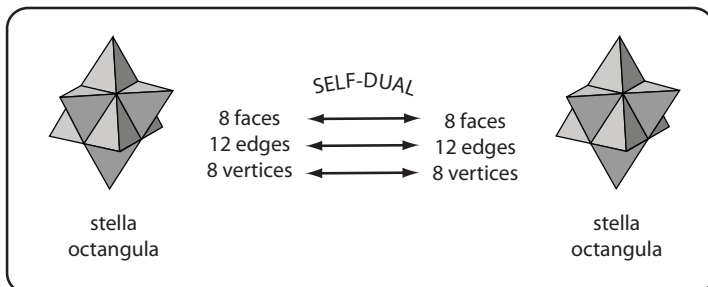
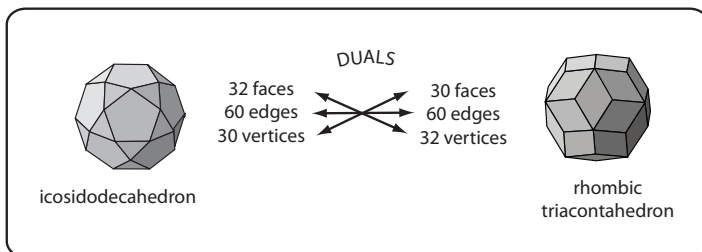
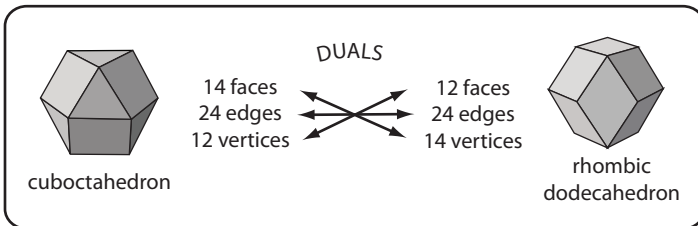

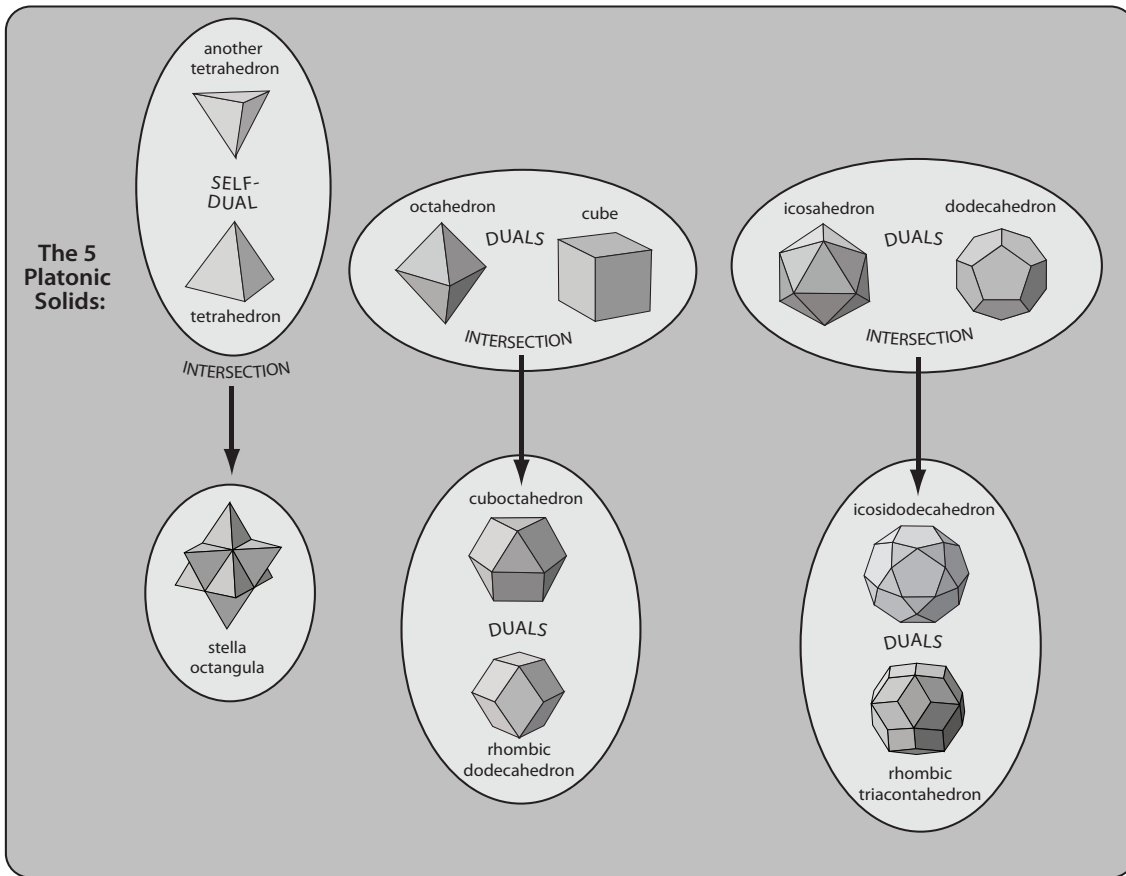

Now we have an inventory of 10 nicely related shapes. Five are Platonic solids, the cuboctahedron and the icosidodecahedron are Archimedean solids. The final 3 are not members of these clubs, but that doesn't really matter. They are fabulously interconnected with the others, like one big happy family.

What kind of organization did Dee envision for this of a “Decad “ of related shapes?

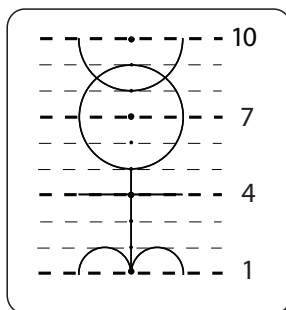

Throughout the Monas Dee has hinted at the 1, 4, 7, 10 organization of the Decad. It's built into the very fiber if the spine of the Monas symbol.

The Denarian symmetry harks back to how Paracelsus described it in his *Aurora of the Philosophers*. Let's first focus on the $3 + 4 = 7$ step, then return to the adventure of getting from 7 to 10 later.

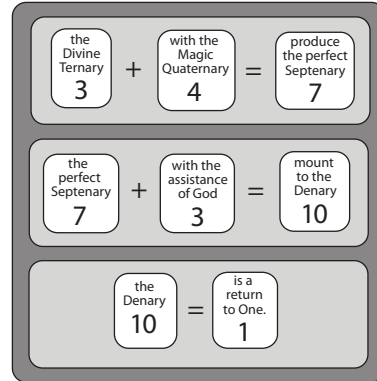

The 4 digits plus 3 digits can be seen in the "Below half" of the "Thus the World Was Created" chart.

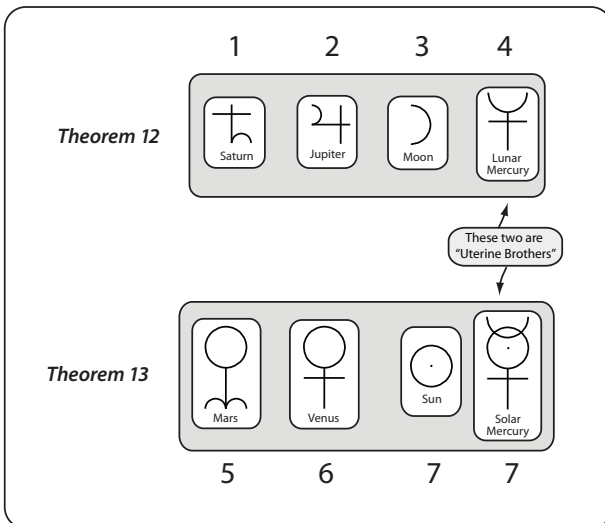
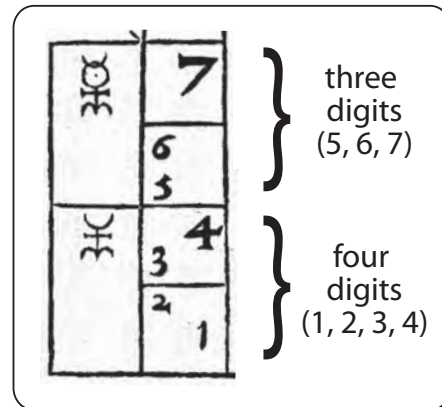

Dee first introduces this organization in his depiction of the Lunary and Solary planets in Theorems 12 and 13.

Even though the Sun and Solar Mercury seem like two separate things, Dee reiterates in the "Inferior Astronomy" digram that they both correspond with the number 7.

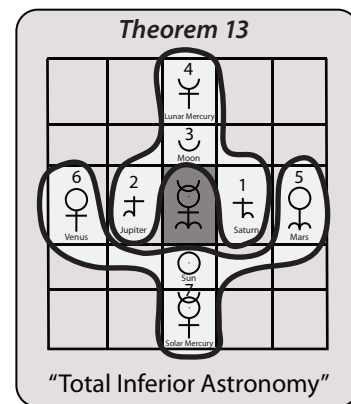

This $4+3=7$ organization can also be seen in the “Egg” diagram of Theorem 18.

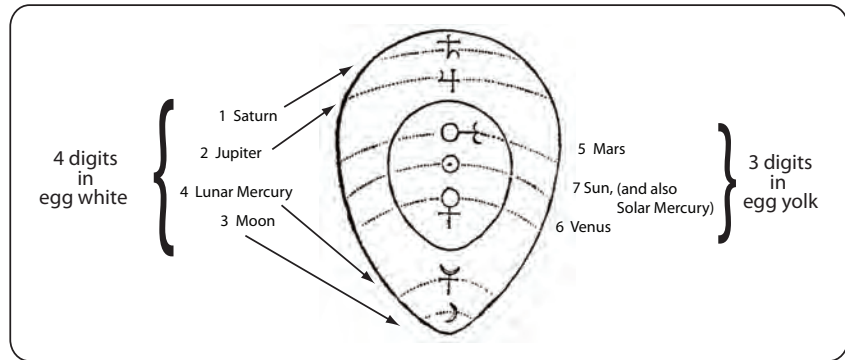

All this suggests that the “Seven planets” are a metaphor for this organization of the 5 Platonic solid and the 2 “intersections” produced by the pairs of duals.

Lunar Mercury(4) represents the cuboctahedron. Solar Mercury (7) represents the icosidodecahedron.

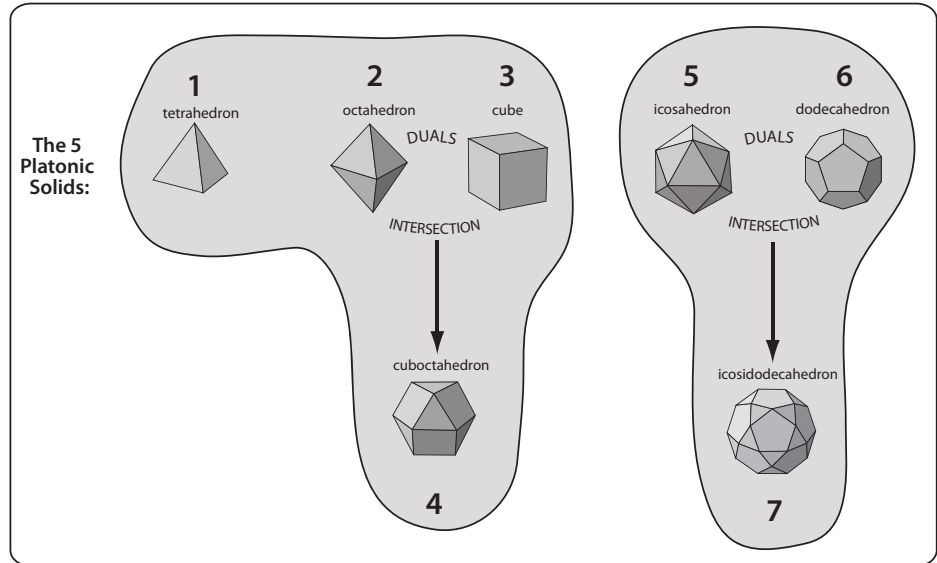

What about the remaining three shapes? I think the stella octangula corresponds with the number 8, the rhombic dodecahedron with the number 9, and the rhombic triacontahedron with the number 10?

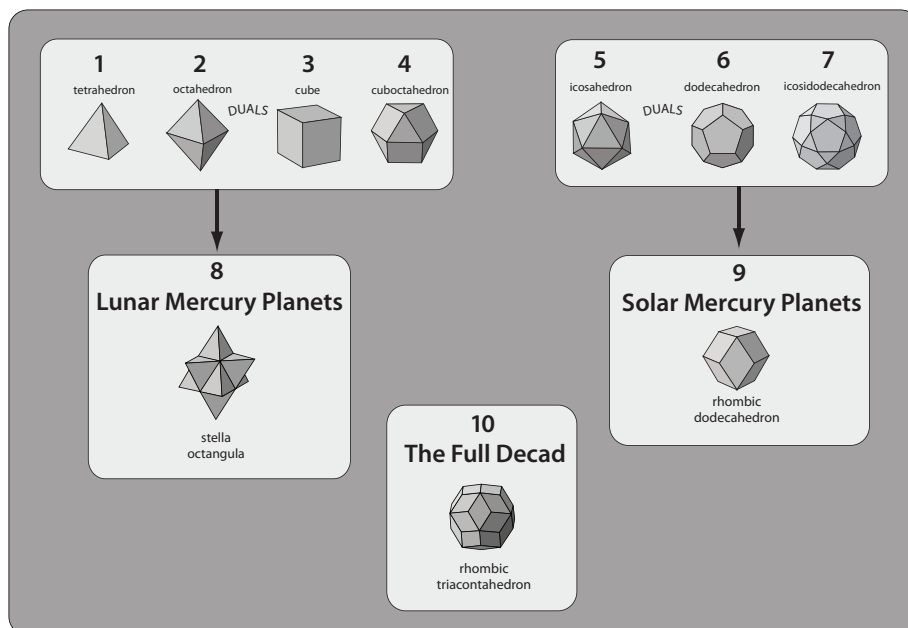

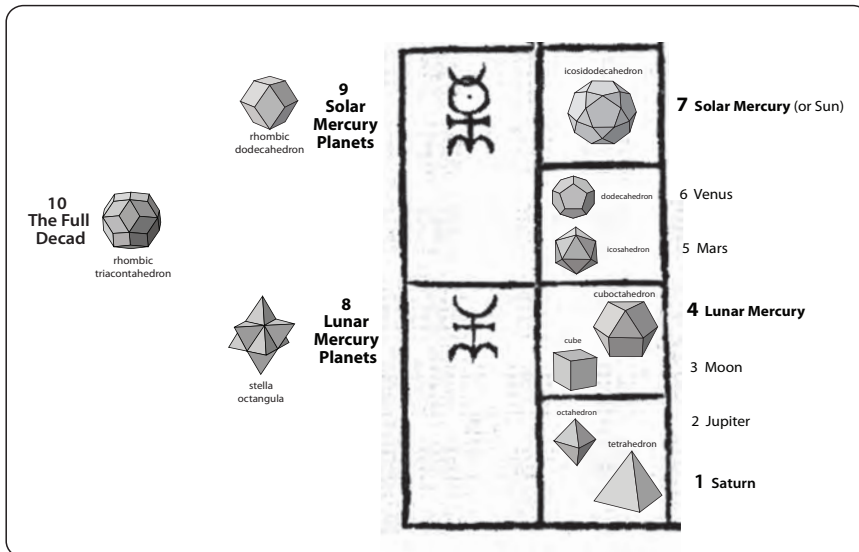

Here's another view of that summary, using Dee's framework.

Why
stella octangula=8
rhombic dodecahedron=9
and rhombic triacontahedron=10?
The brief answer:

I think that the stella octangula represents 8, not simply because it's an "8 pointed star," but because it is intrinsically related to the tetrahedron. (We'll return to a more in-depth look at this important shape in a moment.)

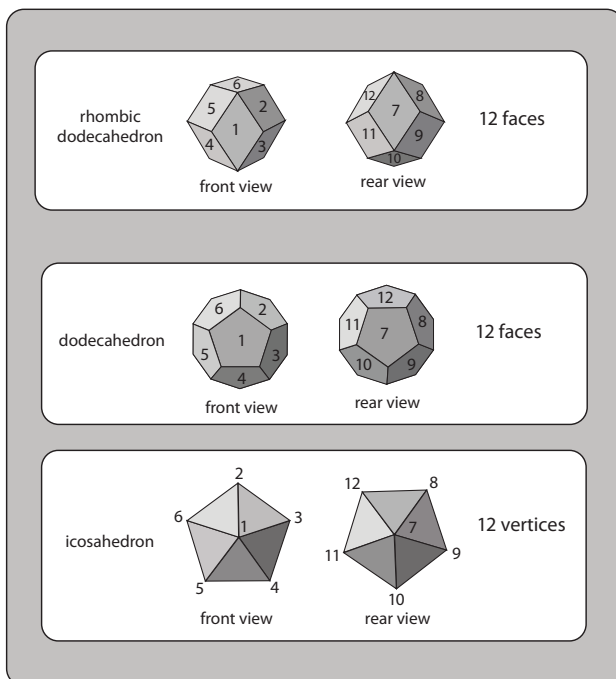
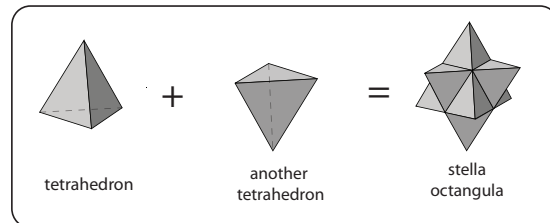

The rhombic dodecahedron is also a good candidate to be 8, because it is the dual of the cuboctahedron.

But it's also related closely to the dodecahedron as they both have twelve sides. (Thus also relating it to the icosahedron, which has 12 vertices.)

Thus, the rhombic dodecahedron is 9, the Solar Mercury Planets number.

In its "realm" of Solary planets are the icosahedron, the dodecahedron, and their intersection, the icosidodecahedron.

(We'll also return to this relationship in a moment as well, but let's complete the decad first.)

The remaining shape, the rhombic icosidodecahedron seems as though it might be a good candidate for 9 as it is the dual of the icosidodecahedron, but of all these shapes, it is also the most related to “Ten-ness”, so it corresponds to the final number, 10.

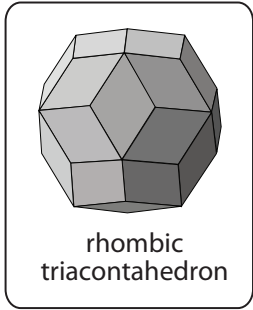

To see its “ten-ness,” instead of viewing of the shape looking “head on at one of the rhombi”...

...let’s view it “head-on to one of its vertices where 5 lines meet”. Here is a front view and a rear view. (But be aware there are some rhombic faces on the sides hidden in each of these views.”

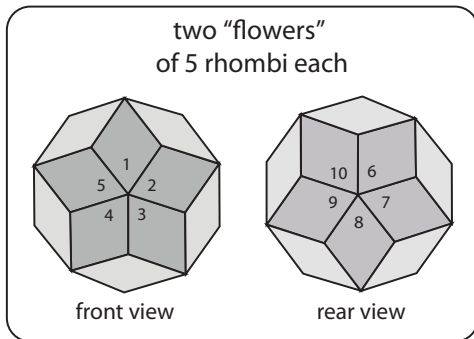
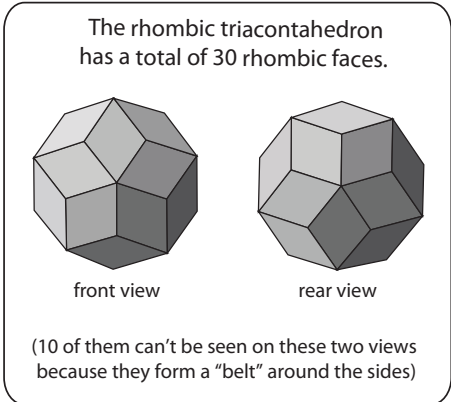

Now, we can see a 5 rhombus-petaled “flower” on each view, making a total of 10 rhombi.

Surrounding the flower on each view is a “necklace of 5 diamonds,” accounting for 10 more rhombi, now making the total 20.

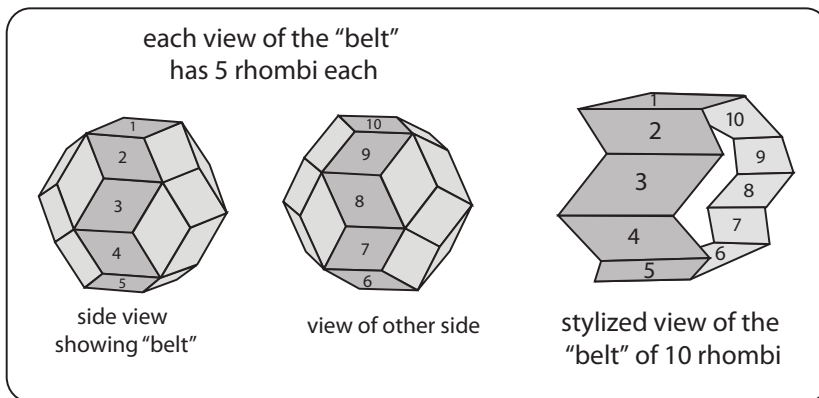
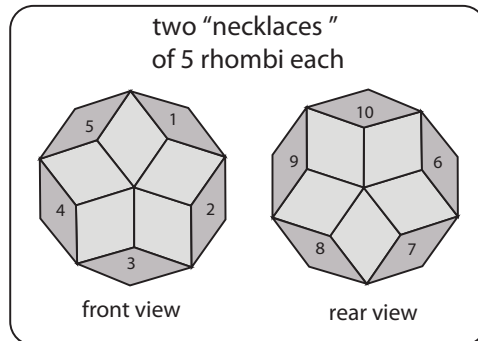

The remaining 10 rhombi make up the “belt” that can be seen in these “side views.”

This summary clearly shows the rhombic triacontahedron can be seen as a “trinity of tens” (*triakonta* is Greek for thirty).

10 rhombi in the 2 “flowers”
 10 rhombi in the 2 “necklaces”
 10 rhombi in the “belt”

 30 rhombi total

The other reason it’s a good candidate for 10 is that, of all these ten shapes, it has the largest number of equal-sized faces, thus it’s closer to being spherical than the other 9.

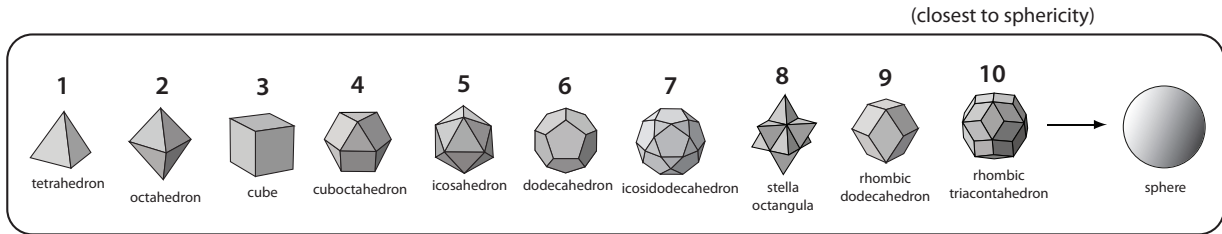

Why
stella octangula=8
rhombic dodecahedron=9
 and *rhombic triacontahedron*=10?
The longer, more satisfying answer:

The key to understanding shapes Dee chose for 8, 9, and 10 has to do with **why he divided shapes 1, 2, 3, 4, 5, 6, and 7 into two groups.**

It’s not simply because the “Lunar Planets”
 [tetrahedron, octahedron, cube, and cuboctahedron]
 have fewer edges than the Solary Planets
 [icosahedron, dodecahedron and icosidodecahedron].

The the two groups have different “symmetry schemes.”
 What does that mean? How can there be different kinds of symmetry?

A full explanation of symmetry would require a whole book. Indeed, Istvan and Magdolna Hargittai’s *Symmetry, A Unifying Concept* is a profusely illustrated elucidation of this topic. Their quote from the famous geometer H.S.M. Coxeter’s book *Regular Polytopes* is pertinent here,

“the chief reason for studying regular polyhedra
 is still the same as in the times of the Pythagoreans,
 that their symmetrical shapes appeal to one’s artistic sense.”

(Hargattai and Hargattai, p. 91)

Rotational symmetry

To grasp what “rotational symmetry” is all about let’s first step back into 2-D world of triangles, squares and pentagons.

While pivoting on its center point, how many ways can an “upright” equilateral triangle be rotated so that it still looks like an “upright” equilateral triangle?

The answer is 3 ways. At a 60 degree turn it clicks into an identical triangle. It does it again at 120 degrees, and again back at 360 (or the original position). An equilateral triangle has **3-fold** symmetry. Pretty simple.

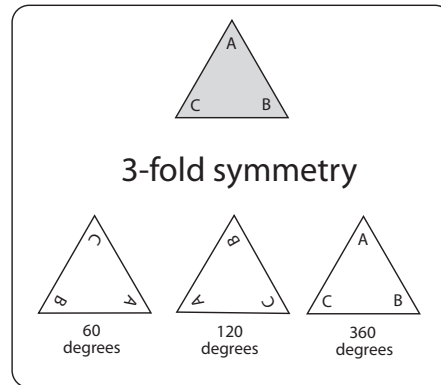

An “upright” square makes identical like an “upright” square at the “rotational click-stops” of 90, 180, 270, and 360 degrees. Thus a square has **4-fold** symmetry.

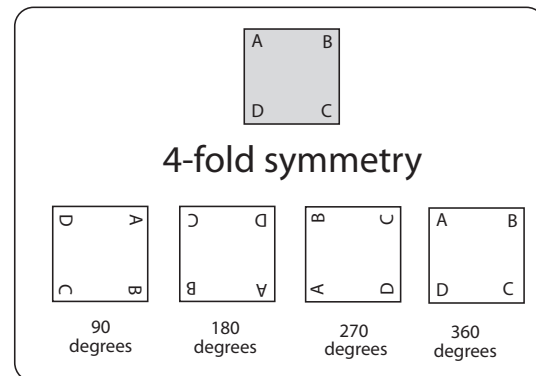

And you guessed it, a regular pentagon has 5 -fold symmetry, at 72, 144, 216, 288, and 360 degrees. (recall how $72 \times 5 = 360$ is an equation found in Metamorphosis)

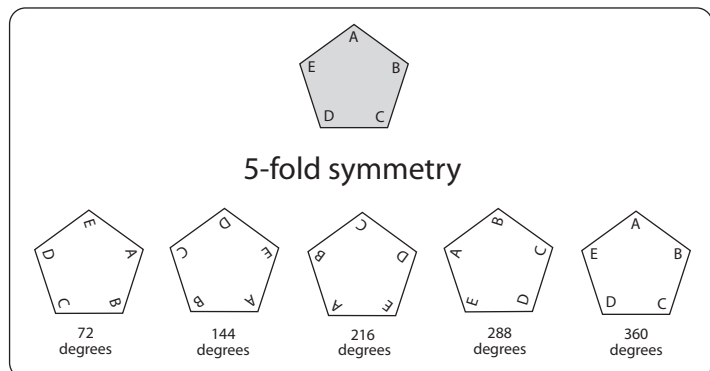

Back up in the 3-D realm,
there are **three viewpoints** geometers consider
when analyzing the the symmetry of a polyhedra:

Viewing it “flat-on” to one of its **edges**.

Viewing it “flat-on to one of its **faces**

Viewing it flat-on to one of its **vertices**.

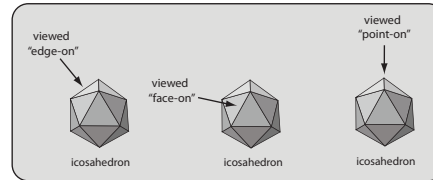
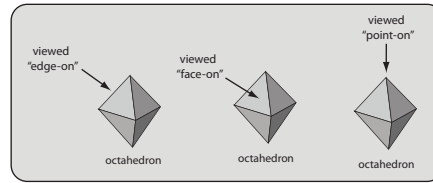
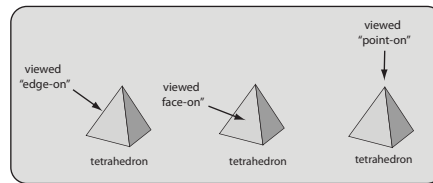

*Among the Platonic and Archimedean solids there are only three kinds of symmetry:
tetrahedral, octahedral and icosahedral*

A tetrahedron viewed
“edge-on” has 2 click-stops,
viewed “face-on” it has 3, and
viewed “vertex-on” it also has 3.

This “**2-fold, 3-fold, and 3-fold**”
symmetry is called
tetrahedral symmetry.

“tetrahedral symmetry”

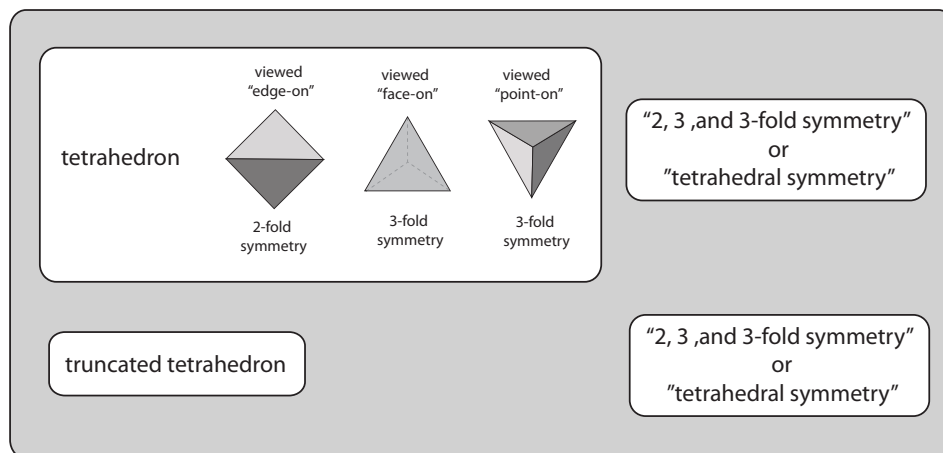

The only other Platonic or Archimedean Solid
with tetrahedral symmetry is the truncated tetrahedron.

An octahedron viewed “edge-on” has 2 click-stops, viewed “face-on” it has 3, and viewed “vertex-on” it also has 4.

This “**2-fold, 3-fold, and 4-fold**” symmetry is called **octahedral symmetry**.

The cube has the exact same symmetry scheme, but geometers still categorize it as octahedral symmetry. (The viewing sequence has changed with the cube from edge-face-point to edge-point-face, but its not the order that’s important, only the overall tally of how many different kinds of symmetry there are.)

Note that the cuboctahedron is among the Archimedean solids with octahedral symmetry.

“octahedral symmetry”

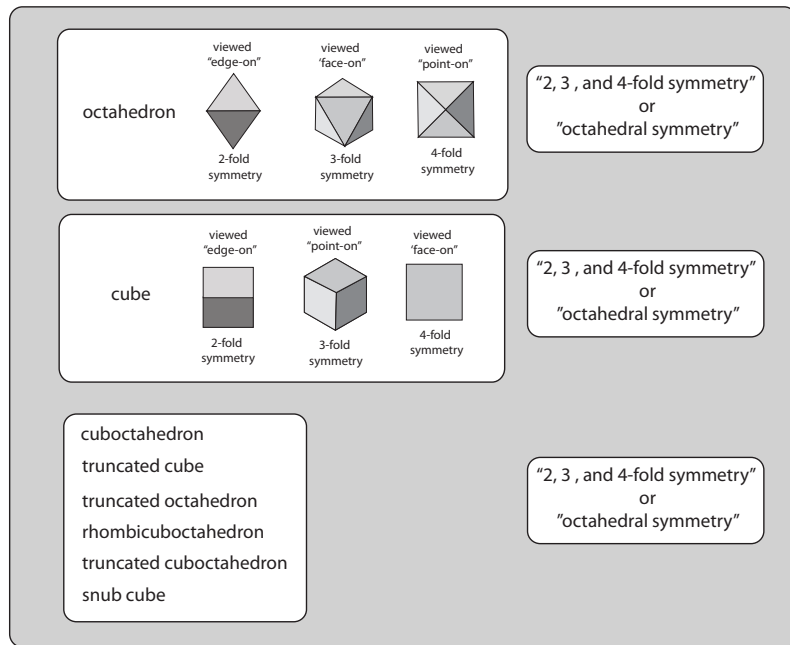

“icosahedral symmetry”

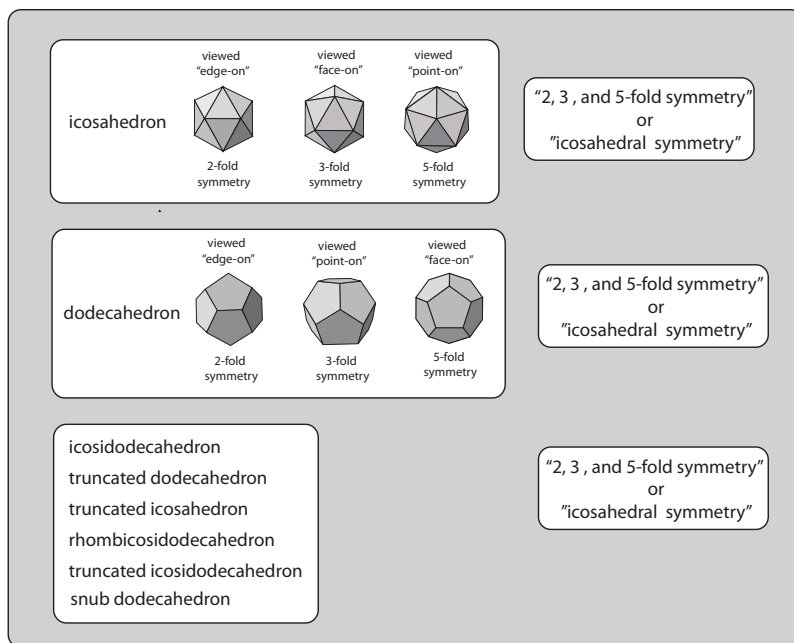

An icosahedron viewed “edge-on” has 2 click-stops, viewed “face-on” it has 3, and viewed “vertex-on” it has 5.

This “**2-fold, 3-fold, and 5-fold**” symmetry is called **icosahedral symmetry**.

The dodecahedron has the exact same symmetry scheme, but geometers still categorize it as icosahedral symmetry. (Again the sequencing has been altered, but the overall tally is the same)

Note that the icosidodecahedron is among the Archimedean solids with icosahedral symmetry.

With this understanding of the 3 kinds of symmetry schemes, it's easier to see why Dee divided Lunar Planets from Solar Planets.

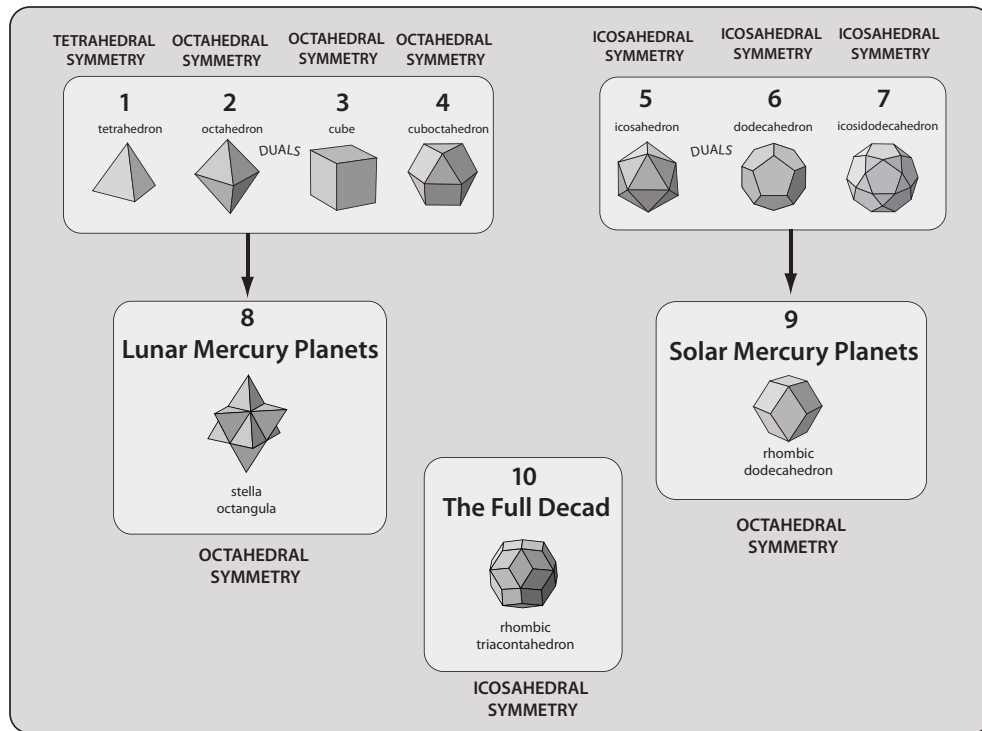

But something seems wrong here

In this chart, the symmetries of the last 3 shapes don't seem to correspond very well to the symmetries of the first 7 shapes.

It would seem more logical to have the rhombic dodecahedron as 8 (an "octahedral symmetry" shape summarizing mostly "octahedral symmetry" shapes)

and the rhombic triacontahedron as 9 (an "icosahedral symmetry" shape summarizing 3 "icosahedral symmetry" shapes).

That would make the stella octangula 10.

But certain clues indicate that Dee saw the organization exactly as I have depicted and enumerated it in the it in the above chart.

While exploring these clues, the rationale behind this ordering will not only become clear, but Dee will teach us an important lesson about Nature's most basic 3-D shapes. Let's explore them one at a time.

The stella octangula is number 8

Let's return to the stella octangula (Dee's Lunar Mercury Planets Symbol) and see just how closely it's related to the first four shapes (Dee's 4 Lunar Planets).

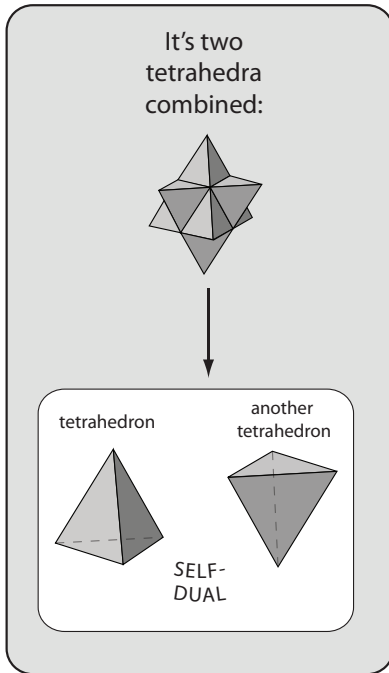
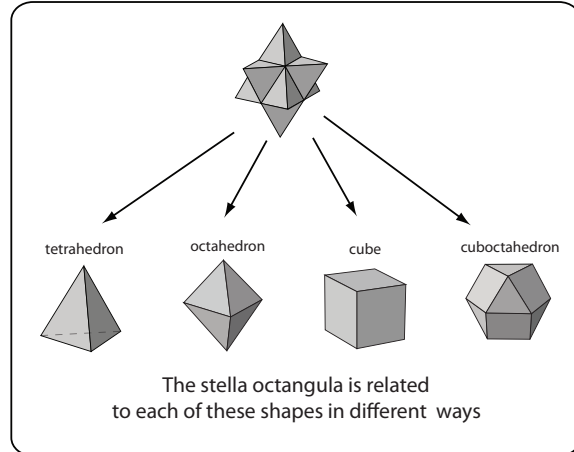

We've seen that it is two tetrahedra mated together.

And the intersection of those two tetrahedra (or simply deleting the 8 star-tips) is an octahedron.

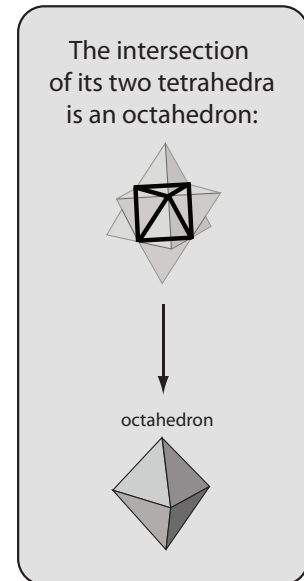

The 8 pointy-tips of the stella octangula correspond to the 8 corners of a cube. As Bucky puts it, "two equal tetrahedra (positive and negative) joined at their common centers define the cube"

(Fuller, *Synergetics* 1, p.196; 462.00; Edmundson, p.46)

Have you figured out the stella octangula relates to the cuboctahedron?

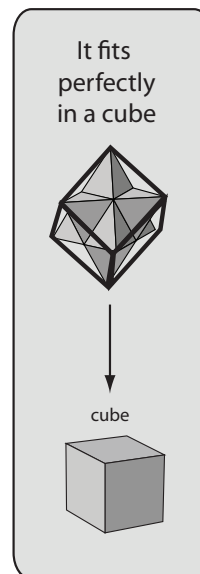

Imagine the two intersecting tetrahedron are loose, or unbound to each other. If we slowly “pull them apart” by moving the “upright” tetrahedron downward and moving the “inverted” tetrahedron upwards, and stop when their two vertices coincide, look what we’ve got: a Bucky bowtie, or two tip-to-tip tetrahedra!

They are even in the correct orientation to each other (no rotation is needed) as three of their edges align to make long, continuous straight lines.

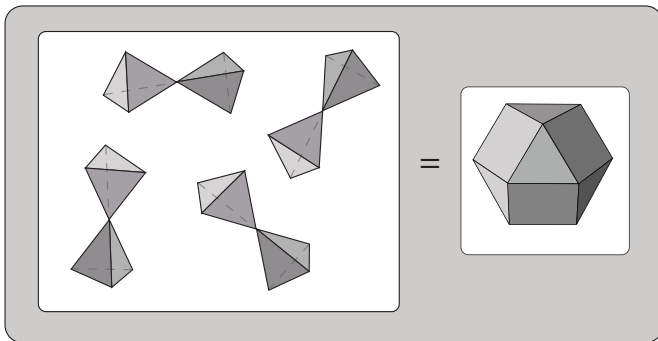
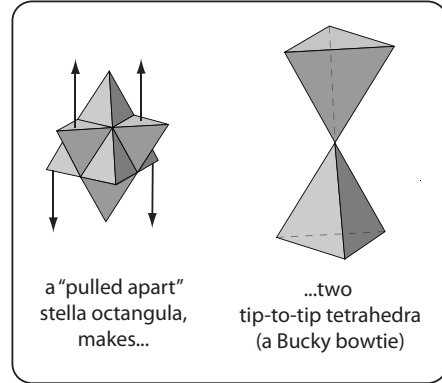

4 pairs of tip-to-tip tetrahedra assemble into a cuboctahedron

And, of course, 4 of these Bucky bowties, sharing a common central point, make a cuboctahedron.

And these four pairs of “opposites” reflect the octave rhythm found in number, which create all the wonderful transpalindromes in the 9 Wave (18 and 81, 27 and 72, 36 and 63, 45 and 54, the 99 Wave, the 1089 Wave, etc.)

At what Bucky calls “mid-passage” in this morphing from stella octangula to Bucky bowtie, another important shape is formed.

The top vertex of the “upright” tetrahedron coincides with the face centerpoint of the “roof” of the “inverted” tetrahedron. And vice versa. I call this stage “two tip-to-face tetrahedra.”

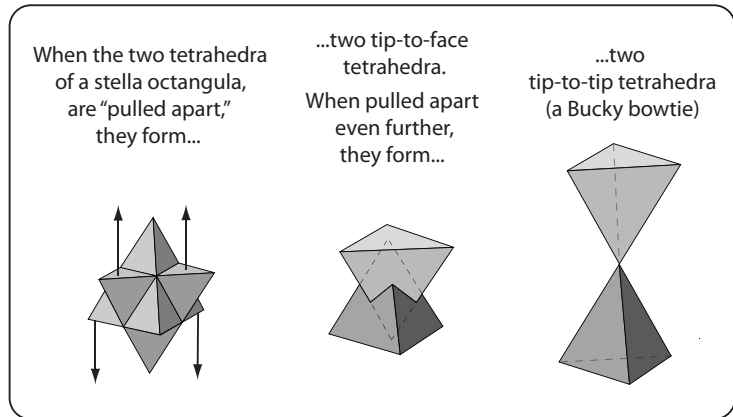

As those two vertices are touching faces, there are only 6 “projecting” vertices.

Connect them and you’ve got an octahedron!

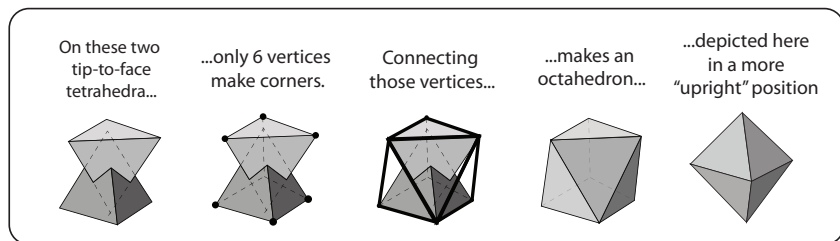

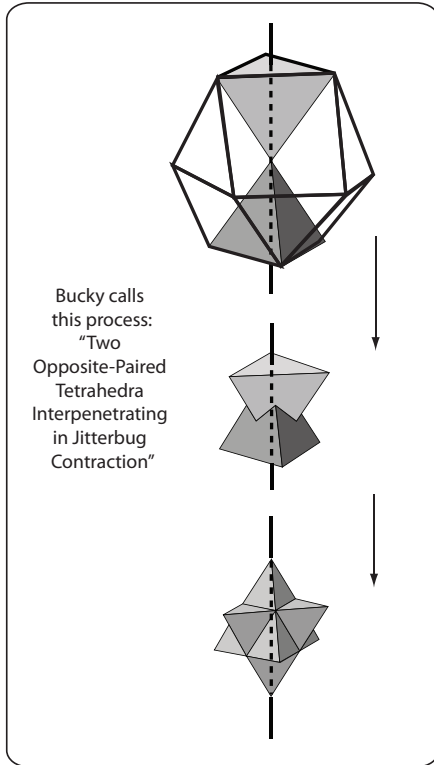

In *Synergetics 2*, Bucky describes the reverse process of these three stages I have just shown, calling it a "jitterbug contraction," because there are three distinct click-stops (just like in the other kind of jitterbugging).

He starts with two tip-to-tip tetrahedra inside a cuboctahedron. (Their axis is the "Prince of Rays," to use the term Leon Battista Alberti's employed in his description of how vision works.)

As Bucky puts it,
"As one axis remains motionless, two polar-paired, vertex-joined tetrahedra progressively interpenetrate one another to describe in mid-passage an octahedron, and [then] a cube-defining star polyhedron of symmetrical congruence."

(Fuller, *Synergetics 2*, Fig.1033.43, p. 395)

The chart below summarizes some of the key interrelationships between Dee's "Lunary Planets" and their "summarizer" the stella octangula.

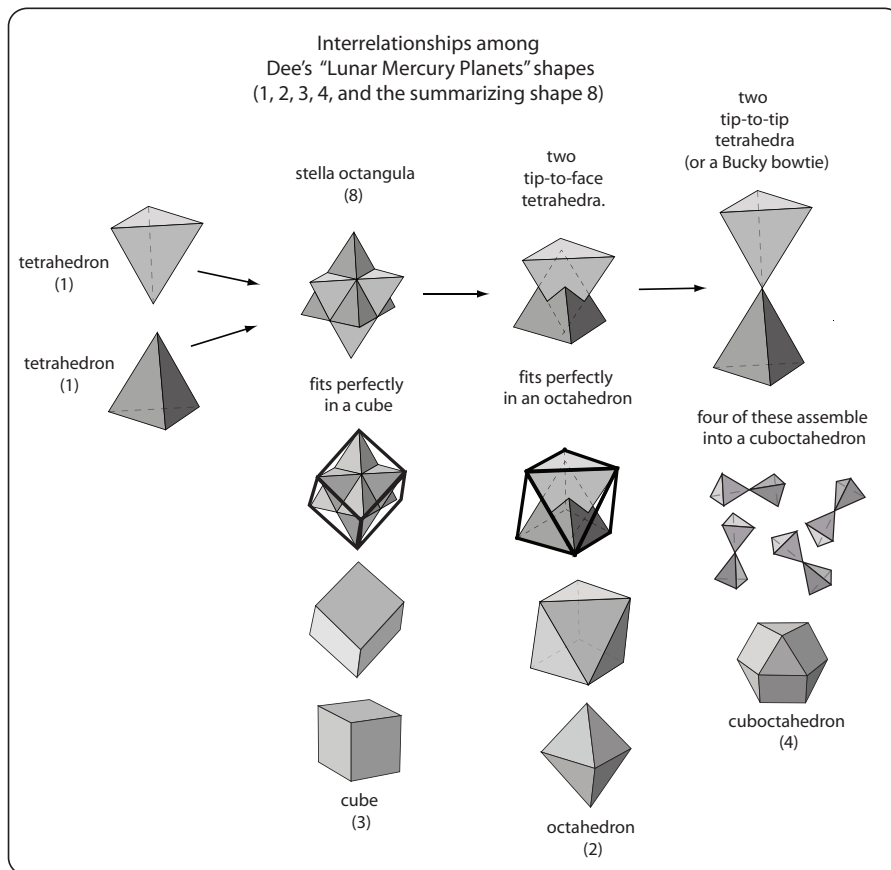

The fact that the stella octangula was simply a different version of “two tip-to tip tetrahedra would have been of great significance to Dee.

To make this easier to see, let’s pull a stella octangula apart sideways.

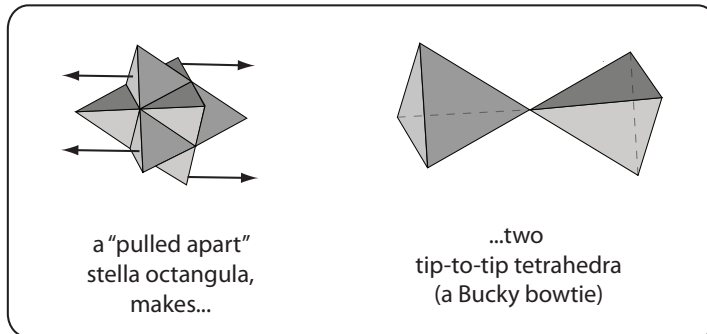

The Bucky bowtie is nothing more than Nature’s simplest 3-D shape united with itself.

It’s Nature’s most economical 3-D expression of retrocity.

It’s the “coincidentia oppositorum,” the “union of opposites.”

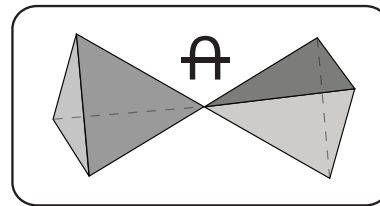

It’s the “upright” and “inverted”
Monas symbols.

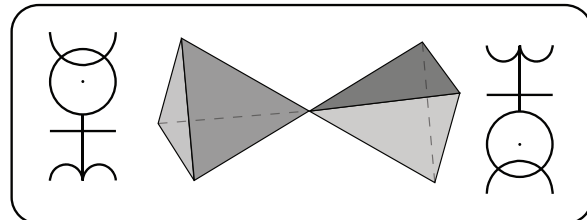

It’s Dee’s Sun and Moon.

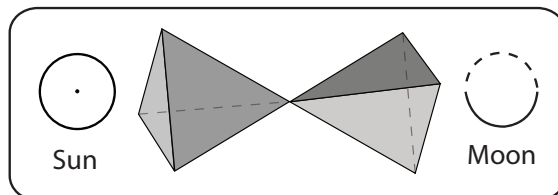

It’s the two circles of the design
plan for the John Dee Tower.

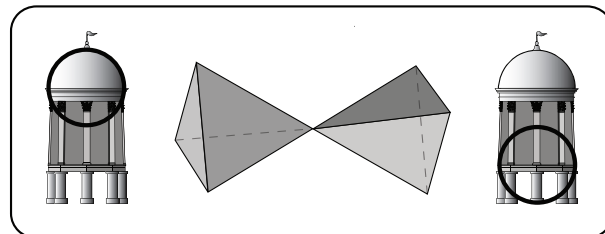

It's the most economical geometric depiction of the behavior of light in a camera obscura.

Or as Dee puts it, "forma circulata," the completeness of something going "full circle."

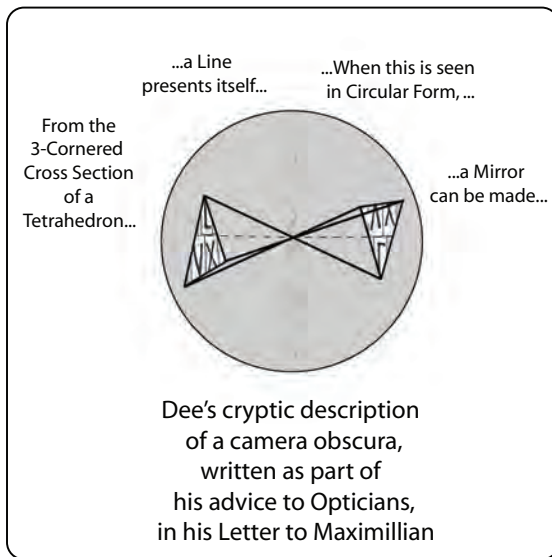
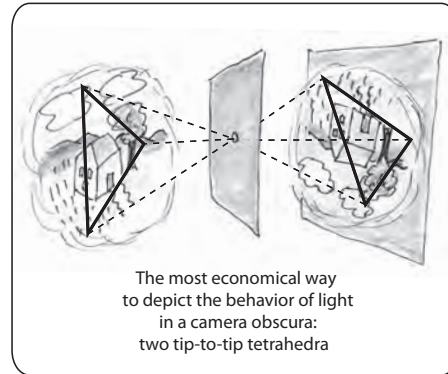

Each of the 8 spiky projections on the stella octangula is a perfect tetrahedron.

So another way to see the connection between these two shapes is to remove the 8 "mini-tetrahedral star-tips" of the stella octangula and then recombine them to make a cuboctahedron.

(What's "left over" is the octagon at the heart of the stella octangula. And this is exactly the shape needed by the cuboctahedron in order for it to fill "all space.")

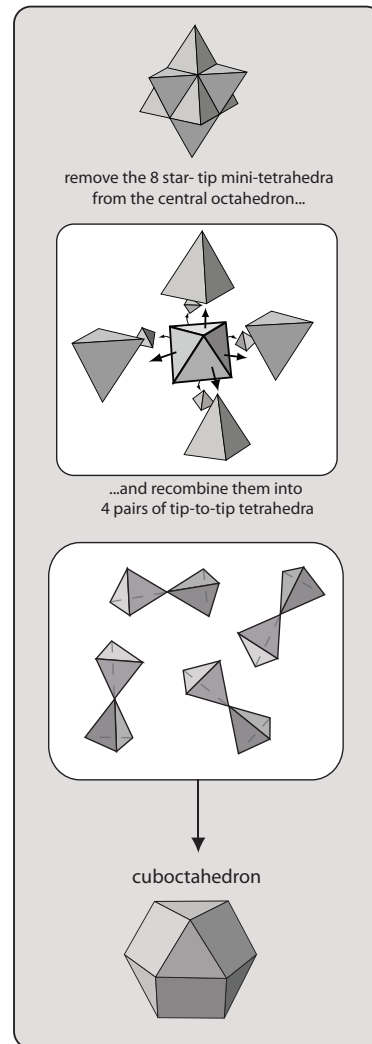

Yet another way to see the connection is to note their corresponding numbers. This becomes vivid when the first 8 shapes are seen in Dee's octave chart. The cuboctahedron is 4 and the stella octangula is 8, echoing Bucky's "+4,-4, octave" rhythm of number.

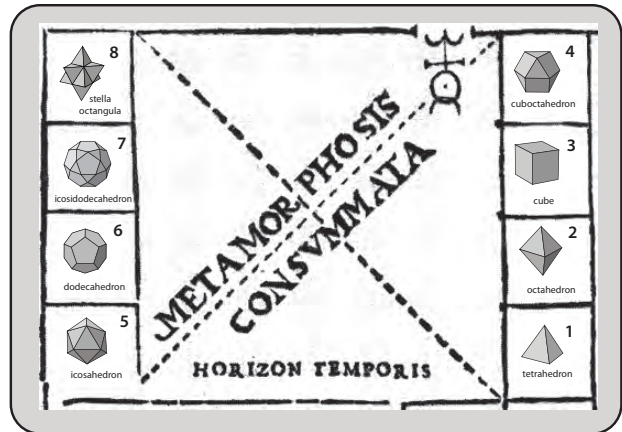
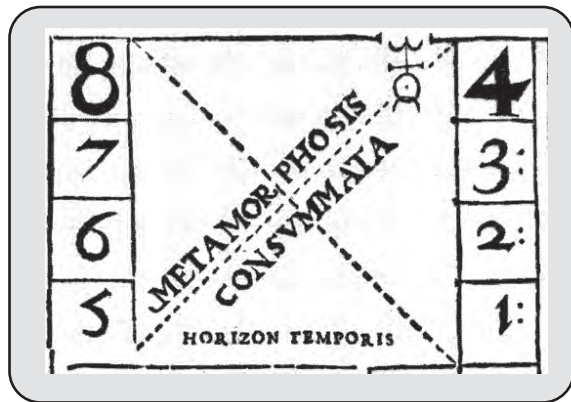

In many places in the *Monas*, Dee emphasizes another numerical equation involving 8, that is:

$$7+1=8.$$

He hints at it in Theorem 6 by calling the Cross Ternary, then Quaternary, then Septenary, and then Octonary.

He graphically shows it in the Artificial Quaternary after obtaining the "additive result" of 8.

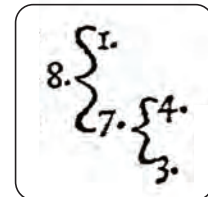

1+7=8
in the Artificial
Quaternary chart



He emphasizes 7 in the "Below" half of his summary chart, and 8 in the "Above" half.

It's the first "round" of his "maxim of the flowing ribbons":
"Mercurius becomes the female parent (8)
of all the planets (7)
when made perfect by a sharp, stable point (1)"

1 + 7 = 8
expressed by the first "round"
of the "maxim of the flowing ribbons"
on the Title page:

*Mercurius
becomes the female parent (8)
of all the planets (7),
when made perfect (consummata)
with a sharp, stable point (1)*

But there is one more place in the book where Dee is expressing the idea of $7+1=8$ as a cryptic expression of the stella octangula. It's on the colophon (Grerek for “summit” or “finishing touch”) or the emblem on the back cover of the *Monas Hieroglyphica*.

On the surface, it appears to simply be a decorative illustration used to fill up the back cover. But every detail of the *Monas* holds important clues; nothing is superfluous in Dee's little book.

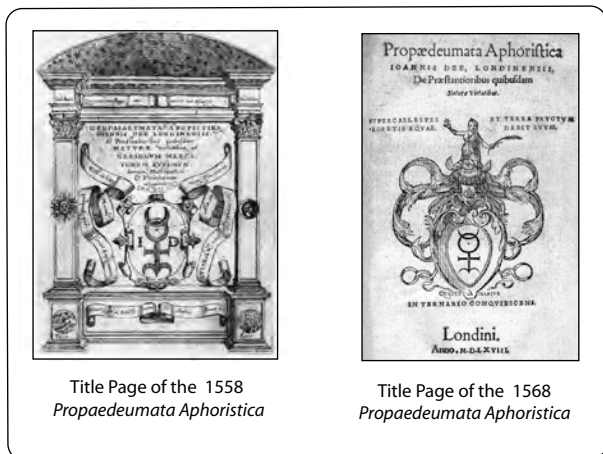

In fact, Dee felt this illustration was so important, he used it as his “new” cover on the 1568 second edition of the *Propaedeumata Aphoristica*. And he didn't simply use the same engraving to save on cost, because he had the whole illustration re-engraved.

At first glance, this illustration doesn't appear to express “stella octangula” or “eightness.” It's the Monas symbol on a shield embraced by a wildly gyrating plant having unusually long leaves. A woman is holding a seven-pointed star. This is hardly an expression of eightness.

Beneath her is the 4-letter name of God, YHVH, written in Hebrew. Dee has reused the quote from “Genesis 27” he used on the foundation of the architecture on the Title page, only here he has cut the quote into two parts and typeset the words vertically. Literally translated it reads: “THE WATERY DEW OF HEAVEN” “AND OF THE FRUIT OF THE EARTH, HE WILL GIVE”

I'll cut to the chase.

The upheld star clearly has seven points, but the stem or frond the woman is holding in her other hand makes another pointy tip, the eighth. She is expressing “ $7+1=8$ ” pictorially. The “watery dew from Heaven” is the 7-pointed star. The “fruit of the Earth” is the one pointed plant-stem. They are “connected” by the word “AND” (ET in Latin)





Lady Occasion from the Title page of Dee's *General and Rare Memorials*

This might seem conjectural, but there are more clues to support it. The woman balancing the star shape is no svelte young goddess (like the way Dee depicted Lady Occasion on the Title page of *General and Rare Memorials*.)

This is a mature, full-figured, woman. Like a mother. A female parent. Dee's metaphor for the number eight.



the "female parent" which is Dee's metaphor for the number 8

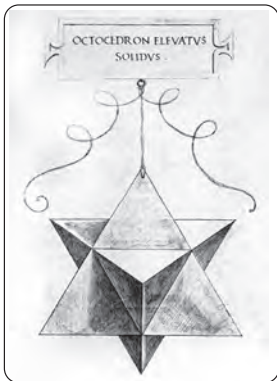

Pacioli and da Vinci called it an "OCTACEDRON ELEVATUS"

Furthermore, Dee would have referred to the shape of two intersecting tetrahedron as "octacedron elevatus," following Pacioli and da Vinci. (The name "stella octangula" wasn't coined until the early 1600's, by Johannes Kepler)

Dee seems to be punning with this name, in the sense that the woman is clearly "elevating" the star-shape in her hand. She's not elevating the single plant stem very high, but Dee made it more elevated when it was re-engraved for the *Propaedeumata Aphoristica* of 1568.



The "female parent" elevates the representation of "eight-ness" even higher on the Title page of the 1568 *Propaedeumata Aphoristica*

One visual characteristic of a solid stella octangula is that no matter how you hold it, you can only see a maximum of 7 vertices at once. The eighth is always hidden from view in the back. This is very apparent when you physically hold the shape, but its a little harder to see by drawing it because it's challenging to draw.

Note especially the "flat on" view. It makes a hexagram star!

(As the 8 vertices of a stella octangula correspond to a cube, the same principle holds. Try to draw a solid cube in perspective (and add shading the sides so it's not simply a skeleton of edges) and you'll get a sense of this "7 visible and 1 hidden" phenomenon.)

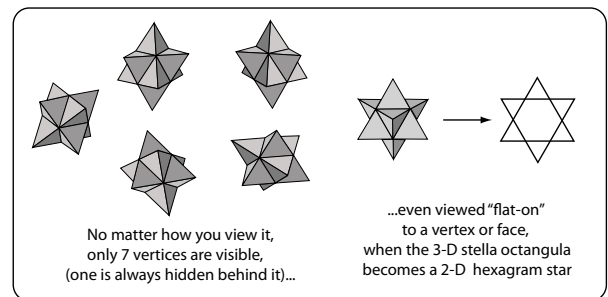

This is precisely what the "female parent (8)" is expressing (in her own cryptic graphic way).

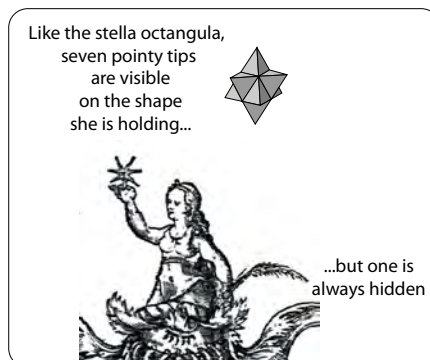

But the most compelling evidence that Dee is expressing “8” on the back page emblem. It is a visual game, much like game he plays with the two flowing ribbons of the Title page.

Recall that, when superimposed, the flowing ribbons make the super-serpentine numeral 8.



The graphic numeral 8 made by overlapping the “flowing ribbons”

When the back page is folded so the baselines of the type meet up...

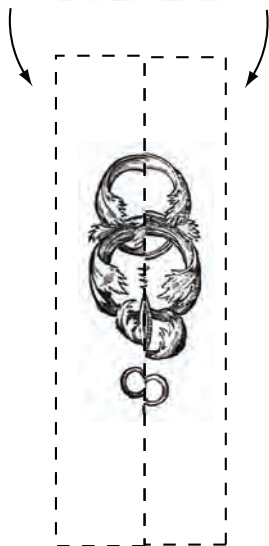

...the hidden number 8 appears.

First, fold the back page symmetrically right down the vertical midline of the emblem.

Then fold back the left side, to the baseline of the words “RORATIS AQUAES” (“watery dew”). The folded edge should align with the baseline of the type that reads “DABIT SVVM” (“He will give”).

Now the only things visible are the parts of those unusually curvy, long leaves and they form the numeral 8!

(Dee made those lines of type run vertically expressly for this purpose.)

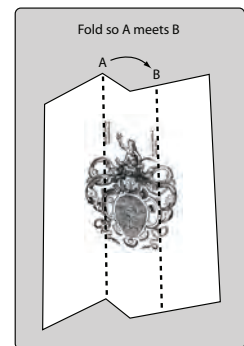

The overall symmetry of the emblem is like the “union of opposites” between the left side and the right side.

In the realm of 3-D geometry, the stella octangula is an exquisite expression of this retrocity.

In the realm of number, the retrocity is perfectly portrayed by “+4, -4, octave” rhythm of Consummata.

Geometry

stella octangula

“oppositeness”

+4 and -4
The “octave” of Consummata

Number

To summarize, when Dee looked at the back cover, he saw all these things relating to 8, the octave.

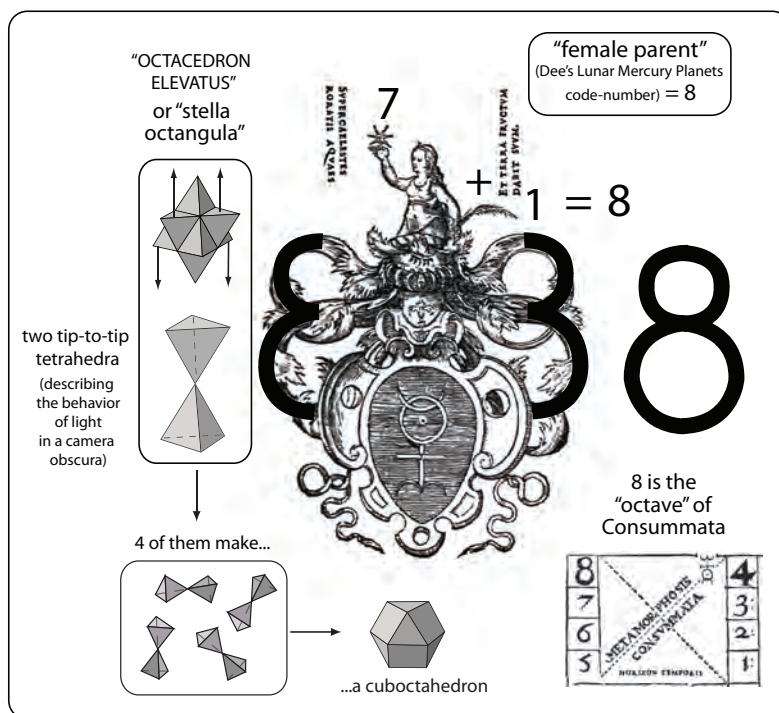

That’s a lot of stuff “hidden beneath the surface.”

But at the bottom of the page preceding this emblem, Dee drops a hint to he reader:
 “The Eye of the vulgar will, here, be Obscured and most Distrustful.”

The rhombic dodecahedron is 9

The connection between the rhombic dodecahedron and the dodecahedron is evident in their names. They are the only 2 members of Dee’s decad of shapes that have 12 sides.

But we must look a little deeper to see the rhombic dodecahedron’s relationship with the icosahedron.

The icosahedron is a different animal

Bucky recognized that the “icosahedron behaves differently than other polyhedra.” Edmondson calls it “*nonconformist*” as it’s “dominating 5-fold symmetry distinguishes it from the cosmic hierarchy,” which abounds in 3-fold and 4-fold rotational symmetries. (Edmondson, p. 163-5)

She finds that its “out of phase” with the Space Frame, which incorporates the tetrahedron, octahedron and cuboctahedron so well. This “out of phase” characteristic can be physically seen in the process of jitterbugging.

The collapsing cuboctahedron definitely click-stops at the octahedron stage and again at the tetrahedral stage. But the icosahedral phase is a “transient phase” of the jitterbug. Edmondson writes, “It is approximate. We have to eye the distances between vertices, guessing whether or not they are equal to one. The dance does not stop naturally at this point; we just recognize the familiar shape along the way.”

Bucky says the icosahedron is in a “different frequency system,” citing as evidence the fact that when 12 spheres are arranged in an icosahedral shape, a 13th sphere will not be able to fit in the midst of them. (Only the cuboctahedron can claim that distinction.)

Edmondson points out that the icosahedral symmetry of the icosahedron and the tetrahedral and octahedral symmetries of the Space Frame are “out of phase” by a special amount, an amount that involves the Golden Ratio. (This is the very remarkable ratio of 1:.618..., which we will explore in depth momentarily)

In a chapter entitled **Icosahedron and the Rhombic Dodecahedron**, Edmondson puts a 12-vertexed icosahedron inside a 12-faced rhombic dodecahedron. Predictably, the 12 vertices of the icosahedron are not at the centerpoints of the faces of the rhombic dodecahedron. They are in what she calls a “skew position,” or slightly off-center. However, it’s a very important off-centeredness.

Let’s isolate one of the diamond faces and one of the skewed vertices of the icosahedron. The point of contact divides the long diagonal of the diamond face into the Golden Ratio!

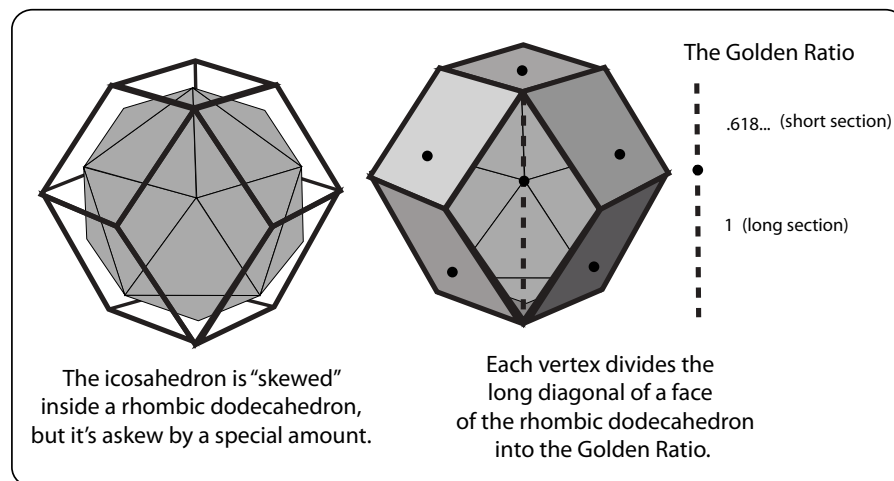

She adds, “Ever reliable, the Golden section reinforces our awareness of the underlying order in space.” (Edmondson, p. 167-8)

Edmondson next discusses the “*Pentagonal Dodecahedron*,” noting that the pentagon is a “prime source of golden section ratios.” The Pentagonal dodecahedron is of course also out-of-phase with the IVM [Space Frame]. That’s because “its symmetry is the same as that of its dual, the icosahedron.”

Now a clearer picture emerges. The Lunar Planets [tetrahedron, octahedron, cube octahedron] are all involved in the Space Frame. The Solary Planets [icosahedron, dodecahedron, and icosidodecahedron] are “out of phase” with the Space Frame— but not completely unrelated. They relate to it by way of the Golden Ratio (with which the dodecahedron is saturated)

Confirming Clues

You won't find pretty pictures of the stella octangula and the rhombic dodecahedron in the *Monas*, nor are they even mentioned. They are meant to be inferred. But once found, trustworthy Dee always provides a confirming clue the reader is on the right track.

In the "Thus the World Was Created" chart, the Lunar Mercury Planets Symbol represents number 8, or the stella octangula, which has 12 edges. Follow that row all the way over to the last Quaternary and you'll find the number 12.

Similarly, the Solar Mercury Planets Symbol represents 9 or the rhombic dodecahedron, which has 24 edges. Follow that row all the way over to the last quaternary and you'll find the number 24.

9
Solar Mercury Planets



8
Lunar Mercury Planets



A rhombic dodecahedron
has 24 edges

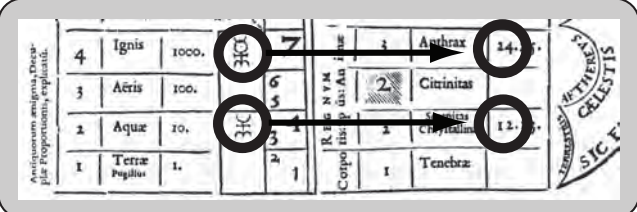

A stella octangula
has 12 edges

Granted, 12 and 24 are meant to infer other things (like the equinox hours, the first two Metamorphosis numbers, and the 12 vertices and 24 edges of the cuboctahedron), but doesn't mind using the same clue for different puzzles. It's rather clever how he has synthesized at all.

Did Dee know about the Golden Ratio?

To answer to this question wil become obvious as we briefly review what the Golden Ratio is and its history.

Here's an easy way to get
a feel for the Golden Ratio.

Imagine a line whose length is 1.

Find the exact point along that line
where the ratio of the "longer section"
to the "smaller section" is equivalent
to the ratio of the whole line to the
"longer section."

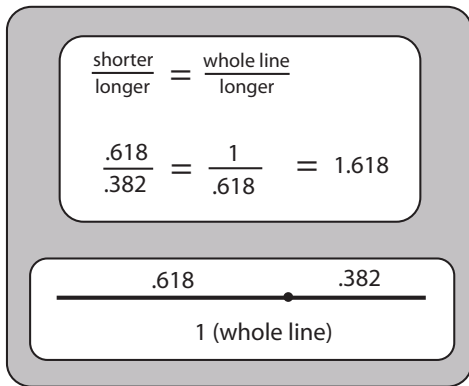
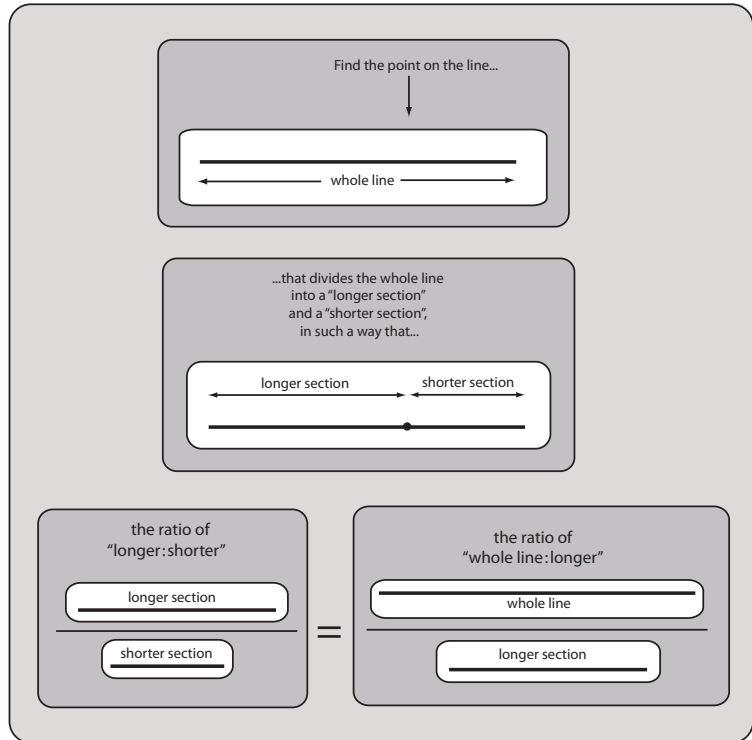

There is only one solution to this problem (and it's not a whole number). The length of the longer section is .6180339887...

This makes the smaller section .3819661... To simplify, let's round these off to .618 and .382. Popping these numbers into the equation, we find both ratios are equal to 1.618.

Rounding off even more, the special point we were looking for is about at "the 61% mark" on the line. This is significantly more than half-way (the 50% mark), but not quite two thirds (the 66% mark).

To describe all the wonders of the Golden Ratio would take a whole book, but I'll be brief. (Indeed, Mario Livio has written an excellent one entitled *The Golden Ratio: The Story of Phi, The World's Most Astonishing Number*.)

The Golden Ratio (or Golden Section or Φ , Phi) is by no means a recent discovery. Mathematicians have known about it for centuries. There is a suggestion that was known to Pythagoras and his gang (around 500 BC), but it was certainly known to Euclid (around 300 BC). (Livio p. 78)

In *Elements*, Book 6, Definition 3, Euclid calls the Golden Ratio the “extreme and mean ratio.”

“A straight line is said to be cut in the extreme and mean ratio when, as a whole line is to the greater segment, so is the greater to the less.”

In *Book 13, Proposition 6*, Hypsicles (purportedly the real author of Euclid’s Book 13, around 150 BC) describes one way that the Golden Ratio can be found in the diagonals of a regular pentagon.

Connect any two pairs of vertices with straight lines. These lines will cut each other into two parts, which in the Golden Ratio to each other.

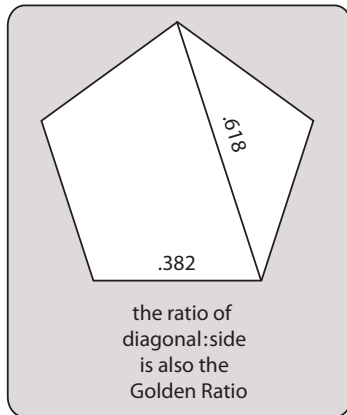
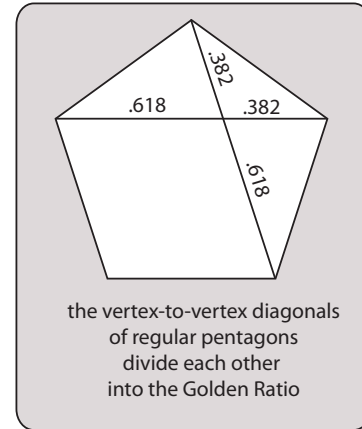

In addition, the ratio between one of these vertex-to-vertex diagonals and the side of the pentagon is also the Golden Ratio.

The ratio between a side of the pentagon and this “shorter section” of the diagonal is also the Golden Ratio.

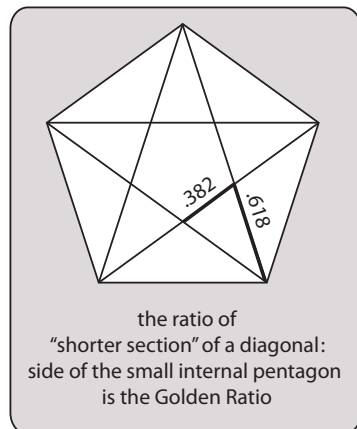
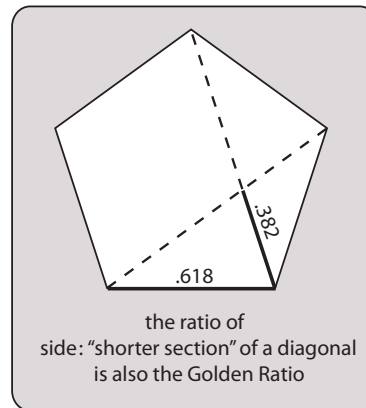

Making a full pentagram star (with the 5 diagonals) creates a smaller pentagon in the middle. The ratio of a “short section” of the diagonal to the side of the small pentagon is also the Golden Ratio!

As you can see, the pentagon is saturated with the Golden Ratio (and thus the dodecahedron, made from 12 pentagons, is as well).

Fibonacci lights the way

The
Fibonacci
Sequence

↓
0+1=1
1+1=2
2+3=5
3+5=8
5+8=13
8+13=21
13+21=34
21+34=55
34+55=89
55+89=144
89+144=233
144+233=377
233+377=610
377+610=987
610+987=1597
987+1597=2584
1597+2584=4181
2584+4181=6765
(etc...)

As Euclid knew about this ratio, all the Neoplatonic and Medieval mathematicians who were Euclid buffs knew about it as well. In the year 1202, Leonardo Fibonacci published *Liber Abaci (Book of the Abacus)* introducing the Hindu-Arabic numbers to the West.

His father Guglielmo Bonacci was a customs officer who took his son Leonardo (Fibonacci means “filius” or son of Bonacci) on trading missions to Greece, Syria, Egypt, and Algeria.

Fibonacci was a sponge for the “new math” that had migrated from India through the Arab world. He learned of a special series of numbers, which has come to be called the Fibonacci sequence.

It's created quite simply.

After 0 and 1, the rest of the numbers are totals of the previous two members of the sequence..

But what's amazing about these numbers is that the larger they get, the closer any two neighboring numbers get to being in the Golden Ratio.

The ratio between
consecutive numbers
in the Fibonacci Sequence...

1/1=1.000000000...
2/1=2.000000000...
3/2=1.500000000...
5/3=1.666666666...
8/5=1.600000000...
13/8=1.625000000...
21/13=1.615384615...
34/21=1.619047619...
55/34=1.617647059...
89/55=1.618181818...
144/89=1.617977528...
233/144=1.618055555...
377/233=1.618025751...
610/377=1.618037135...
987/610=1.618032787...
1597/987=1.618034448...
2584/1597=1.618033813...
4181/2584=1.618034056...
6765/4181=1.618033963...

↓
...keeps getting closer
to the Golden Ratio
1.6180339887...

Renaissance mathematicians, searching to understand the keys to God and Nature, got all juiced up about the Golden Ratio.

Luca Pacioli calls it the “Divine Proportion” and explains how it is connected to the Platonic solids. He writes that the Platonic solids cannot be compared without the Golden Ratio. He even compares the three measurements involved (the long section, was short section, and the whole line) to the Holy Trinity: Father, Son and Holy Spirit.

Pacioli compares the fact that the Golden Ratio is an unending irrational number to God:

**“Just like God cannot be properly defined,
nor can be understood through words,
likewise our proportion cannot ever
be designated by intelligible numbers,
nor can it be expressed by any rational quantity,
but always remains concealed and secret,
and is called irrational by the mathematicians.”**

(Paciloi, in Livio, p.132)

Just as Dee saw numbers and geometry as the underlying basis for all the arts and sciences, Pacioli writes that his book is a:

“A work necessary for all the clear-sighted and inquiring human minds, in which everyone who loves to study philosophy, perspective, painting, sculpture, architecture, music and other mathematical disciplines will find a very delicate, subtle, and admirable teaching and will delight in diverse questions touching upon a very secret science.”

(Pacioli, in Livio, p. 131)

Pacioli explains various “effects of the Divine Proportion,” limiting them to 13 so they represent Christ and the 12 apostles. He refers to the Divine Proportion as “wonderful,” “essential,” “singular,” and even “supreme.” (Livio, pp. 132-3)

Indeed, a many Renaissance artists and architects started incorporating the Golden Ratio into their design of their works.

Here’s an easy way to draw a rectangle whose width and height are in the Golden Ratio to each other. No irrational numbers or complex formulas are needed.

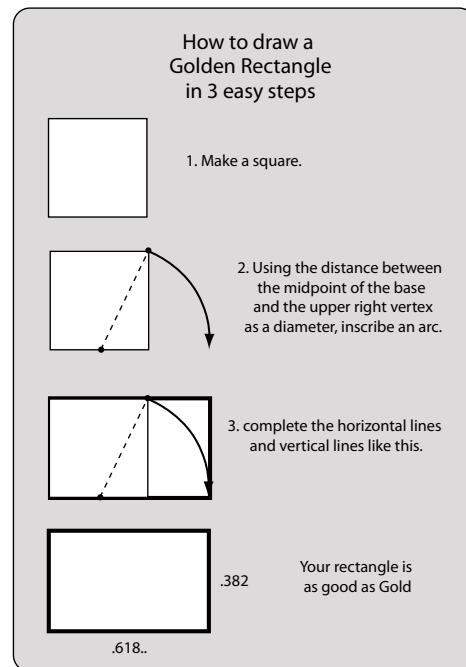

John Dee not only owned Pacioli’s *The Divine Proportion*. Plus Dee was a Euclid whiz and owned 45 translations or commentaries on Euclid’s works. Gerolamo Cardano used the Golden Ratio in his math texts and Dee owned 20 of his books. Dee loved this stuff.

(Roberts and Watson, pp. 233, 215, and 211)

Besides the “influential work of Pacioli and the mathematical/artistic interpretations of the painters Leonardo [da Vinci] and Albrecht [Dürer],” Mario Livio cites the work of “Rafael Bombelli” (1526-1572) and “François de Foix” (Flussas, the Count of Candale, 1502-1594) as mathematicians who discussed the Golden Ratio. Livio writes that Flussas used “the Golden Ratio in a variety of problems involving the pentagon and the Platonic Solids.” (Livio, p.141)

Jens Høyrup, in his 1994 book, *In Measure, Number, and Weight*, puts Flussas and Dee in the same sentence, “Foix de Candale was regarded by contemporaries as ‘le grand Archimede de nostre age’ [the great Archimedes of our age] and Dee refers to Archimedes time and again in the Mathematical Preface...” (Hoyrup cites Jean Bodin, quoted in Westermann 1977:2)

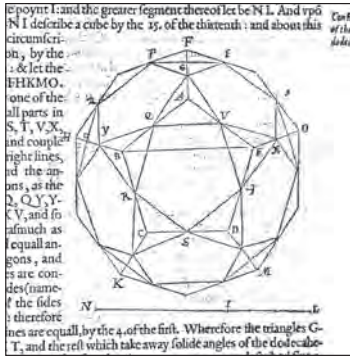

Flussas explains the construction of the icosidodecahedron

First, he divides a diameter of the whole shape (from any small, pointy-tip to it's opposite small, pointy-tip) into the Golden Ratio.

He then finds that the "larger section" of that diameter is twice as long as one of the sides of any of the small pentagonal faces. (That's what this drawing is all about. I'll spare you the proof.)

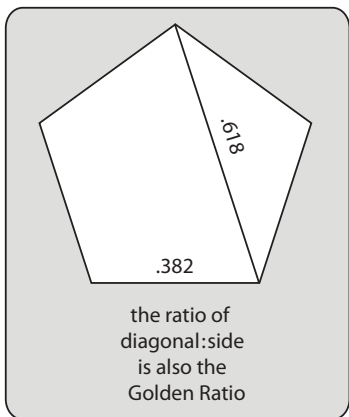
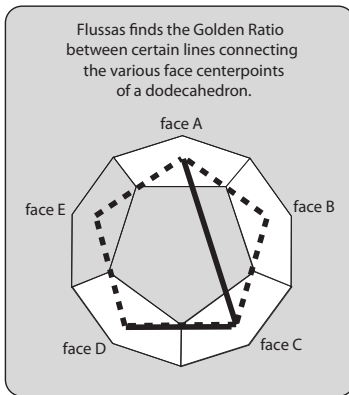
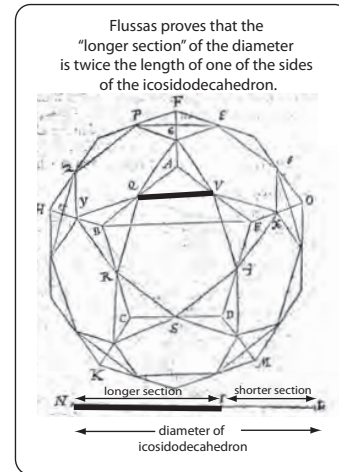

As we seen, Dee not only owned Flussas' translation and commentary on Euclid's *Elements*, he appended Flussas' *Brief Treatise* to the English translation of Euclid he worked on. Flussas' work explains the geometric construction of the cuboctahedron and the icosidodecahedron.

In describing the icosidodecahedron, Flussas, writes a two-page proof that it is involved with the Golden Ratio.

In his description of "The nature of a Dodecahedron," Flussas finds the Golden Ratio relating to three neighboring pentagonal faces (three in a row, like faces A, B, and C shown here, not three faces clustered around a vertex).

A line connecting the face centerpoints of two faces separated by a third face (for example from face A to face C) and a line connecting to neighboring faces of the dodecahedron are in the Golden Ratio.

This can easily be seen without all Flussas' technical proof. Here I have connected the centerpoints of faces A, B, C, D, and E by making a dotted-line pentagon.

This is essentially the same as the diagram shown earlier, where the the ratio between a "vertex-to-vertex diagonal" and the side of the pentagon is the Golden Ratio.

(Flussas, in Billingsley (and Dee), *Euclid's Elements*, pp.459-463)

The bottom line here is that Dee was well-versed in the Golden Ratio, and to find it suggested in the Monas (however cryptic) is not surprising. (Dee didn't need to elucidate upon it, as was well known to contemporary mathematicians. And introducing it would only cause confusion with the other Consummata and Metamorphosis numbers he was cryptically conveying.)

The Golden Ratio is not merely a mathematical curiosity. It is found in innumerable places in the natural world.

As Matila Ghyka explains in his 1977 classic, *The Geometry of Art and Life*, the Golden Ratio can be found in the spiral of a nautilus shell and even in the proportions of a human body.

It can be found in the the curl of an ocean wave before it crashes on the seashore, the whirling pattern of seeds on the head of a sunflower, the arrangement of bracts on a pine cone, the scales of a pineapple, the horns of mountain sheep, the curve of an elephant tusk and even in the spiral tail of a seahorse. (As da Vinci puts it, "The wisest and noblest teacher is nature herself.") There is a journal devoted to research related to the sequence: *The Fibonacci Quarterly*.

Mario Livio summarizes the significance of the Divine Proportion:

"But the fascination with the Golden Ratio is not confined to mathematicians. Biologists, artists, musicians, historians, architects, psychologists, and even mystics have pondered and debated in the basis of its ubiquity and appeal.

In fact, it's probably fair to say that the Golden Ratio has inspired thinkers of all disciplines like no other number in the history of mathematics."

(Livio, p.3)

To conclude, Dee's "Solar Mercury Planets" shape, (number 9 in his decad of shapes), is the rhombic dodecahedron. Its involvement with the icosahedron (5), the dodecahedron (6) and icosidodecahedron (7), involves the Golden Ratio. But this Golden Ratio exploration was not a side-track. Wait till you see how it pervades Dee's tenth and final shape...

Finally, number 10, the wonderful rhombic triacontahedron

This dual of the icosidodecahedron has 30 diamond-shaped faces. It may just look like a jumble of rhombi, but geometrically it's a precious gem.

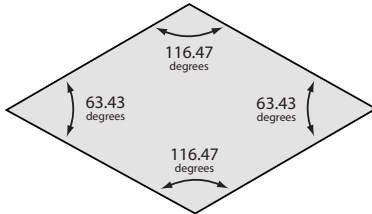
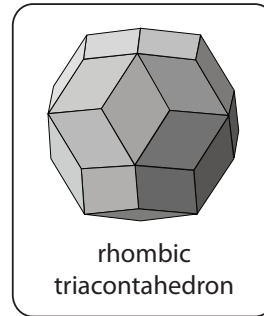

(Note that the angles of this rhombus are different than those of the rhombic dodecahedron, which are 70.53 degrees and 109.47 degrees)

Each of its diamond shaped faces as two acute angles of 63.43 degrees each and 2 obtuse angles of 116.47 degrees each.

Angularly, this might not sound very special, but linearly it's spectacular: **the ratio of the long diagonal to the short diagonal of each face is the Golden Ratio!**

This kind of a rhombus is called a "golden rhombus."

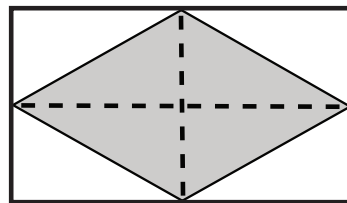
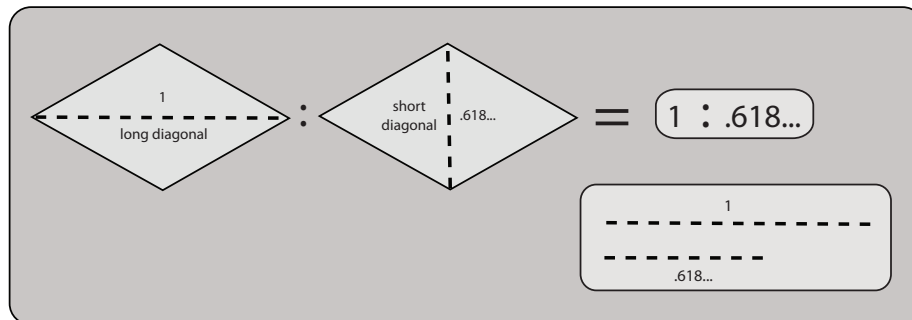

A golden rhombus in a golden rectangle

As you might suspect, a golden rhombus fits perfectly in a golden rectangle

So the rhombic triacontahedron has 30 golden rhombi.
We've struck gold!

Now let's examine its 60 edges.
Interestingly, they are all the same length.

This might not seem special, as we encounter this characteristic in the other basic shapes. But there are only nine convex polyhedra in this exclusive club.

These are 9 out of the 10 shapes in Dee’s “decad of shapes.” The only one not listed here is the stella octangula. The only reason it didn’t make the list is because it’s not a “convex polyhedron (it has stellations). But despite that, it also has edges which are all the same length as well! (After all, it’s simply an “upright” tetrahedron mated with an “inverted” tetrahedron.)

Each of these shapes is “isotoxal” or “edge transitive.” These are geometric terms, which simply mean all of its edges are the same length.

We’ve found membership requirements for Dee’s “decad of shapes”!

The 9 members of the exclusive “Isotoxal Club”



Look who’s hiding inside!

But beauty of the rhombic triacontahedron isn’t just skin deep. Wait till you what’s “hidden” inside— all the other 9 shapes! Let’s take them one at a time. (I have numbered them using Dee’s cryptic sequencing code.)

The rhombic triacontahedron has a total of 32 vertices. Twenty of these vertices correspond to the 20 vertices of an icosahedron.

dodecahedron (6)

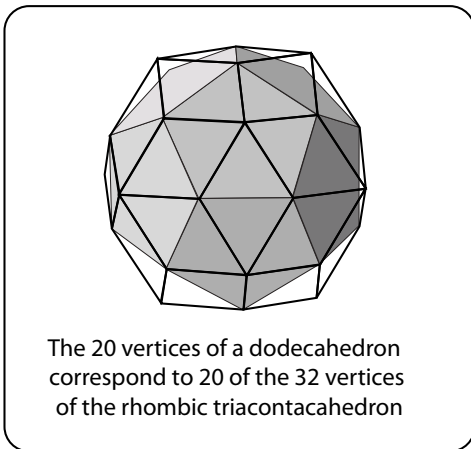

icosahedron (5)

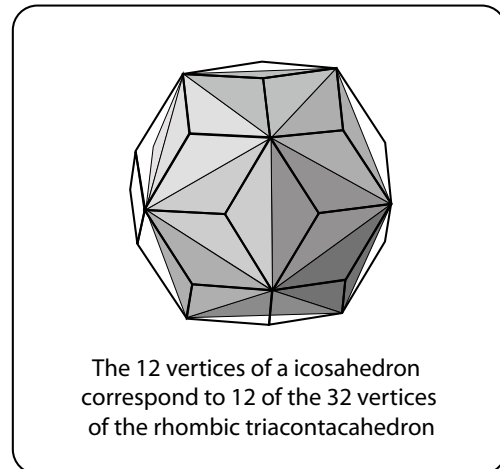

And the remaining 12 vertices correspond to the 12 vertices of any dodecahedron.

These two relationships aren’t that surprising because the rhombic triacontahedron’s dual, the icosidodecahedron, is the intersection of an icosahedron and a dodecahedron.

(Here’s another way to express this interrelationship: Start with rhombic triacontahedron. Connect 12 of the short diagonals of the diamond-faces and you’ll have a dodecahedron. Alternatively, connect 20 of the the long diagonals and you’ll have an icosahedron)

Let's go a step further. The cube and the dodecahedron have an interesting relationship. Eight vertices of a cube correspond to 8 of the 12 vertices of a dodecahedron.

This means that the 8 vertices of a cube will correspond to 8 of the 32 vertices of the rhombic triacontahedron.

cube (3)

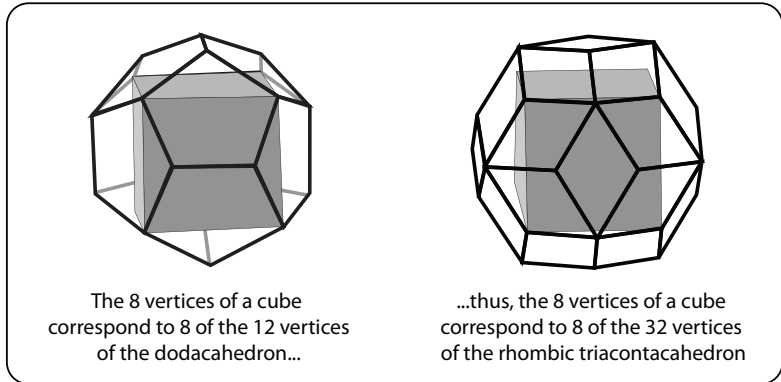

Notice (in the first illustration) that the edges of the cube are diagonals of the pentagonal faces of the dodecahedron.

As each pentagon has 5 diagonals, there are 5 possible “positionings” or orientations of the cube inside the dodecahedron. Thus, there are also 5 possible orientations of the cube inside the rhombic triacontahedron as well.

There is an easy way to see this. In the second illustration, imagine that single centralized vertical diamond face is a window that views the belly-button or face-centerpoint of one of the sides of the internal cube. You can see that there are similar diamond-shaped windows “viewing” the other face-centerpoints of that cube as well.

Each of the 5 orientations of the cube has 6 different windows, making a total of 30 “windows.” These “windows” are the 30 faces of the rhombic triacontahedron. (Perhaps we might call them “triacontawindows”.)

Let's go even a step further. Remember that the 8 vertices of a stella octangula correspond to the 8 vertices of a cube. (Indeed, a stellar octangula lying flat on the table even looks like a cube whose vertices are connected by a diagonals rather than edges.)

stella octangula (8)

Thus the 8 vertices of a stella octangula correspond to 8 of the 32 vertices of the rhombic triacontahedron

(And, like the cube, there are 5 possible orientations of the stella octangula inside the rhombic triacontahedron.)

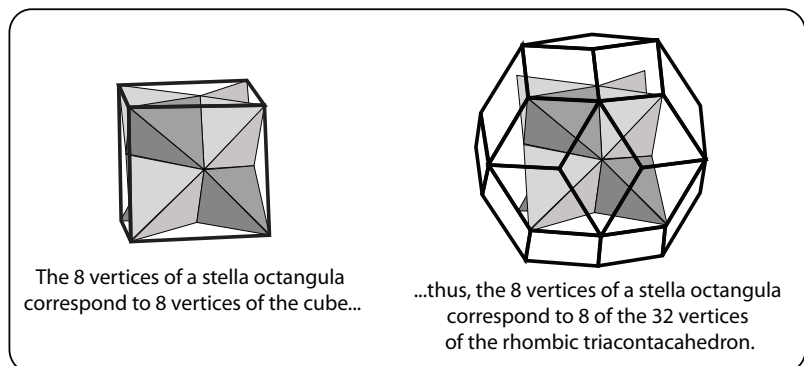

tetrahedron (1)

And a stella octangula is nothing more than 2 mated tetrahedra. Thus, the 4 vertices of a tetrahedron correspond to 4 of the 32 vertices of a rhombic triacontahedron.

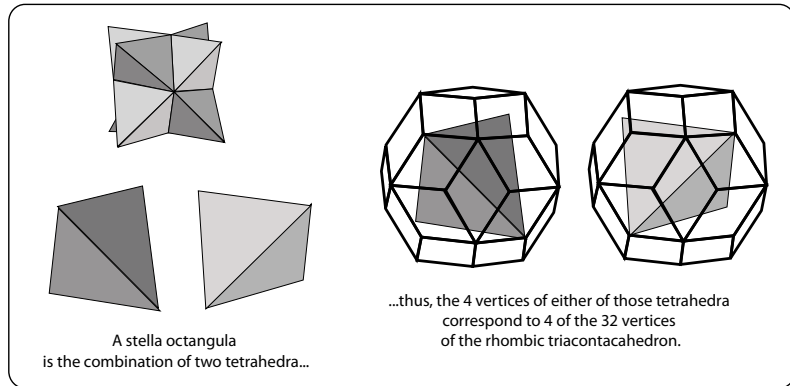

As there are two orientations for the tetrahedra on the cube, and 5 orientations of the cube in the Rhombic triacontahedron, there are 10 possible positionings of a tetrahedron inside a rhombic triacontahedron.

One way to see this is envisioning that centralized diamond-shaped “window” as viewing the midpoint of one edge of a tetrahedron.

As there are 6 edges to each tetrahedron, and 10 positionings, it seems as though there should be 60 windows. But notice that each window sees the edges of two different tetrahedra. (See the two illustrations above on the right, or on the stella octangula illustration shown previously.) As each window does double-duty, we only need 30 of them, the triacontawindows.

These windows might seem like a frivolous triviality, but they provide a way to peer into the fundamental character of the rhombic triacontahedron and thus illuminate an important link to Dee’s mathematical cosmology.

Here we have 10 tetrahedra (which Dee corresponded with the digit 1) fitting inside the rhombic triacontahedron (which Dee cryptically infers is 10). It’s an expression of that important aspect of Dee’s Symmetry of the Decad, “10 is a return to 1.”

The rhombic triacontahedron has this unique-in-the-world characteristic of being pregnant with 10 of “Nature’s most basic shape,” the tetrahedron.

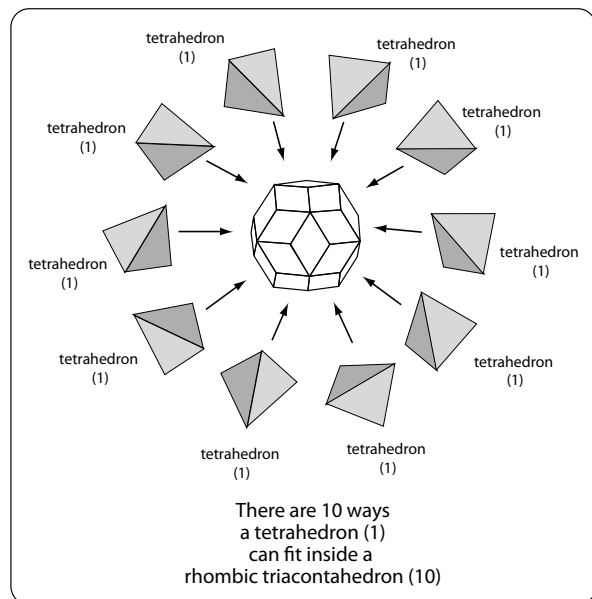

The idea that 10 tetrahedra fit in the rhombic triacontahedron is a natural phenomenon that is quite independent of our Base 10 numbering system. But it shows that the wise mathematicians who chose the Base ten system chose it wisely, as it relates numbers to geometry.

octahedron (2)

Let's dive even deeper. Recall that the core of a stella octangula, the intersection of the two tetrahedra, is an octahedron. Thus, there is an octahedron resting harmoniously and symmetrically inside the rhombic triacontahedron like a nucleus.

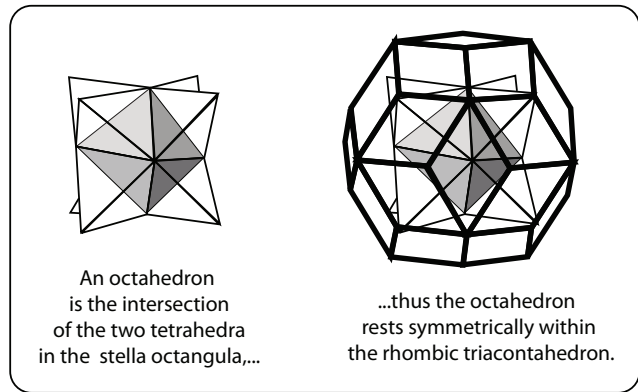

As Kenneth J. M. MacLean writes,

“the Rhombic Triacontahedron therefore elegantly describes the nesting of the five Platonic solids: icosahedron, dodecahedron, cube, tetrahedron, octahedron.”

(kjmaclean.com, and MacLean, p. 136)

MacLean takes it a step further. He notes that when an icosahedron fits inside an octahedron, its 12 vertices break each of the 12 edges of the octahedron into the Golden Ratio!

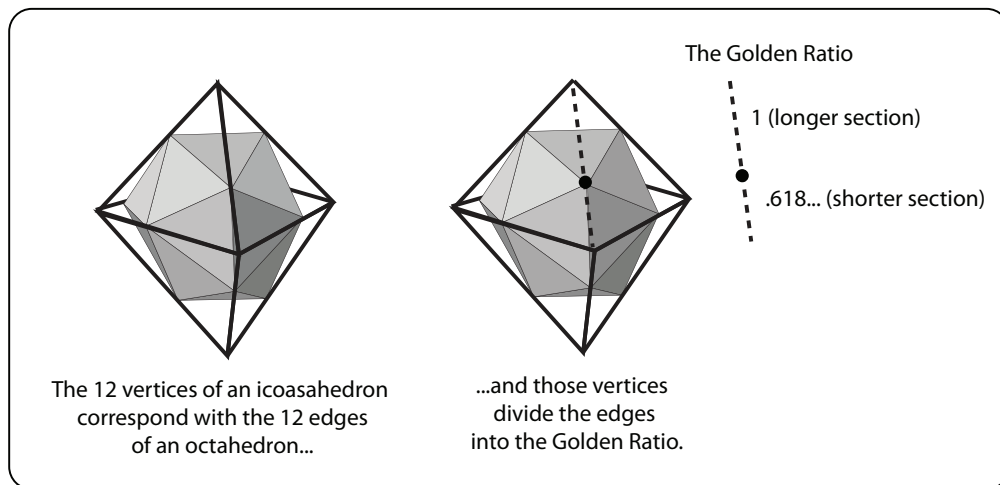

As this octahedron has given birth to another icosahedron. MacLean adds, “this begins the process all over again, and shows that the 5 nested Platonic Solids may not only grow and contract to infinity, but do so in a harmonious way!” (kjmaclean.com)

MacLean calls the rhombic triacontahedron “an extremely fascinating” polyhedron. Certainly Dee was enchanted with it as well. Its faces are all golden rhombi, its edges are all identical, and its vertices correspond with 4 of the Platonic solids and the stella octangula. It deserves a 10 more than Bo Derek.

The 3 remaining shapes also are interrelated with the rhombic triacontahedron.

A cuboctahedron is a degenerately truncated cube, so the cuboctahedron rests harmoniously inside the rhombic triacontahedron.

cuboctahedron (4)

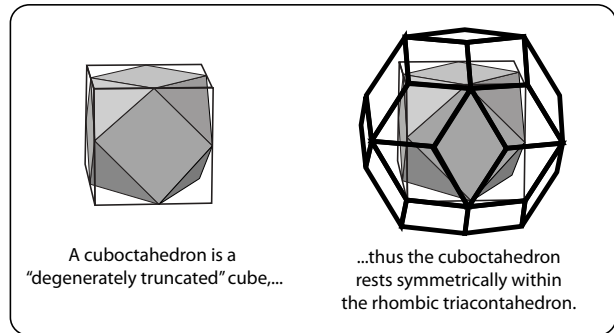

rhombic dodecahedron (9)

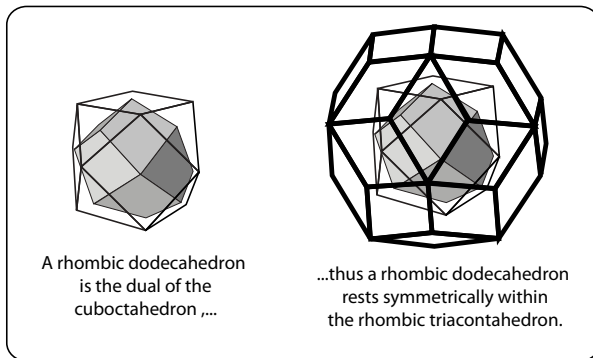

And the rhombic dodecahedron is the dual of the cuboctahedron, so it sits harmoniously inside the rhombic triacontahedron as well.

And finally the icosidodecahedron is the dual of the rhombic triacontahedron.

icosidodecahedron (7)

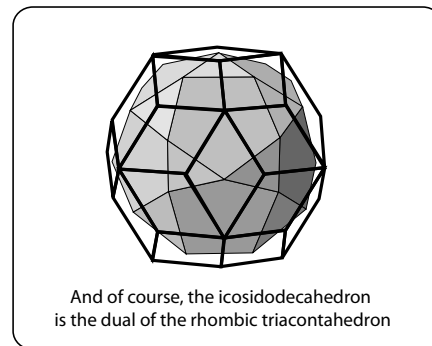

To summarize, we've seen that the "Lunar Planet" shapes [tetrahedron (1), octahedron (2), cube (3), cuboctahedron (4)] jibe with the "Space Frame" (in various ways).

The Solar Planets

[icosahedron (5), dodecahedron (6), icosidodecahedron (7)]

are "out of phase" with the Space Frame, but through their Golden Ratio-ness, they are somewhat interrelated with it.

The stella octangula (8) is an amalgamation of all the "Lunar Planet" shapes.

The rhombic dodecahedron (9) is connected to the icosahedron in a way involving the Golden Ratio. Also, it has 12 faces, just like the dodecahedron.

The rhombic triacontahedron (10) is the golden-rhombused granddaddy of them all, nesting the Platonic solids inwardly and outwardly from here to eternity.

...but now realizing the decad refers to the “decad of basic geometric” shapes it seems likely that the capitalized word REGNUM (REALM) is a cryptic reference to REX (KING or 10).

The King might be an “earthly” King, like King Maximilian (depicted on the Title page as a lion (the king of the jungle). Or it might be the “divine” King (God) which Dee believed to be a “3 persons in 1” Trinity.

Thus, the “Corporis, Sp(iri)tus, Animæ” (Body, Spirit, Soul) may be a cryptic expression of “Son and Holy Spirit, and Father.

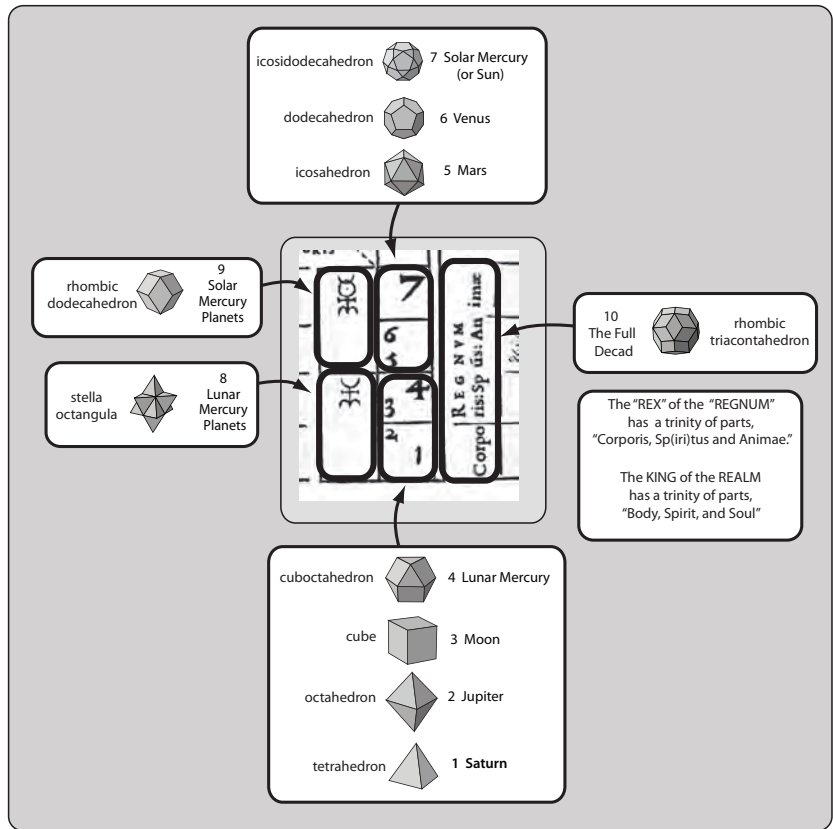

This also sheds new light on Dee’s strange verbal description of an IOD (the Hebrew yod, the Greek iota, or the Latin I).

“ALTHOUGH THE ONENESS OF THE POINT OF A CHIRECK REMAINS MOTIONLESS AT THE APEX, it is still not contrary of us to embrace a trinity of consubstantial monads, which appear to the ONENESS OF THE IOD ITSELF; THAT TRINITY BEING FORMED FROM ONE STRAIGHT LINE AND TWO DIFFERENT PARTS OF THE CIRCUMFERENCE.”

(Dee Monas, Letter to Maximillian, p..5)

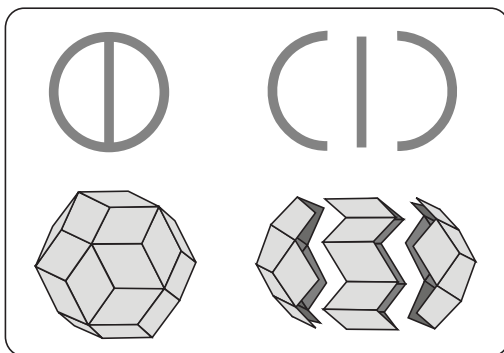

“Oneness”

“Trinity”

(the trinity of 10-faced sections of a rhombic triacontahedron)

He appears to be saying that a circle with a vertical line in it (from which all Latin letters can be made) can be seen as a Trinity of parts: the left part of the circumference, the vertical line, and the right part of the circumference. (His term consubstantial has connotes the Holy Trinity.)

This same “three part harmony” can be seen in the rhombic triacontahedron, Dee’s king of shapes. There are 10 faces on the left part, 10 on the “belt” in the middle and 10 faces on the right part.

Could Dee have known of this dissection of this shape? Most certainly, Johannes Kepler illustrated this 3-part harmony in 1619. (He had a little much trouble accurately rendering the zig-zaggy belt) But after Kepler the world seemed to have forgotten about this gorgeous geometric creature until the Belgian geometer Eugene Catalan “rediscovered” it on his own in 1865.

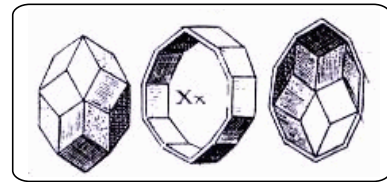

Johannes Kepler's 1625 illustration of the 3 way division of a rhombic triacontahedron

New Life for the neglected King of Shapes

Even though you may never have encountered a rhombic triacontahedron before doesn't mean it some obscure shape of interest to old Renaissance geometry fanatics like Dee and Kepler.

In 2006, creativity author and lecturer Roger von Oech from northern California started marketing a product called “Ball of Whacks.”

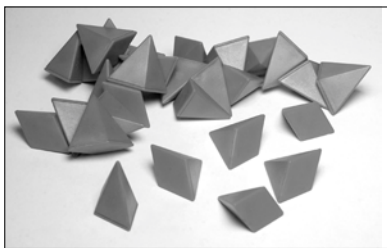

The 30 pyramids with rhombic faces in Roger von Oech's “Ball of Whacks”

Roger, who holds a doctorate in the History of Ideas from Stanford, recognized there is an overlap between the “sensori-motor and cognitive functions” in the brain.

Whether this is actually what is happening neurologically, manipulating an object with your hands (or knitting or fingering piano keys, or modeling clay or using any hand tool...) does seem to stimulate creative thinking.

Using his lifelong fascination with polyhedra, he designed a rhombic triacontahedron out of 30 rhombic-faced pyramids. Inside the colorful plastic pieces are small magnets, so the pieces cling together, but are rearrangeable.

The idea is to use your imagination to create new shapes – like stars, wreaths, even cat faces and flying squirrels. Playing with the pieces stimulates your creative juices like getting a “Whack on the Side of Your Head” (the title of another book by Roger).

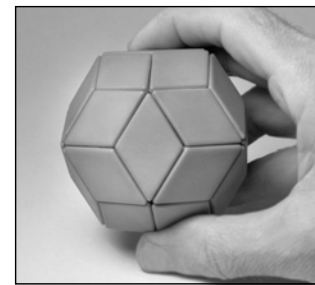

All 30 pieces assembled into a rhombic triacontahedron

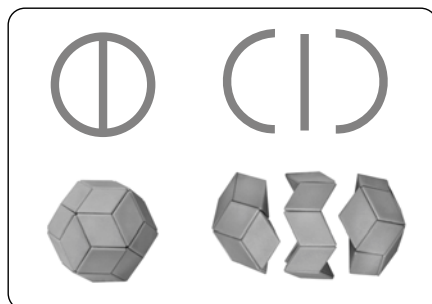

“Oneness”

“Trinity”

Playing with this creativity tool also helps understand the make-up of the rhombic dodecahedron—especially to see it as a Trinity as Dee seemed to see it.

Here is a side view in which I've divided the 30 pieces into three groups of 10 each.

And here is a “front view” showing 10 pieces, a “rear view” showing 10 pieces, and the 10 piece “belt” that fits between them.

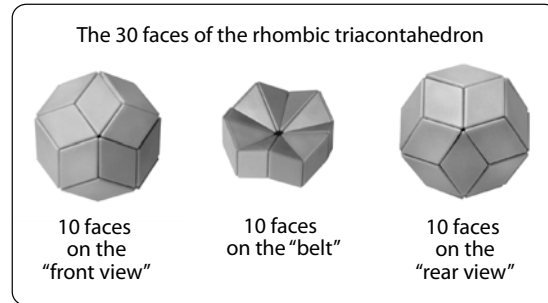

With this “decad of shapes” in mind, it’s worthwhile re-reading Dee’s advice to Arithmeticians and Geometers in the Letter to Maximillian.

1.

Dee’s Admonition to Arithmeticians:

“Will not the ARITHMETICIANS (and I don’t say LOGICIAN) – who treats Numbers as Abstract Bodies, far from being perceived by the senses; who subjects them to various Mental Processes and hides them in the depths of Intellectual Reasoning – will he not be astonished to see, in this our Work, that his numbers are shown to be Concrete and Corporeal, and that their Souls and Lives as Forms are separated from them, so that they may be of service to us?”

2.

Will he not be surprised to see such wonderful Offspring of the MONAD, to which no Other Unit or Numbers need to be added, and which do not need to be Multiplied by any numbers they do not already contain?”

3.

Or by first contemplating Carefully Prepared operations of Division and Equation (as this Art prescribes)?

Will he not be filled with the greatest admiration by this most subtle, yet General Evaluating Rule: that the strength and intrinsic VALUE of the ONE THING, purported by others to be Chaos, is primarily explained (beyond any Arithmetical Doubt) by the Number TEN?”

(Dee, *Monas*, p.5 verso)

He describes numbers as “concrete and corporeal,” having separate “souls and lives as forms.” (This sounds like he’s hinting at geometric shapes)

Where others see chaos he has seen an organization that is “primarily explained by the number 10” (“Denario”). (And these ten shapes do indeed exhibit extraordinary symmetry and harmonious organization.)

Dee’s Admonition to Geometers:

“The GEOMETER (my King) will begin to feel embarrassed, and feel that the very Principles of his Art are insufficiently established (which is quite strange) when he understands what here is Secretly whispered and Intimated: By the SQUARE Mystery of this Hieroglyphic MONAD something CIRCULAR, and wholly Equal, is being conveyed.

Also that the TOILS of Archimedes may be compensated by a most excellent Reward, even though he never solved this Problem. In matters this Great, it is Enough to have had the Intention.”

(Dee, *Monas*, p.5 verso)

Regarding Dee's "square" to "circular" metaphor, his "decad of shapes" start with the pointy tetrahedron and square-faced cube and ends with the quite-spherical rhombic triacontahedron.

But his reference to Archimedes is perhaps the most revealing clue. Among the Archimedean solids are the cuboctahedron and the icosidodecahedron. Archimedes was also aware of the stella octangula, and of course the 5 Platonic solids.

Dee seems to be suggesting that Archimedes never filled out the Decade of shapes because he wasn't aware of the rhombic dodecahedron (9) or the rhombic triacontahedron (10).

But Dee gives him credit for comprehending 8 out of 10 shapes, and gives him an "A for effort" in trying to solve the "Problem" of the "Ancient enigma of the symmetry of the Decad."

Dee's Admonition to Musicians:

And won't the MUSICIAN be rightfully astonished when here he will be able to perceive inexplicable, celestial HARMONIES without any motion or sound?

Dee may be referring to Nicomachus' and Boethius' "greatest and most perfect harmony" (the interrelationships among 6, 8, 9, and 12), but he also may be referring to the interrelationships among his "decad of shapes." Shapes are motionless and mute, but as we've seen, they certainly can be harmonious.

The English author Sir Thomas Browne (1605-1682) wrote a best-seller called *Religio Medici* (*The Religion of a Doctor*) in which he confesses "I have often admired the mystical way of Pythagoras and the secret magike of numbers." He also writes "For there is a music wherever there is harmony, order or proportion; and thus far we may maintain the music of the spheres; for these well-ordered motions and regular paces, though they give no sound to the ear, yet to the understanding they strike a note most full of harmony."

By associating the decad of basic 3-D geometric shapes with the 7 planets, Lunar Mercury and Solar Mercury, Dee seems to be connecting celestial harmony and geometric harmony. Johannes Kepler took it a step past Dee's metaphorical treatment and actually equated the orbits of the planets with the nested Platonic solids.

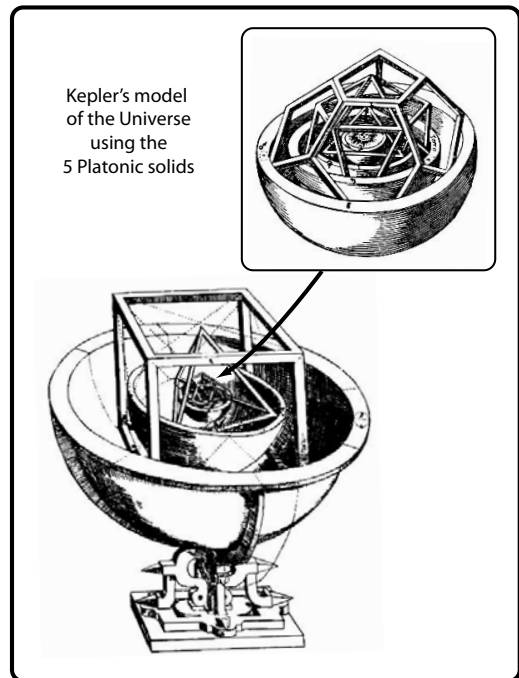

I think Dee envisioned the Title page this way. The “shapes of the four Lunny planets” are next to the Moon. The “shapes of the three Solary planets” are next to the Sun. And the final 3 shapes are in the theater, embraced by the flowing ribbons that express 8, 9, and 10.

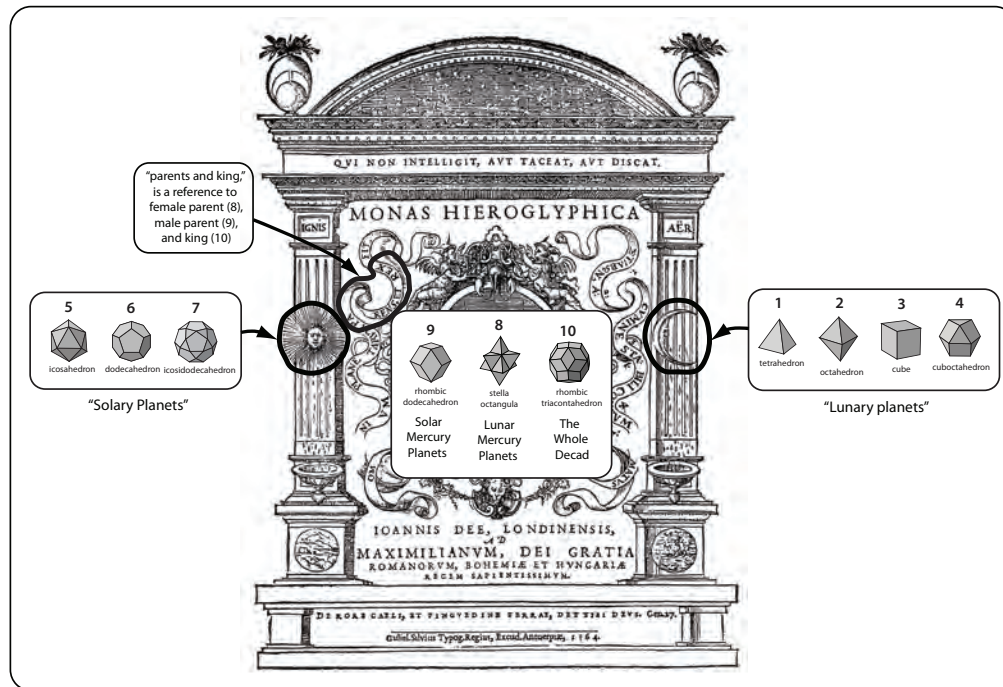

The preceding arrangement seems to ignore the Dee’s locations for of Plato’s associa-
tions: Fire (tetrahedron), Air (octahedron), Earth (cube) and Water (icosahedron).

That’s because Dee seemed to have in mind the alchemical 2-D symbols for these 4 Ele-
ments instead, as shown below. I’ve divided the incredibly symmetrical illustration in half to em-
phasize the two pairs of the “union of opposites.” In each instance, the result is a hexagram star,
which is the “flat-on” view of the stella octangula, or, when pulled apart, two tip-to-tip tetra-
hedra.

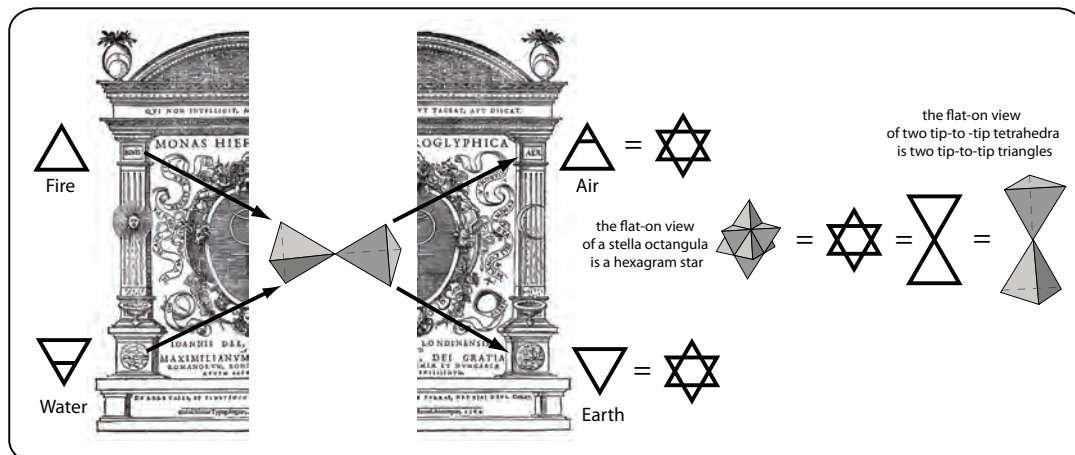

The four key positions in the Symmetry of the Decad are held by:

1 the simple **tetrahedra**

(Nature’s most basic 3-D shape),

4 the elegant **cuboctahedron**

(containing 8 tetrahedra;

or the intersection of its two predecessors,

the cube and the octahedron),

7 the lovely **icosidodecahedron**

(the intersection of its two predecessors,

the icosahedron and the dodecahedron),

and **10** the regal **rhombic triacontahedron**

(the dual of 7, the icosidodecahedron).

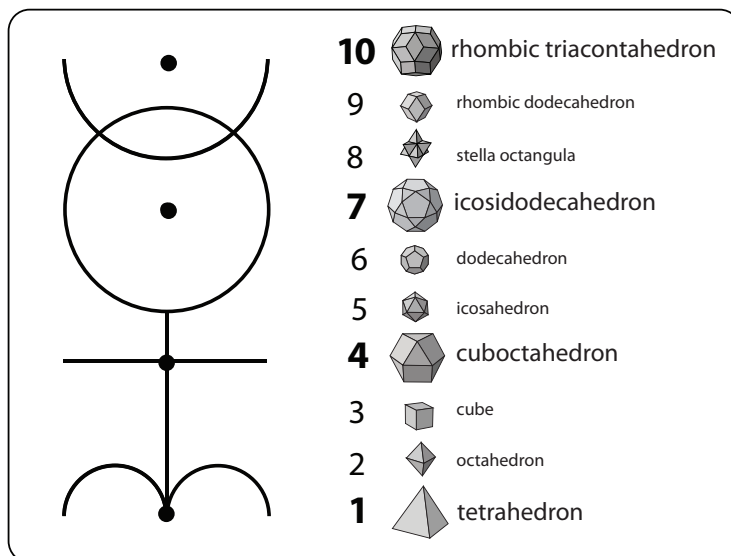

Dee’s approach seems more natural than the typical “5 Platonic Solids and 13 Archimedean Solids” accounting, as it incorporates the ideas of “oppositeness” much more fluidly.

All in all, it’s quite a clever scheme Dee has devised, but for the reader to “get it” requires background knowledge about of the interrelationships of the 10 most basic polyhedra and the octave nature of number (not to mention a metaphorical imagination to match wits with the inventive Dee).

I must reiterate that Dee never mentions many of these ten shapes of the decad. They must be inferred buy what he says about the Elements, the Lunary Planets, and Solary Planets, “8, 9, and 10,” and the Symmetry of the Decad.

It was only after I hand constructed models (and studied their interrelationships) that I was able to comprehend Dee’s intended organization for these ten shapes.

My ideas were confirmed when I read Kenneth J. M. MacLean’s *A Geometric Analysis of Platonic Solids and Other Semi- Regular Polyhedra (with an Introduction to the Phi Ratio) for Teachers, Researchers, and the Generally Curious*.

Quite independently MacLean chose these exact same 10 to explore in his book (not even mentioning any of the other Archimedean Solids). Mclean delves into the geometry and math much more than I have here. He doesn’t list the 10 in the precisely the order that Dee seems to have seen, but he starts with the tetrahedron and ends with the rhombic triacontahedron.

Mclean saw that the rhombic triacontahedron was a summarizing shape that “elegantly nests” the 5 Platonic Solids. Dee in the 1500’s and MacLean in 2000’s saw the exact same thing: Ten interrelated shapes that, as MacLean puts it, “are merely reflections of Nature herself.”

(MacLean, p.2)

Conclusion

Kepler is credited with naming the stella octangula and describing how the cuboctahedron and the rhombic dodecahedron are involved with the closest-packing-of-spheres. But Hreón tells us that even Plato and “the ancients” knew about the cuboctahedron.

As we’ve seen, Pacioli, da Vinci, Dürer, Barbaro, and Flussas studied the cuboctahedron in the 1500’s. Cardano described closest packing of spheres in 1550.

Kepler was inspired to study Atomism by Thomas Harriot.

And Harriot was a Dee’s friend.

In short, Dee knew all this stuff. Intimately. He has cryptically concealed the organization of these 10 important shapes in his *Monas Hieroglyphica*. This is what his equations relating to the Symmetry of the Decad is all about.

This is what his metaphor about “Lunar Mercury Planets” and “Solar Mercury Planets” is all about.

This is what the two words ATOMOS (Atom or Atomism) and ALTHALAMOS (Camera Obscura), encoded in the letters of the flowing ribbons, is all about. Atomism involves closest-packing-of-spheres, the cuboctahedron, and its dual, the rhombic dodecahedron. The cuboctahedron is made from 4 tip-to-tip tetrahedra. Each one is an expression of the behavior of light in a camera obscura. Also, each one can be morphed into a stella octangula.

Though it’s all wondrous, there is nothing magical about it. It’s how Nature operates. Dee and to Bucky just recognized how was dramatic, thrilling and inspirational it all is.

Bibliography

- Aste, Tomaso and Weaire, Denis V., *Pursuit of Perfect Packing*, (Phila., Inst. of Physics Pub., 2000)
- Critchlow, Keith, *Order in Space*, (N.Y., Viking, 1965)
- Cromwell, Peter R., *Polyhedra*, (Cambridge, Cambridge, 1997)
- Edmondson, Amy C., *A Fuller Explanation of the Synergetic Geometry of R. Buckminster Fuller* (Boston, Birkhauser, 1987)
- Ghyka, Matila, *The Geometry of Art and Life*, (N.Y. Dover, 1977)
- Hardie, Colin, (trans.) *The six-cornered snowflake by Johannes Kepler*, (Oxford, Clarendon, 1966)
- Livio, Mario *The Golden Ratio: The Story of Phi, the World’s Most Astonishing Number* (N.Y., Random House, 2002)
- Hargittai, Istvan and Magdolna, *Symmetry, A Unifying Concept*, (Bollinas CA, Shelter Pub., Inc. 1994)
- MacLean, Kenneth J.M., *A Geometric Analysis of the Platonic Solids and Other Semi-Regular Polyhedra* (The Big Picture, 2007)
- Szpiro, George G., *Kepler’s Conjecture*, (New Jersey, Hoboken, Wiley, 2003)
- Sutton, Daud, *Platonic and Archimedean Solids*, (N.Y., Walker, 2002)
- von Oech, Roger, *Ball of Whacks*, (Stamford, Creative Whack, 2006)
- Williams, Robert B., *Geometrical Foundation of Natural Structure*, (N.Y., Dover, 1972)

RENEWED ENTHUSIASM FOR THE PLATONIC AND ARCHIMEDEAN SOLIDS IN THE RENAISSANCE

Did Dee know that the cuboctahedron and rhombic dodecahedron were duals?

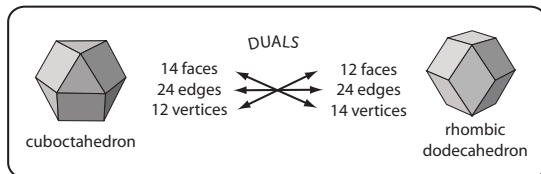

Admittedly, Dee never came out and described the cuboctahedron or the rhombic dodecahedron in any text. But to me it's pretty obvious he was quite familiar with them.

Dee owned over 100 books on mathematics, geometry, arithmetic, algebra, and trigonometry. He taught Euclid in a Parisian university as early as 1552. He was friends with the greatest mathematicians in Europe. (Roberts and Watson, Index 1, p. 238-243)

He provided dozens of insightful commentaries, corollaries, and lemmas to the Billingsley's 1570 translation of Euclid's *Elements*. Appended to that text is the "brief treatise" by the French mathematician Flussas, or Francois de Foix, the Count of Candale. Flussas describes the cuboctahedron, calling it the "**Exoctahedron**," and explains how it is made from the cube and the octahedron.



Flussas derives the cuboctahedron using the midpoints the edges of a cube

He also explains the "**Icosidodecahedron**" is the intersection of an icosahedron and a dodecahedron.

But Billingsley's Euclid's *Elements* was published in 1570, so it's hardly conclusive evidence that Dee knew about the cuboctahedron in 1564 when he wrote the *Monas*.



Flussas explains the construction of the icosidodecahedron

Did Dee know about the cuboctahedron and the rhombic dodecahedron in 1564?

As explained in an earlier chapter, Johannes Kepler (1571-1630) gets the credit for his conjecture that “12 spheres fitting around 1” is the closest-possible-packing-of-spheres, based on his 1611 treatise, *The Six Cornered Snowflake*. But as explained earlier, Geralmo Cardano had written that “12-spheres-fit-around-1” 56 years earlier in his 1554 *De Subtilitate* [on the Subtle things in Nature]

Likewise, Kepler is frequently given credit for discovering the **rhombic dodecahedron**. He saw that a bee’s cell was closed off at the end with three equal rhombi. He noticed that this shape on the sides of the tightly packed seeds inside a pomegranate.

**“These rhombi put it into my head to embark
on a problem of geometry:
whether any body, similar to the five regular solids
and the fourteen Archimedian solids
could be constructed with nothing but rhombi.”**

[This led to his discovery of a shape
**“bounded by twelve rhombi [that had]
affinities to the cube and the octahedron.”**

(Kepler, *The Six-Cornered Snowflake*,
in Hardie, C. Oxford U. Press 1966, p. 11; and Cromwell, Peter, p. 152)

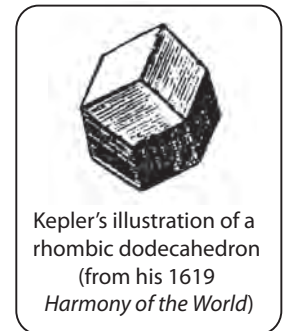

Kepler saw the interconnection between the 12-around-1 cuboctahedral shape and the rhombic cuboctahedron, and became the first to enunciate it in print.

But remember, the German Kepler (1571-1630) was inspired to study atomism in the first place through his correspondence with his English contemporary Thomas Harriot (1560-1621). And Harriot was inspired by his friend John Dee (1527-1608) who was 33 years older than Harriot.

But, alas, this interconnection is still not proof positive that Dee knew about the rhombic dodecahedron.

For that proof we must jump back to Piero della Francesca (1415-1492), the Italian artist and geometer.

Piero della Francesca and Luca Pacioli

Piero della Francesca (1445-1514) studied how intersection of a cube and an octahedron makes a cuboctahedron. He explained that the cuboctahedron can be “cut out” from a cube in his 1450 *Trattato d’Abaco* (*Treatise on the Abacus*).

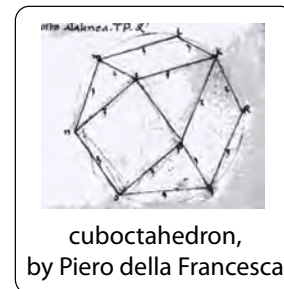

Piero’s manuscript was never printed, and didn’t come to light until the 1900’s. When it did, scholars knew for certain where Piero della Francesca’s student Luca Pacioli (ca. 1445-1517) got a lot of his information for his popular text *De divina proportione* (*The Divine Proportion*).

This plagiarism had been first suggested by Giorgio Vasari in his *Lives of the most Excellent Artists, Sculptors, and Architects*.

Vasari writes that after Piero della Francesca taught Luca Pacioli,

**“all he knew,” [and Pacioli]
 “shamefully and wickedly tried to blot out his
 teacher’s name and to usurp for himself
 the honor which belonged entirely to Piero.”**

(Vasari, *Lives*, Life of Piero della Francesca, in Bull, p. 109)

Pacioli’s friend Leonardo da Vinci did over 50 beautiful illustrations showing 3 types of each of the 5 Platonic solids (normal, truncated and stellated). And each type he depicted in two versions (solid and hollow)



He did these same two versions for prisms and pyramids.

And finally Pacioli had da Vinci do detailed renderings of two special polyhedron he had discovered.

One was the 26-faced Rhombicuboctahedron with 8 triangular faces and 18 square faces.

The other was a 72-side made from parallelograms and isosceles triangles.

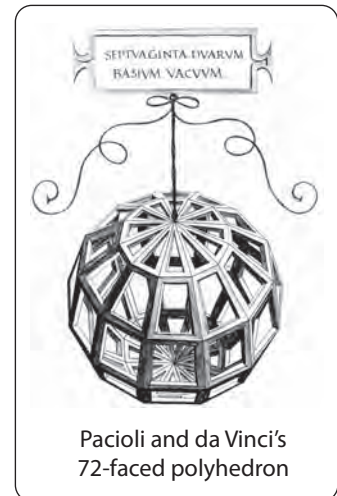

Their depictions of the tetrahedron and octahedron have not been truncated and stellated to their “degenerate” state where they morph into other shapes. However, with the cube, it’s clear Pacioli and da Vinci saw the cuboctahedron and rhombic dodecahedron pop into being (though they didn’t refer to them by those names):

Here are their different versions of the cube – solid and hollow.

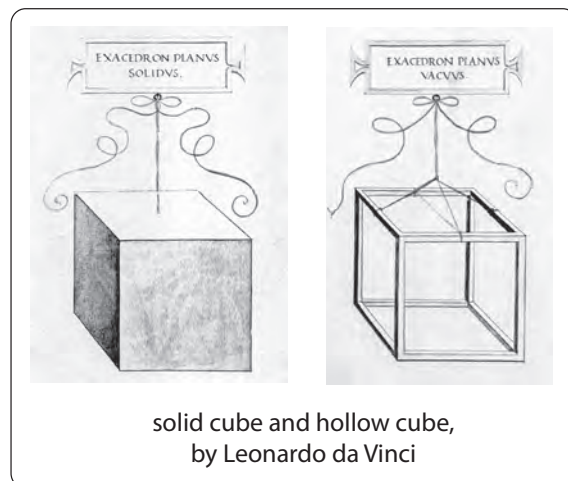

Next he shows a truncated cube which has been perfectly truncated to mid-edge, so it has transformed into a **cubeoctahedron**.

Pacioli calls it an “Exacedron Abscisus.” Exahedron or Hexahedron means “6-sided” which was his name for a cube. Abscisus means “cut-off” or “truncated.”

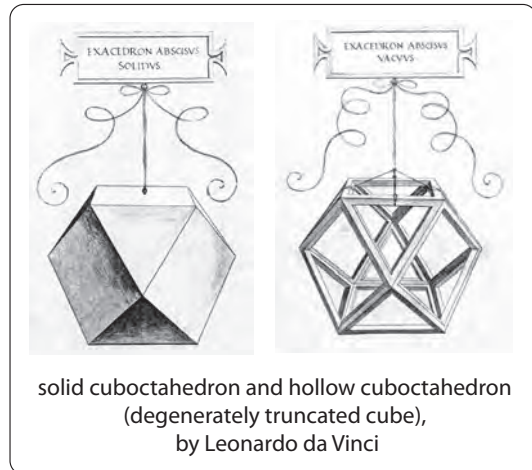

solid cuboctahedron and hollow cuboctahedron (degenerately truncated cube), by Leonardo da Vinci

Take it from someone who has struggled to depict a cuboctahedron, Leonardo’s “hollow” version is perhaps the most revealing rendering of this shape I have come across.

And the stellated cube has morphed into a **rhombic dodecahedron**.

Pacioli calls “Exacedron Eleva,” a “cube” whose sides have been “elevated, or raised.”

Da Vinci’s shading shows the stellation nicely, but somewhat disguises the 12 rhombic faces that have formed. It’s easier to read the rhombic faces in the hollow version than the solid one. (The diamond-shaped faces appear slightly bent in the middle, but they are not).

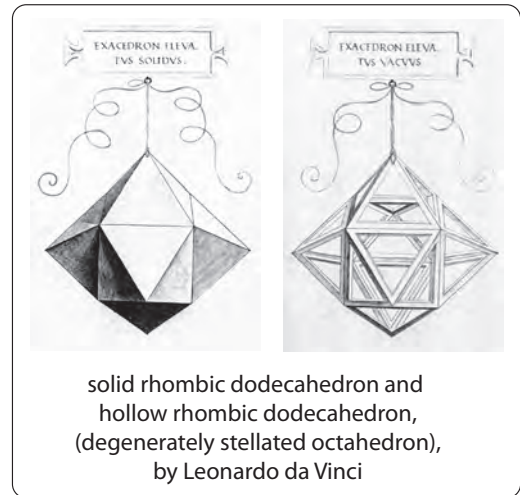

solid rhombic dodecahedron and hollow rhombic dodecahedron, (degenerately stellated octahedron), by Leonardo da Vinci

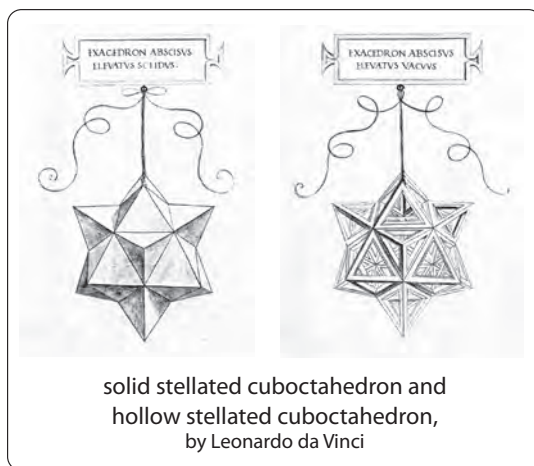

solid stellated cuboctahedron and hollow stellated cuboctahedron, by Leonardo da Vinci

Pacioli even took the cuboctahedron one step further and stellated it, making a star with 14 points.

Here is the solid version and the hollow version.

They depict a **stella octangula**, the mating of an “upright” tetrahedron and an “inverted” tetrahedron.

The name they chose for it, “octace-dron eleva” means octahedron with “elevated” or stellated sides.

They knew that the inner core of this shape was an octahedron.

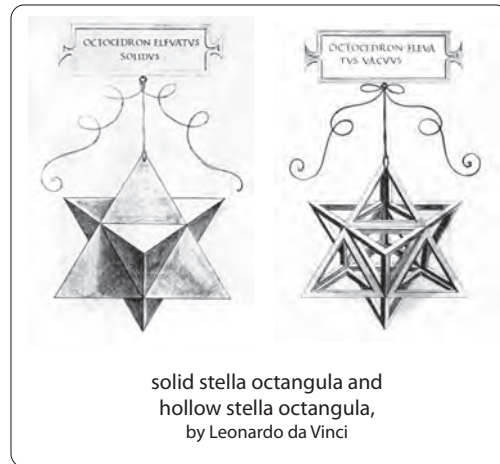

It’s apparent from the names they chose that Luca Pacioli and Leonardo da Vinci were aware of at least some of the “intertransformabilities” among the Platonic solids.

(*The Divine Proportion* was written in Milan sometime between 1496 and 1498, and was published in Venice in 1509. That’s 18 years before Dee was even born.)

Albrecht Dürer

The German artist Albrecht Dürer (1471-1528) twice journeyed from his home in Nuremberg to Venice in order to learn perspective and geometry from the Italian masters. The skills he acquired helped make him one of the finest artists in Europe.

Towards the end of his life, he decided to share his wisdom in *A Manual of Measurement of Lines, Areas, and Solids by Means of a Compass and Ruler... for all Lovers of Art*, which has commonly been called *The Painter’s Manual*.

He starts with plane geometry, then advances to the solid geometry. To more accurately display the number and shape of the sides of various polyhedra, he draws them flattened out in what is called a “net.” The reader can cut these shapes out, fold them, and really get a feel for their shape.

In this manner, he shows a cube, then a “partially truncated” cube, and then a “degenerately truncated cube,” which of course, is the cuboctahedron with its 8 triangular faces and 6 square faces.

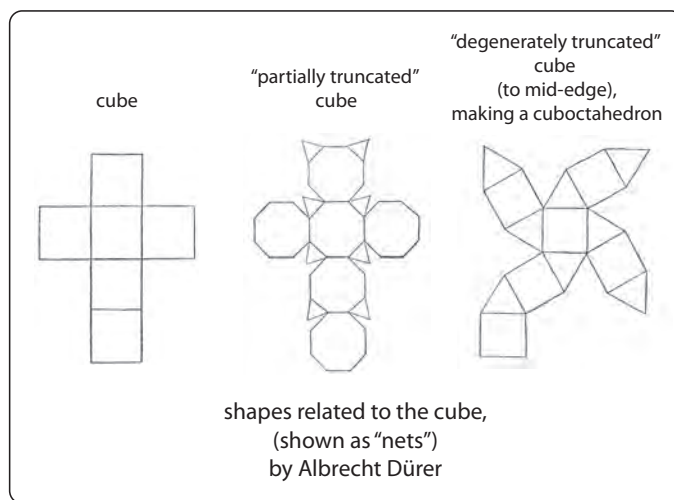

Dee owned *The Divine Proportion* as well as Pacioli's exhaustive study of arithmetic, algebra, geometry and trigonometry called *Summa*. He also owned Dürer's *The Painter's Manual*, which Dee simply referred to as *Geometrica*.

(Roberts and Watson, 14, 303, and 38; and from Dee's 1557 Library list, B 172 and B 192)

At the end of the *Preface to Euclid*, Dee acknowledges both of these authors. While explaining that the English version of Euclid's *Elements* will be of great benefit to the "unlained people" who are not University Scholars, he points out several texts that have been written on the Continent that were intended for the general public.

He writes that the scholars of Italian Universities are not in any way "**disgraced**" or "**hindered**" by the writings of:

"Frater Lucas de Burgo [Luca Pacioli's pen name] or Nicholas Tartaglia, who in Vulgar Italian language have published, not only Euclid's Geometry, but of Archimedes somewhat: and in Arithmetic and Practical Geometry, very large volumes, all in their vulgar speech. Nor in Germany have the famous Universities anyway been discontent with Albrecht Durer, his Geometrical Institutions..."

(Dee, *Preface*, p. Aiiiij)

Inspired by Pacioli's and Dürer's work, the study of the Platonic and Archimedean solids became all the rage in Europe. Among the new books on the subject were:

- 1543 *Geometria* by Augustin Virschvogel
- 1559 *The Practice of Perspective* by Daniele Barbaro
- 1567 *Perspectiva* by Lorenz Stoer
- 1568 *Perspective of Regular Bodies* by Wenzel Jamnitzer
- 1571 *Perspectiva* by Hans Lencker

Wenzel Jamnitzer

Wenzel Jamnitzer (1508-1585) was a wealthy Nuremberg goldsmith who created works for the king and his courtiers. In 1568, he published *Perspectiva Corporum Regularium* (*Perspective of Regular Bodies*). The detailed engravings, done by his friend Jost Amman portray the shapes with great depth and dimension. (He didn't do "hollowed-out" versions, but his renditions of the "solids" out-do even daVinci's solid versions.) (Cromwell, p.128-132)

Jost Amman also made detailed engravings for the "introductory pages" of each of the 5 regular solids. They creatively depict characters and objects associated with each of the corresponding Elements as that Plato assigned to them in *Timaeus*.

Cube
Earth

bull
cornucopia
of fruits and
vegetables



cherub
eating
grapes

rake
sheaf of
wheat
scythe

plow blades

rabbts

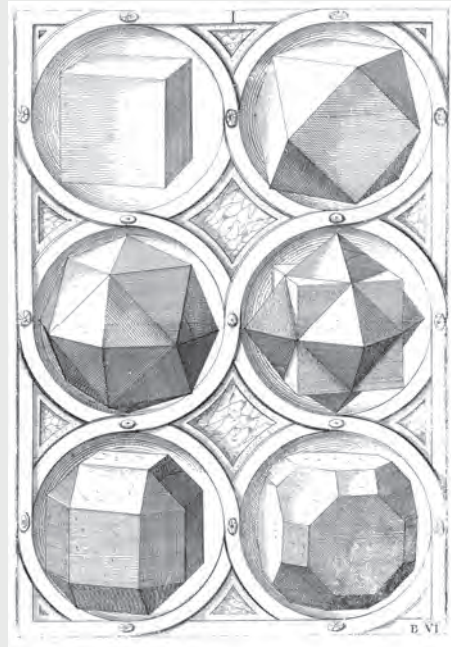

cherub
eating
apples

goats

sickle

thresher

cube

cuboctahedron

(on the right side of the middle row is a
combination of a cube and an octahedron)

Icosadhedron
Water

sea
serpents
lobster
carp



periwinkle
clam

crab Neptune's
trident

eels

frog

cherub
with
water
jug

fish

squid

icosadhedron

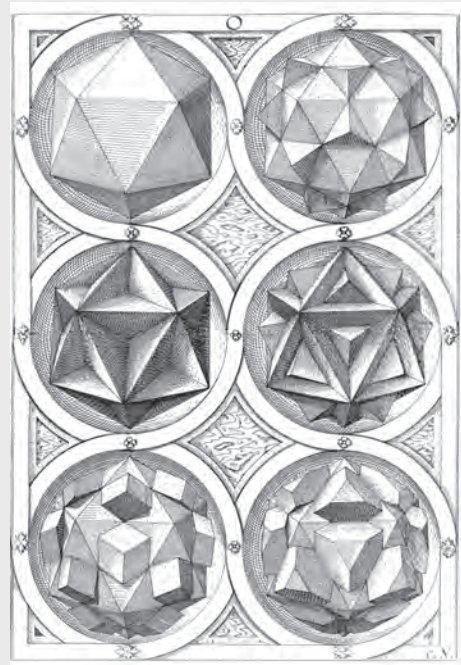

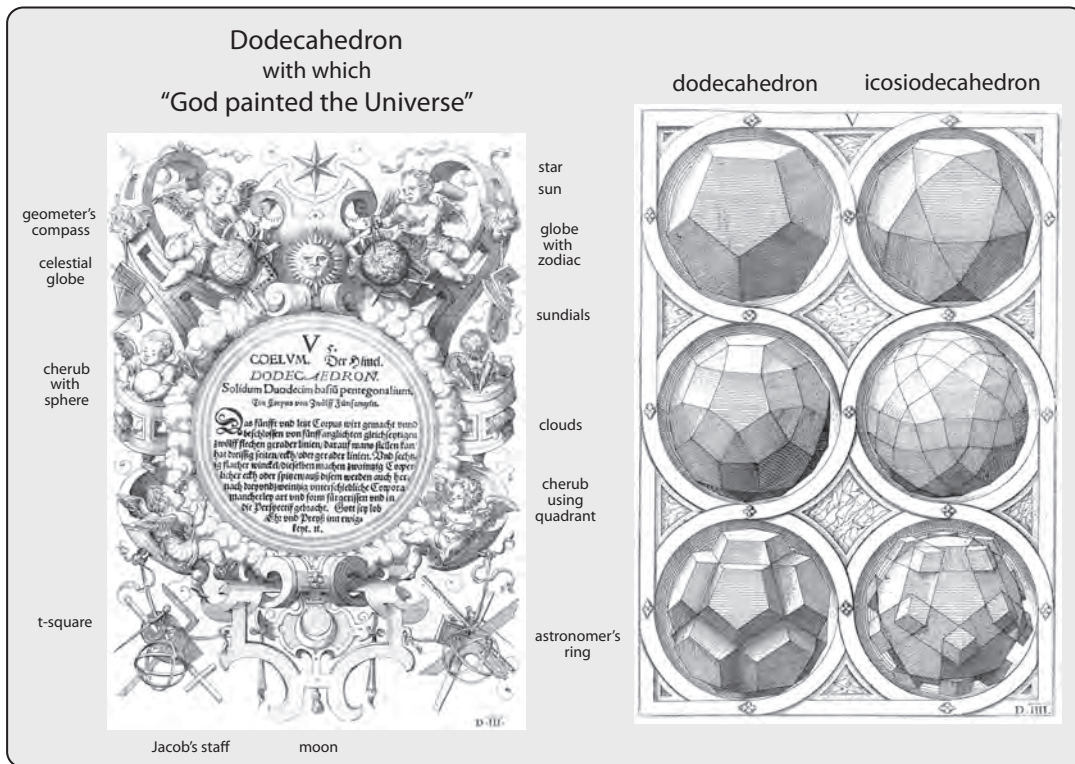

Jamnitzer and Amman had a lot of imaginative fun with Plato's correspondences. Aside from noticing the details, look at the center "theaters" where the type is located:

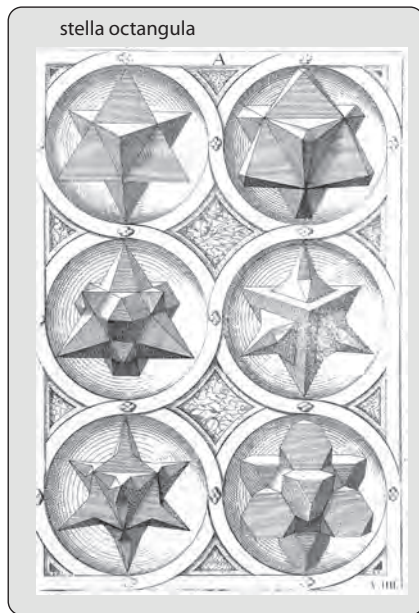

- Fire: circle of flames
- Air: bellows
- Earth: heart-shaped leaf-leaf
- Water: scallop shell
- Heavens: three-ringed cicle in the clouds

They also assigned a vowel and a digit to each correspondence.

- Ignis: A 1
- Aer: E 2
- Terra: I 3
- Aqua: O 4
- Heavens (Coelum): V 5

Among the dozens of shapes they depict is the stella octangula, along with some fascinating improvisations. At the end of the book, they show off with even more complex shapes.

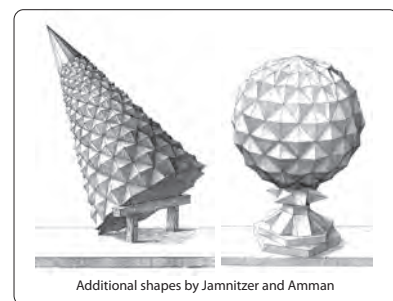

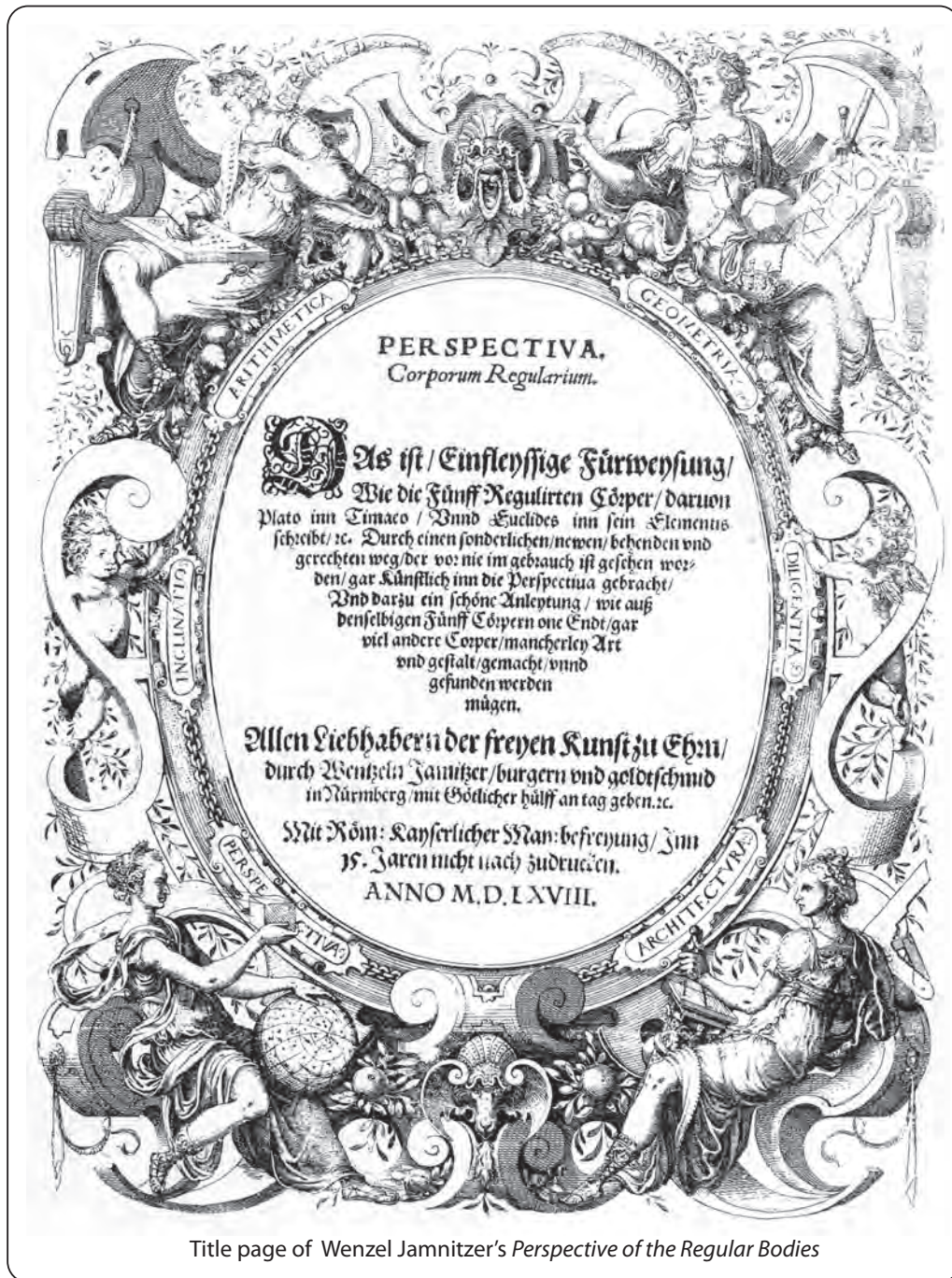

Title page of Wenzel Jamnitzer's *Perspective of the Regular Bodies*

The four interrelated Arts on the Title page also captivated Dee.

Lady Arithmetica is working the numbers,
 Lady Geometria, with a dodecahedron on her lap, has a triangle,
 a square, a pentagon, a circle, and a hexagram star on her tablet,

Lady Perspectiva is eyeballing a cube,
 and Lady Architectura is working a geometer's compass

The two Cherubs are suggesting that all it takes
 to understand these Arts is
 "Inclination" and "Diligence"

Daniele Barbaro



The study of the correspondences among Arithmetic, Geometry, Perspective, and Architecture was a hot topic throughout Europe in the mid 1500's. The design of the John Dee Tower incorporates all these subjects.

But these are rather broad topics. Let's look more specifically at three aspects of the John Dee Tower design that were also of great interest to the Venetian humanist Daniele Barbaro (1514-1570):

1. The Tower as a harmoniously proportioned building based on Vitruvius' description of a **classical round temple**.
2. The Tower as a **camera obscura**.
3. The Tower as a **sundial**.

The Italian polymath and art patron Daniele Barbaro wrote about all these topics. Barbaro (1514-1570) was 12 years older than John Dee (1527-1608). He came from a wealthy and landed Venetian family. After studying in Padua, he became ambassador to England (from 1548 to 1550), during the reign of King Edward VI. (He probably never met Dee, who was on the Continent studying and lecturing during those years.)

Following his 3-year stay in London, Barbaro summarized the culture of England to the Senate in Venice:

“among whom nothing is more inconstant than their decrees on matters of religion, since one day they do one thing and the next day they do another.

This feeds the resistance of those who have accepted the new laws, but still find them most offensive, as was seen in the rebellions of 1549.

And in truth, if they had a leader, even though they have been most severely punished, there is no doubt that they would rebel again.

It is true that the people of London are more disposed than the others to observe what they are commanded, since they are closer to the court.”

(Barbaro, in Alberi 1:2, pp. 242-3)

In 1561, Barbaro was the official representative for Venice at the Council of Trent, which called upon the Pope to institute a reform of the calendar.

In 1556, Barbaro published an Italian translation and commentary of Vitruvius' *Dieci libri della' architettura di M. Vitruvio (Ten Books on Architecture)*. Eleven years later, in 1567, the book came out in a Latin edition. Both editions had the same illustrations, done by the famed Andrea Palladio (1508-1580).

In 1559, inspired by Piero della Francesca and Albrecht Dürer, Barbaro wrote *La Practica della perspettiva (The Practice of Perspective)*, a second edition was published in 1567). Again he hired Andrea Palladio to do the illustrations.

The wealthy Barbaro also commissioned Palladio to design him a palatial home. Villa Barbaro, built between 1560 and 1568, it still stands today in Masera (outside Padua, about 30 miles west of Venice).

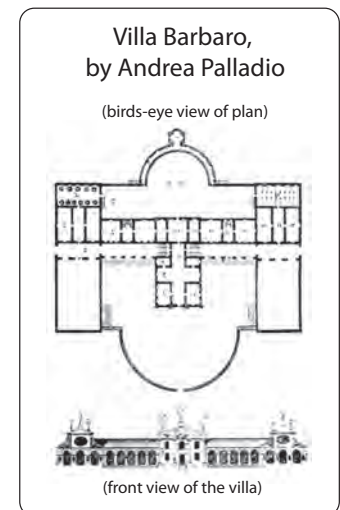

Barbaro also wrote working on a treatise called *De Horologis describendis libellus (Construction of Sundials)*. In it, he discussed the astrolabe, the planisphere, the cross staff, and other astronomical instruments. Unfortunately it was never completed, as in 1570 Barbaro suddenly died.

John Dee owned a copy of Barbaro's 1567 translation and commentary on Vitruvius as well as his book on *Perspective*. (Roberts and Watson, numbers 41 and 98)

Barbaro's book on *Perspective* presents the 5 Platonic solids and 11 of the 13 Archimedean solids. Barbaro shows three aspects of a cuboctahedron.

First he shows a net, similar to Dürer's net. [Except accidentally added one too many triangles. Can you figure out which one should be eliminated?]

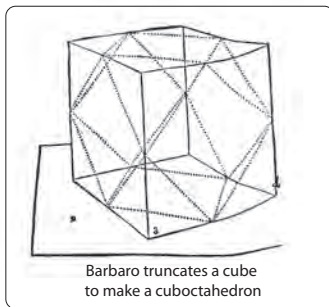

Like Piero della Francesca and Pacioli, Barbaro shows how the cuboctahedron can be made by truncating the corners of a cube to the middle of its edges.

But unlike della Francesca and Pacioli, he also explains the creation of a cuboctahedron by truncating an octahedron to the middle of its edges. (Barbaro, 3:8, pp. 58-60, and Field, J. V., p. 271)

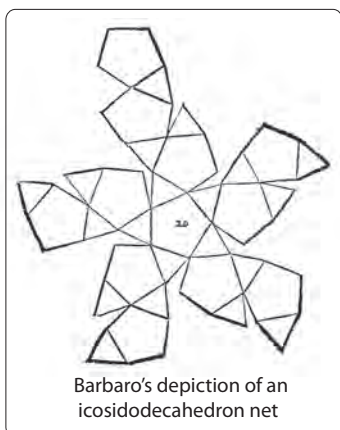
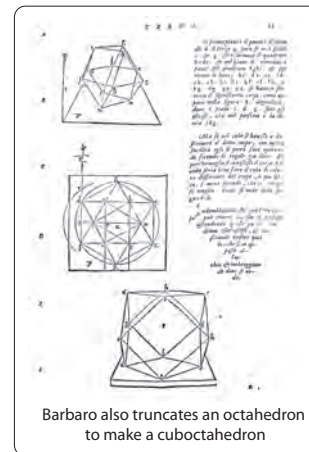
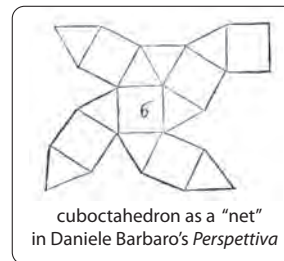

Here is Palladio's net for an icosidodecahedron. Barbaro also explains that an icosidodecahedron can be made by truncating either an icosahedron or a dodecahedron.

(The cuboctahedron and the icosidodecahedron are the two polyhedra that Flussas wrote about in his *Brief Treatise*, which Dee and Billingsley attached at the end of their translation and commentary on Euclid's *Elements* in 1570.)

Judith Field, in an article entitled *Rediscovering Archimedean Polyhedra* explains why Barbaro doesn't prove all his work mathematically:

“Barbaro is addressing himself to a class of readers whose interest in mathematics is subsidiary to their main concerns.”

(J. V. Field, *Rediscovering Archimedean Polyhedra*, pp. 269-274)

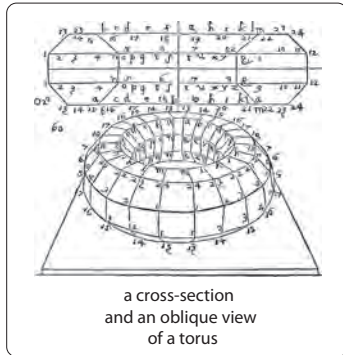

a cross-section and an oblique view of a torus

The drawings of the regular and semi-regular solids are immediately followed more complex shapes.

On the left here is a torus created by a octagon making a full revolution through space (and above it is a cross-section of this geometric doughnut).

On the right is the torus with shading and also cut up into wedges (which he calls mazzocco.)

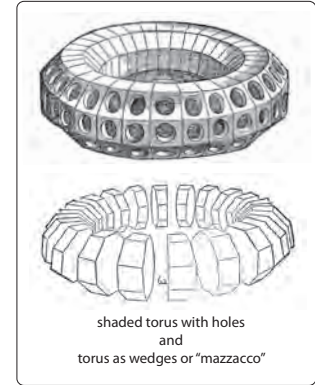

shaded torus with holes and torus as wedges or "mazzocco"

Barbaro then show how this geometrical knowledge can be applied in the field of architecture. Here, a similar torus can be seen in the design for the base of a classical column.

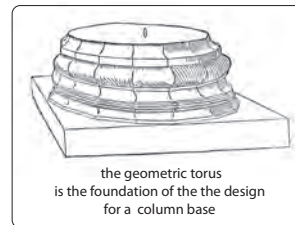

the geometric torus is the foundation of the the design for a column base

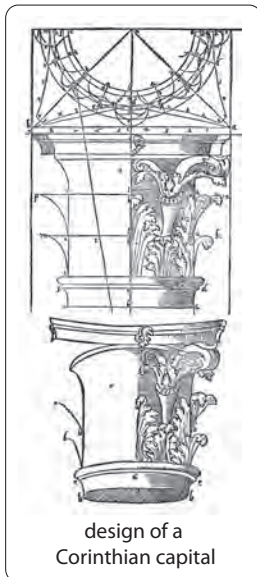

design of a Corinthian capital

He reviews the proportioning of the Doric, Ionic, and Corinthian columns (for example, the Corinthian capital shown here.)

He discusses how the entablatures and roofs should be proportioned to the columns.



details of the entablature and roof of a classical facade

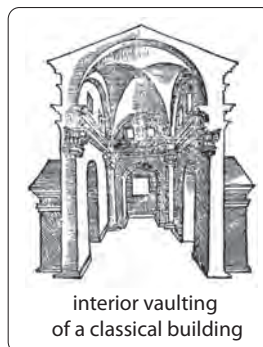

interior vaulting of a classical building

He shows the proper proportioning for interior vaults.

He cites the work on perspective done by Albrecht Dürer, even duplicating Dürer's 1530 illustration of an artist and his assistant drawing a lute in perspective.

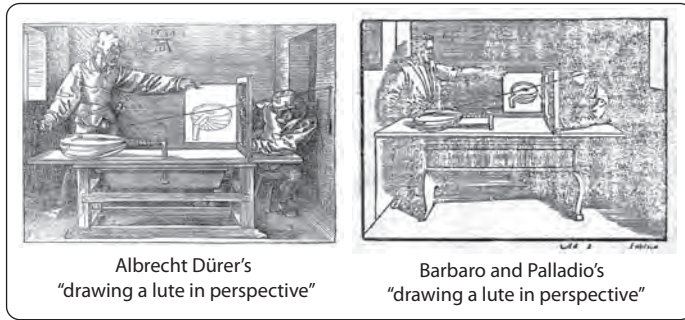

Albrecht Dürer's "drawing a lute in perspective"

Barbaro and Palladio's "drawing a lute in perspective"

Next, he shows Andrea Palladio's illustration of a circular temple that had also appeared in Barbaro's earlier 1556 Italian translation and commentary on Vitruvius.

This illustration also appears in Barbaro's 1567 Latin translation of Vitruvius, so it was published 3 times, in 1556, 1567, and 1568). I have included this here for two reasons.

First, it demonstrates how Barbaro felt that the study of geometric shapes and classical architecture were both in the same field of study.

Second, this illustration shows many similarities to my reconstruction of the John Dee Tower.

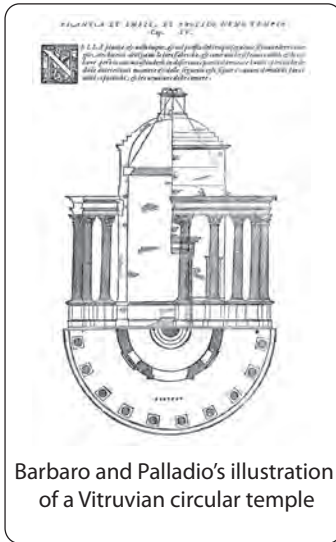

Barbaro and Palladio's illustration of a Vitruvian circular temple

While the John Dee Tower was not surrounded by an outer ring of 20 Corinthian columns, it is quite similar to the central structure here, with a height:diameter proportion of 2:1,

Next to Barbaro's side view of this circular temple are two renderings which I have digitally retouched, but kept to scale.

The first is a full cross-section of the interior. Using the exterior of the dome as a circumference, two circles fit perfectly! (One minor difference is that Barbaro made his interior dome room 12 feet tall while Dee's was a roomier 16 feet tall.)

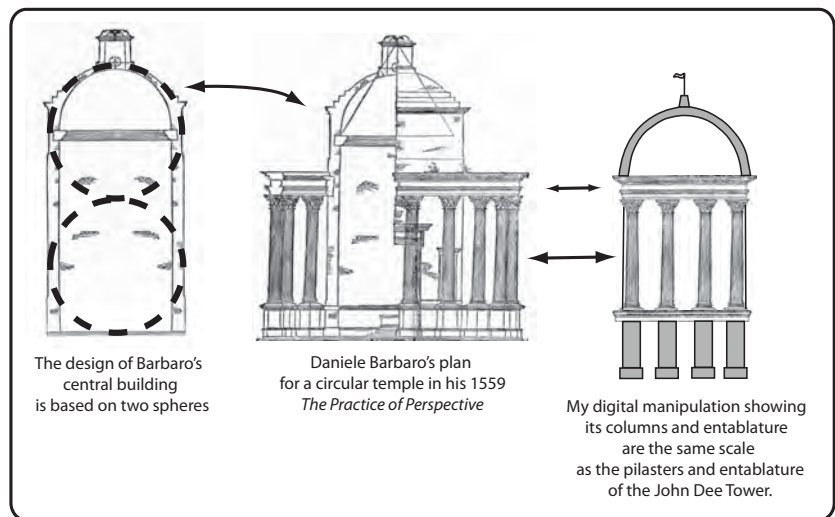

The design of Barbaro's central building is based on two spheres

Daniele Barbaro's plan for a circular temple in his 1559 *The Practice of Perspective*

My digital manipulation showing its columns and entablature are the same scale as the pilasters and entablature of the John Dee Tower.

The second shows my reconstruction of the John Dee Tower, only I have "borrowed" Barbaro's Corinthian columns to simulate Dee's Corinthian pilasters.

If the height of Barbaro's building was 48 feet (to the top of the dome) the height of his columns would be 20 feet, which is the same height of Dee's pilasters. Also, the entablature above the columns would be 4 feet tall, the same size as my restoration of Dee's Tower.

Palladio's illustration seems to be an amalgam of Vitruvius' description and some of the round temples he saw around Rome that were in various states of ruin.

In his 1570 *Four Books on Architecture*, Palladio included his conception of how 3 of these circular temples might have originally looked.

The first is San Stefano Rotundo (also known as the Temple of Hercules Victor, built around 475 AD) on the bank of the Tiber River in Rome. The 20 Corinthian columns exist today, but they have been capped by a conical roof. Palladio envisioned a circular cella that extended well above the colonnade.

(Palladio, Book 4, chapter 16, plate 35 and p.94-95)

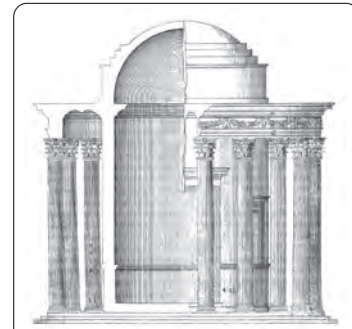

Andrea Palladio's illustration of San Stefano Rotundo, Rome (from his 1570 *Four Books on Architecture*)

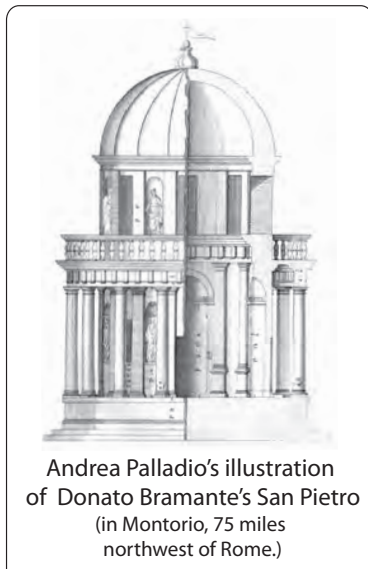

Andrea Palladio's illustration of Donato Bramante's San Pietro (in Montorio, 75 miles northwest of Rome.)

The second is the Temple of Vesta (Roman goddess of the hearth) which sits proudly above a ravine and waterfalls in the more rural Tivoli, 15 miles east of Rome. Originally (back in 50 BC) had 18 Corinthian columns resting on a solid tribunal (raised platform).

About one-third of the temple remains today, but there is no central cella. palladio suggests that it was about twice the height of the surrounding collonade.

(Palladio, Book 4, chapter 23, p.103, and plate 66)

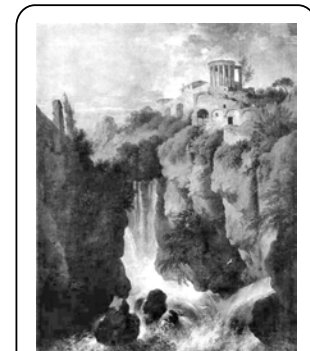

Temple of Vesta Tivoli, by Christian Dietrich (1750)

Palladio also illustrates a more "modern" classical building called San Pietro, which is in the small village of Montorio, 75 miles northwest of Rome. It commemorates the location where Saint Peter was thought to have been crucified.

It was built around 1502 by Donato Bramante (1444-1541) and still stands today. (The great Bramante also designed St. Peter's Basilica in the Vatican.) On a substantial platform, the domed cella extends well above the circular colonnade of 16 Doric columns.

(Palladio, Book 4, chapter 17, p.97 and plate 35)

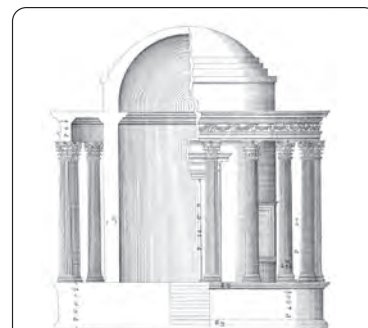

Andrea Palladio's illustration of The Temple of Vesta, (in Tivoli, 15 miles east of Rome)

You can see that Palladio's 1570 illustrations are a lot more refined than the 1556 illustration he did for Barbaro.

According to Dee's 1583 Library catalog, he did not own Palladio's 1570 work, nor did he own Sebastian Serlio's (1475-1554) *General Rules of Architecture*, which was published in six parts between 1537 and 1551. Dee's architectural knowledge paled in comparison to these Italian masters. But what he absorbed from Vitruvius and Leon Baptista Alberti, combined with his real strength in geometry, mathematics, and optics, he quite capable of designing a simple building like the 48-foot John Dee Tower.

By using pilasters instead of columns, and faux entablatures instead of real ones, Dee's design was much easier to construct than these round temples illustrated here. Yet from a distance it would have had their same majestic prowess, harmonious proportioning, and of course one more thing...

Barbaro Obscura

Let's return to Barbaro's 1568 *Perspectiva*. Besides illustrating 5 Platonic Solids, the 11 Archimedean Solids, and a Vitruvian circular temple, **this book also includes Barbaro's description of a camera obscura**, worth repeating here:

**“If you wish to see how nature shows us
the various aspects of things, not only the outlines of the whole,
but also their parts as well as of their colors and shadows,
you must make a hole of the size of a spectacle lens
in the window shutter of a window of a room where you wish to observe.**

**Then take a lens from spectacles used by old men,
that is to say, a lens which is fairly thick at the center and not concave
like the spectacles for younger men who are shortsighted,
and fix this lens in the hole you made.**

**After that, close all the windows and doors of the room,
so that no light is present except that which enters the lens
and you will see on the sheet of paper every detail,
however small, of everything outside the house**

And this will happen most distinctly at a given distance from the lens.

**By moving the sheet of paper towards or away from the lens,
you will find the most suitable position.**

**Here you will see the images on the paper as they are,
and the variations, colours, shadows, movements, clouds,
the rippling of water, birds flying, and everything that can be seen.”**

Barbaro's camera obscura projection isn't fuzzy because he's using a lens to focus a sharp image. He makes note of all the shading, the coloring, as well as the “rippling of water.” No doubt Barbaro saw what I call the scintillating “Fiery Water” effect, as the “rippling of water” is by far more dramatic when backlit by the the bright sun.

And as, as mentioned previously, as a sequel to his *Practice of Perspective*, Barbaro was writing his book on *Horologia*— how the sun is used to tell time and as an aid to navigation.

To summarize, Barbaro was not only excited by the Platonic and Archimedean solids, but also circular temples, camera obscuras, and sundials. These are some of the same things that fascinated Dee, and which he incorporated in his *Monas Hieroglyphica* cosmology and into the John Dee Tower. Dee was not an isolated philosopher on his own wavelength. These subjects were much-studied among scholars all across Europe in the late Renaissance of the mid-1500's.

Rudolph Wittkower, in *Architectural Principles in the Age of Humanism*, writes that Daniele Barbaro,

“embodied the Renaissance ideal of a comprehensive education based on classical scholarship. He was an eminent mathematician, poet, philosopher, theologian, historian, and diplomatist.”

Wittkower asserts:

“Mathematics has its life from the intellect; and those arts which are founded on numbers, geometry and the other mathematical disciplines, have greatness and in this lies the dignity of architecture...”

The thread of these ideas is carried on in the Vitruvian text and here the Aristotelian system is given a Platonic bias.

Where Vitruvius talks about the capacities an architect ought to possess,

Barbaro comments:

‘The artist works first in the intellect and conceives in the mind and then symbolizes the exterior matter after the interior image, particularly in architecture.’

Architecture, in other words, is nearer to the Platonic idea than any other art.

He carries on:

‘Therefore architecture above any other art signifies, i.e., represents, *le cose alla virtù*,’ by which he means that the form comes close to the idea.”

(Wittkower, pp. 66-68)

Wittkower comments on Andrea Palladio::

“In any case, there is no doubt that Palladio was intimately familiar with the content of Barbaro’s Vitruvian commentaries, and Barbaro’s own statement is proof that many of them were even worked out in common consultation.

Palladio’s work embodied for Barbaro his own ideal of scientific, mathematical architecture, and it may be supposed that Palladio himself thought in the categories which his patron had so skillfully expounded.

It is probable that by associating, in the *Quattro libri*, virtue with architecture, Palladio, like Barbaro, regarded as the particular ‘virtue’ in architecture the possibility of materializing in space the ‘certain truth’ of mathematics.

This interpretation is supported by the title-page of the *Quattro libri* which shows allegories of Geometry and Architecture pointing upwards to the crowned figure of Virtue (‘Regina Virtus’) with sceptre and book.”

(Wittkower, p. 68)



Title page of Andrea Palladio's *Four Books on Architecture*

In his *Preface to Euclid*, Dee declares that the Art of Architecture involves working, “in Line, plane, and solid: by Geometrical, Arithmetical, Optical, Musical, Astronomical, Cosmographical (and, to be brief) by all the former Derived Mathematical Arts, and other Natural Arts which are able to be confirmed and established.”

(Dee, *Preface*, p. diij)

Dee adds that you will find the same idea expressed by the, “Incomparable Architect Vitruvius ... and if you should but take his book in your hand and slightly look through it, you would say straight away:

This is Geometry, Arithmetic, Astronomy, Music, Anthropography [study of the body of man], Hydrogagie [study of aqueducts], Horometry, etc, and (to conclude) the Storehouse of all workmanship.”

(Dee, *Preface*, p. diiij)

Barbaro and Dee: two “Renaissance thinkers”

Both Daniele Barbaro and John Dee were polymaths, multi-disciplinarians, or as Bucky would say, comprehensivists. The difference between the two was their social status and environment. Barbaro was a rich, powerful diplomat in the open-minded crossroads of Venice, where the Renaissance had already blossomed. Dee was connected to the court, but always struggled financially. And he lived in a culture still in the throes of religious upheavals, where sticking one’s neck out too far might still get it chopped off.

What's ironic is that Dee was ten times the mathematician that Barbaro was. Though Barbaro certainly sensed that mathematics, architecture and philosophy were entwined, he didn't know all the details of how it all fit together. Dee saw how the puzzle pieces fit.



Kepler, who gets the credit for many of the puzzle pieces, had little respect for the geometers who had lived the era of the late 1500's. He discusses the lack of good geometers in a 1606 letter to his friend Saul Hafenreffer:

**“Look around the nations.
The Italians are in a dream (except for one Commandino
and Giovanni Battista Benedetti, for Clavius is a German).”**

(Kepler, in J. V. Field, *Rediscovering*, p. 273)

Frederico **Commandino** (1506-1575) was indeed a mathematician of Dee's caliber. The two were friends. When Dee visited Commandino in Urbano, Italy in 1563, he gave him a rare copy of Machometus Bagdedinsus' (Mohammed of Baghdad) *De superficium divisionibus* (*On the Division of Surfaces*) which Commandino later published.

Giambattista **Benedetti** (1530-1590) was a Venetian mathematician who discovered that all objects fall at the same rate (even though Galileo gets credit for it). He wrote about physics, Euclid's geometry, perspective, astronomy, military fortifications, acoustics and sundials.

Christopher **Clavius** (1538-1612), the main mathematical force behind Pope Gregory's 1582 Calendar reform, was born in Germany.

In his dedicatory letter to Mercator in the *Propaedeumata Aporistica*, Dee compares the intellectual environment of England to that of the Continent:

He says of his post-graduate years in Europe that he lived
**“on familiar terms with men whose lightest single day of writing
would have furnished matter enough to require the labor
of a full year for comprehension while I formerly sat at home.”**

(Dee, in Schumaker, *Preface*, p. 111)

Dee's paranoia of being “falsely accused” can be
seen in his defensive tone He asks Mercator not to
**“reveal openly to unworthy and profane persons lest...
it should be turned to great harm.”**

In the Letter to Maximillian in the *Monas*, Dee writes about the
“Indignity of False Accusations”
railing against
“the Vulgar, who Pretend to have Knowledge.”

He says such cynics deter others from pursuing honest studies of the arts:

**“Perhaps because Ignorant Judges had Rudely and Arrogantly
condemned their whole study of such noble and divine Mysteries,
they made only mediocre Progress.”**

(Dee, *Monas*, p. 8)

But despite their differences in social status, wealth, and environment, Barbaro and Dee were both enthusiastic about the same things.

Daniele Barbaro

Vitruvian circular temple
Palladio's drawing appears in Barbaro's 1556 *Commentary on Vitruvius* and his 1559 *The Practice of Perspective*

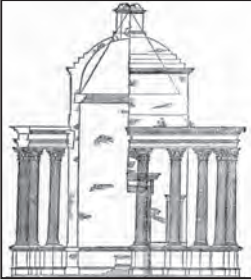

Daniele Barbaro and Andrea Palladio's plan of a circular temple

Camera Obscura
in Barbaro's *The Practice of Perspective*

Mathematics
the 5 Platonic Solids + 11 Archimedean Solids in *The Practice of Perspective*

Horologia
Barbaro's 1570 unfinished treatise

Calendar Reform
Barbaro was the Venetian representative to the Council of Trent that led to the Gregorian Calendar Reform

John Dee

Vitruvian circular temple
classical dome, Corinthian pilasters and entablature

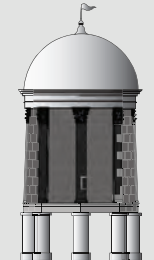

John Dee Tower

Camera Obscura
Three camera obscura rooms in one building

Mathematics
Monas Hieroglyphica involves numbers and both plane and solid geometry

Horologia
all three rooms functioned as solar disc sundials

Calendar Reform
Dee proposed calendar reform for England in 1582

Summary

In his book *Polyhedra*, Peter R. Cromwell emphasizes that in the 1400's and 1500's, translations and commentaries of the important texts of antiquity created much renewed interest in geometry, especially polyhedra. This flood of new ideas challenged the prevailing ideologies. Sometimes the ancients provided puzzling and even conflicting information. As Peter Cromwell puts it:

“Amid this uncertainty there was one body of knowledge which seemed to offer a secure foothold – the axiomatic truths of mathematics.

The publishing of mathematics texts played an important role in spreading new science.

This is particularly true in solid geometry. Increased trade had led to great interest in stereometry – the determination of volumes of containers.

The rediscovery of Plato in the fifteenth century introduced the Pythagorean creed ‘Number is the basis of all things’ and the idea that nature could be understood through mathematics.

The Neoplatonist writings of Plotinus were translated into Latin in 1492. Platonism came into vogue as the Renaissance thinkers sought to throw off medieval scholasticism: it became a major force in the fight against Aristotle.

The Platonic tradition, though never entirely lost in the West, now acquired many new adherents with its attractive fusion of rational explanation with theology through the mathematical design of the Creator.

Contemplating the universe and uncovering the divine plan held great appeal for the Renaissance philosophers.”

(Cromwell, P. R., *Polyhedra*, p. 136-7)

On a less philosophical note, here is Judith Field’s accounting of which Archimedean solids these various scholars were aware of. It shows how knowledge of solid geometry progressed in the 1500’s.

(J. V. Field, *Rediscovering Archimedean Polyhedra*, p. 240)

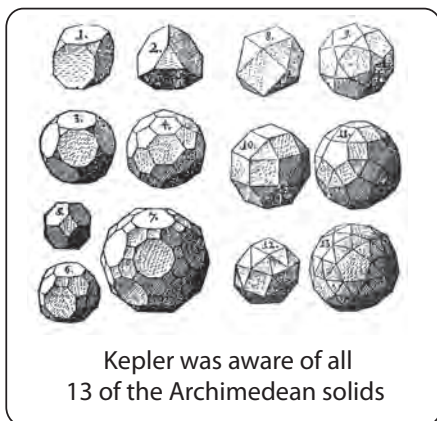

Which of the Archimedean solids were these scholars aware of?

	Piero della Francesca ca.1480	Luca Pacioli 1509	Albrecht Dürer 1525	Daniele Barbaro 1567
truncated cube	yes		yes	yes
truncated tetrahedron	yes	yes	yes	yes
truncated. dodecahedron	yes			yes
truncated icosahedron	yes	yes		yes
truncated octahedron	yes	yes	yes	yes
truncated cuboctahedron			yes	yes
truncated icosidodecahedron				yes
cuboctahedron	yes	yes	yes	yes
icosidodecahedron		yes		yes
rhombicuboctahedron		yes	yes	yes
rhombicosidodecahedron				yes
snub cube			yes	
snub dodecahedron				

By the early 1600’s, all 13 Archimedean solids were known. These illustrations come from Kepler’s 1619 *Harminice mundi (Harmony of the World)*,

To summarize, John Dee lived during the time of renewed enthusiasm of geometry. Dee probably understood the interrelationships among the regular and irregular polyhedra better than artists like della Francesca, Pacioli, or Dürer. None of these men could have lectured on all the hundreds of Propositions in Euclid's *Elements*, the way Dee did in 1552.

Billingsley and Dee used drawings similar to da Vinci's "hollow versions" of the Platonic solids in the Eleventh Book of Euclid's *Elements*.

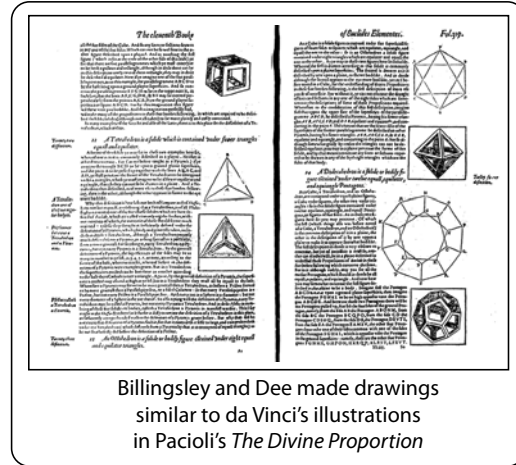

Even though Dee had written a treatise on perspective, he wasn't half as talented an artist as della Francesca, Pacioli, or Dürer. His strong suits were mathematics and his love of Plato. Dee sought a way to combine geometry, mathematics, philosophy, and theology together in one worldview. And his cosmology is infused into the *Monas Hieroglyphica* and the John Dee Tower.

Bibliography

- Cromwell, Peter R., *Polyhedra* (Cambridge, Cambridge University Press, 2001)
- Dürer, Albrecht, *The Painter's Manual*, Walter L. Strauss, translator (New York, Abaris Books, Inc., 1977)
- Field, J. V., "Rediscovering the Archimedean Polyhedra: Piero della Francesca, Luca Pacioli, Leonardo da Vinci, Albrecht Dürer, Daniele Barbaro, and Johannes Kepler," *Archive for History of Exact Sciences*, vol. 50, no. 3, pp. 241-289, 1996
- Nix, L. and Schmidt W., *Hermis Alexandrini Opera Quae Supersunt Omnia*, Vol. II *Mechanica et Catoptrica* (Stuttgart, 1976)
- Vasari, Giorgio, *Artists of the Renaissance*, George Bull, translator (London, Book Club Associates, 1979)
- Wittkower, Rudolf, *Architectural Principles in the Age of Humanism* (N.Y., W.W. Norton & Company, 1971)

Caveat: To understand this analysis you must have a grasp on what I have explained in my other book *The Meaning of the Monas Hieroglyphica*. In it, I explain the ideas of Metamorphosis, Consummata and Dee's decad of 3-D geometric shapes.

BRIEF BIOGRAPHY OF PLATO

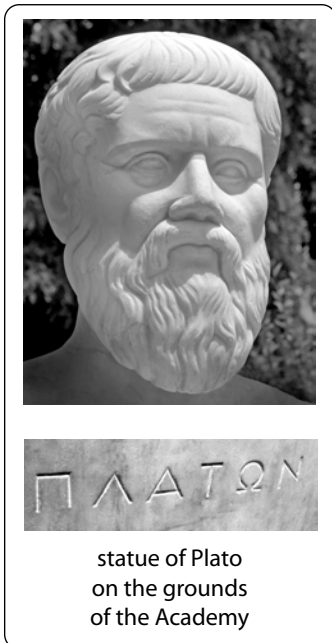

Plato is the geometric mean between Socrates and Aristotle. Socrates was his Plato's teacher and Aristotle was his Plato's pupil. Between the three of them, they "**laid the philosophical foundations of Western Culture.**" (Not a bad thing to have on your resumé.)

As math-whiz and philosopher Alfred North Whitehead puts it, "**The safest general characterization of the European philosophical tradition is that it consists of a series of footnotes to Plato.**"

(Whitehead, *Process and Reality*, 1929, p. 39)

Plato was born in Athens around 427 and died around 347, at around 80 years of age. His father Ariston, was descended from Codrus, the last King of Athens. His mother, Perictione, was related to Solon, the early Greek Lawmaker. He had two older brothers, Glaucon and Adeimantus, and a sister Potone, whose son Speusippus took over the Academy after Plato's death.

His real name was Aristocles, but they called him Plato which means "broad shoulders." He had a wide chest and a high forehead. In his youth, he was a wrestler and enjoyed writing poetry.

At age 20, he went to hear the great philosopher Socrates speak in a grove of trees called Academus. Supposedly, Plato was enthralled with Socrates ideas he went home and burned all of his own poems. Plato continued to absorb Socratic wisdom for the next 7 years, until Socrates' died (in 399 BC.)



Statues of Socrates and Plato
in front of a Neo-Classical
building in Athens

Socrates, who had served as a soldier in the Peloponnesian War, spent most of his later life philosophizing to “young men of promise,” poets, artisans, and politicians about “right and wrong.” He’s most remembered for his admonition “**know thyself.**”

At age 71 he was indicted for “impiety” for “corruption of the young” and “neglect of the gods whom the city worships and the practice of religious novelties.” He was found guilty and sentenced to die. Wanting to control his own destiny, he drank a fatal cup of hemlock.

The reason he’s not more famous than Plato was that he never wrote anything down. All our knowledge of him comes through Plato and the *Memorabilia* of Xenophon.

(Encyclopedia Britannica, Socrates)

Several years before Socrates' death, Plato had decided on a life of politics. But he soon became disillusioned after witnessing his party's violent activities. On Socrates' death, Plato and his Socratic friends journeyed to the city of Megara, just west of Athens. They took temporary refuge with Euclid (not the great mathematician, but another Euclid who was the founder of the Megarian school of philosophy.) In the next few years, Plato is said to have traveled all through Greece and journeyed to lower Italy, Sicily, and perhaps even Egypt.

At age 40 (in 387 BC) Plato founded “The Academy” in Athens. It was dedicated to “the systematic pursuit of philosophical and scientific research,” or basically the study of life. The institution was located about a mile outside the walls of Athens (to the northwest), and included “a grove of trees, gardens, a gymnasium, and other buildings.” It was called The Academy because the site was supposedly sacred to a hero named Academus. (Guthrie, p. 19)

To legally become a society which owned its own land and buildings, The Academy had to be a *thiasos*, or cult association, dedicated to some deity, who became “part owner” (silent partner). Plato chose “The Muses,” the patrons of education.

The members of the Academy, philosophized together and dined together and met in group *symposia*. One rule of the *symposia* was that the master of ceremonies had to “remain completely sober.” (Guthrie, p. 21)

Plato was more into the written word than his teacher Socrates. So Plato's pupils like Aristotle, Speusippus, and Xenocrates were encouraged to preserve their thoughts in writing as well in their own writings. Women were also accepted into the Academy.

At age 60 (in 367 BC), Plato traveled to Sicily to tutor the young Dionysius II, but he soon returned to Greece, where he again presided over his Academy.

Plato died at age 80, either "at a marriage feast" or "while writing" and is supposedly buried somewhere on the Academy grounds. (Encyclopedia Britannica, v.14, p. 532)



Remnants of Plato's Academy in northwest Athens

From Socrates, Plato learned the difference between opinion and knowledge. Since nature is in a state of constant flux, a true statement one day might not be true the next. So man can get opinions, but not knowledge, from his sense perceptions.

But if man could rise above specific objects and ideas to universal ones, he would get a firmer grasp on reality. For example, the circles created by pebbles thrown in a pond or soap bubbles are constantly changing, but a geometric circle is an unchanging universal truth.



Plato felt that these formal structures like a circle or a tetrahedron or a cube were more real than the shapes we see with our senses. Musical instruments can go out of tune, but numerical harmonies are forever. He felt these universal forms translated into universal ideas like justice and temperance.

Just as Plato saw wave-rings in the pond dissipate, and soap bubbles pop, the "ideal state" (or a perfect circle) can only be realized imperfectly in this world. Still, he held it up as an ideal or a goal that mankind should make every effort to achieve.

These examples of "ideal forms" are rich in mathematical relationships, so one might assume that Plato's insights resulted from his prowess as a mathematician.

Was Plato a great mathematician?

Some modern scholars diminish his importance as a mathematician. For example, Otto Neugebauer, in his 1957 *The Exact Sciences in Antiquity*, in the chapter on the “Origin and Transmission of Hellenistic Science” writes:

“I think that it is evident that Plato’s role has been widely exaggerated. His own direct contributions to mathematical knowledge were obviously nil. That, for a short while, mathematicians of the rank of Eudoxus belonged to his circle is no proof of Plato’s influence on mathematical research. The exceedingly elementary character of the examples of mathematical procedures quoted by Plato and Aristotle give no support to the hypothesis that Theaetetus or Eudoxus had anything to learn from Plato. The often adopted notion that Plato “directed” research fortunately is not borne out by the facts. His advice to the astronomers to replace observations by speculation would have destroyed one of the most important contributions of the Greeks to the exact sciences.”

(Neugebauer, p. 152)

Indeed, Plato might not have been a mathematician in the ranks of Thales, Pythagoras, Archimedes or Euclid, but he was a huge proponent of mathematical studies, and his enthusiastic voice was heard for centuries.

They don’t call Nicomachus, Iamblicus, and the Theon of Smyrna (around 200-300 AD) the Neo-Platonists for nothing. They don’t call the regular polyhedra the Platonic solids for no good reason.

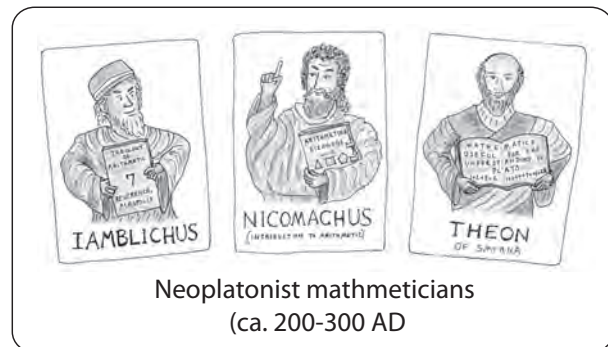

Neoplatonist mathematicians
(ca. 200-300 AD)

Plato might not have been a math whiz technician who wrote theorems and geometric proofs, but he understood the mathematics of his day. And he had the ability to synthesize it into one grand cosmology of how the world worked.

One reason Plato isn’t held in such high esteem as a mathematician is that scholars have not really understood everything that he was expressing.

The most poignant example of this is Plato’s most famous mathematical passages, a description of what is often called “Plato’s Number” in *The Republic* 8:546. With some help from John Dee, we can better understand what Plato’s Number is all about, and perhaps re-nominate Plato for the mathematicians’ Hall of Fame.

PLATO'S NUMBER(S) IN REPUBLIC 8:546

Intro to Plato's Number

Around 340 BC, Plato (427-347 BC) wrote what many consider to be his most famous dialogue, *The Republic*. In Book 8, four characters (Socrates, Glaucon, Polemarchus, and Adeimantus) are philosophizing about the best type of government for a state.

Timocracy – a state whose rulers are motivated by love of honor (timē means honor)

Oligarchy – a state in which a small group of people run the country.

Democracy – a state in which the people elect representatives to govern (dēmos means the people)

Aristocracy – state in which the highest class holds hereditary titles and offices

Tyranny – a state ruled by one person who has absolute power without a legal right to it.

In the midst of all this governmental philosophizing, Plato, through the voice of his character Socrates, describes two numbers, one that represents “**divine births**” and the other that represents a guiding number for “**human births**.”

This whole passage about these two types of “births” is often referred to as Plato’s Number or the Marriage Number or the Nuptial Number. Even though the term “Plato’s Number” is singular, he actually describes two different numbers.

He only devotes one sentence to describing the number of “divine births.” The whole rest of the passage describes the number of “human births.” (When I use the term in the singular, Plato’s Number,” I’m referring to this second type, the number of “human births.”)

How numbers apply to births is strange enough, but Plato’s description of the number is so confusing, it has baffled historians for centuries.

First to get a feel for it, we’ll examine few of the various translations. Then after a brief history of what various scholars through the centuries have determined the numbers to be. Finally I’ll give my solution to the riddle, and explain my reasoning.

Socrates asks Glaucon, how their city, which even has dissention among its rulers, should be changed. Glaucon tosses the question back to Socrates by asking “How?” Then Socrates explains:

“How?”

“Somewhat in this fashion.

Hard in truth it is for a state thus constituted to be shaken and disturbed;
but since for everything that has come into being destruction is appointed,
not even such a fabric as this will abide for all time,
but it shall surely be dissolved, and this is the manner of its dissolution.

Not only for plants that grow from the earth but also for animals that live upon it
there is a cycle of bearing and barrenness for soul and body
as often as the revolutions of their orbs come full circle,
in brief courses for the short-lived and oppositely for the opposite;
but the laws of prosperous birth or infertility for your race,
the men you have bred to be your rulers
will not for all their wisdom ascertain by reasoning combined with sensation,
but they will escape them, and there will be a time
when they will beget children out of season.

Then Socrates talks about the special numbers:

“Now for divine begettings there is a period comprehended by a perfect number
and for mortal by the first in which augmentations dominating and dominated
when they have attained to three distances and four limits
of the assimilating and the dissimilating, the waxing and the waning,
render all things conversable and commensurable with one another,

whereof a basal four-thirds wedded to the pempad yields two harmonies at the third augmentation,
the one the product of equal factors taken one hundred times,
the other of equal length one way but oblong,
--one dimension of a hundred numbers determined by the rational diameters of the pempad
lacking one in each case, or of the irrational lacking two;
the other dimension of a hundred cubes of the triad.

And this entire geometrical number is determinative of this thing, of better and inferior births.
And when your guardians, missing this, bring together brides and bridegrooms unseasonably,
the offspring will not be well-born or fortunate.”

(translation by Paul Shorey, 1935, Loeb Classical Library)

The previous translation was done by the American classical scholar Paul Shorey (1857-1934). Here's how Alexander D. Lindsay (1879-1952) translates the part dealing with the numbers.

“For a divine creature there is a period comprehended by a perfect number;
but for a human creature the number is the first in which multiplications of roots and squares
(which contain three distances and four limits of numbers
that make like and unlike, wax and wane)
make all things consistent and rational with one another.

Of which numbers, three multiplied by four and by five,
and raised to the fourth power, produces two harmonies:
the one is a square so many times a hundred;
the other a rectangle on the one side of a hundred squares of rational diameters of five
diminished by one or of irrational by two,
on the other of a hundred cubes of three.

This complete geometrical number is lord over better or worse births;
and when your guardians, through their ignorance of it,
join brides and bridegrooms at inopportune seasons,
their children will not have good natures or enjoy good fortune”

(A.D. Lindsay, Plato: *The Republic*, 1906, reprinted 1992 in *Everyman's Library*, [N.Y., Alfred A. Knopf, 1992])

As you can see, Lindsay's translation has introduced more specific mathematical terms. Richard W. Sterling and William C. Scott from Dartmouth College translated it in 1985 using mathematical notations.

“There is a cycle for divine procreation that the perfect number comprehends.
There is also a period of time for mortal procreation when at the first moment
multiplication by both roots and squares
with three dimensions and four limits of those elements
producing likeness, unlikeness, growth, and decline
has shown all components to be in proportion and harmony with one another.

All these components have $\frac{4}{3}$ as a base, which, joined to a unit of 5,
produces a double harmony when raised to the third power.
In the first dimension it is equal to the basic unit times 100.
The second dimension has an equal base but is oblong –
one side being 100 times the measurement of the rational numbers of the whole unit of 5 minus 1,
or else of irrational numbers minus 2;
the other side is 100 times the cube of the unit of 3.

This geometrical figure decides when begetting will be seasonable and when not.
When your guardians mistake the figure
and unite brides and bridegrooms out of season,
the children will not be well-favored or fortunate.”

(Richard W. Sterling and William C. Scott, Plato: *The Republic* 1985, reprinted [N.Y., W.W. Norton, 1996])

If you're wondering why the translations vary so much, translate it yourself.
Try and unravel what Plato means, but don't be discouraged,
it has baffled historians and mathematicians for 24 centuries.

esti de theiôî men gennêtôi periodos hên arithmos perilambanei teleios,
anthrôpeiôi de en hôi prôtôi auxêseis dunamenai te kai dunasteuomenai,
treis apostaseis, tettaras de horous labousai
homoioiountôn te kai anomoiountôn kai auxontôn kai phthinontôn,
panta prosêgora kai rhêta pros allêla apephênan:

hôn epitritos puthmên pempadi suzugeis duo harmonias parechetai tris auxêtheis,
tên men isên isakis, hekaton tosautakis,
tên de isomêkê men têi, promêkê de, hekaton men arithmôn apo diametrôn rhêtôn pempados,
deomenôn henos hekastôn,
arrêtôn de duoin,
hekaton de kubôn triados.

sumpas de houtos arithmos geômetrikos, toioutou kurios, ameionôn te kai cheironôn geneseôn,
has hotan agnoêsantes humin hoi phulakes sunoikizôsin numphas
numphiois para kairon, ouk euphueis oud' eutucheis paides esontai.

(Plato's *Republic* 8:546, in the original Greek)

I have analyzed other translations by made by skilled translators like James Adam, R.E. Allen, Robert Brumbaugh, Allan Bloom, Francis Cornford, Tom Griffith, Benjamin Jowett, Desmond Lee, C.D.C Reeve, and H. Spens. They all vary. Many of Plato's terms have several shades of meaning. When you string a few ambiguous words together, the number of interpretations multiply.

Translators aren't always good mathematicians, and mathematicians aren't always good translators. Besides, even someone talented at both will not catch Plato's gist if they haven't first recognized retrocity in number and geometry.

Here's a brief chronology of other philosophers' commentary on this puzzling passage:

Aristotle

Aristotle (384-322 BC), a student of Plato, wrote briefly about it in his *Politics* 5:1316a; 4-9. He references it in a passage where he is criticizing what Plato (through his character Socrates) had to say about revolutions or cycles of change.

Aristotle writes:

**“The subject of revolutions is discussed by Socrates in the Republic –
but it is not discussed very well.”**

Aristotle even quotes Socrates as saying that:

**“change has its origin in those numbers
‘whose foundation 4:3 yoked with the number 5 gives two harmonies’
– meaning whenever the number of this figure becomes solid.”**

Not only has Aristotle reduced Plato’s *Republic* 8:546 passage down to a dozen words, he has added the idea that the resulting number somehow becomes a 3-dimensional shape!

Here is Aristotle’s quote in Greek:

***“archên d’ einai toutôn,
‘hôn epitritos puthmên pempadi suzugeis duo harmonius parechetai’,
legôn hotan ho tou diagrammatos arithmos toutou genêtai stereos”***

(Perseus, Aristotle, *Politics*, 5.1316a, and see Allen, Michael, *Nuptial Arithmetic*, p. 6 note 5)

The philosopher/priest Saint Thomas Aquinas (ca. 1225-1274 AD) even bemoaned the fact that Aristotle’s reference was obscure because it was so brief.

(Saint Thomas Aquinas, *In Aristotle’s Politics*, book 5, lecture 13, in M. Allen, *Nuptial Number*, p. 6, note 5)

(Once you see what Plato’s number is, you’ll see that Aristotle summed it up quite succinctly, and he actually provides a confirming clue to what it is. I’ll give you a hint. The “solid” Aristotle is referring to seems to be the dodecahedron with its 12 pentagonal faces. But first, let’s continue on with to the commentaries on Plato’s number.)

Cicero

The next brief commentary comes from the Roman statesman and orator Marcus Tullius Cicero who was living in Minturno, Italy on the Gulf of Gaeta, 75 miles south of Rome. In a letter dated January 24, 49 BC, Cicero responds to his friend Atticus of Rome: **“I didn’t guess your riddle: it is more obscure than Plato’s number.”** (Cicero 308, A7, 13b)

This doesn’t provide many clues, but it does show that even the wisest of Romans were confounded by Plato’s number.

Nicomachus

The Neoplatonists, Plutarch (ca. 40-120 AD), Nicomachus (ca. 46-122 AD), Iamblichus (ca. 250-325 AD) and Proclus (ca. 410-485 AD) all make references to Plato’s number, but it appears they weren’t really sure what it was either.

In Book 2, 24:10-11 of *Introduction to Arithmetic*, Nicomachus explains some basic math rules:

A square number times another square number always equals another square number (like $4 \times 9 = 36$).

A cube times a cube makes another cube (like $8 \times 27 = 216$).

An even number times another even number makes an even number. (like $2 \times 4 = 8$)

An odd number times an odd number makes an odd number. (like $3 \times 5 = 15$)

An even number times an odd number always makes an even number. (like $2 \times 3 = 6$)

He then adds:

“These matters will receive their proper elucidation in the commentary on Plato, with reference to the passage on the so-called marriage number in the Republic introduced in the person of the Muses.”

(Nicomachus, trans. by D’Ooge, 2: 24: 10-11, p. 844)

That’s not much help. Boethius (ca. 480-525) copied Nicomachus’ ideas practically word for word, but gives no further insight into what it all means. (Masi, Boethius, *Introduction to Arithmetic*, p. 174)

Ficino

Flashing forward to the Renaissance, in 1496 the influential Italian humanist Marsilio Ficino (1433-1499) wrote a text called *De Numero Fatali (On the Fatal Number)* in which he concludes that Plato is talking about the number 1728.

He sees Plato’s “epitritos” (or 4:3 ratio) as meaning 12. Then he brings 12 to its “third augmentation.” The first being 12, the second being “a plane” as the equilateral 144, and the third “a solid” as 1728. In other words, 12 cubed is 1728.

Michael J. B. Allen has written an extensive scholarly analysis of Ficino’s commentary entitled *Nuptial Arithmetic*.

d’Étaples

In 1506, the French humanist Jacques Lefèvre d’Étaples and the Italian theologian Raffaello Maffei wrote works agreeing with Ficino’s number 1728 (though Maffei changed his mind a few years later.)

Barocius

In 1566, the Italian mathematician Francesco Barozzi, whose nickname was Barocius, (1537-1604) wrote a text called “*Commentary on the Geometric number Plato speaks about in Book 8 of his chief Dialogue, the Republic: a maxim which to date no one has been able to explain and is nothing but obscure.*”

Barocius writes:

“My intention is to expound the passage in the eighth book of Plato’s Republic which is the most opaque of all matters accessible to human reason: up until now it has not only not been correctly grasped by anyone: in fact this is the origin of the familiar ancient saying, that assuredly nothing is more opaque than the Platonic numbers.”

(Barocius, in Adam, *The Nuptial Number of Plato*, Kairos, 1985, p. 19)

Barocius summarizes what he has learned from Iamblichus, Saint Thomas Aquinas, Jacques Lefèvre d’Étaples, Raphael Maffei, and others.

In the end he agrees with Ficino that the number is 1728, but he arrives there by taking a slightly different route:

He sees the “basis of the epitritos” as meaning $3+4=7$.

Then he adds the “pempad,” $7+5=12$.

Finally he cubes the 12 and arrives at 1728.

(Brumbaugh, R.S., *Plato’s Mathematical Imagination*, p. 143.)

Melancthon

In 1550, the German humanist Philip Melancthon (1497-1560) groused that Plato's number was an obscurity "greater than that of Sibyl's leaves." (This refers to the tea leaves read by fortune-tellers; "Sibyl" is Greek for prophetess.) (Adam, J. *The Nuptial Number of Plato*, p. 20 note 1)

Cardano

In his 1570 *Opus Novum de Proportionibus*, the Italian mathematician Girolamo Cardano chose a different number that Ficino had used in his analysis, the perfect number 8128.

A perfect number is one whose factors sum up to itself.

The lowest perfect number is 6 (1+2+3=6).

The next is 28 (1+2+4+7+14=28).

Next is 496 (1+2+4+8+16+31+62+124+248=496).

And the fourth is 8128.

Cardano thought this is what Plato meant by "3 distances spanning 4 limits."

Mersenne

In his 1627 *Treatise on Universal Harmony*, the French philosopher Marin Mersenne suggested 729, a number that Plato actually refers to in Book 9 of *The Republic*, as it is 9 cubed (9 x 9 = 81, and 81 x 9 = 729).

Schleiermacher

Around 1800, the German philosopher Friederich Daniel Ernst Schleiermacher (1768-1834) "interrupted his translation of Plato for no less than twelve years in the vain hope of finding the right solution." (James Adam, *The Nuptial Number of Plato*, p. 20, footnote, from Dupuis, 1881)

Hultsch, Dupuis, and Adam

In the late 1800's there was a flurry of interest in Plato's number. In 1886, a commentary by Proclus (ca. 410-485) was discovered and translated, but F. Hultsch found "Proclus contains no direct elucidation of Plato's obscure and ambiguous words, but it is worth noting that most of the difficult expressions that Plato used were picked up by the Neoplatonists and assimilated into their own theories." (Hultsch, in Adam, p. 21, footnote 1)

In 1881, J. Dupuis wrote "*Le Nombre Géométrique de Platon, Interprétation Nouvelle.*"

In 1891, James Adam published *The Nuptial Number of Plato* which he claimed to be "a complete solution of the Number of Plato."

Adam interpreted the number of the "divine creature" to be 1,296,000. He saw the "two harmonies" Plato refers to as $3600 \times 3600 = 1,296,000$ and $4800 \times 2700 = 1,296,000$.

Adams construed Plato's other number, the period for the "mortal creature," to be 216, made from "3 cubed, plus 4 cubed, plus 5 cubed" or $(27+64+125=216)$.

Earlier, Schleiermacher had arrived at 216 by multiplying the two cubes found at the feet of the Platonic Lambda from Timaeus 35-B: "the cube of 2, times the cube of 3" or $(8 \times 27 = 216)$.

Diès

In 1933, the French mathematician Auguste Diès wrote “*Le nombre nuptial de Platon*” in which he agreed with Adam’s conclusions.

Since the 1930’s curiosity about Plato’s number seemed to have waned. When the great scholar Francis M. Cornford translated *The Republic* in 1941, he left the confounding passage out all together! Many other excellent translations of *The Republic* have been made in the past few decades, but when the authors get to 8:546 they are generally influenced by Adam’s assessment of its mathematical meaning.

The solution to the riddle of Plato’s Number(s)

In my opinion, all of the previously listed mathematicians who have written commentaries on *The Republic* 8:546 are on the wrong track (with the exception of Aristotle.)

But back in the 1500’s there was a scholar who had studied Plato, Euclid, the Neoplatonists, and the Arab mathematicians in great depth. He grasped what Plato was driving at. He wrote about it in his most famous mathematical work, but apparently so cryptically that no one caught his drift or followed his path.

That man was **John Dee** and his text was the *Monas Hieroglyphica*. Mathematically speaking, Dee was on Plato’s wavelength because he comprehended the influence of retrocity or the “union of opposites” on the behavior of number.

(Bob Marshall was on this wavelength too, but he was not the least bit interested in what Plato or Dee had to say. It was the numbers themselves that fascinated him. They were important for the bright future of the world, not for its dim, dusty past. My part is simply putting all the puzzle pieces together.)

Dee knew Plato was talking about two numbers, one of “divine births” and one of “human births.”

No, Dee didn’t think either of them was the Exemplar number 12252240. Nor did he think either was the Magistral number 252. Nor did he think they were 12 and 24.

My conclusion is that Dee considered the number of “divine births” to be **2520** (his Sabbatizat) and the number of “human births” to be **360**.

2520
Plato’s
“divine births”
number

360
Plato’s
“human births”
number

(I would have preferred to reveal these numbers in a grand finale at the end of the book, but my interpretation of Plato’s clues will make far more sense if you know the answer up-front. But you’ll still on the edge of your seat throughout the electrifying explanation.)

The numbers 2520 and 360 are prominent in the Monas

The number 2520 is Dee’s “Sabbatizat.”

Dee tells us it took him 7 years (of 360 days each)
or 2520 days to to conceive the *Monas*.

He hid 2520 Roman-Numeralogically in the
“Secret Vessels of the Holy Art” diagram of Theorem 22.

He hid 2520 in the jumbled “first letters” of the Theorems
that spell out “Mene, Mene, Thequel Phares, Nebuchadrezzar’s 2520.

Dee hints at 2520 with his Magistral number 252.

But as Plato provides a much longer description of the “human births” number to 360, let’s put 2520 aside and concentrate on 360.



Dee cryptically hid the “ballooned 360”
in his
“Thus the World Was Made” chart.
In the process, he also hid 12, 24, and 72.

What makes me think 2520 and 360 and the *Monas Hieroglyphica* have anything to do with Plato’s obscure quote in *Republic* 8:546?

The connection between the Monas and Plato’s number?

The most revealing clue that the *Monas Hieroglyphica* cosmology involves Platos’s Number comes at the conclusion of Theorem 23. This is the longest of all the 24 Theorems. It includes the geometrical construction of the Monas symbol and the Monas symbol emblem for rings and seals as well as the Pythagorean Quaternary, the Artificial Quaternary (plus its full-page chart), and the “Thus the World Was Created” chart.

Dee shows a small illustration of the upright Monas symbol and the inverted Monas symbol, then concludes the Theorem this way:

**“Four famous Men who were Philosophizing together (in times past),
through their labors, grasped its real Effect.**

**For a long time, they were Astonished by the Great Wonder of the Thing.
Then, at length, they devoted themselves entirely to Singing and preaching
Praises of the Most Good and Great God.**

**On account of this, they were granted great Abundance,
as well as the Wisdom and Power
to rule over other CREATURES”**

(Dee, *Monas*, Theorem 23, p. 27)

The astonishment at the “**Great Wonder of the Thing**” is Plato’s exposition in *Republic* 8:546. The “**Singing and preaching Praises**” part comes in Plato’s later dialogue, *The Laws* (which we will explore in a bit.)

Who could the Four Famous Philosophers be?

Unlike singing barbers, there aren’t a lot of Philosophers who are famous as a quartet.

A “trio” of famous philosophers who come to mind are Socrates, Plato, and Aristotle. But Socrates and Aristotle never philosophized together. (Socrates died in 399 BC and Aristotle wasn’t even born until 15 years later, in 384 BC.)

The “Persons of the Dialogue” in Plato’s *Republic* are:

- Socrates
- Glaucon
- Adeimantus
- Polemarchus
- Cephalus
- Thrasymachus
- Cleitophon

Of the approximately 500 pages the *The Republic*’s ten books, over 90% of the dialogue is either between Socrates and Glaucon, or between Socrates and Adeimantus. The other 4 characters mostly appear at the beginning of the first book.

(see Plato, *The Republic*, Jowett translation, NY. Random House, 1991)

More specifically, in the approximately 50 pages in Book 8 of *The Republic*, the first 8 pages (including passage about the “Plato’s number”) is a discourse between Socrates and Glaucon. The final 30 pages is a discussion between Socrates and Adeimantus.

However on the second page of Book 8, Plato writes “**then Polemarchus and Adeimantus put in their word.**”

(From Book 8 of Plato’s Republic)



SOCRATES GLAUCON ADEIMANTUS POLEMARCHUS

Thus, during the discussion of Plato’s number there are “**Four famous Men, who were Philosophizing together (in times past).**”

And one of them, Socrates, is perhaps the most famous Philosopher of all time. These are the men who “**grasped its real Effect.**”

AN EVEN CLOSER LOOK AT PLATO'S NUMBER(S) IN REPUBLIC 8:546

For ease of analysis I have divided the passage into 5 parts, shown here in Plato's original Greek, along with my translation.

A	esti de theiôî men gennêtoi periodos hên arithmos perilambanei teleios,	For divine births there is a round circuit that embraces a complete number,
B	<p>anthrôpeiôi de en hôi prôtôi auxêseis dunamenai te kai dunasteuomenai,</p> <p>treis apostaseis, tettaras de horous labousai</p> <p>homoioountôn te kai anomoioountôn kai auxontôn kai phthinontôn,</p> <p>panta prosêgora kai rhêta pros allêla apephênan:</p>	<p>But for human births, <i>[there is a number]</i> that his most honored among these “increasings,” which dominate and are dominated,</p> <p><i>[And which are]</i> attained after three intervals spanning four limits of these “increasings”</p> <p>that organize the similar and dissimilar, ascending and descending,</p> <p>and which organizes all things in proportion and harmony with one another.</p>
C	hôn epitritos puthmên pempadi suzugeis	<i>[It is based on]</i> a foundation of 4:3 yoked together with 5.

D	duo harmonias parechetai tris auxêtheis,	At the third augmentation, two harmonies are brought together,
	tên men isên isakis, hekaton tosautakis,	<i>[the harmonies are]</i> equal to a largeness that is “of the hundreds,”
	tên de isomêkê men têi, promêkê de, hekaton	<i>[one harmony]</i> uses an “equal measure” <i>[to arrive at]</i> “of the hundreds,” <i>[while in the other uses a more]</i> “prolonged measure.”
	men arithmôn apo diametrôn rhêtôn pempados, deomenôn henos hekastôn,	<i>[One part of that “more “prolonged measure” can be seen in]</i> the “well-known” diameters of the pentagon, <i>[considering only]</i> one thing being bound together,
	arrêtôn de duoin,	<i>[the other part involves]</i> the “not-as-well-known” <i>[diameters of a pentagon],</i> in which two things <i>[are bound together]</i> .
	hekaton de kubôn triados.	<i>[One of these ways]</i> to find “of the hundreds,” involves 3 cubed <i>[or 27]</i> .

E	sumpas de houtos arithmos geômetrikos, toioutou kurios, ameionôn te kai cheironôn geneseôn,	This whole thing involves the “geometric” number that rules over generation <i>[of human births]</i> for better or worse.
---	---	--

Let’s take it one part at a time.

Part A

This is the only sentence that refers to “divine births.”

A	For divine births there is a round circuit that embraces a complete number,
---	--

<p style="margin: 0;">2520 is “complete,” in the sense that it is divisible by 1, 2, 3, 4, 5, 6, 7, 8, and 9</p>

There are not a lot of clues here, but 2520 is certainly a “complete number” in the sense that it is the lowest number evenly divisible by all the single digits.

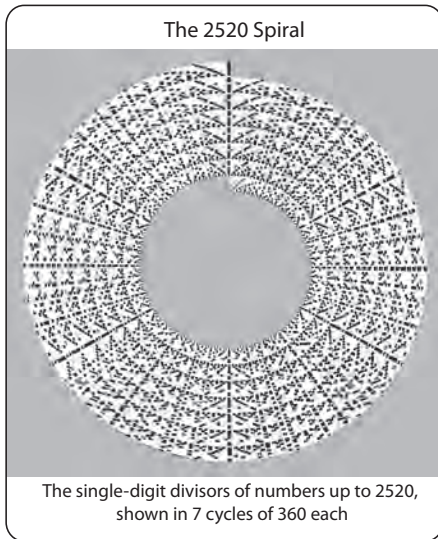

It's also a "round circuit" in the sense that it symmetrically distributes all the primes and the composites that are less than 2520.

This symmetry can be seen in Marshall's 2520 Spiral.

Part B

But for human births, *[there is a number]* that his most honored among these "increasings," which dominate and are dominated,

We shall see why Plato considered this "human births" number" of 360 "most honored."

The "increasings" or "augmentations" are the steps of the Metamorphosis numbers: 12, 24, 72, 360, 2520, etc.

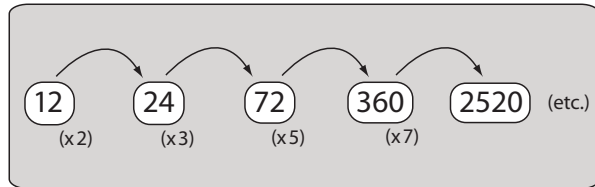

A Metamorphosis number "**dominates**" the Metamorphosis numbers which precede it because it contains the symmetry of each of them.

In turn, it "**is dominated by**" the Metamorphosis numbers that are larger than it is, as they contain its symmetry plus even more symmetries which it doesn't contain. As Marshall puts it, the Holotomes (meaning complete + books) are "whole books within whole books."

[And which are] attained after three intervals spanning four limits of these "increasings"

"Three intervals spanning four limits" of these "increasings" would be 12, 24, 72, and 360.

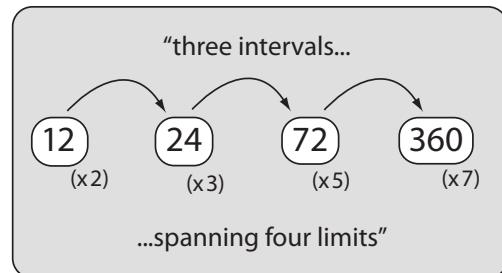

that organize the similar and dissimilar,
ascending and descending,

Metamorphosis numbers organize the “similar” (composites, which do have divisors) and “dissimilar” (primes, which have no divisors).

When numbers are seen as “a two-way street,” they can be seen as ascending or descending.

Dee uses these two words in his “Groundplat” of his *Preface to Euclid* to describe the “uses” of Arithmetic and Geometry

and which organizes all things in proportion
and harmony with one another.

This is also a befitting description
of the Metamorphosis Numbers in general.

Part C

C

[It is based on] a foundation of 4:3
yoked together with 5.

This relationship between the ratio 4:3 and the number 5 is a powerful, relevant concept. I’ll hold off explaining it in full until the rest of Plato’s number has been analyzed, but here are a few clues.

The ratio of 4:3 relates to the Dee’s maxim “Quaternary rests in the Ternary.”

This Greek “epitritos” (the 4:3 ratio), and is a key part of Nicomachus’ and Boethius’ “greatest and most perfect harmony.” (This ratio in Latin is “diatesseron” or sesquitertia.)

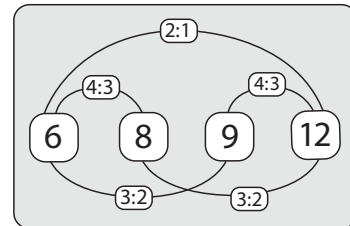

Some commentators on Plato’s Number have suggested that this sentence refers to a 3-4-5 triangle.

Indeed, we might find such a triangle by making a diagonal line across the 4:3 (height: width) proportioned Title page of the *Monas*. However, a 3-4-5 triangle has angles of 37, 53, and 90 degrees and is a sidetrack in this storyline.

Perhaps more germane is the seeing the 12 equal-sized squares on the Title page as multiplying “4 times 3” resulting in the first Metamorphosis number, 12.

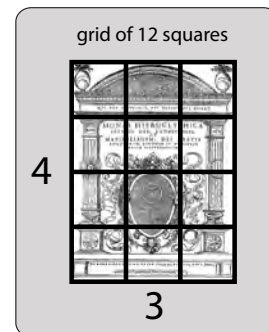

Here’s a curiosity.

The difference between
the first Metamorphosis number, 12,
and it’s reflective mate, 21, is 9.

And 12:9 is in ratio of 4:3.

The difference between
the second Metamorphosis number, 24,
and its reflective mate, 42, is 18.

And 24:18 is also the 4:3 “epitritos” relationship.

$$12 \nleftrightarrow 21$$

$$21 - 12 = 9$$

$$12:9 = 4:3$$

$$24 \nleftrightarrow 42$$

$$42 - 24 = 18$$

$$24:18 = 4:3$$

Part D

D

At the third augmentation,
two harmonies are brought together,

[the harmonies are] equal to a largeness
that is “of the hundreds,”

[one harmony] uses an “equal measure”
[to arrive at] “of the hundreds,”
[while in the other uses a more] “prolonged measure.”

[One part of that “more “prolonged measure” can be seen in]
the “well-known” diameters of the pentagon,
[considering only] one thing being bound together,

[the other part involves] the “not-as-well-known”
[diameters of a pentagon],
in which two things [are bound together].

[One of these ways] to find “of the hundreds,”
involves 3 cubed [or 27].

I’ve grouped these six phrases together because they describe a complete idea involving Metamorphosis and Consummata. Can you guess what it is?

Because the suspense might be too much for you (and to make it easier to follow my interpretation of Plato’s words), I’ll tell you first.

Plato is describing what Marshall called the best insight into the synchronicity between the Cycloflex and the Holotomes.

These are the “two harmonies” Plato is about to cryptically give clues about:

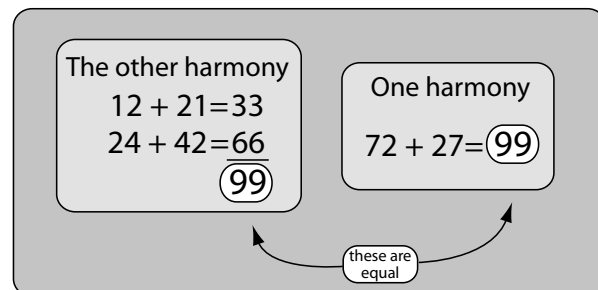

In two instances, Plato uses the word “pempadi,” which literally means “a body of five.”

Most translators read this numerically as the number 5. But here I think Plato is inferring the 5-sided or 5-equal-angled geometrical shape, the pentagon, because later he refers to its *diametrôn*, which means “diameter” or “diagonal.”

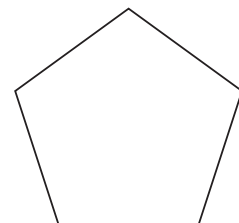

Now, let’s take part D one phrase at a time.

At the third augmentation,
two harmonies are brought together,

The third “augmentation” refers to the
third Metamorphosis number 72.

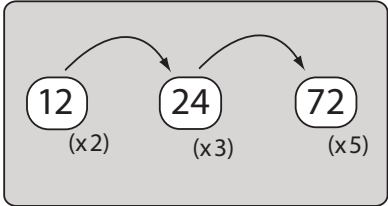

[the harmonies are] equal to a largeness
that is “of the hundreds,”

Most translators read Plato’s word *hekaton* as
the number 100. But as we’ve seen, the 9 Wave and
the 11 Wave meet at 99, which is the largest two-
digit member of the 11 Wave.

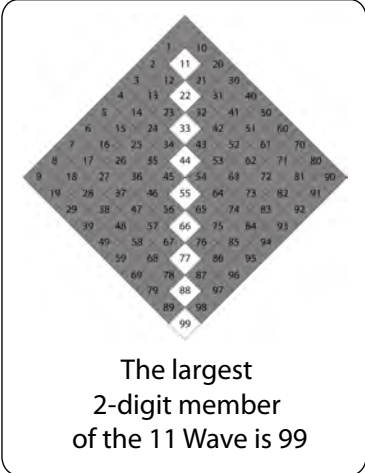

Number 99 is also the sum of each of
the transpalindromic pairs in the 9 Wave.

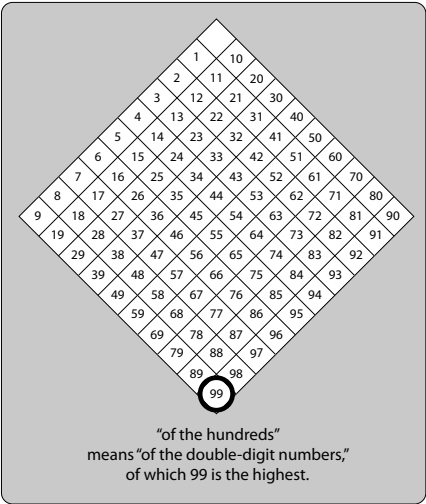
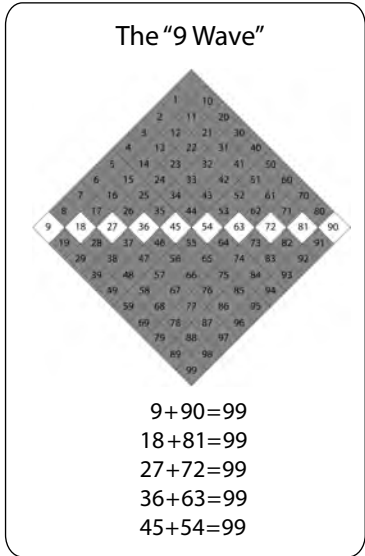

The diamond-shaped chart that shows the symmetry in
the 1-digit and 2- digit range of number seems like it goes up to
100. But you won’t find the 3-digit number “100” on the chart.

As Plato seems to have been aware of this number sym-
metry, I translate *hekaton* as “of the hundreds,” meaning “up to
100” or “ending at 99.”

[one harmony] uses an “equal measure”
 [to arrive at] “of the hundreds,”
 [while in the other uses a more] “prolonged measure.”

The first harmony that Plato is inferring is $72 + 27 = 99$. This harmony is special because 72 and 27 are both members of the 9 Wave.

$$72 + 27 = 99$$

Plato’s term *isomêkê* or “equal in length” (*iso* meaning “equal” plus *mêkos* meaning “length”) is a tricky one. Most scholars have seen think it refers to “squaring” a number or to a “square shape”.

But any regular polygon has sides of equal length. This equilateral triangle connecting 27, 72 and 99 on the chart has sides that are *isomêkê*, equal in length.

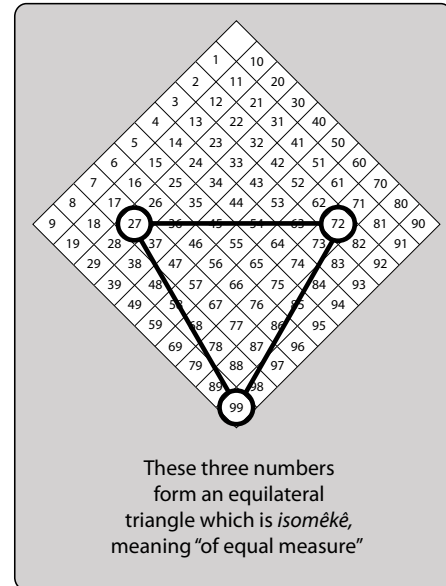

Plato calls the “other harmony” *promêkê*, meaning prolonged or elongated. Most translators suggest this refers to or the product of two unequal numbers, which the Greeks depicted with an an oblong rectangle.

But *promêkê* has also been used to describe the shape of a sword, an arrow, a snake, or a wasp. Plutarch (around 100 AD) refers to Pericles (around 425 BC) as having a “*promêkê de têi kephalêi*,” or an “elongated head. (Plutarch notes that most artists drew Pericles with a helmet on so as not to “reproach him with deformity.”) (Plutarch, *Lives*, 3.1, in Perrin, Bernadette; and Liddell/Scott, *promêkê*)

This “other harmony” involves two Metamorphosis numbers and their reflective mates.

$$(12 + 21) + (24 + 42) = 99$$

When all the numbers are connected on the chart, the resulting shape is much more *promêkê* (or elongated) than the previous *isomêkê* equilateral triangle.

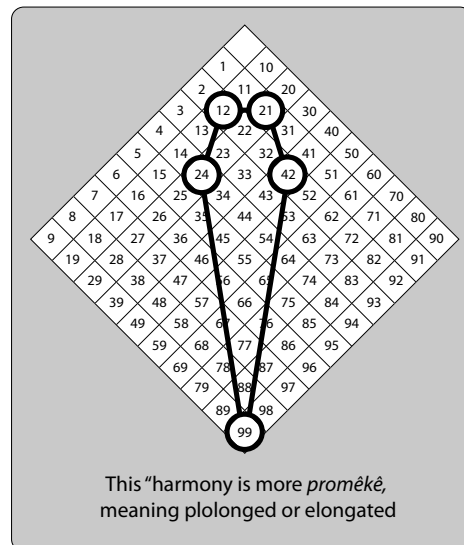

[One part of that “more “prolonged measure” can be seen in] the “well-known” diameters of the pentagon, [considering only] one thing being bound together,

Plato uses the word *diametrôn*, or diameter. Nowadays, we define a diameter as “a straight line passing from one side to the other side, through the center of a figure or body.” But back around 400 BC, the definition wasn’t as specific as it is today. This can be seen by analyzing the word itself.

It is comprised of the root word *metrôn* meaning “a measure.” and the prefix *dia-* meaning “through, across, or between.” So it can mean “measuring through,” or “a measuring across,” or “a measuring between.”

If the “measuring” is done “between” non-adjacent angles, it is a special kind of a *di-ametrôn* called a *diagônion* or a diagonal, which literally means “between angles” (*dia-* means “through, across, or between,” and *gonia* means “angle.”)

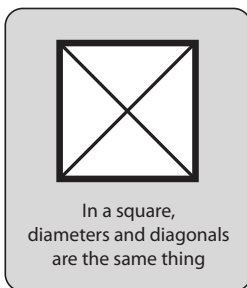

In a square, the diameter and diagonal are the same thing.

But in a pentagon a diameter isn’t necessarily a diagonal.

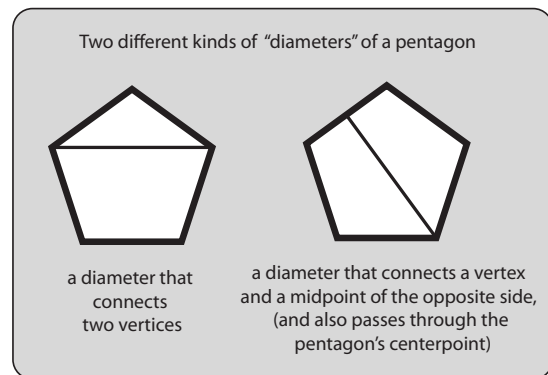

Plato says that one kind is “*rhêton*.” This means “**well-known**” or “famous” or publicly-known (like “rhetoric” is persuasive public speaking).

The other kind Plato calls “*arrêton*” In this word, the letter “a” is an example of “alpha privatatum” indicating “want, absence or negation” (like the “non-cuttable” atom). In other words, “*arrêton*” means “**not-so-well-known.**”

The “**well-known**” diameter of the pentagon is one which connects any two non-neighboring vertices. If all these five diagonals are drawn, a 5-pointed star or pentagram is created. (Note that this type of diameter does **not** go through the centerpoint of the pentagon.)

Plato probably considered it more “well-known” because it’s simpler to draw. Simply connect two corners. To draw a diameter through the center you must first locate either the center, or the halfway point of one of the sides.

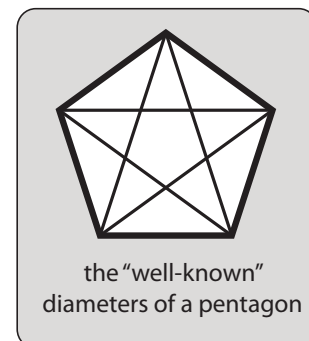

Most translators read “*deomenôn... hekastôn*” in the mathematical way, as “lacking one” or “minus 1.” The word *hekastôn* means “each one,” but *deomenôn* has two meanings.

1. “to lack, miss, or stand in need of ”
2. “to bind, tie, or fetter.”

I think Plato had the second meaning in mind. Thus, I read these words as “one thing bound together.” This doesn’t seem to make much sense until contrasted with the next line in which “two things are bound together.” (Liddell/Scott, p.181)

Each vertex of the pentagon has two diagonals emanating from it. Let’s isolate the two diagonals that intersect the uppermost vertex. They symmetrically divide the pentagon’s 108° interior angle into 3 equal angles of 36 degrees each.

The “one thing” Plato wants us to consider as “bound together” is just one of these 36 degree angles created by these two diagonals.

In modern language, we would say it that a 36 degree angle is “1/3 of a 108 degree angle.” But the Greeks didn’t like fractions. They would probably say “a 108 degree angle is 3 times a 36 degree angle.

When seen in “all the hundreds” we would say that a 36 degree angle is 33.3333...% or 33 1/3% of the 108 degree angle.

But the Greeks didn’t use “percentages” and would not have liked 33 1/3 anyway because it’s a fraction, not a whole number.

If Plato’s “of the hundreds” was 99, then one third becomes a whole number, exactly 33. Zeus is happy.

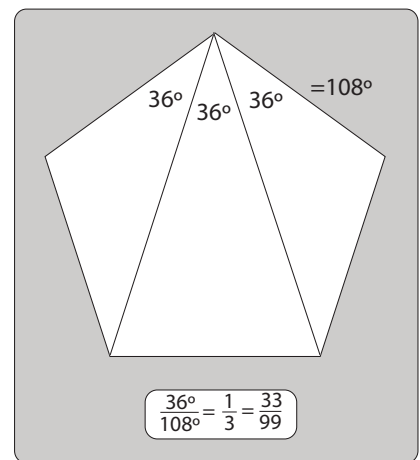

$$12 + 24 = 33$$

And the sum of the first Metamorphosis number, 12, and it’s reflective mate, 21, is precisely that, 33.

[the other part involves] the “not-as-well-known” [diameters of a pentagon], in which two things [are bound together].

The “**not-so-well-known**” diameters of the pentagon start from a vertex, pass through the centerpoint, and end up bisecting the opposite side.

The five diagonals, all combined, divide the pentagon into 10 equal-sized scalene triangles.

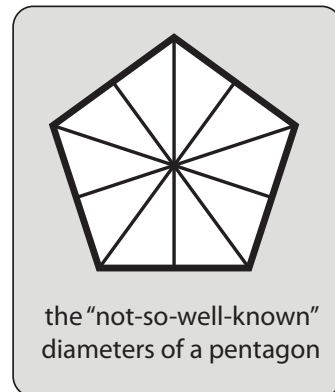

Let's draw 2 non-adjacent diagonals. (For example the 2 shown here, which connect the lowest vertices to the to the midpoints of the 2 uppermost sides).

The central angles are each 72 degrees, and the angle of the two remaining shapes on the sides are each 108 degrees.

Plato asks us to bind two things together, so let's add the two 72 degree angles, making 144 degrees.

The remaining two 108 degrees angles sum to 216 degrees. The numbers 144 is 2/3 of 216. (Just as 72 is 2/3 of 108).

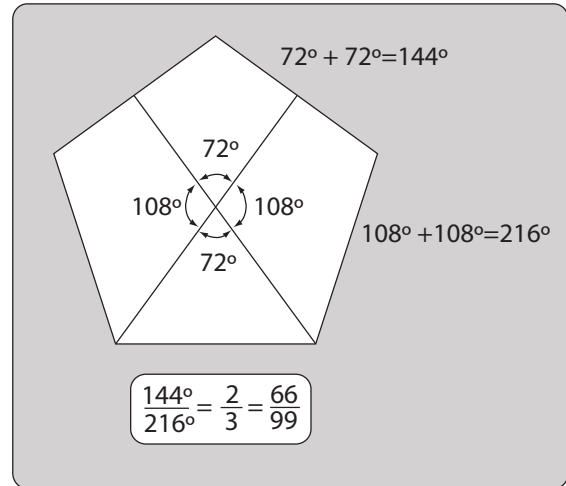

Seeing this “of the hundreds” using our modern eyes would be 66.6666... percent or 66 2/3%. But the fraction-disdaining Greeks would prefer comparing exactly 66 to 99, making the 2:3 ratio.

(Actually they would have seen it as 99:66 being a 3:2 part-to-part ratio, which is essentially the same thing as a 2:3 part-to-part ratio)

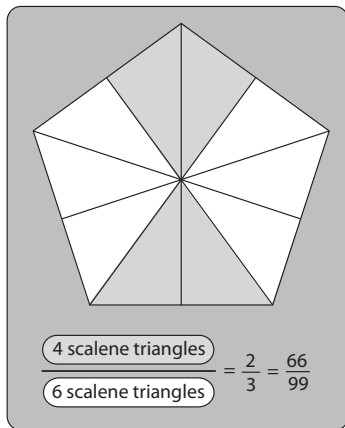

An alternative way to see this 2/3 ratio is to consider the area of the pentagon enclosed by those two diameters “bound together.”

This totals to 4 of the small scalene triangles (in light grey here). What's left over is an area of small 6 scalene triangles (in white here). Comparing these areas, they are in the 4:6 ratio, which is the 2:3 ratio, or the 66:99 ratio.

All this relates to the addition of the second Metamorphosis number 24 and its reflective mate 42, which total to 66.

$$24 + 42 = 66$$

Plato has cleverly used a geometric shape to express an arithmetic relationship. To summarize, in different ways, the two different types of “diameters” of a pentagon express 1/3 (or 33 out of 99) and 2/3 (or 66 out of 99) just like (12 + 21 = 33) and (24 + 42 = 66), totaling to 99.

[One of these ways] to find “of the hundreds,” involves 3 cubed [or 27].

Having painted a full (yet cryptic) picture of these two equivalent harmonies, Plato ends with a confirming clue.

He tells us that one of the harmonies involving involves *kubôn teriados* or “three cubed” or “ $3 \times 3 \times 3 = 27$.”

$$3 \text{ cubed} = 3 \times 3 \times 3 = 27$$

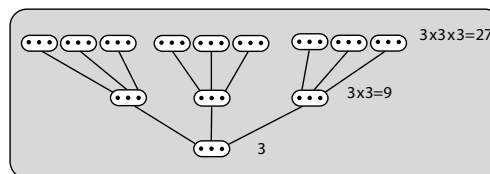

Indeed, not only is 27 the reflective mate of 72, when summed together they make 99. (They are also members of the transpalindromic 9 Wave.)

$$72 + 27 = 99$$

A brief review of the beginning of Part B

The Metamorphosis numbers 12, 24, and 72 are the key players in in these two harmonies.

But remember (from the beginning of Part B), for “human births,” the “most honored number” is “attained after three intervals spanning four limits,” which implies the fourth Metamorphosis number, 360.

But for human births, [there is a number] that his most honored among these “increasings,” which dominate and are dominated,

[And which are] attained after three intervals spanning four limits of these “increasings”

360
is Plato's
“human births”
number

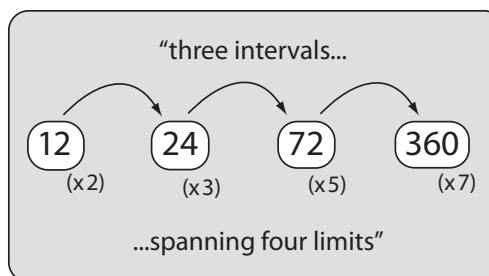

E

This whole thing involves the “geometric” number that rules over generation [of human births] for better or worse.

Plato summarizes by dropping a fat confirming clue. He calls “this whole thing” a “geometric number.” The word “geo-metric” is made from *gē* meaning earth and *metria*, from *-metrēs* meaning “measurer.” The “earth measurer” is a apt description for 360.

Recall that Dee puns around with the compound word “geometrie “ on two occasions in his *Preface to Euclid*.

First he explains that the “**the very etymology of the word, Land measurer**” doesn’t fully express what geometry is all about, and coins a replacement word, “**Megethologia**,” the study of Magnitudes.

Later he quips “**Herein, I would gladly shake off the earthly name of Geometry.**”

(Dee, *Preface*, pp..aij verso and aijj)

Why 360 might be considered a “geometric number”

With modern-day use of longitude and latitude, and 360 degree compass bearings, 360 is a more obvious “earth measurer” to us today than it was to Plato and his pals.

Math historians inform us that the division of a circle’s circumference into 360 parts wasn’t popularized in Greece until around 200 BC to 100 BC, long after Plato’s time.

But the division of the year into 360 parts (12 months of 30 days each) goes way back to the Sumerians, around 2400 BC. Their successors, the Babylonians, adopted the Sumerian calendar and their sexigesimal (Base 60) numbering system.

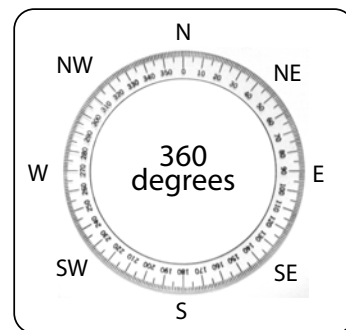

Thales (around 580 BC) knew the length of the year was more like 365 days, but he and the other early Greek astronomers saw the benefits of rounding 365 off to the more highly composite number 360. So 360 is indeed very geo-metric.

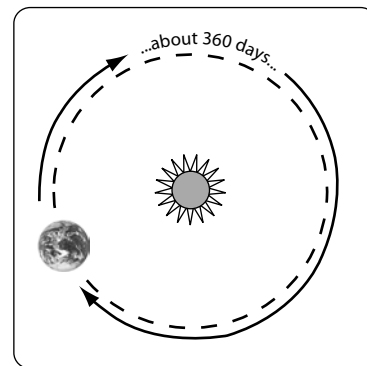

Plato doesn’t really elucidate upon how 360 rules over “human births, for better or worse,” but it’s probably connected to the way that 360 can be divided up in 2, 3, 4, 5, 6, 8, 9, 10 or 12 ways. It has wondrous symmetry.

The only single-digit that doesn’t evenly divide into 360 is 7. And that’s why 7×360 or 2520 is considered even more special than 360, and why it is the number of “divine births.”

We’ve done a lot of mathematical rockin’ and rollin’, so here’s at a simplified overview of Plato’s (cryptic) explanation of his two numbers, 360 and 2520:

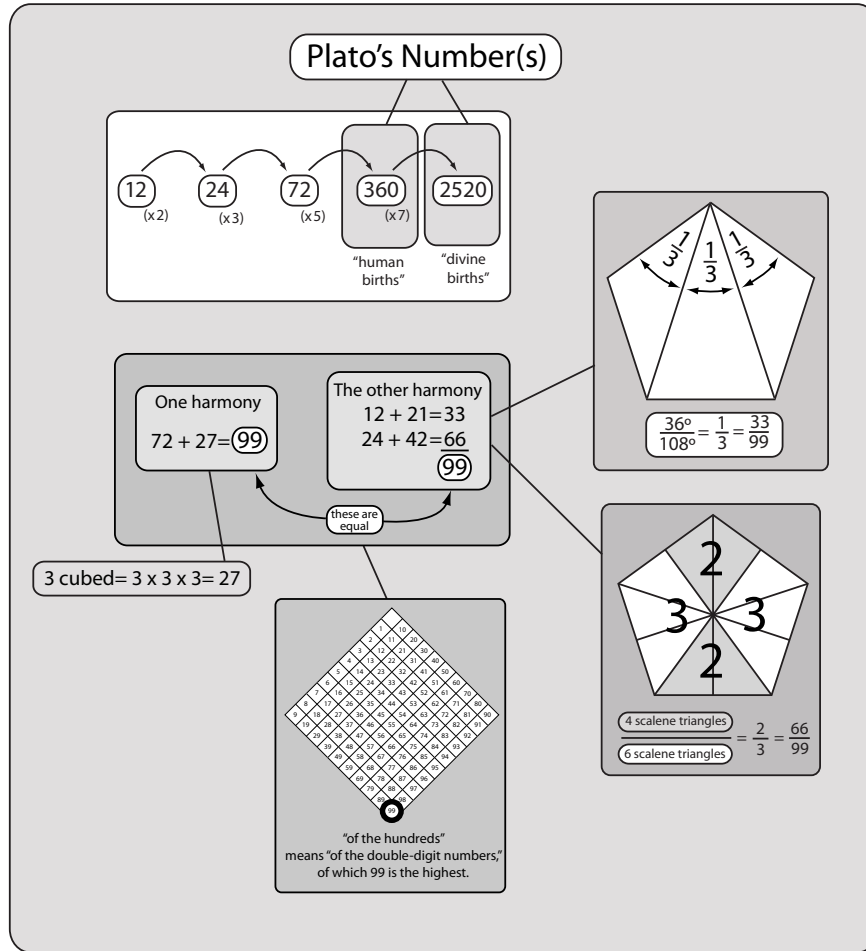

Summary

If my analysis is correct, it seems that Plato's number has finally come to light after being obscured for 24 centuries. But I can hardly claim credit for its rediscovery. Credit should be given to John Dee. Neither Buckminster Fuller nor Robert Marshall analyzed Plato's text, but they provided me with the background to comprehend it.

Actually, Marshall's early associate Iona Miller who had a good grasp of Marshall's Syndex, was the first to suggest that 2520 was "Plato's number." But she did not arrive at her conclusion by analyzing *Republic* 8: 546, nor did she understand that Plato actually mentions two numbers and that the number of "human births" was 360. Her conclusion was probably based on seeing how integral it is in Marshall's Syndex and how it relates other clues Plato provides in his later work, *The Laws*, which we will explore momentarily.

But, first let's delve deeper into what Plato meant in part C:

C	hōn epitritos puthmēn pempadi suzugeis	<i>[It is based on]</i> a foundation of 4:3 yoked together with 5.
----------	---	---

What does *pythmen* mean?

To explore the expression *epitritos pythmen*, let's see how various translators over the years have handled it:

“the 4:3 root” (Ficino)

“the basic ratio of four to three” (Desmond and Lee)

“4/3 as a base” (Sterling and Scott)

“sequitertian progeny” (Adam)

“a ratio of 4 to 3, in its lowest terms” (Shorey)

“a basal four-thirds” (Bloom)

These all basically mean the same thing. As we've seen, *epitritos* is defined as “a whole and one third,” or “in the ratio of 4:3.” (Liddell Scott, p. 305)

An *epitriton* is a loan of which 1/3 is paid as interest (or 33 1/3 percent interest). This term was used by from Xenocrates (396-314 BC), who followed Speusippus as the head of Plato's Academy. (They had pretty stiff rates back then!)

The word *pythmen* is ancient. Generally it means the “base, foundation, or bottom” of something. It's probably related to the Sanskrit word *budhnas* which means “bottom or base.”

In the *Iliad* (written around 850 BC), Homer uses the word *pythmen* to describe the support or base of a “beauteous cup ... studded with bosses of gold: four were the handles thereof, and about each twain doves were feeding, while below were two supports (*pythmenes*). (This “cup” was so heavy only Nestor could lift it, so it was more like a vase or bowl than a cup.) In another place, Homer uses *pythmen* to describe tripods “twenty in all, to stand around the wall of his well-built house.” (Homer, *Iliad* 11.616 and 18.360, and Liddell Scott on Perseus.tufts)

In the *Odyssey*, Homer uses the word *pythmen* to describe the trunk of a tree. “These [goods] they set all together by the trunk [*pythmen*] of the olive tree.” (Homer, *Odyssey*, 13.93)

Plato, in *Phaedrus*, uses *pythmen* with *pelagous* (sea) to mean the “bottom of the sea.” Aratus, a Greek poet living around 225 BC, used *pythmen* to describe the foot of a mountain.

(Perseus Lexicon, Liddell/Scott, *pythmen*)

But *pythmen* is used in conjunction with intangible things as well. Protagoras (ca. 481-420 BC) uses the phrase *pythmenes logon* meaning “fundamental principles.” (Wikipedia, Protagoras)

In an arithmetic sense, *pythmen* had several different meanings. Generally, it meant the “base of a series,” meaning the “lowest number possessing a given property. For example, Apollonius of Perga said 5 was the *pythmen* of the series 5, 50, 500, 5,000, etc. (In other words, the series of a number multiplied by ten and the powers of ten.) (D'ooge p. 216)

To Speusippus, a *ho deka pythmen* was a special number. Of all the numbers lower than a *ho deka pythmen*, half were prime numbers and the other half were composite numbers.

(Speusippus Theological Arithmetic, p. 62)

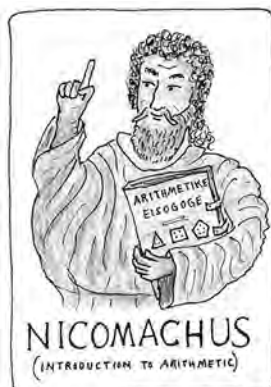

But the arithmetical meaning of *pythmen* which has endured is that given by Nicomachus in his popular-for-a-millennium *Introduction to Arithmetic*: **the lowest pair of numbers which describes a specific ratio.**

Here are all the *epitritos* ratios in in Nicomachus' chart of multiples.

While 60:45, 12:9, 8:6 are all in *epitritos* proportion, only 4:3 is the *epitritos pythmen*, the foundation of all the rest.

the <i>pythmen</i>									
1	2	3	4	5	6	7	8	9	10
2	4	6	8	10	12	14	16	18	20
3	6	9	12	15	18	21	24	27	30
4	8	12	16	20	24	28	32	36	40
5	10	15	20	25	30	35	40	45	50
6	12	18	24	30	36	42	48	54	60
7	14	21	28	35	42	49	56	63	70
8	16	24	32	40	48	56	64	72	80
9	18	27	36	45	54	63	72	81	90
10	20	30	40	50	60	70	80	90	100

Ratios that are *epitritos* (4:3)

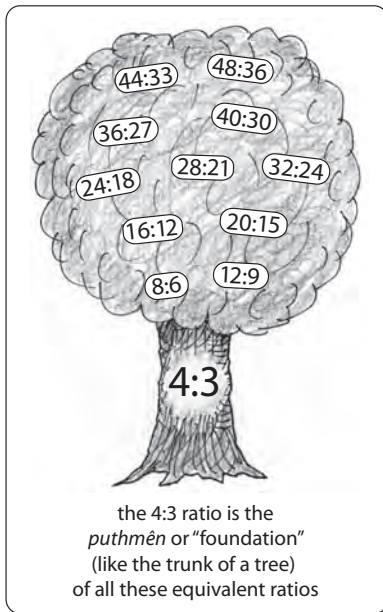

Thus, the 4:3 ratio is the trunk of the tree of equivalent ratios: 8:6, 12:9, 16:12, etc.

Or it's the base of a vase filled with an unlimited amount of those equivalent ratios.

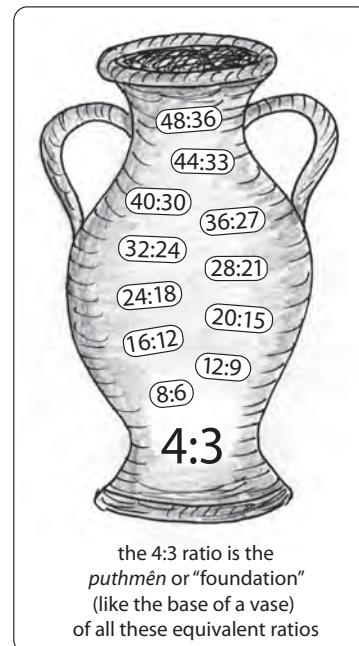

The foundation of epitritos, 4:3, yoked together with the pempad, 5

In the *Preface to Euclid*, Dee quotes Plato as saying “...Geometry is the knowledge of that which is everlasting...” Dee adds that men in his own era have “need of *Megethological Contemplations*” on a million more occasions than in Plato’s time. (Dee, *Preface*, p..aiij)

I noted earlier that the 3-4-5 triangle is a sidetrack. The more important aspect here is that a 4:3 rectangle contains 12 equal-sized squares.

How does that involve 5?

The easy answer is that $3+4+5 = 12$. The main clue here is that 12-ness is somehow involved in this story. The interrelationships among “3, 4, 5 and 12” also expresses themselves eloquently in 3-D geometry.

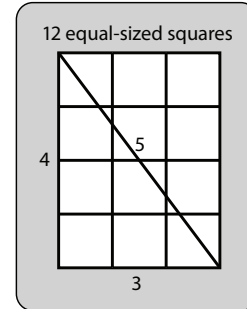

Shapes involving “4-ness and 3-ness”

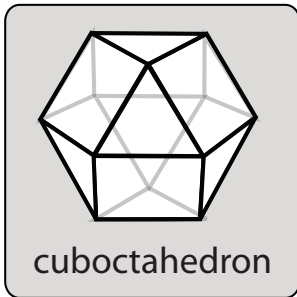

Instead of focusing on numbers let’s “*Megethologically Contemplate*” 3-D geometric shapes. In Dee’s decad of shapes, there is one shape which screams 4:3 louder than the rest. It’s the cuboctahedron, Bucky’s vector equilibrium, or Dee’s “closest-packing-of-eagle’s eggs-and-scarab beetle dungball spheres” shape.

Its square and triangular faces shout 4 and 3. Its 8 square faces and 6 triangular faces are in the ratio of 4:3.

But the cuboctahedron is not an orphan. It’s part of a happy family. Dee (cryptically) refers to this group as the “Lunary Planets.” Modern geometers recognize them as basic polyhedra with “octahedral symmetry.”(or tetrahedral in one instance)

It’s very name, cuboctahedron, reveals the two shapes from which it was born.

It inherited its 6 square faces from the 6 square faces of the **cube** and it’s 8 triangular faces from the 8 triangular faces of the **octahedron**.

Put another way, both a “degenerately truncated” **cube** and a “degenerately truncated” **octahedron** make a cuboctahedron.

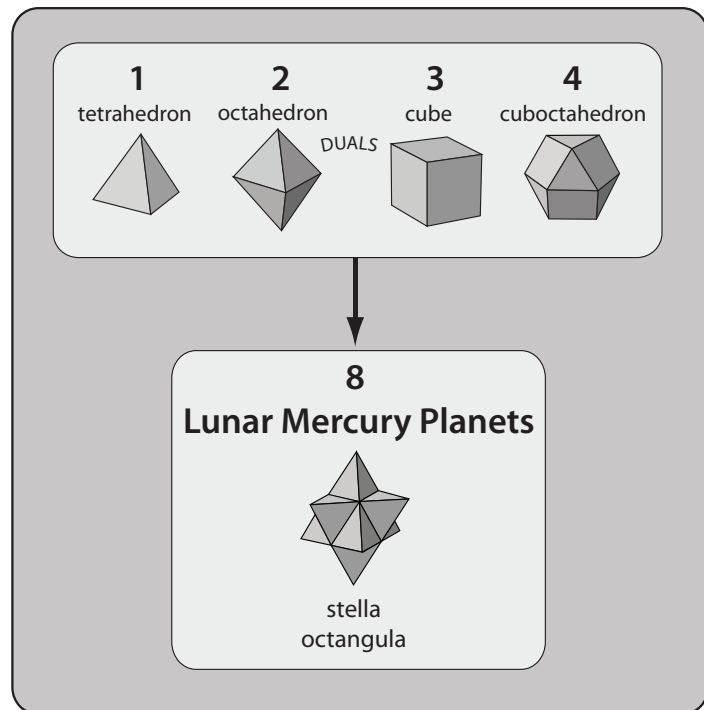

"octahedral symmetry"

("Lunary Planets" with a character of 4-ness and 3-ness)

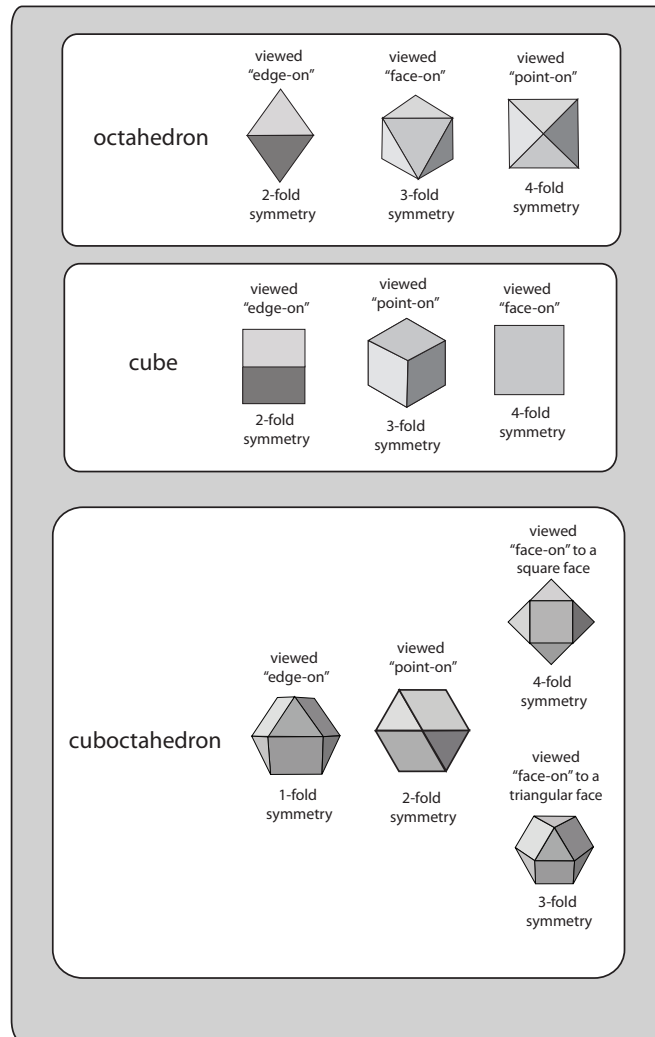

The 4-fold and 3-fold symmetry is quite evident in the "face-on" and "point-on" views of the octahedron and the cube. The 4-fold and 3-fold symmetry of the cuboctahedron can be seen in various "face-on" views.

"tetrahedral symmetry"

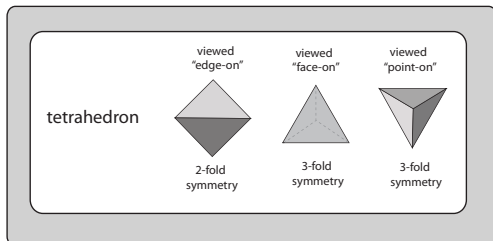

The only member of the "Lunary Planets" without octahedral symmetry is the tetrahedron. Being such a simple shape, it has its own special brand of symmetry, "tetrahedral symmetry."

But this brand still is still involved with 4-ness and 3-ness, as a tetrahedron has 4 faces, all of which are 3-sided triangles.

Two of these tetrahedra mated together (interpenetrating, as Bucky puts it) form what Dee (cryptically) refers to as the "Lunar Mercury Planets" summarizing shape, the stella octangula, which also has octahedral symmetry.

And, of course, these two tetrahedra, pulled apart so that they are tip-to-tip, are the essence of the cuboctahedron. (4 Bucky bow-ties with a common center).

The "Lunar Planets" are close relatives related through their character of 4-ness and 3-ness. **But there's not a trace of 5-ness to be found!**

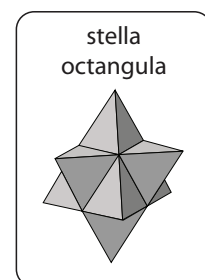

Shapes involving 5-ness are different from those involving 4-ness and 3-ness

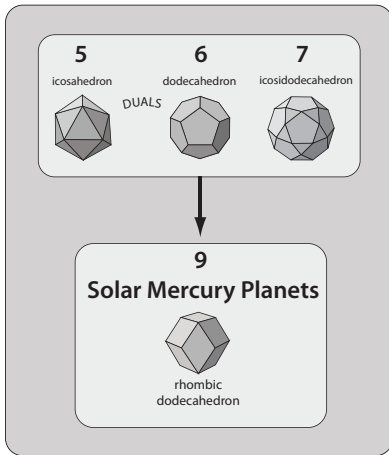

Dee (cryptically again) refers to these shapes involving 5-ness as “Solar Planets.” Modern geometers call them shapes with “icosahedral symmetry.”

This 5-fold symmetry is most obvious when the dodecahedron is viewed face-on or when the icosahedron is viewed vertex-on.

It is also seen when their intersection, the icosidodecahedron is viewed face-on to one of its pentagonal faces.

While it’s true that these 3 “Solar Planets” shapes also have some have 3-fold symmetry, it’s their peculiar character involving 5-ness that distinguishes them from the “Lunary Planets” shapes.

“icosahedral symmetry”

(“Solar Planets” with character of 5-ness)

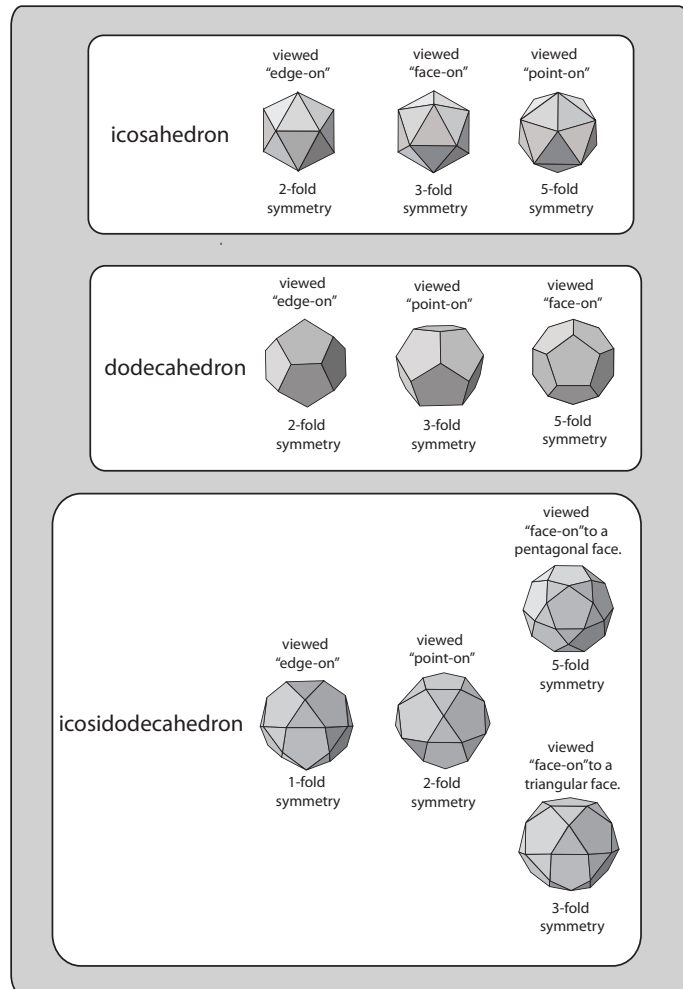

5-ness and 12-ness are related

Though it seems strange, in 3-D geometry, 5-ness is intimately related to 12-ness.

Exactly 12 (no more, no less) pentagons assembled to form a dodecahedron, whose name honors this 12-ness.

On the icosahedron, five edges converge at each of exactly 12 vertices.

And the icosidodecahedron has 12 pentagonal faces.

But the Dodecahedron isn't the only shape famous for its 12-ness. Let's not forget about its two pals, the 12-sided rhombic dodecahedron and the 12-vertexed cuboctahedron.

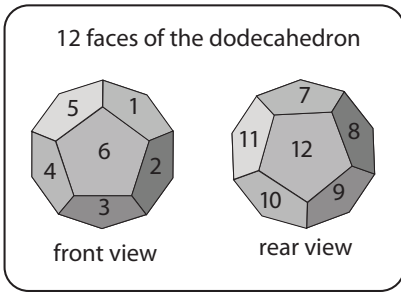
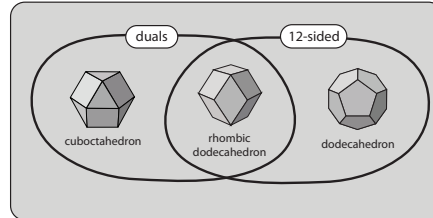

Through the rhombic dodecahedron, the dodecahedron (Plato's implied shape with which "God painted the Universe") is related to the closest-packing-of-spheres cuboctahedron ("Nature's operating system" to Bucky.

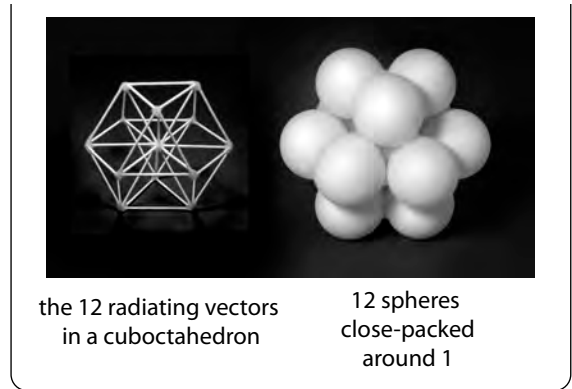

Dee writes about 5-ness or the "QUINARIUM," as he calls it, in Theorem 16.

He notes how the ancient Latin philosophers "not irrationally" represented the 5 as a V, as it is half of 10, which is X. He then goes into a lengthy mathematical gyration involving the "virtue of FIVE" and the "Number FIFTY."

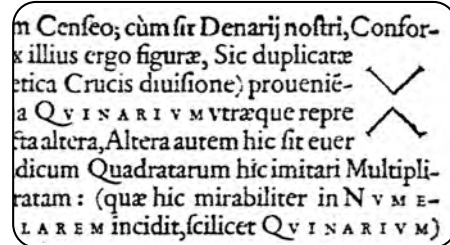

Dee's "QUINARIUM" (or 5) in Theorem 16

Aside from this Theorem the idea of "fiveness" doesn't appear much. Instead, Dee emphasizes the relationship of 4-ness and 3-ness (the Quaternary and the Ternary).

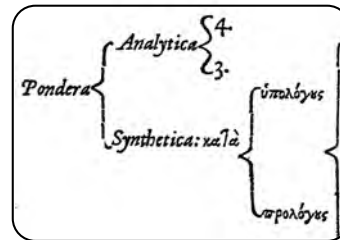

4:3 in the Dee's Artificial Quaternary chart

Dee calls this air shaft "M" and says it is "homologous" to one arm of the Cross

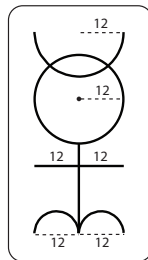
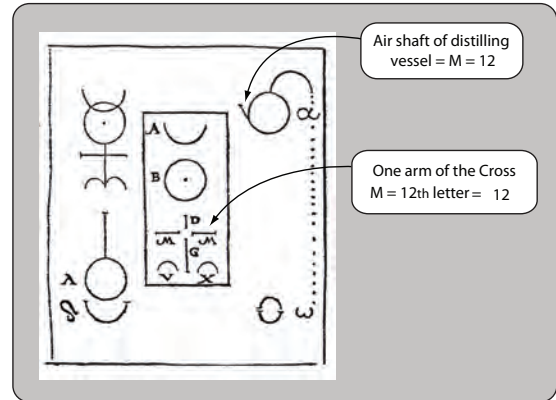

While the Monas symbol loudly expresses 10-ness in the proportioning of its spine, Dee also imbued it with 12-ness in a "measurement" way.

In the "Secret Vessels of the Holy Art" illustration of Theorem 22, Dee makes repeated references to the letter M, which is the 12th letter of the Latin alphabet.



We've seen that the radius of the Moon, the radius of the Sun, each arm of the cross, and the diameters of each of the horns of Aries are all 12.

12-ness in "measurement"

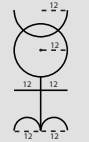
12 vertices	12 faces	12 faces	
			
cuboctahedron	rhombic dodecahedron	dodecahedron	monas symbol

Thus, all these things are related through their character of 12-ness.

Now we have a 3-D view of how "4-ness and 3-ness" things are related to "12-ness." And also how "5-ness" things are also related to "12-ness."

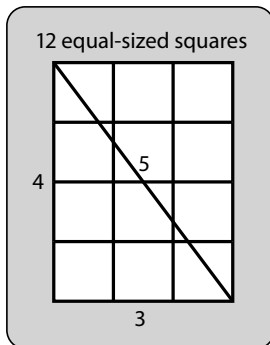

With this understanding 2-D expression in the 3-4-5 Pythagorean triangle is more meaningful in the way it relates "3, 4, 5, and 12."

It's no wonder Dee used the 4:3 proportion for the Title page of the *Monas*.

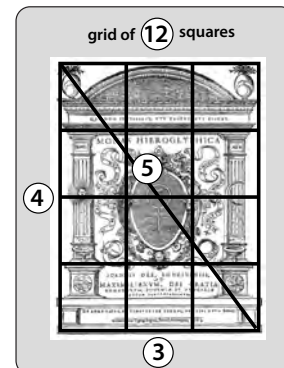

A deeper look into the connection between the Lunary “4:3” group and the Solary “5” group

The rhombic dodecahedron is intimately connected with both groups.

Like most of its “Lunary planets” brethren, it has “octahedral symmetry” involving 4-ness and 3-ness.

Being the dual of a cuboctahedron, the vertex-on view of 6 of its vertices reveals 4-fold symmetry and the vertex-on view of 8 of its vertices reveals 3-fold symmetry. It’s got 4:3 character.

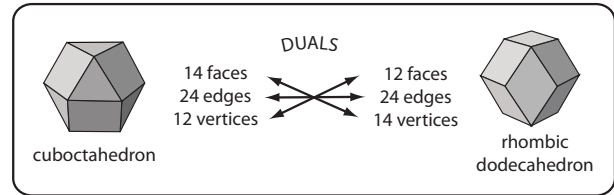

However, like the “Solary Planets,” the rhombic dodecahedron has a “12-ness character.”

You can sense by their names that the rhombic dodecahedron and the dodecahedron are related by their common “12-ness.”

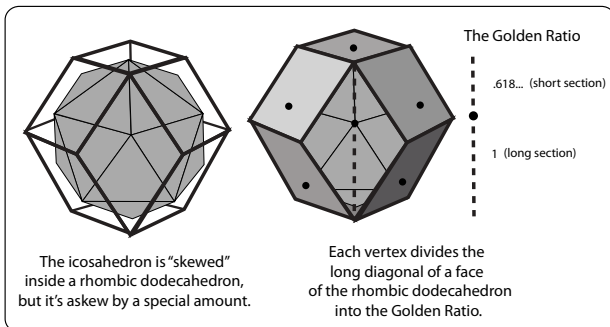
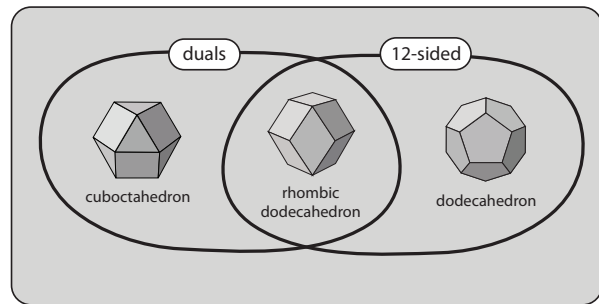

As we saw earlier in Amy Edmondson’s explanation, the 12 vertices of the **icosahedron** are skewed to the 12 face centerpoints of the rhombic dodecahedron by a special amount.

The 12 vertices of the icosahedron break the long diagonals of the rhombic dodecahedron faces into the Golden Ratio.

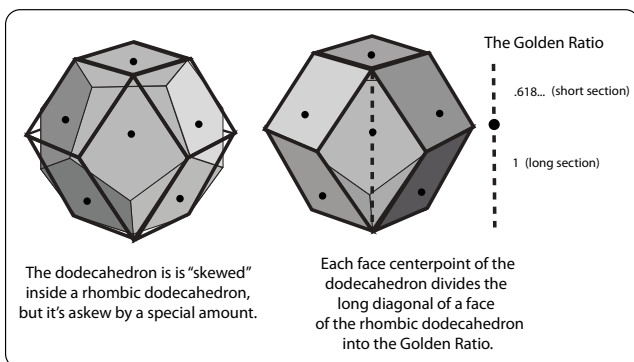

As the icosahedron and dodecahedron are duals, the face centerpoints of the **dodecahedron** also break the long diagonals of the rhombic dodecahedron into the Golden Ratio.

So, the face centerpoints of the rhombic dodecahedron and the dodecahedron are not in the same place. Big deal. That's a minor detail compared to the fact that they each have 12 faces.

If the rhombic dodecahedron and the dodecahedron were both dice, the odds are rolling, say for example, a six, would be the same.

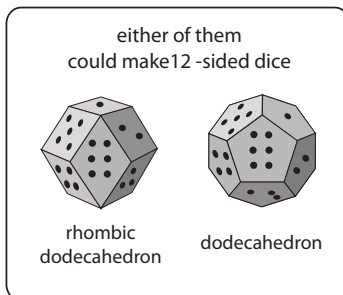

Even though the diamond-shaped faces of the rhombic dodecahedron and the pentagonal faces of the dodecahedron are a different species, in a certain respect they are “similar in size.”

One diamond-shaped face is “one twelfth” of the surface area of a rhombic dodecahedron.
 One pentagonal face is “one twelfth” of the surface area of a dodecahedron.

This might seem obvious and immaterial, but wait till you see how much Plato liked dividing practically everything into twelfths.

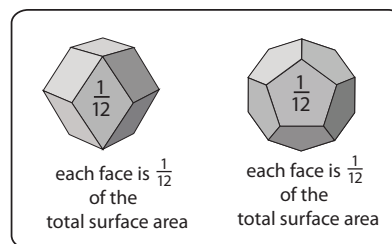

But the dodecahedron and rhombic dodecahedron are related in another way. Eight of the 12 dodecahedron vertices correspond with 8 of the 12 rhombic dodecahedron face centerpoints.

This is most easily seen by first picturing a cube in a dodecahedron and then a cube in a rhombic dodecahedron.

rhombic dodecahedron (9) and the dodecahedron (6)

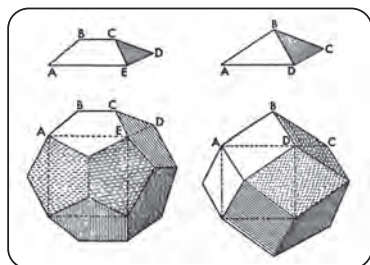
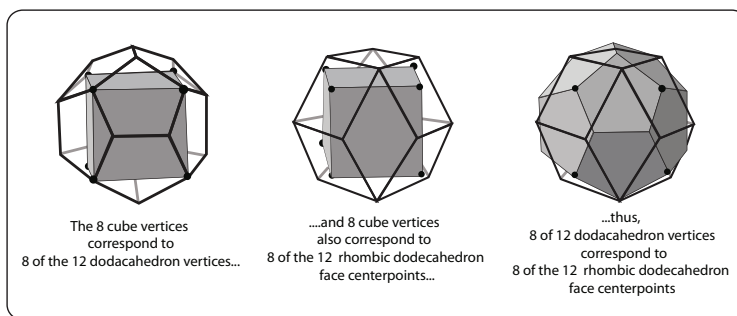

Johannes Kepler's 1625 drawing of the shapes needed to make a cube into to make a dodecahedron (left) and a rhombic dodecahedron (right)

Johannes Kepler, in 1625, knew about the two different shapes required to turn a cube into a dodecahedron versus a rhombic dodecahedron.

rhombic dodacahedron (9)
and
stella octangula (8)

Here's a clarifying corollary. Since the cube and the stella octangula have corresponding vertices, the 8 stella octangula vertices correspond with 8 of the 12 rhombic dodecahedron face centerpoints.

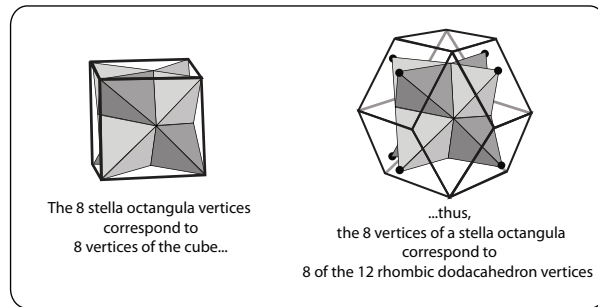

This is significant because it shows a connection between Dee's "Lunar Mercury Planets" "shape (8) and his "Solar Mercury Planets" shape (9).

I hear an echo of the a main theme about the "Moon and the Sun" from Theorem 4 of the *Monas*. The Moon "longs to be imbued by the Solar Rays so much that she becomes Transformed into him."

Even the genders correspond, as 8 is the "female parent" and 9 is the "male parent" in the "maxim of the flowing ribbons" of the Title page.

We might picture this using Dee's symbols. Even though the Solar Mercury Planets symbol looks like the Monas symbol, it's incomplete without its partner, the Lunar Mercury Planets symbol.

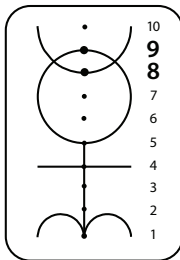
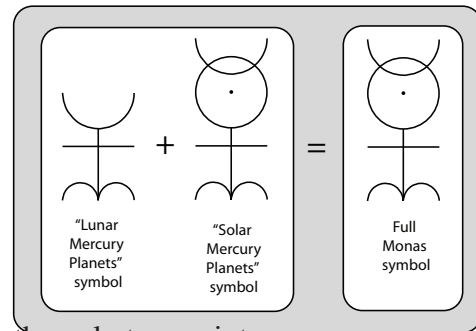

Appropriately, points 8 and 9 are the only two points on the framework of the Monas symbol that are contained in **both** the Moon half-circle and the Sun circle.

The Lunary 8 and Solary 9 in the "Below" half of the "Thus the World Was Made" chart are echoed in "Above" half of the chart by the Octave and Null 9 of Consummata.

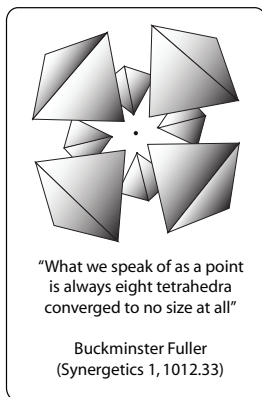
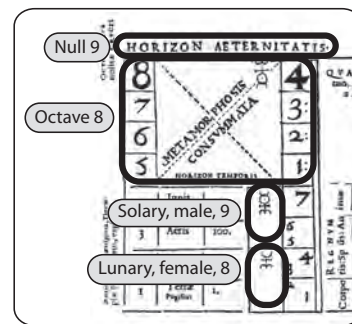

The 8 represents the 8 tip-to-tip tetrahedra of the cuboctahedron and the 9th thing, that nucleus point, which Bucky calls the "locus of vanishment."

In short, we might see the relationship of these two shapes as the “marriage” of those passionate lovers, the Lunar Mrs. Stella Octangula and the Solar Mr. Rhombic Dodecahedron.

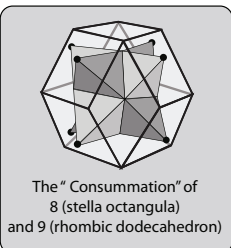

In the realm of numbers, it’s the consummation of the marriage between “Mrs. octave” and “Mr. null 9.”

(Maybe this is why Dee called it “Consummata.”)

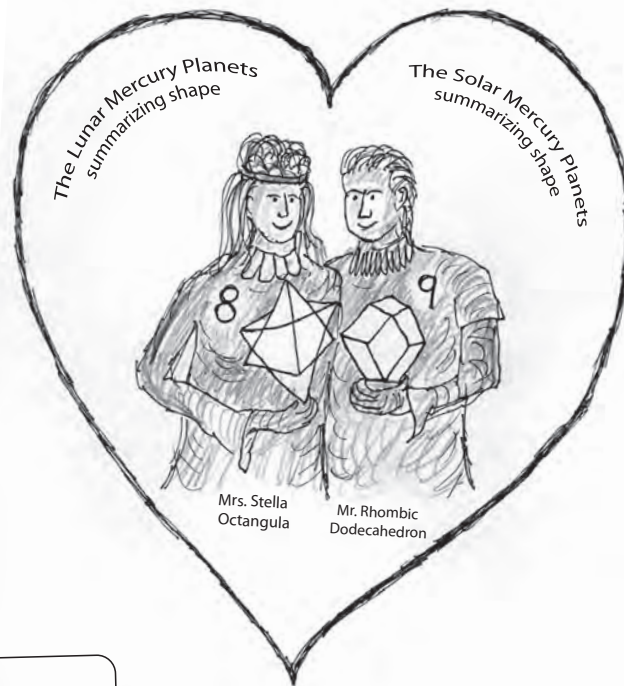

Dee’s
Decad of Shapes
One big happy family

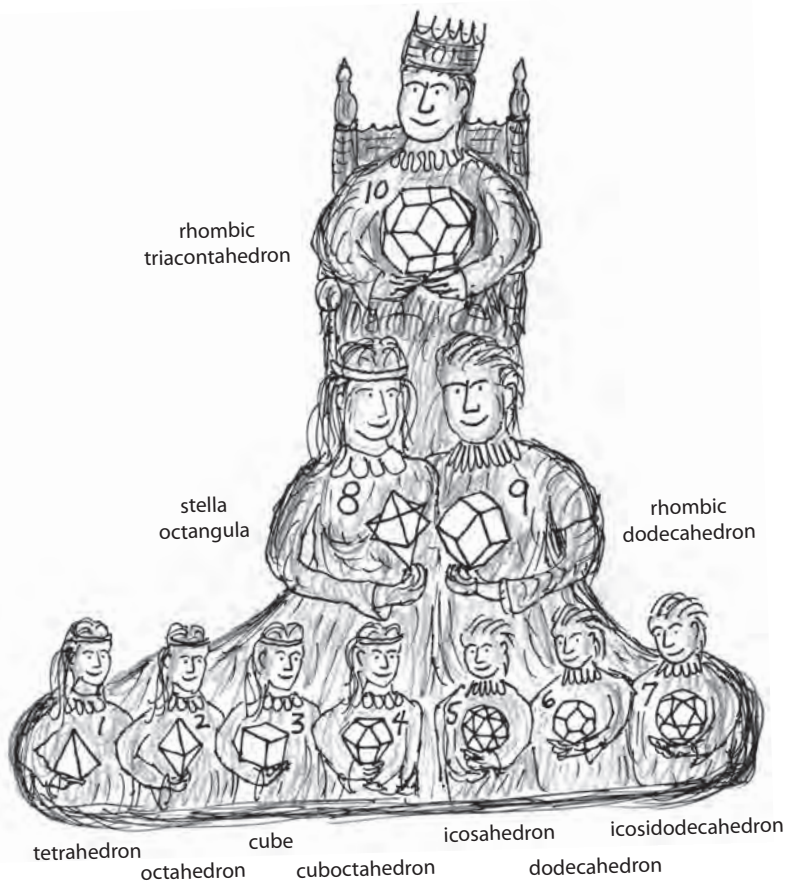

Here’s a picture of the whole happy family. On top is the the perfect 10, the “reX” or King of the Realm.

Below him are the Mr. and Mrs. (Stella kept her maiden name).

And below them are their 7 little kiddies.

1, 2, 3, and 4 have that “**4-ness and 3-ness**” character like their Mom, while 5, 6, and 7 have that “**5-ness character**,” like Pop.

Plato (and Aristotle) used the “Yoke” metaphor:

“...epitritos puthmên pempadi suzugeis...”

... the foundation of the 4:3 ratio, yoked together with the 5...

Various translators of this phrase in *The Republic* have interpreted Platos’s word *su-zugeis* as “joined,” “coupled,” “wedded”, “paired” or “conjoined with.” The literal, original Greek meaning of the word is “**yoked together.**”

You’ll be surprised how familiar you already are with this funny-sounding Greek word *suzugeis* (or *syzygeis*). It’s a combination of the prefix “*sun-*” (meaning with or together) and the verb *zeugunai* (meaning to yoke.) Thus, it simply means “to yoke together,” with an implication of a connection between two things, as a yoke fits two oxen.

The Greek word *zeugunai* is believed to have come from the Proto-Indo-European word *yogom* (yoke) and the verb *yeug* (to join).

In Sanskrit, this was the source of the words *yogi*, *yoga* (union), and *yuga* (one of the 4 ages that unite history).

In Latin, it became *iugum* from which we get words like juxtapose, conjugal, join, adjunct, conjugation, and conjunction.

Directly from the Greek word *suzygeis* we get the word *syzygy* (a pair of connected things like 2 conjunct planets) as well as *zygote* (the union of two gametes making a fertilized ovum). [Didn’t I say you would be familiar with it. You used to be a zygote.]

So instead of Dee’s “Planet” metaphor or my “Family” metaphor, Plato (and Aristotle) used the “Yoke” metaphor.

Incidentally, there are several good reasons why farmers yoke oxen together that non-plowers might be aware of:

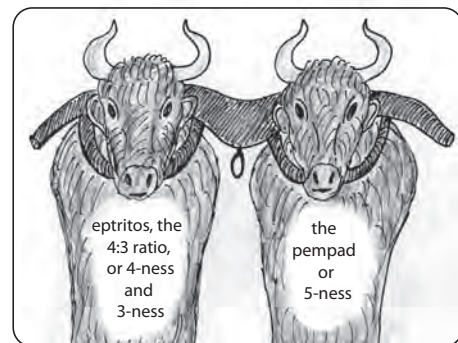

Besides providing more power, with two oxen it’s easier to guide the plow and steer at the same time, especially when making turns.

Two oxen can plow for much longer periods than a single ox, an important thing when planting season pops up.

If one ox stumbles, he will be steadied by being yoked to the other ox.

yoke and yolk

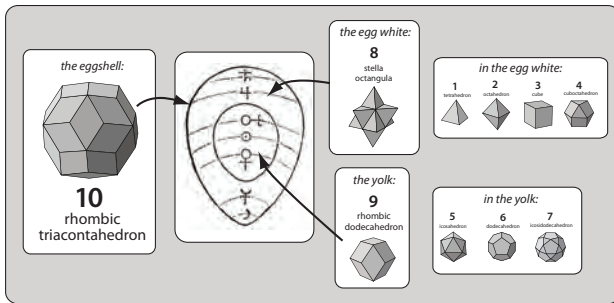

Indeed, Dee's other metaphor, the planets seen in the in the "Egg" diagram, is in some respects a punning with the words yoke and yolk. (Did Dee really do this just for yuks?)

Not really,
Dee was pretty serious about the importance of his cosmology
He provides another clue about his "egg metaphor,"
with regard to "contemplations,"
when he writes:

**"As we were contemplating
both the Theoretical and the Heavenly motions
of that Celestial MESSENGER [Mercury],
we were taught that the figure of an EGG
might be applied to these COORDINATIONS."**

This is the same word Dee uses in the *Preface to Euclid* when he is expounding upon "Megethological Contemplations" (or *Geometrical* contemplations):

**And for us Christian men, we have
a thousand thousand more occasions to have need
of the help of Megethological Contemplations...**

**"No man, therefore can doubt, that toward the knowledge of attaining
incomparable knowledge and Heavenly Wisdom,
Mathematical Speculations, both of Number and Magnitude [Geometry],
are means, aids, and guides: ready, certain, and necessary."**

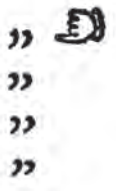

(Dee, *Preface*, p. aiiij, Dee highlighted this line with a "pointing finger" symbol and 4 quotation marks in the margin)

Through "Megethological Contemplations" (in my case, with lollipop sticks, hot glue, and the help of Bucky Fuller and others) Dee expects the reader will soon discover the splendid "intertransformabilities" and the "hierarchy" of what I call Dee's "Decad of Shapes."

But to get back to specifics, what does the rhombic dodecahedron and dodecahedron have to do with Plato's number 360? Or with Plato's "other" number 2520?

The brief answer is that $12 \times 30 = 360$. But to understand why this is important to Plato, we must explore what he is written in his later work *The Laws*.

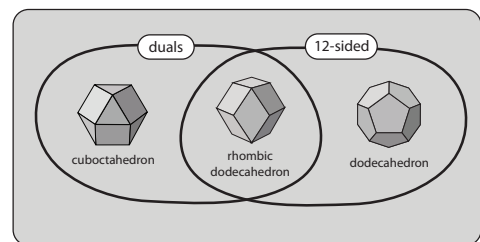

But before getting to that you might be asking this burning question: How can we be so sure that Plato even knew about the cuboctahedron (and the rhombic dodecahedron) when there is no mention of them in any of his Dialogues?

Heron squeals



The great Greek mathematician Hero of Alexandria (better known as Heron) was a whiz at geometry and physics. His *Metrica* is a collection of the accumulated mathematical knowledge of ancient Greece.

Book One gives formulas for the area of triangles (still called Heron's formula), rectangles, and on up to 12-sided polygons.

Book Two gives formulas for the volume of cones, pyramids, cylinders, sections of spheres, and even Plato's five regular solids.

In another of his basic math texts called *Omnia*, he sheds light on Plato's (and some of the ancients' knowledge) of the cuboctahedron.

For time reference, Heron was writing this around 50 AD. He writes about Plato (around 400 BC), Euclid (around 300 BC), and Archimedes (around 200 BC).

Definition 104 is entitled:

**“Apart from the dodecahedron,
the 4 shapes bear a proportion to the sphere.”**

**“In his thirteenth book, *The Elements*,
Euclid demonstrated how he encloses each of these five shapes in a sphere.
For he supposes that those 5 from Plato are the only ones.**

**But Archimedes claims that there are 13 shapes
which can be inscribed in a sphere,
adding 8 to the 5 already spoken of.”**

[later, Pappus of Alexandria, around 325AD, writes that Archimedes knew of 13 semi-regular polyhedra in addition to the 5 regular polyhedra]

**“Of these he [Archimedes] claims that even Plato
knew about the tessaeskaidekehedron [a shape with 14 faces]
and claims that this is of two kinds [diploun].”**

**One is composed of 8 triangles and 6 squares,
that is made from air [octahedron] and earth [cube],
a shape which some of the ancients also knew about.**

**But the other,
which is composed of 8 squares and 6 triangles,
appears to be more difficult.”**

(Heron, *Definitions*, *Omnia*, Vol II, p. 66, translation by Peter Lech and Jim Egan)
(also see Heath, *A history of Greek Mathematics*, Vol 1., p. 295)

The first 14-faced shape Heron mentions, with its “8 triangles and 6 squares,” can be nothing other than the cuboctahedron.

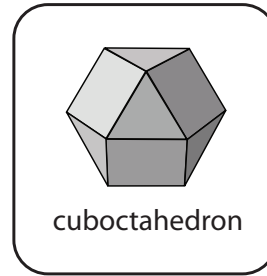

The reason Heron describes the second shape as “**difficult**” is because it is impossible. Six triangles and 8 squares simply can’t be assembled into a complete polyhedron, never mind one that will fit perfectly inside a sphere.

It appears to me that Heron interpreted what Plato meant by his claim that the “shape with 14 faces” was of **two kinds**. Heron probably assumed it was referring to another 14-sided figure.

The phrase translated here as “of two kinds” is the word “*diploun*” in Heron’s original Greek text. “*Diploos*” comes from “*dis-*” meaning twice or doubly and “*haploos*” meaning single.

Plato described the cuboctahedron quite clearly, but didn’t elucidate what he meant by “*diploun*,” which can mean “two-fold, mutual, double, duplex, duo, or dual.”

Plato might have called the cuboctahedron and its partner the “*diploun*” for the same reason we call them “duals” today. It’s an appropriate way to describe their complimentary relationship. All Heron had to do was make a cuboctahedron as Plato described and connect the centerpoints of its faces and he would find its “*diploun*,” a rhombic dodecahedron.

Perhaps Heron received garbled information, (as it had been passed down through more than four centuries). Maybe Heron himself got hung up on the 14-sidedness aspect, not considering that a 12-sided shape could be the “*diploon*” of a 14-sided shape.

The point here is not about what Heron (around 60 AD) or Archimedes (around 200 BC) or Euclid (around 300 BC) knew, but what Plato (around 400 BC) knew.

Plato knew about the cuboctahedron and by unraveling Heron’s comment it appears Plato knew about the cuboctahedron’s dual, the rhombic dodecahedron, with its 12 faces. The other evidence that Plato knew about the rhombic dodecahedron is that he loved the number 12, as we shall now finally see.

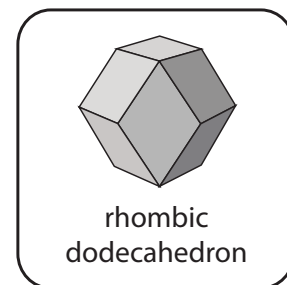

Incidentally, Dee was thoroughly knowledgeable about these ancient math whizzes. He owned 16 books or manuscripts written by Plato, 45 by Euclid, 10 by Archimedes, and 2 by Heron. Dee and his math buddies on the continent were absorbed with all this stuff.

(Roberts and Watson, pp. 244, 215, 209, 217)

PLATO SHOWS HIS LOVE OF 360, 2520, AND 12-NESS IN THE IDEAL CITY OF “THE LAWS”

Plato’s Ideal City in The Laws (737-8)

Written around 360 BC, *The Laws* is Plato’s last and longest dialogue. Plato’s main character, Socrates, doesn’t star in this episode. Instead an “Athenian Stranger”, a Spartan named “Megillos” and a politician from Knossos, Crete named “Kleinias” are journeying on a pilgrimage to the sacred cave of Zeus on the island of Crete.

Kleinias had just been just elected to write the laws for a new Cretan colony of Magnesia (the Greek word for “magnet”). While walking, the three discuss philosophy, religion, politics, music, dance, and natural rights of all citizens.

(The following quotes come from Trevor J. Saunders' excellent 1970 translation of *The Laws* in a chapter he entitles "Distributing the Land" :

The Athenian stranger rhetorically asks,
"So what's the correct method of distribution?"
He then answers his own question.

"First, one has to determine what the total number of people ought to be, then agree on the question of the distribution of the citizens and decide the number and size of the subsections into which they ought to be divided; and the land and houses must be divided equally (so far as possible) among these subsections.

A suitable total for the number of citizens cannot be fixed without considering the land and the neighboring states. The land must be extensive enough to support a given number of people in modest comfort, and not a foot more is needed.

The inhabitants should be numerous enough to be able to defend themselves when the adjacent peoples attack them, and contribute at any rate some assistance to neighboring societies when they are wronged.

When we have inspected the land and its neighbors, we'll determine these points and give reasons for the action we take; but for the moment let's just give an outline sketch and get on with finishing our legislation."

(Plato, *The Laws*, 737 c-d, Sanders, p. 159)

The new colony can't be too big, nor too small, and the Athenian stranger is concerned with how to divide the populace. He then gives what seems to be a hypothetical example in a section Sanders entitles "The Size of the Population."

"Let's assume we have the convenient number of five thousand and forty farmers and protectors of their holdings, and let the land with its houses be divided up into the same number of parts, so that a man and his holding always go together.

Divide the total first by two, then by three: you'll see it can be divided by four and five and every number right up to ten.

Everyone who legislates should have sufficient appreciation of arithmetic to know what number will be most use in every state, and why.

So let's fix on the one which has the largest number of consecutive divisors.

Of course, an infinite series of numbers would admit all possible divisions for all possible uses, but our 5,040 admits no more than 59 (including 1 to 10 without a break), which will have to suffice for purposes of war and every peacetime activity, all contracts and dealings, and for taxes and grants."

(Plato, *The Laws*, 737e-738-b, Sanders, pp. 159-60)

Why did Plato select the number 5040?

Why not a more common number like 5000?

Because 5040 is so highly composite.

It can be divided-up evenly in more ways than 5000.

Plato chooses 5040 not only because it contains the most numerous subdivisions, but also the largest number of "consecutive divisors." Plato clarifies what he means by actually doing the math for us. The number 5040 can be sub-divided 59 different ways because 5040 has 59 factors. (Plato includes 1 as a factor, but not 5040 itself)

Most important to Plato is the fact that 5040 can be divided into halves, thirds, quarters, fifths, sixths, sevenths, eighths, ninths, and tenths, a consecutive list of possible subdivisions.

But 5040 isn't the lowest number that can be divided by 1, 2, 3, 4, 5, 6, 7, 8, 9, and 10.

The number 2520 is!

The number 5040 has that property because it is twice 2520. Three times 2520 (or 7560) or four times 2520 (or 10080) or etc. all have this property as well. But no number less than 2520 has this property.

The Factors of 2520 (there are 47 of them)										
1	2	3	4	5	6	7	8	9	10	
			12	14	15	18	20			
		21	24	28	30	35	36	40		
			42	45	56	60	63	70		
				72	84	90	105			
				120	126	140	168	180		
				210	252	280	315	360		
				420	504	630	840	1260		

The Factors of 5040 (there are 59 of them)										
1	2	3	4	5	6	7	8	9	10	
			12	14	15	16	18	20		
		21	24	28	30	35	36	40		
			42	45	48	56	60	63	70	
				72	80	84	90	105	112	
				120	126	140	144	168	180	
				210	240	252	280	315	336	360
				420	504	560	630	720	840	
					1008	1260	1680	2520		

(The only factors that 5040 has, that 2520 does not have are 16, 48, 80, 112, 144, 240, 336, 560, 720, 840, 1008, and 1680. With all the 47 factors that 2520 does have, having a dozen more doesn't seem that critically important.)

Granted, a population of 5040 would provide more people who were suitable age to be soldiers in a defensive army, but 2520 fits Plato's "divisibility by the members of the decad" requirement just as well as 5040.

If Plato envisioned a city with a big army he could have chosen a population of 10080, which even has a dozen more factors than 5040.

The Factors of 10080
(there are 71 of them)

1	2	3	4	5	6	7	8	9	10
	12	14	15	16	18	20			
21	24	28	30	32	35	36	40		
42	45	48	56	60	63	70	72	80	
84	90	96	105	112	120	126	140		
144	160	168	180	210	224	240			
252	280	288	315	336	360	420			
480	504	560	630	672	720	840			
	1008	1120	1260	1440	1680				
	2016	2520	3360	5040					

The Factors of 2500
(there are only 14 of them)







1	2	4	5	10
20	25	50	100	
125	250	500		
625	1250			

The number 2520 can only be subdivided 47 different ways as opposed to 5040's 59 different ways.

But 47 different ways is still quite a lot, considering 2500 can only be subdivided in a paltry **14 different ways**.

To put it visually, 5040 is double the Auric Number, or two of Marshall's Great Eagles, it's a double-Sabbatizat, or a double Mane-Mane-Thequel-Phares.

The number 5040 isn't a bad number to pick, it's just that 2520 has the same extraordinary ability to be divisible by all the single digits. Plus it's more "economical" (it's a lower number).

<table style="width: 100%; border-collapse: collapse;"> <tr><td style="text-align: center;">2520</td><td style="text-align: center;">2520</td></tr> <tr><td style="text-align: center;">The Great Eagle</td><td style="text-align: center;">The Great Eagle</td></tr> <tr><td style="text-align: center;"></td><td style="text-align: center;"></td></tr> </table>	2520	2520	The Great Eagle	The Great Eagle			=	5040
2520	2520							
The Great Eagle	The Great Eagle							
								
<table style="width: 100%; border-collapse: collapse;"> <tr><td style="text-align: center;">The Auric Number</td><td style="text-align: center;">The Auric Number</td></tr> <tr><td style="text-align: center;">2520</td><td style="text-align: center;">2520</td></tr> </table>	The Auric Number	The Auric Number	2520	2520	=	5040		
The Auric Number	The Auric Number							
2520	2520							
<table style="width: 100%; border-collapse: collapse;"> <tr><td style="text-align: center;">Sabbatizat</td><td style="text-align: center;">Sabbatizat</td></tr> <tr><td style="text-align: center;">2520</td><td style="text-align: center;">2520</td></tr> </table>	Sabbatizat	Sabbatizat	2520	2520	=	5040		
Sabbatizat	Sabbatizat							
2520	2520							
<table style="width: 100%; border-collapse: collapse;"> <tr><td style="text-align: center;">Mane Mane Thequel Phares</td><td style="text-align: center;">Mane Mane Thequel Phares</td></tr> <tr><td style="text-align: center;">2520</td><td style="text-align: center;">2520</td></tr> </table>	Mane Mane Thequel Phares	Mane Mane Thequel Phares	2520	2520	=	5040		
Mane Mane Thequel Phares	Mane Mane Thequel Phares							
2520	2520							

36,000
- 10,080
25,920
(the number of years in Copernicus' Great Year)

We'll see shortly how 5040 was also important to Dee, but, as a side-note, I want to point out something about "double 5040" or 10080.

When subtracted from 36000 (which is a close cousin of 360) the result is 25,920 the number Copernicus used for the Great Year of the Precession of the Equinox. It's amazing how all those numbers are related.

More of Plato's Mathematical Cosmology

A few pages later, (in *The Laws* 745 c-e) Plato describes what Saunders calls the “Administrative Units of the State.”

“After this, the legislator’s first job is to locate the city as precisely as possible in the center of the country, provided that the site he chooses is a convenient one for a city in all other respects too (these are details which can be understood and specified easily enough.)

Next he must divide the country into twelve sections. But first he ought to reserve a sacred area for Hestia, Zeus, and Athena (calling it the ‘acropolis’), and enclose its boundaries;

he will then divide the city itself and the whole country into twelve sections by lines radiating from this central point.

The twelve sections should be made equal in the sense that a section should be smaller if the soil is good, bigger if it is poor.”

Here’s a rough idea of what the Idea City might look like:

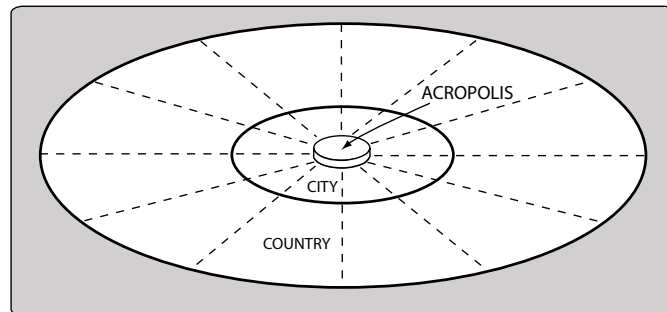

Plato's Ideal City is divided into “12 sections”

The Athenian Stranger continues,

“The legislator must then mark out 5040 holdings, and further divide each into two parts; he should then make an individual holding consist of two such parts coupled so that each has a partner near the center or the boundary of the state as the case may be.

(A part near the city and a part next to the boundary should form one holding, the second nearest the city with the second from the boundary should form another, and so on.)

He must apply to the two parts the rule I’ve just mentioned about the relative quality of the soil, making them equal by varying their size.”

Basically, Plato suggests dividing the rural countryside into 10080 parts (5040 x 2).
And each landowner gets 2 parcels.

If a landowner is lucky enough to get a parcel very close to the city, his second parcel is way out by the outer border.

The landowner with the second “closest to the city” parcel gets a second parcel that is in a bit from the outer border, etc.

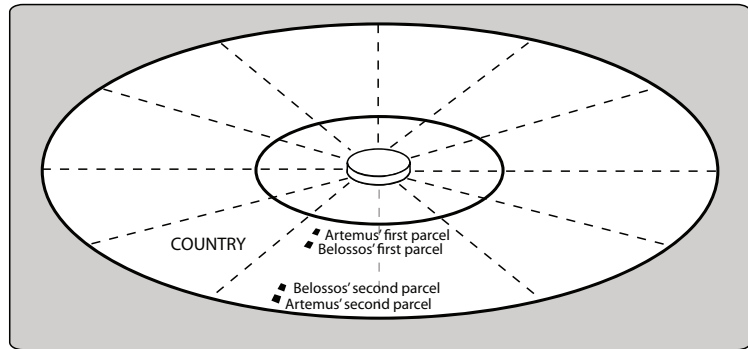

Equitable land ownership

“He should also divide the population into twelve sections, and arrange to distribute among them as equally as possible all wealth over and above the actual holdings (a comprehensive list will be compiled).”

Plato is suggesting the rich and the poor should be intermingled so no tribe is richer than the next.

“Finally, they must allocate the sections as twelve ‘holdings’ for the twelve gods, consecrate each section to the particular god which it has drawn by lot, name it after him, and call it a ‘tribe’.”

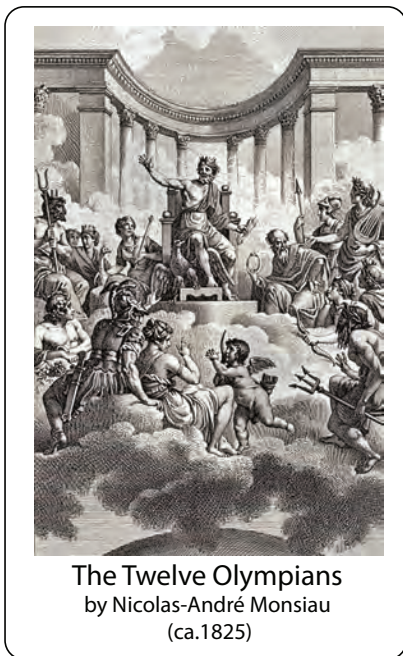

The 12 Olympians, or the “*Dodekatheon*” (*dodeka* meaning “12” and *theo* meaning “gods”) which reside on Mount Olympus.

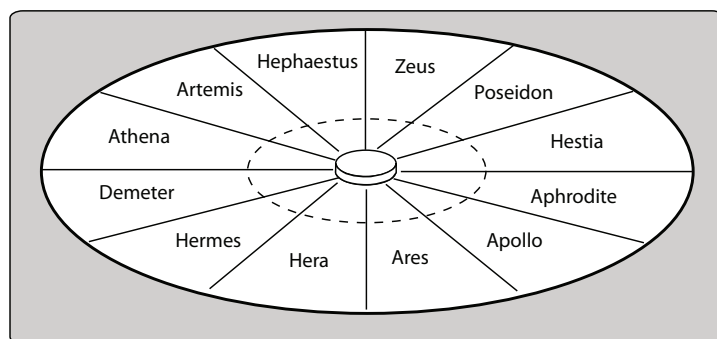

The 12 tribes are named after the 12 Olympians

(In his dialogue entitled *Phaedrus*, Plato actually corresponds these 12 gods with the 12 signs of the Zodiac.)

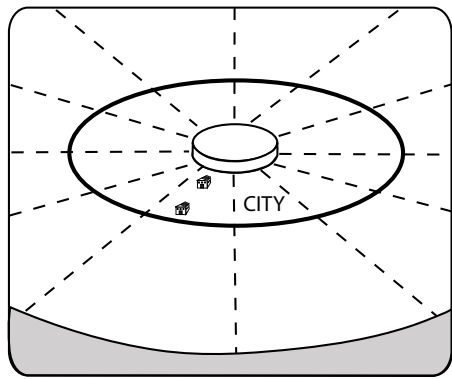

Two houses in the City

“Again, they must divide the city into twelve sections in the same way as they divided the rest of the country; and each man should be allotted two houses, one near the center of the state, one near the boundary. That will finish off the job of getting the state founded.”

Further on in *The Laws* is what Sanders calls “The Organization of Religious Festivals,” in which Plato continues to be methodically mathematical.

“The best way to start the next section of our code will be to deal with matters of religion.

First, we should go back to the figure of 5,040 and reflect again how many convenient divisors we found both in this total and its subdivisions, the tribe (which is one-twelfth of the total, as we specified, that is, exactly the product of twenty-one multiplied by twenty).

Our grand total is divisible by twelve, and so is the number of persons in a tribe, and in each case this subdivision must be regarded as holy, a gift of God, corresponding to the months of the year and the revolution of the universe.”

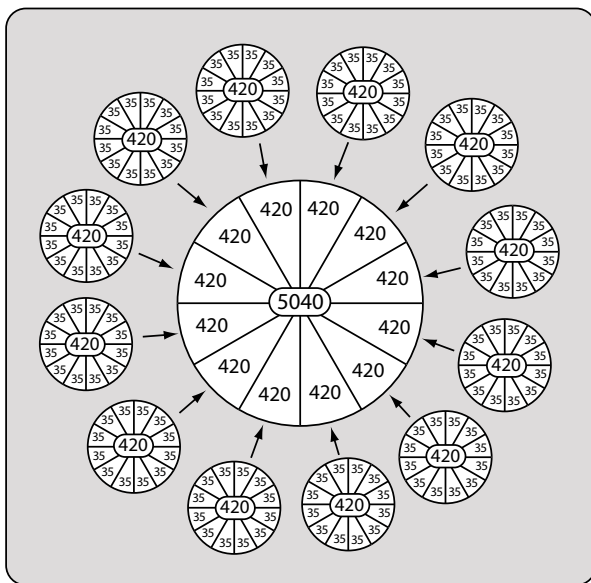

12 “sub-tribes” of 35 people each = 420 people per tribe

Let’s analyze Plato’s math.

Dividing the total population of 5040 into 12 tribes makes 420 people per tribe.

Dividing the 420 people in a tribe in 12 “sub-tribes” makes 35 people per “sub-tribe.”

Seen mathematically:

$$12 \times 35 = 420$$

$$420 \times 12 = 5040$$

But, why does Plato describe 420 as being 21 x 20?

$$21 \times 20 = 420$$

$$420 \times 12 = 5040$$

Well, $12 \times 35 \times 12 = 5040$ is quite nice, but $12 \times 20 \times 21 = 5040$ contains clues as to why 5040 is so special.

Two of the three factors
Plato selects are 12 and 21.

Not only are they reflective mates,
they are the first transpalinromic pair!

And they multiply to 252,
Dee's Magistral number!

In other words, a "5040 pizza pie,"
divided 20 ways,
makes slices of 252 each.

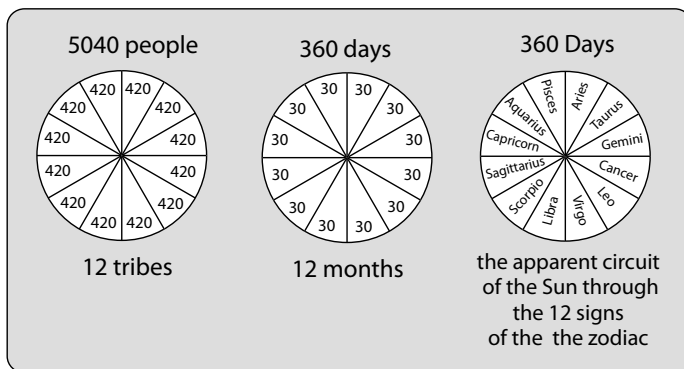
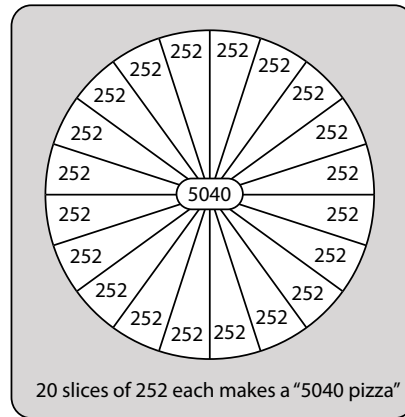

Plato also compares the Ideal City's 12 divisions to the **12 months** of the year and the annual march of the sun through the **12 signs of the zodiac** over the course of a year.

He is using the same mathematical cosmology for the land division, population, the organization of time, and astronomy!

“This is exactly why every state is guided by innate intuition to give these fractions the sanction of religion, though in some cases the divisions have been made more correctly than in others and the religious backing has proved more successful.

So for our part we claim that we had every justification for preferring 5,040, which can be divided by every number from one to twelve, except eleven

(a drawback that's very easily cured:

one way to remedy it is simply to omit two hearths).

The truth of this could be demonstrated very briefly in any idle moment.”

The number 5040 is not evenly divisible by 11,
(as $5040 \div 11 = 458.1818\dots$).

But $11 \times 458 = 4038$, which is only 2 shy of 5040.

So by “omitting two hearths,” division by 11 is possible.

Plato recommends a “sub-division block party” once a month
and a “full tribal festival” once a month as well:

**“So let’s trust to the rule we’ve just explained,
and divide our number along those lines.**

**We must allocate a god, or child of a god, to each division
and subdivision of the state and provide altars and the associated equipment;**

**we must establish two meetings per month for the purposes of sacrifice,
one in each of the twelve tribes into which the state is divided, and another
in each of the twelve local communities that form the divisions of each tribe.**

**This arrangement is intended to ensure, first,
that we enjoy the favour of the gods and heaven in general,
and secondly (as we’d be inclined to stress) that we should grow
familiar and intimate with each other in every kind of social contact.”**

Plato extends his mathematical cosmology even further in a passage that Saunders titles
“The Pre-eminence of Mathematics.” (*The Laws* 746-d to 747-d, pp. 171-2)

**“Now that we’ve decided to divide the citizens into twelve sections,
we should try to realize (after all, it’s clear enough)
the enormous number of divisors the subdivisions of each section have,
and reflect how these in turn can be further subdivided
and subdivided again until you get to 5,040.**

**This is the mathematical framework which will yield you
your brotherhoods, local administrative units, villages,
your military companies and marching-columns,
as well as units of coinage,
liquid and dry measures,
and weights.**

**The law must regulate all these details so that the proper
proportions and correspondences are observed.”**

Wow! Plato also wants such varied things as the militia, the monetary system, and all
weights and measures to relate to 12-ness and 5040

And he doesn’t want it to be a recommendation. He wants it to be the law!

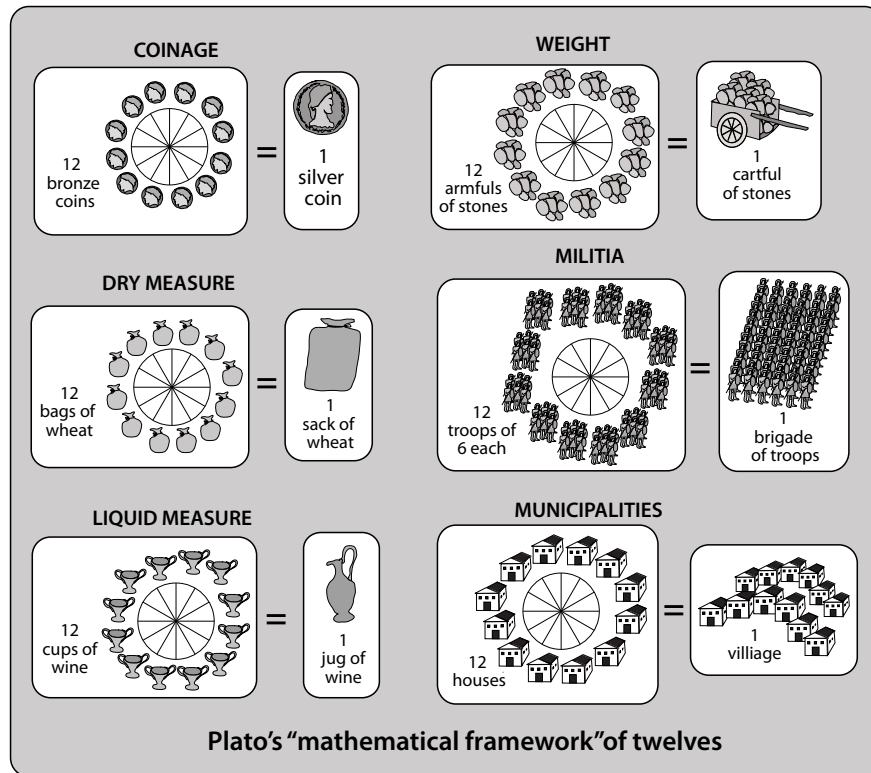

Here's a creative sketch of how some of these things are divided into twelfths.

Add to these things the 12 part division of the land, population, and time and the gods.

12 tribes = 5040 citizens

12 months = 360 days

12 part division of land = 5040 parts

12 Greek gods = dodektheon

Plato would probably recommend 12 channels for the TV sets as well!

(or maybe 144 or 2520 or 5040 if he had cable TV)

“And not only that: the legislator should not be afraid of appearing to give undue attention to detail.

He must be bold enough to give instructions that the citizens are not to be allowed to possess any equipment that is not of standard size.

He'll assume it's a general rule that numerical division in all its variety can be usefully applied to every field of conduct.

It may be limited to the complexities of arithmetic itself, or extended to the subtleties of plane and solid geometry; it's also relevant to sound, and to motion (straight up or down or revolution in a circle).

The legislator should take all this into account and instruct all his citizens to do their best never to operate outside that framework.”

Plato's pretty emphatic that manufactured goods conform to his mathematical cosmology as well – in fact “every field of conduct.” It's an “all-purpose” system.

It's a system that is arithmetical and geometrical.

In “plane geometry,” this means a circle divided up into 12 parts (recall Benedict Arnold's mark on the first Governor's chair) or a rectangle divided into 12 parts (recall the 4:3 ratio of the Title page of Dee's *Monas Hieroglyphica*).

Plato says his general rule applies to “solid geometry.” The most obvious solids that can be divided into twelfths are the dodecahedron or the rhombic dodecahedron. Another example of twelveness is the 12 spheres- around-1 sphere cuboctahedral shape.

Plato implies his cosmology is relevant to music (like Nicomachus' and Boethius' greatest and most perfect harmonies express musical fourths, fifths, the octave and the tone) and to movement (in a line or in a circle).

Again he stresses that lawmakers should make sure everyone and everything operates according to this organized numerical system.

Plato ends with an advertisement for mathematics that would make any Math teacher smile:

**“For domestic and public purposes, and all professional skills,
no single branch of a child's education
has such an enormous range of applications as mathematics;**

**but its greatest advantage is that it wakes up the sleepy ignoramus
and makes him quick to understand, retentive and sharp-witted;
and thanks to this miraculous science he does better
than his natural abilities would have allowed.”**

To conclude, even though Plato says 5040 and not 2520, it's pretty obvious that he worked a lot with 2520 and was aware that it held all the wonders of 5040 yet was even more economical.

Why Plato chose 5040 rather than 2520

There appear to be several reasons that Plato made his city population 5040 instead of the more economical 2520. First, he wanted to be cryptic so philosophers “would do the math” and perceive the beauty of 2520 for themselves.

Second, a population of “around 5000” makes a big city strong enough to defend itself. But a population of “around 2500” would be more like a small town that would dependant upon on alliances for military protection.

Third, Plato liked to divide things into 12 parts. Dividing 5040 by 12 makes tribes of 420 people. A tribe of 420 can be divided by 12 to make 35 subdivisions.

The number 2520 can be divided into 12 parts of 210 people each. But when 210 is divided by 12, the result is 17.5, and having a “half-of-a-person” is impossible. Thus, he bumped 2520 up to 5040.

What Aristotle meant by “The Number of the Figure Becomes a Solid”

Let’s return to Aristotle’s brief quote about Plato’s number:

**“change has its origin in those numbers
‘whose foundation 4:3 yoked with the number 5 gives two harmonies’
– meaning whenever the number of this figure becomes solid.”**

(Aristotle, Politics 5:11:1316a, my translation)

To understand what Aristotle means by **“this figure becomes a solid,”** let’s return to Plato’s description of the 5 Platonic solids in *Timaeus* 55-c.

Though he doesn’t actually call them these names, he describes how their sides are constructed (except he didn’t describe the dodecahedron)

Plato chose this order because the first three all have triangular faces, the cube has square faces and the dodecahedron has pentagonal faces.

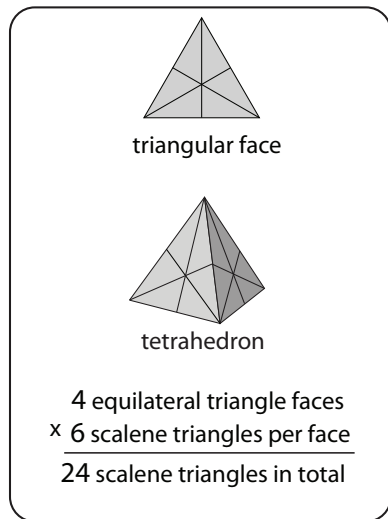
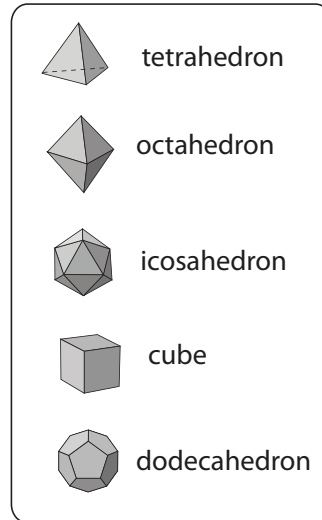

He describes the tetrahedron as being constructed from 4 equilateral triangles.

But he also divides each of those triangular faces into 6 smaller triangles by drawing in three diameters. Thus the tetrahedron is made from 24 scalene triangles.

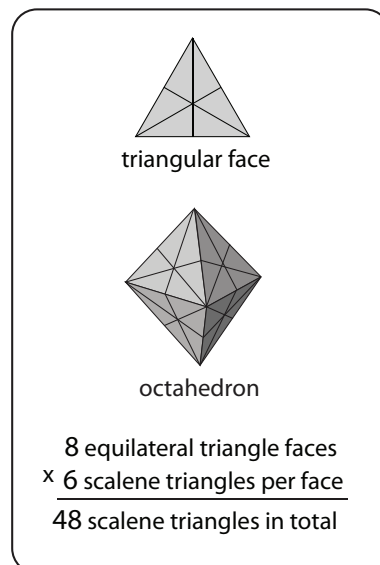

Next, the octahedron is constructed from 8 equilateral triangles, each of which is subdivided into 6 scalene triangles, making a total of 48 scalene triangles.

The icosahedron is constructed from 20 equilateral triangles. Again each one is subdivided into 6 scalene triangles, making a total of 120 scalene triangles.

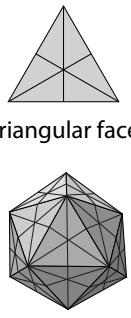

triangular face

icosahedron

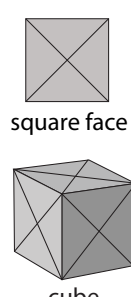
$$\begin{array}{r} 20 \text{ equilateral triangle faces} \\ \times \quad 6 \text{ scalene triangles per face} \\ \hline 120 \text{ scalene triangles in total} \end{array}$$

square face

cube

$$\begin{array}{r} 6 \text{ square faces} \\ \times \quad 4 \text{ isosceles triangles per face} \\ \hline 24 \text{ scalene triangles in total} \end{array}$$

The cube is constructed from 6 square faces.

Plato breaks each square face into 4 isosceles triangles by drawing the diameters that form a big X. Thus, a cube is made from 24 isosceles triangles.

Plato only writes one sentence about the fifth figure:

**“And as still there was one more compound shape,
a fifth one,
God used it to paint the Universe.”**

(Plato, *Timaeus*, 55c, my translation)

There are no other regular polygons with all triangular faces or all square faces, so Plato must be implying the regular polygon made from pentagonal faces. This is the dodecahedron with its 12 pentagonal faces.

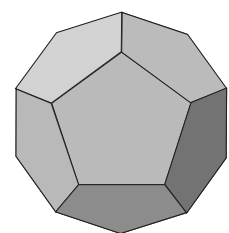

dodecahedron
with
12 pentagonal
faces

What does “diazôgraphôn” mean?

Looking closer into Plato’s description of this fifth shape, we find another connection to Dee.

Let’s focus on the last part of this which in Greek is “...*epi to pan ho theos autêi tíat-echresato ekeino diazographon.*” This literally translates word-for-word as: “upon with, the, the whole, the God, self, furnished, the thing, painted.”

Let’s explore that final word, *diazôgraphôn*, which I have simply translated as “painted.” It has 3 parts *dia* – meaning “through, across or between”, *zoê* meaning “life” and *graphie* meaning “writing or drawing.”

I asked my Greek translator Peter Lech to search through the literary passages cited in the *Thesaurus Linguae Graecae* and in different places it seemed to mean “to represent, to paint, to sculpt, to fashion, to mold, to decorate, or to depict.” One ancient author, Dionysius Thrax, says that some of the heroes in the times of Homer were illiterate, but could communicate in messages with pictograms which they called *diazôgraphein*.

Here’s the connection to Dee. In his renowned *Preface to Euclid*, Dee explains 19 “Sciences and Artes Mathematicall” that derive from Arithmetic and Geometry. On that list is **Zographye**:

**“How the intersection of all visual Pyramids,
made by any plane assigned
(the Center, distance, and lights being determined)
may be by lines and due proper colors represented.”**

(Dee, *Preface*, p. d.ij. verso)

In Greek, a Zographer is “one who paints from life.” But Dee incorporates sculpting in this category even citing the work of Giorgio Vasari (1511-1574) who wrote *Lives of the Most Excellent Painters, Sculptors and Architects*. As we’ve seen, Dee also incorporates the “**odd Art called Althamasat**” or the use of the camera obscura in Zography. He’s quite vague about what it is, but explains that it can be of great benefit to sculptors, engravers, and painters.

In short, the Universe was made from a dodecahedral pattern by molding, sculpting, drawing or even painting with a rainbow of colors. It was like God’s art project on the theme of twelve pentagons arranged as an almost spherical shape.

In the midst of his description of Zography, Dee writes,

**“... the most excellent Painter,
(who is but the proper Mechanician,
and Imitator sensible, of the Zographer)....**

He later refers to a painter as a Mechanical Zographer. What Dee seems to be implying is that a painter from life can only imitate or make a representation of the amazing painting the Great Zographer in the Sky has already created.

Dee seems to have gotten this image of god being a Zographer from Plato’s description in *Timaeus* 55c of *pan ... theos ... diazôgraphôn*, “God painting the Universe.”

As you may have realized, Dee’s English word Zography never really caught on. You won’t find it in any modern dictionaries or even in the Oxford English Dictionary.

[Incidentally, modern-day researchers like Jeffery Weeks, studying NASA cosmic background radiation data suggest the Universe may indeed be dodecahedral]

(Sean Markey, *National Geographic News*, October 8, 2003)

How should these pentagonal faces be subdivided?

Plato used “diameters” to subdivide the equilateral triangle. They all go through the triangle’s centerpoint. He couldn’t draw “diagonals” (between angles) because a diagonal of a triangle is simply the side of the triangle.

The subdividing lines on the square faces might be considered either “diameters” (which means “through measure,” as they pass through the centerpoint of the square) or “diagonals” (which means “between angles,” as they connect opposing angles.)

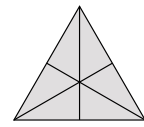

triangular face

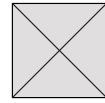

square face

diameters
that connect
non-adjacent vertices

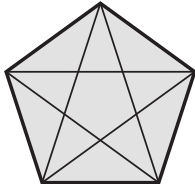

(these diameters
do not pass
through the pentagon's
centerpoint)

diameters
that connect a vertex
and the midpoint
of the opposing edge

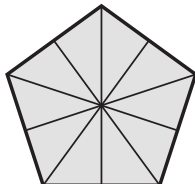

(these diameters
pass through
the pentagon's
centerpoint)

“two kinds of “diameters” of a pentagon

But on the pentagon, there are two types of diameters.

One kind connects non adjacent vertices and results in a pentagram star. (Plato’s “well-known” diameter)

The other kind connects each vertex with the midpoint of its opposing edge. This kind of diameter passes through the centerpoint of the pentagon. (Plato’s “not-so-well-known” diameter)

The pentagram star method results in 10 isosceles triangles and a small pentagon left over in the center. The other method results in 10 scalene triangles.

Which one did Plato have in mind?

The answer seems to be: **BOTH.**

He ordered the combo platter.

When these two sets of “diameters” are superimposed, their criss-crossing lines make 30 triangles. (Count ‘em, there are 30.)

They aren’t all equal in size, but they are all scalene.

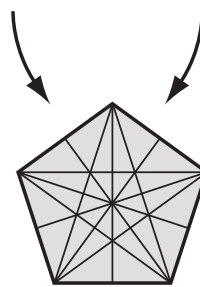
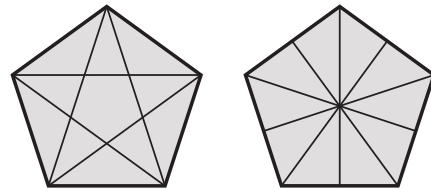

30 scalene triangles
(though not all equal in size)

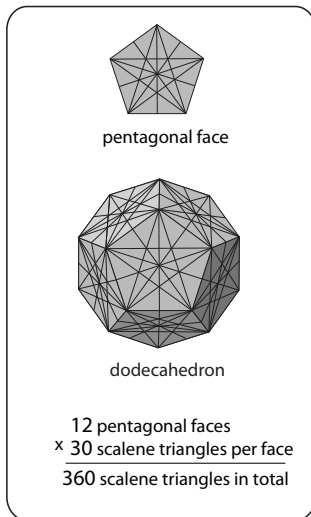

On the dodecahedron,
if all 12 pentagonal faces
have 30 scalene triangles,
that makes a total of
360 scalene triangles!

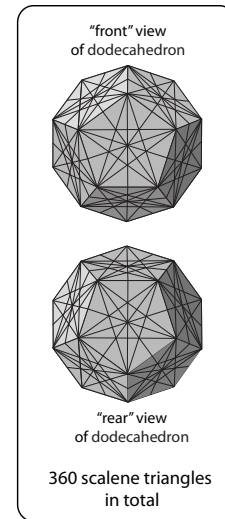

So when Aristotle says
that Plato was referring to...

**“change has its origin in those numbers ‘whose
foundation 4:3 yoked with the number 5
gives two harmonies’
– meaning whenever the number
of this figure becomes solid.”**

...he seems to be presenting an abbreviated version of Plato’s number:
The “solid” is the dodecahedron with 12 faces (4x3)
that are each pentagons (5 sides),
and in the pentagons there are 2 harmonies (or kinds of diameters).
Aristotle might have been brief, and somewhat cryptic,
but he provides important clues to decoding Plato’s *Republic* 8:546.

Alcinous sees 360 different scalene triangles

A confirming clue that this is what Aristotle (and Plato) had in mind comes from the Greek philosopher Alcinous (pronounced like Alkinous), who wrote a work called *The Handbook of Platonism* around 175 BC (about 125 years after Aristotle’s time).

**“The other one, I mean the isosceles, becomes the component of the cube;
for the conjunction of four isosceles triangles makes a square
and from six of these squares one gets a cube.**

**The dodecahedron God utilized for the universe as a whole,
because one sees in the heavens twelve zodiacal signs in the zodiacal circle,
and each of them is divided into thirty degrees,
even as the dodecahedron is composed of twelve pentagons
each divided into five triangles,
of which each in turn is composed of six triangles,**

**so that one finds in the dodecahedron as a whole
three hundred and sixty triangles,
which is the same number as the degrees of the zodiac?”**

(Alcinous, *The Handbook of Platonism*, 13:169, in Dillon, John M., translator, p. 22)

As you can see, Alcinous describes the “net” lines in the pentagon slightly differently.

He first divides the pentagon into 5 isosceles triangles. (they may look equilateral, but one side is slightly longer than the other two)

Then he divides each of the isosceles triangle into 6 scalene triangles. Like Plato’s implied model, these scalene triangles are not all of equal size.

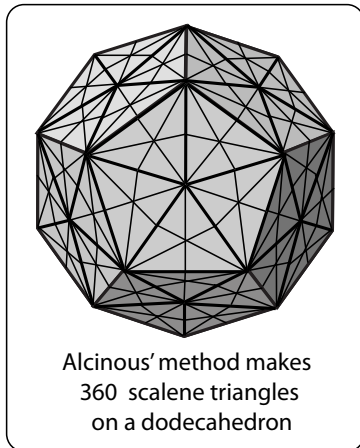
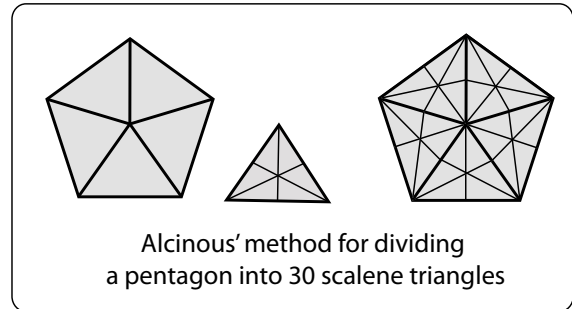

The “net” result is that Alcinous’ dodehedron has 360 scalene triangles.

(For comparaisn, on the right here is a dodecahedron divided using Plato’s implied method.

With which net did God paint the Universe?

I can’t answer that one, but visualizing these nets will give us insight into Plato’s numerical cosmology.

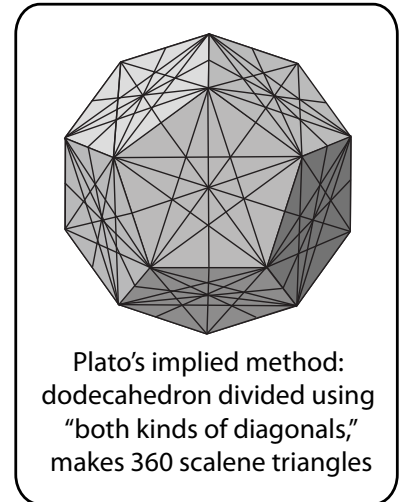

The two nets are similar in one regard. The initial lines that Alcinous used to divide the pentagon are part of the “vertex-to-opposing mid-edge” diagonals used in Plato’s implied method.

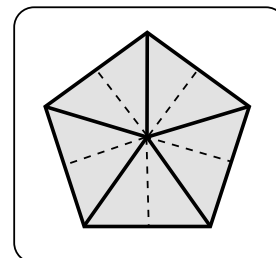

About 275 years later, Plutarch (ca. 46 AD-120 AD) in *Platonic Questions* comments on Plato and Aristotle’s dodecahedron:

“Is their opinion true who think that he ascribed a dodecahedron to the globe, when he says that God made use of its bases and the obtuseness of its angles, avoiding all rectitude, it is flexible, and by circumtension, like globes made of twelve skins, it becomes circular and comprehensive.”

(Quaestiones Platonicae 5.1, 1003C (R. Brown trans.), in Plutarch’s *Morals*, ed. W.W. Goodwin (1870), vol. 5, p.433, as quoted and Giorgio de Santillana and Hertha von Dechend, *Hamlet’s Mill*, p. 187)

As Santilla and von Dechund put it in *Hamlet’s Mill*, to Plato, the “**world is a dodecahedron.**”



Plutarch writes about “the obtuseness of its angles, avoiding all rectitude.” He simply means all the angles are larger than the 90 degree right (*rect*) angle.

When he writes that it “is flexible and by circumtension, like globes made of twelve skins, it becomes circular and comprehensive.” He’s describing an inflated dodecahedron – like a primitive soccer ball.

(Modern-day day soccer balls are a little different. Some of the faces are 5-sided and some are 6-sided. Geometrically, they are actually the intersection of an icosahedron and a dodecahedron.)

In *Phaedo*, one of Plato’s earlier works, Socrates even declares that,
“ the earth when seen from above is said to look like those balls that are covered with twelve pieces of leather”

(Plato, *Phaedo* trans. by Harold North Fowler, Loeb, p. 379)

Plutarch describes the 12 pentagons (calling them “**equilateral and equiangular quin-quangles**” (now there’s a fun word).

He also says each of the interior angles of the pentagon is “one and the fifth part of a right angle,” his way of saying 108 degrees. (One fifth of a ninety degree angle is 18 degrees; and $90 + 18 = 108$).

He also says that each of the pentagons consists of 30 scalene triangles, adding,
“Therefore it seems to resemble both the Zodiac and the year, it being divided into the same number of parts as these.”

(Ibid, Santillana and von Dechund, p. 187)

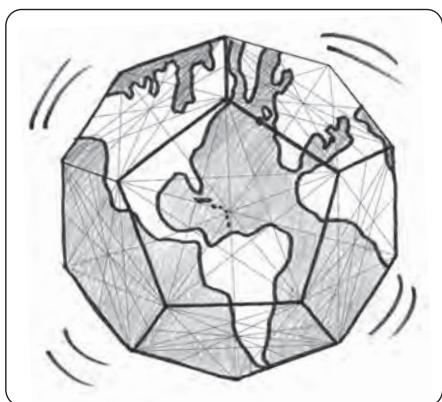

Did Plato see the earth as a dodecahedron”

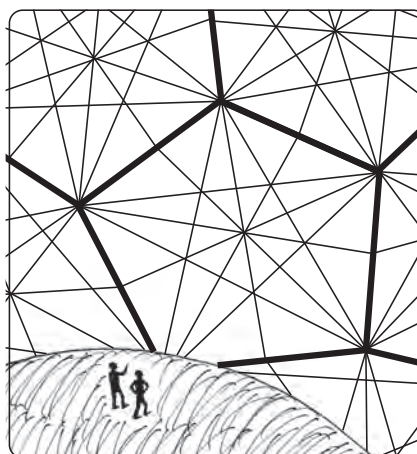

Did Plato see the Universe as a dodecahedron?

The angles found in the pentagon might ring a bell

To Dee, geometry and arithmetic were sisters. In his *Preface to Euclid* he emphasizes these are the two “principal” mathematical Arts upon which all the others are based. Robert Marshall called geometry and number “two sides of the same coin.” So let’s see what numbers pop up in the surface angles of these various subdivisions.

Plato’s subdivision of the equilateral triangle makes equal-sized 30-60-90 degree triangles.

His subdivision of the square makes equal-sized 45-45-90 degree triangles.

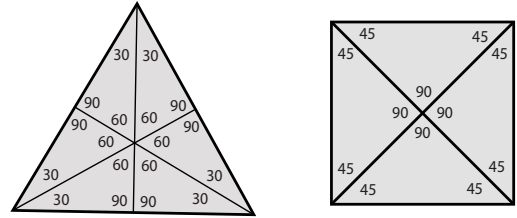

Plato's subdivision of the equilateral triangle and the square

Plato's implied method of dividing a pentagon with diagonals

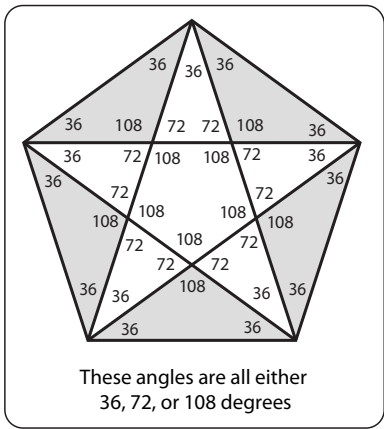

These angles are all either 36, 72, or 108 degrees

The pentagon divided by its “vertex-to-vertex diameters” makes angles of 36, 72, and 108 degrees.

The pentagon divided by the “vertex-to-opposing mid-edge” diameters makes angles of 36, 54, and 90 degrees.

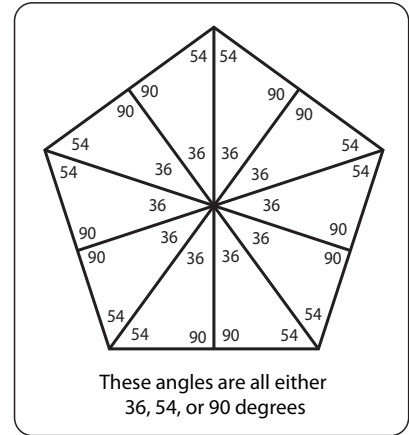

These angles are all either 36, 54, or 90 degrees

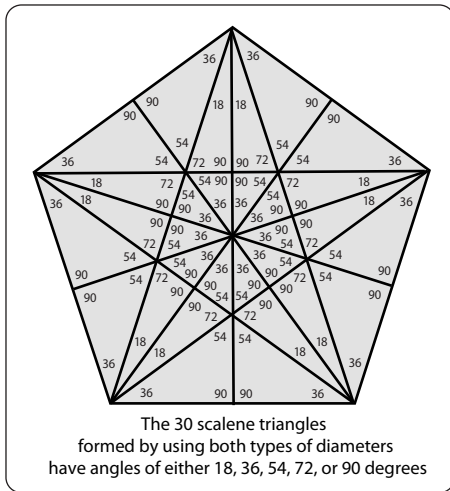

The 30 scalene triangles formed by using both types of diameters have angles of either 18, 36, 54, 72, or 90 degrees

The pentagon divided by both types of diameters combined make angles of 18, 36, 54, 72, or 90 degrees.

Do these numbers sound familiar? They are all members of the “9 Wave” of Consummata! (multiples of 9).

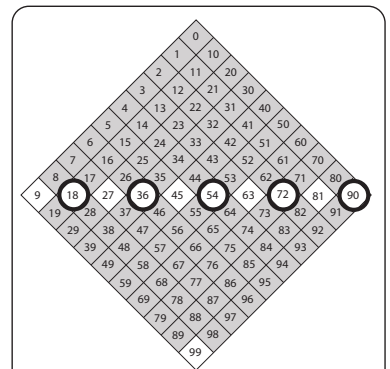

18, 36, 54, 72, and 90 are all members of the “9 Wave”

Alcinous' method of dividing a pentagon

Alcinous first divides the pentagon into 5 parts. They may look 5 equilateral triangles, but they're not. They're 54-54-72 degree triangles.

He then divides these isosceles triangles into 6 parts each. This renders 27-63-90, and 27-54-90, and 36-63-81 degree triangles. Notice anything familiar?

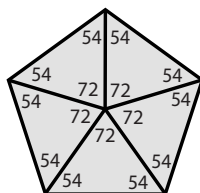

Alcinous' first divides the pentagon into 5 parts.

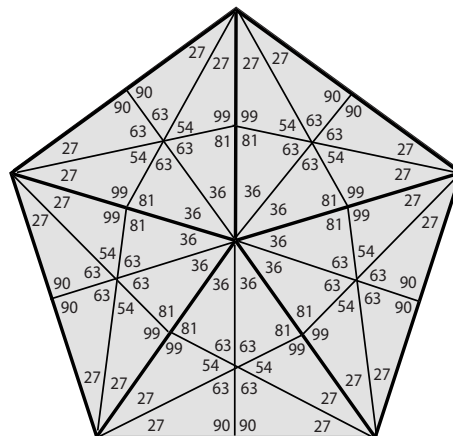

The 30 scalene triangles created using Alcinous' method have angles of either 27, 36, 54, 63, 81, or 99 degrees.

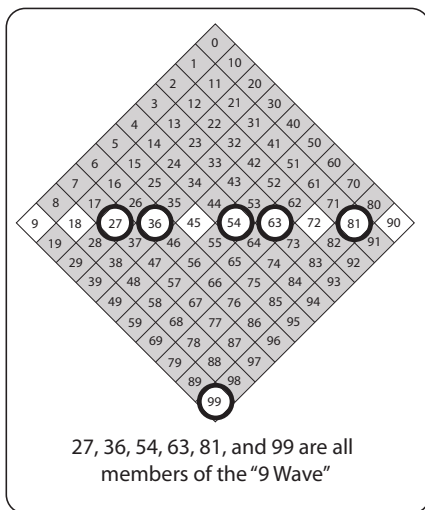

27, 36, 54, 63, 81, and 99 are all members of the "9 Wave"

More hints of Consummata

Again, all these numbers are members of the "9 Wave" of Consummata!
A synthesis of Geometry and Number.

Hints of Metamorphosis

There are hints of Metamorphosis in the air as well. Instead of the two types of diameters, here are the two types of radiuses. Both create arrays of five 72 degree angles. clustered around a centerpoint. This is an echo of the step in Metamorphosis from 72 to 360. (72 x prime number 5 = 360)

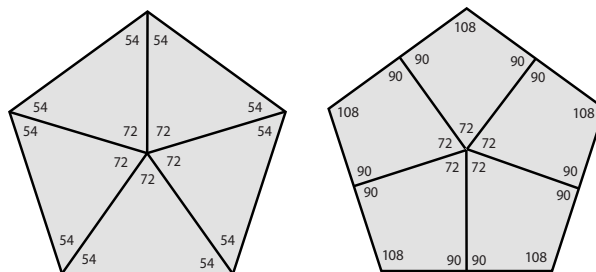

The "2 different types of radiuses" yield angles of either 54, 72, 90, or 108 degrees

And let's not overlook the most obvious connection to Metamorphosis. Plato's implied method or Alcinous' method each make a "Metamorphosis number of scalene triangles": 360.

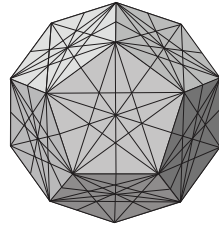

Plato's implied method makes 360 scalene triangles on a dodecahedron

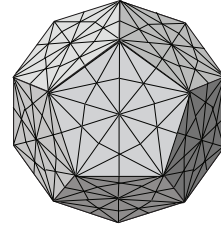

Alcinous' method makes 360 scalene triangles on a dodecahedron

The Magistral number and the Syndex Pretzel pop up again

We've already seen that the internal angles of a pentagon are 108 degrees each, making each of the external angles 252 degrees, Dee's Magistral number.

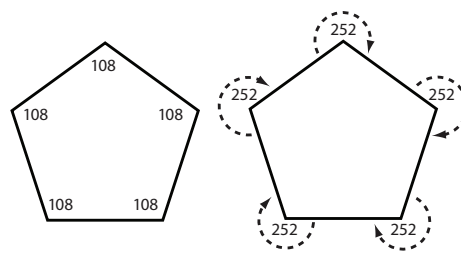

Interior angle of 108 degrees means exterior angles of 252 degrees

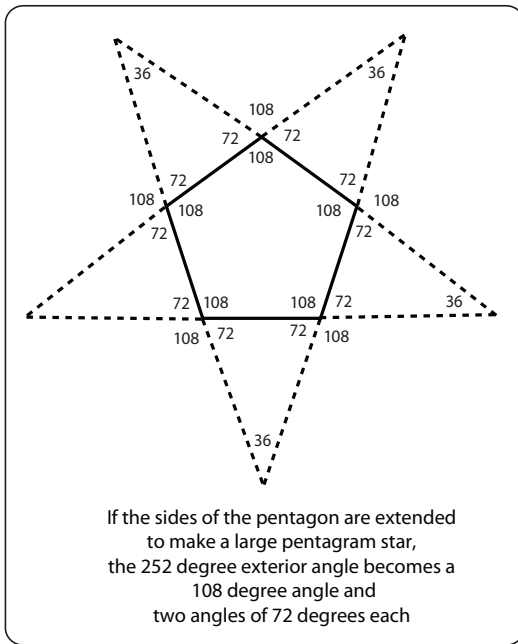

But by extending the edges of the pentagon until they meet and form a large-pentagram star, the 252 can now be seen as being made up of a 108 degree angle and two 72 degree angles (that special Hindu number 108 and two of the Metamorphosis numbers 72)

Adding those two 72 degree angles together makes 144. In other words, each corner of the pentagon can be seen as an expression of the left side of the Syndex Pretzel, $108 + 144 = 252$

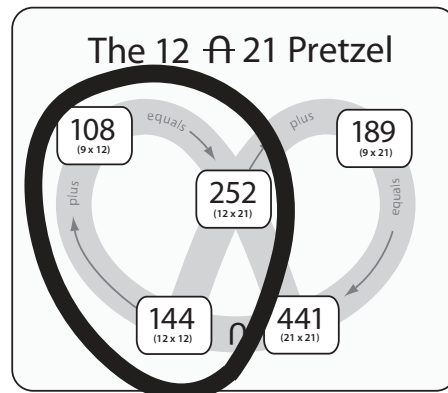

Are you starting to get a feel for why Dee felt Geometry and Number were sisters?

Recap of this geometric journey

To summarize, let's review Dee's revealing quote in Theorem 23 of the *Monas*.

**“Four famous Men who were Philosophizing together (in times past),
through their labors, grasped its real Effect.**

For a long time, they were Astonished by the Great Wonder of the Thing.

**Then, at length, they devoted themselves entirely to Singing and preaching
Praises of the Most Good and Great God.**

**On account of this, they were granted great Abundance,
as well as the Wisdom and Power
to rule over other CREATURES”**

(Dee, *Monas*, Theorem 23, p. 27)

Dee seemed to feel that Plato, in *The Republic* 8:546,
“...grasped its real Effect ...” and was “...Astonished by the Great Wonder ...”
of 12-ness, 360-ness and 2520-ness.

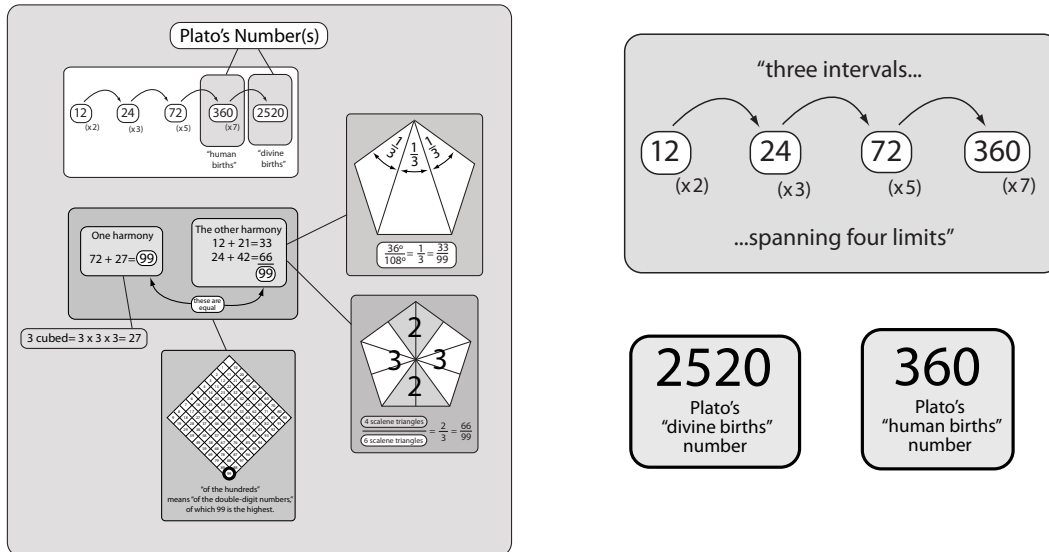

Dee also seemed to feel that Plato, in the Ideal City of *The Laws* is
“...Singing and preaching Praises...”
of 12-ness, 360-ness and 2520-ness

Dee's metaphor for the "yolking" of things with 4:3 character and things of 5 character is not two oxen, but "female, Lunary planets" and "male, Solary planets." This organization is the basis of what I call Dee's "Decad of Shapes."

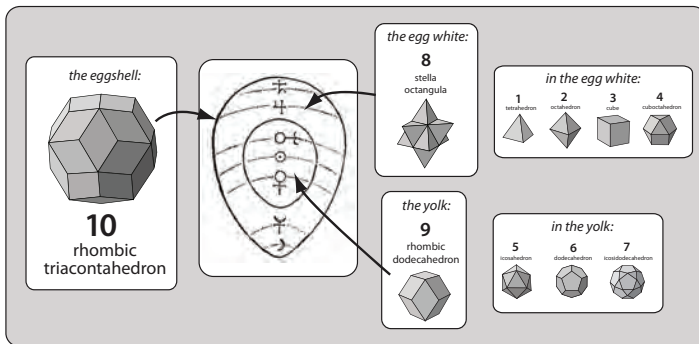
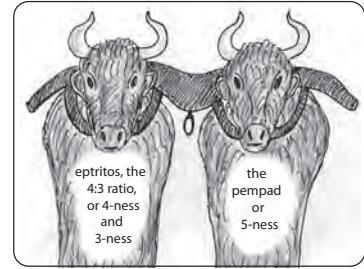

Here Dee portrays the results of his "Megethological Contemplations" using a "parts of an Egg" metaphor, but I like to picture them as one big happy family.

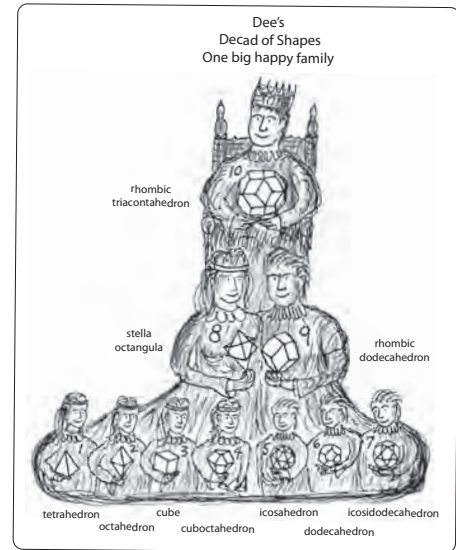

DEE PLANTS MORE CLUES ABOUT PLATO'S NUMBER

*Dee's chart of the number
of possible ways
7 planets can be joined*

At the end of the *Propaedeumata Aphoristica* Dee presents his only chart in the whole text.

It looks dauntingly mathematical, but its really quite simple when analyzed one column at a time.

First let's break it down into two charts (as Dee has done), one for Aphorism 116 and the other for Aphorism 117.

Pro Aphorismo CXVI.				Pro Aphorismo CXVII.			
1	1	0	0	0	7	5040	
2	2	21	42	2	6	15120	
3	6	35	210	3	5	4200	
4	24	35	840	4	4	840	
5	120	21	2520	5	3	120	
6	720	7	5040	6	2	14	
7	5040	1	5040	7	0	1	
				13692		25335	
Plantae inaequaliter fortitudinis conuictae p.				Varietates conuictioem habent, ac- neculis daturae.		Aequalitates secundum conuictioem vari- tatis, conuictioem rationem vari- tatis, ex aequalitate p. b. d. a.	
				Conuictioem variatam per conuictioem numerum transpositionis, Multiplicationis.		Plantae aequaliter fortitudinis conuictae.	
				Transpositiones secundum inaequalitatis for- titudinis daturae.			

Dee's chart for Aphorisms 116 and 117
in the *Propaedeumata Aphoristica*

The First Chart (Conjunct planets of unequal strength)

1 planet alone	○	1	1	0	0
2 planets	○○	2	2	21	42
3 planets	○○○	3	6	35	210
4 planets	○○○○	4	24	35	840
5 planets	○○○○○	5	120	21	2520
6 planets	○○○○○○	6	720	7	5040
7 planets	○○○○○○○	7	5040	1	5040
					13692

First Column

The first column of the first chart is simply the numbers from 1 to 7, but they represent different groupings of planets.

1	1	0	0
2	2	21	42
3	6	35	210
4	24	35	840
5	120	21	2520
6	720	7	5040
7	5040	1	5040
			13692

Second Column

The second column shows the number of possible permutations found in each of these 7 groupings.

The easiest example to perceive is the grouping of 3 planets, let's call them planets A, B, and C. If order matters, they can be "conjunct" or "paired together" in 6 different ways.

This is "*Noster Metathesos Canon*" or "Our Canon of Transposition" that Dee writes about after presenting the Pythagorean Quaternary in Theorem 23 of the *Monas*. The example he uses there is four things. To find the number of possible permutations he multiplies $1 \times 2 \times 3 \times 4$ and gets 24 possible permutations (just as he has done on this chart).

In other words, column 2 shows the "factorials" of the first column, which in modern-day lingo is "n!"

So when "n," the number of planets, is 7, then $7!$ or $1 \times 2 \times 3 \times 4 \times 5 \times 6 \times 7 = 5040$.

The number of citizens in Plato's Ideal City pops up in Dee's chart!

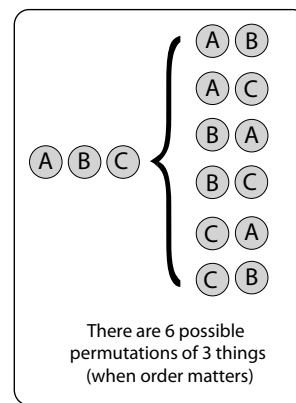

A brief history of permutations

D.E. Smith, in *The History of Mathematics*, writes that the subject of permutations goes back to the Chinese *I Ching*. The Greeks showed some interest in the subject, but didn't develop it into mathematical theorems.

Around 1100 AD, Hebrew astronomers like Rabbi ben Ezra studied this very problem of the permutations and combinations of the 7 planets, inspired by the anonymously written *Sepher Yetzira* (the Hebrew *Book of Creation*).

**“Two stones build 2 houses
 Three stones build 6 houses
 Four stones build 24 houses
 Five stones build 120 houses
 Six stones build 720 houses
 Seven stones build 5040 houses.”**

(Sepher Yetzirah 4:16)

The “stones” actually refer to “letters of the alphabet” and the “houses” refer to the possible “words” that can be constructed from them. Note that these are all the same results as the second column on Dee’s chart.

In the 1300’s, the Hebrew astronomer Levi ben Gerson and the French philosopher Nicholas Orseme explained the rules for permutations and combinations.

My example using people sitting around a table actually comes from Luca Pacioli’s 1464 *Suma*. Gerolamo Cardano and his rival Nicolo Tartaglia both used this math knowledge to figure out the odds in throwing dice. The French mathematician Johannes Buteo used it to calculate the permutations of the cylinder positions in a combination lock.

So it’s not as if Dee was breaking new ground with his math.

1	1	0	0
2	2	21	42
3	6	35	210
4	24	35	840
5	120	21	2520
6	720	7	5040
7	5040	1	5040
			13692

Third Column

The third column Dee labels “*Varietates conjunctionum, binorum, ternorum, &.,*” meaning the “varieties of conjunctions,” like 2 planets conjunct at a time, 3 planets are conjunct at a time, etc.

Let’s take the example of 2 of these 7 planets being conjunct at the same time. But instead, let’s envision it as at it as 7 people sitting around a table. How many different conversations between 2 (and only 2) people can there be?

With 7 people around a table there can be 21 different 2-person conversations.

Here you can count the number of 2-way conversations, they are the 21 interconnection lines.

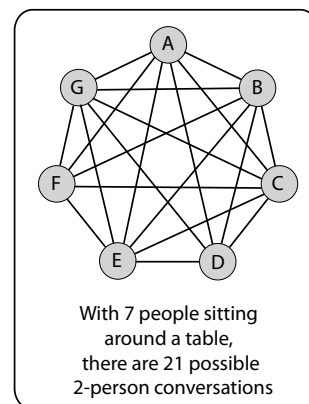

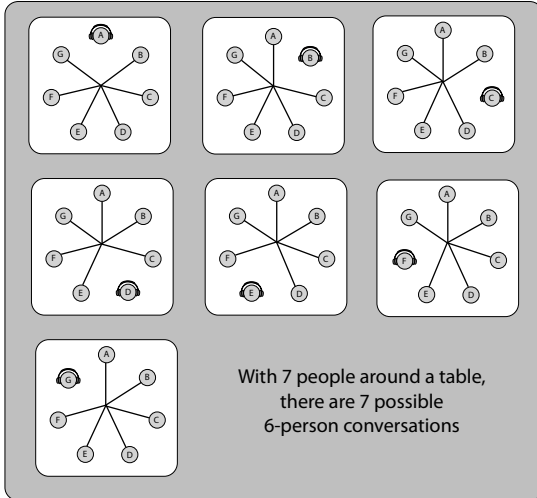

As another example, let's look at how many 6-person conversations can take place among these 7 people.

Let's give the silent person headphones, so he doesn't hear the cacophony.

Without getting into the mathematics of it, the numbers in this column can be figured out using the formula:

$$\frac{7!}{(7-n)! n!}$$

where n is the number of planets in conjunction (or the number of people in on the conversation).

Notice that the top box in Dee's third column is zero. If there is only one planet, there's no other planet for it to be conjunct with. (If everyone at the table has headphones on, you can't converse with anyone.)

Dee notes in the text of Aphorism 116 that there are 120 total conjunctions in this column (which is also the number of Aphorisms in his book).

It seems strange that the numbers in this column go 21, 35, 35, 21, but that's how the math works out. (Mathematicians will recognize this as part of one of the rows in Pascal's Triangle and will understand the connection.)

1	1	0	0
2	2	21	42
3	6	35	210
4	24	35	840
5	120	21	2520
6	720	7	5040
7	5040	1	5040
			13692

Fourth Column

The final column in this chart is simply the results of column 2 times the results of column 3.

These results show the number of ways the various groupings are conjunct when no two powers of the planets is the same.

But look who shows up!

Dee's Sabbatizat, 2520,
and Plato's Ideal City population, 5040.

The other results are factors of 2520:

(840 x 3 = 2520),
(210 x 12 = 2520),
and (42 x 60 = 2520)

The Second Chart (Conjunct planets of equal strength)

The second chart, as described in the text Aphorism 117, shows the number of ways the various groupings are conjunct when the relative strengths of the planets is ignored.

First Column (of the second chart)

The first column of this chart lists the possible groupings of planets.

(This is essentially the same as the “First Column of the first chart” except that the first entry is zero, representing the case where no two planets have equal strength.)

0	7	5040
2	6	15120
3	5	4200
4	4	840
5	3	120
6	2	14
7	0	1
		25335

0	7	5040
2	6	15120
3	5	4200
4	4	840
5	3	120
6	2	14
7	0	1
		25335

Second Column (of the second chart)

Without digging into the full mathematical reasoning here, the second column is basically number 8 minus the results in the “First Column in the first chart.”

Third Column (of the second chart)

The third column is the result of the second column factorialized and then multiplied by the 0, 21, 35, 35, 21, 7, 1 results found earlier in the first chart.

0	7	5040
2	6	15120
3	5	4200
4	4	840
5	3	120
6	2	14
7	0	1
		25335

For example, when the conjunction of 2 planets is considered (regardless of their relative strengths), the result is:

$$(1 \times 2 \times 3 \times 4 \times 5 \times 6) \times 21 = 15120$$

For 3 planets the result is:

$$(1 \times 2 \times 3 \times 4 \times 5) \times 35 = 4200$$

For 4 planets the result is:

$$(1 \times 2 \times 3 \times 4) \times 35 = 840$$

For 5 planets the result is:

$$(1 \times 2 \times 3) \times 21 = 126$$

Hold on a second. 126 is not the result Dee gives in his chart. He wrote 120. Whats going on here?

Pro Aphorismo CXVI.		Pro Aphorismo CXVII.	
1	1	0	0
2	2	21	42
3	6	35	210
4	24	35	840
5	120	21	2520
6	720	7	5040
7	5040	1	5040
		13692	25335

This should be 126, not 120.

Wayne Shumaker noted this error when translating Dee's work in 1978:

“Dee slipped in computing the number of conjunctions when five and only five bodies are equal.”

Shumaker was absolutely right. However, I contend it was an “intentional error,” not an “accidental error,” for several good reasons.

First, Dee was very detail oriented and would not have let such an egregious error slip through the cracks.

Second, when the book was reprinted in 1568, ten years after the original printing, the “error” was not corrected. For the second edition numerous changes were made in the text, it was totally re-typeset, and this chart was completely re-drawn. There is no way such an error would have passed by all Dee's readers during the decade when it was first published.

Finally, Dee has shown a pattern of hiding clues with intentional errors (like the Engraved 2 in the “Thus the Word Was Created” chart or the Title Page emblem before it has been “re-stored” to its proper height).

Dee used the number 120 instead of 126 for several reasons.

First, it is also the number of Aphorisms he chose to write in the *Propaedeumata Aphoristica*. Second, the reflective mate of 120 is 21, and $120 \times 21 = 2520$, the Sabbatizat.

Third, but just as significant, if 120 is corrected to 126, the grand total at the bottom of the column becomes 25341 instead of 25335. And Dee would consider 25,341 special because it contains all the single digits up to 5.

25341 contains the digits 1, 2, 3, 4, and 5

This might not seem very special – just a fun numerological coincidence – but Dee saw numbers differently than we do. Remember, he was so thrilled about the component parts found in 12, 252, 240, he presented the Exemplar number as a gift to the King of the Holy Roman Empire.

And there is a fourth reason. Can you figure it out?

The belly-button summarizes it all

Don't be concerned if you didn't follow all of Dee's mathematical gyrations in these charts. The main thing is you became familiarized with the numbers on the chart. Notice that Plato's “Ideal City” number 5040 appears 4 times!

Recall that 5040 makes 12 tribes of 420 people each. Notice that the numbers 42 and 4200 can also be found on Dee's chart.

But the most outstanding graphic feature of the chart is its belly-button, its exact center.

Drawing two diagonals on my version of the chart, the centerpoint falls precisely on 2520.

Admittedly I have altered the width of the columns by making them all the same shape rectangle.

1	1	0	0	0	7	5040
2	2	21	42	2	6	15120
3	6	35	210	3	5	4200
4	24	35	840	4	4	840
5	120	21	2520	5	3	120
6	720	7	5040	6	2	14
7	5040	1	5040	7	0	1
			13692			25335

This extra column with the angled hatch marks serves no apparent purpose.

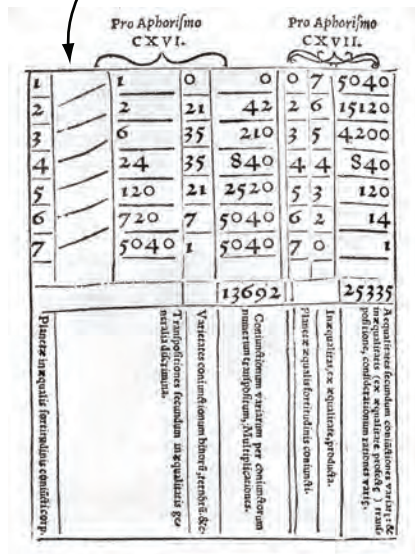

I have even deleted an empty column that Dee appears to have included as a visual red herring.

(Its diagonal lines *seem* to connect certain numbers in the first column with other numbers in the second column, but if you look closely, the top two diagonal lines *do not* correspond with the digits in the second column. Also, these hatch marks serve no purpose with regards to the mathematics of the chart.)

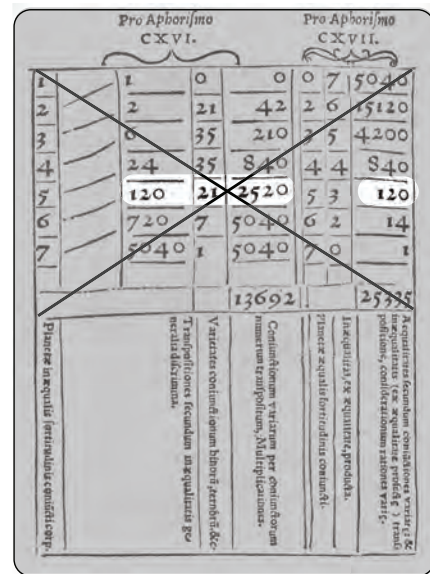

The exact center of Dee's chart is highlighting not only 2520, but also the multiplication of 120 x 12 that produced it.

Dee's "intentional mistake" of writing 120 (instead of 126) seems to be another one of Dee's "confirming clues." That 120 is in the same horizontal row as this important equation which involves a 120.

The multiplication of 120 x 21=2520 is pretty darn similar to the multiplication of 12 x 21=252, the first transpalindromic pair making Dee's Magistral number.

Recall that this multiplication is at the heart of the Syndex Pretzel.

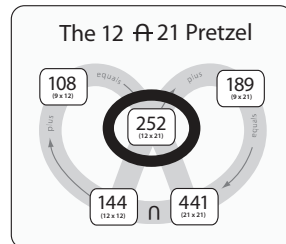

(Incidentally, the number that should be the "correct" number of Dee's intentional mistake, 126, is exactly half of 252.)

The text of Aphorism 116 mentions the “greatest philosopher”

Besides Dee’s number clues, there is a huge clue in the **written text** of Aphorism 116. Dee explains in words how he derives the numbers 21, 35, 35, 21, 7, and 1 (Third Column of the first chart) and 2, 6, 24, 120, 721, and 5040 (Fourth Column of the first chart). In the midst of his explanation he writes (partially in Latin and partially in Greek):

“verissimeque summus dictet philosophus,
quod ἐν αὐταῖς κείται ἡ γνώσις
τῶν γινομένων ἐν τῷ κόσμῳ,
τῆς γενέσεως καὶ τῆς φθορᾶς:”

“Most truthfully, the greatest philosopher tells us,
that in these lies the knowledge
of things born in the universe,
of their origin and of their destruction:”

This is one of the few passages in Dee’s *Propaedeumata Aphoristica* that is written in Greek. The “greatest Greek philosopher,” in Dee’s mind, can be none other than Plato himself.

Plato’s legendary mathematical passage of *The Republic* 8:546 is concerned with the number for divine birth (2520) and of human birth (360), which is like Dee’s reference here to “things born in the Universe.”

Furthermore, both of these numbers are intrinsically connected with 5040 of the Ideal City in *The Laws*. Recall that 2520 has all the special “consecutive single digit divisors that 5040 has, at half the price. And Plato tells us that the 12 divisions of 5040 correspond to the 12 months of 30 days each in the 360 day year.

Recall also that in the *Preface to Euclid*, Dee quotes Boethius,

**“All things
(which from the very first original being of things,
have been framed and made)
do appear to be Formed by the reason of Numbers
for this was the principal example or pattern
in the mind of the Creator.”**

(After which drops his clue about the Exemplar Number
12252240, which is quite related to 2520).

In Dee’s same work, he cites Plato’s dialogue *De Republica* twice (page a.j verso and page a.i.j verso).

One reference is to *The Republic* 7:528, where Plato recommends students study not only plane geometry [2-D] and also solid geometry [3-D], “a subject currently neglected.”

Plato (through his character Socrates) then explains why: “There are two reasons...” (First, cities don’t hold the study of 3-D geometry in high esteem and second a capable director for such studies is hard to find.)

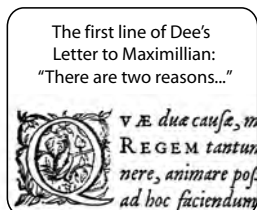
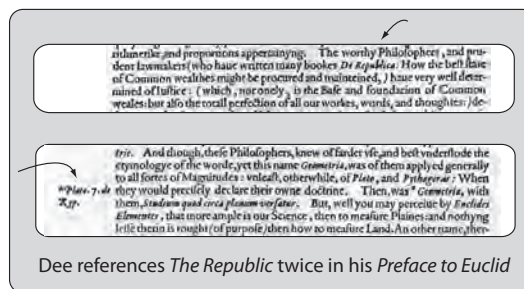

You may recall that this is the very first line of Dee’s Letter to Maximilian, “There are two reasons...” (With his *Monas Hieroglyphica* as his calling card, Dee was subtly suggesting the King should hire him).

Lets look at how Dee seems to be dropping another cryptic clue with the first words of his *Preface to Euclid*.

The “Big D” Clue

Dee’s first two words are
“Divine Plato.”
 Dee glowingly calls him,
**“the great Master of many
 worthy Philosophers.”**

But there’s a real clue in the “drop-cap D” that starts the word Divine. Look at how big it is. It’s larger than half the width of the typeset page, and its overall shape is perfectly square.

On one level, it’s Dee punning about his own name again – he even includes a triangle to emphasize his intent.

But it also includes the Monas symbol, and what appears to be Dee’s family coat of arms.

I think Dee included this shield
 so he could represent a pentagon,
 (even though it’s a its not a regular pentagon,
 and several corners are somewhat rounded)

Thus he has a **triangle** (his name-symbol),
 a **square** (the shape the “drop-cap D” fits in),
 and a **pentagon** (shield).

These shapes are visual representation of **3, 4, and 5**,
 an integral aspect of Plato’s number
 (**epitritos**, 4:3, along with the **pempad**, 5).

At the risk of putting words in Dee’s mouth, it seems to me that Dee is cryptically expressing the number for “divine births,” or 2520.

To support this idea, I’ll show you how Dee hid “the foundation 4:3 yoked to 5 “ in the Pythagorean Y diagram.

(Incidentally, Dee uses a similar shield in the emblem on the Title page of his 1573 text about the Paradoxical Compass,. In this case the standing lion is reaching towards a lunar crescent.)



The first page of Dee’s 1570
Preface to Euclid

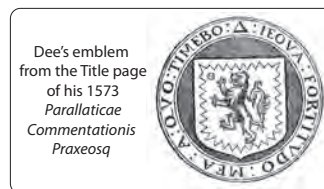
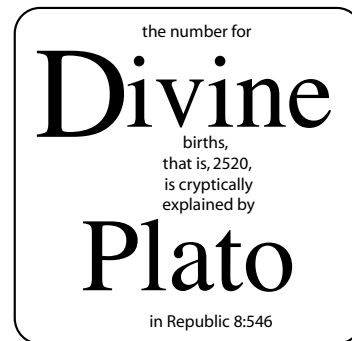
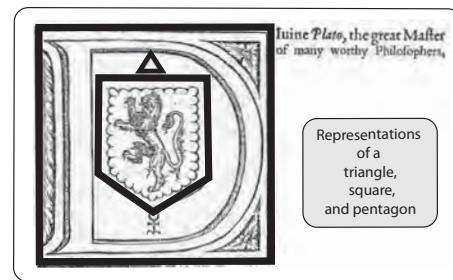

“the foundation 4:3 yoked to 5” in Dee’s Tree of Rarity diagram

In the Arbor Raritatis (Tree of Rarity) illustration Dee makes a subtle graphic reference to the “3, 4 and 5” of Plato’s Number.

It involves that one dotted-line that seems out of place in the midst of all this symmetry. We’ve explored it before, but looking closer, there is a lot more to it.

this unusual dotted line seems assymetrical compared to all the other symmetrical lines

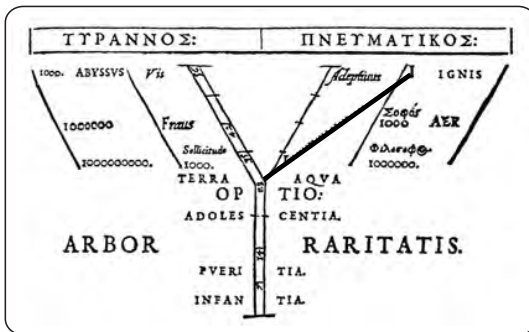
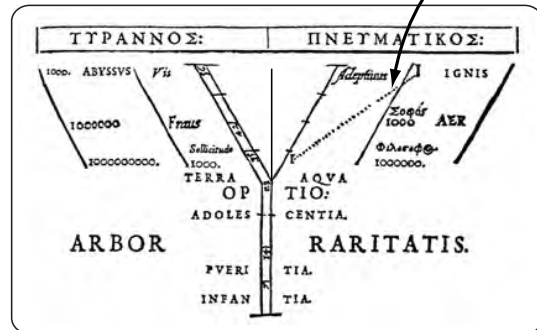

If the line is continued, it intersects the “diverging point” of the two paths on the main stem of the “Y.”

To symmetrically balance it, let’s make a similar line angling to the upper left. This line terminares at the letter V in ABYSSVS (or “abyss”, a bottomless pit, from which we get the word abysmal).

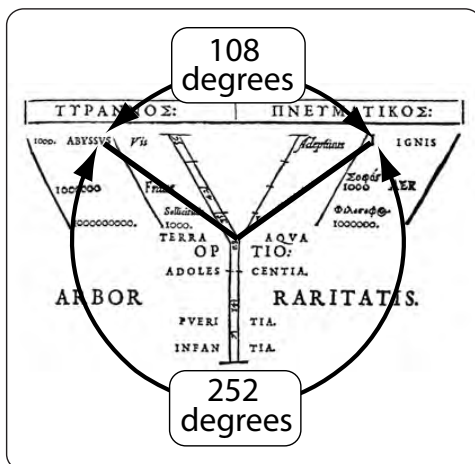
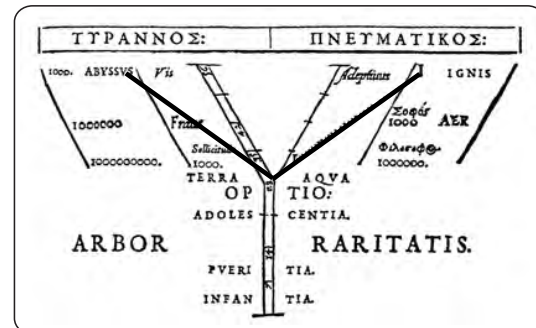

As seen earlier, each of these lines is 54 degrees from vertical, so a full angle 108 degrees has been created. And, as $108 + 252 = 360$, the outer angle is 252 degrees, Dee’s Magistral number.

But 108° is also the angle of each of the 5 interior angles in a regular pentagon. Thus, without much creativity we can imagine a regular pentagon whose vertex coincides with the “diverging point” of the Y. There’s only one way the pentagon can be drawn (pointing downwards), but it might be any scale.

And of course, Dee always provides confirming clues. There are two conspicuous clues here. Can you find them?

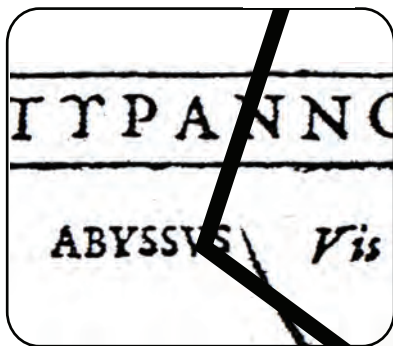
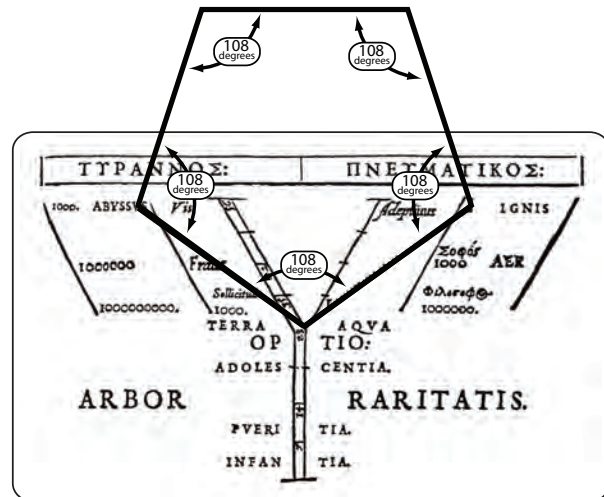

Close-up view of the letter “V” in ABYSSVS at the one of the vertices of the of the pentagon

The first is that that important corner of the pentagon is at the letter “V” in ABYSSVS.

As Dee discusses in Theorem 16, the letter V “was used by “most Ancient Latin Philosophers” to denote the “QUINARIUM” (the number 5). A pentagon has V (5) sides, and V (5) angles as well.

To find the next confirming clue, instead of looking “up-close” at a detail, we must back-off and look at the “big picture.”

I had always been puzzled by the idea that this diagram was about the divergent pathways of life choices, yet Dee entitled it “Tree of Rarity.” Why did he mix metaphors?

But suddenly now the tree has appeared before our very eyes. It has a solid trunk (28 years of growth) and a large pentagon-shaped crown, like an oak or a maple that has grown to its full natural shape in the middle of an open field.



We have previously seen that there is an equilateral triangle nesting in the two arms of the Y.

And we found a square whose side-length is equal to that of the triangle. Recall that “within” the square are the letters RA (from TERRA), AQV (from AQUA), and the letter “d” (from Sollicitudo), which spell QUAdRA, the Latin word for square.

And of course the triangle, square, and pentagon which might be seen as representing the “*epitritos (4:3) yoked together with the pempadi (5)*” from Plato’s cryptic description of his number of “human births.”

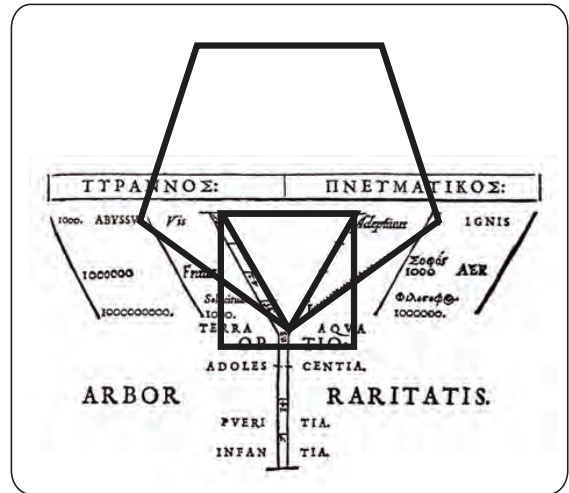

The idea of two oxen in a yoke echoes the idea of the two pathways in Dee’s Tree of Rarity illustration. The two paths are integrated with representations of 3-ness, 4-ness, and 5-ness.

The symmetry of the two pathways of the Tree of Rarity chart echoes the two bulls yoking together “4-ness and 3-ness” with “5-ness.”

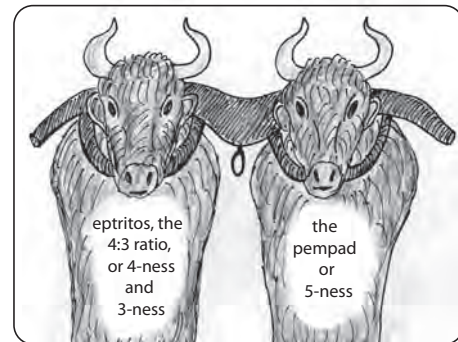

Dee provides some clues that seem to confirm this connection.

First, the word yoke can be found in the letters of PNEYMATIKOS.

(They are even arranged in neighboring pairs equally distant from one of the edges of the pentagon)

The word “yoke” goes all the way back to Old English of the 1100’s.

In 1399, William Langland wrote about “steeris well y-yokyd.”

In 1578, Robert Lindsay wrote that the “Earle of Angus and the Earle of Gencairneis was yokit together.”

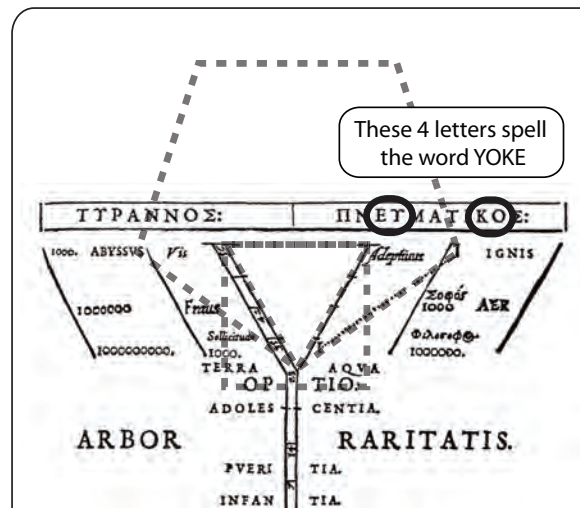

Also, the “SS” in ABYSSUS falls between a “Y” and a “V (or U),” just as the “Z” in SUZUGEIS falls between two U’s. These two “u’s” are the Greek letter upsilon, which, in its capitalized form, looks like the Latin letter Y. (ΣΥΖΥΓΕΙΣ or SYZYGEIS)

***The Romans borrowed U,
and then Y from the same Greek letter, upsilon***

Around 700 BC the Etruscans “borrowed” the upsilon for their alphabet. When the Romans “borrowed” it from the Etruscans a century later, they simply wrote it as a capital letter U (even though the Romans shaped it like the English alphabet’s V).

For centuries employed the U as a useful vowel sound.

Around 100 AD, when more and more Greek words were being absorbed into the Latin language, the Romans added two letters to cope with pronouncing these new words, the letters a Z (zeta) and Y (upsilon).

That’s right, the Latins actually “borrowed” the same letter twice. So Dee’s Latin word ABYSSVS, the Y and the V (or U) are both like Greek upsilons.

As for the z in *suzugeis*, we’ve seen that the Romans borrowed the zeta (Z), but they didn’t employ it much in their own words. This is reflected by the fact that Z is still the least-used letter of the English alphabet. As David Sacks calculated in his book *Letter Perfect*, “

**For every 1000 appearances
by E (our most-used letter),
Q appears about 50 times,
X 44,
and Z a measly 22.”**

(Sacks, *Letter Perfect*, p. 360)

Sacks also quotes Dee’s contemporary, Richard Mulcaster, who wrote 1582,

**“Z is a consonant much heard amongst us,
but seldom seen.”**

For some reason, even in words that sound like they should be spelled with a Z, an S is used instead, like words rose, phrase, or toes. Sachs suggests that the Z just looked “too foreign” to the English, and they use it only in words they borrowed from the Arabic (like azimuth and zenith) or from the Greeks (like zodiac). (This might account for why Dee’s word Zography never caught on.)

(Sacks, *Letter Perfect*, p. 360-361)

Summary

With all these clues, a clearer picture of Dee's Tree of Rarity illustration emerges. We might see the two splaying arms of the Y as a yoke, both visually and in the sense that the word **yoke begins with Y**.

The word **yoke** is hidden in the letters of PNEYMATIKOS.

The word **SUZUGEIS** is hidden in the letters of ABYSSVS, IGNIS and AER."

The giant "Y" is yoking together the *epitritos*, the 4:3 ratio (represented by the equilateral **triangle** and the **square**) and the *pempadi*, the 5 (represented by the **pentagon**).

These three shapes form the crown of the "Tree of Rarity," the lower part of which is the trunk. And the Greek term for trunk (or foundation or base) is **pythmen**.

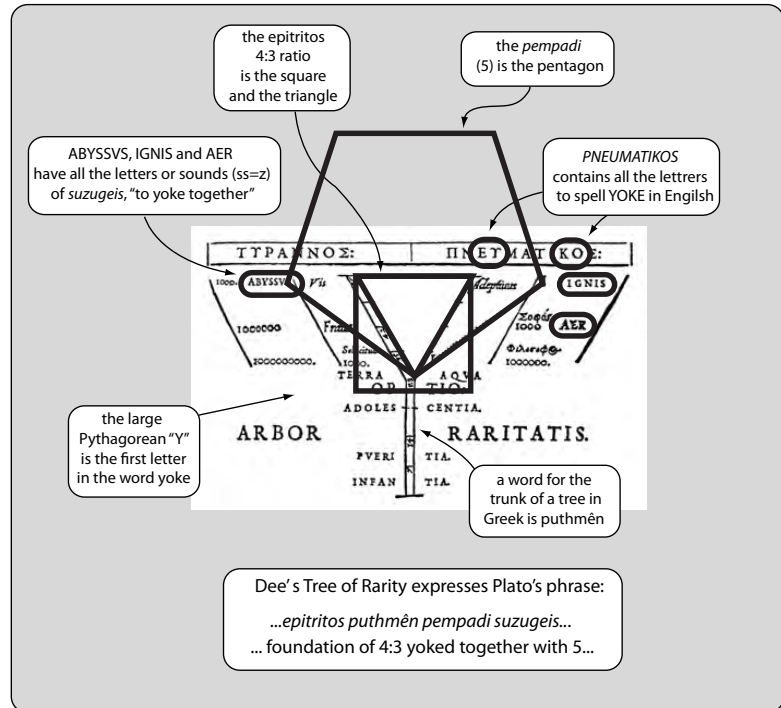

Dee's whole illustration is shouting out "**the foundation of 4:3 yoked together with 5,**" but nobody can hear it unless they are tuned into Dee's wavelength. And Dee's wavelength is Plato's wavelength in Republic 8:546

yoke and yolk are homonyms

Dee provides a big clue to this interpretation of the Pythagorean Y as a "yoke" in Theorem 18, which involves the "yolk" of an Egg.

Dee writes "we were taught that the figure of an EGG" was useful while "contemplating" the "Theoretical and Heavenly motions" of Mercury. In other words, while Dee was doing his "*Megethological Contemplations*" about Plato's key phrase "the foundation of the 4:3 ratio **yoked** to the pempad," the idea of a "**yolk**" occurred to him.

The word “yolk” was used in England as early as 1000, but it’s not really related to its homonym yoke. “Yolk” derives from the Old English word *yeoiu*, or yellow. (And Dee didn’t think of this as one big joke, as joke wasn’t an English word until the mid-1600’s, from the Latin word *jocus*, meaning “jest or wordplay.”)

Indeed, the yolk is his Solar Mercury Planets shape the rhombic dodecahedron and included in it are the Solar Planets, the icosahedron, the dodecahedron, and the icosidodecahedron.

And the egg white is all the “Lunary Planets” shapes, (tetrahedron, octahedron, cube, cuboctahedron and the summarizing stella octangula. And the egg’s outer shell, the rhombic dodecahedron, summarizes them all.

The Tree of Rarity and the Egg Diagram express the same thing in different ways – the yoking together of the Lunary Planets (with their 4:3 character) and the Solary Planets (with their 5 character).

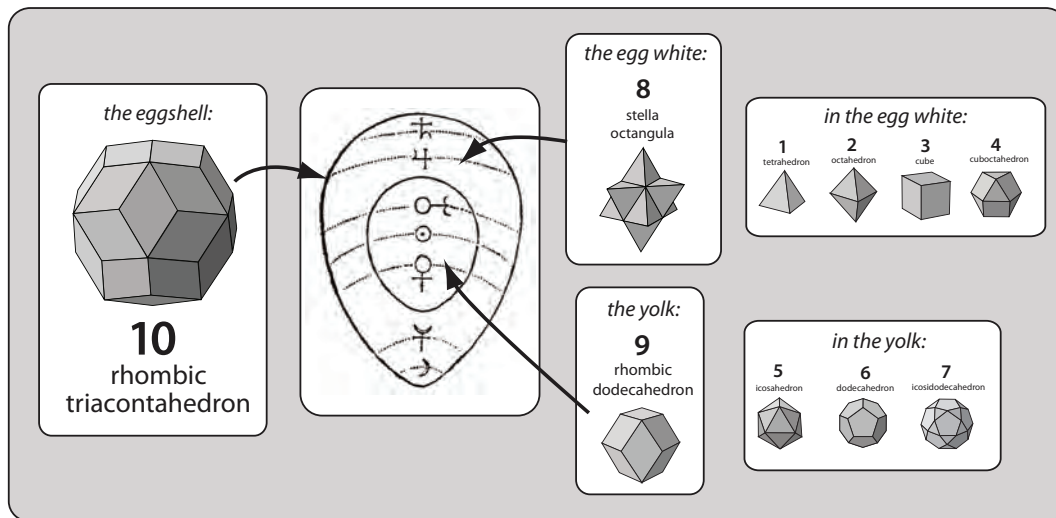

Dee is expressing his Platonic-based geometric cosmology in a creative, graphic way. This is similar to the creative graphic way he expresses his numerical cosmology involving Metamorphosis and Consummata, and his physics cosmology of the closest packing of spheres. It’s up to the reader to assemble them into one big picture. I hope you get the picture. Click!

If you don’t, then re-read this book. If you do, either share it with others or figure out how it can be used to benefit mankind and life on earth, our 360 home.

Bibliography

- Adam, James, *The Nuptial Number of Plato*, (Great Britain, Kairos, 1985)
- Adam, James, *The Nuptial Number of Plato: Its Solution and Significance*, (London 1891, reprint 1985, London and Wellingborough)
- Allen, Michael J.B., *Nuptial Arithmetic*, (Berkeley, U. of California Press, 1994)
- Brumbaugh, Robert S., *Plato's Mathematical Imagination*, (Bloomington, Indiana University Press, 1954)
- Cornford, Francis MacDonald, *The Republic of Plato*, (London, Oxford U. Press 1941, 1945)
- Diès, Auguste, "Le nombre nuptial de Platon (Rép. 546 B/C)" *Comptes rendus de l'Académie des inscriptions et belles-lettres*, (Paris, 1933) p. 228-235
- Hamilton, Edith and Cairns, Huntington, *The Collected Dialogues of Plato*, (Princeton, Princeton U. Press, 1961)
- Lee, Sir Desmond, *Plato, The Republic*, (London, Penguin, 1987)
- Lindsay, A.D. (translator), *Plato: The Republic*, (N.Y., Alfred A. Knopf, 1906, 1935, 1976)
- McKeon, Richard, *The Basic Works of Aristotle*, (N.Y., Modern Library, 2001)
- Rouse W.H.D. (translator), *Great Dialogues of Plato*, (N.Y., Signet, Penguin 1999)
- Sacks, David, *Letter Perfect*, (N.Y., Broadway Books, 2003)
- Saunders, Trevor, *Plato: The Laws*, (London, Penguin, 1970)
- Shorey Paul (translator), *Plato: The Republic*, (Cambridge, Mass., and London Loeb Classical Library, first printed 1953)
- Sterling, Richard W. and William C. Scott (translators), *Plato: The Republic*, (N.Y. Norton, 1985, 1996)

