



Services du Premier Ministre
Programmation de la Politique scientifique
Rue de la Science 8
1040 BRUXELLES
BELGIQUE



Diensten van de Eerste Minister
Programmatie van het Wetenschapsbeleid
Wetenschapsstraat 8
1040 BRUSSEL
BELGIE

**ACTIONS DE
RECHERCHE CONCERTÉES**

**GECONCERTEERDE
ONDERZOEKSACTIES**

ACTION INTERUNIVERSITAIRE

INTERUNIVERSITAIRE ACTIE

OCEANOLOGIE

OCEANOLOGIE

Rapports des journées d'études
(1980)

Verslag van de studiedagen
(1980)

1875
1876
1877
1878
1879
1880
1881
1882
1883
1884
1885
1886
1887
1888
1889
1890
1891
1892
1893
1894
1895
1896
1897
1898
1899
1900

VLIZ (vzw)

VLAAMS INSTITUUT VOOR DE ZEE
FLANDERS MARINE INSTITUTE

Oostende - Belgium

20476

**ACTIONS DE
RECHERCHE CONCERTÉES**

**GECONCERTEERDE
ONDERZOEKSACTIES**

ACTION INTERUNIVERSITAIRE

INTERUNIVERSITAIRE ACTIE

OCEANOLOGIE

OCEANOLOGIE

W. J. ...
...
...

ORDONNANCE
...

...

...

...

...

...



Services du Premier Ministre
Programmation de la Politique scientifique
Rue de la Science 8
1040 BRUXELLES
BELGIQUE



Diensten van de Eerste Minister
Programmatie van het Wetenschapsbeleid
Wetenschapsstraat 8
1040 BRUSSEL
BELGIE

**ACTIONS DE
RECHERCHE CONCERTÉES**

**GECONCERTEERDE
ONDERZOEKSACTIES**

ACTION INTERUNIVERSITAIRE

INTERUNIVERSITAIRE ACTIE

OCEANOLOGIE

OCEANOLOGIE



UNIVERSITY OF TORONTO
 LIBRARY
 130 St. George Street
 Toronto, Ontario
 M5S 1A5



UNIVERSITY OF TORONTO
 LIBRARY
 130 St. George Street
 Toronto, Ontario
 M5S 1A5

RESEARCH IN
 GEOGRAPHY

RESEARCH IN
 GEOGRAPHY

INTERNATIONAL ACTION

INTERNATIONAL ACTION

1967

1967

UNIVERSITY OF TORONTO
 LIBRARY

UNIVERSITY OF TORONTO
 LIBRARY

Table of contents

| | | |
|--|-------|-----|
| The rate of utilization of nitrate-nitrite by natural phytoplankton populations in a reactor | | |
| by L. GOEYENS, A. VANDENHOUDT, G. DECADT, W. BAEYENS | 15424 | 9 |
| C.M. 1980/L:20 Biological Oceanography Committee | | |
| Strategy for the study of sea-air exchanges in the Belgian coastal zone | | |
| by H. DEDEURWAERDER, M. DEJONGHE, F. DEHAIRS | 15425 | 27 |
| C.M. 1980/C:24 Hydrography Committee | | |
| The biogeochemical cycle of barium in the open ocean. An evaluation | | |
| by F. DEHAIRS | 15427 | 39 |
| C.M. 1980/C:23 Hydrography Committee | | |
| Determinations of mercury in various compartments of a coastal marine ecosystem | | |
| by G. DECADT, M. BOGAERT, L. GOEYENS and W. BAEYENS | 15428 | 59 |
| C.M. 1980/E:37 Marine Environmental Quality Committee | | |
| Trace metals (Zn, Cd, Pb, Cu, Sb and Bi) levels (ionic and dissolved organic complexes) in the Southern Bight (Belgian coast). Technique to avoid contamination during sampling and filtration and to improve representativity | | |
| by G. GILLAIN, C. DUYCKAERTS and A. DISTECHE | 15433 | 75 |
| C.M. 1980/E:38 Marine Environmental Quality Committee | | |
| Spatial pattern and biochemical content of North Sea zooplankton (Belgian coast) [1979-1980] | | |
| by J.H. HECQ, A. GASPARD and H. PICARD | 15434 | 95 |
| C.M. 1980/L:21 Biological Oceanography Committee | | |
| Ecometabolism of the coastal area of the Southern Bight of the North Sea | | |
| by the workgroup "Organic Matter" | 15435 | 109 |
| C.M. 1980/L:22 Biological Oceanography Committee | | |
| Benthic studies of the Southern Bight of the North Sea and its adjacent continental estuaries. Fluctuations of the meiobenthic communities in the Westerschelde estuary | | |
| by D. VAN DAMME, R. HERMAN, Y. SHARMA, M. HOLVOET and P. MARTENS | | 131 |
| C.M. 1980/L:23 Biological Oceanography Committee | | |

15436

- Population dynamics of copepods in the Southern Bight of the North Sea (1977-1979). Use of a multicohort model to derive biological parameters
 by M. BOSSICART 15441 171
 C.M. 1980/L:24 Biological Oceanography Committee
- Some mechanisms promoting or limiting bioaccumulation in marine organisms
 by F. NOËL-LAMBOT, J.M. BOUQUEGNEAU and A. DISTECHE . 15442 183
 C.M. 1980/E:39 Marine Environmental Quality Committee
- The residual circulation of the North Sea
 by Jacques C.J. NIHOUL and Yves RUNFOLA 15445 209
 C.M. 1980/C:22 Hydrography Committee
- The use of the brine shrimp Artemia in aquaculture 15447 251
 by Patrick SORGELOOS
- Nursery culturing of bivalve spat in heated seawater ù
 by C. CLAUS, L. VAN HOLDERBEKE, H. MAECKELBERGHE and G. PERSOONE . 283

15450

15424

The rate of utilization of nitrate-nitrite
by natural phytoplankton populations in a reactor

L. GOEYENS, A. VANDENHOUDT, G. DECADT, W. BAEYENS

Laboratorium voor Analytische Scheikunde
Vrije Universiteit Brussel, Belgium

Abstract

Nutrient uptake rates of natural phytoplankton taken from the Belgian coastal area have been assessed. On the one hand, we used a perturbation technique, this provided a drastic modification of the external substrate concentration. On the other hand, it was done by a dynamic method, which allowed a gradual and slow change of the external substrate concentration.

The obtained uptake rate versus substrate concentration (nitrate-nitrite) curves show that the maximum uptake rates range from $8.6 \times 10^{-3} \text{ h}^{-1}$ to $18 \times 10^{-3} \text{ h}^{-1}$. From these curves can also be deduced that nitrogen (as $\text{NO}_3^- - \text{NO}_2^-$) can be a limiting nutrient in our coastal area.

Introduction

Owing to the monthly surveys of the national monitoring program, a quite detailed picture of the spatial-temporal nutrient distributions in the Belgian coastal zone, has been obtained. The twenty sampling stations as well as the subdivision of the coastal area in four sectors are shown in figure 1. Considering the results of nitrate-nitrite in 1978 (figure 2), we observe strong seasonal variations in the four sectors, which are not due to external inputs but to local endogeneous biological activity in the watercolumn and the sediments (Mommaerts *et al.*, 1979). In that context fundamental questions, concerning the dynamics of our coastal ecosystem, raised. Is there a limiting nutrient? How does it limit planktonic production? As is already concluded in a previous paper (Mommaerts *et al.*, 1979), we were unable to define the exact nature of the most probable

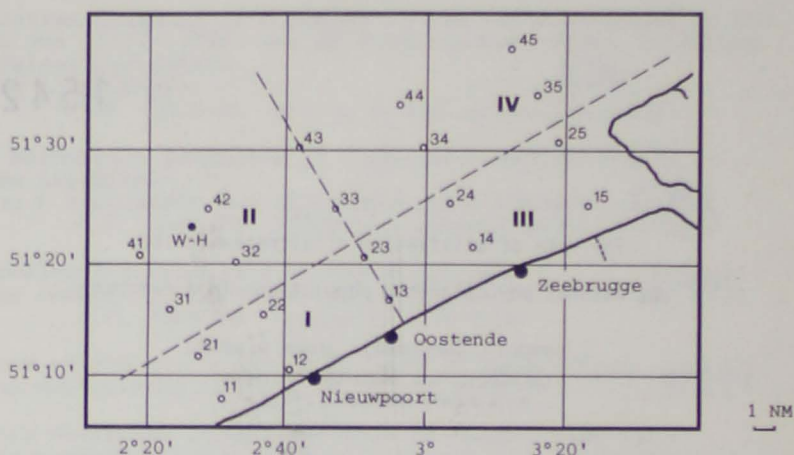

fig. 1.

Sampling stations and subdivision in four sectors of the Belgian coastal area

limiting element on the basis of in situ measurements, without help of a more direct approach : enrichment experiments conducted at sea, kinetic uptake studies in a reactor.

Our goal was therefore to establish the kinetic curves which describe the overall substrate uptake regulation for natural phytoplankton populations of the North Sea. The first phase of this study includes no other limiting nutrients than nitrate-nitrite.

Sampling

The Management Unit of the North Sea and Scheldt Estuarium, Mathematical Models, Ministry of Public Health and Environment, took care of the sampling and the transport of the samples to the laboratory. Seawater samples were collected at point 23 or at the West-Hinder (51°23'N-02°26'E) near point 42 (see figure 1). Fifty litres of seawater were collected with a rotational pump at a depth of 3 m and were then stored in two polyethylene containers of 25 l each. The samples were transferred to the laboratory as quickly as possible (the transport time ranges from four

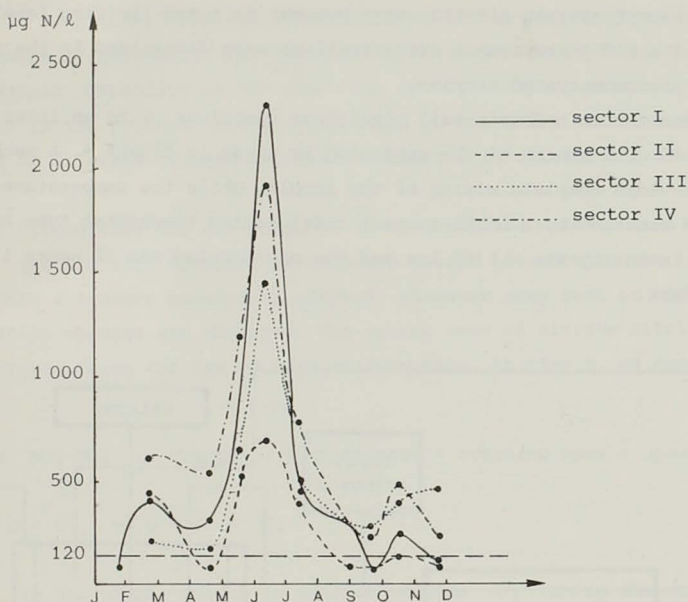

fig. 2.

Seasonal variations of nitrate-nitrite in the four sectors in 1978

to six hours). There they were immediately, or after preconcentration (this takes about three hours), taken to the reactors and thermostated at 10°C.

Methods and materials

The analysing methods for nutrients (ammonium, nitrate-nitrite, phosphate and silicate) have been described in a previous paper (Mommaerts *et al.*, 1979). Chlorophyll a was measured, using the method of Strickland and Parsons and SCOR-UNESCO (Strickland and Parsons, 1968). Phaeopigments were determined, according to the method of Lorenzen (Lorenzen, 1967). On the basis of these results, we estimated the phytoplankton biomass.

The nutrient concentrations were measured in the natural samples, the preconcentrated samples, if any, and the filtrate (0.22 µm pore-size Millipore filter). At the beginning of the experiment, all nutrient concen-

trations, except nitrate-nitrite, were brought to a non-limiting level. The chlorophyll a and phaeopigment concentrations were determined in the natural and preconcentrated samples.

The reactor is a double-wall plexiglass container, with an inner content of 4.75 l. A scheme of the apparatus is given in figure 3. A mechanical stirrer provides complete mixing of the sample, while the temperature is maintained constant by a LAUDA compact refrigerated thermostat type RC20. The light intensity was 13 300 lux and the photoperiod was 12 hours light-12 hours dark.

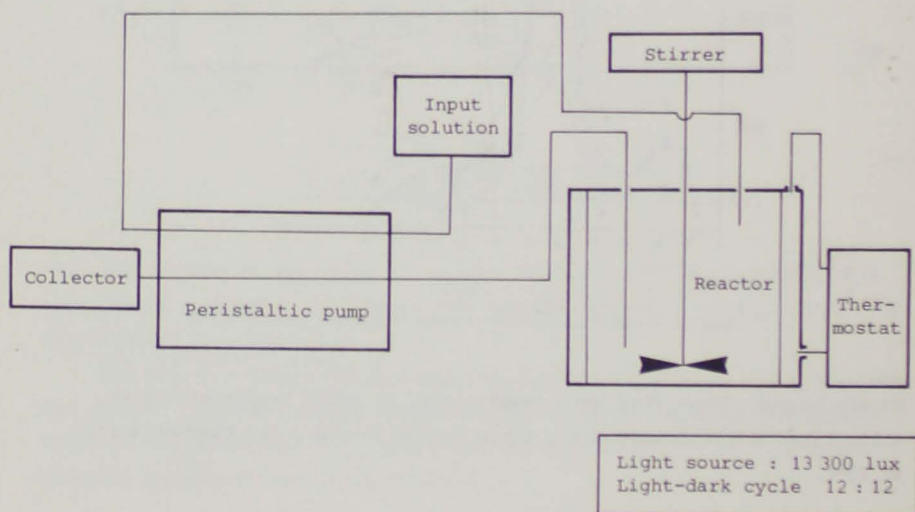

fig. 3.

Scheme of the apparatus

Sampling of reactor solution can be carried out manually with a syringe or automatically with a peristaltic Technicon pump. This pump regulates the input and output flows of the reactor (in these experiments both flows are taken identical). The output tube is connected with a Gilson fraction collector. Thus, time integrated samples are obtained (the period is adjustable). The collected samples were finally analysed by an automated analyser. In this way, the evolution of the nitrate-nitrite concentrations can be

followed in real time, allowing a modification of the parameter conditions, at any moment if necessary. The input solution is generally filtrated natural sample. Depending on the evolution of the limiting nutrient concentration in the reactor, its concentration in the inlet solution will be increased or filtrate of aged seawater, exhausted in nitrate-nitrite, will be used.

The uptake kinetics are assessed in an automated manner. As a general rule, the limiting nutrient is measured every hour during the light period. This frequency however is adapted whenever very fast or slow concentration changes are observed. The uptake rate of nitrate-nitrite can be derived using the law of mass conservation. At time t , we can write :

Change of $\text{NO}_3^- - \text{NO}_2^-$ in reactor = ingoing mass - outgoing mass + uptake

$$\frac{d(VC)}{dt} = Q \times C_{in} - Q \times C + U_r \quad (1)$$

where V is the sample volume in reactor at time t ; C is the nitrate-nitrite concentration in the reactor at time t which is, as a consequence of the complete mixing of the reactor solution, equal to its concentration in the outlet; Q is the input-output flow rate; C_{in} is the nitrate-nitrite concentration in the inlet solution; U_r is the decrease of nitrate-nitrite in the reactor at time t due to assimilation by the living organisms. The uptake rate U_r , expressed in mass of nutrient per unit time, can thus be determined at any moment. When we divide this value by the reactor volume and the biomass at time t , we get the commonly used uptake rate in h^{-1} .

All other nutrient concentrations as well as phytoplankton biomass are measured at the beginning and at the end of the light period. These latter analyses require 50 ml sample, which are manually withdrawn from the reactor. This causes a corresponding volume decrease every 12 hours.

Results and discussion

Steady-state experiments, such as described by Droop (1968, 1974), enable the assessment of nutrient uptake rates by selected algal species, versus a broad spectrum of substrate concentrations. In our case however, these experiments are not utilizable, because they run over several weeks. It is obvious that the population composition will strongly change during this time.

Using the perturbation technique of Caperon and Meyer (1972), Harrison and Davis (1977) were able to measure the nutrient uptake rates of the natural population versus a broad range of substrate concentrations in a short time. During the first phase they let the nutrient concentrations decrease until one of them reached zero. Then, at the beginning of the second phase, they injected a known amount of the limiting nutrient, while all other nutrient concentrations were brought to a non-limiting level. We wanted to test the feasibility of their method for our purposes. The initial physico-chemical conditions as well as parameter conditions of our sample are shown in table 1.

Table 1
Initial conditions of the sample

| Sampling time Situation | Temperature | Biomass $\mu\text{g chlor a/l}$ | $\text{NO}_3^- + \text{NO}_2^-$ $\mu\text{g N/l}$ | NO_2^- $\mu\text{g N/l}$ | PO_4^{--} mg P/l | Si $\text{mg SiO}_2/\text{l}$ |
|------------------------------------|-------------|------------------------------------|--|--------------------------------------|---------------------------------------|----------------------------------|
| 26-07-78 11.00 a.m. Point 23 | 14 °C | 4.8 | 418 | 12 | 0.35 | 1.6 |

Phytoplankton was concentrated 4-fold using a reverse flow filter system (filter diameter is 142 mm; filter poresize is 1.2 μm). The efficiency of the concentration is estimated from measurements of chlorophyll a and phaeopigments before and after concentration (Table 2). The loss was due to cells which stuck to the filter. On 27-06-78 at 9 a.m. (beginning of the first light period) 50 μmoles of phosphate and silicate were added to the concentrated population. This provided a non-limiting phosphate and silicate concentration of respectively 1.9 ppm P and 3.0 ppm SiO_2 . During the first phase nutrient levels were

Table 2
Concentrations of chlorophyll a and phaeopigments
before and after preconcentration

| Method | Before $\mu\text{g chlor a/l}$ | After $\mu\text{g chlor a/l}$ | Concentration efficiency (%) | |
|--------------------|-----------------------------------|----------------------------------|------------------------------------|----|
| Strickland-Parsons | 4.9 | 19.6 | 75 | |
| SCOR - UNESCO | 4.8 | 19.1 | 75 | |
| Lorenzen | chlorophyll | 3.3 | 15.0 | 86 |
| | phaeopigments | 2.6 | 7.6 | 55 |

followed by manual sampling, until the nitrogen ($\text{NO}_3^- + \text{NO}_2^-$) concentration approached zero. This occurred near the end of the fourth light period. Therefore the second phase of the perturbation experiment started at the beginning of the light period of 01-07-78. Table 3 represents nutrient and chlorophyll a concentrations at the beginning of the second phase and of two light periods later.

Table 3
Nutrient and chlorophyll a concentrations
during the second phase of the perturbation experiment

| Date | $\text{NO}_3^- + \text{NO}_2^-$ $\mu\text{g N/l}$ | NO_2^- $\mu\text{g N/l}$ | PO_4^{3-} mg P/l | Si $\text{mg SiO}_2/\text{l}$ | Biomass SC. UN. $\mu\text{g chlor a/l}$ |
|--------------------|--|--------------------------------------|---------------------------------------|----------------------------------|--|
| 01-07-78 9.00 a.m. | 4.0 ¹ 286 ² | 1.8 | 1.7 | 1.4 | 36.6 |
| 02-07-78 8.40 p.m. | 4.4 | 0.9 | 1.7 | 0.3 | 51.8 |

(1) Before spiking with NO_3^-

(2) After spiking with NO_3^-

The disappearance of nutrients was measured by automated sampling (each sample is a 25 minutes averaged sample) during the light period. From the perturbation results (figure 4) we concluded that

$$V_{\max} = 8.6 \times 10^{-3} \text{ h}^{-1}$$

and that

$$K_s = 43 \mu\text{g N/l}.$$

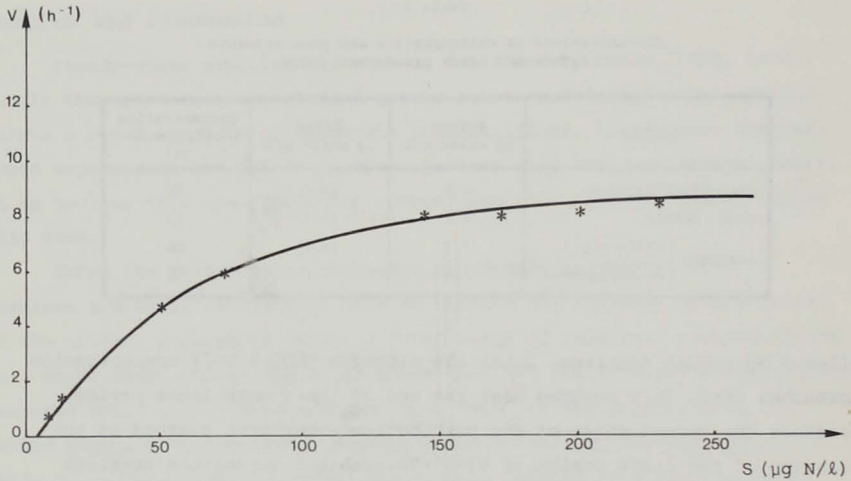

fig. 4.

Uptake rate versus substrate concentration
obtained with the perturbation technique

Though this method gave quite good results, we abandoned the perturbation concept because we can never ensure that the uptake proceeds fast enough to complete the experiment in a reasonable period of time. According to Mommaerts (personal communication, 1978), the experiment should be carried out in maximum three days to avoid unacceptable diversity changes of the population.

We thought it more realistic to start the assessment of the uptake rates, as soon as the sample was transferred to the reactor.

As we are able to adjust the input mass rate of the limiting nutrient, only gradual and relatively slow changes of the external substrate concentration are induced. In addition, such procedure has the advantage that :

- (1) the biological system will anyhow be less disturbed than could possibly occur by a large injection of the limiting substrate;
- (2) and that the uptake kinetics of any nutrient can be studied.

According to this new approach, nitrate-nitrite uptake rates of natural phytoplankton populations have been studied on four samples, which were collected in the period April-May 1979. The initial physico-

chemical conditions as well as parameter concentrations are summarized in table 4.

Table 4
Initial conditions of the samples

| Sample | Situation and date | Temperature °C | Biomass µg chl a/ℓ S.P. | NO ₃ ⁻ + NO ₂ ⁻ µg N/ℓ | PO ₄ ³⁻ µg P/ℓ | Si mg SiO ₂ /ℓ |
|--------|--------------------|-------------------|-------------------------------|---|---|------------------------------|
| I | W-H 19-04-79 06.00 | 7.5 | 8.48 | 50 | 27 | 0.4 |
| II | W-H 25-04-79 04.00 | 8 | 7.27 | 35.8 | 23.5 | 0.29 |
| III | W-H 08-05-79 04.00 | 8 | 7.48 | 15 | 24.3 | 0.56 |
| IV | W-H 17-05-79 04.00 | 9 | 9.48 | 1.4 | 13.3 | 0.21 |

Because of the relatively high biomass contents, preconcentration of these samples was not necessary. As an example, the evolution of the nitrate-nitrite concentration versus the time for the experiments IV-A and IV-B, carried out respectively on the original sample IV and on a 1:1 dilution with its filtrate (0.22 µ) are shown in figure 5. The input mass rate of the limiting nutrient is sometimes higher than the uptake rate; this explains why the overall nitrate-nitrite concentration profile increases in the time.

Figure 6 gives a global picture of the various uptake rates in function of the substrate concentration, obtained for the four samples. A synopsis of reactor conditions (temperature, flows, light,...), initial parameter concentrations in the reactor, and obtained results for each experiment are given in table 5. From these results it appears that :

- the ratio final biomass : initial biomass ranges from 1.29 to 1.76;
- the evolution of the nitrate-nitrite concentration is minimum 1 µg N/ℓh and maximum 15 µg N/ℓh.

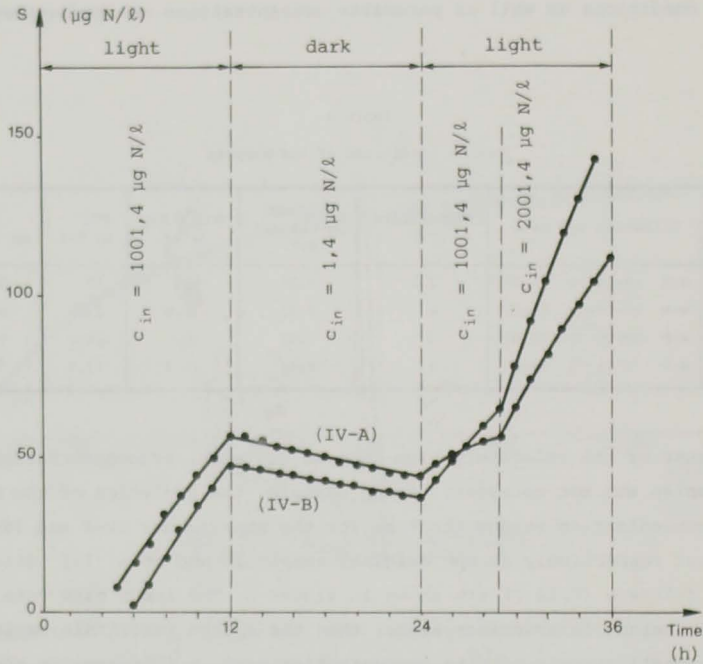

fig. 5.

Substrate concentration versus time
Experiment IV-A and IV-B

With respect to the non-perturbating simulation of nitrate-nitrite assimilation by natural phytoplankton species in a reactor, we see that the applied experimental procedure is very satisfactory. The concentrations of the two main parameters change in a gradual, moderate way, leaving at the biological system the time to adapt itself continuously.

For reasons which are explained above, most of the experiments do not cover a broad substrate concentration range. Therefore, all obtained results are brought together in one figure (figure 6), showing the relation between uptake rates and substrate concentrations. As those determinations are carried out on different samples or under different experimental conditions of nitrate-nitrite nutrition or/and phytoplankton biomass, we expected a rather large dispersion of the results. It is therefore

Table 5
Summary of the four experiments

| Experiment | Start | Biomass | | Nutrient concentrations | | | | | | Input output flow rate | Input concentration NO ₃ ⁻ µg N/ℓ | Concentration range | Uptake rate × 10 ⁻³ h ⁻¹ |
|------------|----------------|--------------|-------|--|--------------------------------------|---------------------------|--|--------------------------------------|---------------------------|------------------------|---|--|---|
| | day : hour | µg chlor a/ℓ | | Initial | | | Final | | | | | | |
| | End day : hour | Initial | Final | NO ₃ ⁻ , NO ₂ ⁻ µg N/ℓ | PO ₄ ³⁻ µg P/ℓ | Si µg SiO ₂ /ℓ | NO ₃ ⁻ , NO ₂ ⁻ µg N/ℓ | PO ₄ ³⁻ µg P/ℓ | Si µg SiO ₂ /ℓ | | | | |
| I | 10.04:12.00 | 8.5 | 10.9 | 50 | 27 | 400 | 26.2 | 1500 | 3300 | 0.0096 | 50 | 25-50 | 5.07 |
| | 11.04:12.00 | | | | | | | | | | | | |
| II A | 25.04:11.00 | 7.2 | 11.8 | 35.8 | 23.5 | 295 | 56 | 1470 | 3290 | 0.0096 | 1095 | 35-55 | 6.62 |
| | 26.04:15.00 | | | | | | | | | | | | |
| II B | 25.04:11.00 | 7.3 | 9.6 | 35.8 | 23.5 | 295 | 41.2 | 1520 | 3540 | 0.0096 | 606 | 35-42 | 5.22 |
| | 26.04:19.00 | | | | | | | | | | | | |
| III A | 08.05:12.00 | 7.5 | 11.3 | 15 | 24.3 | 560 | * | 1540 | 3350 | 0.0096 | 1000 | 15- ? | 5.32 |
| | 10.05:11.00 | | | | | | | | | | | | |
| III B | 08.05:12.00 | 7.5 | 7.5 | 15 | 24.3 | 560 | * | 1520 | 3380 | 0.0096 | 500 | 15- ? | 3.0 |
| | 10.05:11.00 | | | | | | | | | | | | |
| IV A | 17.05:12.00 | 9.5 | 16.2 | 1.4 | 13.3 | 210 | 125 | 1500 | 3100 | 0.0427 | 1001.4 | 8-16 16-23 23-30 30-37 37-43 43-49 49-55 | 2.98 3.49 3.99 4.46 4.91 5.38 5.82 |
| | 18.05:19.00 | | | | | | | | | | 1.4 | 55-42 | |
| | | | | | | | | | | | 1001.4 | 42-46 46-50 50-52 52-54 54-55 | 7.15 8.33 9.48 10.61 11.14 |
| | 18.05:19.00 | | | | | | | | | | 2001.4 | 55-64 64-73 73-81 81-89 89-96 96-103 103-110 | 12.85 12.90 13.11 13.36 13.58 13.81 14.04 |
| | | | | | | | | | | | 1001.4 | 2-9 9-18 18-26 26-33.5 33.5-40 40-46.5 | 2.79 4.24 5.69 7.04 8.40 10.28 |
| | | | | | | | | | | | 1.4 | 46.5-36 | |
| | | | | | | | | | | | 1001.4 | 36-42 42-48 48-53 53-58.5 58.5-63 | 8.55 9.45 10.37 11.24 11.74 |
| | | | | | | | | | | | 2001.4 | 63-77 77-91 91-104 104-117 117-130 130-142 | 10.53 11.32 12.14 12.94 13.70 14.78 |
| | | | | | | | | | | | | | |

* Non detectable

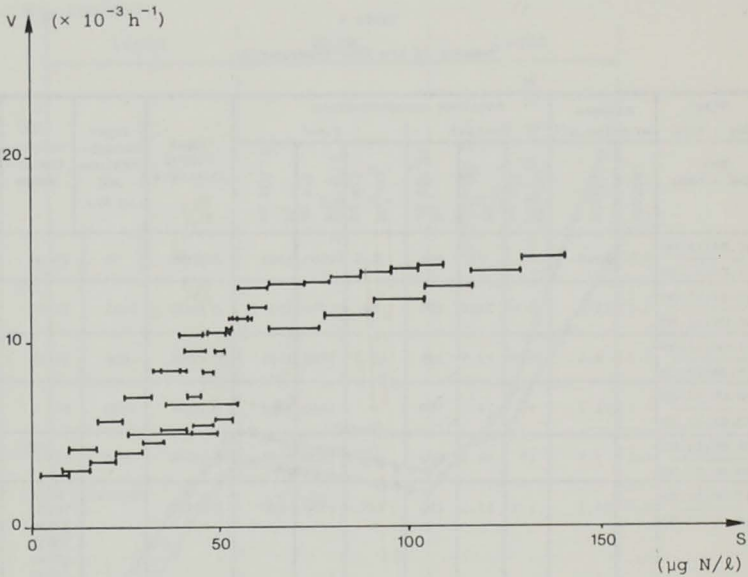

fig. 6.

Uptake rate versus substrate concentration for the four samples
(Period April-May 1979)

very surprising to notice that on the one hand the relation tends asymptotically to a maximum and that on the other hand the uptake rates are of a comparable magnitude at any chosen substrate concentration. At this moment, however, we are not able to answer the question whether such behaviour is due to

- (1°) the fact that all samples were taken in the spring bloom period and hence are qualitatively quite similar or
- (2°) the fact that the uptake kinetics of phytoplankton from the Belgian coastal zone obey all one and the same equation.

In the experiments IV A and IV B uptake rates are determined for a wide range of substrate concentrations. Through the set of experimental data points, the following linear transformations of the Michaëlis-Menten relation have been fitted (Mahler and Cordes, 1969; Lehninger, 1970; Falkowski, 1975) :

$$\frac{1}{V} = \frac{1}{V_{\max}} + \frac{K_s}{V_{\max}} + \frac{1}{S} \quad (\text{Lineweaver-Burk})$$

$$\frac{S}{V} = \frac{K_s}{V_{\max}} + \frac{1}{V_{\max}} \times S \quad (\text{Wolf})$$

$$V = V_{\max} - K_s \times \frac{V}{S} \quad (\text{Eadie-Hofstee})$$

None of these three relations fits well with the experimental points of experiment IV A. Indeed the uptake rate versus substrate concentration curve, shown in figure 7, indicates that the curve tends to a constant value for increasing substrate concentration values. For the lower substrate concentration values, it does not follow a Michaëlis-Menten relation. Nevertheless in a graphical way, an estimation can be made for :

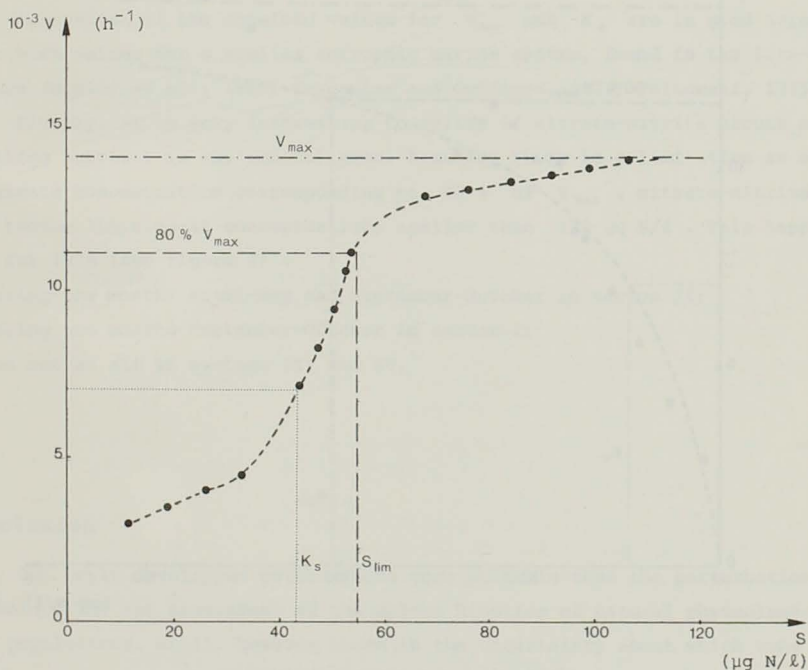

fig. 7.
Uptake rate versus substrate concentration
Experiment IV A

$$V_{\max} = 14.2 \times 10^{-3} \text{ h}^{-1}$$

and

$$K_s = 44 \text{ } \mu\text{g N/l} .$$

The uptake rate profile (figure 8), determined on half the original amount of biomass (experiment IV B), can much better be described by a Michaëlis-Menten relation.

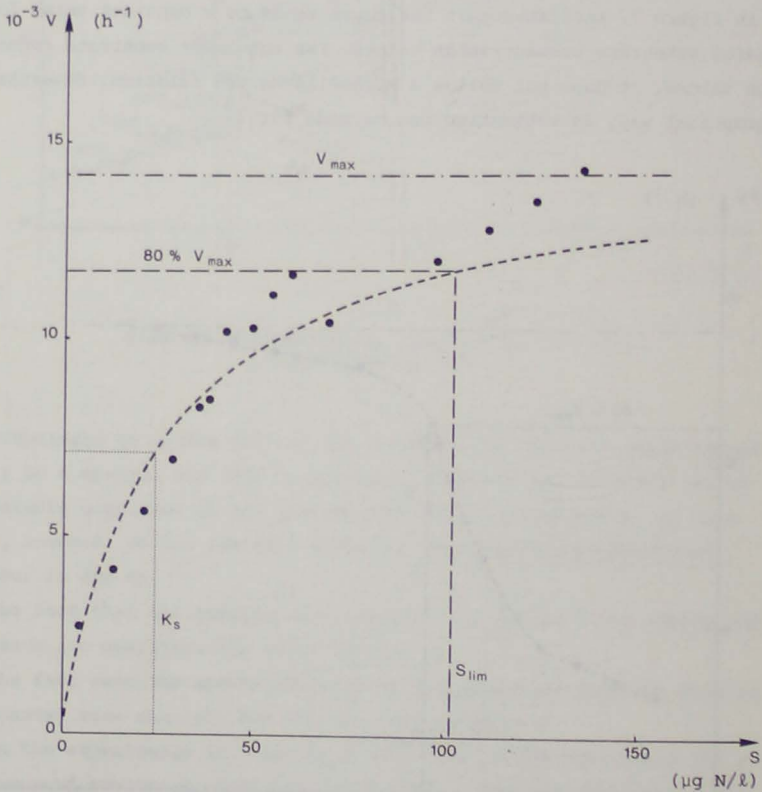

fig. 8.

Uptake rate versus substrate concentration
Experiment IV B

To determine the equation parameters V_{\max} and K_s a least-squares method has been applied. Table 6 shows that the best correlations are obtained with equations (1) and (2). V_{\max} ranges from 14.8 to $18 \times 10^{-3} \text{ h}^{-1}$ and K_s from 26.3 to $40.9 \mu\text{g N/l}$ depending on the kind of equation used.

Table 6
Calculation of V_{\max} and K_s
Experiment IV B

| Linear transformation | Equation | Corr. coeff. | V_{\max} (h^{-1}) | K_s ($\mu\text{g N/l}$) |
|-----------------------|--------------------------------------|--------------|-----------------------------------|--------------------------------|
| (1) Lineweaver-Burk | $y = 67.53 + 1776.3 x$ | 0.95 | 14.8×10^{-3} | 26.3 |
| (2) Woolf | $y = 2267.9 + 55.5 x$ | 0.97 | 18×10^{-3} | 40.9 |
| (3) Eadie-Hofstee | $y = 16.20 \times 10^{-3} - 31.15 x$ | 0.81 | 16.2×10^{-3} | 31.2 |

Comparison of the obtained values for V_{\max} and K_s are in good agreement with values for a similar eutrophic marine system, found in the literature (Eppley et al., 1969; Carpenter and Guillard, 1971; Falkowski, 1975).

Finally, it is very interesting to verify if nitrate-nitrite occurs as limiting nutrient in our coastal area. Assuming there is a limitation at a substrate concentration corresponding to 80 % of V_{\max} , nitrate-nitrite may become limiting at concentrations smaller than $120 \mu\text{g N/l}$. This happened for 1978 (see figure 2) :

- during the months April-May and September-October in sector II;
- during the months September-October in sector I;
- and not at all in sectors III and IV.

Conclusion

Our newly developed method seems more suitable than the perturbation technique for the assessment of the uptake kinetics of natural phytoplankton populations. Still, however, there is the uncertainty about which type of function these uptake kinetics obey. Uptake rate versus substrate concentration curves, determined in one single experiment as well as the overall uptake pattern, which is obtained from the total set of experiments

(figure 6), do not exclude a Michaelis-Menten relation. An increased number of experiments, allowing a more elaborated statistical treatment, could possibly clarify this problem.

It is also clear that not only the period of April-May has to be considered. To perform uptake kinetics on North Sea samples, September and October seem to be favourable months as well.

Moreover, until now we only considered $\text{NO}_3^- - \text{NO}_2^-$ as limiting nutrient. However, with our dynamic procedures we are able to study the uptake kinetics of any substrate. For the study of the uptake kinetics for other substrates and for other periods of the year, a more suitable biomass determination should be developed, allowing us a higher frequency of biomass determination.

Acknowledgment

For their help by the realization of this work, we especially want to acknowledge Mr. H. De Deurwaerder, Mr. M. Dejonghe and Mrs M. Cludts.

We are also grateful to the members of the Management Unit of the North Sea and Scheldt Estuarium and to the members of the Belgian Navy, who took care of the sampling and of the transport to the laboratory.

References

- CAPERON, J. and MEYER, J. (1972). Nitrogen-limited growth of marine phytoplankton - I. Changes in population characteristics with steady-state growth rate, *Deep-sea Research*, 19, 601-618.
- CARPENTER, E.J. and GUILLARD, R.R.L. (1971). Intraspecific differences in nitrate half-saturation constants for three species of marine phytoplankton, *Ecology*, 52, 1, 183-185.
- DROOP, M.R. (1968). Vitamin B 12 and marine ecology - IV. The kinetics of uptake, growth and inhibition in *Monochrysis lutheri*, *J. Mar. Biol. Ass. U.K.*, 48, 688-733.
- DROOP, M.R. (1974). The nutrient status of algal cells in continuous culture, *J. Mar. Biol. Ass. U.K.*, 54, 825-855.
- EPPLEY, R.W., ROGERS, J.N. and MCCARTHY, J.J. (1967). Half-saturation constants for uptake of nitrate and ammonium by marine phytoplankton, *Limnology and Oceanography*, 14, 912-920.
- FALKOWSKI, P.G. (1975). Nitrate uptake in marine phytoplankton : comparison of half-saturation constants for seven species, *Limnology and Oceanography*, 20, 412-417.

- HARRISON, P. and DAVIS, C.O. (1977). Use of the perturbation technique to measure nutrient uptake rates of natural phytoplankton population, *Deep-sea Research*, 24, 247-255.
- LEHNINGER, A.L. (1970). *Biochemistry*, Worth Publishers Inc., New York, 10011.
- LORENZEN (1967). Determination of chlorophyll and phaeopigments : spectrophotometric equations, *Limnology and Oceanography*, 12, 343-347.
- MAHLER, H.R. and CORDES, E.H. (1969). *Biological chemistry*, Harper and Row, New York, Evanston, London; John Weatherhill Inc., Tokyo.
- MOMMAERTS, J.P., BAEYENS, W. and DECADT, G. (1979). *Synthesis of research on nutrients in the Southern Bight of the North Sea*, International Council for the Exploration of the Sea, CM 1979/E : 60.
- STRICKLAND, J.D.H. and PARSONS, T.R. (1968). Pigment Analysis, IV, 3, 185-206, *A practical Handbook of Seawater Analysis*, Fisheries Research Board of Canada.

15425

Strategy for the study of sea-air exchanges in the Belgian coastal zone

H. DEDEURWAERDER, M. DEJONGHE, F. DEHAIRS

Laboratorium voor Analytische Scheikunde
Vrije Universiteit Brussel, Belgium

Abstract

In order to assess the contribution of the sea to the global atmospheric circulation of heavy metals in the North Sea area, we have started the study of the chemical composition of the sea-surface microlayer and of the marine aerosol.

Introduction

Sea-air exchange processes must be studied when looking for processes able to induce enrichment of heavy metals in the marine aerosol. Indeed, the air-sea interface appears to consist of a complex microenvironment which influences strongly and differentially the exchange of elements through it.

As well the chemical species of the elements as the relative amounts exchanged between the sea and the atmosphere can be affected by the composition of the microlayer itself.

Setting of the problematics

For several heavy metals (Cu, Fe, Zn, V, Pb, Cd, ...) the study of the marine aerosol has revealed a strong enrichment, which was not *a priori* expected when considering seawater and crustal material as sole sources (Piotrowicz *et al.*, 1972). Furthermore, such strong enrichments are also

observed in remote, unindustrialized areas, such as the Antarctic continent, although absolute concentrations are smaller by a few orders of magnitude (Duce et al., 1975 ; Maenhaut et al., 1979). Due to the smallness of tropospheric exchange between the northern and southern hemisphere, anthropogenic influence is but poorly sensed in the southern hemisphere (Duce et al., 1975). Therefore, natural processes are generally invoked (Piotrowicz et al., 1972 ; Duce et al., 1975 ; Hunter, 1977). Of these, high and low temperature volatilisation processes (resp. vulcanism and biological methylation) and extraction processes in the sea-air interface are considered (Duce et al., 1975 ; Szekiolda et al., 1972 ; Lantzy and Mackenzie, 1979). We will discuss the latter process with more detail.

An enrichment of heavy metals in the sea-surface microlayer has been observed (Piotrowicz et al., 1972 ; Szekiolda et al., 1972 ; Duce et al., 1972 ; Pattenden and Cambray, 1977 ; Hunter, 1977). There exists evidence that this enrichment is induced as a result of the accumulation of surface active organometal complexes at the sea-air interface (Piotrowicz et al., 1972 ; Duce et al., 1975 ; Hunter, 1977).

Through the bursting of air bubbles at the sea surface, microtomial sections of the enriched surface microlayer are expelled into the atmosphere together with water droplets (Duce et al., 1975 ; Piotrowicz, 1977 ; Fasching et al., 1974 ; Buat-Menard et al., 1979). Such a mechanism could provide highly enriched marine aerosols. A more detailed description of the marine aerosol formation is given in Figure 1.

The study of the element enrichment in function of the aerosol size allows a distinction of the aerosol sources. Small particles (i.e. sizes $< 1 \mu\text{m}$) appear to be produced mainly by evaporation/condensation processes, which can result as well from natural as from anthropogenic processes. Typical marine particles are generally found in the sizes $> 1 \mu\text{m}$ (Hunter, 1977 ; Duce et al., 1976). As a result of their relatively large size such particles can remain only for a few days suspended in the atmosphere (Pattenden and Cambray, 1977 ; Cambray et al., 1975). However, in coastal areas these large, typically marine aerosols can reach the continent and contribute in a significant way to the global aerosol composition (Rossknecht et al., 1973).

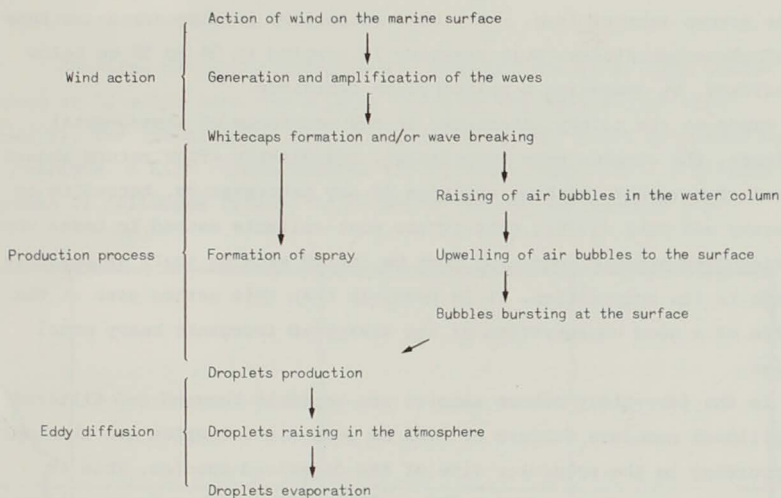

fig. 1.

(After Resch, 1978)

Proposed study

Both the composition of the sea-surface microlayer and of the marine aerosol will be studied.

1.- THE SEA-SURFACE MICROLAYER

The surface microlayer is sampled with the Garrett-screen technique (Garrett, 1965). The screen framework is all plexiglass and nylon mounted and stretches a nylon screen with openings of 400 by 400 μm and a fabric thickness of 440 μm .

The sampling is done aboard a small rubber boat, away from possible contamination by the research vessel.

The operator, wearing rubber gloves, immerses the screen vertically into the water and retrieves it horizontally. By surface tension a film of water, including the surface microlayer, is captured between the meshes of the screen. The thickness of the film sampled approximates the thickness

of the screen fabrics (i.e. ~ 0.4 mm). Successive samples are drawn into polyethylene containers. Bulk seawater is sampled at 20 to 30 cm below the surface, by immersing a polyethylene container.

Since we are mainly interested in the occurrence of organo-metal complexes, the samples were deep-frozen, immediately after return aboard the research vessel, without addition of any preservative. According to Wangersky and Zika (1978), this is the most reliable method in cases where the dissolved organic component must be stored with as small as possible changes in its composition. It is possible that this method goes at the expense of a good conservation of the dissolved inorganic heavy metal species.

In the laboratory ashore samples are rapidly thawed and filtered on Millipore membrane filters of $0.45 \mu\text{m}$ pore size. Samples are then split up according to the molecular size of the dissolved species. This is performed by ultrafiltration on 500 to 1000 Dalton membranes in a large volume (2 litre) cell. Heavy metal analyses are done on both the filtrate and the concentrate. Preconcentration of heavy metal in the filtrate is done by conventional APDC-MIBK complexation and Chelex ion-exchange techniques. The dialysed concentrate is analysed directly for heavy metal content, by AAS (flame or flameless technique).

Further studies involve the separation of the concentrate according to molecular weight of the dissolved organic materials present. This is performed by injection of a small aliquot of the concentrate on a Sephadex gel filtration column.

Since most microlayer sampling techniques induce a too large dilution of the microlayer with bulk seawater the extent of the heavy metal enrichment is difficult to assess. This emphasizes the need to study the microlayer as a discrete unit. The freezing and PVC-spray technique (Hamilton and Clifton, 1979) look very promising in avoiding this too large dilution. These techniques are also interesting since the microlayer with associated particulates is trapped onto a substrate suitable for analysis with the photonic and electronic microscope and electron microprobe.

2.- MARINE AEROSOLS

Sampling of marine aerosols is performed aboard a light vessel anchored at 20 miles from the Belgian coast on the West-Hinder Bank (Figure 2). The vessel moves freely around the anchor point as guided by tide currents. A high volume sampler (30 m³/hour) pumps the air through a Whatman 41 cellulose filter. Up to 300 m³ of air are sampled per

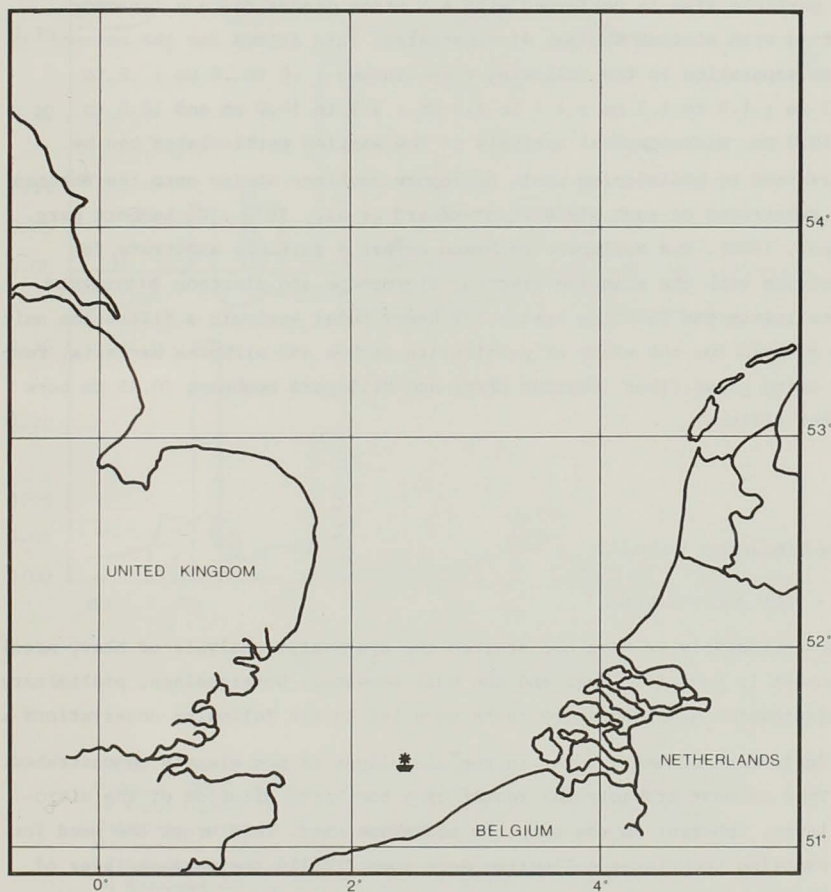

fig. 2.

Geographical location of the marine aerosol monitoring station
(West-Hinder light vessel) in the North Sea

filter. The volume of air sampled is measured with a gas-meter. The air filtration unit is all PVC mounted and is located at about 10 m above sea level, away from possible contamination by the vessel.

The sampling is automatically steered by a wind-direction and wind-speed monitor, obeying to preset boundary conditions. Sampling is performed only for wind blowing from the bow of the vessel in an angle of max. 60° and exceeding a speed of 3 knots. Aerosol sampling in function of particle size is performed with a 5 stage Sierra cascade impactor fitted with slotted Whatman 41 substrates. This allows for the aerosol size separation in the following size classes : .0 to .6 μm ; .6 to 1.3 μm ; 1.3 to 1.7 μm ; 1.7 to 4.9 μm ; 4.9 to 10.0 μm and 10.0 to > 10.0 μm . Microscopical analysis of the sampled particulates can be performed by positioning small Nuclepore membrane strips onto the Whatman 41 substrates of each stage (Buat-Ménard *et al.*, 1979 ; C. Lambert pers. comm., 1980). The Nuclepore membrane offers a suitable substrate for analysis with the scanning electron microscope and electron microprobe. Parallel to the sampling system for heavy metal analysis a filtration unit is mounted for the study of particulate carbon and airborne bacteria, resp. by using glass fiber (Whatman GF/F) and Millipore membrane (0.45 μm pore size) filters.

Preliminary results

1.- THE MICROLAYER

Presently we have not started the systematic analysis of heavy metal content in the microlayer and the bulk seawater. Nevertheless, preliminary measurements and laboratory tests have led to the following observations :

- Enrichment of heavy metal in the microlayer is not clearly demonstrated. This is most probably the result of a too large dilution of the microlayer, inherent to the sampling technique used. This urges the need for sampling techniques collecting more specifically the surface layer of the sea (*vide supra*).
- Humates are an important component of the dissolved organic load in the sea (Hunter, 1977; Baier *et al.*, 1974; Sieburth *et al.*, 1976; Sieburth

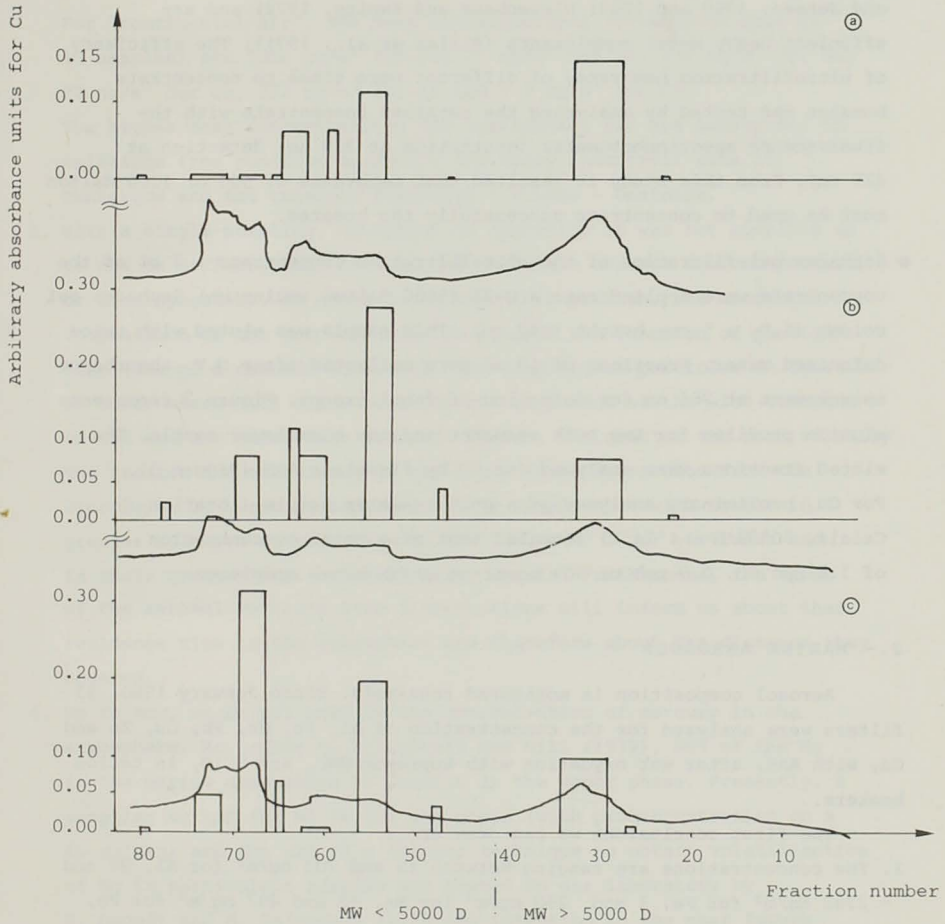

fig. 3.

Sephadex G-25 elution profiles for concentrate-fraction of samples ultrafiltered through a 1000 D membrane. Profile represents U.V. absorbance (at 254 nm) by the eluted fraction (each 10 ml). Profile-shapes are typical for humates. Histograms: Cu-content of some of the eluted fractions as measured by flameless AAS; bar-width = sample volume.

- (a) Bulk seawater collected 04-03-80, location 51°08'04" N - 2°33'04" E.
 (b) Microlayer collected 04-03-80, location 51°08'04" N - 2°33'04" E.
 (c) Bulk seawater collected 05-03-80, location 51°23' N - 2°26' E (West-Hinder Bank).

and Jensen, 1968 and 1969; Nissenbaum and Kaplan, 1972) and are efficient heavy metal complexants (Pillai *et al.*, 1971). The efficiency of ultrafiltration membranes of different pore sizes to concentrate humates was tested by analysing the retained concentrate with the fluorescence spectrophotometer (excitation at 319 nm; detection at 425 nm). From this study it resulted that membranes of 500 or 1000 dalton must be used to concentrate successfully the humates.

- Sephadex gel-filtration of the ultrafiltration concentrate : 5 ml of the concentrate were applied onto a G-25 (5000 dalton exclusion) Sephadex gel column (I.D. : 5 cm; height : 40 cm). This sample was eluted with twice deionized water. Fractions of 10 ml were collected after U.V. absorbance measurement at 254 nm for detection of phenol groups. Figure 3 represents elution profiles for two bulk seawater and one microlayer sample. The eluted fractions were analysed for Cu by flameless AAS (Figure 3). For Cu, preliminary analyses of a bulk seawater sample (location : Calais, 50°58'N - 1°24'E) revealed that of a total concentration of 1.6 ppb Cu, 0.8 ppb or 50% occur as organometal complexes.

2.- MARINE AEROSOLS

Aerosol composition is monitored routinely. Since January 1980, 33 filters were analyzed for the concentration of Al, Fe, Mn, Pb, Cu, Zn and Cd, with AAS, after wet oxydation with Suprapur HNO_3 and HClO_4 in teflon beakers.

The first conclusions we can draw are :

1. The concentrations are ranging between 15 and 703 ng/m^3 for Al, 98 and 2283 ng/m^3 for Fe, 3 and 250 ng/m^3 for Mn, 35 and 487 ng/m^3 for Pb, 1.5 and 88 ng/m^3 for Cu, 5 and 1460 ng/m^3 for Zn and between .5 and 10 ng/m^3 for Cd.
2. If we plot the concentrations of heavy metals in function of the wind direction, significant differences are observed between "marine air" (wind blowing from the sector North-West to North-East) and "continental air" (wind blowing from the sector South-West to East). For "marine air" the mean concentrations (arithmetic mean of 9 samples) are 200 ng/m^3 for Fe, 7.2 ng/m^3 for Mn, 160 ng/m^3 for Pb, 11 ng/m^3 for Cu, 64 ng/m^3 for Zn and 1.3 ng/m^3 for Cd.

For "continental air", the mean concentrations (arithmetic mean of 19 samples) are 1056 ng/m³ for Fe, 72 ng/m³ for Mn, 276 ng/m³ for Pb, 22 ng/m³ for Cu, 332 ng/m³ for Zn and 4.2 ng/m³ for Cd.

The higher mean concentrations for continental air are mainly due to emissions from punctual sources : the heavy industrial zone of Dunkerque and the triangle Zeebrugge - Brugge - Oostende.

3. With a single sampling equipment in operation it was not possible up to now to differentiate between the different aerosol sources (natural or anthropogenic). In order to resolve this problem, the elemental composition of the aerosols will be studied in function of particle size (use of a cascade impactor). The sampling of particles in function of their sizes will allow to study the influence of the wind velocity on the sea-air extraction process. Indeed, the greater the wind velocity the greater the efficiency of the heavy metal extraction from the microlayer by bursting bubbles. In the sample this will result in a greater relative contribution of the larger (> 1 µm) particles and in their greater enrichment in heavy metals. Furthermore, the study of the aerosol particle size distributions will inform us about their residence time in the atmosphere and therefore about the distance they covered.
4. Up to now, we do not measure the concentration of mercury in the atmosphere. According to Fitzgerald and Gill (1979), 96% of the Hg in the marine atmosphere is present in the vapor phase. Presently, a sampling method for Hg in the gas phase (with preconcentration on a Au-column) and the use of a furnace technique to obtain volatilisation of Hg in particulate samples are tested in our laboratory by G. Decadt and M. Dejonghe. It is our intention in the near future to monitor the Hg concentration routinely aboard the light-vessel West-Hinder.

Acknowledgments

This work was done in the framework of a National Research and Development Program. We thank the Ministry of Science Policy for financial support.

We also thank the crew of the West-Hinder light vessel for technical assistance.

References

- BAIER, R.E., GOUPIL, D.W., PERLMUTTER, S. and KING, R., (1974). Dominant chemical composition of sea surface films natural slicks and foams, *J. Rech. Atm.*, 8, 571.
- BUAT-MENARD, P., LAMBERT, C.E., EZAT, E., FONTUGNE, M. and CHESSELET, R., (1979). Preliminary data from electron microscopy and carbon isotopes mass spectrometry related to the sea-air exchange processes, *Searex Newsletter*, 2, 11-22.
- CAMBRAY, R.S., JEFFERIES, D.F. and TOPPING, G., (1975). An estimate of the input of atmospheric trace elements into the North Sea and the Clyde Sea (1972-3) AERE report, 7733, 26 pp.
- DUCE, R.A., HOFFMAN, G.L. and ZOLLER, W.H., (1975). Atmospheric trace metals at remote northern and southern hemisphere sites, pollution or natural ?, *Science*, 187, 59.
- DUCE, R.A., QUINN, J.G., OLNEY, C.E., PIOTROWICZ, S.R., RAY, B.J. and WADE, T.L., (1972). Enrichment of heavy metals and organic compounds in the surface microlayer of Narragansett Bay, *Science*, 176, 161.
- DUCE, R.A., RAY, B.J., HOFFMAN, G.L. and WALSH, P.R., (1976). Trace metal concentrations as a function of particle size, *Geophys. Res. Letters*, 3, 339.
- FASCHING, J.L., COURANT, R.A., DUCE, R.A. and PIOTROWICZ, S.R., (1974). A new surface microlayer sampler utilizing the bubble microtorne, *J. Rech. Atm.*, 8, 649.
- FITZGERALD, W.F. and GILL, G.A., (1979). Subnanogram determination of mercury by two-stage gold amalgamation and gas phase detection applied to atmospheric samples, *Anal. Chem.*, 51, 1714.
- GARRETT, W.D., (1965). Collection of slick-forming materials from the sea surface, *Limnol. Oceanogr.*, 10, 602.
- HAMILTON, E.I. and CLIFTON, R.J., (1979). Techniques for sampling the air-sea interface for estuarine and coastal waters, *Limnol. Oceanogr.*, 24, 188.
- HUNTER, K.A., (1977). *Chemistry of the sea surface microlayer*, Ph. D. Thesis, University of East Anglia, G.B.
- LANTZY, R.J. and MACKENZIE, F.T., (1979). Atmospheric trace metals : global cycles and assessment of man's impact, *Geochim. Cosmochim. Acta*, 43, 511.
- MAENHAUT, W., ZOLLER, W.H., DUCE, R.A. and HOFFMAN, G.L., (1979). Concentration and size distribution of particulate trace elements in the South Polar atmosphere, *J. Geophys. Res.*, 84, 2421.

- NISSENBAUM, A. and KAPLAN, I.R., (1972). Chemical and isotope evidence for the *in situ* origin of marine humic substances, *Limnol. Oceanogr.*, 17, 570.
- PATTENDEN, N.J. and CAMBRAY, R.S., (1977). Investigations into the sea-surface enrichment of trace elements and its effect upon the atmospheric aerosol, Natural Environment Research Council, Intern. report.
- PILLAI, T.N.V., DESAI, M.V.M., MATHEW, E., GANAPATHY, S. and GANGULY, A.K., (1971). Organic materials in the marine environment and the associated metallic elements, *Current Science*, 40, 75.
- PIOTROWICZ, S.R., (1977). *The sea to air transport of trace metals*, Ph. D. Thesis, University of Rhode Island, USA.
- PIOTROWICZ, S.R., RAY, S.J., HOFFMAN, G.L. and DUCE, R.A., (1972). Trace metal enrichment in the sea-surface microlayer, *J. Geophys. Res.*, 77, 5243.
- RESCH, F., (1978). Incidence des activités humaines sur les cycles atmosphériques à l'échelle globale, Ecole Européenne d'été d'environnement, Peyresq, septembre.
- ROSSKNECHT, G.F., ELLIOTT, W.P. and RAMSAY, F.L., (1973). The size distribution and inland penetration of sea-salt particles, *J. Appl. Meteor.*, 12, 825.
- SIEBURTH, J.Mc.N. and JENSEN, A., (1968). Studies on algal substances in the sea. I. Gelbstoff (humic material) in terrestrial and marine waters, *J. Exp. Mar. Biol. Ecol.*, 2, 174.
- SIEBURTH, J.Mc.N. and JENSEN, A., (1969). Studies on algal substances in the sea. II. The formation of Gelbstoff (humic material) by exudates of phaeophyta, *J. Exp. Mar. Biol. Ecol.*, 3, 275.
- SIEBURTH, J.Mc.N., WILLIS, P., JOHNSON, K.M., BURNEY, C.M., LAVOIE, D.M., HINGA, K.P., CARON, D.A., FRENCH, F.W., JOHNSON, P.W. and DAVIS, P.G., (1976). Dissolved organic matter and heterotrophic microneuston in the surface microlayers of the North Atlantic, *Science*, 194, 1415.
- SZEKIELDA, K.H., KUPFERMAN, S.L., KLENAS, V. and POLIS, D.F., (1972). Element enrichment in organic films and foam associated with aquatic frontal systems, *J. Geophys. Res.*, 77, 5278.
- WANGERSKY, P.J. and ZIKA, R.G., (1978). The analysis of organic compounds in sea water, Nat'l Rech. Council. Canada Rep., 3, 177 pp.

Faint, illegible text, possibly bleed-through from the reverse side of the page.

15427

The biogeochemical cycle of barium in the open ocean
An evaluation

F. DEHAIRS

Laboratorium voor Analytische Scheikunde
Vrije Universiteit Brussel, Belgium

Abstract

This study constitutes our contribution to the international oceanographical GEOSECS program (Geochemical Ocean Sections). The Ba content of suspended particulate matter was studied by neutron activation analysis. Analyses with the electron microscope and electron microprobe equipment have allowed the identification of the mineral barite as the main carrier of Ba in oceanic suspensions. Strong evidence is offered for a biological formation of these barite microcrystals. An estimation of the amount of Ba introduced into the deep ocean by dissolution of the barite crystals was possible. Finally, our results enabled a modelling of the general biogeochemical cycle of Ba in the ocean.

Introduction

The distribution of several trace elements, such as Cd, Zn, Cu, ... in the oceanic watercolumn and the sediments is influenced by processes depending on the biological activity in the surface water (Boyle *et al.*, 1976 and 1977; Bruland *et al.*, 1978). Such processes can be : adsorption and/or incorporation on/by phyto- and zooplankton ; ingestion of biogenic particulate material, as well as abiogenic material, by zooplankton; sedimentation of dead organisms and fecal material to the deep sea; partial decomposition and/or dissolution of this sedimenting material; sedimentation of the undecomposed fraction.

Furthermore, the impact of the biological processes upon the geochemistry or more accurately the biogeochemistry of trace elements, can

result in the sustainment in seawater of systems out of thermodynamic equilibrium.

This work concerns the biogeochemistry of the trace element Ba. Biological activity governs to a large extent the distribution of this element in the watercolumn and produces the Ba-mineral barite, which should not occur in seawater from a purely thermodynamical point of view.

During the past twenty years, several dissolved Ba profiles have been measured throughout the World Ocean (Chan *et al.*, 1977; Chow and Goldberg, 1960; Bacon and Edmond, 1972; Wolgemuth and Broecker, 1970).

These profiles are characterized by low dissolved Ba concentrations in the surface water ($< 7 \mu\text{g Ba/kg SW}$). In general concentrations increase, with increasing depth, towards an asymptotic value at mid-depth (world average value of $\sim 16 \mu\text{g Ba/kg SW}$). The general shape of such a profile suggests a biological control : ● consumption of dissolved Ba in surface waters during biological activity and concentration of this Ba in the particulate phase ; ● input of dissolved Ba in the deep sea as a result of decomposition and dissolution of the sedimenting biogenic Ba-carriers.

Up to recently, it were essentially the diatoms which were considered to be the organisms controlling the dissolved Ba distribution in the watercolumn (Bacon and Edmond, 1972; Li *et al.*, 1973). This conclusion was drawn from the observation that dissolved Ba and Si did correlate well. However, more recently it was shown that the correlation between dissolved Si and Ba was not always as good as observed earlier, (Chan *et al.*, 1977). Furthermore, dissolved Ba correlated also well with alkalinity (Chan *et al.*, 1977). The only conclusion which could be drawn from these observations was that the dissolved Ba profile was more likely to result from the settling and dissolution of slowly dissolving biogenic structures, such as opal and aragonite, calcite than from the decomposition of the more labile tissue components, (Chan *et al.*, 1977). It is clear that the high correlations observed between dissolved Ba, Si and alkalinity do not necessarily imply these elements to cohabit the same particulate biogenic phase.

We studied the occurrence of Ba in the oceanic suspended matter. Particulate matter suspended in seawater constitutes a field in oceanography which up to recently has been but poorly investigated.

Methods

The experimental techniques are described in detail elsewhere (Dehairs, 1979; Dehairs et al., 1980). A short description is given hereafter. Most samples of suspended matter studied here were collected during the GEOSECS cruises in the Atlantic and Pacific Ocean, resp. between 1972 - 1973 and 1973-1974 (Table 1). Some samples were collected during several

Table 1

Geographical position of stations and investigated depth intervals

| Stations | Positions | Investigated depth interval (in m) | | | |
|----------------|------------------|------------------------------------|------|---|---|
| Atlantic Ocean | | | | | |
| GEOSECS ST 17 | 74°56'N-01°07'W | 992 to 3439 | | x | + |
| 5 | 56°54'N-42°47'W | 363 | 2464 | x | |
| 3 | 51°01'N-43°01'W | 28 | 3660 | x | + |
| 27 | 42°00'N-41°59'W | 1441 | 4858 | x | |
| 120 | 33°15'N-56°34'W | 900 | 3187 | | + |
| 115 | 28°04'N-25°54'W | 1145 | 3732 | | + |
| 31 | 27°00'N-53°31'W | 1 | 5500 | | + |
| 37 | 12°01'N-51°00'W | 949 | 1940 | | + |
| 58 | 27°02'S-37°00'W | 197 | 4422 | x | + |
| 67 | 44°58'S-51°10'W | 40 | 5580 | x | + |
| 91 | 49°36'S-11°37'E | 486 | 3074 | x | |
| 82 | 56°15'S-57°38'W | 1 | 5202 | x | + |
| ATLANTIS II | | | | | |
| ST 715 | 52°56'N-36°13'W | 2000 | | x | |
| 2111 | 33°41'N-57°38'W | 954 | 2195 | x | + |
| HARMATAN 1971 | | | | | |
| ST 6 | 04°30'N-19°35'W | 2000 | 3000 | x | |
| 15 | 00°00' -05°30'W | 1000 | 4000 | x | + |
| MIDLANTE 1974 | | | | | |
| ST Madcap | 28°40'N-25°25'W | 1075 | 5043 | | + |
| 9 | 24°03'N-28°56'W | 910 | 2265 | | + |
| 50 | 34°43'N-29°34'W | 985 | 3510 | | + |
| TRANSAT 1975 | | | | | |
| ST 17 | 34°06'N-61°17'W | 5 | 4380 | | + |
| 37 | 14°48'N-74°12'W | 1000 | | | + |
| Pacific Ocean | | | | | |
| GEOSECS ST 257 | 10°10'S-170°00'W | 1263 | 5182 | x | + |
| 263 | 16°36'S-167°05'W | 676 | | x | |
| 269 | 23°59'S-174°26'W | 1253 | 6348 | x | + |
| 310 | 26°55'S-157°11'W | 1557 | 4789 | x | + |
| 282 | 57°35'S-169°36'E | 2131 | 5187 | x | + |

x Inspected for BaSO₄ presence by SEM - EMP+ Analysed for total Ba₀ by INAA

French cruises in the North and Equatorial Atlantic between 1972 and 1977 (Table 1). Samples were taken with 30 litre Niskin bottles. Of this seawater volume 10 litre were filtered under pressure on 47 mm Nuclepore membrane filters of 0.4 μm pore size. The analysis of the suspended matter was carried out by : 1) Scanning Electron Microscope and Electron Microprobe (SEM-EMP) to collect qualitative and semi-quantitative data on the morphology and the elemental composition of single particles. Both, wavelength and energy dispersive spectrometers were used. This part of the study was carried out at the Laboratoire de Géochimie (Université Libre de Bruxelles); 2) Instrumental Neutron Activation Analysis (INAA) for the quantitative analysis of particulate Ba. This part of the study was carried out at the Centre des Faibles Radioactivités (CNRS, Gif sur Yvette, France) using the facilities of the Pierre Sûe Activation Analysis Laboratory (Commissariat à l'Energie Atomique, Saclay, France).

Results and discussion

1.- MEASUREMENT OF TOTAL PARTICULATE Ba

A total of 20 profiles of particulate Ba were measured for the Atlantic and Pacific Oceans (Dehairs, 1979; Dehairs et al., 1980). In figure 1 we reproduce the particulate Ba profiles measured for 9 GEOSECS stations in the Atlantic and Pacific Oceans as well as 3 profiles measured for Atlantic stations visited during French cruises. For the remaining profiles no sufficient data were obtained to establish vertical profiles. The general features of the particulate Ba profiles for which sufficient data were obtained are : ● minimal concentrations in the first 100 m ; ● increase of the concentration towards a max. located generally at less than 100 to 1000 m depth ; ● decrease of the concentration down to mid-depth ; ● relatively constant or more slowly decreasing concentrations down to the bottom water ; ● occasionally a sharp increase of the concentration in bottom waters, when a nepheloid layer is present. Such characteristics suggest that the following processes occur in the water column : ● a production of particulate Ba at some depth below the surface but generally outside the euphotic layer ; ● a dissolution of the particulate phase(s) with increasing depth ; ● an input of sedimentary Ba , close to the sea

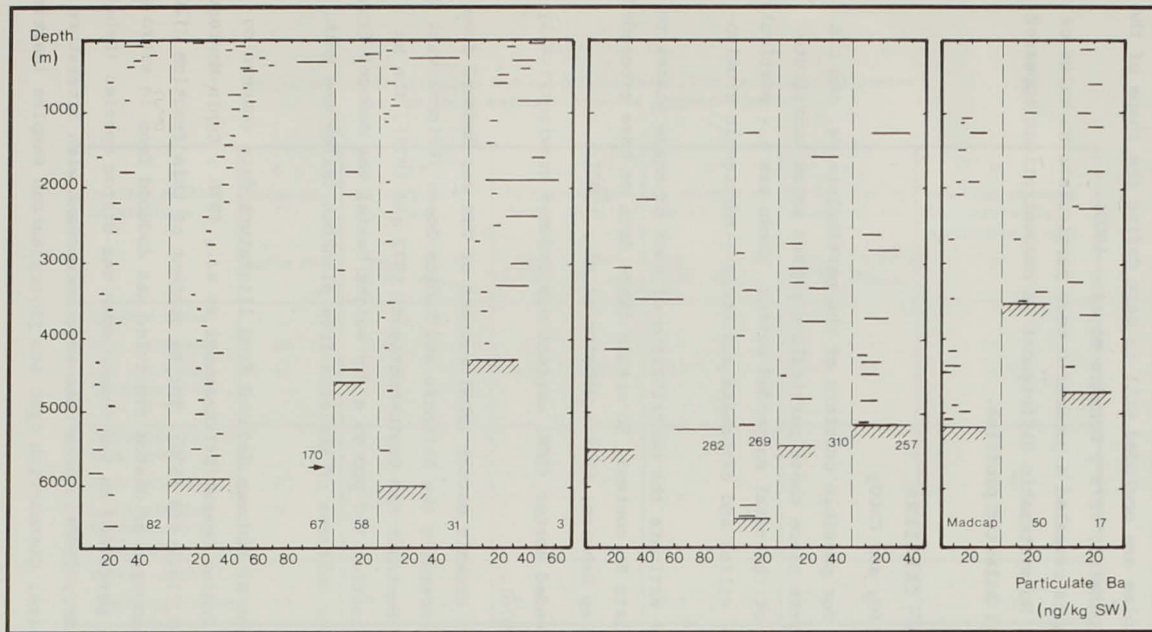

fig. 1.

Profiles of particulate Ba measured by INAA. GEOSECS Atlantic stations 82, 67, 58, 31, 3; GEOSECS Pacific stations 282, 269, 310, 257; MIDLANTE Atlantic stations Madcap, 50; TRANSAT Atlantic stations 17. For geographical location, see table 1. The depths of the watercolumns are indicated by a hatched line; at station 82 this depth is 7873 m.

floor in regions with a nepheloid layer. Furthermore, our study has shown that for the fine particulate load advective movement of the watermasses in which the particles are occluded will in part define the shape of the vertical profile (Dehairs, 1979 ; Dehairs et al., 1980).

Our measurements revealed a geometric mean particulate Ba value of 20 ng/kg seawater. No systematic differences in concentrations appeared between Pacific and Atlantic profiles.

2.- POSSIBLE Ba - CARRIERS

2.1.- Ba in POM, SiO₂ and CaCO₃

When looking for possible carriers of the particulate Ba, one can consider in the first place those particulate phases which constitute the main fraction of the total suspended matter. These are : - particulate organic matter ; - silica and carbonate skeletons ; - terrigenous aluminosilicate material.

In Table 2 we estimate the contribution of each of these phases to the total particulate Ba content. To obtain these data we have proceeded as follows (see also Dehairs, 1979 ; Dehairs et al., 1980).

1° The total suspended matter (TSM) content was deduced gravimetrically (Brewer et al., 1976).

2° The particulate organic matter (POM) content of TSM was deduced from literature data concerning the Atlantic and Indian Ocean (Krishnaswami et al., 1976 ; Copin-Montegut and Copin-Montegut, 1972 and 1978). The Ba content of this fraction (60 ppm on a dry weight basis) was deduced from literature data for cultures of skeleton-free plankton (Riley and Roth, 1971).

3° The SiO₂ content of TSM was deduced from literature data concerning the Atlantic and Indian Ocean (Krishnaswami et al., 1976 ; Copin-Montegut and Copin-Montegut, 1972 and 1978). The Ba content of this fraction (120 ppm) which is mainly composed of diatom frustules was deduced from *in vitro* Ba uptake studies we performed on two common open sea diatom species (Dehairs, 1979; Dehairs et al., 1980). These data were concordant with literature data concerning composite, diatom-rich open sea phytoplankton samples (Martin and Knauer, 1973).

Table 2

Contribution of siliceous and calcareous tests, POM and aluminosilicates to the total barium content of suspended matter

| Section of the watercolumn | A | B | | C | | D | | E | | F |
|---|--|---|-------------------------------|--|-------------------------------|--|-------------------------------|---|-------------------------------|---|
| | Total Ba _p (1) ng/kg SW | Ba carried by SiO ₂ tests (2) $\frac{\text{ng}}{\text{kg SW}}$ | % of Ba _{p total} | Ba carried by CaCO ₃ tests (3) $\frac{\text{ng}}{\text{kg SW}}$ | % of Ba _{p total} | Ba carried by POM (4) $\frac{\text{ng}}{\text{kg SW}}$ | % of Ba _{p total} | Ba carried by aluminosilic. (5) $\frac{\text{ng}}{\text{kg SW}}$ | % of Ba _{p total} | Fraction of total Ba _p carried by non-barite phases % |
| <i>Surface water</i> | | | | | | | | | | |
| High latitudes | 27 | 2.4 | 9 | 2.4 | 9 | 7.2 | 27 | | 5 | 50 |
| Low latitudes (between 45°N and 45°S) | 11 | 0.6 | 5.5 | 0.6 | 5.5 | 1.8 | 16.5 | 1.3 | 12 | 39.5 |
| <i>Intermediate and deep water</i> | | | | | | | | | | |
| High latitudes | 27 | | 1 | | 1 | | 3.5 | | 3 | 8.5 |
| Low latitudes (between 45°N and 45°S) | 10 | 0.3 | 3 | 0.3 | 3 | 0.9 | 9 | 0.8 | 8 | 23 |
| <i>Bottom water (nepheloid layer)</i> | 14 | 0.3 | 2 | 0.3 | 2 | 0.9 | 6.5 | 2.7 | 19 | 29.5 |

(1) Dehairs (1979) ; Dehairs et al. (1980).

(2) SiO₂ tests contain 120 ppm of Ba ; Dehairs (1979) ; Dehairs et al. (1980).

(3) CaCO₃ tests contain a max. of 200 ppm Ba ; from Church (1970).

(4) POM contains 60 ppm of Ba ; from Martin and Knauer (1973) ; Riley and Roth (1971).

(5) aluminosilicates contain 600 ppm of Ba ; from Turekian (1968) and Turekian and Wedepohl (1961).

4° The CaCO_3 content of TSM was deduced from our data on particulate Ca, as measured by INAA, for the same samples analyzed for Ba. The Ba content of the biogenic CaCO_3 phase (200 ppm) in suspension was taken from the literature (Church, 1970).

5° The aluminosilicate content of TSM was deduced from our data on particulate Al, as measured by INAA for the same samples analyzed for Ba. The Ba content of the aluminosilicate material in suspension (600 ppm) was taken from literature data concerning the Ba content of shales (Turekian, 1968 ; Turekian and Wedepohl, 1961). Indeed, since the Al content of aluminosilicate material suspended in seawater was observed to be similar to the Al content of shales (Lambert, 1979 ; Arrhenius, 1963 ; Buat-Menard and Chesselet, 1979), this was assumed to hold also for the Ba content of suspended aluminosilicate material (Dehairs, 1979 ; Dehairs et al., 1980).

In Table 2 we compare the average Ba contribution of these different phases with our average total particulate Ba values (only Atlantic Ocean values were considered) for surface water (first 300 m), intermediate and deep water (300 + 3000 m) and bottom water (3000 m + sea floor). On the basis of the TSM content in the Atlantic Ocean (Brewer et al., 1976) a distinction was made between high and low latitudes (*i.e.* between latitudes north and south of resp. 45°N and 45°S and latitudes between 45°N and 45°S) for the surface water and the intermediate + deep water boxes. The higher TSM contents at high latitudes are the result of a greater productivity in these waters (Brewer et al., 1976). No such regional differentiation of the TSM content exists for the bottom water box (Brewer et al., 1976).

From Table 2 it appears that the main fraction of total particulate Ba is carried by one or more non identified carrier(s).

2.2.- Ba as barite

The investigation of the suspended matter samples with the SEM-EMP revealed the presence of discrete micron-sized particles, containing Ba and S (Plate I). These particles occurred in any investigated sample at any depth (Table 1). Therefore, they can be considered as an ubiquitous component of oceanic suspended matter.

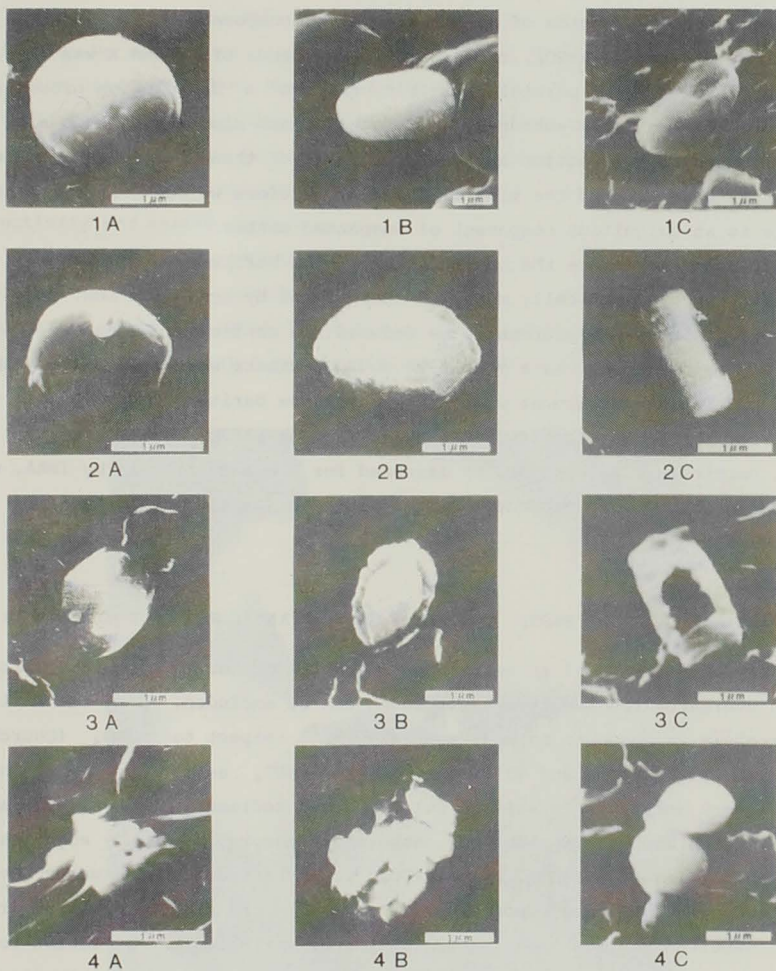

Plate I

Morphological types of barite particles in suspension in seawater

- 1) Ellipsoidal or spherical particles : A = GEOSECS station 67, 1499 m; B = GEOSECS station 3, 28 m; C = GEOSECS station 82, 832 m.
- 2) Particles with a crystalline habit : euhedral, automorphic particles : A, B, C = GEOSECS station 67, 658 m, 2982 m, 2982 m.
- 3) Irregularly shaped particles, probably affected by dissolution : A, B, C = GEOSECS station 67, 2982 m, 2193 m, 5599 m.
- 4) Aggregates of very small particles with or without a crystalline habit : A, B = GEOSECS station 67, 62 m, 4424 m; C = GEOSECS station 3, 105 m.

Besides the presence of Ba and S as major components, what suggests that they consist of $BaSO_4$, the occasional presence of Sr and K was observed. Most of these particles exhibit traces of a dissolution process; some are still clearly euhedral. Aggregates of sub-micron prisms do also occur. Electron diffraction analyses upon some of these particles revealed that they consisted of the mineral *barite*. Therefore we can conclude that barite is an ubiquitous component of suspended matter.

In order to deduce the contribution of the barite crystals as Ba-carriers, we systematically measured their sizes by using the SEM. From these particle-size measurements we deduced the particle volumes and the particle masses as Ba. As a result we could estimate what fraction of the total particulate Ba amount was carried by these barite crystals.

From this SEM-EMP study it appeared that up to 70% and more of the total particulate Ba content, as measured for the *same* filters by INAA, was accounted for by the suspended barite particles (Dehairs, 1979; Dehairs *et al.*, 1980).

3.- ORIGIN OF THE $BaSO_4$ CRYSTALS IN OCEANIC SUSPENDED MATTER

The possibility of an authigenic formation of barite, by precipitation in an oversaturated seawater environment can be excluded, since the entire watercolumn is shown to be undersaturated with respect to $BaSO_4$ (Church, 1970 and 1979; Church and Wolgemuth, 1972). $BaSO_4$ saturation conditions are present only in interstitial waters of the sediments (Church, 1970 and 1979; Church and Wolgemuth, 1972). However, a theoretical study suggests that a solid solution of $BaSO_4$ with $SrSO_4$ could be stable in seawater (Hanor, 1969). We have observed minor amounts of Sr in the suspended barite crystals. Nevertheless, the observation of highly variable Sr/Ba ratios for such particles in the *same* sample is inconsistent with their authigenic formation in a single parcel of seawater, considered as a given physico-chemical environment.

There is much more evidence that the production of these barite crystals is controlled by a biological process. The particulate Ba content in the upper part of the watercolumn is positively related with the primary productivity (Figure 2). The data in Figure 2 were obtained as follows. Particulate Ba data represent average values for the first 1000 m of the watercolumn.

This depth interval was chosen, since it is between these limits that the particulate Ba maximum is generally observed (see above). The organic production data were taken from the paper of Koblentz (Mishke *et al.*, 1970) and apply to the general vicinity in which GEOSECS stations are located. Since we have shown that it is barite which accounts for most of the total particulate Ba. The relationship in figure 2 holds also between organic productivity and barite content.

As concerns the mechanism of barite formation by the biological activity, 3 possibilities can be considered :

1° Formation of barite crystals in biological detritus, such as fecal pellets.

Detritus can represent a microenvironment with specific physico-chemical



Plate II

Dark-field micrograph obtained with a 1 MeV transmission electron microscope of a barite grain (indicated by the arrow) inside an organic pellet, collected at 1860 m at GEOSECS Pacific station 306. [From J. Klossa, Laboratoire "R. Bernas", Orsay and Centre des faibles Radioactivités, Gif-sur-Yvette.]

properties, different from those present in the surrounding seawater. In fact we observed barite crystals inside particles giving no elemental signal when inspected by EMP and consisting of a low density material (Plate II). We suppose such particles to represent organic detritus, with barite having precipitated within it.

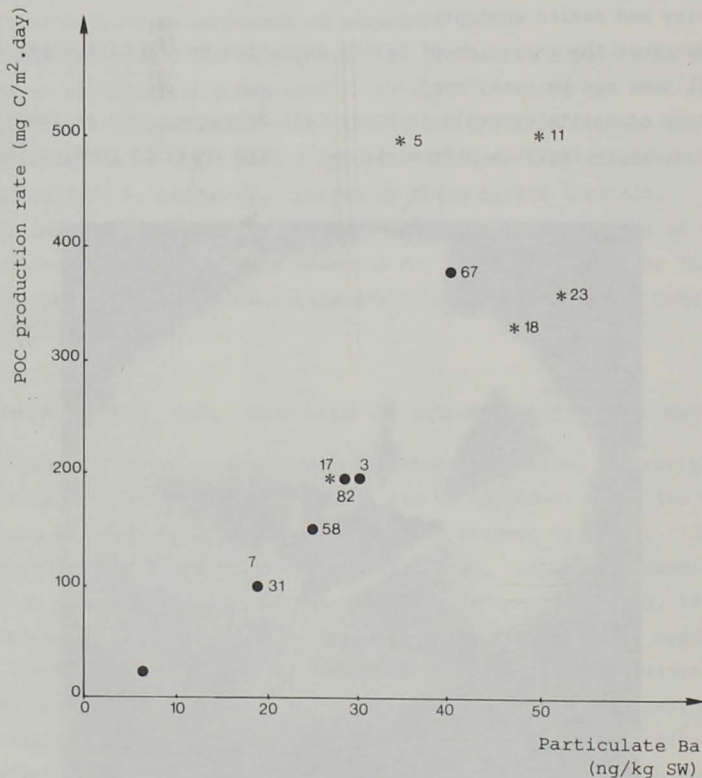

fig. 2.

Relationship between the average particulate Ba content in the first 1000 m of the watercolumn and the organic C production rate. Numbers refer to station numbers (see table 1), all stations in Atlantic Ocean.

● : own data for particulate Ba.

* : data of P. Brewer (GEOSECS unpublished results).

Organic C production rate data as given in Koblentz-Mishke (1970) for the same general vicinity of the station locations.

- 2° Formation of barite crystals through the intermediary of *Acantharia*. *Acantharia* are *Radiolaria* with a celestite (SrSO_4) skeleton. They are an ubiquitous component of oceanic plankton (Botazzi and Schreiber, 1971). At the death of such organisms, the SrSO_4 skeleton will dissolve in the sea water. Celestite is much more soluble than barite, but Ba might substitute for Sr in the celestite crystal lattice, in a tendency to produce a mineral more stable in seawater (Church, pers. comm., 1979). The endpoint of such a continuous substitution would be barite which itself, however, is undersaturated in the watercolumn (Church, 1970 and 1979; Church and Wolgemuth, 1972).
- 3° The direct formation of barite crystals by the living cell. Several observations stress the importance of the latter mechanism :
- ♦ *Xenophyophora*, which are benthic protozoa of the *Rhizopoda* classis, were observed to contain barite crystals inside vacuoles (Tendal, 1972).
 - ♦ The central capsuls of some species of the collosphaerid *Radiolaria* contain crystals which were tentatively identified by Haeckel as barite and/or celestite crystals (Haeckel, 1862). To our knowledge no further reports of such crystals were done since that early observation.
 - ♦ Marine chromophytes of the *Pavlova*les ordo were observed to carry barite crystals inside their vacuole (Gayral and Fresnel, 1979; Fresnel et al., 1979).

These three mechanisms of biological barite formation might actually occur together. They could induce the particulate Ba maximum which is observed in surface waters, generally below the euphotic zone. Indeed, the occluded barite crystals will only be liberated into the seawater, at the death of the barite producing organisms, when these start to decompose.

4.- THE FATE OF THE BARITE CRYSTALS IN THE WATERCOLUMN

Our observations with the SEM clearly showed that most of the suspended barite crystals are affected by dissolution. This is consistent with the fact that the watercolumn is undersaturated with respect to BaSO_4 (Church,

1970 and 1979; Church and Wolgemuth, 1972). Our data on the barite particle size distributions allowed us to estimate the amount of Ba dissolving per unit time in the deep ocean.

The amount J of material which is dissolving per unit time is given by (see also Lal and Lerman, 1973 and 1975) :

$$J = \frac{dM}{dt} = \frac{\pi}{6} \rho \frac{d(ND^3)}{dt} \quad (1)$$

where $\frac{dM}{dt}$ is the amount of $BaSO_4$ dissolving per unit time, ρ is the specific weight of $BaSO_4$, N is the particle number, D is the particle diameter.

By assuming that particles settle according to the Stokes sedimentation law and that the particle flux remains constant, equation (1) can be worked out

$$J = \frac{1}{3} \rho ND^2 k \quad (2)$$

where k is the barite dissolution rate constant which is dependend on the state of undersaturation of $BaSO_4$ in seawater. All terms on the right hand side of equation (2) are known with the exception of k .

By applying a Stokes settling and dissolution rate model to the size distribution data obtained for successive samples taken inside a *same* deep watermass it was possible to deduce k for the deep sea (Dehairs, 1979; Dehairs *et al.*, 1980). The k value obtained ($0.04 \mu\text{m}/\text{yr}$) is consistent with the state of undersaturation of deep Atlantic Ocean water, when considering the barite dissolution to obey a second order reaction as observed *in vitro* for other sulphate phases ($PbSO_4$, $CaSO_4 \cdot 2H_2O$, $SrSO_4$) and for the crystallisation of $BaSO_4$, $PbSO_4$ and $CaSO_4 \cdot 2H_2O$ (Campbell and Nancollas, 1969; Nancollas, 1968; Nancollas and Purdie, 1963).

As a result we could deduce an average deep-ocean J_{Ba} value of $0.4 \mu\text{g Ba}/\text{cm}^2 \cdot \text{yr}$ (see figure 3).

However, it is important to verify the input of dissolved Ba in the deep sea as resulting from the dissolution of SiO_2 and $CaCO_3$ skeletal phases. Indeed, although the latter were observed to contain but minor amounts of Ba, the fact that their turn-over rate is faster than the one of barite, may finally result in an important additional input of dissolved Ba in the deep sea.

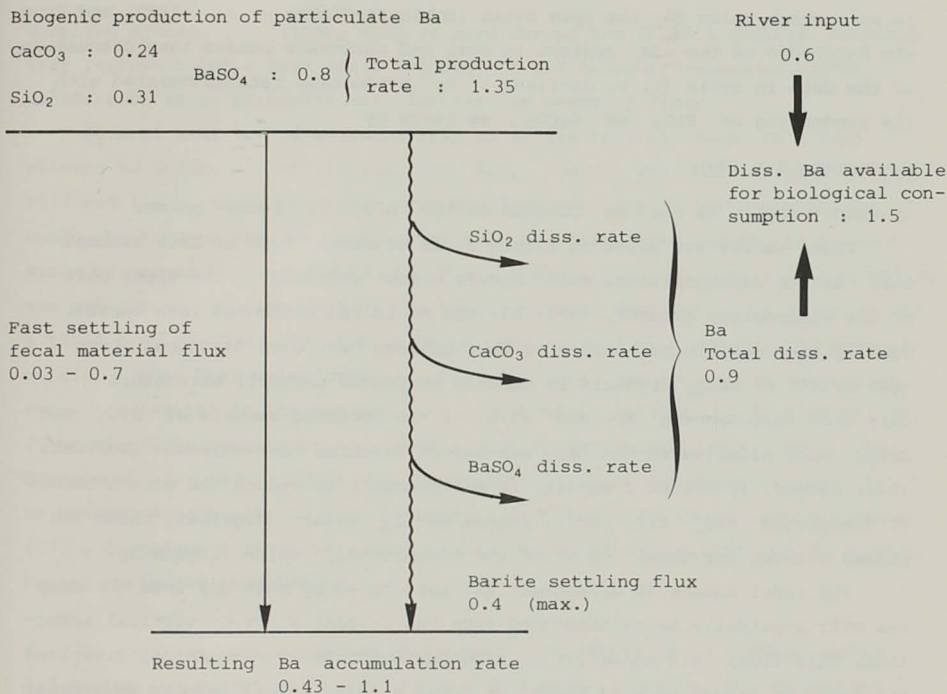

fig. 3.

Numerical values for the components of the oceanic barium cycle
All values in $\mu\text{g Ba/cm}^2\cdot\text{yr}$

The estimation of the amounts of SiO₂ and CaCO₃ dissolving in the deep sea is based on mass balance computations of Wollast (1974) and Berger (1970).

In order to estimate the amount of dissolved Ba introduced in the deep sea as a result of the dissolution of the SiO₂ and CaCO₃ carriers, we have calculated in the first place the production rate of Ba as associated with the production of SiO₂ and CaCO₃. From the following relationship :

$$\frac{(A)}{(\text{POC})} \times \text{POC prod. rate},$$

where A is the SiO₂ or CaCO₃ content of TSM (see discussion of table 2); POC is the particulate organic carbon; POC production rate = 7 mg C/cm².yr

is an average value for the open ocean (Koblentz-Mishke *et al.*, 1970) and from the knowledge of the Ba content in opal and carbonate phases (see discussion of the data in table 2), we obtained a Ba production rate associated with the production of SiO_2 or CaCO_3 , as given by

$$\text{prod. rate A} \times (\text{Ba})_A$$

in which $(\text{Ba})_A$ is the Ba content of the SiO_2 or CaCO_3 phase.

These values are given in figure 3. As concerns POM we have assumed that at its decomposition, which occurs almost entirely in the upper part of the watercolumn (Menzel, 1974) all the Ba is redistributed into barite. Some of the possible mechanisms of that process have been described above (see origin of BaSO_4 crystals in oceanic suspended matter). Literature data show that between 80 and 90 % of the produced amounts of SiO_2 and CaCO_3 will dissolve in the deep sea before reaching the sediments (Wollast, 1974; Berger, 1970). As a result, it was possible to deduce the contributions of dissolving SiO_2 and CaCO_3 phases to J_{Ba} -total. Together, these two phases account for about 55 % of the overall J_{Ba} value (figure 3).

The total amount of dissolved Ba introduced by this way into the deep sea will eventually be reintroduced into the surface water by vertical advection. This flux, $0.9 \mu\text{g}/\text{cm}^2.\text{yr}$, together with the average annual dissolved Ba input by rivers [$0.6 \mu\text{g Ba}/\text{cm}^2.\text{yr}$ (Chan *et al.*, 1976)] results in a total flux of dissolved Ba to surface waters of $1.5 \mu\text{g}/\text{cm}^2.\text{yr}$ which is of the same magnitude as the consumption requirements of Ba by biological activity ($1.35 \mu\text{g}/\text{cm}^2.\text{yr}$, figure 3).

Not all of the settling particulate Ba dissolves in the deep sea. Part of it can be incorporated into the sediments. The flux of settling barite crystals to the sediments was estimated by assuming Stokes law to be obeyed. We have calculated this flux from our data for the barite size-distributions for samples closest to the ocean floor. These bottom water particles were assumed not to be affected any further by dissolution before their incorporation in the sediments. A max. $0.4 \mu\text{g Ba}/\text{cm}^2.\text{yr}$ was deduced for the particulate Ba flux of the sediments (figure 3). This flux is supplemented by the one resulting from the fast settling of large particles such as fecal pellets and foraminifera. Due to their scarcity such large particles are not sampled quantitatively by conventional small volume

sampling systems (30 litre), such as used during the GEOSECS cruises. Although they represent but a very small fraction of the biogenic suspended matter stock, such large particles are important in terms of fluxes.

Several analyses of sediment trap materials from the deep ocean have allowed to deduce a vertical flux for SiO_2 , CaCO_3 and POM (Bishop *et al.*, 1977 and 1979) resulting mainly from the fast settling of large particles. Again, by knowing the Ba content of each of these three phases, it was possible to deduce the associated Ba flux. A range of 0.03 to 0.7 $\mu\text{g Ba/cm}^2\cdot\text{yr}$ was calculated. Supplemented by the barite crystal flux (max. 0.4 $\mu\text{g Ba/cm}^2\cdot\text{yr}$) a total flux of 0.43 to 1.1 $\mu\text{g Ba/cm}^2\cdot\text{yr}$ is deduced (Dehairs, 1979; Dehairs *et al.*, 1980). This value compares well with known average Ba accumulation rates (as barite) in the sediments [0.8 $\mu\text{g/cm}^2\cdot\text{yr}$, range 0.16-4 $\mu\text{g/cm}^2\cdot\text{yr}$ (Dehairs, 1979; Dehairs *et al.*, 1980; Turekian and Tausch, 1964; Hanor, 1972; Boström *et al.*, 1973)]. This Ba accumulating in the sediments is known to be present essentially as barite (Church, 1970 and 1979; Church and Wolgemuth, 1972). Therefore part of the particulate Ba settling onto the sea floor must be redistributed into barite.

To conclude, our study has shown that particulate Ba in oceanic suspended matter is present mainly as the biogenic mineral barite. The biological production of barite in surface water and the subsequent dissolution of those crystals in the deep sea are important parts of the overall oceanic Ba cycle. It is shown that most of the Ba consumed in surface waters (60 %) is accounted for by the cyclic component.

Acknowledgments

This work was carried out under the promotorship of Prof. R. Chesselet, Prof. J. Jedwab and Prof. I. Elskens. It could not have been achieved without the kind assistance of C.E. Lambert, P. Buat-Menard and J. Klossa. This work was supported by a GEOSECS - NSF grant.

References

- ARRHENIUS, G. (1963). *Pelagic sediments*, in *The Sea*, N.N. Hill (Editor), Wiley-Interscience, N.Y., 3, 655.
- BACON, M.P. and EDMOND, J.M. (1972). Barium at GEOSECS III in the south-east Pacific. *Earth Planet. Sci. Letters*, 16, 66.

- BERGER, W.H. (1970). Biogenous deep-sea sediments ; fractionation by deep-sea circulation. *Geol. Soc. Am. Bull.*, 81, 1385.
- BISHOP, J.K., EDMOND, J.M., KETTEN, D.R., BACON, M.P. and SILKER, W.B. (1977). The chemistry, biology and vertical flux of particulate matter from the upper 400 m of the Equatorial Atlantic Ocean. *Deep-Sea Res.*, 24, 511.
- BISHOP, J.K.B., KETTEN, D.R. and EDMOND, J.M. (1979). The chemistry, biology and vertical flux of particulate matter from the upper 400 m of the Cape Basin in the south-east Atlantic Ocean. *Deep-Sea Res.*, 25, 1121.
- BOSTRÖM, K., JOENSUU, O., MOORE, C., BOSTRÖM, B., DALZIEL, M. and HOROWITZ, A. (1973). Geochemistry of barium in pelagic sediments. *Lithos*, 6, 159.
- BOTAZZI, E.M. and SCHREIBER, B. (1971). Acantharia in the Atlantic Ocean, their abundance and preservation. *Limnol. Oceanogr.*, 16, 677.
- BOYLE, E.A., SCLATER, F. and EDMOND, J.M. (1976). On the marine geochemistry of cadmium. *Nature*, 263, 42.
- BOYLE, E.A., SCLATER, F.R. and EDMOND, J.M. (1977). The distribution of dissolved copper in the Pacific. *Earth Planet. Sci. Letters*, 37, 38.
- BREWER, P.G., SPENCER, D.W., BISCAYE, P.E., HANLEY, A., SACHS, P.L., SMITH, C.L., KADAR, S. and FREDERICKS, J. (1976). The distribution of particulate matter in the Atlantic Ocean. *Earth Planet. Sci. Letters*, 32, 393.
- BRUN-COTTAN, J.C. (1976). Contribution à l'étude de la granulométrie et de la cinétique des particules marines. Thèse de Doctorat ès Sci. Phys., Paris 6.
- BRUN-COTTAN, J.C. (1976). Stokes settling and dissolution rate model for marine particles as a function of size distribution. *J. Geophys. Res.*, 81, 1601.
- BRULAND, K.W., KNAUER, G.A. and MARTIN, J.H. (1978). Zinc in north-east Pacific water. *Nature*, 271, 741.
- BUAT-MENARD, P. and CHESSELET, R. (1979). Variable influence of the atmospheric flux on the trace metal chemistry of oceanic suspended matter. *Earth Planet. Sci. Letters*, 42, 399.
- CAMPBELL, J.R. and NANCOLLAS, G.H. (1969). The crystallization and dissolution of strontium sulfate in aqueous solution. *J. Phys. Chem.*, 73, 1735.
- CHAN, L.H., DRUMMOND, D., EDMOND, J.M. and GRANT, B. (1977). On the barium data from the Atlantic GEOSECS expedition. *Deep-Sea Res.*, 24, 613.
- CHAN, L.H., EDMOND, J.M., STALLARD, R.F., BROECKER, W.S., CHUNG, Y.C., WEISS, R.F. and KU, T.L. (1976). Radium and barium at GEOSECS stations in the Atlantic and Pacific. *Earth Planet. Sci. Letters*, 32, 258.
- CHOW, T.J. and GOLDBERG, E.D. (1960). On the marine geochemistry of barium. *Geochim. Cosmochim. Acta*, 20, 192.
- CHURCH, T.M. (1970). *Marine barite*. Ph. D. Thesis, Univ. of California.
- CHURCH, T.M. (1979). *Marine barite*, in *Marine Minerals*, R.G. Burns (Editor), Min. Soc. Am., short course notes, 6, 175.

- CHURCH, T.M. and WOLGEMUTH, K. (1972). Marine barite saturation. *Earth Planet. Sci. Letters*, 15, 35.
- COPIN-MONTEGUT, C. and COPIN-MONTEGUT, G. (1972). Chemical analysis of suspended particulate matter collected in the north-east Atlantic. *Deep-Sea Res.*, 19, 445.
- COPIN-MONTEGUT, C. and COPIN-MONTEGUT, G. (1978). The chemistry of particulate organic matter from the south Indian and Antarctic Ocean. *Deep-Sea Res.*, 25, 911.
- DEHAIRS, F. (1979). *Discrete suspended particles of barite and the barium cycle in the open ocean*. Doctoral thesis in science, Vrije Universiteit Brussel.
- DEHAIRS, F., CHESSELET, R. and JEDWAB, J. (1980). Discrete suspended particles of barite and the barium cycle in the open ocean. *Earth Planet. Sci. Letters*, GEOSECS collected papers volume, September issue, in press.
- FRESNEL, J., GALLE, P. et GAYRAL, P. (1979). Résultats de la microanalyse des cristaux vacuolaires chez deux chromophytes unicellulaires marines : *Exanthemachrysis gayraliae*, Pavlova sp. (Prymnesiophycées, Pavlovacées). *C.R. Acad. Sci. Paris*, D 288, 823.
- GAYRAL, P. et FRESNEL, J. (1979). *Exanthemachrysis gayraliae* Lepaillieur (Prymnesiophyceae, Pavlovales) : ultra-structure et discussion taxinomique. *Protistologica*, 15, 271.
- HAECKEL, E. (1862). Radiolarien (*Rhizopoda Radiolaria*), eine Monographie, G. Reimer Verlag, Berlin.
- HANOR, J.S. (1969). Barite saturation in sea water. *Geochim. Cosmoch. Acta*, 33, 894.
- HANOR, J.S. (1972). Rates of barium accumulation in the Equatorial Pacific. *Geol. Soc. Am.*, Abstracts with Programs, 4, 526.
- KOBLENTZ-MISHKE, O.J., VOLKOVINSKY, V.V. and KABANOVA, J.G. (1970). Plankton primary production of the world ocean, in *Scientific Exploration of the South Pacific*, W.S. Wooster (Editor), U.S. Natl. Acad. Sci., Washington D.C., 183.
- KRISHNASWAMI, S., LAL, D. and SOMAYAJULU, B.L.K. (1976). Investigations of gram quantities of Atlantic and Pacific surface particulates. *Earth Planet. Sci. Letters*, 32, 403.
- LAL, D. and LERMAN, A. (1973). Dissolution and behaviour of particulate biogenic matter in the ocean : some theoretical considerations. *J. Geophys. Res.*, 78, 7100.
- LAL, D. and LERMAN, A. (1975). Size spectra of biogenic particles in ocean water and sediments. *J. Geophys. Res.*, 80, 423.
- LAMBERT, C.E. (1979). *Contribution à l'étude du fer et de l'aluminium particulaires dans l'océan*. Thèse de diplôme d'Etudes Supérieures, Univ. Picardie, France.
- LI, Y.H., KU, T.L., MATHIEU, G.G. and WOLGEMUTH, K. (1973). Barium in the Antarctic Ocean and implications regarding the marine geochemistry of Ba and Ra²²⁶. *Earth Planet. Sci. Letters*, 19, 352.

- MARTIN, J. and KNAUER, G.A. (1973). The chemical composition of plankton. *Geochim. Cosmochim. Acta*, 37, 1639.
- MENZEL, D.W. (1974). Primary productivity, dissolved and particulate organic matter and the sites of oxidation of organic matter, in *The Sea*, E.D. Goldberg (Editor), Wiley Interscience, N.Y., 659.
- NANCOLLAS, G.H. (1968). Kinetics of crystal growth from solution. *J. Cryst. Growth*, 3-4, 335.
- NANCOLLAS, G.H. and PURDIE, N. (1963). Crystallization of barium sulphate in aqueous solution. *Trans. Far. Soc.*, 59, 735.
- RILEY, J.P. and ROTH, I. (1971). The distribution of trace elements in some species of phytoplankton grown in culture. *J. Mar. Biol. Ass. U.K.*, 51, 63.
- TENDAL, O.S. (1972). A monograph of the *Xenophyophoria*, Galathea Report, 12, 8.
- TUREKIAN, K.K. (1968). Deep-sea deposition of barium, cobalt and silver. *Geochim. Cosmochim. Acta*, 32, 603.
- TUREKIAN, K.K. and TAUSCH, E.H. (1964). Barium in deep-sea sediments of the Atlantic Ocean. *Nature*, 201, 696.
- TUREKIAN, K.K. and WEDEPOHL, K.H. (1961). Distribution of the elements in some major units of the Earth's crust. *Geol. Soc. Am. Bull.*, 72, 175.
- WOLGEMUTH, K. and BROECKER, W.S. (1970). Barium in sea water, *Earth Planet. Sci. Letters*, 8, 372.
- WOLLAST, R. (1974). *The silica problem*, in *The Sea*, E.D. Goldberg (Editor), Wiley, N.Y., 5, 659.

Determinations of mercury in various compartments
of a coastal marine ecosystem

G. DECAET, M. BOGAERT, L. GOEYENS and W. BAEYENS

Laboratorium voor Analytische Scheikunde
Vrije Universiteit Brussel, Belgium

Abstract

Accurate determinations of mercury in the different compartments of the ecosystem are a basic requirement for the study of its circulation. Sampling and analyzing techniques have been examined for the watercolumn, analyzing techniques for the sediments and the biological compartment. Two seawater sampling techniques (Niskin bottle and peristaltic pump) are compared; they give statistically no different results. For the preconcentration of dissolved mercury a self-synthesized resin seems to satisfy very well. In three different sediment samples mercury has been assessed after total, strong and weak attacks. The most reproducible results are obtained with HF/HNO₃ (total attack) and HNO₃/KMnO₄ (strong attack). Several mineralisation-digestion techniques for the analysis of mercury in plants have been tested. HF/HNO₃, KMnO₄/H₂SO₄/HNO₃ and H₂SO₄/HNO₃/V₂O₅, KMnO₄ provided the best results.

The spatial patterns of total and particulate mercury in the Belgian coastal zone confirm the earlier observed concentration gradients. In addition the adsorption capacity studies on particulate matter of the Scheldt estuary suggest that for mercury the particulate, solid phase is more important than the dissolved phase.

Introduction

The first step towards a better understanding and eventual modelisation of the mercury circulation in the Southern Bight of the North Sea requires the knowledge of its distribution among the different compartments of the ecosystem and its spatial-temporal fluctuations in each of these compartments. The distribution of mercury among the various compartments of the North Sea

and Scheldt ecosystems has been described in a previous paper (Baeyens et al., 1979a). For the study of spatial-temporal patterns, we focused our attention on the watercolumn, owing to the dynamical features of this system. But from an analytical point of view, the watercolumn is also the compartment where the risks for contamination or losses are greatest and the detection limit is lowest. Therefore special attention was paid to storage and measuring methods — different procedures for the determination of total and particulate mercury in the watercolumn have been compared (Baeyens et al., 1979b) — but other analytical aspects remained untouched.

This paper deals with some of these untouched analytical problems related to the watercolumn :

- to which extent are the results affected by the applied sampling procedure;
- which is the ratio of dissolved : particulate mercury

and with mercury determinations in the sediments and living matter. Concerning the sediments, one of the major problems is the interpretation of the results. For example, total, strong and moderate attacks of the sample provide different results. These are not necessarily correlated to environmental factors such as the anthropogenic fraction, bioavailability, ... Concerning the biological compartment, we investigated the possibilities for including plants and seabirds. Therefore reliable measuring methods have been developed.

This paper also includes some results of the second phase of our program, where we intend to study the dynamical aspects of the mercury circulation. In this regard, the interaction between dissolved mercury and particulate suspended matter is one of the most important processes. Thereat adsorption capacity and adsorption rate studies will bring more insight.

Sampling methodology for seawater

During each consecutive treatment phase — sampling, storage and analysis — it is possible to perturb the mercury concentration in the sample. Such a perturbation is usually not due to the analytical techniques, but is in the methods used to obtain a representative sample which is free from errors, introduced during sampling and storage (Paulsen et al., 1974).

Until now, the practice was to take a sample by means of a Niskin bottle at a depth of 5 m. To verify if sampling with Niskin bottles could be a source of contamination, we made a comparison with samples taken by a sampling system devised by Gillain (Gillain *et al.*, 1979). Figure 1 shows a schematic representation of this sampling device. The principle is to collect continuously subsamples (0.5 l/min) from a much larger flow (5 l/min), screened from atmospheric pollution.

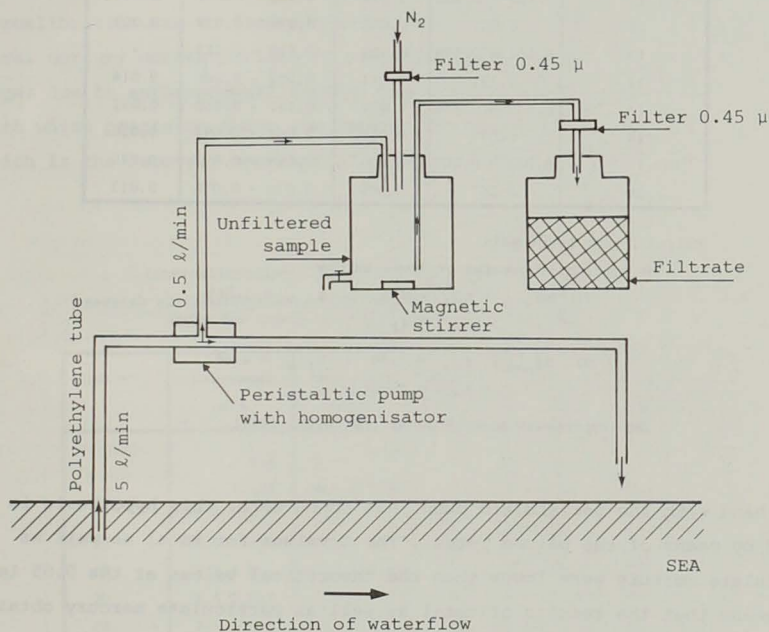

fig. 1.

Sampling system devised by Gillain (Gillain *et al.*, 1979)

In table 1 we compare the results of total as well as particulate mercury obtained with both sampling techniques. The samples were collected during the cruise of October 1979 in our Belgian coastal zone. If the sampling technique has no effect on the results, the mean difference between the two data sets (on the one hand obtained with the Niskin bottle, on the

Table 1

Comparison sampling Niskin bottle - peristaltic pump

Cruise October 1979
 Storage in polyethylene bottles at - 20 °C
 (Acidification to pH = 1)

| Identification | Niskin bottle | | Peristaltic pump | |
|----------------|------------------|------------------|------------------|------------------|
| | Hg total µg/ℓ | Hg part. µg/ℓ | Hg total µg/ℓ | Hg part. µg/ℓ |
| 11 | 0.199 - 0.200 | 0.014 | 0.203 - 0.208 | 0.010 |
| 22 | 0.057 | 0.007 | 0.036 - 0.038 | 0.009 |
| 13 | 0.164 - 0.178 | 0.102 | 0.119 - 0.123 | - |
| 33 | 0.121 | 0.011 | 0.102 - 0.106 | 0.014 |
| 24 | 0.137 - 0.150 | 0.057 | 0.152 - 0.158 | 0.072 |
| 44 | 0.077 | 0.015 | 0.084 - 0.094 | 0.010 |
| 15 | 0.063 - 0.065 | 0.030 | 0.065 - 0.073 | 0.045 |
| 35 | 0.067 | 0.009 | 0.075 - 0.076 | 0.013 |

Paired T-test hypothesis :

No systematic greater or lower values

$$1) \text{ Hg}_{\text{total}} : t_{\text{obs}} = 0.65 ; t_{0.975} = 2.365$$

$$t_{\text{obs}} < t_{0.975}$$

$$2) \text{ Hg}_{\text{part.}} : t_{\text{obs}} = 1.44 ; t_{0.975} = 2.447$$

$$t_{\text{obs}} < t_{0.975}$$

⇒ hypothesis acceptable at the 0.05 level.

other hand with the peristaltic pump) has to be zero. This hypothesis is tested by means of the paired T-test. The t-values for total as well as particulate mercury were lower than the theoretical values at the 0.05 level. This means that the results of total as well as particulate mercury obtained with a Niskin bottle give statistically no systematic greater or lower values than those obtained with a peristaltic pump. However, for other metals such as Zn, Pb, Cu, ... sampling with a peristaltic pump seemed to cause less contamination (Gillain et al., 1979).

The determination of dissolved mercury in seawater

The concentration of dissolved mercury in seawater is usually very low, often close to the detection limit of the commercially available instruments (Minagawa *et al.*, 1980). After modification of the single-beam standard apparatus type MAS-50 into a double-beam, we are now able to determine concentrations of 5 ng Hg/l with a 5% accuracy. In order to value our method, we participated in an intercalibration exercise of mercury in seawater, organized by Olafsson (ICES, 1979). The main purpose of this intercalibration was to find out which laboratories were able to measure natural mercury concentrations in seawater and to follow the concentration changes due to anthropogenic inputs. Therefore we investigated

- with which precision these low levels can be measured ;
- which is the recovery capacity of added quantities of mercury.

Table 2

Intercalibration : determination of mercury in seawater
Results of laboratories, reporting less than 10 ng Hg/l in seawater
(ICES Sub-Group on Contaminant Levels in Seawater)

| Lab n° | Sea-water ng/l | Sea-water + spike I | | Sea-water + spike II | |
|--------|-------------------|---------------------|----------|----------------------|---------|
| | | ng/l | % rec. | ng/l | % rec. |
| 1 | 5.3 ± 0.8 | 21 ± 0 | 102 | 108 ± 4 | 72 |
| 4 | 7.2 ± 1.5 | 20.7 ± 0.6 | 87 | 133 ± 1.5 | 88 |
| 11 | 2.9 ± 0.7 | 17.9 ± 3.3 | 97 | 146 ± 7 | 102 |
| 12 | 7.1 ± 1.9 | 26.5 ± 2.5 | 126 | 110 ± 5 | 72 |
| 18 | 2.2 ± 0 | 17.5 ± 0.6 | 100 | 130 ± 2 | 89 |
| 20 | 2.4 ± 0.4 | 17.2 ± 2.9 | 96 | 145 ± 5 | 100 |
| 24 | 2.5 ± 0.4 | 18.1 ± 0.8 | 102 | 143 ± 4 | 98 |
| 26 | 3 ± 0 | 17.5 ± 1.9 | 94 | 153 ± 11 | 105 |
| 27 | 7.2 ± 2.5 | 25.3 ± 1.5 | 118 | 181 ± 19 | 121 |
| 28 | 7.5 ± 0.9 | 25.2 ± 3.2 | 115 | 137 ± 11 | 91 |
| 29 | 2.9 ± 1.1 | 16.9 ± 1.6 | 91 | 141 ± 7 | 96 |
| 30 | 2.4 ± 0.3 | 19.6 ± 1.0 | 112 | 143 ± 3 | 98 |
| 32 | 3.8 ± 0.5 | 19.0 ± 0.5 | 98 | 138 ± 8 | 94 |
| 34 | 2.1 ± 0.2 | 19.4 ± 0.9 | 112 | 150 ± 3 | 104 |
| 35 | 3.9 ± 0.4 | 24.5 ± 0.9 | 134 | 176 ± 5 | 121 |
| 36 | 8.2 ± 1.3 | 26.2 ± 1.2 | 117 | 164 ± 8 | 109 |
| N : 16 | 4.4 ± 2.3 | 20.8 ± 3.5 | 106 ± 13 | 144 ± 20 | 98 ± 14 |

In table 2 our results correspond with Lab n° 1. From these results we deduce that :

- the precision of our method for the measurement of very low mercury levels is very good (compared with the mean value of 16 laboratories, which give concentrations below 10 ng/l) ;
- the recovery of the added quantities of mercury is relatively good.

Preconcentration of dissolved mercury

In spite of the good accuracy we can achieve with our apparatus, it is still very difficult to measure fluctuations of the mercury concentration in the dissolved phase. Furthermore the efficiency of most storage procedures used for mercury determinations is not subject to an unanimous judgement (Topping *et al.*, 1972 ; Fitzgerald, 1974 ; Feldman, 1974 ; Carr *et al.*, 1978 ; Baeyens *et al.*, 1979b). In order to avoid these alterations one could use concentration methods such as extraction (Chester *et al.*, 1973 ; Gardner *et al.*, 1974), amalgamation (Carr *et al.* 1972 ; Olaffson, 1974 ; Baker, 1977 ; Fitzgerald *et al.*, 1979) or resins (Minagawa *et al.*, 1980). However, amalgamation seems to be a technique which is rather laborious to use on board a ship, extraction rather unreliable. A more suitable concentration technique to use on board a ship is probably fixation on a resin. The chelating resin synthesized and tested in our laboratory is a styrene-divinylbenzene copolymer containing sulfonamide groups. The eluting reagent is cysteine hydrochloride. Preliminary results suggest that : (1) the exchange capacity is high ($\pm 10^{-4}$ equivalents Hg/g resin) (2) the retention of Hg(II) and Hg(II)- complexes is complete (3) the elution of fixed mercury is complete (4) the flow rate is very high (± 20 ml/min) which makes it possible to obtain a high concentration rendement. We intend now to test this preconcentration method during one of the next surveys.

Total and particulate mercury concentrations in the Belgian coastal zone

Table 3 shows total and particulate mercury concentrations observed during the cruises of January and October 1979. Figures 2, 3, 4 and 5 represent graphically the spatial distribution. These figures show the same characteristics as those observed in 1978 (Baeyens *et al.*, 1979b), for total as well as for particulate mercury :

- a zone with relatively high concentrations, situated near the Scheldt estuary ;
- a progressive transfer to an open-sea zone where concentrations become comparable with those of relatively unpolluted seawater.

Table 3

Total and particulate mercury concentrations in the Belgian coastal zone
(January and October 1979)

| Identification | January 1979 | | October 1979 | |
|----------------|--------------------------------|---------------------------------|--------------------------------|---------------------------------|
| | Hg tot. ($\mu\text{g}/\ell$) | Hg part. ($\mu\text{g}/\ell$) | Hg tot. ($\mu\text{g}/\ell$) | Hg part. ($\mu\text{g}/\ell$) |
| 11 | 0.051 | 0.040 | 0.197 | 0.014 |
| 21 | 0.051 | 0.050 | 0.040 | 0.009 |
| 31 | 0.017 | 0.009 | 0.023 | 0.012 |
| 41 | 0.050 | 0.054 | 0.025 | 0.010 |
| 12 | 0.056 | 0.045 | 0.108 | 0.015 |
| 22 | 0.068 | 0.035 | 0.057 | 0.015 |
| 32 | 0.062 | 0.040 | 0.065 | 0.010 |
| 42 | 0.073 | 0.052 | 0.082 | 0.003 |
| 13 | 0.162 | 0.120 | 0.171 | 0.102 |
| 23 | 0.107 | 0.107 | 0.086 | 0.087 |
| 33 | 0.056 | 0.035 | 0.121 | 0.007 |
| 43 | 0.025 | 0.015 | 0.034 | 0.011 |
| 14 | 0.787 | 0.570 | 0.363 | 0.284 |
| 24 | 0.239 | 0.250 | 0.144 | 0.115 |
| 34 | 0.037 | 0.030 | 0.030 | 0.010 |
| 44 | 0.059 | 0.040 | 0.077 | 0.015 |
| 15 | 0.125 | 0.108 | 0.064 | 0.029 |
| 25 | 0.150 | 0.133 | 0.090 | 0.045 |
| 35 | 0.076 | 0.058 | 0.067 | 0.009 |
| 45 | - | - | 0.047 | 0.010 |

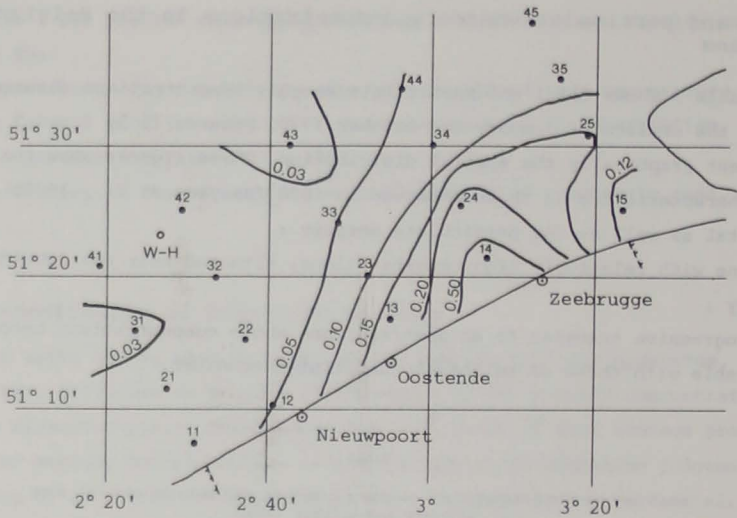

fig. 2.
Spatial distribution of total mercury ($\mu\text{g}/\text{l}$)
January 1979

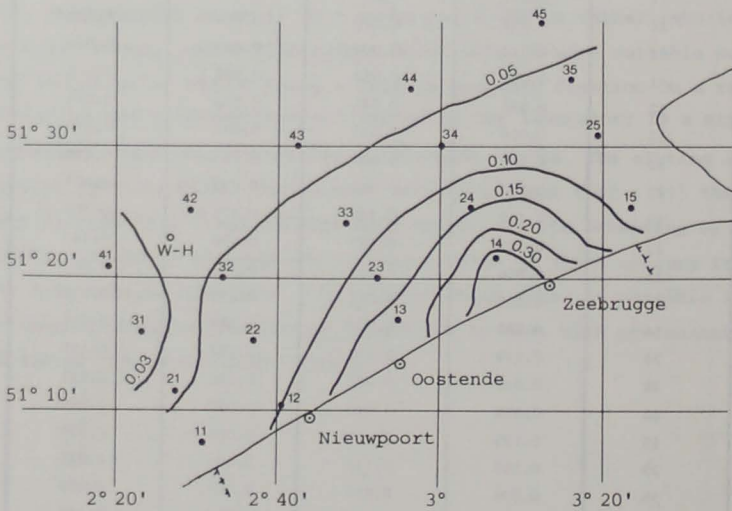

fig. 3.
Spatial distribution of total mercury ($\mu\text{g}/\text{l}$)
October 1979

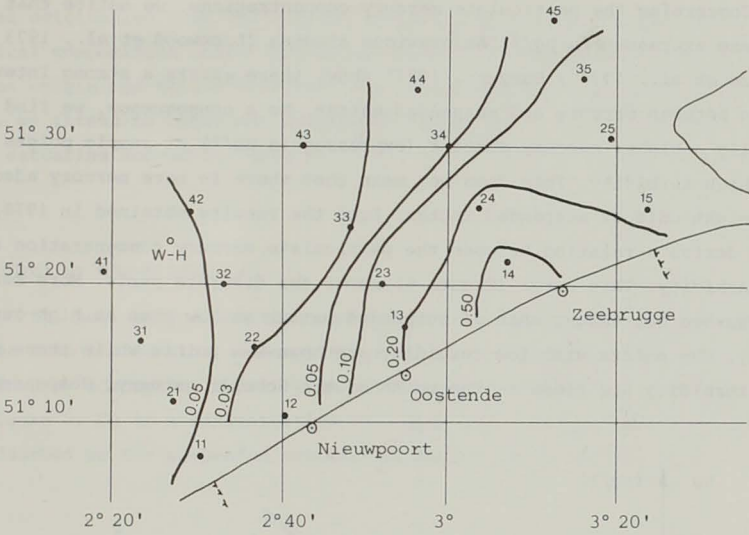

fig. 4.

Spatial distribution of particulate mercury ($\mu\text{g}/\ell$)
January 1979

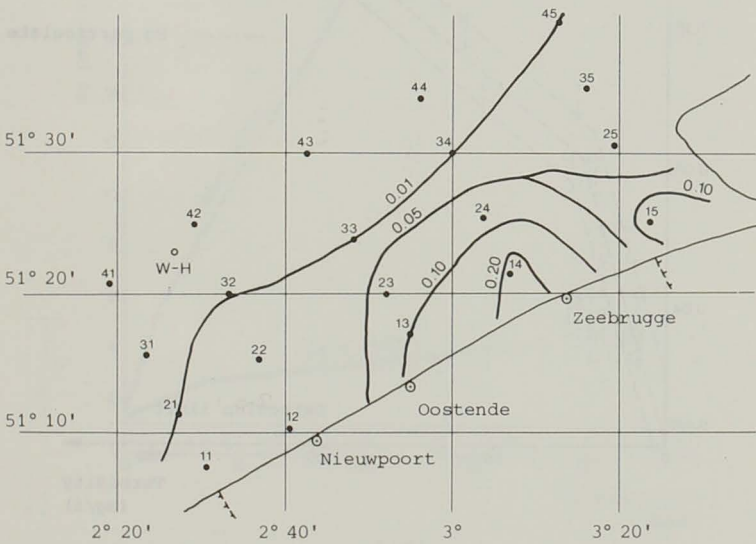

fig. 5.

Spatial distribution of particulate mercury ($\mu\text{g}/\ell$)
October 1979

Concerning the particulate mercury concentrations, we notice that they are expressed in $\mu\text{g}/\ell$. As previous studies (Lockwood *et al.*, 1973 ; Reimers *et al.*, 1974 ; Baeyens, 1977) show, there exists a strong interaction between mercury and suspended matter. As a consequence, we find normally a higher mercury content (expressed in $\mu\text{g}/\ell$) at sample points with high turbidity. This does not mean that there is more mercury adsorbed per weight-unit of suspended matter. From the results obtained in 1978, we could derive a relation between the particulate mercury concentration and the turbidity. This curve (Figure 6) shows two discrete parts. More mercury is adsorbed per weight-unit of suspended matter at low than at high turbidity. The points with low turbidity are open-sea points while these with high turbidity are close to the mouth of the Scheldt estuary. Suspended

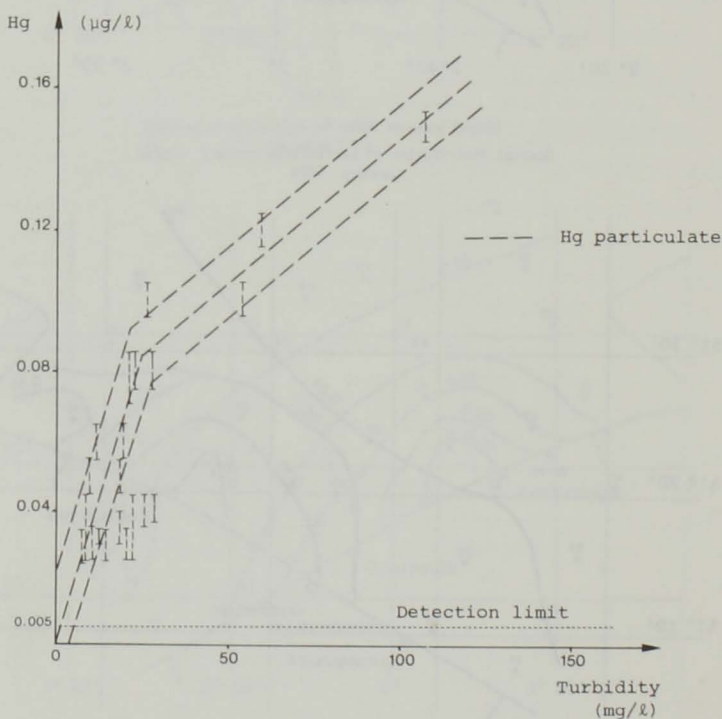

fig. 6.

Particulate mercury content versus turbidity

matter originating from the Scheldt estuary has probably a different chemical composition and/or granulometry than the suspended matter from marine origin and thus a different adsorption behaviour. To investigate this, we intend to carry out adsorption experiments on suspended matter from estuarine and marine origin.

Adsorption experiments

Until now, only adsorption experiments are carried out on suspended matter from the Scheldt estuary (Baeyens, 1977 ; Decadt, 1977). The results, obtained by adsorption capacity experiments, are represented graphically in Figure 7. Up to a concentration of 2 ppm, practically all the mercury is adsorbed on the suspended matter, in fresh as well as salt water

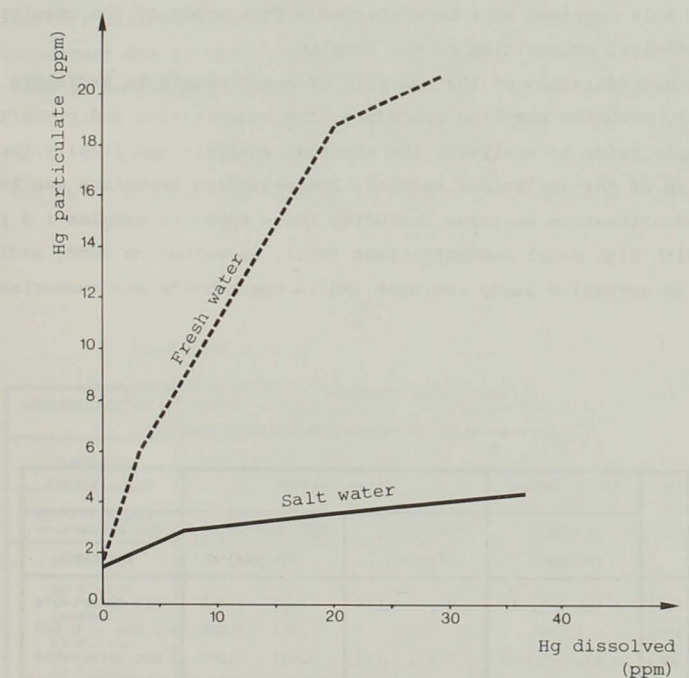

fig. 7.

Adsorption capacity of suspended matter
from the Scheldt estuary

conditions. As natural mercury concentrations in the estuary are a few orders of magnitude lower than the adsorption capacity of the suspended matter, this suggests that on a long term the particulate phase will be enriched in mercury which will be in turn transported to areas where sedimentation occurs. Consequently, monitoring of sediments could give important information about the influence of mercury from anthropogenic origin on the aquatic environment.

Determination of mercury in sediments

To determine the anthropogenic fraction in the sediments, one can use two procedures : (1) a comparison between the mercury concentrations in recent sediments and in sediments anterior to industrialization or (2) analyzing sediment cores which show a clear age profile versus depth. It is clear that this approach must be completed with a study of the chemical and mineralogical composition of the samples.

The standardization of the analysis of heavy metals in sediments deals subsequently with the sampling procedure, the conservation and preparation of the sample prior to analysis, the chemical analysis and finally the presentation of the analytical results. The measuring technique was tested in an intercalibration exercise including three types of samples : a river sediment with high metal concentrations (MS1), an estuarine muddy sediment (MS2) and an estuarine sandy sediment (MS3). Our results are summarized in table 4.

Table 4
Determination of mercury in sediment samples

| | Total attack | Strong attack | | Weak attack |
|------|-----------------------------------|---|---|----------------------------|
| | HF / HNO ₃ (Hg-ppm) | HNO ₃ /KMnO ₄ (Hg-ppm) | H ₂ O ₂ /HNO ₃ /H ₂ PO ₄ (Hg-ppm) | HAc-extraction (Hg-ppm) |
| MS 1 | 1.102 - 1.142 | 0.996 - 1.016 | 1.002 - 1.353 | Not detectable |
| MS 2 | 1.898 | 1.825 | 1.644 - 1.666 | 0.069 - 0.069 |
| MS 3 | 0.042 - 0.058 | 0.016 - 0.016 | 0.005 - 0.005 | Not detectable |

The variation coefficients, calculated on the ensemble of results obtained by the different laboratories, show that : the spread is small for the total attack and the $\text{HNO}_3/\text{KMnO}_4$ strong attack ; the spread is much greater in the case of a $\text{H}_2\text{O}_2/\text{HNO}_3/\text{H}_2\text{SO}_4$ strong attack ; and the spread is unacceptable with a HAc -extraction. Since most chemists do not like the use of HF , and since the results obtained with a $\text{HNO}_3/\text{KMnO}_4$ attack approach very good those obtained with HF/HNO_3 , the total mercury content in sediments can be estimated quite well with a $\text{HNO}_3/\text{KMnO}_4$ digestion. However a study of the correlation between the results obtained with a weak or moderate attack and the bioavailable fraction seems not yet feasible.

Determination of mercury in biological materials

The analyzing method of mercury in biological material (entirely organic matter) differs somewhat from these used for sediments (mainly inorganic matter) due to their different composition. The basic principle in this case is to oxidize as complete as possible the organic matrix. A detailed study has been carried out on different materials such as milk-powder (MP), two aquatic plants (LM and PR) and one terrestrial plant (OE) to test our methods. The main results of this study are summarized in table 5.

Table 5

Determination of mercury in biological materials

| MINERALISATION | HF/HNO_3 (teflon bomb) | $\text{H}_2\text{SO}_4/\text{HNO}_3/\text{V}_2\text{O}_5$ (under reflux) | |
|----------------|--|--|------------------------|
| Digestion | $\text{KMnO}_4/\text{H}_2\text{SO}_4/\text{HNO}_3$ | KMnO_4 | H_2O_2 |
| Identification | Mercury (ppm) | Mercury (ppm) | Mercury (ppm) |
| OE-62-169 | 0.19 | 0.21 | 0.11 |
| MP-63-161 | 0.005 | < 0.01 | 0.002 |
| LM-60-170 | 0.24 | 0.25 | 0.25 |
| PR-61-170 | - | 0.13 | 0.12 |
| PR-61-168 | 0.12 | - | 0.12 |

The three mineralisation-digestion methods gave all reliable results except in one case (OE). Moreover, it was proved that the biological matrix (after mineralisation and digestion) did not interfere with the measurements and that both organic and inorganic mercury compounds (as far as they were extracted from the biological material) were oxidized to ionic mercury. The same mineralisation-digestion methods were also evaluated for the determination of mercury in muscle tissues of seabirds. All methods provided similar results, but the results obtained with the H_2O_2 -method showed a greater spread.

Conclusion

The development or adaptation of sampling and analyzing techniques will provide us more reliable data of mercury in most of the compartments of the marine ecosystem. An important compartment which has not been considered yet is the atmosphere. However, a method for measuring mercury in the gasphase is available and will be published very soon. In the future we will also try (1) to distinguish between inorganic (free or chelated) and organic mercury compounds and (2) to assess the interaction kinetics between the most important mercury species and natural suspended matter.

References

- BAEYENS, W. (1977). *Bijdrage tot de studie van adsorptiemechanismen van kwik in een estuarium. Ontwikkeling van een bidimensionaal getijafhankelijk dispersiemodel*, Doctoraatsthesis, Vrije Universiteit Brussel.
- BAEYENS, W., DECADT, G. and ELSKENS, I. (1979a). A study of the distribution of mercury in the various compartments of the North Sea and Scheldt estuary ecosystems. *Oceanologica Acta*, vol. 2, n° 4, 447-457.
- BAEYENS, W., DECADT, G. and ELSKENS, I. (1979b). Determination of dissolved, particulate and total mercury in the watercolumn of the Southern Bight of the North Sea, with adapted analytical procedures. International Council for the Exploration of the Sea, CM 1979/E : 61.
- BAKER, C.W. (1977). Mercury in surface waters of seas around the United Kingdom. *Nature* (London), 270, 230-232.
- CARR, R.A., HOOVER, J.B. and WILKNISS, P.W. (1972). Cold vapour atomic absorption for Hg in the Greenland Sea. *Deep Sea Research*, 19, 747-752.

- CARR, R.A. and WILKNISS, P.E. (1978). Mercury short-term storage of natural waters. *Envir. Sc. Techn.*, **7**, 62-63.
- CHESTER, R., GARDNER, F., RILEY, J.P. and STONER, J. (1973). Mercury in some surface waters of the world ocean. *Mar. Pollut. Bull.*, **4**, 28-29.
- DECADT, G. (1977). *Studie van de adsorptiefenomenen van kwik met gesuspendeerd materiaal uit het Schelde-estuarium*, Licentiaatsthesis, Vrije Universiteit Brussel.
- FELDMAN, C. (1974). Preservation of dilute mercury solutions. *Anal. Chem.*, **46**, 1, 98-102.
- FITZGERALD, W.F., LYONS, W.B. and HUNT, C.D. (1974). Cold trap preconcentration method for the determination of mercury in sea water and other natural materials. *Anal. Chem.*, **46**, 13, 1882-1885.
- FITZGERALD, W.F. and GILL, G.A. (1979). Subnanogram determination of mercury by two-stage gold amalgamation and gas phase detection applied to atmospheric analysis. *Anal. Chem.*, **51**, 1714-1720.
- GARDNER, D. and RILEY, J.P. (1974). Mercury in the Atlantic around Iceland. *Journal du Conseil*, Conseil International pour l'Exploration de la Mer, **35** (2), 202-204.
- GILLAIN, G., DUYNKAERTS, G. and DISTECHE, A. (1979). The determination of trace metals in seawater and suspended matter by classical anodic stripping (Zn, Cd, Pb, Cu) or differential pulse anodic stripping voltammetry with a hanging mercury drop electrode (Zn, Cd, Pb, Cu, Sb, Bi) - An approach to speciation, in *Actions de Recherches Concertées, Rapport des Journées d'Etudes*, Programmation de la Politique Scientifique (Editor), Bruxelles, 123-132.
- LOCKWOOD, R.A. and CHEN, K.Y. (1973). Adsorption of Hg(II) by hydrous manganese oxides. *Envir. Sc. Techn.*, **7**, 11, 1028-1034.
- MINAGAWA, K., TAKIZAWA, Y. and KIFUNE, I. (1980). Determination of very low levels of inorganic and organic mercury in natural waters by cold-vapour atomic absorption spectrometry after preconcentration on a chelating resin. *Anal. Chim. Acta*, **115**, 103-110.
- OLAFFSON, J. (1974). Determination of nanogram quantities of mercury in seawater. *Anal. Chim. Acta*, **68**, 207-211.
- OLAFFSON, J. (1980). Report on the ICES intercalibration of mercury in seawater for the Joint Monitoring Group of the Oslo and Paris Commissions, p. 29.
- PAULSEN, K.E., SMITH, E.F. and MARK, H.B. (1975). Considerations in the design of *in situ* sampling techniques for trace elements in seawater. *Advan. Chem. Ser.*, **147**, 22-29.
- REIMERS, R.S. and KRENKEL, P.A. (1974). Kinetics of mercury adsorption and desorption in sediments. *J. Wat. Poll. Contr. Fed.*, **46**, 352-365.
- TOPPING, G. and PIRIE, J.M. (1972). Determination of inorganic mercury in natural waters. *Anal. Chim. Acta*, **62**, 200-203.

Trace metals (Zn, Cd, Pb, Cu, Sb and Bi) levels (ionic forms and dissolved organic complexes) in the Southern Bight (Belgian coast)

Technique to avoid contamination during sampling and filtration
and to improve representativity

G. GILLAIN, C. DUYCKAERTS and A. DISTECHE

Laboratory of Analytical Chemistry and Laboratory of Oceanology (Chemistry Unit)
University of Liège, Belgium

1.- Optimization of sampling methodology - The problem of contamination and representativity

The difficulties in obtaining non contaminated and representative samples of sea water have been outlined in a previous paper where a short description of the sampling apparatus we recommend can also be found (Gillain et al. (1979a)). The principle is to continuously collect small samples of water from a very large volume delivered by a peristaltic pump and screened from atmospheric pollution besides to try and avoid all possible contamination due to the vessel or any other cause during manipulations. The sampling kit has further been improved and will now be described in more detail together with the precautions to be taken to use it properly.

1.1.- DESCRIPTION OF SAMPLING AND FILTRATION KIT

The kit is schematically represented in fig. 1. It is protected by a wooden box with a lid. The total weight is only 25 kg and the floor space required reduced to a minimum (80 × 70 × 35 cm). Conical flexible polyethylene connectors allow to connect the nitrogen supply, a tridistilled water (Milli-Q) tank and a collector for waste water.

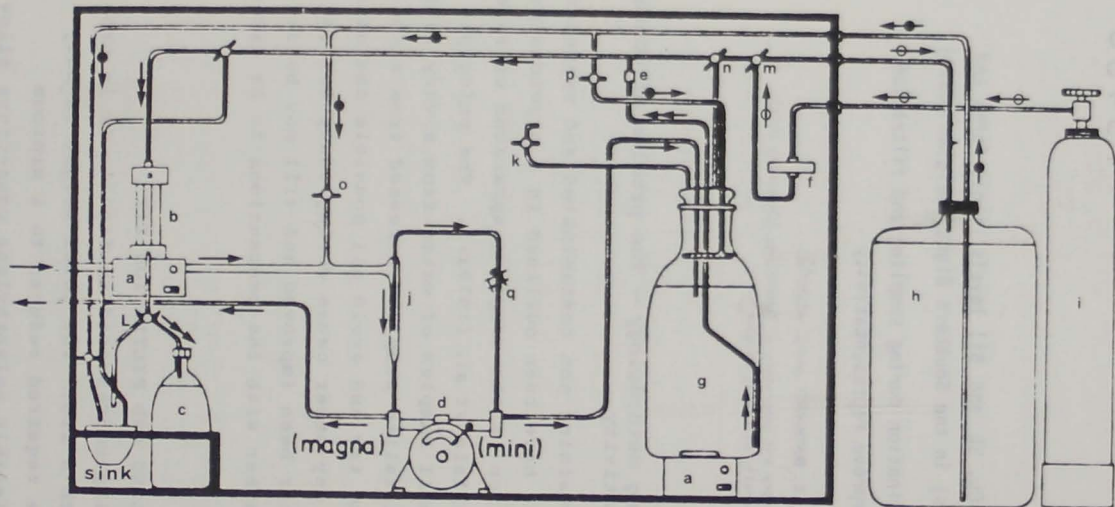

a) magnetic stirrer
 b) filtration unit
 c) filtered sea water

d) peristaltic pump
 e) one way valve
 f) millipore filter (0,22 μm)

g) unfiltered sea water
 h) tridistilled water
 i) nitrogen tank

← Sampling circuit
 ←○ Filtration circuit
 ←○● Gas circuit
 ←● Rinsing circuit

fig. 1.

Diagram of seawater sampling and filtration kit

1.1.1.- THE SAMPLING CIRCUIT (→ in figure 1)

The sampling circuit consists in a double peristaltic pump simultaneously driven by a speed controlled motor and 20 m PVC tube. Speed reducers are fitted on each sides of the motor shaft. At one end a "Magna" pump is driven with a suction height of 9 m and a maximum output of 5 to 6 l/min. The other pump is a "Mini" type, supplying 400 to 500 ml/min depending on the diameter of the internal flexible tubing. It takes water in front of the large pump at point (j) as shown in figure 1.

A small volume of water is thus continuously drawn from the large main flow, the rest of which is returned to sea. The sampled water is stored in a graduated Pyrex container (5 l) [(g) in figure 1], equipped with a magnetic stirrer.

1.1.2.- THE FILTRATION CIRCUIT (→→ in figure 1)

The collecting container (g) is fitted with a ground glass stopper with five passages allowing to connect the container to the atmosphere (k) or to the 4 following circuits :

1. the sampling circuit ("Mini" pump)
2. the filtration circuit starting at the bottom of the container
3. the pressurized gas circuit
4. the rinsing circuit from the tridistilled water bottle.

The filtration unit (b) is made from a Pyrex glass tube 120 mm long and 47 mm \varnothing fitted in between two PVC lids with silicone seals. The lowest one contains a fritted glass plate supporting the filter. The upper one can easily be removed, sliding upwards, which allows to change the filter. It is fitted with an air-outlet vane and a magnetic rod is suspended to it a few millimeters above the filter to retard clogging by vigorous stirring.

The sea water filtered under pressure (nitrogen) is continuously collected in a polyethylene flask (c) which is used to store the sample. Its stopper has an air-outlet. Excess water is sent to the sink by vane (L).

1.1.3.- THE GAS CIRCUIT (⊖→ in figure 1)

Nitrogen from the pressure tank (i) is released at $0,3 \text{ kg/cm}^2$ and is filtered through a $0,22 \text{ }\mu\text{m}$ Millipore filter (f) to remove dust to reach vanes (m) and (n). Vane (m) sends the gas in the distilled water reservoir for rinsing or to the filtration unit. Vane (n) puts the filtration unit under pressure either directly or through the Pyrex collector (g). This is useful when clogging occurs to empty the filtration unit in order to change the filter. A one way security valve (e) then avoids pressure to be applied to collector (g).

1.1.4.- THE RINSING CIRCUIT (●→ in figure 1)

Tridistilled water (Milli-Q) can be distributed from tank (h) either to the sampling circuit (vane o) or the filtration circuit (vane p). One will notice that the distilled water goes into collector (g) through a sprayer to increase cleaning efficiency and minimize the amount of water needed.

1.2.- CLEANING, SAMPLING, FILTERING, RINSING, STORAGE

1.2.1.- CLEANING

The sampling and filtration kit including the 20 m PVC tube as well as the bottles which will contain the final sea water samples are treated during a week with 6 N HCl. Large amounts of "Milli-Q" water is used for rinsing. The kit is kept filled with tridistilled water until used. The filters (Millipore $0,45 \text{ }\mu\text{m}$) are kept in diethylenetriamine penta-acetic acid (DTPA) 10^{-2} M , pH 6 (complexing agent); they are rinsed several times with large volumes of "Milli-Q" water, dried at 50°C , weighed and kept in Petri boxes. Cleaning efficiency is severely followed analytically.

1.2.2.- SAMPLING

Sampling from an oceanographic vessel even with a sophisticated system as described above, means to try and avoid all causes of contamination due to the ship herself. A sea area will be chosen where the ship has not yet been; one will try and find

the best location to put the PVC sampling tube overboard, away from outlets of all sorts, propellers, etc ; the sampling will be carried out with the boat adrift and on the lee side to meet continuously renewed water masses. A telescopic mast 4 m long will be used to hang the tube as far as reasonably permitted from the boat ; the inlet of the sampling tube (protected by a stopper when not used) will be kept at about 2.5 m below the keel (that is at 5 m in our case) ; a lead lest inside a leak proof PVC container is used to keep the tube at depth.

Pumping through the kit, emptied from its distilled water and flushed with nitrogen, is then started the first liters being returned to the sea by closing clamp (q) (see fig. 1). After 10 minutes the collecting container (g) is filled, the pumps are stopped and tridistilled water is sent into the sampling circuit to eliminate residual sea water. The PVC sampling tube is carefully stoppered.

1.2.3.- *FILTERING*

Nitrogen is sent into container (g) where the sea water is continuously stirred and the filtration chamber is filled. Stirring above the Millipore filter is started. Filtration then proceeds under pressure when one opens vane (L) to remove the first ml towards the sink or next to fill the sample storage polyethylene bottle (c). 1 l water in this bottle is in fact representative of 60 l sea water.

Even when the bottle is full filtration is continued until clogging to collect the greatest possible amount of suspended matter, excess water being sent to the sink. The filter is then removed as described above under continuous nitrogen flow to avoid any contamination.

1.2.4.- *RINSING*

After filtration, rinsing is carried out first at the level of the sampling circuit with the pumps in action for a few seconds, continuing with the collecting container and finally with the filtration circuit. After rinsing, a new filter is introduced again under nitrogen flow. The system is then ready for a new operation.

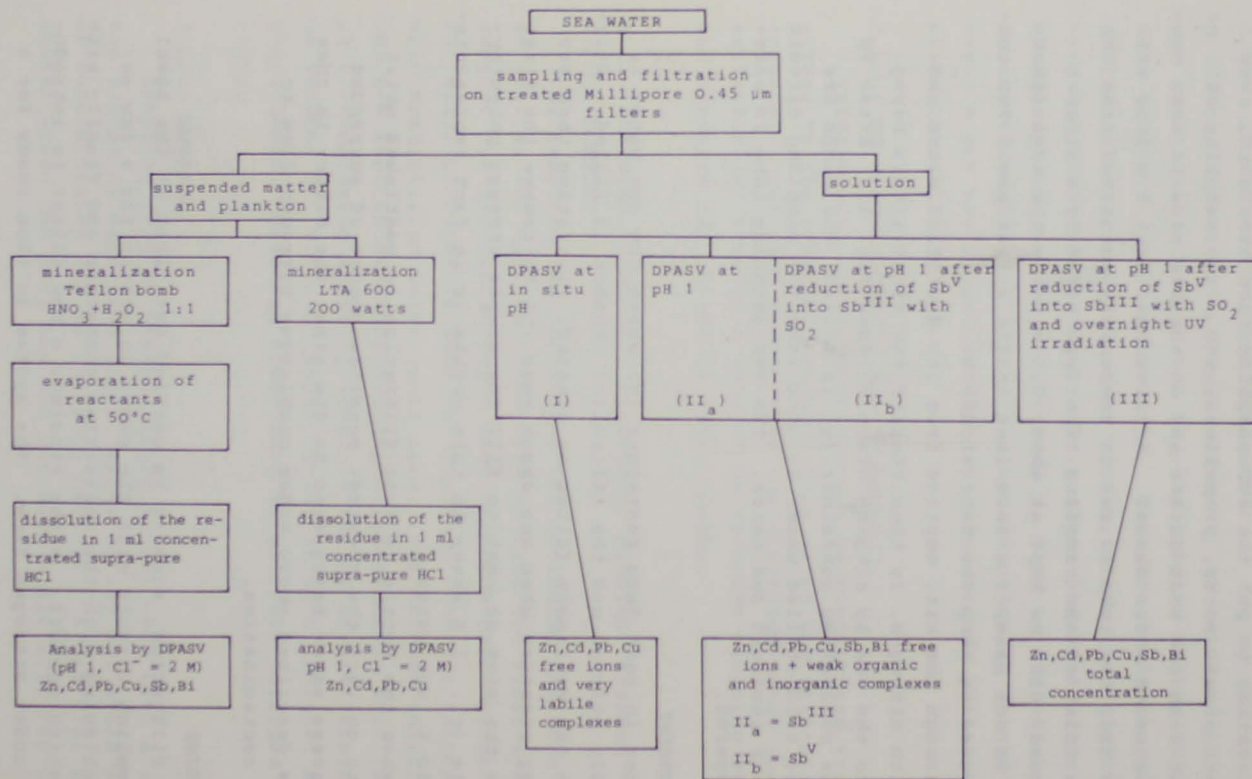

fig. 2.

Analytical protocol to analyse Zn, Cd, Pb, Cu, Sb and Bi in suspended matter, plankton and to study speciation of metals in solution in the water column.

LTA : low temperature ashing (activated O₂).

1.2.5.- STORAGE OF SAMPLES

The 1 l sea water samples are immediately deepfrozen at - 20 °C and thawing is carried out in the laboratory just before analysis.

2.- Analytical methods

Differential pulse anodic stripping voltammetry with hanging mercury drop electrode (DPASV) is used as described earlier (Gillain et al. (1979a,b)). The full analytical protocol is given in fig. 2 but we will in this paper only describe results regarding ionic forms and soluble organic complexes.

3.- Results

The results described in this paper refer to samples collected in October 1979 during a surveyance cruise along the Belgian Coast to detect the distribution of trace metals, the effect of coastal discharges, dumping, rivers (mainly the Scheldt with its estuarian regime), the importance of speciation. The stations are located as indicated in fig.3 along grid lines perpendicular to the coast numbered from 1 to 5.

Going back to the general analytical protocol (fig. 2) it is easy to see that the results expressed in $\mu\text{g}/\text{l}$ given by steps (I), (IIa - IIb) and III, allow to estimate the different species of dissolved Zn, Cd, Pb, Cu, Sb and Bi in sea water passing through Millipore 0.45 μm filters.

The data are given in table 1. The spatial distribution is illustrated by figures 4 to 9.

The fraction detected in step I at *in situ* pH refers rather arbitrarily to ionic species since very labile complexes (probably inorganic) can also be involved. It concerns Zn, Cd, Pb and Cu. Sb and Bi cannot be measured because of hydrolysis of their salts at *in situ* pH.

Table 1
Concentration in $\mu\text{g/l}$

| Stations | Zn | | Cd | | Pb | | Cu | | Sb | | Bi | | |
|----------|------------|-----------------|------------|-----------------|------------|-----------------|------------|-----------------|---------------------------|----------------------|------------|-----------------|-------|
| | In situ pH | UV | In situ pH | UV | In situ pH | UV | In situ pH | UV | acid pH + SO ₂ | UV + SO ₂ | In situ pH | acid pH | |
| | I | II _a | I | II _a | I | II _a | I | II _a | II _a | II _b | I | II _a | III |
| 11 | 0.15 | 0.95 | 0.12 | 0.18 | <0.05 | 1.10 | 2.21 | 0.11 | 1.05 | n.d. | 0.17 | n.d. | n.d. |
| 21 | 0.21 | 2.70 | 0.03 | 0.08 | 0.22 | 1.00 | 2.20 | 0.20 | 1.14 | n.d. | 0.08 | 0.14 | 0.20 |
| 31 | 0.10 | 1.10 | 0.02 | 0.14 | 0.07 | 0.40 | 1.13 | 0.10 | 0.25 | n.d. | 0.12 | n.d. | n.d. |
| 41 | 0.10 | 0.70 | 0.02 | 0.05 | <0.05 | 0.61 | 1.03 | 0.06 | 0.12 | n.d. | 0.12 | n.d. | n.d. |
| 12 | 0.50 | 1.10 | 0.05 | 0.20 | 0.10 | 0.30 | 3.15 | 0.15 | 0.40 | n.d. | 0.10 | n.d. | n.d. |
| 22 | 0.75 | 1.90 | 0.08 | 0.16 | <0.05 | 0.30 | 1.40 | 0.25 | 0.60 | n.d. | 0.14 | n.d. | 0.08 |
| 32 | 0.36 | 1.30 | 0.04 | 0.05 | <0.05 | 0.15 | 1.00 | 0.10 | 0.40 | n.d. | 0.10 | n.d. | 0.15 |
| 42 | 0.10 | 2.25 | 0.02 | 0.06 | <0.05 | 0.16 | 3.02 | <0.10 | 0.10 | n.d. | 0.12 | n.d. | 0.07 |
| 13 | 0.50 | 1.23 | 0.06 | 0.10 | 0.14 | 0.75 | 1.11 | 0.20 | 0.40 | n.d. | 0.17 | n.d. | <0.05 |
| 23 | 0.30 | 1.50 | 0.04 | 0.04 | 0.11 | 0.80 | 1.22 | 0.60 | 0.90 | n.d. | 0.12 | n.d. | 0.18 |
| 33 | 0.50 | 2.12 | 0.05 | 0.10 | 0.16 | 0.80 | 1.80 | 0.30 | 0.80 | n.d. | 0.05 | n.d. | n.d. |
| 43 | 0.20 | 1.20 | 0.05 | 0.08 | 0.08 | 0.20 | 1.60 | 0.06 | 0.20 | n.d. | 0.15 | n.d. | n.d. |
| 14 | 0.54 | 1.42 | 0.70 | 0.08 | 0.16 | 0.44 | 1.20 | 0.30 | 0.84 | n.d. | 0.26 | n.d. | <0.05 |
| 44 | 0.30 | 2.00 | 0.03 | 0.03 | <0.05 | 0.30 | 1.80 | 0.10 | 0.30 | n.d. | 0.18 | n.d. | n.d. |
| 15 | 0.80 | 4.50 | 0.02 | 0.08 | <0.05 | 1.20 | 1.80 | 0.12 | 1.50 | n.d. | 0.30 | n.d. | 0.10 |
| 35 | 0.30 | 5.08 | 0.05 | 0.06 | 0.07 | 1.54 | 3.80 | 0.54 | 1.12 | n.d. | 0.25 | n.d. | 0.08 |
| 35 | 0.50 | 3.65 | 0.70 | 0.02 | 0.08 | 1.23 | 3.40 | 0.15 | 0.80 | n.d. | 0.16 | n.d. | 0.20 |
| 45 | 0.30 | 2.25 | 0.02 | 0.05 | 0.08 | 1.98 | 3.21 | 0.15 | 0.80 | n.d. | 0.10 | n.d. | n.d. |

n.d.: Below detection limit ($\leq 0.05 \mu\text{g/l}$)

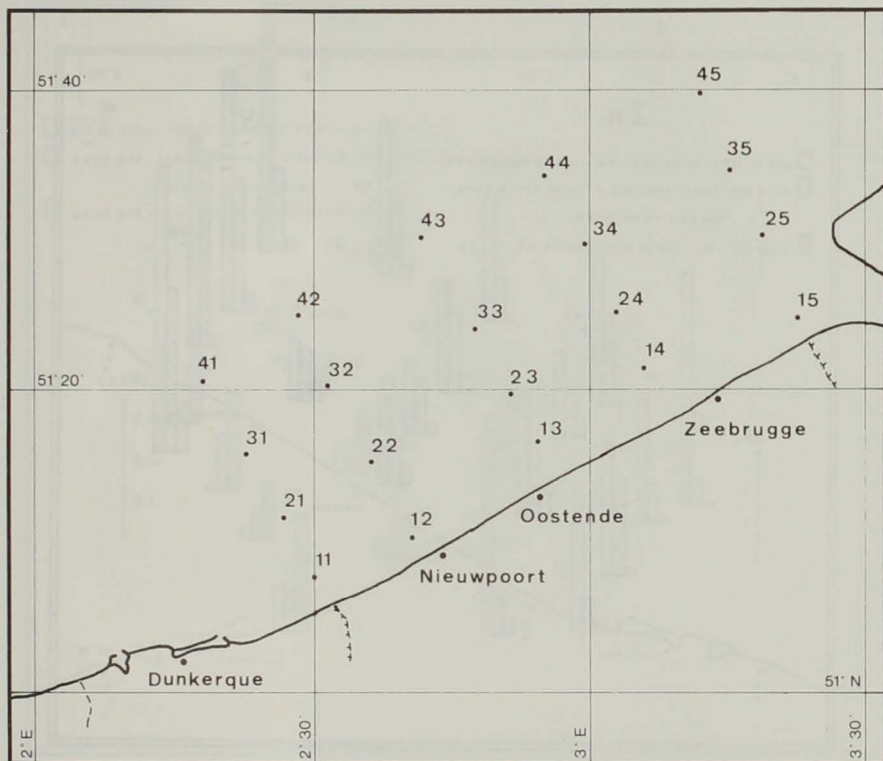

fig. 3.

Location of sampling stations in the North Sea (Belgian coast)

The difference between the results obtained in steps IIa (acid pH) and I corresponds to weak complexes. In the case of Sb and Bi, the ionic form cannot be dissociated from weak complexes, IIa gives the sum of the two forms.

Regarding Zn, Cd, Pb, Cu and Bi the IIb step gives after treatment by SO_2 and DPASV at acid pH values identical to those obtained in step IIa. But the IIb data for Sb correspond to the sum of Sb^{III} and Sb^{V} .

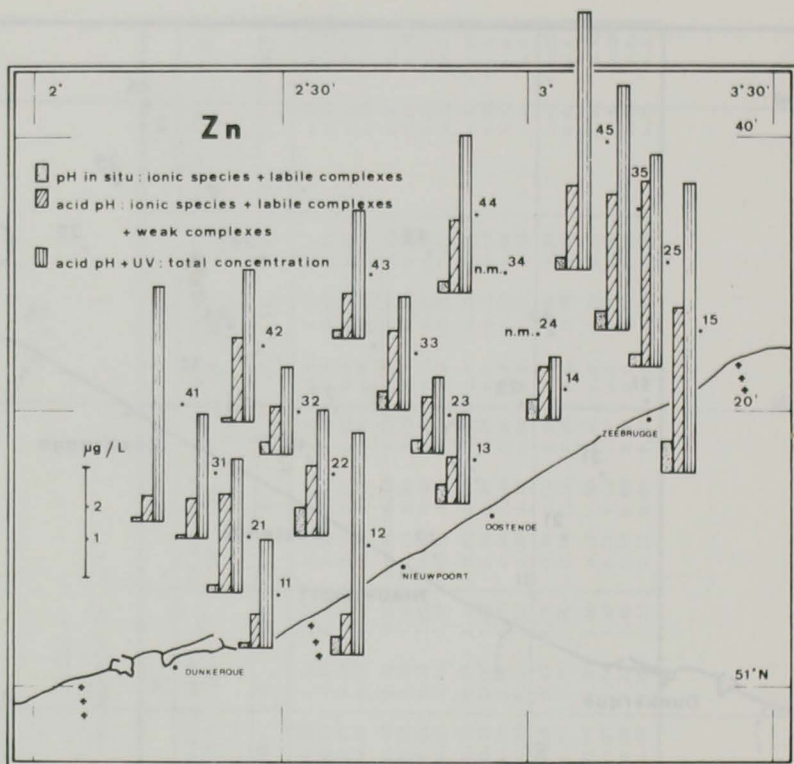

fig. 4.

Dissolved metal concentration
Distribution of Zn along the Belgian coast in October 1979

Finally step III (SO_2 + UV treatment, analysis at acid pH) allows to find the total concentrations of the six elements.

The difference between the concentrations detected in step III and (IIa - IIb) corresponds to strong complexes.

The results for Sb lead to the conclusion that this metal is dissolved mainly as Sb^{V} . The percentage of Sb complexed by organic matter can be estimated to vary between 20 and 40 % of the total metal concentration.

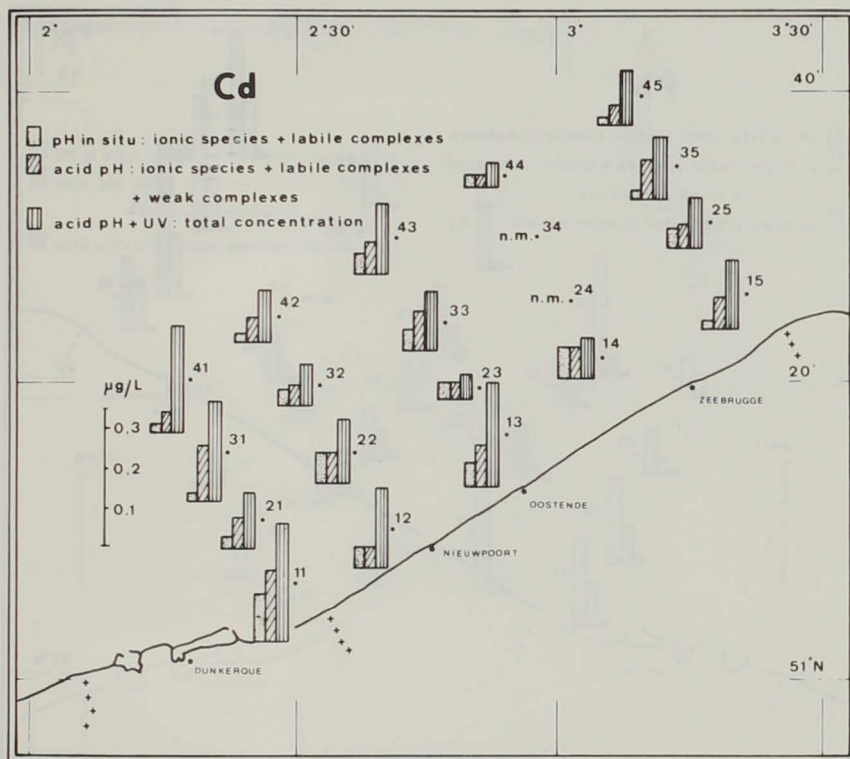

fig. 5.

Dissolved metal concentration
Distribution of Cd along the Belgian coast in October 1979

The data for Bi show concentrations often below detection limit ($< 0,05 \mu\text{g}/\text{l}$) ; a few results have been obtained after UV treatment on samples collected close to the coast (grid points 21, 22, 13, 14) and in the vicinity of the Scheldt estuary (grid points 15, 25). This might indicate that Bi diffuses from the coast and is rapidly diluted or removed by unknown processes from the water column offshore.

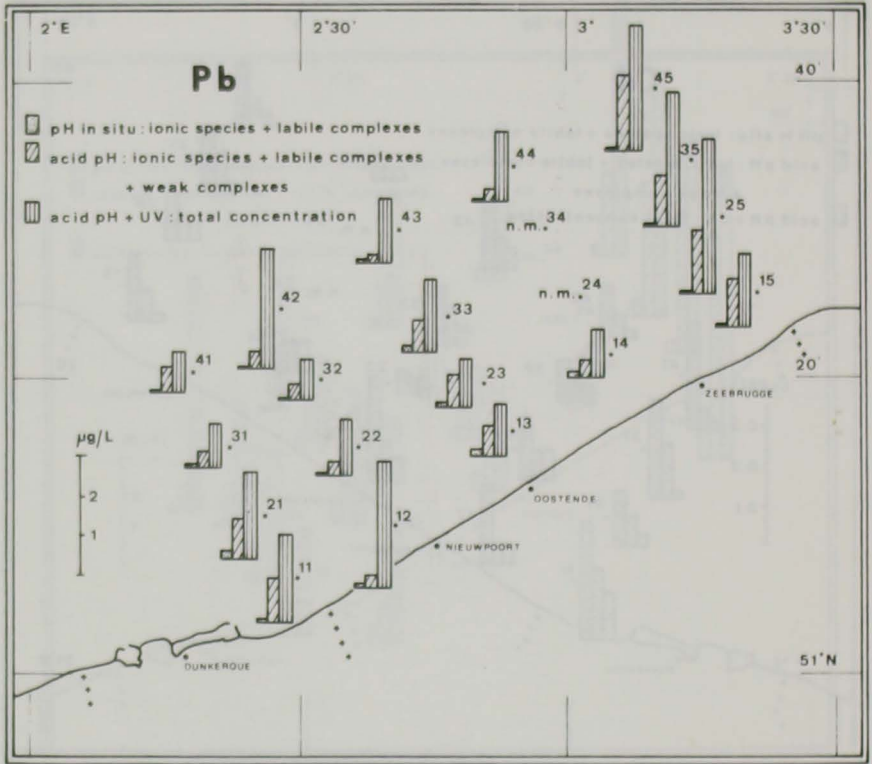

fig. 6.

Dissolved metal concentration
Distribution of Pb along the Belgian coast in October 1979

For Zn and Pb they appear to be rather uniformly distributed, although some maxima are found along grid lines 5 and at some other grid points (12, 41 and 42). This probably reflects coastal and estuarine influence.

This observation is not confirmed for Cd and Cu which show significant concentration differences from point to point.

The amounts of Zn, Cd, Pb, Cu involved in organic complexes often correspond to an important fraction of the total concentration with great variations from point to point: 12 to 87 % for

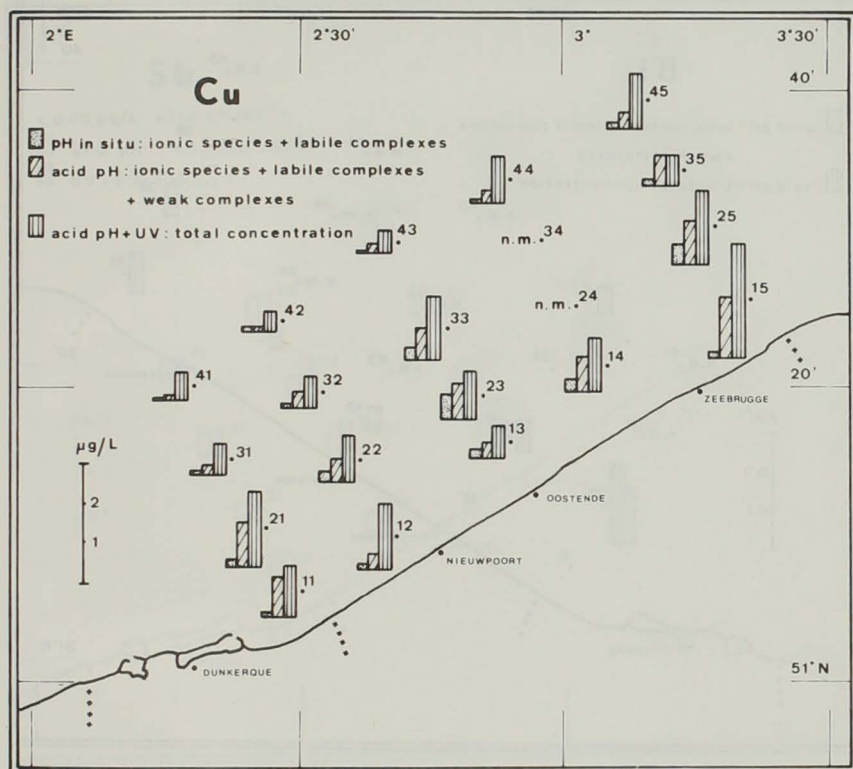

fig. 7.

Dissolved metal concentration
Distribution of Cu along the Belgian coast in October 1979

Zn, 20 to 80 % for Cd, 33 to 87 % for Pb, 20 to 83 % for Cu. This is of great importance in the study of the fate of heavy metals in the sea, their relative toxicity and is closely connected to the study of organic matter.

Although the grid covers some regions of dumping of important quantities of chemicals in solution containing heavy metals, no heavily polluted zone can be detected. Rate of dispersion is of course very high in well mixed shallow waters.

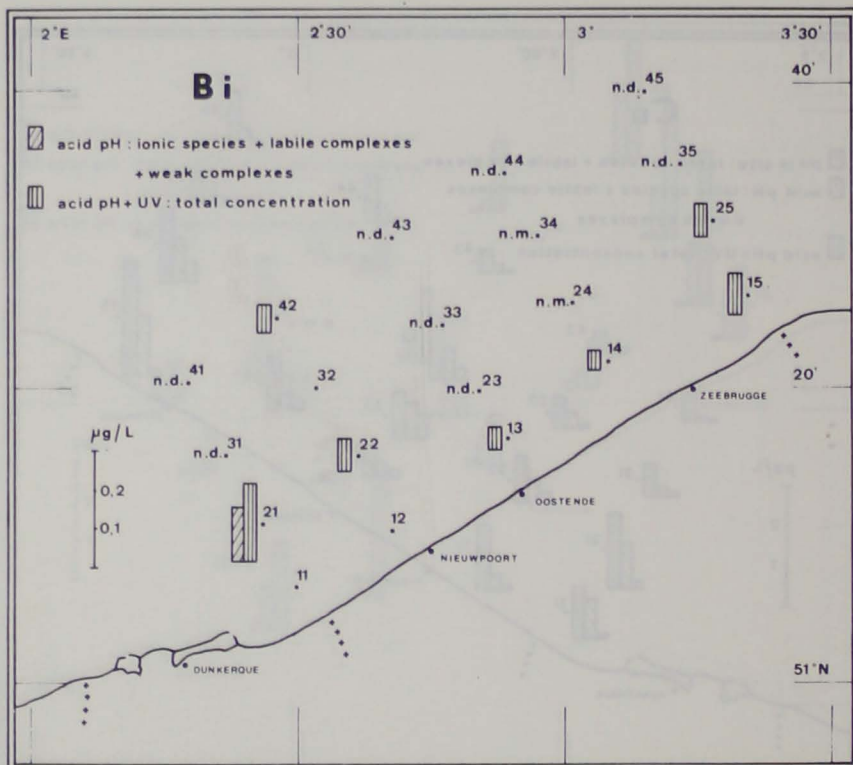

fig. 8.

Dissolved metal concentration
 Distribution of Bi along the Belgian coast in October 1979

We will finally compare the results obtained in 1979 with our actual sampling method with those resulting from the analysis of samples collected using other techniques during october cruises carried out in the same region since 1972.

Fig. 10 shows that from 1972 until 1977 included the values for Zn, Cd, Pb and Cu are rather high and that dispersion is important.

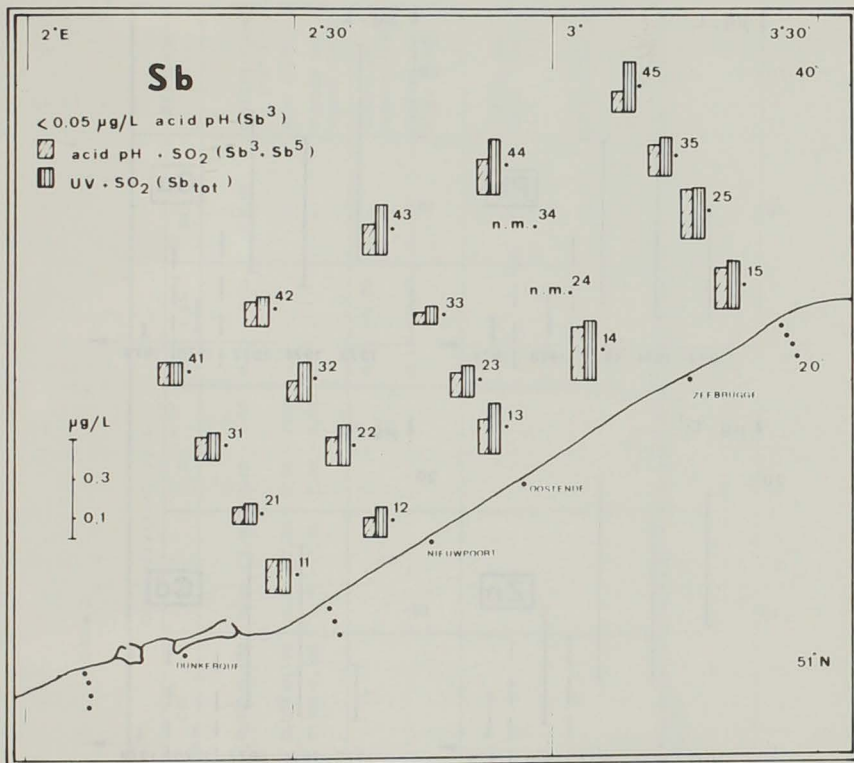

fig. 9.

Dissolved metal concentration
Distribution of Sb along the Belgian coast in October 1979

From 1978 on, one observes a progressive and important diminution of the concentrations and a reduction of dispersion.

This, we believe, is due to several steps taken to avoid contamination during sampling and filtration.

In 1978, the samples for routine work were still collected with a Niskin bottle as during the preceding years, but filtration by suction was replaced by filtration under pressure. In

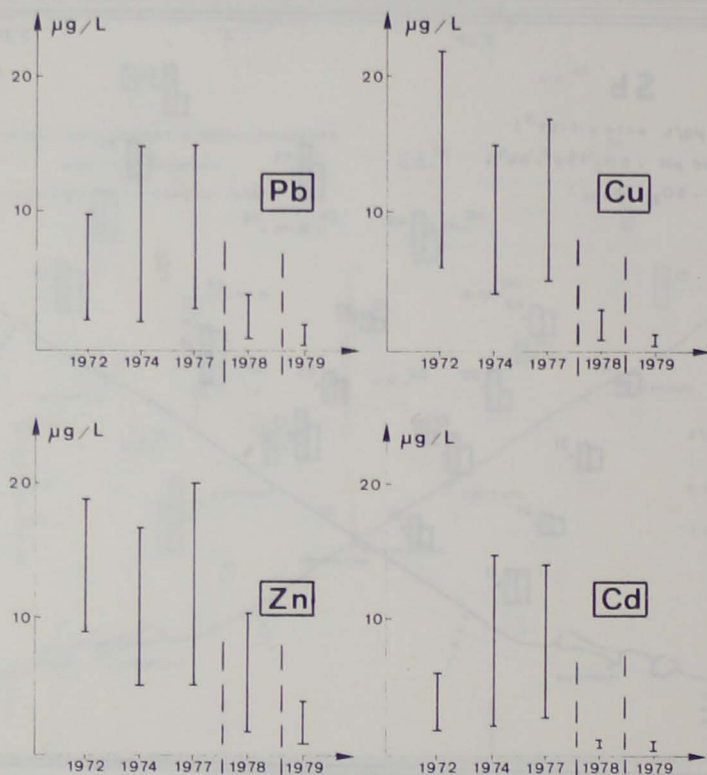

fig. 10.

Zn, Cd, Pb, Cu concentrations measured during cruises along the Belgian coast in October 1972, 1974, 1977, 1978, 1979. Broken line indicate improvement of filtering technique (under pressure instead of suction) in 1978, of sampling and filtering system in 1979.

1979 the new sampling kit described here, which began to be tested in 1978 [see Gillain et al. (1979a)] but in a less sophisticated form, was systematically used with further obvious improvement of the results.

For the same geographical site our actual data are comparable to results obtained in August 1976 by Mart (table 2) along a line Ostend - Den Helder. Sampling was carried manually at 50 cm depth from a small rubber boat using plastic bottles attached to

Table 2

| Geographical locations | Date of sampling | Analytical method | Concentration, $\mu\text{g}/\text{L}$ | | | | | | References |
|------------------------|------------------|--------------------------------------|---------------------------------------|------------------|------------------|------------------|-------------------------------------|-------------------|----------------------------|
| | | | Zn ⁺⁺ | Cd ⁺⁺ | Pb ⁺⁺ | Cu ⁺⁺ | Sb ³⁺ + Sb ⁵⁺ | Bi ⁺⁺⁺ | |
| <u>North Sea</u> | | | | | | | | | |
| Belgian coast | oct. 1979 | DPASV pH=1 | 0,70 - 5,10 | 0,030-0,180 | 0,20 - 1,90 | 0,10 - 1,50 | 0,05 - 0,26 | < 0,05 | GILLAIN (this paper) |
| Belgian coast | aug. 1976 | DPASV pH=2 | - | 0,024-0,110 | 0,10 - 2,60 | 0,34 - 2,00 | - | - | MART (1976) |
| Dutch coast | 1975-1976 | DPASV pH=2,7 | 3,00 -20,10 | 0,100-0,300 | 1,70 - 3,30 | 1,00 - 2,50 | - | - | DUINKER and KRAMER (1977) |
| Atlantic | 1963 | activation | - | - | - | - | 0,11 - 0,58 | - | SCHUTZ and TUREKIAN (1965) |
| Irish Sea | 1965 | extraction MIBK + colorimetry | - | - | - | - | 0,13 - 0,40 | - | PORTMAN and RILEY (1966) |
| English Channel | 1965 | ion exchange + emission spectroscopy | - | - | - | - | - | 0,025 | PORTMAN and RILEY (1966) |
| Irish Sea | | | | | | | | 0,039 | |
| North Atlantic Ocean | | | | | | | | 0,033 | |
| South Atlantic Ocean | 1960 | id. | - | - | - | - | - | 0,017 | BROOKS (1960) |
| Pacific Ocean | 1973 | ASV | - | - | - | - | - | 0,020-0,11 | FLORENCE (1974) |

Note : DPASV = Differential pulse anodic stripping voltammetry
MIBK = Methylisobutylketon
ASV = Anodic stripping voltammetry

a telescopic plastic rod to avoid contamination. Heavy sea conditions make this method quite hazardous and considerably limits its use.

Other data are available for a nearby region, along a line in front of the Rhine Estuary. They are reported by Duinker and Kramer (1977) and are higher. It is difficult to tell whether this can be due to contamination or reflects the Rhine output. Bottles were used for sampling, but filtration was carried out under pressure (nitrogen).

Regarding Sb and Bi data are scarce and comparison can only be made with results obtained with other analytical techniques and in very different locations (table 2). However the order of magnitude seems to be correct. It is obvious that in the case of Sb and Bi contamination problems are much less acute than for Zn, Cd, Cu and Pb, which find a variety of use in ship building.

In conclusion one can only say that sampling is the most hazardous step in detecting trace metals at the levels found in sea water. It is believed that the new sampling and filtering technique presented here meets the requirements for water sampling at moderate depth, allows to work from large or small research vessels, even in rough conditions. It could easily be adapted to be fed under nitrogen pressure from slightly modified Niskin bottles for deep sea operations.

Needless to say it looks obvious to the authors that a proper evaluation of trace metal levels to assess pollution for instance or to understand chemical processes in the sea (complexation is one example) will only be achieved for eventual comparisons with other marine regions if analysts come together to intercalibrate not only their analytical tools but also, and this is urgent, their sampling procedures.

References

- BROOKS, R.R. (1960). The Use of Ion-Exchange Enrichment in the Determination of Trace Elements in Sea Water. *Analyst*, 85, 745-748.
- DUINKER, J.C. and KRAMER, C.J.M. (1977). An experimental study on the speciation of dissolved Zn, Cd, Pb, Cu in River Rhine and North Sea water by differential pulsed anodic stripping voltammetry. *Mar. Chem.*, 5, 207-228.
- FLORENCE, T.M. (1974). Determination of Bi in marine samples by anodic stripping voltammetry. *J. Electroanal. Chem.*, 49, 255.
- GILLAIN, G., DUYCKAERTS, G. and DISTECHE, A. (1979a). The determination of trace metals in sea water and suspended matter by classical anodic stripping (Zn, Cd, Pb, Cu) or differential pulse anodic stripping voltammetry with a hanging mercury drop electrode (Zn, Cd, Pb, Cu, Sb and Bi). An approach to speciation. In : *Rapports des journées d'études 1979. Actions de recherche concertées. Action interuniversitaire. Océanologie. Services du Premier Ministre. Programmation de la Politique Scientifique, Bruxelles*, pp. 123-132.
- GILLAIN, G., DUYCKAERTS, G. and DISTECHE, A. (1979b). Direct and simultaneous determinations of Zn, Cd, Pb, Cu, Sb and Bi dissolved in sea water by differential pulse anodic stripping voltammetry with a hanging mercury drop electrode. *Anal. Chim. Acta*, 106, 23-37.
- MART, L. (1979). Doctorat thesis, RWTH, Aachen.
- PORTMAN, J.E. and RILEY, J.P. (1966). The determination of Bi in sea and natural water. *Anal. Chim. Acta*, 34, 201-210.
- PORTMAN, J.E. and RILEY, J.P. (1966). The determination of Sb in natural water with particular reference to sea water. *Anal. Chim. Acta*, 35, 35-41.
- SCHUTZ, D.F. and TUREKIAN, K.K. (1965). The investigation of the geographical and vertical distribution of several trace elements in sea water using neutron activation analysis. *Geochim. Cosmo. Acta*, 29, 259-268.

Spatial pattern and biochemical content of North Sea zooplankton
(Belgian coast) [1979-1980]

J.H. HECQ¹, A. GASPAR¹ and H. PICARD²

Abstract

Seasonal changes in chlorophyll and zooplankton concentrations have been studied in comparison with its biochemical content (proteins, lipids and carbohydrates).

Zooplankton biomass shows a first peak in spring and a second one in autumn in the offshore area but only one in spring in the coastal area.

Zooplankton and phytoplankton are distributed into two patches (zooplankton offshore and phytoplankton near the coast).

A maximal lipid content suggesting a higher nutritional activity was observed in the central area interposed between the two patches.

The lipid content of the zooplankton increases from spring up to autumn and decreases at the end of winter, just before the spring bloom.

Introduction

The traditional schemes of the planktonic food chain usually accept the existence of direct and instantaneous relationships between the phytoplankton and the herbivorous zooplankton (Harvey (1950), Riley (1970), Parsons and Lebrasseur (1970)).

As far as a large scale of time and space is considered, these trophic schemes can be taken as a whole in the Strait of Dover (Hecq (1975)) and in

1. Laboratoire de biologie générale, Université de Liège, Quai Van Beneden, 22, B-4020 Liège (Belgium).

2. Unité de gestion du Modèle mathématique de la mer du Nord, DER Caserne Bootsman Jonsen, B-8400 Oostende (Belgium).

the North Sea (CIPS (1977)) where one half of zooplankton is herbivorous and the other one omnivorous.

However many attempts to draw instantaneous correlations between the zooplankton and phytoplankton biomass have remained unsuccessful (Nihoul *et al.* (1972)). As a matter of fact, the abundance maxima of the different trophic levels (herbivorous, producers, carnivorous) are following one another, in a definite area, with a minimal delay of ten days (Hecq (1976)). As the phytoplankton turnover time is only three days, it seems therefore impossible to explain why zooplankton biomass maximum only appears ten days later if the sole vegetal organic material is immediately used for production.

On the other hand, the rate of the zooplankton oxygen consumption appears to be somewhat higher than the primary production (expressed in the same unit : $\text{mg C/m}^2 \cdot \text{d}$) and thus higher than the grazing rate on the phytoplankton. This suggests that zooplankton can use either non-living (particular or dissolved) organic material, or organic material in the form of metabolic reserves.

This hypothesis has been considered in the present paper through the analysis of the biochemical composition of zooplankton collected during a whole year in the southern part of the North Sea.

Material and methods

Zooplankton samples were collected every month from January 1979 to February 1980 in 20 spots along the Belgian coast (fig.2) thanks to the Belgian Navy collaboration and one cubic meter of water was pumped on board and filtered through a 50μ mesh net ; the samples were immediately deepfrozen and the measurements performed in laboratory within the month. Temperature and salinity were also measured. Chlorophyll content was determined spectrophotometrically (Strickland and Parsons (1968)).

Samples were defrosted and fractionated on the one hand for species numeration and on the other hand for biochemical analysis.

Proteins were extracted in a NaOH 2 N solution during one hour at 100°C . The extract was then neutralized with HCl 2 N. Protein contents were determined according to Schacterle and Pollack (1973) by using beef serumalbumin as a standard.

Carbohydrates were extracted in a 10 % trichloroacetic acid solution during one hour at 100 °C. Carbohydrate amounts were measured according to Dubois et al (1956) by using glucose as a standard.

Fatty acids and lipids were extracted with a 2/1 chloroform-methanol mixture by homogenization with an ultraturrax (Freeman et al. (1957)). The extract was left two hours at 20 °C and overnight at 4 °C. Filtered extracts were purified from non-lipidic substances by the Folch et al. (1956) method. Lipid content was determined according to Marsh and Weinstein (1966) by using stearic acid as a standard.

Chlorophyll content of chloroform extracts of the samples was taken as an estimation of the vegetal biomass.

Dry weight is determined by dessication in an oven during 24 hours at 70 °C.

Dry weight and "organic weight" (OW) are expressed in mg by cubic meter. Organic weight is considered here as the total amount of proteins, carbohydrates and lipids. Chitin and free amino-acids are neglected with the consequence of a 10 % underestimate.

Protein, carbohydrate and lipid contents are expressed in % organic weight.

Results

Most species of the examined zooplankton samples are Copepods : *Temora longicornis*, *Acartia clausi* and *Pseudocalanus elongatus* represent from 90 to 95% of the total. The different species proportions are more or less constant during the whole year and on the whole network.

Total biomass presents variations. Mean evolution of the zooplankton biomass (OW) during the whole year (fig.1 curve 2, dotted line) shows an important peak in June (500 mg/m³) and another one in October (350 mg/m³). These peaks follow phytoplankton bloom in April-May (18 mg chl a/m³) and in October (9 mg chl a/m³) and correspond to periods of maximal variations of temperature.

Biomass presents an important variability on the whole network : it is due to considerable differences between two groups of homogeneous values : those obtained along the coast and those offshore. Indeed June data show a

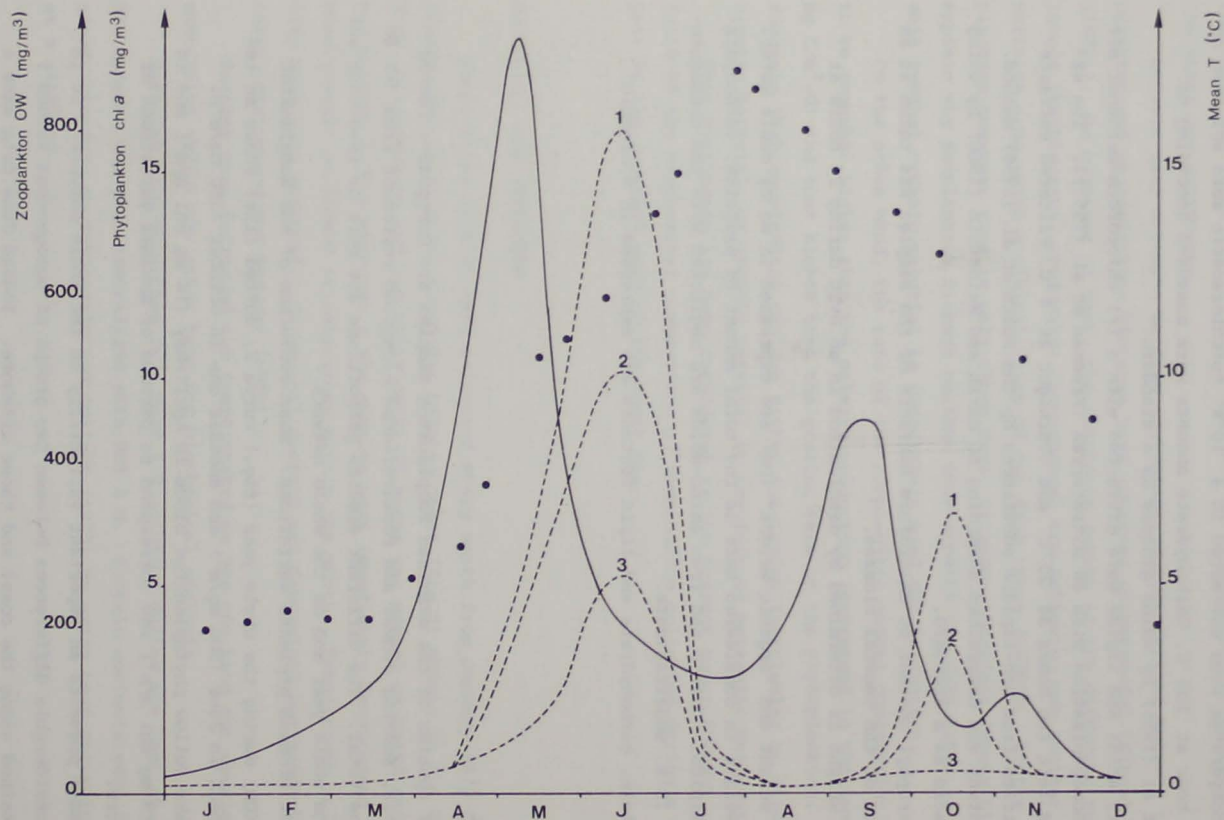

fig. 1.

Zooplankton (dotted line) and phytoplankton (continuous line) biomass evolution along the Belgian coast in 1979. Curve 2 represents mean values of the whole network and curves 1 and 3 respectively the offshore and coastal ones. Points represent mean temperature values.

high zooplankton biomass (OW) offshore (797 ± 177 mg OW/m³) and a lower one along the coast (252 ± 120 mg OW/m³).

On the other hand, the chlorophyll data are maximum along the coast and especially near the Scheldt estuary (6 mg chl a/m³).

Moreover, both phytoplankton and zooplankton show a gradient from the coast to the open sea, positive for zooplankton and negative for phytoplankton (fig.2).

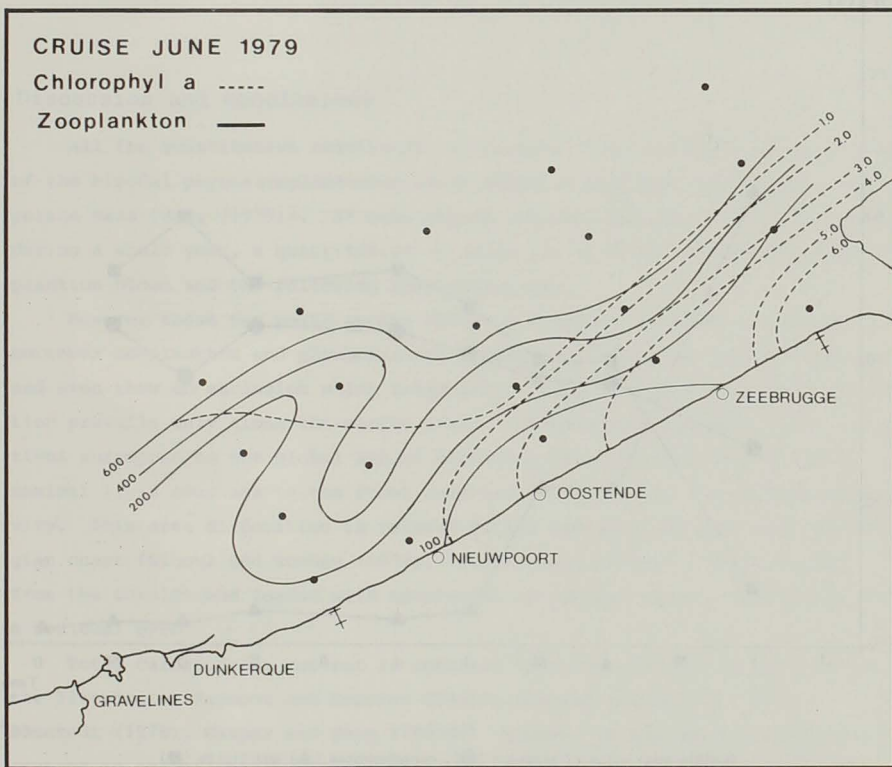

fig. 2.

Zooplankton (mg OW/m³) and phytoplankton (mg chl a/m³) biomass.
The sampling stations are represented by points.

The offshore area presents higher biomass variations than those in the coastal one : during the spring bloom, the offshore zooplankton averages reach 800 mg OW/m^3 and the coastal one 250 mg OW/m^3 . The autumn bloom is only observed in the offshore area (250 mg OW/m^3) and remains negligible at the coast (fig.1, curves 1 and 3).

Apart these two maxima, the whole network is homogeneous and zooplankton biomassa remain negligible.

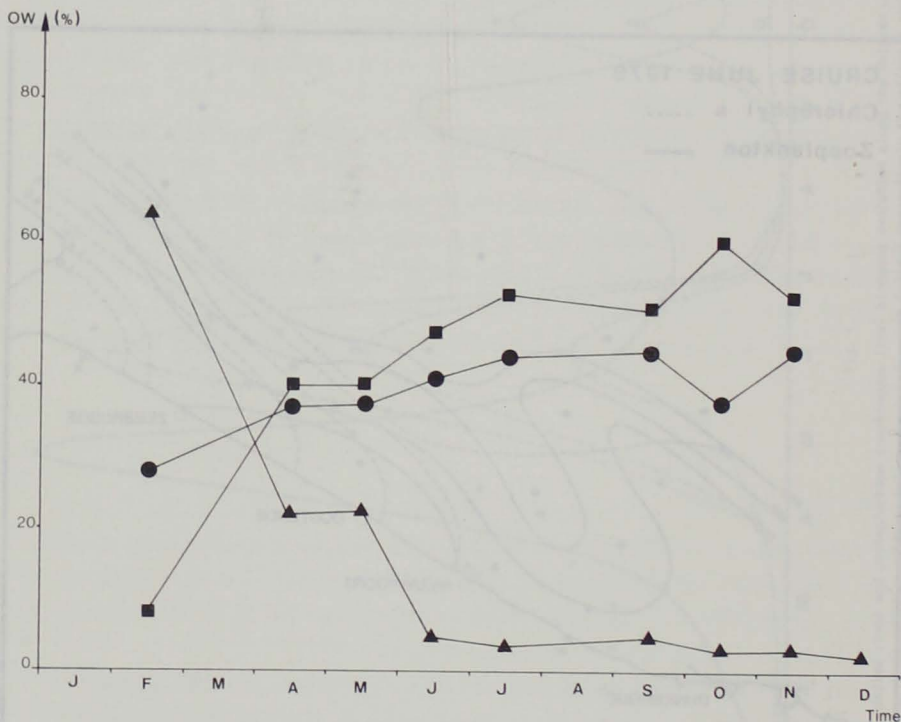

fig. 3.

Monthly mean value of proteins (●), carbohydrates (▲) and lipids (■) expressed in % of the total organic matter (OW)

Zooplankton biochemical content is presented in figure 3. Average protein amount is more or less constant during the whole year (35 - 45 %). Carbohydrate concentrations, very important in April-May (20 to 30 % of OW)

fall to about 3% in June and remain so. Lipid content increases from February to October and afterwards decreases (the too small number of winter data prevents us from formulating any relations to the carbohydrate content).

At a spatial point of view, lipid repartition is rather homogeneous off-shore and along the coast (for example 52% in June) ; but the higher contents (65%) are always observed on the front separating these two areas ; protein contents are rather constant. Along the coast, the higher carbohydrate contents are due to the greater concentration of the phytoplankton.

Discussion and conclusions

All the quantitative results of our cruises show once more the existence of the bimodal phyto-zooplanktonic cycle which is characteristic of the temperate seas (Hecq (1975)). If mean values are considered on a large area and during a whole year, a quantitative relation can be drawn between the phytoplankton bloom and the following zooplankton one.

However these two peaks appear within a delay of one month at least ; moreover zooplankton and phytoplankton spatial distributions are different and even show an exclusion which could let us suppose that herbivorous nutrition prevails only along the narrow front. Furthermore important local variations surimpose to the global annual variation of lipid content and reveal maximal lipid stockage in the front area and thus a higher nutritional activity. This area disposition is related to the hydrological flow off the Belgian coast (Nihoul and Runday (1974a, 1974b), Hecq (1979)) : water coming from the Scheldt and loaded with nutrients, is carried away to the South in a residual gyre.

Total carbohydrate content is constant from June on ($\pm 3\%$) according to the literature (Raymont and Conover (1961), Mayzaud and Martin (1975), Båmstedt (1978), Gaspar and Hecq (1980)). However in the early spring this content is exceptionally high at the coast (20% of OW) and is likely to be related to phytoplankton which can represent up to 40 % of the sample.

The whole results show that in the early spring, when the phytoplankton peak reaches its maximum, total animal biomass is low and its proteins represent a high percentage of the organic weight. Feeding would be directly used either for proteogenesis (growth) or for reproduction (increasing of indivi-

duals number) ; furthermore respiratory metabolism is very high at this period (Hecq (1973)). Later on, at the end of the bloom, the zooplankton biomass reaches its maximal value and then decreases ; lipid amount goes on increasing (up to about 50% of the OW). Respiratory quotient, although lower than in bloom beginning, however presents a higher value than the grazing one ; phytoplankton biomass is moreover low. During this period animals would call upon other food sources. Animals become less numerous but contain more lipids.

This situation is comparable to the Korsfjorden (Norway) one (Båmstedt (1978)) : the Copepod *Chiridius armatus* has a constant carbohydrate amount during the whole year whereas lipid concentration presents variations bound to the bloom peaks : lipid content regularly decreases from October on and again increases at the spring beginning. The author suggests that these variations are linked to trophic phenomena. Individual average lipid amount decreases from August to March and this decrease is on direct opposition to the protein amount.

Conover and Corner (1968) have analysed lipidic content of *Calanus finmarchicus* and *Metridia longa* collected from September to May in the Gulf of Maine : the values for the herbivorous species *Calanus finmarchicus* are always higher than those of the carnivorous species *Metridia longa* ; in both cases, lipids progressively decrease during winter.

Moreover, Corner and Cowey (1968) and Lee et al. (1971) have shown that lipid consumption coefficient is variable : *Calanus finmarchicus*, which can stock lipids up to 40% of its dry weight, only uses 1 to 2% of these lipids daily during an experimental fast whereas an omnivorous species such as *Acartia clausi* uses up to 60% of its lipid weight during the same period. Therefore it seems that lipid combustion is more rational in herbivorous than in carnivorous Copepods.

In conclusion, trophic relations could be generalized as follows (fig.4). During phytoplankton maxima, low amounts of zooplankton feed mostly on vegetals (important grazing) and their respiratory quotient is high (>1 mg C/mg C/D) : a great part of ingested energy (carbohydrates) is used for protein production (growth and reproduction) (=phase 1). During this period, amylase activity would be the greatest ; Boucher and Samain (1974) have stressed the close relationship between grazing and amylase activity.

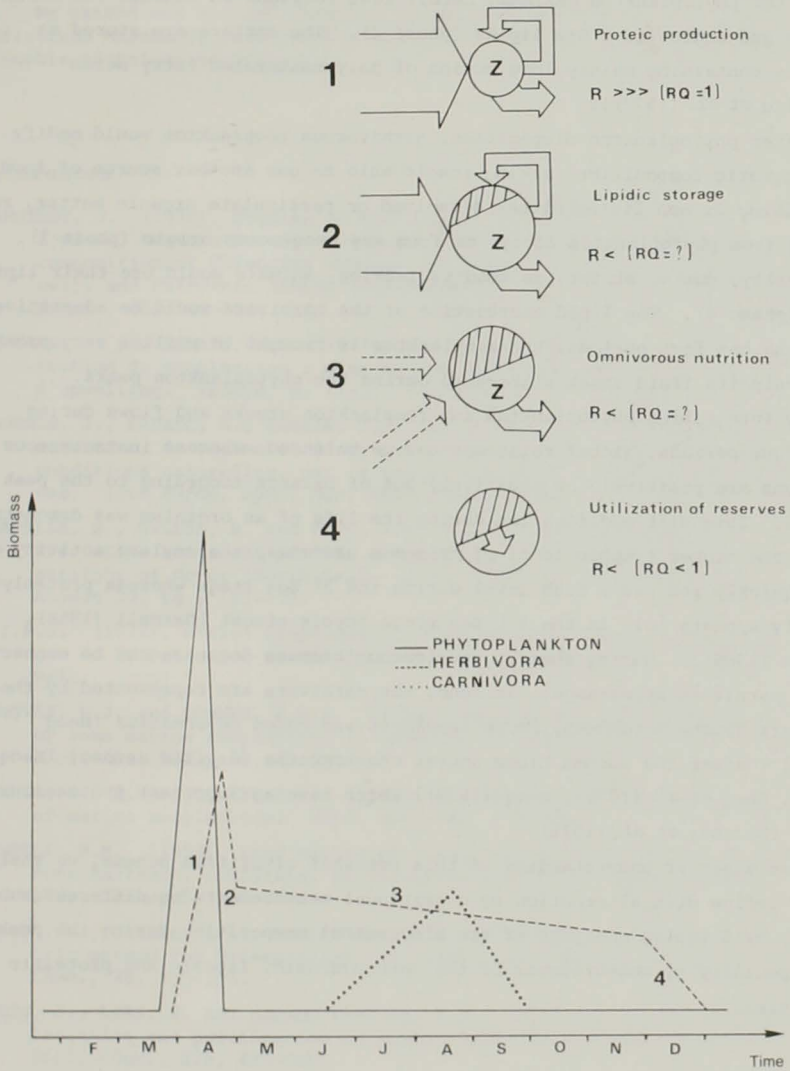

fig. 4.

Schematization essay of phyto/zooplankton relations in the Southern Bight of the North Sea
 (explanations in the text)

After phytoplankton maximum, herbivorous zooplankton reaches its maximum biomass and begins to store lipids (phase 2). The latter are stored as droplets containing mainly long chains of polyunsaturated fatty acids (Chapelle et al. (1979)).

After phytoplankton disappearance, herbivorous zooplankton would modify its enzymatic composition, making itself able to use another source of food e.g. living or non living either dissolved or particulate organic matter, resulting from phytoplankton decay, or from any exogenous origin (phase 3). And finally, during winter, as food is lacking, animals would use their lipid stock (phase 4). The lipid consumption of the herbivora would be adaptive, as during the fast periods, the zooplankton is brought to utilize very progressively its lipid stock elaborated during the phytoplankton peaks.

By integrating phytoplankton and zooplankton stocks and flows during these four periods, global relations can be balanced, whereas instantaneous relations are positively or negatively out of balance according to the peak periods. This diet modification during the life of an organism was demonstrated at the higher trophic level of *Palaemon serratus*, the amylase activity of which quickly reaches a high level during the 2^d Zoe stage whereas proteolytic activity appears only in the 5th Zoe stage (Mysis stage) (Darnell (1958), Pandian (1969)). During summer, herbivorous biomass decrease can be connected to the carnivora appearance. In June, the carnivora are represented by the Cladocera *Evadne nordmanni*, *Podon leuckarti* and *Podon intermedius* (Hecq (1976)) ; after the autumn bloom appear Chaetognatha (*Sagitta setosa*) (Hecq (1976), Hecq et al. (1976), Hecq (1979)) which have an important protease activity (Boucher et al. (1975)).

For a better understanding of this somewhat simplified scheme, we shall try to define diet alternation by nutritional measurements on different substrates, by detailed analysis of the biochemical composition during the peaks and especially by measurements of the carbohydrase, lipase and protease activities.

Acknowledgments

This work has been carried out under Professor J. Godeaux direction. The authors wish to thank him for his advices and his encouragements. They also thank the "Unité de Gestion du Modèle mathématique de la mer du Nord", Mechelen crews and DER Service of Belgian Navy for sampling.

We extend our special thanks to Chantal de Ridder, Carine Gougnard, Christiane Marchand, Jacqueline Mossoux and Marie-Thérèse Venzon for their valuable technical assistance.

References

- BÅMSTEDT, U. (1978). Studies on the deep-water pelagic community of Korsfjorden, Western Norway. Seasonal variation in weight and biochemical composition of *Chiridius armatus* (Copepoda), *Boreamysis arctica* (Mysidacea), and *Eukrohnia hamata* (Chaetognatha) in relation to their biology. *Sarsia*, 63, 145-154.
- BOUCHER, J. and SAMAIN, J.F. (1974). L'activité amylasique. Indice de la nutrition du zooplancton : mise en évidence d'un rythme quotidien en zone d'upwelling. *Tethys*, 6, (1-2), 179-188.
- BOUCHER, J., LAUREC, A., SAMAIN, J.F. and SMITH, S.L. (1975). Etude de la nutrition, du régime et du rythme alimentaire du zooplancton dans les conditions naturelles, par la mesure des activités enzymatiques digestives. *10th Europ. Symp. Mar. Biol.*, Ostend, Belg., 2, 85-110.
- CHAPELLE, S., GILLES, R. and HECQ, J.H. (1979). Phospholipids, fatty acids free amino acids and proteic amino acids in zooplankton from the straight of Dover (North Sea). *Europ. Soc. for compar. Phys. and Bioch.*, August 79, Lg., 177-178.
- C.I.P.S. (1977). Chaîne trophique et cycle des nutriments. Modèle mathématique de la Pollution en mer du Nord. Rapport de synthèse 8, Ed. Nihoul et Polk.
- CONOVER, R.J. and CORNER, E.D.S. (1968). Respiration and nitrogen excretion by some marine zooplankton in relation to their life cycle. *J. mar. biol. Ass. U.K.*, 48, 49-75.
- CORNER, E.D.S. and COWEY, C.B. (1968). Biochemical studies on the production of marine zooplankton. *Biol. Rev.*, 43, 393-426.
- DARNELL, R.M. (1958). Food habits of fishes and larger invertebrates of Lake Pontchartrain, Louisiana, an estuarine community. *Publ. Inst. mar. Sc. Univ. Texas*, 5, 353-416.
- DUBOIS, M., GILLES, K.A., HAMILTON, P.A.R. and SMITH, F. (1956). Colorimetric method for determination of sugars and related substances. *Anal. Chem.*, 28, 350-356.
- FOLCH, J., LEES, M. and SLOANE STANLEY, G.H. (1956). A simple method for the isolation and purification of total lipids from animal tissues. *J. Biol. Chem.*, 226, 497-509.
- FREEMAN, N.K., LINDGREN, F.T., NG, Y.C. and NICHOLS, A.V. (1957). Serum lipid analysis by chromatography and infrared spectrophotometry. *J. Biol. Chem.*, 227, 449-464.
- GASPAR, A. and HECQ, J.H. (1980). Cycle annuel de la composition biochimique du zooplancton dans la baie de Calvi (in preparation).

- HARVEY, H.W. (1950). On the production of living matter in the sea off Plymouth. *J. mar. biol. Ass. U.K.*, 29, 97-137.
- HECQ, J.H. (1973). Essais du dosage du taux respiratoire du zooplancton en mer du Nord. Modèle mathématique de la Pollution en mer du Nord. Technical Report, Biol.06, 1-19.
- HECQ, J.H. (1975). Cycle annuel du zooplancton à Boulogne-sur-Mer (Pas de Calais) 1970-71. I. Le méroplancton. Ses variations saisonnières. *Bull. Soc. Roy. Sc. Lg.*, 44, 477-485.
- HECQ, J.H. (1976). Cycle annuel du zooplancton à Boulogne-sur-Mer (Pas de Calais) 1970-71. II. L'holoplancton. *Bull. Soc. Roy. Sc. Lg.*, 45, 443-457.
- HECQ, J.H. (1979). Caractérisation du comportement des masses d'eau de petite dimension par les indicateurs zooplanctoniques. XXVIème Cong. C.I.E. S.M. (Antalya), 25-26, 8, 117-118.
- HECQ, J.H., HEYDEN, D. and MOERMANS, R. (1976). Biologie de *Sagitta setosa* dans le Pas de Calais et le sud de la mer du Nord. *Bull. Soc. Roy. Sc. Lg.*, 45, 653-667.
- HECQ, J.H., GASPARD, A. and PICARD, H. (1980). Résultats des campagnes océanographiques en mer du Nord (1979-1980) (in preparation).
- LEE, R.F., HIROTA, J. and BARNETT, A.M. (1971). Distribution and importance of wax esters in marine copepods and other zooplankton. *Deep-Sea Res.*, 18, 1147-1165.
- MARSH, J.B. and WEINSTEIN, D.B. (1966). Simple charring method for determination of lipids. *Journ. Lipid Research*, 7, 574-576.
- MAYZAUD, P. and MARTIN, J.L.M. (1975). Some aspects of the biochemical and mineral composition of marine plankton. *J. exp. mar. Biol. Ecol.*, 17, 297-310.
- NIHOUL, J.C.J., PICHOT, G., HECQ, J.H. and DUBOIS, D.M. (1972). Exploitation des données et modelage du système marin. C.I.P.S., Modèle mathématique de la Pollution en mer du Nord. Rapport de synthèse, 2, 9-33.
- NIHOUL, J.C.J. and RONDAY, F.C. (1974a). The influence of the tidal stress on the residual current. *Prog. Nat. Belg. Envir.*, Ministry of Science Policy, Rapp. 32.
- NIHOUL, J.C.J. and RONDAY, F.C. (1974b). The effect of the "tidal stress" on the residual circulation of the North sea with application to the deposition of mud and the dynamics of ecosystems in the Southern Bight. *Prog. Nat. Belg. Envir.*, Ministry of Science Policy, Rapp. 42.
- PANDIAN, T.J. (1969). Feeding habits of the fish *Megalops cyprinoids* BROUSONET in the Cooum backwaters, Madras. *J. Bombay nat. Hist. Soc.*, 65, 569-580.
- PARSONS, T.R. and LEBRASSEUR, R.J. (1970). The availability of food to different trophic levels in the marine food chains. In : Steele, Oliver et Boyd (Ed.), *Marine Food Chains*, Edinburgh, 325-343.
- RAYMONT, J.E.G. and CONOVER, R.J. (1961). Further investigation on the carbohydrate content of marine zooplankton. *Limnol. Oceanogr.*, 6, 154-164.

- RILEY, G.A. (1970). Particulate and organic matter in sea water. *Adv. mar. Biol.*, 8, 1-118.
- STRICKLAND, J.D.H. and PARSONS, T.R. (1968). *A practical handbook of seawater analysis*, Stevenson, J.C. (Ed.), Ottawa, 311 p.
- SCHACTERLE, G.R. and POLLACK, R.L. (1973). A simplified method for the quantitative assay of small amounts of protein in biologic material. *Anal. Biochem.*, 51, 654-655.

Faint, illegible text at the top of the page, possibly a header or introductory paragraph.

Second block of faint, illegible text, appearing as a separate paragraph.

Third block of faint, illegible text, continuing the document's content.

Fourth block of faint, illegible text, showing further details or a list.

Fifth block of faint, illegible text, possibly a concluding paragraph or signature area.

Final block of faint, illegible text at the bottom of the page.

Ecometabolism of the coastal area
of the Southern Bight of the North Sea

Report of the workgroup "Organic Matter" (1979)

C. LANCELOT¹, M.H. DARO², J.M. BOUQUEGNEAU³, G. BILLEN¹, C. JOIRIS²,
M. BOSSICART², A. BERTELS², S. VERBEUSTEL¹, J. NYS², C. NIHOUL⁴,
J. PUTMAN¹, J. WYNANT², A. HEISE¹, L. GOEYENS⁵

Introduction

The study of the ecometabolism of any biotope requires

i) firstly, the identification of the main biological activities taking part in production and consumption of the organic matter and the stocks involved.

ii) secondly, the study of the main regulating mechanisms inducing a well balanced dynamic system.

The first point has already been developed in the coastal area of the Southern Bight of the North Sea (Billen *et al.*, 1976; Joiris *et al.*, 1979). However, as mentioned by these authors, some specific problems remained to be solved, and the "Organic Matter" workgroup has tried to do so by applying more refined methods for a better identification of the main biological activities and a proper understanding of the factors regulating the intensity of these activities.

1. Laboratoire d'Océanographie, Université libre de Bruxelles.

2. Laboratorium voor Ekologie en Systematiek, Vrije Universiteit Brussel.

3. Laboratoire d'Océanologie, Université de Liège.

4. Beheerseenheid van het mathematisch model van Noordzee en Schelde estuarium.

5. Laboratorium voor Analytische Scheikunde, Vrije Universiteit Brussel.

One important problem lies in the observation of a significant imbalance between the amount of organic matter produced by phytoplankton (main source of organic matter in area under study) and the amount of organic matter consumed, so that heterotrophic consumption was three times as high as production. In the absence of important exogeneous imports of organic matter, this had to be attributable to inadequate measures of phytoplankton gross production (underestimated ?) and/or heterotrophic consumption (overestimated ?). New methodologies were thus developed (Joiris et al., 1979) to obtain better measurements of all the fluxes involved in the gross phytoplankton production on the one hand and heterotrophic consumption on the other hand. The former includes phytoplankton particulate and dissolved production and phytoplankton respiration, the other, *sensu stricto* heterotrophic activity and phytoplankton respiration. Only this last parameter has not yet been measured. However new results lead to the hypothesis that phytoplankton respiration was more important than anticipated (Joiris et al., 1979). A method for measuring phytoplankton respiration had to be developed in order to verify this assumption.

Another important problem arising from the construction of the carbon budget concerned the recycling of the organic matter produced by phytoplankton. In contrast with the situation in the Northern Atlantic waters, where the recycling of phytoplankton production is classically accomplished by zooplankton (Daro, 1979), the recycling in the coastal area of the Southern North Sea presents the particularity of being accomplished almost exclusively by bacteria. The study of some regulatory mechanisms acting at sites of branching of the trophic web, decisive in the overall phytoplankton - zooplankton - bacteria - bifurcation was undertaken in order to understand this particular structure of the trophic web.

This work presents the last developments in the identification of the prevailing paths in the circulation of the organic carbon in the coastal area of the Southern Bight of the North Sea. An important part of this work will however be devoted to the description of some mechanisms of regulation, particularly important for the fate of the organic carbon produced by phytoplankton. This last point has needed larger ranges of concentrations and biological activities. Therefore, two other biotopes characteristic of the Southern Bight of the North Sea were sampled. A

richer one (station 'Hansweert' in the eutrophied Scheldt estuary) and a poorer one (station 'Calais' in the Channel). The position of the three sampled stations is indicated on fig. 1.

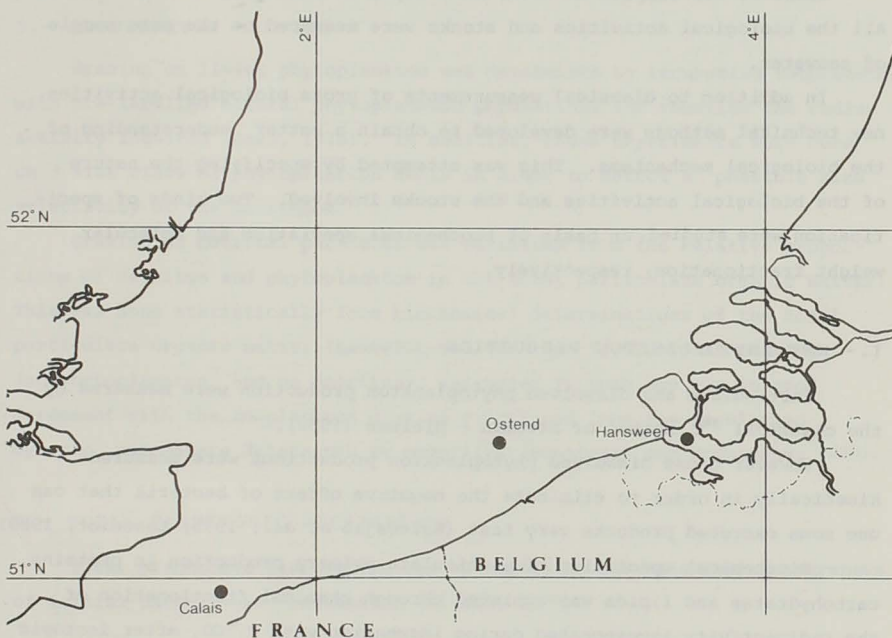

fig. 1.

Position of the sampling station visited

It must be still added that some other important results, more particularly concerned with the physiology and biochemistry of the plankton communities (phytoplankton, bacteria, zooplankton) were obtained during the cruises. Not directly useful for this work, they were discussed in separated papers (Billen *et al.*, 1980; Bossicart, 1980; Daro, 1980; Lancelot *et al.*, 1980).

Methods

The experimental part of this work was done on board of the *R. V. Mechelen* (coordinator : H. Picard).

Seawater was sampled at noon, at a depth of 3 m using Niskin's bottles. All the biological activities and stocks were measured on the same sample of seawater.

In addition to classical measurements of gross biological activities, new technical methods were developed to obtain a better understanding of the biological mechanisms. This was attempted by specifying the nature of the biological activities and the stocks involved. Two kinds of specification were studied, on basis of biochemical speciation and molecular weight fractionation, respectively.

1.- NET PHYTOPLANKTON PRODUCTION

Particulate and dissolved phytoplankton production were measured by the classical ^{14}C method of Steeman - Nielsen (1952).

However gross dissolved phytoplankton productions were measured kinetically in order to eliminate the negative effect of bacteria that can use some excreted products very fast (Nalewajko *et al.*, 1975; Lancelot, 1980).

Biochemical speciation of particulate primary production in proteins, carbohydrates and lipids was achieved through chemical fractionation of the radioactivity incorporated during incubation with H^{14}CO_3 after isotopic equilibrium (Morris *et al.*, 1974).

On the other hand, a first step to the biochemical speciation of the dissolved primary production was accomplished in separating the total excreted into small metabolites directly usable by heterotrophs and metabolites of high molecular weight. Ultrafiltration with membrane of 500 d porosity was applied on this experimental part (Lancelot, 1980, submitted).

2.- PHYTOPLANKTON DARK RESPIRATION

The method for measuring phytoplankton respiration was derived from the classical radiocarbon method of Steeman - Nielsen (1952). This flux was defined as the initial decrease of the radioactivity uniformly incorporated in phytoplankton cells when they are put into darkness.

Daily phytoplankton respiration was estimated assuming that the factors that quantitatively regulate respiration and particulate production are identical. This hypothesis still has to be verified.

3.- ZOOPLANKTON GRAZING

Grazing on living phytoplankton was determined by incubating zooplankton with pre-labelled natural phytoplankton populations and counting the radioactivity ingested (Daro, 1978). In addition, these experiments were done on 3 size class of phytoplankton cells in order to detect a possible size selectivity of the nutrition.

Grazing on detrital particles was estimated from the relative proportions of detritus and phytoplankton in the total particulate organic matter. This was done statistically from biochemical determinations of the total particulate organic matter (Lancelot-Van Beveren, 1980). Total grazing (on phytoplankton and on detritus), estimated in such way was in good agreement with the zooplankton grazing calculated from the population dynamic parameters determined by modelling (Bossicart and Mommaerts, 1979).

4.- TOTAL PLANKTONIC RESPIRATION

Total planktonic respiration was estimated by the classical measurement of initial dark oxygen consumption (Joiris, 1977).

5.- "SENSU STRICTO" HETEROTROPHIC ACTIVITY

Dissolved organic matter -the substrate of micro heterotrophs- involves a huge diversity of molecules about which little is actually known. According to Ogura (1975) and Billen *et al.* (1980), only a few are directly usable by heterotrophic bacteria.

This pool includes only small molecules (DUOM). The others must be first transformed to be usable by bacteria; for this reason they were called NDUOM (non directly usable dissolved organic matter).

"*Sensu stricto*" heterotrophic activity was then defined as the rate of utilization of the small DUOM molecules. The method for determining it consists of measuring the uptake kinetics of ^{14}C labelled organic molecules with high specific activity (Billen *et al.*, 1980).

Results and discussion

1.- GENERAL PICTURE OF THE ECOSYSTEM

Figure 2 shows the circulation of organic carbon at the first trophic levels in the coastal area of the Southern Bight of the North Sea during the spring phytoplankton bloom (March to July).

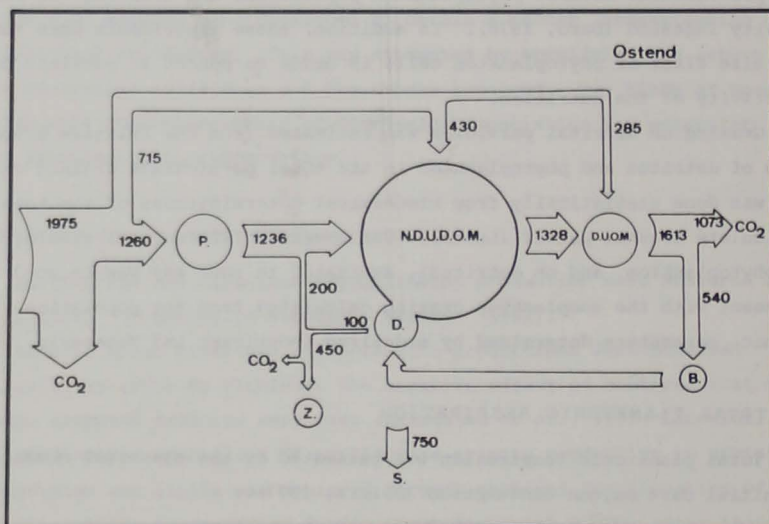

fig. 2.

Circulation of carbon budget (mg C/m².day) between the first trophic levels at the station 'Ostend' (period March - July).

Abbreviation :

P : phytoplankton Z : zooplankton S : sediments

B : bacteria D : detritus

NDUODM : non directly usable dissolved organic matter

DUOM : directly usable organic matter

Some remarks can be made from this figure, namely:

- The direct production of DUOM by phytoplankton is not very important (14% of the net phytoplankton production). Moreover it contributes to only 17% of the total *sensu stricto* heterotrophic activity whose substrates appear to be chiefly sup-

plied by hydrolysis of the degradation products of died phytoplankton cells.

- Recycling of the organic carbon produced by phytoplankton is mainly attributable to heterotrophic microorganisms. This confirms the idea of a minor role of zooplankton in the recycling of organic carbon produced by phytoplankton in the coastal area of the Southern Bight of the North Sea (Billen *et al.*, 1976; Joiris *et al.*, 1979).
- Phytoplankton respiration appears to be more important than generally estimated in marine waters (Steeman-Nielsen and Hansen, 1959). Its contribution to the total planktonic respiration is greater than *sensu stricto* heterotrophic activity itself.

However the carbon budget (Table 1) shows a little discrepancy between the measured total planktonic respiration and the sum of *sensu stricto* heterotrophic activity and phytoplankton respiration, the two components of the total planktonic respiration.

Table 1

Carbon budget at the station Ostend (period March-July) in $\text{mg C/m}^2\cdot\text{day}$

| | | | |
|--------------------------------|------|------------------------------|------|
| Net phytoplankton production | 1975 | Heterotrophic activities | 1913 |
| particulate | 1260 | <i>Sensu stricto</i> | 1613 |
| dissolved | 715 | Zooplankton grazing | 300 |
| Phytoplankton respiration | 1930 | Total planktonic respiration | 5500 |
| Gross phytoplankton production | 3905 | Phytoplankton respiration | 1930 |

Some observations still lead to the conclusion that the contradiction should be attributable to underestimated values of phytoplankton respiration caused by the lack of correct daily values, *i.e.*

i) the budget of net phytoplankton production and heterotrophic activities (*sensu stricto* and zooplankton grazing) are well balanced.

ii) the comparison with the same measurements accomplished in Hansweert, a biotope where the contribution of phytoplankton to the pool of organic matter is minor compared to the terrigenous imports (Wollast, 1976; Joiris *et al.*, 1979) indicates that phytoplankton respiration contributes effectively to less than 20% of the total planktonic respiration (fig. 3).

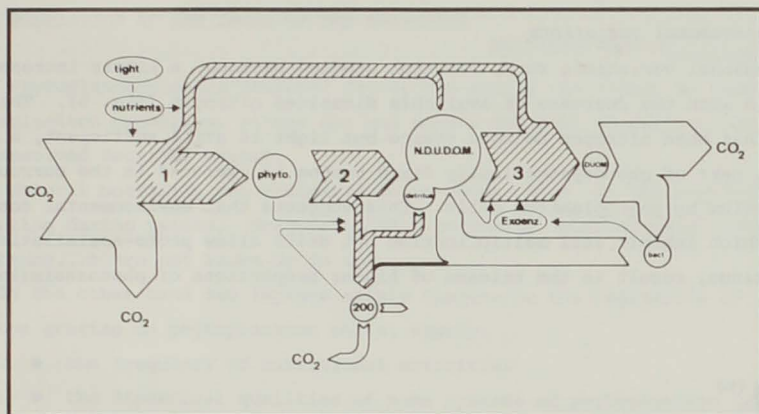

fig. 4.

Main regulation mechanisms of the carbon circulation between the first trophic levels in marine ecosystems

2.1.- REGULATION OF THE RELATIVE PROPORTIONS OF PARTICULATE AND DISSOLVED PHYTOPLANKTON PRODUCTION

The relative value of dissolved versus particulate production is known to be influenced by both, the light intensity and the available nutrients (Fogg *et al.*, 1965; Hellebust, 1965; Nalewajko, 1966; Anderson and Zeutschel 1970; Thomas, 1971 and Berman and Holm - Hansen, 1974).

No light intensity effect could be detected from our own experiments. However, the percentage of phytoplankton extracellular release (P.E.R) was found to be entirely dependent on the disponibility of dissolved mineral nitrogen. Two kinds of observations have led to this conclusion.

2.1.1.- Geographical variations

Geographical variations show that the richer a biotope, the weaker P.E.R. (Table 2).

Table 2

Mean P.E.R. in the three biotopes

| Biotopes | P.E.R. | Ranges of nitrogen ($\mu\text{mole/l}$) |
|-----------|--------|---|
| Calais | 50 % | 2 - 16 |
| Oostende | 40 % | 8 - 28 |
| Hansweert | 15 % | 300 - 450 |

2.1.2.- Seasonal variations

Seasonal variations show, for each studied biotope, a linear increase of P.E.R with the decrease of available dissolved nitrogen (fig. 5). This means that when nitrogen becomes scarce but light is still sufficient, a greater part of photosynthetically fixed carbon is excreted in the surrounding medium by phytoplankton cells. This suggests that environmental conditions which inhibit cell multiplication but still allow photo-assimilation to continue, result in the release of higher proportions of photoassimilated carbon.

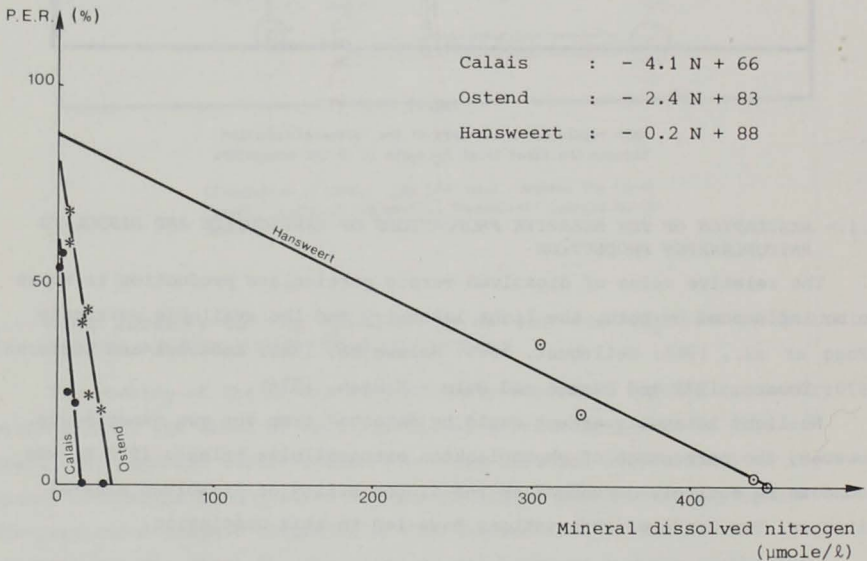

fig. 5.

Seasonal variations of the percentage extracellular release (P.E.R.) by phytoplankton in three biotopes characteristic of the Southern North Sea.

Results show in addition that the physiological response of phytoplankton cells to nutritional changes in the external medium appears to be specific to each biotope.

2.2.- REGULATION AT THE LEVEL OF THE BRANCHING

phytoplankton $\left\{ \begin{array}{l} \rightarrow \text{detritus} \\ \rightarrow \text{zooplankton} \end{array} \right.$

Phytoplankton cells produced during the spring can either be ingested by zooplankton organisms, either die and supply the pool of particulate and dissolved detrital matter.

Natural mortality was estimated to be about 80 % of the particulate production during spring. Reasons of this mortality (physiological stress, senescence...) are not known up to now.

On the other hand two factors mainly operate on the regulation of zooplankton grazing on phytoplankton cells, namely:

- the frequency of nutritional activities
- the dietetical qualities of some classes of phytoplankton cells whose dimensions do correspond to the filtration capacity of zooplankton organisms.

2.2.1.- Frequency of nutritional activities of zooplankton

A few day-and-night experiments of zooplankton grazing indicate a great variation in zooplankton feeding activities, partly attributable to vertical migrations (fig. 6).

Integrated daily and nightly measurements of grazing indicate that the latter is in general more important than the former (Table 3). However this phenomenon is not established but on some occasions, the night value can be 7 times the day value.

Study of the regulation of this phenomenon is in progress.

Table 3

Daily and nightly grazing of zooplankton

| Biotope | Sample | Daily grazing $\mu\text{g chl. a/m}^2$ | Nightly grazing $\mu\text{g chl. a/m}^2$ |
|----------|----------|---|---|
| Oostende | 01-04-78 | 142 | 275 |
| | 09-04-78 | 310 | 380 |
| | 10-04-78 | | 1 227 |
| | 13-04-78 | 520 | 1 080 |
| | 16-04-78 | 181 | 180 |
| | Calais | 03-04-78 | 10 |
| 04-04-78 | | 22 | 32 |
| 07-04-78 | | 25 | 32 |
| 11-04-78 | | 13 | 95 |
| 17-04-78 | | 16 | 39 |

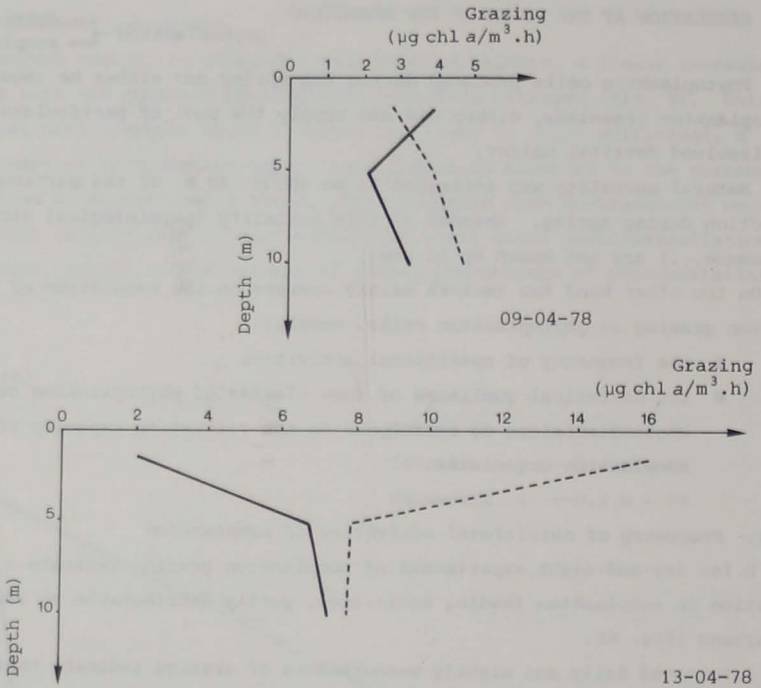

fig. 6.

Day-night vertical distribution of zooplankton grazing
 0 h : broken line 12 h : continuous line

2.2.2.- *Dietetical qualities of phytoplankton cells*

Zooplankton feeding activities are known to be dependent on the quantity and quality (size and biochemical composition) of phytoplankton cells (Boucher et al., 1975; Friedman and Strickler, 1975; Hargrave and Geen, 1970; Mayzaud and Poulet, 1978). Two aspects of the incidence of biochemical composition of phytoplankton cells on zooplankton feeding activities were studied :

i) the seasonal variations of the biochemical composition of phytoplankton cells, its distribution among different size classes and its regulation.

ii) the natural selectivity of zooplankton grazing in some size classes of phytoplankton cells.

i) The biochemical characterization of phytoplankton includes the determination of proteins, carbohydrates and lipids, the necessary metabolites of zooplankton growth.

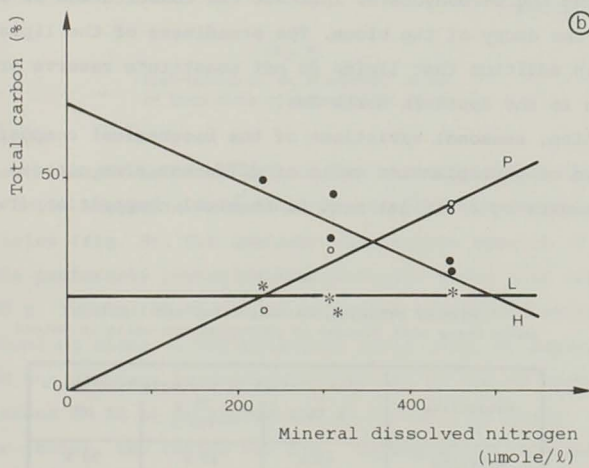
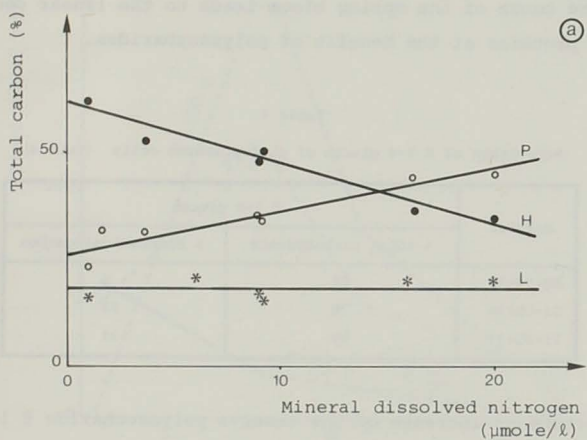

fig. 7

Variations of the percentage of proteins, carbohydrates and lipids in phytoplankton cells in function of the availability of the dissolved mineral nitrogen

(a) Marine biotopes

(b) Estuarine biotope

The seasonal variations of the phytoplankton productions of proteins, carbohydrates and lipids indicate that the biochemical composition of phytoplankton cells is regulated by the availability of dissolved mineral nitrogen in marine and estuarine biotopes (fig. 7). The decrease of dissolved mineral nitrogen in the course of the spring bloom leads to the linear decrease of the amount of proteins at the benefit of polysaccharides.

Table 4

Percentage of β 1-4 glucan of phytoplankton cells (Ostend)

| Samples | β 1-4 glucan | |
|----------|----------------------|----------------------|
| | % total carbohydrate | % biochemical carbon |
| 02-04-79 | 18 | 5 |
| 03-05-79 | 39 | 22 |
| 21-05-79 | 56 | 34 |

The simultaneous increase of the reserve polysaccharide β 1-4 glucan (Table 4) among the carbohydrates indicate the constitution of storage products during the decay of the bloom. The steadiness of the lipids during the bloom shows in addition that lipids do not constitute reserve products for phytoplankton in the Southern North Sea.

In addition, seasonal variations of the biochemical composition lead to the succession of phytoplankton cells of different size classes (fig. 8), characterized however by a similar mean biochemical composition (Table 5).

Table 5

Part of proteins, carbohydrates and lipids among three size classes of phytoplankton cells in Ostend

| Metabolite | Size classes of phytoplankton cells | | |
|---------------|-------------------------------------|---------------------------|-------------|
| | < 25 μ | > 25 μ < 100 μ | > 100 μ |
| Proteins | 38 % | 43 % | 38 % |
| Carbohydrates | 43 % | 35 % | 50 % |
| Lipids | 19 % | 20 % | 12 % |

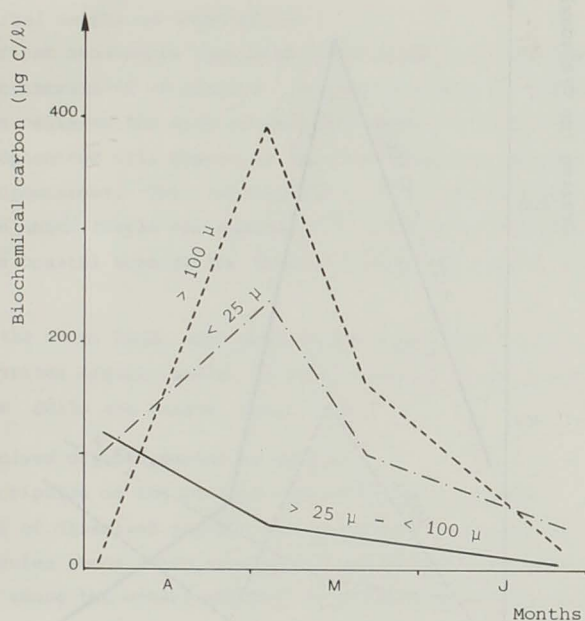

fig. 8.

Distribution of the biochemical carbon
in three sizes of phytoplankton cells.

ii) Moreover, experiments of zooplankton grazing on these three sizes of phytoplankton cells suggest a natural selectivity in the choice of phytoplankton particles (fig. 9). The dominant zooplankton species of spring, *Temora*, ingests preferably phytoplankton particles whose size ranges between 25μ and 100μ (up to 80%). These particles correspond unfortunately to the less abundant class of phytoplankton cells (fig. 8) occurring during spring. Indeed the dominant phytoplankton species of spring includes small flagellates, alone ($< 25 \mu$) or aggregated ($> 100 \mu$). The former are too small for the filter-feeder, the latter too big. Consequently, the numerous phytoplankton cells produced during spring cannot be grazed by zooplankton. Set in the poor nutritive conditions of the end of the bloom, these phytoplankton cells die and increase the pool of detrital organic matter.

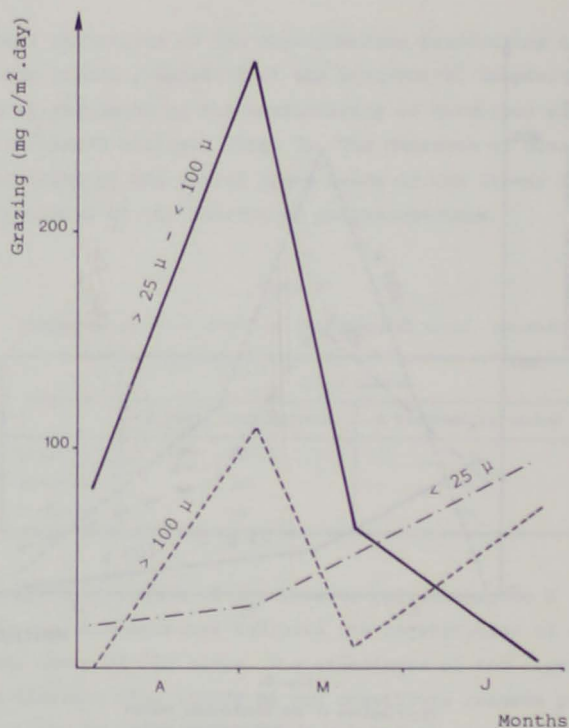

fig. 9.

Selectivity of zooplankton grazing in the choice of three sizes of phytoplankton cells

2.3.- REGULATION AT THE LEVEL OF BRANCHING

detrital matter —┬─ zooplankton
 └─ heterotrophic bacteria

Detrital matter arises mainly from dead organisms belonging to originating from the trophic web in the coastal area of the Southern Bight of the North Sea. Particulate and dissolved detritus are both to be found in the surrounding medium.

Particulate matter can be ingested by zooplankton organisms and other particle feeders. However it must be first hydrolysed into small metabolites to be taken up by bacteria.

2.3.1.- Detrital matter → zooplankton

i) A first reasonable approximation consists in considering that the selectivity criterium of zooplankton for detritus must be related as for phytoplankton cells to the size of detrital particles. Regulation of their intake by zooplankton will depend on the production of detrital particles of adequate dimensions. This interaction is thus mainly under control of phytoplankton which checks the quantity and quality of detrital organic matter in the coastal area of the Southern North Sea (Lancelot - Van Beveren, 1980).

ii) On the other hand, some preliminary experiments seem to assume that dissolved detrital organic matter is never intaken by zooplankton even when phytoplankton cells are scarce (Hecq, 1979).

2.3.2.- Dissolved organic matter → bacteria

i) Description of the pool of dissolved organic matter

The pool of dissolved organic matter includes a huge diversity of organic molecules among which some are directly usable by micro-heterotrophs (DUOM); some among the others (NDUDOM) can become usable by means of some chemical transformations.

The comparative study of initial rates of organic matter consumption (v_i , table 6) measured on total dissolved organic matter and the pool of small metabolites (M.W. < 500 d) isolated by ultrafiltration shows that the low molecular weight fraction accounts for most of the directly usable organic matter (DUOM). Part of that pool evidently includes free amino

Table 6

Comparison between concentration and biological usability
of organic matter before and after ultrafiltration
(molecular weight < 500 d)

| Samples | Total organic carbon (mg C/ℓ) | Total carbohydrates (mg C/ℓ) | BOD ₅ (mg C/ℓ) | v_i (mg C/ℓ) |
|----------|----------------------------------|---------------------------------|------------------------------|-------------------|
| Calais | | | | |
| seawater | 6 | 1.7 | 0.6 | - |
| < 500 d | 11 | 0.5 | 0.5 | - |
| Ostend | | | | |
| seawater | 15 | 1.9 | 0.8 | 0.024 |
| < 500 d | 22 | 1 | 0.5 | 0.026 |

acids and their small oligomers, monosaccharides and small oligosaccharides, ..., as previously shown (Billen et al., 1980). Moreover, the comparison of BOD₅ and TOC measurements (and even carbohydrates analyses) indicates that an important part of the low molecular weight substances are not quickly used by micro-heterotrophs.

The pool NDUDOM on the other hand, probably includes in addition to the small metabolites non directly usable, biological polymers that must be first converted into small substrates to be usable by bacteria. Part of the pool appears however to be refractory to any degradation and will compose fossil organic matter. Some, on the other hand, will be hydrolysed into small metabolites. Preliminary experiments (Table 6) seem to indicate that this degradation would be however very slow (more than 5 days).

ii) Which mechanisms will determine the intensity of the degradation of dissolved organic matter? Two possible aspects have been examined in this study:

a. A direct method has been used in order to test the biodegradability of macromolecules, by following the effect of their addition on the oxygen consumption as a function of the time. First results are presented in table 7. They show the usability of starch within a few days. In the case of cellulose the utilization is much more slower and proceeds at a rate which seems independent of the amount added.

Table 7

Test of biodegradability of added macromolecules
in natural seawater

| Day | Addition (mg C/l) | | | | |
|-----|-------------------|------|-----------|------|------|
| | Starch | | Cellulose | | |
| | 0.5 | 5 | 0.5 | 0.3 | 3 |
| 1 | 0.00 | 0.04 | 0.01 | 0.11 | 0.11 |
| 5 | 0.22 | 0.43 | 0.28 | - | - |
| 6 | - | - | - | 0.24 | 0.36 |
| 10 | 0.22 | 0.15 | 0.57 | 0.27 | 0.48 |
| 15 | - | - | - | 0.33 | 0.83 |

b. Exoenzymatic activity of natural seawater. Labelled high molecular weight proteins and carbohydrates obtained from a phytoplankton culture

have been added to natural seawater filtered on a 0.22 μ pore size filter, and to artificial seawater. The study of the appearance in the medium of labelled low molecular weight substances revealed an exoenzymatic hydrolysing activity of the natural seawater (for detailed data, see Billen et al., 1980 b).

Conclusions

The picture of the trophic web of the coastal area of the Southern Bight of the North Sea has outlined two important particularities if compared with classical trophic webs. Namely:

- an important contribution of phytoplankton respiration (more than 50 %) to total planktonic respiration.
- a minor role of zooplankton organisms in the recycling of the organic matter produced by phytoplankton.

The study of some important regulatory mechanisms directly involved in the destiny of the carbon produced by phytoplankton has carried some explanations about the working of this ecosystem.

The minor role of zooplankton in the recycling of organic matter produced by phytoplankton is mostly attributable to the inadequacy of the size of phytoplankton cells. From then nutritional qualities of phytoplankton cells seem not to be decisive in the feeding activities of zooplankton although these nutritional qualities are not equivalent during the phytoplankton bloom. Indeed the physiology of phytoplankton cells appears to be controlled by the availability of dissolved mineral nitrogen. The lack in this essential nutrient lead to a shift in the destiny of the photo-assimilated carbon. Higher quantities of reserve polysaccharides and extracellular metabolites will be built when nitrogen becomes scarce. These last metabolites contribute directly to the supply of the pool of dissolved organic matter, substrate of heterotrophic bacteria.

However the carbon budget has shown that this pool is mainly supplied by degraded phytoplankton cells.

Among the huge diversity of molecules involved in this pool, a very little part is however directly usable by heterotrophs (DUOM). The others (NDUDOM) must first be converted into substrate DUOM to be usable by heterotrophs.

Some preliminary tests have shown that the transformation of substratum NDUDOM into DUOM would be very slow probably because more than one mechanism is involved in this chemical transformation. Among these, the action of exoenzymes should be taken into account.

Acknowledgement

We are especially grateful to R. Biondo (U. Lg), J. Nys, R. Swaelens and R. Vanthomme (V.U.B.) for technical assistance.

References

- ANDERSON, C.G. and ZEUSCHEL, R.P. (1970). Release of dissolved organic matter by marine phytoplankton in coastal and offshore areas of the Northeast Pacific Ocean, *Limnol. Oceanogr.*, **15**, 402-407.
- BERMAN, T. and HOLM-HANSEN, O. (1974). Release of photo-assimilated carbon as dissolved organic matter by marine phytoplankton, *Mar. Biol.*, **25**, 305-310.
- BILLEN, G., BOSSICART, M., DARO, N., DE BOEVER, R., DE CONINCK, L., GOVAERE, J., HECQ, J., HEIP, C., HOVART, P., JANSSENS, D., JOIRIS, C., MOMMAERTS, J.P., PICHOT, G., POLK, Ph., REDANT, F., THIELEMANS, L., RUNFOLA, Y., VAN BEVEREN, Ch., VAN DAMME, O., VAN DE VELDE, J. (1976). *Trofische ketens en cyclus der nutriënten*, boekdeel 8, J.C.J. Nihoul and Ph. Polk ed., Nationaal Onderzoek en ontwikkelingsprogramma, Leefmilieu, Projekt Zee, Programmatie van het Wetenschapsbeleid, Brussel.
- BILLEN, G., BOUQUEGNEAU, J.M., JOIRIS, C., VERBEUSTEL, S., PUTMAN, J., WYNANT, J., PICHOT, G., HEISE, A. (1980). Groupe "Matière organique", Sous-groupe "Microbiologie", Rapport de synthèse 1979, Synthèse OM/1979 01.
- BILLEN, G., JOIRIS, C., WYMANT, J., GILLAIN, G. (1980). Concentration and metabolization of small organic molecules in estuarine, coastal and open sea environments in the Southern North Sea, *Estuar. Coast. Mar. Sci.*, in press.
- BOSSICART, M., MOMMAERTS, J.P. (1979). A mathematical model of the population dynamics of the dominant copepod species in the Southern Bight of the North Sea, 1977-1978, ICES Report C.M. 1979/L 24, Biological Oceanography Committee.
- BOSSICART, M. (1980). Etude du zooplancton en mer du Nord. Dynamique des copépodes (cas de plusieurs espèces et de plusieurs générations) en une station fixe : le West-Hinder L.V. de janvier à juillet 1977-1978, Techn. report W.H./1980-01.
- BOUCHER, J., LAUNEC, A., SAMAIN, J.F. and SMITH, S.L. (1975). Etude de la nutrition, du régime et du rythme alimentaire du zooplancton dans les conditions naturelles par la mesure des activités enzymatiques digestives, 10th European Symposium on Marine Biology, Ostend, Belgium, vol. 2, 85-110.

- DARO, M.H. (1978). A simplified ^{14}C method for grazing measurements on natural planktonic populations, *Helgoländer Wiss. Meeresunters.*, **31**, 241-248.
- DARO, M.H. (1979). Field study of diel feeding of a population of *Calanus finmarchicus* of the end of a phytoplankton bloom, *Meteor. Forschungsergebnisse*, in press.
- DARO, M.H. (1980). Grazing selectivity, Synthèse OM/1979-03.
- FRIEDMAN, M. and STRICKER, J. (1975). Chemoreceptors and feeding in Calanoid Copepods (Arthropoda : crustacea), *Proc. Nat. Acad. Sci. USA*, **72** (10), 4185-4188.
- FOGG, G.E., NALEWAJKO, C. and WATT, W.I. (1965). Extracellular products of phytoplankton photosynthesis, *Proc. R. Soc. B.*, **162**, 517-534.
- HARGRAVE, B. and GEEN, G.H. (1970). Efforts of copepods grazing on two natural phytoplankton populations, *J. Fish Res. Bd. Canada*, **27** (8), 1395.
- HELLEBUST, J.A. (1965). Excretion of some organic compounds by marine phytoplankton, *Limnol. Oceanogr.*, **10**, 192-206.
- HELLEBUST, J.A. (1974). Extracellular products in algal physiology and biochemistry, *Botanical monographs*, **10**, Edt. W.D.F. Stewart, Blackwell Scientific publications Ltd.
- JOIRIS, C. (1977). On the role of heterotrophic bacteria in marine ecosystems : some problems, *Helgoländer Wiss. Meeresunters.*, **30**, 611-621.
- JOIRIS, C., BILEN, G., LANCELOT, C., MOMMAERTS, J.P., DARO, M.H., BOSSICART, M., GILLAIN, G., BERTELS, A., HECQ, J.H. and WYNANT, J. (1979). Dynamics of organic matter in three planktonic ecosystems of the Southern North Sea, Report of the workgroup "Organic Matter" 1977-1978, Actions de Recherches concertées (Océanologie), Belgique.
- LANCELOT, C. (1979). Gross excretion rates of natural marine phytoplankton and heterotrophic uptake of excreted products in the Southern North Sea as determined by short-term kinetics, *Mar. Biol. Prog. Sci.*, **1**, 179-186.
- LANCELOT-VAN BEVEREN, C. (1980). A statistical method to estimate the biochemical composition of phytoplankton in the Southern Bight of the North Sea, *Estuar. Coast. Mar. Sci.*, **10**, 467-478.
- LANCELOT, C. (1980). Extracellular release of small and large molecules by phytoplankton in the Southern Bight of the North Sea, submitted to *Limnol. Oceanogr.*
- LANCELOT, C., BERTELS, A., NYS, J., NIHOUL, C., GOEYENS, L. (1980). Groupe "Matière organique", Synthèse des recherches sur le phytoplankton (1979), Synth. OM/1979-02.
- MAYZAUD, P. and POULET, S. (1978). The importance of the time factor in the response of zooplankton to varying concentration of naturally occurring particulate matter, *Limnol. Oceanogr.*, **23** (6), 1144-1154.
- MORRIS, I., GLOVER, H.E. and YENTSCH, C.S. (1974). Products of photosynthesis by marine phytoplankton : the effect of environmental factors on the relative rates of protein synthesis, *Mar. Biol.*, **27**, 1-10.
- NALEWAJKO, C. (1966). Photosynthesis and excretion in various planktonic algae, *Limnol. Oceanogr.*, **11**, 1-10.

- OGURA, N. (1975). Further studies on decomposition of dissolved organic matter in coastal seawater, *Mar. Biol.*, 31 (2), 101-112.
- STEEMAN-NIELSEN (1952). The use of radioactive carbon C^{14} for measuring organic production in the sea, *J. Cons. Int. Explor. Mer*, 18, 117-140.
- STEEMAN-NIELSEN and HANSEN (1959). *Physiologia plant*, 12, 353-370.
- THOMAS, J.P. (1971). Release of dissolved organic matter for natural populations of marine phytoplankton, *Mar. Biol.*, 11, 311-332.
- WOLLAST, R. (1976). *Transport et accumulation de polluants dans l'estuaire de l'Escaut*, in *L'estuaire de l'Escaut*, Programme national de Recherche et de Développement, Environnement, Eau, Projet Mer, vol. 10, J.C.J. Nihoul et R. Wollast éd., Bruxelles.

Benthic studies of the Southern Bight of the North Sea
and its adjacent continental estuaries

Progress Report II

Fluctuations of the meiobenthic communities
in the Westerschelde estuary

D. VAN DAMME, R. HERMAN, Y. SHARMA, M. HOLVOET and P. MARTENS

Zoology Institute, Marine Biology Section
State University of Gent, Belgium

Abstract

The meiofauna community of the Westerschelde estuary was examined along five transects over an one year period. All meiofaunal groups, excluding nematodes, occurred in very low numbers along the estuary, except at the salt marsh Saaftinge, where they attain normal to high values. The average number of taxa decline from 4.3 at the mouth of the estuary at Vlissingen to 1.5 at Doel. Similar trends are observed for annual mean density: $2.2 \cdot 10^6$ ind./m² at Vlissingen and $0.16 \cdot 10^6$ ind./m² at Doel. This general trend of a decline in all qualitative and quantitative parameters from the eu-polyhaline zone at the mouth towards the meso-oligohaline zone at the head of the estuary is examined in relation to the environmental parameters in particular, salinity gradients and sediment grain size composition. The low values of community parameters in the vicinity of Doel can only be attributed to chemical pollution. Fine sand with a medium grain size below 200 μ m, an unstable relief and low amounts of organic matter result in a sparse interstitial fauna in the sandbanks. On the other hand, a high annual production at the salt marsh of Saaftinge is explained by the large amount of organic detritus present along with the protected position against extreme environmental conditions and direct pollution.

Introduction

The Westerschelde (Western Scheldt) is the remains of an eastward extending sea arm which connects the river Schelde (Scheldt) near Antwerpen. It belongs to the type of flat land estuaries with partial mixing. The river Schelde is used over its entire length as an open sewer for domestic and industrial wastes. As a result the Westerschelde estuary receives about 250,000 ton per year organic matter and the incoming water is loaded with such toxic elements as ammonium, hydrosulfide and heavy metals (Wollast, 1976).

In a previous report (Heip et al., 1979), a summary of ongoing research at our laboratory on benthic communities in the Southern Bight of the North Sea and adjacent estuaries was presented. This report dealt with patterns of species composition, density and biomass, reinforcing the suggestion that their spatial and temporal stability makes them suitable as baseline data in monitoring surveys from which information on systems functioning can be obtained (Heip, 1979).

The following report examines quantitative aspects of the meiofauna community such as density, biomass, diversity and community structure. These data, collected over five transects to provide an idea of gradients occurring in the Westerschelde, are examined in relation to environmental parameters, in particular, salinity gradients and sediment grain size composition.

Material and methods

The transect Doel was sampled seasonally from May, 1977 to May, 1978 (5 sampling periods). The other transects in the estuary were sampled seasonally from September, 1978 to September, 1979 (5 sampling periods), while the salt marsh of Saaftinge, due to its inaccessibility was only sampled during winter and summer.

Intertidal samples were collected by a hand-held plastic corer (10.2 cm²) and subtidal samples were collected with a 'meio-sticker' (Govaere and Thielemans, 1979) or a Reineck box-corer. The organisms were fixed in warm formalin and extracted from the sediments by elutriation techniques. Biomass was determined with an accuracy of 0.1 µg with a Mettler ME 22/BA 25 micro-balans.

To measure species diversity H in samples we used the Brillouin formula (Pielou, 1975) :

$$H = \frac{1}{N} \log \frac{N!}{n_1 n_2 n_3 \dots n_s}$$

where H is expressed in bits per individual, N is the total number of individuals, n_i the number of individuals belonging to i^{th} species ($i = 1, \dots, s$).

Percentage organic matter was determined by combustion at 550 °C. Further details of sampling methods and laboratory techniques are described in our previous report (Heip *et al.*, 1979).

Results

1.- THE PHYSICAL ENVIRONMENT

1.1.- GENERAL DATA

After Doel the river Schelde leaves its single relatively narrow channel and meanders over a very large bed, mainly consisting of ontertidal sand banks and shoals through which the deeper channels run (Peters and Sterling, 1976). Former lateral extensions such as floodplains have disappeared either by natural or artificial causes and only one large (7500 acres) salt marsh 'het Verdronken Land van Saafinge' remains. The location of stations and their co-ordinates are given in fig. 1 and table 1.

The meso-oligohaline (salinity range : 2.1 ‰ - 14.8 ‰ ; \bar{x} : 8.5 ‰) headwaters of the estuary are the site of our first station group at Doel (9 sampling stations: WS 11-14; BASF 1-5). They are characterized by a very low oxygen saturation as low as 0 ‰ (Billen and Smitz, 1978), a high BOD₅ and very high concentrations of phosphates and nitrates, indicating that the selfpurifying capacity of the water is far exceeded.

In addition, at low tide, some of the sampling stations are also affected by thermal effluents of the nuclear power plant at Doel. According to the Sladeczek (1965) classification these waters are meso- to polysaprobic (1000 - 2000 coliforms per ml).

Maximal pollution and the lowest oxygen concentrations occur after dry periods when the heavily concentrated sewage is flushed by spring or autumn

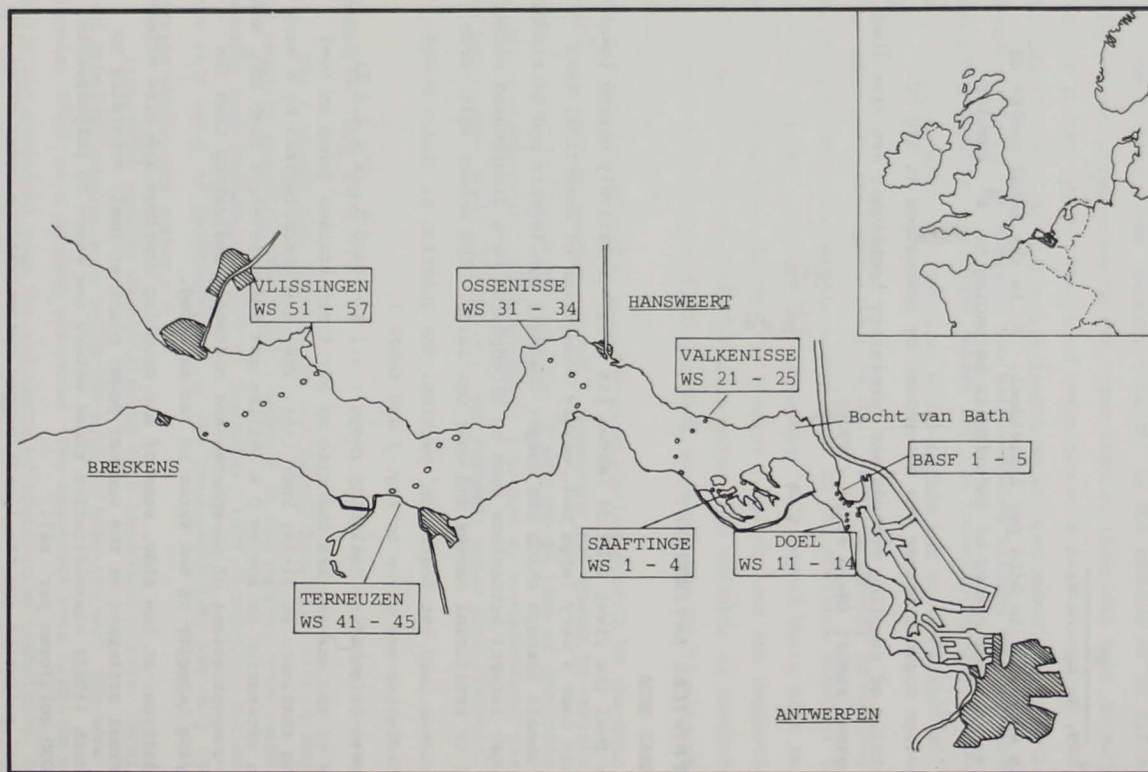

fig. 1.

Location of the six sampling station groups along the Westerschelde

Table 1

Co-ordinates and depth of the Westerschelde stations

| Station | Level | N lat. | E long. | Station | Level | N lat. | E long. |
|---------|-------|-----------|-----------|---------|-------|-----------|-----------|
| WS 51 | + 0.5 | 51°23'15" | 03°35'48" | WS 21 | - 2.0 | 51°22'00" | 04°05'24" |
| WS 52 | + 0.5 | 51°23'33" | 03°36'42" | WS 22 | + 1.0 | 51°22'42" | 04°05'39" |
| WS 53 | + 0.5 | 51°24'00" | 03°38'00" | WS 23 | - 2.5 | 51°23'15" | 04°05'51" |
| WS 54 | - 3.0 | 51°24'21" | 03°39'12" | WS 24 | + 0.5 | 51°23'36" | 04°07'18" |
| WS 55 | - 3.5 | 51°25'03" | 03°40'18" | WS 25 | -15.0 | 51°23'52" | 04°07'42" |
| WS 56 | - 3.0 | 51°25'33" | 03°41'09" | WS 1 | + 0.5 | 51°21'11" | 04°07'07" |
| WS 57 | - 1.0 | 51°26'15" | 03°42'18" | WS 2 | + 0.5 | 51°20'41" | 04°08'31" |
| WS 41 | - 2.5 | 51°20'48" | 03°48'00" | WS 3 | + 0.5 | 51°21'40" | 04°09'15" |
| WS 42 | + 0.5 | 51°21'33" | 03°49'12" | WS 4 | + 0.5 | 51°21'12" | 04°11'11" |
| WS 43 | 0.0 | 51°21'42" | 03°51'30" | WS 11 | - 1.5 | 51°19'45" | 04°15'57" |
| WS 44 | - 5.0 | 51°22'42" | 03°52'00" | WS 12 | - 2.5 | 51°20'21" | 04°15'42" |
| WS 45 | - 0.4 | 51°23'42" | 03°52'24" | WS 13 | - 3.0 | 51°20'39" | 04°15'48" |
| WS 31 | - 2.5 | 51°24'36" | 03°59'12" | WS 14 | + 0.5 | 51°20'30" | 04°16'33" |
| WS 32 | - 0.5 | 51°25'30" | 03°59'24" | BASF1 | - 0.5 | 51°21'22" | 04°15'04" |
| WS 33 | - 2.0 | 51°26'03" | 03°58'12" | BASF2 | - 0.5 | 51°21'37" | 04°14'37" |
| WS 34 | - 0.5 | 51°26'33" | 03°57'06" | BASF3 | - 0.5 | 51°21'41" | 04°14'19" |
| | | | | BASF4 | - 1.0 | 51°22'11" | 04°14'00" |
| | | | | BASF5 | - 0.5 | 51°22'03" | 04°14'19" |

Level : depth (in m) expressed in relation to the mean tidal level
(range : - 2.7 m to + 3.1 m).

rains into the estuary (De Pauw, 1975). In zones of 1 ‰ to 5 ‰ salinity, the organic material in suspension starts to flocculate with approximately 115,000 ton of organic matter sedimented per year (Wollast, 1976).

This flocculation zone, depending on the stream velocity, shifts from upstream well before Antwerpen to downstream as far as the Bocht van Bath where our second station group is located at Valkenisse (5 sampling stations; WS 21-25). Due to the decrease of heterotrophic bacterial activity and dilution effect the oxygen concentration rapidly increase in the mesohaline part of the estuary (salinity range : 7.5 ‰ - 20.9 ‰; \bar{x} : 15.3 ‰).

Close to this transect lies the salt marsh of Saaftinghe where four stations (WS 1-4) were chosen in the largest most accessible channels. This salt marsh is protected from direct mixing with outgoing polluted waters of the estuary by a sill which only allows the entrance of highly diluted incoming waters during flood. Moreover, due to local stream patterns the

watermass that goes in and out the marsh largely remains the same. Only in winter is part of this mass swept away and replaced by estuarine waters (De Pauw, 1975).

The third station group at Ossensisse (4 sampling stations : WS 31-34) lies in the poly-mesohaline zone (salinity : 10.7 ‰ - 26.8 ‰ ; \bar{x} : 20.3 ‰).

Here in the Hoek van Bath, where the single channel splits up into multiple channels, begins the part of the estuary with a good mixing of water layers. This complex topography favors local water circulations around and over the sandbanks, thus creating regions of stagnant water (Peters and sterling, 1976). The average oxygen saturation here is usually more than 80 % while the ammonium concentration is strongly reduced due to an intense nitrification process between Bath and Hansweert (table 2). The waters downstream of Hansweert are oligosaprobic and contains less than 50 coliforms per ml (De Pauw, 1975).

Table 2
Range of environmental parameters from five transects
of the Westerschelde¹

| | Vlissingen | Terneuzen | Ossensisse | Valkenisse | Doel |
|--|------------|------------|------------|------------|-------------|
| Temp. (°C) | 0.2-18.8 | 0.4-19.1 | 0.4-19.2 | 1.0-19.8 | 3.2-31.0 |
| Salinity (‰) | 24.3-32.0 | 20.4-28.5 | 10.7-26.8 | 7.5-20.9 | 2.1-14.8 |
| pH | 7.4-8.1 | 7.5-8.1 | 7.5-8.1 | 7.4-7.8 | 7.3-7.7 |
| O ₂ (mg.l ⁻¹) | 5.9-10.7 | 6.8-9.7 | 5.6-9.2 | 4.4-7.2 | 0.8-2.8 |
| O ₂ (% saturation) | 66-115 | 80-101 | 58-105 | 56-85 | 5-28 |
| BOD ₅ (mg O ₂ .l ⁻¹) | 0.2-4.9 | 0.7-2.9 | 0.8-5.2 | 1.4-4.9 | 1.6-8.0 |
| NH ₄ -N (mg N.l ⁻¹) | 0.03-0.94 | 0.03-1.39 | 0.05-2.78 | 0.45-3.28 | 1.64-5.96 |
| tPO ₄ -P (mg P.l ⁻¹) | 0.09-0.33 | 0.22-0.58 | 0.38-0.74 | 0.45-1.10 | 0.71-2.35 |
| TOC (mg C.l ⁻¹) | 4.6-9.9 | 6.1-12.0 | 8.3-14.1 | 5.1-15.4 | 11.2-24.6 |
| MPN Eyk (MPN.ml ⁻¹) ² | 78-4900 | 3300-13000 | 7900-79000 | 1700-49000 | 4900-130000 |

¹ Data obtained from seasonal reports (Sept. 1978 - Sept. 1979) of the Rijks-instituut voor Zuivering van Afvalwateren, the Netherlands.

² MPN Eyk : Thermotolerant bacteria of the coli-group on Eykman-lactose medium, in MPN per ml.

The fourth station group at Terneuzen (5 sampling stations : WS 41-45) is situated a little eastward of the port of Terneuzen in the polyhaline zone (salinity range : 20.4 ‰ - 28.5 ‰; \bar{x} : 24.9 ‰). This area receives industrial and domestic wastes from the harbour, the highly industrialized Gent-Terneuzen channel and chemical plants situated at the shore near WS 41. However, no increase of oxygen concentration as a reaction to the incoming sewage nor an increase of heavy metals is noticeable in the surface waters probably due to the very high dilution factor (De Pauw, 1975).

The last station group at Vlissingen (7 sampling stations : WS 51-57) is situated at the mouth of the estuary between the ports of Breskens and Vlissingen. Here, the watermasses pass mainly through two large channels, one in the south and another along the coast in the north. With the outgoing tide most of the estuarine water passes through the southern channel and with incoming tide it is pushed into the estuary mainly through the northern channel.

At this transect the southern stations (WS 51-54) hence lie in a zone of reduced salt concentration (salinity range : 26 ‰ - 30 ‰; \bar{x} : 28 ‰) while at the northern stations (WS 55-57) this concentration is higher (salinity range : 29 ‰ - 32 ‰; \bar{x} : 30.8 ‰). The oxygen saturation at this transect may drop considerably in autumn. According to De Pauw (1975) this decline is not caused by the relatively important domestic sewage input at Vlissingen and Breskens but is the result of algal blooms in summer.

1.2.- *SEDIMENT COMPOSITION AND LOCAL RELIEF AT THE SAMPLING STATION*

Since the main deeper channels are continually dredged to keep them open for seagoing vessels most of the sampling stations are located on intertidal sandbanks and shallows. Stations of the intertidal zone are exposed daily for more than one hour and usually have fine to medium sand sediment with a very low mud and organic matter content (table 3). Two stations (WS 51, 21) are situated on mudflats. In the salt marsh of Saaftinge the top layer of the sediment consists of detritus rich mud.

The relief of the sandbanks varies considerably as a function of stream velocity. Large mega-ripples and undulating unstable surfaces are found at transects Valkenisse and Ossenisse. At transect Terneuzen the topography is much flatter, slightly undulating and the surface is covered with small ripple marks. At transect Vlissingen the relief is totally flat.

Table 3

Sediment analysis per station.
 Mean annual values of the medium grain size of the sandfrac-
 tion in mm and percentage mud- and organic matter content.

| Station | Md mm | % Mud | % O.M. |
|---------|-------|-------|--------|
| WS 51 | 0.106 | 21.05 | 8.56 |
| WS 52 | 0.172 | 1.90 | 4.17 |
| WS 53 | 0.156 | 6.02 | 5.17 |
| WS 54 | 0.210 | 13.28 | 6.53 |
| WS 55 | 0.310 | 0.13 | 2.16 |
| WS 56 | 0.268 | 0.26 | 1.88 |
| WS 57 | 0.187 | 11.39 | 4.81 |
| WS 41 | 0.151 | 7.60 | 5.94 |
| WS 42 | 0.136 | 2.89 | 4.90 |
| WS 43 | 0.197 | 0.42 | 1.91 |
| WS 44 | 0.250 | 0.21 | 2.07 |
| WS 45 | 0.184 | 0.99 | 3.11 |
| WS 31 | 0.236 | 0.38 | 1.19 |
| WS 32 | 0.210 | 0.39 | 1.36 |
| WS 33 | 0.199 | 0.64 | 1.62 |
| WS 34 | 0.155 | 2.94 | 4.38 |
| WS 21 | 0.162 | 6.55 | 14.93 |
| WS 22 | 0.130 | 3.78 | 3.15 |
| WS 23 | 0.188 | 0.08 | 1.51 |
| WS 24 | 0.179 | 1.09 | 1.01 |
| WS 25 | 0.151 | 16.20 | 5.20 |
| WS 11 | 0.156 | 0.35 | 2.28 |
| WS 12 | 0.246 | 1.64 | 1.78 |
| WS 13 | 0.179 | 4.66 | 4.48 |
| WS 14 | 0.166 | 53.21 | 23.91 |
| BASF 1 | 0.257 | 4.29 | 2.13 |
| BASF 2 | 0.169 | 1.79 | 1.30 |
| BASF 3 | 0.159 | 2.03 | 1.42 |
| BASF 5 | 0.188 | 5.24 | 4.16 |

At four stations peat deposits (WS 14,57) or Dunkerquian clays (WS 55,56) underlie the thin sandcover. Due to the very strong currents this whole top layer is occasionally swept away.

2.- MEIOBENTHOS

2.1.- NUMBER OF TAXA

The meiobenthos species occurring in our samples belong to ten major taxonomic groups : Hydrozoa, Gastrotricha, Turbellaria, Nematoda, Oligochaeta, Polychaeta, Harpacticoida, Mollusca, Ostracoda and Tardigrada. Halacarida were also found sporadically but are omitted here.

All taxa occur from eu- to mesohaline waters but in the highly polluted meso-oligohaline zone at Doel only nematodes are common while harpacticoids, oligochaetes and polychaetes occur occasionally. There is a gradual decrease in the annual number of taxa from 4.3 at Vlissingen to 1.5 at Doel (fig. 3). The highest annual average (4.7) is noted in Saaftinge. The mean density and average number of taxa along the Westerschelde are presented in tables 4 and 5. The seasonal fluctuations of total meiobenthic density is represented in fig. 2b and summarized in table 5, and will be dealt with in the discussion of individual taxa.

2.2.- INFREQUENT TAXONOMIC GROUPS

Since nematodes and harpacticoids are the only hard-bodied true meiobenthic taxa present, which are relatively abundant, they have been the subject of a more detailed study. The infrequently occurring taxonomic groups are briefly dealt with here.

The percentage of samples in which these groups occurred in the estuary during the 1978 - 1979 survey is : Hydrozoa (6.7 %), Gastrotricha (24 %), Turbellaria (57 %), Oligochaeta (23 %), Polychaeta (42 %), Mollusca (15 %), Ostracoda (20 %) and Tardigrada (5.8 %).

2.2.1.- Hydrozoa

Halammohydra intermedia and *H. vermiformis* are found in the medium sands of the eu-polyhaline zone (WS 55,56). *Protohydra leuckarti*, a typical inhabitant of brackish water, only occurred in three estuarine samples and in all summer samples at Saaftinge. A maximal density of 8 ind./10 cm² for *Halammohydra* and 104 ind./10 cm² for *Protohydra* were recorded in the estuary and salt marsh respectively. Hydrozoa are absent at the Terneuzen, Valkenisse and Doel transects. The biomass calculations presented in table 7 are based upon an individual dry weight of 3.0 µg.

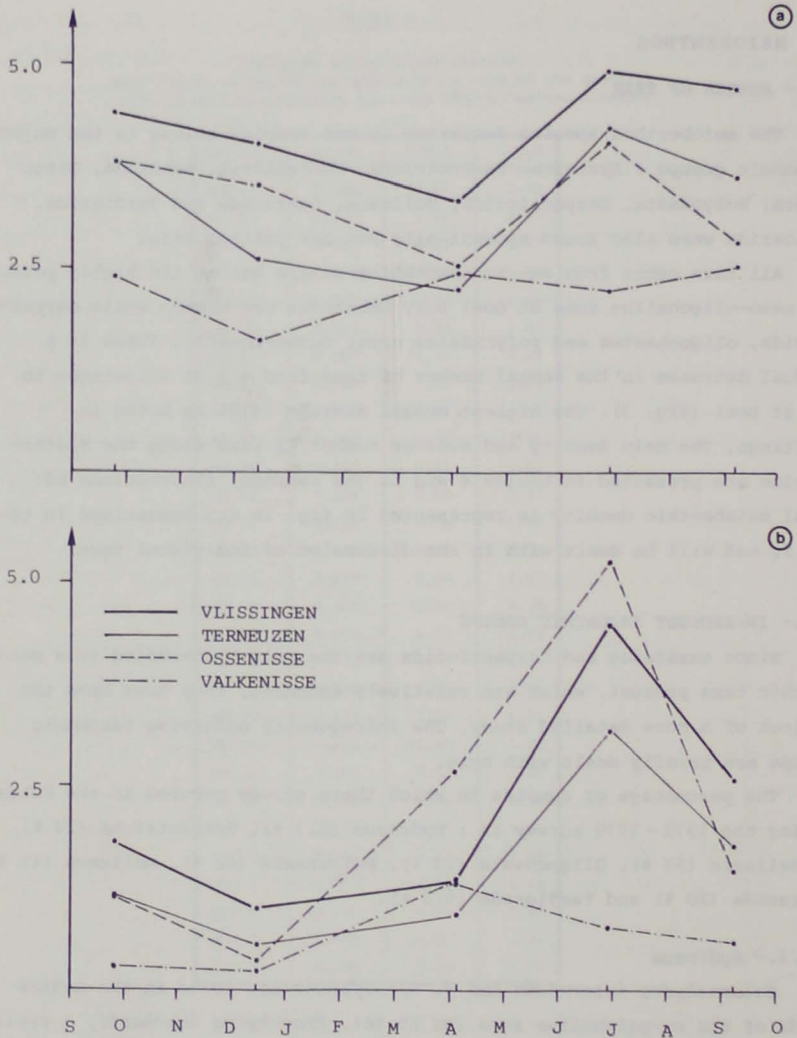

fig. 2.

Seasonal fluctuations at four transects of the Westerschelde sampled from September 1978 to September 1979.

(a) Average number of meiobenthic taxa.

(b) Mean density of total meiobenthos (10^6 ind./ m^2).

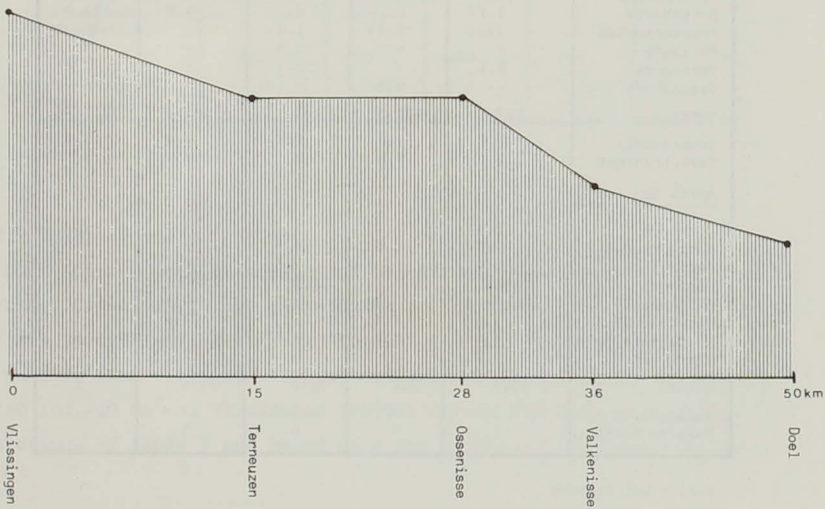
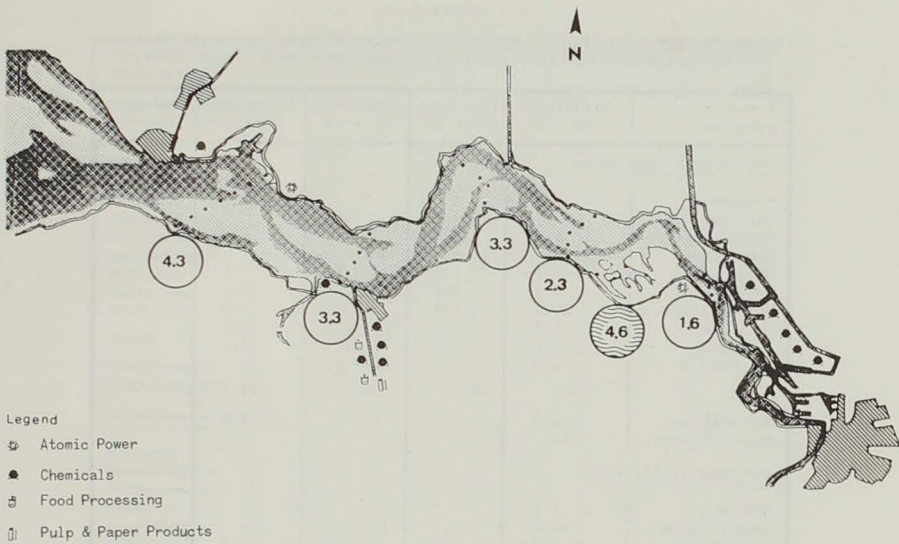

fig. 3.

Annual means of higher taxa at six station groups of the Westerschelde (salt marsh Saafingte not included in graph)

Table 4

Mean density (ind./10 cm²) and average number of taxa per sample along the Westerschelde over five sampling periods (Sept.1978 - Sept.1979).

| Transect Stations | Vlissingen 51 - 57 | Terneuzen 41 - 45 | Ossensisse 31 - 34 | Valkenisse 21 - 25 | Saaftinge 1 - 4 |
|-------------------------------|-----------------------|----------------------|-----------------------|-----------------------|--------------------|
| <u>September 27-29, 1978.</u> | | | | | |
| Hydrozoa | 1.0 | - | - | - | n.s. |
| Gastrotricha | 51.1 | 4.8 | 3.8 | - | - |
| Turbellaria | 6.3 | 1.2 | 6.8 | 2.6 | - |
| Nematoda | 1708 | 1109 | 1097 | 259 | - |
| Oligochaeta | 6.1 | 1.2 | 1.8 | 4.6 | - |
| Polychaeta | 0.6 | 5.4 | - | 0.2 | - |
| Harpacticoida | 20.4 | 1.8 | 5.8 | 1.8 | - |
| Mollusca | 1.4 | 3.8 | 1.0 | 0.8 | - |
| Ostracoda | 9.6 | 5.8 | 0.3 | 4.2 | - |
| Tardigrada | 0.7 | - | - | - | - |
| Total | 1805 | 1133 | 1116 | 274 | - |
| Taxa/sample | 4.4 | 3.8 | 3.8 | 2.4 | - |
| Taxa/transect | 10 | 8 | 7 | 7 | - |
| <u>December 11-13, 1978.</u> | | | | | |
| Hydrozoa | 1.1 | - | - | - | - |
| Gastrotricha | 30.0 | 0.2 | 16.5 | - | - |
| Turbellaria | 6.9 | 2.0 | 3.3 | 0.4 | 5.0 |
| Nematoda | 912 | 512 | 298 | 193 | 5000 |
| Oligochaeta | 15.3 | 2.4 | 0.5 | 8.6 | 103.0 |
| Polychaeta | 3.1 | 6.2 | 2.5 | 0.8 | 180.8 |
| Harpacticoida | 7.9 | 1.4 | 1.0 | - | 36 |
| Mollusca | - | - | 0.3 | - | - |
| Ostracoda | 0.1 | - | 0.5 | - | 0.8 |
| Tardigrada | - | 0.2 | - | - | - |
| Total | 977 | 525 | 323 | 203 | 5326 |
| Taxa/sample | 4.0 | 2.6 | 3.5 | 1.6 | 5.0 |
| Taxa/transect | 8 | 7 | 8 | 4 | 6 |
| <u>April 3-5, 1979.</u> | | | | | |
| Hydrozoa | 0.1 | - | - | - | n.s. |
| Gastrotricha | 9.7 | 0.2 | 14.5 | - | - |
| Turbellaria | 9.3 | - | 7.0 | 1.0 | - |
| Nematoda | 1294 | 923 | 2638 | 1269 | - |
| Oligochaeta | - | 0.4 | 4.5 | 0.6 | - |
| Polychaeta | 1.4 | 7.4 | 2.3 | 4.8 | - |
| Harpacticoida | 1.7 | 0.4 | 6.5 | 0.4 | - |
| Ostracoda | 2.4 | - | - | - | - |
| Total | 1319 | 932 | 2672 | 1276 | - |
| Taxa/sample | 3.3 | 2.2 | 2.5 | 2.4 | - |
| Taxa/transect | 7 | 5 | 6 | 5 | - |

n.s. = not sampled

Table 4 (continued)

| Transect Stations | Vlissingen 51 - 57 | Terneuzen 41 - 45 | Ossenissee 31 - 35 | Valkenisse 21 - 25 | Saaftinge 1 - 4 |
|----------------------|-----------------------|----------------------|-----------------------|-----------------------|--------------------|
| June 24-26, 1979. | | | | | |
| Hydrozoa | 0.3 | - | - | - | 28.8 |
| Gastrotricha | 12.1 | 4.8 | 7.5 | 0.8 | - |
| Turbellaria | 10.6 | 13.6 | 12.0 | 2.4 | - |
| Nematoda | 4429 | 3178 | 5275 | 766 | 5615 |
| Oligochaeta | 3.4 | - | - | - | 5.8 |
| Polychaeta | 4.7 | 2.2 | 6.3 | 6.8 | 189.0 |
| Harpacticoida | 23.0 | 2.2 | 9.5 | - | 86.0 |
| Mollusca | 0.6 | 0.2 | 3.8 | 0.8 | 0.8 |
| Ostracoda | 1.6 | 0.2 | 1.3 | - | 0.3 |
| Tardigrada | 0.1 | - | - | - | - |
| Total | 4486 | 3201 | 5315 | 777 | 5926 |
| Taxa/sample | 4.9 | 4.2 | 4.0 | 2.2 | 4.3 |
| Taxa/transect | 10 | 7 | 7 | 5 | 7 |
| September 3-5, 1979. | | | | | |
| Hydrozoa | 0.7 | - | 0.3 | - | n.s. |
| Gastrotricha | 74.6 | 2.0 | 11.5 | - | - |
| Turbellaria | 11.3 | 12.6 | 6.3 | 4.6 | - |
| Nematoda | 2461 | 1734 | 1395 | 886 | - |
| Oligochaeta | 13.3 | - | - | 0.4 | - |
| Polychaeta | 10.3 | 1.2 | 0.8 | 2.0 | - |
| Harpacticoida | 21.7 | 0.6 | 32.0 | 1.6 | - |
| Mollusca | - | 0.2 | - | - | - |
| Ostracoda | 0.7 | 22.6 | - | - | - |
| Tardigrada | - | - | 0.8 | 0.2 | - |
| Total | 2593 | 1773 | 1446 | 894 | - |
| Taxa/sample | 4.7 | 3.6 | 2.5 | 2.8 | - |
| Taxa/transect | 8 | 7 | 7 | 6 | - |

n.s. = not sampled

2.2.2.- Gastrotricha

Four species were discerned and tentatively identified as *Paraturbanella dorhni*, *Cephalodasys* sp., *Macrodasys* sp. and *Turbanella cornuta*. Only the first two species are relatively frequent and are found in detritus rich sand ranging from Vlissingen to Valkenisse. The highest density recorded was 360 ind./10 cm² at Vlissingen (WS 52) during September. The biomass calculations of table 7 are based on a dry weight of 0.15 µg per individual.

2.2.3.- Turbellaria

As live samples were examined, small sized groups were not studied. The following species were distinguished : *Cirrifera aculeata*, *Paratoplana*

Table 5

Annual mean density (ind./10 cm²), average and total number of meiobenthic taxa and percentage of Nematoda at six stationgroups of the Westerschelde.

| Transect Stations | Vlissingen 51 - 57 | Terneuzen 41 - 45 | Ossenisse 31 - 34 | Valkenisse 21 - 25 | Saafinge 1 - 4 | Doel 11 - 14 BASF 1-5 |
|----------------------|-----------------------|----------------------|----------------------|-----------------------|-------------------|-----------------------------|
| Hydrozoa | 0.6 | - | 0.1 | - | 16.3 | - |
| Gastrotricha | 35.5 | 2.4 | 10.8 | 0.2 | - | - |
| Turbellaria | 8.9 | 5.9 | 7.1 | 2.2 | 2.5 | - |
| Nematoda | 2160 | 1489 | 1958 | 820 | 6000 | 164 |
| Oligochaeta | 7.6 | 0.8 | 1.4 | 2.8 | 61.2 | 0.9 |
| Polychaeta | 4.0 | 4.5 | 2.4 | 2.9 | 207.0 | 1.5 |
| Harpacticoida | 14.9 | 1.3 | 10.9 | 0.8 | 68.6 | 0.1 |
| Mollusca | 0.4 | 0.8 | 1.0 | 0.3 | 0.4 | - |
| Ostracoda | 2.0 | 5.7 | 0.4 | 0.8 | 0.6 | - |
| Tardigrada | 0.2 | 0.04 | 0.2 | 0.04 | - | - |
| Total | 2236 ± 622 | 1513 ± 467 | 1992 ± 864 | 833 ± 325 | 6356 ± 350 | 167 ± 53 |
| Mean number of taxa | 4.3 ± 0.3 | 3.3 ± 0.4 | 3.3 ± 0.3 | 2.3 ± 0.2 | 4.7 ± 0.4 | 1.5 ± 0.2 |
| Total number of taxa | 10 | 9 | 10 | 9 | 8 | 4 |
| % Nematoda | 97 | 98 | 98 | 98 | 94 | 98 |

capitata, *Philosyrtris* sp., *Neoschizorhynchus parvorostro*, *Limirhynchus danicus*, *Thylacorhynchus caudatus* and *Diascorhynchus rubrus*.

The maximum density recorded was 55 ind./10 cm² at Terneuzen (WS 45) during summer. The biomass calculations are based upon an individual weight of 2.4 µg dwt/ind. obtained from North Sea specimens (Van Damme and Heip, 1977).

2.2.4.- Oligochaeta

Representatives of this group belong to the temporary meiobenthos, and therefore no further identification was attempted. The maximal density noted was 93 ind./10 cm² at Vlissingen (WS 51) during winter. At Doel the maximal value recorded was 13 ind./10 cm² but in most samples of this transect no oligochaetes were found. Yet, according to several authors such as Brinkhurst (1972) and Oliff et al. (1976), certain species are considered to be excellent indicators of polluted brackish waters since they abound in such environments. Arlt (1975) found that the number of oligochaetes increased from 63 ind./10 cm² in the unpolluted zone to 1150 ind./10 cm²

at the polluted station in front of the sewage outlet. For biomass calculations a mean dry weight of 5.6 μg dwt per individual was used.

2.2.5.- Polychaetes

The species occurring here also belong to the temporary meiofauna. In the estuarine samples juvenile spionids usually represented this group while *Fabricia sabella* was extremely abundant at Saaftinge. The maximal densities recorded are ± 25 ind./10 cm^2 at most transects in the estuary including Doel and 400 ind./10 cm^2 at Saaftinge. Biomass calculations are based on the individual dry weight of 6.3 μg of *Fabricia sabella*.

2.2.6.- Mollusca

At most stations no bivalves were found. The specimens counted were juvenile bivalves not exceeding 2 mm and achieve a maximum density of 15 ind./10 cm^2 at WS 34 during June. An individual dry weight of 1.7 μg dwt was used for biomass calculations.

2.2.7.- Ostracoda

Only one species, *Leptocythere lacertosa*, occurred in the estuary but at Saaftinge, a juvenile of an unidentified species was also found. The maximal density recorded was 112 ind./10 cm^2 at Terneuzen (WS 42) during September. Biomass calculations are based on an individual dry weight of *L. lacertosa* (9.7 μg dwt/ind.).

2.2.8.- Tardigrada

Battilipes mirus, typical for the intertidal zone, occurred at several stations with a maximum density of 25 ind./10 cm^2 at Vlissingen (WS 57) during September. Biomass calculations are based upon an estimated dry weight of 1.5 μg dwt per individual.

2.3.- NEMATODA

2.3.1.- Density

The highest densities noted in the estuary were 17500 ind./10 cm^2 (WS 34), 13200 ind./10 cm^2 (WS 42) and 12300 ind./10 cm^2 (WS 53). They all occurred in summer samples where the sediment was characterized by a low

medium grain size (± 0.150 mm) and a relatively high content of organic matter. In the mesohaline part a maximum of 7500 ind./10 cm² was noted in spring while the highest value recorded at Doel was 1100 ind./10 cm² (WS 14). At Saaftinge, a value of 10200 ind./10 cm² was recorded. The sedimentary characteristics of these samples were as mentioned above.

Low densities in the order of 10 to 100 ind./10 cm² are found at all transects except at Saaftinge where a minimum of 2500 ind./10 cm² was recorded. It is of significant interest that samples without nematodes were found at Doel. These low values all occur in samples consisting of very pure sand with a medium grain size in excess of 0.200 mm.

Other studies where values above ten million individuals per m² are mentioned, relate to detritus rich fine sediment and poly- to euhaline waters : 22 10⁶ ind./m² from intertidal mudflat, Warwick and Price (1979); 12 10⁶ ind./m² from lagoon, Lasserre et al. (1975); 16.3 10⁶ ind./m² from salt marsh, Teal and Wieser (1966); 10 10⁶ ind./m² from salt marsh, Nixon and Oviatt (1973). Generally, however, values fluctuating between 0.5 to 2.0 10⁶ ind./m² are cited.

Skoolmun and Gerlach (1971) record a minimum of 7700 ind./m² from a sand bank in the Weser estuary which lies both under the influence of high turbulence and high pollution. Elmgren (1975) found densities decreasing to 500 ind./m² in the Baltic depths where the oxygen saturation declines to zero. In the Westerschelde estuary the low densities at the mouth are found at localities where the whole sandlayer is periodically swept away. Since lower densities further inward also occur at the stations with the coarsest sediment, turbulence may also be the determining factor here.

2.3.2.- Seasonal fluctuations

At the Doel transect the lowest seasonal average density is 3000 ind./m² in spring during which period the oxygen concentration of the surface water has declined to below 5 % and ammonium concentration increased to 5.12 mg N/l. The highest average (5 10⁵ ind./m²) occurred in fall when 20 % oxygen saturation and 1.0 mg N/l ammonium was measured.

At the other transects there is a clear summer peak and a reversed peak during winter (fig. 2b). This figure represents the seasonal fluctuations of total meiobenthic densities. Since nematodes comprises more than 95 % of the density and about 85 % of biomass, they follow an identical

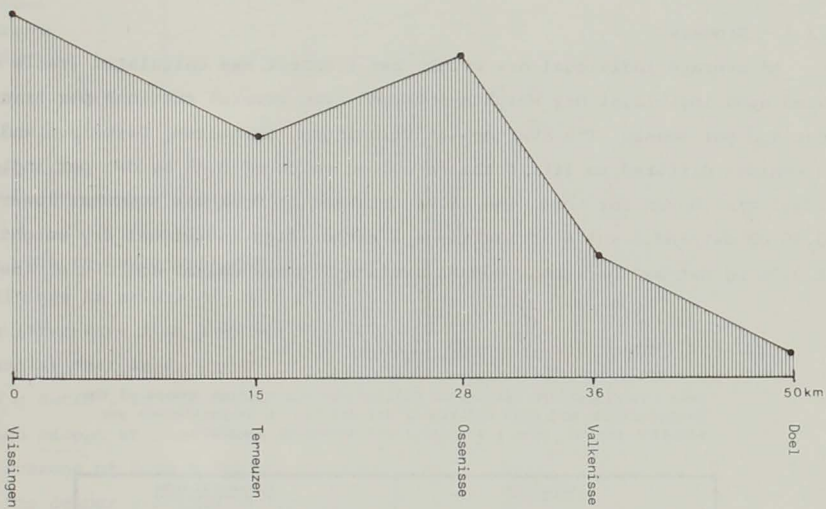
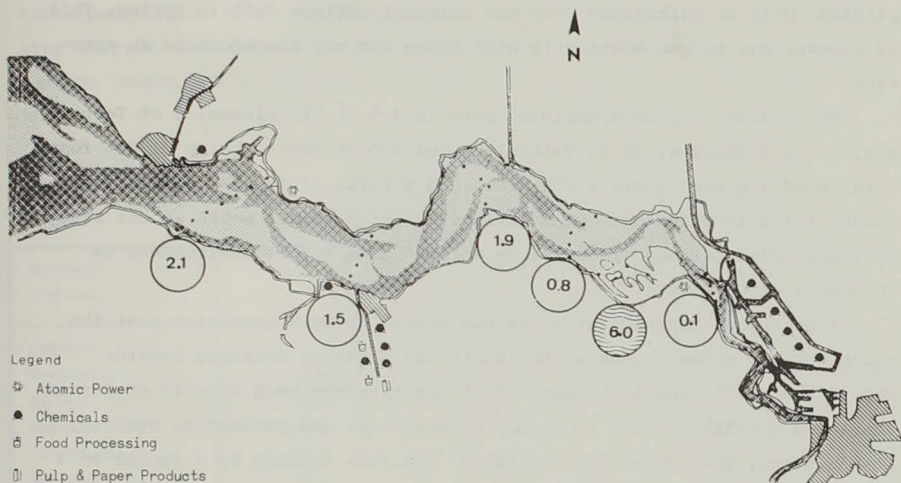

fig. 4.

Annual mean densities of Nematoda (10^6 ind./m²) at six station groups of the Westerschelde (salt marsh Saaftinge not included in graph)

pattern. Only at Valkenisse does the seasonal optimum fall in spring. This is however due to one aberrantly high value and may therefore be an artefact.

The seasonal optimum/minimum ratio is 4.5 at Vlissingen, 6 at Terneuzen, 16 at Ossensisse, 10 at Valkenisse and 166 at Doel. Stripp (1969) found a ratio of 1.6 and Juario (1975) recorded a ratio of 1.8. A comparative value of 1.4 is found only at Saaftinge. The high values noted in our study indicate brief periods of abundance while a more stable environment is indicated at Saaftinge.

A graphical representation of the annual average densities over the whole estuary shows a peak at the mouth and a steady decrease towards Doel (fig. 4). It should be noted that the reversed peak occurs at Terneuzen and a similar pattern is found for most taxa and parameters studied. At Saaftinge, the annual average ($6 \cdot 10^6$ ind./m²) exceeds by a factor of 3 the highest average found in the estuary.

2.3.3.- Biomass

An average individual dry weight per transect was calculated (table 6) based upon individual dry weights obtained from several stations per transect and per season. The averages at Vlissingen, terneuzen, Ossensisse and Valkenisse differed so little that a common value of 0.45 μ g dwt per individual was chosen for them. The value obtained at Doel was somewhat lower (0.30 μ g dwt/ind.) while at Saaftinge a rather high individual dry weight of 0.76 μ g dwt was obtained. Annual average biomass values follows an iden-

Table 6

Mean individual dry weights of Nematoda at six station groups of the Westerschelde and mean individual dry weights of Harpacticoida per sampling period (mean \pm st. err.; n = number of samples).

| Transect | Nematoda | | Period | Harpacticoida | |
|------------|-----------------|----|-----------|-----------------|----|
| | μ g dwt | n | | μ g dwt | n |
| Vlissingen | 0.47 \pm 0.05 | 11 | Sept. '78 | 0.67 \pm 0.17 | 12 |
| Terneuzen | 0.45 \pm 0.07 | 10 | Dec. '78 | 0.76 \pm 0.33 | 8 |
| Ossensisse | 0.42 \pm 0.07 | 10 | Apr. '79 | 0.43 \pm 0.17 | 8 |
| Valkenisse | 0.49 \pm 0.14 | 8 | June '79 | 1.97 \pm 0.91 | 10 |
| Saaftinge | 0.76 \pm 0.13 | 6 | Sept. '79 | 1.20 \pm 0.62 | 10 |
| Doel | 0.37 \pm 0.06 | 4 | | | |

tical pattern, in view of the similar dry weight used, as the annual density (fig. 4; table 7) with the highest value (0.98 g dwt/m²) at Vlissingen and the lowest (0.02 g dwt/m²) at Doel.

Table 7

Annual mean biomass (mg dwt/m²) of meiobenthic taxa and contribution of the Nematoda (in %) at six stationgroups of the Westerschelde.

| Transect Stations | Vlissingen 51 - 57 | Terneuzen 41 - 45 | Ossensisse 31 - 34 | Valkenisse 21 - 25 | Saaftinge 1 - 4 | Doel 11 - 14 BASF 1-5 |
|---------------------------------|-----------------------|----------------------|-----------------------|-----------------------|--------------------|-----------------------------|
| Hydrozoa | 1.9 | - | 0.3 | - | 49.2 | - |
| Gastrotricha | 5.3 | 0.4 | 1.6 | 0.03 | - | - |
| Turbellaria | 21.1 | 14.2 | 17.0 | 5.3 | 6.0 | - |
| Nematoda | 980 | 673 | 884 | 355 | 4579 | 24 |
| Oligochaeta | 42.7 | 4.5 | 7.8 | 15.7 | 344.0 | 5.0 |
| Polychaeta | 25.4 | 28.4 | 15.1 | 18.3 | 1313.2 | 9.3 |
| Harpacticoida | 18.3 | 1.5 | 12.9 | 0.7 | 221.0 | 0.1 |
| Mollusca | 2.3 | 1.4 | 1.7 | 0.5 | 0.7 | - |
| Ostracoda | 28.0 | 55.3 | 3.9 | 7.8 | 5.8 | - |
| Tardigrada | 0.2 | 0.1 | 0.2 | 0.1 | - | - |
| Total in g dwt/m ²) | 1.1 ± 0.2 | 0.8 ± 0.2 | 0.9 ± 0.4 | 0.4 ± 0.1 | 5.8 ± 0.7 | 0.04±0.01 |
| Total in g C/m ²) | 0.45±0.11 | 0.31±0.08 | 0.41±0.17 | 0.14±0.03 | 2.32±0.29 | 0.01±0.005 |
| % Nematoda | 87 | 86 | 89 | 88 | 70 | 63 |

Due to the higher individual dry weight the calculated biomass at Saaftinge is relatively much higher (4.57 g dwt/m²). Biomasses cited in the literature from salt marshes are usually distinctly lower than the ones found at Saaftinge. Wieser and Kanwisher (1961) found a maximum of 4.6 g dwt/m². In the estuary proper, the biomass values fall in the normal range except at Doel where it is distinctly very low. Gray (1976) noted an average of 0.09 g dwt/m² in the exposed coastal stations and 0.4 g dwt/m² in the deeper stations of the polluted Thees estuary.

2.3.4.- Diversity

The nematode diversity is relatively low in all the eu-polyhaline zones (H = 2.27 and 2.44 at Vlissingen and Terneuzen, respectively). It reaches a peak in the poly-mesohaline zone where H = 3.01 and declines to H = 1.63 in

the meso-oligohaline zone (table 8). At Saaftinge a diversity value of $H = 2.86$ was found.

Table 8

Percentage distribution of the dominant Nematoda species from the Westerschelde in five salinity-zones.

| Species | Ft | MO | MS | M | MP | P | EP |
|----------------------------------|----|------|------|------|------|------|------|
| <i>Antomicron elegans</i> | 1A | 0.1 | 2.9 | - | - | - | - |
| <i>Ascolaimus elongatus</i> | 1B | 3.0 | 0.3 | 11.6 | 2.0 | * | 7.1 |
| <i>Calyptronema maxweberi</i> | 2B | 0.6 | 6.2 | - | 2.0 | - | - |
| <i>Chromadorita nana</i> | 2A | 11.5 | - | 2.5 | - | - | - |
| <i>Enoplolaimus littoralis</i> | 2B | 3.8 | - | - | - | - | - |
| <i>Enoplolaimus propinquus</i> | 2B | 0.8 | - | 11.1 | - | 25.8 | 7.1 |
| <i>Halalaimus gracilis</i> | 1A | - | 6.3 | - | - | - | - |
| <i>Leptolaimus papilliger</i> | 1A | 0.2 | 12.8 | 0.5 | - | - | - |
| <i>Mesotheristus setosus</i> | 1B | 24.5 | 2.3 | 1.0 | 1.0 | * | - |
| <i>Microlaimus marinus</i> | 2A | 2.4 | 11.1 | - | 1.0 | 12.9 | 7.1 |
| <i>Monhystera</i> sp. | 1B | 3.8 | 3.8 | - | - | - | - |
| <i>Oncholaimus oxyuris</i> | 2B | 0.3 | 5.8 | - | - | - | - |
| <i>Spilophorella paradoxa</i> | 2A | 0.2 | 20.4 | - | - | - | - |
| <i>Theristus blandicor</i> | 1B | - | - | 18.6 | 10.1 | * | - |
| <i>Theristus</i> sp. | 1B | 7.4 | 0.8 | 2.0 | 0.5 | 3.2 | - |
| <i>Trichotheristus mirabilis</i> | 1B | 24.6 | - | 6.6 | - | - | 21.4 |
| <i>Tripyloides marinus</i> | 1B | 3.1 | 13.4 | - | 7.1 | - | - |
| <i>Viscosia viscosa</i> | 2B | 0.6 | 1.5 | 16.6 | 9.1 | 19.4 | 7.1 |
| Number of samples | | 63 | 4 | 2 | 1 | 1 | 1 |
| Total identified individuals | | 3200 | 395 | 109 | 99 | 31 | 14 |
| Total number of species | | 64 | 33 | 19 | 14 | 10 | 10 |
| Mean per sample : | | | | | | | |
| Identified individuals | | 49 | 99 | 55 | 99 | 31 | 14 |
| Number of species | | 8 | 18 | 12 | 14 | 10 | 10 |
| Diversity | | 1.63 | 2.86 | 2.13 | 3.01 | 2.44 | 2.27 |
| Feeding type - % 1A | | 2.2 | 23.7 | 1.5 | - | - | 7.1 |
| - % 1B | | 64.7 | 22.7 | 70.4 | 50.5 | 22.6 | 57.1 |
| - % 2A | | 24.8 | 32.7 | 4.5 | 38.4 | 12.9 | 7.1 |
| - % 2B | | 8.3 | 18.2 | 23.6 | 11.1 | 51.6 | 14.3 |

* Indicates presence of this species in samples of other periods.

Legend : Ft = Feeding type; MO = meso-oligohalinic; MS = mesohalinic;
M = mesohalinic (other stations); MP = meso-polyhalinic;
P = polyhalinic; EP = eu-polyhalinic.

Several authors have noted a decrease in diversity with decreasing medium grain size and percentage mud composition (Warwick and Buchanan, 1970; Heip and Decraemer, 1974). Tietjen (1977) also pointed out that muddy substrates were characterized by low species diversity and high species dominance while the reverse was found in sandy sediments.

In other studies from sands and silty sands, the following values are recorded : $H = 5.38$ (German Bight, Juario, 1975), $H = 2.70$ (Eastern Scheldt, Heip et al., 1979) and $H = 2.20$ (mouth of Westerschelde estuary near Walcheren, Bisschop, 1977). Low values for sandy sediments are recorded either from polluted areas ($H = 1.11$, Belgian coast before Cadzand; $H = 0.30$, harbor of Zeebrugge; Bisschop, 1977) or where currents are extremely strong, thereby reworking the sediment ($H = 0.60$, mouth of Oosterschelde, Heip et al., 1979). The average of $H = 1.63$ at the Doel transect is hence low while the minimum of $H = 0$ found at several stations of this transect has not been noted in other studies.

According to Ott (1972), diversity decreases with an increase of the environmental parameter fluctuations. Wolff (1973) in his study of the macrofauna of the delta region in the Netherlands also concluded that diversity is highest in the polyhaline zone and declines to zero in the oligohaline zone. The low average diversity in the oligohaline part of the Westerschelde may hence be a natural phenomenon, not necessarily correlated to pollution. The relatively low diversities in the sandy sediment at the seaward part of the esuary may be explained in function of turbulence and periodical reworking of the upper sediments, analogous with the findings at the mouth of the Oosterschelde (Heip et al., 1979).

At Westerschelde stations where the sediment is fine grained and rich in detritus, the average of $H = 2.93$ (WS 14) and $H = 2.86$ (Saaftinge) falls in the same range as values cited in literature for similar sediments ($H = 2.55$, German Bight, Juario, 1975; $H = 2.38$, Oostzee, Elmgren, 1976).

2.3.5.- Community structure

The nematode fauna of the Westerschelde is composed of approximately 100 species from 15 families. It was extensively studied only in the meso-oligohaline zone at Doel (Holvoet, 1978). Here low nematode density often results in very low species numbers per sample and in a few samples none or only one species (*Mesotheristus setosus*) was found. The average number

of species occurring at the Doel transect is 8 (range: 0-22 at WS 12 and BASF, respectively).

From a total of 3200 identified nematodes in 63 samples, 64 species are found, of which 70 % are represented by less than 10 individuals over the entire sampling period. Because of their infrequent and scarce occurrence, these species will not be considered here. Instead, the dominant nematode species comprising more than three percent of the fauna of a salinity zone are listed in Table 8. The periodic disturbance by strong tidal currents at several of the stations enhances the circulation of species in suspension (Gerlach, 1977) and explains the frequent occurrence of sporadic species.

The three dominant species in the meso-oligohaline zone at the Doel transect are *Mesotheristus setosus* (24.5 %); *Trichotheristus mirabilis* (24.6 %) and *Chromadorita nana* (11.5 %). Their highest densities occur in June, September and October, 1977. *T. mirabilis* is absent from muddy-sand stations and is the dominant species at WS 11 and WS 12 (sandy stations). *Chromadorita nana* only occurs in sand stations, while *M. setosus* is also found in muddy sand stations. *M. setosus* is a typical euryhaline species that may also be found in zones with very low salinity (Riemann, 1975; Brenning, 1973). In agreement with Gerlach (1951), we found that *M. setosus* in the finer sediment is smaller and has shorter setae.

Species found in the high salinity zones but absent from the meso-oligohaline zone are: *Bathylaimus capacosus*, *Daptonema tenuispiculum* and *Oncholaimus calvadosicus*. On the other hand, a considerably larger number of species occur in the oligo-mesohaline zones but are absent in the few samples studied from the eu-polyhaline and polyhaline zones.

These species are *Camacolaimus longicaudata*, *Haliplectus* sp., *Oncholaimus oxyuris*, *Theristus pertenuis*, *Theristus scanicus*, *Tripylloides marinus*, *Enoplolaimus littoralis*, *Tylopharynx fastidus* and *Merlinius* sp..

Most of the species absent from the eu-polyhaline zones, such as *Monhystera anophthalma*, *M. microphthalma* and *Panagrellus* sp. are typical for the brackish water region. However, it is also interesting to note that while *Theristus blandicor* and *T. flevensis* are dominant in the meso-polyhaline zones, they are absent from the oligo-mesohaline zones where they are replaced by *Theristus pertenuis* and *T. scanicus*.

A different biotope is present at Saaftinge and station WS 14 with a few species such as *Calyptronema marweberi*, *Leptolaimus papiliger*, *Spilophorella paradox* and *Tripylloides marinus* confined to these locations.

Species, such as *Ascolaimus elongatus*, *Enoplolaimus propinquus*, *Mesotheristus setosus* and *Viscosia viscosa* are found in all salinity zones. While the eurytypic distribution of *V. viscosa* may be explained by its predaceous habit, the distribution of the other species can only be attributed to their tolerance of a wide range of salinity environments and their omnivorous habit.

The structure of the nematode buccal cavity provides an indication of their feeding habit. According to Wieser (1953) we can distinguish four types: Selective deposit feeders (1A); Non-selective deposit feeders (1B) Epigrowth feeders (2A); Omnivorous with capacity for predation and predators (2B). The selective deposit feeders are most abundant at Saaftinge but are absent from, or occur in very low numbers at the other stations as they presumably utilize the large amount of organic matter found in these sediments. At all sites, except at Saaftinge and meso-polyhaline zones, both of which contain a high proportion of fine silt and mud, the nonselective deposit feeders predominate. Instead, these two locations have a large proportion of epigrowth feeders which are often indicated as utilizing the phytobenthos as a food source. The occurrence of the predators and omnivores is not so easily explained as they compete with meiofaunal groups for their food source.

2.4.- HARPACTICOIDA

2.4.1.- Density

The highest densities noted were 128 ind./10 cm² at a pure sand station (WS 32) and 109 ind./10 cm² in a similar sediment at Vlissingen (WS 55), both in autumn. In 50 % of the 1978-1979 samples no harpacticoids were found and a maximum value of two ind./10 cm² was noted at Doel. Maxima and minima densities at Saaftinge were 160 and 10 ind./10 cm².

Clear summer-autumn peaks only occurred at Vlissingen and Ossensisse and a reversed peak in spring after the very severe winter.

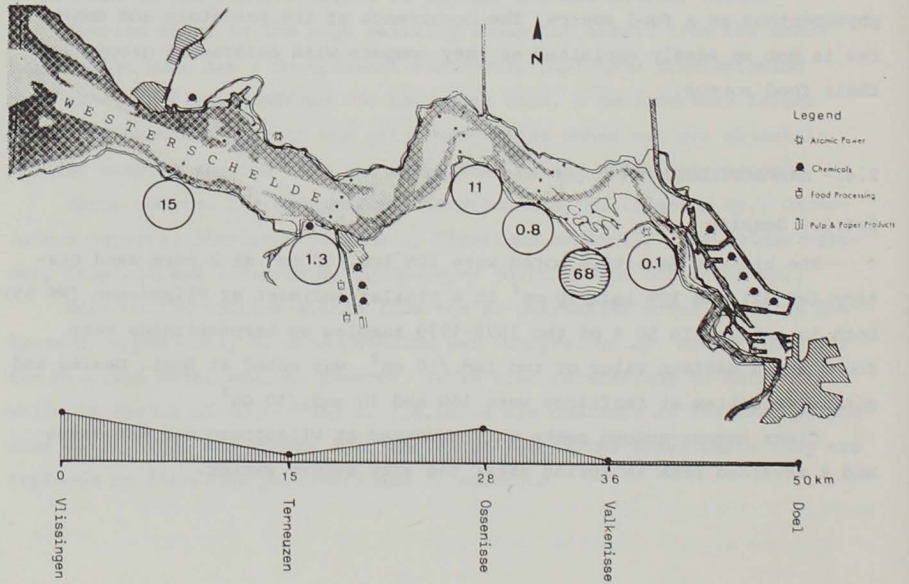
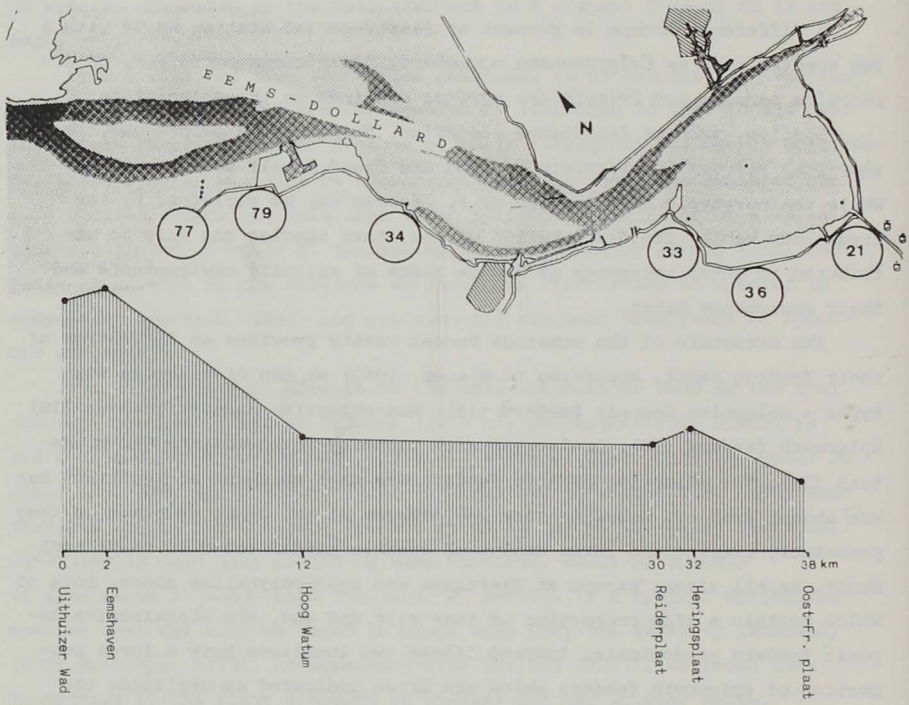

The graphical representation of annual average densities along the estuary (fig. 5) shows an optimum of 15 ind./10 cm² at the mouth and a decline to 0.1 ind./10 cm² at Doel. Again a very low value is noted at Terneuzen. The annual average at Saaftinge is four times higher than that at the mouth of the estuary.

In the adjacent estuaries, average summer densities of 119 ind./10 cm² from an intertidal mudflat of the Oosterschelde and 200 ind./10 cm² from subtidal muds of lake Grevelingen are cited (Surkyn, 1977). Heip et al. (1979) record 655 ± 67 ind./10 cm² during late autumn in the lake Grevelingen. In the organically polluted Eems Dollard (Waddenzee, the Netherlands) annual averages decline from 77 ind./10 cm² at the mouth to 21 ind./10 cm² at the most polluted inland stations (Heip et al., 1979).

The graphical comparison of densities in the two polluted estuaries suggest that organic pollution does not necessarily have a negative influence on this parameter (fig. 5). This is in agreement with the study of Arlt (1975) who found 88 ind./10 cm² in front of the outlet of domestic sewage and 165 ind./10 cm² thirty meter farther off in the oligohaline Greifs Walder Bodden, while at a nonpolluted station, representative of the remaining area, the number again decreased to 96 ind./10 cm².

The following densities cited for unpolluted estuaries and brackish waters are all above values found in the Westerschelde : 27-790 ind./10 cm² in Danish brackish waters (Muus, 1967), 47-87 ind./10 cm² from N.E. United States (Tietjen, 1969), 46 ind./10 cm² in a N.E. salt marsh (Nixon and Oviatt, 1973), 55 ind./10 cm² in the littoral Baltic (Elmgren and Ganning, 1974) and 279 ind./10 cm² in Lynher estuary (Warwick et al., 1979).

2.4.2.- Biomass

Annual average biomass was calculated on the basis of seasonal individual dry weights (table 6) obtained by calculating the biomass of each station from individual dry weights of the species present (table 9). It shows a gradual decline from 18.3 mg dwt/m² at the mouth to 0.14 mg dwt/m² at Doel. A maximum of 146 mg dwt/m² was noted in summer at WS 53 while at Saaftinge, the comparatively high average of 221 mg dwt/m² was noted.

←
fig. 5.

Comparison of annual mean densities (ind./10 cm²) of harpacticoid copepods in two polluted estuaries (salt marsh Saaftinge not included in graph)

Table 9

Individual biomass B_i (in μg dry weight) per species, distribution and abundance (number of individuals N , dominance in % and absolute frequency) of copepod species in the five salinity zones over the whole sampling period.

| Copepoda Harpacticoida | B_i | EP st= 3 n=15 | | | P st= 9 n=44 | | | PM st= 4 n=20 | | | M st= 5 n=23 | | | MO st= 9 n=63 | | |
|---------------------------------------|-------|------------------|------|---|-----------------|------|----|------------------|------|---|-----------------|------|---|------------------|------|---|
| | | N | % | f | N | % | f | N | % | f | N | % | f | N | % | f |
| Westerschelde estuary | | | | | | | | | | | | | | | | |
| <i>Canuella perplexa</i> | 3.90 | - | - | - | 4 | 1.4 | 3 | - | - | - | - | - | - | - | - | - |
| <i>Halectinosoma sarsi</i> | 8.40 | - | - | - | 3 | 1.0 | 3 | - | - | - | - | - | - | - | - | - |
| <i>Pseudobradaya beduina</i> | 1.50 | 1 | 0.3 | 1 | 5 | 1.7 | 5 | - | - | - | - | - | - | - | - | - |
| <i>Pseudobradaya quoddiensis</i> | 1.50 | - | - | - | 4 | 1.4 | 2 | 1 | 0.4 | 1 | - | - | - | - | - | - |
| <i>Arenosetella germanica</i> | 0.63 | 1 | 0.3 | 1 | - | - | - | - | - | - | - | - | - | - | - | - |
| <i>Hastigerella sp.</i> | 0.63 | - | - | - | - | - | - | 4 | 1.7 | 1 | 1 | 5.5 | 1 | - | - | - |
| <i>Euterpina acutifrons</i> | 1.80 | 4 | 1.4 | 2 | - | - | - | - | - | - | - | - | - | - | - | - |
| <i>Tachidius discipes</i> | 1.90 | - | - | - | 103 | 35.8 | 8 | 30 | 13.2 | 1 | - | - | - | - | - | - |
| <i>Harpacticus flexus</i> | 1.80 | 1 | 0.3 | 1 | - | - | - | - | - | - | - | - | - | - | - | - |
| <i>Harpacticus littoralis</i> | 1.80 | - | - | - | 2 | 0.7 | 1 | - | - | - | - | - | - | - | - | - |
| <i>Stenelia palustris</i> | 3.19 | 2 | 0.7 | 1 | 50 | 17.4 | 11 | 5 | 2.2 | 2 | 9 | 50.0 | 1 | 4 | 57.1 | 4 |
| <i>Robertgurneya sp.</i> | 0.80 | - | - | - | 15 | 5.2 | 4 | 2 | 0.8 | 2 | - | - | - | - | - | - |
| <i>Nitocra typica</i> | 0.20 | - | - | - | - | - | - | - | - | - | - | - | - | 1 | 14.2 | 1 |
| <i>Paramesochra similis</i> | 0.20 | 68 | 25.2 | 6 | - | - | - | - | - | - | - | - | - | - | - | - |
| <i>Kliopsyllus constrictus</i> | 0.20 | 76 | 28.2 | 7 | - | - | - | 10 | 4.4 | 3 | - | - | - | - | - | - |
| <i>Evansula pygmaea</i> | 0.25 | 22 | 8.1 | 6 | 4 | 1.4 | 1 | 1 | 0.4 | 1 | - | - | - | - | - | - |
| <i>Leptastacus laticaudatus</i> | 0.23 | 1 | 0.3 | 1 | - | - | - | - | - | - | - | - | - | - | - | - |
| <i>Paraleptastacus espinulatus</i> | 0.25 | 88 | 32.7 | 8 | 1 | 0.3 | 1 | 160 | 70.7 | 4 | 7 | 38.8 | 1 | - | - | - |
| <i>Arenocaris bifida</i> | 0.23 | 4 | 1.4 | 3 | - | - | - | - | - | - | - | - | - | - | - | - |
| <i>Huntemannia sp.</i> | 2.80 | - | - | - | 1 | 0.3 | 1 | - | - | - | - | - | - | - | - | - |
| <i>Paronychocamptus curticaudatus</i> | 2.60 | - | - | - | 24 | 8.3 | 3 | 1 | 0.4 | 1 | - | - | - | - | - | - |
| <i>Asellopsis intermedia</i> | 1.00 | 1 | 0.3 | 1 | 71 | 24.7 | 10 | 2 | 0.8 | 1 | 1 | 5.5 | 1 | 2 | 28.5 | 1 |
| <i>Plathychelipus littoralis</i> | 3.56 | - | - | - | 1 | 0.3 | 1 | - | - | - | - | - | - | - | - | - |
| Total number of individuals | | 269 | | | 287 | | | 226 | | | 18 | | | 7 | | |
| Total number of species | | 13 | | | 14 | | | 10 | | | 4 | | | 3 | | |
| Salt marsh | | | | | | | | | | | | | | | | |
| st= 4 n= 7 | B_i | | | | | | | | | | N % f | | | | | |
| <i>Altheuta depressa</i> | 8.00 | | | | | | | | | | 1 0.2 1 | | | | | |
| <i>Stenelia palustris</i> | 3.19 | | | | | | | | | | 94 16.1 7 | | | | | |
| <i>Hannopus palustris</i> | 3.40 | | | | | | | | | | 311 53.5 7 | | | | | |
| <i>Paronychocamptus nanus</i> | 0.60 | | | | | | | | | | 1 0.2 1 | | | | | |
| <i>Plathychelipus littoralis</i> | 3.56 | | | | | | | | | | 81 13.9 7 | | | | | |
| Total number of individuals | | | | | | | | | | | 488 | | | | | |
| Total number of species | | | | | | | | | | | 5 | | | | | |

EP : eu-polyhalinicum, P : polyhalinicum, PM : poly-mesohalinicum, M : mesohalinicum, MO : meso-oligo-halinicum; st : number of stations, n : number of samples.

In the Eems Dollard annual averages declined from 106 mg dwt/m² at the mouth to 22 mg dwt/m² in the polluted mudflat (Heip *et al.*, 1979).

Other values cited for estuaries and salt marshes are : 50 mg dwt/m² (Nixon and Oviatt, 1973), 275-850 mg dwt/m² (Tietjen, 1969), 788 mg dwt/m² (Warwick *et al.*, 1979) and 300 mg dwt/m² (Elmgren and Ganning, 1974). The highest annual average biomass recorded from the Westerschelde is hence lower than the value found at the most polluted stations in the Eems Dollard nor are comparative low values found in the literature.

2.4.3.- Diversity

Maxima of the diversity, $H = 1.67$ at WS 55 in December and $H = 1.52$ at WS 56 in September were noted in medium pure sand stations with a very high turbulence and periodic removal of the sand cover. The highest diversity noted in muddy sand stations, rich in organic matter was $H = 1.24$ at WS 52, during December. Except at Vlissingen, diversity is usually below one in the rest of the estuary, and in 70 % of the estuarine samples not including those at Doel it was zero. In 90 % of the April samples, $H = 0$. At Saaftinge, the minimum and maximum noted were respectively, $H = 0.76$ and $H = 1.37$.

Annual averages along the estuary follow the same pattern as most studied parameters (fig. 6), with the highest average occurring at Vlissingen ($H = 0.52$) and the lowest at Doel ($H = 0.01$). Again a Higher value is noted in the poly-mesohaline zone at Ossensisse ($H = 0.12$) compared to the polyhaline zone at Terneuzen ($H = 0.08$), most likely due to the reappearance of interstitial forms.

The annual average at Saaftinge is $H = 1.13$, which is twice the highest average in the estuary. While the steady decline of diversity is in agreement with Wolff's (1973) and other author's findings for estuarine macrobenthos, the fact that the highest values are found at Saaftinge in the mesohaline zone is not. It is also in contradiction with the fact that in fine sediments diversity is lower than in coarser ones (Noodt, 1957; Perkins, 1974).

Comparative studies in adjacent unpolluted polyhaline estuarine areas during late summer yielded an average diversity from seven stations of

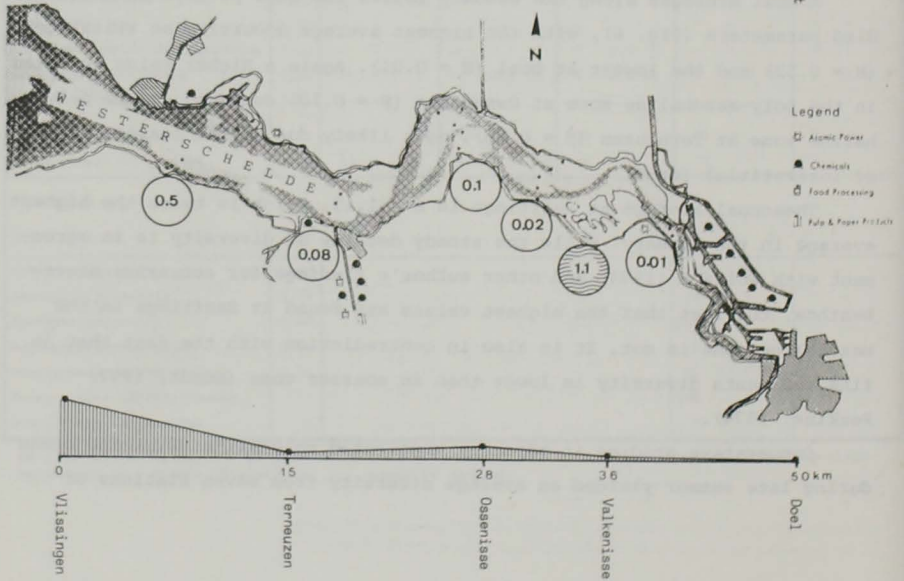
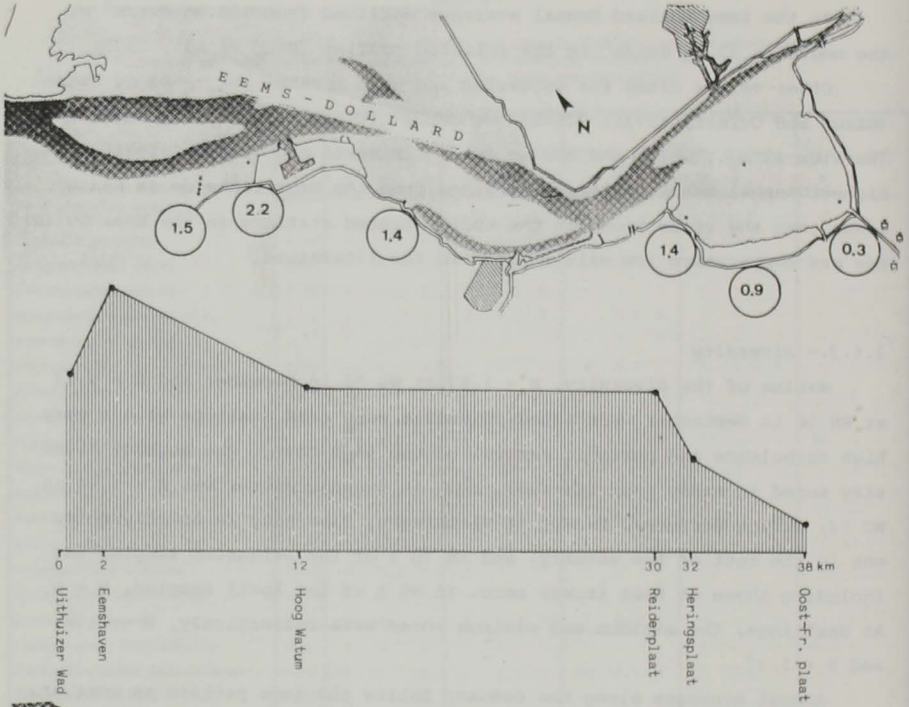

$H = 1.8$ for an intertidal mudflat of Oosterschelde estuary, and an average diversity of $H = 1.9$ for a subtidal mudflat of Grevelingen (Heip *et al.*, 1979).

In the Eems Dollard estuary which is polluted by a potato flour mill, Vaeremans (1977) found annual averages declining from the polyhaline zone at the mouth ($H = 1.5$) to the meso-oligohaline mudflat inland ($H = 0.3$) which receives about 7000 to 10000 tons of organic matter during autumn (fig. 6). Only in ten percent of the samples, in this most polluted zone, is the diversity equal to zero.

The highest averages found in the Westerschelde hence lie close to the lowest values from the organically polluted Eems Dollard. The very low diversity in the Westerschelde can primarily be attributed to the low densities and specifically to the absence of interstitial forms in most sandy stations. According to Wieser (1960), a medium grain size of 0.200 mm is the lower limit for interstitial life while Ward (1975) notes that 7 % of silt clay particles is sufficient to fill the interstices.

Van Damme and Heip (1977) found that in the polluted Belgian coastal zone interstitial life was absent in sediment with a mud content of more than 2.5 percent. Only at four stations (WS 31, 44, 55 and 56) does the medium grain size remain above 0.200 mm over the whole year, maintaining a clean sandy sediment.

It would thus seem that suitable environments for interstitial life are rare and localized due to the predominance of finer sediments on the sandbanks. Due to this confinement they may be easily destroyed when the sediment is rearranged during periods of turbulence.

On the other hand, the very low organic content of the sediment at most stations does not allow the presence of the large endo- and epibenthic detritus feeders. The above mentioned limiting factors do not however fully explain the scarcity of harpacticoid life since in stations with sediment rich in organic matter (WS 22, 51) or in stations with pure medium sized sand (WS 44) the diversity also remains low.

←
fig. 6.

Comparison of annual mean diversity H (in bits) of harpacticoid copepods in two polluted estuaries (salt marsh Saafteinge not included in graph)

2.4.4.- Community structure

A total of 27 species was found in the estuary (table 9). In the eu-polyhaline zone (WS 55-57), 13 species occurred over the entire sampling period. The fauna was typical interstitial at stations WS 55 and WS 56 and dominated by *Paraleptastacus espinulatus*, *Kliopsyllus constrictus* and *Paramesochra similis*. At station WS 57 only epibenthic harpacticoids *Euterpina acutifrons* and *Asellopsis intermedia* occurred probably due to the high turbulence here. The following species remain confined to the eu-polyhaline zone : *Arenosetella germanica*, *Euterpina acutifrons*, *Harpacticus flexus*, *Paramesochra similis*, *Leptastacus laticaudatus* and *Arenocaris bifida*.

At Vlissingen (WS 51-54) and at Terneuzen (WS 41-45), in the polyhaline zone, 14 species were counted. Although the sediment at WS 43-45 consists of very pure fine to medium sand no interstitial harpacticoids with the exception of four individuals of *Evansula pygmaea* in one sample were found. At the other stations of this zone the amount of organic matter is higher and the medium grain size is too low to permit interstitial life. Hence the fauna is dominated by epibenthic and endobenthic species : *Tachidius discipes*, *Asellopsis intermedia*, *Stenhelia palustris*, *Pseudobrydya beduina* and *Paronychocamptus curticaudatus*. The species which were confined to the polyhalinicum were : *Camuella perplexa*, *Halectinosoma sarsi*, *Harpacticus littoralis* and *Huntemania* sp.

In the poly-mesohaline zone at Ossensisse (WS 31-34) the total number of species decreased to ten. At the sandy stations four interstitial forms are found but *Paraleptastacus espinulatus* is the only species which is relatively abundant at this transect.

At Valkenisse (WS 21-25) in the mesohaline zone the number of species dwindles to four with a frequency of one. They are : *Stenhelia palustris*, *Paraleptastacus espinulatus*, *Hastigerella* sp. and *Asellopsis intermedia*.

In the salt marsh of Saaftinge a slightly higher number of five species is found. All are large endo- and epibenthic species and dominant is *Nannopus palustris* followed by *Stenhelia palustris* and *Plathychelipus littoralis*. *N. palustris*, *Paronychocamptus nanus* and *Altheuta depressa* were only found at Saaftinge. *P. littoralis* which occurred in all samples was absent from the estuarine stations with the exception of one individual at WS 51.

In the meso-oligohaline zone at Doel the total number of species is further reduced to three : *Stenhelia palustris*, *Asellopsis intermedia* and *Nitocra typica*. *S. palustris* is the most frequent with four individuals from 63 samples while *Nitocra typica* is found only in this zone.

There is a clear seasonal fluctuation in the total number of species from the Westerschelde with a minimum of seven species in April after the very severe and long cold winter of January-March, 1979. Only *P. espinulatus* and *Asellopsis intermedia* had a frequency of two while the other five species were each represented by a single individual in one station. A peak occurred during summer with a total of 17 species over the whole estuary.

The epibenthic species, *Stenhelia palustris* and *Tachidius discipes*, are dominant and widespread in the summer while interstitial forms such as *Paraleptastacus espinulatus* are more numerous and frequent in autumn. In a study of plankton in the Westerschelde De Pauw (1975) found the following species : *Ameira parvula*, *Canthocamptus staphilinus*, *Dactylopusia thisboides*, *Euterpina acutifrons*, *Microarthridion littorale*, *Nannopus palustris*, *Nitocra hibernica*, *Nitocra lacustris* and *Stenhelia palustris*. Of these, *M. littorale* and *E. acutifrons* were collected over the whole estuary.

With the exception of two individuals of *E. acutifrons* at WS 57, we failed to find representatives of these two species in the sediment samples, although *M. littorale* is the dominant species of the benthic harpacticoid community in the polluted Belgian coastal zone (Van Damme and Heip, 1977; Govaere et al., in press). It is unlikely that *M. littorale* has disappeared from the Westerschelde since De Pauw's study, because this species seems to thrive in highly polluted sediments (Govaere et al., in press; Arlt, 1975). Some populations in the subtidal muddy sediments of the estuary were probably not sampled during our survey.

To the above-mentioned species from the Westerschelde must also be added *Paramphiascopsis longirostris*, *Halectinosoma herdmanni* and *Pseudobradya minor* which were found in the polyhaline zone during a preliminary survey in May, 1976.

2.4.5.- Annual production

This parameter is only briefly discussed here because the few data available as yet only allow estimations. Annual production was calculated on the basis of the estimated life cycle turnover rate of every taxonomic group and the number of generations that might be expected in a year (table 10).

Table 10

Annual mean production (mg dwt/ m². y.) of meiobenthic taxa and contribution of the Nematoda (in %) at six stationgroups of the Westerschelde.

| Transect Stations | Vlissingen 51 - 57 | Terneuzen 41 - 45 | Ossensisse 31 - 34 | Valkenisse 21 - 25 | Saafdinge 1 - 4 | Doel 11 - 14 BASF 1-5 |
|------------------------------------|-----------------------|----------------------|-----------------------|-----------------------|--------------------|-----------------------------|
| Hydrozoa | 17.4 | - | 2.7 | - | 388.0 | - |
| Gastrotricha | 47.7 | 3.2 | 14.6 | 0.3 | - | - |
| Turbellaria | 190.3 | 127.4 | 153.4 | 47.5 | 54.0 | - |
| Nematoda | 9802 | 6728 | 8842 | 3554 | 45786 | 240 |
| Oligochaeta | 64.0 | 6.6 | 11.7 | 23.4 | 310.0 | 7.2 |
| Polychaeta | 37.9 | 42.4 | 22.6 | 47.0 | 1969.0 | 11.8 |
| Harpacticoida | 274.2 | 22.5 | 133.5 | 9.9 | 1315 | 2.1 |
| Mollusca | 20.3 | 12.2 | 18.3 | 4.0 | 0.1 | - |
| Ostracoda | 251.6 | 497.6 | 14.0 | 59.8 | 52.4 | - |
| Tardigrada | 2.2 | 1.5 | 2.2 | 0.1 | - | - |
| Total P in g dwt/m ² .y | 10.7 ± 3.0 | 7.4 ± 3.2 | 9.3 ± 4.2 | 3.8 ± 1.3 | 52.1 ± 10.3 | 0.3 ± 0.1 |
| Total P in g C /m ² .y | 4.3 ± 1.2 | 3.0 ± 0.9 | 3.7 ± 1.7 | 1.5 ± 0.5 | 20.8 ± 4.2 | 0.11 ± 0.04 |
| % Nematoda | 92 | 90 | 95 | 94 | 88 | 91 |

Gerlach (1971) synthesized the existing data and concluded that a turnover of P/B = 9 per year was acceptable for the meiobenthos *in toto*. For nematodes, McIntyre (1969) and Gerlach (1971) use a P/B ratio of 10. Warwick and Price (1979) calculated production on the relationship $P/(P + R) = 0.38$ based upon experimental data of Marchant and Nicholas (1974) and thus obtained a rather close value of P/B = 8.4 or 8.7 for nematodes. Warwick *et al.* (1979) obtained a P/B ratio of 11.1 for the true meiofauna.

In this study, a P/B ratio of 15 is used for harpacticoids following Heip and Van Damme (1977). For Oligochaeta and Polychaeta a rather low P/B ratio of 1.5 (Govaere *et al.*, 1977) is used, although a P/B = 2.5 was

noted in a study of *Nereis diversicolor* (Heip and Herman, 1978). Warwick et al. (1979) suggest a higher value for these two groups, namely, $P/B = 5.5$ for short lived polychaetes (Based upon respiration experiments on *Ampelodesma acutifrons*) and a $P/B = 3$ for oligochaetes (Haka et al., 1974 from Warwick and Price, 1979). For the other groups, not mentioned here, a P/B of 9 was used.

The annual production calculated for the mouth of the Westerschelde is $10.7 \text{ g dwt/m}^2\text{.yr}$. Assuming that carbon comprises 40 % of the animal dry weight (Steele, 1974) we derive the value of $4.28 \text{ g C/m}^2\text{.yr}$. It declines to $0.3 \text{ g dwt/m}^2\text{.yr}$ ($0.08 \text{ g C/m}^2\text{.yr}$) at Doel while at Saaftinge the production is $52.1 \text{ g dwt/m}^2\text{.yr}$ ($20.8 \text{ g C/m}^2\text{.yr}$).

In comparison, Warwick et al. (1979) obtained a very high production value of $20.3 \text{ g C/m}^2\text{.yr}$ for true plus temporary meiofauna in the Lynher estuary, which is identical with our value for Saaftinge. Heip and Van Damme (1977) found a production of $5.13 \text{ g C/m}^2\text{.yr}$ in the polluted zone near the Belgian coast and $4.9 \text{ g C/m}^2\text{.yr}$ in the unpolluted Open Sea zone, which is similar to that found in the seaward part of the estuary.

Discussion

The following trends were observed in all qualitative and quantitative parameters studied from the Westerschelde :

1. A decline from the eu-polyhaline zone at the mouth towards the meso-oligohaline zone at the head of the estuary.
2. Extremely low values in the meso-oligohaline waters.
3. Lower values in the polyhaline zone at Terneuzen and in the poly-mesohaline zone at Ossensisse.
4. Relatively very high values in the salt marsh of Saaftinge.
5. When compared to other estuaries, both polluted and unpolluted, extremely low values for all meiofaunal groups, except nematodes were noted in the estuary and normal to high values in the salt marsh of Saaftinge.

At Doel, in the meso-oligohaline headwaters of the estuary, a decline in species richness and diversity is normal but very low values of the quantitative parameters is not. Indeed, because of the enormous organic

enrichment of these waters, at least some species, in particular eurytopic representatives of the nematodes and oligochaetes, should proliferate on these bottoms.

Indeed, Bouwman and Kop (1979) record maximal densities and minimal diversities of these groups in the most organically polluted part of the Eems Dollard, where the water periodically becomes anoxic. Since the top layer of the sediment is always re-aerated during low tide, a periodic decrease in oxygen concentration on the intertidal stations of the Westerschelde may explain a seasonal decline of quantitative parameters, but not an overall low value and minima of zero individuals. We must therefore assume that the quantitative parameters in the meso-oligohaline waters are not correlated with the organic pollution.

At the other transects, quantitative parameters of nematodes are normal, and even very high densities may be noted. However, quantitative and qualitative parameters of other groups remain low. This may be explained by the fact that the banks which were sampled consist of fine sands with a medium grain size below 200 μm , which is inimical for interstitial life, and also have a low organic matter content, which is inimical for epibenthic and endobenthic detritus feeders. Hence, natural conditions, not considering pollution, turn these areas into deserts and continual shifting and rearranging of the sediments enhance these conditions. Only where currents are very strong or slack, other environments are found.

In the first instance, in areas where strong currents prevail, fine particles do not settle so that sands with a medium grain size above 200 μm occur throughout the year. In such environments interstitial life appears, and qualitative parameters increase. Nevertheless, nematode and total meio-benthic density is low here because of the biological interactions between the interstitial groups present and also because the high turbulence is an important stress factor.

Where stream velocity is low, fine clastics and detritus can settle for prolonged periods. In such detritus rich, very fine to fine sands with medium grain size below 150 μm , very high densities of nematodes were found. Qualitative and quantitative parameters of the epi- and endobenthic harpacticoid copepods however remained low when compared to those in the literature, although all conditions for a rich fauna are present.

Similar contradictory data are found in medium sands before the harbour of Terneuzen, where a richer interstitial fauna should be expected. Yet not only the diversity of harpacticoids but also quantitative parameters in seven of the ten taxa present are very low in comparison to the polyhaline samples at Vlissingen and even lower than the ones from the poly-mesohaline zone at Ossensisse. According to t-tests, there is no significant difference in these values from Terneuzen and Ossensisse on the 90 % level; nevertheless, this occurrence is too persistent to be coincidental.

A tentative conclusion regarding the disparity in fauna between the sites, can be derived from the foregoing study. In the salt marsh of Saaf-tinge the high densities and individual dry weights, hence a high annual production can be explained by the large amount of organic detritus present, the protected position amidst the channels against extreme environmental conditions and the protection against direct pollution by the elevation at the marsh entrance. Because of the low amounts of organic material, the grain size of the sand and the unstable relief, the sandbanks in the estuary are not suitable for meiobenthic life and the low values found are primarily correlated with stream velocity and turbulence.

However, these factors can not be used to explain : the poverty of meiobenthic life, including nematodes, in the organically enriched meso-oligohaline muddy sands of the estuary; the absence or scarcity of endo- and epibenthic copepods and other groups in detritus rich sediments; or the absence of an interstitial fauna at the Terneuzen transect in pure sands with a medium grain size of more than 200 μm .

Since sediments which are both rich and poor in detritus are affected along with high as well as low wave energy areas, the above summarized observations would suggest that not organic but chemical pollution could be the limiting factor. Further research however is needed in the sublittoral parts of the estuary that are protected against turbulence and exposure. This would allow precise estimation of the abundance and dispersal of meiofauna and their regulating factors in this polluted estuary.

Acknowledgments

The work reported was partially assisted by biology students among whom Gonda Bisschop, Rudy Surkyn and Marleen Vaeremans have been particularly helpful. Technical assistance from Alex Braeckman, Marc De Keere, Anita Van Bost and Dirk Van Gansbeke is gratefully acknowledged. We are also particularly grateful to all public service offices that have always assisted us with great competence: the Management Team of the Mathematical Model North Sea (Ministry of Public Health, Belgium), the Sea Service of Antwerpen (Ministry of Public Works, Belgium), the Rijkswaterstaat at Vlissingen (Ministry of Public Works, The Netherlands). We would like to extend a special thanks to the crew of the *R.V. Welsinga* and *R.V. Wijtvliet* for their assistance and hospitality during our sampling cruises.

References

- ARLT, G. (1975). Remarks on indicator organisms (meiofauna) in the coastal waters of the GDR. *Merentutkimuslait. Julk./Havsforskningsinst. Skr.*, **239**, 272-279.
- BILLEN, G. and SMITZ, J. (1978). Mathematical model of water quality in a highly polluted estuary. In : J.C.J. Nihoul (Ed.), *Hydrodynamics of Estuaries and Fjords. Elsevier Oceanography Series*, **23**, 546 pp.
- BISSCHOP, G. (1977). *Bijdrage tot de studie van de Nematodenfauna van de Noordzee en de Westerschelde ter hoogte van haar monding*. M.S. thesis, State University of Gent, 129 pp.
- BOUWMAN, L.A. and KOP, A.J. (1979). De Dollard. De invloed van afvalwaterlozingen op het ecosysteem. *Ntur Tech.*, **47**(12), 668-683.
- BRENNING, U. (1973). The distribution of littoral nematodes in the Wismarbucht. *Oikos Suppl.*, **15**, 98-104.
- BRINKHURST, R.O. (1972). The role of sludge worms in eutrophication. *Ecol. res. Ser.*, **472**, 1-69, Washington.
- DE PAUW, C. (1975). *Bijdrage tot de kennis van milieu en plankton in het Westerschelde Estuarium*. Ph.D. thesis, State University of Gent, 380 pp.
- ELMGREN, R. (1976). Baltic benthos communities and the role of the meiofauna. *Contr. Askø Lab.*, **14**, 1-31.
- ELMGREN, R. and GANNING, B. (1974). Ecological studies of two shallow, brackish water ecosystems. *Contr. Askø Lab.*, **6**, 56 pp.
- GERLACH, S.A. (1951). Freilebende Nematoden aus der Verwandtschaft der Gattung *Theristus*. *Zool. Jb. (Syst.)*, **80**, 379-406.
- GERLACH, S.A. (1971). On the importance of marine meiofauna for benthos communities. *Oecologia*, **6**, 176-190.

- GERLACH, S.A. (1977). Means of meiofauna dispersal. *Mikrofauna Meeresboden*, **61**, 89-103.
- GOVAERE, J.C.R. and THIELEMANS, L.K.H. (1979). A simple device for taking undisturbed sediment cores in shallow waters. *Biol. Jb. Dodonae*, **47**, 137-139.
- GOVAERE, J.C.R., THIELEMANS, L.K.H. and DE BOEVER, R. (1977). *Studie van het macrobenthos in de zuidelijke Noordzee*, in boekdeel 7: *Inventarie van de fauna en flora*, Nationaal Onderzoeks- en ontwikkelingsprogramma. Leefmilieu. Project Zee. Programmatie van het Wetenschapsbeleid, Brussel, pp. 115-165.
- GOVAERE, J.C.R., VAN DAMME, D., HEIP, C. and DE CONINCK, L.A.P. (in press). Benthic communities in the Southern Bight of the North Sea and their use in ecological monitoring. *Helgoländer wiss. Meeresunters.*
- GRAY, J.S. (1976). The fauna of the polluted River Tees estuary. *Est. and Coastal Mar. Sci.*, **4**, 653-676.
- HAKA, P., HOLOPAINEN, I.J., IKONEN, E., LEISMA, A., PAASIVIRTA, L., SAARISTO, P., SARVALA, J. and SARVALA, M. (1974). Pääjärven pohjaeläimistö. *Luonnon Tutk.*, **78**, 157-173. (from Warwick *et al.*, 1979).
- HEIP, C. (1979). Density and diversity of meiobenthic copepods: the oscillatory behaviour of population and community parameters. In : E. Naylor and R.G. Hartwell (Eds.), *Cyclic Phenomenon in Marine Plants and Animals*, Pergamon Press, Oxford, New York, 43-47.
- HEIP, C. and DECREAEMER, W. (1974). The diversity of nematode communities in the southern North Sea. *J. mar. biol. Ass. U.K.*, **54**, 251-255.
- HEIP, C. and HERMAN, R. (1979). Production of *Nereis diversicolor* O.F. Müller (Polychaeta) in a shallow brackish-water pond. *Est. and Coastal Mar. Sci.*, **8**, 297-305.
- HEIP, C. and VAN DAMME, D. (1977). *Het meiobenthos in de Zuidelijke Noordzee*, in boekdeel 8: *Trofische ketens*, Nationaal Onderzoeks- en ontwikkelingsprogramma. Leefmilieu. Project Zee. Programmatie van het Wetenschapsbeleid, Brussel, pp. 121-166.
- HEIP, C., WILLEMS, K.A. and GOOSSENS, A. (1977). Vertical distribution of meiofauna and the efficiency of the Van Veen grab on sandy bottoms in Lake Grevelingen (The Netherlands). *Hydrobiol. bull.*, **11**, 35-45.
- HEIP, C., HERMAN, R., BISSCHOP, G., GOVAERE, J.C.R., HOLVOET, M., VAN DAMME, D., VANOSMAEL, C., WILLEMS, K.R., and DE CONINCK, L.A.P. (1979). Benthic studies of the Southern Bight of the North Sea and its adjacent continental estuaries (Progress Report I). In: *Geconcentreerde Onderzoeksacties Oceanologie*. Programmatie van het Wetenschapsbeleid, Brussel, pp. 133-163.
- HOLVOET, M. (1978). *Nematoda van de Westerschelde te Zandvliet-een eerste benadering*, M.S. thesis, State University of Gent, 103 pp.

- JUARRO, J.V. (1975). Nematode species composition and seasonal fluctuation of a sublittoral meiofauna community in the German Bight. *Veröff. Inst. Meeresforsch. Bremerh.*, **15**, 283-337.
- LASSERRE, P., RENAUD-MORNANT, J. and CASTEL, J. (1975). Metabolic activities of meiofaunal communities in a semi-enclosed lagoon. Possibilities of trophic competition between meiofauna and mugilid fish. G. Persoone and E. Jaspers (Eds.), *Proc. Tenth Eur. Mar. Biol. Symp.*, Universa Press, Wetteren, Belgium, 393-414.
- MARCHANT, R. and NICHOLAS, W.L. (1974). An energy budget for the free-living nematode *Pelodora* (Rhabditidae). *Oecologia*, **16**, 231-252.
- Mc INTYRE, A.D. (1969). Ecology of marine meiobenthos. *Biol. Rev.*, **44**, 245-290.
- MUUS, B.J. (1967). The fauna of Danish estuaries and lagoons. Distribution and ecology of dominating species in the shallow reaches of the mesohaline zone. *Meddr. Damm. Fisk. og Havunders.*, **5**, 1-316.
- NIXON, S.W. and OVIATT, C.A. (1973). Ecology of a New England salt marsh. *Ecol. Monogr.*, **43**(4), 463-498.
- NOODT, W. (1957). Zur Ökologie der Harpacticoidea (Crust. Cop.) des Eulittorals der Deutschen Meeresküste und der angrenzenden Brackgewässer. *Z. Morph. u. Ökol. Tiere*, **46**, 149-242.
- OLIFF, W.B., BERRISFORD, C.D., TURNER, W.D., BALLARD, J.A. and McWilliams, D.C. (1967). The ecology and chemistry of sandy beaches on nearshore submarine sediment of Natal. *Water Res.*, **1**, 115-146.
- OTT, J.A. (1972). Studies on the diversity of the nematode fauna in inter-sediments. In: A. Battaglia (Ed.), *Fifth European Marine Biology Symposium*, Padua and London (Piccin Editore), 275-285.
- PERKINS, J. (1974). *The Biology of Estuaries and Coastal Waters*, Academic Press, London and New York, 678 pp.
- PETERS, J.J. and STERLING, A. (1976). *Hydrodynamique et transports de sédiments de l'estuaire de l'Escaut*, in boekdeel 10: *Het Schelde-Estuarium*, Nationaal Onderzoeks- en ontwikkelingsprogramma. Leefmilieu. Projekt Zee. Programmatie van het Wetenschapsbeleid, Brussel, pp. 1-70.
- PIELOU, E.C. (1975). *Ecological Diversity*, Wiley-Interscience, New York, 165 pp.
- SKOOLMUN, P. and GERLACH, S.A. (1971). Jahreszeitliche Fluktuationen der Nematodenfauna im Gezeitenbereich des Weser-Astuars (Deutsche Bucht). *Veröff. Inst. Meeresforsch. Bremerh.*, **13**(1), 119-138.
- RIEMANN, F. (1975). Einwanderung mariner Nematoden in das Süßwasser. Untersuchungen in Kolumbien im Vergleich mit außertropischen Regionen. *Int. Revue ges. Hydrobiol.*, **60**(3), 393-407.

- SLADECEK, V. (1965). The future of the saprobity system. *Hydrobiologia*, **25**(3-4), 518-537.
- STEELE, J.H. (1974). *The Structure of Marine Ecosystems*. Blackwell, Oxford, 128 pp.
- STRIPP, K. (1969). Jahreszeitliche Fluctuationen von Macrofauna und Meiofauna in der Helgoländer Bucht. *Veroff. Inst. Meeresforsch. Bremerh.*, **12**, 65-94.
- SURKYN, R. (1977). *Vergelijking van de fauna van permanent ondergelopen slikken in de Grevelingen met bestaande slikken in the Oosterschelde*. M.S. thesis, State University of Gent, 56 pp.
- TEAL, J.M. and WIESER, W. (1966). The distribution and ecology of nematodes in a Georgia salt marsh. *Limnol. Oceanogr.*, **11**, 217-222.
- TIETJEN, J.H. (1969). The ecology of shallow water meiofauna in two New England estuaries. *Oecologia*, **2**, 251-291.
- TIETJEN, J.H. (1977). Population distribution and structure of the free-living nematodes of Long Island Sound. *Mar. Biol.*, **43**, 123-136.
- VAEREMANS, M. (1977). *De Copepoda Harpacticoida van het Eems-Dollard Estuarium*, M.S. thesis, State University of Gent, 78 pp.
- VAN DAMME, D. and HEIP, C. (1977). *Het meiobenthos in de Zuidelijke Noordzee*, in Boekdeel 7: *Inventaris van de fauna en flora*, Nationaal Onderzoeks- en ontwikkelingsprogramma. Leefmilieu. Project Zee. Programmatie van het Wetenschapsbeleid, Brussel, pp. 1-118.
- WARD, A.R. (1975). Studies on the sublittoral free-living nematodes of Liverpool Bay. II. Influence of sediment composition on the distribution of marine nematodes. *Mar. Biol.*, **30**, 217-225.
- WARWICK, R.M. and BUCHANAN, J.B. (1970). The meiofauna off the coast of Northumberland. I. The structure of the nematode population. *J. mar. biol. Ass. U.K.*, **50**, 129-146.
- WARWICK, R.M. and PRICE, R. (1979). Ecological and metabolic studies on free-living nematodes from an estuarine mud-flat. *Est. and Coastal Mar. Sci.*, **9**, 257-271.
- WARWICK, R.M., JOINT, I.R. and RADFORD, P.J. (1979). Secondary production of the benthos in an estuarine environment. In: R.L. Jefferies and A.J. Davy (Eds.), *Ecological Processes in Coastal Environments*, Blackwell Scientific Publications, Oxford, 429-450.
- WIESER, W. (1953). Die Beziehung zwischen Mundhohlengestalt, Ernährungsweise Verkommen bei freilebenden marinen Nematoden. Ein Ökologisch-morphologische Studie. *Ark. Zool.*, **4**(2), 439-484.
- WIESER, W. (1960). Benthic studies in Buzzards Bay. II. The meiofauna. *Limnol. Oceanogr.*, **5**, 121-137.

- WIESER, W. and KANWISHER, J. (1961). Ecological and physiological studies on marine nematodes from a small salt marsh near Woods Hole, Massachusetts. *Limnol. Oceanogr.*, **6**, 262-270.
- WOLFF, W.J. (1973). The estuary as a habitat. (An analysis of data on the soft-bottom macrofauna of the estuarine area of the rivers Rhine, Meuse and Scheldt). *Zool. Verhand.*, **126**, 1-242.
- WOLLAST, R. (1976). *Transports et accumulation de polluants de l'estuaire de l'Escaut*, in boekdeel 10: *Het Schelde-Estuarium*, Nationaal Onderzoeks- en Ontwikkelingsprogramma. Leefmilieu. Projekt Zee. Programmatie van het Wetenschapsbeleid, Brussel, pp. 191-218.

15441

Population dynamics of copepods
in the Southern Bight of the North Sea
(1977-1979)

Use of a multicohort model to derive biological parameters

M. BOSSICART

Laboratorium voor Ekologie en Systematiek
Vrije Universiteit Brussel, Belgium

Introduction

The aim of this study is the analysis and the interpretation of the population density fluctuations in time so that we can attempt an evaluation of dynamic parameters such as growth rate, mortality rate, fecundity and also of the net production.

Contrasting to our approach this problem has been studied *in vitro* in most cases (Gaudy, 1974; Heinle, 1970; Mc Laren, 1975; Paffenhöfer, 1970, 1976; Razouls, 1974).

However, it is often useful to assess values of such parameters for *in situ* natural conditions. But the situation is then much obscured since the zooplankton contains together different development stages and even different generations.

In order to solve this problem of sorting out and calculating population parameters and production values, a multicohort model simulating the life history of the copepods has been developed.

The first development stage is a tiny larva called nauplius (fig. 1). Nauplii grow in size and weight until a transformation occurs. Meanwhile, a number of them have died. The development stage that follows this transformation is called copepodite. Again copepodites grow and some of them die until the transformation to the adult stage occurs. Adults grow very little but females produce eggs so that the cycle can start again.

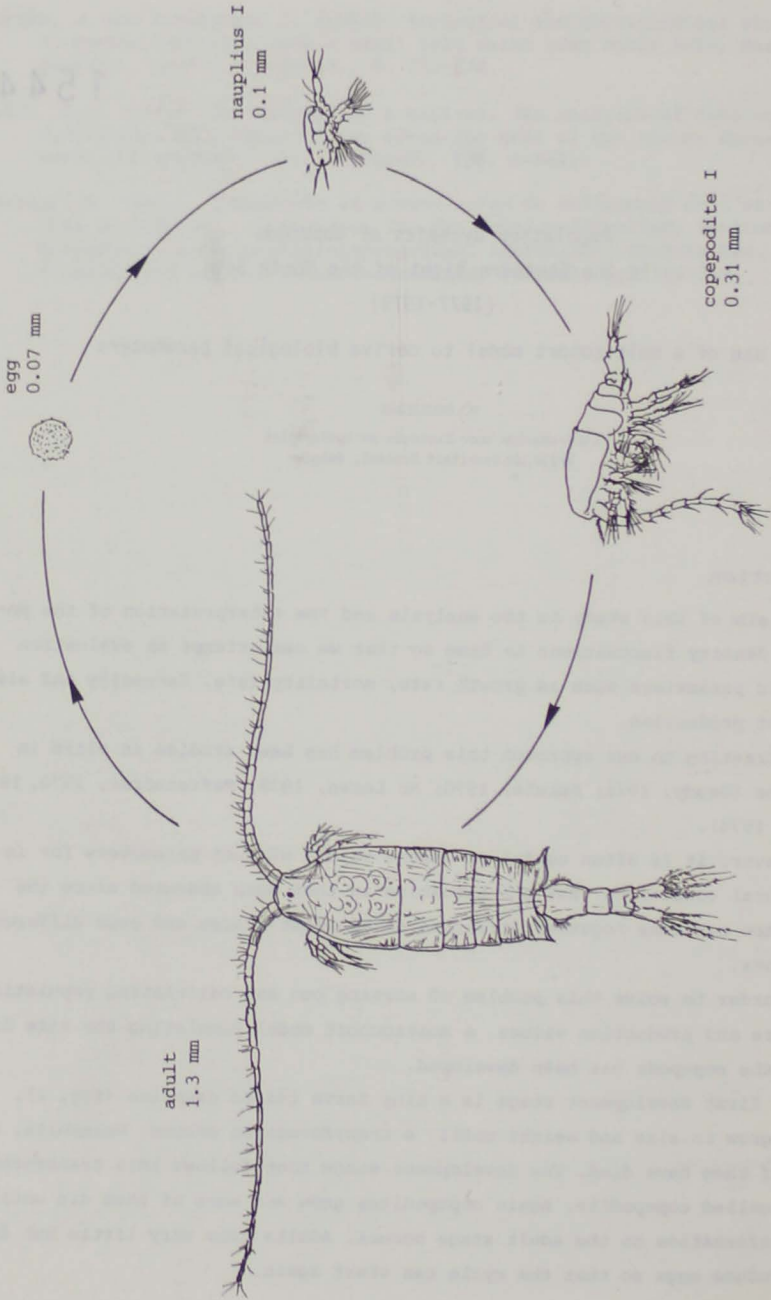

fig. 1.
Development stages of a copepod

In the North Sea three populations predominate : *Temora longicornis*, O.F. Müller; *Pseudocalanus elongatus*, Boeck and — to a lesser extent — *Acartia clausi*, Giesbrecht. The evolution of the two more abundant populations has been simulated with the model.

The simulation model

The numbers daily hatched during a given period are not constant : there is an increase at first and then a decrease.

This aspect is very important for the working of our simulation model. Indeed a special function describing this phenomenon, generates every day a new cohort, and thus serves as forcing function for the model.

A normal law has been chosen for the simulation of the hatching function in a simple way. Table 1 explains the different symbols.

Table 1

| Nauplii | Copepodites | Adults | Populations parameters |
|----------|-------------|--------|---|
| N_j^j | | | Number of nauplii hatched on day j (= cohort j) |
| N_t^j | | | Numbers in cohort j , still alive on day t |
| N_t | C_t | A_t | Numbers (all cohorts) observable at time t |
| m_1 | m_2 | m_3 | Specific mortality rate |
| i_1 | i_2 | i_3 | Age of a given individual (days) |
| P_1 | P_2 | P_3 | Maximum age of a given individual (days) |
| | | | Stocks and production parameters |
| B^N | | | Biomass of an individual |
| B_0^N | | | Initial biomass of an individual |
| k_1 | | | Specific exponential growth rate |
| P_t^N | | | Net production (all cohorts) on day t |
| | | | Spawning and hatching |
| α | | | Coefficient giving the dispersion of the normal curve |
| β | | | Day with the highest hatched number |
| b | | | Number of nauplii hatched on day β |

1.- THE HATCHING FUNCTION

$$N^j = b e^{-a(t - \beta)^2} \quad (1)$$

2.- EQUATION FOR THE NAUPLIAR STAGES

For a cohort j the numbers of individuals decrease in function of the exponential mortality rate m_1 :

$$N_t^j = b e^{-a(t - \beta)^2 - m_1 i_1} \quad (2)$$

Hence, the number of living individuals at a time t between t_0 and t_f is

$$N_t = \int_0^{p_1} b e^{-a(t - \beta - i_1)^2 - m_1 i_1} di_1 \quad (3)$$

3.- EQUATIONS FOR THE OTHER DEVELOPMENT STAGES

Similar equations are developed for the copepodites and the adults :

$$C_t = \int_0^{p_2} b e^{-a(t - \beta - p_1 - i_2)^2 - m_1 p_1 - m_2 i_2} di_2 \quad (4)$$

$$A_t = \int_0^{p_3} b e^{-a(t - \beta - p_1 - p_2 - i_3)^2 - m_1 p_1 - m_2 p_2 - m_3 i_3} di_3 \quad (5)$$

4.- EQUATIONS FOR THE NET PRODUCTION

Combining the equation for the net production of a single individual (e.g. a nauplius) during a given day (e.g. i_1) :

$$B_t^N = B_0^N e^{k_1 i_1} (e^{k_1} - 1) \quad (6)$$

with the equation for the numbers [e.g. equation (3)], one has

$$P_t^N = \int_0^{p_1} b e^{-a(t - \beta - i_1)^2 - m_1 i_1} B_0^N e^{k_1 i_1} (e^{k_1} - 1) di_1 \quad (7)$$

Application of this model

This model has been applied in the Southern Bight of the North Sea. Sampling was done daily from the lightship *West-Hinder* during the years 1977, 1978, 1979.

Two species predominate in this area : *Temora longicornis*, O.F. Müller and *Pseudocalanus elongatus*, Boeck. Figures 2(a,b), 3(a,b) and 4(a,b) show the seasonal evolution of numbers for the three categories of development stages in the predominating populations. The curves of 1977 are smoothed, using a floating-average technique. The seasonal evolution of the two species clearly shows a succession of three generations.

These population curves are synchronized for both species but with a marked opposition between the abundance patterns which is suggestive of interspecific competition.

We have no explanation for the higher numbers of nauplii observed in 1978 and for the low numbers observed in 1979.

The population curves generated by the model, after fitting, are given in figures 2(c,d), 3(c,d) and 4(c,d). The parameters of the model are adjusted so that an optimal fit is obtained with the field observations. The values for the growth rate, mortality rate and life span calculated thanks to the simulation are given in table 2.

LIFE-HISTORY PARAMETERS

1.- Life span

The life span computed for *Temora longicornis* varies between 23 and 39 days. Harris and Paffenhöfer (1976) have determined values in the range 21-30 for the same species grown *in vitro*. For *Pseudocalanus elongatus* the model gives a span of 19.5-25 days whereas Paffenhöfer and Harris (1976) find 24-29 days *in vitro*. Corkett and Urry (1968) give figures comprized between 14 and 116 days *in vitro*.

2.- Growth rate

According to the simulation, the growth rate tends to increase with the generation number. The rate computed for the nauplii of *Temora longicornis* varies between 0.09 and 0.24 day^{-1} . Harris and Paffenhöfer (1976) find a range of 0.12-0.21 *in vitro*. The copepodites exhibit growth rates between

Temora longicornis (O.F. Müller)

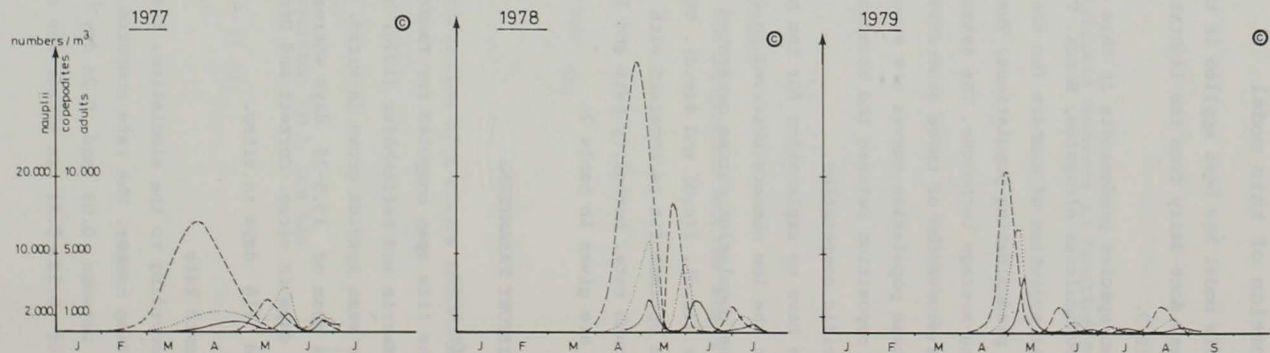
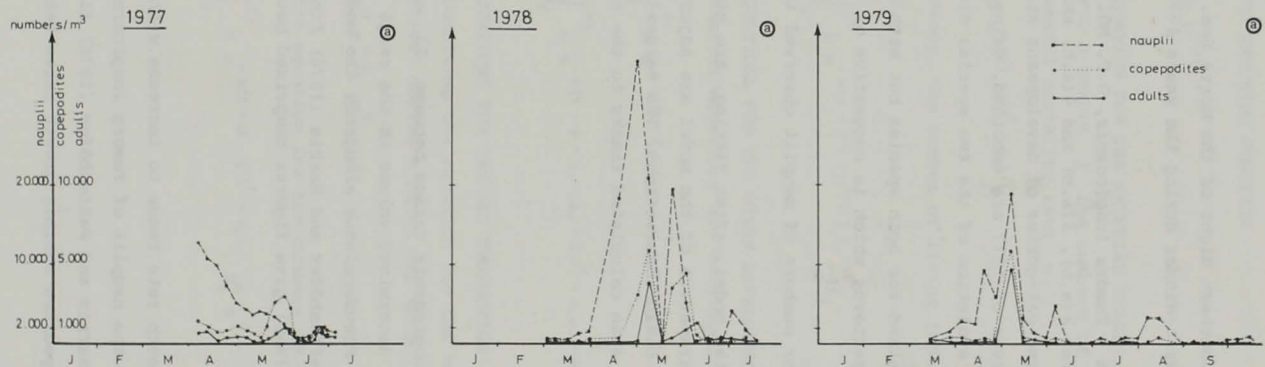

fig. 2.

fig. 3.

fig. 4.

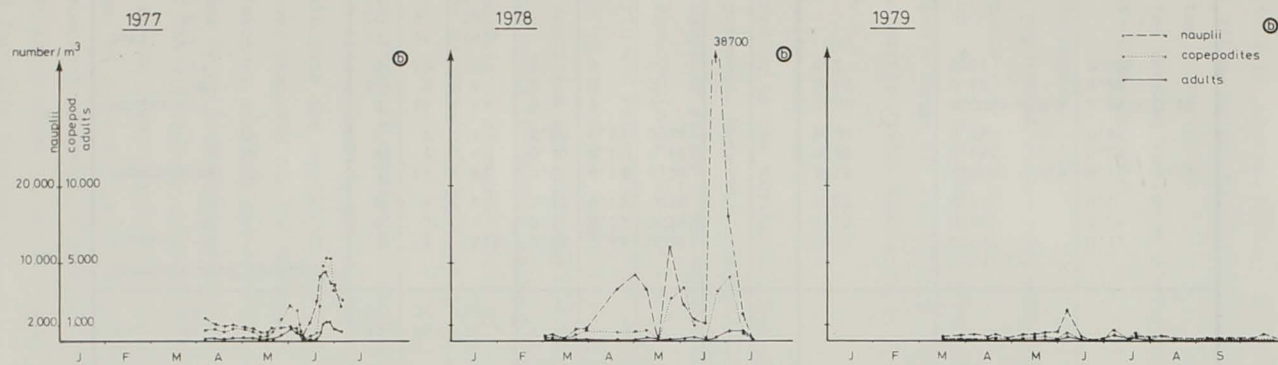

fig. 2.



fig. 3.

fig. 4.

0.13 and 0.33 whereas Harris and Paffenhöfer (1976) find a range of 0.14 - 0.54 *in vitro*. As far as *Pseudocalanus elongatus* is concerned, the simulation gives rates in the range 0.22 - 0.43 for the nauplii and 0.14 - 0.24 for the copepodites whereas the above mentioned authors find respectively 0.14 - 0.18 and 0.04 - 0.38 *in vitro*.

3.- Viable eggs

The population curves simulated imply minimal numbers i.e. viable eggs. These numbers vary here between 1 and 14 for a female of *Temora longicornis* and 7 to 93 for a female of *Pseudocalanus elongatus*. Harris and Paffenhöfer (1976) find a range of 17 - 871 for *Temora longicornis in vitro* and Paffenhöfer and Harris (1976) find a range of 2 - 136 for *Pseudocalanus elongatus in vitro*.

4.- Mortality rate

According to the simulation, the mortality rate decreases as the development proceeds. Moreover, adaptations of the rate are generally not needed for the naupliar stages : for *Temora longicornis* the range is 0.10 to 0.22 and for *Pseudocalanus elongatus* it is 0.13 to 0.25.

Harris and Paffenhöfer (1976) and Paffenhöfer and Harris (1976) find respectively 0.012 - 0.064 and 0.008 - 0.059 *in vitro* (recalculated figures). Where copepodites are concerned the ranges computed are 0.001 - 0.3 for *Temora longicornis* [0 - 0.0023 in Harris and Paffenhöfer (1976)] and 0.005 - 0.4 for *Pseudocalanus elongatus* [0 - 0.021 in Paffenhöfer and Harris (1976)]. There are no comparable data available for the adults.

Thus, there is generally a good agreement between the figures computed for an *in situ* situation and the figures determined *in vitro* where life span and growth rate are concerned. Discrepancies of one or two orders of magnitude are however observed for the mortality rate figures. This can be explained by the differences existing between the natural environment and the aquarium : none seems to be food-limiting but the natural environment is much more hazardous. The differences observed in the numbers of viable eggs could be explained by the lower probability for a female to reach maturity in nature.

Thus, in order to achieve reasonably good predictive properties, an improved zooplankton model, regulated by the environmental conditions prevailing in the Southern Bight of the North Sea, should put the emphasis on the mortality and fertility functions.

Budget of metabolic activities

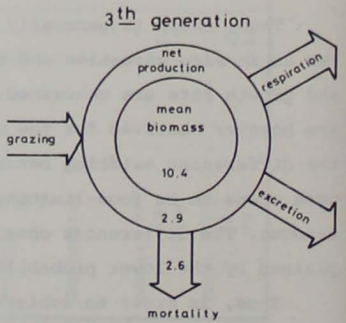
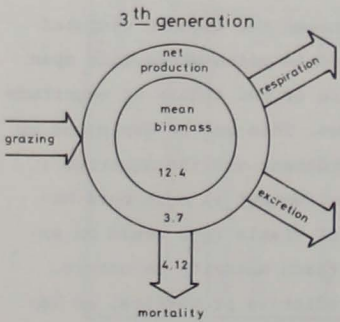
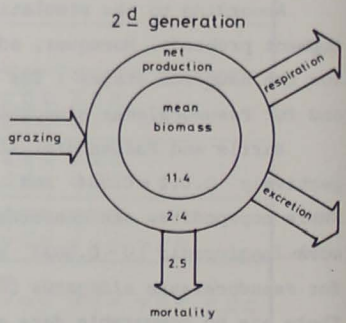
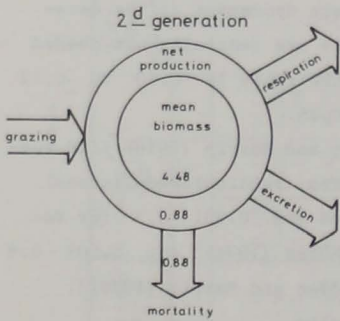
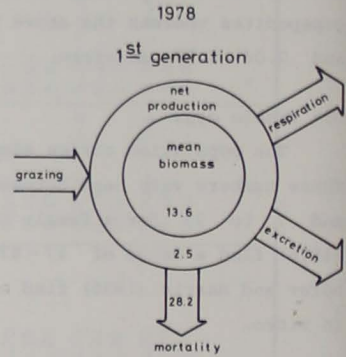
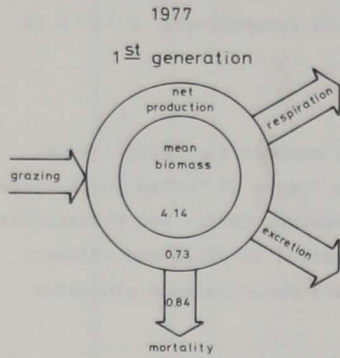
Pseudocalanus elongatus and *Temora longicornis* (mg C/m^3)

1979

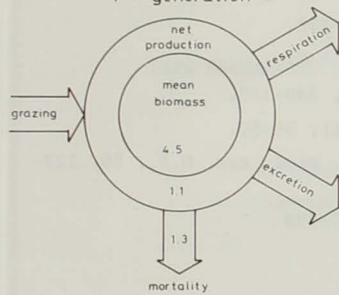
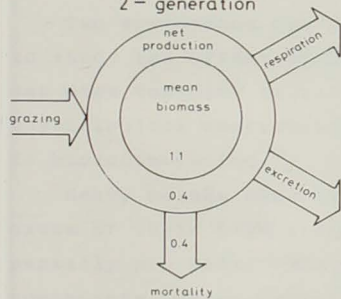
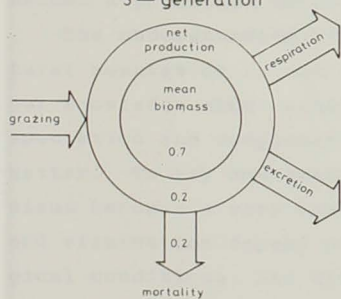
1st generation2^d generation3th generation

References

- CORKETT, C.J. and URRY, D.L. (1968). *J. Mar. Biol. Ass. U.K.*, 48, 97-105.
- GANDY, R. (1974). *Mar. Biol.*, 25, 125-141.
- HARRIS, R.P. and PAFFENHÖFER, G.A. (1976). *J. Mar. Biol. Ass. U.K.*, 56, 675-690.
- HEINLE, D.R. (1970). *Helg. Wiss. Meeres.*, 20, 360-372.
- Mc LAREN, I.A. (1965). *Limnol. Oceanogr.*, 10, 528-538.
- PAFFENHÖFER, G.A. (1970). *Helg. Wiss. Meeres.*, 20, 346-359.
- PAFFENHÖFER, G.A. (1976). *Limnol. Oceanogr.*, 21 (1), 39-50.
- PAFFENHÖFER, G.A. and HARRIS, R.P. (1976). *J. Mar. Biol. Ass. U.K.*, 56, 327-344.
- RAZOULS, S. (1974). *Ach. Zool. Exp. Gen.*, 115, 387-399.

Some mechanisms promoting or limiting bioaccumulation
in marine organisms

F. NOËL-LAMBOT, J.M. BOUQUEGNEAU and A. DISTECHE
Laboratory of Oceanology (Ecotoxicology Unit)
University of Liège, Belgium

Introduction

Two approaches can be followed separately or simultaneously to study the effect of heavy metals on marine organisms. Either one does toxicity tests and eventually tries to understand the physiological perturbations involved, or one is more interested in bioaccumulation.

Heavy metals tend to accumulate in living matter, simply because of their high affinity for numerous organic substances, especially proteins. Their binding to enzymes, or other cellular components, often explains their toxicity but inert traps - or at least apparently so - may exist. Heavily loaded animals then become a potential danger for predators.

The understanding of the fate of heavy metals released by natural sources or by man in the sea depends to a large extent on our knowledge about bioaccumulative processes without neglecting speciation and complexation with dissolved or suspended organic matter. To try and predict contamination levels in marine organisms becomes a very complicated matter furthermore since uptake and elimination depend on environmental circumstances, physiological conditions, and differ from species to species.

We will describe in this paper some mechanisms controlling the bioaccumulation of heavy metals, mainly Hg and Cd, by marine organisms.

Uptake

Heavy metals are taken up by marine animals either from water or from food. The relative importance of both routes varies from metal to metal and from animal to animal, but direct uptake from water is often much more important as we have shown earlier [Bouquegneau et al. (1976, 1979)].

Most of the metals in food are therefore found back in faeces at high concentrations, thus favouring vertical transport of heavy metals in the sea [Boothe and Knauer (1972) ; Benayoun et al. (1974)].

In most aquatic animals large surfaces are in direct contact with the surrounding water and hence with dissolved metals : gills, digestive tract and skin. Moreover, the digestive tract of teleosts and gills are submitted to a large continuous flow of water likely to increase adsorption probability.

The factors that control the direct entry are many : type of metal, its speciation, relative permeability of different organs, size of surface of contact, environmental factors (salinity, temperature, etc.), physiological conditions (age, etc.). For a recent review of the matter one should consult the papers from Bryan (1979) and Coombs (1980). To take an example from our own work, the gills of teleosts reveal to be less permeable to inorganic Hg^{++} than to $(\text{CH}_3\text{Hg})^+$ and their permeability for Cd^{++} is even smaller [Bouquegneau (1975) ; Noël-Lambot (1980)].

Several physiological mechanisms can be implied in the metal uptake by marine organisms. For instance, in most plants [see Coombs (1980)] simple passive diffusion phenomena are involved and, in that case, there exists a linear relationship between initial rate of intake and external concentration, but there are some examples in animals where the former increases more slowly than the latter, suggesting that heavy metal uptake might then

involve mechanisms that imply facilitated diffusion, i.e. carrier assisted transport, or even active transport as in the case with Na, K and Ca. This was shown in our laboratory working on *Serranus cabrilla* (Bouquegneau and Radoux, to be published) and also at the level of cadmium uptake by mussels [Coombs and George (1978)].

When considering metals bound to particulate or colloidal matter, there are moreover examples that the metal can be taken in by a process of endocytosis, as shown for the common mussel *Mytilus edulis*, able in that way to absorb iron and lead, present in sea water as colloidal hydrous oxides [George et al. (1976) ; Schulz-Baldes (1978)].

Release

The metal taken up by the animal is released at a rate varying considerably from case to case.

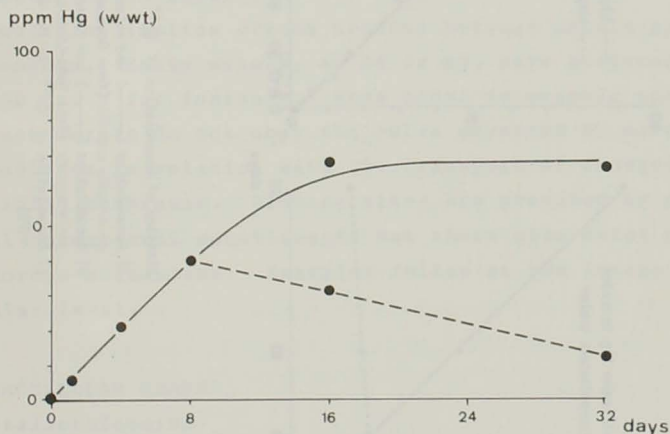

fig. 1.

Kinetics of accumulation and release of Hg in a tissue displaying a high rate of elimination : *Anguilla anguilla* gills.

— : intoxication in sea water containing 100 ppb Hg⁺⁺ as HgCl₂
 - - - : intoxicated fish put back in clean water (from Bouquegneau, 1975)

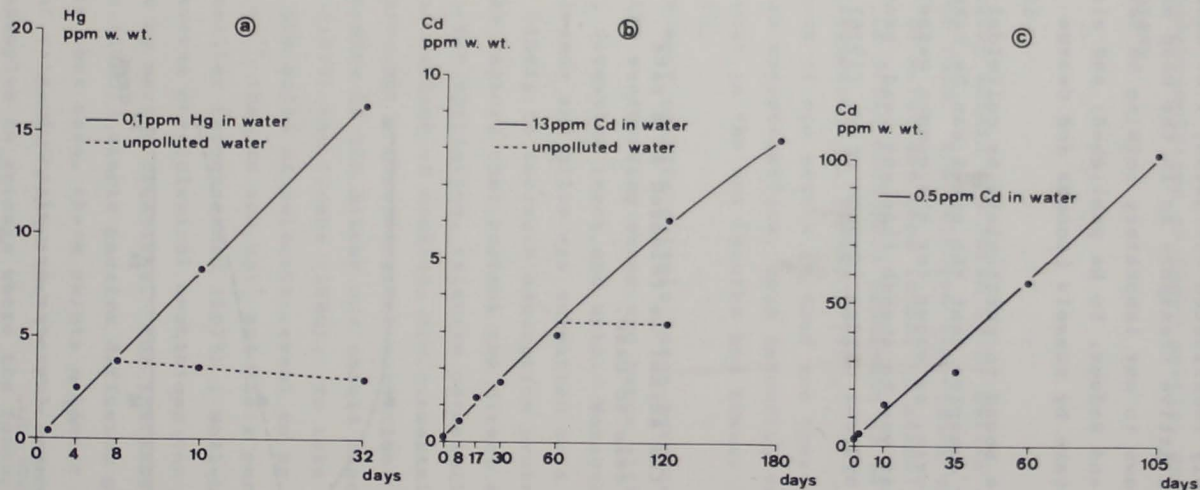

fig. 2.

Kinetics of accumulation of Hg^{++} or Cd^{++} in animals with slow elimination rate

- Accumulation (—) and release (-----) of Hg^{++} (HgCl_2) in the whole body of *Anguilla anguilla* (from Bouquegneau, 1975).
- Accumulation (—) and release (-----) of Cd^{++} in the whole body of *Anguilla anguilla* (from Noël-Lambot, 1960).
- Accumulation of Cd^{++} in the whole body of *Patella caerulea* (from Noël-Lambot, 1979).

If elimination is fast, the metal output will quickly balance the input and the metal concentration in the tissues will reach a plateau. Fig.1 describes such a case for *Anguilla anguilla* gills.

The same type of curve can of course also be observed in the absence of fast elimination, when for instance the rate of uptake is slowed down for some reason like for example the formation of a protective mucus layer [Bouquegneau et al. (1979) ; Radoux and Bouquegneau (1979)].

If the elimination is very slow, the kinetic of accumulation becomes linear. Fig.2 shows three examples for *Anguilla anguilla* and *Patella vulgata* intoxicated with Cd^{++} or Hg^{++} .

Accumulation - Storage mechanisms

If, as in the case in fig.2, the elimination of the heavy metal is extremely slow, why is it that uptake continues whilst the metal concentration in most of the tissues greatly exceeds that of the contaminated water ?

Accumulation implies strong binding between metals and cellular components. Heavy metals, as Cd or Hg, have a strong affinity for -SH group for instance. When bound to organic constituents such metals do not obey the rules governed by electrochemical gradients in relation with the transport of charged ions across living membranes. Binding sites are provided by practically all normal cell constituents but there also exist more specific storage mechanisms. Examples follow at the intra- and extracellular level.

1.- INTRACELLULAR TRAPS

1.1.- Metallothioneins

The properties of metallothioneins - low molecular weight proteins (6000 - 7000) with high cystein content (about 30 % of total amino acids) and a metal load corresponding to one atom for two or three cysteins - extracted from marine animals either Hg

or Cd intoxicated have been described in earlier papers [Noël-Lambot et al. (1978a,b) ; Bouquegneau et al. (1979)] and recent reviews are available on this subject [Bouquegneau and Noël-Lambot (1978) ; Kāgi and Nordberg (1979)]. Metallothioneins have first been considered to explain the resistance of animals when intoxicated with heavy metals [Piscator (1964) ; Nordberg (1971) ; Bouquegneau et al. (1975) ; Bouquegneau (1979)]. Actually, more attention is drawn on their role in bioaccumulation and we will here essentially deal with the case of Cd.

Cd induces the biosynthesis of metallothioneins in tissues where, in absence of exposure, no or very small amounts of these proteins can be detected. The total amount of metallothioneins grows steadily during intoxication and one is faced with a storage system, the size of which increases the more Cd there is to be trapped, either because of longer exposure or a larger Cd concentration.

One example of this phenomenon is given in fig.3. It shows the change with time of total Cd in the animal and that found at subcellular level in *Patella caerulea* tissues. The curve showing the kinetic of accumulation in the whole body is identical with the one presented in fig.2c.

The amount of Cd found in the MT fraction (see fig.3) - that is bound to metallothioneins - can be considered as a reliable estimate of the abundance of these proteins [Noël-Lambot et al. (1978b), (1980)]. Their concentration increases with time.

These laboratory results are quite comparable with observations made on a population of limpets (*Patella vulgata*) naturally exposed to Cd in the Bristol Channel.

Fig.4 shows a linear relationship between Cd concentration and body size [good indicator of age, see Noël-Lambot et al. (1980)], whereas in the case of Zn and Cu an inverse relationship is observed.

Most of the Cd in heavily loaded limpets is bound to metallothioneins, but this is not the case for Zn and Cu. Fig.5 shows a sharp correlation between total accumulated Cd and the Cd attached to thioneins.

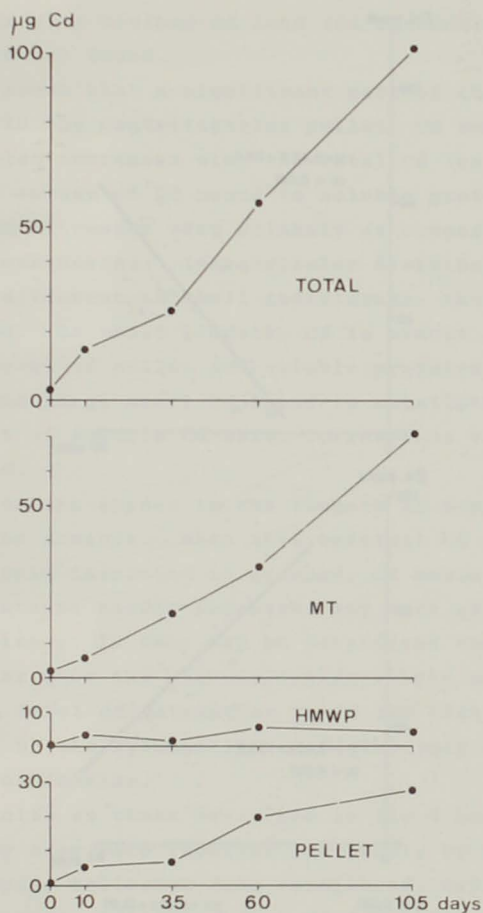

fig. 3.

Cd accumulation in whole limpets (*Patella caerulea*) and in their various subcellular fractions during an intoxication in sea water containing 0,5 ppm Cd. For each time of intoxication, the soft parts of three specimens were pooled and homogenized. After centrifugation, Cd was measured in the pellet and in the supernatant fractions separated by gel chromatography. All concentrations are expressed in μg metal/g whole tissue. MT = metallothioneins ; HMWP = soluble proteins of high molecular weight. (From Noël-Lambot, 1979.)

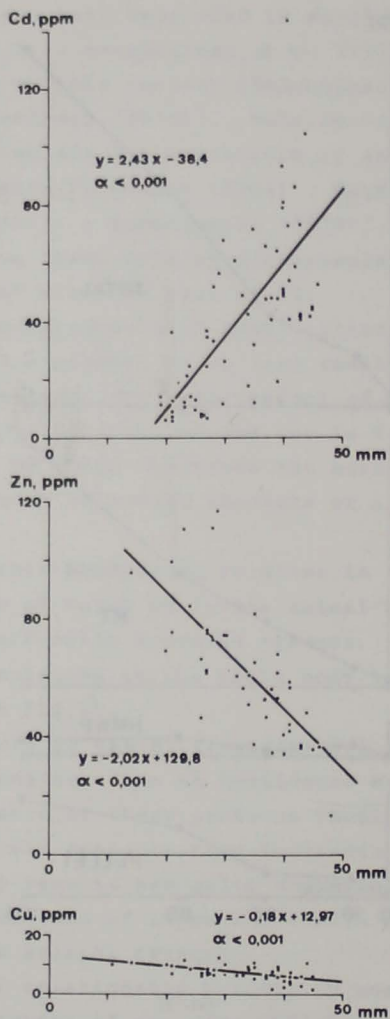

fig. 4.

Relation between metal concentration in soft tissue (ppm w.wt.) and shell length for Cd, Zn and Cu in limpets (*Patella vulgata*) collected from Weston-super-Mare. (From Noël-Lambot *et al.*, 1980.)

In young limpets with minimum Cd load (Cd concentration < 13 ppm) Cd-thioneins are not found.

Fig.5 also shows that a significant part of the total Cd is always present in the centrifugation pellet. Cd concentration in this fraction also increases with the total Cd load. On the other hand, the amount of Cd bound to soluble proteins of high molecular weight increases very slightly as compared to cadmium bound to metallothioneins. Intracellular distribution of Cd is, however, quite different in small individuals, thus having a low Cd concentration. In small limpets, Cd is almost exclusively stored at the level of pellet and soluble proteins of high molecular weight ; in large ones, Cd bound to metallothioneins represents about 85 % of soluble Cd which corresponds to approximately 50 % of total Cd.

Thus metallothioneins appear in the limpets at a critical level of Cd load in the tissues. When this critical Cd concentration for metallothionein induction is reached, Cd bound to high-molecular-weight proteins hardly increases any more as the total Cd concentration rises. It thus may be considered that metallothioneins only appear when the high-molecular-weight soluble proteins reach a certain level of saturation by Cd and that, from then on, Cd accumulation in the cytosol almost exclusively occurs at the level of metallothioneins.

Similar results as those described in fig.4 between metal content and body size were reported previously by Boyden (1974) for *Patella vulgata* collected from Portishead, Bristol Channel. This work, like ours, indicates that Cd displays a relationship opposite to Zn and Cu (fig.4), suggesting quite different metabolic pathways of these elements.

Concerning the increase of Cd concentration with body weight, Boyden (1974) concluded : "... this relationship can best be explained as being due to removal of this element from body circulation and accumulation within specific tissue, possibly as a result of some exceptional affinity".

Our results with Cd-thioneins confirm and allow to better understand this interpretation. Metallothioneins may be considered

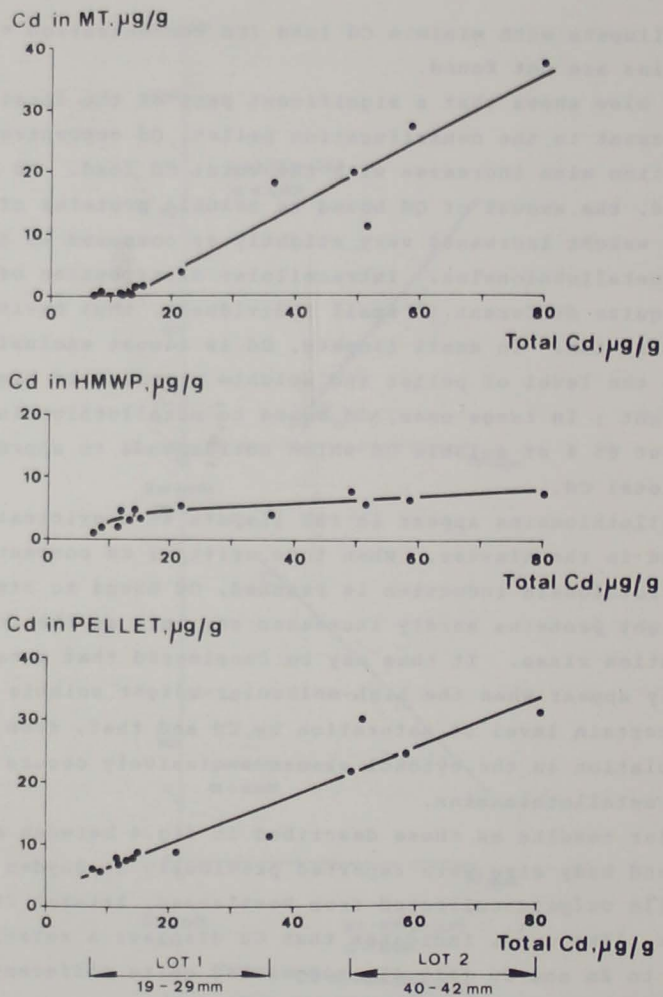

fig. 5.

Relation between Cd concentration in whole soft parts of limpets (*Patella vulgata*) collected from Weston-super-Mare and concentrations of Cd associated with (1) metallothioneins (MT); (2) high-molecular-weight proteins (HMWP) - both isolated by gel filtration of the supernatant of the homogenate; (3) the centrifugation pellet of this homogenate. All concentrations expressed in $\mu\text{g Cd/g}$ wet tissue. Based on shell length, limpets were classed into two lots. (From NoEl-Lambot *et al.*, 1980.)

as the specific Cd-binding compound responsible for the unusually high levels of Cd in old limpets. It is evident that increase in the amounts of metallothioneins with time corresponds to an equivalent increase of Cd-binding sites and thus to a more and more extensive capacity of Cd storage.

Moreover, as we previously pointed out [Bouquegneau et al. (1979)], binding of Cd to metallothioneins may explain how limpets from the Bristol Channel can tolerate such high Cd levels in their tissues : Cd complexed to thioneins may be considered as toxically inert. But can this mechanism be really considered as a protective system ? In other words, do metallothioneins protect limpets against Cd injury during a long term exposure ? The problem is not as simple as one would believe at first thought. There is no doubt that the synthesis of metallothioneins favours Cd bioaccumulation. But this means that in the eventual absence of synthesis of these proteins, one might expect that Cd concentration in the limpets or other animals either from the Bristol Channel or intoxicated in the laboratory would not reach such high values.

The question of the so called "protective effect" of metallothioneins thus consists in determining whether the presence of such proteins really reduces to a significant extent the amounts of Cd available to interact with normal cellular functions. The study of the uptake and intracellular location of Cd in relation to the synthesis of metallothioneins might help solve this question as well as further work on the general physiology of these animals, contaminated or not.

Results presented in fig.5 concern whole soft parts of limpets. Viscera have twice higher Cd concentrations than foot muscles but metallothioneins can be detected in both tissues where they bind about 80 % of soluble Cd.

It is surprising to observe relatively high levels of Cd bound to metallothioneins in limpet muscular tissues. This is quite different from observations made in vertebrates where muscles never reach concentrations higher than 1 or 2 ppm wet weight, even in the case of drastic Cd intoxication [Noël-Lambot and Bouquegneau

(1977)]. Moreover, muscle is to our knowledge the only tissue in which the existence of metallothioneins has so far not been reported. Once again, high Cd concentrations in tissue and abundance of metallothioneins seem to be closely linked.

When limpets from the Bristol Channel are exposed for 80 days to unpolluted sea water, the Cd level of the animals does not decrease and as previously observed for other species under laboratory conditions [Bouquegneau *et al.* (1979)], the largest part of the metal persists as Cd-thionein, although the cause of the formation of these proteins has disappeared [Noël-Lambot *et al.* (1980)]. Cadmium is thus really trapped by the metallothioneins.

The observations on limpets have been confirmed and complemented by studies on other invertebrates collected in the Bristol Channel, in the British Channel or at Cape Gris-Nez.

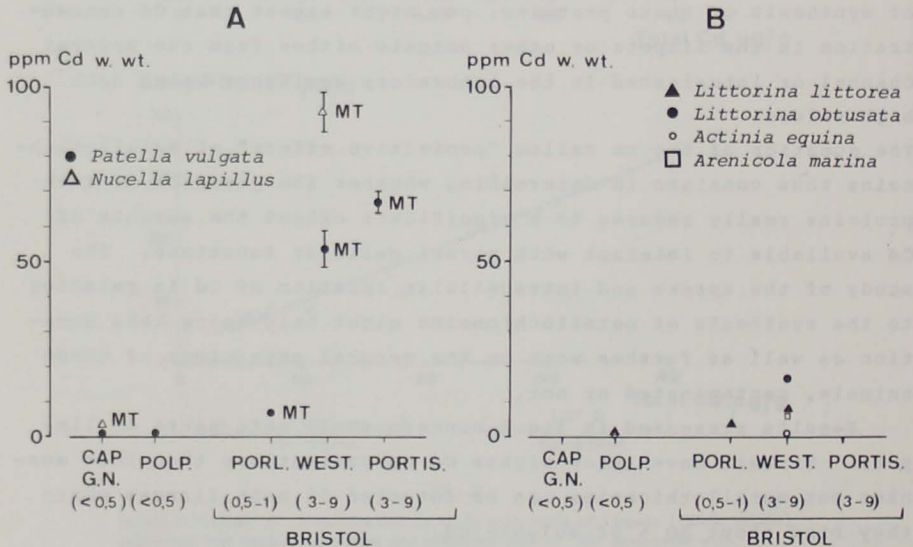

fig. 6.

Cd concentration ($m \pm$ standard error) and occurrence of metallothioneins in some invertebrates collected from various localities of the Bristol Channel or from unpolluted areas (see figure 7). For species presented in graph A, metallothioneins were identified in the population living in the Bristol Channel. This is indicated by the mention "MT". For species of graph B, metallothioneins were undetectable in all populations. Approximate Cd concentration in water (in ppb) is given under the name of the stations.

Fig.6 (see fig.7 for the location of the explored sites) shows clearly that in all the studied species high Cd concentration is always related to high metallothionein content.

Cd content increases with age only in animals with metallothioneins.

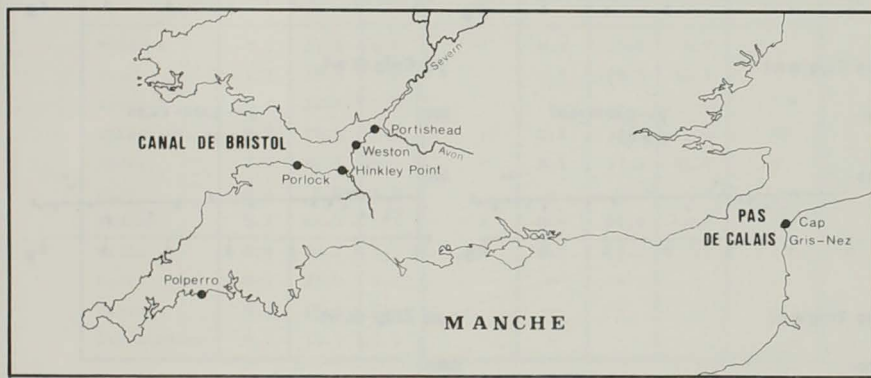

fig. 7.

Location of stations referred to in fig. 6

When the Cd level required to induce metallothionein formation is low (as is the case for dog whelk, *Nucella lapillus*), there is a direct relationship between Cd concentration and size, even in populations exposed to very low Cd concentrations (Cape Gris-Nez, fig.8).

No such correlation is observed in limpets living in non polluted water [Boyden (1974)] and no metallothioneins are formed [Noël-Lambot et al. (1978a)].

In eels and flets (*Anguilla anguilla* and *Platichthys flesus*) collected in the Bristol Channel, similar observations can be made. Table 1 gives the Cd, Zn and Cu levels in various organs. As was observed in laboratory experiments [Noël-Lambot (1980)] on fish exposed to large concentrations of Cd, the tissues displaying the highest Cd level are also those that contain thio-

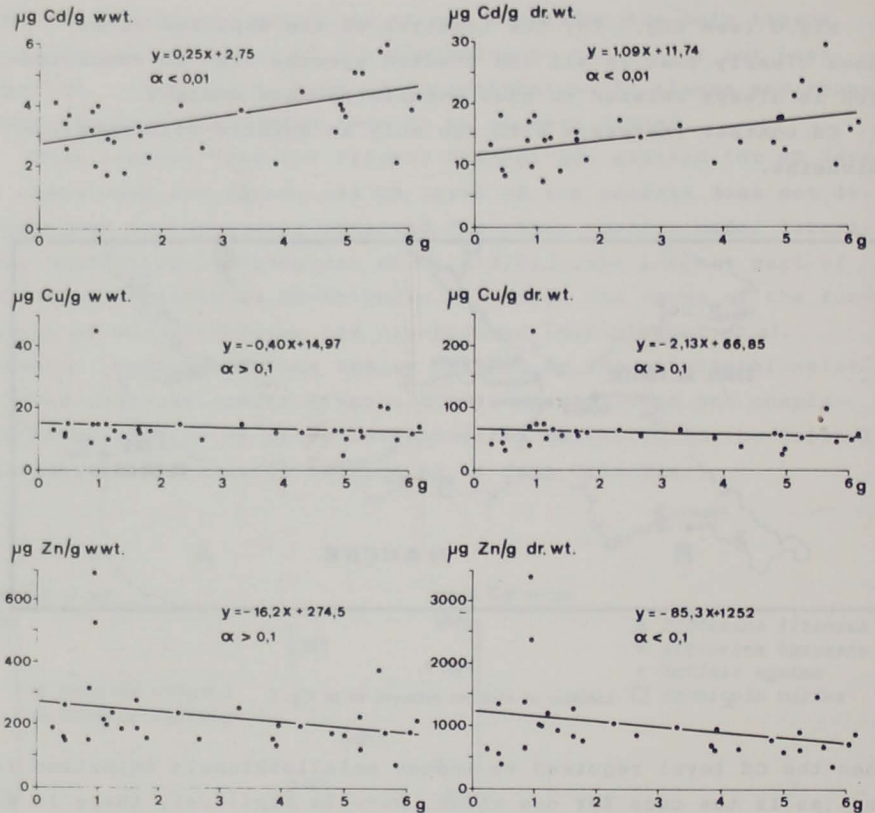

fig. 8.

Relationship between Cd, Cu or Zn concentrations in soft tissue (ppm wet or dry weight) and total wet weight of the animals (with shell) in dogwhelks, *Nucella lapillus*, collected from Cape Gris-Nez, Pas-de-Calais, France.

neins. In liver and kidney for instance, it is possible to detect an increase of Cd with age (Mears and Eisler (1977), Müller and Prosi (1978)), but this has never been shown for muscle (Lovett et al. (1972) ; Stevens and Brown (1974) ; Tong (1974)).

To conclude briefly the capacity of marine animals to synthesize metallothioneins when exposed to Cd explains the well known process of cumulative absorption, the long half-time of the bound

Table 1

Concentration of Cd, Zn and Cu in various organs of two teleosts captured at Hinkley Point (Bristol Channel) in connection with the presence or not of metallothioneins (from Noël-Lambot, 1980).

| | <i>Anguilla anguilla</i> (49 cm) | | | | <i>Platichthys flesus</i> (31 cm) | | | |
|-------------|----------------------------------|------|------|----------------|-----------------------------------|-------|------|----------------|
| | Concentration, µg/g | | | Presence of MT | Concentration, µg/g | | | Presence of MT |
| | Cd | Zn | Cu | | Cd | Zn | Cu | |
| Muscles | 0.3 | 11.5 | 0.5 | - | 0.3 | 13.5 | 0.6 | - |
| Skin | 1.1 | 18.2 | 3.6 | | 0.2 | 138.3 | 13.1 | |
| Stomach | 0.3 | 22.0 | 1.5 | | - | - | - | |
| Intestine | 0.5 | 24.0 | 2.0 | +? | 0.5 | 37.3 | 2.4 | +? |
| Liver | 2.9 | 42.5 | 20.7 | + | 0.4 | 53.2 | 25.1 | + |
| Bile | 0.4 | 5.8 | 4.9 | | - | - | - | |
| Kidney | 9.5 | 68.3 | 3.1 | + | 0.5 | 87.9 | 4.0 | +? |
| Gills | 0.4 | 20.1 | 1.3 | - | 0.2 | 20.2 | 1.2 | - |
| Heart | <0.2 | 23.8 | 2.1 | | - | - | - | |
| Brain | 0.2 | 18.0 | 2.2 | | - | - | - | |
| Air-bladder | 0.2 | 15.2 | 10.5 | | - | - | - | |

+ : clear evidence of MT

+?: MT near the detection limit

- : MT below the detection limit

metal and how some animals can tolerate extremely high contamination levels when chronically exposed.

The existence of these proteins to which Hg, Cu and Zn also bind cannot be ignored in ecotoxicological research applied to marine systems. They were so far only studied in mammals and their existence in other phyla was only shown recently. Reviews written by Kāgi and Nordberg (1979), Noël-Lambot *et al.* (1980) tend to show that these proteins might well be widely distributed in the biosphere.

It is interesting to note that properties of metallothioneins extracted from limpets living in the Bristol Channel (see tables 2 and 3) are very similar to those from other molluscs and from vertebrates (Kāgi and Nordberg (1979) ; George *et al.* (1979) ; Franckene *et al.* (1980)). Limpets have at least two metallothioneins carrying different charges, they probably as in mammals correspond to isoproteins (Kojima and Kāgi (1978)).

Table 2

Amino acid composition of metallothioneins from *Patella vulgata* (from Noël-Lambot *et al.*, 1980)

| Amino acid | Number of residues (%) □ | |
|------------------|--------------------------|------|
| | MTa | MTb |
| Lysine | 8.8 | 8.6 |
| Histidine | 1.0 | 1.4 |
| Arginine | 0.8 | 0.9 |
| Aspartic acid | 11.2 | 12.0 |
| Threonine | 7.2 | 6.8 |
| Serine | 8.8 | 8.5 |
| Glutamic acid | 7.7 | 8.5 |
| Proline | 3.8 | 4.1 |
| Glycine | 11.0 | 10.6 |
| Alanine | 8.7 | 8.9 |
| △ Cysteine (1/2) | 21.0 | 20.0 |
| Valine | 3.2 | 2.7 |
| ○ Methionine | 0.5 | 0.5 |
| Isoleucine | 1.8 | 1.5 |
| Leucine | 2.6 | 2.7 |
| Tyrosine | 1.8 | 1.8 |
| Phenylalanine | 1.0 | 1.0 |
| ▶ Tryptophan | - | - |

□ 24 h hydrolysis

△ Determined as cysteic acid

○ Determined as methionine sulfone

▶ Not determined

It is clear that the fate of Cd discharged in the environment depends greatly on the presence or absence of metallothioneins in living matter and what happens after death. A knowledge of threshold Cd concentrations triggering the biosynthesis of these proteins and of the rate at which they are formed appears to be essential to investigate the impact of Cd pollution.

Table 3

Metal content (number of metallic ions per 30 cysteinyl residues) of metallothioneins from *Patella vulgata* (from Noël-Lambot *et al.*, 1980)

| | Cd | Zn | Cu | Total | Cysteine metal |
|-----|------|----|-----|-------|----------------|
| MTa | 12.4 | 0 | 0.9 | 13.3 | 2.3 |
| MTb | 12.0 | 0 | 1.0 | 13.0 | 2.3 |

1.2.- Membrane limited granular structures

Besides being capable of storing heavy metals on thioneins, many animals can accumulate these toxics in intracellular granules or vesicles. This phenomenon of metal storage in particulate structures is very widespread in marine and terrestrial invertebrates and its occurrence has been shown in numerous phyla [Ballan-Dufrançais et al. (1979) ; George and Pirie (1979) ; Janssen and Scholz (1979) ; Georges et al. (1980) ; for a review, see Coombs (1980)].

Some recent results suggest that metallothioneins may also be associated with particulate structures within the cell and not be freely available within the cytoplasm [George and Pirie (1979); C. Ballan-Dufrançais and A.Y. Jeantet, personal communication (1979)].

2.- EXTRACELLULAR TRAPS

The mucus layer or the cuticle of water exposed tissues (skin, intestine, gills) of marine animals and microorganisms through which metals penetrate the body may be considered as extracellular traps because of their high affinity for many heavy metals [Martin (1970) ; Cossa (1976) ; Wright (1977) ; Kremling et al. (1978)]. These external storage sites generally act as a limiting factor to the entry of the metals and in some way control internal bioaccumulation.

2.1.- Branchial mucus of teleosts

The mucus layer on fish gills has a very high affinity for Hg as shown in table 4. In eels adapted to sea water the gills are the main route of entry of dissolved Hg (Bouquegneau (1975)). Fixation of Hg by branchial mucus is an important step, since it means that the metal is first heavily concentrated in mucus before it reaches the branchial tissue where it is found at a much lower concentration, to be finally transported to the different organs by the blood circulation.

Table 4

Time evolution of the mercury concentration in the mucus of the gills, the gill tissue and the whole body of eels (*Anguilla anguilla*) intoxicated in sea water containing 50 ppb Hg (HgCl_2)

| Time of exposure | Hg concentration (ppm w.wt.) | | | |
|------------------|------------------------------|-----------------|------------------|------------|
| | sea water | Branchial mucus | Branchial tissue | Total body |
| 1 day | 0.05 | 31 | 3 | 0.5 |
| 2 days | 0.05 | 14 | 4 | 1 |
| 4 days | 0.05 | 60 | 1 | 2 |

Some of the heavy metals are known to stimulate mucus production by fish [Eisler (1974) ; Varanasi and Markey (1978)]. They also can induce increased mucus shedding [Baker (1969) ; Coombs et al. (1972)].

Working with *Serranus cabrilla* we have observed an increase of mucus production by gills during HgCl_2 intoxication. It results both from a stimulation of secretion and from an increase of the number of mucus producing cells in the branchial epithelium (Bouquegneau and Radoux, to be published). This increase of the mucus layer considerably limits the absorption of Hg^{++} , since the Hg loaded mucus is regularly shed. The accumulation kinetics in the whole body reflects this limiting process : although elimination of Hg stored inside the animal is very slow, the level reached in these animals quickly comes to a plateau [see Bouquegneau et al. (1979) ; Radoux and Bouquegneau (1979)]. This observation is clearly explained by a limitation of the rate of entry because of mucus formation and subsequent delamination.

In *Anguilla anguilla*, where the whole body accumulation of Hg is linear in time (fig.2), no effect of the metal has been found on the production of mucus (Bouquegneau et al., to be published).

2.2.- Intestinal corpuscles in teleosts

In several species of sea water fish, white mucous corpuscles may be observed in the intestinal lumen of unfed animals (fig.9).



fig. 9.

Intestinal corpuscles in *Anguilla anguilla* in a longitudinal section of the intestine

This material, regularly evacuated by the anus was termed "intestinal corpuscles" [Distèche (1974) ; Noël-Lambot (1980)]. Its content in Ca and Mg is very high ; these metals are probably present in the form of carbonates precipitated from the sea water contained in the intestine at the level of an organic support made of mucus and cellular debris.

In fish intoxicated with CdCl_2 , ZnCl_2 or CuCl_2 added to sea water, the corpuscles are found to contain enormous concentrations of these metals and although their weight is small, they carry a very large part of the total metals found in the animals. The data presented in fig.10 show the intestinal corpuscles retain more than 99 % of the Cd present in the intestine and this amount of trapped Cd is even greater than the total Cd accumulated by all the tissues of the animal during 6 hrs intoxication. The corpuscles are eliminated with the faeces. The presence of

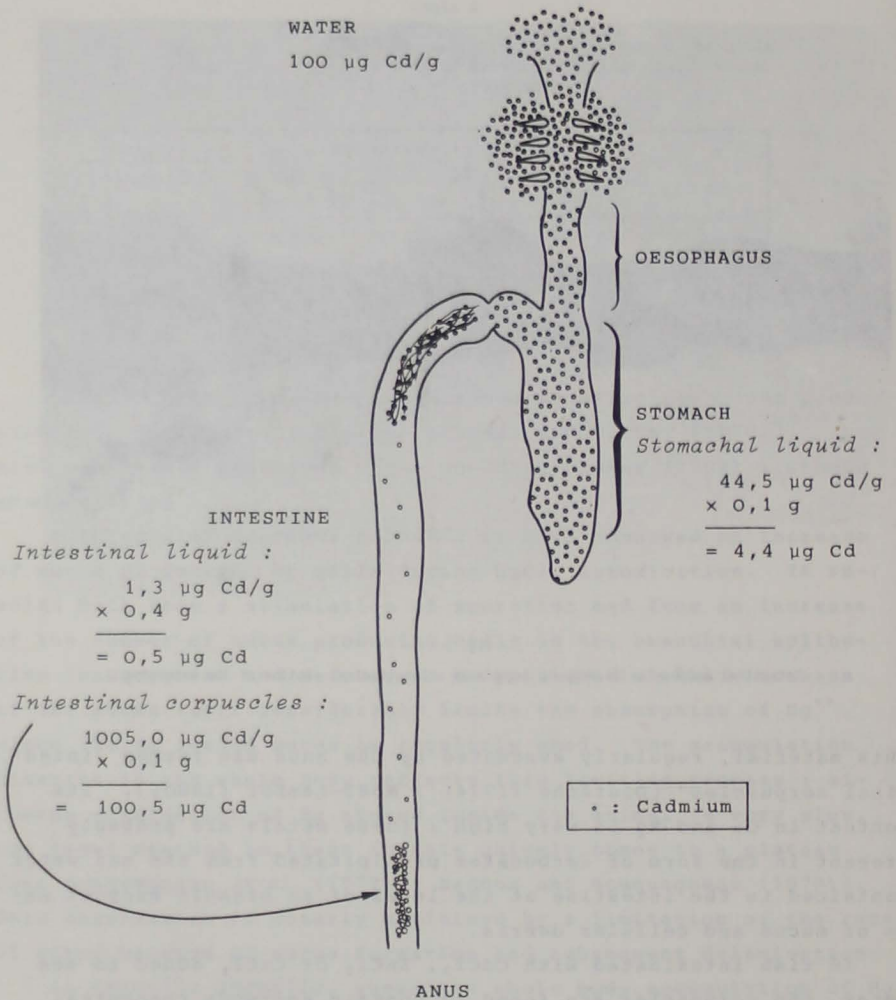

fig. 10.

Cd concentration inside the digestive tract of eels intoxicated during 6 hrs in sea water containing 100 ppm Cd. For each constituent the Cd concentration (ppm or µg/g) is given as well as the load (µg) equal to the product of the concentration and the weight of the constituent considered. The loads are calculated for eels the weight of which being adjusted to 100 g.

intestinal corpuscles, directly accumulating Cd or other metals from the sea water ingested by the animals, seems therefore to

greatly limit the entry of heavy metals through the intestinal wall and thus protect fish against these pollutants.

2.3.- "Mucous pellets" in Tunicates

The mucous secretions of the branchial pharynx and of the intestine of Tunicates can accumulate large quantities of Cd. Mucous filaments or pellets enriched in Cd are regularly ejected by the exhalant siphon. The mean Cd concentration of these secretions is 1700 ppm when the water concentration is kept at 0.5 ppm. As in fish the amount of Cd attached on these little mucous filaments is larger than the total Cd present in the whole animal (fig.11).

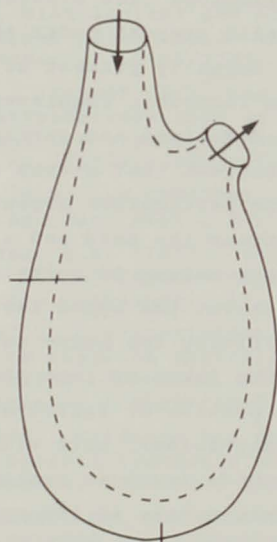

Soft tissues :

Cd conc. : 5,3 ppm
w.wt
Cd content : 32 μ g

Mucous pellets :

Mean Cd conc. : 1700 ppm
w.wt.
Cd content of the pellets produced during 10 days : 170 μ g.

Tunic : Cd conc. : 13 ppm w.wt.
Cd content : 65 μ g

fig. 11.

Cd concentration and content in mucus pellets and in the tissues of *Halocynthia papillosa* after 10 days intoxication in sea water containing 0.5 ppm Cd (CdCl_2)

It is well known that in these animals the branchial pharynx, especially the endostyle, produces large amounts of mucus and protein secretions (Thorpe and Barrington (1965)). Olsson (1963) has shown that some of the excreted proteins are rich in sulphur which might explain Cd fixation.

Conclusions

While we don't know yet the exact details of the physico-chemical and physiological mechanisms implied in the translocation of heavy metals, we have to bear in mind a general picture of the fate of heavy metals discharged in a marine environment when dealing with ecotoxicology (and bioaccumulation).

Few or no metals remain present under their ionic form. Some, like iron and lead, are normally present as colloidal hydrous oxides. Other ones form inorganic complexes, but most of heavy metals are bound to the dissolved and particulate organic matter.

In this regard, we suggest that plants and animals should be considered as part of the particulate organic matter. There is indeed a competition between the dead and alive particulate organic matter to adsorb heavy metals in solution.

When considering animals, the mucus layer which covers the whole body has a high affinity for heavy metals. First adsorbed at that level, they may be taken up into the tissues by physiological processes such as passive or facilitated diffusion and active transport. Those mechanisms, both with the high affinity of some intracellular compounds (such as proteins), may lead to a huge accumulation of toxic metals in the organisms.

How can organisms tolerate such high concentration since, in many cases, they remain able to survive and reproduce normally?

Two storage mechanisms inside the cells, can account for such phenomena : either a binding to metallothioneins or a storage inside vesicles.

Another way to control high concentrations is to increase the rate of excretion of the pollutant or to decrease the rate of en-

try into the cells, for example by an increase of the mucus secretion by the external tissues.

Another mechanism responsible for the accumulation of heavy metals in organisms is an uptake via the food chain. In some cases (inorganic Hg, Cd), it has been shown that little metal could be taken up by that way. The consequence is then an important increase of the metal faeces concentrations which, after elimination and sedimentation, may lead to an enrichment in heavy metals of benthic ecosystems.

References

- BAKER, J.T.P. (1969). Histological and electron microscopical observation on copper poisoning in the winter flounder. *J. Fish. Res. Bd Canada*, 28, 2785-2793.
- BALLAN-DUFRANCAIS, C., JEANTET, A.Y. and QUINTANA, C. (1979). Toxicologie du méthylmercure chez un Insecte : mise en évidence du métal dans les lysosomes par microsonde électronique. *C. R. Acad. Sc. Paris*, 288, 847-849.
- BENAYOUN, G., FOWLER, S.W. and OREGIONI, B. (1974). Flux of Cd through Euphausiids. *Mar. Biol.*, 27, 205-212.
- BOOTHE, P.B. and KNAUER, G.A. (1972). The possible importance of fecal material in the biological amplification of trace and heavy metals. *Limnol. Oceanogr.*, 17, 270-274.
- BOUQUEGNEAU, J.M. (1975). *L'accumulation du mercure et ses effets physiologiques chez Anguilla anguilla (Linnaeus, 1758) et Myoxocephalus scorpius (Linnaeus, 1758)*. Thèse de doctorat en sciences zoologiques - Université de Liège, Belgique.
- BOUQUEGNEAU, J.M. (1979). Evidence for the protective effect of metallothioneins against inorganic mercury injuries to fish. *Bull. Environm. Contam. Toxicol.*, 23, 218-219.
- BOUQUEGNEAU, J.M., GERDAY, Ch. and DISTECHE, A. (1975). Fish Hg-binding thionein related to adaptation mechanisms. *FEBS Letters*, 55, 173-177.
- BOUQUEGNEAU, J.M., NOËL-LAMBOT, F. and DISTECHE, A. (1976). Le problème de l'intoxication directe et indirecte par les métaux lourds. In : J.C.J. Nihoul and A. Distèche (Ed.), Contamination des Produits de la mer, Programme national de Recherche et de Développement. Environnement Eau - Projet Mer. Services du Premier Ministre, Programmation de la Politique Scientifique, Bruxelles, pp.266-292.

- BOUQUEGNEAU, J.M. and NOËL-LAMBOT, F. (1978). Les métallothionéines : structure, fonction et incidence dans les milieux marins pollués par les métaux lourds. In : Actualités de Biochimie marine : les métaux en milieu marin. Editions du CNRS.
- BOUQUEGNEAU, J.M., NOËL-LAMBOT, F. and DISTECHE, A. (1979). Fate of heavy metals in experimental aquatic food chain, uptake and release of mercury and cadmium by some marine organisms. Role of metallothioneins. *ICES, CM 1979/E : Environ.Qual.Com.*
- BOYDEN, C.R. (1974). Trace element content and body size in molluscs. *Nature*, 251, 311-314.
- BRYAN, G.W. (1979). Bioaccumulation of marine pollutants. In : The assessment of sublethal effects of pollutants in the sea. *The Royal Society, London*, pp. 483-505.
- COOMBS, T.L. and GEORGE, S.G. (1978). Mechanisms of immobilization and detoxication of metals in marine organisms. In : D.S. Mc Lusky and A.J. Berry (Ed.), *Physiology and behaviour of marine organisms*. Pergamon Press, Oxford, pp. 179-187.
- COOMBS, T.L. (1980). Heavy metal pollutants in the aquatic environment. In : R. Gilles (Ed.), *Animals and environmental fitness*. Pergamon Press, Oxford.
- COOMBS, T.L., FLETCHER, T.C. and WHITE, A. (1972). Interaction of metal ions with mucus from the plaice, *Pleuronectes platessa* L. *Biochem. J.*, 128, 128-129.
- COSSA, D. (1976). Sorption du Cd par une population de la diatomée *Phaeodactylum tricornutum* en culture. *Mar. Biol.*, 34, 163-167.
- DISTECHE, A. (1974). Physiological effects of some pollutants. In : Belgian National R-D Program on the Environment - Water-Sea Project. Mathematical Model. Annual Report IV. Office of the Prime Minister. I.C.S.P., pp. 247-296.
- EISLER, R. (1974). Radiocadmium exchange with seawater by *Fundulus heteroclitus* (L.) (Pisces : Cyprinodontidae). *J. Fish Biol.*, 6, 601-612.
- FRANKENNE, F., NOËL-LAMBOT, F. and DISTECHE, A. (1980). Isolation and characterization of metallothioneins from cadmium-loaded mussels *Mytilus edulis*. *Comp. Biochem. Physiol.* (in press).
- GEORGE, S.G., CARPENE, E., COOMBS, T.L., OVERNELL, J. and YOUNGSON, A. (1979). Characterization of cadmium-binding proteins from mussels, *Mytilus edulis* (L.), exposed to cadmium. *Biochim. Biophys. Acta*, 580, 225-233.
- GEORGE, S.G. and PIRIE, B.J. (1979). The occurrence of cadmium in sub-cellular particles in the kidney of the marine mussel, *Mytilus edulis*, exposed to cadmium. The use of electron microprobe analysis. *Biochim. Biophys. Acta*, 580, 234-244.
- GEORGES, S.G., PIRIE, B.J.S. and COOMBS, T.L. (1976). The kinetics of accumulation and excretion of ferric hydroxide in

- Mytilus edulis* (L.) and its distribution in the tissues. *J. exp. mar. Biol. Ecol.*, 23, 71-84.
- GEORGES, S.G., PIRIE, B.J. and COOMBS, T.L. (1980). Isolation and elemental analysis of metal-rich granules from the kidney of the scallop. *J. exp. mar. Biol. Ecol.* (in press, cited by COOMBS, 1980).
- JANSSEN, H.H. and SCHOLZ, N. (1979). Uptake and cellular distribution of cadmium in *Mytilus edulis*. *Mar. Biol.*, 55, 133-141.
- KÄGI, J.H.R. and NORDBERG, M. (1979). Metallothionein. *Experientia*, Supplementum 34, Birkhäuser Verlag, Basel.
- KOJIMA, Y. and KÄGI, J.H.R. (1978). Metallothionein. *Trends Biochem. Sci.*, 3, 90-93.
- KREMLING, K., PIUZE, J., VON BRÖCKEL, K. and WONG, C.S. (1978). Studies on the pathways and effects of cadmium in controlled ecosystem enclosures. *Mar. Biol.*, 48, 1-10.
- LOVETT, R.J., GUTENMANN, W.H., PAKKALA, I.S., YOUNGS, W.D., LISK, D.J., BURDICK, G.E. and HARRIS, E.J. (1972). A survey of the total Cd content of 406 fish from 49 New York State fresh waters. *J. Fish. Res. Bd Canada*, 29, 1283-1290.
- MARTIN, J.H. (1970). The possible transport of trace metals via moulted copepod exoskeletons. *Limnol. Oceanogr.*, 15, 756-761.
- MEARS, H.C. and EISLER, R. (1977). Trace metals in liver from Bluefish Tautog and Tilefish in relation to body length. *Chesapeake Sc.*, 18, 3, 315-318.
- MÜLLER, G. and PROSI, F. (1978). Verteilung von Zink, Kupfer und Cadmium in verschiedenen Organen von Plötzen (*Rutilus rutilus* L.) aus Neckar und Elsenz. *Z. Naturforsch.*, 33C, 7-14.
- NOËL-LAMBOT, F. (1979). Cadmium accumulation correlated with increase in metallothioneins concentration in the limpet *Patella caerulea*. 1st Conf. European Society Comparative Physiology Biochemistry "Animals and Environmental Fitness", 27-31 August 1979. Liège, Belgium. Pergamon Press.
- NOËL-LAMBOT, F. (1980). *La bioaccumulation du cadmium en milieu marin*. Thèse de doctorat, Université de Liège, Belgique, University Microfilms International, Ann Arbor, Michigan, 1980.
- NOËL-LAMBOT, F. and BOUQUEGNEAU, J.M. (1977). Comparative study of toxicity, uptake and distribution of cadmium and mercury in the sea water adapted eel *Anguilla anguilla*. *Bull. Environ. Contam. Toxicol.*, 18, 418-424.
- NOËL-LAMBOT, F., BOUQUEGNEAU, J.M., FRANKENNE, F. and DISTECHE, A. (1978a). Le rôle des métallothionéines dans le stockage des métaux lourds chez les animaux marins. *Rev. intern. Océanogr. méd.*, 49, 13-20.
- NOËL-LAMBOT, F., BOUQUEGNEAU, J.M., FRANKENNE, F. and DISTECHE, A. (1980). Cadmium, zinc and copper accumulation in limpets (*Patella vulgata*) caught off the Bristol Channel with special reference to metallothioneins. *Mar. Ecol. Prog. Ser.*, 2, 81-89.

- NOËL-LAMBOT, F., GERDAY, Ch. and DISTECHE, A. (1978b). Distribution of Cd, Zn and Cu in liver and gills of the eel *Anguilla anguilla* with special reference to metallothioneins. *Comp. Biochem. Physiol.*, 61C, 177-187.
- NORDBERG, G.F. (1971). Effects of acute and chronic cadmium exposure on the testicles of mice with special reference to protective effects of metallothionein. *Environ. Physiol.*, 1, 171-187.
- OLSSON, R. (1963). Endostyles and endostylar secretions : a comparative histochemical study. *Acta Zoologica*, 44, 299-328.
- PISCATOR, M. (1964). Cd in the kidneys of normal beings and the isolation of metallothionein from liver of rabbits exposed to Cd. *Nord. Hyg. Tidskr.*, 45, 76-82.
- RADOUX, D. and BOUQUEGNEAU, J.M. (1979). Uptake of mercuric chloride from sea water by *Serranus cabrilla*. *Bull. Environ. Contam. Toxicol.*, 22, 771-778.
- SCHULZ-BALDES, M. (1978). Lead transport in the common mussel, *Mytilus edulis*. In : D.S. Mc Lusky and A.J. Berry (Eds.). *Physiology and Behaviour of Marine Organisms*. Pergamon Press, Oxford and New York, pp. 211-218.
- STEVENS, J.D. and BROWN, B.E. (1974). Occurrence of heavy metals in the Blue Shark *Prionace glauca* and selected pelagic in the N.E. Atlantic Ocean. *Mar. Biol.*, 26, 287-293.
- THORPE, A. and BARRINGTON, E.J.W. (1965). The histochemical basis of iodine binding in *Ciona*. Abstracts of papers for the 3d Conf. Eur. Comp. Endocrinologists. August 2-5, 1965. *Gen. Comp. Endocrin.*, 5, (6).
- TONG, S.S.C. (1974). Trace metals in Lake Cayuga lake trout (*Salvelinus namayoush*) in relation to age. *J. Fish. Res. Bd Canada*, 31, 238-239.
- VARANASI, U. and MARKEY, D. (1978). Uptake and release of lead and cadmium in skin and mucus of Coho Salmon (*Oncorhynchus kisutch*). *Comp. Biochem. Physiol.*, 60C, 187-191.
- WRIGHT, D.A. (1977). The effect of salinity on cadmium uptake by the tissues of the shore crab, *Carcinus maenas* (L.). *J. exp. Biol.*, 63, 137-146.

15445

The residual circulation of the North Sea

Jacques C.J. NIHOUL and Yves RUNFOLA

with contributions from

Francis CLEMENT, Pol CLOSSET, Christiane DEMEZ, Salim DJENIDI,
Eric MAITREJEAN and François C. RONDAY

Geophysical Fluid Dynamics, Liège University

Introduction

Hydrodynamic models of the North Sea are primarily concerned with tides and storm surges and the associated currents which can have velocities as high as several meters per second.

However the period of the dominant tide is only about a half day and the characteristic life time of a synoptic weather pattern is of the order of a few days. The very strong currents which are produced by the tides and the atmospheric forcing are thus relatively transitory and a Marine Biologist will argue that over time scales of biological interest, they change and reverse so many times that they more or less cancel out, leaving only a small residual contribution to the net water circulation.

The importance of tidal and wind induced currents on the generation of turbulence and the mixing of water properties is of course not denied but many biologists would be content with some rough parameterization of the efficiency of turbulent mixing and, for the rest, some general description of the long term transport of "water masses".

Although the concept of "moving water masses", and its train of pseudo-lagrangian misdoings, appeal to chemists and biologists who would like to find, in the field, near-laboratory

conditions, it is impossible to define it in any scientific way and charts of the North Sea's waters like the one shown in figure 1 and reproduced from Laevastu (1963) are easily misinterpreted and often confuse the situation by superposing a flow pattern on an apparently permanent "geography" of water masses.

The notion of "residual" circulation - which, at least, has an Eulerian foundation - has long remained almost as vague. Some people have defined it as the observed flow minus the computed tidal flow. Such a definition is understandable from a physical point of view but one must realize that the residual flow so-defined contains all wind-induced currents, including small scale fluctuations. It is definitely not a steady or quasi-steady flow and some attempts to visualize it by means of streamlines are questionable. What it represents, in terms of marine chemistry or marine ecology is not at all clear.

Actually, if one wants to take the point of view of the marine ecologist, what one should really look at is the *mean flow* over some appropriate period of time of biological interest.

It is customary for experimentalists to compute, from long series of observations, daily, weekly and monthly averages.

What such averages actually represent is debatable.

No doubt that tidal currents are essentially removed in this process. However with tidal velocities, one or two orders of magnitude higher than residual velocities and the latter of the order of traditional current-meters' errors, one may fear that, as a result of the non-linearities of the equipment, the error remains the same order of magnitude after averaging and leads to a 100 % inaccuracy in the calculated mean residual (e.g. Nihoul, 1980).

Moreover the choice of the periods of time over which the averages are made is not obvious as it seems to rely more on the calendar than on physical processes. One must be quite clear of what one gets from such averages.

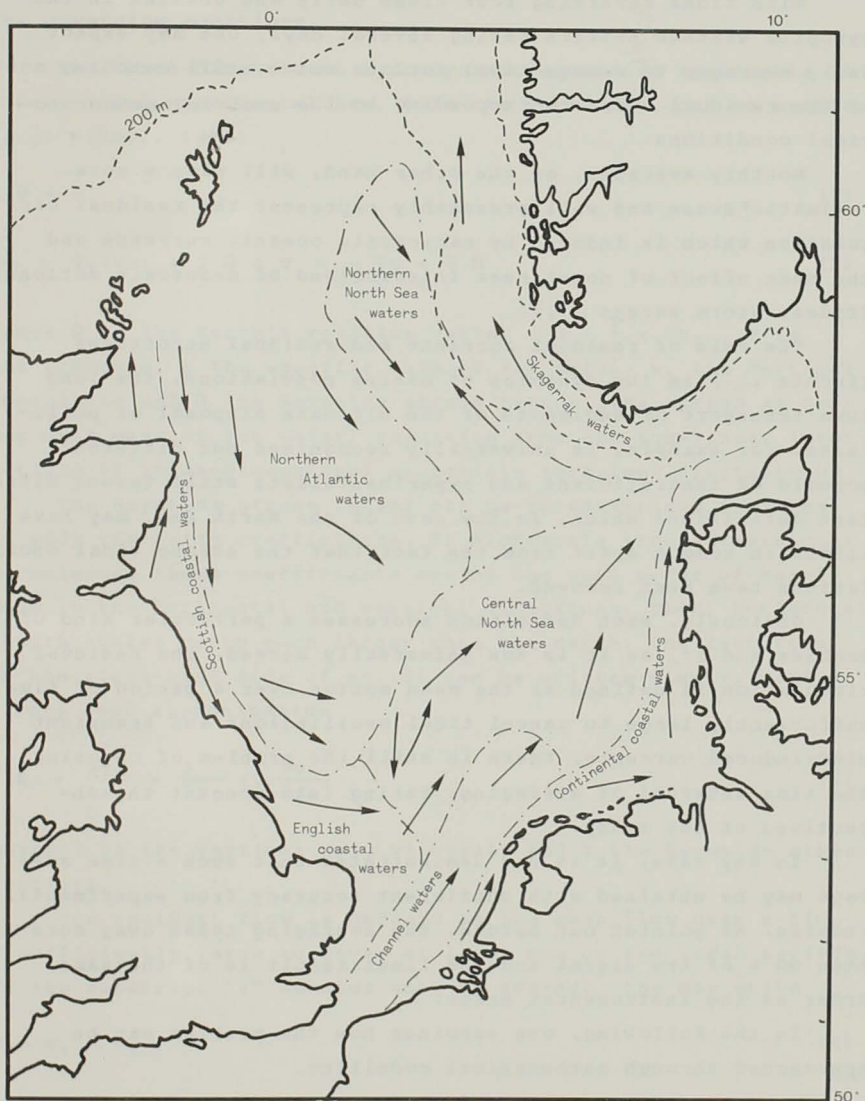

fig. 1.

Water types in the North Sea according to Laevastu (1963)

With tides reversing four times daily and changes in the synoptic weather pattern taking several days, one may expect daily averages to remove tidal motions while still catching most of the residual currents responding to the evolving meteorological conditions.

Monthly averages, on the other hand, will have a more "climatic" sense and will presumably represent the residual circulation which is induced by macroscale oceanic currents and the mean effect of non-linear interactions of mesoscale motions (tides, storm surges ...).

The role of residual currents and residual structures (fronts ...) in the dynamics of marine populations, the long term transport of sediments or the ultimate disposal of pollutants, for example, is universally recognized but different schools of theoreticians and experimentalists still favour different definitions which, in the case of the North Sea, may have little in common apart from the fact that the strong tidal oscillations have been removed.

Obviously, each definition addresses a particular kind of problem and if, as it is now universally agreed, the residual circulation is defined as the mean motion over a period of time sufficiently large to cancel tidal oscillations and transient wind-induced currents, there is still the problem of choosing the time interval of averaging, taking into account the objectives of the study.

In any case, it is not demonstrated that such a time average may be obtained with sufficient accuracy from experimental records. As pointed out before, the averaging takes away more than 90 % of the signal and the final result is of the same order as the instrumental error.

In the following, one examines how the problem can be approached through mathematical modelling.

The governing equations

The three-dimensional hydrodynamic equations applicable to a well-mixed continental sea, like the North Sea, can be written (e.g. Nihoul, 1975)

$$\nabla \cdot \mathbf{v} = 0 \quad (1)$$

$$\frac{\partial \mathbf{v}}{\partial t} + \nabla \cdot (\mathbf{v}\mathbf{v}) + 2 \boldsymbol{\Omega} \wedge \mathbf{v} = - \nabla q + \nabla \cdot \mathbf{R} \quad (2)$$

where $\boldsymbol{\Omega}$ is the Earth's rotation vector, $q = \frac{P}{\rho} + gx_3$, P is the pressure, ρ the specific mass of sea water, x_3 the vertical coordinate and \mathbf{R} the Reynolds stress tensor (the stress is here per unit mass of sea water) resulting from the non-linear interactions of three-dimensional microscale turbulent fluctuations.

The Reynolds stress tensor can be parameterized in terms of eddy viscosity coefficients. In microscale three-dimensional turbulence, these coefficients are of the same order of magnitude in the horizontal and vertical directions. Then, horizontal length scales being much larger than the depth, the last term in the right-hand side of eq. (2) can be written simply, with a very good approximation

$$\nabla \cdot \mathbf{R} = \frac{\partial \boldsymbol{\tau}}{\partial x_3} = \frac{\partial}{\partial x_3} (\tilde{\nu} \frac{\partial \mathbf{v}}{\partial x_3}) \quad (3)$$

where $\tilde{\nu}$ is the vertical eddy viscosity and $\boldsymbol{\tau}$ the Reynolds stress (vector).

The residual flow is defined as the mean flow over a time T sufficiently large to cover at least one or two tidal periods. If the subscript "0" denotes such an average, one may write

$$\mathbf{v} = \mathbf{v}_0 + \mathbf{v}_1 \quad (4)$$

with

$$\frac{1}{T} \int_t^{t+T} \mathbf{v} dt = \mathbf{v}_0 \quad (5)$$

$$\frac{1}{T} \int_t^{t+T} \mathbf{v}_1 dt = 0 \quad (6)$$

What V_0 and V_1 , respectively include depends on the time of integration T .

If T is of the order of one day (exactly two or three periods of the dominant M_2 tide), $T \sim 10^5$, the averaging eliminates the tidal currents and smoothes out all current fluctuations, -generated by variations of the wind field, for instance- , which have a time smaller than T .

However, as mentioned before, changes in the synoptic weather pattern have time scales comparable with $T \sim 10^5$. Thus, unless one considers periods of negligible meteorological forcing, $T \sim 10^5$ does not correspond to a valley in the energy spectrum of the currents. In that case, one cannot derive an equation for V_0 by averaging eq.(2) and assuming that, as for an ensemble average, the averaging commutes with the time derivative. Furthermore, V_0 defined in this way, depends very much on time and doesn't correspond to the quasi-steady drift flow the biologists have in mind when they talk about residuals.

One might argue that such a time dependent daily mean is still worth calculating to follow the response of the sea to the evolving weather pattern especially in storm conditions. However a time step of the order of 10^5 is too large to predict the storm-induced currents with accuracy and it is much wiser, in that case, to forget about averaging and solve eq.(1) and (2) for tides and storm surges simultaneously.

Thus, "daily" residuals do not seem to be appropriate to describe real situations in the North Sea.

From a mathematical point of view, however, one can always consider the mean currents over two or three tidal periods, neglecting all atmospheric influence. Such "tidal residuals" emphasize the part played by tidal motions in determining the residual circulation and, with very much less computer work needed, they give a fairly good idea of the "climatic residual circulation" described below.

If one takes, now, a much greater time of averaging, say T of the order of 10^6 (\sim two weeks) to 10^7 (\sim four months) one may expect, over such a long time, a great variety of different

meteorological conditions resulting in an almost random atmospheric forcing on the sea. The current patterns will reflect the atmospheric variability and, on the average, there will be only a small residue.

The mean flow over a time $T \sim 10^6, 10^7$ may be regarded as the "climatic residual" flow which affects the dynamics of biological populations, the long term transport of sediments and the slow removal of pollutants.

The climatic circulation in the North Sea is produced by the inflow and outflow of macroscale Atlantic currents, by the action of the mean wind stress and, as shown below, by the mean effect of non-linear interactions of mesoscale motions (tides, storm surges ...).

The equations for the climatic residual flow may be obtained by taking the average of eqs. (1) and (2) over the chosen time T ($T \sim 10^6, 10^7$).

The time derivative in the left-hand side of eq. (2) gives a contribution

$$\frac{\mathbf{v}(t+T) - \mathbf{v}(t)}{T} \quad (7)$$

Since the time T has been chosen a multiple of the main tidal period and large enough to cover a great variety of meteorological events, one should expect the numerator of (7) to be of the same order as the residual velocity \mathbf{v}_0 . If one takes it to be one order of magnitude larger to be on the safe side, one finds

$$\frac{\mathbf{v}(t+T) - \mathbf{v}(t)}{T} \lesssim 0(10^{-5} v_0) \quad (8)$$

The average of the Coriolis acceleration is

$$2 \boldsymbol{\Omega} \wedge \mathbf{v}_0 \sim 0(10^{-4} v_0)$$

One may thus neglect the contribution of the time derivative in the equation for \mathbf{v}_0 .

The climatic residual circulation is then given by the steady state equations

$$\nabla \cdot \mathbf{v}_0 = 0 \quad (10)$$

$$\nabla \cdot (\mathbf{v}_0 \mathbf{v}_0) + 2 \boldsymbol{\Omega} \wedge \mathbf{v}_0 = - \nabla q_0 + \frac{\partial \tau_0}{\partial x_3} + \nabla \cdot \mathbf{N} \quad (11)$$

where

$$\mathbf{N} = (- \mathbf{v}_1 \mathbf{v}_1)_0 \quad (12)$$

Since \mathbf{v}_0 is one or two orders of magnitude smaller than \mathbf{v}_1 , which contains in particular the tidal currents, the first term in the left-hand side of eq. (12) is completely negligible. The tensor \mathbf{N} in the right-hand side plays, for mesoscale motions, a role similar to that of the turbulent Reynolds stress tensor \mathbf{R} in eq. (2) and may be called the "mesoscale Reynolds stress tensor". The last term in the right-hand side of eq. (11) represents an additional force acting on the residual flow and resulting from the non-linear interactions of mesoscale motions (tides, storm surges ...).

The importance of this force was discovered, first, by depth-integrated numerical models of the residual circulation in the North Sea (Nihoul 1974, Nihoul and Ronday 1975) and the associated stress was initially referred to as the "tidal stress" to emphasize the omnipresent contribution of tidal motions.

The mesoscale Reynolds stress tensor

The tensor \mathbf{N} can be computed explicitly by solving eqs. (1) and (2) for mesoscale motions and taking the climatic average of the dyadic $\mathbf{v}_1 \mathbf{v}_1$.

In fact the solution of eqs. (1) and (2) with appropriate wind forcing and open sea boundary conditions yields

$$\mathbf{v} = \mathbf{v}_0 + \mathbf{v}_1$$

and one may reasonably ask the question why one must go through the process of computing \mathbf{N} and solving eqs. (10) and (11) to obtain the residual velocity \mathbf{v}_0 i.e. why one cannot solve (1) and (2) for the total velocity \mathbf{v} and simply derive \mathbf{v}_0 from \mathbf{v} directly, by averaging the solution of eqs. (1) and (2).

The problem here, again, is that, in the North Sea, \mathbf{v}_1 represents 90 % of \mathbf{v} . If one allows for an error $\delta\mathbf{v}$ on \mathbf{v} of, say, 10 %, resulting from the imprecision of open sea boundary conditions and from the approximations of the numerical method, the error is of the same order of magnitude as the residual flow \mathbf{v}_0 .

Because of non-linearities, one may fear that, in the averaging process, this error does not, for the essential, cancel out as \mathbf{v}_1 does. Thus averaging the solution \mathbf{v} of eqs. (1) and (2), one gets $\mathbf{v}_0 + (\delta\mathbf{v})_0$ i.e. the residual velocity with an error which may be as large as 100 % (Nihoul and Roday, 1976a).

The procedure is conceivable when modelling a very limited area (near a coast, for instance) where the mesh size of the numerical grid can be reduced and where the open-sea boundary conditions can be determined with greater accuracy by direct measurements. Then $\delta\mathbf{v}$ can be made small enough for the average $\mathbf{v}_0 + (\delta\mathbf{v})_0$ to provide a satisfactory evaluation of the residual flow \mathbf{v}_0 .

In the case of the North Sea or, even, the Southern Bight or the English Channel, models of such a high accuracy are prohibitively expensive and cannot be considered for routine forecasting.

However, the classical models give \mathbf{v}_1 with a fair accuracy and they can be used to compute the mesoscale stress tensor \mathbf{N} .

The latter can be substituted in eq. (11) and the system of eqs. (10) and (11) can be solved very quickly to obtain \mathbf{v}_0 .

One can show that, in this way, one can determine \mathbf{v}_0 with good accuracy.

Typical values for the North Sea show that, in general, the two terms $2 \boldsymbol{\Omega} \wedge \mathbf{v}_0$ and $\nabla \cdot (-\mathbf{v}_1 \mathbf{v}_1)_0$ are of the same order of magnitude.

If $\delta \mathbf{v}_1$ is the error on \mathbf{v}_1 , one has

$$\begin{aligned} \delta [\nabla \cdot (-\mathbf{v}_1 \mathbf{v}_1)_0] &\sim [\nabla \cdot (-\mathbf{v}_1 \mathbf{v}_1)_0] \frac{\delta v_1}{v_1} \\ &\sim O(2\Omega v_0 \frac{\delta v_1}{v_1}) \end{aligned}$$

This error induces an error $\delta \mathbf{v}_0$ on \mathbf{v}_0 given by

$$2 \Omega \wedge \delta \mathbf{v}_0 \sim \delta [\nabla \cdot (-\mathbf{v}_1 \mathbf{v}_1)_0] \sim O(2\Omega v_0 \frac{\delta v_1}{v_1})$$

i.e.

$$\frac{\delta v_0}{v_0} \sim \frac{\delta v_1}{v_1}$$

Hence the *relative* error is the same on \mathbf{v}_0 and on \mathbf{v}_1 and not the *absolute* error as before. Thus if v_1 can be computed with, say, a 90 % precision, the solution of the averaged equations (10) and (11) will give the residual circulation with the same 90 % precision.

The equation for the horizontal transport

If one writes

$$\mathbf{v} = \mathbf{u} + w \mathbf{e}_3 \quad ; \quad \mathbf{u} = \mathbf{u}_0 + \mathbf{u}_1 \quad (13); (13')$$

emphasizing the horizontal velocity vector \mathbf{u} , one defines the residual horizontal transport as

$$\mathbf{U}_0 = \int_{-h}^{\zeta_0} \mathbf{u}_0 \, dx_3 = H_0 \bar{\mathbf{u}}_0 \quad (14)$$

where $\bar{\mathbf{u}}_0$ is the depth-averaged velocity, $H_0 = h + \zeta_0$, h is the depth and ζ_0 the residual surface elevation. ($H_0 \sim h$ because $\zeta_0 \ll h$).

The derivation of equations for the residual transport by integration of eqs. (10) and (11) over depth is quite straight-

forward (e.g. Nihoul, 1975a). One finds, after some reordering,

$$\nabla \cdot \mathbf{U}_0 = 0 \quad (15)$$

$$f \mathbf{e}_3 \wedge \mathbf{U}_0 = -H_0 \nabla q_0 - \kappa \mathbf{U}_0 + \Theta \quad (16)$$

where

$$\kappa = \frac{D \|\bar{\mathbf{u}}_1\|_0}{H_0} \quad (17)$$

$\bar{\mathbf{u}}_1$ denoting the depth-mean of \mathbf{u}_1 , and Θ standing in brief for

$$\tau_0^s + \tau_0^n - \tau_0^b$$

where

(i) τ_0^s is the residual wind stress

(ii) τ_0^n is the mesoscale Reynolds stress

$$\tau_0^n = \int_{-h}^{\zeta_0} \nabla \cdot (-\mathbf{v}_1 \mathbf{u}_1)_0 \, dx_3 \quad (18)$$

(iii) τ_0^b is the mesoscale "friction stress"

$$\tau_0^b = (D \|\bar{\mathbf{u}}_1\| \bar{\mathbf{u}}_1)_0 \quad (19)$$

The friction stress is the part of the residual bottom stress (the first part is $-\kappa \mathbf{U}_0$) which results from the non-linear interactions of mesoscale motions. It is analogous to the Reynolds stress τ_0^n and represents an additional forcing on the residual flow.

Since \mathbf{U}_0 is a two-dimensional horizontal vector, eq. (15) suggests the introduction of a stream function $\psi(x_1, x_2)$ such that

$$U_{0,1} = -\frac{\partial \psi}{\partial x_2} \quad (20)$$

$$U_{0,2} = \frac{\partial \psi}{\partial x_1} \quad (21)$$

Eliminating q_0 between the two horizontal components of eq. (16), one obtains then a single elliptic equation for ψ , viz. [using (20)]

$$\begin{aligned} \frac{K}{h} \nabla^2 \psi + \frac{\partial \psi}{\partial x_1} \left[\frac{\partial}{\partial x_1} \left(\frac{K}{h} \right) + \frac{\partial}{\partial x_2} \left(\frac{f}{h} \right) \right] + \frac{\partial \psi}{\partial x_2} \left[\frac{\partial}{\partial x_2} \left(\frac{K}{h} \right) - \frac{\partial}{\partial x_1} \left(\frac{f}{h} \right) \right] \\ = \frac{\partial}{\partial x_1} \left(\frac{\theta_2}{h} \right) - \frac{\partial}{\partial x_2} \left(\frac{\theta_1}{h} \right) \end{aligned} \quad (22)$$

This equation must be solved with appropriate boundary conditions. If one can simply take $\psi = \text{const.}$ along the coasts, the conditions on the open-sea boundaries are much more difficult to assess. One has estimates of the total inflows through the Straits of Dover [$\sim 7400 \text{ km}^3 \cdot \text{y}^{-1}$ (Van Veen, 1938; Carruthers, 1935)], the Northern boundary [$\sim 23000 \text{ km}^3 \cdot \text{y}^{-1}$ (Kalle, 1949; Laevastu, 1963)], through the Skagerrak [$\sim 479 \text{ km}^3 \cdot \text{y}^{-1}$ (Ices Skagerrak Expedition)] as well as of the contribution of the main rivers [$\sim 245 \text{ km}^3 \cdot \text{y}^{-1}$ (Mc Cave, 1974)] but the distribution of these flows along the boundaries are poorly known and one must resort to interpolation formulas which may or may not represent adequately the contribution, to the residual circulation of the North Sea, of inflowing or outflowing oceanic macroscale currents (e.g. Rondoy, 1975). A better determination of the conditions along open-sea boundaries is needed and should be considered with the highest priority in the near future.

Eq. (22) shows the influence on the residual flow of the residual friction coefficient K and its gradient, of the distribution of depths, on the curl of the residual wind stress and of the mesoscale stresses τ_0^n and τ_0^l .

In relatively coarse grid models of the whole North Sea (where the variations of K and h are partly smoothed out), the effect of the mesoscale stresses appears to be the most spectacular. This is illustrated by figures (2), (3) and (4), figuring the residual circulation in negligible wind conditions. Figure (2) shows the residual flow pattern assuming a constant depth of 80 m and neglecting τ_0^n and τ_0^b .

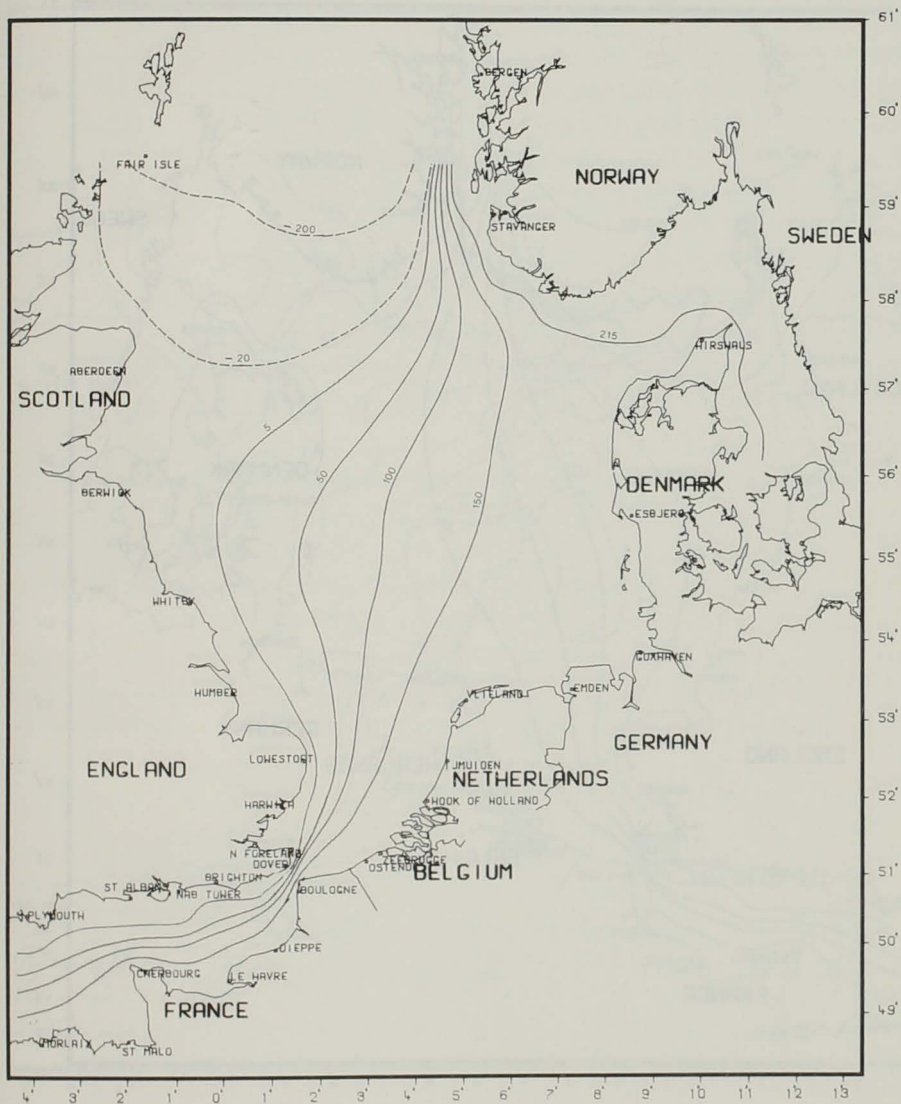

fig. 2.

Residual circulation in the North Sea calculated in negligible wind conditions assuming a constant depth and neglecting the mesoscale stresses. (Streamlines in $10^3 \text{ m}^3 \text{ s}^{-1}$)

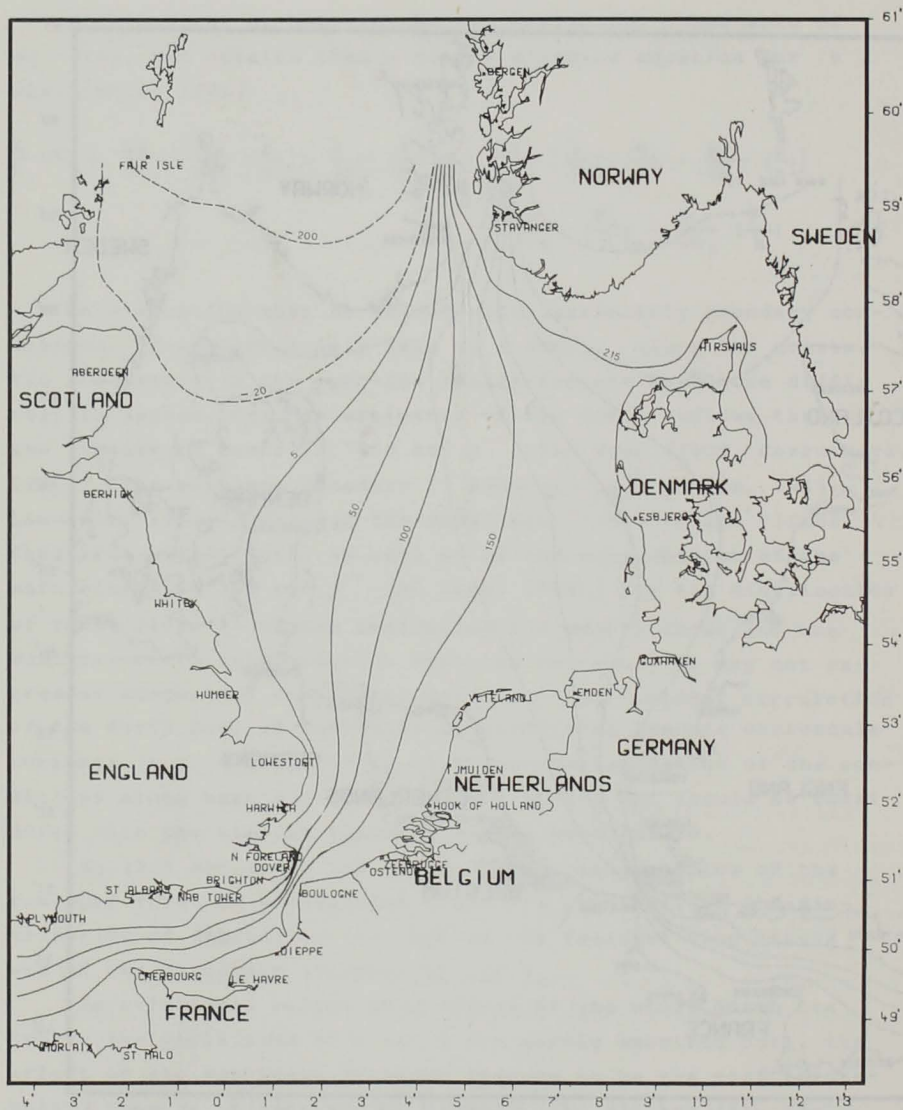

fig. 3.

Residual circulation in the North Sea calculated in negligible wind conditions with the real depth distribution neglecting the mesoscale stresses. (Streamlines in $10^3 \text{ m}^3 \cdot \text{s}^{-1}$)

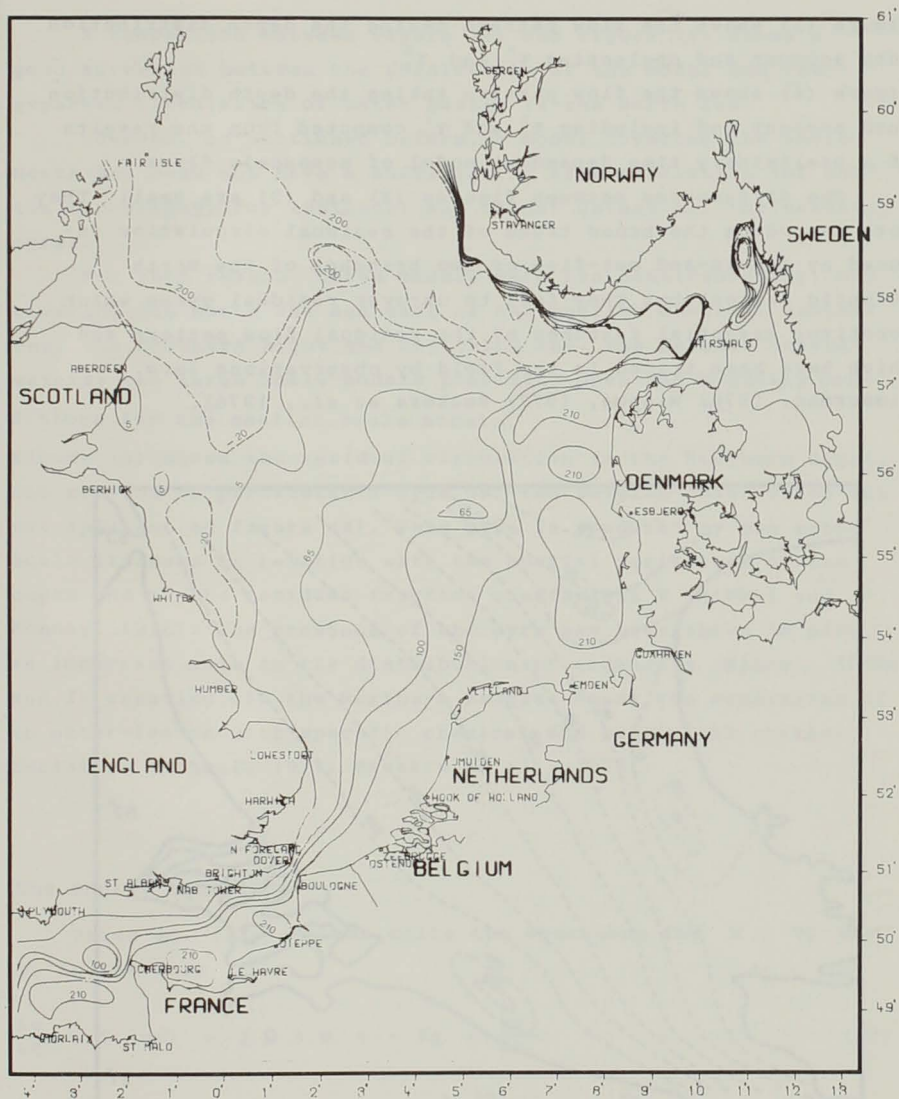

fig. 4.

Residual circulation in the North Sea calculated in negligible wind conditions with the real depth distribution, taking the mesoscale stresses τ_0^n and τ_0^i into account. (Streamlines in $10^3 \text{ m}^3 \cdot \text{s}^{-1}$)

Figure (3) shows the flow pattern taking the depth distribution into account and neglecting τ_0^n and τ_0^b .

Figure (4) shows the flow pattern taking the depth distribution into account and including τ_0^n and τ_0^i computed from the results of a preliminary time dependent model of mesoscale flows.

The differences between figures (2) and (3) are small. They both reproduce the broad trend of the residual circulation induced by the in-and out-flow of two branches of the North Atlantic current but they fail to uncover residual gyres which constitute essential features of the residual flow pattern and which have been traced in the field by observations (e.g. Zimmerman, 1976; Rieppma, 1977; Beckers et al., 1976).

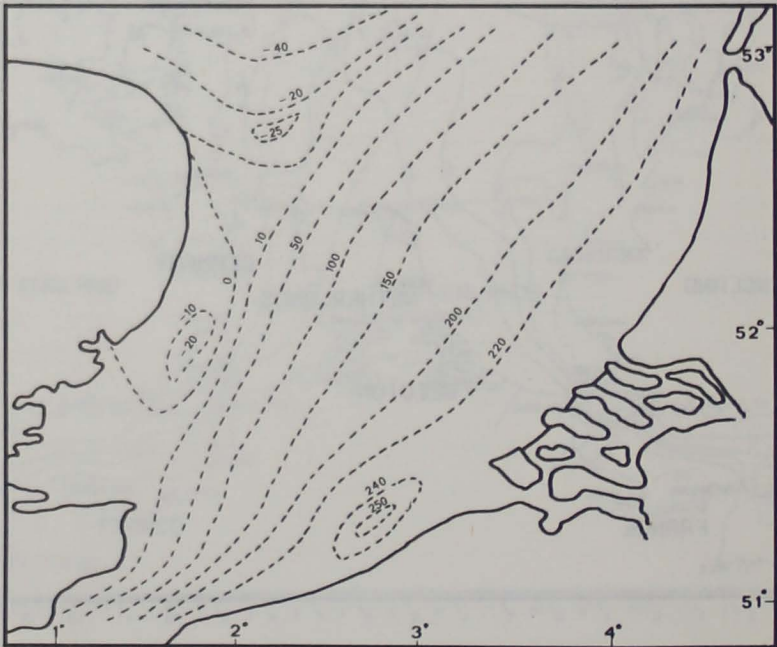

fig. 5.

Residual circulation in the Southern Bight calculated in negligible wind conditions, with the real depth distribution, taking into account the mesoscale stresses τ_0^n and τ_0^i . (Streamlines in $10^3 \text{ m}^3 \cdot \text{s}^{-1}$)

A comparison between figure (4) and figure (1) shows a good agreement between the predictions of the model and the expected circulation of water masses in the North Sea.

However, as mentioned before, a model covering the whole North Sea does not have a sufficiently fine resolution (of bottom topography, for instance) and cannot detect all the existing gyres.

For that reason, three models were run simultaneously, one covering the North Sea and part of the English Channel, another one, the Southern Bight and the third one, the Belgian coastal waters; the large scale models providing open-sea boundary conditions for the smaller scale models.

Figure (5) shows the residual circulation in the Southern Bight. One notices in particular a gyre off the Belgian coast which was not apparent on figure (4). This gyre is produced by the meso-scale stresses in relation with the spatial variations of the depth and of the residual friction coefficient K (Nihoul and Runday, 1976). The presence of the gyre has been shown to play an important role in the distribution of sediments (Nihoul, 1975b) and in creating off the Northern Belgian coast the conditions of an outer-lagoon with specific chemical and ecological characteristics (Nihoul, 1974; Beckers *et al.*, 1976).

The energy equations

Using eq. (3), one can write the equations for \mathbf{v} , \mathbf{v}_0 and \mathbf{v}_1 in the form

$$\frac{\partial \mathbf{v}}{\partial t} + \nabla \cdot (\mathbf{v}\mathbf{v}) + 2 \boldsymbol{\Omega} \wedge \mathbf{v} = - \nabla q + \frac{\partial \tau}{\partial x_3} \quad (23)$$

$$\nabla \cdot (\mathbf{v}_0 \mathbf{v}_0) + 2 \boldsymbol{\Omega} \wedge \mathbf{v}_0 = - \nabla q_0 + \frac{\partial \tau_0}{\partial x_3} + \nabla \cdot \mathbf{N} \quad (24)$$

$$\begin{aligned} \frac{\partial \mathbf{v}_1}{\partial t} + \nabla \cdot [\mathbf{v}_1 \mathbf{v}_0 + \mathbf{v}_0 \mathbf{v}_1 + \mathbf{v}_1 \mathbf{v}_1 - (\mathbf{v}_1 \mathbf{v}_1)_0] + 2 \boldsymbol{\Omega} \wedge \mathbf{v}_1 \\ = - \nabla q_1 + \frac{\partial \tau_1}{\partial x_3} \end{aligned} \quad (25)$$

with

$$\nabla \cdot \mathbf{v} = \nabla \cdot \mathbf{v}_0 = \nabla \cdot \mathbf{v}_1 = 0 \quad (26), (27), (28)$$

One can see that the equation for \mathbf{v}_1 is essentially the same as the equation for \mathbf{v} . They only differ by terms which are orders of magnitude smaller. It is the reason why, one can, with the appropriate boundary conditions, determine the mesoscale velocity \mathbf{v}_1 , in a first step, and the residual velocity \mathbf{v}_0 , in a second step, taking the coupling between the two types of motion into account in the calculation of \mathbf{v}_0 only.

Taking the scalar products of eqs. (23), (24) and (25) respectively by \mathbf{v} , \mathbf{v}_0 and \mathbf{v}_1 , using (26), (27) and (28), and averaging over T , one finds, neglecting again the contributions from the time derivatives under the assumption that T is sufficiently large :

$$\nabla \cdot \left(\mathbf{v} \frac{v^2}{2} + \mathbf{v} \mathbf{q} \right)_0 = \frac{\partial}{\partial x_3} (\mathbf{v} \cdot \boldsymbol{\tau})_0 - \left(\boldsymbol{\tau} \cdot \frac{\partial \mathbf{v}}{\partial x_3} \right)_0 \quad (29)$$

$$\nabla \cdot \left(\mathbf{v}_0 \frac{v_0^2}{2} + \mathbf{v}_0 \mathbf{q}_0 - \mathbf{v}_0 \cdot \mathbf{N} \right) = \frac{\partial}{\partial x_3} (\mathbf{v}_0 \cdot \boldsymbol{\tau}_0) - \boldsymbol{\tau}_0 \cdot \frac{\partial \mathbf{v}_0}{\partial x_3} - \mathbf{N} : \nabla \mathbf{v}_0 \quad (30)$$

$$\nabla \cdot \left(\mathbf{v}_0 \frac{v_1^2}{2} + \mathbf{v}_1 \frac{v_1^2}{2} + \mathbf{v}_1 \mathbf{q}_1 \right)_0 = \frac{\partial}{\partial x_3} (\mathbf{v}_1 \cdot \boldsymbol{\tau}_1)_0 - \left(\boldsymbol{\tau}_1 \cdot \frac{\partial \mathbf{v}_1}{\partial x_3} \right)_0 + \mathbf{N} : \nabla \mathbf{v}_0 \quad (31)$$

The terms in the left-hand sides of eqs. (29), (30) and (31) are of the divergence form. They represent fluxes of energy in physical space. The terms in the right-hand sides represent rates of energy production or destruction or energy exchanges between scales of motion.

Integrating over depth, one can see for instance that the first terms represent the average rate of work of the wind stress $\boldsymbol{\tau}^s$, i.e.

$$(\mathbf{v}^s \cdot \boldsymbol{\tau}^s) = \mathbf{v}_0^s \cdot \boldsymbol{\tau}_0^s + (\mathbf{v}_1^s \cdot \boldsymbol{\tau}_1^s)_0 \quad (32)$$

where \mathbf{v}^s denotes the surface velocity.

The second term in the right-hand side of eq. (29) is related to the average dissipation of energy. Using eq. (3), one has, indeed

$$-\tau \cdot \frac{\partial \mathbf{v}}{\partial x_3} = -\tilde{\nu} \left\| \frac{\partial \mathbf{v}}{\partial x_3} \right\|^2 \quad (33)$$

where $\tilde{\nu}$ is the eddy viscosity.

The depth-averaged dissipation rate

$$\varepsilon = \frac{1}{H_0} \int_{-h}^{\xi_0} \left(\tau \cdot \frac{\partial \mathbf{v}}{\partial x_3} \right) dx_3 \quad (34)$$

can be split in two parts, as seen from eqs. (30) and (31), i.e.

$$\varepsilon = \frac{1}{H_0} \int_{-h}^{\xi_0} \tau_0 \cdot \frac{\partial \mathbf{v}_0}{\partial x_3} dx_3 + \frac{1}{H_0} \int_{-h}^{\xi_0} (\tau_1 \cdot \frac{\partial \mathbf{v}_1}{\partial x_3}) dx_3 \quad (35)$$

The contribution of the residual stress τ_0 to the energy budget

The second term in the right-hand side of eq. (35) is obviously related to the energy dissipated by the mesoscale motions. It is, by far, the essential contribution to ε and may serve as a first approximation of it. It is however the first term one is interested in, here, to explain the physical mechanisms which contribute to shape the residual circulation.

In evaluating this term, one can obviously restrict attention to the horizontal components of the vectors τ_0 and \mathbf{v}_0 , and this is also true for any scalar product of the form $\tau \cdot \frac{\partial \mathbf{v}}{\partial x_3}$

One has indeed, from the continuity equation,

$$\frac{\partial w}{\partial x_3} \leq \nabla \cdot \mathbf{u} \sim O\left(\frac{U}{L}\right)$$

where L is the characteristic scale of horizontal variations. On the other hand

$$\frac{\partial \mathbf{u}}{\partial x_3} \sim O\left(\frac{U}{h}\right)$$

Since $h \ll L$, the contributions from the vertical velocity are completely negligible in the integrals of eq. (35).

The application of the three-dimensional equations (1) and (2) to the North Sea (Nihoul, 1977; Nihoul et al., 1979) shows that

(i) the turbulent stress can be written

$$\tau = \tau^s \xi + \tau^b (1 - \xi) + \kappa \|\tau^b\|^{\frac{1}{2}} H \sum_1^{\infty} A_n \lambda(\xi) \frac{df_n}{d\xi} \quad (36)$$

where τ^s and τ^b are respectively the surface stress and the bottom stress (per unit mass of sea water), $\xi = H^{-1}(x_3 + h)$, $H = h + \zeta$, h is the depth and ζ the surface elevation, the A_n 's are functions of t , x_1 and x_2 involving τ^s , τ^b and their time derivatives, κ is the Von Karman constant,

$$\lambda(\xi) = \frac{\bar{v}}{\kappa \|\tau^b\|^{\frac{1}{2}} H}$$

and the functions $f_n(\xi)$ are the eigenfunctions of the problem

$$\frac{d}{d\xi} \left(\lambda \frac{df_n}{d\xi} \right) = -\alpha_n f_n \quad (37)$$

$$\lambda \frac{df_n}{d\xi} = 0 \quad \text{at} \quad \xi = 0 \quad \text{and} \quad \xi = 1 \quad (38)$$

α_n being the corresponding eigenvalue.

The last term in the right-hand side of eq. (36) plays an important role in the determination of the velocity field \mathbf{v} but its effect is limited to relatively short periods of weak currents (at tide reversal, for instance) (Nihoul, 1977; Nihoul et al., 1979) and it contributes very little to the residual turbulent Reynolds stress obtained by averaging over a time T covering several tidal periods.

Hence, setting $z = x_3 + h$, one may write, with a good approximation

$$\tau_0 \sim \tau_0^b + \left(\frac{\tau^s - \tau^b}{H} \right)_0 z \quad (39)$$

(ii) the bottom stress τ^b is a function of τ^s , the depth-averaged velocity \bar{u} and the time derivatives of \bar{u} .

If one excepts, again, short periods of weak currents, τ^b can be approximated by the classical "quadratic bottom friction law"

$$\tau^b = D \|\bar{u}\| \bar{u} \quad (40)$$

where D is the drag coefficient.

Averaging over a time T as before, one obtains then

$$\tau_0^b \sim D \|\bar{u}_1\|_0 \bar{u}_0 + (D \|\bar{u}_1\| \bar{u}_1)_0 \quad (41)$$

i.e., using eqs. (17) and (19)

$$\tau_0^b \sim H_0 K \bar{u}_0 + \tau_0^f \quad (42)$$

Changing variable to z and using (39), one can write

$$\begin{aligned} \frac{1}{H_0} \int_{-h}^{z_0} \tau_0 \cdot \frac{\partial \mathbf{v}_0}{\partial x_3} dx_3 &\sim \frac{1}{H_0} \int_{z_0}^{H_0} \tau_0 \cdot \frac{\partial \mathbf{u}_0}{\partial z} dz \\ &\sim \frac{1}{H_0} \int_{z_0}^{H_0} \tau_0^b \cdot \frac{\partial \mathbf{u}_0}{\partial z} dz + \frac{1}{H_0} \int_{z_0}^{H_0} \left(\frac{\tau^s - \tau^b}{H} \right)_0 \cdot \frac{\partial \mathbf{u}_0}{\partial z} z dz \end{aligned} \quad (43)$$

The horizontal velocity \mathbf{u} , however it may vary for the rest with depth, always has a logarithmic profile near the bottom. This implies that $\frac{\partial \mathbf{u}}{\partial x_3}$ behaves like z^{-1} near $z = 0$. A first consequence of this asymptotic behaviour of the velocity profile is that integrals over depth are, strictly speaking, not taken from $z = 0$ to the surface but from some very small height z_0 (the "rugosity length") to the surface. This has been taken into account in eq. (43). A second consequence is that the first integral in the right-hand side of eq. (43) is largely dominant, the singularity at $z = 0$ being cancelled in the second integral by the factor z .

Since the second integral is only a small correction, one may make the approximation

$$\left(\frac{\tau^s - \tau^b}{H} \right)_0 \sim \frac{\tau_0^s - \tau_0^b}{H_0}$$

Eq. (43) can thus be rewritten

$$\frac{1}{H_0} \int_{-h}^{z_0} \tau_0 \cdot \frac{\partial \mathbf{v}_0}{\partial x_3} dx_3 \sim \frac{\tau_0^b}{H_0} \cdot \int_{z_0}^{H_0} \left(1 - \frac{z}{H_0}\right) \frac{\partial \mathbf{u}_0}{\partial z} dz + \frac{\tau_0^s}{H_0} \cdot \int_{z_0}^{H_0} \frac{z}{H_0} \frac{\partial \mathbf{u}_0}{\partial z} dz \quad (44)$$

Integrating by parts, one gets

$$\frac{1}{H_0} \int_{-h}^{z_0} \tau_0 \cdot \frac{\partial \mathbf{v}_0}{\partial x_3} dx_3 \sim \frac{\tau_0^b \cdot \bar{\mathbf{u}}_0}{H_0} + \frac{\tau_0^s \cdot (\mathbf{u}_0^s - \bar{\mathbf{u}}_0)}{H_0} \quad (45)$$

i.e., using eq. (42)

$$\frac{1}{H_0} \int_{-h}^{z_0} \tau_0 \cdot \frac{\partial \mathbf{v}_0}{\partial x_3} dx_3 \sim K \bar{u}_0^2 + \frac{\tau_0^i \cdot \bar{\mathbf{u}}_0}{H_0} + \frac{\tau_0^s \cdot (\mathbf{u}_0^s - \bar{\mathbf{u}}_0)}{H_0} \quad (46)$$

The first two terms in the right-hand side of eq. (30) integrated over depth give then

$$\int_{-h}^{z_0} \left[\frac{\partial}{\partial x_3} (\mathbf{v}_0 \cdot \tau_0) - \tau_0 \cdot \frac{\partial \mathbf{v}_0}{\partial x_3} \right] dx_3 = \int_{-h}^{z_0} \mathbf{v}_0 \cdot \frac{\partial \tau_0}{\partial x_3} dx_3 \sim \tau_0^s \cdot \bar{\mathbf{u}}_0 - KH_0 \bar{u}_0^2 + \tau_0^i \cdot \bar{\mathbf{u}}_0 \quad (47)$$

i.e. the same result one would have obtained from the depth integrated transport equation for the contribution of the wind stress and the bottom stress, by taking the scalar product of eq. (16) by $\bar{\mathbf{u}}_0$.

One notes that, in the right-hand side of eq. (46), only the first term can be associated without ambiguity to the dissipation of energy. The second term represents the rate of work of the mesoscale friction stress. Although its "bottom friction" origin is clear, its sign cannot be set a priori and there is no reason why it could not actually provide energy to the residual flow.

The same can be said for the last term in the right-hand side of eq. (30). This term appears with the opposite sign in eq. (31). It thus represents an exchange of energy between residual and mesoscale flows; this term can be either positive or

negative. There is no way of knowing *a priori* whether the energy is extracted from the mean flow and goes from macroscales to mesoscales or if it is supplied to the mean flow by mesoscale motions.

The exchange of energy between scales of motion

The exchange of energy between macroscales and mesoscales can be characterized, at each point of the North Sea, by the depth-averaged rates of energy transfer

$$\epsilon_N = \frac{1}{H_0} \int_{-h}^{\xi_0} (\mathbf{N} : \nabla \mathbf{v}_0) dx_3 \quad (48)$$

$$\epsilon_F = \frac{1}{H_0} (\boldsymbol{\tau}_0^f \cdot \bar{\mathbf{u}}_0) \quad (49)$$

These quantities, which may be positive or negative should be compared with the rate of energy dissipation by the residual motion : i.e.

$$\epsilon_D = K \bar{u}_0^2 \quad (50)$$

The mesoscale Reynolds stress tensor \mathbf{N} also contributes to the term $\nabla \cdot (-\mathbf{N} \cdot \mathbf{v}_0)$ in the left-hand side of eq. (30).

This is a completely different effect because it implies a flux of energy in physical space while $\mathbf{N} : \nabla \mathbf{v}_0$, appearing in both eq. (30) and (31), represents a transfer of energy between scales, i.e. a flux of energy in Fourier space.

This effect cannot however be ignored if one wants to understand the mechanisms by which the mesoscale stresses act on the residual flow. One shall define

$$\delta = \frac{1}{H_0} \int_{-h}^{\xi_0} [\nabla \cdot (-\mathbf{N} \cdot \mathbf{v}_0)] dx_3 \quad (51)$$

It may be noted here that

$$H_0 (\delta + \epsilon_N) = \int_{-h}^{\xi_0} [\mathbf{v}_0 \cdot (\nabla \cdot \mathbf{N})] dx_3$$

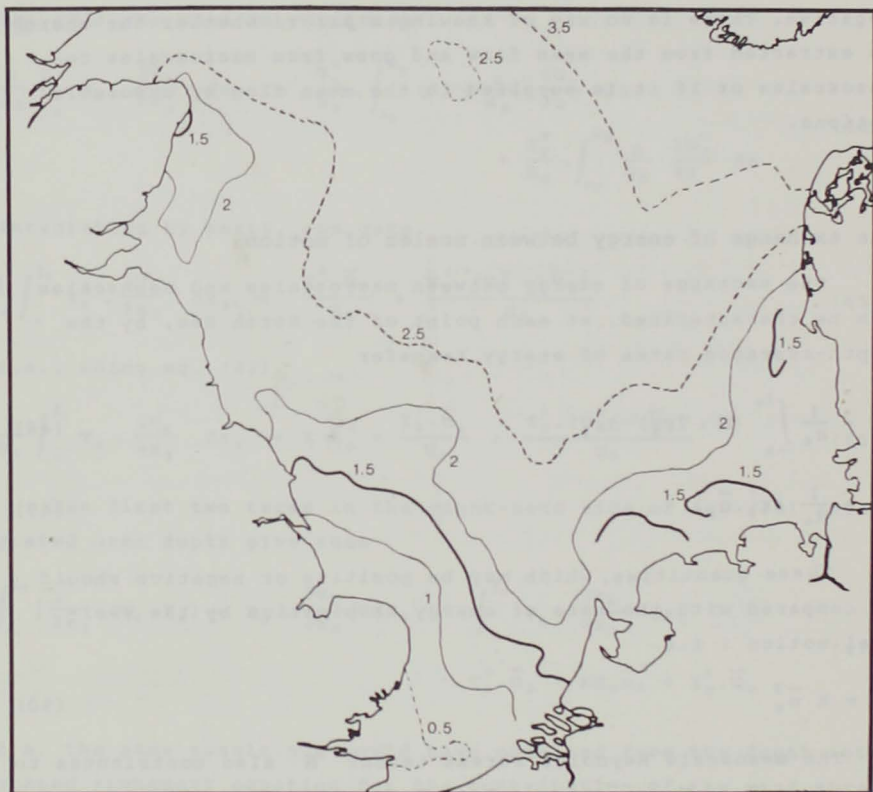

fig. 6.

Curves of equal values of the Simpson-Hunter parameter
 $S = \log_{10}(10^{-4}\epsilon^{-1})$ in the North Sea.

is not quite the same as the rate of work of the mesoscale Reynolds stress τ_0^n as one would evaluate it by taking the scalar product of eq.(16) by \bar{u}_0 .

It has seemed interesting to explore the interactions between the residual flow and the mesoscale motions in the North Sea by calculating ϵ_N , ϵ_F , ϵ_D and δ using the results of the three-dimensional model mentioned earlier (Nihoul, 1977; Nihoul et al., 1979). Taking, to begin with, a situation of negligible

wind forcing, the model was applied to the determinations of the tidal flow, of the tidal residuals and of the transfer functions ϵ_N , ϵ_F , ϵ_D and δ . The depth-averaged dissipation rate ϵ (eq. 34) was also computed for comparison.

Figure 6 shows the distribution over the North Sea of the non-dimensional parameter

$$S = \log_{10} \frac{\epsilon^*}{\epsilon} \quad (52)$$

where ϵ^* is a value of reference taken here as $10^{-4} \text{ m}^2 \cdot \text{s}^{-3}$.

The parameter S was introduced by Simpson and Hunter who argued that the critical value $S = 1.5$ indicated the regions where fronts were likely to form in the summer. This prediction appears to be fairly well confirmed by observations (e.g. Pingree and Griffiths 1978, Nihoul 1980).

One can see on figure 6 that ϵ varies from values of the order of 10^{-5} or larger in the Southern Bight to 10^{-6} in coastal areas and 10^{-7} in the Northern part of the North Sea.

There is some similitude between the distribution of ϵ and that of ϵ_D , ϵ_N and δ but ϵ_D , ϵ_N and δ are in general about two orders of magnitude smaller than ϵ . Furthermore, while ϵ_D is positive definite, both positive and negative values of ϵ_N and δ are found.

Positive values of ϵ_N indicate a transfer of energy from the mean (residual) flow to the mesoscale motion (a positive mesoscale eddy viscosity in the terminology of turbulence). Such positive values are found in rather well-marked often isolated regions which have the appearance of large mesoscale eddies with smaller mesoscale eddies inside them. This can be seen on figure 7 which shows the distribution of the positive values of

$$\hat{\epsilon}_N = \frac{\epsilon_N}{\epsilon_D} \quad (53)$$

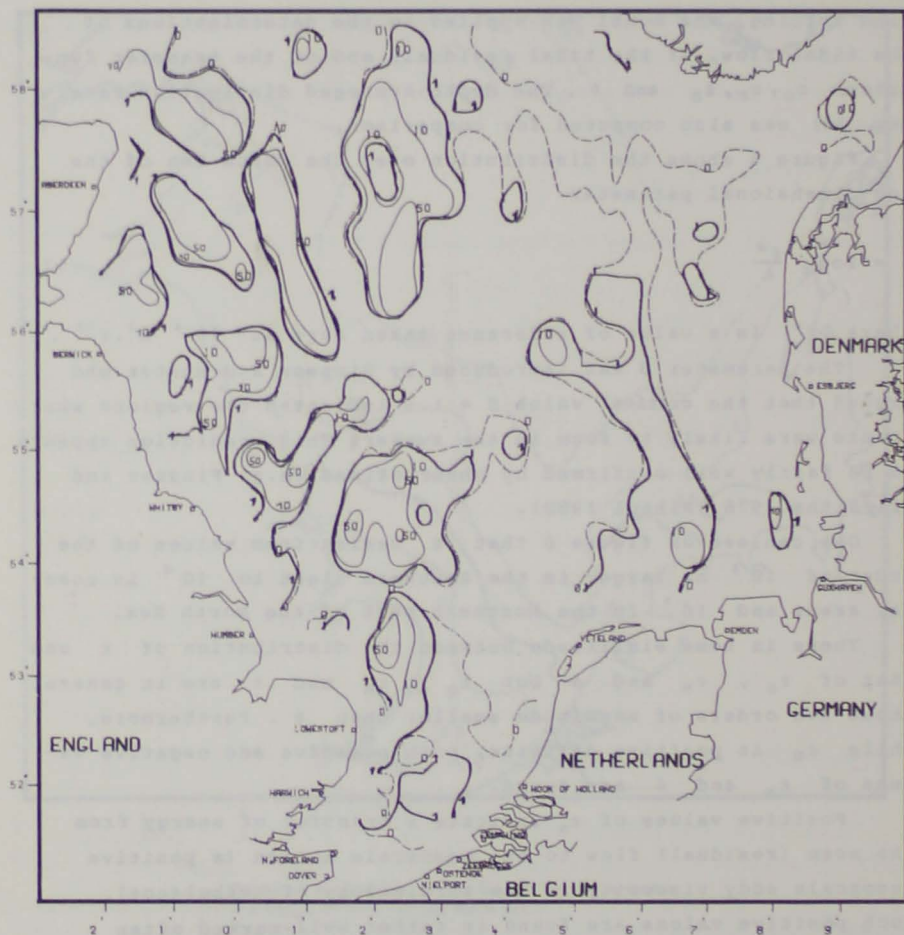

fig. 7.

Distribution of the positive values of the normalized transfer function $\hat{\epsilon}_N$ in the North Sea (no wind).

The heavy line is the curve $\hat{\epsilon}_N = 1$. In many places, it nearly coincides with the line "0" where ϵ_N changes sign*.

* In interpreting figure 7 and those which follow, one must remember that having to calculate horizontal gradients, the model can only provide results one grid point away from the coast. One cannot say anything from the figures about the coastal fringe.

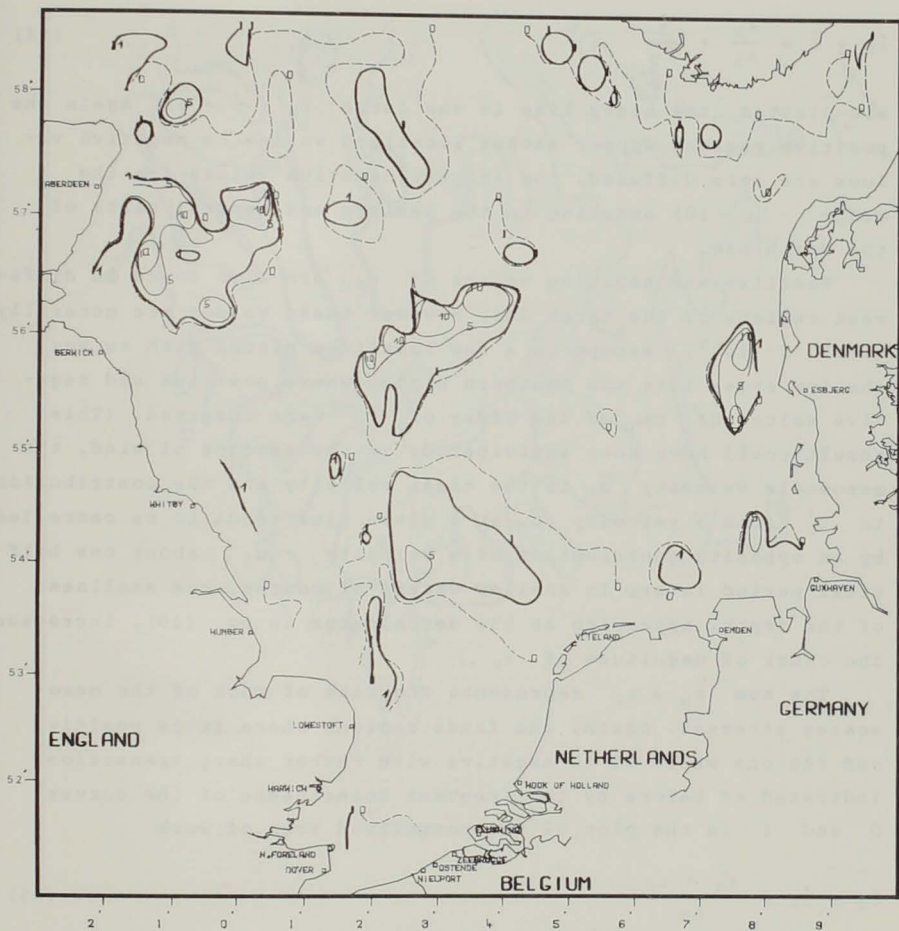

fig. 8.

Distribution of the positive values of the normalized function $\epsilon_N + \delta$ in the North Sea (no wind).

The distribution of δ is roughly the opposite. δ is generally negative where ϵ_N is positive. As a result the sum $\epsilon_N + \delta$ drops by almost one order of magnitude as shown in figure 8 where the positive values of

$$\hat{\epsilon}_N + \hat{\delta} = \frac{\epsilon_N}{\epsilon_D} + \frac{\delta}{\epsilon_D} \quad (54)$$

are plotted (the heavy line is the curve $\hat{\epsilon}_N + \hat{\delta} = 1$). Again the positive regions appear rather localized while the negative values are more diffused, the largest negative values (in the range $-1, -10$) occurring in the western and central parts of the North Sea.

Positive and negative values of ϵ_F are also found in different regions of the North Sea. However these values are generally small ($\sim 10^{-9}$) except in a few localized places such as very shallow areas like the Southern Bight, where positive and negative values of ϵ_F of the order of 10^{-7} are observed. (This result could have been anticipated. In the absence of wind, the mesoscale velocity \bar{u}_1 is the tidal velocity and the contribution to τ_0^f from a velocity \bar{u}_1 at a given time tends to be cancelled by an opposite contribution of a velocity $-\bar{u}_1$, about one half tidal period later. In shallow waters of course, the smallness of the depth, appearing at the denominator in eq. (49), increases the order of magnitude of ϵ_F .)

The sum $\epsilon_N + \epsilon_F$ represents the rate of work of the mesoscales stresses. Again, one finds regions where it is positive and regions where it is negative with rather sharp transitions indicated as before by the frequent coincidence of the curves 0 and 1 in the plot of the normalized rate of work

$$\hat{\epsilon}_N + \hat{\epsilon}_F = \frac{\epsilon_N + \epsilon_F}{\epsilon_D} \quad (55)$$

Positive and negative values of $\hat{\epsilon}_N + \hat{\epsilon}_F$ are found in the range 0 - 10 with large regions where it is of order 1.

The pattern of the total rate of energy production (or destruction).

$$\hat{\epsilon}_N + \hat{\epsilon}_F + 1 = \frac{\epsilon_N + \epsilon_F + \epsilon_D}{\epsilon_D} \quad (56)$$

is rather similar to the pattern of $\hat{\epsilon}_N + \hat{\epsilon}_F$. (Because of the sharp transitions, the addition of 1 is determinant only in a few places.)

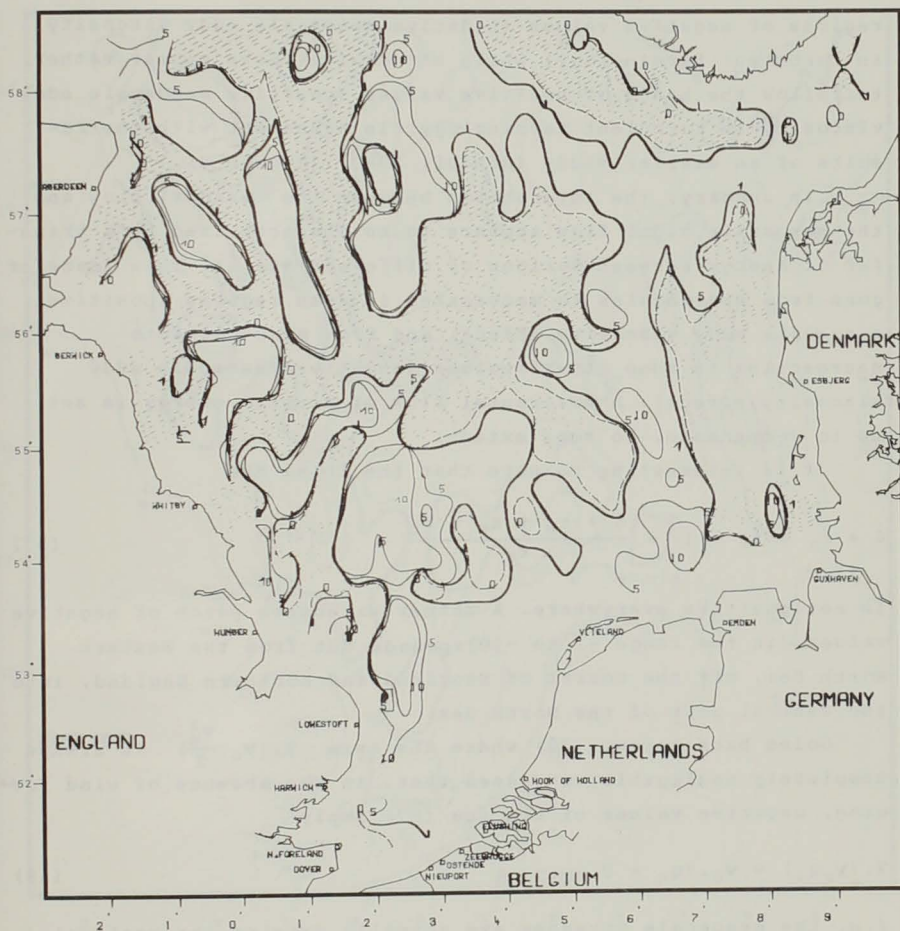

fig. 9.

Distribution of positive values of $1 + \hat{\epsilon}_N + \hat{\epsilon}_F$ in the North Sea (no wind)

The two patterns are less patchy. Regions of positive and negative values form more connected zones. Comparing with the corresponding residual circulation, one finds that well-identified residual gyres are generally associated with

regions of negative values (negative mesoscale eddy viscosity in turbulent terminology) while streamwise flows appear rather to follow the bands of positive values (positive mesoscale eddy viscosity in turbulent terminology) in agreement with the results of an earlier study (Nihoul, 1980). (Figure 9).

In summary, the interaction between the residual flow and the mesoscale tidal flow appears to be characterized by a transfer of energy between motions of different scales. This transfer goes from macroscales to mesoscales in some regions (positive mesoscale eddy viscosity effect) and from mesoscales to macroscales in some other regions (negative mesoscale eddy viscosity effect). A horizontal flux of kinetic energy is set up to compensate, to some extent.

It is interesting to note that the total sum

$$\hat{\delta} + \hat{\epsilon}_N + \hat{\epsilon}_F + 1 = \frac{\delta + \epsilon_N + \epsilon_F + \epsilon_D}{\epsilon_D} \quad (57)$$

is not positive everywhere. A rather extensive patch of negative values (in the range -1 to -10) spreads out from the Western North Sea, off the coasts of Scotland and Northern England, into the central part of the North Sea.

Going back to eq. (30) where the term $\nabla \cdot (\mathbf{v}_0 \frac{v_0^2}{2})$ is always completely negligible, one sees that, in the absence of wind forcing, negative values of the sum (57) imply

$$\nabla \cdot (\mathbf{v}_0 \mathbf{q}_0) = \mathbf{v}_0 \cdot \nabla \mathbf{q}_0 > 0 \quad (58)$$

i.e. the mesoscale stresses are actually driving the residual flow "up the residual slope and pressure gradient".

The effect of the wind

As pointed out, in the introduction, the tidal residuals considered in the preceding sections can only constitute a first approximation of what a real climatic residual circulation is. The atmospheric forcing has been neglected both in determining

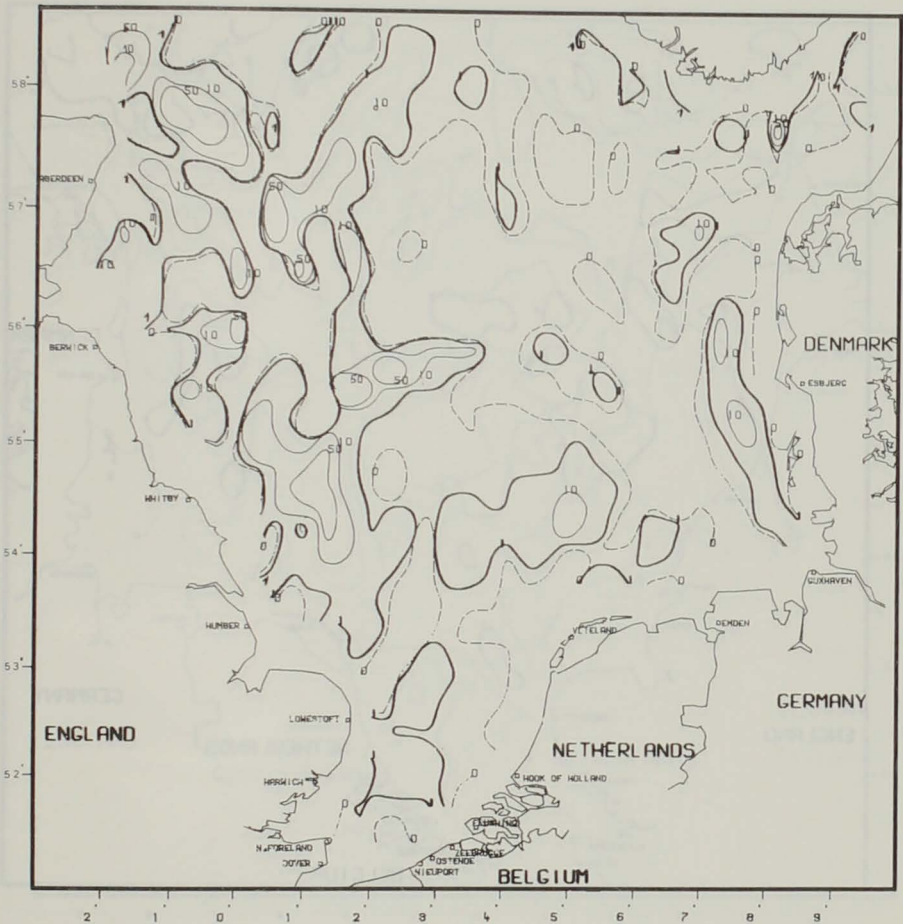

fig. 10.

Distribution of positive values of ϵ_N in the North Sea
 (uniform constant wind of 15 m.s^{-1} from the North-West)

the mesoscale motion and in computing the resulting residuals. The advantage was that the time of averaging could be limited to two or three tidal periods. This is not possible if one includes the effect of a wind field which itself evolves with a characteristic time of the same order.

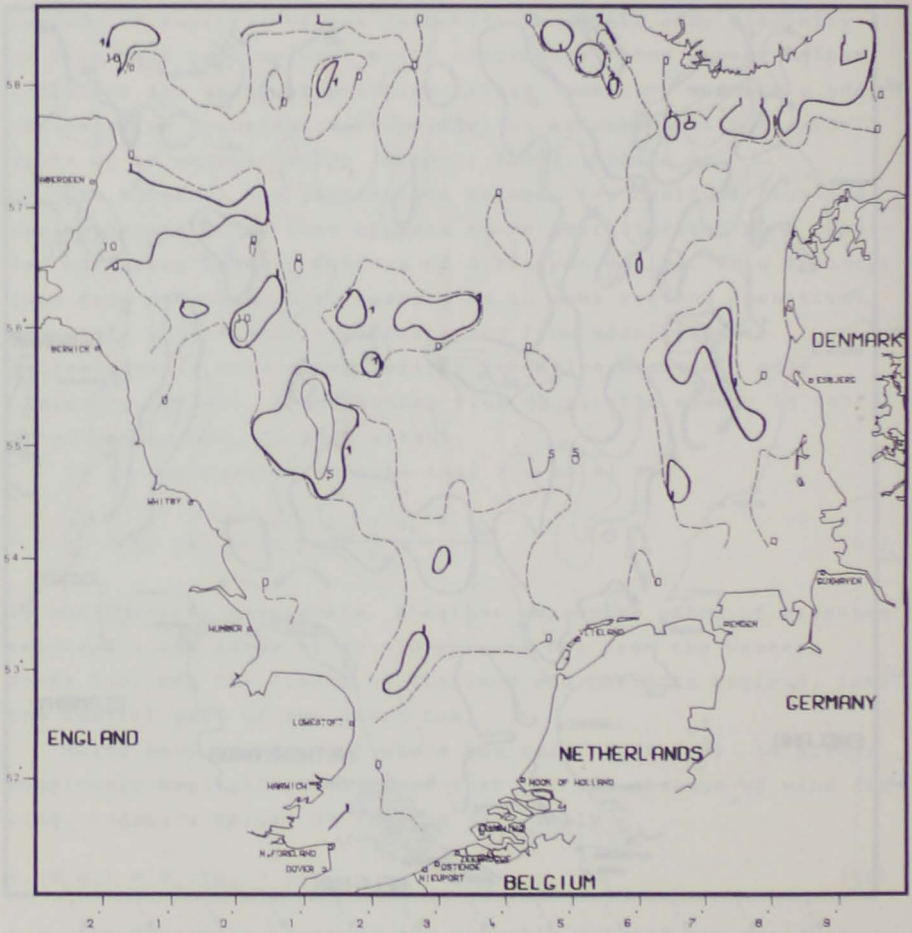

fig. 11.

Distribution of positive values of $\bar{\epsilon}_N + \delta$ in the North Sea
(uniform constant wind of 15 m.s^{-1} from the North-West)

In some cases, one may have to go to averaging over several weeks to ensure that the average is meaningful. This implies that the mesoscale velocity field must be calculated over the same period of time and the cost of operating the model becomes rapidly prohibitively large.

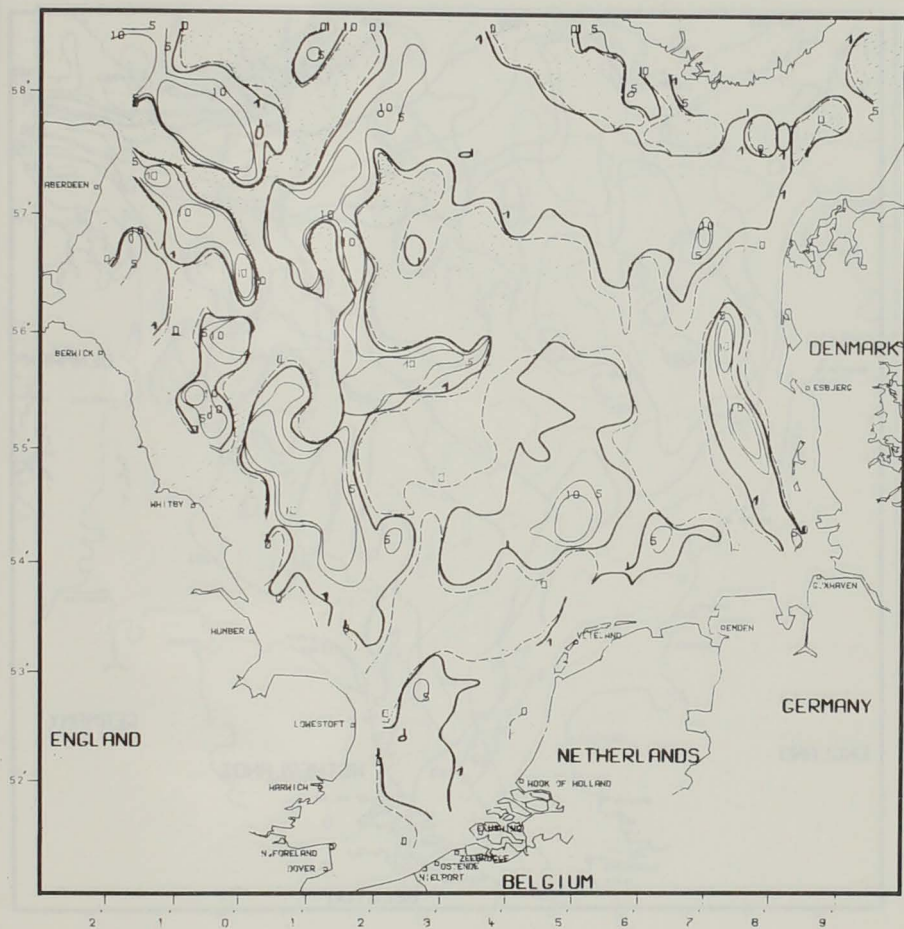

fig. 12.

Distribution of positive values of $1 + \hat{\epsilon}_N + \hat{\epsilon}_F$ in the North Sea
(uniform constant wind of 15 m.s^{-1} from the North-West)

Although an effort of this size is now being considered to model the residual circulation during the period of the JONSDAP 76 experiment, it has not been possible so far to apply the three-dimensional model with real atmospheric conditions. However to have some idea of the effect of the wind forcing, two cases of constant uniform wind fields have been considered.

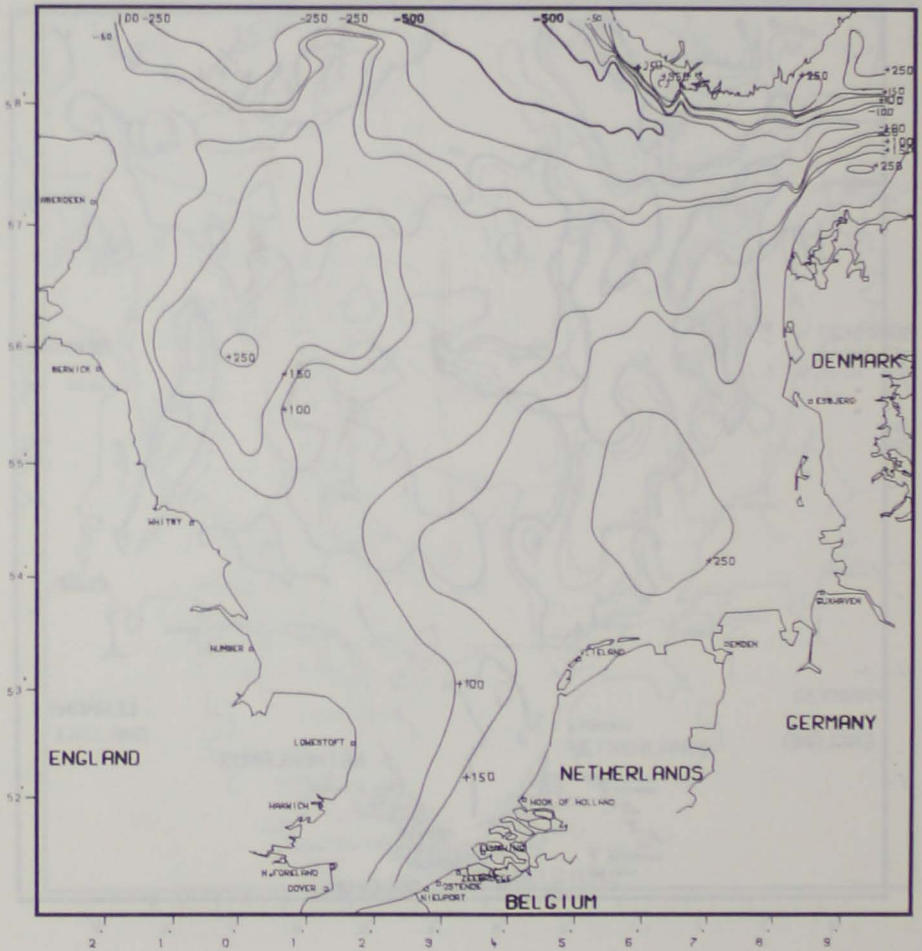

fig. 13.

Residual circulation in the North Sea (streamlines in $10^3 \text{ m}^3 \cdot \text{s}^{-1}$)
 (uniform constant wind of $15 \text{ m} \cdot \text{s}^{-1}$ from the North-West)

The concept of a uniform wind field over the whole North Sea is certainly idealistic. Moreover, the direct effect of the wind on the residual circulation, which is associated with the curl of the wind stress, is not taken into account. The hypothesis that the wind is constant in time (i.e. that it has a

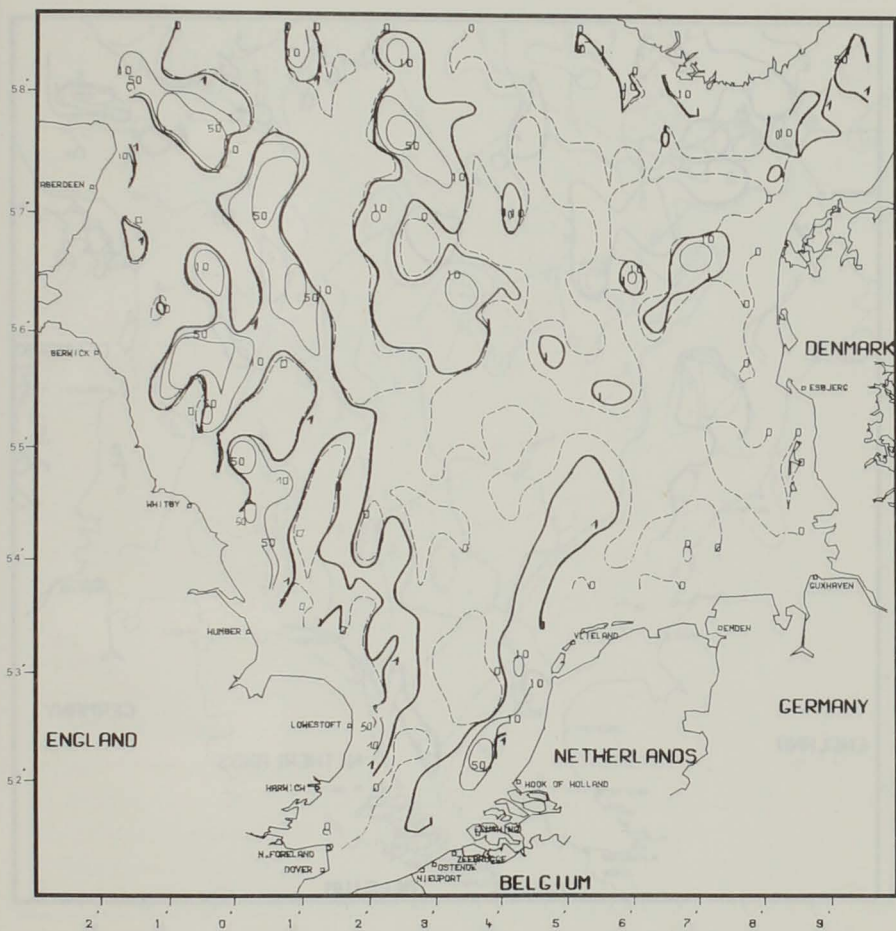

fig. 14.

Distribution of positive values of $\hat{\epsilon}_N$ in the North Sea
(uniform constant wind of 15 m.s^{-1} from the South-West)

very large characteristic time of evolution), however, justifies the averaging over a few tidal periods as this corresponds again to a valley in the energy spectrum of the currents.

Figures 10, 11, 12 and 13 correspond to a uniform constant wind of 15 m.s^{-1} from the North-West.

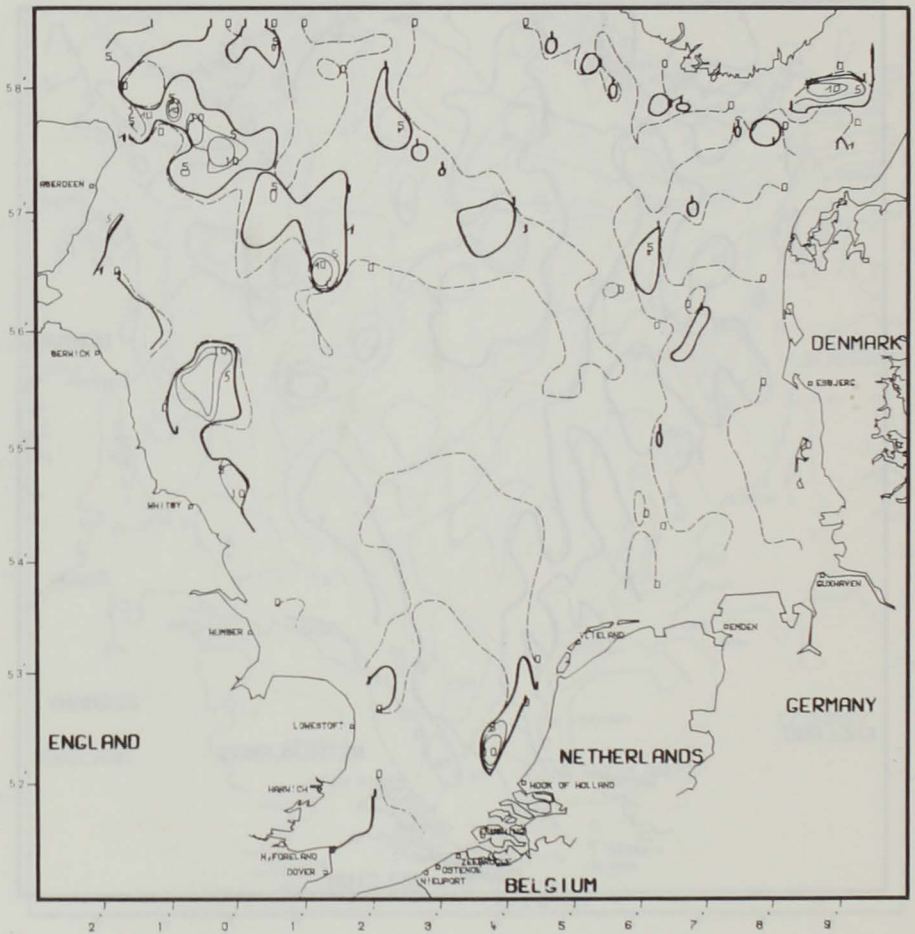

fig. 15.

Distribution of positive values of $\hat{\epsilon}_N + \delta$ in the North Sea
(uniform constant wind of 15 m.s^{-1} from the South-West)

Figure 10 shows again a rather patchy distribution of $\hat{\epsilon}_N$ with alternating regions of positive and negative values. These values are roughly of the same order of magnitude as in the absence of wind. In this case also, one finds that ϵ_N and δ compensate each other to a certain extent. This effect seems

Figures 14, 15, 16 and 17 correspond to a uniform constant wind of 15 m.s^{-1} from the South-West. Here again, one finds a patchy distribution of $\hat{\epsilon}_N$ with positive and negative values of the same order of magnitude as previously. The compensation between ϵ_N and δ is found, in this case also, and appears to be extremely efficient (figure 15).

The spatial distribution of the total rate of energy production (or destruction) $1 + \hat{\epsilon}_N + \hat{\epsilon}_F$, represented in figure 16, can be compared again to the residual flow pattern (figure 17). The Southern branch of the North Atlantic current is deflected to the West, in this case and this reflects in the deformation of the positive bands in the pattern of $1 + \hat{\epsilon}_N + \hat{\epsilon}_F$.

Conclusions

Although the three cases considered in this paper cannot give more than an approximate idea of the residual circulation in the North Sea in real conditions, they provide valuable information on the mechanisms which generate the residual currents.

(i) The general trend of the residual circulation reflects the flow through the North Sea of two branches of the North Atlantic current; the Southern branch passing the Straits of Dover and progressing Northward until it merges with the Northern branch penetrating the North Sea through the Western part of the Northern boundary and flowing out through the Eastern part of the boundary.

(ii) The detailed pattern of the residual circulation is determined by the action of the mesoscale stresses which represent the residual effect of the non-linear interactions of mesoscale motions (tides, wind induced currents, storm surges...).

In particular, residual gyres, - most of which have been traced in the field -, cannot be reproduced if the mesoscale stresses are not included in the model.

(iii) The existence of gyres and other residual secondary flows appears to be related to the work done by the mesoscale

stresses which extract energy from the main residual streams and supply energy to the other regions, setting up more or less compensating horizontal fluxes of kinetic energy.

(iv) The distributions of the energy transfer functions are very irregular and different situations corresponding to different meteorological conditions appear very much like sequences of an evolving field of turbulent eddies.

Inasmuch as the comparison is valid, the mesoscale eddy viscosity associated with the mesoscale eddies, may be positive or negative in different regions of the North Sea.

The concept of a mesoscale turbulence, figuring the non-linear interactions of mesoscale motions, is worth keeping in mind. It may help to understand some aspects of marine chemistry or marine biology (the patchiness of biological populations, for instance) which are otherwise very difficult to interpret.

References

- BECKERS, O., NIHOUL, J.C.J. and WOLLAST, R. (1976). La circulation résiduelle et la caractérisation des masses d'eau dans la zone côtière belge, in *Modélisation des systèmes marins*, edited by J.C.J. Nihoul, Projet Mer, Rapport final, Services du Premier ministre, Programmation de la Politique scientifique, Bruxelles, 1976, vol. 1, 95-130.
- CARRUTHERS, J.N. (1935). The flow of water through the Straits of Dover, *Fishery Invest.*, London, 2, 14, 1-67.
- KALLE, K. (1949). Die natürlichen Eigenschaften der Gewässer, in *Handbuch der Seefischerei Nordeuropas*, Schweizerbart, Stuttgart, 1, part 2.
- LAEVASTU, T. (1963). Water types in the North Sea and their characteristics, in *Serial Atlas of Marine Environment*, edited by Amer. Geogr. Soc. Folio, 2 cartes.
- Mc CAVE, I.N. (1974). Mud in the North Sea, in *North Sea Science*, edited by E.D. Goldberg, M.I.T. University Press, Cambridge, Mass., 74-100.
- NIHOUL, J.C.J. (1974). Mesoscale secondary flows and the dynamics of ecosystems in the Southern Bight of the North Sea, *Mémoires Société Sc. Lg.*, 7, 83-91.
- NIHOUL, J.C.J. (1975a). *Modelling of marine systems*, Elsevier, Amsterdam, 272 pp.
- NIHOUL, J.C.J. (1975b). Effect of the tidal stress on residual circulation and deposition in the Southern Bight of the North Sea, *Pure and Appl. Geophys.*, 113-114, 577.

- NIHOUL, J.C.J. (1977). Three-dimensional model of tides and storm surges in a shallow well-mixed continental sea, *Dynamics of Atmospheres and Oceans*, 2, 29-47.
- NIHOUL, J.C.J. (1980). Residual circulation, long waves and mesoscale eddies in the North Sea, *Oceanologica Acta*, 3, 309-316.
- NIHOUL, J.C.J. (1980). The turbulent ocean, in *Marine Turbulence*, edited by J.C.J. Nihoul, Elsevier, Amsterdam, 1-19.
- NIHOUL, J.C.J. and RONDAY F.C. (1975). The influence of the tidal stress on the residual circulation, *Tellus*, 29, 484-490.
- NIHOUL, J.C.J. and RONDAY, F.C. (1976). Hydrodynamic models of the North Sea, *Mémoires Société Sc. Lg.*, 10, 61-96.
- NIHOUL, J.C.J., RUNFOLA, Y. and ROISIN B. (1979). Non-linear three-dimensional modelling of mesoscale circulation in seas and lakes, in *Marine Forecasting*, edited by J.C.J. Nihoul, Elsevier, Amsterdam, 235-259.
- PINGREE, R.D. and GRIFFITHS, D.K. (1978). Tidal fronts on the shelf seas around the British Isles, *J. Geophys. Res.*, 83, 4615-4622.
- RIEPMA, H. (1977). Spatial variability of residual currents in an area of the Southern North Sea, ICES Hydrography Committee, CM 1977/C:43, 7 pp.
- RONDAY, F.C. (1975). *Modèles de circulation hydrodynamique en mer du Nord*, Ph. D. dissertation, Liège University.
- SIMPSON, J.H. and HUNTER, J.R. (1974). Fronts in the Irish Sea, *Nature*, London, 1250, 404-406.
- VAN VEEN, J. (1938). Water movements in the Straits of Dover, *J. du Conseil*, Copenhagen, 13, 7-38.
- ZIMMERMAN, J.T.F. (1976). Mixing and flushing of tidal embayments in the Western Dutch Wadden Sea - II, *Neth. J. Sea Res.*, 10, 397-439.

The use of the brine shrimp *Artemia* in aquaculture

Patrick SORGeloos
Artemia Reference Center
State University of Ghent, Belgium

Introduction

One of the major differences between aquaculture and cattle-breeding is that the larvae of most aquatic animal species of commercial interest, which are grown in intensive hatchery systems, have to be offered a live food whereas cattle accept inert diets throughout their live cycle (Kinne and Rosenthal, 1977).

Concluding the zooplankton that normally constitutes the natural food of fish and shrimp larvae, is either commercially unfeasible or technically hard to realize (Girin and Person-Le Ruyet, 1977). As a result "... the efforts of early pioneers to rear marine fish were hampered by inadequate and unsuitable larval food supplies" (Shelbourne, 1968).

A very significant progress in hatchery aquaculture was realized through the finding of Seale (1933) in the U.S.A. and Rollefsen (1939) in Norway that the .4 mm nauplius larva of *Artemia* constitutes an excellent food source for newborn fish larvae.

Technically speaking the advantage of using *Artemia* is that one starts from an apparently inert product, namely the dry cysts. These cysts which are in fact inactive embryos are commercially available, can be stored for years and only have to be incubated for 24 hours in seawater to produce free-swimming larvae. Furthermore, brine shrimp are very well accepted as a food source. It is not exactly known if this is due to their biochemical composition, their very thin carapace, the fact that they are a moving prey (swimming) or a combination of all these factors.

Artemia has been found to be a suitable food for the most diversified groups of organisms of the animal kingdom, e.g. foraminifers, coelenterates, flatworms, polychaetes, squids, insects, chaetognaths and of course a wide variety of both marine and freshwater crustaceans and fishes. In this treatise on *Cultivation of Marine Organisms*, Kinne (1977) pertinently indicated that "... more than 85 % of the marine animals cultivated thus far have been offered *Artemia salina* as food source, either together with other foods or, more often, as a sole diet".

It has been proved many times that a diet of live *Artemia* gives better results than any preparation of dead brine shrimp (Beck, 1979; Schauer et al., 1979; Serfling et al., 1974; Carlberg and Van Olst, 1975). The recent finding of Flüchter (1980), however, that "... whitefish larvae get through metamorphosis equally well whether they are given *Artemia* that is shock-frozen in liquid nitrogen (- 196 °C) or living *Artemia*", but not when given slow-frozen nauplii, might lead to the biochemical determination of the essential substance(s) that is (are) lost during freezing and freeze-drying. In a few cases, it has been demonstrated that dried brine shrimp can be successfully used as protein source in pelletized diets for fish and shrimp (Deshimaru and Shigueno, 1972; Gabaudan et al., 1980).

In most cases brine shrimp are used as freshly hatched nauplii. Although ongrown *Artemia* larvae are reported to be a better food than nauplii for many predators (Kelly et al., 1977; Purdom and Preston, 1977), the fact that they have to be cultured for a few days has restricted this type of application in many aquaculture hatcheries (Brouillet, 1977). Adult brine shrimp are harvested from saline biotopes as a food source for the larvae of lobsters (Shleser and Gallagher, 1974) and the freshwater prawn *Macrobrachium rosenbergii* (Anonymous, 1978).

Historical aspects of the "supply and demand" of cysts

Initially the commercial supply of cysts, first from saltponds in the San Francisco Bay area (CA - U.S.A.) and later also from Great Salt Lake (UT - U.S.A.) and Little Manitou Lake (Saskatchewan - Canada), seemed to be unlimited. The exponentially increasing demand of brine shrimp cysts by aquarium hobbyists and aquaculture hatcheries, however, soon exceeded by far the yearly harvest of approximately 30 to 50 metric tons. From the late sixties on

the dramatic impact of the aggravating cyst shortage on the expansion of aquaculture was repeatedly underlined at international conferences (Provasoli, 1969; FAO, 1972; ASEAN, 1976, 1977; FAO, 1976). Resolutions, such as the one taken by FAO that "... a fuller exploration and exploitation of the world's resources of *Artemia* for aquaculture purposes were considered to be of special importance", all pointed to the urgency of the problem. The situation did not improve however; prices continued to soar, and the hatching quality of the product delivered became less and less reliable. When one was lucky enough to receive a brand of good quality, only 4 gram cyst-material was needed to produce 1 million nauplii; in the worst case however, it took up to 50 g - a 90 % difference in output (Sorgeloos et al., 1978). As a result commercial aquaculture has been impeded very seriously. This is especially true for the farming of *Macrobrachium* and *Penaeus* which are entirely dependent of an *Artemia* diet for a long period of their larval development (Bledsoe et al., 1978; Glude, 1978a,b; Smith et al., 1978). In addition third world countries could hardly afford to import the very expensive cysts. At a regional workshop in Indonesia in 1977 it was concluded that "... the inadequate supply of brine shrimp for feeding shrimp larvae remains as the major constraint in the mass propagation of penaeids in Thailand as in the other countries" (ASEAN, 1977).

Although we had announced at the Kyoto 1976 FAO Technical Conference on Aquaculture (Sorgeloos, 1979a) that the cyst shortage was a technical and only temporal problem, many people remained sceptical. It was not before the end of 1978 that a change in the situation became visible, first through the exploitation of several new natural sources of *Artemia* in Europe, Asia, North and South America and Australia (Sorgeloos, 1979b) and second through the success of the *Artemia* inoculation in North-East Brazil (Sorgeloos et al., 1979b). According to the latest data available cyst provisions exceed 100 metric tons per year.

The increased availability of cysts resulted in competition among dealers and a substantial lowering of prices to about 35 to 40 US dollars per kilogram (FOB-prices). Furthermore, due to the application of new harvesting techniques, the hatching quality of the cysts put on the market improved and became more reliable. The classic method of harvesting cysts from the shore required an air-classified treatment as a final purification step in order to remove small dirt particles included in the harvest (Helfrich, 1973).

In addition during their stay on the shore the cysts are often subjected to repeated hydration-dehydration cycles which affect the energetic content of the embryos and eventually lead the embryonic development to the breaking stage. In this latter situation many so called "light" cysts are harvested which are in fact empty cyst shells (Sorgeloos *et al.*, 1976; Benijts *et al.*, 1977). A very pure cyst-product which does not need air classifying processing can be obtained by harvesting the cysts directly from the water surface. Accumulation of cysts on the shore by wind and wave action can be prevented by the construction of dikes or the installation of floating barriers (Sorgeloos, 1978). Since cysts are mainly produced at high salinities, they remain ametabolic even during light rains, provided that the water is sufficiently turbulent to prevent salinity stratification ["... fresh rainfall on a calm lake provides a lower salinity surface layer where eggs could hatch" (Post, 1977)].

Conditions for maximal hatching output

The production of *Artemia* nauplii by incubation of cysts in seawater is a very simple procedure. However, when working on a larger scale and with high densities of cysts (which is mostly the case in aquaculture enterprises) the application of appropriate techniques is imperative to obtain maximum hatching efficiencies and to minimize the quantity of cysts needed to produce a specific weight or number of *Artemia* nauplii.

During the last years we have had the opportunity to study in detail the effect of various abiotic parameters on the hatching process (see review in Sorgeloos, 1979c). Although the quantitative data vary from one geographical strain to another, the qualitative effect of each individual parameter is similar for all strains studied.

1.- TEMPERATURE

The various effects of water temperature on the hatching metabolism of *Artemia* cysts are summarized in figure 1. The fastest hatching rate and the maximum hatching efficiency are attained around 30 °C. An interesting observation is that as long as the cysts have not reached the breaking stage, an increase of the water temperature within the range of about 33 to 40 °C

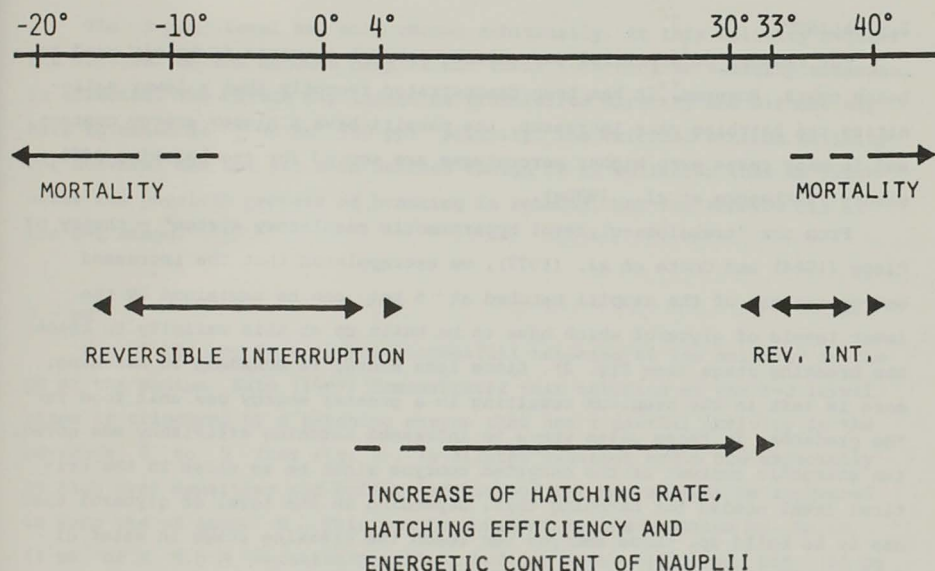

fig. 1.

Schematic diagram of the effect of water temperatures from below -20°C to over 40°C , on the cyst metabolism in *Artemia*.

causes a reversible interruption of the cyst metabolism (Sorgeloos, 1975). When hours or even days later, the water temperature is adjusted to the optimal level for hatching, the cyst metabolism is resumed and the nauplii are born. In the meantime, however, the hatching rate decreased as a function of the duration of exposure to the temperatures above the optimum (Sorgeloos et al., 1976; Benijts et al., 1977).

Molecular biology studies have recently been initiated to study this phenomenon more in detail (Vallejo et al., 1980). In practice, it can be deduced from this observation that cysts which have been exposed by accident (e.g. a technical failure of a heating device) for a short period of time to temperatures above 30°C (but below 40°C), are not necessarily useless but can be saved by decreasing the temperature of the medium, and can still produce nauplii.

2.- SALINITY

For reasons of practical convenience natural seawater is mainly used to hatch cysts. However, it has been demonstrated recently that a lower salinities the hatching rate increases, the nauplii have a higher energy content, and in many cases even higher percentages are scored for the hatching efficiency (Vanhaecke et al., 1980a).

From the "trehalose-glycerol hyperosmotic regulatory system" - theory of Clegg (1964) and Conte et al. (1977), we extrapolated that the increased energy content of the nauplii hatched at 5 ppt can be explained by the lower levels of glycerol which have to be built up at this salinity to reach the breaking stage (see fig. 2). Since less energy is consumed in hatching, more is left in the nauplius resulting in a greater energy per unit food for the predator. In those cases where an increased hatching efficiency was noted, the energetic content of the encysted embryos might be so close to the critical level needed for hatching that, depending on the level of glycerol that has to be build up, these embryos can reach the breaking stage in water of 5 ppt salinity but not in natural seawater.

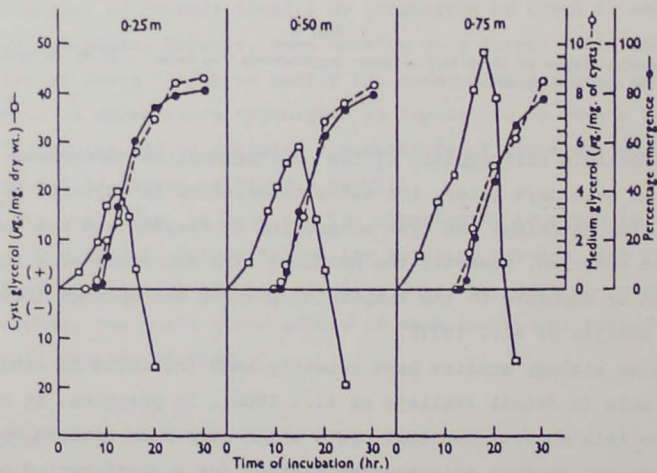

fig. 2.

Relation between the concentration of glycerol in the cysts (○), the glycerol level in the medium (□), the percentage of cysts in "breaking" (●) and the time of incubation of *Artemia* cysts with three different concentrations of NaCl. (0.25 m NaCl = 14.6 ppt salinity) (after Clegg, 1964)

The 5 ppt level has been chosen arbitrarily. At this salinity neither the survival of the hatched nauplii nor their tolerance to salinity stresses is affected. The larvae may indeed be transferred directly and without any harm to seawater of up to 150 ppt salinity. The critical minimum salinity for survival has not yet been defined though it is wellknown that in freshwater the physical process of breaking is reached, but the embryos die at the E-1 stage.

3.- pH

One of the key factors for successful hatching at low salinity is the pH of the medium. Sato (1967) demonstrated that hatching at the E-2 larval stage is triggered by a hatching enzyme that has a maximal activity in the pH-range 8 to 9 (see fig. 3). In diluted seawater media and especially at high cyst densities the buffer capacity of the medium must be increased to keep the pH above 8. This can be achieved by the addition of Na_2CO_3 (1 ml of a 0.5 M solution per liter medium; Jones, 1972) or CaO (65 mg per liter medium). The poor hatching results reported by many authors using artificial seawater or diluted seawater are probably related to a large extent of this pH-effect.

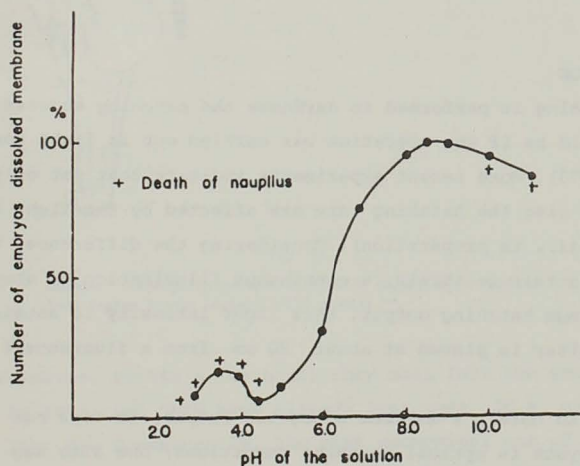

fig. 3.

Influence of the pH of the incubation medium on the activity of the hatching enzyme in *Artemia* embryos (after Sato, 1967).

4.- OXYGEN

Artemia cysts can be hatched at oxygen concentrations as low as 1 mg per liter (Sorgeloos and Persoone, 1975). At lower levels the metabolism is reversibly interrupted. In order to obtain a maximal hatching efficiency, oxygen levels close to saturation are recommended, and most important, all cysts should be kept in suspension. Indeed accumulation of cysts on the bottom of the hatching container creates anaerobic zones which interrupt the cyst metabolism.

Optimal hatching can be achieved with various types of funnel-shaped containers that are aerated from the bottom. We found a very handy solution in using heat-sealed plastic bags made from polyethylene sheets.

5.- CYST DENSITY

As demonstrated by Kurata (1967), who incubated up to 17 g cysts per liter medium, the hatching process is not affected by cyst density, provided however that the other prerequisites are fulfilled. In view of the technical problems encountered in maintaining high oxygen levels without inducing foaming or mechanical injury of the hatched nauplii, it is recommended not to exceed densities of 10 gram per liter, especially when working with large quantities.

6.- ILLUMINATION

When hatching is performed in darkness the hatching success is only half of what it would be if the operation was carried out in light conditions (Sorgeloos, 1973). More recent experiments indicate that not only the hatching efficiency but also the hatching rate are affected by the light intensity (Vanhaecke *et al.*, in preparation). Considering the differences which are observed from strain to strain, a continuous illumination of about 1,000 lux assures a maximum hatching output. This light intensity is attained when the hatching container is placed at about 20 cm from a fluorescent light tube of 60 watt.

In order to obtain a maximum energetic output, it does not suffice to incubate the cysts in optimal hatching conditions; one also has to harvest the nauplii at the right moment (Benijts *et al.*, 1976). Upon hatching, the instar I nauplii are not able to take up food yet and completely thrive on

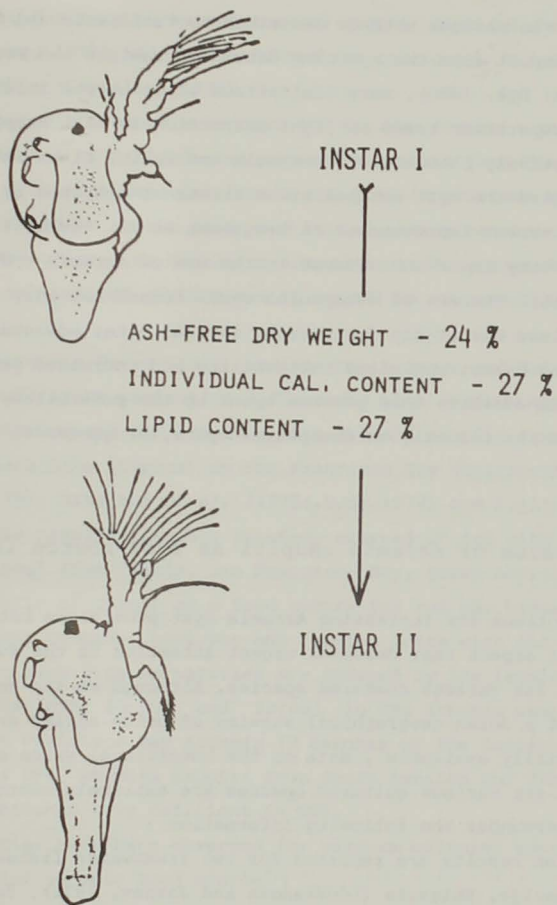

fig. 4.

Changes in energetic content of *Artemia* nauplii upon molting from instar I into instar II-III nauplii.

their energy reserves. Within a few hours they molt into the second and third larval stage. By this time they have already lost over 20 % of their energy reserves (see fig. 4). Consequently, the most economical use of *Artemia* cysts implies incubation of the cysts under strictly defined conditions with regard to the abiotic parameters outlined above, and harvest of larvae in the instar I stage.

In spite of the various methods described to facilitate and maximize the separation of nauplii from the hatching debris (Sorgeloos and Persoone, 1975; Sorgeloos, 1979a; Dye, 1980), many limitations still exist. This is particularly true for separation based on light attraction in that nauplii of some strains are negatively photoactive (Venezuela and Spain; Claus *et al.*, 1977).

In this regard the cyst decapsulation treatment proposed by Sorgeloos *et al.* (1977), with recent improvements in Bruggeman *et al.* (1979, 1980), can be considered as a very important advance in the use of *Artemia* cysts for aquaculture hatcheries. The use of decapsulated cysts indeed not only eliminates all separation problems but it has furthermore several other advantages, e.g. disinfection of the cysts, maximized hatchability and increased naupliar energetic content. In addition this process opens up the possibility of feeding the cultured species directly on decapsulated cysts (Bruggeman *et al.*, 1980).

Nutritional value of *Artemia* nauplii as food source in aquaculture hatcheries

With the outlook for increasing *Artemia* cyst provisions better than ever before, the next aspect that deserves urgent attention is the food value of *Artemia* nauplii for various cultured species. Although at the end of 1978 cysts from about a dozen geographical strains of brine shrimp are, or will soon be commercially available*, data on the nutritional value of the freshly hatched nauplii for various cultured species are extremely scarce. We tentatively report hereunder the following information :

- Good production results are reported for two freshwater fishes fed nauplii from Burgas-Pomorije, Bulgaria (Lüdskanova and Joshev, 1972), for *Dicentrarchus labrax* fed nauplii from the Camalti saltern-Izmir, Turkey (Uçal, 1979), for various marine and freshwater fishes fed on several brine shrimp strains from the USSR (Oleynikova and Pleskachevskaya, 1979; Spektorova, 1979 and pers. comm.), for *Palaemon spec.* and *Penaeus japonicus* fed *Artemia* originating from Little Manitou Lake, Canada (Kurata, 1967 respectively Fujinaga and

* Buenos Aires (Argentina), Shark Bay (Australia), Macau-area (Brazil), Chaplin Lake (Canada), Lavalduc (France), Gujarat-area (India), Tientsin (People's Republic of China), Barotac Nuevo (Philippines), Cadiz-area (Spain), San Francisco Bay (CA - USA) and Great Salt Lake (UT - USA).

Kittaka, 1967), for *Penaeus kerathurus* fed nauplii from San Fernando-Cadiz, Spain (Rodriguez, 1975) and for *Macrobrachium americanum* fed *Artemia* from Manaure, Colombia (Cantillo, 1978).

- No significant differences were reported for the criteria growth and survival of the larvae of *Palaemonetes pugio* fed *Artemia* from Chaplin Lake, Canada or San Francisco Bay, California - U.S.A. (Provenzano and Goy, 1976). However, this Canadian strain performed better than other non-specified *Artemia* strains when offered to *Panulirus interruptus*; "... considerable variations in growth and survival of phyllosomes in regard to source of *Artemia*" (Dexter, 1972).

- Fuchs and Person-Le Ruyet (1976) and Person-Le Ruyet and Salaun (1977) did not observe significant production differences when feeding the larvae of *Solea*, *Dicentrarchus* and *Scophthalmus* with *Artemia* nauplii from either Sète (France), Larnaca Lake (Cyprus) or San Francisco Bay (California - USA).

- Watanabe (1979), Watanabe *et al.* (1978a,b,c; 1979) and Fujita *et al.* (1980) compared *Artemia* nauplii (freshly hatched, starved or fed with enriched diet up to 3 days long) from Canada, San Francisco Bay, South America and Tientsin (People's Republic of China) as a food source for red sea bream larvae *Pagrus major*. From their chemical analyses and feeding tests with the red sea bream it appears that high fish mortalities are induced by low levels of the essential fatty acids (EFA) 20:5 ω 3 and 22:6 ω 3 in the *Artemia* nauplii. Canadian, Chinese and San Francisco Bay *Artemia* (2 batches of the latter) contained high amounts of EFA, whereas nauplii from South America and from 4 other San Francisco Bay batches were deficient in EFA.

High mortalities have been observed for various cultured species fed Great Salt Lake nauplii as sole food source* :

- ◊ after 3 weeks feeding on this diet, sole and plaice larvae refused to further ingest these nauplii, did not undergo metamorphosis and died (Schelbourne, 1968); GSL-nauplii were reported by Slobodkin (1968, in Kinne, 1977) to be toxic to plaice larvae;
- ◊ Little (1969), Reed (1969) and Reeve (1969) observed high mortalities in their decapod cultures which were fed with *Artemia* of Great Salt Lake;

* We do not consider here the poor performance results with GSL-nauplii (Great Salt Lake) that are related to the large size of the nauplius and the resulting inability of the predator to ingest the prey (Smith, 1976).

- *Palaemon serratus* larvae fed on GSL nauplii died upon metamorphosis (Forster and Wickins, 1967; Wickins, 1972);
- Bookhout and Costlow (1970) fed GSL-nauplii to the larvae of 4 crab species and report high mortalities and abnormal developments in the megalopa and first crab stage. Similar observations were published by Roberts (1971, 1974);
- the total length of the period of larval development in *Palaemonetes pugio* is unaffected by the geographical origin of the brine shrimp diet; however, much higher mortalities are noted with GSL-nauplii than with SFB-*Artemia* (San Francisco Bay) (Provenzano and Goy, 1976).
- Matsuoka (1975, in Murai and Andrews, 1978) reports that Chinese *Artemia* nauplii are toxic for the larvae of *Macrobrachium rosenbergii*. Pesticide analyses revealed 5 times and 10 times higher concentrations of DDT, respectively chlorinated hydrocarbons in Chinese than in SFB-*Artemia*.

Various theories have been formulated to explain the poor performances of the Great Salt Lake *Artemia*-diet :

- residual pesticides from the surrounding agricultural lands are drained into the Great Salt Lake and accumulate in the GSL-*Artemia* (Slobodkin, 1968 in Kinne, 1977);
- through the past centuries GSL-*Artemia* might have developed immunity for a toxic alkaloid secreted by algal blooms in the Great Salt Lake and concentrated in the *Artemia* cysts (Shelbourne, in Provasoli, 1969);
- the Great Salt Lake being of athalassohaline origin, Oppenheimer (in Provasoli, 1969) considered mineral deficiency as the possible source of problems.

The few analytical data that have been published with regard to the chemical composition of GSL-*Artemia* are very confusing :

- Bookhout and Costlow (1970) detected 3 times more DDT in GSL-*Artemia* than in cysts from the San Francisco Bay;
- pesticides, heavy metals, carotenoids, sterols and fatty acids were analyzed in both SFB- and GSL-*Artemia* by Wickins (1972), "... some differences were found but none of them could be confidently labeled as the cause of the poor food value of the GSL-*Artemia* nauplii";
- Helfrich and Shigueno (in Helfrich, 1973) found high levels of DDT in both SFB- and GSL-nauplii;
- the observation of Wickins (1972) that GSL-nauplii, when fed during two days with live algae, become a good food for *Palaemon*-larvae, incited Claus

et al. (1979) to perform a detailed biochemical analysis of fed and non-fed *Artemia* larvae from Great Salt Lake and San Francisco Bay origin. Their results, however, were not conclusive in explaining earlier reports of poor performances of freshly hatched GSL-brine shrimp as a food source in aquaculture hatcheries.

Aside from the specific knowledge with regard to red sea-bream culturing in Japan (see above), it is not presently possible to define the chemical and/or nutritional parameters which determine the biological effectiveness of a specific batch or strain of *Artemia* as a good diet for particular cultured species; the analytical methods varied from one study to another, the cyst batches used were never the same, the culturing tests were performed with fish and crustacean larvae which probably show interspecific differences in nutritional requirements and/or sensitiveness.

As a result there is great need for a thorough characterization study of *Artemia* strains which should be undertaken on an interdisciplinary level. Guidelines for the selection of *Artemia* strains for specific uses in the aquaculture hatcheries are urgently needed since at present the choices of new sources of brine shrimp with regard to their potential suitability for the cultured species are arbitrary and as such not without risks.

Such an interdisciplinary research program was initiated in 1978 through the *Artemia* Reference Center at the State University of Ghent in Belgium under the title of "International Study on *Artemia*" (ISA) based on the collaboration of five laboratories from different countries. The participants to this study and their specific research tasks are as follows :

- ◊ *Artemia* Reference Center, State University of Ghent (coordinator : P. Sorgeloos) [biometrical analyses; hatching, growth and reproductive characteristics in function of different temperature-salinity combinations; hybrid tests; preparation and standardization of research material for the participating laboratories];
- ◊ Department of Food Science and Technology, Nutrition and Dietetics, University of Rhode Island, USA (Coordinator : K.L. Simpson) [chemical and biochemical analyses of cysts, nauplii and adults : amino acids, lipids, cartonoids, chlorinated hydrocarbons and heavy metals];
- ◊ Environmental Research Laboratory, Environmental Protection Agency at Narragansett, Rhode Island, USA (Coordinator : A.D. Beck) [biological effectiveness of brine shrimp for the fishes *Menidia menidia* and *Pseudopleuronectes*

americanus, and the crustaceans *Menippe mercenaria*, *Mysidiopsis bahia* and *Rhithropanopeus harrisi*; naupliar swimming behavior];

◊ Center for Mariculture Research, Port Aransas Marine Laboratory of the University of Texas Marine Science Institute, USA (Coordinator : O.A. Roels) [biological effectiveness of brine shrimp for the fish *Cynoscion nebulosus* and the crustacean *Penaeus vanamei*];

◊ St. Croix Marine Station, University of Texas Marine Science Institute, US Virgin Islands (Coordinator : O.A. Roels) [production performances of in the local artificial upwelling mariculture system; production of nauplii, cysts and/or adults as testmaterial for the other participating laboratories];

◊ Department of Genetics, University College of Swansea, UK (Coordinator : J.A. Beardmore) [genotype characterization; inheritance of specific quantitative characteristics; temperature and salinity adaptation studies].

Five strains were selected for an initial characterization study :

◊ Great Salt Lake harvest 1977 made available by "Sander's brine Shrimp Cy";
 ◊ Macau (Rio Grande do Norte-Brazil) harvest 1978 made available by "Companhia Industrial do Rio Grande do Norte" (CIRNE);

◊ Margherita di Savoia (Italy) harvest 1977 made available by P. Trotta ("Laboratorio per lo Sfruttamento biologico delle Lagune", Lessina - Italy);

◊ San Francisco Bay batch Living World 1628 purchased from "San Francisco Bay Brand Cy";

◊ Shark Bay (W-Australia) batch 114 made available by "World Ocean Pty".
 These strains were selected on the basis of the following criteria : availability; their use in aquaculture hatcheries (all except Margherita di Savoia); same genotype but produced in different habitats (the Macau salt ponds were inoculated with San Francisco Bay *Artemia* in 1977; Sorgeloos *et al.*, 1979); geographical isolation free from contamination by urban, industrial and/or agricultural waste waters (Macau and Shark Bay) and genetic differences (Margherita di Savoia and Shark Bay are parthenogenetic strains, the others zygotenic).

During the course of this study we have been informed that Living World batch 1628 cysts were not harvested from San Francisco Bay saltworks (as stated on the label of the commercial product) but from San Pablo Bay salt ponds in the Nappa Valley, north of San Francisco (A. Schmidt, pers. comm.). Although these two *Artemia* habitats are situated within a few hundred kilometers from each other, the San Pablo Bay drains much more agricultural run-off waters to

the ocean than the San Francisco Bay. In expectation of further data on the exact origin of San Francisco Bay *Artemia sensu lato*, San Pablo Bay *Artemia* ("Living World, San Francisco Bay Brand Cy" batch 1628) are considered as distinct from San Francisco Bay *Artemia* (cysts sold under the label "San Francisco Bay Brand Cy").

The results of the detailed characterization study of the five selected strains of *Artemia* are reported in Beck *et al.* (1980), Johns and Walton (1979), Johns *et al.* (1980), Klein-MacPhee *et al.* (1980), Olney *et al.* (1980), Schauer *et al.* (1980) and Seidel *et al.* (1980). A wider range of strains was studied for their genetic similarities (Abreu-Grobois and Beardmore, 1980) their biometrical characteristics (Vanhaecke and Sorgeloos, 1980a), their growth and production performances on live algae in a batch culturing system (Vanhaecke and Sorgeloos, 1980b) and in a flow-through system (Tobias *et al.*, 1980), their carotenoid composition and metabolism (Soeijma *et al.*, 1980) and their naupliar locomotory rates, patterns and photoresponses (Miller *et al.*, 1979).

From this ISA-study it appears that for most parameters studied, considerable variability exists between *Artemia* strains. These initial data already provide pertinent information for the selection and practical use of brine shrimp nauplii in aquaculture: e.g. the difference in the nutritional value of particular strains for specific predators, the size, biochemical composition and energetic content of the freshly hatched nauplii, etc. It is clear that this comparative ISA-program should be further extended not only to more cyst samples but also to more test-organisms, in order to further unravel the parameters that define the "suitability" of *Artemia* nauplii as food source in aquaculture hatcheries. In this regard the following *Artemia* strains have been selected for the 1979-1980 ISA-program: *Artemia* Reference Cysts (see Report Workshop I "Characterization of *Artemia* strains for application in aquaculture", this symposium), Chaplin Lake, Lavalduc and Tientsin. Very valuable research material will furthermore result from the production of *Artemia* cysts in standardized culturing tests with feeding of the brine shrimp with formulated diets containing various amounts of EFA and pesticides.

Through application of the latest developments in quantitative genetics, the ISA-program aims, on a long term basis, to develop new strains of brine shrimp for the benefit of aquaculture; e.g. availability of minute *Artemia* nauplii, smaller than 150 μm in length, could eliminate the need for expensive and cumbersome rotifer production, necessary for the culturing of fishes

with very small larvae (milkfish, mullet, turbot, etc.) and crustaceans as shrimp and crab.

The use of Adult *Artemia* as food source

Although for technical reasons the use of *Artemia* is limited in most cases to freshly hatched nauplii, adult brine shrimp definitely deserve more attention for many reasons :

- Adult *Artemia* are 20 times larger and weigh 500 times more than freshly hatched nauplii (Reeve, 1963); their nutritional value changes considerably during growth : the fat content decreases from $\pm 20\%$ to less than 10% of the dry weight and the protein content increases from $\pm 42\%$ to over 60% (Von Hentig, 1971; Helfrich, 1973); whereas nauplii are deficient in histidine, methionine, phenyllalanine and threonine, adult brine shrimp are rich in all essential amino acids (Stults, 1974; Watanabe et al., 1978b; Claus et al., 1979; Gallagher and Brown, 1975).
- *Artemia* is a euryhaline and eurythermal crustacean and a non-selective particle filter-feeder; contrary to many other crustaceans its food requirements do not change during growth; it has a high food conversion efficiency and can be cultured in very high densities (Helfrich, 1973; Sorgeloos and Persoone, 1975).
- *Artemia* has a short generation time (minimum of about 2 weeks), a high fecundity rate (up to over 100 offsprings every 4 days) and a long life-span (up to more than 6 months) [Nimura, 1967; Ivleva, 1969].
- The exoskeleton of the adult is only $1\ \mu\text{m}$ thick which allows consumption of the whole animal without previous processing; for many aquaculture organisms pre-adult or adult *Artemia* are known to be a much better reference diet than formulated feeds : e.g. for *Homarus americanus* (Hughes et al., 1974, Gallagher et al., 1976), *Macrobrachium rosenbergii* (Aquacop, 1977), *Penaeus kerathurus* (San Feliu et al., 1976), *Penaeus aztecus* (Venkataramiah et al., 1975), *Callinectes sapidus* (Milliken et al., 1980), *Solea solea* and *Scophthalmus maximus* (Aronovich and Spektorova, 1971), *Sparus auratus* (Alessio, 1974) and *Dicentrarchus labrax* (Barahona-Fernandes and Girin, 1976).

In view of its high price (wholesale price up to 20 US dollars per kilogram fresh weight), live as well as frozen *Artemia* adults are presently used as a luxury food source in the pet market and, to some extent, for re-

search work in lobster and prawn farming (Anonymous, 1978). Although natural brine shrimp populations are still the most important source of commercially available *Artemia*, they are only exploited in a few areas in Canada, France and the USA with a total yearly output of approximately 1,000 metric tons. The future output from nature where *Artemia* has to date been recorded from more than 150 habitats (Persoone and Sorgeloos, 1980) will probably increase considerably. However, new exploitations should be carefully planned, taking into account maximum sustainable yields (in order not to affect cyst production) and the potential local role of *Artemia* as energy source for migrating and breeding waterbirds (Herbst and Dana, 1980; Rooth, 1965). New suitable areas for the production of substantial tonnages of *Artemia* biomass (and eventually cysts) can furthermore be considered, without any serious risks for ecological disturbances, by converting thousands of hectares of hypersaline lagoons and abandoned salt-ponds, which can be found all over the world (Serence and Webber, in Hempel, 1970; Rabanal and Beuschel, 1978), into *Artemia*-biotopes; this implies of course well-defined inoculation and production projects.

Lately, another interesting source of *Artemia* production has come into perspective. Tertiary treatment plants for industrial effluents of high salinity are capable of producing substantial amounts of adult *Artemia*. However, attention shall be paid to the eventual bioaccumulation of toxic substances (Milligan et al., 1980).

The present output of brine shrimp from controlled intensive culturing systems is still limited. However, in view of the very important progresses made in this field (see hereunder) the interest in this type of *Artemia* production is considerably increasing. When it comes to a choice, cultured *Artemia* are always to be preferred over brine shrimp harvested from nature. The latter animals indeed often carry parasites or suffer from bacterial and fungal diseases (Persoone and Sorgeloos, 1980); furthermore they have mostly been starved for days before shipping to their final destination.

Since it has been shown that "... progressively larger *Artemia* ... were required by the fish as they grew themselves" (Purdom and Preston, 1977) an adequate and simple technology for cheap production, in the aquaculture hatcheries, of brine shrimp larvae of intermediate size will receive more and more attention (Barahona-Fernandes et al., 1977).

Progress in controlled intensive *Artemia* culturing

Most of the techniques which have been described in the past for high density culturing of *Artemia* in batch systems have only limited application. This is due to either the complexity of the technique and/or the limited availability or the high price of the food used (see reviews in Bossuyt and Sorgeloos, 1980; Dobbeleir et al., 1980).

A major innovation in the technology of *Artemia* batch culturing with potential for worldwide application is the air-water-lift raceway, originally developed for the intensive culture of post-larval penaeid shrimp (Mock et al., 1973) but modified for brine shrimp culturing at the *Artemia* Reference Center (Sorgeloos et al., 1977b). Details on design and construction as well as the description of simple food distribution systems are given in Bossuyt and Sorgeloos (1980). Food dosing in this raceway method is based on readings of water turbidity, which allow automatization of the food distribution by use of turbidimetric devices (Versichele et al., 1979). A cheap and worldwide available food source was found in using ricebran (Sorgeloos, 1978; Sorgeloos et al., 1980). It now appears that many other types of agricultural waste products, such as whey-powder can also be used successfully as a monodiet for brine shrimp culturing (Dobbeleir et al., 1980).

Presently 10 gram cysts can be converted into 2 kg pre-adult *Artemia* within two weeks in a raceway of 1 m³. The protein content and amino acid composition of *Artemia* fed ricebran do not differ significantly from those of brine shrimp harvested from nature (Sorgeloos et al., 1980). However, in view of the differences in fatty acid composition, further studies are needed to evaluate the nutritional value of brine shrimp raised on waste products for various cultured organisms and, if necessary, to consider diet formulations and/or alternations (Dobbeleir et al., 1980).

Whereas batch culturing in air-water-lift raceways has a potential worldwide application in aquaculture hatcheries for the production of brine shrimp of various sizes, a much more intensified mass production can be achieved in flow-through systems. This is, however, only possible in a very restricted number of situations. In a joint collaboration effort, the St. Croix Marine Station of the University of Texas Marine Science Institute and the *Artemia* Reference Center developed a technique for flow-through culturing of brine shrimp in very high densities (Tobias et al., 1979). The keys to success with this particular technology are the circular screen cylinder (which must be

changed regularly) and the cleaning effect of an aeration collar fixed at the bottom of the filter cylinder to keep the screen free from clogging.

The flow-through tests carried out in St. Croix were run with the effluent of the two algal ponds of the local Artificial Upwelling Project (Roels *et al.*, 1976). By extrapolation from repeated 100 liter trials (Tobias, pers. comm.) it has been calculated that 30 gram cysts can be converted in a 1 m³ tank into 25 kg adult biomass within two weeks! The maximum productivity potential of flow-through culturing has not yet been reached in St. Croix. Water temperatures during the period of the experiments were rather low (22 - 25 °C), and has a consequence of the limited cell densities in the algal cultures (5 10⁴ *Chaetoceros curvisetus* cells ml⁻¹) the maximum *Artemia* density had to be restricted to 12,000 individuals l⁻¹. Laboratory tests indicate, however, that densities in flow-through cultures may reach 40,000 *Artemia* l⁻¹ (Nimura, 1967).

The successes obtained so far in replacing live algae by inert diets such as wheypowder or ricebran, will now be further studied. At the same time endeavours will be made to further automatize the flow-through culturing technique.

ISA-studies on the production potential of various *Artemia* races [e.g. differences in growth rate (Tobias *et al.*, 1980; Vanhaecke and Sorgeloos, 1980b), temperature optimum, food conversion efficiency, protein content, etc.] indicate that it will become possible to select strains with improved characteristics for intensive culturing.

As pointed out above the potential sites where *Artemia* flow-through production is possible are much more limited than for batch culturing in closed raceways, especially with regard to the need for large volumes of seawater at a temperature within the range 20 to 30 °C. As potential sources of alternative energy, Ocean Thermal Energy Conversion systems (OTEC) as well as geothermal projects are gaining more and more interest (Bardach, 1979; Anonymous, 1979). In an OTEC-plant *Artemia* could be grown in the effluent on an inert diet or on phytoplankton cultures produced in an artificial upwelling system of the St. Croix-type (Roels *et al.*, 1976) connected to the same OTEC-plant. Since the salinities of geothermal water range from brackish up to 100 ppt brine, *Artemia* is the only invertebrate which can be cultured in such a wide salinity range. For the same reason flow-through culturing of brine shrimp can be considered in the warm brine effluent of desalination plants.

Semi-industrial production of *Artemia* should now be started in pilot-plants in order to assess the economical feasibility of a potential annual output of thousands of tons of animal protein from these new bio-industries.

Potential use of *Artemia* as protein source

From the foregoing it already appears that the yearly production of brine shrimp may increase substantially during the next decade. Aside from an improved perspective for the use of *Artemia* in the aquaculture hatcheries, it becomes obvious that other applications show very high potential even including direct use in human nutrition. Although the acceptability of brine shrimp as food for man might seem to be speculative or restricted to a few areas in the world, it is certainly worthwhile to be considered, not the least for third world countries. From an energetic point of view brine shrimp production is a much more efficient way to produce animal protein than culturing of carnivorous fish and crustaceans with *Artemia* and fish meal as diet ingredients!

Direct consumption of brine shrimp by man has been and is still practised by primitive tribes in America and Africa: "... Indians inhabiting this region used to collect large quantities of this crustacean which they dried and used as food" (Jensen, 1918). The Dawada-people in Libya consume dried *Artemia* flakes as "... a superb source of protein rich in β -carotene and riboflavine" (Ghannudi and Tufail, 1978) and market these "... pains d'*Artemia*" as a nutritious delicacy over a wide area (Oudney, 1828, in Bovill, 1968; Delga et al., 1960; Monod, 1969). Taste panel tests on *Artemia* conducted in Hawaii should be further extended since "... the response to an experimental shrimp tempura prepared from frozen brine shrimp was quite favorable" (Davidson, 1974; Helfrich, 1973).

If not used directly as human food, *Artemia* meal can be used as a rich source of animal protein in livestock diets (Anonymous, 1978). In this regard dried brine shrimp may be used as a valuable alternative to fish meal, especially in those countries that are entirely dependent on fish meal import.

Concluding remarks

In conclusion *Artemia* should no longer be considered as a luxury food in aquaculture but rather as a cheap and high quality source of animal protein. Now, more than ever, many aspects dealing with the use of *Artemia* in aquaculture need to be studied further in order to reach this goal. A first promising step in this direction is the Aquaculture Planning Program for Hawaii (Anonymous, 1978) in which brine shrimp has been considered as a first priority species.

Table 1

Overall state-of-the-art and market potential of 24 of the most important aquaculture candidate species or groups of species.

1 : no; 5 : yes; 2 to 4 : in-between scorings (after Nash, 1974, in Kinne and Rosenthal, 1977)

| | Oysters | Mussels | Clams | Scallops | Abalone | Crabs | Shrimps | Lobster | Krill | <i>Artemia</i> | Salmon | Flatfish | Mullet | Rabbitfish | Dolphinfish | Pompano | Yellow-tail | Anchovy | Herrings | Eels | Milkfish | Octopus | Turtles | Bloodworm |
|------------------------------------|---------|---------|-------|----------|---------|-------|---------|---------|-------|----------------|--------|----------|--------|------------|-------------|---------|-------------|---------|----------|------|----------|---------|---------|-----------|
| Controlled spawning possible | 5 | 5 | 5 | 4 | 4 | 2 | 1 | 3 | 1 | 5 | 5 | 4 | 4 | 1 | 1 | 1 | 2 | 4 | 1 | 3 | 1 | 2 | 4 | 1 |
| Simple larval development achieved | 5 | 5 | 5 | 5 | 5 | 4 | 5 | 5 | 2 | 5 | 5 | 5 | 2 | 1 | 1 | 1 | 3 | 5 | 3 | 3 | 5 | 3 | 4 | 1 |
| Mas produced in hatchery | 5 | 5 | 5 | 4 | 3 | 1 | 4 | 4 | 1 | 5 | 5 | 5 | 1 | 1 | 1 | 1 | 1 | 1 | 2 | 1 | 1 | 4 | 1 | |
| Fast growth rate potential | 5 | 5 | 4 | 4 | 4 | 3 | 4 | 4 | 4 | 5 | 5 | 4 | 4 | 4 | 5 | 5 | 5 | 4 | 4 | 5 | 5 | 4 | 3 | 3 |
| Satisfactory feeds known | 5 | 4 | 4 | 3 | 3 | 1 | 3 | 3 | 3 | 5 | 5 | 3 | 3 | 1 | 2 | 1 | 5 | 3 | 3 | 5 | 5 | 3 | 3 | 2 |
| Commercial feeds available | 1 | 1 | 1 | 1 | 1 | 1 | 2 | 1 | 1 | 1 | 5 | 1 | 1 | 1 | 1 | 1 | 3 | 1 | 1 | 2 | 1 | 1 | 1 | 1 |
| High conversion efficiency | 2 | 2 | 2 | 2 | 2 | 3 | 3 | 3 | 3 | 4 | 5 | 4 | 3 | 2 | 4 | 4 | 4 | 3 | 3 | 5 | 5 | 3 | 2 | 1 |
| Hardy in captivity | 5 | 5 | 3 | 3 | 3 | 5 | 3 | 3 | 3 | 5 | 5 | 5 | 5 | 3 | 3 | 3 | 5 | 2 | 3 | 5 | 5 | 2 | 3 | 3 |
| High disease resistance | 4 | 4 | 4 | 4 | 4 | 4 | 3 | 4 | 3 | 5 | 4 | 4 | 4 | 3 | 3 | 3 | 4 | 2 | 3 | 4 | 4 | 3 | 2 | 4 |
| High density potential | 5 | 5 | 5 | 5 | 4 | 5 | 3 | 3 | 5 | 5 | 4 | 4 | 3 | 4 | 4 | 4 | 5 | 5 | 5 | 4 | 3 | 3 | 5 | 5 |
| Farming systems developed | 5 | 5 | 3 | 3 | 3 | 1 | 4 | 2 | 1 | 5 | 4 | 4 | 4 | 1 | 1 | 3 | 5 | 1 | 1 | 5 | 5 | 1 | 3 | 4 |
| High price range | 5 | 2 | 4 | 4 | 4 | 1 | 4 | 5 | 1 | 5 | 5 | 3 | 2 | 1 | 4 | 4 | 5 | 2 | 2 | 5 | 1 | 4 | 5 | 3 |
| High market potential U.S. | 5 | 1 | 5 | 5 | 5 | 2 | 5 | 5 | 1 | 5 | 5 | 3 | 1 | 1 | 5 | 5 | 4 | 3 | 3 | 2 | 1 | 3 | 5 | 5 |
| High market potential foreign | 5 | 5 | 5 | 5 | 5 | 3 | 5 | 5 | 3 | 5 | 5 | 4 | 4 | 4 | 5 | 4 | 5 | 4 | 4 | 5 | 5 | 5 | 5 | 3 |
| Matrix total | 62 | 54 | 55 | 52 | 51 | 36 | 49 | 50 | 32 | 65 | 67 | 53 | 42 | 27 | 40 | 40 | 55 | 40 | 37 | 56 | 48 | 38 | 47 | 37 |

In his mathematical evaluation of the overall value and market potential of 24 of the most important aquaculture candidate species or groups of species, Nash (1974, in Kinne and Rosenthal, 1977) ranks brine shrimp second after salmon (table 1). The recent finding of cheap inert diets for brine shrimp lifts this species to top place in rank of importance in the field of aquaculture.

References

- ABREU-GROBOIS, F.A., BEARDMORE, J.A. (1980). *International Study on Artemia*. II. Genetic characterization of *Artemia* populations, in *The brine shrimp Artemia*. Vol. 1 : *Morphology, Genetics, Radiobiology, Toxicology*, Eds G. Persoone, P. Sorgeloos, O.A. Roels, E. Jaspers, Universa Press, Wetteren (Belgium), in press.
- ALESSIO, G. (1974). Riproduzione artificiale di orata *Sparus auratus* (L.) (Osteichthyes, Sparidae). III. Produzione su vasta scala di fito e zooplancton per l'alimentazione delle larve e degli avanotti, *Boll. Pesca Piscic. Idrobiol.*, 29 (2), 133-147.
- ANONYMOUS (1978). *Aquaculture development for Hawaii*, Aquaculture Planning Program, Department of Planning and Economic Development, State of Hawaii.
- ANONYMOUS (1979). Eurocean report n° 1, Association européenne océanique, Monaco.
- AQUACOP (1977). *Macrobrachium rosenbergii* (De Man) culture in Polynesia : progress in developing a mass intensive larval rearing technique in clear water, in *Proc. 8th Ann. Meeting WMS*, J.W. Avault jr. ed., Louisiana State University, Baton Rouge (LA - USA), pp. 311-326.
- ARONOVICH, T.M. and SPEKTOROVA, L.V. (1971). Cultivation of food organisms in connection with the problem of artificial propagation of young stages of marine fishes (in Russian), *Proc. All-Union Res. Inst. Mar. Fish. Ocean*, 81, 190-204; *Fish. Res. Bd Can.*, translation series, n° 2385.
- ASEAN (1976). Report of the ASEAN Seminar / Workshop on shrimp culture, Iloilo City (Philippines), 15-23 November 1976, Asean National Secretariat of the Philippines, Manila.
- ASEAN (1977). First Asean Meeting of Experts on Aquaculture, Technical Report, Asean, Semarang (Indonesia), Jan. 31 - Feb. 6, 1977.
- BARAHONA-FERNANDES, M.H. and GIRIN, M. (1976). Preliminary tests on the optimal pellet-adaptation age for sea bass larvae (Pisces, *Dicentrarchus labrax* L., 1758), *Aquaculture*, 8, 283-290.
- BARAHONA-FERNANDES, M.H., GIRIN, M. and METAILLER, R. (1977). Expériences de conditionnement d'alevins de bar (Pisces, *Dicentrarchus labrax*) à différents aliments composés, *Aquaculture*, 10, 53-63.
- BARDACH, J.E. (1979). Keynote address, in *Proc. 10th Ann. Meeting WMS*, in press.
- BECK, A.D. (1979). Laboratory culture and feeding of the Atlantic silverside *Menidia menidia*, in *Cultivation of fish fry and its live food*, EMS Spec. Publ. n° 4, Eds. E. Styzyńska-Jurewicz, T. Backiel, E. Jaspers, G. Persoone, Institute for Marine Scientific Research, Bredene (Belgium).
- BECK, A.D., BENGTON, D.A. and HOWELL, W.H. (1980). *International Study on Artemia*. V. Nutritional value of five geographical strains of *Artemia* : Effects on survival and growth of larval Atlantic Silverside, *Menidia menidia*, in *The brine shrimp Artemia*. Vol. 3 : *Ecology, Culturing, Use in Aquaculture*, Eds G. Persoone, P. Sorgeloos, O.A. Roels, E. Jaspers, Universa Press, Wetteren (Belgium), in press.
- BENIJS, F., VANDEPUTTE, G. and SORGELOOS, P. (1977). Energetic aspects of the metabolism of hydrated *Artemia* cysts, in *Fundamental and applied research on the brine shrimp, Artemia salina* (L.) in Belgium, EMS Special

- Publication n° 2, E. Jaspers ed., Institute for Marine Scientific Research, Bredene (Belgium).
- BENIJTS, F., VANVOORDEN, E. and SORGeloos, P. (1976). Changes in the biochemical composition of the early larval stages of the brine shrimp *Artemia salina* L., in *Proc. 10th European Symposium on Marine Biology*, vol. 1, G. Persoone and E. Jaspers eds., Universa Press, Wetteren (Belgium).
- BLEDsOE, L.J., SHLESER, R.A. and GLUDE, J.B. (1978). Development of research priorities for aquaculture planning, Washington Sea Grant, WSG-MR 78-2, University of Washington, Seattle.
- BOOKHOUT, C.G. and COSTLOW, J.D. jr. (1970). Nutritional effects of *Artemia* from different locations on larval development of crabs, *Helgolander wiss. Meeresunters*, 20, 435-442.
- BOSSUYT, E. and SORGeloos, P. (1980). *Technological aspects of the batch culturing of Artemia in high densities*, in *The brine shrimp Artemia*. Vol. 3 : *Ecology, Culturing, Use in Aquaculture*, Eds. G. Persoone, P. Sorgeloos, O.A. Roels, E. Jaspers, Universa Press, Wetteren (Belgium), in press.
- BOVILL, E.W. (1968). *The Niger explored*. Oxford University Press, London.
- BRUILLET, S. (1977). *Approche technique et économique comparée d'écloseries-nurseries du bar et de la sole*, Mémoire de DEA Halieutique.
- BRUGGEMAN, E., BAEZA-MESA, M., BOSSUYT, E. and SORGeloos, P. (1979). Improvements in the decapsulation of *Artemia* cysts, in *Cultivation of fish fry and its live food*, EMS Spec. Publ. n° 4, Eds. E. Styczyńska-Jurewicz, T. Backiel, E. Jaspers and G. Persoone, Institute for Marine Scientific Research, Bredene (Belgium).
- BRUGGEMAN, E., VANHAECKE, P. and SORGeloos, P. (1980). *Improvements in the decapsulation-technique of Artemia cysts*, in *The brine shrimp Artemia*. Vol. 3 : *Ecology, Culturing, Use in Aquaculture*, Eds. G. Persoone, P. Sorgeloos, O.A. Roels and E. Jaspers, Universa Press, Wetteren (Belgium), in press.
- CANTILLO, M. (1978). *Desarrollo artificial de los estados larvales del camarón de río Macrobrachium americanum (Bate 1860)*, Universidad del Valle, Departamento de Biología, Colombia.
- CARLBERG, J.M. and VAN OLST, J.C. (1976). Brine shrimp (*Artemia salina*) consumption by the larval stages of the american lobster (*Homarus americanus*) in relation to food density and water temperature, in *Proc. 6th Ann. Meeting WMS.*, J.W. Avault jr. ed., Louisiana State University, Baton Rouge (LA - USA).
- CLAUS, C., BENIJTS, F. and SORGeloos, P. (1977). Comparative study of different geographical strains of the brine shrimp *Artemia salina*, in *Fundamental and applied research on the brine shrimp Artemia salina (L.) in Belgium*, EMS Special Publication n° 2, E. Jaspers ed., Institute for Marine Scientific Research, Bredene (Belgium).
- CLAUS, C., BENIJTS, F., VANDEPUTE, G. and GARDNER, W. (1979). The biochemical composition of the larvae of two strains of *Artemia salina* (L.) reared on two different algal foods, *J. exp. mar. Biol. Ecol.*, 36, 171-183.
- CLEGG, J.S. (1964). The control of emergence and metabolism by external osmotic pressure and the role of free glycerol in developing cysts of *Artemia salina*, *J. exp. Biol.*, 41, 879-892.

- CONTE, F.P., DROUKAS, P.C. and EWING, R.D. (1977). Development of sodium regulation and de novo synthesis of Na+K-activated ATPase in larval brine shrimp *Artemia salina*, *J. exp. Zool.*, 202 (3), 339-361.
- DAVIDSON, J.R. (1974). A new industry — and perhaps a new protein source, Sea Grant Technical Report UNIHI-Seagrant-MR-74-02.
- DELGA, J., MEUNIER, J.L., PALLAGET, C. and CARIOUS, J. (1960). Les mangeurs de vers, *Annls Falsif. Expert. chim.*, 617.
- DESHIMARU, O. and SHIGUENO, K. (1972). Introduction to the artificial diet for prawn *Penaeus japonicus*, *Aquaculture*, 1, 115-133.
- DEXTER, D.M. (1972). Molting and growth in laboratory reared phyllosomes of the California spiny lobster, *Panulirus interruptus*, *Calif. Fish and Game*, 58 (2), 107-115.
- DOBBELEIR, J., ADAM, N., BOSSUYT, E., BRUGGEMAN, E. and SORGeloos, P. (1980). *New aspects of the use of inert diets for high density culturing of brine shrimp*, in *The brine shrimp Artemia*. Vol. 3 : *Ecology, Culturing, Use in Aquaculture*, Eds. G. Persoone, P. Sorgeloos, O.A. Roels, E. Jaspers, Universa Press, Wetteren (Belgium), in press.
- DYE, J.E. (1980). *The production and efficient use of freshly-hatched brine shrimp nauplii (Artemia) in the larval rearing of marine fish at the hatcheries of the British White Fish Authority*, in *The brine shrimp Artemia*. Vol. 3 : *Ecology, Culturing, Use in Aquaculture*, Eds. G. Persoone, P. Sorgeloos, O.A. Roels, E. Jaspers, Universa Press, Wetteren (Belgium), in press.
- FAO (1972). Report on the first session of the ACMR/IABO working-party on aquaculture, Rome, 17-23 May 1972, FAO Advisory Committee on main resources research, 7/73/WP.6.
- FAO (1976). Report of the FAO Technical Conference on Aquaculture, Kyoto, Japan, 26 May - 2 June 1976, FAO Fish. Rep., 188.
- FLÜCHTER, J. (1980). Review of the present knowledge of rearing whitefish (Coregonidae) larvae, *Aquaculture*, 19, 191-208.
- FORSTER, J.R.M. and WICKINS, J.F. (1967). Experiments in the culture of the prawn *Palaemon serratus* (Pennant), ICES C.M./EB.
- FUCHS, J. and PERSON-LE RUYET, J. (1976). Etude comparative des possibilités d'élevage larvaire de quelques poissons marins avec une nouvelle souche d'*Artemia salina*, ICES C.M./E 24.
- FUJINAGA, M. and KITAKA, J. (1967). The large-scale production of the young Kuruma prawn, *Penaeus japonicus* Bate, *Inf. Bull. Planktol. Japan*, Commemorative n° for Dr. Matsue's 60th birthday, 35-46.
- FUJITA, S., WATANABE, T. and KITAJIMA, G. (1980). *Nutritional quality of Artemia from different locations as a living feed from the viewpoint of essential fatty acids for marine fish*, in *The brine shrimp Artemia*. Vol. 3 : *Ecology, Culturing, Use in Aquaculture*, Eds. G. Persoone, P. Sorgeloos, O.A. Roels, E. Jaspers, Universa Press, Wetteren (Belgium), in press.
- GABAUDAN, J., PIGOTT, G.M. and HALVER, J.E. (1980). The effect of processing on protein ingredients for larval diets : biological evaluation, in *Proc. 11th Ann. Meeting WMS*, in press.

- GALLAGHER, M. and BROWN, W.D. (1975). Composition of San Francisco Bay brine shrimp (*Artemia salina*), *J. Agric. Food Chem.*, 23 (4), 630-632.
- GALLAGHER, M.L., CONKLIN, D.E. and BROWN, W.D. (1976). The effects of pelleted protein diets on growth, molting and survival of juvenile lobsters, in *Proc. 7th Ann. Meeting WMS*, J.W. Avault jr. ed., Louisiana State University, Baton Rouge (LA - USA).
- GHANNUDI, S.A. and TUFAIL, M. (1978). A report on a two-day visit to eight salt-water lakes of Ramla Az-Zallaf, Fezzan, Libyan Arab Jamahiriya, *Libyan Journal of Science*, 8 (A), 69-74.
- GIRIN, M. and PERSON-LE RUYET, J. (1977). L'élevage larvaire des poissons marins : chaînes alimentaires et aliments composés, *Bull. franç. Piscic.*, 264, 88-101.
- GLUDE, J.B. (1978a). The marine shrimp *Penaeus* spp. A literature review and analysis of the use of thermal effluent in the culture of penaeid shrimp, Seattle (WA - USA).
- GLUDE, J.B. (1978b). The freshwater prawn *Macrobrachium rosenbergii* (de Man). A literature review and analysis of the use of thermal effluents in the culture of the freshwater prawn, Seattle (WA - USA).
- HELFRICH, P. (1973). The feasibility of brine shrimp production on Christmas Island, Sea Grant Technical Report UNIH-SeaGrant-TR-73-02.
- HEMPEL, G. (1970). Fish-farming, including farming of other organisms of economic importance. Convener's report of an informal session, held on September 11, during the international Helgoland Symposium 1969, *Helgolander wiss. Meeresunters.*, 21, 445-465.
- HERBST, D.B. and DANA, G.L. (1980). *Physiological studies on a population of Artemia from Mono Lake, California. The effects of increasing lake water salinity on survival, respiration rate and internal solute regulation*, in *The brine shrimp Artemia*. Vol. 2 : *Physiology, Biochemistry, Molecular Biology*, Eds. G. Persoone, P. Sorgeloos, O.A. Roels, E. Jaspers, Universa Press, Wetteren (Belgium), in press.
- HUGHES, J.T., SHLESER, R.A. and TCHOBANOGLIOUS, G. (1974). A rearing tank for lobster larvae and other aquatic species, *Progr. Fish-Cult.*, 36, 129-132.
- IVLEVA, I.V. (1969). Branchiopoda, in *Mass cultivation of invertebrates. Biology and Methods*, Acad. Sci. of the USSR, All-Union Hydrobiological Society, Izdatel'stvo "Nauka", Moskva. Translated in english by Israel Program for Scientific Translations, Jerusalem, 1973.
- JENSEN, A.C. (1918). Some observations on *Artemia gracilis*, the brine shrimp of Great Salt lake, *Biol. Bull.*, 34 (1), 18-28.
- JOHNS, D.M., PETERS, M.E. and BECK, A.D. (1980). *International Study on Artemia*. VI. *Nutritional value of geographical and temporal strains of Artemia : effects on survival and growth of two species of brachyuran larvae*, in *The brine shrimp Artemia*. Vol. 3 : *Ecology, Culturing, Use in Aquaculture*, Eds. G. Persoone, P. Sorgeloos, O.A. Roels, E. Jaspers, Universa Press, Wetteren (Belgium), in press.
- JOHNS, D.M. and WALTON, W. (1979). *International Study on Artemia*. X. *Effects of food source on survival, growth and reproduction in the mysid, Mysis diopsis bahia*, *Amer. Zool.*, in press.

- JONES, A.J. (1972). An inexpensive apparatus for the large scale hatching of *Artemia salina* L., *J. Cons.*, 34 (3), 351-356.
- KELLY, O., HASELTINE, A.W. and EBERT, E.E. (1977). Mariculture potential of the spot prawn, *Pandalus platyceros* Brandt, *Aquaculture*, 10, 1-16.
- KINNE, O. (Ed.) (1977). *Marine Ecology*, vol. III, *Cultivation*, part 2, John Wiley and Sons, New York.
- KINNE, O. and ROSENTHAL, H. (1977). Commercial cultivation (aquaculture), in *Marine Ecology*, vol. III, *Cultivation*, part 3, pp. 1321-1398. Ed. O. Kinne, John Wiley and Sons, New York.
- KLEIN-MACPHEE, G., HOWELL, W.H. and BECK, A.D. (1980). International Study on *Artemia*. VII. Nutritional value of five geographical strains of *Artemia* to winter flounder (*Pseudopleuronectes americanus*) larvae, in *The Brine Shrimp Artemia*, vol. 3, *Ecology, Culturing, Use in Aquaculture*. Eds G. Persoone, P. Sorgeloos, O.A. Roels and E. Jaspers, Universa Press, Wetteren (Belgium), in press.
- KURATA, H. (1967). Note on the brine shrimp eggs (in Japanese), *Aquaculture*, 14 (4), 205-219.
- LITTLE, G. (1969). The larval development of the shrimp *Palaemon macrodactylus* Rathbun reared in the laboratory and the effect of eyestalk extirpation on development, *Crustaceana*, 17, 69-87.
- LUDSKANOVA, J. and JOSHEV, L. (1972). Die Anzucht von *Artemia salina* L. als Nahrung für Pflanzenfresser, *Z. Binnenfischerei DDR*, 19 (6), 177-181.
- MATSUOKA, T. (1975). Culture of the giant prawn, *Yoshoku*, 12, 48-52.
- MILLER, D.C., LANG, W.H., MARCY, M., CLEM, P. and PECHENIK, J. (1979). International study on *Artemia*. Naupliar locomotory rates, patterns and photo-responses: a comparative study of various strains of *Artemia salina*, Abstract of the International Symposium on the brine shrimp, *Artemia salina*, Corpus Christi, Texas, U.S.A., Aug. 20-23, 1979.
- MILLIGAN, D.J., QUICK, J.A., HILL, S.E., MORRIS, J.A. and HOVER, R.J. (1980). Sequential use of bacteria, algae and brine shrimp to treat in industrial wastewater at pilot plant scale, in *The brine shrimp Artemia*, vol. 3, *Ecology, Culturing, Use in Aquaculture*. Eds G. Persoone, P. Sorgeloos, O.A. Roels and E. Jaspers, Universa Press, Wetteren (Belgium), in press.
- MILLIKEN, M.R., BIDDLE, G.N., SIEWICKI, T.C., FORTNER, A.R. and FAIR, P.H. (1980). Effects of various levels of dietary protein on survival, molting frequency and growth of juvenile blue crabs (*Callinectes sapidus*), *Aquaculture*, 19, 149-161
- MOCK, C.R., NEAL, R.A. and SALSER, B.R. (1973). A closed raceway for the culture of shrimp, in *Proc. 4th Ann. Meeting WMS*, pp. 247-259. Ed. J.W. Avault, Jr., Louisiana State University, Baton Rouge, U.S.A.
- MONOD, T. (1969). A propos du Lac des Vers ou Bahr ed-Dud, *Bull. Inst. fondam. Afr. noire (A)*, 31 (1), 25-41.
- MURAI, T. and ANDREWS, J.W. (1978). Comparison of feeds for larval stages of the giant prawn (*Macrobrachium rosenbergii*), in *Proc. 9th Ann. Meeting WMS*, pp. 189-193. Ed. J.W. Avault, Jr., Louisiana State University, Baton Rouge, U.S.A.

- NASH, C.E. (1974). Potential for the development of aquaculture in the Indo-Pacific region, FAO Paper (Bangkok, Thailand), IPFC/74/Sym., 12, 1-11.
- NIMURA, Y. (1967). Biology of the brine shrimp (in Japanese), *Bull. Jap. Soc. Sci. Fish.*, 33 (7), 690-702.
- OLEYNIKOVA, F.A. and PLESKACHEVSKAYA, T.G. (1979). *Artemia salina* as food in mariculture, *Proc. 7th Japan-Soviet Joint Symp. Aquaculture*, Sept. 1978, Tokyo.
- OLNEY, C.E., SCHAUER, P.S., McLEAN, S., YOU LU and SIMPSON, K.L. (1980). International study on *Artemia*. VIII. Comparison of the chlorinated hydrocarbons and heavy metals in five different strains of newly hatched *Artemia* and a laboratory-reared marine fish, in *The brine shrimp Artemia*, vol. 3, *Ecology, Culturing, Use in Aquaculture*. Eds G. Persoone, P. Sorgeloos, O.A. Roels and E. Jaspers, Universa Press, Wetteren (Belgium), in press.
- LOUDNEY, W. (1828). Excursion to the Westward of Mourzuk in June, July and August 1828, in *Narrative of travels and discoveries in North and Central Africa*, pp. 64-111. Eds D. Denham, H. Clapperton and W. Oudney. Reprinted by Hakluyt Soc., 1966, Cambridge University Press, London.
- PERSON-LE RUYET, J. and SALAUN, A. (1977). Etude comparative des possibilités d'élevage larvaire de quelques poissons marins avec une souche d'oeufs d'*Artemia salina* de Chypre, *ICES C.M./E32*, 13 p.
- PERSOONE, G. and SORGELOOS, P. (1980). General aspects of the ecology and biogeography of *Artemia*, in *The brine shrimp Artemia*, vol. 3, *Ecology, Culturing, Use in Aquaculture*. Eds G. Persoone, P. Sorgeloos, O.A. Roels and E. Jaspers, Universa Press, Wetteren (Belgium), in press.
- POST, F.J. (1977). The microbial ecology of the Great Salt Lake, *Microbial Ecology*, 3 (2), 143-165.
- PROVASOLI, L. (1969). Laboratory methods in cultivation, in *Marine Biology*, vol. 5, *Proc. 5th Interdisciplinary Conference on Marine Biology*, pp. 225-398. Ed. J.D. Costlow, Jr., Gordon and Breach, New York.
- PROVENZANO, A.J., Jr. and GOY, J.W. (1976). Evaluation of a sulphate lake strain of *Artemia* as a food for larvae of the grass shrimp, *Palaemonetes pugio*, *Aquaculture*, 9, 343-350.
- PURDOM, C.E. and PRESTON, A. (1977). A fishy business, *Nature*, 266, 396-397.
- RABANAL, H.R. and BEUSCHEL, G.K. (1978). The mangroves and related coastal fishery resources in the United Arab Emirates, FAO report to the Government of the United Arab Emirates, 98 p.
- REED, P.H. (1969). Studies of diet and diet concentration effects on Dungeness crab zoeae, *Proc. Natl. Shellfish Ass.*, 59, 12.
- REEVE, M.R. (1963). Growth efficiency in *Artemia* under laboratory conditions, *Biol. Bull.*, 125 (1), 133-145.
- REEVE, M.R. (1969). The laboratory culture of the prawn *Palaemon serratus*, *Fishery Invest. Lond.*, Ser. II, 26 (1), 38 p.
- ROBERTS, M.H., Jr. (1971). Larval development of *Pagurus longicarpus* Say reared in the laboratory. II. Effects of reduced salinity on larval development, *Biol. Bull.*, 140, 104-116.

- ROBERT, M.H., Jr. (1974). Larval development of *Pagurus longicarpus* Say reared in the laboratory. V. Effect of diet on survival and molting, *Biol. Bull.*, 146, 67-77.
- RODRIGUEZ, A.M. (1975). Experiencias de cria de larvas y post-larvas de langostinos, *Penaeus kerathurus* (Forsk.) (Forsk.), *Publ. Tec. Junta Est. Pesca*, 11, 367-386.
- ROELS, O.A., HAINES, K.C. and SUNDERLIN, J.B. (1976). The potential yield of artificial upwelling mariculture, in *Proc. 10th European Symposium on Marine Biology*, Ostend (Belgium), Sept. 17-23, 1975, vol. 1, *Research in mariculture at laboratory and pilot scale*, pp. 381-390. Universa Press, Wetteren (Belgium), 620 p.
- ROLLEFSEN, G. (1939). Artificial rearing of fry of seawater fish. Preliminary communication. *Rapp. Proc. - Verb. Reun. Cons. perm. Explor. Mer*, 109, 133.
- ROOTH, J. (1965). The flamingos on Bonaire (Netherlands Antilles). Habitat, diet and reproduction of *Phoenicopterus ruber ruber*, *Uitgave Natuurwetenschappelijke Studiekring van Suriname en de Nederlandse Antillen*, Utrecht, n°41, 171 p.
- SAN FELIU, J.M., MUNOZ, F., AMAT, F., RAMOS, J., PENA, J. and SANZ, A. (1976). Cultivo experimental de larvas de crustaceos y peces en tanques, *Inf. Tecn. Inst. Inv. Pesq.*, 36, 47 p.
- SATO, N.L. (1967). Enzymatic contribution to the excystment of *Artemia salina*, *Sci. Rep. Tohoku Univ.*, Ser. 4 (Biol.), 33 (3-4), 319-327.
- SCHAUER, P.S., JOHNS, D.M., OLNEY, C.E. and SIMPSON, K.L. (1980). International study on *Artemia*. IX. Lipid level, energy content and fatty acid composition of the cysts and newly-hatched nauplii from five geographical strains of *Artemia*, in *The brine shrimp Artemia*, vol. 3, *Ecology, Culturing, Use in Aquaculture*. Eds G. Persoone, P. Sorgeloos, O.A. Roels and E. Jaspers, Universa Press, Wetteren (Belgium), in press.
- SCHAUER, P.S., RICHARDSON, L.M. and SIMPSON, K.L. (1979). Nutritional status of marine larval and juvenile *Menidia menidia* reared on *Artemia salina* and various artificial diets, in *Cultivation of fish fry and its live food*, pp. 159-176. EMS Spec. Publ. n°4. Eds E. Styczynska-Jurewicz, T. Backiel, E. Jaspers and G. Persoone, Institute for Marine Scientific Research, Bredene (Belgium), 534 p.
- SEALE, A. (1933). Brine shrimp (*Artemia*) as a satisfactory live food for fishes, *Trans. Am. Fish. Soc.*, 63, 129-130.
- SEIDEL, C.R., KRZYNOWEK, J. and SIMPSON, K.L. (1980). International study on *Artemia*. XI. Amino acid composition and electrophoretic protein patterns of *Artemia* from five geographical locations, in *The brine shrimp Artemia*, vol. 3, *Ecology, Culturing, Use in Aquaculture*. Eds G. Persoone, P. Sorgeloos, O.A. Roels and E. Jaspers, Universa Press, Wetteren (Belgium), in press.
- SERFLING, S.A., VAN OLST, J.C. and FORD, R.F. (1974). An automatic feeding device and the use of live and frozen *Artemia* for culturing larval stages of the American lobster, *Homarus americanus*, *Aquaculture*, 3, 311-314.
- SHELBOURNE, J.E. (1968). The culture of marine fish larvae with special references to the plaice (*Pleuronectes platessa*) and the sole (*Solea solea*), Thesis, London University, 143 p.

- SHLESER, R. and GALLAGHER, M. (1974). Formulations of rations for the American lobster, in *Proc. 5th Ann. Meeting of the WMS*, pp. 157-164. Ed. J.W. Avault, Jr., Louisiana State University, Baton Rouge, U.S.A.
- SLOBODKIN, L.B. (1968). Aspects of the future of ecology, *Biol. Sci. Tokyo*, 18, 16-23.
- SMITH, T.I.J., HOPKINS, J.S. and SANDIFER, P.A. (1978). Development of a large scale *Artemia* hatching system utilizing recirculated water, in *Proc. 9th Ann. Meeting WMS*, pp. 701-714. Ed. J.W. Avault, Jr., Louisiana State University, Baton Rouge, U.S.A.
- SMITH, W.E. (1976). Larval feeding and rapid maturation of bluegills in the laboratory, *Prog. Fish Cult.*, 38 (2), 95-97.
- SOEJIMA, T., KATAYAMA, T. and SIMPSON, K.L. (1980). International study on *Artemia*. XII. The carotenoid composition of eight geographical strains of *Artemia* and the effect of diet on the carotenoid composition of *Artemia*, in *The brine shrimp Artemia*, vol. 2, *Physiology, Biochemistry, Molecular Biology*. Eds G. Persoone, P. Sorgeloos, O.A. Roels and E. Jaspers, Universa Press, Wetteren (Belgium), in press.
- SORGELOOS, P. (1973). First report on the triggering effect of light on the hatching mechanism of *Artemia salina* dry cysts, *Mar. Biol.*, 22, 75-76.
- SORGELOOS, P. (1975). *De invloed van abiotische en biotische factoren op de levenscyclus van het pekelkreeftje, Artemia salina L.*, Thesis, State University of Ghent, 235 p.
- SORGELOOS, P. (1978). The culture and use of brine shrimp *Artemia salina* as food for hatchery raised larval prawns, shrimp and fish in South East Asia, FAO Report THA/75/OO8/78/WP3, 50 p.
- SORGELOOS, P. (1979a). The Brine Shrimp, *Artemia salina* : A Bottleneck in Mariculture ?, in *FAO Technical Conference on Aquaculture*, Kyoto, 1976. Eds Pillay, T.V.R. and Dill, A.W., Fishing News Books Ltd., Farnham, U.K., pp. 321-324.
- SORGELOOS, P. (1979b). List of commercial harvesters-distributors of *Artemia* cysts of different geographical origin, *Aquaculture*, 16, 87-88.
- SORGELOOS, P. (1979c). *Het gebruik van het pekelkreeftje Artemia spec. in de aquacultuur*, Thesis, State University of Ghent, 319 p.
- SORGELOOS, P., BAEZA-MESA, M., BENIJTS, F. and PERSOONE, G. (1976). Current research on the culturing of the brine shrimp *Artemia salina* L. at the State University of Ghent, Belgium, in *Proc. 10th European Symposium on Marine Biology*, vol. 1, Eds Persoone, G. and Jaspers, E., Universa Press, Wetteren (Belgium), pp. 473-495.
- SORGELOOS, P., Baeza-Mesa, M., Bossuyt, E., Bruggeman, E., Dobbeleir, J., Versichele, D., Laviña, E. and Bernardino, A. (1980). The culture of *Artemia* on ricebran : the conversion of a waste-product into highly nutritive animal protein, *Aquaculture*, 21, in press.
- SORGELOOS, P., Baeza-Mesa, M., Claus, C., Vandeputte, G., Benijts, F., Bossuyt, E., Persoone, G. and Versichele, D. (1977). *Artemia salina* as life food in aquaculture, in *Fundamental and applied research on the brine shrimp, Artemia salina (L.) in Belgium*, EMS Special Publication n°2, Ed. E. Jaspers, Institute for Marine Scientific Research, Bredene (Belgium), pp. 37-46.

- SORGELOOS, P., BOSSUYT, E., Bruggeman, E., Cooreman, A., Dobbeleir, J., Vanhaecke, P. and Versichele, D. (1979). Progress report on the research activities of the *Artemia* Reference Center. ICES C.M./F:54, 206-214.
- SORGELOOS, P., Bossuyt, E., Laviña, E., Baeza-Mesa, M. and Persoone, G. (1977a). Decapsulation of *Artemia* cysts : a simple technique for the improvement of the use of brine shrimp in aquaculture, *Aquaculture*, 12 (4), 311-316.
- SORGELOOS, P. and PERSOONE, G. (1975). Technological improvements for the cultivation of invertebrates as food for fishes and crustaceans. II. Hatching and culturing of the brine shrimp, *Artemia salina* L., *Aquaculture*, 6, 303-317.
- SORGELOOS, P., PERSOONE, G., Baeza-Mesa, M., Bossuyt, E. and Bruggeman, E. (1978). The use of *Artemia* cysts in aquaculture : the concept of "hatching efficiency" and description of a new method for cyst processing, in *Proc. 9th Ann. Meeting WMS*, Ed. J.W. Avault, Jr., Louisiana State University, Baton Rouge (LA, USA), pp. 715-721.
- SPECTOROVA, L.V. (1979). Rearing live feed in the USSR, in *Cultivation of fish fry and its live food*, EMS Spec. Publ., n°4, Eds E. Styczynska-Jurewicz, T. Backiel, E. Jaspers and G. Persoone, Institute for Marine Scientific Research, Bredene (Belgium), pp. 403-407.
- STULTS, V.J. (1974). *Nutritional value of brine shrimp cysts. Encysted eggs of Artemia salina*, Thesis, Michigan State University (East Lansing, USA), Diss. Abstr., 75-7262, 110 p.
- TOBIAS, W.J., SORGELOOS, P., BOSSUYT, E. and ROELS, O.A. (1979). The technical feasibility of mass-culturing *Artemia salina* in the St. Croix "Artificial Upwelling" Mariculture System, in *Proc. 10th Ann. Meeting WMS*, Ed. J.W. Avault, Jr., Louisiana State University, Baton Rouge (LA, USA), pp. 203-214.
- TOBIAS, W.J., SORGELOOS, P., ROELS, O.A. and SHARFSTEIN, B.A. (1980). International Study on *Artemia*. XIII. A comparison of production data of 17 geographical strains of *Artemia* in the St. Croix Artificial Upwelling-Mariculture System, in *The brine shrimp Artemia*, vol. 3, *Ecology, Culturing, Use in Aquaculture*, Eds G. Persoone, P. Sorgeloos, O.A. Roels and E. Jaspers, Universa Press, Wetteren (Belgium), in press.
- UCAL, O. (1979). *Artemia salina* (L.) collected from Camalti Saltern (Izmir) and its use as a nutrient material in fish culture, *Rapp. Comm. Int. Mer Medit.*, 25/26 (8), 127-128.
- VALLEJO, C.G., DE LUCHI, F., LAYNEZ J. and MARCO, R. (1980). The role of cytochrome oxidase in the resumption of the development of *Artemia* dormant cysts, in *The brine shrimp Artemia*, vol. 2, *Physiology, Biochemistry, Molecular Biology*, Eds G. Persoone, P. Sorgeloos, O.A. Roels and E. Jaspers, Universa Press, Wetteren (Belgium), in press.
- VANHAECKE, P., COOREMAN, A. and LAVENS, P. (1980a). Vergelijkende studie van de geografische rassen van het pekelkreeftje, *Artemia*, Jaarverslag F.K. F.O. 2.0010.78, 42 p.
- VANHAECKE, P., COOREMAN, A. and SORGELOOS, P. (1980b). International Study on *Artemia*. XV. The effect of light intensity on the hatching rate of *Artemia* cysts from various geographical origin, *Mar. Biol.*, submitted for publication.

- VANHAECKE, P. and SORGeloos, P. (1980a). International Study on *Artemia*. IV. The biometrics of *Artemia* strains from different geographical origins, in *The brine shrimp Artemia*, vol. 3, *Ecology, Culturing, Use in Aquaculture*, Eds G. Persoone, P. Sorgeloos, O.A. Roels and E. Jaspers, Universa Press, Wetteren (Belgium), in press.
- VANHAECKE, P. and SORGeloos, P. (1980b). International Study on *Artemia*. XIV. The growth and survival of *Artemia* larvae from various geographical origin in a standard culture test, *Mar. Ecol. Progr. Ser.*, submitted for publication.
- VENKATARAMIAH, A., LAKSHMI, G.L. and GUNTHER, G. (1975). Effect of protein level and vegetable matter on growth and food conversion efficiency of brown shrimp, *Aquaculture*, 6, 115-125.
- VERSICHELE, D., BOSSUYT, E. and SORGeloos, P. (1979). An inexpensive turbidimeter for the automatic culturing of filter-feeders, in *Cultivation of fish fry and its live food*, EMS Spec. Publ., n°4, Eds E. Styczynska-Jurewicz, T. Backiel, E. Jaspers and G. Persoone, Institute for Marine Scientific Research, Bredene (Belgium), pp. 415-422.
- VON HENTIG, R. (1971). Einfluss von Salzgehalt und Temperatur auf Entwicklung, Wachstum, Fortpflanzung und Energiebilanz von *Artemia salina*, *Mar. Biol.*, 9, 145-182
- WATANABE, T. (1979). Nutritional quality of living feeds used in seed production of fish, *Proc. 7th Japan-Soviet Joint Symposium Aquaculture*, Sept. 1978, Tokyo, pp. 49-57.
- WATANABE, T., ARAKAWA, T., KITAJIMA, C., FUKUSHO, K. and FUJITA, S. (1978a). Proximate and mineral compositions of living feeds used in seed production of fish, *Bull. Jap. Soc. sc. Fish.*, 44 (9), 979-984.
- WATANABE, T., ARAKAWA, T., KITAJIMA, C. and FUJITA, S. (1978b). Nutritional evaluation of proteins of living feeds used in seed production of fish, *Bull. Jap. Soc. sc. Fish.*, 44 (10), 985-988.
- WATANABE, T., OOWA, F., KITAJIMA, C. and FUJITA, S. (1978c). Nutritional quality of brine shrimp, *Artemia salina*, as a living feed from the viewpoint of essential fatty acids for fish, *Bull. Jap. Soc. sc. Fish.*, 44 (10), 1115-1121.
- WATANABE, T., OOWA, F., KITAJIMA, C. and FUJITA, S. (1979). Relationship between dietary value of brine shrimp *Artemia salina* and their content of 3 highly unsaturated fatty acids, *Bull. Jap. Soc. sc. Fish.*, in press.
- WICKINS, J.F. (1972). The food value of the brine shrimp, *Artemia salina* L., to larvae of the prawn, *Palaemon serratus* Pennant, *J. exp. mar. Biol. Ecol.*, 10, 151-170.

Nursery culturing of bivalve spat in heated seawater

C. CLAUS, L. VAN HOLDERBEKE, H. MAECKELBERGHE and G. PERSOONE

Laboratory for Mariculture
State University of Ghent, Belgium

Abstract

The controlled nursery culturing of mollusc spat produced todate by millions in commercial hatcheries is an intermediate step in mollusc farming which is receiving more and more attention.

Different technologies for nursery culturing indoors as well as outdoors have been developed at different places.

The principles are always basically the same and consist of culturing postlarvae of a few millimeters in size up to a size of a few centimeters in densities as high as possible in specific devices in seawater which is eventually enriched with live unicellular algae or inert foods.

This paper reports on the first results obtained in Belgium in an indoor experimental nursery with spat of *Ostrea edulis*, *Crassostrea gigas* and *Venerupis semidecussata*.

On the basis of the results obtained in this small experimental unit, a semi-industrial pilot-scale plant has been designed and was recently built at the border of the Sluice-dock in Ostend, Belgium.

This pilot nursery has been conceived as a multivariable unit the ultimate goal of which is to determine the cost-benefit of an industrial nursery utilizing the heated effluent of a power plant.

Introduction

For several decades the construction of shellfish hatcheries has been preconized for the propagation of desirable commercial molluscs in areas where they do not reproduce naturally or where natural seed is either insufficient or suffers from adverse environmental effluents (Davis and Calabrese, 1969).

Many hatcheries have however failed economically in the past due to the unwillingness and the inexperience of oyster farmers in handling the small cultch-free seed produced artificially and the lack of suitable techniques and equipment for further ongrowth of the molluscs in the natural environment. Besides, scientists also found that mortality of the very young spat was very high during the two or three months immediately after transplantation from the tanks to the sea (Walne, 1961). Large differences between the temperature in the indoor hatchery and the natural environment seem to be the major cause of mortality. It has indeed been experienced many times that mortality of young spat is always high when they are moved outside in the winter and early spring, whatever their size. Moreover, spat of less than 1 mm (only a few days old) cannot be transferred at any season to outdoor conditions with reasonable chances of growth and survival (Walne, 1974), and as a result seed below 2 mm is rarely sold.

Ongrowth in outdoor conditions is most efficient when the seed has already a size of 8-10 mm, which also simplifies counting and eliminates tray losses.

Rearing spat up to this size, however, puts considerable pressure on commercial hatcheries. For economic reasons industrial molluscs hatcheries can indeed not upscale the very expensive indoor algal production to fulfill the increasing food demands of the growing spat (Persoone and Claus, 1980).

As a result, new methodologies for the controlled rearing of bivalve molluscs from post-larval size to market size have been developed and have proven to be technically feasible (Pruder, 1975; Ryther et al., 1972; Roels et al., 1976).

To be economically feasible, however, such systems must provide and maintain the physical, chemical and biological conditions suitable for a rapid growth, in high densities, at low costs, for commercially interesting bivalve species.

The recirculating system proposed by Pruder (*op. cit.*) with a diet of cultured monospecific algal species and the flow through system worked out by Roels et al. (*op. cit.*), in subtropical upwelling conditions have to date still to prove their applicability at commercial scale.

This means that presently the intermediate semi-controlled "nursery" culturing is the only technology currently practiced to grow spat from hatcheries up to a size of 1 to 2 cm where it can be transplanted to the natural

environment for further ongrowth. Because nursery conditions are less sophisticated and demanding than hatchery conditions, molluscs nurseries can hold spat longer at less cost, until it is sold to ongrowers; this intermediate stage furthermore ensures a more gradual passage from the hatchery to the non-controlled grow-out in the wild (Lucas, 1976a).

Bayes (1979) is even more extreme when he states that : "it is particularly important not to push any one stage past its limit. For example the oysters should be taken out of the hatchery at 2-4 mm , out of the nursery at 10-15 mm , and out of the trays at 30-40 mm" to be put out in parcs. "Seed to about one gram is probably as large as one should go in a nursery."

Different technologies for nursery culturing indoors as well as outdoors have been developed at different locations. The basic principles are, however, the same for all systems : namely culturing the postlarvae in densities as high as possible in specific devices in running natural seawater eventually heated and enriched with live unicellular algae on inert foods.

Food and temperature are the two first requirements of bivalves for maximal growth which Ryther and Tenore (1971) call "often mutually exclusive : first the water temperature must be in the proper range for the animals to pump and filter water; second the water must contain enough microscopic food organisms of the proper size and composition to provide food for the shellfish. These two prerequisites are often not present simultaneously in the same environment. Tropical and semi-tropical waters are naturally poor in nutrients and normally lack the level of primary productivity (*i.e.* phytoplankton growth) for substantial mollusc growth. The more eutrophic temperate and boreal waters have temperatures too low for feeding and growth of bivalves for at least part and often as much as half the year. Clearly the use of heat under these circumstances would enhance the growth of the molluscs during the inproductive winter months and improve the prospects of their artificial cultivation."

Yet it is obvious to anyone who cares to look at the economics of the problem, that artificial heating of the large volumes of seawater needed for commercial mollusc production is theoretically prohibitively expensive. A solution to this problem can, however, be found by using, for example, the waste heat of power plant. Since the increasing demands for electric energy have resulted in the location of numerous power plants in estuarine and

coastal environments, enormous volumes of heated seawater are at present available for maricultural purposes. Some scientists preconize the direct use of marine cooling waters as culturing medium for the molluscs. An example of such as direct use of thermal effluents for growing spat of oysters and clams is that of the commercial hatchery-nursery of the International Shellfish Enterprise at Moss Landing, California (Rutherford, 1975).

The problems inherent to a direct utilization of cooling waters for mollusc culturing are of three kinds :

- ① The temperature rise of the seawater (ΔT) across the condensers of operating power plants with once-through cooling system ranges from 5 to 40°C with a mean value of 18-20°C (Schubel and Marcy, 1978). This means that along with the control of the temperature of the ambient or intake water, the temperature of the culturing water should be monitored carefully by dilution with unheated water or by additional heating in function of the temperature optima and tolerances of the shellfish. In this connection, it should be pointed out that molluscs in general, and some bivalve species such as oysters in particular, are among the organisms most capable of withstanding heat and especially cold shock (from 20 to 5°C, according to Ryther and Tenore, 1971).
- ② In order to keep the cooling system free of fouling, biocides are added to the intake water at regular intervals. It is obvious that these "blow down products", usually of the type of chlorine, many cause severe mortalities of the shellfish, if discharged into the shellfish nursery.
- ③ Entrainment through the cooling system of a power plant is very harmful for planktonic organisms. Thermal, but also physical and chemical stresses can result in a complete kill of phytoplankton populations. Schubel and Marcy (*op. cit.*) have demonstrated that usually 75 % of the unicellular algae do not survive the passage through the cooling system. Shellfish cultures may thus suffer severe food shortage if they do not receive additional food. From a detailed study of the effect on marine life of entrainment through the cooling system of a power plant the same authors concluded that environmental damage decreases with increasing excess temperature of the cooling water at which the power plant is operated. "The choice of a low excess temperature is seldom if ever, best."

From what is said above, it is obvious that indirect use of thermal effluents in a shellfish nursery culture system seems by far more interesting.

Materials and Methods

An experimental nursery-culturing unit was built during spring 1978 at the border of the Sluice-dock in Ostend (Belgium). This shallow bassin (86 ha) connected via sluices to the harbour and the sea, is well-known for its extremely high productivity resulting in excellent fattening of 18 months oysters seeded on the bottom (Polk, 1965).

Seawater from the Sluice-dock ($\pm 28 \%$) is pumped automatically into a storage tank of 600 l from which it is pumped continuously via an intermediate tank into a distributing reservoir of 200 l. The water level in the latter reservoir is kept constant by an overflow which permits distribution of seawater from this tank to all culturing units by gravity flow. The seawater in the distributing-tank is preheated to a constant temperature (12°C) by means of four electric heaters.

For the experiments at higher temperatures (15°C) heating of the seawater is performed directly in the culturing tanks by separate aquarium heaters equipped with thermostats.

The non-heated control units receive water directly from the storage tank; the culturing temperature in the controls thus varied during the course of the experiments parallel to the changes of the outdoor seawater temperatures in the Sluice-dock.

In function of the type of experiments, the volume of the culturing tanks ranged from 35 to 21. The flow rate of the water was chosen in proportion to the volume of the culturing units and adjusted to retention times of $1/2$, 1 and 2 hours, respectively.

Circulation of the water in the culturing tanks was realized by air-water pumps. In some of the experiments the air-water lifts are integrated in so called "upflow" or 3 D-cylinders placed in the culturing tanks (Bayes, 1979). The water flows in through the mesh bottom of the cylinder. The water flows upwards through the layer of oysters which cover the bottom and flows out close to the top via an aperture in the wall of the cylinder in an U-shaped air-water lift which ensures the aeration in the tank and the continuous circulation of the water in the cylinder.

The advantages of such upflow systems is that they permit culturing of spat piled in several layers instead of the classical mono-layer practice which requires more than one hundred times as much tray space. Furthermore, the young oysters do not stick to the trays when they are grown in this

"semi-fluidised" manner, and the faeces and pseudofaeces produced are not accumulated upon or between the spat and do not clog the meshes of the bottom.

In most of the experiments the unique food supply for the shellfish consisted of the natural phytoplankton present in relatively high concentration in the Sluice-dock seawater; in some of the experiments, however, additional food was provided by separate inflow of a suspension of living unicellular algae, micronized rice bran or spray-dried *Spirulina* cells. The different feeding regimes were preset at the aid of peristaltic pumps. The algal cultures supplied as extra food in some experiments were natural phytoplankton blooms obtained in culturing tanks, outdoors or indoors, depending of the scale of the experiment set up and the time of the year. A detailed description of the outdoor algal units and the yields obtained are given in De Pauw *et al.* (1980).

The bivalve species used for all experiments are the oysters *Ostrea edulis* and *Crassostrea gigas*, the clam *Venerupis semidecussata* and the mussel *Mytilus edulis*. The oyster and clam spat (sizes of 3-4 mm) originated from commercial hatcheries in France and in the U.K. The mussel spat was collected on a breakwater in Ostend.

The different growth experiments were conducted at various temperatures and lasted for several months. As parameters for growth shell height (linear distance from umbo to bill) and live individual weight were measured at regular intervals of approximately one month. Relative growth rates (r_L based on length and r_w based on growth) were calculated with the formulas :

$$r_L = \frac{\ln L_t - \ln L_0}{t} ,$$

$$r_w = \frac{\ln W_t - \ln W_0}{t}$$

where L_0 is the initial length (in mm), L_t the length at time t (in mm), W_0 the initial weight (in mg), W_t the weight at time t (in mg) and t the time (in days).

Temperature of the seawater was checked daily. Dissolved oxygen, ammonia and nitrite concentration and procentual mortality of the shellfish were measured monthly.

The filtration by the shellfish of the suspended food particles was roughly estimated by the difference in P.O.M. (particulate organic matter)

and concentration of chl. a in the inflowing and outflowing seawater. P.O.M. was measured by the ash-free dry-weight of the residue on glassfiber filter, and chl. a by *in vivo* fluorimetry.

We have to underline here that the test temperatures in the heated tanks could not be stabilized rigorously for several reasons; they thus represent the prevailing mean temperature for the whole experimental period.

Temperature curves based on the daily checkings are given in the figures. Sharp drops in the curves of the test temperatures in the heated tanks are due to technological difficulties (defective heaters, power failures, etc.).

Results

EXPERIMENT 1

Growth experiments were started end April 1978 with juvenile *Mytilus edulis*, *Ostrea edulis*, *Crassostrea gigas* and *Venerupis semidecussata*, and lasted for eight weeks.

Three stocking densities were tried out : 1, 2 and 4 g/l live weight in culturing tanks of 35 l. Flow rates were 35 l, 17.5 l and 8.75 l/hour, respectively.

The test temperature was 18°C, with controls in unheated water. The chl. a content and P.O.M. of inflowing and outflowing seawater were checked weekly.

The results are given in figure 1.

Data on the effect of flow rate and stocking density on the growth rate of shellfish have been omitted in this report for the sake of clarity. Temperature and chl. a content of the inflowing seawater are included in the same figure.

From the data, it appears that each shellfish species has its proper growth rate, more or less independent of the size at the start of the experiment. Both oyster species are fast growers, while juvenile mussels and clams grow by far more slowly. For *Mytilus edulis*, the shell length increased right from the start of the experiment and growth was clearly improved by heating the incoming seawater to a temperature of 18°C. This is not the case for the other shellfish species. No significant differences were indeed found in the growth rates during the first half of the experiment in heated versus non

Experiment 1

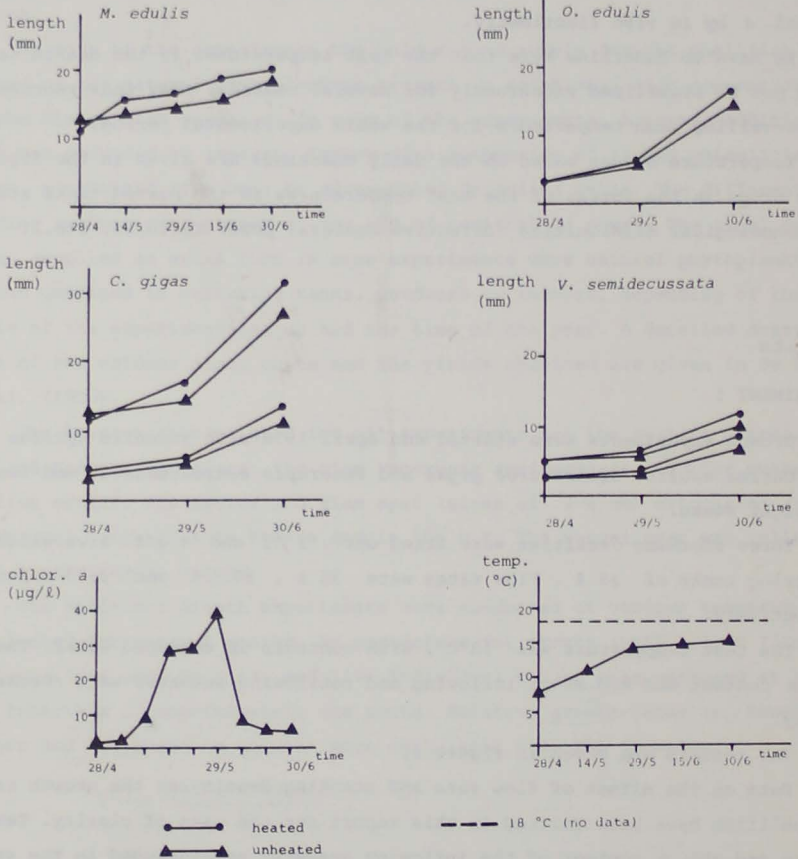

fig. 1.

heated seawater. In the second half, on the contrary, a difference in growth rate was observed, despite the relatively small increase of the experimental temperature during this period of the experiment (3°C).

Temperature in this case was thus not the unique growth determining factor. It is obvious that the typical bloom of phytoplankton during spring in the Sluice-dock of Ostend, reflected very well by the content in chl. a, markedly affected the growth of the shellfish, especially of *O. edulis*, *C. gigas*

and *V. semidecussata*. The critical phytoplankton concentration for growth of juvenile *M. edulis* is clearly reached earlier during the test.

EXPERIMENT 2

Another series of growth experiments was started early February 1979 with spat of *Venerupis semidecussata* and *Crassostrea gigas* and lasted for 3 months.

Three stocking densities were used, namely 0.5 , 1 and 2 g live weight/l , in tanks of 17.5 l contenance; flow rates were fixed at 17.5 l per hour.

The test organisms were kept in an upflow cylinder as described above. Chl. a and P.O.M. measurements were carried out as in the previous experiment.

For each of the test combinations two different experimental temperatures were set up, namely 12 and 15°C , with one control tank with unheated seawater for each species.

The results are given in figure 2.

Data on the effect of flow rate and stocking density are not considered here.

The results of this experiment corroborate the results of previous experiment, insofar that growth of both shellfish species is minimal during February and March in spite of the higher temperature of the culturing water. A significant effect of the raise in temperature can only be observed from April on, when the food level in the seawater reaches the critical minimum. For *V. semidecussata*, this critical concentration is reached earlier than for *C. gigas*. However, once the growth process is resumed relative growth rates are higher for the oyster than for the clam and is for both these species, higher at 15°C than at 12°C .

Since this experiment was started earlier in the year than the previous one, it can be excluded that the poor growth performances which were recorded in the first half of the experiment are due to some impediment of the growth reaction of the shellfish caused by a slow adaptation to the experimental conditions.

EXPERIMENT 3

This experiment is a replicate of both previous experiments on a smaller scale, but was carried out only on clams of various shell length.

Experiment 2

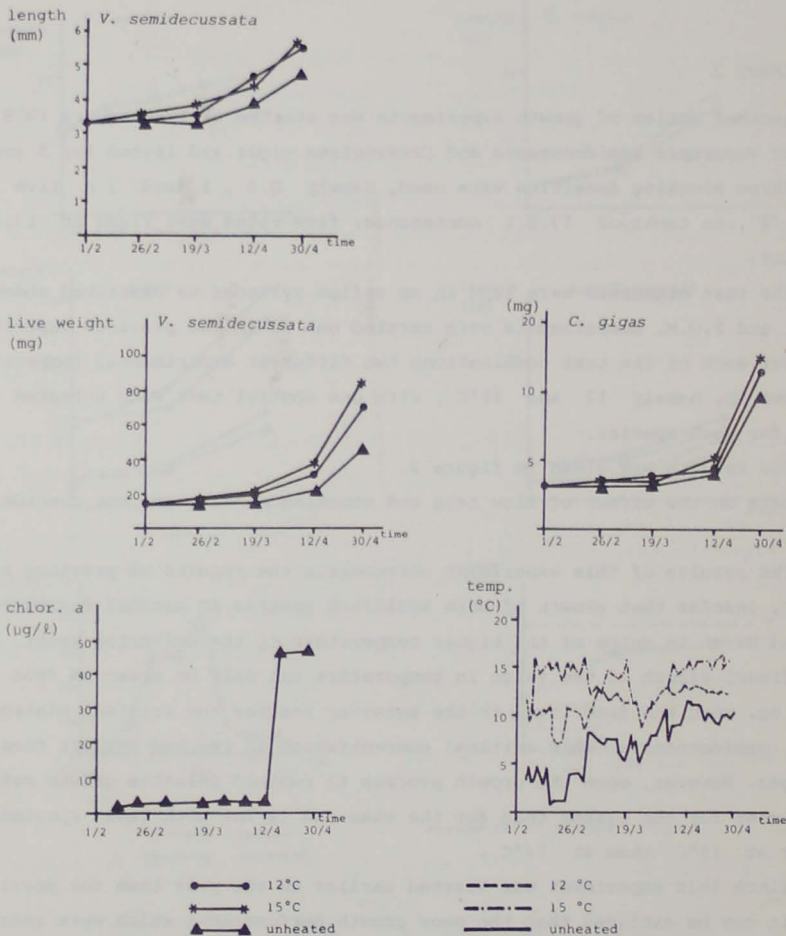

fig. 2.

The tests started early in November 78 and ended in May 1979. The culturing vessels had a volume of 2 l ; the flow rate was adjusted so as to obtain a retention time of 1 hour ; the stocking densities were 1 , 2 and 4 g live weight/l . The test temperature was 12°C with controls in unheated seawater.

The data, taken into consideration for this paper, are represented graphically in figure 3.

Experiment 3

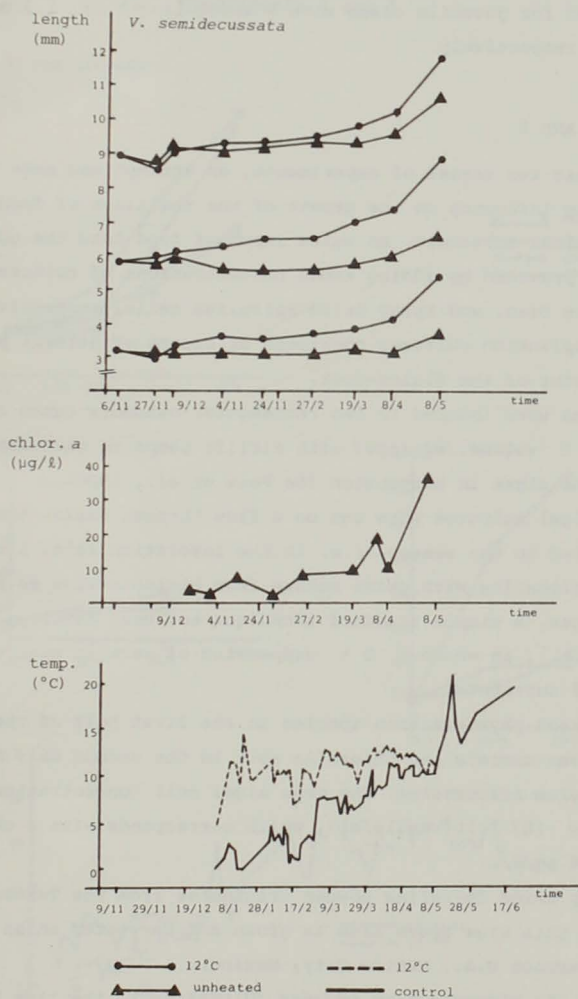

fig. 3.

The results also corroborate those obtained in both previous experiments, namely that the growth of *V. semidecussata* in a controlled system, is enhanced by increasing the temperature of the culturing water, on condition that the content in chl. a of the water exceeds a critical threshold. This phenomenon can be observed for juvenile clams with a shell length of ± 3 mm , ± 6 mm and ± 9 mm , respectively.

EXPERIMENTS 4 AND 5

In the last two series of experiments, an attempt was made to eliminate the restraining influence on the growth of the shellfish of food concentrations below the critical threshold. An extra input of food into the culturing system was therefore provided by adding known concentrations of cultured phytoplankton, micronized rice bran, and spray dried *Spirulina* cells, respectively.

The phytoplankton cultures consisted of blooms of natural phytoplankton from the seawater of the Sluice-dock.

The blooms were induced in two rectangular outdoors tanks of 1 m² surface and 250 l volume, equipped with airlift pumps to circulate the medium and to keep the algae in suspension (De Pauw et al., 1980).

As the algal cultures were run on a flow through basis, the dilution rate was adapted to the season, i.e. to the insolation rate. After several years of experimenting with swine manure from bioindustries as a nutrient source for algae, a simple standard technique has been developed by De Pauw et al. (op. cit.), in which a 2 % suspension of aerated manure is used as sole source of nutrients.

The dominant phytoplankton species in the first half of the experiment were *Skeletonema costata* and *Chlorella* sp.; in the second half *Nitzschia* sp. and *Phaeodactylum tricorutum*. The mean algal cell concentration in the shellfish tanks was 163×10^3 cells/ml , which corresponds with a chl. a content of minimum 24 $\mu\text{g/l}$.

The spray dried *Spirulina* powder originates from the Texcoco Lake in Mexico, where this blue green alga is grown and harvested on an industrial scale (Sosa Texcoco S.A., Mexico City, Mexico).

Prior to the micronization process (Ultrafine[®]), the rice bran was extracted in order to reduce the fat content of this waste product to 1.5 - 2 % . This processing prevents the inert food to become rancid when suspended in the oyster culture tanks.

Growth experiments with *Venerupis semidecussata*, *Ostrea edulis* and *Crassostrea gigas* were carried out as in the experimental series described previously. The experimental temperature was 15-20°C ; water and food suspension

Experiments 4 and 5

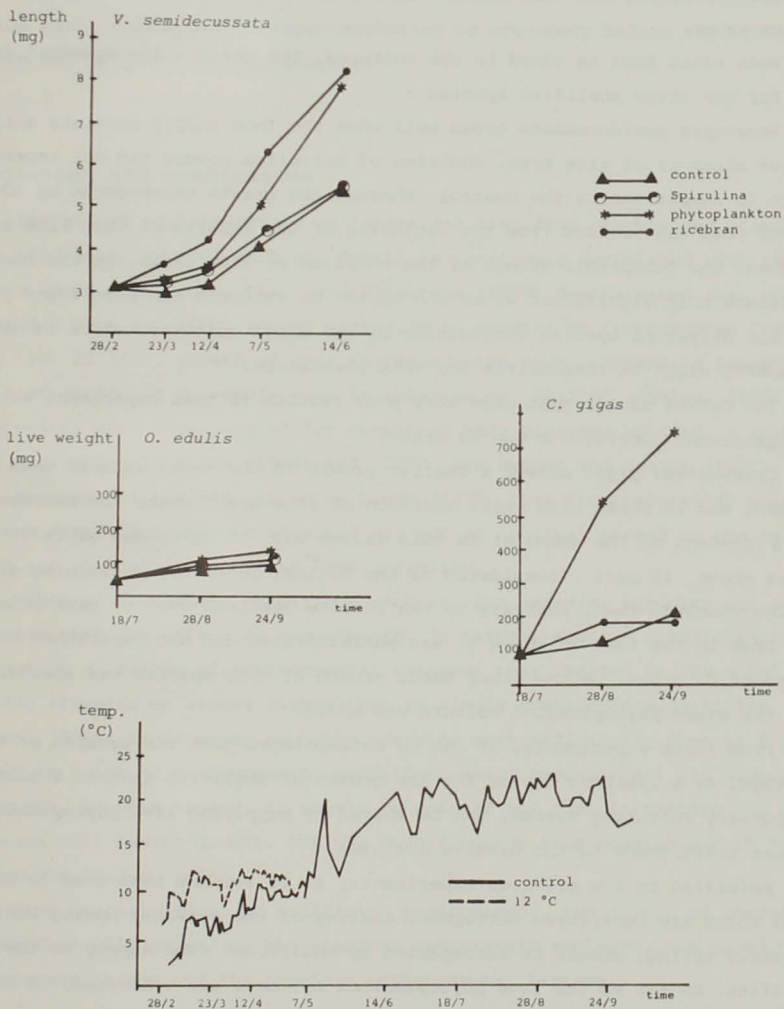

fig. 4.

were added continuously but separately. The experiments with *V. semidecussata* were not conducted simultaneously with the experiments with oysters.

The results of the growth experiments are given in figure 4.

From these data, it is clear that the growth results in the controls follow the general principle of the previous experiments, namely growth of the shellfish is in the first place determined by the amount of food available in the sea water.

When extra food is added to the cultures, the results are somewhat different for the three shellfish species :

Venerupis semidecussata grows well when the food supply consists either of live algae or of rice bran. Addition of *Spirulina* powder did not improve growth in comparison to the control. Whereas the growth enhancement by addition of food was obvious from the beginning of the experiment when rice bran was used, the favourable effect of the addition of live algae, on the contrary, became only significant after one month. No evidence has been found yet that the different species composition of the algal cultures, which is season dependent, might be responsible for this phenomenon.

The *Ostrea edulis* spat gave very poor results in this experiment so that no significant conclusions can be drawn.

Crassostrea gigas showed a similar growth in the tanks without food enrichment and in those with extra addition of rice bran. Since the average chl. a content of the seawater in this season was 16 $\mu\text{g}/\text{l}$ and since it was always above 10 $\mu\text{g}/\text{l}$ (considered as the minimal level for sustaining growth), one can conclude that, contrary to the results obtained with *V. semidecussata*, rice bran in the form in which it was administered did not contribute to the growth of *C. gigas*. On the other hand, growth of this species was spectacular when the mixed phytoplankton culture was added.

From these experiments, it can be extrapolated that the problem of food shortage, as a limiting factor for the growth of shellfish spat in a controlled nursery culturing system, can be solved by supplying live phytoplankton or some inert foods to the bivalve cultures.

Referring to the previous experiments, it is evident that even in biotopes which are considered eutrophic, heating of the seawater during winter and early spring, should be accompanied by additional food supply to the shellfish. As far as the live phytoplankton cultures are concerned, it should be pointed out that algal yields under our temperate climatological conditions,

vary with the seasons and are minimal during winter. Very large algal culturing units are thus necessary to cover the nutritional requirements during the colder periods of the year to meet the food demand of a relatively small scaled nursery. It is not fully understood yet to what extent the species composition of a mixed phytoplankton culture contributes to its nutritional value.

The use of inert foods in shellfish culture had such precarious results in the past, that a lot of experimentation is necessary before any reliable advice can be given on this subject.

Discussion and conclusions

The effect of temperature on larvae and spat from oysters and clams has been studied by several authors. Growth is positively correlated with temperature up to some limit. Davis and Calabrese (1969) demonstrated that spat of *O. edulis* kept at 10°C showed virtually no growth; at temperatures from 12.5 to 27.5°C, growth of spat increased with each increase in temperature. The best growth of *O. edulis* spat is obtained at 24-25°C (Walne, 1974). The "biological zero temperature" for growth of many bivalves species is around 13°C according to Walne (1965) and 10°C for Ryther and Tenore (1971).

However, it has been shown by Lough (1975) that temperatures at which a maximum growth response is obtained may put an abnormal stress on the animals which can ultimately result in high mortality.

Other environmental conditions such as, for example, salinity can indeed interact with the effect of temperature. In nature, aquatic invertebrates are subject to a variety of environmental changes; they respond to the total resulting stimulus or stress rather than to single environmental entities (Kinne, 1970). An organism probably operates most efficiently when it finds itself in a set of environmental conditions which maximize all its biological responses. In this regard, it should be pointed out that increasing the temperature will hasten growth, but may divert energy from somatic growth to gonad growth (Walne, 1976).

When transferred to an artificial environment, the effect of increased temperature will depend on the absolute temperature employed, the speed of temperature change and the previous environmental history.

In any case, it is of uttermost importance that an adequate food supply is provided when temperature is raised. The experiments described by Walne

(1974) demonstrate that there is little difference in growth between 14°C and 24°C when *O. edulis* spat were only fed 5 *Tetraselmis* cells per μl per day. If the ration was raised to 10 cells per day, some positive influence could be seen resulting from the elevation of temperature, but it was not until 20 cells per day were fed that full advantage was taken of the highest temperature.

The experiments at larger scale carried out by Mann and Ryther (1977) with spat of *Crassostrea gigas*, *Crassostrea virginica*, *Ostrea edulis*, *Tapes japonica*, *Mercenaria mercenaria* and *Mytilus edulis* corroborate these findings. Consistent higher values for live weight, dry meat weight and condition index were recorded throughout the study at 15°C than at 20°C. Our own results should thus be interpreted in the same context.

A temperature regime optimal for growth must compromise between the stimulation of feeding and meat production, on one hand and minimizing excessive shell growth, production of gonadal material and potential physiological stresses associated with high temperatures on the other hand.

The exploitation of the advantages of increased temperature results in an increased vulnerability to prolonged stress, since the animal is dependent on limited stored reserves to maintain a normal metabolic rate during periods when the food collected is inadequate to support this rate (Ansell and Sivadas, 1973).

When molluscs are cultured at optimal temperatures, their metabolism, water pumping, and feeding activity are functioning at high levels; if the water, however, does not contain adequate food in quality and quantity for their growth or even for their metabolic requirements, the animals may be in a far worse situation than if they were allowed to "hibernate" at a low level of metabolism in unheated water (Ryther and Tenore, *op. cit.*).

A pertinent question is whether the food should be supplied in the form of algal supplements to relatively small volumes of heated seawater, or by providing a greater flow of enriched seawater through the stock tanks (Helm, Holland and Stephenson, 1973). Anyhow, in designing artificial rearing systems for bivalves, current speed should always be considered as a very important variable, since the most productive culture system always implies both the elimination of all organisms which compete for the same food source as the species cultured, and the establishment of optimum physical conditions for growth (Kirby-Smith, 1972). A suitable water current is necessary to stimulate

feeding and to carry away the faeces produced (Walne, 1976). The filtration rate of the bivalves is indeed significantly correlated with the flow rate of sea water. Clearly, at some point the animal reaches its maximum filtering rate and increasing flow rate will have no further effect (Walne, 1972). Optimal results are found when 30-60 % of the chl. *a* present in the seawater is removed (Kirby-Smith, *op. cit.*; Walne, 1972). When the algal cell concentration is inferior to a particular critical level, the bivalve spat spends relatively too much of its energy for pumping, and at very low cell densities, the filtering system itself may even become completely inadequate (Epifanio and Ewart, 1977; Walne and Spencer, 1974).

In addition to the quantitative aspect of the food supply, the qualitative aspect should also be considered.

Many studies have been devoted to the nutritional value of a wide array of species of algae to European, Japanese and American oyster larvae; little attention on the contrary has been paid yet to the value of different algal species to post-larval bivalves (Walne, 1970; Epifanio and Mootz, 1976). A reasonable explanation for this phenomenon is the fact that feeding studies with juvenile and adult oysters are much more difficult to carry out because of the large quantities of microalgae needed and the limited capacities of most algal culture systems (Persoone and Claus, 1980). From the few studies available, it appeared that bivalves fed equal quantities of different species of algae showed different growth rates and these growth rates were, besides, dependent of the concentration of algae in the water. Algae which were good or bad foods for one species of bivalve were in most cases also good or bad to other bivalve species. Analyses of amino and fatty acid composition of representative good and bad foods showed no substantial qualitative or quantitative differences (Epifanio, 1975). Diets consisting of mixtures of several species of algae generally yield better growth than particular species used separately (Epifanio, 1979).

From the practical maricultural point of view, it is quite understandable that recent attention has been focused more on mixed mass cultures of phytoplankton than on monospecific algal cultures. At various locations, several attempts have been successful to induce more or less "controlled eutrophication", in which maximum potential production of both algae and molluscs is obtained, without the risks and instability of highly eutrophic natural systems; the technologies are based on compartmentalizing the units for the

growth of the molluscs and their food separately (Ryther, Dunstan, Tenore and Huguenin, 1972; Mann and Ryther, 1977; Roels, Haines and Sunderlin, 1976; Lucas, 1976b).

On the basis of these studies and the results obtained in our experimental small-scale nursery, a semi-industrial pilot-scale plant has been designed and was recently built at the border of the Sluice-dock in Ostend.

It consists of 4 outdoor algal tanks of approximately 100 m² surface and 100 m³ capacity, each equipped with different systems of circulation of the algal suspension.

The nursery proper is located indoors and consists of 4 tanks with rows of 8 up-flow cylinders.

The whole system is conceived in such a way that the influence of the variation of many parameters can be assessed, such as for example, temperature (indirect heating of the seawater), flow rate, recycling of the water, stocking density, type and quantity of food, etc.

The ultimate goal of this pilot scale plant is to determine the cost benefit of an industrial nursery utilizing the heated effluent of a power plant.

References

- ANSELL, A.D. and SIVADAS, P. (1973). Some effects of temperature and starvation on the bivalve *Donax vittatus* (da Costa) in experimental laboratory populations, *J. exp. mar. Biol. Ecol.*, 13, 229-262.
- BAYES, J.C. (1979). How to rear oysters, *Proc. 10th annual Shellfish Conference*, The Shellfish Association of Great Britain, London, 7-13.
- DAVIS, H.C. and CALABRESE, A. (1969). Survival and growth of larvae of the European oyster (*Ostrea edulis* L.) at different temperatures, *Biol. Bull.*, 136, 193-199.
- DE PAUW, N., VERLET, H. and DE LEENHEER, L. (1980). Heated and unheated outdoor cultures of marine algae with animal manure, *Proc. 1st International Symposium on Production and Use of Microalgae Biomass*, Acco, Israel, Sept. 1978 (in press), Ed. by G. Shelef, G.J. Soeder and M. Balaban, Elsevier North-Holland Biomedical Press.
- EPIFANIO, C.E. (1975). Culture of bivalve molluscs in recirculating system. Nutritional requirements, *Proc. 1st International Conference on Aquaculture Nutrition*, Lewes, U.S.A., 1975, 173-194. Ed. by K.S. Price, in N. Shaw and K.S. Dauberg, University of Delaware, U.S.A.
- EPIFANIO, C.E. (1979). Growth in bivalve molluscs : nutritional effects of two or more species of algae in diets fed to the American oyster *Crassostrea virginica* and the hard clam *Mercenaria mercenaria*, *Aquaculture*, 18, 1-12.

- EPIFANIO, C.E. and EWART, J. (1977). Maximum ration of four algal diets for the oyster *Crassostrea virginica* Gmelin, *Aquaculture*, 11, 13-29.
- EPIFANIO, C.E. and MOOTZ, C.A. (1976). Growth of oysters in a recirculating maricultural system, *Proc. National Shellfisheries Association*, 65, 32-37.
- HELM, M.M., HOLLAND, D.L. and STEPHENSON, R.R. (1973). The effect of supplementary algal feeding of a hatchery breeding stock of *Ostrea edulis* L. on larval vigour, *J. mar. biol. Ass. U.K.*, 53, 673-684.
- KINNE, O. (1970). Temperature-animals : invertebrates, in *Marine Biology*, vol. I, part 1, 407-514. Ed. by O. Kinne, New York, Wiley-Interscience.
- KIRBY-SMITH, W.W. (1972). Growth of the bay scallop : the influence of experimental water currents, *J. exp. mar. Biol. Ecol.*, 8, 7-18.
- LOUGH, R.G. (1975). A reevaluation of the combined effects of temperature and salinity on survival and growth of bivalve larvae using response surface techniques, *Fish Bull.*, 73 (1), 86-94.
- LUCAS, A. (1976a). Aspects of the rearing and cultivation of *Venerupis*, *Proc. 7th Shellfish Conference*, The Shellfish Association of Great Britain, London, 32-36.
- LUCAS, A. (1976b). A new type of nursery for rearing bivalve postlarvae. Construction, equipment and preliminary results, *Proc. 10th European Symposium on Marine Biology*, Ostend, Belgium, 1975, vol. I, 257-270. Ed. by G. Persoone and E. Jaspers, Wetteren, Universa Press.
- MANN, R. and RYTHER, J.H. (1977). Growth of six species of bivalve molluscs in a waste recycling-aquaculture system, *Aquaculture*, 11, 231-245.
- PERSOONE, G. and CLAUS, C. (1980). Mass culture of algae : a bottle-neck in the nursery culturing of molluscs, *Proc. 1st International Conference on the Production and Use of Microalgae Biomass*, Acco, Israel, 1978 (in press). Ed. by G. Shelef, C.J. Soeder and M. Balaban, Elsevier North-Holland Biomedical Press.
- POLK, P. (1965). Productivity of the Bassin de Chasse in Ostend, *Nature*, 205, 101-103.
- PRUDER, G.D. (1975). Engineering aspects of bivalve molluscan mariculture : culture system configurations, *Proc. 6th Annual Meeting of World Mariculture Society*, Seattle, U.S.A., 1975, 203-212. Ed. by J.W. Avault and R. Miller, Louisiana State University, U.S.A.
- ROELS, O.A., HAINES, K.C. and SUNDERLIN, J.B. (1976). The potential yield of artificial upwelling mariculture, *Proc. 10th European Symposium on Marine Biology*, Ostend, Belgium, 1975, vol. I, 381-390. Ed. by G. Persoone and E. Jaspers, Wetteren, Universa Press.
- RUTHERFORD, D. (1975). California Shellfish hatchery supplies world market, *Fish Farming International*, 2 (2), 26-29.
- RYTHER, J.H. and TENORE, K.R. (1971). Integrated systems of mollusc culture (unpublished manuscript).
- RYTHER, J.H., DUNSTAN, W.M., TENORE, K.R. and HUGUENIN, J.E. (1972). Controlled eutrophication - increasing food production from the sea by recycling human wastes, *Bioscience*, 22 (3), 144-152.

- SCHUBEL, J.R. and MARCY, B.C. (1978). *Power Plant Entrainment. A Biological Assessment*, New York - London, Academic Press, Inc., 271 p.
- WALNE, P.R. (1965). Observations on the influence of food supply and temperature on the feeding and growth of the larvae of *Ostrea edulis* L., *Fish Invest.*, *Min. Agric. Fish. Food*, London, Series II, 24, 1-45.
- WALNE, P.R. (1970). Studies on the food value of nineteen genera of algae to juvenile bivalves of the genera *Ostrea*, *Crassostrea*, *Mercenaria* and *Mytilus*, *Fishery Invest. Lond.*, Ser. 2, 26 (5), 62 p.
- WALNE, P.R. (1972). The influence of current speed, body size and water temperature on the filtration rate of five species of bivalves, *J. mar. Biol. Ass. U.K.*, 52, 345-374.
- WALNE, P.R. (1974). *Culture of bivalve molluscs : 50 years experience at Conwy*, Fishing News (Books) Ltd., West Byfleet, 179 p.
- WALNE, P.R. (1976). Factors affecting the relation between feeding and growth in bivalves, in *Harvesting Polluted Waters*, 169-176. Ed. by O. Devik, New York and London, Plenum Press.
- WALNE, P.R. and SPENCER, B.E. (1974). Experiments on the growth and food conversion efficiency of the spat of *Ostrea edulis* L. in a recirculation system, *J. Cons. Perm. Int. Explor. Mer.*, 35 (3), 303-318.

Achévé d'imprimer le 5 février 1981
sur la presse offset d'é.t.a.b.é.t.y.p.
72, quai de Longdoz - 4020 LIEGE
Tél. : 041/42.59.21 et 041/71.58.10

1890
1891
1892
1893
1894
1895
1896
1897
1898
1899
1900

THE UNIVERSITY OF CHICAGO
LIBRARY

