

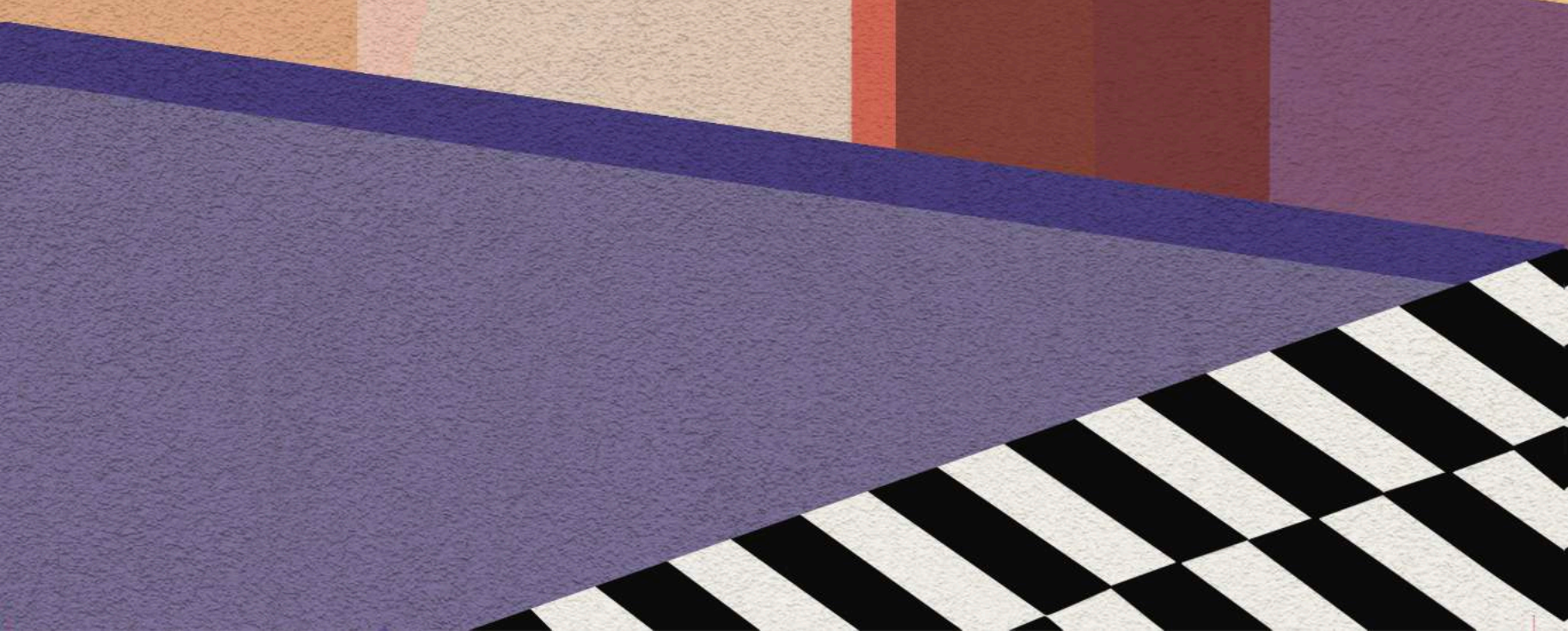

WOJNAROWSKI

PREZENTUJE

soulful lighting
utua®

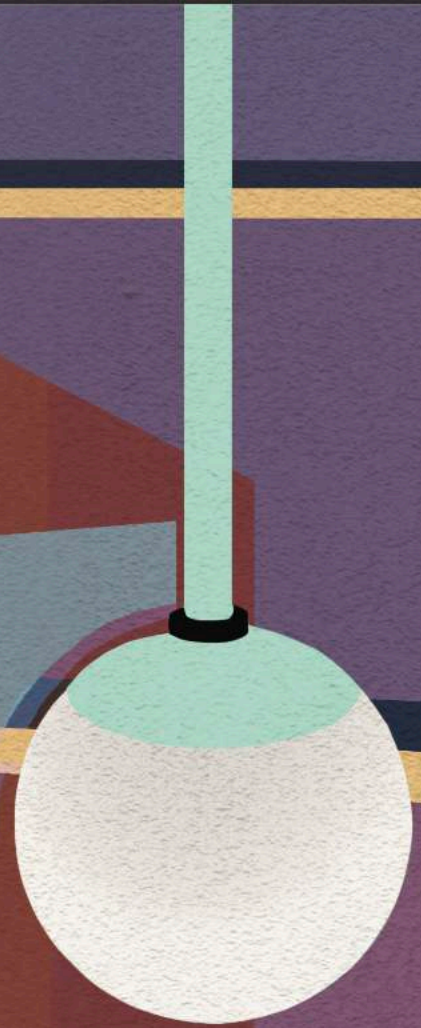



10



11



12



13



16



45



46



47



49



51



17



19



20



21



23



52



33



56



57



59



24



25



27



29



31



60



61



63



64



65



32



33



35



36



37



67



69



71



72



73



39



0



41



43



44



74



75



77



79



80



83



85



86



87



89



118



119



121



122



123



90



91



94



95



96



125



126



127



129



130



97



99



101



102



103



131



133



105



107



108



109



111



112



113



114



115



117

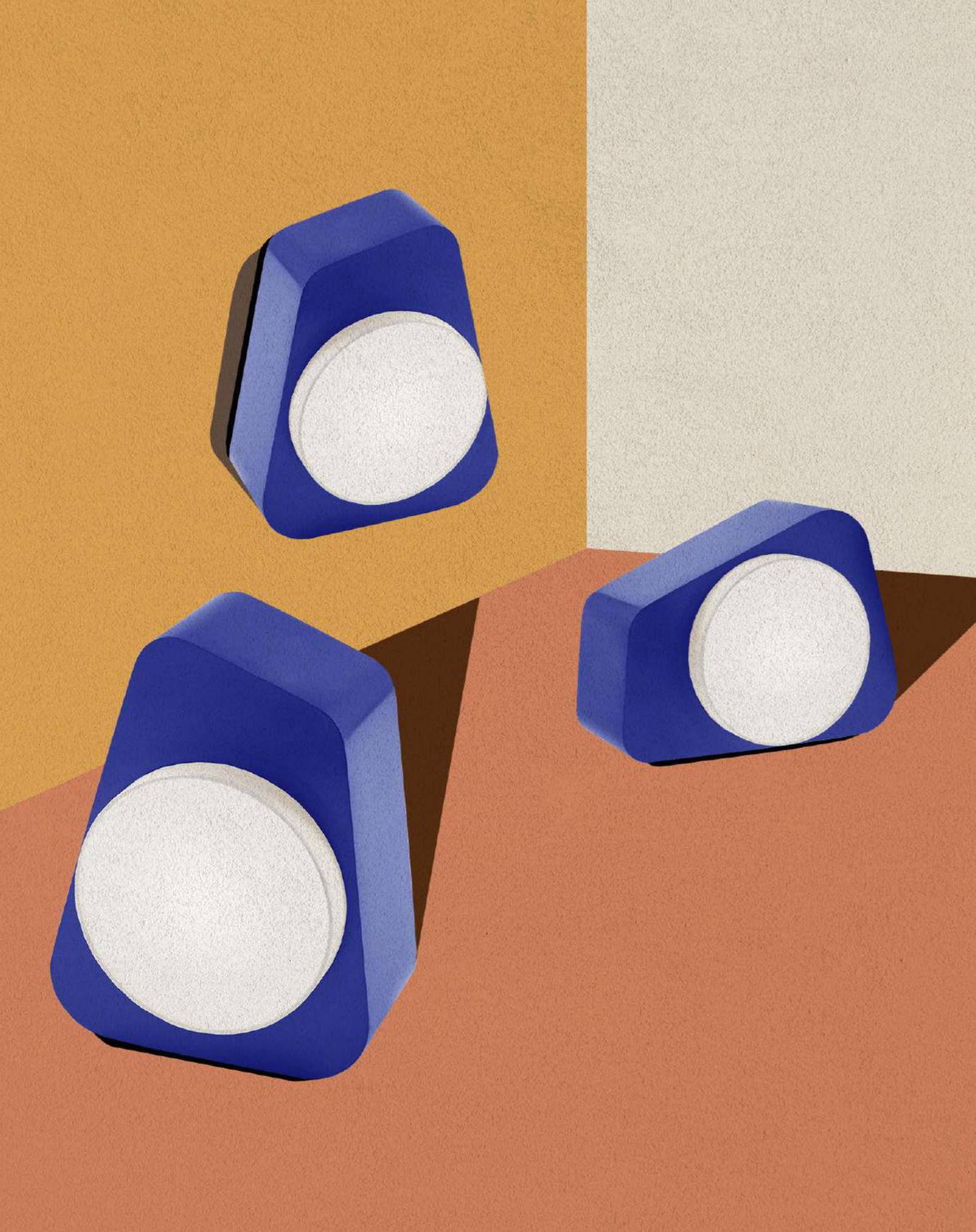

We welcome you to our world, where creativity, quality and reliability are the guidelines.

Lighting contributes tremendously to how one experiences spaces, as it is able to, very efficiently, influence the perception and appearance of what surrounds us, to shift sensations and feelings.

Utu soulful lighting is the response to an urge to create lighting solutions which enrich spaces with individuality and meaning.

Born from the creative hub Mambo unlimited ideas, Utu presents a versatile lighting collection, with pieces holding a quite distinctive character, including suspension, table, floor and wall lamps in a wide range of possible finishes.

We produce unique, quality products - while our work draws inspiration from every corner of the globe, it nevertheless remains rooted in local knowledge and crafts expertise. Utu's growing international presence reflects our approach and reputation: we offer unique products and a dedicated team ready to collaborate with professionals worldwide.

A iluminação contribui tremendamente para a vivência dos ambientes, sendo capaz de influenciar a percepção e aparência do que nos rodeia, de proporcionar diferentes sensações e experiências.

A Utu soulful lighting responde ao desejo de criar peças de iluminação que enriqueçam os espaços com individualidade e significado. Nascida no seio da Mambo unlimited ideas, a Utu apresenta uma ampla coleção com diferentes conceitos e soluções funcionais, disponíveis numa interessante variedade de acabamentos.

Produzimos produtos únicos e de qualidade - recolhendo inspiração em vários cantos do planeta, não deixamos nunca de valorizar as nossas raízes de conhecimento e as nossas competências de fabrico. A crescente presença dos produtos Utu no mercado internacional reflecte a nossa abordagem e reputação: temos para oferecer produtos únicos e uma equipa pronta para colaborar com profissionais de todo o mundo.

Benvido ao nosso universo, onde a criatividade, qualidade e confiança são as directrizes.

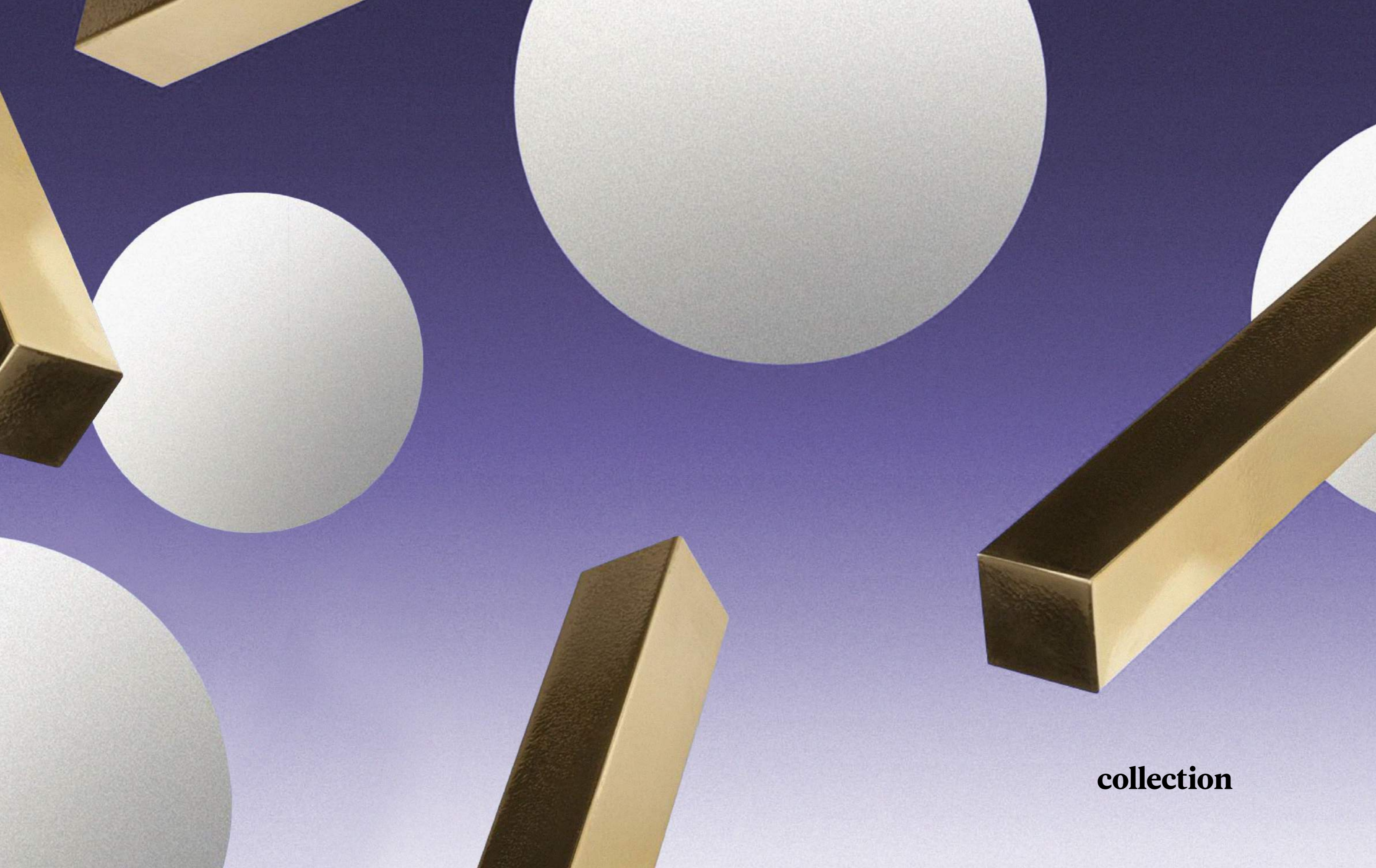

collection



1



1

monaco

w: 94 cm / 37"
d: 73 cm / 29"
h: 99 cm / 39"

structure: lacquered metal / detail: lacquered wood
globes: glass
light cylinders: lacquered metal, natural rattan
circles: polished or satin brass or nickel
bulbs 9 x LED G9 max. 7W

estrutura: metal lacado / detalhe: madeira lacado
globos: vidro
cilindros de luz: metal lacado, palhinha natural
círculos: latão ou níquel polido
lâmpadas 9 x LED G9 máx. 7W

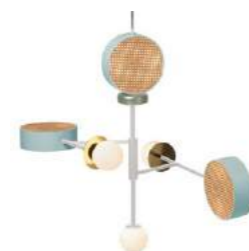
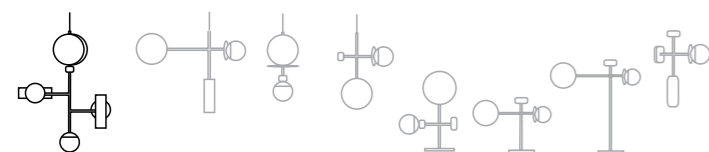

2



3

monaco I

w: 30 cm / 12"
d: 15 cm / 6"
h: 57 cm / 22"

structure: lacquered metal
globes: glass
light cylinders: lacquered metal, natural rattan
circles: polished or satin brass or nickel
bulbs 5 x LED G9 max. 7W

estrutura: metal lacado
globos: vidro
cilindros de luz: metal lacado, palhinha natural
círculos: latão ou níquel polido
lâmpadas 5 x LED G9 máx. 7W

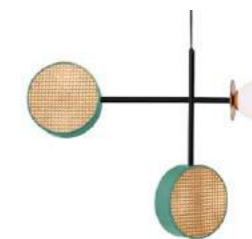
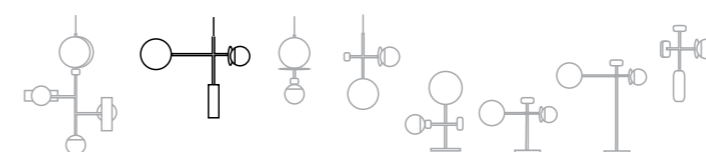

2



3





1

monaco II

w: 45 cm / 18"
d: 15 cm / 6"
h: 65 cm / 26"

structure: lacquered metal / **detail:** lacquered wood
globes: glass
light cylinders: lacquered metal, natural rattan
circles: polished or satin brass or nickel
bulbs 3 x LED G9 max. 7W ☞

estrutura: metal lacado / **detalhe:** madeira lacado
globos: vidro
cilindros de luz: metal lacado, palhinha natural
círculos: latão ou níquel polido
lâmpadas 3 x LED G9 máx. 7W ☞

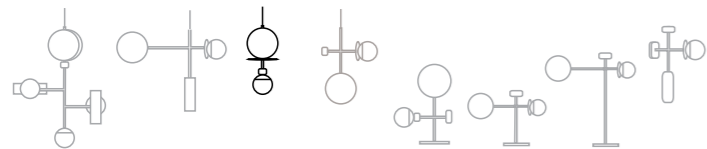

2

3



1

monaco III

w: 102 cm / 40"
d: 27 cm / 11"
h: 70 cm / 28"

structure: lacquered metal / **detail:** lacquered wood
globes: glass
light cylinders: lacquered metal, natural rattan
circles: polished or satin brass or nickel
bulbs 3 x LED G9 max. 7W ☞

estrutura: metal lacado / **detalhe:** madeira lacado
globos: vidro
cilindros de luz: metal lacado, palhinha natural
círculos: latão ou níquel polido
lâmpadas 3 x LED G9 máx. 7W ☞

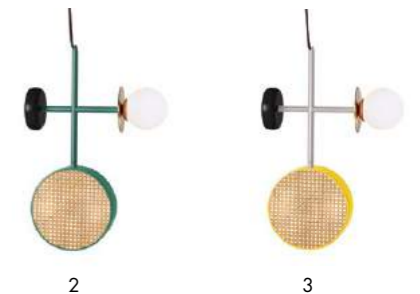
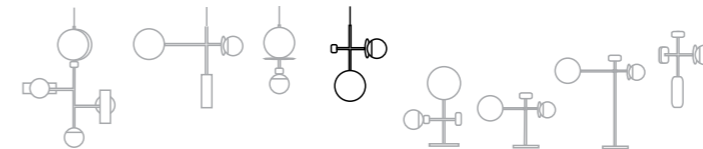

2

3



table lamp

floor lamp



I

1

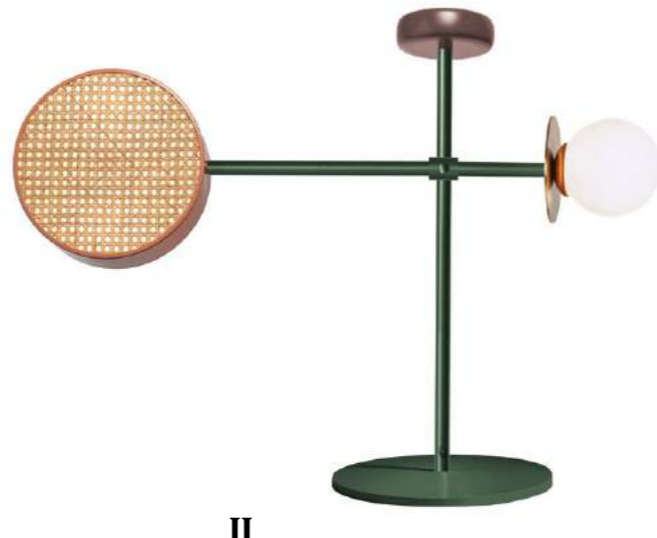

II

2



1

monaco table I/II (adjustable arm/braço ajustável)

w: 45 cm / 18" II w: 65 cm / 26"
d: 25 cm / 10" d: 25 cm / 10"
h: 65 cm / 26" h: 75 cm / 30"

structure: lacquered metal / detail: lacquered wood
globes: glass
light cylinders: lacquered metal, natural rattan
circles: polished or satin brass or nickel
bulbs 3 x LED G9 max. 7W

estrutura: metal lacado / detalhe: madeira lacado
globos: vidro
cilindros de luz: metal lacado, palhinha natural
círculos: latão ou níquel polido
lâmpadas 3 x LED G9 máx. 7W

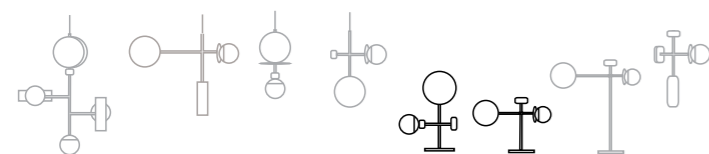

3



4

monaco floor (adjustable arm/braço ajustável)

w: 110 cm / 43"
d: 40 cm / 16"
h: 169 cm / 67"

structure: lacquered metal / detail: lacquered wood
globes: glass
light cylinders: lacquered metal, natural rattan
circles: polished or satin brass or nickel
bulbs 3 x LED G9 max. 7W

estrutura: metal lacado / detalhe: madeira lacado
globos: vidro
cilindros de luz: metal lacado, palhinha natural
círculos: latão ou níquel polido
lâmpadas 3 x LED G9 máx. 7W

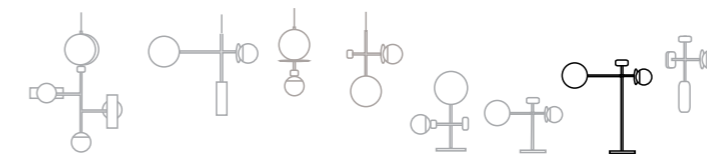

2



3





wall lamp



1

monaco wall

w: 45 cm / 18"
d: 15 cm / 6"
h: 65 cm / 26"

structure: lacquered metal / detail: lacquered wood
globes: glass
light cylinders: lacquered metal, natural rattan
circles: polished or satin brass or nickel
bulbs 3 x LED G9 max. 7W 

estrutura: metal lacado / detalhe: madeira lacado
globos: vidro
cilindros de luz: metal lacado, palhinha natural
círculos: latão ou níquel polido
lâmpadas 3 x LED G9 máx. 7W 

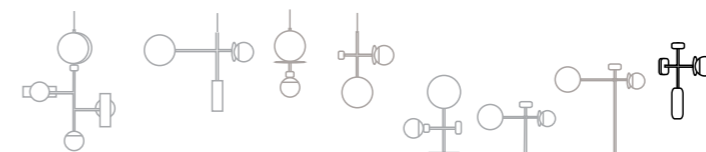

2

3



1



1

frame

w: 123 cm / 48"
d: 18 cm / 7"
h: 75 cm / 30"

structure: lacquered metal, rattan
globes: glass
half-circle: terrazzo
bulbs 5 x LED G9 max. 7W

estrutura: metal lacado, palhinha natural
globos: vidro
meio círculo: terrazzo
lâmpadas 5 x LED G9 máx.7W

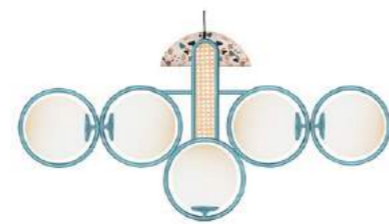
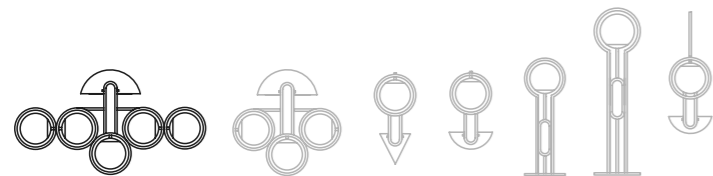

2

frame I

w: 70 cm / 28"
d: 18 cm / 7"
h: 64 cm / 25"

structure: lacquered metal, rattan
globes: glass
half-circle: terrazzo
bulbs 3 x LED G9 max. 7W

estrutura: metal lacado, palhinha natural
globos: vidro
meio círculo: terrazzo
lâmpadas 3 x LED G9 máx.7W

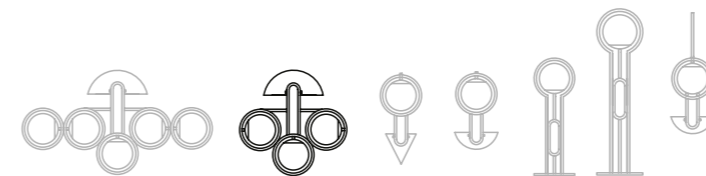

2

3



suspension lamp



1



2

frame II

w: 28 cm / 11"

d: 18 cm / 7"

h triangle: 54 cm / 21" h half-circle: 50 cm / 20"

structure: lacquered metal, rattan

globe: glass

triangle/half-circle: terrazzo

bulbs 1 x LED G9 max. 7W 

estrutura: metal lacado, palhinha natural

globo: vidro

triângulo/meio círculo: terrazzo

lâmpadas 1 x LED G9 máx.7W 

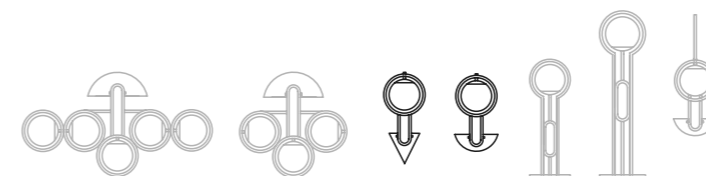

3

3

table lamp



1

floor lamp



1



frame table

w: 35 cm / 14"
d: 20 cm / 8"
h: 65 cm / 26"

structure: lacquered metal, rattan
globe: glass
half circle: terrazzo
bulbs 1 x LED G9 max. 7W

estrutura: metal lacado, palhinha natural
globo: vidro
base: terrazzo
lâmpadas 1 x LED G9 máx.7W

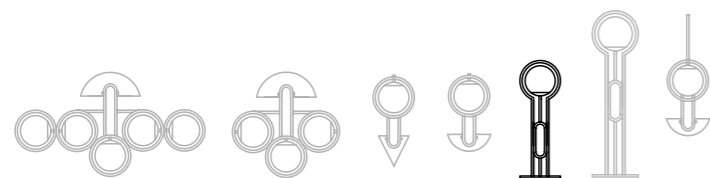

2

3

frame floor

w: 40 cm / 16"
d: 30 cm / 12"
h: 170 cm / 67"

structure: lacquered metal, rattan
globe: glass
base: terrazzo
bulbs 1 x LED G9 max. 7W

estrutura: metal lacado, palhinha natural
globo: vidro
base: terrazzo
lâmpadas 1 x LED G9 máx.7W

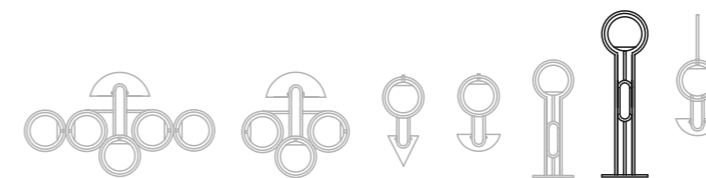

2

3



wall lamp



1

frame wall

w: 45 cm / 18"
d: 28 cm / 11"
h: 70 cm / 27"

structure: lacquered metal, rattan
globe: glass
half circle: terrazzo
bulbs 1 x LED G9 max. 7W 

estrutura: metal lacado, palhinha natural
globo: vidro
meio círculo: terrazzo
lâmpadas 1 x LED G9 máx.7W 

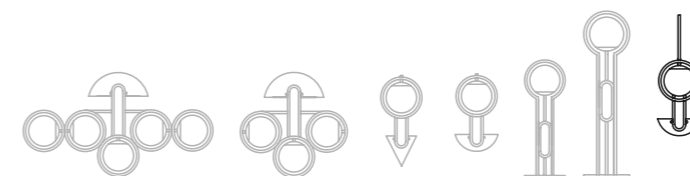

2

3



suspension lamp



1

29

helio

w: 130 cm / 51"
 d: 70 cm / 28"
 h: 80 cm / 31,5"

structure: lacquered metal, polished or satin brass or nickel.
 globes: glass
 half spheres: lacquered wood
 bulbs 7 x LED G9 max. 7W

estrutura: metal lacado, latão ou nickel polido ou satinado
 globos: vidro
 meias esferas: madeira lacada
 lâmpadas 7 x LED G9 máx.7W



2



3



suspension lamp



1

31

helio I

w: 115 cm / 45"
d: 98 cm / 39"
h: 113 cm / 44"

structure: lacquered metal, polished or satin brass or nickel.

globes: glass

half spheres: lacquered wood

bulbs 9 x LED G9 max. 7W 

estrutura: metal lacado, latão ou nickel polido ou satinado

globos: vidro

meias esferas: madeira lacada

lâmpadas 9 x LED G9 máx.7W 



2



3



1



1

helio II

w: 35 cm / 14"
d: 12 cm / 4,7"
h: 50 cm / 20"

structure: lacquered metal, polished or satin brass or nickel
globes: glass
half spheres: lacquered wood
bulbs 2 x LED G9 max. 7W

estrutura: metal lacado, latão ou nickel polido ou satinado
globos: vidro
meias esferas: madeira lacada
lâmpadas 2 x LED G9 máx.7W

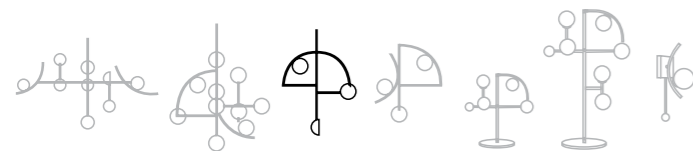

2



3

helio III

w: 63 cm / 25"
d: 12 cm / 4,7"
h: 73 cm / 29"

structure: lacquered metal, polished or satin brass or nickel.
globes: glass
half spheres: lacquered wood
bulbs 2 x LED G9 max. 7W

estrutura: metal lacado, latão ou nickel polido ou satinado
globos: vidro
meias esferas: madeira lacada
lâmpadas 2 x LED G9 máx.7W

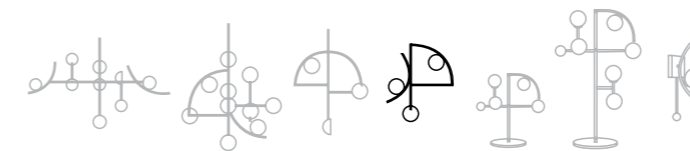

2



3



table lamp





1

35

helio table

w: 50 cm / 20"
d: 25 cm / 10"
h: 67 cm / 26"

structure: lacquered metal, polished or satin brass or nickel
globes: glass
half spheres: lacquered wood
bulbs 4 x LED G9 max. 7W 

estrutura: metal lacado, latão ou nickel polido ou satinado
globos: vidro
meias esferas: madeira lacada
lâmpadas 4 x LED G9 máx.7W 



2



3

floor lamp



1

wall lamp



1



helio floor

w: 95 cm / 37"
d: 30 cm / 12"
h: 169 cm / 67"

structure: lacquered metal, polished or satin brass or nickel
globes: glass
half spheres: lacquered wood
bulbs 6 x LED G9 max. 7W

estrutura: metal lacado, latão ou nickel polido ou satinado
globos: vidro
meias esferas: madeira lacada
lâmpadas 6 x LED G9 máx.7W



2



3

helio wall

w: 15 cm / 6"
d: 27 cm / 11"
h: 60 cm / 24"

structure: lacquered metal, polished or satin brass or nickel
globes: glass
half spheres: lacquered wood
bulbs 1 x LED G9 max. 7W

estrutura: metal lacado, latão ou nickel polido ou satinado
globos: vidro
meias esferas: madeira lacada
lâmpadas 1 x LED G9 máx.7W



2



3



SOCIÉTÉ BUDAPEST,
BUDAPEST

suspension lamp



1

39

globe

Ø: 100 cm / 39"
h: 50 cm / 20"

structure: lacquered metal, polished or satin brass, copper or nickel or bronze
globes: glass
bulbs 10 x LED G9 max. 7W

estrutura: metal lacado, latão, cobre ou nickel polido ou satinado ou bronze
globos: vidro
lâmpadas 10 x LED G9 máx.7W



2

3

suspension lamp

table lamp



1



1

41

globe I

Ø: 80 cm / 32"
h: 50 cm / 20"

structure: lacquered metal, polished or satin brass, copper or nickel or bronze

globes: glass
bulbs 8 x LED G9 max. 7W

estrutura: metal lacado, latão, cobre ou nickel polido ou satinado ou bronze

globos: vidro
lâmpadas 8 x LED G9 máx.7W

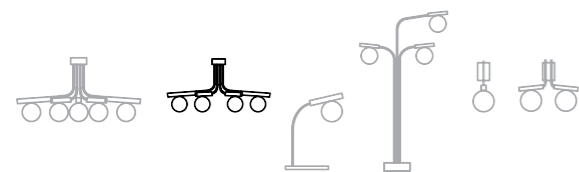

2

3

globe table

w: 42 cm / 17"
d: 20 cm / 8"
h: 59 cm / 23"

structure: lacquered metal, polished or satin brass, copper or nickel or bronze

globes: glass
optional base: marble
bulbs 1 x LED G9 max. 7W

estrutura: metal lacado, latão, cobre ou nickel polido ou satinado ou bronze

globos: vidro
base opcional: mármore
lâmpadas 1 x LED G9 máx.7W



2

3



TEMAKINHO,
ROME

floor lamp



1

globe floor

w: 93 cm / 37"
d: 15 cm / 6"
h: 169 cm / 67"

structure: lacquered metal, polished or satin brass, copper or nickel or bronze
globes: glass
optional base: marble
bulbs 3 x LED G9 max. 7W

estrutura: metal lacado, latão, cobre ou nickel polido ou satinado ou bronze
globos: vidro
base opcional: mármore
lâmpadas 3 x LED G9 máx.7W



2

3

wall lamp



1

globe wall

w: 15 cm / 6"
d: 27 cm / 11"
h: 40 cm / 16"

structure: lacquered metal, polished or satin brass, copper or nickel or bronze

globes: glass

bulbs 1 x LED G9 max. 7W

estrutura: metal lacado, latão, cobre ou nickel polido ou satinado ou bronze

globos: vidro

lâmpadas 1 x LED G9 máx.7W



wall lamp



1

globe wall 1

w: 36 cm / 14"
d: 33 cm / 13"
h: 41 cm / 16"

structure: lacquered metal, polished or satin brass, copper or nickel or bronze

globes: glass

bulbs 2 x LED G9 max. 7W

estrutura: metal lacado, latão, cobre ou nickel polido ou satinado ou bronze

globos: vidro

lâmpadas 2 x LED G9 máx.7W

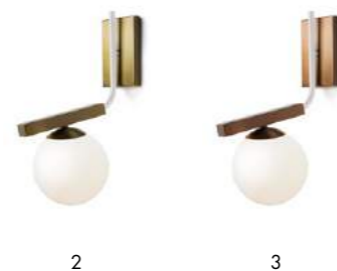

suspension lamp



1

link

w: 100 cm / 39"
d: 64 cm / 25"
h: 100 cm / 39"

structure: lacquered metal, polished or satin brass, copper or nickel or bronze

globes: glass
bulbs 4 x LED G9 max. 7W

estrutura: metal lacado, latão, cobre ou nickel polido ou satinado ou bronze

globos: vidro
lâmpadas 4 x LED G9 máx.7W

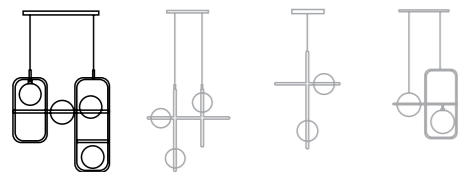

2

suspension lamp



1

link I

w: 100 cm / 39"
d: 33 cm / 13"
h: 100 cm / 39"

structure: lacquered metal, polished or satin brass, copper or nickel or bronze

globes: glass
bulbs 3 x LED G9 max. 7W

estrutura: metal lacado, latão, cobre ou nickel polido ou satinado ou bronze

globos: vidro
lâmpadas 3 x LED G9 máx.7W

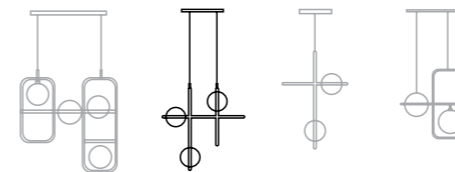

2

47



suspension lamp



1

link II

w: 64 cm / 25"
d: 33 cm / 13"
h: 100 cm / 39"

structure: lacquered metal, polished or satin brass, copper or nickel or bronze

globes: glass

bulbs 2 x LED G9 max. 7W 

estrutura: metal lacado, latão, cobre ou nickel polido ou satinado ou bronze

globos: vidro

lâmpadas 2 x LED G9 máx.7W 

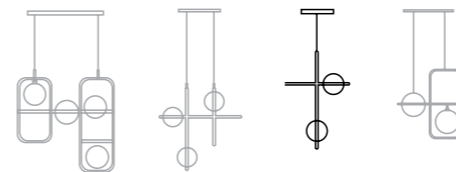

49



2



suspension lamp



1

link III

w: 64 cm / 25"
d: 64 cm / 25"
h: 64 cm / 25"

structure: lacquered metal, polished or satin brass, copper or nickel or bronze
globes: glass
bulbs 2 x LED G9 max. 7W 

estrutura: metal lacado, latão, cobre ou nickel polido ou satinado ou bronze
globos: vidro
lâmpadas 2 x LED G9 máx.7W 

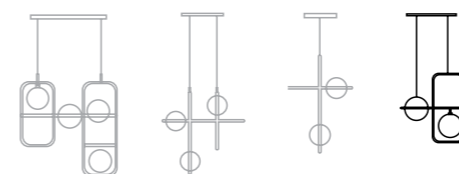

2

51



1



1

jules

Ø: 73 cm / 29"
h: 72 cm / 28"

structure: lacquered metal, polished or satin brass, copper or nickel or bronze
tubes: polished brass, nickel cooper or bronze.
abat-jour: linen
energy saving bulb E27 / 1x23W

estrutura: metal lacado, latão, cobre ou nickel polido ou satinado ou bronze
tubos: latão, nickel, cobre ou bronze polido
abat-jour: linho
lâmpada económica E27 / 1x23W

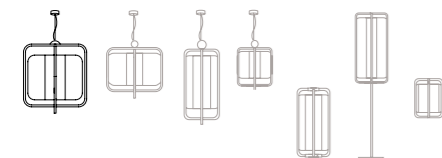

2



3

jules I

Ø: 63 cm / 25"
h: 57 cm / 21"

structure: lacquered metal, polished or satin brass, copper or nickel or bronze
tubes: polished brass, nickel cooper or bronze.
abat-jour: linen
energy saving bulb E27 / 1x23W

estrutura: metal lacado, latão, cobre ou nickel polido ou satinado ou bronze
tubos: latão, nickel, cobre ou bronze polido
abat-jour: linho
lâmpada económica E27 / 1x23W

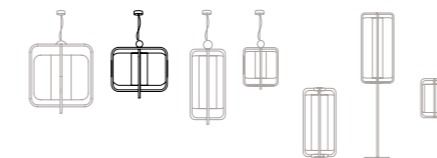

2



3



suspension lamp



1

jules II

Ø: 30 cm / 12"
h: 64 cm / 25"

structure: lacquered metal, polished or satin brass, copper or nickel or bronze

tubes: polished brass, nickel cooper or bronze.

abat-jour: linen

energy saving bulb E27 / 1x23W 

estrutura: metal lacado, latão, cobre ou nickel polido ou satinado ou bronze

tubos: latão, nickel, cobre ou bronze polido

abat-jour: linho

lâmpada económica E27 / 1x23W 

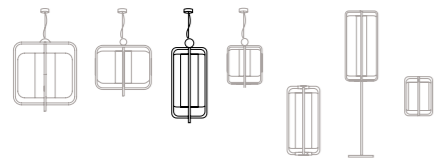

2



3

suspension lamp



1

jules III

Ø: 38 cm / 15"
h: 44 cm / 17"

structure: lacquered metal, polished or satin brass, copper or nickel or bronze

tubes: polished brass, nickel cooper or bronze.

abat-jour: linen

energy saving bulb E27 / 1x23W 

estrutura: metal lacado, latão, cobre ou nickel polido ou satinado ou bronze

tubos: latão, nickel, cobre ou bronze polido

abat-jour: linho

lâmpada económica E27 / 1x23W 

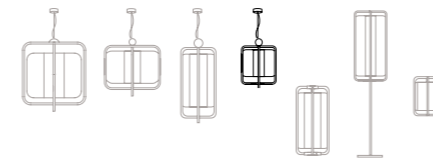

2



3





table lamp



1

jules table

Ø: 30 cm / 12"
h: 63 cm / 25"

structure: lacquered metal, polished or satin brass, copper nickel or bronze

tubes: polished brass, nickel cooper or bronze.

abat-jour: linen

energy saving bulb E27 / 1x23W 

estrutura: metal lacado, latão, cobre ou nickel polido ou satinado ou bronze

tubos: latão, nickel, cobre ou bronze polido

abat-jour: linho

lâmpada económica E27 / 1x23W 

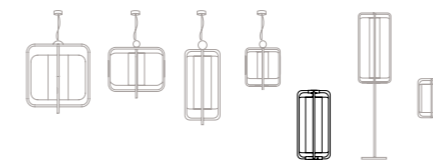

2



3

floor lamp



1

jules floor

Ø: 38 cm / 15"
h: 177 cm / 38"

structure: lacquered metal, polished or satin brass, copper or nickel or bronze
tubes: polished brass, nickel cooper or bronze.

abat-jour: linen
energy saving bulb E27 / 1x23W

estrutura: metal lacado, latão, cobre ou nickel polido ou satinado ou bronze
tubos: latão, nickel, cobre ou bronze polido
abat-jour: linho
lâmpada económica E27 / 1x23W

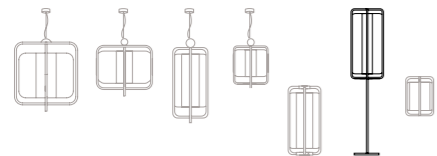

2



3

wall lamp



1

jules wall

w: 40 cm / 16"
d: 23 cm / 9"
h: 40 cm / 16"

structure: lacquered metal, polished or satin brass, copper or nickel or bronze
tubes: polished brass, nickel cooper or bronze.

abat-jour: linen
energy saving bulb E14 / 1x20W

estrutura: metal lacado, latão, cobre ou nickel polido ou satinado ou bronze
tubos: latão, nickel, cobre ou bronze polido
abat-jour: linho
lâmpada económica E14 / 1x20W

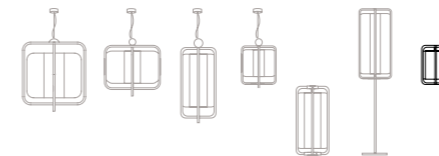

2



3





TABERNA LOS GALLOS,
MADRID

suspension lamp



1

comb

Ø: 74 cm / 29"
h: 60 cm / 24"

structure: lacquered metal
rings: lacquered metal, polished or satin brass or copper
energy saving bulb E27 / 1x23W 

estrutura: metal lacado
anéis: metal lacado, latão ou cobre polido ou satinado
lâmpada económica E27 / 1x23W 

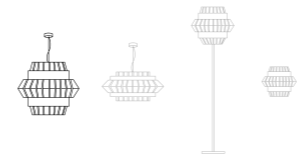

2



3

suspension lamp

floor lamp



1



1

comb I

Ø: 75 cm / 30"
h: 35 cm / 14"

structure: lacquered metal
rings: lacquered metal, polished or satin brass or copper
energy saving bulb E27 / 1x23W

estrutura: metal lacado
anéis: metal lacado, latão ou cobre polido or satinado
lâmpada económica E27 / 1x23W

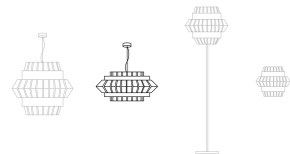

2

3

comb floor

Ø: 54 cm / 21"
h: 175 cm / 69"

structure: lacquered metal
rings: lacquered metal, polished or satin brass or copper
energy saving bulb E27 / 1x23W

estrutura: metal lacado
anéis: metal lacado, latão ou cobre polido ou satinado
lâmpada económica E27 / 1x23W

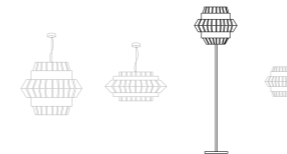

2

3



wall lamp



1

61

comb wall

w: 37 cm / 15"
 d: 13 cm / 5"
 h: 34 cm / 13"

structure: lacquered metal
 rings: lacquered metal, polished or satin brass or copper
 energy saving bulb E14 / 1x15W ◐

estrutura: metal lacado
 anéis: metal lacado, latão ou cobre polido or satin
 lâmpada económica E14 / 1x15W ◐

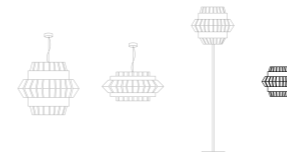

2



3



*FAHRENHEIT SEVEN,
COURCHEVEL

suspension lamp





1

69

loop

w: 55 cm / 22"
d: 25 cm / 10"
h: 77 cm / 30"

structure: lacquered metal, polished or satin brass, copper or nickel, or bronze
globe: glass
bulbs 1 x LED G9 max. 7W 

estrutura: metal lacado, latão, cobre ou nickel polido ou satinado, ou bronze
globo: vidro
lâmpadas 1 x LED G9 máx.7W 



2

3



suspension lamp



1

loop I

w: 26 cm / 10"
d: 15 cm / 6"
h: 74 cm / 29"

structure: lacquered metal, polished or satin brass, copper or nickel, or bronze
globe: glass
bulbs 1 x LED G9 max. 7W

estrutura: metal lacado, latão, cobre ou nickel polido ou satinado, ou bronze
globo: vidro
lâmpadas 1 x LED G9 máx. 7W



2



3

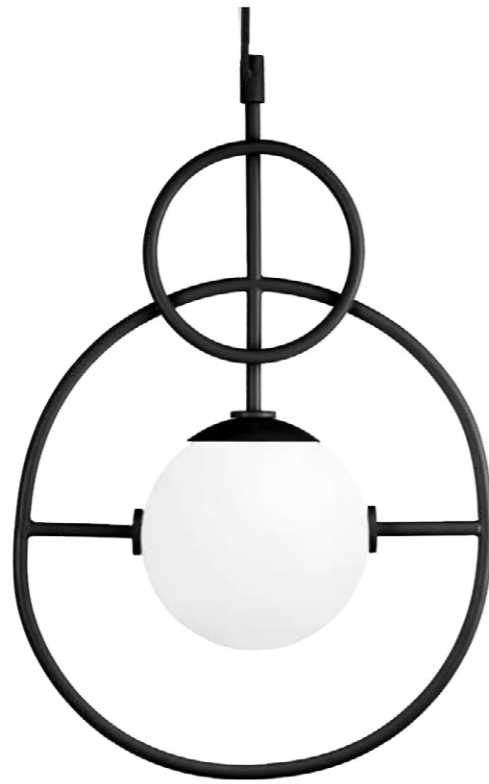

1



1

loop II

w: 31 cm / 12"
d: 15 cm / 6"
h: 47 cm / 18"

structure: lacquered metal, polished or satin brass, copper or nickel, or bronze
globe: glass
bulbs 1 x LED G9 max. 7W

estrutura: metal lacado, latão, cobre ou nickel polido ou satinado, ou bronze
globo: vidro
lâmpadas 1 x LED G9 máx.7W

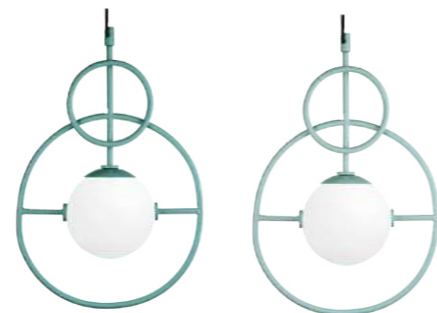
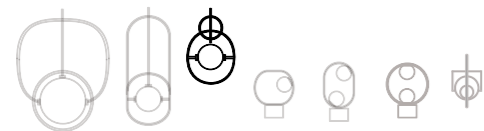

2

3

loop table

w: 36 cm / 14"
d: 15 cm / 6"
h: 38 cm / 15"

structure: lacquered metal, polished or satin brass, copper or nickel, or bronze
globe: glass
optional base: marble
bulbs 7 x LED G9 max. 7W

estrutura: metal lacado, latão, cobre ou nickel polido ou satinado, ou bronze
globo: vidro
base opcional: mármore
lâmpadas 7 x LED G9 máx.7W

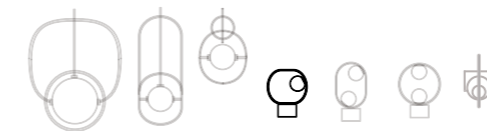

2

3

table lamp



table lamp



75

loop table I

w: 30 cm / 12"
d: 15 cm / 6"
h: 50 cm / 20"

structure: lacquered metal, polished or satin brass, copper or nickel, or bronze

globe: glass

optional base: marble

bulbs 2 x LED G9 max. 7W 

estrutura: metal lacado, latão, cobre ou nickel polido ou satinado, ou bronze

globo: vidro

base opcional: mármore

lâmpadas 2 x LED G9 máx.7W 



2



3

loop table II

w: 43 cm / 17"
d: 15 cm / 6"
h: 47 cm / 19"

structure: lacquered metal, polished or satin brass, copper or nickel, or bronze

globe: glass

optional base: marble

bulbs 2 x LED G9 max. 7W 

estrutura: metal lacado, latão, cobre ou nickel polido ou satinado, ou bronze

globo: vidro

base opcional: mármore

lâmpadas 2 x LED G9 máx.7W 

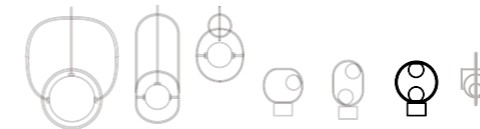

2



3

CASA DECOR,
MADRID



wall lamp



1

loop wall

w: 15 cm / 6"
d: 30 cm / 12"
h: 27 cm / 11"

structure: lacquered metal, polished or satin brass, copper or nickel, or bronze
globe: glass
bulbs 1 x LED G9 max. 7W 

estrutura: metal lacado, latão, cobre ou nickel polido ou satinado, ou bronze
globo: vidro
lâmpadas 1 x LED G9 máx.7W 

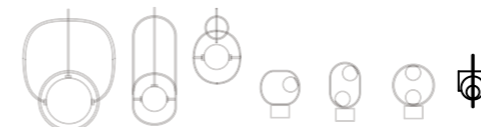

2



3





NA MOSFILMOVSKAYA RESTAURANT
MOSCOW

suspension lamp



1

magnolia

Ø: 65 cm / 26"
h: 68 cm / 27"

top: lacquered metal
 structure: lacquered metal, polished or satin brass, copper, or nickel, or bronze
 ring: lacquered metal, polished or brushed metal
 energy saving bulb E27 / 1x23W ◐

topo: metal lacado
 estrutura: metal lacado, latão, cobre ou nickel polido ou satinado, ou bronze
 anel: metal lacado, metal polido ou escovado
 lâmpada económica E27 / 1x23W ◐

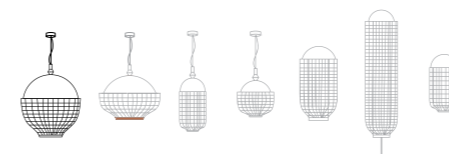

2



3

suspension lamp



1

magnolia I

Ø: 65 cm / 26"
h: 47 cm / 19"

top: lacquered metal
structure: lacquered metal, polished or satin brass, copper, or nickel, or bronze
ring: lacquered metal, polished or satin brass, copper or nickel, or bronze
energy saving bulb E27 / 1x23W

topo: metal lacado
estrutura: metal lacado, latão, cobre ou nickel polido ou satinado, ou bronze
anel: metal lacado, latão, cobre ou nickel polido ou satinado, ou bronze
lâmpada económica E27 / 1x23W

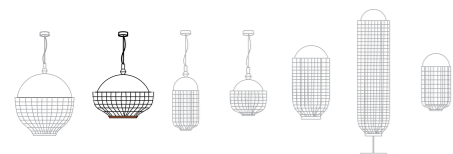

2

3

suspension lamp



1

magnolia II

Ø: 27 cm / 11"
h: 59 cm / 23"

top: lacquered metal, polished or brushed metal
structure: lacquered metal, polished or satin brass, copper, or nickel, or bronze
ring: lacquered metal, polished or satin brass, copper or nickel, or bronze
abat-jour: cotton
energy saving bulb E27 / 1x23W

topo: metal lacado
estrutura: metal lacado, latão, cobre ou nickel polido ou satinado, ou bronze
anel: metal lacado, latão, cobre, bronze ou nickel polido ou satinado
anel: metal lacado, latão, cobre ou nickel polido ou satinado, ou bronze
lâmpada económica E27 / 1x23W



2

3



TEMAKINHO,
MILAN



suspension lamp



1

83

magnolia III

Ø: 31 cm / 12"
h: 42 cm / 17"

top: lacquered metal, polished or satin brass, copper, or nickel, or bronze
 structure: lacquered metal, polished or satin brass, copper, or nickel, or bronze
 ring: lacquered metal, polished or satin brass, copper or nickel, or bronze
 abat-jour: cotton
 energy saving bulb E27 / 1x23W

topo: metal lacado, latão, cobre ou nickel polido ou satinado, ou bronze
 estrutura: metal lacado, latão, cobre ou nickel polido ou satinado, ou bronze
 anel: metal lacado, latão, cobre ou nickel polido ou satinado, ou bronze
 abat-jour: algodão
 lâmpada económica E27 / 1x23W



2

3

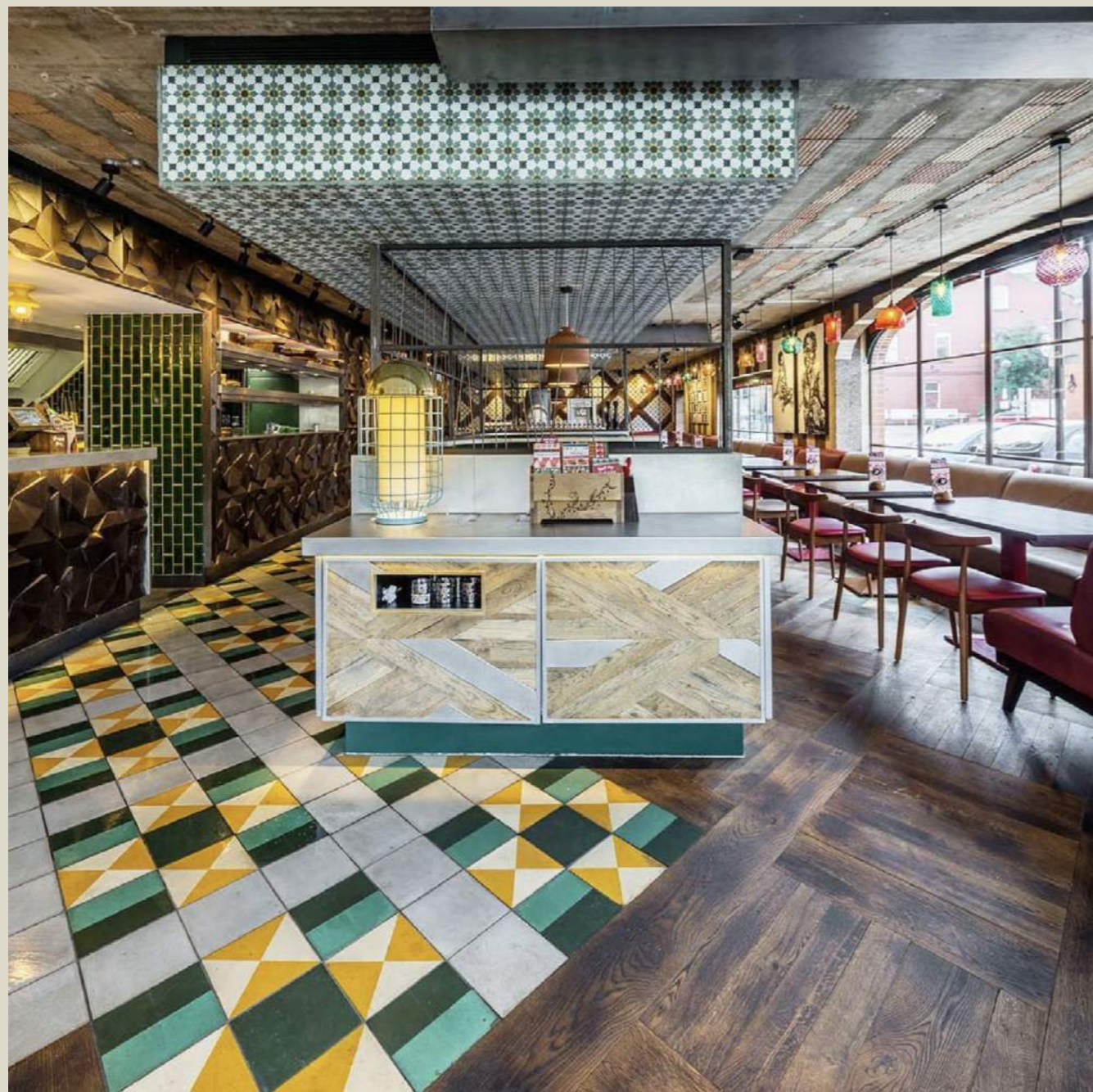

NANDO'S RESTAURANT,
SOUTHAMPTON

table lamp



1

magnolia table

Ø: 32 cm / 13"
h: 63 cm / 25"

top: lacquered metal, polished or satin brass, copper, or nickel, or bronze
estrutura: lacquered metal, polished or satin brass, copper, or nickel, or bronze
abat-jour: cotton
energy saving bulb E27 / 1x23W ☞

topo: metal lacado, latão, cobre ou nickel polido ou satinado, ou bronze
estrutura: metal lacado, latão, cobre ou nickel polido ou satinado, ou bronze
abat-jour: algodão
lâmpada económica E27 / 1x23W ☞

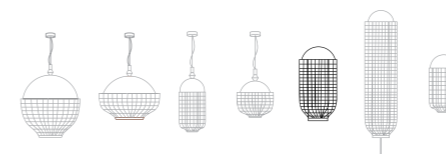

2



3

floor lamp



1

wall lamp



1

magnolia floor

Ø: 37 cm / 15"
h: 170 cm / 67"

top: lacquered metal, polished or satin brass, copper, or nickel, or bronze
estrutura: lacquered metal, polished or satin brass, copper, or nickel, or bronze
abat-jour: cotton
energy saving bulb E27 / 1x23W

topo: metal lacado, latão, cobre ou nickel polido ou satinado, ou bronze
estrutura: metal lacado, latão, cobre ou nickel polido ou satinado, ou bronze
abat-jour: algodão
lâmpada económica E27 / 1x23W

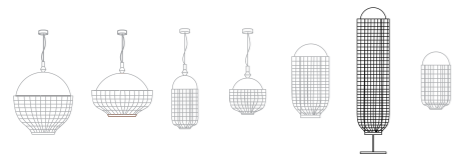

magnolia wall

w: 30 cm / 12"
d: 13 cm / 5"
h: 56 cm / 22"

top: lacquered metal, polished or satin brass, copper, or nickel, or bronze
estrutura: lacquered metal, polished or satin brass, copper, or nickel, or bronze
abat-jour: cotton
energy saving bulb E27 / 1x23W

topo: metal lacado, latão, cobre ou nickel polido ou satinado, ou bronze
estrutura: metal lacado, latão, cobre ou nickel polido ou satinado, ou bronze
abat-jour: algodão
lâmpada económica E27 / 1x23W



2



3



2



3



OLYMPO RESTAURANT,
SANTA CRUZ DE TENERIFE
BY ESTUDIO DISFORM

suspension lamp





89

1

carousel

5 arms 5 braços 3 arms 3 braços
Ø: 110 cm / 43" Ø: 89 cm / 35"
h: 40 cm / 16" h: 40 cm / 16"

estrutura: lacquered metal
abat-jours: cotton
energy saving bulb E27 / 3 or 5 x23W 

estrutura: metal lacado
abat-jours: algodão
lâmpada económica E27 / 3 or 5 x23W 

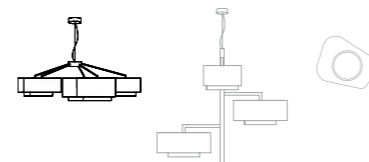

2



3

suspension lamp



1

carousel I

Ø: 97 cm / 38"
h: 86 cm / 34"

estrutura: lacquered metal
abat-jours: cotton
energy saving bulb E27 / 3x23W

estrutura: metal lacado
abat-jours: algodão
lâmpada económica E27 / 3x23W

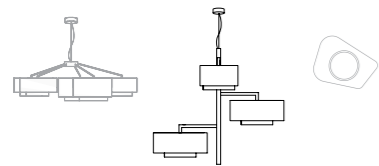

2



3

wall lamp



1

carousel wall

w: 40 cm / 16"
d: 18 cm / 7"
h: 30 cm / 12"

cup: lacquered metal
abat-jour: cotton
energy saving bulb E27 / 1x20W

estrutura: metal lacado
abat-jours: algodão
lâmpada económica E27 / 1x20W



2



3



suspension lamp



1

expand

Ø: 50 cm / 20"
h: 70 cm / 28"

structure: lacquered metal
energy saving bulb E27 / 1x23W

estrutura: metal lacado
lâmpada económica E27 / 1x23W



2



3



suspension lamp



1

revolution

Ø: 55 cm / 22"
h: 70 cm / 28"

structure: lacquered metal
energy saving bulb E27 / 1x23W

estrutura: metal lacado
lâmpada económica E27 / 1x23W



2



3



suspension lamp



1

suspension lamp



1



97

circus

Ø: 56 cm / 22"
h: 73 cm / 29"

structure: lacquered metal, polished, satin or oxidized brass
abat-jour: cotton
energy saving bulb E27 / 5x23W

estrutura: metal lacado, latão polido, satinado ou escovado
abat-jour: algodão
lâmpada económica E27 / 5x23W

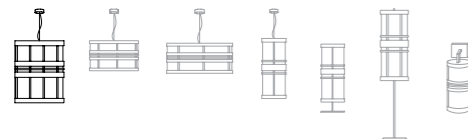

2



3

circus I

Ø: 56 cm / 22"
h: 38 cm / 15"

structure: lacquered metal, polished, satin or oxidized brass
abat-jour: cotton
energy saving bulb E27 / 5x23W

estrutura: metal lacado, latão polido, satinado ou escovado
abat-jour: algodão
lâmpada económica E27 / 5x23W

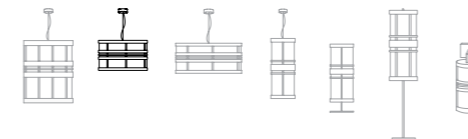

2



3



suspension lamp



99



circus II

Ø: 65 cm / 26"
h: 34 cm / 13"

structure: lacquered metal, polished, satin or oxidized brass
abat-jour: cotton
energy saving bulb E27 / 5x23W

estrutura: metal lacado, latão polido, satinado ou escovado
abat-jour: algodão
lâmpada económica E27 / 5x23W

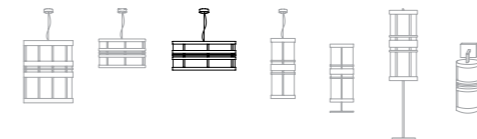

1



2



3



suspension lamp





101

1

circus III

Ø: 38 cm / 15"
h: 66 cm / 26"

structure: lacquered metal, polished, satin or oxidized brass
abat-jour: cotton
energy saving bulb E27 / 5x20W 

estrutura: metal lacado, latão polido, satinado ou escovado
abat-jour: algodão
lâmpada económica E27 / 5x20W 

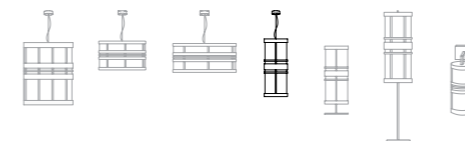

2



3

table lamp



1

floor lamp



1

circus table

Ø: 30 cm / 12"
h: 76 cm / 30"

structure: lacquered metal, polished, satin or oxidized brass
abat-jour: cotton
energy saving bulb E27 / 1x15W

estrutura: metal lacado, latão polido, satinado ou escovado
abat-jour: algodão
lâmpada económica E27 / 1x15W

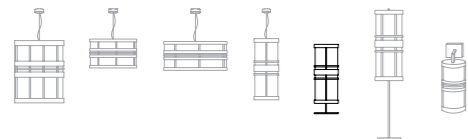

2



3

circus floor

Ø: 35 cm / 14"
h: 170 cm / 67"

structure: lacquered metal, polished, satin or oxidized brass
lamp shade: cotton
energy saving bulb E27 / 6x15W

estrutura: metal lacado, latão polido, satinado ou escovado
abat-jour: algodão
lâmpada económica E27 / 6x15W

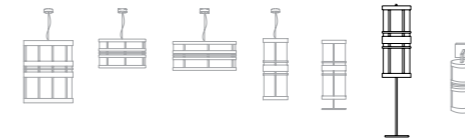

2



3





wall lamp





1

15

circus wall

w: 27 cm / 11"
d: 30 cm / 11"
h: 62 cm / 24"

structure: lacquered metal, polished, satin or oxidized brass
abat-jour: cotton
energy saving bulb E14 / 1x20W 

estrutura: metal lacado, latão polido, satinado ou escovado
abat-jour: algodão
lâmpada económica E14 / 1x20W 

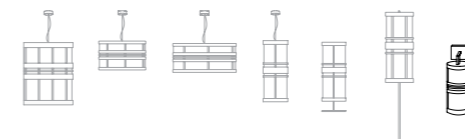

2



3



FIREEYE OFFICES,
THE NETHERLANDS

suspension lamp



1

up

Ø: 55 cm / 22"
h: 72 cm / 28"

structure: lacquered metal
ring: lacquered metal
abat-jour: cotton
energy saving bulb E27 / 1x23W 

estrutura: metal lacado
anel: metal lacado
abat-jour: algodão
lâmpada económica E27 / 1x23W 

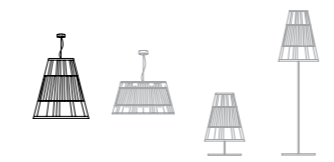

2



3



suspension lamp

table lamp



1



1t

up I

Ø: 68 cm / 27"
h: 39 cm / 15"

structure: lacquered metal
ring: lacquered metal
abat-jour: cotton
energy saving bulb E27 / 1x23W

estrutura: metal lacado
anel: metal lacado
abat-jour: algodão
lâmpada económica E27 / 1x23W

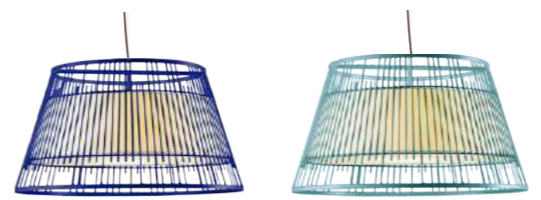

2

3

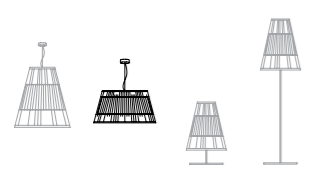

up table

Ø: 44 cm / 17"
h: 72 cm / 28"

structure: lacquered metal
ring: lacquered metal
abat-jour: cotton
energy saving bulb E27 / 1x15W

estrutura: metal lacado
anel: metal lacado
abat-jour: algodão
lâmpada económica E27 / 1x15W



2

3





HOTEL DAS SONNREICH,
GERMANY

floor lamp



1

up floor

Ø: 47 cm / 19"
h: 170 cm / 67"

structure: lacquered metal
ring: lacquered metal
abat-jour: cotton
energy saving bulb E27 / 1x23W 

estrutura: metal lacado
anel: metal lacado
abat-jour: algodão
lâmpada económica E27 / 1x23W 



2



3



suspension lamp



1

extrude

Ø: 60 cm / 24"
h: 70 cm / 28"

structure: lacquered metal
abat-jour: cotton
energy saving bulb E27 / 1x23W

estrutura: metal lacado
abat-jours: algodão
lâmpada económica E27 / 1x23W

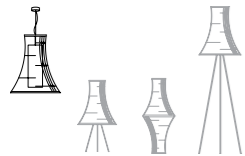

2

3

table lamp



1

extrude table

Ø: 34 cm / 13"
h: 70 cm / 28"

structure: lacquered metal
energy saving bulb E27 / 1x15W

estrutura: metal lacado
lâmpada económica E27 / 1x15W

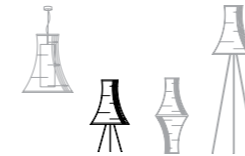

2

3

table lamp



1

extrude table I

Ø: 14 cm / 5"
h: 75 cm / 30"

structure: lacquered metal
energy saving bulb E27 / 1x15W

estrutura: metal lacado
lâmpada económica E27 / 1x15W

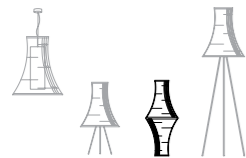

2



3

floor lamp



1

extrude floor

Ø: 50 cm / 20"
h: 175 cm / 69"

structure: lacquered metal
energy saving bulb E27 / 1x23W

estrutura: metal lacado
lâmpada económica E27 / 1x23W



2



3





DRAKE & MORGAN AT KING'S CROSS,
UNITED KINGDOM

suspension lamp



1

star

Ø: 80 cm / 32"
h: 70 cm / 28"

structure: lacquered metal, polished or satin brass, copper or nickel
abat-jour: linen
energy saving bulb E27 / 1x23W 

estrutura: metal lacado, latão, cobre ou nickel
abat-jour: linho
lâmpada económica E27 / 1x23W 

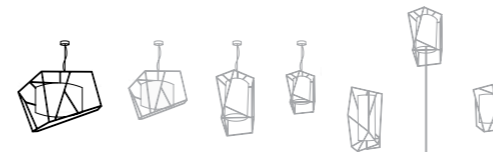

2



3

suspension lamp



1

star I

Ø: 60 cm / 24"
h: 50 cm / 20"

structure: lacquered metal, polished or satin brass, copper or nickel
abat-jour: linen
energy saving bulb E27 / 1x23W 

estrutura: metal lacado, latão, cobre ou nickel
abat-jour: linho
lâmpada económica E27 / 1x23W 

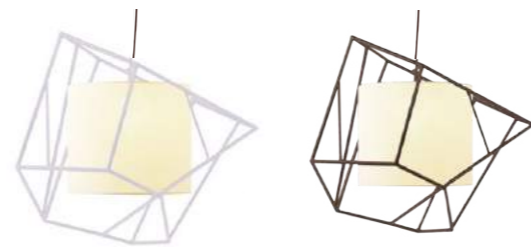
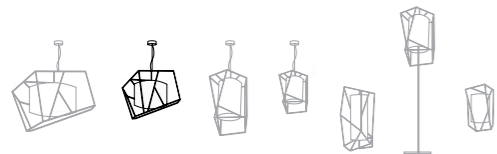

2

3

suspension lamp



1

star II

Ø: 45 cm / 18"
h: 72 cm / 28"

structure: lacquered metal, polished or satin brass, copper or nickel
abat-jour: linen
energy saving bulb E27 / 1x23W 

estrutura: metal lacado, latão, cobre ou nickel
abat-jour: linho
lâmpada económica E27 / 1x23W 

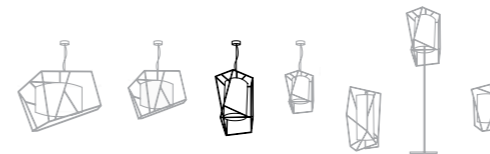

2

3



suspension lamp



1

star III

Ø: 35 cm / 14"
h: 53 cm / 21"

structure: lacquered metal, polished or satin brass, copper or nickel
abat-jour: linen
energy saving bulb E27 / 1x23W 

estrutura: metal lacado, latão, cobre ou nickel
abat-jour: linho
lâmpada económica E27 / 1x23W 

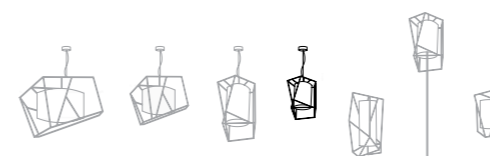

2



3

table lamp



1

floor lamp



1

star table

Ø: 33 cm / 13"
h: 72 cm / 28"

structure: lacquered metal, polished or satin brass, copper or nickel
abat-jour: linen
energy saving bulb E27 / 1x15W 

estrutura: metal lacado, latão, cobre ou nickel
abat-jour: linho
lâmpada económica E27 / 1x15W 

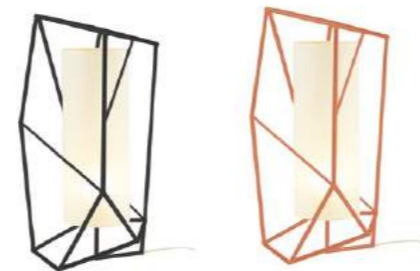
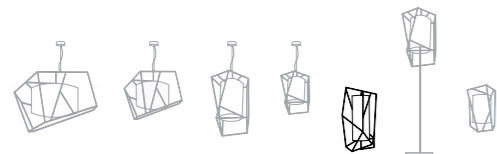



2

3

star floor

Ø: 45 cm / 18"
h: 170 cm / 67"

structure: lacquered metal, polished or satin brass, copper or nickel
abat-jour: linen
energy saving bulb E27 / 1x23W 

estrutura: metal lacado, latão, cobre ou nickel
abat-jour: linho
lâmpada económica E27 / 1x23W 

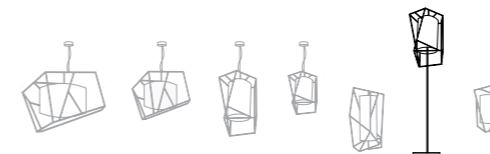

2



3





wall lamp



1

star wall

w: 28 cm / 11"
d: 20 cm / 67"
h: 170 cm / 67"

structure: lacquered metal, polished or satin brass, copper or nickel
abat-jour: linen
energy saving bulb E27 / 1x20W 

estrutura: metal lacado, latão, cobre ou nickel
abat-jour: linho
lâmpada económica E27 / 1x20W 

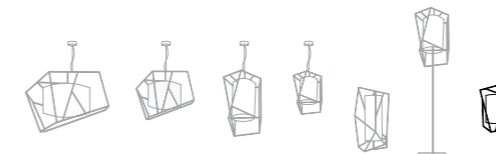

2



3

suspension lamp



1

spider

Ø: 70 cm / 28"
h: 35 cm / 14"

structure: lacquered metal
ring: lacquered metal, polished or satin brass, copper or nickel
energy saving bulb E27 / 1x23W

estrutura: metal lacado
anel: metal lacado, latão, cobre ou nickel
lâmpada económica E27 / 1x23W



2



3

suspension lamp



1

spider I

Ø: 52 cm / 20"
h: 70 cm / 28"

structure: lacquered metal
ring: lacquered metal, polished or satin brass, copper or nickel
energy saving bulb E27 / 1x23W

estrutura: metal lacado
anel: metal lacado, latão, cobre ou nickel
lâmpada económica E27 / 1x23W



2



3





MR. SAMMI BISTRO
THE NETHERLANDS

suspension lamp



1

spider II

Ø: 70 cm / 28"
h: 100 cm / 39"

structure: lacquered metal
ring: lacquered metal, polished or satin brass, copper or nickel
energy saving bulb E27 / 1x23W 

estrutura: metal lacado
anel: metal lacado, latão, cobre ou nickel
lâmpada económica E27 / 1x23W 



2



3

table lamp



1

floor lamp



1



spider table

Ø: 24 cm / 9"
h: 60 cm / 20"

structure: lacquered metal
ring: lacquered metal, polished or satin brass, copper or nickel
abat-jour: cotton
energy saving bulb E27 / 1x15W

estrutura: metal lacado
anel: metal lacado, latão, cobre ou nickel
abat-jour: algodão
lâmpada económica E27 / 1x15W



2

3

spider floor

Ø: 30 cm / 12"
h: 140 cm / 55"

structure: lacquered metal
abat-jour: cotton
energy saving bulb E27 / 2x23W

estrutura: metal lacado
abat-jour: algodão
lâmpada económica E27 / 2x23W



2

3



wall lamp



1

spider wall

Ø: 25 cm / 10"
d: 15 cm / 6"
h: 25 cm / 10"

structure: lacquered metal, polished or satin brass
ring: lacquered metal, polished or satin brass, copper or nickel
abat-jour: cotton
energy saving bulb E14 / 1x15W 

estrutura: metal lacado
anel: metal lacado, latão, cobre ou nickel
abat-jour: algodão
lâmpada económica E14 / 1x15W 



2



3

**technical
information**



suspension lamps

monaco

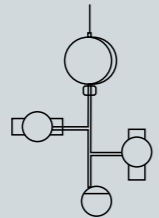

37" / 9 cm
230V / 50Hz 51 lb | 23 kg
9 x max. G9 / 7W 0,55 m³
120V / 60Hz
9 x max. G9 / 7W
Cable 59" / 1,5m

monaco I

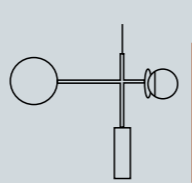

40" / 102 cm
230V / 50Hz 40 lb | 12 kg
5 x max. G9 / 7W 0,55 m³
120V / 60Hz
5 x max. G9 / 7W
Cable 59" / 1,5m

helio III

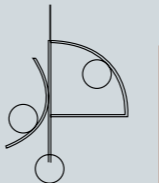

25" / 65 cm
230V / 50Hz 7 lb | 3 kg
2 x max. G9 / 7W 0,13 m³
120V / 60Hz
2 x max. G9 / 7W
Cable 59" / 1,5m

globe

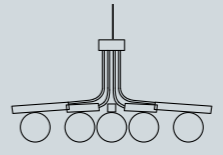

20" / 50 cm
39" / 100 cm
230V / 50Hz 17,6 lb | 8 kg
10 x max. G9 / 7W 0,42 m³
120V / 60Hz
10 x max. G9 / 7W
Cable 59" / 1,5m

globe I

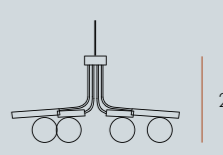

20" / 50 cm
32" / 80 cm
230V / 50Hz 8,8 lb | 4 kg
8 x max. G9 / 7W 0,20 m³
120V / 60Hz
8 x max. G9 / 7W
Cable 59" / 1,5m

monaco II

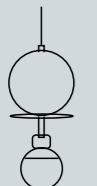

18" / 45 cm
26" / 65 cm
230V / 50Hz 27 lb | 12 kg
3 x max. G9 / 7W 0,09 m³
120V / 60Hz
3 x max. G9 / 7W
Cable 59" / 1,5m

monaco III

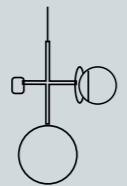

12" / 30 cm
23" / 57 cm
230V / 50Hz 27 lb | 12 kg
3 x max. G9 / 7W 0,09 m³
120V / 60Hz
3 x max. G9 / 7W
Cable 59" / 1,5m

frame

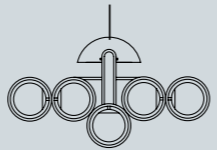

48" / 123 cm
30" / 75 cm
230V / 50Hz 44 lb | 20 kg
5 x max. G9 / 7W 0,42 m³
120V / 60Hz
5 x max. G9 / 7W
Cable 59" / 1,5m

link

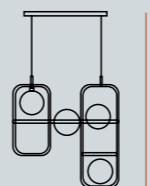

39" / 100 cm
39" / 100 cm
230V / 50Hz 33 lb | 15 kg
4 x max. G9 / 7W 0,85 m³
120V / 60Hz
4 x max. G9 / 7W
Cable 59" / 1,5m

link I

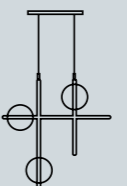

39" / 100 cm
39" / 100 cm
230V / 50Hz 26 lb | 12 kg
3 x max. G9 / 7W 0,55 m³
120V / 60Hz
3 x max. G9 / 7W
Cable 59" / 1,5m

link II

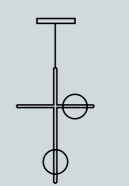

25" / 64 cm
39" / 100 cm
230V / 50Hz 20 lb | 9 kg
2 x max. G9 / 7W 0,25 m³
120V / 60Hz
2 x max. G9 / 7W
Cable 59" / 1,5m

frame I

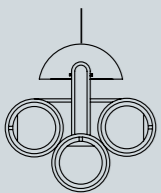

25" / 64 cm
28" / 70 cm
230V / 50Hz 34 lb | 15 kg
3 x max. G9 / 7W 0,42 m³
120V / 60Hz
3 x max. G9 / 7W
Cable 59" / 1,5m

frame II

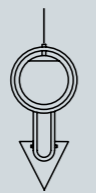

21" / 54 cm
29" / 74 cm
230V / 50Hz 15 lb | 7 kg
1 x max. G9 / 7W 0,09 m³
120V / 60Hz
1 x max. G9 / 7W
Cable 59" / 1,5m

frame II

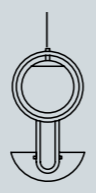

20" / 50 cm
29" / 74 cm
230V / 50Hz 15 lb | 7 kg
1 x max. G9 / 7W 0,09 m³
120V / 60Hz
1 x max. G9 / 7W
Cable 59" / 1,5m

link III

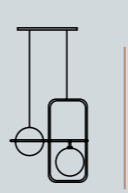

25" / 64 cm
25" / 64 cm
230V / 50Hz 15 lb | 7 kg
2 x max. G9 / 7W 0,27 m³
120V / 60Hz
2 x max. G9 / 7W
Cable 59" / 1,5m

jules

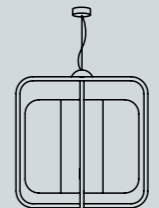

28" / 72 cm
25" / 63 cm
230V / 50Hz 19 lb | 9 kg
E27/1x23W CFL 0,42 m³
120V / 60Hz
E26/1x18W CFL
Cable 59" / 1,5m

jules I

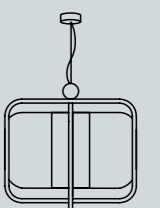

22" / 57 cm
25" / 63 cm
230V / 50Hz 19 lb | 9 kg
E27/1x23W CFL 0,21 m³
120V / 60Hz
E26/1x18W CFL
Cable 59" / 1,5m

helio

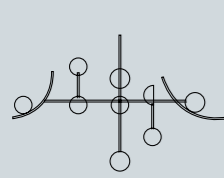

32" / 80 cm
51" / 130 cm
230V / 50Hz 18 lb | 8 kg
7 x max. G9 / 7W 0,42 m³
120V / 60Hz
7 x max. G9 / 7W
Cable 59" / 1,5m

helio I

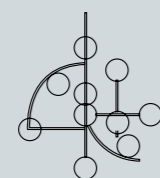

39" / 98 cm
45" / 115 cm
230V / 50Hz 9 lb | 9 kg
9 x max. G9 / 7W 0,42 m³
120V / 60Hz
9 x max. G9 / 7W
Cable 59" / 1,5m

helio II

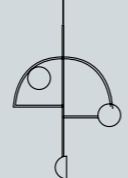

20" / 50 cm
14" / 35 cm
230V / 50Hz 7 lb | 3 kg
2 x max. G9 / 7W 0,13 m³
120V / 60Hz
2 x max. G9 / 7W
Cable 59" / 1,5m

jules II

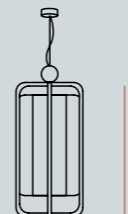

25" / 64 cm
12" / 30 cm
230V / 50Hz 13 lb | 6 kg
E27/1x23W CFL 0,09 m³
120V / 60Hz
E26/1x18W CFL
Cable 59" / 1,5m

jules III

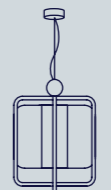

17" / 44 cm
15" / 38 cm
230V / 50Hz 11 lb | 5 kg
E27/1x23W CFL 0,05 m³
120V / 60Hz
E26/1x18W CFL
Cable 59" / 1,5m

comb

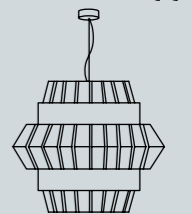

24" / 60 cm
29" / 74 cm
230V / 50Hz 35 lb | 16 kg
E27/1x23W CFL 0,42 m³
120V / 60Hz
E26/1x18W CFL
Cable 59" / 1,5m

comb I

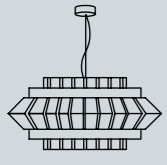

14" / 35 cm

30" / 75 cm

230V / 50Hz 35 lb | 16 kg
● E27/1x23W CFL 0,23 m³
120V / 60Hz
● E26/1x18W CFL
Cable 59" / 1,5m

loop

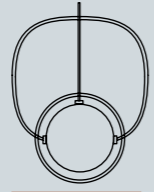

30" / 77 cm

22" / 55 cm

230V / 50Hz 4,4 lb | 2 kg
● 1 x max. G9 / 7W 0,13 m³
120V / 60Hz
● 1 x max. G9 / 7W
Cable 59" / 1,5m

loop I



29" / 74 cm

10" / 26 cm

230V / 50Hz 2,2 lb | 1 kg
● 1 x max. G9 / 7W 0,05 m³
120V / 60Hz
● 1 x max. G9 / 7W
Cable 59" / 1,5m

circus



29" / 73 cm

22" / 56 cm

230V / 50Hz 35 lb | 14 kg
● E27/5x23W CFL 0,42 m³
120V / 60Hz
● E26/5x18W CFL
Cable 59" / 1,5m

circus I

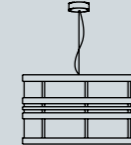

15" / 38 cm

22" / 56 cm

230V / 50Hz 28 lb | 13 kg
● E27/5x23W CFL 0,25 m³
120V / 60Hz
● E26/5x18W CFL
Cable 59" / 1,5m

circus II

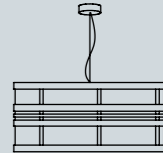

13" / 34 cm

26" / 65 cm

230V / 50Hz 30 lb | 14 kg
● E27/5x23W CFL 0,23 m³
120V / 60Hz
● E26/5x18W CFL
Cable 59" / 1,5m

loop II

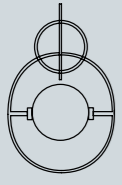

18" / 47 cm

12" / 31 cm

230V / 50Hz 2,2 lb | 1 kg
● 1 x max. G9 / 7W 0,05 m³
120V / 60Hz
● 1 x max. G9 / 7W
Cable 59" / 1,5m

magnolia

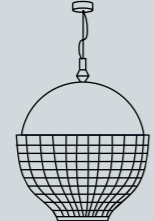

27" / 68 cm

26" / 65 cm

230V / 50Hz 19 lb | 9 kg
● E27/1x23W CFL 0,42 m³
120V / 60Hz
● E26/1x18W CFL
Cable 59" / 1,5m

magnolia I

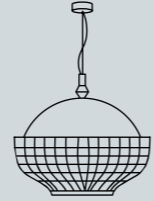

19" / 47 cm

26" / 65 cm

230V / 50Hz 19 lb | 9 kg
● E27/1x23W CFL 0,21 m³
120V / 60Hz
● E26/1x18W CFL
Cable 59" / 1,5m

circus III



26" / 66 cm

12" / 30 cm

230V / 50Hz 17 lb | 8 kg
● E27/1x20W CFL 0,09 m³
120V / 60Hz
● E26/1x18W CFL
Cable 59" / 1,5m

up

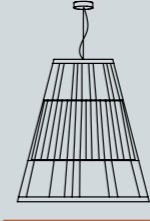

28" / 72 cm

22" / 55 cm

230V / 50Hz 19 lb | 9 kg
● E27/1x23W CFL 0,42 m³
120V / 60Hz
● E26/1x18W CFL
Cable 59" / 1,5m

up I

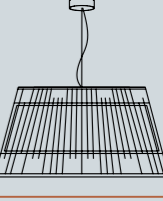

15" / 39 cm

27" / 68 cm

230V / 50Hz 34 lb | 15 kg
● E27/1x23W CFL 0,25 m³
120V / 60Hz
● E26/1x18W CFL
Cable 59" / 1,5m

magnolia II



23" / 59 cm

11" / 27 cm

230V / 50Hz 13 lb | 6 kg
● E27/1x23W CFL 0,09 m³
120V / 60Hz
● E26/1x18W CFL
Cable 59" / 1,5m

magnolia III

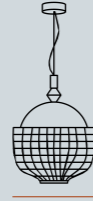

17" / 42 cm

12" / 31 cm

230V / 50Hz 11 lb | 5 kg
● E27/1x20W CFL 0,05 m³
120V / 60Hz
● E26/1x15W CFL
Cable 59" / 1,5m

carousel

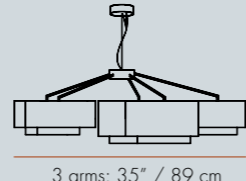

16" / 40 cm

3 arms: 35" / 89 cm
5 arms: 43" / 110 cm

230V / 50Hz 44 lb | 20 kg
● E27/3/5 x23W CFL 0,55 m³
120V / 60Hz
● E26/3/5x18W CFL
Cable 59" / 1,5m

extrude

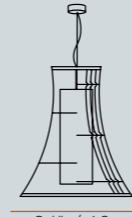

28" / 70 cm

24" / 60 cm

230V / 50Hz 19 lb | 9 kg
● E27/1x23W CFL 0,42 m³
120V / 60Hz
● E26/1x18W CFL
Cable 59" / 1,5m

star

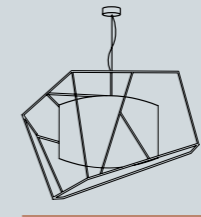

28" / 70 cm

32" / 80 cm

230V / 50Hz 13 lb | 6 kg
● E27/1x23W CFL 0,42 m³
120V / 60Hz
● E26/1x18W CFL
Cable 59" / 1,5m

star I

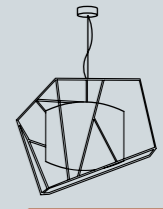

20" / 50 cm

24" / 60 cm

230V / 50Hz 13 lb | 6 kg
● E27/1x23W CFL 0,28 m³
120V / 60Hz
● E26/1x18W CFL
Cable 59" / 1,5m

carousel I

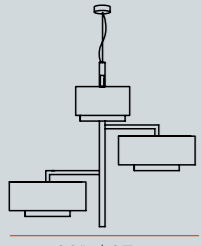

34" / 86 cm

38" / 97 cm

230V / 50Hz 44 lb | 20 kg
● E27/3x23W CFL 0,55 m³
120V / 60Hz
● E26/3x18W CFL
Cable 59" / 1,5m

expand

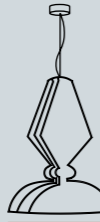

28" / 70 cm

20" / 50 cm

230V / 50Hz 17 lb | 8 kg
● E27/1x23W CFL 0,42 m³
120V / 60Hz
● E26/1x18W CFL
Cable 59" / 1,5m

revolution



28" / 70 cm

22" / 55 cm

230V / 50Hz 17 lb | 8 kg
● E27/1x23W CFL 0,42 m³
120V / 60Hz
● E26/1x18W CFL
Cable 59" / 1,5m

star II

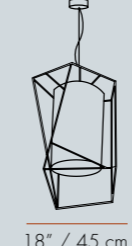

28" / 72 cm

18" / 45 cm

230V / 50Hz 11 lb | 5 kg
● E27/1x23W CFL 0,17 m³
120V / 60Hz
● E26/1x18W CFL
Cable 59" / 1,5m

star III

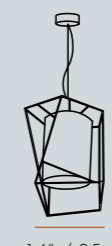

21" / 53 cm

14" / 35 cm

230V / 50Hz 8 lb | 4 kg
● E27/1x20W CFL 0,18 m³
120V / 60Hz
● E26/1x15W CFL
Cable 59" / 1,5m

spider

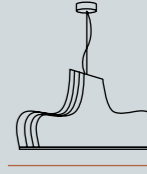

14" / 35 cm

28" / 70 cm

230V / 50Hz 17 lb | 8 kg
● E27/1x23W CFL 0,26 m³
120V / 60Hz
● E26/1x18W CFL
Cable 59" / 1,5m

spider I

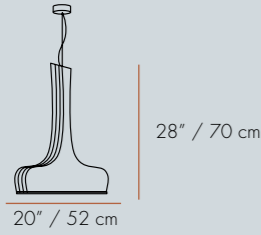

230V / 50Hz
● E27/1x23W CFL 19 lb | 9 kg
 0,42 m³
120V / 60Hz
● E26/1x18W CFL
Cable
59" / 1,5m

spider II

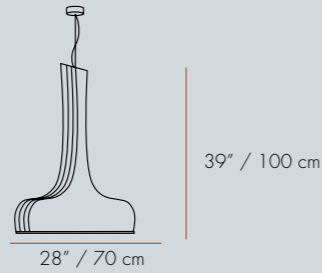

230V / 50Hz
● E27/1x23W CFL 26 lb | 12 kg
 0,59 m³
120V / 60Hz
● E26/1x18W CFL
Cable
59" / 1,5m

table lamps

magnolia table

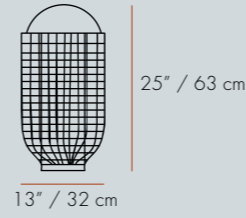

230V / 50Hz
● E27/1x15W CFL 17 lb | 8 kg
 0,09 m³
120V / 60Hz
● E26/1x13W CFL

circus table

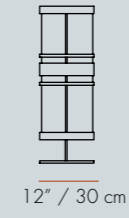

230V / 50Hz
● E27/1x15W CFL 17 lb | 8 kg
 0,09 m³
120V / 60Hz
● E26/1x13W CFL

up table

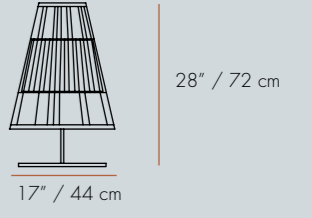

230V / 50Hz
● E27/1x15W CFL 19 lb | 9 kg
 0,16 m³
120V / 60Hz
● E26/1x13W CFL

monaco table

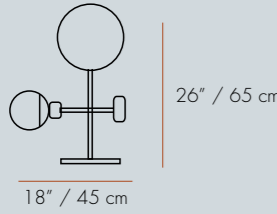

230V / 50Hz
 3 x max. G9 / 7W 29 lb | 14 kg
 0,09 m³
120V / 60Hz
 3 x max. G9 / 7W

monaco table

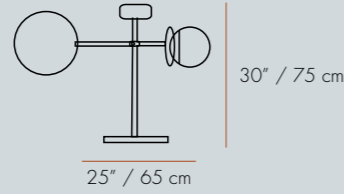

230V / 50Hz
 3 x max. G9 / 7W 30 lb | 15 kg
 0,16 m³
120V / 60Hz
 3 x max. G9 / 7W

frame table

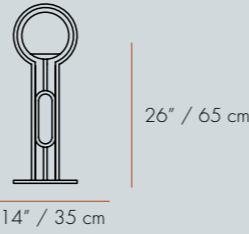

230V / 50Hz
 1 x max. G9 / 7W 26 lb | 12 kg
 0,09 m³
120V / 60Hz
 1 x max. G9 / 7W

extrude table I

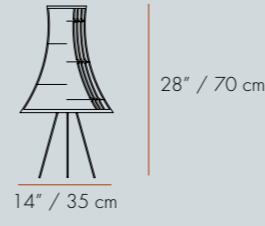

230V / 50Hz
● E27/1x15W CFL 13 lb | 6 kg
 0,09 m³
120V / 60Hz
● E26/1x13W CFL

extrude table II

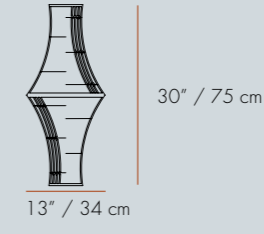

230V / 50Hz
● E27/1x15W CFL 15 lb | 7 kg
 0,09 m³
120V / 60Hz
● E26/1x13W CFL

star table

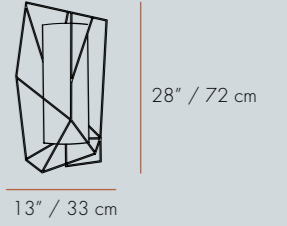

230V / 50Hz
● E27/1x15W CFL 9 lb | 4 kg
 0,16 m³
120V / 60Hz
● E26/1x13W CFL

helio table

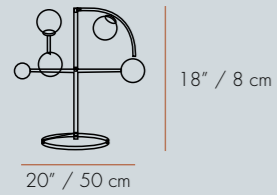

230V / 50Hz
 4 x max. G9 / 7W 11 lb | 5 kg
 0,13 m³
120V / 60Hz
 3 x max. G9 / 7W

globe table

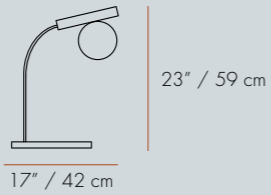

230V / 50Hz
● 1 x max. G9 / 7W 35 lb | 16 kg
 0,42 m³
120V / 60Hz
● 1 x max. G9 / 7W

jules table

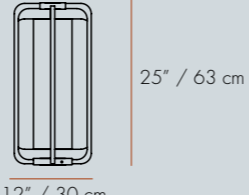

230V / 50Hz
● E27/1x15W CFL 17 lb | 8 kg
 0,09 m³
120V / 60Hz
● E26/1x13W CFL

spider table

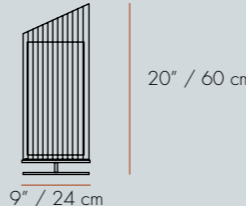

230V / 50Hz
● E27/1x15W CFL 15 lb | 7 kg
 0,09 m³
120V / 60Hz
● E26/1x13W CFL

floor lamps

monaco floor

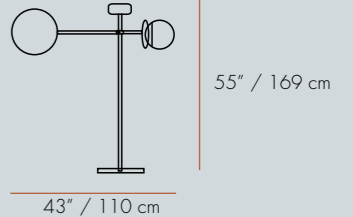

230V / 50Hz
 3 x max. G9 / 7W 26 lb | 25 kg
 0,38 m³
120V / 60Hz
 3 x max. G9 / 7W

loop table

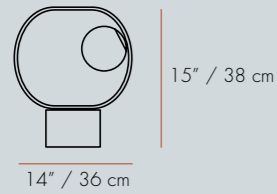

230V / 50Hz
 1 x max. G9 / 7W 4,4 lb | 2 kg
 0,03 m³
120V / 60Hz
 1 x max. G9 / 7W

loop table I

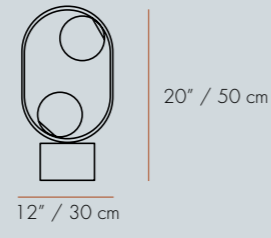

230V / 50Hz
 2 x max. G9 / 7W 6,6 lb | 3 kg
 0,03 m³
120V / 60Hz
 2 x max. G9 / 7W

loop table II

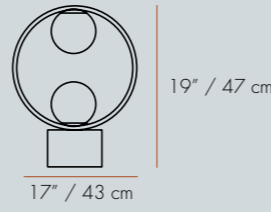

230V / 50Hz
 2 x max. G9 / 7W 6,6 lb | 3 kg
 0,04 m³
120V / 60Hz
 2 x max. G9 / 7W

frame floor

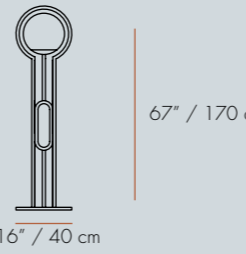

230V / 50Hz
 1 x max. G9 / 7W 26 lb | 25 kg
 0,38 m³
120V / 60Hz
 1 x max. G9 / 7W

helio frame

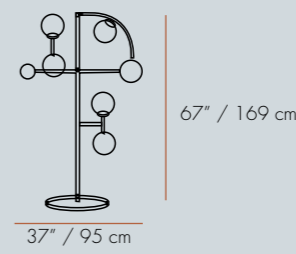

230V / 50Hz
 6 x max. G9 / 7W 24 lb | 10 kg
 0,38 m³
120V / 60Hz
 6 x max. G9 / 7W

globe floor

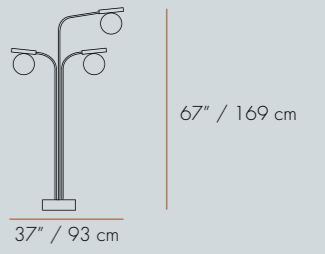

230V / 50Hz
 3 x max. G9 / 7W 19,85 lb | 9 kg
 0,24 m³
120V / 60Hz
 3 x max. G9 / 7W

jules floor

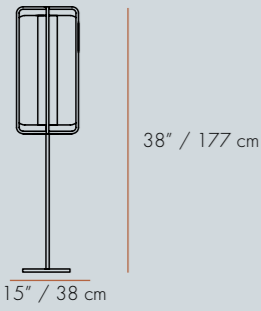

38" / 177 cm

15" / 38 cm

- 230V / 50Hz
- E27/1x23W CFL
- 26 lb | 12 kg
- 0,38 m³
- 120V / 60Hz
- E26/1x18W CFL



comb II

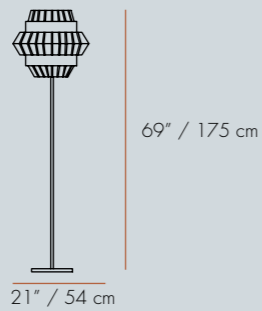

69" / 175 cm

21" / 54 cm

- 230V / 50Hz
- E27/1x23W CFL
- 30 lb | 14 kg
- 0,65 m³
- 120V / 60Hz
- E26/1x18W CFL



magnolia floor

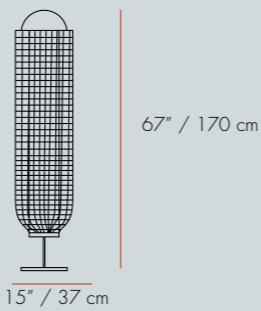

67" / 170 cm

15" / 37 cm

- 230V / 50Hz
- E27/2x23W CFL
- 26 lb | 12 kg
- 0,38 m³
- 120V / 60Hz
- E26/2x18W CFL



globe wall

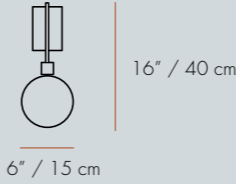

16" / 40 cm

6" / 15 cm

- 230V / 50Hz
- 1 x max. G9 / 7W
- 2,2 lb | 1 kg
- 0,02 m³

- 120V / 60Hz
- 1 x max. G9 / 7W



globe wall I

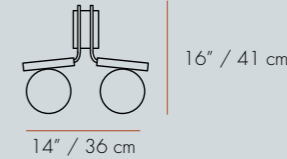

16" / 41 cm

14" / 36 cm

- 230V / 50Hz
- 2 x max. G9 / 7W
- 4,4 lb | 2 kg
- 0,05 m³

- 120V / 60Hz
- 2 x max. G9 / 7W



jules wall

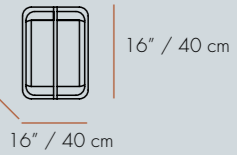

16" / 40 cm

9" / 23cm

- 230V / 50Hz
- E14/1x20W CFL
- 8 lb | 4 kg
- 0,05 m³

- 120V / 60Hz
- E12/1x15W CFL



circus floor

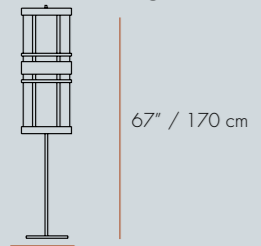

67" / 170 cm

14" / 35 cm

- 230V / 50Hz
- E27/6x15W CFL
- 37 lb | 17 kg
- 0,38 m³
- 120V / 60Hz
- E26/6x13W CFL



up floor

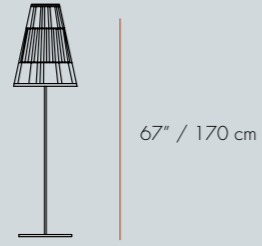

67" / 170 cm

19" / 47 cm

- 230V / 50Hz
- E27/1x23W CFL
- 27 lb | 12 kg
- 0,49 m³
- 120V / 60Hz
- E26/1x18W CFL



extrude floor

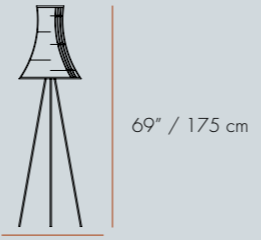

69" / 175 cm

20" / 50 cm

- 230V / 50Hz
- E27/1x23W CFL
- 26 lb | 12 kg
- 0,57 m³
- 120V / 60Hz
- E26/1x18W CFL



comb III



13" / 34 cm

5" / 13cm

15" / 37 cm

- 230V / 50Hz
- E14/1x20W CFL
- 11 lb | 5 kg
- 0,05 m³
- 120V / 60Hz
- E12/1x15W CFL



loop wall



11" / 27 cm

6" / 15 cm

- 230V / 50Hz
- 1 x max. G9 / 7W
- 2,2 lb | 1 kg
- 0,02 m³

- 120V / 60Hz
- 1 x max. G9 / 7W



magnolia wall

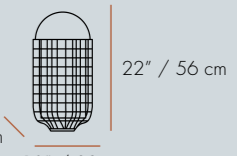

22" / 56 cm

5" / 13cm

12" / 30 cm

- 230V / 50Hz
- E14/1x20W CFL
- 8 lb | 4 kg
- 0,05 m³
- 120V / 60Hz
- E12/1x15W CFL



star floor

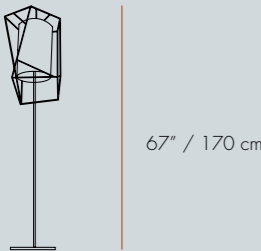

67" / 170 cm

18" / 45 cm

- 230V / 50Hz
- E27/1x23W CFL
- 19 lb | 9 kg
- 0,38 m³
- 120V / 60Hz
- E26/1x18W CFL



spider floor

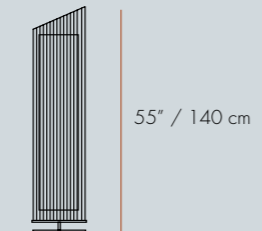

55" / 140 cm

9" / 24 cm

- 230V / 50Hz
- E27/2x23W CFL
- 26 lb | 12 kg
- 0,38 m³
- 120V / 60Hz
- E26/2x18W CFL



wall lamps

monaco wall

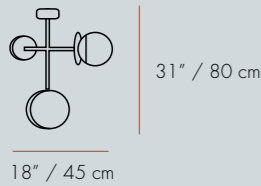

31" / 80 cm

18" / 45 cm

- 230V / 50Hz
- 1 x max. G9 / 7W
- 22 lb | 10 kg
- 0,17 m³

- 120V / 60Hz
- 1 x max. G9 / 7W



frame wall

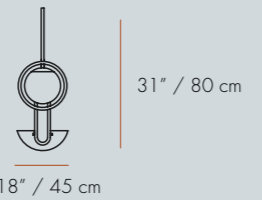

31" / 80 cm

18" / 45 cm

- 230V / 50Hz
- 1 x max. G9 / 7W
- 22 lb | 10 kg
- 0,17 m³

- 120V / 60Hz
- 1 x max. G9 / 7W



helio wall

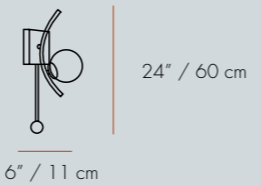

24" / 60 cm

6" / 11 cm

- 230V / 50Hz
- 1 x max. G9 / 7W
- 7 lb | 3 kg
- 0,09 m³

- 120V / 60Hz
- 1 x max. G9 / 7W



carousel wall

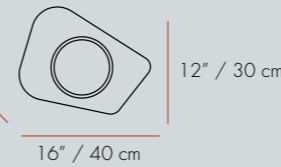

12" / 30 cm

7" / 18 cm

16" / 40 cm

- 230V / 50Hz
- E27/1x20W CFL
- 11 lb | 5 kg
- 0,05 m³
- 120V / 60Hz
- E26/1x15W CFL



circus V

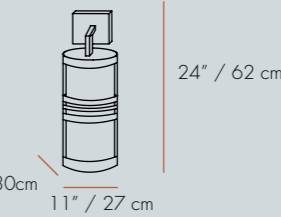

24" / 62 cm

12" / 30cm

11" / 27 cm

- 230V / 50Hz
- E27/1x20W CFL
- 17 lb | 8 kg
- 0,09 m³
- 120V / 60Hz
- E26/1x18W CFL



star wall

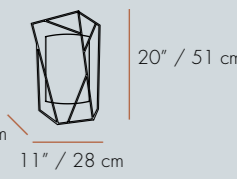

20" / 51 cm

8" / 20 cm

11" / 28 cm

- 230V / 50Hz
- E14/1x20W CFL
- 6 lb | 3 kg
- 0,05 m³
- 120V / 60Hz
- E12/1x15W CFL



spider wall

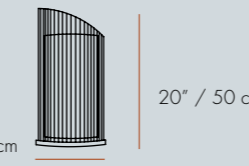

20" / 50 cm

6" / 15 cm

10" / 25 cm

- 230V / 50Hz
- E14/1x20W CFL
- 11 lb | 5 kg
- 0,05 m³
- 120V / 60Hz
- E12/1x15W CFL



finishings

cords fios



brown textile cord¹
fio têxtil castanho



black textile cord²
fio têxtil preto



transparent rubber cord³
fio de borracha transparente



yellow textile cord⁴
fio têxtil amarelo



black and white textile cord⁴
fio têxtil preto e branco



red and blue textile cord⁴
fio têxtil vermelho e azul

abat-jours



cotton
algodão



linen
linho

lacquered metal metal lacado



white

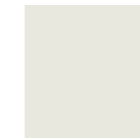

ivory



taupe



dream



emerald



moss



jade



mint



cobalt



lipstick



yellow sun



lilac



brown



black



copper color



salmon

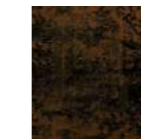

spotted brown*

polished, satin and oxidized metal metal polid, satinado e oxidado



polished brass
latão polido



satin brass
latão satinado

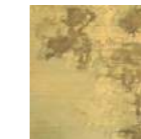

oxidized brass
latão oxidado

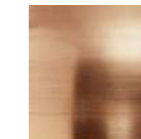

polished copper
cobre polido



satin copper
cobre satinado

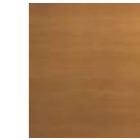

bronze
escovado



polished nickel
níquel polido



polished nickel
níquel polido

laquered wood madeira lacada



aloe



blossom



wine



black



terrazzo

¹ standard for all suspension lamps (except black ones)
standard para candeeiros de suspensão (excepto pretos)

² standard for black suspension lamps
standard para candeeiros de suspensão pretos

³ standard for all table and floor lamps
standard para candeeiros de mesa e chão

⁴ available on extra charge
disponível com custo adicional

* spotted brown is a painted color
spotted brown é uma cor pintada

POLISHED AND SATIN METAL PIECES:
this product is handmade; any small stain or roughness
is a feature of the product, not a defect.

PEÇAS EM METAL POLIDO E SATINADO:
este produto é feito artesanalmente; qualquer pequena
rugosidade ou mancha é uma característica, não um defeito.

Sample box available.
Caixa de amostras disponível.





WOJNAROWSKI

tel . 32 735 0 684

biuro@wojnarowskilighting.pl

Porcelanowa 23, bud. B
40-246 Katowice

NIP: 9542793763

REGON: 380582520

WWW.WOJNAROWSKILIGHTING.PL