

AD-755 241

**RADAR WAVE DIRECTION SENSORS FOR COASTAL  
RESEARCH**

Walter L. Mudgett, et al

Raytheon Service Company

**Prepared for:**

**Army Coastal Engineering Research Center**

**22 June 1972**

**DISTRIBUTED BY:**

**NTIS**

**National Technical Information Service  
U. S. DEPARTMENT OF COMMERCE  
5285 Port Royal Road, Springfield Va. 22151**

**Best  
Available  
Copy**

AD 755241



Contract DACW72-72-C-0008

1972 June 22

**RADAR WAVE DIRECTION SENSORS  
FOR COASTAL RESEARCH**

Approved for public release;  
distribution unlimited.

**Submitted to:**

Director

U.S. Army Coastal Engineering Research Center  
5201 Little Falls Road, Northwest  
Washington, District of Columbia 20016

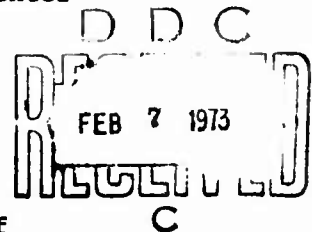

**Prepared by:**

Raytheon Service Company, a Subsidiary of  
Raytheon Company  
12 Second Avenue  
Burlington, Massachusetts 01803  
Telephone: 617-272-9300

Reproduced by  
**NATIONAL TECHNICAL  
INFORMATION SERVICE**  
U S Department of Commerce  
Springfield VA 22151

*W. Mudgett*

Walter L. Mudgett, Principal Investigator

*Raymond C. Remington*

Raymond C. Remington, Field Engineering Manager

142

FOREWORD

This report presents the results of a Study of Radar Wave Direction Sensors for Coastal Research conducted by Raytheon Service Company, a Subsidiary of Raytheon Company, for the Coastal Engineering Research Center (CERC), U.S. Army Corps of Engineers, under Contract DACW72-72-C-0008.

The primary objective of the study was to assess the feasibility of using a radar system to measure the direction of arrival of ocean waves arriving at a shoreline.

The study was conducted at the Headquarters of Raytheon Service Company under the direction of Mr. Walter L. Mudgett as Principal Investigator, with the staff of Mr. Raymond C. Remington, Field Engineering Manager.

Some of the initial concepts leading to this study were developed by Mr. Leo C. Williams of CERC (retired). Successful implementation of the study was largely due to Dr. D. Lee Harris of CERC, who provided the initial direction and guidance, and to Mr. Rudy Savage, CERC Research Division Chief.

Many groups within Raytheon contributed concepts to this study. We especially mention Messrs. Edward F. Hudson, Alan H. Greene, and Aaron S. Soltes of the Equipment Division, and Dr. David O. Cook of the Submarine Signal Division.

CONTENTS

FOREWORD . . . . . ii

CONTENTS . . . . . iii

ABSTRACT . . . . . 1

EXECUTIVE SUMMARY . . . . . 3

    Study Objective . . . . . 3

    Findings . . . . . 3

    Recommendations . . . . . 6

1. INTRODUCTION AND SUMMARY . . . . . 7

    1.1 Study Objective . . . . . 7

    1.2 General Background . . . . . 7

    1.3 Study Rationale and Approach . . . . . 9

    1.4 Findings . . . . . 10

    1.5 Recommendations . . . . . 12

    1.6 Organization of this Report . . . . . 13

2. SHOALING WAVES . . . . . 15

    2.1 Scope . . . . . 15

    2.2 Wave Theory . . . . . 15

    2.3 Wave Types and Terminology - Sea States . . . . . 24

    2.4 Statistics and Prediction . . . . . 34

    2.5 Nonlinear and Other Problems . . . . . 35

3. SENSOR REQUIRED . . . . . 36

4. SENSOR TYPES - GENERAL . . . . . 38

5. ELECTROMAGNETIC SENSOR TYPES - RADAR . . . . . 43

    5.1 General . . . . . 43

    5.2 Wavelength . . . . . 43

    5.3 Coherence . . . . . 43

    5.4 Modulation . . . . . 44

    5.5 Processing . . . . . 46

    5.6 Antennas . . . . . 48

Contents (Continued)

6.	RADAR SYSTEM CALCULATIONS . . . . .	50
6.1	System Concepts . . . . .	50
6.2	Sea Echos . . . . .	52
6.3	A Doppler Approach . . . . .	58
6.4	Geometry. . . . .	63
6.5	Propagation . . . . .	65
6.6	Antenna System . . . . .	68
6.7	Signal Versus Noise . . . . .	71
6.8	Data Output . . . . .	73
6.9	Safety . . . . .	75
7.	TYPE I AND TYPE II DESIGNS . . . . .	77
8.	EXISTING SUITABLE RADARS . . . . .	80
9.	PROPOSED EXPERIMENTS . . . . .	83
10.	REFERENCES . . . . .	85
10.1	General . . . . .	85
10.2	Numerical List of References . . . . .	86
10.3	Alphabetical Author Index . . . . .	113
	APPENDICES . . . . .	
1.	SEA ECHO . . . . .	123
2.	LIST OF SYMBOLS/GLOSSARY . . . . .	134
	FIGURES	
1.	The parts of a wave . . . . .	16
2.	The ocean wave spectrum . . . . .	17
3.	The development of waves . . . . .	18
4.	Wave spectrum for fully arisen seas caused by winds of twenty, thirty, and forty knots	19
5.	Wave group advance. . . . .	20
6.	Shallow- and deep-water waves . . . . .	21
7.	Composite of $\sigma^0$ data for "medium" sea . . .	55
8.	Representative exemple of the variation of $\sigma^0$ with grazing angle . . . . .	56

Contents - Figures (Continued)

9.	Basic doppler relationships . . . . .	59
10.	Doppler geometry . . . . .	60
11.	Doppler spectrum versus geometry . . . . .	62
12.	Site geometry . . . . .	64

TABLES

1.	Sea-State and Wind Scales . . . . .	26
2.	Wave Height Distribution Worldwide and Fully Arisen Conditions . . . . .	28
3.	Nominal Radar Frequency Bands . . . . .	30
4.	Detailed Band and Subband Letter Designations for Microwave Radar Bands . .	31
5.	Instruments for Measuring Waves . . . . .	39

**ABSTRACT**

A study was conducted to assess the feasibility of using an on-shore radar to measure the azimuthal arrival direction of medium period ocean waves arriving at a shore.

In a survey of the applicable oceanographic and radar literature, little was found of direct relevance to measuring wave direction with a radar, including radar-like laser systems, even amid the extensive literature on radar clutter signals backscattered from the sea, or the literature on wave height sensors. No applications of Bragg scattering concepts were found that were directly applicable to measuring wave direction.

A theoretical model was developed for the needs of this study, emphasizing the idea of measuring wave direction by locating the radar azimuth exhibiting a suitable maximum of observed doppler shift in the radar backscatter signal. The principal remaining limitations of this model are in its treatment of three areas: (1) estimation of the clutter coefficient  $\sigma^0$  (which is essentially the fractional reflectance, or albedo, of the sea surface relative to an ideal lambertian surface); (2) doppler spreading of the back-scattered radar signal, caused principally by small-scale phenomena like capillary waves and spray; and (3) estimation of the value and precise consequences of the critical grazing angle  $\theta_c$  (so-called pseudo-Brewster angle) between the plane of the mean sea surface and the radar illumination ray, below which  $\sigma^0$  falls off very rapidly. The effect of the uncertainty in  $\sigma^0$ , and the principal effect of the uncertainty in  $\theta_c$ , are to create uncertainties about precisely how much transmitted radar power is required under extreme (and statistically rare) conditions. The uncertainty in doppler spreading also ultimately has implications on required radar power, plus a more



fundamental implication on measurement accuracy and ability to discriminate/resolve between multiple wave systems. The uncertainty in  $\theta_c$  limits available geometries. None of these limitations prevents a first order calculation of the desired system parameters.

Subject to these model limitations, conceptual radar systems were derived and analyzed for an inexpensive unattended surveillance radar ("Type I") and for a more flexible research system ("Type II"). Existing radars potentially suitable for evaluation of these Type I and Type II conceptual designs are discussed.

A brief plan for suggested further research is presented. Emphasis is on limited field trials, using an appropriately modified existing radar, to validate the basic model and to derive more accurate design data, in the areas of limitation of the model, from which the detailed design of Type I and Type II radars could proceed.

## EXECUTIVE SUMMARY

### Study Objective

The general objective of this study is to assess the suitability of radar for measuring the azimuthal direction of arrival of medium period ocean waves at a shore. The principal individual study objectives are to:

1. Review the state of the art of applicable radar technology.
2. Study economically and logistically feasible radar equipment configurations for measuring wave direction, with emphasis on two particular applications:

Type I - A simple configuration suitable for unattended operation in surveillance networks.

Type II - A more flexible version for general coastal research.

3. Briefly study appropriate field trials which could experimentally verify the theoretical findings of the study.
4. Report on any findings in the course of the literature search indicating that signal information on wave characteristics other than direction (such as height, period, or wavelength) may also be present in a radar backscatter signal.

### Findings

This study arrives at the following findings:

1. There is little in the literature for radar, or for ocean processes, that is directly relevant to the use of a radar to measure wave direction.



RAYTHEON  
SERVICE  
COMPANY

2. There is a great deal of published information on the general character of radar backscatter signal returns from the sea, primarily in studies where the sea return is viewed as a contaminating or obscuring "clutter" signal. Many studies treat the clutter spectrum (power spectral density within the signal band), and report theoretical and experimental findings of the effects on spectra of such parameters as radar wavelength, sea state, and orientation of the radar illuminating ray with respect to the local vertical and the local surface wind direction.
3. There is a small but growing body of literature on radar wave height sensors. One typical class of wave height radars is the frequency modulated continuous wave (FMCW) radar, similar to existing aircraft altimeter radars; evaluations are typically in experiments where the radar is mounted on a fixed tower or pier, and aimed straight down at the nearby sea surface. Other typical types include continuous wave or short pulse versions (pulse lengths of a few nanoseconds, corresponding to range resolution of a few feet) operated at various illumination ray aspects, from aircraft and satellites. Laser "profilometers" are reported, which are in effect optical wavelength radars.
4. Imaging radars of several types exist. In the side looking radar (SLR), an aircraft or satellite carries a highly sophisticated, synthetic antenna aperture radar that can produce radar photographs comparable in resolution with optical photographs. Most of the literature on SLR types is classified. Typical SLR systems do not measure wave direction directly.

5. No substantial information was found in the literature to suggest that wave characteristics other than direction and height can be measured directly with a radar, except for a diffuse kind of correlation between radar signal spectral characteristics and such loosely defined wave characteristics as "sea state". Among the possibilities for indirect measurements, measurement of wind direction seems often implied; use of conventional marine surface search radars with plan-position indicator (PPI) displays fall in this category.
6. Within the scope of this study, conceptual designs for Type I and Type II radar applications are developed, and an analysis of their performance is presented.
7. The principal limitations of the theoretical model used to develop the Type I and Type II designs are in:
  - (a) Estimation of the lower bound on the clutter coefficient .
  - (b) Estimation of doppler spectrum spreading versus small scale effects.
  - (c) Estimation of the value of the critical grazing angle  $\theta_c$  between the radar illuminating ray and the sea surface, and estimation of the detailed consequent rapid drop off in  $\sigma^0$  for grazing angles smaller than  $\theta_c$ .

Uncertainties (a) and (c), and to a lesser extent (b), limit the calculation of maximum radar power required for extreme conditions. Uncertainty (b) also limits calculation of available performance even if unlimited radar signal power were available. Uncertainty (c) implies limits on the available combinations of radar on-shore antenna tower

height and range coverage to seaward. None of the limitations prevents a first order calculation of the desired system parameters.

8. Relatively simple experiments are configured which can provide validation data for the theoretical models developed in this study, and provide more accurate design data for ultimate equipment design for Type I and Type II applications.

### Recommendations

1. In the light of present good prospects for development of Type I and Type II radars, the radar approach to wave direction measurement in the coastal region should be pursued further.
2. A limited program of field measurements should be implemented to validate the conceptual designs, and to obtain refined design data for equipment design.
3. The field trials should be conducted for a limited time at a very well instrumented site -- either at a shore or in a tank as found most convenient. Instrumentation to obtain "true" wave direction during these trials should be carefully chosen. Photographic coverage, and the use of arrays of wave height gages are suggested methods.
4. Radar equipment for the trials should be chosen from existing equipment, modified as required for the controlled tests. No new equipment design is warranted until the results of these trials have been evaluated.
5. Further theoretical studies should be planned, but should not be extensively implemented until the findings of the field trials have been evaluated.

1. INTRODUCTION AND SUMMARY

1.1 Study Objective

The general objective of this study is to assess the suitability of radar for measuring the azimuthal direction of arrival of medium period ocean waves at a shore. The principal individual study objectives are to:

1. Review the state of the art of applicable radar technology.
2. Study economically and logistically feasible radar equipment configurations for measuring wave direction, with emphasis on two particular applications:

Type I - A simple configuration suitable for unattended operation in surveillance networks.

Type II - A more flexible version for general coastal research.

3. Briefly study appropriate field trials which could experimentally verify the theoretical findings of the study.
4. Report on any findings in the course of the literature search indicating that signal information on wave characteristics other than direction (such as height, period, or wavelength) may also be present in a radar backscatter signal.

1.2 General Background

For many of the Coastal Engineering Research Center's researches in ocean wave and coastal processes, there is a need for more successful automatic, real-time sensors for measuring the directions of arrival of medium period ocean wave systems incident upon a coastline. Improved wave direction sensors would be especially useful in fulfilling the Center's major mission in research on sand transport by shoaling waves.

For operational surveillance networks, and for some types of research, a sensor very commonly used until recently has been a human observer, who visually determines both the number of wave directions and also their various direction azimuths of arrival (or of departure for outgoing waves). This approach has been valuable in the very practical work of real-time surveillance and warning systems, and in collecting large quantities of data from which broad climatological statistics could be derived.

However, wave theory has developed to the point where a more automatic, objective wave direction sensor is needed to continue the development of the theory of wave information, propagation, and interaction with and effect on shoreline features. The presently known wave direction sensors of many types do not fully meet all the needs of research for accuracy, automaticity, portability, ability to determine direction for a single wave system under conditions where chop or the like is superimposed upon the waves, ability of the sensor to resolve and distinguish wave systems from multiple directions, or ability of the sensor to respond only to a determined range of wave periods.

Of the several possible types of wave direction sensors presently known, radars in various configurations, especially coherent doppler radar, offer many potential advantages for wave direction measurement that have not been fully exploited either analytically or in field use. However, a large body of partially relevant theoretical and field experience has been accumulated for such radars, primarily by users whose interest in wave dynamics was only in connection with the unwanted radar clutter signals waves produce, plus a few applications where very localized wave dynamics were of interest for navigational, geodesic, or surveillance purposes.

This study is intended to begin a more concerted exploitation of this extensive radar art to fill the needs of coastal research.

### 1.3 Study Rationale and Approach

Because of the multidisciplinary nature of this study task, a major requirement has been to maintain a balanced presentation of material. For specialists in either radar or coastal processes, some of the material will seem so familiar as to be almost tutorial, while their counterparts of the other discipline may find the same material enlightening. This use of tutorial communication has been adopted as the most effective way of meeting these interdisciplinary needs.

Within these tutorial implications, many types of radars are treated at least briefly, including such marginally applicable types as optical wavelength radars using a laser as the radar transmitter, and imaging types such as the side looking radar (SLR) with a large synthetic antenna aperture derived from vehicle motion and sophisticated signal processing.

However, the major emphasis is on relatively simple doppler-shift measuring radars, either continuous wave (CW) or pulsed, that would measure wave direction by searching (actually or in effect) for a maximum magnitude of radar signal doppler shift when the horizontal component of the radar look direction vector is parallel with the velocity vector of the ocean wave motion.

Ideally the active radar industry would by now have produced equipments that were fortuitously just what is needed for Type I and Type II wave measuring applications, or at least just right for experimental trials, but none has yet been found that is unequivocally an ideal wave radar. However, radars have long been designed, and



often built, on a modular basis, so that modifying an existing radar (or collection of radar functional modules) for tests should not be difficult or expensive, and subsequent actual equipment design of wave radars should not require unique or intensive skills, nor extensive design efforts beyond the normal requirements for a new model of an existing series.

#### 1.4 Findings

This study arrives at the following findings:

1. There is little in the literature for radar, or for ocean processes, that is directly relevant to the use of a radar to measure wave direction.
2. There is a great deal of published information on the general character of radar backscatter signal returns from the sea, primarily in studies where the sea return is viewed as a contaminating or obscuring "clutter" signal. Many studies treat the clutter spectrum (power spectral density within the signal band), and report theoretical and experimental findings of the effects on spectra of such parameters as radar wavelength, sea state, and orientation of the radar illuminating ray with respect to the local vertical and the local surface wind direction.
3. There is a small but growing body of literature on radar wave height sensors. One typical class of wave height radars is the frequency modulated continuous wave (FMCW) radar, similar to existing aircraft altimeter radars; evaluations are typically in experiments where the radar is mounted on a fixed tower or pier, and aimed straight down at the nearby sea surface. Other typical types include continuous wave or short pulse versions (pulse lengths of a

few nanoseconds, corresponding to range resolution of a few feet) operated at various illumination ray aspects, from aircraft and satellites. Laser "profilometers" are reported, which are in effect optical wavelength radars.

4. Imaging radars of several types exist. In the side looking radar (SLR), an aircraft or satellite carries a highly sophisticated, synthetic antenna aperture radar that can produce radar photographs comparable in resolution with optical photographs. Most of the literature on SLR types is classified. Typical SLR systems do not measure wave direction directly.
5. No substantial information was found in the literature to suggest that wave characteristics other than direction and height can be measured directly with a radar, except for a diffuse kind of correlation between radar signal spectral characteristics and such loosely defined wave characteristics as "sea state". Among the possibilities for indirect measurements, measurements of wind direction seems often implied; use of conventional marine surface search radars with plan-position indicator (PPI) displays fall in this category.
6. Within the scope of this study, conceptual designs for Type I and Type II radar applications are developed, and an analysis of their performance is presented.
7. The principal limitations of the theoretical model used to develop the Type I and Type II designs are in:
  - (a) Estimation of the lower bound on the clutter coefficient  $\sigma^0$ .
  - (b) Estimation of doppler spectrum spreading versus small scale effects.

- (c) Estimation of the value of the critical grazing angle  $\theta_c$  between the radar illuminating ray and the sea surface, and estimation of the detailed consequent rapid drop off in  $\sigma^0$  for grazing angles smaller than  $\theta_c$ .

Uncertainties (a) and (c), and to a lesser extent (b), limit the calculation of maximum radar power required for extreme conditions. Uncertainty (b) also limits calculation of available performance even if unlimited radar signal power were available. Uncertainty (c) implies limits on the available combinations of radar on-shore antenna tower height and range coverage to seaward. None of these limitations prevents a first order calculation of the desired system parameters.

8. Relatively simple experiments are configured which can provide validation data for the theoretical models developed in this study, and provide more accurate design data for ultimate equipment design for Type I and Type II applications.

### 1.5 Recommendations

1. In the light of present good prospects for development of Type I and Type II radars, the radar approach to wave direction measurement in the coastal region should be pursued further.
2. A limited program of field measurements should be implemented to validate the conceptual designs, and to obtain refined design data for equipment design.
3. The field trials should be conducted for a limited time at a very well instrumented site -- either at a shore or in a tank as found most convenient. Instrumentation to obtain

"true" wave direction during these trials should be carefully chosen. Photographic coverage, and the use of arrays of wave height gages are suggested methods.

4. Radar equipment for the trials should be chosen from existing equipment, modified as required for the controlled tests. No new equipment design is warranted until the results of these trials have been evaluated.
5. Further theoretical studies should be planned, but should not be extensively implemented until the findings of the field trials have been evaluated.

#### 1.6 Organization of the Report

The remainder of this report is organized as follows: Section 2 summarizes some of the elementary wave and coastal processes theory needed to define the scope of the radar design problem.

Then Section 3 outlines the general requirements for a wave direction sensor. In Section 4, different categories of possibly suitable sensors are discussed qualitatively, including both radar and non-radar types.

Beginning in Section 5, the field of possibilities is narrowed to radar types (broadly construed) exclusively, and Section 5 gives additional qualitative details for various types. In Section 6, quantitative system analyses are presented which take into account the detailed sensor requirements developed in Section 3, and the various signal processing characteristics of the radar types discussed in Section 5, plus the interaction of these elements with the backscattering properties of the sea and local geometry.

In Section 7, candidate designs for Type I and Type II radars are presented. Section 8 discusses the availability of existing suitable radars.

Section 9 discusses proposed field trials to validate the findings of this study and to develop more refined design data.

Final conclusions and recommendations appear in Section 10, followed by the references and appendices.

## 2. SHOALING WAVES

### 2.1 Scope

This section presents a brief synopsis of some selected topics in elementary ocean wave theory. The presentation here is limited to the scope and detail needed to define the present study program. The viewpoint of the radar designer and general system engineer is emphasized.

The treatment here is lucidly and more extensively treated in Bascom<sup>130</sup>, Skolnik<sup>104</sup>, and Harris<sup>111</sup>. Bascom's<sup>130</sup> popularized treatment is particularly useful to non-specialists in oceanography. Skolnik<sup>104</sup> is a major milestone in the documentation of radar, and although it is highly specialized toward its subject, the material in it that is relevant here is notably free from unnecessary jargon; it is highly recommended that users of this study should also read the entirety of Section 26 "Sea Echo" in Skolnik<sup>104</sup>.

The material in Harris<sup>111</sup> is specific to several of the problems of interest here, especially in three areas: (1) the discussion of why wave spectra are often subject to almost contradictory interpretations (display conventions, statistical convergences, degree of bimodality); (2) the discussion of arrays of wave height sensors, which we suggest are important candidates for instrumentation to calibrate and evaluate any wave direction radar; and (3) the photographs, figures<sup>111</sup> 15-17, which (with other photographs available to Harris, private communication) are useful in establishing conceptual definitions of wave motion parameters.

### 2.2 Wave Theory

Ocean waves are characterized in principle by their height, wavelength, and period as shown in Figure 1 (Figures 1 through 6

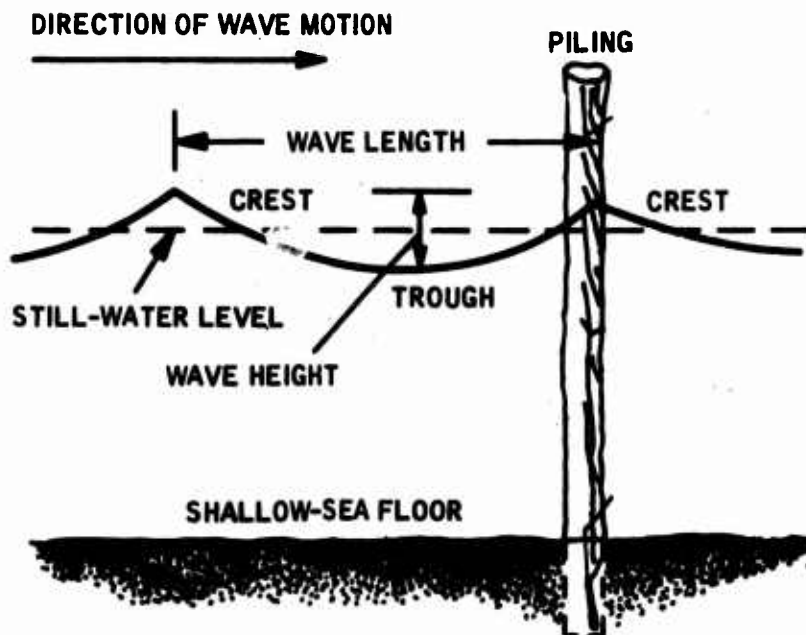

Figure 1. The parts of a wave. The period of the wave is the time spent for two successive crests to pass a fixed point such as the piling.

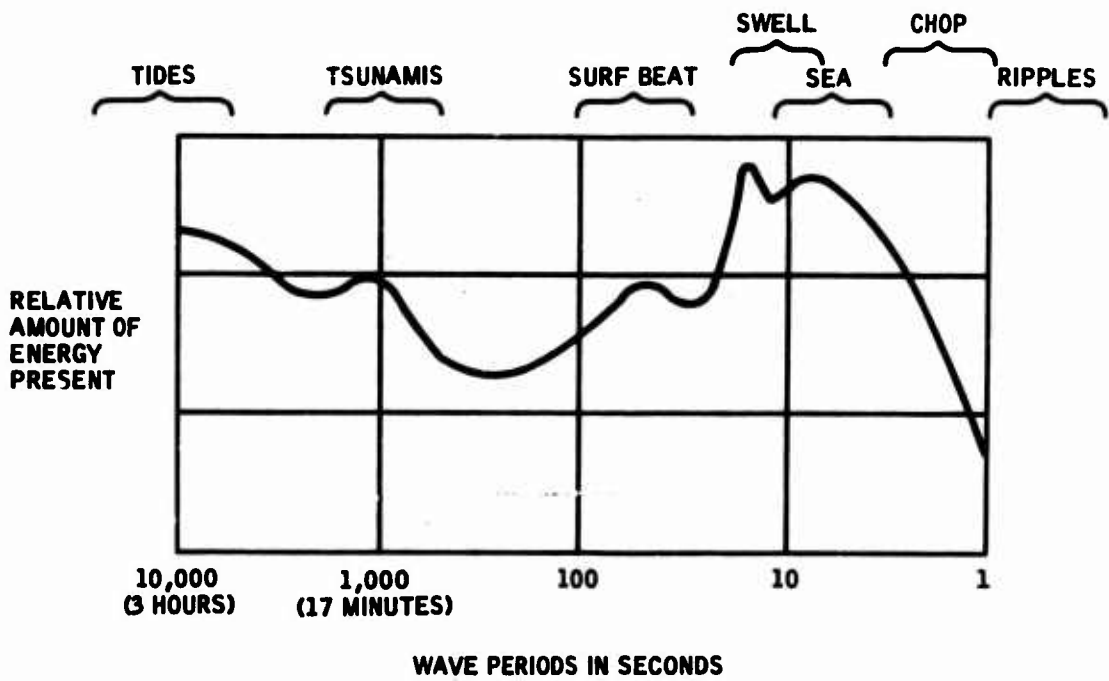

Figure 2. The ocean wave spectrum



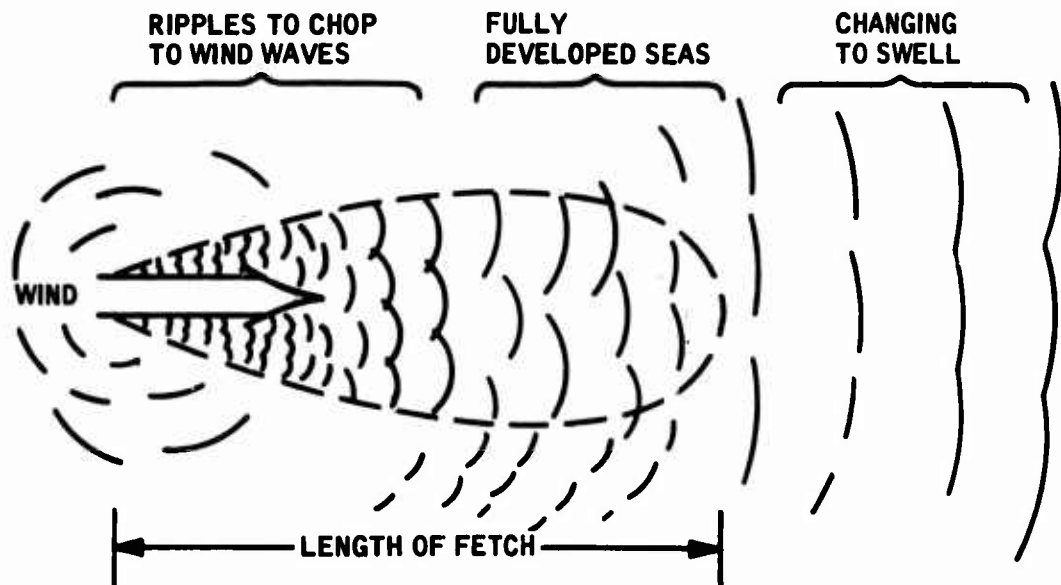

Figure 3. The development of waves (conceptual). The fetch, within the dashed line, is the area of water on which a wind blows to generate waves.

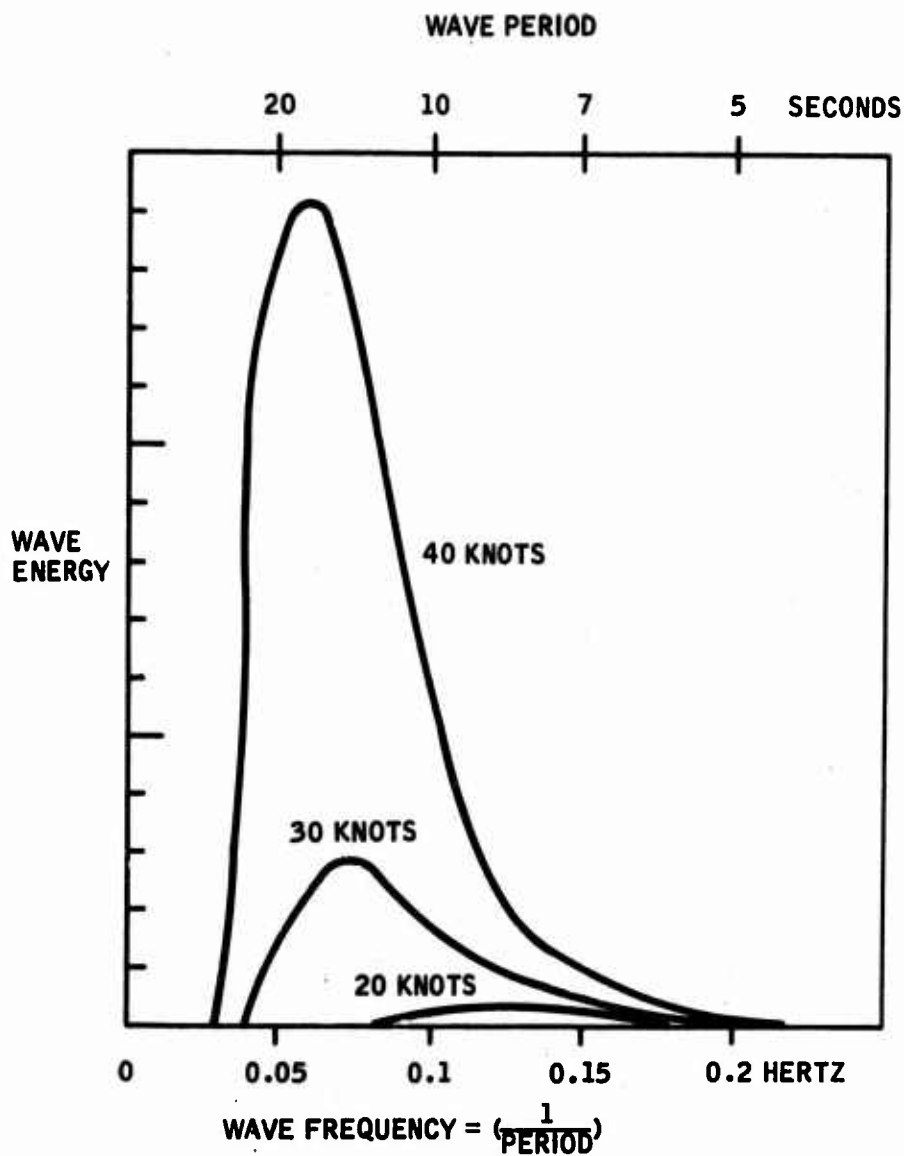

Figure 4. Wave spectrum for fully arisen seas caused by winds of twenty, thirty, and forty knots. (after Pierson, Neumann and James<sup>11</sup>)

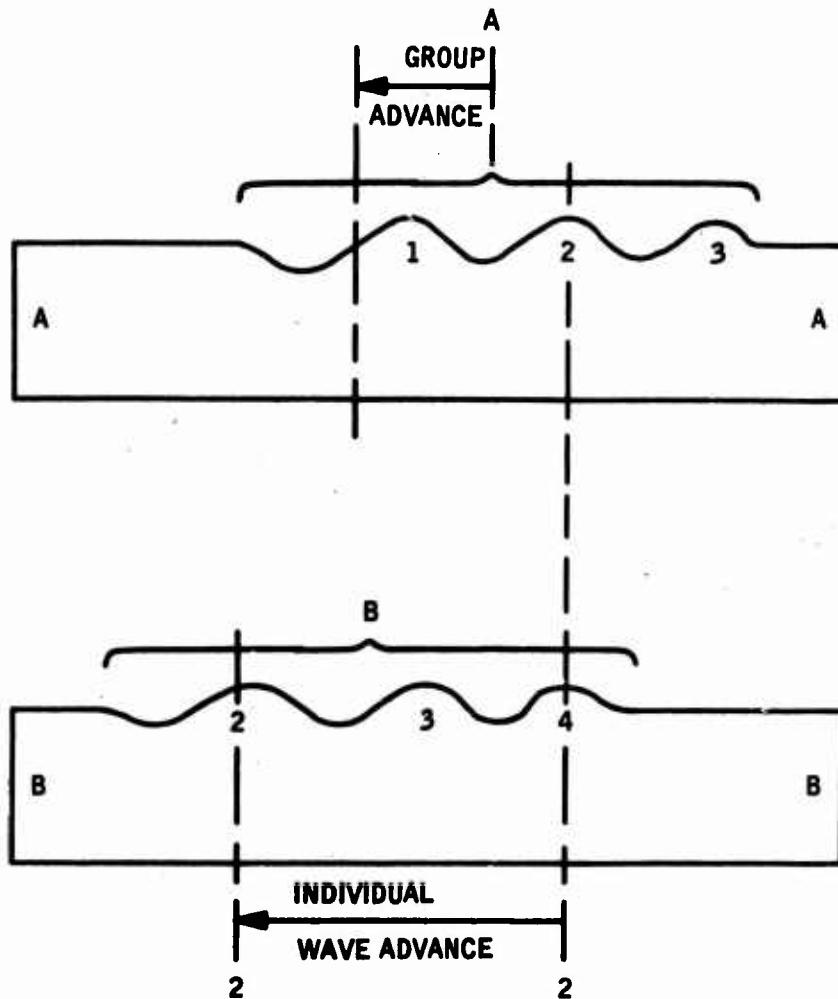

Figure 5. Wave group advance. As the center of the wave group advances from A to B, wave number 1 dies out and wave number 4 forms behind. Since waves number 2 and 3 are moving at normal velocity, the velocity of a group of waves is only half that of the individual waves.

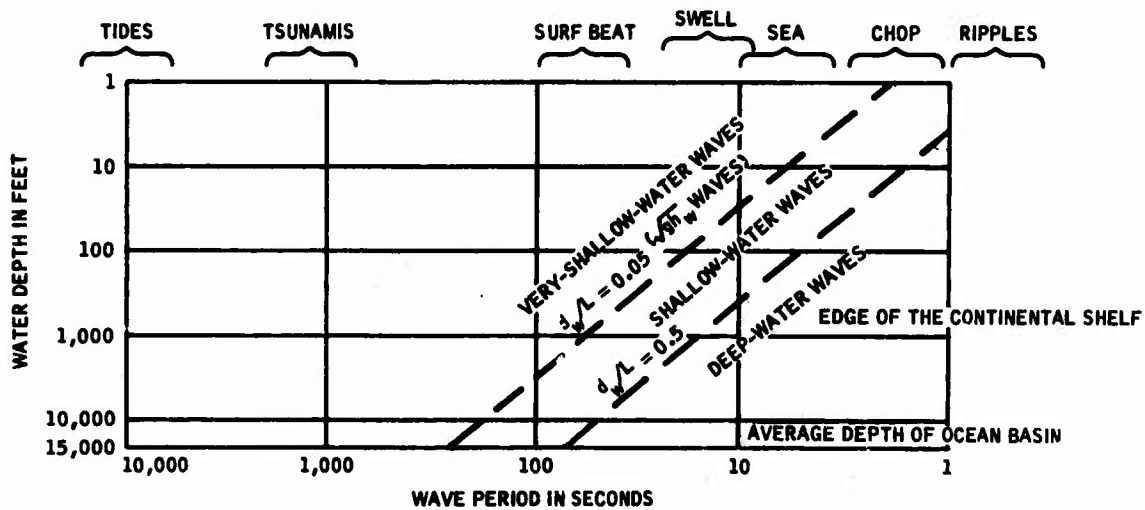

Figure 6. Shallow- and deep-water waves

are after Bascom<sup>130</sup>). The various possible kinds of waves, classified by wave period, are summarized in Figure 2 (the energy distribution cited in Figure 2 is not in itself directly relevant here). The 12-hour and 24-hour tidal components appear at the far left, the typical 20-minute seismic sea waves (tsunamis, also called "tidal waves") peak at about 1200 seconds. The surf beat, swell, sea, chop, and ripples complete the principal types shown, with the sea and swell portions being of primary interest here.

The seas and swells of principal interest are generated by winds blowing for a period of time along a fetch as shown in Figure 3. For ideal sinusoidal assumptions, wavelength  $\lambda_w$  and period T are related by

$$T = \frac{2\pi\lambda_w}{\sqrt{g}} \quad (1)$$

where g is gravitational acceleration, and both  $\lambda_w$  and T are (ideally) independent of wave height H. Figure 4 shows the relative energy (proportional to  $H^2$ ) for fully developed seas for some typical wind speeds of interest. It should be emphasized that the single-peak (unimodal) distributions of Figure 4 are now regarded as atypical. More often than not there is a second peak of comparable amplitude and spectral frequency. See Harris<sup>111</sup> for additional details, including the sensitivity of apparent modality to display conventions.

These ideal waves travel with a wave velocity (individual waves) of

$$c_w = \sqrt{\frac{g\lambda_w}{2\pi} \tanh \frac{2\pi d_w}{\lambda_w}} \quad (2)$$

where  $c_w$  is the depth of the water (mean surface to bottom). For deep and shallow waves respectively, the wave velocity simplifies to

$$c_w \sim \sqrt{\frac{g \lambda_w}{2\pi}} \quad \text{for } 0.5 \ll \frac{d_w}{\lambda_w}, \text{ "short" or "deep" waves} \quad (3)$$

$$c_w \sim \sqrt{gd_w} \quad \text{for } \frac{d_w}{\lambda_w} \ll 0.05, \text{ "long" or "shallow" waves}$$

As shown in Figure 5, the group velocity of a train of swell waves moving across the open ocean is only half that calculated above for individual waves.

Until bottom drag and the like become significant, a particle of water, or a particle of foreign matter in the water, is not transported along at the wave velocity or group velocity, but instead principally "orbits" in place, only very slowly migrating in the direction of wave travel.

The orbiting motion of the particles adds to the wave velocity  $c_w$  from equation (2), constructively at the wave crests and destructively at the troughs, so that the local forward speed is highest at the crests and lowest in the troughs.

Figure 6 shows the kinds of waves again, here arranged by water depth and wave period. This figure is useful in explaining several phenomena associated with the variable propagation speed  $c_w$  in equation (2). For instance, tsunamis have very long periods, ( $T \sim 1000$  s\*) and hence their wavelength  $\lambda_w$  from equation (1) is also very long, much longer than the depth of even the deep ocean basin, making the tsunamis "shallow" waves as defined in equation (3).

As the wave approaches a shore, shoaling effects set in. Wave period is less effected, but wavelength adjusts to fulfill the relationships cited. Waves running perpendicular to the shore may be greatly amplified at certain near-shore depths, and at different such depths for waves of different period. Waves running parallel

\*SI units and unit symbols are generally used in this paper; e.g. see Westman<sup>108</sup>.

to a shore experience less amplification, but tend to turn toward the shore if the shoreline is long enough.

### 2.3 Wave Types and Terminology - Sea States (After Skolnik<sup>104</sup>)

The terminology the oceanographer uses to describe the sea is often unfamiliar to the radar engineer. Some common terms and concepts are given below<sup>1</sup>:

Wind wave: a wave resulting from the action of the wind on a water surface. While the wind is acting on it, it is a sea; thereafter, it is a swell.

Gravity wave: a wave whose velocity of propagation is controlled primarily by gravity. Water waves of wavelength greater than about 5 centimeters are considered to be gravity waves.

Capillary wave (also called ripple, or capillary ripple): a wave whose velocity of propagation is controlled primarily by the surface tension of the liquid in which the wave is traveling. Water waves of wavelength less than about 2.5 centimeters are considered to be capillary waves.

Fetch: (1) (Also called generating area) an area of the sea surface over which seas are generated by wind action usually assumed to be wind of constant direction and speed); (2) the length of the fetch area, measured in the direction of the wind generating the seas.

Internal wave: a wave generated, and principally acting within the water, under the surface.

Duration: the length of time the wind blows in essentially the same direction over the fetch.

Swell: ocean waves that have traveled out of their generating area. Swell characteristically exhibits a more regular and a longer period and has flatter crests than waves within their fetch.

Sea: waves generated or sustained by winds within their fetch; opposed to swell.

Wave spectrum: a graph showing the distribution of wave heights (or square of the wave heights) as a function of wave frequency, as in a wave record.

Sea state: the numerical or qualitative description of ocean-surface roughness. Ocean sea state may be defined more precisely as the average height of the highest one-third of the waves observed in a wave train, referred to a numerical code as shown in Table 1a (see further below).

Fully developed sea (also called fully arisen sea): the maximum height to which ocean waves can be generated by a given wind force blowing over sufficient fetch, regardless of duration, as a result of all possible wave components in the spectrum being present with their maximum amount of spectral energy.

Significant wave height: the average height of the one-third highest waves of a given wave group. (Height is the vertical distance between a crest and a trough).

Three numerical scales have been commonly used to describe sea and wind state. Two of them are shown in Table 1a. The Douglas scale has been widely used; World Meteorological Organization (WMO) Code 75<sup>1</sup> has been proposed to replace it. The Douglas scale in its complete form specifies two numbers, one to describe the sea and the other the swell; only the sea-state number is shown here. A third system is the Beaufort wind scale for reporting wind speeds shown in Table 1b. The Beaufort number, in addition to specifying the wind



Table 1 Sea-State and Wind Scales

a. Douglas and WMO Sea-State Scales

Sea-State number	WMO Code 75 wave height, feet	Douglas Scale	
		Wave height, feet	Description
0	0	0	Calm
1	0-0.33	Under 1	Smooth
2	0.33-1.67	1-3	Slight
3	1.67-4	3-5	Moderate
4	4-8	5-8	Rough
5	8-13	8-12	Very rough
6	13-20	12-20	High
7	20-30	20-40	Very high
8	30-45	Over 40	Precipitous
9	Over 45	.....	Confused

b. Beaufort Wind Scale

Beaufort number	Descriptive term	Wind speed, knots
0	Calm	Under 1
1	Light air	1-3
2	Light breeze	4-6
3	Gentle breeze	7-10
4	Moderate breeze	11-16
5	Fresh breeze	17-21
6	Strong breeze	22-27
7	Near gale	28-33
8	Gale	34-40
9	Strong gale	41-47
10	Storm	48-55
11	Violent storm	56-63
12	Hurricane	Over 64

speed, has been used to describe the corresponding effect on the sea. (Any qualitative description of the sea is not as meaningful to the radar designer as specifying the value of  $\sigma^0$ , the radar clutter coefficient or relative reflectivity that corresponds to the sea conditions).

Kinsman<sup>2</sup> gives the estimates of the percentage occurrence of wave heights for the ocean as a whole shown in Table 2a. Thus 45 percent of the ocean waves are less than 4 feet (1.2 meters) high, 80 percent are less than 12 feet (3.7 meters) high, and only 10 percent are greater than 20 feet (6.1 meters) high. These numbers give an idea of the kinds of wave heights that may ultimately arrive at an unobstructed shoaling region from the open sea.

Sea waves are generated by the wind and differ from swell in both physical appearance and in their effect on radar echo. Individual sea waves are more peaked than pure sine waves and tend to be skewed in the direction of propagation. They are irregular, chaotic, short-crested (length along the crest of the same order of magnitude as the wavelength), mountainous, and unpredictable except in a statistical sense. Sea waves contain many small waves superimposed on the larger waves, and their spectra cover a wide range of frequencies and directions. Swell waves are more regular than sea waves, are longer-crested, have more rounded tops, and are more predicatable. Their spectrum covers a narrow range of frequencies and directions. Swell waves in the absence of wind, return considerably less microwave radar echo than sea waves, when viewed at low grazing angles.

Gravity-wave characteristics are controlled by gravity. Both wind-generated sea waves and swell are gravity waves. Their properties are given ideally in equations (1) and (3), and Figures

Table 2 Wave Height Distribution  
Worldwide and Fully Arisen Conditions

a. Distribution of Wave Heights for the Ocean as a Whole  
(After Kinsman<sup>2</sup>)

Wave height, feet	Frequency of occurrence, %
0-3	20
3-4	25
4-7	20
7-12	15
12-20	10
Over 20	10

b. Conditions in Fully Developed Seas (After Bascom<sup>130</sup>)

Wind Velocity, knots	Distance Length of fetch, nautical miles	Time hours	Waves			
			Average height, feet	H <sub>3</sub> , sig. hgt.	H <sub>10</sub> , avg. of the highest 10%, ft.	Period where most of energy is concentrated seconds
10	10	2.4	0.9	1.4	1.8	4
15	34	6	2.5	3:5	5	6
20	75	10	5	8	10	8
25	160	16	9	14	18	10
30	280	23	14	22	28	12
40	710	42	28	44	57	16
50	1420	69	48	78	99	20

1 to 6. Equation (1) to (3) apply to individual sine waves, and it should be cautioned that they might not correctly describe measurements of the average parameters of an irregular sea.

Capillary waves have periods less than 0.1 second. Like sea waves, they are generated by the wind but surface tension rather than gravity is the force controlling their characteristics. Waves with a wavelength of less than about 2.5 centimeters are considered capillary waves. (Waves of longer period and length for which surface tension cannot be neglected are sometimes classed as "ultragravity" waves.) Capillary waves are fairly sensitive to the wind. If the breeze that generated the capillary waves dies out, they soon flatten, and the sea abruptly becomes smooth again. If the wind generating gravity waves stops, they continue to run and become swell. The phase velocity of capillary waves decreases with increasing wave height, opposite to the behavior of gravity waves. When capillary waves interact with the longer gravity waves, the capillary waves appear to be concentrated, at times, on the forward face of the gravity wave just before the sharp crest <sup>44</sup>. Capillary waves seem to be the dominant scatterer when the sea is viewed by radars at the higher microwave frequencies (X band\* or greater).

Wave height is not fixed in relation to the wavelength but depends on the wind generating it. Theoretical considerations show that a wave becomes unstable and breaks if the angle formed by the crest approaches  $120^\circ$  and that the height can be no greater than one-seventh of the length. Observations of gravity waves indicate the height-to-length ratio varies from 0.1 to 0.008 (see Reference 2). The ratios for capillary waves can be greater.

\* See Tables 3 and 4 for a definition of radar bands. X band usually implies a radar wavelength in the range 2.8 to 5.8 cm, and a frequency of 5.2 to 10.9 GHz.

Table 3 Nominal Radar Frequency Bands (after Skolnik<sup>104</sup>)

Nomenclature	Frequency range, gigahertz	Wavelength range, centimeters
VHF	0.03-0.3	1000-100
UHF	0.3 -1	100-30
P band	0.23-1	130.4-30
L band	1-2	30-15
S band	2-4	15-7.5
C band	4-8	7.5-3.75
X band	8-12.5	3.75-2.4
K band	12.5-18	2.4-1.667
K <sup>u</sup> band	18-26.5	1.667-1.132
K <sup>a</sup> band	26.5-40	1.132-0.75
Millimeter	Over 40	Under 0.75

TABLE 4  
Detailed Band and Subband Letter Designations  
for Microwave Radar Bands (after Westman<sup>108</sup>)

<u>Subband</u>	<u>Frequency gigahertz</u>	<u>Wavelength centimeters</u>
	P Band	
(None)	0.225	133.3
	0.390	76.9
	L Band	
p c l y t s x k f z	0.390	76.9
	0.465	64.5
	0.510	58.8
	0.725	41.4
	0.780	38.4
	0.900	33.3
	0.950	31.6
	1.150	26.1
	1.350	22.2
	1.450	20.7
	1.550	19.3
	S Band (and C Band*)	
e f t c q y g s a w h z* d*	1.55	19.3
	1.65	18.3
	1.85	16.2
	2.00	15.0
	2.40	12.5
	2.60	11.5
	2.70	11.1
	2.90	10.3
	3.10	9.67
	3.40	8.32
	3.70	8.10
	3.90	7.69
	4.20	7.14
	5.20	5.77

TABLE 4 (Continued)

<u>Subband</u>	<u>Frequency gigahertz</u>	<u>Wavelength centimeters</u>
X Band (and C Band*)		
a*	5.20	5.77
q*	5.50	5.45
y*	5.75	5.22
d	6.20	4.84
b	6.25	4.89
r	6.90	4.35
c	7.00	4.29
l	8.50	3.53
s	9.00	3.33
x	9.60	3.13
f	10.00	3.00
k	10.25	2.93
	10.90	2.75
K Band (with K <sub>1</sub> Band **)		
p	10.90	2.75
s	12.25	2.45
e	13.25	2.26
c	14.25	2.10
u**	15.35	1.95
t**	17.25	1.74
q**	20.50	1.46
r	24.50	1.22
m	26.50	1.13
n	28.50	1.05
l	30.70	0.977
a	33.00	0.909
	36.00	0.834
Q Band		
a	36.0	0.834
b	38.0	0.790
c	40.0	0.750
d	42.00	0.715
	44.0	0.682
e	46.0	0.652

TABLE 4 (Continued)

<u>Subband</u>	<u>Frequency gigahertz</u>	<u>Wavelength centimeters</u>
	V Band	
a	46.0	0.652
b	48.0	0.625
c	50.0	0.600
d	52.0	0.577
e	54.0	0.556
	56.0	0.536
	W Band	
None	56.0	0.536
	100.0	0.300

\* C Band includes S<sub>z</sub> Band through X<sub>y</sub> Band, 3.90-6.20 gigahertz, 7.69-5.22 centimeters

\*\* K<sub>1</sub> Band includes K<sub>u</sub> Band through K<sub>q</sub> Band, 15.35-24.50 gigahertz, 1.95-5.22 centimeters



Once the wind is blowing, it takes a finite time for a sea to develop. The term fully developed sea describes the condition when the ocean waves have reached their maximum height for a given generating wind force and fetch length. Table 2b gives an indication of the range of parameters involved.

#### 2.4 Statistics and Prediction

Theories for predicting wave processes are developed in Pierson, Neuman, and James<sup>11</sup>. Less accurate but quicker methods are contained in Sverdrup and Munk<sup>205</sup>, and in Reference 206. Many recent advances make extensive use of digital computers and such techniques as the Fast, also called "Finite" Fourier Transform.

These and related theories treat both amplitude-wavelength-period calculations, and also the theory of diffraction and refraction that so heavily influences shoaling activity near any shore.

When separate wave systems, arising from separate fetches, affect the same coastal point, many theories combine the separate components by linear superposition. Any such treatment ignores actual dependence of other wave parameters upon wave height, statistical problems and their practical effects such as breaking seas or swells when wave crest angles exceed the maximum permissible 120 degrees, and other effects. More accurate combinatorial methods are used principally only for accurate specialized research work.

Any complete theory or other description of waves must account for the fact that they rarely occur as long ranks of parallel crests. For the most part, waves appear, from instant to instant, to be made up of seemingly all kinds of "humps" that appear, disappear, and move with considerable independence one from another.

The resultant real spectra and statistics are extensively treated in Pierson, Neuman, and James<sup>11</sup>. These statistical reinforcement phenomena, with or without the additional reinforcement of multiple wave systems, mean that "wave direction" can be difficult to define, let alone to measure. Statistical estimation theory relevant both to the wave process themselves, and even more especially to radar signals from a wave direction sensor, is given in Blackman and Turkey<sup>126</sup> and elsewhere. Statistical estimates of actually occurring wave parameters are reported in many places in the hydrographic literature.

For the radar designer, it would be convenient if the existing body of statistical technique and data could readily transform to well known radar target scintillation dynamics, but such is not the case. Stationarity and ergodicity are often substantially absent, especially over intervals longer than about 20 minutes. Sampling intervals and sample populations are often inadequate. Assumed distribution function become unreliable. Much of the data on radar returns from the sea fail to specify even such basics as whether there was a substantial current present, which affects most matters of interest to either the oceanographer or the radar design engineer. These problems are treated further in Section 6.2.

## 2.5 Nonlinearity and Other Problems

The radar designer should be aware that nonlinear processes can result in energy coupling from one wave system to another. High frequency components in a wave system can "fail" (be substantially attenuated) as the system crosses an area like the Gulf Stream, but may reappear. Shear phenomena can become substantial. Deep focusing becomes frequency dependent when  $d_w$  becomes less than  $\lambda_w/2$ . All these factors influence the radar backscatter signal in the coastal zone.

### 3. SENSOR REQUIRED

In the context of the application concepts developed in Section 2, the principal present requirement is for wave direction sensors with approximately the following characteristics:

1. Deployment: As portable as feasible. To be located out of water on the shore or on a pier. Any tower, required to give required antenna height, to be part of the sensor system. For the Type I application (as defined in Section 1.1), the individual radar may be semipermanently installed, but the basic concept should permit portability. For the Type II application, the unit should ideally be self-contained, for example in a van.

2. Angular coverage: 180 degrees in azimuth to seaward (assuming an essentially straight local shoreline).

3. Angular accuracy: Goal of 5 degrees for single incident wave systems, best conditions.

4. Angular resolution (of ambiguities): Goal of ability to distinguish wave systems with arrival-angle differences of 15 degrees, best conditions.

5. Wave parameters of waves of interest (which are the only waves the sensor should ideally respond to):

- Period: Approximately 3 to 15 seconds, preferably 5 to 12 seconds, obtained by adjustable signal processing if feasible. (Waves in this range of periods are typically the major cause of sand transport).
- Wavelength: Consistent with wave period for typical shoreline conditions.

- Wave amplitude: Consistent with Beaufort scale condition number 1 to 8 (approximately the same as Douglas or WMO Code 75 sea state number 0<sup>+</sup> to 6<sup>+</sup>, see Table 1), wave height 0.5 to 15 feet, (0.15 to 4.6 meters). Wave height not itself a principal limit except as an indication of sea conditions.
- Wave and group propagation velocities: Consistent with wave period for typical shoreline conditions.
- Sea state: See wave amplitude above.
- General conditions: Sensor should be capable of dealing with either sea or swells, within stated sea state limits.

A further general requirement is that the sensor should lend itself to being incorporated into automatic networks; sensors requiring some real-time digital computer processing at a central location in the network may be acceptable.

#### 4. SENSOR TYPES - GENERAL

Many satisfactory sensors exist with which to measure a variety of wave properties. Table 5, after Bascom,<sup>130</sup> gives a representative list.

It is to be noted that the only wave-direction sensor listed in Table 5 is the Rayleigh disc., and Bascom<sup>130</sup> says "No wave-direction recorder has ever worked very well... (because of multiple arrival directions, etc., including the ) ... Rayleigh disc...". According to Willard Pierson (recent private communication) there is still none.

Some partially successful wave-direction sensors include the following:

1. Rayleigh disc.: A gimballed or tethered bottom mounted disc that rides in the waves, and orients itself with the horizontal component of its normal vector parallel to the direction of the wave motion; Typically requires fixed mount, in part to allow sensing of disc orientation, and thus either electrical or other connections to the shore. Cannot of itself resolve ambiguities when waves arrive from multiple directions, except possibly by complex external calculations.

2. Human observers: They are used in many functioning observational networks, and the observer can "intergrate." over the entire field of his view to derive a usable azimuthal datum from a very complex wave field, but the sensor is insufficiently accurate, or automatic for future needs.

3. Mathematical analyses of the results from various kinds of wave amplitude sensors, resulting in after-the-fact determination of direction of arrival: Cumbersome, and usually non-real-time except in interferometer schemes such as in (4) and (5) below.

Table 5  
 Instruments for Measuring Waves (Adapted from Bascom<sup>130</sup>)

Property to be sensed	Means of sensing	How used
Light reflection	Visual Camera Side Looking Radar (SLR)*	Many ways
Height of water surface	Float in pipe Spar buoy  Aneroid barometer Radio waves  Echo sounder  Step gauge  Paired wires	Standard tide gauge In deep water with deep damping disk Measures heave of ship Radio altimeter on low-flying aircraft, or satellite Pointed down from buoy in shallow water or up from submarine in deep water Water closes contacts between spark plugs For model tank experiments with very small waves
Pressure at sea floor	Flexible bellows plus: Bourdon tube Potentiometer Variable inductance Thermopile  Strain gauge  Air bladder  Vibrator	Uncoiling tube drives pen Bridge circuit to galvanometer Measures change in magnetic field Measures adiabatic heating of air Measures change in length of metal Directly drives pen via air hose to surface Changes frequency as pressure changes
Water motion (velocity or acceleration)	Accelerometer  Accelerometer-pressure combination  Rotor	Mounted on buoy to measure acceleration of waves Shipboard wave recorder that computes wave height for several sensors Measures currents caused by waves
Drag	Strain gauge	Senses wave forces acting on special pile

Table 5 (Continued)

Property to be sensed	Means of sensing	How used
Direction	Rayleigh disk	Orients itself parallel to wave front
Impact	Dynamometer Diaphragm Piezoelectric disks	Sliding bar moves to show maximum force Same as above plus hydrostatic force Electronic amplification of force

\* SLR operates at microwave frequencies, gives image resolution comparable to optical photographs

4. 2-point interferometer of amplitude sensors: Cannot resolve ambiguities if waves arrive from multiple directions; not usually portable.

5. 5-point interferometer of amplitude sensors: Better than 2-point interferometer, but still not good enough at resolving ambiguities; not usually portable.

6. Experimental articulated stick-like devices: Typically not portable, and unless the hinges have intersecting axes, troublesome cross coupling terms occur. Also, the number of hinges determines the number of degrees of freedom of the sensor, and only a very complex, many-hinged systems can even in principle accommodate many multiple wave directions simultaneously.

7. Laser backscatter devices: Proposed to measure direction by a variety of doppler-shift and signal intensity dependence principles. Both continuous wave and pulsed varieties suggested. Such systems suffer from extreme loss of signal in the presence of capillary or other small scale phenomena. Sometimes the principle signal backscatters in a direction other than to the laser receiver. (Such a device is actually an electromagnetic radar, but because of the later introduction of such short wavelength devices, and the special phenomena that are characteristic of such wavelengths, it is still customary to arbitrarily exclude these devices from the category "radar").

8. Photographic techniques: If a photograph of the sea, typically taken from an overflying aircraft, shows the wave structure of the sea surface, then in principle one can determine the wave direction



as being perpendicular to the line of crests. Single frame data would not permit determination of direction sense (e.g., seaward versus landward). Requires clear seeing at the wavelength used. This technique is basically a variation on the approach of using human observers.

9. Side looking radars: As discussed in the next section, these expensive systems can potentially provide photographic quality resolution in photographs that are taken essentially at the radar wavelength. Basically a variation of (8) above. Clearer seeing under a wider range of weather conditions, depending on choice of radar wavelength.

10. Search radars: Conventional pulse radars, employing Plan-Position Indicator (PPI) displays. Typical varieties include marine surface search radars, and airborne weather radars. Also basically a variation of (8) above. Known to be of use to marine interests, as a convenience of opportunity, but largely unpredictable as to availability of a suitable signal.

## 5. ELECTROMAGNETIC SENSOR TYPES - RADAR

### 5.1 General

The definition of "radar" is now so broad that it includes any instrument that radiates electromagnetic waves from one or more transmitters to one or more receivers in such a way that the received signal tells something about some target. Extreme examples might include a laser interferometer for laboratory evaluation of optical components; or the radio networks that have been described as monitoring nuclear bursts and missile launches from beyond-the-horizon distances by noting signal changes resulting from changes in the ionosphere caused in turn by the target. Some now call sonars acoustic radars.

### 5.2 Wavelength

The radar principle has been applied over the wavelength/frequency range from a few megahertz (e.g., 1 MHz  $\rightarrow$  300 m) to ultra-violet laser radars (e.g., 300 nm  $\rightarrow$  1000 THz). Virtually all the radar processes have some version available at most wavelengths. A wave direction radar can be built (whether cheaply or not) at any wavelength likely to be of interest.

### 5.3 Coherence

The primary meaning of "coherent" in radar has come to mean that the phase of the electromagnetic signal is controlled and utilized. In a coherent radar the transmitter usually amplifies, and in a pulse type also time gates, some phased replica of the waveform being generated in some internal reference oscillator. The radar makes use of some form of this reference signal in a heterodyne mixing process somewhere in the receiver. Pulse magnetron transmitters, in which the magnetron power oscillator is turned on and

off, are thus noncoherent transmitters and a radar using a pulsed magnetron is usually noncoherent. Radars like police speed radars are often said to be partially coherent: in the receiver heterodyne process, frequency components above and below the transmitted frequency are "folded" together in a "homodyne" process where the reference for the frequency mixer is at the identical frequency as the transmitted frequency. This folding makes the radar incapable, without adding features given up to attain its simplicity, of distinguishing positive from negative doppler shifts, and hence of distinguishing one direction sense from another.

Some "COHO" radars use incoherent transmitters, e.g., magnetrons, but "recohere" the receiver local oscillator to each transmitter pulse, and for the echo returns from that pulse the receiver is coherent - the magnetron frequency stability is usually good enough during a single pulse to permit this type of operation. Some noncoherent radars measure doppler shift by determining the total shift of their continuous spectrum, rather than using the characteristic method for coherent radars of measuring the spectral shift of lines in the discrete spectrum for the coherent radar. Radars of this type require very large doppler shift if the radar is to be effective.

The approach to wave direction measurement being followed here makes use of doppler shift. A coherent radar is almost certainly required. The homodyne "beat to zero" approach might have limited or special applications, especially since the homodyne system is simple and cheap.

#### 5.4 Modulation

Radars usually modulate the basic continuous wave (CW) reference oscillator signal in some way to transmit a more complex waveform.

The simplest types use no modulation at all, and are called CW radars. Pulse types interrupt transmission as one kind of amplitude modulation; they are characterized by a pulse length, a pulse repetition rate, and a duty factor or "duty cycle" which is the fraction of the time the transmitter is on. Frequency/phase modulation types (FM and PM) vary the phase angle of the transmitter reference oscillator signal. FM and PM are different ways of describing what is essentially the same process; the differences are important in the subtleties of radar design, but are usually not of much interest to the user.

Mixed types, marginal types, and redundant designations exist. A pulse doppler (PD) radar usually has a high pulse repetition rate and a large duty factor, perhaps 0.3. It is usually a complicated system for such applications as weapon fire control in a high performance aircraft. Altimeters are often "FMCW"; the redundant "CW" comes from the fact that originally most altimeter radars were pulse types, and the "FM" tells how they modulate. Finally, "coded" and "noise" radars use such a complex modulation that the angle and amplitude modulation processes are not separable.

Pulse radars are convenient for measuring range, and CW types for measuring velocity (actually "range rate", the time derivative of the length of the path from transmitter to receiver). But each can also measure the other variable. The more important difference is that pulse radars can be made to not see targets at certain ranges, and CW coherent radars can be made to not see targets at certain speeds.

For our application a CW radar will be recommended because it seems adequate and is far simpler. But the added ability of a pulse radar to control the area of the sea to be measured may be

wanted for a Type II application, or even a multimode system with selection options ("multimode" in radar usually means something else -- such as combined PD radar and passive infrared systems).

### 5.5 Processing

The term "processing" is often used to describe a radar which obtains very fine resolution along the radar-to-target range direction, or in the angular directions perpendicular to the range direction, or in some other sense, through the use of elaborate signal processing. The term processing has always been a diffuse one, and seems to be growing more so.

In a synthetic aperture, side looking radar (SLR), the typical configuration employs a coherent radar in an aircraft or satellite, with the radar real antenna pointing at the sea or ground in a direction perpendicular to the aircraft's velocity vector. A large synthetic antenna aperture is created by signal processing that combines the signals received at different times from a target, while the antenna occupies successively different positions along the line of aircraft travel. The antenna is made effectively longer, and the antenna beam is thus narrower, giving finer angular resolution. A signal processor commonly used has been the optical signal processor<sup>104</sup>, in which the electrical signal in the radar receiver is converted to a modulated light beam, and the light beam passes through lenses and weighting-function filters, and ultimately is reconverted to a spatially filtered electrical signal again.

For resolution in the range direction, pulse compression radars can similarly process long-pulse signals to produce the equivalent of a very-short-pulse radar, thus giving fine range resolution. Pulse compression radars can also employ an optical signal processor for certain required functions.

Holograms, either at optical or microwave wavelengths, can be used to produce a quasi 3-dimensional image, giving added information that can be compared to additional resolution.

Two-dimensional images are readily produced by such a "passive radar" as a camera viewing the sea illuminated by sunlight. Adding a flashbulb or searchlight transmitter makes the system active; using a laser instead of the flashbulb makes the system coherent; using a holographic configuration extends the image to an essentially 3-dimensional character.

Even ordinary incoherent pulse search radars form a 2-dimensional image of a sort in a plan-position indicator (PPI) display.

All of the sophisticated processing systems are of interest principally as possible standards of comparison during proof trials of a wave direction radar, but otherwise are of little interest here. Without adding even more complexity to a typically already very complex and expensive system, they do not produce anything like a direct measurement of wave direction.

Simpler imaging systems such as produce ordinary photographs also are not automatic. PPI presentations are often useful to experienced marine operators in determining things about wave direction, but the performance of the typical system is erratic in practice and difficult to predict even under fairly well controlled (or known) conditions.

None of the processing radars or imaging systems seems applicable here, with the possible exception of some Dutch work cited in Section 10.1

## 5.6 Antennas

In principle, the radar antenna can take many forms. If actual spatial selectivity is required, then real beam antennas are indicated, otherwise configurations like active interferometers (the limiting case of so-called partially filled arrays) are possible.

In a beam antenna, if the beam is narrow in the azimuth direction, the radar always sees signals from essentially a single direction (contaminated more or less by side lobes in the antenna beam pattern). If the beam is also narrow in the elevation direction, the entire beam illuminates only, and sees echos reflected only, from a small patch of ocean surface. At very low grazing angles the patch can become quite long in the range direction unless pulse modulation is used. If the beamwidth is sufficiently small, all the area seen at any one time is seen at essentially the same grazing angle; thus eliminating some grazing-angle variation problems.

The real beam, or the synthetic beam of an interferometer, must be scanned appropriately to provide the wanted doppler-versus-azimuth information. For a real beam, the antenna must be physically moved (except in elaborate versions of little interest here). For an interferometer, the direction of the synthetic beam is controlled by electrically phasing the transmit and receive antennas, so great ease and flexibility of beam steering is possible in more elaborate versions.

Finally, antennas can be multiple. In multistatic radars the transmitter(s) and receiver(s) are not at the same place. No advantage of interest here can be associated with any such disjoint or diverse geometry.

A possibility considered was to place 2 or more fixed antennas with their beams pointing to seaward in different directions. Each such antenna would support a separate radar (or the radar could be simply switched among the antennas). From each antenna a different doppler would be received for each incident wave system. (See Section 6.3 for details). From this set of doppler data the arrival directions of the incident wave systems could possibly be determined without the need for mechanical beam scanning. Such an approach was judged so probably too expensive for Type I applications, and so inflexible for Type II applications, that it was not pursued further; the approach might have limited application to field trials of basic techniques, or for accumulating climate data.

For the major applications of interest here, a fairly straightforward mechanically scanned beam antenna is judged optimum.



## 6. RADAR SYSTEM CALCULATIONS

### 6.1 System Concepts

From the many considerations presented in Section 5, it appears clear that the appropriate configuration for a wave direction radar is a relatively simple, coherent doppler radar, with doppler sense capability, and with a mechanically scanned beam antenna — either a continuous wave (CW) type for the simplest version (especially for Type I applications) or a pulsed type if its additional capability to reduce the extent in range of the illuminated area of the sea is found necessary, or desirable for flexibility in a Type II research application.

The remainder of Section 6 is organized as follows. Section 6.2 summarizes the known radar signal properties of the sea, with emphasis on the effects of grazing angle, radar wavelength, and sea state upon the magnitude and doppler characteristics of the radar echo signal from the sea.

In Section 6.3 the relationships between doppler shift, and radar look direction relative to wave direction, are discussed in detail to establish the basic measurement functions of the radar.

Section 6.4 gives detailed geometry calculations dealing with antenna beam width, antenna height, and the location and extent of the illuminated sea area in the range dimension.

Section 6.5 treats the propagation path calculations (the so-called radar range equation).

In Section 6.6 the required antenna dimensions are derived from the desired antenna beam size parameters.

Section 6.7 completes the primary calculations by selection of radar power (and some other parameters) to provide a system with adequate signal to noise in the final processed signal available from the radar.

Section 6.8 treats various available methods of data output, including local displays, and data transmission to remote locations.

Section 6.9 treats some topics in personnel safety for unattended applications.

## 6.2 Sea Echos

The basic problem for this study has three principal parts: (1) what signals, especially doppler signals, does or can a radar receive from a patch of the sea as a target, (2) what techniques will in principle extract from the signal the desired wave direction information, and (3) what are the conceptual design parameters and system configuration for an actual Type I or Type II radar; this section deals with the first of those questions.

### Clutter Coefficient

A basic quantity of interest is the radar cross section  $\sigma$ , which is the equivalent collecting area of the illuminated target under the assumption (for purposes of numerical normalization only) that the energy backscattered to the radar arises from isotropic (non-directional) re-radiation from the target of all the energy collected by the target.

Since the extended surface of the sea completely fills the radar antenna beam, the radar cross section depends on the antenna beam size.

A normalizing clutter coefficient  $\sigma^0$  is introduced, defined by  $\sigma^0 = \sigma / a_i$ , where  $a_i$  is the sea area illuminated by the radar. Alternatively, some authors normalize the radar cross section to the projected area  $a_p$  by introducing a quantity

$\gamma = \sigma / \partial \rho$  also called a clutter coefficient (hence confusion with  $\sigma^0$ ), defined by  $\gamma = \sigma^0 \csc \phi$ , where  $\phi$  is the grazing angle.

Estimates of  $\sigma^0$  vary. Spizzichino's facet theory<sup>6</sup> predicts

$$\sigma^0 = \mu \cot^2 \beta_0 \exp(-\cot^2 \phi / \tan^2 \beta_0) \quad (4)$$

where  $\mu$  is a parameter with value about unity at X band (wavelength about 3cm) and in the millimeter wave region, but with a value about 0.1 at UHF (wavelength about 30 cm)\*.

But Katzin<sup>17</sup> estimates that in the interference region (see below)

$$\sigma^0 \sim (\phi / \phi_c)^4 \quad (5a)$$

and that

$$\sin \phi_c = \lambda_r / 2 \hat{H}_{10} \quad (5b)$$

where  $\hat{H}_{10}$  is the wave height exceeded by 10% of the waves,  $\lambda_r$  is the radar wavelength, and  $\phi$  and  $\phi_c$  are the grazing angle and critical angle.

\*  $\beta_0$  is the angle for which  $\tan \beta_0$  is the root mean square slope of the facets.

The whole subject of clutter coefficient variation with grazing angle and other variables is discussed in detail in Appendix 1. The variation of clutter coefficient with grazing angle is summarized in Figures 7 and 8. Figure 7 shows a composite from several sources described in Appendix 1. Figure 8 is a conceptual general example.

### Doppler

Some of the fluctuations observed in sea echos result from the doppler frequency shift produced by the motions of the individual scatterers. The different doppler shifts beat with one another to generate observed fluctuation. The analysis of the amplitude fluctuations as the superposition of the doppler contributions is equivalent to the analysis assuming the superposition of signals with time-varying phase shifts caused by the relative motions. Measured spectra of sea echo amplitude fluctuations at microwave frequencies show the spectral width to be proportional to the radar frequency, as it should be if due to a doppler effect. The spectral width corresponds to a few knots velocity.

The observed peak doppler corresponds more closely to the medium period wave motion as a whole if the radar wavelength is commensurate with the sea wavelength, and less closely for much shorter radar wavelengths where wind driven components of the sea wave begin to dominate.

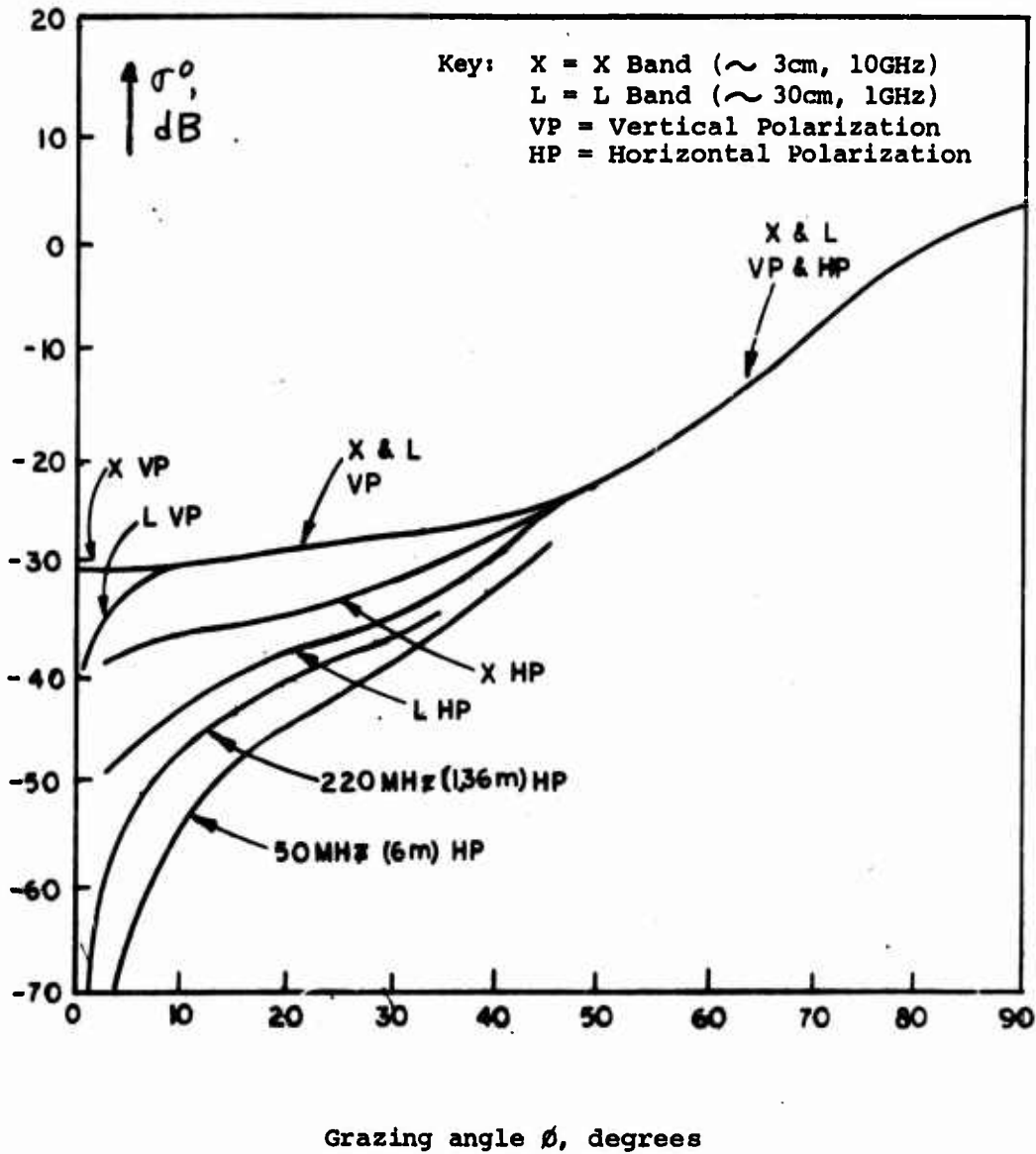

Figure 7. Composite of  $\sigma^0$  data for "medium" sea.

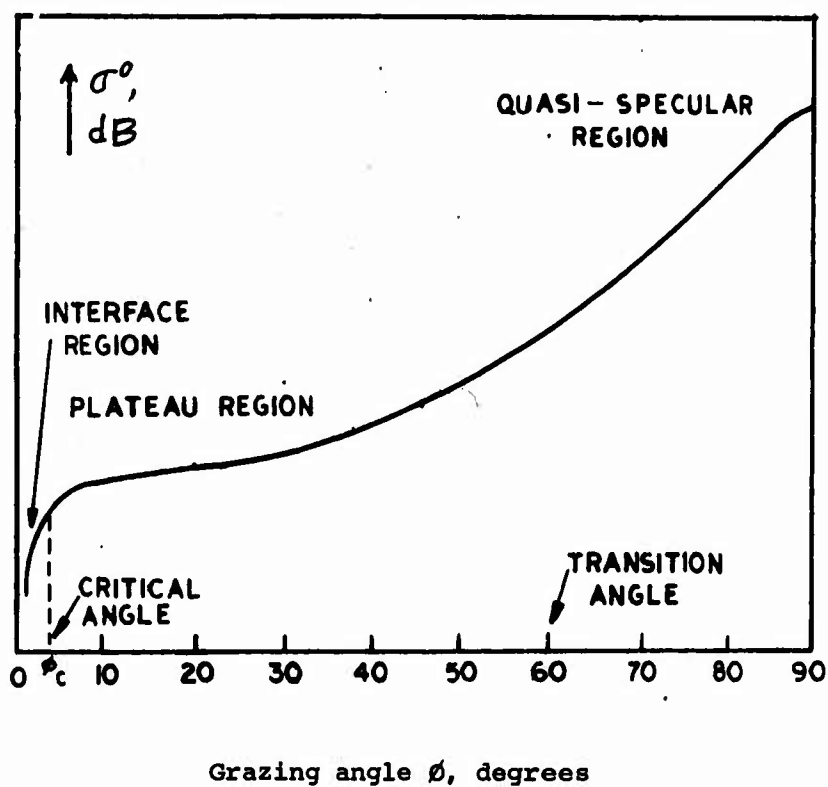

Figure 8. Representative example of the variation of  $\sigma^0$  with grazing angle.

### Polarization

Radar polarization effects the radar signal, and especially so at low grazing angles. However nothing in the available theory seems to permit detailed calculation of polarization effects for a wave direction radar. Diverse polarization capability would be desirable in a Type II radar.

### Amplitude Fluctuations

Sea echo can exhibit large, rapid fluctuations in the amplitude of the total received signal. A Rayleigh probability density function (pdf) is often assumed, and would be valid if the fluctuation arises from the combined contributing of many independent scatterers of about equal size. Other suggestions<sup>36,37</sup> are for a log-normal pdf, which agrees with some high resolution results. A log-normal pdf results in an increase in the large-signal portion of the distribution.

### Pulse Length

When the illumination cell of a pulsed radar is smaller than the wavelength of the sea, the radar can resolve the ocean waves. The resolution of the waves depends on both the range and angle resolution of the observing radar. Thus pulse radars can provide a kind of sea wavelength discrimination, and hence of period discrimination depending upon wave velocity.



### 6.3 A Doppler Approach

The basic method proposed for wave direction determination is as follows. Figures 9, 10, and 11 describe the process for a radar located on a shoreline. Figure 9a shows one wave system (perhaps of several), travelling toward the shore with a specified heading and speed. The radar line of sight (LOS, shown here projected onto the horizontal plane) has a heading  $\beta$ . Figure 9b shows the doppler component  $v_d$  of the total speed  $c_w$  experienced by the radar for various directions of the LOS. (The sinusoidal curve is shown dotted for values that would require the radar to look to landward; if the radar were mounted on a tower in open water, doppler could still be measured in the directions shown dotted.)

The maximum negative doppler shift,  $v_d = -c_w$ , occurs when

$$\beta = \alpha, \text{ which in this example is to the right of } \beta = +\pi/2.$$

Figure 10 develops the same doppler geometry further. Axes as in Figure 9a are designated  $x$  and  $y$ . Another orthogonal set  $u$  and  $v$  are aligned respectively perpendicular and parallel to the wave heading. For the same set of  $\alpha$  and  $\beta$  values as previously, the length of the vector  $v_d$  is such that the two circles shown constitute, versus LOS angle  $\beta$ , the loci of terminators (free ends) on of the  $v_d$  vector.

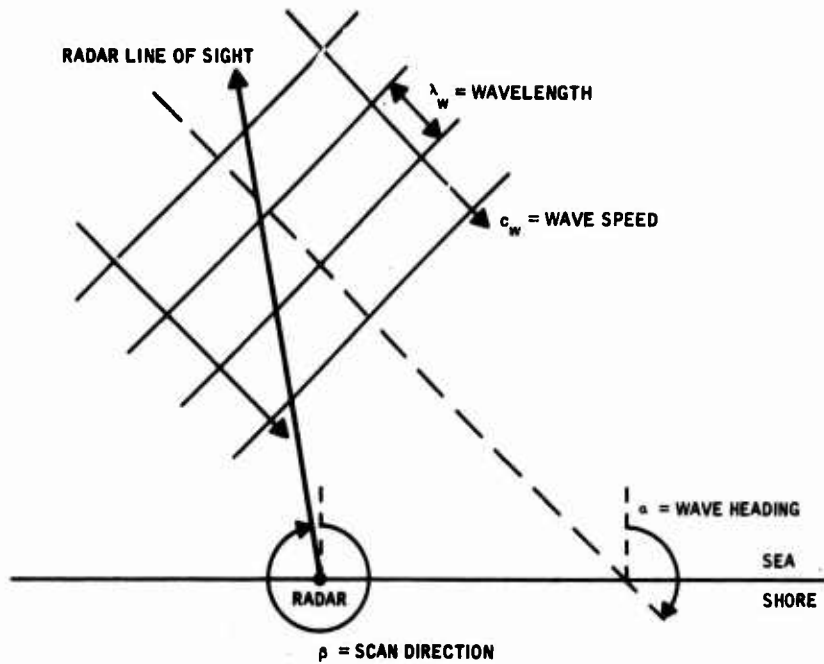

a. Plan View

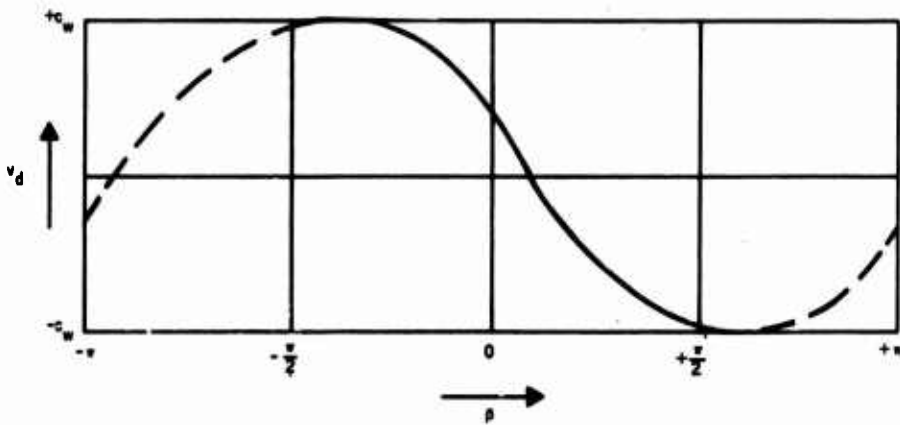

b. Doppler Velocity versus Radar Look Direction

Figure 9. Basic doppler relationships

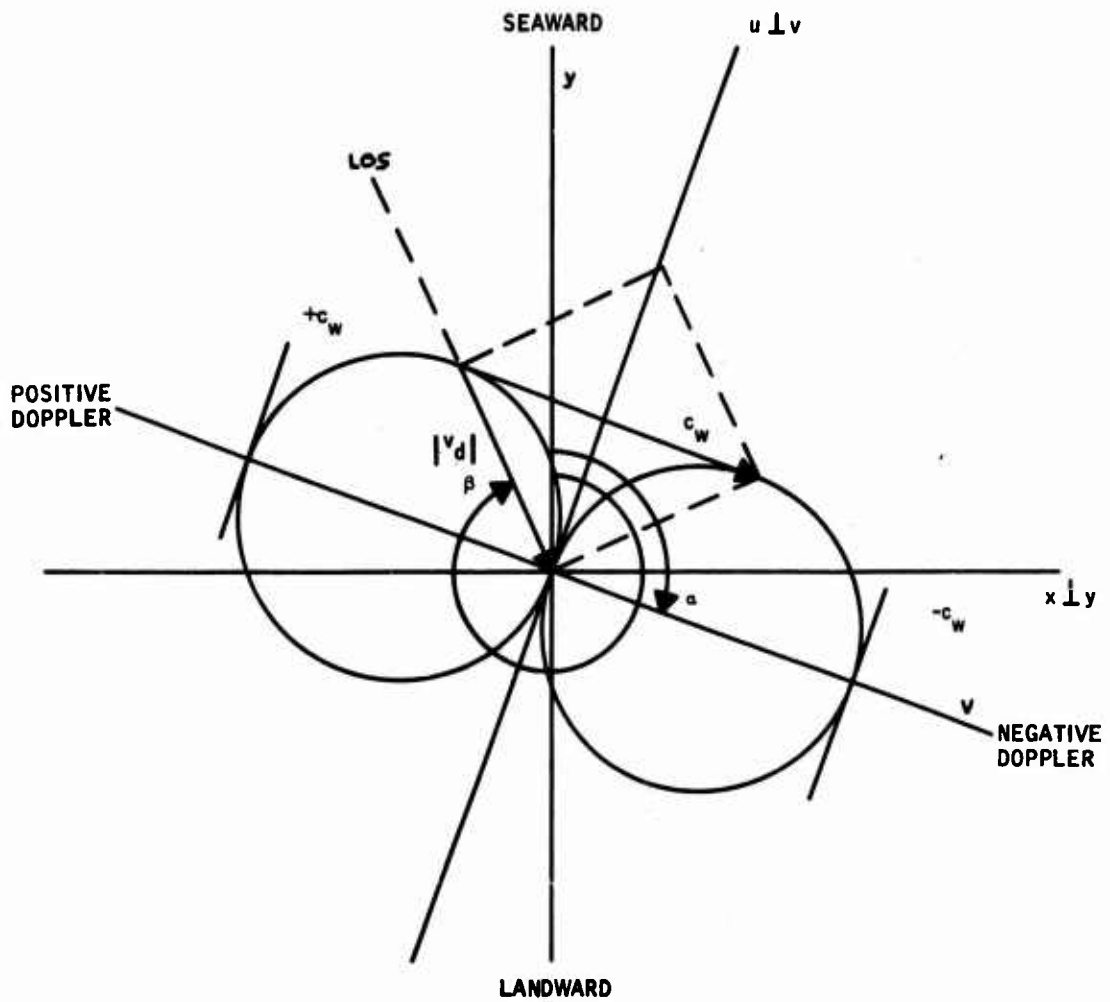
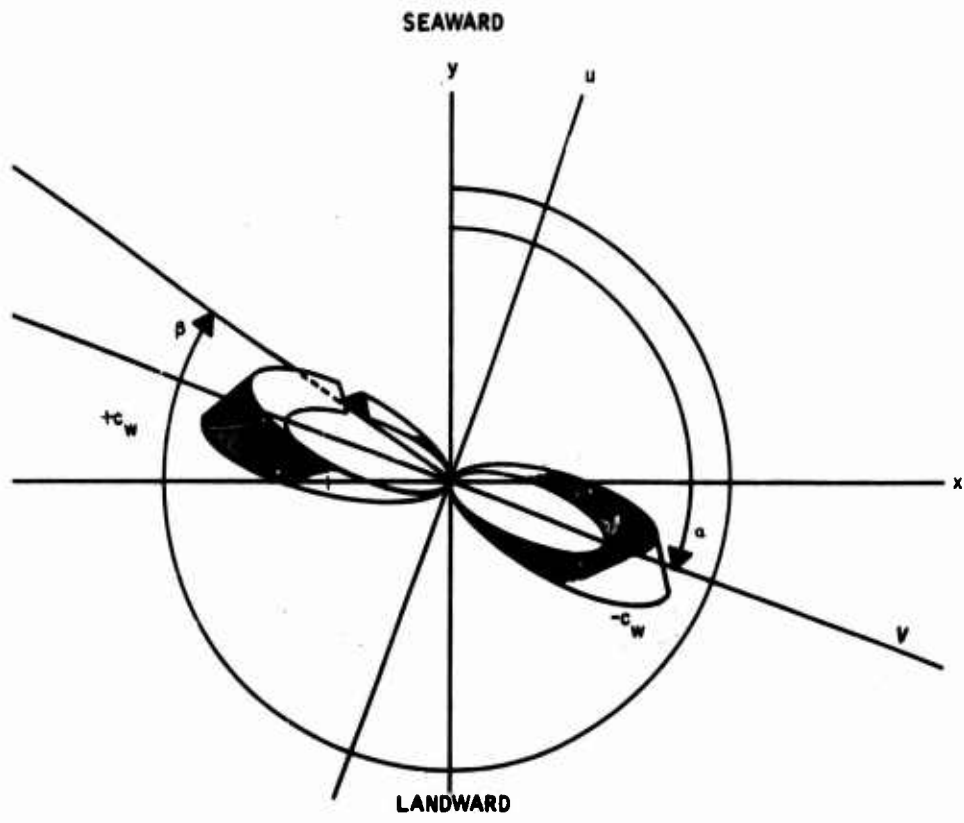

Figure 10. Doppler Geometry

Continuing the same geometry in Figure 11, the solid figure in Figure 11a represents the doppler spectra for various values of  $\beta$ . Along any cut of the solid figure at some angle  $\beta$ , the resultant spectrum is as shown in Figure 11b. The solid figure in Figure 11a has a sharp ridge, whose projection onto the x-y plane is the pair of circles in Figure 10; the ridge is made sharp for emphasis, although the doppler spectrum would not actually be cusped.

The determination of wave heading for a single wave system consists conceptually of locating the orientation of the solid figure in Figure 11a. For multiple wave systems there will be such a figure for each system, and the signal power densities will be additive. The object of the signal processing in the radar (see Section 6.8 below) will be to locate the orientation of each of the solid figures. Note that measurement of wave heading is not dependent on the scale of doppler shift being exactly that for which  $v_d$  has a maximum magnitude equal to  $c_w$ .



a. Geometry

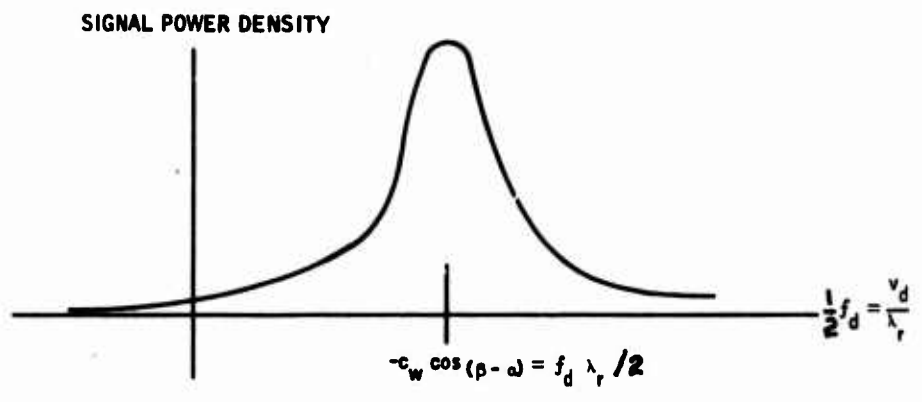

b. Doppler Spectrum

Figure 11. Doppler Spectrum versus Geometry

#### 6.4 Geometry

The radar site geometry is shown in Figure 12. A dish antenna of diameter  $D_a$  is located at a height  $H_a$  above mean sea level. The slant range to the illuminated sea is  $R$  along the LOS. The projected and actual areas of the illuminated cell are  $A_p$  and  $A_i$ ; the axes of the illuminated ellipse are  $d_r$  and  $d_a$ . The antenna beamwidth is  $\theta_b$  and the grazing angle is  $\phi_c$ . The horizontal range to the illuminated ellipse is  $R_H$ .

$H$  and  $R$  are related by

$$H = R \tan \phi \quad (6)$$

and the extent of the ellipse in range is related to  $H$  by

$$\frac{H}{d_r} = \frac{\sin \phi \tan \phi}{\theta_b} \quad (7)$$

$$\frac{H}{d_r} \sim \frac{\phi^2}{\theta_b}, \quad \phi \text{ small}$$

For a pulse radar of pulse length  $\tau$ , the full ellipse is not illuminated.

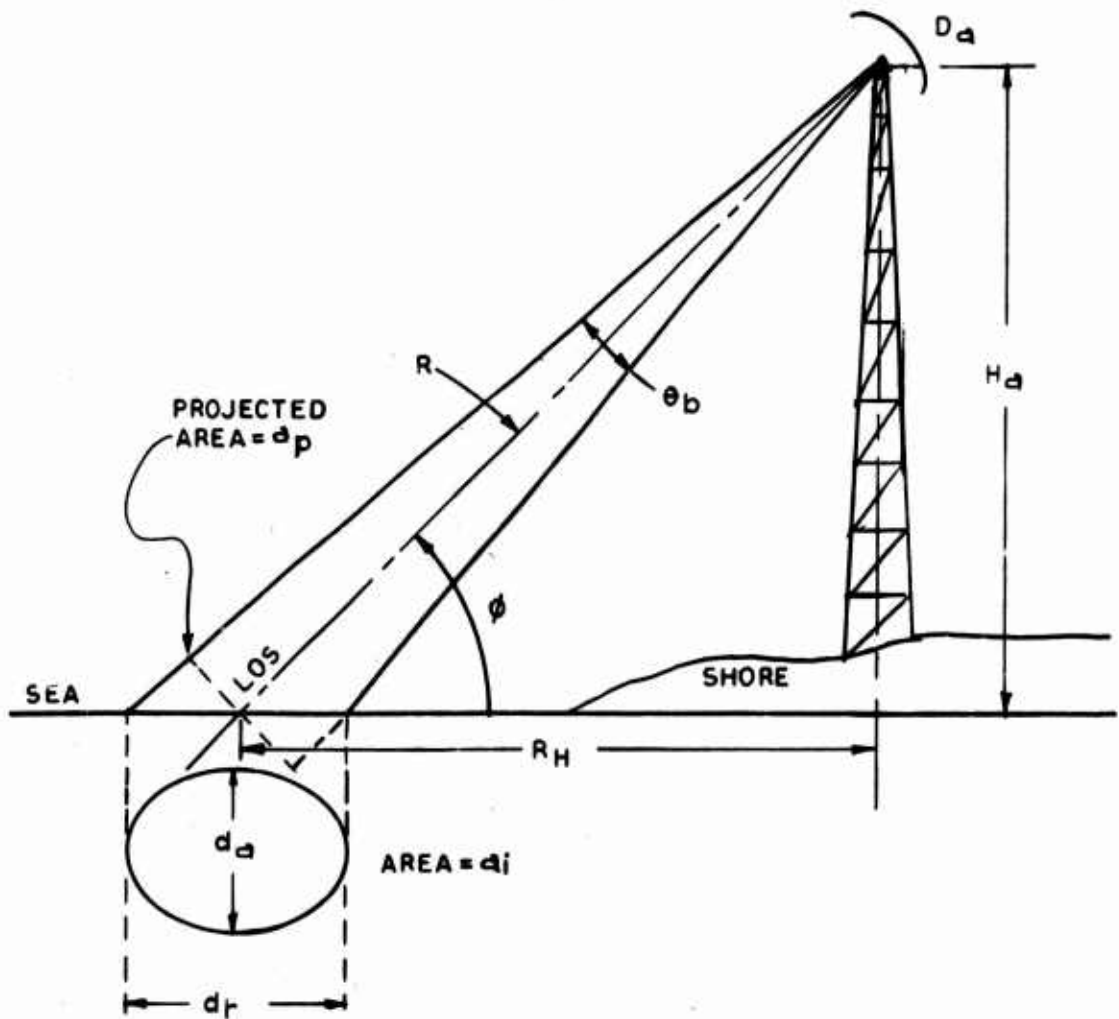

Figure 12. Site Geometry

Summarizing the various relationships

Value of $\phi$	Type of Radar	$d_a$	$d_r$
Large	CW	$R\theta_b$	$R\theta_b$
	Pulse		
Small	CW		$R\theta_b \sec \phi$
	Pulse		$\frac{1}{2} c_r \tau \sec \phi$

where  $c_r$  is the velocity of electromagnetic propagation. These relationships will be used in Section 7 for the candidate designs.

6.5 Propagation

For a point target, one expanded form of the propagation portion of the so-called radar equation is

$$\begin{matrix}
 P_t & \cdot & \frac{1}{L_t} & \cdot & G_t & \cdot & \frac{1}{4\pi R^2} & \cdot & \frac{1}{L_r} & \cdot & \sigma & \cdot & \frac{1}{4\pi R^2} & \cdot & \frac{1}{L_r} & \cdot & \frac{\lambda_r^2}{4\pi} & \cdot & G_r & \cdot & \frac{1}{L_r} & = & P_r & (9) \\
 (1) & & (2) & & (3) & & (4) & & (5) & & (6) & & (7) & & (8) & & (9) & & (10) & & (11) & & (12)
 \end{matrix}$$



where the numbered terms are:

- (1)  $P_t$  = transmitter power output
- (2)  $L_t$  = transmitter system loss
- (3)  $G_t$  = transmitter antenna gain
- (4)  $R$  = radar range; total denominator term is "spreading loss" =  $4\pi R^2$
- (5)  $C_1$  = one-way propagation loss
- (6)  $\sigma$  = radar cross section
- (7) as in (4) for return path
- (8) as in (5) for return path
- (9)  $\lambda_r$  = radar wavelength; term is the collecting area of an isotropic (non-directional) receiver antenna illuminated at wavelength  $\lambda_r$
- (10)  $G_r$  = receiver antenna gain
- (11)  $L_r$  = receiver system loss
- (12)  $P_r$  = received power

so

$$\frac{P_r}{P_t} = \frac{G_t G_r \sigma \lambda^2}{(4\pi)^3 R^4 L_0^4}, \text{ where} \tag{10}$$

$$L_0^4 = L_t L_r L_i^2$$

Equation (10) will be used in subsequent calculations. Effects due to the distributed (extended target) are treated in the next Section.

## 6.6 Antenna System

Treated here are the antenna system itself, and some of the effects of the distributed sea target.

In practice the radar uses the same antenna for transmit and receive, so

$$\begin{aligned}
 G_t &= G_r = G \\
 G_t G_r &= G^2
 \end{aligned}
 \tag{11}$$

The antenna beamwidth  $\theta_b$  is related to the antenna diameter by

$$\begin{aligned}
 \theta_b &= k_\theta \frac{\lambda_r}{D_a}, \\
 k_\theta &\sim 1
 \end{aligned}
 \tag{12}$$

For the assumed conical ("pencil") beam, the solid angle  $\psi_b$  subtended by the conical beam of included plane angle  $\theta_b$  is

$$\begin{aligned}
 \psi_b &= 4\pi \sin^2 \frac{\theta_b}{4} \\
 \psi_b &\sim \frac{\pi \theta_b^2}{4} \text{ for small } \theta_b
 \end{aligned}
 \tag{13}$$

But the power gain  $G$  of an antenna is

$$G = k_g \frac{4\pi}{\psi_b} \quad (14)$$

$$k_g \sim 1$$

so we get the relation

$$G \sim \frac{16 k_g}{\theta_b^2} \quad (15)$$

$$\text{and } G \sim \frac{16 k_g D_a^2}{k_\theta^2 \lambda_r^2} \quad (16)$$

And the area illuminated is

$$a_i = R^2 \psi_b \quad (17)$$

or

$$\begin{aligned} a_i &\sim R^2 \cdot \frac{\pi \theta_b^2}{4} \\ &= R^2 \\ a_i &\sim \frac{\pi k_\theta^2 R^2 \lambda_r}{4 D_a^2} \end{aligned} \quad (18)$$

So the distributed sea target has a cross section

$$\sigma = \sigma^0 a_i \sim \frac{\pi \sigma^0 k_\theta^2 R^2 \lambda_r^2}{4 D_a^2} \quad (19)$$

And the radar equation, Equation (10) becomes

$$\frac{P_r}{P_t} = \frac{G^2 \sigma \lambda_r^2}{(4\pi)^2 R^4 L_0^4} \quad (20)$$

$$\text{or } \frac{P_r}{P_t} = \frac{1}{\pi^2} \left( \frac{k_g}{k_\theta} \right)^2 \frac{\sigma^0 D_a^2}{R^2 L_0^4}$$

which is independent of wavelength

6.7 Signal Versus Noise

The competing thermal noise power  $N$  in the radar receiver is

$$N = kT_0 B \bar{N}F \quad (21)$$

where  $k$  = Boltzmann's constant  
 $= 1.380 \times 10^{-23} \text{ JK}^{-1}$

$T_0$  = receiver reference absolute temperature

$B$  = effective bandwidth of receiver

$\bar{N}F$  = factor receiver noise factor

and  $T_0$  is usually chosen so that

$$kT_0 = 400 \times 10^{-23} \text{ J} = 4 \times 10^{-21} \text{ WHZ}^{-1}, \text{ so}$$

$$T_0 = \frac{kT_0}{k} = \frac{400 \times 10^{-23}}{1.380 \times 10^{-23} \text{ JK}^{-1}} = 289.86 \text{ K}$$

But the doppler shift  $f_d$  due to a signed wave doppler velocity  $v_d$  is

$$f_d = 2 \frac{v_d}{c_r - v_d} f_r$$

(22)

$$f_d \sim \frac{2v_d}{\lambda_r}$$

and to cover a range  $\Delta v_d$  of doppler velocities, with a corresponding band of doppler frequencies  $\Delta f_d$  require a bandwidth

$$B = \Delta f_d = \frac{2\Delta v_d}{\lambda_r} \quad (23)$$

as a minimum.

Thus the receiver noise is at least

$$N = k T_0 \left( \frac{2 \Delta \nu_d}{\lambda_r} \right) \overline{NF} \quad (24)$$

$$N = \frac{2 k T_0 \Delta \nu_d \overline{NF}}{\lambda_r}$$

and the receiver signal-to-noise power ratio is

$$X = \frac{P_r}{N} = \frac{P_t \frac{1}{\pi^2} \left( \frac{k_g}{k_0} \right)^2 \frac{\sigma^0 D_2^2}{R^2 L_0^2}}{\frac{2 k T_0 \Delta \nu_d \overline{NF}}{\lambda_r}} \quad (25)$$

$$\text{or } X = \frac{k_g^2 D_2^2 \lambda_r P_t \sigma^0}{2 \pi^2 k T_0 k_0^2 R^2 \Delta \nu_d \overline{NF} L_t L_r L_i^2} \quad (26)$$

for a CW radar. For a pulse radar similar derivations take into account that the receiver bandwidth for no doppler at all must be of the order of  $B = 1/\tau$ .

## 6.8 Data Outputs

Using the concepts of Figures 9, 10, and 11 in Section 6.3, there are several ways to use the radar to measure wave direction. A very simple approach would be to equip the radar with a doppler frequency meter, and rotate the antenna in azimuth to obtain a maximum magnitude of doppler shift. At this azimuth the radar LOS is pointing in line with the direction of wave motion, and the waves are approaching or receding according to whether the sign of the doppler shift is respectively positive or negative.

In any 180 degree interval of azimuth scan, there will be at least one LOS angle that produces a maximum magnitude of doppler, and another angle, located 90 degrees from the first, at which the doppler shift is passing through zero. As a practical matter, it may be difficult to locate the angle of maximum doppler magnitude accurately because there the slope of the curve of  $f_d$  versus LOS angle is zero, as shown in Figure 9b. But in the region of zero doppler, where the magnitude of the slope is largest, feedthrough of transmitter leakage signals in a CW radar can make the measurement difficult, or require expensive equipment to reduce the leakage, and the signal return at that azimuth may be at a minimum anyway.

If more than a single wave system is present, then each system will in effect produce a separate solid describing figure in Figure 11a. These describing figures will in general differ in orientation (wave direction), diameter (wave effective speed), and height from the plane (amount of signal return). The total describing figure for the set of wave systems would be a composite of the individual describing figures. At each intersection of one or more individual describing figures, the total power spectral density would be sum of the incoherently added power spectral densities of the



individual describing figures unless the waves were somehow correlated.

At each LOS angle, the total power spectral density corresponding to Figure 11b would generally show one peak, or mode, for each individual wave system present. A simple frequency meter would be unsuitable for analyzing such a spectrum.

The output of the radar could also be a spectrum analyzer screen displaying something like Figure 11b as the antenna scanned in azimuth. To locate a maximum, or a zero-doppler null, it would only be necessary to keep track of the changes of each of the modes separately. Tracking one of the modes through a point where another mode crossed it would present some problems, but use of the continuity of  $f_d$  versus LOS angle should make it feasible to cross the intersection properly.

A more elaborate local display could be an oscilloscope display superficially like that of a plan-position indicator (PPI) display. Position on the scope would indicate position on the land and sea, as in a PPI display. Through signal processing in the radar, the scope could display some version of the Figure 11a, where increasing intensity on the scope would represent increasing power spectral density. The required memory to keep a full display continuously on the screen could be supplied internally, or by the phosphor of the display cathode ray tube as in a PPI display.

Some convention would be required to distinguish positive from negative doppler values of  $f_d$ , but any convenient coding would do, for instance use of two colors.

The maximum magnitude of doppler shift for any one wave system would be in a mode centered at  $f_d = 2c_w/\lambda_r$ . For example even if the wave speed were as high as  $c_w = 40 \text{ knots} = 20.6 \text{ ms}^{-1}$ , and the radar

wavelength as small as  $\lambda_r = 3 \text{ cm} = 0.03 \text{ m}$  ( $f_r = 10 \text{ GHz}$ ), the doppler magnitude would be only  $f_d = (2)(20.6 \text{ ms}^{-1})/(0.03 \text{ m}) = 1372 \text{ Hz}$ , and the required receiver bandwidth for a CW receiver would be only  $B = (2)(1372 \text{ Hz}) = 2744 \text{ Hz}$ . And B would be even smaller for slower waves and longer radar wavelengths.

This range of frequencies, translated down to the VF (Voice Frequency) band, could easily be handled by a good quality voice grade telephone line, which will usually carry analog data over a bandwidth of something like 3500 Hz with reasonably useful signal-to-noise ratios.

It could therefore, be quite feasible to transmit the entire instantaneous output of the wave radar receiver to a remote location. At the remote location, sophisticated time shared computer processing in a single system could supply the equivalent of elaborate data or signal processing at the individual radars. If desired, and a separate telephone line were available to return data to the radar, then even a Type II radar could be simplified.

## 6.9 Safety

A problem of potential concern is that unattended wave radars might cause RF hazards to personnel that were casually in the area. At the modest power levels that a wave radar would use, the principal hazard would be from damage caused by heating of tissue, especially damage to the eyes and testes.

In the past year or so, much new emphasis on this kind of hazard has come from the widespread new use of microwave ovens in homes, vending areas, restaurant kitchens, and aboard large commercial aircraft, as well as from continuing growth in the use of microwave heating in industry, and clinical and therapeutic use of microwave diathermy.

The U.S. Department of HEW has recently become very active in this field, as have the governments of Massachusetts and one or two other states. Initial confusion has among public officials been reported to exist over the highly technical distinctions between the problem of a microwave oven hurting passengers in a 747 aircraft, and the danger of the microwave oven interfering with critical electronic systems in the aircraft.

Thus there is a fair degree of widespread new confusion over what is safe, and how to treat the matter legally. No new substantive regulations are known to have been made by government, but are rumored to be imminent.

The older standards<sup>104</sup> still in effect set limits on the time-integrated power density (from the Poynting vector) where the personnel are located. In general, the accepted limit for continuous expose is  $100 \text{ Wm}^{-2}$  ( $= 10 \text{ mWcm}^{-2}$ ) average power.

The far-field power density of exposure in the peak of the antenna beam is

$$p_e = P_t \cdot \frac{1}{L_t} \cdot G_t \cdot \frac{1}{4\pi R^2} \cdot (4)$$

$$p_e = \frac{P_t G_t}{\pi R^2 L_t} \quad (27)$$

where  $P_t$ ,  $L_t$ ,  $G_t$ , and  $R$  are as in Section 6.5, and the final factor of 4 in the top line arises from the assumption that there is perfect reinforcement between the direct ray and a ray reflected from the earth.

## 7. TYPE I & TYPE II DESIGNS

Using the design equations developed in Section 6, basic parameters for radars for suitable Type I and Type II applications, as well as an intermediate case, were derived as follows.

<u>Parameter</u>	<u>Unit</u>	<u>Type I</u>	<u>Inter- mediate</u>	<u>Type II</u>
Radar wavelength $\lambda_r$	cm	15	30	40
Radar frequency $f_r$	GHz	2	1	0.75
Antenna height above sea $H_a$	m	10	15	20
Grazing angle $\theta$	degrees	5	5	5
Illuminated elementwidth $d_a$	m	5.7	12.9	15.3
Illuminated element length $d_r$	m	66	148	175
Ground range R	m	114	172	230
Slant range R	m	115	172	230
Antenna diameter $D_a$	m	3	4	6
Antenna beamwidth $\theta_b$	degrees	2.9	4.3	3.8

<u>Parameter</u>	<u>Unit</u>	Type <u>I</u>	Inter- <u>Mediate</u>	Type <u>II</u>
Antenna gain G	dB	38	35	36
Peak doppler velocity accomodated $v_d$	knot	38.9	38.9	38.9
Doppler Bandwidth B	Hz	530	270	200
Antenna constants, $k_G$	-	1	1	1
$k_e$	-	1	1	1
Clutter coefficient	-	0.1	0.1	0.1
Noise figure $\overline{NF}$	dB	5	5	5
Transmitter losses $L_t$	dB	3	3	3
Receiver losses $L_r$	dB	3	3	3
One-way Losses $L_1$	dB	4.5	4.5	4.5
Transmitter Power $P_t$	mW	1	1	1
Signal-to-noise ratio x	dB	+79	+77	+76
Power density at R=10 <sup>3</sup> m P	*	-14.9	-18.5	-17.4
* dB above 100 Wm <sup>-2</sup>				

For both types, a mechanical scan is recommended, with any convenient rate not less than 1 scan per minute.

The value of CW power chosen, 1 mW, is rather arbitrarily chosen; any convenient value in the range 1  $\mu$ W to 1W would be satisfactory (except for the radiation level at a distance of 10 meters).

The describing-figure display (pseudo-PPI) discussed in Section 6.8 is recommended for Type II application; a phone line connection to a central processor, as discussed in Section 6.8 is recommended for Type I applications.

For the Type II application, an additional pulse mode with controllable pulse length down to 10 ns (approximately 5-foot resolution) is recommended.

For the Type II application, especially for early evaluation, polarization diversity is suggested. A variety of antenna feed structures are available to provide this function, and even switchable polarization may be advantageous.

Although a specific frequency is assigned to each radar in the tabulation above, it would be very desirable to have the radar tunable over as wide a frequency range as can be readily obtained, with a maximum tuning time that is less than 20 minutes by an order of magnitude or more.

## 8 EXISTING SUITABLE RADARS

One of the general objectives of this study has been to identify, if possible, an existing radar type that could serve as a Type I or Type II radar in its existing form.

To the time of this report, no such radar type already in service has been identified that meets even most of the requirements, and the more examples that are considered, the less promising the prospect becomes.

Sophisticated doppler, pulse doppler, and short pulse radars of many kinds are available, but all are clearly too complex and expensive for even a Type II application.

Ordinary pulse surveillance radars, including marine search radars, are incoherent, and doppler processing is thus impossible in the existing configuration.

It had been hoped that existing police radars might be applicable but they are found to be typically of the homodyne type, in which the received signal is "beat-to-zero" by heterodyning it with the transmitted frequency, and these radars thus do not distinguish doppler polarity in their existing forms. This seems a major disadvantage, although the radars are inexpensive and reasonable modifications could possibly give them doppler sense capability. Another disadvantage of the police radar is that it is usually at the fixed FCC-assigned frequency at 10.525 GHz (2.85 cm), when a lower frequency has been indicated, and flexibility for evaluation is so desirable.

It is felt that of the radar types we have seen, none could be so easily modified for immediate service, without any further substantial evaluation or field authentication, that such an effort

could be justified.

It is therefore our suggestion that emphasis for the immediate future should be on a careful definition of proof experiments dealing with the sensing technique itself, and that equipments suitable for the more limited objectives of the tests should be sought instead.

Many potentially suitable equipments for experiments are readily available. The appropriateness of each candidate equipment depends so strongly on the detailed choice of experimental details that we suggest that the experimental details should be developed before even a trial radar should be chosen.

Typical candidates for evaluation include several in-house prototype equipments at Raytheon, and other major radar producers would undoubtedly also have such residual equipment. Some radars in production at Raytheon and elsewhere might be inexpensive to procure as-is, or in parts, before experiencing the substantial added value of extensive testing for its normal application. But the details depend so strongly on the particulars of the manufacturer's production schedule that no long range plans along these lines are feasible.

A radar could also be assembled from commercially available modules for many of the radar functions needed for trials. For example, Hewlett-Packard offers 35300 Series X-Band Doppler Radar Modules, providing an entire transmitter-receiver combination at a price in the \$200 range. These units also use the homodyne configuration, lack doppler sense capability, and the present series is fixed in frequency in the band 9.35 to 10.6 GHz (3.21 to 2.83 cm). Modifications to give doppler sense capability would not be prohibitive for these modular types or for typical police radars.



A satisfactory antenna system for tests could be readily assembled from surplus or inexpensive dish antennas, and surplus trackers such as the ubiquitous surplus AN/SCR-584 van.

Finally, the Dutch work reported in Section 10.1 may lead to other equipment prospects.

Providing a suitable, inexpensive radar for tests should prove no great or expensive problem when the details of the experiment are established.

## 9 PROPOSED EXPERIMENTS

The absence of good design data with which to fully validate in advance the design of a wave direction radar suggests that exploratory experiments should be planned.

The emphasis in such experiments should be on careful control of conditions and high quality of instrumentation, and not at all on any attempt to design a new radar, nor on long programs of mass data taking.

Tests out of doors should ideally provide means for adjusting antenna height. For example, the Naval Undersea R&D Center's Oceanographic Research Tower in coastal water off San Diego offers such a capability, plus a wide network of wave height sensors with which to form a realistic wave-direction validation sensor.

Tests in-doors allow for close control of wind effects, especially in combined wind/wave tanks reported in the literature.

A suggested detailed test plan would comprise at least the following elements:

- (1) A most careful definition of ocean truth for the simplest occurring wave systems at an outdoor test site, or in an indoor combined wind/wave tank.
- (2) Review of the range of wave periods that must be distinguished in the radar data, since the ability of the radar to make such a discrimination by signal processing alone is not promising, and the effectiveness of discrimination by use of the angular selectivity of the antenna has not been demonstrated to be effective, and in any case would be indirect because essentially based on wavelength rather than wave period.

- (3) Choice of a compatible and inexpensive radar and antenna system, presumably from surplus or very inexpensive components (even laboratory test equipment could simulate most of the important radar functions other than the properties of the antenna).
- (4) For any outdoor range, or indoor wind/wave tank, an extensive planning effort to provide acceptable instrumentation to establish ocean truth during trials. A combination of arrays of wave height gages plus aerial photography or side looking radar surveillance seems indicated for the outdoor range.
- (5) Careful pre-planning of the statistical analysis that would follow data taking. A relatively small amount of data, properly handled, might clearly establish the feasibility of the concept.
- (6) Assembly of a small team of oceanographic and radar engineering personnel, down to the technician level, with sufficient interdisciplinary complement to encourage the most conclusive results possible.

## 10 REFERENCES

### 10.1 General

During the considerable literature search activity for this study, the following were some of the principal areas of search:

- (1) Oceanography in the littoral zone, limiting attention to work on relevant sensors and coastal wave processes, especially tutorial work of interest to the radar designer.
- (2) Radar technology (including optical wavelengths) explicitly dealing with the sea as a target.
- (3) Radar scattering theory in general, including Bragg, Mie, and Rayleigh scattering processes as relevant to a wave radar. (See Appendix 1 for more details.)
- (4) Doppler and amplitude spectra characteristics and statistics for sea returns, including clutter signals. Specific emphasis on correlation of doppler spectral characteristics with wave direction.
- (5) Work indicating other wave data (height, period, wavelength, etc.) that might be contained in the radar data.
- (6) Statistical theory where relevant to a wave radar sensing parameters of coastal processes.
- (7) Marginal topics such as side looking radars and classified literature and applications with possible unclassified applications to wave radars.
- (8) Relevant work by the Dutch.

The principal findings are given in Section 1.4. In addition, the following literature findings are reported here:

- (1) No potential wave radar applications of Bragg scattering theory<sup>209</sup> were found, in work on either microwave radars or laser radars.



- (2) No relevant unclassified work on side looking radar applications were found, but extensive declassifications in this field are reported to be in progress and the present situation may change substantially in the near future.
- (3) A growing body of literature on radar measurement of wave height and sea state was found, and many relevant titles are included in the references given here. Measurements of upwind-downwind differences in radar signals often loosely implied that the radar could measure something about the surface winds themselves.
- (4) No significant indications were found of work suggesting that other wave parameters could be measured by radar.
- (5) Correspondence with Dutch workers both in the USA and in the Netherlands has uncovered (private communications) that Dutch radars at X band and shorter wavelengths were used over the waters near Norway to measure wave direction to within an accuracy of 10 degrees. This work was declassified by the Dutch only very recently, and as of the date of this report promised copies of the Dutch work had been received.

## 10.2 Numerical List of References

1. B. B. Baker, Jr., W. R. Deebel, and R. D. Geisendorfer, editors, 1966 (2nd edition), Glossary of oceanographic terms, Naval Oceanographic Office Special Publication SP-35.
2. B. Kinsman, 1965, Wind waves, Prentice-Hall, Inc.
3. W. Hogben and F. E. Lumb, 1967, Ocean wave statistics, Ministry of Technology, H.M. Stationary Office, London.
4. H. J. McLellen, 1965, Elements of physical oceanography, Pergamon Press.
5. R. W. Fairbridge, editor, 1966, The encyclopedia of oceanography, vol. 1, Reinhold Publishing Corporation.
6. P. Beckman, and A. Spizzichino, 1963, The scattering of Electromagnetic waves from rough surfaces, Pergamon Press.
7. H. Goldstein, 1949 October, A primer of sea echo, U.S. Navy Electronics Laboratory Report 157.
8. M. W. Long, R. D. Wetherington, J. L. Edwards, and A. B. Abeling, 1965 July, Wavelength dependence of sea echo, Georgia Institute of Technology, Final Report, Project A-840.
9. C. R. Grant, and B. S. Yaplee, 1957 July, Back scattering from water and land at centimeter and millimeter wavelengths, Proc. IRE, vol. 45, pp. 972-982.
10. F. C. MacDonald, 1956, The correlation of radar sea clutter on vertical and horizontal polarization with wave height and slope, IRE Convention Record, vol. 4, pt. 1, pp. 29-32.
11. Deleted
12. J. W. Wright, 1966 November, Backscattering from capillary waves with application to sea clutter, IEEE Trans., vol. AP-14, pp. 749-754.
13. D. E. Kerr, editor, 1951, Propagation of short radio waves, MIT Radiation Laboratory Series, vol. 13, McGraw-Hill Book Company. See especially pp. 481-581 by H. Goldstein.

14. A. H. Schooley, 1962 April, Upwind-downwind ratio of radio return calculated from facet size statistics of a wind-disturbed water surface, Proc. IRE, vol. 50, pp. 456-461.
15. G. F. Meyers, 1958 October 12, High-resolution radar, part IV, sea clutter analyses, Naval Research Laboratory Report 5191.
16. F. C. MacDonald, 1963, Radar sea return and ocean wave spectra, in Proceedings of the conference on ocean wave spectra, pp. 323-329, Prentice-Hall, Inc.
17. D. J. Povejsil, R. S. Raven, and P. Waterman, 1961, Airborne radar, D. Van Nostrand Company, Inc.
18. H. Goldstein, 1946 December 01 and 15, Frequency dependence of the properties of sea echo, Phys. Review, vol. 70, pp. 938-940.
19. J. C. Daley, J. T. Ransone, Jr., J. A. Burkett, and J. R. Duncar, 1968 November, Sea clutter measurement on four frequencies, Naval Research Laboratory Report 6806.
20. J. C. Wiltse, S. P. Schleisinger, and C. M. Johnson, 1957 February, Backscattering characteristics of the sea in the region from 10 to 50 kMc, Proc. IRE, vol. 45, pp. 220-228.
21. A. V. Jelalian, 1968 May, Sea echo at laser wavelengths, Proc. IEEE, vol. 56, pp. 828-835.
22. W. S. Ament, J. A. Burkett, F. C. MacDonald, and D. L. Ringwalt, 1958 November 19, Characteristics of radar sea clutter, Observations at 220 Mc, Naval Research Laboratory Report 5218.
23. A. M. King, C. M. Morrow, C. G. Myers, and C. L. Moody, 1968 June, The airborne sea state radar principle and preliminary analysis of an experimental evaluation, Naval Research Laboratory, Mem. Report 1884.
24. M. Katzin, 1957 January, On the mechanisms of radar sea clutter, Proc. IRE, vol. 45, pp. 44-54.

25. C. R. Burrows, and S. S. Attwood, 1949, Radio wave propagation, Academic Press Inc.
26. J. W. Wright, 1968 March, A new model for sea clutter, IEEE, Trans., vol. AP-16, pp. 217-223.
27. A. H. Schooley, 1956 August, Some limiting cases of radar sea clutter noise, Proc. IRE, vol. 44, pp. 1043-1047.
28. H. Urkowitz, 1953 August, Filters for the detection of small radar signals in noise, J. Appl. Phys., vol. 24, pp. 1024-1031.
29. H. Davies, and G. G. MacFarlane, 1946 November, Radar echoes from the sea surface at centimeter wavelengths, Proc. Soc., vol. 58, pt. VI, pp. 717-729.
30. M. W. Long, 1967 February, Polarization and sea state, Electron. Letters, Vol. 3, pp. 51-52.
31. M. W. Long, 1965 September, On polarization and the wavelength dependence of sea echo, IEEE Trans., vol. AP-13, pp. 749-754.
32. J. C. Daley, J. T. Ransone, Jr., J. A. Burkett, and J. R. Duncan, 1969 April 14, Upwind-downwind-crosswind sea clutter measurements, Naval Research Laboratory Report 6881.
33. J. D. DeLorenzo, and E. S. Cassedy, 1966 September, A study of the mechanisms of sea surface scattering, IEEE Trans., vol. AP-14, pp. 611-620.
34. P. Beckman, 1965 May, Shadowing of random rough surface, IEEE Trans., vol. AP-13, pp. 384-388.
35. R. A. Brickelman, and T. Hagfors, 1966 September, Note on the effect of shadowing on the backscattering of waves from a random rough surface, IEEE Trans., vol. AP-14, pp. 621-626.
36. A. M. Findlay, 1968 February 12, Seaclutter measurement by radar-return sampling, Naval Research Laboratory Report 6661.
37. S. F. George, 1968 October 04, The detection of nonfluctuating targets in log-normal clutter, Naval Research Laboratory Report 6796.



38. D. D. Crombie, 1951 April, Doppler spectrum of sea echo at 13.56 Mc/s nature, vol. 175, pp. 681-682.
39. J. G. Steele, 1967 May 23, Backscatter of radio waves from progressive and standing waves in the ocean, 1967 URSI Spring Meeting, Ottawa, Canada.
40. R. P. Ingalls, and M. L. Stone, 1957 January, Characteristics of sea clutter at HF, IRE Trans., vol. AP-5, pp. 164-165.
41. W. Marks, 1965, The application of airborne radar backscatter to measurement of the state of the sea, in Oceanography from Oceanographic Institution, Woods Hole, Massachusetts, See also reference 175.
42. B. L. Hicks, N. Knable, J. J. Kovaly, G. S. Newell, J. P. Ruina, and C. W. Sherwin, 1960 March, The spectrum of x-band radiation backscattered from the sea surface, J. Geophys. Res., vol. 65, pp. 825-837.
43. J. Wu, 1967 December, Wind stress and surface roughness at air-sea interface, Hydronautics Inc., Technical Report 231-18.
44. G. Neumann, and W. J. Pierson, Jr., 1966, Principles of physical oceanography, Prentice-Hall, Inc.
45. B. G. Smith, 1967 September, Geometrical shadowing of a random rough surface, IEEE Trans., vol. AP-15, pp. 668-671.
46. F. G. Bass, I. M. Fuks, A. I. Kalmykov, I. E. Ostrovsky, and A. D. Rosenberg, 1968 September, Very high frequency radiowave scattering by a distributed sea surface, IEEE Trans., vol. AP-16, pp. 554-568.
47. M. Katzin, 1955, Back scattering from the sea surface, IRE Convention Record, vol. 3, no. 1, pp. 72-77.
48. F. C. MacDonald, 1957 March 19, Characteristics of radar sea clutter, part I, persistent target-like echoes in sea clutter, Naval Research Laboratory Report NRL 4902.

49. C. Cox and W. Munk, 1954, Measurement of the roughness of the sea surface from photographs of the sun's glitter, J. Opt. Soc. Am. vol. 44, pp. 838-850.
50. G. G. MacFarlane, 1945 February, Sea returns and the detection of Schnorkel, Telecommunications Research Establishment, Report No. T1787.
51. J. M. Fuks, 1966, Contribution to the theory of radio wave-scattering on the perturbed sea surface, Izvestia Vysshikh Uchebnykh Zavedenii Radiofizika, vol. 5, p. 876.
52. G. H. Hagn, 1967, The direct backscatter of high-frequency radio waves from land, sea-water, and ice surfaces, IEEE International Convention Record, vol. 15, pt. 2, p. 150.
53. M. E. Annett, 1952 July, Engineering report on analysis of ASW flight data, Philco Report H-1084, (AD5707).
54. D. E. Barrick, 1968 April 09-12, Radar signal spectrum distortions produced by volume and surface distributed scatterers, 1968 USNC/USRI Spring Meeting, National Academy of Sciences, Washington, D.C.
55. D. K. Barton, 1964, Radar systems analysis, Prentice-Hall, Inc.
56. L. J. Battan, 1959, Radar meteorology, University of Chicago Press.
57. C. I. Beard, I. Katz, and L. M. Spetner, 1965 April, Phenomenological vector model of microwave reflection from the ocean, IRE Trans., vol. AP-4, no. 2.
58. C. I. Bear, I. Katz, 1957 April, The dependence of microwave radio signal spectra on ocean roughness and wave spectra, IRE Trans., vol. AP-5, no. 2, pp. 183-191.
59. C. I. Beard, 1961 September, Coherent and incoherent scattering of microwaves from the ocean, IRE Trans., vol. AP-9, no. 5, pp. 470-483.

60. C. I. Beard, 1966 December, Behavior of non-rayleigh statistics of microwave forward scatter from a random water surface, Boeing Research Laboratory Report DI-82-0587, Seattle, Washington.
61. R. S. Berkowitz, editor, 1965, Modern radar-analysis, evaluation and system design, John Wiley & Sons, Inc.
62. J. G. Boring, E. R. Flint, M. W. Long, and V. R. Widerquist, 1957 August 01, Final report project no. 157-96, sea return study, Georgia Institute of Technology Engineering Experimental Station Report (AS246180).
63. C. O. Britt, et al., 1957 November 08, Back scattering cross-sections at 4.3 millimeter wavelengths of moderate sea surfaces, University Texas Report 95.
64. J. J. Bussgang and D. Middleton, 1965, December, Optimum sequential detection of signals in noise, IRE Trans. IT-1, pp. 5-18.
65. J. J. Bussgang, P. Nesbeda, and H. Safran, 1959 October, A unified analysis of range performance of CW, pulse and pulse doppler radar Proc. IRE, vol. 47, no. 10, pp. 1753-1762.
66. J. P. Campbell, 1958 May, Back-scattering characteristics of land and sea at x-band, Aeronautical Electronics, 1958 National Conference Proc., Dayton, Ohio, pp. 12-14.
67. N. Clark, D. Nielson, G. Hagn, and L. Rorden, 1960 May, An investigation of the backscatter of high frequency radio waves from land, sea water, and ice, Stanford, Research Institute Project 2090.
68. W. T. Cochran, et al., 1967 October, What is the fast fourier transform, Proc. IEEE, vol. 55, no. 10, pp. 1664-1674.
69. J. R. Conlon, 1957 August 29, High resolution radar, part II-sea clutter measurements, Naval Research Laboratory Report NRL-4951, Washington, D.C.

70. C. E. Cook, and M. Bernfeld, 1967 March, Radar signals - an introduction to theory and applications, Academic Press, Inc.
71. J. W. Cooley, and J. W. Tukey, 1965 April, An algorithm for the machine calculation of complex fourier series, Mathematics Computation, vol. 19, pp. 297-301.
72. Charles Cox, 1965 November, The relation of backscattered radiation to wind-stress at the sea surface, International Symposium on Electromagnetic Sensing of Earth Satellites, Miami Beach, Fla.
73. J. Croney, 1966 September, Improved radar visibility of small targets in sea clutter, Radio Electronic Engineer, pp. 135-148 (also A.S.W.E. Lab. Note XRA-65-1, 1965 June 01, Portsmouth, England).
74. G. F. Curry, 1964 May 25, A study of radar clutter in tradex, M.I.T./Lincoln Lab., Group Report 1964-29 (also IRE Trans., vol. MIL 9, no. 1, pp. 39-44, 1965 January).
75. J. C. Daley, 1966 August 17, Sea clutter measurements at x and c band, Naval Research Laboratory Letter Report 5720-18A: JCD.
76. W. B. Davenport, Jr., and W. L. Root, 1958, Introduction to the theory of random signals and noise, McGraw-Hill Book Company.
77. I. D. Demin, 1966 August 08, The effect of sea roughness on radar visibility of small ships, Leningrad-Central Naval Science-Research Institute Navigation Commun., no. 20, issue 79 (translation), Air Force Systems Command/Foreign Technology Division, pp. 56-63 (AD643974).
78. G. Hagn, 1962 May, Investigation of direct backscatter of high frequency radio waves from land, sea water, and ice, Stanford Research Final Report 2, Nonr2917-(00), Menlo Park, California.

79. A. Harrison, 1964 April, Methods of distinguishing sea targets from clutter on a civil marine radar, Radio Electronic Engineer, vol. 27, pp. 261-275.
80. B. L. Hicks, et al., 1958 May, Sea clutter spectrum studies using airborne coherent radar III, Control Sys. Lab./University of Illinois Report R-105.
81. R. M. Hoover and R. J. Urick, 1957 November, Sea clutter in radar and sonar, IRE Convention Record, 1957, pt. 9, p. 17.
82. I. M. Hunter and T. B. A. Senior, 1966 November, Experimental studies of sea-surface effects on low-angle radars, Proc. IEE, vol. 113, no. 11, pp. 1731-1740.
83. C. M. Johnson, S. P. Schlesinger, and J. C. Wiltse, 1956 May, Backscattering characteristics of the sea in the region from 10 to 60 kMc, Johns Hopkins University Radiation Laboratory Technical Report 35.
84. J. J. Kovaly, et al., 1953 June 26, Sea clutter studies using airborne coherent radar, University of Illinois Control Sys. Laboratory Report 37.
85. P. E. Lane and R. L. Robb, 1955 August 19, Sea clutter measurements at s and x band, A.S.R.E. Tech. Note NX 55-6, Portsmouth, Hants, England (AD 302300).
86. R. M. Lhermitte, 1963, November, Motions of scatterers and the variance of the mean intensity of weather radar signals, Sperry Rand, Research Center Program 38310, SRRC-RR-63-57, Atmospheric Physics Department, Sudbury, Massachusetts.
87. M. W. Long, 1966 September, Backscattering of circular polarization, Electron. Letters, vol. 2, p. 341.
88. F. C. MacDonald, 1955, Correlation of radar sea clutter on vertical and horizontal polarizations with wave height and slope, Proc. IRE, vol. 43, no. 14.2,

89. J. W. McGinn, and E. W. Pike, 1960, A study of sea clutter spectra, in Proc. symposium on statistical methods for radio wave propagation held 1958 June 18-20 at UCLA, Pergamon Press, Inc.
90. G. F. Meyers, 1958 October 21, High-resolution radar, part 3, sea clutter analysis, Naval Research Laboratory Report 4952, Washington, D.C.
91. V. W. Pidgeon, 1966 May, Bistatic cross section of the sea, IEEE Trans., vol. AP-14, no. 3, pp. 405-406.
92. V. W. Pidgeon, 1967 May, Bistatic cross section of the sea for a beaufort 5 sea, Space Sys. Planetary Geol. Geophys., American Astronautical Society.
93. V. W. Pidgeon, 1967 May, Time, frequency, and spatial correlation of radar sea return. Space Sys. Planetary Geol. Geophys., American Astronautical Society.
94. V. W. Pidgeon, 1968 February 15, The doppler dependence of radar sea return, J. Geophys. Res..
95. A. W. Ross, D. C. Fakley, and L. R. Palmer, 1950 September 07, Sea-clutter investigations, Admiralty Signal and Radar Establishment, England, R4/50/15.
96. M. I. Skolnik, 1962, Introduction to radar systems, Mc-Graw-Hill Book Company.
97. J. G. Steele, 1965 August, Backscatter of 16 Mc/s radio waves from land and sea, Austral. J. Phys., vol. 18, pp. 317-327 (See also Proc. IEEE, vol. 55, no. 9, pp. 1583-1590, 1967 September).
98. P. Swerling, 1954 March 17, Probability of detection of fluctuating targets, Rand Corporation, RM-1217.

99. P. Swerling, 1966 March, Probability of detection from some additional fluctuating target cases, Aerospace Corp. Report TOR-699 (9990)-14, El Segundo, California.
100. S. L. Valley, editor, 1965 April, Handbook of geophysics and space environments, McGraw-Hill Book Company.
101. R. Voles, 1966 June, Frequency correlation of clutter, Proc. IEEE (Letters), vol. 54, no. 6, pp. 881, 882.
102. A. Wald, 1959, Sequential analysis, John Wiley & Sons, Inc.
103. P. R. Wallace, 1952 September, Interpretation of the fluctuating echo from randomly distributed scatterers, Can. J. Phys., vol. 31, pt. 2, pp. 995-1009.
104. M. I. Skolnik, editor, 1970, Radar handbook, McGraw-Hill Book Company.
105. Anonymous, 1971 September 21-24, Record, 1971 Conference on Engineering in the Ocean Environment, San Diego, California, IEEE Publication 71C 40-C, see also reference 106.
106. R. R. Unterberger, Tides and waves measured by radar, in reference 105, section on monitoring the environment, pp. 341-344.
107. Willard Bascom, 1957 August, Ocean waves, Scientific American, vol. 201, pp. 74-84.
108. H. P. Westman, editor, 1968, Reference data for radio engineers, Howard W. Sams & Co., Inc., subsidiary of ITT Corporation, (5th edition).
109. N. Arthur Pore, 1970 May, Summary of selected reference material on the oceanographic phenomena of tides, storm surges, waves and breakers; Systems Development Laboratory, Weather Bureau, Environmental Science Services Administration, U.S. Department of Commerce, Silver Spring, Maryland, ESSA Technical Memorandum WBTM TDL 30.

110. R. E. Meyers, editor, Waves on beaches; 1972; proceedings of advanced seminar on waves on beaches held 1971 October 11-13 at University of Wisconsin, Madison, Wisconsin, jointly sponsored by University of Wisconsin Mathematics Research Center and U.S. Army Corps of Engineers Coastal Engineering Research Center, Academic Press (in press 1972 Spring). See also reference 111.
111. D. Lee Harris, Characteristics of wave records in the coastal zone; in reference 110.
112. F. A. Barnes, editor, with foreward by Frank J. Gardiner, 1968, Electro-optics handbook, a compendium of useful information and technical data, Commercial Engineering, RCA Corporation, Harrison, New Jersey, Technical Series EOH-10.
113. Henry Jasick, editor, 1961 (1st edition), Antenna engineering handbook, McGraw-Hill Book Company, LC 59-1445.
114. Herbert J. Summers, Harold D. Palmer, and David O. Cook, 1971 September, Some simple devices for the study of wave induced surges, Journal of Sedimentary Petrology, pp. 861-866.
115. H. G. Canmitz and R. R. Rogers, 1965 March 10, Project wave, an experimental and theoretical study of scattering from water waves, Cornell Aeronautical Laboratories, of Cornell University, Buffalo, New York, CAL No. RM-1933-P-1, Final Report for Office of Naval Research under Contract Nonr-4481(00).
116. R. H. Allen and E. L. Spooner, 1968 July, Annotated bibliography of BEB and CERC publications, U.S. Army Coastal Engineering Research Center, Miscellaneous Paper No. MP 1-68.
117. Anonymous, Library accession list, periodical, U.S. Army Corps of Engineers Coastal Engineering Research Center.



118. Norman F. Barber, 1962 September, Detecting sea waves by their diffraction of a radio wave, Woods Hole Oceanographic Institution, Woods Hole, Massachusetts, Reference No. 62-39, Office of Naval Research Contract Nonr-3351(00).
119. W. Stanley Wilson, 1969 August, Field measurements of swell off the island of Aruba, Chesapeake Bay Annex, The Johns Hopkins University, Technical Report 56, Reference 69-9.
120. W. A. Forden, 1970 May 01, Environmental factors influencing radar system design, Given at Symposium on Radar Techniques and Systems, New Delhi, India, reprinted by Equipment Division, Raytheon Company.
121. Fred E. Nathanson, 1969, Radar design principles, signal processing and the environment, McGraw-Hill, LC 79-80973.
122. George T. Ruck, Donald E. Barrick, William D. Stuart, Clarence K. Krichbaum, 1970, Radar cross section handbook, 2 volumes, Plenum Press, LC 68-26774, supported in part by the Advanced Research Projects Agency of the United States Department of Defense.
123. Granino Korn and Theresa M. Korn, 1961, Mathematical handbook for scientists and engineers, 2nd edition, McGraw-Hill, LC 67-16304.
124. August W. Richaczek, 1969, Principles of high resolution radar, McGraw-Hill.
125. Donald R. Rhodes, 1959, Introduction to monopulse, McGraw-Hill, LC 58-11988.
126. R. B. Blackman and J. W. Tukey, 1958, The measurement of power spectra, from the point of view of communications engineering, Dover. Revised version of reference 127.

127. R. B. Blackman and J. W. Tukey, 1958 January (part I) and 1958 March (Part II), The measurement of power spectra, from the point of view of communications engineering, Bell System Technical Journal, vol. 37, see also reference 126.
128. Fr. A. Willers, translated by Robert T. Beyer, 1948, Practical analysis, Dover.
129. Edwin L. Crow, Frances A. Davis, Margaret W. Maxfield, 1960, Statistics manual, Dover, republication of NAVORD Report 3369-NOTS 948.
130. Willard Bascom, 1964, Waves and beaches. The dynamics of the ocean surface, Anchor Books, Doubleday, LC 64-11735.
131. Myron H. Nichols and Lawrence L. Rauch, 1956 (2nd edition), Radio telemetry, Wiley, LC 56-8002.
132. Julian J. Bussgang and Walter L. Mudgett, 1960 September, A note of caution on the square-law approximation to an optimum detector, IRE Transactions on Information Theory, pp. 504-505.
133. Ephraim Weiss, M. Kolker, and C. Mundo, 1970 April, Final report, space geodesy altimetry, verification experiment design study (VEDS), with errata sheet dated 1970 July 24, Raytheon Company, Sudbury, Massachusetts, SR70-4108, under NASA Contract NASW-1920, for NASA Code RED-IDB-12SS, Wallops Station, Wallops Island, Va. H. R. Stanley, technical monitor. See also reference 135.
134. E. Genest, M. Kolker, and C. Mundo, 1970 May, Final report, space geodesy aircraft experiment, Raytheon Company, Sudbury, Massachusetts, under NASA Contract NASW 1932 for NASA Code RED-IDP-RSS, Wallops Station, Wallops Island, Va. (A. Selser, technical monitor)
135. B. Kinsman, Ocean surface conditions (Ocean truth), in reference 133, appendix 0, pp. 0-1 to 0-46.

136. Peter C. Fritsch, guest editor, 1965 August, Special issue on radar reflectivity, published as Proceedings of the IEEE, vol. 53, no. 6. Includes preface by Fritsch, 29 papers (including reference 137 below), and 34 short papers.
137. Henry A. Corriher, Jr. and Berry O. Pyron, 1957-1964, A bibliography of articles on radar reflectivity and related subjects, in reference 136, pp. 1025-1064, topically classified bibliography of 1420 references, to contributions by over 1225 authors, from over 275 journals or other open literature sources, with alphabetical author index.
138. (Various authors), A series of comprehensive collections of abstracts and references bearing the title, A bibliography of radar reflection characteristics, have been compiled by Georgia Tech and issued in six volumes, three in 1952 and three in 1958. Volume I-VI are available from the Defense Documentation Center as documents AD-13 211, AD-3 414, AD-8 866, AD-210 185, AD-301 851, and AD-304 852, respectively. A related "textbook" issued in 1952 is available as AD-60 221 and AD-54 294.
139. (Various authorship), 1960 November-December, Report of the United States of America National Committee to the XIII General Assembly of the International Scientific Radio Union, London, England, September 5 to 15, 1960, J. Res., NBS, vol. 64D, No. 6, pp. 591-767.
140. (Various authorship), 1964 April, The U.S. National Committee Report for Commission 6 of URSI, Subcommission 6.3, Electromagnetic, J. Res. NBS, vol. 68D, pp. 435-517.
141. D. Atlas, 1960 June, Radar detection of the sea breeze, J. Meteorol., Vol. 17, No. 3, pp. 244-258.

142. E. Eastwood and G. C. Rider, 1961 March, A radar observation of a sea-breeze front, *Nature (GB)*, vol. 189, no. 4769, pp. 978-980.
143. (Various authors), 1964 September 14-18, Proceedings of the World Conference on Radio Meteorology (incorporating the 11th Weather Radar Conference), Boulder, Colorado. See also references 144-145, 147.
144. S. G. Geotis, On sea breeze angels, in reference 143.
145. D. R. Hay, Radar and refractometer investigation of clear-air stratification, in reference 143.
146. M. G. H. Ligda and S. G. Bigler, 1958 December, Radar echoes from a cloudless cold front, *J. Meteorol.* Vol. 15, no. 6, pp. 494-501.
147. H. V. Senn and H. P. Gerrish, Three dimensional analysis of a precipitation-free, sea-breeze front by radar, *Tiros, Visual and Mesosynoptic Data*, in reference 143.
148. E. C. Jordan, editor, *Proceedings of the Symposium on Electromagnetic Theory and Antennas*, Copenhagen Denmark, 1962 June 25-30, sponsored by URSI, the Technical University of Denmark, the Danish Academy of Technical Sciences, and the Danish National Committee of URSI. Published as: *Electromagnetic Theory and Antennas*, edited by E. C. Jordon, Pergamon Press, Oxford (1963). see also reference 149.
149. L. Boithias, A. Spizzichino, and C. Taieb, Study of reflections from the sea by means of a goniometer, in reference 148.
150. J. Brauns and H. G. Mokler, 1961 May, Interference in radar equipment by reflections from sea movements, *Hochfrequenstech. u. Elect-Akust. (Germany)*, vol. 70 no. 2, pp. 39-46.
151. C. S. Durst, 1958 April, The sea surface and doppler, *J. Inst. Navig. (England)*, vol. 11, no. 2, pp. 143-45.

152. A. Haubert, 1958 July-September, Radio echoes observed on sea swell at the Casablanca Ionospheric Sounding Station, Ann. Geophys. (France), vol. 14, no. 3, pp. 368-72.
153. E. Sofaer, 1958 July, Phase-coherent back-scatter of radio waves at the surface of the sea, Proc. Instn. Elect. Engrs (England), vol. 105, no. 22, pt. B, pp. 383-84.
154. I. Katz, 1963 July, Radar reflectivity of the ocean surface for circular polarization, IEE Trans. On Antennas and Propagation, vol. AP-11, pp. 451-53.
155. V. I. Mikhaylov, 1960, On a theory of the scattering of electromagnetic waves on the surface of the sea, Akad. Nauk SSSR, Izvestiia, Ser. Geofiz., no. 8, pp. 1229-33 (CC Trans).
156. J. K. Parks, 1964 September, Toward a simple mathematical model for microwave backscatter from the sea surface at near-vertical incidence, IEEE Trans. on Antennas and Propagation, vol. AP-12, pp. 590-605.
157. N. Ye. Ter-Markaryants, 1957, Reflection of radiation by the sea in the presence of waves, Gldvnaya Geofiz. Obs. Leningrad. Trudy (USSR), no. 68, pp. 166-71 (Trans: OTS PB 141228T)
158. N. Ye. Ter-Markaryants, 1957, Reverse scattering of radiation by the sea, Glavnaya Geofiz. Obs. Leningrad. Trudy (USSR), no. 68, pp. 178-80 (Trans: OTS PB 141228T).
159. R. P. Chapman and H. D. Scott, 1964 September, Surface back-scattering strengths measured over an extended range of frequencies and grazing angles, J. Acoust. Soc. Amer., vol. 36, no. 9, pp. 1735-37.
160. G. R. Garrison, S. R. Murphy, and D. S. Potter, 1960 January, Measurements of the backscattering of Underwater Sound from the sea surface, J. Acoust., Soc. Amer., vol. 32, no. 1, pp. 104-11.

161. V. L. Herman, 1958, The phase structure of the field and velocity of medium range radiowave distribution over the sea surface during turbulence, Ukrayin. Fiz. Zh. (USSR), vol. 3, no. 6, pp. 712-20.
162. T. Marukawa, 1962 April, Effective reflection coefficient and propagation of radar waves on sea surface in 3.2 cm wave-length, Mem. Defense Acad. (Japan), vol. 2, no. 2, pp. 75-88.
163. T. Marukawa, 1962 August, Surface roughness and effective reflection coefficients of the sea in 9 Gc/s-band wave propagation, J. Inst. Elect. Commun. Engrs. Japan, vol. 45, no. 8, pp. 1071-75.
164. T. Marukawa, 1962 November, Experimental research on circularly polarized wave propagation over sea surface in 3.2 cm wave-length, Mem. Defense Acad. (Japan), vol. 2, no. 3, pp. 1-7.
165. R. McFee and T. M. Maher, 1959 April, Effect of surface reflections on rain cancellation of circularly polarized radars, IRE Trans. on Antennas and Propagation, vol. AP-7, pp. 199-201.
166. A. V. Men', S. Ya. Braude, and V. I. Gorbach, 1959 April, Fluctuations of phase-fronts in the propagation of ten-centimetre radio-waves over the sea-surface, Dokl. Akad. Nauk SSSR, vol. 125, no. 5, pp. 1019-22.
167. S. Ya. Braude, 1958, On the distribution of scattering elements during the propagation of radio waves over a rough sea surface, Izvestiya Vysshikh Uchebnykh Zavedeniy. Radiofizika (USSR), vol. 1, no. 3, pp. 25-29 (Trans: LC or SLA 59-20659; OTS 59-13545)
168. S. Ya. Braude and F. G. Bass, 1953, On the possibility of determining the function of distribution of scattering elements on a rough sea surface by radar methods, Izvestiya Vysshikh Uchebnykh Zavedeniy. Radiofizika (USSR), vol. 1, no. 3, pp. 161-62 (Trans: LC or SLA 59-20689; OTS 59-13547)

169. S. Ya. Braude, N. N. Komarov, and I. E. Ostrovskii, 1958, On the statistical character of the scattering of centimeter waves by an agitated sea-surface, Radiotekhnika i Elektronika, vol. 3, no. 2, pp. 172-79. (CC Trans)
170. R. C. Staley, 1958, Some problems in modelling water waves for the study of backscattering of microwave radio energy, Deutsche Hydrographische Z. (Germany), vol. 11, no. 6, pp. 255-58.
171. M. Kerker, editor, 1963, Proceedings of the interdisciplinary conference on electromagnetic scattering, Potsdam, New York, August 1962. Published as: Electromagnetic scattering, Pergamon, Press.
172. (Various authors), Proceedings of the Conference on Lasers and their Applications, London, England, September 29-October 1, 1964, sponsored by Institution of Electrical Engineers.
173. (Various authors), 1968 October, Space geodesy altimetry study, Raytheon Company Final Report, R-68-4459.
174. Denzil Stilwell, Jr., 1969 April, Directional energy spectra of the sea from photographs, Journal of Geophysical Research, vol. 74, no. 8, p. 1974.
175. G. C. Ewing, editor, 1965, Oceanography from space, Woods Hole Oceanographic Institution, reference no. 65-10. See also references, 41, 182, 186a.
176. I. Katz, 1964 September-October, Ocean wave measurements, APL Technical Digest.
177. L. F. Bailey, 1966, The use of historical Tsunami wave height data in forecasting runup, ESSA Symp. on Earthquake Prediction, U.S. Government Printing Office.
178. B. B. Baker, et al., 1966, Glossary of oceanographic terms, U.S. Naval Oceanographic Office Special Publication SP-35.

179. D. K. Barton and H. R. Ward, 1969, Handbook of radar measurement, Prentice-Hall.
180. J. A. Ewing, 1969, A note on wavelength and period in confused seas, J. Geophys. Res. 74, pp. 1406-1408.
181. Deleted
182. I. Katz, 1965, Radar backscatter from the sea, in oceanography from space, WHOI, p. 367. See also reference 175.
183. M. S. Longuet-Higgins, 1957, The statistical analysis of a random, moving surface, Phil Trans Ray Soc, London A 249 (1957), p. 321.
184. R. L. Miller, and J. S. Kohn, 1962, Statistical analysis in the geological sciences, Wiley.
185. E. C. Monahan, 1968, Sea spray as a function of low elevation wind speed, J. Geophys Res., vol. 73, pp. 1127-1137.
- 186a. R. K. Moore, 1965, Satellite radar and oceanography, an introduction in oceanography from space, WHOI, Ref. no. 65-10. See also reference 175.
- 186b. L. I. Moskowitz, 1967, Evaluation of spectral wave hindcasts using the automated wave prediction program of the naval oceanographic office, U.S. Naval Oceanographic Office.
187. W. H. Munk, 1966, Low-frequency tail of wave spectra, 6th Naval Hydrodynamics Symposium.
188. J. J. Myers, C. H. Holm and R. F. McAllister, 1969, Handbook of ocean and underwater engineering, McGraw-Hill, p. 1100.
189. W. J. Pierson, 1954, An interpretation of the observable properties of sea waves in terms of energy spectrum of a Gaussian record, Trans Amer Geophys Union, 35, 747.
190. W. J. Pierson and L. Moskowitz, 1964, A proposed spectral form for fully developed wind seas based on the similarity theory of Kitaigorodskii, J. Geophys. Res. 69, 5181.



191. J. W. Rouse, et al., 1966, Use of orbital radars for geoscience investigations, Proc. Third Space Congress, pp. 77-94.
192. O. D. Waters, 1967, Ocean science program of U.S. Navy.
193. Anonymous, 1967, WDC catalogue of data-oceanography, World Data Center A.
194. G. F. Williams, 1969, Microwave radiometry of the ocean and the possibility of marine wind velocity determination from satellite observations, Journal of Geophys. Res. vol. 18, pp. 4591-4594.
195. P. M. Wolff, et al., 1967, Synoptic analyses and prediction of conditions and process in the surface layers of the sea, Fleet Numerical Weather Facility, Monterey.
196. J. Wu, 1969, Wind stress and surface roughness at air-sea interface, J. Geophys. Res. 74, pp. 444-445. See also reference 43.
197. B. D. Xetler, 1967, Tides and other long period waves, Trans Amer Geophys Un, 48, pp. 591-595.
198. B. Bean, and E. Dutton, 1966, Radio meteorology, National Bureau of Standards Monograph 92, p. 337, 2, 339.
199. Anonymous, 1961, Handbook of geophysics, United States Air Force, Air Research and Development Command, Air Research Division, Geophysics Research Directorate, The MacMillian Company, New York, pp. 3-2, 3-3.
200. F. Berry, E. Bolay, and N. Beers, editors, Handbook of meteorology, McGraw-Hill Book Company, pp. 989-992.
201. M. Kolker and E. Weiss, 1969, Space geodesy altimetry study, NASA CR-1298, Raytheon Company, Sudbury, Massachusetts.
202. A. Defant, 1961, Physical oceanography, vol. 1, Pergamon Press.
203. H. Sverdrup, M. Johnson, and R. Fleming, 1942, The oceans, Prentice-Hall, Inc.

204. H. Bigelow and D. Edmundson, 1962, Wind waves at sea, breakers and surf, Publication No. 602, U. S. Navy Hydrographic Office, Washington, D.C.
205. H. V. Sverdrup and W. H. Munk, 1947, Wind, sea, and swell: theory of relations for forecasting, U.S. Hydrographic Office, Department of the Navy, Hydrographic Office Publication No. 601.
206. Anonymous, 1951, Techniques for forecasting wind, waves and swell, U.S. Hydrographic Office, Department of the Navy Hydrographic Office Publication No. 604.
207. G. F. Meyers, 1971 February 01, Wave height measurement by radar, U.S. Naval Research Laboratory, NRL Report 7231.
208. W. J. Pierson, Jr., G. Neuman, and R. W. James, 1955 (and subsequent republishing), Practical methods for observing and forecasting ocean waves by means of wave spectra and statistics, U.S. Hydrographic Office, Department of the Navy, Hydrographic Office Publication No. 603.
209. E. U. Condon and Hugh Odishaw, 1958, Handbook of physics, McGraw-Hill Book Company.
210. Gerard V. Trunk, 1972 March, Radar properties of non-Rayleigh sea clutter, IEEE Trans. on Aerospace and Electronic Systems, vol. AES-8, no. 2, pp. 196-204.
211. G. R. Valenzuela, 1970 January, Study of doppler spectra of radar sea echoes, J. Geophys, Res., vol. 75, pp. 551-563.
212. N. W. Guinard and J. C. Daley, 1970 April, An experimental study of a sea clutter model, Proc. IEEE, vol. 58, pp. 543-550.
213. Gerard V. Trunk and S. F. George, 1970 September, Detection of targets in non-Gaussian sea clutter, IEEE Trans. Aerospace and Electronic Systems, vol. AES-6, pp. 620-628.

214. Gerard V. Trunk, 1971 May, Further results on the detection of targets in non-Gaussian sea clutter, IEEE Trans. Aerospace and Electronic Systems, vol. AES-7, pp. 553-556.
215. J. C. Daley, W. T. Davis, and N. R. Mills, 1970 September, Radar sea return in high sea states, U.S. Naval Research Laboratory, NRL Report 7142.
216. N. W. Guinard, 1969 May, The four-frequency radar systems, U.S. Naval Research Laboratory, NRL Progress Report.
217. D. D. Crombie, 1971, Backscattering of HF radio waves from the sea, in reference 218.
218. J. R. Wait, editor, Electromagnetic probing in Geophysics, Golem Press. See also reference 217.
219. G. E. McVehil, R. L. Peace, Jr., and Roland J. Pilie, 1965. January 30, Project lake effect, a study of interactions between the Great Lakes and the atmosphere, Cornell Aeronautical Laboratories, CAL Report No. VC-1967-P-1, Report No. 1 for period 1964 July 01 to 1965 January 01, Contract No. DA-28-043-AMC-00306(E) for U.S. Army Electronics Laboratories, Fort Monmouth, New Jersey.
220. Anonymous, 1963 June 25, A proposal for an investigation of the applicability of doppler radar to the measurement of the directional properties of water waves, Cornell Aeronautical Laboratories, CAL Proposal No. 229, for U.S. Army Corps of Engineers Beach Erosion Board.
221. W. Stanley Wilson, 1969 August, Field measurement of swell off the island of Aruba, Chesapeake Bay Annex, The Johns Hopkins University, Report 56 "Reference 69-6".

222. David O. Cook, 1969 December, Sand transport by shoaling waves, Department of Geological Sciences, University of Southern California, Report Number USC Geology 70-2, Technical Report for Office of Naval Research, Contract NR 083-144. (Also published in a related version as a doctoral thesis.)
223. Anonymous, 1972 March 08 (solicitation date), Solicitation number DAAD05-72-R-0081 ("provide radar backscatter data from water and selected targets..."), U.S. Army Aberdeen Proving Ground, Maryland, announcement in Commerce Business Daily, 1972 March 09, page 5, column 3.
224. Chester C. Slama, 1962 May, Operational test of an airborne profile recorder system, U.S. Army Map Service, Washington, D.C.
225. Anonymous, 1960 September/October, Airborne profile recorder system, U.S. Army Map Service, in The Military Engineer, volume 52, no. 349, pp. 408-409.
226. Anonymous, 1960 July, Calibration of radar antenna and positioning camera axes of the airborne profile recorder system, U.S. Army Map Service, Washington, D.C.
227. I. S. Nikitin, translated by Valys Zilius, 1957, The radar method of studying sea currents (radiolokatsionnyi metod izucheniia morskikh techenii), Meteorologiya i Gidrologiya, no. 4, pp. 47-50, translated 1960 May, American Meteorological Society.
228. H. M. Oudshoorn, 1960 August, The use of radar in hydrodynamic surveying, Proc. of the 7th Conf. on Coastal Engineering, The Hague, Netherlands, vol. 1, pp. 59-76.
229. Anonymous, 1944 May, Preliminary instruction manual, weather forecasting for radar operations, Weather Division, Headquarters Army Air Force, Report No. 614.

230. C. M. Morrow, 1964, Ocean wave profiling radar system, U.S. Naval Research Laboratory, NRL Report 6052.
231. A. M. King, C. M. Morrow, C. G. Myers, and C. L. Moody, 1968, Scintillation range noise and related phenomena in water wave profiling with microwave radar, U.S. Naval Research Laboratory, Memorandum Report 6641.
232. G. F. Andrews, and H. W. Hiser, 1969, Radar sea state analyzer, period 1968 May 15 to 1969 August 15, Rosenstiel School of Marine and Atmospheric Sciences, University of Miami, ML 70012, AD 702 469.
233. J. Darbyshire, 1970 October, Wave measurement with a radar altimeter over the Irish Sea, Deep-Sea Research, vol. 17, no. 5, pp. 893-901.
234. V. V. Dremlyug, 1969, Methods and instruments, use of ship's radar for the determination of wave parameters, Oceanology, vol. 9, no. 4, pp. 575-578.
235. V. V. Vinogradov and N. N. Lazarenko, 1969 February, Some results of the use of the doppler effect for remote sensing of sea waves, Oceanology, vol. 9, no. 3, pp. 414-421.
236. John W. Rouse, Jr., 1970, Wavelength dependence of backscattering from rough surface, Remote Sensing Center, Texas A&M University, Technical Report RSC-12.
237. Thomas R. Mee, Jr., 1963, Project sea surface, an investigation of the dynamics of water waves, Cornell Aeronautical Laboratory, Inc., CAL Report RG-1623-P-1.
238. Carl M. Bennet and Edward P. Pittman, 1965 February, A data processing system for multiple time series analysis of ocean-wave-induced bottom pressure fluctuations, U.S. Navy Mine Defense Laboratory, Panama City, Florida, Report No. 241.

239. L. B. Ross, Jr., D. A. Planquin and R. J. Sheil, 1967 May 01 to 03, Observing ocean surface waves with a helium neon laser, at 5th U.S. Naval Symposium of Military Oceanography.
240. Mary D. Cermak, 1969 October, Time variation of the rough sea surface and its effects on an incident laser beam, IEEE Trans. Geophysical Electronics, vol. 7, no. 4, pp. 235-243.
241. Duncan D. Ross, Vincent J. Cardone, and Jack W. Conway, Jr., 1970 October, Laser and microwave observations of sea surface conditions for fetch-limited 12 to 25-m/s winds, IEEE Trans. Geophysics Electronics, vol. 8, no. 4, pp. 326-336.
242. Calvin C. Teague, 1971 October, Bistatic-radar techniques for observing long-wavelength directional ocean-wave spectra, IEEE Trans. Geoscience Electronics, vol. 9, no. 4, pp. 211-215.
243. Anonymous, 1972 January 24 (request date), Wave direction radars, a report bibliography, U.S. Defense Documentation Center, Search Control No. 076124.
244. R. S. Kasevich, C. H. Tang and S. W. Henriksen, 1971 August 25-27, Analysis and optical processing of sea photographs for energy spectra, at 3rd International Geoscience Electronics Symposium, Washington, D.C.
245. George F. Andrews, 1970 November 17 to 20, Spectrum analysis of radar and radar sea return, at 14th Radar Meter Meteorology Conference, Tucson, Arizona.
246. Herbert P. Raabe, 1965 June 15, Airborne radar with sea clutter suppression, U.S. Patent 3,189,900.
247. John J. Schule, Jr., Lloyd Simpson, and P. S. Deteonibus, 1971 June 20, A study of fetch limited wave spectra with an airborne laser, J. of Geophysical Research, vol. 76, no. 18, pp. 4160-4171.

248. R. Robson, 1955 August and September (2 parts), Radar methods in ocean current detection, Civil Engineering & Public Works Review, Melbourne and Metropolitan Board of Works, Melbourne, Victoria, Australia, part 1, 1955 August, pp. 880-883, part 2, 1955 September, pp. 1000-1001.

10.3 Alphabetical Author Index

Alphabetical index of last names cited in numbered references in 10.2; different persons with same last name not distinguished in this list.



Abeling - 8  
Allen - 116  
Ament - 22  
Andrews - 232, 245  
Annett - 53  
(Anonymous, including unspecified and "et al.") - 63, 68, 80, 84, 105  
117, 138, 139, 140, 143, 172, 173, 178, 191, 193, 195, 199, 206,  
220, 223, 225, 226, 229, 243  
Atlas - 141  
Attwood - 25  
Bailey - 177  
Baker - 1, 178  
Barber - 118  
Barnes - 112  
Barrick - 54, 122  
Barton - 55, 179  
Bascom - 107, 130  
Bass - 46, 168  
Battan - 56  
Bean - 198  
Beard - 57, 58, 59, 60  
Beckmann - 6, 34  
Beers - 200  
Bennet - 238  
Berkowitz - 61  
Berry - 200  
Bernfeld - 70  
Beyer - 128  
Bigelow - 204  
Bigler - 140

Blackman - 126, 127  
Boithias - 149  
Bolay - 200  
Boring - 62  
Braude - 166, 167, 168, 169  
Brauns - 150  
Britt - 63  
Brockelman - 35  
Burkett - 19, 22, 32  
Burrows - 25  
Bussgang - 64, 65, 132  
Campbell - 66  
Cannitz - 115  
Cardone - 241  
Cassedy - 33  
Cermak - 240  
Chapman - 159  
Clark - 67  
Cochran - 68  
Condon - 209  
Conlon - 69  
Conway - 241  
Cook - 70, 114, 222  
Cooley - 71  
Corriher - 137  
Cox - 49, 72  
Crombie - 38, 217  
Croney - 73  
Crow - 129  
Curry - 74

Daley - 19, 32, 75, 212, 215

Darbyshire - 233

Davenport - 76

Davies - 29

Davis - 129, 215

Deebel - 1

Defant - 202

(Deleted) - 181

DeLorenzo - 33

Demin - 77

Deteonibus - 247

Dremlyug - 234

Duncan - 19, 32

Durst - 151

Dutton - 198

Eastwood - 142

Edmundson - 204

Edwards - 8

Ewing - 175, 180

Fairbridge - 5

Fakley - 95

Findlay - 36

Fleming - 203

Flint - 62

Forde - 120

Fritsch - 136

Fuks - 46, 51

Gardner - 112

Garrison - 160

Geisenderfer - 1

Genest - 134  
George - 37, 213  
Geotis - 144  
Gerrish - 147  
Goldstein - 7, 13, 18  
Gorbach - 166  
Grant - 9  
Guinard - 212, 216  
Hagfors - 35  
Hagn - 52, 67, 78  
Harris - 111  
Harrison - 79  
Haubert - 152  
Hay - 145  
Henriksen - 244  
Herman - 161  
Hicks - 42, 80  
Hiser - 232  
Hogben - 3  
Holm - 188  
Hoover - 81  
Hunter - 82  
Ingalls - 40  
James - 11, 208  
Jasick - 113  
Jelalian - 21  
Johnson - 20, 83, 203  
Jordan - 148  
Kalmykov - 46  
Kasevich - 244

Katz - 57, 58, 154, 176, 182  
Katzin - 24, 47  
Kerker - 171  
Kerr - 13  
King - 23, 231  
Kinsman - 2, 135  
Knable - 42  
Kohn - 184  
Kolker - 133, 134, 201  
Komarov - 169  
Korn - 123  
Kovaly - 42, 84  
Krichbaum - 122  
Lane - 85  
Lazarenko - 235  
Lhermitte - 86  
Ligda - 146  
Long - 8, 30, 31, 62, 87  
Longuet-Higgins - 183  
Lumb - 3  
MacDonald - 10, 16, 22, 48, 88  
MacFarlane - 29, 50  
Maher - 165  
Marks - 41  
Marukawa - 162, 163, 164  
Maxfield - 129  
McAllister - 188  
McFee - 165  
McGinn - 89  
McLellan - 4

McVehil - 129  
Mee - 237  
Men' - 166  
Meyers - 15, 90, 110, 207  
Middleton - 64  
Mikhaylov - 155  
Miller - 184  
Mills - 215  
Moody - 23, 231  
Mokler - 150  
Mohahan - 185  
Moore - 186a  
Morrow - 23, 230, 231  
Moskowitz - 186b, 190  
Mudgett - 132  
Mundo - 133, 134  
Munk - 49, 187, 205  
Murphy - 160  
Myers - 23, 188, 231  
Nathanson - 121  
Nesbeda - 65  
Neumann - 11, 44, 208  
Newell - 42  
Nichols - 131  
Nielson - 67  
Nitkin - 227  
Odishaw - 209  
Ostrovskii (See also transliteration "Ostrobsky") - 169  
Ostrovsky (See also transliteration "Ostrovskii") - 46  
Oudshoorn - 228

Palmer - 95, 114  
Parks - 156  
Peace - 219  
Pidgeon - 91, 92, 93, 94  
Pierson - 11, 44, 189, 190, 208  
Pilie - 219  
Pike - 89  
Pittman - 238  
Planguin - 239  
Pore - 109  
Potter - 160  
Povejsil - 17  
Pyron - 137  
Raabe - 246  
Ransome - 19, 32  
Rauch - 131  
Raven - 17  
Rhodes - 125  
Rider - 142  
Rihaczek - 124  
Ringwalt - 22  
Ribb - 85  
Robson - 248  
Rogers - 115  
Root - 76  
Rorden - 67  
Rosenberg - 46  
Ross - 95, 239, 249  
Rouse - 191, 236  
Ruck - 122

Ruina - 42  
Safran - 65  
Schleisinger - 20, 83  
Schooley - 14, 27  
Schule - 247  
Scott - 159  
Selser - 134  
Senior - 82  
Senn - 147  
Sherwin - 42  
Shiel - 239  
Simpson - 247  
Skolnik - 96, 104  
Slama - 244  
Smith - 45  
Sofaer - 153  
Spizzichino - 6, 149  
Spetner - 57  
Spooner - 116  
Staley - 170  
Steele - 39, 97  
Stilwell - 174  
Stone - 40  
Stuart - 122  
Summers - 114  
Sverdrup - 203, 205  
Swerling - 98, 99  
Taled - 149  
Tang - 244  
Teague - 242



Ter-Markaryants - 157, 158  
Trunk - 210, 213, 214  
Tukey - 71, 126, 127  
Unterberger - 106  
Urick - 81  
Urkowitz - 28  
Valenzuela - 211  
Valley - 100  
Vinogradov - 235  
Volles - 101  
Wait - 218  
Wald - 102  
Wallace - 103  
Ward - 179  
Waterman - 17  
Waters - 192  
Weiss - 133, 201  
Westman - 108  
Wetherington - 8  
Widerquist - 62  
Willers - 128  
Williams - 194  
Wilson - 119, 221  
Wiltse - 20, 83  
Wolff - 195  
Wright - 12, 26  
Wu - 43, 196  
Xetler - 197  
Yaplee - 9  
Zilius - 227

## APPENDIX 1 - SEA ECHO

The material in this appendix treats two related topics: (1) the effect of grazing angle on backscattered radar signals, and (2) the general mechanism of backscattering from the sea. The treatment here closely follows Skolnik<sup>104</sup>. Reference numbers and Figure numbers used here refer to the same-numbered References and Figures in the main text, principally in Section 6.

### Grazing Angle

Figure 2 depicts how  $\sigma^0$  typically varies as a function of the grazing angle\*. Three distinct regions can be identified. In the quasi-specular region near vertical incidence the radar echo is fairly large. Measured values of a  $\sigma^0$  at  $90^\circ$  often lie between 0 and +10 dB. The large echo at vertical incidence is called the altitude return and is apparently due to specular scatter from facet-like surfaces oriented in the direction of the radar. (Altitude return is of importance in designing radars that operate over water since the echo at vertical incidence can be large enough to allow energy to enter the radar via the antenna sidelobes and interfere even when the main beam is pointing at some angle at which the sea echo is low.)

Water waves cannot achieve too large a slope without breaking and becoming spray and droplets. Thus, below some grazing angle there will be little likelihood of significant specular return from the facets constituting the surface of the sea. The maximum included angle at the crest can be no less than  $120^\circ$ , where the minimum grazing angle for quasi-specular reflection is  $60^\circ$ . The pla-

---

\*The term grazing angle is more commonly used than incidence angle. Grazing angle is measured from the horizontal, incidence angle from the vertical. The depression angle is also measured from the horizontal but at the radar antenna rather than where the radar beam intersects the surface.

teau region is the name given to that part of Figure 8 where the grazing angles are below those producing quasi-specular reflection from facets. Sometimes this is called the diffuse region. The boundary between the plateau region and the quasi-specular region is called the transition angle. The transition is a gradual one, and it is difficult to define a precise boundary. The value of  $\sigma^0$  in the plateau region for vertical polarization decreases slightly with decreasing angle; some experiments show a decrease of about 0.15 dB/deg at microwave frequencies. With horizontal polarization, the slope of the  $\sigma^0$  curve seems to be greater the lower the frequency. Backscatter from the sea in the plateau region is similar to backscatter from a rough surface. The chief scatters are those elements of the sea that are of a dimension comparable to a radar wavelength.

At very low grazing angles, of the order of several degrees or less for microwave frequencies,  $\sigma^0$  decreases rapidly with decreasing angle. In this region the direct wave interferes with the wave reflected from the surface in a manner similar to that experienced for propagation over a smooth earth; hence the name interference region. The approximate angle at which transition occurs between the plateau and interference regions is called the critical angle. The critical angle is generally easier to identify experimentally than the transition angle. With sufficiently low frequency the critical angle may be high enough so that neither a critical angle nor a transition angle can be readily identified. Below the critical angle, simple theory indicates that  $\sigma^0$  varies as the fourth power of the grazing angle. The critical angle is difficult to determine precisely but is found to depend on the frequency, polarization, and sea state.<sup>8</sup>

The echo at low grazing angles with vertical polarization is also affected by the Brewster angle.\* At the Brewster angle the reflection coefficient is a minimum, the forward scattered wave is small, and interference effects are less prominent. Also, at low angles, shadowing of the area behind the waves can modify the nature of the echo.

Measurements of  $\sigma^0$  as a function of angle have been carried out in at least three different ways. The most convenient is from land looking over the water. Grazing angles at microwave frequencies are then usually limited to less than  $10^\circ$ . In such experiments care must be taken to select sites that observe sufficiently deep water so that the effect of the shore does not enter into the measurements. Sea-echo measurements have also been made from bridges overlooking water. Higher grazing angles can be obtained but bridge sites generally do not overlook water typical of ocean conditions. A third method for sea-echo measurements is an aircraft-mounted radar. Higher angles of elevation can be obtained from aircraft than from a land site. Aircraft have the further advantage that they can observe sufficiently far from land and can cover a wide region of the ocean. However, it is more difficult to know the environmental conditions and precise character of the sea from an aircraft and to make an accurate, absolute calibration of the measurement apparatus. Blimps also have been used as airborne radar platforms for sea-echo measurement.

---

\*According to Burrows and Attwood<sup>25</sup>, this should be called the pseudo-Brewster angle for the case of the sea. The classical Brewster angle is observed only for reflections from pure dielectrics. However, much of the literature on radar sea echo, including this chapter, fails to make this distinction.

Figure 7 shows a composite of data derived from the results of several experiments, chiefly from those conducted over the years by the Naval Research Laboratory. It does not correspond to any particular set of experimental data but it represents the trends. As mentioned previously, the variability of experimental sea-echo data is great and does not warrant the preciseness with which Figure 7 is apparently drawn. Instead of a thin line to depict the data, a broad strip at least  $\pm 3$  dB in width should be drawn to indicate uncertainty. (This was not done in this figure since it would have resulted in a confused drawing because of the overlap among the bands  $\pm 3$  dB in width). Figure 7 was derived from a variety of data extending from 10- to 20-knot wind speeds. Although this is a relatively broad range of wind and sea state, the variability of the available data does not permit narrower limiting of these parameters at the time of writing.

The sea state ranges from 2 to 4 for winds ranging from about 10 to 20 knots. Thus Figure 7 data might be described as a medium sea and might correspond to a state 3 sea. Figure 7 also indicates the frequency and polarization dependence. The data for 220 MHz<sup>22</sup> (1.36 m) extended only to  $14^\circ$  but were extrapolated to higher angles. The experimental data for 50 MHz<sup>2,3</sup> (6 m) did not extend to low angles but, since this is in the interference region, the curve was extrapolated according to a  $\phi^4$  law. Both the 220 MHz (1.36 m) and the 50 MHz (6 m) data were taken at a lower sea state than the higher-frequency data.

Above about  $10^\circ$  the data for vertical polarization appear the same at both X and L bands. There is some indication that the sea echo with vertically polarized radiation is independent of frequency in the plateau region and the quasi-specular region if

the frequency is below X band.<sup>19</sup> Above X band the vertically polarized echo seems to increase with frequency, as indicated by the data of Grant and Yaplee<sup>9</sup>. In the quasi-specular region, sea echo appears independent of both the frequency (at least at X band and below) and the polarization.

#### General Mechanisms

Understanding the physical mechanism causing radar sea echos permits design of radars for the detection of targets on or near the surface of the sea and the principles involved also apply to the measurement of wave direction. If the precise physical nature of the sea were known, classical theory could be used to compute the nature of the radar echo. It has proved difficult, however, to provide a realistic model of the sea that can account mathematically for all observed experimental data. There are several reasons for this situation. The sea is an everchanging target affected by many forces. However, the dynamic nature of the sea should not in itself prove a fundamental limitation since statistical methods might be applied, as in dealing with receiver noise or fluctuating target echoes.

To understand the sea as a radar target, one must understand something about the hydrodynamics of the sea surface and the nature of the coupling between the sea and the wind. The theorist must have a knowledge of electromagnetic scattering theory and the theory of ocean surface waves. The problem is made difficult by the fact that the oceanographers who study waves on the sea are generally interested in water wavelengths considerably longer than those that affect radar, but radar scatter is primarily determined by the water waves of wavelength comparable to the radar wavelength.

Figure 8 showed the three regions into which the grazing angle is divided: the interference plateau, and quasi-specular

regions. Although the goal is to identify a single mechanism that correctly describes the radar backscatter for any grazing angle, it has usually been found easier to consider models applicable to each region separately. For microwave frequencies observed in the quasi-specular region, scattering can be explained as being due to facets large compared with the radar wavelength. In the plateau region the scatterers are the facets or capillary waves that are comparable in size to the radar wavelength. In the interference region the vector addition of the direct ray and the ray scattered from the water surface plays the dominant role.

Schooley<sup>27</sup> examined limiting cases of the radar sea return. One limiting case is a perfectly smooth surface of perfect conductivity. (The clutter coefficient  $\sigma^0$  at normal incidence over a smooth surface is equal to one-fourth the gain of the radar antenna.) The decrease in  $\sigma^0$  with angle from the normal is fairly rapid. A perfect Lambertian surface produces a clutter coefficient  $\sigma^0 = 4 \sin^2 \phi$  if the diffuse surface is perfectly conducting. A perfectly smooth surface predicts values higher than generally observed at normal incidence, and a perfectly rough surface predicts values higher than observed at angles other than normal. Thus it does not seem likely that the sea can be described as being either perfectly smooth or perfectly rough.

Goldstein<sup>7,13,18</sup> first attempted to explain sea echo by the application of diffraction theory to the large-scale sea waves, or macrostructure of the sea surface. He considered as a model a sinusoidally corrugated mirror and employed conventional physical-optics techniques for analysis. The model resulted in a polar diagram for the scattered intensity like that of a grating and showed discrete peaks at the angles corresponding to the various grating lobes. Goldstein stated this obviously does not correspond to the

true situation<sup>7</sup>. (Later work indicates that under certain conditions grating lobes in the scattering pattern do exist<sup>33</sup>.) Davies and Macfarlane<sup>29</sup> made an attempt to consider a sufficiently irregular model by assuming the sea to consist of sinusoidal waves, with successive waves having different amplitudes and wavelengths distributed according to a gaussian law.

Although these models gave qualitative agreement with some of the experimental data (in particular, they gave an angular dependence similar to that observed), they did not explain the differences with polarization, and the echo intensity calculated was many orders of magnitude less than measure. In hindsight it appears that the smooth surface of the sine-wave model is not realistic for microwave frequencies. It is known that a long, relatively smooth distributed target will scatter poorly in the back direction unless there are discontinuities in the target or if the surface is rough. Goldstein<sup>13</sup> stated that for the theory to explain the experimental results the "maximum sea wavelength which contributes to the echo is only one-half wavelength". At microwave frequencies "these waves can thus only be small irregularities on the surface of the larger waves. In fact these correspond to ripples smaller than have been as yet observed." These ripples do exist, and they can be important in radar scatter at microwave frequencies.

Goldstein also examined the hypothesis that scattering results from spray droplets thrown up above the water surface. Droplets over the water surface could explain qualitatively the polarization effects observed experimentally at low grazing angles. It was suggested that the droplets are illuminated by a direct ray from the radar and a ray reflected from the surface of the water. These two rays combine vectorially at the water droplets. With horizontal



polarization, the magnitude of the reflection coefficient is very nearly unity and the phase shift on reflection is approximately  $\pi$  radians. Thus at low grazing angles the two rays will destructively interfere, and little or no energy will illuminate the droplets. The less energy illuminating the target, the less will be the magnitude of the echo.

A similar effect occurs with vertical polarization except for the important difference that at the Brewster angle the magnitude of the reflection coefficient is less than unity so that the direct and reflected rays do not produce as complete cancellation as observed with horizontal polarization. Thus the vertically polarized waves place more of the radiated energy at low angles and give a greater reflection than with horizontal polarization. Simple theory predicts that the echo with horizontally polarized radiation over a perfectly reflecting surface will vary as  $\phi^4$  at low grazing angles.

As the sea becomes rougher, the differences observed experimentally with the two polarizations become less. This is explained in the droplet theory by stating that as the sea becomes rougher the interference pattern, especially at the minima, tends to be destroyed. Since the drops are small compared with the wavelength, the droplet theory predicts that the target echo should vary as  $f_r^4$  in rough weather and  $f_r^8$  in calm weather. This dependence of is not usually observed. Another reason to suspect the validity of the droplet theory is that the polarization dependence is observed experimentally to be greatest in a calm sea when there is no spray. For these and other reasons, Goldstein concluded that it is "not likely that the drop mechanism represents the actual state of affairs". The major interest in the droplet theory is the polar-

ization dependence. This does not depend necessarily on the scatters being droplets, so that in seeking a better model one might look for a different type of scatterer but keep the concept of direct and reflected rays at low grazing angles. Breaking waves cause whitecaps and spray that result in a spiky echo of short duration. Thus spray, droplets, or whitecaps can produce a radar echo but they do not seem to be major contributors to the total echo from the sea. Although there may be a correlation between a whitecap and the appearance of a spiky echo, it is not clear whether the major contribution to the echo comes from the spray or from the very peaked crest that develops before the wave breaks.

(Continued on page 132)

Katzin suggested that, instead of droplets, the scattering elements are small patches, or facets, that overlie the main large-scale wave pattern. He considered the surface of the sea to be the superposition of facets of various sizes, with orientations distributed about the main sea contour. He assumed that the phases of the signals scattered from the facets were independent and reasoned that since the values of  $\sigma^\circ$  at low grazing angles were small ( $10^{-3}$  or less) the scattering mechanism should be rather highly directive. This suggested to him that the scattering properties of inclined flat plates (facets) be investigated. Katzin claimed this theory accounts for the behavior in the interference region and the critical angle and that it explains the approximate polarization dependence, the approximate frequency dependence, and the behavior near normal incidence. It is also said to account for the spikiness observed with horizontal polarization at low grazing angles.

Katzin's facet theory failed to explain the observed upwind-downwind ratio of sea echo<sup>6,9,12,13,14,41</sup>. Schooley<sup>14</sup> suggested this was due to a lack of measurements of the facet size and slope distributions upon which to base calculations. Schooley measured the statistics of the facet sizes in a laboratory water wind tunnel and from these measurements calculated the upwind-downwind ratio as a function of depression angle at several frequencies. His results were in sufficient qualitative agreement with measurements as to lend support to Katzin's facet model.

Both Schooley and Katzin assumed that the scattering from the facets was essentially independent of the polarization. Wright<sup>12,26</sup> has studied both experimentally and theoretically the scattering from capillary waves at intermediate grazing angles in the plateau region. He suggested that the elemental scatterers are more appropriately thought of as patches of water waves whose scattering properties prove

to be strongly polarization-dependent. Capillary waves are small wind-generated ripples, of wavelength less than about 2.5cm, that ride on top of the larger wave structure. They are important to the scattering mechanism at X band and higher frequencies since the scattering is attributed to water waves of propagation constant  $k_0 = 2\pi/\lambda_w$ , which is related to the microwave propagation constant  $k = 2\pi/\lambda_r$  by  $k = 2k_0 \cos \phi$ , where  $\lambda_w$  and  $\lambda_r$  are the water wave and radar wavelengths, and  $\phi$  is the grazing angle.

Wright derived a theoretical relation for the scattering from such waves and was able to obtain good agreement between theory and experimental measurements of the variation of  $\sigma^0$  as a function of grazing angle for vertical polarization. The agreement for horizontal polarization was not as good. Wright's work<sup>12</sup> is of interest since he carried out his experiments under controlled laboratory conditions in a wave tank. Although the wave tank may not represent the ocean in all respects, controlled laboratory experiments give an understanding of the factors determining the radar echo from the real ocean. Wright's application of first-order (small-amplitude) scattering theory appears to have been more successful than previous attempts to associate quantitatively radar sea echo with the properties of the ocean waves.

It seems to have been well established that theories describing radar scattering from the ocean must take account of the small-wave structure (ripples, capillaries, facets) as well as the large-wave structure. If the frequency is low enough the effect of the small-scale wave structure should be negligible and only the large waves will affect the sea echo. At the lowest practical radar frequencies the radar wavelengths are comparable to the water wavelengths that begin to interest oceanographers, and data on oceanwave spectra including these components are more likely to be available than the spectra of the capillary waves that affect the higher microwave frequencies.

APPENDIX 2 - LIST OF SYMBOLS/GLOSSARY

<u>Symbol</u>	<u>Meaning</u>	<u>MKS Unit</u>
$a_i$	Area of the sea illuminated by the radar	$m^2$
$a_p$	Project area corresponding to $a_i$	$m^2$
B	Receiver bandwidth	Hz
$c_w$	Group propagation velocity of speed of water wave	$ms^{-1}$
$c_r$	$c_r = f_r \cdot \lambda_r$ = speed of electromagnetic propagation = $2.998 \times 10^8$ $ms^{-1}$ = $0.984$ ft $ns^{-1}$	$ms^{-1}$
$D_a$	Antenna diameter	m
$d_a$	Transverse (minor) axis of illuminated ellipse	m
$d_r$	Radial (major) axis of illuminated ellipse	m
$d_w$	Water depth (mean surface to bottom)	m
e	2.718.....	*
exp	Exponential; $\exp x = e^x$ for any x	-
$f_d$	Doppler frequency shift = $2v_d / \lambda_r$	Hz
$f_r$	Radar transmitted frequency	Hz
g	Acceleration of gravity	$ms^{-2}$
G	Radar antenna = $G_t = G_r$	*
$G_r$	Receiver antenna gain	*
$G_t$	Transmitter antenna gain	*
H	Wave height of water wave (crest to trough)	m
$H_a$	Height of antenna above sea level	m

$H_3$	Significant wave height; equals average of highest 1/3 of the waves	m
$H_{10}$	Average wave height of highest 1/10 of the waves	m
$\hat{H}_{10}$	Wave height exceeded by 10% of waves	m
$k$	(1) Propagation constant of water wave, $k = 2\pi/\lambda_w$ (2) Boltmann's constant = $1.380 \times 10^{-23} \text{ JK}^{-1}$	$\text{m}^{-1}$ $\text{JK}^{-1}$
$k_G$	Antenna gain constant = $\psi_b G/4\pi$	*
$k_0$	Propagation constant for radar, $k_0 = 2\pi/\lambda_r$	$\text{m}^{-1}$
$k_e$	Antenna gain constant = $e_{bD_a}/\lambda_r$	*
$L_0$	Defined by $L_0^4 = L_t L_r L_1^2$	*
$L_r$	Receiver system losses	*
$L_t$	Transmitter system losses	*
$L_1$	One-way propagation path loss	*
$N$	Receiver noise power	W
$\overline{NF}$	Receiver noise figure	*
$P_e$	Power density (of exposure)	$\text{Wm}^{-2}$
$P_r$	Received power at radar receiver	W
$P_t$	Radar transmitter power output	W
$R$	Radar slant range	m
$R_H$	Horizontal range from radar to illuminated ellipse	m
$T$	Wave period of water wave	s

$T_0$	Receiver reference noise temperature	K
$v_d$	Doppler velocity of radar target; equals rate of change of path length from radar transmitter to target to radar receiver	$\text{ms}^{-1}$
$x$	Receiver signal-to-noise power ratio	*
$\alpha$	Water wave heading angle, measured as $\beta$	rad*
$\beta$	Radar line of sight (LOS) azimuth direction, measured clockwise from the horizontal perpendicular to the local shoreline	rad*
$\beta_0$	Angle for which $\tan \beta_0$ is the root mean square slope of the facets in Spizzichivo's expression for $\sigma^0$	rad*
$\gamma$	Clutter coefficient = $\sigma/a_p$ ; see also $\sigma^0$	*
$\theta_b$	Antenna beam width	rad*
$\lambda_r$	Radar wavelength	m
$\lambda_w$	Wavelength of water wave	m
$\mu$	Parameter in Spizzichin's expression for $\sigma^0$	*
$\pi$	3.14159...	*
$\sigma$	Radar cross section	$\text{m}^2$
$\sigma^0$	Clutter coefficient (radar reflectance, albedo) = $\sigma/a_r$ ; see also $\gamma$	*
$\tau$	Radar pulse length	s
$\theta$	Grazing angle: acute angle between mean horizontal water surface and centerline ray of radar illuminating beam, measured where ray intersects the horizontal surface	rad*

$\theta_c$  Critical angle (pseudo Brewster angle) rad\*

$\psi_b$  Antenna beam solid angle sr\*

---

\*Asterisked quantities are dimensionless.