

UNCLASSIFIED

AD **223 343**

*Reproduced
by the*

D SERVICES TECHNICAL INFORMATION AGENCY
ARLINGTON HALL STATION
ARLINGTON 12, VIRGINIA



UNCLASSIFIED

NOTICE: When government or other drawings, specifications or other data are used for any purpose other than in connection with a definitely related government procurement operation, the U. S. Government thereby incurs no responsibility, nor any obligation whatsoever; and the fact that the Government may have formulated, furnished, or in any way supplied the said drawings, specifications, or other data is not to be regarded by implication or otherwise as in any manner licensing the holder or any other person or corporation, or conveying any rights or permission to manufacture, use or sell any patented invention that may in any way be related thereto.

Unannounced

D

223 343

TECHNICAL PAPER

NO. 5

223 343

IGLOO AND REVETMENT

TESTS

AD. No. **223 343**
ASTIA FILE COPY

NAVAL PROVING GROUND, ARCO, IDAHO

OCTOBER, 1946

ASTIA
RECEIVED
NOV 13 1962
ASTIA

75250

Army-Navy Explosives Safety Board 2029 Tempo 2 Building
Washington, D. C.

TECHNICAL PAPER

NO. 5

**IGLOO AND REVETMENT
TESTS**

NAVAL PROVING GROUND, ARCO, IDAHO

OCTOBER, 1946

Army-Navy Explosives Safety Board 2029 Tempo 2 Building
Washington, D. C.

This report, prepared by Commander R. L. Mann, Bureau of Yards and Docks, U.S.N., while on duty with the Army-Navy Explosives Safety Board, reviews, summarizes and interprets the results from the full scale (500,000 and 250,000 net pounds each) explosives safety tests made by the Board at the U. S. Naval Proving Ground, Arco, Idaho, during the fall of 1946. The results of these tests are also compared and coordinated with the results of similar tests made by the Board during the fall of 1945 (Board Technical Paper No. 3, "Igloo Tests, Arco, Idaho, 1945").

The publication of this report is authorized as one of a series of papers being prepared by the Board to promote explosives safety within and without the military services.

5 January 1948

D. C. HALL
Colonel, Ordnance Department,
President, Army-Navy
Explosives Safety Board

Experimental explosions at the Naval Proving Ground, Arco, Idaho, during October, 1946, of:

- Two standard 80-foot earth-covered igloo magazines each containing 500,000 pounds TNT,
- One standard 80-foot igloo magazine with double normal earth cover, containing 250,000 pounds TNT,
- One open revetment containing 500,000 pounds TNT,
- One open revetment containing 250,000 pounds TNT,

in which the foregoing elements were spaced at half the minimum distances presently specified, showed that:

Clear distances between standard igloos abreast in line may be reduced to 185 feet,
and, at the same time,

The maximum quantity of HE permitted per igloo may be raised to 500,000 net pounds,
without incurring undue risk of propagation of explosion from one igloo to another.

The tests also showed that reducing the protective distance to inhabited buildings prescribed by the American Table of Distances by 50 percent, which is permitted when there is a barricade between the explosives and the buildings, is unwarranted in the case of standard earth-covered igloos. It was demonstrated by the damage to test barracks and by numerous records of blast pressures and other data that the detonation of 500,000 pounds of TNT within an earth-covered igloo only justifies a reduction of approximately 20 percent of the unbarricaded inhabited building distance prescribed by the American Table of Distances.

A considerable amount of scientific data on large explosions was accumulated by representatives of various Government research organizations.

CONTENTS

	Page
I. INTRODUCTION	1
II. OBJECTS OF THE TESTS	4
III. PROCEDURE:	
1. Description of site and field conditions	4
2. Field layout	7
3. Order of tests	14
4. Explosive charges	14
5. Priming and firing	14
6. Instrumentation and observations by ANESB	18
7. Observations by other organizations	26
IV. RESULTS	
A. MEASUREMENTS AND OBSERVATIONS BY ANESB:	
1. Test 1—Explosion of Igloo D:	
(a) General	29
(b) High-speed motion pictures	29
(c) Air blast	32
(d) Crater	34
(e) Ground movement	41
(f) Permanent displacement of target igloos	41
(g) Transient arch deflections of target igloos	41
(h) Damage to target igloos	42
(i) Damage to revetments	44
(j) Damage to barracks	47
2. Test 2—Explosion of Igloo E:	
(a) General	59
(b) High-speed motion pictures	61
(c) Air blast	61
(d) Crater	68
(e) Ground movement	69
(f) Permanent displacement of target igloo	69
(g) Transient arch deflections of target igloo	72
(h) Damage to target igloo	72
(i) Damage to revetments	74
(j) Damage to barracks	75
3. Test 3—Explosion of Igloo F:	
(a) General	86
(b) High-speed motion pictures	86
(c) Air blast	87
(d) Crater	88

	Page
(e) Ground movement	97
(f) Damage to revetments	97
(g) Damage to barracks	97
4. Test 4—Explosion of Revetment 1:	
(a) General	104
(b) High-speed motion pictures	104
(c) Air blast	104
(d) Crater	104
(e) Ground movement	106
(f) Damage to Revetment 2	106
(g) Damage to barracks	106
5. Test 5—Explosion of Revetment 2:	
(a) General	117
(b) Crater	117
(c) Ground movement	117
(d) Damage to barracks	119
B. RESULTS OBTAINED BY OTHER ORGANIZATIONS:	
1. Naval Ordnance Laboratory:	
(a) General	123
(b) Measurements of microbarographic waves.....	123
2. Naval Ordnance Test Station, Inyokern:	
(a) General	123
(b) Air blast records	123
(c) Information gained from high-speed photography.	124
3. Signal Corps, U.S.A.....	124
4. U. S. Weather Bureau:	
(a) General	124
(b) Tables and diagrams	124
(c) Weather conditions	126
(d) Conclusions from meteorological data.....	130
5. St. Louis University	130
6. Woods Hole Oceanographic Institution	
(a) General	130
(b) Air blast measurements	130
7. Office of Naval Research:	
(a) General	131
(b) Subsurface velocity zones	131
(c) Surface displacements and accelerations.....	131

V. DISCUSSION:

1. Review of explosion manifestations as perceived by observers:	
(a) Typical appearance	131
(b) Effect of igloo on appearance of explosion	132
(c) Effect on explosion when charge is stored in igloo with augmented earth cover	132
(d) Appearance of shock wave	133
(e) The double report	133
2. Information obtained from high-speed motion pictures:	
(a) Chronology of destruction of exploded igloo.....	133

	Page
(b) Order of appearance of explosion phenomena.....	134
(c) Appearance of shock front	134
(d) Air blast	135
3. Air blast measurements by ball crusher gages, foil and paper meters:	
(a) General	135
(b) Asymmetry of blast	140
(c) Comparison with values predicted from NDRC chart and with data furnished by other participating groups	140
(d) Effect of door barricade	140
(e) Effect of storing charge in a standard igloo rather than in open	140
(f) Effect of increased earth cover over primary igloo	142
4. Cratering:	
(a) General	143
(b) Comparison of crater sizes with those of previous tests and those calculated from formulas.....	143
5. Ground movement:	
(a) Comparison with 1945 tests	144
(b) Horizontal vs. vertical movement	144
(c) Movement in igloo explosions compared with movement in revetment explosions.....	145
(d) Ground shock and effect on target igloos	
6. Permanent displacement of target igloos:	145
(a) General	145
(b) Differential displacement of arch with respect to floor	145
(c) Comparison with displacements in 1945 test.....	145
(d) Indications regarding damage or propagation of explosion	145
7. Transient arch deflections of target igloos:	
(a) Comparison of slide and string gage readings.....	146
(b) Comparison with deflections in 1945 test	146
(c) Stress study	146
8. Damage to target igloos:	
(a) Comparison with damage sustained in 1945 tests.	147
(b) Incipient arch failure	147
(c) End wall failure	147
(d) Damage to floor	148
(e) Damage to minor appurtenances	148
(f) Disturbance of contents	148
9. Damage to revetments:	
(a) Effect on earth embankments or windrows	148
(b) Disturbance of contents	148
10. Damage to barracks:	
(a) Comparison with barracks damage in 1945 tests..	148
(b) Decrease in damage with increase in distance.....	148
(c) Nature of superficial damage	149
(d) Nature of structural damage	149
(e) Failure of glazing materials	150

	Page
VI. CONCLUSIONS:	
1. Increase in permissible quantity of high explosives per igloo magazine	153
2. Reduction of intra-line igloo magazine spacing.....	153
3. Inhabited building distance	153
4. Effect of increased cover	155
5. Types of window glass and substitutes which might reduce dangers of injury from broken glass	155
6. Danger radius for blasting of broken glass from windows	155
7. Pressures and velocities of the shock waves in air.....	155
VII. LIST OF REFERENCES	155
VIII. APPENDICES:	
A. Field Instrument Records	156
B. Calibration of Foil and Paper Blast Meters	158

PART I. INTRODUCTION

The tests described herein are a continuation of the program of ammunition storage tests undertaken by the Army-Navy Explosives Safety Board at the Naval Proving Ground, Arco, Idaho, in August 1945.

The program was originally recommended by letter from the Board to the Secretaries of War and Navy dated 10 October 1944, as a measure to determine whether standard intermagazine distances might safely be reduced, and ammunition might safely be stored in open stacks midway between existing magazines. It was anticipated that over-congestion of storage facilities expected upon the cessation of hostilities, and consequent serious hazards, might thereby be avoided without the necessity of purchasing additional land. It was also considered that the proposed tests would extend the available data on quantity distance relations for storage of high explosives, in particular serving as a check on the inhabited building safety distance for barricaded storage prescribed by the American Table of Distances.

Approval of the Secretary of the War subject to concurrent action by the Secretary of the Navy was given on 27 October 1944, and approval of the latter followed on 23 November 1944. Funds in the amount of \$90,000 from each service were made available to the Bureau of Yards and Docks, Navy Department, which contracted for construction of four test igloo magazines, three revetments, and a test wood-frame barracks building in the spring of 1945. A quantity of obsolescent and surplus TNT and Torpex loaded bombs and mines was made available by the Ordnance Department, Army, and the Bureau of Ordnance, Navy Department. The tests were started 29 August and concluded on 19 October 1945.

The 1945 tests indicated that:

(a) The Army¹ standard intra-line spacing of 400 feet clear distance edge-to-edge, between

¹ The Navy standard has been 500 feet.

earth-covered reinforced concrete arch-type ("igloo") magazines limited to 250,000 net pounds of high explosives in each, may be reduced to 185 feet (the clear distance resulting when an additional magazine is built midway between two existing ones at standard interval) without appreciable risk that a detonation of the entire contents of one such magazine will propagate to another,

(b) Structural damage done to an igloo when a 250,000-pound charge is detonated in a neighboring igloo at 185-foot clear distance is slight,

(c) When 250,000 pounds of high explosives are detonated in an open revetment between igloos 400 feet apart, it is improbable that the explosion will propagate to either igloo, and they will not suffer severe damage,

(d) A two-story, wood-frame, standard-type barracks building is not entirely safe from structural damage, and its occupants are likely to suffer severe injury from flying fragments of window glass, when 250,000 net pounds of high explosives are detonated within an earth-covered igloo magazine at a distance of 2.155 feet, the safety distance specified by the American Table of Distances for inhabited buildings from a barricaded storage of such quantity.

Reference (1) is the detailed report on the 1945 tests.

At a meeting on 19 February 1946, the Board voted to continue the test program during the coming summer, inasmuch as adequate funds remained on hand and it appeared that further information of vital concern to the armed forces with respect to the safety of explosives and surrounding structures and personnel could be obtained.

It was decided to investigate further the possibility of safely increasing the potential storage capacities of existing ammunition storage reservations, without the necessity of acquiring additional land, by raising the present limit per igloo magazine to 500,000 net

pounds of high explosives. If this could be done without risking the propagation of an accidental explosion of one unit to its neighbors with consequent probable catastrophic losses and damage, the volumetric capacities of individual igloo magazines could be twice as efficiently utilized for stowage of bombs, mines, and other ammunition of high charge-to-weight ratio, except in cases of magazines on the peripheries of storage areas whose distances from the nearest inhabited buildings would not be adequate to permit their containing greater quantities of high explosives than 250,000 net pounds. This would result in nearly doubling the storage capacities of existing depots and arsenals, more particularly in the cases of the larger, isolated reservations, without any physical change whatsoever.

It seems pertinent to note that the maximum concentration provided for by the American Table of Distances is 500,000 net pounds of explosives. The armed forces have long limited the quantity per storage unit to 250,000 pounds, which for strategic and economic reasons was regarded as the maximum quantity whose loss could be risked at one time. However, with the close of World War II ammunition tonnages on hand were so vast that the earlier considerations were no longer valid, and the question of safety of surrounding populations and structures and the avoidance of major losses became the only impediments to raising the limit.

The Board further contemplated that it might be both safe and feasible to double the quantity per magazine at *halved intra-line spacing*, which would result in a potential four-fold increase in the tonnage storable at a given depot without acquiring additional land. Studies of typical Army layouts such as those at Tooele, Utah, and Umatilla, Oreg., revealed that the number of magazines per block (usually 100 units on a 10x10 isometric, or diamond-pattern, grid, with the long dimensions of the magazines parallel to the long axes of the diamonds, and separation distances 400 feet each way) could be doubled without increasing the outside dimensions of the block, merely by adding a new magazine at each halved intra-line interval wherever possible. The term "line" as used herein refers to a row of magazines in which the units are abreast of, or parallel to,

each other, and not to lines at 60° or 120° to the first line. In placing the new magazines as described above, the number of lines is not increased, but the number of units per line is doubled. Each new magazine so placed would be 185 feet, clear distance, from its immediate neighbors in line, and 360 feet, clear distance, from the units directly in front of and behind it. These distances, then, were chosen by the Board for the separation of the magazines in the Arco tests. Studies of typical Naval ordnance depots also indicated that the number of magazines per block could be doubled, but since in Naval layouts the long dimensions of the magazines were usually placed perpendicular to the long dimensions of the diamonds, the new magazines would probably have to be placed at right angles to the existing ones in order to obtain optimum distances and make use of existing roads.

Having studied the rather unexpectedly severe damage to the test barracks building and particularly to the extensive flying glass in the 1945 test in conjunction with a review of the design of the standard igloo magazine and its earth cover, Capt. E. R. Gayler, CEC, USN (ret.), member of the Board, brought out that the weight of earth cover in pounds per pound of explosive stored in the standard igloo (about 12) was much less than the corresponding ratio (about 37) for the type of storage used for many decades by commercial dynamite and powder manufacturers and consequently, that the igloo could not be expected to damp the blast wave as much as the old conventional storage. If this were so, it followed that explosives stored in standard service igloos could not be considered fully "barricaded" in the sense of the term contemplated by those who formulated the American Table of Distances, and the halving of the standard ATD safety distance permitted for barricaded storage was unwarranted in the case of these magazines. Captain Gayler postulated that it was not unlikely that if the earth covering on a modern magazine were increased to 35 or 40 pounds per pound of high explosive, that the structure could be considered barricaded and possibly the present safety distances maintained.

Accordingly, the Board proposed to perform tests using a number of one-tenth scale model igloos which were available to determine the

effect that heavily increased earth cover on igloos would have on blast phenomena. (These model tests were held in the summer of 1946 and are reported in reference 2.) It was further agreed that the last remaining large-size igloo in the 1946 program would be covered with additional earth, in order to obtain further data on the effects of augmented cover on blast damage and window breakage in nearby habitation-type structures in a full-scale test.

Inasmuch as unacceptably severe damage and flying glass had occurred in a building at the halved (barricaded) ATD inhabited building distance in the 1945 test, it was decided to place several buildings at various distances from the explosion in the 1946 test, with a view to obtaining information on the diminution in damage with increasing distance and determining what safety distances should be maintained between inhabited buildings and high explosives in igloo type magazines. The plan as finally approved called for three buildings, one at the ATD distance for barricaded storage (half the distance for unbarricaded storage), one at two-thirds of the distance, unbarricaded, and one at the full distance unbarricaded. It was believed that both a degree of damage which might be deemed acceptable and the limiting distance for flying glass would fall between these limits.

The Board evinced considerable interest in tests of window glass and glass substitutes, in the hope of finding some material that would either withstand blast or break into harmless pieces, and at the same time be economical enough for widespread use. Some previous blast tests of glass had been made, but only with small quantities of explosives, and it was felt that this program offered a worthwhile opportunity to compare the behaviour of various commercially available glazing materials under realistic conditions and under impinge-

ment of blast waves having long impulse-times, such as are generated only by explosions of large charges.

Approval by the Secretary of War and the Secretary of the Navy (Facilities Review Board) for the continuance of the program was given in early April 1946, and the Bureau of Yards and Docks then contracted for the construction of the test structures, i.e., two igloos, two revetments, and three modified barracks. Surplus and unserviceable ammunition in the form of aircraft bombs and anti-tank mines was furnished by the Ordnance Department, Army. The Board acquired blast gages from several agencies, and arranged for a contract to be entered into by the Naval Ordnance Plant, Pocatello, Idaho, for the taking of high-speed motion pictures. The construction, loading of magazines and revetments, accumulation of instruments and other preparations were completed early in September, and accordingly the first explosion was scheduled to be held on 1 October 1946.

The unprecedented size of these experimental explosions of conventional military-type high explosives evoked interest on the part of a number of scientific organizations who participated in the program in order to record close-range blast phenomena, meteorological, and seismic data at long distances, and obtain other information of scientific and engineering interest. These activities were coordinated through the Bureau of Ordnance and the Office of Naval Research. Included among the participating organizations were the Naval Ordnance Laboratory, Washington, D. C.; Naval Ordnance Test Station, Inyokern, Calif.; Signal Corps Engineering Laboratories, Belmar, N. J.; United States Weather Bureau, Washington, D. C.; St. Louis University, St. Louis, Mo.; Woods Hole Oceanographic Institution, Woods Hole, Mass.

PART II. OBJECTS OF THE TESTS

The primary purposes of these tests were to determine:

(1) Whether the present explosives limits for standard 80-foot Army and Navy igloo type magazines could be safely raised from 250,000 to 500,000 net pounds of high explosives without increasing the present standard intermagazine distances.

(2) Whether the present standard Army and Navy igloo type intra-line distances could be reduced one-half if the explosives limit were raised to 500,000 net pounds of high explosives.

(3) What safety distances should be maintained between unbarricaded, inhabited buildings and standard Army and Navy igloos con-

taining 500,000 net pounds of high explosives.

(4) The possibility of reducing the effect of a detonation of the explosives contained in an igloo type magazine, by increasing the volume of earth cover on the igloo.

(5) What types of window glass and substitutes might reduce the dangers of injury from broken glass to a minimum.

(6) The danger radius for the blasting of broken glass from windows.

(7) The velocity and pressure of the shock waves in air and other phenomena attending large detonations, by means of high-speed motion picture cameras and other instruments and gages.

PART III. PROCEDURE

I. Description of Site and Field Conditions.

(a) *Location.*—The Naval Proving Ground, Arco, Idaho, a subsidiary of the Naval Ordnance Plant, Pocatello, Idaho, is about 65 miles northwest of Pocatello on U. S. Route 20, and about 20 miles east of the small town of Arco from which it takes its name. The area selected for the tests was a level stretch of terrain about 2 miles long by 1 mile wide, located near the middle of the proving ground. This site was ideal for the purpose, as there were no obstructions to vision in any direction, and isolation was adequate, the nearest buildings being about 8 miles away.

(b) *Topography.*—The proving ground lies on the Snake River Plain, a relatively level desert region stretching generally to the west and northwest from the Snake River in southeastern Idaho. Ten miles to the west, the southern spurs of the rugged Lost River Mountains rise abruptly from the plain. On each side of this range is a valley in which a river flows southwesterly out into the plain, the Big Lost River to the south and the Little Lost River to the north. The two rivers approach each other in the north end of the proving ground where they disappear in "sinks." To the north and southwest at greater distances lie other ranges comprising the southern limits

of the high mountain masses of south central Idaho. To the east and south, the desolate plain stretches away for from 40 to 60 miles to the banks of the Snake, but its monotony is relieved by numerous large and small buttes of eccentric shapes. The largest of these, Big Southern Butte, is about 12 miles south of the proving ground, and rises 2,300 feet above the surrounding plain. The average elevation of the proving ground is about 4,850 feet. Vegetation on the plain includes sagebrush, bunch grass, dwarf cacti, and an occasional stunted cedar.

(c) *Climate and Weather.*—The region is semiarid, with a mean annual precipitation of 12.5 inches, most of which falls in the winter and spring. During the tests, the weather varied from overcast with light rain in the morning just before the first explosion, to bright, cloudless days for subsequent tests. The air was usually still in the mornings but a breeze, generally from the southwest, sprang up in the afternoons, reaching velocities of about 20 miles per hour on some occasions. The temperature varied from 45 to 62° F., and the barometer from 25.00 to 25.19" Hg., and the mean relative humidity was 70–80 percent.

(d) *Geology.*—The plain was formed when repeated lava flows, mainly in the Pliocene, surged from fissures and vents, filling a wide,

deep depression. The upper layers consist of basalt and kindred volcanic rocks locally interbedded with sediments, which were laid down intermittently until Pleistocene and in some instances until Recent times. (Craters of the Moon National Monument, with lava flows only a few hundred years old, is located about 40 miles southwest of the proving ground.) The great mass of volcanic rock underlying the plain is termed the "Snake River Basalt," and its total thickness is of the order of 1 mile. In numerous places older basaltic, rhyolitic and

tracytic formations emerge from the plain, forming the buttes. There is evidence that many of these were volcanoes. Over much of the plain the basalt is bare or nearly so but on the test site there is an overburden of sand and gravel up to perhaps 20 feet thick, brought down by streams from the adjoining mountains. Covering the alluvium is a layer of loess from 1- to 6-feet thick. The latter material was classified as a silty sand by the United States Engineer Office, Portland, Oreg.

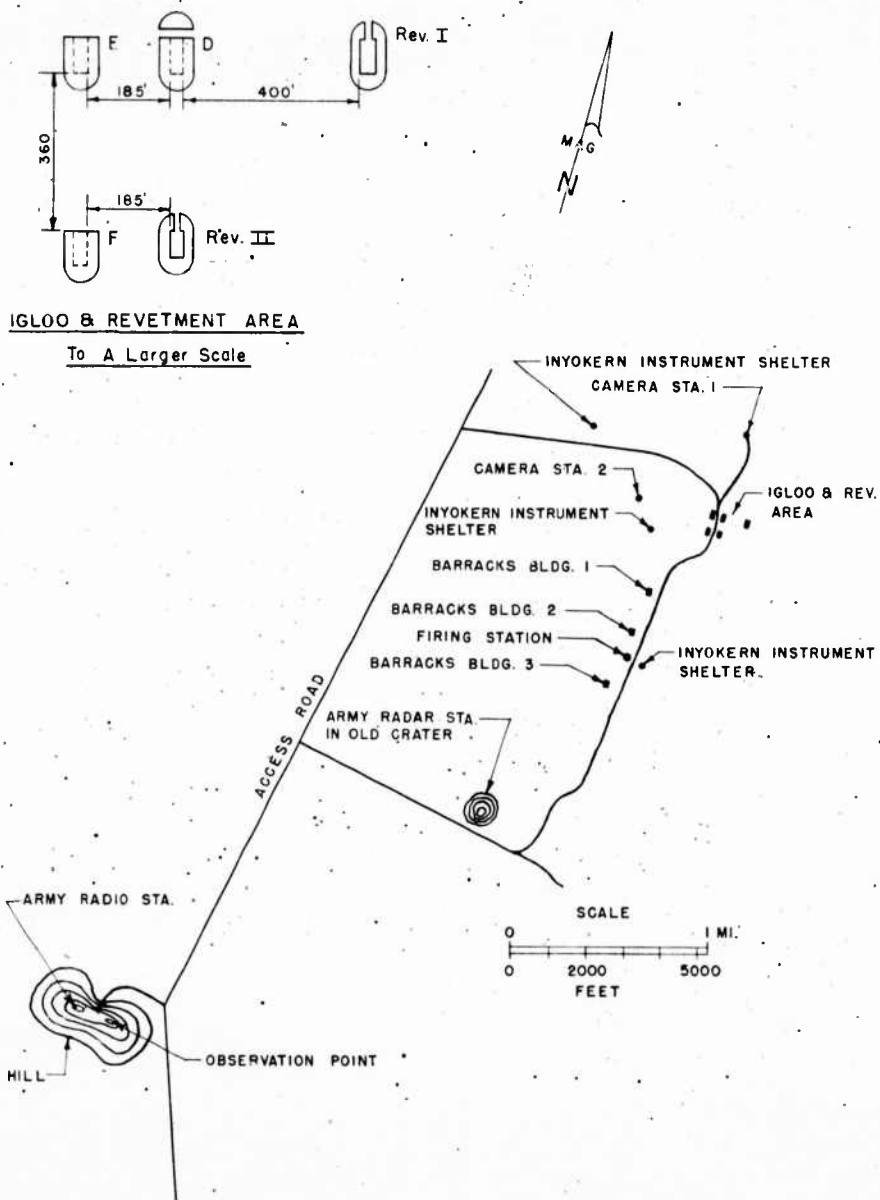

FIGURE 1. Location Plan of Test Structures



FIGURE 2. General view looking north toward explosion area, showing Barracks 1 and 2 to left and igloos on right.



FIGURE 3. View of front end and door barricade, Igloo D

2. Field layout.

(a) *General*.—Figure 1 is a general plan of the test area, showing the three igloos, two revetments, and three barracks buildings. It also shows locations of accessory structures, such as the firing station and camera stations, and of the observation station, 4.1 miles southwest of Igloo D. For a general view of the scene from the vicinity of one of the barracks, see figure 2.

(b) *Igloos*.—All igloos were earth-covered, reinforced concrete arch type, constructed in accordance with standard plans. For various views of these structures, see figures 3 to 6, inclusive. Igloo D was of Navy type (Bureau of Yards and Docks drawing nos. 357423-357430, inclusive) with a door barricade, but the door itself was of Army type. Igloos E and F were of Army medium-footing type (Corps of Engineers, Army, drawings nos. 652-687-652-693, inclusive) without door barricade. Major dimensions were as follows:

	Army	Navy
Length, inside	81'	80'
Width, inside	26'-6"	25'
Crown height above floor, inside	12'-9"	12'-1 $\frac{3}{4}$ "
Radius of intrados	13'-5"	12'-9 $\frac{3}{4}$ "
Arch thickness at crown	6"	6"
Arch thickness at springing section	1'-4"	10 $\frac{7}{8}$ "
End wall thickness	12"	10"
Thickness of earth cover at crown	2'	2'

Arch barrel reinforcement in the Army igloo consisted of $\frac{1}{2}$ " round rods 12" o.c. transversely and $\frac{3}{8}$ " round rods 3' o.c. longitudinally, in each face. In the Navy igloo it consisted of 4" x 4" wire mesh weighing 62 pounds per square foot, in the extrados surface only. The concrete mix was designed for a compressive strength of 2,500 pounds per square inch at 28 days. The Navy design was a war-time type in which steel had been omitted because of conservation, whereas the Army plans were for prewar construction and brooked no sacrifice in safety factor. However, the differences in reinforcement were inconsequential as the Navy igloo was the first to be exploded. The amount of earth cover on the Navy igloo was about 30,000 cubic feet, whereas that on the Army igloo which is not concentric but is carried out further horizontally before curving down to a 1 $\frac{1}{2}$:1 slope was about 40 percent greater, or 42,000 cubic feet. The Navy igloo had a door barricade containing about 6,000 cubic feet. The earth was borrowed from a pit near the igloo site, and consisted of a silty sand containing about 15 percent gravel. It might have been suspected that the differences in shape and amount of cover would cause some difference in blast pressures, particularly directly in front and close to the igloo. Subsequent to the second test and in preparation for the explosion of Igloo F, the cover on that igloo was increased to approximately twice the normal value and

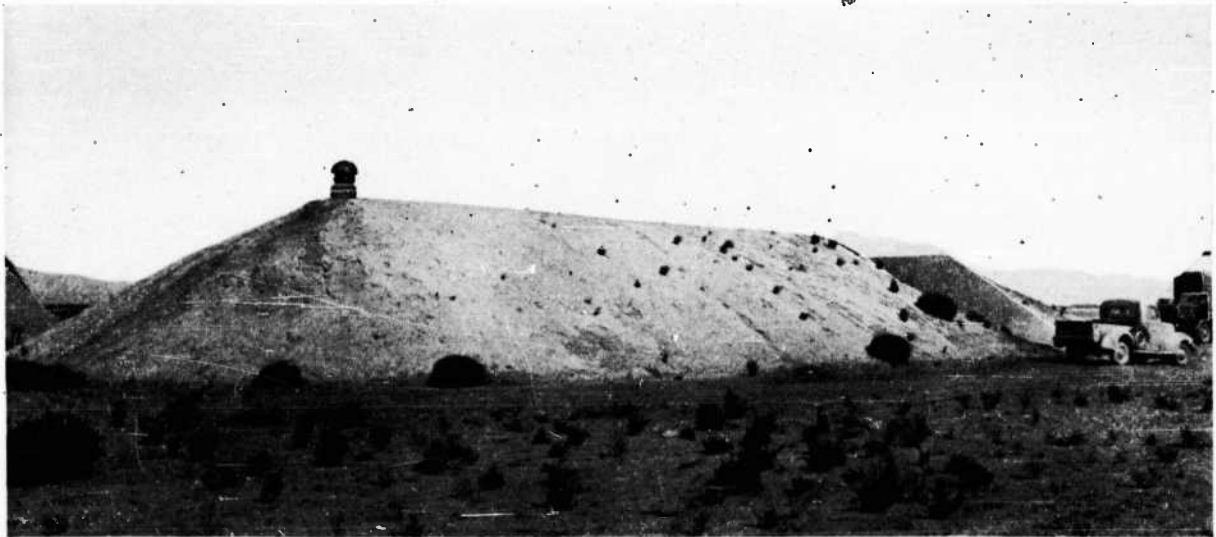

FIGURE 4. Three-quarter view of Igloo D from rear



FIGURE 5. Three-quarter view of Igloo E from rear



FIGURE 6. Three-quarter front view of Igloo F

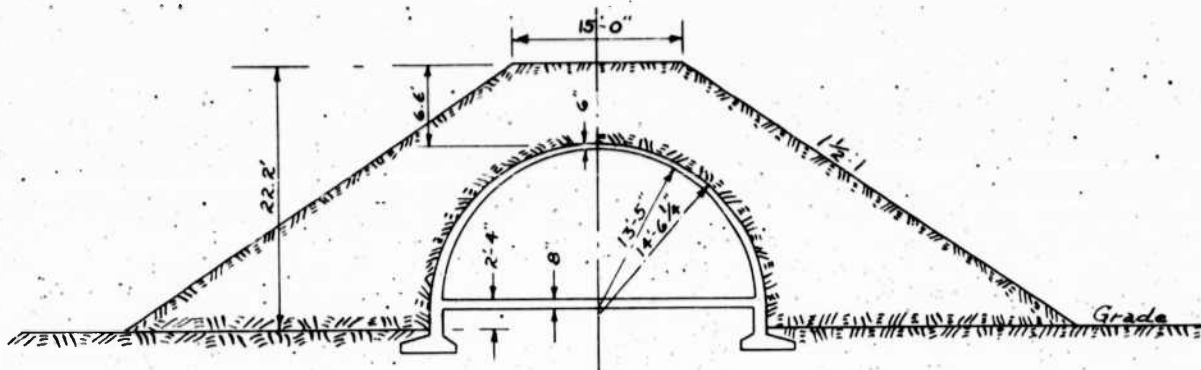

NOTE -

FRONT SLOPE (FROM TOP OF FILL TO EDGE OF COPING) AND REAR SLOPE WERE 1 1/2 : 1.

FIGURE 7. Cross-section of increased earth cover on Igloo F for Test 3

made to the shape illustrated by figure 7. In placing earth on the igloos, water was used as an aid in obtaining compaction.

(c) *Revetments*.—Both revetments were of standard cross-section used by the Army for surrounding open stacks of ammunition, being 7' high, 3' wide on top, and having side-slopes of 1 1/2:1. The inside plan measured 30' x 80', in the case of revetment 1, which was made especially large in order to accommodate 500,000 pounds of TNT. Revetment 2 was 30' x 55' in plan inside. Figures 8 and 9 are photographs of these revetments.

(d) *Barracks*.—The three barracks-type buildings were identical two-story wood-frame structures of the simplest type of construction. They were founded on timber posts, had gable roofs, double-hung windows, and were without interior finish, trim or equipment of any kind. Aside from their foundations, they were structural prototypes of Navy frame B-1B barracks (Bureau of Yards and Docks drawings nos. 188655-188661) but were only 3' instead of 14 bays long. Exterior siding was 15 pound asphalt-saturated felt, secured with roofing nails and vertical wood battens, over diagonal wood sheathing. They were 36' x 37' in plan and were 26' high from grade to bottom of second-floor ceiling joists. For plans and general views, see figures 10, 11, and 12. The 30 windows of each building were glazed in accordance with a scheme for testing various kinds of glass and glass substitutes, as listed

and depicted in figure 13. Each building was so oriented that there was an angle of 30° between the plane of the east elevation and the line from the center of Igloo D. The glazing materials used were as follows:

- (1) Common double-strength sheet window glass, B quality (Federal Specification DD-G-451). This was installed in various window lights in the normal manner using glazier's points and putty on the outside of the sash. One window in the north wall of each building was entirely glazed with this glass and backed up by galvanized steel wire mesh, 1/2" square opening, 0.08" wire, the latter being cut to fit each sash and well stapled to the inside surfaces of the sash rails and stiles.
- (2) Wire glass, 1/4" thick, installed in normal manner.
- (3) "Lumapane," a product of Celanese Plastics Corp., 180 Madison Ave., New York City. This comprises a laminate of two sheets of 0.015" clear cellulose acetate with 14 mesh wire screen in between. The screen greatly impairs vision through this material. It was mounted as indicated in figure 13.
- (4) "Vimlite," also produced by Celanese Plastics Corp., is 12 mesh wire screen coated with cellulose acetate. It is little thicker than the bare screen, and is translucent but hardly transparent. It was mounted as indicated in figure 13.
- (5) "Lumarith," also a Celanese Plastics Corp. product, is clear cellulose acetate sheet. The thickness used in these tests was 0.06". It was mounted according to figure 13.



FIGURE 8. Revetment 1, three-quarter front view

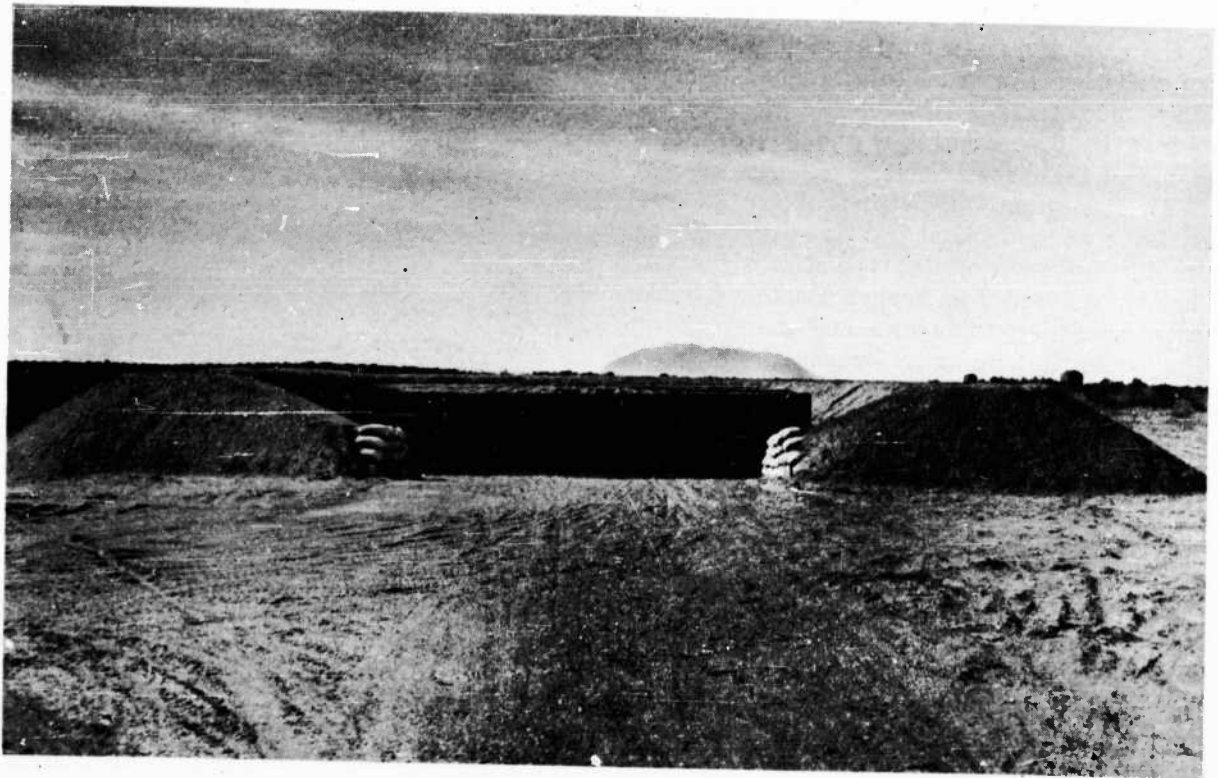
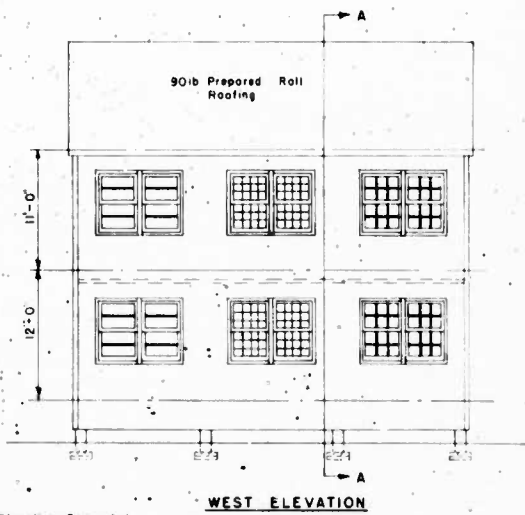
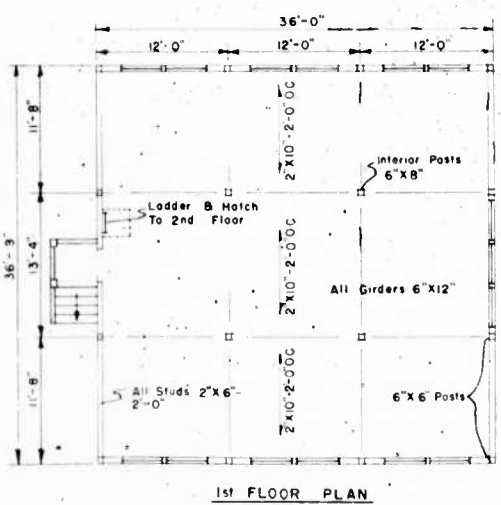
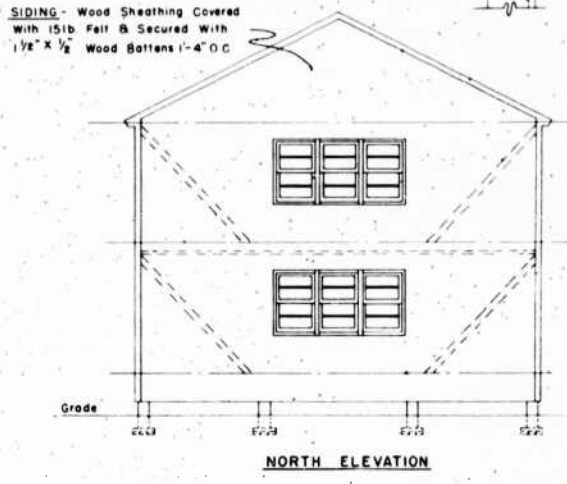
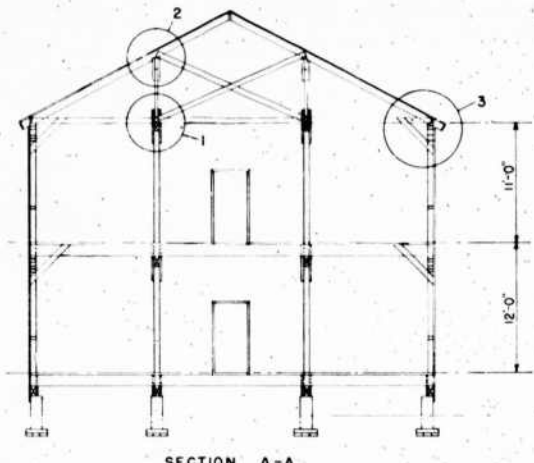
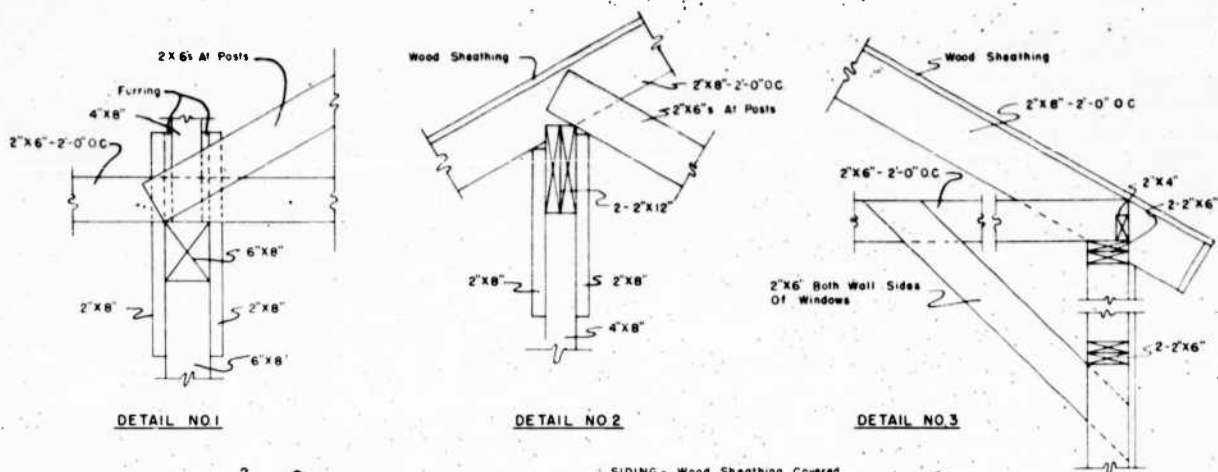

FIGURE 9. Revetment 2, front view



NOTE -
2nd Floor Same Except
Stairs Were Not Built

NOTE -
East Elevation Same But
To Opposite Hand

FIGURE 10. Construction Plans, Test Barracks .

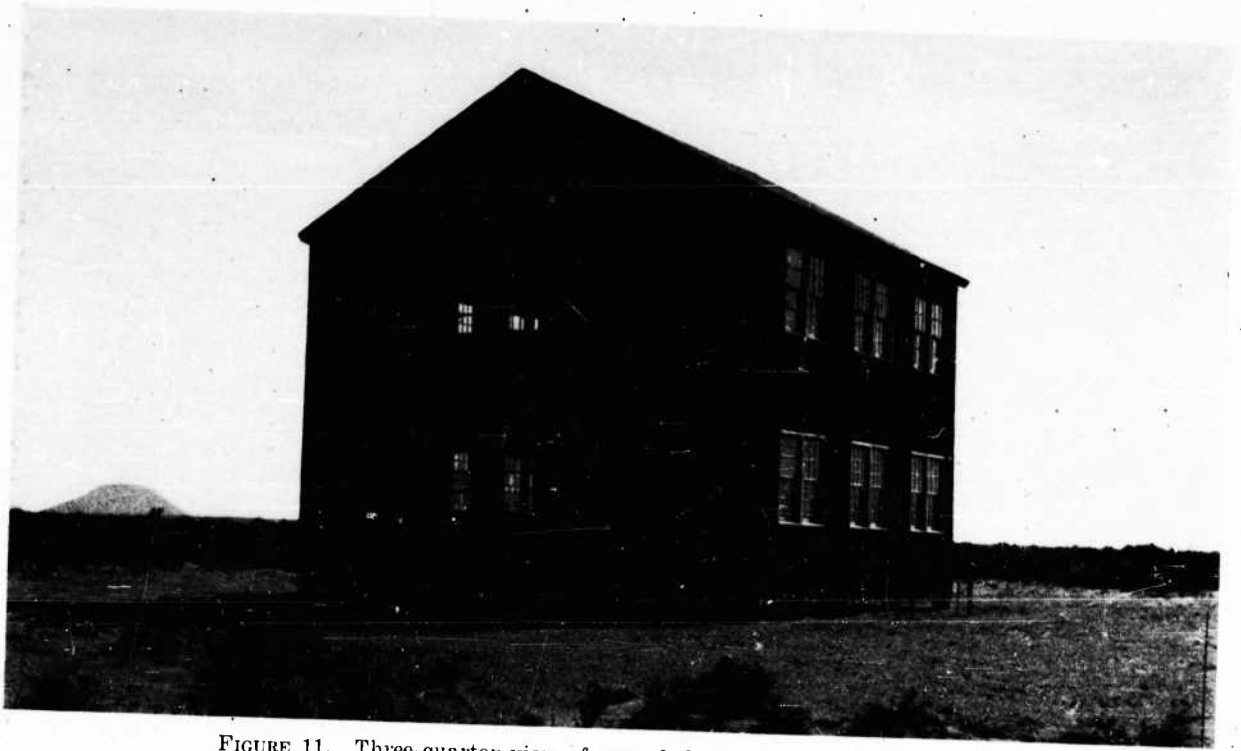

FIGURE 11. Three-quarter view of one of the barracks, looking southeast



FIGURE 12. Interior view of the second floor of one of the barracks, looking northeast

WINDOW NO -

1	2	3
3		1
	4	1
5		1
	6	1

2ND STORY

4	5	6
6		1
	9	1
4		1
	3	1

1ST STORY
NORTH ELEVATION

7	8

9	10

2ND STORY

13	14

1ST STORY
WEST ELEVATION

11	12

15	16

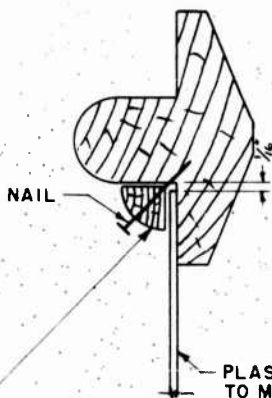

MASTIC APPLIED TO BOTH STRAIGHT SIDES OF 1/4 ROUND MOLDING:

19	20
5	5 3 3
	6 7 2
6	6 3 8 3
	9 2

21	22
2	4 7 4
6	3 6 3
5	2 5 2
4	4 8
3	6 3 9 6
	5 5

2ND STORY

23	24
4	4 8
	2 2
4	4 9
	2 2

25	26
6	6 2 7
	9 4 4
5	5 2
8	6 4 4

27	28
5	7 5
4	3 4 9 3
	6 8 6
2	5 2 5
3	4 3 4
	6 2 6 2

1ST STORY
EAST ELEVATION

Section Thru Muntin

Types & Quantities Of Glazing Materials In Each Building For Test I				
KEY NO	MATERIAL	SIZE		
		37 ⁵ / ₈ X 14 ³ / ₄	11 ⁵ / ₈ X 14 ³ / ₄	8 ⁵ / ₈ X 9 ¹¹ / ₁₆
BLANK	DS SHEET GLASS	17	104	147
1	SAME, BACKED BY 1/2" SQ, NO.14 WIRE MESH	8	-	-
2	WIRE GLASS, PLAIN, 1/4" THICK	4	8	7
3	LUMAPANE, .035"	2	8	8
4	VIMLITE, .03"	2	8	8
5	LUMARITH, .06"	1	4	8
6	LUCITE, .06"	1	4	5
6	LUCITE, .15"	1	2	3
7	TEMPERED GLASS, 1/4"	1	2	2
8	FLEXSEAL, 1/4"	1	2	2
9	DUPLATE, 1/4"	2	2	2

FIGURE 13. Glazing Plan for Barracks, Test No. 1

- (6) "Lucite," a clear sheet of acrylic resin, product of E. I. Du Pont de Nemours & Co., Wilmington, Del. This was tested in two thicknesses, 0.06" and 0.015". It was mounted in the same manner as the other plastics but the stapling was omitted, on recommendation of the manufacturer.
- (7) "Duplate," a laminated safety plate glass (two sheets of plate glass with a vinyl butryacetate core) ¼" in thickness, produced by the Pittsburgh Plate Glass Co., Pittsburgh, Pa. This was mounted with glazier's points and putty in the usual manner.
- (8) "Flexseal," also a laminated plate glass ¼" thick, is similar to Duplate but the core extends beyond the edges of the glass itself, and is made the full thickness of the plate. The extended plastic is secured to the frame and acts as a shock absorber, minimizing stresses in the glass. This plate must be made up at factory in sizes specified. It is manufactured by the Pittsburgh Plate Glass Co. Installation was by glazier's points and putty.
- (9) "Herculite," a tempered plate glass ¼" thick, also made by the Pittsburgh Plate Glass Co. In the tempering process, the outer surfaces of the plate are suddenly cooled while the core cools slowly, placing the former in compression and the latter in tension. Having initial compression, the extreme fibers are not as highly stressed in tension under flexure and hence the plate is much stronger. This plate cannot be cut after manufacture. Mounting was in the usual manner.

The buildings were located at distances from Igloo D as specified by the American Table of Distances for inhabited buildings for 500,000 net pounds of explosives, as follows: Building 1, 2,705 feet (barricaded distance); Building 2, 3,605 feet (two-thirds the unbarricaded distance); and Building 3, 5,410 feet (full unbarricaded distance). After the second test and before the explosion of Igloo F, Building I was repaired and reglazed, but the other buildings were left as they were.

3. Order of tests.

- (a) Detonation of explosives in Igloo D (500,000 pounds), 1 October 1946.
- (b) Detonation of explosives in Igloo E (500,000 pounds), 8 October 1946.
- (c) Increase of earth cover on Igloo F. Repair and reglazing of Barracks 1.
- (d) Detonation of explosives in Igloo F (250,000 pounds), 16 October 1946.

(e) Detonation of explosives in Revetment 1 (500,000 pounds), 23 October 1946.

(f) Detonation of explosives in Revetment 2 (250,000 pounds), 25 October 1946.

4. Explosive charges.

(a) *Igloos D and E.*—These igloos were identically loaded. Each contained 930 Navy Mark 36 1,000 pound aircraft demolition bombs, stacked as illustrated by the diagram, figure 14. Figure 15 is a photograph taken through the open doorway of Igloo E, showing the completed stacks. The net weight of TNT filler per bomb was 538 pounds, and the total net weight of TNT per magazine was 500,340 pounds.

(b) *Igloo F.*—This magazine was loaded with 465 of the same type of bombs as used in Igloos D and E. The total net charge weight was 250,170 pounds. The stacking plan for Igloo F is shown in figure 16, and an interior view of the igloo, showing some of the stacks in place, by the photograph, figure 17.

(c) *Revetment 1.*—This contained 40,323 Army antitank mines, M6-R7ARA. The net charge per mine was 12.4 pounds, making a total weight of 500,005 pounds of TNT in the stack. The mines were piled in a solid rectangular mass 21 high by 28 wide by 68 long, plus 339 on the center of the top. The mines were not removed from their metal crates before being stacked.

(d) *Revetment 2.*—20,162 M6-R7ARA mines were placed in a solid rectangular stack 16 high by 26 wide by 48 long, plus 194 on top. Figure 9 is a front view of this stack, which contained a total net weight of 250,008 pounds of TNT.

5. Priming and firing.

(a) *Igloos.*—The charges in Igloos D and E were primed according to figure 14. A section of primacord was introduced into the nose fuse well of each of four bombs selected at random in each stack. Composition C-2 was packed around the primacord, filling the cavity, in order to hold the primacord in place and act as an additional booster (the regular booster charges were in place in the bombs). Leads from one stack plus those from seven others were brought to a central point in the longitudinal aisle, and connected to two special

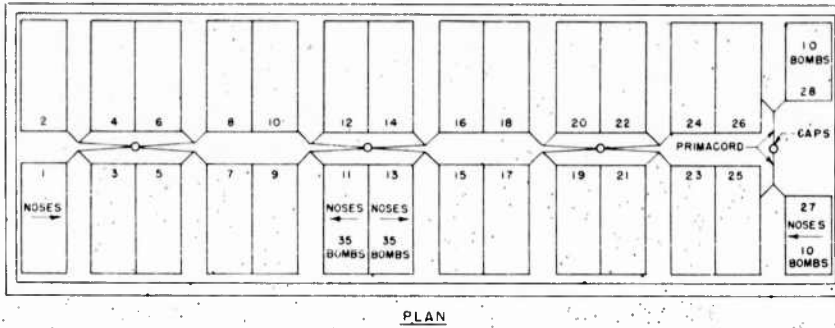
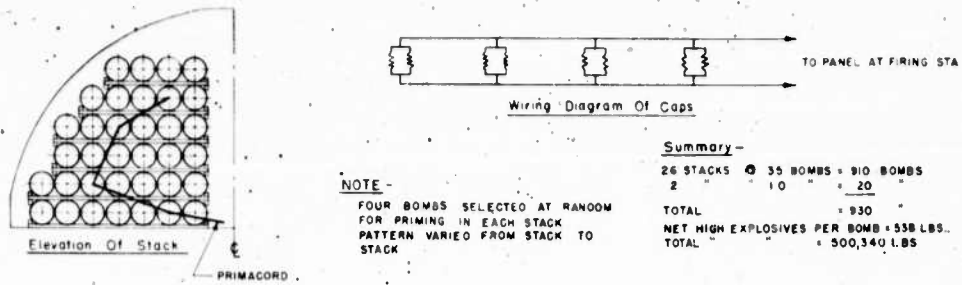

FIGURE 14. Stacking and Priming Plan, Igloos D and E, Tests 1 and 2

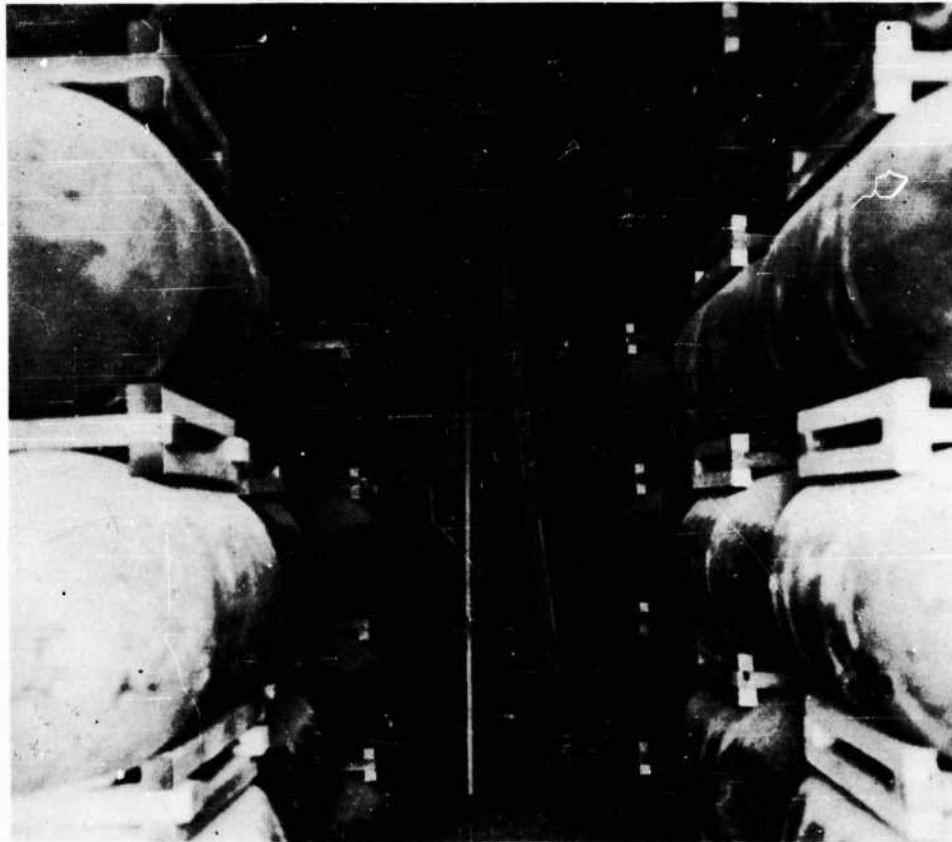
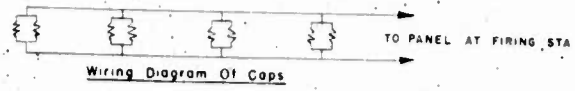
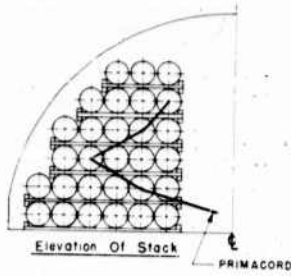

FIGURE 15. Interior of Igloo E from door, showing bomb stacks before priming



NOTE -
FOUR BOMBS SELECTED AT RANDOM,
FOR PRIMING, IN EACH STACK
PATTERN VARIED FROM STACK TO
STACK

Summary

16 STACKS @ 29 BOMBS	464 BOMBS
TOTAL	465
NET HIGH EXPLOSIVES PER BOMB	538 LBS
TOTAL	250,170 LBS

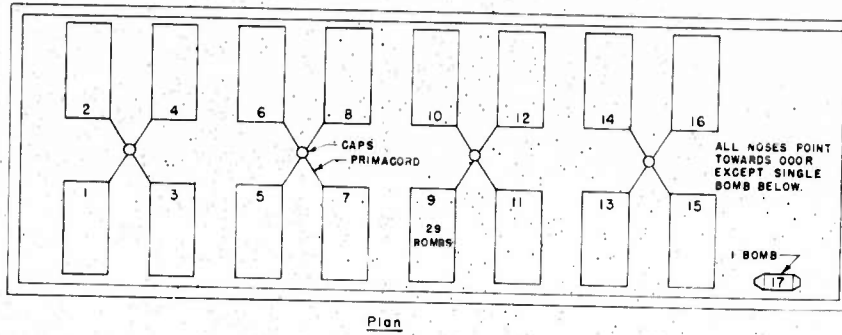

FIGURE 16. Stacking and Priming Plan, Igloo F, Test 3

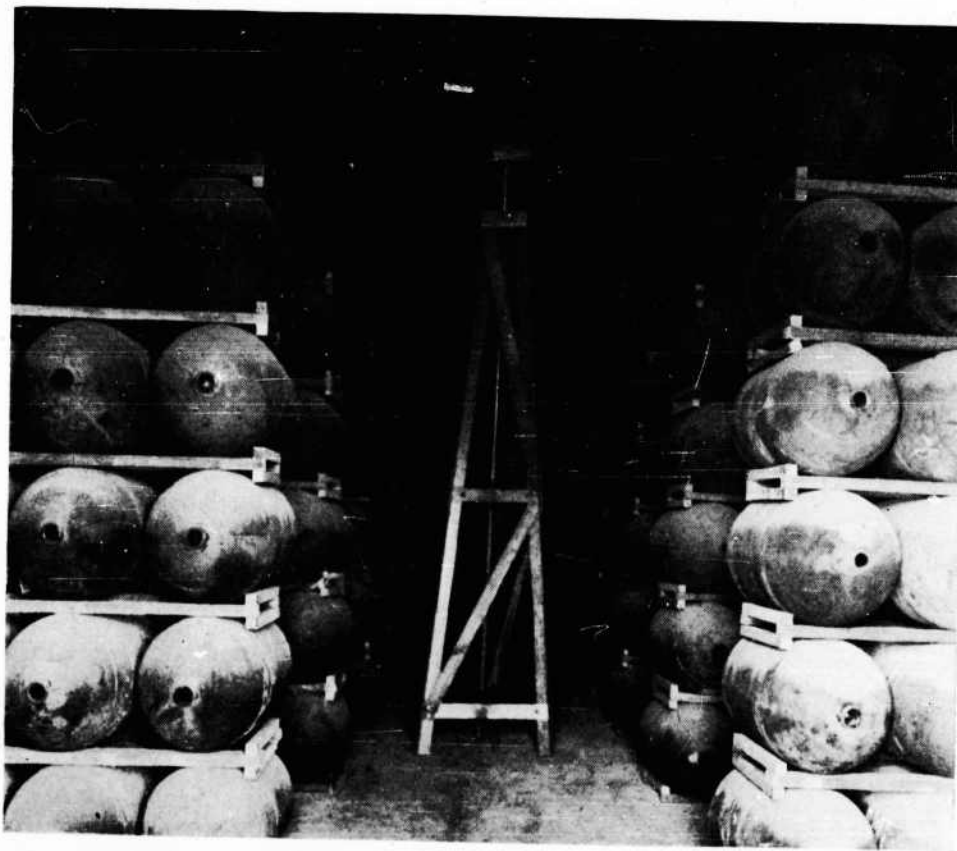

FIGURE 17. Bomb stacks in Igloo F

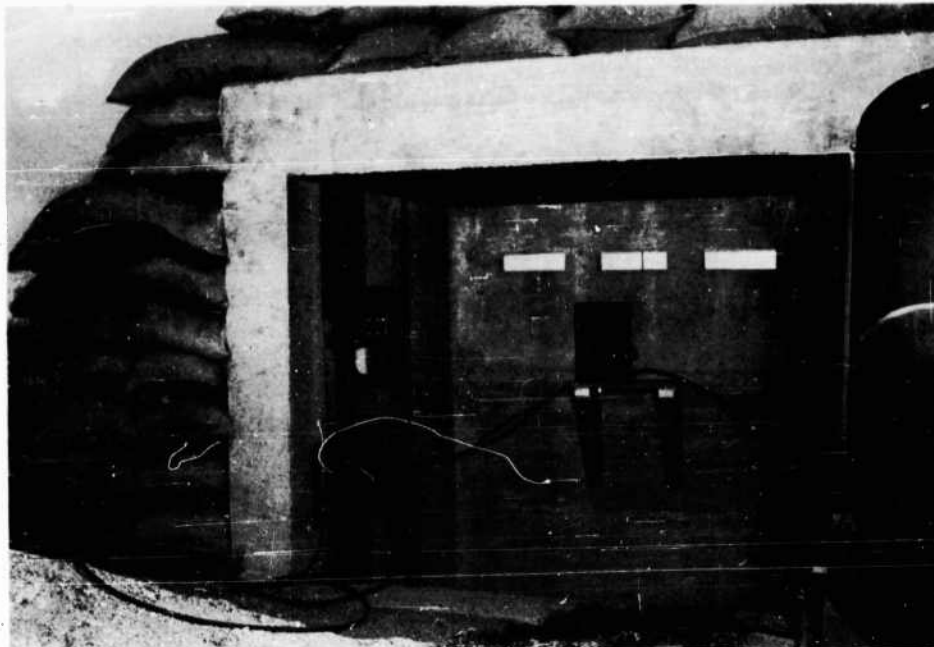

FIGURE 18. Firing shelter, view from rear. Part of generator is visible at right margin

engineer's tetryl electric blasting caps. There were three such groups, each firing eight stacks, and one group firing four stacks. All primacord leads were cut to equal length in the hope that the detonation waves would reach the primed bombs in each stack in the same instant. All caps were connected in parallel across firing wires which were led down each side of the central aisle. Near the door, the firing wires were spliced to a 2-conductor no. 12 A.W.G. insulated firing cable which was laid on the ground from the igloo to the firing station 4,800 feet south of Igloo D. Igloo E was not primed until after the explosion of Igloo D and Igloo F was not primed until after Igloo E had been exploded. Igloo F was primed in the same manner as Igloos D and E, except that there were fewer stacks per group.

(b) *Revetments*.—Fifty-eight mines were primed in revetment 1. These were located as follows: 7 on the front vertical face of the stack and a like number on the rear face, 16 on each side face, 3 on side of the top near the edge, and 6 in vertical line extending downward starting with the second from the top in the center of the stack. The mines in each face alternated from top to bottom in irregular fashion. The mines in the side and end faces were primed by in-

serting bights from a single length of primacord in the adapter cavities and pressing composition C-2 around the primacord and packing it around the outside. The primacord zigzagged around the four sides of the stack. The mines on top were primed by inserting knotted ends of primacord in the activator wells, packing C-2 around the primacord in and around the outside of the wells and connecting the leads to the primacord belt around the sides of the stack. The six mines beneath the center of the top were primed similarly and connected to a separate piece of primacord passed from one side to the other across the top of the stack. The same general plan was used in priming revetment 2.

(c) *Firing station*.—Figure 18 is a photograph of the firing dugout, a heavy concrete semiunderground structure with a thick overhanging slab roof covered with sandbags and slit observation windows of plate glass about 2" thick. The switches and controls for the firing line and relay circuits to cameras and other equipment were mounted on three panels in the dugout. The power leads ran from a portable gasoline engine, 120 volt, single phase AC generator set up just behind the dugout to the first panel, which contained a main line

switch, a dash-pot type time delay relay, two safety plug receptacles for interrupting the firing circuit, and a firing switch. With the generator running, main line switch closed and safety plugs in place, closing the firing switch would energize a circuit leading to the second panel and simultaneously start the plunger of the time delay relay in motion. The second and third panels contained switches and a bus to which control circuits to the various cameras, oscilloscopes and other equipment were connected. At the end of one second, during which interval the cameras and other apparatus commenced operating, the time delay relay would close the firing circuit and initiate the charge. Certain equipment which required a longer interval than 1 second to warm up or become operational was energized by switches thrown manually at the proper time before the firing switch was closed. In order for the detonation to be set off accurately at a predetermined time, to enable coordination of observations by distant stations, radio time signals consisting of 500 cycle peeps at 1-second intervals and vocal announcements were broadcast on 3490 and 6980 kcs. by an Army Signal Corps field transmitter set up on the observation point. The firing personnel in the dugout received the time signals on a portable receiver and the firing switch was thrown manually on the minus 1-second peep. It is estimated that the error introduced by manual operation in this manner should not exceed one-fifth of a second.

6. Instrumentation and observations by ANESB.

(a) *Air blast measurements.*—Peak air blast pressures resulting from the explosions were measured by three types of devices: Naval Ordnance Laboratory ball crusher gages, and a modification thereof, foil diaphragm gages of a type developed by the Bureau of Ordnance for the Bikini tests, and Aberdeen Proving Ground paper blast meters. The ball crusher and foil diaphragm gages were set out on radial meter lines in the open. Paper meters were placed in five types of locations: (1) along radial meter lines in the open, (2) in defiladed positions in old craters and dry stream beds, (3) outside of and behind barracks, (4) inside barracks, (5) inside a target igloo. The positions of all gages as set up in the field for the test are

shown by figures 19, 20, 21, and 22. Positions of paper meters at the barracks are shown by figure 35. The gages themselves are illustrated by figures 23, 24, and 25. They are described in the following paragraphs:

NOL ball crusher gage.—This gage measures relatively high values of peak blast pressure and is used close to the charge. It consists of a heavy brass housing about 1½" in diameter and 1½" long, containing a hardened steel piston ½" in diameter one end of which is exposed to the atmosphere. The other end contacts a specially heat treated copper ball seated on a hardened steel anvil. External pressure impinging on the piston causes deformation of the ball, the amount of which is a measure of the force exerted. The diameter of the ball used in these tests was 5/32", and the dynamic calibration values for this size ball when the gage is used in air (rather than under water, for which use the gage was designed) were determined by calculation involving certain approximations as described in appendix B of reference (2). The values vary with distance from the charge; at the distances used in these tests they were as follows:

Distance from charge, feet	100	120	140	160
k, in. x 10 ⁶ / lb. / in. ²	32.7	32.8	32.8	32.9

Peak pressure is determined by dividing the ball deformation (loss of diameter) in micro-inches by the value of k. The gages were mounted in "side-on" orientation, i.e., with the plane of the exposed face of the piston parallel to a line from the center of the detonated charge to the gage. The gage was partly buried in the ground, with the piston exposed flush with the surface, and the body fastened into the top of a piece of pipe driven about 18 inches into the ground vertically beneath it, in order to provide inertia against movement during impingement of the blast wave. The face of the gage containing the exposed piston was sealed with a piece of drafting tape to prevent dust entering between the piston and cylinder walls. The gages were handled as gently as possible after being loaded in order to avoid predeformations of the balls; however, this probably happened in many cases. Unfortunately, the gages gave quite erratic readings during the tests. Ground shock is believed to be one of the major causes of the wide scatter in the data. In order to use

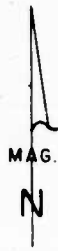

Line No 1

LEGEND

- P - ABERDEEN PAPER BLAST METER
- F - BIKINI TYPE FOIL " "
- C - NOL BALL CRUSHER GAGE
- A - ARCO. " " "

- 6000 P
- 5310 P
- 4690 P
- 4140 P
- 3650 P
- 3220 P
- 2845 P
- 2515 P
- 2220 P
- 1960 P
- 1730 P
- 1530 P
- 1350 P
- 1190 P
- 1055 P
- 930 PF
- 820 PF
- 725 PF
- 640 PF
- 565 PF
- 500 PF
- 440 F
- 385 F
- 330 F
- 275 F
- 225 F
- 175 F
- 160 CA
- 150 CA
- 140 CA
- 130 CA
- 120 CA

PAPER METERS IN CRATERS
 - 50' EAST - 300' EAST
 - 10' DEEP - 20' DEEP

NUMBER INDICATES DISTANCE
 IN FEET FROM CENTER OF
 CHARGE TO METER

D

Some As Line No.1

2030' PAPER METER IN DRAW 12' DEEP

Same As Line No.1
 But Omit Foil
 Meters.

900' PAPER METER IN
 DRAW 7' DEEP.

Line No.3

FIGURE 19. Blast Meter Layout, Test 1



LINE NO. 1

- 6000 P
- 5310 P
- 4690 P
- 4140 P
- 3650 P
- 3220 P
- 2845 P
- 2515 P
- 2220 P
- 1960 P
- 1730 P
- 1530 P
- 1350 P
- 1190 P
- 1055 P
- 930 PF
- 820 PF
- 725 PF
- 640 PF
- 565 PF
- 500 PF
- 440 F
- 385 F
- 330 F
- 275 F
- 225 F
- 175 F
- 160 CA
- 150 CA
- 140 CA
- 130 CA
- 120 CA

LEGEND

- P - ABERDEEN PAPER BLAST METER
- F - BIKINI TYPE FOIL " "
- C - NOL BALL CRUSHER GAGES
- A - ARCO BALL " "

NUMBER INDICATES DISTANCE
IN FEET FROM CENTER OF
CHARGE TO METER.

SAME AS LINE 1
BUT OMIT FOIL
GAGES.

4A & 1C AT THIS POINT.
REST OF LINE SAME AS
LINE 1.

LINE NO. 3

LINE NO. 2

E

140

29°10'

11°17'

FIGURE 20. Blast Meter Layout, Test 2

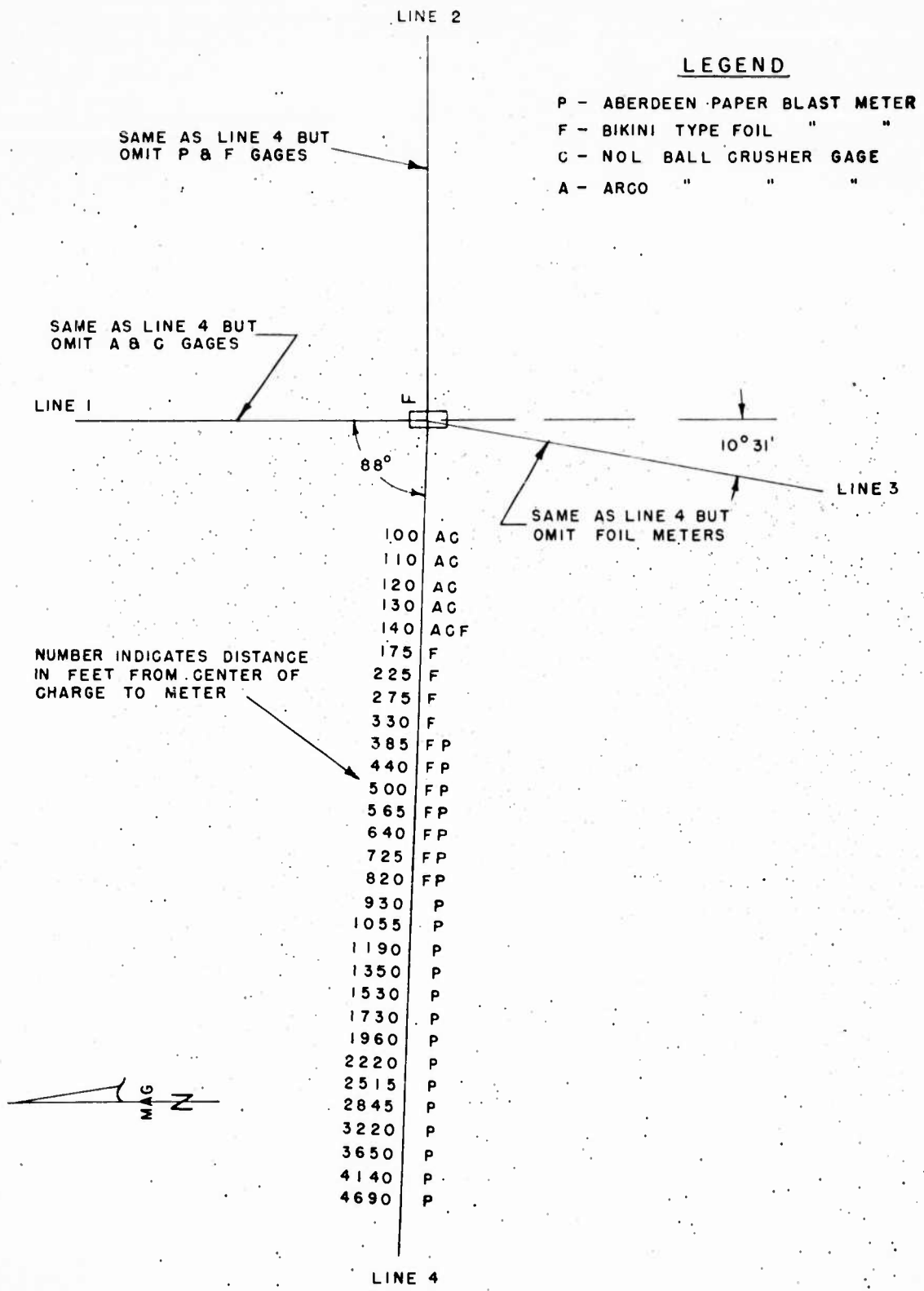

FIGURE 21. Blast Meter Layout, Test 3



LINE 1

6000	P
4690	P
3650	P
2845	P
2220	P
1730	P
1350	P
1055	P
930	F
820	P
725	F
640	P
565	F
500	P
444	F
330	F
225	F
160	AC
150	AC
140	AC
130	AC
120	AC

LEGEND

- P - ABERDEEN PAPER BLAST METER
- F - BIKINI TYPE FOIL " "
- C - NOL BALL CRUSHER GAGE.
- A - ARCO " " "

NUMBER INDICATES DISTANCE
IN FEET FROM CENTER OF
CHARGE TO METER.

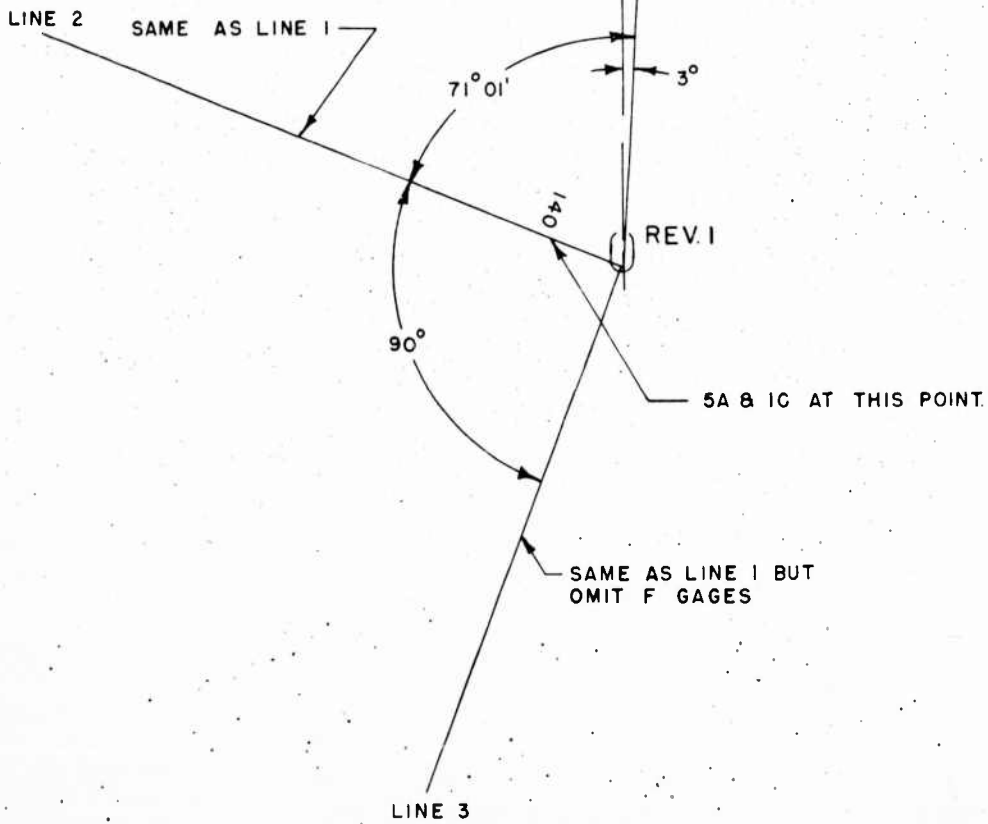

FIGURE 22. Blast Meter Layout, Test 4

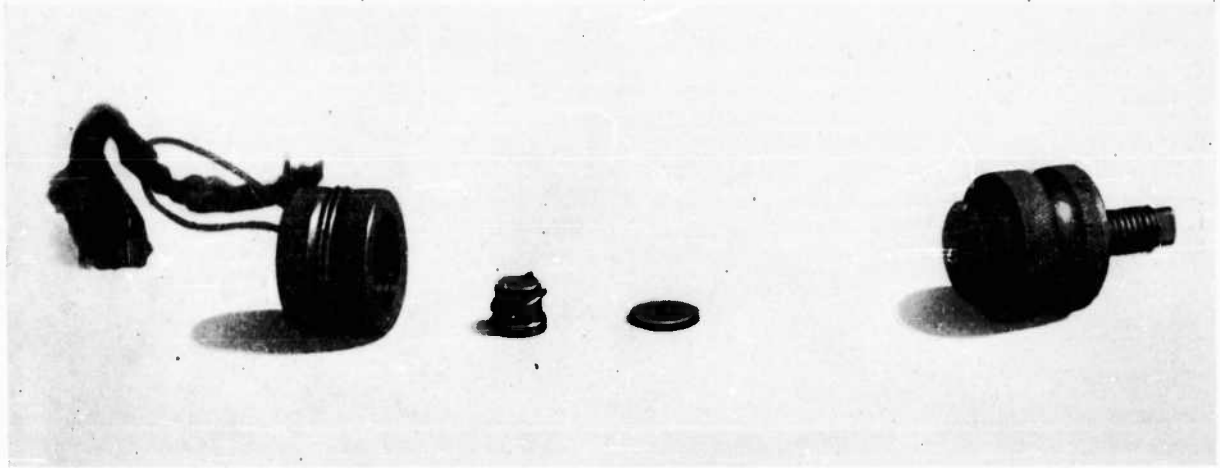

FIGURE 23. Exploded view of NOL ball crusher gage

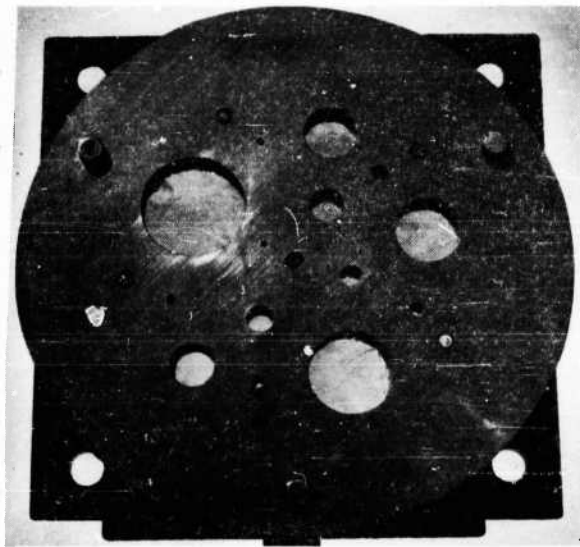

FIGURE 24. Close-up front view of Bikini-type foil blast meter, loaded with aluminum foil

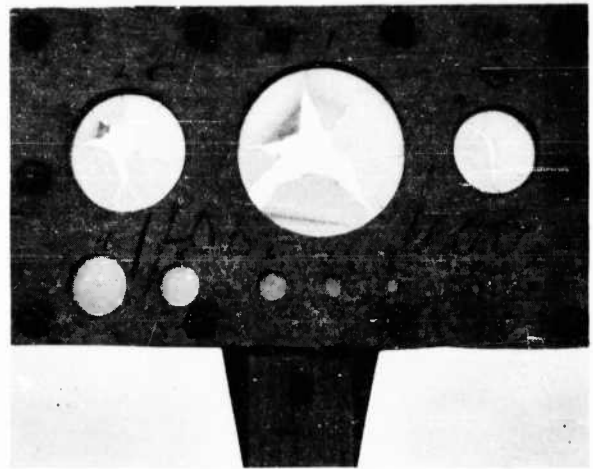

FIGURE 25. Close-up of an Aberdeen paper blast meter, after blast

these gages in such tests more successfully, a better technique of handling and mounting them in the field will have to be worked out.

Arco ball crusher gage.—This gage was the same as the NOL gage in all respects except that the piston diameter was 1.128" and the face area 1 square inch. In this gage about five times as much force was exerted on the copper ball as in the NOL gage and thus greater and more easily readable deformations were obtained. Thus, it was hoped, the percentage of error could be reduced; however, due to its greater piston mass this gage was slower acting

and seemed to be subject to errors as bad as those of the NOL gage. The constants for this gage were as follows:

Distance from charge,				
feet	100	120	140	160
k, in. $\times 10^6$ /lb./in. 2	163	164	164	164

Foil blast meter.—This was a heavy hollow steel cylinder about 14" in diameter by 14" deep, with one closed end and the other end fitted for mounting two heavy brass orifice plates containing 14 orifices of graduated sizes. The meter was loaded by inserting a ready-cut

sheet of aluminum foil between the plates and securing the plates in position by means of the studs and nuts provided for the purpose. The assembled meter was mounted on a channel iron post driven in the ground and was oriented with the orifices "side on" to the blast. This meter was read by noting and recording the smallest orifice in which the foil was ruptured by the blast. Pressures corresponding to the various hole sizes for the aluminum foil used, which was 2SO foil 0.0012" thick, are given below:

TABLE I.—*Calibration of 0.0012" A1 Foil in Bikini type blast meter*

Smallest diaphragm ruptured		Peak blast pressure lbs./in. ²
No.	Diameter (in.)	
1	3.00	5.2
2	2.40	6.4
3	1.92	7.9
4	1.54	9.7
5	1.24	12.0
6	.984	14.8
7	.781	18.5
8	.625	22.8
9	.500	28.1
10	.404	34.3
11	.323	42.4
12	.257	52.6
13	.205	65
14	.166	79

The above calibration was obtained by firing standard charges whose pressure-distance relation was known in the presence of meters set up at various distances. A function for peak pressure in terms of smallest hole size ruptured was determined from the mean of the readings obtained. This calibration is described more fully in appendix B.

Aberdeen paper blast meter.—This meter consists of two 20" x 11" pieces of 3/4" plywood bolted together around their edges and containing ten orifices, the diameters of which are given in table II. The paper is placed between the boards and the assembled meter mounted by a bolt on a 2" x 4" stake driven vertically in the ground. These meters are set up "face-on" to the blast (except inside and behind the barracks) i.e., the plane of the paper is perpendicular to the line from the center of the charge to the meter. The paper used was "Rap-in-

Wax" waxed paper made by the Rap-in-Wax Paper Co. of Minneapolis, Minn., and was about .001" thick. This paper loaded in these blast meters was calibrated prior to the test program in the same manner and simultaneously with the calibration of the aluminum foil diaphragm meters. The procedure used is described in appendix B, and the results are given below:

TABLE II.—*Calibration of Rap-in-Wax Paper in Aberdeen paper blast meters*

No.	Smallest diaphragm ruptured	Peak blast pressure, lbs./in. ²
	Diameter, in.	
1	5.625	0.25
2	4.00	.38
3	2.82	.60
4	2.00	.94
5	1.38	1.53
6	1.00	2.30
7	.75	3.34
8	.50	5.64
9	.38	8.16
10	.25	13.8

Although mounted facing the explosion, these gages used with the above calibration give the equivalent "side-on" or hydrostatic peak pressure.

(b) *Craters.*—The apparent craters from the explosions of Igloos D and E were cross-sectioned by a survey crew, and contour plans drawn. The apparent craters of Igloo F and the two revetments were sectioned and profiles drawn for the north-south and east-west axes. At the deepest point in each crater, an excavation was made to determine the true depth and the value noted on the drawing.

(c) *Ground movement.*—A grid or network of 2" x 2" wood hubs was placed around each primary igloo in a pattern 500 feet square. The stakes were driven flush with the ground, and their elevations and horizontal distances from each other were noted before the explosion. After the explosion, their elevations and distances were again measured and compared with the previous readings in order to obtain permanent movements of the surface of the ground.

(d) *Permanent displacement of target igloos.*—The positions of Igloos E and F were observed before and after the explosion of Igloo D by transit located on the original longitudinal axis extended and also on westward

extensions of horizontal lines lying in the outer surface of the front end walls, in order to detect longitudinal or lateral movement. Before-and-after elevations were run on points on the floor and on the inner surface of the arch directly above the floor points. In addition, mechanical deflection gages of a simple type were installed in the igloos. The location of these gages and diagrams indicating how they functioned are given by figure 26. The slide type of gage measured the permanent change, either positive or negative, in the distance from arch to floor between the points where installed. The string gage measured the permanent change in either direction in the diagonal distance from the spring section of the arch on

one side of the igloo to the quarter point on the other side in the same transverse section. There were six slide gages and four string gages in each target igloo.

(e) *Transient displacement of target igloos.*—The slide and string gages also recorded the maximum transient changes in the dimensions measured, in either the positive or negative direction. It is recognized that both types of gages are subject to errors due to lost motion of parts, overdrive, elasticity of the wire used in the string gages, and other causes. Insofar as practicable, however, the mechanisms were designed to minimize such errors. The slide gage reading contains a component due to floor heave or subsidence as well as that due to arch

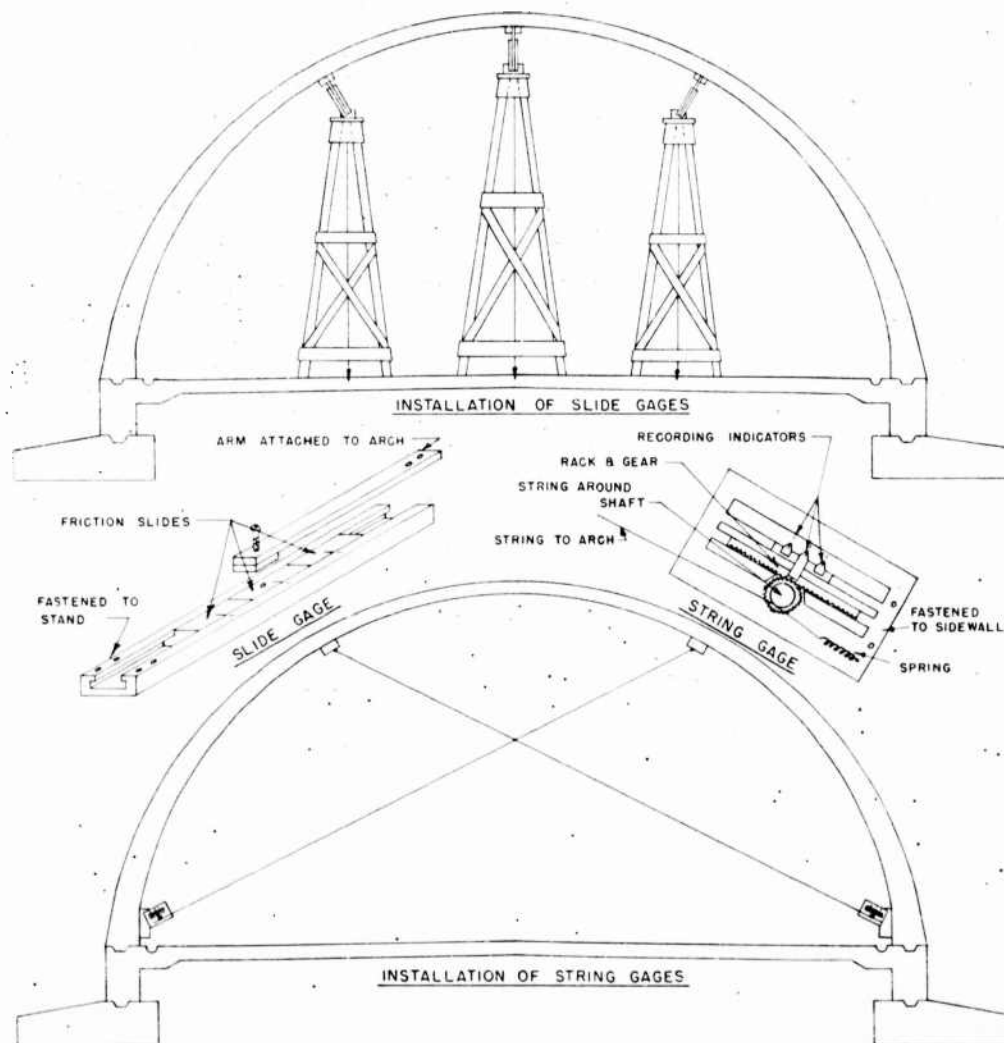

FIGURE 26. Deflection Gages, Tests 1 and 2

deflection, and the components cannot easily be separated. The string gage reads the algebraic sum of deflections of two points of the arch. Nevertheless, it is believed that the gages give a good indication of the relative severity of arch distortions under the blast loading.

(f) *Damage to target igloos.*—After each explosion, remaining igloos were carefully inspected from both outside and inside, except that earth cover was not removed to permit inspection of external arch surfaces. Notes were made and photographs taken of cracks, spalled places, and other evidences of failure. The contents of the igloos were inspected to disclose whether they had been disturbed.

(g) *Damage to revetments.*—Revetments were inspected, distortion or erosion of the earth embankments noted, and disturbance of the stacks of mines recorded. Photographs were taken where pertinent.

(h) *Damage to barracks.*—After the Igloo D explosion, the three barracks were inspected and note made of displaced foundations, broken studs, sheathing, rafters, wall displacements, torn siding and roofing, broken window frames, fractured sash and window panes, and other evidences of damage. Numerous photographs of typical instances of structural failure and breakage, as well as of window damage, were taken. Subsequent to the Igloo E explosion, the buildings were inspected again, and information recorded as to additional damage and window breakage. Prior to the explosion of Igloo F, Barracks 1 was repaired and reglazed; after the explosion, notes of structural and window damage to Barracks 1 were made as in the case of the first explosion, and superficial inspections were made of Barracks 2 and 3. Photographs of the four elevations of each barracks were taken after each of the first three explosions.

(i) *Motion pictures.*—High-speed motion pictures were taken of Igloo E during the explosion of Igloo D from a point 2,250 feet to the north, and of Igloo F during the explosion of Igloo E from a point 2,000 feet to the west, using an Eastman Hi-Speed 16 mm. camera with a 6" telephoto lens. The film was Eastman Super XX and was exposed at speeds of from 600 to 900 frames per second. The scenes recorded showed the blast waves, missiles, and

smoke and debris clouds resulting from the explosions. A 35 mm. Fastax camera without a telephoto lens was used to record the explosion scene at speeds of from 1,000 to 3,500 frames per second in each test including the explosions of Igloo F and the revetments. A diagram showing the positions of the Hi-Speed and Fastax cameras is given by figure 27. In addition to the high-speed pictures, standard 35 mm. films (at 16 frames per second) were made with a Cine-Kodak from the observation station in each test. A 16 mm. kodachrome film was made from the observation station in the explosion of Igloo E. Several other films were taken by newsreel cameramen and other observers, but have not been obtained by the Board.

(j) *Fragmentation.*—Because of the short time interval between explosions and because of the fact that many previous tests had littered the area with fragments, it was not possible to make a detailed missile survey and study. Only general observations were made.

7. Observations by other organizations.

(a) *Naval Ordnance Laboratory.*—Micro-barograph records were taken at widely dis-

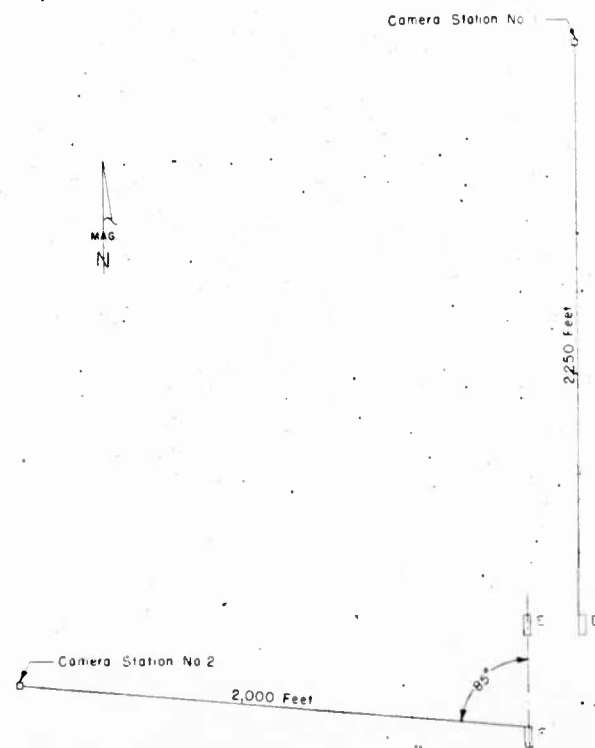

FIGURE 27. Location of Camera Stations

persed stations, the farthest which recorded an impulse being at Great Falls, Mont., 280 airline miles distant. Other stations receiving impulses were located at the proving ground, 8 miles; town of Arco, 20 miles; Pocatello, 55 miles; Burley, Idaho, 87 miles; Clearfield, Utah, 181 miles; West Yellowstone, Mont., 116 miles. The equipment used was the NOL Acoustic System, Mark I, in which the pulse received by a diaphragm is measured by a variable inductance bridge.

(b) *Naval Ordnance Test Station, Inyokern.*—This organization took air blast measurements using Bikini-type foil gages mounted in five positions: (1) facing toward (face-on), (2) facing right (side-on), (3) facing left (side-on), (4) facing up (side-on), and (5) facing down (side-on). They measured the velocity of propagation of the shock wave by photographing a line of cellophane bags inflated with argon, which possesses the property of luminescence under pressure changes, and also by means of foil bridges in which electrical contacts made by thin strips of foil were broken by the blast, sending impulses to an oscilloscope where they were photographed on the screen along with a sine-wave which furnished a time-base. This group also obtained pressure-time curves at various distances from the explosions, by means of lens-shaped diaphragm strain gages constructed by the Pasadena physics branch of the N.O.T.S. They also took high-speed motion pictures of the first two explosions.

(c) *Signal Corps, Army.*—The primary interest of this group was the study of sound propagation resulting from the explosions in order to determine the parameters of the upper atmosphere for meteorological purposes. In conducting these studies the time and the vertical angle of arrival of sound waves was measured by the use of two arrays, each consisting of two microphones on a 3-mile base line on a location remote from the source of the explosion. From the data thus obtained it was hoped that information on the vertical structure of the atmosphere could be obtained. These observations were accomplished by the use of special pressure type microphones designed and constructed at the Signal Corps Engineering Laboratories and having a response from 0.06 to 1 cycle per second.

A radar set was installed near the site of the explosion in an attempt to measure directly the speed of vertical movement of sound waves as they travel away from the radar set after having passed beyond this equipment.

To assist in the coordination of observations by all parties, a radio transmitting station was set up (on the observation hill) and a timing signal broadcast to provide accurate synchronization of sound observation at all remote stations.

Short range observations were also made using similar microphones to those described above except that the frequency response of those microphones ascends to 0.5×10^{-3} cps. The response of these microphones is approximately flat from this point up to 0.06 cps and then drops 6 db per octave toward higher frequencies. Such a response permitted observations at close range without the likelihood of damaging the equipment as the peak energy of the blast was expected to occur in the neighborhood of 1 cycle per second. From these observations it was hoped that the frequency distribution of the blast wave could be obtained. An attempt was also made to pick up any low frequency sound which may have been reflected vertically downward from temperature discontinuities in the upper atmosphere.

The equipment used was as follows:

- a. Radio transmitting station to give timing signals.
- b. Sound ranging microphones as described above.
- c. Radio set SCR-658-() with Radio Receptor AN/FMQ-1() to make radio-wind finding and radiosonde meteorological observations to 80,000 feet or higher for purposes of correlation with sound propagation measurements.
- d. Meteorological Station SCM-1 for tracking vertical rate of ascent of compression wave.

(d) *United States Weather Bureau.*—Microbarographs equipped with high-speed Esterline Angus time recorders were installed at the following locations at the stated distances from Igloo D for the tests of October 1 and 8:

1. Two miles south.
2. Observation point, 4.1 miles.
3. Naval Proving Ground warehouse, 3 miles.
4. Arco, Idaho, 20 miles.
5. Dubois, Idaho (Sheep Experimental Station), 57 miles.
6. Idaho Falls, Idaho, 48 miles.
7. Burley, Idaho, 87 miles.

In addition high altitude soundings of temperature, pressure, relative humidity, and in some cases wind, were made at the following locations:

Auburn, Calif.	Grand Junction, Colo.	Phoenix, Ariz.
Big Springs, Tex.		Rapid City, S. D.
Bismarek, N. D.	Great Falls, Wyo.	Santa Maria, Calif.
Boise, Idaho	Lander, Wyo.	
El Paso, Tex.	Las Vegas, Nev.	Spokane, Wash.
Ely, Nev.	Medford, Ore.	Tatoosh Island, Wash.
Glasgow, Mont.	Oakland, Calif.	
	Ogden, Utah	

Two-thousand-gram balloons were used to carry the radiosondes to altitudes considerably higher than those generally attained in radio-sonde observations. Wherever practicable, the balloon's path was also observed by means of a theodolite or an SCR-658 radio-direction-finding set.

(e) *St. Louis University.*—The Bureau of Ordnance through the Office of Naval Research arranged with St. Louis University for measurements to be taken of fluctuations in atmospheric pressure due to the explosions by means of large diaphragm type microbarographs. Stations were set up at the proving ground, at a distance of 8 miles (airline); at Pocatello, 55 miles; near Dubois, Idaho, 57 miles; and at West Yellowstone, Mont., 116 miles. The equipment operated in the following manner: movement of the diaphragm due to a pressure pulse was communicated to a coil in a magnetic field, generating a current which was led to a d'Arsonval galvanometer the mirror of which rotated accordingly and in turn caused movement of a spot of light on photographic paper. The paper was mounted on a drum recorder

which was driven by clockwork and revolved at constant speed, thus furnishing a time base. The amplitude and direction of the graph drawn by the light spot was proportional to the amount and direction of change in atmospheric pressure.

(f) *Woods Hole Oceanographic Institution.*—On invitation of the Bureau of Ordnance, this organization sent a group to measure impulse and peak pressure in the shock waves emanating from the explosions. They used a free-piston gage in which the motion of the piston on receiving the blast impulse was recorded by a metal scribe on paper fixed on a drum revolving at constant speed. This produced a deflection-time curve, the first derivative or slope of which at any point was proportional to piston velocity and hence its momentum and impulse received up to that instant. The second derivative represented acceleration of the piston and hence was proportional to the force acting upon it. Thus the initial value of the second derivative was a function of the initial or peak pressure. The gage was mounted in a horizontal position with the piston level and supported on nearly frictionless roller bearings. One end of the piston was exposed to external pressure.

(g) *Office of Naval Research.*—A representative of this office was sent to make measurements of seismic phenomena caused by the revetment explosions. Neumann-Labarre displacement meters were set up at the proving ground gun emplacement, 7.2 miles from the explosion, and at a point on the railroad spur leading into the proving ground, 9.9 miles from the explosions. These instruments measured the horizontal component of the ground wave.

PART IV. RESULTS

A. MEASUREMENTS AND OBSERVATION MADE BY ANESB

I. Test I.

(a) *General.*—The contents of Igloo D were detonated at 1100 MST, 1 October. Light showers had been falling until a short while before the explosion, and there was an unbroken overcast about 1,000 feet above the plain. The temperature was 62° F, the barometric pressure 25.00" Hg., and there was no wind. The detonation appeared as a bright yellowish flash followed by a heavy dark grey smoke and debris cloud in which red flames were visible for a moment, and which mushroomed outward and upward with a boiling motion, penetrating the natural cloud ceiling, its upper portion being lost to view. Figure 28 is a photograph of the cloud at this stage. It continued to expand laterally and eventually reached a diameter at the ground of over a mile. Figure 29 shows its later development. Atmospheric conditions were favorable for perceiving the trace of the air blast or shock wave, which appeared as a wraith-like semicircular arc, centered on the igloo, expanding at high velocity. It emerged from the smoke cloud early in the latter's formation and could be seen easily until it had travelled about 2 miles from the point of origin. The phenomenon seen was not the wave front but was actually atmospheric vapor condensed by adiabatic cooling in the rarefaction phase of the blast wave. No ground shock was felt by observers at the observation station, which was located on a basalt outcrop 4.1 miles from Igloo D. The sound of the explosion arrived about 19 seconds after the flash was observed, and consisted of two separate and distinct sharp reports, about a second apart. The second report seemed slightly less loud than the first. The blast or concussion was felt simultaneously; at that distance it was mild. There was no doubt that the detonation was of high order and complete. No satisfactory explanation has been offered for the double report. It is not believed that

the second report was due to a reflection, but it is thought that in some way a second peak in the pressure-time curve of the blast wave was formed. Such often occurs in detonations of small quantities of high explosives.

(b) *High-speed motion pictures.*—The most interesting photographic results were obtained from the Eastman Hi-Speed camera, which produced a film in which the trace of the shock wave was clearly visible as it passed over Igloo E. The effects of the detonation as seen in this film may be described as follows: The instant of detonation was marked by a sudden brightening of the scene, caused by the flash. A few frames later, the shock wave appeared, advancing at high velocity across the field of view. At first it was visible only at points where it intersected the silhouetted outlines of the igloos. The ground surface behind the wave front was obscured by a pall of turbulent, flying dust set in motion by the blast. When the wave struck the sloping earth embanked on Igloo E, it was reflected upward, and a "Mach" wave was formed. The intersection of the incident, reflected, and Mach waves, known as the "triple point" was distinctly visible as the front moved up the slope and over the top of the igloo. At this point, the camera speed as determined from timing marks on the film was approximately 700 frames per second, and the elapsed time from the instant of detonation until the arrival of the shock front at the centerline of the igloo was 0.07 seconds. This corresponds to a velocity of 3,000 ft./sec., assuming the wave originated at the center of the charge at the instant of detonation. This, of course, does not actually occur, as the wave is not developed until the volume of the products of detonation is more than 5 times the original volume. As the shock wave passed the center of Igloo E, its mean velocity was about 2,250 ft./sec. The forward edge of the flame, smoke and dust cloud, in the air above the igloo, moved across the scene at about 1,250 ft./sec. Then came a

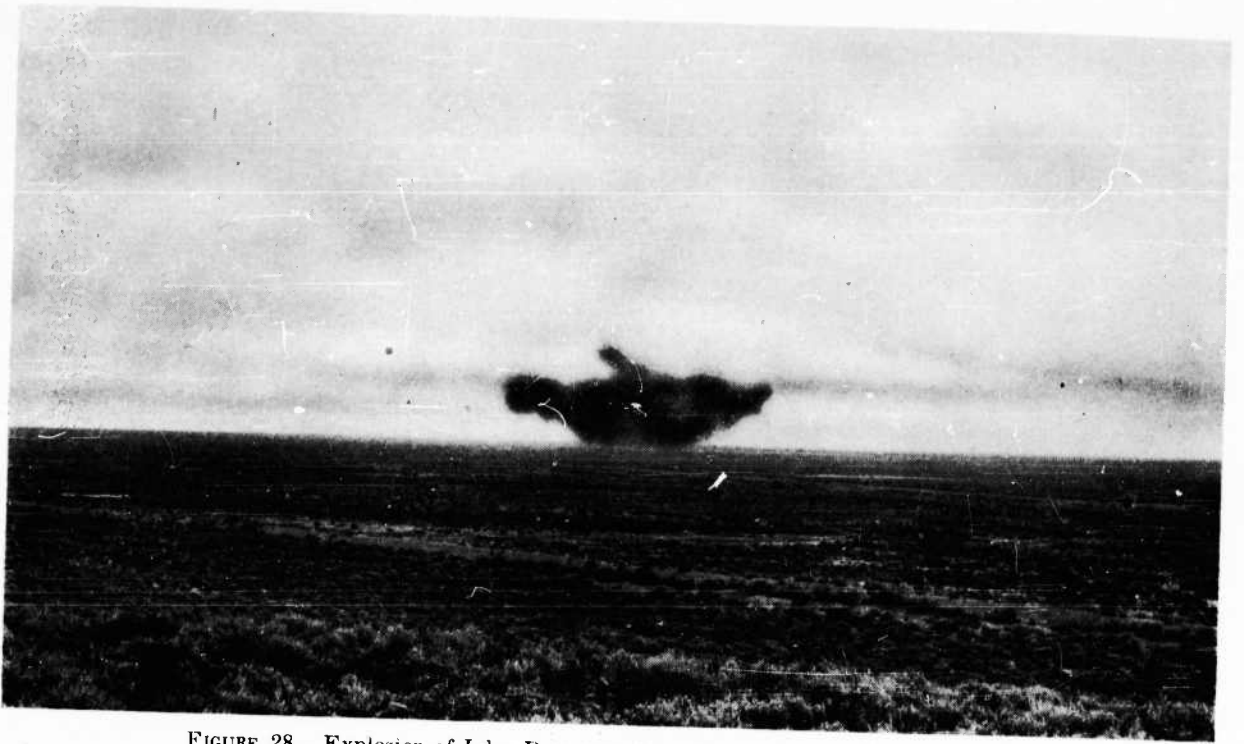

FIGURE 28. Explosion of Igloo D as seen from observation station (early stage)



FIGURE 29. Explosion of Igloo D (later stage)



a. Fire and smoke cloud nearing target igloos, .046 sec. after flash. Shock front visible where it cuts slope of Igloo F.

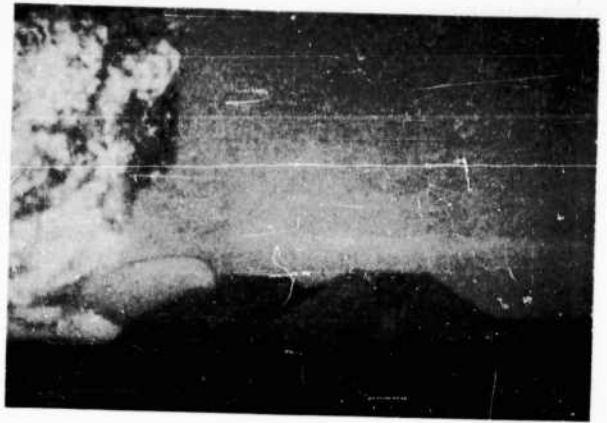

b. .056 sec. after flash. Shock front visible where it cuts headwall of Igloo F near top.



c. .062 sec. after flash. Shock front halfway up slope of Igloo E. Note lighter shade behind front, due to raised dust.

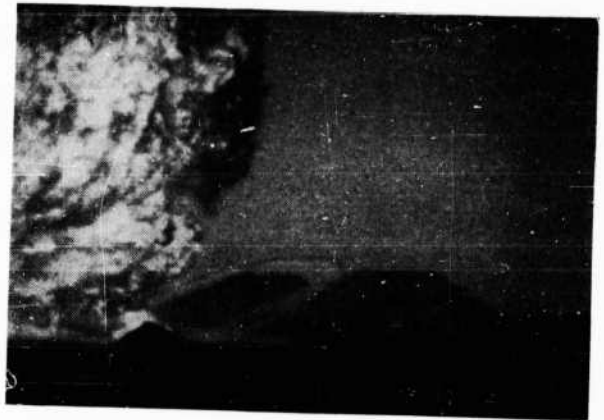

d. Wave at top of slope of Igloo E, .068 sec. after flash. Incident, reflected, and "mach" waves intersect at bend in wave front, called "triple point".



e. Wave front has reached center of Igloo E, .074 sec. after flash.

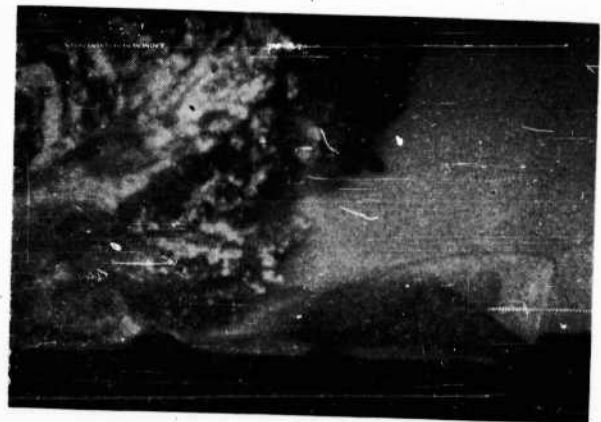

f. Wave cuts horizon line on far side of igloo .100 sec. after flash. Second dark front is believed to be dust.

FIGURE 30. Selected frames from Eastman Hi-Speed film, Test 1

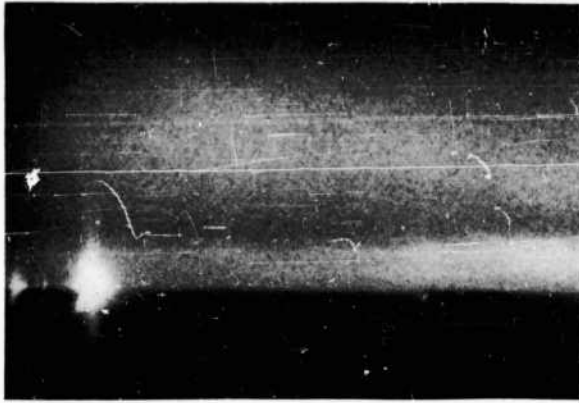

a. Flash at rear of Igloo D. Flame jets at front and along top of igloo. Igloo F is faintly visible at right.

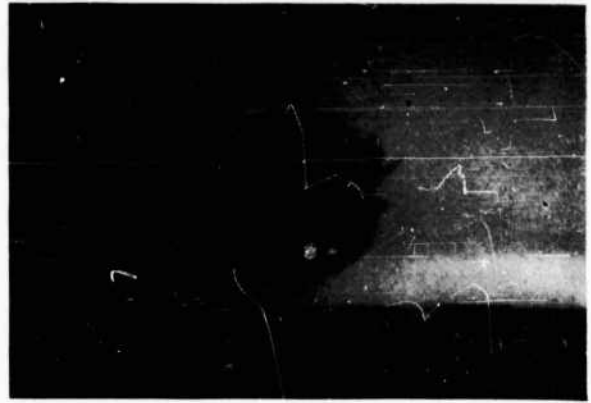

b. Cloud 0.23 sec. after flash. Dust on ground denoting presence of shock wave has reached Igloo F.

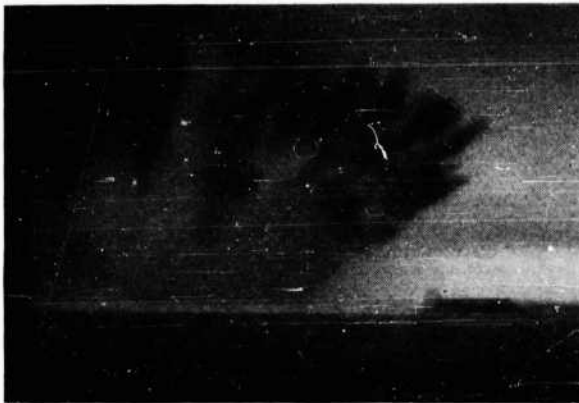

c. Cloud 0.35 sec. after flash. Vapor cloud formed in negative phase has reached Igloo F.



d. Cloud at 0.46 sec. almost obscured by vapor.

FIGURE 31. Selected frames from Fastax film, Test 1

group of fragments trailing light-colored smoke and travelling low, flat trajectories at about 1,150 ft./sec. Next, a white, vaporous cloud emerged from the base of the main cloud and quickly enveloped the entire scene, obscuring everything else from view. At about this time, some of the close-in portions of the cloud were beginning to drift backward, showing that the negative phase of the blast was commencing. Selected frames from this film are reproduced in figure 30.

The Fastax camera's field of view was broad enough to include all three igloos, although due to the lack of a telephoto lens the images were quite small, and in addition, the exploding igloo (D) was behind Igloo E and obscured by it. The Fastax film showed first a thin streak of flame shooting up from the rear of the igloo,

then on the next frame a large bright flash appeared at the rear and a smaller flash at the front. In the succeeding frames, the flames merged and developed into an expanding ball of fire in which black smoke first tinged the lower edges and then grew over the entire surface of the cloud as the fire played out. The shock wave was not visible, evidently because of unfavorable light conditions. However, its effects were seen, particularly as it passed over Igloo E, the shade of which turned from dark to light, owing to the earth which was blasted up. The same white vaporous cloud seen in the Eastman Hi-Speed film emerged from the base of the dark cloud mass and soon blotted everything else from view. Selected frames from the Fastax film are reproduced in figure 31.

(c) *Air blast.*—Peak pressures obtained

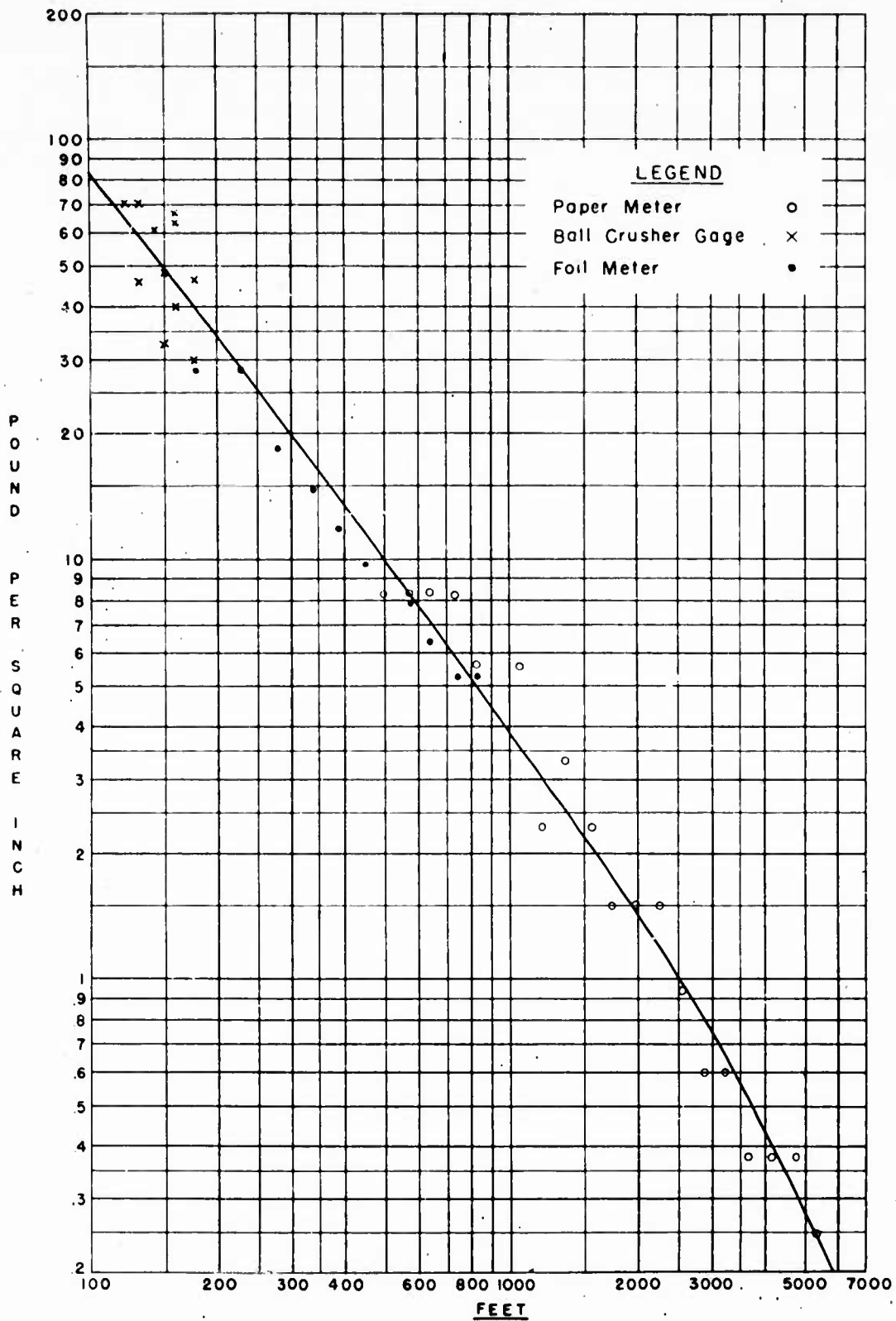

FIGURE 32. Peak Blast Pressure vs Distance from charge, Test 1, Line 1 (Off Front)

from the NOL and Arco modification of the ball crusher gages are presented in table III. Unfortunately, the scatter of this data is bad.

TABLE III.—Peak blast pressures, p.s.i., from ball crusher gages, test 1

Distance from charge, feet	Line 1		Line 2		Line 3	
	NOL	Arco	NOL	Arco	NOL	Arco
120	70	36?	58	66	43	85
130	46	71	46	46	45	125?
140	49	61	70	52	61	29?
150	40	33	46	55	40	32
160	64	66	152?	52	152?	15?
175	46	30

Pressures obtained from the Bikini-type foil and Aberdeen paper blast meters placed along the three meter lines are given in the following table:

TABLE IV.—Peak blast pressures, p.s.i., from foil and paper meters, test 1

Distance from charge, feet	Line 1		Line 2		Line 3
	Foil	Paper	Foil	Paper	Paper
175	28.1
225	28.1
275	18.5	28.1
330	14.8	18.5
385	12.0	18.5
440	9.7	14.8
500	9.7	8.2	9.7	8.2
565	7.9	8.2	7.9	8.2	8.2
640	6.4	8.2	7.9	8.2	8.2
725	5.2	8.2	6.4	8.2	5.6
820	5.2	5.6	6.4	8.2	5.6
930	<5.2	5.2	5.6	5.6
1,055	5.6	3.3	3.3
1,190	2.3	3.3	3.3
1,350	3.3	2.3	3.3
1,530	2.3	3.3	2.3
1,730	1.5	3.3	1.5
1,960	1.5	1.5	.94
2,220	1.594	1.5
2,5159494	.94
2,8456094	.60
3,2206060	.60
3,6503838	.38
4,1403825	.38
4,6903825	.38
5,3102525	<.25
6,000	<.2525	<.25

In figures 32, 33, and 34, pressures from the foregoing tables are plotted against distance from the center of the charge on logarithmic graph paper. As the points seem to follow a slightly concave downward curve better than a straight line, such a curve has been fitted by eye to the data in the graph for each meter line. The curves indicate that the peak pressures were of the order of 80 p.s.i. at a distance of 100 feet, dropped to about 4 p.s.i. at 1,000 feet, and were less than 1 p.s.i. at 2,705 feet, at which distance the nearest barracks was located.

Registration of the paper meters placed in defiladed positions (two in craters 10- to 15-foot deep 820 feet from the charge, one in a dry wash bottom 7-foot deep 900 feet from the charge, and one at 2,030 feet in a dry stream bed 12-foot deep) was in all cases the same as the registration of the meters on the open meter lines at the same distances. Registration of the paper meters inside of and around the outside of three barracks buildings is given by figure 35. There was only one case of rupture of a diaphragm inside the buildings apparently due to blast instead of flying glass, and this case may also have been due to flying glass although it did not appear so. Pressures indicated on the near sides of the buildings agreed well with those on the meter lines at corresponding distances. Meters in the lee of the house (on the south and west sides) either registered pressures much less than those on the exposed sides or did not register at all, indicating that considerable protection was afforded by the buildings.

(d) Crater.—The crater was oval, its north-south diameter being 17-feet greater than its east-west diameter. Its average apparent diameter was 165 feet and its maximum apparent depth was 13.5 feet. It was not quite concentric, as the center was offset to the west about 5 feet. See figure 36 for a contour plan and profiles on the north-south and east-west axes. Figure 37 is a photograph of the crater taken looking eastward from the top of Igloo E, and figure 38 is a photograph taken from the east rim looking westward. The latter shows the typical appearance of the interior of the crater. The white objects are fragments of concrete from the igloo, which was so well demolished that no pieces over about 3 feet in longest dimension remained. The timbers which may be seen in the crater were evidently blown into it during the suction phase of the blast; before the explosion, they were on the ground 150 feet or more to the north. Examination of the soil in the bottom disclosed that the true depth (the depth actually excavated by the explosion, which is decreased when earth which was blown out falls back into the crater) was only from 2 to 2½ feet more than the apparent depth. The soil which had fallen back was blackened and unstratified, and all large aggregate had been fractured. The soil

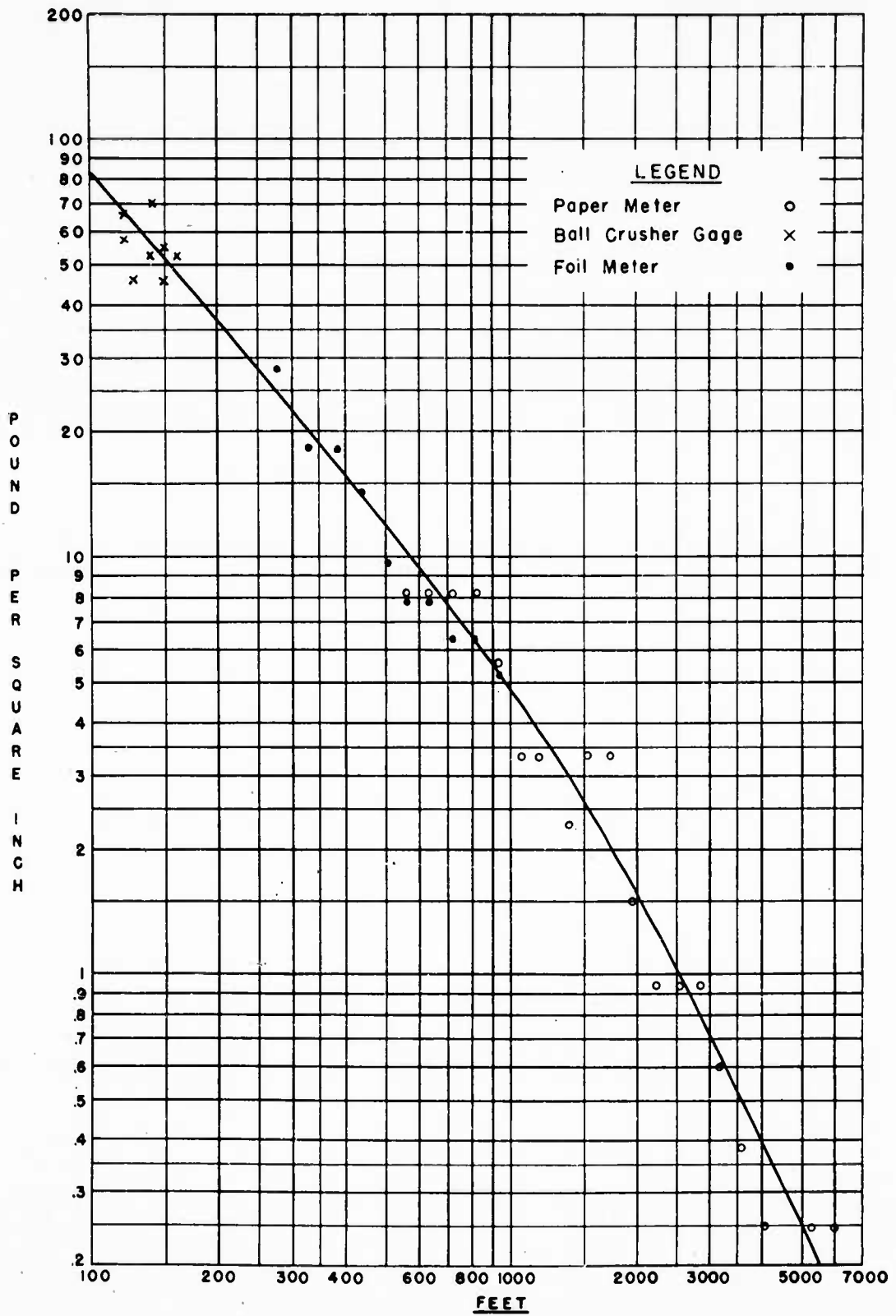

FIGURE 33. Peak Blast Pressure vs Distance from Charge, Test 1, Line 2 (Off Side)

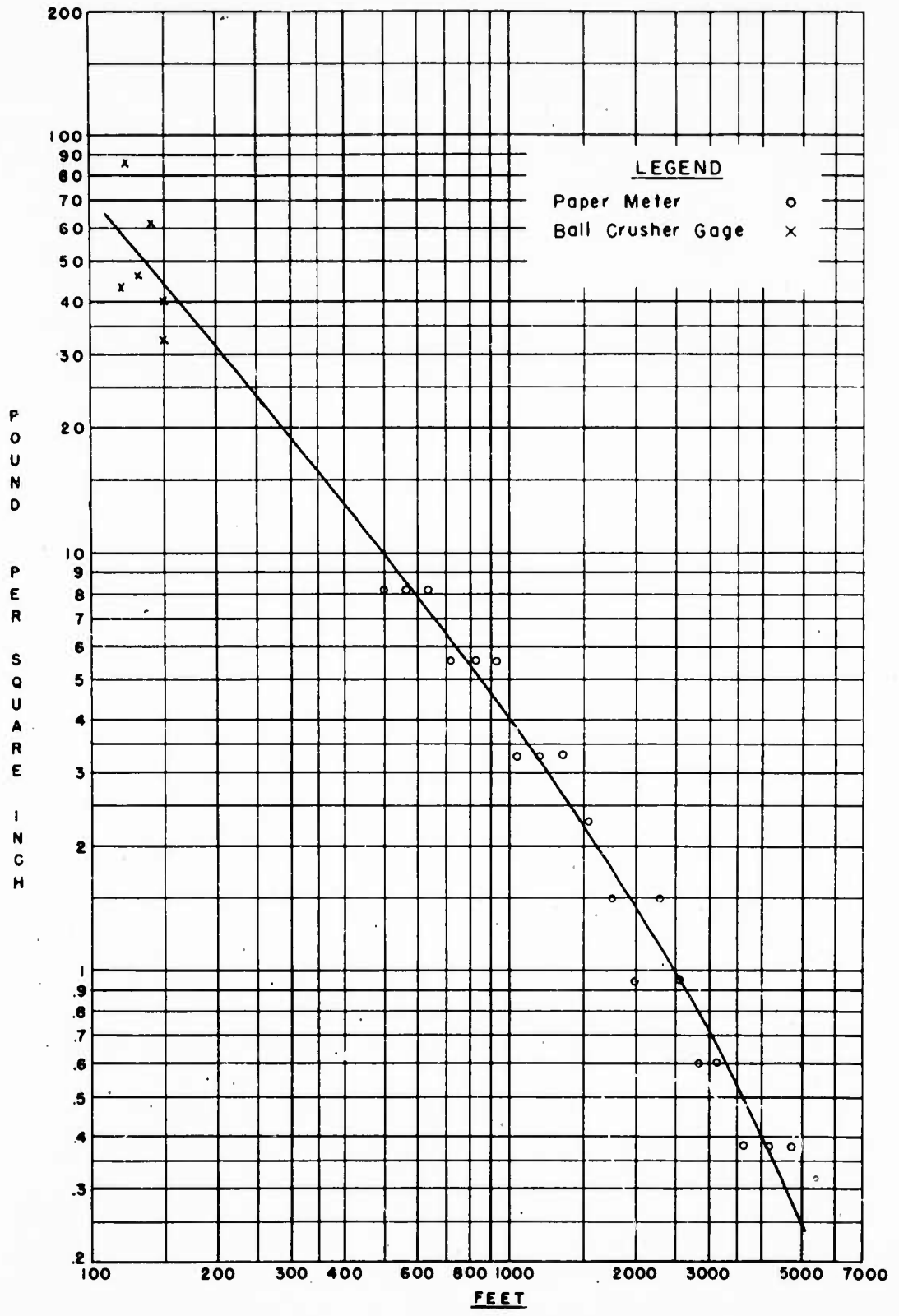

FIGURE 34. Peak Blast Pressure vs Distance from Charge, Test 1, Line 3 (Off Rear)

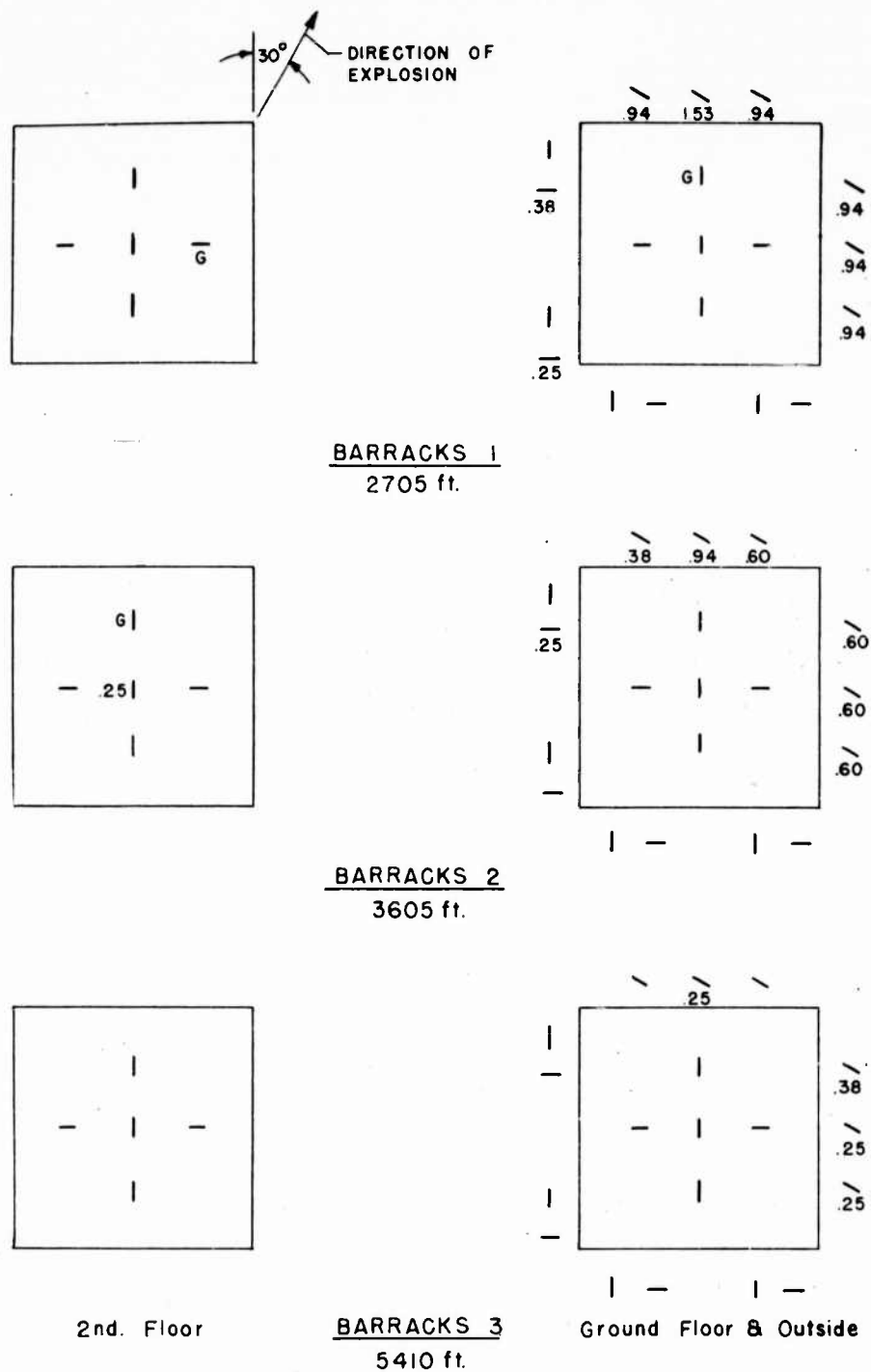

FIGURE 35. Placement and Registration of Paper Blast Meters at Barracks (Pressure in lbs / sq in) Test 1

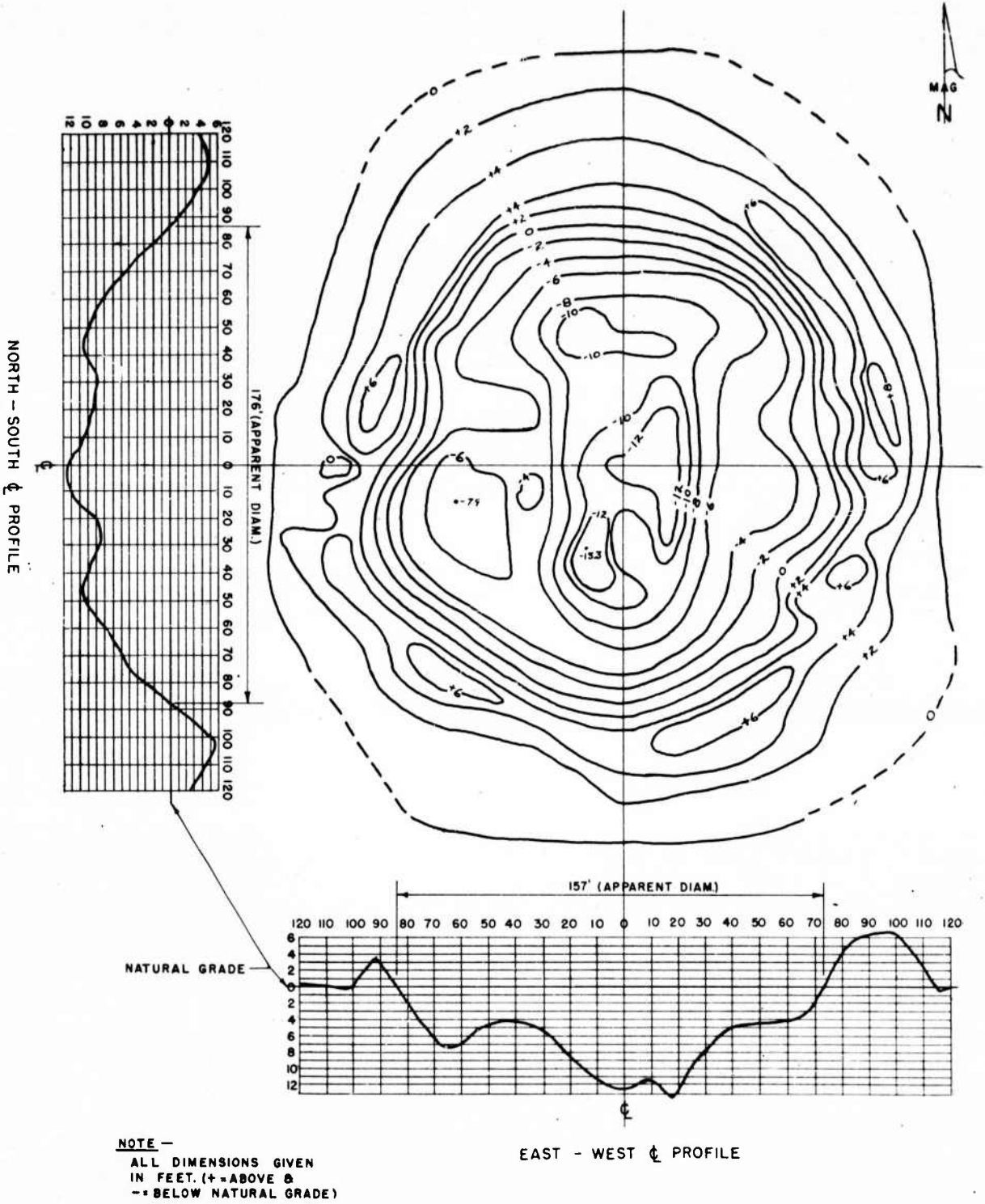

FIGURE 36. Crater Plan and Profiles, Test 1

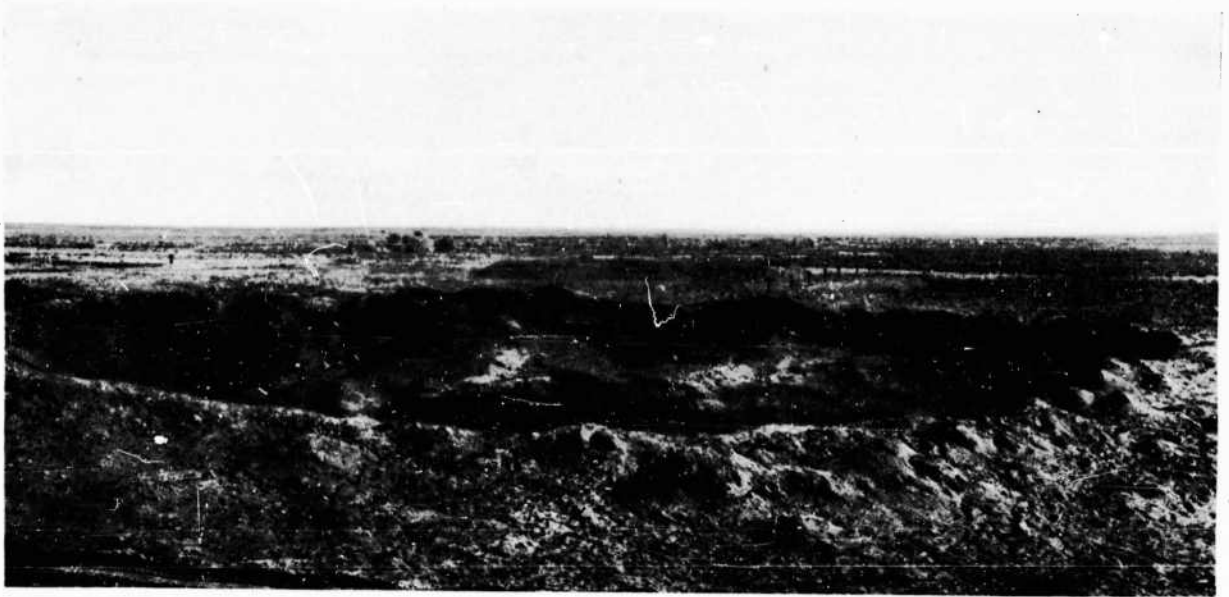
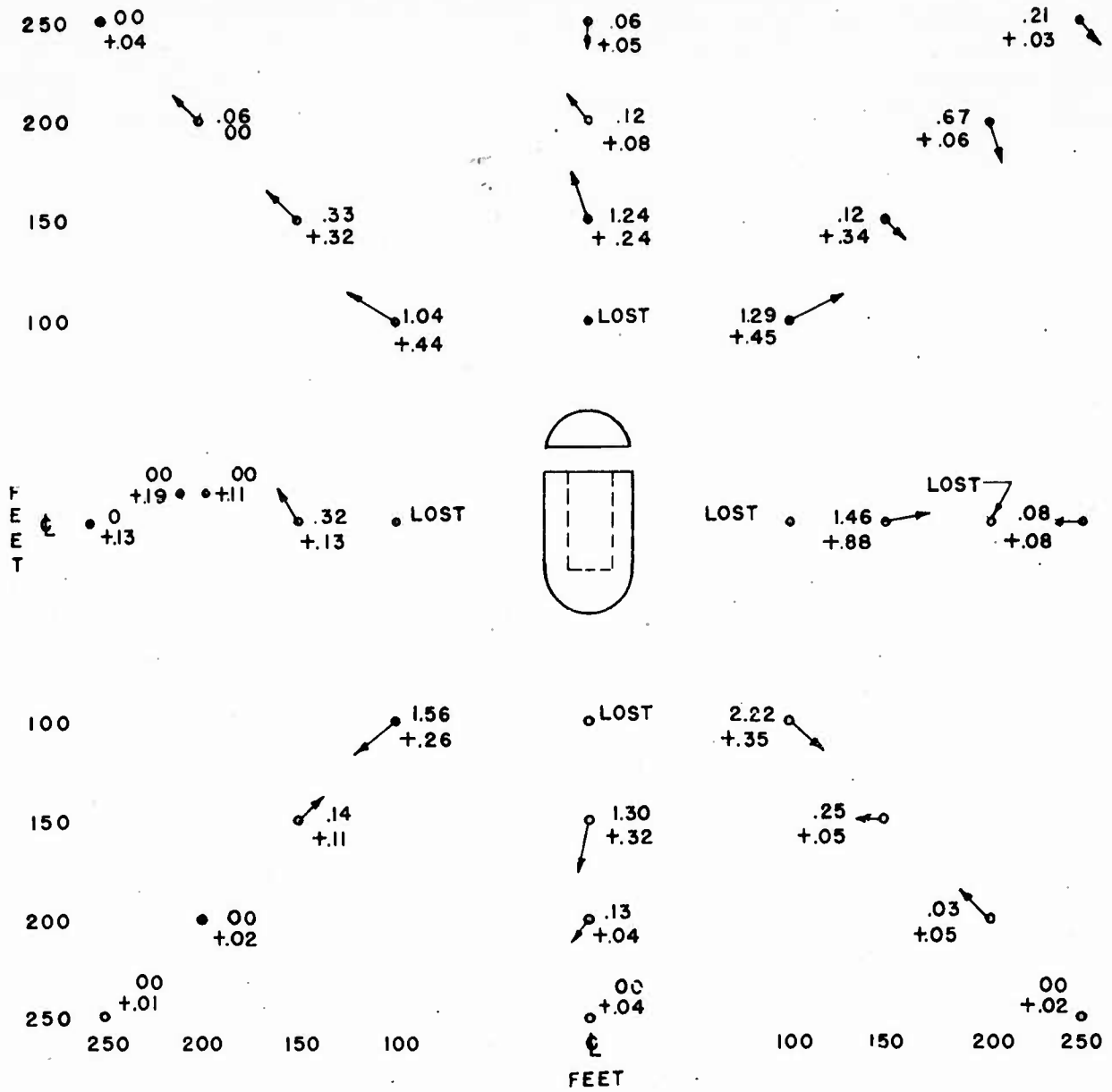

FIGURE 37. Crater resulting from explosion of Igloo D viewed from top of Igloo E



FIGURE 38. Crater from Igloo D explosion viewed from east rim



LEGEND

- .14 - HORIZONTAL MOVEMENT IN DIRECTION OF ARROW
- + .11 - VERTICAL MOVEMENT (UP)
- - 2"X2" WOOD HUB FLUSH WITH GROUND

NOTE -

ALL MOVEMENT GIVEN IN FEET.

FIGURE 39. Permanent Horizontal and Vertical Earth Displacement, Igloo D, Test No. 1

below true bottom was a sand and gravel bed which was not noticeably disturbed except that most large stones were fractured. The percentage of fractured aggregate decreased appreciably in the depth of a few feet. No lava was encountered in the excavation in this crater, which went to 6 feet below the deepest point of the bottom, or to 20 feet below normal grade.

(e) *Ground movement.*—Permanent horizontal and vertical displacement of the surface of the ground which took place around the exploding igloo is depicted by figure 39. Movement was generally away from the explosion and upward, but there are a few exceptions. At 100 feet from the center of the igloo, horizontal movement was of the order of 1 to 1½ feet, and upward displacement was from about 1/10 to 9/10 of a foot. At a distance of 250

feet from the center, movement diminished to less than 1/10 of a foot outward and about the same amount, or less, in the upward direction.

(f) *Permanent displacement of target igloos.*—The survey party could detect no translation or rotation of the target igloos in the horizontal plane, but did record change in elevation of the floor and ceiling as indicated by figure 40. Permanent deformation of internal dimensions of the igloos as measured by the mechanical deflection gages are given by figure 41.

(g) *Transient arch deflections of target igloos.*—Maximum and minimum values of floor-ceiling dimensions and diagonals from springing section on one side of the igloo to quarter point of arch on the other side as recorded by the slide and string deflection gages are given by figure 42.

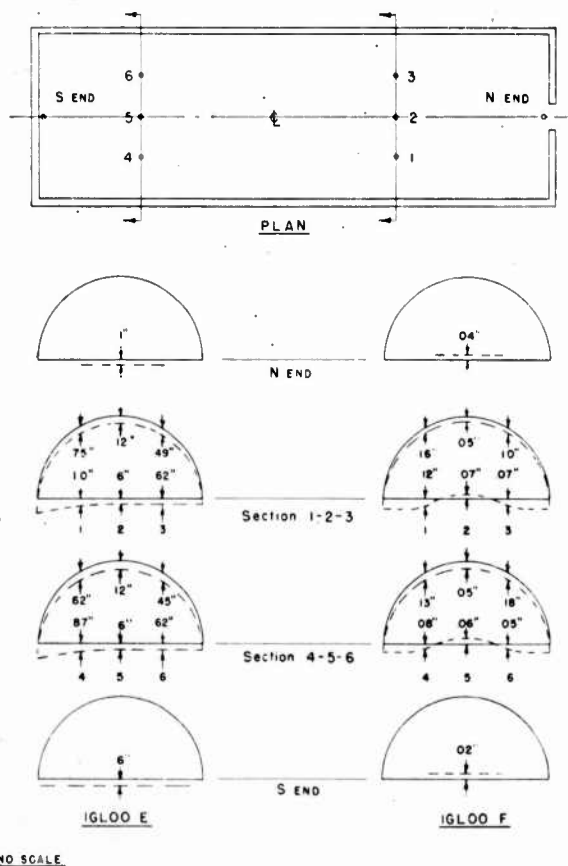

FIGURE 40. Permanent Changes in Elevation of Points on Floor and Ceiling in Igloos E and F as Determined by Survey, Test 1

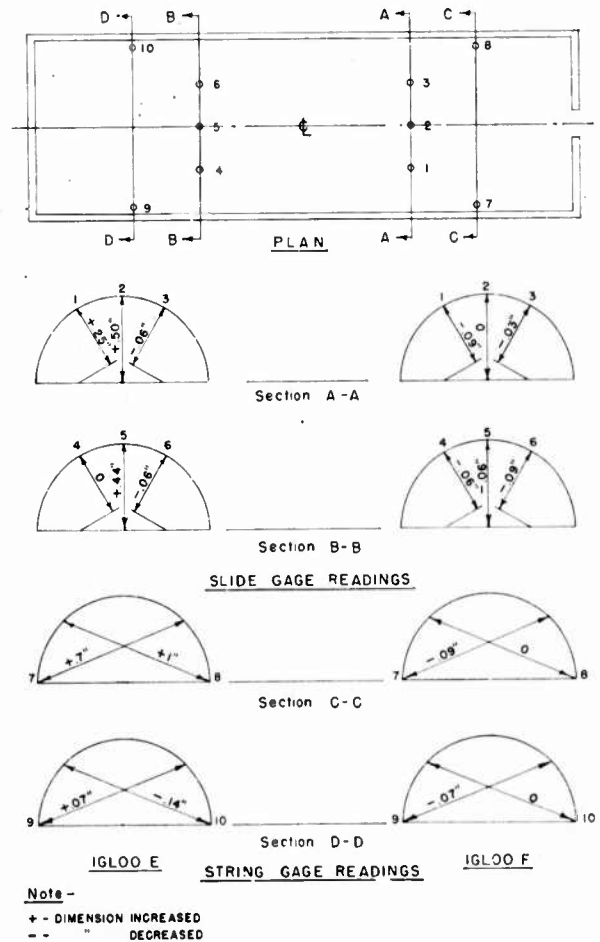

FIGURE 41. Permanent Changes in Internal Dimensions of Igloos E and F as Measured by Deflection Gages, Test 1

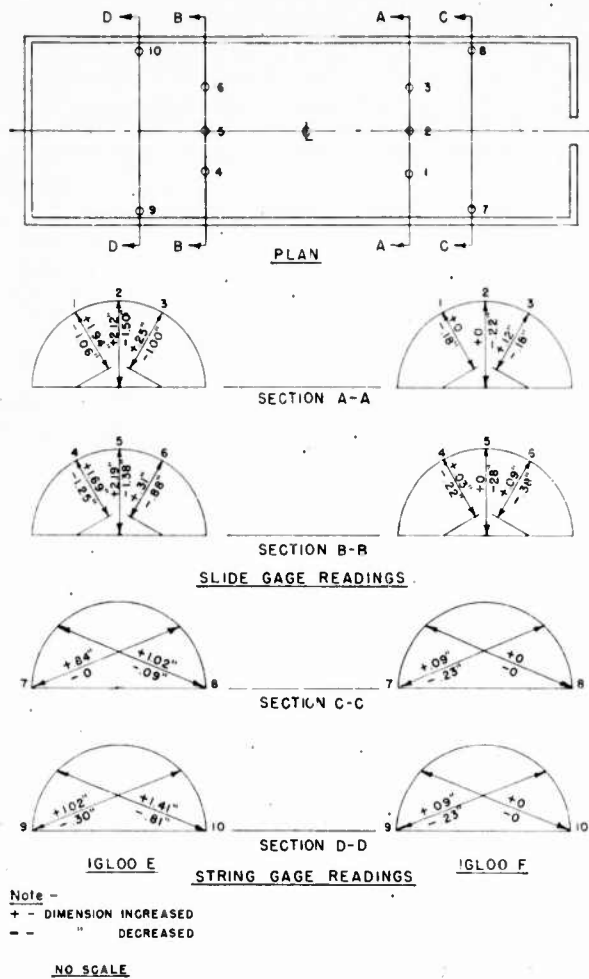

FIGURE 42. Transient Distortions of Internal Dimensions of Igloos E and F as Measured by Deflection Gages, Test 1

(h) *Damage to target igloos: (1) Igloo E.*— For views of this igloo taken immediately after the explosion, see figures 43 through 46. The photographs show that the igloo stood substantially as it had before the explosion, although the earth cover was dishevelled and the concrete ventilator blasted askew. Measurements of the depth of earth cover over the crown disclosed that near the rear of the igloo, earth had descended from the debris cloud and actually increased the thickness of cover. Adjacent to the headwall, however, about 6 inches of earth had been blown off. On opening the door, it was found that the bomb stacks had not been disturbed or displaced in any manner whatsoever. The headwall suffered severe cracking, mostly above 6 feet from the ground, and was displaced outward, its bottom edge being entirely separated from the floor slab on the inside, leaving a gap about 2" wide on the near side (toward the explosion) and 1" wide on the far side. The circumferential joint between the arch barrel and headwall was ruptured with much spalling; this was most severe on the near side. The main cracks in the wall went through from inside to out and were open up to about $\frac{1}{2}$ ". At points where cracks branched, there was considerable spalling. There was bad spalling of concrete on the pilasters on the outside face, and the reinforcing was exposed in several places. The door, which was 4' $5\frac{3}{8}$ " wide by 8' $1\frac{1}{4}$ " high and built up of $\frac{5}{8}$ " steel plate with an asbestos blanket under a $\frac{1}{8}$ " cover plate on its inner

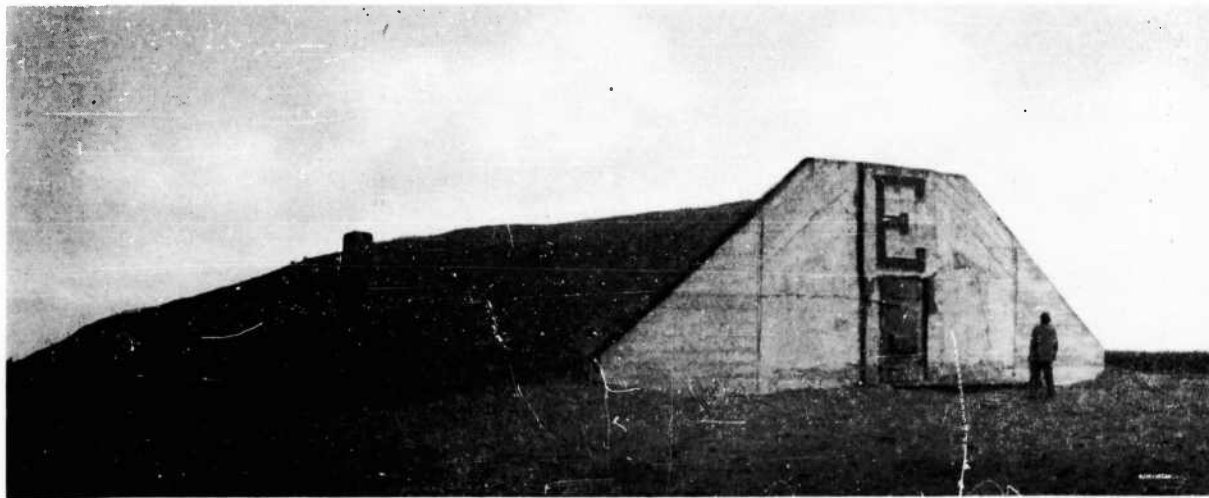

FIGURE 43. Three-quarter front view of Igloo E after Test 1

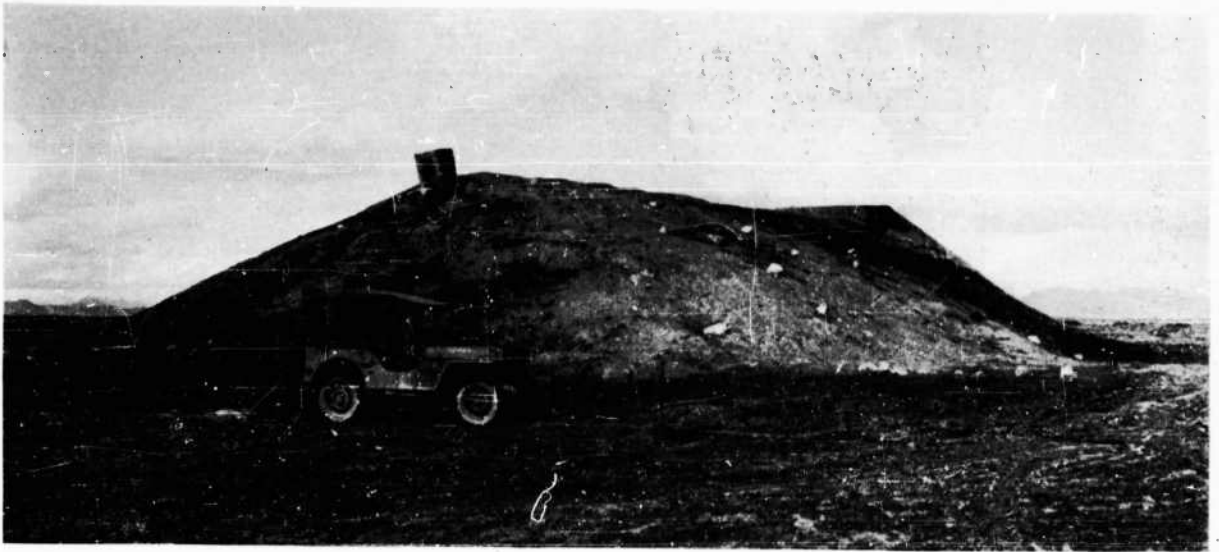

FIGURE 44. Three-quarter rear view of Igloo E after Test 1

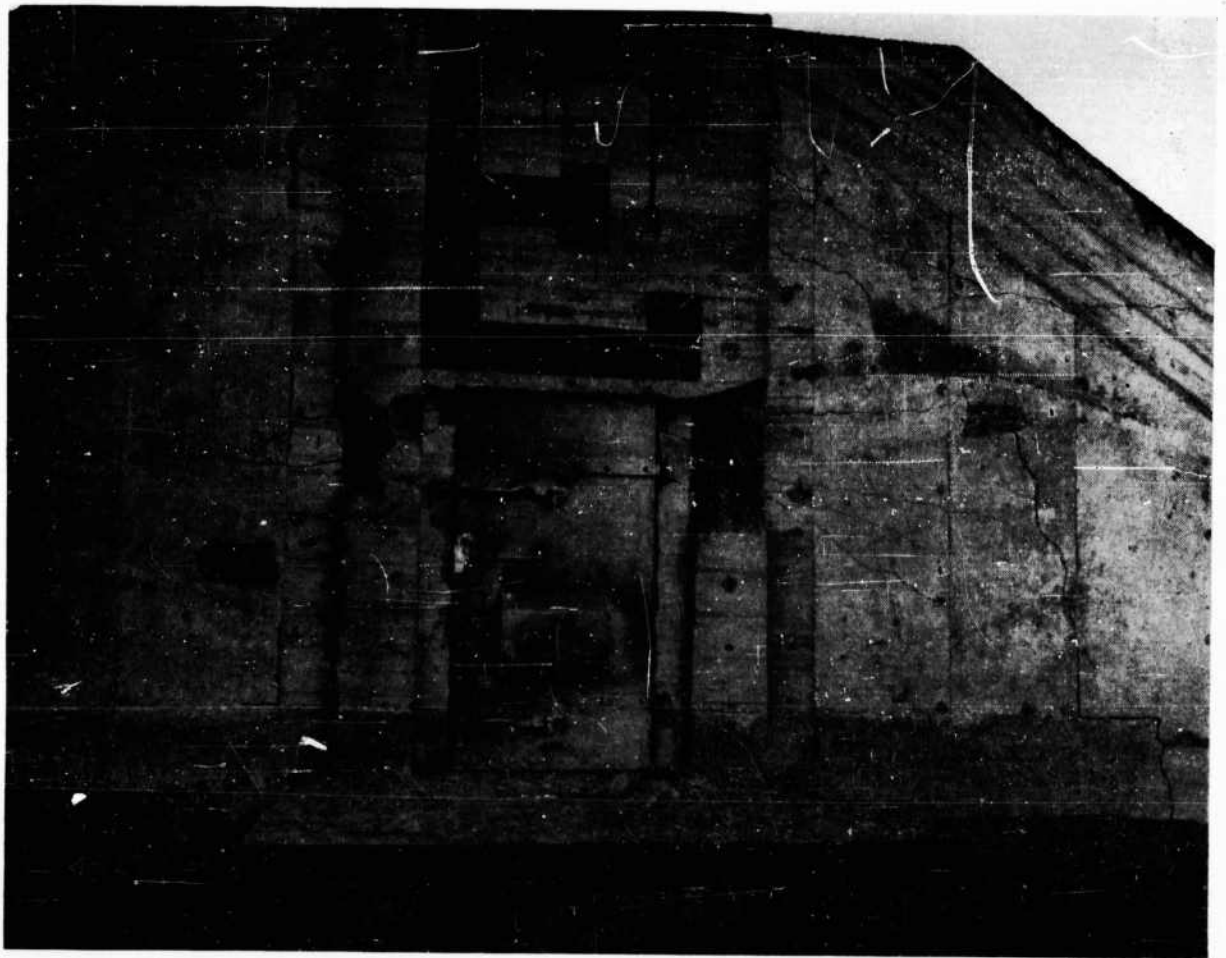

FIGURE 45. Close-up of front of Igloo E after Test 1



FIGURE 46. View from inside Igloo E after Test 1, showing separation of front wall from door slab.

face, was bellied in at its center about $7/16'$, but opened without difficulty. The arch barrel sustained three fine circumferential cracks on the near side, the first a branching one from 3 to 4 feet back from the headwall, starting near the floor and running to the crown; the second was about 30 feet back and ran from the floor upward to about 10 feet; the third was 40 feet back, and also ran up to about 10 feet above the floor. A longitudinal crack started 7 feet above the floor on the near side and ran generally horizontally toward the rear. At 50 feet back from the headwall, it branched to two cracks, one 7 feet and one 10 feet above the floor. At 60 feet back, there were three cracks, at 6, 8, and 9 feet up the arch. On the far side of the igloo, there was a diagonal crack starting at the floor 5 feet from the headwall and running up and toward the rear; at 20 feet from the headwall there were two diagonal cracks at average heights of 7 and 9 feet up from the floor; at 30 feet back, these cracks had become horizontal at 8 and 10 feet above the floor. At 40 feet back, a vertical crack ran from floor to crown. At 50 feet to the rear from the headwall, there was a horizontal

crack 9 feet up. All of these cracks were fine and closed up tight. In the rear wall, there was a single crack running down from the ventilator opening in the top of the wall to a point on the floor 3 feet on the far side of the centerline. This crack was open not over $1/32''$. The concrete ventilator flue was broken loose from the rear wall and tipped away from the blast. The floor of the igloo was intact; no cracks could be found in those portions not covered by bomb stacks. In a few places there was slight cracking around the edges where the floor joined the side wall. The ground slab or stoop in front of the door was broken away from the headwall, leaving a gap about 4" wide.

(2) *Igloo F.*—Figure 47 shows the general appearance of Igloo F after the explosion. Although its front wall suffered some bad cracks, as shown by figure 48, this igloo suffered considerably less damage than Igloo E. The most severe cracks in the headwall, which were open up to about $1/2''$, went through to the inner surface, and followed generally the line of the arch. The crack system was less extensive than in Igloo E, there was no bodily outward displacement of the wall, and no spalling of concrete. There was some cracking of the joint between the bottom of the headwall and the floor on the inside. The door was undamaged. As in Igloo E, there was no evidence of any jostling or disturbance of the bomb stacks. No cracks could be found in any part of the inside surface of the arch barrel. There were no cracks in the rear wall, and the ventilator was intact. The floor was not cracked in any portion not covered by bomb stacks except for two short, fine irregular cracks about two-thirds of the way in from the front end, which were suspected of being shrinkage cracks overlooked in the pre-test inspection. The junction of the floor slab with the arch abutments was cracked slightly, particularly within the first 10 feet back from the headwall. The cover on this igloo was practically undisturbed, except for a small amount of subsidence of the fill at the toes of the slopes.

(i) *Damage to revetments:* (1) *Revetment 1.*—There was no appreciable erosion of the earth forming the revetment windrows, although there may have been some subsidence or sliding, particularly along the inner slope of the windrow on the near side. On this side, as well as

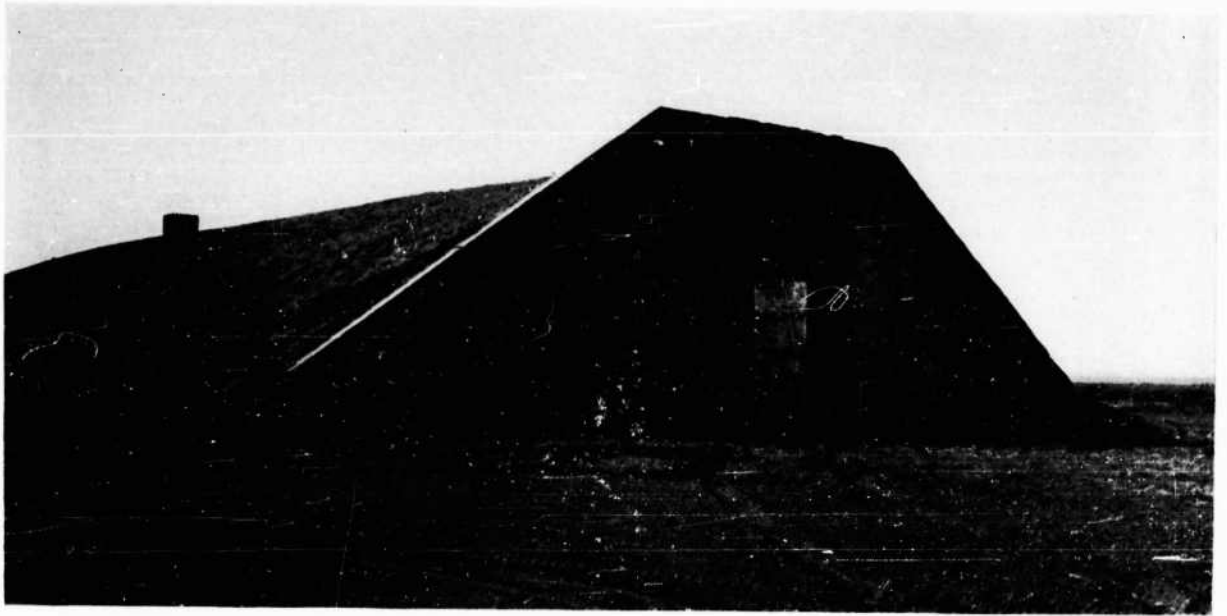

FIGURE 47. Three-quarter front view of Igloo F after Test 1



FIGURE 48. Close-up of front of Igloo F after Test 1

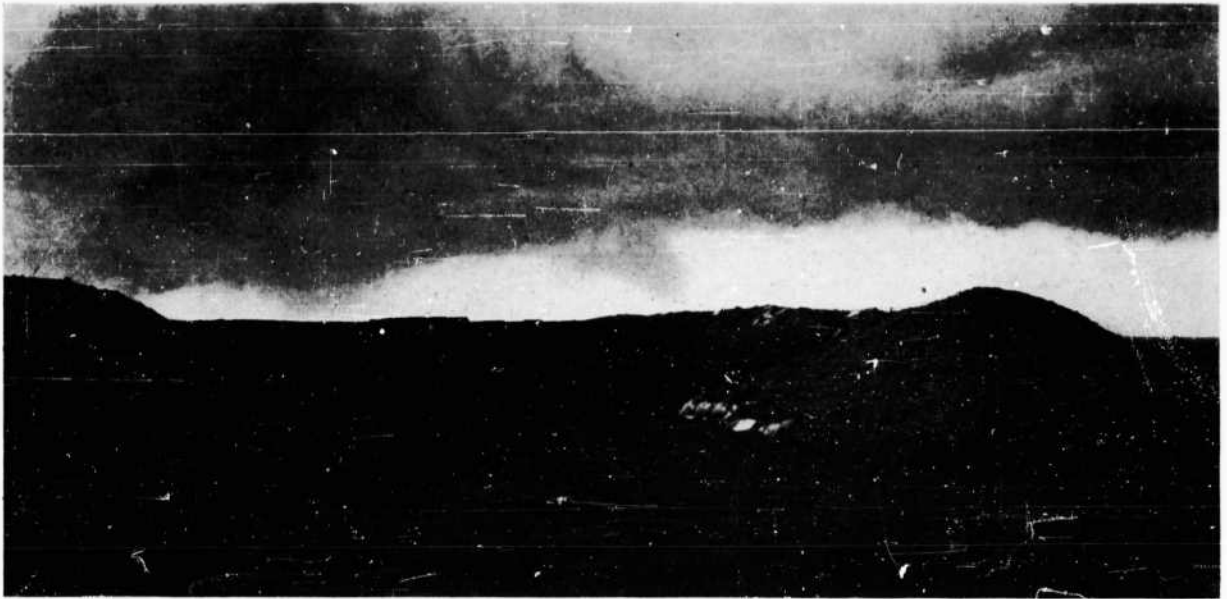

FIGURE 49. Front of Revetment 1 after Test 1

on top of the near side of the stack of mines, several inches of earth (up to about 4") had descended. On the far side of the stack, a thin layer of earth, not over 1" thick, had settled. All over the top of the stack there were also scattered small pieces of concrete, and a few short sections of reinforcing bars and wire mesh. The disturbance of the mines themselves was the most notable feature of the damage done. This is illustrated by the photographs.

figures 49 through 52. Apparently the suction phase of the blast was responsible for the toppling over of the middle third of the first tier of mines on the near side of the pile, the collapse of the corners of the stack and the wide scattering of individual mines. Twenty-one mines were counted on the ground on the near side of the revetment, the farthest lying about 40 feet from the edge of the stack, and 32 mines lay on the upper part of the windrow.

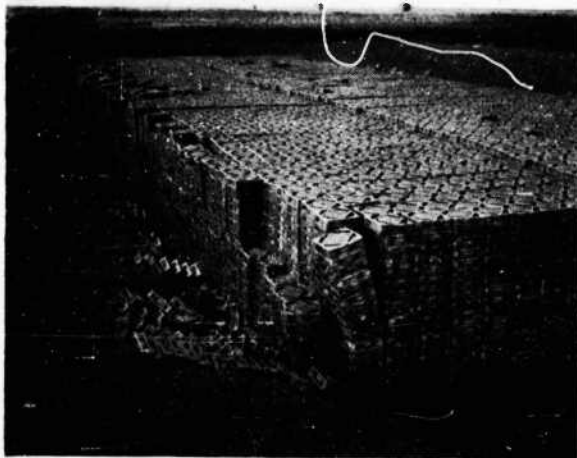

FIGURE 50. Revetment 1 after Test 1, looking northeast from southwest corner



FIGURE 51. Revetment 1 after Test 1. Looking north along edge of mine stack from southwest corner

There were about a hundred mines in the collapsed tiers lying in between the near side of the stack and the toe of the revetment slope. A few of the scattered mines were almost completely buried by earth that had descended on them. On the far side of the revetment, both corners had partially collapsed and some thirty-odd mines had fallen from the top edge of the side of the stack and lay at the bottom of the earth slope. No mines lay on the upper part of the slope or had been blown out of the revetment on the far side. A few of the mines had been struck by missiles; in some cases mines were broken out of their crates and in one instance the mine itself was badly dented.

(2) *Revetment 2*.—Figure 53 shows the appearance of the front of this revetment after the explosion. Mines were evidently sucked from the top two or three layers at the front of the stack and scattered over the ground to as far as about 35 feet from the stack. The number missing from the front face of the stack and from the front corners which had toppled over was counted as 101. The two rear corners also had collapsed; and in addition 18 mines were missing from the top of the rear-most tier. A few mines had fallen from the top edges along the sides of the stack. A small amount of debris littered the top of the stack. The earth windrows were practically intact, but there may have been some sliding at the bottom of the slopes along the sides. The sandbags at

the bottom of the slope on one side of the entrance were toppled over.

(j) *Damage to barracks*.—Damage sustained by the three wood-frame buildings will be described under three headings: (1) superficial, (2) structural, and (3) glass.

(1) *Superficial*.—Superficial damage is defined for the purposes of this report as damage to covering and trim, i.e., roofing, siding, facia, window frames and sash (excluding glazing) door frames and doors, casing, etc.

Barracks 1 sustained extensive superficial damage. See figures 54, 55, 56, and 57, photographs of its exterior. On the north side, all except one of the windows was blown in, along with two of the frames on the second floor and all of the frames on the ground floor. All the window trim and casing was blasted off. The asphalt felt siding was torn loose in numerous places. On the east elevation, about half of the sash were blown out of the frames. Other sash remained in place but were loosened or hanging askew, and still others had broken stiles, rails, or muntins. The asphalt felt siding was torn loose at one point. On the west elevation, two sash were blown out of their frames, and another was loosened and left in a canted position. On the east slope of the roof near the south end of the ridge, a piece of asphalt felt roofing about 7-feet long was torn off, exposing the sheathing. It was shaped like a tear-drop, with the point toward the north.

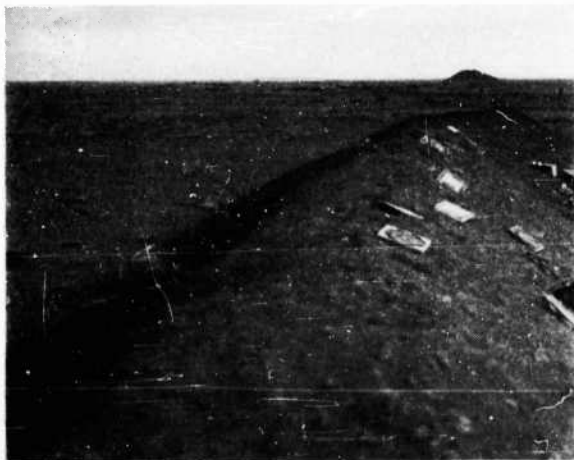

FIGURE 52. Revetment 1 after Test 1. Looking north along top of west windrow



FIGURE 53. Front of Revetment 2 after Test 1

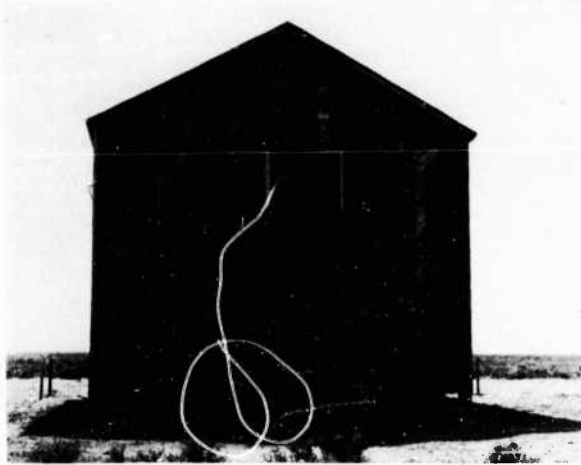

FIGURE 54. North elevation of Barracks 1 after Test 1



FIGURE 55. East elevation of Barracks 1 after Test 1



FIGURE 56. West elevation of Barracks 1 after Test 1



FIGURE 57. South elevation of Barracks 1 after Test 1

On the south elevation, the first floor door frame was displaced inward 2 inches at its top.

Barracks 2 received superficial damage similar to that of Barracks 1 but less severe. Two sash were blown in on the north wall, and four others loosened. The frame and casing was broken on the upper triple window but remained in place. The felt siding was torn in two spots on the north wall. On the east elevation, four sash were blasted in and exterior trim was missing in two places. On the south elevation, the second floor door casing was pulled downward 2 inches and in 1 inch at the top. There was a tear-shaped torn spot in the roofing on the south end of the east slope, in the

same place as in Barracks 1. The tear was not quite as large as was the case in Barracks 1, however. Figures 58 and 59 are photographs of the north and east elevations of Barracks 2 after Test 1.

Barracks 3 sustained no superficial damage other than a tear-shaped torn spot in the roofing near the south end of the east slope of the roof, which was in size, shape, and location nearly identical to the torn spots in the roof of Barracks 1 and 2. See figures 60 and 61. The tear in the siding next to the upper left window in the latter photograph was done by wind before the explosion.

(2) *Structural*.—In this report, structural



FIGURE 58. North elevation of Barracks 2 after Test 1



FIGURE 59. East elevation of Barracks 2 after Test 1



FIGURE 60. North elevation of Barracks 3 after Test 1



FIGURE 61. East elevation of Barracks 3 after Test 1

damage is considered to be failure or displacement of structural members, including foundation posts, floor beams and joists, subflooring, plates, studs, columns, rafters, and sheathing.

Barracks 1 suffered structural damage as follows: There was evidence that the building had been rocked on its foundations, viz., the 12" x 12" foundation posts had been pushed away from the blast and then back again, leaving a void about 1" wide between the ground and the north and south faces of each post. In the north wall, every 2" x 6" stud on the ground floor was either fractured or pushed inward off the lower plate, both upper and lower plates were split, 2" x 6" diagonal corner braces were

broken, several sheathing boards were broken and pulled away from the studs and the 2" x 6" framing at the sill and jamb on one side of the window opening was split. On the second floor, the north wall suffered one-third of its studs broken and displaced inward, both upper and lower plates fractured, several sheathing boards broken inward, and head and sill framing of the window opening fractured. The gable wall sustained breakage of about one-third of its 2" x 4" studs and some sheathing was broken. The east wall of the building had one stud cracked beneath the north window on the ground floor. The roof girder or purlin on the east side was badly fractured, and seven

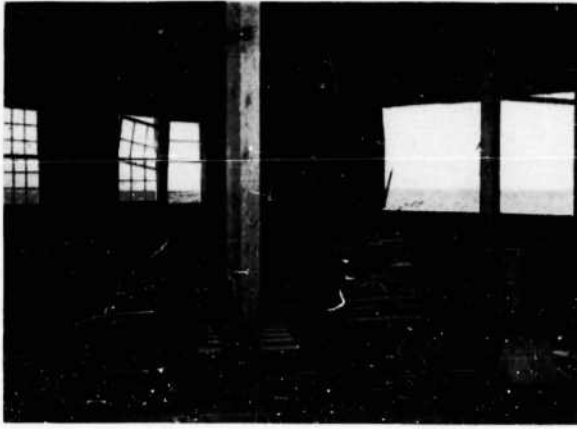

FIGURE 62. Interior of Barracks 1 after Test 1.
Ground floor, looking northwest



FIGURE 63. Interior of Barracks 1 after Test 1.
Ground floor, looking southeast

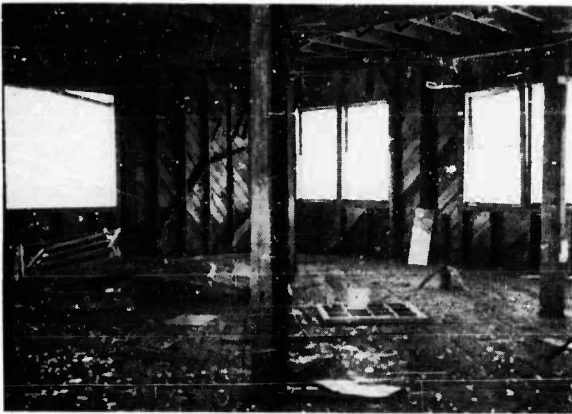

FIGURE 64. Interior of Barracks 1 after Test 1.
Ground floor, looking northeast



FIGURE 65. Interior of Barracks 1 after Test 1.
Ground floor, looking southwest



FIGURE 66. Interior of Barracks 1 after Test 1.
Second floor, looking southwest



FIGURE 67. Interior of Barracks 1 after Test 1.
Second floor, looking northeast

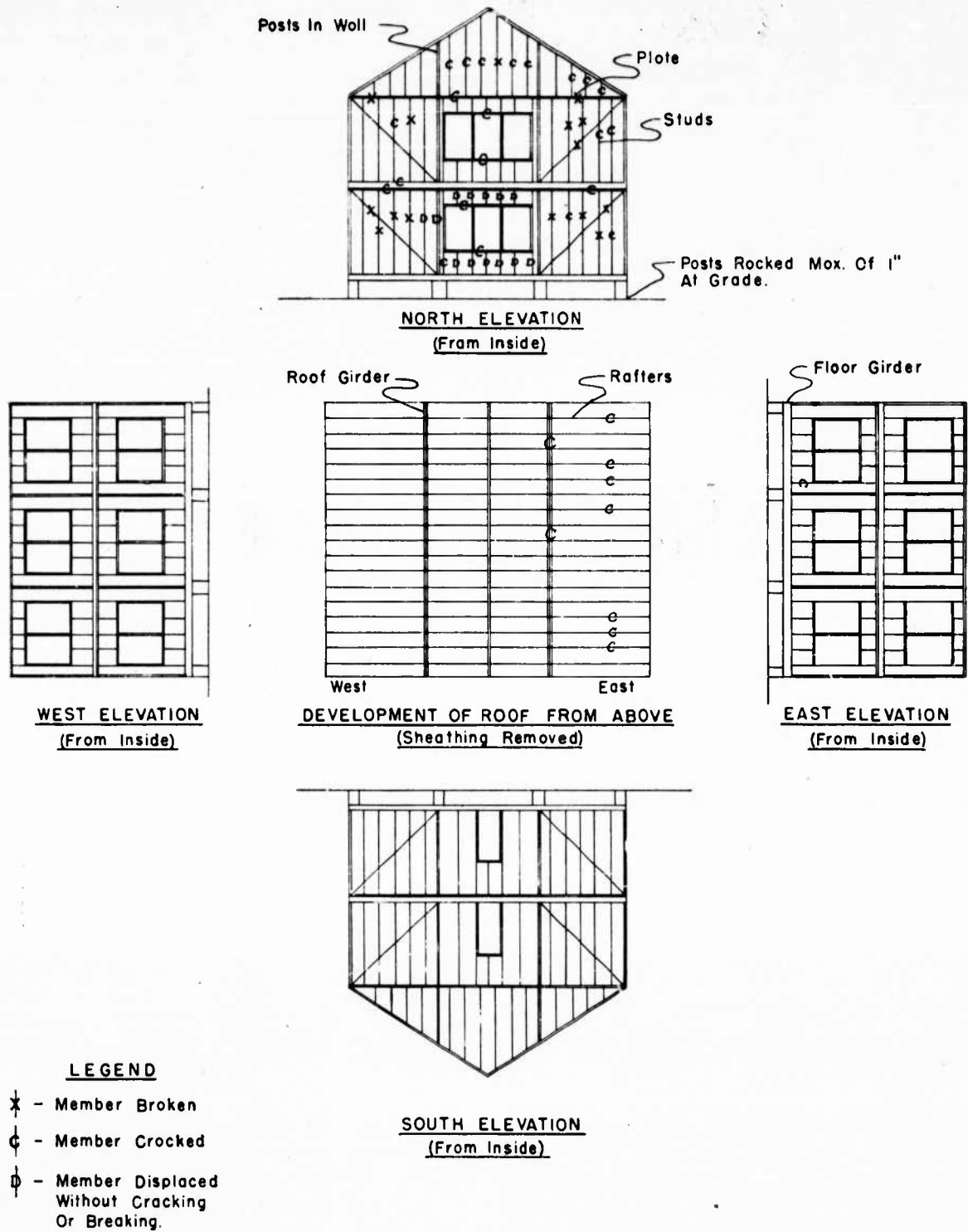

FIGURE 68. Damage to Barracks, Barracks 1. Test 1

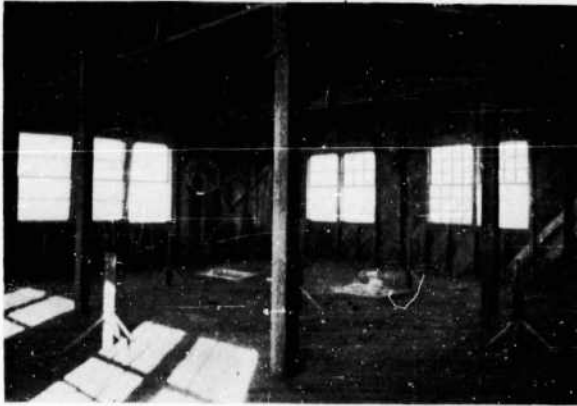

FIGURE 69. Interior of Barracks 2 after Test 1. Ground floor, looking northeast

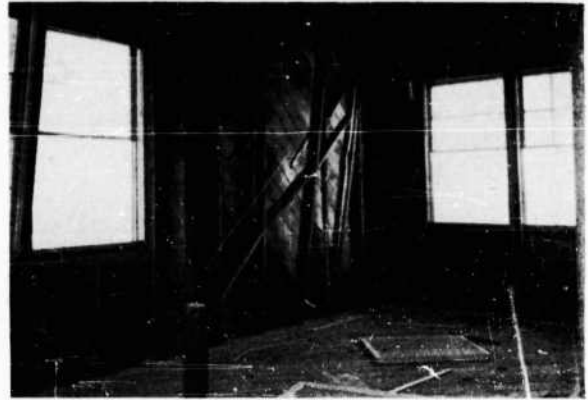

FIGURE 70. Interior, Barracks 2 after Test 1. Ground floor, northeast corner, showing broken and displaced studding and brace



FIGURE 71. Interior, Barracks 2 after Test 1. Second story, looking northwest

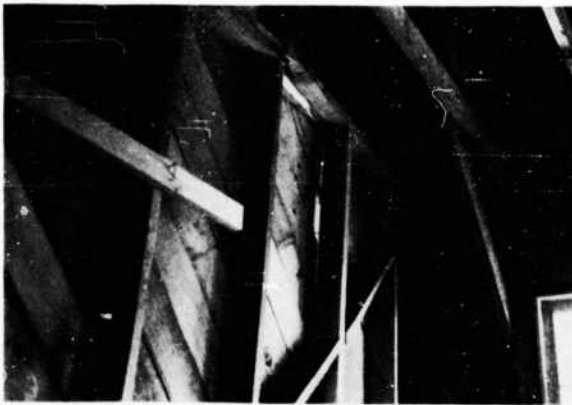

FIGURE 72. Interior, Barracks 2 after Test 1. Second story, northeast corner, showing broken plate and displaced stud



FIGURE 73. Interior, Barracks 2 after Test 1. Second story, northwest corner, showing displaced and fractured studding

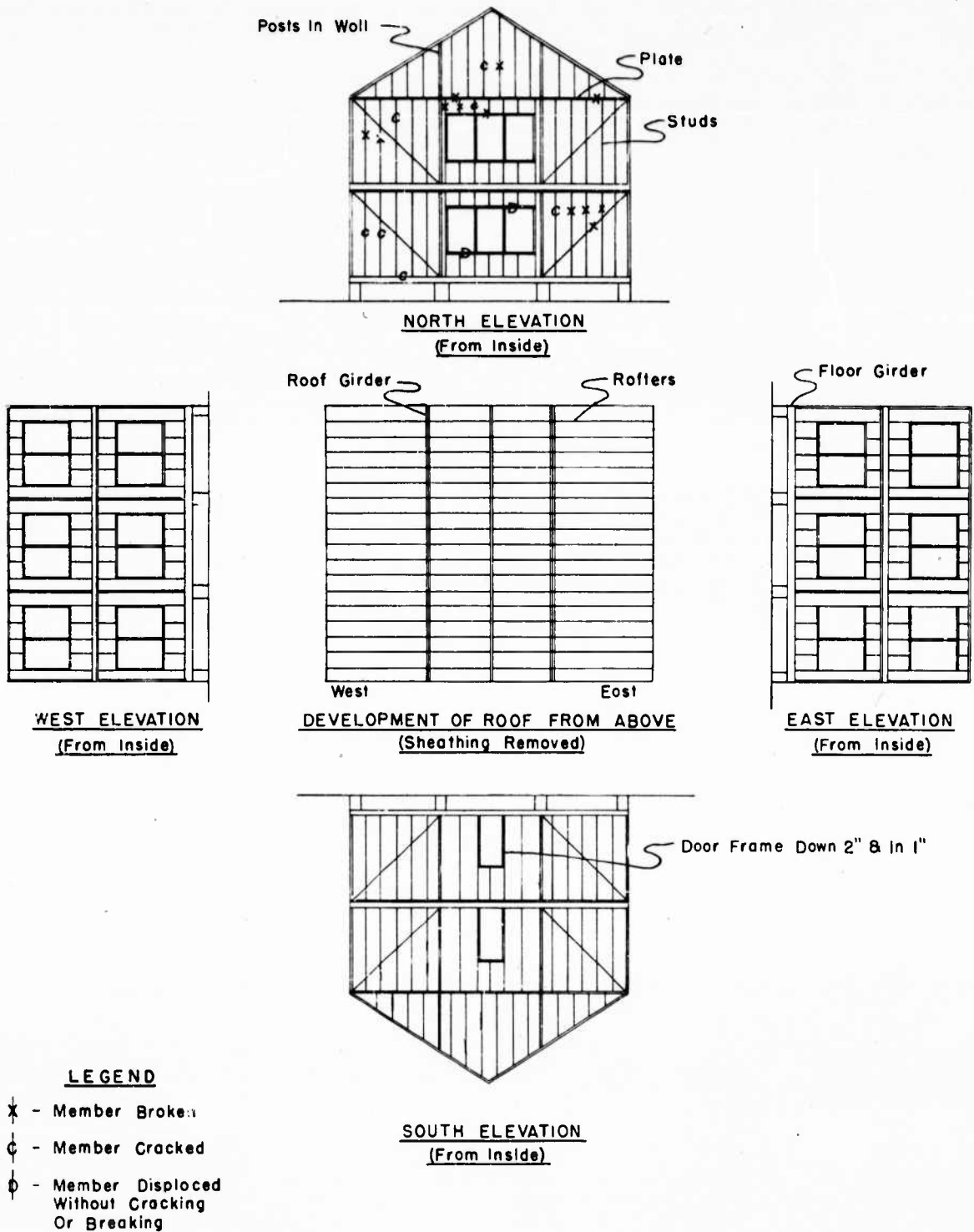

FIGURE 74. Damage to Barracks, Barracks 2, Test 1



FIGURE 75. Interior, Barracks 3 after Test 1. Broken stud in north wall, second story

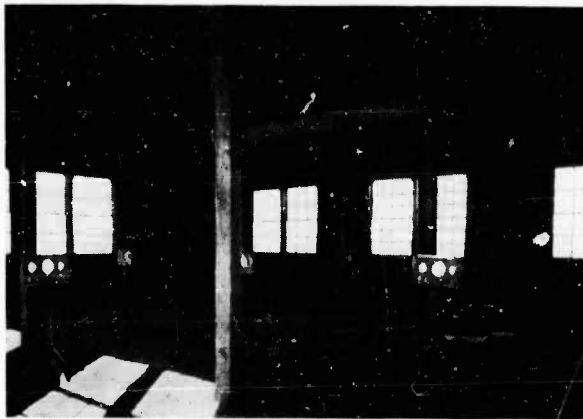

FIGURE 76. Interior of Barracks 3 after Test 1. Ground floor, looking northeast

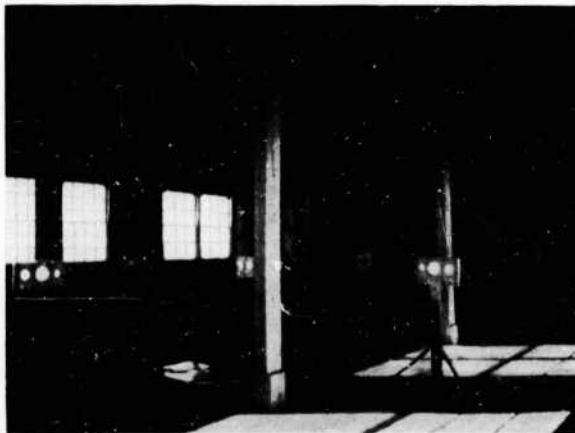

FIGURE 77. Interior, Barracks 3 after Test 1. Looking southeast on second floor

rafters were split. A missile had penetrated the east slope of the roof leaving a hole about 3 inches in diameter in the sheathing. For various interior views of Barracks 1 see figures 62 to 67, inclusive. For a diagram illustrating the damage see figure 68.

Barracks 2 suffered damage similar in character but less in extent than that of Barracks 1. In the north wall on the ground floor, four studs were shattered near the east end, the sheathing was split and pulled away from the studs, and a 2" x 6" corner brace was broken. Two studs were cracked near the west corner. The lower plate was cracked. The head and sill framing of the window opening was pushed askew. In the upper story, three studs were split in the west end, three above the window where the upper plate was also broken, and sheathing was broken in beneath the window. Jamb framing on one side was fractured. The upper plate was split and sheathing pushed in near the east corner as well. Two studs were split in the north gable wall. There was no other structural damage. For photographic views of typical instances of damage, see figures 69-73, inclusive. Figure 74 is a diagram in which the damage is detailed.

Barracks 3 received only two broken studs in the north wall, one in each story on the north wall. Figure 75 is a photograph of one of these. There was no other structural damage. For views showing the appearance of the interior, see figures 76 and 77.

(3) *Glass*: Glass damage is defined as cracked, shattered, displaced or missing (from sash) window glazing material. Intact panes in blown-out sash were not considered damaged. Bent plastic panes which maintained a weather seal were not classed as damaged.

Barracks 1 suffered 92 percent glass damage on the north elevation, about 75 percent on the east elevation, and about 10 percent on the west elevation. A detailed record of the glass damage is given by figure 78, which depicts the location, size, and composition of each pane broken or displaced from its sash in the building. The violence with which the windows were broken is indicated by the sash and frames blown into the building and halfway across the floor, and the broken glass and pieces of other glazing material scattered over the floors as far as the opposite walls. In one instance a small

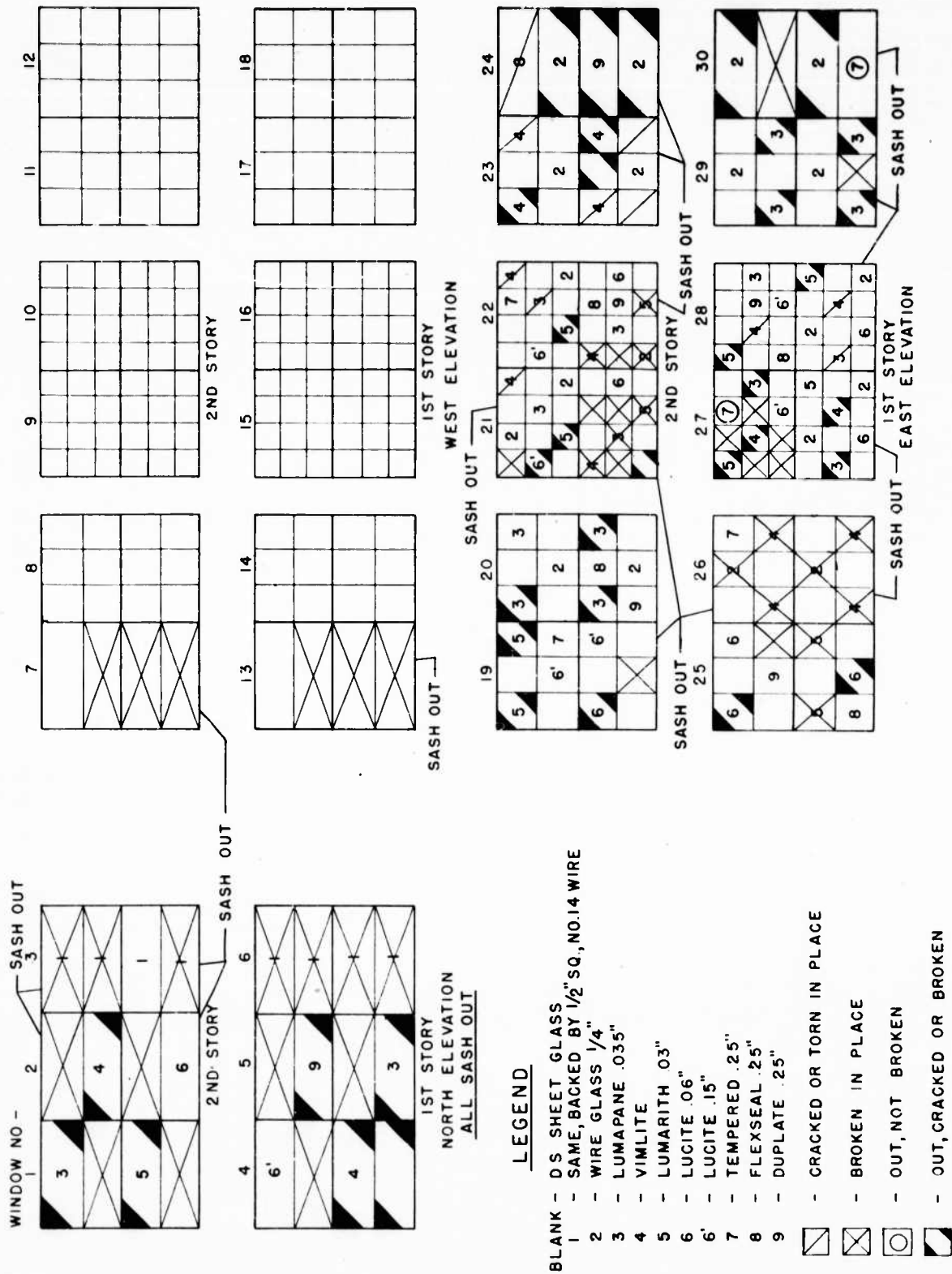
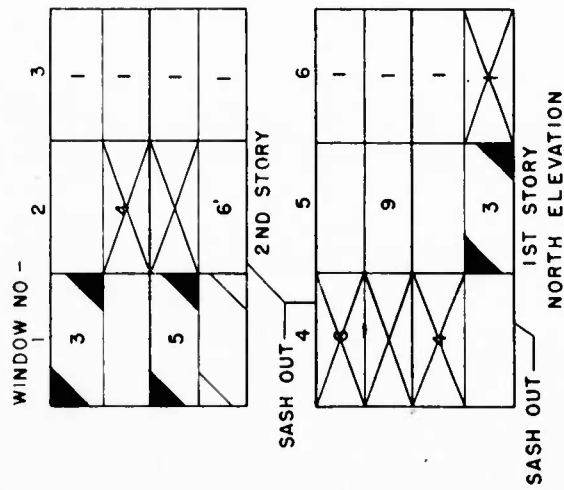

FIGURE 78. Glass Damage, Barracks 1, Test 1



LEGEND

- BLANK - DS SHEET GLASS
- 1 - SAME, CRACKED BY 1/2" SQ, NO.14 WIRE
- 2 - WIRE GLASS 1/4"
- 3 - LUMAPANE .035"
- 4 - VIMLITE
- 5 - LUMARITH .03"
- 6 - LUCITE .06"
- 6' - LUCITE .15"
- 7 - TEMPERED .25"
- 8 - FLEXSEAL .25"
- 9 - DUPLATE .25"
- ☐ - CRACKED OR TORN IN PLACE
- ⊗ - BROKEN IN PLACE
- - OUT, NOT BROKEN
- ◼ - OUT, CRACKED OR BROKEN

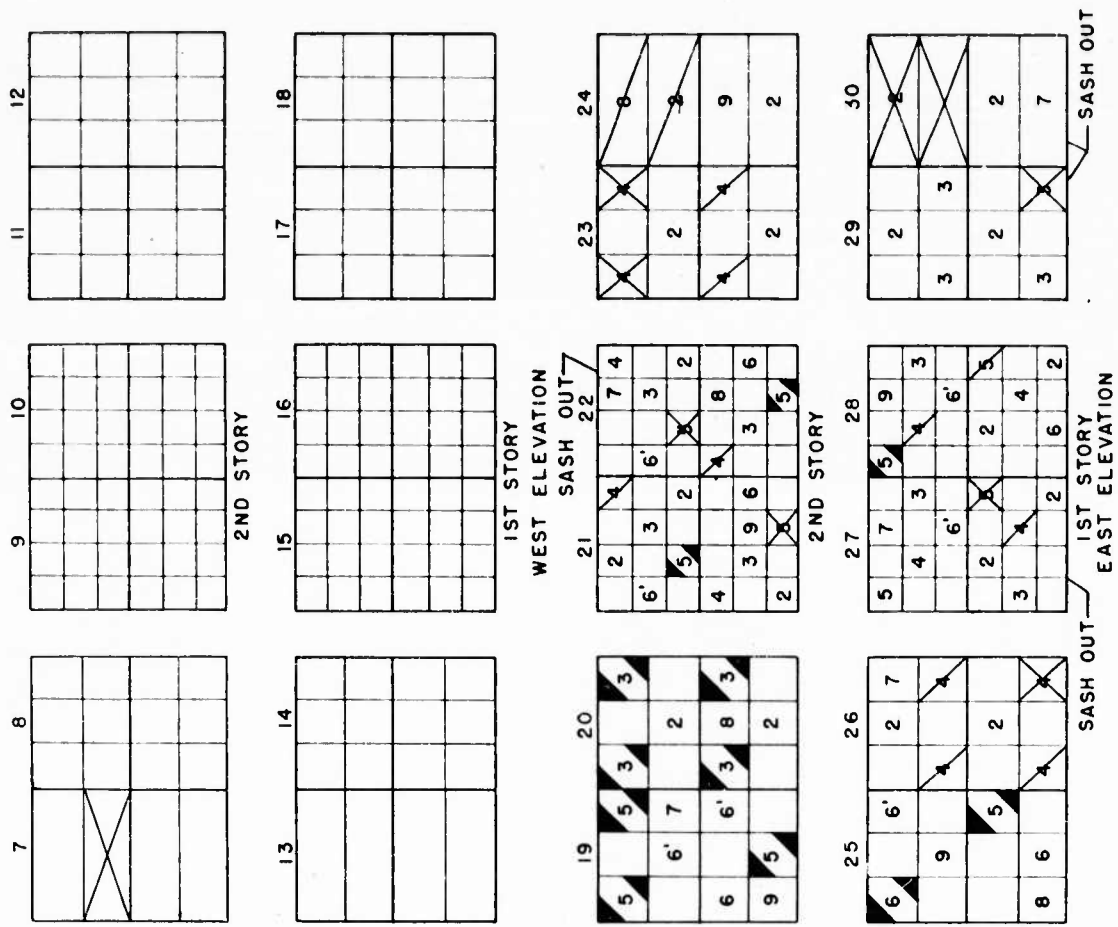

FIGURE 79. Glass Damage, Barracks 2, Test 1

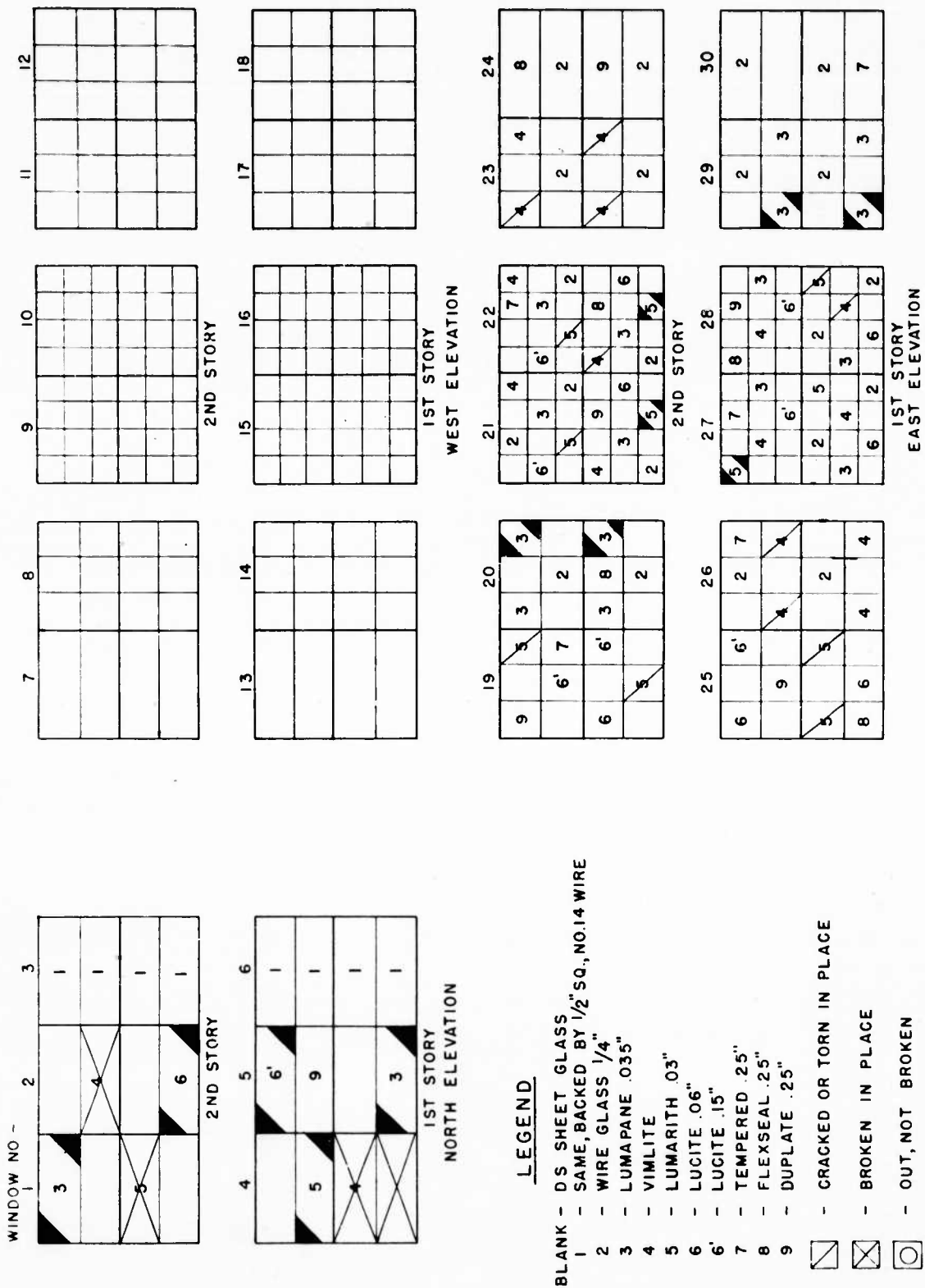

FIGURE 80. Glass Damage, Barracks 3, Test 1



FIGURE 81. Explosion of Igloo E—1st stage

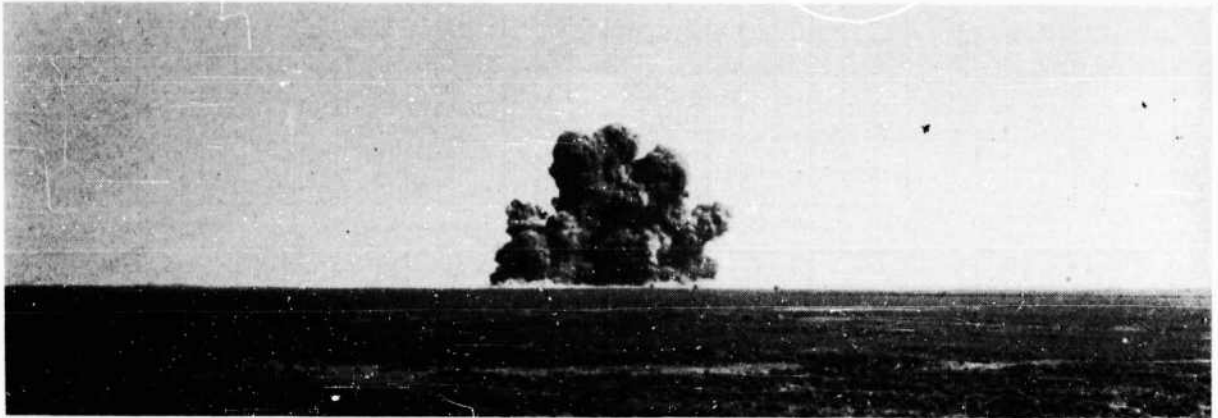

FIGURE 82. Explosion of Igloo E—2nd stage



FIGURE 83. Explosion of Igloo E—3rd stage



FIGURE 84. Explosion of Igloo E—4th stage

piece of glass was found embedded in one of the timber columns, at a point about three feet above the floor. The flying glass would have been a grave hazard to any person occupying the building at the time of the explosion.

Barracks 2 suffered 38 percent of its panes damaged on the north elevation, 20 percent on the east side, and only one broken (0.6 percent) on the west side. Figure 79 is the detailed record of glass damage in this building. While flying glass was not as severe as in Barracks 1, fragments were propelled over two-thirds of the distance across the building interiors. Several sash were blown into the building, and one came to rest about a third of the way across the floor. Anyone within the building would have been in serious danger of injury from both the glass fragments and the broken window members.

Barracks 3 also received 38 percent glass damage on the north elevation, but only 12 per-

cent on the east elevation and none on the west side. Figure 80 shows the damage in detail. It is interesting to note that there was only one case of breakage of a pane of common DS window glass in this building. Nevertheless there were fragments of this glass as well as of plastic glazing material scattered half way across the floor. While not in as hazardous a position as occupants of the closer buildings, any person inside this barracks at the time of the explosion may have been injured by flying glass.

2. Test 2.

(a) *General.*—Igloo E's charge was fired at 1100 MST, 8 October. The weather was sunny with few clouds. The temperature was 45° F., the barometer 25.19" Hg., and there was a breeze of from 0 to 2 miles per hour from the southwest. The detonation showed first a bright flash which became a symmetrical flame-filled cloud with sharp-pointed plumes shooting

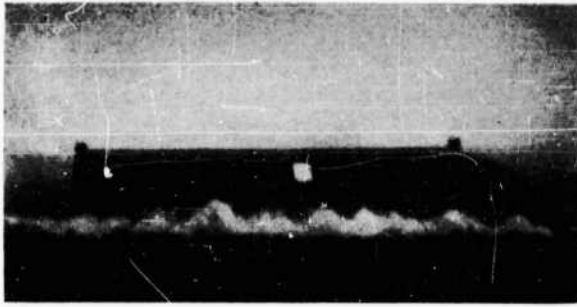

a. Igloo F at instant when shock wave strikes the headwall, .18 sec. after flash. Line of smoke in foreground is from primacord set off to actuate certain instruments.

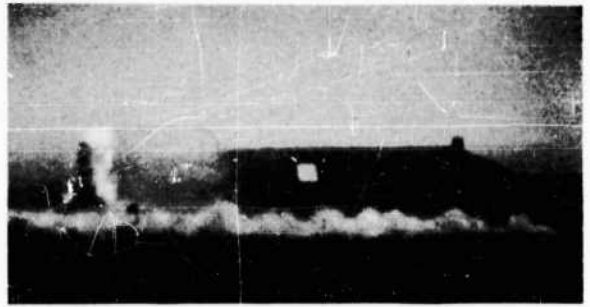

b. Shock wave has travelled over a quarter of the length of the igloo, .20 sec. after flash.

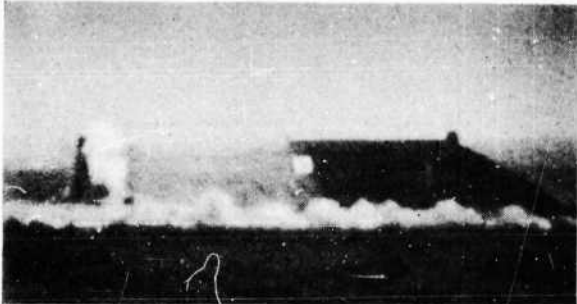

c. Shock wave is over halfway down the igloo, at .22 sec. Note soil blown from behind headwall by eddy currents.



d. Wave has travelled three-quarters of the length of the igloo, .23 sec. after flash.



e. Wave has reached ventilator at end of igloo at .24 sec. Plywood sign on side of igloo is breaking up.



f. Wave front has passed igloo, whose entire surface is made shades lighter by earth blasted up. Plywood sign has flown to pieces. Time, .24 sec. after flash.

FIGURE 85. Selected frames from Eastman Hi-Speed film, Test 2

rapidly upward. As it grew larger, the cloud spread out farther laterally, the sharp plumes became dark grey boiling rolls, with a great ball of red fire playing inside. See figures 81 and 82 for photographs of its early stages of development. As the fire died out the cloud seemed to spiral upward more rapidly than it spread laterally, until it began to form a mushroom-like head above a relatively narrow neck. After reaching a maximum height of about

8,600 feet the top became separated from the neck and drifted away in an eastward direction. See figures 83 and 84 for photographs of the cloud in its latter stages. The head ultimately was about 2 miles in breadth, while the base attained a diameter of more than a mile. The trace of the negative phase of the shock wave was again clearly visible as it emerged from the cloud while the latter was still in its sharp-plumed stage, and spread outward like a

bubble expanding at high velocity. It became less distinct as it expanded and could no longer be seen when its radius exceeded 2 miles. The observers, 4.1 miles distant, felt no ground shock, but again heard two distinct reports a fraction of a second apart. In this case, the second report was considerably less loud than the first. The air blast or concussion accompanying the reports felt like a sudden wind puff of low velocity.

(b) *High-speed motion pictures.*—The high-speed film of Igloo F taken during the explosion of Igloo E showed the effects of the shock wave as it swept across the field of view. The reflected wave from the front end wall of the target igloo is visible in these pictures when projected, but cannot be distinguished in the individual frames. Selected frames from this film, which show the igloo and progress of the wave front in several stages as it swept from headwall to toe of rear slope, are reproduced in figure 85. Behind the front, the earth embankment turns several shades lighter, probably due to turbulence of surface soil picked up by the blast. The mean camera speed in this sequence was about 700 frames per second, as calculated from the timing marks on the film. The shock wave arrived at the front of the igloo 0.18 seconds after the flash, corresponding to an average velocity of propagation from the center of charge to this point of 2,220 ft./sec. The mean velocity of the wave as it traveled the length of Igloo F was about 1,375 ft./sec. A 4' x 8' plywood sign which had been laid on the earth cover on the near side of the igloo was blasted to pieces, which traveled away from the explosion during the positive phase, and then returned to the field of view in the negative phase, coming to rest not far from their original position.

The Fastax camera, located at camera station Number 1, 2,250 feet to the north, provided a film showing the development of the explosion from a preliminary tongue of flame which emerged from the front of the igloo, to a large bulbous cloud having a fiery center ringed by sharp plumes of dark smoke shooting radially outward. At the end of this film, the usual white cloud was developing from the lower parts of the main cloud mass. The shock wave was not visible in this film, but its effect on the ground in the form of a change to a

lighter shade, could be observed propagating away from the explosion. Because of the lack of a telephoto lens on the camera, smaller details of the explosion phenomena, such as wave reflections and missiles, were not visible. Figure 86 shows selected frames from this film.

(c) *Air blast.*—Pressures registered by the ball crusher gages are tabulated in table V. Many of these gages were lost or damaged by missiles in this test, particularly on the north meter line. There is considerable scatter in this data, as there was in the first test.

TABLE V.—Peak blast pressures, p.s.i., from ball crusher gages, test 2

Distance from charge, feet	Line 1		Line 2		Line 3	
	NOL	Arco	NOL	Arco	NOL	Arco
120	152	x	76	64	52	38
130	231?	x	43	49	49	33
140	143	x	43	45	27	26
140	44
140	61
140	45
140	52
150	x	x	37	45	40	x
160	x	88	52	41	27	x

x signifies no reading because gage was lost or damaged.

Pressures obtained from the foil and paper blast meters are presented in table VI.

TABLE VI.—Peak blast pressures, p.s.i., from foil and paper blast meters, test 2

Distance from charge, feet	Line 1		Line 2		Line 3
	Foil	Paper	Foil	Paper	Paper
175	x	34.3
225	x	28.1
275	34.3	22.8
330	34.3	14.8
385	18.5	12.0
440	14.8	12.0
500	22.8	8.2	12.0	x	8.2
565	12.0	13.8	9.7	8.2	8.2
640	14.8	8.2	7.9	8.2	8.2
725	9.7	5.6	6.4	8.2	5.6
820	7.9	5.6	6.4	5.6	5.6
920	6.4	5.6	5.2	5.6	5.6
1,055	3.3	3.3	3.3
1,190	3.3	5.6	2.3
1,350	3.3	2.3	2.3
1,53094	2.3	2.3
1,730	1.5	1.5	1.5
1,96060	2.3	.94
2,2206060	.60
2,5156094	.60
2,8452538	.60
3,2203838	.38
3,6506038	.60
4,1402538	.38
4,69038	<.38	<.38
5,31038	<.38
6,000	<.38	<.38

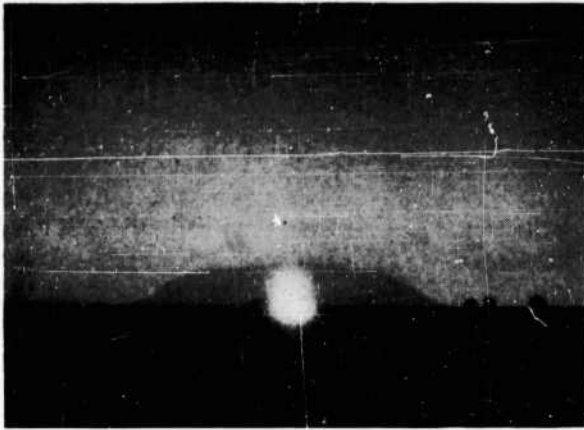

a. Flash at front of Igloo E.

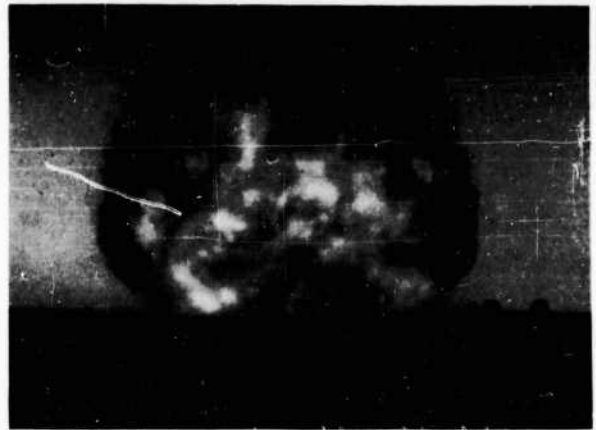

b. Smoke and fire cloud 0.1 sec. after flash.



c. Cloud 0.22 sec. after flash.

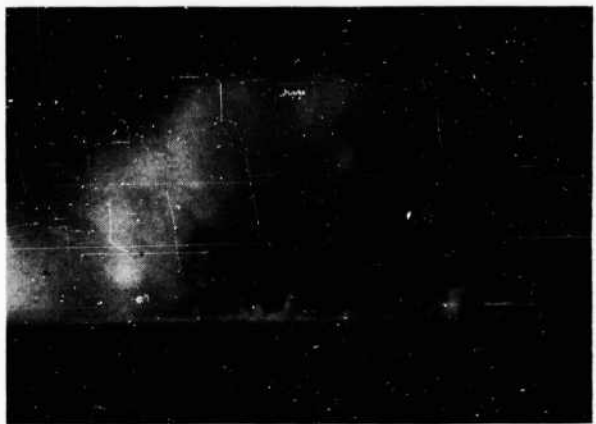

d. Cloud 0.48 sec. after flash. Vapor ring has formed. Dust geysers in foreground caused by missiles striking earth.

FIGURE 86. Selected frames from Fastax film, Test 2

The pressures in the above tables have been plotted as a function of distance from center of charge in figures 87, 88, and 89, which show off-front, off-side, and off-rear pressures, respectively. As was the case in test 1, a slightly concave downward curve appears to fit the data better than any other, and such a curve has been selected by eye in each graph. These curves indicate that the pressure was of the order of 200 p.s.i. directly in front of the igloo at a distance of 100 feet from the center, while only from 50 to 60 p.s.i. off the sides and rear at the same distance. Pressures on all three lines were about 4 p.s.i. at a distance of 1,000 feet, and dropped to from 0.5 to 0.7 p.s.i. at 2,705 feet, where the nearest barracks was located. In this test, two Aberdeen paper blast

meters had been placed inside Igloo F, one near the front end and one near the rear, both located on the centerline and both facing north, or toward the door. Neither of these meters registered, indicating that the blast pressure, which was of the order of 15 p.s.i. above atmospheric outside, failed to communicate to the interior to an appreciable extent. Paper meters placed in and around the three barracks registered as depicted by figure 90. In Barracks 1, the westernmost meter on each floor registered a pressure of 0.25 p.s.i. It is believed that these meters registered only because the north windows had been broken or blown out by the previous explosion and the meters were located in line with the blast entering through these openings. Readings of meters

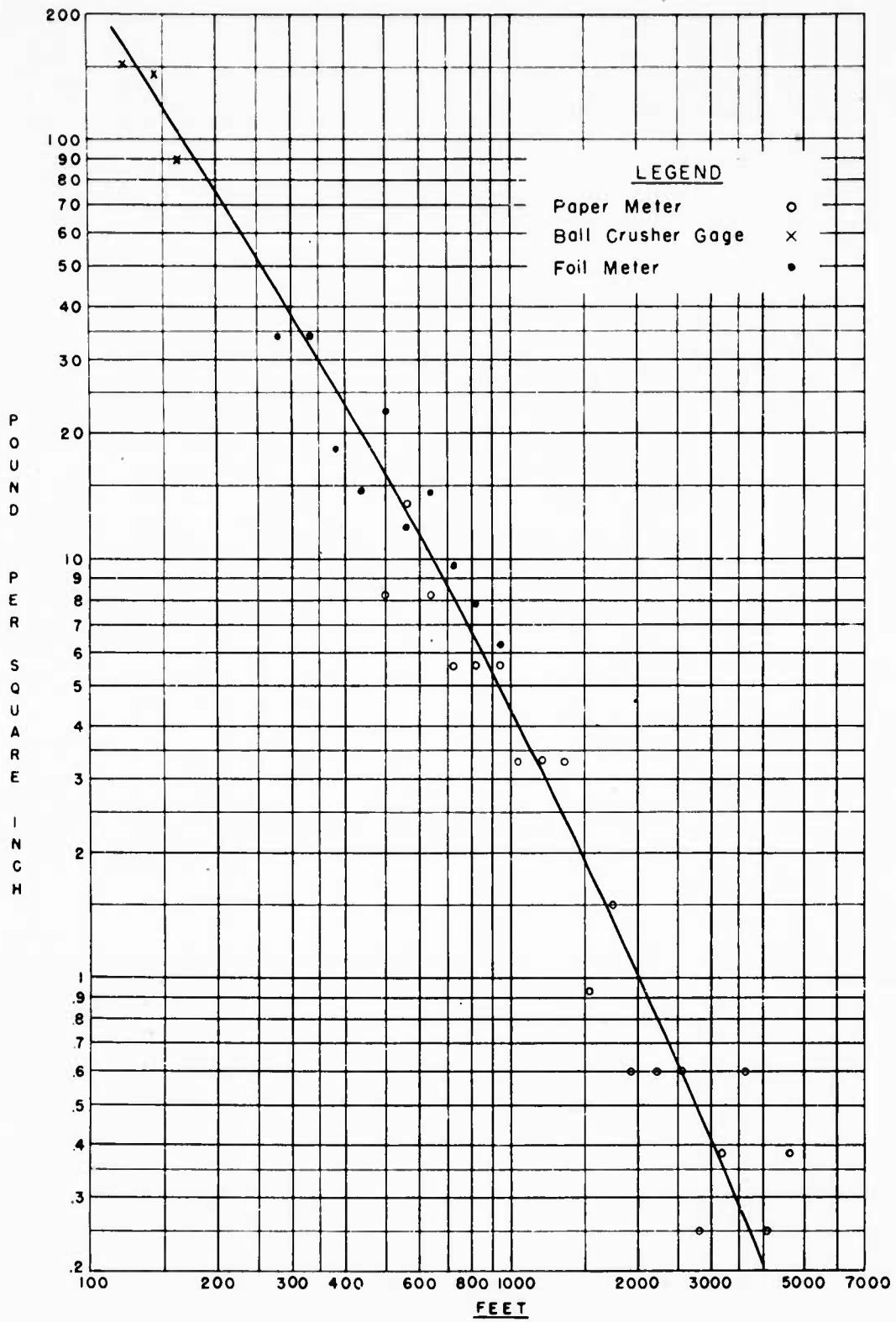

FIGURE 87. Peak Blast Pressure vs Distance from Charge, Test 2, Line 1 (Off Front)

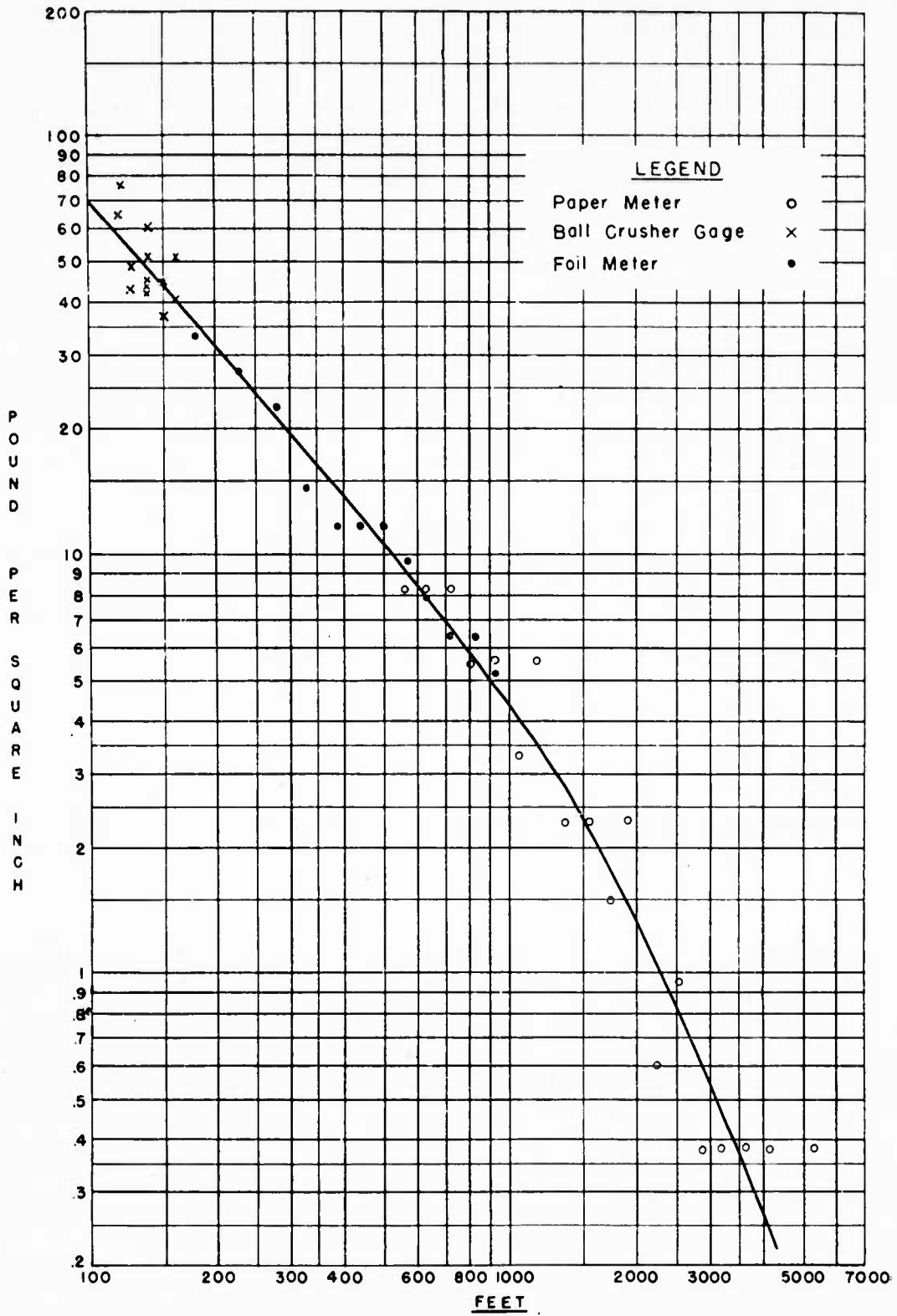

FIGURE 88. Peak Blast Pressure vs Distance from Charge, Test 2, Line 2 (Off Side)

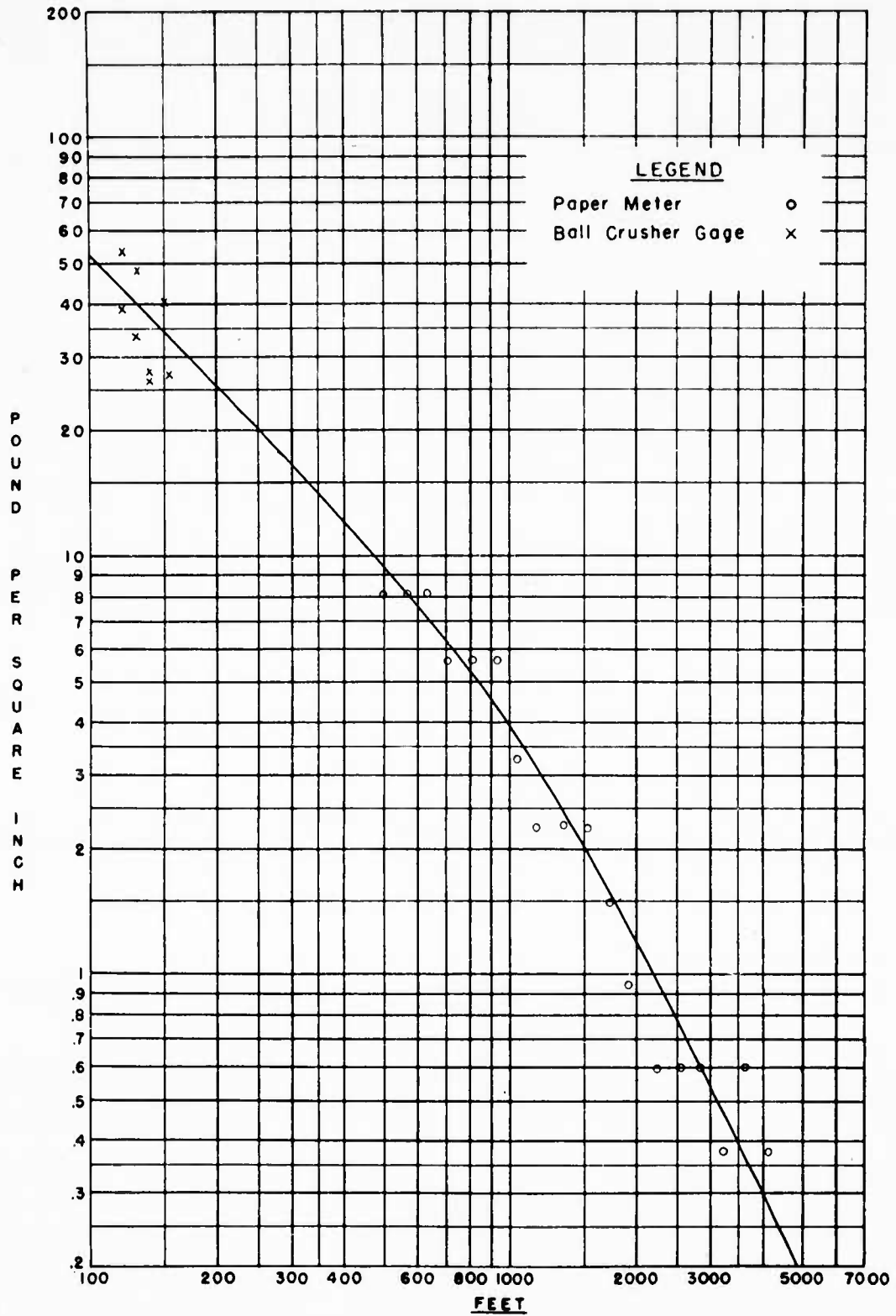
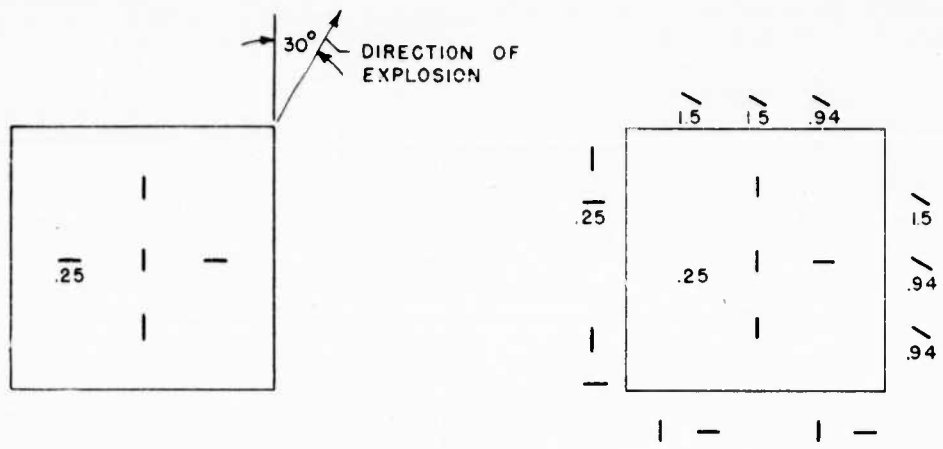
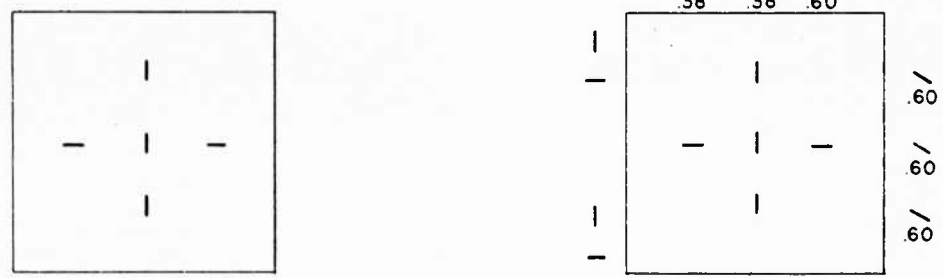

FIGURE 89. Peak Blast Pressure vs Distance from Charge, Test 2, Line 3 (Off Rear)



BARRACKS 1
2705 ft.



BARRACKS 2
3605 ft.

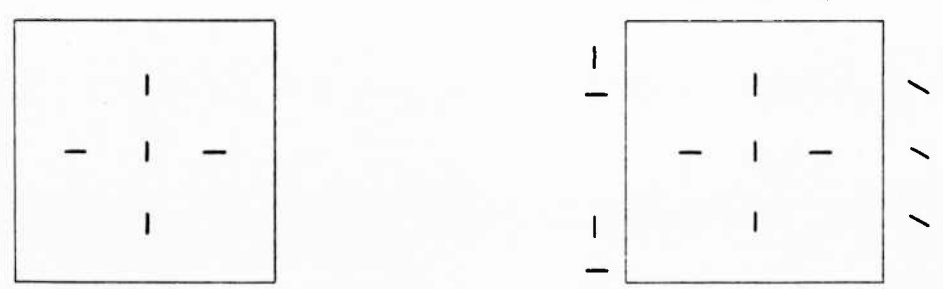

2nd Floor

BARRACKS 3
5410 ft.

Ground Floor & Outside

LEGEND
 \ - METER (TOP EDGE VIEWED FROM ABOVE)

FIGURE 90. Placement and Registration of Paper Blast Meters at Barracks (Pressure in lbs / sq in), Test 2

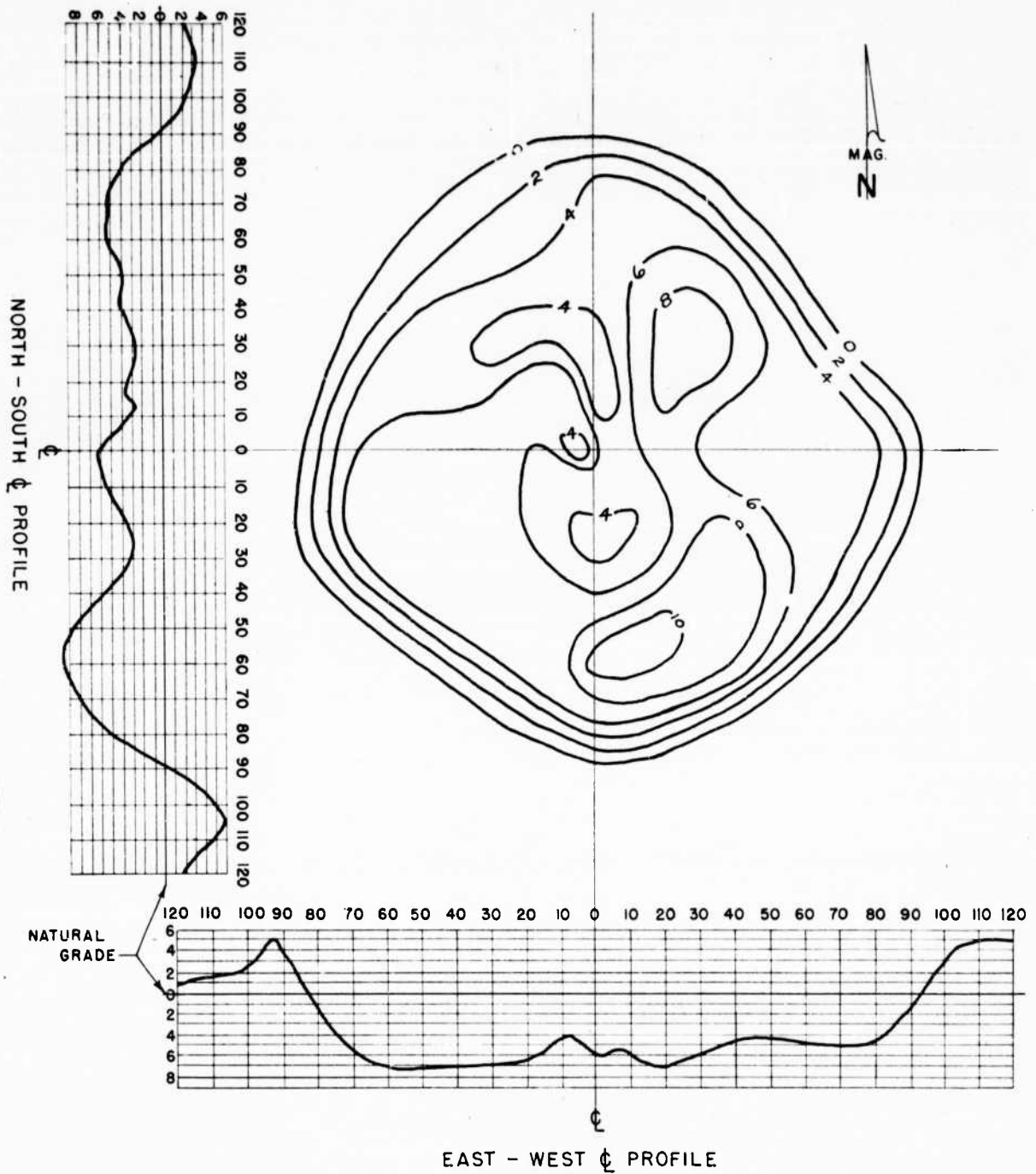

NOTE -
ALL DIMENSIONS ARE IN FEET.

FIGURE 91. Crater Plan and Profile, Test 2

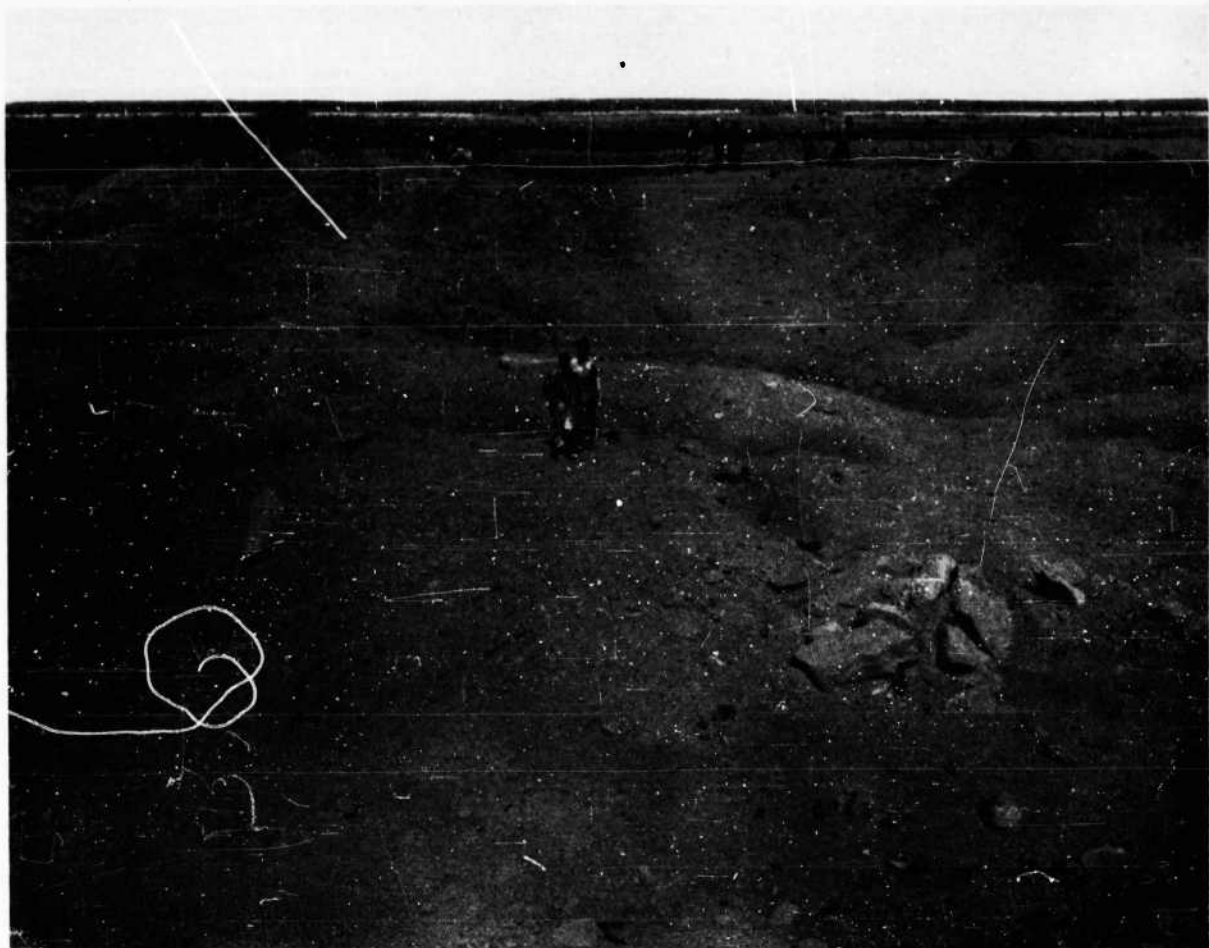

FIGURE 92. Crater of Igloo E, looking east

outside the buildings were a bit higher than those of meters along meter line 3 at the same distance. Along the north and west elevations of Barracks 1, readings averaged 1.2 p.s.i. whereas the meter line at the same distance gave a value of about 0.7 p.s.i. Meters at Barracks 2 averaged 0.5 p.s.i. while the meter line gave about .3 p.s.i. at the corresponding distance. It is not thought advisable to permit the readings of the meters at the barracks to influence the average curve drawn for the meter line, because of the possibility that registration of the meters at the barracks may have been affected by reflections of the shock wave from the walls of the buildings. Meters in the lee of the buildings again registered no pressure or much less pressure than the meters on the exposed sides.

(d) *Crater.*—In plan, this crater was nearly circular, the north-south and east-west apparent diameters differing by only about 2 feet. The average diameter was 177 feet, and the maximum depth was 10 feet. This crater appeared much shallower than that of Igloo D, and had a more uneven bottom with many heaped-up places. The rim of this crater did not quite meet the rim of the first crater, the space left between the two being wide enough for a jeep to drive through. For plan and profiles of this crater, see figure 91. For photographs, see figures 92 and 93, which illustrate the unevenness of the bottom and the distribution of concrete fragments. Excavation at the deepest point of the bottom disclosed that the true depth was from 2 to 2½ feet greater than the apparent depth. The excavation was car-



FIGURE 93. Crater of Igloo E, looking southwest

ried to a depth of about 5 feet below apparent bottom, or to about 15 feet below grade, and was stopped when a stratum of light grey volcanic rock was encountered. In the sides of the excavation the true crater bottom appeared as a sharp line; the earth above was dark in color, unstratified, and contained much fractured gravel, while the earth below lay apparently undisplaced although almost all large aggregate was cracked and the volcanic rock seemed to have been shattered.

(e) *Ground movement.*—Permanent horizontal and vertical displacement of the ground surface caused by the explosion of Igloo E is given by figure 94. Movement recorded along the eight radii was predominately away from the explosion and upward, although there were a few instances of inward and downward dis-

placement. At 100 feet from the center, horizontal movement varied from 1.2 to 0.45 feet outward with an average of 0.8 feet, and vertical movement was from 0.22 feet down to 0.36 feet up, with an average value of 0.12 feet up. At 250 feet, displacements were from 0 to 0.4 feet outward with an average of 0.1 feet, and from 0 to 0.12 feet upward with an average of 0.08 feet.

(f) *Permanent displacement of target igloo.*—There was no detectable movement of Igloo F in the horizontal plane, but the igloo apparently was lifted bodily about one-tenth of an inch. The changes in elevation as determined by survey are recorded in figure 95, which also shows the permanent changes in internal arch dimensions. The latter varied from plus to minus 1/16".

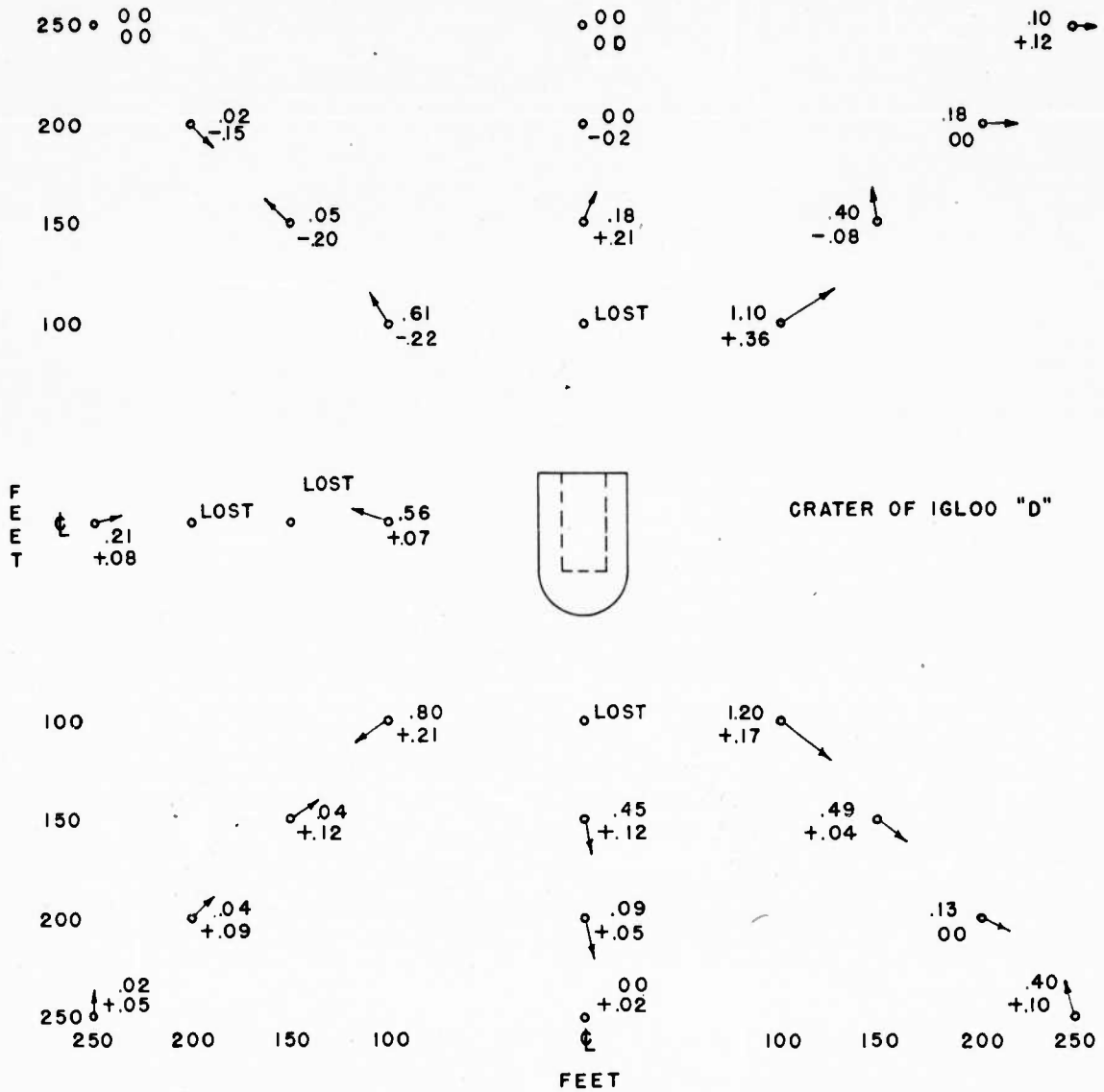
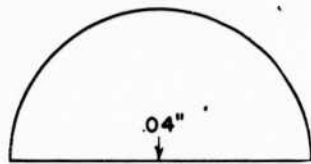
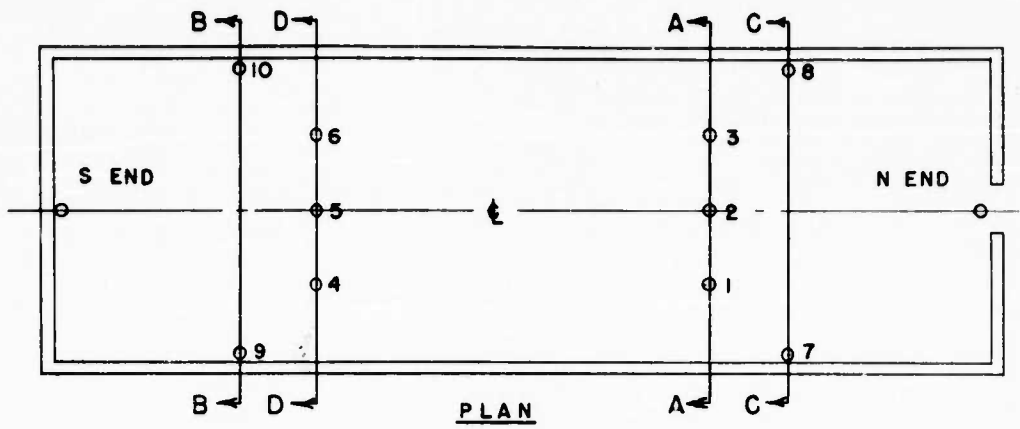
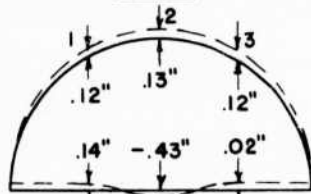

FIGURE 94. Permanent Horizontal and Vertical Earth Displacement, Igloo E, Test No. 2



N. END



SECTION A-A

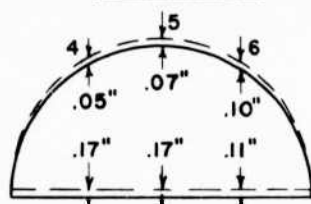

SECTION B-B

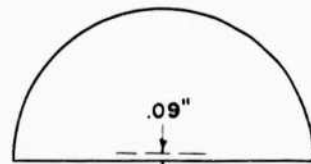

S. END

CHANGES IN ELEVATION AS DETERMINED BY SURVEY

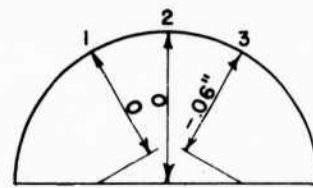

SECTION A-A

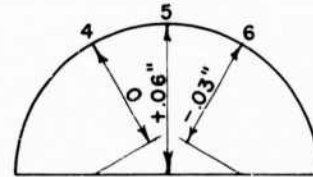

SECTION B-B

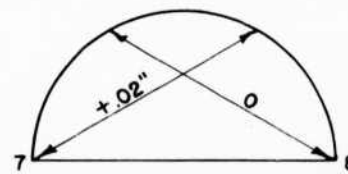

SECTION C-C

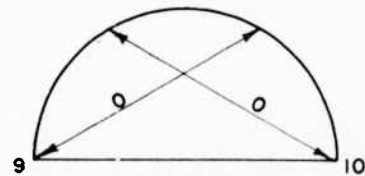

SECTION D-D

CHANGES IN DIMENSIONS AS DETERMINED BY DEFLECTION GAGES

FIGURE 95. Permanent Changes in Elevation of Points on Floor and Ceiling and Permanent Changes in Internal Dimensions of Igloo F, Test 2

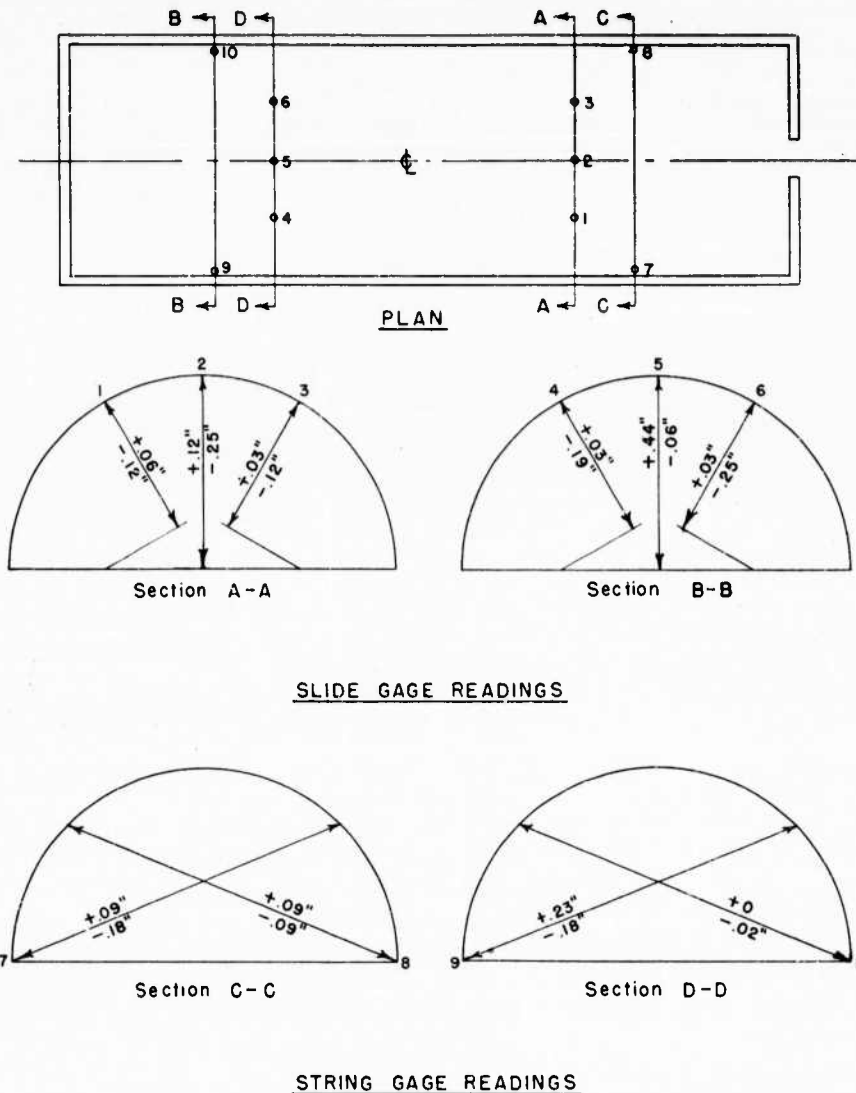

FIGURE 96. Transient Distortions of Internal Dimensions of Igloo F as measured by Deflection Gages, Test 2

(g) *Transient arch deflections of target igloo.*—Maximum and minimum changes in arch-floor distances and diagonal distances from points on the arch on one side to springing section on the other side are depicted in figure 96. The values vary from about $\frac{1}{4}$ " plus to a like amount in the minus direction (decrease in dimension).

(h) *Damage to target igloo.*—Igloo F was not seriously damaged by the second explosion. The front wall, which was cracked in the first test, suffered additional cracks and the previous cracks were extended and opened wider. See figure 97, which shows the front wall shortly after the explosion. Missiles struck the wall

in numerous places, leaving indentations up to a foot in diameter, but no missiles penetrated through the wall. The pilasters on either side of the door suffered severe spalling of the concrete, as may be seen from figures 98, 99, and 100. The failure of the front wall was such that it bellied inward about 2 inches in the middle (note edge view in figure 99). Three of the principal cracks reached the top of the wall and a scab or broken piece of concrete was dislodged from the top edge (see figures 101 and 102). The door and frame were bent inward slightly but were in operating order when the igloo was opened. The bottom hinge anchor was nearly torn out of the plaster, as



FIGURE 97. Front of Igloo F after Test 2

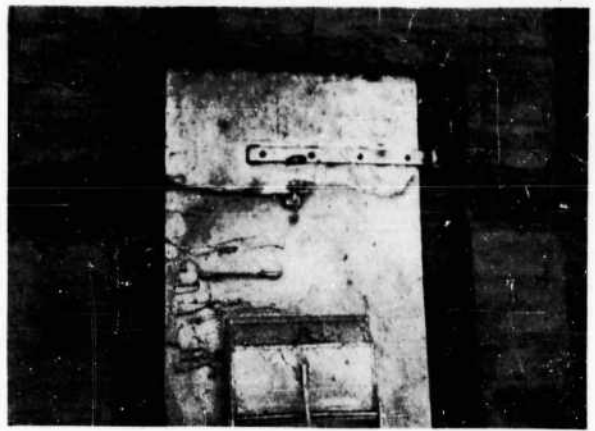

FIGURE 98. Close-up of upper part of door and pilasters; Igloo F after Test 2



FIGURE 99. Open door, showing condition of front wall at door jamb; Igloo F after Test 2



FIGURE 100. Close-up of lower door hinge and pilaster, showing fractured concrete over hinge anchor; Igloo F after Test 2

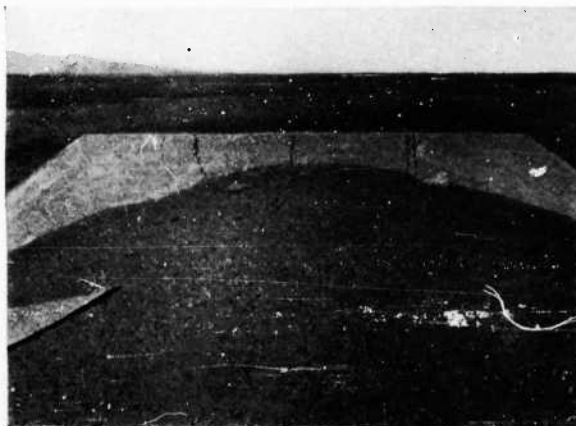

FIGURE 101. Rear view of upper part of front wall as viewed from top of igloo; Igloo F after Test 2

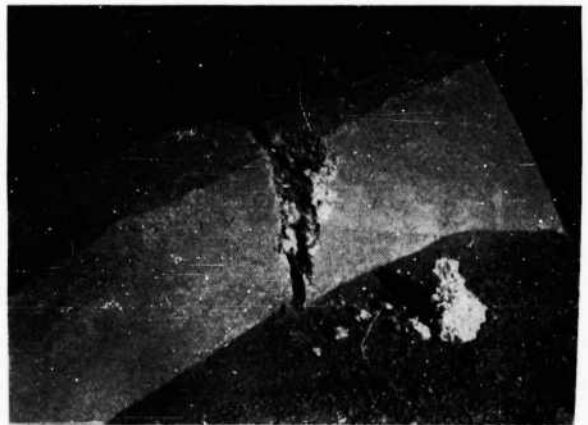

FIGURE 102. Close-up of crack and "scab" from rear of upper edge of front wall; Igloo F after Test 2

may be seen in figure 100. On the inside, the front wall was broken away from the floor slab, and most of the exterior cracks could be seen on the inner surface. In addition, there were a few spalled places, particularly around the door where the inward deflection was greatest. There was no appreciable damage to the rest of the igloo. No cracks could be found in the arch barrel, rear wall, or floor (other than the few fine shrinkage cracks previously existing). The ventilator flue was intact. There was no loss of earth cover except for slight erosion immediately back of the front wall. There was apparently no disturbance of the stacks of bombs, which stood just as they had before the test.

(i) *Damage to revetments: (1) Revetment 1.*—Little or no loss of earth was suffered through blast erosion. An inch or two of additional earth settled on the windrows and on top of the mines, mostly on the near side. More fragments of concrete and pieces of reinforcing steel also fell on top of the pile. The mines themselves, which had not been restacked after the previous explosion, were not further scattered except to a minor extent. For photographs showing the condition of this revetment, see figures 103 and 104.

(2) *Revetment 2.*—This revetment was also little disturbed by the second explosion. A number of additional mines were pulled from the top edge of the front of the pile and scat-



FIGURE 103. Revetment 1 after Test 2, looking north from southeast corner

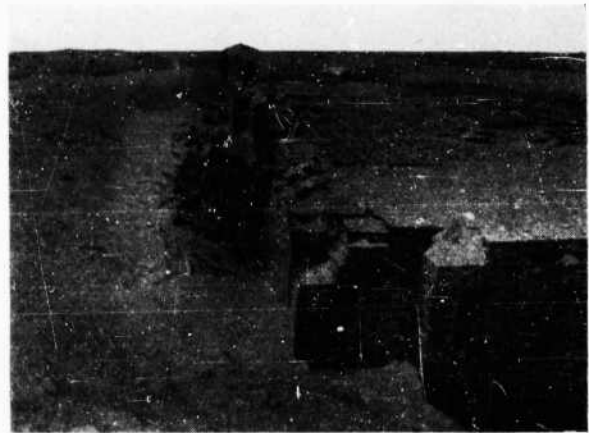

FIGURE 104. Revetment 1 after Test 2, looking north from southwest corner



FIGURE 105. Revetment 2 after Test 2, looking diagonally toward front of mine stack from northwest corner



FIGURE 106. Revetment 2 after Test 2, looking eastward at rear of mine stack from southwest corner

tered on the ground, and a few more mines were dislodged from the rear and side faces of the stack. See figures 105 and 106.

(j) *Damage to barracks: (1) Superficial.*—*Barracks 1* lost large areas of asphalt felt siding and the battens which covered it, principally in the gable and on both sides of the second-floor windows of the north wall. In the east elevation, two sash which had been loosened in the first blast were blown into the building, old torn spots in the siding were made larger and new ones started. Battens were extensively broken, door frames and trim and the doors themselves were pushed out of line by the bulged-out south elevation. On the west elevation, four sash and parts of their frames

and trim in the south end of the ground floor were blown outward, evidently by blast from within that entered through the openings in the north and east walls. The torn spot in the roofing on the south end of the east slope was enlarged and a second tear started just north of the first. For photographs of the four elevations, see figures 107, 108, and 109.

Barracks 2 suffered further tearing of torn spots in the siding on the north elevation and three sash which had been loosened in the first test were blown into the building from this side. Additional exterior window trim was also lost. On the east elevation, as well, three more sash were blown from their frames into the building, and two others were broken in

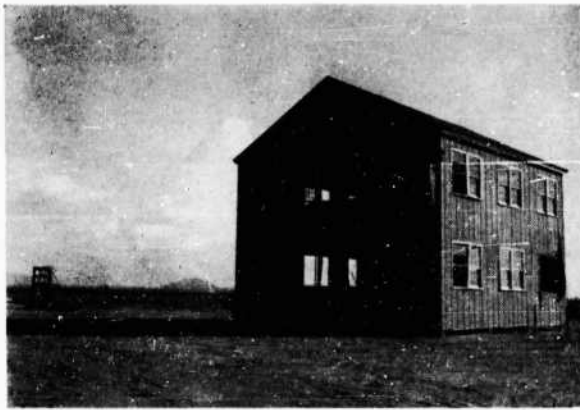

FIGURE 107. North and west elevations of Barracks 1 after Test 2



FIGURE 108. East elevation of Barracks 1 after Test 2

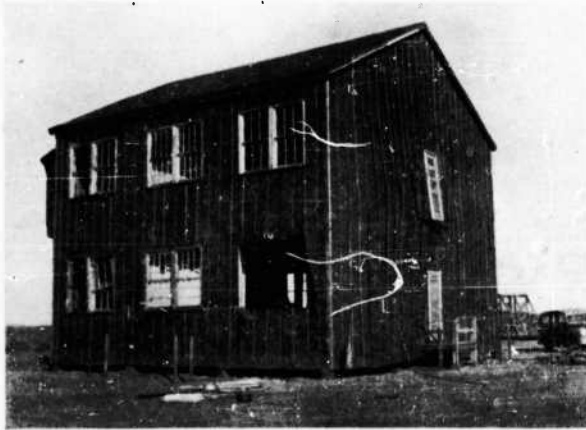

FIGURE 109. South and west elevations of Barracks 1 after Test 2



FIGURE 110. North elevation of Barracks 2 after Test 2

place. The south wall was not damaged except for the loss of a piece of exterior trim over the ground floor door. The west elevation was not further damaged. The tear in the roofing in the upper portion, south end, of the east slope of the roof was made about twice as long as it was after the first blast. Views of the four sides of the building after test 2 are given in figures 110 through 113.

Barracks 3 lost one previously broken sash from the second floor windows of the north elevation. Two other sash were loosened, and some exterior window trim was displaced from position. The east elevation escaped with no further superficial damage, as did the south side. In the lower part of the west side, however, a large section of asphalt felt siding was torn off. The torn spot in the roofing on the south upper portion of the east slope of the roof was lengthened so that it was almost as long as the buildings. Figures 114, 115, and 116 show the north, east and west elevations of this building after the second blast.

(2) *Structural: Barracks 1* received the following additional structural damage: The building was rocked on its foundation posts, leaving crevices between the timber and earth 1" wide on the south and east sides, $\frac{1}{2}$ " wide on the north side, and closed up on the west side of the posts. These measurements were taken on posts on the east side of the building. Apparently the building deflected bodily away from the explosion, then toward it during the negative phase, and returned to a central position somewhat west of its original position. In the north wall on the ground floor, studs which had been merely cracked before were now badly fractured or broken out of position. A 6" x 6" post in the wall was knocked out of position and lay on the floor. More sheathing was broken and the jamb framing on one side of the window opening was split. In the same wall on the second floor, several studs which had been previously cracked were now completely broken or separated from the sheathing and plates. In the gable wall, two additional studs were broken, two others loosened, and the sheathing broken up near the peak. The east and west walls did not suffer additional structural damage, but the south wall, which received an outward impulsive force from the blast entering through the broken north and

east windows, was displaced outward a maximum of 12 inches at the midheight of the building. On the ground floor, the bottom plate and several studs were broken. A 6" x 6" post which supported a 6" x 12" second floor girder was pushed outward with the wall so far that the end of the girder was no longer bearing on it, and the second floor was left unsupported at this point. On the second floor, the south wall had many broken studs and cracked sheathing. In the roof, previously cracked rafters were now badly fractured, and the broken purlin was further split and knocked askew. Figure 109 illustrates the bulging-out of the south wall, and figures 117 through 121 show typical instances of displacement and failure inside the building. Figure 122 is a diagrammatic representation of the structural damage to this building.

Barracks 2 was also rocked on its foundation posts, leaving crevices between the earth and sides of the post 2 inches wide on the north, $\frac{1}{2}$ inch wide on the east, $1\frac{1}{2}$ inches wide on the south, and $\frac{1}{2}$ inch wide on the west sides. In addition, the stringer bearing on the exterior line of posts was pushed inward, exposing parts of the tops of the posts, and carrying the wall with it. This deflection amounted to 3 inches on the north side, 2 inches on the east side, and $1\frac{1}{2}$ inches on the west side. In the north wall on the ground floor, studding that had been cracked or loosened in the first blast was more seriously broken and separated farther from the plates and sheathing. In the second story, previously broken studs, plates, and sheathing were deflected farther inward. Damage in the gable wall was similarly increased. There was no appreciable increase in structural damage to the remainder of the building. Figures 123 through 127 illustrate typical cases of failure and displacement of interior members, and figure 128 shows the damage to the building in diagrammatic form.

Barracks 3 sustained one additional broken stud in the north wall on each story, but no other structural damage. Figures 129 and 130 show the appearance of the interior of each story after the second test.

(3) *Glass: Barracks 1.*—There were only three additional panes broken in the second test, all of these being in the east elevation. Two were $11\frac{3}{8}$ " x $14\frac{3}{4}$ " DS panes and the other



FIGURE 111. East elevation of Barracks 2 after Test 2

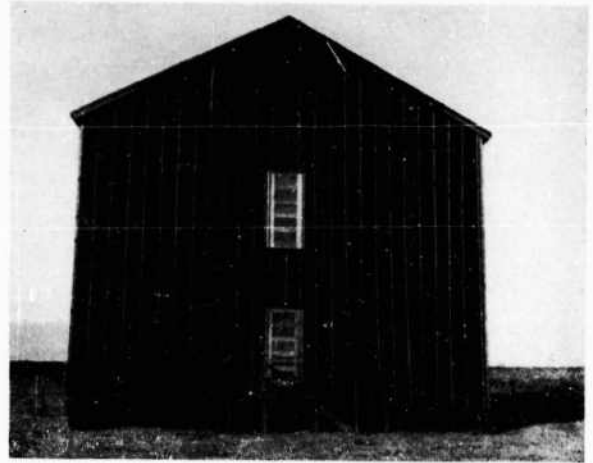

FIGURE 112. South elevation of Barracks 2 after Test 2

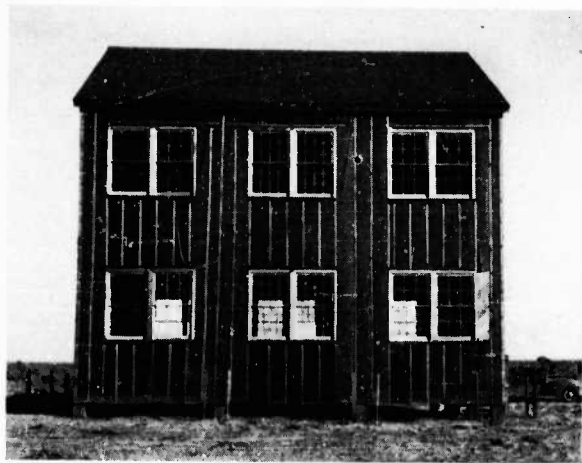

FIGURE 113. West elevation of Barracks 2 after Test 2



FIGURE 114. North elevation of Barracks 3 after Test 2

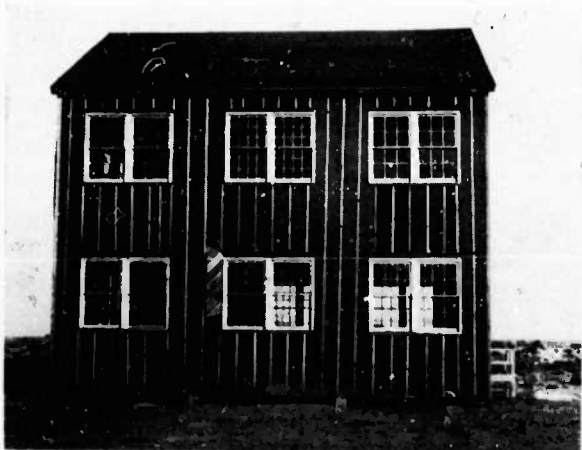

FIGURE 115. East elevation of Barracks 3 after Test 2



FIGURE 116. West elevation of Barracks 3 after Test 2

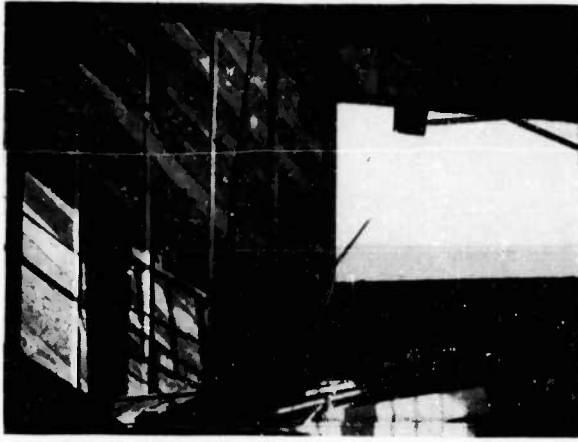

FIGURE 117. Damage to north wall, ground floor of Barracks 1 after Test 2

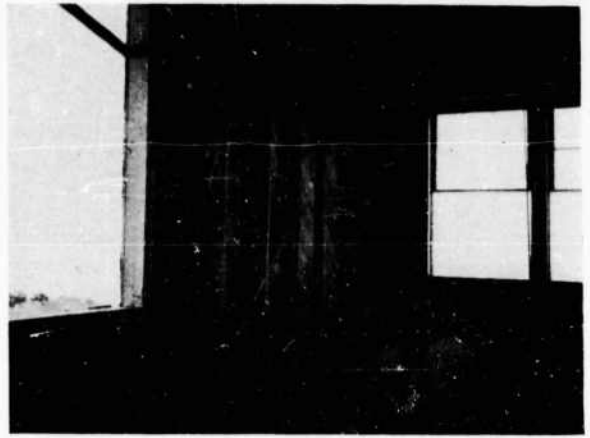

FIGURE 118. Damage in northeast corner, ground floor of Barracks 1 after Test 2



FIGURE 119. Displacement and failure of studs and plate, south wall, ground floor, Barracks 1 after Test 2



FIGURE 120. Displacement of south wall and column supporting 2nd floor, ground floor, Barracks 1 after Test 2



FIGURE 121. Looking up from ground floor, showing separation of south wall from 2nd floor framing, Barracks 1 after Test 2

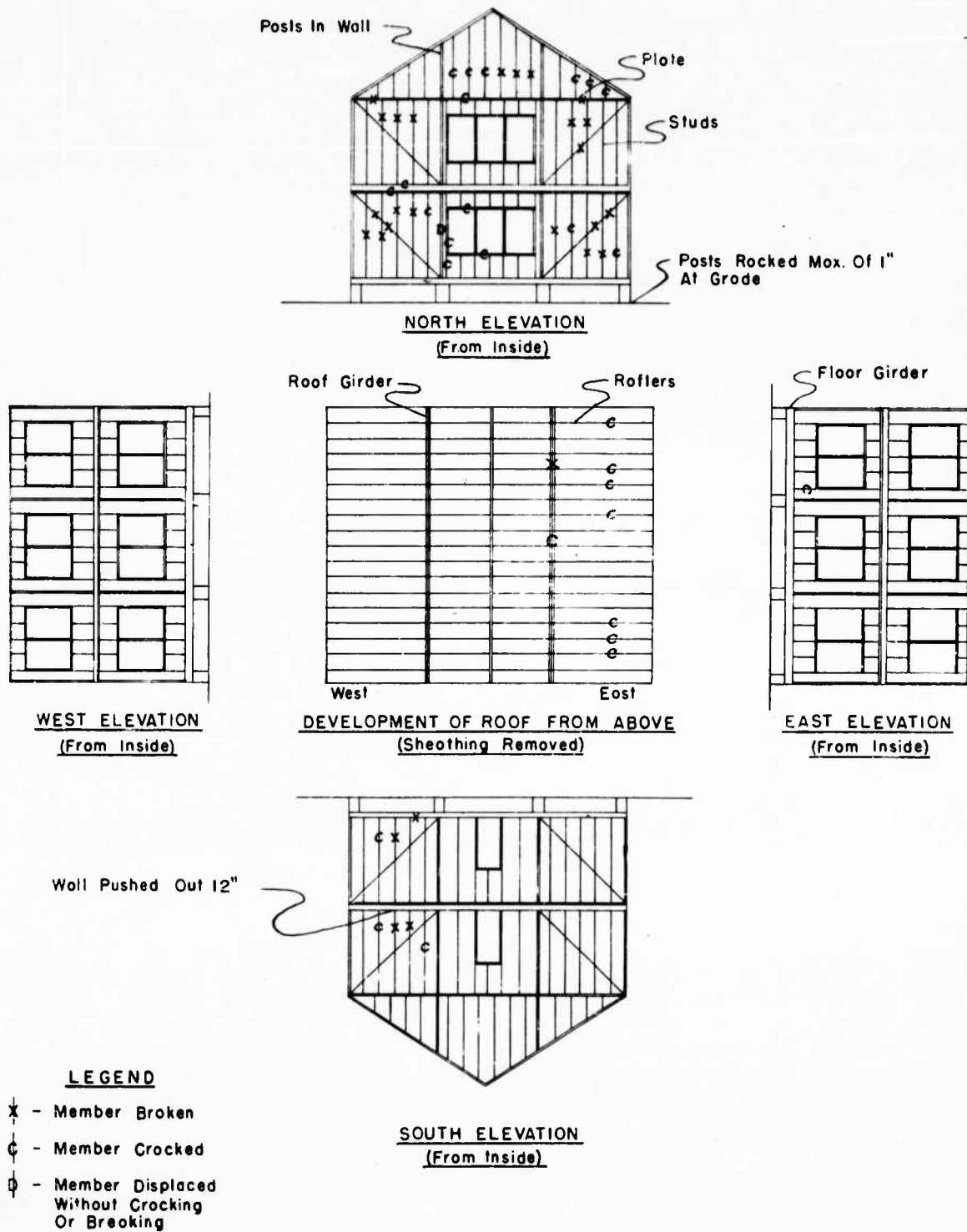

FIGURE 122. Damage to Barracks, Barracks 1, Test 2

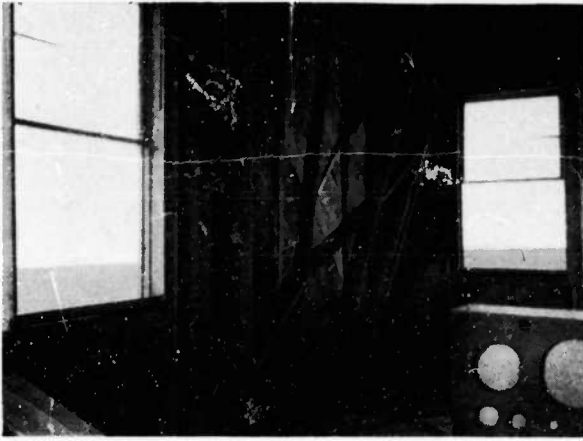

FIGURE 123. Damage in northeast corner of ground floor, Barracks 2 after Test 2

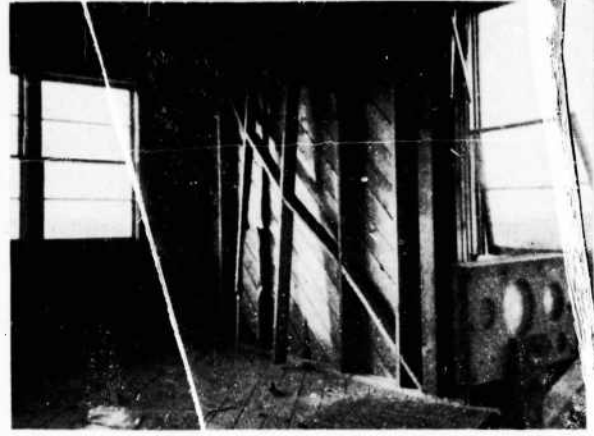

FIGURE 124. Broken studding in west part of north wall, ground floor, Barracks 2 after Test 2

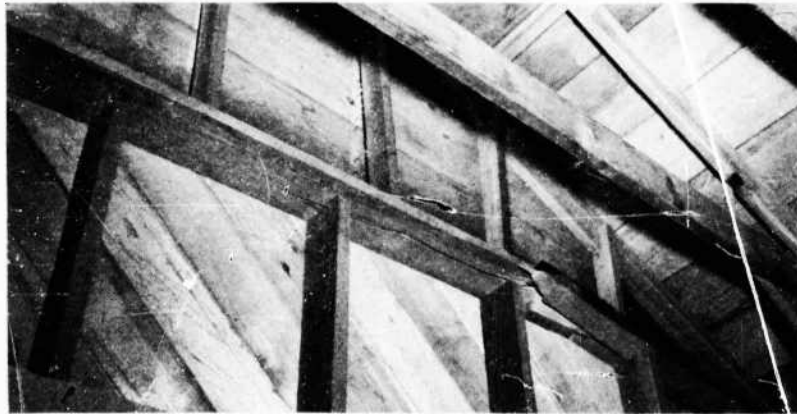

FIGURE 125. Broken stud and plate in north wall, second floor, Barracks 2 after Test 2



FIGURE 126. Broken studs in north gable, Barracks 2 after Test 2



FIGURE 127. Broken and displaced studs, north wall, second story, Barracks 2 after Test 2

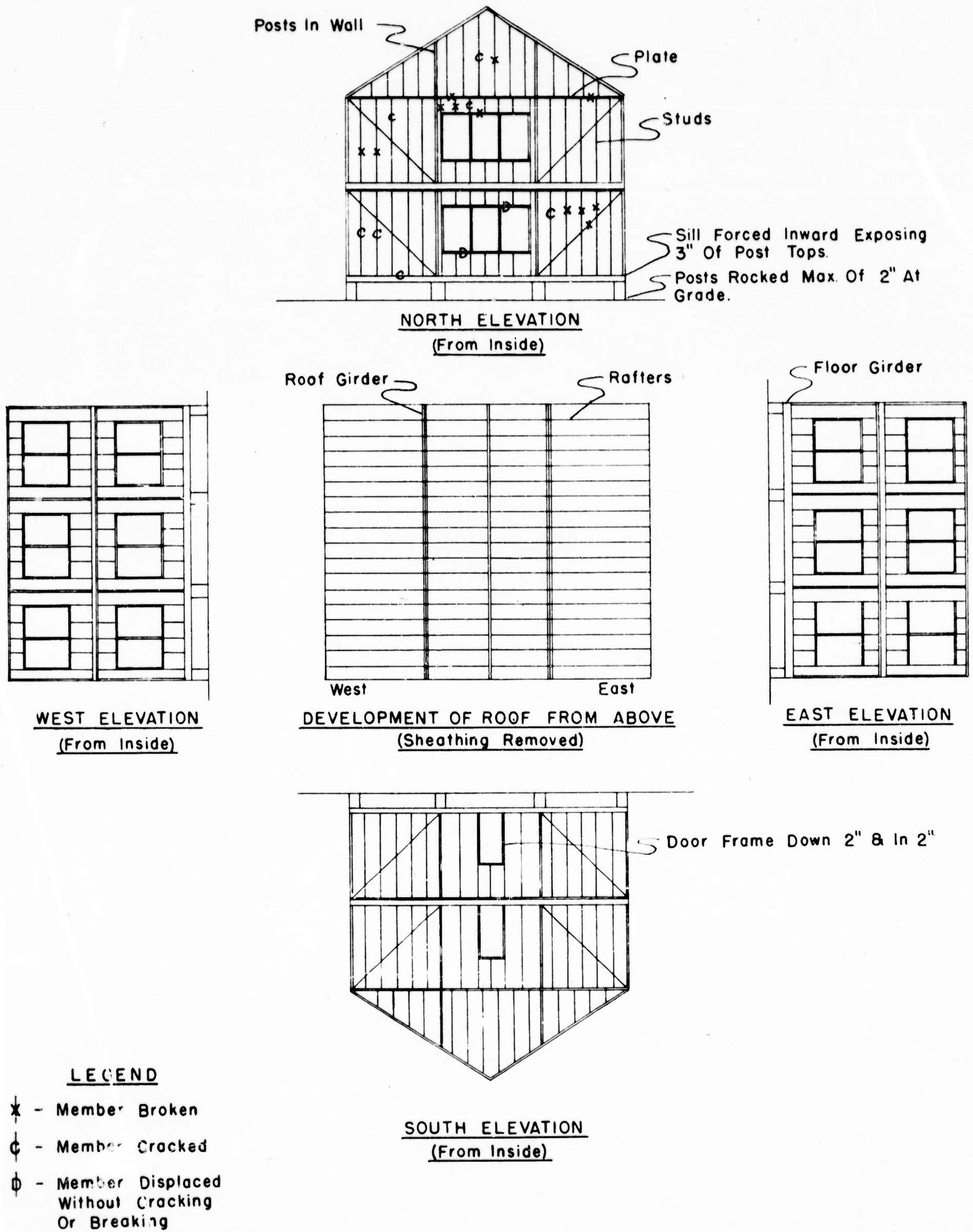

FIGURE 128. Damage to Barracks, Barracks 2, Test 2



FIGURE 129. Interior of lower story, looking northeast, Barracks 3 after Test 2



FIGURE 130. Interior of upper story, looking southeast, Barracks 3 after Test 2

was a $8\frac{5}{8}$ " x $9-11/16$ " piece of Lumapane. Of course, unbroken panes in sash which had blown into the building as a result of the first blast were not subjected to a proper test in the second explosion and breakage of such panes was not recorded. Figure 131 gives the total glass breakage as it stood after the second test.

Barracks 2.—Five additional panes were out of the lower story sash of the north elevation. Four were DS and were broken; the fifth, which was Duplate, was dislodged from its sash but was not broken. One DS pane was also broken in the upper story windows of the north side. Two more panes were out on the east elevation. One of these was a $35\frac{7}{8}$ " x $14\frac{7}{8}$ " piece of wire

glass which was shattered, and the other was an $8\frac{5}{8}$ " x $9-11/16$ " Vimlite pane which was torn from its sash. See figure 132 for a complete record.

Barracks 3.—On the north elevation, four panes of DS glass backed by wire mesh and one with no backing were demolished in place. On the east side, three $11\frac{5}{8}$ " x $14\frac{3}{4}$ " pieces and two $8\frac{5}{8}$ " x $9-11/16$ " pieces of Vimlite were either torn loose, left hanging, or were completely missing. One light of Lumapane $11\frac{5}{8}$ " x $14\frac{3}{4}$ " in size and one small pane of the same material were blown in. Figure 133 gives the total glass damage to this building following test 2.

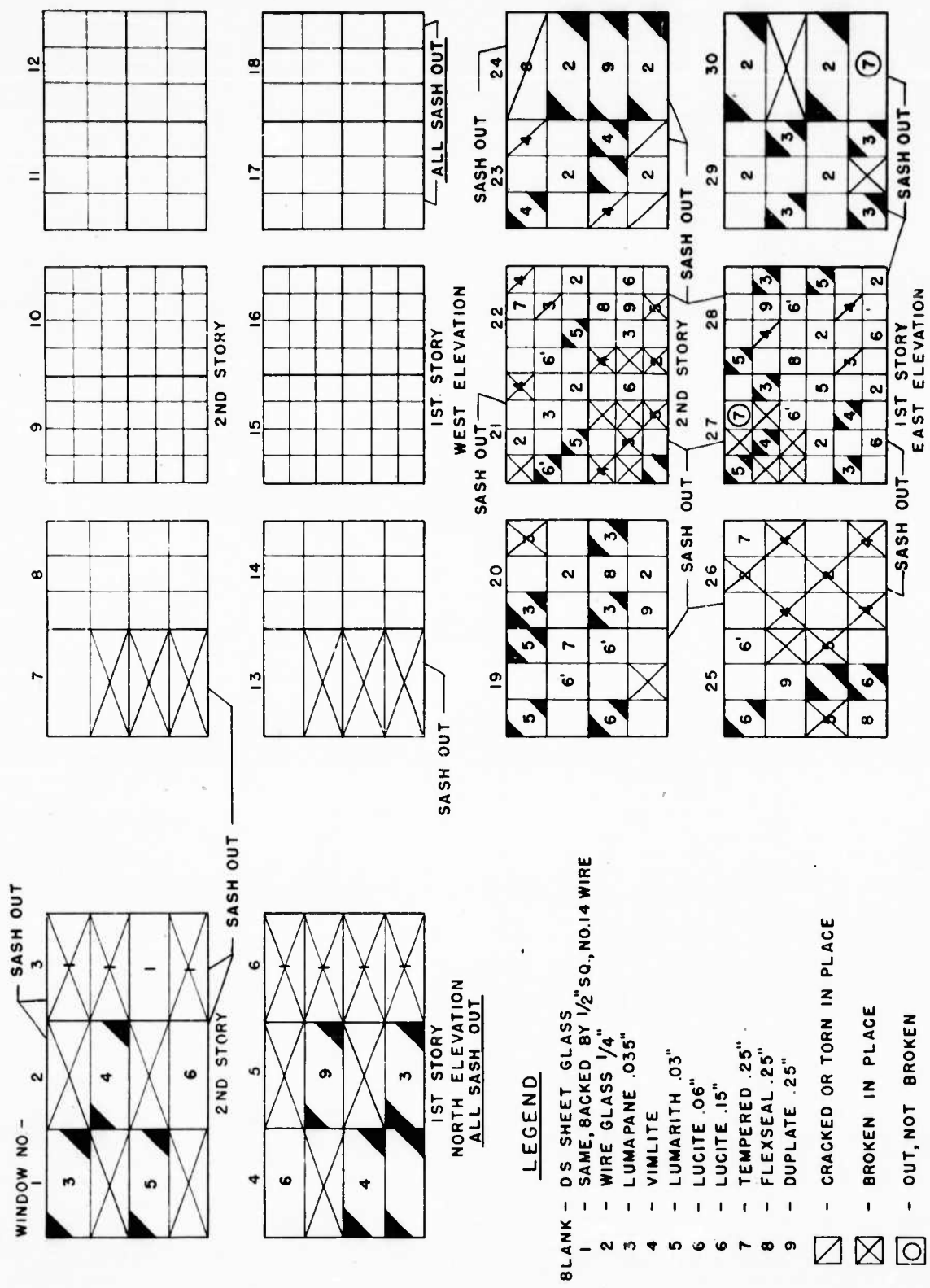

LEGEND

BLANK - DS SHEET GLASS
 1 - SAME, BACKED BY 1/2" SO, NO. 14 WIRE
 2 - WIRE GLASS 1/4"
 3 - LUMAPANE .035"
 4 - VIMLITE
 5 - LUMARITH .03"
 6 - LUCITE .06"
 6 - LUCITE .15"
 7 - TEMPERED .25"
 8 - FLEXSEAL .25"
 9 - DUPLATE .25"

- CRACKED OR TORN IN PLACE
 - BROKEN IN PLACE
 - OUT, NOT BROKEN
 - OUT, CRACKED OR BROKEN

FIGURE 131. Glass Damage, Barracks 1, Test 2

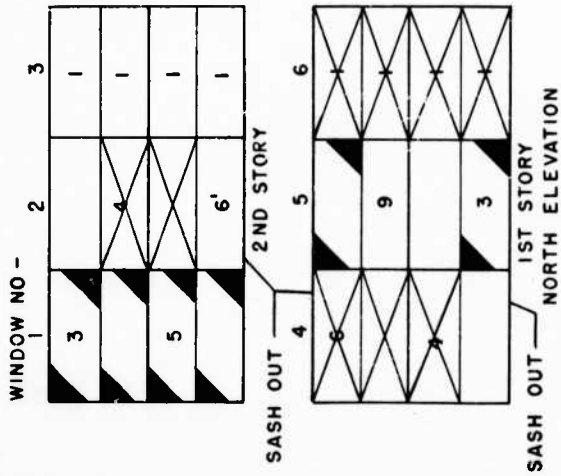

LEGEND

- BLANK - DS SHEET GLASS
- 1 - SAME, BACKED BY 1/2" SQ., NO. 14 WIRE
- 2 - WIRE GLASS 1/4"
- 3 - LUMAPANE .035"
- 4 - VIMLITE
- 5 - LUMARITH .03"
- 6 - LUCITE .06"
- 6' - LUCITE .15"
- 7 - TEMPERED .25"
- 8 - FLEXSEAL .25"
- 9 - DUPLATE .25"
- ☐ - CRACKED OR TC RN IN PLACE
- ⊗ - BROKEN IN PLACE
- - OUT, NOT BROKEN
- ◼ - OUT, CRACKED OR BROKEN

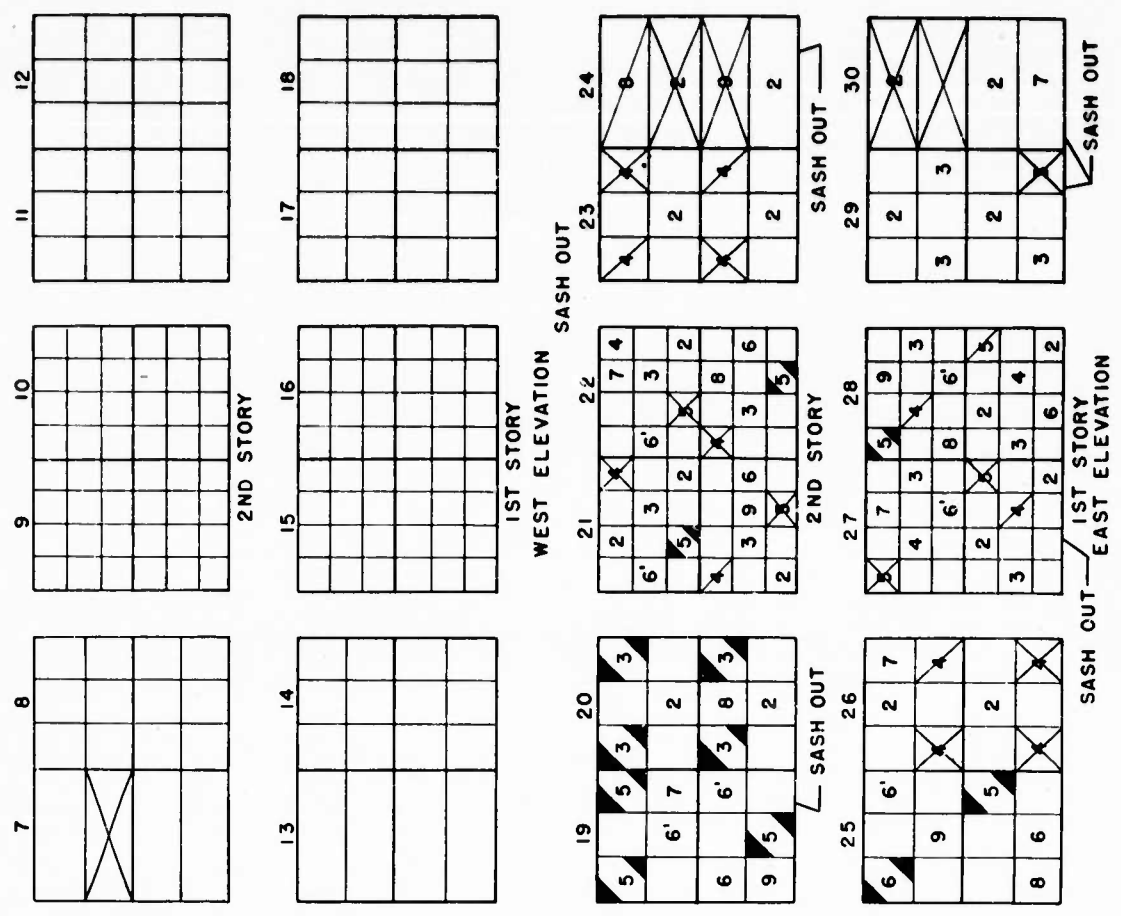

FIGURE 132. Glass Damage, Barracks 2, Test 2

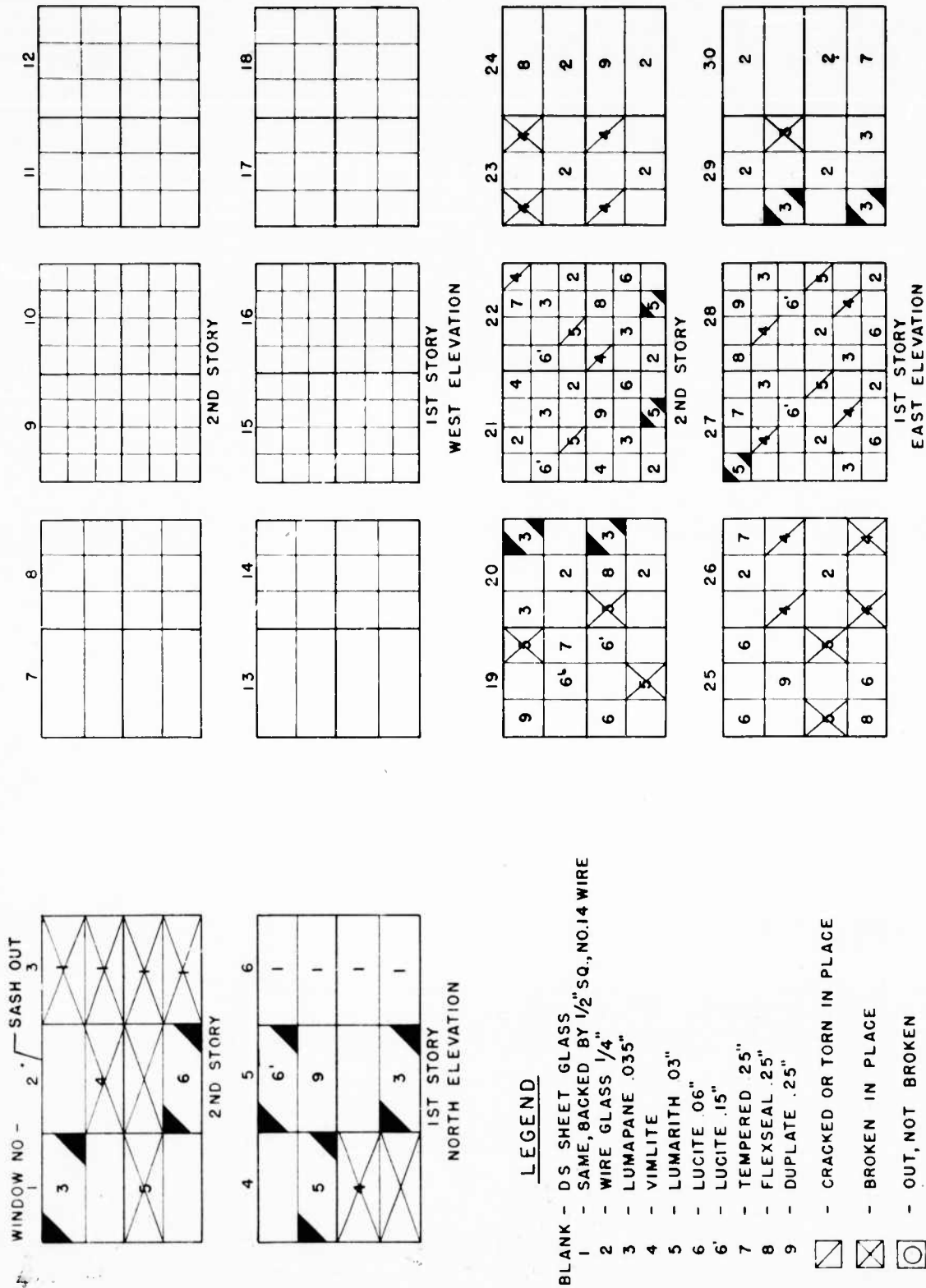

FIGURE 133. Glass Damage, Barracks 3, Test 2

3. Test 3.

(a) *General.*—Prior to this test, the earth cover on Igloo F was increased according to plan (see figure 7). Figures 134–136, inclusive, show its appearance after this was done. The detonation of its charge took place at 1100 MST, 16 October. The sky was about 50 percent overcast with thin cirrus formations at a high altitude. There was a north wind of velocity of about 16 m.p.h. The temperature was 51° F., and the barometer 25.10" Hg. The explosion started as a nearly spherical cloud with bright fire inside, then entered a stage in which sharp plumes radiated outward from the point of origin, and within a fraction of a second assumed an irregular hemispherical form in which the plumes became rounded rolls spreading as fast horizontally as vertically. At this stage the upper portion appeared as dark boiling smoke with little or no fire visible, while the lower portion was skirted with expanding sprays of light brown dust. Suddenly a head of dark smoke shot upward from the main mass, reaching a maximum altitude of about 7,200 feet above the desert. For a time it remained connected to the main mass by a short twisted neck and then, as the wind blew the main mass rapidly southward, the head became disconnected from the lower portion. It was elongated but remained nearly vertically above the point of origin, as there was little wind above an altitude of about 4,500 feet. As the lower cloud was driven south, it enveloped some

of the observers who felt the sting of flying sand, while visibility in all directions was obscured by dust. The cloud, with all the aspects of a sand and dust storm, later swept over the proving ground headquarters, 9 airline miles south of the explosion site. Its course was visible for perhaps 20 miles until it gradually dissipated. The trace of the shock wave was not visible in this test. As was the case in the first two tests, a double report was heard at the main observation station simultaneously with the arrival of the air shock wave. The two reports seemed equally intense and the interval between them was less than a second. Figures 137–140, inclusive, show the development of the smoke and debris cloud in this explosion.

(b) *High-speed motion pictures.*—The Fastax film showed the formation of the flame, smoke, and debris cloud as viewed from camera station number 1, 2,250 feet north of the crater of Igloo D. The cloud exhibited the same general characteristics as that of the previous explosions, except that it spread somewhat more laterally in proportion to its height and the proportion of fire to the dark masses seemed less. Its size was not as great as that of the 500,000 pound explosions. The white vaporous cloud seen in the previous films was again visible, but not as extensive; it formed an expanding circumferential band which moved outward at high velocity and passed out of the field of view. It is thought that this white cloud is formed of moisture condensed during the rarefaction phase of the blast wave and is



FIGURE 134. Three-quarter front view of Igloo F prior to Test 3

the same phenomenon which was seen by the observers on the hill 4.1 miles southwest of the explosion in tests 1 and 2. The fact that it was not visible from the hill in this test is in accord with its lesser extent and more ephemeral character as seen in the high-speed film. Selected frames from this film are reproduced in figure 141.

(c) *Air blast.*—Pressures obtained by means of ball crusher gages, foil meters and paper blast meters are presented in tables VII and VIII.

These values are plotted on logarithmic paper in figures 142, 143, and 144, giving off-front, off-side, and off-rear pressures, respectively, as a function of distance from the center of

TABLE VII.—Peak blast pressures, p.s.i., from ball crusher gages, test 3

Distance from charge, feet	Line 2		Line 3		Line 4	
	NOL	Arco	NOL	Arco	NOL	Arco
100	37?	44	49	9?	x	x
110	268?	43	49	10?	x	x
120	43	36	37	31	27	9?
130	82?	26	46	42	x	x
140	30	36	55	8?	76?	31

x Signities lost or damaged gage.

charge. Average curves, fitted to the plotted data by eye, show pressures of the order of 50 p.s.i. besides and to the rear of the igloo at a distance of 100 feet, and a pressure of perhaps 80 p.s.i. in front of the igloo at the same distance. At 1,000 feet, pressures were about 2.5

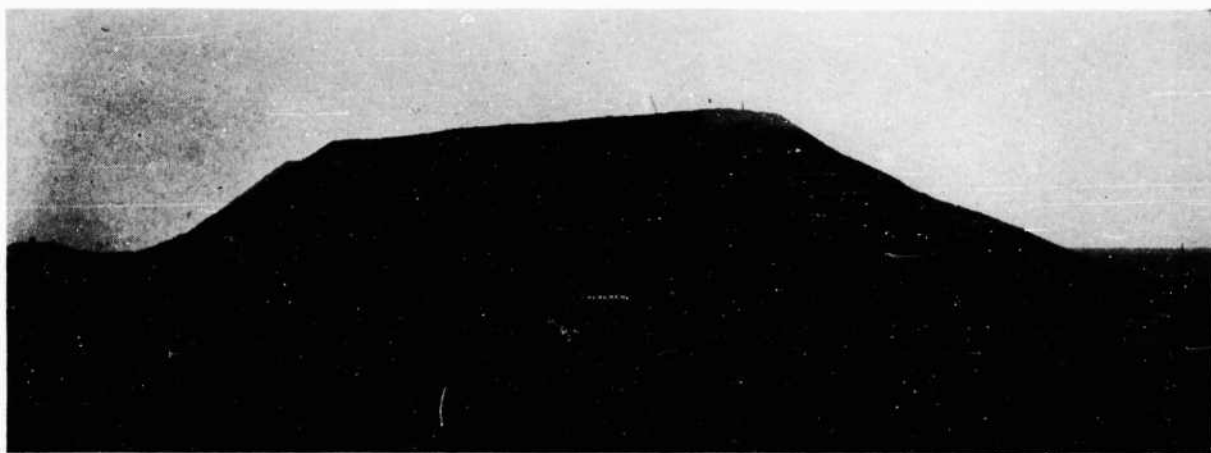

FIGURE 135. Three-quarter rear view of Igloo F prior to Test 3

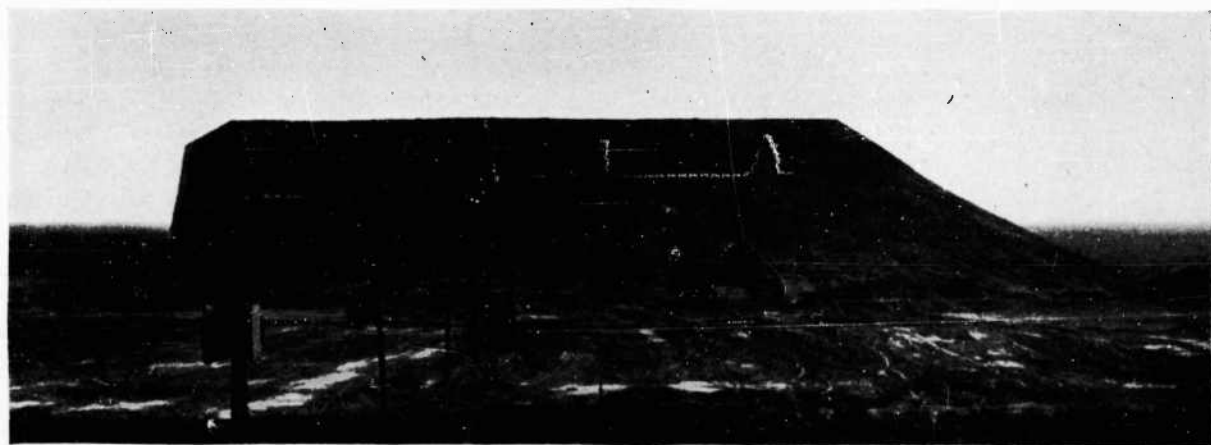

FIGURE 136. Side view of Igloo F prior to Test 3

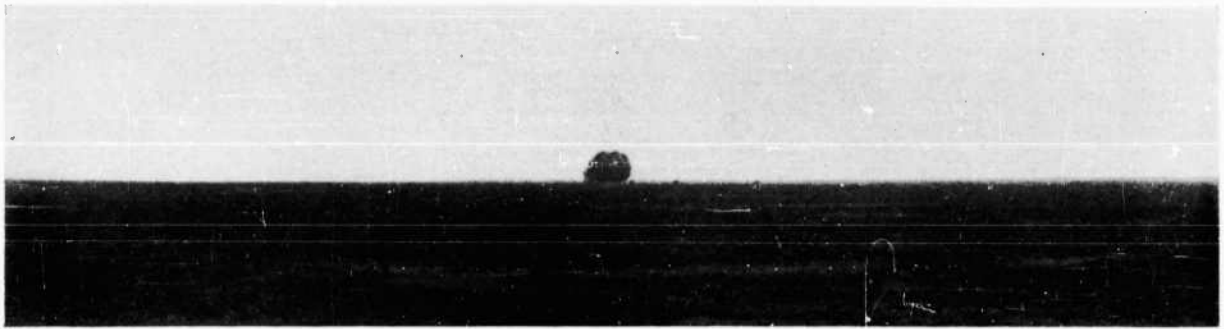

FIGURE 137. Explosion of Igloo F, 1st stage

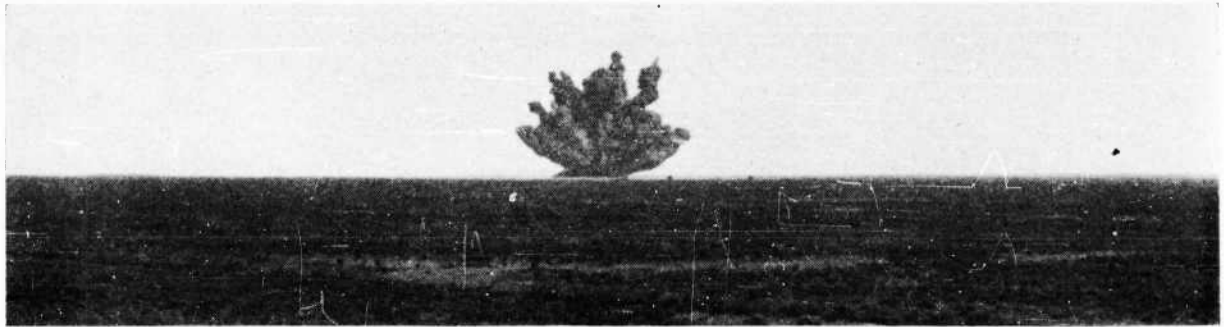

FIGURE 138. Explosion of Igloo F, 2nd stage

TABLE VIII.—Peak blast pressures, p.s.i., from foil and paper meters, test 3

Distance from charge, feet	Line 1		Line 3	Line 4	
	Foil	Paper	Paper	Foil	Paper
140	x	22.8
175	x	x
225	x	14.8
275	x	14.8
330	x	x
385	18.5	8.2	8.2	12.0	x
440	12.0	8.2	8.2	9.7	x
500	7.9	5.6	5.6	7.9	x
565	6.4	8.2	5.6	6.4	x
640	9.7	8.2	5.6	5.2	5.6
725	7.9	5.6	3.3	<5.2	5.6
820	6.4	5.6	2.3	<5.2	3.3
930	3.3	2.3	3.3
1,055	2.3	2.3	2.3
1,190	1.5	2.3	2.3
1,35094	2.394
1,53060	1.5	1.5
1,73060	.9494
1,960	<.25	.6094
2,22025	.6060
2,51525	.6068
2,845	<.25	.6038
3,220	<.25	.6038
3,650	<.25	.2538
4,140	<.25	.25	<.25
4,690	<.25	<.25	<.25

x Signifies lost or damaged meter.

p.s.i. in all directions from the source and at 2,705 feet (the distance at which Barracks 1 was located), peak values had diminished to the order of 0.5 p.s.i. on the side and rear meter lines and apparently to about 0.2 p.s.i. on the front line.

(d) *Crater*.—The crater was approximately round, with an average apparent diameter of 137 feet and a maximum apparent depth of 9 feet. While roughly symmetrical with respect to the longitudinal axis, it was quite eccentric with respect to the original lateral axis through the center of the igloo, the south radius being 87 feet while the north radius was only 48 feet. Thus the crater's center was 36 feet south of its normal position. Apparently the expanding explosion gases excavated more soil under the heavily earth covered portion of the igloo than near the uncovered front end. The bottom of the crater was peculiar in that the deeply excavated portion was shaped like a horseshoe, with the open end pointing north. A ridge of ground extended southward from where the

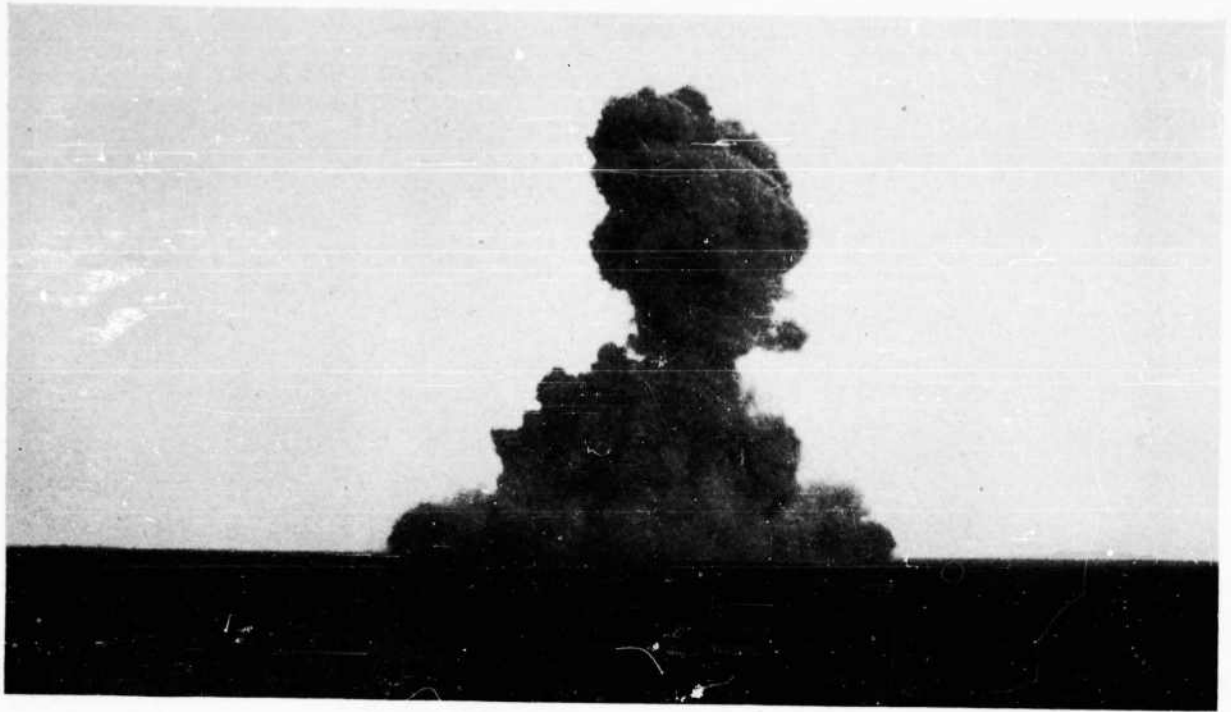

FIGURE 139. Explosion of Igloo F, 3rd stage

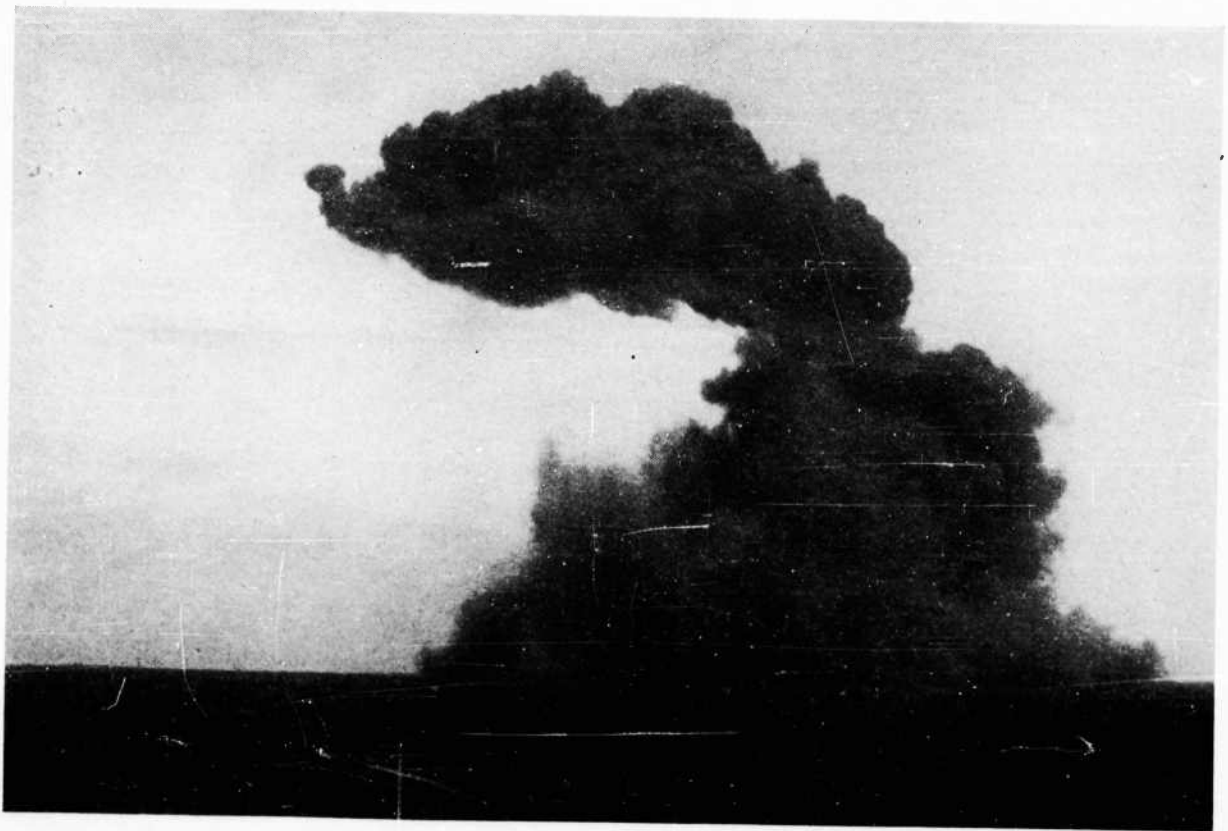
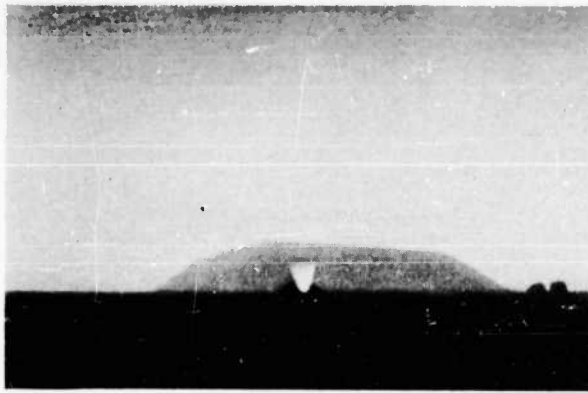
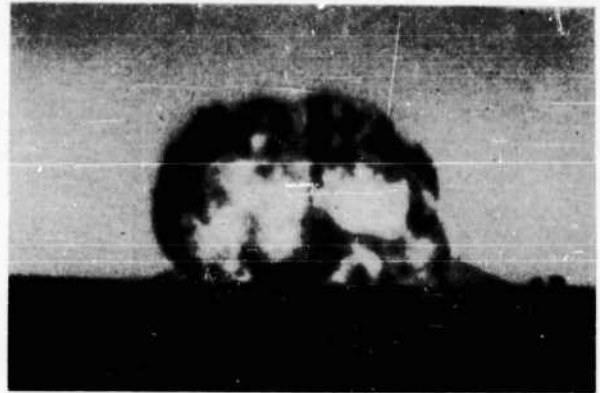

FIGURE 140. Explosion of Igloo F, 4th stage



a. Flame jet at door of Igloo F. Butte in background.



b. Fire and smoke cloud 0.12 sec. after (a).



c. Cloud 0.4 sec. after (a). Vapor ring has formed.

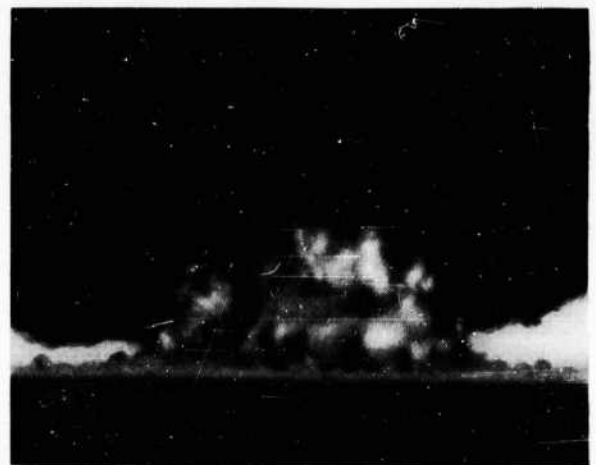

d. Cloud 1.0 sec. after (a).

FIGURE 141. Selected frames from Fastax film, Test 3

front of the igloo had been, gradually sloping down into the deeper channel in the south part of the crater. The top of the ridge was nearly at grade at the north end, where it connected to outside grade, there being no lip on the crater at one point. The lip was high around the sides, but highest of all at the south edge, where some of the soil appeared to have been lower portions of the rear slope which were not completely displaced by the blast. There were large segments of foundation walls and spread footings piled up near east and west rims, some of these being as much as 15 feet long. Such pieces were extensively cracked or shattered, with twisted and bent reinforcing rods protruding from their broken surfaces. Some were found outside the crater, on the outer slope of

the lip, at distances as great as 150 feet from the center. Ball crusher gages buried beneath such pieces were not recovered. The true crater depth, determined by excavation at the deepest point, was only from 6 to 12 inches greater than the apparent depth. The soil in this excavation had the same general appearance and characteristics as that in the craters of Igloos D and E. Rock was not encountered though the excavation was carried about 15 feet below natural grade. Figure 145 is a view looking northerly across the crater from a point on the south rim, and figure 146 was taken from the west edge looking northeasterly. In the latter picture, the flag near the left margin marks the longitudinal centerline. A section of shattered footing lies in the foreground.

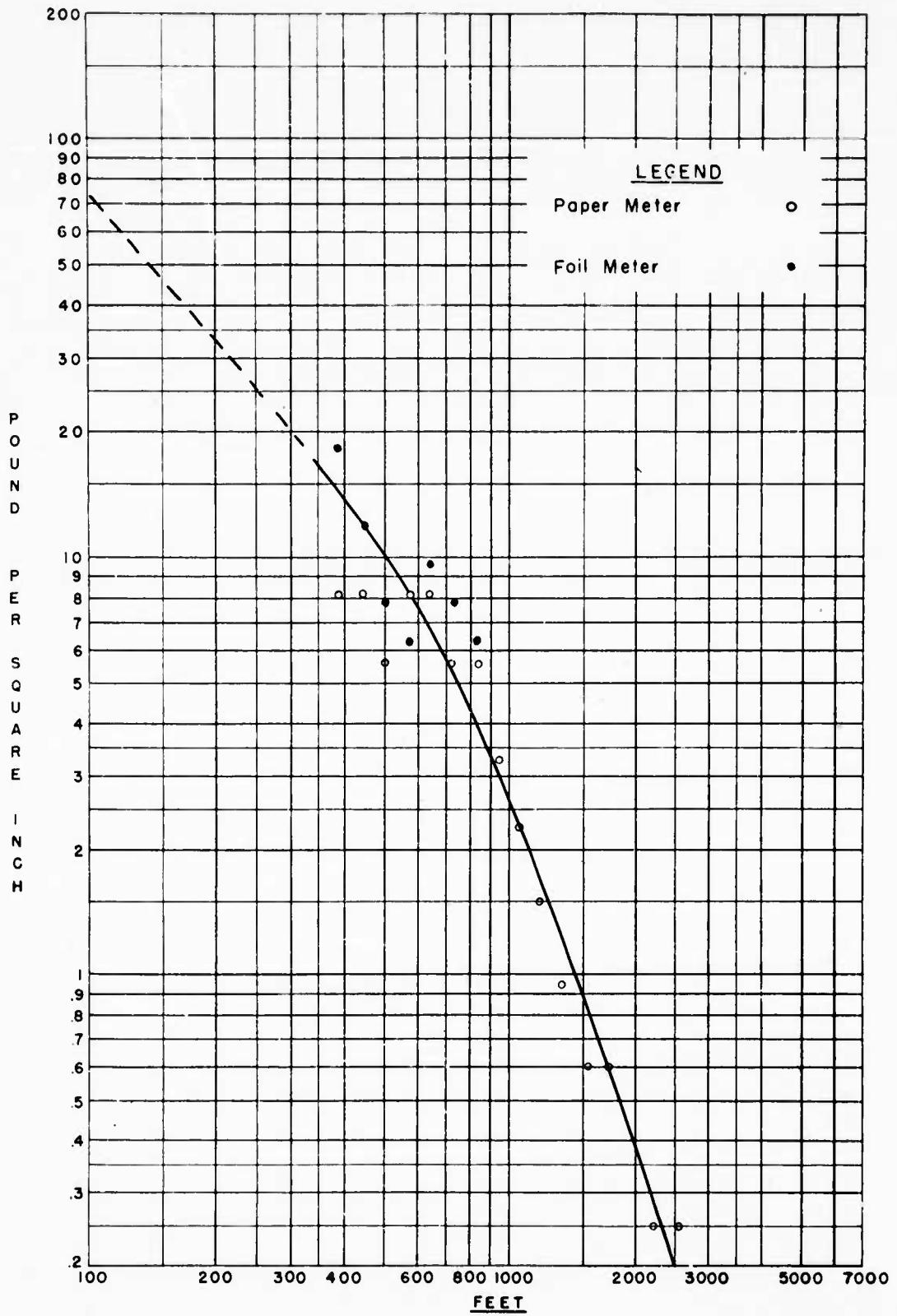

FIGURE 142. Peak Blast Pressure vs Distance from Charge, Test 3, Line 1 (Off Front)

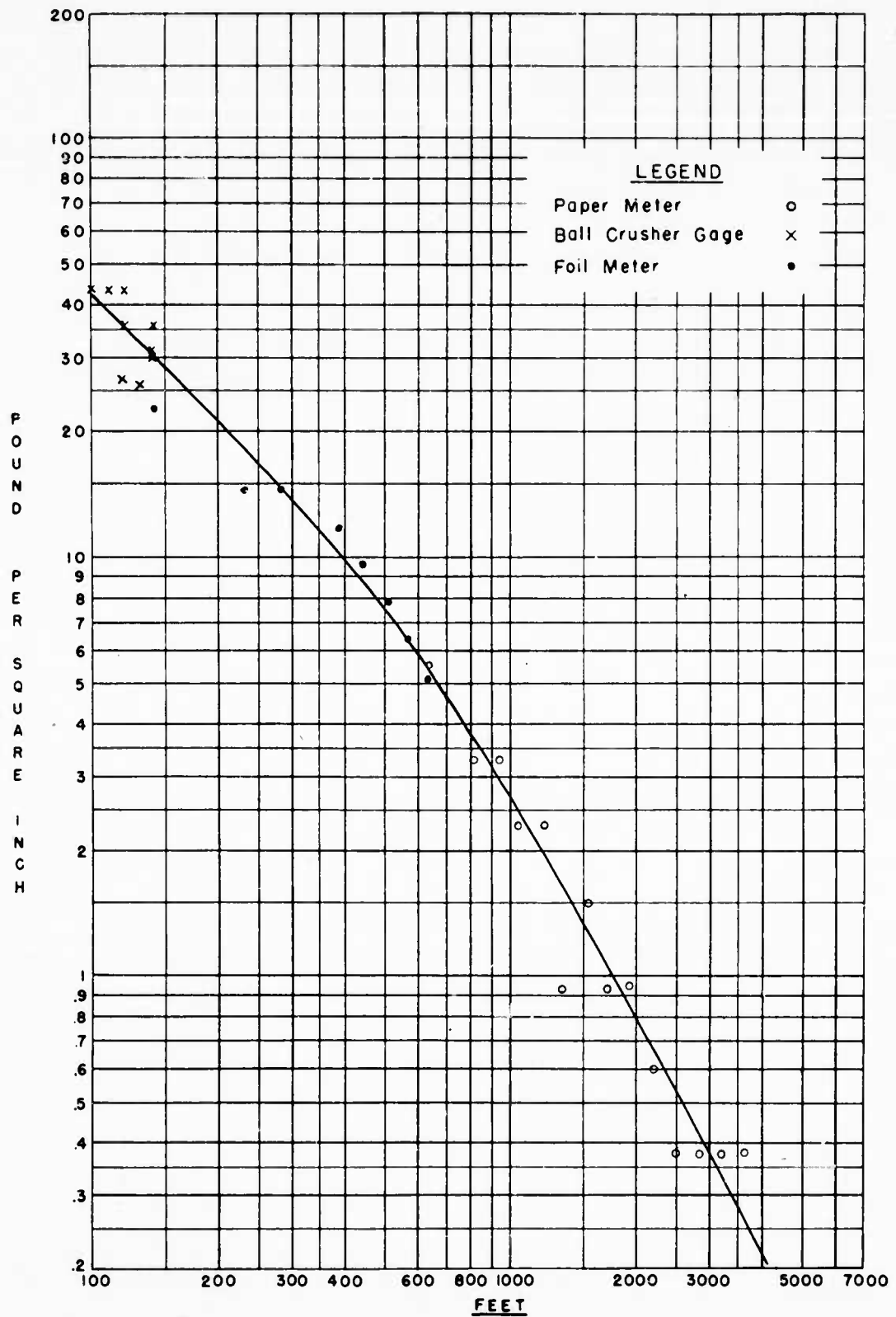

FIGURE 143. Peak Blast Pressure vs Distance from Charge, Test 3, Line 2 and 4 (Off Sides)

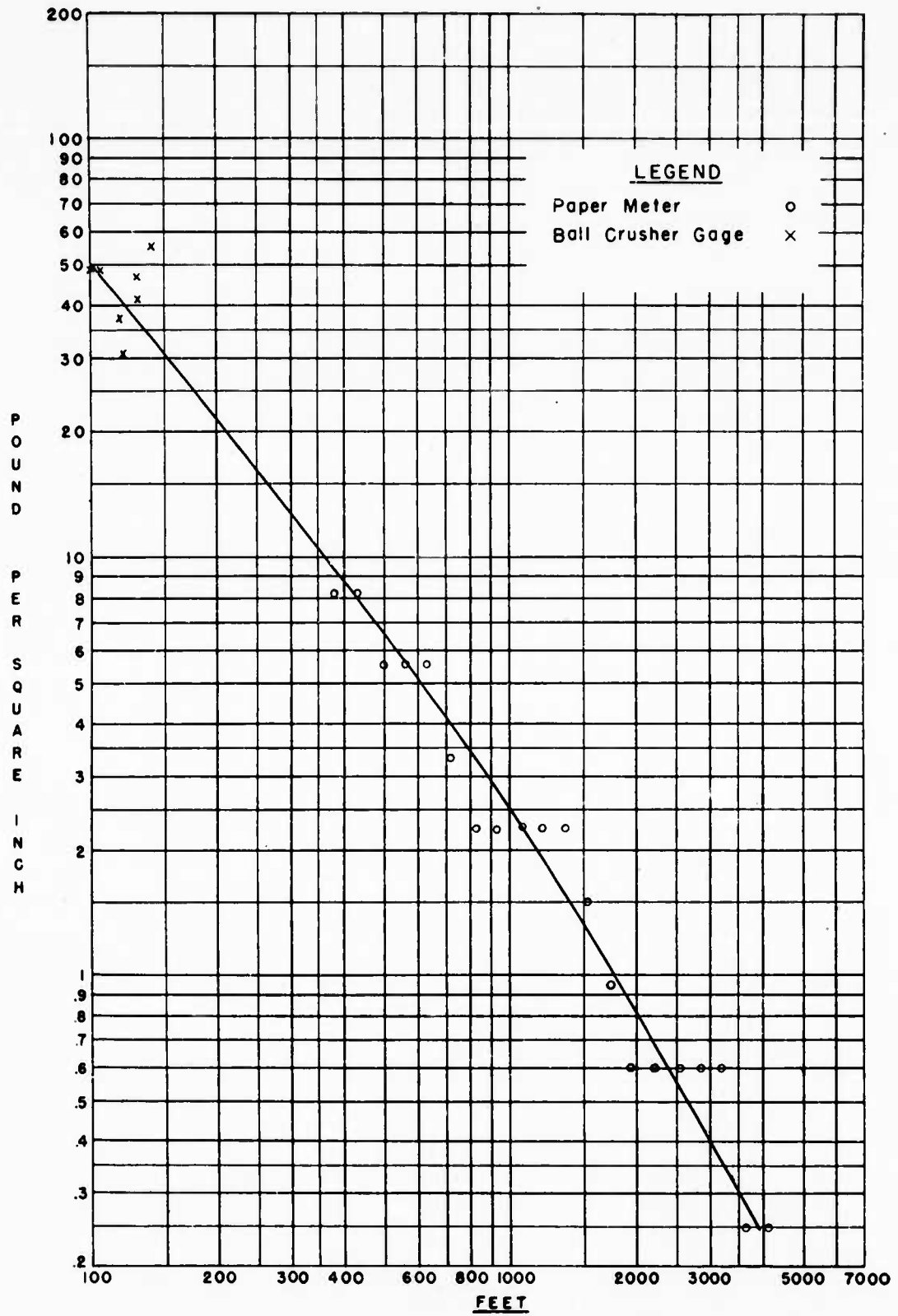

FIGURE 144. Peak Blast Pressure vs Distance from Charge, Test 3, Line 3 (Off Rear)

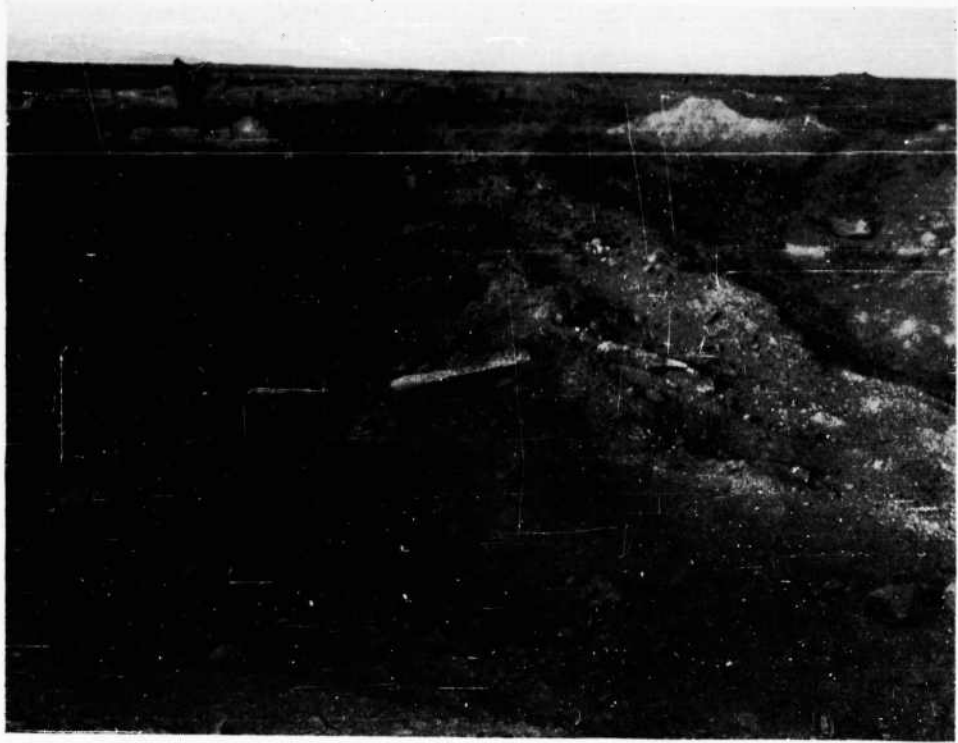

FIGURE 145. Crater of Igloo F, looking north from south rim

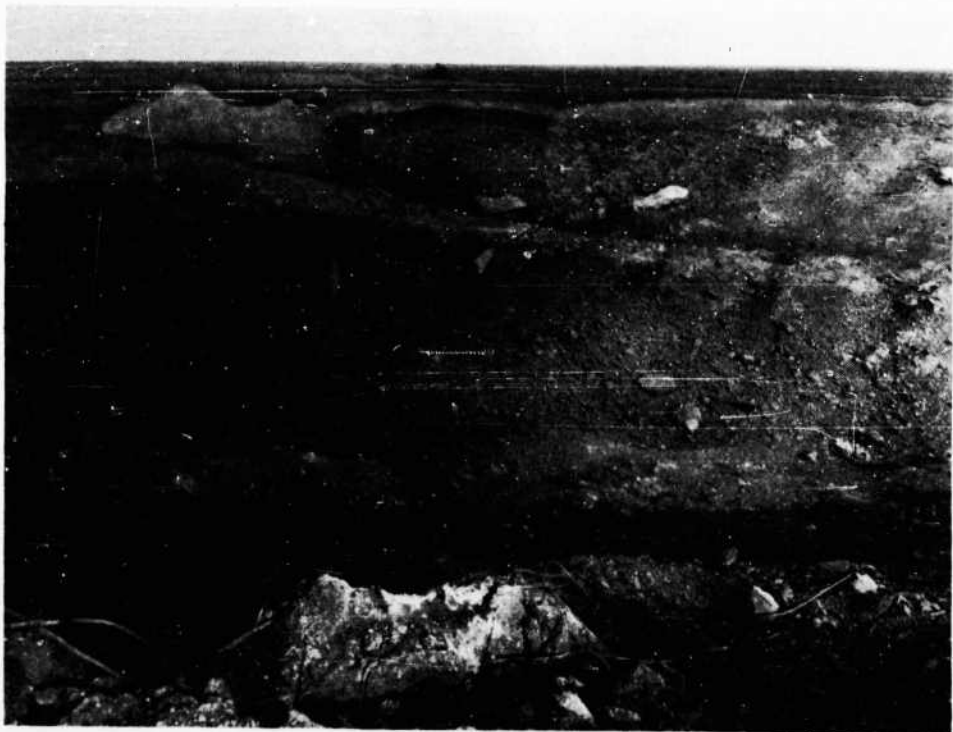
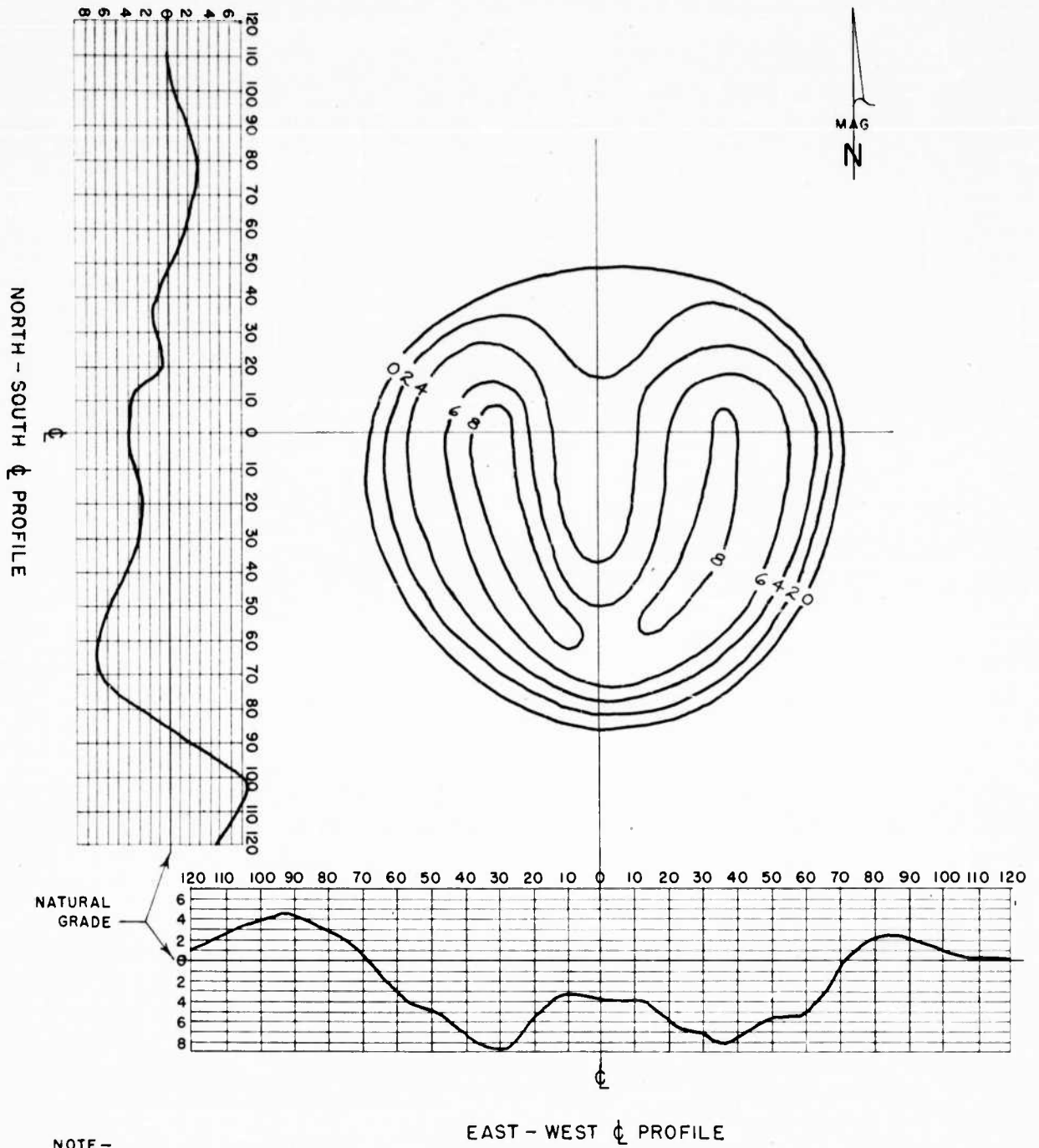
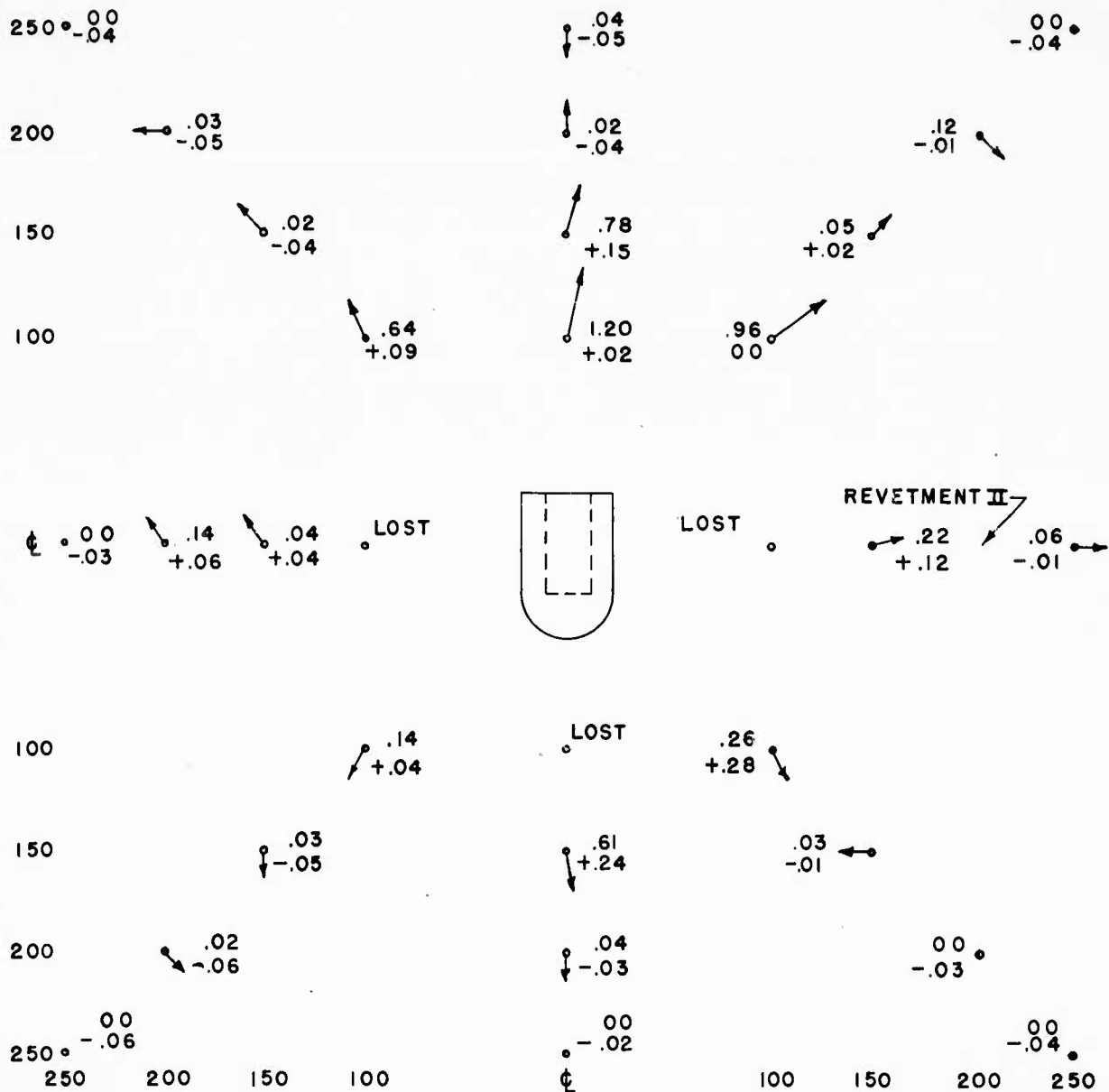

FIGURE 146. Crater of Igloo F, looking northeast from west rim



NOTE-
ALL DIMENSIONS ARE IN FEET.

FIGURE 147. Crater Plan and Profiles, Test 3



LEGEND

- .14 - HORIZONTAL MOVEMENT IN DIRECTION OF ARROW.
- + .11 - VERTICAL MOVEMENT (+UP; - DOWN)
- o - 2"X2" WOOD HUB FLUSH WITH GROUND.

NOTE -

ALL MOVEMENT GIVEN IN FEET.

FIGURE 148. Permanent Horizontal and Vertical Earth Displacement, Igloo F, Test No. 3

Figure 147 gives the profiles of this crater along the north-south and east-west axes.

(e) *Ground movement.*—Figure 148 shows the permanent horizontal and vertical ground displacement determined by measurements of the grid stakes around Igloo F after the latter's explosion. As in the previous tests, movement was predominately away from the center and upward. Horizontal displacements varied from 1.2 feet outward at 100 feet from the center of charge to 0.04 feet inward at 250 feet. Horizontal movement was generally considerably greater in front of the igloo than off the sides or rear. Vertical displacement varied from 0.24 feet upward at 150 feet south to 0.06 feet downward at 350 feet southwest of the center.

(f) *Damage to revetments: (1) Revetment 1.*—The mines in this revetment had been restacked prior to this test. The revetment and its contents were undisturbed except for one column of mines which toppled on the west side of the stack. A small amount of earth descended upon the top of the stack, as well as a few small fragments of concrete.

(2) *Revetment 2.*—These mines had also been restacked before the third test. As a result of the explosion under heavily increased earth cover, the revetment was deluged with earth and the mines were badly shaken and scattered about. Many crates were broken open, mines dented, and a number of loose activators were found on the ground at one point on the east side of the revetment. Most of the

scattered mines were blown away rather than toward the explosion as in previous tests. Mines found lying on and beyond the far windrow numbered about 150. The space between the near side of the mine stack and the near windrow was filled with earth to within one or two feet of the top of the stack. Earth was up to 2 feet thick on top of the near side of the stack, and the entire stack was covered so that no mines could be seen except near the far edge. Three pieces of reinforcing steel rod were found protruding from the top of the stack. Fragments of concrete, wire mesh, and other debris were abundant in the earth covering the mines. Figure 149 is a view looking eastward across the top of the half-buried pile from the west (near) side. Figure 150 shows the east edge of the stack as viewed from the southeast corner. In the foreground may be seen a large number of scattered mines.

(g) *Damage to barracks: (1) Superficial.*—*Barracks 1* had been repaired before test 3, except for torn siding which was merely tacked back in place, and except for roofing. Broken window sash, frames, and trim were completely renewed. See figures 151–154 for views of the building after the explosion of Igloo F. The north end of the building lost all previously torn areas as well as additional areas of asphalt felt siding and the battens which covered it, to the extent that about one-half of the sheathing was laid bare. One lower sash was blown into the building. On the east elevation, one sash was blown into the building, two were blown



FIGURE 149. Revetment 2 after Test 3, looking east from west side



FIGURE 150. Revetment 2 after Test 3, looking north from southeast corner



FIGURE 151. North elevation of Barracks 1 after Test 3



FIGURE 152. East elevation of Barracks 1 after Test 3

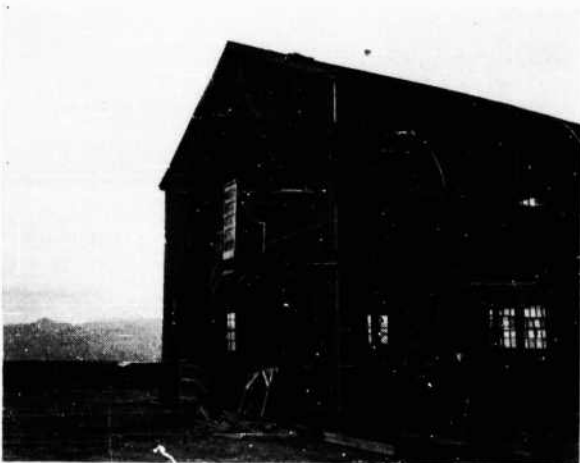

FIGURE 153. Three-quarter view: south and east sides of Barracks 1 after Test 3

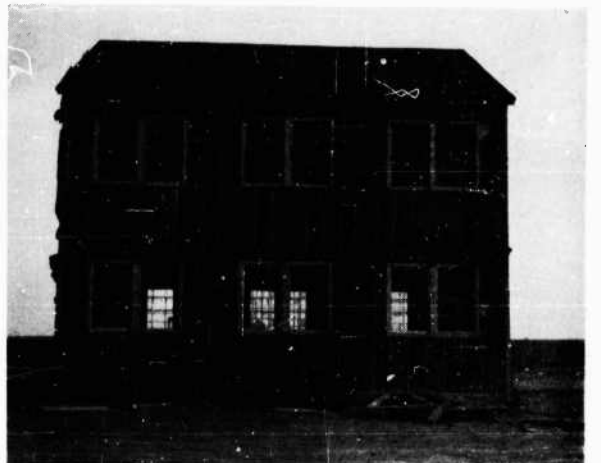

FIGURE 154. West elevation of Barracks 1 after Test 3



FIGURE 155. North elevation of Barracks 2 after Test 3



FIGURE 156. East elevation of Barracks 2 after Test 3



FIGURE 157. South elevation of Barracks 2 after Test 3

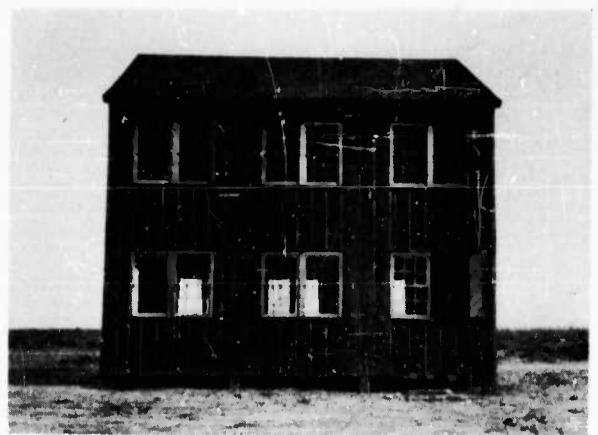

FIGURE 158. West elevation of Barracks 2 after Test 3



FIGURE 159. North elevation of Barracks 3 after Test 3

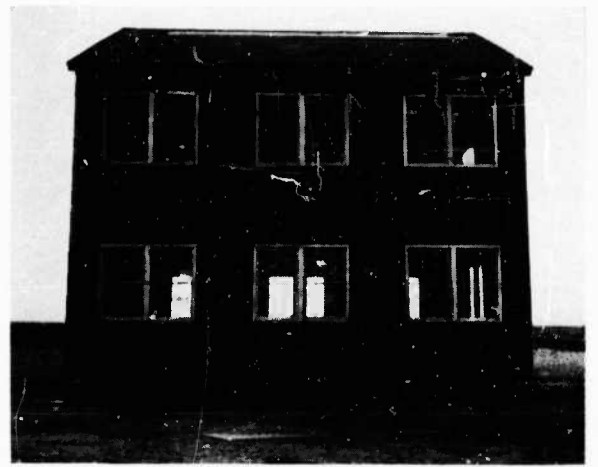

FIGURE 160. East elevation of Barracks 3 after Test 3



FIGURE 161. South elevation of Barracks 3 after Test 3



FIGURE 162. West elevation of Barracks 3 after Test 3

out, and two others were demolished in place. On the south side, siding and battens were blasted off in several places. The west elevation lost siding alongside upper and lower story windows at the south end of the building. On the east slope of the roof, the previously torn spot did not seem to have been made any larger.

Barracks 2 was not repaired prior to the third test. On the north face, a large piece of siding which had been started in the previous blast was torn off. Additional exterior trim was broken around the windows and one sash which had been left leaning inward after test 2 was now missing from its frame. The east and south elevations did not receive additional superficial damage, but on the west side the southernmost window on the ground floor was blown out and lay on the ground outside. On the roof, there was no further tearing of asphalt felt roofing. The external appearance of the building is shown by figures 155-158.

Barracks 3 was not damaged further except for a single tear in the siding on the east elevation and some increase in inward displacement of second story windows in the north elevation. Figures 159-162 illustrate the appearance of the building following the third test.

(2) *Structural: Barracks 1.*—The structural repairs to this building did not make it as strong as it was originally. Badly fractured studs, plates, and other members were replaced but those which were merely cracked were nailed up and left in place. Displaced members were forced back into position and spiked in place. Broken siding was patched with short pieces. The broken rafters and roof girder were not renewed. Consequently, damage was more severe than would have been the case with a new building. On the north side, nearly all studs were broken on the ground floor, and the 6" x 6" post which was found lying on the floor after the previous test was again knocked down. Figures 163 and 164 illustrate this damage. In the second story, half the studs and the upper plate in the north wall were broken, and the wall was displaced inward about 6 inches above the windows. Several pieces of sheathing were missing and much of the remaining sheathing was loosened. See figure 165. Half the studs in the north gable were broken or displaced, and the sheathing loosened. The east and south elevations escaped without structural

damage, but the south wall was pushed outward from within in the same manner as in the previous explosion. The maximum displacement was 6 inches, and occurred at the second floor level about 10 feet east of the west corner of the building. Figure 166 shows how the wall moved out, carrying the studs off the lower plate and fracturing the latter member. Siding was broken where it was racked between studs that moved out and the 6" x 6" posts that remained in position. One of these posts on the ground floor was leaning in about 3 inches at its top. The roof of the building suffered no further damage, but a piece of the previously fractured roof girder fell down on the ceiling joists, as shown by figure 167. There was no evidence that the entire building rocked or shifted on its foundation posts. See figure 168 for a diagram of the damage.

Barracks 2, which had not been repaired before the test, suffered little additional structural damage. Previously cracked or displaced members were cracked worse or displaced farther out of position, but no additional members were broken.

Barracks 3, which also had not been repaired, received no further structural damage.

(3) *Glass damage.*—*Barracks 1*, which had been completely reglazed, suffered glass damage as recorded by figure 169. Thirteen, or one more than half the panes were broken on the north side. Sixty-four, or 36 percent were broken in the windows on the east side. The upper sash of window 22 in the second story was freakishly demolished without all of its panes being broken. None of the panes on the west side of the building were broken. Although the window breakage was not as violent as in test 1, and fewer sash were blasted out of their frames, there was nevertheless considerable flying glass as evidenced by fragments scattered over the floors of both stories. Most of the pieces were propelled with sufficient force to carry them about two-thirds of the distance across the interior of the building, so that any occupant of the building would have been in considerable danger of injury.

Barracks 2 had not been reglazed and there was no further glass damage except in the single window blown out of the west side of the building on the ground floor.

Barracks 3 had not been reglazed and suffered no further glass damage.

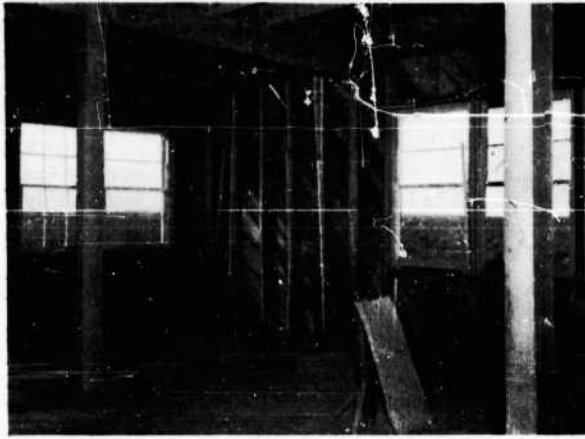

FIGURE 163. Interior, Barracks 1 after Test 3, showing broken studding, northwest corner, ground floor

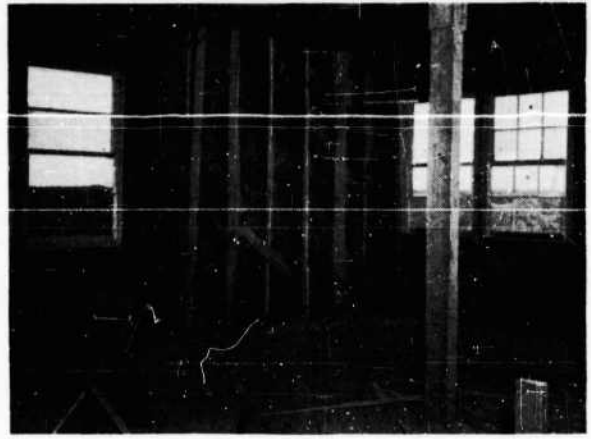

FIGURE 164. Interior, Barracks 1 after Test 3, showing broken studding, northeast corner, ground floor



FIGURE 165. Interior, Barracks 1 after Test 3, showing condition of northeast corner, 2nd story



FIGURE 166. Interior, Barracks 1 after Test 3, illustrating displacement of south wall at second floor level

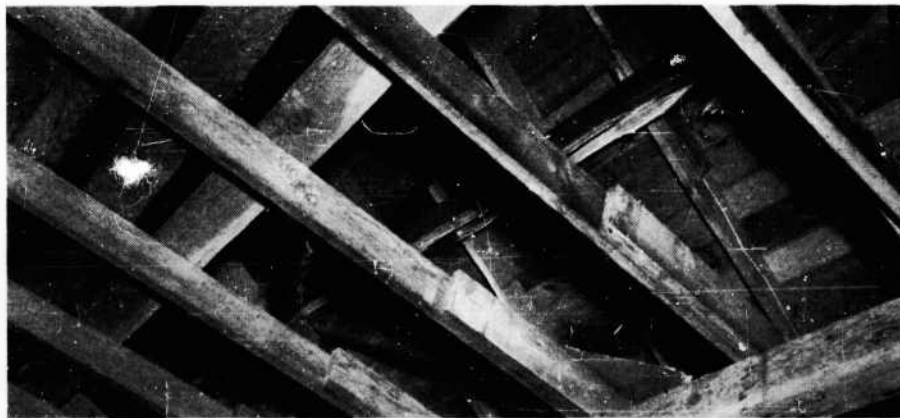

FIGURE 167. East section of roof framing, Barracks 1 after Test 3, showing broken purlin

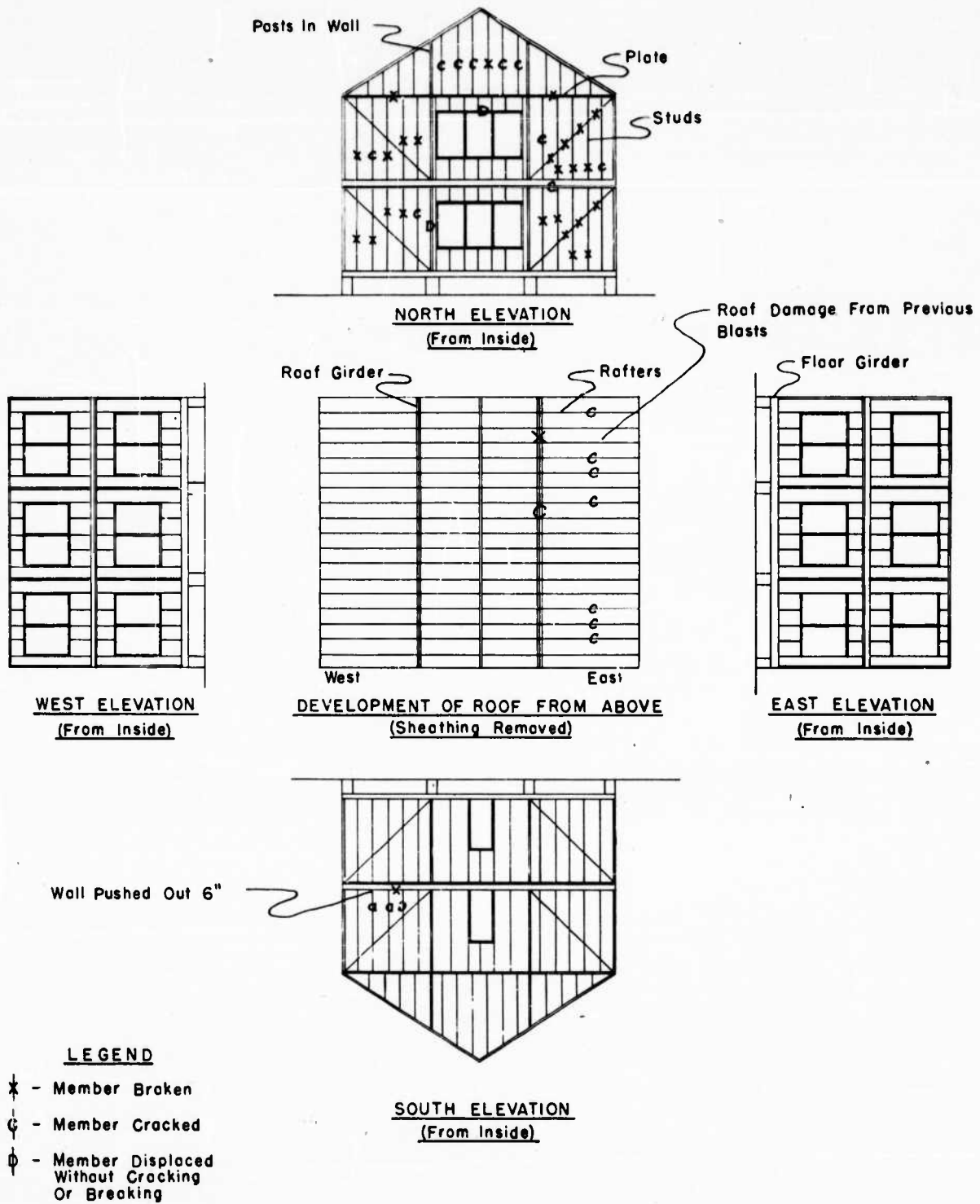
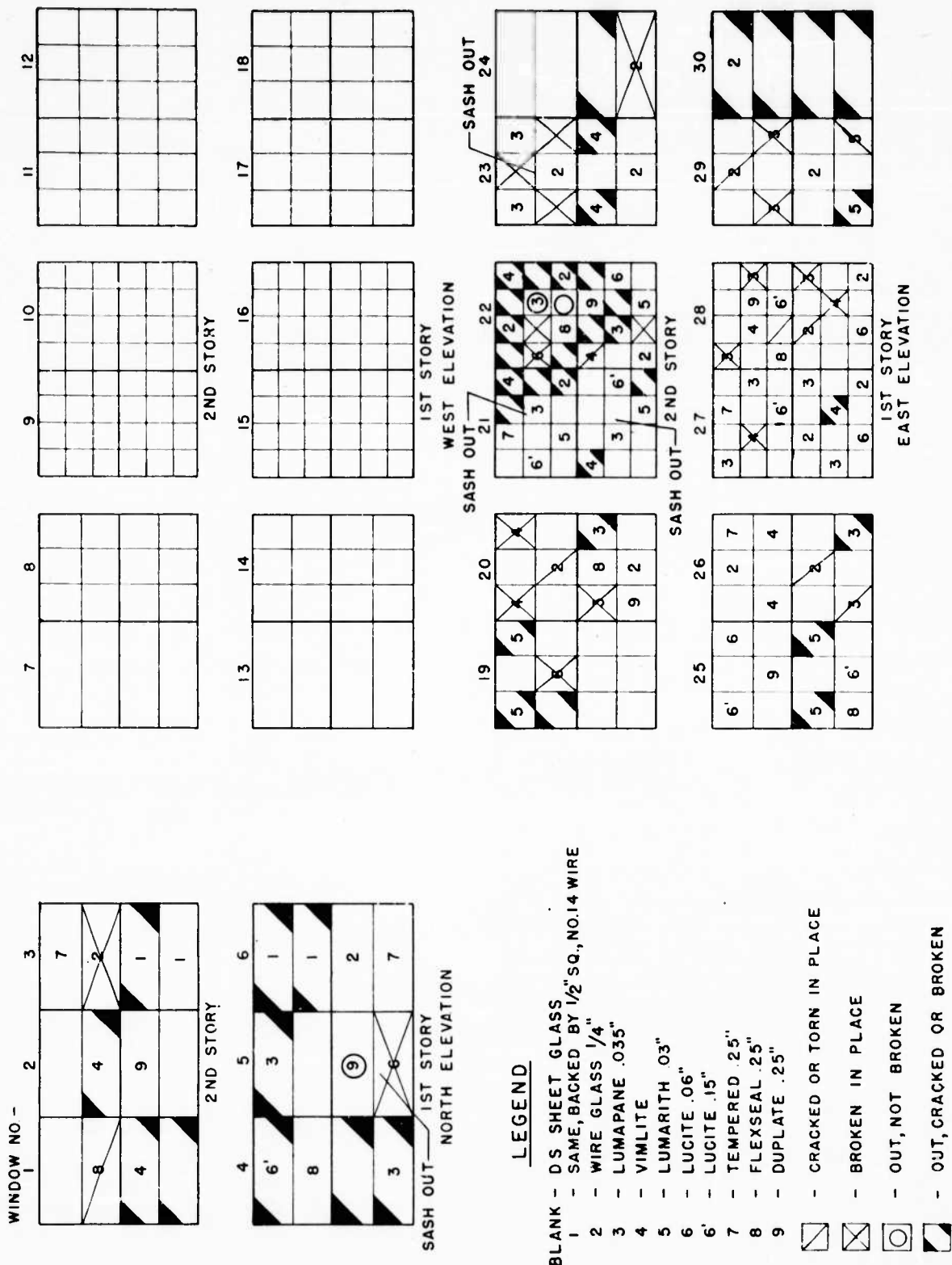

FIGURE 168. Damage to Barracks, Barracks 1, Test 3



LEGEND

BLANK - DS SHEET GLASS
 1 - SAME, BACKED BY 1/2" SQ., NO. 14 WIRE
 2 - WIRE GLASS 1/4"
 3 - LUMAPANE .035"
 4 - VIPLITE
 5 - LUMARITH .03"
 6 - LUCITE .06"
 6' - LUCITE .15"
 7 - TEMPERED .25"
 8 - FLEXSEAL .25"
 9 - DUPLATE .25"

☐ - CRACKED OR TORN IN PLACE
 ☒ - BROKEN IN PLACE
 ○ - OUT, NOT BROKEN
 ◐ - OUT, CRACKED OR BROKEN

Figure 169. Glass Damage, Barracks 1, Test 3

4. Test 4.

(a) *General.*—Revetment 1 was detonated on 23 October, a clear, sunny day with a few scattered cumulus clouds. The appearance of the explosion was markedly different from those of the igloo tests. Following a bright flash there was a rapidly expanding mass of fire which was first round, then cone-like with its base on the ground. Within a second, a ball of fire tinged with smoke shot vertically upward from the tip of the cone. As the ball grew larger, the fire diminished and it became a cabbage-shaped mass of black smoke, ascending swiftly. From the bottom of this head plumes of smoke projected downward like tentacles, reaching the tip of the cone-shaped base which now appeared as a mass of dirt and dust expanding laterally. As the head rose higher, it continued to eject smoke plumes downward, forming a column connecting the head to the base. At maximum altitude, which was about 12,000 feet, the moisture in the head condensed, turning it white. It became elongated horizontally and drifted away from the stem, taking on the appearance of an ordinary cumulus cloud, about a mile in breadth. Meanwhile, the dust front on the ground dissipated, after reaching maximum diameter of approximately three-quarters of a mile. Figures 170–173 show the development of the smoke and debris cloud from an early stage on.

(b) *High-speed motion pictures.*—As seen in the Fastax film the explosion in this test differed considerably in appearance from the previous explosions. Starting as a blinding flash, the fire quickly built up in columnar shape and went above the top of the frame, so that the climbing ball of fire visible in the still pictures taken from the observation hill could not be seen. That portion still visible in the Fastax film, the cone-shaped base, remained largely of flame for some time, and then gradually changed to a dark smoke mass. Its lateral development was not nearly as great as in the case of an igloo explosion. Selected frames from the film are reproduced in figure 174.

(c) *Air blast.*—Peak pressures were measured by ball crusher gages, foil meters, and paper meters. Values obtained are given in tables IX and X, and plotted on logarithmic paper in figures 175–177. The average curves drawn through the plotted points indicate that

pressures were of the order of 250 p.s.i. directly in front of the revetment at a distance of 100 feet from the center, but only about 150 p.s.i. off the sides and rear of the revetment at the same distance. Pressures in all three directions were about 5 p.s.i. at a distance of 1,000 feet, and at 2,705 feet they were from 0.75 to 1.2 p.s.i., the latter value being obtained on meter line 1 (off front of revetment).

TABLE IX.—Peak blast pressures, p.s.i., from ball crusher gages, test 4

Distance from charge, feet	Line 1		Line 2		Line 3	
	NOL	Arco	NOL	Arco	NOL	Arco
120	225	212	92	100	85?	27?
130	190	129	122	111	128	68
140	107	235?	183	77	125	107
140	49
140	37
140	46
150	125	101	85	60	103	71
160	18?	75	73	35	37?	55

TABLE X.—Peak blast pressures, p.s.i., from foil and paper blast meters, test 4

Distance from charge, feet	Line 1		Line 2		Line 3
	Foil	Paper	Foil	Paper	Paper
225	53	42
330	34	28
440	15	18
500	13.8	8.2	8.2
565	12	15
640	8.2	8.2	8.2
725	7.9	9.7
820	5.6	5.6	8.2
930	6.4	5.2
1,055	5.6	2.3	5.6
1,350	3.3	3.3	5.6
1,730	2.394	1.5
2,220	1.5	1.5	1.5
2,8459460	.60
3,6506038	.60
4,6902525	.38
6,000	<.25	<.25	<.25

(d) *Crater.*—Profiles along the north-south and east-west axes are given by figure 178. The average apparent diameter was 138 feet, and the maximum apparent depth was 16 feet. This crater was more truly conical in shape than those of the igloo tests; the sides sloped more or less uniformly to the deepest part, which was close to the center. While quite symmetrical with respect to the east-west axis, the crater was not so with respect to the north-south axis, its center being about 15 feet south of the lateral axis of the stack of mines. The earth in this crater was nearly devoid of debris, and presented an appearance markedly different



FIGURE 170. Explosion of Revetment 1, 1st stage



FIGURE 171. Explosion of Revetment 1, 2nd stage



FIGURE 172. Explosion of Revetment 1, 3rd stage

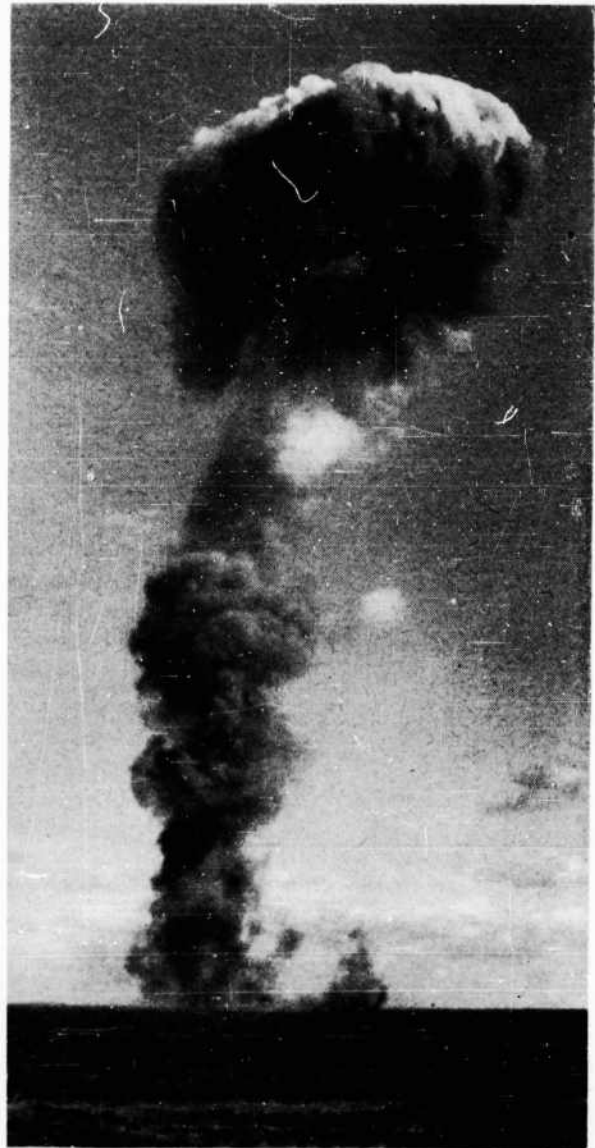
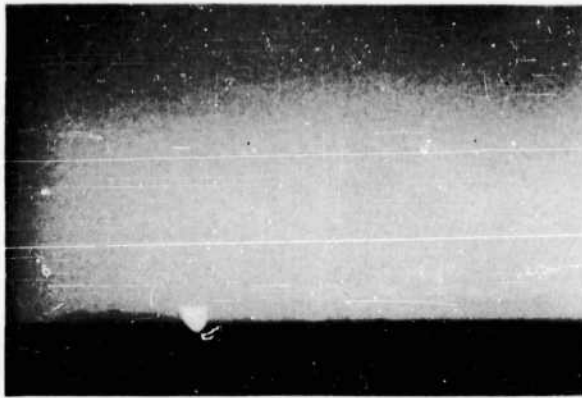
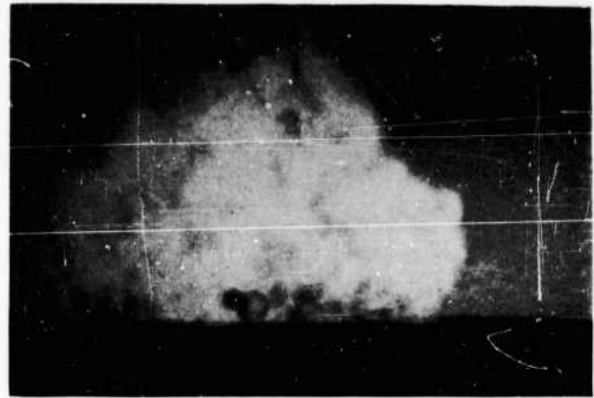

FIGURE 173. Explosion of Revetment 1, 4th stage



a. Flash.



b. Fire mass 0.06 sec. after flash.

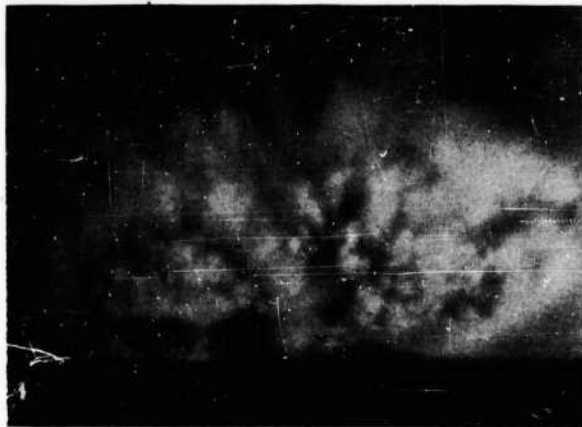

c. Cloud 0.25 sec. after flash.

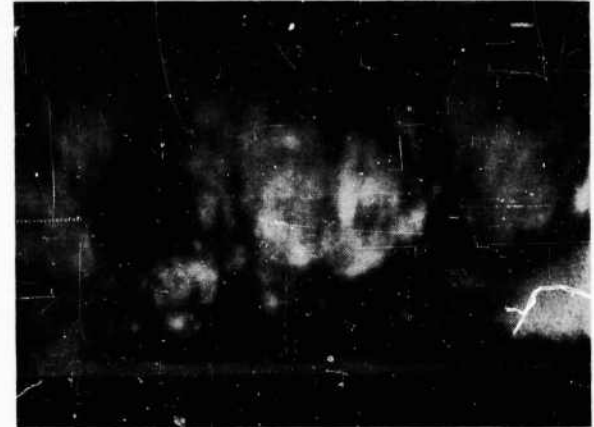

d. Cloud 0.78 sec. after (a).

FIGURE 174. Selected frames from Fastax film, Test 4

from that of any of the igloo explosions, particularly in that it was largely composed of sift and fine sand which appeared to have been compressed in layers which then broke into sharp angular fragments, in many cases foliated or schistose in structure. This condition is illustrated in the foreground of figure 179, which is a view of the crater looking eastward from the west rim. The ground surrounding the crater within a distance of 300 feet in all directions was littered with small metallic-looking spheres which were hollow and could be crushed in one's hand like cinders. This slag-like material was probably produced by fusing and oxidation of the sheet steel mine cases and crates.

(e) *Ground movements.* — Permanent displacement of the ground surrounding the explosion is recorded on figure 180. Movement was predominately outward and upward, and

ranged from the order of 0.6' away and 0.4' up at a distance of 140 feet from the center, to zero away and about 0.2' down at 350 feet.

(f) *Damage to Revetment 2.*—Figures 181 and 182 show the appearance of this revetment following the fourth explosion. Mines thrown outside of the revetment in the previous test had been replaced. In this test they were not as severely scattered but merely shaken up and displaced without being thrown violently from the pile. Some additional earth descended on the stack.

(g) *Damage to barracks: (1) Superficial.*—*Barracks 1*, not having been repaired prior to this test, lost nearly all of the remaining asphalt felt siding and battens on the north elevation, to the extent that about 90 percent of the sheathing was uncovered. Another sash was blown into the building from the upper story windows on the north side. On the east eleva-

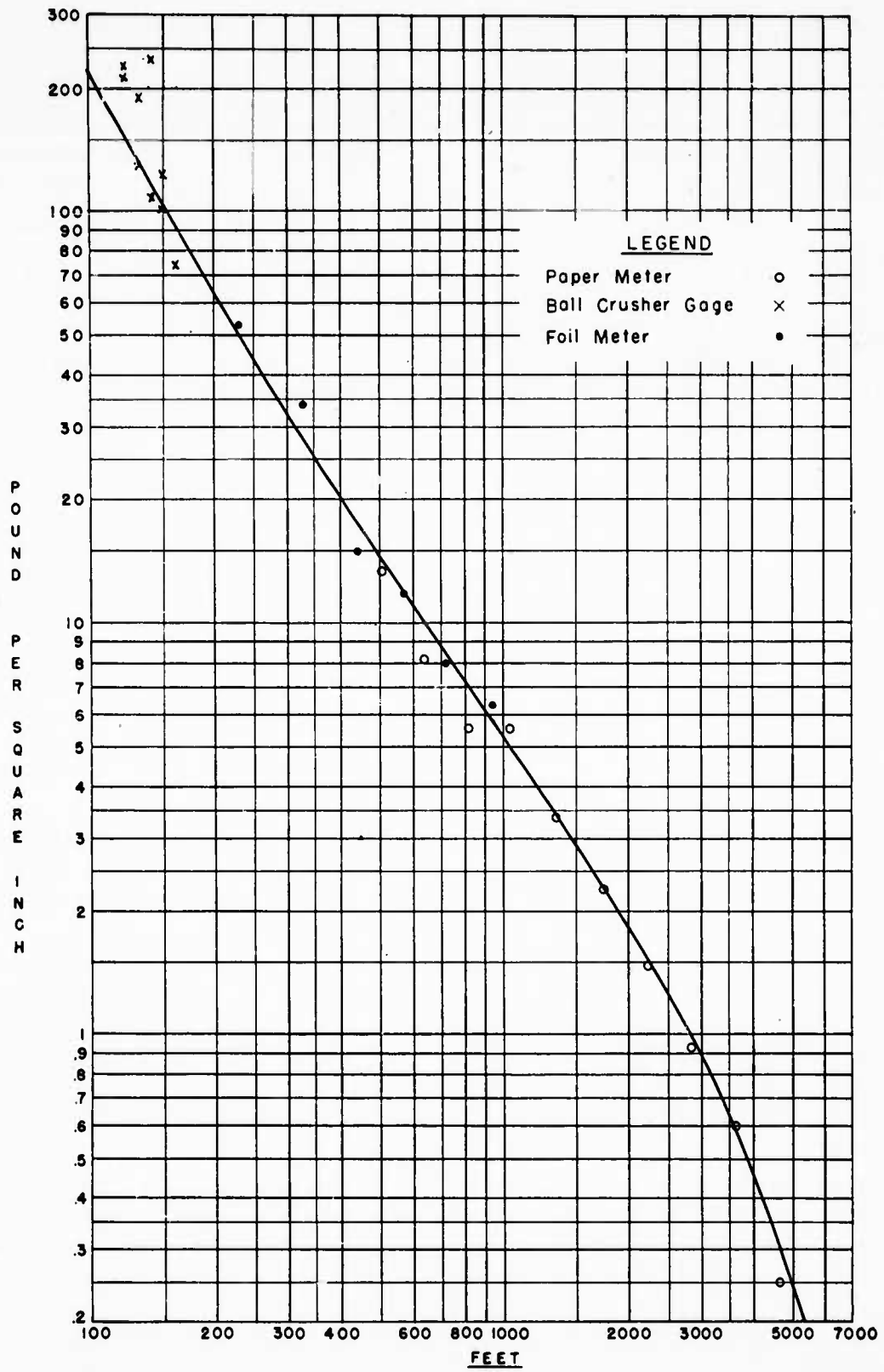

FIGURE 175. Peak Blast Pressure vs Distance from Charge, Test 4, Line 1 (Off Front)

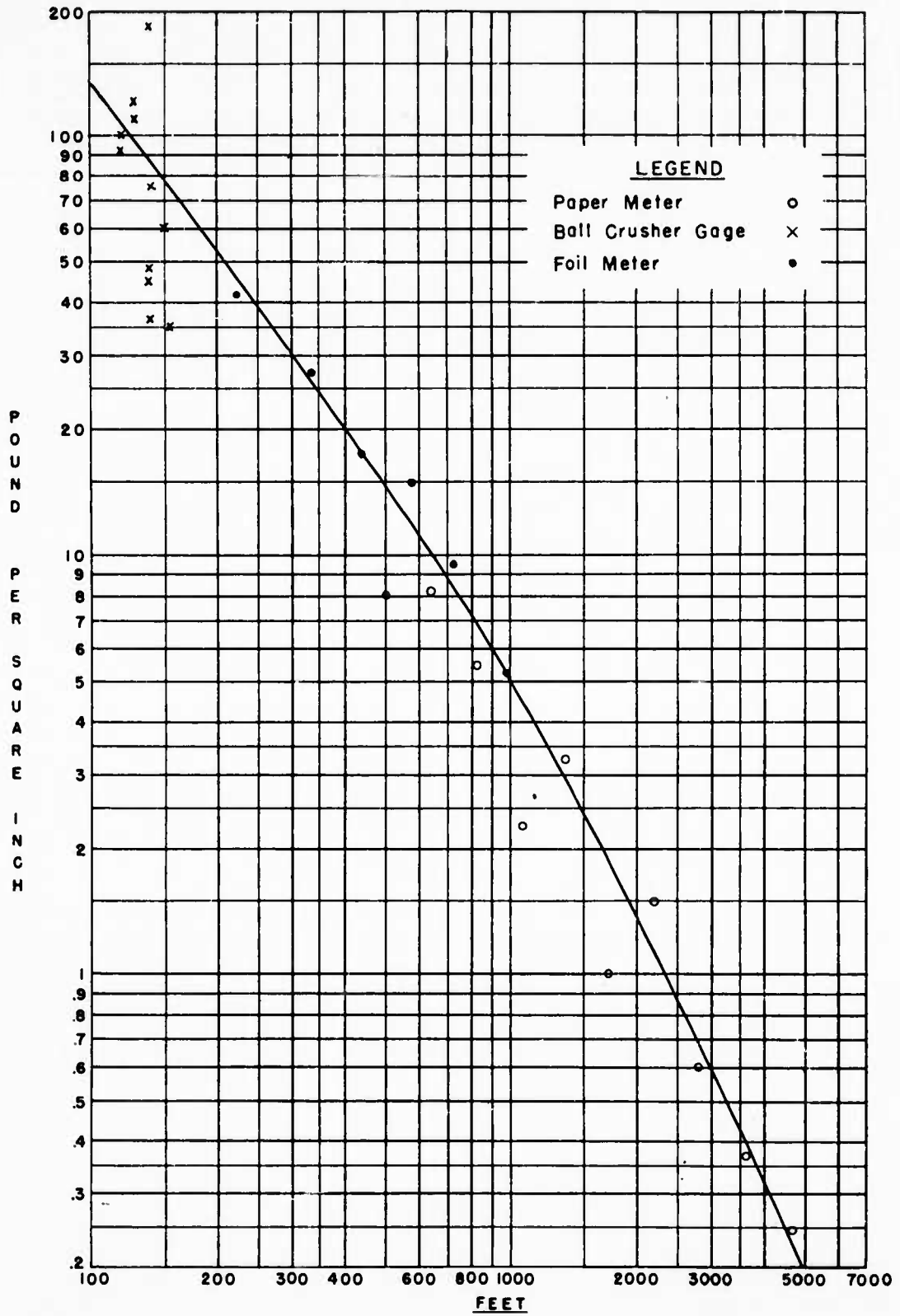

FIGURE 176. Peak Blast Pressure vs Distance from Charge, Test 4, Line 2 (Off Side)

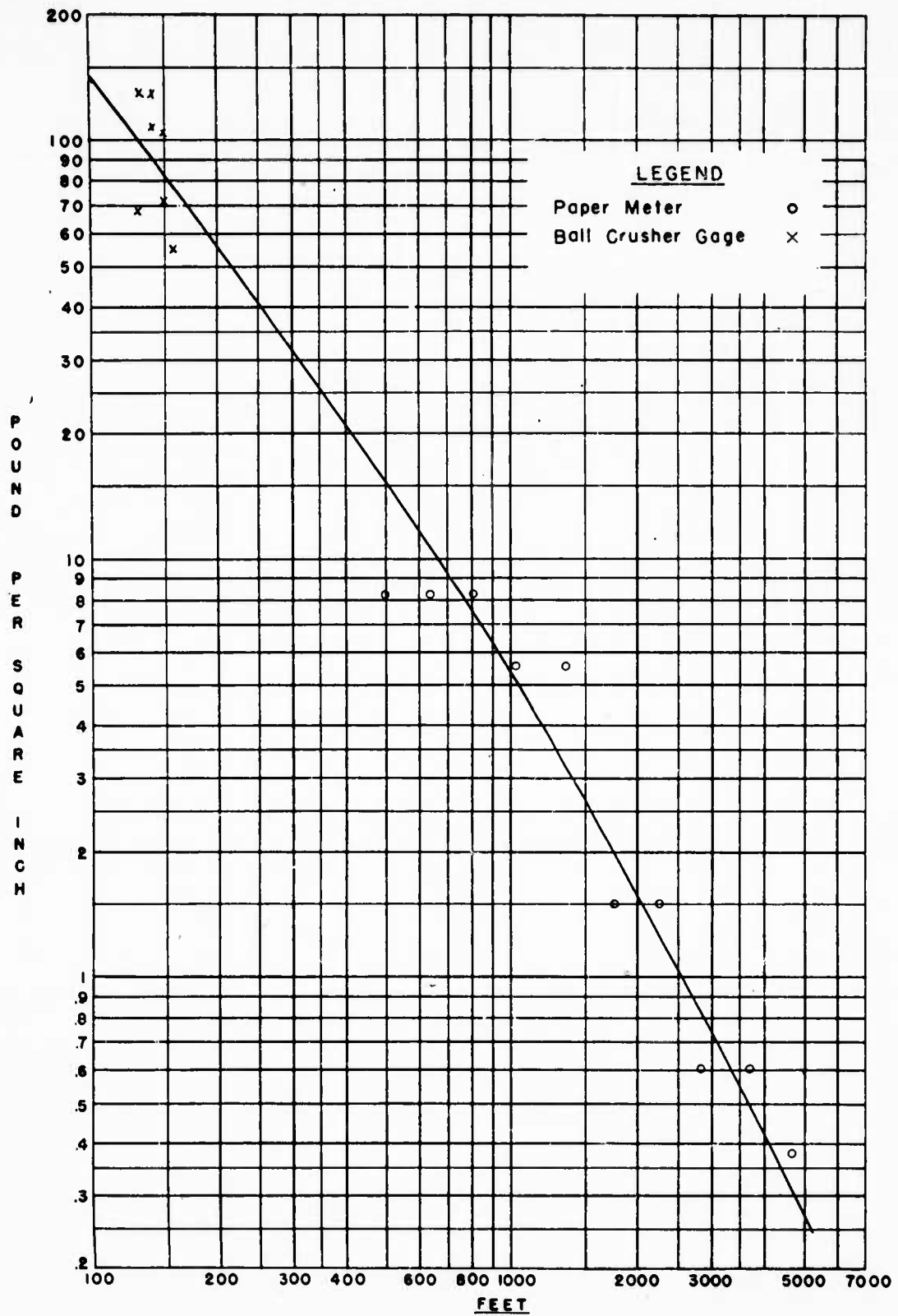

FIGURE 177. Peak Blast Pressure vs Distance from Charge, Test 4, Line 3 (Off Rear)

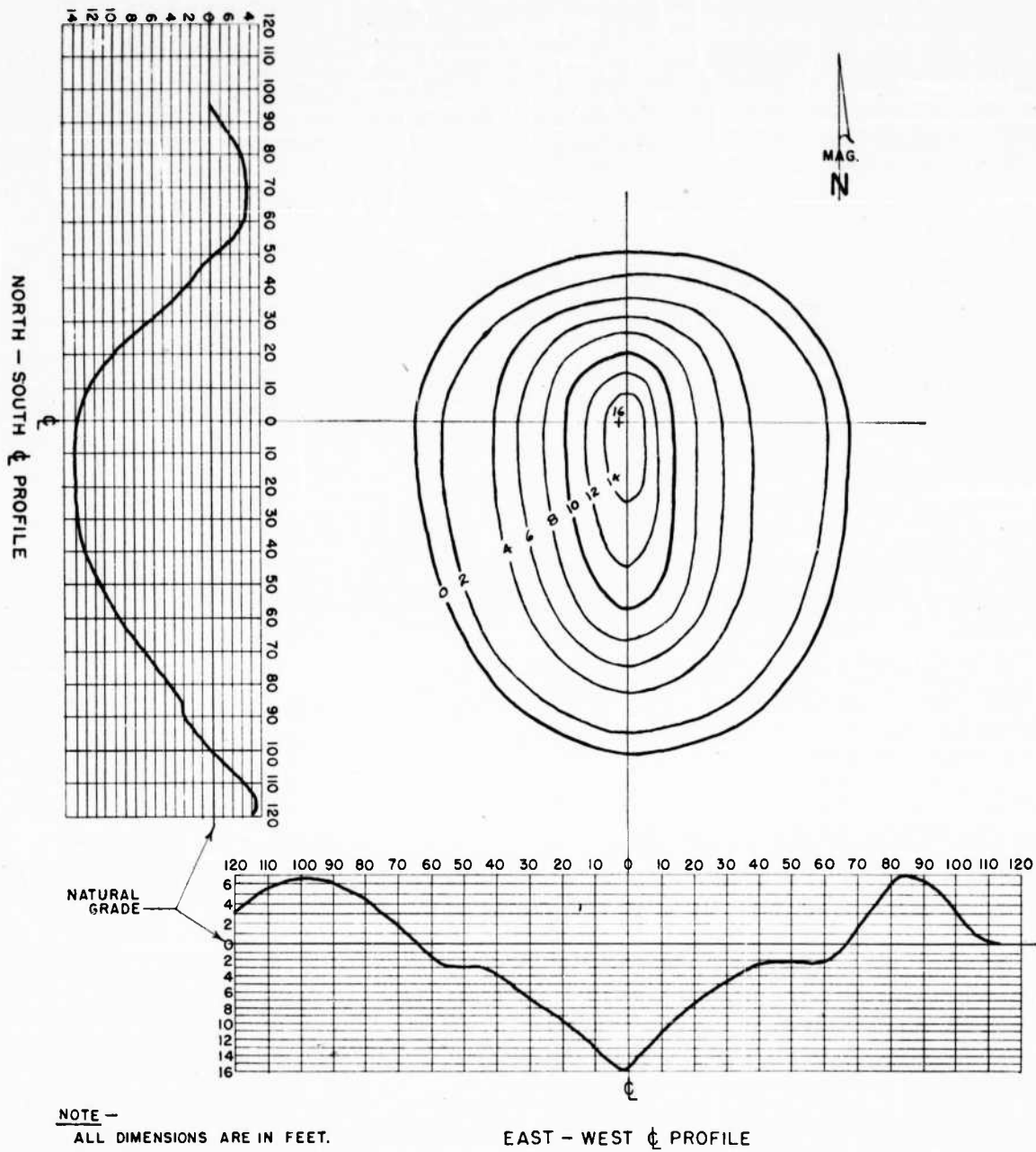

FIGURE 178. Crater Plan and Profiles, Test 4

tion, a few previously torn spots in the siding were made worse, five additional sash were blown in and one left hanging askew. Further damage was done to exterior window trim. On the south face, torn siding now exposed about one-third of the sheathing, and parts of the second-story door frame and trim were broken and missing. The west elevation lost a little more siding at the south end of the building

and the muntins were broken out of two upper-story sash. The four elevations of the building are shown in figures 183-186.

Barracks 2 suffered a large tear in the siding on the north gable. The upper-story windows in the north wall were displaced inward further but not blown completely out of their frames. On the east side, one additional sash was blown in on the ground floor, and one of the upper



FIGURE 179. Crater of Revetment 1, looking east from west rim

windows lost parts of its exterior trim. On the south elevation the upper-story door was blown out and there was a tear in the siding next to the lower-story door. There were two additional tears in the siding on the west side of the building. See figures 187-190.

Barracks 3 did not receive further superficial damage except for a small amount of inward deflection of the upper windows in the north side, together with displacement of trim. See figures 191-194.

(2) *Structural*.—*Barracks 1* lost a number of sheathing boards on both the north and south sides, and most of the remaining were either fractured or displaced from position. The entire north wall bulged inward about a foot, while the south wall bulged outward a like amount. Practically all of the studs were either broken or out of place in the north wall, and about half the studs were in similar condition in the south wall. A 4" x 6" post in the south wall which had supported the end of a floor girder was knocked down, leaving the second floor hanging at this point. A few studs were cracked in the east and south walls, and a few more rafters were broken on the east side of the roof near the north end. Although damage was quite extensive, the building was in no danger of collapsing, inasmuch as the interior columns and the east and west walls were nearly intact, structurally. Typical scenes inside this building are given in figures 195 and 196.

Barracks 2 suffered similarly but much less in extent. Most of the studs were broken in the

north wall, permitting it to bulge inward, particularly around the windows. Some studs were broken in the south wall as well, and it was displaced outward, the maximum deflection being about 8 inches at the second-floor level.

Barracks 3 escaped further structural damage.

(3) *Glass damage*.—Inasmuch as the windows had already been exposed to repeated blasts and suffered extensive breakage, detailed records of additional breakage were not made in the field. The following descriptions are based on a study of photographs.

Barracks 1 lost five additional lights from the north windows, one being a pane of Duplate, another being wire glass and the other three common glass. On the east elevation, four common glass, one Lucite, and one Flexseal pane were broken in the windows with medium-sized panes. All the remaining sash with small-sized panes were blown into the building. Seven panes were broken in the west windows.

Barracks 2 received another broken pane of common glass on the north side. Four additional panes were out on the east elevation, these being medium-sized panes of wire glass, Lumapane, Flexseal and Duplate. Some panes were broken in the window blown out of its frame on the west side of the building.

Barracks 3 lost a pane of Duplate (which may not have been broken) from the north elevation and a medium-sized pane of Lumapane was torn out of one of the east windows. The west windows remained unscathed.

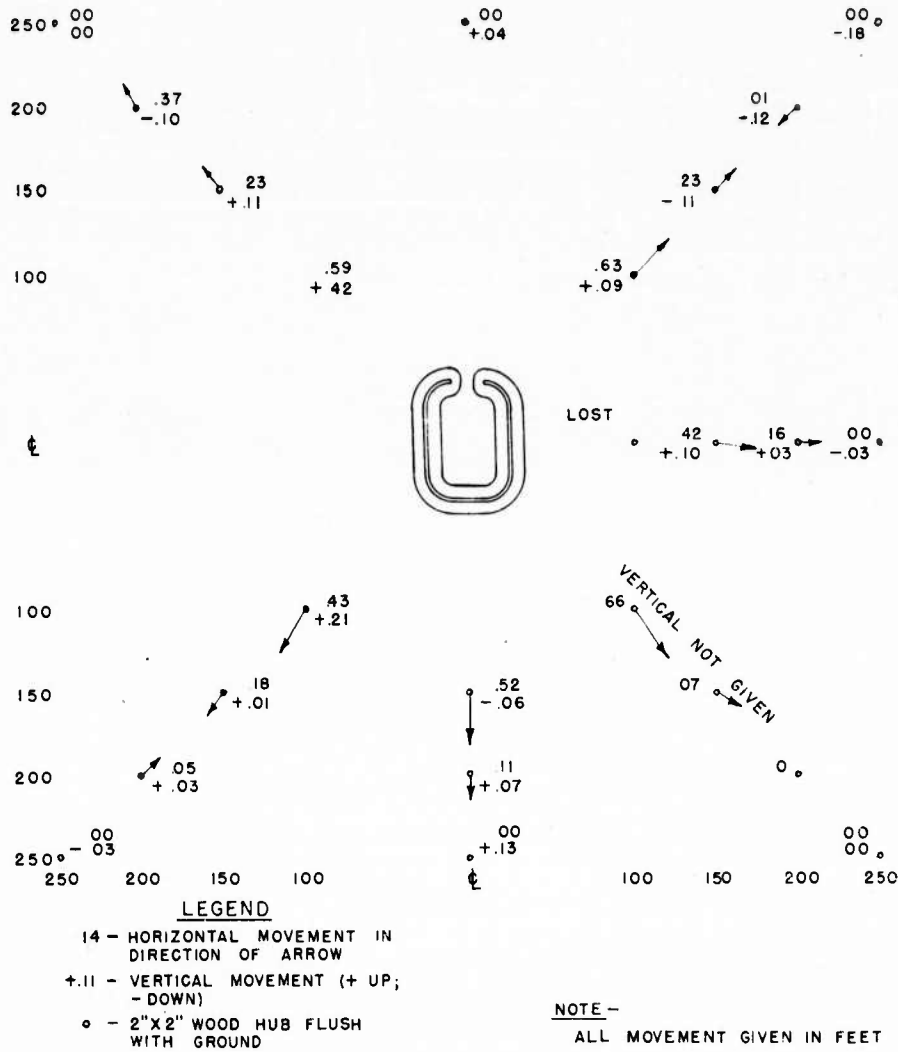

FIGURE 180. Permanent Horizontal and Vertical Earth Displacement, Retevment No. 1, Test No. 4



FIGURE 181. Retevment 2 after Test 4, looking north from south windrow



FIGURE 182. Retevment 2 after Test 4, looking north from southeast corner

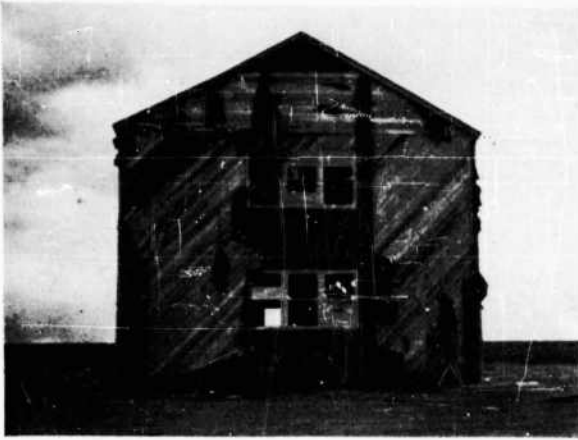

FIGURE 183. Barracks 1 after Test 4;
north elevation

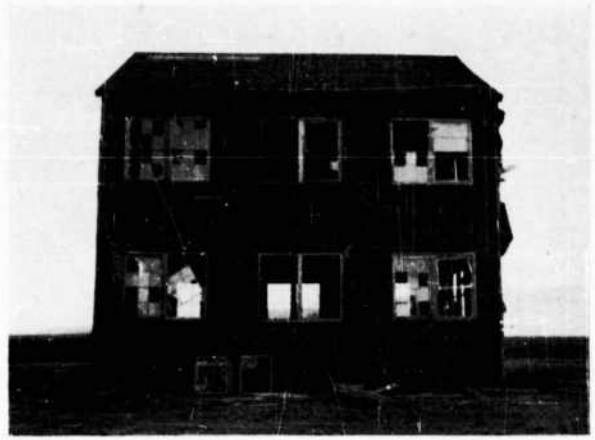

FIGURE 184. Barracks 1 after Test 4;
east elevation



FIGURE 185. Barracks 1 after Test 4;
south elevation

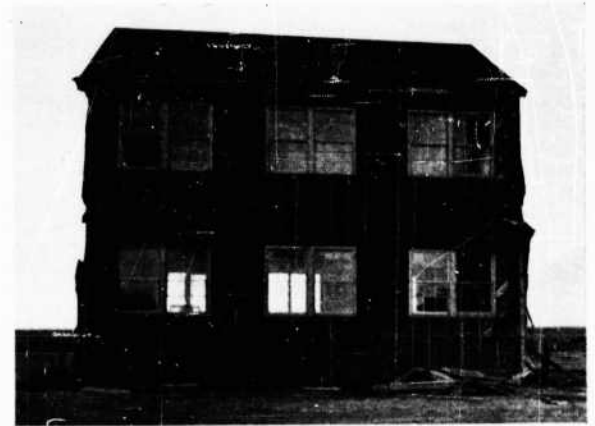

FIGURE 186. Barracks 1 after Test 4;
west elevation



FIGURE 187. Barracks 2 after Test 4;
north elevation



FIGURE 188. Barracks 2 after Test 4;
east elevation

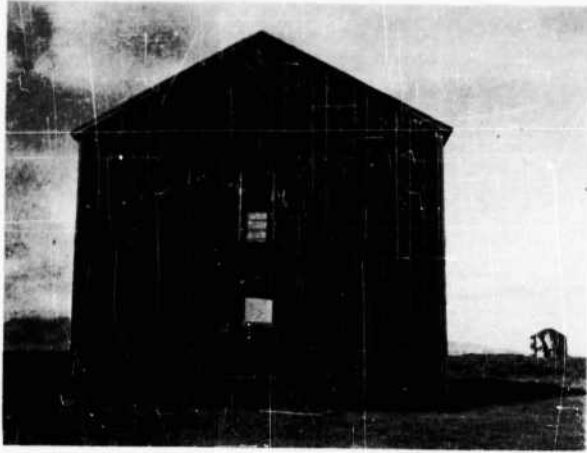

FIGURE 189. Barracks 2 after Test 4; south elevation



FIGURE 190. Barracks 2 after Test 4; west elevation

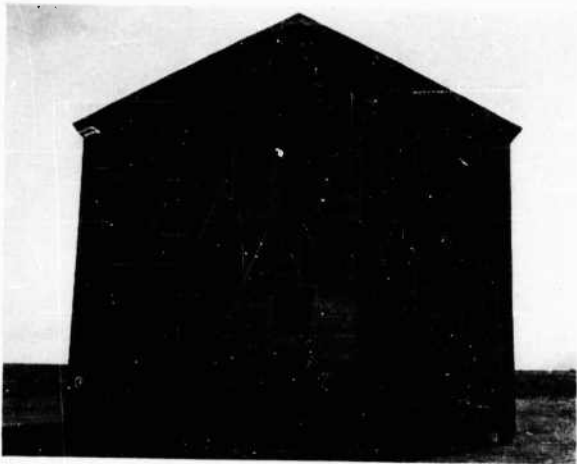

FIGURE 191. Barracks 3 after Test 4; north elevation



FIGURE 192. Barracks 3 after Test 4; east elevation

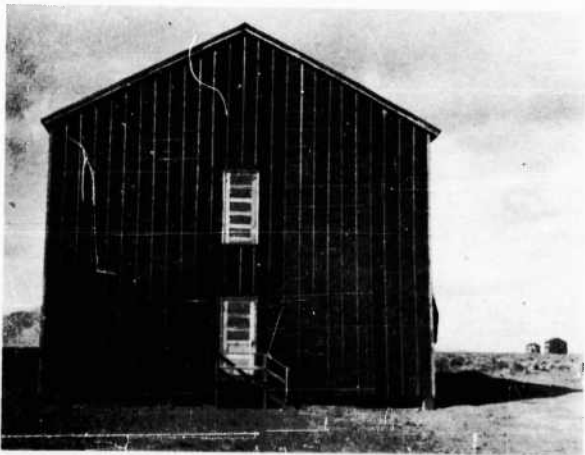

FIGURE 193. Barracks 3 after Test 4; south elevation

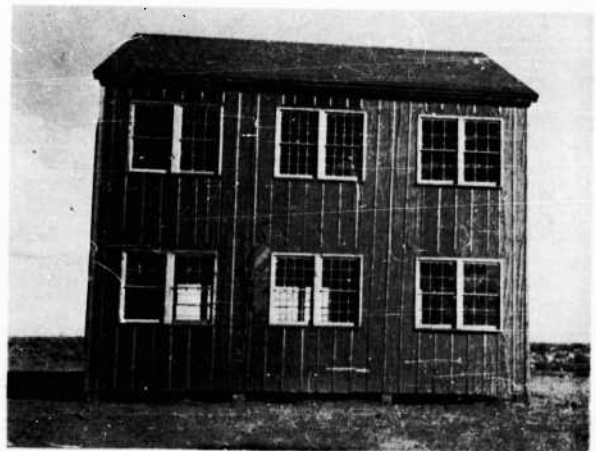

FIGURE 194. Barracks 3 after Test 4; west elevation



FIGURE 195. Interior of Barracks 1 after Test 4, looking toward northeast corner on second floor



FIGURE 196. Interior of Barracks 1 after Test 4, showing separation of south wall from second floor, and missing sheathing



FIGURE 197. Explosion of Revetment 2, 1st stage



FIGURE 198. Explosion of Revetment 2, 2nd stage



FIGURE 199. Explosion of Revetment 2, 3rd stage

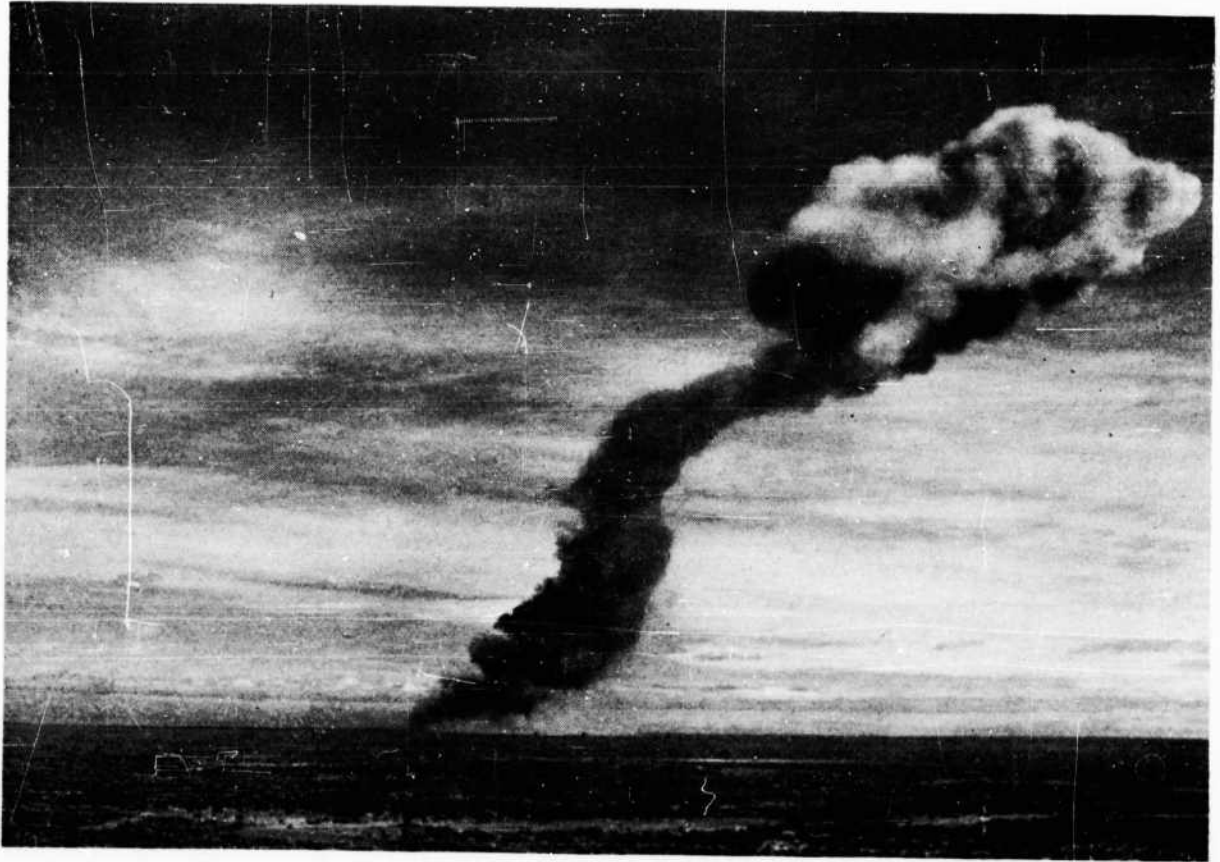
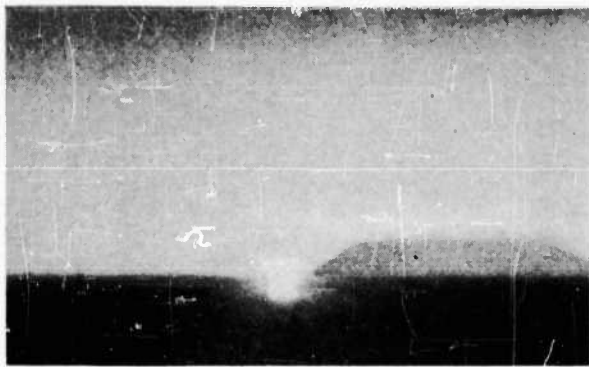
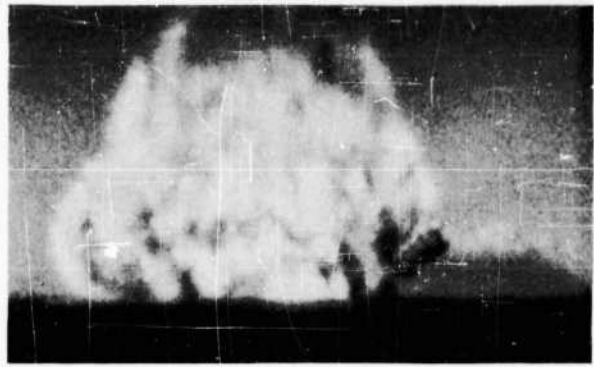

FIGURE 200. Explosion of Revetment 2, 4th stage



a. Flash.



b. 0.14 sec. after flash.

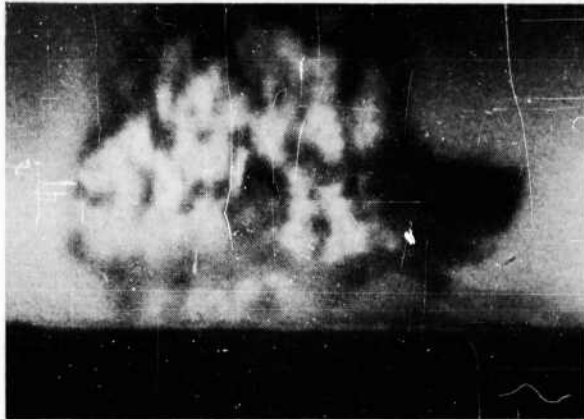

c. 0.45 sec. after flash. Vapor obscures base of cloud.

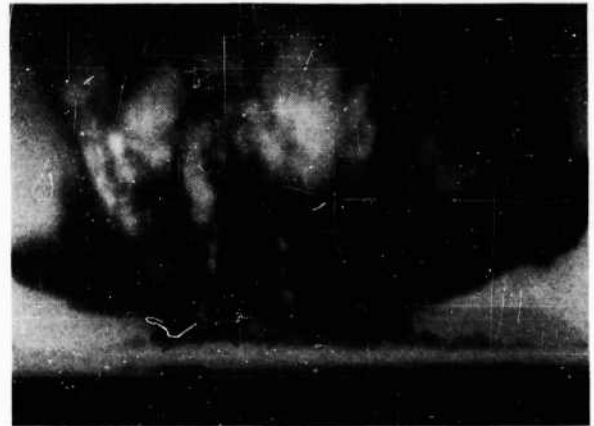

d. Cloud 1.43 sec. after flash. There is still flame in the cloud. The "dust front" on the ground has progressed beyond the margin of the picture.

FIGURE 201. Selected frames from Fastax film, Test 5

5. Test 5.

(a) *General*.—The explosion of Revetment 2, which took place on 25 October, appeared much the same as that of the first revetment, except that the head of the smoke cloud, after reaching a maximum altitude of about 6,500 feet, was blown rapidly away by a northwest wind at the upper levels. Figures 197–200 illustrate the development of the cloud as recorded by still camera at the observation point, and figure 201 shows selected frames from the Fastax film, taken from camera station number 1.

(b) *Crater*.—The average apparent diameter was 122 feet and the maximum apparent depth 9.6 feet. The shape was roughly conical, the deepest part being at the center. For east-west and north-south profiles, see figure 202. The earth in this crater had the same appearance

which characterized that in the crater of test 4, consisting of sharply broken clods of compressed fine-grained soil with a peculiar schistose structure. The clods were friable, however, and not indurated. Figure 203, a photograph of the crater looking westward from the east rim, illustrates the appearance of this soil.

(c) *Ground movement*.—Figure 204 gives permanent horizontal and vertical displacements of the ground surface surrounding this explosion. Horizontal movement was predominately away from the center, and varied from 0.37' at 140 feet to zero at 250 feet. Vertical movement was mostly upward in close to the explosion but subsidence prevailed at 150 feet and beyond. Values ranged from 0.17' upward at 140 feet to a maximum downward movement of 0.07' at 200 feet, and a minimum downward movement of 0.01' at 350 feet from the center.

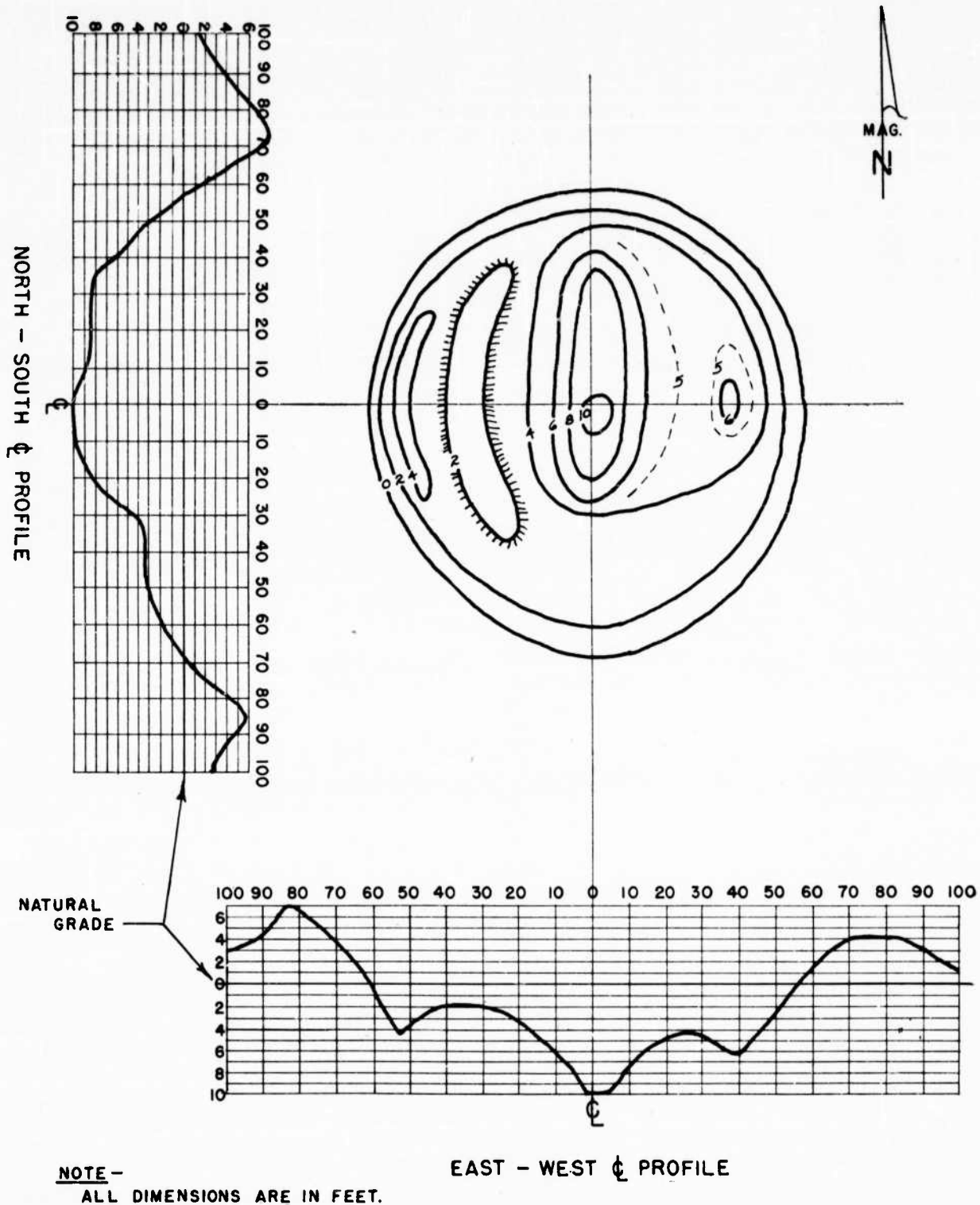

FIGURE 202. Crater Plan and Profiles, Test 5

(d) *Damage to barracks: (1) Superficial.*—*Barracks 1*, another sash was blown in from one of the north windows, and there was a little more tearing of the asphalt felt siding on the north side. On the east elevation a sash which had been left hanging askew in the previous blast was now missing from its frame, and the siding on this side was torn a little more. The south elevation lost more siding to the extent that half the sheathing was uncovered, and the upper story door was blown out. On the west side, there was further tearing of siding and a previously broken upper sash was blown in from one of the second-story windows. For photographs of the elevations, see figures 205-207.

Barracks 2, a little more siding was gone in the north gable and alongside the door in the south elevation. Another sash was missing from one of the north windows. Figures 208-211 are views of the four sides of the building.

Barracks 3, figures 212-215 show that there was no appreciable further damage, other than a loose sash falling to the ground from an upper-story window in the north wall.

(2) *Structural.*—*Barracks 1*, more sheathing was broken and missing on the north and south elevations, and these walls were distorted further. The roof seemed to sag a bit more where broken. No additional major framing members failed, however, and the building was still in no danger of collapsing.

Barracks 2, outside of some further cracking and displacement of previously broken members, and some increase in distortion of the building as a whole, there was no additional structural damage.

Barracks 3, no further structural damage was noted.

(3) *Glass damage.*—*Barracks 1*, one additional light of common glass backed by wire mesh was missing from one of the north windows.

Barracks 2, three more medium-sized panes of common glass were broken or missing on the east elevation. The panes in the upper sash blown out of the second-story windows on the north side were probably broken by the fall to the ground.

Barracks 3, no further glass damage.



FIGURE 203. Crater of Revetment 2, looking west from east rim

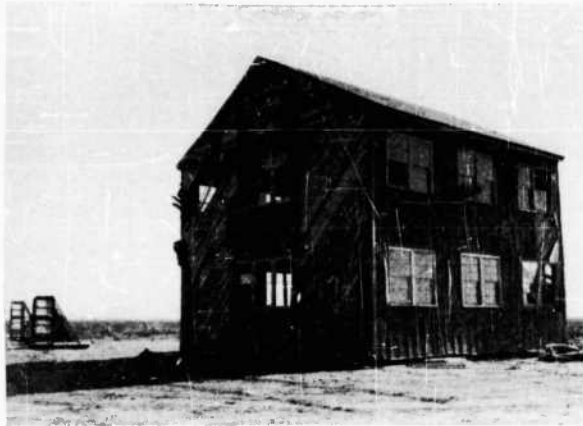

FIGURE 205. North and west elevations of Barracks 1 after Test 5

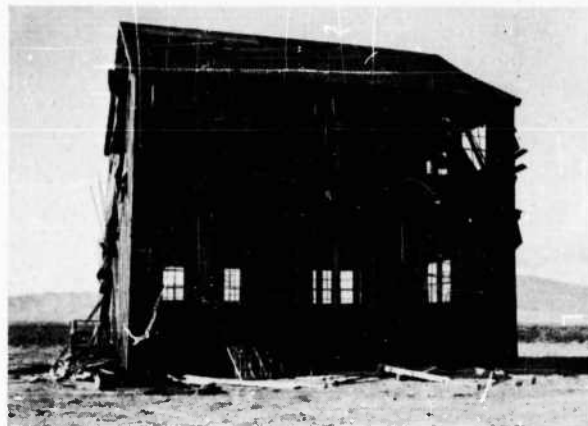

FIGURE 206. East elevation of Barracks 1 after Test 5



FIGURE 207. South elevation of Barracks 1 after Test 5



FIGURE 208. North elevation of Barracks 2 after Test 5

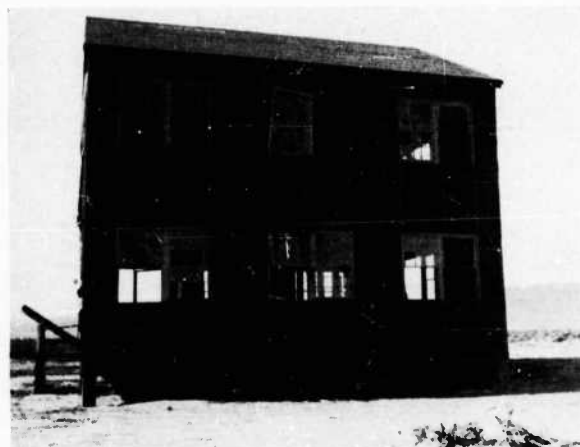

FIGURE 209. East elevation of Barracks 2 after Test 5



FIGURE 210. South elevation of Barracks 2 after Test 5

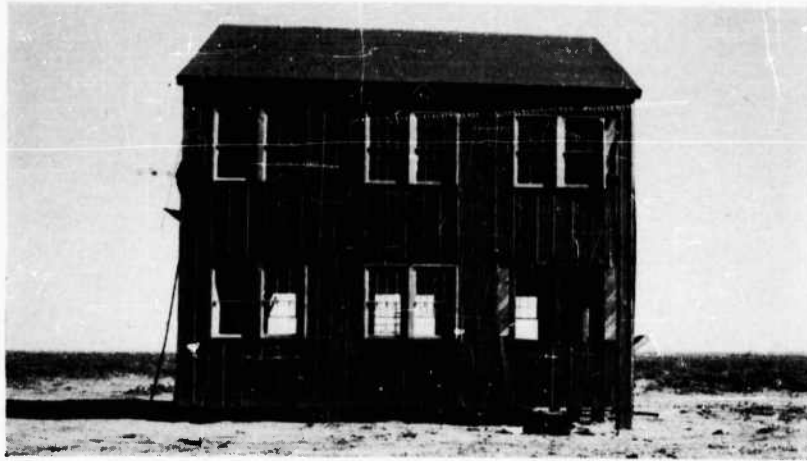

FIGURE 211. West elevation of Barracks 2 after Test 5



FIGURE 212. North elevation of Barracks 3 after Test 5

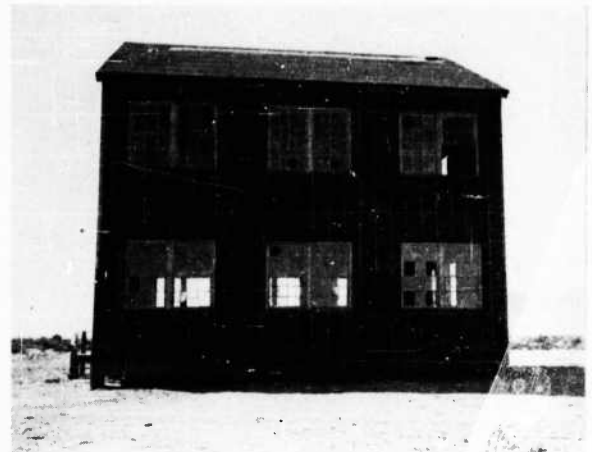

FIGURE 213. East elevation of Barracks 3 after Test 5



FIGURE 214. South elevation of Barracks 3 after Test 5



FIGURE 215. West elevation of Barracks 3 after Test 5

B. RESULTS OBTAINED BY PARTICIPATING ORGANIZATIONS

I. Naval Ordnance Laboratory.

(a) *General.*—Preliminary information on the results obtained by this group is summarized below. The final report depends on correlation with results of the United States Weather Bureau and the Army Weather Service (Signal Corps) participation and is not expected for some time.

(b) *Measurements of microbarographic waves.*—Pressure waves were recorded by the subsonic frequency ($\sqrt{< 2}$ cps) microbarographs at stations 141, 182, 292, and 452 km distant (Burley, Idaho; West Yellowstone, Mont.; Clearfield, Utah; Great Falls, Mont.). Both normal and abnormal¹ signals were recorded at 182 and 292 km; no clear abnormal signals were observed at 141 km. The largest recorded signal at 182 km. was an abnormal velocity, 3 cycle wave train 220 dynes cm.⁻² peak-to-peak pressure, from a 250,000-pound explosion. No consistent signal travel time differences resulted from changing charge weight between 6,400 and 500,000 pounds of TNT (several explosions of small open stacks of land mines, not included in the program were set off in order to extend the range of microbarograph data), nor were signal strengths predictable from charge weight. Incidence

¹ B. Gutenberg, *Handbuch der Geophysik* 9, 89 (1932); *Bull. Am. Meteor. Soc.* 20, 192 (1939); *J. Acous. Soc. Am.* 14, 151 (1942).

angles of rays descending at 182 km. are unknown, but this distance approximates the inner boundary of the abnormal audibility zone at this season. Calculations assuming a constant positive temperature gradient above each highest point of observed temperature, and neglecting wind, establish 34 km. as a *minimum* altitude at which ground temperature could be reached.

2. Naval Ordnance Test Station, Inyokern.

(a) *General.*—Given herewith is a synopsis of the results obtained by this group. The complete reports are filed in the Bureau of Ordnance.

(b) *Air blast records.*—Shock wave velocities measured by means of the foil bridges in test 1, as well as peak pressures calculated from the velocities by means of the Rankine-Hugoniot relation, and peak pressures determined by the Bikini type foil gages in five different orientations are presented in table XI. No results were obtained from the diaphragm strain gages because of excessive cable "hash" which obscured the signals from the gages.

From the data obtained, it was concluded that the measurement of shock velocity provides a simple and accurate method of deducing peak pressure. By cross checks obtained from independent measurements, the method ap-

TABLE XI.—Air blast data from N.O.T.S., Inyokern, test 1

Velocity Measurements					Pressures from Foil Gages in psi					
Distance Feet	S 5° 30' W line		North line		Distance Feet	Orientation				
	Velocity Ft./sec.	Pressure psi	Velocity Ft./sec.	Pressure psi		0°	90° (down)	90° (up)	90° (left)	90° (right)
95	2836	78	2851	78	
155	2347	48	2321	47	
235	1958	29	1945	29	
333	1724	19.5	1733	20	335	20.2-24.5	17.1-21.0	17.1-21.0	17.1-21.0	14.0-17.1
.....	390	16.9-20.2
453	1545	12.9	1544	12.8	455	14.0-16.9	11.4-14.0	11.4-14.0	11.4-14.0	14.0-17.1
.....	520	11.6-14.0	9.3-11.4	11.4-14.0	11.4-14.0	9.3-11.4
593	1435	9.1	1426	8.9	595	9.65-11.6	9.3-11.4	7.6-9.3	9.3-11.4	7.6-9.3
.....	670	7.98-9.65	6.2-7.6	7.6-9.3	7.6-9.3	6.2-7.6
754	1345	6.3	1351	6.5	755	6.62-7.98	6.2-7.6	7.6-9.3	6.2-7.6	6.2-7.6
.....	840	5.48-6.62
935	1290	4.6	1285	4.5	935	4.55-5.48	5.06-6.2	5.06-6.2	5.06-6.2	0-5.06
.....	1030	3.77-4.55
.....	1250	2.60-3.11
.....	1500	2.60-3.11

peared to be accurate to better than 1 percent. Pressures obtained close to the charge were considerably greater than the estimated values, which were based on experience with smaller charges. It was stated that one obvious effect which contributes to the failure of the simple cube root theory is the circumstance that, because of the large physical size of the charge in this test, it cannot be detonated simultaneously, so that for a considerable distance away from the charge the shock wave will continue to be supplied with additional energy from behind, and perhaps will travel as much as a thousand feet before its attenuation becomes normal.

With respect to the Bikini type foil gages, it was stated that the overestimation of peak pressures by these gages in face-on orientation when the "Crossroads" calibration was used, is consistent with the assumption that in this orientation the gage responds to some extent to the impulse of the blast, as well as to peak pressure. The ratio of impulse to peak pressure at Arco was probably much higher than that obtaining during the calibration of the gages (performed at Aberdeen Proving Ground).

No dependence of peak pressure on height above the ground was found at a given station when pressure was simultaneously measured with foil gages from the ground level up to a height of 5 feet.

The attempt to measure shock wave velocity by means of the argon flares was unsuccessful, as the flare traces did not show on the films. It was thought that they were engulfed by obscuring earth before the shock wave arrived. This could only have happened to the nearest flares, however.

(c) *Information gained from high-speed photography.*—The Pasadena physics section's Fastax pictures of the explosion of Igloo D show the assymetry imparted in the forward, rearward, and upward directions. The rearward shock is the weakest of the three. The forward, although strongest initially because of the absence of earth cover, at about 0.04 seconds falls behind the vertical shock. The maximum shock velocity attained, aside from the initial jet at the igloo door, is for the forward direction and is given by both the Fastax and Bowen RC-4 records as approximately 5,800 feet per second.

Initial details of the explosion are furnished by both films:

1. An initial jet at the door of the igloo which attains a velocity of 16,000 feet per second.
2. Formation of a Mach Y-type wave front some 50 feet in front of the igloo.
3. Details of destruction of the igloo. Initially, the front and unsupported face is blown out; next the top of the igloo, starting at the front. As the rupture develops, it is rapidly followed by the escaping shock which finally merges with the shock front escaping at the rear ventilator. (Note: The ANESB Fastax record of Igloo D's explosion, which showed the magazine broadside-on, clearly shows the largest initial flame to be at the rear of the igloo.)

3. Signal Corps, Army.

The data obtained by the Signal Corps in these tests are in the process of being analyzed and it is anticipated that a complete report will be available about 15 April 1947.

4. United States Weather Bureau.

(a) *General.*—The following information is extracted from a preliminary report by the Weather Bureau. More complete data, including the results of the high altitude soundings at remote locations, will appear in a final report.

(b) *Tables and diagrams.*—Figures 216 and 217 are the surface weather maps for 1130 MST on the mornings of the first and second tests, respectively. Figure 218 is a reproduction of a section of one of the microbarograph traces that indicated a possible pressure wave passage. The black arrow points to the portion of the trace showing a deflection attributed to the explosion. Tables XII and XIII list the seven stations where the high speed microbarographs were installed to record the passage of the shock wave. The azimuth and distance in miles are indicated for each station. The computed time of passage of the pressure wave was derived from the distance and the formula $v = 20.1 \sqrt{T}$, where v is the velocity of sound in m/sec. and T the surface absolute temperature between the explosion point and the station. The computed values for the velocity of sound on October 1 ranged from 1120.2 to 1126.5 ft/sec. and on October 8 from 1105.0 to 1106.6 ft/sec. Additional columns contain the observed

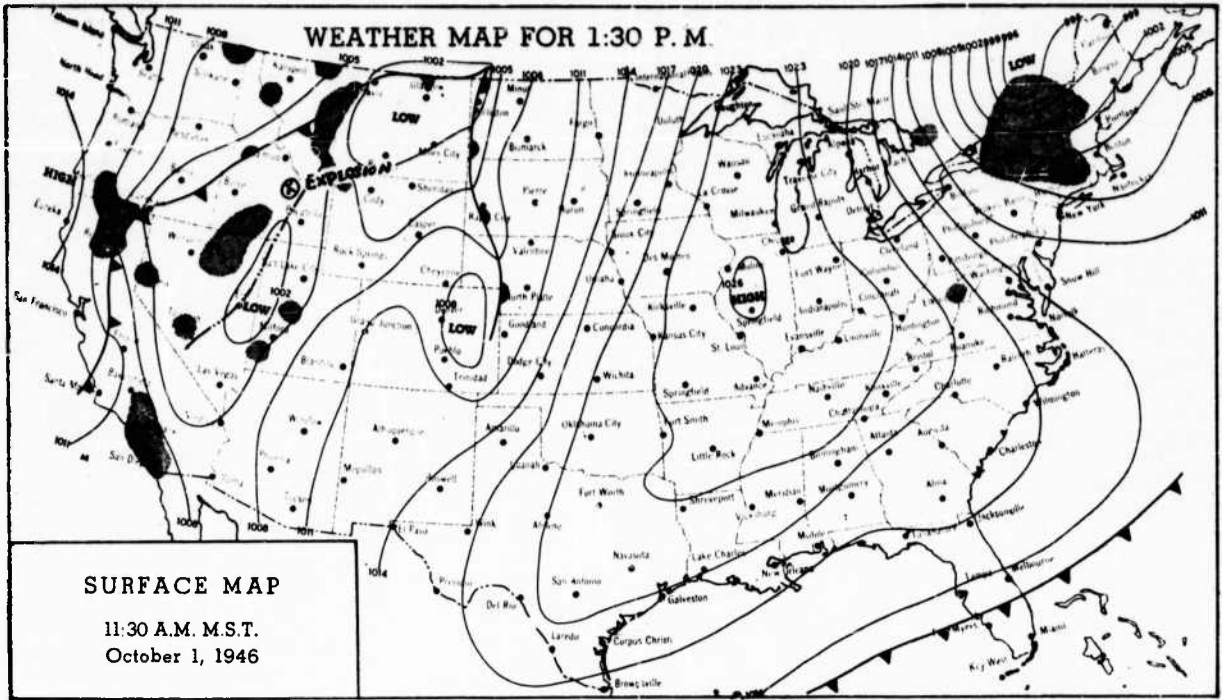

FIGURE 216. Weather Map, Test 1

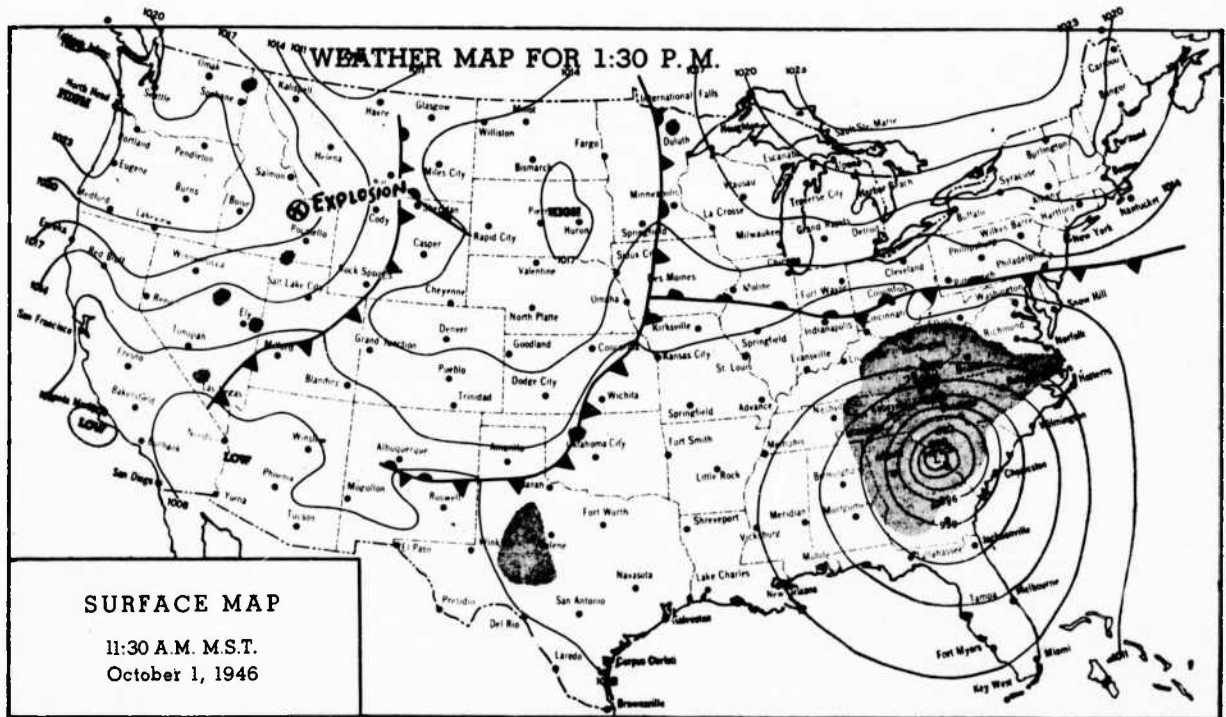

FIGURE 217. Weather Map, Test 2

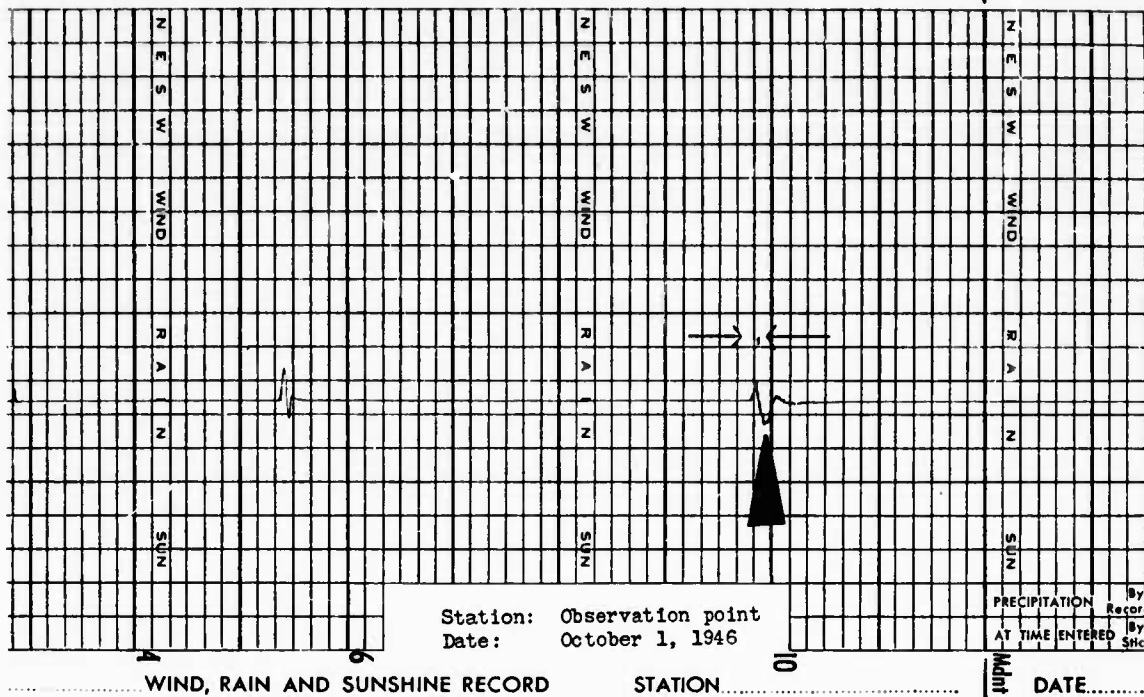

FIGURE 218. Microbarograph Record, Test 1

time of passage as calculated from the traces, the character of the pressure wave trace, the amplitude of the maximum compression wave, the description of any sound heard and some information on the weather at the station. Figures 219 and 220 summarize some of the data from the tables on polar coordinate paper. In these diagrams the position of the various stations are plotted with respect to the explosion point together with a symbol indicating whether or not the microbarograph trace indicated the passage of a pressure wave and whether the sound was heard at the estimated time of passage of the wave. Howe, Idaho, where the sound of the explosion was heard, according to a newspaper report, is included.

(c) *Weather conditions.*—October 1, 1946: Squally weather associated with passage of a cold front. Widespread thunderstorm activity reported over entire area. Intermittent rain-showers reported over the test area with a ceiling of 1,500 feet. Wind was from SSE at 6 m.p.h. The observer at the Observation Point reported a “hemispheric concussion visible for about 6–8,000 feet from the explosion. It had the appearance of fog forming and dissipating

as it moved.” Due to the high relative humidity, adiabatic expansion caused by the explosion cooled the air to its dew point at each rarefaction, while the following compression wave heated the air sufficiently to dissipate the condensed particles. In order to estimate the intensity of the pressure wave in the area where the fog was forming and dissipating, calculation of the pressure fall associated with this condensation was made. The only station pressure available was 24.936 in. of mercury at the Warehouse and the nearest station reporting both temperature and dew point temperature was Idaho Falls. These values yield approximately 35 m.b.s. (equivalent to about 0.5 p.s.i.) as the degree of rarefaction necessary for this formation of fog. This is a minimum value and the actual pressure drop may have been larger.

October 8, 1946: An entirely different weather situation existed. An upper cold front had passed over the area during the previous night, causing rain in the general area. On the morning of the test, relatively clear weather prevailed over the explosion area. Surface winds were still from the SE while winds aloft were from the northwest. Photographs of the

TABLE XII.—Results of explosion at Arco Naval Proving Grounds at 1100 M. S. T. October 1, 1946, as recorded by Weather Bureau high speed microbarographs

Station	Distance	Azimuth	Calculated time	Observed time	Character of trace	Amplitude (MBS)	Sound reported ¹	Surface wind	Sky and weather conditions	Temperature (°F)
Radar	<i>miles</i> 2.2	<i>degrees</i> 205	10.3 sec.	(²)	(²)	(A)4.74 ² .. (B)14.22 ..	Not heard. Station in pit 8' x 8' and 10' deep	SSE/6	⊕15⊕ RW-	60
Observation Point . . .	4.1	225	19.2 sec.	17.7- 19.8 sec.	1 sharp wave; several shallow	6.10	SSE/6	⊕15⊕ RW-	60
Warehouse .	8	210	37.5 sec.	(³)	Very slight ² . . .	20.34	SSE/6	⊕15⊕ RW-
Arco	20	266	1 min. 33.8 sec.	1 min. 37.8-39.0 sec.	Very weak . . .	Not measurable
Idaho Falls	44	105	3 min. 26.5 sec.	3 min. 35.9-42.5 sec.	Series of small wiggles	Not measurable	No sound or tremors felt at station	S/24	⊕35⊕ R-(int)	59
Dubois	50	45	3 min. 55.7 sec.	No discernible deflection	Dull faint report heard at 3 min. 53 sec. after explosion	SE/14	⊕10⊕	53
Burley	88	209	6 min. 52.5 sec.	No discernible deflection	ENE/8	⊕45⊕	64

¹ Newspaper account reported sound of explosion heard at Howe, Idaho 12 miles NW of explosion.

² See detailed discussion in body of paper.

³ 37 sec. reported on Naval Ordnance Laboratory electric microbarograph as time of wave passage.

TABLE XIII.—Results of explosion at Arco Naval Proving Grounds at 1100 M. S. T. October 8, 1946, as recorded by Weather Bureau high speed microbarographs

Station	Distance	Azimuth	Calculated time	Observed time	Character of trace	Amplitude (MBS)	Sound reported	Surface wind	Sky and weather conditions	Temperature (°F)
Radar	<i>miles</i> 2.2	<i>degrees</i> 205	10.5 sec.	10.0- 10.2 sec.	Very sharp . . .	12.54	SE/6	45 ⊕	44
Observation Point . . .	4.1	225	19.6 sec.	19.2- 20.8 sec.	One sharp wave with several shallower	7.46	Two reports, fraction of second apart	SE/6	45 ⊕	44
Warehouse	8	210	38.2 sec.	37.8- 39.0 sec.	One wave, smooth	1.36	SE/6	45 ⊕
Arco	20	266	1 min. 35.4 sec.	1 min. 39 sec. ¹	SE/10	40 ⊕
Idaho Falls	44	105	3 min. 30.2 sec.	3 min. 26.7- 27.5 sec.	Very weak. Several	0.34	Sound reported 3½ minutes after fire signal	SSE/6	30 ⊕	41
Dubois	50	45	3 min. 58.9 sec.	No discernible deflection	Indistinct sound resembling thunder . .	calm	40 ⊕	40
Burley	88	209	7 min. 0.5 sec.	No discernible deflection	W/8	12 ⊕	41

¹ Regular observer ill. 1 min. 30 sec. reported on Naval Ordnance Laboratory electric microbarograph as time of wave passage.

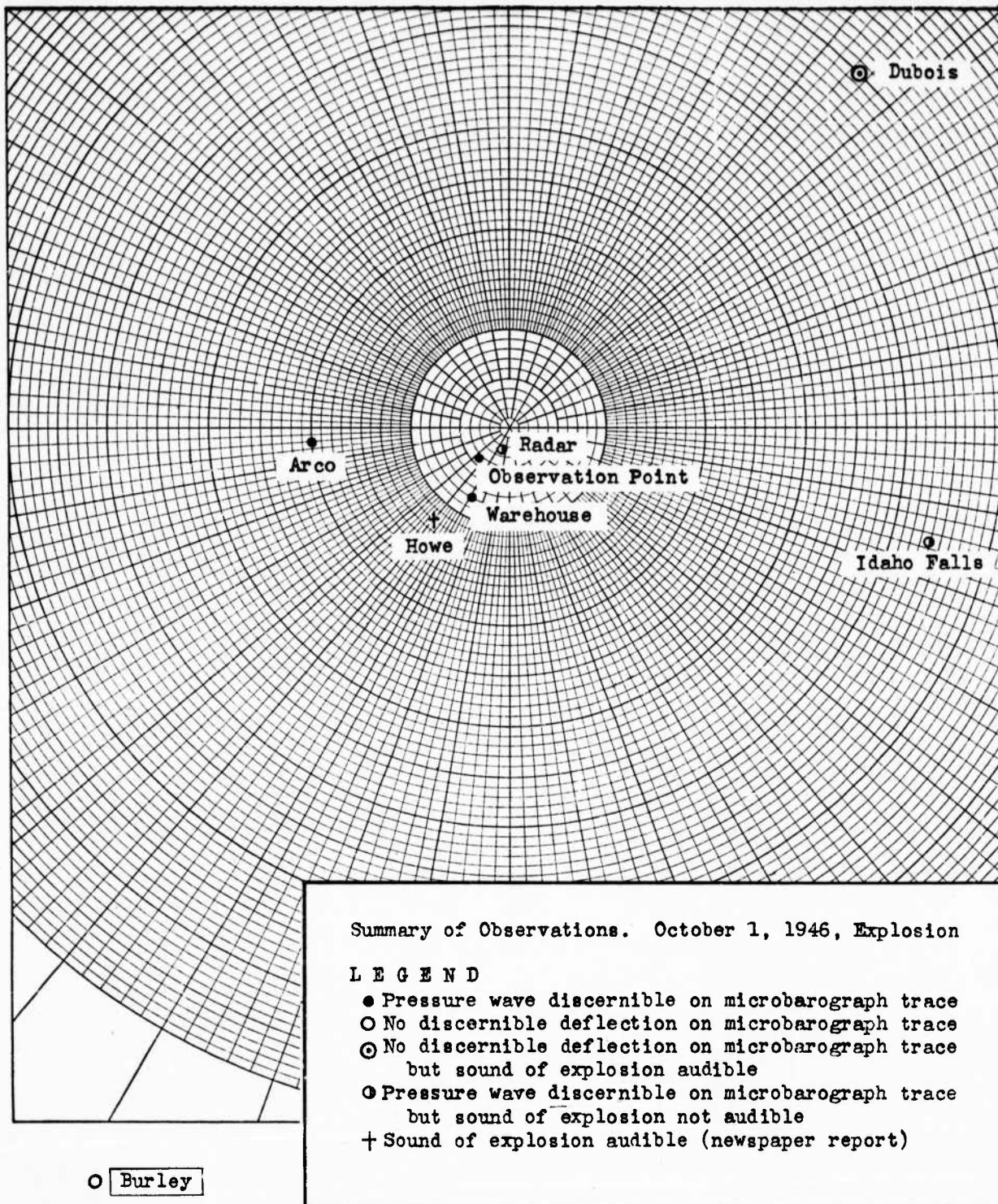

FIGURE 219. Plot of Observation Stations, Test 1

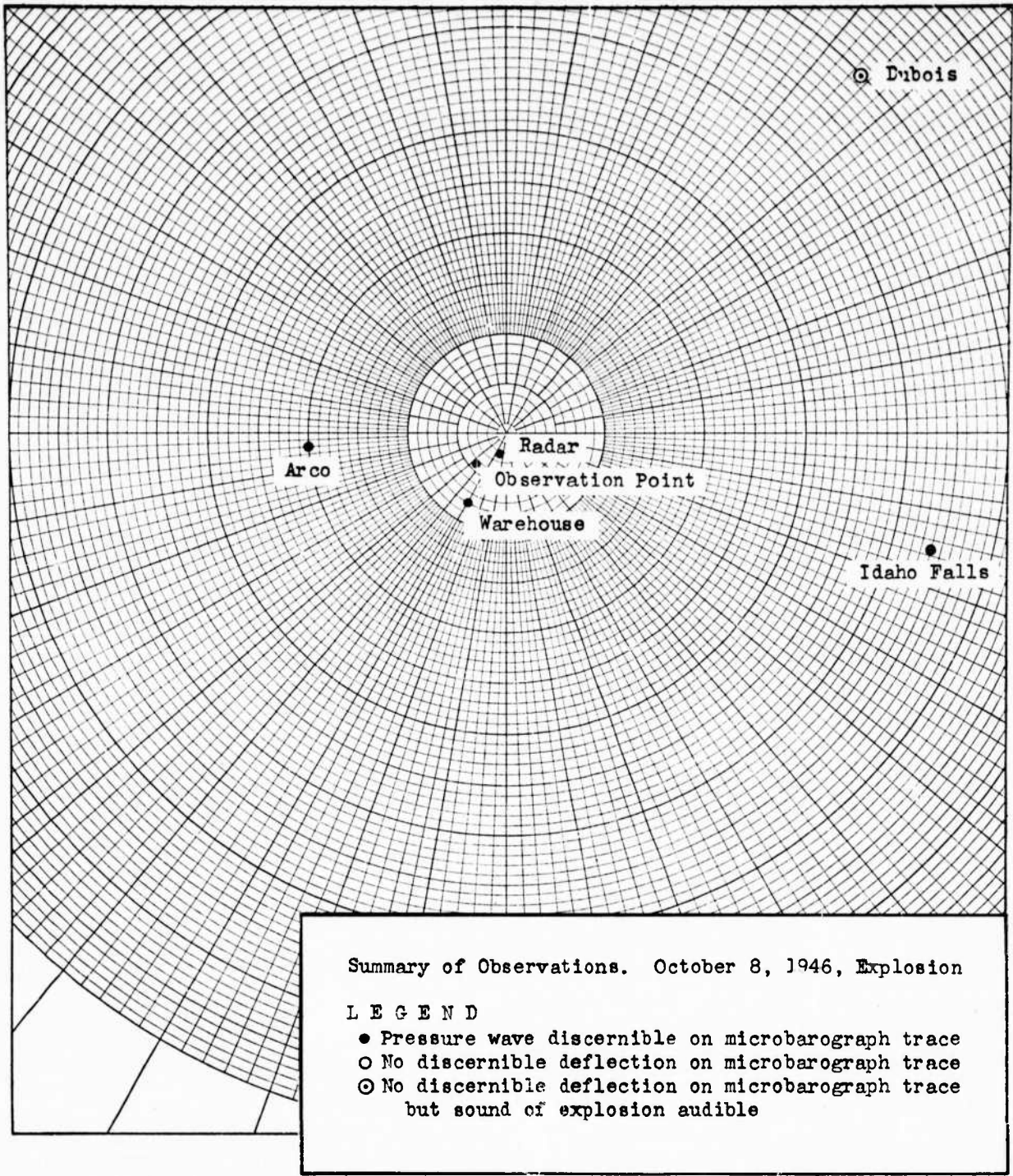

FIGURE 220. Plot of Observation Stations, Test 2

explosion reveal that the lower section of the explosion cloud was carried to the northwest by the surface winds while aloft the winds carried the upper portion of the cloud to the southeast. A sounding at Boise showed that a very stable layer of air existed in the lower levels over the Southern Idaho area. This stable layer favored a more pronounced pressure wave as was seen from the difference in amplitudes of the pressure waves recorded on the microbarographs for the two days.

(d) *Conclusions from meteorological data.*—

1. Within 20 miles of the explosion, the high speed microbarographs were able to record deflections due to passage of the pressure wave.

2. Very weak deflections due to the passage of a pressure wave were recorded at a distance of 44 miles.

3. Beyond 44 miles, no deflections due to the passage of a pressure wave were discernible.

4. A zone of audibility extends at least up to 50 miles. Burley (88 miles) is in a zone of silence.

5. The amplitude of the pressure wave decreases with the distance from the explosion.

6. The character of the trace caused by the passage of a pressure wave is (a) one larger wave and several smaller ones of diminishing amplitude for stations within 10 miles of the explosion and (b) sinusoidal waves of uniform small amplitude beyond the 10-mile point.

7. Waves of greater amplitude were observed in the more stable atmosphere except in the immediate vicinity of the explosion.

5. St. Louis University.

At this writing, information as to the results obtained by this group is not at hand, but it is expected that a report will be available in the near future through the Office of Naval Research.

6. Woods Hole Oceanographic Institution.

(a) *General.*—A complete report on the participation of this organization in the tests and the results obtained by means of their free piston gages is on file with the Board of the Bureau of Ordnance. The following is a synopsis of the results.

(b) *Air blast measurements.*—It was found

from results on four of the tests (Igloo E, Igloo F, Revetment 1, Revetment 2) that no great difference could be discerned in peak pressure versus reduced distance between open revetments and earth covered concrete igloo-type magazines at pressures of less than 5 p.s.i. Therefore, in reporting results, all four tests were grouped together.

Interpretation of the positive impulse versus distance data also showed that, within the range of pressures measured, the 500,000 pound charge in an igloo was equivalent to a bare charge of approximately 170,000 pounds of TNT.

In the equations given below of other parameters measured, the following symbols are used:

I_p = positive impulse (lbmsec/in.²)

I_n = negative impulse (lbmsec/in.²)

P_n = negative pressure (lb/in.²)

τ_p = positive duration (msec.)

τ_n = negative duration (msec.)

R = distance from center of charge (ft.)

W = weight of charge (lb.)

$$\frac{I_p}{W^{1/3}} = 23.3 \left(\frac{W^{1/3}}{R} \right)^{0.81}$$

$$\frac{I_n}{W^{1/3}} = 29.5 \left(\frac{W^{1/3}}{R} \right)^{0.78}$$

$$P_n = 9.4 \left(\frac{W^{1/3}}{R} \right)^{0.88}$$

$$\frac{\tau_p}{W^{1/3}} = 0.46 \left(\frac{R}{W^{1/3}} \right)^{0.24}$$

$$\frac{\tau_n}{W^{1/3}} = 4.1 \left(\frac{R}{W^{1/3}} \right)^{0.19}$$

Some representative pressure-distance measurements are as follows:

$\frac{R}{W^{1/3}}$ (ft/lb ^{1/3})	80	38	21	15	12.5	10.8	8.5	6.8
Peak Pressure (lb/in ²)	0.5	1	2	3	4	5	7	10

It is estimated that systematic errors inherent in the gage cause positive impulse results to be low by about 10 percent and peak pressures to be low by about 5 percent.

Second shocks were shown by the free piston gage records to have occurred in the explosions of Igloo E and the two revetments. It was stated that the time of occurrence of the second shock (the period) measured from the arrival

of the initial peak, depends upon the nature of the explosive, the presence or absence of a case, the weight of charge, and the distance from the charge.

7. Office of Naval Research.

(a) *General*.—The interest of the representatives of this agency, who collaborated with the United States Coast and Geodetic Survey, lay largely in determination of velocities accelerations and other characteristics of seismic waves and, through interpretation of the data, obtaining information on the subsurface structure of the lava plain. A report containing some of the results has been published by the United States Coast and Geodetic Survey and is in the Board's files. A more complete report is expected in the near future. Some of the information obtained is summarized below.

(b) *Subsurface velocity zones*.—Three distinct velocity zones are indicated. The subsurface to a depth of 700 feet is shown by logs of two water wells. The first zone, comprising thick beds of lava separated by thin layers of clay, sand and gravel, has a sound velocity of 6,600 ft/sec. and is approximately 500 feet thick. The second zone is similar to the first to a depth of 700 feet except for the presence of water. The sound velocity in this bed is

9,900 ft/sec. It apparently starts at the water table and extends to a depth of 4,500 feet. The third zone transmits the sound wave at 19,800 ft/sec. and may be tightly folded sediments or igneous rock.

Absorption coefficients for the third zone are as follows:

P wave - Period 0.2 sec. $a = 0.14$ per km.

S wave - Period 0.5 sec. $a = 0.09$ per km.

(c) *Surface displacements and accelerations*.—The following data refers to 250,000-pound explosions. Maximum ground displacement at the 7.2 mile station was approximately 0.00035 cm., and at 9.9 miles it was approximately 0.0002 cm. Accelerations at these distances were about 0.05 and 0.025 cm/sec.², respectively. These data were plotted on graphs together with similar data from the 1945 Arco tests, and average lines showing displacement and acceleration as a function of distance from the charge were drawn. On logarithmic paper, these lines were straight. At a distance of about 0.11 mile, maximum displacement was about 0.3 cm. in a wave having a period of 0.2 sec. Waves of longer period may have had greater displacements. Acceleration at 0.11 mile was about 520 cm/sec., representing a horizontal thrust of $0.53w$ pounds at the base of any object on the ground, where w is the weight of the object in pounds.

PART V. DISCUSSION

1. Review of explosion manifestations as perceived by observers.

(a) *Typical appearance*.—The simplest type of explosion included in the program was that represented by the revetment shots. These typified the case of detonation of an open charge with its center of gravity at or slightly above the earth's surface. The forms taken by the fire, smoke and shock wave in the case of a detonation of 500,000 pounds of TNT in a revetment as seen by the observers from a distance of 4.1 miles are illustrated by the sketches of an idealized explosion of this type, in figure 221. First to appear is the flash, shown in sketch (a). At about 0.1 second after the flash,

there is a mass of bright yellow fire whose lower edges are tinged with dark smoke, as depicted by (b). The protuberance at the top of the mass is the beginning of the fire ball which later pushes out of the top and emerges from the lower mass. The shock wave is leaving the mass at this stage, but cannot be seen as well as the arc drawn in this sketch, if it can be distinguished at all. In (c), the fire ball has emerged from the lower mass and is ascending rapidly. From its lower edges, it is ejecting masses of dark smoke and missiles which leave visible trails. The color of the fire has changed to orange or even red at this stage, which is of the order of one second after the flash. The lower mass consists of dark smoke and dust

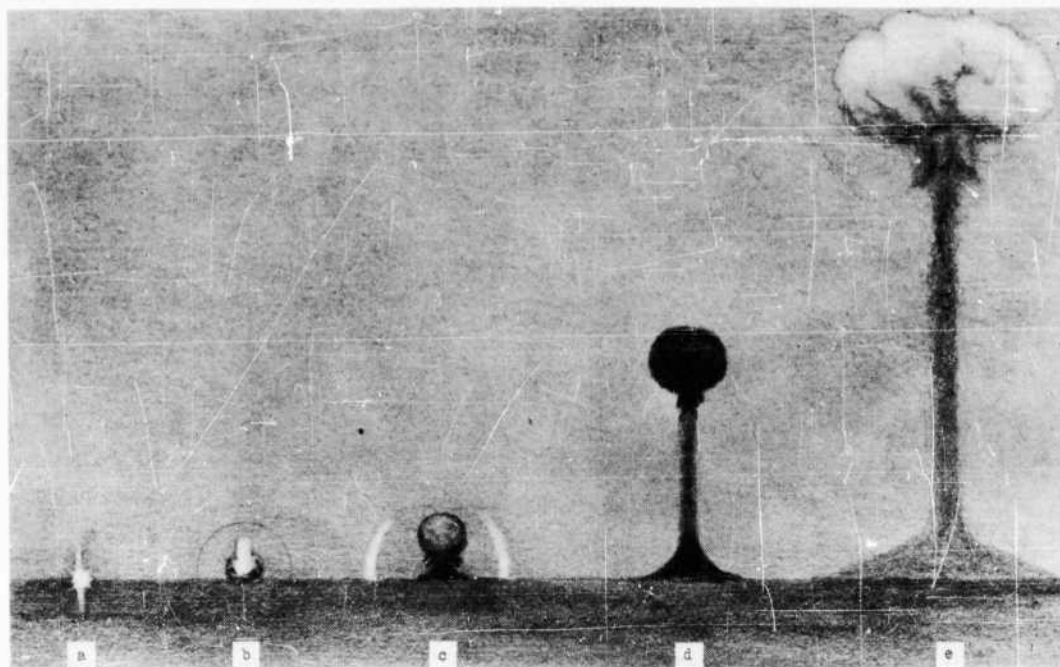

FIGURE 221. Forms of an idealized revetment explosion

and is shaped like a cone. The white vapor ring has emerged from the base and is at some distance from the center, appearing as a thin white arc moving radially outward at high speed. This is condensed vapor in the rarefaction portion of the shock wave, which is usually clearly visible and is erroneously thought to be the shock front itself by many observers. In sketch (d), the visible fire has played out of the ball, which now appears as dense black smoke, and is still rising rapidly, the smoke ejected from its bottom forming a continuous column connecting it to the funnel-shaped base. This stage is reached at from 10 to 15 seconds after the detonation. Sketch (e) shows the final stage of the cloud, prior to dissipation. It has reached maximum altitude, in this case about 10,000 feet, and the head has turned white, owing to condensation of water vapor in the explosion gases. The stem has expanded and is less dense, and the base has reached its maximum breadth (about $\frac{3}{4}$ mile), and is about to dissipate. The cloud reaches this form approximately 45 seconds after the detonation.

(b) *Effect of igloo on appearance of explosion.* — In the case of a detonation initiated within an igloo, the resulting fire and smoke

cloud is restrained by the concrete and earth cover in its initial vertical development, and is made to spread more in horizontal directions. The eventual height reached by the cloud is probably independent of the cover, being mainly a function of the mass of the hot gases and atmospheric conditions prevailing at the time. Figure 222 illustrates various stages of an idealized igloo explosion. The open fire-ball stage is much more brief and is supplanted immediately by the dark round smoke and earth cloud having sharp plumes shooting radially outward, shown in sketch (c). The fire is present inside the cloud but is largely obscured. In the next stage (d), the cloud takes a large irregular form and is composed of dense black or dark brown boiling or billowing rolls. In the final stage (e) the stem is much thicker than in an open explosion and expands as it descends to the wide, flaring base.

(c) *Effect on explosion when charge is stored in igloo with augmented earth cover.*—The effect of twice the standard amount of earth on the exploding igloo is to increase the breadth of the base of the cloud still further. Although the head of the cloud is not changed, it rests upon a fat pyramidal base without any intervening stem or neck. The maximum diameter



FIGURE 222. Forms of an idealized igloo explosion

of the base seems to be at least doubled. Figure 139 is a good illustration of this.

(d) *Appearance of shock wave.*—It was not the shock wave itself but its effect on the ground and the atmosphere that was seen by the observers on the hill 4.1 miles from the explosions. As it advanced over the surface of the ground, the blast picked up dust and loose surface soil and set them in turbulent motion. This formed a pall several feet in thickness, with its top parallel to the earth's surface and possessing a higher light reflectivity than the undisturbed ground. Passage of the shock wave was thus marked by a rapidly expanding circle of lighter-colored ground, which followed the blast wave until the latter's intensity dropped to a point at which it would no longer entrain dust and loose earth. In addition to the advancing "dust front" the presence of the wave was indicated by condensed atmospheric vapor in the rarefaction phase. As the pressure dropped below normal, the temperature fell below the dew point and droplets of water appeared, forming a whitish cloud which disappeared as soon as the pressure returned to normal; thus was created the wraith-like semi-circular band which traveled outward in the wake of the shock front.

(e) *The double report.*—Instrumental evidence of the existence of the second report as heard by the observers on the hill 4.1 miles from the explosions is found in the results obtained by the Woods Hole group with the free piston gages. Pressure-time curves based on their data show the pressure returning to normal following a relatively short negative phase, and then increasing above normal on a steep slope. Peak pressure values of the second shock were not indicated, but they were evidently a great deal lower than those of the primary shock. As previously stated, no adequate explanation of this phenomenon has been given. It seems probable that the shape of the charge, the degree of compactness or separation in groups, and the manner of detonation are intimately connected with this question.

2. Information obtained from high-speed motion pictures.

(a) *Chronology of destruction of exploded igloo.*—The Fastax films of the igloo explosions showed in every case that the front and rear walls failed first, as tongues of flame appeared at the ends before they emerged from the top. In the second or third frame after the flames

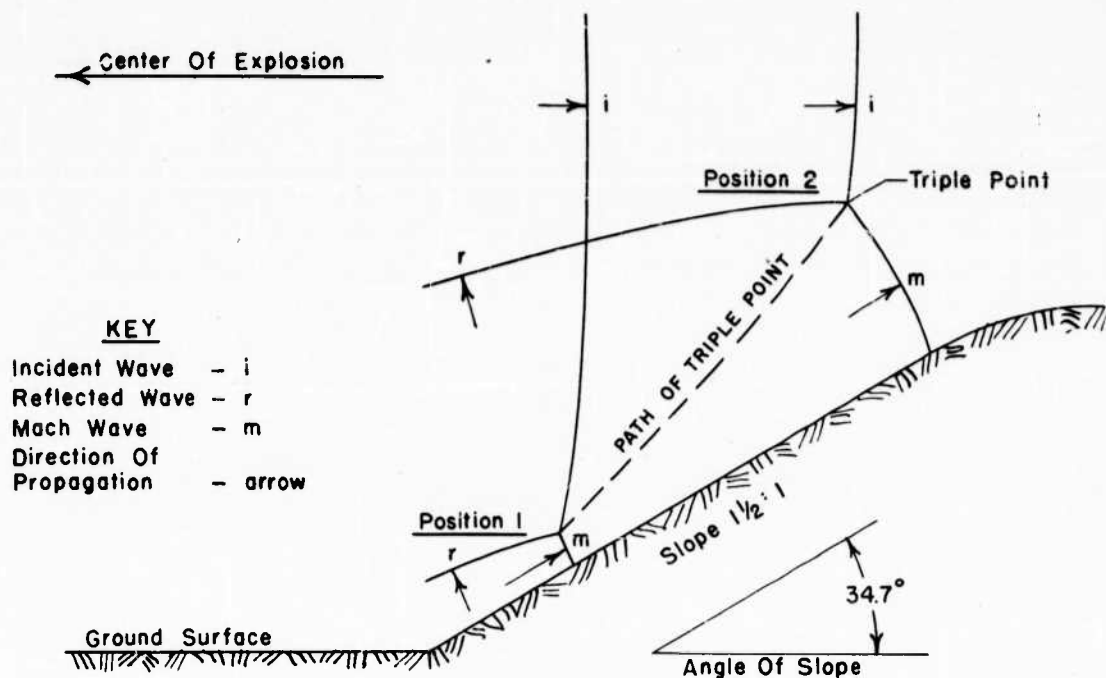

FIGURE 223. Mach reflection on sloping earth embankment of target igloo

appeared at the ends, small jagged tongues were seen emerging all along the top, as the latter disintegrated. Within two or three more frames, all flames had grown to such proportions as to join in one large mass of fire, and no portion of the structure could thereafter be distinguished. This sequence plus the fact that damage to target Igloo E in test 1 consisted almost entirely of failure of the front wall would seem to indicate that the weakest portion of the standard igloo as now designed is the end wall. For a time all that could be seen was brilliant flame; this indicates that a large part of the explosion gases had found their way past the solids of which the structure and its cover were composed. It is during this stage that the gases are pushing back the surrounding atmosphere and "piling it up" in a compression or shock wave which will travel outward separately as soon as the expansion of the ball of gases begins to slow down. Then the fire ball becomes tinged with smoke, and dark masses emerge, rapidly changing it into a dark gray or black cloud with plumes shooting outward and upward. The dark masses consist of the heavier matter, including smoke, earth, and small fragments of the structure, which are carried beyond the envelope of flame by their

greater particle momentum, while the flame recedes to the interior of the cloud and begins to die out.

(b) *Order of appearance of explosion phenomena.*—As recorded in the Eastman Hi-Speed films, the agents sent out appeared at a point about 200 feet from the center of a 500,000 pound igloo explosion in the following order: shock front, fire and smoke cloud, vapor cloud, and missiles. The shock front and vapor cloud of course continued to propagate away from the source at a diminishing velocity, approaching that of sound. The expansion of the fire and smoke cloud decelerated, however, permitting the missiles, which were relatively large fragments with considerable momentum, to overtake it. By the time the cloud had reached a diameter of 500 or 600 feet, most of the larger missiles were probably beyond it.

(c) *Appearance of shock front.*—The shock front itself, being a curved surface (theoretically spherical) in the atmosphere at which the pressure rises discontinuously from normal to a peak value, cannot be seen, for pressure or a change of pressure is not a visible entity. However the zone of compressed air refracts light rays passing through it in such a way as to distort objects seen through it, in much the same

manner as "heat waves" rising from a hot surface, such as a tarred roof in the summer sun. Where the shock front cuts across outlines of an object in the background, the outlines may be shifted and made discontinuous. When viewed from a suitable angle, preferably with illumination from a point on the opposite side of the wave from the observer, the zone of compression sometimes refracts the rays so as to form a dark line like the outline of a bubble. In the Hi-Speed film, the reflected waves appear in this manner, while the primary front is not visible. However, the latter's effect in distorting the background is apparent, and its position is marked by displacements of the outlines of background objects such as Igloo F.

(d) *Air blast: (1) Shock wave velocities and peak pressures.*—As calculated from the timing marks on the Hi-Speed films, the velocity of propagation of the wave is approximately 2,250 feet per second at 214 feet from the center of the explosion, and approximately 1,400 feet per second at 440 feet from the center, when the charge is 500,000 net pounds of TNT detonated in an igloo. By reference to the Rankine-Hugoniot function relating velocity of propagation of a shock front with increase in pressure behind it, pressures corresponding to these velocities have been calculated, giving values of 4.7 and 1.73 atmospheres, respectively. One atmosphere at the elevation of Arco being about 12.3 p.s.i. absolute, these values reduce to 45.3 and 8.9 p.s.i., gage pressure, which agree reasonably well with the pressures recorded by the blast meters, as recorded in figures 32 and 85 (about 35 p.s.i. 210 feet off-side of Igloo D in test 1 and 11 p.s.i. 440 feet off rear of Igloo E in test 2).

(2) *Mach reflection.*—As previously stated, a Mach reflection took place when the shock wave impinged on the sloping embankment of Igloo E in the first test. The triple point, or intersection of incident, reflected, and mach waves, appeared to form at the bottom of the slope and followed a characteristic rising path as it progressed up the slope. The relation of the three waves to one another and their directions of propagation are illustrated by figure 223, which shows the phenomena more clearly than any of the photographs. When a Mach reflection takes place, pressures on the reflecting plane may be several times the hydrostatic

value. The increase in pressure depends upon the angle of incidence of the wave on the plane. Under the conditions obtaining in the first test, the overpressure on the earth slope of Igloo E was of the order of 6 times normal atmospheric pressure at that distance, or about 62 p.s.i. instead of between 35 and 45 p.s.i. hydrostatic pressure behind the incident wave front. The angle of slope of the earth cover (1½:1) is rather favorable and avoids the extreme overpressure ratios of up to 10 or 12 which would occur on steeper slopes. The critical angle of slope in this test would have been about 54 degrees. Flatter slopes, of course, would decrease the overpressure, the lower limit being the "side-on" or hydrostatic value.

(3) *Blast loading on target igloos.*—From the foregoing information and the duration of the positive phase of the blast wave of 58 milliseconds at a distance of 200 feet from the center of an explosion of 500,000 pounds, determined from the equation presented in the Woods Hole report (Sec. IV-B) it is possible to construct a diagram, figure 224, approximately representing the positive pressure-time loading on the near side slope of a standard igloo in the event of an explosion of its next-in-line neighbor containing 500,000 net pounds of high explosives. This diagram does not represent conditions on top or on the lee side, because of differences in reflection and diffraction effects; however, it would probably be conservative to apply it over the entire igloo in design. Pressures indicated are for a distance of 200 feet. As the wave passes across the igloo, the pressures decrease, while the duration and wave-length increases. Pressures are believed to be considerably attenuated in passing through the earth cover to the surface of the concrete. The negative phase is not shown because the maximum negative pressure is only from about one-half to one-fifth of the peak positive value. The negative duration is several times the positive duration, however.

3. Air blast measurements by ball crusher gages, foil and paper meters.

(a) *General.*—To facilitate comparison and study, the peak pressure-distance curves obtained in the first four tests have been repeated in figure 225, but in this case pressure is plotted

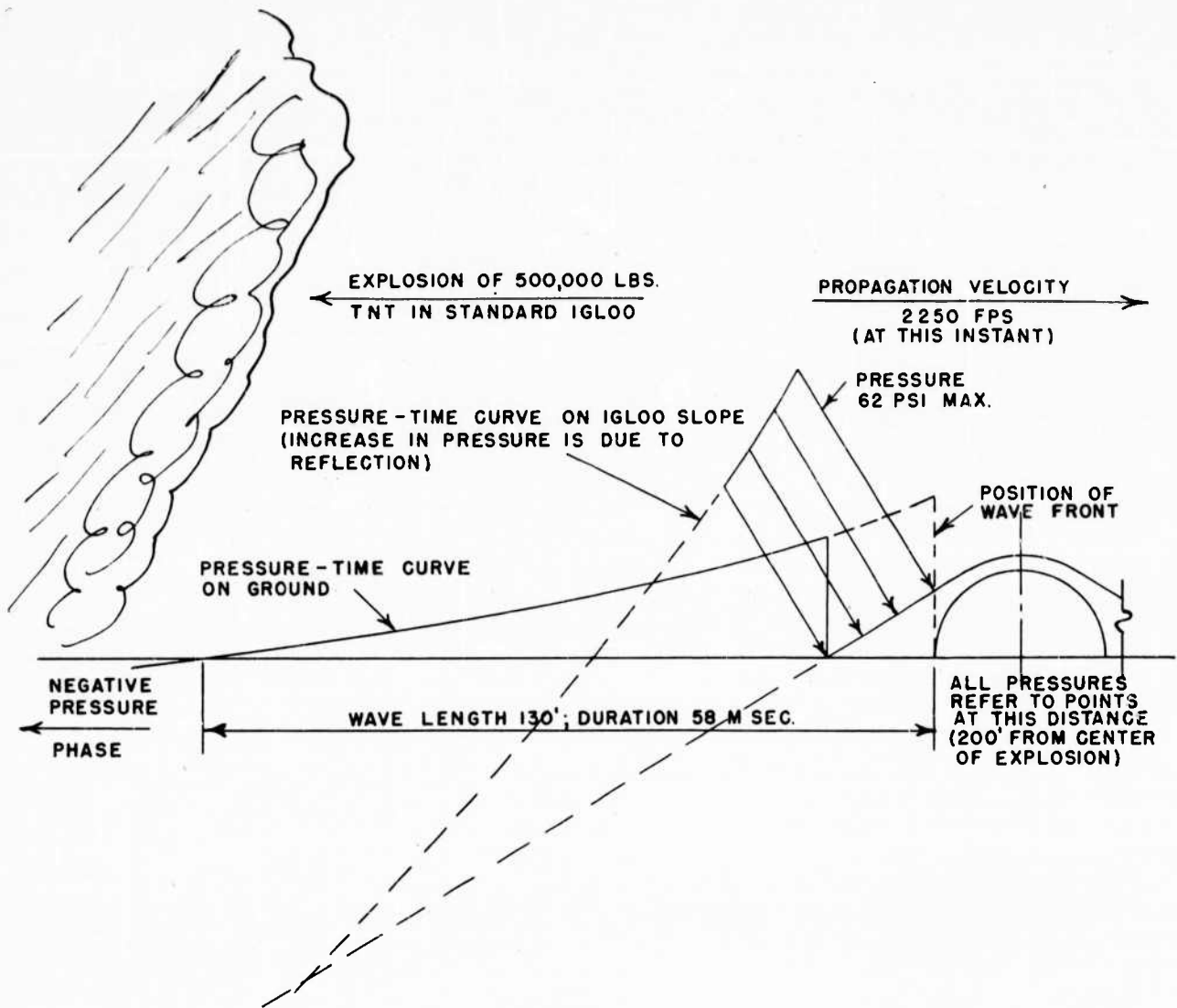

FIGURE 224. Blast loading on near side of igloo

as a function of reduced distance (distance divided by cube root of charge weight) in order that all might be plotted together, regardless of charge weight. In figure 225 (a), all off-front pressures are grouped together, and in figures 225 (b) and (c), off-side and off-rear pressures are grouped. For purposes of reference, the pressure-reduced distance curve reported in reference (3) for the 1945 Arco igloo tests is reproduced on the three graphs, as is also the pressure-reduced distance curve determined by the Woods Hole group with free-piston gages, in the 1946 tests. It will be noted that the three sets of curves form somewhat loose bundles whose means are fairly close to the

1945 curve and the 1946 curve determined from the Woods Hole piston gages. The latter represent average pressures on all sides of an explosion. At the lower end (region of greatest distances), however, the Woods Hole curve deviates considerably, becoming concave upward, whereas the ANESB curves tend to be concave downward, indicating lower pressures than Woods Hole at the extreme distances. The fact that the ANESB values were obtained from paper meters whereas the others were determined by a more advanced type of instrument would seem to indicate that greater credence should be placed on the latter in this region.

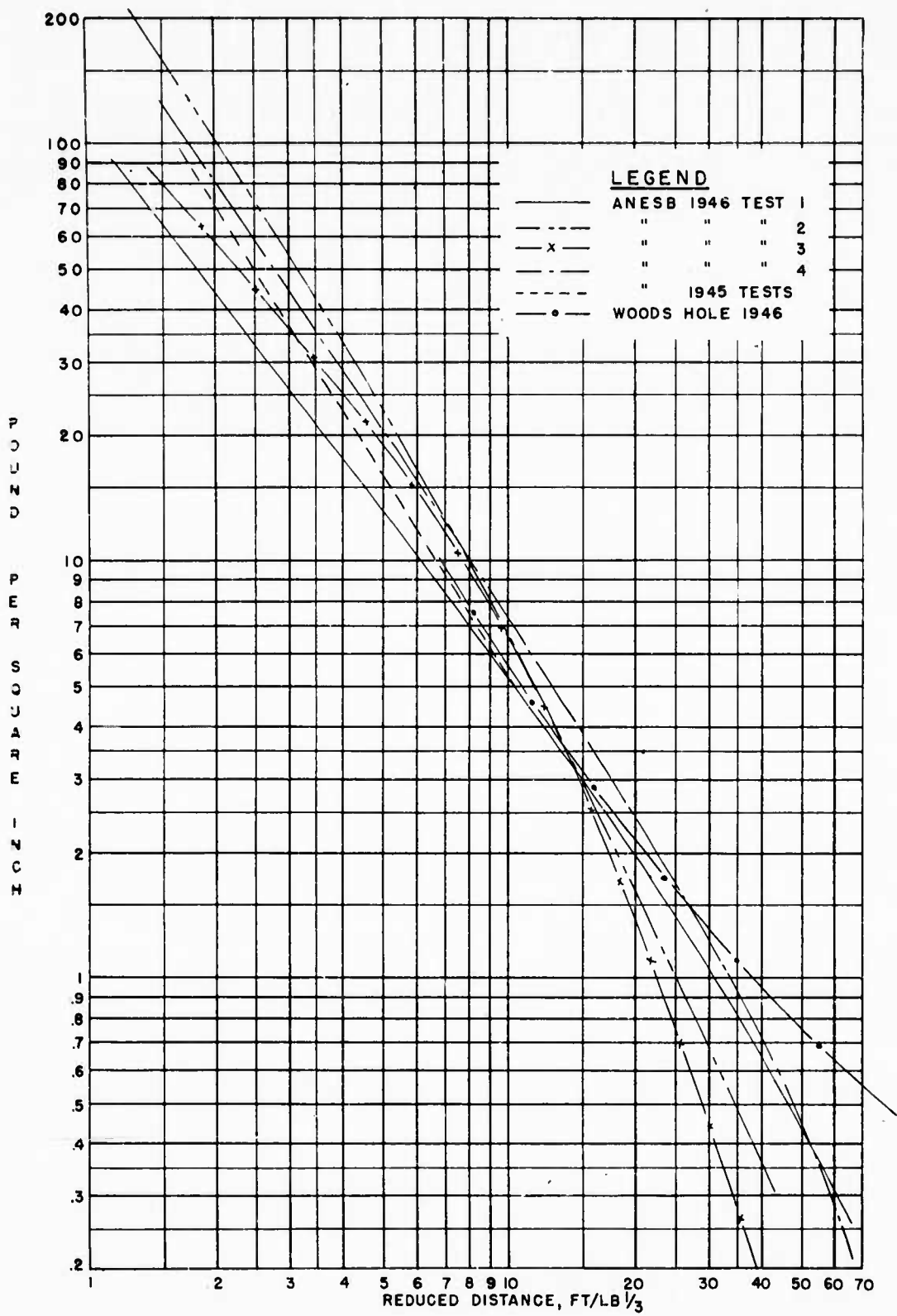

FIGURE 225A. Pressure-Reduced Distance Curves for Tests 1-4 incl. (Off Front)

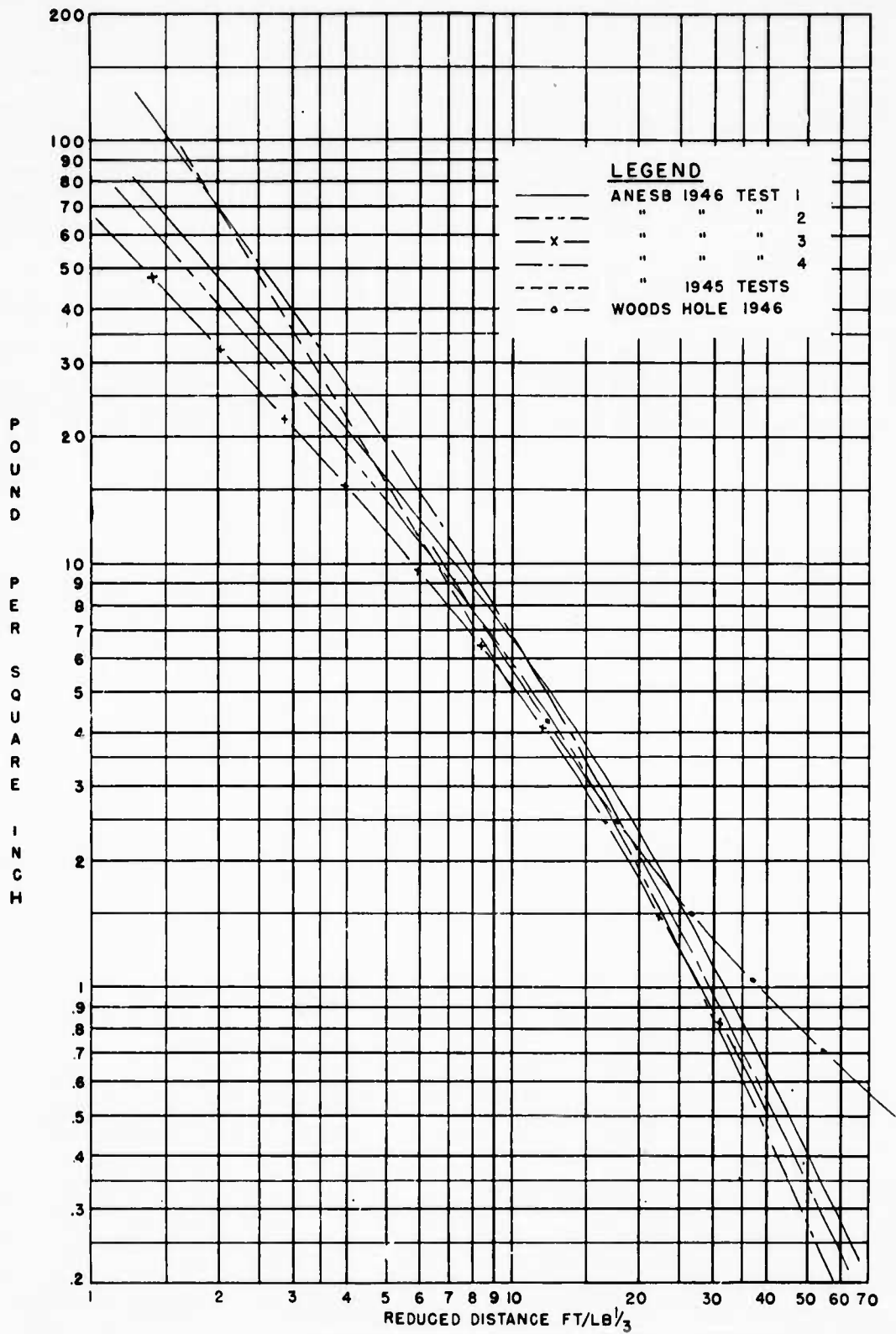

FIGURE 225B. Pressure-Reduced Distance Curves for Tests 1-4 incl. (Off Side)

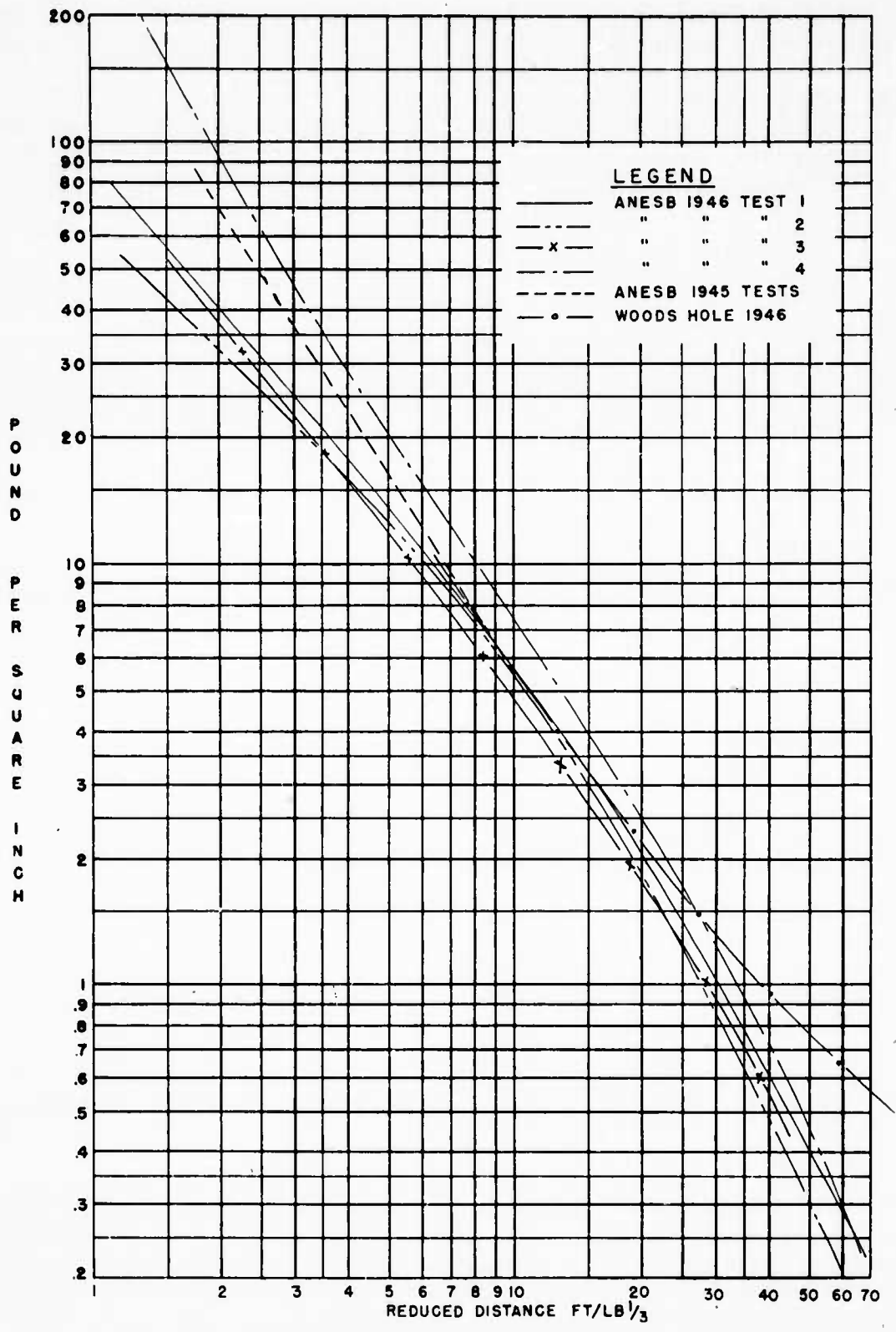

FIGURE 225C. Pressure-Reduced Distance Curves for Tests 1-4 incl. (Off Rear)

(b) *Asymmetry of blast.*—Other reports have indicated that in igloo explosions off-side pressures are greater than off-front pressures, and that off-front pressures are greater than off-rear pressures at the same distance. Figure 225 fails to show any consistent trend in these directions. If there were such an effect in these tests, it seems to have been submerged in the scatter of the data.

(c) *Comparison with values predicted from NDRC chart and with data furnished by other participating groups.*—Figure 226 is a pressure-reduced distance curve obtained by plotting values from the nomogram, "Peak Blast Pressure as a Function of Distance and Weight of Explosive," chart 3A1, Reference (4), together with a plot of the mean of the several igloo pressure-reduced distance curves as well as a plot of the mean of the revetment pressure-reduced distance curves in figure 225. The 1945 and 1946 Woods Hole curves are also redrawn on this figure. In addition, a curve representing the Inyokern data is plotted. The NDRC curve, which represents data from a large number of measurements on all types of bombs and explosives (estimated accuracy about 25 percent, almost coincides with the Revetment 1 curve from about 10 to about 2 p.s.i., but deviates markedly from the latter outside of this range, being concave upward while the revetment curve is concave downward. Values obtained by the Woods Hole group in the 1945 igloo tests do not confirm the upward divergence of the NDRC curve at higher pressures, but tend to agree with the curves obtained by the ANESB group. In the lower pressure ranges, however, the curve from the Woods Hole piston gages in the 1946 tests closely follow the NDRC curve, which may throw further doubt on the credence of the paper meters at pressures below about 1 p.s.i. The Inyokern pressures, obtained from velocity measurements, agree remarkably well with the ANESB mean igloo curve.

(d) *Effect of door barricade.*—As shown in figure 225 (a) and by a comparison of the ball crusher gage and foil meter readings on line 1 in tables III, IV, V and VI, pressures at close ranges in front of the exploding igloo were consistently much greater in test 2 than in test 1. This may be interpreted as an indication that the standard earth and concrete door barricade,

which was provided in front of Igloo D in test 1 but lacking in test 2, was of considerable effectiveness in reducing blast pressures in front of the exploding igloo at short and medium distances. For example, at 150 feet, the pressure was reduced from about 120 to about 50 p.s.i., and at 400 feet, from 23 to 13 p.s.i. The difference decreases with distance, however, and beyond 1,000 feet is uncertain. The greater severity of blast at close range in front of an igloo without door barricade was also demonstrated in the effect on the surrounding ground and nearby objects. The nearest foil meters and other objects such as steel pipes driven in the ground which were relatively unharmed in test 1 were riddled with missiles, torn apart or blasted away in test 2. In addition, there was a larger burned area on the ground in front of Igloo E than there was in front of Igloo D.

(e) *Effect of storing charge in a standard igloo rather than in open.*—From figure 226 it is evident that average pressures at close range from an igloo explosion are considerably less than from an open revetment explosion. At long range, however, the curves tend to converge, and in view of the vagaries of the individual curves of figure 225, the advantage of igloos over revetments indicated in the lower portions of the curves of figure 226 may not be significant. However, the difference between the curves in the lower range is comparable with that found to exist in the model igloo tests (reference (2)). If the difference is assumed to be reasonably near the correct amount, the following interpretation may be made: At a pressure of 0.2 p.s.i., the reduced distance value for the revetment test is 68 ft./lb.^{1/3}, and for the igloo tests is 60 ft./lb.^{1/3}. The true distance in the former case is 5,400 feet, and in the latter case is 4,760 feet. The American Table of Distances specifies 5,410 feet, as the inhabited building distance for 500,000 pounds of high explosives, while 4,780 feet is specified for 350,000 pounds of high explosives. Based on these figures, it may be said that storing ammunition containing 500,000 net pounds of high explosives in an igloo warrants a reduction in inhabited building distance of about 12 percent and is the equivalent of an open revetment storage of ammunition containing about 350,000 net pounds of high explosives. The foregoing is based on an assumption that equal

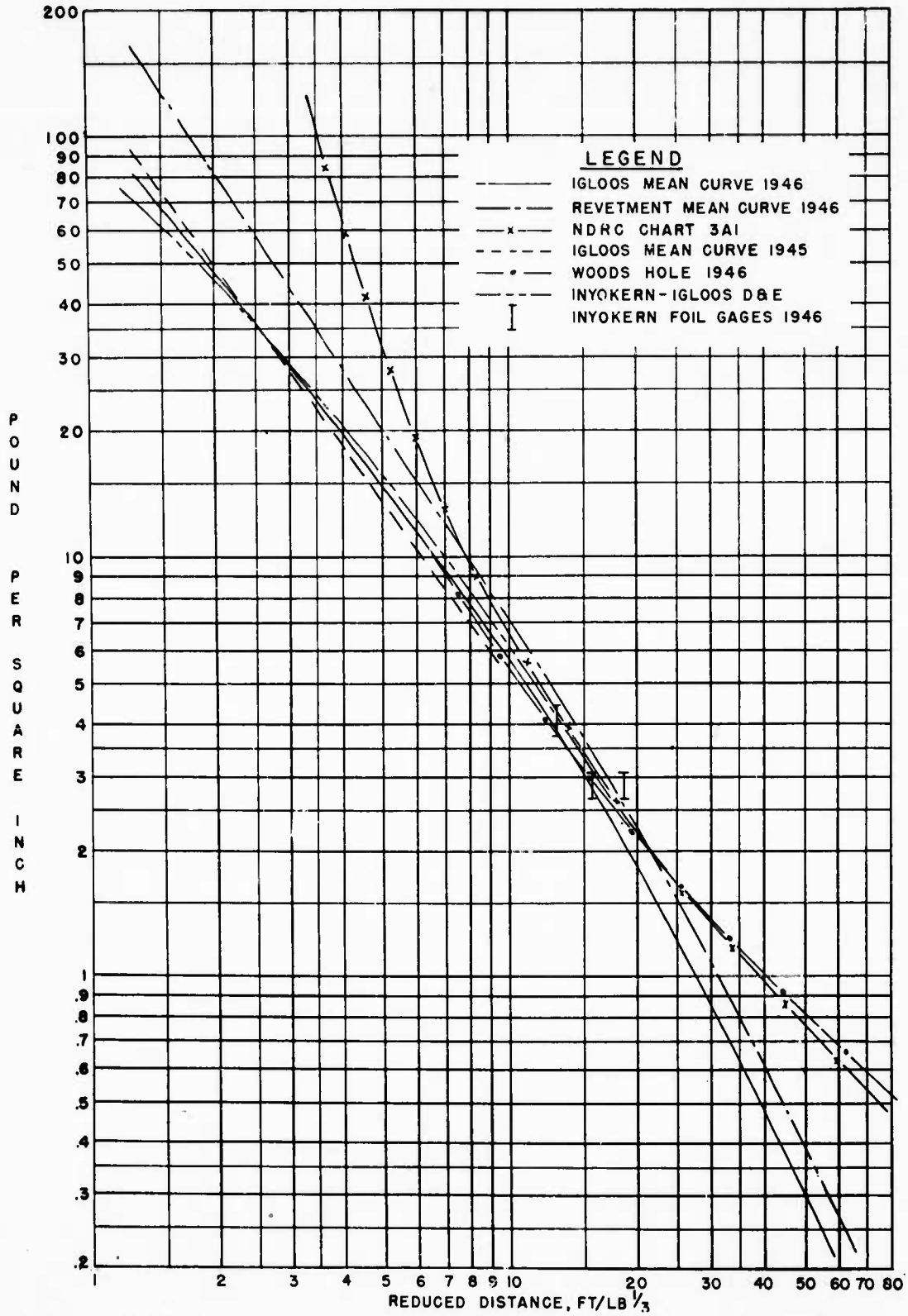

FIGURE 226. Comparison of Pressure-Distance Curves from Igloos and Rev. 1 with Curves from other Sources

damage will result from equal peak pressures, which is not quite correct. An equally important criterion of ability to do damage, i.e., positive impulse in the blast wave, has so far been neglected, inasmuch as no measurements of this parameter were made by the ANESB group. As reported in part IV-B hereof, however, the Woods Hole group obtained measurements of positive impulse in the last four tests, and concluded that the impulse from detonation of a 500,000-pound charge in an igloo was equivalent to that from approximately 170,000 pounds of bare TNT. The American Table of Distances specifies a distance of about 3,900 feet for the latter weight, which corresponds to the distance specified for 500,000 pounds reduced by 28 percent. Part of the reason for the greater reduction based on the Woods Hole results may be the fact that blast intensities from bare charges are greater than from cased charges such as the mines detonated in the revetments in these tests. It also may be true that casing and earth cover may reduce positive impulse proportionately more than it reduces peak pressure. True evaluation of ability to damage a specific structure or member thereof must take both parameters into account (for if the load is not great enough an elastic structure will not fail regardless of how long the load is applied; and con-

versely, if the load is great enough to produce failure but is not applied for sufficient time, the structure will not reach critical distortion but will oscillate about its normal position and finally return to rest) as well as reflection phenomena and the physical properties of the structure or member itself and even in the case of a simple frame house is a tremendously complicated problem. Efforts have been made to correlate damage levels with impulse statistically, such as in the case of bomb damage suffered by heavily built-up areas of London in World War II. This correlation was only partially successful and would not apply to areas where other than brick bearing-wall construction predominated or where detonations of much larger quantities of high explosives were involved. In the present instance the values of peak pressure and impulse are utilized merely as general guides to estimated changes in degree of damage which might result from a change in another variable in a given case.

(f) *Effect of increased earth cover over primary igloo.*—Comparison of the pressure reduced-distance curves for tests 1, 2, and 3 in figure 225 fails to disclose any consistent tendency to different pressures in the case of test 3. Accordingly, it cannot be said that these tests showed a decrease in blast pressure as a result of the doubled earth cover on Igloo F.

TABLE XIV.—Comparison of craters

Test	Charge pounds	Explosive	Shelter	Crater diameter—d ft. (average)	Crater depth—h ft. (apparent)	$\frac{d}{W^{1/3} (1)}$	$\frac{h}{W^{1/3} (1)}$
Arco No. 1 ('45) ..	250,000	50-50 amatol	Igloo	175	8	2.78	.127
Arco No. 2 ('45) ..	125,000 do	Revetment	81	7.7	1.62	.154
Arco No. 3 ('45) ..	250,000	Torpex	Igloo	142	17.8	2.25	.283
Arco No. 5 ('45) ..	250,000	.. do	do	146	10.7	2.32	.170
Arco No. 6 ('45) ..	125,000	50-50 amatol	Revetment	88	10.9	1.76	.218
Arco No. 7 ('45) ..	250,000	Amatol and other ..	None	110	3.9	1.75	.062
Arco No. 8 ('45) ..	250,000	TNT	do	112	14.9	1.78	.236
Camp Edwards No. 1	250	80-20 amatol	do	14.5	2.5	2.30	.397
Camp Edwards No. 2	250 do	do	15	3.6	2.38	.572
Arco							
Model No. 1	250 do	Igloo (standard cover) ..	15.8	2.1	2.51	.333
Model No. 1A	250 do do	14.5	2.0	2.30	.317
Model No. 2	250 do	Igloo (2 x stand. cover)...	14.0	2.2	2.22	.349
Model No. 3	250 do	Igloo (4 x stand. cover)...	15.2	2.4	2.41	.381
Model No. 4	500 do	Igloo (standard cover)....	20.4	2.1	2.57	.264
Model No. 5	500 do	Igloo (2 x stand. cover)...	16.0	3.3	2.02	.415
Model No. 6	250 do	None	11.2	1.8	1.78	.286
Model No. 7	250	do	Revetment	10.1	2.5	1.61	.397
Arco No. 1 ('46) ..	500,000	TNT	Igloo	165	13.5	2.08	.170
Arco No. 2 ('46) ..	500,000	do	do	177	10	2.23	.126
Arco No. 3 ('46) ..	250,000	do	Igloo (2 x stand. cover)...	137	9	2.19	.143
Arco No. 4 ('46) ..	500,000	do	Revetment	138	16	1.74	.202
Arco No. 5 ('46) ..	250,000	do	do	122	9.6	1.94	.152

(1) Crater dimension divided by cube root of charge weight, ft/lbs.^{1/3}

The model igloo tests (reference (2)) also had indicated very little decrease in pressure until the quantity of earth was quadrupled. Results from Woods Hole as stated in section IV-B indicated that no difference in pressures could be discerned and contained no conclusions regarding the effect on impulse, perhaps because of an insufficiency of data in the latter case. Obviously, if earth cover were increased to a sufficient extent, blast intensities would be reduced, for if a charge is buried deep enough underground, there is little or no air blast at all, the total explosion energy being absorbed in the ground. But in the case of a standard igloo or one with twice standard cover, the proportion of the total explosion energy which is absorbed in the cover is evidently not great. Assuming that the kinetic energy of the concrete and earth as it is propelled outward is deducted from the energy available for formation of the air blast wave, there would be a loss of $\frac{1}{2}Wv^2/g$ or about $\frac{1}{2} \times 4,500,000 \times 1000^2/32.2$ (W is approximate weight of concrete and earth in standard cover, pounds; v is mean maximum velocity of particles, assumed to be 1,000 ft/sec.; g is acceleration of gravity, 32.2 ft/sec.²) which reduces to 7×10^{10} foot pounds. The heat of explosion of TNT is 1,080 calories per gram, whence the total energy released by the explosion is 500,000 pounds \times 453.6g/lb \times 1,080 cal/g \times 3.09 ft lb/cal = 76×10^{10} foot pounds. The loss being of the order of 9 percent of the total available, it does not appear that its effect would be easily discerned from gages whose deviation from the mean is as much as 30 percent unless a great many more measurements were taken.

4. Cratering.

(a) *General.*—Craters from the igloo explosions were roughly circular in plan, or elliptical with the long axis parallel to the longitudinal centerline of the igloo. The maximum apparent depth was no more than about one-tenth of the average apparent diameter, and the deepest point, though not at the center, was no more than half a radius from it. Much of the earth excavated by the explosion fell back into the crater at random, forming haphazardly located hollows and mounds, so that the general effect was one of great irregularity and unevenness. Lips about half as high as the greatest depth

were formed on all sides but tended to be lower where the front of the igloo, which had no earth cover, had been. The true depth was from 2 to 3 feet deeper than the apparent depth at points investigated. Backfill was blackened and all large stones and pieces of gravel were shattered. Earth below true bottom was apparently undisplaced but much aggregate was cracked. In the igloo craters, the upper layers consisted of sand and gravel from the beds below the igloo foundations, but in the revetment craters, exposed soil was largely the silt from the overburden on the gravel beds. This fine-grained soil, when acted upon by the heat and pressure, formed a schistose material broken up in angular clods. In the igloo craters there was much structural debris, ranging from small bits of concrete and steel to large sections of foundation wall, shattered but recognizable. Such pieces were larger in the 250,000-pound explosion than in the 500,000-pound explosions. In the former case the walls had been pushed laterally to the edges of the crater and some pieces cast outside, whereas in the latter cases demolition was more complete, pieces were smaller and more scattered. Close examination of some of the broken pieces of concrete revealed that the cement bonding the aggregates together was apparently weakened, for such fragments were somewhat friable and not sound, as new, properly cured concrete should be. Many pieces remaining from the previous year's tests in nearby old craters were totally disintegrated, although this condition in their case was undoubtedly aided by a winter's frost. In the revetment craters there was little debris other than an occasional stick of wood or piece of sagebrush sucked into the center by the negative phase of the blast, but scattered on the ground around these craters were a large number of small slag-like hollow spheres about $\frac{1}{4}$ " in diameter, which could be crumbled easily between the fingers. These are believed to have resulted from fusion and oxidation of the sheet steel mine cases and crates.

(b) *Comparison of crater sizes with those of previous tests and those calculated from formulas.*—Data on the 1945 Arco craters, the Woods Hole model igloo craters, and the ANESB model igloo and revetment craters, previously reported in reference (2), are reproduced in table XIV together with data on

the craters from the present tests, to facilitate comparison and study. Some of the effects shown by this table are:

1. Craters from igloo explosions are, on the average, about 40 percent greater in apparent diameter than those resulting from explosions of charges either surrounded or not surrounded by revetments.

2. Increased earth cover on an igloo up to four times the standard amount seems to have no consistent effect on the dimensions of the crater formed by its explosion.

3. There is no consistent difference in the apparent depth of craters from igloos and those from revetments or unrevetted piles.

4. Apparent depths do not follow the cube root law; however, they may be estimated by the formula $h = .72W^{0.21}$ (h = apparent depth in feet and w = weight of explosives in pounds). Depths are more erratic than diameters, no doubt due to the haphazard manner in which earth falls back into the crater. It is possible that the presence of volcanic rock underlying the gravel beds just below the bottoms of the craters may be partly responsible for the failure of the depths to follow the cube root law, hence the above expression may not hold good for locations other than Arco.

The formula for apparent depth of the Arco craters is compared below with formulas given by other authorities:

Source	Formula	Diameter for 500,000 lbs. H.E.
British	$d = 8/3 Q^{1/3}$ (where d = dia. in feet, Q = charge weight in pounds).	212
French	$r = 0.5 P^{1/3}$ (r = radius in meters, P = charge in kilograms).	200
Capt. E. R. Gaylor, (C.E.C.), USN, Ret.	$d = 2.5 Q^{1/3}$	199
Olsen	$r = .69 Q^{1/3}$ (r = radius in feet)	470
Arco	$d = 2.3 W^{1/3}$	183

The first four give values somewhat too large for the results of these tests, and evidently the Olsen formula is applicable only to small charge weights.

5. Apparent depths are unaffected by the presence of cover or lack of it.

6. Apparent diameters follow the cube root

law in the Arco soil and may be predicted within about 15 percent by the formula $d = 2.3\sqrt[3]{W}$ (where d is diameter in feet and W charge weight in pounds) for igloo explosions and by $d = 1.7\sqrt[3]{W}$ for explosions of revetments or unrevetted stacks. These formulas should hold good for any soil similar to that of Arco, i.e., gravel, sand, silt, and clay mixtures, provided that the shape of the pile of explosives is rectangular and its proportions do not differ radically from those of these tests.

5. Ground movement.

(a) *Comparison with 1945 tests.*—Horizontal ground displacements in the Igloo F test, in which the charge weight was the same as in the 1945 tests, were less than but followed the same general pattern as those of the 1945 tests. In the explosion of Igloo A in 1945, movement at 100 feet from the center was from 2 to 3 feet outward, whereas it was only about 1 foot outward in the Igloo F test. At 250 feet from the center, outward movement averaged about $3/4$ inch for Igloo A and about $1/4$ inch for Igloo F. Comparison of vertical displacements at 100 feet is uncertain due to the number of stakes lost in the explosion of Igloo F, but comparison at 250 feet shows an average upward movement of about $1/4$ inch in the case of Igloo A, while there was a downward movement of about $5/8$ inch in the Igloo F test. There appears to be no satisfactory explanation for this disagreement. It is questionable whether the increased earth cover on Igloo F is responsible; the differences may be wholly fortuitous.

(b) *Horizontal vs. vertical movement.*—In the range of distances from 100 to 150 feet from the center, the greater movement was in the horizontal direction in all tests, including the revetments. Beyond these distances, however, horizontal movement attenuates more rapidly than vertical and at 250 to 350 feet, becomes quite small or dies out, while the vertical movement is still about 0.8 inch, on the average. At the distance at which a next-in-line igloo would be located (214 feet when standard intermagazine spacing is halved) the horizontal and vertical displacements are roughly $2\frac{1}{2}$ inches outward and 1 inch up or down, but when a next-in-line igloo is actually present, as in test 1, horizontal displacement evidently fails to develop to the extent that it

does on free ground, for in test 1 there was no measurable horizontal movement at or immediately around Igloo E. However, vertical displacement seems aggravated where an igloo is present, possibly due to subsidence of the structure itself.

(c) *Movement in igloo explosions compared with movement in revetment explosions.*—Horizontal and vertical displacements at distances from 100 to 150 feet from the center in the igloo tests were about double the values measured in the revetment tests. The difference was probably due to the enlarged crater diameters in the case of the igloo explosions. At 350 feet from the center, however, there was no appreciable difference in displacements between the two types of tests, which indicates that the effect of an igloo and its earth cover on surface ground movement is wholly local.

(d) *Ground shock and effect on target igloos.*—It is assumed that permanent displacement of the ground surface is indicative of the amplitudes of the surface earth waves which produced them, for "permanent set" in a material is a function of the causative stress. Thus it is inferred that surface ground shock at the distance of the target igloo (214 feet center-to-center) from the 500,000 pound explosions was about twice as great horizontally as vertically. However, since Igloo E failed to move horizontally but did move vertically as much or more than free ground surface at the same distance, it is thought that the structure through its foundations may have responded to body waves in the earth instead of surface waves, or that it settled because of blast pressure pressing down upon it, and that the surface displacement measurements are of limited significance insofar as effects on the target igloo are concerned, under the conditions obtaining in these tests. Nevertheless, the measurements showed that surface earth displacements are not sufficient to cause damage other than minor cracking to an igloo at half the standard distance from an igloo exploded when containing 500,000 pounds of TNT.

6. Permanent displacement of target igloos.

(a) *General.*—The floor of target Igloo E settled about 0.6" along the centerline. There was a slight tendency to tilt longitudinally downward toward the front where settlement

was about 0.4" more than at the rear wall. The levels also indicate that the igloo tipped laterally toward the explosion, subsidence being of the order of 0.25" greater on the near side. Target Igloo F in test 1 did not settle evenly; the arch and outer portions of the floor subsided about 0.1" while along the centerline the floor raised an average of 0.5". In test 2, Igloo F raised bodily about 0.1" except near the front along the centerline where the floor subsided 0.04".

(b) *Differential displacement of arch with respect to floor.*—There is fair agreement between the relative arch-floor movements as indicated by the slide gages and those determined by survey. Although the slide gage measured the radial component while the survey determined the vertical component of movement at each point, the readings should be comparable since the angle between the two component directions is not great. The disagreements are considerable in some cases, but their random nature leads to the belief that they were due to errors in taking readings, particularly since a small difference in location could make a relatively large difference in level reading when the rod was held against the under side of the arch. The general indications of the data are that the arch, perhaps in the negative phase of the blast wave, was raised slightly with respect to the floor in Igloo E, the greatest difference being 0.48" at the crown. In Igloo F, the arch was depressed in both tests, the maximum values being 0.13" at a point on the west side in test 1 and 0.10" at a point on the east side in test 2.

(c) *Comparison with displacements in 1945 test.*—Target Igloo B, subjected to a 250,000 pound explosion in the 1945 program, behaved similarly to Igloo E in the present tests, but the amplitude of settlement was only from $\frac{1}{2}$ to $\frac{1}{5}$ as great. This seems reasonable, in view of the fact that air blast pressures and, presumably, ground shock, were much greater in the 1946 explosion. Igloo B also tipped laterally slightly toward the explosion.

(d) *Indications regarding damage or propagation of explosion.*—The fact that displacements were slight confirms other observations to the effect that the target igloos were in little danger of incurring severe damage, and that their contents were not seriously disturbed.

There was, consequently, no appreciable danger of propagation of explosion. The displacements would have gone unnoticed in ammunition handling and storage operations in these igloos. In the case of Igloo E, the tipping of the structure toward the explosion is probably due to the greater blast pressure exerted upon the near side.

7. Transient arch deflections of target igloos.

(a) *Comparison of slide and string gage readings.*—In the case of target Igloo E, the slide gages indicated radially inward transient strains, presumably due to positive external pressure, of as much as 1.25" at the near-side third-point, 1.50" at the crown, and 1.0" at the far-side third-point. The string gage readings were much less, the greatest being only 0.81" at the near-side third-point and 0.30" at the far-side third-point. Two factors would tend to make the slide gages read high; these are overdrive of the slide indicator and the fact that upward floor heave would also register. Several factors would also tend to make the string gages read low; these are elastic shortening of the music wire, inertia and lost motion of the parts, and the angle between the wire and the radial direction. There is no way of knowing how much each of these factors contributed to the disagreement. In target Igloo F, deflections were much less than in E. The slide gages indicated maximum inward movements of 0.22" at the east-side third-point, 0.28" at the crown and 0.38" at the west-side third-point; the string gages indicated no movement at the east-side third-point and 0.23" at the west-side third-point. Positive or outward-movement readings, indicating strains presumably due to the suction phase of the blast, were generally larger than the inward-movement readings in Igloo E. This may be due to the fact that the minor cracking which occurred in the positive pressure phase reduced the effective stiffness of the arch in resisting the outward force. In Igloo F, outward movements were smaller than the inward values, perhaps because cracking did not occur in the arch barrel.

(b) *Comparison with deflections in 1945 tests.*—Arch strains in Igloo B in the 1945 program, according to the slide gages, were 0.95" inward and 1.15" outward at the near-side

third-point, 0.78" inward and 1.68" outward at the crown, and 0.71" inward and 1.17" outward at the far-side third-point. String gage readings were 0.22" (doubt was cast on this figure) inward and 0.04" outward at the near-side third-point, and 0.02" inward and 0.01" outward at the far-side third-point. These readings are generally less than those of the 1946 tests, as would be expected in view of the lower pressures exerted in the earlier explosion. The string gage readings differ from the slide gage values in the same direction but more markedly than in the 1946 test.

(c) *Stress study.*—Since it was inferred from the cracking of the inner surface of the arch barrel of Igloo E that the arch was near the point of technical failure, although probably not near the point of actual collapse, it was thought worthwhile to attempt to determine the stresses corresponding to the strains measured by the gages. In this calculation, only extreme fiber stresses due to bending of the arch were considered, and direct stresses were neglected. Various assumptions were made, some of which varied considerably from actual conditions. The arch was assumed to have fixed ends, which was not quite correct, since the footings as constructed were not rigidly connected to the floor slab nor the subgrade. The strain values used were those determined by the slide gages, in which an unknown error due to floor heave and other causes exists. The loading on the arch was assumed to be static and to consist of two parts: the first a unit horizontal pressure (1 p.s.i.) distributed over the vertical projection of the side elevation, and the second a vertical pressure, one-third of the lateral value, distributed over the span of the arch and acting downward. This loading assumption does not agree well with the actual case, in which pressures are greatest immediately behind the shock front and act normal to the sloping embankment, and in which the highest pressure is due to a Mach reflection on the near slope before the load extends over the entire arch (see figure 223). The procedure followed in the analysis, which was made in the Office of the Chief of Engineers, Army, was as follows:

- (1) Treating the arch as fixed, with static unit loading as described above, bending moments at a number of stations over the arch were calculated, and the moment diagram drawn.

- (2) Treating the arch as a conjugate beam, loaded with the M/EI (moment divided by product of modulus of elasticity and moment of inertia) diagram, its elastic curve, or deflection at any point, was determined.
- (3) Actual deflections at each point measured by a slide gage were divided by the deflections due to the unit loading, the quotient being the actual equivalent static loading which would have caused the deflection as read from the gage. The values agreed reasonably well and gave an average pressure of about 50 p.s.i., which is remarkably close to the peak dynamic pressures as measured by the blast meters at the same distance.
- (4) Equivalent static extreme fiber stresses for the concrete and steel due to the maximum bending moments, i.e., those corresponding to maximum actual deflections, were calculated. These were 18,500 p.s.i. compression in the concrete and 566,000 p.s.i. tension in the steel. These values are roughly 6 (the igloo concrete tested 3200 p.s.i. and 9 times the normal static ultimate strengths of concrete and steel, respectively. These values compare favorably with the ratios of equivalent static stress at point of dynamic failure to normal static ultimate strength, as determined by other investigators.

From the foregoing results, which are admittedly subject to errors due to incorrect assumptions, it might be said, lacking any better information for the time being, that external blast loading of 50 p.s.i. on one side of an igloo is equivalent to the static loading which would stress the steel and concrete of the arch to their ultimate strengths. This value of static loading is about 5 p.s.i. Since the target igloo stood up well and little if any safety factor seems necessary in designing igloo arch barrels to resist blast, it would seem that if the structure is designed to withstand a static loading of 5 to 6 p.s.i. applied horizontally against the vertical projection of the side elevation, plus 1.7 to 2 p.s.i. applied downward across the span of the arch, it will withstand the explosion of 500,000 pounds of TNT in the next-in-line igloo 185 feet distant. Since the front wall of the igloo actually failed, however, this portion of the structure should probably be designed for a somewhat greater value of static load, such as 10 p.s.i.

8. Damage to target igloos.

(a) *Comparison with damage sustained in 1945 tests.*—As reported in reference (1) dam-

age to target igloos in the 1945 tests was confined to blowing off of ventilators, some slumping of earth fill and minor cracking of concrete. Cracks were quite minute even in the closest igloo, in which the worst crack, which passed over the crown of the arch, was a continuation of a previously noted crack. Generally speaking, the damage was almost negligible in the 1945 tests. That which occurred in the 1946 tests was of similar character but more severe, as would be expected inasmuch as blast pressures were of the order of 30 percent greater.

(b) *Incipient arch failure.*—In Igloo E after test 1, longitudinal cracks on the inner surface of the arch were grouped about 7 feet above the floor on each side of the igloo. These groups of cracks were in the same locations as those experienced on the sides of the target igloos in the model igloo tests (reference (2)). Presumably as the blast wave struck the near side of the igloo broadside on, the live loading reaching the concrete arch was so distributed as to cause maximum positive bending moment (resulting in maximum tension in arch intrados surface) at a level about one-third of the distance from springing section to crown. As the blast wave propagated across the igloo, the unsymmetrical loading traveled around the arch, causing a second maximum positive moment about one-third of the distance from springing section to crown on the far side. If the blast loading were great enough, buckling would probably occur at these "lower sixth points," followed by collapse of the arch barrel. It should be borne in mind that Igloo E was of Army pre-war design and contained intrados reinforcement, as did Igloo B in the 1945 tests. What extent of arch failure would have taken place had the target igloos been of wartime design, with reinforcement in the extrados only, is a matter of conjecture, although it appears unlikely that collapse would have occurred. In the model tests the target igloos, which simulated wartime construction and lacked intrados reinforcement, sustained much more severe longitudinal cracking but were in no immediate danger of collapse.

(c) *End wall failure.*—The front end wall of Igloo E suffered rather severely, the tendency being to tear it off the end of the arch barrel. It was probably cracked and deflected inward during the positive phase, and then as the out-

side pressure fell below that existing inside, it was pushed violently outward. Where the wall was separated from the edges of the arch barrel, the failure appeared to be in bond and not tension failure of the steel. It seems that in order to bring the strength of the front end wall up to that of the balance of the igloo, the section modulus should be increased and greater bond surface provided in the peripheral joint between wall and barrel. Inasmuch as the rear end wall suffered negligibly, the front wall could be as well protected by placing an earth embankment against it; however, this would entail considerably greater expense in providing a tunnel entrance or one flanked with retaining walls, and storage operations would be hindered. Although the case of an igloo having a standard earth and concrete door barricade was not tested in this program, it appears doubtful whether in such case the barricade would have been effective in preventing the front wall damage, in view of the direction of approach of the shock wave.

(d) *Damage to floor.*—The floor slabs suffered no appreciable damage and appear well designed.

(e) *Damage to minor appurtenances.*—(1) Door: The Army door design appears to be adequate and no changes appear necessary. The Navy type door, which is larger, was not tested in this program but in the 1945 tests appeared to be weak and in need of strengthening. (2) Ventilator: The Army type ventilator (concrete chimney type) was sheared off the rear wall by a transverse twisting or torsion. A Navy umbrella-shaped terra-cotta ventilator would undoubtedly have been blown off. Since it is desirable to ventilate igloos effectively in order to minimize moisture condensation and dispel fumes, some form of ventilator protruding above the earth cover appears inevitable; the optimum design would appear to consist of a concrete flue extending not more than about 4 inches above the surface of the earth cover, surmounted by a metal or ceramic static wind-actuated type of ventilator which would be blown off in the event of a nearby explosion but could be replaced at less expense than would be entailed in reconstructing a concrete chimney type of ventilator. (3) Door pad: The concrete slab in front of the door was separated from the front wall of the

igloo in test 1 but otherwise intact. No change seems necessary.

(f) *Disturbance of contents.*—Inasmuch as damage was slight and ground shock evidently not severe, the stacks of bombs were not visibly disturbed or displaced, and it is safe to conclude that there is little danger of initiation of explosion from ammunition falling to the floor of the magazine under conditions such as those which existed in test 1, provided the ammunition is properly stowed and secured in stable stacks.

9. Damage to revetments.

(a) *Effect on earth embankments or windrows.*—Erosion and subsidence were minor in extent and speak well for the stability of embankments of granular soil such as that encountered at Arco on a 1½:1 slope, when subjected to nearby heavy explosions such as those of these tests.

(b) *Disturbance of contents.*—The violent displacement and scattering of the mines, as well as the shower of debris which fell upon them, would seem to indicate that had the explosive filler been of a type sensitive to ignition through shock due to acceleration, impact, or denting of the container, the probability of an explosion would have been great. Thus it appears that revetment storage at 400-foot clear distance from a 500,000 pound concentration of high explosives would be risky if the explosives stored in the revetment were much less stable or insensitive than TNT.

10. Damage to barracks.

(a) *Comparison with barracks damage in 1945 tests.*—The present tests generally confirmed the results of the 1945 program insofar as extent of damage to the barracks at the halved (unbarricaded) A.T.D. inhabited building distance was concerned. Superficial damage, involving torn siding, demolished window frames, sash and trim, and blown-in doors, frames and trim was about equal in both tests. The incidence of flying glass was approximately the same in both tests. Structural damage, i.e., displaced, cracked or splintered framing members and sheathing was somewhat more severe in the 1946 test.

(b) *Decrease in damage with increase in distance.*—The table entitled "Type of damage"

shows how the extent of damage diminished rapidly as the distance from the explosion increased in test 1.

Type of damage

Barracks	Superficial	Glass	Structural
1 (2,705 ft.)	a. 100 sq. ft. of siding torn, north side. b. 20 sq. ft. of roofing torn, east slope. c. 3 window frames and trim blown in. d. 26 sash blown in or out.	a. 93 panes (all types) cracked, broken or missing. b. Flying glass—severe.	a. 25 studs and 4 diagonal braces damaged in north wall. b. 1 damaged stud in east wall. c. Several plates broken in north wall. d. Some broken sheathing boards on north wall. e. Post knocked out of north wall. f. 7 rafters split. g. East roof girder broken.
2 (3,605 ft.)	a. 4 sq. ft. of siding torn, north side. b. 15 sq. ft. of roofing torn, east slope. c. 6 sash blown in or out.	a. 42 panes (all types) damaged. b. Flying glass—extensive.	a. 9 damaged studs and 1 broken diagonal brace in north wall. b. A few plates split. c. Some sheathing broken.
3 (5,410 ft.)	a. 15 sq. ft. of torn roofing, east slope.	a. 30 panes (all types) damaged. b. Flying glass moderate.	a. 2 studs cracked in north wall.

(c) *Nature of superficial damage.*—The asphalt felt siding was torn in numerous places, and the tearing and exposure of sheathing progressively worsened with repeated blasts. This cannot be construed as a guide to the nature of damage to ordinary wood siding, which undoubtedly would have withstood the explosions much better. It is believed that stucco or brick veneer siding would have sustained considerable damage consisting of extensive cracking and perhaps falling out or toppling of sections, however. The roll roofing, which was of lightest grade normally used in buildings, suffered remarkably little, and the single tear in each building did not worsen a great deal with repeated blasts. Perhaps a roofing of asphalt or wood shingles or shakes, which has many projecting edges under which

blast may exert a force, would have suffered more, but the heavier types of felt, built-up, metal, asbestos cement, or tile roofing would have withstood the blasts with no damage, in all probability. Exterior trim stood up remarkably well, suffering only to a minor extent even in the closest building. Window frames and sash sustained severe damage in the nearest building, limited damage in the medium-distance building, and negligible damage in the farthest building. Many whole frames together with the sash were blown violently into the building in Barracks 1, and odd sash were blown in in other windows in which the frames remained in place. Other sash suffered broken rails and muntins without being dislodged from position. Obviously the windows were the weakest members of the building, and suffered the most serious damage, which does not speak well for the strength of the mounting nor of the windows themselves. Doors, although in the lee side of the buildings, showed indications of damage similar to that of the windows. Superficial damage (except to inside window casing) in the building interiors did not occur inasmuch as the buildings were not finished inside; however, there is a strong presumption that plastered walls and ceilings would have suffered seriously in the nearest building, to a considerable extent in the second building, and perhaps to a minor extent or not at all in Barracks 3. Had the first building been a completely finished and equipped structure, it is estimated that the cost of repairs to windows, interior surfaces, equipment, and property would have exceeded \$2,000. In Barracks 2, the cost would probably have been of the order of \$1,000, while in Barracks 3, it would probably have been under \$250.

(d) *Nature of structural damage.*—The rocking of the buildings on their foundations apparently did not result in appreciable permanent strains or distortions and seems of minor importance, particularly since ordinary buildings built on concrete footings or foundation walls would not be displaced as easily. On the other hand, if the buildings moved soon enough after impingement of the shock front, pressure on the superstructure may have been relieved to some extent, resulting in less damage to framing members. Failures of such members in the first test were confined largely to the north

wall, and consisted mostly of split and displaced studding, plates and sheathing. Plates apparently broke in flexure due to a force from the exterior, while some studs seemed to split in longitudinal shear due to flexure or perhaps in cross-grain tension due to "scabbing effect," i.e., the tendency of material near one surface of a member to fly off upon an impact being received on the opposite surface. Other studs were merely pushed inward, separating from the sheathing, without failure or with cracking only at ends due to resistance at points where they were nailed to upper or lower plates.

The greater incidence of damage to the north wall than to the east wall cannot be explained by reference to the peak pressures which theoretically were exerted upon these walls. Although the north wall was more nearly facing the blast (30° from face-on) than the east wall (60° from face-on), the latter was close to the critical angle for Mach reflection. Based on a peak hydrostatic pressure of 1 p.s.i. behind the shock front at Barracks 1, the pressure due to the reflection on the east wall was 2.4 p.s.i. and on the north wall was 2.0 p.s.i. The failure of the east wall to incur the greater damage leads to the presumption that the pressures possibly did not follow the theory because of lack of rigidity of the walls, or that impulses rather than pressures governed the damage. However, the theoretical relationship between the impulses on the two walls is not known, and experimental results of certain other tests tend to show that impulses are generally maximum under the same conditions of reflection as peak pressures. Glass breakage, which is governed nearly wholly by peak pressure, was much greater on the north wall than on the east wall in all buildings. It therefore seems most probable that the effective pressure on the north wall was in fact greater than on the east wall, and that there is some break-down in attempting to apply the theory in the case of these barracks.

There is no direct and simple way of correlating the failure of framing members (the incidence of which was roughly 50 percent in the north wall of Barracks 1 with the peak pressure, about 2 p.s.i., probably exerted on that wall. If a single 2" x 6" x 12' stud is treated as a vertical beam, simply supported at top and bottom, and continuously loaded with

the total pressure on a strip of exterior sheathing 12' in height and in width equal to the stud spacing (2'), and, assuming a modulus of rupture in flexure of 7,800 p.s.i. for the wood, the pressure causing rupture would be 1.1 p.s.i., which fortuitously is about the same as the hydrostatic pressure behind the shock front at Barracks 1. The actual peak pressure, about 2 p.s.i., attenuated to zero in about 0.2 second, before the full effect of impact developed, i.e., before failure progressed to the extent that would have been caused by a step-front non-decaying wave. As previously stated, it is not known whether the studs failed in flexure or by "scabbing."

Another obstacle in the way of correlating measurable blast pressures with structural damage is the fact that critical dynamic stresses differ from the static values. Impact tests on reinforced concrete beams in flexure have indicated that the dynamic moduli of rupture may be of the order of ten times as great as the static moduli.

To summarize, two factors tend to make blast damage more serious than that which would be due to a static load equal to the hydrostatic peak pressure measured by the blast meters: (1) Reflections, which increase the effective pressure on the wall, and (2) Impact effect, due to suddenness of application of the load. Two other factors tend to make blast damage less than that due to the same static load: (3) Rapid decay of the pressure, and (4) Higher moduli of rupture under dynamic loading. Probably in the case of the studding in the north wall of Barracks 1, these effects balance each other, so that there is apparent agreement between the critical value of a static load and the hydrostatic peak blast pressure obtaining at that distance.

Additional experimental data on hydrostatic peak pressure values of blast waves resulting in 50 percent incidence of failure of various structural elements exposed at various angles of orientation (e.g., 0° , 30° , 60° , and 90°) for a range of charge weights may lead to a practical method of designing structures to withstand air blast.

(e) *Failure of glazing materials.*—Table XV gives the number of each size of pane of each type cracked, broken, or torn in the north and east elevations of each barracks for test 1, and

TABLE XV.—Cracked and broken window panes in north and east elevations of barracks

Type	Pane size <i>Inches</i>	Test 1									Test 3		
		Barracks 1			Barracks 2			Barracks 3			Barracks 1		
		Exposed	Damaged	Damaged	Exposed	Damaged	Damaged	Exposed	Damaged	Damaged	Exposed	Damaged	Damaged
<i>Number</i>	<i>Number</i>	<i>Percent</i>	<i>Number</i>	<i>Number</i>	<i>Percent</i>	<i>Number</i>	<i>Number</i>	<i>Percent</i>	<i>Number</i>	<i>Number</i>	<i>Percent</i>		
DS glass	38 x 15	17	16	94	17	5	29	16	1	6	16	10	62
	12 x 15	32	6	19	32	0	0	32	0	0	35	4	11
	9 x 10	50	11	22	51	0	0	50	0	0	52	13	25
Wire glass 0.25"	38 x 15	4	4	100	4	2	50	4	0	0	4	3	75
	12 x 15	8	2	25	8	0	0	8	0	0	8	3	37
	9 x 10	8	1	12	8	0	0	9	0	0	8	5	62
Lumapane ...	38 x 15	2	2	100	2	2	100	2	2	100	2	2	100
	12 x 15	8	8	100	8	5	62	8	4	50	8	6	75
	9 x 10	8	5	50	8	0	0	8	0	0	11	5	45
Vimlite	38 x 15	2	2	100	2	2	100	2	2	100	2	2	100
	12 x 15	8	8	100	8	8	100	8	5	62	6	6	100
	9 x 10	8	8	100	8	4	50	8	3	37	8	8	100
Lumarith	38 x 15	1	1	100	1	1	100	2	2	100	—	—	—
	12 x 15	4	4	100	4	4	100	4	4	100	6	6	100
	9 x 10	8	7	87	8	8	100	7	6	86	3	0	0
Lucite 0.06"	38 x 15	1	0	0	1	1	100	1	1	100	1	1	100
	12 x 15	3	3	100	3	1	33	3	0	0	2	1	50
	9 x 10	5	1	20	3	0	0	4	0	0	4	1	25
Lucite 0.15"	38 x 15	1	0	0	1	0	0	1	1	100	1	1	100
	12 x 15	3	0	0	3	0	0	3	0	0	2	0	0
	9 x 10	3	0	0	4	0	0	4	0	0	4	0	0
Herculite 0.25"	38 x 15	1	0	0	1	0	0	1	0	0	2	0	0
	12 x 15	2	0	0	2	0	0	2	0	0	1	0	0
	9 x 10	2	0	0	2	0	0	2	0	0	2	0	0
Flexseal 0.25"	38 x 15	1	1	100	1	1	0	1	0	0	2	0	0
	12 x 15	2	0	0	2	0	0	2	0	0	2	0	0
	9 x 10	2	0	0	2	0	0	2	0	0	2	0	0
Duplate 0.25"	38 x 15	2	2	100	2	0	0	2	0	0	2	0	0
	12 x 15	2	0	0	2	0	0	2	0	0	2	0	0
	9 x 10	2	0	0	2	0	0	2	0	0	2	0	0

in Barracks 1 (in which all windows were re-glazed prior to the explosion) for test 3. The table also shows percentages of pane failures to the total number exposed in each case. In the following subparagraphs, the behavior and characteristics of each type of glazing material tested is discussed in order of blast resistance as determined by the percentages of failure, the most highly resistant being taken up first:

1. *Herculite*.—(tempered plate glass, 1/4" thick). Though blown out of the sash in some cases, this material was never cracked or broken either by blast or by falling to the floor. It probably would never fail under blast except at reduced distances less than about 10 ft/lb^{1/2} but might break under impact of a relatively heavy missile at greater distances. When broken, tempered plate glass separates into a large number of small nearly cube-shaped pieces, the length of a side of one cube being the same as the thickness of the plate. Being small and tending to cling together, these pieces do not fly far and do not present as great a hazard as large, jagged fragments. Tempered glass is probably the ideal material for resisting the effects of explosion; however, its high cost precludes general use.

2. *Flexseal*.—(laminated safety glass, 1/4" thick, with plastic edge zone). This glass cracked in

several instances but the fragments were successfully held together by the plastic core and there was no flying fragment hazard. The plastic edge did not appear to be of great benefit in reducing breakage.

3. *Duplate*.—(plain laminated safety glass 1/4" thick). This material withstood the blasts about as well as *Flexseal*. When it cracked, the fragments were held together by the core and prevented from flying into the building. Because of its relatively high resistance to blast and its nonfrag-menting characteristic this glass would furnish a high degree of security from the flying glass hazard to occupants of any building at one-half the A.T.D. distance for inhabited buildings. However, it is too costly for general use.

4. *Lucite*.—(acrylic resin sheet, 0.15" thick). Although this material was more resilient than glass, on reaching critical deflection it broke into irregular fragments similar to those of glass; and being lighter in weight, these pieces were propelled further into the building. One 38" x 15" pane was blown out intact and found on the floor next to the opposite wall. When the panes broke, the edges were not generally as sharp as those of glass fragments. Thus it appears that *Lucite* is somewhat more blast resistant and presents less of a flying fragment hazard than common glass. However, the acrylic resins are too expensive for general glazing purposes.

5. *DS glass*.—(common sheet window glass, about 0.12" thick). It sustained a high incidence of breakage, behaving characteristically. Large numbers of sharp-edged fragments were scattered over the floors, most extensively in the closest building. Jagged sections were frequently left in the sash. The personnel injury hazard was higher than with any other material tested, except where the glass was backed up by wire mesh having $\frac{1}{2}$ " square openings. When the mesh was present, scattering of fragments was greatly reduced. Only a few of the smallest fragments found their way through the mesh, and these did not travel more than 8 or 10 feet from the wall containing the window.

6. *Wire glass*.—($\frac{1}{4}$ " thick). Although the incidence of breakage of this glass was greater than that of *DS glass*, it did not fragment as badly, the pieces being held together by the hexagonal wire mesh, and the flying glass hazard was hardly more than in the case of the safety glasses.

7. *Lucite*.—(acrylic resin sheet, 0.06" thick). This was the strongest of the light plastic sheets tested. It did, however, break into sharp fragments in the same manner as the thicker *Lucite*. Since it was too light to withstand the blast well, its use seems to offer no advantage.

8. *Lumapane*.—(laminated, wire-mesh reinforced sheet cellulose acetate about 0.04" thick). This material frequently tore out of the sash in one piece. Sometimes it split into several pieces. The fragments were light, and were propelled well into the interiors of the buildings, although they would not have constituted a serious hazard to any person who may have been occupying the building. Some panes stayed in place, although badly bulged.

9. *Vimlite*.—(wire mesh coated with cellulose acetate). This material had little blast resistance and tore like cloth, along two lines at right angles to each other. Strips were frequently left attached to the sash while the remainder was blown well into the building. The pieces were light, however, and did not constitute a severe hazard.

10. *Lumarith*.—(plain sheet cellulose acetate, 0.06" thick). This had the least blast resistance of any material tested. It frequently was blown out of the sash by wind before the explosions took place. It tore easily, and in random directions. Being light, its fragments were blown into the buildings at high speed, but owing to the relatively soft and flimsy nature of the pieces, no great hazard existed.

Summing up, it appears that where blast resistance is of prime importance and cost is secondary, tempered and laminated safety glasses offer the best solution. If economy is essential and the hazards due to flying glass must be avoided, common DS sheet window glass in small panes backed up by wire mesh

may prove to be the best compromise. Where safety glass or common window glass backed by wire mesh is used, attention should be given to assuring adequate strength of the window frame and sash, in order that failure of these members will not nullify the benefit of the stronger glazing. The thinner plastics are more difficult to mount, are generally poor from a visibility standpoint, and do not offer much resistance to blast. Their advantage lies chiefly in the fact that they fail quickly and relieve the pressure on the building to some extent, thereby reducing other forms of damage, in all probability. Further, they are light and do not present a serious flying fragment hazard.

It is recognized that the results of these tests do not in all cases offer a fair comparison of the different types of glazing materials, size for size and thickness for thickness, owing to the many variables imposed by the conditions of the tests. The tests were not true tests of the glazing materials but rather of windows glazed with them, in which the strengths of the window frames, sash, methods of mounting, and even orientation and location, entered the problem as well as the strengths of the panes themselves. Sometimes the mountings gave way and whole panes were blown inside the buildings; in such cases there is no way of knowing whether the pane would have failed had the mounting held fast. The thin plastics were especially subject to this difficulty, and were classed as damaged when torn away from the staples which held them to the sash; however, had a more secure mounting (such as a continuous clamp or compression stop) been employed, the percentages of failures of these panes, particularly Lumapane, might have been lower.

The effect of orientation on incidence of glass damage is strikingly demonstrated by the tests. Windows on the north side (angle of incidence of shock front 30°) sustained about twice as much glass damage as the east side (angle of incidence 60°), and of the order of 10 times as much as the west or lee side which was facing 120° away from the explosion. It would seem that in the laying out of ammunition plants, window damage could be minimized to a great extent by omitting windows on those sides of buildings which face the hazard, wherever possible.

PART VI. CONCLUSIONS

I. Increase in permissible quantity of high explosives per igloo magazine.

In view of the facts brought out by these tests, namely, that:

(a) in three tests in each of which 500,000 net pounds of TNT were detonated, involving eight possibilities of explosion propagation as enumerated below, there were no detonations, low-order explosions, nor any noticeable effect upon the TNT filler of the bombs and mines stored in the target magazines and revetments:

	Net pounds	Stored in	At clear distance in feet
Test 1 ...	500,000	Igloo E	185
		Igloo F	400
		Revetment 1	400
		Revetment 2	360
Test 2 ...	250,000	Igloo F	360
		500,000	Revetment 1
Test 4 ..	250,000	Revetment 2	400
	 do	538

(b) the crater radius was less than half the distance to the nearest target igloo or revetment in each instance;

(c) the bomb stacks within the target igloos were not displaced from position nor appreciably disturbed;

(d) the mine stacks survived scattering of upper layers and toppling of border tiers of mines;

(e) displacements of the target igloos were inconsequential;

(f) missiles failed to penetrate to the interior of the target igloos;

(g) damage to the target igloos was minor, there was no serious scabbing of concrete from inner surfaces and no danger of collapse of the magazines;

it is concluded that the probability of propagation of explosion from one standard igloo magazine to another at present standard spacing (400 feet) when the charge per magazine is 500,000 net pounds of TNT in ammunition, is extremely remote. Therefore, it is believed that it would be safe to raise the limit of high explosives not more sensitive to shock than

cast TNT to 500,000 net pounds in ammunition per standard 80-foot reinforced concrete arch, earth covered, igloo type magazine, at present standard distances from neighboring magazines and revetments, provided adequate distances for 500,000 pounds of explosives are maintained from inhabited buildings, railways, and highways.

2. Reduction of intra-line igloo magazine spacing.

The failure of the charge in Igloo E to explode, detonate, or suffer noticeable effects in test 1, coupled with the facts enumerated under items (b), (c), (e), (f), and (g) in the foregoing section, leads to the conclusion that there is small probability of propagation of explosion from one igloo magazine containing 500,000 net pounds of TNT to another parallel to the first, at a clear distance of 185 feet. It is true that since there was only one trial fulfilling this condition, there is justification in stating that there is no proof that upon a second trial, or within a few successive trials, a propagation would not occur. However, observers with long experience in military high explosives, after examining the condition of the target magazine and its contents were unanimous in the opinion that there was little likelihood of a detonation. Consequently, it is believed that under normal conditions, i.e., with igloos of proper construction on sound ground, and with the ammunition stored in stable piles, it would be reasonably safe to permit a reduction in spacing of standard igloo magazines, limited to 500,000 net pounds per magazine of high explosives not more sensitive to shock than cast TNT, from 400 to 185 feet, measured between the near outside walls, at grade, of magazines abreast in line.

3. Inhabited building distance.

The term "safety distance" though appearing in part II, Objects of the tests, hereof, has been purposely omitted because it is felt that it was inappropriately used. Safety is defined as

"freedom from danger or hazard; exemption from hurt, injury, or loss." This state is never truly achieved in explosions except at tremendous, impracticable distances. Those who formulated the American Table of Distances seemed to studiously avoid the term and made no pretense that their distances would provide safety from the effects of explosions, but based the table on prevention of "substantial structural damage" which would thereby, they concluded, avoid "serious risk" to occupants of buildings. They defined "substantial structural damage" as follows:

(1) In stone or brick houses. The serious weakening of or displacement of portions of supporting walls (i.e., foundations, side walls or interior supports) and the breaking of roof rafters or other important roof supports or floor joists.

(2) In frame buildings. The serious weakening of or displacement of foundations, the breaking of any of the main supports in the side walls or interior supporting walls, and the breaking of any main supports of the roof or floors.

. . . no distinction was made as to whether the building involved was structurally strong or the reverse, as much weight being given to a flimsy building as to one of brick or stone, and the distances prescribed to embrace the extreme cases of damage.

No attempt is made here to determine a "safety distance," or a lesser distance involving exercise of judgment as to the degree of risk or level of damage deemed acceptable; but, rather, an effort is made in the following to find that distance which, in these tests, would have avoided "substantial structural damage" as defined above. In the first explosion of 500,000 pounds of TNT in an igloo magazine in these tests, Barracks 1, at 2,705 feet, sustained many broken and displaced studs, plates, braces, sheathing, cracked rafters, a fractured roof girder, a supporting post knocked out of an exterior wall, and many windows blown in. It is clear that this was "substantial structural damage," and that there would have been "serious risk" to occupants of the building. Barracks 2, at 3,605 feet, suffered a considerable number of cracked, broken and displaced studs, plates and braces, some broken sheathing and several window sash were blown in. A building occupant might easily have been struck by one of these sash (as well as seriously cut by flying glass which was considered minor by the makers of the A.T.D.). The plaster or wall-

board over the entire north wall would have had to be removed to effect structural repairs. This damage, though lesser in extent than in Barracks 1 and perhaps a borderline case, is nevertheless considered to be "substantial" since the breakage of a group of studs is interpreted as equivalent to the breaking of a main support in a side wall, in ordinary frame construction. Barracks 3, at 5,410 feet, sustained only 2 cracked studs and clearly was not substantially damaged. From the foregoing, it appears that the limiting distance for substantial structural damage lies between 3,605 and 5,410 feet, being closer to the former. To approach the problem from another angle, consider the relationships of peak blast pressures and positive impulses for explosions of 500,000 pounds of HE in the open, for which the A.T.D. distance is 5,410 feet, and within an igloo magazine. The tests showed that peak pressures were little less from the igloo shots than from the open shots, the most that the igloos could be credited with, and this is optimistic, being a reduction in peak pressure corresponding to a reduction of open charge from 500,000 to 350,000 pounds. The A.T.D. distance for the latter quantity is 4,780 feet. The tests also showed that positive impulses were reduced by the presence of igloos to values corresponding approximately to those from an open charge of 170,000 pounds, for which the A.T.D. distance is 3,930 feet. Since peak pressure and positive impulse are equally important as criteria for damage, it seems best to give them equal weight, and take the average of the two latter distances. This results in a value of 4,350 feet as the estimated distance at which damage from an explosion of an igloo containing 500,000 pounds of HE would be equivalent to that caused by an open explosion of the same quantity. As this figure is between 3,605 and 5,410 feet, being closer to the former, it checks with the approach on the basis of actual damage done to the barracks, and appears to be as close as can be come to the limiting distance for "substantial structural damage." on the basis of these tests. Accepting the same degree of risk and damage level as contemplated by the A.T.D., the distance of 4,350 feet is therefore considered to be the distance that should be maintained between unbarricaded inhabited buildings and standard Army and Navy

igloos containing 500,000 net pounds of high explosives. This comprises a re-evaluation of the efficacy of standard earth-covered igloos as "barricades" for it is obvious from the pressure and impulse data, as well as the actual damage, that the igloo is not sufficiently offensively barricaded to warrant dividing the unbarricaded A.T.D. distance in two, as has been customary for many years. Indeed, there seems to be good reason for doubting the value of barricades in reducing air blast generally, except perhaps when located close to the structure to be protected.

4. Effect of increased earth cover.

The tests failed to disclose any consistent tendency to lower values of peak blast pressure or positive impulse when the earth cover on a standard igloo was doubled. Damage to barracks appeared as severe but since the buildings had been subjected to previous blasts no great significance is placed on this. Suffice it to say that there is no evidence that the increase in earth cover was sufficient to warrant any reduction in inhabited building distances.

5. Types of window glass and substitutes which might reduce dangers of injury from broken glass.

Tempered and laminated safety type plate glasses stood up well, but if not securely mounted were blown into the interiors of the buildings, acting as missiles. These glasses were the most expensive of types tested. None

of the thin plastics tested were very satisfactory, as they were torn out whole or went to pieces fairly easily. Their fragments did not constitute dangerous missiles, however. Visibility through them was generally poor, and they were relatively expensive. Common double-strength window glass shattered easily but when backed up by a well-secured screen of heavy wire mesh seemed to be the best compromise. For further details, see part V, section 10 (e).

6. Danger radius for blasting of broken glass from windows.

There was some "flying glass," arbitrarily defined as window glass that traveled further horizontally than it fell vertically, even in Barracks 3, hence the limiting distance was not bracketed. It is estimated, however, that flying glass would not have occurred to any great extent beyond about 6,000 feet.

7. Pressures and velocities of the shock waves in air.

At 214 feet from the center of detonation of a 500,000-pound charge, hydrostatic peak blast pressures were of the order of 35 p.s.i. gage, and at 2,700 feet they were of the order of 1 p.s.i. gage. Velocities of propagation were of the order of 2,250 feet per second at 214 feet, and close to the velocity of sound at 2,700 feet. For other data on these and other phenomena, see parts IV and V.

REFERENCES

- (1) Igloo Tests, Arco, Idaho, 1945; Army-Navy Explosives Safety Board Technical Paper No. 3; Washington, D. C., 1 June 1946.
- (2) Report on Scale Model Igloo Magazine Explosion Tests held at the Naval Proving Ground, Arco, Idaho; Army-Navy Explosives Safety Board, Washington, D. C.
- (3) Tests on Scale Model Igloo-type Storage Magazines; W. D. Kennedy and W. E. Curtis, Woods Hole Oceanographic Institution, Woods Hole, Mass., 1 August 1946.
- (4) Weapon Data—Fire, Impact, Explosion; National Defense Research Council, Princeton, N. J., 1 October 1945.
- (5) Use of the Free-Piston Gauge for Air Blast Measurements on Full-Scale Igloo Tests; W. E. Curtis and P. E. Shafer; Woods Hole Oceanographic Institution, Woods Hole, Mass., 15 February 1947.
- (6) The Calibration of Aberdeen Paper Blast Meters Assembled with "Rap-in-Wax" Waxed Paper and of Tin-Foil Diaphragm Indentation Blast Gages, Ballistic Research Laboratories, Aberdeen, Md., Memorandum Report No. 430. 22 May 1946.

APPENDIX A. FIELD INSTRUMENT RECORDS

Ball crusher gage record

TEST 1. NOL GAGES

Distance from charge, feet	Calibration in x 10 ⁶ /lb/in ²	Line 1		Line 2		Line 3	
		Deformation in x 10 ⁶	Pressure lb/in ²	Deformation in x 10 ⁶	Pressure lb/in ²	Deformation in x 10 ⁶	Pressure lb/in ²
120	32.8	2,300	70	1,900	58	1,400	43
130	32.8	1,500	46	1,500	46	1,500	46
146	32.8	1,600	49	2,300	70	2,000	61
150	32.8	1,300	40	1,500	46	1,300	40
160	32.9	2,100	64	5,000	152?	5,000	152?
175	32.9	1,500	46				

TEST 1. ARCO GAGES

120	164	5,900	36	10,900	66	14,000	85
130	164	11,700	71	7,500	46	20,500	125
140	164	10,000	61	8,500	52	4,800	29
150	164	5,000	33	9,000	55	5,300	32
160	164	10,900	66	8,500	52	2,500	15
175	164	5,000	30				

TEST 2. NOL GAGES

120	37.8	5,000	152	2,500	76	1,700	52
130	37.8	7,600	232?	1,400	43	1,600	49
140	37.8	4,700	143	1,400	43	900	27?
150	37.8	x	1,200	37	1,300	40
160	32.9	x	1,700	52	900	27?

TEST 2. ARCO GAGES

120	164	x	10,500	64	6,300	38
130	164	x	8,000	49	5,400	33
140	164	x	7,300	45	4,300	26
150	164	x	7,400	45	x
160	164	14,400	88	6,700	41	x
140	7,200	44
140	10,000	61
140	7,400	45
140	8,600	52

TEST 3. NOL GAGES

		Line 2		Line 3		Line 4	
106	32.7	1,200	37?	1,600	49	x
110	32.8	8,800	268?	1,600	49	x
120	32.8	1,400	43	1,200	37	900	27
130	32.8	2,700	82?	1,500	46	x
140	32.8	1,000	30	1,800	55	2,500	76

TEST 3. ARCO GAGES

		Line 2		Line 3		Line 4	
100	163	7,200	44	1,400	9?	x
110	164	7,000	43	1,600	10?	x
120	164	6,000	36	5,000	31	1,400	9?
130	164	4,300	26	6,900	42	x
140	164	6,000	36	1,300	8?	5,000	31

TEST 4. NOL GAGES

		Line 1		Line 2		Line 3	
120	32.8	7,400	225	2,800	85	3,000	92
130	32.8	6,200	190	4,200	128	4,000	122
140	32.8	3,500	107	4,100	125	6,000	183
150	32.8	4,100	125	3,400	103	2,800	85
160	32.9	600	18?	1,200	37	2,400	73

TEST 4. ARCO GAGES

120	164	34,700	212	4,400	27?	16,400	100
130	164	21,200	129	11,200	68	18,300	111
140	164	38,500	235?	17,500	107	12,700	77
150	164	16,600	101	11,700	71	9,900	60
160	164	12,300	75	9,000	55	5,700	35
140	164	8,100	49
140	164	6,100	37
140	164	7,500	46

x indicates gage lost or damaged. No reading obtained.

Aberdeen paper blast meter records

TEST NO. 1 DATE 1 OCTOBER 1946

Distance, feet	Number of smallest diaphragm ruptured			
	Meter line No. 1	Meter line No. 2	Meter line No. 3	Meter line No. 4
500	9		9	
565	9	9	9	
640	9	9	9	
725	9	9	8	
820	8	9	8	
930		8	8	
1,055	8	7	7	
1,190	6	7	7	
1,350	7	6	7	
1,530	6	7	6	
1,730	5	7	5	
1,960	5	5	4	
2,220	5	4	5	
2,515	4	4	4	
2,845	3	4	3	
3,220	3	3	3	
3,650	2	2*	2	
4,140	2	1	2	
4,690	2	1	2	
5,310	1	1	1	
6,000	0	1	0	
820 (50' E in crater 10' deep)	9			
820 (300' E in crater 20' deep)	9			
2,030 (In stream bed 12' deep)		5		
900 (In wash 7' deep)			8	

* Actual distance was 3,500'

TEST NO. 2 DATE 8 OCTOBER 1946

500	9		9	
565	10	9	9	
640	9	9	9	
725	8	9	8	
820	8	8	8	
930	8	8	8	
1,055	7	7	7	
1,190	7	8	6	
1,350	7	6	6	
1,530	4	6	6	
1,730	5	5	5	
1,960	3	6	4	
2,220	3	3	3	
2,515	3	5	3	
2,845	1	2	3	
3,220	2	2	2	
3,650	3	2	3	
4,140	1	2	2	
4,690	2	0	0	
5,310		2	0	
6,000		0	0	

TEST NO. 3 DATE 16 OCTOBER 1946

Distance, feet	Number of smallest diaphragm ruptured			
	Meter line No. 1	Meter line No. 2	Meter line No. 3	Meter line No. 4
385	9		9	
440	9		9	
500	8		8	
565	9		8	
640	9		8	8
725	8		7	8
820	8		6	7
930	7		6	7
1,055	6		6	6
1,190	4		6	6
1,350	4		6	4
1,530	3		5	5
1,730	3		4	4
1,960	0		3	4
2,220	1		3	3
2,515	1		3	2
2,845	0		3	2
3,220	0		3	2
3,650	0		1	2
4,140	0		1	0
4,690	0		0	0

TEST NO. 4 DATE 23 OCTOBER 1946

500	10		9	9
640	9		9	9
820	8		9	8
1,055	8		8	6
1,350	7		8	7
1,730	6		5	1
2,220	5		5	5
2,845	4		3	3
3,650	3		3	2
4,690	1		2	1
6,000	0		0	0

Aluminum foil blast meter records

TEST NO. 1 DATE 1 OCTOBER 1946

Distance, feet	Number of smallest diaphragm ruptured			
	Meter line No. 1	Meter line No. 2	Meter line No. 3	Meter line No. 4
175	9			
225	9			
275	7	9		
330	6	7		
385	5	7		
440	4	6		
500	4	4		
565	3	3		
640	2	3		
725	1	2		
820	1	2		
930	0	1		

Aluminum foil blast meter records—continued

TEST NO. 2 DATE 8 OCTOBER 1946

Distance, feet	Number of smallest diaphragm ruptured			
	Meter line No. 1	Meter line No. 2	Meter line No. 3	Meter line No. 4
175		10		
225		9		
275	10	8		
330	10	6		
385	7	5		
440	6	5		
500	8	5		
565	5	4		
640	6	3		
725	4	2		
820	3	2		
930	2	1		

TEST NO. 3 DATE 16 OCTOBER 1946

Distance, feet	Number of smallest diaphragm ruptured			
	Meter line No. 1	Meter line No. 2	Meter line No. 3	Meter line No. 4
140				8
175				
225				6
275				6
330				
385	7			5
440	5			4
500	3			3
565	2			2
640	4			1
725	3			0
820	2			0

TEST NO. 4 DATE 23 OCTOBER 1946

225	12	11		
330	10	9		
440	6	7		
565	5	6		
725	3	4		
930	2	1		

APPENDIX B

Calibration of Foil and Paper Blast Meters (performed at the Naval Proving Ground, Arco, Idaho, before the Igloo Tests).

1. Bikini type aluminum foil diaphragm meters.

Fourteen meters were loaded with 0.0012" 2SO aluminum foil and set up along a radius at distances from 15.3 to 70.0 feet from a standard 100-pound charge comprising a right circular cylinder of cast TNT 12" in diameter and 16" high, mounted on a wooden stand with the center of the charge 5' above grade. The meters were oriented "side-on," i.e., faced 90° away from the explosion. Five shots were made. Peak hydrostatic or "side-on" pressures at each distance were determined from the pressure-distance function given for the standard charges in Ref. (6), except that for distances less than 30 feet, the data was extrapolated, the equation $P = 10,060/D^{1.79}$ (in which P is peak pressure, p.s.i. gage, and D distance in feet) being assumed to hold true. Readings were taken by recording the number of the smallest

hole in which the diaphragm was ruptured in each meter. These readings were as follows:

Mean distance feet	Known blast pressure, p.s.i.	Number of smallest diaphragm broken					Arithmetic mean diameter, inches
		Shot 1	Shot 2	Shot 3	Shot 4	Shot 5	
15.3	75.0	14	14	14	14	14	0.166
17.2	61.3	14	11	13	14	14	.205
20.2	45.7	10	11	10	11	11	.355
22.6	37.5	10	11	9	10	11	.391
26.0	29.3	9	10	10	10	10	.423
29.9	22.9	8	8	7	8	9	.631
33.7	18.5	7	8	7	6	7	.790
38.0	14.8	4	6	6	6	6	1.095
41.7	12.6	4	6	4	5	6	1.258
46.9	10.3	4	4	4	4	4	1.540
53.9	7.9	4	4	3	4	4	1.616
57.9	7.0	2	2	3	3	3	2.112
64.2	5.8	1	2	1	2	1	2.760
70.0	5.0	1	1	1	2	1	2.880

The right-hand column of the above tabulation contains the arithmetic mean of the smallest diameters ruptured at each distance. The arithmetic mean is considered to be that diameter which, were it present, would be most frequently the smallest one ruptured by the pressure existing at a given distance. When the arithmetic mean diameters are plotted against

pressure on logarithmic paper, the points lie approximately along a straight line; hence a function of the form $P = aD^b$ (where a and b are constants) was assumed to hold true. The constants were calculated by the method of least squares and were found to be: $a = 14.62$, $b = -0.942$. From this equation, the pressures corresponding to the actual hole sizes in the meter were calculated to be:

Hole number	Hole diameter, inches	Pressure, p.s.i.
1	3.00	5.20
2	2.40	6.41
3	1.92	7.90
4	1.54	9.74
5	1.24	11.95
6	.984	14.8
7	.781	18.5
8	.625	22.8
9	.500	28.1
10	.404	34.3
11	.323	42.4
12	.257	52.6
13	.2055	65.0
14	.166	79.0

These pressures are considered to be those which must exist if the corresponding hole diameters are those most frequently the smallest ones ruptured. In measuring blast pressure at a point with a single meter, the smallest hole ruptured is regarded as the size most frequently the smallest ruptured, whence the most

probable pressure is that given above for the corresponding size of hole. If a number of meters were placed at the same distance, an arithmetic mean smallest hole ruptured could be determined, from which a more probable pressure could be calculated from the formula $P = 14.62D^{-0.942}$. By placing a number of meters on a radial line and plotting the diameters of the smallest holes ruptured versus distance on logarithmic paper, an average straight line may be drawn from which mean diameter may be picked off for each distance, whence pressure may be calculated from the formula. However, by plotting the pressures from the table above for each hole diameter directly against distance, an average straight line may be drawn which gives pressures at all distances very close to those calculated from the formula using the mean diameters, and a step is saved.

2. Aberdeen paper blast meters.

The calibration was performed in the same manner as for the aluminum foil meters, except that two lines at right angles were used, 16 meters on each. Tabulations of the readings and of the resulting pressure corresponding to each hole diameter are given in the accompanying table. The equation determined was $P = 2.305D^{-1.292}$.

Results of calibration shots, paper blast meters

Distance, feet	Known peak blast pressure, p.s.i.	Diameter of smallest hole broken, inches										Arithmetic mean diameter, inches
		Shot 1		Shot 2		Shot 3		Shot 4		Shot 5		
		Line 1	Line 2	Line 1	Line 2	Line 1	Line 2	Line 1	Line 2	Line 1	Line 2	
40	13.5	10	10	10	9	9	10	9	9	10	10	0.302
45	11.0	9	10	9	9	9	10	9	9	9	9	.354
50	9.1	9	9	10	9	9	9	9	9	9	9	.367
55	7.6	9	9	9	9	9	9	9	9	9	9	.380
60	6.6	9	9	9	9	9	8	9	9	9	9	.392
70	4.9	8	9	9	8	8	8	8	7	8	9	.489
80	3.85	7	7	8	7	7	7	7	7	7	7	.725
95	2.82	7	7	7	7	7	7	7	7	7	7	.750
110	2.19	6	7	6	7	6	7	6	6	6	5	.963
130	1.67	6	6	5	5	6	5	5	5	6	5	1.228
150	1.26	5	6	5	4	5	5	5	5	5	5	1.466
170	1.02	5	5	4	4	3	4	4	4	5	4	1.897
200	.76	4	4	4	4	4	3	4	3	3	3	2.332
230	.59	3	3	3	3	3	3	3	3	3	3	2.820
260	.48	3	3	2	1	2	2	2	3	2	2	3.814
300	.37	2	2	1	2	1	1	3	3	3	1	4.309
350	.28	0	0	0	2	0	1	0	1	1	0

CALIBRATION

Hole No.	1	2	3	4	5	6	7	8	9	10
Diameter, inches	5.65	4.00	2.83	2.00	1.38	1.00	0.75	0.50	0.38	0.25
Pressure, p.s.i.	.25	.38	.60	.94	1.53	2.30	3.34	5.64	8.16	13.75