



Navy Department - Office of Research and Inventions

FR-2885

NAVAL RESEARCH LABORATORY
Washington, D.C.

* * *

Ship-Shore Radio Division - Transmitter Section

DECLASSIFIED by NRL Contract
Declassification Team
Date: 17 Nov 2016
Reviewer's name(s): A. THOMPSON,
P. HANNA
Declassification authority: NAVY DECLASS
GUIDE, 11 DEC 2012

26 June 1946

DETERMINATION OF RC-120-B
FACSIMILE EQUIPMENT
CHARACTERISTICS

By

A. D. Watt
- Report R-2885 -

Unclassified
R-1515 - 328/51
LPPB
8/21/51

DECLASSIFIED: By authority of:
SOCA January 1958
Entered by: E. Bliss Code 2027

* * *
DISTRIBUTION STATEMENT A APPLIES
Further distribution authorized by _____
UNLIMITED only.

Approved by:

R. B. Meyer - Head, Transmitter Section

L. A. Gebhard, Superintendent
Ship-Shore Radio Division

H. A. Schade, Commodore, USN
Director, Naval Research Laboratory

Preliminary Pages . . .	a-h
Numbered Pages . . .	31
Tables	10
Plates	85
Distribution List . . .	i

ABSTRACT

The operation of the RC-120-B Facsimile Equipment is briefly described after which the characteristics of the various component units are presented so as to permit an evaluation of each unit's effect on the overall system characteristics. The system definition is shown to be limited by the transmitter aperture and the 1800 cycle carrier frequency. It is also pointed out that an increase in definition or speed of transmission is not feasible over existing long distance radio circuits due to multipath effects. The halftone characteristics of the various units are combined to give the system halftone characteristics in a manner which permits a qualitative evaluation of the distortion introduced by the various units. The effect of random noise is discussed as well as the optimum contrast range which is shown theoretically to be around 15 to 20 db. Experimental evidence is included which shows a range of 15 db to be superior to the 8 db range normally employed with this equipment.

DECLASSIFIED

TABLE OF CONTENTS

ABSTRACT	page b
INTRODUCTION	1
Basic Description	1
Theory of Operation	2
GENERAL MECHANICAL FEATURES	2
TRANSMITTER CHARACTERISTICS	3
Definition	3
Modulator Circuit	5
Amplifier and Output Circuits	5
Halftone Characteristics	5
RECEIVER CHARACTERISTICS	7
Amplifier and Input Circuits	7
Recording Methods and Circuits	7
Photographic Characteristics	7
Density	8
Characteristic Curves	8
Spectral Sensitivity	8
Photographic Papers	9
Photographic Recording	10
Receiver Definition	11
Receiver Halftone Characteristics	11
Color Pictures	12
Record Direct Characteristics	12
SYSTEM AND GENERAL CHARACTERISTICS	13
System Halftones	13
System Definition	14
Phasing Circuit Characteristics	15
db Meter Characteristics	15
Fork oscillator Characteristics	16
Drum Drive System	17
Transmission Circuits Required	18
Band Width Requirements	18
Phase Characteristics	18
Interfering Signals	19
Fading, Multipath, and Echo Effects	20
Power Supply Characteristics	20
Vacuum Tube Operating Conditions	21
CONCLUSIONS	21
ACKNOWLEDGMENTS	22
REFERENCES	23
APPENDIX I Calculation of Facsimile Signal Output Spectrum	24
APPENDIX II Optimum Contrast Range in Regard to Noise	28
APPENDIX III Radio Interference from RC-120-B Transceiver	30
APPENDIX IV Definition of Terms	31
TABLE 1 Weights and Dimensions	

TABLE 2	Output Circuits and Voltages Available
TABLE 3	Input Circuits and Voltages Required
TABLE 4	Potentials Applied to Electrodes of Vacuum Tubes
TABLE 5	A.C. Power Requirements
TABLE 6	Effect of Line Voltage Variation on Transmitter and Receiver Outputs
TABLE 7	Effect of Line Voltage Variation on Regulated Voltages
TABLE 8	General Specifications
TABLE 9	Signal to Noise Ratios
TABLE 10	Radio Interference from RC-120-B
PLATE 1	Transceiver Optical System
PLATE 2	Spectrum Analysis while Scanning 0.045 inch Black and White Lines
PLATE 3	Spectrum Analysis while Scanning 0.014 inch Black and White Lines
PLATE 4	Spectrum Analysis while Scanning 0.011 inch Lines Spaced 0.5 inch
PLATE 5	Transmitter Amplifier Halftone Characteristics
PLATE 6	Transmitter Amplifier Frequency Response
PLATE 7	Transmitter Amplifier Phase Characteristics
PLATE 8	Transmitter Amplifier Delay Characteristics
PLATE 9	Transmitter Halftone Characteristics
PLATE 10	Transmitter db Meter Calibration
PLATE 11	Receiver db Meter Calibration
PLATE 12	Receiver Amplifier Halftone Characteristics
PLATE 13	Receiver Amplifier Frequency Response
PLATE 14	Receiver Amplifier Phase Characteristics
PLATE 15	Receiver Amplifier Delay Characteristics
PLATE 16	Photo Record Circuit Linearity

DECLASSIFIED

- PLATE 17 Crater Lamp Recording Characteristics
- PLATE 18 Receiver Halftone Characteristics (Linear)
- PLATE 19 Receiver Halftone Characteristics (Log-Log)
- PLATE 20 Comparison of Film Sensitometric Characteristics
- PLATE 21 Variation in Development Time for Type A Film
- PLATE 22 Receiver Halftone Characteristics, Negative + Paper
- PLATE 23 Receiver Direct Positive and Teledeltos Halftone Characteristics
- PLATE 24 Static System Halftone Characteristics
- PLATE 25 Dynamic System Halftone Characteristics
- PLATE 26 Teledeltos Characteristics
- PLATE 27 Time Fax Characteristic
- PLATE 28 Stylus Voltage vs. Gain Setting
- PLATE 29 Frequency Variation vs. Control Setting and Effect of Frequency Deviation on Skew
- PLATE 30 Fork Oscillator Stability
- PLATE 31 Variation in Ambient Temperature
- PLATE 32 Variation in Relative Humidity
- PLATE 33 Percent Readability vs. Audio Signal to Noise
- PLATE 33a Noise Characteristics
- PLATE 34 Multiple Signals and Delay Time
- PLATE 34a Transceiver Circuit Diagram
- PLATE 34b Power Supply Circuit Diagram
- PLATE 34c Determination of Optimum Contrast Range
- PLATE 34d Relative Side Band Amplitudes, $\frac{\sin \frac{2n\pi k}{2}}{(\frac{n\pi k}{2})^2}$
- PLATE 35 Seven Diameter Enlargement Showing Mosaic Structure
- PLATE 36 Oscillograms of Transmitter Output

DECLASSIFIED

- PLATE 37 Definition Test Chart No. 1 Original
- PLATE 38 Test Chart No. 1 Transmitted Over Wire Circuit, 12 db Contrast Range
- PLATE 38a Test Chart No. 1 Transmitted Over Wire Circuit, 8 db Contrast Range
- PLATE 39 Definition Test Chart No. 2 Original
- PLATE 40 Test Chart No. 2., First Transmission over Wire Circuit
- PLATE 41 Test Chart No. 2, Retransmission of Plate 40 over Wire Circuit
- PLATE 42 Definition Test Chart No. 3 Original
- PLATE 43 Test Chart No. 3 Transmitted Over Wire Circuit, 12 db Range, No. 4 Paper
- PLATE 43a Test Chart No. 3 Transmitted Over Wire Circuit, 12 db Range, No. 5 Paper
- PLATE 44 White House Original
- PLATE 45 White House Transmitted Over Wire Circuit Type A Film
- PLATE 46 White House Transmitted Over Wire Circuit, Type C Film
- PLATE 47 White House "Flat" Low Contrast Range Original
- PLATE 48 White House (Flat Original) Transmitted Over Wire Circuit
- PLATE 49 Direct Photographic Recording of White House on Royal Bromide F1 Paper
- PLATE 50 Teledeltos Copy of Test Chart No. 2
- PLATE 50a Teledeltos Copy of Test Chart No. 3
- PLATE 51 Teledeltos Copy of White House
- PLATE 52 Transmitter Line Voltage Varied During Transmission
- PLATE 53 Receiver Line Voltage Varied During Reception
- PLATE 54 Test Chart No. 1 Signal to Noise = 12 db
- PLATE 55 Test Chart No. 1 Signal to Noise = 9 db
- PLATE 56 Test Chart No. 1 Signal to Noise = 6 db
- PLATE 57 Test Chart No. 1 Signal to Noise = 3 db

DECLASSIFIED

- PLATE 58 Test Chart No. 1 Signal to Noise = 0 db
- PLATE 59 Test Chart No. 1 Signal to Noise = -3 db
- PLATE 60 Marine Barracks Original
- PLATE 61 Marine Barracks Signal to Noise = 30 db
- PLATE 62 Marine Barracks Signal to Noise = 20 db
- PLATE 63 Marine Barracks Signal to Noise = 15 db
- PLATE 64 Marine Barracks Signal to Noise = 12 db
- PLATE 65 Marine Barracks Signal to Noise = 9 db
- PLATE 66 Marine Barracks Signal to Noise = 3 db
- PLATE 67 Marine Barracks Signal to Noise = 0 db
- PLATE 68 Enlargement of Portion of Plate 64
- PLATE 69 Marine Barracks Contrast Range = 4 db, Signal to Noise = 15 db
- PLATE 70 Marine Barracks Contrast Range = 8 db, Signal to Noise = 15 db
- PLATE 71 Marine Barracks Contrast Range = 12 db, Signal to Noise = 15 db
- PLATE 72 Test Chart No. 3 Transmitted over Poor Radio Circuit Showing Effects of Echo Signals
- PLATE 73 Transceiver and Power Supply with Covers On
- PLATE 74 Front View - Covers Removed
- PLATE 75 Rear View - Covers Removed
- PLATE 76 Transceiver with Top Removed
- PLATE 77 Motor and Oscillator Detail
- PLATE 78 Rear, Right Corner - Back Removed
- PLATE 79 Rear View - Back Removed
- PLATE 80 Exciter Lamp and Switching Detail
- PLATE 81 Crater Lamp Mount Detail
- PLATE 82 Bottom View

DECLASSIFIED

PLATE 83 Power Supply, Top Front View

PLATE 84 Power Supply, Bottom View

PLATE 85 Stylus Detail

DECLASSIFIED

INTRODUCTION

1. As authorized by reference (a), the RC-120-B Facsimile equipment has been subjected to comprehensive tests and study to determine its characteristics relative to operation over Navy Radio Circuits. An attempt has been made to explain rather completely the basic operation of the RC-120-B since many of these basic principles of operation are also used in other facsimile equipments. The results of tests have been divided into a study of the various component units in order to determine the effect on the facsimile signal from the scanning head, where the signal originates, to the recording system, where the signal is recorded to form the received copy. A section on "System Characteristics" has been included to give the overall characteristics of the system in addition to covering the characteristics of the units not specifically connected with only transmitting or receiving. Appendix IV contains definitions of many of the terms which are peculiar to facsimile. The section on "Transmission Circuits Required" gives a qualitative view of the transmission requirements of the facsimile signals, and the limitations imposed by radio and wire circuits. Although the discussion is brief, it is hoped that the relationship between possible speeds of picture transmission and the delay characteristics as well as band width of the circuit will be seen.

2. This equipment might be used to transmit weather maps, battle damage, plans, diagrams, and news pictures.

Basic Description

3. The RC-120-B Facsimile Equipment provides a means of transmitting pictures, printed matter, or line drawings over radio or wire circuits. The subject copy transmitted should be 7 x 8-5/8 inches; however, smaller copy may be transmitted if desired. At the receiving end any one of four methods of recording may be used; they are: Teledeltos, Timefax, photographic positive, and photographic negative. The Teledeltos method uses a specially prepared wax coated paper upon which the image is formed by means of an arc. No additional processing is required after the completion of the transmission. The paper is dry and reception is possible under normal lighting conditions; however, only one copy is obtained and the definition and halftone characteristics are poor. The Timefax paper recordings are made in the same manner as the Teledeltos; however, at the completion of the transmission the copy is in the form of a master copy which can be used in the normal manner with the hectograph process to make approximately 20 copies. The quality of these copies is not very good and halftone reproduction is not satisfactory. This method might be quite useful for weather map reception. The photographic recordings are of much higher quality; however, the reception must be in the dark with a photographic safelight or else inside the light-proof tent furnished with the equipment. Normal photographic processes must be used on the film or paper before the recorded copy can be examined.

DECLASSIFIED

Theory of Operation

4. Transmission is accomplished by breaking the picture up into small elementary areas by means of a scanning head which systematically scans each elementary area of the copy to be transmitted. The elementary areas are approximately 0.013 inch wide by 0.011 inch high. The scanning is accomplished by placing the subject on a 2-3/4-inch diameter drum which rotates at 90 rpm and is moved laterally by means of a lead screw with 96 threads per inch. The scanning head consists of a lens and aperture system which permits reflected light from a small area on the subject copy to reach a photo-tube cathode. The amount of light reaching the cathode is dependent on the reflection density of the area being scanned. Plates 1 and 81 illustrate how the scanning head is arranged.

5. The phototube is in one arm of a bridge modulator circuit which amplitude modulates an 1800 cycle carrier. A contrast control is provided which permits either positive or negative transmission in addition to setting the "Contrast" or change in signal level resulting from scanning a black and then white area. When transmitting "positive" a black area results in a maximum signal and a white area in a minimum signal. The signal levels for "negative" transmission are just the reverse of "positive" transmission.

6. Transmission is accomplished either by direct wire lines or by using the amplitude modulated 1800 cycles to modulate an r-f carrier. This type of transmission can be used only with relatively short circuits where fading is not experienced. If long distance transmissions are to be made, supplementary units must be used with this equipment to change the amplitude modulated 1800 cycles into some other form. At present there are two methods available for changing the signal. The first is to change the amplitude modulated 1800 cycles into a frequency-shift audio sub-carrier. The second is to use the amplitude variations to shift the r-f frequency of the transmitter. There are special units available for both types of conversion, the CV-2/TX for sub-carrier frequency shift and the FSD for carrier shift. Reports on both of these converters will be forwarded at a later date.

GENERAL MECHANICAL FEATURES

7. The general mechanical design and construction of the RC-120-B are not considered suitable for shipboard use. The chassis construction which depends on the back and bottom for strength is not considered desirable and in addition provisions have not been made for satisfactory shock mounting. There are several places which are very inaccessible such as the bottoms of the tube sockets on the shelf at the rear of the equipment and on the side of the oscillator unit. Both of these shelves can be seen on Plate 79. The operation selector switch is also inaccessible.

8. The very fine threaded lead screw is not considered desirable and since it is in a rather exposed position the chance

of grit and dust getting in the leadscrew mechanism is also very great.

9. The clamping bar on the drum is not considered as desirable as the recessed bar supplied with the newer TXC-1 facsimile equipments.

10. The exciter lamp and phototube mounting has several undesirable features. There is a considerable amount of flexibility in the mount which makes it rather difficult to position the exciter lamp accurately. This flexibility might also produce a considerable loss of detail under conditions of extreme vibration. A satisfactory means of focusing the spot has not been provided. It was necessary to remove the phototube and place an illuminated reflecting surface in its place before the lens barrel and aperture could be adjusted properly.

11. The crater-lamp mount does not provide a satisfactory means for adjusting the crater lamp and condenser lens so that the crater-lamp image appears at the objective lens. Focusing of the light spot is also rather difficult since it depends on a trial and error method.

TRANSMITTER CHARACTERISTICS

Definition

12. The definition in a given direction is the minimum width of line perpendicular to the given direction which will cause the output of the circuit to change from the steady state output of the background condition to that attained for a larger area of the same density as that of the line. Reference 2. For example, if a black line on a white background is considered, and the contrast range is set up for 12 db, the narrowest black line which will give a 12 db change in signal determines the definition of the scanner. The minimum definition obtainable is dependent on several factors including the spot size and the number of scanning lines per inch. The scanner spot size was measured by removing the phototube and replacing it with a reflecting surface which reflected light from the exciter lamp through the lens and aperture system into the drum. The drum was moved to one side and a piece of exposed film placed on it so that it extended over the end. The spot was focused while observing the image by means of a magnifying glass. After the spot was focused its size was measured by means of a traveling microscope and found to be 0.008 inch x 0.0105 inch with the narrower dimension in the direction of scanning. Due to the short focal length and large aperture size, the scanner focus is very critical. Variations in paper thickness, difficulty in focusing, and the rubber mounting of the photocell which prevents accurate positioning of the lens assembly all combine to make the effective size of the scanning spot somewhat larger. Other measurements indicate that this effective size is approximately 0.011 inch x 0.013 inch. The actual transmitter definition in the direction of scanning is rather difficult to determine exactly because of the

██████████
DECLASSIFIED

low ratio between carrier frequency and keying frequency. The minimum definition that can be expected is 0.011 inch, and this figure would have to be increased to 0.018 inch in order to be sure that a carrier maximum would occur while the envelope was at a maximum. This value is obtained by adding the length of one cycle to 0.011 inch (see Figure 1, Appendix 1). The length of one cycle is needed, since half-wave rectification is employed at the receiver. The definition in the direction perpendicular to the direction of scanning will be at best 0.013 inch if the line is centered with respect to the scanning spot, and it is probable that this will increase to 0.026 inch in most cases.

13. The output frequency spectrum is dependent on the scanning spot size, the rate of scanning, the material being scanned, the contrast range, the carrier frequency, and the amplifier characteristics. A theoretical investigation of the output frequency spectrum is included in Appendix I, where the output frequency spectrum for a single isolated line is calculated and found to compare rather closely with the measured spectrum included in Plate 4.

14. Measured output spectra are also included in Plates 2 and 3 for subject copy with alternate black and white lines where the line widths are 0.045 inch and 0.014 inch. The output frequencies were measured by means of a General Radio 736-A Wave Analyzer. This instrument has a band pass of approximately 4 cycles; however, since the dial calibration is not very accurate, a General Radio interpolation oscillator was used to accurately determine the position of each component. It must be realized that the output spectrum is dependent on the subject copy; however, it is evident that due to the finite aperture size, there is a limit to the band-width necessary for satisfactory reproduction. An examination of the theoretical and measured spectra shows that the side bands are down approximately 20 db from the first side bands at 800 cycles out from the carrier. Neglecting the side bands below 20 db, it would follow that the band pass required is approximately 1600 cycles. Further evidence which supports this value has been found by passing the rectified output of the transmitter through a low pass filter, such as is done in the CV-2/TX and FSD frequency shift converters, and recording the output in the form of oscillograms. Several filters were available and it was found that one with a cut-off frequency of 600 cycles did not pass some very fine lines. These same lines were passed by a filter with an 800-cycle cut-off with about the same contrast range as the output of the transmitter.

15. An examination of the measured output spectrum reveals that a considerable amount of second harmonic, 3600 cycles energy, is present and that the third harmonic of the carrier is also present. These frequencies contribute nothing to the intelligence, and are likely to cause adjacent channel interference. From this consideration, and also that of noise in the receiver, it is considered desirable that a satisfactory 1600-cycle band pass filter be incorporated in the equipment.

DECLASSIFIED

Modulator Circuit

16. The modulator circuit (Plate 34a) consists of a bridge with a phototube in one of the arms. The capacity between the cathode and anode is balanced out by means of the additional anode and R42. The output voltage which appears at the grid of the 7C7 is dependent on the setting of the Contrast Control R45 and the illumination of the phototube. The contrast control is so arranged that it can vary the position of the null. This permits not only variation in contrast range, but also selection of either positive or negative transmission.

17. The halftone characteristics of this circuit are discussed in Paragraphs 20 to 22 on Halftone Characteristics.

Amplifier and Output Circuits

18. The halftone characteristics of the amplifier are shown on Plate 5. Although there is a considerable amount of nonlinearity present, this exists outside the normally used range. The transmitter amplifier frequency response is shown on Plate 6. From this plate it is quite evident that the amplification of the low frequency side bands in some cases is less than one half that of the higher frequency side bands. This effect is very evident in the measured output frequency spectra, Plates 2, 3, and 4. The phase and delay characteristics are given in Plates 7 and 8, respectively. In Paragraphs 60 to 63 the effects of phase and delay distortion are analyzed, and it is shown that delay differences of less than several tenths of a millisecond will not degrade the facsimile signal. Plate 8 shows that the amplifier is well within this range.

19. Three Output Circuits are provided, which permit the transmitter to be used with a wide variety of communications terminal equipment. The following table gives the output voltage range and load impedance for each circuit.

TRANSMITTER OUTPUTS

<u>Output Circuit</u>	<u>RMS Voltage</u>		<u>Load Ohms</u>
	<u>-10 db</u>	<u>+2 db</u>	
Balanced Line	0.14	0.62	500
Xmtr. jack	0.12	0.54	200
Line jack	2.9	10.3	500

The balanced line terminals and Xmtr. jack can be seen quite plainly in Plate 76. The line jack shown in Plate 78 is not of a desirable type, since the plug can be plugged into the 110-volt line. This usually results in damage to the associated equipment.

Halftone Characteristics

20. Before describing transmitter halftone characteristics, a few of the terms used will be defined, and the desirability of

using logarithmic scales for graphic presentation explained. Two terms which will be used are "copy density" and "copy brightness." The copy brightness is a relative figure where very white, fixed-out photographic paper is taken as a reference of 100 per cent, the copy brightness of a particular subject being the per cent light it reflects relative to the fixed-out paper. The copy density is expressed as $D = \log_{10} \left(\frac{100}{B} \right)$ where B is the brightness in per cent. The reflection densitometer which was used to make the density measurements employed an incident beam of light at 45° to the surface with a viewing axis normal to the surface. The incident light was interrupted by means of a rotating shutter, and the reflected light intensity was measured by means of a phototube and amplifiers. A voltmeter with a logarithmic scale was used to give density directly. The calibration of this densitometer was checked against an Eastman reflection type densitometer and found to agree very closely. The reflection density range of most photographic prints is from 0 to 1.6 or in some cases 0 to 1.8.

21. To properly interpret the significance of the transmitter and receiver halftone characteristics, it is necessary to realize that the response of the human eye is approximately logarithmic. This means that a variation in light from 80 to 100 per cent will give approximately the same visual effect as a change from 8 to 10 per cent. Consequently, a small variation of subject brightness in the dark areas of a picture is much more noticeable than the same brightness variation in the light areas. In order to determine the visual effect of the circuit, the halftone characteristics in many cases are plotted using log-log coordinates. A linear plot of the circuit characteristics is also included in most cases, since this type of presentation permits an easier analysis of the circuit.

22. The transmitter halftone characteristics are shown on Plate 5, using both linear and log-log presentation. The input voltage was applied to the grid of the 7C7 modulator tube with a 3.3 meg-ohm resistor to ground in place of R50 and the phototube. The nonlinearity of this circuit is not very great; in fact, it is desirable except for the reverse curvature at the very low levels, since throughout the rest of the range there is a tendency to compress the higher levels. The overall transmitter halftone characteristics are shown on Plate 9. It can readily be seen from the log-log plot that the dark greys of the picture are crowded into a small portion of the output range. This is even more evident in the positive transmission characteristics. The result of this compression can easily be observed by examining the shadow areas of a transmitted picture and comparing it with the original. For example, compare Plate 44 with 45. The effect on the halftones of a picture cannot be deduced from the transmitter characteristics alone; however, it will be seen later that unfortunately the transmitter and receiver distortions are additive and the overall characteristics reveal a very decided compression in the darker

greys.

RECEIVER CHARACTERISTICS

Amplifiers and Input Circuits

23. Three input circuits are provided which permit operation with a wide range of input voltages and input impedances. A list of the input circuits, their corresponding impedances and required signal voltages are given in the following table.

RECEIVER INPUT CIRCUITS

<u>Input Circuit</u>	Voltage required for +2 db		<u>Impedance Ohms</u>
	<u>Min.</u>	<u>Max.</u>	
Balanced line	0.009	0.10	500
Rcvr. jack	0.40	5.0	2500*
Line jack	0.009	0.10	500

* Note: This can be changed to 250 ohms for receivers with low impedance outputs.

The receiver amplifier uses the same circuit as the transmitter amplifier with the addition of one or two tubes, depending on the type of recording. All the measurements are for "record photo" unless otherwise designated. Plate 12 shows that the amplifier linearity is very good. The receiver frequency response is better than that of the transmitter; however, it can be seen from Plate 13 that the amplification at the lower frequencies is considerably less than at the carrier frequency. Unfortunately, the response is low at the same end for both amplifiers, and the result is additive. One advantage in having the gain low at the low frequencies is that 60 and 120 cycle hum is not as likely to be present in the output; however, this condition should not be obtained at the expense of the facsimile signal sidebands.

24. The phase and delay characteristics, Plates 14 and 15, show that very little degradation of the facsimile signal will be caused in this circuit by delay distortion.

Recording Methods and Circuits

25. Two main types of recording are employed by the RC-120-B equipment. They are "record photo" and "record direct". The method of scanning in both cases is very similar to that when transmitting, since the material used for recording is mounted on the same drum that is used for transmitting. The relative merits of each type of recording, and the characteristics of each, will be covered separately in the following sections.

Photographic Characteristics

26. Although it is beyond the scope of this report to give

more than a very brief description of the photographic processes, it is considered desirable at this point to define some of the terms used and describe a few of the properties of photographic materials.

27. Density. In general most photographic processes make use of the properties of a photosensitive layer or emulsion to vary the amount of light it transmits or reflects, the amount of transmission or reflection depending on the exposure and processing to which the material is subjected. There are two main types of sensitized materials - film and paper. The primary difference is that the film has a transparent base and the paper has an opaque or translucent paper base. In general the film has a much faster emulsion than the paper; i.e., the film is very sensitive to light and the paper less sensitive. The reflecting characteristic of the processed paper print is expressed as reflection density and has already been defined in Paragraph 20. The light transmitting properties of the film are defined in a similar manner as

$$D_t = \log_{10} \left(\frac{100}{x} \right)$$

where x is the per cent of light passing through the film relative to all the light striking the film. There are two ways of specifying the density; they are "diffuse density" and "specular density." Diffuse density is a measure of all the light transmitted through the given film, while specular density is a measure of only the light which passes through the film without change in direction. The densities given in this report are diffuse densities as measured by a Kodak Model B densitometer.

28. Characteristic Curves. One of the most important relations of photosensitive materials is that showing the relation between the exposure of the material and the resulting density of the silver deposit. An example of this characteristic is shown in Plate 20, where the density vs. log exposure is plotted for several types of film. The exposure is a function of time and light intensity and is approximately equal to $k \times t \times I$, where k is a constant, t is time, and I is light intensity. This relationship is not exactly true, and the departure from it is called the "reciprocity failure." Reference 10, page 128. This failure is likely to enter into sensitometric measurements of facsimile negatives, since the time of exposure is very short compared to the time used for ordinary sensitometric work. Several important characteristics of the film can be found from its characteristic curves. The speed of a given film determines its horizontal position on the graph, while the slope is dependent on the density variation for a given light variation. The slope of the straight line portion of the curve is called "gamma" and in general, for a given film an increase in development time gives a corresponding increase in gamma. An example of this is shown in Plate 21.

29. Spectral Sensitivity. Another important characteristic of a photographic emulsion is its relative spectral sensitivity or sensitivity to colored light. This sensitivity varies with the type of emulsion. In general there are three main types of

emulsions, they are: (1) ordinary or blue sensitive, (2) orthochromatic, and (3) panchromatic. The blue sensitive emulsions are sensitive to blue and ultraviolet light; however, for practical purposes the spectrum can be considered as being from 4000 to 5000 Angstroms, since the glass in most lens systems will not pass the shorter wavelengths. Orthochromatic materials are sensitive to green, as well as blue light, and have a spectrum of approximately 4000 to 6000 Angstroms. Panchromatic materials cover, in general, the entire visible spectrum of from 4000 to 7000 Angstroms. It should be noted that these are generalizations, and that the characteristics of particular films vary considerably. For information on particular film, it is desirable to consult the manufacturer's data.

30. Photographic Films Employed. Two types of films are used. They are: Transmission Type A and Transmission Type C films. The Type A film is a blue sensitive emulsion on a transparent safety base, which permits exposure through the base. The Type C film is an orthochromatic emulsion on a safety base with an antihalation backing. This film must necessarily be exposed from the emulsion side. The characteristics of these films are compared with commercial ortho, commercial pan, and panatomic x on Plate 20. The Type C film appears to be faster than the Type A at first glance; however, closer examination shows that there is little difference in speed. Both of these films can be handled under a Series 1 safelight, which is a fairly bright red light.

31. Photographic Papers. There are many different types of papers; however, we shall consider only a few of the pertinent characteristics, such as surface, speed, and contrast grade. The surface texture varies in two general respects: Character of texture, such as smooth, fine grained, or rough; and the sheen, or gloss, such as glossy, lustre, or matte. The available reflection density varies with the surface, and is greatest for the glossy surface, which is used for the plates in this report. An exception to this is the surface of the actual photographs of the equipment, which are on a smooth semimatte paper.

32. The speed of photographic papers is in general less than films and varies from the very slow contact paper, such as is used in producing most of the plates in this report, to the very fast enlarging paper, such as Royal Bromide, which can be used to make photographic positives directly. Although this paper is one of the fastest available, it is still too slow to give good reproduction, as is shown in Plate 23.

33. The contrast of a paper involves two factors: density range and exposure scale. A typical paper characteristic curve is shown in the lower right-hand corner of Plate 24. The density range is the range of reflection densities available, and varies from approximately 1.8 for glossy surfaces to 1.2 for matte surfaces. The exposure scale is related to the range of light intensities required to produce all the useful halftones from white to black. Unlike negative materials, the slope of the characteris-

tic curve does not vary appreciably with development time. Instead, the effective speed of the paper changes. An increase in development increases the speed; that is, it moves the curve to the left with little change in slope. The slope of the characteristic curve varies with the grade of paper. Number 0 paper has the least slope and Number 5 has the greatest slope. In order to obtain a proper print it is necessary that the exposure range of the paper equal approximately the density range of the negative. Normal negatives require a contrast grade of approximately 2.

PHOTOGRAPHIC RECORDING

34. The photographic materials are mounted on the drum in the same manner as the subject copy. Type A film is mounted with the emulsion side towards the drum, which permits the film on the drum to be handled without fear of fingerprinting it. A sheet of black paper is placed between the drum and the film emulsion to reduce halation and keep the emulsion in focus. These sheets of black paper are contained in the film box between each sheet of film. Type C film is mounted with the emulsion side up, and it is not necessary to use the sheets of black paper. The ease of mounting either film is about equal, since in one case the black paper must be mounted with the film, and in the other case the emulsion side of the film is up and requires that greater care be taken to prevent fingerprinting the negative.

35. The light source for exposing the films is a Sylvania type R-1130 glow modulator tube or crater lamp, which has the property that the light output varies with the current through the tube. The light from the crater lamp is passed through an aperture and focused on the drum by means of a lens system. A view of the crater lamp mount and lens barrel is shown in Plate 81. The size of the projected spot is changed by screwing the lens barrel in or out and then focusing the spot by loosening the clamping screw and moving the whole mount in or out. The spot that is projected on the drum was measured and found to be 0.0107 inches by 0.0074 inches. These measurements were made by exposing a sheet of Type A film and measuring the resulting spot with a traveling microscope. The spot size increases with increase of exposure, due to halation. This effect can be noticed by careful examination of an enlarged picture. The best spot size adjustment was found by adjusting for no over-or-under lap on the medium grey areas. The intensity of the spot varies considerably with the position of the crater lamp, and the means of positioning the lamp are very poor. To aid in adjusting the lamp, it was found desirable to have a piece of tubing, which just slipped over the lens barrel. A not too dense film was placed over the end of this tubing, and the lamp was adjusted until the spot was in the center of the film and did not change position when the tubing was moved in and out. The mosaic structure of the received picture can be seen by examining Plate 35, which is a 7-diameter enlargement. The rectangles are approximately one 1800-cycle wavelength long in the direction of scanning, since halfwave rectification is used. The apparent overlap is greater in the direction of scanning than it is

between adjacent scanning lines; however, the effect is not very noticeable in the original size picture.

36. Receiver Definition. It has been shown in Paragraph 12 that the best definition that can be expected at the transmitter is 0.011 inch and that this value increases to 0.018 if the definition is to be consistent regardless of carrier phase. A careful examination of the horizontal lines on test chart No. 3, Plate 43, reveals that the lines start to reach maximum density at approximately 0.011 inch, and that the density of the lines vary as their sizes increase, until 0.018 inch is reached. After 0.018 inch width is reached, all the lines have at least part of their width at maximum density, and this condition continues to exist as the lines increase in size. This would indicate that the definition of the receiver is as good as the transmitter and that the multiple line definition is as good as single line definition. The definition of the receiver can be varied somewhat by changing the grade of paper and exposure times.

37. Receiver Halftone Characteristics. The density of each elementary area is a function of the time intensity integral of the exposure. Since the time of effective exposure is approximately the same for the normal range of signal levels, the exposure is primarily a function of the light intensity, which is in turn dependent on the current through the crater lamp. The average crater lamp current vs. grid voltage of the 6AC5G driver is shown on Plate 16. The film transmission density for both Type A and Type C film vs. crater lamp average current is shown on Plate 17; however, it should be noted that this is effectively a semilogarithmic plot. The receiver halftone characteristics from the input to the film are shown on Plates 18 and 19 in linear and log-log plots. There is a considerable amount of nonlinearity; however, the paper and transmitter characteristics must be considered before making any conclusions. The overall receiver halftone characteristics are shown in Plate 22, where the paper characteristics are added to the results of Plate 19. The effect the receiver has on the overall halftones will be covered later in Paragraphs 41 to 43 on System Halftone Characteristics. The halftone characteristics of the receiver, when using Royal Bromide, Aero Enlarging, and Koda-Bromide papers directly, are shown on Plate 23, where it is readily seen that their emulsions are not fast enough to make a pleasing picture. The density at +2 db is only 0.56 for the Royal Bromide, which is the fastest of the three and one of the fastest paper emulsions available. Contrast grade F1 papers were used in each case, since this is the fastest of the various grades. These prints were all developed for 2 minutes, which is the maximum time recommended, in 1:2 D72 at 68° F.

37a. The Receiver Halftone Characteristics indicate that the recording spot light intensity is not great enough to stay within the linear exposure range of the Type A film characteristic. An increase in the available light output would be desirable since it would permit operation on the straight line portion of the film characteristic. It would also permit positive recordings of higher

quality. The optical system could be improved to give greater efficiency since at present the diaphragm, see Plate 1, permits approximately only 0.15 per cent of the incident light to pass. In addition the F/2.2 objective lens is not being fully utilized since light is incident on only approximately one quarter of the total area.

38. Color Pictures. It is possible to transmit color pictures with these equipments by the color separation process. Three fairly flat black-and-white prints are required at the transmitting end. These should be made from the blue, green, and red color separation negatives. The three prints are transmitted in the usual manner, care being taken to keep the conditions and processing as constant as possible for all three prints. The negatives at the receiving end should be developed to the gamma which will give a pleasing print on Grade 2 paper, or a density range of approximately 1. For most conditions this will require 5 or 6 minute development in 1:2 D72 at 68° F. of Type A film. The received negatives are used to make wash-off reliefs, which are employed in the usual manner, with process red, process blue, and yellow dyes to make the color prints. For further information on this process see Reference 10, Chapter XXII. It should be mentioned that the color printing process is very difficult and should be undertaken only by experienced personnel in a well-equipped laboratory.

Record Direct Characteristics

39. Teledeltos paper provides a means of direct recording which produces a facsimile copy under normal lighting conditions and which requires no further processing at the end of the transmission. The definition is poorer than that of the photographic recordings as can be seen by comparing Plate 50 with Plate 40. A teledeltos copy of the White House Plate 44 is shown on Plate 51, and it can readily be seen that the halftone characteristics of the teledeltos paper are also much poorer than the photographic recordings. Compare Plates 45 and 51. The teledeltos paper is a light grey wax-coated paper upon which the received images are burned by means of a stylus, see Plate 85, which rests with a slight pressure against the paper on the drum. The stylus is normally in the position shown, except when the selector switch is in the record direct position. When in this position a mechanical lever system releases the stylus and a spring keeps it in contact with the paper on the drum. The halftone characteristics of the teledeltos paper are shown on Plate 23, where the paper reflection density is plotted vs. the receiver input. Other characteristics of the teledeltos paper are shown on Plate 26, where the paper resistance, stylus voltage, and stylus current are all plotted against receiver input voltage. This type of recording permits rapid transmission of line drawings and printed material. It also is possible to receive halftone pictures if the received copy need not be very high quality. One of the other disadvantages with this type of recording is that only one copy is received,

and rapid duplication is not possible.

40. Timefax paper provides a means of producing multiple copies from a master copy which is produced in the same manner as teledeltos recordings. The Time Fax paper consists of a light top coating, which is burned away by the current from the recording stylus when this current is high. There is a layer of dye underneath the top coating, which is transferred to the hectograph pad at the points where the top layer has been removed. Copies are produced by placing the master copy face down on a very moist hectograph pad for a moment. Removing and repeating the above process increases the quality of the copies. The second time the master copy is left on the pad for a minute or two to permit adequate transfer of the dye to the gelatin pad. Approximately 20 copies of the original can now be produced in the usual manner. The definition obtainable with this process is very nearly the same as that of the teledeltos. The halftone characteristics are much poorer than with teledeltos paper, since the hectograph copy is either blue or white, with almost no gradations. The electrical characteristics are shown on Plate 27, and it can be seen by comparing this plate with Plate 26 that the stylus current for Time Fax recording is much lower than with teledeltos recording. This is due to the fact that the dynamic paper resistance of the Time Fax is much higher. This type of recording is not considered very desirable, since the hectograph copies are usually very light; however, this could probably be improved, in which case the process might be used to produce multiple copies of weather maps or similar black and white material.

SYSTEM AND GENERAL CHARACTERISTICS

System Halftones

41. The halftone characteristic of both transmitter and receiver have been discussed in their respective sections. The individual results are, however, of little value until they are compared with each other to determine the combined halftone characteristics of the equipment. A system with ideal halftone characteristics would be one where the density of any point on the recorded copy would be the same as that of the corresponding point on the subject copy, irrespective of the range of the subject copy. In practice, it is found that most systems depart from this considerably. The amount of this departure is a measure of the halftone distortion. The static halftone characteristics of the system and the method used in obtaining them are shown on Plate 24, where the characteristics of the transmitter, receiver, and photographic paper are added together. Examination of the resulting system halftone reveals that the darker half of the subject density range is compressed into 1/6 of the recorded copy density range. A rough examination of the transmitter characteristics reveals that the upper half of the density range is compressed into approximately 1/4 of the output db range. Applying the same test reveals that the lower half of the receiver db range is compressed into a little more than 1/3 of the total film density

range. This compression is more than compensated, however, over this particular range, by the paper, which expands the lower half of the receiver db input range into slightly more than the upper half of the recorded copy density range. This would indicate that most of the distortion was in the transmitter. However, a closer investigation reveals that this is not entirely true.

42. Consider the upper half of the subject density range and follow this through the system. As stated before, the upper half of the subject density range is compressed into the lower 1/4 of the output db range. This 1/4 is still further compressed by the receiver into approximately 1/9 of the total film density range. The paper expands this 1/9 of its exposure range to 1/6 of the copy density range. From this analysis it would appear that for this particular case and point that approximately 2/3 of the total compression is due to the transmitter and 1/3 due to the receiver.

43. The dynamic halftone characteristics of the system were obtained by placing a calibrated step wedge on the transmitter and recording with Type A film on the receiver. The transmitter was set up for +2 to -6 db on the phasing ring, and the receiver was set at +2 db for a maximum signal. Direct wire connection was used between the machines and normal procedure was used throughout the test. After processing the films they were used to make several prints, and the densities of the one closest to the original were measured on the reflection densitometer. The results of this test are plotted on Plate 25, where they are compared with the values obtained from Plate 24 for static characteristics. The undesirability of this compression can readily be seen by comparing Plates 44 and 45 in the shadow areas.

System Definition

44. The overall system definition on photographic recording is the same as that of the transmitter, or 0.018 inch in the direction of scanning. This can be observed by carefully examining Plate 43 with a magnifying glass. Examining the horizontal lines, start at the left end and move to the right until a point is reached where all the lines have at least some part of their width at maximum density and that this condition continues beyond this point. The line width at this point is 0.018 inch which is the definition. Using the procedure described above on the vertical set of lines, the definition in the direction perpendicular to the direction of scanning is found to be very close to that of the transmitter definition, or 0.026 inch.

45. When attempting to apply the above procedure to the tele-deltos paper, it is very difficult to arrive at any intelligent conclusion. In view of this fact, it is considered desirable to consider the resolution of the system as a factor of merit, the resolution being defined as the number of lines per inch in a given direction which the facsimile system will resolve as separate lines. The numbers on test chart Number 3 are the line widths

in thousandths of an inch, and this can readily be converted to lines per inch. An examination of Plate 43 indicates that the vertical resolution is approximately 135 lines/inch, and the horizontal resolution is 115 lines/inch, while the 45 degree resolution is approximately 140 lines/inch. Applying the same analysis to Plate 50a, we obtain a vertical resolution of 110 lines per inch, a horizontal resolution of 100, and a 45 degree resolution of 110 lines/inch for teledeltos recording.

Phasing Circuit Characteristics

46. The phasing circuit provides a means of phasing the receiving drum with the transmitting drum so that the clamping bars at the receiving and transmitting ends pass the scanning spot at the same instant. The machines are phased by scanning the phasing ring at the transmitter and pushing the phasing button at the receiver. This connects the incoming signal to the phasing circuit, which is so arranged that a sudden increase in signal level generates a pulse which releases the drum. This occurs at the beginning of the white phasing mark on negative transmission and occurs at the end of the white phasing mark on positive transmission. The receiver phasing stop is usually set so that half of the clamping bar is in one end of the received picture for negative transmission and on the other end for positive transmission.

47. The phasing error was measured after first adjusting the phasing magnet adjusting screw (see Plate 77). The optimum length of clutch stop arm engaged by the trip armature was found to be between 0.02 inch and 0.03 inch, which is slightly less than the 1/16 inch recommended in the instruction book. The phasing error was found by recording the phasing marks after phasing 15 to 20 times and measuring the maximum misalignment of these marks. The per cent phasing error is equal to the maximum deviation divided by the drum circumference. For 12 db positive transmission the error is 0.06 inch or 0.7 per cent, and for 12 db negative transmission the error is 0.05 inch or 0.58 per cent.

48. If the receiver stop arm is adjusted to give optimum phasing on negative transmission, the error introduced by positive transmission would be equal to the width of the phasing mark, or approximately 0.4 inch, which would mean that the effective picture size would be reduced from 7x8 inches to 7x7.6 inches.

Db Meter Characteristics

49. There are a number of undesirable inherent errors in the set db meter. The fact that it reads differently when removed from the panel is undesirable, since it prevents accurately controlled results. One of the more serious errors introduced by the meter is the fact that while on record direct, the stylus voltage is not constant with a constant meter reading when the gain control is varied (see Plate 28). This causes the teledeltos recordings to be lighter than usual whenever it is necessary to

set the receiver gain control above 50. The db meter calibrations for transmit, record photo, and record direct are shown on Plates 10 and 11.

Fork Oscillator Characteristics

50. The fork oscillator unit supplies a signal of high frequency stability to drive the rotating drum. This 1800-cycle signal is also used as a carrier for the phototube bridge-modulator circuit, and as a signal source for the exciter lamp constant-output amplifier. The frequency is dependent on a number of factors, including temperature, humidity, barometric pressure, and amplitude of vibration. Temperature regulation is not used; however, the effect of temperature variation has been reduced by the construction of the fork. The amplitude of the fork oscillation is dependent on the drive and an attempt has been made to keep this relatively independent of line voltage variations. An examination of Plate 31 shows that the oscillator is very stable in this respect, since a variation of line voltage of from 105 to 125 volts in approximately five minutes resulted in a frequency change of 0.01 cycles, or 5.5 parts per million.

51. The oscillator frequency was measured by recording the one second impulses from WWV and measuring the skew. This provided a means of measuring the frequency to within 1 part per million, provided reasonable care is taken in measuring the skew. The effect of frequency deviation on skew is shown on Plate 29, and it is possible to obtain the total skew in a picture for a given frequency difference by multiplying the corresponding skew in inches per inch by 7.

52. The frequency of the oscillator can be varied over a small range by means of Control R25. The physical position of this control can be seen in Plate 77, and its location in the cathode lead of the 7C5 fork driver is shown in the schematic diagram, Plate 34a. The frequency variation is obtained by varying the drive supplied to the tuning fork, since an increase in amplitude results in a decrease in frequency. The frequency deviation obtainable in this manner is approximately 0.4 cycles (see Plate 29). A four and one-half hour stability run was made simultaneously on two equipments in adjacent rooms. The results of this test are shown on Plate 30. The maximum frequency deviation of the one equipment was 0.02 cycles, while that of the other was 0.08 cycles. These changes correspond to stabilities of 11 and 44 parts per million, respectively.

53. The effects of temperature and humidity are shown in Plates 31 and 32, where it is observed that an increase in temperature causes a decrease in frequency. The decrease in frequency with increase in humidity is not as great as the change due to temperature variation; however, the humidity does have a decided and fairly rapid effect on the frequency. The results of the temperature run are summarized in the following table.

VARIATION IN AMBIENT TEMPERATURE

<u>Temperature Change °C</u>	<u>Frequency Change Cycles</u>	<u>Parts/million/°C.</u>
-15 to 0	-0.011	-0.4
0 to 20	-0.019	-0.5
20 to 35	-0.025	-0.9
35 to 50	-0.022	-0.8
	Average:	0.65

Due to the fact that the transceivers may be subjected to fairly large changes in temperature, humidity, and pressure it is considered desirable that the oscillator stability be improved in these respects.

54. A change of tubes test was made on the oscillator for each of the tubes connected with it. Four tubes were tried in each case, with a resulting maximum frequency change of 0.023 cycles. A tilt test was also conducted in which the equipment was placed in various positions. The resulting maximum frequency change was less than 0.01 cycles.

Drum Drive System

55. The rotating drum is driven by a synchronous motor through a worm gear and friction clutch system. The motor and drive assembly can be seen in Plate 77. The synchronous motor has an extra winding and a set of brushes which are placed in contact with a commutator for starting. The rotor is spring-mounted to assist in synchronizing; and if these springs are not adjusted properly, the synchronizing may be difficult. The worm on the motor shaft is meshed with a fiber gear on the drive shaft, which is connected to the lead screw and drum through a friction clutch. This clutch permits phasing, since the motor continues to run when the drum is stopped for phasing. Incorrect adjustment of this clutch can cause difficulty in phasing.

56. Gear pattern is not noticeable in the received copy. It is probably eliminated by the small piano wire spring which connects the drum to the lead screw. This is just inside the right end of the drum looking at the front of the equipment. During the tests a considerable amount of jitter appeared in one of the machines. It was traced to the drum, and examination revealed that this small spring, which connects the drum to the drive shaft, was broken. This allowed the drum to rotate freely over several degrees between two stops. The jitter resulting from this broken spring was very noticeable and it is considered desirable that this spring be mentioned in the instruction book, and that failure of this spring be included as one of the possibilities of introducing jitter.

57. Horizontal motion is imparted to the drum by a lead screw with 96 threads per inch. It is not considered desirable to have this fine thread in such an exposed position; however, the surface of the lead screw withstood very rough treatment without apparent harm. The lead screw must be kept clean, since grit on the lead screw may cause jitter or skew in the recorded picture.

Transmission Circuits Required

58. The transmission requirements of facsimile signals are very rigorous, since it is not only necessary that the density of each elementary area of the subject copy be reproduced as faithfully as possible, but also that the size and position of these areas be very nearly the same as the original. Some of the characteristics of the transmission circuits which must be considered in determining the fidelity of reproduction are: frequency band width and amplitude variations throughout this band, phase characteristics, interfering signals present, fading, selective fading, multipath effect, and echo effect. The last four effects are mainly confined to radio circuits. The effect on the received copy of each of the various transmission characteristics will be considered briefly in the following paragraphs.

59. Band Width Requirements. The facsimile signal has been shown in Appendix I to be an 1800-cycle amplitude modulated wave with significant side bands approximately 800 cycles on both sides of the carrier. This is the band width required for high quality reproduction; however, it is possible to cut the side bands down to 600 cycles with only a small loss in the resolution of the system. An actual test with some frequency shift conversion equipment revealed that with an 800-cycle low pass filter for the modulating wave, the resolution was still approximately 135 lines/inch and that this dropped to approximately 100 lines/inch when a 600 cycle filter was used. It is desirable that the circuit gain be fairly uniform from 1,000 to 2,600 cycles; however, this factor is not exceptionally important, especially if the departures are near the ends of the pass band.

Phase Characteristics

60. Phase characteristics of circuits transmitting facsimile signals are very important. It has been pointed out previously that the band width required is dependent on the speed of scanning and the definition required. The phase characteristics which a circuit must have are also dependent on the speed and definition. If the steady state transmission characteristics of a circuit are analyzed by comparing the phase of the output with that of the input, we obtain a characteristic curve of phase shift in degrees vs. frequency (see Plates 7 and 14).

61. In reference (7) it is shown that if the phase characteristic is a straight line through the origin, or has a y intercept of $n2\pi$, where n is an integer, the circuit will not introduce any phase distortion. In most transmission circuits the phase vs.

frequency characteristic is not a straight line, and the amount of departure from a straight line is some measure of the phase distortion introduced.

62. In considering the effect of phase distortion on the RC-120-B facsimile signal, the primary interest is its effect on the build-up and decay of the facsimile signal. This build up and decay time is first of all determined by the scanning head aperture size. An example of this build up and decay time is shown in Plate 36, where an oscillogram of the output is shown. In references (7) and (8) it is shown that if a sinusoidal voltage is impressed for a short time at the input of a circuit with phase distortion, the output will be longer than the input, due to the fact that certain components of the wave are delayed longer than others. The elongation that occurs is shown to be a function of the differences in envelope delay time over the frequency range required for the pulse transmission, the envelope delay time being defined as $\frac{dB}{\omega}$ where B is in radians, and ω is equal to $2\pi f$ where f is in cycles per second. The resulting delay is in seconds. This formula can be simplified and expressed in degrees and cycles as $\frac{\Delta \theta}{360\Delta f}$. Experimental results are shown in these references, which verify the above conclusions.

63. Since the aperture limits the build-up time to approximately 1 millisecond, a delay distortion of up to 0.25 millisecond would probably be permissible without appreciable reduction in system definition or resolution where the 0.25 millisecond is the maximum delay difference throughout the band required.

64. Interfering Signals. The transmission circuits for high quality reproduction should be relatively free from noise and interfering signals. In order to determine the experimental effect of random noise on the quality of the received copy, a number of transmissions were made with various signal-to-noise ratios. The results of Plates 54 to 59 were analyzed by means of a paper strip, which masked all but one character at a time. The number of letters or characters of a given type size on a given plate which could be determined with certainty were recorded, and this figure was divided by the total number of letters or characters in the particular group. This ratio is defined as the per cent readability, and the results of this test are shown on Plate 33. These tests were all conducted at audio frequencies with a RBK receiver as a noise source. The noise output is approximately a random noise, with the exception, of course, that the peak amplitudes are limited by the amplifiers. The peak-to-rms ratio of 2.3, given in Table 9, is an approximation obtained by observing the noise on an oscilloscope. This peak voltage is the maximum voltage which is not exceeded more than 5 or 10 per cent of the time. The noise spectrum was analyzed by means of the GR736A wave analyzer, and the resulting spectrum is shown on Plate 33a. The analyzer voltmeter varied between the limits shown in a somewhat erratic manner.

65. Some theoretical considerations regarding optimum contrast

range in respect to noise are included in Appendix III. It is shown here that the optimum signal contrast range for a linear log-log receiver halftone characteristic is 15 to 20 db in most cases. Experimental comparisons of 4, 8, and 12 db signal ranges are included in Plates 69, 70, and 71, respectively, where the signal to noise ratio was held constant at 15 db. It can readily be seen that the 12 db range is superior; however, to obtain this range at the receiver it was necessary to overdrive the crater lamp somewhat.

66. Fading, Multipath, and Echo Effects. These effects are all present to varying degrees in most radio circuits. The degree to which they affect the received signal is dependent on the frequency being used, the geographic location of the two terminals, and the time of day, among other things. The origin of most of these effects can be seen by observing Plate 34, where some of the possible paths for transatlantic transmission are shown. When it is recalled that the ionosphere effectively consists of several ionized layers, it can readily be seen that the multiplicity of paths becomes great. Since any particular path is subject to variations in attenuation and length, it is possible for the resultant of two or more rays to cancel or add, with wide variations in resulting signal strength at the receiver. This effect is a type of "fading". Some types of "fading" can be combatted to a certain extent by various converters, which change the AM facsimile carrier to a frequency shift carrier. In addition to fading, it is shown in Plate 34 that the arrival time for the various paths may differ as much as 3 or 4 milliseconds. This amounts to 0.04 or 0.05 inches on the received copy, which is equal to the height of the small 8-point type letters. It can readily be seen that this type of transmission circuit will limit the speed with which facsimile machines can transmit intelligence. An example of this is shown in reference (5), page 16, where received copy at different drum speeds are compared. In this illustration it is evident that the scanning speed with this particular transmission circuit must not exceed 10 inches per minute if type-written copy is to be legible. This speed is slightly less than the 13.1 inches per second scanning speed of the RC-210-B. It is also pointed out in this reference that the amount of multipath delay is likely to be less at the higher frequencies (around 18 megacycles) than it is at the lower frequencies.

67. In addition to multipath effects, there are times when echoes are very annoying. Plate 72 shows an example where the return echoes are 0.2 inch behind the desired signal. Since the transmitter and receiver in this case were fairly close to each other, the echoes must be coming from a reflecting area approximately 1,400 miles away.

Power Supply Characteristics

68. The power supply for the RC-120-B is contained in a separate unit, which is connected to the transceiver by a 4-foot flexible cable. The power supply is seen on the right of the

transceiver in Plates 73 and 74. In addition to the regular plate and filament supply, a constant output amplifier is also contained in the power supply. This amplifier receives an 1800-cycle signal from the fork amplifier and by means of a special regulator, supplies a constant output of from 6 to 8 volts to the exciter lamp. A view of the control which determines the output voltage is shown in Plate 84. The regulated B+ is obtained from the regulator in the transceiver. The tubes for this regulator can be seen in Plate 79, where they are located on the left end of the shelf at the rear of the equipment.

Vacuum Tube Operating Conditions

69. The vacuum tube operating conditions for most types of equipment operation are shown on Table 4. In general, most of the tubes are operating within JAN limits; however, there are a few exceptions. The 6AC5G recording amplifier has 530 volts on the plate when on record-direct. The JAN maximum is 275 volts. The two 7C5 voltage regulator ballast tubes are operating with 250 volts between heater and cathode. The JAN maximum in this case is 100 volts. In the power supply, the 7N7 amplifier section is operating with a plate voltage of 510 volts, which is in excess of the JAN limit of 330 volts maximum. The two 7C5 power amplifiers in the power supply are operating with a plate voltage of 520 volts, which is in excess of the JAN limit of 350 volts. The 7L7 voltage regulator also in the power supply has 162 volts between heater and cathode, which is in excess of the JAN limit of 100 volts. These conditions are not desirable, since all tubes should be operated within JAN specifications limits.

CONCLUSIONS

70. The RC-120-B provides a means of transmitting fairly high quality pictures over radio and wire circuits. Extraneous patterns such as are caused by lead screw and gear irregularities are not discernable in the recorded copy, when using a pair of properly adjusted machines. Jitter is also so small that it cannot be detected by the unaided eye unless one of the machines has a dirty lead screw. In this case the jitter may become objectionable. The system definition when using photographic recording is approximately 0.018 inch in the direction of scanning and 0.026 inch perpendicular to the direction of scanning. These figures were obtained while using an ideal transmission circuit with negligible delay distortion and very wide band pass. The system definition is limited by the transmitter scanning aperture and the carrier frequency. The latter limitation could be reduced to one half by using full wave rectification at the recorder in place of the half wave rectification now employed.

71. The halftone characteristics introduce a considerable amount of distortion which is especially noticeable in the darker grey areas. Most of this distortion is introduced by the transmitter scanner and can be reduced by employing flat and light grey subject copy. This, however, is not a desirable solution in most cases. Improvement of the system halftone characteristics

will probably require not only a change of the scanner characteristics but also an increase in film speed or effective crater lamp output since the receiver is now working on the toe or curved portion of the film characteristic.

72. The transmission circuits used with this equipment should have a pass band of from 1000 cycles to 2600 cycles if the full definition of the equipment is to be realized. In addition the delay distortion should be less than 0.25 millisecond where the delay is expressed as $\frac{dB}{d\omega}$ and the distortion is the maximum deviation encountered throughout the required frequency band.

73. For recorded copy with halftones the signal to noise ratio should be 20 to 30 db or greater if the effect of noise is to be negligible. At signal to noise ratios of 3 to 0 db the recorded copy begins to become unintelligible. For black and white copy the signal to noise ratio may be as low as 9 to 12 db before the effect of the noise becomes apparent.

74. In order to minimize the effect of noise on the recorded halftone copy it is desirable to increase the contrast range to 15 or 20 db; however, with the present film, crater lamp and optical system it is not feasible to increase the contrast range above the present 8 db value.

75. The transmission speed over radio circuits is found to be limited by multiple effects rather than band width, and it would be desirable to have some means of rapidly changing the scanning speed to utilize the maximum capabilities of the transmission circuit.

76. From an operational standpoint this equipment has a number of disadvantages which are enumerated as follows:

- (a) The necessity of operation in the dark for photographic recording is considered undesirable.
- (b) The necessity of loading the subject matter and recording medium on a cylindrical drum is considered undesirable.
- (c) The type of construction and lack of shock mounting would not permit sustained operation under conditions of severe shock and vibration.
- (d) The inaccessibility of some parts of the equipment is not desirable.

ACKNOWLEDGMENTS

Acknowledgment is made to Mr. C. B. Davis who suggested many of the procedures used and assisted in determining desirable nomenclature, and to Mr. C. C. Rae and Mr. R. B. Rappaport who performed many of the tests and aided in the solution of the problems

which arose during these tests.

Acknowledgment is also due the Measurements and Direction Finding Section for measurement of the conducted and radiated noise included in Table 10.

REFERENCES

1. BuShips ltr 945-3208 of 21 April 1945 to NRL
2. Standards on Facsimile, Definition of Terms, 1942, I.R.E.
3. Standards of Facsimile, Temporary Test Standards, 1943, I.R.E.
4. Kodak Reference Handbook, Eastman Kodak Company, Rochester, New York.
5. T. L. Eckersley, "Multiple Signals in Short Wave Transmission," Proc. I.R.E., Vol. 18, No. 1, January 1930.
6. H. M. Dowsett, "Echo Signals in Transatlantic Picture Telegraphy," Journal of the Television Society, Vol. 1, December 1931, pp. 84-97.
7. C. E. Lane, "Phase Distortion in Telephone Apparatus," Bell Telephone System Monograph B-481, May 1930.
8. S. P. Mead, "Phase Distortion and Phase Distortion Correction," Bell System Technical Journal, Vol. 7, April 1928, pp. 195-224.
9. F. E. Terman, "Radio Engineers' Handbook," McGraw-Hill Book Company, 1943, pp. 21-22.
10. K. Henney and Dudley, "Handbook of Photography."

DECLASSIFIED

CALCULATION OF OUTPUT SPECTRUM
FACSIMILE SIGNAL

The output of the facsimile transmitter consists of an amplitude modulated 1800-cycle carrier where the instantaneous amplitude of the carrier is dependent on the density of the subject being scanned. This output voltage e_o can be represented by the following equation:

$$e_o = F(d) \text{ sine } \omega_c t \quad (1)$$

where ω_c is the 1800-cycle carrier and $F(d)$ is a function of the subject density, and the minimum and maximum voltages. By means of a Fourier series or integral analysis, $F(d)$ can be represented by a dc component and a series of sine waves. It can readily be seen that the output spectrum will be dependent on the subject being scanned, and that there are a large number of possible configurations. There are, however, several cases which would enable us to determine the maximum band width required for satisfactory transmission. One of the simpler, and yet significant, cases is that of a single isolated line with a width equal to that of the effective scanning aperture. This is theoretically the narrowest line which will cause the transmitter level to change the full amount.

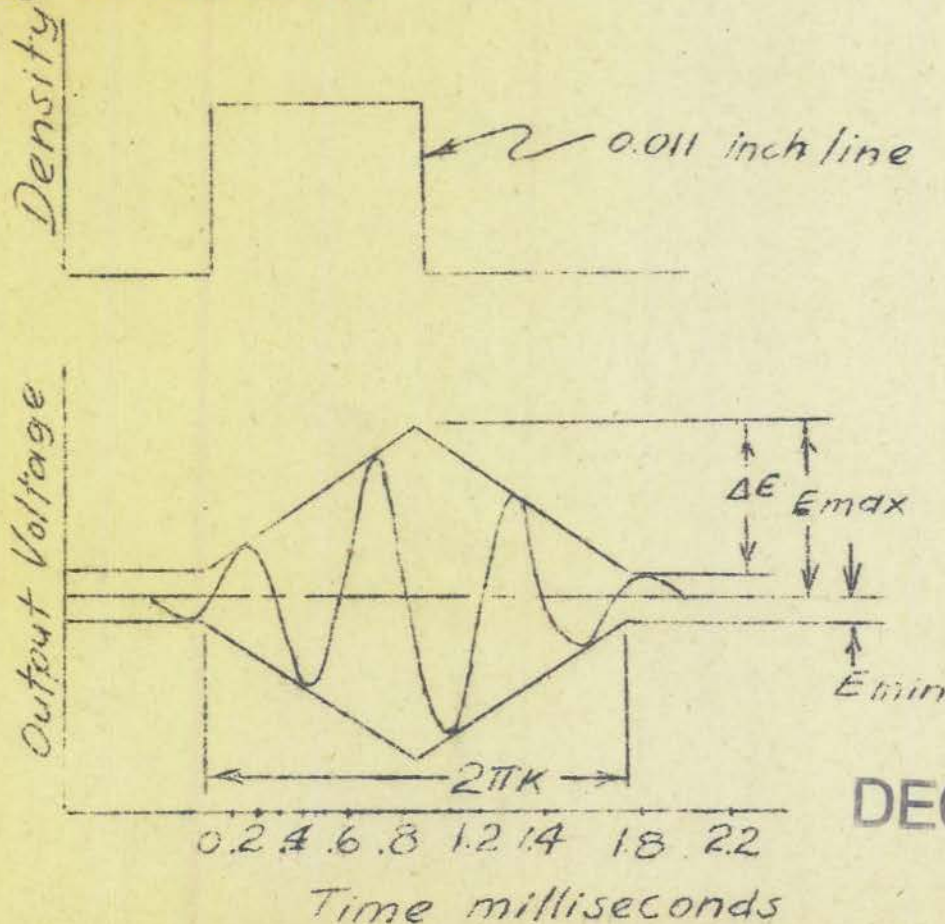

DECLASSIFIED

Figure 1

APPENDIX I

Figure 1 indicates the line and the type of output which can be expected. The expected amplitude variation of the 1800-cycle carrier is also indicated. This, of course, can vary somewhat, depending on the relative phase of the carrier to the pulse.

For purposes of comparison with the measured values shown in Plate 4, a series of 0.011-inch lines spaced approximately 0.5-inch will be considered. It will be shown later that the relative amplitudes of the side bands are independent of the line spacing and are dependent only on the width of the effective aperture, which is equal to the line width. The amplitude of the various components of a recurring triangular pulse can be represented by the following equation (Reference 9, Page 22):

$$y = \frac{E_k}{2} + \sum \left\{ \frac{\Delta E_k \sin^2 \left(n\pi \frac{k}{2} \right)}{\left(n\pi \frac{k}{2} \right)^2} \right\} \cos nx \quad (2)$$

$\frac{\Delta E_k}{2}$ is the average or dc value

ΔE is the maximum change in level

k is the ratio of base width to period of recurrence

n is the order of harmonic, and x is equal to 2π times the recurrence rate.

The actual value of F(d) is $y + E_{\min}$ which gives the following equation for F(d).

$$F(d) = E_{\min} + \frac{\Delta E_k}{2} + \sum \left\{ \frac{\Delta E_k \sin^2 \left(n\pi \frac{k}{2} \right)}{\left(n\pi \frac{k}{2} \right)^2} \right\} \cos nx \quad (3)$$

Before replacing F(d) in equation (1) with its value given in equation (3), consider the following simplified equation.

$$e_o' = (E_{dc} + \Delta E_k \cos \omega_x t) \sin \omega_c t \quad (4)$$

$$= E_{dc} \sin \omega_c t + \Delta E_k \cos \omega_x t \sin \omega_c t \quad (5)$$

By means of trigonometric identities, equation (5) can be rewritten as follows:

$$e_o' = E_{dc} \sin \omega_c t + \frac{\Delta E_k}{2} \sin (\omega_c + \omega_x) t + \frac{\Delta E_k}{2} \sin (\omega_c - \omega_x) t \quad (6)$$

DECLASSIFIED

~~RESTRICTED~~

From this and equation (3) it follows that equation (1) can be rewritten as

$$e_o = (E_{\min} + \frac{\Delta Ek}{2}) \sin \omega_c t + \sum \left\{ \frac{\Delta Ek}{2} \frac{\sin^2(\frac{n\pi k}{2})}{(\frac{n\pi k}{2})^2} \right\} \sin (\omega_c + n\omega_x) t \quad (7)$$

$$+ \sum \left\{ \frac{\Delta Ek}{2} \frac{\sin^2(\frac{n\pi k}{2})}{(\frac{n\pi k}{2})^2} \right\} \sin (\omega_c - n\omega_x) t$$

From the above equation the carrier amplitude is

$E_{\min} + \frac{\Delta Ek}{2} = 0.23 + \frac{0.67 \times 0.044}{2} = 245$ millivolts. where the measured values of $E_{\min} + \frac{Ek}{2}$ are 0.23 and 0.67 respectively. The side bands are seen to be symmetrical about the carrier and spaced by the frequency equal to the recurrence rate $\frac{\omega_x}{2\pi} = 24$ cycles/sec.

Since $K \ll 1$ the amplitude of the first side band is approximately equal to

$$\frac{\Delta Ek}{2} = \frac{0.67 \times 0.044}{2} = 14.8 \text{ millivolts}$$

The relative amplitudes of the side bands are proportional to

$$\frac{\sin^2(\frac{n\pi k}{2})}{(\frac{n\pi k}{2})^2}$$

A plot of this is given in Plate 34d. A comparison of the measured values with the calculated values is given in Plate 4.

An examination of equation (7) reveals that when $k \ll 1$ the relative amplitudes of the frequency components are dependent on the pulse width and independent of the spacing between lines, provided, of course, the frequency in question is an integral number of harmonics from the carrier. The relative amplitude at any frequency f_1 is a function of $n \times k$ where n is equal to f_1 divided by the fundamental frequency and k is equal to the pulse width divided by the period or separation between pulses. Combining the two we get

$$n \times k = \frac{f_1}{\text{fundamental frequency}} \times \text{Pulse width} \times \text{fundamental frequency} \quad (8)$$

$$= f_1 \times \text{pulse width} \quad (9)$$

APPENDIX I

where f_1 is in cycles/second and the pulse width at the base is in seconds.

In the particular case we have been studying, the pulse width is equal to twice the aperture size, or 1.7 milliseconds. Equation (9) now reduces to

$$nk = f_1 \times 1.7 \times 10^{-3} \quad (10)$$

This can be used in conjunction with Plate 34d to find the relative amplitude at any frequency for a single isolated line.

DECLASSIFIED

OPTIMUM CONTRAST RANGE IN REGARD TO NOISE

In considering the effect of noise on the recorded copy, it is necessary to first determine its characteristics and how it affects the facsimile signal. Considering a facsimile signal with an 1800-cycle carrier and a maximum modulating frequency of 800 cycles, it is readily apparent that a band pass of from 1000 to 2600 cycles is necessary at the receiver. If a filter is employed which will just pass this band of frequencies, the noise components on either side will be eliminated. Since this band is just slightly over one octave wide, the resulting noise wave can be represented approximately by a sine wave with variable phase and amplitude. Since the frequencies of the signal and noise voltages are nearly the same, they can be considered as adding vectorily.

$$E_0 = (E_{\text{sig}} + E_{\text{noise}}) \cos \phi \quad (1)$$

where ϕ is the instantaneous phase angle between the waves. Since ϕ and E_{noise} will vary the same regardless of the contrast range employed, it can be assumed that E_0 , the instantaneous value of the sum of the two voltages, will be a function of the sum of the noise meter and signal meter readings. To determine the visual effect of noise on the recorded copy when various contrast ranges are employed, several possible receiver halftone characteristics are plotted on Plate 34c. In order to have a basis for comparison, linear log-log characteristics are used in all cases. The four straight lines which originate at the upper right hand corner and slope downward to the left represent the receiver halftone characteristics for 4, 10, 20 and 30 db contrast range. The graph is so constructed that all halftone characteristics pass through point "A" which is maximum signal of 10 volts and 0 recorded copy density. The point of intersection at the black or 1.6 end of the density scale determines the contrast range of the halftone characteristic in question. It can readily be seen that the lines drawn represent only a few of the ranges possible and that intermediate ranges lie between the given lines. Assuming a signal with the intensity necessary to give a recorded copy density of 0.8 and a signal-to-noise ratio of 20 db, the input voltage will be inside the range of $E_{\text{signal}} \pm$ one volt values. The shaded area indicates the range of density variations probably for any contrast range and it can readily be seen that this is least around a contrast range of 15 to 20 db. The curves labeled signal/noise = 20 db, 1 volt, about density of 0.8 were obtained by first finding the voltage required to give a density of .8 for each halftone characteristic; then since the input voltage could be expected to vary \pm 1 volt about the mean, the corresponding density limits were marked. The curves connecting these points are the two lines bounding the shaded area. Since the eye responds equally to equal density variations it is apparent that the most desirable case is where the shaded area has the least width. Curves are also shown, which indicate the visual effect of noise at the minimum and maximum signal levels. When the departure at maximum signal level

APPENDIX II

is observed, it appears that a 30 db contrast range is most desirable; however, the increase in distortion at the minimum signal level is greater than the decrease at the maximum signal level. This can be seen by means of the curve labeled signal/noise = 20 db, 1 volt above minimum signal, and the horizontal line 20 db below maximum signal. The ΔD is the variation in density due to noise and is the horizontal distance measured at the point of intersection with the halftone characteristic in question. For a 30 db contrast range the ΔD at the black end is 0.68 while at the white end it is only 0.04. From this and the previous case it is apparent that the optimum contrast range is approximately 15 to 20 db. The way in which the densities of the elementary areas vary about a mean value can be seen on Plate 68, which is an enlarged portion of Plate 64. The apparent effect of the noise is greatest in the darker grey areas, as is to be expected. It should be noted that this analysis applies only to receivers which have linear or approximately linear log-log characteristics.

DECLASSIFIED

RADIO INTERFERENCE FROM RC-120-B TRANSCEIVER

In order to determine the effect of the RC-120-B on adjacent equipment, the following tests were performed with the equipment in the "Direct Record" position, operating normally with a +2 db signal input. Power was supplied to the equipment from a 115-volt, 60-cycle source. 1800-cycle audio was supplied from an audio oscillator. Conducted interference was measured across the a.c. supply leads and across the audio leads. Radiated interference was measured at a distance of three feet from the equipment.

The results of the tests are given on Table 10. It was noted that up to one megacycle the conducted noise was originating in the power supply unit. Above one megacycle the conducted noise seemed to be caused chiefly by the synchronous motor circuit. The radiated noise originated mainly at the recording spark.

DECLASSIFIED

DEFINITION OF TERMS

Most of the terms defined here have been defined elsewhere in this report, but are grouped here as a matter of convenience. The definitions used are in general the same as are given in the IRE Standards on Facsimile, reference 2, which should be consulted for a much more extensive list of terms. The term "definition perpendicular to the direction of scanning" has a slightly different meaning in this report than that given in reference 3, where it is measured by disengaging the cross feed mechanism and manually moving the scanning head or drum to determine the width of the narrowest isolated line on the subject copy for which the response of output of the system will just reach the steady-state value which is attained for a larger area of the same density as that of the line.

The term "resolution" is not included in references 2 and 3; however, it is a term which is used on optical systems and in photographic reproduction. Its use not only permits a rapid overall evaluation of facsimile systems, but it is almost the only means that can be used to evaluate the detail obtainable when using teledeltos recording paper.

1. Contrast Range. Sometimes called "white to black amplitude range". It is the signal voltage or current ratio of picture white to picture black, or the reciprocal, at any point in the system and is usually expressed in decibels.
2. Definition (in a given direction). The width of the narrowest isolated line of the subject copy perpendicular to the given direction, for which the response of the system (or portion thereof under consideration) will just reach the steady-state value which is attained for a larger area of the same density as that of the line. In this report the normal feed of the machine was used in measuring the definition in each direction considered.
3. Density. A measure of the light-reflecting or transmitting properties of an area. It is expressed by the logarithm (base 10) of the ratio of incident to transmitted or reflected light.
4. Halftone Characteristics. A relation, usually shown by a graph, between the density of the recorded copy and the density of the subject copy. This term is also used to relate the amplitude of the facsimile signal to the density of the subject copy or recorded copy, or the input vs. output of any circuit which affects the overall halftone characteristics.
5. Index of Cooperation (International). The product of the drum diameter by the number of scanning lines per unit length. It is necessary that this index be the same if two machines are to work together without introducing lineal distortion of the picture.

APPENDIX IV

6. Jitter. The distortion in the received picture caused by momentary errors in synchronism between scanner and recorder. The presence of this distortion causes straight lines to become jagged in the recorded copy.
7. Overlap. The amount by which the effective width of the scanning spot exceeds the nominal width of the scanning line.
8. Phase Distortion. That form of wave distortion in which the relative delays (either phase or envelope) of the different frequency components of the wave are changed.
9. Resolution (in a given direction). The number of equal black and white lines per inch perpendicular to the given direction, which the facsimile system will resolve as separate lines. This is usually measured by means of a set of convergent lines and the resolution obtained by finding the point up to which all the lines can be determined consistently as separate lines.
10. Scanning. The process of analyzing successively the densities of the subject copy according to the elements of a predetermined pattern or of synthesizing corresponding densities in the recording.
11. Skew. The deviation of the received frame from rectangularity due to asynchronism between scanner and recorder. Skew is expressed numerically as the tangent of the angle of this deviation.
12. Underlap. The amount by which the effective width of the scanning spot falls short of the nominal width of the scanning line.

DECLASSIFIED

TABLE 1

RC-120-B FACSIMILE EQUIPMENT

Weights and Dimensions

<u>Unit</u>	<u>Length Inches</u>	<u>Height Inches</u>	<u>Width Inches</u>	<u>Weight Pounds</u>
1 - CH - 117	26	19-1/2	13	107-3/4 (full)
1-Facsimile Transceiver	22-1/4	8	14	65-1/2
1-KC Coupling Coil				1/4
1-UC Coupling Coil				3/4
2-Instruction Books				
1 - CH - 116	25-1/2	17	16	107(full)
1-Power Supply	13	12-1/2	10-1/4	47-1/2
1-1000 Sheets of Teledeltos				7-1/4
2-Developing Tanks				3-1/4
1-Set Vacuum Tubes				(2-1/4
1-Set Special Tubes				(1-7/8
3-Pads of Message Paper				
1 - Case PH-410 Containing Photographic Equipment	30	13-1/2	13-1/2	68
1 - Bag BG-124 Duffle Bag for Dark Tent	34 x 8" Dia.			18-1/4

TABLE 2

RC-120-B FACSIMILE EQUIPMENT

Output Circuits and Voltages Available

<u>Circuit</u>	<u>Terminal Voltage (rms)</u>		<u>Load Impedance</u>
	<u>-10 db</u>	<u>+2db</u>	
Balanced Line	0.16	0.69	500 ohms
Xmtr. Jack	0.15	0.60	200 ohms
Line Jack	3.5	15	500 ohms

225
500

DECLASSIFIED



TABLE 3

RC-120-B FACSIMILE EQUIPMENT

Input Circuits and Voltages Required

<u>Circuit</u>	<u>Gain Control Setting</u>	<u>Voltage Req. for +2 db</u>	<u>Circuit Impedance</u>
Balanced Line	10 , 70 ₂	0.10 , 0.009	500 ohms
Rcvr. Jack	10 , 70	5.0 , 0.40	2500 ohms ¹
Line Jack	10 , 70	0.1 , 0.009	500 ohms

1. Rcvr. impedance can be changed to 250 ohms.
2. Maximum gain setting used because of effect shown on Plate 28.

TABLE 4

RC-120-B FACSIMILE EQUIPMENT

Potentials Applied to Electrodes of Vacuum Tubes

Power Supply PE-140-B Line Voltage = 115 V.

Types of Operation:

1. TRANSMIT - +2 db on meter.
2. SET RANGE - +2 db on meter.
3. RECORD PHOTO - No signal.
4. RECORD DIRECT - No signal.
5. RECORD PHOTO-PHASE CONTROL DEPRESSED - +2db signal.

<u>Tube and Function</u>	<u>Type of Operation</u>	<u>Voltages - Pin to Ground</u>							
		<u>1</u>	<u>2</u>	<u>3</u>	<u>4</u>	<u>5</u>	<u>6</u>	<u>7</u>	<u>8</u>
7L7									
Fork Pick-up 7C5	1, 2, 3, 4	gnd	21	97	2.7	N.C.	0	2.7	F
Fork Driver 7N7	1, 2, 3, 4	gnd	245	245	N.C.	N.C.	0	40	F
Fork Buffer 7C7	1, 2, 3, 4	gnd	6.8	167	0	0	175	6.4	F
1st Volt Amp 7L7	1, 2, 3, 4	gnd	47.5	65	0	0	0	2.2	F
2d Volt Amp 7C5	1, 2, 3, 4	gnd	90	67	2.0	N.C.	-0.3	2.0	F
Trans. Output Driver 7N7	1, 2, 3	gnd	250	250	N.C.	N.C.	0	15.5	F
Driver and Meter Amp	1, 2	gnd	0	65	-1.5	-6	0	16.5	F
	3	gnd	0	33	-0.2	0	0	18	F
	4	gnd	0	33	-0.3	0	250	18.5	F
	5	gnd	0	65	-0.3	0	0	17.0	F

DECLASSIFIED

TABLE 4 (Contd)

Tube and Function	Type of Operation	Voltages - Pin to Ground							
		1	2	3	4	5	6	7	8
6AC5G									
Recordg P.A.	3	N.C.	Gnd	150	N.C.	0	N.C.	F	0
	4	N.C.	gnd	530(3)	N.C.	0	N.C.	F	0
	5	N.C.	gnd	150	N.C.	-0.2	N.C.	F	9.0
7L7									
Volt.Reg	1, 2, 3, 4	gnd	225	245	80	N.C.	70	80	F
2-7C5								(4)	
V.R. Ballast	1, 2, 3, 4	gnd	475	475	N.C.	N.C.	232	250	F
7C5									
Motor Amp.	1, 2, 3, 4	gnd	250	250	N.C.	N.C.	0	16.5	F
	5	gnd	250	250	N.C.	N.C.	0	15.5	F
2-6AC5G									
Motor Amp P.A.	1, 2, 3, 4.	N.C.	gnd	440	N.C.	-3(1)	N.C.	F	0
7L7	5	gnd	207	178	9.5	N.C.	0	9.5	F
Phasing Amp	1, 2, 3, 4.	gnd	207	178	0	N.C.	0	0	F
885									
Phasing Trigger	1,2, 3, 4		gnd	250	N.C.	0	N.C.		55

Power Supply PE-140B - Tube Socket Voltages (DC) 115 V A.C.

1800 Cycle Regulator

7S7	3, 4	gnd	127	N.C.	-2.6	60	0	1.6	F
Input Mixer	1, 2	gnd	31	N.C.	-2.6	157	-11	1.4	F
7N7	3, 4	gnd	31	510(6)	0	-67	-67	0	F
Amp and Rect.	1, 2	gnd	19	475	0	-300	-300	0	F
2-7C5	3, 4	gnd	520(5)	0	N.C.	N.C.	-6(1)	9.3(2)	F
Power Amp	1, 2	gnd	480	250	N.C.	N.C.	0	26	F
7L7	3, 4	gnd	0	0	0	N.C.	-42	0	F
Volt. Reg	1, 2	gnd	-17	-3.5	-162	N.C.	-162	-162	F
80									
Rectifier			Efil A.C. 4.3 v.	Eac-Plates to gnd 610 v.			Edc Fil to gnd 612 v.		

- (1) Indicates bias obtained through grid rectification.
- (2) The two 7C5's in the P.A. for the 1800A Regulator (PE-140-B) draw approximately 11 ma of grid current each when the set is in Record positions. In these positions the screens are grounded eliminating plate and screen current. Thus any signal applied to the grids will be rectified as there will be no cathode bias present.
- (3) JAN Max. 275 volts.
- (4) JAN Max. E_{bk} 100 volts.
- (5) JAN Max. 350 volts
- (6) JAN Max. 330 volts

DECLASSIFIED

TABLE 5

RC-120-B FACSIMILE EQUIPMENT

A.C. Power Requirements

<u>Condition and Type of Operation</u>	<u>E</u>	<u>Line I</u>	<u>ExI</u>	<u>Input Watts</u>	<u>Power Factor Per Cent</u>
Transmit					
+2 db into 500 ohms	110	2.15	236.5	210	88.9
Set Range					
+2db on meter	110	2.15	236.5	211	89.2
Stand by	110	1.27	139.7	112	80.3
Record Photo					
+2 db on meter	110	1.9	208.9	185	88.5
Record Direct					
+2 db - Teledeltos	110	1.78	195.8	170	86.9

TABLE 6

RC-120-B FACSIMILE EQUIPMENT

Effect of Voltage Variation on Transmitter and Receiver Outputs

<u>Line Voltage</u>	<u>Transmitter Output Volts</u>	<u>Receiver Crater lamp Milliampers</u>
103.5	0.82	32.8
109.3	0.83	33
115	0.84	33.6
120.7	0.84	34.5
126.5	0.84	35.5

Transmitter output = +2 db at 115 volts.
 Receiver input - Constant = +2 db at 115 volts.

TABLE 7

RC-120-B FACSIMILE EQUIPMENT

Effect of Line Voltage Variation on Regulated Voltages

<u>Line Voltage</u>	<u>B+ Output Volts</u>	<u>Regulated 1800 cycles Output - Volts</u>	<u>Regulated B+ Volts</u>
103.5	450	5.85	255
115	480	6.0	253
126.5	530	6.15	252

DECLASSIFIED

TABLE 10

RC-120-B FACSIMILE EQUIPMENTRadio Interference

<u>Frequency</u> <u>Megacycles</u>	<u>Conducted Interference</u> <u>Input to</u> <u>Power Supply</u>	<u>Conducted Interference</u> <u>Audio Signal</u> <u>Input</u>	<u>Radiated Inter-</u> <u>ference Radiated</u> <u>at 3 feet</u>
0.16	50	1.5	2
0.24	80	4	2
0.35	50	2	2
0.60	7	0	2
1.00	0	0	1
1.50	0	0	T
2.00	0	0	T
4.00	1	1	1
6.00	3.5	1	T
8.00	13	1	T
10.00	70	1.5	1
12.0	500	14	2
15.0	110	7	1
20.0	477	53	T
30.0	150	150	34
50.0	100	60	T
75.0	105	150	T
100.0	88	44	20
125.0	0	11	96
150.0	2	2	53

NOTE:

1. "T" denotes trace - too low to measure
2. Conducted values in microvolts
3. Radiated values in microvolts per meter

DECLASSIFIED



TRANSCIEVER OPTICAL SYSTEM

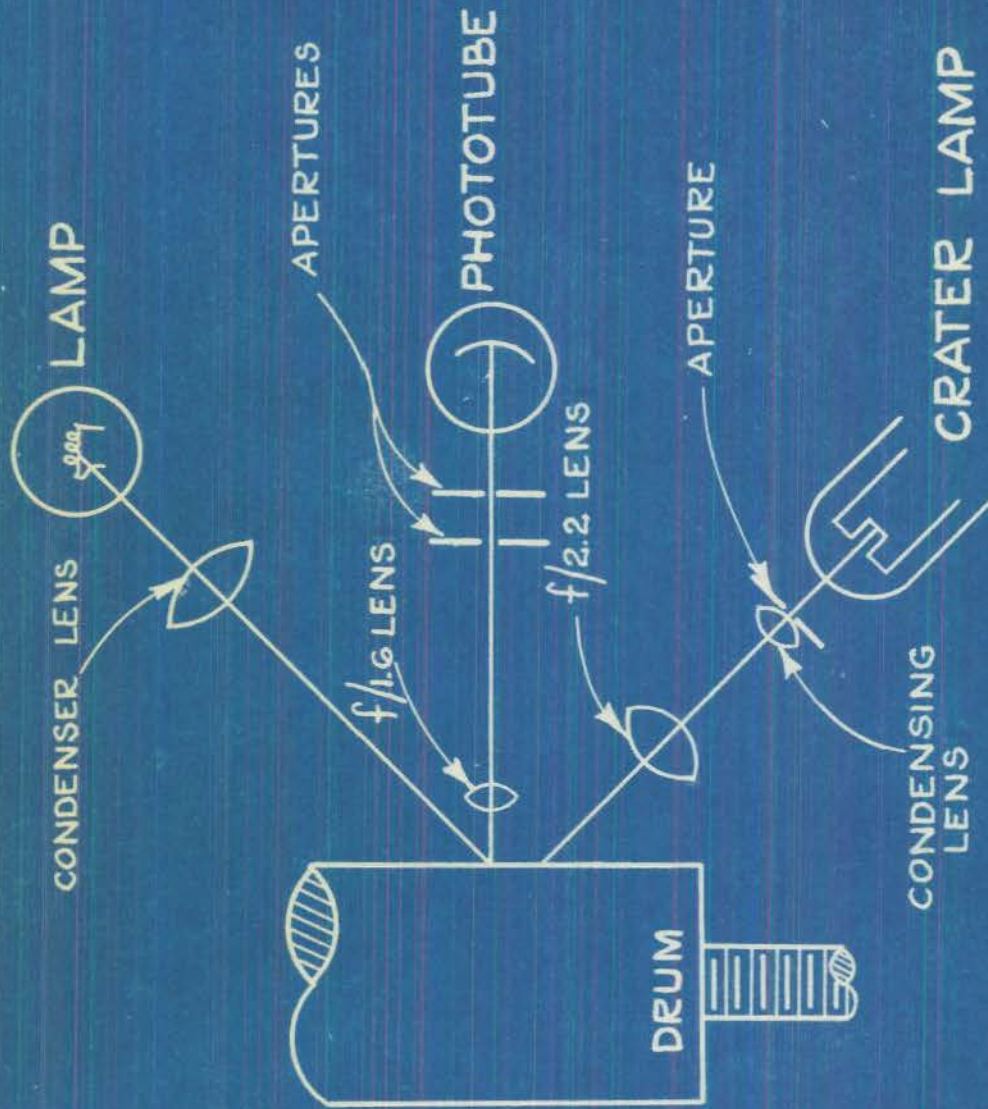

DECLASSIFIED

RESTRICTED

R-2885

PLATE I

TABLE 8

RC-120-B FACSIMILE EQUIPMENT

General Specifications

Line Voltage	105/125 Volts. AC 50/60 cycles or 6/8 volts D.C.
Power Consumption	210 watts - 60 cycles
Index of Cooperation	264
Lines per inch	96
Drum Speed	90 r.p.m.
Drum Diameter	2-3/4 inches <i>TTD = 8.66</i>
Drum Length	7-1/4 inches
Film size and type	7 x 8-5/8 Type A or C
Amplitude Modulated Carrier	1800 cycles
Transmission Band required	1000 to 2600 cycles

Speed

8.1 in²/min assuming no bar

TABLE 9

RC-120-B FACSIMILE EQUIPMENT

Signal to Noise Ratios

rms signal held constant at 0.3 volts.
Peak noise/rms noise equals 2.3.

<u>rms/rms</u>	<u>Peak/peak</u>
-3	-6.6
0	-4.4
3	-1.6
6	1.6
9	4.5
12	6.4
15	8
20	12.6
30	22

DECLASSIFIED

same speed

9.17 in²/min

DECLASSIFIED

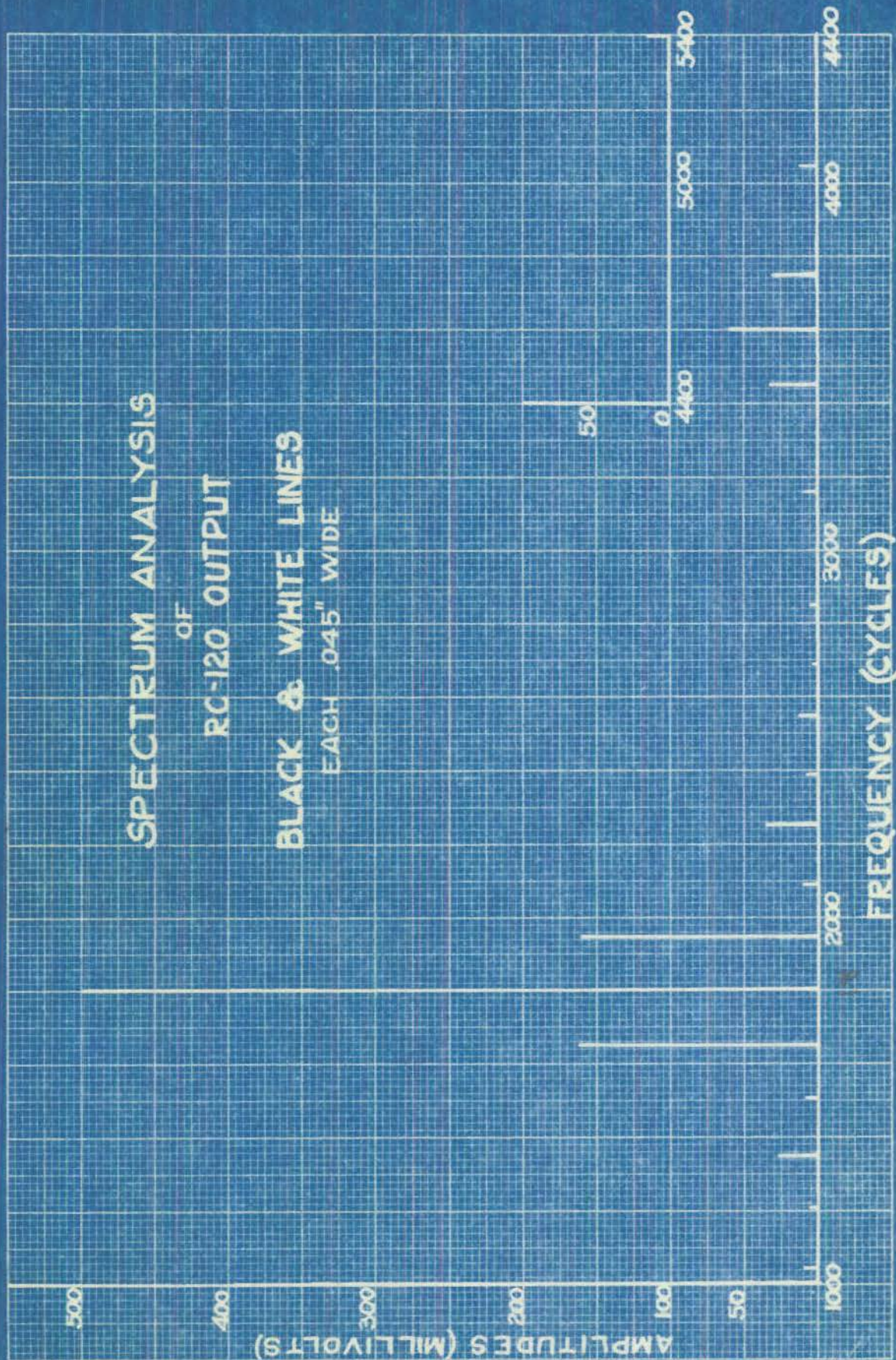

R-2885

PLATE 2



DECLASSIFIED

RESTRICTED



AMPLITUDES (MILLIVOLTS)

FREQUENCY (CYCLES)

R-2885

PLATE 3

DECLASSIFIED

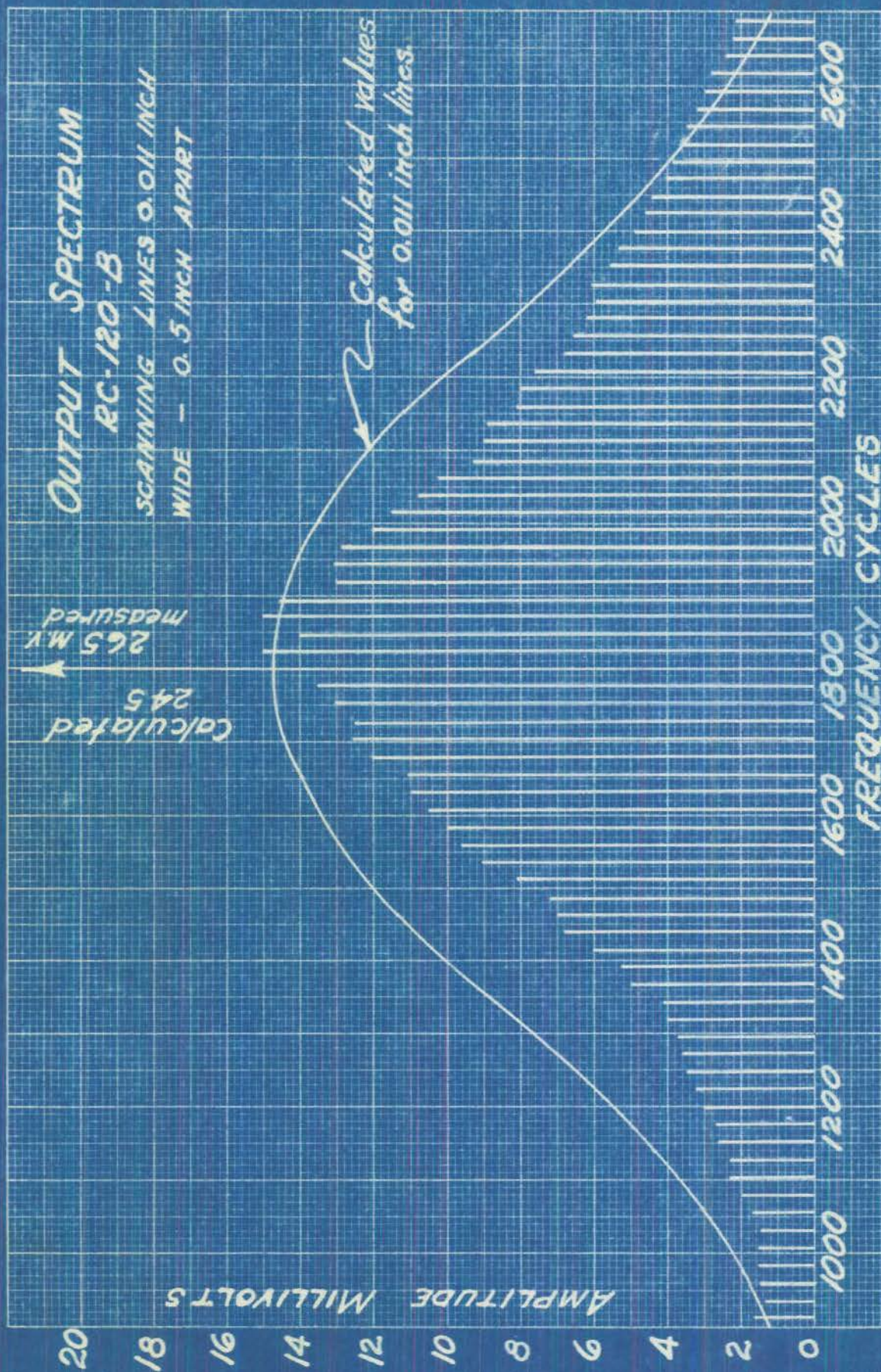

RESTRICTED

R-2885

PLATE 4

DECLASSIFIED

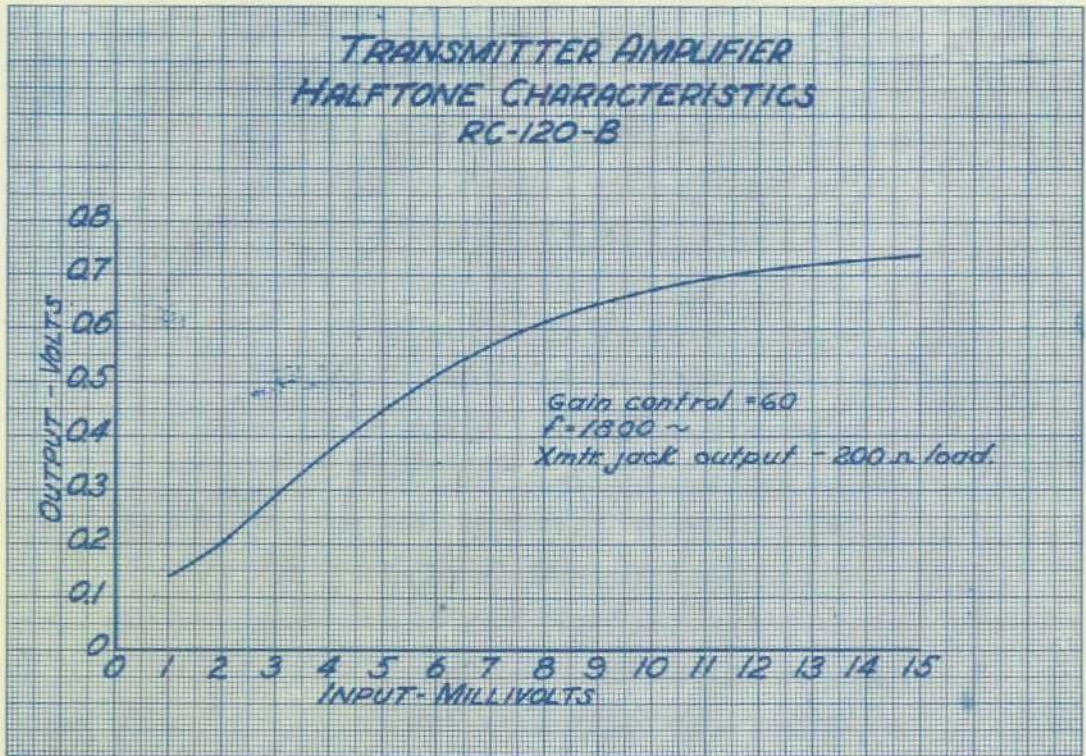

FIG. 1

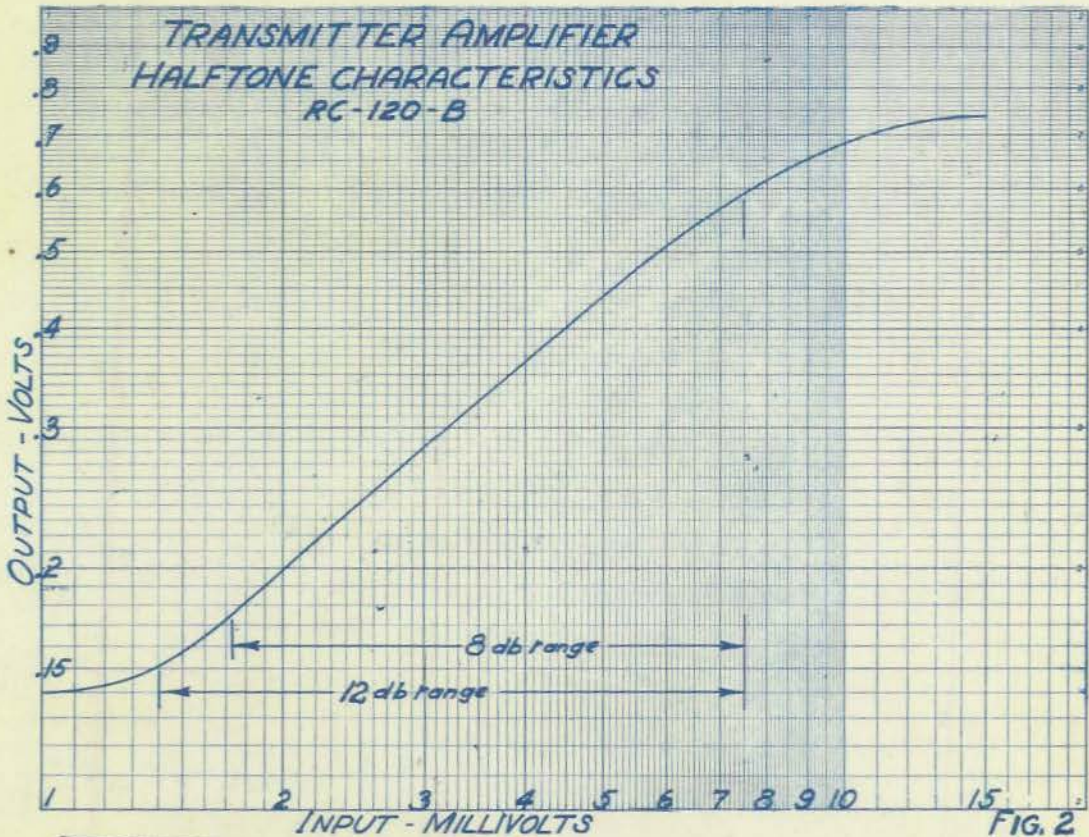

FIG. 2
PLATE 5

RESTRICTED

R-2885



DECLASSIFIED

RESTRICTED

TRANSMITTER AMPLIFIER FREQUENCY RESPONSE



R-2885

PLATE 6



DECLASSIFIED

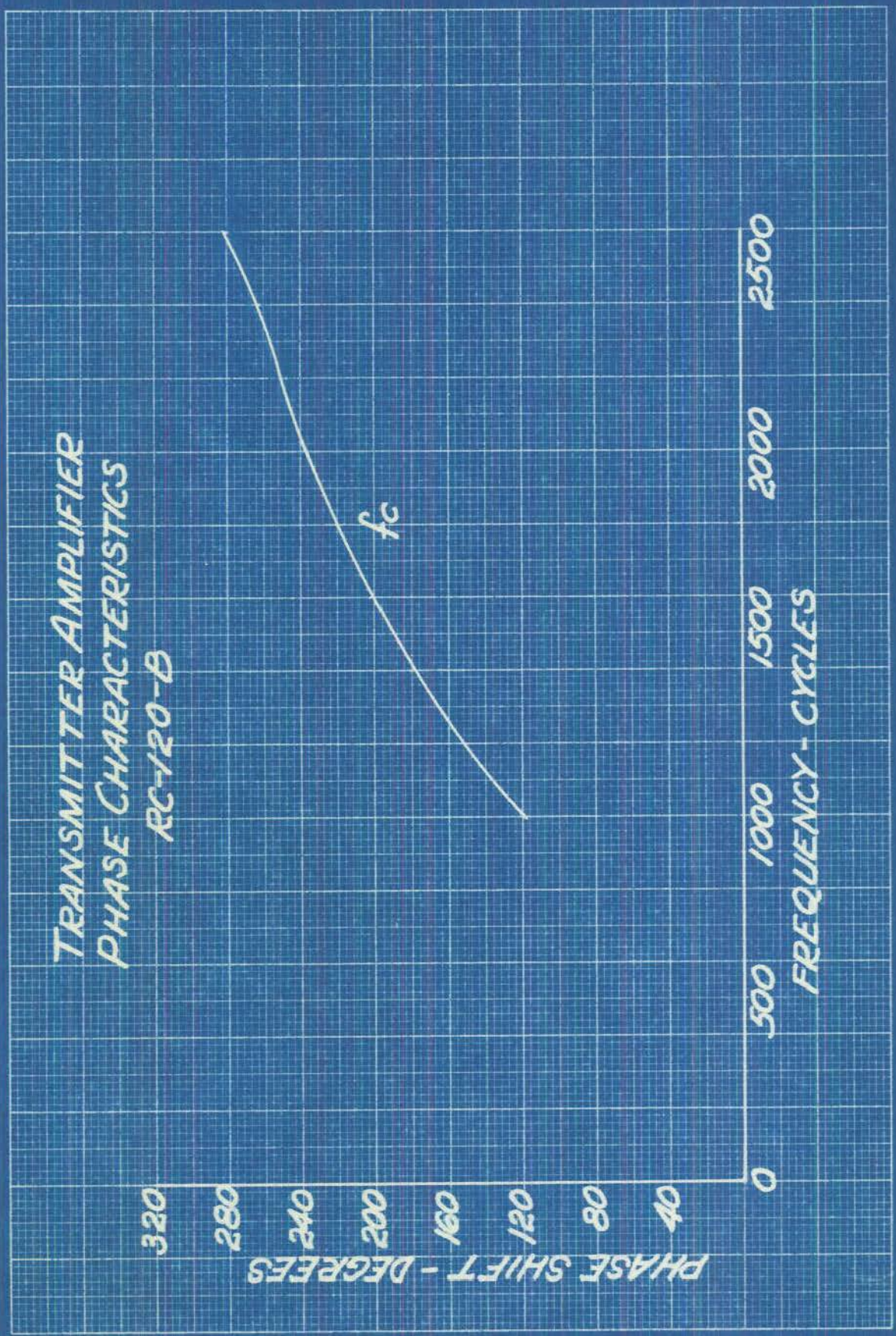

RESTRICTED

R-2885

PLATE 7



DECLASSIFIED

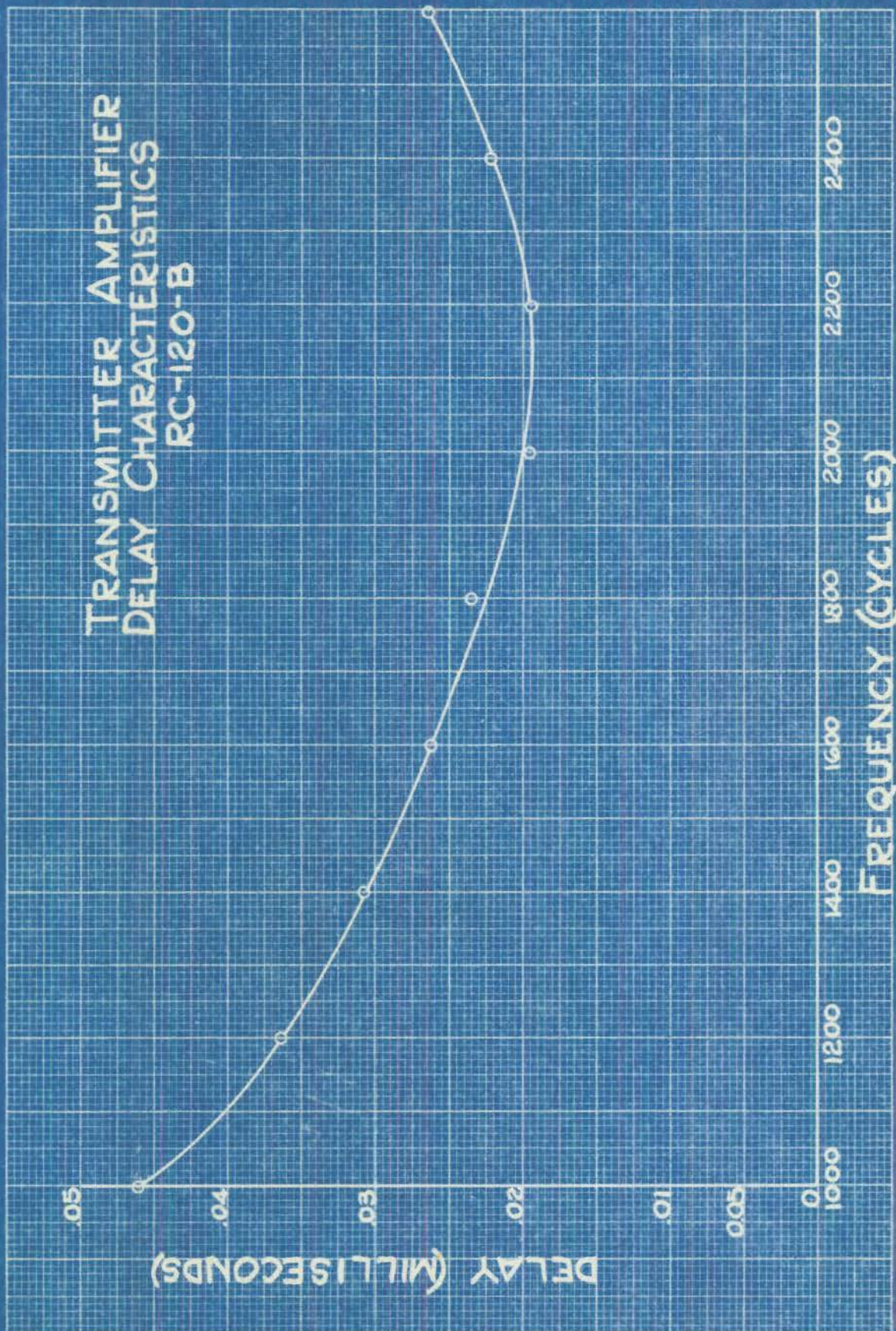

RESTRICTED

R-2885

PLATE 8

DECLASSIFIED

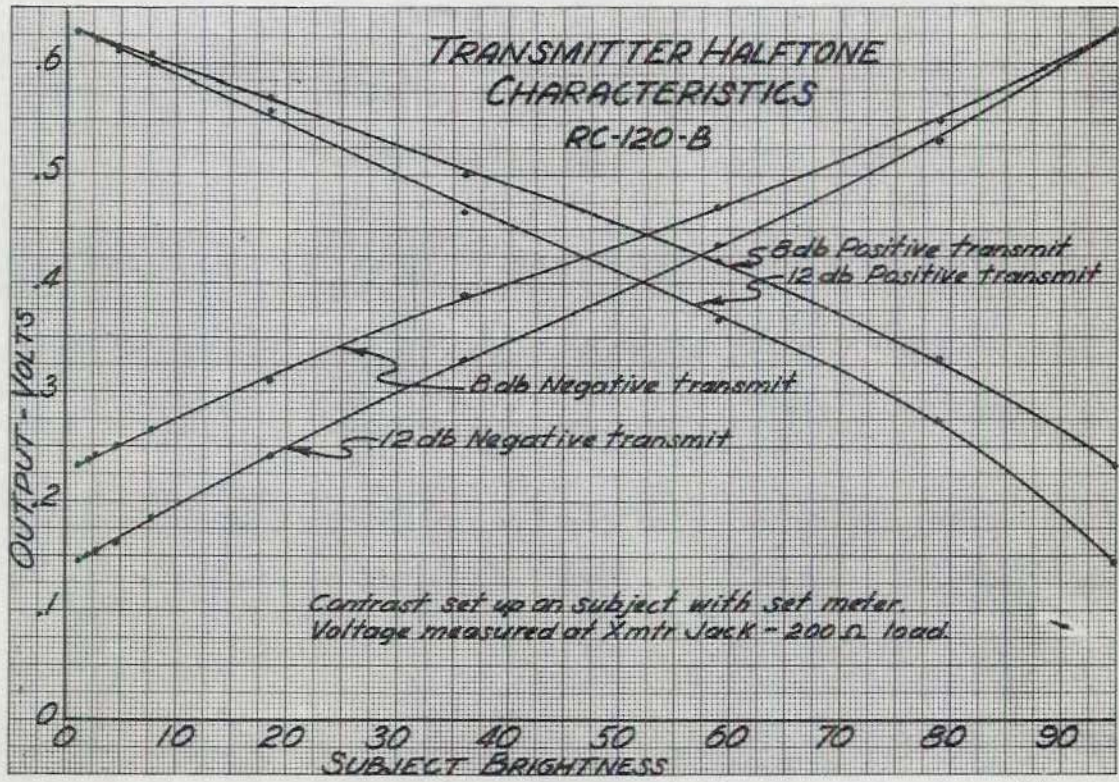

FIG. 1

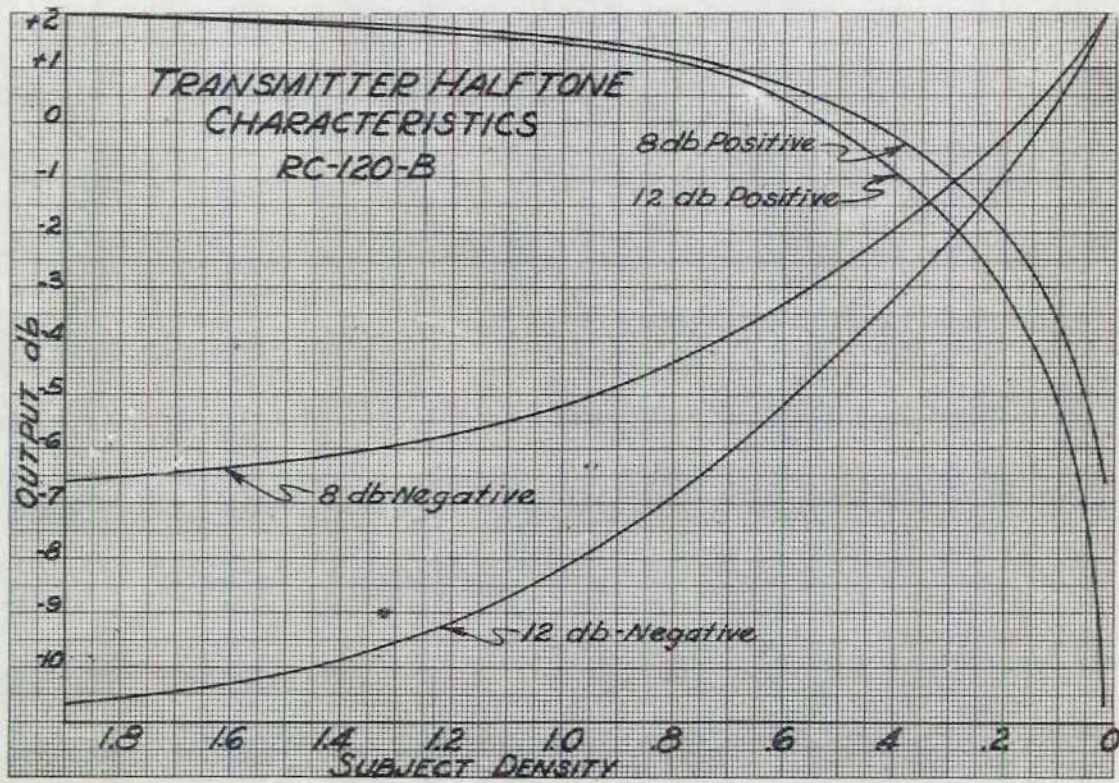

FIG. 2

RESTRICTED

R-2885

PLATE 10



DECLASSIFIED

db METER CALIBRATION RC-120-B TRANSMIT

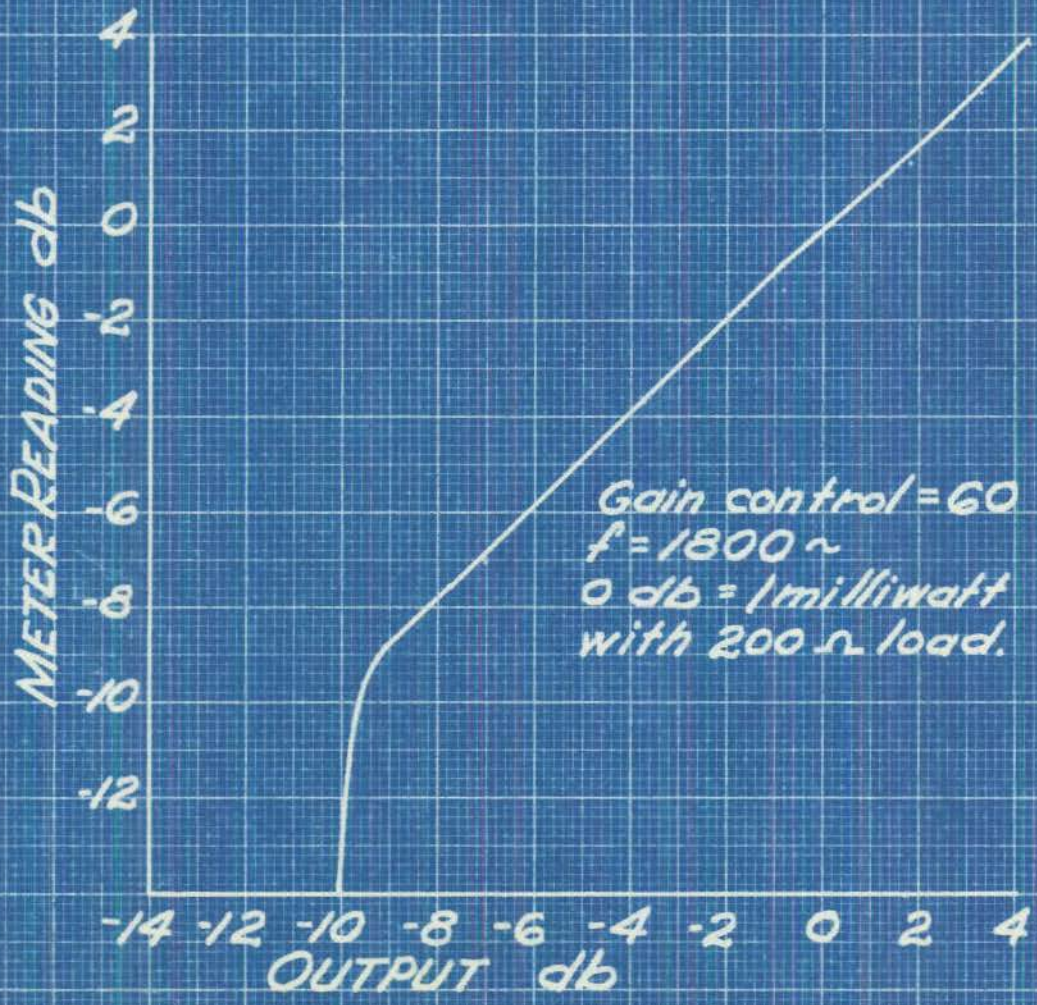

RESTRICTED

R-2885

PLATE 10



DECLASSIFIED

RECEIVER db METER CALIBRATION

RC-120-B

SERIAL No 170

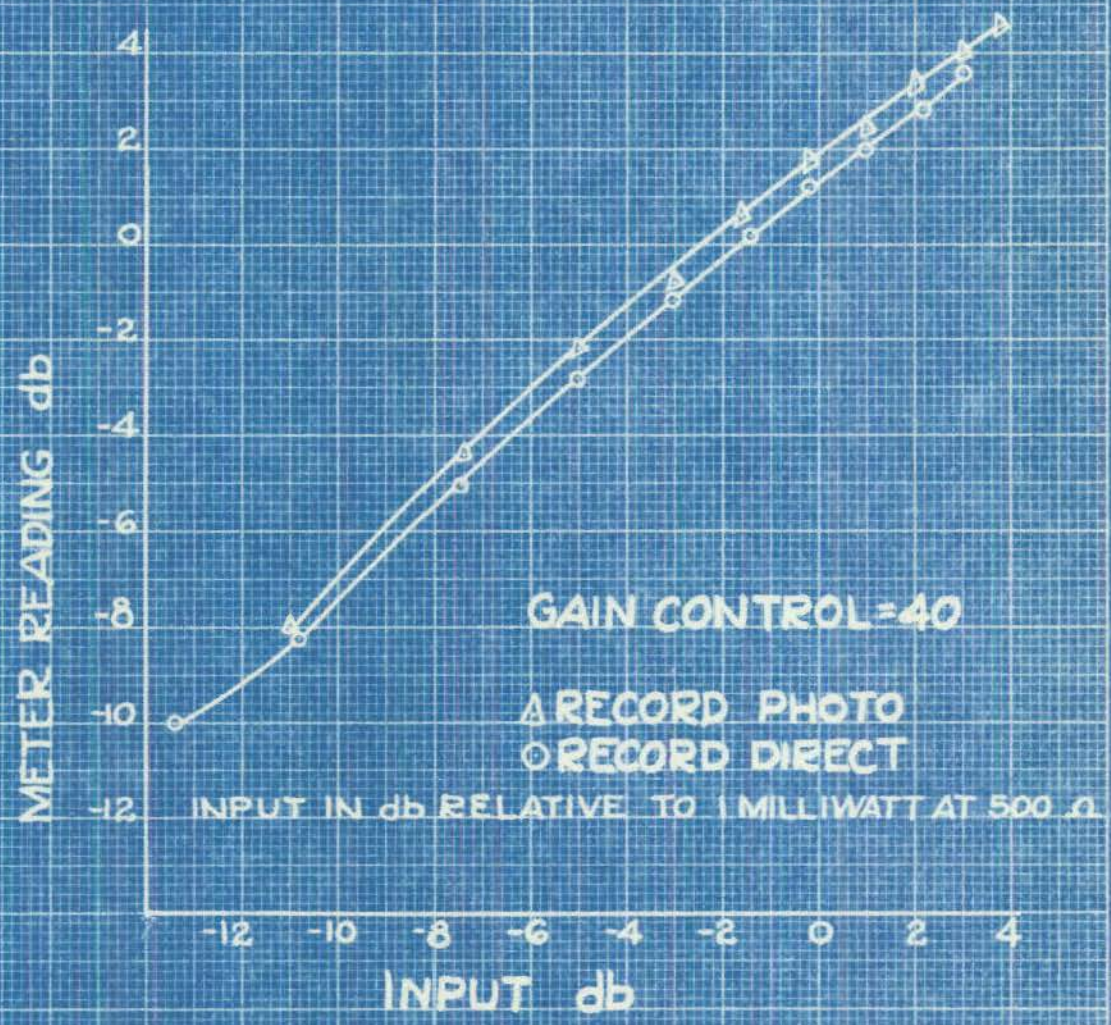

~~RESTRICTED~~

R-2885

PLATE II

DECLASSIFIED

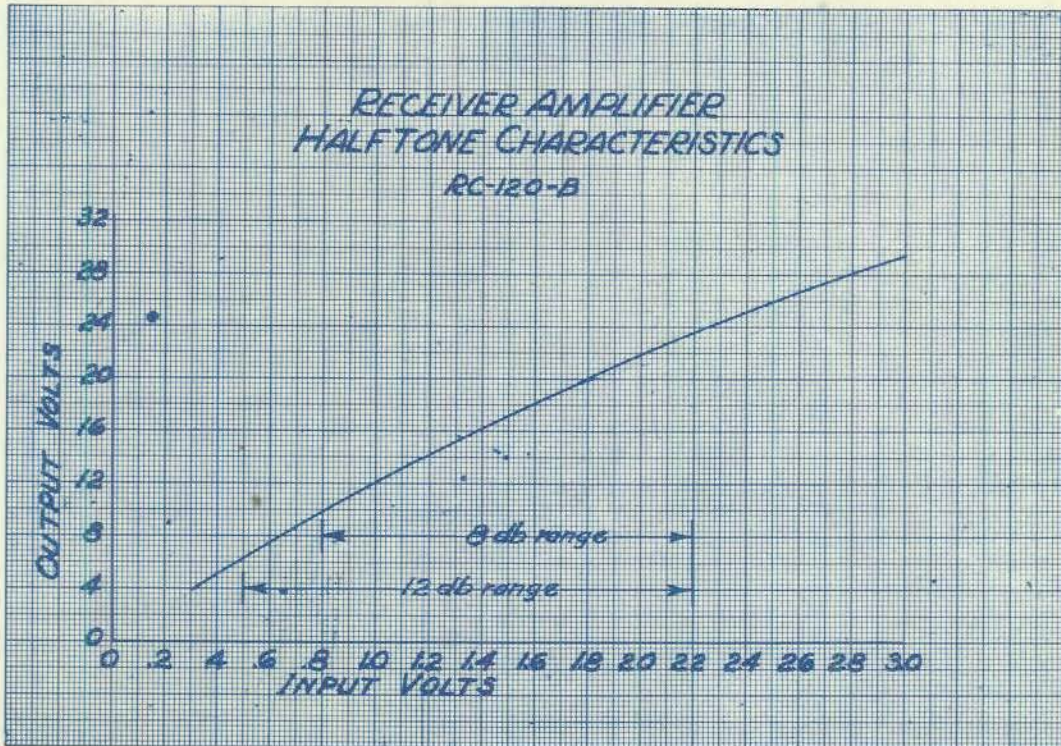

FIG. 1

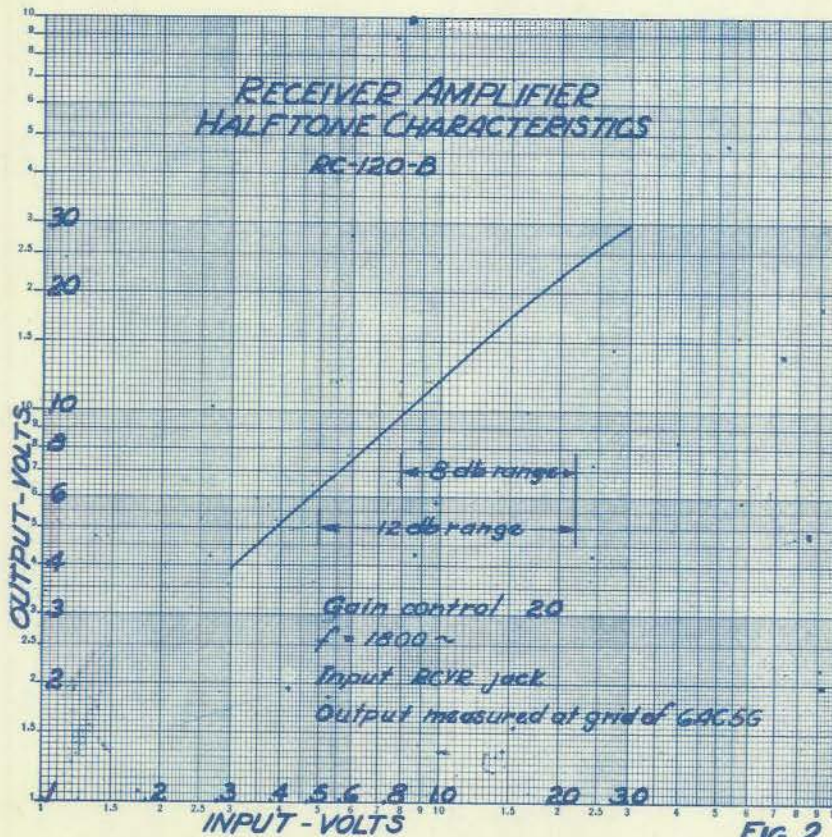

FIG. 2

RESTRICTED

R-2885

PLATE 12



DECLASSIFIED

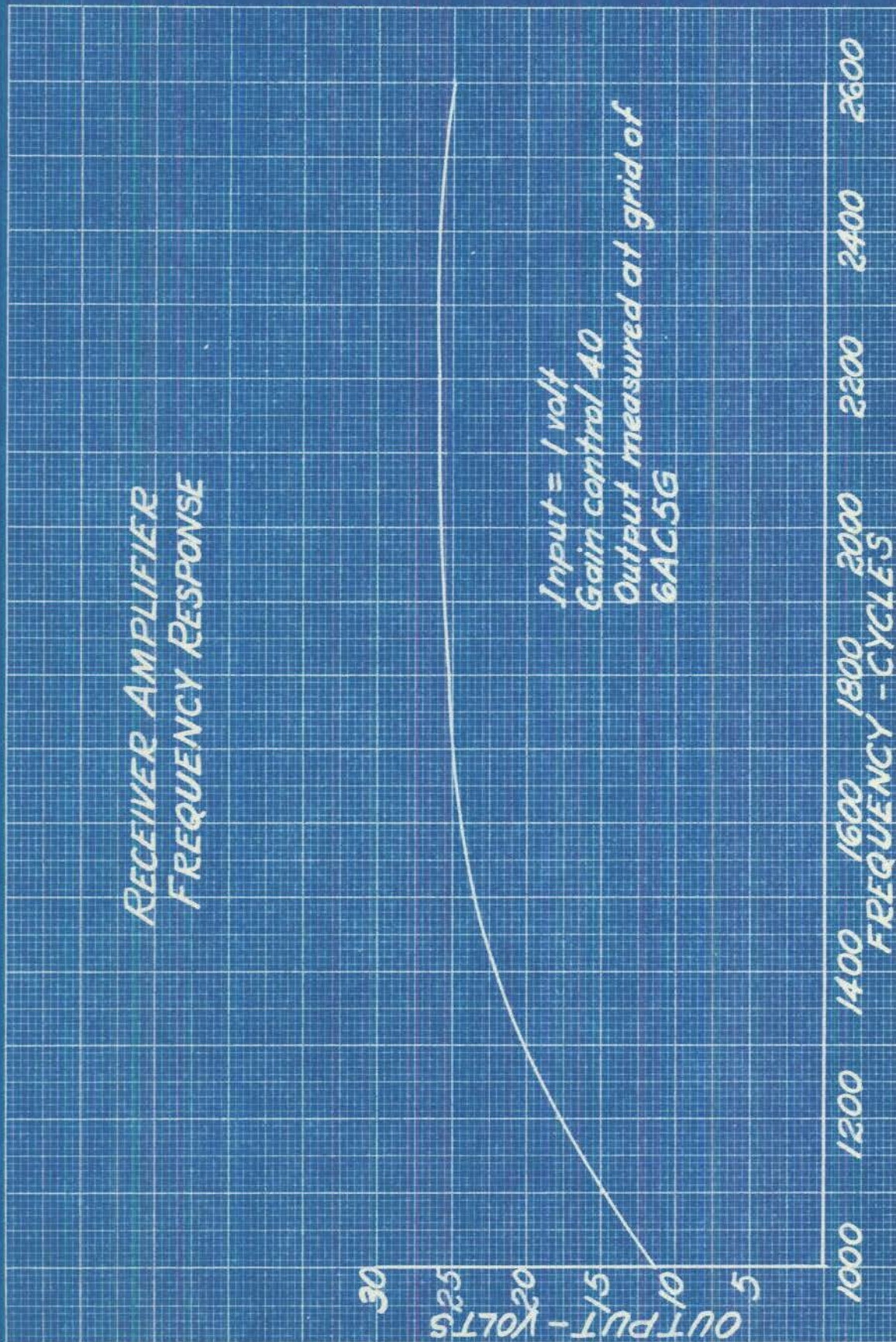

RESTRICTED

R-2885

PLATE 13

DECLASSIFIED

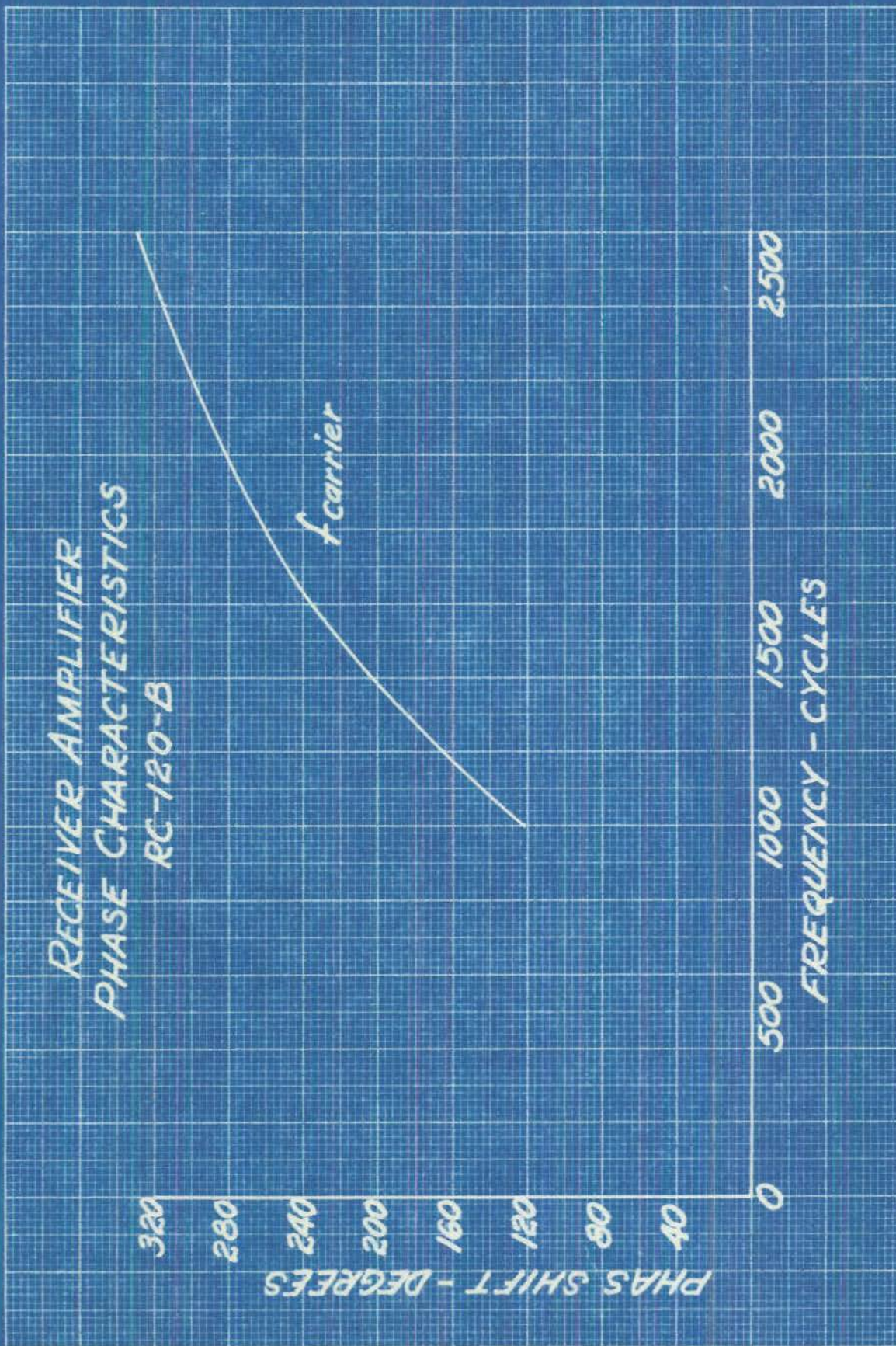

RESTRICTED

R-2885

PLATE 14

DECLASSIFIED

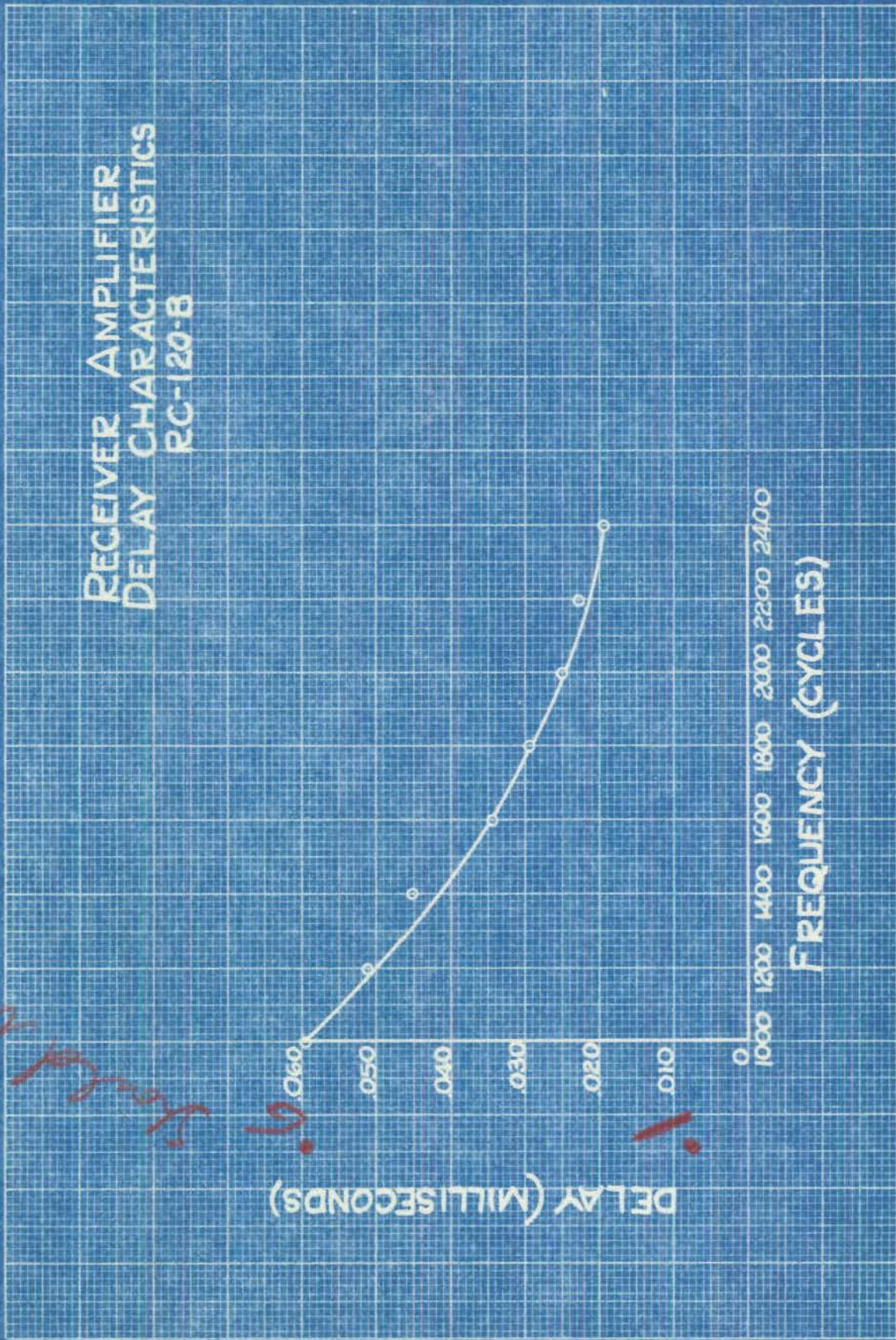

Handwritten notes:
0.160
0.050
0.040
0.030
0.020
0.010
!

~~RESTRICTED~~

R-2885

PLATE 15

DECLASSIFIED

PHOTO RECORD CIRCUIT

LINEARITY RC-120-B

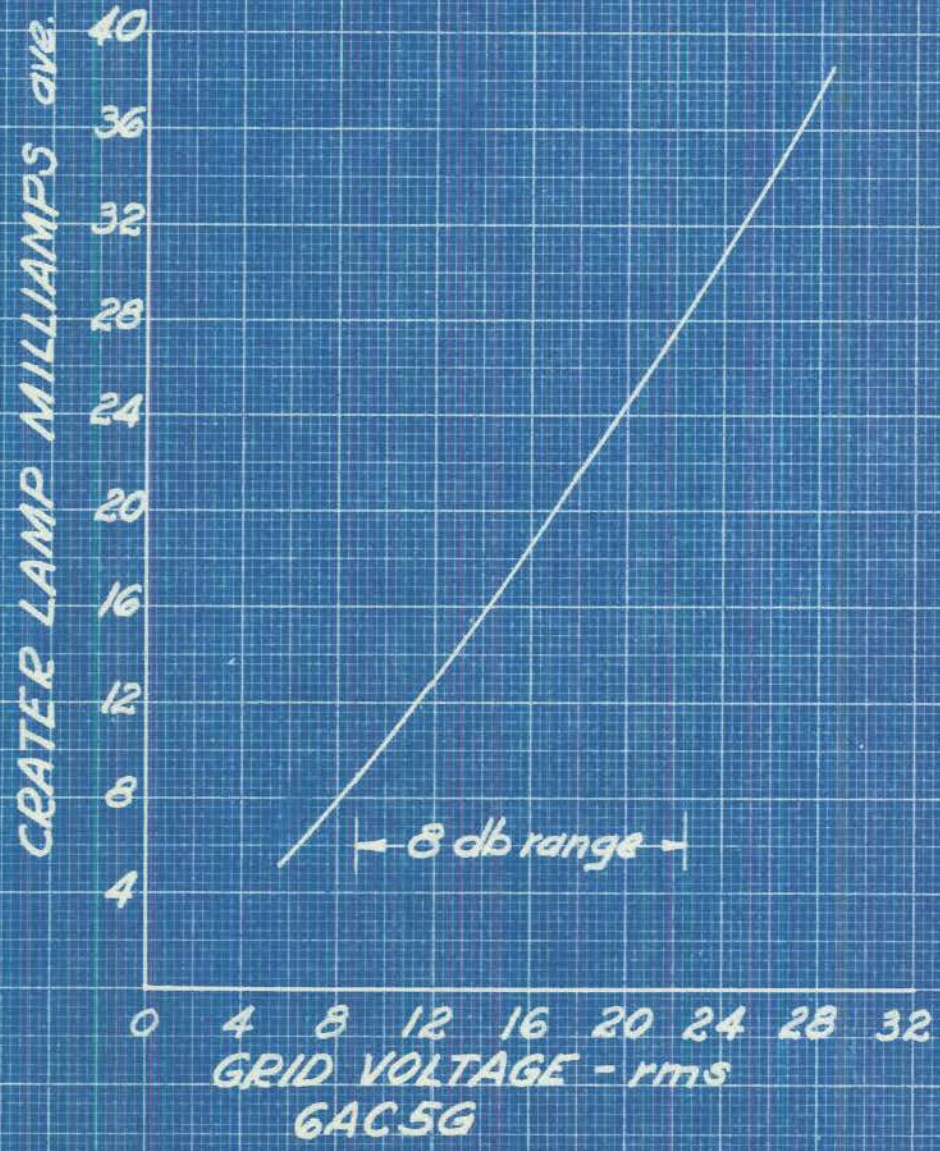

DECLASSIFIED

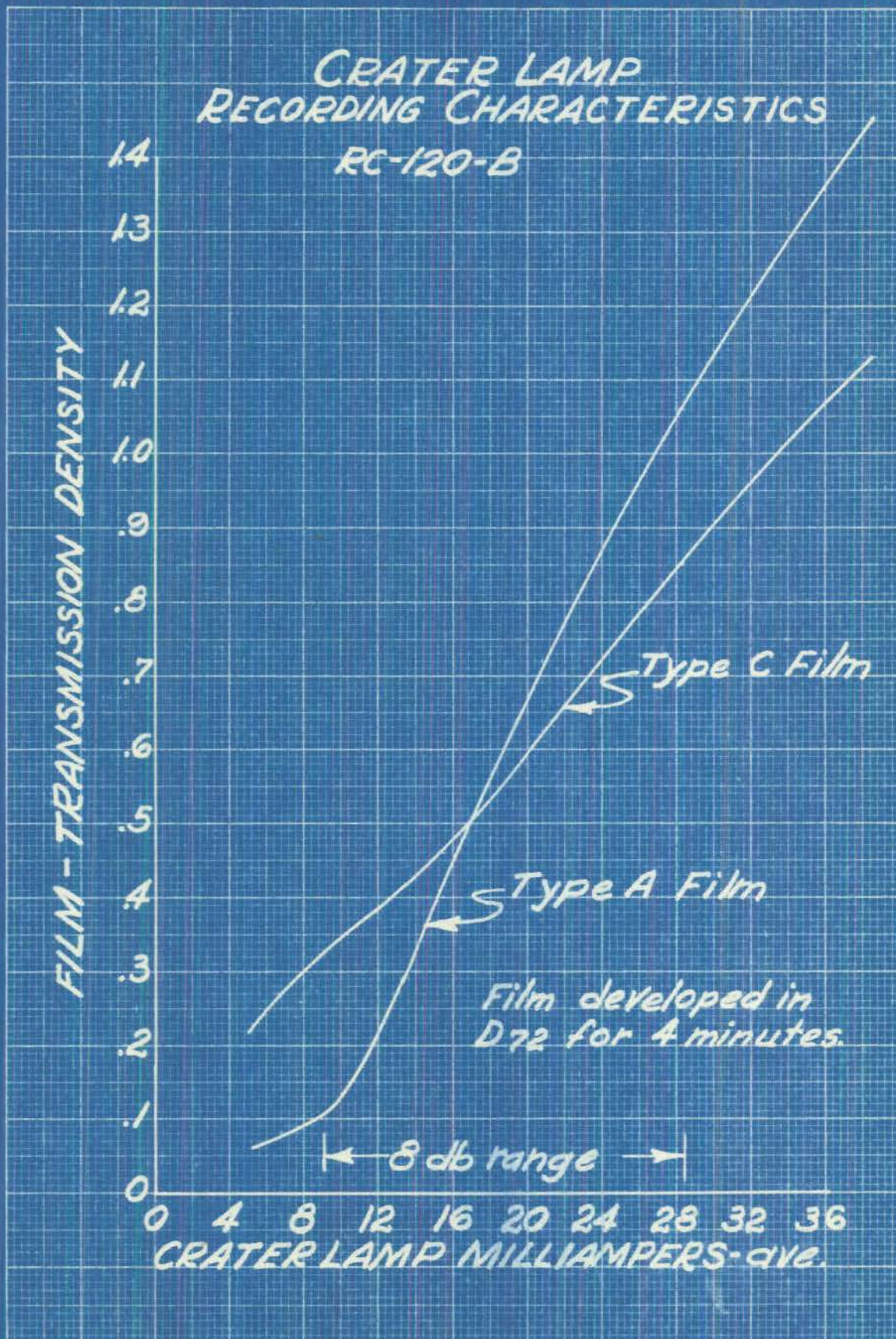



DECLASSIFIED

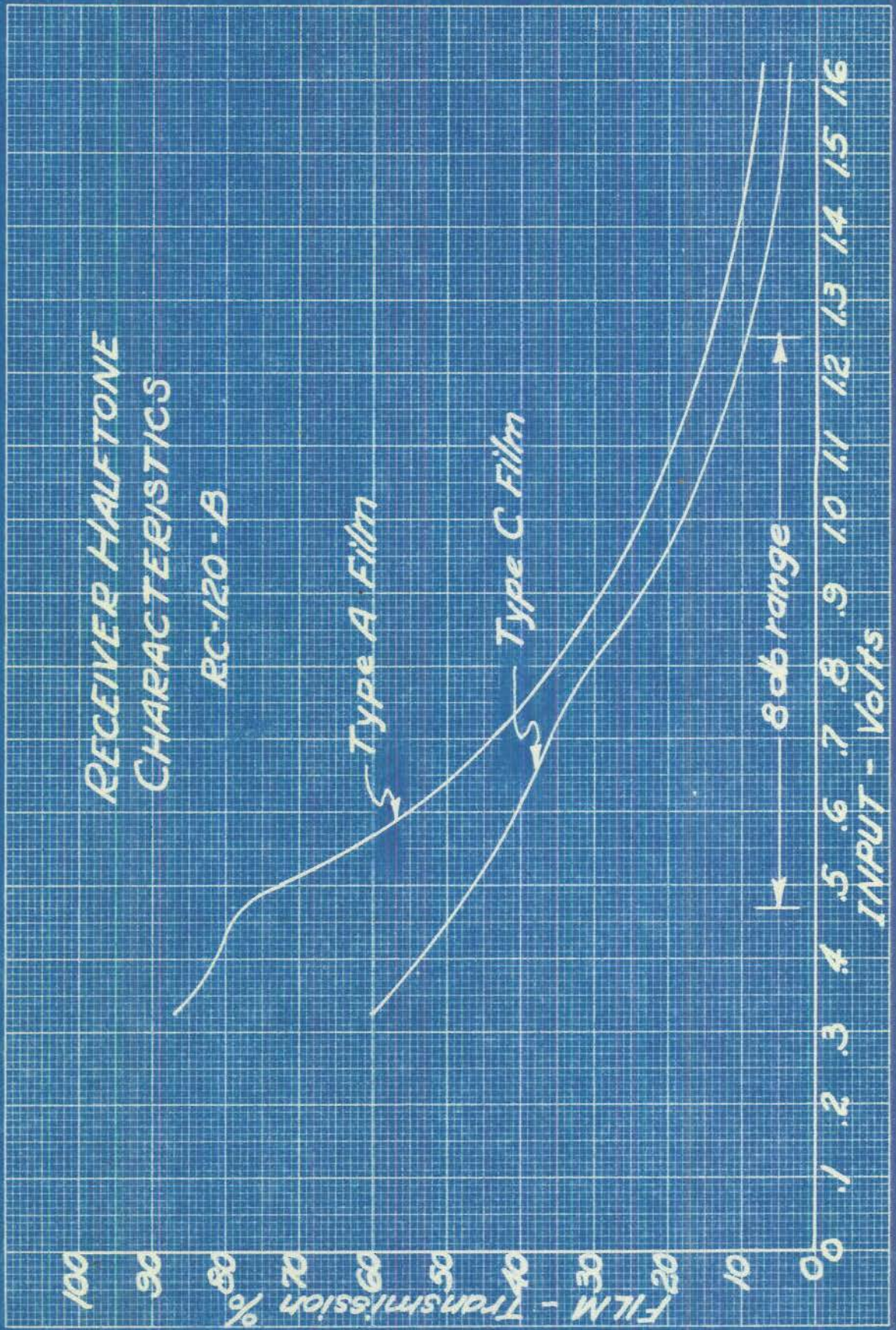

~~RESTRICTED~~

R-2885

PLATE 18

DECLASSIFIED

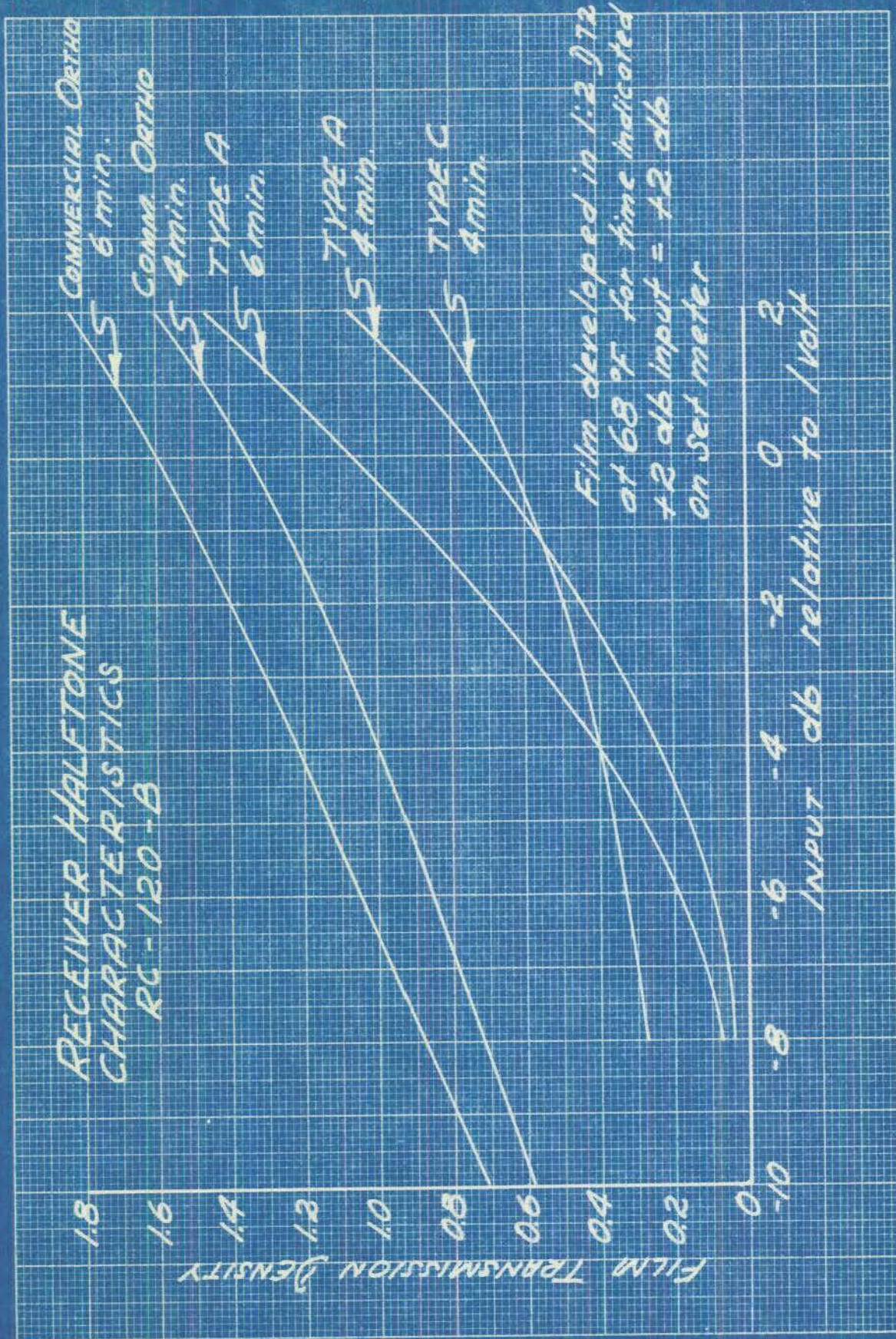

RESTRICTED

R-2885

PLATE 19

DECLASSIFIED

Test No. _____
Emission No. VV6109-29-6
Transmission Type A
Date 25 Oct, 1945
Project No. T-1760-53
Write It No. _____
Exposure 1b
Process P.P.s. Machs.
Developer D-72
Time 2, 3, & 4 Min.
Temperature 68°F.
Gamma _____
D. Min. _____
D. Min. _____
Remarks ~~Gamma~~ ~~Time~~
21 = 1.55 .05
31 = 1.74 .07
41 = 1.89 .08

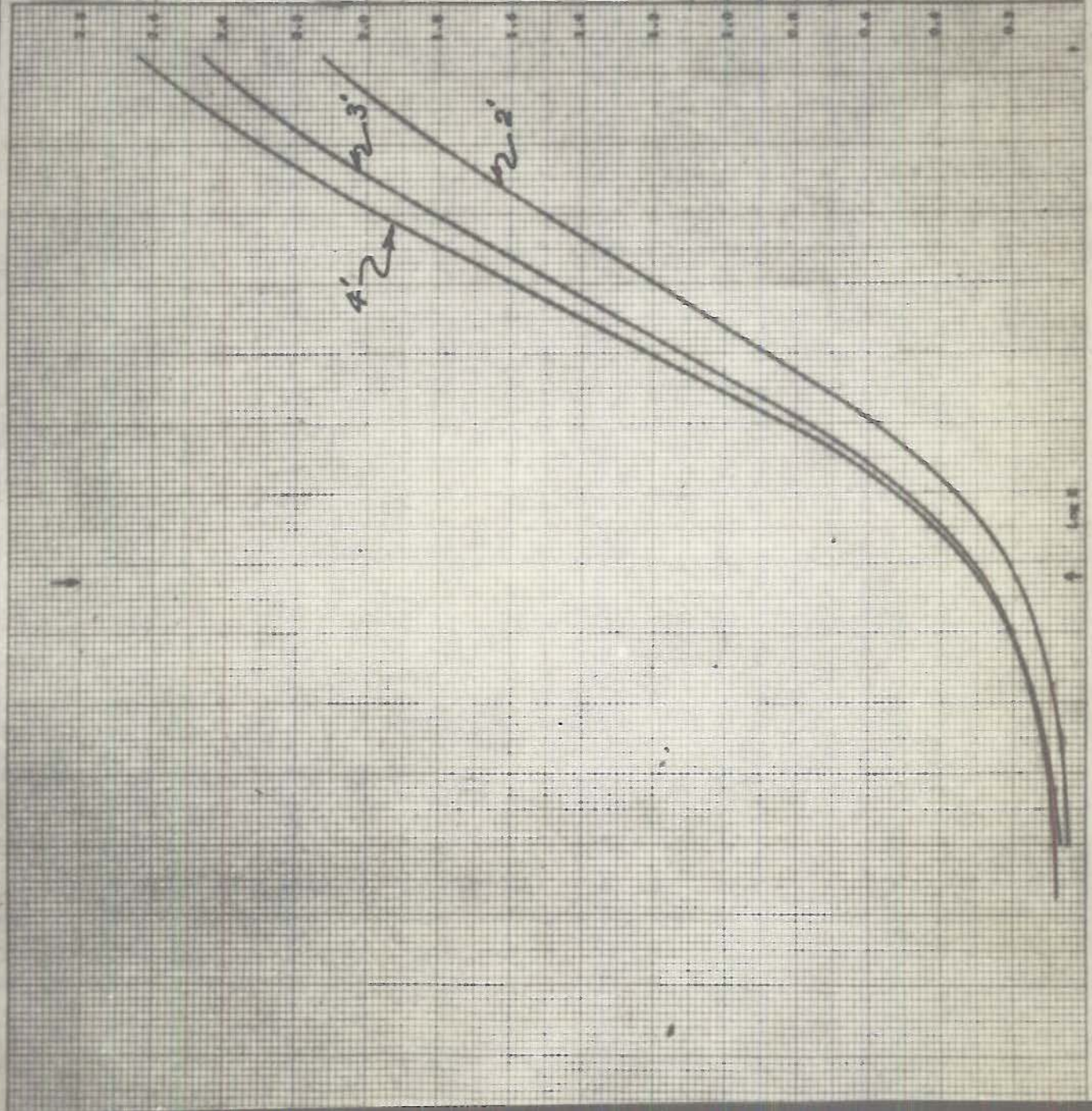

Technical
Developments
Section
Photo Science
Laboratory

RESTRICTED

R-2885

PLATE 21

DECLASSIFIED

1.18
 1.16
 1.14
 1.12
 1.10
 .98
 .96
 .94
 .92
 0 .90

Type A Film
 D-72 at 68°F
 4 min

AZO F4 paper

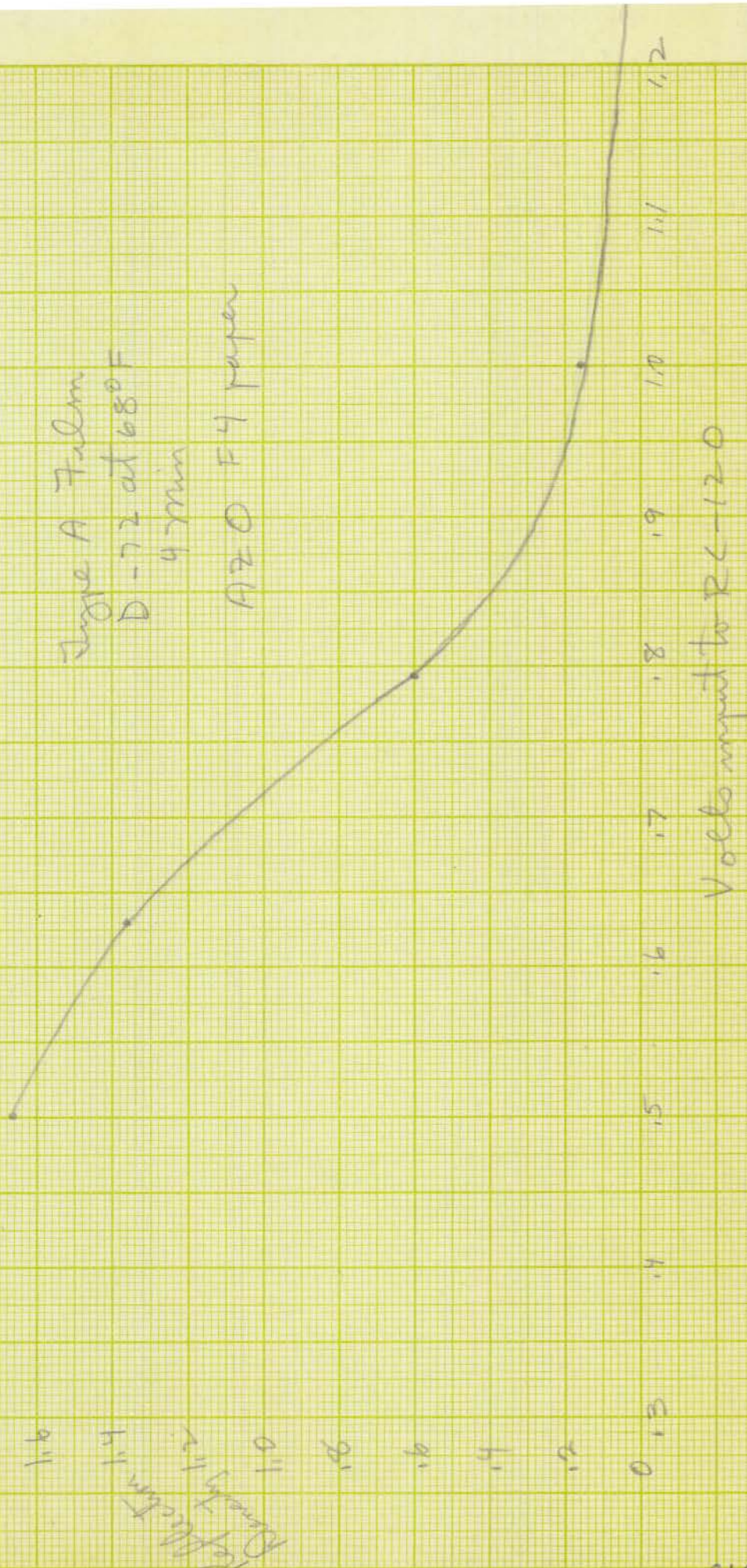

Volts input to RC-120



DECLASSIFIED

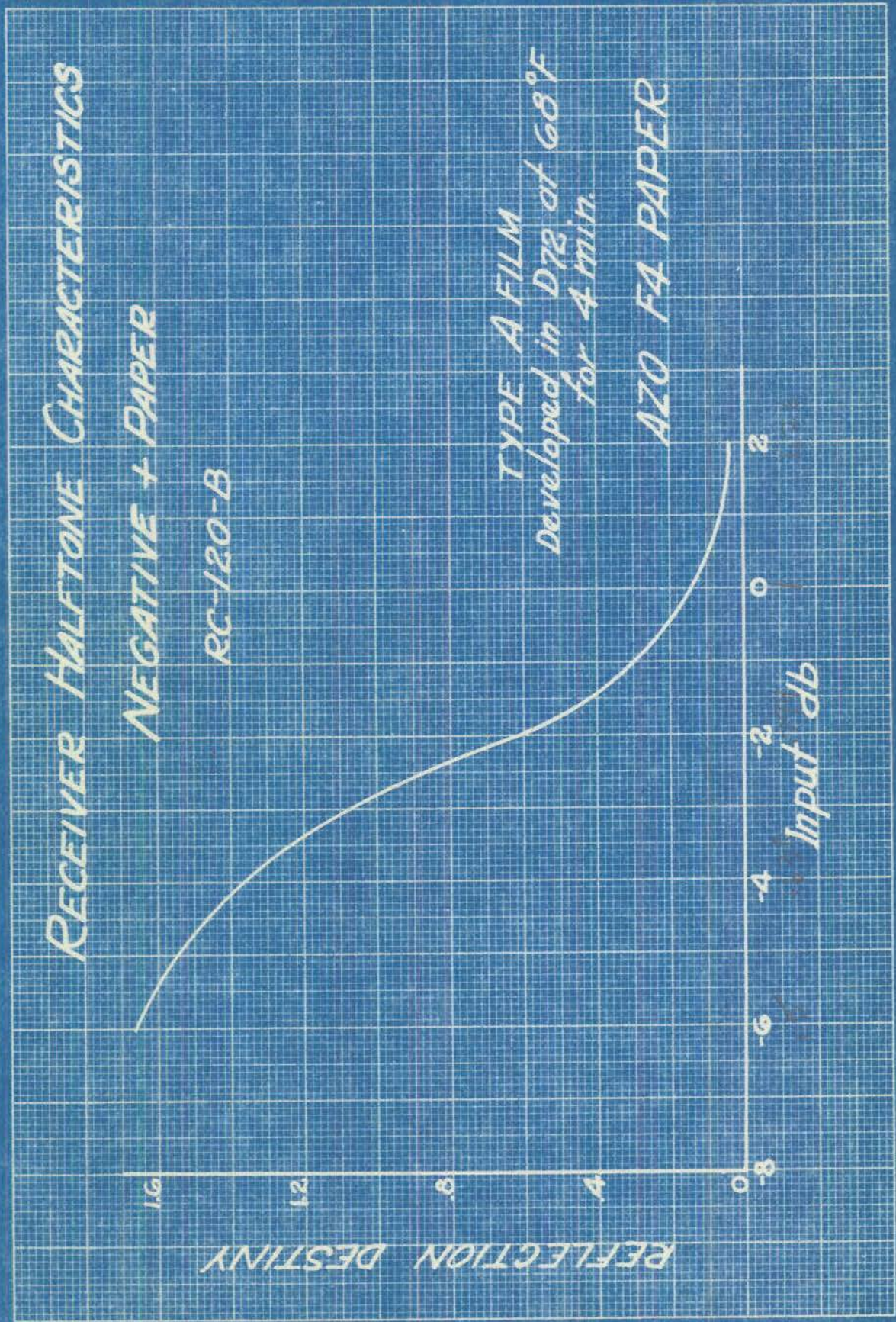

R-2885

PLATE 22

DECLASSIFIED

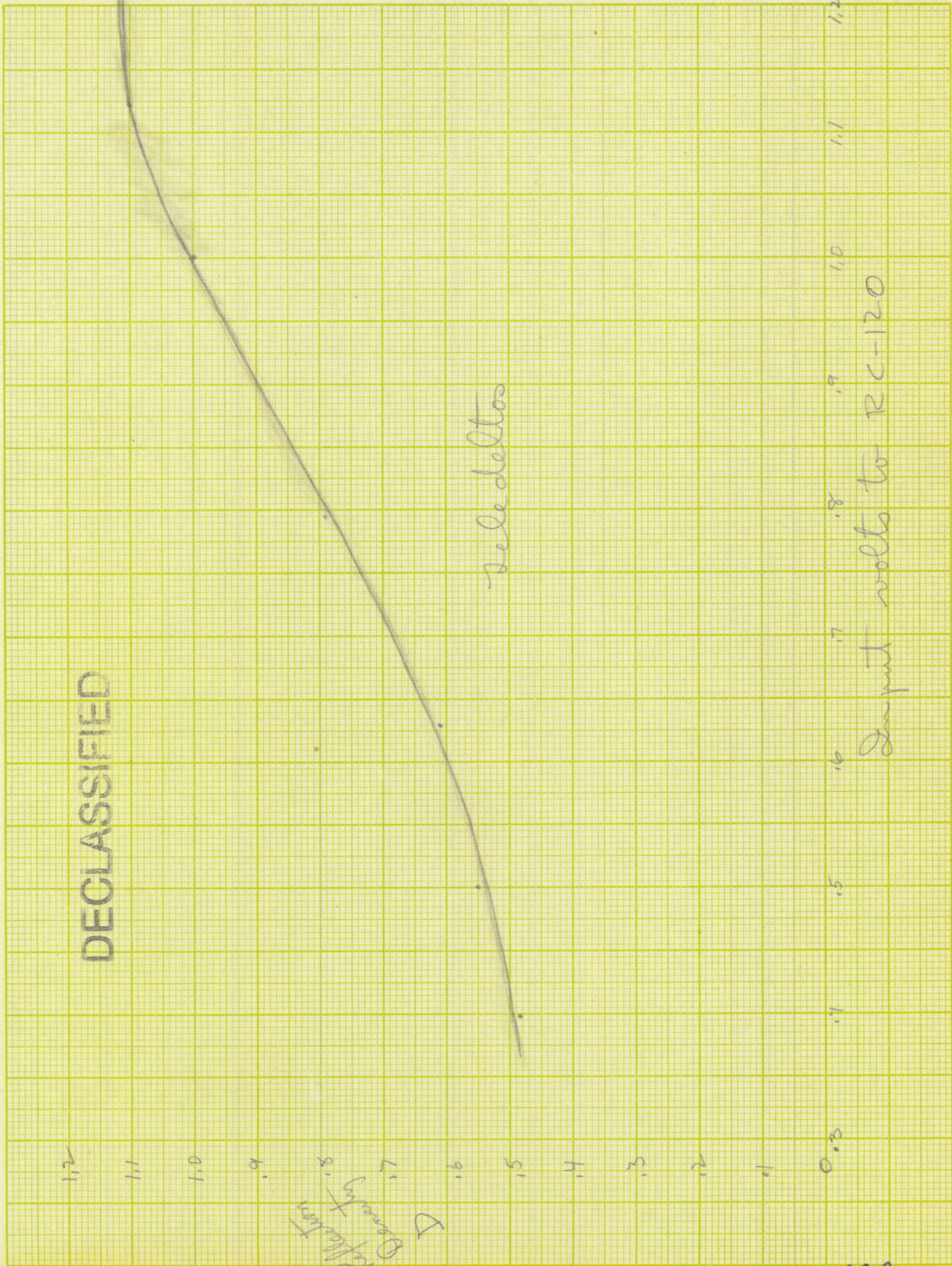

Reflection
 Coefficient
 Δ



DECLASSIFIED

RECEIVER HALFTONE CHARACTERISTICS

RC-120-B

Gain = 40, $f = 1800 \sim$

+2 db input = +2 db on set meter = 1 Volt input on Direct Record.

Record = 0.7 volts on Photographic Record.

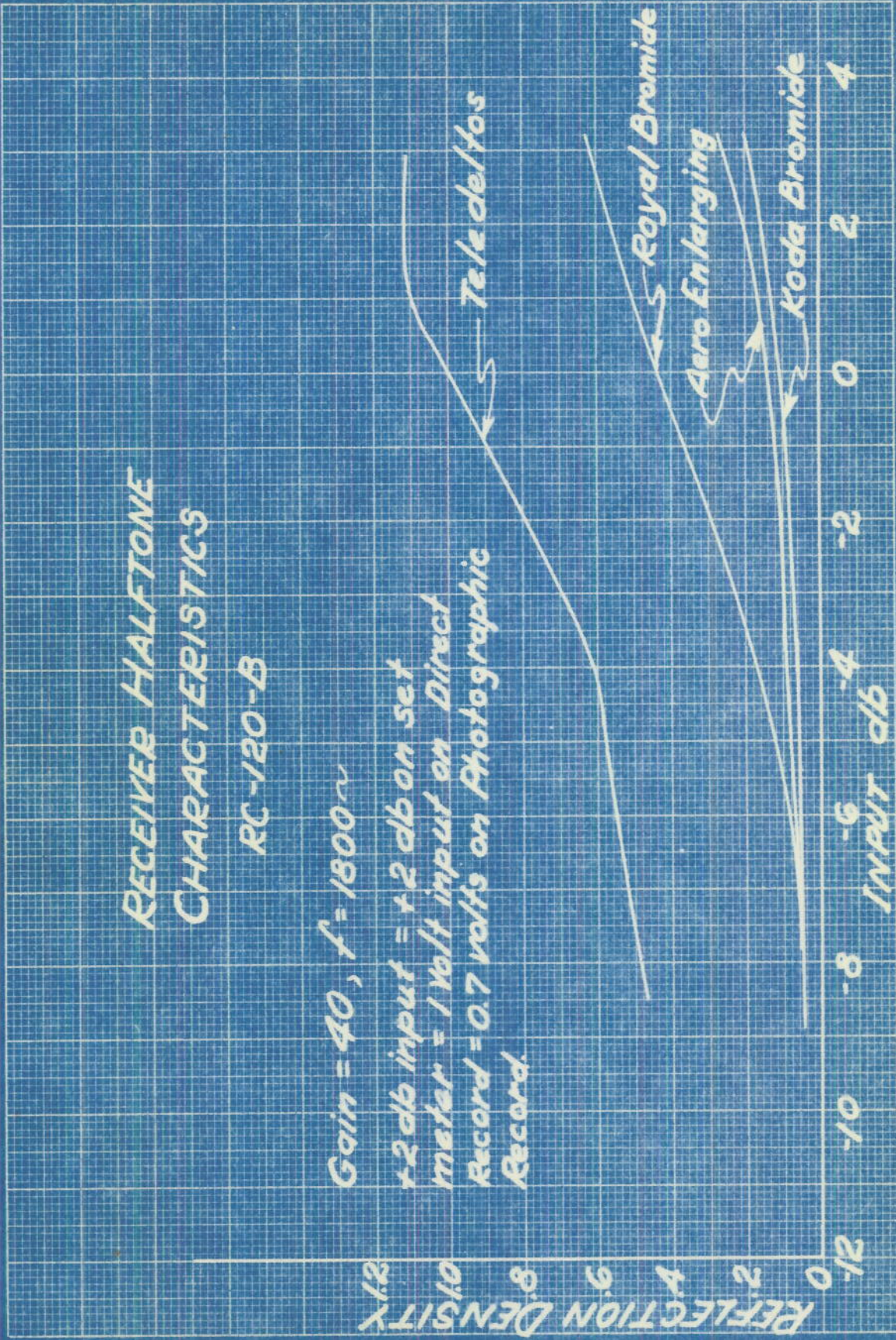

1378 571 1830 774 630 1-26

RADIO

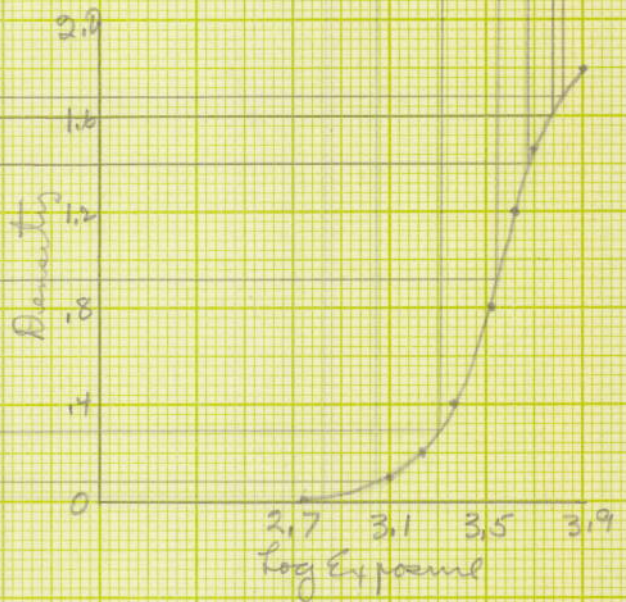
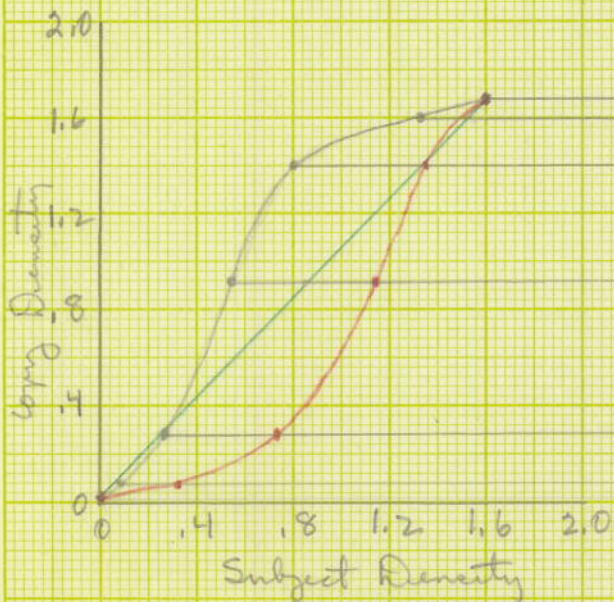
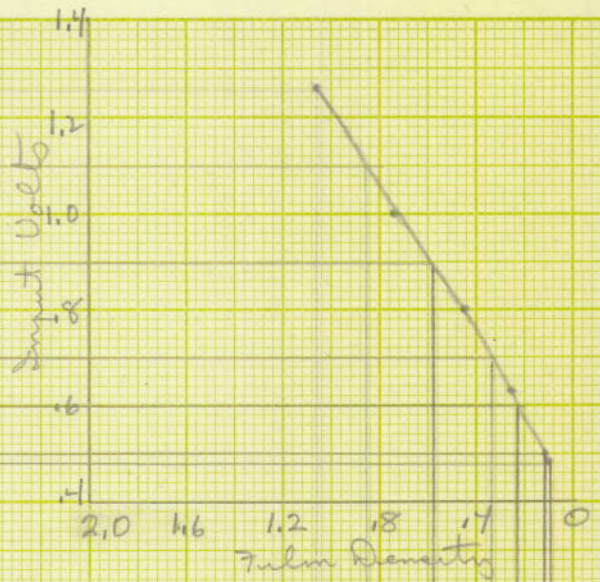
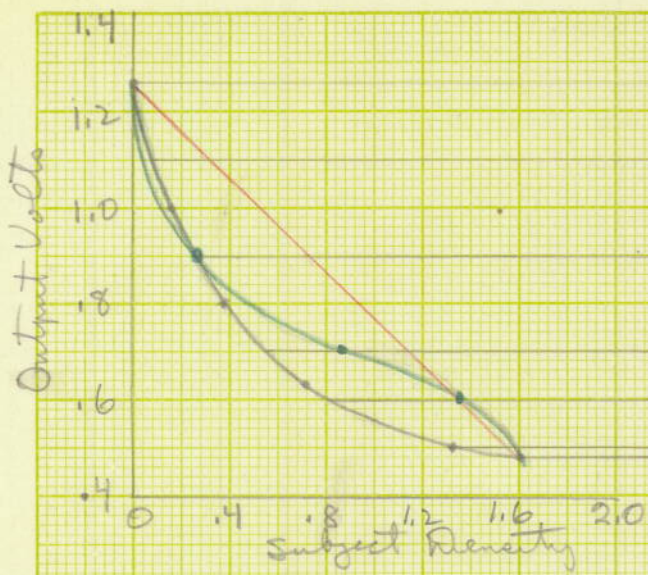

DECLASSIFIED

DECLASSIFIED

STATIC SYSTEM HALFTONE RC-120-B

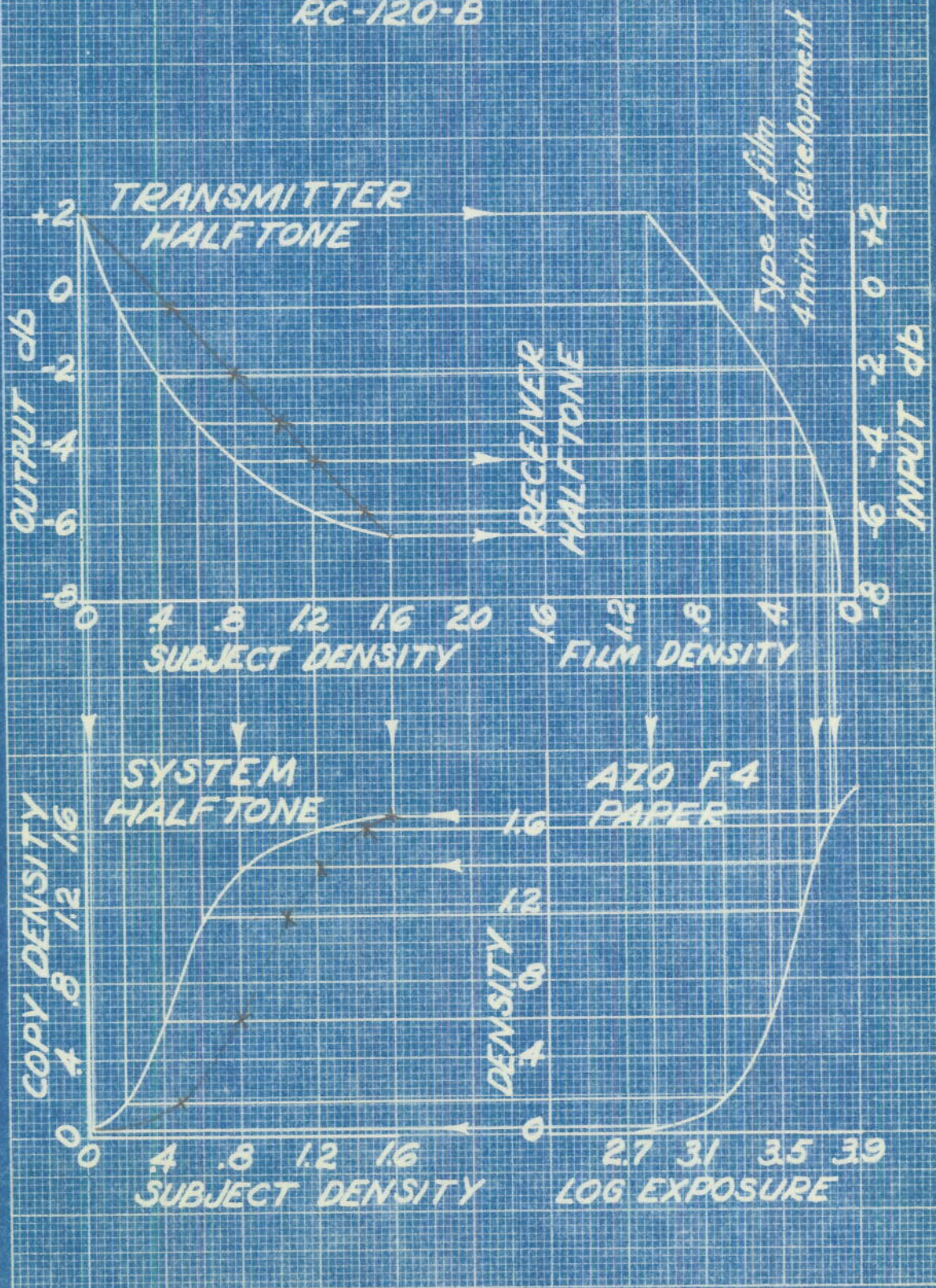



DYNAMIC SYSTEM HALFTONE RC-120-B

Film: Type A, developed in 1:2 D72
for 4 minutes, 68 °F.

Paper: F4 AZO, 11 sec. exposure
developed in 1:2 D72, 68 °F
for 1 minute.

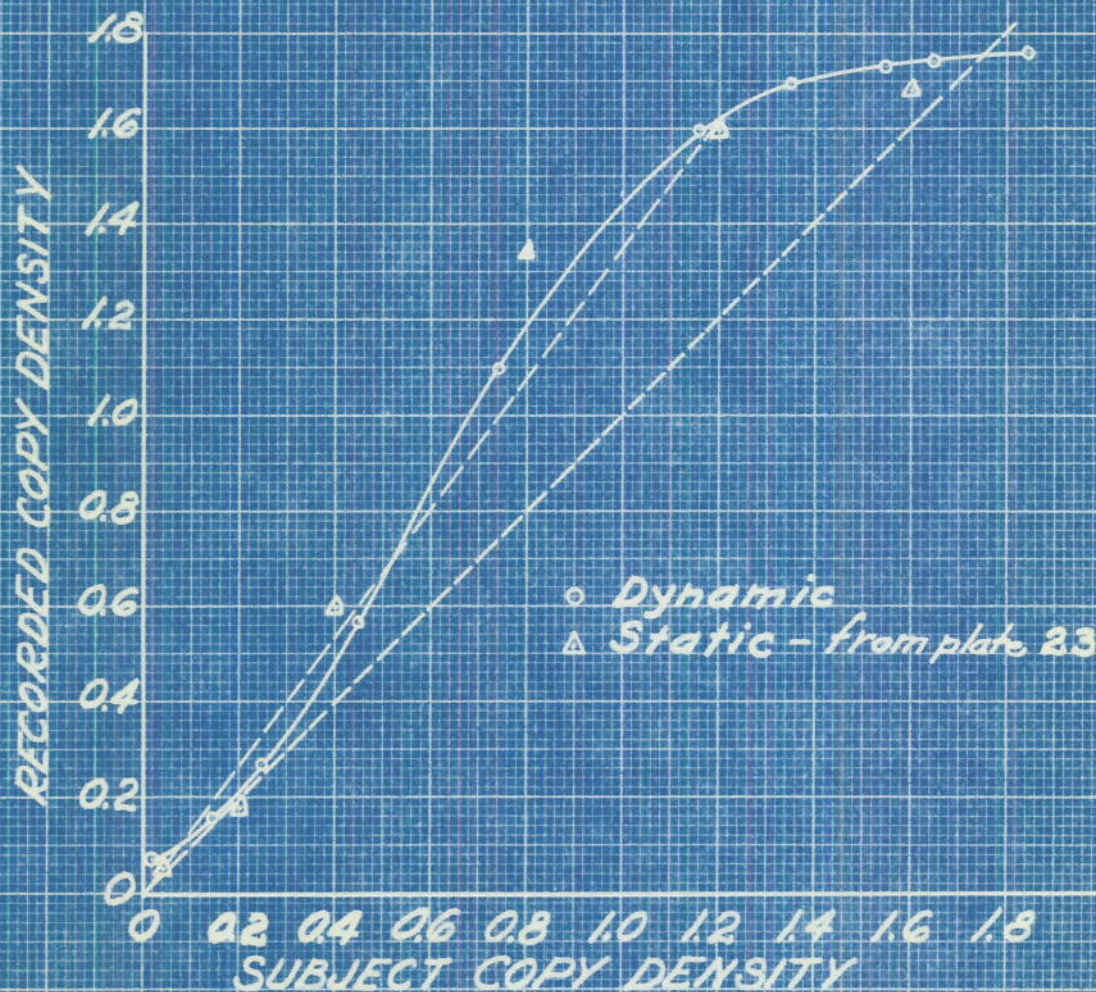

DECLASSIFIED

TELEDELTO CHARACTERISTICS RC-120-B

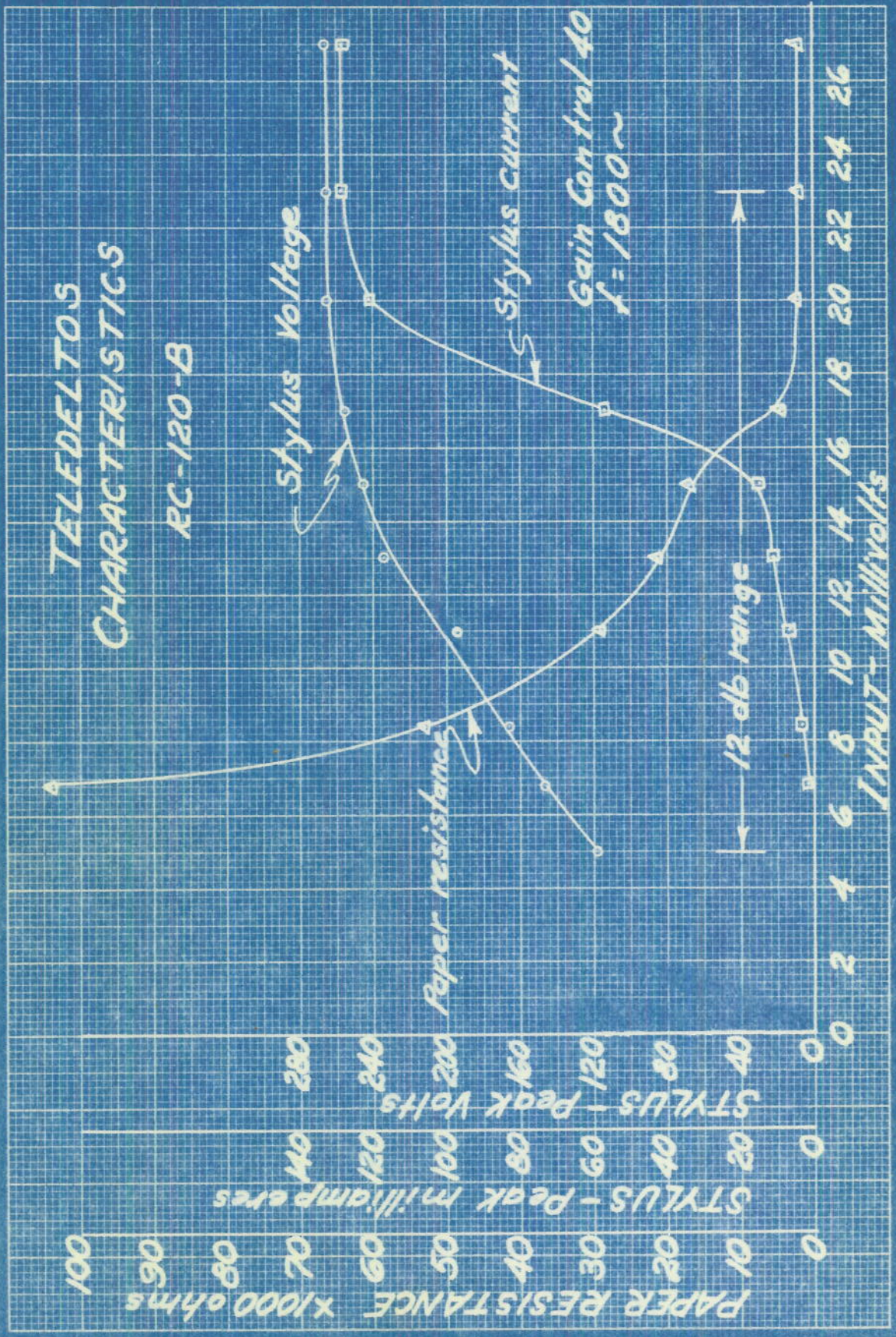

RESTRICTED

R-2885

PLATE 26



DECLASSIFIED

TIME FAX CHARACTERISTICS

RC-120-B

Gain control 40
 $f = 1800 \sim$

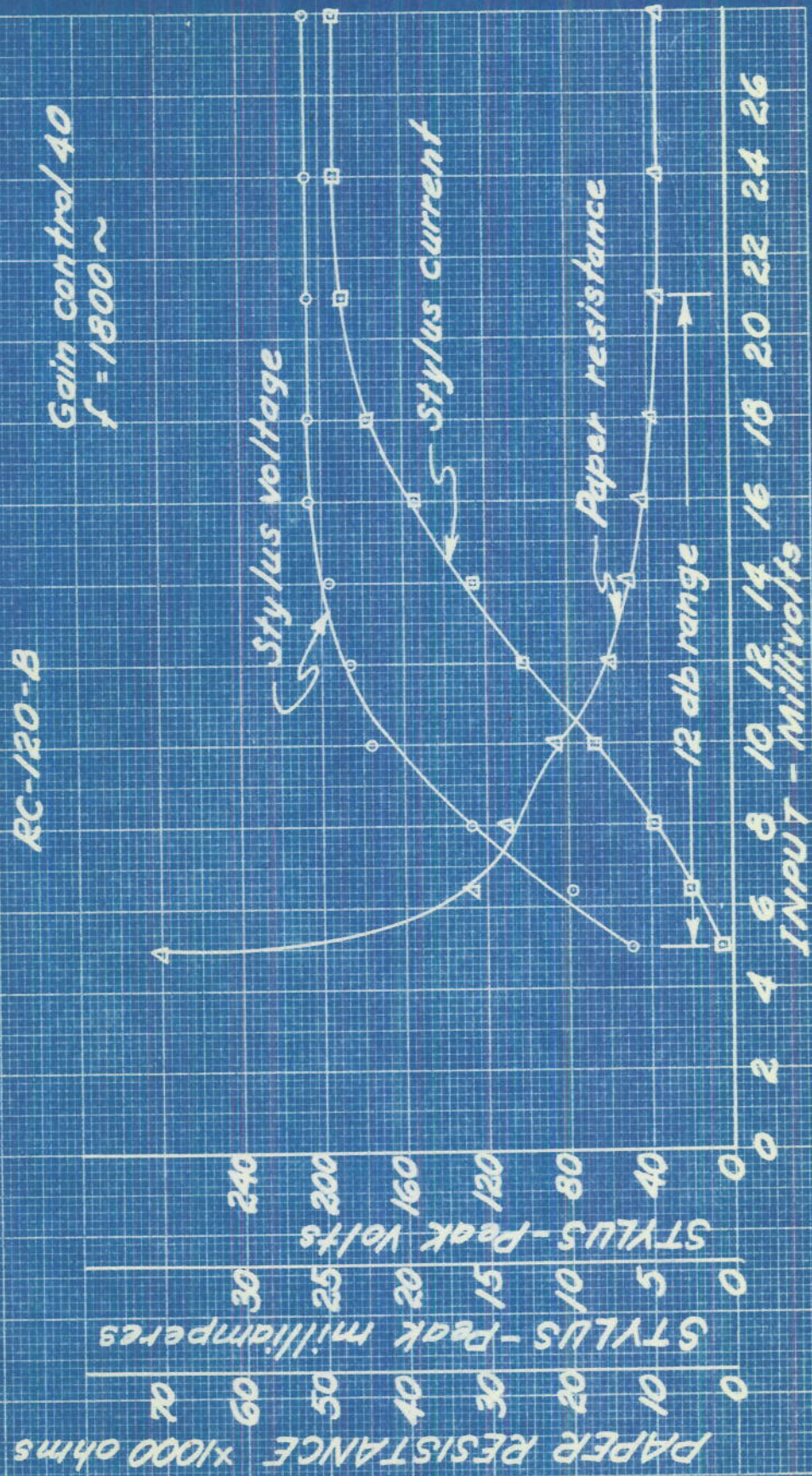

RESTRICTED

R-2885

PLATE 27



DECLASSIFIED

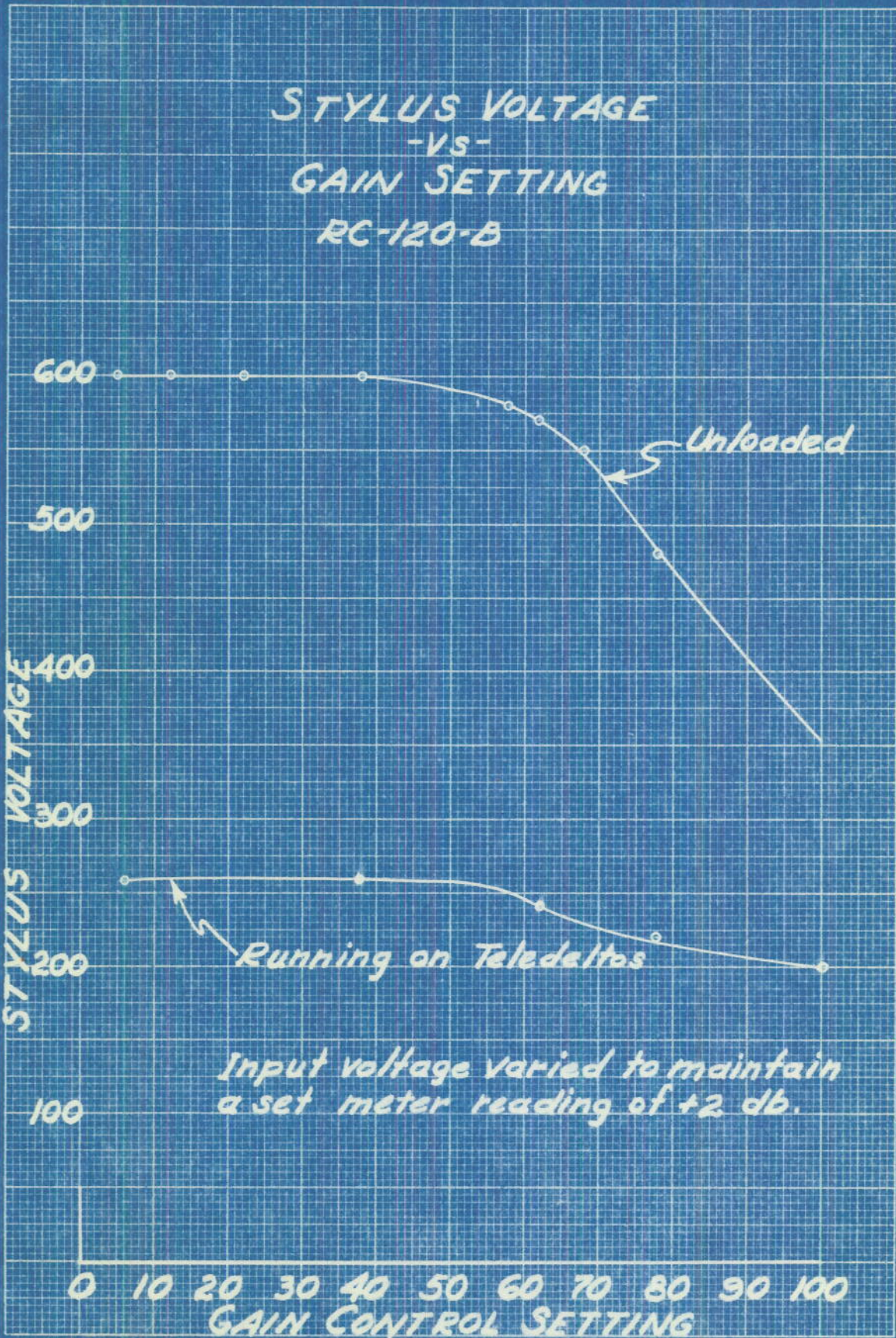

RESTRICTED

R-2885

PLATE 28



DECLASSIFIED

FORK OSCILLATOR STABILITY

RC-120-B

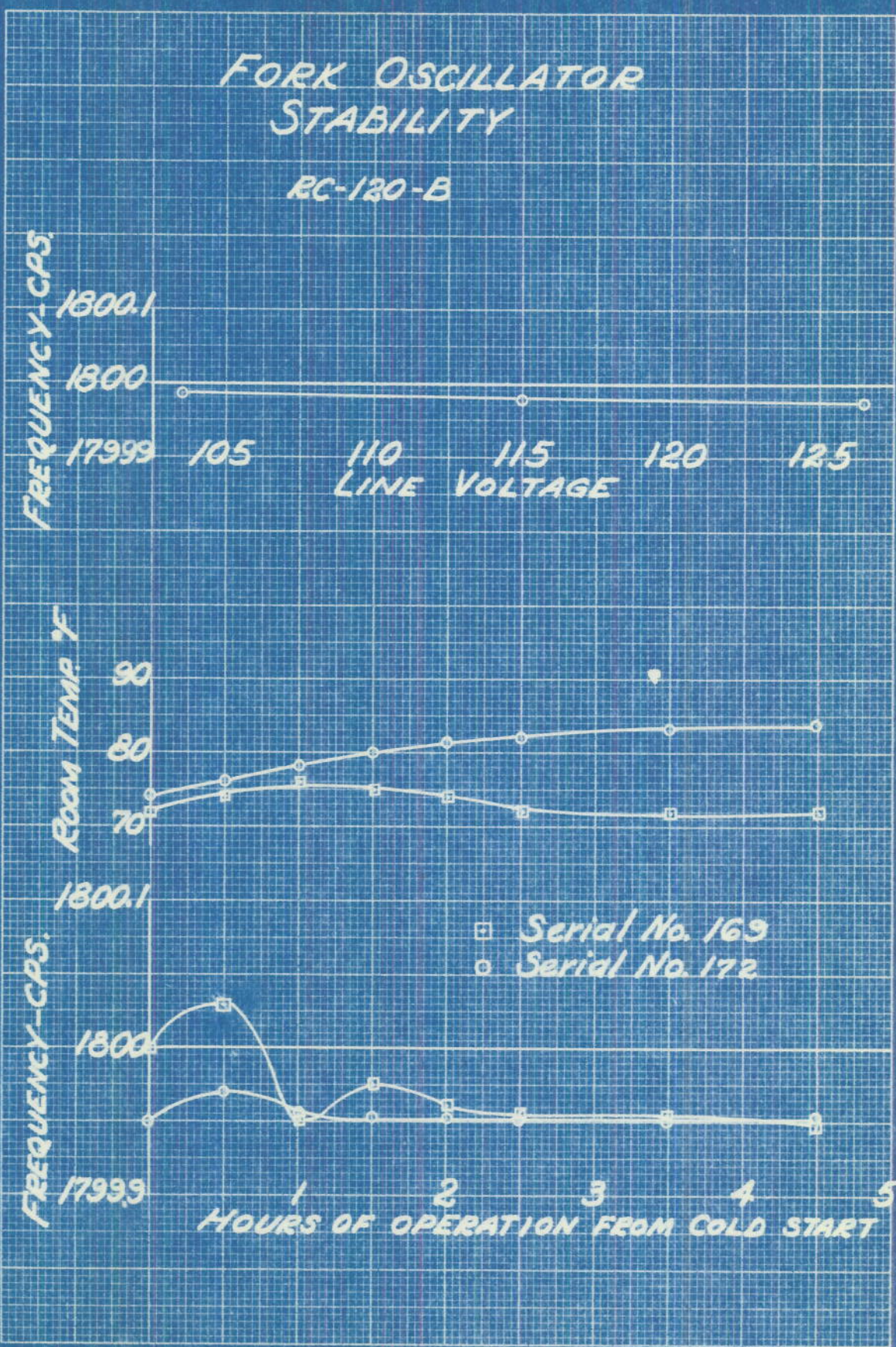

RESTRICTED

R-2885

PLATE 30



VARIATION IN AMBIENT TEMPERATURE AVERAGE HUMIDITY LESS THAN 10% RC-120-B SERIAL No. 172

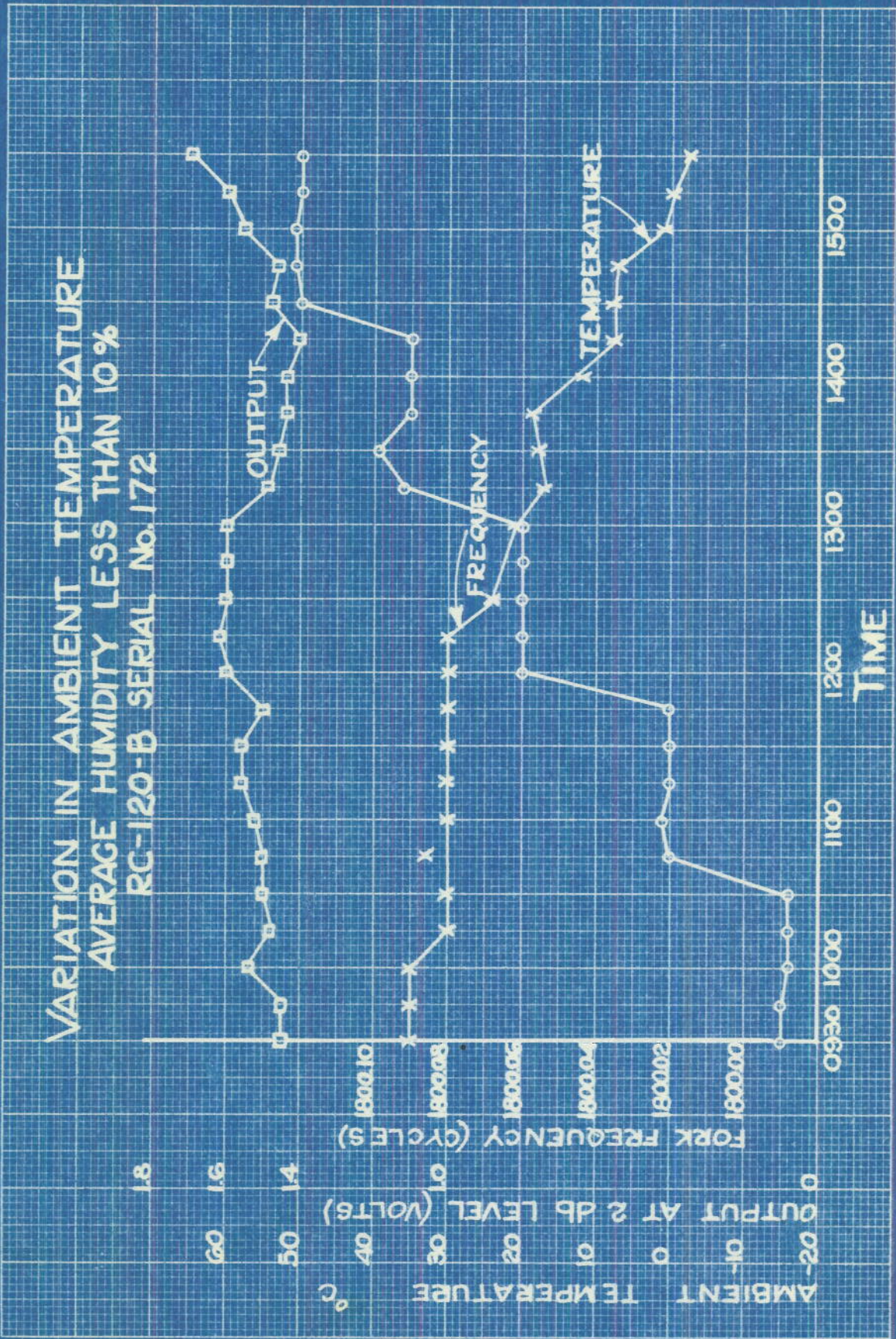

RESTRICTED

R-2885

PLATE 31



DECLASSIFIED

RESTRICTED

R-2885

PLATE 32

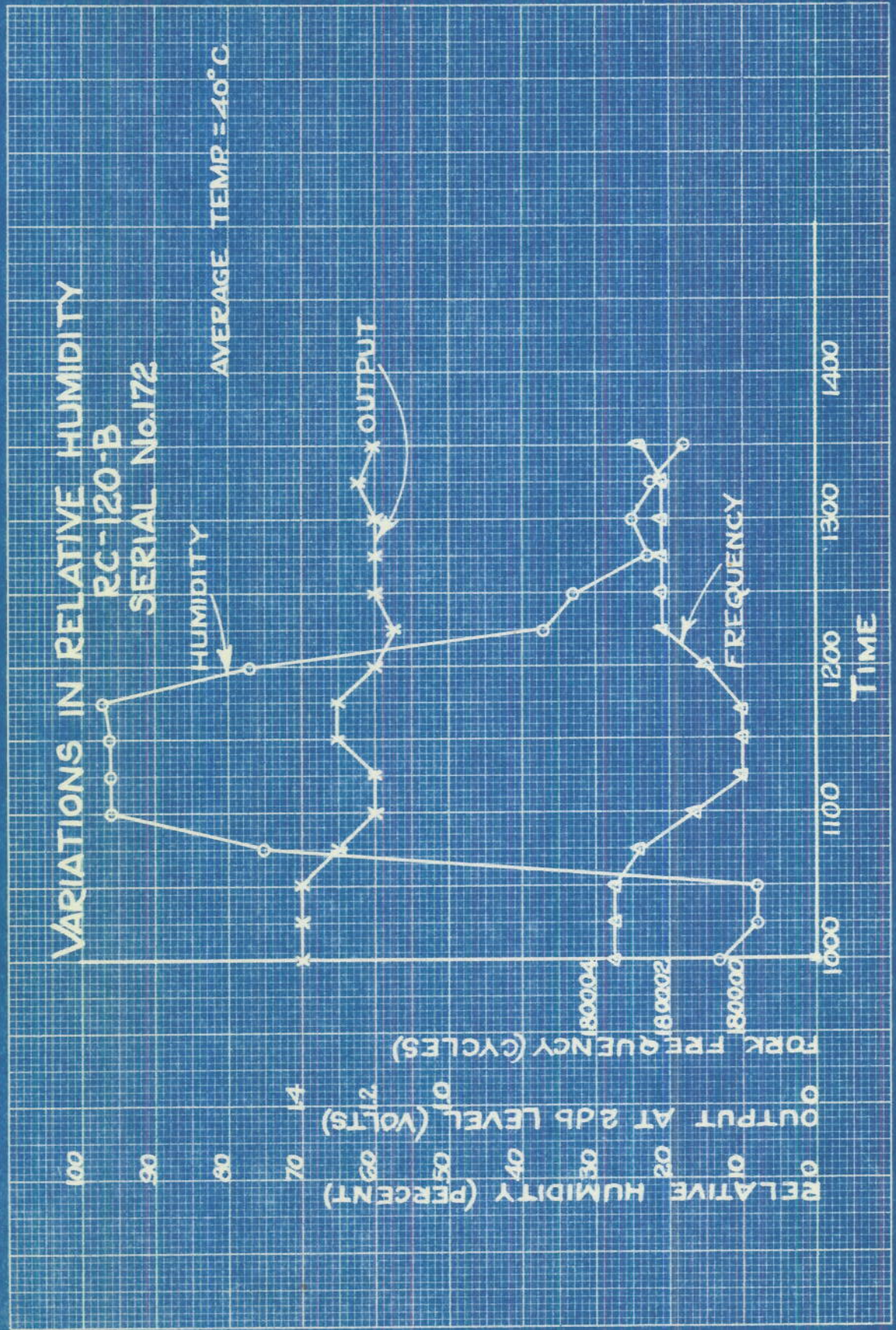



DECLASSIFIED

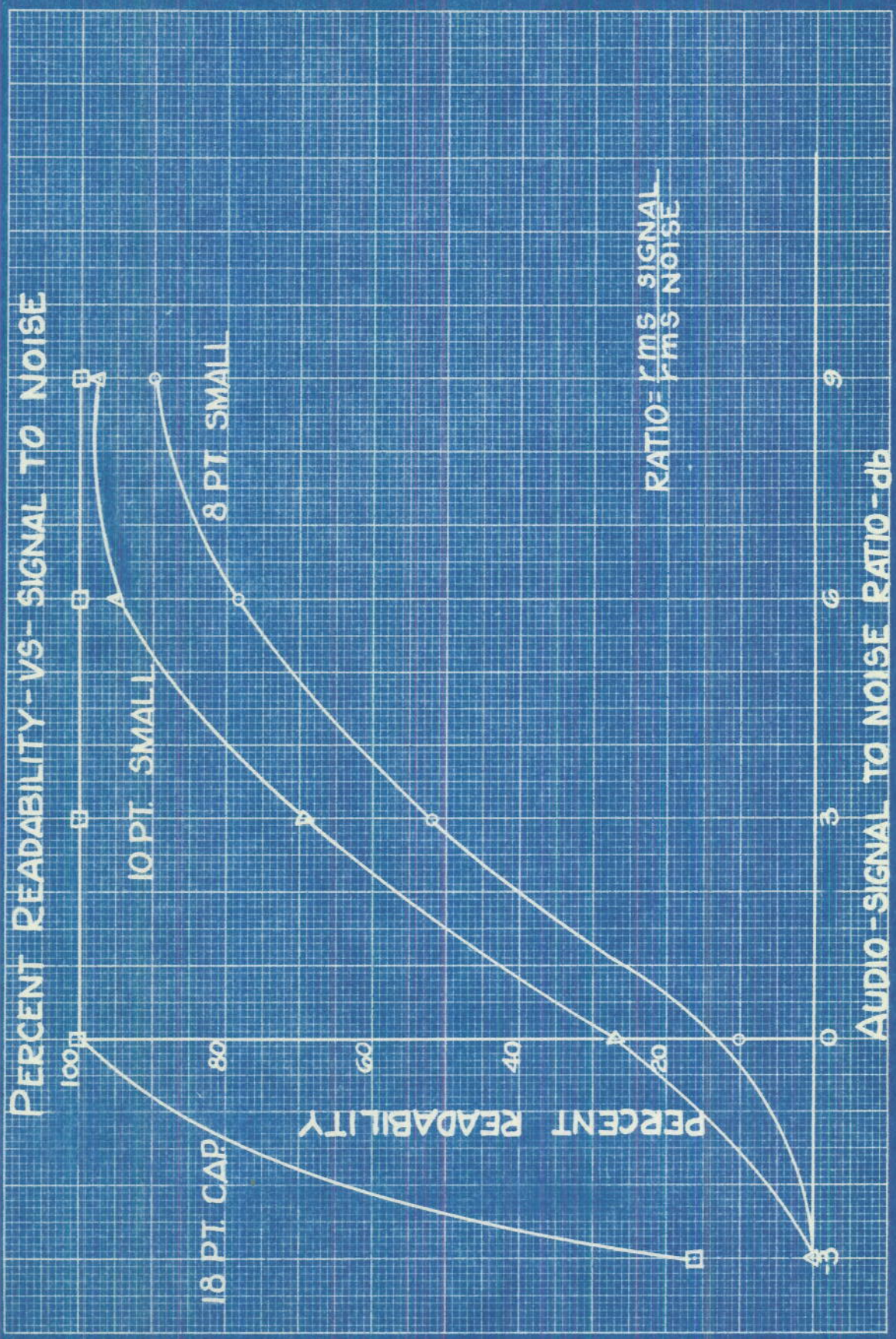

RESTRICTED

R-2885

PLATE 33



DECLASSIFIED

RESTRICTED

NOISE CHARACTERISTICS

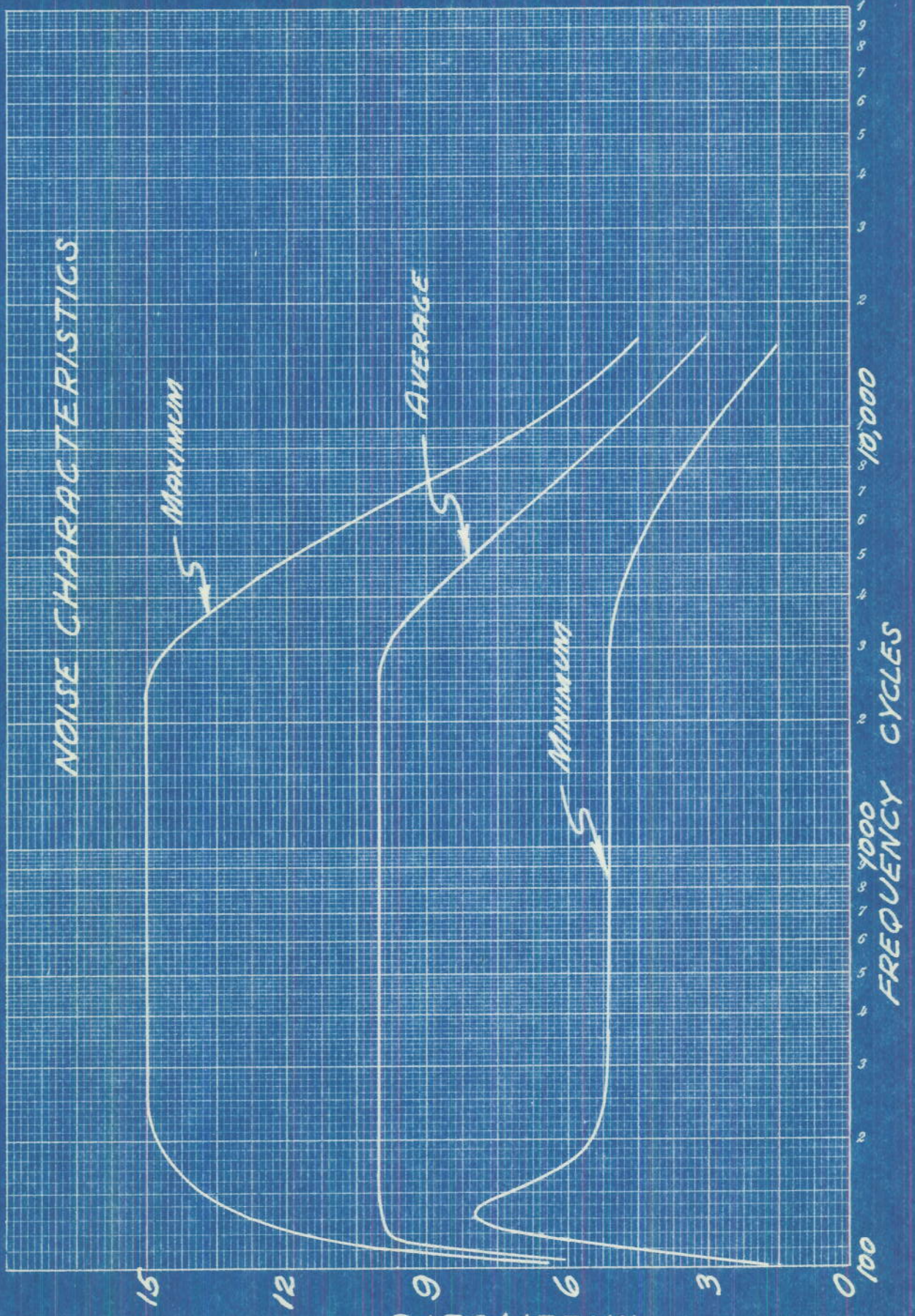

SL70A1771W
R-2885

PLATE 33a

MULTIPLE SIGNALS OVER TRANSATLANTIC PATH

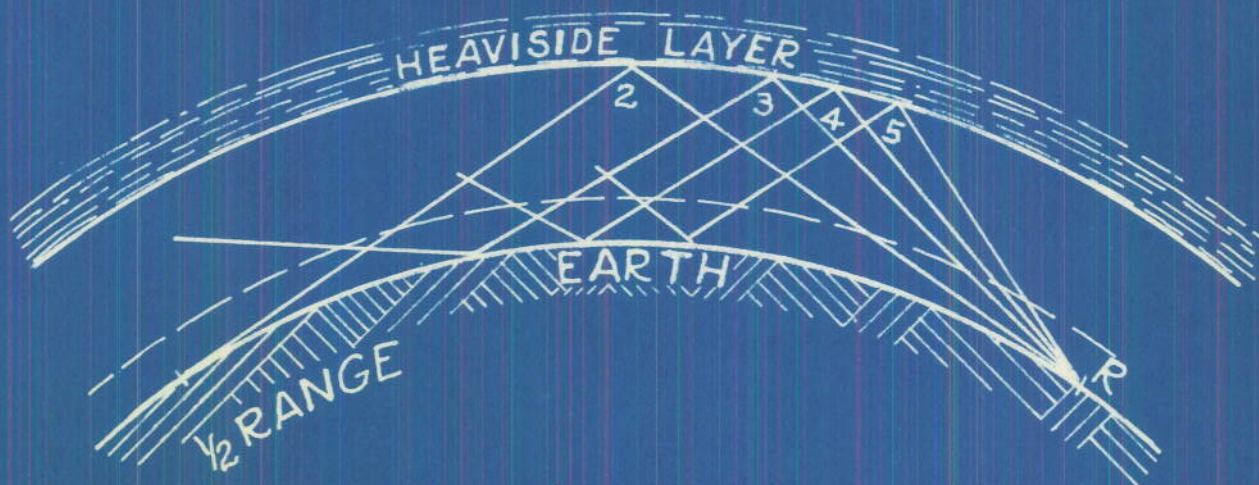

THE PRODUCTION OF MULTIPLE ECHOES BY RAYS
LEAVING THE TRANSMITTER AT DIFFERENT ANGLES.



RESTRICTED

FROM REFERENCE 5

PLATE 34

R-2885

DECLASSIFIED

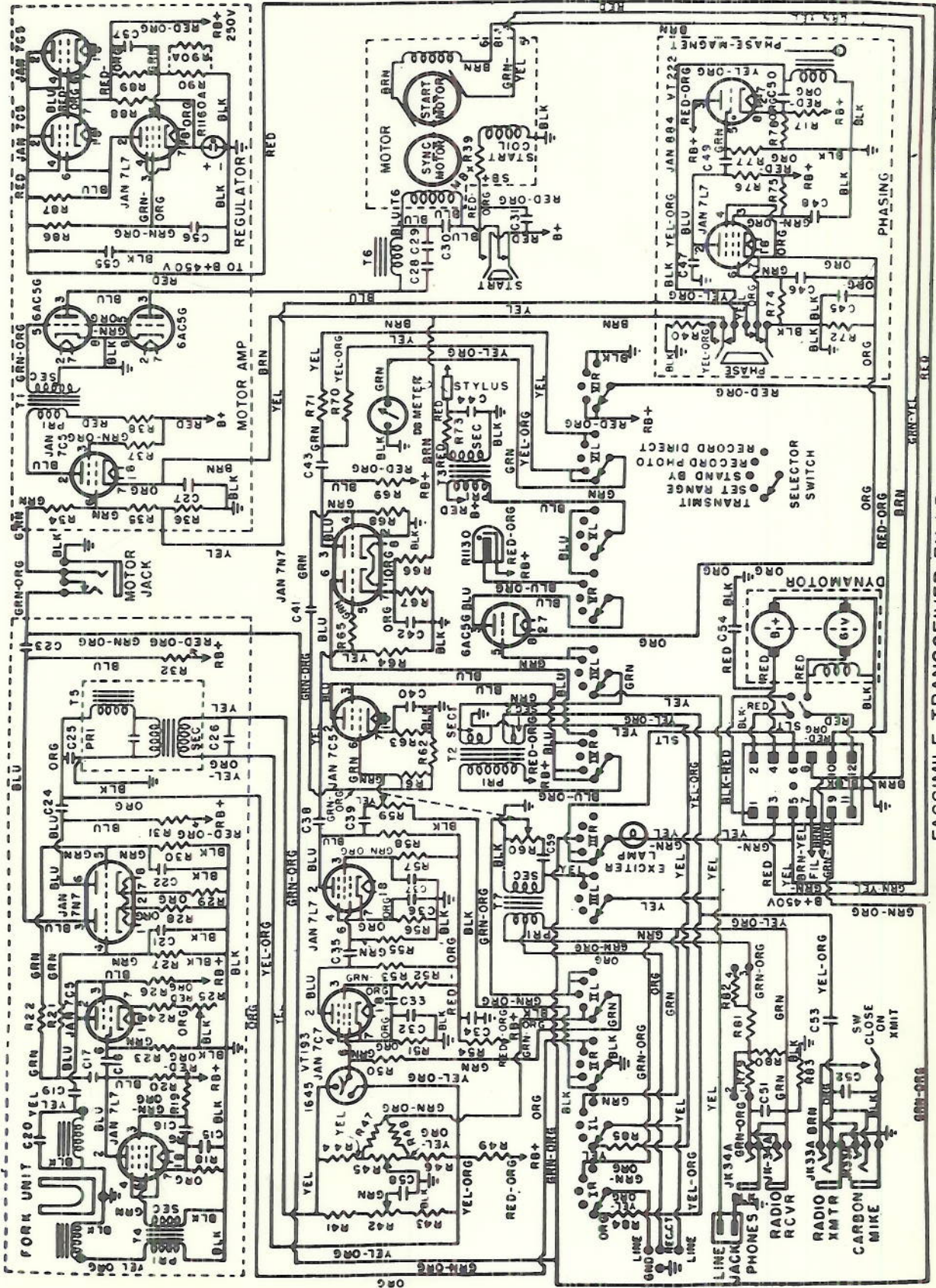

TL 50818

FACSIMILE TRANSCEIVER FX-1B

RESTRICTED

DECLASSIFIED

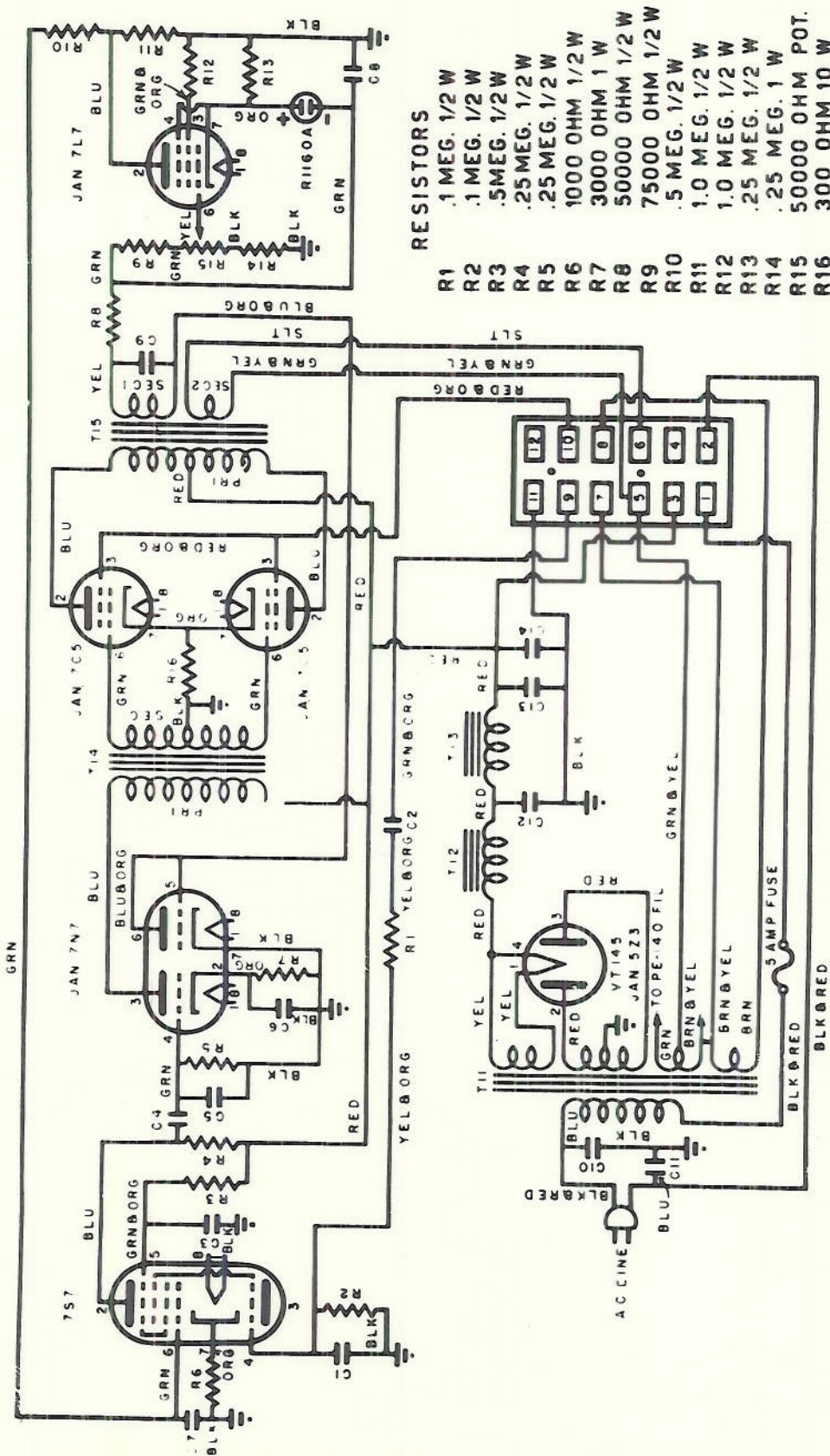

RESISTORS

- R1 .1 MEG. 1/2 W
- R2 .1 MEG. 1/2 W
- R3 .5 MEG. 1/2 W
- R4 .25 MEG. 1/2 W
- R5 .25 MEG. 1/2 W
- R6 1000 OHM 1/2 W
- R7 3000 OHM 1 W
- R8 50000 OHM 1/2 W
- R9 75000 OHM 1/2 W
- R10 .5 MEG. 1/2 W
- R11 1.0 MEG. 1/2 W
- R12 1.0 MEG. 1/2 W
- R13 .25 MEG. 1/2 W
- R14 .25 MEG. 1 W
- R15 50000 OHM POT.
- R16 300 OHM 10 W

RESTRICTED

DETERMINATION OF OPTIMUM CONTRAST RANGE

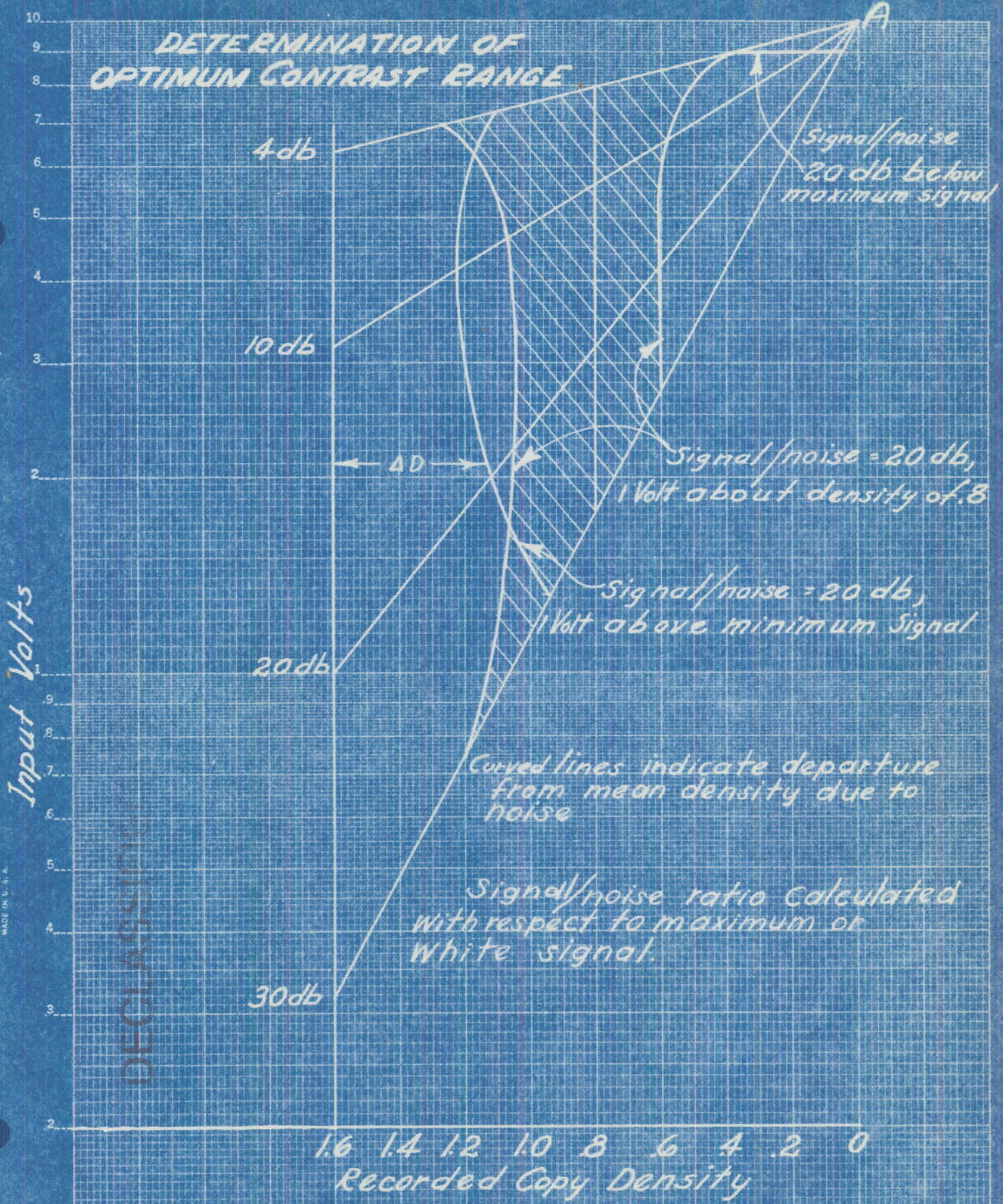

DECLASSIFIED

KODAK SAFETY FILM CO., N. Y. NO. 25662
Semi-Transparent, 2 1/2" x 3 1/2" to the inch
MADE IN U. S. A.

$\frac{13}{.0075}$ $\frac{1}{1800}$ $\frac{1}{3000}$
 $\frac{1}{1000}$ $\frac{1}{1500}$
 $\frac{1}{3500}$
 $\frac{13''}{3000}$
 3.6 millo. moment $\frac{1}{2}$ cycle
 1.3m

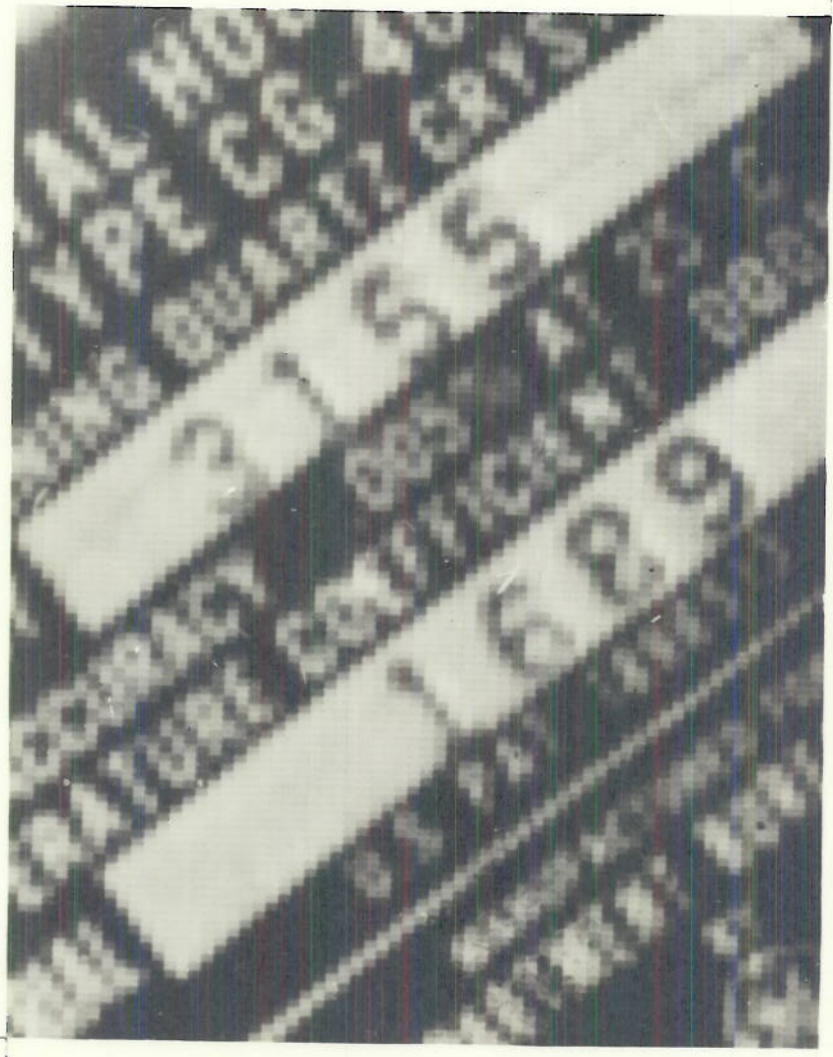

SEVEN DIAMETER ENLARGEMENT OF RECORDED COPY

DECLASSIFIED

RESTRICTED

OSCILLOGRAMS OF TRANSMITTER OUTPUT



A

B

C

D

E

F

G

A - 0.045 INCH LINES

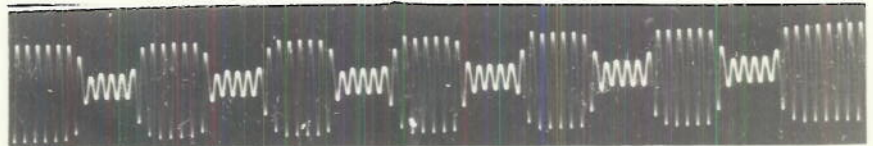

B - 0.022 INCH LINES

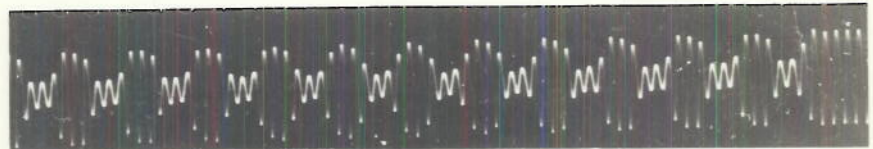

C - 0.011 INCH LINES

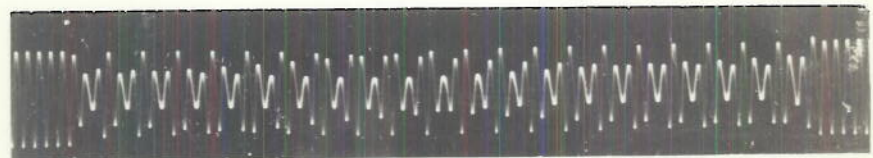

D - 0.0055 INCH LINES

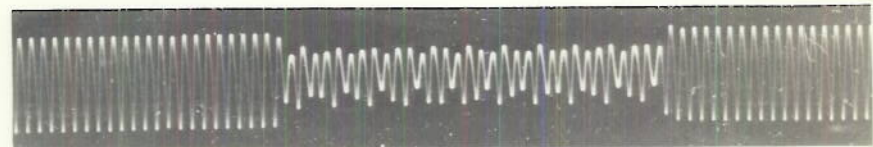

E - 0.045 INCH LINES



F - 0.022 INCH LINES



G - 0.011 INCH LINES

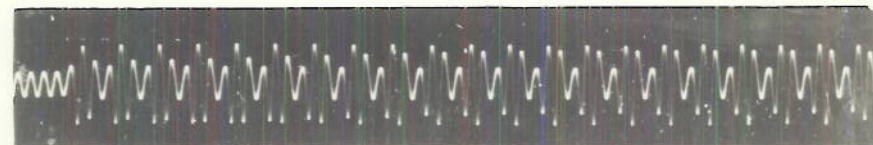

DECLASSIFIED

RESTRICTED

DEFINITION TEST CHART

EIGHTEEN POINT

abcdefghijklmnopqrstuvwxy 1234567890
ABCDEFGHIJKLMNOPQRSTUVWXYZ&

FOURTEEN POINT

abcdefghijklmnopqrstuvwxy 1234567890
ABCDEFGHIJKLMNOPQRSTUVWXYZ&

TWELVE POINT

abcdefghijklmnopqrstuvwxy 123456
ABCDEFGHIJKLMNOPQRSTUVZ

TEN POINT

abcdefghijklmnopqrstuvwxyfiffiffiæ
ABCDEFGHIJKLMNOPQRSTUVWXYZ

SIX POINT

abcdefghijklmnopqrstuvwxyfiffiffiæ 1234567890
ABCDEFGHIJKLMNOPQRSTUVWXYZ&Æ

EIGHT POINT

abcdefghijklmnopqrstuvwxyfiffiffiæ 12345678
ABCDEFGHIJKLMNOPQRSTUVWXYZ&Æ

TYPEWRITER PICA TYPE

abcdefghijklmnopqrstuvwxy
ABCDEFGHIJKLMNOPQRSTUVWXYZ

TYPEWRITER ELITE TYPE

abcdefghijklmnopqrstuvwxy
ABCDEFGHIJKLMNOPQRSTUVWXYZ

40 1/in. 60 1/in. 80 1/in. 100 1/in. 120 1/in. 140 1/in.



ORIGINAL OF TEST CHART NO. 1

DECLASSIFIED

DEFINITION TEST CHART

EIGHTEEN POINT

abcdefghijklmnopqrstuvwxy 1234567890
ABCDEFGHIJKLMN OPQRSTUVWXYZ&

FOURTEEN POINT

abcdefghijklmnopqrstuvwxy 1234567890
ABCDEFGHIJKLMN OPQRSTUVWXYZ&

TWELVE POINT

abcdefghijklmnopqrstuvwxy 123456
ABCDEFGHIJKLMN OPQRSTU VZ

TEN POINT

abcdefghijklmnopqrstuvwxy zffiffllae
ABCDEFGHIJKLMN OPQRSTU VWXYZ

SIX POINT

abcdefghijklmnopqrstuvwxy zffiffllae
ABCDEFGHIJKLMN OPQRSTU VWXYZ & E 1234567890

EIGHT POINT

abcdefghijklmnopqrstuvwxy zffiffllae 12345678
ABCDEFGHIJKLMN OPQRSTU VWXYZ & E

TYPEWRITER PICA TYPE

abcdefghijklmnopqrstuvwxy
ABCDEFGHIJKLMN OPQRSTU VWXYZ

TYPEWRITER ELITE TYPE

abcdefghijklmnopqrstuvwxy
ABCDEFGHIJKLMN OPQRSTU VWXYZ

40 1/in. 60 1/in. 80 1/in. 100 1/in. 120 1/in. 140 1/in.



TRANSMITTED OVER WIRE CIRCUIT 12 db RANGE

DECLASSIFIED

DEFINITION TEST CHART

Bookman No. 98

Tiffany Gothic Foundry

18-Point

IT MATTERS NOT HOW
Large Or Small The Job Is

TWELVE POINT NO. 2

ABCDEFGHIJKLMNOP12345

TWELVE POINT NO. 1

ABCDEFGHIJKLMNOPQRS123456

SIX POINT NO. 4

ABCDEFGHIJKLMNOPQRSTU123456

SIX POINT NO. 3

ABCDEFGHIJKLMNOPQRSTUVWXYZ 1234567

SIX POINT NO. 2

ABCDEFGHIJKLMNOPQRSTUVWXYZ \$1234567890

SIX POINT NO. 1

ABCDEFGHIJKLMNOPQRSTUVWXYZ \$1234567890

14-Point

THE NEXT TIME YOU HAVE
a make-up job of any importance
pause a moment and \$1234567890

Typewriter Faces

EIGHT POINT REMINGTON NO. 70L

abcdefghijklmnopqrstuvwxy 1234567890

ABCDEFGHIJKLMNOPQRSTUVWXYZ

12-Point

IT IS BEYOND DISPUTE THAT ALL
persons who look to an industry for their live-
lihood are interested in reducing \$1234567890

TEN POINT REMINGTON NO. 70L

abcdefghijklmnopqrstuvwxy123

ABCDEFGHIJKLMNOPQRSTUVWXYZ

10-Point

IT IS BEYOND DISPUTE THAT ALL PERSONS
who look to an industry for their livelihood are inter-
ested in reducing the cost of production \$1234567890

TWELVE POINT REMINGTON NO. 70L

abcdefghijklmnopqrst123

ABCDEFGHIJKLMNOPQRSTUVWXYZ

8-Point

IT IS BEYOND DISPUTE THAT ALL PERSONS WHO
look to an industry for their livelihood are interested in reducing
the cost of production in that industry as far as \$1234567890

ELEVEN POINT REMINGTON RIB. NO. 17L

abcdefghijklmnopqrst1234

ABCDEFGHIJKLMNOPQRSTUVWXYZ

6-Point

IT IS BEYOND DISPUTE THAT ALL PERSONS WHO LOOK TO
an industry for their livelihood are interested in reducing the cost of pro-
duction in that industry as far as possible. Keeping this thought \$1234567890

TEST CHART NO. 2 ORIGINAL

DECLASSIFIED

PLATE 39

DEFINITION TEST CHART

Bookman No. 98

Tiffany Gothic Foundry

18-Point

IT MATTERS NOT HOW
Large Or Small The Job Is

14-Point

THE NEXT TIME YOU HAVE
a make-up job of any importance
pause a moment and \$1234567890

12-Point

IT IS BEYOND DISPUTE THAT ALL
persons who look to an industry for their live-
lihood are interested in reducing \$1234567890

10-Point

IT IS BEYOND DISPUTE THAT ALL PERSONS
who look to an industry for their livelihood are inter-
ested in reducing the cost of production \$1234567890

8-Point

IT IS BEYOND DISPUTE THAT ALL PERSONS WHO
look to an industry for their livelihood are interested in reducing
the cost of production in that industry as far as \$1234567890

6-Point

IT IS BEYOND DISPUTE THAT ALL PERSONS WHO LOOK TO
an industry for their livelihood are interested in reducing the cost of pro-
duction in that industry as far as possible. Keeping this thought \$1234567890

TWELVE POINT NO. 2

ABCDEFGHIJKLMN OP12345

TWELVE POINT NO. 1

ABCDEFGHIJKLMN OPQRS123456

SIX POINT NO. 4

ABCDEFGHIJKLMN OPQRSTU V123456

SIX POINT NO. 3

ABCDEFGHIJKLMN OPQRSTU VWXYZ 1234567

SIX POINT NO. 2

ABCDEFGHIJKLMN OPQRSTU VWXYZ 01234567890

SIX POINT NO. 1

ABCDEFGHIJKLMN OPQRSTU VWXYZ 01234567890

Typewriter Faces

EIGHT POINT REMINGTON NO. 70L

abcdefghijklmnopqrstu vwxyz 1234567890
ABCDEFGHIJKLMN OPQRSTU VWXYZ

TEN POINT REMINGTON NO. 70L

abcdefghijklmnopqrstu vwxyz123
ABCDEFGHIJKLMN OPQRSTU VWXYZ

TWELVE POINT REMINGTON NO. 70L

abcdefghijklmnopqrst123
ABCDEFGHIJKLMN OPQRSTU VW

ELEVEN POINT REMINGTON RIB. NO. 17L

abcdefghijklmnopqrst1234
ABCDEFGHIJKLMN OPQRSTU VWX

FIRST TRANSMISSION OVER WIRE CIRCUIT 12 db RANGE

DECLASSIFIED

PLATE 40

DEFINITION TEST CHART

Bookman No. 98

Tiffany Gothic Foundry

18 Point

**IT MATTERS NOT HOW
Large Or Small The Job Is**

14-Point

**THE NEXT TIME YOU HAVE
a make-up job of any importance
pause a moment and \$1234567890**

12-Point

**IT IS BEYOND DISPUTE THAT ALL
persons who look to an industry for their live-
lihood are interested in reducing \$1234567890**

10-Point

**IT IS BEYOND DISPUTE THAT ALL PERSONS
who look to an industry for their livelihood are inter-
ested in reducing the cost of production \$1234567890**

8-Point

**IT IS BEYOND DISPUTE THAT ALL PERSONS WHO
look to an industry for their livelihood are interested in reducing
the cost of production in that industry as far as \$1234567890**

6-Point

**IT IS BEYOND DISPUTE THAT ALL PERSONS WHO LOOK TO
an industry for their livelihood are interested in reducing the cost of pro-
duction in that industry as far as possible. Keeping this thought \$1234567890**

TWELVE POINT NO. 2

ABCDEFGHIJKLMN^{OP}123456

TWELVE POINT NO. 1

ABCDEFGHIJKLMN^{OPQRS}123456

SIX POINT NO. 4

ABCDEFGHIJKLMN^{OPQRSTUV}123456

SIX POINT NO. 3

ABCDEFGHIJKLMN^{OPQRSTUVWXYZ}1234567

SIX POINT NO. 2

ABCDEFGHIJKLMN^{OPQRSTUVWXYZ} 01234567890

SIX POINT NO. 1

ABCDEFGHIJKLMN^{OPQRSTUVWXYZ} 01234567890

Typewriter Faces

EIGHT POINT REMINGTON NO. 70L

abcdefghijklmnopqrstu^{vwxyz} 1234567890
ABCDEFGHIJKLMN^{OPQRSTUVWYZ}

TEN POINT REMINGTON NO. 70L

abcdefghijklmnopqrstu^{vwxyz}123
ABCDEFGHIJKLMN^{OPQRSTUVWYZ}

TWELVE POINT REMINGTON NO. 70L

abcdefghijklmnopqrstu^l123
ABCDEFGHIJKLMN^{OPQRSTUVW}

ELEVEN POINT REMINGTON RIB. NO. 17L

abcdefghijklmnopqrstu^l1234
ABCDEFGHIJKLMN^{OPQRSTUVWX}

RETRANSMISSION OF PLATE 40 OVER WIRE CIRCUIT 12db RANGE

DECLASSIFIED

PLATE 41

DEFINITION TEST CHART No. 3

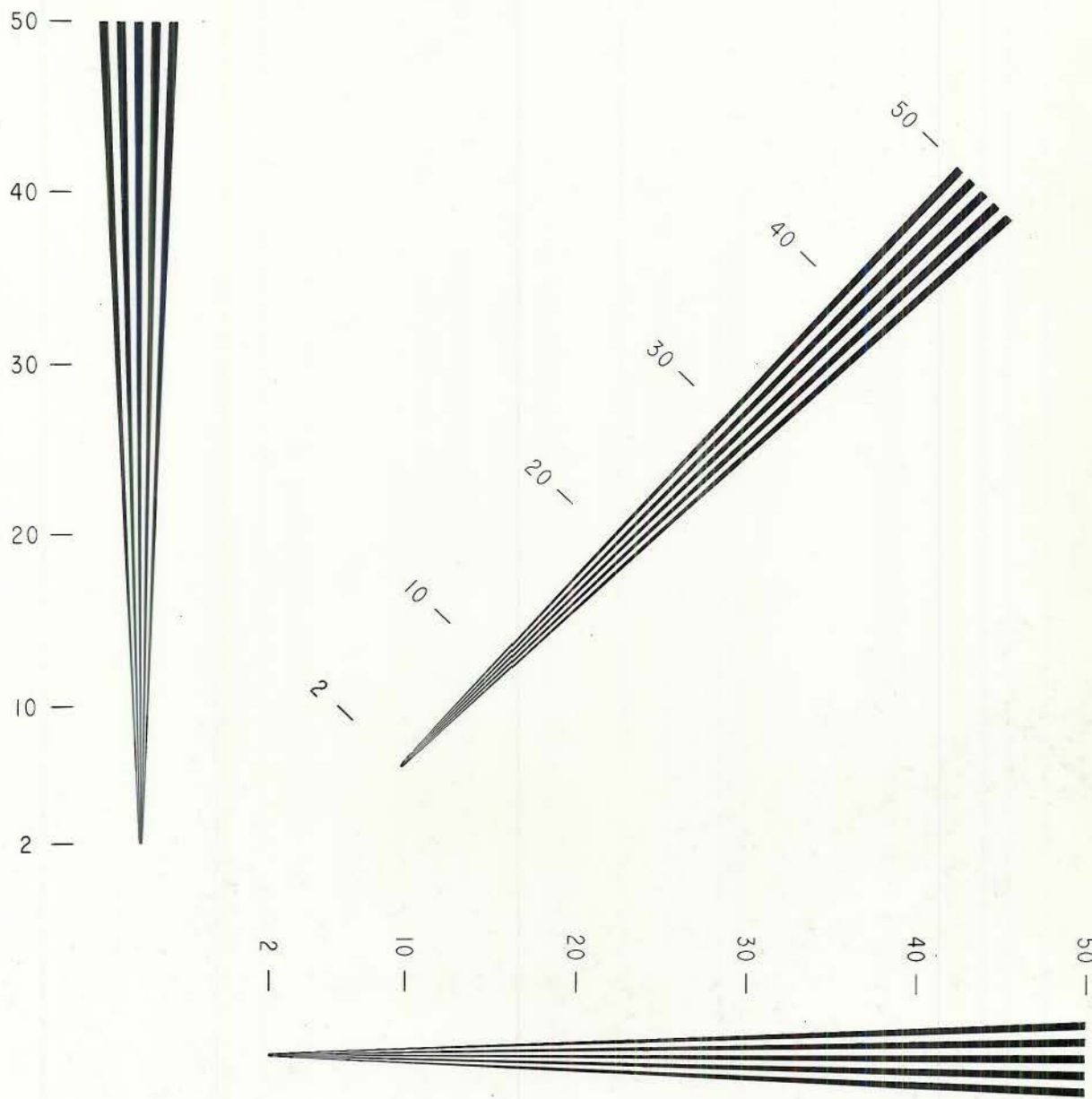

ORIGINAL

DECLASSIFIED



DEFINITION TEST CHART No. 3

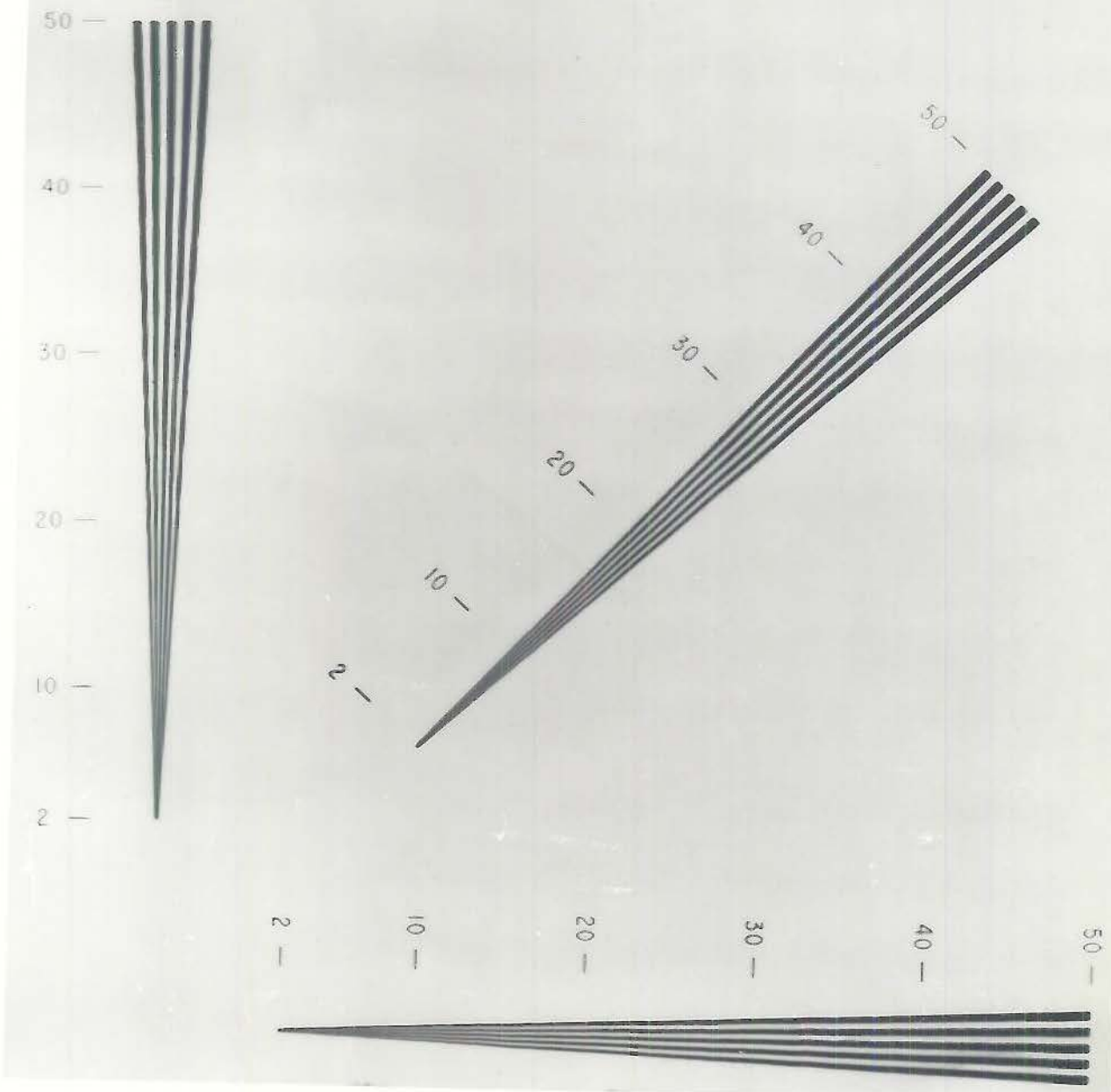

TRANSMITTED OVER WIRE CIRCUIT 12; db RANGE - PAPER, NO. 4 AZO

DECLASSIFIED

PLATE 43



DEFINITION TEST CHART No 3

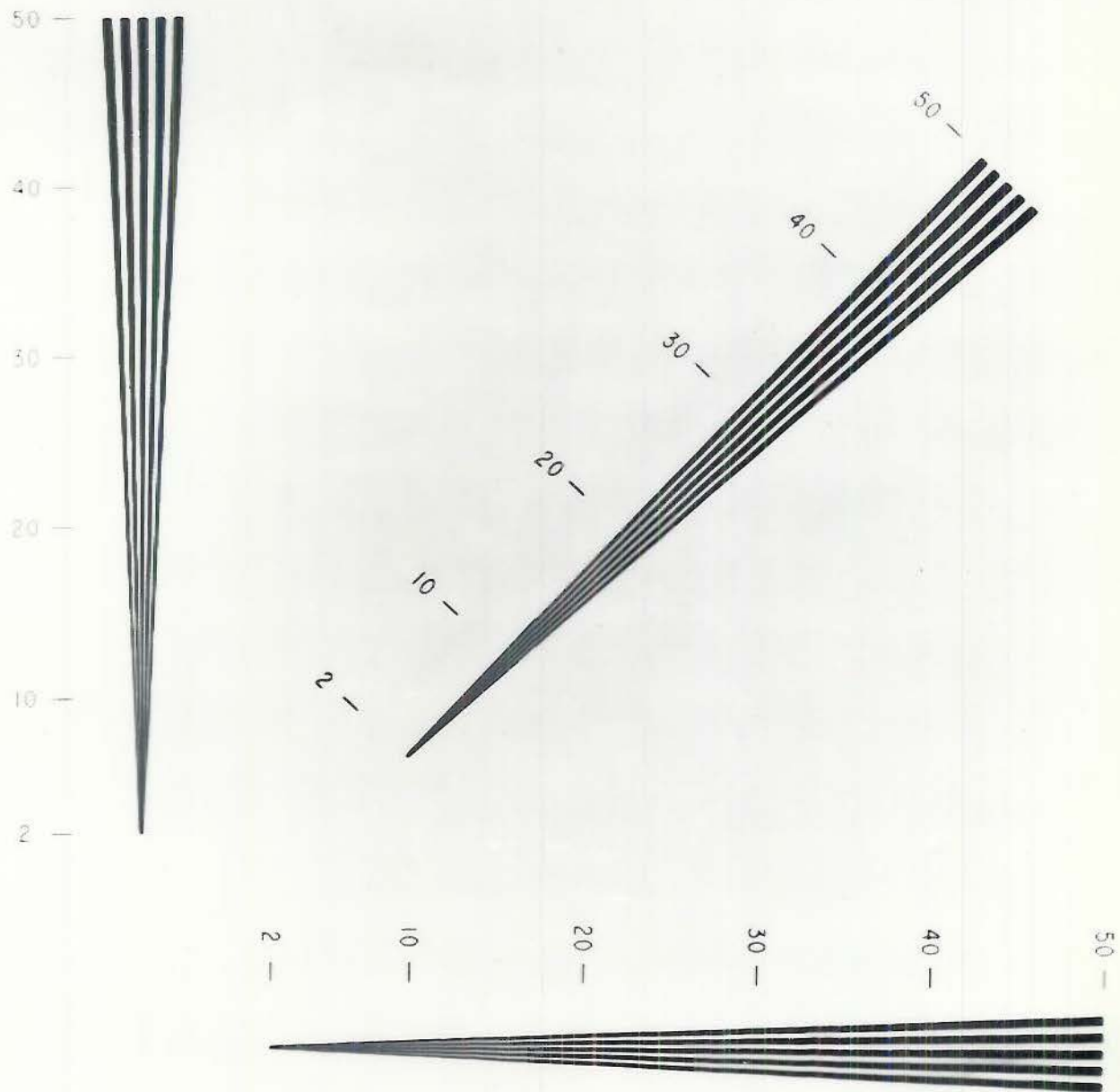

TRANSMITTED OVER WIRE CIRCUIT 12 db RANGE - PAPER, NO. 5 AZO

DECLASSIFIED

PLATE 43 A



WHITE HOUSE ORIGINAL

DECLASSIFIED

PLATE 44



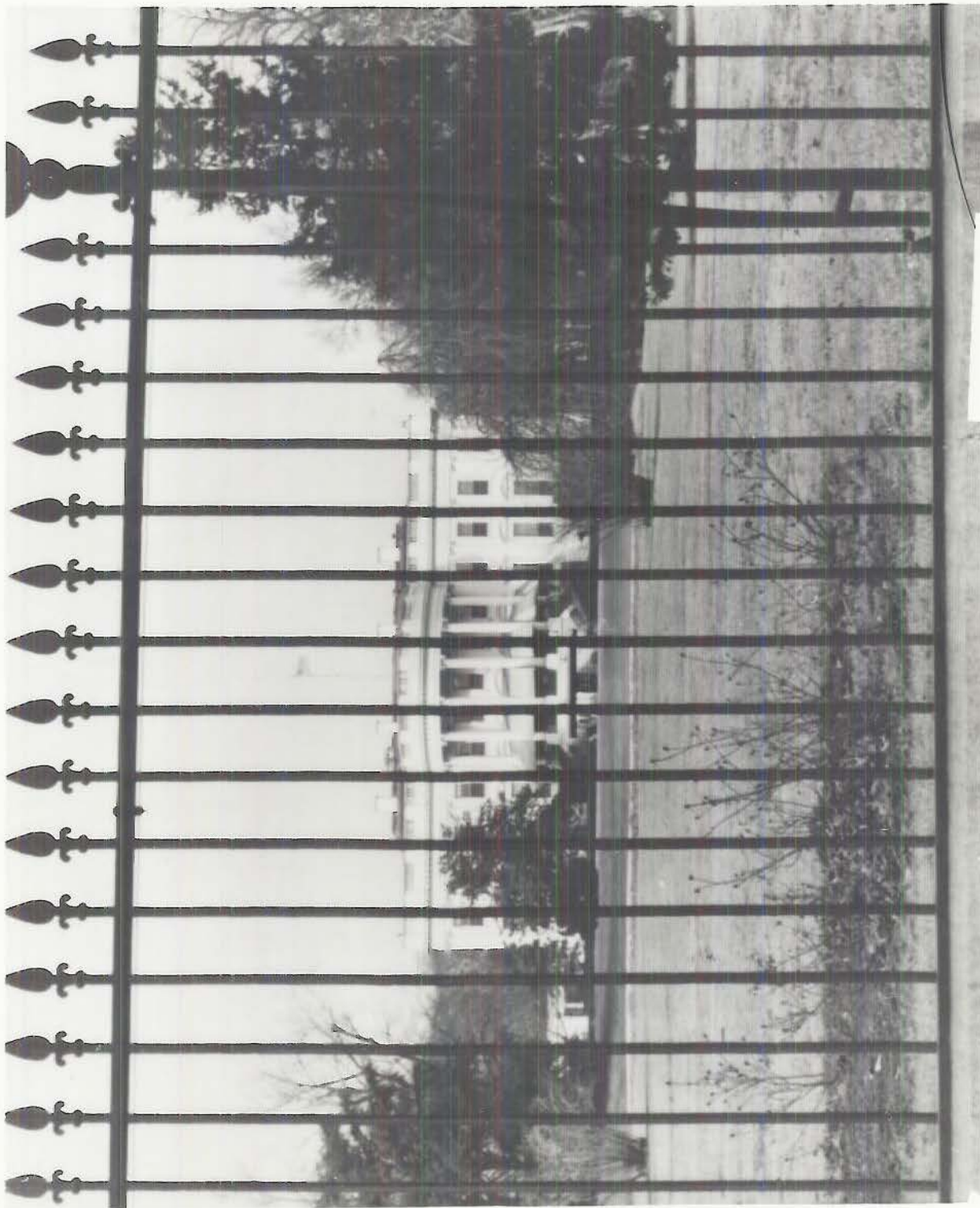

TRANSMITTED OVER WIRE CIRCUIT 8 db RANGE, TYPE A FILM

DECLASSIFIED

PLATE 45



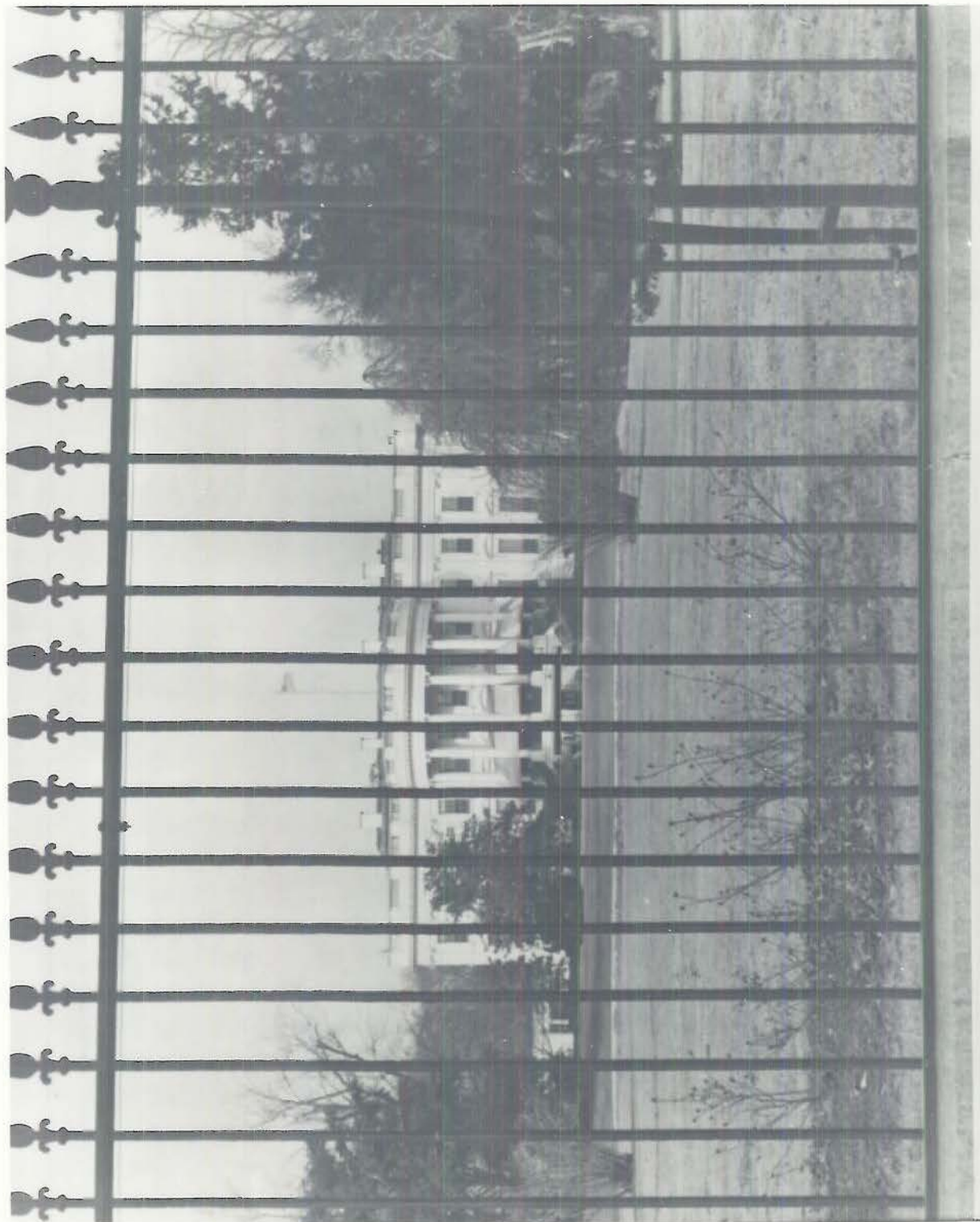

TRANSMITTED OVER WIRE CIRCUIT 8db RANGE, TYPE C FILM

DECLASSIFIED

PLATE 46



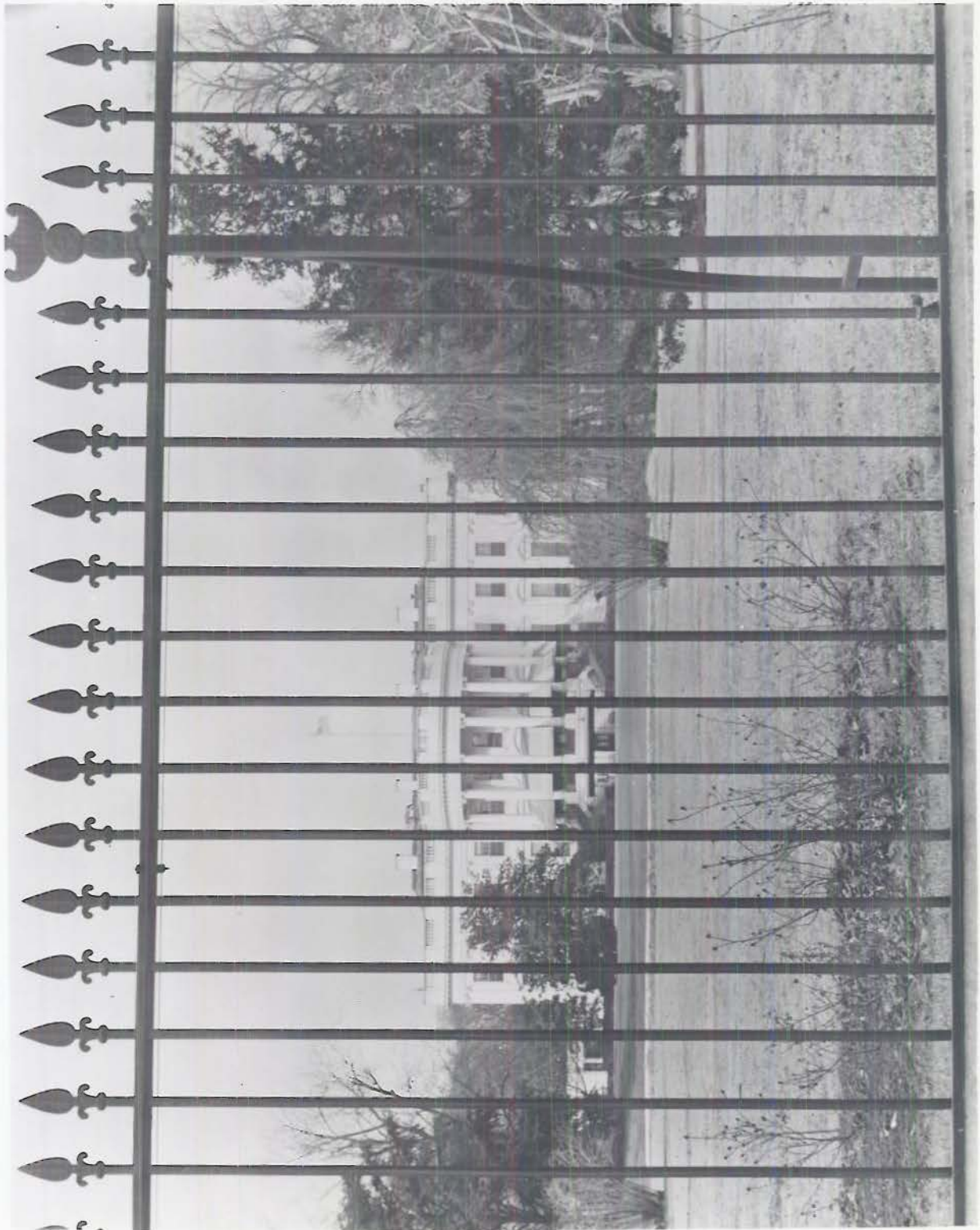

WHITE HOUSE "FLAT". LOW CONTRAST RANGE ORIGINAL

DECLASSIFIED

PLATE 47





TRANSMITTER LINE VOLTAGE VARIATION 103, 115, AND 126.5 VOLTS IN THREE STEPS

~~RESTRICTED~~

DECLASSIFIED

PLATE 52



RECEIVER LINE VOLTAGE VARIATION 103, 115, AND 126.5 VOLTS IN THREE STEPS

RESTRICTED

DECLASSIFIED

PLATE 53

DEFINITION TEST CHART

EIGHTEEN POINT

abcdefghijklmnopqrstuvwxy z 1234567890
ABCDEFGHIJKLMN OPQRSTUVWXYZ&

FOURTEEN POINT

abcdefghijklmnopqrstuvwxy z 1234567890
ABCDEFGHIJKLMN OPQRSTUVWXYZ&

TWELVE POINT

abcdefghijklmnopqrstuvwxy z 123456
ABCDEFGHIJKLMN OPQRSTU VZ

TEN POINT

abcdefghijklmnopqrstuvwxy zffiffiffiaer
ABCDEFGHIJKLMN OPQRSTU VWXYZ

SIX POINT

abcdefghijklmnopqrstuvwxy zffiffiffiaer
ABCDEFGHIJKLMN OPQRSTU VWXYZ& ER 1234567890

EIGHT POINT

abcdefghijklmnopqrstuvwxy zffiffiffiaer 12345678
ABCDEFGHIJKLMN OPQRSTU VWXYZ& ER

TYPEWRITER PICA TYPE

abcdefghijklmnopqrstuvwxy z
ABCDEFGHIJKLMN OPQRSTU VWXYZ

TYPEWRITER ELITE TYPE

abcdefghijklmnopqrstuvwxy z
ABCDEFGHIJKLMN OPQRSTU VWXYZ

40 1/in. 60 1/in. 80 1/in. 100 1/in. 120 1/in. 140 1/in.



SIGNAL TO NOISE 12db - 12db CONTRAST RANGE

RESTRICTED

DECLASSIFIED

PLATE 54

DEFINITION TEST CHART

EIGHTEEN POINT

abcdefghijklmnopqrstuvwxyz 1234567890
ABCDEFGHIJKLMNQPQRSTUVWXYZ&

FOURTEEN POINT

abcdefghijklmnopqrstuvwxyz 1234567890
ABCDEFGHIJKLMNQPQRSTUVWXYZ&

TWELVE POINT

abcdefghijklmnopqrstuvwxyz 123456
ABCDEFGHIJKLMNQPRTUVZ

TEN POINT

abcdefghijklmnopqrstuvwxyzffiffiffiaee
ABCDEFGHIJKLMNQPRTUVWXYZ

SIX POINT

abcdefghijklmnopqrstuwxzffiffiaee 1234567890
ABCDEFGHIJKLMNQPRTUVWXYZ&E

EIGHT POINT

abcdefghijklmnopqrstuwxzffiffiffiaee 12345678
ABCDEFGHIJKLMNQPRTUVWXYZ&E

TYPEWRITER PICA TYPE

abcdefghijklmnopqrstuvwxyz
ABCDEFGHIJKLMNQPRTUVWXYZ

TYPEWRITER ELITE TYPE

abcdefghijklmnopqrstuvwxyz
ABCDEFGHIJKLMNQPRTUVWXYZ

40 1/in. 60 1/in. 80 1/in. 100 1/in. 120 1/in. 140 1/in.



SIGNAL TO NOISE 9db - 12db CONTRAST RANGE

DECLASSIFIED

RESTRICTED

DEFINITION TEST CHART

EIGHTEEN POINT

abcdefghijklmnopqrstuvwxyz 1234567890
ABCDEFGHIJKLMNOPQRSTUVWXYZ&

FOURTEEN POINT

abcdefghijklmnopqrstuvwxyz 1234567890
ABCDEFGHIJKLMNOPQRSTUVWXYZ&

TWELVE POINT

abcdefghijklmnopqrstuvwxyz 123456
ABCDEFGHIJKLMNOPQRSTUVZ

TEN POINT

abcdefghijklmnopqrstuvwxyzhiflflaer
ABCDEFGHIJKLMNOPQRSTUVWXYZ

SIX POINT

abcdefghijklmnopqrstuvwxyz123456
ABCDEFGHIJKLMNOPQRSTUVWXYZ&E

EIGHT POINT

abcdefghijklmnopqrstuvwxyzhiflflaer12345678
ABCDEFGHIJKLMNOPQRSTUVWXYZ&E

TYPEWRITER PICA TYPE

abcdefghijklmnopqrstuvwxyz
ABCDEFGHIJKLMNOPQRSTUVWXYZ

TYPEWRITER ELITE TYPE

abcdefghijklmnopqrstuvwxyz
ABCDEFGHIJKLMNOPQRSTUVWXYZ

40 1/in. 60 1/in. 80 1/in. 100 1/in. 120 1/in. 140 1/in.



SIGNAL TO NOISE 6db - 12db CONTRAST RANGE

RESTRICTED

DECLASSIFIED

PLATE 56

DEFINITION TEST CHART

EIGHTEEN POINT

abcdefghijklmnopqrstuvwxy 1234567890
ABCDEFGHIJKLMN OPQRSTUVWXYZ&

FOURTEEN POINT

abcdefghijklmnopqrstuvw xy 1234567890
ABCDEFGHIJKLMN OPQRSTUVWXYZ&

TWELVE POINT

abcdefghijklmnopqrstuvwxy 123456
ABCDEFGHIJKLMN OPQRSTU VZ

TEN POINT

abcdefghijklmnopqrstuvwxy 1234567890
ABCDEFGHIJKLMN OPQRSTU VXYZ

SIX POINT

abcdefghijklmnopqrstuvw xy 1234567890
ABCDEFGHIJKLMN OPQRSTU VXYZ 1234567890

EIGHT POINT

abcdefghijklmnopqrstuvw xy 1234567890
ABCDEFGHIJKLMN OPQRSTU VXYZ 1234567890

TYPEWRITER PICA TYPE

abcdefghijklmnopqrstuvwxy
ABCDEFGHIJKLMN OPQRSTU VXYZ

TYPEWRITER ELITE TYPE

abcdefghijklmnopqrstuvwxy
ABCDEFGHIJKLMN OPQRSTU VXYZ

40 1/in. 60 1/in. 80 1/in. 100 1/in. 120 1/in. 140 1/in.



SIGNAL TO NOISE 3db - 12db CONTRAST RANGES

RESTRICTED

DECLASSIFIED

PLATE 57

DEFINITION TEST CHART

EIGHTEEN POINT

abcdefghijklmnopqrstuvwxyz 1234567890
ABCDEFGHIJKLMNOPQRSTUVWXYZ&

FOURTEEN POINT

abcdefghijklmnopqrstuvwxyz 1234567890
ABCDEFGHIJKLMNOPQRSTUVWXYZ&

TWELVE POINT

abcdefghijklmnopqrstuvwxyz 123456
ABCDEFGHIJKLMNOPQRSTUZY

TEN POINT

abcdefghijklmnopqrstuvwxyz 1234567890
ABCDEFGHIJKLMNOPQRSTUVWXYZ

SIX POINT

abcdefghijklmnopqrstuvwxyz 123456
ABCDEFGHIJKLMNOPQRSTUVWXYZ

EIGHT POINT

abcdefghijklmnopqrstuvwxyz 1234567890
ABCDEFGHIJKLMNOPQRSTUVWXYZ

TYPewriter PICA TYPE

abcdefghijklmnopqrstuvwxyz
ABCDEFGHIJKLMNOPQRSTUVWXYZ

TYPewriter ELITE TYPE

abcdefghijklmnopqrstuvwxyz
ABCDEFGHIJKLMNOPQRSTUVWXYZ

40 1/in. 60 1/in. 80 1/in. 100 1/in. 120 1/in. 140 1/in.



SIGNAL TO NOISE 0db - 12db CONTRAST RANGE

RESTRICTED

DECLASSIFIED

PLATE 58

DEFINITION TEST CHART

abcdefghijklmnopqrstuvwxyz 1234567890
ABCDEFGHIJKLMN O PQRSTU VWX YZ

abcdefghijklmnopqrstuvwxyz 1234567890
ABCDEFGHIJKLMN O PQRSTU VWX YZ

abcdefghijklmnopqrstuvwxyz 1234567890
ABCDEFGHIJKLMN O PQRSTU VWX YZ

abcdefghijklmnopqrstuvwxyz 1234567890
ABCDEFGHIJKLMN O PQRSTU VWX YZ

abcdefghijklmnopqrstuvwxyz 1234567890
ABCDEFGHIJKLMN O PQRSTU VWX YZ



SIGNAL TO NOISE -3db 12db CONTRAST RANGE

RESTRICTED

DECLAS ED

PLATE 59



MARINE BARRACKS ORIGINAL



DECLA

FIED

PLATE 60



SIGNAL TO NOISE 30db - 8db CONTRAST RANGE

~~RESTRICTED~~

DECLASSIFIED



SIGNAL TO NOISE 20db - 8db CONTRAST RANGE

RESTRICTED

DECLASSIFIED

PLATE 62



SIGNAL TO NOISE 15db - 8db CONTRAST RANGE

RESTRICTED

DECLASSIFIED

PLATE 63

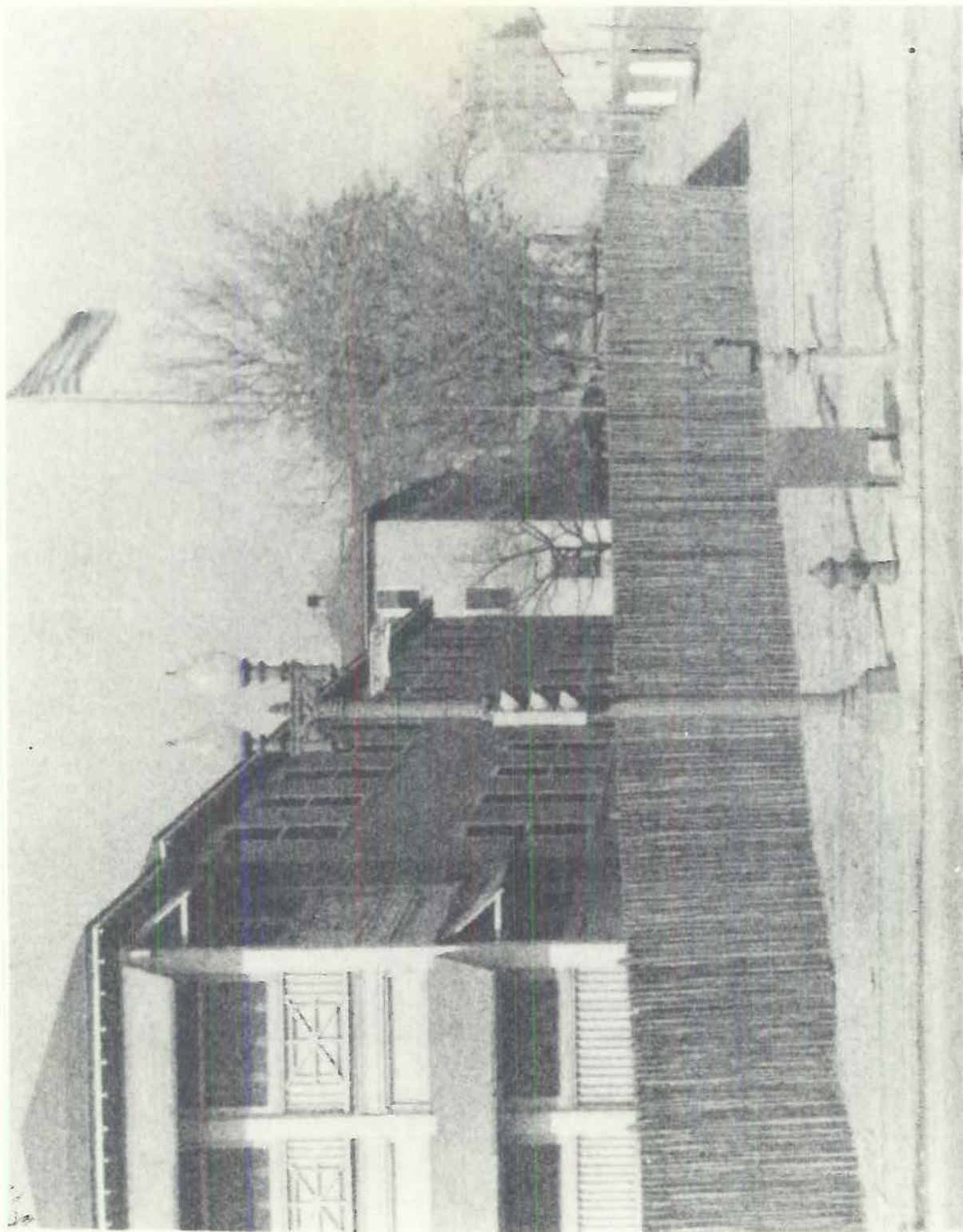

SIGNAL TO NOISE 12db - 8db CONTRAST RANGE

RESTRICTED

DECLASSIFIED

PLATE 64

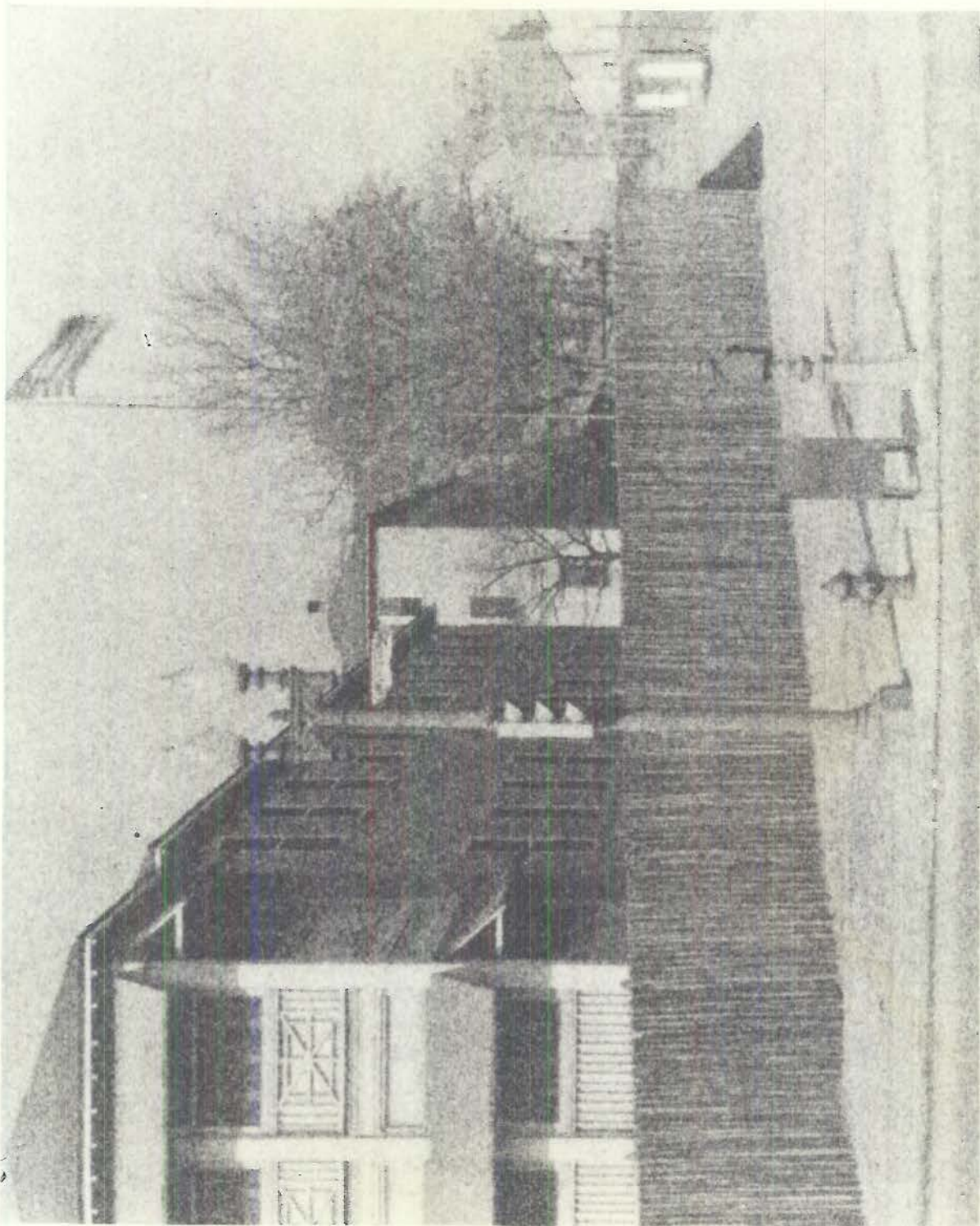

SIGNAL TO NOISE 9db - 8db CONTRAST RANGE

DECLASSIFIED

RESTRICTED

PLATE 65



SIGNAL TO NOISE 3db - 8db CONTRAST RANGE

~~RESTRICTED~~

DECLASSIFIED D



SIGNAL TO NOISE 0db - 8db CONTRAST RANGE

RESTRICTED

DECLASSIFIED

PLATE 67

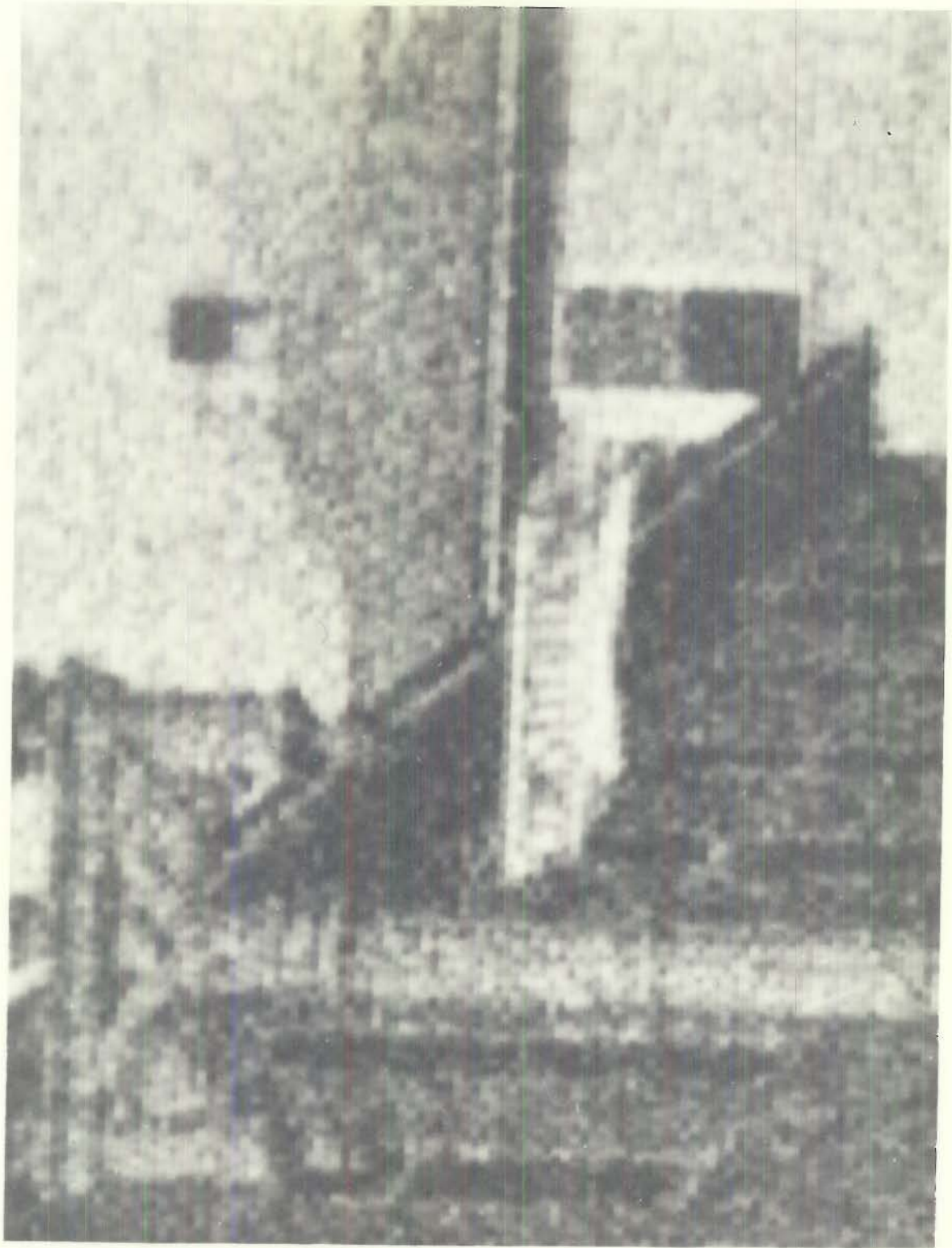

ENLARGEMENT OF PLATE 64

RESTRICTED
DECLASSIFIED

PLATE 68

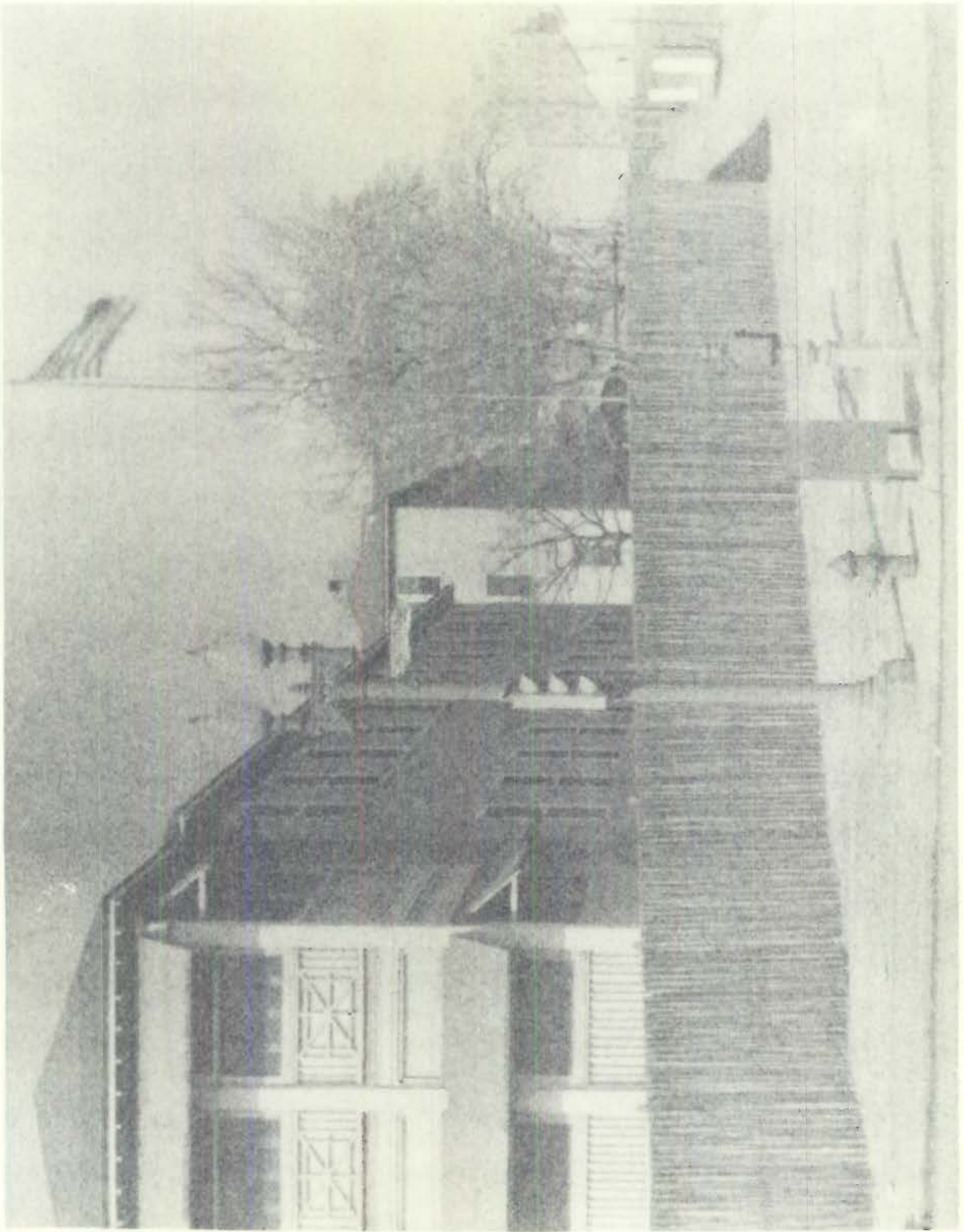

4db CONTRAST RANGE SIGNAL TO NOISE 15db

RESTRICTED

DECLASSIFIED

PLATE 69



8db CONTRAST RANGE SIGNAL TO NOISE 15db

~~RESTRICTED~~

DECLASSIFIED

PLATE 70

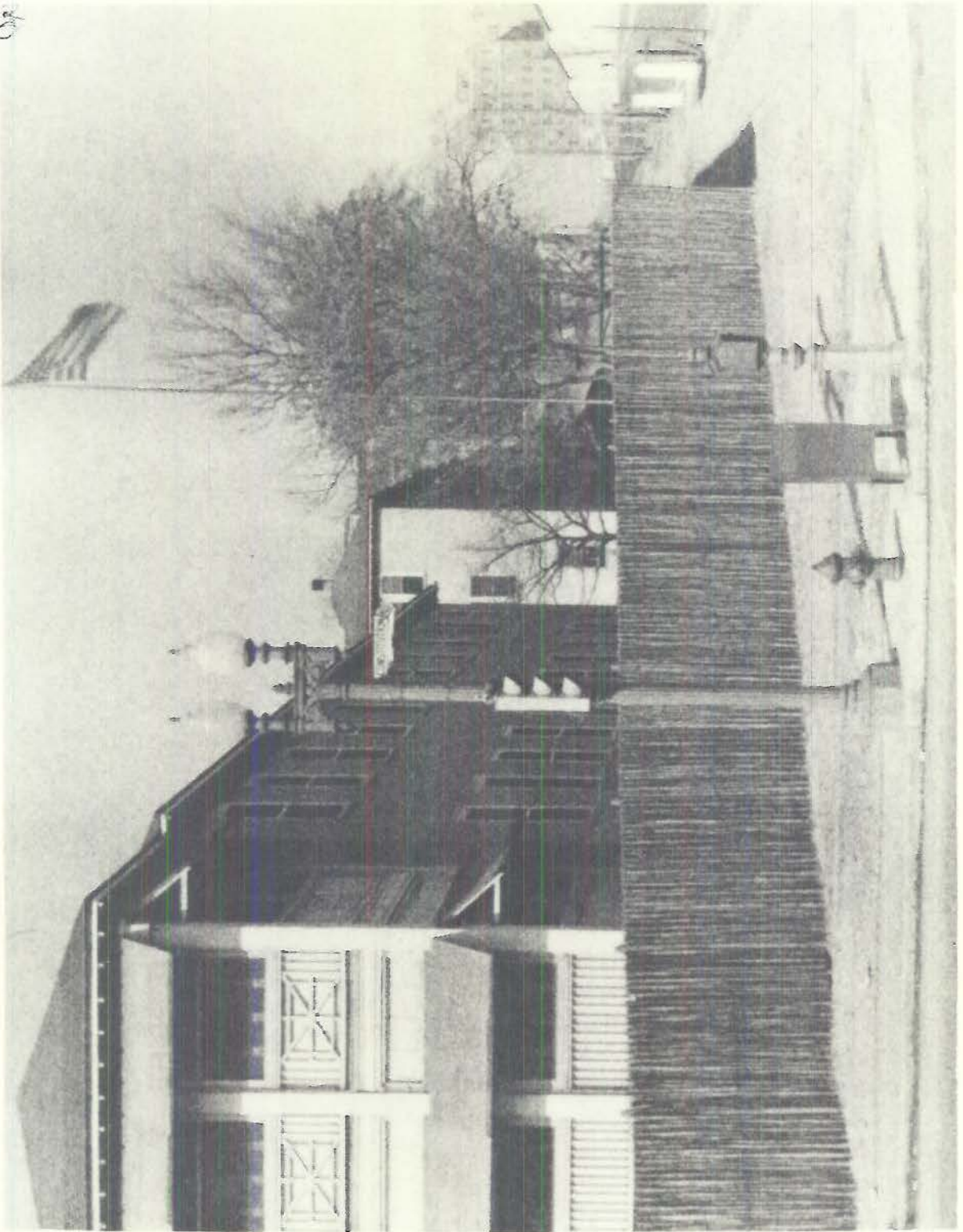

12db CONTRAST RANGE SIGNAL TO NOISE 15db

RESTRICTED

DECLASSIFIED

PLATE 71

DEFINITION TEST CHART No. 3

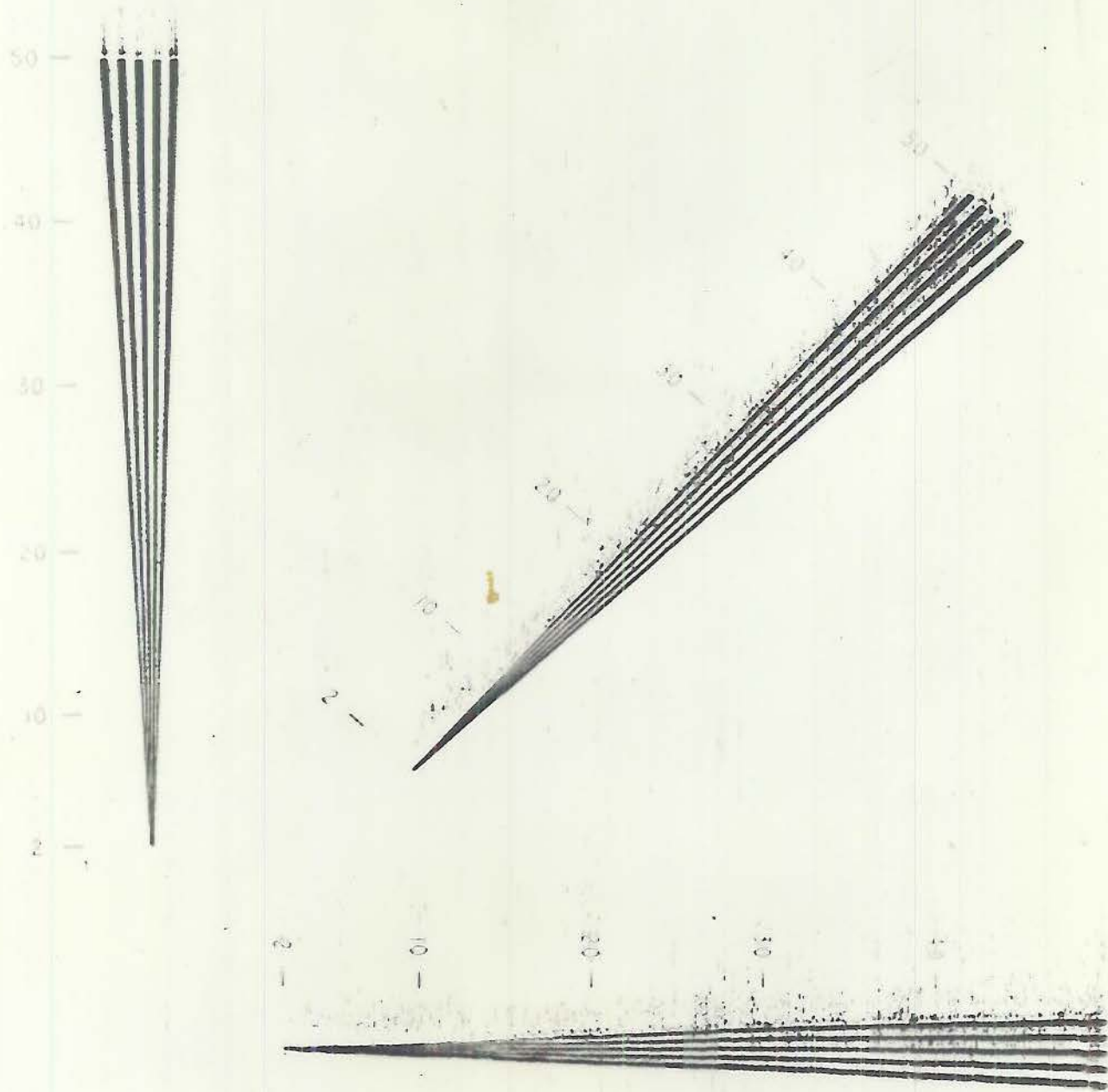

TRANSMITTED OVER POOR RADIO CIRCUIT SHOWING ECHO SIGNALS

DECLASSIFIED

PLATE 72

RESTRICTED



~~RESTRICTED~~

DECLASSIFIED

PLATE 73

RESTRICTED

DECLASSIFIED



PLATE 74



RESTRICTED

DECLASSIFIED

PLATE 75

RESTRICTED

DECLASSIFIED

PLATE 76

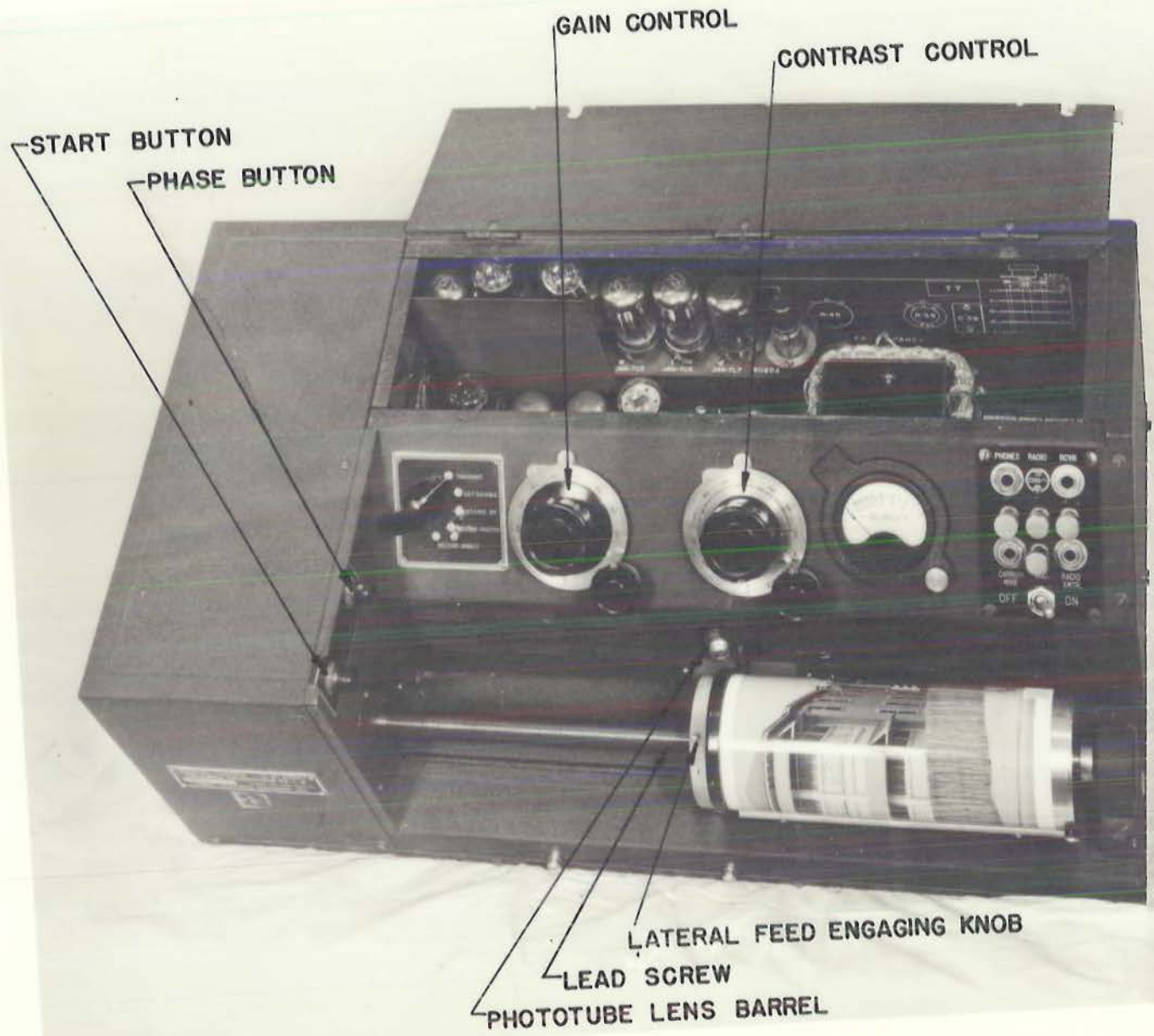

GAIN CONTROL

CONTRAST CONTROL

START BUTTON

PHASE BUTTON

LATERAL FEED ENGAGING KNOB

LEAD SCREW

PHOTOTUBE LENS BARREL

RESTRICTED

DECLASSIFIED

PLATE 77

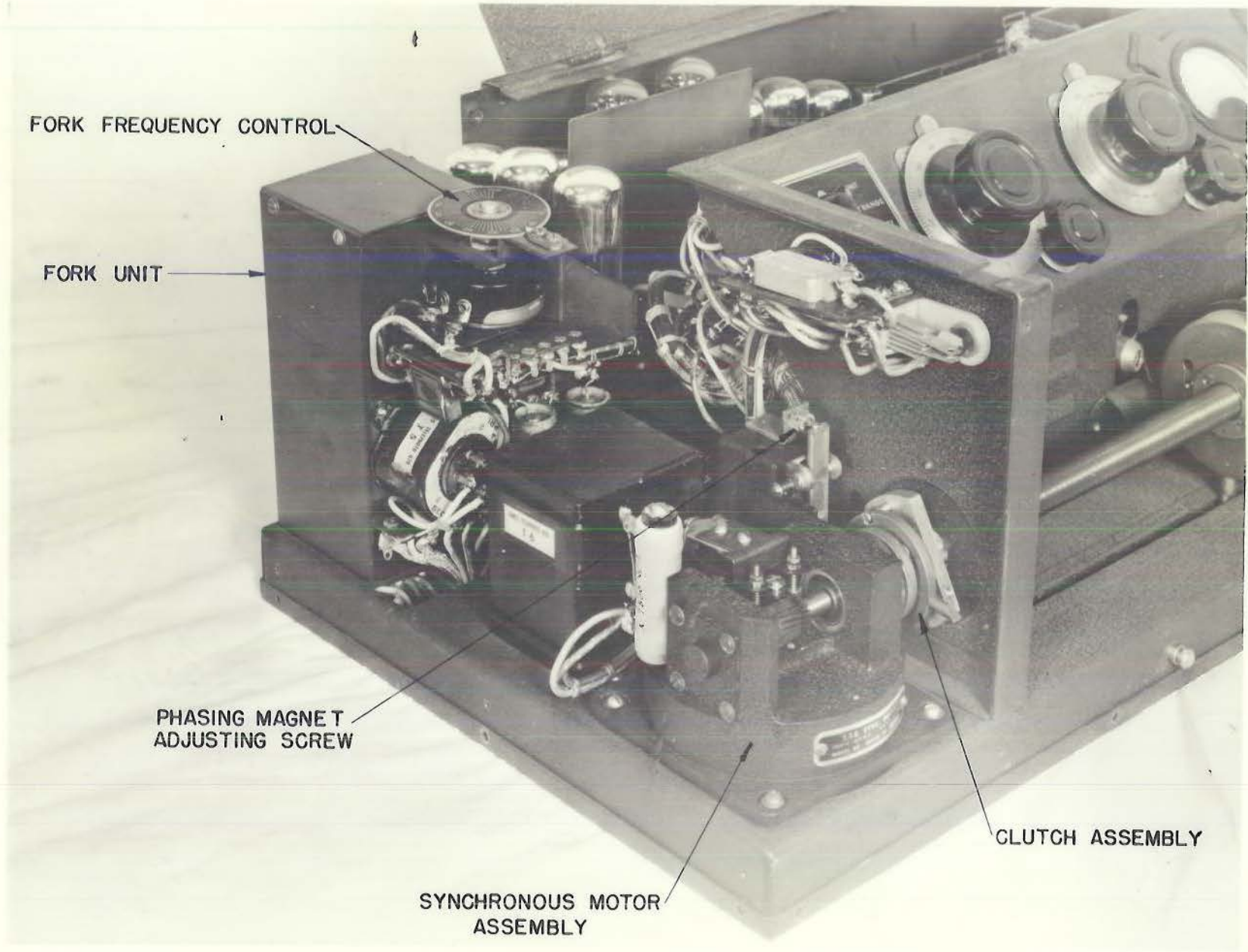

FORK FREQUENCY CONTROL

FORK UNIT

PHASING MAGNET
ADJUSTING SCREW

SYNCHRONOUS MOTOR
ASSEMBLY

CLUTCH ASSEMBLY

RESTRICTED

DECLASSIFIED

PLATE 78

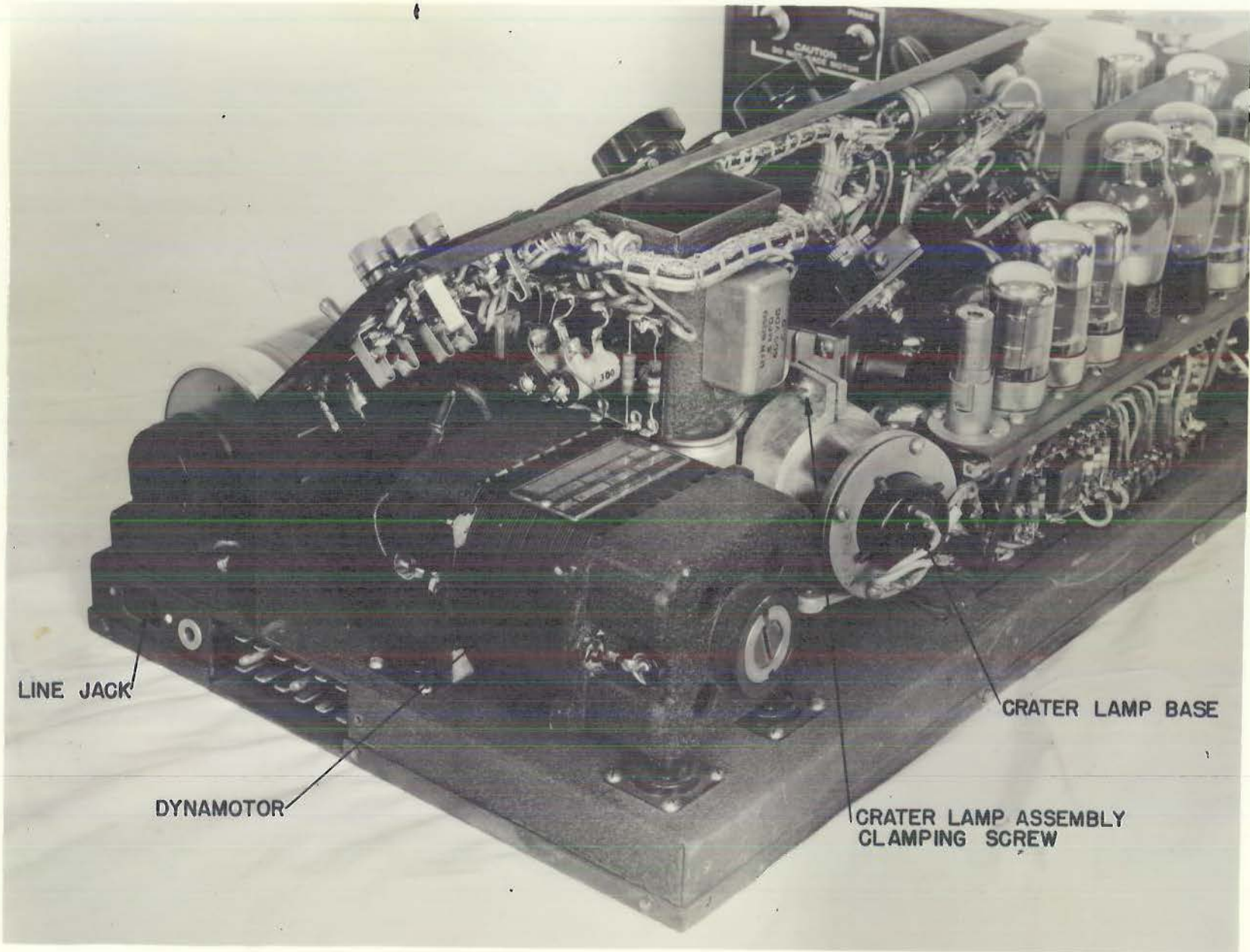

LINE JACK

DYNAMOTOR

CRATER LAMP BASE

CRATER LAMP ASSEMBLY
CLAMPING SCREW

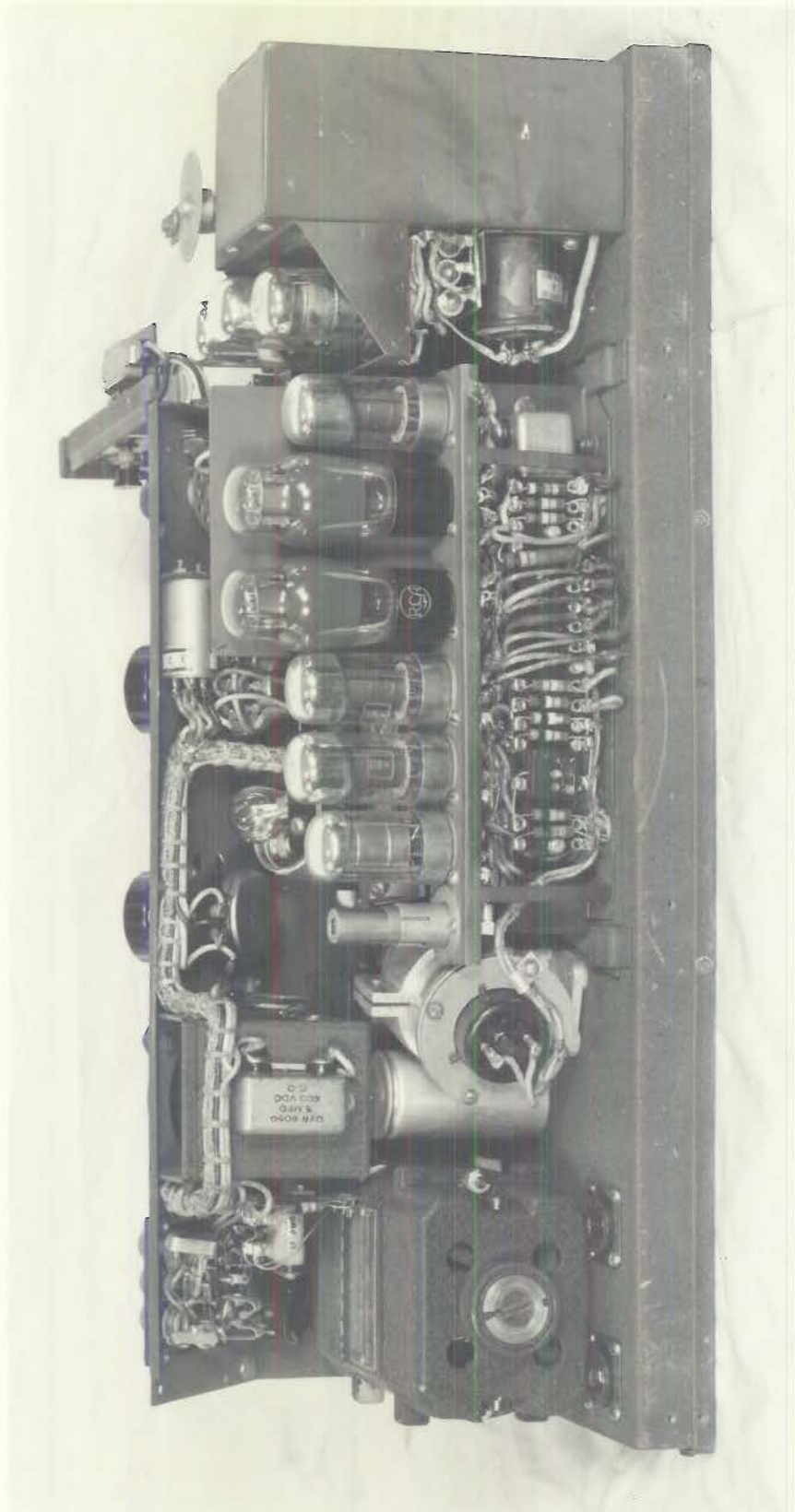

DECLASSIFIED

PLATE 79

~~RESTRICTED~~



EXCITER LAMP

DECLASSIFIED

RESTRICTED

RESTRICTED

DECLASSIFIED

PLATE 81



CONDENSER LENS

PHOTOTUBE HOUSING

PHOTOTUBE BARREL CLAMPING SCREW

GRATER LAMP LENS BARREL ADJUSTING RING

DTR 5050
5 MED
600 VDC
C.O.

100

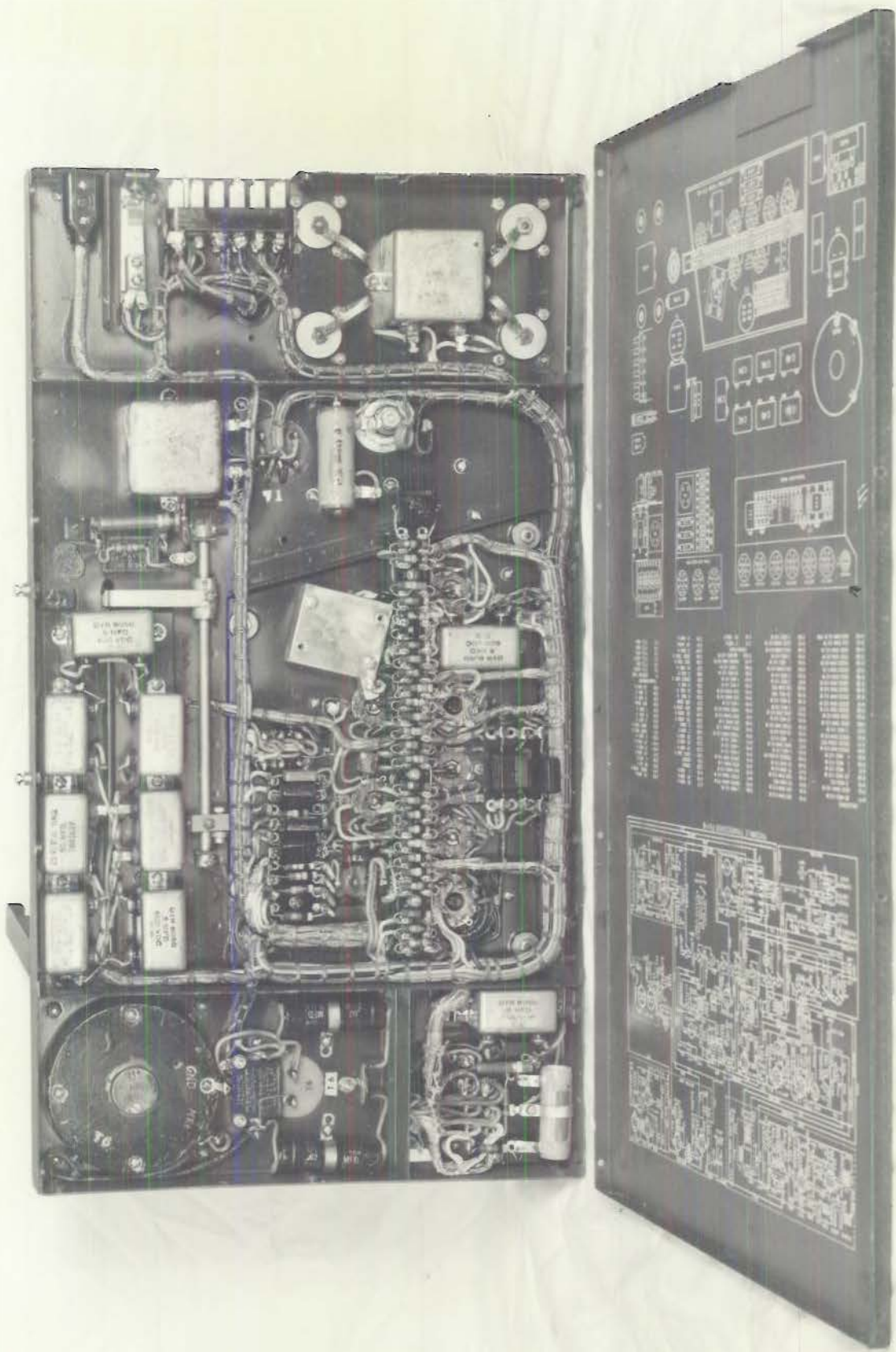

RESTRICTED

DECLASSIFIED

PLATE 82



DECLASSIFIED

PLATE 83

~~RESTRICTED~~

EXCITER LAMP
VOLTAGE CONTROL

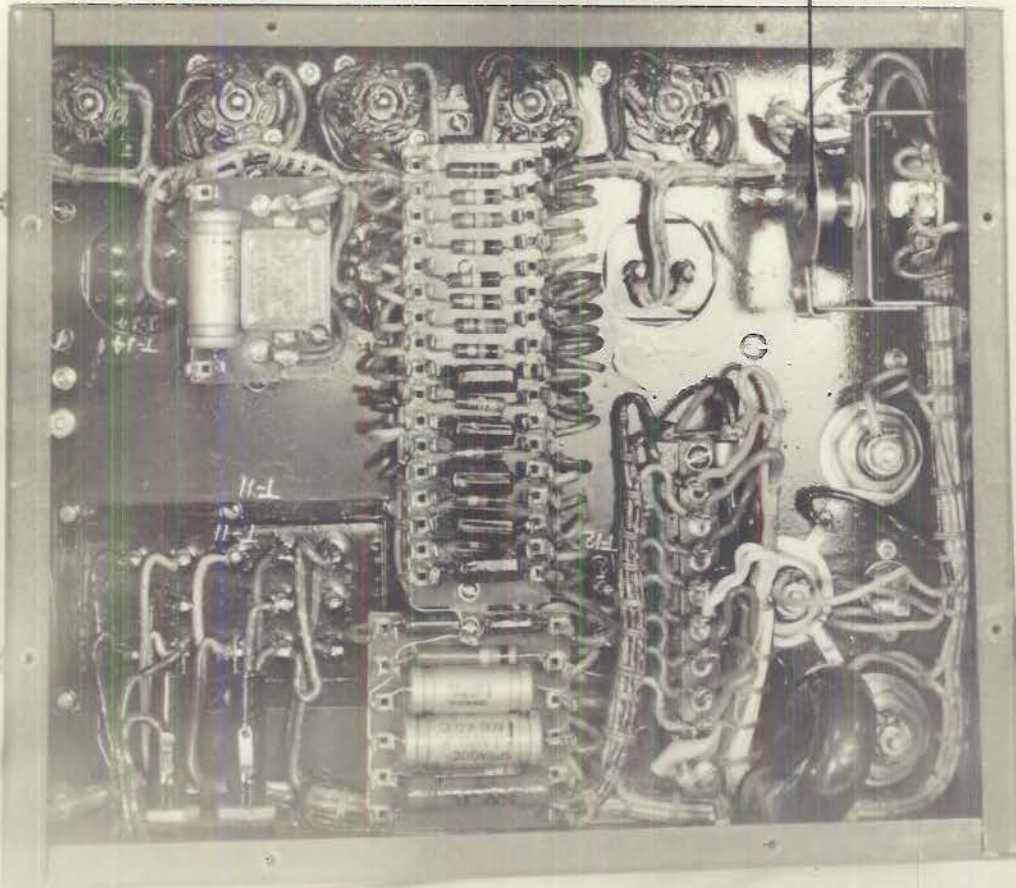

DECLASSIFIED

RESTRICTED

PLATE 84



DIRECT RECORDING
STYLUS

DECLASSIFIED

~~SECRET~~