

WATERWORLD

AQUARIUM IN BALANCE

Nº 3

3rd revised edition



Hints and tips for an „aquarium in balance“, by the Dennerle aquarium plant pros

The Five Dennerle Elements

Less work and less algae thanks to a balanced aquarium.

Nature — our passion

Join us on our travels to fascinating water worlds around the world.

Four times the power

Find out why CO₂ is so important for your aquarium plants.

Feeding means understanding

The effects of balanced feeding on the overall biology inside your tank.

Comprehensive catalog included

Nominal charge: 1.95 EUR



Experience Nature

Nature, aquatic plants, simplicity, lifestyle, decreasing blood pressure — combine all these terms and — at least in our opinion — you'll get the result „aquarium“. For us there is no other hobby that is so varied, exciting and yet so relaxing.

The way the aquarium hobby has developed and how easy it is to keep and maintain a beautiful tank nowadays — our founder Ludwig Dennerle may not even have dreamt of this over 50 years ago. But his thoughts went in the right direction, and he considered an aquarium to be a functional ecosystem with plants at a time when the hobby was mostly still all about fish in a bleak glass container.

Today, Dennerle is an international company. The focus of our product strategy is on a simple, nature-oriented, easily comprehensible system. And the one thing has not changed in all these years: We only have products that are useful for you. Only when we are absolutely convinced of the suitability an article it may enter our product range. We prefer developing and producing our products in the Palatinate region, which is our home, and in Germany. This guarantees that we have the full control over the quality and functionality.

Why „Waterworld“? This magazine is the follow-up of our silver book „Der große Dennerle-Ratgeber“ and an explanation of how we see and practice aquatics, with many pictures. We admit: During the last 50 years we have been peeking and copying from Mother Nature, and with the „aquarium in balance“ we have developed a system to recreate natural processes inside a glass tank simply and efficiently. Your curiosity has been piqued? The next pages are all about you and your tank — or as we hope — your tanks.

Yours, the Dennerle Team

53-55

Aquascaper by nature

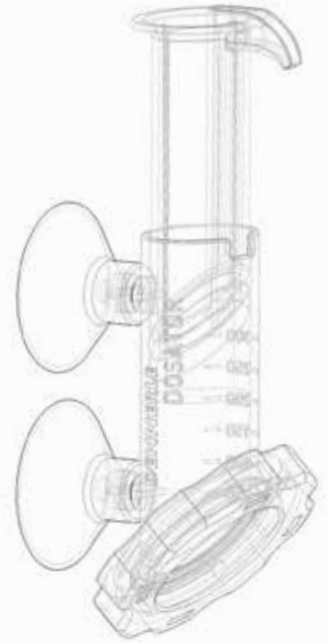

10-13

Dennerle Quality and inclusion in the world of work

38-43

For beginning shrimpkeepers



126-129

Plant care and fertilization



94-95

NanoCubes & Nano Scaper's Tanks



Aquarium in balance

4-7



18-21

Life-giving water



CO₂ – The stuff plants are made of

78-85



114-115

Aquarium substrates: Nutrient media and quartz gravel

Water maintenance

105-107



Contents

Aquarium in balance	4 – 7
Nine good reasons for an aquarium	8 – 9
Dennerle Quality and inclusion in the world of work	10 – 15
Prizes and Awards / Meet & Greet	16 – 17
Life-giving water	18 – 21
All in One! Elixier	22 – 23
Natural remedies	24 – 25
A quantum leap in the field of fish nutrition!	26 – 31
The guppy – a millionfish	32 – 33
The discus, king of the aquarium	34 – 37
For beginning shrimpkeepers	38 – 43
Code name COP – The dwarf crayfish from Lake Patzcuaro.	44 – 47
Keen on green	48 – 53
Aquascaper by nature!	53 – 55
Step by step - setting up an aquarium is really fun!	56 – 59
Gravels from all over the world	60 – 61
To grow well, plants need nutrients	62 – 65
Genie in a bottle	66 – 67
The story of the Dosator	68 – 71
Children's aquaria	72 – 73
Let there be light!	74 – 77
CO ₂ – The stuff plants are made of	78 – 85
Algae - thanks to algae, planet Earth has an	86 – 91
Aquarium Mythbuster	92 – 93

The world of Dennerle products

NanoCubes & Nano Scaper's Tanks	94 - 95
Nano Light & equipment	96 - 98
Nano food & ShrimpKing	99 - 101
Fish food	102 - 104
Water maintenance	105 - 107
Water conditioning	108 - 109
Light – the motor of life. Trocal fluorescent tubes and LED	110 - 113
Aquarium substrates: nutrient media and quartz gravels	114 - 115
Plantahunter natural gravels	116 - 117
Nano substrates & nano care	118 - 119
Carbon dioxide fertilization for a strong aquarium	120 - 125
Plant care & fertilization	126 - 129
Aquarium accessories / books	130 - 131

SIMPLY DENNERLE

5 Dennerle elements for an aquarium that is easy to care for.

Every aquarium is a complex biological system whose components are intertwined and influence each other. Creating a stable, natural balance between these components is the aim of every true aquarium enthusiast. The Dennerle Balance System helps you control each element easily and safely — always in a good balance.

Since Dennerle's foundation in the year 1966, we have been cultivating a holistic view of the aquarium ecosystem as we want to reproduce the biological cycles in such a system as true to nature as possible. We have found the five important elements that influence the biological system inside your tank: animals, water, light, substrate and plants. This is the point where our product development starts, resulting in a system of ideally fine-tuned products that help you create underwater worlds to your desire, which can be maintained easily and safely. This is all you need to keep your aquarium in balance — to have a fascinating intact piece of nature in your living room!

- **The animals**

- **The water**

- **The light**

- **The substrate**

- **The plants**



*“The perfect symbiosis of
the five Dennerle
elements”*





Keeping them healthy is the responsibility of every tankkeeper. Food that complies with their natural needs and that regulates their digestion helps keep the biological pollution of the water down and protects the biological balance.



The ideal aquarium water can be created safely and easily thanks to the help of carefully balanced products for water conditioning and maintenance. Biologically active ingredients create conditions that are plant and animal friendly, just like in nature.



Flourescent tubes and LED systems with especially filtered light spectra enhance plant growth and prevent algal growth at the same time. Moreover, you can individually control your lights and create unique effects.



Gravels, other substrates and soil: a great choice of materials offers you the possibility of individually creating your aquarium layout and of providing your plants and aquarium inhabitants with the ideal conditions. At once and in the long run.



Plants are the most sensitive element, they indicate the water quality and they are crucial for the health of the fish. If they are provided with optimal conditions, they will grow as beautifully and healthily as in nature. This is what we work for!



A lush green submersed paradise, with healthy, vividly colored fish: this is the ideal image of a well-functioning aquarium. In our philosophy, natural balance is based on healthy plants.

The plants constantly clean the water and break down pollutants, they filter out superfluous nutrients and produce oxygen, which is vital for the animals living in the tank.

Therefore, healthy plants play a vital role in our balance concept. In ideal conditions they will grow beautifully, just like in nature. Our well-balanced products for targeted fertilization and CO₂ supply eliminate nutrient gaps and enhance photosynthesis – whilst never losing sight of the system as a whole. With improved plant growth, more oxygen is produced, and unwanted algae are inhibited. At the same time, you can control the pH and create natural conditions for your fish.

We provide you with all the well-balanced, finely coordinated products you need for turning your aquarium into a functional miniature ecosystem, enabling you to control each one of the five elements – for a well-balanced aquarium.

Conditioning that creates water as you find it in the natural habitats, appropriate lighting and a biologically active substrate form part of the system, as does the first prebiotic natural food, which has been created in view of the animals' health needs and a low water pollution.

Enthusiasm, lots of experience and modern research help us wholesome, sustainable products. Our innovations are captivating! Get to know the full range of the Dennerle Balance System in all its diversity and discover the balance of nature!



Nine good reasons

When you look at a nice aquarium you immediately feel that this living picture speaks to your soul — but why? Maybe it is due to the fact that we all used to live in an underwater world in the womb? Most advanced civilizations developed in regions bordering on water, and when we take a holiday we often choose the seaside or a lake as our destination.

There are hardly any pets that are easier to care for than aquarium animals. There is no need to go for a walk with fish and shrimp, they don't have to be groomed, and the modern aquarium equipment is usually low-maintenance. „Experience nature“ — this is easily done with an aquarium in your living room — and a beautiful underwater world is a powerful competitor for any flat screen.

An aquarium is relaxing

You've just come home, and after the first few minutes of sitting in front of your aquarium, all the stress that has built up during your workday vanishes. Deceleration and work-life balance — these very modern requirements are fulfilled by your aquarium without further ado. Just by looking at a planted tank our brains produce alpha waves, which are also called „the door to meditation“, and which only occur when we are relaxed. In the USA, sometimes aquaria have been prescribed by the doctor.

Doesn't have to be large

In 2008, Dennerle pioneered a movement that revolutionized the aquarium hobby. NanoCubes starting at a volume of 10 l (2.6 US gal), whose technical equipment is finely coordinated and which really function, are a great choice for shrimp or snails. A NanoCube with a volume of 30 l (8 US gal) is suitable for dwarf crayfish or a Betta fish. The more plants and the less animals you have the higher the biological stability of your underwater world will be.

An aquarium fits into every room

Nano aquaria can be placed on almost any writing desk, onto the kitchen countertop, or onto the sideboard in your hallway. For those with more space, standard aquaria of almost all sizes with a volume of up to 500 liters (130 US gal) made by various manufacturers are readily available at your local aquarium store (or online). It is important to choose a place for your new tank where the sun doesn't shine — direct sunlight over several hours per day may cause algae to grow.

Aquarium maintenance isn't necessarily complicated

If you know about the biological processes in your tank and what to look out for, an aquarium is easy to keep. Ideally, the system is biologically balanced. Dennerle has developed the „Aquarium in Balance“ system, which consists of five simple elements. If you keep them in mind you will have an aquarium that runs really well and that is very easy to care for.

Aquarium maintenance doesn't necessarily take much time

The weekly maintenance time is around 15 – 20 minutes if you use the Dennerle Five Elements system for your aquarium. Once a week you need to clean the inside of the glass with a magnetic cleaner and to change around 20 % of the water. For larger tanks with a volume of 60 liters or more (15 US gal), changing water every two weeks is sufficient. Once a month the plants are trimmed and thinned out.

Fertilizing becomes very easy if you use the Dennerle Dosator, and a CO₂ injection system with a pressurized cylinder is also extremely low in maintenance. Feeding the fish and inverts is something we do not consider work ... it is a part of the daily communication with our living underwater world.

Good aquarists are Climate experts

For those who run their aquarium based on the five elements of Dennerle and achieved the „aquarium in balance“ status will automatically understand the basic climatic and ecological processes on our planet. Personal note from the editor: every politician should have an aquarium in his office and maintain it by himself.

You can go on holiday without further ado

Have you ever heard of boarding kennels for aquaria? No? Well, that's because they do not exist. No other pet can look after themselves as perfectly as an aquarium. An automated feeder provides your fish and shrimp with food for up to four weeks, and if you change water before your trip and clean the filter a few days before that water change you are on the safe side and can just go.

Kids and teens get smarter

An aquarium is like a kid magnet, and with a little support they can successfully keep their own. Playfully, the new hobby will show your kids how an aquatic ecosystem works and how biology, chemistry and physics are intertwined, without schedules, curricula or timetables. It's totally simple — learning by doing.

Dennerle aquaria do not consume much electricity

The biggest cost factor in every aquarium is the heater. It is needed to bring the water to a tropical, cozy 25 °C (77 °F). Most shrimp and dwarf crayfish, however, that can be kept in the Dennerle NanoCubes are most comfortable at room temperature. A 30 l (8 US gal) therefore costs less than 2 Euros (2.20 USD) for electricity and water per month (local water and electricity prices may vary). The cost for energy and maintenance for an aquarium with a volume of approximately 200 l (53 US gal) lies at around 15,00 € (16.50 USD) — also much cheaper than most people might think.

**Of course there are many more reasons for an aquarium, but our editors have limited the number of pages for this article ...*

Dennerle Quality

For us, this means fulfilling our customers' wishes as completely as possible.



The term „quality“ is a dynamic one! It is crucial for quality to keep up with the demands of the customers, which usually means that it needs to grow.

A good quality is worth the money. In the long run, bad quality is more expensive, and the joy about a seemingly good deal is often overshadowed by the long hassle with bad products. It's a fact: At some point in time, the price falls into oblivion — but quality remains!

Quality is strongly connected to an enterprise or even an entire country. „Made in Germany“ or „as precise as a Swiss watch“, or, in contrast, „Made in China“. However, not

everything that comes from China is necessarily of a bad quality! A strict and — most importantly — permanent quality control of the entire production chain is always crucial, though.

A quality-oriented enterprise does not leave the quality of its products to chance, At Dennerle we live quality, every day! From the management to every single employee, we are all obsessed with quality. If a company con-

sequently dedicates itself to only produce and sell high-quality products, the people working there have every reason to be proud of „their“ enterprise. At Dennerle, everybody does their utmost so we can offer you a constant high quality.

*Of the over 400 articles shown in this magazine,
over 250 have been produced in Germany.*



***That's why it's important to always
have an open ear for the customer.
Only if you do, you will know what
people actually need and what they
define as quality for themselves.***

Lee Iacocca, the well-known American automotive industry manager, once said it was really the only way to make good products, to price them sensibly and to offer a good customer service to have customers knocking down your doors.

At Dennerle, we are happy when our customers are happy with our products! The customer's satisfaction has a lot to do with quality — in the long run, we want the customers to return, not our products to be returned!

The biggest enemy of quality is haste. Customer requests are thoroughly researched at Dennerle, and we always go for a well-founded answer. We are very interested in treating complaints fairly, but every such case triggers a tiny earthquake of internal research, brainstorming how we can improve, and documentations. All of this takes time. When we develop new products we test them intensely over a long time; and we research the market thoroughly to make sure that the new product really hits it off. Rush jobs are not our thing. We are successful because we approach common stuff in an uncommon way.

This principle applies to our fertilizers, our food varieties, to our new natural gravels and to our ground-breaking light control system, the Trocal LED Control.

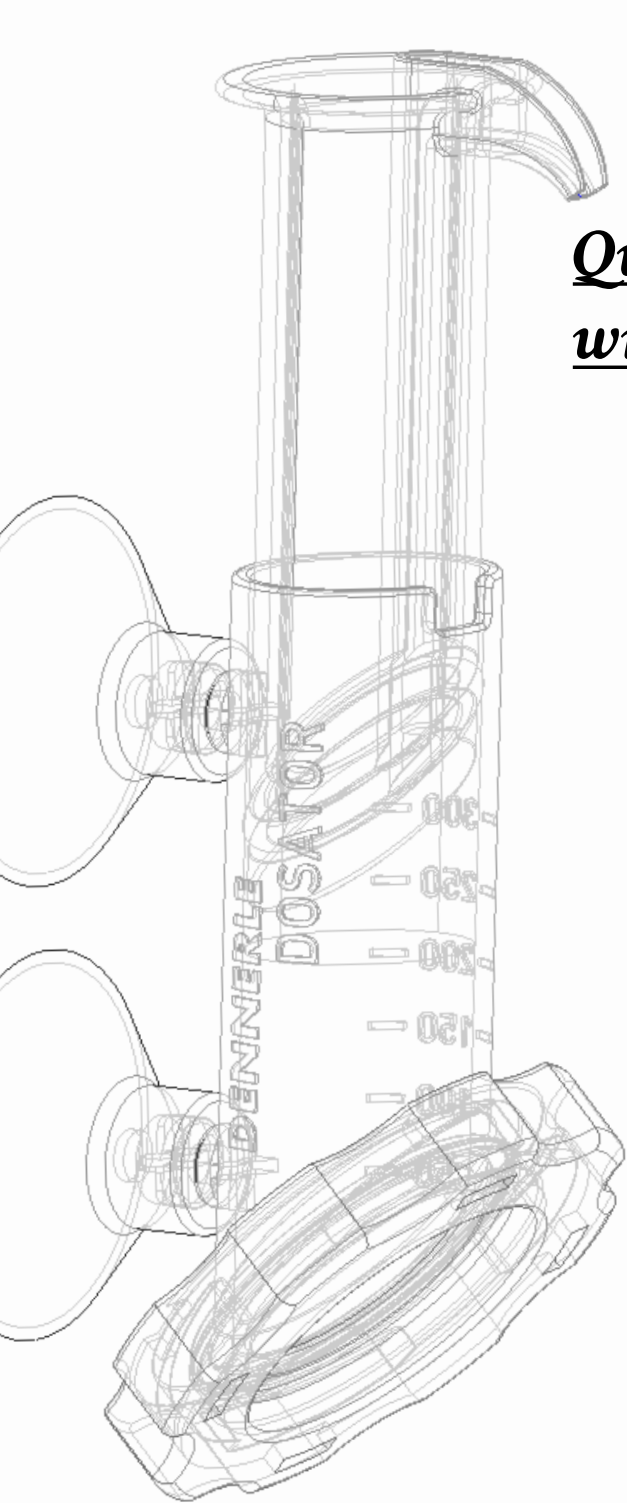

Quality starts with an idea.

As a groundbreaking enterprise with a company history of over 50 years, Dennerle has gained distinctive competence on the subject of aquatics, especially in the fields of aquatic plants, garden ponds and the aquarium hobby. We develop products and solutions to enable our customers to successfully keep their aquarium inhabitants, no matter if they are fish, crustaceans, snails, plants or corals. It is our aim to bring a piece of nature to your home to bring you joy and to increase your quality of life.

At Dennerle, a team of researchers, developers, product managers, purchasers and quality developers is responsible for developing a product idea into a finished product. Every member of this group is an expert in their field. Every department is held to offer suggestions for new products, but often these ideas also come from pet shop staff, creative hobbyists or passionate cooperation partners.

It is our product management's constant quest for ideas that enables us to develop products that make your underwater world more beautiful or easier to care for. Which new trends have cropped up in the aquarium hobby? Are there new ingredients that make tank maintenance simpler? How can we improve plant growth? Which new technologies, functions and materials are there, and do they make sense in an aquarium? What do our customers want?

Clear goals

When the decision has been made to launch a new product we get together and list the characteristics this product needs to have. What are the purpose and the special characteristics of the product? What should it look like? Are there products from the competition that are comparable, and what can they do? In which aspects can we do better? And of course, as we compete in a tight market, the final price also plays an important role. From all these criteria and aspects we create a product concept for our R&D department. They have the important task of developing all these ideas and wrapping them up into the finished product. And of course, a successful product needs sensible packaging. It needs to look attractive, and moreover, it must protect its contents during transport and while stored.

Every product starts with an idea – born from the passion for functionality, effectiveness, performance and, of course, quality.

Our own research & development department

All our research is based on a deep understanding of the biological processes in aquatic habitats. Only if you are familiar with this area of knowledge you can find innovative solutions to specific problems. Each of our products has been designed to enhance and to boost the aquarium biology as efficiently as possible. This applies to the different substrates, water conditioners and fertilizers in our product range as well as to the filters, the foods and the lighting. We want to give the tiny ecosystem in your living room the ability to stabilize itself.



In our opinion, any aquarium should function as smoothly and with as little effort on your side as possible. This goal is the prerogative for all the product tests in the Dennerle research facilities. Another important criterium is that everything needs to be easy to use, and safety is another highly important point. In addition to our own tests and examinations we work with several renowned testing institutes and competent experts. And last but not least we need to take the legal provisions valid for each product group into account ... usually these are quite extensive. The sustainability and the eco-compatibility of our products are also of the utmost importance to us.

Competent production partners

When the product has been finished and is commercially viable it goes into serial production. To do so we work closely together with competent business partners who have specialized in the production of specific product groups, like for example fertilizers, foods or technical products like LED lighting systems and CO₂ pressure reducers. To enable them to realize our product idea exactly as we projected it, all the product characteristics and the different stages in the production process need to be specified in minute detail. Since we are convinced of our product quality we give our customers a warranty of up to four years.

The technical aspects are by no means the only field to which our quality standards apply. We also have high standards when it comes to the conditions our products are manufactured in, and we take our social responsibility towards everybody involved in the production process very seriously. We have been cooperating successfully with sheltered workshops for many years, for example.

Strict quality management

Each incoming delivery must pass the incoming goods inspection. In accordance with statistical rules, the quality management department chooses a certain number of articles per batch and puts them through very thorough tests. They check whether the quality of the products corresponds to the given specification, for example by comparing them with the prototypes in detail. The performance and function of the technical products is also verified, fertilizers and water conditioners are tested in the Dennerle lab. Important features we cannot test ourselves are examined by renowned independent testing institutions. Only if all the specifications are met and if the product is impeccable it will be released for sale.

Close to the customer

Our after-sales service is especially important for us. After all, these people are in daily contact with our customers. The quality provided by Dennerle does not end when with the purchase! We take your criticism seriously. Do you have suggestions for improvement of existing products? Which products would you like to see from us in the future? Our competent after-sales-service department is available at any time. Our aim is answer your questions and requests as fast and as uncomplicatedly as possible. We are always interested in hearing more about your wishes and ideas so we are able to develop high-quality products that make the underwater experience in your own home even more comfortable and beautiful for you.

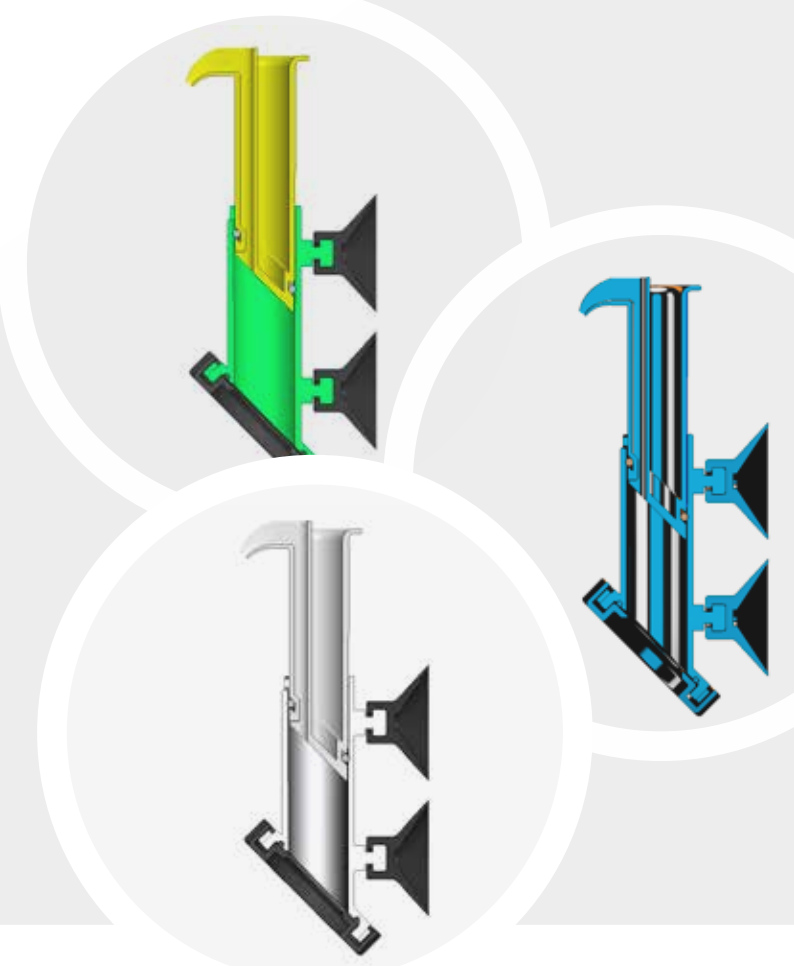

Inclusion in the world of work

Dennerle's cooperation with renowned sheltered workshops



Giving people with disabilities a job, targeted vocational training and special encouragement is only possible thanks to the co-operation of sheltered workshops and the industry — a true win-win situation. Working with people with disabilities makes you more sensitive for the needs of others and more open. These people often have excellent skills in specific areas, and just like their colleagues who are not handicapped they are highly motivated experts in their particular line of work.

Dennerle works in close cooperation with the Heinrich Kimmler Foundation in Pirmasens, the Werkstattzentrum für behinderte Menschen WZB (a sheltered workshop centre) in St. Wendel and the

Ökumenische Gemeinschaftswerk (ecumenical community services) in Landstuhl / Blieskastel. In these facilities, disabled people are trained and accompanied in their day-to-day work life. The workshops have modern machines, and their DIN EN ISO 9001 certification guarantees the utmost quality.

For 15 years, over 100 workers with a physical or mental disability have been confectioning various articles from the vast Dennerle product range, over 400 different types at the moment. Dennerle has become a strong and important partner for the sheltered workshops. Its commissions have safeguarded the integration of people with a disability into the labour market.

Moreover, Dennerle employs a total of 4 workers with a disability at its branches in Muenchweiler and Vinningen. At Dennerle, people with and without a handicap work together. We face our social responsibilities especially in the much-discussed field of inclusion. For us, the focus is on people as human beings, not on their disability, and we are looking forward to the continuation of an appreciative and extremely pleasant cooperation.



For 15 years, over 100 workers with a physical or mental disability have been confectioning various articles from the vast Dennerle product range.

PRIZES AND AWARDS

2018



Also in 2018 Dennerle was awarded the Brand Star. Every year, this prize is awarded to companies that have come up with innovative new products or special applications for the aquatic hobby – such as the „water world“.

2017



The CO₂ Quicktest is named Top Innovation 2016 / 2017 by the trade magazine PET. For this award, German retailers and wholesalers choose the most innovative product of their branch.

2016



During the aqua EXPO trade show 2016 in Dortmund, Dennerle was elected „Brand Star 2016“. This award is given to companies with innovative products and a strong involvement in promoting the aquarium hobby.



In Paris, Dennerle wins the contest „Animal Challenge“ as one of the best pet product suppliers. In the category „Aquarium Plants“, Dennerle wins all the criteria, and we also receive the silver „Coup de coeur“ as special prize for our new fish food.

2015



The readers of the trade magazine PET and the web portal petonline.de choose the currentless automatic fertilizer doser „Dosator“ for TOP INNOVATION 2014 / 2015 for aquarium / terrarium / pond. The fish food Dennerle Complete Gourmet Menu is rated „good“ by futtertester.de

2014



The Dosator is awarded an innovation ticket by Fressnapf / Mega-Zoo within the framework of the Innovation Award 2014.

2013



The aquascaping tank „Scaper's Tank“, introduced in 2012, is elected Product of the Year by one of the largest French pet store chains.

2012



Once again, Dennerle is named one of the best pet product suppliers during the Animal Challenge contest in Paris: 1st place for aquarium plants, 4th place for aquarium and pond supplies.

2011



Dennerle is given the „TopSeller Silver Award 2011“ for the NanoCube Marinus Complete Plus by the trade magazine „ZoofachTrend“.

Meet & Greet

Germany:
aqua-Fisch, Friedrichshafen
Fisch & Reptil, Sindelfingen

France:
Animal Expo, Paris

USA:
Aquatic Experience, New Jersey

Japan:
Interpet, Tokyo

The Netherlands:
Vivarium, Rosmalen

Italy:
Pets festival, Piacenza

Dennerle has booths at various aquarium trade shows — here we have the chance to meet the people for whom we develop and manufacture our products.

During trade shows around the world we present our newest products and aquatic plants, we give our customers advice and we „talk shop“. The Plantahunter Stefan Hummel and the Crustahunter Chris Lukhaup drop by at the Dennerle booth frequently.





Life-giving water

Water is the most important element for aquatic plants, fish and many invertebrates.



In the course of evolution, they have perfectly adapted to the conditions in their wet habitats. Aquatic animals are in direct contact with the wet element that surrounds them with their skin and their gills, which take up vital minerals and get rid of waste. Plants to the same with their leaves. The quality and composition of the water have an enormous effect on the health and well-being of the organisms living therein. A closer look at the biotopes of ornamental fish, aquatic invertebrates and plants reveals that they are by no means uniform; every landscape has one or several typical types of natural waters.

The Plantahunter Stefan Hummel has seen many of them during his numerous expeditions to the tropics and subtropics. His personal experience and extensive analyses of the soil and water in situ are a much-appreciated contribution when we develop our nature-friendly products.

Not all water is the same

In most tropic and subtropic regions from where our aquarium fish and plants originate, the water is usually low in minerals (“soft”) and rich in humins, it contains a high level of carbon dioxide and no pollutants whatsoever. Dead animal or plant matter is quickly decomposed by fungi and other microorganisms. The minerals, trace elements and vitamins produced during this process nourish other organisms. In spots with nutrient-rich seepages, you can find lush plant populations.

Humins

The aquatic ecologist Prof. Dr. Christian Steinberg from the Humboldt University Berlin has done research in the field of „Humins and their importance for the fauna in fish biotopes“ for years. Globally, waterbodies rich in humins and with a pH of under 7 are the most frequently found type. Their sheer amount makes humins a highly important factor in the carbon cycle of fauna and flora. No natural habitats of our freshwater aquarium animals are without humins. For this reason, the question really is whether it is appropriate to keep fish, shrimp, snails and such in an aquarium in whose water no humins are present, and what the consequences would be for these animals. The role of humins needs to be re-assessed, especially since the pet trade and the aquarium hobbyists alike are more and more aware of the importance of a species-appropriate and animal-friendly habitat inside their aquaria. Humins have an enormous potential of improving the conditions for our aquarium inhabitants. At the end of his paper, Prof. Steinberg has put the somewhat provoking question: „Aquaria without humins can be considered a torture for the animals therein, right?“ **[Source: Das Branchen Forum 12 / 2013]** For humic substances you can use Dennerle Humin Elixier or our two soil types.

Tip: for our nano cubes just fill the filter extension with soil and click it onto the corner filter. This is a good way to add humic substances and trigger many water treating effects even without soil as a substrate.

Water parameters

The water quality can be determined by measuring its physical and chemical qualities — the “water parameters”. There is a range for every parameter to which the plants and animals are optimally adapted. Here they are well, grow, are in good health and reproduce. If the parameter falls below or exceeds this optimum level, the animals and plants start being unwell — the higher the deviation, the more. Parameters that are off by much may lead to life-threatening situations. This principle applies to basically every water parameter.

No natural habitats of our aquarium animals are without humins.

Water conditioning

In our aquaria we ought to mimic the natural habitat of the animals and plants we keep as closely as possible. Appropriate water parameters, a “balanced aquarium”, are not only the basis for healthy, colorful animals and plants, they also enable us to have an unhindered look into this impressive aquatic community. Aquaria that are biologically stable are quite close to the demands of a species-appropriate, animal-friendly habitat. In the course of our 50-year company history, we have developed a deep understanding of the biological complexities in the aquarium. The most recent result of the Dennerle R&D is a compact water conditioning program that contains everything you need to turn tap water into natural water just like in the biotopes. We want your animals and plants to be well, and help you promote the biology inside the aquarium optimally. There’s no need to use all conditioners at the same time. Choose those that make sense for the current state your aquarium is in. Basically, there are two groups of products:

One group consists of products that add desirable substances present in the natural habitats but missing in tap water, or which are easily exhausted during natural processes inside the aquarium. Examples for this product line: Humin Elixier and Vital Elixier. The other group has products that remove undesirable substances not present in the natural habitats but possibly present in tap water or being created inside the aquarium in the course of biological processes. Examples for this product line: Aqua Elixier Moringa, Bacto Elixier FB7 and Clear Water Elixier.

If your tap water is not useful for the plants, fish or inverts you would like to keep, for example because it is too hard, RO water mixed with a special re-mineralizing product is a real and simple alternative. Add the proper mineral salt to the water in a container outside your aquarium before you add the water to your tank.

For smaller aquaria, the Dennerle Filter Extension filled with Soil is the best solution to make hard water aquarium-friendly.

Water change

Most of our aquarium animals originate from running waters or lakes. In nature, a constant water change takes place there: New water is added by rain, sources and tributaries all the time. An aquarium, on the other hand, is a closed system. Through food, nutrients are added on a daily basis. The concentration of organic and inorganic pollutants (on which algae feed) created by the metabolic processes of the animals rises. Even the most efficient filter is powerless against some of them. Growth inhibitors may accumulate that bring plant growth to a halt even though you add fertilizer on a regular basis. In an aquarium, new water is only added to the system through a partial water change. This regular refreshment is one of the keys to a well-functioning system. Your fish, shrimp and so on will stay healthy, and pest algae do not stand a chance. For this reason we recommend to siphon off 20 – 50 % of the aquarium water and to add the same amount of fresh water at roughly the same temperature. If necessary, treat your fresh water with the proper conditioners before you add it to your tank.



RECOMMENDED PRODUCT

CLICK
HERE



All in One! Elixier

8.99 € ID No.: 2848

13.99 € ID No.: 2849

17.99 € ID No.: 2850

In case you like it nice and easy our new All in One! Elixier is the best solution for you.

It is water-, plant care and carbon supply in one and contains 12 carefully coordinated active components: carbon, iron, plant nutrients, nutrient stabiliser, amino acids, vitamins, trace elements, herbal extracts, aloe vera, dexpanthenol, iodine and a filter booster. Easy to use, it ensures visible results within weeks. Simply add 20 ml per 100 litre aquarium water once a week and your aquarium is in balance.

All in One! Elixier is also suitable for the Dosator: One fill (10 ml) per 50 litre aquarium water weekly.



In the course of their 50-year company history, Dennerle has developed a deep understanding of the biological complexities in the aquarium.

All in One! Elixier

The aquarium easy-care for fish, shrimp, plants, filter and water.

Each aquarium is a complex biological system, whose elements depend and interact with each other. Fish, plants, water, lighting, aquarium bed – everything interacts. Therefore, you must always consider an aquarium as a whole complex in order to understand it.

The goal of every aquarist is to create a natural balance. An Aquarium in balance is easy to handle and stabilises itself. The fish show vibrant colours and are active, the plants are lush and vigorous, the water looks clear and healthy. To achieve this state, a gapless supply of vital elements is required. Scientists know: if there is even only one single nutrient missing, plants grow poorly. And poorly growing plants immediately promote algae growth.

Against this background and with more than 50 years of know-how in the cultivation of aquarium plants as well as a deep understanding of the biological relationships, Dennerle invented a new and complete care product: All in One! Elixier. It supplies the aquarium with 12 carefully coordinated active components.

Each active complex supports the natural metabolic processes and cycles in its own way, directly and indirectly. Synergistic effects help the ecosystem aquarium to help itself. Based on a regular use, the positive effects are visible within a few weeks.

The dosage takes place once a week and is even more practical with the Dennerle Dosator. One fill (10 ml) supplies a 60 cm aquarium fully automatic with vital nutrients for a whole week.

With All in One! Elixier the care of modern aquaria becomes much easier. Thus, the little piece of nature in one's four walls can be enjoyed even more relaxedly. The aquarium in balance with healthy fish and shrimp, magnificent plants and clear water.

Carbon

03

All in One! Elixier offers the simplest method of carbon supply. Plants can absorb the containing carbon compounds via the leaves and use them as building material or energy carrier. The product can also be used in combination with conventional CO₂ fertiliser systems for an additional promotion of plant growth. The contained carbon compound is the same as our Carbo Exlixier Bio and therefore the All in One! Elixier does not contain Glutaraldehyde.

Iron

03

Due to its functional components of many important enzymes, iron is of crucial importance for all aquarium plants. For example, in the production of leaf greens (chlorophyll), iron is involved in three different ways as a cofactor. Without chlorophyll, plants cannot photosynthesize, which means that they cannot gain any energy to grow. Iron deficiency leads to yellow leaves.

Plant nutrients

03

All in One! Elixier supplies aquarium plants with all the nutrients they need for powerful, lush growth like potassium, magnesium, manganese, molybdenum, sulphur, boron, nickel, cobalt, lithium and vanadium. Even in case of a long-term, regular use, it can not lead to adverse enrichment of individual nutrients.

Nutrient stabilisers

03

All in One! Elixier comes with a trick: chelates. Chelates are substances, which create a protection cover around the nutrients and protect them from the reaction of other substances in the water. The term derives from the greek ‚chele‘ which means crabclaw. We copied this trick from nature because nature often works with chelates. All relevant nutrients in All in One! Elixier are effectively protected in this way. This means in practice: the nutrients in the aquarium are accessible on a long-term base and can be used in the best possible way.

Amino acids

01

02

04

All in One! Elixier provides all 20 proteinogenic amino acids in a biologically balanced composition for the benefit of fish and plants. It promotes natural microbial growth (biofilm) as valuable supplement for fish, shrimps and snails. At the same time amino acids support the important work of the filter bacteria – for clear and healthy water.



01



02



Vitamins

01

02

All in One! Elixier adds a carefully composed vitamin-complex to the aquarium. Vitamin B1, for example, is essential for the function of the nervous system and the energy metabolism. Vitamin B3 plays a key role in the metabolism of protein, fats and carbohydrates. Vitamin C serves as one of the most meaningful catchers for radicals and antioxidants.

Trace elements

02

03

All in One! Elixier provides all fish, shrimps, crayfish and other freshwater aquarium inhabitants with a targeted supply of essential minerals, which are not found in tap water or become depleted in the aquarium. It contains all physiological relevant trace elements – from „A“ like Aluminium to „Z“ like zinc. All in One! Elixier promotes health, vitality and radiant colours. Diseases caused by a lack of trace elements can be avoided effectively. Useful filter bacteria are supported in their development.

Herbal extracts

02

All in One! Elixier contains a carefully composed mix of selected herbs, in particular: Asian Ginseng (*Panax ginseng*), mistletoe (*Viscum album*), yarrow (*Achillea millefolium*), pure chamomile (*Matricaria chamomilla*), hop (*Humulus lupulus*) and valerian (*Valeriana officinalis*). Based on the experience of the popular medicine, herbs can have an anti-inflammatory, wound-healing, antiseptic, strengthening, stress-reducing and immune-stimulating effect.

Aloe vera

02

All in One! Elixier contains valuable Aloe Vera extracts from the juice of freshly cut leaves. By now there are more than 200 ingredients known. Particular highlights are the natural mucilage, built and made of D-Glucoses and D-Mannosem, which serve as a natural protection of the mucous membrane.

Iodine

02

All in one! Elixier supplies fish and shrimp with essential iodine and effectively prevents an undersupply and iodine deficiency-related diseases. Shrimps, like all crustaceans, have an exoskeleton. To be able to grow, they have to shed their skin regularly throughout their lives. The central molting hormone is called ecdysone. Iodine is also needed for this process.

Filter Booster

01

04

All in One! Elixier specifically promotes bacterial growth in the aquarium by means of a specially formulated nutrient combination. More and more active purification bacteria ensure clear, clean and healthy water. Filter performance and biological self-cleaning power are increased, the entire aquarium stabilises. Another positive effect: The biofilm is rich in nutrients. It serves as a valuable, natural supplementary feed for all animals that graze surfaces. This benefits in particular bottom fish (catfish) and shrimp.

Dexpanthenol

02

Dexpanthenol has long been proven as a therapeutical efficient substance in the cursory treatment of diseases regarding the skin and mucous membranes. Dexpanthenol nourishes and protects the sensitive mucous membranes of fish and heals smaller injuries such as those that may occur during transport,



repositioning or territorial fights. But even shrimps benefit from the nurturing effects. In particular, the sensitive molting process of the animals is supported.

03



04





Natural remedies

If you want to prevent infections with bacteria or fungi, or if you have a slowly progressing infection in your aquarium you don't necessarily have to fall back on chemical treatments but may resort to natural cures first.

Some basic rules: If you collect natural materials yourself, make always sure the plants have not been treated with pesticides and that they are not subject to pollution. Only collect away from large streets. Green leaves are ideally collected during the warm season, when they are fully developed. The sun ought to shine on them for at least three hours before collection. Then nitrate levels are well down, and the production of essential oils is at its peak.

Plant parts are dried in a well-aerated place that is not subject to heat or direct sunlight. Do not use that cozy spot directly over your heater, or your baking oven in order not to lose too many essential oils. Dry the leaves until they crackle when you scrunch them up. They are best stored in containers that are permeable to air, like paper or fabric bags or cardboard boxes. This reduces the risk of mould to practically nil.

FOR ACUTE FUNGAL OR BACTERIAL INFECTIONS:

It is easiest to resort to products from trade - here you can be sure to get the best quality and that the products are safe for your aquarium inhabitants."

Do not boil over natural remedies before putting them into your aquarium — otherwise you would deactivate the helpful substances or wash them away altogether.

FOR TREATING ACUTE BACTERIAL INFECTIONS:

Willow bark (antibacterial)

Dosage: for 54 liters (or 15 US gal) you take 2 to 3 strips of willow bark, around 5 cm long and 2 cm wide (2" to 0.8"), if your tank is very well stocked or the disease is acute, you can take up to three times this amount. Exchange the strips of bark after two weeks. It is important to stop this treatment after four weeks in order to avoid the formation of resistant bacteria.



Alternative: Indian almond bark from the trade (antibacterial) Use according to the instructions on the package.

Brown autumn leaves (antibacterial and antifungal)



Dosage: You can either add the entire leaves or crunch them up. Even a thick layer on the bottom of the tank is safe for shrimp, given that the leaves were totally brown and dry.

Brown autumn leaves contain humins, which have an antibacterial and antifungal effect. Oak and — to a somewhat lesser extent — beech leaves contain an especially high amount of humins. You can easily verify this: These leaves will give your water a slightly brownish to amber-colored stain. It is completely harmless, and many aquarium animals even like it very much. Besides their antibacterial and antifungal properties, humins stabilize the pH and enhance the molting process.

Only use totally dry brown autumn leaves from broad-leaved trees. If possible, do not use leaves that were lying on the ground.

Black alder cones (antibacterial and antifungal)

Dosage: depends very much on the time the alder cones have spent hanging in the rain. If you pick them directly after the first frost they will contain a much bigger amount of humins than those you harvest later on. Fresh black alder cones can stain your water considerably, thus you ought to work your way up to the correct dosage. As a rule of thumb you can take 1 to 2 black alder cones to 20 l of aquarium water (5 US gal). After two to four weeks in the water the cones lose their effect, however, you can leave them in the tank as shrimp will eat them. If necessary, put some new cones in. If you are unsure of your black alder cone source you can buy them in trade.





CLICK
HERE

A quantum leap in the field of fish nutrition!

The first prebiotic and probiotic natural food completely free from fishmeal

Our concept: For the new Dennerle fish food range, we have completely re-thought the subject of feeding fish. We've analyzed the fish feeds that are currently available, we've studied scientific literature, read travelogs and, most importantly, we've wondered how we could get better.

Most fishkeepers want to provide their fish with a high-quality, healthy diet. However, often they don't even know what they really feed their fish with. Many fish food labels only list ingredient groups, like e.g. „fish and fish by-products“, „vegetable by-products“ and so on. The actual components stay in the dark.

For economical reasons, some standard foods for ornamental fish contain cheap fillers like grain and fishmeal as main ingredient. To induce the fish to still eat that, these mixtures are frequently „enhanced“ with attractants. Many fish food recipes originally come from fish farming — but there the main goal is to get maximum growth in as little time as possible, at as low a cost as possible. Whether this food is appropriate for the respective fish species is a secondary thought at best.



Natural, high-quality food for healthy fish and a well-functioning aquarium.

During our manifold expeditions we've been looking at the natural habitats of our aquarium fish up close for decades. We have found that the food spectrum of these animals is by far larger and much more diversified than what most standard industrial fish foods provide.

Most of our ornamental fish belong to omnivorous species and can therefore make use of a particularly wide food spectrum. Please keep in mind: Even carnivorous fish do not only eat meat. The intestinal tract of their prey contains mostly food of vegetable origin! This component is rich in vitamins and fibre, and it is vital for the predators that they are supplied with these substances, too. At the same time, herbivorous fish do not feed on plants or plant parts only. The algae layers they often nibble at are home to a host of tiny animals that are accidentally ingested by the fish when grazing — and these animals are a vital source of protein for them. These points need to be considered if you want to develop truly natural and species-appropriate fish foods.

Most ornamental fish are not predatory and, in consequence, do not eat other fish. A main food mostly based on fishmeal can therefore not really be considered appropriate. Depending on the species, habitat and season, fish are known to eat different food in nature — for example crustaceans, insects, insect larvae, snails, mussels, worms, algae, aquatic plants, fruit, seeds, pollen, leaves, plant rests, aufwuchs (biofilms) and detritus.

Natural fishkeeping starts with the right kind of food. Therefore, Dennerle has developed entirely new recipes based on the actual feeding habits and needs of the different ornamental fish.

There are three basic feeding types:

carnivores – they prefer food of animal origin

herbivores – they have specialized in eating plants

omnivores – they eat animal-based as well as plant-based foods



Special features

Modeled on nature All Dennerle fish food varieties only contain ingredients fish will eat in nature. We use over 35 carefully selected ingredients of the highest quality — every food variety is as diversified as in nature. Depending on the requirements of each fish group these ingredients are mixed in a predefined ratio, and they are given their final form in a vitamin-preserving production process. The quality and compliance with our high standards is closely monitored during each step in the production process.

No fishmeal Most ornamental fish don't predate on other fish, and therefore we refrain from using fishmeal or fish by-products. We have replaced fishmeal with soldier fly larvae (*Hermetia* sp.), which are extremely high in protein — an ideal alternative to fishmeal. *Hermetia* are very easy to breed in high numbers, and using them protects natural resources and contributes to the reduction of overfishing the oceans: practical sustainability and responsibility towards our environment.

No cheap fillers, no artificial preservatives

In our food varieties we deliberately refrain from using cheap fillers like blood meal, feather meal, powdered egg or slaughterhouse waste. Dennerle fish food does not contain any other parts of warm-blooded animals either as they are not usually eaten by fish in nature. Thanks to high-quality raw materials and species-appropriate recipes, the Dennerle food varieties are generally accepted very well — no need for attractants! For preserving the food we use natural herbal extracts, no need for artificial preservatives either.

Ideal ratio of protein to fat The ideal ratio of protein and fat is important. When food doesn't contain enough fat, the fish „burns“ proteins for gaining energy, creating free ammonium/ammonia, which can harm the delicate gills. Too high a fat content may lead to excessive visceral fat, with a very negative effect on the health of the fish and on life expectancy. We use a natural protein-to-fat ratio of approx. 5:1 in almost all our food varieties.

Open declaration We put a comprehensive list of all the single components of each food on every package so every fishkeeper knows exactly what they are feeding — one swift glance at the declaration is sufficient. We have nothing to hide from our customers, after all! Just compare our food to the fish foods you have been using up to now, and decide for yourself which is the right food for your fish.

The soft granules enthusiasm With the innovative soft granulate we have come a bit closer to the role model nature. Just because the natural food animals of our aquarium fish, such as mosquito larvae, worms or plankton, are soft. Traditional granulated food for ornamental fish, however, is hard. The fish take it, but spit out the granules mostly because they think they have caught a pebble. As part of our intensive research work, we have therefore developed a special softening process based on natural plant extracts. This makes our granules as soft as natural food animals. This delights the fish and at the same time ensures less water pollution.

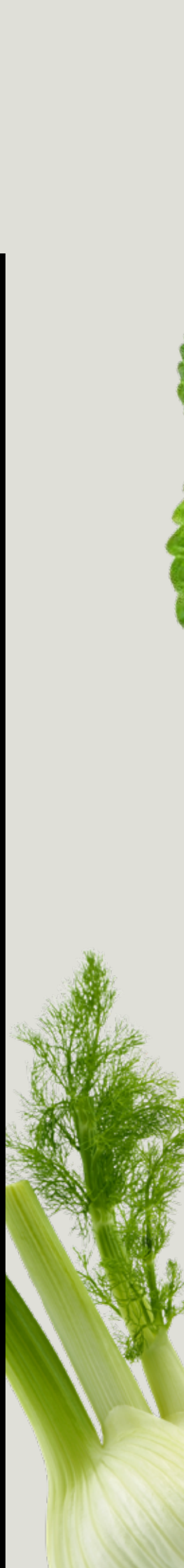



The Biotik System

The innovative Dennerle Biotik System consists of a carefully selected combination of three highly effective components:

- **1. Live lactic acid bacteria**

As the first fish food manufacturer ever, Dennerle uses probiotic lactic acid bacteria in food for ornamental fish. The bacterium *Pediococcus acidilactici* was especially created and officially approved for the use in fish food. Probiotic lactic acid bacteria have multiple positive effects on an organism's health. They can suppress harmful bacteria and actively enhance the function of the digestive tract — for well-being and health. These bacteria work very well in the human body, and they work excellently in fish, too. Improved digestion means the fish excretes less nutrients and, as a consequence, the water is less polluted with organic waste.

- **2. Prebiotics**

Prebiotic substances are indigestible by the fish itself — but can be used by probiotic bacteria. A well-known prebiotic is inulin, for example. We do not only use probiotic lactic acid bacteria, but we also feed them in addition so they can reproduce faster and become stronger, and their positive characteristics are enhanced even further — this gives the intestinal flora an additional boost to fulfill its vital functions.

- **3. Beta-glucans**

Beta-glucans are natural components in the cellular wall of yeasts and other microorganisms. Figuratively speaking, they alert the immune system, it is pre-warned and can thus react to actual pathogens much faster and more efficiently. The risk for the outbreak of a disease is significantly reduced.

The ingredients

of all Dennerle foods for fish and invertebrates

Brine shrimp and brine shrimp nauplii

Brine shrimp are high in vitamin C and carotenoids that enhance red and orange hues, and they are one of the most favorite foods of fish and inverts.

Daphnia

Daphnia contain practically all the substances other aquatic animals require, and they are a natural food source for fish and aquatic invertebrates.

Arctic krill

Krill contains essential amino acids, B vitamins and minerals. Chitin improves digestion and gives crustaceans all they need for their exoskeleton.

Amphipods

Their high content in chitin supplies the fish with important fibre for a good digestion and gives crustaceans all the building blocks for a good molt.

Red mosquito larvae (bloodworms)

The relativ soft larvae of the non-biting midge are an important food for many fish and quite a few inverts. The larvae are red thanks to hemoglobin.

Grasshoppers

Insects form part of the basic food for most fish and many invertebrates. Grasshoppers contain a well-balanced mix of proteins and fats, and chitin.

Fly larvae

The protein-rich larvae of the soldier fly are the alternative to fishmeal. Hermetia is bred easily — an important contribution to reduce overfishing.

Cuttlefish

Cuttlefish are mollusks, and their flavor is well-accepted by most fish. Moreover, cuttlefish contain nutritious proteins and amino acids.

Green-lipped mussel

The green-lipped mussel from New Zealand is rich in essential amino acids and polysaccharids, and it also has vitamins, minerals and trace elements.

Omega-3 marine oil

Omega-3 marine oil is made of marine organisms, and it is chock-full of vital and nutritious omega-3 fatty acids, which can be metabolized very easily.

Yeast

Yeast cells contain many vitamins, minerals and trace elements. Their cell wall is rich in β -glucanes, which can boost and enhance the immune system.

Nannochloropsis algae

Micro algae have a lot of unsaturated fatty acids and vital phytochemicals. Nannochloropsis is part of the phytoplankton, basic food for many animals.

Chlorella algae

Chlorella contains — amongst others — important essential amino acids, minerals, trace elements, vitamins, unsaturated fatty acids and polysaccharids.

Red coralline algae

The calcium naturally contained in red coralline algae is highly bioavailable and can be metabolized especially well by fish, crustaceans and mollusks.

Spirulina algae

Spirulina is rich in proteins and vitamins, and it has a great spectrum of minerals and trace elements. It even contains more carotene than carrots!

Beta-glucans

Beta-glucans form part of the cell walls of bacteria, fungi and grains. Many studies link Beta-glucans to a positive stimulation of the immune system.

Active lactic acid bacteria

Live probiotic lactic acid bacteria have many positive effects on the organism, especially on digestion, and can even suppress detrimental bacteria.

Cabbage

Cabbage is high in fibre, has a high vitamin C content and contains bacteriostatic mustard-seed oil glycosides that have an anti-inflammatory effect.



Kale

The fibre-rich kale leaves are chock-full of vitamins, minerals and phytochemicals like carotenoids. Most herbivorous fish just love the taste of kale.

Fennel

Some of the phytochemicals and vitamins contained in fennel are bacteriostatic, and it has long been used for disease prevention in the aquarium hobby.

Spinach

Spinach is very high in minerals, vitamins and protein. The high content of carotene enhances the colors of fish and inverts, especially red and yellow.

Garlic

Garlic contains a high proportion of beneficial phytochemicals and has, in addition to its other health-promoting properties, a bacteriostatic effect.

Chickweed

Chickweed tissue is especially tender and easy to digest. It is very popular with herbivorous fish, and with practically all freshwater invertebrates.

Balm

The antiseptic balm juice has been in use for disease prevention for ages. The tender balm leaves are very attractive for herbivorous fish and inverts.

Rosemary

Rosemary contains many aromatic and other beneficial substances. Some of them have an antimicrobial effect on noxious bacteria, yeasts and moulds.

Anise

The aromatic medicinal plant anise has been used for its health-promoting effect for centuries — and fish and freshwater inverts just love its taste.

Grape seed flour

Fibre-rich grape seed flour has a high content of phytochemicals, many antioxidants that protect the cells and an excellent ratio of fat to protein.

Wheat protein

Wheat protein contains many essential amino acids and is stable in water. It makes food granules more stable, thus protecting the water from pollution.

Inulin from chicory

Inulin is a prebiotic component enhancing the formation of beneficial bacteria in the intestine, with a positive effect on the health of their host.

Birch leaves

Birch leaves are rich in phytochemicals and fibre. Leaves form an integral part of the natural diet of many freshwater aquarium fish and invertebrates.

Mulberry leaves

The tissue of mulberry leaves is especially tender and very easy to digest. The leaves are chock-full of vitamins, trace elements and phytochemicals.

Papaya leaves

The leaves of the Papaya tree contain anti-inflammatory mustard seed oil glycosides with antibiotic properties as well as vitamins, fibre and minerals.

Moringa oleifera

Moringa leaves are extremely rich in essential vitamins, fatty acids, minerals and other vital substances. Natural carotenoids enhance color intensity.

Walnut leaves

Walnut leaves contain tannic acids, flavonoids and vitamin C, with antibacterial and fungicidal effects — and fish and inverts just love their taste.

Pollen

Pollen has highly useful amino acids and vitamins. The double wall of the pollen grain is high in fibre, which is beneficial for the digestive tract.

Guppies are as well known as goldfish, and they are one of the most popular aquarium fish in the world.

THE GUPPY – A MILLIONFISH

The guppy (*Poecilia reticulata*, PETERS 1859) is also known as millionfish. It was given this name because there are literally millions of guppies in the habitats, and also because it reproduces very quickly even in the aquaria of beginning fishkeepers, who may look forward to a large population in their tanks without having much work. And this has brought us to an important point: the difference between merely reproducing and breeding these live-bearing toothcarps.

Aquarium guppies: Guppies are highly adaptable when it comes to keeping them in an aquarium. Temperatures of 20 to 28 °C (68 to 82 °F) and hard to soft water are possible. Please keep in mind that the guppies you buy are still used to specific water parameters

larvae) origin. Nowadays, there are special guppy foods, flakes as well as granules, which have been tailored to the special needs of these livebearers, especially regarding their content, particle size and floating behaviour. The same rule applies to all the animals we

Young guppies love powdered food in alternation with powdered Spirulina and decapsulated brine shrimp eggs. Those who want to raise their young guppies in the best way possible can fall back on freshly hatched brine shrimp larvae.

In the aquarium, the guppy is a peaceful fish that will use all the water zones. One male to two females is most recommendable if you want your fish to be healthy. The males keep chasing the females to mate with them. If there are more females than males, the females get a rest once in a while when the male finds another female more attractive. Guppies can easily be socialized with all kinds of catfish, shrimp and snails. If you house them in the same tank as characins or cichlids you'll have to take into account that they can wreak havoc on your young guppies. Guppies are cannibals – they are born this way. Sometimes, even the mother of the young fish turns around immediately after giving birth to eat her new baby. Especially albinotic breeding forms show this kind of behavior, breeds with a grey basic color also have the drive, but it is not as pronounced in them. A densely planted tank helps the young fish survive, as they find many places to hide.



and that you need to adapt them to their new surroundings slowly and carefully. Slight changes in temperature do not harm them, though, on the contrary, they are beneficial for their immune system.

Guppies are omnivorous fish (derived from the Latin words *omnis* 'everything' and *vorare* 'to eat'), which means that they eat foods of vegetable (e.g. algae, *aufwuchs*) or animal (e.g. *Artemia salina*, or young fish

keep in our tanks: feeding a varied diet with miscellaneous foodstuffs is better than giving them the same food day in, day out. Feeding frozen foods like brine shrimp, bloodworms and blackworms, daphnia and lobster eggs is highly recommendable, as are food tabs with a high algae content, or live foods like white worms (enchytraeids), and live brine shrimp larvae.

*Genes are defined as
units of hereditary
information in the
genetic material of all
living beings.*

When high-breeding guppies, the breeder needs basic knowledge about the Mendelian Laws of Heredity. As guppies are bred for scientific research in many countries, its genetic traits are much more well-examined than those of most other ornamental fish. Many of its genes (with genes being defined as the units in the genetic material of all living beings that carry hereditary traits that are passed on to the offspring without or with some alterations during sexual or asexual reproduction) even have a name (e.g. zebrinus) and have been investigated thoroughly. For over 100 years female guppies have been known to store sperm, which enables them to give birth to offspring several times after one successful fertilization. Fresh sperm (from later copulations) are preferred over older sperm in the oviduct. Knowledge of this fact is elementary for successful breeding!



The young fish are sexed and separated early on. Usually you can discern their sex as early as the third or fourth week of their lives (if necessary use a magnifying glass). This procedure is quite time-consuming, however, it is essential if you want to breed with selected couples, due to the females' ability to store sperm. In Germany, hobbyist breeders are mainly responsible for maintaining the standard of guppy high breeds, and follow their goals in the comparatively small framework of their hobby. In South-East Asia as well as in Israel, there are large farms where these colorful gorgeous fish are bred for the mass market. It is an economical fact that they do not select the fish according to breeding standard fin shapes or follow any breeding aims but aim to breed, although sophisticatedly, in large quantities. Of course there are also very active hobbyists in these countries, who breed the guppy according to

the international standards and to their own preferences. This is often done in breeding facilities of 30 to 80 aquaria, which are out of doors. Water temperatures of around 28 °C are quite common for Asian guppy breeders.

There are guppy clubs in almost all countries, and nearly all of them have their own championships (club championships, countrywide and continental ones, and even international championships). During these contests, an experienced jury judges the outcome of guppy high breeding according to very strict rules.



Recommendations by Yann Hoiret

For you, the discus is the king of the aquarium hobby?

You and me, we definitely agree in this point!



This majestic fish fascinates with its behavior and its colors, however, keeping and breeding discus can lead to strong frustration ... it does not if you get a few things right, though!

In the aquarium hobby, keeping and breeding discus really took off in the 70s of the last century. Back then, most of the discus you could buy were collected in the wild, however, German and American breeders soon managed to breed them in captivity, and started selective breeding soon afterwards. With growing resources, the prices for captive-bred discus went down, and the number of discus keepers kept climbing — quite logically. In spite of this democratization, the discus has managed to maintain its image as a fish that is difficult to keep. If you keep to some basic rules, keeping discus gets much easier, though.

Together we're strong!

When buying discus fish, please take into account that they are social animals. You ought to keep a group of at least five to six discus of approximately the same size. Unfortunately, beginning discus keepers have this fatal tendency to only buy two or three discus to start with — a very common mistake!

The king in our tanks wants to live in a group where a hierarchy can form. As the number of individuals grows, aggressive behavior is reduced. If you keep too low a number of discus, the risk that the dominant fish harass the lower-ranked ones is much higher. Moreover, everybody knows: You are stronger in a group, and larger numbers have a reassuring effect on the group members. Please make sure you do not choose too many color variants, and that your group of discus consists of fish that are more or less the same size.



A good water quality is very important for an aquarium with discus fish. For the preparation of very hard water with a total hardness of 15 or higher, a reversed osmosis is the right choice.

In case you have a good water quality and therefore only want to lower down the hardness slightly, the use of our soil is the perfect match. Just use it as a filter medium (packed in a net), put it in your external filter and regularly control the water value with our water test stripes. It does not get any easier.

Hard water? I don't like that!

The water quality is one of the most important aspects if you want to keep discus successfully. Most of the problems are caused by it. Even though nowadays, captivity-bred discus are somewhat more tolerant we must never forget that they still like their water on the acidic side, and pretty warm. The captivity-bred form of the discus should be kept at a carbonate hardness of 2 to 4 °dKH, a total hardness of 4 to 6 °dGH, a pH of 6 to 7.2 and a maximum temperature of 28 to 30 °C. If you're in luck and your tap water has these parameters, please test it for some other things before using it in a discus tank: first and foremost, nitrate, phosphate and silicate should be low. In most cases, you'll need to use a reverse osmosis system, though. I have been using the Osmose Professional 190 for years, to my full satisfaction. There are two ways of bringing the RO water to suit the needs of the discus: You can use the mineral salt „ReMineral +“ to add minerals to the RO water that are optimally fine-tuned to the water parameters a discus needs. This method has the enormous advantage of adding minerals to the RO water without the risk of pollutants possibly present in tap water entering your discus aquarium. Or you can mix tap water and RO water. In this case I recommend the use of Avera water conditioner to eliminate unwanted substances.

The water parameters in a discus aquarium should be tested at least once a month. Add a few Indian almond leaves (aka catappa leaves) to your tank as they have multiple benefits. The Dennerle Catappa Leaves are well prepared, they do not influence the water quality in a negative way. Catappa leaves add a slight amber stain to the water, which really brings out the colors of your fish.

Fast food is a no-no!

The everyday diet plays an important part in preventing health issues. The food always needs to be selected with the needs of the respective animal in mind. Nowadays we have a great selection of aquarium fish food: frozen foods or freeze-dried, plankton, flakes, pellets or granules, homemade fish food, ... Granulated food has the advantage of being easy to dose. It is also interesting as it can be given with an automatic feeder, which is very practical especially during the holidays or if you are away from your home a lot. A good granulated food can be used as basic food for discus. Amend it with a food rich in fibre such as chitin once a day, like for example frozen or freeze-dried food. A well-balanced diet prevents digestive issues and parasite infections and keeps potentially harmful pathogens in the guts in check.

Choose your granulated food carefully. Often, people mistake tastiness for quality, however, the quality of a food is not determined by its taste alone! Comparing the labels really pays off. Here you can find important information (or not, which speaks for itself). The granulated fish food „Diskus Soft“ for example has many beneficial properties, especially for adult discus. It is a very well-balanced food, rich in insects, marine algae and without preservatives or chemical flavor enhancers. It also contains shrimp. „Diskus Soft“ is — as the name says — a soft food that is accepted very well. It doesn't swell in the fish's stomach after being eaten. Discus that are one year old do well with two to three meals a day. Feeding time is an important time as you can see and critically evaluate the health of your fish. Do they eat? Do they eat actively? Do they look healthy?

Take care!

A discus tank needs regular maintenance. To keep nitrate and phosphate on a low level you ought to change a part of the water on a regular basis. The amount and frequency of these water changes vary with the number of fish present and the volume of the aquarium. As a rule of thumb you change around 30 % of the water in a show tank per week. The regular water changes are important as they guarantee a stable, good water quality. Condition your fresh water before filling it into the aquarium, and adjust the water parameters so they meet the requirements of your discus fish. When changing water, use a gravel cleaner to remove fish droppings and other organic substances from the substrate that are not taken in by the filter. Check your life-supporting aquarium equipment on a regular basis (filter, heater and lighting) as well as the water parameters.

Don't be afraid of large volumes!

The discus is a large, beautiful cichlid that needs a group of conspecifics to do well. You'll need a large tank to house them. A volume of 300 liters (80 US gal) is suitable for a group of six discus. A rectangular form with a good depth is preferable. The technical equipment should be of a high quality, and reliable, and the filter volume should suit the tank size so the relatively large fish do not pollute the water too much.

Discus do not like very intense light from above. The LED lighting systems by Dennerle offer a great color rendition and are, moreover, ideal for the plants when it comes to color spectrum and light intensity.

How you set up your aquarium is very important as it is not only a question of looks but also of facilitating an easy maintenance. This is an important point; you always need to keep your discus tank quite clean, and if this work is too difficult or too finicky some people may get a bit sloppy.



Discus tanks — a living image!

It is still possible to have a beautiful tank that is still easy to clean. When choosing plants, please take into account that the high temperatures in a discus tank are not suitable for all plants.

The substrate should be light in color and not too coarse. Before you fill in the substrate you can add an undergravel heating cable to your tank to make sure that your substrate always has a good water circulation, and the undergravel fertilizer „Deponit Mix“ as well.

Personally, I prefer well-balanced, large groups of the same plants to a mixup of many different plant species.

To make the living picture perfect, you may add other fish to your discus tank. However, try to avoid fidgety fish that would disturb your discus, and try to keep the number of fellow aquarium occupants low. Surface-oriented fish like hatchet fish are great in a discus tank. Please keep in mind that they jump, and keep your tank well-covered at all times. Classic characins like *Hemigrammus bleheri* or the Red Neon Tetra are suitable, too, as well as some armored catfish, given that they tolerate the high temperatures. If the water is clean and the oxygen content is high, plecos with a high temperature tolerance are great too, like *Ancistrus* sp. and *Peckoltia* sp.

The key to success is in your hands!

Most problems I hear about have their cause in the points I've talked about above. Now you're holding the keys to successful discus keeping. Are you ready to join the enthusiasts? But be careful ... once you've started it's difficult to stop!

Diskus Soft 11,21 € Art.no. 7521

These nutritious granules were especially developed for discus fish. The special softening procedure makes the granules easy to chew, just like the prey discus eat in nature. Even finicky discus accept the food very well.

The animal constituents come from aquatic food animals such as krill (5.2 %) and mollusks or insects (25 %). Valuable algae and other high-quality plant-based ingredients such as vegetables (6 %) and Moringa (1 %) complete the diet.

RECOMMENDED PRODUCT

CLICK
HERE



For beginning shrimpkeepers

Shrimp are no fish, and even experienced aquarium keepers may run into surprises with their shrimp tanks once and again.



To provide you with the smoothest possible start into the freshwater shrimp hobby we give answers to the most frequently asked questions about starting a freshwater aquarium dedicated to shrimp in the following.



The tank

Unlike most fish, shrimp can be kept in aquaria with a length of under 60 cm (24 inches) very well. Most standard complete aquarium kits with a volume of 54 liters (14 US gal) that you can purchase in the pet trade are designed for fishkeeping, and the filter is not quite safe for shrimp. A NanoCube Complete, on the other hand, is an example for a great tank for beginning shrimpkeepers. Here all the equipment is shrimp-safe from the start, which spares you double purchases (e. g. for a shrimp-safe filter to replace the standard device). In smaller water volumes, the biological stability is a bit harder to achieve than in large tanks, but if you change water regularly and don't overfeed you can very well start with a small tank with a volume of 20 liters (5 US gal).

“The right tank for shrimp.”

The water

There are some shrimp species (like for example the highly popular red-and-white or black-and-white Bee Shrimp) that originate from biotopes with soft, slightly acidic water. You can keep them in harder water, too, however, their offspring will have trouble growing up. If your tap water is hard, there are alternatives: Either you get a species that comes from harder waters (like all the colorful variants of the genus *Neocaridina*), or you prepare water that meets the requirements of the shrimp. For doing so, just use RO water and a re-mineralizing salt to create the suitable parameters. Don't worry, this is not as complicated as it sounds! Sometimes, water companies have been known to add chlorine to the tap water, for example to fight bacteria. Unfortunately, chlorine is highly poisonous for all aquatic animals, and when you can smell it the concentration is far too high already. To be on the safe side you should always use water from a shower head for your aquarium, or aerate the water in a bucket for a few hours, creating a strong surface movement with the help of an air pump. Copper (just like silver, which is used in some water filters for disinfection) is deadly poisonous for shrimp, too. Traces of dissolved copper may be present in water that has stood in copper pipes for some time. Easy remedy: only use fresh water for your aquarium, for example when the faucet has been running for a bit, or after you've taken a shower. In warm water, more copper can dissolve, so only use cold. If the temperature of your cold water is too low, just let it stand near a heater for a day to reach room temperature. **If you want to be on the safe side when using tap water, use a water conditioner that binds to potentially dangerous substances and renders them harmless.** Most dwarf shrimp do well at room temperature (18 to 24 °C, or 64 to 75 °F). A heater in the aquarium is only necessary if you plan on keeping a species originating from a warmer habitat or if the water temperature is constantly below 18 °C (64 °F).



The filter

Standard internal filters: (often included in complete kits) are in many cases not really suitable for shrimp tanks as they take in the water through relatively wide slots. If a shrimp manages to get into the filter (which they do, actively and often), it is hacked into pieces by the filter wheel. You can make such a filter shrimp-safe by covering the slots with a nylon sock or something comparable. Fix well! This is only a makeshift measure, though. Especially tiny shrimplets will always find a way into the filter even if you think you have covered everything. Moreover, these safety nets need to be cleaned frequently as they tend to clog incredibly fast. It is much better to choose a shrimp-safe internal filter like the Dennerle corner filter from the beginning.

To make it absolutely safe for the smallest baby shrimp you can clip on a very fine grid, the Baby Protect, which is sold separately.

External filters and hang-on filters: These filter types can be safeguarded with a piece of fine filter mat which is slipped onto the filter intake. Another positive aspect: External filters and hang-on filters do not take up any space inside the aquarium.

No matter which filter you choose, it needs to run day and night if you do not only want it to clean the water mechanically. The filter bacteria that clean the water biologically will die off if they are not permanently supplied with oxygen-rich water. In the worst case, a filter that does not run all the time can turn into a breeding ground for harmful bacteria.

Cleaning the filter: Only do so when the water coming out of the filter is a mere trickle. Clogged filter mats can be rinsed with tap water (only if it is not chlorinated) at aquarium temperature or cooler, or in a bucket of aquarium water. Do not use detergent or hot water, and do not clean too thoroughly in order to preserve the filter bacteria.

Our tip: the Dennerle Corner filter can be easily extended with our attachable additional filter - just click it on.

If you use our soil here as filter medium, there are many positive soil effects, even in aquaria without soil as substrate. A simple test with test stripes will let you know, when a refill is necessary.



“It’s time for cleaning when the filter outflow is a mere trickle.”

Aeration

When the temperatures rise during the hot months, or if you notice your shrimp always sitting in the upper area of the aquarium in the morning, the oxygen level needs to be raised in the tank, which is best done with an air stone and an air pump. Often it is sufficient to run the air pump during the night when the lights are out, as the plants produce additional oxygen during the day.

The substrate

Inert natural gravels or colorful resin-coated shrimp gravels are ideal for shrimp. If you plan on creating a soft-water aquarium you could alternatively choose an active soil like the [Dennerle Shrimp Soil](#) that influences the water parameters and makes them shrimp-friendly.



Crystal Red Shrimp

Bee shrimp have been widely spread in the aquarium hobby, almost every shrimp enthusiast knows them. Their varied colors and patterns make it the undisputed queen of all freshwater shrimp, and have helped all invertebrates to a growing popularity in the hobby.

Fertilizing

Plant fertilizers only contain copper (if at all) in very weak concentrations and do not harm shrimp if dosed correctly and according to the instructions on the label.

The plants

Plants newly purchased in a shop or off the Internet may have been treated with agricultural chemicals. If they were exported recently, insecticide and fungicide residues can still be present, which were used in the exporting countries to rid the plants of pests and diseases. For this reason, Dennerle always quarantines imported plants; in our greenhouses in Germany and Sri Lanka, we use beneficial organisms as well as non-toxic insect traps for pest control. Still, you should always quarantine conventionally grown plants no matter of which brand for two weeks in a separate container if they are destined to go into a shrimp tank. Most pesticides break down over this period of time. Please make sure the plants get sufficient light! Before you put them into the quarantine tank, remove the rock wool around the roots as completely as possible as unwanted substances may accumulate in there. Unfortunately, this quarantine does not eliminate any unwanted guests that may sit in your plants, like snails, worms, or limpets. For this reason the plants need to be fully submerged in carbonated water (the more sparkling the better) for about 20-30 seconds. The CO₂ contained in this water kills off all these organisms, unfortunately, their eggs will survive the ordeal. After two weeks, practically all the eggs will have hatched, however, the young pests have not reached adulthood yet so they will not have laid more eggs. For this reason, the plants should be submerged in carbonated water for another 20-30 seconds after two weeks.

Those who want to make absolutely sure that the plants do not host any unwanted accompanying fauna should use Dennerle Plant-It! plants produced from tissue culture. They never come into contact with algae, pest insects or pesticides while cultivated. Just rinse off the gelatinous substrate and plant them. It's as simple as that.

Decorative materials — driftwood

Mopane is a heavy, rather dark wood that does not float. Often the pieces are sanded to give them a more interesting appearance. Pieces of mopane wood usually have a rather rough structure and a gnarled look. Moorwood and red moorwood are of a lighter color, with a smoother surface and a finer structure. Moorwood is weighs less and thus tends to float in the beginning. To prevent this, pieces of moorwood should be pre-soaked in a separate container until they stay down, or, if you prefer putting them into your aquarium right away you ought to weigh them down with a piece of rock. After a few weeks they will have absorbed enough water to stay down on their own. In some shops you can buy pre-soaked, salted pieces of moorwood. Rinse off the salt really well. After that you can use those pieces of driftwood in your tank right away without the need for weighing them down. Mangrove wood is dark and has a rougher structure than moorwood. It tends to float in the beginning and should therefore be pre-soaked or weighed down in the tank. Natural driftwood may add a brownish stain to the water. This is not harmful for fish or inverts, and the stain will let off after a while all by itself. If the pieces of driftwood were not pre-soaked a whitish layer may form on them in the tank — it consists of bacteria that feed on sugar residue in the wood. These layers will disappear all by themselves after all the sugar has been processed.

Decorative materials — rocks

Rocks are a very nice decoration for shrimp tanks. If you plan on keeping shrimp from soft-water habitats like the beautiful red-and-white or black-and-white Bee shrimp, please make sure the rocks do not contain limestone, which would harden the water. To test this, just drip a few drops of vinegar essence or citric acid onto the piece of rock in question. If it starts foaming it contains limestone. In this case, the stone should only be used in aquaria with a pH over 7. In such a tank, you can easily keep shrimp of the genus Neocaridina, like Red Fire or Red Sakura, for example.

Leaves

Brown fallen leaves are not only a great staple food for our invertebrates but also give off humins to the water. These substances are helpful for crustaceans as they make the molt easier, and moreover, they can even bind to toxins. Totally brown autumn leaves from native trees are suitable — oak, beech, elm, to name just a few. Ideally the leaves are picked directly from the trees in autumn. Let them dry until they crackle in your hand. Then you can store them practically forever. Use paper or cloth bags or carton boxes. You can add these leaves to your tanks without pre-treating them — then they'll float for a few days before they go under —, or boil them over — then they will sink immediately. Never boil them for a longer time, too many humins would be washed out and discarded. Alder cones and Indian almond leaves fulfill the same purpose. In addition, they have mild antibacterial and fungicidal properties. Dried green walnut leaves (best harvested in July and August in full sun) also act against bacteria and fungi, and in addition, shrimp just love eating them. For more details, please see our article „Natural remedies“ starting on page 22.

Cycling

An aquarium should be allowed to cycle without fish or inverts for at least two weeks. This allows the filter bacteria to reproduce and to adapt to their new surroundings. These bacteria turn ammonia and nitrite into the comparatively much more harmless nitrate. Many aquarium keepers add a little (!) fish food to such an empty tank to give the bacteria something to feed on and to speed up their development. When the bacteria start working, at first the ammonium (NH₃) / ammonia (NH₄) level rises steeply and goes down again, after that the same happens with nitrite (NO₂), which is toxic for fish and inverts. When this so-called nitrite peak has ebbed down again your tank is ready for its new inhabitants. Adding an ampoule of living dormant bacteria to bring a large number of beneficial microorganisms into the biological system makes a lot of sense. If you do so, the nitrite peak may be very weak or even non-existent. As nitrifying bacteria live in biofilms adhering to solid substrates and not in the water, using water from a running tank to fill the new aquarium has absolutely no beneficial effect. When the nitrite readings are back to normal, i. e. very low, levels, you can slowly start adding animals to your tank. Please keep in mind that the bacteria need to keep up with the growing organic load — if you add too many animals in too short a time, nitrite may peak again, with a possibly fatal outcome for your new aquarium stock.

The animals

Shrimp are social animals and should be kept in groups of at least 10 (of each species). Some species like swimming more than others, like the active Amano shrimp (*Caridina multidentata*), for example, and should therefore be kept in a tank with a length of at least 60 cm or 24 inches. Some shrimp that belong to the same genus can interbreed, shrimp that belong to different genera (for example *Neocaridina* and *Caridina*) don't.

Maintenance

Usually it is sufficient to siphon off the substrate once a month. Shrimp do not do overly well in very clean tanks. They like searching for food in some muck, and they even eat the muck itself. Clean your aquarium glass once a week when you change water. Many shrimp breeders only clean the front and leave the sides and the back of the aquarium alone. The biofilms that form there are a great grazing ground especially for baby shrimp. Keep your aquarium front clean, though — after all, you want to have a good view of your precious shrimp!

Changing water

Many keepers and breeders have had good success with weekly water changes of approximately 10 to 20 % of the aquarium volume. If you use a lot of fertilizer and feed large amounts you need to increase this amount to up to 50 %. If you have shrimp or tiny fish in your tank make sure you secure the hose you use for drawing out the water, for example with a nylon sock or a piece of filter mat. Fill in the fresh water with a watering can with a rose spout. A strong jet of water would upset your substrate, the decoration and the plants.

“Shrimp are omnivores”

Feeding

Shrimp are omnivores and scavengers, they eat biofilms, algae layers, microorganisms and so on, and they do not starve to death easily. When buying food make sure its ingredients correspond to the needs of your shrimp. It should only contain proteins in the form of aquatic animals or insects, the fibre content needs to be high and the starch content should be low. A good shrimp food has a high plant content, and all the ingredients come from strictly monitored sustainable sources and have been carefully processed — in a way that preserves the nutrients.

Shorten the cycling period with AquariumStarter Rapid

Animals may be added to the tank as early as after 24 hours.

For rapid biological activation of the filter material and the substrate

Add the “right” bacteria to your tank from the start!

CLICK
HERE





Code name: CPO

The dwarf crayfish from Lake Patzcuaro.



Brian Kabbes, a Dutch fish and plant collector, brought the wild form of these crayfish from Mexico in the late 1990s, and ultimately this was the reason for them becoming the most popular crayfish in the aquarium hobby in all the world. However, the most popular form of this crayfish, the orange variety, was bred by another Dutch invert enthusiast, namely Juan Carlos Merino. Brian gave him some of the crayfish, and he successfully bred the beautiful orange-colored CPOs we know and love today from the yellowish-brown stock he had. And what a happy coincidence that they turned orange of all colors — especially for the Dutch, who have a very special connection with the color orange as it is the color of their royalty, the Oranjes.



The dwarf crayfish of the genus Cambarellus from the highlands of von Mexiko, whose wild form is of a light to dark brown, are distributed in a rather small area around the Lago Patzcuaro in the Mexican state of Michoacan. Lake Patzcuaro, praised by many as the most beautiful lake in Mexico, is surrounded by forested hills and volcanic landscapes. In the scientific description of the species, the lake is mentioned as only habitat, however, we can safely assume that Cambarellus patzcuarensis is also found in the surrounding streams. Most of the crayfish are found in the dense aquatic plants along the lakeshores.

The claws of female *Cambarellus patzcuarensis* are shorter and wider, just like in practically all *Cambarellus* species. The body of the male is much slimmer and looks less robust than that of the female. As a rule, adult females grow larger than males of the same age. In the aquarium, the females can reach a body length of up to 5 cm (2 inches). Female *Cambarellus patzcuarensis* „orange“ (often shortly called CPO) can reach an age of two years or more when living in good conditions, the males tend to die an earlier death. In those two years, the females can carry eggs for four to five times, which means that their offspring is plentiful. Depending on her size, the female can carry between 25 and 50 eggs (or newly hatched craylets, respectively) under her pleon (abdomen). Quite often, the females have unfertilized eggs, though. They can easily be discerned as they are of a yellowish to orange color, whereas viable eggs are dark brown. Usually the females remove unfertilized eggs to prevent the entire batch from developing a fungal infection. The reason for unfertilized eggs is assumed to lie in the water hardness, however, this is not quite true, according to our experiences. Successful breeding has been reported from tanks with a water hardness much lower than known from Lake Patzcuaro, and the same is true for the pH. In the lake, it is between 8 and 9, as a rule, however, in 1995 one measurement resulted in a pH of only 7.5 (source: Comisión Nacional del Agua, Mexico). In our opinion, there must be other reasons for the relative frequency of unfertilized eggs in CPOs. A possible reason might be inbreeding, as the entire population was bred out of very few crayfish.



Water temperatures in Lake Patzcuaro vary between 15 and 25 °C (59 to 77 °F), however, in the shallow areas on the lakeshore, the water reaches much higher temperatures when the sun is shining. In the aquarium, no heater is required — of course, if you keep your CPOs together with fish and inverts that need higher temperatures, this does not apply!

As CPOs are active during the day you will be able to watch them mating time and again. If they do not seem inclined to reproduce you can help them along a bit by separating the males from the females for a few days. If you put a pair together in a small container like a bucket or a bowl, they will spontaneously mate in many cases. Then the male grabs the females with his claws and tries to turn her onto her back or her side. With his walking legs, the male clutches the female to hold her in position. The hooks of the bases of the male leg pairs (the so-called ischium hooks) are very helpful for this, as they serve as holding organs and fit the basis of the female leg pairs like a key to its lock. If the male

is successful, both crayfish lie with their ventral sides turned towards each other, and the mating process can begin. The act itself only lasts around 15 minutes, after that the male releases the female and the crayfish separate, usually very fast by beating their tails forward.

Several hours after mating, the female starts pressing out the eggs after thoroughly cleaning the setae on her abdomen. Then she folds her pleon under her cephalothorax, forming a brood chamber that is protected against its environment by a thick mucus. The eggs are pressed into this brood cavity.

At this time, the females are very susceptible to stress and eat almost nothing or nothing at all. If the female is disturbed she may eat her eggs or neglect brood care, which may lead to losing her offspring altogether. For this reason is not recommendable to put her into another tank, as catching may stress the female so much that she loses her eggs. After around 3 weeks you can shake the fully deve-

loped young crayfish off the female and put them into a roomy raising tank of their own. This will significantly increase the number of young fish that survive. Suitable caves for the young crays are for example the crayfish caves offered by Dennerle, which are available in every aquarium shop.

If you leave the young crayfish with their mother they will leave her on their own after around three weeks, too, after which they will move freely in the aquarium. They are often eaten by older crayfish or fish, as they are truly tiny!

The list of fish you can keep those crayfish with is very long. Livebearers and characins are unproblematic, as are armored catfish and suckermouth plecs. Larger cichlids or predating catfish will eat the small crayfish, though. Of course it may happen from time to time that an armored catfish nibbles on a tiny newly hatched crayfish or that large characins or swordtails eat a juvie.

In a dedicated tank, more juvenile crayfish will reach adulthood, however, as they are pretty cannibalistic they eat each other or are eaten by older tankmates. To prevent this, feed a balanced diet rich in protein.

I cannot recommend keeping CPOs with small Caridina shrimp. In a densely populated tank, the crayfish try mating with the shrimp, which does great damage to these delicate inverts, and they often lose limbs or are eaten entirely.

“If you have excess snails in your tank the tiny orange crayfish will work wonders.”



If you have a snail overpopulation in your aquarium, the tiny orange crayfish are more than happy to rid you of them, in a surprisingly short time.

Cambarellus patzcuarensis is active during the night and during the day, which makes it a great aquarium inhabitant. They do not eat plants and can therefore be kept in a beautifully planted tank without any problems — something you can't do with most crayfish.

The CPO just loves a varied diet, as it is an opportunist. We should keep this in mind when feeding them in our aquaria. At first glance, crayfish seem to be easy to feed, and as most species are omnivores, this is in fact true, you just need to keep some basic things in mind.

The food needs to be balanced, crayfish need



food of vegetal as well as animal origin. On the one hand, a high-protein diet can minimize cannibalism (give that the tank is not overstocked), on the other hand, omnivorous crayfish also need vegetarian food. In nature, leaves in the water form a large part of their natural food. Moreover, crayfish can filter algae and animal plankton from the water, this is most frequently done by the juveniles. They catch small planktonic crustaceans, which have a very positive effect on their growth as they contain the molting hormone ecdyson, which is absolutely vital for successful molts.

When feeding your crayfish please keep in mind that they are messy eaters. They hold their food with their maxillipeds and tear off shreds with their mandibles. The food is transported through the very short esophagus into the stomach, where it is finely ground. This fine food mush is brought into the digestive tract. When the crayfish eat some foods, literally clouds of fine food particles may rise around the crayfish that remain uneaten and can pollute the water.





“The ways of decorating an aquarium are almost unlimited.”

Planning an underwater landscape in an aquarium is a fascinating and captivating task. Just like in a garden, the possibilities are seemingly endless — and there’s no accounting for taste, as we all know. True aquatic plants form, in fact, only a relatively small proportion of the wide choice of aquarium plants. These plants will die off when taken out of the water, and in nature you only find them in permanently flooded areas.

The largest part of the aquarium plant range is formed by bog plants. They are veritable chameleons as they live in the most different habitats in the tropics and subtropics. Their natural biotopes are characterized by changing water levels. At times, these plants will grow with their rootstock in the damp, boggy soil, while their stems and leaves grow above the waterline — this is called emersed growth. When the water rises, the plant adapts to life under water and assumes its submersed form.

In plant culture, bog plants are basically always grown emersed. Everything grows and thrives above the waterline! In some plants, the difference between the emersed and the submersed form is very big, and you might think these forms belong to two different plant species. The emersed form of many species is all green, and they show their true colors only when cultivated under water, in an aquarium. Even the form of the leaves and the growth habit can change completely — and watching these changes take place is really exciting. You’ll need a bit of patience, though — they do not go through a metamorphosis like a butterfly, this adaptation will take some time.

Keen on green

A well-planted freshwater aquarium is a true eye-catcher, and the wondrous harmony of the animals and plants in such a tank always has the spectator spellbound.

Life on our planet would not be possible without plants. Like terrestrial plants, bog plants and aquatic plants fulfill an important function in their ecosystems. This applies to the miniature ecosystem in an aquarium, too, of course. The plants growing in the water produce oxygen, without which the animals in the aquarium could not survive, and they remove nutrients from the water that are added to the system when the animals in the tank are fed. Especially fast-growing plants use up phosphates and nitrates and prevent the algae from taking over. Moreover, the fish and invertebrates find hiding-places in the plants, and the plants also serve to mark territorial boundaries.

The imagination knows no limits — however, there are a few things you should keep in mind when choosing plants for your layout.

Stem plants are a very large group among the aquarium plants. Their growth habit is relatively upright, and most of them are extremely fast growers. In nature or in very large show tanks their stems can reach enormous lengths. In normal standard aquaria they ought to be cut back on a regular basis, though. Sometimes this is hard, especially if you have a nice group that is about to reach the water surface ... but no worries — a timely, courageous trimming session improves a compact growth habit. Plant stem plants one by one or in little tufts of 3 — 4 stems into the substrate of your aquarium. To achieve a balanced picture always plant a larger area with the same plant. „Less is more“ is not true in the case of stem plants. A dense, large group looks very impressive and fascinates the onlooker.

The new leaves of rosette plants always sprout at the basis, and they form a dense rosette. Echinodorus and Cryptocorynes are typical representatives of this plant type. They do not grow as fast as stem plants, and they need much less maintenance. Smaller species can be used as a group planting, and the larger ones make great solitary plants in the middle and background. Echinodorus and Cryptocorynes love an ample supply of nutrients that they can take up with their roots. A substrate rich in nutrients gives them a good start, and Power Tabs guarantee long-term healthy growth.



Plants that spread through runners are often quite finely structured. They form so-called runners, either above or in the substrate. On their nodes, small young plants sprout — and bit by bit, a dense plant carpet forms. Amongst these plants there are some like for example Vallisneria that need to be somewhat confined or else they would take over your entire layout. Superfluous runners are simply cut off with a sharp pair of scissors.

Anubias are probably the most well-known representatives of the rhizome plants. Rhizomes look a lot like roots, but they really are thick shoots. In their natural habitat in Africa, these plants grow on pieces of driftwood and rocks. The popular Java fern, *Bucephalandra* (of recent fame) and the African water fern *Bolbitis* all are representatives of this special plant type. They all have one thing in common — the rhizome must not be covered in substrate to prevent it from rotting. Rhizome plants grow best when tied to pieces of driftwood or rocks.

Decorative items are not only beautiful but also enrich the living space of the inhabitants.



Mosses look great in any aquarium! They give a very natural look to any landscape, and add a touch of the archaic. Most mosses will take hold on decorative materials like rocks or pieces of driftwood. Frequent trimming with a pair of sharp plant scissors gives the moss cushions a compact, dense appearance. Cut-off moss shoots can easily be used in another place — just tie them onto another piece of wood or a rock.

“The stem plants are a vast group of aquarium plants.”

Bulbous plants are rather rare in our aquaria as many of them need a resting period. Thanks to their storage organ — the bulb — these plants can live on in their natural habitat even though the water may completely fall dry. Some species even need this kind of resting period when cultivated in an aquarium or they will die off. The tiger lotus *Nymphaea lotus* and the bulbous plant *Crinum* are probably the most well-known representatives of this group in the hobby.

There are no limits for your imagination — however, there are certain guidelines when it comes to choosing the right plants for your layout. Plants that need a lot of light need a well-lit area under a good lamp, plants that prefer the shade should be placed in areas with less light. The water parameters and the temperature need to correspond to the requirements of the plants, and an ample amount of the necessary nutrients ought to be supplied. When everything's right, cultivating plant is easy: If the plants are well, the fish are well. Algae growth is not something you see in a densely planted tank with healthy, well-growing plants!





Aquascaper by nature!

*One of the most recent trends in the
aquarium hobby: aquascaping.*

For some years now, this special way of creating aquarium layouts has been spreading all over the world, and contents are held internationally during which the best compete. Volker Jochum, one of the best aquascapers of Germany and the winner of the contest „The Art Of the Planted Aquarium“, has made a job out of his hobby, and he works as aquarium layout designer for Dennerle.

„A real stroke of luck“, he says, answering the question how he came to aquaristics, and to Dennerle. When the former head of the Dennerle marketing department and Volker first met in 2010, it was all about repairing a bicycle. Besides being an aquascaper, Volker is a passionate cyclist, mountain-biker and a trained bicycle mechanic, and he was working in a bicycle repair shop back then. Somehow they got talking about nature and aquaria, and the fact that Dennerle was looking for someone to take care for their aquaria and to set up show tanks for trade fairs. Spontaneously Volker decided to take that side job — after all, he had been thinking about getting an aquarium for quite a while, and where can you learn the basics better than directly at the source, a company selling aquarium plants and equipment? That he can do much more than just change water on a weekly basis soon became clear. The rest is history: After a little less than one year, Volker took part in the aquascaping contest „The Art of the Planted Aquarium“ for the first time, the most important live layouting contest in Europe. He made the top ten right away, and in the following year, he won first place.



AQUASCAPING GUIDE

*The Dennerle standard
reference with more
than 140 pages,
many tips and tricks
and great
species-section.*

ID No. 4914
ISBN 978-3-943968-20-0
14,95 €



*“Nature is full of
inspiration”*



*The Palatinate Forest fascinates
with breathtaking views of a deep
green landscape strewn with
towering sandstone rocks.*



His love for nature is what has been driving Volker ever since, and it also was what got him interested in aquascaping. For him, aquascaping means to „bring nature into the tank“. Volker finds his inspiration during his hikes through the Palatinate Forest. If you take a closer look at the stones he uses in his aquarium landscapes you will find that he often chooses red sandstone — the typical rock of Volker’s homeland. The Palatinate Forest gives us grand views over deep green landscapes with towering sandstone formations, but you will also find astonishing miniature landscapes with huge moss cushions, bizarre, contorted roots or weirdly structured fallen trees. The mixed forest presents itself with a great number of leaf forms and colors. Up to a short while ago, Volker used to use his bike, but now it is mostly his cuddly four-legged friend that makes him go out, into the forest.

He fell in love with the Cairn Terrier during an aquascaping workshop in Bordeaux, France. During the two-day event in a pet shop he kept walking by the little guy, and finally Volker adopted him. Whenever he is not on a long-distance hike, Lolo is always with him. „He knows how to make my heart melt, with his funny looks and his affectionate, good-natured ways.“

Aquascaping is often said to be an art form that draws its strength from the fact that it works with live material. Basically, images of nature or typically perfect landscapes are created, which do have the advantage over a painting that they are in fact alive and can develop. This fascinates and enthralls Volker Jochum: pondering beforehand how he could add a landscaping detail he saw during one of his hikes to the three-dimensional work of art that is in the making. It is not sufficient to just set up the layout, the piece needs to develop to reach its full beauty. Besides a feel for details, this requires thorough knowledge about the growth patterns of plants.



A plain, simple planted tank can be realized in one or two hours, and with the appropriate care you can get a really beautiful planted tank within four to six weeks. For a real aquascape, Volker needs much more time to prepare — it may take several weeks before he can even start setting up the layout. In the beginning, there is the idea, often inspired by mere chance. The next step is choosing the material — rocks, pieces of driftwood, plants. Volker ponders many ideas (and dismisses most of them after a while) until the hardscape, i.e. the basic landscape consisting of decorative materials, is complete. Sometimes, he needs to whip some rocks into shape using hammer and chisel, and time and again, pieces of driftwood need to be glued together. Afterwards we come to the planting stage. Setting up the layout may take two to three days, and until the aquascape has reached its optimum stage of development, another two to three months may pass. It is crucial for good plant development to trim the plants in accordance with their growth behavior during this period.

Among Volker's favorite materials there are the red sandstone we have mentioned further above, and Talawa Wood, whose structure looks a lot like the trees growing in the Palatinate Forest, Volker's homeland. *Hygrophila pinnatifida*, a stem plant with pinnate leaves, and the smallest Anubias, *Anubias nana* „Bonsai“ are the plants Volker prefers working with. „In my opinion, the perfect aquarium is an appropriate habitat fine-tuned for the requirements of the fish and the other aquarium inhabitants and pleasing to the eye at the same time,“ says Volker. „I think an aquascape activates the imaginations of its beholders on different levels. But a three-dimensional image of nature, with the plants softly swaying in the current and a school of fish passing by, along the ‚horizon‘ — this is pleasing to everybody.“



Setting up an aquarium is really fun!



In the following pictures, a simple yet very effective underwater landscape is created. With a few ingredients and a bit of skill, it is incredibly easy to replicate. The variety of plants is of course almost limitless, but the plants should suit each other in terms of requirements and growth.

The first step is to build up the substrate. The Deponit nutrient substrate is distributed wherever lush plants are to be grown later. Distribute the first layers of crystal quartz gravel at the rear corners. Now it is time to start building up the hardscape with „sea mountain“ stones. More gravel is added. Spread decorative gravel towards the front – no plants are to be grown here.





Now the planting begins. Many aquascapers put the plants in a dry tank and the water is only added at the end. This allows very precise manipulation of the small seedlings. The plants that are already positioned are sprayed from time to time to prevent drying out.



In this example, some of the plants are put in position „dry“ – then some water is added and the softer submerged species are planted. When slowly adding the water, it is helpful to use paper or film as a cover – this stops the newly added plants from floating away and prevents the different substrate materials from mixing.



The planting

You do not have to be a horticulturist to be able to plant an aquarium beautifully. In addition to the creative activities, a few basic preparations should be made.



Pot plants



Pull the stone wool or coconut culture substrate out of the pot.



Trim the roots to 2-3 cm. This trimming encourages the formation of new roots in the aquarium substrate.



Remove coarse pieces with your fingers.



Insert the plants into the gravel or soil using plant tweezers. Pay attention to the planting depth! Ideally aim for the same depth as in the pot.



Remove from the root ball with the aid of scissors or a fork.



Gently press the gravel back around the base of the plant – and you're done. Depending on the species, the first new roots will form within a few days.

Stem plants



Stem plants are planted as what are known as tip cuttings. Cut the stems low down with sharp plant scissors.



Plant the cut stems approx. 2-3 cm deep in the gravel using plant tweezers.



Always arrange stem plants in a large group. The distance between the stems depends on the species. Plants with small leaves can be arranged closer together than large-leaved stem plants. A good rule of thumb is 3 - 5 cm.

Cushion-forming plants



Cushion-forming plants usually have very fine, thin roots and can be detached from the stone wool easily.



Divide the root network into small portions.



A portion ready for planting in the substrate.



Press the small cushion into the gravel approx. 1 - 2 cm deep using plant tweezers.



Weigh the seedlings down with some gravel – this supports the tender shoots while the plants take root.



The new plantahunter gravel from dennerle is based on the founder's philosophy, Ludwig Dennerle, true to the motto "experience nature" and is for 100% pure natural gravel without artificial colouring.



Gravels from all over the world

Which substrate you choose for your tank depends entirely on your personal taste, the plants you want to use and of course on the animals you are planning to keep in your aquarium.

The new Plantahunter gravels by Dennerle are — true to our motto „Experience nature“ — all 100 % natural without artificial colorants. Their special colors and shapes make them an intrinsic detail of the aquarium decoration. The all-natural Plantahunter gravels make the set-up of enthralling underwater landscapes very easy, and they are highly suitable for the re-creation of natural biotopes from the homelands of our aquarium fish. At the same time they lend themselves for the creation of beautiful color contrasts and eye-catching accents — also in aquaria that are already running.

The Plantahunter gravels, carefully selected and at present available in 14 varieties, were initiated by Dennerle's „Plantahunter“ Stefan Hummel. He is well-known as a wayfarer in the name of aquatic plants, but also as a juror for numerous aquascaping contests. From his expeditions in all corners of the globe, the Plantahunter has not only brought new aquarium plants but also plenty of impressions from the natural biotopes of these plants, which have grown into great ideas for the creation and reproduction of highly naturalistic land- and riverscapes. To make putting them into practice easier, we have carefully selected attractive natural gravels from different parts of the world. They just look beautiful with their many colors and shapes, and they had to undergo strict practical tests. Therefore we can guarantee for their biological function in your aquarium. The grain size goes from fine quartz sand with only 0.1-0.6 mm (0.04 to 0.2 inches) over medium-sized grains to colorful river gravels with a stone size of 10-30 mm (0.4 to 1.2 inches).

In order to create a naturalistic landscape we recommend you use various grains of one gravel variety and to add different layers to your layout, like a hill, for example. If you want stronger contrast you can always combine the gravel you selected with a white or a black variety. The diversified natural colors of these gravels create a feeling of harmony and serenity, especially together with the greens and the reds of the plants.

Natural Plantahunter gravels are ideal for aquascapes, too, as their different colors and shapes make creating underwater landscapes very easy. They also lend themselves optimally for accentuating parts of an aquascape, which can even be done in an existing tank, to add fascinating new contrasts and eye-catching spots.



**To grow well,
plants need
nutrients.**

If only a single one is missing in the aquarium, plants stop growing, and their leaves turn yellowish or even glassy. In nature, in locations such as in Bonito, the flowing water brings all the necessary nutrients to the plants constantly. In a tank, the aquarium keeper needs to supply the right nutrients and the correct amount of them.

Quite frequently, there is an oversupply of nutrients like phosphate and nitrate, which are excreted by the fish, other nutrients are deficient or missing entirely. Thus it is necessary to fertilize our aquarium plants on a regular basis. To prevent algae from growing, this is as important as the weekly partial water change.

The most important nutrient for all terrestrial and aquatic plants, whose significance cannot be overrated, is carbon dioxide (CO_2). In the air, there are always sufficient levels of CO_2 , however, this is very often not the case in our aquarium water. This is the reason why so many aquarium plants are only of a pale green and do not grow well. Adding CO_2 to the aquarium is thus a must if you want your plants to grow really well and to look healthy and vital. In the pet trade, there are systems that supply your aquarium with CO_2 , for example from a pressurized gas cylinder.

Some nutrients, like phosphate or nitrate, are in abundance thanks to the fish, while others are deficient or miss entirely.

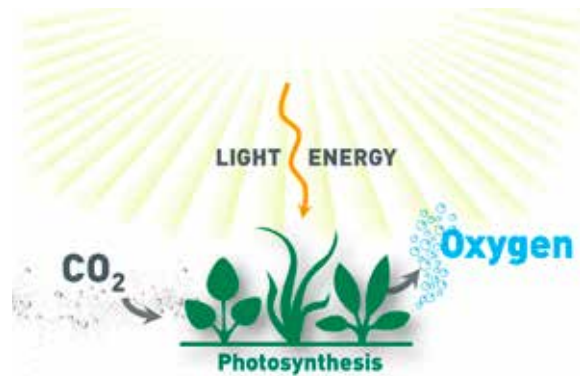

RECOMMENDED PRODUCT!

*“Readily available nutrients for
beautiful aquarium plants”*

E15 FerActiv

9,59 € Art. no.: 4469

Highly available iron
fertilizer tabs

CLICK
HERE

S7 VitaMix

8,59 € Art. no.: 4463

Vital micronutrients for
plants and fish alike

CLICK
HERE

V30 Complete

8,59 € Art. no.: 4457

Highly concentrated
complete fertilizer for
vigorous plant growth

CLICK
HERE



PERFECT PLANT SYSTEM



E15



S7



The Perfect Plant System from Europe's large aquatic plant nursery.

The Dennerle fertilizer system consists of a basic fertilizer combined with fertilizer supplements. The basic fertilizers E15 FerActiv iron fertilizer and V30 Complete special fertilizer add all those nutrients that can be used for stock fertilization. The supplementation of vital nutrients that are used up quickly and therefore need to be given on a weekly basis is done with S7 VitaMix.

All liquid supplements by Dennerle are highly concentrated: they last long and come at a favorable price, and have a great performance.



V30

*Easy use:
The product names tell you
when to give them: E15 is added on
the 15th of each month, V30 on the
30th, S7 every seven days.*

CLICK
HERE

Genie in a bottle

Developing a product with a double effect.

*Interview with Carsten Gretenkord,
the head of the Dennerle R&D*

Dr. Gretenkord, with Carbo Elixier Bio, Dennerle has presented a true first, an example of innovation.

What was it that gave you the idea?

Liquid carbon fertilizers have been around in the aquarium hobby for a while. They are usually based on glutaraldehyde. These products work well, however, as glutaraldehyde is considered a hazardous substance you need to be very careful when handling it. The thought of a biological alternative crossed our minds, and we started investigating and developing.

How does Carbo Elixier Bio work?

In order to understand the way Carbo Elixir Bio works you need to think back and remember biology class, the catchword being „photosynthesis“. In this biochemical process, the plant catches sunlight and turns it into highly energetic carbon compounds, which it uses as universal sources of energy or to produce building blocks for its tissue. The sugar a plant produces, for example, is on the one hand used for generating energy, on the other hand, the plant needs it to build cellulose, the substance responsible for a plant's stability. With Carbo Elixier Bio, we offer the plants natural raw materials that, in this or a similar form, occur in their normal metabolism. The plant can take in these substances through its leaves, process them in its metabolism and turn them into building blocks for healthy growth. Moreover, Carbo Elixier Bio contains other vital nutrients for plants, like iron, potassium and manganese.





Which are the advantages for the hobbyists?

They get a more beautiful aquarium — it's as simple as that. The effect of the elixir is astonishing. After only a few weeks of regular use you will find your plants to be growing much faster, they look more vigorous and are in an overall better health. The leaves get stronger and have more intense colors. My personal hint: Always look to the shoot tips and the young leaves — here you can see this effect first. Another positive aspect: the higher competitiveness of the plants makes life more difficult for algae. Personally, I use Nano Carbo Elixir Bio in my 30 liter shrimp cube in my office, adding 15 drops every morning, and my plants do beautifully. This is my new favorite Dennerle product!

How does the development process for such a product look?

It's like an obstacle race (laughing). But this is the case for the development of almost every

product, we're used to that. In this special case we had a deep look at the plant metabolism. Which are the substances that occur naturally during this process? Which are the substances the plant can actually make use of? Another question was which substances can actually be absorbed by the plant through its leaves. We then tested these substances with selected aquarium plants during practical trials. All in all, we've tested over 30 different combinations and concentrations.

Is there something you need to know before using Carbo Elixir Bio?

Carbo Elixir Bio is really for everybody who wants their aquarium plants to be more beautiful. Just adjust the dosage to your tank — for this reason we do not give an exact dosage but recommend a certain range. If you have a well-planted tank, use a bit more, if your tank has fewer plants, simply use a bit less.

How was the product received by the customers?

The resonance has been really good. Many users have expressed their surprise how well the elixir works. We have conducted an online test on the pages of www.futtertester.de. Here Carbo Elixir Bio was rated „good“ in February 2016, which means it got 8 out of 10 stars.

Is the new Carbo Elixir Bio the end of the classic CO₂ injection with pressurized gas?

No, not at all! The classic CO₂ supply with pressurized gas is still the be-all and end-all in CO₂ fertilization, even though Carbo Elixir Bio comes really close.

During our laboratory tests we set up aquaria with a pressurized CO₂ injection system as a positive control, i.e. we used them as the standard with which the test aquaria were compared.

In the end it is a question of your personal standards which kind of CO₂ supply you choose. The facts are: Plants need CO₂, or rather, carbon, it is the most important plant nutrient. If the aquarium water does not contain a sufficient level — and aquaria without a CO₂ supply almost always don't — the plants will not grow well. At the same time your risk of an explosive algae growth increases rapidly. Adding carbon from whichever source will boost plant growth enormously and prevent bothersome algae very efficiently.

Is this product compatible with the Dennerle Dosator?

During the development of Carbo Elixir Bio, we carefully took into consideration to make aquaristic even more easy.

How it works, you will find on our homepage at our Dosator.



CLICK
HERE

Dosator

*There's nothing wrong
with being lazy.*

In our modern times it has become quite a trend to be lazy, and for deceleration, laziness is a crucial trait. Even when it comes to fertilizing aquaria, laziness can be really helpful ... at least, the prerequisite „reduce the workload“ played a vital role during the development of the Dennerle Dosator.

In large waterbodies the nutrient level is more or less constant, and if aquatic plants find the nutrient content suitable, they will grow — with all the advantages this has. In an aquarium, two factors determine the nutrient supply of the aquatic plants: The addition of nutrients from the outside and the conversion of organic matter by bacteria (remine-ralization). Aquatic plants are „finicky eaters“: If only a single nutrient is in low supply this shortage will limit their growth entirely. This „minimum law“ was formulated by the German chemist Justus von Liebig in 1828, and it has been one of the most basic principles in plant fertilization ever since. In the course of evolution, aquatic plants have adapted to a more or less constant nutrient level. Too high a level of one or more nutrients will not do the plants any good but enhance the growth and development of the less sophisticatedly structured algae. The same applies if the higher plants are weak and do not grow well — then they are no competition for the algae. No matter how we fertilize our tanks: using [Scaper's Green](#) once a day or once a week, or using the Dennerle fertilizer system — no daily/weekly/monthly fertilizing



The story of the Dosator or “when laziness turns to good”

Everything started with a rather casual miniature test in a home aquarium. The fertilizer was filled into a small plastic tube, with tiny, only 1 mm wide holes that allowed contact to the aquarium water. The more holes there were, the more fertilizer was given off — the concentration of the remaining **V30** could easily be seen during the test as the color kept getting paler. The principle functioned as expected, however, the much more difficult part was to develop a marketable product that is safe to use and brings the customer real advantages.

Then Dr. Carsten Gretenkord and Matthias Scheen from the R&D department at Dennerle took over the project, tinkering with the function of this device for many hours. Soon they found out that the tiny submersed holes that let the fertilizer permeate to the outside were ideal feeding places for bacteria, and that bacterial plaque soon covered them when the device was permanently used in an aquarium. The term „I expect the hole to be crawling with bacteria“ became a running gag in every meeting, but it describes the problem pretty well.

regime is as constant as nature. In order to keep the nutrient level in the optimum zone at all times, to the detriment of the algae, Dennerle has developed a new automated fertilizing dosator.

In 2011 the story of the Dosator began with the question of how we could make aquarium fertilization easier. The Dennerle fertilizer system with its time-tested components **V30** (complete fertilizer), **S7** (trace elements) and **E15** (iron) comes close to perfection, but nature is still a little better. One of our biologists at Dennerle tried to unite the physical principle of osmotic pressure with the automatic addition of fertilizer, first trying with his own aquarium at home. He wanted to have a simple, easy system for the constant addition of nutrients that had the ability to remind him when he needed to add new fertilizer.

The technician Matthias Scheen then came up with the truly brilliant idea to take the place where the fertilizer leaves the Dosator out of the water to get the better of the bacteria. In the new Dosator system, the osmotic pressure is created by the semipermeable membrane that is located in the water. Here water can enter, but the much larger molecules of the actual fertilizer cannot leave. Consequently, the pressure inside the Dosator increases, and V30 or S7 are pressed into the riser pipe and drip into the aquarium from above. One Dosator filling is sufficient to supply a 300 l (80 US gal) aquarium with V30 for four weeks, or with S7 for one week, drop by drop. Before the Dosator is first used, you can stick on dosage rings of different sizes, depending on your aquarium volume. As the membrane surface is made smaller, less fertilizer is added to the tank.

What is osmosis?

Liquids with a different concentration of dissolved substances always try to get to a level concentration. This phenomenon is made use of with osmosis. Here we have a semipermeable membrane between these liquids that lets water particles through but not the minerals. A good example for osmosis is our skin when we've spent some time in

the bathtub. The bathwater contains only little salt, in contrast to the human body. Therefore the water enters the skin, trying to level off the salt concentration — the skin expands and gets wrinkly. Osmotic pressure is the pressure that increases thanks to the incoming water.

- Optimal nutrient concentration ○ Daily fertilization ○ Weekly fertilization ○ Fertilization with a Dosator

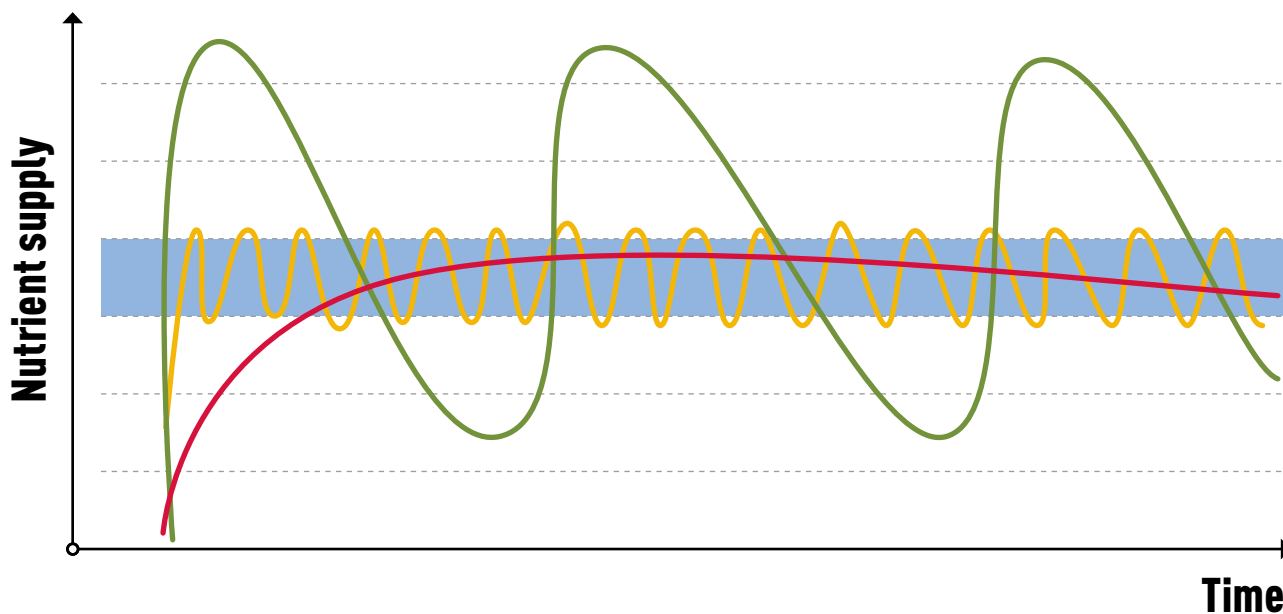

“The technician saved the day.”



The function of the Dosator is not limited to S7 and V30, basically the principle of osmotic pressure can be used with other fertilizers and even with liquid carbon. Tests of the R&D at Dennerle have shown that the fertilizers Scaper's Green, NPK booster and the CarboElixir Bio can be dripped into the tank with the Dosator. The combination of V30 and the CarboElixir is ideal — what no one would have deemed possible is now a reality and especially perfect for small tanks with a volume of up to 60 l: Now the combined, constant supply of a complete fertilizer and a source of carbon to an aquarium is possible.

Addition of fertilizer under water — the „hole crawling with bacteria“ threatens to implode the project. The project-saving idea by the technician: the fertilizer is added above the waterline, contact to the aquarium water via a membrane.



The Dosator, ready for use: Soon the increasing pressure will force the fertilizer into the riser pipe, supplying fertilizer to the aquarium drop by drop, for 24 hours per day and 7 days per week.

“Will the Dosator also work in a marine tank?”

Unfortunately, it won't. The high salt concentration in seawater would reverse the osmotic effect.

The function of the Dosator is most reliable with V30 or S7, as these fertilizers are highly concentrated. V30 lasts for up to 4 weeks in a 300 l (80 US gal) tank, S7 lasts for 7 days. Our tests of the Dosator 2.0 also comprised the other fertilizers manufactured for Dennerle, and we found that for example Scaper's Green works very well in tanks with a volume of up to 100 l (26 US gal) for 7 days. You can even mix V30 and the CarboElixir Bio — this gives you the possibility to add fertilizer at the same time as a source of carbon.

Why is the membrane mounted at a 45-degree angle?

The first Dosators had a horizontal membrane. This worked very well in the unplanted test tanks, however, when the Dosators were used in real aquaria they sometimes stopped dripping. The plants were producing oxygen, and a gas bubble had accumulated under the membrane, separating it from the water. Now the membrane is slanted, and the gas bubbles can rise to the surface.

Are there Dosators for larger tanks?

Unfortunately, the development and manufacturing costs of such a product are very high in Germany. For those with larger aquaria ... you could always use two Dosators for tanks with a volume of up to 600 liters (160 US gal).

CHILDREN'S AQUARIA



Children love water

Water has an attractive fascination for children, which most of us have also experienced ourselves. Playing with friends on the beach is wonderfully enjoyable and usually wet. We have all happily risked the consequences of our mothers chastising us for our muddy clothes.

For many children, the aquarium bug starts at home when their parents have a large aquarium in the living room. A visit to the zoo or a botanical garden is also sometimes the experience that sparks this new hobby.

But children often see an aquarium differently from adults. A good combination of taking responsibility for the living beings in the aquarium, its functionality and an individual design with decorative objects make an aquarium a true experience of nature in a child's bedroom.





Colourful aquarium inhabitants

Children like it colourful! From the aquarium gravel to ridescent decorative figures and brightly coloured fish. In the smaller Nano Cubes, colourful shrimps, crayfish and snails play the main role. Small nano fish may also be used.

The most popular fish for children's aquaria are probably guppies and platys. They come in all possible varieties and colours. The absolute minimum volume for platys is 60 L, to ensure optimum husbandry for healthy fish.



Let there be light!

Render your underwater world more beautiful with the right light



For photosynthesis, for health and good growth, plants need light. Without light, there is no life!

What exactly is light?

Light is composed of electromagnetic waves. We see each wavelength as a separate color. With the help of a prism you can subdivide daylight into its spectral colors — just like a rainbow. Visible light starts with the blue spectrum and ends with red. Blue light consists of short waves and is the highest in energy, and it goes down the farthest in water. There is almost no red light even at shallow depths.

“Which kind of light do plants need?”

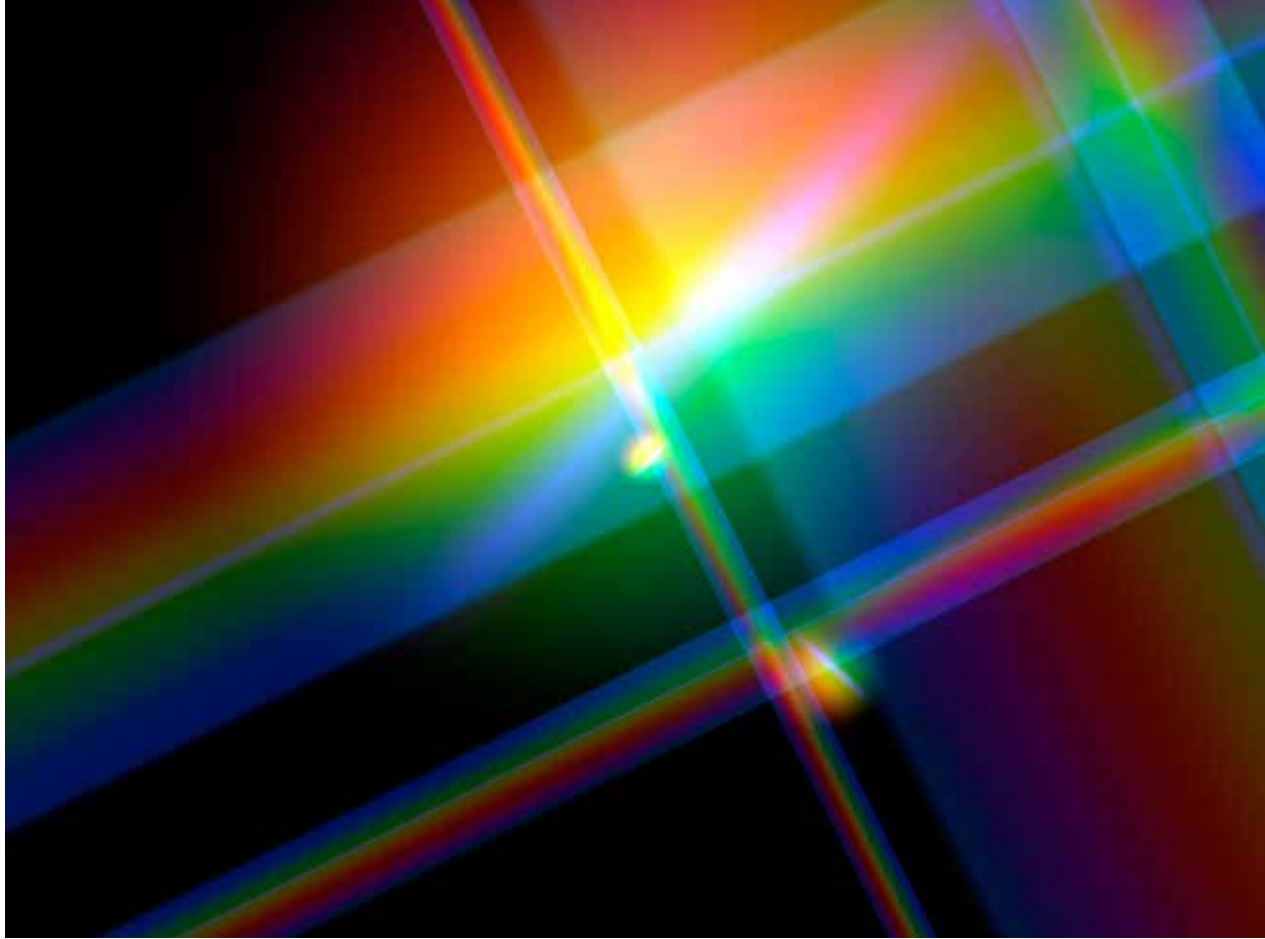

Light can consist of very different wavelengths. White light is always a mixture, and its composition may vary considerably. A plant “perceives” light very differently.

The crucial factors for plant growth are the light spectrum, the amount of light and of course the length of the illumination time. Plants can only use those parts of the spectrum that they can absorb and turn into chemical energy — for doing so, they need chlorophyll and other color pigments like carotenoids and xanthophylls. Plants cannot make use of green light, which they reflect — which is the reason why most plants look green for our eyes. The light plants can make the best use of is blue and red. Light does not only influence plant growth, but also seed germination, the plants’ growth habit, the length of its internodes, the color and shape

of its leaves, budding and flowering and seed maturation. This is also true for aquarium plants — their appearance and growth habits are influenced by the light spectrum. Under low light, many plants tend to grow out long internodes so they reach the water surface faster, where they have access to more light. These plants often look straggly and weak. Under strong lights, however, the internodes are short, and the plant looks strong, healthy and compact.

If you exchange one or all of your fluorescent tubes or replace them with an LED light, the light spectrum may change. Then the plants need to adapt the pigments in their tissue that they use for photosynthesis to the new conditions so they can make full use of the new light. This may take days or even a few weeks. During this time, plant growth may

stagnate even though the new lamp seems brighter to your eyes.

Many standard aquarium lamps and lights are built with two things in mind: (a) low cost and (b) light that looks good for human eyes. The effect the light has on plant growth often remains unregarded. Imbalanced spectra do not promote photosynthesis actively, which may result in weak plant growth and usually in algae problems.

In contrast to these, Dennerle’s Trocal fluorescent lamps and LED lights are optimized for maximum plant growth and still enhance the appearance of the aquarium.



Which light do fish and invertebrates prefer?

Most fish and invertebrates prefer dim light. In a darker environment they feel safer as potential predators cannot see them as well. Under very bright light they tend to display stress colors, which are usually weaker. If the light is somewhat dimmed, their color intensity improves. This is where plants come into play: Floating plants, for example, cover a part of the water surface and shade the aquarium off a bit. High-growing stem plants in the background of the tank provide the animals therein with natural hiding-spots. A regular rhythm of light and dark phases is crucial so the internal clock of the fish and inverts stays tuned. The light color is unimportant, however, all the animals in the tank depend on healthy, strong plants that are able to fulfill their job: producing oxygen and reducing the organic waste in the water — and they depend on the right light to do so efficiently.

Algae prevention with light?

In most freshwater systems, algae play an important part in maintaining the ecological balance, and they are a healthy addition to the diet of aquatic animals. Many fish and invertebrates are known to snack on the algae carpet or eat the tiny organisms that live in the algae films. Therefore we do not aim to keep our tanks free from algae — we aim to prevent them from taking over. An important factor in this constant struggle is the right light.

It is a basic fact that plants and algae compete against each other for light, space and nutrients. Well-lit aquatic plants that can draw upon an ample nutrient supply will grow vigorously and will give the algae a hard time growing.

Many algae species make use of the energy-rich blue light spectrum and of ultraviolet light as well.

If you remove some of the blue light waves and do away with the UV portion in your aquarium light, the plants will hardly know the difference, but you will withhold the algae's favorite light and thus inhibit their development — less light, less growth!

Throughout many tests we finally found a light spectrum that promotes plant growth and inhibits algae at the same time. We cover those

***Algae** belong to the most ancient inhabitants of planet Earth. The first blue-green algae existed as early as 3.5 billion (3.500.000.000) years ago, with green and red algae developing somewhat later on. Much later still, the higher plants (to which our aquarium plants belong) evolved from them.*

lamps whose spectrum contains a certain amount of UV-A light with a special foil for UV protection that filters out the entire spectrum below 400 nm. This has another advantage: The UV protection foil serves as a protection against splinters, too. Should a lamp break, no shards will fall into your tank. The Trocal LED lamps for freshwater tanks do not emit any UV radiation at all.

How much light do I need for my aquarium?

The light intensity you require for your tank depends not only on the size of the aquarium, but also on the plants. A simplified rule of thumb for the average planted tank is: (a) with fluorescent lamps: 0.5 watts per liter of aquarium water (b) with the Dennerle Trocal LED lamps: 0.25 watts per liter. Increase the intensity for heavily planted tanks and for plants that prefer a well-lit environment, reduce somewhat for sparsely planted tanks and for plants that come from a shaded environment. If your aquarium has just been set up, increase the light quantity bit by bit. New plants cannot use the full amount of light for photosynthesis, they need to adapt to their new environment first.

During the first week it is recommendable to only use 50 % of the light intensity, during the second week you can go to around 70 %, during the third week you can increase to 85 %. After three weeks you can finally use the full light intensity of 100 %.

If possible, use lamps with separate switches to achieve this kind of increase. If you do not have a sufficiently large number of lamps above your tank, you can alternatively simply increase the time the lights are turned on. The Dennerle LED-Control light control unit is ideal for adjusting the light quantity emitted by Trocal LED lamps.



We recommend to light well-cycled tanks for 10 hours a day. During our many experiments we have found that switching the light off for two to three hours after it was on for around five hours is very beneficial for plant growth.

And remember — vigorous, healthy plants that grow well are a strong antagonist of the algae in the tank.

For the plants, photosynthesis is hard work! For this reason, plants respond very well to a lighting pause around midday. During this pause, their metabolism can regenerate, and potentially harmful waste products like reactive oxygen species (ROS) can be rendered harmless. In the tropics, you often have dark skies around noon, as thundery showers are typical during this time of day.

Please note: If you have a CO₂ supply system with a night shut-off valve, just connect it to the clock timer you use to switch your lights on and off. Plants will only use CO₂ when the sun is shining.

T8, T5 or LED?

Fluorescent tubes are a time-tested way to light aquaria. Your focus ought to be on a long useful life and brilliant colors. This is guaranteed with lamps that use the three-band technology. The UV radiation, which would unnecessarily promote algal growth, should be filtered out.

T8 tubes have a diameter of $\frac{5}{8}$ inches, or 25.4 mm. They come at relatively low prices and are great for aquaria with a somewhat lower light demand. The technology of the T5 tube is more modern. They have a diameter of $\frac{5}{8}$ inches, or 16 mm, and they emit more intense light than T8 tubes of the same length. They are ideal for deeper aquaria and for tanks with plants that require brighter light.

With the Trocal LED series, Dennerle has added high-performing LED lamps to its product range that are true pacemakers when it comes to energy efficiency. For example, one Trocal LED lamp with 24 watts is as powerful as two T5 fluorescent tubes with 24 watts — which saves 50 % electricity. This is great news for the environment and your wallet! All these lamps were developed to emit the ideal light wave mix for photosynthesis and for maximum plant growth. Thanks to their excellent color-rendition properties, all your aquarium pets and plants will show brilliant, natural colors. High-end CREE®-LEDs and an elaborate temperature management are the guarantee for a long useful life. Each lamp comes with two light colors: 4,000 K warm white and 6,500 K cold white, which can be controlled separately with the light computer LED-Control. This enables you to create naturalistic sunrises and sunsets and a change of light color as the day goes by, a lighting pause at noon and even lunar phase simulations.

For the highly from 10 to Dennerle compact Nano and Style

popular Nano Cubes 60 l (2.6 to 16 US gal), has developed the high-intensity Power LED lamp the new Nano LED lamps.



Please note when using fluorescent lamps

A good reflector like the Trocal Power Reflect can more than double the amount of light that is reflected downwards. If your tank is equipped with several fluorescent tubes, only add one reflector at a time — ideally, you start in the back, where the plants normally grow most densely. After two weeks, add the next reflector, and so on, until all your fluorescent tubes are equipped with a reflector. This gives the plants time to adapt to the new, higher amount of light they are supplied with. More light automatically means more growth, and the plants therefore require more nutrients, too — so please make sure to increase your fertilization regimen and the amount of CO₂ you add to your tank correspondingly.

CO₂

The stuff plants are made of

Carbon dioxide for a stable aquarium ecosystem

Besides light, aquatic plants need nutrients: nitrogen, potassium, phosphate, trace elements and — very importantly — carbon. Without carbon, plants cannot generate energy. During photosynthesis, which is the most important step in planet Earth's metabolism, the plants use sunlight to turn carbon dioxide and water into sugar as a form of storing energy. For doing so, aquatic plants fully rely on the CO₂ dissolved in the water. In natural waters, the carbon dioxide content is usually very high. In the closed system of an aquarium, CO₂ is often deficient. A clear sign for this are weakly-growing plants.

Strong, vigorous, intensely colored plants do not only look nice, they also help keep the algae in check. Well-growing plants use up the nutrients faster than the algae and take away their biological niche. Aquarium animals and the filter bacteria benefit from the oxygen the plants produce when photosynthesizing, and with their roots, healthy plants create a special microclimate in the substrate, preventing oxygen-deprived rotting zones from forming in the first place. A well-running tank can be easily identified as the plants inside grow healthily — when the plants do well, the entire ecosystem does well. The incredibly attractive impression of a stable, healthy aquarium is hard to achieve without the addition of CO₂.



Carbon is one of the most important nutrients for our aquatic plants. Without carbon, they cannot photosynthesize to generate energy. During this most important step in planet Earth's metabolism, carbon dioxide and water are turned into sugar as a form of storing energy. This is done with the help of sunlight. Terrestrial plants do not have problems taking up sufficient amounts of CO_2 , as the CO_2 concentration in the air is sufficiently high. Aquatic plants, however, need to fully rely on the CO_2 dissolved in the water, which is practically almost always deficient in artificial systems. Carbon is the most important building block for the tissue of terrestrial as well as aquatic plants.

For a well-functioning ecosystem inside an aquarium with healthy, beautiful plants, fish and invertebrates, a good carbon supply is crucial. Light, CO_2 and nutrients need to be present in the right ratio, though. If you only add more of one of these elements, you will most probably not get good results but merely cause an increase the population of pest algae: Algae are much better at utilizing surplus nutrients than the more highly developed plants in an aquarium.

If we add a CO_2 injection system to our aquarium setup we need to make sure that the plants get sufficient light and that the necessary nutrients and trace elements are added to the substrate and the water.

How much CO_2 is necessary?

It's all in the dosage: Too high a CO_2 content may cause the pH to drop too much. Moreover, plants can only use CO_2 for photosynthesis when there is light, which may have unpleasant consequences for the aquarium animals especially in the morning hours. Their breathing is inhibited by a high CO_2 content of the water, they cannot get rid of the CO_2 in their blood any more — in extreme cases this may even lead to suffocation. For this reason we adamantly warn of lowering the pH with the addition of CO_2 , which is unfortunately still recommended quite frequently.

CO₂ knowledge

Biogenic decalcification

Nature knows no boundaries, and of course, aquatic plants have devised a backup plan just in case the CO₂ levels of the water are too low. If the CO₂ dissolved in the water is insufficient, many plants can break down calcium bicarbonates to gain access to the carbon stored therein. This process, known as „biogenic decalcification“, can be



seen very well in some natural habitats. On the upper side of the leaves, a grayish white, grainy calcium deposit will form. Biogenic decalcification can also be observed in an aquarium if the carbon originating from the respiration of fish, invertebrates, plants and microorganisms is used up. Then the function of the carbonate hardness as the most important acid buffer is compromised, and the pH may drop steeply and become unstable.

How does the CO₂ get into rivers and lakes?

In natural systems, the number of aquatic plants can be much higher than in our aquaria, and you never see a CO₂ injection system installed on a river or a lakeshore, and no one doses liquid carbon sources either. How does Mother Nature handle the CO₂ supply? Aerial CO₂ dissolves in the water on the water surface, and in the course of all the respiratory processes of fish, invertebrates, microorganisms and aquatic plants, CO₂ is produced.

Water poor in oxygen and rich in **carbon dioxide enters natural** systems from subterranean seepage springs, and wherever those occur, the content of dissolved CO₂ is elevated. When did you last walk into a natural waterbody? In many natural waters, the bottom is covered with a layer of mud consisting of dead plant parts, dead tree leaves and so on. Some of us humans think this mud layer is pretty yucky when it oozes out between our toes ... but bacteria and other microorganisms just love this part of the substrate. They produce a lot of CO₂ when **digesting organic matter**.



CO₂-supply

“How to bring carbon dioxide into an aquarium.”

01



„My plants are doing fine without a CO₂ injection“ or „you really don't have to follow each and every trend in the aquarium hobby“ – we've heard all this, and more. However, you have now the opportunity of trying out the effect of the addition of carbon on aquatic plants and on your aquarium as a whole, and at a very low cost thanks to the new „Carbo“ products by Dennerle. The liquid carbon contained in the [CarboElixir Bio](#) and in [CarboBooster Max](#) is easily available for aquatic plants, and you will see a significant improvement of your aquarium after only a few weeks of use. The difference between the Max and the Elixir is, that the carbon used in the CarboElixir comes from biological sources only, that it contains trace elements in addition and that – quite a bit of a sensation produced by our R&D – CarboElixir can be added to the tank with the help of a Dosator. Both Carbo products are added on a daily basis. As they do not contain free carbon dioxide, your permanent CO₂ test will not read correctly.

02



01 During the trial stage we were able to see that the CarboBooster Max had a greater effect on aquaria that were prone to algal growth than the closely related CarboElixir Bio.

02 Everything's working just fine! Intense lighting, fertilization with trace elements and a good CO₂ supply induce aquatic plants to produce large amounts of oxygen.

Gaseous CO₂



03

03 Low demand: tank with lid, small surface-to-volume ratio, low light, low fertilizer dosage, low number of animals, unheated tank at room temperature, low number of plants, slow-running filter, not much water movement, no additional aeration



04

04 Besides bio CO₂: there are CO₂ injection systems with disposable and recyclable pressurized gas cylinders. In these cylinders, liquid CO₂ is kept under a relatively high pressure. For this reason, you need a pressure reducer for dosing the carbon dioxide. Always keep pressurized gas cylinders in an upright position. The CO₂ they contain is liquid in the lower part of the cylinder and gaseous in the upper part. As the CO₂ evaporates, temperatures fall considerably due to evaporative heat loss. If the cylinder lies on its side the valves may freeze, which would lead to an uncontrollable CO₂ escape.

**“Bubble counter
is not a derogative
term”**

The pressure reducer is decisive for the reliability and the consistency of the CO₂ system and how easily you can adjust the CO₂ dosage — the so-called bubble count. The pressure reducer needs to lower the pressure inside the bottle, which is around 60 bar, in a way that allows us to supply 5 — 60 bubbles per minute to our aquarium. The pressure reducer is connected to a special CO₂-tight hose. Too much CO₂ would diffuse through the walls of standard silicone hoses and PVC air hoses, they are not suitable for this purpose! Shortly after the pressure reducer you insert a special CO₂ check valve into the hose to prevent aquarium water from entering the pressure reducer or the CO₂ cylinder.

Factors that influence the amount of CO₂ a biological system needs:

High demand: open-topped tank, large surface-to-volume ratio, intense light, high amount of fertilizer, a large number of animals, higher temperatures, many plants, a fast-running filter, strong water movement, additional aeration

Low demand: tank with lid, small surface-to-volume ratio, low light, low fertilizer dosage, low number of animals, unheated tank at room temperature, low number of plants, slow-running filter, not much water movement, no additional aeration

*“A
good
guideline
is 20 mg
CO₂ per
liter.”*

A permanent CO₂ test is a great yet very simple method of monitoring the CO₂ content of the aquarium water.



Those who still know the old needle valves, with which the bubble count was adjusted in former times, will never ever want to do without the convenience of the Dennerle pressure reducers. The large adjustment wheel allows you to fine-tune your bubble count very precisely. In order to inject the CO₂ into the aquarium you need a device that prolongs the contact time of the gas bubbles with the surrounding water to allow as much CO₂ to dissolve as possible. The most

economic method is having individual gas bubbles rise in the water in a zigzagging or spiraling course that is as long as possible. On this course the bubble shrinks, theoretically until it disappears. Practically its size does not change that much as other gases dissolved in the surrounding water enter the bubble.

High-quality CO₂ injection devices, or flippers, discharge these other gases and make sure that even the last little bit of CO₂

is dissolved. The flipper should be clearly visible from the outside of the tank so you can immediately see when something does not go as planned, and act upon it. Those who want to determine the exact amount of CO₂ that is added to their aquarium install a bubble counter on the hose near the pressure reducer.

The speedometer for the CO₂ supply — the permanent CO₂ test

A permanent CO₂ test is a great yet very simple method of monitoring the CO₂ content of the aquarium water. The test container holds a small amount of liquid pH indicator. The indicator liquid does not come into contact with the aquarium water directly but indirectly via an air bubble.

CO₂ from the aquarium water diffuses into this air bubble inside the test container and then dissolves in the indicator liquid, lowering its pH. The indicator changes its color as the pH changes. The most exact tests are those with a pre-mixed indicator liquid, like the Dennerle permanent tests. If the indicator is blue, there is not sufficient CO₂ in the water, if it is green, the CO₂ concentration is at its optimum of approximately 20 mg/l. If the indicator liquid turns yellow the CO₂ concentration in the water is too high. When adjusting the bubble count please keep in mind that it takes the liquid around 1 – 2 hours to change its color after the CO₂ concentration in the aquarium has been altered.

With a solenoid valve you can switch the CO₂ supply on and off by means of an electric switch. If the solenoid valve does not get any electrical power, the CO₂ supply is cut off — which is of great use during the night, as the plants do not use any CO₂ anyway when there is no light. It makes a lot of sense to control the solenoid valve with the same clock timer that switches your aquarium lights on and off. If you want to control the CO₂ supply of your aquarium even more precisely you may want to think about using an electronic control unit. This device uses an electrode to measure the pH in the aquarium water and adjusts the CO₂ supply accordingly. If the pre-adjusted value is exceeded the CO₂ supply is cut off with a solenoid valve. If the value falls below this value the valve is opened and CO₂ is added.

Which CO₂ system is right for me?

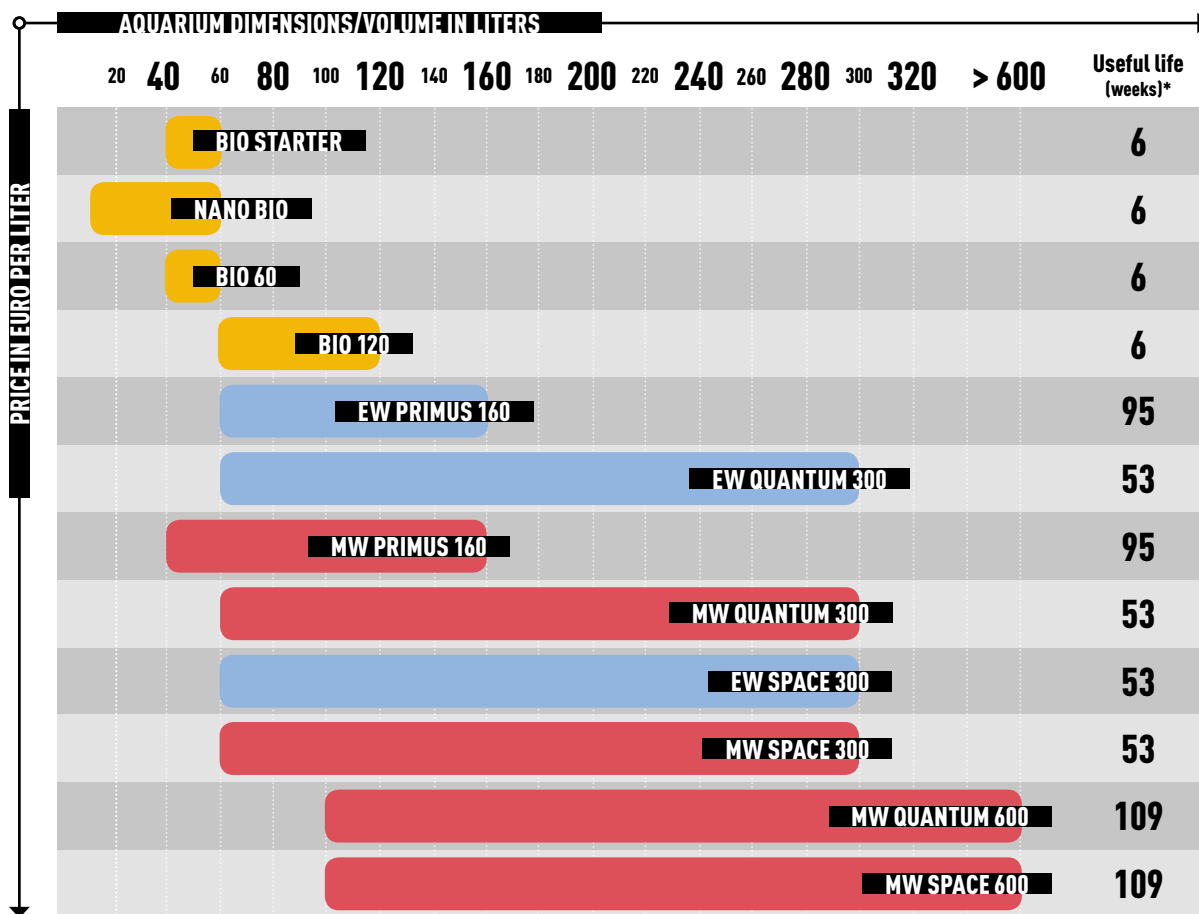

Calculated as useful life per cartridge / cylinder, with a lighting time of 10 hours / day (with night shut-off / only for pressurized systems, 10 bubbles per minute per 100 l of aquarium water.)

○ Bio CO₂
 ○ Disposable cylinder
 ○ recyclable cylinder

1985



1992



TODAY



Most frequently asked questions

How long does one CO₂ cylinder last?

Roughly spoken you may say you need 1 to 1.5 g of CO₂ per 100 liters (26 gal) of aquarium water per day. A cylinder with 500 g on a tank with 100 l (26 US gal) will last 333 to 500 days.

How can you determine how much CO₂ a cylinder in use contains?

The cylinder pressure taken at the manometer on the pressure reducer does not say much about the actual amount of CO₂ inside the cylinder. The largest part of the CO₂ contained in there is liquid. Above it, there is a layer of gas that accounts for the actual pressure. Thus the manometer will show a pressure of approximately 60 bar at 20 °C (68 °F). If you take out gas, some liquid CO₂ will turn gaseous at once: The cylinder pressure remains at a constant 60 bar (at 20 °C or 68 °F) as long as there is still liquid CO₂ inside. When the last drop of liquid CO₂ has evaporated and CO₂ is still taken out, the bottle pressure will drop. Therefore you can only determine the exact amount of CO₂ that's still left inside your cylinder by weighing it. The weight of the empty cylinder (tare) is indicated on all one-way or refillable cylinders.

Why does the tank water enter CO₂ hoses?

If you interrupt the CO₂ supply, the gas in the hose keeps dissolving in the water, creating negative pressure in the hose. Water from the aquarium is sucked in. Water may creep up the hose and reach the solenoid valve you possibly use for switching off your CO₂ supply overnight, and destroy it. For this reason, it is highly important to mount a check valve suitable for the use in CO₂ hoses before the solenoid valve or the pressure reducer to prevent this. Check valves for air that are used with air pumps are not suitable!

Can the injection of CO₂ prevent algae?

CO₂ fertilization is an indirect algae inhibitor as it furthers the growth of higher plants very effectively. Thus the plants will use up more nutrients and be able to compete efficiently against the algae. As a general rule you can say that you will see a considerable reduction of the algae growing in your tank after a few weeks of CO₂ fertilization. When you install your CO₂ system it is recommendable to add some fast-growing stem plants, too.

Can I switch between disposable and refillable CO₂ cylinders?

Unfortunately, the threads on disposable and refillable CO₂ cylinders are different, however, there are adapters that can be screwed into the pressure reducer very easily if you want to switch to another system.

How long will my plants take to respond to the addition of CO₂?

CO₂ is the most vital plant nutrient. If you had enough light over your tank and added sufficient amounts of fertilizer up to now but no CO₂, the low level of CO₂ in the water was the limiting factor for plant growth. Add CO₂ now, and you'll see a growth spurt in your plants. You will notice the effect of CO₂ in the shoot tips of the stem plants first.

Can CO₂ harm my fish?

CO₂ is a metabolic product that fish and other aquatic animals discharge through their gills. At a low concentration, CO₂ is harmless as a rule. However, if the CO₂ content of the water is very high, your tank inhabitants will have a hard time breathing out CO₂ as it does not dissolve readily in the water any more, and their breathing rate will increase dramatically. A CO₂ level of approximately 20 mg/l has proven to be a good compromise. The plants grow excellently, and this concentration is harmless for fish and invertebrates.

Can I use CO₂ to achieve a certain pH?

The more CO₂ dissolves in water, the lower the pH will fall. However, to protect the animals in your tank from harm your CO₂ content never ought to be over 20 mg/l. Therefore, there are limitations to using CO₂ to lower the pH.



Algae

*Thanks to algae, planet Earth
has an atmosphere.*



The subject of algae growth might be the most frequently discussed topic in the aquarium hobby ...

... and one thing is sure: Algae and aquarium keepers will never be true friends. Often our beautiful hobby meets its untimely end even before it has really taken off. In many cases, the culprit is an excess of algae that does not seem to let up. The bad news are: There is not one single aquarium that runs completely without algae! Algae are natural inhabitants of all the different waterbodies of the Earth, and they also come into our aquaria in our homes quite naturally. Many algae reproduce through spores that may be introduced with the tap water or even come through the air.

Algae play an important role in the aquarium, they stabilize the system and — just like higher plants — they keep the biological cycles running. And yet, algae carpets are not something the average aquarium keeper or aquascaper wants to see in their beautiful underwater landscapes.

**“The arm of the Plantahunter with
some stonewort.
Sounds hard, but
it’s really
called that.”**



What exactly are algae?

Algae were the first organisms on our planet to produce energy from sunlight. These so-called blue-green algae were the reason our oxygen atmosphere came into being. The algae evolved, and now we have hundreds of thousands of different algae species. Today they still are responsible for 40% of the oxygen produced on our planet. Without algae, higher plants as we know them today could not have developed. The green leaf color — the

chlorophyll — goes back to blue-green algae migrating into the tissue of the very early plants. Algae fixate nutrients, they are an important food for different animals and they produce oxygen when they photosynthesize. In our aquaria, algae are direct competitors of the aquatic plants we cultivate, a competition that can also be observed in nature. During our Plantahunter tours we have seen and documented this phenomenon time and again: in nutrient-rich seepages low in oxygen and with

a high content of carbon dioxide, true aquatic plants and marsh plants are at their optimum. In areas with a high oxygen content, trace elements are often oxidized and precipitate, and carbon dioxide is low. Here algae do much better than higher plants.

“Graceful beauties”

Algae are ugly — this is a statement you will often hear from aquarium hobbyists. That it is not always true is a fact we have realized during our Plantahunter tours.

The world of stoneworts is multifaceted and very interesting. These algae look more like a flowering plant, and you can easily mistake them for the more well-known hornwort *Ceratophyllum*. No wonder — some botanists assume that stoneworts are the direct ancestors of our modern terrestrial plants. The genus *Chara*, which is the botanical name of the stoneworts, can be found on every continent. There are several different species in Europe, even in Germany. There is one thing they all have in common — they like waters with low levels of nutrients and, as a rule, with a high lime content. As many waterbodies are more and more polluted with organic waste, most *Chara* species are found on the Red List of Endangered Species.



Wherever you see stoneworts you may safely assume that the environment is still intact. During our Plantahunter tour to Brazil we found this gracefully beautiful algae for the first time, and only one year later we met it again during our tour on the island of Sulawesi. The multitude of *Chara* forms in the Malili Lake System was absolutely stunning and fascinated us deeply.

What is the best remedy against algae?

The answer is relatively easy if you know how things work in nature. A low level of organic pollution, well-growing, healthy plants and a number of fish that is neither too high nor too low for the tank: These things make life easier for the plants and more difficult for the algae. The aquarium keeper has a vital task — fertilization. Creating a competition against the algae by having healthy, well-growing plants is really the best remedy and the easiest way of fighting algae. Carbon dioxide fertilization is primary. A CO₂ injection system or liquid carbon sources like Carbo Booster Max or Carbo Elixir Bio provide the plants with everything they need to grow and to consume nutrients that would otherwise feed the algae. In our experience, an aquarium with a good carbon supply runs much more stably than an aquarium without the addition of CO₂. Our new product Carbo Booster Max has proven to be highly efficient. It boosts plant growth at such a high degree that it is even possible to render an aquarium almost algae-free. No matter whether we used Carbo Booster Max as only carbon source or in addition to a CO₂ injection system during our tests, it always proved its potential of significantly reducing the algae.

However, the supply of the other main nutrients and trace elements is also crucial if you want well-growing plants — either with a nutritious undergravel medium or with liquid fertilizer, or both. Ideally we proceed as nature does: With the Dennerle Dosator, minute doses of fertilizer (V30, S7) are added all day long. Many aquarium hobbyists have told us about their success with this method via our customer service or at our booth at exhibitions. Of course, the lighting, the plants and the animals in the tank need to be in sync with the fertilizer regime. Intense light, slow-growing plants and lots of nutrients are a combination that give the algae a huge advantage, and they will spread explosively. A frequent water change of around 30% every week or every two weeks is also a good way to keep the algae in check as you remove pollutants and add fresh nutrients for the plants.

The best algae prevention is a relatively low stock of fish, which at the same time means that less food is added to the biological system. The kind of food you choose for the animals you keep in your aquarium can also have a significant effect on the growth of algae. High-quality natural foods can help reduce the algae population, as our tests with our own food range show. We refrain from using fillers, cheap fishmeal and preservatives, and our food goes exactly where it should:

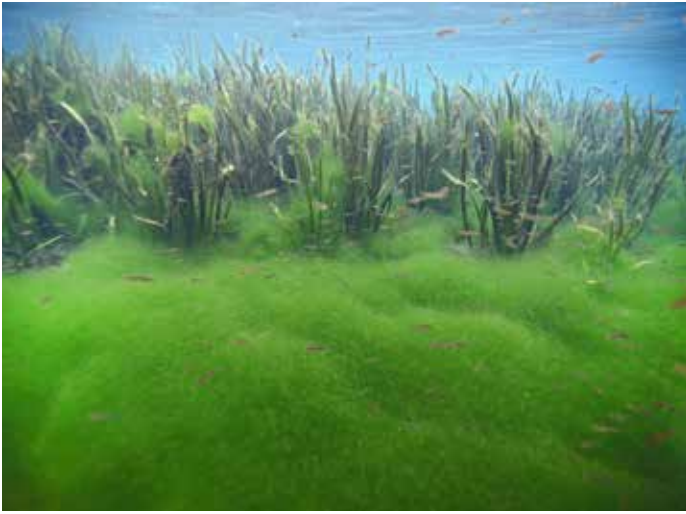

to the bodies of the fish and not as excretion into the water. With our foods you can feed your fish with the most natural food today's knowledge and production technology can provide. The intensity of the light and the duration of your lights-on period also have a great influence on plant growth. The lights should not be on for over 10 hours, as in longer periods of lighting time the photosynthesizing systems of the plants may go inactive or even suffer damage. Switching the lights off for 3 — 4 hours around noon has proven quite effective too, as the plants can use this pause to regenerate their photosynthesizing system.

Algae eaters

Try to refrain from using algicides as they only cure the symptoms and do not tackle the root of the problem. In general they also harm the higher plants. It is much better to use algae-eating fish, shrimp and snails — given that the aquarium is of an appropriate size and that the water parameters correspond to the requirements of the inhabitants. *Otocinclus* catfish like the dwarf oto *Otocinclus vittatus* are great algae eaters.

Most livebearers like guppies, platies and black mollies also love eating algae, but some of the most efficient algae eaters is the Amano shrimp *Caridina multidentata*. Even a small group works miracles and, for this reason, they are found in almost every aquascaping tank. They graze on the substrate, rocks and driftwood, feeding on algae, biofilms and detritus. Snails like the zebra nerite or the sun snail are the perfect glass cleaners thanks to their rasping tongues, but they will also rid rocks and driftwood from algae growth.

Green weapons against algae

When we set up a new aquarium we have a great choice: There are over 200 aquarium plant species of all forms and many colors that grow in the Dennerle greenhouses. Two of them even have a great potential as algae killers:

Hornwort

We never set up any tank without hornwort (*Ceratophyllum demersum*), whose name derives from the hard (horn-like) structure of its leaves. The great advantage of this plant is that it can be kept as floating plant and that it will start consuming surplus nutrients immediately. The other plants are able to take root without having to compete against the algae. Later on they will take over and provide for a biological balance in the aquarium. When the hornwort has done its job you simply take it out of the tank and keep it in a large glass vase — a beautiful decoration for every room!

Marimo balls

They are also called moss balls ... maybe people didn't want to use the name „algae balls“, even though it would have been correct, since these hollow fuzzy balls are in fact formed by green algae of the genus *Aegagropila*. In their center there are microorganisms that break down nitrates, thus taking away nutrients from the algae.

RECOMMENDED PRODUCT!

“For algae prevention”



Carbo Elixir Bio

Carbon fertilizer based on natural raw materials, with vital plant nutrients

Nano Carbo Elixir Bio

Carbon fertilizer based on natural raw materials, for nano tanks

Carbo Booster Max

Active carbon for increased plant growth

The types of algae

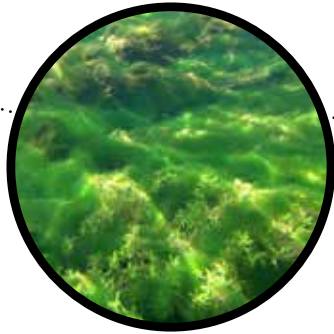

◦ Blue-green algae

Blue-green algae, aka BGA or cyanobacteria, are often found in aquaria. They are the most ancient algae — in fact, they aren't algae at all but are counted among the bacteria as they do not have a true cell nucleus. BGA grow fast, forming a blue-green layer on the substrate, rocks and driftwood. In the case of a BGA infestation a light-out over 5 — 6 days helps. No light may enter the aquarium during this time: Use a piece of cloth or cardboard to shade it off completely. After that, change 50 % of the water three days in a row. Blue-green algae can produce poisons, which makes these large water changes so important.



◦ Green algae

Green algae are quite comparable to higher plants when you look at their metabolism and their structure. Small green spots on the glass and on leaves of slow-growing plants like Anubias belong to the green algae, as do algae with long filamentous structures or algae that grow in cushions.



◦ Red algae

There are two highly unpopular kinds of red algae, which respond very well to the anti-algal measures we give in the text: Beard algae and staghorn algae prefer an environment with little CO₂, and they like growing in places with a stronger current. If more CO₂ is present in the water, red algae will incorporate less lime into their cellular structures, and algae eaters will eat them better.

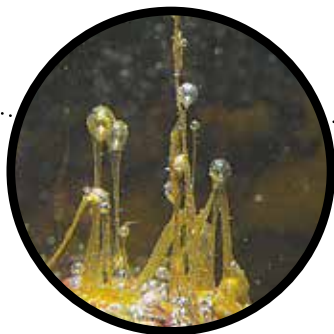

◦ Diatoms

Diatoms form a brown layer on rocks, driftwood and other decorative materials. Fast-growing plants and the rasping mouths of snails or Otocinclus catfish reduce diatoms efficiently. Usually these algae appear during the cycling phase of a tank and disappear all by themselves after a few weeks.



Aquarium Mythbuster

Mythos 01 Nature Aquaria à la Amano and aquascapes as a whole only have a very limited time of life.

Why shouldn't an aquascape be kept for a longer period of time? With the right maintenance, in-time trimming and truly suitable fertilizers and water conditioners this is really nothing so special. It is important not to solely trust in the soil substrate as nutrient supply but to use liquid fertilizers that are added to the water as the nutrients in the soil will at some point in time be used up. If stem plants become unsightly after some time, cut off the still beautiful top shoots, remove the old plants with the roots and stick the top shoots into the substrate. They will sprout roots very quickly.

Throughout the aquarium hobby you'll hear many myths and pieces of "wisdom".

***Mythos 02* Using water from a cycled tank will shorten the cycling time of a new aquarium.**

This is definitely wrong, as the nitrifying bacteria that break down organic waste in the water are substrate-bound, living in the gravel, on decorative materials, plants and in the filter media. Everywhere but the water column. To inoculate a new aquarium, use a gravel cleaner to siphon off some muck from the substrate and put it into the new tank or take a used filter sponge and squeeze it slightly in the new aquarium — but don't overdo it, you do not want to cover your new plants in deep muck, after all. If you want to make absolutely sure that you have the full spectrum of beneficial bacteria in your new tank, use a bacteria starter like Bacto Elixier Bio. In any case, a newly set-up tank should be allowed to cycle for at least two weeks before you start adding animals — this is for the best of the future inhabitants (and your wallet). Add a little food during the cycling period to give the bacteria something to do.

***Mythos 03* Fish will adapt their body size to the size of the tank.**

If only it were true! Apparently, some fish dealers still tell their customers that the fish they are buying will adapt their body size to the size of their tank. But if I take a young angelfish with a size of 3 — 4 cm (1.2 — 1.5 inches), which grows to a total height of 25 cm (almost 10 inches) in nature, and put it into a tank with a height of only 30 cm (12 inches), will it really stay that small over the years? Hardly! Too small a tank may, however, lead to crooked growth and shorten the life of a fish dramatically — this should not be confused with adaptation, though, that would sound far too nice for such a gruesome fate.

***Mythos 04* Aquarium maintenance takes much time and effort.**

Of course it always depends on how large your tank is and what you want to do with it, but as a rule of thumb you will need half an hour to an hour per month for your basic maintenance work like changing some of the water every week or every fortnight and cutting back the plants time and again. Not included are the quick jobs like feeding and watching the fish or adding fertilizer. Larger tanks, aquaria with high-bred shrimp or aquascapes need a bit more work, though. If you choose your stock wisely you can let them do a lot of work for you. Algae-eating snails will clean your glass, for example, shrimp will eat leftover food, and a large plant population will help you keep the water clean. The little bit of extra work you have with a proper fertilizing regime will be more than made up by the fact that you won't have to throw out dying plants all the time and re-plant your aquarium.

***Mythos 05* Snails are a pest and will kill off your plants.**

Nope. The most popular aquarium snails do not eat plants, as their rasping tongue is much too soft to break down healthy plant tissue. The snail population will only explode if they find a lot of food in the aquarium. Their reproductive rates really kick off when they have an all-you-can-eat buffet, which can on the one hand be created by overfeeding. On the other hand, however, poorly fed plants may be the indirect reason for too many snails. Weak, dwindling plants are no competition for the algae, and many aquarium snails just love eating algae films, or eating dead plant matter. Thus, if the plants die off altogether the snails find very much food, too.

***Mythos 06* Worms in the aquarium are always harmful.**

Only too often you can hear the alarm call „Planarian!“ as soon as you can see something crawling on the aquarium glass that's longer than wide. Here we'd like to give you the all-clear. Most aquatic worms are, in fact, harmless and even useful as they eat leftover food and dig in the substrate, thus preventing it from compacting. Thanks to their burrowing activities, oxygen-rich water is brought to the plant roots, together with nutrients. The True Planarians are predatory. You can identify them quite easily as many of them have a arrow-tip shaped head, two visible eye spots and a Y-shaped intestine that ends in a light-colored oblong spot in their body center, their pharynx.

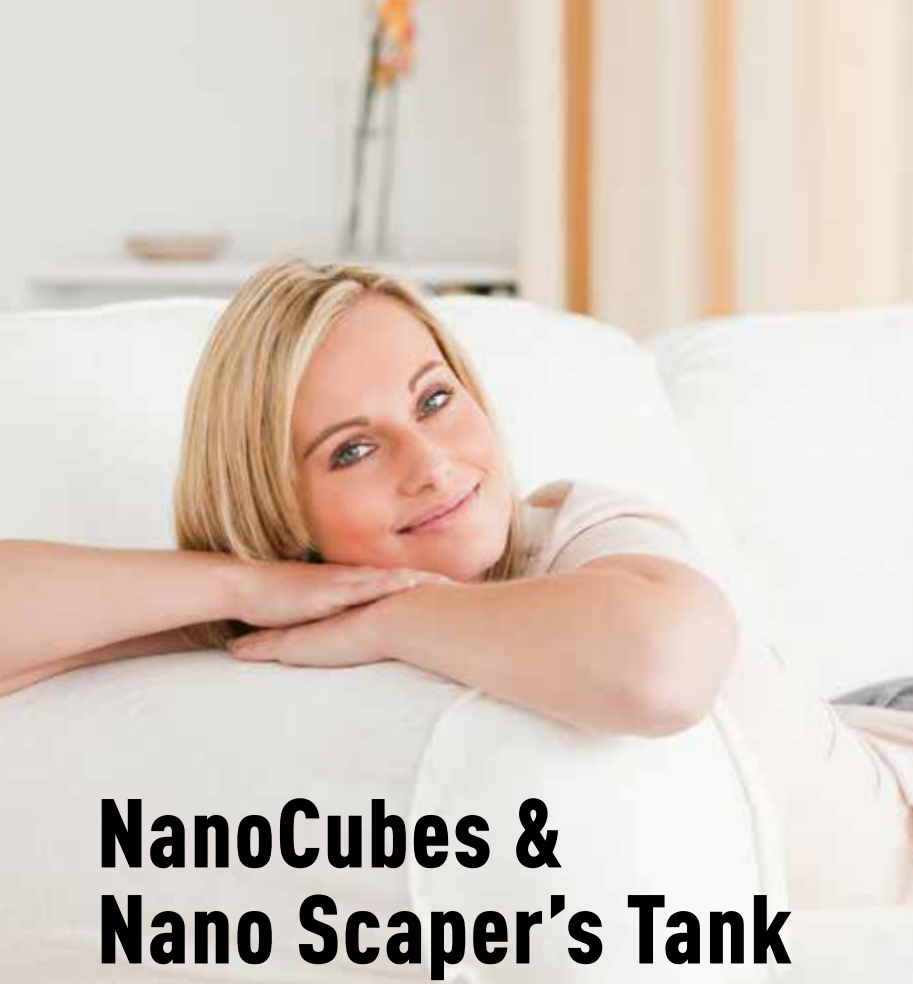

NanoCubes & Nano Scaper's Tank

Small, easy to care for and simply beautiful: With the NanoCubes and Nano Scaper's Tanks you can create whole miniature worlds under water, in which invertebrates and aquatic plants live together in tiny amounts of water, with as little maintenance as possible. The aquaria have a special depth effect due to the panoramic front glass with curved front corners.

The sets contain a glass cover, a thermometer, a backsheet (NanoCubes), a low-noise filter and a safety pad made of sponge rubber. When it comes to lighting, you can choose between the 5.0 Power LED enclosed in the NanoCube set with soil, or the new Style LED available with three different wattages. Perfect for beginning nano aquarium keepers: The complete sets enable you to set up your very own natural aquarium and to create breathtaking underwater landscapes. The filters these sets contain are low-noise and make the water crystal clear. Besides technical equipment like lighting and a filter, the Complete Sets contain Nano DeponitMix, a care set and black shrimp gravel. All you need is water, rocks and driftwood as decoration, and plants.



Nano Scaper's Tank 35 liters

CLICK HERE



Nano Scaper's Tank 55 liters

Name	Volume	Dimensions	ID No.	MSRP	Nano Corner Filter	Nano Corner Filter XL	Nano Style LED L	Nano Power LED 5.0 W
Nano Scaper's Tank	35 litres	40 x 32 x 28 cm	5591	65.99 €				
Nano Scaper's Tank	55 litres	45 x 36 x 34 cm	5593	79.99 €				
Nano Scaper's Tank Basic LED 5.0	35 litres	40 x 32 x 28 cm	5592	149.99 €	x			x
Nano Scaper's Tank Basic Style LED	55 litres	45 x 36 x 34 cm	5594	194.99 €		x	x	
Cover plate for Scaper's Tank	35 litres	38 x 30 ccm	5610	13.79 €				
Cover plate for Scaper's Tank	55 litres	43 x 44 cm	5611	13.79 €				

Nano Scaper's Tank

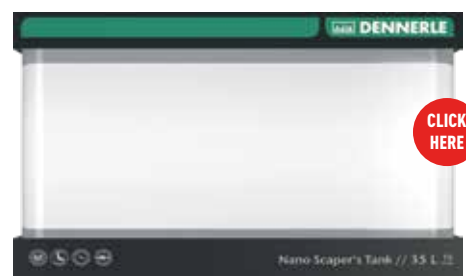

CLICK HERE

*Manufacturer's suggested retail price, please ask your specialist dealer for the exact final price.



CLICK
HERE

NanoCube with Style LED



CLICK
HERE

NanoCube with LED 5.0 und Soil



CLICK
HERE

NanoCube Complete

NanoCube

Name	Volume	Dimensions	ID No.	MSRP	Nano Corner Filter	Nano Corner Filter XL	Nano Style LED S	Nano Style LED M	Nano Style LED L	Scaper's Back black	Nano Power LED 5.0W	Shrimp GravelBed Sulawesi Black	DeponitMix Nutrient Medium	Scaper's Soil 4 liters	Nano Thermometer	Sponge rubber safety pad	Glass cover
NanoCube Basic Style LED M	20 liters	25 x 25 x 30 cm	5579	114.99 €	X			X		X						X	X
NanoCube Basic Style LED M	30 liters	30 x 30 x 35 cm	5580	124.99 €	X			X		X						X	X
NanoCube Basic Style LED L	60 liters	38 x 38 x 43 cm	5581	179.99 €		X			X	X						X	X
NanoCube Complete Style LED S	10 liters	20 x 20 x 25 cm	5582	129.99 €	X		X			X		2 kg	1 kg		X	X	X
NanoCube Complete Style LED M	20 liters	25 x 25 x 30 cm	5583	139.99 €	X			X		X		4 kg	2 kg		X	X	X
NanoCube Complete Style LED M	30 liters	30 x 30 x 35 cm	5584	149.99 €	X			X		X		4 kg	2 kg		X	X	X
NanoCube Complete Style LED L	60 liters	38 x 38 x 43 cm	5585	239.99 €		X			X	X		6 kg	3 kg		X	X	X
NanoCube Complete Soil LED 5.0	20 liters	25 x 25 x 30 cm	5586	154.99 €	X					X	X			X	X	X	X
NanoCube Complete Soil LED 5.0	30 liters	30 x 30 x 35 cm	5587	164.99 €	X					X	X			X	X	X	X
NanoCube 10 liters	10 liters	20 x 20 x 25 cm	5575	34.99 €						X						X	X
NanoCube 20 liters	20 liters	25 x 25 x 30 cm	5576	42.99 €						X						X	X
NanoCube 30 liters	30 liters	30 x 30 x 35 cm	5577	48.99 €						X						X	X
NanoCube 60 liters	60 liters	38 x 38 x 43 cm	5578	74.99 €						X						X	X

The rounded corners of the glass tanks are our trademark



CLICK
HERE

Scaper's Back

Removable adhesive foil, fitting our Nano Scaper's Tanks (in the 55 liter tank, the lowermost 3 cm remain uncovered) or NanoCubes, 450 x 310 mm.

Scaper's Back – black ID No. 5792  MSRP* 8.29 €

Scaper's Back – milk ID No. 5785  MSRP* 8.29 €

*Manufacturer's suggested retail price, please ask your specialist dealer for the exact final price.

Nano Light & equipment

Nano Style-LED S / M / L

The Dennerle Nano Style LED was developed for NanoCubes with a volume of 2 – 10 liters (model S), 10 – 30 liters (model M) and 60 liters (model L, which also fits the 55 liter Scaper´s Tank very well).

Osram LEDs with a useful life of 50,000 operative hours and 6,500 K (the same color temperature as Amazon Day) provide aquarium plants with an excellent grow light and bring out the natural colors inside the aquarium.

Safe thanks to low voltage, made in Europe. Output: 100 lumens (Style S), 500 lumens (Style M) and 1,000 lumens (model L).

The arrangement of the LEDs creates shimmering sunlight effects in the aquarium.



Name	Units	For aquarium volume	Output	ID No.	MSRP*
NANO Style LED S – 3 W	1	2 – 10 liters	100 Lumens	1131	49.99 €
NANO Style LED M – 6 W	1	10 – 30 liters	500 Lumens	1132	69.99 €
NANO Style LED L – 8 W	1	30 – 60 liters	1.000 Lumens	1133	89.99 €

CLICK HERE

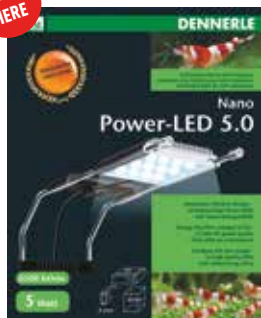

Nano Power-LED 5.0 Watts

The Nano Power LED 5.0 has a high-quality aluminium design and contains 12 brand LEDs that give off a bright, clear light with the luminous color of 6,500 K. Its special characteristics are the natural-looking sunlight effect and the good growth light for all aquatic plants. The holder can be adjusted vertically and fits on aquarium walls with a thickness of up to 5 mm.

Nano Power-LED 5.0 Watts 1 pc. ID No. 5710 MSRP* 79.99 €

CLICK HERE



Nano Amazon Day 9 Watts

Spare bulb for the attachable Nano Light.

We recommend exchanging the bulb every 12 months. Please note: will be sold as long as stocks last.

Nano Amazon Day 9 W	1 pc.	ID No. 5923	MSRP* 17.19 €
Nano Amazon Day 11 W	1 pc.	ID No. 5924	MSRP* 18.19 €



NANO BIO CO₂

CO₂ is produced through controlled and constant yeast fermentation. The depot contains a fermentation control gel and supplies aquaria with a volume of 10 – 60 liters constantly with CO₂ for over 30 days (= 300,000 CO₂ bubbles). The compact CO₂ Injector is connected to the Nano CornerFilter. With holding box for the depot and the CO₂ bubble cleaner that purifies the CO₂.

Nano BIO CO₂ 1 pc. ID No. 5692  MSRP* 15.59 €

*Manufacturer's suggested retail price, please ask your specialist dealer for the exact final price.

Nano accessories

NEW



Nano Heater Compact

[CLICK HERE](#)

The newest generation of fully electronically regulated, shatter-proof heater for aquaria from 10 to 230 litre

The proven and with 9 mm super flat heater can be easily obscured in the decoration thanks to their dark colour.

Now with led-display and one-hand operation for a secure use. The heaters adjust the desired temperature within a wide temperature range from 20 to 33 degrees of celsius.

The shatter-proof plastic housing and the entire control heater are „Made in EU“. Of course, the very durable regulators have overheating protection and are suitable for fresh and salt water.

Name	ID No.	MSRP*	Weight	Height	Width (mm)	Depth (mm)	For aquaria sizes with a desired temperature of 28 °C	For aquaria sizes with a desired temperature of 25 °C
Nano Heater Compact 25 W	5697	22.99 €	185 g	163	48	25	10 – 30 litres	10 – 40 litres
Nano Heater Compact 50 W	5698	25.29 €	185 g	163	48	25	30 – 60 litres	30 – 80 litres
Nano Heater Compact 100 W	5699	27.39 €	215 g	208	48	25	60 – 120 litres	60 – 150 litres
Nano Heater Compact 150 W	5691	37.99 €	310 g	274	48	25	90 – 180 litres	90 – 230 litres

Nano Scaper's Flow - hang-on filter



[CLICK HERE](#)

Hang-on filter for aquaria from 30 – 120 l. With a pivotable lily pipe also adjustable in height for easy adaptation to the water level, which creates a whirl that cleans the water surface. Output 360 l/h, power consumption 5.6 watts. Super silent. Easy clean system: completely removable, easy to clean. Filter media included: pre-filter sponge, high-performance biological filter medium and fine filtering pad. For a tank size of 30 – 120 liters.

Nano Scaper's Flow - Hangon-Filter 1 pc. ID No. 5790 **MSRP* 82.99 €**



Nano Scaper's Flow Tubes 1 pc. ID No. 5603 **MSRP* 8.99 €**

Nano Scaper's Flow Sponge 3 pc. ID No. 5604 **MSRP* 3.89 €**

Nano Scaper's Flow Tubes

For fresh and marine water, neutral in water. Biological filter medium with an enormous surface.

Nano Scaper's Flow Sponge

Nano filter sponge



[CLICK HERE](#)

Nano Alginator 2500

The clever magnetic cleaner with a rounded cleaning surface, able to clean the typical rounded Nano corners easily and effortlessly, too. As the internal part does not have a floating body it fits behind the aquarium equipment and decoration. High-quality neodymium magnet with 2.5 kgs of holding power and ergonomic handle on the external part.

Nano Alginator 2500 1 pc. ID No. 5659 **MSRP* 17.99 €**



[CLICK HERE](#)

Nano HangOn Thermometer

Thermometer with magnifying glass effect that can be hung in rounded corners. Suitable for glass up to 6 mm thick.

[CLICK HERE](#)

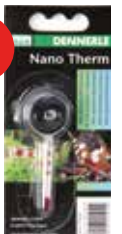

Nano Thermometer

Miniature thermometer for nano tanks

Nano HangOn Thermometer 1 pc. ID No. 5657 **MSRP* 11.39 €**

Nano Thermometer 1 pc. ID No. 5919 **MSRP* 4.49 €**

*Manufacturer's suggested retail price, please ask your specialist dealer for the exact final price.

Nano filtration

Nano CornerFilter / CornerFilter XL

Adjustable internal filter with a pumping capacity of 150l/hour. The pump runs extremely silently and is very quiet. Energy consumption: only 2 watts - this preserves our natural resources! The nozzle pipe is inserted into the filter outlet (turnable by 90 degrees). The three-ply filter element makes the water crystal-clear and provides useful filter bacteria with an enormous surface to live on. Shrimp-safe thanks to fine water inlet slots and a pre-filter sponge. The Corner Filter XL has two filter elements and the same pumping capacity.

Nano CornerFilter	1 pc.	ID No. 5925	MSRP* 21.99 €
Nano CornerFilter XL	1 pc.	ID No. 5860	MSRP* 31.99 €



Nano FilterElement

Nano Clean replacement filter element for the CornerFilter, providing a large surface for filter bacteria

Nano FilterElement	1 pc.	ID No. 5926	MSRP* 5.89 €
--------------------	-------	-------------	--------------



Nano FilterElement 3

Nano Clean spare filter elements, 3 units, for the CornerFilter

Nano FilterElement 3	3 pc.	ID No. 5865	MSRP* 14.49 €
----------------------	-------	-------------	---------------



Nano FilterModul

Fillable filter basket, which can be used instead of the filter element. Especially recommendable for Cubes with fish and when the CornerFilter XL is used.

Nano FilterModul	4 pc.	ID No. 5845	MSRP* 8.79 €
------------------	-------	-------------	--------------



Nano BabyProtect

Additional easy-to-use clip-on protection for the Corner Filter, prevents even the smallest shrimp babies from getting in.

Nano BabyProtect	1 pc.	ID No. 5846	MSRP* 7.69 €
------------------	-------	-------------	--------------

Nano FilterExtension

Especially recommendable for tanks with fish.

Increases the filter performance, or can be temporarily equipped with phosphate binder or active carbon to provide additional filtration. It is clipped onto the filter like a backpack. Filter volume can't be replaced by anything — only by filter volume.

Tip: Filled with soil, the water hardness will sink as well as humic substances will be released to the water.

Nano FilterExtension	1 pc.	ID No. 5840	MSRP* 8.79 €
----------------------	-------	-------------	--------------



Nano ActiveCarbon

Pelleted for clean handling and the highest performance pH neutral, does not release any phosphates that would promote algal growth, for crystal-clear, healthy water

Nano ActiveCarbon	300 ml	ID No. 5841	MSRP* 8.99 €
-------------------	--------	-------------	--------------



Nano AlgaeStop

Phosphate remover for freshwater nano aquaria removes the main reason for pest algae actively for up to 3 months, does not give off the bound phosphate

Nano AlgaeStop	300 ml	ID No. 5842	MSRP* 10.99 €
----------------	--------	-------------	---------------



Nano BioFilterGranules

Made of a special, open-pored clay granules for effective pollutant removal. Provides a huge colonization area for biological filtration.

Nano BioFilterGranulat	300 ml	ID No. 5844	MSRP* 8.99 €
------------------------	--------	-------------	--------------

*Manufacturer's suggested retail price, please ask your specialist dealer for the exact final price.

Nano food & ShrimpKing

ShrimpKing Yummy Gum

Adhesive gummy food for shrimp, for biologically appropriate feeding. This shrimp food can be pressed onto rocks, driftwood or onto the aquarium glass where it forms a grazing surface for the shrimp to feed on.

ShrimpKing Yummy Gum contains all the vital nutrients and building blocks that shrimp need on a daily basis.

For all shrimp species



Tip: ShrimpKing Yummy Gum is ideal for feeding snails, and moreover it is also a nice snack for many small fish species.

ShrimpKing Yummy Gum 55 g ID No. 6119  MSRP* 9.99 €



NanoGran

Thanks to the small size of the granules (0.3 – 0.4 mm) this food is ideal for small fish.

For healthy growth and increased resistance against diseases.

NanoGran 55 g ID No. 5915  MSRP* 6.89 €



CrustaGran Baby

Basic feed for raising shrimp and dwarf crayfish. Contains 20 % algae: 10 % Spirulina, Chlorella, Dunaliella, Ascophyllum

Stable in water for up to 24 hours – does not cloud the water

CrustaGran Baby, basic feed 100 ml ID No. 5941  MSRP* 6.89 €



CrustaGran

Sinkable basic feed, the appropriate nutrition for freshwater shrimp and dwarf crayfish, with high-grade proteins from aquatic feed animals and a high content of useful algae, with a total of 20 %. CrustaGran retains its form in water for up to 24 hours. Avoids undue water pollution and does not cloud the water.

CrustaGran, basic feed 100 ml ID No. 5918  MSRP* 6.89 €

*Manufacturer's suggested retail price, please ask your specialist dealer for the exact final price.

For a complete overview of the food ingredients and declarations, please go to: www.dennerle.com

Nano food & ShrimpKing



ShrimpKing Complete 30 g
ID No. 6070 MSRP* 9.69 €

ShrimpKing Complete

The premium shrimp food ShrimpKing is oriented on the feeding habits of ornamental shrimp in nature (Caridina and Neocaridina species). It contains all the important nutrients, building blocks and other vital substances the shrimp need for healthy, balanced growth, intense colors and a good reproductive rate.

High-grade proteins and essential amino acids from aquatic feed animals ensure a balanced growth. Fibre from various leaves and deciduous tree barks promote a healthy digestion. Vitamins and vital substances from different sorts of algae and vegetables serve as „lubricants“ for well-functioning metabolic processes. β-glucans derived from yeast promote the body's defenses, and natural carotinoids enhance the full formation of the species-specific colors. The numerous ingredients guarantee a balanced diet that is contained in each and every food stick. Besides the basic feed, there are various special food varieties that have won over shrimp keepers in all the world. Quality and innovation - made in Germany.

Sinkable food sticks for feeding shrimp daily, containing all the important nutrients, building blocks and vital substances shrimp need for healthy, balanced growth, intense colors and fertility.

ShrimpKing Mineral



ShrimpKing Mineral 30 g ID No. 6073 MSRP* 10.19 €

Food sticks for specific food supplementation, with an extra portion of minerals. With 7 % calcium and 10 % montmorillonite. For smooth molts and a strong exoskeleton.
Tip: ShrimpKing Mineral is also ideal for feeding crayfish, dwarf crayfish, crabs and snails.

ShrimpKing Protein



ShrimpKing Protein 30 g ID No. 6072 MSRP* 10.19 €

Food sticks for targeted protein supplementation, containing high-grade proteins and essential amino acids, may increase the egg formation in females. Protein content: 42,2 %.

ShrimpKing Color



ShrimpKing Color 30 g ID No. 6075 MSRP* 10.19 €

As carrier substances for the natural color enhancers contained in this shrimp food, we use high-grade proteins and essential amino acids coming from aquatic feed animals, for well-balanced growth. Vitamins and other vital substances from various algae and vegetables serve as „lubricants“ for well-functioning metabolic processes and a strong immune system.

ShrimpKing Baby



ShrimpKing Baby 30 g ID No. 6071 MSRP* 10.19 €

Micro granules for daily feeding. Especially fine-tuned to the feeding requirements of baby shrimp. For shrimp of all ages. For healthy growth and smooth molts.

ShrimpKing 5in1



Choosing is difficult, and for that reason we have put together a little testing package of several varieties.

The set consists of:

- » ShrimpKing Complete – daily staple feed
- » ShrimpKing Protein – for more offspring
- » ShrimpKing Mineral – for a strong exoskeleton
- » ShrimpKing Snow Pops – healthy and simply fun to eat
- » ShrimpKing 5 Leaf Mix – the biologically active vegetable snack

ShrimpKing 5in1 1 pc. ID No. 6099 MSRP* 13.99 €

*Manufacturer's suggested retail price, please ask your specialist dealer for the exact final price.

For a complete overview of the food ingredients and declarations, please go to: www.dennerle.com

ShrimpKing Cambarellus



CLICK
HERE

Dwarf crayfish of the genus *Cambarellus* are the stars in many nano tanks. We have the VIP food for them: these thin, sinkable sticks consists of 100 % natural ingredients and are rich in calcium. The dwarf crayfish can hold the sticks with their claws and chew on them like on a burrito – as it becomes a true Mexican. *Cambarellus* sticks give them all they need for a strong exoskeleton and provide them with the color booster Astaxanthin for great colors.

ShrimpKing Cambarellus 30g ID No. 6078 MSRP* 10.19 €

ShrimpKing Atyopsis



CLICK
HERE

This powdered food was especially developed for supplying freshwater fan shrimp with a biologically balanced diet. ShrimpKing Atyopsis is especially suitable for all species of the genera *Atya*, *Atyopsis* and *Atyoida*, e.g. *Atya gabonensis*, *Atya innocus*, *Atya margaritacea*, *Atya scabra*, *Atyopsis moluccensis* and *Atyoida pilipes*.

ShrimpKing Atyopsis 35g ID No. 6118 MSRP* 9.99 €

ShrimpKing SnailStixx



CLICK
HERE

Basic food sticks for supplying freshwater snails that mainly eat biofilms with a biologically balanced diet. Contains all the important nutrients, building blocks and vital substances. With carrots, kelp algae, tomatoes and spinach, with additional calcium for a strong, beautiful shell.

ShrimpKing SnailStixx 45g ID No. 6122 MSRP* 8.99 €

Crusta Spinach Stixx



CLICK
HERE

Food supplement rich in vital substances for shrimp, made of 100 % natural spinach, containing useful vitamins and trace elements, rich in vital substances and minerals.

Crusta Spinach Stixx 30g ID No. 5854 MSRP* 6.99 €

Crusta Stinging Nettle Stixx



CLICK
HERE

A natural alternative food for invertebrates with high acceptance, rich in natural minerals and trace elements, containing many vital substances. With a high content of the vitamins A and C.

Crusta Stinging Nettle Stixx 30g ID No. 5866 MSRP* 6.99 €

ShrimpKing Snow Pops

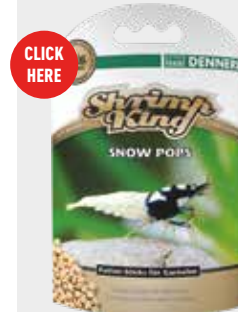

CLICK
HERE

ShrimpKing Pops are yummy and fun to eat for all shrimp. They pop up in the tank quickly and the food scatters a little, forming a feeding pad so every shrimp finds sufficient food.

For healthy growth, intense colors and a good reproduction rate. Thanks to the high fibre content, these sticks are broken down by bacteria only bit by bit and can therefore remain in the tank for a longer time. For this reason, Snow Pops are the ideal weekend food. Professional Asian breeders swear by them!

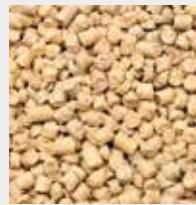

Sinkable food sticks made of organic soy husks. Soy beans belong to the legumes, and are known as a source of high-grade protein. The husks are rich in vital amino acids, vitamins, polyunsaturated fatty acids and micronutrients like folic acid and selenium, which protect the cells.

ShrimpKing Snow Pops 40g ID No. 6069 MSRP* 10.19 €

Algae plates



CLICK
HERE

The appropriate food supplement for shrimp, made of 100 % natural algae rich in vitamins and trace elements. Tip: Use our practical feeding tongs to hold the algae plates so you can comfortably watch your shrimp nibble away on this healthy snack.

Nano Algae plates 40 pc. ID No. 5917 MSRP* 6.89 €



CLICK
HERE

Feeding tong

Just pinch the algae plate to hold it, place the tongs at the desired place inside your tank and take out the tongs together with uneaten food after the shrimp stop eating.

NANO Feeding tong 1 pc. ID No. 5868 MSRP* 8.99 €

*Manufacturer's suggested retail price, please ask your specialist dealer for the exact final price.

For a complete overview of the food ingredients and declarations, please go to: www.dennerle.com

Fish food



CLICK HERE

SOFT GRANULES

Complete Gourmet Menu

For the occupants of a classical community tank we have developed this granulated food. The fine granules consist of almost 30 different ingredients and are accepted very well by fish of different sizes.

This food consists of 27 % tasty insect larvae, natural crustaceans and mollusks (12 %) and valuable herbs (1.5 %). For the first time in a fish food, the leaves of the „miracle tree“ Moringa oleifera are processed with their high trace element and vitamin content.

Complete Gourmet Menu 100 ml	42 g	ID No. 7506	MSRP* 6.11 €
Complete Gourmet Menu 200 ml	84 g	ID No. 7507	MSRP* 11.21 €



CLICK HERE

Complete Gourmet Flakes

For the occupants of the classical community tank, we have developed this flake food consisting of over 20 different ingredients. Fish of nearly all sizes receive them very well. This food consist to 40 per cent of tasty insect larvae and to 8 per cent of nourishing crustaceans.

Name	Content	ID No.	MSRP*
Complete Gourmet Flakes 100 ml	19 g	7500	4.07 €
Complete Gourmet Flakes 200 ml	38 g	7501	5.39 €
Complete Gourmet Flakes 750 ml	142 g	7502	15.29 €
Complete Gourmet Flakes 1,000 ml	190 g	7503	20.39 €



Dennerle fish food is produced in Germany, and it is probably the one food in the market whose contents are oriented very closely on what our aquarium occupants eat in nature (we describe this more in detail on pages 26-31).

Dennerle fish food does not contain fishmeal or other cheap fillers, on the contrary, it consists of 100 % high-quality natural raw materials, which we carefully selected in accordance with the requirements of ornamental fish. This is the very first prebiotic and probiotic feed for your aquarium fish!

Soft granules – like natural food animals

Dennerle has developed a special softening process as part of intensive research work. As a result, the granules are as soft as natural food animals and ensure a high level of acceptance. Specially choosy species or sophisticated breeding forms benefit from it.

Feeding is fun if you know the ingredients!



*Manufacturer's suggested retail price, please ask your specialist dealer for the exact final price.

For a complete overview of the food ingredients and declarations, please go to: www.dennerle.com

CLICK
HERE



Cookies Special Menu

A fast-sinking food in the form of cookies, for omnivorous ground-dwelling fish like armored catfish, kuhli loaches, sucking loaches, bichirs and many catfish species.

Naturally only with animal ingredients such as insect larvae (25 %) and high-quality plant components such as Moringa leaves (1 %) and grape seed flour.

Cookies Special Menu 100 ml	38 g	ID No. 7510	MSRP* 6.11 €
Cookies Special Menu 200 ml	76 g	ID No. 7511	MSRP* 11.21 €

CLICK
HERE



SOFT GRANULES

Guppy & Co Booster

Especially designed for the popular guppies, platies and mollies: This fish food is based on their natural food spectrum.

It contains a high number of natural color enhancers, which help these extremely colorful fish reach their full potential. The immune boosters beta-glucan and the prebiotic and probiotic ingredients build your livebearers' resistance against unspecific bacterial infections.

Guppy & Co Booster 100 ml	42 g	ID No. 7523	MSRP* 6.11 €
---------------------------	------	-------------	---------------------

CLICK
HERE



SOFT GRANULES

Betta Booster

A basic feed for gouramis and bettas. These fish take up more food of animal than vegetable origin in their natural habitat.

The almost 30 ingredients consist of 27 % tasty insect larvae, krill (6.5 %), crayfish (1 %) and valuable vegetarian components.

Betta Booster 30 ml	12 g	ID No. 7410	MSRP* 3.59 €
---------------------	------	-------------	---------------------

CLICK
HERE



SOFT GRANULES

Neon & Co Booster

Basic feed for neon tetras and other small ornamental fish like tetras, barbs, danios or guppies. The fine granules consist of many high quality ingredients, such as insects (27 %) and krill, as well as garlic (1 %) and spinach (3 %), thus ensuring a balanced diet. The fine food particles are rich in astaxanthin, which enhances the species-specific coloration.

Neon & Co Booster 100 ml	45 g	ID No. 7524	MSRP* 6.11 €
--------------------------	------	-------------	---------------------

CLICK
HERE



SOFT GRANULES

Color Booster

Based on the Complete feed, a color boosting ingredient has been added to this fish food: Astaxanthin.

The granule size of 0.5 mm can be taken up even by small fish, larger fish will just swallow 2 - 3 of the particles at a time. The color-boosting effect becomes visible after just a few days of adding this food as a regular supplement to the diet of the fish.

Color Booster 100 ml	42 g	ID No. 7508	MSRP* 6.11 €
Color Booster 200 ml	84 g	ID No. 7509	MSRP* 11.21 €

CLICK
HERE



Pleco Menu

Basic feed for all algae-eating catfish, especially plecos from the genera Ancistrus, Peckoltia, Glyptoperichthys, Baryancistrus and Hypancistrus. With natural foliage (9 %, for a fiber content like in nature and as a high-quality lignin source), vitamin-rich vegetables and algae (16 %), crustaceans and insect larvae.

The relatively firm cookies are around 15 mm wide, and the plecos can munch on them, just like they eat their food in nature.

Pleco Menu 100 ml	36 g	ID No. 7512	MSRP* 6.11 €
Pleco Menu 200 ml	72 g	ID No. 7513	MSRP* 11.21 €

*Manufacturer's suggested retail price, please ask your specialist dealer for the exact final price.

For a complete overview of the food ingredients and declarations, please go to: www.dennerle.com

Fish food



SOFT GRANULES

CLICK HERE



Goldy Booster

For goldfish and their high-bred variants like veiltail, shubunkin, comet and lionhead.

With animal ingredients such as insect larvae (7 %), green lipped mussels and water fleas, and plant-based ingredients such as spinach (7 %), the goldfish derived from carp fish are nourished as they would in nature.

Astaxanthin enhances their colors, and probiotic lactic acid bacteria and beta-glucan strengthen their immune system.

Goldy Booster 100 ml	48 g	ID No. 7514	MSRP* 6.11 €
Goldy Booster 200 ml	96 g	ID No. 7515	MSRP* 11.21 €

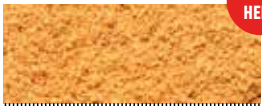

CLICK HERE

Calanus FD Natural

Tip: Thanks to its high content of nutritious oils, amino acids and proteins, Calanus makes an excellent food for baby fish.



Dennerle Calanus FD enables you to feed your fish just like in nature. In their habitats, many ornamental fish eat zooplankton, a large part of which usually consists of small crustaceans. This floating FD food contains 100 % arctic zooplankton of the species Calanus finmarchicus.

These small crustaceans are highly nutritious and round off the diet of any ornamental fish.

Numerous essential amino acids and proteins serve as building blocks for tissues and keep the metabolism of the fish active. They are the basis for a well-balanced growth and vitality. Natural marine oils provide the fish with readily available energy, and natural carotenoids, most importantly astaxanthin, enhance their colors.

This exquisite fish snack is not only a smash hit nutritionally, it also tastes great! Fish just love Calanus — even the picky eaters that usually do not eat dry food, or delicate wild-caught fish go for Calanus with great enthusiasm.

Calanus FD Natural 100 ml	12 g	ID No. 7504	MSRP* 7.13 €
Calanus FD Natural 200 ml	24 g	ID No. 7505	MSRP* 12.23 €



SOFT GRANULES

CLICK HERE



Cichlid Veggy

This fish food has been designed for all aufwuchs-eating cichlids like Tropheus. It contains a high proportion of vegetable ingredients. With vegetables rich in vital substances such as kale (13.5 %) and spinach (9.8 %), as well as algae such as spirulina and chlorella, the fish are given a species-appropriate, high-fiber and raw-fiber-rich diet as in nature. Since even plant-eaters take in a certain amount of small crustaceans and insects that live in the aufwuchs when eating algae, we have added a small amount of those to this fish food.

Cichlid Veggy 200 ml	90 g	ID No. 7516	MSRP* 11.21 €
Cichlid Veggy 1,000 ml	450 g	ID No. 7517	MSRP* 20.39 €



SOFT GRANULES

CLICK HERE



Cichlid Carny

In nature, many carnivorous cichlids from the lakes Malawi and Tanganyika, e.g. the enormously numerous genus Neolamprologus eat zooplankton and crustaceans.

Cichlid Carny contains 17.5 % insects, crabs and artemia, 9.8 % krill and as a perfect complement noble green lipped mussels. The practical granules mimic the natural diet of a mostly carnivorous cichlid perfectly.

Cichlid Carny 200 ml	100 g	ID No. 7518	MSRP* 11.21 €
Cichlid Carny 1,000 ml	500 g	ID No. 7519	MSRP* 20.39 €



SOFT GRANULES

CLICK HERE

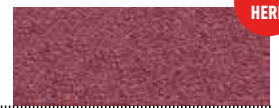

Diskus Soft

This nutritious granulated food was designed with the special requirements of discus in mind. It is biologically well-balanced and provides the king of all aquarium fish with every important nutrient, with all the vitamins, minerals, trace elements and omega 3 fatty acids, which discus need on a daily basis. The special softening method makes the granules soft, just like the animals the discus feeds on in nature. This leads to a high acceptance even with finicky eaters. The animal constituents come from aquatic food animals such as krill (5.2 %) and mollusks or insects (25 %). Valuable algae and other high-quality plant-based ingredients such as vegetables (6 %) and Moringa (1 %) complete the diet.

Diskus Soft 200 ml	90 g	ID No. 7521	MSRP* 11.21 €
Diskus Soft 1,000 ml	450 g	ID No. 7522	MSRP* 23.45 €

*Manufacturer's suggested retail price, please ask your specialist dealer for the exact final price.

For a complete overview of the food ingredients and declarations, please go to: www.dennerle.com

Water maintenance



One of the five Dennerle balance elements is the water. We have the perfect solution for every possible problem with the aquarium water.

Our suspensions containing beneficial microorganisms are the heart and soul of our water conditioning products: Just like in nature, these minuscule beings are the key to success in any aquatic system. In all the Dennerle products containing microorganisms, we use time-tested, highly efficient strains of: Nitrosomonas (turns ammonium / ammonia into nitrite), Nitrobacter (turns nitrite into nitrate) and Paracoccus (turns nitrate into gaseous nitrogen in anaerob environments). All of this happens in the so-called biofilms, which cover all firm surfaces in the aquarium.

Adding beneficial microorganisms at regular intervals has been proven to have a positive influence on the composition of these biofilms. All these three classes of microorganisms do not form spores, but we still have found an effective way of conserving and stabilizing them in this solution for at least two years.



CLICK HERE

WaterTest 6in1

50 test strips for simultaneous measurement of the six most important water parameters: pH, KH, GH, nitrate, nitrite and chlorine.

WaterTest 6in1
ID No. 1683 MSRP* 16.99 €



CLICK HERE

Clear Water Elixier

Just like tiny magnets, the mineral particles form a cleaning cloud immediately after you add this water conditioner, and they catch minuscule particles that stain the water or cause turbidities, eliminate unpleasant smells, ammonia, heavy metals, drug residues and other problematic substances.

The water turns impressively brilliant and clear. For vital, healthy fish. 100 ml are sufficient for 500 l of aquarium water.

Clear Water Elixier 250 ml ID No. 1677 MSRP* 10.99 €

Clear Water Elixier 500 ml ID No. 1678 MSRP* 15.99 €

Aquarium Starter Rapid



CLICK HERE

DOUBLE EFFECT

A highly effective product for starting newly set-up tanks safely and quickly. You can add the first aquarium pets after as little as 24 hours. One of the components that make this possible is the highly concentrated suspension of microorganisms we use — with a guaranteed content of 500 million bacteria per milliliter at filling.

The second crucial component is a bacteria-boosting nutrient solution. We have especially developed this bacteria food to enhance the settlement and reproduction of the beneficial bacteria you add with this aquarium starter. Sufficient for 100 l of aquarium water.

Aquarium Starter Rapid 200 ml ID No. 1681 MSRP* 12.99 €



CLICK HERE

Aqua Elixier

Use this water conditioner for every water change: It removes poisonous substances like chlorine or heavy metals from tap water, and adds beneficial agents that tap water lacks. It protects the gills, mucous membranes and the fins of the fish, thanks to high-quality protective colloids and Moringa tree leaf extracts. 100 ml are sufficient for 500 l of aquarium water (dose only for the amount of fresh tap water you add during the water change).

Aqua Elixier 250 ml ID No. 1670 MSRP* 7.69 €

Aqua Elixier 500 ml ID No. 1671 MSRP* 10.99 €

*Manufacturer's suggested retail price, please ask your specialist dealer for the exact final price.

Water maintenance



CLICK
HERE

All in One! Elixier

Is the new and complete easy-care for a beautiful aquarium, where fish, shrimp and plants feel comfortable. Ideal for a simple start into the probably most beautiful hobby in the world.

All in One! Elixier is water, plant care and carbon supply in one and contains 12 carefully coordinated active components. Easy to use, it ensures visible results within weeks. Simply add 20 ml per 100 litre aquarium water once a week and your aquarium is in balance. All in One! Elixier is also compatible with the Dennerle Dosator.

All in One! Elixier	100 ml	ID No. 2848		MSRP* 8.99 €
All in One! Elixier	250 ml	ID No. 2849		MSRP* 13.99 €
All in One! Elixier	500 ml	ID No. 2850		MSRP* 17.99 €



CLICK
HERE

BactoElixier Bio

An extra boost of microorganisms, with 100 million bacteria per milliliter (measured at filling). Ideally used every time after you cleaned your filter, when you add new fish, after medicating the aquarium, or if too much muck forms. Our top tip when you add new fish: The number microorganisms in the filter is adapted to the amount of organic waste usually created by the fish in the aquarium. When you add more fish, the bacteria in the filter need some boosting.

BactoElixier Bio 50 ml — INT ID No. 1682 MSRP* 4.99 €



CLICK
HERE

BactoElixier FB7

A highly efficient mix of carefully chosen live filter bacteria useful for giving the microbiology of the aquarium a boost on a regular basis. It recharges the biofilms that cover all the firm surfaces inside the aquarium with beneficial microorganisms, which enhances the biological self-purification power of the aquarium again and again. Contains 15 million bacteria per milliliter (measured during filling).

250 ml are sufficient for 1,250 l of aquarium water.

Bacto Elixier FB7	250 ml	ID No. 1679		MSRP* 10.99 €
Bacto Elixier FB7	500 ml	ID No. 1680		MSRP* 15.99 €

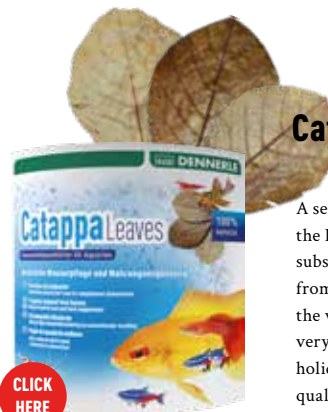

CLICK
HERE

Catappa Leaves

A secret shared by Asian fish breeders: The ripe dried leaves of the Indian almond tree Terminalia catappa add those natural substances to the water that our pet fish and invertebrates know from the waters of their original habitats. These substances make the water mildly acidic and stabilize the pH. The leaves decompose very slowly in the water, and they make a great supplementary and holiday food for shrimp, crayfish, crabs, snails and catfish. Premium quality: these hand-picked leaves are harvested from the trees, and afterwards they are cleaned and carefully dried.

Catappa Leaves 10 unit ID No. 2744 MSRP* 10.39 €

*Manufacturer's suggested retail price, please ask your specialist dealer for the exact final price.



Humin Elixier

Besides microorganisms, humins are another crucial factor for successful fish and invert keeping and breeding in an aquarium. This mixture of important humic and fulvic acids inhibits harmful germs and can thus prevent diseases.

Makes the adaptation period smoother, especially for fish from blackwater habitats, like discus, neon tetras, angelfish, dwarf cichlids and plecos, and keeping them easier. The water is rendered more natural, which reduces stress. In contrast to many of the more traditional products containing peat, Humin Elixier will not stain the water. Does not contain phosphoric acid or hydrochloric acid — guaranteed! 250 ml are sufficient for 1,250 l of aquarium water.

Humin Elixier	250 ml	ID No. 1672		MSRP* 7.69 €
Humin Elixier	500 ml	ID No. 1673		MSRP* 10.99 €



KH+ Elixier

For raising the carbonate hardness to the correct level quickly and safely, increases and stabilizes the pH.

Dissolves readily, easy to use.
For healthy growth, vitality and well-being
For all freshwater aquaria

Ideal for re-mineralizing RO water.
Dose 20 ml per 100 liters of aquarium water to increase the carbonate hardness by 0.6 °d and the conductivity by approx. 20 µS/cm.

KH+ Elixier	250 ml	ID No. 1676		MSRP* 8.69 €
-------------	--------	-------------	--	---------------------



Vital Elixier

Contains iodine for a normal, healthy function of the thyroid. With B complex vitamins crucial for stress reduction, and natural extract of Aloe vera. Targeted addition of those minerals that are deficient in tap water or that are consumed quickly in the aquarium, like iron, zinc, manganese, molybdenum and lithium. Prevents or alleviates diseases caused by a lack of trace elements.

250 ml are sufficient for 1,250 l of aquarium water.

Vital Elixier	250 ml	ID No. 1674		MSRP* 7.69 €
Vital Elixier	500 ml	ID No. 1675		MSRP* 10.99 €



Catappa Barks

The little brother of our Catappa Leaves has identical positive effects on the water and the health of your aquarium pets, but cannot be eaten. The pieces of Catappa bark are a beautiful decorative element, though.

Catappa Barks	10 Unit	ID No. 2756		MSRP* 8.69 €
---------------	---------	-------------	--	---------------------



Black Cones

Fish Viagra! Water maintenance for aquaria the natural way, and at the same time a beautiful decorative element. Especially recommended for fish from tropical blackwater areas, like discus, neon tetras, angelfish, dwarf cichlids, plecos and so on, and for shrimp, too. Slightly reduces the carbonate hardness without lowering the pH too much. Natural steroids increase the willingness to spawn (only in fish, though ...).

Black Cones	40 g	ID No. 2748		MSRP* 6.59 €
Nano Black Cones	20 g	ID No. 5911		MSRP* 5.49 €

*Manufacturer's suggested retail price, please ask your specialist dealer for the exact final price.

Water conditioning

Conditioning tap water may become necessary for several reasons. It may be too hard or too soft, or it may contain too many pollutants.

If the water is too soft, conditioning is easy: Just add the right amount of one of the re-mineralizing preparations presented here, and — presto, your water has the correct parameters. If the water is too hard you'll need a reverse osmosis system, or RO system.

This is how it works: The pressure of the tap water presses the tiny water molecules through a micro membrane. The residual water retains all the other substances dissolved in the water: hardness builders, pollutants and other molecules. The RO water either is mixed with tap water until the desired parameters are reached, or it is optimized for aquarium use with re-mineralizing salts.

Tip: You can use residual water for watering or fertilizing your flowers, for example.

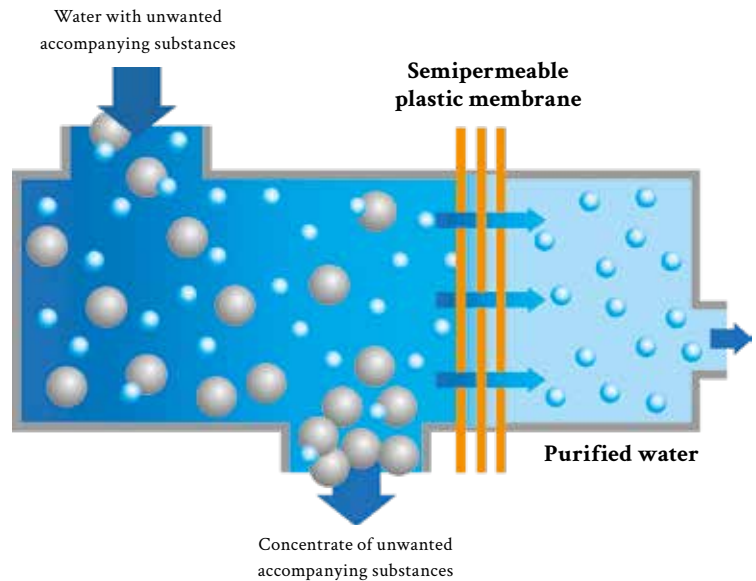

CLICK HERE

Osmose ReMineral+

Perfect for re-mineralizing RO water, providing an optimal supply of minerals while keeping the pH stable at the same time. This well-balanced multi mineral preparation is oriented on the natural mineral mix in tropical waters. Total hardness and carbonate hardness builders provide a stable pH.

In addition, fish and plants in the aquarium are provided with important trace elements like boron, fluorine, iodine and others. B vitamins are crucial as they protect the animals from stress. Carefully chosen organic active substances activate the filter bacteria. Dennerle exclusively uses highly pure mineral salts of pharmaceutical quality.

With ReMineral+ you can create water parameters just like those in the original habitats of tropical ornamental fish and aquarium plants. Ideal for all freshwater aquaria and especially for discus tanks!

Osmose ReMineral+ 250 g for 5,000 hardness liters ID No. 7035  MSRP* 14.79 €

Osmose ReMineral+ 1,100 g for 22,000 hardness liters ID No. 7036  MSRP* 36.99 €



CLICK HERE

Nano Crusta Mineral

Vital minerals for shrimp and crayfish

Contains important natural montmorillonite as well as bioactive calcium and magnesium for healthy growth. Purifies and clarifies the water, inactivates pollutants.

Nano Crusta Mineral 35 g MSRP* 6.49 €

Freshwater shrimp (species of the genera Caridina and Neocaridina) are specialized in grazing off the biofilm from firm surfaces.

Their bristly claws are not really built for taking things apart but more for combing off microorganisms.

Natural biofilms aka aufwuchs of a good quality are crucial when it comes to raising baby shrimp. The shrimp salts by ShrimpKing have been designed to deliberately boost the formation of natural aufwuchs in the aquarium.

Bacteria, unicellular organisms and other microorganisms can feed on carefully selected natural ingredients, which enhance their development. The permanent regeneration of the „green patina“ on rocks and driftwood — consisting of algae rich in vitamins — is also safeguarded.

*Manufacturer's suggested retail price, please ask your specialist dealer for the exact final price.



Osmosis

Filters the tap water through a special membrane made of polyamide / polysulfone with ultra-fine pores. These pores are so fine that they only let the tiny water molecules through — soft, ultra-pure reverse osmosis (RO) water is the result.

Pollutants have larger molecules than water, as do hardness builders and other salts. They are filtered out. Even bacteria and viruses are removed. You can collect the residual water and use it in your household. Dennerle osmosis systems are equipped with a microfilter and an active carbon filter, and they are ready to use. All you need is a 3/4" tap connector („washing machine connection“). RO water can either be mixed with tap water or — for the utmost water quality — be re-mineralized with Osmosis ReMineral+.

Tip: In case you want to slightly lower down the water hardness in your Nano Cube or Scapers Tank, the use of our soil is the perfect match.

Just fill the Dennerle Filter Extension with soil and click it onto the Dennerle Corner Filter.

Why is reverse osmosis called reversed osmosis?

Osmosis is the term for the phenomenon that two liquids will always tend to equalize their concentration of ions through diffusion. If you separate two liquid with different ion concentrations with a membrane that only lets through water molecules (semipermeable), the water will always go from the lower concentration to the higher concentration. By using normal tap water pressure you can reverse this process — that's where the name „reverse osmosis“ comes from. Usually people use the abbreviation RO instead of „reverse osmosis“, as in „RO water“.

Osmose Professional 190



Maximum output 190 l/day (at 25 °C and a pressure of 4.1 bar).

Ratio of RO water to residual water = 1:2.5 — 1:4 (dependent on temperature and pressure).

Increased membrane life and permanently high performance thanks to a flush valve — removes residue on the membrane that would otherwise have a negative effect on its performance.

Osmose Professional 190 1 Unit ID No. 7040 **MSRP* 103.99 €**

Osmose Compact 130



Maximum output 130 l/day (at 25 °C and a pressure of 4.1 bar).

Ratio of RO water to residual water = 1:2.5 — 1:4 (dependent on temperature and pressure)

Osmose Compact 130 1 Unit ID No. 7039 **MSRP* 82.99 €**

ShrimpKing Sulawesi Salt



Creates ideal water parameters for keeping and breeding shrimp successfully that originate from the Ancient Lakes of Sulawesi, especially the Freshwater Cardinal shrimp *Caridina dennerli*.

Results in a slightly alkaline pH of approx. 7.8 — 8.5. For well-balanced growth, health and vitality.

This product has been designed based on the water parameters that were measured on location during our Plantahunter Tour 2011 to Sulawesi.

Sulawesi Salt 200 g for 1,000 l osmosis water ID No. 6150 **MSRP* 15,49 €**

Sulawesi Salt 1,000 g for 5,000 l osmosis water ID No. 6151 **MSRP* 28,99 €**



ShrimpKing

Shrimp Salt GH/KH+

Creates ideal water parameters for keeping and breeding shrimp successfully that need a neutral to slightly alkaline pH of 7.0 — 7.5. Ideal for species of the genus *Neocaridina* and their high-bred variants like Sakura, White Pearl, Rili, Blue Dream and so on, as well as for all variants of the Tiger shrimp *Caridina mariae*.

Shrimp Salt GH+/KH+ 200 g for 1,330 l osmosis water ID No. 6134 **MSRP* 15,49 €**

Shrimp Salt GH+/KH+ 1,000 g for 6,650 l osmosis water ID No. 6135 **MSRP* 28,99 €**



ShrimpKing

Bee Salt GH+

Re-mineralizing salt containing vital minerals, trace elements and vitamins. For creating the ideal water parameters required for successfully keeping and breeding ornamental shrimp from softwater habitats, like Bee shrimp or Bumblebee shrimp.

Results in a slightly acidic pH of around 6.0 — 6.5. For well-balanced growth, health, vitality and successful breeding.

Bee Salt GH+ 200 g for 1,330 l osmosis water ID No. 6127 **MSRP* 15,49 €**

Bee Salt GH+ 1,000 g for 6,650 l osmosis water ID No. 6128 **MSRP* 28,99 €**

*Manufacturer's suggested retail price, please ask your specialist dealer for the exact final price.

Light – the motor of life

T5

T8

Dennerle Trocal fluorescent tubes

The secret for the best aquarium light possible lies in the right color spectrum mix. If you have a close look at how nature does it, you'll get the best solution quite easily:

For our aquarium plants (a majority of which are, in fact, bog plants that grow above the waterline at least a part of the time in nature) to develop nicely, they need long-wave red and yellow light and no UV light.

Algae, on the other hand, are strictly aquatic and depend on blue spectra and UV light. These findings have led to the name of our plant lights, by the way: TROCAL is an acronym for Tropical Contra Algae Light.



T5 and T8

The names for these two generations of fluorescent tubes are derived from the English „tube“. The numbers give the diameter in eights of an inch (rounded). One inch is 2.54 cm and an eighth of an inch is therefore 3.175 mm. A T8 tube has a diameter of 26 mm (8 x 3.175 mm) and a T5 tube is 16 mm in diameter.

UV protection

Dennerle fluorescent tubes are equipped with an UV block that cuts off all wavelengths below 400 nm. This puts the plants at an advantage and the algae at a disadvantage.

High lumens values

All Dennerle fluorescent tubes are coated with three color pigments, with the effect that the light they emit is especially bright and brilliant. Especially the light output of our T5 tubes makes them a great and cost-efficient alternative to many LED lighting systems in the market.

Little loss of light output

The Dennerle fluorescent tubes have a useful life of 15,000 operating hours (T8), or 10,000 operating hours (T5), respectively. This protects the environment, the natural resources and also your wallet. In comparison with the tubes of other brands, Dennerle fluorescent tubes have the longest useful life and can be used at least twice as long. This is made possible by the Alon-C coating (Trocal Longlife technology, Star Trek fans amongst us, please continue reading further below) that protects the color pigment coat from the quicksilver in the gaseous mix inside the tube.

A little explanation regarding Alon-C, which may not have anything to do with Dennerle Trocal tubes directly but is still interesting enough to mention: Alon-C is a household name for the Star Trek enthusiasts among us. It is known from the movie „Star Trek IV – The Voyage Home“, where it describes transparent aluminium. In reality, AION is aluminium oxynitride, a transparent ceramic material based on aluminium. In the movie, chief engineer Scotty hands over the formula to the plexiglass manufacturer Plexicorp to build a gigantic tank for two humpback whales in 1986.

You can choose from three different light colors with different effects:

Spectrum Amazon Day

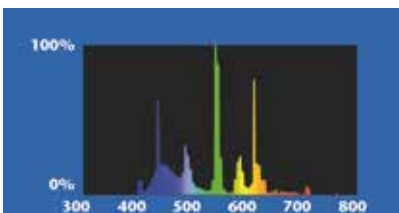

In our view it is the best aquarium light in the world. The light temperature of 6,000 kelvin is that of a bright, clear day around noon, and it makes your aquarium shine brightly and brilliantly. The fish and plants display the full spectrum of their stunning colors, and the aquarium plants grow really nicely. This light is ideal especially if your tank has only one tube or if you need more light, for example for an aquascape. The participants in the contest „Art of the planted Aquarium“ swear by Amazon Day as lighting source for their submersed works of art.

Spectrum Color Plus

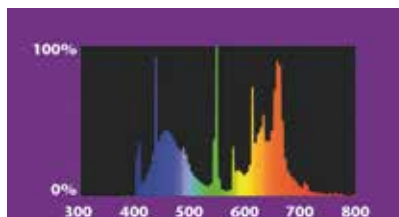

When used as front tube in the combination with the Special Plant tube in the back, the light spectrum of the Color Plus tube with its extra peaks in the red / orange / blue spectrum enhances the natural colors of the fish and plants exceptionally well. Also great in combination with the Amazon Day tube.

Spectrum Special Plant

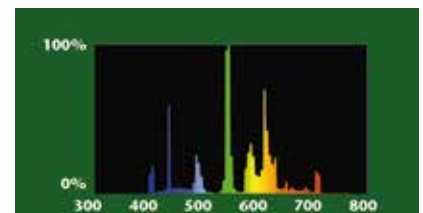

A telltale name: When developing this lighting tube, we fully concentrated on the needs of the plants. The light temperature of 3,000 kelvin results in a warm, harmonious light, which is ideal to enhance photosynthesis. Even demanding plants grow vigorously under this light. As a rule, most aquarium plants are placed in the background of the tank, or in the midground. If you have two-row lighting in your tank it is recommendable to use the Special Plant tube in the back.

*Manufacturer's suggested retail price, please ask your specialist dealer for the exact final price.

Trocal T5/T8



Wattage	Length (mm)	Lumens	EEL	CLICK HERE	ID No.	MSRP*	Lumens	EEL	CLICK HERE	ID No.	MSRP*	Lumens	EEL	CLICK HERE	ID No.	MSRP*
Amazon Day							Special Plant					Color Plus				
24 W	438**	1,650	A		2918	21.99 €	1,750	A		2912	21.99 €	590	B		2924	21.99 €
24 W	549	1,800	A		2904	22.49 €	1,950	A		2900	22.49 €	650	B		2908	22.99 €
28 W	590**	2,100	A		2919	22.99 €	2,250	A		2913	22.99 €	750	B		2925	22.99 €
35 W	742**	2,850	A		2920	29.99 €	3,050	A		2914	24.99 €	1,000	B		2926	29.99 €
39 W	849	3,250	A		2905	25.99 €	3,500	A+		2901	29.99 €	1,140	B		2909	25.99 €
45 W	895**	3,600	A		2921	25.99 €	3,800	A		2915	25.99 €	1,350	B		2927	25.99 €
54 W	1.047**	4,350	A		2922	28.99 €	4,650	A		2916	27.99 €	1,575	B		2928	28.99 €
54 W	1.149	4,550	A		2906	28.99 €	5,000	A+		2902	27.99 €	1,680	B		2910	28.99 €
54 W	1.200**	4,650	A		2923	27.99 €	5,000	A		2917	28.99 €	1,700	B		2929	28.99 €
80 W	1.449	6,650	A		2907	32.49 €	7,000	A+		2903	32.49 €	2,500	B		2911	32.49 €

**fitting Juwel aquaria

Wattage	Length (mm)	Lumens	EEL	CLICK HERE	ID No.	MSRP*	Lumens	EEL	CLICK HERE	ID No.	MSRP*	Lumens	EEL	CLICK HERE	ID No.	MSRP*
Amazon Day							Special Plant					Color Plus				
15 W	438	900	B		1331	21.99 €	950	B		1121	17.49 €	280	C		1341	21.99 €
18 W	590	1,300	A		1332	22.49 €	1,350	A		1122	18.49 €	400	C		1342	22.49 €
25 W	742	2,100	A		1333	22.99 €	2,200	A		1123	19.49 €	650	B		1343	22.99 €
30 W	895	2,300	A		1334	23.49 €	2,400	A		1124	20.99 €	750	C		1344	23.49 €
36 W	1.200	3,250	A		1335	25.99 €	3,350	A		1125	21.99 €	970	B		1345	25.49 €
38 W	1.047	3,000	A		1336	24.99 €	3,300	A		1126	21.49 €	970	C		1346	22.99 €
58 W	1.500	5,000	A		1337	28.99 €	5,200	A		1127	23.49 €					



Made in Germany

This stands for the utmost quality and reliability of all Dennerle products. Short transport routes are sustainable and protect our environment.

A tiny German flag behind the ID number indicates which products are made in Germany. One great example for the Dennerle product management is the Cleanator (upper left): The company that produces this sponge on our behalf is located in Baden. All the components are produced in Germany, the sponge comes from Swabia, the foil packaging from Thuringia, the carton packaging from the Black Forest and the stainless steel mesh from the Ruhr area.

*Manufacturer's suggested retail price, please ask your specialist dealer for the exact final price.

Trocal T5 Overview

Trocal T8 Overview

Trocal LED

Trocal LED

The aquarium light with the highest performance in its class.

Long useful life thanks to high-quality Cree LEDs on cooling ceramics

- extremely high output density: 60 W/m or 5,600 lm/m, respectively
- highly efficient, which saves energy
- excellent color rendition
- one Trocal LED replaces 2 T5 tubes
- optimal color temperature for plants and fish, all the aquarium occupants display their natural beautiful colors under this light
- light spectrum for excellent plant growth
- bright, lively daylight with a beautiful sunlight effect
- for all freshwater aquaria
- modern design, compact dimensions
- ballast unit included
- adapter for mounting in an existing lid for T5 / T8 available separately

LED module in a high-quality aluminium housing;

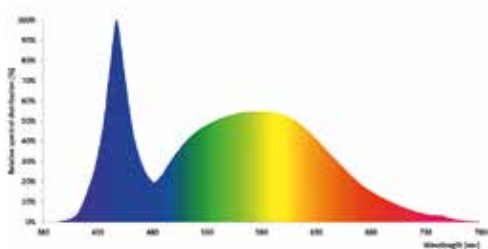

with easy-to-mount universal V4A stainless steel holder whose length can be adjusted, for all aquaria.

Most LEDs currently used in the aquarium hobby were originally developed as background lighting for monitors. These plastic-cast LED chips are very low-price, however, the heat dissipation is quite bad, which shortens their useful life considerably. For lighting aquaria, they are therefore only of limited use.

The Dennerle Trocal LED, on the other hand, is equipped with high-quality LEDs with an extremely high output density, and you will find its optimal heat management and its long useful life with around 80,000 operative hours very convincing. The ceramic substrate, on which the LEDs are mounted, dissipates the heat extremely well. Thanks to this, a very high light luminous flux is possible, and yet the LEDs have an extraordinarily long useful life, and there is only little loss on the luminous flux during the entire operating life of the lamp. This results in a very high luminous power despite the lower number of LEDs and a lower power consumption.

The high output density enhances plant growth considerably, and the fish display their most beautiful colors. In addition, the subtle sunlight effect gives that certain something to any aquarium, since these photorefractive effects just look like natural sunlight.



CLICK
HERE



Trocal LED - overview

Name	Length	Output	For aquarium width	For aquarium volume	Lumens	Replaces 2 T5 tubes	Replaces 2 T8 tubes	ID No.	MSRP*
Trocal LED	40 cm	18 W	38 – 55 cm	approx. 50 – 80 l	1,680	24 W – 438 mm	15 W – 438 mm	5550	129.00 €
Trocal LED	50 cm	24 W	48 – 65 cm	approx. 70 – 110 l	2,240	24 W – 549 mm / 28 W – 590 mm	18 W – 59 mm	5551	159.00 €
Trocal LED	60 cm	30 W	58 – 75 cm	approx. 90 – 140 l	2,800	-	-	5552	179.00 €
Trocal LED	70 cm	36 W	68 – 85 cm	approx. 110 – 170 l	3,360	35 W – 742 mm	25 W – 742 mm	5553	189.00 €
Trocal LED	80 cm	42 W	78 – 95 cm	approx. 130 – 200 l	3,920	39 W – 849 mm / 45 W – 895 mm	30 W – 895 mm	5554	199.00 €
Trocal LED	90 cm	48 W	88 – 105 cm	approx. 150 – 220 l	4,480	-	-	5556	219.00 €
Trocal LED	100 cm	54 W	98 – 115 cm	approx. 170 – 250 l	5,040	54 W – 1,047 mm	38 W – 1,047 mm	5557	239.00 €
Trocal LED	110 cm	60 W	108 – 125 cm	approx. 190 – 280 l	5,600	54 W – 1,149 mm / 54 W – 1,200 mm	36 W – 1,200 mm	5558	269.00 €
Trocal LED	120 cm	66 W	118 – 135 cm	approx. 200 – 300 l	6,160	-	-	5559	299.00 €
Trocal LED	130 cm	72 W	128 – 145 cm	approx. 220 – 330 l	6,720	-	-	5560	319.00 €
Trocal LED	140 cm	78 W	138 – 155 cm	approx. 240 – 360 l	7,280	80 W – 1,449 mm	58 W – 1,500 mm	5561	409.00 €
Trocal LED	150 cm	84 W	148 – 165 cm	approx. 260 – 400 l	7,840	-	-	5562	429.00 €
Trocal LED	160 cm	90 W	158 – 175 cm	approx. 280 – 420 l	8,400	-	-	5563	449.00 €

*Manufacturer's suggested retail price, please ask your specialist dealer for the exact final price.

Trocal LED

CLICK
HERE

Technical data:

- Input: 12 – 24 V DC
- Output / Channel (max.): 2.5 A
- Connections: USB; 4 x Mini Power DIN 3-pole
- Dimensions: 130 mm x 84 mm x 24 mm
- Max. controllable performance / lamp: 120 W at 24 V

CLICK
HERE

Control unit



Trocal LED Connect

Necessary whenever a second Trocal LED is to be connected to an LED Control control unit.

Technical data:

- » Cable length: 1.5 m
- » Plug: Mini Power DIN 3-pole

Trocal LED Connect
ID No. 5549

1 pc.
MSRP* 19.99 €

Trocal LED Retro Fit Kit

With the Retro Fit Kit you can integrate the Dennerle TROCAL LED in 6 different positions into an existing T5 / T8 light bar.

Trocal LED Retro Fit Kit
No. 5548

1 pc. ID
MSRP* 14.99 €

Trocal LED CONTROL

LED control unit for the simulation of natural light in freshwater and marine tanks. If a high performance and extremely simple handling is equally important to you, LED Control is the control unit of your choice.

4 channels for up to 2 Trocal LED lamps can be controlled at once.

Sunrise and sunset can be simulated with color changes, and you can also program the unit to switch off the lights at noon for the lighting pause around midday strongly recommended Dennerle.

With a moon phase simulation and an acclimatization program that helps fish and plants to adapt to their new surroundings or for the alleviation of algae problems.

Programming is possible on the device or via PC (USB connection). Data are stored during a power failure thanks to a buffer.

Suitable for all Dennerle Trocal LEDs.

For an easy start, 4 time-tested lighting scenarios have been pre-programmed (can be modified).

Trocal LED Control 1 pc. ID No. 5564 MSRP* 119.99 €

Trocal LED Retro Fit Kit



The set consists of:

- 2 x holding brackets, (L-shaped) of stainless steel V4A, dimensions: 130 x 56 x 22
- 2 x adapter T5 (plastic, color: black)
- 2 x adapter T8 (plastic, color: black)
- 2 x lid, fitting the adapter T5 / T8 (plastic, color: black)



*Manufacturer's suggested retail price, please ask your specialist dealer for the exact final price.

Aquarium substrates



Quartz gravel

CLICK
HERE

Dennerle quartz gravel is a true classic in our product range — time has proven that it is one of the very best aquarium gravels you could use in your tank. The combination of a truly beautiful look and the perfect biological function of this gravel are probably unique in this combination. This gravel does not harden the water, it is lightfast and resistant to CO₂, it can be re-used multiple times and keeps its color even after many years. Our quartz gravel is colored with iron oxide, neutral in water and guaranteed to be free from toxic substances.

The grain of 1 — 2 mm is beneficial for bottom-dwelling fish and reduces the risk of muck gathering in larger spaces between the grains. Our fine-grained quartz gravel is also highly suitable for plants with small root systems. Since the granules are rounded, the risk of injury is very small. The tiny spaces between the granules are a perfect substrate for important filter bacteria. You needn't pre-rinse Dennerle quartz gravel (with the exception of the natural white color).

Name	Content	ID No.	MSRP*
Crystal quartz gravel natural white	5 kg	1743	11.19 €
Crystal quartz gravel natural white	10 kg	1729	18.99 €
Crystal quartz gravel dark brown	5 kg	1744	15.99 €
Crystal quartz gravel dark brown	10 kg	1730	25.49 €
Crystal quartz gravel slate grey	5 kg	1748	15.99 €
Crystal quartz gravel slate grey	10 kg	1731	25.49 €
Crystal quartz gravel roe brown	5 kg	1749	15.99 €
Crystal quartz gravel roe brown	10 kg	1732	25.49 €
Crystal quartz gravel diamond black	5 kg	1755	15.99 €
Crystal quartz gravel diamond black	10 kg	1733	25.49 €



Gravel cleaner

Simply siphon off organic particles from the uppermost substrate layer. Shake a few times and the gravel cleaner starts working. The slim suction tube is 50 cm long, an ideal length for planted aquaria. You can reach even small nooks and crannies easily when cleaning. Length of the tube = 180 cm.

Gravel cleaner ID No. 5890 MSRP* 22.99 €



FB1 SubstrateStart

FB1 SubstrateStart is a highly active mix of carefully selected soil bacteria. It is simply sprinkled onto the layer of DeponitMix. Cover with gravel afterwards. The bacteria contained in FB1 are activated by water and immediately start turning the substrate into an active bio filter. Live humus bacteria make the nutrients available for the plants. For a quick, safe start.

FB1 SubstrateStart, 50 g ID No. 4561 MSRP* 9.79 €

*Manufacturer's suggested retail price, please ask your specialist dealer for the exact final price.

What do I need to build my substrate system?

Volume	54 liters	63 liters	112 liters	128 liters	160 liters	200 liters	240 liters	300 liters	375 liters
Dimensions L x W x H	60 x 30 x 30 cm	60 x 30 x 35 cm	80 x 35 x 40 cm	80 x 40 x 40 cm	100 x 40 x 40 cm	100 x 40 x 50 cm	120 x 40 x 50 cm	120 x 50 x 50 cm	150 x 50 x 50 cm
With nutrient medium and gravel									
recommended substrate height	5 cm	5 cm	6 cm	6 cm	7 cm	8 cm	8 cm	8 cm	9 cm
amount of gravel required	10 kg	10 kg	20 kg	25 kg	35 kg	40 kg	50 kg	60 kg	90 kg
amount of nutrient medium required (DeponitMix 9in1 or NutriBasis 6in1)	2.4 kg	2.4 kg	4.8 kg	4.8 kg	9.6 kg	9.6 kg	12 kg	14.4 kg	19.2 kg



The little brother of our top-notch nutrient substrate provides the plants with all the important nutrients and trace elements in the long run thanks to its efficient depot form.

The difference to our 9in1 Nutrient Medium lies in the absence of the activator pearls, a slightly reduced nutrient content and the fact that the 6in1 Nutrient Medium comes dry, and in a plastic bag.

Name	For aquarium volumes of	Content	ID No.	MSRP*
NutriBasis 6in1	50 – 70 Liter	2.4 kg	4586	9.59 €
NutriBasis 6in1	100 – 140 Liter	4.8 kg	4587	14.59 €
NutriBasis 6in1	160 – 250 Liter	9.6 kg	4588	24.69 €



DeponitMix Professional 9in1

Building on their vast knowledge of the natural biotopes where the most popular aquarium plants grow, the Dennerle aquarium plant nursery has developed a long-time undergravel mineral nutrient medium rich in humus especially for the use in an aquarium, to optimize the nutrient intake for the plants through their vast root system. This enables you to keep even tender plant species successfully whose cultivation in the aquarium is normally rather difficult.

Of course, DeponitMix does not contain phosphates or nitrates, i.e. nutrients that could promote algal growth when present in high concentrations. Use the nutrient substrate as lowermost layer and cover with a gravel.

Long-term practical experience shows: Deponit-Mix can efficiently prevent algae problems. The combination of nutritious iron depots, trace elements and clay minerals that balance the nutrient supply provides the aquarium plants with the right amount of all the nutrients they require. Natural peat, rich in humins, creates a slightly acidic environment inside the substrate and makes the nutrients better available for the plants. DeponitMix is lightly moist, and the clay minerals, humus substances and the bottom bacteria are already active. The oxygen supply for the bacteria is safeguarded by the two holes in the lid of the container.

Another unique feature are the white activator pearls that act like a filling station for the bacteria and make sure that the beneficial microorganisms in the substrate run on full power from day one on. Dependent on the plant density, the strength of the lighting and the amount of other fertilizers, DeponitMix can be effective for up to ten years.

Name	Content	ID No.	MSRP*
DeponitMix Professional 9in1	for volumes of 50 – 70 liters	4595	14.99 €
DeponitMix Professional 9in1	for volumes of 100 – 140 liters	4596	20.99 €
DeponitMix Professional 9in1	for volumes of 160 – 250 liters	4597	36.99 €

Undergravel heater Eco-Line ThermoTronic



The DENNERLE ThermoTronic undergravel heater creates a slow thermic water circulation in the aquarium substrate, which mimic natural nutrient seepages. This results in an optimal nutrient supply and, in turn, in the best conditions for lush and vigorous plants. The substrate is turned into a huge bio filter. The mild warmth in the substrate activates root growth.

Sold as long as stocks last.

Name	Output	ID No.	MSRP*
Eco-Line ThermoTronic	10 W	1632	52.99 €
Eco-Line ThermoTronic	20 W	1633	58.99 €

*Manufacturer's suggested retail price, please ask your specialist dealer for the exact final price.

Nutrient media

Plantahunter natural gravels

The Plantahunter gravels are 100 % natural and pure, Made in Germany, and do not contain any artificial colorants — a crucial part of a naturally decorated aquarium. In order to create a truly natural underwater garden, we recommend the use of several grains of the same gravel variety and to add the gravel at different levels.

If you want to create stronger contrasts, simply combine with white or black varieties. The Plantahunter natural gravel variants are ideal for aquascaping since they allow you to create your very own absolutely natural-looking underwater landscape. The various colors and forms bring interesting details to individual zones and make adding fascinating accents and exciting contrasts to the aquarium layout very easy.

Tip: Fish prefer a dark substrate and display their most beautiful colors then.

Bioactive natural gravel

In order to preserve the natural biofilms, Dennerle Plantahunter gravel is not pre-cleaned. Thanks to this, a highly beneficial, active natural bacterial fauna is added to your aquarium, which starts reducing organic pollution immediately. Please rinse with cold water only in order to make sure the bacteria survive.

CLICK HERE



Baikal (3 – 8 mm)

Baikal (10 – 30 mm)

Beach



Natural gravel Baikal 3 – 8 mm
ID No. 6909  content 5 kg **MSRP* 12.99 €**

Natural gravel Baikal 10 – 30 mm
ID No. 6910  content 5 kg **MSRP* 12.99 €**

Natural gravel Beach 0.1 – 0.6 mm
ID No. 6911  content 5 kg **MSRP* 15.99 €**

*Manufacturer's suggested retail price, please ask your specialist dealer for the exact final price.



An impossible mix?

During the live demos we hold at numerous aquarium trade shows we have shown again and again how great the Plantahunter gravel varieties look in combination with the Dennerle Crystal Quartz Gravel. Our most favorite combinations are:



Rio Xingu / roe brown



River S / slate grey



River S / diamond black

Rio Xingu MIX



Natural gravel Rio Xingu MIX 2 — 22 mm
ID No. 6912  content 5 kg

MSRP* 10.99 €

River S



Natural gravel River S
ID No. 6923  content 5 kg

MSRP* 10.99 €

River L



Natural gravel River L
ID No. 6924  content 5 kg

MSRP* 10.99 €

*Manufacturer's suggested retail price, please ask your specialist dealer for the exact final price.

Nano substrates & care

Shrimp Gravel Bed

Our Nano Shrimp Gravel Bed is guaranteed to be safe for shrimp and crayfish alike.

Tip: In combination with gravels of different grain sizes (Crystal Quartz Gravel or the natural Plantahunter gravels) you can create wonderful substrate compositions with a natural feel.

Does not harden the water, is neutral in water, lightfast, resistant to CO₂, granules are rounded, grain 0.7 – 1.2 mm.

CLICK
HERE

Name	Content	ID No.	MSRP*
Nano Shrimp Gravel Bed, Arkansas grey	2 kg	5857	9.69 €
Nano Shrimp Gravel Bed, Borneo brown	2 kg	5914	9.69 €
Nano Shrimp Gravel Bed, Sulawesi black	2 kg	5913	9.69 €
Nano Shrimp Gravel Bed, Sumatra brown	2 kg	5856	9.49 €
Nano Shrimp Gravel Bed, Sunda white	2 kg	5858	9.69 €



Borneo brown



Sulawesi black



Sumatra brown

What do I need to build my substrate system?

Volume	10 liters	20 liters	30 liters	35 liters	55 liters	60 liters
Dimensions L x W x H	20 x 20 x 25 cm	25 x 25 x 30 cm	30 x 30 x 35 cm	40 x 32 x 28 cm	45 x 34 x 36 cm	38 x 38 x 43 cm

With nutrient medium and gravel	10 liters	20 liters	30 liters	35 liters	55 liters	60 liters
total recommended substrate height	4 – 5 cm	4 – 5 cm	4 – 5 cm	4 – 5 cm	4 – 5 cm	4 – 5 cm
amount of gravel required	2 kg	4 kg	4 kg	6 kg	6 kg	6 kg
amount of nutrient medium required (Nano DeponitMix)	1 kg	1 kg	2 kg	2 kg	3 kg	3 kg

With Soil	10 liters	20 liters	30 liters	35 liters	55 liters	60 liters
amount of Soil	2 l	3 l	4 l	6 l	8 l	8 l



Arkansas grey



Sunda white

Dennerle Soil

Dennerle Soil consists of different natural earths only. They have been carefully selected and contain vital minerals and trace elements.

Moreover, it serves as a natural source of important humic and fulvic acids, without staining the water. Like a sponge, soil bonds to superfluous nutrients, which it then gives off to the plant roots in well-dosed portions. At the same time, soil lowers the carbonate hardness and the pH, which is beneficial for most tropical aquarium plants.

Tip: within the first four weeks, we recommend a weekly water change of 50 per cent.

ShrimpKing Active Soil

CLICK
HERE



This soil is an especially good choice for shrimp species preferring soft and slightly acidic water, like the popular Bee, Crystal Red, Red Bee, Tigerbee or Taiwan Bee / Shadow shrimp. In contrast to standard Scaper's Soil, ShrimpKing Soil contains less plant nutrients, which results in a thicker biofilm on the granules. Especially baby shrimp just love grazing on this nutritious layer.



ShrimpKing Active Soil 4L ID No. 6177 MSRP* 18.99 €

ShrimpKing Active Soil 8L ID No. 6178 MSRP* 34.99 €

CLICK
HERE



Scaper's Soil

If you'd just love to experience turbo fast plant growth in combination with absolutely problem-free use, Scaper's Soil is the substrate of choice for you. In our experience, the positive effects of this active substrate can last for up to two years. The irregular form of the soil granules, 1-4 mm in diameter, gives this substrate a perfectly natural appearance. The dark color contrasts beautifully against the bright colors of the plants, fish and shrimp.



Scaper's Soil 4L ID No. 4580 MSRP* 20.69 €

Scaper's Soil 8L ID No. 4581 MSRP* 35.99 €

*Manufacturer's suggested retail price, please ask your specialist dealer for the exact final price.

Nano Deponit Mix

Long years of practical experience have shown that our Nano DeponitMix can prevent algae problems. The combination of nutritious iron depots, trace elements and clay minerals that balance the nutrient supply provides the aquarium plants with the right amount of all the nutrients they require. Natural peat, rich in humins, creates a slightly acidic environment inside the substrate and makes the nutrients better available for the plants.

Guaranteed: safe for invertebrates.

Nano Deponit Mix 1 kg ID No. 5912  **MSRP* 9.29 €**



Nano gravel cleaner

Simply siphon off organic particles from the uppermost substrate layer. Thanks to the innovative pump valve you needn't aspire the water any more. The slim suction tube and the thin tube of the Nano gravel cleaner are ideal for planted nano tanks. With a practical tube holder and a flow regulator.

Nano gravel cleaner ID No. 5878 **MSRP* 22.99 €**

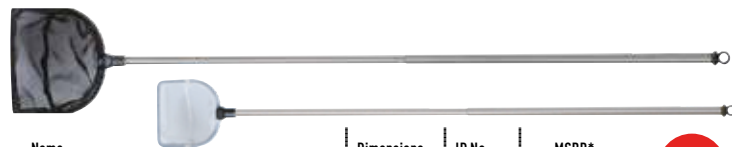

Name	Dimensions	ID No.	MSRP*
Nano Shrimp Net, small, white	50 x 50 mm	2478	9.99 €
Nano Shrimp Net, small, black	50 x 50 mm	2479	9.99 €
Nano Shrimp Net, large, white	75 x 60 mm	2480	10.99 €
Nano Shrimp Net, large, black	75 x 60 mm	2481	10.99 €

HIER KLICKEN

Nano Shrimp Net

Sturdy and stainless steel telescopic version, which can be extended from 24 to 62 cm.

Tip: If you want to catch shrimp, you will be better off with the white net, because shrimp are not so easily scared of this color. If you only want to catch leaf debris or fish, you are well equipped with the black version.

Nano care



Nano Crusta-Fit

Vital substances for shrimp and crabs. Dexpanthenol and calcium ensure a smooth moult. Sufficient for 20 weeks for a 30 l cube.

Nano Crusta-Fit 15 ml ID No. 5909  **MSRP* 6.89 €**



Nano care kit

Nano water treatment, Nano daily fertilizer, Nano Crusta-Fit

Nano care kit 3 x 15 ml ID No. 5910  **MSRP* 16.99 €**



Nano daily fertilizer

Highly active nutrients for rich green leaves and intense bright colors. Not algae-promoting. The vial suffices an incredible 100 days for a 30 l Nano cube.

Nano daily fertilizer 15 ml ID No. 5907  **MSRP* 6.79 €**



Nano Catappa Leaves

Sea almond leaves are ideal to create natural, tropical water. At the same time they are a valuable additional food (holiday food!) For crayfish and shrimp.

Nano Catappa Leaves 12 pc. ID No. 5916 **MSRP* 6.89 €**



Nano water treatment

Neutralizes hazardous chlorine immediately and binds toxic heavy metals. Adds natural bio-active substances and care substances. Sufficient for 40 weeks at a 25 % water change interval in a 30 l cube.

Nano water treatment 15 ml ID No. 5908  **MSRP* 6.79 €**



Nano Catappa Bark

The bark of the sea almond tree has the same positive qualities as its leaves but is not decomposed or eaten.

Nano Catappa Bark 8 pc. ID No. 5867 **MSRP* 5.49 €**



Nano FB7 Bacto Elixier

The microorganisms contained remove excrement products, feed and plant residues. For a 30 l cube, sufficient for 20 weeks.

Nano FB7 Bacto Elixier 15 ml ID No. 5855  **MSRP* 6.89 €**



Nano Black Cones

Viagra for the fish! Natural water care for aquariums and at the same time natural decoration.

Nano Black Cones 25 pc. ID No. 5911 **MSRP* 6.59 €**

*Manufacturer's suggested retail price, please ask your specialist dealer for the exact final price.

Carbon dioxide fertilization for a strong aquarium

You have the following options of supplying your tank with carbon:

1. Liquid carbon that needs to be added to the tank every morning (CarboElixir Bio can be used in the Dosator)
2. Gaseous bio CO₂ produced by yeast, which digest sugars and breathe out CO₂ while metabolizing
3. Pressurized systems, the most precise variant offering the highest performance, but at the same time, also the one with the highest store price. These systems are super easy to operate, and their low follow-up costs are very low



CLICK HERE



CarboElixir Bio

CarboElixir Bio provides your aquarium plants with easily available carbon and with trace elements. The special formula is based on several components, all of them based on 100% biological raw materials. It prevents carbon deficiencies in plants effectively. Moreover, CarboElixir Bio contains vital nutrients for the plants, like potassium, iron, manganese and boron.

Success becomes visible after a few short weeks — you will observe better growth at the shoot tips, and a more intense color in young leaves. Also complementary to a CO₂ supplying system. 250 ml for 12,500 liters of water, 500 ml for 25,000 liters of water.

Dosage depends on the plant density and the growth conditions: Add 1-3 ml per 100 liters of aquarium water per day, or use in a Dosator.

CarboElixir Bio	250 ml	ID No. 3111	MSRP* 9.49 €
CarboElixir Bio	500 ml	ID No. 3112	MSRP* 14.99 €

CLICK HERE



CarboBooster Max

CarboBooster Max provides your aquarium plants with liquid carbon based on glutaraldehyde. Its effect is somewhat stronger than that of CarboElixir Bio, and it is especially recommendable for aquaria with a slight tendency towards a certain amount of algal growth. CarboBooster Max does not contain trace elements and cannot be used in the Dosator.

Success becomes visible after a few short weeks — you will observe better growth at the shoot tips, and a more intense color in young leaves. Also complementary to a CO₂ supplying system. 250 ml for 12,500 liters of water, 500 ml for 25,000 liters of water. Dosage depends on the plant density and the growth conditions: Add 2-4 ml per 100 liters of aquarium water per day.

CarboBooster Max	250 ml	ID No. 3114	MSRP* 8.99 €
CarboBooster Max	500 ml	ID No. 3115	MSRP* 13.99 €

CLICK HERE



CO₂ Quicktest



With this double test you can find out quickly and easily if your aquarium contains sufficient levels of CO₂ (liquid carbon compounds are not shown). Simply fill aquarium water into the test tube, shake a little and you get a color reaction that gives you the result.

Tip: In the morning, usually there is plenty of CO₂ in the water, but it is used up by the plants quickly. It is best to test the water for CO₂ after around half of the lighting time has elapsed

CO ₂ Quicktest	ID No. 3106	MSRP* 3.99 €
---------------------------	-------------	--------------



*Manufacturer's suggested retail price, please ask your specialist dealer for the exact final price.

BIO 60 Complete set



- micro flipper
- bubble counter
- starter capsule
- depot
- stand
- CO₂ tubing



Produces at least 300,000 CO₂ bubbles (0.125 mg / bubble = 37.5 g CO₂) over a period of at least 4 weeks

The simple way of adding CO₂: Producing CO₂ based on controlled and constant yeast fermentation. Ideal for everyone who wants to give CO₂ fertilization a try. You will see considerable improvements after only a few weeks.

DENNERLE Bio CO₂ makes use of the well-known fact that yeast cells can produce CO₂ from sugar. When baking bread you take advantage of exactly that principle: The yeast dough is fermented and the CO₂ the yeasts produce makes the dough fluffy and raises it.

DENNERLE Bio CO₂ with CO₂ Control Gel produces an almost constant amount of CO₂ over 30 days! Each CO₂ depot gives off far more than 300,000 CO₂ bubbles to supply your tank with the optimal amount of CO₂ day after day after day.

The sets consist of:

- CO₂ depot with CO₂ Control Gel and a starter capsule
- CO₂ diffuser
- stand
- CO₂ tubing

Satisfaction guarantee*: test without risk for 8 weeks.

If you decide to buy a liquid CO₂ system by Dennerle you will be credited the purchase price.

* valid if you buy from shops that participate in this campaign

Name	Content		MSRP*	ID No.
BIO CO ₂ StarterSet	1 Unit	for aquaria with a volume up to 60 liters	10.99 €	3007
BIO 60 complete set	1 Unit	for aquaria with a volume up to 60 liters	21.49 €	3008
BIO 120 complete set	1 Unit	for aquaria with a volume up to 120 liters	37.49 €	3009
Bio-CO ₂ -depot	1 Unit	1 x depot	8.79 €	3004
Bio-CO ₂ -depot value pack	2 Unit	2 x depot	15.99 €	3005
Co30 starter capsule	5 Unit	triggers the fermentation process in the bio CO ₂ systems	2.99 €	1557

CLICK HERE

Which CO₂ system is right for my aquarium?

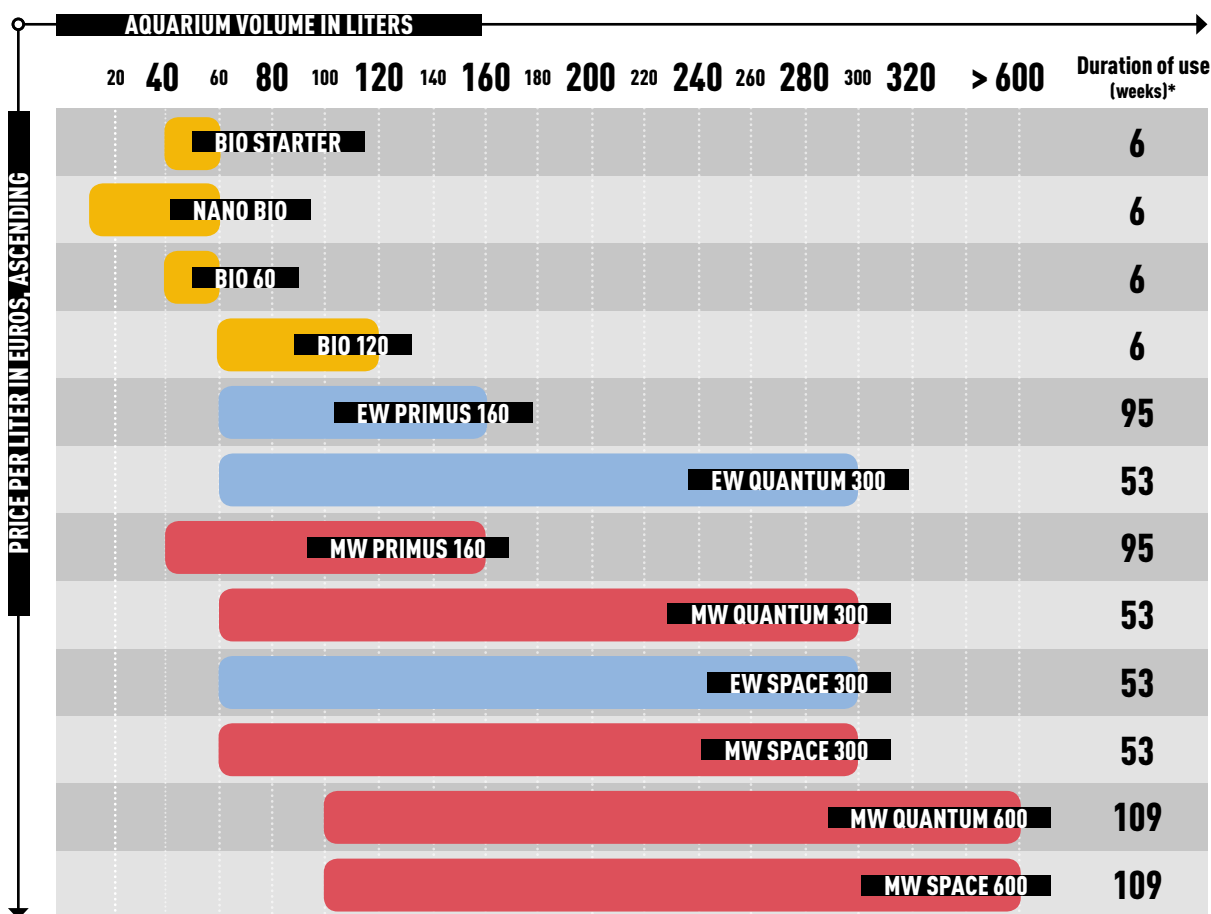

*calculated as operational range per cartridge/bottle; for a lighting period of 10 hours per day (with night shut-off [for pressurized gas systems only]), 10 bubbles per minute per 100 l of tank water).

Bio CO₂ One-way System Refillable System

*Manufacturer's suggested retail price, please ask your specialist dealer for the exact final price.

Pressurized CO₂

A planted tank without an external source of carbon can only be regarded as a makeshift solution, since carbon is THE most important plant nutrient (please see our article on pages 78 ff.), and any aquarium with plants will run much better with sufficient levels of it.

The systems using liquified CO₂ gas by Dennerle can rightfully be counted among the best CO₂ injection systems in the world. They are easy to operate and have an extraordinarily long useful life thanks to a manufacturing process safeguarding the utmost quality and precision.

The heart and soul of all CO₂ injection systems is the pressure reducer, which reduces the pressure in the bottle to a working pressure that can be regulated. All our three pressure reducers alike share the highly precise control mechanism — the „egg“, as we call it. With this turning knob you can control the amount of CO₂ that is added to the tank extremely precisely and slowly.

Thanks to the DVC technology (Dynamic Valve Control) we use here, a sudden increase in the number of bubbles that can occur when you use a standard needle valve is a thing of the past, as are unwanted changes in the number of bubbles in general.

Primus: Does everything we except from a good pressure reducer. The turning knob on the „egg“ regulates the amount of CO₂ injected into the aquarium slowly and precisely. Of course, it comes with a micro filter, overpressure protection and automatic pressure compensation.

Quantum: Our most-sold system, which is equipped with a manometer that controls the pressure inside the cylinder in addition to the turning knob, and with a bubble counter.

Space: The only pressure reducer with an integrated solenoid valve (with a safe voltage of 9 V). Without electricity, the solenoid valve is closed — for the safety of your aquarium occupants. When the blue LED at the front lights up the solenoid valve is working and your tank is supplied with CO₂.



CO₂ solenoid valve

Controls the CO₂ supply by means of a clock timer or the pH Controller Evolution Deluxe.

CO₂ solenoid valve 1 pc.
ID No. 2970 MSRP* 89.99 €

Our pressurized CO₂ injection systems differ when it comes to the extras and refillability. Depending on the size of the aquarium, various diffusers are at your disposal. Thanks to many extra features like a permanent CO₂ test, 2 meters of CO₂ tight tubing, a check valve, a tool set and a fertilizer set you can set out into the future of your aquarium right away. In addition to the standard additions, the CO₂ injection systems of our Special Edition contain a solenoid valve and a clock timer for an easy night shut-off.

CO₂ adapter



Number	Name	ID No.	MSRP*
1.	Nano- / Space pressure regulator for disposable cylinder	2997	20.99 €
2.	Nano- / Space pressure regulator for reusable cylinder	2998	22.49 €
3.	Disposable pressure regulator for reusable cylinders	2999	22.49 €
4.	Reusable pressure regulator for disposable cylinders	3000	20.99 €

One-way



Supplies CO₂ by means of liquified gas in a recyclable one-way cylinder.

Refillable



Supplies CO₂ by means of liquified gas in a refillable cylinder.

*Manufacturer's suggested retail price, please ask your specialist dealer for the exact final price.



CO₂ pressure reducer QUANTUM

[CLICK HERE](#)

Quantum: Our most-sold system, which is equipped with a manometer that controls the pressure inside the cylinder in addition to the turning knob, and with a bubble counter.

CO₂ pressure reducer QUANTUM
ID No. 3062 **MSRP* 139.99 €**



CO₂ pressure reducer SPACE

Space: The only pressure reducer with an integrated solenoid valve (with a safe voltage of 9 V). Without electricity, the solenoid valve is closed. When the blue LED at the front lights up the solenoid valve supplies your tank with CO₂.

CO₂-pressure reducer SPACE
ID No. 3063 **MSRP* 215.99 €**



CO₂-pressure reducer Nano

Special design for nano aquaria that need smaller amounts of CO₂. Pressure reducer with connection thread fitting the Dennerle Crystal-Line CO₂ cylinders

CO₂-pressure reducer Nano
ID No. 2996 **MSRP* 75.99 €**

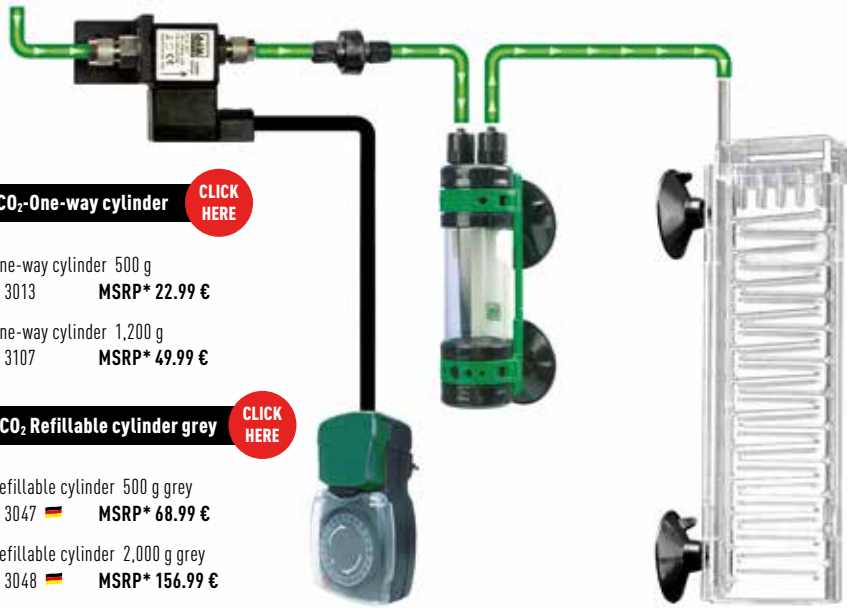

CO₂-One-way cylinder

[CLICK HERE](#)

CO₂-One-way cylinder 500 g
ID No. 3013 **MSRP* 22.99 €**

CO₂-One-way cylinder 1.200 g
ID No. 3107 **MSRP* 49.99 €**

CO₂ Refillable cylinder grey

[CLICK HERE](#)

CO₂-Refillable cylinder 500 g grey
ID No. 3047 **MSRP* 68.99 €**

CO₂-Refillable cylinder 2.000 g grey
ID No. 3048 **MSRP* 156.99 €**

Name	ID No.	MSRP	Refillable cylinder 2.000 g	Refillable cylinder 500 g	One-way cylinder 500 g	Pressure reducer Evolution Primus	Pressure reducer Evolution Space	Pressure reducer Evolution Quantum	CO ₂ -Maxiflipper	CO ₂ -Flipper	CO ₂ -Miniflipper	Permanent test Correct	Perfect Plant Set 300 l	Solenoid valve	Clock timer	CO ₂ -Spezial check valve	Adapter for one-way PR to refillable	Adapter for Nano PR to one-way cylinder	Adapter for Nano PR to refillable cylinder	CO ₂ tubing Softflex 2m	pH Controller Evolution de Luxe	pH calibration solution 450 ml	pH calibration solution 750 ml	Aqua Dest - 250 ml
One-way 160 PRIMUS	2972	119.99 €		X	X						X	X	X			X				X				
One-way 160 PRIMUS Special Edition	2975	174.99 €		X	X						X	X	X	X	X	X				X				
One-way 300 QUANTUM	2974	149.99 €			X			X		X		X	X			X				X				
One-way 300 QUANTUM Special Edition	2976	204.99 €			X			X		X		X	X	X	X	X				X				
One-way 300 SPACE	2973	223.99 €			X		X			X		X	X			X			X	X				
Refillable 160 PRIMUS	3074	179.99 €	X			X					X	X	X			X	X			X				
Refillable 160 PRIMUS Special Edition	3039	244.99 €	X			X					X	X	X	X	X	X	X			X				
Refillable 300 QUANTUM	3076	213.99 €		X				X		X		X	X			X	X			X				
Refillable 300 QUANTUM Special Edition	3044	269.99 €		X				X		X		X	X	X	X	X	X			X				
Refillable 300 SPACE	3077	285.99 €		X			X			X		X	X			X			X	X				
Refillable 600 QUANTUM	3078	339.99 €	X					X	X			X	X			X	X			X				
Refillable 600 SPACE	3079	384.99 €	X				X		X			X	X			X			X	X				
Refillable 600 SPACE Special Edition	3046	469.99 €	X				X		X			X	X			X			X	X	X	X	X	X

*Manufacturer's suggested retail price, please ask your specialist dealer for the exact final price.

CO₂ accessories

Permanent CO₂ test Correct



Permanent CO₂ test + pH measurement

For monitoring the CO₂ content of the aquarium water permanently, also functions as pH test.

Ready-to-use special CO₂ indicator. No need to first mix it with aquarium water – just use the pure solution.

CO₂ safe hoses



Our CO₂ safe hoses are really CO₂ gas tight, which can not be said for conventional air and silicone hoses.

Permanent CO ₂ test Correct	1 pc.	ID No. 3040		MSRP* 21.99 €
CO ₂ Special Indicator refill pack	5 pc	ID No. 3061		MSRP* 16.99 €

CO ₂ safe hose Softflex	2 m	ID No. 3060		MSRP* 11.49 €
CO ₂ safe hose Softflex	5 m	ID No. 3061		MSRP* 16.99 €



KCL solution

For storing pH electrodes



pH calibration solution

Calibration solution for pH electrodes.

Name	Content	ID No.	MSRP*
CO ₂ pH electrode	1 Unit	3089	83.29 €
pH electrode holder	1 Unit	3094	11.49 €
pH electrode set	1 Unit	2971	107.99 €
KCL solution	50 ml	1448	7.49 €
pH calibration solution 4	50 ml	1445	7.49 €
pH calibration solution 7	50 ml	1446	7.49 €
Aqua Dest - distilled water for rinsing pH electrodes	250 ml	1452	3.99 €

CO₂ pH electrode	pH electrode holder	pH electrode set
Permanent measuring unit	Holder	pH measuring unit
For permanent pH measurement in freshwater and marine tanks.	Keeps the pH electrode safely in place in the aquarium.	Complete set, consisting of a gel electrode with holder, calibrating station and calibration solutions (pH 4, pH 7, distilled water).

*Manufacturer's suggested retail price, please ask your specialist dealer for the exact final price.

CO₂ accessories



[CLICK HERE](#)

CO₂-Maxi-Flipper

MW 600 QUANTUM
MW 600 SPACE



[CLICK HERE](#)

CO₂-Flipper

EW 300 QUANTUM
MW 300 QUANTUM
MW 300 SPACE



[CLICK HERE](#)

CO₂-Mini-Flipper

BIO 120 Complete set
EW 160 PRIMUS
MW 160 PRIMUS



[CLICK HERE](#)

CO₂-Micro-Flipper

BIO 60 Complete set



[CLICK HERE](#)

CO₂-Nano-Flipper

CO₂ Flipper

The CO₂ bubbles move slowly upward in the flipper and dissolve bit by bit. Made of high-quality Macrolon, can be taken apart for cleaning.

Name	Content	Content	Dimensions	This CO ₂ set contains a flipper	ID No.	MSRP*
CO ₂ -Maxi-Flipper	1 pc.	for aquaria with a volume up to 600 liters	11 x 36 x 4 cm	3078 / 3079	3070	53.99 €
CO ₂ -Flipper	1 pc.	for aquaria with a volume up to 300 liters	9 x 25 x 4 cm	2974 / 3076 / 3077	3069	32.69 €
CO ₂ -Mini-Flipper	1 pc.	for aquaria with a volume up to 160 liters	6.2 x 22.7 x 4 cm	2972 / 3009 / 3074	3071	26.99 €
CO ₂ -Micro-Flipper	1 pc.	for aquaria with a volume up to 60 liters	4.5 x 10.5 x 3.5 cm	3008	3075	20.79 €
CO ₂ -Nano-Flipper	1 pc.	for aquaria with a volume up to 10 – 40 liters	2.8 x 4.5 x 0.95 cm		5987	16.29 €



[CLICK HERE](#)

CO₂ Diffusor pipe



[CLICK HERE](#)

CO₂ Micro diffusor



[CLICK HERE](#)

Permanent CO₂ test



[CLICK HERE](#)

CO₂ bubble counter



[CLICK HERE](#)

CO₂ Special

Diffuses the CO₂ gas into thousands of microfine bubbles that dissolve in the water quickly and easily.

Monitors the CO₂ content of your aquarium water easily and exactly.

Helps you adjust the number of bubbles more easily, quickly and exactly.

Protects all CO₂ devices reliably from return water.

Name	Content	ID No.	MSRP*
CO ₂ diffusor pipe	1 pc. for aquaria with a volume up to 60 liters	2982	16.69 €
CO ₂ Micro diffusor	1 pc. for aquaria with a volume up to 200 liters	3065	16.59 €
Permanent CO ₂ test Maxi Crystal	1 pc.	2986	22.49 €
Permanent CO ₂ test Mini Crystal	1 pc.	2985	19.79 €
CO ₂ bubble counter Exact	1 pc.	3050	22.29 €
CO ₂ Special check valve	1 pc.	3053	16.69 €

*Manufacturer's suggested retail price, please ask your specialist dealer for the exact final price.

Plant care

At Dennerle, we are all about practicable aquatics, since we know that a well-balanced aquarium brings a lot of joy alongside very little work. Well-growing aquatic plants are a must if you want to achieve this goal. Based on the experience of one of the world's largest aquarium plant nurseries, Dennerle has developed various fertilizing concepts.



For medium light / a low number of plants

The introduction into the Dennerle world of plant care. Provides the aquarium plants with all the vital nutrients over their leaves. Against yellow or transparent leaves that are a consequence of iron or potassium deficiencies.

For intense green, healthy plants with bright colors. Ideal in combination with the undergravel fertilizer Deponit NutriBalls.

Dosage:

- 10 ml per 50 liters of aquarium water per week
- 250 ml per 1,250 liters will last:
- 54 l tank: 24 weeks
- 112 l tank: 12 weeks
- 240 l tank: 5 weeks

The highly concentrated complete fertilizer V30 Complete provides your aquarium plants with all the nutrients they need for vigorous and lush growth. Highly effective protective covers — the so-called chelates — make the nutrients available for the plants for a long time. Alleviates deficiencies with a long-lasting effect, guaranteed to be free from phosphates and nitrates, does not promote algae.

You can use V30 Complete as sole fertilizer and within the framework of the Dennerle fertilizing system.

Tip: For smaller tanks with a volume of up to 100 liters, you can mix V30 with CarboElixier Bio and add it with a Dosator.

E15 FerActiv iron fertilizer provides all aquarium plants with immediately available divalent nutritious iron, ensuring fresh, lush green plants. Deficiencies like yellow or transparent leaves are remedied to the greatest possible extent, and young shoots assume an intense green color from the beginning.

Iron is necessary for the formation of chlorophyll, without which the plant cannot photosynthesize. An iron deficiency results in yellowing leaves — the so-called iron chlorosis. Important fact: Plants are only able to use the so-called divalent iron, which quickly turns into trivalent, or brown iron. Usual iron tests do not indicate the presence of chelated iron.

Name	Content	Dosage for	ID No.	MSRP*
PlantElixir	250 ml	1,250 liters	4539	7.59 €
PlantElixir	500 ml	2,500 liters	4540	10.99 €
Name	Content	Dosage for	ID No.	MSRP*
V30 Complete	50 ml	1,600 liters	4457	8.69 €
V30 Complete	100 ml	3,200 liters	4458	14.99 €
V30 Complete	250 ml	8,000 liters	4522	31.99 €
V30 Complete	500 ml	16,000 liters	4523	50.99 €
Name	Content	Dosage for	ID No.	MSRP*
E15 FerActiv	20 pc.	2,000 liters	4549	9.69 €
E15 FerActiv	40 pc.	4,000 liters	4550	16.99 €
E15 FerActiv	100 pc.	10,000 liters	4551	34.99 €

Costs per week**

- 0.45 € 500 ml bottle PlantElixir
- 0.68 € PerfectPlant set for 1600 liters
- 0.54 € 250 ml bottle Scaper's Green

** Referring to the manufacturer's suggested retail price and a tank with a volume of 112 liters (80 cm)

*Manufacturer's suggested retail price, please ask your specialist dealer for the exact final price.

For a complete overview of the fertilizer components and declarations please go to: www.dennerle.com



In order to stay healthy and grow vigorously, aquarium plants need a constant, regular supply of nutrients, as they have in nature. Normally, fertilizer is added to aquaria in the form of a stock fertilization, i. e. a larger amount of fertilizer is given at regular intervals.

With the Dosator, in contrast, you can create a low yet very constant supply of fertilizer for your aquarium plants, just like in nature. The Dennerle Dosator is made of high-quality plastic and its method of work follows the principle of osmosis. The semi-permeable membrane guides water from the aquarium into the depot. The rising pressure sends the nutrient solution into a little riser pipe that releases the fertilizers into the aquarium drop by drop.

This method has two effects: firstly, the aquarium is always provided with only the amount of fertilizer that is needed at the exact moment, and secondly: The Dosator acts as a gauge. Bit by bit, water enters the depot, pressing the fertilizer into the tank, and the mixture of fertilizer and water in the depot of the Dosator turns more and more transparent as the proportion of the water increases. When the depot content loses color (S7 is orange, V30 yellowish green), you know it is time for a refill. With the Dosator you can add V30, S7, Scaper's Green and CarboElixier Bio to your aquarium.

Dosator 1 pc ID No. 4585 MSRP* 13.29 €

Spare part set Dosator 1 pc ID No. 4606 MSRP* 1.18 €
suction cup / seals

S7 VitaMix - vital micronutrients for aquarium plants and aquarium fish, which need minerals, trace elements and other vital substances to thrive, as do the microorganisms in the filter.

In tap water, these micronutrients are normally not present in sufficient amounts, and therefore the aquarium should be supplied with them on a regular basis.

The 3rd building block of the Dennerle fertilizing system.

Can be added to the tank with the Dosator.

Scaper's Green

A powerful fertilizer with an ideal combination of nutrients for demanding planted aquaria. Scaper's Green is a true high-performance fertilizer. It was especially developed for planted tanks and aquascapes with a very high demand for nutrients.

Suitable as weekly fertilizer (10 ml per 100 liters of aquarium water), daily fertilizer (1.4 ml/day/100 liters) or can be added with the Dosator.

NPK-Booster

Extra phosphate and nitrate power for sophisticated plant aquariums and aquascaping.

Name	Content	Dosage for	ID No.	MSRP*
S7 VitaMix	100 ml	3,200 liters	4544	14.99 €
S7 VitaMix	250 ml	8,000 liters	4505	31.99 €
S7 VitaMix	500 ml	16,000 liters	4506	50.99 €

Name	Content	Dosage for	ID No.	MSRP*
Scaper's Green	100 ml	1,200 liters	4530	7.29 €
Scaper's Green	250 ml	2,500 liters	4531	13.49 €
Scaper's Green	500 ml	5,000 liters	4532	20.59 €

Name	Content	Dosage for	ID No.	MSRP*
NPK-Booster	100 ml	1,000 liters	4533	7.29 €
NPK-Booster	250 ml	2,500 liters	4534	13.49 €
NPK-Booster	500 ml	5,000 liters	4535	20.59 €



*Manufacturer's suggested retail price, please ask your specialist dealer for the exact final price.

For a complete overview of the fertilizer components and declarations please go to: www.dennerle.com

Plant care

Especially plants with a strong root system like Echinodorus or Cryptocorynes love a good nutrient supply via the substrate.

With NutriBalls or PowerTabs, you can refresh old, exhausted substrates.

In the photos you can see very well how great plants develop that are supplied with nutrients via their roots, especially in comparison with the control plant on the far left. Your plants tell you exactly when they need new fertilizer: Just watch the new growth closely. If the young leaves look pale and grow slowly it is time to boost the nutrients.



After addition of 6 balls

Final plant weight:
133 grams

After addition of 2 balls

Final plant weight:
92 grams



Perfect Plant System Set

The complete fertilizer system from the large European aquatic plant nursery.

3 components for lush and vigorous aquarium plants:

- V30 complete fertilizer (50 ml)
- S7 trace elements (50 ml)
- E 15 iron fertilizer (20 tablets)

Perfect Plant System Set for 1,600 litres contains V30 50 ml, S7 50 ml, E15 10 tabs

The range of this concentrate is enormous: A 100 litre aquarium can be fertilised up to 33 weeks. At a retail price of 22.99 €, that is just 70 cents a week.

Perfect Plant System Set 1,600 l ID No. 4578 MSRP* 22.99 €



PlantaGold 7

The secret recipe from the aquarium plant nursery

Pure growing power thanks to natural, biological enzymes for even more powerful plants. Cell division is promoted and unused plant nutrients are re-activated. Plantagold visibly improves the state of your plants even when they are already doing quite well. PlantaGold 7 has several effects: It promotes plant growth, growth-enhancing natural enzymes boost cell division. Leaf formation is encouraged and the overall plant gets stronger.

Nutrient re-activator

In an aquarium, true treasure lies hidden in the water, in the substrate and in the muck: Useful yet unused nutrients. The unique catalyzing function of PlantaGold 7 makes them available for the plants again. Turn your entire tank into a motor for growth! Additional active chelated iron gives the plant leaves an intense green color.

Name	Content	for Aquarium volume	ID No.	MSRP*
PlantaGold 7	10 pc.	1,000 liters	4552	9.69 €
PlantaGold 7	20 pc.	2,000 liters	4553	16.99 €
PlantaGold 7	40 pc.	5,000 liters	4554	34.99 €

*Manufacturer's suggested retail price, please ask your specialist dealer for the exact final price.

For a complete overview of the fertilizer components and declarations please go to: www.dennerle.com



**without
Nutriballs**

Final plant weight:
48 grams

Using Nutriballs in an exhausted aquarium substrate

The photos were taken 3 months after the start of the experiment.
The plants were the same size when the experiment started!



Power Tabs

Special undergravel fertilizer for aquarium plants

This special fertilizer is taken up by the root system of the plants, for extra vigor and lush, strong growth. With iron and manganese for intensely colored leaves. Ideal for a good start and for „recharging“ the substrate.

Power Tabs provide your aquarium plants with all the important nutrients they need to grow healthily and vigorously. All nutritious elements are in a form that is directly available for the plants, with immediate and long-term effect. Vital trace elements like iron, magnesium and manganese tint the leaves intensely green. Red colors and attractive leaf patterns are intensified, too.

Dennerle PowerTabs refill the nutrient depots in the substrate in a targeted way. They close nutrient gaps that unavoidably occur when the aquarium ages, especially in the field of vital trace elements.

Name	Content	ID No.	MSRP*
Power Tabs	10 pc.	4556	6.89 €
Power Tabs	30 pc.	4557	15.69 €



DeponitNutriBalls

Universal undergravel fertilizer for a good start and for “recharging” the substrate.

Deponit NutriBalls are a universal nutrient depot based on natural clay, for aquarium plants like Cryptocoryne or Echinodorus that take up most of the nutrients via their root system.

They help newly introduced plants settle in, and the vigour of older plants gets a boost. Depending on the size of the plant, insert 1 – 4 of the balls into the substrate in the root zone.

Name	Content	ID No.	MSRP*
Deponit NutriBalls	10 pc.	4558	5.99 €
Deponit NutriBalls	30 pc.	4559	13.49 €

*Manufacturer's suggested retail price, please ask your specialist dealer for the exact final price.

For a complete overview of the fertilizer components and declarations please go to: www.dennerle.com

Aquarium accessories



SnailCatcher

Snails in the aquarium are not a bad thing at all. Quite to the contrary, most species feed on growth or organic residues in the aquarium and thus contribute to its maintenance.

In case of too many snails simply guide the snail catcher along the aquarium glass and convey the snails (size max 6 mm) with the roller into the catching container. The extendable telescopic handle (max. 31 cm) keeps your hands dry.

Also less feeding reduces snails!

SnailCatcher 1 pc.
ID No. 4039 MSRP* 10.49 €



The assassin snail or killer snail is the wolf among the snails and feeds on other snails – but it feeds on tablets as well.

Cleanator cleaning sponge



The stainless steel side of the Cleanator removes even the most stubborn algae and lime deposits effortlessly and efficiently. Thanks to the imitation of a natural sponge on the other side, the Cleanator allows you a good grip and it adapts to all rounded and angled corners and goes well under braces and such. Does not scratch the glass – guaranteed, since stainless steel is softer than glass.

MADE IN GERMANY

Cleanator cleaning sponge 1 pc. ID No. 4603 MSRP* 5.99 €

Stainless steel tools for aquaria



Nano Aquascaping set ID No. 5891 MSRP* 37.49 €

Planting tweezers XL

A pair of especially stable, long planting tweezers for large and high aquaria. With a length of 45 cm also suitable for placing large plants.

Number	Name	ID No.	MSRP*
1.	Curved PLANTER 365	5733	13.99 €
2.	Precision PLANTER 310	5734	11.99 €
3.	Curved CUT 300	5739	22.99 €
4.	Wavy CUT 200	5737	21.99 €
5.	Spring CUT 155	5740	24.99 €
6.	Pflanzpinzette XL	5892	16.29 €

Sale while stocks last.

*Manufacturer's suggested retail price, please ask your specialist dealer for the exact final price.

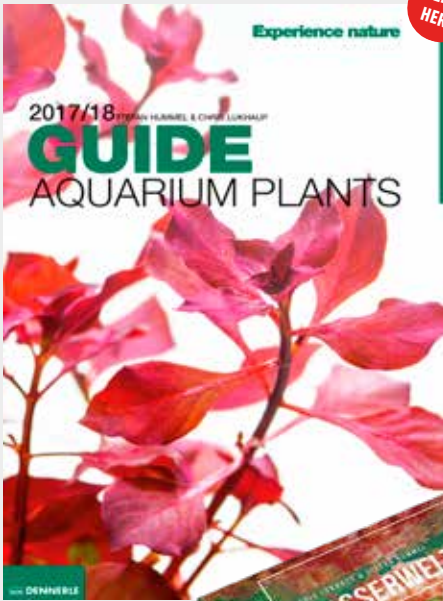

CLICK
HERE

Make your aquarium work even better
The 4th edition of the Dennerle Aquarium plants guide
has grown to a beautiful 158 pages.

In this guide, the Plantahunter Stefan Hummel takes you on a journey through the world of the aquarium plants produced by Dennerle. He shares insights into his expeditions and introduces you to the biology and cultivation of aquatic plants in an easy-to-understand, simple way. You'll find awesome hints and tips on how to care for an aquarium in the best possible manner. Moreover, this highly successful book contains a vast overview over the different species of aquatic plants, with lots of information and photos of the terrestrial as well as the aquatic form of the plants.

Aquarium plants guide ID No. 2793
 ISBN 978-3-943968-25-5 **4.95 €**

CLICK
HERE



„Wasserwelten“ Anniversary edition

In 2016, Dennerle turned 50. We have always been true to our company motto „Experience nature“ through all these years. The company founder Ludwig Dennerle did it, and the Plantahunter Stephan Hummel and the Crustahunter Chris Lukhaup followed his example: They went to numerous tropical and subtropical habitats to explore water worlds above and below the waterline. You can own the most beautiful, the most breathtaking photos taken during these journeys on the 200 pages of this stunning anniversary edition. In English, French and German.

Wasserwelten Anniversary edition, in English, French, German ID No. 2001
 ISBN 978-3-943968-21-7 **29.95 €**



This stands for the utmost quality and reliability of all Dennerle products.
Short transport routes are sustainable and protect our environment.

A tiny German flag behind the ID number indicates which products are made in Germany.

One great example for the Dennerle product management is the Cleanator (upper left): The company that produces this sponge on our behalf is located in Baden. All the components are produced in Germany, the sponge comes from Swabia, the foil packaging from Thuringia, the carton packaging from the Black Forest and the stainless steel mesh from the Ruhr area.

Imprint

3rd revised edition, October 2019



Dennerle © GmbH
 Industriestraße 4
 66981 Münchweiler a. d. Rodalb
 Germany

Editing and images: Dennerle © GmbH

All rights reserved. Full or partial reproduction, distribution through images, radio, television and on the Internet, through photomechanical reproduction, sound storage media and data processing systems of any kind subject to the written permission of the publisher.

Alterations of prices, the product range and types are reserved. No liability is assumed for errors and misprints. The prices given in this catalog are the manufacturer's suggested retail prices.

WATERWORLD

AQUARIUM IN BALANCE

ID No. 2827

