

SEEDER OPERATION AND PARTS MANUAL



TO THE PURCHASER

This manual contains valuable information about your new Seeder It has been carefully prepared to give you helpful suggestions for operating, adjusting, servicing and ordering repair parts.

Keep this manual in a convenient place for quick and easy reference. Study it carefully. You have purchased a dependable and sturdy seeder, but only by proper care and operation can you expect to receive the service and long life designed and built into it.

Sometime in the future your seeder may need new parts to replace those that are worn or broken. If so, go to your dealer and provide him with the model and part number.

Customer Information

Name _____

Purchased From _____

Date Purchased _____

Model No. _____

Serial No. _____

It is the purchaser and/or operator's responsibility to....

- **Read and understand the information contained in this manual.**
- **Operate, lubricate, assemble and maintain the equipment in accordance with all instructions and safety procedures in this manual.**
- **Inspect the equipment and replace or repair any parts that are damaged or worn which under continued operation would cause damage, wear to other parts, or cause a safety hazard.**
- **Return the equipment or parts to the authorized King Kutter dealer, from where it was purchased, for service or replacement of defective parts that are covered by warranty. (The King Kutter Factory may inspect equipment or parts before warranty claims are honored.)**
- **Payment of all costs incurred by the dealer for traveling to or transporting the equipment for warranty inspection and or claims.**

CONTENTS

ITEM	PAGE
Introduction	6
General Information	6
Safety Information	10
Connections	15
Fertilizer Spreader Use	17
General Maintenance	23
Replacement Parts	26
Spreading Chart	27
Warranty	28

1. INTRODUCTION

The centrifugal fertilizer spreaders are machines used for the distribution of solid, granular fertilizers and seeds in the field. They can be used whether with tractors of small/medium power. It is recommended to carefully read this operator's manual of use and maintenance and follow the recommendations to help ensure safe and efficient operation with and on the machine.

This manual has been written, in order to give the customer all the information and safety rules on the machine, as well as use and maintenance instructions that let to make good use of the potentialities of the machine.

The manual must always be handy, so as to consult it, in order to check the operational cycle. If it gets lost or damaged, it will be necessary to ask for a substitutive copy.

In case of some difficulties of interpretation on texts or tables, or if the drawings/sketches are not clear enough, please get immediately in touch with the manufacturer or dealer of the machine for having all the clarifications through the experts in the working/maintenance or through the person who wrote the manual.

We are completely available for a real collaboration, in order to improve the understanding of the whole manual.

2. GENERAL INFORMATION

2.1. USING THIS MANUAL

This manual gives all the information for the use and maintenance of the machine. The good working and its life depends on the good maintenance and to the attention during the use.

Some pictures in this manual show details or accessories that could be different from those of your machine, some components could be removed, in order to assure the clearness of the pictures.

Some signal words are put on the machine and the operator shall see to keep them in a perfect visual condition, replacing them when they are not readable anymore.



The symbol on the left, joined to the words under shown:

DANGER!
ATTENTION!
WARNING!

are used in this manual to draw your attention on the safety and good work of the machine. Therefore, it is necessary to observe all the written rules.

We recommended to use the original spare parts and accessories.

The not original parts, besides to decline the guarantee, could be dangerous reducing the length and the performances of the machine.

2.2. INFORMATION ON THE MACHINE

The models introduced in this manual have been designed and made exclusively allowing the distribution of solid, granular fertilizers and of seeds in the field. The machine is not indicated for being used in different sectors from the agricultural one.

These machines are usually used during the day. If it is required the nocturnal use or with poor visibility, it must use the lighting system of the tractor or of the equipment to which the machine is connected.

A different use, like the above mentioned one is considered improper.

Any arbitrary modification made to this machine relieve the manufacturer from any responsibility for damages or lesions, also serious, that can be caused to the operators, to third parties or to things.

2.2.1. NAME PLATE

On the hopper of every machine, a name plate is fixed showing the model, the number of series and the year of construction of the machine.

When some spare parts are required, it is always necessary to refer to the type of machine, to the serial number and to the manufacturing year.



Location of the name plate on the machine

2.2.2. CHARACTERISTICS OF THE MACHINE

The hardness of the steel welded frame, together with the remarkable life of the plastic hopper, let to obtain a highest quality level of the pull type spreaders.

The painting is made by an epoxy varnish with successive backing at 150 °c with the application of the primer bath, assuring a great protection and long life of the machine.

The fertilizer spreader P model has a distributor of fertilizer completely in stainless steel equipped with a spreader disc with four adjustable vains in four different positions, in order to obtain the maximum spreading precision and uniformity in the distribution, depending on the kind of product that must be spread.



Spreader disc

The feeding of the disc is by gravity through an opening, located on the bottom of the hopper, inside of which a mix/agitator is applied, in order to prevent the fertilizer lumps formation. A sheet case is placed in front of the disc, in order to prevent the spreading in the front side of the machine.

The fertilizer delivery is controlled by properly opening of the orifices in the hopper bottom, through lock devices operated by a lever.

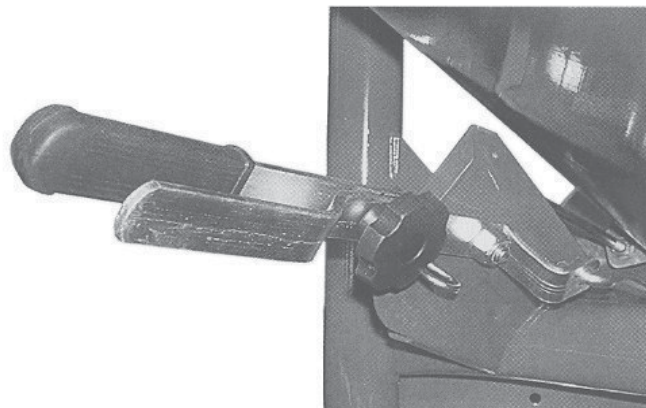
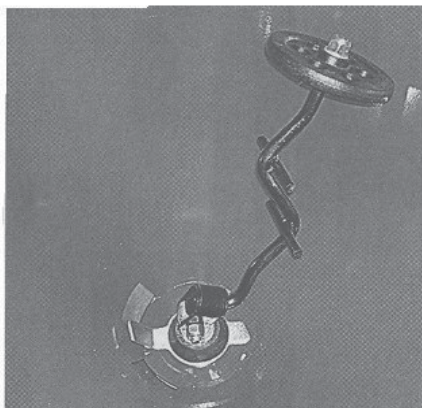

The fertilizer spreader is connected through a gear box (1:1) with gearsmodule 17 in order to be resistant, absorbing possible power stress.

2.2.3. TERMINOLOGY

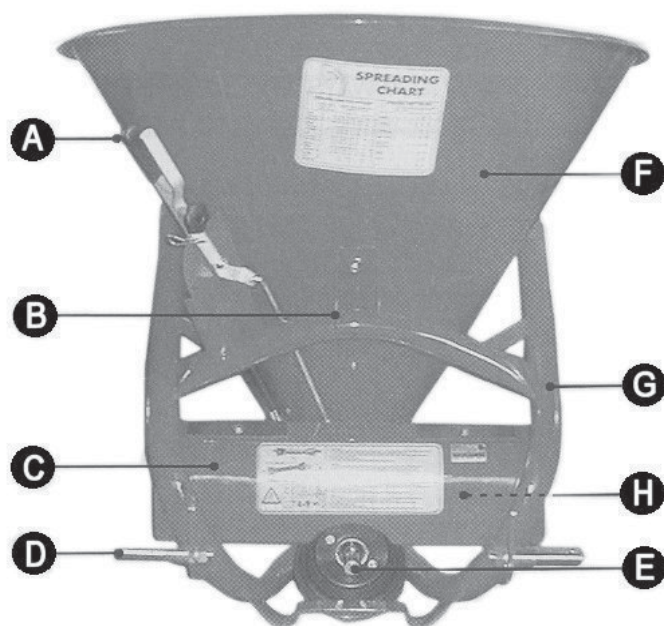

- A.** Regulating lever
- B.** Third Hitch Point
- C.** Sheet Case
- D.** Hitch Pin
- E.** PTO Shaft Hitch
- F.** Hopper
- G.** Steel Frame
- H.** Distributor Vanes

2.2.4. TECHNICAL DATA

TECHNICAL CHARACTERISTICS

HOPPER CAPACITY (liters/gallons) (Kg/Lb)	165/44 213/470	220/58 285/628	260/79 335/739	300/79 387/853	345/91 450/992
Weight of the machine (Kg/Lbs)	54/119	56/123	58/128	60/132	63/139
Loading Height (Meters/Inches)	0.91/36	1.01/40	1.05/41	1.07/42	1.13/44.5
Hopper Width (Meters/Inches)	.90/35.43	1.00/39.37	1.05/41.33	1.08/52.71	1.11/43.89
Spreading Width (Meters/Ft) Granular Crystalline	12.14/39-46 6-7/20-23	12.14/39-46 6-7/20-23	12.14/39-46 6-7/20-23	12.14/39-46 6-7/20-23	12.14/39-46 6-7/20-23
Power Required at 540 RPM (Kw/Hp)	8/6	8/6	8/6	8/6	8/6

3. IMPORTANT SAFETY INFORMATION

THE FOLLOWING SAFETY RECCOMENDATIONS ARE TO SAFEGUARD YOUR INCOLUMITY: THEREFORE IT IS NECESSARY TO READ THEM CAREFULLY, MEMORIZING AND ALWAYS APPLYING THEM.

The present warnings in this manual regard exclusively the allowed uses and reasonably foreseeable. All below instructions must be integrated by the common sense and by the experience of who works, indispensable measures to prevent accidents.

The machine must be used by a single operator. It is forbidden the use of the machine to under-ages.

All the listed instructions must be carefully respected.

Possible changes on the machine, not preventively authorized by the manufacturer (by written copy), exclude his responsibility.

Check the correct functioning of the machine, before every employment.

General advices

- Read carefully this manual before proceeding to start, operate, employ or maintenance on the machine.
- Watch, in addition to the warnings of this manual, all the safety, accident prevention rules and of general nature.
- The manual must always be handy, so as to consult it, in order to check working cycle and safety information. In case of loss or damage, it will be necessary to ask for a substitutive copy.



ATTENTION!

Any work of maintenance, regulation and cleaning must be done with the machine on the ground (in stable conditions), turning off the tractor engine and removing the key.

- Read carefully the safety signal words applied on the machine and follow the instructions. In case of wear and tear or insufficient readability of the safety signal words, clean them up or replace them, placing the signal words in the right position, as shown in paragraph 3.1.



ATTENTION! - WARNING!

The operator, during the period of use, maintenance, repair, handling or storing of the machine, must wear accident-prevention shoes and safety gloves. Moreover, if it is necessary he must wear suitable hearing protections such as earmuffs or earplugs, dust masks and protective glasses.

- During loading phase, there is the danger of powders inhalation produced by fertilizer mixing. It is suggested to use tractors with filters on the ventilation system of the cabin, to use suitable safety systems of breathing, like powder masks or masks with filter.

-
-
- The machine is designed for being used by a single operator who, during the use, must always stay in the stationing control on the tractor.
 - Never work with this machine if you are tired, sick or after having took drinks, drugs or medicines.



DANGER!

It is forbidden to climb or to transport somebody when the machine is in motion.
Do not let inside the hopper for any reason.

- Keep the machine cleaned up from foreign bodies (detritus, tools, miscellaneous), as they could damage the operations or the operator. **Generally the fertilizers are rather corrosive. For this reason, it is important that any particle of the fertilizer stay in the machine for a long period of time. Clean the hopper and the distributor after each use of the machine.**
- If during cleaning operations it is used air or water with pressure, it is necessary to wear glasses and safety masks keeping away possible persons or animals from the machine.
- Before connecting the machine to the tractor or to other self-moving means check that this is in good conditions and that brakes work correctly, especially if you work on sloping grounds.
- Switch off the machine from tractor only on a compact and level ground (with empty hopper), checking that the machine is stable.



WARNING!

During transport operations, stocking and employment of the fertilizers, the operators must follow all the label indications and particularly to the content of the written risks and the precaution suggestions.



ATTENTION!

The Manufacturer does not answer to possible damages caused by an improper and unforeseen use of the machine.

The Manufacturer is not responsible in case of:

- improper use of the machine, use by not trained staff;
- serious deficiencies in the foreseen maintenance;
- changes or not allowed interventions;
- use of not original or specific spare parts;
- total or partial inobservance of the instructions;
- inobservance of the common safety rules during work;
- unusual cases.

Connection of the machine to the tractor

- The third hitch point of the tractor and the fertilizer spreader must coincide or must be adapted.
- Make sure that the pto shaft is engaged in right way after every linkage operation of the machine and that it does not come uncoupled when the machine is lowered in order to fill the hopped up.



ATTENTION! DANGER!

Check that the protections of the pto shaft are complete and in good conditions.

- In case of breaking or deterioration of the pto shaft protections, please replace them immediately.
- When the machine is not linked to the power unit, the pto shaft must be placed on the appropriate support.
- The presence of the machine can influence the manoeuvrability of the tractor, in particular during transport.



ATTENTION!

Do not come, for any reason, between the tractor and the fertilizer spreader when the engine is running and the power take-off is on.

Operation of the machine

- Make a check of the machine before switching it on. Start to work only if the machine is in perfect conditions.
- Before using the machine, please be sure that all the safety devices are correctly placed and in good state; in case of breakdowns or damages to the protections, please replace them immediately.



ATTENTION!

During work, please be sure that for a radius of 50 meters there are not any person or animals. When you work in proximity of roads or public places, it is ABSOLUTELY OBLIGATORY to keep away persons and to increase the precautions.



ATTENTION!

Anybody who comes up to the machine is in a danger area, therefore he becomes "AN EXPOSED PERSON". The operator must prevent anybody to come into the danger area and to work with the maximum caution. If somebody comes up, please stop immediately the tractor engine.

- Before every use of the centrifugal spreader, please always check the wear of the vanes and of the spreader disc. Check that all the fixing components (screws, bolts etc.) are in and fixed.
- The machine must never be unattended when it is moving.
- Keep always the machine in good operating conditions and make regularly the maintenance.

Transfer on the road



ATTENTION!

Please follow scrupulously the Highway code in force in the country of use.
During moves on public roads, it is obligatory to empty the hopper.

- Remember that during moving on public roads, special attention must be done, besides to possible and special regulations noted on the registration book of the tractor, choosing an appropriate speed especially when the street is crowded, winding or sloping.
- If the spreader hides with its shape the back signalling lights of the tractor, it is necessary to put a lights bar and/or some back signalling signs.
- During the moving on the road, please clean tyres or the working mechanism, in order to avoid to dirty the feather edge with earth or other material.



ATTENTION!

During the moving on the road, the warning flasher, yellow or orange, assembled on the tractor must always be in function also during the day.



ATTENTION!

During transport with raised machine, please always check that the control lever of the rear lifter is locked, in order to avoid the accidental lowering of the machine.

3.1. SAFETY SIGNALS



ATTENTION!

Be sure that the safety labels are readable. Clean them up using a cloth, water and soap. Replace the damaged labels placing them in the right position, as subsequently described.

The safety signs on the machine supply the most important indications: their observance helps your safeness.



1. ATTENTION! Before making any operation on the machine, stop the engine of the tractor or of the self-moving means, remove the key, put on the parking brake and read carefully the operator's manual.



2. ATTENTION! DANGER of entangling and dragging. Do not put hands near the running gear box.



3. ATTENTION! Check the sense of rotation and the number of revolutions (540 rpm) of the tractor power before placing the pto shaft.



4. ATTENTION! DANGER of crushing. Do not stop between the machine and tractor when the tractor engine is running.



5. ATTENTION! - DANGER! Possible throwing of material and/or objects, please do not stop or come up to the machine. Keep a safety distance of 50 meters, at least, from the machine.



6. ATTENTION! DANGER of shearing. Do not approach limbs to the spreader disc when the machine is running.



7. ATTENTION! Use the individual Protection Devices, as required.

Where placing the safety signals on the machine

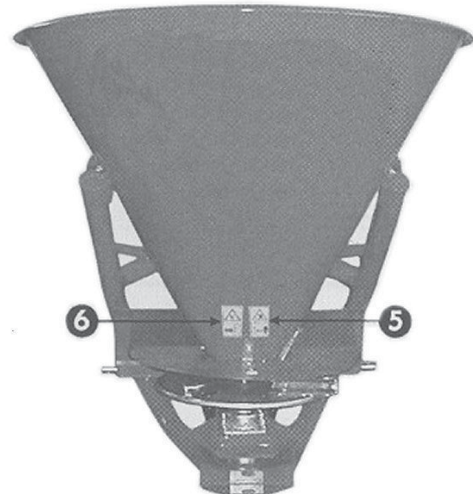
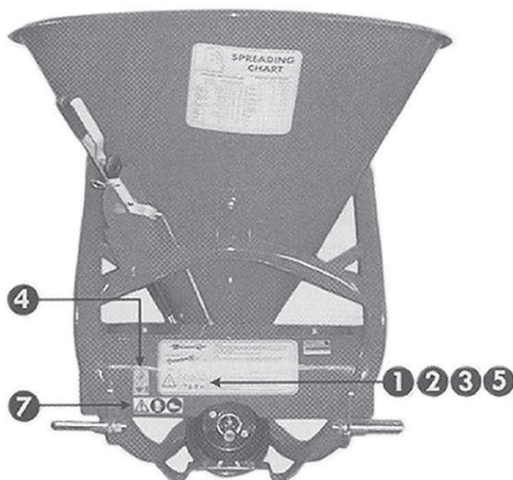

4. CONNECTIONS

Before coupling the machine to the 3-point hitch, positioning the safety devices to the tractor, so that it is not possible the involuntary and/or accidental raising and lowering of the arms.

The 3-point hitch of the tractor and of the machine must coincide or must be adapted.

In proximity of arms rods of the back lifter of the tractor, there is the danger of wounding, because of crushing and cutting points.

Do not use the external controls for the lifting of the machine.

During transport position block the lateral stop of the rods.

4.1. CHECK THE RAISING ABILITY OF THE TRACTOR



DANGER!

It is obligatory to check the raising ability and the stability of the tractor (before carrying out the connection with the machine) in order to avoid the overturning and/or the loss of wheels grip.

Check the raising ability and the stability of the tractor through the following formula and if it is necessary please apply some ballasts on the back.

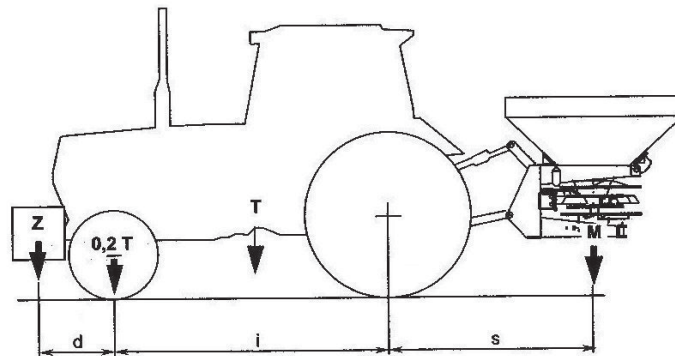

$$M s \leq 0,2 T i + Z (d + i)$$

$$M \leq 0,3 T$$

i	=	Wheels base of the tractor
d	=	Distance of load ballast back axle
s	=	Bounce of the machine rear axle
T	=	Tractor load + 75 kg (operator)
Z	=	Load ballast
M	=	Machine load

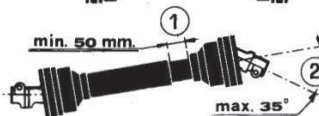

MAX.540 giri

ATTENTION

1. Check the length of the PTO shaft, ensuring that it has a minimum axial play of 50 mm. (2 in.) in the shortest position. (But not under pressure.) Check also the length of the PTO shaft at the point of farthest extension to ensure that the insert length between the two halves of the shaft is not less than 100 mm. (4 in.).

2. It is good practice not to operate the PTO shaft with an angle over 35 degrees. It may be necessary when lowering tub for loading to unhook PTO shaft.

4.2. CONNECTION TO THE 3-POINT HITCH OF THE TRACTOR



ATTENTION!

Every time that somebody comes down from the tractor, it is necessary to disconnect the pto shaft, stopping the engine and to put on the parking brake.

For the connection of the machine to the tractor, please operate in the following way:

- Step backwards with the tractor until arriving in proximity of the lower connections of the fertilizer spreader.
- Fix the lower connections of the tractor to the pins of the machine and lock them with the safety plugs.
- Connect the upper linkage of the machine to the 3-point hitch of the tractor putting the appropriate pin and block the anti-unscrewing device of the 3-point hitch;
- Raise the machine of some centimetres by the ground and operate on the lateral ties of the lifter bars and on the two turnbuckles, in order to block the lateral movement, so as to prevent excessive oscillations during the working phase.

The machine must be positioned, through the raising of the lower connections of the tractor, so that the land distance from the lower extremity of the distributor disc is approximately of 70 cm. To obtain a regular distribution, it is important that the distributor disc is in horizontal position compared to the land.

- After having made these operations, the pto shaft must be linked to the splined shaft of the gearbox of the machine (covered by a safety cowling) and after to the tractor power take-off.



ATTENTION!

The pto shaft must always be connected at last to the tractor power take off and disconnected at first, when you stop working.

4.3. DRIVELINE INSTALLATION

Before using the pto shaft, please consult the use and maintenance manual attached to the pto shaft.

In case that the pto shaft, supplied with the machine, is not used, please check that the cowlings of the machines and of tractors are overlapped to the pto shaft's shield of 5 cm., at least.

For a correct and safe operation of the machine, please use exclusively pto shafts with CE mark.

Please use pto shafts with integral shields.

- Grease periodically, the pto shaft following the instruction supplied by the pto shaft manufacturer (see the use and maintenance manual of the pto shaft).
- Observe the sense of assembly of the pto shaft, as indicated by the manufacturer and shown on the outer cover of the shield (tractor drawing on the external tube of the pto shaft towards the power take-off of the same tractor).

-
-
- Fasten the safety anti-rotation chains and make sure that the safety anti-removing block (push connecting ring nut) is correctly placed and blocked in the right lodging.



ATTENTION!

Check the rotation sense and the speed regulation of the power take-off of the tractor to be at 540 rpm, as the machine is projected for this kind of speed.

The length of the pto shaft must be adapted to the type of used tractor.

When the pto shaft is released from the power take-off of the tractor must ALWAYS be laid on the appropriate support.

COSMO Company is not responsible for the damages caused by an incorrect assembly and use of the pto shaft.

5. FERTILIZER SPREADER USE



ATTENTION!

Before use, please check that gears are adequately greased (see paragraph 5.1).



ATTENTION!

During the use of the machine, please be sure that for a radius of 50 meters there are not any person or animals. If somebody comes up, please stop immediately the tractor engine.

Recommendations for a correct distribution

- Please test always the kg/ha that you wish to spread before starting to work.
- Use a fertilizer in perfect conditions: a humid fertilizer could not be spreaded uniformly and correctly.
- Avoid to spread the fertilizer during windy days, in order to improve the uniformity of the distribution.

5.1. ADJUSTMENTS

It is not possible to have an exact spreading chart for equipments that make use of the centrifugal principle, given that the distributed quantity depends on the feed speed, on the radius of distribution, on the quality and humidity of the fertilizer and on the roughness of the land.

The fertilizer must always be stored and conserved adequately, so as to keep its physical characteristics unchanged.

It is necessary to set the speed of the centrifugal spreader, before starting the operation of distribution, trying, in the possible limits, to keep it constant for all its duration.

The spreading charts contain the *indicative information*, in order to determine the quantity to spread in the field; these must be completed by the experience and competence of the operator.

5.1.1. HOW TO ADJUST THE SPREADER VANES

In order to assure an homogenous distribution on both sides of the centrifugal spreader, depending on the different specific weight of the used fertilizer, the distributor vanes on the disc can have different positions.

When all the vanes are put in hole **1** (as shown in the picture), the distribution of the product is increased towards left, compared to the way of the tractor moving. On the contrary, if the vanes are put in hole **4**, the distribution will be bigger towards right.

Moreover, moving the vanes from position **1** to position **4**, at the same speed, there will be an increase of the distributing width of fertilizer distribution.

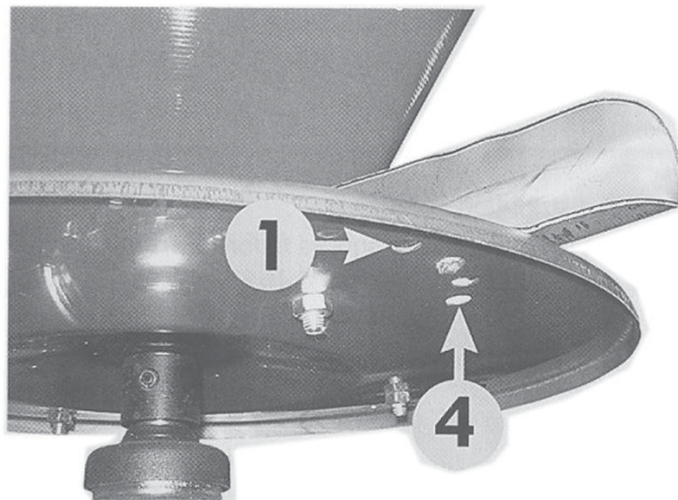

Regulation of the distributor vanes

This regulation must be made compared to the type of used fertilizer and to the experience of the operator.

5.1.2. HOW TO ADJUST THE SPREADING

The fertilizer spreading is regulated through the regulation lever that moves the opening section on the bottom of the hopper.

In order to carry out the regulation, after having consulted the spreading table, according to the type of product to spread and to the spreader speed, it is necessary to move the lever "A" along the graduated scale "E" and blocking it in the chosen position with the pin "D".

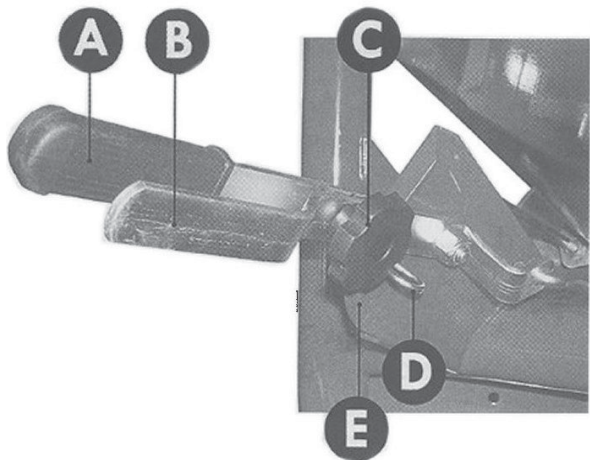

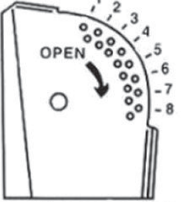

SPREADING CHART

SPREADING CHART FOR FERTILIZER									SPREADING CHART FOR SEED						
	SPEED (MPH)	QUANTITY SPREAD IN LBS/ ACRE AT VARIOUS GATE SETTINGS								SPEED (MPH)	QUANTITY SPREAD IN LBS/ ACRE AT VARIOUS GATE SETTINGS				
		2	3	4	5	6	7	8	8.5		5	6	7	8	
LARGE GRANULAR FERTILIZER	2.5	132	245	402	635	929	1014	1140	1248	WHEAT	3	0	46	129	268
	5.0	66	123	201	318	465	507	570	624		5	0	28	77	161
	7.5	44	82	134	212	310	338	380	416	ALFALFA & CLOVER	3	43	163	340	645
MEDIUM GRANULAR FERTILIZER	2.5	—	311	448	709	925	1025	1118	1182		5	26	98	204	387
	5.0	—	156	224	355	463	513	559	591		7	19	70	146	277
	7.5	—	104	149	237	309	342	373	394	FESCUE & RYEGRASS	3	0	0	85	161
FINE GRANULAR FERTILIZER	2.5	112	189	322	529	747	842	963	1051		5	0	0	51	97
	5.0	56	95	166	265	374	421	482	526	RED CLOVER	3	44	167	333	642
	7.5	37	63	111	177	249	280	321	351		5	26	100	200	385
CRYSTAL (AMMON. SILPHATE)	2.5	226	368	560	890	1236	1354	1522	1632		7	19	72	143	275
	5.0	113	184	280	445	618	677	761	816	KENTUCKY BLUE GRASS & BERMUDA GRASS	3	30	131	311	660
	7.5	75	123	187	297	412	451	507	544		5	18	78	186	396
THOMAS MEAL (BASIC SLAG)	4.0	—	—	571	—	1270	—	1685	—		7	13	56	133	283
	8.0	—	—	286	—	635	—	843	—	SUDAN GRASS	3	0	49	131	271
											5	0	29	79	163
											7	0	21	56	116
										BARLEY	3	0	25	81	186
											5	0	15	49	111
											7	0	11	35	80
										RYE	3	0	25	81	186
											5	0	15	49	111
											7	0	11	35	80

In order to spread from both sides (ref. I), "A" and "B" levers must be in the same position, connected through grip handle "C".

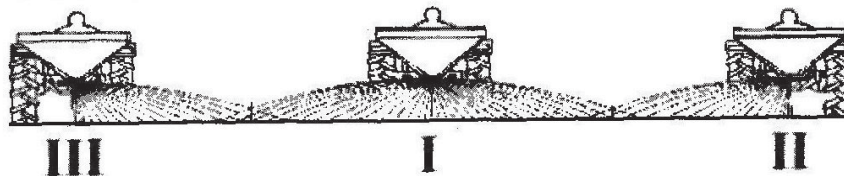

In order to carry out the spreading only through the left side (ref. II), it is necessary to disconnect the two levers removing the "C" grip handle, to set the lever "A" in the chosen position, given by the spreading chart, and to bring the lever "B" towards the higher part (position 1) in order to close the shutter of the right side.

In order to spread only on to the right side (ref. III) you have to move the lever "A" up, (in position 1) and regulate the quantity to spread with the lever "B".

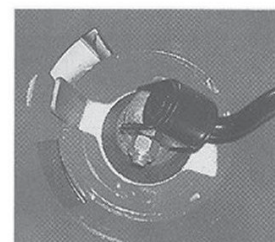
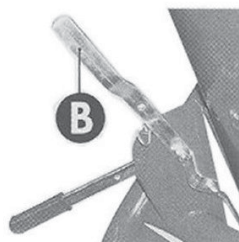
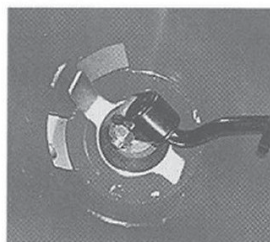

Distribution on right side (ref. III)

Distribution on left side (ref. II)

5.2. HOPPER LOAD

It is advised not to carry out the hopper loading manually but using a lifter or suitable mechanical means.



ATTENTION!

The hopper must be loaded only after having hitched the spreader to the tractor.

Do not drive for very long distances with a full load and do not put full bags on the fertiliser loaded in the hopper during the transport to the field or during the working, in order not to overload the capacity of the machine and to compress the fertilizer.



WARNING!

During the operations of transport, stock and use of fertilizers, the operator must be behaved in compliance with the indications on the label of the product and in particular with the content of the sentences of risk and the precaution advices.

5.3. SPREADING OF THE FERTILIZER IN THE FIELD

ATTENTION! - WARNING!



The operator, during the period of use, maintenance, repair, transport or storing of the machine, must wear accident-prevention shoes and gloves of security. If it is necessary, he will have, moreover, to wear headset, mask and glasses.

After having hitched the machine to the tractor and having carried out the necessary regulations, it is possible to begin to work.



ATTENTION!

Before getting off from the spreader and before every operation of maintenance and regulation, set in action the parking brake, turn off the engine, remove the ignition key from the dashboard and await the stop of all the moving parts.

Engage the axle with the pin, so that the spreader can be set in action by the turning wheels, only when the spreading operation has to be carried out.

Various ways there are to spread the fertilizer in the field. One of the simplest methods is, as follows:

- Position the spreader at the beginning of the field you intend to fertilise, to a distance ($D/2$) that is the half of the working width that is used (point 1);
 - Drive in the field, distributing the fertilizer on all the perimeter;
 - Stop the tractor at one distance (D) from the point 1, equivalent to the set working width (point 2);
 - Begin the spreading proceeding in line, straight to point 3. Turn the tractor and drive a D distance, equal to the working width (point 4);
- Repeat such procedure until all the plot will be covered.

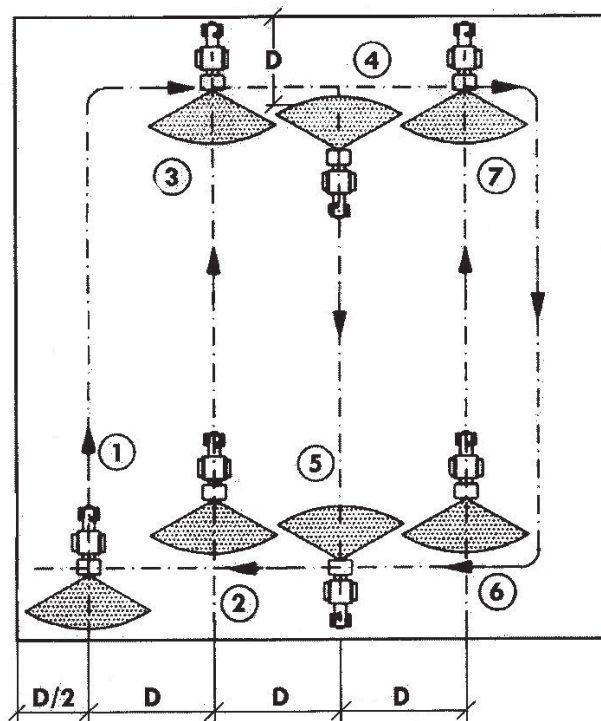

5.3.1. SPREADING MISTAKES

Mistakes of use

- Drive speed;
- Incorrect spreading width;
- The spreading disc is not in a horizontal position compared to the land;
- Drive speed is different to those suggested by the spreading tables, or however not suitable for that particular type of fertilizer;
- Drive mistakes (lack of superimposition of the spreading surfaces);
- Lack of cleaning of distributing discs and the gates opening.

Mistakes due to the fertilizer

- Fertilizer of poor quality. Wet or excessive humid fertilizer;
- Incorrect fertilizer composition or it does not correspond to what declared from the vendor;
- Presence of excessive fertilizer lumps or with particular great dimensions that influence negatively on the yield of the spreading;
- Foreign body in the fertilizer.

Mistakes due to the spreader.

- Spreading exits clogged;
- Parts of the spreading disc worn away or damaged.

6. GENERAL MAINTENANCE

The ordinary maintenance criteria we suggest, are based on the company experience and on the advices and suggestions from our customers.

Such criteria are not exhaustive can be further integrated also with the collaboration of the customers that we thanks in advance.

A good ordinary maintenance keeps the operating costs of the machine low and provide an integral exploitation of its potentialities.



ATTENTION!

Whichever work of maintenance, regulation and cleaning must be carried out with the machine on the ground (in stable conditions), engine turned off, handbrake set, key of ignition off and removed from the ignition board.

In damage case, the operator must stop the machine immediately, assess the entity of the problem and proceed with eventual actions on the machine.

If pressure water or compressed air is used for the cleaning of the machine, it is necessary to protect oneself with proper glasses or protection masks and to remove eventual persons or animals near the machine. Do not use inflammable fluids.



ATTENTION!

For the maintenance operations, always use the fit Individual Protection Devices (accident-prevention footwear and gloves) and to prepare all the accident-prevention steps for the type of operation in course.

Every 8 hours of effective job, control the tightness of all nuts and bolts.

In case of anomalous vibrations, verify the status of wear of the vanes of the spreading disc, the corrected tightness of all the nuts and bolts and the lubrication of the gear box.

The excessive vibration of the machine, besides the specific annoyance, is dangerous and damaging for the entire structure subjecting the mechanical parts to more and more stress cycles compared to the advice pictures.

As regards particular actions that the user does not know or regarding broken parts replacing which are not shown in this manual, it is necessary to consult specialised personnel, making use of the Assistance service by the manufacturer or its distributors.

LUBRICATION

Before using the seeder for the first time, put at least **(35 shots with a hand grease gun)** of grease in zerk shown below. After every 8 hours of use put in **(3 to 4 shots with a hand grease gun)**.

Make sure the grease zerks are clean from dirt and other foreign materials before injecting the grease.

NOTE: Use only a grade Type II or Lithium tube grease.

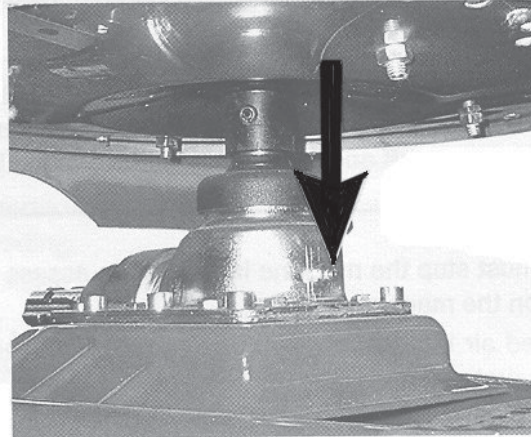

POINT TO GREASE

REPLACEMENT OF THE SPREADER VANES

In case the spreader vanes of the disc brake or get damaged, it will be necessary to replace them with new ones.

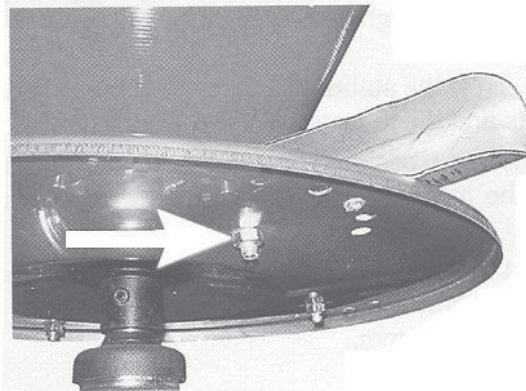

Unscrew the nut and replace the damaged vane. The nuts and bolts you remove, if not damaged may be reused. If they are damaged or worn replace them with the same type and size nuts and bolts.

6.3. STORAGE

It is a good use not to wait for using the machine to carry out repairing and maintenance. To repair and to replace the parts that are broken or damaged before the storage, in order to have always the machine ready for being used.

To store the machine in a sheltered place away from atmospheric agents and protect it in order to avoid deteriorations.

The fertilizers are generally corrosive. For this reason it is important that no particles of fertiliser remains on the machine for long period of time.

Before storing the machine for long periods, it is opportune to operate as follows:

- wash accurately the machine and the inside of the hopper;
- to carry out a general control by sight of the machine in order to check eventual structural damages, to find eventual deep abrasions on the paint;
- to check that the safety signals are presents in their positions, that they are integral and readable, and in case they are deteriorated or unreadable, carry out immediately their substitution (see par. 3.1);
- to grease all the mechanical parts (to see par. 5.1);
- to store, if possible, the machine in a sheltered place.

6.4. SPARE PARTS

For the replacement of parts of the centrifugal spreader Mod. P-PL, the customer must use just original parts, ordering them directly to the manufacturer of the machine to authorized dealers.

Carrying out the order, it is necessary to specify what the identification label brings, in particular:

- serial number;
- model;
- manufacturing year;
- number of frame.

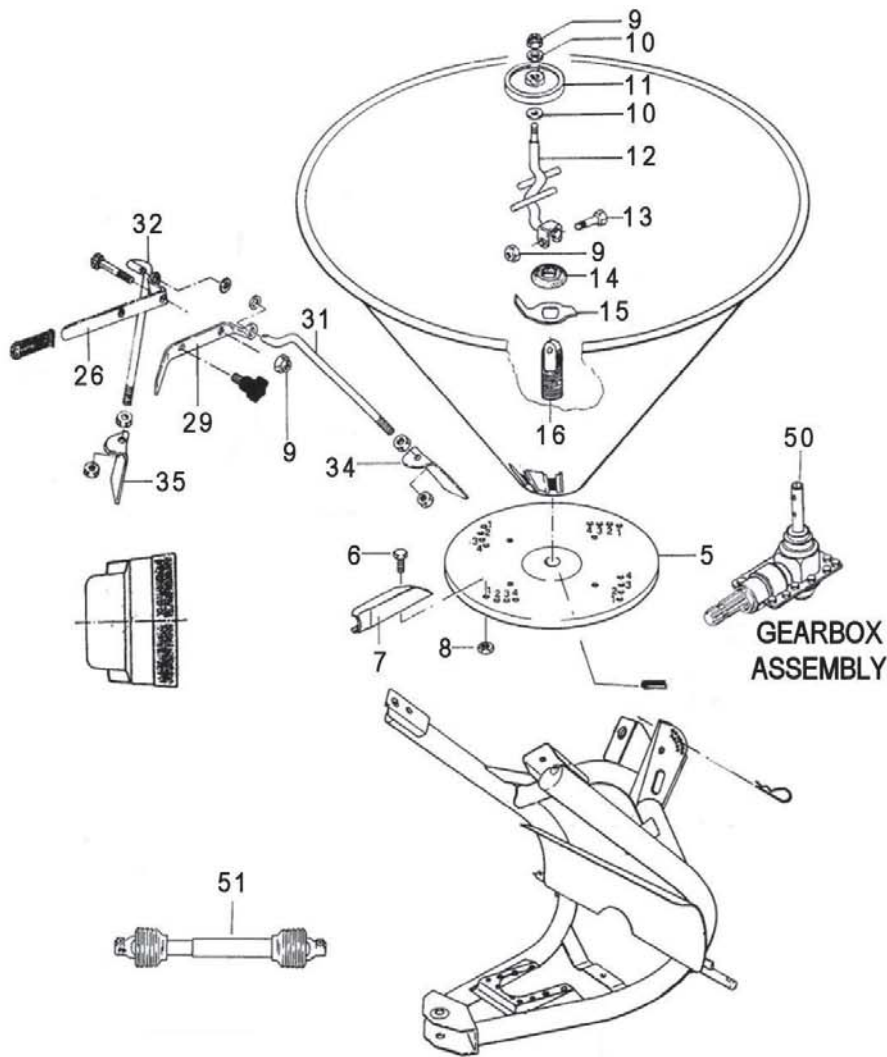

Ref. No.	Part Name	Part Number
5-8	Spreader Disc /w Blades	900004
9-13	Agitator	900138
11	Buffer Wheel	900005
14-16	Lower Agitator Kit	509000
26	Left Hand Shutter Lever	900120
29	Right Hand Shutter Lever	900122
31	Right Hand Lever Tie Rod	900123
32	Left Hand Lever Tie Rod	900121
34-35	Shutters 1-Left & 1-Right	509001
50	Gearbox	900110
51	20" PTO Shaft	147020

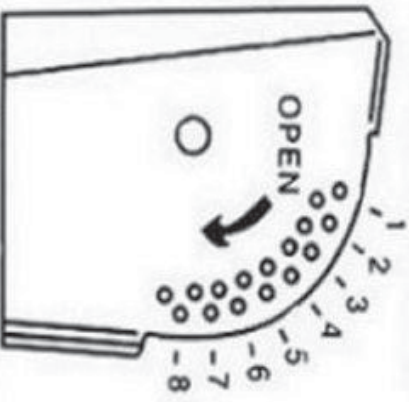

SPREADING CHART

SPREADING CHART FOR FERTILIZER

QUANTITY SPREAD IN LBS/ ACRE
AT VARIOUS GATE SETTINGS

SPEED (MPH)	2	3	4	5	6	7	8	8.5
LARGE GRANULAR FERTILIZER	132	245	402	635	929	1014	1140	1248
MEDIUM GRANULAR FERTILIZER	66	123	201	318	465	507	570	624
FINE GRANULAR FERTILIZER	44	82	134	212	310	338	380	416
CRYSTAL (AMMON. SILPHATE)	2,5	112	189	322	529	747	842	963
THOMAS MEAL (BASIC SLAG)	5,0	56	95	166	265	374	421	482
	7,5	37	63	111	177	249	280	321
	2,5	226	358	560	890	1236	1354	1522
	5,0	113	184	280	445	618	677	761
	7,5	75	123	187	297	412	451	507
	4,0	--	--	571	--	1270	--	1685
	8,0	--	--	286	--	635	--	843

SPREADING CHART FOR SEED

QUANTITY SPREAD IN LBS/ ACRE
AT VARIOUS GATE SETTINGS

SPEED (MPH)	5	6	7	8
WHEAT	3	0	46	129
	5	0	28	77
	7	0	20	55
ALFALFA & CLOVER	3	43	163	340
	5	26	98	204
	7	19	70	146
FESCUE & RYEGRASS	3	0	0	85
	5	0	0	51
	7	0	0	36
RED CLOVER	3	44	167	333
	5	26	100	200
	7	19	72	143
KENTUCKY BLUE GRASS & BERMUDA GRASS	3	30	131	311
	5	18	78	186
	7	13	56	133
SUDAN GRASS	3	0	49	131
	5	0	29	79
	7	0	21	56
BARLEY	3	0	25	81
	5	0	15	49
	7	0	11	35
RYE	3	0	25	81
	5	0	15	49
	7	0	11	35



1. Limited Warranty.

King Kutter, Inc. ("King Kutter"), P.O. Box 1200, Winfield, Alabama 35594, warrants to the original retail purchaser ("Purchaser") that the product that is the subject of this sale is free from defects in material and workmanship at the time of sale.

Under this warranty, King Kutter will repair the defective product free of charge to the Purchaser, with either new or used and reconditioned replacement parts. All warranty service will be performed at service centers designated by King Kutter. If King Kutter is unable to repair the product to conform to the warranty after a reasonable number of attempts, King Kutter will provide, at its option, one of the following: (a) a replacement for the product or, (b) a full refund of the purchase price. Repair, replacement, or refunds are the Purchaser's EXCLUSIVE remedies against King Kutter under this limited warranty. King Kutter will not be liable for any special, incidental or consequential damages based upon breach or warranty, breach of contract, negligence, strict tort liability, or any other legal theory. Such damages include, but are not limited to, loss of profits, loss of savings or revenue, loss of use of the product or any associated equipment, cost of capital, cost of any substitute equipment, facilities or services, down time, the claims of third parties including customers, and injury to property. These limitations also apply, to the extent allowed by law, to personal injury.

The purchaser must notify the Seller in writing of any defect in material or workmanship within one (1) year following the date of purchase. If the equipment is used for commercial purposes, the Purchaser must notify the Seller in writing of any defect in material or workmanship within ninety (90) days following the date of purchase. In no event will King Kutter be liable under this warranty unless written notice is received by the Seller within one (1) year from the date of original retail sale.

2. Warranty of Title.

King Kutter warrants that it transfers a good title to the product free of any encumbrances, and free of the rightful claim of any third party for infringement of patent or copyright.

3. What is Not Covered by This Limited Warranty.

King Kutter will not be responsible for damage to or failure in the product which results from accident, misuse, abuse, neglect, installation of attachments not provided by King Kutter, modifications to the product, or damage caused by use of the product for purposes other than those for which it was designed.

4. No Other Warranties.

Unless modified in writing and signed by both parties, this agreement is understood to be the complete and exclusive agreement and warranty between King Kutter and Purchaser, superseding all prior agreements, oral and written, and all other communication between King Kutter and Purchaser related to the subject matter of this agreement.

THIS LIMITED WARRANTY IS IN LIEU OF ALL OTHER WARRANTIES, EXPRESS OR IMPLIED, INCLUDING, BUT NOT LIMITED TO, THE IMPLIED WARRANTY OF MERCHANTABILITY AND THE IMPLIED WARRANTY OF FITNESS FOR A PARTICULAR PURPOSE. No employee of King Kutter nor anyone else is authorized to make any warranty or representation in addition to or different from those made in this agreement.

5. Allocation of Risk.

This agreement allocates the risk of product failure between King Kutter and the Purchaser. This Allocation is