

Systematic, phylogenetic and biological considerations on the genera *Bathyporeia*, *Amphiporeia*, *Pontoporeia* and *Priscillina*, with redescription of the West-Atlantic *Bathyporeia* species and description of a new *Priscillina* from Svalbard (Crustacea, Amphipoda)

by Cédric d'UDEKEM d'ACOUZ

Abstract

The two West-Atlantic species of *Bathyporeia*, *B. parkeri* and *B. quoddyensis* are re-described. They exhibit a large number of differences with East-Atlantic and Mediterranean *Bathyporeia* species. Cladistic analyses of morphological characters of all known *Bathyporeia* species indicate that the two geographic groups are sister clades. There is strong evidence that in the genus *Bathyporeia* the character state 'short antennae in mature males' is the plesiomorphic condition and that 'long antennae in mature males' is the apomorphic condition. Representatives of the genera *Amphiporeia*, *Pontoporeia* and *Priscillina* are characterised and illustrated, as a basis of comparison with *Bathyporeia*. These three genera are traditionally considered to be the closest relatives of *Bathyporeia* and grouped together in the family Pontoporeiidae. The systematic position of these four alleged 'pontoporeiid' genera is investigated in a cladistic analysis including several other amphipods which are either morphologically similar or potentially plesiomorphic. In this analysis the monophyly of the genus *Bathyporeia* is supported by a very high number of synapomorphies. *Bathyporeia* itself forms a strongly supported clade (the Bathyporeiidae) with the genus *Amphiporeia*. There is no cladistic support for a sister relationship between *Bathyporeia* + *Amphiporeia* and *Pontoporeia* + *Priscillina*. The Bathyporeiidae seem to have stronger affinities with the Gammaridae sensu stricto and especially with the Pontogammaridae. The Bathyporeiidae are therefore considered as belonging to the superfamily Gammaroidea. Cladistic analyses of morphological characters suggest loose relationships between the genera *Haustorius*, *Pontoporeia* and *Priscillina*. However these three genera are separated by a considerable morphological gap. The morphological isolation of the genus *Priscillina* justifies the creation of a monotypic family Priscillinidae fam. nov. for it. The superfamily Pontoporeioidea is retained for the Pontoporeiidae and Priscillinidae fam. nov. The material of *Priscillina* used in this study includes a new species from Svalbard, which is described as *Priscillina herrmanni* sp. nov.

Key-words: *Bathyporeia*, *Amphiporeia*, *Pontoporeia*, *Priscillina*, Bathyporeiidae, Gammaridae, Melitidae, Melphidippidae, Pontogammaridae, Pontoporeiidae, Priscillinidae fam. nov., Amphipoda, Crustacea, taxonomy, phylogeny, cladistic, North Atlantic.

Résumé

Les deux espèces ouest-atlantiques de *Bathyporeia*, *B. parkeri* et *B. quoddyensis* sont redécrites. Elles présentent un grand nombre de différences avec les espèces est-atlantiques et méditerranéennes de *Bathyporeia*. Des analyses cladistiques des caractères morphologiques de toutes les espèces connues de *Bathyporeia* indiquent que les deux groupes géographiques sont des clades sœurs. Il y a de sérieuses évidences qu'au sein du genre *Bathyporeia*, l'état de caractère 'antennes courtes chez le male mature' soit plesiomorphe. Des représentants des genres *Amphiporeia*, *Pontoporeia* et *Priscillina* sont caractérisés et illustrés, en tant que point de comparaison avec *Bathyporeia*. Ces trois genres sont traditionnellement considérés comme les plus proches parents de *Bathyporeia* et sont alors regroupés dans la famille des Pontoporeiidae. La position systématique de ces quatre genres supposés appartenir aux Pontoporeiidae est investiguée au moyen d'une analyse cladistique incluant plusieurs autres amphipodes, lesquels sont soit morphologiquement similaires, soit potentiellement plesiomorphiques. Dans cette analyse, la monophylie du genre *Bathyporeia* est étayée par un nombre très élevé de synapomorphies. *Bathyporeia* lui-même forme un clade très robuste (les Bathyporeiidae) avec le genre *Amphiporeia*. Il n'y a pas la moindre évidence cladistique que le clade *Bathyporeia* + *Amphiporeia* soit le taxon sœur de *Pontoporeia* + *Priscillina*. Les Bathyporeiidae semblent avoir davantage d'affinités avec les Gammaridae sensu stricto et surtout avec les Pontogammaridae. Les Bathyporeiidae sont donc considérés comme appartenant à la superfamille des Gammaroidea. L'analyse cladistique de caractères morphologiques suggère une parenté possible entre les genres *Haustorius*, *Pontoporeia* et *Priscillina*. Cependant, les évidences sont faibles et peu convaincantes, et qui plus est, ces trois genres sont séparés par des différences morphologiques profondes. L'isolement morphologique du genre *Priscillina* justifie la création de la famille monotypique des Priscillinidae fam. nov. La superfamille des Pontoporeioidea est retenue pour les Pontoporeiidae et les Priscillinidae fam. nov. Le matériel utilisé pour cette étude inclut une nouvelle espèce du Svalbard qui est décrite sous le nom de *Priscillina herrmanni* sp. nov.

Mots-clés: *Bathyporeia*, *Amphiporeia*, *Pontoporeia*, *Priscillina*, Bathyporeiidae, Gammaridae, Melitidae, Melphidippidae, Pontogammaridae, Pontoporeiidae, Priscillinidae fam. nov., Amphipoda, Crustacea, taxonomie, phylogénie, cladistique, Atlantique Nord.

1. Introduction

The taxonomy and morphology of the genus *Bathyporeia* LINDSTRÖM, 1855 have been the object of several recent papers: D'UDEKEM d'ACUZ & BERGE (2003), D'UDEKEM d'ACUZ (2004), D'UDEKEM d'ACUZ & MENIOUI (2004), D'UDEKEM d'ACUZ & VADER (2004, 2005a, 2005b) and D'UDEKEM d'ACUZ et al., (2006). The present paper, which is the last part of this study, consists of two sections. In the first section, the two West-Atlantic *Bathyporeia* species are re-described, illustrated, and compared with the *Bathyporeia* species from the other side of the Atlantic. Cladistic analyses are run on all known species of *Bathyporeia*. They show that the West-Atlantic species are the sister clade of the East-Atlantic / Mediterranean species and that evolutionary direction apparently goes towards an elongation of the second antennae in males.

The second section of this paper is focused on the systematic position of the genus *Bathyporeia* and its alleged and putative relatives. In literature the genus *Bathyporeia* LINDSTRÖM, 1855 is traditionally assigned to the family Pontoporeiidae DANA, 1853, along with *Amphiporeia* SHOEMAKER, 1929, with *Pontoporeia* KRØYER, 1842 and its satellites *Diporeia* BOUSFIELD, 1989 and *Monoporeia* BOUSFIELD, 1989, and with *Priscillina* STEBBING, 1888. However, these genera are grouped together more by tradition than on the basis of serious phylogenetic evidence. The morphology and biology of these genera are briefly outlined and compared, and at least one representative of every group is illustrated in detail. A cladistic analysis is run with 4 *Bathyporeia* species, one *Amphiporeia*, one *Pontoporeia*, one *Priscillina* and 21 other species of amphipods. From this analysis, it appears that the genus *Bathyporeia* LINDSTRÖM, 1855 is the sister taxon of the genus *Amphiporeia* SHOEMAKER, 1929. On the other hand, there is no evidence that *Pontoporeia* and *Priscillina* are very closely related to the *Amphiporeia* / *Bathyporeia* lineage and there is only loose evidence that the two former genera are closely related to each other. Therefore the family Bathyporeiidae BOUSFIELD & SHIH, 1994, which has received little support so far, is recognized as valid and used for the clade *Bathyporeia* + *Amphiporeia*. The monotypic family Priscillinidae fam. nov. is created to accommodate *Priscillina* and the Pontoporeiidae are restricted to the genera *Diporeia*, *Monoporeia* and *Pontoporeia*. For the time being, the Priscillinidae fam. nov. and the Pontoporeiidae are retained in the superfamily Pontoporeioidea. Despite profound differences they share a number of specialized characters and presumably have a similar life cycle.

2. Terminology and abbreviations

The terminology of appendages and the model of descriptions for *Bathyporeia parkeri* and *B. quoddyensis* are similar to those used by D'UDEKEM d'ACUZ (2004) and D'UDEKEM d'ACUZ & MENIOUI (2004). Interspecific differences are usually small and are often not perceived at first glance, even by a trained eye. Differences concerning proportions of appendages cannot be objectively phrased and are expressed as

ratios. The values given should be considered as indicative only, since ratios have been measured on one or two specimens only. After the examination of all known species of *Bathyporeia*, some ratios used in previous papers have proved to be redundant or to have low information content. Such ratios have been abandoned in the present paper. The term 'pseudorostrum' denotes the enlarged first article of the peduncle of the first antenna. The terminal crown of setae of the third article of the maxillipedal palp is not illustrated. The 'carpal fang' is a long and strong modified seta found on the carpus of the third and fourth pereopods in all *Bathyporeia* species. In *Bathyporeia*, the medial border of the outer ramus of the third uropod normally has long plumose setae orientated in the same plane as the outer ramus; each plumose seta is either single or forms a group with one (sometimes two or three) non-setulose spiniform setae pointing obliquely upwards; these spiniform setae, which are not present in all species, are called 'accessory spiniform setae'.

The following abbreviations of morphological features are adopted in the present paper, either systematically or in some parts of the text: A1: first antenna; A2: second antenna; Coxae 1-7: coxal plates of the first to seventh pereopods; Ep1-Ep3: first to third epimeral plates; Md: mandible; Mx1: first maxilla; Mx2: second maxilla; Mxp: maxilliped; P1: first pereopod (first gnathopod); P2: second pereopod (second gnathopod); P3-P7: third to seventh pereopods; U1-U3: first to third uropods.

The following abbreviations of Scientific Institutions are used: ARC: Atlantic Reference Centre, Huntsman Marine Sciences Centre, St Andrews, New Brunswick, Canada; AWI: Stiftung Alfred-Wegener-Institut für Polar- und Meeresforschung in der Helmholtz-Gemeinschaft, Bremerhaven, Germany; CMNC: Canadian Museum of Nature, Ottawa, Canada; NOAA: NOAA National Benthic Inventory, NOS Center for Coastal Environmental Health and Biomolecular Research, Charleston, South Carolina, USA; SRTC: Southern Regional Taxonomic Center, Marine Resources Research Institute, Charleston, South Carolina; TMU: Tromsø Museum, University of Tromsø, Tromsø, Norway; UNIS: The University Centre Svalbard, Longyearbyen, Norway; USNM: United States Natural History (Smithsonian Institution), Washington, D.C., USA; ZMO: Zoologisk Museum, Oslo, Norway.

3. Results and discussion

3.1. Part 1. The American *Bathyporeia* and evolutionary trends in the genus *Bathyporeia*

3.1.1. Systematics

Genus *Bathyporeia* LINDSTRÖM, 1855

***Bathyporeia parkeri* BOUSFIELD, 1973**
(Figs. 1–8)

Bathyporeia quoddyensis; BOUSFIELD, 1965: 171, at least in part (material from Woods Hole)

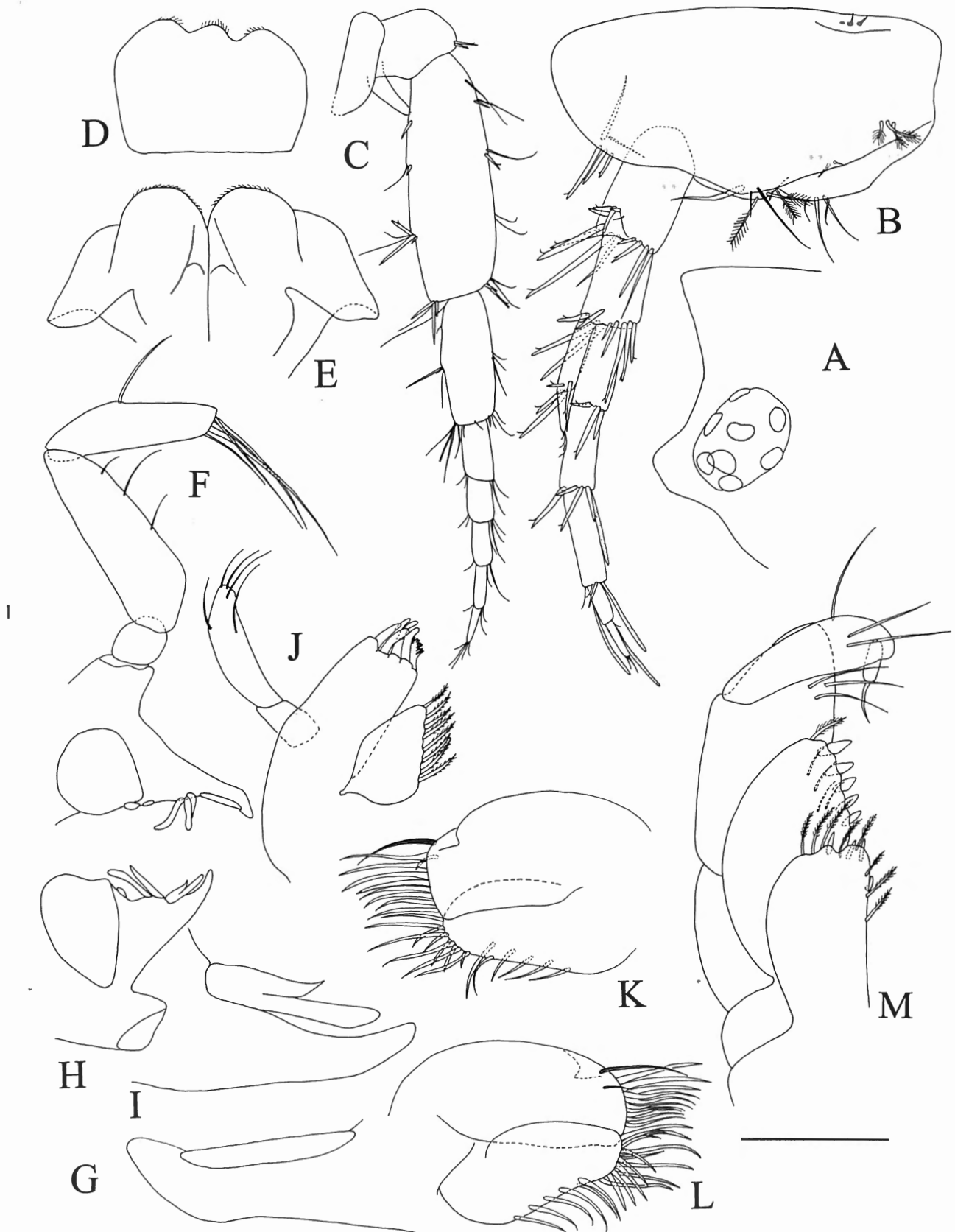

Fig. 1. *Bathyporeia parkeri* BOUSFIELD, 1973, females. A-L, South Carolina: off Folly Island, TMU 12 618; M, South Carolina, Gray's Reef, GR 02-35-1, Crustacea 154 202. A, anterior part of head; B, left A1; C, right A2; D, upper lip; E, lower lip; F, left Md; G, tip of incisor process of left Md with lacinia mobilis; H, right Md (palp not illustrated); I, tip of incisor process of right Md with lacinia mobilis; J, Mx1; K, right Mx2, dorsal side; L, right Mx2, ventral side; M, left Mxp. Scale bar: C, 0.21 mm; A, B, 0.14 mm; D, E, F, H, J, M, 0.10 mm; K, L, 0.071 mm; G, I, 0.025 mm.

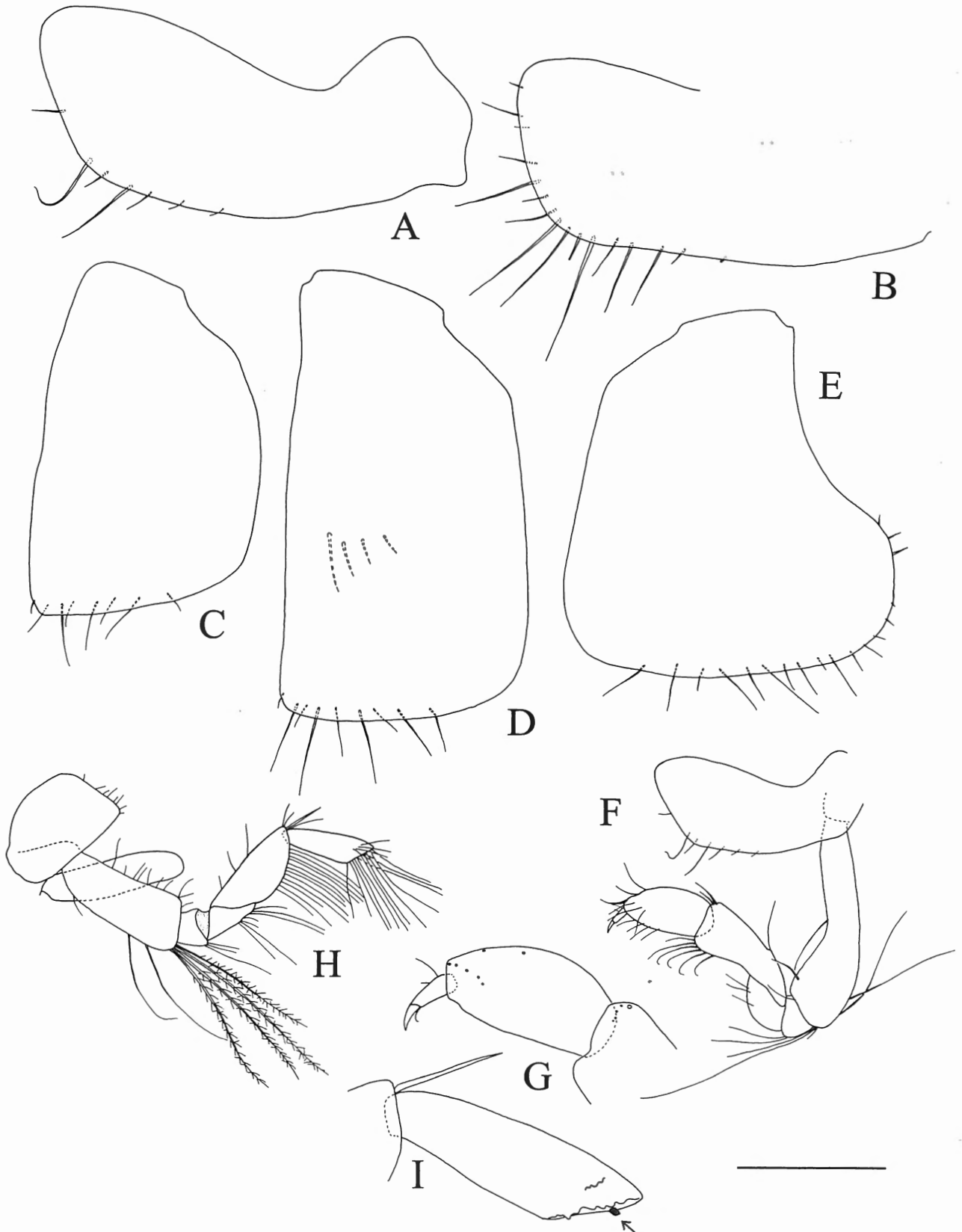

Fig. 2. *Bathyporeia parkeri* BOUSFIELD, 1973, females. A, C-I, South Carolina: off Folly Island, TMU 12 618; B, very large specimen, South Carolina, Gray's Reef, st. GR 02-35-1, Crustacea 154 202. A, B, left coxa 1; C, right coxa 2; D, right coxa 3; E, left coxa 4; F, left P1; G, carpus (tip of), propodus and dactylus of left P1 (carpal and propodal setae not shown); H, right P2; I propodus and vestigial dactylus (in black) of right P2 (propodal and dactylar setae not shown). Scale bar: H, 0.42 mm; E, F, 0.21 mm; B, C, D, 0.14 mm; A, G, 0.1 mm.

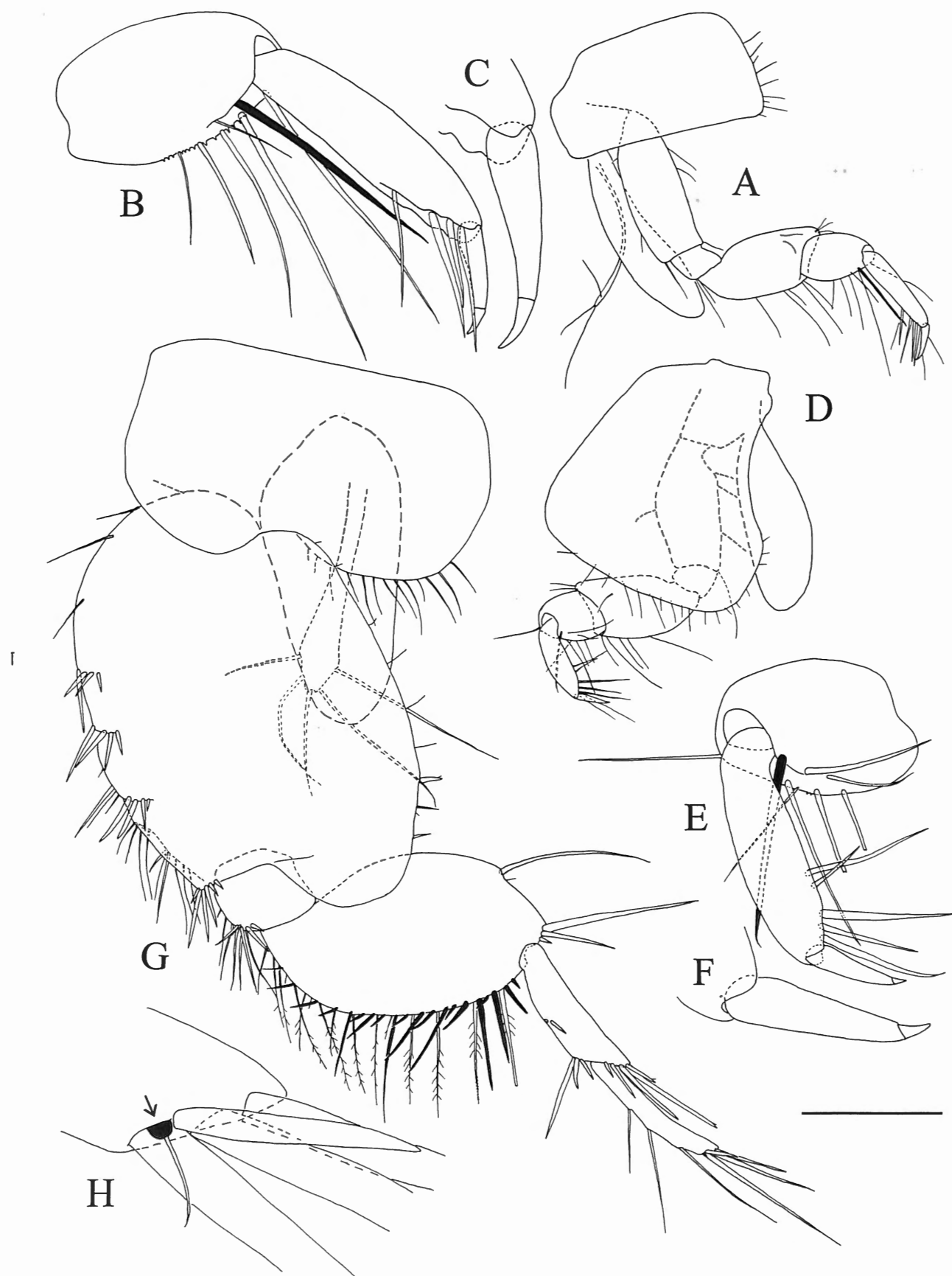

Fig. 3. *Bathyporeia parkeri* BOUSFIELD, 1973, female, South Carolina: off Folly Island, TMU 12 618. A, right P3; B, anterior part of right P3 (medial spines/setae of propodus not shown); C, dactylus of right P3; D, left P4; E, anterior part of left P4 (medial spines/setae of propodus not shown); F, dactylus of left P4; G, left P5; tip of left P5 with vestigial dactylus (in black; the resolution of the microscope did not allow to see if the apical seta was setulose or not). Scale bar: A, D, 0.30 mm; G, 0.21 mm; B, E, 0.10 mm; C, F, 0.05 mm; H, 0.025 mm.

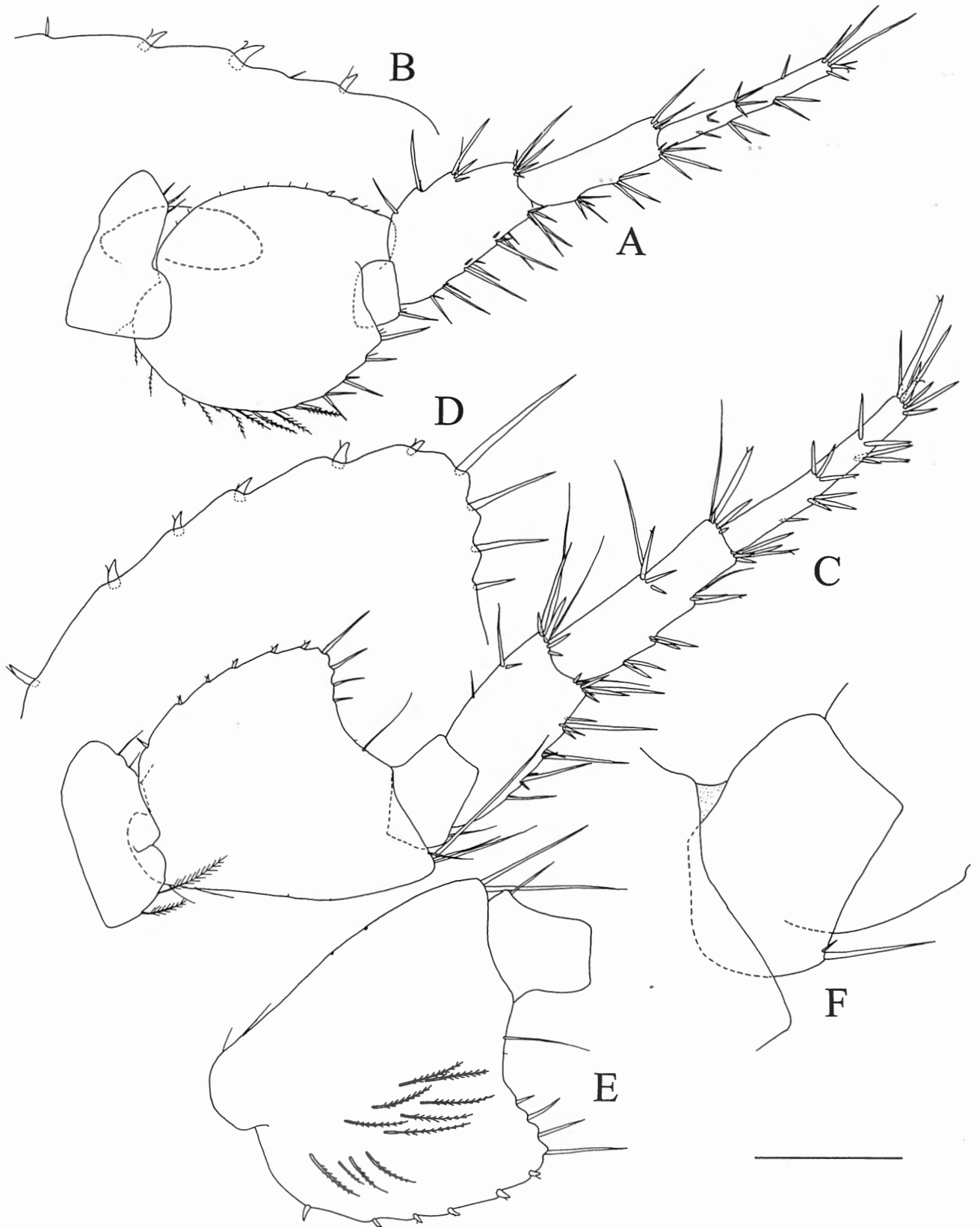

Fig. 4. *Bathyporeia parkeri* BOUSFIELD, 1973, female, South Carolina: off Folly Island, TMU 12 618. A, left P6; B, distal part of posterior margin of basis of left P6; C, left P7; D, posterior margin of left P6; E, medial side of basis and ischium of left P7; F, ischium of left P7 (outer side). Scale bar: A, 0.35 mm; C, 0.25 mm; E, 0.21 mm; D, F, 0.10 mm; B, 0.083 mm.

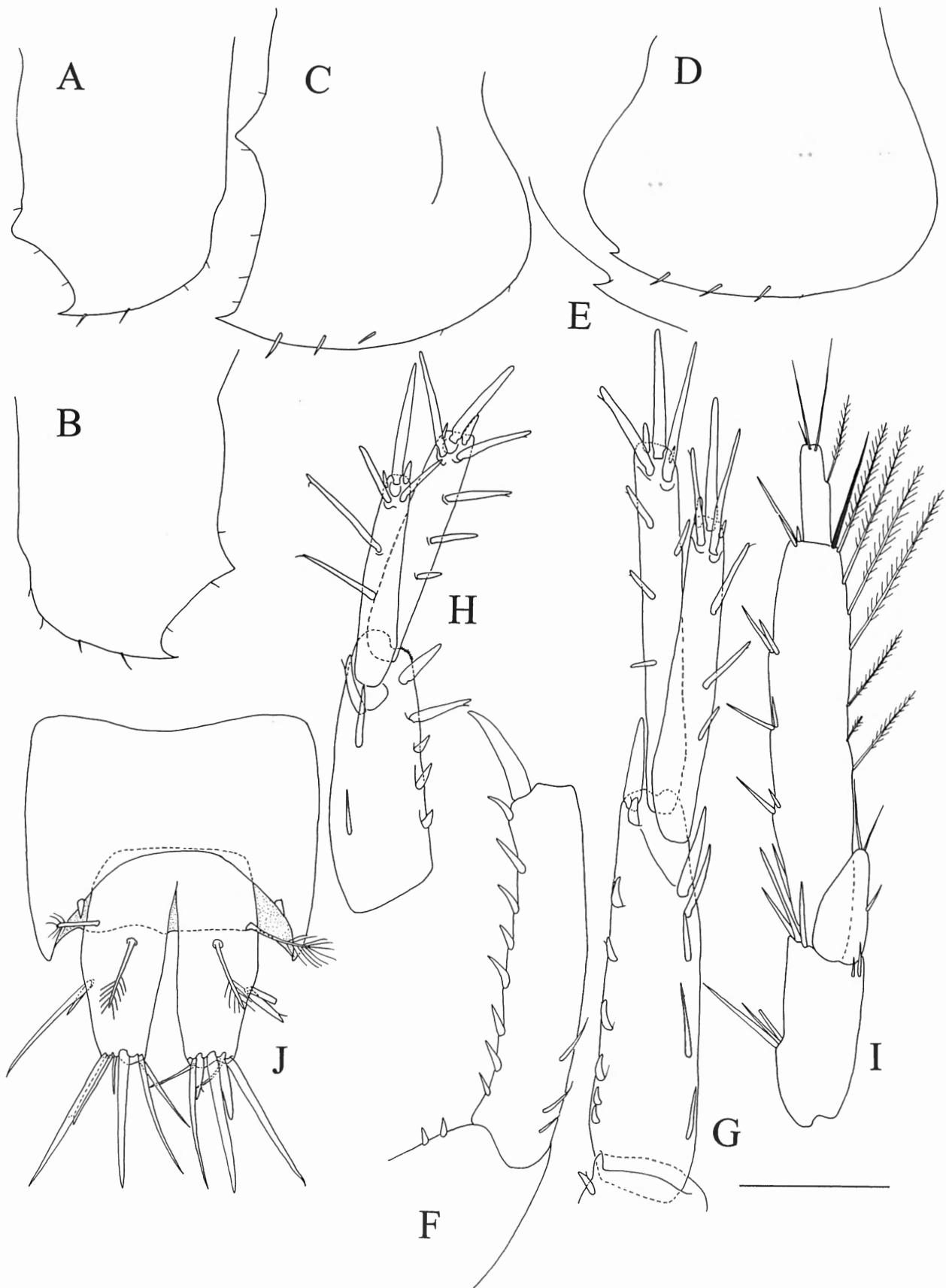

Fig. 5. *Bathyporeia parkeri* BOUSFIELD, 1973, females. A-E, G-H, J, South Carolina: off Folly Island, TMU 12 618; F-I, South Carolina, Gray's Reef, st. GR 02-35-3, Crustacea 154 402. A, right Ep1; B, left Ep1; C, right Ep2; D, right Ep3; E, posteroventral angle of right Ep3; F, peduncle of left U1 and posteroventral part of left urosomite 1 (lateral view); G, peduncle of right U1 and posteroventral part of right urosomite 1 (dorsal view); H, left U2 (dorsal view), I, right U3 (dorsal view); J, telson and urosomite 3 (dorsal view). Scale bar: A, B, C, D, F, I, 0.21 mm; G, H, 0.14 mm; J, 0.12 mm; E, 0.1 mm.

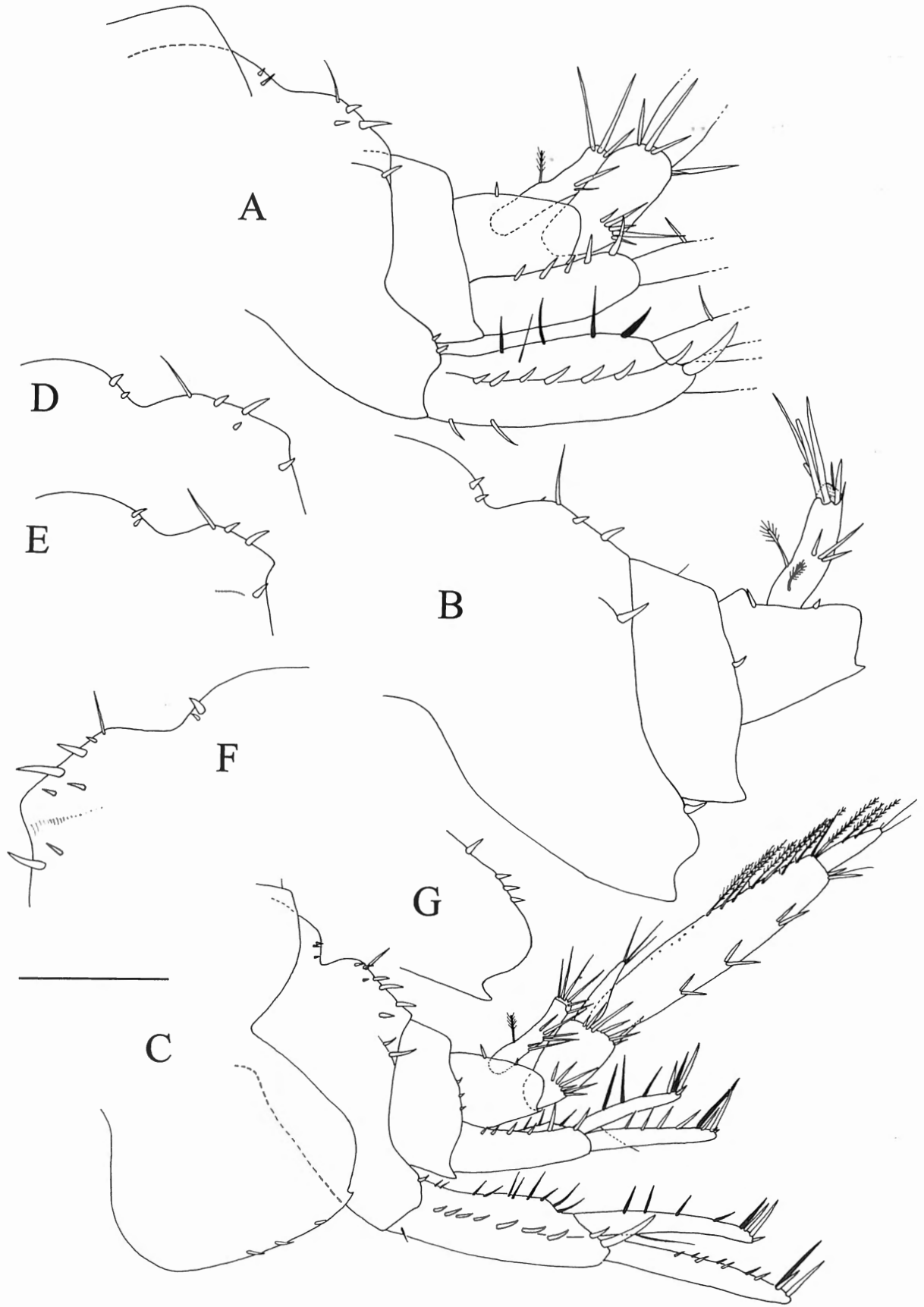

Fig. 6. *Bathyporeia parkeri* BOUSFIELD, 1973, females. A, South Carolina: off Folly Island, TMU 12 618; B-G, various females (C, female 3: very large specimen), South Carolina, Gray's Reef: B, C, D, E, st. GR 02-35-1, Crustacea 154 202; F, G, St. GR 02-35-3, Crustacea 154 402. A-C, posterior part of abdomen (left side, medial spines of U1-U2 in black); D-F, dorsal part of urosomite 1 (D, E, left side and F, right side); G, posteroventral part of urosomite 1 (left side). Scale bar: C, 0.42 mm; A, B, D, E, F x 0.21 mm, G, 0.10 mm.

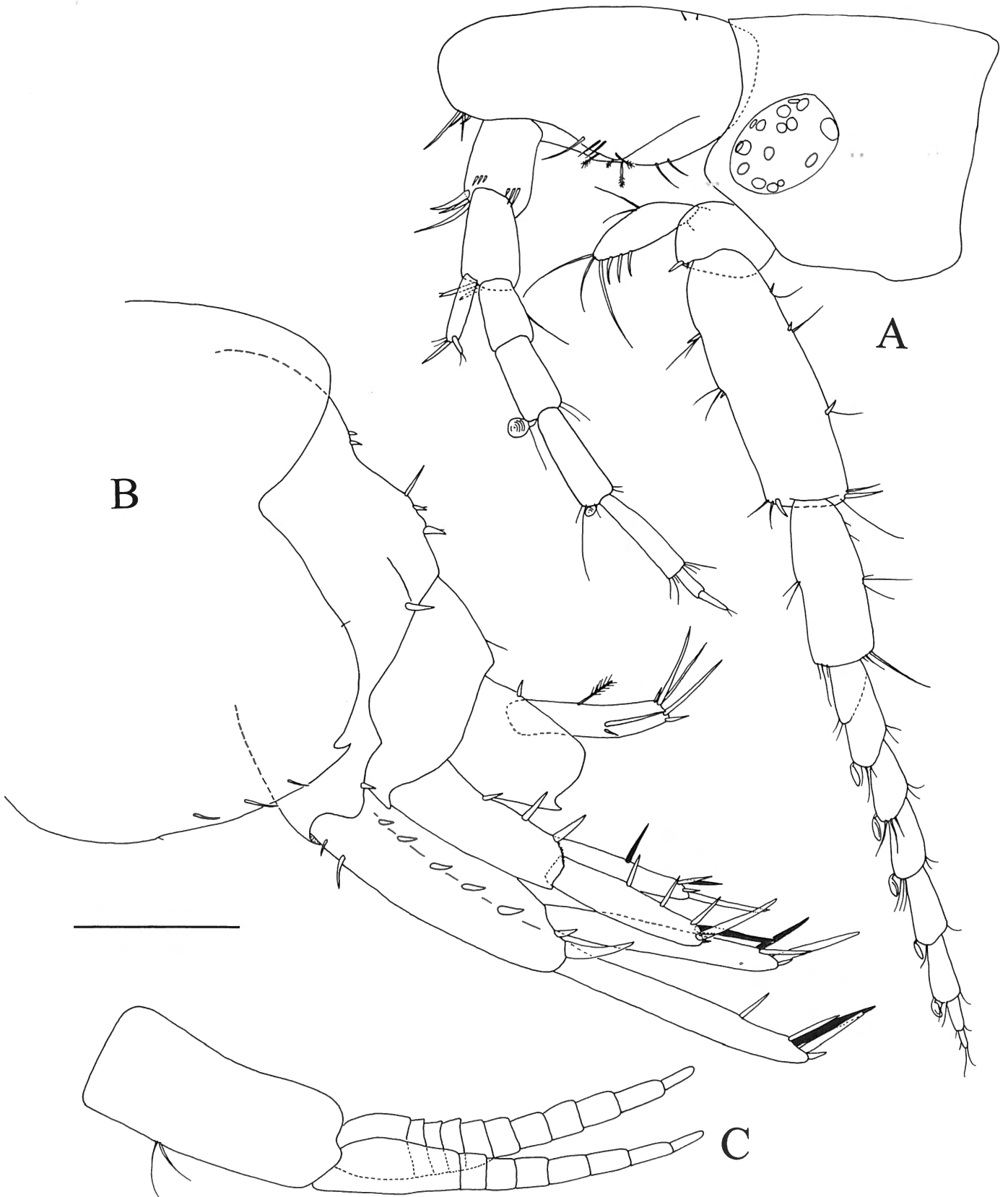

Fig. 7. *Bathyporeia parkeri* BOUSFIELD, 1973. A, B, mature male 1, South Carolina, Gray's Reef, St. GR 02-35-1, Crustacea 154 202; C, South Carolina : off Folly Island, TMU 12 618. A, head with antennae and mandibular palp; B, posterior part of abdomen (left side, medial spines of U1-U2 in black); C right pleopod 1. Scale bar: C, 0.42 mm; A, B, 0.21 mm.

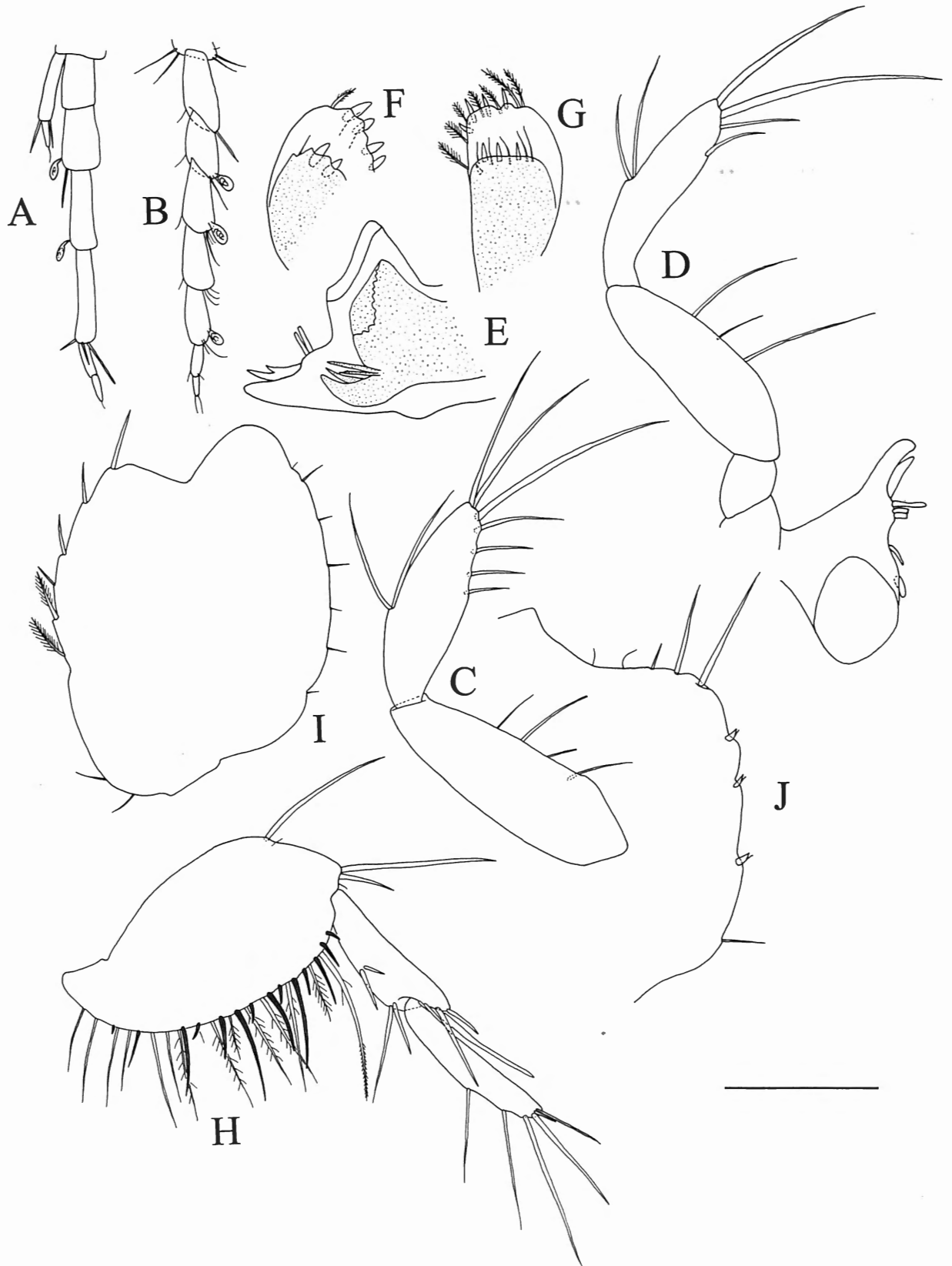

Fig. 8. *Bathyporeia parkeri* BOUSFIELD, 1973, mature males, South Carolina, Gray's Reef, St. GR 02-35-1, Crustacea 154 202. A-B, D-G, I-J, male 2; C, H, male 3. A, flagellum of left A1 (exhibiting 2 calceoli); B, flagellum of left A2 (exhibiting 3 calceoli); C, mandibular palp; D, left Md (teeth of incisor process damaged); E, right Md (extra moult in preparation: new cuticle seen by transparency); F, left outer plate of left Mxp (extra moult in preparation: new cuticle seen by transparency); G, inner plate of right Mxp (extra moult in preparation: new cuticle visible by transparency); H, distal part of left P5; I, basis of right P6; J, posterior border of basis of right P7. Scale bar: A, B, H, I, 0.21 mm; J, 0.14 mm; C, D, E, F, G, 0.10 mm.

Bathyporeia parkeri BOUSFIELD, 1973: 105, pl. 23 fig 1; D'UDEKEM D'ACUZ & VADER, 2005a: 2789 (key)

TYPE LOCALITY

Original description simply stating that the species is distributed from "South side of Cape Cod to northern Florida" (Bousfield, 1973).

MATERIAL

Massachusetts, Woods Hole, 10/vi/1964: 2 females (previously erroneously identified as *B. quoddyensis*), USNM 203/872; North Carolina, 34°24'24"N 076°36'00"W, S-M grab, 24 ms depth, 13/viii/1981: 1 female, USNM 221219; BST 85.5, label of the «Duke Marine Lab. Beaufort, N.C.», 24/vi/1965: 2 males, 1 female and 1 juvenile, TMU 12 615; South Carolina, off Folly Island, within 4 km radius of 32°40'N 079°44'W, 11 to 15 m depth, bottom salinity 34.5 to 34.8 0/00, bottom temperature 27 to 28.5 °C, composite sample consisting of 4 different Smith-McIntyre grabs P55 78119, P55 78120, P55 78126, P55 78150, 08-14/iii/1978: 13 females, SRTC (6 specimens deposited in the Tromsø Museum, TMU 12 618, of which one has been fully dissected illustrated and mounted in FAURE's liquid on 15 slides; first pleopod of an additional female mounted on one slide); about 3 km ESE of the seaward end of the south jetty at Winyah Bay entrance, 8 m depth, bottom salinity about 34 0/00, bottom temperature about 9°C, SMITH-MCINTYRE grab P56 830024, 15/ii/1983: 1 female, SRTC; GRAY's Reef, station 02_35_1: 189 specimens (2 males dissected and mounted in Faure's liquid, each on 2 slides), NOAA, label 154202; Gray's Reef, station 02_35_3: 24 specimens, NOAA, label 154402.

DESCRIPTION

Species of normal robustness. Eye with well-developed ommatidia in adults but in reduced number: 8 in female examined, 16 in male examined [6 in the female of Bousfield (1973)] (most ommatidia are separated from each other by a large space). Pseudorostrum with fairly rounded tip, high, slightly overhanging, with 2-3 (sometimes 4) short proximoventral setae in adults; 4 to 5 short and slender apical spines; median ventral projection not very developed. Major flagellum of A1 with 5 articles in females, 6 in males; first article of accessory flagellum without non-apical groups of spines. Flagellum of A1 in males of normal length (combined length of major flagellum and distal two articles of peduncle always much shorter than twice length of pseudorostrum). Anterior border of third article of peduncle of A2 with one group of spinules and setae in apical position only; 4th article with lateral and apical spinules; flagellum with 5 articles in females, 7-8 in males; A2 of adult males much shorter than body length, flagellum about as long as peduncle. Penultimate article of mandibular palp elongate. Ultimate article of mandibular palp in males with comb of 1-4 setae only on flexor border. Left lacinia mobilis entire; right lacinia mobilis cleft with a short upper blade and a long lower blade. Mx2 with only two strong setae on anterodistal part of ven-

tral surface.

Third article of palp of maxilliped without longitudinal row of setae on dorsal side (two transversal groups of anterior setae only are present), second article with 3 strong setae arising from dorsal surface; outer plate with 4-5 nodular spines. Coxa 1 with tip rounded, without ventral tooth, with strong anteroventral angular discontinuity, with 7-16 irregular-sized setae, of which 2-7 are anterior to the anteroventral angular discontinuity; no apical setule markedly shorter than other setae.

Coxa 2 without posterior tooth; transition between anterior and ventral border with weak angular discontinuity; anterior border almost straight, barely convex; anterior and posterior borders almost parallel, not converging downwards; with ventral border with about 8 short and narrow irregular-sized setae in adult females; no medial setae in dissected specimen. Coxa 3 without posterior tooth; anterior and posterior border parallel, not converging downwards; ventral border with about 9 irregular-sized short and narrow setae in adult females, of normal width and length, 4 medial setae.

Coxa 4 with 18 irregular-sized short and narrow setae in adult females; posterior setae not setulose.

P3 with carpal fang not reaching tip of propodus, distally styliform, without accessory setule; propodus rather robust; outer spines/setae of propodus few in number (4), of normal size and shape; dactylus very slender, with well-developed unguis, with posterior border weakly concave. Propodus of P3 longer than propodus of P4.

Ratio between propodus length and merus length of P3 in adult female: 0.78.

Ratio between dactylus length and propodus length of P3 in adult female: 0.31.

Ratio between length and width of dactylus of P3 in adult female: 4.5.

Ratio between unguis length and total length of dactylus of P3 in adult female: 0.26.

Ratio between unguis length and dactylus width in P3 of adult female: 1.2.

P4 with carpal fang not reaching tip of propodus, distally styliform, without accessory setule; propodus fairly robust; outer spines/setae of propodus few in number (5), of normal size and shape; dactylus slender, with rather short unguis, with posterior border straight on almost all its length, becoming slightly concave at unguis level.

Median part of anterior border of basis of P5 distinctly convex; posterior border of basis convex, with one conical spine in dissected female; merus elliptic and very broad; postero-median seta group of merus with one long and strong major seta and 1 minute non-setulose accessory seta; posterodistal seta group with 2-3 strong straight seta (one long reaching about tip of carpus; shortest very robust, spiniform), and 0-1 setule, 0.06 times as long as major posterodistal seta (no sexual dimorphism); anterodistal area with 1-2 seta that are only proximally plumose.

Posterodistal lobe of basis of P6 protruding; anterior border strongly and regularly convex; posterior border distinctly convex but less than anterior border, with 0-3 conical spines; in females, anterior border with setulose setae followed more distally by strong non setulose setae. Merus of P6 with 3-5 posterior groups of spines/setae and 5 anterior groups; long-

est seta of each anterior seta group not of significantly increasing size towards distal part of merus; carpus without posterior spines (distal group not considered); propodus with 3 posterolateral, and 3 anteromedial groups of spines (terminal crown of spines not considered). Spines of carpus and merus long and of normal slenderness.

Basis of P7 very broad; posterior border forming an acute triangular protrusion, with conical spines on proximal side of the triangle, with long and strong setae on the distal side of the triangle; both kind of spines regular-sized; total number of spines and setae on posterior border: 9-11; medial side without spines in females. Ischium not elongate, reaching 0.33 of outer side of merus; anterodistal border straight on outer side, faintly concave on medial side; posterodistal border faintly concave both on outer and medial side. Spines of carpus and merus slender and long.

Middle of posterior border of Ep1 and Ep2 strongly angular and produced in tooth; ventral border with short single spines, without plumose setae or a single plumose seta on Ep2.

Ep3 with posteroventral border with tooth followed by a notch, posterior border strongly convex, ventral border with 3 (sometimes 2 or 4) single spines, without setules on posterior border.

Urosomite 1 with one pair of rather short anteriorly directed setae, and a considerable number of spines: 2 (sometimes 3) pairs of dorsal spines on the anterior hump (very anterior to the pair of setae), 2-7 pairs of dorsal spines on the posterior hump behind the pair of setae or just in front of it, 1-2 pairs of dorsolateral spines close to the posterior margin, 1-2 (sometimes 4) pairs of posterolateral spines (just above the insertion of the peduncle of the first uropod); ventrolateral border without strong setae arising from outer side.

Urosomite 2 with 0-3 spines on posterior border.

Urosomite 3 with a pair of short dorsolateral spines (one spine on each side of the insertion of telson).

Peduncle of uropod 1: outer dorsal border with 7-9 spines consisting of following succession: 1) 5-7 short robust spines, 2) the usual penultimate short robust spine, 3) very short space followed by very strong distal spine; dorsomedial border with styliform spines, mostly single but sometimes in groups of two (4-5 groups or more). Rami of normal length and slender; inner ramus with border facing outer ramus, with only one long spine in subdistal position. Spines of rami rather slender.

Peduncle of uropod 2: of normal proportions, outer dorsal border with 5 spines, the 3 proximal much shorter than the 2 distal ones; dorsomedial border with 3 single spines. Rami of normal length and rather slender; inner ramus with border facing outer ramus with only one long spine in subdistal position. Spines on rami rather slender. Dorsal ratio between length and width of inner ramus 5.5.

Setation of uropod 3 without significant strong sexual dimorphism. Peduncle of uropod 3 with distal spines in low number (3-4 dorsal and 3-4 ventral ones), longest spine may overreach or not tip of inner ramus (endopodal spines excluded); outer border of peduncle of uropod 3 with only one group of setae (actually a transverse row of 3-6 setae). Inner ramus ovate and rather long, with 3 normal-sized spines. Outer ramus with first article narrow, second article rather

short to normal sized. Second article of outer ramus with 1-2 lateral setae, on medial side. Medial side of outer ramus (first and second articles together) with 8-16 plumose setae of normal morphology, some of them sometimes associated with a minute accessory non setulose seta, last plumose seta of first article associated with very long slender accessory spiniform non-setulose seta; all (except sometimes one or two proximalmost) plumose setae longer than longest spines of outer side; 4 outer spines of normal size. Ratio between length of second article and length of 1st article: 0.24-0.31. Ratio between length of second article and width of 1st article: 1.2-1.4.

Telson lobes without medial setae.

Size.- male, 3 mm (BOUSFIELD, 1973); female, 5 mm (present data).

ECOLOGY

Exposed sandy beaches, fine sand, from just below the breaker zone (BOUSFIELD, 1973) to 24 m (present data); ovigerous females from June to September in New England (BOUSFIELD, 1973). It is rather scarce in New England (BOUSFIELD, 1973) but may be the dominant amphipod species of sand beaches in some localities on the east coast of Florida (CHARVAT et al., 1990).

DISTRIBUTION

South of Cape Cod to northern Florida (BOUSFIELD, 1973).

REMARKS

DÖRJES & HOWARD (1975) report the occurrence of 3 unnamed *Bathyporeia* species in Georgia. Maybe they all refer to *B. parkeri*, which proves to be rather variable. This species exhibits important variation in the number of spines on the urosome, the largest specimens being usually the spiniest. One single specimen examined had two pairs of outer spines on the telson, just like in *Amphiporeia virginiana* SHOEMAKER, 1933. I have never seen this anomaly in any East Atlantic *Bathyporeia* species.

In the genus *Bathyporeia*, the females always go through several fertile intermoult (SALVAT, 1967). The situation could be more complex in males. In long-antennated species the puberty moult could well be the terminal one, although this has not been experimentally demonstrated (D'UDEKEM D'ACQZ, 2004). An original observation indicates that mature males of *B. parkeri*, i.e. a short-antennated species, go through several fertile intermoult. A specimen with calceoli on the first (fig. 8A) and second (fig. 8B) antennae (an unmistakable sign of maturity in male *Bathyporeia*) was preparing an extra moult. Indeed the new cuticle in formation is distinct inside the mandible (fig. 8E), the outer (fig. 8F) and the inner (fig. 8G) plate of the maxilliped.

Bathyporeia quoddyensis SHOEMAKER, 1949 (Figs. 9-13)

Bathyporeia quoddyensis SHOEMAKER, 1949: 389, fig. 1-2;

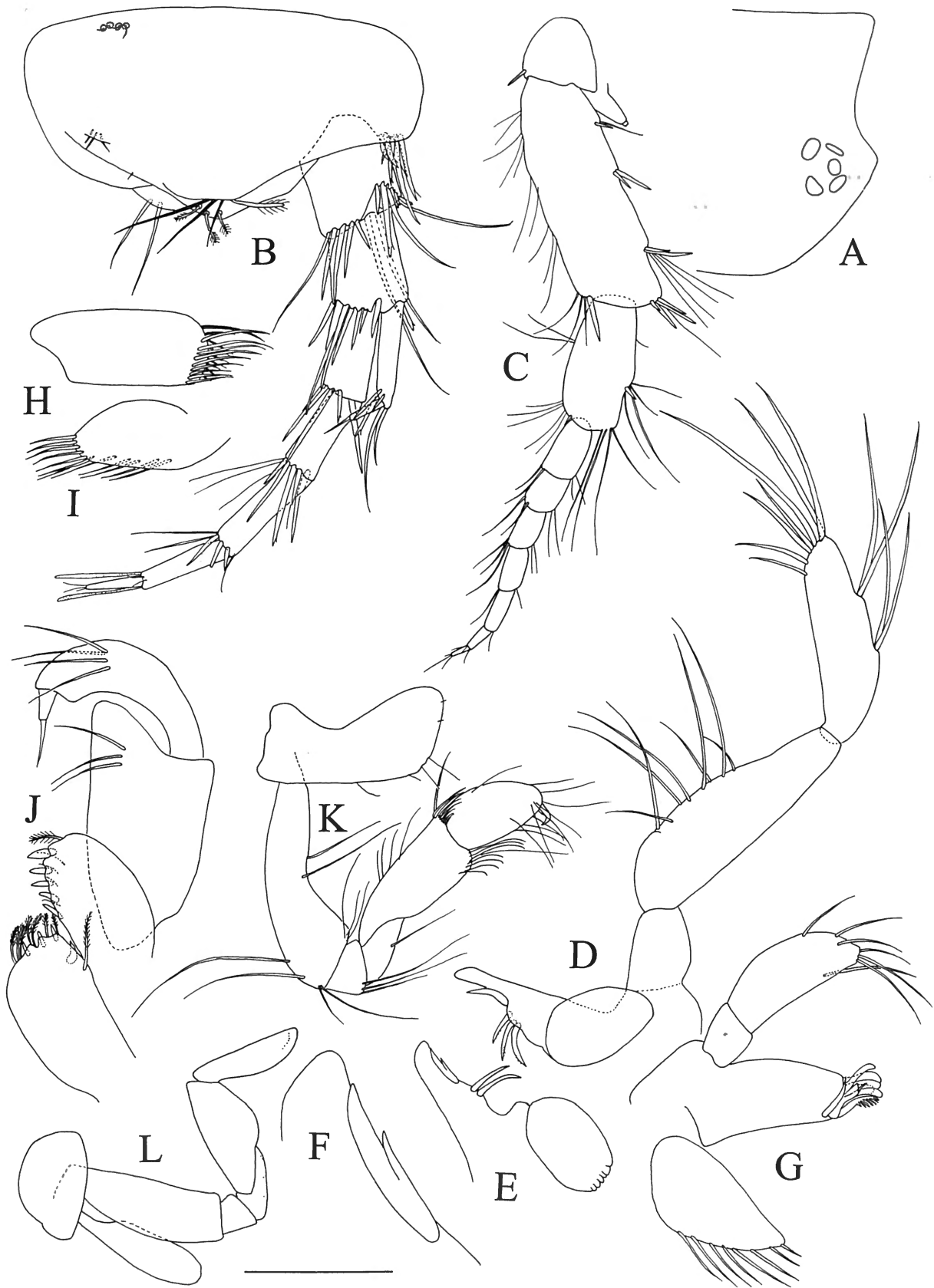

Fig. 9. *Bathyporeia quoddyensis* SHOEMAKER, 1949, mature female, New York, ARC 50398. A, anterior part of head; B, right A1; C, left A2; D, right Md; E, left Md; F, tip of incisor process of left Md with lacinia mobilis; G, Mx1; H, outer plate of Mx2; I, inner plate of Mx2; J, Mxp; K, right P1; L, right P2 (setae not shown). Scale bar: L, 0.42 mm; A, 0.30 mm; C, K, 0.21 mm; B, 0.14 mm; D, E, G, H, I, J x 0.10 mm.

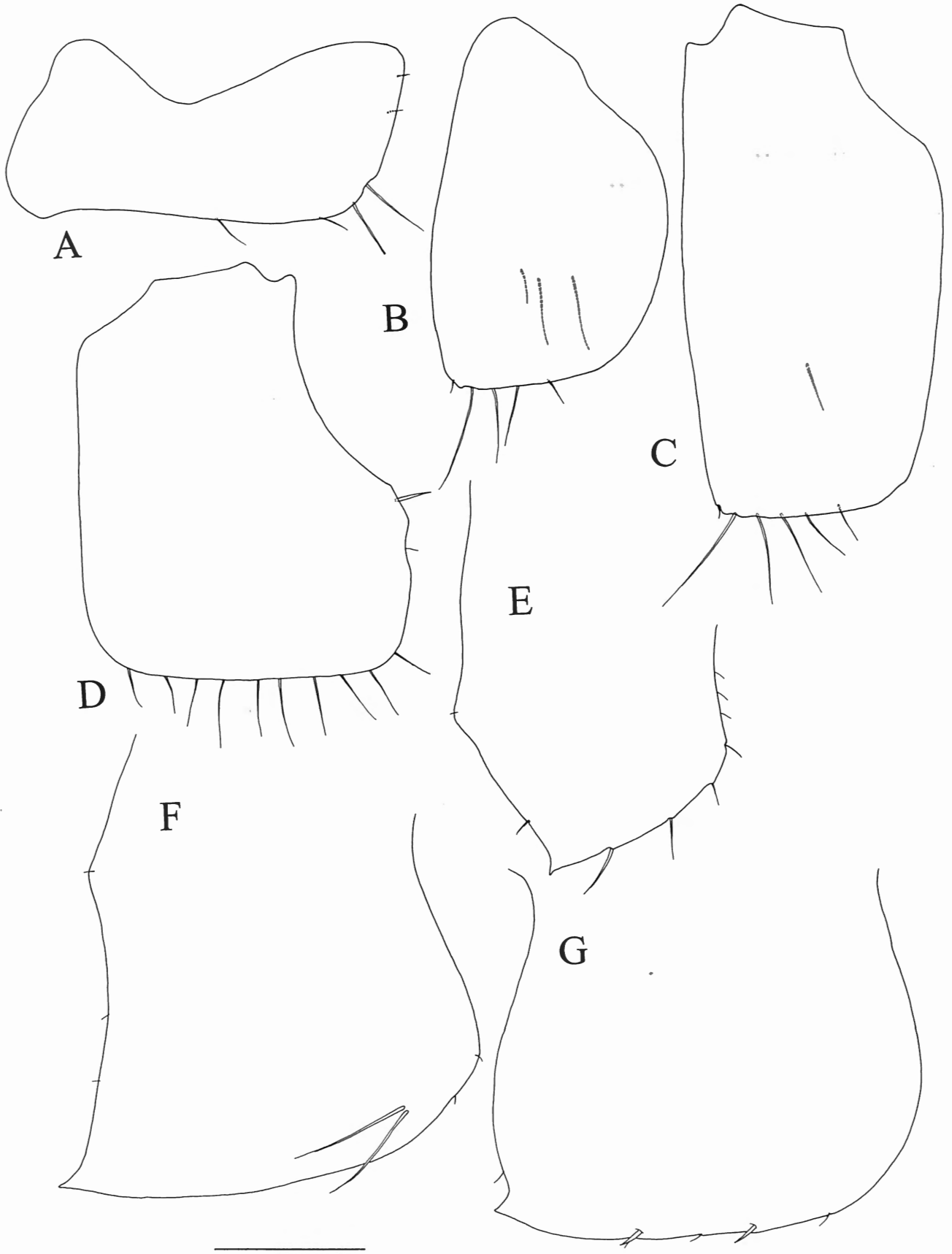

Fig. 10. *Bathyporeia quoddyensis* SHOEMAKER, 1949, mature female, New York, ARC 50398. A, right coxa 1; B, right coxa 2; C, right coxa 3; D, left coxa 4; E, right Ep1; F, right Ep2; G, right Ep3. Scale bar: D, 0.18 mm; E, F, G, 0.15 mm; B, C, 0.12 mm; A x 0.10 mm.

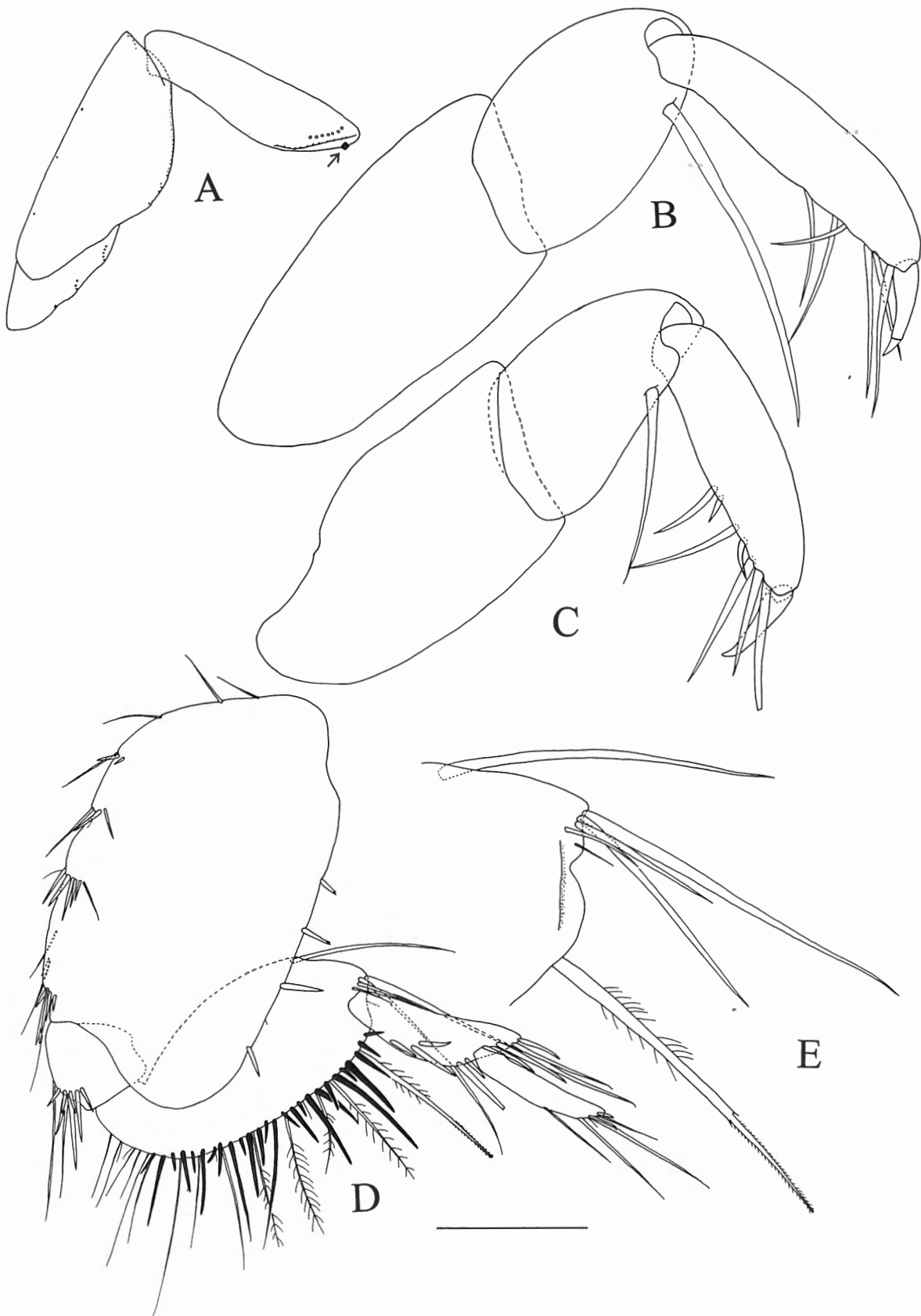

Fig. 11. *Bathyporeia quoddyensis* SHOEMAKER, 1949, mature female, New York, ARC 50398. A, anterior part of right P2 (setae not shown; vestigial dactylus in black); B, anterior part of right P3 (medial spines/setae of propodus not shown); C, anterior part of right P4 (medial spines/setae of propodus not shown); D, left P5; E, tip of merus of left P5. Scale bar: A, D x 0.21 mm; B, C, E x 0.10 mm.

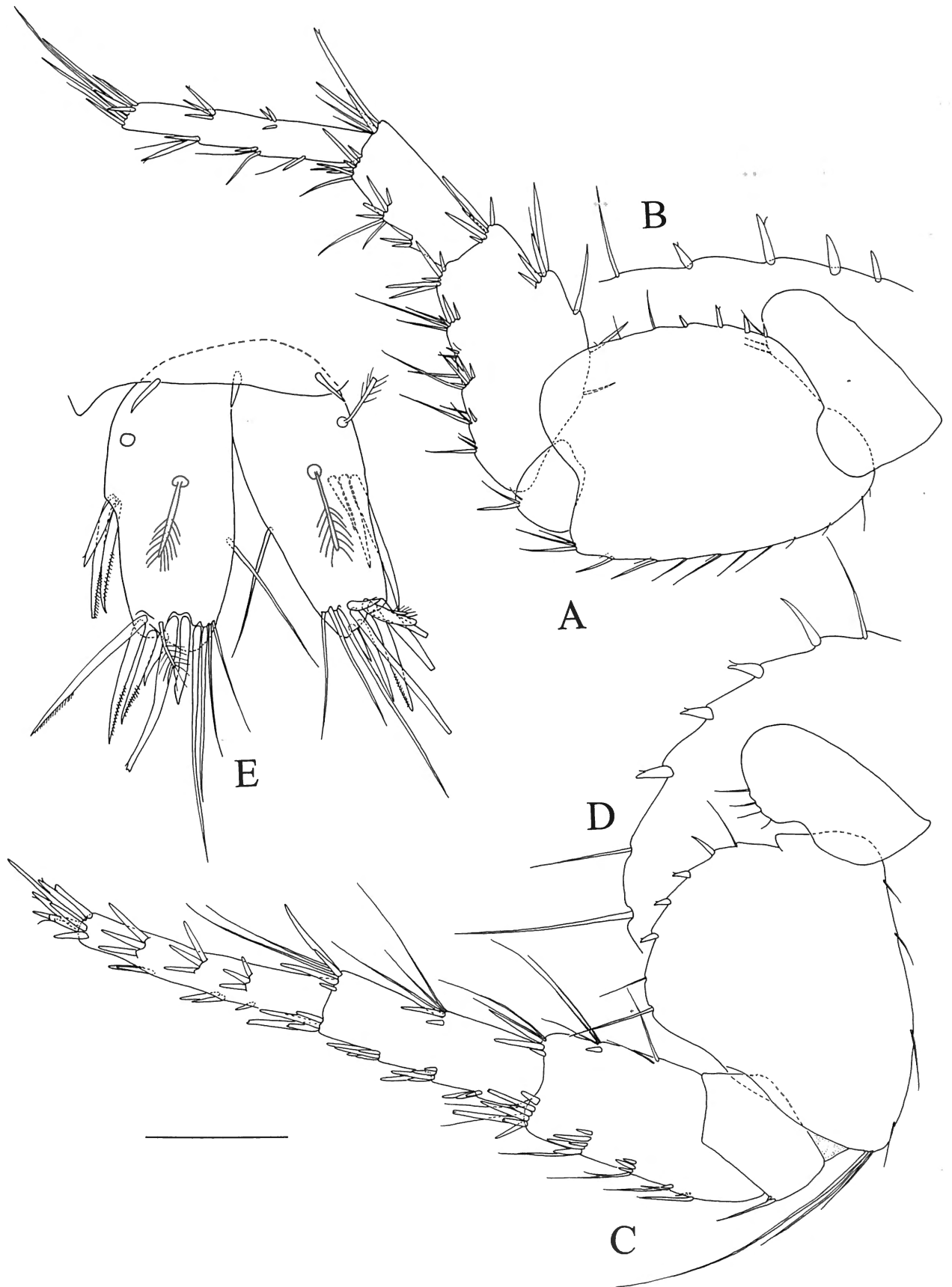

Fig. 12. *Bathyporeia quoddyensis* SHOEMAKER, 1949, mature female, New York, ARC 50398. A, right P6; B, posterior border of basis of right P6; C, right P7; D, posterior border of basis of right P7; E, telson and posterior margin of urosomite 3. Scale bar: A, 0.25 mm; C, 0.21 mm; B, D, E, 0.10 mm.

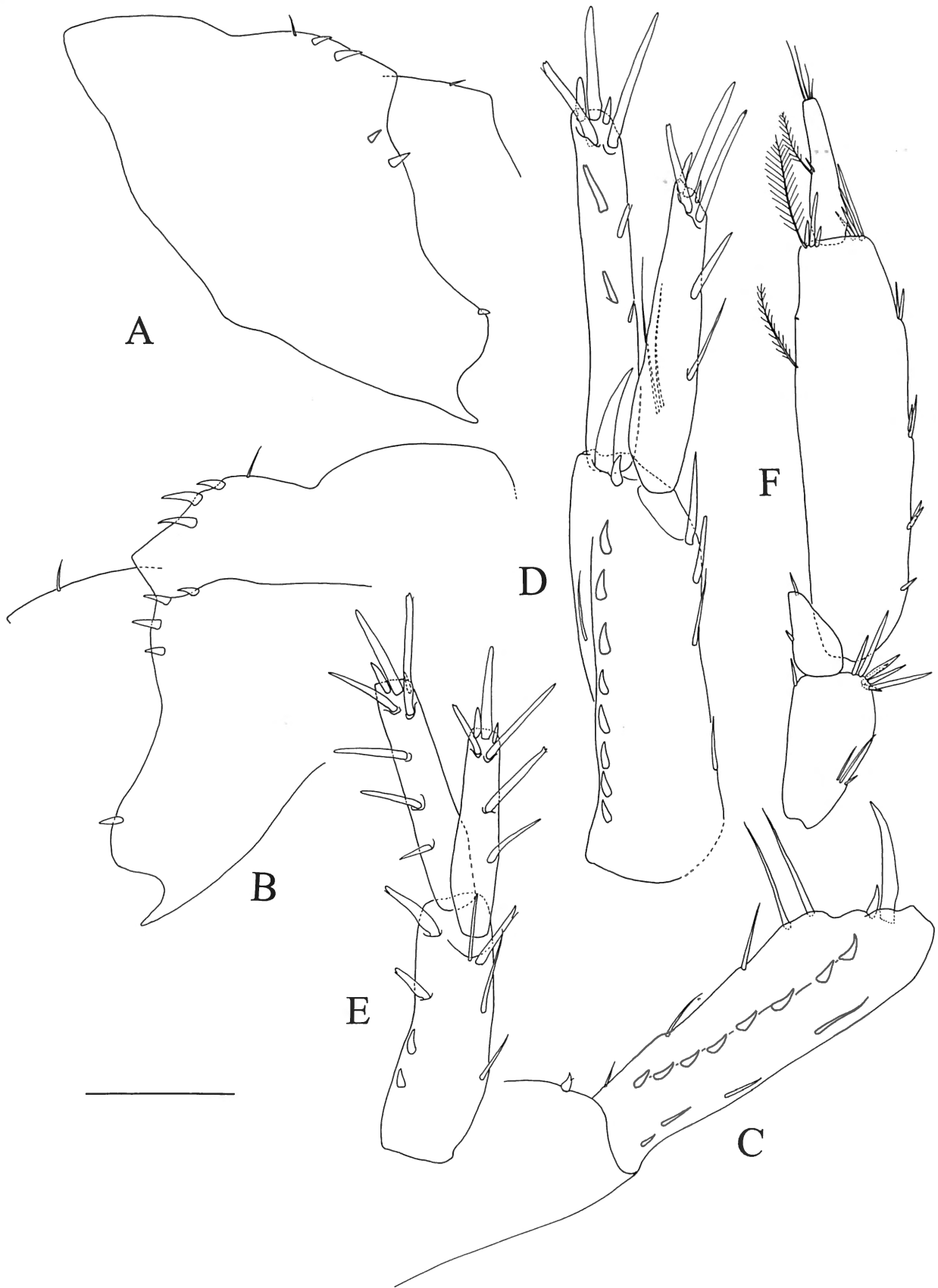

Fig. 13. *Bathyporeia quoddyensis* SHOEMAKER, 1949, mature females, New York, ARC 50398. A, B: different specimens than other drawings. A, B, urosomite 1 and dorsal part of urosomite 2 (A, left side; B, right side); C, peduncle of U1 and ventrolateral part of urosomite 1 (lateral view); D, right U1; E, right U2; F, right U3. Scale bar: F, 0.21 mm; A-E, 0.14 mm.

BOUSFIELD, 1973: 105, pl. 23 fig. 2; BARNARD & BARNARD, 1983: 568, fig. 27c (after BOUSFIELD); D'UDEKEM D'ACOZ & VADER, 2005a: 2790 (key)

TYPE

"A female taken inside West Quoddy Head, Maine, August 13, 1912, surface to 10 fathoms, fine sand, Biol. Board Canada no. 00410" (Shoemaker, 1949).

MATERIAL

USA, NEA Reference Collection, New York, East Rockaway, Field #: Z50398 09/05/2000 Collectors: 1, Northern Ecological Association (collected by U.S. Army Corps Engineers), 09/v/2000: 9 specimens (females and juveniles only; one female mounted on 18 slides), ARC 50398.

DESCRIPTION (MOSTLY BASED ON ONE DISSECTED FEMALE)

Species of normal robustness. Eye with well-developed ommatidia in adults but in reduced number (4 sometimes 5); most ommatidia separated from each other by a large space. Pseudorostrum with fairly rounded tip, high, not overhanging, with 1-2 short proximoventral setae in adults; about 6 apical spines of normal morphology; median ventral projection very protruding. Major flagellum of A1 with 5-6 articles in females; first article of accessory flagellum without non-apical groups of spines. Anterior border of third article of peduncle of A2 with one group of spinules and setae in apical position only; 4th article with lateral and apical spinules; flagellum with 6-7 articles in females; according to Bousfield (in litt.) A2 of adult males much shorter than body length, flagellum about as long as peduncle.

Penultimate article of mandibular palp elongate. Left lacinia mobilis entire; right lacinia mobilis cleft with a short upper blade and a long lower blade.

Mx2 with only two strong setae on anterodistal part of ventral surface.

Third article of palp of maxilliped without longitudinal row of setae on dorsal side (two transversal groups of anterior setae only are present), second article with 3 strong setae arising from dorsal surface; outer plate with 5 nodular spines.

Coxa 1 with tip rounded, without ventral tooth, with strong anteroventral angular discontinuity, with 6 short setae, of which 4 are anterior to the anteroventral angular discontinuity; no apical setule markedly shorter than other setae.

Coxa 2 without posterior tooth; transition between anterior and ventral border with no angular discontinuity; anterior border slightly convex; anterior and posterior borders converging downwards; with ventral border with about 5 narrow setae of normal size in adult females, of size decreasing towards anterior end; 3 medial setae in dissected specimen.

Coxa 3 without posterior tooth; anterior and posterior border almost parallel, barely converging downwards; ventral border with about 6 narrow setae of normal size in adult females, of size decreasing towards anterior end, 1 medial seta.

Coxa 4 with anterior and posterior border straight and paral-

lel to each other, both forming a right angle with the ventral border which is also straight, with 12 regular-sized short and narrow setae in adult females; posterior setae not setulose.

P3 with carpal fang not overreaching tip of propodus, distally styliform, without accessory setule; propodus rather robust; outer spines/setae of propodus few in number (6), of normal size and shape; dactylus very slender, with well-developed unguis, with posterior border weakly concave. Propodus of P3 longer than propodus of P4.

Ratio between propodus length and merus length of P3 in adult female: 0.81.

Ratio between dactylus length and propodus length of P3 in adult female: 0.28.

Ratio between length and width of dactylus of P3 in adult female: 3.9.

Ratio between unguis length and total length of dactylus of P3 in adult female: 0.25.

Ratio between unguis length and dactylus width in P3 of adult female: 0.94.

P4 with carpal fang not reaching tip of propodus, distally styliform, without accessory setule; propodus fairly robust; outer spines/setae of propodus in normal number (7), of normal size and shape; dactylus slender, with well developed unguis, with posterior border weakly concave.

Median part of anterior border of basis of P5 slightly convex; posterior border of basis almost straight with 4 conical spines in dissected female; merus elliptic, not very broad; postero-medial seta group of merus with one long and strong major seta and no accessory seta in dissected female; posterodistal seta group with 4 strong straight seta (one long overreaching tip of carpus; shortest slender), and 1 setule (not clearly distinct from smallest seta), 0.12 times as long as major posterodistal seta; anterodistal area with 1 seta that is only proximally plumose; longest posterior spine of carpus overreaching tip of propodus.

Posterodistal lobe of basis of P6 protruding; anterior border almost straight, barely convex; posterior border distinctly convex, more than anterior border, with 3-4 conical spines in dissected female. Merus of P6 with 4-5 posterior groups of spines/setae and 4-6 anterior groups; longest seta of each anterior seta group of significantly increasing size towards distal part of merus; carpus without posterior spines (distal group not considered); propodus with 2 posterolateral, and 3 anteromedial groups of spines (terminal crown of spines not considered). Spines of carpus and merus long and of normal slenderness. Basis of P7 very broad; posterior border forming a blunt triangular protrusion, with conical spines on the middle of the proximal side of the triangle, with long and strong setae on both extremities of the proximal side of the triangle, not on the distal side of the triangle; both kind of spines regular-sized; total number of spines and setae on posterior border: 7; medial side without spines in females. Ischium not elongate, reaching 0.28 of outer side of merus; anterodistal and posterodistal border almost straight. Spines of carpus and merus rather robust and short.

Middle of posterior border of Ep1 and Ep2 weakly angular and not produced in tooth; ventral border with few setae, without spines, in dissected specimen.

Ep3 with posteroventral border with tooth followed by a notch, posterior border weakly convex, ventral border with

2-3 single spines, with 1 setule on posterior border. Urosomite 1 with one pair of quite short anteriorly directed setae, without dorsal spines on the hump anterior to the pair of setae but with a number of spines posterior to the pair of setae: 2-3 pairs of dorsal spines on the posterior hump, 2-4 pairs of dorsolateral spines often close to the posterior margin, 1 pair of posterolateral spines (just above the insertion of the peduncle of the first uropod); ventrolateral border without strong setae arising from outer side.

Urosomite 2 without spines on posterior border in dissected specimen.

Urosomite 3 with a pair of slender dorsolateral spines (one spine on each side of the insertion of telson) and a single median spine.

Peduncle of uropod 1: outer dorsal border with 9-10 (7 in juveniles) spines consisting of following succession: 1) 7-8 (5 in juveniles) short robust spines, 2) the usual penultimate short robust spine, 3) very short space followed by very strong distal spine; dorsomedial border with 4-5 single styli-form spines. Rami of normal length and slender; inner ramus with border facing outer ramus, with only one long spine in subdistal position. Spines of rami of normal length and slenderness.

Peduncle of uropod 2: of normal proportions (dorsal ratio between length and width in mature female 3.0), outer dorsal border with 3-4 spines, the 1-2 proximal much shorter than the distal one(s); dorsomedial border with 2 single spines and 1 pair of spines. Rami of normal length and slenderness; inner ramus with border facing outer ramus with only one long spine in subdistal position. Spines on rami of normal slenderness.

Peduncle of uropod 3 with distal spines in normal number (5 dorsal and at least 2 ventral ones), longest spine nearly reaching tip of inner ramus (endopodal spines excluded); outer border of peduncle of uropod 3 with only one group of setae (actually a transverse row of 3 setae). Inner ramus ovate and rather long, with 2 short spines. Outer ramus with first article broad, second article of normal size. Second article of outer ramus with 1-2 lateral setae on medial side, of which one may be associated with a short and strong spine; or second article of outer ramus with a spine and no plumose setae. Medial side of outer ramus (first and second articles together) with 0-4 plumose setae of normal morphology. Distal medial corner of the first article with 2 or 3 very strong and rather long spines associated or not with a plumose seta. All plumose setae longer than longest spine of outer side. Outer ramus with 5 quite short outer groups of spines. Ratio between length of second article and length of 1st article: 0.33. Ratio between length of second article and width of 1st article: 1.3.

Telson lobes with medial setae.

Size.- Female, 5 mm; male 4 mm (BOUSFIELD, 1973).

ECOLOGY

A predominantly subtidal species, but can be found in low densities on the lower part of the shore (CROKER et al., 1975); can be found down to more than 40 m, in fine sand, along semi-protected shores; life cycle annual; ovigerous fe-

males from April to July (BOUSFIELD, 1973). Present in tidal plankton (HAGER & CROKER, 1980).

DISTRIBUTION

Outer coast of Nova Scotia and the Gulf of Maine (incl. Bay of Fundy) south to Chesapeake Bay; recorded in Cape Cod Bay and off Long Island (BOUSFIELD, 1973).

REMARKS

B. parkeri and *B. quoddyensis* are very closely related species. They can be distinguished by the following identification key:

- Basis of P5 broad and elliptic with posterior border strongly convex. Posterior border of basis of P7 strongly angular, with setae beyond the median angle. Middle of posterior border of Ep1-Ep2 pointed. Ep3 posteriorly strongly convex, projecting well behind posterior tooth. Urosomite 1 with 2 (sometimes 3) pairs of spinules on the anterior hump. Medial side of outer ramus of U3 with 1 plumose seta and a long slender spiniform non-setulose seta at the tip of the first article. Telson lobes without medial setae *B. parkeri* Bousfield, 1973

- Basis of P5 rather narrow with anterior border nearly straight and posterior border straight, both borders parallel. Posterior border of basis of P7 obtusely angular with setae only on the median angle and behind it. Middle of posterior border of Ep1-Ep2 barely angular. Ep3 posteriorly weakly convex, not projecting behind posterior tooth. Urosomite 1 without spinules on the anterior hump (only on the posterior hump). Medial side of outer ramus of U3 with 2-3 very strong spines and often a plumose seta at the tip of the first article. Telson lobes with 1-2 pairs of medial setae *B. quoddyensis* Shoemaker, 1949

3.1.2. Phylogeny of the genus *Bathyporeia*

The study of all *Bathyporeia* species and of its geographical variations has yielded a considerable amount of morphological data allowing a tentative reconstruction of their phylogeny by the cladistic method.

There is considerable disagreement concerning selection and coding of characters in cladistic analyses. Each case is different and a coding method appropriate for one data set can be totally irrelevant for another. There is no doubt that the methods adopted here will not satisfy some purists and that alternative options would have been possible. There are only 22 characters which can be considered as naturally binary and without overlap. Their cladistic analysis gave a very poorly resolved tree (not shown). Therefore it was decided worthwhile to incorporate continuous and multistate characters, even if they are reputed to be of inferior quality (KITCHING et al., 1998). Two coding methods have been used, the second being a simplified version of the first one. In the first method, continuous and multistate characters have been scored in a variable number of ordered non polarised character states, the number of states chosen depending on the distribution of values within and across species. In the second method, the

multistate character states of the first matrix have been fused to obtain a set of binary non-polarised characters, each fusion being decided subjectively. The core reason for coding the same crude data set with two different methods is to try to satisfy carcinologists with opposite dogmatic positions concerning the coding character states. From a methodological point of view, the analysis preserving the multistate nature of characters seems preferable to me because the effect of the subjective cutting values is diluted by the number of character states. In the binary coding the impact of the cutting values (which are even more subjective) is higher, with a risk of circularity (scoring the value in order to get the desired tree). Furthermore, it was a priori feared that a binary rescoring of all data would have resulted in an unacceptable loss of resolution of the tree. In reality this fear was unjustified. The two analyses gave very similar results and there is no evidence that the 'multistate tree' is better than the 'binary tree'.

The method used for scoring the multistate and continuous characters in the multistate matrix is a kind of compromise between the precision required and the time necessary for creating the matrix. The *Bathyporeia* case should be understood as follows: the genus is extremely homogeneous and most characters are continuous with character states often overlapping between species. An empirical examination of the distribution of character states indicates that the level of homoplasy is high. Measurements have usually been made on 3 to 5 specimens, rarely 10 (forms A and B of *B. elegans*). For some species only 2 specimens were available for study and only one was dissected. Since the animals are small (usually < 5 mm), measurements are extremely time consuming and some require dissection. Many characters are ratios and are therefore the combination of two measurements. Such data are by definition less precise than those based on a single measurement. Orientation artefacts on microscope slides do not improve this situation. So, as a consequence of the reduced number of measurements and their limited precision, a few character states may have been erroneously scored for some species. In other words, the set of characters is large, but many characters are poor and the data are not always very precise.

Concerning the continuous and the discrete multistate characters, the scoring system adopted here is a simple gap coding method. The application of sophisticated methods such as those of WIENS (1995) and SMITH & GUTBERLET (2001) would have required the recognition of a very high number of character states or the division of characters in 'sub-characters'. This would have needed a prohibitive amount of time for constructing the matrix. It is dubious that it would have resulted in better resolved trees because the present data set is rather coarse. Therefore the continuous and discrete multistate characters have been divided into a reduced number of character states (2 to 7) depending on the distribution of values. The cutting values are as far as possible round numbers. When several measurements are available per species, the scoring is based on the average value if not stated otherwise.

In the case of pairs or triplets of strongly correlated characters, only one has been retained. Otherwise no character with significant interspecific differences has been rejected. Seventy characters have been used. Twenty-two characters are

considered as naturally binary. The forty-eight remaining characters are either continuous or naturally multistate. Those with very scattered values have been binarized. Others have been coded as multistate. All characters considered have been coded according to the Wagner optimisation, i.e. as ordered, non-polarised and freely reversible (KITCHING et al., 1998). The character weights have been scaled so that the total influence of each character is the same, regardless of the number of states, as recommended by THIELE (1993), SWOFFORD (1993) and KITCHING et al. (1998). The total weight of each character set is 840. This is a number which can be divided by all numbers ≤ 10 except 9 and is therefore adequate for the numbers of character states used in this analysis, PAUP requiring round numbers. For the analysis of the second matrix, the cost of all changes is one, since all characters are binary. The 70 characters and their character states used in the two matrixes are described in appendix 1. The distribution of character states of the multistate matrix is given in appendix 2. The second matrix is not given due to lack of space but it can be easily reconstructed in using the rules of conversion given in appendix 1. In the main analysis of the multistate matrix and in the single analysis of the binary matrix, the outgroups are *Amphiporeia virginiana* SHOEMAKER, 1933 (illustrated on figs. 21-28) and *Gammarus oceanicus* SEGERSTRÅLE, 1947, which have been made paraphyletic. This imposed branching pattern is in agreement with the cladistic analysis of amphipod genera given in the second part of this paper. Subordinate analyses of the multistate matrix include *Pontoporeia femorata* KRØYER, 1842 or artificial taxa as outgroups.

The heuristic analysis of the 70 characters of the two matrixes was run with the program PAUP 4.0b 10: Deltran, stepwise addition, random addition sequence, 1000 replicates, TBR branch swapping, MulTrees on. The analysis of the multistate matrix yields a single most parsimonious tree: tree 1A (fig. 14). Its ensemble consistency index (CI) is very low: 0.3232, and its ensemble retention index (RI) is not very high: 0.6025. The low ensemble consistency index confirms the empirical impression that the level of homoplasy is high. In other words, the existence of a single most parsimonious tree does not mean that the relationships between the taxa on the tree are highly supported. The Bremer or decay index has been calculated for each branch. Since many characters are multistate and all have heavy weights (to get only round numbers), the length of the most parsimonious tree is extremely high: 181944. Therefore it was felt inappropriate to give the decay index in absolute value. The decay index has been given in percentage of length increase of the tree at which the branch collapses. Example: a branch with a decay index of 1 % is a branch that is not found in all trees with a length equal or longer than $181944 + (1\% \times 181944) = 183763$ but which is found in all trees with a length < 183763. The heuristic analysis of the binary matrix yields two trees of which the strict consensus (tree 2A) is given at fig. 16. These 'binary' trees are much shorter (length = 231) than the 'multistate' trees since the cost of each change is 1. Therefore the decay index of the branches could have been given in absolute value. However it seemed preferable to give it in percent as in tree 1, so the support of the branches of the two trees can be compared. In addition to the most parsi-

monious trees, the multistate and binary bootstrap trees (1000 bootstrap replicates, 200 replicates in each bootstrap replicate, 50% majority rule consensus, sampling characters with equal probability but applying weights) are presented (fig. 15: tree 1A; fig. 17: tree 2B). Differences between most parsimonious and bootstrap trees are interpreted as topological instabilities in the most parsimonious trees.

The multistate and the binary most parsimonious trees are very similar but not identical. All the clades of tree 1A are named by Latin letters. The same letters have been used for identical or similar clades found on tree 2A. Greek letters have been used for naming the clades of tree 2A which are not present on tree 1A. According to the analysis of the two matrixes, *Bathyporeia* (clade A) would consist of two clades B and C, of different geographical affinities, which are strongly supported both by the decay index and the bootstrap values (figs 14–17). Clade B includes the two West-Atlantic species (*B. parkeri* and *B. quoddyensis*) and clade C includes all the East-Atlantic / Mediterranean species. This can be interpreted as follows. The broadening of the Atlantic would have interrupted the gene flow between both sides of this Ocean early after the formation of the genus *Bathyporeia*, and the two resulting lineages would have followed independent evolutionary pathways. At the next more inclusive level, *B. microceras* D'UDEKEM D'ACOEZ & MENIOUI, 2004 appears as the sister clade of all other species (clade D), on all trees. This second dichotomy is also very highly supported by the decay index and the bootstrapping. At the next branching of tree 1A (fig. 14), *B. griffithsi* D'UDEKEM D'ACOEZ & VADER, 2005 appears as the sister clade of all other species (clade E). With a decay index of 0.2% this branching is extremely poorly supported. In tree 2A, *B. griffithsi* occurs at a more inclusive level, at the basis of the clade ϵ , and is the sister clade of the clade Q. The clade ϵ also has a weak decay index, 0.4% (fig. 16). It occupies an intermediate position on the two bootstrap trees (fig. 15, 17), which also have a weak support (< 50%). The topologic instability of this species may be explained by its character states which are rather apomorphic but in a combination different from other groups.

The next branching of tree 1A (fig. 14) separates the species with a blunt-tipped carpal fang (clade F) from the remaining species (clade K). This clade F is also present on the tree 2A where it occupies a more inclusive position, being the sister clade of clade L, these two clades forming the clade α (fig. 15). A similar topology is also observed on the two bootstrap trees. The clade F is well supported by the decay index (1.2% on tree 1A and 0.9% on tree 2A), well supported by the bootstrap (62% on tree 1B but weakly supported by the bootstrap on tree 2B (40%). On clade F in tree 1A, only two more inclusive clades, clade H (*B. pilosa* LINDSTRÖM, 1855 and *B. sarsi* WATKIN, 1938) and clade J (*B. elkaimi* D'UDEKEM D'ACOEZ & MENIOUI, 2004 + *B. gladiura* D'UDEKEM D'ACOEZ & VADER, 2005) are reasonably supported. These two clades are the only two elements of clade F common to tree 1A, tree 2A and the bootstrap trees. On tree 2A, only clade H has a reasonable support (0.9%). The two clades have bootstrap values over 50% on tree 1B but not on tree 2B. This low internal resolution of clade F can be explained by the strong differences between its species. The

fairly well supported grouping between the two sympatric Northwest European species *B. pilosa* and *B. sarsi* (clade H) in all trees seems logical because they share several unusual characters such as their very special third uropods. The fairly good support for the grouping of the Moroccan / South Iberian *B. elkaimi* and *B. gladiura* in tree 1A and 1B is more surprising but does not seem a priori impossible.

Clade K of tree 1A (figs. 14) unites most apomorphic species with a slender carpal fang. This grouping is very poorly supported by the decay index (value = 0.2%) and is not found on the trees 1B, 2A and 2B. Clade K itself consists of two large clades: L and Q, which are also present on trees 1B, 2A and 2B, albeit with a different topological position. Clade L is highly supported by the decay index (0.8% on tree 1A and 1.3% on tree 2A) and the bootstrap (71% on tree 1B and 73% on tree 2B). In this clade L, *Bathyporeia borgi* D'UDEKEM D'ACOEZ & VADER, 2005 is the sister species of clade M on all trees. In this very highly supported clade M (decay index: 1.6% on tree 1A, 2.6% on tree 2A; bootstrap: 89% on tree 1B, 91% on tree 2B), *B. gracilis* G.O. SARS, 1891 appears as the sister taxon of the 'complex *tenuipes*' on both trees. The 4 species of this complex (*B. tenuipes* MEINERT, 1877, *B. lindstromi* STEBBING, 1906; *B. chevreuxi* D'UDEKEM D'ACOEZ & VADER, 2005; *B. cunctator* D'UDEKEM D'ACOEZ & VADER, 2005) are distributed in 3 successive dichotomies on tree 1A (clade N) with an extremely weak decay index (0.1%) and form an unresolved quadritomy on tree 2 (clade β). The 3 successive dichotomies are also present in the two bootstrap trees, with values lesser than 50%. This quartet of cryptic species can only be separated by ill-defined characters (I strongly hesitated to consider them as different species) and their empirical examination suggested an alternative pattern of dichotomies. Since these 4 cryptic species have a parapatric distribution, the quadritomy shown on tree 2 possibly reflects their genuine historical pattern of relationships.

Clade Q groups together *B. elegans* WATKIN, 1938, *B. guilliamsoniana* (BATE, 1857), *B. pelagica* (BATE, 1857), *B. nana* TOULMOND, 1966 and *B. phaiophtalma* BELLAN-SANTINI, 1973 on trees 1A and 2A (figs. 14, 16). *B. nana* occupies the same position on the binary bootstrap tree (fig. 17) but has a more exclusive position on the multistate bootstrap tree (fig. 15). The position of *B. nana* at the basis of the clade Q is very poorly supported on tree 1A (decay index = 0.2%) and 2B (bootstrap = 31%) but highly supported on tree 2A (decay index = 1.3%). The poorly supported position of *B. nana* on tree 1A may be interpreted as side effects of its 'neotenic' character states (it is a very small species). However its much better support on the similar but not identical tree 2A suggests that the low value on tree 1A may result from spurious effects of topologic constrains. On tree 2A, the position of *B. nana* would be stabilized by the presence of the not so different *B. griffithsi* at the next more exclusive level and by a wider separation from the other dwarf species *Bathyporeia borgi* of clade L. Actually *B. nana* is very difficult to separate from juvenile *B. elegans* and the two species are presumably very close relatives. In other words clade Q makes sense despite its very weak support on tree 1A. The next most inclusive clade (clade R) is reasonably well supported on tree 1A (decay index = 0.7%) and 1B (bootstrap =

53%) but not on tree 2A (decay index = 0.4%) and 2B (bootstrap = 36%). It makes *B. phaiophthalma* the sister taxon of clade S, which seems a priori possible. On tree 1A and tree 2A, the forms A and B of *B. elegans* are not grouped in a clade and *B. elegans* appears as paraphyletic, which seems illogical. The decay index is low both on tree 1 and 2 (value = 0.4%). Empirical observations suggest that the two forms are sister clades (there are several minute differences between the two forms but none are absolute) and the branching pattern seems suspect. On the two bootstrap trees, the two forms of *B. elegans* form a clade with a support higher than 50%, suggesting that the multistate and binary most parsimonious trees are unreliable in this topologic area. *B. guilliamsoniana* forms a well supported clade with *B. pelagica* (clade U) (decay index = 1% on tree 1A, 0.9% on tree 2A; bootstrap = 69% on tree 1B, 54% on tree 2B). This is no surprise since they share unusual characters such as the occurrence of a tooth on the third epimeral plate and especially the pronounced sexual dimorphism on the posterodistal strong seta of the merus of the fifth pereopod, which is not found in any other *Bathyporeia* species. The morphologically variable Mediterranean and the homogeneous West European populations of *B. guilliamsoniana* form a strongly supported clade. There is no topological instability as for the geographical races of *B. elegans*.

So, the different (most parsimonious and bootstrap) trees conflict with each others and with empirical observations as well. This prevents the construction of an adequate and objective consensus tree. However I feel necessary to propose a graphical summary of the information at hand, combining both cladistic and non-cladistic data. This graphical summary is the pen and paper phylogenetic tree presented at the figure 18, which retains all the strongly supported clades present in all analyses and where the position of *B. nana* and the relative position of the two forms of *B. elegans* have been determined on the basis of empirical observations. This figure can be considered as objectionable from a methodological point of view (not the result of a computation), but I strongly believe it helps to visualize the acceptable hypotheses the relationships between the various species of *Bathyporeia*, as currently understood.

Despite the analysis of no less than 70 characters, the relationships between the species of *Bathyporeia* species are rather poorly resolved (the decay index and bootstrap value of many branches is weak). This can be explained by the very high rate of homoplasy (CI = 0.3232 on tree 1A and 0.3030 on tree 2A). In other words the large number of available characters only partly compensates for their poor quality. Rampant homoplasy is a general problem in amphipods (BARNARD & DRUMMOND, 1978) and the present case has nothing exceptional. Another problem is that some changes are possibly irreversible (or rarely reversed). Since it was not possible to make objective decisions concerning the degree of reversibility of characters, there was no other choice than to score all of them as freely reversible. This unconstrained scoring could have resulted in a tree which does not match optimally the historical pattern of relationships. A cladistic analysis based on molecular data would have been a useful tool for testing the accuracy of the morphological one and would perhaps have yielded a more resolved tree. Unfortu-

nately all our attempts to run a PCR reaction on *Bathyporeia* DNA were unsuccessful. This can be explained by the small size of *Bathyporeia* (usually ≤ 5 mm) and the general fragility of amphipod DNA, which is often impossible to fix properly in standard field conditions (ENGLISH, 2001).

Despite the rather low resolution of the trees obtained with the present cladistic analysis, they allow to investigate an important question in amphipod evolution: what is the polarity of the character 'length of second antennae in mature males'? Considering some characters as a priori polarised and some changes as irreversible, BOUSFIELD & SHIH (1994) divided the amphipods in two groups or evolutionary grades: the plesiomorphic Natantia (in which they put the 'pontoporeioideans', thus also *Bathyporeia*) and the apomorphic Reptantia. If their views are correct, 'long second antennae in mature males' would be the plesiomorphic condition and 'short second antennae in mature males' would be the apomorphic character state. In most amphipod genera only one character state (long or short) is observed. However *Bathyporeia* includes species with long, short and mid-sized second antennae in mature males. It is therefore an ideal genus for testing the hypothesis of BOUSFIELD & SHIH (1994), its monophyly being beyond doubt.

If the present cladistic analysis accurately reflects the historical pattern of relationships between the species and if the chosen outgroups are adequate, then the evolutionary pattern in *Bathyporeia* falsifies the predictions of BOUSFIELD & SHIH (1994): short antennae in mature males would be the plesiomorphic character state and the long antennae would have arisen several times independently (fig. 19). This character state would also present reversions (fig. 19). This pattern results from the choice of outgroups but there are good reasons to believe that this choice was pertinent. *Amphiporeia virginiana* (fig. 21-28) has been chosen as first outgroup because there is strong cladistic support (and empirical evidence) that the genus *Amphiporeia* is the sister taxon of *Bathyporeia* (see the second part of this paper). The second outgroup is *Gammarus oceanicus*, i.e. a classical Gammaridae. Classical Gammaridae seem excellent as outgroup because 1) they exhibit a remarkable overall similarity with *Bathyporeia* and 2) there is little doubt that their thoracic and abdominal appendages are highly plesiomorphic when compared to *Bathyporeia*. In other words every character state of *Bathyporeia* is easily derivable from classical Gammaridae. This similarity between *Gammarus* and *Bathyporeia* may reflect genuine phylogenetic relationships as suggested by the molecular data of ENGLISH (2001) and the cladistic analyses of amphipod genera given in the second part of this paper. Both *A. virginiana* and *G. oceanicus* (as well as all other *Amphiporeia* and Gammaridae species) have short antennae in adult males.

Within the ingroup, the first dichotomy separates the West Atlantic *Bathyporeia* species from the East Atlantic / Mediterranean ones (figs. 14-19). As seen above these two clades are very strongly supported. Furthermore the western clade seems to be globally more plesiomorphic than the eastern one. Whilst PAUP gives a similar number of synapomorphies for both clades (13 for the Western clade and 14 for the Eastern clade), many of them concern characters of minor impor-

tance. A visual inspection indicates that the Western clade exhibits the following clear-cut character states not found in their eastern counterparts (they are interpreted as symplesiomorphies by PAUP): 1) the first article of the accessory flagellum of A1 has no lateral spines; 2) the laciniae mobiles are asymmetrical; 3) they have several strong spines/setae on the posterodistal seta group of the merus of P5 (instead of one); 4) they have strongly developed spination on the urosomites; 5) they have a longer inner ramus of U3 than the eastern species; 6) in *B. quoddyensis* the distomedial seta of the first article of the outer ramus of U3 is associated with several accessory spines instead of one. On the other hand, the western clade exhibits only two putative pronounced synapomorphies: 1) their eyes have a reduced number of ommatidia and 2) the basis of their P7 is posteriorly strongly expanded. This general trend for plesiomorphy in American species strengthens the idea that 'short antennae in mature males' would be a seventh plesiomorphic character state. Actually, it is in the West Atlantic that the Bathyporeiidae as a whole are the most plesiomorphic. Indeed it is the only part of the world where the more basal bathyporeiid genus *Amphiporeia* is present (at least today). On the other hand there are only 5 Bathyporeiidae species in the West Atlantic, while there are no less than 19 species in the East Atlantic and the Mediterranean. An explanatory factor would be the high diversification of Haustoriidae in the West Atlantic (BOUSFIELD, 1965, 1973), which would have inhibited the evolutionary radiation of the Bathyporeiidae in this area.

B. microceras forms a strongly supported basal dichotomy with all other East Atlantic / Mediterranean *Bathyporeia*. This species which shares several characters with American *Bathyporeia* also has short antennae in adult males. At more inclusive levels the character 'short antennae in adult males' become scattered and less frequent, and is totally absent in clade Q. The basal clustering of the character state 'short antennae in mature males' in Bathyporeiidae strongly suggests that it is plesiomorphic.

The fact that *G. oceanicus* and *A. virginiana* seem a priori to be excellent outgroups does not imply that this choice was necessarily pertinent. Therefore alternative analyses have been run with other real or artificial outgroups. *Pontoporeia femorata* (figs. 29-33) has been used as alternative outgroup because it is traditionally considered a close relative of *Bathyporeia*. *Pontoporeia* and its satellite genera *Diporeia* and *Monoporeia* which are considered as gammaroids sensu lato by BARNARD & BARNARD (1983) have long antennae in mature males as do a number of *Bathyporeia* species. They seem strongly apomorphic in many characters (in a direction different than the one observed in *Bathyporeia*) and do not exhibit general similarity with *Bathyporeia*. As a result of these important differences, the coding of the character states of *Pontoporeia femorata* was difficult and not always possible, a problem not met with *G. oceanicus* and *A. virginiana*. In a first analysis, *Pontoporeia femorata* replaces *Gammarus oceanicus* as basal outgroup but *Amphiporeia virginiana* is retained as next outgroup. The resulting tree stays identical at the ingroup level. The character 'long antennae' of *Pontoporeia femorata* becomes short at the node *A. virginiana* + *Bathyporeia* spp. and the polarity pattern of this

character remains the same within the ingroup *Bathyporeia*. The rooting of the tree remains unchanged. However in a second analysis where *Pontoporeia femorata* is used as the single outgroup (fig. 20), long antennae become the plesiomorphic condition in the ingroup and the rooting of the tree is completely altered, the complex *tenuipes* becoming the sister clade of all other *Bathyporeia* species. This tree seems a priori much less probable because 1) the removal of the first outgroup *A. virginiana* which is presumably a very close relative of *Bathyporeia* is illogical, and 2) the alternative outgroup *P. femorata* is strongly apomorphic in a direction different to that of *Bathyporeia*. Furthermore on the new tree the West Atlantic species no longer form the sister clade of East Atlantic / Mediterranean species, which seemed very natural.

Other alternative cladistic analyses have been run with a single outgroup, either *G. oceanicus* or *A. virginiana*. The resulting cladograms are identical to tree 1A (fig. 14, 19). There is no change in topology, the root remains at the same place and the evolution of the length of antennae in mature males remains the same, 'short' being the plesiomorphic condition in the ingroup (and the outgroup). This result is not surprising and simply means that both *Gammarus* and *Amphiporeia* have the same effect on the rooting of the cladogram. In other words they are interchangeable outgroups.

In a further analysis, two outgroups are used again. The basal outgroup nicknamed 'longicorn *G. oceanicus*' is an artificial taxon identical to *G. oceanicus* except for its second male antennae which are made long (flagellum > 4 times as long as peduncle). The other outgroup remains *A. virginiana*. The resulting tree remained identical in branching and rooting position with tree 1A (fig. 14, 19). The character 'long antennae' of the longicorn *G. oceanicus* becomes short at the node *A. virginiana* + *Bathyporeia* spp. and the polarity pattern of this character remains unchanged within the ingroup. When an analysis is run with two artificial outgroups: longicorn *G. oceanicus* and longicorn *A. virginiana* (*A. virginiana*-like artificial taxon with male flagellum of second antenna > 4 times as long as peduncle), then the tree structure and rooting position remain the same. However with these improbable outgroups the basal polarity of the second antennae in the ingroup is reversed: long antennae become plesiomorphic at the basal node of the ingroup. In other words, 1) the general tree topology and its rooting position stay stable for a wide range of acceptable outgroups, and 2) severe artificial modifications in outgroups are necessary to obtain the character state 'long antennae' as the plesiomorphic condition of the ingroup. This strongly advocates that 'short antennae' is the plesiomorphic condition in *Bathyporeia*.

As a conclusion it can be stated that in at least one amphipod group (the genus *Bathyporeia*) there is compelling evidence that the polarity of antenna length goes in the sense of lengthening through evolution. The ideas of BOUSFIELD & SHIH (1994) concerning the evolution of antennal length in males cannot be completely rejected on the basis of this single case, but they can no longer be accepted as universal and unequivocal. However studies of other amphipod groups may go farther in challenging these ideas. Indeed amphipods are well known for their trend to undergo parallel evolutions

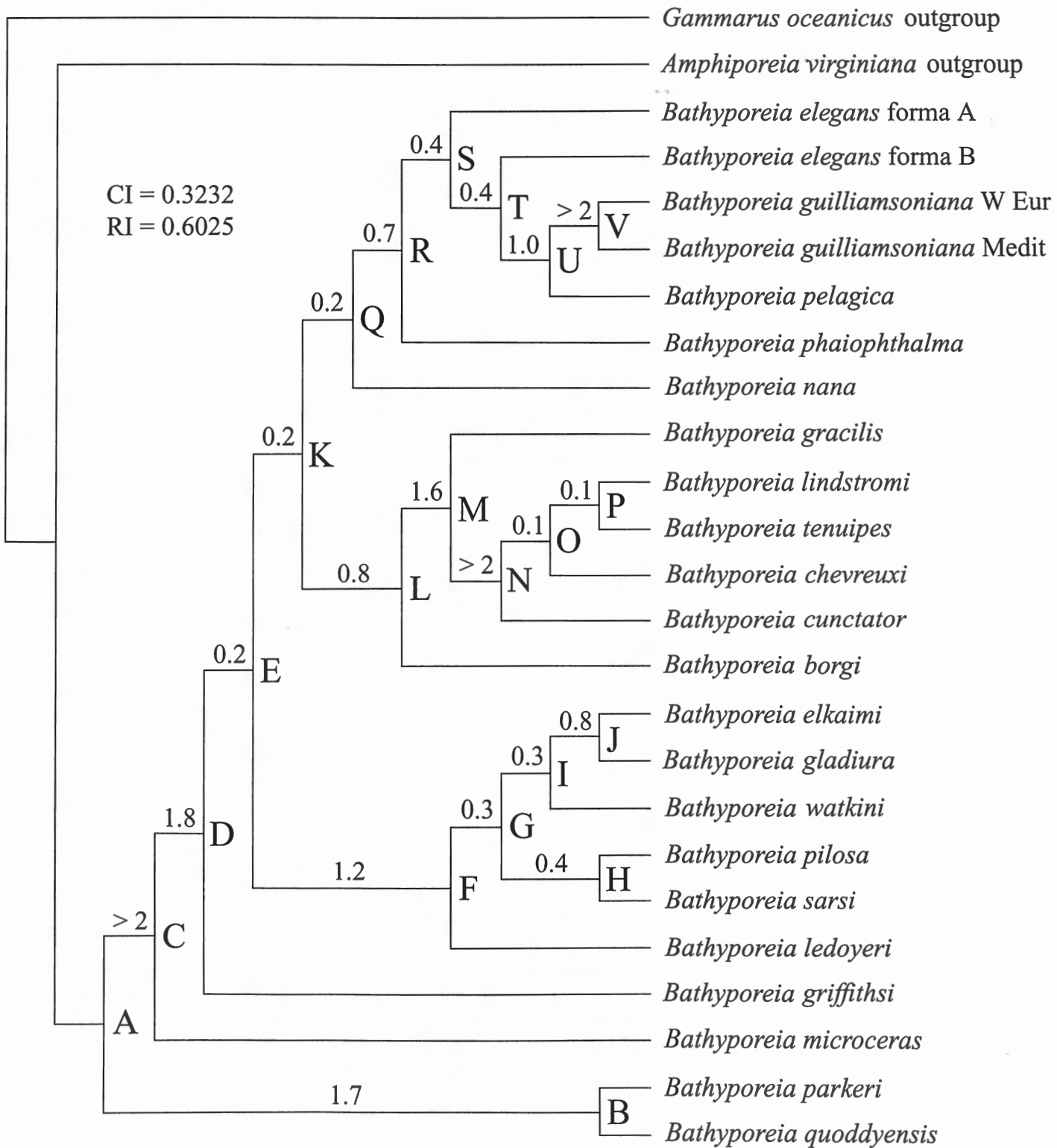

Fig. 14. Tree 1 A: most parsimonious cladogram of the genus *Bathyporeia* obtained from the cladistic analysis of 70 Wagner binary and multistate characters. Clades are labelled by capital letters. The Bremer or decay index (expressed in % of increase in tree length necessary for branch collapse) is indicated for each branch (see text for details).

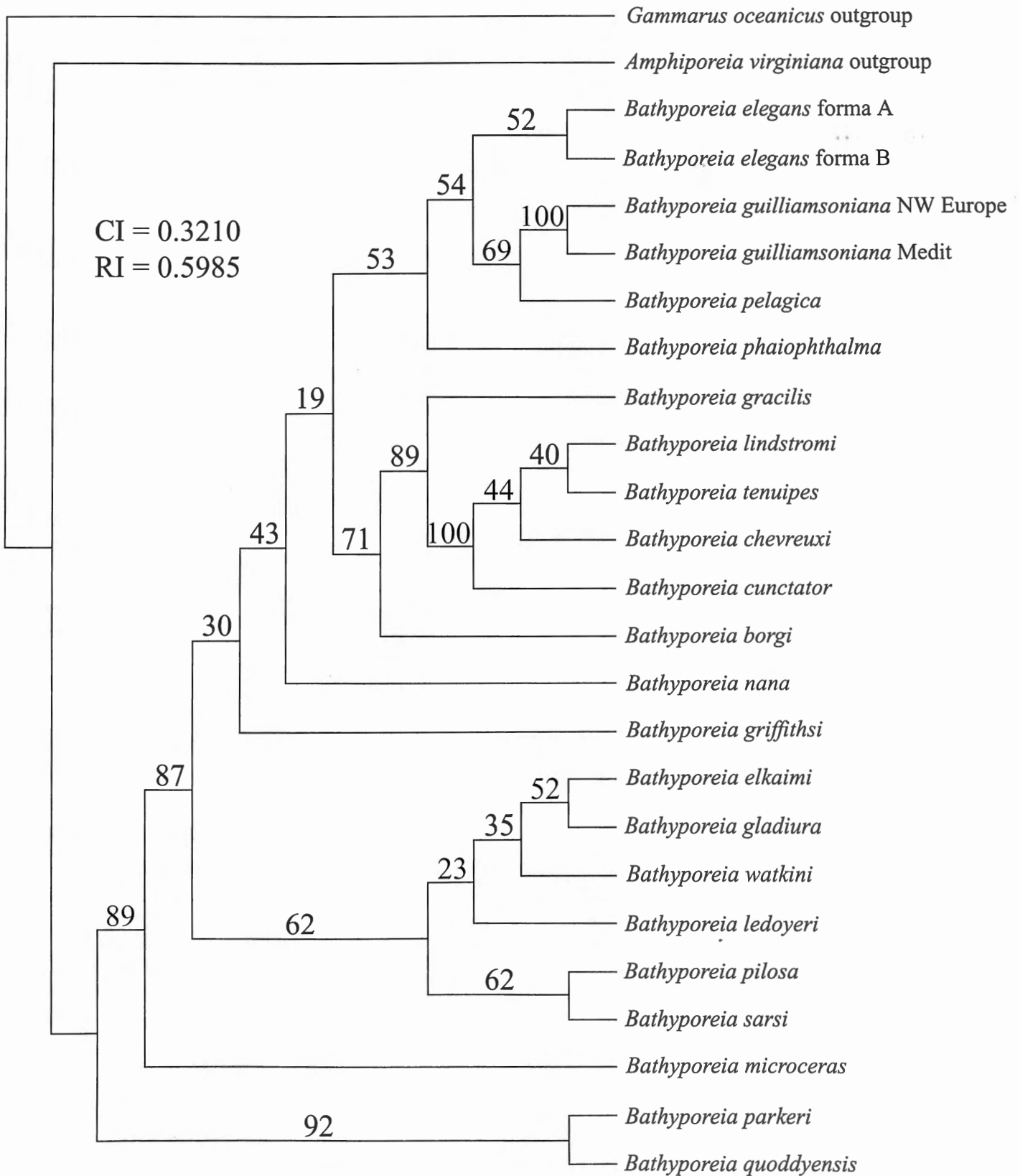

Fig. 15. Tree 1 B: bootstrap tree of the genus *Bathyporeia* obtained from the cladistic analysis of 70 Wagner binary and multistate characters (1000 bootstrap replicates, 200 replicates in each bootstrap replicate, 50% majority rule consensus, sampling characters with equal probability but applying weights).

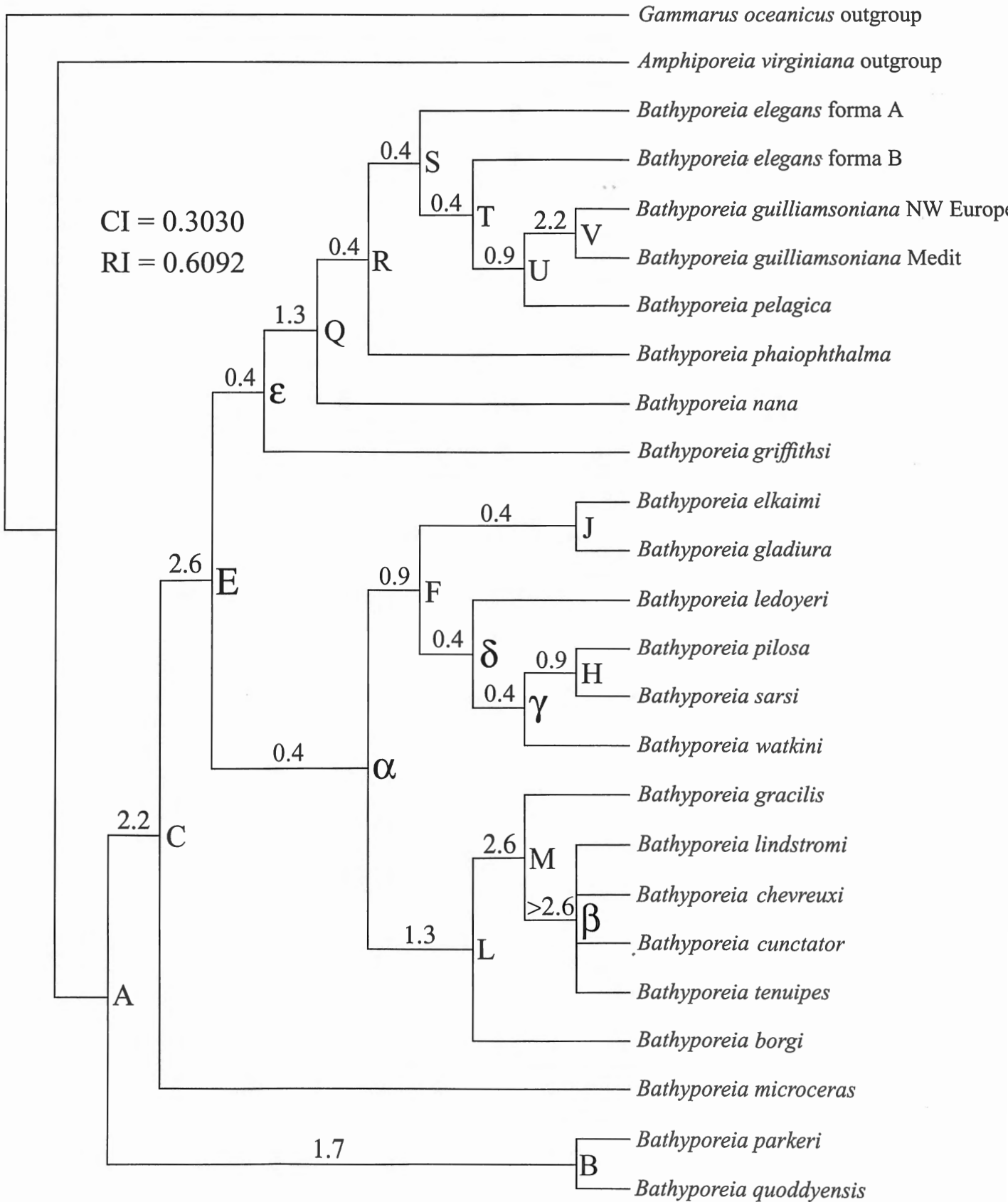

Fig. 16. Tree 2 A: most parsimonious cladogram of the genus *Bathyporeia* obtained from the cladistic analysis of 70 binary freely reversible characters. Clades identical or similar to those of tree 1 are labelled by the same Latin letters; clades not found on tree 1 are labelled by Greek letters. The Bremer or decay index (expressed in % of increase in tree length necessary for branch collapse) is indicated for each branch (see text for details).

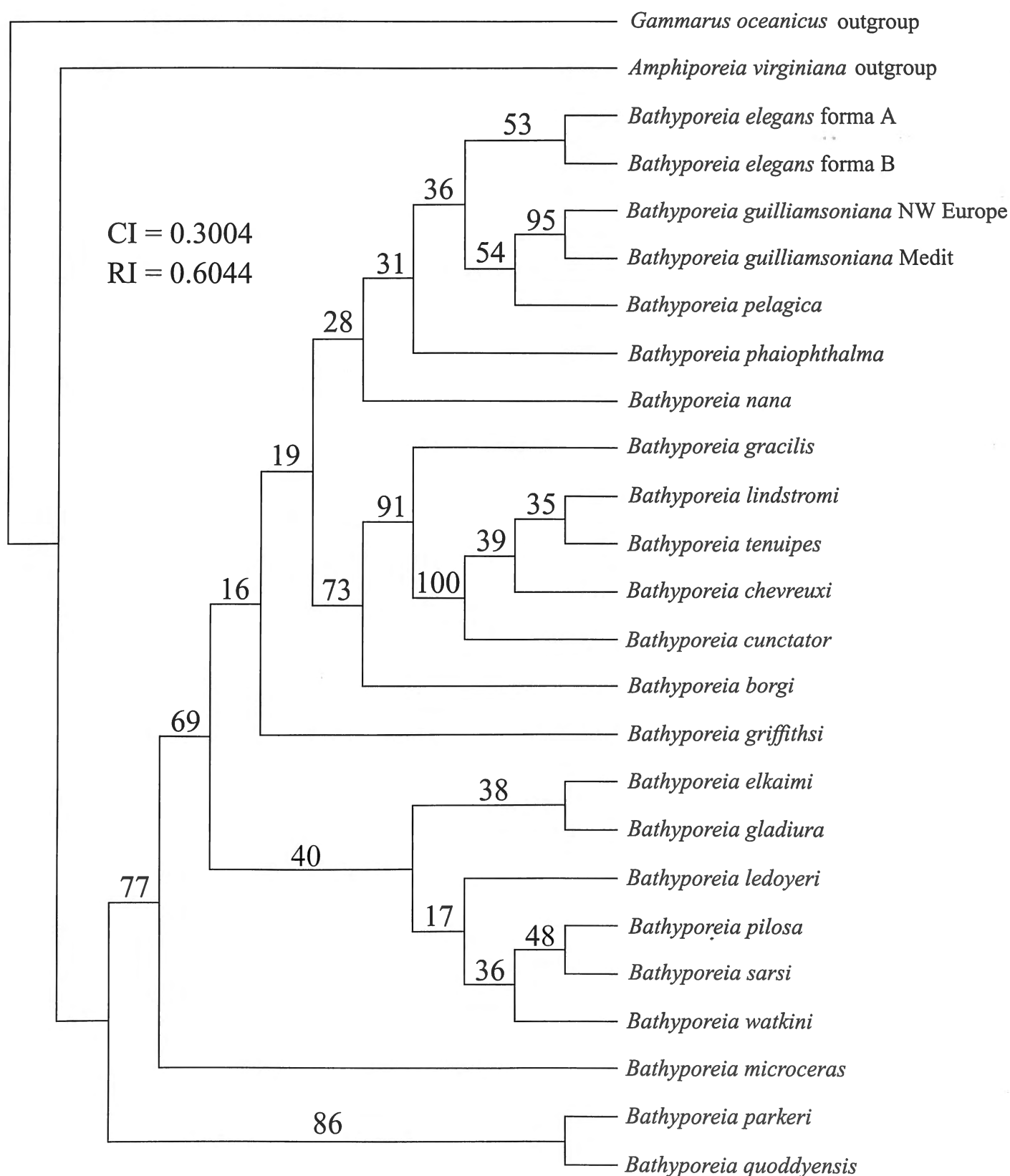

Fig. 17. Tree 2 B: bootstrap tree of the genus *Bathyporeia* obtained from the cladistic analysis of 70 binary freely reversible characters (1000 bootstrap replicates, 200 replicates in each bootstrap replicate, 50% majority rule consensus, sampling characters with equal probability but applying weights).

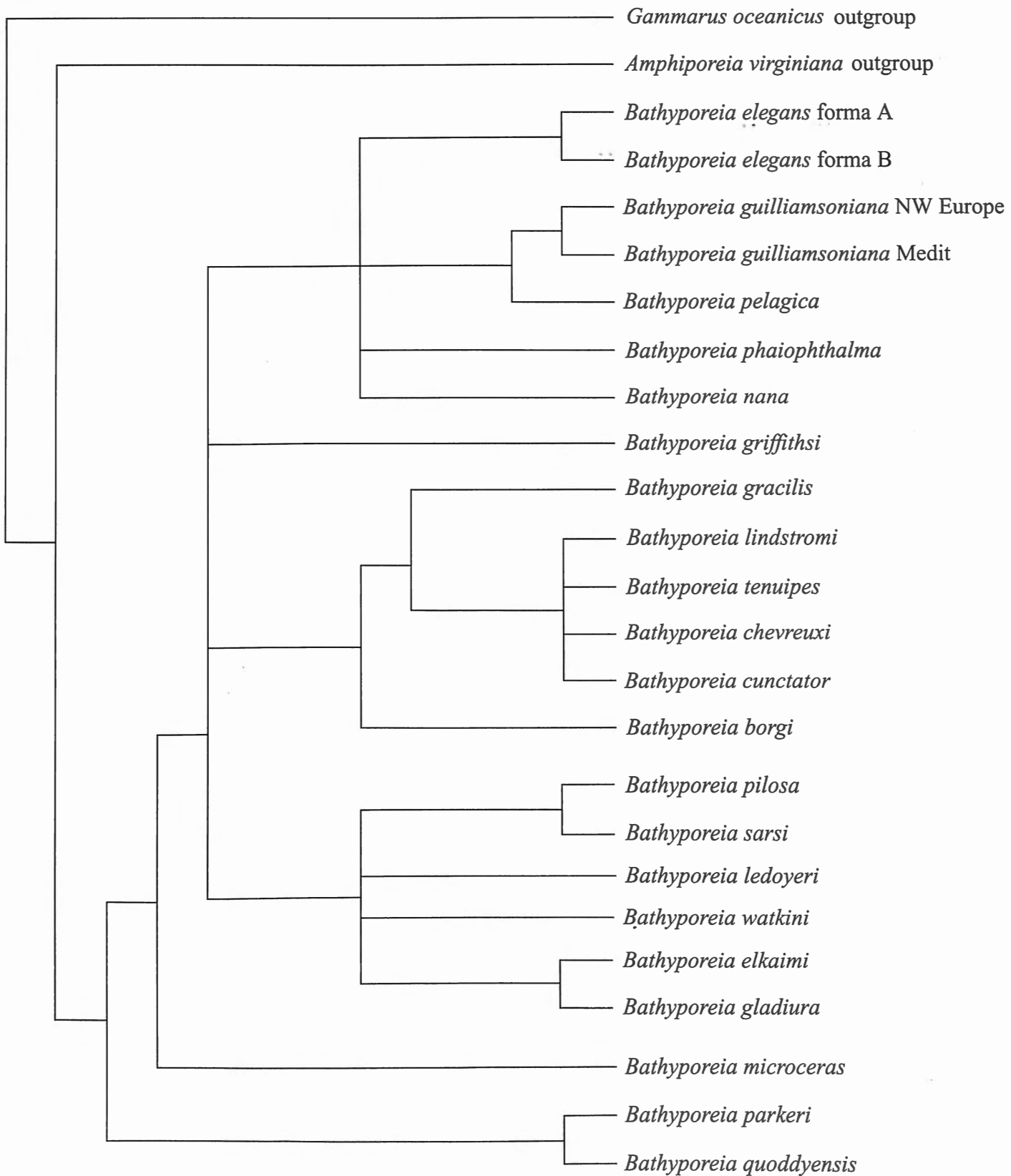

Fig. 18. Tree 3: pen and paper phylogenetic tree retaining the most strongly supported clades present in all most parsimonious and bootstrap trees and retaining the phylogenetic position of *Bathyporeia nana* and of the two forms of *B. elegans* suggested by the empirical examination of data.

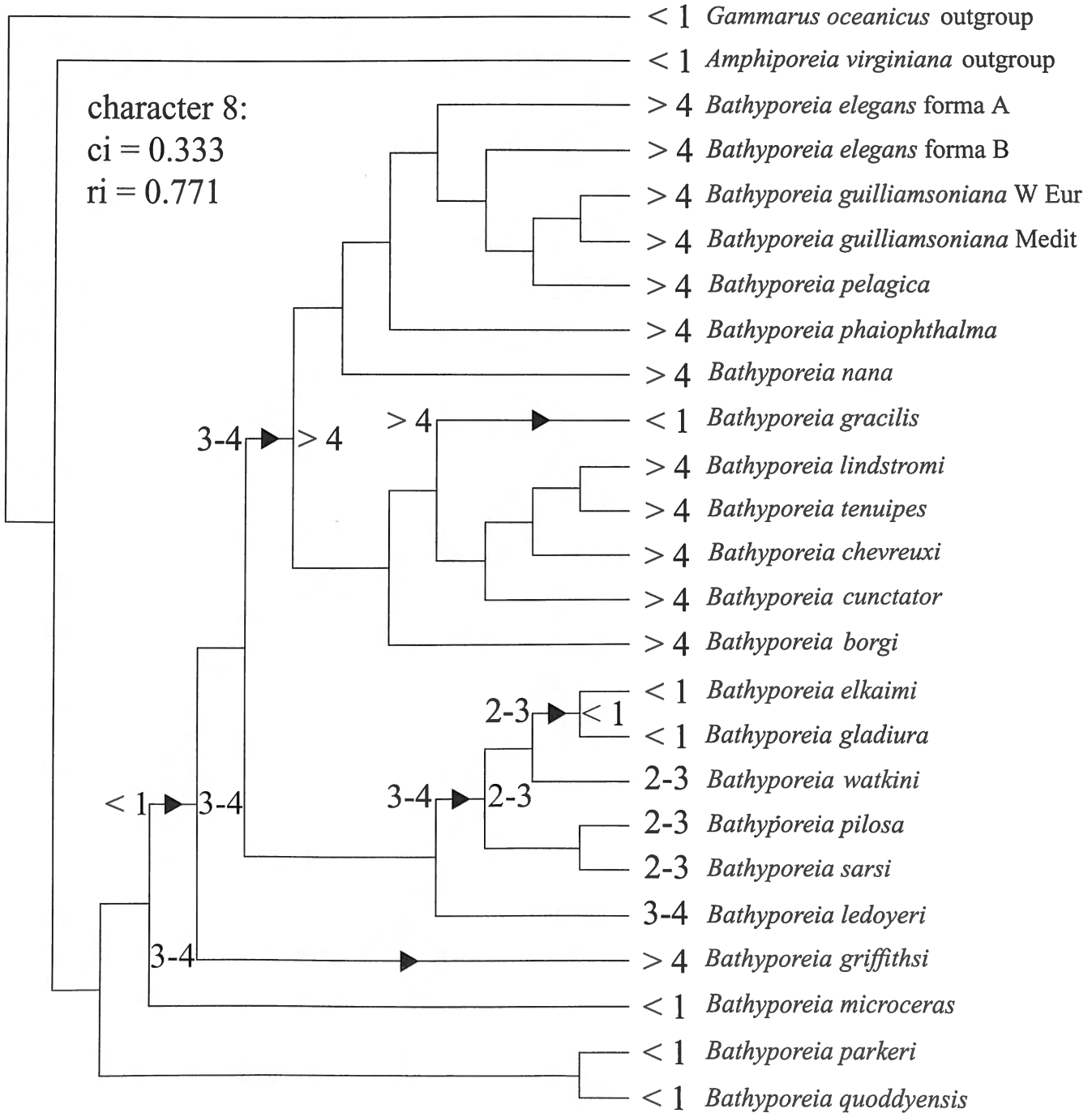

Fig. 19. Evolution of the length of the second antenna in adult males (character 8) on the most parsimonious cladogram of the genus *Bathyporeia* obtained from the cladistic analysis of 70 Wagner binary and multistate characters, with *Amphiporeia virginiana* and *Gammarus oceanicus* as outgroup (tree 1 A). The values indicated are the ratio between the length of the flagellum and the length of the peduncle.

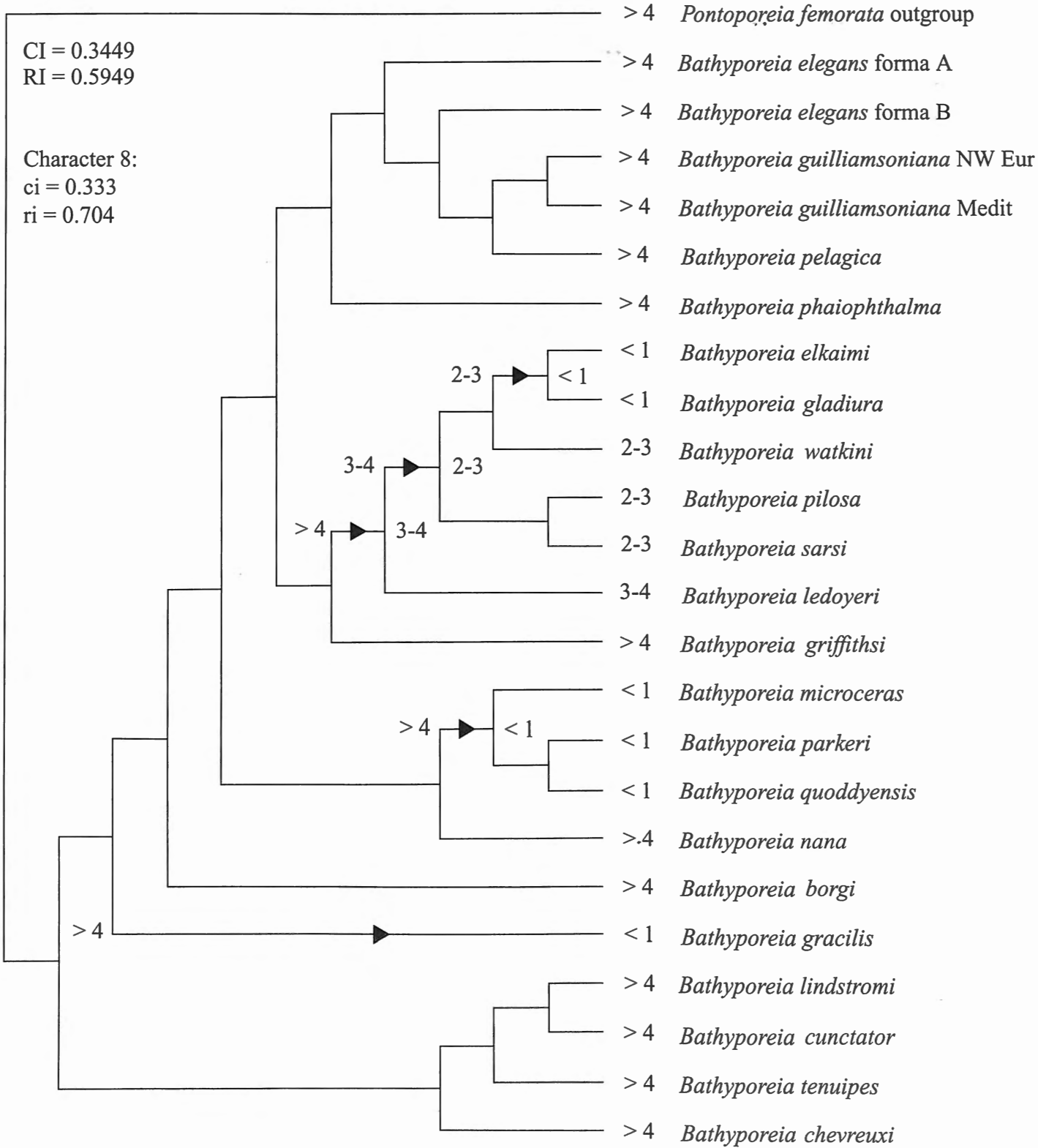

Fig. 20. Evolution of the length of the second antenna in adult males (character 8) on the most parsimonious cladogram of the genus *Bathyporeia* obtained from the cladistic analysis of 70 Wagner binary and multistate characters, with *Pontoporeia femorata* as outgroup (tree 3). The values indicated are the ratio between the length of the flagellum and the length of the peduncle.

(BARNARD & DRUMMOND, 1978; BARNARD & BARNARD, 1983) and it would be no surprise if the evolutionary pattern of antennae observed in *Bathyporeia* would have been replicated in other amphipod lineages, such as the true Pontoporeiidae (*Diporeia*, *Monoporeia* and *Pontoporeia*) or the Phoxocephaloidea.

3.2. Part 2. Systematic position of the genus *Bathyporeia*

The first section of this paper (§ 3.1) included the last part of the revision of the genus *Bathyporeia* started by D'UDEKEM D'ACUZ (2004) coupled with a phylogenetic analysis of the genus. In this second part, the position of *Bathyporeia* amongst the amphipods is investigated in 3 steps. Step 1: the genus *Bathyporeia* itself and its alleged closest relatives are redescribed properly. Step 2: the diverging statements of old and modern authors are revised and discussed on the basis of empirical evidences and of previous cladistic analyses. Step 3: a new cladistic analysis of morphological characters is run and discussed.

3.2.1. A brief review of the Bathyporeiidae and its alleged closest relatives

Superfamily Gammaroidea LEACH, 1814

COMPOSITION

Families Acanthogammaridae, Anisogammaridae, Baikalogammaridae, Bathyporeiidae, Eulimnogammaridae, Gammaracanthidae, Gammaridae, Gammaroporeiidae, Macrohectopidae, Mesogammaridae, Micruropodidae, Odontogammaridae, Pachyschesidae, Pallaseidae, Pontogammaridae and Typhlogammaridae.

REMARKS

The Pontoporeioidea are presumably close to the Gammaroidea and will possibly have to be merged with them in the future. On the other hand, the Crangonyctidae, the Melitidae and the Niphargidae were formerly included in the Gammaroidea and even merged into the Gammaridae (STEBBING, 1906) but this view is no longer accepted (BOUSFIELD, 1979, 1982). The delimitation of the superfamily Gammaroidea is a very complex issue that is still far to be settled. Selected aspects are discussed further down but the problem as a whole falls outside of the scope of the present paper.

Family Bathyporeiidae BOUSFIELD & SHIH, 1994

Gammaridae; BRUZELIUS, 1859: 37 (in part)
 Gammaridae: subfamily Pontoporeinae DANA, 1853: 912 (in part); BOECK, 1871: 122 (in part)
 Gammaridae: subfamily Lysianassides [sic]; BATE, 1862: 64 (in part)
 Gammaridae: subfamily Pontoporeina [sic]; LILLJEBORG, 1865: 18 (in part)

Gammaridae: subfamily Pontoporeinae [sic]; BOECK, 1876: 194 (in part)

Haustoriidae STEBBING, 1906: 118 (in part); STEPHENSEN, 1928: 119 (in part); STEPHENSEN, 1929: 79 (in part); SCHELLENBERG, 1942: 156; GURJANOVA, 1951: 328 (in part); BARNARD, 1959: 76 (in part); LINCOLN, 1979: 312

Haustoriidae: subfamily Pontoporeiinae; BOUSFIELD, 1965: 166 (in part); BOUSFIELD, 1973: 100 (in part)

Pontoporeiidae; G.O. SARS, 1883: 22 (in part); G.O. SARS, 1891: 121 (in part); BARNARD & DRUMMOND, 1982: 5 (in part; discussion); BARNARD & BARNARD, 1983: 352, 562 (in part)

'Bathyporeid' [sic] LINCOLN & HURLEY, 1981: 106

Bathyporeiidae BOUSFIELD & SHIH, 1994: 92, 94, 114, 128

DESCRIPTION

Gammaroid facies. Appendages more spiny than setose, modified for endopsammic life. Head with anteroventral angle rounded. Rostrum obsolete. Eye somewhat elongate. Ophthalmic surface flat. First article of peduncle of A1 massive, geniculate, forming a pseudorostrum, much longer than second and third articles, which are of equal length to each other. Pseudorostrum with ventroapical group of long robust spines (apical spines), outer row of long narrow acute-tipped opaque and usually non-setulose spiniform setae (anteroventral spiniform setae) proximal to articulation with second article, one fairly short blunt-tipped transparent pappose seta present at anterior part of that row; similar transparent pappose setae of different sizes occurring more ventrally in unordered disposition (anteroventral blunt setae), longitudinal row of long plumose setae ventroproximally, sometimes reduced to a single seta (proximoventral plumose setae), two longitudinal rows of about 3 tiny robust setae (anterior and posterior short setae) above proximoventral setae. Second and third article of peduncle of first antenna subequal and considerably shorter than first article, each with a transverse row of spines. Minor flagellum of A1 always two-jointed. Flagellum of A2 and usually of A1 in mature males with circular calceoli. Calceoli absent in females and immature males. Calceoli stalked; surface with concentric grooves (fingerprint-like pattern). No calceoli on peduncle of A1 and A2. A2 of males increasing in size at maturity or not. Mouthparts of gammaroid type. Lower lip with inner lobes. Md variable but always with well developed molar and incisive process and well developed 3-articulate palp. Mx1; palp either with both spines and setae or with setae only; inner plate well developed, triangular, with many strong setae. Mx2 basal; inner plate with oblique facial row of strong setae. Mxp rather basal; inner plate with a single pair of curved ventromedial interlocking spines; second article of palp with longitudinal row of long and strong setae on dorsal surface. Setae and teeth of Mx1, Mx2 and Mxp not degenerating at maturity. Oostegites narrow and not unusually long. Gn1 subchelate, normal-sized or very small. Gn2 either subchelate or highly transformed: with dactylus vestigial, and elongate propodus with very long strong setae on posterior border. P3-P4 basal. Carpus of P3-P4 with one long posterodistal spine distinctly stronger than the rest (carpal fang). Propodus of P3-P4 not shovel-shaped, without setae

on dorsal border; ventral spines and setae not forming two distinct rows. P5 highly transformed: basis elliptic with posterior transverse combs of spines; merus elliptic, posterior border with 2 well developed groups of setae (one on 0.6 and one distal), rarely with a third group in more proximal position, anterior border with an outer marginal comb of spines and a medial comb of long setae; carpus and propodus small, cylindrical and narrow; dactylus very short or vestigial. P6 with basis subcircular; merus, carpus and propodus with transverse groups of strong spines. P7 moderately transformed, variable, with strong pappose setae on medial surface of basis; ischium quadrate or pentagonal; merus, carpus and propodus with transverse groups of strong spines; coxal gill absent. Posterior border of Ep1-Ep2 protruding. Ep3 with ventral border anteriorly not setose, without marginal strong spiniform setae on posteroventral angle. Peduncle of pleopods elongate. U1 peduncle with more than 2 single long outer ventral spiniform setae. Rami of U1-U2 broad on all their length, distally truncated (not tapering); tip with one long stout spine and a minute spine on each side of this long stout spine. Outer border of peduncle of U3 with variable ornamentation. Inner ramus of U3 much shorter than outer ramus, without strong sexual dimorphism. Outer ramus of U3 long and narrow with well developed second article; outer border with groups of spines; inner border with long plumose setae at least in mature males, sometimes associated with spines. Telson cleft on almost all its length; lobes not acute-tipped; lateral and terminal spines present; each lobe with 2 large dorsal transparent pappose blunt-tipped setae. Terminal stage not always present. Mating system: pelagic.

GENERA

Bathyporeia LINDSTRÖM, 1855 (type genus) and *Amphiporeia* SHOEMAKER, 1929

ECOLOGY

Marine and sometimes brackish water. Sand-dwelling amphipods. Mostly intertidal and in coastal waters. Females usually breeding several times in their life span. At least in one species (*Bathyporeia parkeri*), the adult males continue to moult after the moult of puberty.

DISTRIBUTION

Northwestern Atlantic, entire Eastern Atlantic from northern Norway to South Africa, Mediterranean Sea, Black Sea. Recorded in subarctic to tropical conditions.

REMARKS

The family name 'Bathyporeid' [sic] was introduced by LINCOLN & HURLEY (1981). This name is invalid because it is not Latinized and has been introduced after 1900 (International Code for Zoological Nomenclature, fourth edition, art. 11.7.2). The family name Bathyporeiidae has been introduced by BOUSFIELD & SHIH (1994) but this taxon has never been formally described. However such a formal description is not mandatory and the name meets all the criteria of avail-

ability required by the International Code for Zoological Nomenclature (fourth edition), art. 11.7. So far this family has received little support in literature, the genera *Bathyporeia* and *Amphiporeia* being usually put either in the family Pontoporeiidae or, in earlier literature in the Haustoriidae. For more details on these previous familial assignments, see § 3.2.2.1.

LINCOLN & HURLEY (1981) have stressed the similarity between the calceoli of *Bathyporeia* and those of Gammaridae. The calceoli of *Amphiporeia* are very similar to those of *Bathyporeia* but differ considerably from those of the Pontoporeiidae (figures of BOUSFIELD & SHIH, 1994).

Genus *Bathyporeia* LINDSTRÖM, 1855

(Figs. 1-13)

Bathyporeia Lindström, 1855: 37, 59; BRUZELIUS, 1859: 90; BOECK, 1861: 647; BATE, 1862: 172; BATE & WESTWOOD, 1862: 302; LILLJEBORG, 1865: 18; BOECK, 1871: 126; 1876: 208; STEBBING, 1888: 286; G.O. SARS, 1891: 127; DELLA VALLE, 1893: 751; STEBBING, 1906: 119; CHEVREUX & FAGE, 1925: 91; STEPHENSEN, 1928: 129; STEPHENSEN, 1929: 82; SHOEMAKER, 1930: 34; WATKIN, 1938: 211; SCHELLENBERG, 1942: 164; BOUSFIELD, 1965: 169; BARNARD, 1969: 254; BOUSFIELD, 1973: 104; LINCOLN, 1979: 314; LINCOLN & HURLEY, 1981: 106 (calceoli); BARNARD & DRUMMOND, 1982: 5, 6, 7; BARNARD & BARNARD, 1983: 98, 567; BELLAN-SANTINI, 1989: 365; D'UDEKEM D'ACOZ, 2004: 19.

Thersites BATE, 1856: 59 (nomen nudum); BATE, 1857: 146 (Non *Thersites* L. PFEIFFER, 1855 = Mollusca)

DIAGNOSIS

Ultimate article of peduncle of A2 distinctly shorter than penultimate. Flagellum of A1 and A2 not with especially strong and long posterior setae. In some but not all species, A2 of males increasing in size at maturity (and less commonly near maturity); the size increase essentially results of enlargement of articles, not so much of fission. Incisor process of mandible with 2 erect spines on one side and 3 on the other. Lacinia mobilis blade-shaped. Third article of mandibular palp with comb of stiff setae in mature males only. Palp of Mx1 with scattered setae, without spines. Third article of palp of maxilliped elongate. Second article of palp of maxilliped with a medial lobe pointing forward. Outer plate of maxilliped with a single anterior setulose seta, morphologically very distinct from medial nodular spines. Coxa 1 anteriorly directed, with anterior border strongly concave. P1 reduced, not sexually dimorphic. P2 highly transformed, neither chelate nor subchelate; dactylus vestigial, propodus elongate with very long strong setae on posterior border; not sexually dimorphic. Merus of P3-P4 very stout. Dactylus of P5 truly vestigial. P7 with posterior border of basis straight or angular, never broadly rounded, distally not produced; ischium pentagonal. Posterior border of Ep1-Ep2 slightly to strongly angular. Ep3 never crescent-shaped in adults, with posterior border straight or convex; posteroventral angle with or without tooth followed by a notch. Urosomite 1 with two dorsal humps; posterior hump with pair of anteriorly di-

rected setae, with or without posteriorly directed spines. Peduncle of U3 with outer non-distal strong setae and/or spines. Inner ramus of U3 very short and broadly elliptic. Outer ramus of U3 with variable number of spine groups on outer border, second article with or without setae on outer border. Telson with a single group of outer spines/setae (very rarely two in abnormal specimens).

SPECIES

Bathyporeia borgi D'UDEKEM D'ACUZ & VADER, 2005; *Bathyporeia chevreuxi* D'UDEKEM D'ACUZ & VADER, 2005; *Bathyporeia cunctator* D'UDEKEM D'ACUZ & VADER, 2005; *Bathyporeia elegans* WATKINS, 1938; *Bathyporeia elkaimi* D'UDEKEM D'ACUZ & MENIOUI, 2004; *Bathyporeia griffithsi* D'UDEKEM D'ACUZ & VADER, 2005; *Bathyporeia gladiura* D'UDEKEM D'ACUZ & VADER, 2005; *Bathyporeia guilliamsoniana* (BATE, 1857); *Bathyporeia gracilis* G.O. SARS, 1891; *Bathyporeia ledoyeri* D'UDEKEM D'ACUZ & MENIOUI, 2004; *Bathyporeia lindstromi* STEBBING, 1906; *Bathyporeia microceras* D'UDEKEM D'ACUZ & MENIOUI, 2004; *Bathyporeia nana* TOULMOND, 1966; *Bathyporeia parkeri* BOUSFIELD, 1973; *Bathyporeia pelagica* BATE, 1857; *Bathyporeia phaiophthalma* BELLAN-SANTINI, 1973; *Bathyporeia pilosa* LINDSTRÖM, 1855; *Bathyporeia quoddyensis* SHOEMAKER, 1949; *Bathyporeia sarsi* WATKIN, 1938; *Bathyporeia tenuipes* MEINERT, 1877; *Bathyporeia watkini* D'UDEKEM D'ACUZ, ECHCHAOUI & MENIOUI, 2006. All known species have been available for study. Two of them, *B. parkeri* and *B. quoddyensis* are described and illustrated in the first part of this paper.

BIOLOGY

Marine and sometimes brackish water (VADER, 1965). Intertidal and coastal waters (D'UDEKEM D'ACUZ, 2004). Sand-dwelling animals; about 90 % of the *Bathyporeia* specimens are found in the first 50 mm of the sand, and they have not been recorded deeper than 120 mm in the sediment (SALVAT, 1967). Feed on epipsammic epiflora (NICOLAISEN & KANNEWORFF, 1969). Females breeding during several successive intermoult (SALVAT, 1967). Mature males of *B. parkeri* with successive intermoult (present data). Males of long-antennated species presumably with single fertile intermoult (but this has to be experimentally demonstrated). Pelagic mating system, at least in species with long- and medium-sized antennated males (WATKIN, 1939). At least one species with short-antennated male, *B. quoddyensis* occurs in the tidal plankton (HAGER & CROKER, 1980), suggesting a pelagic mating system also in such species. Premating pairs have not been recorded in literature. The reduced P1 and the non-chelate P2 seem a priori unsuitable for grasping the female. Biology reviewed in more detail by D'UDEKEM D'ACUZ (2004).

DISTRIBUTION

Subarctic and temperate Northwestern Atlantic, all Eastern Atlantic (from North Cape to South Africa), Mediterranean Sea, Black Sea.

Genus *Amphiporeia* SHOEMAKER, 1929

Amphiporeia SHOEMAKER, 1929: 167; SHOEMAKER, 1930: 30; GURJANOVA, 1962: 417; BOUSFIELD, 1965: 169; BARNARD, 1969: 254; BOUSFIELD, 1973: 102; BARNARD & DRUMMOND, 1982: 5, 6; BARNARD & BARNARD, 1983: 566

DIAGNOSIS

Ultimate article of peduncle of A2 equal to penultimate. Flagellum of A1 and A2 with strong and long posterior setae. Incisor process of mandible with about 7 erect spines. Lacinia mobilis circular in cross section (not blade-shaped). Third article of mandibular palp with ventral setae in both sexes. Palp of Mx1 with a distal row of setae and a distal row of spines. Second article of palp of maxilliped without a medial lobe pointing forward. Third article of palp of maxilliped broad. Outer plate of maxilliped with two anterior setulose setae, barely distinct from medial nodular spines. Anterior border of coxa 1 nearly straight. P1 not reduced, slightly sexually dimorphic. P2 basal, subchelate, very similar to P2, with slight sexual dimorphism. Merus of P3-P4 rather stout but less than in *Bathyporeia*. Dactylus of P5 small but not vestigial. P7 with posterior border of basis broadly rounded, distally produced; ischium quadrate. Posterior border of Ep1 slightly protruding but not angular; posterior border of Ep2 barely or not protruding. Ep3 with posterior border concave with tooth not followed by notch (Ep3 crescent-shaped) or posterior border straight and junction with ventral border bluntly angular. Urosomite 1 without dorsal humps (profile dorsally rectilinear); without spines and setae. Peduncle of U3 without outer non-distal setae and or spines. Inner ramus of U3 elongate, 1/3 to 1/2 times as long as endopod. Outer ramus of U3 normally with 3 groups of spines on outer border (on first article), sometimes with a reduced fourth proximal; second article with setae if any on medial border only. Telson with one or two groups of outer spines/setae.

SPECIES

Amphiporeia gigantea BOUSFIELD, 1973; *A. lawrenciana* SHOEMAKER, 1929 (type species); *A. virginiana* SHOEMAKER, 1933. Only one *Amphiporeia* species, *A. virginiana* has been available for study. It is illustrated in detail here below. Good accounts of *B. lawrenciana* have been given by SHOEMAKER (1929, 1930) and BOUSFIELD (1973) and of *A. gigantea* by BOUSFIELD (1973) and GLENNON (1979).

BIOLOGY

Marine species. The biology of *A. lawrenciana* has been studied by DOWNER & STEELE (1979) and that of *A. virginiana* by HAGER & CROKER (1979). These two interesting papers indicate that the two species exhibit both similarities and significant differences in their life style. Although some aspects need confirmation, the most important observations and deductions given by these authors are summarized here, since they may have some evolutionary significance.

Both species are sand-dwelling species. For *B. lawrenciana*,

it is known that the animals only bury in the superficial layer of the sediment, between 2.5 and 15 mm (DOWNER & STEELE, 1979). Concerning *A. virginiana*, the vast majority of animals burrow into the upper 25 mm of sand, although the species has been found as deep as 150 mm (HAGER & CROKER, 1979).

According to DOWNER & STEELE (1979), *A. lawrenciana* is a filter feeder and extracts food from the water or sand while swimming or burrowing. HAGER & CROKER (1979) make very different observations on *A. virginiana*, and state: "*Amphiporeia virginiana* is a detritivore. We believe that the species prefers well-decomposed detritus, as large pieces of algae and animal tissue were ignored until decomposition set in. Coprophagy was observed among animals with no other food available. The gnathopods are used to grasp detritus and push it directly to the mouthparts. Animals were also seen trapping food particles on the antennal setae and then transferring these particles to the mouthparts".

Both in *A. lawrenciana* and *A. virginiana*, the male is significantly smaller than the female (DOWNER & STEELE, 1979; HAGER & CROKER, 1979), just as in American *Bathyporeia* species. Concerning *A. lawrenciana*, DOWNER & STEELE (1979) state: "Males appear to stop growing after they reach maturity, but the females continue to grow and their fecundity increases with size and age". In *A. virginiana* the occurrence of calceoli on the antennae of males is unrelated to size (HAGER & CROKER, 1979), suggesting the occurrence of several successive fertile intermoult in males of that species. In *A. lawrenciana*, the females undergo several successive broods between May and August, interrupted in late summer / autumn by a diapause during which the oostegites lose their setae (DOWNER & STEELE, 1979). As concerns *A. virginiana*, HAGER & CROKER (1979) indicate that there is no evidence that females produce more than one brood during a breeding period. In *A. lawrenciana* the mating was "similar to that described for the genus *Gammarus* by several authors" (DOWNER & STEELE, 1979). The same authors indicate that "precopula was never seen and is unlikely in view of the size differential between males and larger females". However HAGER & CROKER (1979) observed precopulae in *A. virginiana*: "Animals in precopula were commonly seen swimming in surface runoff during ebbing tide. Frequently, females were observed with two males attached, a phenomenon not reported before for the Amphipoda. Males attach to the female's dorsum with the dactyl of gnathopod 2 and orient obliquely or perpendicular to the long axis of the female."

DISTRIBUTION

Northwestern Atlantic.

Amphiporeia virginiana SHOEMAKER, 1933 (Figs. 21-28)

Amphiporeia virginiana SHOEMAKER, 1933: 212, fig. 1-2; BOUSFIELD, 1965: 169 (key); BOUSFIELD, 1973: 103, pl. 22 fig. 2

TYPE

"Virginia beach, Virginia, between tides, July 17, 1916, collected by the U. S. Bureau of Fisheries steamer 'Fish Hawk'; female holotype (cat. No. 66074, U.S.N.M.)" (Shoemaker, 1933).

MATERIAL

USA, Maine, Reid State Park, coll. Les WATLING, 06/VI/2003: 20 specimens in absolute alcohol, TMU 12 596; USA, Atlantic coast, BST. 212. D, label of the «Duke Marine Lab. Beaufort, N.C.», 22/XI/1965: 2 specimens, TMU 12 613; USA, Atlantic coast, BST. 2. C., label of the «Duke Marine Lab. Beaufort, N.C.», 01/IV/1965: over 100 specimens, TMU 12 614; USA, Atlantic coast, BST. 2. C. label of the «Duke Marine Lab. Beaufort, N.C.», 01/IV/1965: 1 very large female, TMU 12 616.

ECOLOGY

Surf sand beaches, mid water to slightly subtidal levels; often concentrated at fresh water stream outflows over sand flats (BOUSFIELD, 1973). On sand beaches with substantial wave action and salinities of at least 27‰; found in a wide range of sediment textures, from very coarse to very fine sand (HAGER & CROKER, 1979). The species is rare or absent on protected beaches with little wave action and is absent from estuarine sands (HAGER & CROKER, 1979). Locally the dominant amphipod species of intertidal sand communities in New England (CROKER et al., 1975). Swims actively at high tide (HAGER & CROKER, 1980). In northern New England, recruitment occurs from May to January, peaking in June; the species has two annual generations: a rapid growing, short-lived summer generation, and a slower growing, longer-lived overwintering generation (HAGER & CROKER, 1979).

DISTRIBUTION

From eastern Nova Scotia (Guysborough Co.) south along the Gulf of Maine to the Middle Atlantic states and North Carolina (BOUSFIELD, 1973), and down to northern South Carolina (HAGER & CROKER, 1979).

Superfamily Pontoporeioidea DANA, 1853

COMPOSITION

The superfamily Pontoporeioidea is here restricted to the families Priscillinidae fam. nov. and Pontoporeiidae DANA, 1853.

ECOLOGY

Sand- and mud-dwelling amphipods with various life styles.

DISTRIBUTION

Arctic to tropical parts of the northern hemisphere.

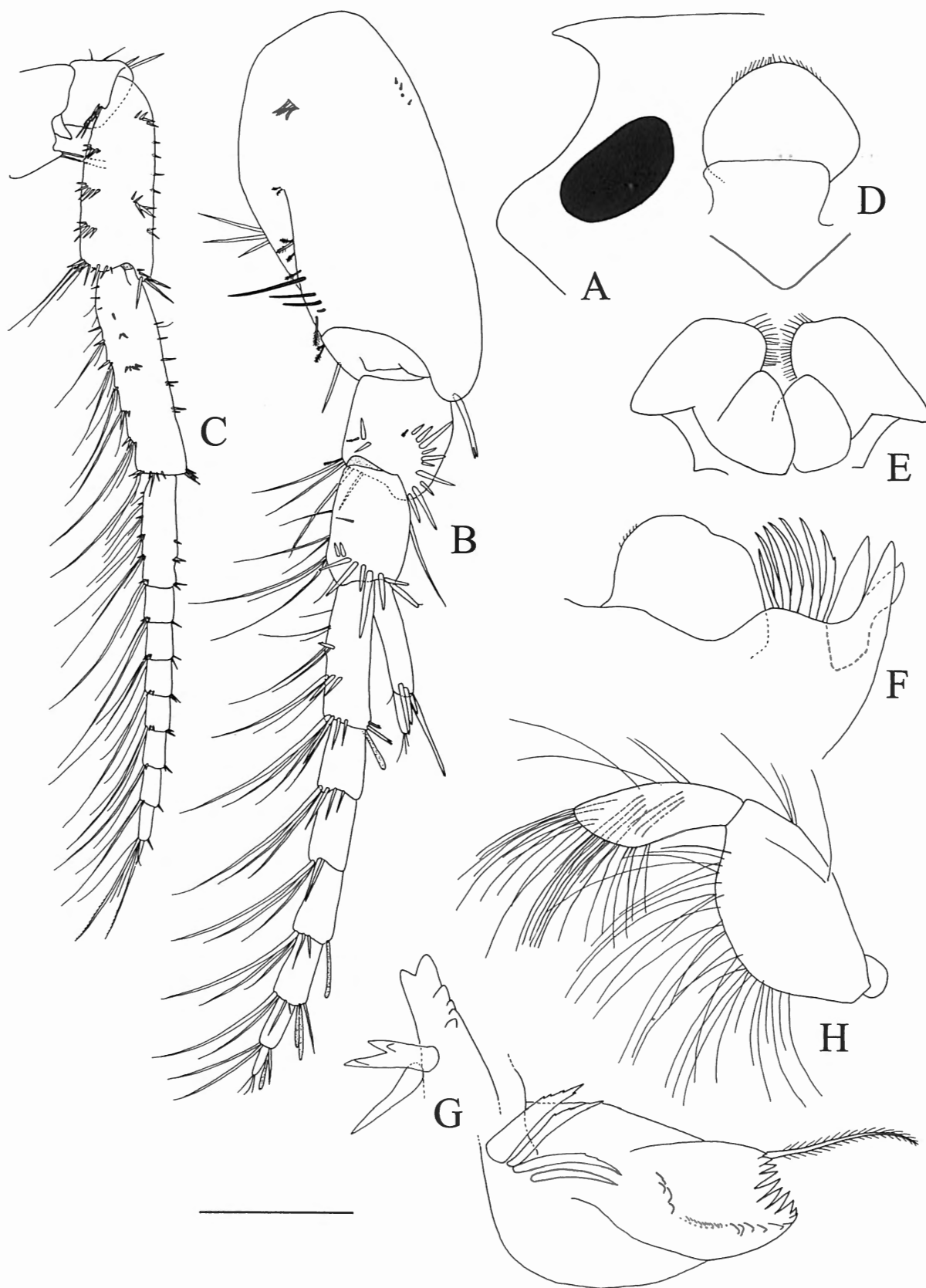

Fig. 21. *Amphiporeia virginiana* SHOEMAKER, 1933, mature female, Reid State Park, TMU 12 596. A, anterior part of head; B right A1; B, right A2; D, upper lip; E, lower lip; F, left Md; G, right Md (incisor process broken); H, mandibular palp of right Md. Scale bar: A, 0.42 mm; A, B, D, E, H, 0.21 mm; F, G, 0.10 mm.

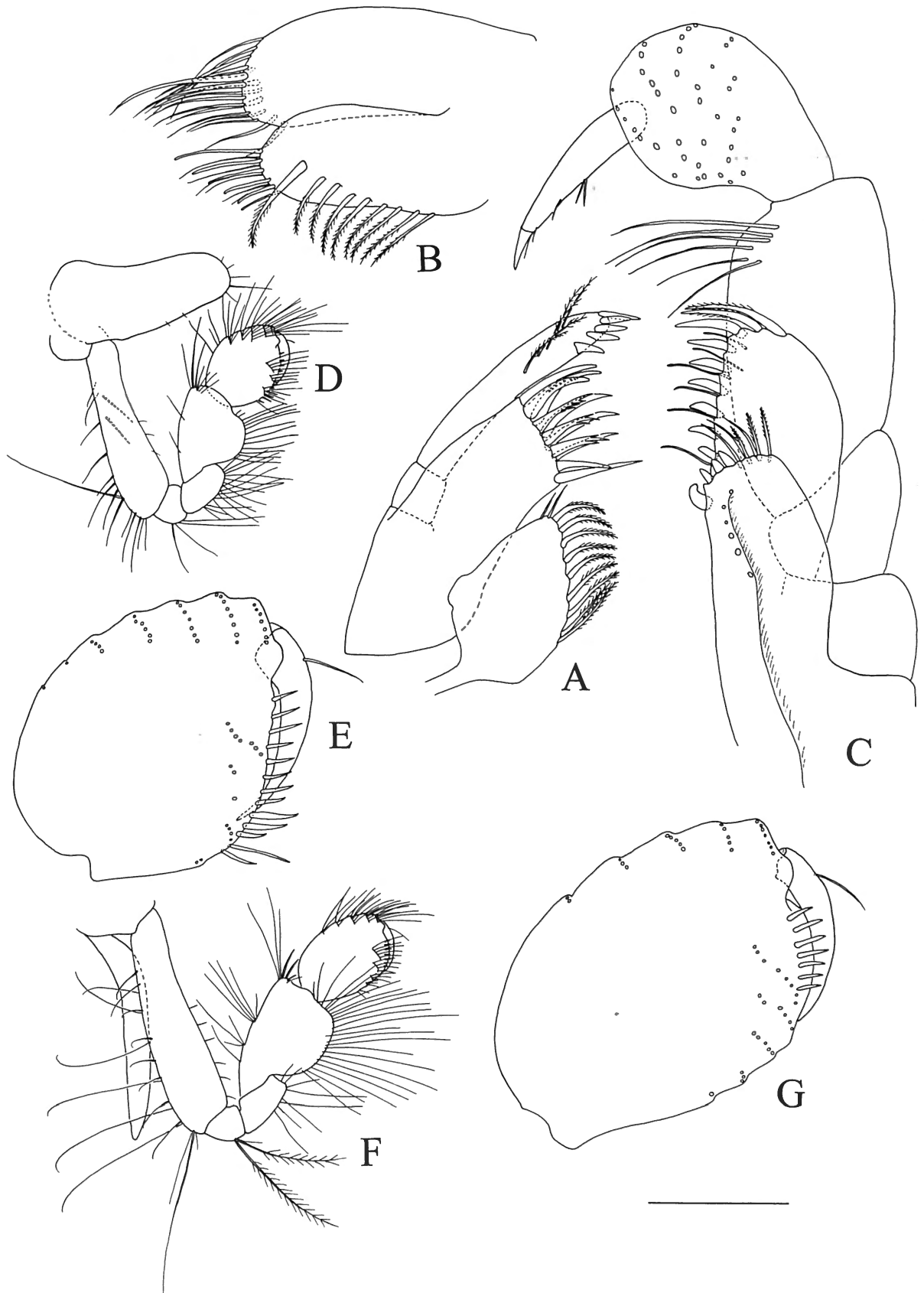

Fig. 22. *Amphiporeia virginiana* SHOEMAKER, 1933, mature female, Reid State Park, TMU 12 596. A, Mx1 (palp seen on the edge); B, right Mx2; C, right Mxp (insertion of setae on penultimate article and on medial border of inner plate indicated by a circle; marginal setae of antepenultimate article not shown); D, right P1; E, chela of right P1 (insertion of setae on propodus indicated by a circle); F, right P2; G, chela of right P2 (insertion of setae on propodus indicated by a circle). Scale bar: D, F, 0.42 mm; E, G, 0.12 mm; A, B, C, 0.10 mm.

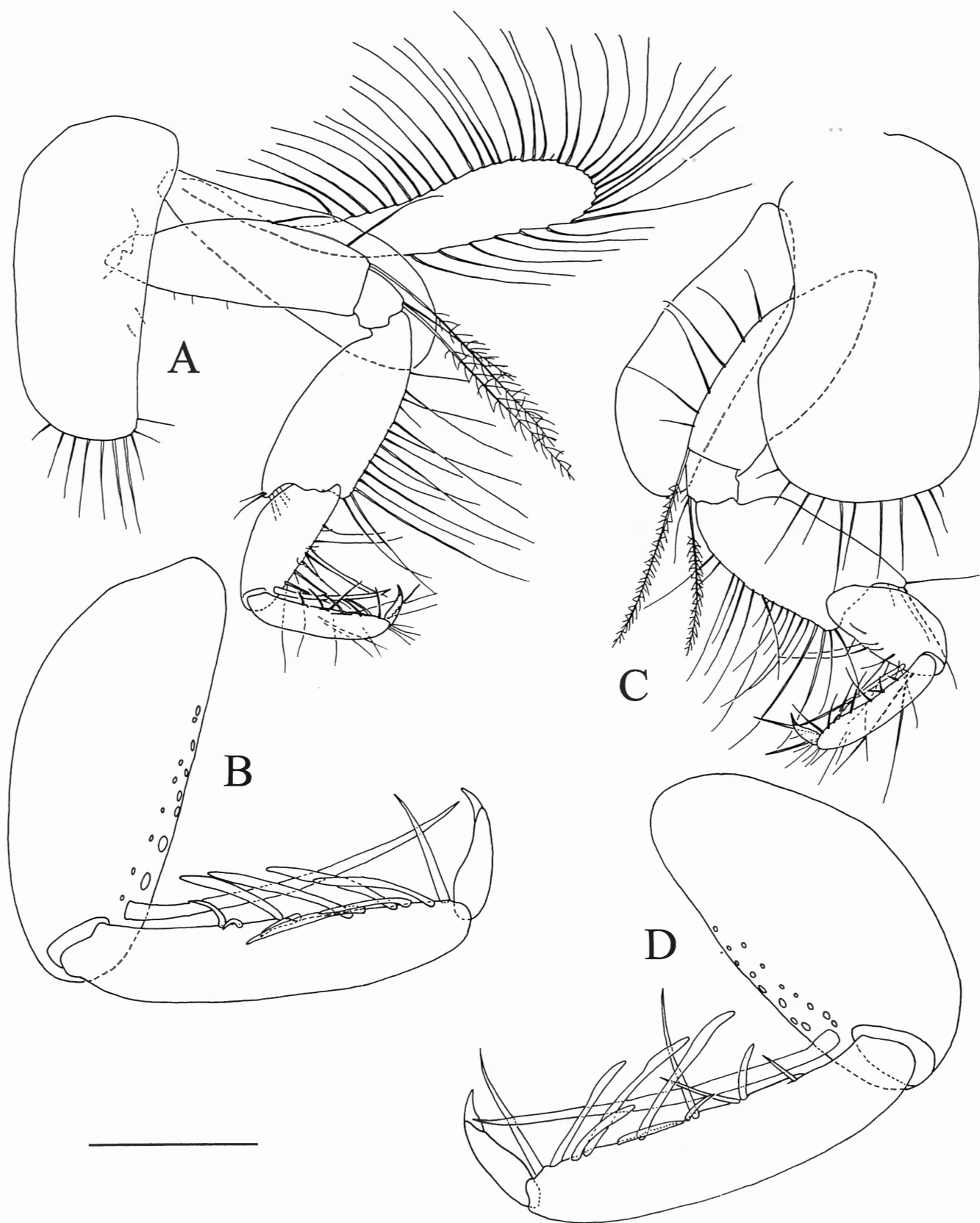

Fig. 23. *Amphiporeia virginiana* SHOEMAKER, 1933, mature female, Reid State Park, TMU 12 596. A, left P3; B, anterior part of left P3 (medial spines/setae of propodus not shown); C, right P4; D, anterior part of right P4 (medial spines/setae of propodus not shown). Scale bar: A, C, 0.42 mm; B, D, 0.15 mm.

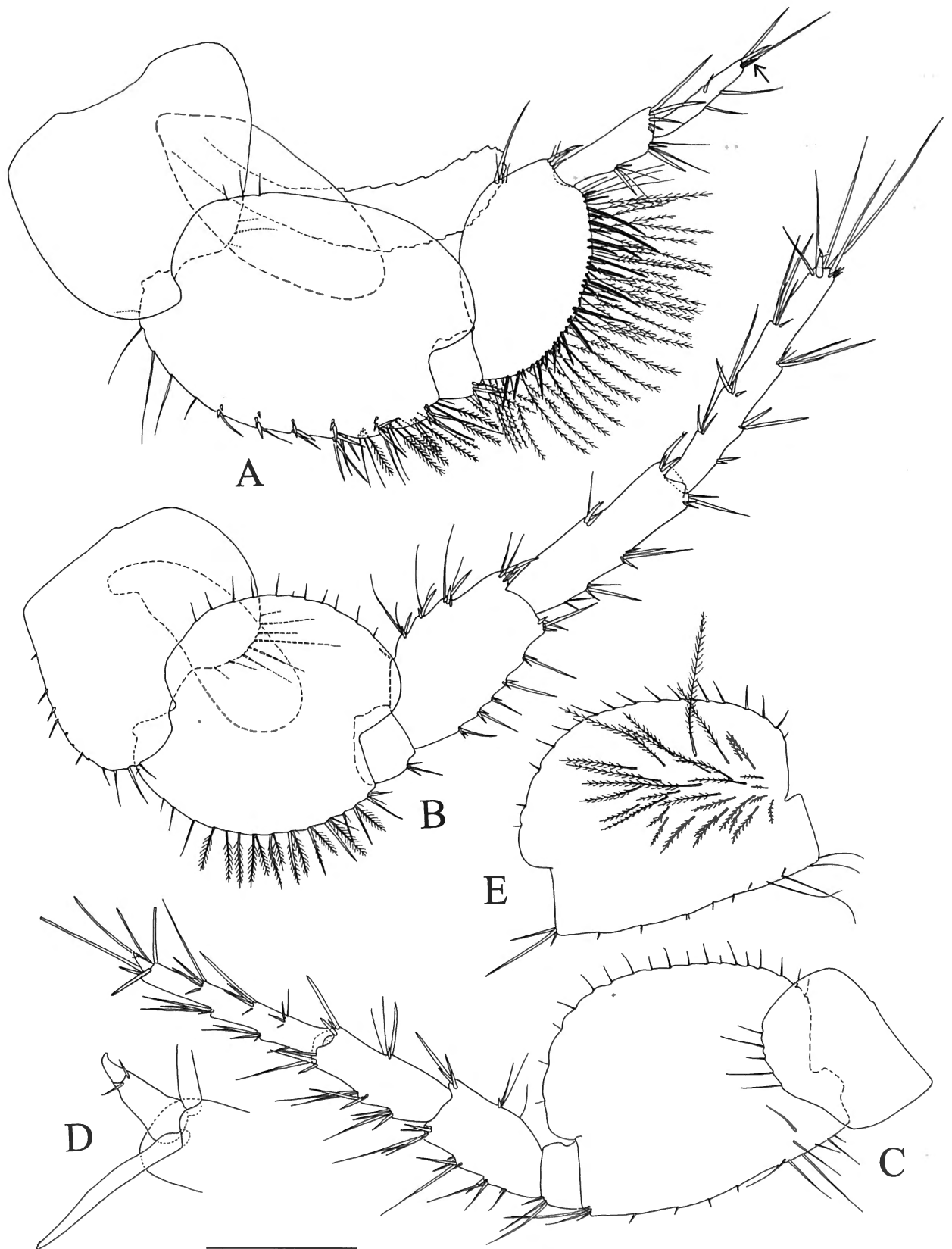

Fig. 24. *Amphiporeia virginiana* SHOEMAKER, 1933, mature female, Reid State Park, TMU 12 596. A, left P5 (setae of oostegite not shown; dactylus in black, indicated with an arrow); B, left P6; C, tight P7; D, tip of right P7; E, basis of right P7 (medial view). Scale bar: A, B, C, E, 0.42 mm; D, 0.1 mm.

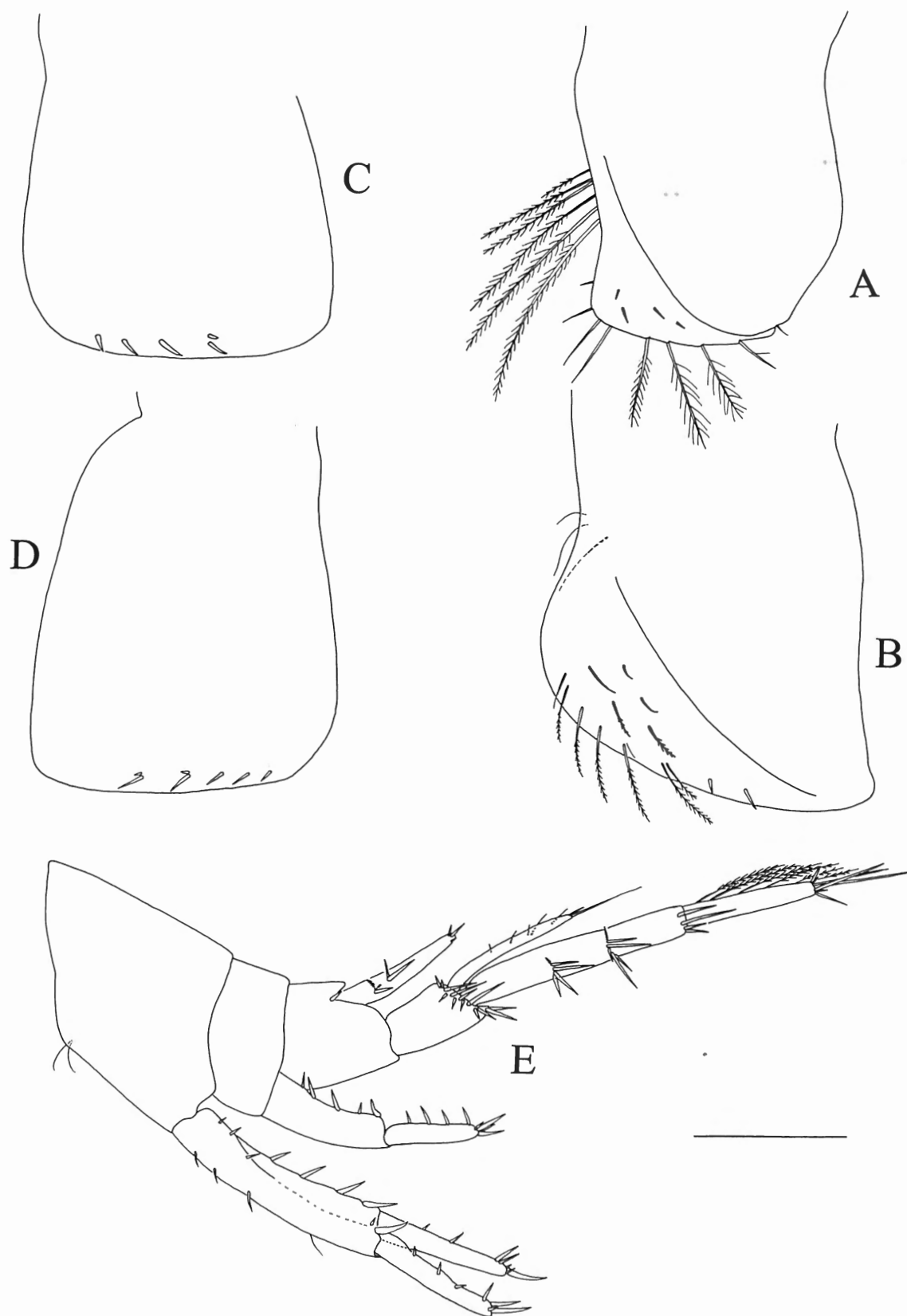

Fig. 25. *Amphiporeia virginiana* SHOEMAKER, 1933, mature female, Reid State Park, TMU 12 596. A, left Ep1; B, left Ep2; C, left Ep3; D, right Ep3; E, posterior part of body. Scale bar: E, 0.42 mm; A, B, C, D, 0.30 mm.

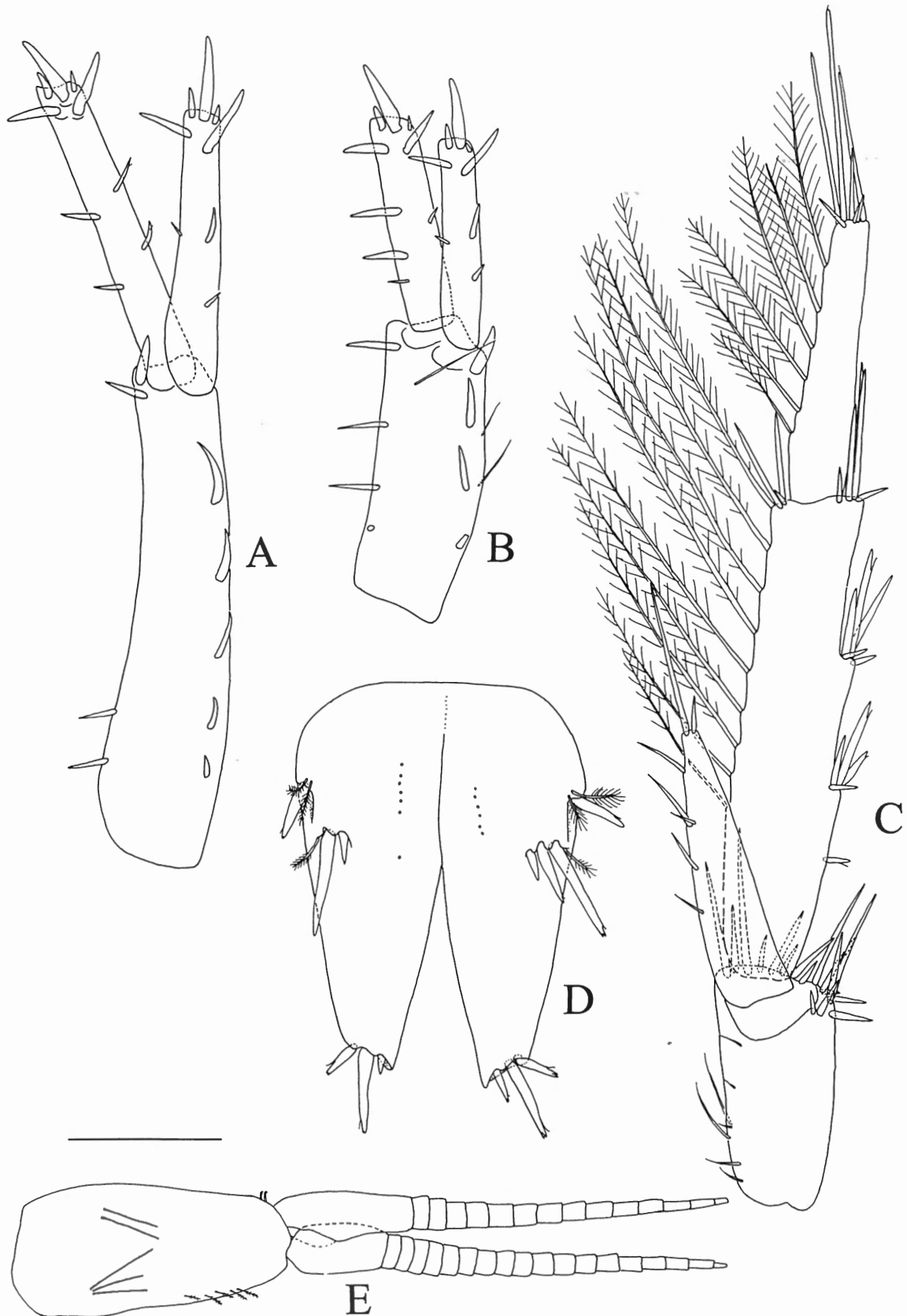

Fig. 26. *Amphiporeia virginiana* SHOEMAKER, 1933, mature female, Reid State Park, TMU 12 596. A, right U1; B, right U2; C, left U3; D, telson; E, right pleopod 1. Scale bar: E, 0.42 mm; A, B, D, 0.21 mm; D, 0.14 mm.

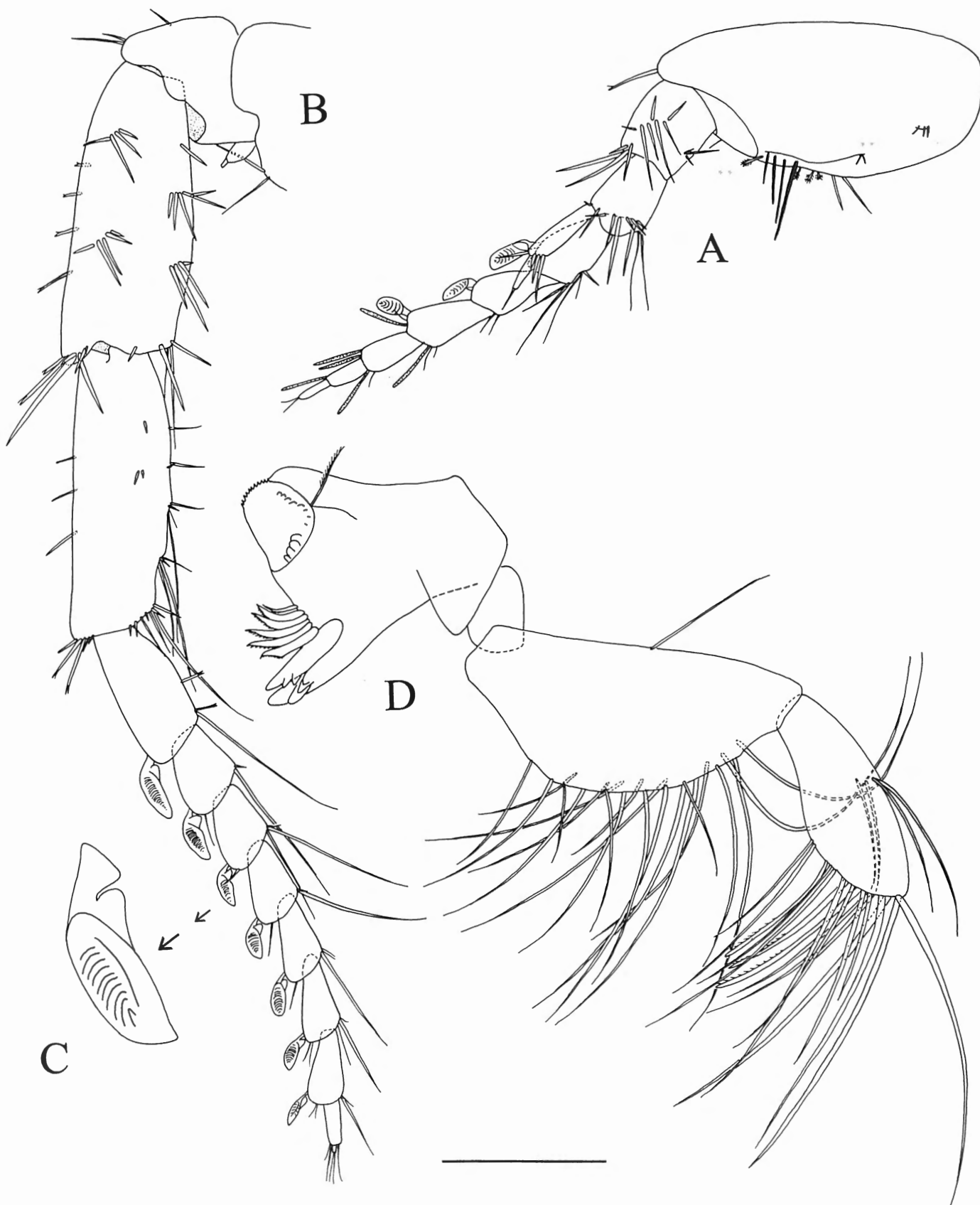

Fig. 27. *Amphiporeia virginiana* SHOEMAKER, 1933, mature male, Reid State Park, TMU 12 596. A, left A1; B, left A2; C, calceolus of third article of flagellum of A2; D, left Md. Scale bar: A, B, 0.21 mm; D, 0.10 mm; C, 0.05 mm.

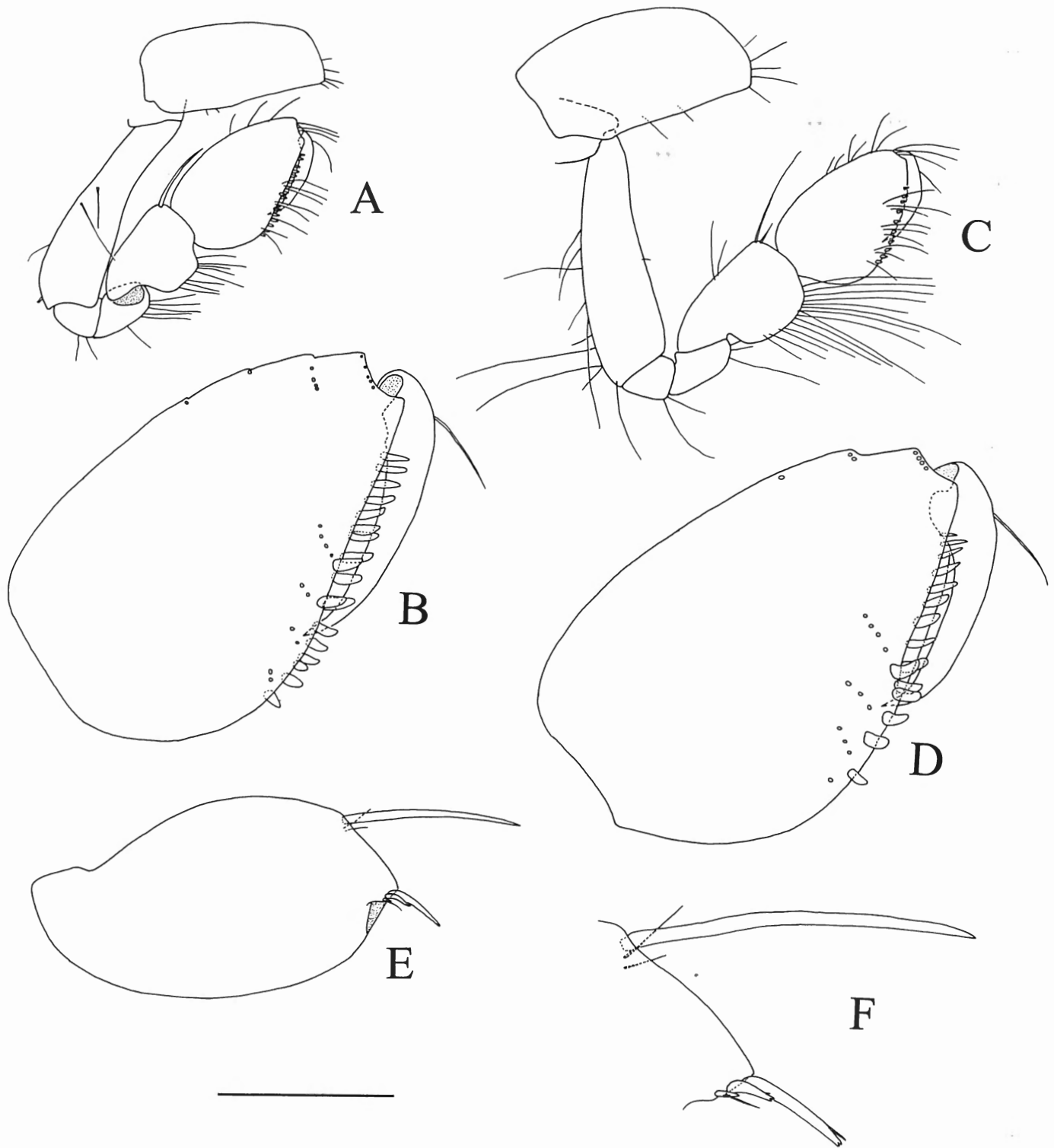

Fig. 28. *Amphiporeia virginiana* SHOEMAKER, 1933, mature male, Reid State Park, TMU 12 596. A, right P1; B, chela of right P1 (insertion of setae on propodus indicated by a circle); C, right P2; D, chela of right P2 (insertion of setae on propodus indicated by a circle); E, merus of left P5 (anterior setae and spines not shown); F, posterior border of tip of merus of left P5. Scale bar: A, C, 0.30 mm; E, 0.21 mm; B, D, F, 0.10 mm.

REMARKS

The superfamily Pontoporeioidea is extremely heterogeneous. There is only faint evidence that it is a monophyletic group but there is also no evidence that it is not monophyletic. Its validity and composition should be reassessed when new data on the Haustoriidae, Pontoporeiidae, Priscillinidae and various genera currently included in the superfamily Gammaroidea will be available.

Family Pontoporeiidae DANA, 1853

Gammaridae; BRUZELIUS, 1859: 37 (in part)
 Gammaridae: subfamily Pontoporeinae DANA, 1853: 912 (in part); BOECK, 1871: 122
 Gammaridae: subfamily Lysianassides [sic]; BATE, 1862: 64 (in part)
 Gammaridae: subfamily Pontoporeina [sic]; LILLJEBORG, 1865: 18 (in part)
 Gammaridae: subfamily Pontoporinae [sic]; BOECK, 1876: 194 (in part)
 Haustoriidae STEBBING, 1906: 118 (in part); STEPHENSEN, 1928: 119 (in part); STEPHENSEN, 1929: 79 (in part); SCHELLENBERG, 1942: 156; GURJANOVA, 1951: 328 (in part); BARNARD, 1959: 76 (in part); GURJANOVA, 1962: 395 (in part); LINCOLN, 1979: 312
 Haustoriidae: subfamily Pontoporeiinae; BOUSFIELD, 1965: 166 (in part); BOUSFIELD, 1973: 100 (in part)
 Pontoporeiidae; G.O. SARS, 1883: 22 (in part); G.O. SARS, 1891: 121 (in part); BOUSFIELD, 1979: 359 (in part; discussion); BARNARD & DRUMMOND, 1982: 5 (in part; discussion); BARNARD & BARNARD, 1983: 352 (in part); BOUSFIELD, 1982: 258 (in part); BOUSFIELD, 1983: 267 (in part); BOUSFIELD, 1989: 1715 (in part); BOUSFIELD & SHIH, 1994: 92, 94, 97, 98, 128
 Pontoporeids; BARNARD & BARNARD, 1983: 562 (in part)

GENERA

Diporeia BOUSFIELD, 1979; *Monoporeia* BOUSFIELD, 1979; *Pontoporeia* KRØYER, 1842 (type genus).

DESCRIPTION

Gammaromorph facies. Appendages more setose than spiny, modified for burrowing in the sediment. Posteroventral angle of head produced but not hooked. Rostrum obsolete. Eye well developed. A1 peduncle with setae but without spines. First article of peduncle of A1 massive, not geniculate, without spines, with setae only, longer than second article; second article subequal to third. Accessory flagellum of females and immature males with 2 articles; with more than 2 articles in terminal males. Ultimate article of peduncle of A2 subequal to penultimate. Flagellum of A2 of males increasing in size near and at maturity; the size increase essentially results from the fission of articles. Calceoli in mature males only, on flagella of A1 and A2, not on stalk. Calceoli surface with straight grooves perpendicular to axis of calceoli. Mouthparts of gammaromorph type. Lower lip with inner

lobes. Md with well developed molar and incisor process and well developed 3-articulate palp. Mandibular palp slender, distal article with setae on borders. Mx1 basal; palp with both spines and setae. Setose border of inner plate of Mx1 rather short. Mx2 basal. Mxp basal; inner plate with 2 (sometimes 1) pairs of curved ventromedial interlocking spines. Outer plate of maxilliped with anterior setulose setae not significantly distinct from medial nodular spines. Mouthparts or setation of mouthparts degenerating at maturity in males. Coxae 1-4 apically broad, with ventral setae of normal length. Oostegites very broad and very long. P1 and P2 morphologically distinct, subequal in size, not very large; P1 subchelate; P2 parachelate. Anterior border of merus of P3-P4 setose. Carpus of P3-P4 with several spiniform posterolateral spines, much shorter than propodus. Ornamentation of propodus of P3-P4 strongly biseriata: 1) dorsolateral setae forming longitudinal rows interrupted by hairless spaces, 2) a continuous longitudinal row of long and strong ventral setae. Propodus of P3-P4 not transformed in shovel. Dactylus of P3-P4 well developed; posterior border of dactylus with 2-3 very long strong setae. P5 moderately transformed, with marginal plumose setae, with very few spines. Basis of P5-P6 quadrate, without posteroproximal spur, with setae of posterior border normal-sized. Basis of P5 without longitudinal rows of spiniform setae on outer face. Merus of P5-P6 with parallel borders and not overdeveloped; carpus long, of normal stoutness. Propodus of P5 rather short. Propodus of P6 of normal length. Dactylus of P5-P6 normally developed. P7 rather short, moderately transformed, with many marginal setose setae; coxal gill absent. Posterior border of basis of P7 strongly expanded with narrow setose setae which are not unusually setose; ischium quadrate; carpus and propodus of P7 setose, with very few spines; carpus slightly shorter than merus and not especially stout. Pleonites without erect posterior dorsal projections. Posterior border of Ep1-Ep2 not protruding. Ep3 with ventral border anteriorly setose, with marginal strong spiniform setae on posteroventral angle and posterior border. Peduncle of pleopods rather elongate. Urosomite 1 variable, but always with 2 more or less developed humps and never simultaneously without spines and without setae. Outer border of peduncle of U1 with regularly spaced spines; these spines are stout except the most proximal which are narrow; distal spine by far the largest. Rami of U1 straight with numerous narrow not very long spines; tip rather broad (but not quadrate) with large terminal conical spine; no spinule on each side of these apical spines. Outer border of peduncle of U2 with long, regularly spaced very slender spines; shorter stout distal spine. Rami of U2 straight with numerous narrow not very long spines; tip with large conical spine; no spinule on each side of these apical spines. Outer dorsal border of peduncle of U3 with distal spines only (no ornamentation on outer border). Outer ramus of U3 short with second article vestigial, or according to BOUSFIELD (1989) sometimes absent. Length of inner ramus of U3 not strongly sexually dimorphic, subequal to outer ramus. Telson cleft on 0.5-0.8 of its length; lobes separated from each other by a slit; tip of lobes with about 2-3 spines; lateral spines absent; each lobe with a pair of minute dorsolateral setae.

ECOLOGY

Subtidal; marine, brackish waters, freshwater; mud-dwelling (BOUSFIELD, 1989). In *Monoporeia affinis*, both sexes breed only once (SEGERSTRÅLE, 1937, 1950). In *Pontoporeia femorata*, the male breeds only once, but there is indirect evidence that after a first breeding season the females enter in diapause and breed again the next winter (STEELE & STEELE, 1978). Adult males of *Pontoporeia* do not feed (SEGERSTRÅLE, 1937, 1959). *Pontoporeia* spp. migrate at night in the water column and it is presumably during this pelagic stage that mating occurs (SEGERSTRÅLE, 1937, 1950). The genus *Pontoporeia* is detritivore (SEGERSTRÅLE, 1959; BOUSFIELD, 1989).

DISTRIBUTION

Arctic and cold-temperate parts of the northern hemisphere.

REMARKS

The 3 genera of Pontoporeiidae *Diporeia*, *Monoporeia* and *Pontoporeia* are extremely similar. However the recognition of 3 different genera is justified, since they are separated by profound genetic differences (VÄINÖLA & VARVIO, 1989; VÄINÖLÄ, 1990). An illustrated account of one genus (*Pontoporeia*) suffices in the context of this paper. The other genera are only briefly treated. For more detail see BOUSFIELD (1989).

Adult males were not available for studies. The information on calceoli given here comes from the figure of BOUSFIELD & SHIH (1994: 92, fig. 9) for *Diporeia brevicornis* and *D. hoyi*. For authors who admit the validity of the Pontoporeiidae it usually consists of the genera *Priscillina*, *Pontoporeia* sensu lato, *Amphiporeia* and *Bathyporeia*. However BOUSFIELD & SHIH (1994) created a separate family for the two last genera, the Bathyporeiidae. Their opinion is confirmed by the cladistic analysis given here and the family Bathyporeiidae is excluded from the Pontoporeioidea. BARNARD & BARNARD (1983: 562) include the subantarctic genus *Zaramilla* STEBBING, 1888 in the Pontoporeiidae and LINCOLN & HURLEY, 1981 considers this genus as a 'bathyporeid' [sic]. This genus comprises a single species, *Zaramilla kergueleni* STEBBING, 1888, which has been collected in shallow marine environments of Kerguelen Islands (STEBBING, 1888). It is difficult to ascertain its systematic position without studying actual specimens, but at first glance it looks very different from the Pontoporeiidae and the Pontoporeioidea. Therefore it is here considered as incertae sedis and excluded from the Pontoporeioidea, as did BOUSFIELD (1989).

Priscillina shares a number of uncommon characters with *Diporeia*, *Monoporeia* and *Pontoporeia* but at the same time it exhibits a considerable number of differences. In our cladistic analysis, *Priscillina* and *Pontoporeia* do not form a clade in the most parsimonious tree. A close phylogenetic relationship between these two genera which have both common features and significant differences is possible but not certain. However the morphological gap between *Diporeia* + *Monoporeia* + *Pontoporeia* and *Priscillina* is very consider-

able, and in our opinion justifies the creation of a separate family for the latter.

Genus *Diporeia* BOUSFIELD, 1989

Genus *Diporeia* BOUSFIELD, 1989: 1714

SPECIES

Diporeia hoyi (S.I. SMITH, 1874) (type species); *D. filiformis* (S.I. SMITH, 1874); *D. kendalli* (NORTON, 1909); *D. erythrophthalma* (WADRON, 1953); *D. brevicornis* (SEGERSTRÅLE, 1937); *D. intermedia* (SEGERSTRÅLE, 1977).

BIOLOGY

Freshwater species. Confined to deep, summer-cold continental, glacial relict lakes (BOUSFIELD, 1989). Pelagic mating system (BOUSFIELD, 1989).

DISTRIBUTION

North America (BOUSFIELD, 1989).

Genus *Monoporeia* BOUSFIELD, 1989

Genus *Monoporeia* BOUSFIELD, 1989: 1714

SPECIES

M. affinis (LINDSTRÖM, 1855) (type species); *M. gurjanovae* (BIRULA, 1937); *M. microphthalma* (G.O. SARS, 1896).

BIOLOGY

Coastal marine, mainly brackish lakes and estuaries, and marine-glacial relict lakes, especially of the Fennoscandia and Karelian regions, and the Kamtchatka peninsula (BOUSFIELD, 1989). Pelagic mating system (BOUSFIELD, 1979).

DISTRIBUTION

Circumarctic (BOUSFIELD, 1989). One species endemic to the Caspian Sea: *M. microphthalma* (see G.O. SARS, 1896).

Genus *Pontoporeia* KRØYER, 1842

Genus *Pontoporeia* KRØYER, 1842: 152; BRUZELIUS, 1859: 37, 47; BATE, 1862: 82; LILLJEBORG, 1865: 18; BOECK, 1871: 123; G.O. SARS, 1891: 122; STEBBING, 1906: 127; STEPHENSEN, 1928: 124; STEPHENSEN, 1929: 81; SCHELLENBERG, 1942: 156; GURJANOVA, 1951: 345; BOUSFIELD, 1965: 168; BARNARD, 1969: 258; BOUSFIELD, 1973: 100; BARNARD & DRUMMOND, 1982: 5, 6, 7; BARNARD & BARNARD, 1983: 563; BOUSFIELD, 1989: 1714

SPECIES

P. femorata KRØYER, 1842 (type species); *P. ekmani* BULYCHEVA, 1936. According to BOUSFIELD (in litt.), *P.*

femorata is a complex of cryptic species. The genus will be revised in a forthcoming paper by this author. In the present paper, *Pontoporeia femorata* sensu lato is used as example of a typical Pontoporeiinae and it is illustrated in detail.

BIOLOGY

Coastal marine (shelf) waters, southward in the North Pacific and North Atlantic, where summer temperatures remain below 10°C (BOUSFIELD, 1989). Pelagic mating system (BOUSFIELD, 1989).

DISTRIBUTION

Circumarctic (BOUSFIELD, 1989).

Pontoporeia femorata KRØYER, 1842 sensu lato (Figs. 29-33)

Pontoporeia femorata KRØYER, 1842: 153; KRØYER, 1845: 530; KRØYER, 1846: pl. 23 fig. 2; BATE, 1862: 82, pl. 14 fig. 1 (after KRØYER); BOECK, 1871: 123; 1876: 197; G.O. SARS, 1891: 123, pl. 41 fig. 1; STEBBING, 1906: 128; STEPHENSEN, 1928: 126, fig. 124.1; 1929: 82, fig. 20.90; SCHELLENBERG, 1942: 157, fig. 128, 129; GURJANOVA, 1951: 346, fig. 204 (after SARS); BOUSFIELD, 1965: 169 (key); BARNARD, 1969: 258, fig. 98a, 98d, 99f, 100c, 100n (after SARS); BOUSFIELD, 1973: 101, pl. 21 fig. 1; BARNARD & BARNARD, 1983: 564, fig. 27a, 28a (after SARS); Bousfield, 1989: 1715, fig. 1A, E, F, 2A

Pontoporeia femorata femorata; GURJANOVA, 1962: 421

Pontoporeia furcigera BRUZELIUS, 1859: 49; BOECK, 1873: 123; 1876: 200

Pontoporeia sinuata EKMAN, 1913: 3, fig. 1-8

TYPE LOCALITY

"E mari Groenlandiæ australi misit clariss. *Holböll*." (KRØYER, 1842).

MATERIAL

Norway, Tromsø area, Skatøra: about 20 specimens (one female mounted on 5 slides; Mxp of another female mounted on 1 slide), TMU 1095.

ECOLOGY

Marine species, burrowing in muddy and sandy mud bottoms, especially along channel banks, in shallow water, from just subtidal to more than 50 m (BOUSFIELD, 1973), sometimes down to 188 m (STEBBING, 1906). Life Cycle: ovigerous females October-February; one brood per year; mature males pelagic in fall and winter (BOUSFIELD, 1973). See also the general section on the ecology of Pontoporeiidae.

DISTRIBUTION

Circumpolar and subarctic (BOUSFIELD, 1973), with a separated population in the Baltic Sea (SCHELLENBERG, 1942).

REMARKS

Only immature specimens have been available for study. According to BOUSFIELD (in litt.) the adult males have more than 2 articles on the accessory flagellum of A1, and the oostegites are very large and broad. This author also informed me that *Pontoporeia femorata* sensu lato is actually a complex of allopatric cryptic species. This problem is out of the scope of the present paper.

Family Priscillinidae fam. nov.

DESCRIPTION

Gammaromorph facies. Appendages more setose than spiny, modified for burrowing in the sediment. Posteroventral angle of head produced and hooked. Rostrum obsolete. Eye scarcely distinct in recently fixed specimens. A1 peduncle with setae; a few spines present on second and third articles. First article of peduncle of A1 massive, not geniculate, without spines, with setae only, longer than second article (but not so much); second article much longer than third. Accessory flagellum always with more than 2 articles, usually with 4 articles. Ultimate article of peduncle of A2 distinctly shorter than penultimate. Flagellum of A2 of males increasing in size near maturity (and presumably at maturity); the size increase essentially results from the fission of articles. Presence or absence of calceoli unknown (so far no mature male has been available for study). Mouthparts of gammaromorph type. Lower lip with inner lobes. Md with well developed molar and incisor process and well developed 3-articulate palp. Mandibular palp stout, distal article with setae on borders and row of setae on surface. Mx1 basal; palp with a row of slender spines and a row of longer strong setae. Setose border of inner plate of Mx1 well developed. Mx2 basal. Mxp basal; inner plate with 2 or 3 pairs of curved ventromedial interlocking spines. Outer plate of maxilliped with anterior setulose setae not significantly distinct from medial nodular spines. Setation of mouthparts degenerating at maturity in females (and presumably in males). Coxae 1-4 apically pointed, with very long slender ventral setae. Oostegites very broad and very long. P1 and P2 extremely similar in shape and in size, not very large, subchelate. Anterior border of merus of P3-P4 without setae. Carpus of P3 without spiniform posterolateral spines (only distal transverse group of setae present). Carpus of P4 with a single spiniform posterolateral spine, much shorter than propodus. Ornamentation of propodus of P3-P4 strongly biseriolate: ventrolateral longitudinal row of spines on almost all the length of propodus and short distal ventromedial row of longer spiniform setae. As a result of the 2 rows of spines/setae and of the depressed ventral surface in-between, the propodus of P3-P4 is somewhat transformed in shovel. Dactylus of P3-P4 very small; posterior border of dactylus without setae. P5 moderately transformed, with long marginal plumose setae and a number of slender and rather long spines. Basis of P5 and sometimes of P6 with posteroproximal spur, with setae of posterior border quite long. Basis of P5-P6 with longitudinal rows of spiniform setae on outer face. Merus of P5-P6 with borders slightly diverging downwards and not overdeveloped; carpus

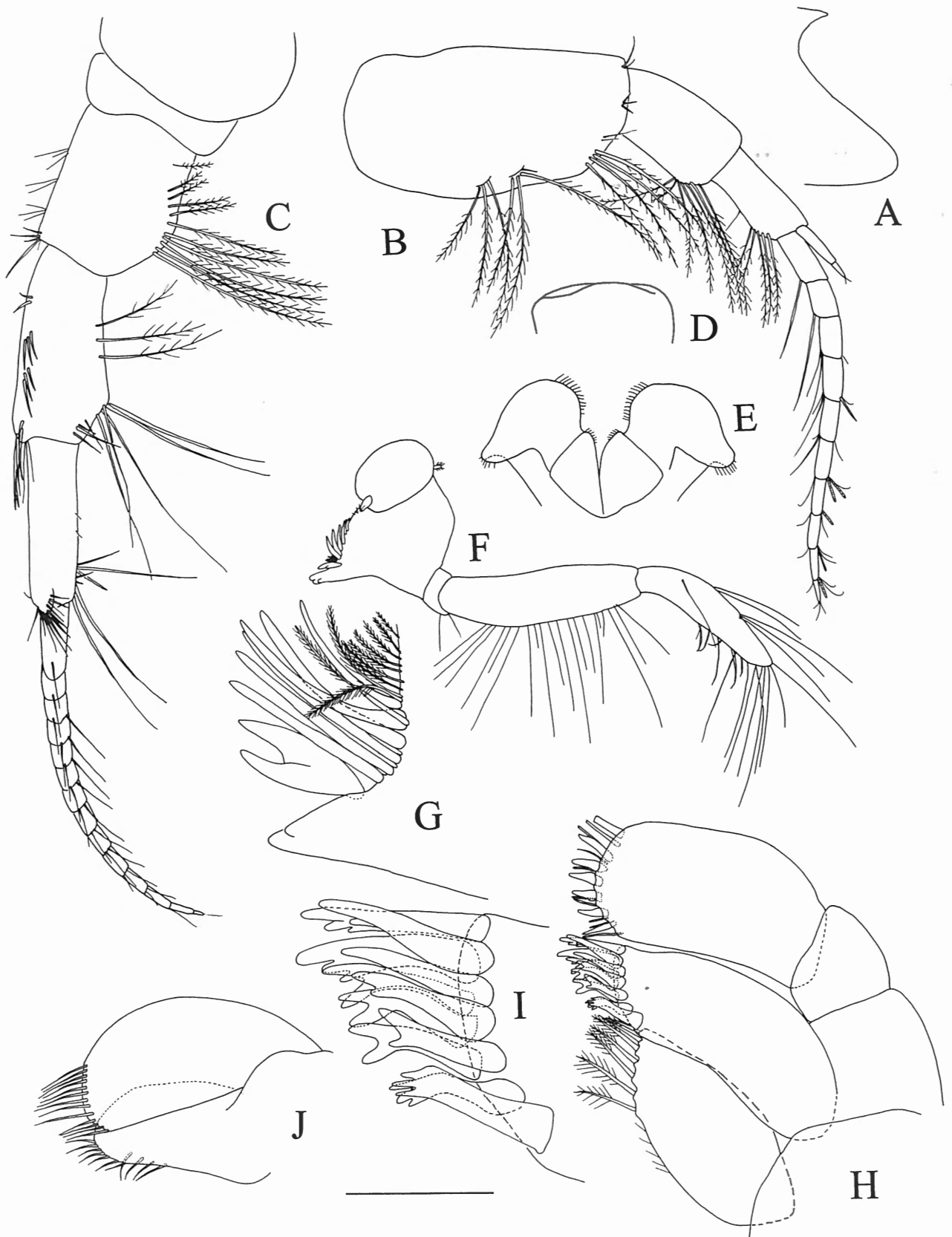

Fig. 29. *Pontoporeia femorata* KRØYER, 1842, immature female, Norway, Skatora, TMU 1095. A, anterior part of head; B, right A1; C, left A2; D, upper lip; E, lower lip; F, left Md; G, incisor process of right Md; H, Mx1; I, medial border of outer plate of Mx1; J, Mx2. Scale bar: A, B, C, D, E, F, 0.42 mm; J, 0.21 mm; F, 0.14 mm; G, 0.10 mm; I, 0.050 mm.

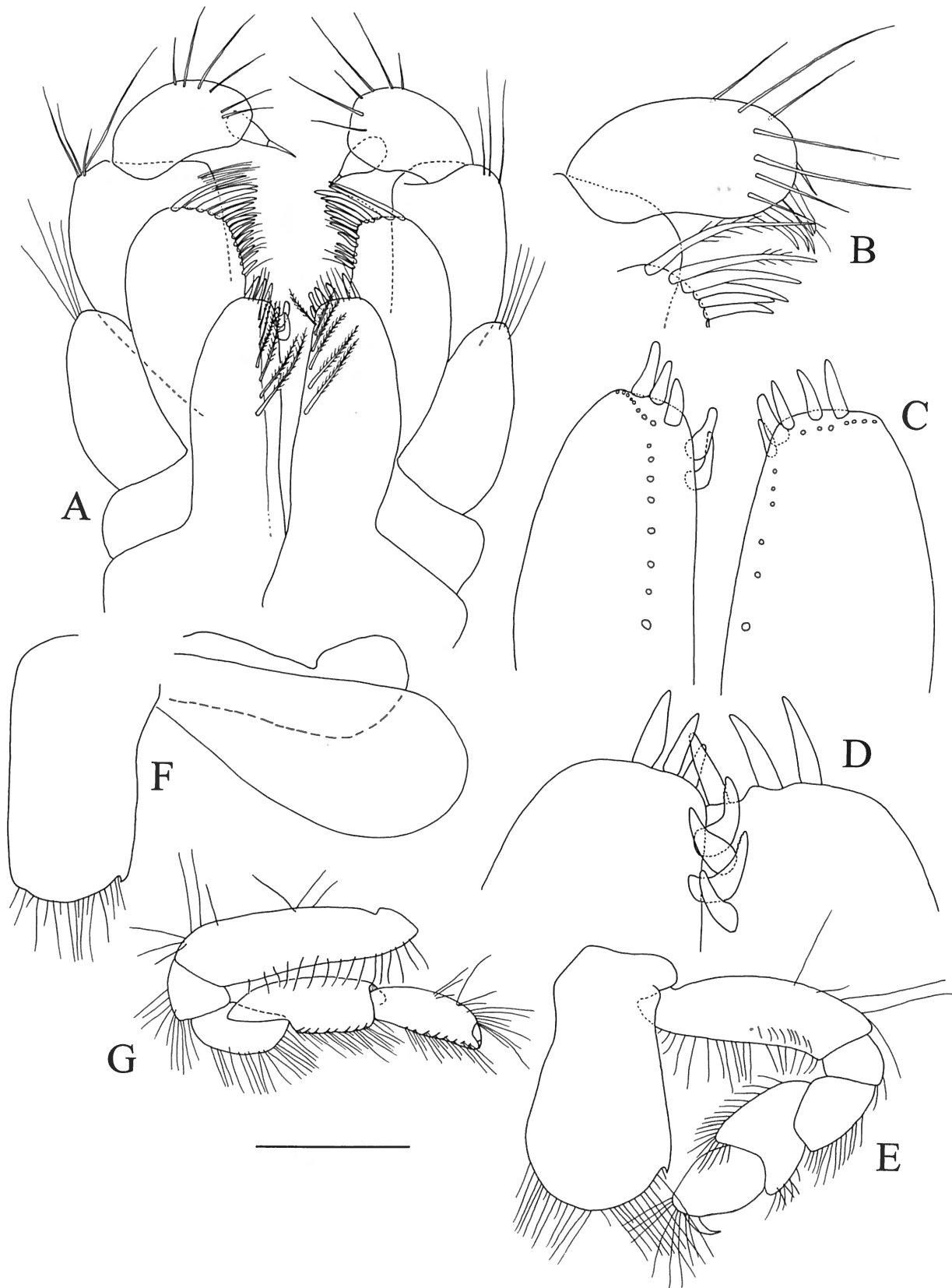

Fig. 30. *Pontoporeia femorata* KRØYER, 1842, immature females, Norway, Skatora, TMU 1095 (B and D = other specimens than for other figures). A, Mxp (dorsal view; terminal crown of spines of penultimate article not shown); B, tip of palp of left Mxp; C, inner plates (dorsal view); D, inner plates (ventral view); E, left P1; F, coxa of left P1; G, right P1. Scale bar: E, F, G, 0.62 mm; A, 0.18 mm; B, 0.10 mm; C, 0.083 mm; D, 0.050 mm.

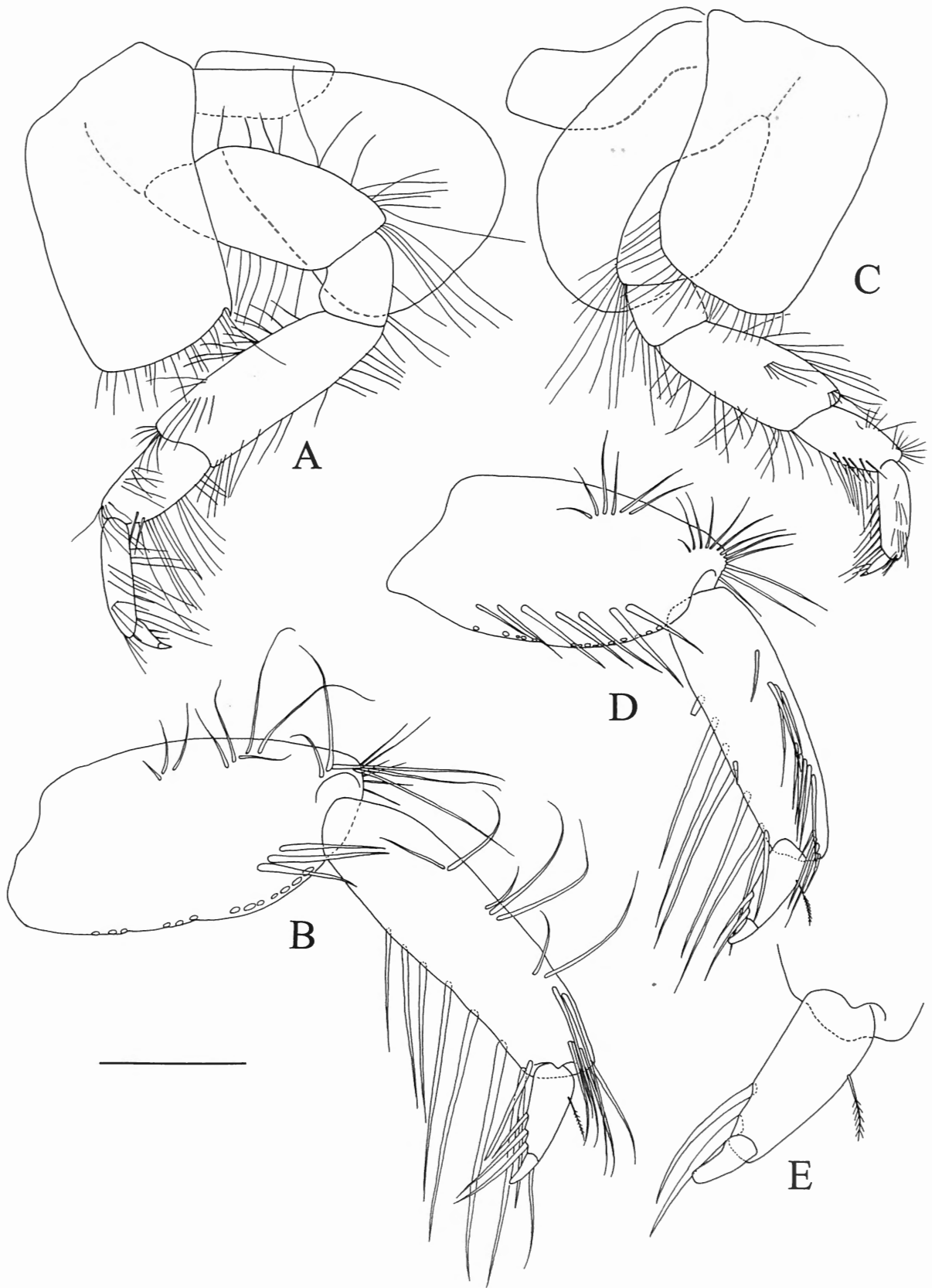

Fig. 31. *Pontoporeia femorata* KRØYER, 1842, immature female, Norway, Skatora, TMU 1095. A, left P3; B, anterior part of left P3 (insertion of setae of ventral row of carpus indicated by circles); C, right P4; D, anterior part of right P4 (insertion of setae of ventral row of carpus indicated by circles); E, dactylus of right P4. Scale bar: A, C, 0.62 mm; B, D, 0.21 mm; E, 0.10 mm.

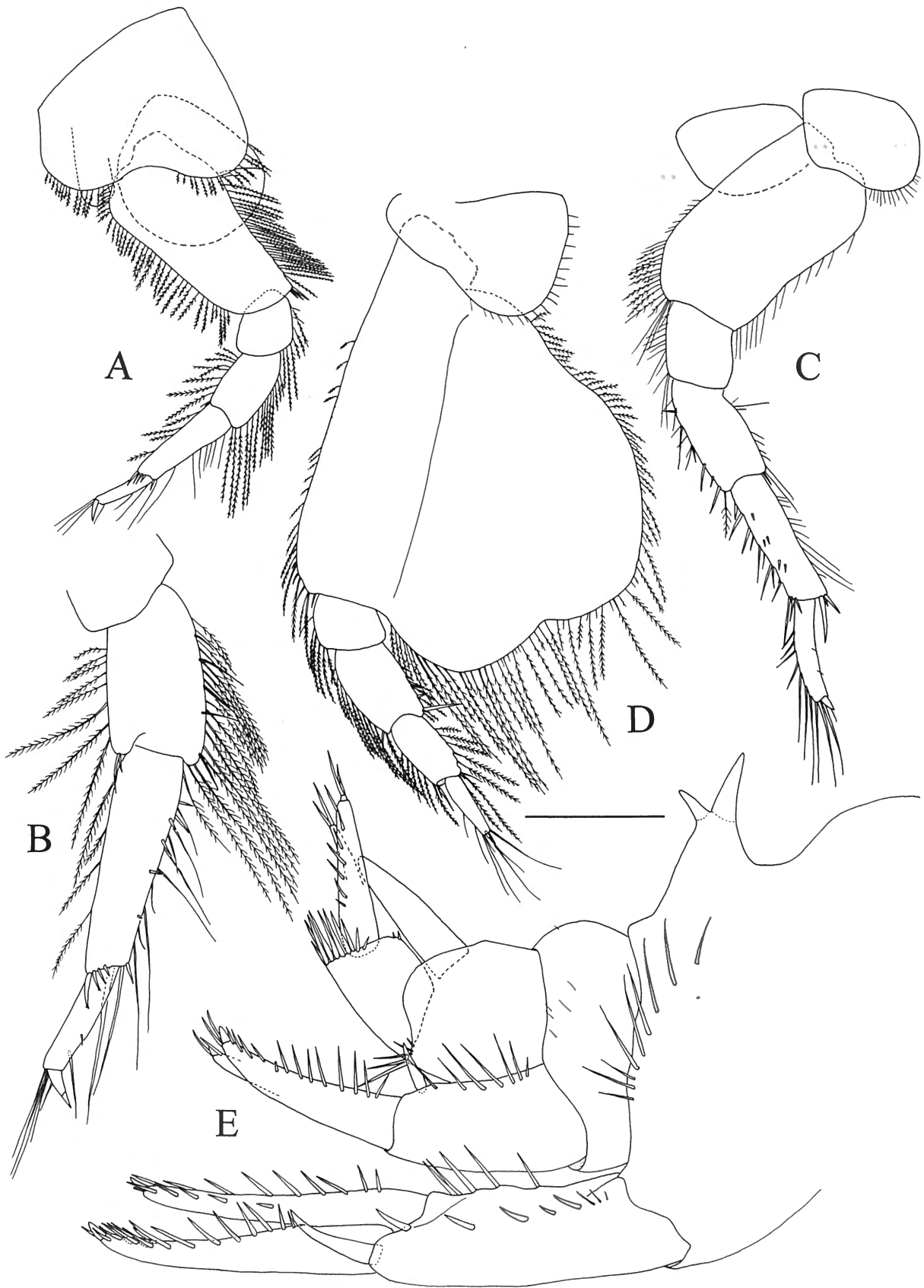

Fig. 32. *Pontoporeia femorata* KRØYER, 1842, immature female, Norway, Skatora, TMU 1095. A, right P5; B, distal part of right P5; C, left P6; D, left P7, outer view (remark: there are no setae on medial surface of basis); E, posterior part of body. Scale bar: A, C, 0.88 mm; D, 0.60 mm; B, E, 0.42 mm

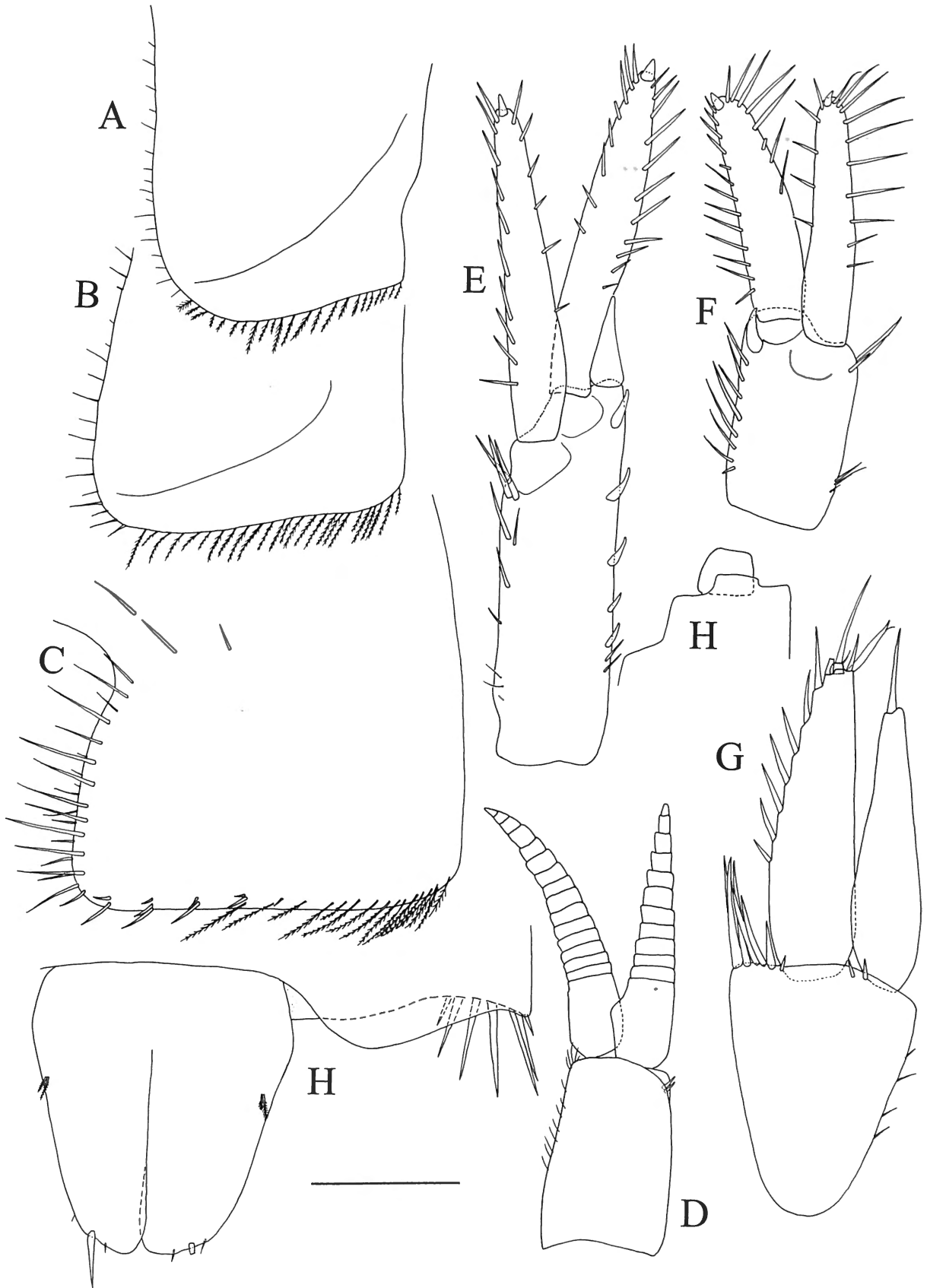

Fig. 33. *Pontoporeia femorata* KRØYER, 1842, immature females; A-C, Norway, Skatora, TMU 1095. A, right Ep1; B, right Ep2; C, right Ep3; D, first left pleopod; E, left U1; F, right U2; G, right U3; H, telson and right side of posterior border of urosomite 3. Scale bar: D, 0.60 mm; A, B, C, 0.42 mm; E, F, 0.35 mm; G, 0.21 mm.

long, of normal stoutness. Propodus of P5 and P6 of normal length. Dactylus of P5-P7 vestigial. P7 rather short, moderately transformed, with many marginal setose setae; coxal gill absent. Posterior border of basis of P7 strongly expanded with very strong pappose setae, which are as densely setulose as fox tails; ischium slightly pentagonal; carpus with anterior and distal spines forming transverse rows, with posterior strong pappose setae; propodus with anterior and distal spines forming oblique rows; carpus slightly longer than merus and stout. Pleonite 3 (and sometimes pleonite 2 and 1) with erect posterior dorsal projections. Posterior border of Ep1-Ep2 not protruding. Ep3 with ventral border anteriorly setose, with marginal strong spiniform setae on posteroventral angle. Peduncle of pleopods rather elongate. Urosomite 1 with 2 poorly developed humps and without spines and setae. Outer border of peduncle of U1 with regularly spaced or paired spines; these spines are slender; distal spine not or barely stronger than others. Rami of U1 upcurved with rather small number of narrow and not very long spines; tip acute and without terminal spine. Outer border of peduncle of U2 with long but not always regularly spaced very slender spine; no shorter stout distal spine. Rami of U2 slightly upcurved with numerous narrow long spines; tip acute and without terminal spine. Outer dorsal border of peduncle of U3 with distal spines only (no ornamentation on outer border). Outer ramus of U3 short with second article vestigial. Length of inner ramus of U3 strongly sexually dimorphic: about 0.3 times as long as outer ramus in females, about 0.8 times as long as outer ramus in males. Telson cleft on only 0.2 of its length; lobes separated from each other by a V-shaped notch; tip of lobes with about 4-7 short spines; lateral spines absent; each lobe with a pair of minute dorsolateral setae.

TYPE GENUS

Priscillina STEBBING, 1888

COMPOSITION

The subfamily is monotypic, being restricted to the genus *Priscillina* Stebbing, 1888.

Genus *Priscillina* STEBBING, 1888

Pontoporeia; BOECK, 1861: 648 (in part)

Priscilla BOECK, 1871: 124; 1876: 202; G.O. SARS, 1891: 125 (name preoccupied, Coleoptera)

Priscillina STEBBING, 1888: 1680; GURJANOVA, 1951: 334; BOUSFIELD, 1965: 168; BARNARD, 1969: 258; BOUSFIELD, 1973: 100; BARNARD & BARNARD, 1983: 565; BARNARD & DRUMMOND, 1982: 5, 6, 7; BARNARD & BARNARD, 1983: 565

SPECIES

Priscillina armata (BOECK, 1861) (type species); *Priscillina herrmanni* sp. nov. There are several undescribed but closely related species in the arctic parts of the Pacific Ocean (BOUSFIELD, in litt.).

BIOLOGY

Marine, on sand and gravel. There is strong evidence that both sexes breed during a non-feeding terminal stage (see comments under *P. armata*). No terminal males have been recorded so far, but the second antenna significantly increases in size in large immature males, which suggest that they have a pelagic mating system. BOUSFIELD (in litt.) thinks that it would be very important to describe their calceoli (if there are any) when such males will finally be available for study. The gut content of *Priscillina* suggests detritivore feeding habits (see below, under *Priscillina herrmanni* sp. nov.).

DISTRIBUTION

Circumarctic.

REMARKS

The genus *Priscillina* seems to be extremely homogeneous.

Priscillina herrmanni sp. nov.

(Figs. 34-42)

MATERIAL

Svalbard, western coast, Ny-Ålesund, 78°55'N 11°56'E, Brandal, probe 1, very coarse gravel, 5 m depth, 08/VIII/2003: 1 large immature male (holotype, mounted in FAURE's liquid on 17 slides) and 2 paratype females (one mounted in FAURE's liquid, on 20 slides), Scuba diving, leg. Marko HERRMANN, TMU 13 635.

ETYMOLOGY

The species is dedicated to Marko HERRMANN (AWI) who collected the specimen. The name is a genitive.

DIAGNOSIS

Outline of eye vaguely distinct, no ommatidia distinct. Inner plate of Mxp with 3 pairs of interlocking spines. Outer spines of propodus of P3-P4 robust. Basis of P5 with large upcurved posterior spur. Basis of P6 without posterior spur. Ratio length width of basis of P7 about 1.3. Second and third urosomite with posterior erect protrusion. Peduncle of U1-U2 with spines forming loose pairs (each pair consisting of a large and a smaller spine). Exopod and endopod of U1 with a few spines.

Size.- 7 mm in rolled position.

ECOLOGY

The type material has been collected in very shallow water (5 m depth) in an arctic fjord. The digestive tract of one dissected specimen contained a sausage-shaped mass of dark stuff, which looked amorphous when examined under the microscope. Grab samplings made by the author in September 2004 at the type locality indicate that the fine fraction of

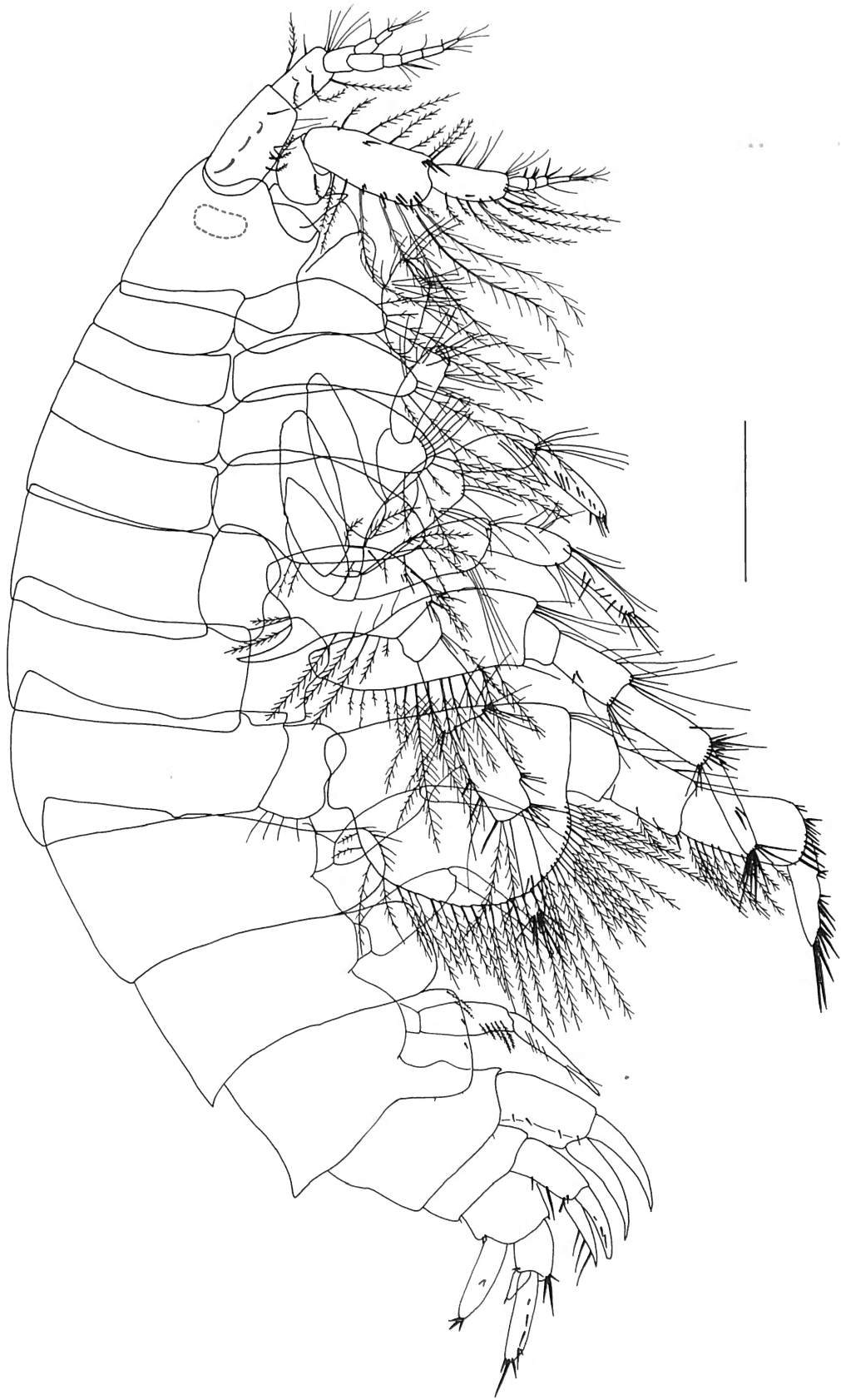

Fig. 34. *Priscillina herrmanni* sp. nov., small female, paratype, habitus, Svalbard, Ny-Ålesund, TMU 13 635. Scale bar: 0.56 mm.

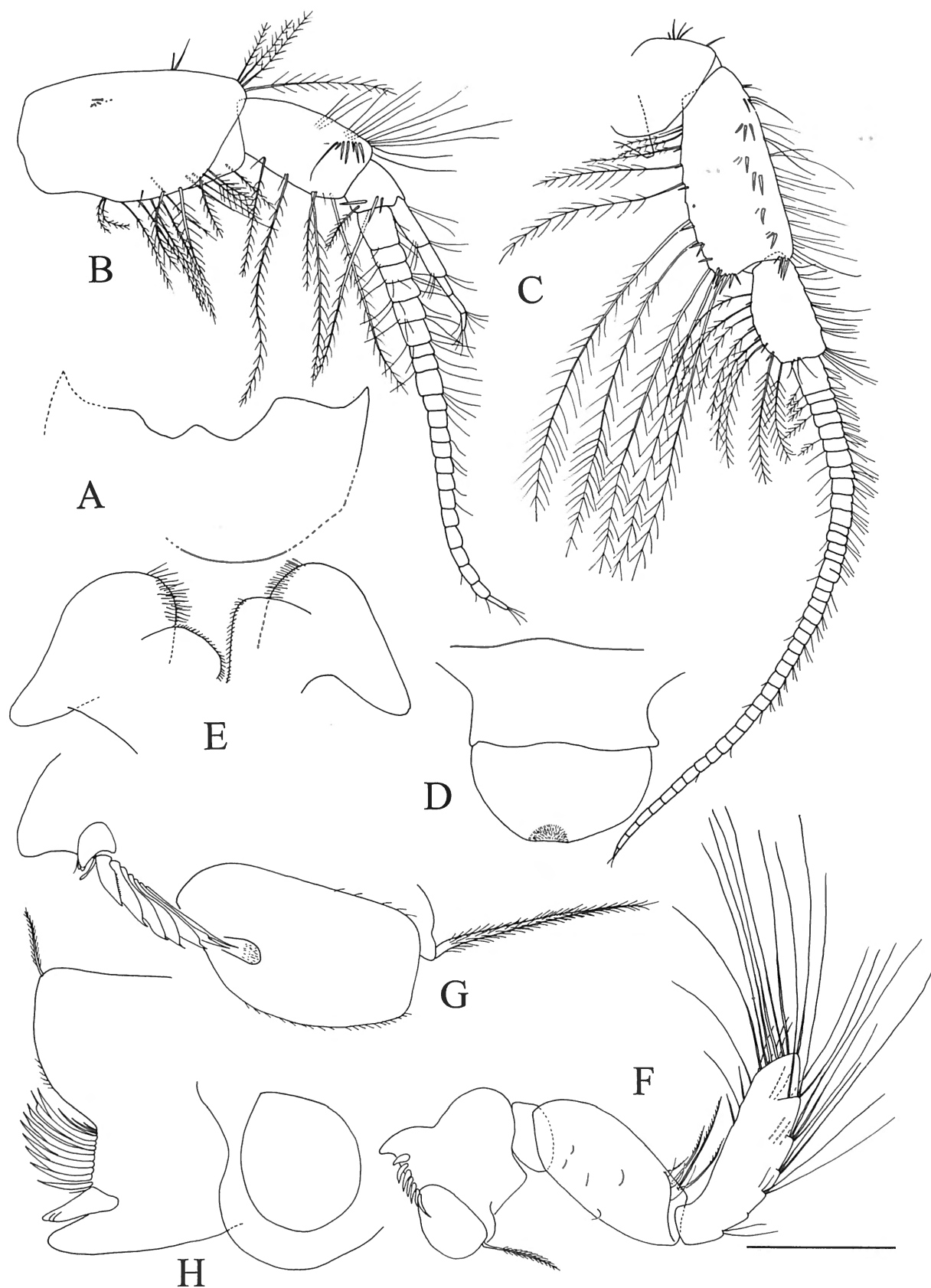

Fig. 35. *Priscillina herrmanni* sp. nov., immature male, holotype, Svalbard, Ny-Ålesund, TMU 13 635. A, head seen from above; B right A1; C, right A2; D, upper lip; E, lower lip; F, right Md; G, right Md (high magnification); H, left Md (high magnification). Scale bar: A, 0.88 mm; C, 0.60 mm; B, D, F, 0.42 mm; E, 0.30 mm; H, 0.21 mm; G, 0.14 mm.

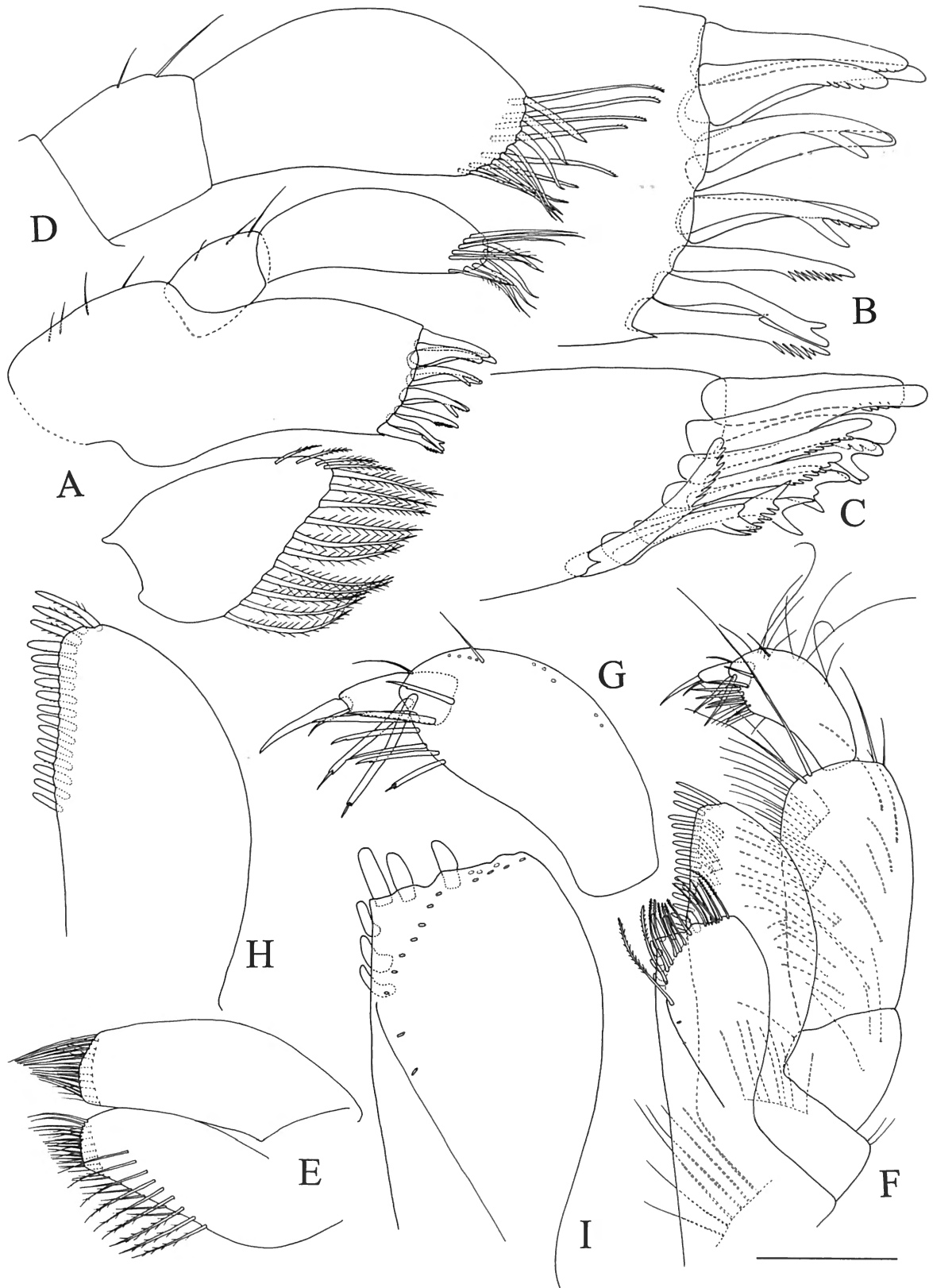

Fig. 36. *Priscillina herrmanni* sp. nov., immature male, holotype, Svalbard, Ny-Ålesund, TMU 13 635. A, Mx1 (palp in somewhat oblique orientation); B, medial border of outer plate of Mx1; C, medial border of outer plate of Mx1 (other Mx1, seen from the edge); D, palp of Mx1 (flat orientation; other Mx1 than in A); E, right Mx2; F, right Mxp; G, tip of palp of right Mx1 (insertion of anteroventral setae indicated by dotted circles; posteroventral setae not shown); H, outer plate of right Mxp; I, inner plate of right Mxp (insertion of dorsal setae indicated by black circles; insertion of ventral setae indicated by dotted circles). Scale bar: E, F, 0.21 mm; A, H, 0.14 mm; D, G, I, 0.10 mm; B, C, 0.050 mm.

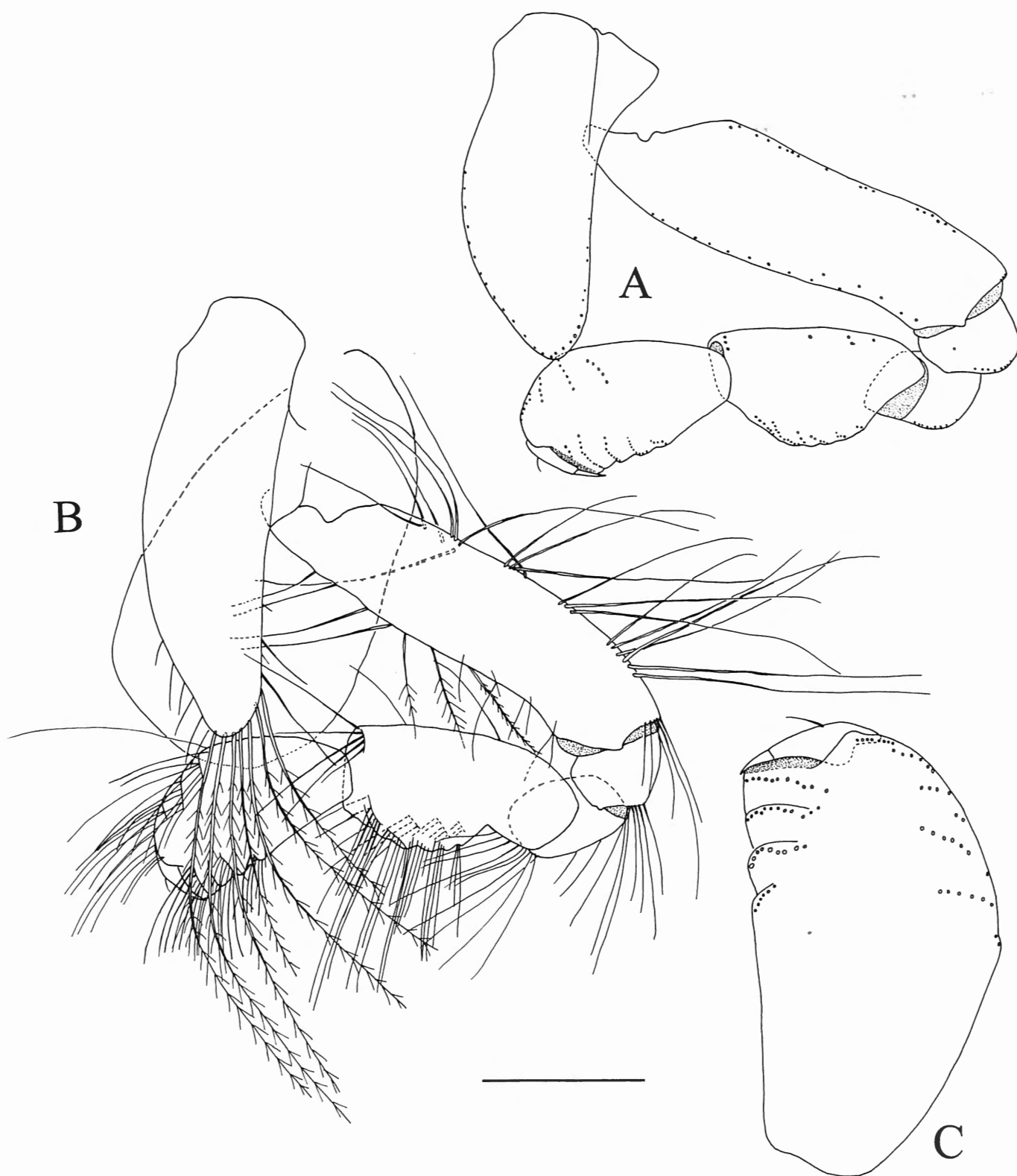

Fig. 37. *Priscillina herrmanni* sp. nov., immature male, holotype, Svalbard, Ny-Ålesund, TMU 13 635. A, left P1 (insertion of setae indicated by circles); B, left P2; C, chela of left P2 (insertion of setae indicated by circles). Scale bar: A, B, 0.42 mm; C, 0.21 mm.

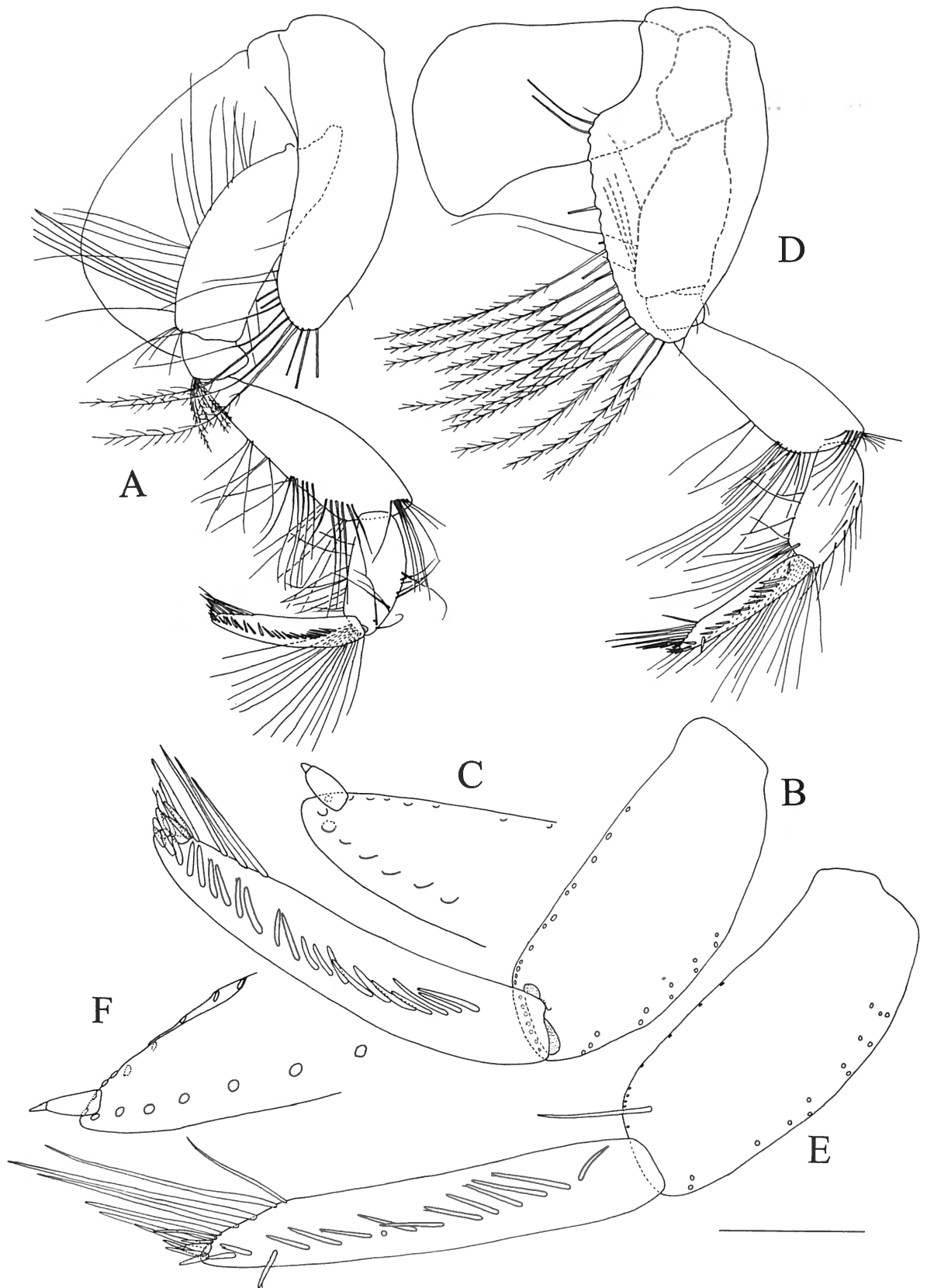

Fig. 38. *Priscillina herrmanni* sp. nov., immature male, holotype, Svalbard, Ny-Ålesund, TMU 13 635. A, right P2; B, anterior part of right P3 (insertion of propodal setae indicated by circles); C, tip of right P3 (propodal spines indicated by insertion marks); D, right P4; E, anterior part of right P4 (insertion of propodal setae indicated by circles; single posterolateral spine of propodus illustrated); F, tip of right P4 (propodal spines indicated by insertion marks). Scale bar: A, D, 0.60 mm; B, E, 0.21 mm; C, F, 0.10 mm.

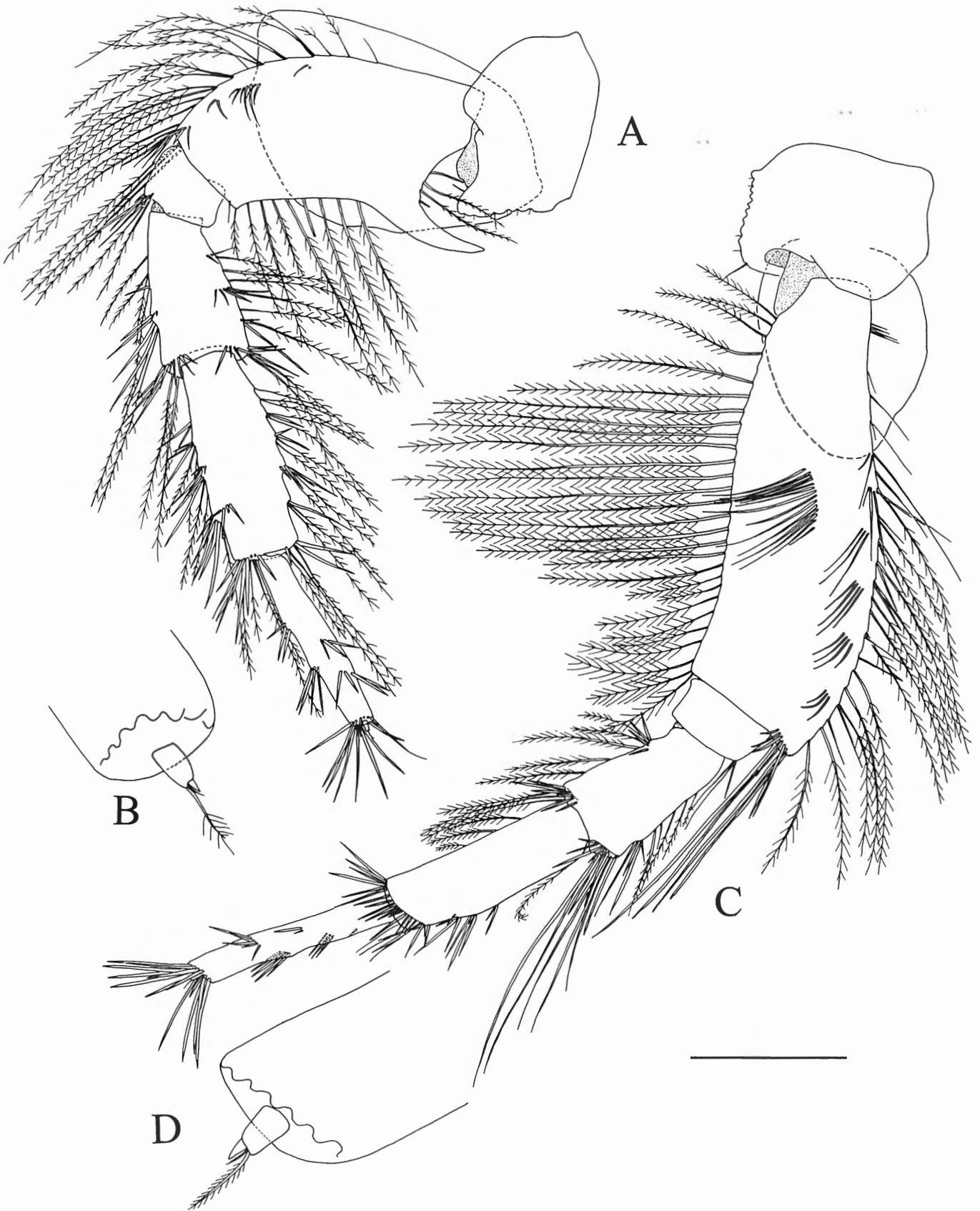

Fig. 39. *Priscillina herrmanni* sp. nov., immature male, holotype, Svalbard, Ny-Ålesund, TMU 13 635. A, left P5; B, tip of left P5 (terminal crown of spines of propodus not shown); C, right P6; D, tip of left P6 (terminal crown of spines of propodus not shown). Scale bar: A, C, 0.53 mm; B, D, 0.10 mm.

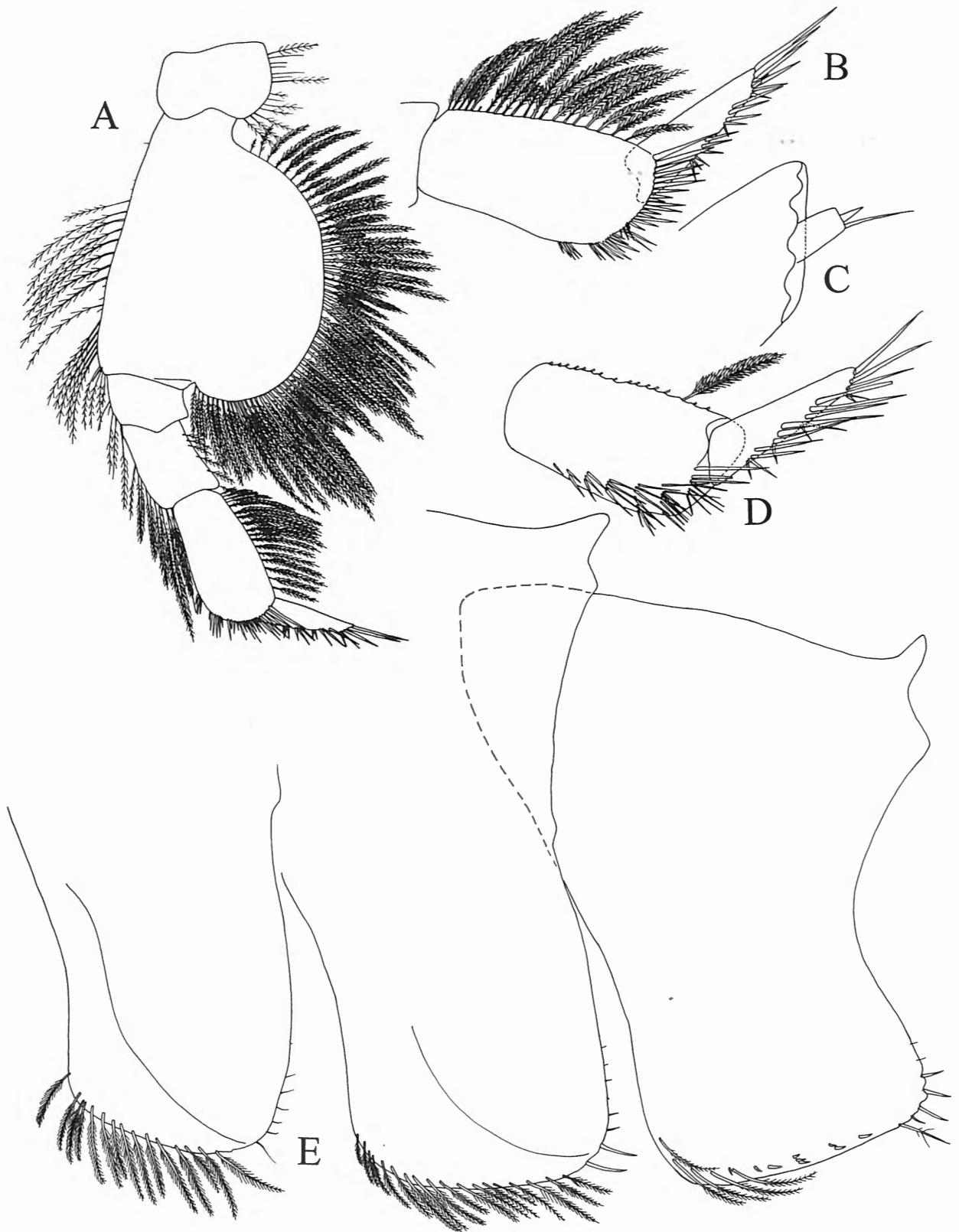

Fig. 40. *Priscillina herrmanni* sp. nov., immature male, holotype, Svalbard, Ny-Ålesund, TMU 13 635. A, left P7, outer view (remark: there are no setae on medial surface of basis); B, distal part of left P7, outer view; C, tip of left P7 (terminal crown of spines of propodus not shown; it was not possible to see if the apical seta of dactylus was setulose or not); D, distal part of right P7, medial view; E, left pleosomites 1-3. Scale bar: A, 0.88 mm; B, D, 0.53 mm; E, 0.42 mm; C, 0.10 mm.

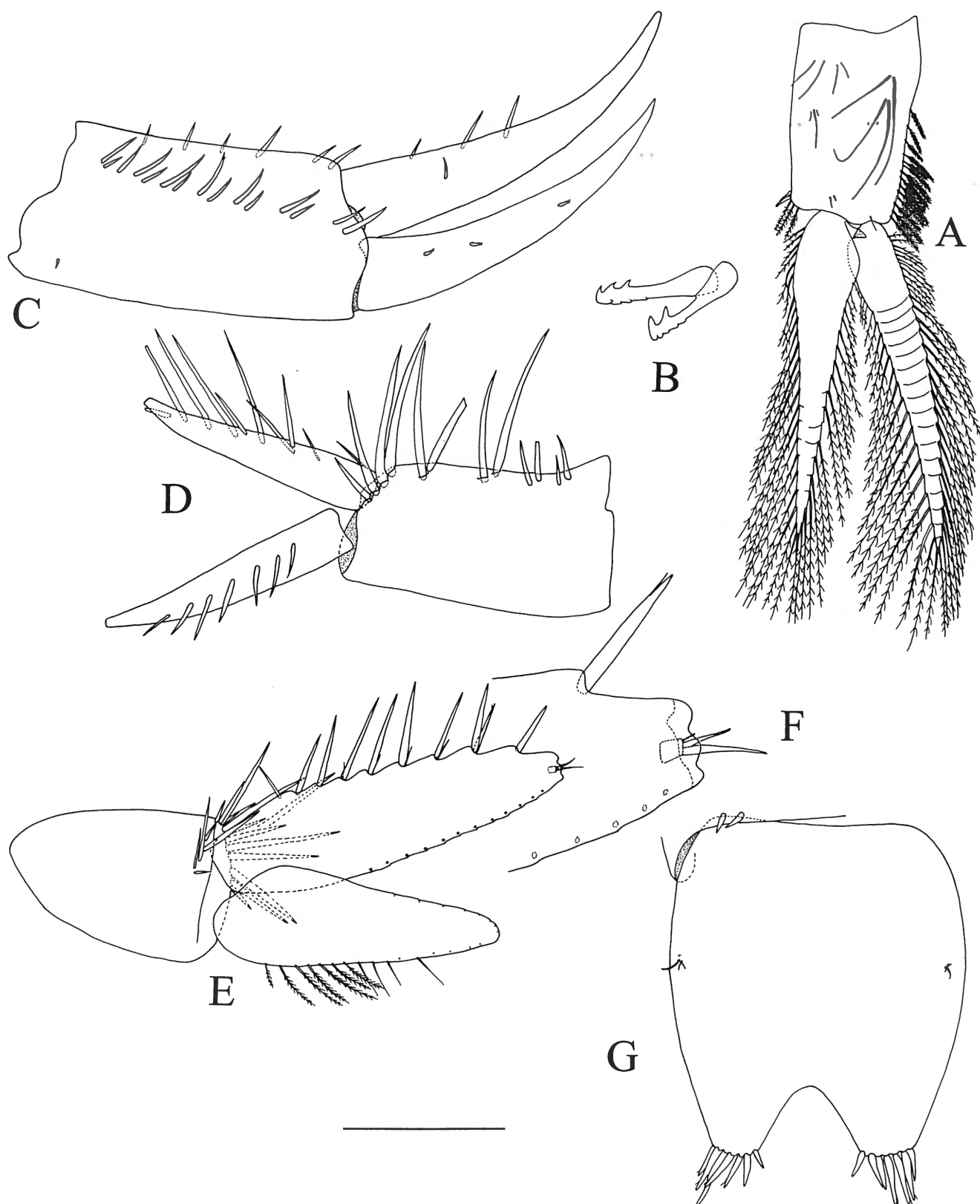

Fig. 41. *Priscillina herrmanni* sp. nov., immature male, holotype, Svalbard, Ny-Ålesund, TMU 13 635. A, left first pleopod; B, coupling hooks of the first pleopod; C, left U1; D, right U2; E, right U3; F, tip of exopod of right U3; G, telson. Scale bar: A, 0.60 mm; C, D, E, G, 0.30 mm; B, F, 0.10 mm.

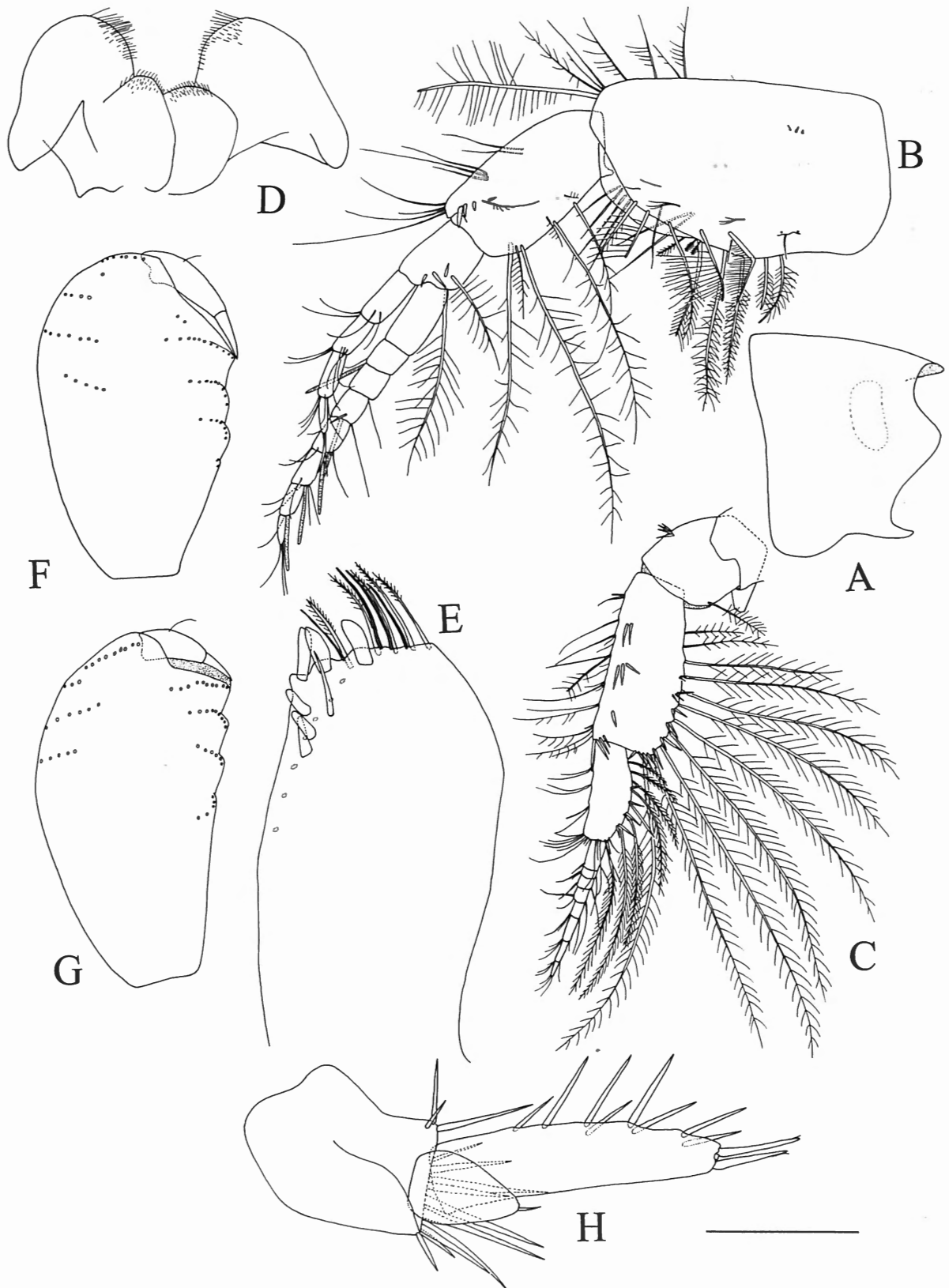

Fig. 42. *Priscillina herrmanni* sp. nov., female paratypes (A, small female; B-H, large female), Svalbard, Ny-Ålesund, TMU 13 635. A, head; B, left A1; C, left A2; D, lower lip; E, inner plate of left Mxp (ventral view; ventrodistal setae filled in black; dorsodistal setae not filled; insertion of dorsal setae indicated by dotted circles); F, chela of right P1 (insertion of setae indicated by circles); G, chela of right P2 (insertion of setae indicated by circles); H, right U3. Scale bar: A, 0.42 mm; B, C, 0.60 mm; D, 0.30 mm; F, G, 0.21 mm; H, 0.26 mm; E, 0.10 mm.

the sediment is black. This would suggest a detritivore diet. No further specimens were collected in these grab samples, suggesting that the species is rare.

DISTRIBUTION

Svalbard.

REMARKS

In a recent key to the species of *Priscillina*, BOUSFIELD (in prep.) refers to the present form as *Priscillina* sp. Until recently *P. armata* (BOECK, 1861) was the only named *Priscillina* species. However the study of BOUSFIELD (in prep.) indicates that there are several species extremely close to each other. In the present conditions, it is extremely difficult to give a detailed description of the species, but I have done my best to provide detailed and accurate figures. *P. herrmanni* sp. nov. can be easily separated from the other Atlantic *Priscillina* species, *P. armata* (BOECK, 1861) by the shape of the basis of P6, which has a posteroproximal spur in *P. armata* (fig. 44F, 44K) but not in *P. herrmanni* sp. nov. (fig. 34, 39C). The *P. herrmanni* sp. nov. examined had 3 pairs of interlocking spines on the inner plate of their maxilliped, whilst *P. armata* had only two. Some *P. armata* examined had an erect posterodistal protrusion on the 3 first pleonites, while in the *P. herrmanni* sp. nov. examined so far, they are only present on the second and the third one. Otherwise both species look extremely similar to each other. The undescribed species erroneously identified as *P. armata* by GURJANOVA (1962) is also devoid of spur on the basis of P6. It has apparently stouter articles on P7 than in *P. herrmanni* sp. nov. However the main differences concern the first uropod. GURJANOVA's species has short stout unpaired spines on the outer dorsal border of the peduncle of U1 instead of slender paired spines and it has only a single spine on the exopod and none at all on the endopod, whilst there are several spines on both endopod and exopod in *P. herrmanni* sp. nov.

***Priscillina armata* (BOECK, 1861)**
(Figs. 43-45)

Pontoporeia armata BOECK, 1861: 648

Priscilla armata; BOECK, 1871: 124; 1872: pl. 2 fig. 4; 1876: 203; G.O. SARS, 1891: 126, pl. 42; 1876: 203

Priscillina armata; STEBBING, 1888: 1719; STEBBING, 1906: 126; SHOEMAKER, 1930: 20; GURJANOVA, 1930: 244; BOUSFIELD, 1965: 169 (key); GURJANOVA, 1951: 335, fig. 196 (after SARS); BARNARD, 1969: 258, fig. 97a, 98g, 99e, 100e, 100m (after SARS); BARNARD & BARNARD, 1983: 565, fig. 27b, 28c (after SARS)

Not *Priscillina armata*; GURJANOVA, 1962: 415, fig. 139 (= undescribed species close to *P. herrmanni* sp. nov.)

TYPE LOCALITY

Unknown. BOECK (1861: 648) states: "Pontoporeia Kr. Denne KRÖYER's Slaegt, som er opstillet paa den grønlandske Art: *femorata*, og som ved LINDSTRØM og

BRUZELIUS er forøget med tre Arter, kan her endmere forøges med en ny, som fandtes i Universitetets zoologiske Museum, uden Angivelse af Findested, men som formodentlig er fra Bergenskysten". This can be translated as follows: "Pontoporeia Kr. This KRÖYER's genus, which has been created for the Groenland species *femorata*, and which has been increased to 3 species by LINDSTRØM and BRUZELIUS, can be increased once more with a new one, which is present in the Zoological University Museum, without indication of origin, but which is presumably from the coast of Bergen". Four syntypes are still preserved in the Zoologisk Museum, Oslo (Åse WILHELMSSEN, in litt.).

MATERIAL

CNMC-1984-123, Acquisition No. 1981-004, Canada, North Atlantic, Burin Peninsula Grand banks, Sta. 125, Station # Stewart-19800714, 46°40'N 48°42'W, coll. P. S. STEWART, MacLaren, Plansearch Inc., 26.vii.1980: 3 large immature females in alcohol; second label: MacLAREN MAREX INC., St. John's, Newfoundland, proj. Mobil, 26 Jul 80, stn 125, sample 148, 46°40'N 48°47'W; third label indicating 2 br. [square symbol] females, 1 imm. male [this apparently means that extra specimens have been mounted on slides]; **CMNC 2004-1541**, Acquisition No 1951-015, USA, Maine, Washington Co. (ME), Bay of Fundy, inside Quoddy Head, station DFO (Atl. Biological Station) - 19120813, cat 2026, 44°50'N 066°58'W, fine sand, 5-10 f [= fathoms?] on label [catalogue data report indicating collection depth 0-18 m], 13.viii.1912: 3 immature males in fluid, coll. Fisheries & Oceans, St Andrews, N.B.; **CNMC 2004-1542**, Acquisition No 1961-091, Canada, Nova Scotia, off Sable Island bank, Vessel A.T. Cameron, cruise 37, station Gorham 1961 G3, 43°35'10"N 062°29'30"W, sand and gravel, 73.2 m depth, 29.iv.1961: 5 immature specimens in alcohol (1 male, 4 females), leg. Stanley W. GORHAM, (second label indicating 1 female, 1 male slide mounts); **CMNC 2004-1542**, Canada, Nova Scotia, off Sable Island bank, Stn # 3, acc. 1961-91, 29.iv.1961: 1 penultimate male, length 9.5 mm, coll. S.W. GORHAM, 1 slide, Nat. Mus. Canada; **CMNC 2004-1542**, Canada, Nova Scotia, off Sable Island Banks [sic], Stn # 3, acc. 1961-91, 29.iv.1961: 1 ovigerous female, length 10 mm, coll. S.W. GORHAM, 1 slide; **CMNC 2004-1543**, no acquisition number, Canada, Baffin 2 st. 102, cat 10678: 6 immature specimens in alcohol (3 males, 2 females, 1 sex unidentified) (second label indicating: 2 males slide; see also below) all specimens have a posterior dorsal tooth on pleonites 1-3 [The information sheet of this sample indicates: collection data links tentative, original label data only "Baffin 2 Stn 102". Then it gives the supposed data of this sample: unknown collector, 30.vi.1949, North America: Canada; Nunavut, Forbes Sound, 60°23'30"N 064°52'00"W, glacial mud, station Calanus 1949 102 B-2, Vessel Calanus, collection depth 91-128 m, steelcrete dredge]; **CMNC 2004-1543**, Canada, Baffin Island 2, Stn 102, cat 10678: 1 penultimate male, length 11 mm, 1 slide; **CMNC 2004-1543**, Canada, Baffin Island, stn 102: 1 penultimate male, length 11 mm and 1 female, length 8 mm, 1 slide.

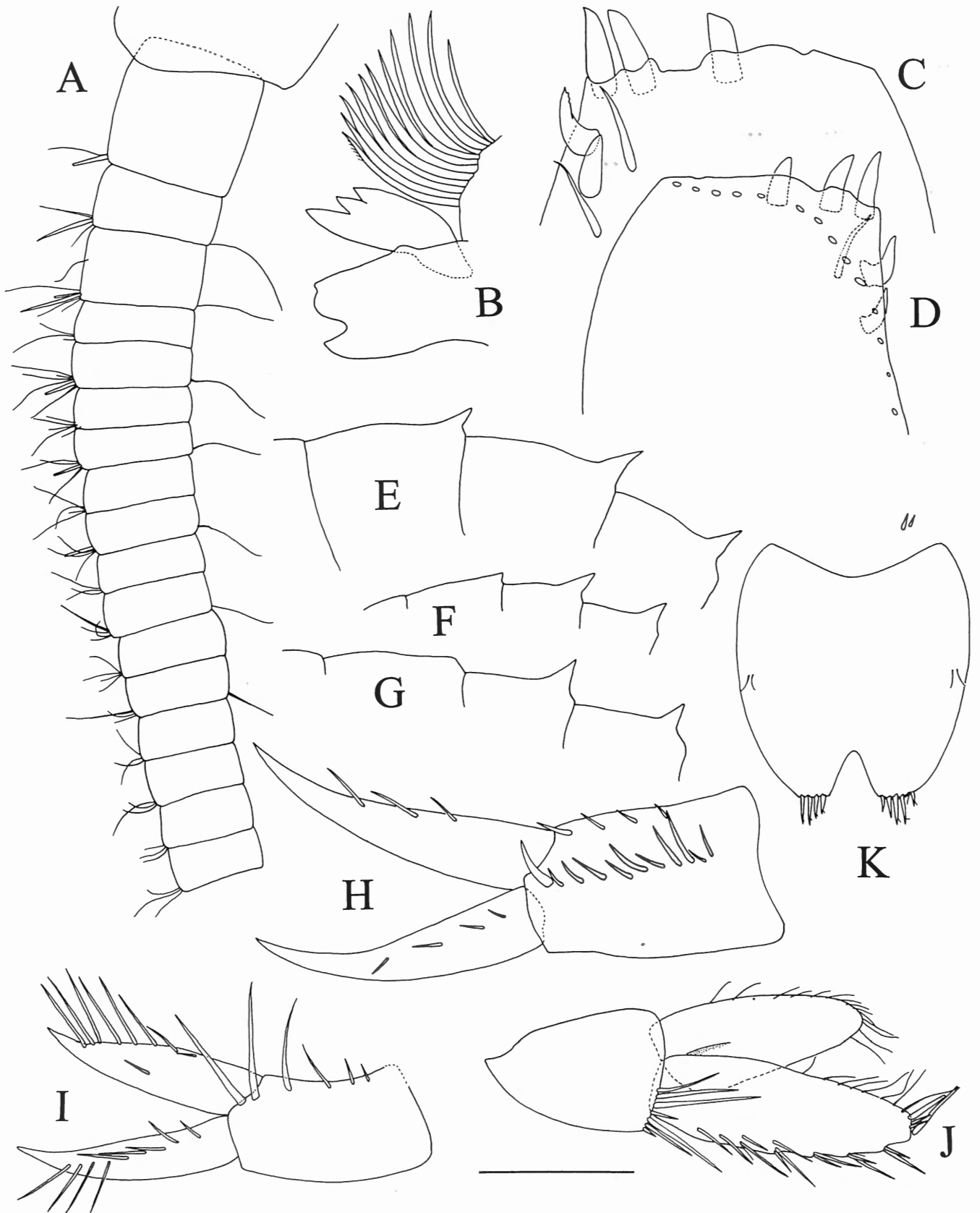

Fig. 43. *Priscillina armata* (BOECK, 1861), East Canada. A, B, C, D, E, H, I, J, K, immature males; F, G, immature females. A, B, D, E, F, H, I, CMNC 2004-1543; C, G, CMNC 2004-1542. A, proximal part of flagellum of left A2 showing the fission of articles; B mandible; C, inner plate of left maxilliped (ventral view); D inner plate of left maxilliped (dorsal view); E, F, G, pleosomites 1-3; H, right U1; I, right U2; J, right U3; K, telson. Scale bar: E, F, G, 1.24 mm; H, I, J, K, 0.42 mm; A, 0.21 mm; B, 0.14 mm; C, D, 0.10 mm.

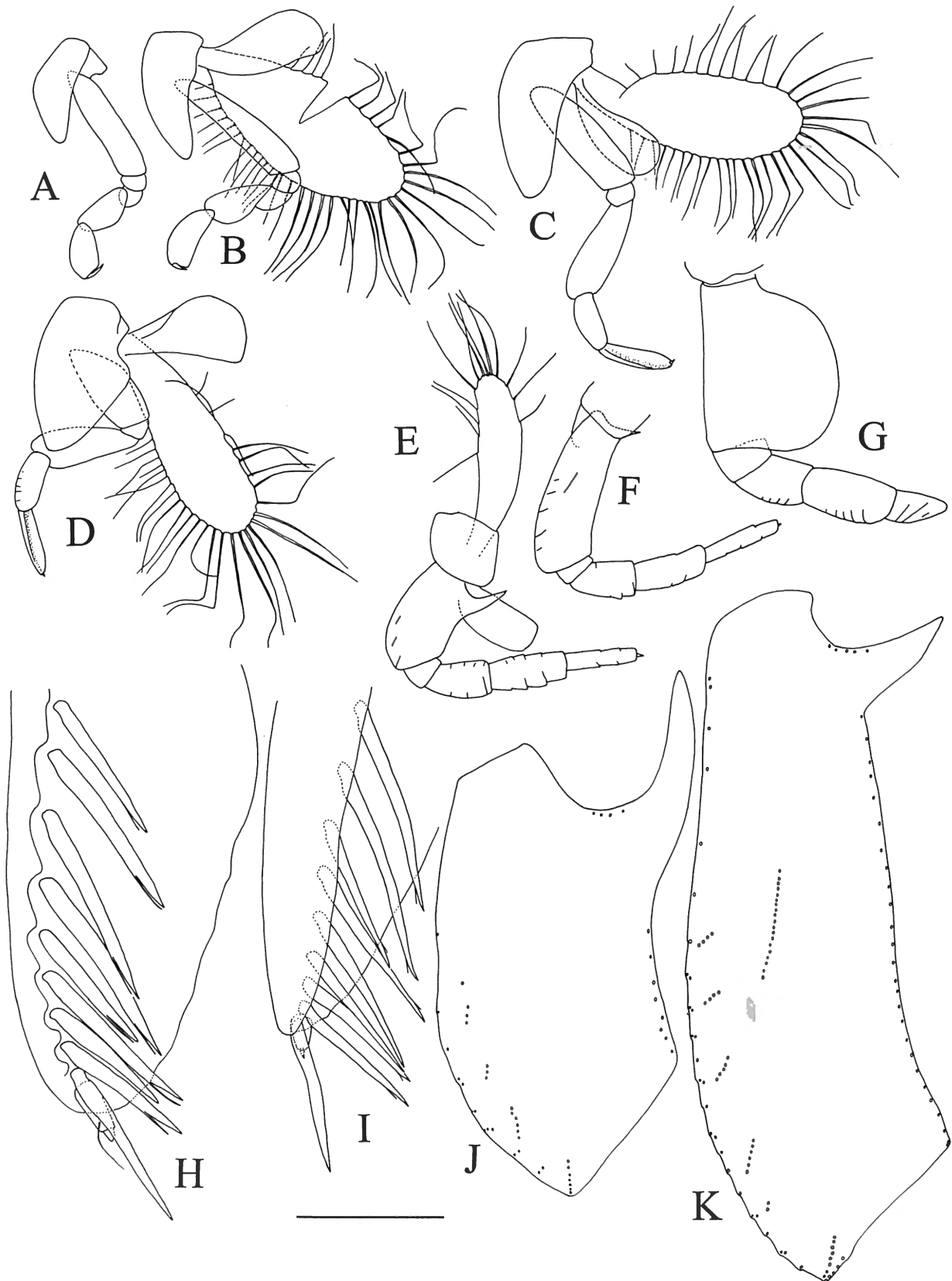

Fig. 44. *Priscillina armata* (BOECK, 1861), East Canada. A-H, ovigerous female, CMNC 2004-1542; I, J, K, male, CMNC 2004-1543. A, left P1; B, left P2; C, left P3; D, left P4; E, left P5; F, left P6; G, left P7; H, tip of P3 (outer view); I tip of P4 (outer view); J, basis of left P5; K, basis of left P6. Setae indicated by insertion marks only, except for oostegites and tip of P3-P4. Scale bar: A-G, 1.76 mm; J, K, 0.42 mm; H, I, 0.10 mm.

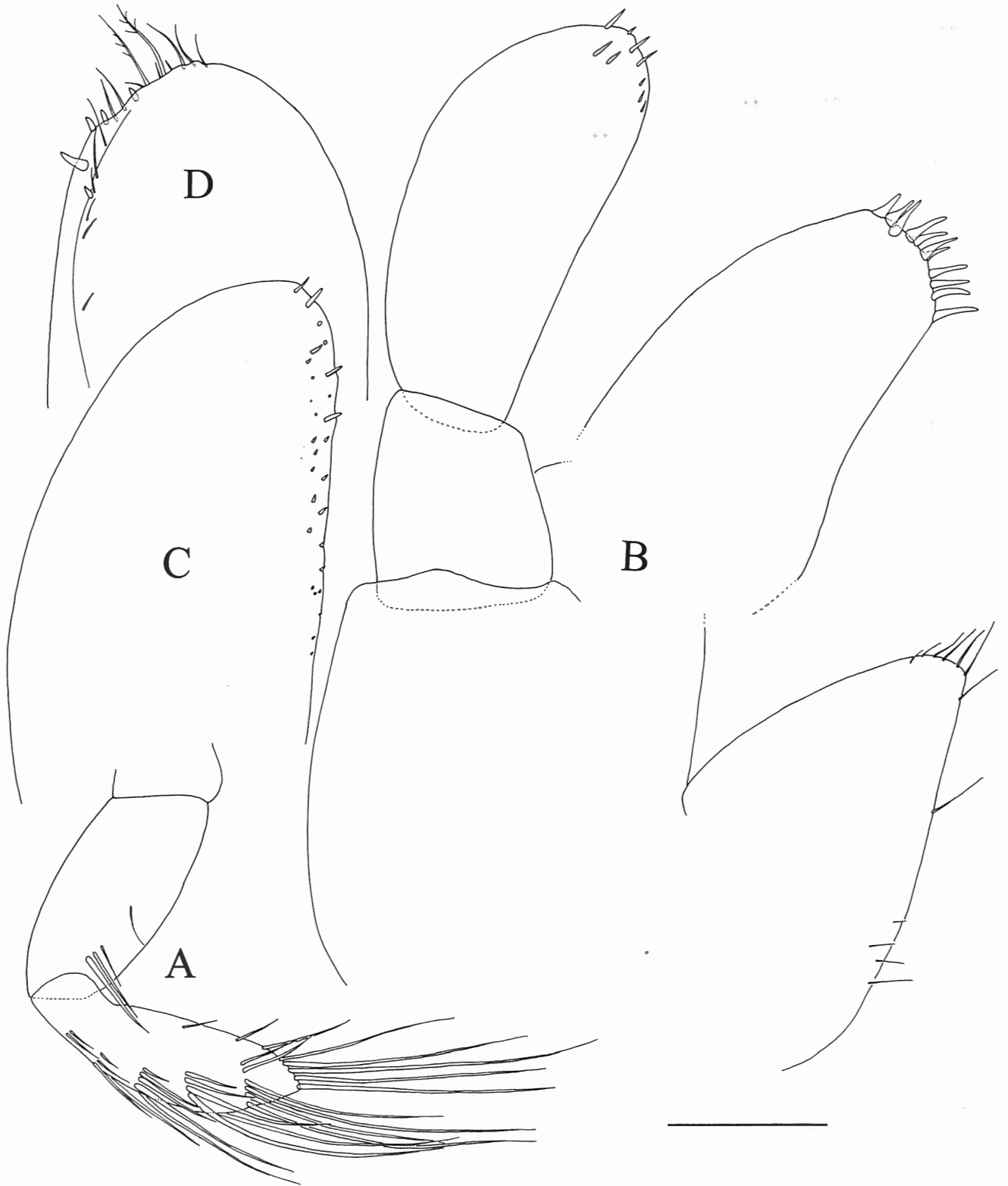

Fig. 45. *Priscillina armata* (BOECK, 1861), East Canada, CMNC 2004-1542, ovigerous female. A, mandibular palp; B, Mx1; C, outer plate of Mxp; D, inner plate of Mxp. Scale bar: A-D, 0.10 mm.

ECOLOGY

Found on sandy bottoms (Hansen 1888; present data) and sand and gravel bottoms between about 20 m (present data) and 88 m (Hansen 1888). The specimens of GURJANOWA (1930) were all collected with a dredge on fine clean muddy sand [auf feinem reinen, schlammigen Sande] at depth between 5 and 15 m. GURJANOVA (1951) considers it as a shallow Arctic form of the sandy bottoms.

DISTRIBUTION

BOECK (1861) indicated that the type material had no label but that he suspected that it comes from Bergen area (see above). According to BOECK (1876) the type locality of *Priscillina armata* is the Søndfjord, area of Bergen, Western Norway, where it would have been collected by Prof. RASCH. However since it has never been found again in Norway and since the type material of BOECK species has no original label, it is dubious that this locality indication is correct, as already pointed out by STEPHENSEN (1925). GURJANOWA (1930) stated that "es is nicht bekannt, ob das von BOECK beschriebene Exemplar aus dem Grönlandmeer stammt oder an der norwegischer Küste erbeutet worden ist". The idea of GURJANOWA (1930) that the type specimens are possibly from Greenland is supported by the fact that BOECK studied other species from that island, such as *Pontogeneia inermis* (KRØYER, 1838). After its original description, *P. armata* has been recorded from West Greenland (HANSEN, 1888), the White Sea (GURJANOWA, 1930) and East coast of Canada (SHOEMAKER, 1930). The records from the White Sea by GURJANOWA (1930) are presumably correct because she stated that "Sie stimmen alle vollkommen mit der Beschreibung und den Abbildung von G. SARS (1899) überein." The North West Pacific *Priscillina armata* of GURJANOVA (1962) do not belong to that species and will be described as a new one by BOUSFIELD (in prep.).

REMARKS

At my request, Mrs Åse WILHELMSSEN re-examined the 4 remaining syntypes of *Priscillina armata*, which are held in the Oslo Museum. They all have a posteroproximal spur on the basis of P6. Microscope preparations of an ovigerous female *Priscillina armata* from Canada have been examined. With the exception of its mandibular palp which is normal, all mouthparts have very reduced spines and setae (fig. 45), suggesting that it has a non-feeding terminal stage. Its oostegites are remarkably large, suggesting that at maturity it uses its complete energy resource for a single very large brood. Terminal males of *Priscillina* have never been found so far. As already pointed out by SHOEMAKER (1930), the Canadian specimens have often a posterior dorsal protrusion on the first pleosomite, a character which is not distinct on the figures of BOECK (1872) and G.O. SARS (1891). On the illustration of G.O. SARS (1891) the spines of the propodus of P4 look much longer and much slender than in Canadian specimens. The figure of the same appendage given by BOECK (1872), albeit small, is more in agreement with Canadian specimens.

3.2.2. Phylogenetic considerations on some lineages of sand- and mud-dwelling amphipods

3.2.2.1. Family assignation of *Bathyporeia* and alleged relatives in literature

Dana created the subfamily Pontoporeiinae as a subfamily of the Gammaridae, as early as 1853 (DANA, 1853). This subfamily was elevated to the rank of family by G.O. SARS (1883). STEBBING (1906) renamed this family Haustoriidae STEBBING, 1906, without comment. He presumably made this name substitution because the genus *Haustorius* was described before *Pontoporeia* (1775 versus 1842). Such a name change is unjustified according to the International Code for Zoological Nomenclature, 4th and earlier editions. Old authors included quite a large number of genera in the Pontoporeiidae-Haustoriidae, the most restrictive views being those of STEBBING (1906) who included the genera *Bathyporeia*, *Cardenio* STEBBING, 1888, *Haustorius* MÜLLER, 1775, *Platyschnopus* STEBBING, 1888, *Pontoporeia*, *Priscillina*, *Urothoe* DANA, 1852 and *Urothoides* STEBBING, 1891. The views of STEBBING (1906) have been accepted by a number of authors such as CHEVREUX & FAGE (1925), SCHELLENBERG (1942), GURJANOVA (1951) and even LINCOLN (1979). However, there is currently a consensus for removing the genera *Cardenio*, *Platyschnopus*, *Urothoe* and *Urothoides* from the Haustoriidae (BOUSFIELD, 1979; BARNARD & KARAMAN, 1983). On the other hand the genera *Amphiporeia*, *Bathyporeia*, *Pontoporeia* and *Priscillina* are still often considered as close relatives of *Haustorius* and its satellite genera. BARNARD & BARNARD (1983) added the genus *Zaramilla* to the Pontoporeiidae. However the systematic position of this poorly known genus described by STEBBING (1888) from the Austral Ocean seems highly questionable and could only be ascertained by the re-examination of actual specimens. BOUSFIELD (1965) has shown that there are profound differences between the *Haustorius* flock and other Pontoporeiidae. Therefore he divided the Haustoriidae sensu lato in two subfamilies: the Pontoporeiinae and the Haustoriinae. In more recent papers such as BOUSFIELD (1979, 1983) and BARNARD & BARNARD (1983) the Pontoporeiinae were re-elevated to the rank of family. However BOUSFIELD & BARNARD have opposite views concerning the suprafamilial position of these families and their phylogenetic affinities. Bousfield believed in a close phylogenetic relationship between the Pontoporeiidae and the Haustoriidae sensu stricto, while BARNARD did not. For instance, BOUSFIELD (1979) states "In most characters the family Haustoriidae seems readily derivable from the *Amphiporeia*-*Bathyporeia* branch of the family Pontoporeiidae" (without giving details on how they would be derivable) and BOUSFIELD & SHIH (1994) unite the Haustoriidae sensu stricto to the Pontoporeiidae in the superfamily Pontoporeioidea, in opposition to the superfamily Phoxocephaloidea, in which he put a large number of families of sand-dwelling amphipods. On the other hand, BARNARD & DRUMMOND (1982: 5) state: «We do not believe *Pontoporeia* and *Haustorius* are confamilial and we therefore remove *Pontoporeia* and its cohorts [from

Haustorioidea] to Gammaroidea» and on the next page, the same authors stress the major differences between the Haustoriidae and the Pontoporeiidae. Again BARNARD & DRUMMOND (1982: 7) state that “The pontoporeiids would appear to be the most primitive of the group [of Haustorioidea] but this is not to suggest that they are ancestral to the others. The differences are so strong that one may not conclude that any evolutionary flow has occurred between pontoporeiids and other haustorioid groups.” On page 10 they claim that “Haustoriids are probably the most specialized of haustorioids because of numerous specialized oddities in the mouthparts rarely encountered in other amphipods.”

In order to investigate the systematic position of the Stegocephalidae, BERGE et al. (2000), ran a cladistic analysis based on 150 species and 137 morphological binary characters, mostly extracted from literature data. In this study, the genera belonging to the Pontoporeioidea and the Phoxocephaloidea sensu BOUSFIELD & SHIH (1994) form a clade called ‘Clade 3’ by the authors. In the same study *Gammarus*, *Gammaracanthus*, *Gammarellus* and many Melitidae are grouped in the first dichotomy of the sister clade of Clade 3, called ‘Clade 4’ by the authors. However the melitid genus *Eriopisa* is grouped in the distant ‘Clade 1’ together with the caprellid and the domicolous amphipods. Since the study of BERGE et al. (2000) was not focused on the genera and families investigated here, a large number of relevant characters were not taken into consideration and the results of their analysis should therefore be considered with reserve, as the authors themselves recommend.

In a recent thesis, ENGLISCH (2001) studied the phylogenetic relationships between 76 amphipod species in using the DNA sequence coding for the mitochondrial RNA of the small ribosomal unit. She ran several analyses with different algorithms, resulting in different (but not totally dissimilar) trees. Her results are sometimes ambiguous or even puzzling (e.g. polyphyly of Ampeliscidae). One of her most interesting result is that the Oedicerotidae would be the sister taxon of all other amphipods. Unfortunately this does not help to understand the polarity of characters in amphipod evolution (that would have been useful here) because oedicerotids are evidently strongly apomorphic. Amongst the species treated by ENGLISCH there are several true Gammaridae: *Gammarus pulex* LINNAEUS, 1758; *Gammarus* cf. *salinus* SPOONER, 1947; *Gammarus troglophilus* HUBRICHT & MACKIN, 1940 and *Gammarus duebeni* LILJEBORG, 1851, one Eulimnogammaridae: *Eulimnogammarus obtusatus* (DAHL, 1938), one Acanthogammaridae: *Parapallasaea lagowskii* (DYBOWSKY, 1874), two Melitidae: *Paraceradocus gibber* ANDRES, 1984 and *Maera inaequipes* (COSTA, 1851), one Haustoriidae: *Haustorius arenarius* SLABBER, 1778; one Bathyporeiidae: *Bathyporeia pilosa* LINDSTRÖM, 1855, one Urothoidea: *Urothoe brevicornis* (BATE, 1862) and one Phoxocephalidae: *Fuegophoxus abjectus* BARNARD & BARNARD, 1980, one Gammarellidae: *Gammarellus homari* FABRICIUS, 1779, and three Calliopiidae including *Calliopiopsis laeviusculus* (KRØYER, 1838). In the various ENGLISCH analyses, *Bathyporeia* is either the sister taxon of the clade Gammaridae + Acanthogammaridae + Eulimnogammaridae (GAE), *Haustorius* being at the next

more exclusive level, or *Bathyporeia* forms a clade with *Haustorius*, which is the sister clade of GAE. All ENGLISCH's trees indicate that the Acanthogammaridae would be nested inside the Gammaridae. The position of *Urothoe* and *Fuegophoxus* is very variable from tree to tree but they are never extremely distant from the GAE + *Bathyporeia* + *Haustorius* (GAEBH). Usually *Urothoe* and *Fuegophoxus* are part of a larger terminal clade including GAEBH, the Niphargidae, the Crangonyctidae and sometimes some other families like the Gammarellidae (but never with the Melitidae which have a very basal position and seem polyphyletic).

3.2.2.2. Phylogenetic relationships between the genera *Bathyporeia*, *Amphiporeia*, *Pontoporeia* and *Priscillina*: a cladistic and empirical approach.

The question of the phylogeny of amphipods is immensely complex and the account given in section 3.2.1 gives only a glimpse of the problem. BARNARD & DRUMMOND (1978: 7) state that convergence is rampant in amphipods and that «Convergence and replication of evolutionary trends occur in numerous clusters otherwise remotely related to each other.» BERGE et al. (2000) add that “it is the high level of parallelism and/or convergence generally found within the Amphipoda, which has prevented amphipod taxonomists from constructing a stable and widely accepted classification based upon presumed phylogenetic relationships”. In the current state of confusion, it seems unrealistic to ascertain the precise phylogenetic position of the various amphipod groups in using morphological cladistic characters alone. However this method is used here in order to investigate 3 simpler questions:

- which genus is the sister taxon of *Bathyporeia*?
- which amphipods are likely to be close relatives of *Bathyporeia*?
- is there any evidence that the Pontoporeiidae include other genera than *Diporeia*, *Monoporeia* and *Pontoporeia*?

Unlike BERGE et al. (2000) who largely had to rely on literature data, only species that could be directly examined have been considered here, since published accounts are usually incomplete and often prove to be misleading. The number of species considered is also considerably less, being restricted to 28 (appendix 4). It was decided to include the genera traditionally included in the Pontoporeiidae (*Amphiporeia*, *Bathyporeia*, *Pontoporeia*, *Priscillina*), one haustoriid genus (*Haustorius*) because they were previously put in the Pontoporeiidae, one urothoid (*Urothoe*) and one phoxocephalid (*Phoxocephalus*) because their relationships with the Pontoporeiidae and the Haustoriidae are controversial (BARNARD & DRUMMOND, 1978, 1982 vs BOUSFIELD & SHIH, 1994), some basal domicolous amphipods (*Erichthonius*, *Gammaropsis* and *Unciola*) because BARNARD & BARNARD (1983) suspected they were the most primitive amphipods, one Oedicerotidae (*Paroediceros*) because in all the trees of ENGLISCH (2000) they are the sister clade of all other amphipods, and finally a wide range of rather unspecialized ‘gammaromorph’ amphipods (*Calliopiopsis*, *Echinogammarus*, *Eriopisa*, *Euxinia*, *Gammaracanthus*, *Gammarellus*, *Gammarus*, *Maera*, *Melita*, *Melphidippa*,

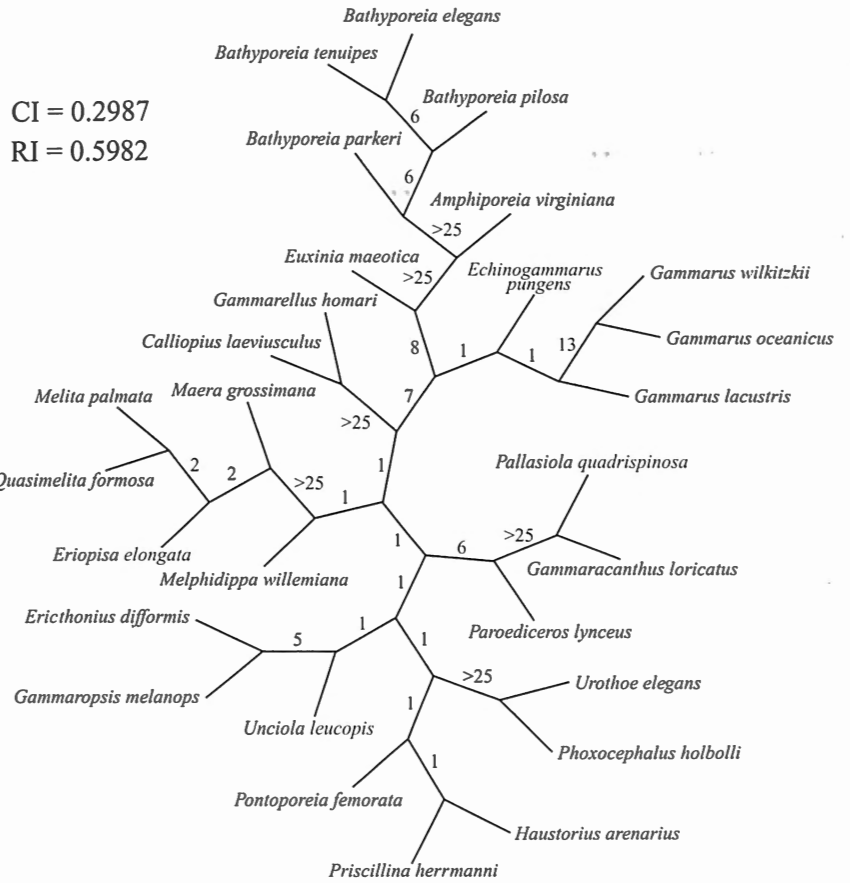

Fig. 46. Unrooted most parsimonious cladogram resulting from the cladistic analysis of 137 characters in 28 amphipod species. The decay index is indicated for each branch. It has not been calculated if higher than 25 because the computation time is exceedingly long.

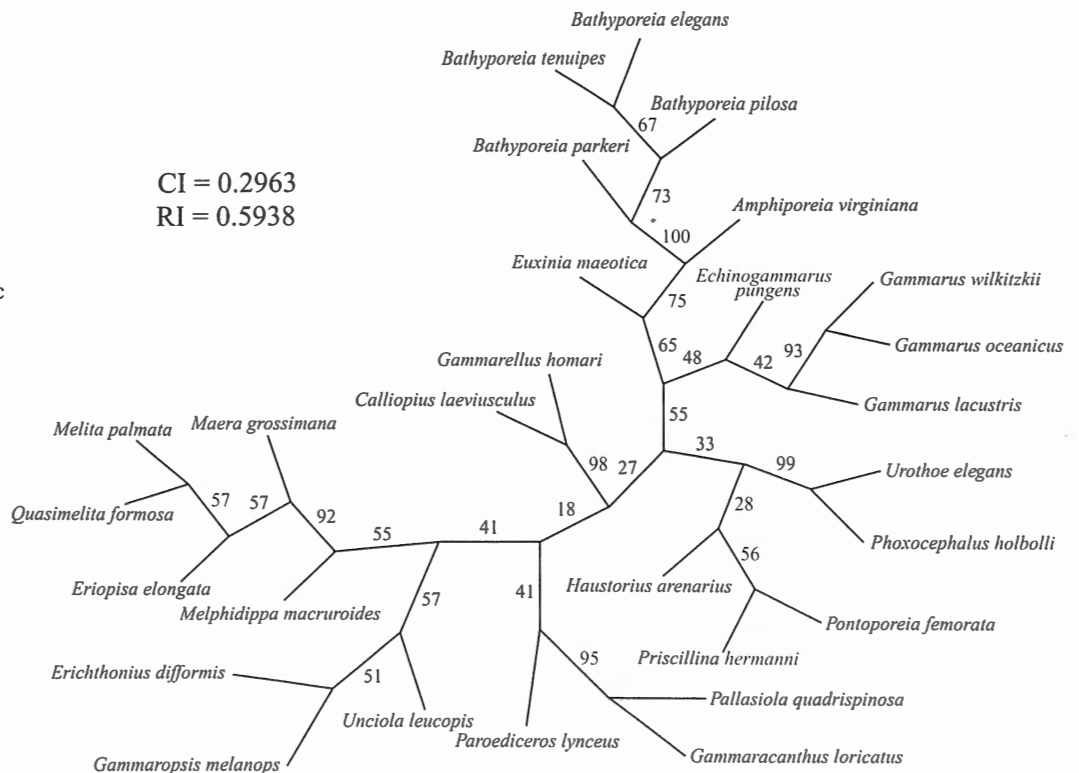

Fig. 47. Unrooted bootstrap tree resulting from the cladistic analysis of 137 characters in 28 amphipod species (1000 bootstrap replicates, 200 replicates in each bootstrap replicate, 50% majority rule consensus, sampling characters with equal probability but applying weights).

Pallasiola, *Quasimelita*).

The character sets consist of 137 unpolarised and freely reversible characters: 78 binary characters and 30 multistate ordered characters (Wagner optimisation) with 3 to 4 character states and 29 multistate unordered characters (Fitch optimisation) with 3 to 4 character states. Wagner optimisation has been used mostly for coding the transition between two well defined character states, rather than for coding true multistate character states. Therefore, the weight of the Wagner characters has been scaled so that the total influence of each character is the same, regardless of the number of states, as recommended by THIELE (1993) and SWOFFORD (1993). This weight is 6 for Fitch characters, 6 for binary Wagner character states, 3 for Wagner characters with 3 character states, 2 for Wagner characters with 4 character states. The morphology observed in the different taxa being often very different, it was not always easy to categorize them and in some cases alternative options would have been possible. Such problems are inescapable in this kind of study. A few characters are inapplicable for some species, such as characters of the second article of the outer ramus of U3 in species lacking this second ramus. There are no true missing data. The characters are described in appendix 3 and the matrix of characters is given in appendix 4.

A heuristic analysis of these 137 characters was run with the program PAUP 4.0b 10: Deltran, stepwise addition, random addition sequence, 1000 replicates, TBR branch swapping, MulTrees on. The analysis yields a single most parsimonious tree (fig. 46). The tree was not rooted because there are too many uncertainties and controversies concerning general evolutionary patterns in Amphipoda. Its ensemble consistency index (CI) is very low: 0.2992 and its ensemble retention index (RI) is not very high: 0.5994. The low ensemble consistency index confirms the empirical impression that the level of homoplasy is high. In other words, the existence of a single most parsimonious tree does not mean that the relationships between the taxa on the tree are highly supported. For each branch, the absolute value of the Bremer or decay index is indicated as an estimation of the support of the branches. The bootstrap tree (fig. 47) has also been computed (1000 bootstrap replicates, 200 replicates in each bootstrap replicate, 50% majority rule consensus, sampling characters with equal probability but applying weights). It is very similar but not identical to the most parsimonious tree. Differences between most parsimonious and bootstrap trees are interpreted topological instabilities in the most parsimonious tree.

The backspine of the most parsimonious tree is poorly resolved but some groupings appear as very strongly supported. *Calliopius* and *Gammarellus* form a strongly supported clade (decay index > 25; bootstrap = 97%). This is in agreement with the opinion of some authors like BOUSFIELD (1979, 1982) but conflicts with the trees of ENGLISCH (2001) where both genera are never very close to each other. The clustering of domicolous amphipods (*Erichthonius*, *Gammaropsis* and *Unciola*) is no surprise since previous cladistic analyses suggest they form a clade (MYERS & LOWRY, 2003). The bootstrap gives a much better support for the domicolous group (52%) than the decay index (value = 1). There is some support (decay index = 1; bootstrap = 63%)

for grouping *Melphidippa* and the Melitidae in a clade. This seems a priori not impossible but should not be accepted in the absence of further evidence.

Gammaracanthus and *Pallasiola* (both "gammaroids of Baikal type") form a very strongly supported clade (decay index > 25; bootstrap = 96%). This results from the shared occurrence of many unusual characters. In the most parsimonious and the bootstrap trees this clade is very distant from the 'classical' Gammaridae, the Pontogammaridae and the Bathyporeiidae. This result conflicts with the observations of SHERBAKOV et al. (1999), ENGLISCH (2001) and VÄINÖLA et al. (2001). Indeed the molecular data of these authors strongly suggest that the "gammaroids of Baikal type" would be close to the Gammaridae and that some of them would even be nested inside the Gammaridae. The highly specialized morphology of *Pallasiola* and *Gammaracanthus* may well have resulted in a spurious position in our cladogram. On the other hand it seems difficult to accept that the co-occurrence of many rare or unique characters in these two genera results from a parallel evolution. The clade *Gammaracanthus* + *Pallasiola* form an ambiguously supported clade together with *Paroedicerus* (Oedicerotidae): decay index = 6 (i.e. high value), but bootstrap = 35% (i.e. low value). This grouping probably results from superficial similarities and is presumably spurious. Indeed the cladistic analyses of molecular data by ENGLISCH (2001) and ENGLISCH et al. (2003) strongly suggest that the Oedicerotidae would be the sister clade of all other amphipods. Furthermore there is no empirical evidence that *Paroedicerus* would be related to *Gammaracanthus* and *Pallasiola*.

Bathyporeia appears as monophyletic, with a very strong support (decay index > 25; bootstrap = 100%), which is no surprise. Interestingly *B. parkeri* has a basal position in the genus *Bathyporeia*, as in most cladistic analyses including all *Bathyporeia* species (compare figs. 46-47 with figs. 14-18). *Bathyporeia* forms itself a strongly supported clade with *Amphiporeia* (decay index > 25; bootstrap = 80%), confirming the validity of the family Bathyporeiidae BOUSFIELD & SHIH, 1994.

There is rather high support (decay index = 8; bootstrap = 59%) for grouping together the Bathyporeiidae and the Pontogammaridae (represented here by *Euxinia maeotica*) in a clade. Of course it may be argued that they cluster together as a result of convergence but at least some distant relationships seem possible. The Bathyporeiidae and the Pontogammaridae have distinct biogeographical affinities. The first family is predominantly marine and is widely distributed in the Atlantic and the Mediterranean Sea (a single Atlanto-Mediterranean species, *Bathyporeia guilliamsoniana*, penetrates the non-brackish parts of the Black Sea). On the other hand, the natural range of the second family is restricted to the Pontocaspian area, where it dwells in brackish and fresh waters (BARNARD & BARNARD, 1983). If there is any real phylogenetic relationship between the Bathyporeiidae and the Pontogammaridae, it must be an ancient one since the Paratethys (the former inland sea occupying the Pontocaspian area) has been separated from the world oceans since the upper Miocene and it is only recently in the Lower Quaternary that both biogeographical areas have re-

entered in contact by the opening of the Bosphore (EKMAN, 1953).

The genus *Gammarus* form a very weakly supported clade and the same can be said for the group *Gammarus* + *Echinogammarus* (Gammaridae). On the other hand the constituents of the Gammaridae and the clade Bathyporeiidae + Pontogammaridae form themselves a moderately supported clade (decay index = 7; but bootstrap = only 48%), which can be referred as the 'gammaromorph gammaroids'. Actually it is very easy to derive *Bathyporeia* and *Amphiporeia* from the Gammaridae or the Pontogammaridae. Especially the P3, P4, P6, Ep1-Ep2, U1-U2 (and to a lesser extent U3) and the telson of the Bathyporeiidae are very similar to those of the Gammaridae and Pontogammaridae. In this context, it must be pointed out that the Bathyporeiidae and the Gammaridae have only partly overlapping biogeographical and ecological affinities. The Gammaridae are distributed throughout arctic and temperate parts of the northern hemisphere (freshwater, brackish water and very shallow marine waters) (BARNARD & BARNARD, 1983). The Bathyporeiidae are distributed in subarctic, temperate and tropical parts of North and South Atlantic and live in marine and brackish waters, never in freshwater (D'UDEKEM D'ACUZ, 2004; D'UDEKEM D'ACUZ & VADER, 2005b).

The gammaromorph gammaroids exhibit profound differences in the aforementioned appendages with *Haustorius*, *Pontoporeia* and *Priscillina*, and as a consequence they have distant positions on the trees. *Haustorius*, *Pontoporeia* and *Priscillina* form a very weakly supported clade (decay index = 1; bootstrap = 26%). Interestingly the relative position of these *Haustorius*, *Pontoporeia* and *Priscillina* is not the same on the most parsimonious and on the bootstrap tree. *Haustorius* and *Priscillina* clusters together on the most parsimonious tree with a low decay index (value = 1), whilst on the bootstrap tree *Priscillina* and *Pontoporeia* form a fairly well supported clade (bootstrap = 56%). The clade *Haustorius* + *Pontoporeia* + *Priscillina* forms itself a weakly supported clade with the clade *Phoxocephalus* + *Urothoe* (decay index = 1; bootstrap = 27%), here referred as the Phoxocephaloidea. *Phoxocephalus* and *Urothoe* strongly cluster together (decay index > 25; bootstrap = 100%), which is in agreement with the ideas of BARNARD & DRUMMOND (1978, 1982), BOUSFIELD (1979, 1982) and LINCOLN & HURLEY (1981) who consider the Phoxocephalidae and the Urothoidea as related. However this conflicts with the cladograms of ENGLISH (2001) where these 2 families never form a clade. While it is possible that *Haustorius*, *Pontoporeia* and *Priscillina* are phylogenetically not so distant from each other, their extreme morphological modification towards a fossorial way of life (considerably more important than in the Pontogammaridae and the Bathyporeiidae, and with alternative transformations of appendages) blurs their real affinities. Therefore it remains possible that they have all undergone a separate specialisation from a gammaroid or an immediate pre-gammaroid amphipod, despite the results of the present cladistic analysis, which must be considered with caution.

Concerning the genera previously included in the old haustoriid-pontoporeiid conglomerate, in my opinion, it seems preferable to consider morphologically homogeneous

clades as families, with the data currently at hand. So, the family Bathyporeiidae (including *Amphiporeia* and *Bathyporeia*) is accepted, the Haustoriidae are restricted to *Haustorius*-like amphipods (of the northern hemisphere), the Pontoporeiidae to the genera *Diporeia*, *Monoporeia* and *Pontoporeia* and the new family Priscillinidae fam. nov. is created for the highly characteristic genus *Priscillina*. The case of austral fossorial haustoriomorph genera has been discussed at length by BARNARD & DRUMMOND (1978, 1982) and TAYLOR & POORE (2001) and will not be reconsidered here. As stated above the Bathyporeiidae are reallocated to the superfamily Gammaroidea, as a consequence of our cladistic analyses. The superfamilial assignation of the morphologically very isolated families Haustoriidae, Pontoporeiidae and the Priscillinidae fam. nov. is problematic and the cladistic analyses do not suggest straightforward solutions. Since an empirical comparison between the Pontoporeiidae and the Priscillinidae fam. nov. indicates that they share a number of important morphological characters, and since they probably have a similar life cycle with a terminal non-feeding stage, they are kept together in the superfamily Pontoporeioidea. The most isolated Haustoriidae are retained in the superfamily Haustorioidea, which is now considered as monotypic. However there is little doubt that the position of the Haustoriidae, Pontoporeiidae and Priscillinidae fam. nov. will have to be reconsidered when new data will be available.

An interesting side result concerns the Melitidae. They form a strongly supported clade (decay index > 25; bootstrap = 93%) and are very distant from the Gammaridae. While the Melitidae are superficially similar to the Gammaridae, they exhibit profound differences in many details when they are carefully examined. The proportions and the ornamentation of the antennae are different, as is the size of the coxal plates 1-4. The posterior ornamentation of the basis 5-7 is different. The urosomites are dorsally typically toothed but normally without spines and setae. The peduncle of uropod 1 has almost always a single very long and strong ventrolateral spine in the Melitidae while the ornamentation is variable but always different in the Gammaridae and their relatives. Finally the third uropod lacks natatory plumose setae in melitids, which usually also have a very characteristic telson consisting of two arched lobes usually terminated in a strong tooth. These differences may explain the widely separated positions of the two families on the tree, which I do not consider as artefacts of computation. In classical literature such as STEBBING (1906), the Melitidae are not distinguished from the Gammaridae and this position is still accepted in some fairly recent books such as KARAMAN (1982). However, most current authors accept the opinion of BOUSFIELD (1979, 1982) who considers them as unrelated to the Gammaridae. This wide phylogenetic gap is supported by the molecular studies of ENGLISH (2001). According to the cladograms of the later author, the Melitidae are basal amphipods and the Gammaridae advanced one, despite their superficial similarity. However, according to her analysis the Melitidae would not be a monophyletic group, which strongly conflicts with our cladistic analysis of a morphological dataset. So the morphological similarity between the Gammaridae and the Melitidae would result from the unspecialized nature of their

character states, a rather similar free-living benthic way of life and probably does not reflect any close relationship. Many small but significant differences between two plesiomorphic lineages are more likely to reflect an ancient divergence than spectacular differences between a plesiomorphic and an apomorphic group. Indeed in the case of similar plesiomorphic groups there is no strong evolutionary pressure for differentiation, whilst a real shift of ecological niche requires strong and fast morphological modifications. This idea is supported by authors like KITCHING et al. (1998) who state, in referring to MAYR (1969), that characters of low adaptative value should be weighted higher than characters of high adaptative value. Actually the case of the plesiomorphic similar-looking families Gammaridae and Melitidae sharply contrasts with that of the apomorphic (fossorial) families Bathyporeiidae, Haustoriidae, Pontoporeiidae and Priscillinidae and their extravagant morphological divergences. The numerous small differences between the Gammaridae and the Melitidae can probably be interpreted with more confidence as ancient divergence than the profound differences of the second group of families. A classification scheme is proposed for the species used in the present cladistic analysis. It combines views generally adopted in recent literature and the results of this analysis that seem reliable. One can wonder if the allocation of *Gammaracanthus* and *Pallasiola* to separate families is justified since they share many putative synapomorphies. However since this problem is out of the scope of the present paper, their current standard familial assignation is retained.

Order Amphipoda

Superfamily Oedicerotoidea

Family Oedicerotidae

Paroedicerus lynceus (M. SARS, 1858)

Superfamily Melphidippoidea

Family Melphidippidae

Melphidippa willemania d'UDEKEM d'ACQZ, 2006

Superfamily Hadzioidea

Family Melitidae

Eriopisa elongata (BRUZELIUS, 1859)

Maera grossimana (MONTAGU, 1808)

Melita palmata (MONTAGU, 1804)

Quasimelita formosa (MURDOCH, 1866)

Superfamily Corophioidea

Family Photidae

Gammaropsis melanops G.O. SARS, 1879

Family Ischyroceridae

Ericthonius difformis H. MILNE-EDWARDS, 1830

Family Unciolidae

Unciola leucopis (KRØYER, 1845)

Superfamily Eusiroidea

Family Gammarellidae

Gammarellus homari (J.C. FABRICIUS, 1779)

Family Calliopiidae

Calliopiopus laeviusculus (KRØYER, 1838)

Superfamily Phoxocephaloidea

Family Phoxocephalidae

Phoxocephalus holbolli (KRØYER, 1842)

Family Urothoidae

Urothoe elegans (BATE, 1857)

Superfamily Pontoporeioidea

Family Pontoporeiidae

Pontoporeia femorata KRØYER, 1842

Family Priscillinidae fam. nov.

Priscillina herrmanni sp. nov.

Superfamily Haustorioidea

Family Haustoriidae

Haustorius arenarius (SLABBER, 1769)

Superfamily Gammaroidea

Family Pallaseidae

Pallasiola quadrispinosa G.O. SARS, 1861

Family Gammaracanthidae

Gammaracanthus loricatus (SABINE, 1821)

Family Gammaridae

Echinogammarus pungens H. MILNE EDWARDS, 1840

Gammarus oceanicus SEGERSTRÅLE, 1947

Gammarus wilkitzkii BIRULA, 1897

Gammarus lacustris G.O. SARS, 1863

Family Pontogammaridae

Euxinia maeotica (SOWINSKY, 1894)

Family Bathyporeiidae

Amphiporeia virginiana SHOEMAKER, 1933

Bathyporeia parkeri BOUSFIELD, 1973

Bathyporeia pilosa LINDSTRÖM, 1855

Bathyporeia tenuipes MEINERT, 1877

Bathyporeia elegans WATKIN, 1938

4. Conclusions

The genus *Bathyporeia* comprises twenty-one known valid species, of which nine have been described as new during the present revision of the genus. The alphataxonomic study has been difficult because some species are very close to each other, because many important diagnostic characters were not previously known and because there was considerable taxonomic confusion among Mediterranean species. More new species are to be expected from the tropical Eastern Atlantic which is a true 'mare incognita' for amphipods. The sister taxon of *Bathyporeia* is *Amphiporeia*. These two genera form the family Bathyporeiidae which is morphologically close to the Gammaridae and the Pontogammaridae. A sister relationship between the Bathyporeiidae and the haustoriid / pontoporeiid / priscillinid triad is not supported by a cladistic analysis of morphological characters. However morphological hyperspecialisation tends to blur the phylogenetic affinities of the last three families, and some degree of relationship between them and the Bathyporeiidae, the Gammaridae and the Pontogammaridae is therefore not precluded. Within the genus *Bathyporeia*, the American species are the most plesiomorphic species and they form a basal dichotomy with the species from the other side of the Atlantic. Cladistic analyses of morphological characters strongly suggest that in *Bathyporeia* evolution goes in the sense of an elongation of the second antennae in mature males. Therefore the case of *Bathyporeia* falsifies the hypothesis of BOUSFIELD & SHIH (1994) who considered that in amphipods the polarity of this character was always opposite.

5. Acknowledgements

I would like to express my most sincere acknowledgements towards Prof. Wim VADER (TMU), Dr. Ed BOUSFIELD (Ottawa) and Dr. Stefan Koenemann (Hannover) for their constructive and highly informative discussions during this study. Dr. Jørgen BERGE (UNIS) assisted me in learning how to use of the program PAUP, and he suggested me to use the decay index for assessing the support of clades in phylogenetic trees. Finally I would like to thank sincerely Dr. J.D. DUBICK (NOAA), Dr. David M. KNOTT (SRTC) Dr. Ed HENDRYCKS (CNMC), M. Sc. Marko HERRMANN (AWI), Dr. Gerhard POHLE (ARC), Mrs Judith PRICE (CNMC), Dr. Rafael LEMAITRE (USNM), Dr. Les WATLING (University of Maine), who kindly provided me with specimens of essential importance. Finally, I would like to thank Mrs Åse WILHELMSSEN (ZMO), who confirmed the identity of the syntypes of *Priscillina armata* for me.

6. References

- BARNARD, J.L., 1958. Index to the families, genera, and species of the gammaridean Amphipoda (Crustacea). *Allan Hancock Foundation Publications of the University of Southern California, Occasional Paper*, 19: 1-145.
- BARNARD, J.L., 1969. The Families and Genera of Marine Gammaridean Amphipoda. *United States National Museum Bulletin*, 271: i-vi + 1-535.
- BARNARD, J.L. & BARNARD, C.M., 1983. Freshwater Amphipoda of the world, I. Evolutionary patterns and II. Handbook and bibliography. Hayfield Associates, Mt. Vernon, Virginia, viii + 830 pp.
- BARNARD J.L. & DRUMMOND, M.M., 1978. Gammaridean Amphipoda of Australia, part III.: The Phoxocephalidae. *Smithsonian Contributions to Zoology*, 245: i-viii + 1-551.
- BARNARD, J.L. & DRUMMOND, M.M., 1982. Gammaridean Amphipoda of Australia, Part V: Superfamily Haustorioidea. *Smithsonian Contributions to Zoology*, 360: i-iv + 1-148.
- BARNARD, J.L. & KARAMAN, G.S., 1991. The Families and Genera of Marine Gammaridean Amphipoda (Except Marine Gammaroids). *Records of the Australian Museum*, Supplement 13: 1-866.
- BATE, C.S., 1856. On the British Edriophthalma. *Report of the British Association for the Advancement of Sciences, London*, twenty-fifth meeting, year 1855: 18-62 + pls. 12-22.
- BATE, C.S., 1857. A synopsis of the British Edriophthalmous Crustacea. Part. I. Amphipoda. *Annals and Magazine of Natural History*, ser. 2, 19: 135-152.
- BATE, C.S., 1862. Catalogue of the specimens of Amphipodous Crustacea in the collection of the British Museum. Printed by order of the trustees, London, iv + 399 pp. + 58 pls.
- BATE, C.S. & WESTWOOD, J.O., 1866-1868. A History of British sessile-eyed Crustacea. John VAN VOORST, London. Vol. 2, 536 pp.
- BELLAN-SANTINI, D., 1989. Genus *Bathyporeia*. In: RUFFO, S. (ed.), *The Amphipoda of the Mediterranean*, part 2, Gammaridea (Haustoriidae to Lysianassidae). *Mémoires de l'Institut Océanographique, Monaco*, 13: 365-380.
- BERGE, J., BOXSHALL, G. & VADER, W., 2000. Phylogenetic analysis of the Amphipoda, with special emphasis on the origin of the Stegocephalidae. *Polskie Archiwum Hydrobiologii*, 47 (3-4): 379-400.
- BOECK, A., 1861. Bemærkninger angaaende de ved de norske Kyster forekommende Amphipoder. *Forhandlinger ved de Skandinaviske Naturforskeres ottende Møde i Kjøbenhavn*, year 1860: 631-677.
- BOEK, A., 1871. Crustacea amphipoda borealia et arctica. *Forhandlinger i Videnskabs-Selskabet i Christiania*, year 1870: 83-280 + i-viii.
- BOECK, A., 1872. *De skandinaviske og arktiske amphipoder*. A. W. BRØGGER, Christiania, Første Hefte, 1 frontispiece + pp. 1-160 + pls. 1-7.
- BOECK, A., 1876. *De skandinaviske og arktiske amphipoder*. A. W. BRØGGER, Christiania, Andet Hefte, pp. i-iv + pp. 161-712 + pls. 8-31.
- BOUSFIELD, E.L., 1965. Haustoriidae of New England (Crustacea: Amphipoda). *Proceedings of the United States National Museum*, Vol. 117, Nr 3512: 159-239.
- BOUSFIELD, E.L., 1973. Shallow-water gammaridean Amphipoda of New England. Comstock Publishing Associates, a division of Cornell University Press, Ithaca & London, 1 frontispiece + xii pp. + 312 pp.
- BOUSFIELD, E.L., 1979. A revised Classification and Phylogeny of Amphipod Crustaceans. *Transactions of the Royal Society of Canada*, ser. 4, 16: 343-390.
- BOUSFIELD, E.L., 1982. Amphipoda. In: PARKER, S.S. (Ed.), *Synopsis and classification of living organisms*. McGraw-Hill Book Company, New York, pp. 254-293.
- BOUSFIELD, E.L., 1983. An updated phyletic classification and palaeohistory of Amphipoda. In: F.R. Schram (Ed.), *Crustacean Phylogeny*. Crustacean Issues Vol. 1, A.A. Balkema, Rotterdam, pp. 257-277.
- BOUSFIELD, E.L., 1989. Revised Morphological Relationships Within the Amphipod Genera *Pontoporeia* and *Gammaracanthus* and the "Glacial Relict" Significance of their Postglacial Distributions. *Canadian Journal of Fisheries and Aquatic Sciences*, 46: 1714-1725.
- BOUSFIELD, E.L. & SHIH, C.-T., 1994. The phyletic classification of amphipod crustaceans: problems in resolution. *Amphipacifica*, 1 (3): 76-134.
- BRUZELIUS, R.M., 1859. Bidrag till Kännedomen om Skandinaviens Amphipoda Gammaridea. *Kongliga Svenska vetenskaps-akademiens handlingar*, new series, 3 (1): 1-104 + pls. 1-4.
- CHARVAT, D.L., NELSON, W.G. & ALLENBAUGH, T.A., 1990. Composition and seasonality of sand-beach amphipod assemblages of the east coast of Florida. *Journal of Crustacean Biology*, 10 (3): 446-454.
- CHEVREUX, E. & FAGE, L., 1925. Amphipodes. *Faune de France*, 9, Paul Lechevalier, Paris: 1-488.
- CROKER, R.A., HAGER, R.P. & SCOTT K.J., 1975. Macrofauna of northern New England marine sand. II. Amphipod-dominated intertidal communities. *Canadian Journal of Zoology*, 53(1): 42-51.
- DANA, J.D., 1853. Crustacea, Part II. United States Exploring Expedition during the years 1838, 1839, 1840, 1841, 1842 under the command of Charles Wilkes, U. S. N., 14: 689-1618 (not seen).
- DELLA VALLE, A., 1893. Gammarini del Golfo di Napoli. *Fauna und Flora des Golfes von Neapel und angrenzenden Meeres-Abschnitte*, 20: i-xi + 1-948 + pls 1-68.
- DÖRJES, J. & HOWARD, J.D., 1975. Estuaries of the Georgia Coast, U.S.A.: Sedimentology and Biology. IV. Fluvial-Marine Transition Indicators in an Estuarine Environment, Ogeechee River - Ossabaw Sound. *Senckenbergiana maritima*, 7: 137-179.

- DOWNER, D.F. & STEELE, D.F., 1979. Some aspects of the biology of *Amphiporeia lawrenciana* Shoemaker (Crustacea, Amphipoda) in Newfoundland waters. *Canadian Journal of Zoology*, 57 (1): 257-263.
- EKMANN, S., 1913. Zwei neue europäische Arten der Amphipodengattung *Pontoporeia* KRÖYER. *Arkiv for Zoologi*, 8 (8): 1-13 + pls. 1-3
- EKMANN, S., 1953. Zoogeography of the Sea. Sidgwick & Jackson, London, xiv + 417 pp.
- ENGLISCH, U., 2001. Analyse der Phylogenie der Amphipoda (Crustacea, malacostraca) mit Hilfe von Sequenzen des Gens der RNA der kleinen ribosomalen Untereinheit. Dissertation zur Erlangung des Grades eines Doktors der Naturwissenschaften der Fakultät für Biologie der Ruhr-Universität Bochum, iv pp. + 155 pp. + 150 pp. (appendix).
- ENGLISCH, U., COLEMAN, C.O. & WÄGELE, J.W., 2003. First observations on the phylogeny of the families Gammaridae, Crangonyctidae, Melitidae, Niphargidae, Megalurotopidae and Oedicerotidae (Amphipoda, Crustacea), using small subunit rDNA. *Journal of Natural History*, 37 (20): 2461-2486.
- GLENNON, T.A., Jr., 1979. Description of the male of *Amphiporeia gigantea* Bousfield (Amphipoda, Haustoriidae). *Crustaceana*, 37 (3): 304-310.
- GURJANOWA [sic], E.[F.], 1930. Beiträge zur Fauna der Crustacea-Malacostraca des arktischen Gebietes. *Zoologischer Anzeiger*, 86: 231-248.
- GURJANOVA, E.F., 1951. Gammaridea of the seas of the U.S.S.R. and adjacent waters. *Akademiia Nauk SSSR, Opredeliteli po Faune SSSR*, 41: 1-1031 (in Russian).
- GURJANOVA, E.F., 1962. Gammaridean Amphipoda of the northern part of the Pacific Ocean. Part 1. *Akademiia Nauk SSSR, Opredeliteli po Faune SSSR*, 74: 1-440 (in Russian).
- HAGER, R.P. & CROKER, R.A., 1979. Macrofauna of Northern New England marine sand. IV. Infaunal ecology of *Amphiporeia virginiana* SHOEMAKER, 1933 (Crustacea: Amphipoda). *Canadian Journal of Zoology*, 57 (8): 1511-1519.
- HAGER, R.P. & CROKER, R.A., 1980. The sand-burrowing amphipod *Amphiporeia virginiana* SHOEMAKER 1933 in the tidal plankton. *Canadian Journal of Zoology*, 58 (5): 860-864.
- HANSEN, H.J., 1888. Malacostraca marina Groenlandiæ occidentalis. Oversigt over det vestlige Grønlands Fauna af malakostrake Havkrebssdyr. *Videnskabelige meddelelser fra dansk Naturhistorisk Forening, Kjøbenhavn*, year 1887: 5-226 + pls. 2-7 + 1 map.
- International Commission on Zoological Nomenclature, 1999. *International Code of Zoological Nomenclature, Fourth Edition adopted by the International Union of Biological Sciences*. The International Trust for Zoological Nomenclature, the Natural History Museum, London, xxix + 306 pp.
- KARAMAN, G.S., 1982. Family Gammaridae (sensu lato). In: RUFFO, S. (Ed.), *The Amphipoda of the Mediterranean*. Part 1. Gammaridea (Acanthonotozomatidae to Gammaridae). *Mémoires de l'Institut Océanographique, Monaco*, 13: 245-364.
- KITCHING, I.J., FOREY, P.L., HUMPHRIES, C.J. & WILLIAMS, D.M., 1998. *Cladistics*. Second edition. The theory and practice of parsimony analysis. Oxford Science publications, 228 pp.
- KRØYER, H.N., 1842. Nye nordiske Slægter og Arter af Amphipodernes Orden, henhørende til Familien Gammarina. *Naturhistorisk Tidsskrift*, 4: 141-166.
- KRØYER, H.N., 1845. Karcinologiske Bidrag. *Naturhistorisk Tidsskrift*, Kjøbenhavn, Ny Række, 1: 283-345 + 403 + 453-638 + pls. 1-3 + pls. 6-7 (not seen).
- KRØYER, H.N., 1846. Voyage de la commission scientifique du Nord ; en Scandinavie, en Laponie, au Spitsberg et aux Ferö, pendant les années 1838-1840, sur la corvette la Recherche, commandée par M. FABVRE. Publiés par ordre du Roi sous la direction de M. Paul GAIMARD. Atlas, plates 10-25.
- LILLJEBORG, W., 1865. On the *Lysianassa magellanica* H. Milne Edwards, and on the Crustacea of the suborder Amphipoda and subfamily Lysianassina found on the coast of Sweden and Norway. *Transactions of the scientific Society at Upsala (Nova Acta Regiae Societatis Scientiarum Upsaliensis)*, ser. 3, 6: 1-38 + pls. 1-5.
- LINCOLN, R.J., 1979. British Marine Amphipoda: Gammaridea. British Museum (Natural History), London, 1 frontispiece + 658 pp.
- LINCOLN, R.J. & HURLEY, D.E., 1981. The calceolus, a sensory structure of gammaridean amphipods (Amphipoda : Gammaridea). *Bulletin of the British Museum of Natural History (Zoology)*, 40: 103-116.
- MAYR, E., 1969. Principles of Systematic Zoology. McGraw-Hill Book Company: 1-428.
- MYERS, A.A. & LOWRY, J.K., 2004. A phylogeny and a new classification of Corophiidea Leach, 1814 (Amphipoda). *Journal of Crustacean Biology*, 23 (2): 443-485.
- NICOLAISEN, W., & KANNEWORFF, E., 1969. On the burrowing and feeding habits of the amphipods *Bathyporeia pilosa* Lindström and *Bathyporeia sarsi* Walker. *Ophelia*, 6: 231-250.
- SALVAT, B., 1967. La macrofaune carcinologique endogée des sédiments meubles intertidaux (Tanaidacés, Isopodes et Amphipodes), éthologie, bionomie, et cycle biologique. *Mémoires du Muséum national d'Histoire Naturelle, Paris*, sér. A, 45: 1-275.
- SARS, G.O., 1883. Oversigt af Norges Crustaceer med foreløbige Bemærkninger over de nye eller mindre bekendte Arter. I. (Podophthalmata - Cumacea - Isopoda - Amphipoda). *Forhandlinger i Videnskabs Selskabet i Christiania*, year 1882 (18): 1-124 + pls. 1-6.
- SARS, G.O., 1890-1895. *An account of the Crustacea of Norway, with short descriptions and figures of all the species. Vol. 1. Amphipoda*. Christiania and Copenhagen, published by Alb. Cammermeyer, 711 pp + pls. 1-240 + pls. i-viii.
- SARS, G.O., 1896. Crustacea Caspia. Contributions to the Knowledge of the carcinological Fauna of the Caspian Sea. Amphipoda. Supplement. *Bulletin de l'Académie Impériale des sciences de St.-Pétersbourg*, 4 (5): 421-489 + pls. 1-12.
- SHELLENBERG, A., 1942. Krebstiere oder Crustacea IV: Flohkrebse oder Amphipoda. *Die Tierwelt Deutschlands und der angrenzenden Meeresteile nach ihren Merkmalen und ihrer Lebensweise*, 40. Teil, Verlag von Gustav Fischer, Jena: i-iv + 1-252.
- SEGERSTRÅLE, S.G., 1937. Studien über die Bodentierwelt in südfinnländischen Küstengewässern III. Zur Morphologie und Biologie des Amphipoden *Pontoporeia affinis*, nebst einer Revision der *Pontoporeia*-Systematik. *Societas Scientiarum Fennica Commentationes Biologicae*, 7 (1): 1-183 + pls. 1-19.
- SEGERSTRÅLE, S.G., 1950. The amphipods on the coasts of Finland - some facts and problems. *Societas Scientiarum Fennica Commentationes Biologicae*, 10 (14): 1-28.
- SEGERSTRÅLE, S.G., 1959. Synopsis of Data on the Crustaceans *Gammarus locusta*, *Gammarus oceanicus*, *Pontoporeia affinis*, and *Corophium volutator* (Amphipoda Gammaridae). *Societas Scientiarum Fennica Commentationes Biologicae*, 20 (5): 3-23.
- SHERBAKOV, D. YU., KAMALTYNOV, R.M., OGARKOV, O.B., VÄINÖLA, R., VAINO, J.K. & VERHEYEN, E., 1999. On the phylogeny of Lake Baikal amphipods in the light of mitochondrial and nuclear DNA sequence data. *Crustaceana*, 72 (8): 911-919.

- SHOEMAKER, C.R., 1929. A new genus and species of amphipod from the Grand Manan, N.B. *Proceedings of the Biological Society of Washington*, 42: 167-170.
- SHOEMAKER, C.R., 1930. The Amphipoda of the Cheticamp Expedition of 1917. *Contributions to Canadian Biology and Fisheries*, 5 (10): 221-359.
- SHOEMAKER, C.R., 1933. A new amphipod of the genus *Amphiporeia* from Virginia. *Journal of the Washington Academy of Sciences*, 23 (4): 212-216.
- SHOEMAKER, C.R., 1949. Three new species and one new variety of amphipods from the bay of Fundy. *Journal of the Washington Academy of Sciences*, 39 (1): 389-394.
- SMITH, E.N. & GUTBERLET, R.L., JR., 2001. Generalized Frequency Coding: A Method of Preparing Polymorphic Multistate Characters for Phylogenetic Analysis. *Systematic Biology*, 50 (2): 156-169.
- STEBBING, T.T.R., 1888. Report on the Amphipoda collected by H.M.S. Challenger during the years 1873-1876. *Report on the Scientific Results of the Voyage of H.M.S. Challenger during the years 1873-76*, Zoology, 29: i-xxiv + 1-1737 + pls 1-210.
- STEBBING, T.T.R., 1906. Amphipoda 1: Gammaridea. Das Tierreich, 21, Verlag von R. FRIEDLÄNDER und Sohn, Berlin, xxxix + 806 pp.
- STEELE, D.H. & STEELE, V.J., 1978. Some aspects of the biology of *Pontoporeia femorata* and *Pontoporeia affinis* (Crustacea, Amphipoda) in the northwestern Atlantic. *Astarte*, 11 (2): 61-66.
- STEPHENSON, K., 1925. Crustacea Malacostraca. VI. (Amphipoda. II.). *The Danish Ingolf-Expedition*, 3 (9): 101-180.
- STEPHENSON, K., 1928. *Storkrebs II. Ringkrebbs 1. Tanglopper (Amfipoder)*. Danmarks Fauna, 32, G.E.C. Forlag, København: 1-399.
- STEPHENSON, K., 1929. *Amphipoda*. Tierwelt der Nord- und Ostsee, 14 X. f: 1-188.
- SWOFFORD, D.L. & OLSEN, D.P., 1993. PAUP: Phylogenetic Analysis Using Parsimony, Version 3.1. User's Manual. Illinois Natural History Survey, Champaign, Illinois, 280 pp.
- TAYLOR, J. & POORE, G.C.B., 2001. Descriptions of a new species of *Birubius* (Amphipoda: Phoxocephalidae) from Australia and Papua New Guinea with comments on the *Birubius-Kulgaphoxus-Tickalerus-Yan* complex. *Memoirs of Museum Victoria*, 58 (2): 255-295.
- THIELE, K., 1993. The holy grail of the perfect character: the cladistic treatment of morphometric data. *Cladistics*, 9: 275-304.
- UDEKEM D'ACCOZ, C. D', 2004. The genus *Bathyporeia* Lindström, 1855 in Western Europe (Crustacea, Amphipoda, Pontoporeiidae). *Zoologische Verhandelingen, Leiden*, 348: 1-162.
- UDEKEM D'ACCOZ, C. D' & BERGE, J., 2003. Vestigial structures in pontoporeiid and stegocephalid amphipods (Crustacea, Amphipoda, Gammaridea). *Bulletin de l'Institut royal des Sciences Naturelles de Belgique, Biologie / Bulletin van Het Koninklijk Belgisch Instituut voor Natuurwetenschappen, Biologie*, 73: 107-113.
- UDEKEM D'ACCOZ, C. D', ECHCHAOU, H.M.C. & MENIOU, M., 2006. Further observations on North African and South Iberian *Bathyporeia*, with the description of a new species. *Contribution to Zoology*, 74(3/4) [year 2005]: 279-300.
- UDEKEM D'ACCOZ, C. D' & MENIOU, M., 2004. On 3 new *Bathyporeia* from the Atlantic coasts of North Africa (Crustacea, Amphipoda, Pontoporeiidae). *Cahiers de Biologie Marine*, 45: 175-195.
- UDEKEM D'ACCOZ, C. D' & VADER, W., 2004. Case 3311. *Bathyporeia elegans* Watkin, 1938 (Crustacea, Amphipoda): proposed conservation. *Bulletin of Zoological Nomenclature*, 61 (3): 162-164.
- UDEKEM D'ACCOZ, C. D' & VADER, W., 2005a. New records of West and South African *Bathyporeia*, with the description of four new species and a key to all the species of the genus (Crustacea, Amphipoda). *Journal of Natural History*, 39 (30): 2759-2794.
- UDEKEM D'ACCOZ, C. D' & VADER, W., 2005b. The Mediterranean *Bathyporeia* revisited (Crustacea, Amphipoda, Pontoporeiidae), with the description of a new species. *Bollettino del Museo Civico di Storia Naturale, Verona*, 29: 3-38.
- VADER, W., 1965. Intertidal distribution of haustoriid amphipods in the Netherlands. Proceedings of the Fifth Marine Biological Symposium, Göteborg 1965. *Botanica Gothoburgensia*, 3: 233-246.
- VÄINÖLÄ, R., 1990. Molecular time scales for evolution in *Mysis* and *Pontoporeia*. *Annales Zoologici Fennici*, 27: 211-214.
- VÄINÖLÄ, R. & VARVIO, S.-L., 1989. Molecular divergence and evolutionary relationships in *Pontoporeia* (Crustacea: Amphipoda). *Canadian Journal of Fisheries and Aquatic Sciences*, 46: 1705-1713.
- VÄINÖLÄ, R., VAINO, J.K. & PALO, J.U., 2001. Phylogeography of "glacial relict" *Gammaracanthus* (Crustacea, Amphipoda) from boreal lakes and the Caspian and White seas. *Canadian Journal of Fisheries and Aquatic Sciences*, 58: 2247-2257.
- WATKIN, E.E., 1938. A revision of the amphipod genus *Bathyporeia* Lindström. *Journal of the marine biological Association of the United Kingdom*, 23: 211-236.
- WATKIN, E.E., 1939. The pelagic phase in the life history of the amphipod genus *Bathyporeia*. *Journal of the marine biological Association of the United Kingdom*, 23: 467-481.
- WIENS, J.J., 1995. Polymorphic Characters in Phylogenetic Systematics. *Systematic Biology*, 44 (4): 482-500.

Appendix 1

Characters used for cladistic analyses of the species of the genus *Bathyporeia*. Binary characters are the same in all analyses (they include naturally binary characters and binarized continuous characters). Other characters are coded as multistate for most analyses but are binarized for an alternative analysis. The conversion rule is given for these characters. The weight (W) of each state change in the multistate analysis is given for each character (see text for details). In the binary analysis, the weight of any change is always one.

- [1] Ommatidia, number; true binary character; states: (0) normal; (1) reduced. W = 840. N.B: in *B. gracilis* the development of ommatidia is imperfect, but their number is normal. *B. gracilis* has therefore been scored as 'normal'.
- [2] Ratio in pseudorostrum, height at insertion of 2nd article / maximum height in females; 4 ordered character states: (0) <0.50; (1) [0.50-0.60]; (2) [0.60-0.70]; (3) ≥0.70. W = 280. Binary conversion: "0" = (0) + (1); "1" = (2) + (3).
- [3] Article 1 of peduncle of A1 (pseudorostrum), angularity; 4 ordered character states: (0) regularly rounded; (1) barely angular; (2) angular; (3) acute. W = 280. Binary conversion: "0" = (0) + (1); "1" = (2) + (3).
- [4] Article 1 of peduncle of A1 (pseudorostrum), rate of overhanging; 4 ordered character states: (0) not overhanging; (1) barely overhanging; (2) moderately overhanging; (3) strongly overhanging. W = 280. Binary conversion: "0" = (0) + (1); "1" = (2) + (3). The individual variability is not very high.
- [5] A1 in male, ratio length of flagellum + articles 2-3 of peduncle / length of article 1; 7 ordered character states: (0) <1.30; (1) [1.30-1.50]; (2) [1.50-1.70]; (3) [1.70-1.90]; (4) [1.90-2.10]; (5) [2.10-2.30]; (6) ≥2.30. W = 140. Binary conversion: "0" = (0) + (1) + (2) + (3); "1" = (4) + (5) + (6).
- [6] A1 accessory flagellum, lateral spines; true binary character: (0) absent; (1) present. W = 840.
- [7] A1 major flagellum in mature males, ratio length/width; binarized character; states: (0) <0.90; (1) >1.4. W = 840. The individual variability of this ratio is high and it is difficult to measure with precision. However in a few species it has definitely an unusually high value and therefore two character states have been recognized.
- [8] A2 in mature males, ratio length of flagellum / combined length of peduncle articles; 5 ordered character states: (0) <1; (1) [1-2]; (2) [2-3]; (3) [3-4]; (4) ≥4. W = 210. Binary conversion: "0" = (0); "1" = (1) + (2) + (3) + (4). The individual variability is not very high. No species exhibits the character state (1).
- [9] Md palp in males, number of stiff hairs on ventral border of last article; 3 ordered character states: (0) 1-5; (1) 6-7; (2) ≥8. W = 420. Binary conversion: "0" = (0) + (1); "1" = (2). The individual variability of this character is high. However in a few species the number of stiff setae is definitely low.
- [10] Md palp, ratio length / width of second article; 3 ordered character states: (0) <3.0; (1) [3.0-3.5]; (2) ≥3.5. W = 420. Binary conversion: "0" = (0) + (1); "1" = (2). The ratios are based on (a) female(s), except for *B. microceras* for which mandible data are known for one male only. This character does not seem to be sexually dimorphic. The apparent individual variability is significant. It is probably not real and would result from orientation artefacts on microscopic slides.
- [11] Md palp, ratio length / width of second article; binarized character; states: (0) <4; (1) >4. W = 840.
- [12] Lacinia mobilis in left and right mandible; true binary character; states: (0) very different, (1) identical or nearly so. W = 840.
- [13] Mxp palp penultimate article. row of longitudinal dorsal setae (sometimes reduced to a single seta); binarized character; states: (0) present at least in some individuals; (1) absent. W = 840. *B. microceras* is known by 2 specimens only, there is 0 seta in the male and 1 in the juvenile which is presumably a female.
- [14] Mxp palp antepenultimate article, number of setae on dorsal surface; binarized character; states: (0) <5; (1) ≥5. W = 840.
- [15] Coxa 1-4 setation; binarized character; states: (0) reduced; (1) not reduced. W = 840.
- [16] Coxa 1, ornamentation of ventral border; 3 ordered character states: (0) nothing; (1) notch at least in some individuals; (2) tooth. W = 420.
- [17] Coxa 1, ratio length / minimal median width; 4 ordered character states: (0) <3.0; (1) [3.0-3.5]; (2) [3.5-4.0]; (3) ≥4.0. W = 280. Binary conversion: "0" = (0) + (1); "1" = (2) + (3).
- [18] Coxa 1, anteroventral angularity; binarized character; states: (0) present (sometimes weak); (1) absent. W = 840.
- [19] Coxae 2-3, occurrence of irregular-sized setae, some of them being unusually strong and other slender; binarized character; states: (0) no; (1) yes. W = 840.
- [20] Coxa 2, ornamentation of posteroventral angle; 4 ordered character states: (0) nothing; (1) notch; (2) small tooth; (3) strong tooth. W = 280. Binary conversion: "0" = (0) + (1); "1" = (2) + (3). In *Bathyporeia griffithsi*, the 3 first character states have been observed. The species is coded as having a notch (i.e. the intermediate character state).
- [21] Coxa 2, ratio length / width; 5 ordered character states: (0) <1.30; (1) [1.30-1.40]; (2) [1.40-1.50]; (3) [1.50-1.60]; (4) ≥1.60. W = 210. Binary conversion: "0" = (0) + (1) + (2); "1" = (3) + (4).
- [22] Coxa 2 shape; true binary character; states: (0) quadrate to rounded; (1) trapezoid. W = 840.
- [23] P3-P4, carpal fang shape; true binary character; states: (0) entire; (1) bifid. W = 840. *B. gracilis* has been coded as having an entire carpal fang but in one case we found a bifid one. *Gammarus oceanicus* has several spines at the position where the carpal fang does occur in *Bathyporeia* and the carpal fang presumably derives of one of them. Therefore the character state of these spines observed in *G. oceanicus* has been scored as if they were carpal fangs.
- [24] P3-P4, carpal fang, apical profile; true binary character; states: (0) blunt; (1) acute. W = 840. For the scoring of *Gammarus oceanicus*, see character [24].
- [25] Ratio length of propodus of P3 / propodus of P4; binarized character; states: (0) <1.10, (1) >1.10. W = 840. This character has been difficult to detect because the propodus of P3 and P4 are very similar. However it is significant, since it opposes the group *tenuipes* to almost all other species.
- [26] P3, ratio length of carpal fang / length of propodus; 3 ordered character states: (0) <0.80, (1) [0.80-0.90]; (2) ≥0.90. W = 420. Binary conversion: "0" = (0); "1" = (1) + (2).
- [27] P3, ratio length of ultimate outer spine / length of propodus; 4 ordered character states: (0) [0.10-0.20]; (1) [0.20-0.30]; (2) [0.30-0.40]; (3) ≥0.40. W = 280. Binary conversion: "0" = (0) + (1); "1" = (2) + (3).
- [28] P3, ratio length of ultimate outer spine / penultimate outer spine; binarized character; states: (0) <1.80; (1) >1.80. W = 840.
- [29] P4, ratio length of propodus / length of merus; 3 ordered character states: (0) <0.70; (1) [0.70-0.80]; (2) ≥0.80. W = 420. Binary conversion: "0" = (0); "1" = (1) + (2).
- [30] P4, ratio dactylus length / propodus length; 6 ordered character states: (0) <0.25; (1) [0.25-0.30]; (2) [0.30-0.35]; (3) [0.35-0.40]; (4) [0.40-0.45]; (5) ≥0.45. W = 168. Binary conversion: "0" = (0) + (1) + (2); "1" = (3) + (4) + (5).
- [31] P3, ratio dactylus.length / dactylus width; 5 ordered character states: (0) <3.0; (1) [3.0-3.5]; (2) [3.5-4.0]; (3) [4.0-4.5]; (4) ≥4.5. W = 210. Binary conversion: "0" = (0) + (1); "1" = (2) + (3) + (4).
- [32] P3, ratio unguis length / dactylus length (unguis included); 6 ordered character states: (0) <0.25; (1) [0.25-0.30]; (2) [0.30-0.35]; (3) [0.35-0.40]; (4) [0.40-0.45]; (5) ≥0.45. W = 168. Binary conversion: "0" = (0) + (1) + (2); "1" = (3) + (4) + (5).
- [33] P3-P4 dactylus, occurrence of a seta on posterior border near the basis of unguis; true binary character; states: (0) yes; (1) no. W = 840.
- [34] P5 and/or P6, occurrence of very short conical spines on posterior border of basis; true binary character; states: (0) no; (1) yes. W = 840. The outgroup *Gammarus oceanicus* has this kind of spines but on the anterior border of the basis (instead of on posterior border); it has therefore been scored as lacking the character state 'occurrence of conical spines'.
- [35] P5, anterior border of basis shape; 4 ordered character states: (0) strongly convex; (1) convex; (2) weakly convex; (3) straight. W = 280. Binary conversion: "0" = (0) + (1); "1" = (2) + (3). This character is very continuous and some individual variations are observed. In *B. elkaimi* and *B. watkini* it varies between 'straight' and 'weakly convex'. They have been scored as weakly convex, which is the less derived condition and therefore the less likely to cause spurious effects.

- [36] P5, ratio length/width of merus; binarized character; states: (0) <1.90; (1) ≥ 1.90 . W = 840. The intraspecific variability of this character is significant and does not allow a finer subdivision in a higher number of character states.
- [37] P5, ratio in median seta group, length of longest accessory seta / length of major seta; 4 ordered character states: (0) <0.30; (1) [0.30-0.50]; (2) [0.50-0.70]; (3) ≥ 0.70 . W = 280. Binary conversion: "0" = (0) + (1); "1" = (2) + (3). The average value of this ratio exhibits significant differences between species but its individual variability is also fairly high.
- [38] P5, posterodistal group of spines of merus, number of spines or strong setae; true binary character; states: (0) several; (1) one. W = 840.
- [39] P5, posterodistal group of spines of merus, extreme shortening of strong seta(e)/spine(s) in males when reaching maturity; true binary character; states: (0) no; (1) yes. W = 840.
- [40] P5, posterodistal group of spines of merus, spine(s) / strong seta(e) short in both sexes, both in mature and immature individuals; true binary character; states: (0) yes; (1) no. W = 840.
- [41] P6, symmetry of basis; 4 ordered character states: (0) strongly asymmetrical; (1) asymmetrical; (2) nearly symmetrical; (3) symmetrical. W = 280. Binary conversion: "0" = (0); "1" = (1) + (2).
- [42] P6 carpus, occurrence of spines on posterior border (distal group of spines excluded); considered as a true binary character: (0) present in all or most individuals; (1) always absent. W = 840. In large *B. pilosa* there is one group of spines in 80% of individuals and the species has therefore been scored as having spines.
- [43] P6, ratio length of longest dorsal spine/seta of merus / dorsal length of carpus; 3 ordered character states: (0) <0.45; (1) [0.45-0.70]; (2) ≥ 0.70 . W = 420. Binary conversion: "0" = (0); "1" = (1) + (2). The difference between the forma A and B of *B. elegans* has been checked in a number of specimens and it is a genuine one.
- [44] P7, posterodistal concavity of basis; 5 ordered character states: (0) absent; (1) weak; (2) distinct; (3) strong; (4) very strong. W = 210. Binary conversion: "0" = (0) + (1) + (2); "1" = (3) + (4).
- [45] P7, symmetry of borders of basis; 4 ordered character states: (0) (sub)symmetrical; (1) weakly asymmetrical; (2) distinctly asymmetrical; (3) strongly asymmetrical. W = 280. Binary conversion: "0" = (0) + (1); "1" = (2) + (3).
- [46] P7, length of median spines/setae of posterior border of basis; 6 ordered character states: (0) extremely short; (1) very short; (2) short; (3) fairly short; (4) long; (5) very long. W = 168. Binary conversion: "0" = (0) + (1) + (2); "1" = (3) + (4) + (5).
- [47] P7, robustness of median spines/setae of posterior border of basis; 5 ordered character states: (0) very slender; (1) slender; (2) fairly strong; (3) strong; (4) very strong. W = 210. Binary conversion: "0" = (0) + (1) + (2); "1" = (3) + (4).
- [48] P7, ratio length width of triangular anterior protrusion of ischium; 4 ordered character states: (0) <0.40; (1) [0.40-0.50]; (2) [0.50-0.60]; (3) >0.60. W = 280. Binary conversion: "0" = (0) + (1); "1" = (2) + (3).
- [49] P7, ratio length/width of merus; 4 ordered character states: (0) <1.70; (1) [1.70-1.90]; (2) [1.90-2.10]; (3) ≥ 2.10 . W = 280. Binary conversion: "0" = (0) + (1); "1" = (2) + (3).
- [50] P7, number of groups of spines/setae on posterior border of carpus (apical group excluded); 7 ordered character states: (0) 1 group in 100% of specimens examined; (1) 2 groups in up to 33% of specimens; (2) 2 in up to 66%; (3) 2 in up to 100%; (4) 3 in up to 33%; (5) 3 in up to 66%; (6) 3 in up to 100% or 4. W = 140. Binary conversion: "0" = (0); "1" = (1) + (2) + (3) + (4) + (5) + (6).
- [51] Ep1, middle of posterior border; 4 ordered character states: (0) blunt to barely angular; (1) angular; (2) very angular; (3) produced in a tooth. W = 280. Binary conversion: "0" = (0) + (1); "1" = (2) + (3). In *B. watkini* it varies between angular and barely angular; it has been scored as angular which is the less derived condition.
- [52] Ep2 ornamentation; true binary character; states: (0) spines only or setae and spines; (1) setae only. W = 840.
- [53] Ep2, middle of posterior border; binarized character; states: (0) not produced in a tooth; (1) produced in a tooth. W = 840.
- [54] Ep3, posteroventral angle; true binary character; states: (0) produced in a tooth (at least in young); (1) never produced in a tooth. W = 840.
- [55] Ep3, disposition of ventrolateral spines; binarized character; states: (0) not rowed; (1) rowed. W = 840.
- [56] Ep3, number of ventrolateral spines; 3 ordered character states: (0) low; (1) medium; (2) high. W = 420. Binary conversion: "0" = (0) + (1); "1" = (2).
- [57] Dorsal spination of urosomite 1 in adult males; 5 ordered character states: (0) none; (1) sometimes 1 pair; (2) usually 1 pair; (3) usually 2-4 pairs; (4) usually 5 pairs or more. W = 210. Binary conversion: "0" = (0) + (1) + (2); "1" = (3) + (4). This character is important but cannot be coded in a fully satisfactory way because there is a wide range of patterns. The conditions can be different in each sex (more spines in males). Hence only males are here considered. The spination pattern can be polymorphic in the same species. The spines can be either similar-sized or consisting of large and reduced spines. The spines can be normal or setiform. The present coding system is therefore a compromise.
- [58] Urosomite 1, occurrence of a spine just above the insertion of the uropod; true binary character; states: (0) no; (1) yes. W = 840.
- [59] Urosomite 1, occurrence of one or several ventrolateral spine(s); considered as a true binary character; states: (0) yes in all or most individuals; (1) never. W = 840. In *B. sarsi* there is one or several spines in 80% of individuals. In other species the spine(s) is/are always either present or absent.
- [60] Urosomite 3, occurrence of dorso-postero-lateral spines (on sides of telson insertion); true binary character; states: (0) yes; (1) no. W = 840. These spines should not be confused with the dorso-postero-medial spines (in front of the cleft of telson).
- [61] Uropod 1, length of proximal spines/setae of outer dorsal border of peduncle; 3 character states; states: (0) strong and short; (1) slender and fairly long; (2) slender and long. W = 420. Binary conversion: "0" = (0); "1" = (1) + (2).
- [62] Uropods 1-2, number of large spines on outer border of inner rami; true binary character; states: (0) two or more; (1) only one. W = 840.
- [63] Uropod 3, usual number of groups of spines/setae (a group may consist of a single spine/seta) on outer border of peduncle; 7 ordered character states: (0) 0-1; (1) 1 or 2 (25-75% with 2); (2) usually 2 (2 in more than 75%, 3 in less than 25%); (3) 2 or 3 (25-75% with 3); (4) usually 3 (3 in more than 75%, 4 in less than 25%); (5) 3 or 4 (25-75% with 4); (6) 4 in more than 75% or more than 4. W = 140. Binary conversion: "0" = (0); "1" = (1) + (2) + (3) + (4) + (5) + (6).
- [64] Uropod 3, shape of endopod; binary character; states: (0) elongate; (1) broadly elliptic. W = 840.
- [65] Uropod 3, spines/setae on outer border of second article; considered as a true binary character; states: (0) always absent; (1) present in all or most individuals. W = 840.
- [66] Uropod 3, usual occurrence of a well developed accessory spine associated with several non-distal setae of medial border of first article of exopod; binarized character; states: (0) yes; (1) no. W = 840. In the very small species *B. borgi* and *B. nana*, this character applies to males only. Indeed in those species the third uropods are sexually dimorphic and have a strongly reduced seta pattern in females.
- [67] Uropod 3, number of strong accessory spine on distal medial angle of first article of exopod; binarized character: (0) several; (1) 0-1. W = 840.
- [68] Uropod 3, ratio length of longest accessory spine (whatever its position) / width of endopod; 4 ordered character states: (0) <0.50; (1) [0.50-1.00]; (2) [1.00-1.50]; (3) ≥ 1.50 . W = 280. Binary conversion: "0" = (0) + (1); "1" = (2) + (3). The length of the longest accessory spine is rather variable within species.
- [69] Uropod 3, ratio length of second article / length of first article, 6 ordered character states: (0) <0.25; (1) [0.25-0.30]; (2) [0.30-0.35]; (3) [0.35-0.40]; (4) [0.40-0.45]; (5) ≥ 0.45 . W = 168. Binary conversion: "0" = (0) + (1) + (2); "1" = (4) + (5).
- [70] Uropod 3 ratio width of second article / width of first article; binarized character: (0) <0.30; (1) >0.30. W = 840.

Appendix 2

Primary matrix of characters used for the cladistic analyses of the genus *Bathyporeia*: 25 taxa, 70 Wagner multistate and binary characters. The characters are described in the text. The characters and character states are described in appendix 1. This appendix 1 also includes the rules of conversion for obtaining the strictly binary matrix. In *B. microceras*, the character 51 is missing because the first epimeral plate is damaged in the specimens examined. In *B. quoddyensis*, most characters present in mature males only are missing because no males were available for study.

0000000011111111222222223333333344444444555555556666666677
123456789012345678901234567890123456789012345678901234567890

Gammarus oceanicus SEGERSTRÅLE, 1947 (outgroup 1):
00006000210001010001400000004030011100000001203300000040000000000000
Amphiporeia virginiana Shoemaker, 1933 (outgroup 2):
000020102000010000004001011001210000000300031002000011000101060010251
Bathyporeia borgi D'UDEKEM D'ACOZ & VADER, 2005:
020001040211101021012001110134310211101111004112111010020010131001141
Bathyporeia chevreuxi D'UDEKEM D'ACOZ & VADER, 2005:
030311042211101121131010000152410000100300013233611011230011141101031
Bathyporeia cunctator D'UDEKEM D'ACOZ & VADER, 2005:
031211042211101111311010100153410002100300014123311011230012141101041
Bathyporeia elegans WATKIN, 1938 forma A:
0111210422110112200230011200134210312101211302312331111220110131001331
Bathyporeia elegans WATKIN, 1938 forma B:
0222110422110112200230011200224110312101212302312431111220110141101331
Bathyporeia elkaimi D'UDEKEM D'ACOZ & MENIOU, 2004:
02002110111110000010102104351020010101202412112101110011012111031
Bathyporeia gladiura D'UDEKEM D'ACOZ & VADER, 2005:
0100310012011010200010103100021031010121112331300101000011010111051
Bathyporeia gracilis G.O. SARS, 1891:
0202110012111011310330011110224010310101102314132311011230011161001131
Bathyporeia griffithsi D'UDEKEM D'ACOZ & VADER, 2005:
0100310421110110300130011110124010210101211103302301011030110121011041
Bathyporeia guilliamsoniana (BATE, 1857), West Europe:
0111210422110012100220011100213210313111312115020621001220110061111031
Bathyporeia guilliamsoniana (BATE, 1857), Mediterranean:
0211210422110112100230011100113210312111312105030611001220110051111031
Bathyporeia ledoyeri D'UDEKEM D'ACOZ & MENIOU, 2004:
0111610300010010200020101021133010310101312104133311011120110131011021
Bathyporeia lindstromi STEBBING, 1906:
032311042211101111301010000152410001100300113232411011230012141101041
Bathyporeia microceras D'UDEKEM D'ACOZ & MENIOU, 2004:
02004110011100002003200101102545100101013110023030?0000000110101011051
Bathyporeia nana TOULMOND, 1966:
0100310422111010200040011110134010311101212303303021001020110141001221
Bathyporeia parkeri BOUSFIELD, 1973:
1323301001001000200040011130044111000001311430403030000041100100011311
Bathyporeia pelagica BATE, 1857
02332104211101101000020111210012010313111212302320321001220110121101351
Bathyporeia phaiophthalma BELLAN-SANTINI, 1973
0211010422110110100030011100154310210101211302123331011100110141001331
Bathyporeia pilosa LINDSTRÖM, 1855
000051022011011010002010101000100031310110200200131101110110131011000
Bathyporeia quoddyensis SHOEMAKER, 1949:
1110?0?0?10010002000400112302221112100?1310430402001000041100100010221
Bathyporeia sarsi WATKIN, 1938:
0221310211110010100020101110101000210101112202311311011200010121011000
Bathyporeia tenuipes MEINERT, 1877:
0333110422111011211301010000132210002100300014133611011230012141101041
Bathyporeia watkini D'UDEKEM D'ACOZ, ECHCHAOUI & MENIOU, 2006:
0000510211110110000010102100001021010121203200131001023011011011011

Outgroups used in alternative analyses:

Pontoporeia femorata KRØYER, 1842:
0000?004?2101?120003400110?03110030?0?03000340006010112401110000?0100
'longicorn *Gammarus oceanicus*', artificial taxon differing from *G. oceanicus* by char. [8]
00006004210001010001400000000403001110000000120330000004000000000000
'longicorn *Amphiporeia virginiana*', artificial taxon differing from *A. virginiana* by char.[8]
000020142000010000004001011001210000000300031002000011000101060010251

Appendix 3

Characters used in the cladistic analysis aimed to determine the phylogenetic affinities of the genera *Bathyporeia*, *Amphiporeia*, *Pontoporeia* and *Priscillina*. The weight of binary characters is always 6.

- [1] Rostrum: (0) absent or narrow; (1) large and broad.
- [2] Ophthalmic lobe of head: (0) not pointed; (1) pointed.
- [3] Cheek anterior process: (0) hooked or pointed; (1) angular; (2) rounded. Wagner; W = 3.
- [4] Cheek, occurrence of a process pointing outwards: (0) no; (1) yes.
- [5] Head sinus: (0) not V-shaped or absent; (1) V-shaped.
- [6] Occurrence of calceoli on antennular peduncle in adult males: (0) no; (1) yes.
- [7] Eye shape: (0) truly round; (1) slightly to strongly elliptic or reniform.
- [8] Ocular surface: (0) swollen; (1) flat.
- [9] A1, A2, size relationship: (0) A1 much longer than A2; (1) A1 not much longer than A2.
- [10] A1 and A2 peduncle, pilosity: (0) reduced; (1) important and plumose or slender; (2) important, stiff and non plumose. Fitch; W = 6.
- [11] A1, first article of peduncle, occurrence of at least one strong ventral spine: (0) yes; (1) no.
- [12] A1, first article of peduncle, disposition of setae and spines with bathyporeid pattern: (0) no; (1) yes.
- [13] A1, first article of peduncle, stoutness: (0) slender; (1) robust.
- [14] A1, articulation between the first and the second article of peduncle: (0) non geniculate; (1) geniculate.
- [15] A1 peduncle article 2 and 3, occurrence of at least one transverse comb of spines: (0) no; (1) yes.
- [16] A1, size relationships between the 3 articles of the peduncle: (0): third article considerably shorter than others; (1) first article considerably longer than others; (2) size differences between articles moderate. Fitch; W = 6.
- [17] A1, accessory flagellum, number of articles: (0) > two at least in males; (1) always two; (2) zero. Wagner; W = 3.
- [18] A1, major flagellum appearance: (0) not ventrally serrate; (1) ventrally serrate (as a result of the shape of the articles).
- [19] Urinary cone: (0) very sharp; (1) normal.
- [20] A2, penultimate article of peduncle, occurrence of transverse combs of spines: (0) no; (1) yes.
- [21] A2, relative length of last two articles of peduncle: (0) ultimate = or scarcely < penultimate; (1) ultimate significantly < penultimate.
- [22] A2, stoutness of antepenultimate article of peduncle of A2: (0) long; (1) short; (2) very short and anteriorly convex. Wagner; W = 3.
- [23] A2, stoutness of penultimate article of peduncle of A2: (0) slender; (1) medium; (2) stout. Wagner; W = 3.
- [24] A2 flagellum, with many long stout setae on posterior border: (0) no; (1) yes.
- [25] A2, length in mature male: (0) as in female; (1) longer than in female.
- [26] Md incisor process, number of erect spines: (0) not two or three; (1) two or three.
- [27] Lacinia mobilis, shape: (0) not blade-shaped; (1) blade-shaped. [28] Md palp article 2: (0) not expanded; (1) weakly expanded; (3) strongly expanded. Wagner; W = 3.
- [29] Md palp, article 3 with tip broad: (0) no; (1) yes.
- [30] Md palp, article 3, disposition of setae: (0) some forming surface transverse rows; (1) marginal only.

- [31] Md palp, sexual dimorphism, article 3, comb of stiff setae on posterior border: (0) always present or absent; (1) in mature males only.
- [32] Md palp, article 3, comb of stiff setae on posterior border: (0) always absent; (1) present at least in mature males.
- [33] Md palp, article 3, proportions: (0) blade-shaped; (1) subcylindrical.
- [34] Md palp, article 3 falcate: (0) no; (1) yes.
- [35] Mx1 palp, ornamentation: (0) spines and setae; (1) setae only.
- [36] Mx1, shape of inner plate: (0) triangular; (1) elliptic, rounded or elongate.
- [37] Mx1 inner plate, size: (0) normal; (1) reduced.
- [38] Mx2 inner plate, facial row of setae: (0) well developed; (1) lacking or reduced.
- [39] Mxp, second article of palp, anterior lobe: (0) absent; (1) present.
- [40] Mxp, second article of palp, occurrence of a single row of strong setae arising from the dorsal surface (not from the border!): (0) no; (1) yes.
- [41] Mxp, shape of outer plate: (0) normal; (1) narrow.
- [42] Mxp, outer border of outer plate: (0) with setae on less than 20%; (1) with setae on more than 20%.
- [43] Mxp, outer border, anterior setulose setae; (0) more than one and intergrading with medial nodular spines; (1) a single setulose seta, very different from medial nodular spines.
- [44] Mxp inner plate, number of spines on anterior border: (0) two or less; (1) three or more.
- [45] Mxp inner plate occurrence of long glabrous spines on ventral surface close to medial border: (0) yes; (1) no.
- [46] Mxp inner plate, number of short ventromedial spines: (0) zero; (1) one; (2) more than one. Wagner; W= 3.
- [47] Thoracic segments, occurrence of longitudinal dorsal carina and/or posterior tooth on at least one segment: (0) no; (1) yes.
- [48] Transverse grooves on body: (0) no; (1) yes.
- [49] Corpulence of body: (0) not stocky; (1) stocky.
- [50] Coxae 1-4, occurrence of a weak carina directed downwards on coxal surface: (0) no; (1) yes.
- [51] Coxae 1-3, occurrence of a posterior tooth on at least one coxa: (no); (1) yes.
- [52] Coxae 1-3 crescent-shaped: (0) no; (1) yes.
- [53] Coxae 1-3, strength of setae: (0) no flexible setae; (1) flexible setae.
- [54] Coxae 1-3, length of setae: (0) short setae or no setae; (1) long setae.
- [55] Coxa 1, disposition of setae: (0) absent or not restricted to anterior border; (1) restricted to anterior border.
- [56] Coxa 1 anteriorly pointed: (0) yes; (1) no.
- [57] Coxa 1, anterior border, profile: (0) not or barely concave; (1) distinctly concave.
- [58] Coxae 2-4 length: (0) short; (1) medium; (2) long. Wagner; W = 3.
- [59] Coxa 4, shape: (0) not pointed downwards; (1) pointed downwards or nearly so.
- [60] Coxa 4, posteroproximal concavity: (0) yes; (1) no.
- [61] Coxa 5 anterior lobe: (0) not longer than posterior; (1) longer than posterior.
- [62] Oostegites, proportions: (0) slender; (1) broad.
- [63] Gn1-2, nodular spines on or near the cutting edge: (0) zero or one; (1) several.
- [64] P1 size: (0) = or > P2; (1) slightly < P2; (2) much < P2. Wagner; W = 3.
- [65] P1, shape of carpus: (0) narrowly triangular; (1) triangular; (2) subcylindrical. Wagner; W = 3.
- [66] P2 shape: (0) (sub)chelate; (0) not (sub)chelate.
- [67] P2, shape of carpus: (0) narrowly triangular; (1) triangular; (2) subcylindrical; (3) elongate. Wagner; W = 2.
- [68] P2 with chela quite small: (0) no; (1) yes.
- [69] P3 merus, stoutness: (0) slender; (1) medium; (2) stout.
- [70] P3-P4 carpus, long styliform spine (carpal fang): (0) none or several; (1) one.
- [71] P3-P4 propodus, occurrence of setae on anterior border: (0) no; (1) yes.
- [72] P3-4 propodus shovel-shaped: (0) no; (1) yes.
- [73] P3-P4 dactylus, occurrence of one or several setae: (0) yes; (1) no.
- [74] P5-P7 ornamentation: (0) spines dominate; (1) spines and setae co-dominate; (2) setae dominate.
- [75] P5-P7 basis, occurrence of conical spines: (0) yes; (1) no.
- [76] P5, ischium shape: (0) quadrate; (1) pentagonal.
- [77] P5 basis stoutness: (0) narrow; (1) medium; (2) broad. Wagner; W= 3.
- [78] P5 merus, proportions and size: (0) normal or large; (1) overdeveloped; (2) shortened. Fitch; W = 6.
- [79] P5 merus posterodistal longest spine/seta: (0) short; (1) medium; (2) long. Fitch; W = 6.
- [80] P5 merus posterior border ornamentation: (0) at least three groups of spines/setae; (1) at least three groups of spines/setae but two groups are considerably more developed than the rest; (2) one or two groups of spines/setae. Wagner; W= 3.
- [81] P5 dactylus size: (0) not vestigial; (1) vestigial.
- [82] P6, basis stoutness: (0) narrow; (1) broad.
- [83] P6 shape: (0) subquadrate; (1) elliptic.
- [84] P6, dactylus length: (0) short; (1) long.
- [85] P6, dactylus shape: (0) curved; (1) not curved.
- [86] P7, coxal gill: (0) present; (1) absent.
- [87] P7 basis, proportions: (0) narrow; (1) medium; (2) broad. Wagner; W = 3.
- [88] P7 basis, posterodistal corner: (0) developed; (1) not developed.
- [89] P7 posterior margin, ornamentation: (0) serrate with minute setae; (1) not serrate with minute setae.
- [90] P7 basis, occurrence of medial setae: (0) yes; (1) no.
- [91] P7 basis posterior setae/spines: (0) reduced or absent; (1) well developed spines or strong setae; (2) a fringe of strongly feathered or strongly pappose large setae. Wagner; W = 3.
- [92] P7 ischium form: (0) quadrate; (1) pentagonal.
- [93] Ep1 posteroventral angle: (0) blunt; (1) minute tooth; (2) strong tooth. Wagner; W = 3.
- [94] Ep2 shape: (0) crescent-shaped; (1) sub-crescent shaped; (2) not crescent shaped. Wagner; W = 3.
- [95] Pleosomite 3, occurrence of dorsal tooth or longitudinal carina: (0) yes; (1) no.
- [96] Ep3 shape: (0) crescent-shaped; (1) not crescent-shaped.
- [97] Ep3 ventrolateral spines/setae: (0) present; (1) absent.
- [98] Ep3 ventrolateral ornamentation: (0) mostly spines; (1) spines and setae; (2) setae only. Wagner; W = 3.
- [99] Ep3 ventrolateral spines or setae: (0) not rowed; (1) at least some in transverse rows.
- [100] pleopods, length of peduncle: (0) long or medium; (1) short.
- [101] Urosomites with dorsal tooth or keel: (0) no; (1) yes.
- [102] Urosomite 1, occurrence of dorsal seta: (0) no; (1) yes.
- [103] Urosomite 1, occurrence of dorsal spines: (0) yes; (1) no.
- [104] Urosomite 1, occurrence of ventrolateral or distoventral spines: (0) ventrolateral spines; (1) distal spines; (0) no spines. Fitch; W = 6.
- [105] Urosomite 3, occurrence of spines near telson insertion; (0) yes; (1) no.
- [106] U1-U2 rami shape: (0) not curving upwards; (1) curving upwards.
- [107] U1-U2, length inner rami: (0) = or < outer rami; (1) > outer rami.
- [108] U1-U2 rami, length of spines: (0) long; (1) medium; (2) short. Wagner; W = 3.
- [109] U1-U2 spines of rami stoutness: (0) stout; (1) slender.
- [110] U1-U2, outer border of inner ramus, number of spines: (0) more than one; (1) at most one.
- [111] U1-U2 rami, number of spines: (0) not reduced; (1) reduced.
- [112] U1 peduncle, stoutness of outer dorsal spines: (0) robust; (1) styliform.
- [113] U1 peduncle, repartition of outer dorsal spines: (0) on all length; (1) absent at least on the middle of the peduncle.
- [114] U1 peduncle, size of dorsal outer spines: (0) regular; (1) irregular.
- [115] U1 peduncle, ornamentation of the distal corner of the outer dorsal border: (0) a small spine immediately followed by a large one; (1) one spine or one seta.
- [116] U1 peduncle, number of ventrolateral spines: (0) zero; (1) one; (2) two; (3) more than two. Wagner; W = 2.
- [117] U1 peduncle, ventrolateral ornamentation: (0) short spines; (1) long styliform spines; (2) setae; (3) none. Fitch; W = 6.
- [118] U1 length of rami versus length of peduncle: (0) rami and peduncle subequal; (1) rami much shorter than peduncle.
- [119] U1 rami shape: (0) tapering; (1) quadrate.
- [120] U3 length: (0) normal or long; (1) short.
- [121] U3 peduncle, length: (0) broad; (1) elongate.
- [122] U3 peduncle, outer non distal spines/setae: (0) present; (1) absent or reduced.
- [123] U3 outer ramus, length: (0) not stout and not strongly reduced; (1) stout and strongly reduced

