

Guide to Road Design Part 6A
Paths for Walking and Cycling



Austroads



Guide to Road Design Part 6A: Paths for Walking and Cycling



Austroads

Sydney 2017

Guide to Road Design Part 6A: Paths for Walking and Cycling

Second edition prepared by: Peter Aumann and Tony Arnold

Second edition project manager: Gemma Kernich

Abstract

The *Guide to Road Design Part 6A: Paths for Walking and Cycling* provides guidance for designers and other practitioners on the design of paths for safe and efficient walking and cycling, both within the road corridor and outside the road corridor. The guide provides information on considerations that should be given in providing a path, describes the types of paths and covers the requirements of path users, e.g. operating spaces, factors that influence path locations, and geometric design criteria for a path and related facilities such as intersections between paths, and terminal treatments. Detailed guidance is provided on path location, alignment, width, clearances, crossfall, drainage and sight distance requirements.

The location and design of paths may be influenced by a range of aspects that need to be considered and facilities that need to be accommodated within roadsides. In particular, designers should refer to the *Guide to Road Design*:

- Part 6: Roadside Design, Safety and Barriers (Austroads 2010a)
- Part 6B: Roadside Environment (Austroads 2015b).

The design of pedestrian and cyclist paths may also be influenced by design considerations and requirements covered in other parts of the *Guide to Road Design*. In addition, road designers should also refer to relevant parts of the *Guide to Traffic Management* in relation to traffic management devices and requirements that may need to be accommodated within a roadside or may otherwise influence the design.

Keywords

Planning, pedestrian paths, bicycle paths, shared paths, separated paths, path user requirements, operating space, location of paths, alignment, horizontal curvature, gradient, width, clearance, intersections, fences, terminal treatments, bridges, culverts, bicycle safety audits.

Published: June 2017

ISBN 978-1-925451-75-7

Austroads Project No. TP1848

Austroads Publication No. AGRD06A-17

Pages 111

© Austroads Ltd 2017

This work is copyright. Apart from any use as permitted under the *Copyright Act 1968*, no part may be reproduced by any process without the prior written permission of Austroads.

Publisher

Austroads Ltd.
Level 9, 287 Elizabeth Street
Sydney NSW 2000 Australia

Phone: +61 2 8265 3300

austroads@austroads.com.au
www.austroads.com.au



Austroads

About Austroads

Austroads is the peak organisation of Australasian road transport and traffic agencies.

Austroads' purpose is to support our member organisations to deliver an improved Australasian road transport network. To succeed in this task, we undertake leading-edge road and transport research which underpins our input to policy development and published guidance on the design, construction and management of the road network and its associated infrastructure.

Austroads provides a collective approach that delivers value for money, encourages shared knowledge and drives consistency for road users.

Austroads is governed by a Board consisting of senior executive representatives from each of its eleven member organisations:

- Roads and Maritime Services New South Wales
- Roads Corporation Victoria
- Queensland Department of Transport and Main Roads
- Main Roads Western Australia
- Department of Planning, Transport and Infrastructure South Australia
- Department of State Growth Tasmania
- Department of Infrastructure, Planning and Logistics Northern Territory
- Transport Canberra and City Services Directorate, Australian Capital Territory
- Australian Government Department of Infrastructure and Regional Development
- Australian Local Government Association
- New Zealand Transport Agency.

Second edition published June 2017

First edition published October 2009

The second edition has been restructured and contains editorial and technical changes. The title has been amended to better reflect the information on the functions and types of paths covered in this edition. Updated information and new information have been included with the key changes as follows:

- Sections 1 to 4 has been reworded to provide generic information that is relevant for pedestrians and cyclists.
- Section 1.1: Universal Access – additional information on providing universal access.
- Sections 2.2: Pedestrian Path and 2.3: Bicycle Path – amended to include information on levels of service.
- Section 3: Path User Considerations – amended to broaden the range of path user considerations.
- Section 3.2.1: Pedestrians – amended to include information on mobility scooters.
- Section 5.1: Width of Paths – additional information for path widths based on volumes.
- Section 5.7: Sight Distance – additional commentary on pedestrian needs and sight distance and replacement of Figure 7.7 with an equation to determine stopping sight distance.
- Section 6.5: Special Treatments for Intersections of Paths with Paths – new section consolidating treatments for special circumstances.
- Section 7.3: Treatments for Intersections of Paths with Roads – new information on path terminal treatments.
- Section 7.5: Special Treatments for Intersections of Paths with Roads – new section on terminal treatments for special circumstances.
- Section 8.3: Culvert Underpasses – new information on principles in providing paths through culverts.
- Appendix B: Speed Limiting Treatments – new appendix providing information on speed limiting treatments on paths.
- Appendix C.3.1: Bituminous Surface Pavements – additional information on bituminous surfaces.
- Appendix C.4: Life Cycle Costing – new section on life cycle costing.
- Commentary 1: Planning and Need for a Path – transferred from Section 2 as information relates to network plans and operation.

Acknowledgements

The authors acknowledge the role and contribution of the Austroads Road Design Task Force in providing guidance and information during the preparation of this Part. The panel comprised the following members:

Mr Peter Ellis - Roads and Maritime Services, New South Wales

Mr Richard Fanning - Roads Corporation, Victoria

Mr Mike Whitehead - Queensland Department of Transport and Main Roads

Mr Albert Wong - Main Roads Western Australia

Mr William Moodie - Department of Infrastructure, Planning and Logistics Northern Territory

Mr Ben McHugh - Transport Canberra and City Services Directorate

Mr Tony Napoli - Australian Local Government Association

Mr James Hughes - NZ Transport Agency

Mr Tom Brock - Consult Australia

Ms Gemma Kernich - Australian Bicycle Council

Mr Michael Tziotis - ARRB Group Ltd

The authors would like to acknowledge the support from the City of Sydney and City of Adelaide for providing photographs for this Part.

This Guide is produced by Austroads as a general guide. Its application is discretionary. Road authorities may vary their practice according to local circumstances and policies. Austroads believes this publication to be correct at the time of printing and does not accept responsibility for any consequences arising from the use of information herein. Readers should rely on their own skill and judgement to apply information to particular issues.

Contents

1.	Introduction.....	1
1.1	Purpose	1
1.2	Scope of this Part	2
1.3	Safe System Approach.....	3
2.	Types of Path	4
2.1	General.....	4
2.2	Pedestrian Path.....	4
2.3	Bicycle Path.....	5
2.4	Shared Path.....	6
2.5	Separated Path.....	8
3.	Path User Considerations	12
3.1	General.....	12
3.2	Operating Space.....	14
3.2.1	Pedestrians.....	14
3.2.2	Cyclists	18
4.	Design Considerations	20
4.1	Location of Paths.....	20
4.1.1	General.....	20
4.2	Factors of Influence – Path Location.....	20
4.2.1	Factors Influencing Roadside Alignment.....	21
4.2.2	Paths in Medians	22
4.3	Path Width.....	23
4.4	Bicycle Paths	24
5.	Design Criteria	25
5.1	Width of Paths	25
5.1.1	Clear Width	25
5.1.2	Pedestrian Paths	25
5.1.3	Bicycle Paths	27
5.1.4	Shared Paths.....	29
5.1.5	Separated Paths.....	30
5.2	Bicycle Operating Speeds	30
5.3	Horizontal Curvature.....	31
5.4	Path Gradients.....	32
5.4.1	Universal Access	33
5.4.2	Ease of Uphill Travel	33
5.4.3	Safety and Downhill Travel on Paths	34
5.5	Clearances, Batters and Need for Fences	35
5.5.1	Clearances.....	35
5.5.2	Bicycle paths.....	35
5.5.3	Batters and Fences	38
5.6	Crossfall and Drainage.....	42
5.6.1	Crossfall.....	42
5.6.2	Drainage	42
5.7	Sight Distance	44
5.7.1	Bicycle Path Stopping Sight Distance	45
5.8	Changes in Level.....	47
5.9	Surface Treatments	49
5.10	Surface Tolerances	50
5.11	Lighting	51
5.12	Underground Services.....	52

6.	Intersections of Paths with Paths	53
6.1	General.....	53
6.2	Intersection Priority.....	53
6.3	Intersection Signs.....	53
	6.3.1 Control Devices.....	53
	6.3.2 Wayfinding Signs.....	53
6.4	Treatments for Intersections of Paths with Paths.....	54
6.5	Special Treatments for Intersections of Paths with Paths.....	56
7.	Intersections of Paths with Roads	57
7.1	General.....	57
7.2	Intersection Signs.....	57
	7.2.1 Traffic Control Devices.....	57
	7.2.2 Wayfinding Signs.....	57
7.3	Treatments for Intersections of Paths with Roads.....	58
	7.3.1 Road Crossings where the Path has Priority over the Road.....	58
	7.3.2 Road Crossings in a Shared Environment Intersection.....	60
7.4	Ancillary Devices for Intersections of Paths with Roads.....	60
	7.4.1 Push Buttons at Signalised Intersections.....	60
	7.4.2 Holding Rails.....	60
7.5	Special Treatments for Intersections of Paths with Roads.....	61
	7.5.1 General.....	61
	7.5.2 Terminal Design Principles.....	62
	7.5.3 Terminal Treatments for Excluding Vehicles.....	64
	7.5.4 Terminal Treatments for High-conflict Locations.....	68
8.	Paths at Structures	71
8.1	General.....	71
8.2	Road Bridges.....	71
	8.2.1 Use of Pedestrian Paths on Narrow Bridges.....	71
	8.2.2 Shared Path Structures.....	71
8.3	Underpasses.....	73
	8.3.1 General.....	73
	8.3.2 Use of Existing Culverts.....	74
8.4	Bicycle Wheeling Ramps.....	75
9.	Construction and Maintenance Considerations for Paths	77
9.1	General.....	77
9.2	Bicycle Safety Audits.....	77
	References	78
	Appendix A Application of Envelopes and Clearances to Determine the Widths of Paths	81
	Appendix B Speed Limiting Treatments	85
	Appendix C Path Construction and Maintenance	86
	Appendix D Bicycle Safety Audit Checklist	97

Tables

Table 2.1:	Zones associated with pedestrian paths.....	4
Table 4.1:	Factors considered in the choice of path alignment in road related areas.....	21
Table 5.1:	Width requirements for pedestrian paths.....	26
Table 5.2:	Bicycle path widths.....	27
Table 5.3:	Shared path widths.....	30
Table 5.4:	Separated two-way path widths.....	30
Table 5.5:	Separated one-way path widths.....	30
Table 5.6:	Minimum radius of horizontal curves without superelevation.....	32

Table 5.7:	Minimum radius of horizontal curves that have superelevation	32
Table 5.8:	Considerations relating to changes in level	48
Table 5.9:	Suggested surface tolerances – existing surfaces	50

Figures

Figure 1.1:	Flow chart of the Guide to Road Design	2
Figure 2.1:	Examples of pedestrian path zones	5
Figure 2.2:	Example of a bicycle path in a road related area	6
Figure 2.3:	Example of a shared path in a road related area	7
Figure 2.4:	Examples of physical devices to separate bicycle paths and pedestrian paths	9
Figure 2.5:	Example of a separated one-way bicycle path in a road related area	10
Figure 3.1:	Plan view of pedestrian body ellipse	14
Figure 3.2:	Reach dimensions for mobility impaired people	16
Figure 3.3:	Wheelchair turning envelope	16
Figure 3.4:	Pedestrian path width requirements for people with mobility impairment	17
Figure 3.5:	Cyclist design envelope	18
Figure 4.1:	Example of a median path at a road crossing	23
Figure 5.1:	Example of clear width	25
Figure 5.2:	Minimum pedestrian path widths	27
Figure 5.3:	Example of passing areas in constrained locations	27
Figure 5.4:	Path widths for a 50/50 directional split	28
Figure 5.5:	Path widths for a 75/25 directional split	29
Figure 5.6:	Desirable uphill gradients for ease of cycling	34
Figure 5.7:	Clearances between cyclist envelope and potential path hazards	35
Figure 5.8:	Location of path in road reserve	37
Figure 5.9:	Envelope of height requirements	37
Figure 5.10:	Requirement for fence barriers at batters and vertical drops	40
Figure 5.11:	Example of a partial barrier fence	41
Figure 5.12:	Example of a full barrier fence	41
Figure 5.13:	Example of flared bicycle rail terminal	41
Figure 5.14:	Drainage and crossfall requirements	44
Figure 5.15:	Lateral clearances on horizontal curves	46
Figure 6.1:	Intersection of shared paths	54
Figure 6.2:	Example of a shared path intersection	55
Figure 6.3:	Intersection of bicycle path and pedestrian path where cyclists have priority	55
Figure 6.4:	Intersection of a shared path and separated path where pedestrians have priority	56
Figure 6.5:	Example of a staggered T-intersection	56
Figure 7.1:	Example of a simple path connection at an on-road path	58
Figure 7.2:	Example of an intersection where a separated pedestrian path crossing and a separated bicycle path crossing has priority across a local street	59
Figure 7.3:	Example of an intersection where a path crossing has priority over a side street	59
Figure 7.4:	Example of holding rail	61
Figure 7.5:	Separate entry and exit terminal	64
Figure 7.6:	Preferred layout for the use of a central bollard	65
Figure 7.7:	Example of a bollard treatment	66
Figure 7.8:	Example of a bollard treatment with lighting	66
Figure 7.9:	Example of U-rail and hazard board treatment	67
Figure 7.10:	Details of a bollard and U-rail	68
Figure 7.11:	Example of a staggered fence treatment	69
Figure 7.12:	Example of an offset path treatment	70
Figure 8.1:	Illustration of a shared path crossing under a bridge abutment	72
Figure 8.2:	Shared path under a bridge abutment	72
Figure 8.3:	Example of a pedestrian/bicycle path underpass	74
Figure 8.4:	Example of a bicycle wheeling ramp	75
Figure 8.5:	Bicycle wheeling ramp key dimensions	76

1. Introduction

1.1 Purpose

Austrroads *Guide to Road Design* seeks to capture the contemporary road design practice of member organisations; refer to the *Guide to Road Design Part 1: Introduction to Road Design* (Austrroads 2015a). In doing so, it provides valuable guidance to designers in the production of safe, economical and efficient road designs.

Guidance on the design of roadside features and facilities is contained in three parts of the *Guide to Road Design*:

- Part 6: Roadside Design, Safety and Barriers (AGRD Part 6) (Austrroads 2010a)
- Part 6A: Paths for Walking and Cycling (AGRD Part 6A)
- Part 6B: Roadside Environment (AGRD Part 6B) (Austrroads 2015b).

AGRD Part 6 provides an introduction to roadside design and also provides detailed guidance on roadside safety (e.g. hazard identification, mitigation and treatment) and the use and design of safety barriers. *AGRD Part 6A* covers the geometric design of pedestrian and cycling paths and the design of associated facilities, while *AGRD Part 6B* provides guidance on other roadside features and facilities (Figure 1.1).

Paths are provided to meet the transportation and recreational needs of pedestrians and cyclists. They may be situated in road reserves, through parkland reserves, or beside rivers or coastal areas to provide safe and convenient routes and facilities for pedestrians and cyclists. *AGRD Part 6A* therefore provides guidelines for the design of paths generally and not only for the integration of paths into road designs.

Figure 1.1 shows that *AGRD Part 6A* is one of eight guides that comprise the Austrroads *Guide to Road Design*. Collectively these parts provide information on a range of disciplines including geometric design, drainage, roadside design and geotechnical design, all of which may influence the location and design of paths within road related areas.

Figure 1.1: Flow chart of the Guide to Road Design

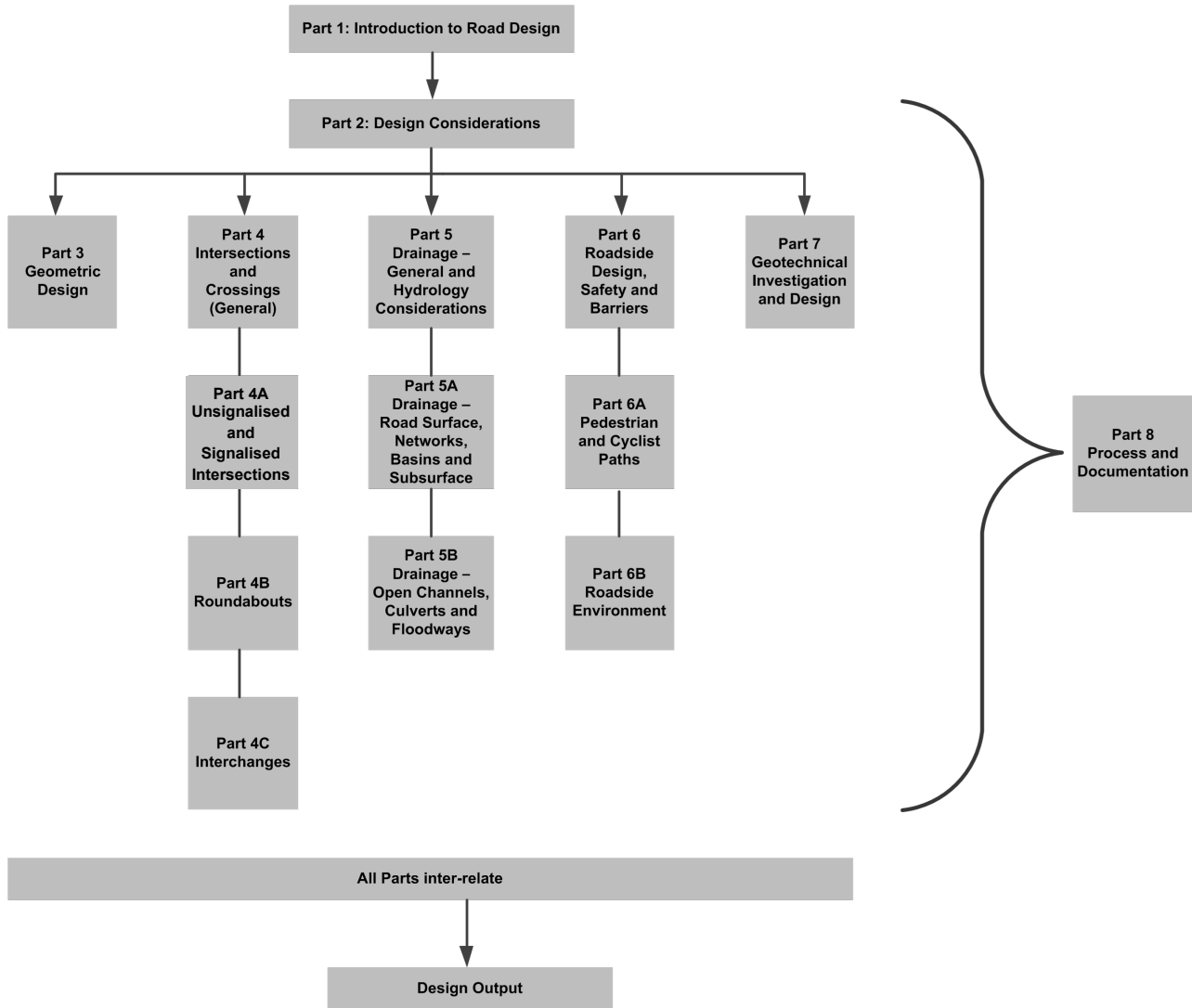

1.2 Scope of this Part

AGRD Part 6A describes the types of paths and their location, provides guidance on alignment, width and other geometric requirements, and information on the design of treatments such as path intersections and terminals.

When used in conjunction with other relevant parts of the *Guide to Road Design* and the *Guide to Traffic Management*, this Part provides guidelines for the geometric design of paths (pedestrian, bicycle and shared paths). It does not provide information on planning matters including the development of bicycle and/or pedestrian networks as this relates to network planning. Information on planning for a path is contained in *Guide to Traffic Management Part 5: Road Management* (Austroads 2014) and the *Guide to Traffic Management Part 4: Network Management* (Austroads 2016a) with some additional information contained in Commentary 1.

[\[see Commentary 1\]](#)

In some situations bicycle paths may also interface with bicycle lanes on the road and reference should be made to the *Guide to Road Design Part 3: Geometric Design* (AGRD Part 3) (Austroads 2016b) and *Guide to Road Design Part 4: Intersections and Crossings: General* (Austroads 2017a) for further information.

For signing and pavement marking requirements for the purposes of establishing the type of paths described in this guide, designers should refer to AS 1742.9:2000.

Designers should understand that the design standard adopted for a particular facility should relate to the transportation role it has in the bicycle or pedestrian network. Some bicycle paths and shared paths are designed to perform an arterial function whilst others have an access function. For example, a veloway is a very high standard bicycle path (in terms of width, alignment, clearances, access etc.) that provides a major arterial link for cyclists and this type of facility should be designed for high operating speeds (e.g. the 7 km long Adelaide Southern veloway alongside the Southern Expressway in South Australia).

1.3 Safe System Approach

Adopting a Safe System approach to road safety recognises that humans, as road users are fallible and will continue to make mistakes, and that the design and operation of road infrastructure, including pedestrian paths and bicycle paths should not penalise people with death or serious injury when they do make mistakes. In a Safe System, therefore, paths should be designed in a manner that ensures that the users of the paths are not killed or seriously injured should a crash occur. This requires the designer to appreciate and understand the interactions between the various elements and in particular the likely crashes that may occur.

Paths outside of the road corridors should be design to be forgiving with minimal hazards. Paths within road corridors may involve conflicts with motor vehicles and preferably any conflicts. A Safe System approach ideally removes conflicts between motor vehicles and vulnerable road users, such as cyclists and pedestrians. For example, an underpass provides an alternative crossing of a busy road. Where conflicts cannot be avoided, the conflict between motor vehicles and vulnerable road users needs to be design or managed to reduce the incidence and severity of crashes, should they occur.

Further information on the Safe System approach can be found in the *Guide to Road Design Part 1: Introduction to Road Design* (Austroads 2015a).

2. Types of Path

2.1 General

The types of paths are:

- pedestrian path
- bicycle path or cycle track¹
- shared path
- separated path.

2.2 Pedestrian Path

A pedestrian path² is reserved for use by pedestrians, people in wheelchairs, mobility scooters and personal mobility devices, such as a walking frame. These paths provide an important part of the transport network either for trips undertaken entirely by walking, or as the first or last link in a trip that utilises other types of transport.

There are distinct zones within the area between the edge of the road and the frontage of adjacent property, and it is important to distinguish between the total width and the width of the zone likely to be used by pedestrians who are walking through this zone (NZ Transport Agency 2009). Table 2.1 describes the zones and Figure 2.1 illustrates them.

The same principles apply in off-road environments, except that one or more of the zones described in Table 2.1 may be absent or duplicated on the opposite side of the path.

Table 2.1: Zones associated with pedestrian paths

Area	Purpose
Street furniture zone	• Used for placing features such as signal poles, lighting columns, hatch covers, sandwich boards, seats and parking meters
	• Can be used for soft landscaping/vegetation
	• Creates a psychological buffer between motorised vehicles and pedestrians
	• Reduces passing vehicles splashing pedestrians
	• Provides space for driveway gradients
Dining zone	• The area for the provision of dining facilities
Through route (or clear width)	<ul style="list-style-type: none"> • The area where pedestrians normally choose to travel (this should be kept free of obstructions at all times) • In retail precincts, people with vision impairment may utilise the building line to assist their orientation along the path

Note: The zones which are located in the area between the street and boundaries of adjacent properties, and also referred to as urban borders (AGRD Part 3 (Austroads 2016b)).

Source: Based on NZ Transport Agency (2009).

1 In some jurisdictions the term cycle track that is a separated bicycle facility in an urban corridor that combines the benefits of a bicycle lane (where bicycles have priority at intersections) and a bicycle path. Refer to Queensland Department of Transport and Main Roads (2015b).

2 It should be noted that in some jurisdictions, pedestrian paths are able to be used by cyclists.

Figure 2.1: Examples of pedestrian path zones

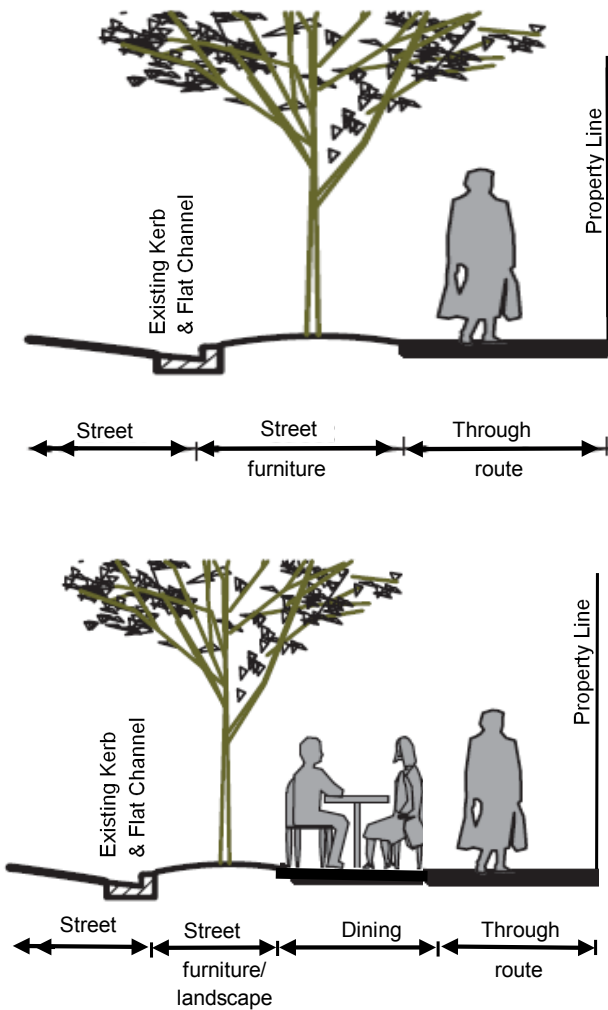

Note: In residential areas the pedestrian path may be offset from the property boundary to facilitate the path alignment and safety. Designers should refer to the local road agency for their requirements.

Source: Adapted from NZ Transport Agency (2009).

2.3 Bicycle Path

A bicycle path³ or track, which may be one-way or two-way, is for the use of cyclists and is most appropriate where:

- there is a significant cycling volume or where an exclusive use path is desirable, and pedestrians are provided with a separate path
- there is limited motor vehicle access across the path
- it is possible to achieve an alignment that generally allows cyclists uninterrupted and safe travel at a relatively consistent speed.

³ For the purposes of this Part the term bicycle path has been used for a bicycle-only path. Where a path is able to be used by pedestrians the path is indicated to be a shared path.

Cyclists generally prefer riding on exclusive off-road bicycle paths, rather than along roads and shared paths that provide a similar level of service (for information on levels of service refer to *Level of Service Metrics (for Network Operations Planning)* Austroads (2015f)). An off-road bicycle path caters for full range of cyclists including inexperienced cyclists or those wanting to avoid travelling alongside motor vehicles and so there may be a broad range of cyclists using the off-road path.

In some locations the provision of suitable off-road bicycle paths may not be able to be achieved due to physical and financial constraints.

Figure 2.2 shows an example of a bicycle path within a road related area. Special attention must be given to the path design in the vicinity of bus and tram stops, and preventative measures may need to be taken to avoid illegal parking of cars and the placement of garbage bins on the paths. It should be noted that a bicycle path for exclusive use by cyclists requires the establishment of signs that indicate its exclusive use as a bicycle path.

Figure 2.2: Example of a bicycle path in a road related area



Source: City of Sydney (personal communication 2016).

2.4 Shared Path

A shared path is where pedestrians and cyclists share the same path space. A shared path may be appropriate where demand exists for both a pedestrian path and a bicycle path but where there is a low number of pedestrians or cyclists and the use is not expected to be sufficiently great enough to provide separate facilities.

Shared paths can be used for a variety of purposes including recreation, local access and providing feeder links between high capacity paths. However, if such a link is provided, it may need to be designed in a manner that moderates cyclist speeds to ensure the safety of pedestrians.

Shared paths that use existing pedestrian paths may be satisfactory where they provide a:

- convenient and safe option for inexperienced cyclists, recreational cyclists and young cyclists
Because pedestrian paths usually have narrow widths and driveway crossings or side streets intersecting at frequent intervals they are only suitable for low cycling speeds.
- safer option for cyclists at squeeze points such as narrow, heavily trafficked sections of road, roundabouts, bridges, underpasses or railway level crossings
In such cases it may be appropriate that the connections between the pedestrian path and the road be properly designed so that cyclists can leave and enter the general traffic stream safely and conveniently. Special ramps that have a flatter gradient and smooth invert can be provided to cater for bicycles.

Figure 2.3 shows an example of a shared path within a road related area.

Figure 2.3: Example of a shared path in a road related area

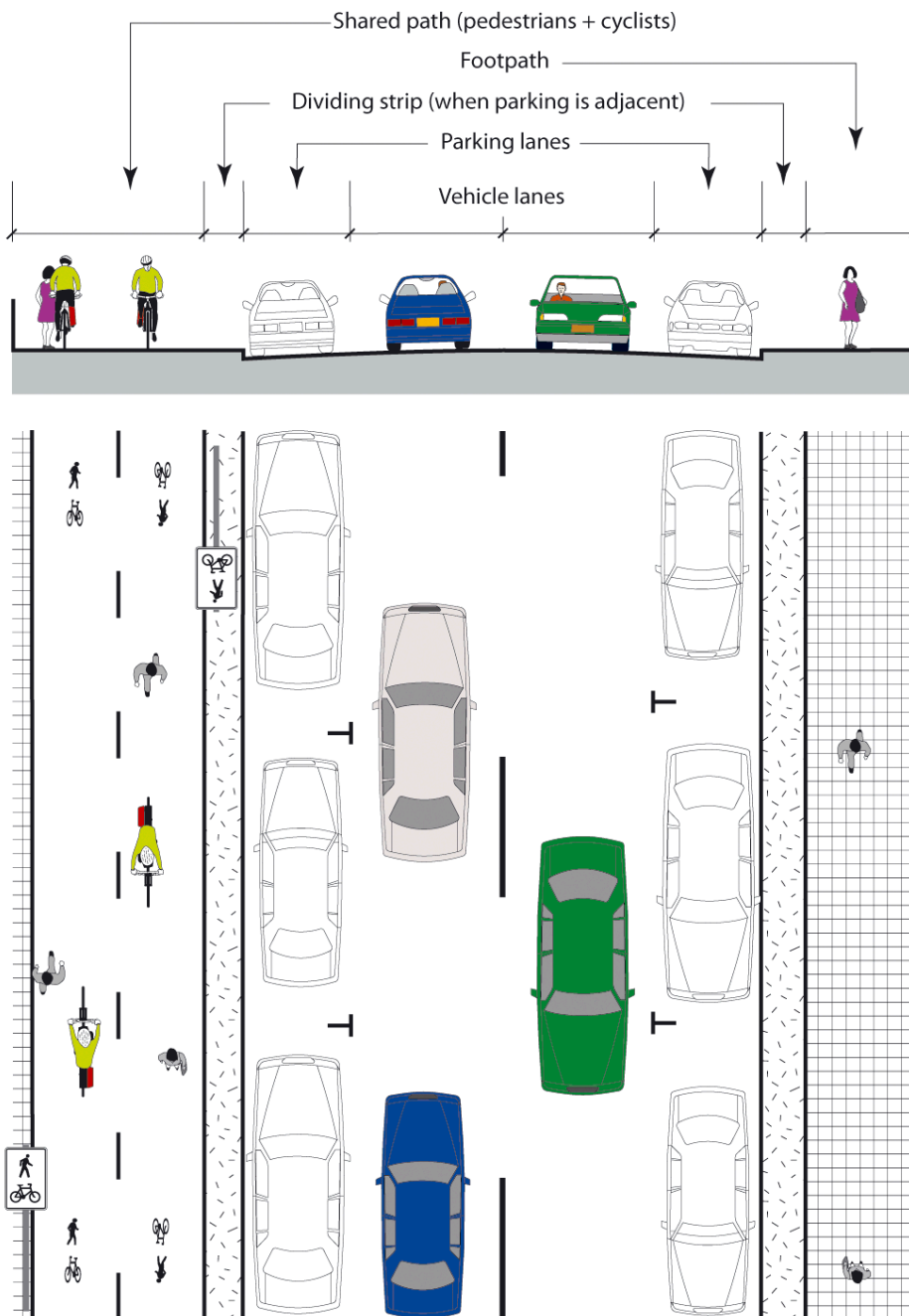

Source: Roads and Traffic Authority (2005).

A significant issue associated with shared paths is the variety of users who display various characteristics that can lead to conflict between them, and discomfort for all path users. These characteristics include differences in speed, space requirements, age, user expectation (as some users expect exclusive or priority use) and predictability (e.g. cyclists, pedestrians walking dogs, in-line skaters, and skateboard riders). Austroads (2006) describes the key conflict issues between pedestrians and cyclists on shared paths and pedestrian paths and provides guidance on key conflict minimisation strategies and options.

2.5 Separated Path

A separated path is a path divided into separate sections, one of which is designated for the exclusive use of cyclists and the other for the exclusive use of pedestrians. A separated path may be appropriate where there are safety or conflict issues such as where there are a high number of pedestrians and/or cyclists (Austroads 2006), or the desired level of service on a shared path is not being met (Austroads 2015f).

These situations typically arise in areas that attract high pedestrian and cyclist movements (e.g. foreshore promenades and major inner city bridges). However, separated paths should not be provided in busy shopping centres where large numbers of pedestrians are expected to cross the path and conflict with cyclists.

The use of a separated path may cause some confusion amongst cyclists and pedestrians as to their correct use. To better clarify the use of these paths, visual cues make it intuitive to users which path they should use through the use of an appropriate path surface (e.g. pavement materials, colours and textures), with a clearly defined separation zone supported by signing, linemarking and pavement symbols being used (Queensland Department of Transport and Main Roads 2015a). Should linemarking be used to separate cyclists from pedestrians then raised tactile separation lines are suggested to assist those with vision impairment to differentiate the pedestrian and cyclist areas.

In addition, it may be appropriate to have the pedestrian path and bicycle path at different levels, separated by a semi-mountable kerb or a small grass dividing strip. Examples of treatments to separate the paths are shown in Figure 2.4.

Where high standard bicycle and pedestrian paths are provided, such as on foreshore promenades, path users may be given priority at intersecting side streets (Austroads 2017a). Austroads (2017a) contains guidance on treatments that provide priority for cyclists and pedestrians at side roads (e.g. 'bent-out' and 'bent-in' treatments).

Figure 2.4: Examples of physical devices to separate bicycle paths and pedestrian paths

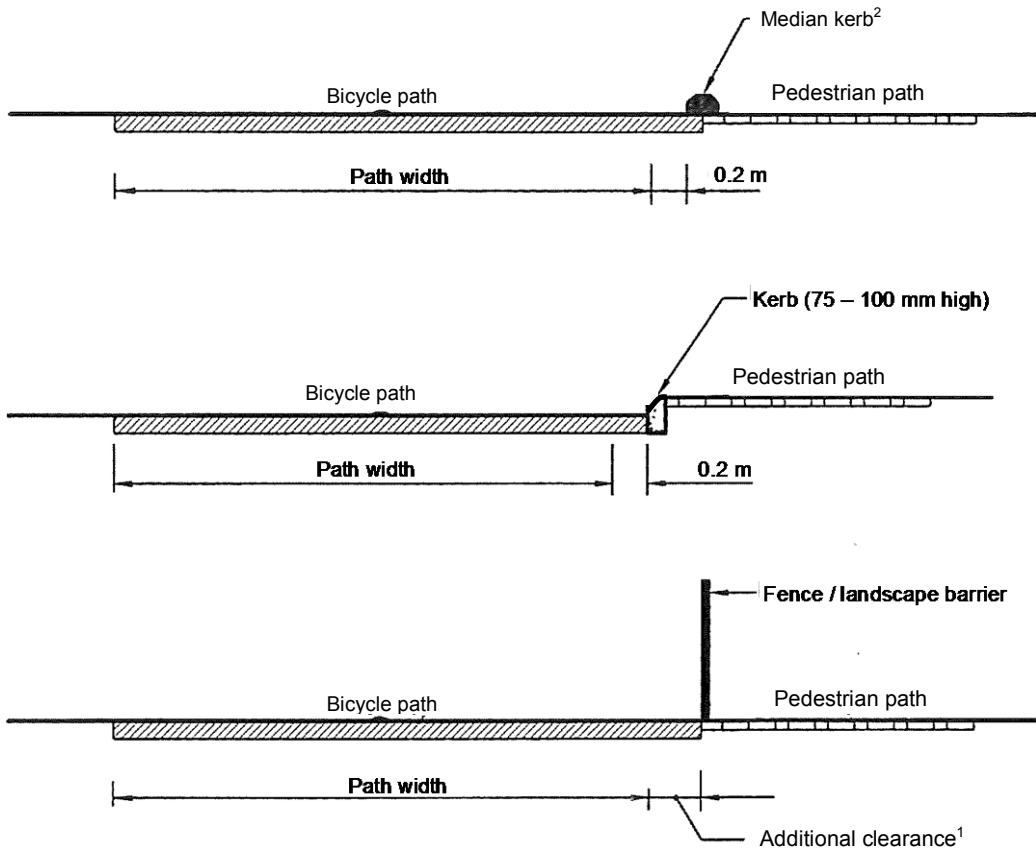

1 For guidance on clearances refer to Section 5.5.

2 The separation between the pedestrian path and bicycle path may also be a flush or mountable type kerb or a painted separation line.

Notes:

The bicycle paths may be one-way or two-way operation.

Different materials may also be used to differentiate and delineate the pedestrian and bicycle treatments.

Any kerb used may be an upright or mountable kerb.

A deflection rail providing 150 mm clearance should be provided where clearances are not able to be achieved, refer to Section 5.5.3.

Where wide nature strips exist, consideration should be given to the construction of separated one-way paths (see Figure 2.5). These paths enable bicycles to travel on the side of the road, in the verge area, in one direction, with bicycle movement in the opposite direction provided on the other side of the road.

The treatment can be advantageous when:

- they are used with other traditional bicycle lane treatments located on roads, in order to maintain continuous access for cyclists past squeeze points
- other constraints exist for the construction of bicycle lanes in the carriageway
- a safety problem exists for cyclists in the road carriageway
- there is a high proportion of inexperienced cyclists.

The treatment is appropriate where:

- there is a limited number of driveway crossings (preferably less than one per 100 m)
- adequate sight lines exist, to significant road and pedestrian path access points
- a separation/barrier exists between the path and the road carriageway.

Figure 2.5: Example of a separated one-way bicycle path in a road related area

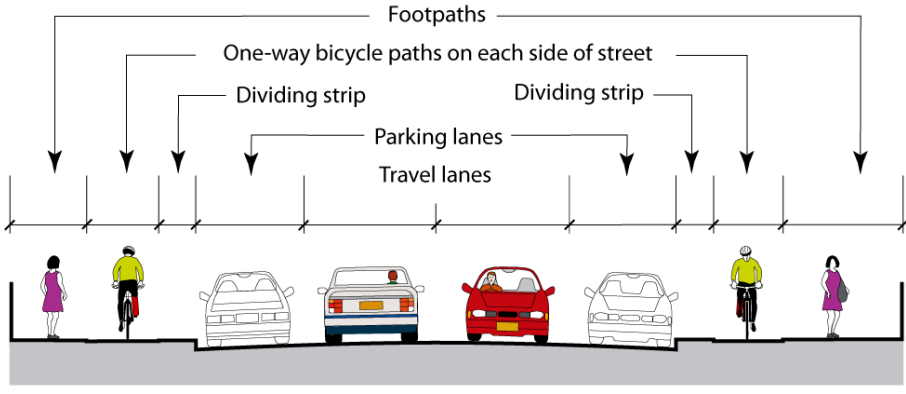

Elevation

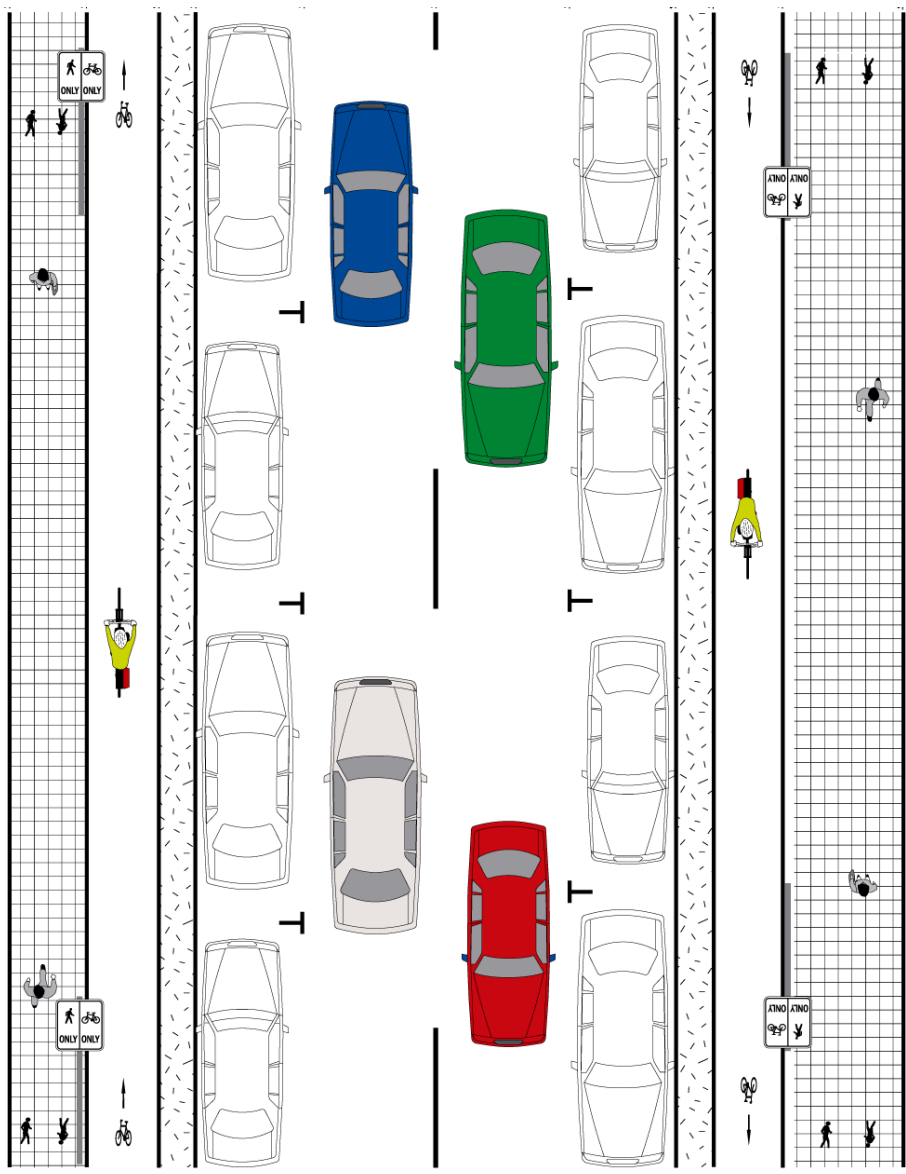

Plan

Source: Roads and Traffic Authority (2005).

A separated one-way path treatment should provide for cyclist travel in the same direction as the adjacent traffic lane, other than in a one-way street. However, designers should confirm the suitability of the treatment with respect to local requirements.

The accommodation of any path in a road related area requires consideration of access for maintenance personnel and equipment and the placement of road furniture (signs, signals, barriers, bus/tram stops) and other items, refer to Section 3.2.2, which may adversely affect operation of the path. This can be problematic with separated paths that require considerable space in order to ensure appropriate use.

The clearances to physical (vertical) separation devices shown in Figure 2.4 are essential. The clearances for kerb and fence separated facilities should be sufficient to ensure cyclists do not catch handle bars in fence components or pedals with upright kerbs. Where fence clearances cannot be met cyclist deflection rails should be installed, refer also to Section 5.5.1 and 5.5.3.

Physical, horizontal or vertical separation of the bicycle path and pedestrian path is preferred to linemarking. Should linemarking be used to separate bicycles from pedestrians then tactile pavement markings are recommended. In assessing the need for physical separation between pedestrian and cyclist areas, factors such as operational width and clearance requirements, speed of cyclists, category of use characteristics, volume of use and the likelihood of pedestrian activity in the cycling space should be considered.

When a barrier is used to separate the bicycle and pedestrian path sections, the desirable minimum width of the pedestrian path section should be 1.5 m, to allow passing manoeuvres on that section of the path, amongst other reasons (e.g. pedestrian volumes). Separated paths should be designed to accommodate the passing of pedestrians by personal mobility devices.

3. Path User Considerations

3.1 General

In order to develop appropriate and practical design solutions designers should have a sound understanding of what is required to ensure that pedestrian and cycling networks offer an environment that provides a convenient, safe and pleasant journey with direct routes that minimise the length of travel and travel time to destination.

The characteristics that contribute to a path network, that serve the needs of pedestrians and cyclists, includes paths that are safe, connected, legible, comfortable, convenient, universal and pleasant (based on NZ Transport Agency 2009 and de Groot 2007).

Safe

Path networks should:

- provide surfaces that provide good surface grip, are free of tripping hazards, smooth, clear of obstructions and are well maintained (e.g. no broken paving)
- have well design landscaping that does not encroach sight lines or operating space
- have adequate lighting to ensure that pedestrians feel safe when using paths at night
- minimise conflicts between path users taking into consideration path widths or the provision of separated paths
- have information signs reminding users of appropriate behaviours in using the path.

Connected

Well-connected paths should:

- have continuous routes and travel paths as short as possible
- integrate with public transport
- provide crossings that are appropriate for the traffic volume and traffic speed environment
- provide crossing opportunities at locations that are difficult to cross (e.g. major roads, railways) with short waiting times at signalised crossings
- provide good access to key destinations
- where path volumes are high and consistent (e.g. inner-city routes) consideration should be given to prioritising and wherever practicable coordinating traffic signals to improve the level of service for pedestrians and cyclists.

Legible

To inform path users, a path network should:

- provide clear distance and directional signs to destinations, and/or pavement marking information
- have clearly visible street name signs and repeater street names
- have clearly visible place names
- enable local features to be identified that can assist path users to orientate themselves and be aware of their location
- be supported with readily available path network information (e.g. published local maps, information boards, tourist information).

Comfortable

In order to provide an appropriate level of comfort the path or route should:

- have path widths that provide the desired level of service (Austroads 2015f)
- be set back from carriageways to create a physical separation from motor traffic
- provide facilities for path users, such as resting places and drinking fountains
- provide adequate and safe storage areas for pedestrians to wait, including at intersections, such that the flow of other path users, including cyclists is not impeded
- be well maintained to ensure maintenance intervention levels are met to provide a smooth surface
- be substantially free from litter, debris and other deposits
- be constructed to prevent ponding of surface water
- have places to rest and shelter from inclement weather
- be adequately lit to ensure that path users feel safe when using the paths at night.

Convenient

A convenient walking environment for pedestrians should:

- be as continuous as practicable
- ensure that streets can be crossed easily and safely (e.g. raise road crossings to path level)
- minimise delays at road crossings (e.g. keep crossing distances and waiting times at signals short)
- include cyclist and pedestrian signals or phases at signalised intersections.

Universal

Paths should cater for all users by:

- having gradients that cater for mobility impaired users where practicable
- having contrasting coloured pavement surfaces to highlight demarcated areas of path
- having tactile treatments and physical features, that may be used to aid wayfinding, including signs to aid in wayfinding by vision impaired persons where required.

Pleasant

A path network can provide a pleasant journey for path users by:

- having high quality supporting facilities, such as seating, resign places, drinking water, interpretative information that is located clear of the operating space of the path
- being located so that scenic features in the vicinity can be viewed from the path.

The design of a path should also consider the level of service that it is intended to be provided on the path. The level of service includes some of these characteristics. More information on levels of service is contained in *Level of Service Metrics (for Network Operations Planning)* (Austroads 2015f).

3.2 Operating Space

3.2.1 Pedestrians

General

While it is not possible to identify all design situations in this Part, basic reach and geometric parameters, and operating envelopes may be established that assist in the appropriate design of all components of the street system and facilities provided for or used by pedestrians. This section provides information regarding maximum limits of reach and minimum dimensions necessary to accommodate most people with disabilities. However, designers should not simply design for these maximum limits and minimum dimensions but should ensure the design provides the highest level of service to pedestrians that is practicable.

As it may be necessary to accommodate a variety of uses in pedestrian areas, design envelopes should include the type of pedestrian activity and local considerations that impact on placement of street furniture or capacity. For example:

- proximity to shops – additional area/width required for people carrying shopping bags
- climate – sub-tropical locations could incorporate umbrellas and similar furniture that requires greater widths and clearances
- the design envelope should allow for backpacks, briefcases and other devices used by pedestrians and which would affect storage capacity generally and on traffic islands in particular
- proximity to retirement centres – additional width and storage length to accommodate personal mobility devices.

Pedestrian space

Body depth and shoulder width are the primary human measurements used by designers of pedestrian spaces and facilities, where shoulder breadth is the factor affecting the practical capacity. The plan view of the average adult male human body occupies an area (the body ellipse) of about 0.14 m². However, a 460 mm by 610 mm body ellipse (Figure 3.1) equivalent to an area of 0.21 m² is used to determine practical standing capacity, allowing for the fact that many pedestrians carry personal articles, natural psychological preferences to avoid bodily contact with others and body sway.

With respect to normal path operation where pedestrians and cyclists are moving at speed and sharing space it is considered that a one metre width should be used as the basis of the design envelope to allow adequate operating space and clearances for pedestrians.

Figure 3.1: Plan view of pedestrian body ellipse

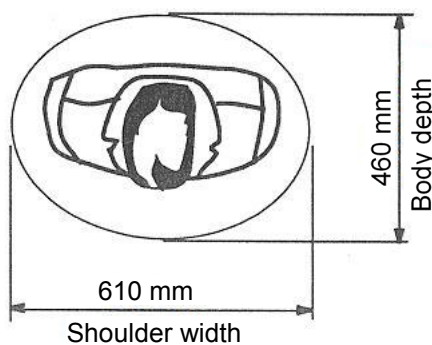

Reach

While there is a wide variation in the size of people and their reach, basic limits that should be adopted for the purposes of design are shown in Figure 3.2. It can be seen that the overlap between the heights is easily accessible by wheelchair users and people with mobility difficulties. This means that anything that must be reached, e.g. holding rails, audio tactile push buttons, by both groups should lie between approximately 0.6 m and 1.57 m above the ground. Wheelchair users are also constrained in the limits of their horizontal reach, as shown in Figure 3.2.

Wheelchairs and mobility scooters

There are a wide variety of wheelchairs and mobility scooters available for people to use to aid their mobility. These include manual wheelchairs, motorised wheelchairs and mobility scooters. The dimensions of these mobility aids can vary and designers should refer to AS/NZS 3695.1:2011 and AS/NZS 3695.2:2013 for information on manual and powered wheelchairs.

Wheelchair and mobility scooter users generally require more space than other people to move around. An example of the reach limits for an occupant of a wheelchair is shown in Figure 3.2. Designers should consider the size of wheelchair or mobility scooter that should be used in the design of specific facilities or treatments and may have to establish the appropriate design vehicle for particular situations within a jurisdiction. As a guide, the Australian Disability Standards for Accessible Public Transport (2002) requires a manoeuvring space of 2.07 m by 1.54 m for a wheelchair or mobility scooter to turn 180°. Reference may also be made to AS 1428.1:2009. Consultation with local community organisations may also provide information on the wheelchairs and mobility scooters.

In considering the minimum width required for wheelchairs and motorised scooters, designers should also refer to AS 1428.1:2009 regarding minimum widths for accessways, walkways, ramps, landings and doorways.

General spatial requirements

Figure 3.5 shows the radius of turn for a wheelchair when wheels are moved in opposite directions and when pivoting about a locked wheel. The radii represent the swept path of the wheelchair and therefore it is essential for designers to allow sufficient clearance from the swept path to fixed objects to allow for variance in the location at which the rider chooses to commence the turn, and to provide comfortable and safe operating conditions. This clearance is necessary to avoid the risk of damage to the wheelchair, damage to street infrastructure and injury to the wheelchair rider.

Figure 3.4 shows the various widths for path users with mobility impairment. While personal mobility scooters are not included in Figure 3.4 it is considered that most scooter models can be accommodated within the widths shown.

Figure 3.2: Reach dimensions for mobility impaired people

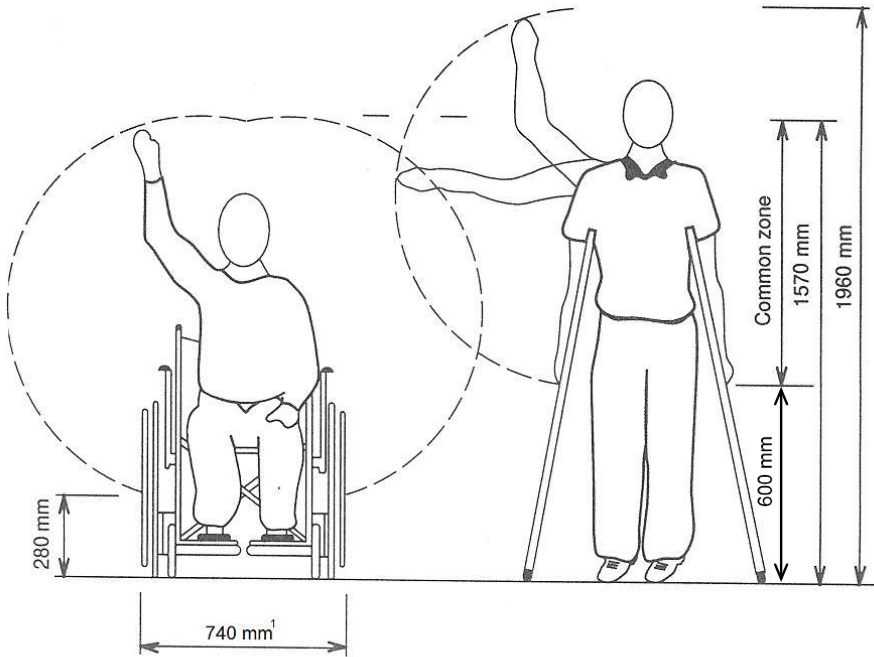

1 Includes clearance for knuckles of hands.

Figure 3.3: Wheelchair turning envelope

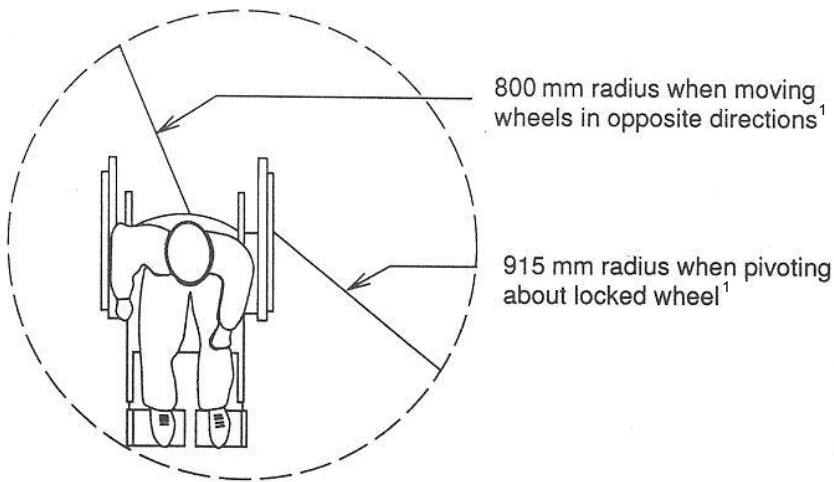

1 Radius is the swept path of the wheelchair; clearance between path and objects (e.g. walls, poles) must be provided.

Figure 3.4: Pedestrian path width requirements for people with mobility impairment

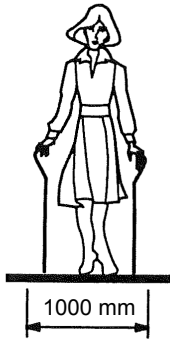

- (a) A clear width of 1000 mm is adequate for people with ambulant disabilities, just allows passage for 80 per cent of people who use wheelchairs, and is in accordance with AS 1428.1

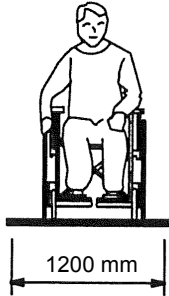

- (b) People who use wheelchairs require a clear width of 1200 mm

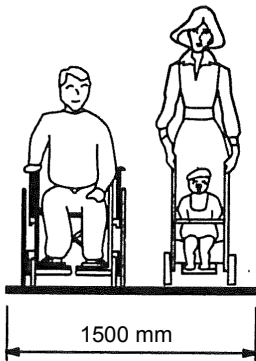

- (c) A clear width of 1500 mm allows a wheelchair and a pram to pass

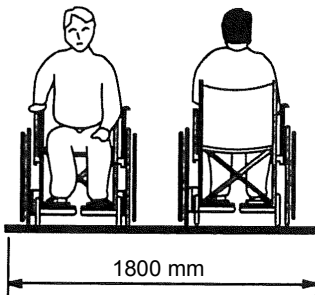

- (d) To allow two wheelchairs to pass comfortably, a clear width of 1800 mm is required

Source: AS 1428.2:1992.

3.2.2 Cyclists

The cyclist design envelope (Figure 3.5) and clearances to obstructions or hazards (see Section 5.5.1) may be used to construct the appropriate width of facility required for cyclists under various conditions. The envelope is assumed to be consistent over the range of operating conditions and allowance for higher speeds is provided through larger clearances to both other cyclists and fixed objects beside the path. Appendix A provides guidance on how the envelope and clearances are applied to particular situations in order to determine satisfactory operating widths.

Figure 3.5: Cyclist design envelope

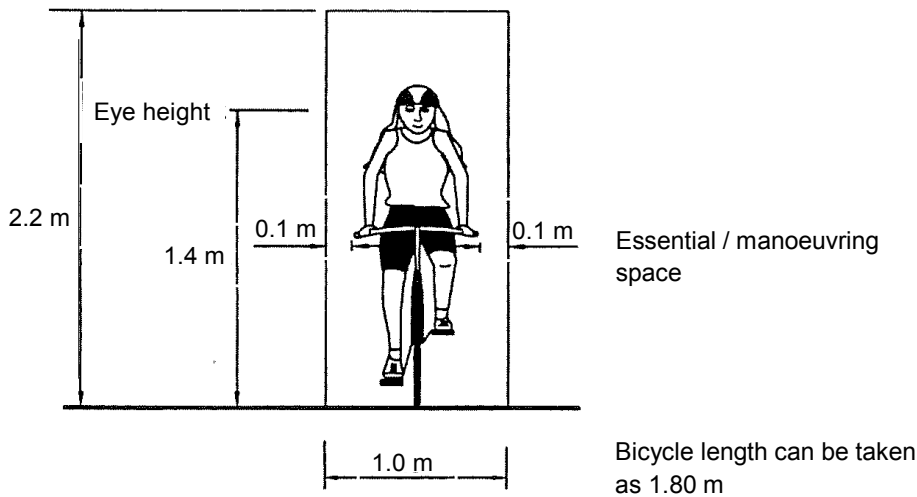

Note: The path width may vary on uphill sections of path, refer to Section 5.4.

The 1.0 m width of the envelope shown in Figure 3.5 allows for the width of a bicycle and for variations in tracking. Not all bicycle riders can steer a straight line and when riding uphill experienced riders work the bicycle from side to side while inexperienced riders may wobble. To allow for this operating characteristic the 1.0 m envelope width should be increased to 1.5 m for uphill travel, refer also to Section 5.1.3 for guidance on path widths. Further guidance on uphill travel is contained in Section 5.4.

Bicycle riders also need adequate clearances to fixed objects and to passing vehicles in addition to the 1.0 m envelope; refer to Section 5.5.1 for guidance on clearances.

Space to ride

Where data is available (e.g. census information and jurisdictional surveys) the space required for new major bicycle paths should be based on an estimation of the likely demand for cycling on the proposed facility.

However, where such information is not available the bicycle design envelope and clearances shown in Figure 5.6 provide the basis for the design of the bicycle facilities described in this part. It is important for designers to understand the basis of the design, including clearance requirements, so that they can make appropriate judgements in constrained situations where knowledge of minimum cyclist space requirements is needed. The envelope is relevant to the design of lanes on roads, off-road paths and bicycle parking facilities (AS 2890.3:2015).

In some situations it may be appropriate to provide for alternative forms of pedal cycles in the design of facilities. For example, it may be appropriate on heavily used recreational paths to allow for the space (e.g. width, length, swept path) required by a bicycle trailer that is commonly used by parents to tow young children.

Smooth surface

A smooth, skid resistant, surface is desirable for bicycles to be used effectively, comfortably and safely. Surfaces used for cycling should desirably be smoother than those acceptable for motor vehicles and persons responsible for path construction and maintenance should be made aware of this requirement. Guidance on surface tolerances is provided in Section 5.10.

It is also important that the design restricts debris from accumulating on paths. Surface water should not flow across the path in situations where soil, mulch or other debris could be carried onto the path. It is generally preferable that water is collected and piped under the path. Similarly, a maintenance regime should be in place to enable the removal of any debris that could inconvenience cyclists or create hazardous conditions by placing a solid object in the path of cyclists or causing the surface to become slippery (e.g. broken glass, rocks, mud after inundation, loose leaves or berries etc.).

Speed maintenance

For bicycles to be most effective as a means of transport, cyclists must be able to maintain speed without having to slow or stop often. While many cyclists typically travel at speeds between 20 km/h and 30 km/h, a significant number of cyclists travel at speeds in excess of 35 km/h to 40 km/h on the flat and may reach speeds in excess of 50 km/h on downhill gradients. Once slowed or stopped it takes considerable time and effort to regain the desired operating speed.

In some locations, such as in commercial precincts or urban residential neighbourhoods, maintaining path speeds may be less important and higher speeds may be counter-productive to encouraging inexperienced cyclists to use the path and may also result in safety concerns involving pedestrians. The higher speeds may also be a deterrent in attracting or encouraging new cyclists. In these areas, the operating speed on the path may need to be moderated to take into consideration the experience levels and the number of the cyclists using the path.

Bicycle routes, especially off-road, should be designed for continuous riding, minimising the need to slow or stop for any reason including steep gradients, rough surfaces, sharp corners, obscured sight lines, intersections, or to give way to other people because the width available is too narrow.

Sight lines

It is important that appropriate sight lines are provided between a cyclist's eye height and pedestrians to assist in minimising conflict, and between a cyclist's eye height and the path surface so that cyclists can stop in the event that a hazard exists on the path (e.g. mud deposited during inundation, potholes due to washouts, broken glass, and fallen tree limbs).

Designers should therefore resist the temptation to provide curves that are smaller than necessary (e.g. to create an artificially winding path for aesthetics or urban design reasons). It is much better for the safety of path users if larger curves with greater sight distance are provided. Refer to Section 5.7 for information on sight distance.

4. Design Considerations

4.1 Location of Paths

4.1.1 General

Paths have a safe functional design requirement to provide a high level of amenity for people, either walking and/or cycling. Paths may be used by the full range of cyclist categories and to achieve this objective a designer should have:

- an understanding of the objectives for the proposed path
- an understanding of the expected numbers of path users
- a recognition of the needs of all pedestrians and cyclists
- an appreciation of the need for appropriate path geometry e.g. width and alignment, to cater for the path users
- an appreciation of the location, available space and destinations.

Paths may be located:

- in road related areas which have direct access to abutting properties
- in reservations of major new or existing access-controlled arterial roads or freeways
- along river frontages and foreshores
- through parkland
- along railway reservations
- leading to and across bridges.

4.2 Factors of Influence – Path Location

Factors that influence the location of paths include the need to:

- recognise the existing desire lines being followed by pedestrians and/or cyclists
- achieve the best alignment possible to provide comfortable, convenient and safe travel, within the available resources. It is acknowledged that cost may be a factor in determining the location and elements of a path.
- identify locations of local features that may be of interest to path users
- avoid sharp horizontal curves, particularly at intersections or at the bottom of steep downgrades, where cyclists use the path
- achieve adequate sight distance along the path to observe other path users
- optimise the personal security of users of paths located in relatively isolated areas
- provide access for emergency service vehicles and maintenance vehicles at path entrances or other strategic points
- landscaping and planting considerations including vegetation removal (especially vegetation that has thorns that may puncture tyres), planting sizes at maturity and maintaining adequate sight distances and accumulation of debris
- owners of private property abutting the reservation, who may be concerned that provision of a path will adversely affect privacy or the security of their property
- the possible advantages that can be derived from incidental lighting from fixed sources or motor vehicles
- the choice of aesthetically pleasing locations (to encourage use)
- constraints such as geographical features, environmentally sensitive areas, areas of significance for Indigenous Australians etc.

4.2.1 Factors Influencing Roadside Alignment

Where a path is located in a road reserve and abutting development results in driveways at frequent intervals, a choice may exist between locating the path:

- adjacent to the kerb
- adjacent to the property boundary
- at an intermediate point, say 1.0 m behind the kerb.

However, in many cases the road related area will be too narrow to allow a choice in the location of a path.

It may be necessary for a path alignment to shift between the road reserve boundary and the kerb in order to retain vegetation, avoid obstacles, utilise bridges or connect to path crossings of the road. The alignment should be easy to follow, continuous and avoid sharp changes in direction.

Factors that influence the choice of alignment are summarised in Table 4.1.

Where there is an issue of vehicles failing to give way as they enter or leave the abutting properties or blocking the path, it may be necessary to reinforce the priority to the path users. Methods to reinforce the priority include continuing the path surface material across driveways to provide a contrast with the driveway surface, or alternatively through the use of appropriate signs or pavement markings.

Where a path crosses the minor road of a T-intersection or major access point and priority is given to the path users, consideration should be given locating the path at an appropriate distance from the main road. This will ensure vehicles are able to store and give way to path users so to not interrupt traffic flow on the adjoining main road. Where this is not possible consideration should be given to reversing the priority at the crossing, refer also to *AGRD Part 4* (Austroads 2017a).

Table 4.1: Factors considered in the choice of path alignment in road related areas

Path location	Factors for consideration
Adjacent to a kerb	<ul style="list-style-type: none"> • In many cases is the only option because of the road reserve width available. • Offers the best visibility of path users to drivers reversing out of their properties, particularly where high screen walls exist at the boundaries. • Will be used in two directions and allows cyclists to run off the path and ride against the flow of motor traffic on the road pavement. Overseas experience has shown wrong-way movements to be a major problem (Cross & Fisher 1977). • May result in parked cars being a hazard to pedestrians and cyclists due to the opening of vehicle doors into the path (refer also to Section 5.5.1). • May result in persons entering and exiting parked cars being put at risk due to the proximity of bicycle movements to the cars (refer also to Section 5.5.1). • Follows the longitudinal profile of the kerb and is therefore generally cheaper to construct because of reduced earthworks. • May be preferred by abutting landowners in terms of privacy and nature strip disruption. • May result in the effective path width being reduced by kerb returns (however, the use of AS 1428.1:2009 style side ramps would be of some assistance at driveways or the path profile being adversely affected at the cross over. • If wide, may be viewed as detracting from the appearance of the streetscape and may imply a higher speed environment. • Is less pleasant because of traffic noise, fumes and speed, and perhaps the splashing of water from gutters. • May be relatively unaffected by the presence of fences varying in height and type, or having sharp or exposed edges or protrusions.

Path location	Factors for consideration
Adjacent to a property boundary	<ul style="list-style-type: none"> • Provides a more pleasant environment and is perceived to be safer. • May limit visibility of path users to drivers reversing out of driveways, or to drivers turning left from the abutting carriageway, where path users are beyond the driver's peripheral vision. • Does not necessarily follow the kerb profile and may result in steeper gradients or be more costly to construct. • May be viewed as having a lower negative visual impact on the street than a kerbside path. • May be unacceptable to abutting land owners. • Is more efficient for the mail service, if the nature strip is very wide. • Should preferably be deviated to a location at least one car length back from road intersections, adjacent to which the path crosses, to facilitate passage behind a queued car. • Allows space for garbage bins to be accommodated clear of the path and for pit lids for utilities to be located outside of the path surface. Locating pits within paths should be avoided as the lids can create an uncomfortable ride and constitute a trip hazard for pedestrians.

4.2.2 Paths in Medians

Paths are not usually located in central medians, however, they may be acceptable where:

- the median is wide and the outer verges narrow
- the spacing of intersections is large
- the speed environment of the road is low
- motor vehicles are required to give way or stop for path users
- safe crossings of the carriageways and intersections can be made (e.g. traffic volumes low to moderate, major intersections controlled by traffic signals).

Similarly, it may also be acceptable to locate a path in an outer separator of a major road, depending on site conditions and traffic conditions. However, this should only be done where there are few entries and exits from the service road, and crossings at these locations can be designed to ensure that they are safe by:

- physically controlling vehicle ingress and egress speeds
- providing good sight distance
- making the priority clear to motorists and path users.

Disadvantages of providing paths in medians include providing access to the path across a carriageway, the median needs to be wide to provide some separation to motor vehicles and motorists do not expect pedestrians or cyclists at median openings and therefore they may be put at risk at these crossings.

Where paths are provided along wide central medians, sufficient distance should be provided between the path crossing points of the road between the carriageways of the main road, to provide adequate storage of vehicles to prevent interruption to traffic flow on the main road.

An example of a path located in a median at a road crossing is shown in Figure 4.1.

Figure 4.1: Example of a median path at a road crossing

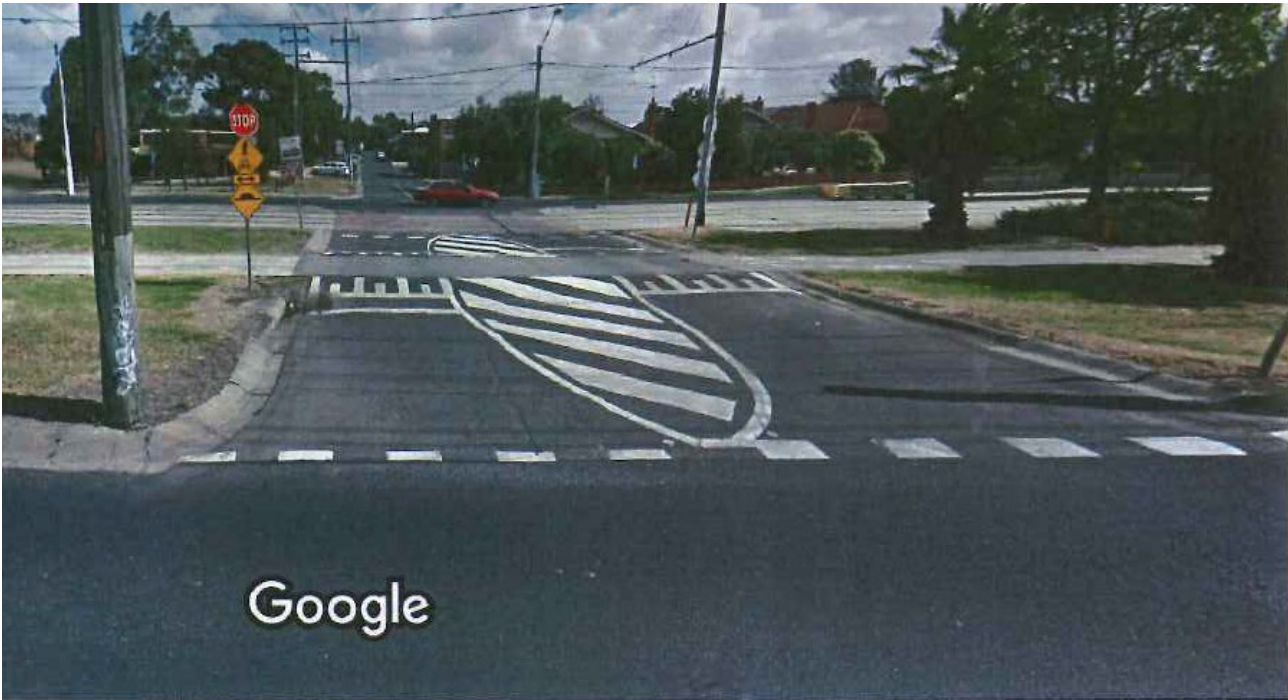

Image capture: Apr 2015 © 2016 Google

Source: Google Maps (2016), 'Victoria', Map data, Google, California, USA.

4.3 Path Width

The path width required depends on the envelope (i.e. space) occupied by pedestrians and/or cyclists using the path together with appropriate clearances. The clearances are required between path users travelling in the same direction or opposite directions, and also between path users and the edge of the path. Some allowance for the ability of cyclists to ride in a consistent wheel path (i.e. tracking of the bicycle within the envelope) is provided. Pedestrian and cyclist envelopes and examples of their application to determine the widths presented in Section 5.1 are contained in Appendix A.

While path width can be developed from cyclist and pedestrian envelopes and required clearances, the choice of a width in many situations is subjective because data is not usually available on the level and type of use that could be expected. Some jurisdictions systematically collect traffic data on existing path networks and some investigation has been done on the development of models to estimate the traffic flow on proposed paths (Land Transport New Zealand 2008). However, in the absence of a relationship between path width and parameters such as cyclist operating speed, volumes of pedestrians and cyclists, mix of pedestrians and bicycles, practitioners should consider a number of factors, such as the:

- level of pedestrian and cyclist use
- types of use expected e.g. where pedestrians may travel in large groups
- types of cyclists likely to be attracted to the path
- objectives of the path (e.g. provide a major link for cyclists including school children)
- speed of cyclists
- traffic regime
- available clearances
- user envelopes.

In many cases there will be more than one type of user to be accommodated and their requirements may differ. For example, where a path follows a scenic route but also is intended to attract cyclists from an alternative high speed road environment, it will be necessary to provide a good experience for cyclists and these cyclists wanting to minimise their travel time should be provided with an alignment and other conditions to minimise the travel time.

With many jurisdictions now allowing cycling on pedestrian paths, the increasing use of personal mobility devices and encouragement to increase cycling and walking, there is growing need to ensure path widths are provided that accommodate safe movements of path users, including passing or overtaking movements. This is particularly the case for separated paths where legislation may restrict the use of the path to only the designated use.

4.4 Bicycle Paths

The principles of designing a path for bicycles are similar to those used in designing roads and it is essential that the path has an alignment and cross-section to suit the function of the path and the speed and volume of traffic, drainage that prevents inundation and debris from washing onto the surface, and adjacent areas that are forgiving to cyclists that leave the path.

The vertical and horizontal alignment (and combinations of these), width of path and clearances adopted, are important to the safe operation of a path. Paths attract a variety of users from experienced cyclists to young children and inexperienced cyclists (Table C1 3) and hence it is desirable to consider the characteristics of all likely users and to design the path to suit the needs of the type of user for which it is intended.

The geometric standard adopted for a path will depend on its role within the bicycle network. Paths may perform an arterial function for a specific user group (e.g. veloway), have a mixed-use function for cyclists, pedestrians and other types of use (e.g. in-line skaters) or have a local access function.

A veloway is a high-standard exclusive bicycle path catering for high-volume and/or high-speed arterial movement. There are few veloways in Australia. This Part does not provide guidelines that are specific to the design of veloways. While the information in this section may assist in the design of veloways the values adopted for design elements will depend on local circumstances and should be determined by the responsible agency.

5. Design Criteria

Paths attract a variety of users as (example outlined in Table C1 3) and the needs of all likely users should be considered in the design of a path (see also Commentary 1).

[\[see Commentary 1\]](#)

5.1 Width of Paths

5.1.1 Clear Width

The widths provided in this Part are for a clear width on a path (Figure 5.1). Intrusions in or over a path, such as vegetation, signs, poles, fences or seats may become obstacles or hazards to path users, reducing the width of the clear path and should be removed wherever practicable. In locations where the intrusion is unable to be removed, path users need to be alerted to the presence of the intrusion with sufficient time to enable the obstacle or hazard to be avoided.

For guidance on the clearances to obstructions or hazards, refer to Section 5.5.

Figure 5.1: Example of clear width

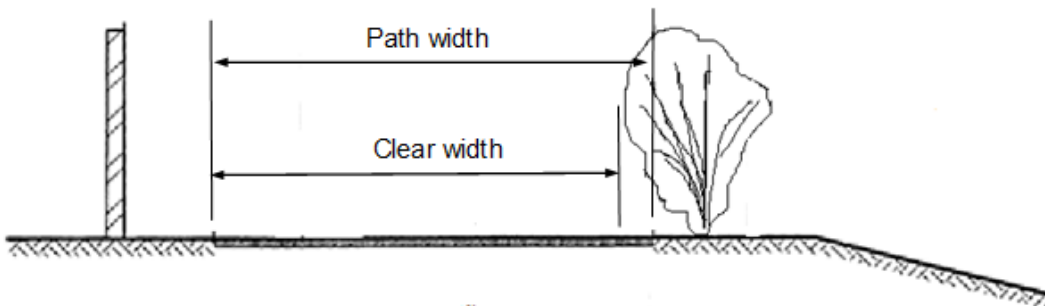

5.1.2 Pedestrian Paths

The suggested width requirements for pedestrian paths are shown in Table 5.1. The operating space required for mobility impaired pedestrians is illustrated in Figure 3.4 and while personal mobility devices (e.g. scooters) are not included in the figure it is considered that most scooters could be accommodated within the widths shown (refer to product suppliers for further information). As a guide, the desirable minimum width of a pedestrian path that has a very low volume is 1.2 m with an absolute minimum of 1.0 m at constrained locations and with agreement by the relevant road agency. These widths should be increased at locations where:

- high pedestrian volumes are anticipated
- a pedestrian path is adjacent to a traffic or parking lane
- a pedestrian path is combined with bicycle facilities
- the pedestrian path is to cater for people with disabilities
- overtaking of path users is expected.

The roadside often has to accommodate many features including paths. It is therefore important that enough space is provided to ensure that all features can be accommodated and pedestrians have a clear space in which to operate. In some cases the relevant road agency may desire to implement an urban design solution within the roadside.

The crossfall of a paved pedestrian path may vary from flat (but achieving an adequately drained surface) to 2.5%. Provided that drainage is satisfactory, a lower crossfall is preferred (i.e. 1.0%) as a higher crossfall may cause problems for some people.

Table 5.1: Width requirements for pedestrian paths

Situation	Suggested minimum width (m)	Comments
General low volume	1.2 ⁽¹⁾	<ul style="list-style-type: none"> General minimum is 1.2 m for most roads and streets. Clear width required for one wheelchair. Not adequate for commercial or shopping environments.
High pedestrian volumes	2.4 (or higher based on volume)	<ul style="list-style-type: none"> Generally commercial and shopping areas.
For wheelchairs to pass	1.8	<ul style="list-style-type: none"> Refer also to AS 1428.1:2009.
For people with other disabilities	1.0	

¹ In constrained locations an absolute minimum of 1.0 m should be provided. In these situations, path users should be able to detect other path users with sufficient time to respond and take appropriate actions.

Notes:

While the minimum width may be used where volume is low it is generally desirable to provide a path that will accommodate two pedestrians side by side.

Wider than the minimum width (e.g. up to 5 m) may also be necessary at locations where pedestrian flows are high or where pedestrians gather such as in the vicinity of schools and associated road crossings, at recreation facilities and at important bus stops.

Where volume is significant it may be necessary to provide adequate congregation areas clear of the path required for through movement of pedestrians.

Where a path is < 1500 mm wide, the path should be widened at regular intervals to provide opportunities for wheelchair users to pass. Refer also to the *Pedestrian Planning and Design Guide* (NZ Transport Agency 2009).

In some instances pedestrian volumes will be very high and a path width corresponding to or greater than those suggested in Table 5.1 for high pedestrian volumes will be required. This may depend on the level of service the path is to provide and designers should also refer to any local planning requirements. Refer to *Level of Service Metrics (for Network Operations Planning)* (Austroads 2015f) for guidance on levels of service.

Constrained widths should be avoided or treated (e.g. by removal of obstacles) wherever practicable. However, where it is not possible to remove the obstacle an absolute minimum width can be used over a very short length at an obstruction (Figure 5.2), and if a narrow pedestrian path cannot be avoided over a greater length passing areas should be provided wherever possible (Figure 5.3).

It is also important that the edges of paths do not have a drop-off that may cause a pedestrian to slip or trip, or cause a wheelchair to overturn, such as along the back of a kerb. This consideration is critical where minimum path widths are used. In addition, any obstruction within the path should be highlighted (e.g. bright contrasting colour) to reduce the likelihood that pedestrians will collide with it, and have any aspects removed that could cause path users to be ‘snagged’ by it.

Figure 5.2: Minimum pedestrian path widths

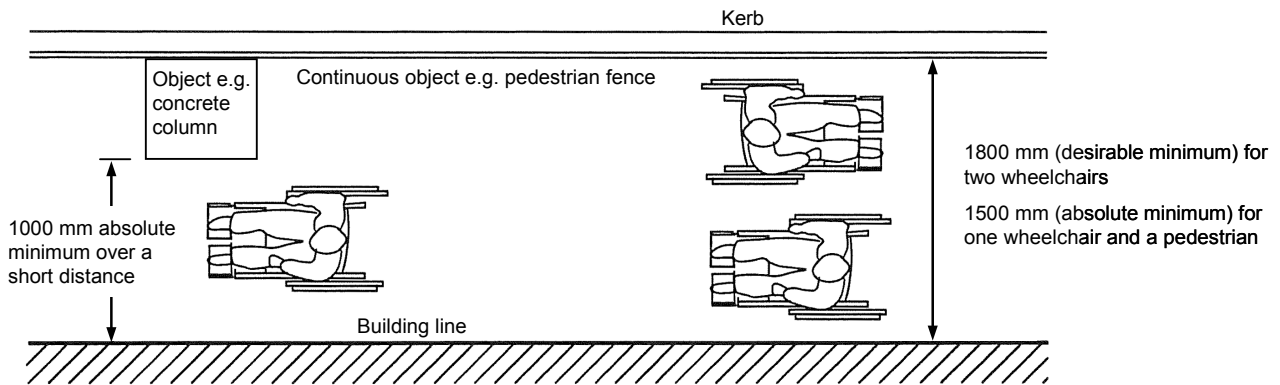
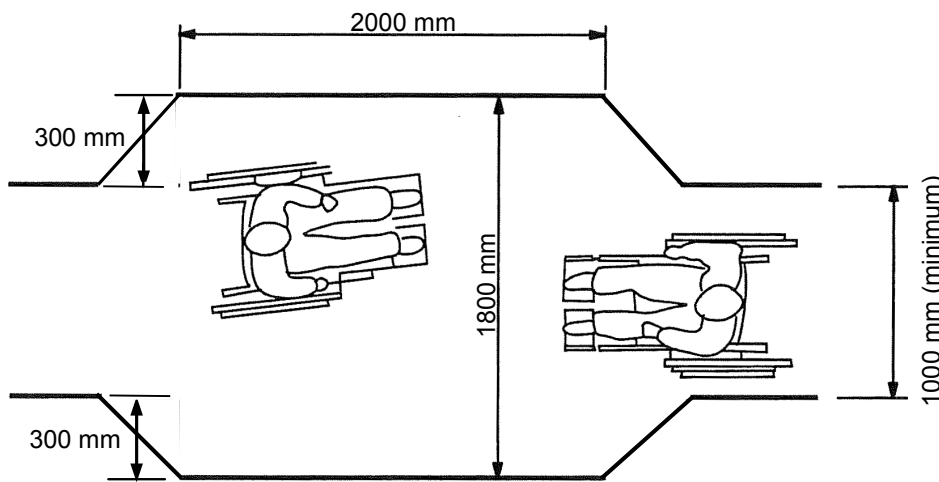

Figure 5.3: Example of passing areas in constrained locations



Notes:

The passing area could also be provided by widening by 600 mm to one side of the path.

Refer to AS 1428.1:2009 for alternative design.

Source: Based on AS 1428.1:2009.

5.1.3 Bicycle Paths

When the volumes of cyclists are not able to be determined, it is suggested that the widths shown in Table 5.2 provide acceptable ranges for bicycle paths. The upper limit of the acceptable range in the table should not discourage designers from providing a greater width where it is needed (e.g. very high demand that may also result in overtaking in both directions).

Table 5.2: Bicycle path widths

	Suggested path width (m)	
	Local access path	Regional path
Desirable minimum width	2.5	3.0
Minimum width – typical maximum	2.0 ⁽¹⁾ – 3.0 ⁽²⁾	2.5 ⁽¹⁾ – 4.0 ⁽²⁾

1 A lesser width should only to be adopted where cyclist volumes and operational speeds will remain low.

2 A greater width may be required where the number of cyclists is very high.

In general, a width less than lowest value of the acceptable range shown in the tables should not be adopted. An exception is the local access path that is provided to connect a local area to a community facility (e.g. shopping centre) and it is expected that the volume of cyclists and operating speeds will remain low throughout the life of the path. In such cases a width less than 2.0 m may be considered. A width greater than the upper value of the acceptable range may be required where a very high number of cyclists are expected to use the path.

When a bicycle path is primarily for high volumes and there is an emphasis on capacity, it is suggested that the path widths shown in Figure 5.4 and Figure 5.5 be used.

Figure 5.4: Path widths for a 50/50 directional split

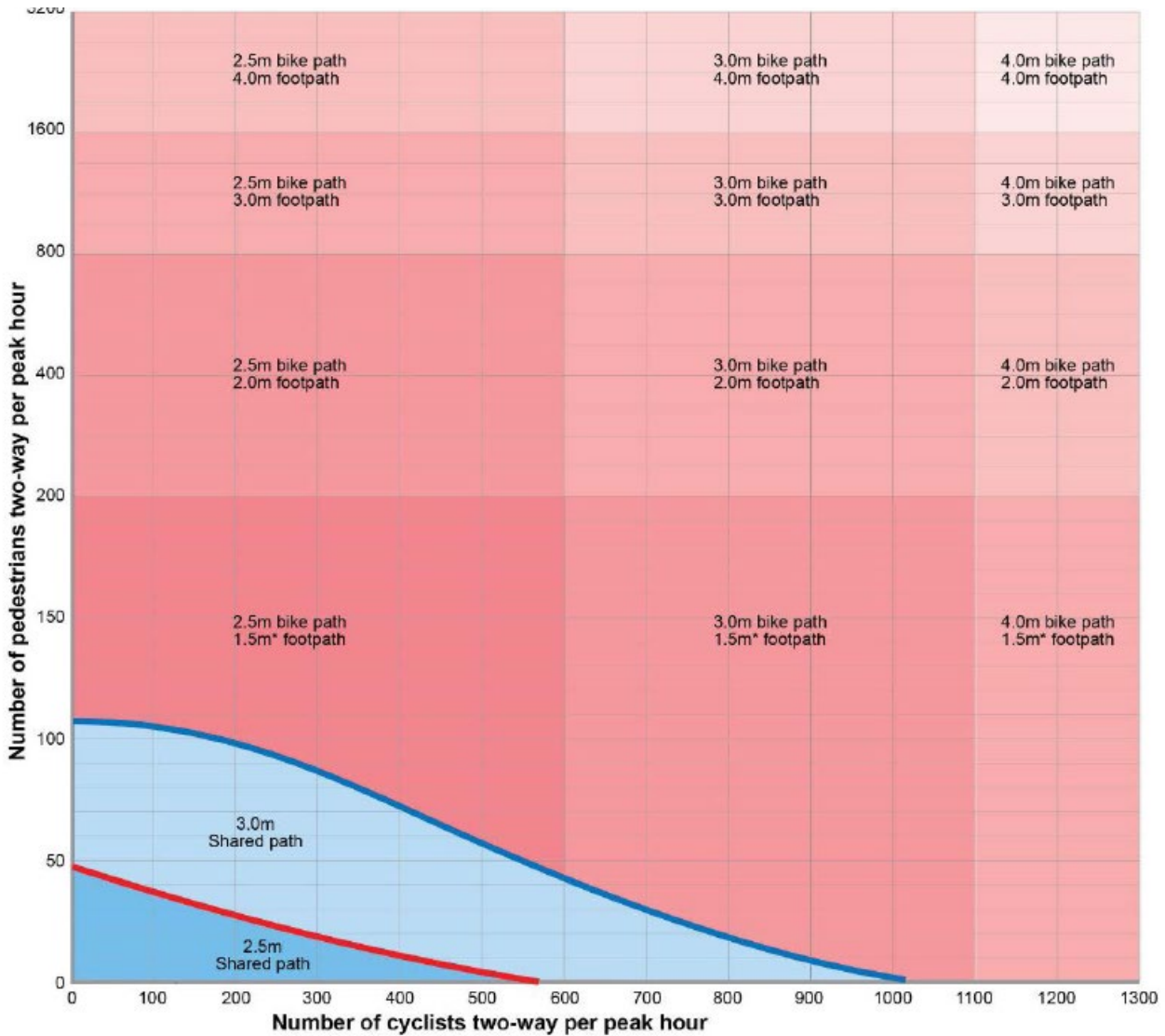

* Indicates that the 1.5 m footpath width is the low use minimum only and is not appropriate at higher pedestrian volumes.

Notes: The chart is not to be used for pedestrian paths only.

In this guide, the term pedestrian path is used for a footpath.

Where the path widths are shown for a bicycle path and a pedestrian (footpath) path together, these are separated paths.

A 50/50 directional split is typical for most recreational paths which have high use in both directions.

The directional split refers to the proportion of the total number of path users travelling in each direction, e.g. a 50/50 directional split means that 50% of the total volume of path users travel in each direction.

Source: Queensland Department of Transport and Main Roads (2015a).

Figure 5.5: Path widths for a 75/25 directional split

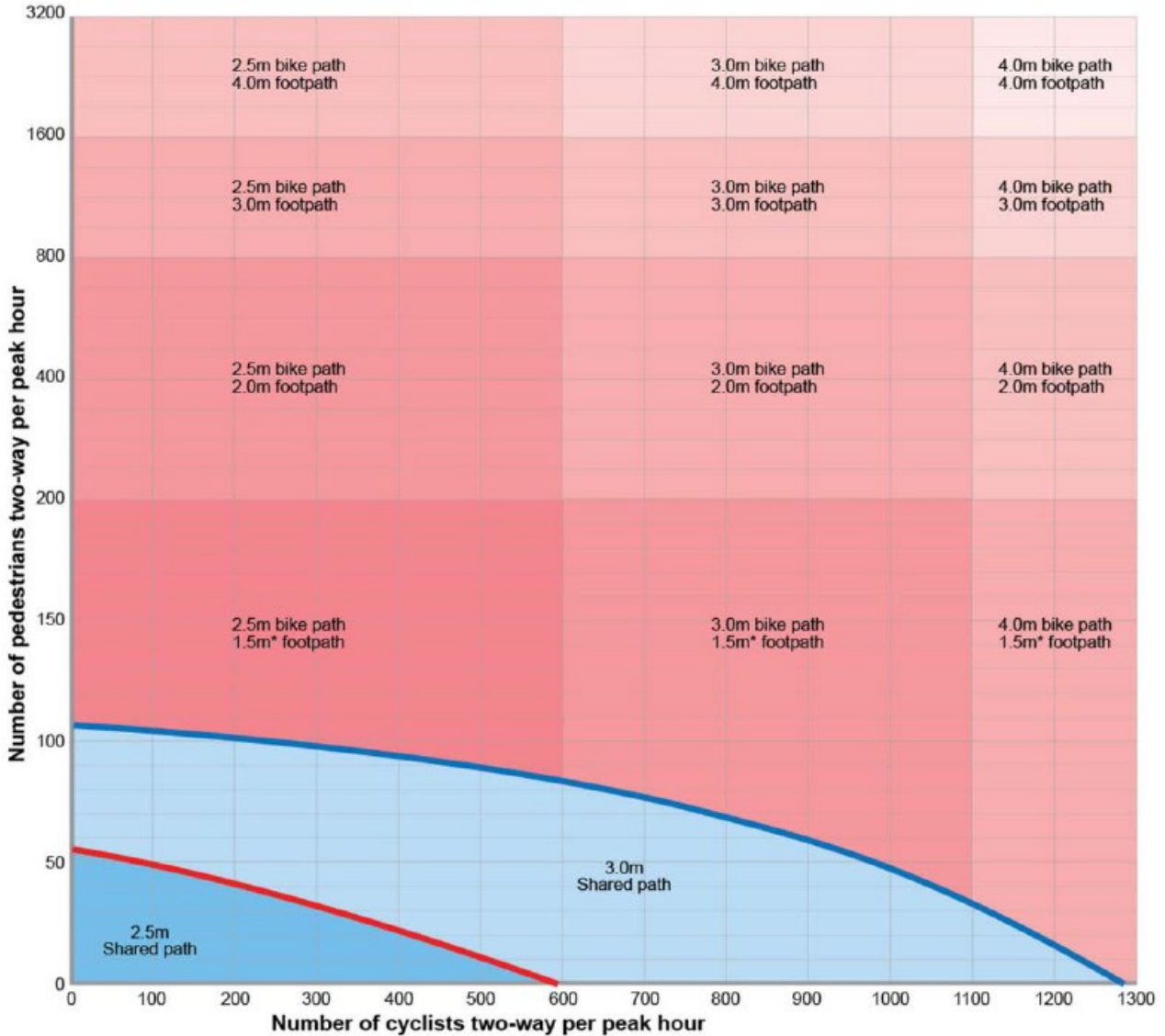

* Indicates that the 1.5 m footpath width is the low use minimum only and is not appropriate at higher pedestrian volumes.

Notes:

This chart is not to be used for pedestrian paths only.

In this guide, the term pedestrian path is used for a footpath.

Where the path widths are shown for a bicycle path and a pedestrian (footpath) path together, these are separated paths.

A 75/25 directional split (i.e. there is a greater volume of path users in one direction) is typical for most commuter paths which have high peak directional volumes.

The directional split refers to the proportion of the total number of path users travelling in each direction, e.g. a 75/25 directional split means that 75% of the total volume of path users travel in one direction and 25% travel in the opposite direction.

Source: Queensland Department of Transport and Main Roads (2015a).

5.1.4 Shared Paths

Table 5.3 shows suggested widths and acceptable ranges of width for shared paths. The upper limit of the acceptable range in the table should not discourage designers from providing a greater width where it is needed (e.g. very high volumes that may also result in overtaking in both directions).

Alternatively, where there is an emphasis on the capacity of the shared path, it is suggested that the path widths shown in Figure 5.4 and Figure 5.5 can be used.

Table 5.3: Shared path widths

	Suggested path width (m)		
	Local access path	Regional path ⁽³⁾	Recreational path
Desirable minimum width	2.5	3.0	3.5
Minimum width – typical maximum	2.0 ⁽¹⁾ – 3.0 ⁽²⁾	2.5 ⁽¹⁾ – 4.0 ⁽²⁾	3.0 ⁽¹⁾ – 4.0 ⁽²⁾

1 A lesser width should only to be adopted where cyclist volumes and operational speeds will remain low.

2 A greater width may be required where the numbers of cyclists and pedestrians are very high or there is a high probability of conflict between users (e.g. people walking dogs, in-line skaters etc.).

3 May be part of a principal bicycle network in some jurisdictions.

5.1.5 Separated Paths

Table 5.4 and Table 5.5 show suggested widths and acceptable ranges of width for two-way and one-way separated paths respectively. However, where it is appropriate designers may provide a greater width than the typical maximum shown in the tables and Figure 5.4 and Figure 5.5 can be used.

Table 5.4: Separated two-way path widths

	Suggested path width (m)		
	Bicycle path	Pedestrian path	Total
Desirable minimum width	2.5	2.0	4.5
Minimum width – typical maximum	2.0– 3.0	≥ 1.5	≥ 4.5

Table 5.5: Separated one-way path widths

	Path width (m)		
	Bicycle path	Pedestrian path	Total
Desirable minimum width	1.5	1.5	3.0
Absolute minimum width	1.2 ⁽¹⁾	≥ 1.2	≥ 2.4

1 A minimum width of 2.0 m is required where passing within the cyclists' path section occurs or where it is desirable that passing manoeuvres by cyclists occur outside of the pedestrian path section of the facility.

5.2 Bicycle Operating Speeds

Bicycle operating speeds on paths are influenced by a combination of human and other factors, including:

- the type of bicycle
- purpose of the trip (e.g. commuting, riding to gain fitness including group riding)
- age, confidence and level of fitness of the cyclist
- condition of surface
- alignment standard of the facility
- gradients
- widths
- path user volumes
- prevailing weather conditions.

It is important to recognise that under appropriate conditions many fit cyclists can maintain relatively high speeds. Speeds in excess of 35 km/h can be maintained on the flat while speeds of over 50 km/h can be attained on moderate gradients.

It is recommended that paths be designed for a speed of at least 30 km/h (Shepherd 1994) wherever possible and desirable given the purpose of the path, and in other cases for the anticipated operating speeds⁴. However, it should be recognised that it may be necessary to adopt higher or lower design speeds in specific circumstances. For example, it is desirable to provide a high standard curve at the bottom of a steep downgrade but designers may be forced to adopt tight curves in providing a path down the face of an escarpment. In such circumstances the potential hazard should be appropriately highlighted (e.g. adequate sight distance, delineation and warning signs).

Where it is considered necessary to moderate the speeds of cyclists, such as at entry points and areas shared with pedestrians, physical treatments may be necessary to moderate cyclist speeds, refer to Appendix B.

There may also be locations where high bicycle speeds cannot be moderated and in these locations consideration should be given to providing a separate pedestrian path.

5.3 Horizontal Curvature

Where a path location or alignment is not constrained by topography or other physical features, a generous alignment consisting of straights and large radius curves is desirable. Such an alignment will provide good sight lines that are essential for safety as well as a pleasant riding experience for cyclists.

While the anticipated type of use is a factor for consideration, the fact that a path is provided primarily for recreational use does not remove the need for a good alignment; nor should it encourage designers to provide tight curves to achieve what they consider to be a visually pleasing alignment. Many recreational cyclists travel at relatively high speeds and the radii of curves should be chosen to cater for the expected operating speed on the particular section of path. In addition, tight curves should not be provided to improve visual amenity because:

- Pedestrians and cyclists are likely to cut across to the opposite side of the path, increasing the likelihood of path user conflict.
- There will be a subsequent requirement to treat the area on the inside of curves at additional cost in order to constrain cyclists and pedestrians to travel along the inadequate alignment.

The minimum horizontal radii shown in Table 5.6⁵ should be used where a flat surface is used and it is not possible or desirable to provide superelevation. Table 5.7 shows the minimum radii that should be used in combination with superelevation. However, AS 1428.1:2009 requires that the crossfall on a path used by pedestrians should not exceed 2.5% (i.e. 1 in 40). Therefore, it follows that the minimum radii used on shared paths should be no less than those shown in Table 5.7, corresponding to a superelevation of 2.5%. It also follows that the values from Table 5.7 for a superelevation greater than or equal to 3% should only be used on exclusive bicycle paths. From a cyclist's perspective curves should generally have positive superelevation so that they can be comfortably negotiated.

Where practicable designers should not design for the minimum radius as tight curves can result in sight distance restrictions, a poor level of service and some cyclists choosing an informal alternative path to avoid the restriction. Exceptions include locations where the alignment is severely constrained (e.g. steeply sloping land) and smaller radii cannot be avoided. However, isolated tight bends that do not have preparatory approach geometry should be avoided as at night, in an unlit environment, curve warning signage may not be visible with bicycle lights.

4 The operating speed should not be confused with the design speed. The design speed is the speed adopted for the design of the path. The operating speed is the speed at which cyclists adopt in travelling along the path.

5 The radius of the horizontal curves shown in Table 5.6 and Table 5.7 have been determined using the horizontal curve equation that can be found in *Guide to Road Design Part 3: Geometric Design* (Austroads 2016b).

It is acknowledged that a curvilinear alignment is often preferred to achieve a visually pleasing path for cyclists. However, minimum radius or sharp curves should not be used to achieve landscaping objectives to the detriment of the level of service and social safety for cyclists on any path that has a commuter, major recreational or utility function.

Table 5.6: Minimum radius of horizontal curves without superelevation

Design speed (km/h)	Minimum radius (m)
20	10
30	25
40	50
50	94

Note: Based on zero superelevation and friction factors of 0.31, 0.28, 0.25 and 0.21 for speeds of 20, 30, 40 and 50 km/h respectively.

Table 5.7: Minimum radius of horizontal curves that have superelevation

	Superelevation (%)				
	2	3	4	5	6
Speed (km/h)	Minimum radius (m)				
20	10	9	9	9	9
30	24	23	22	21	21
40	47	45	43	42	41
50	86	82	79	76	73

Notes:

Based on friction factors of 0.31, 0.28, 0.25 and 0.21 for speeds of 20, 30, 40 and 50 km/h respectively.

For intermediate values of superelevation the horizontal curve equation found in Guide to Road Design Part 3: Geometric Design (Austroads 2016b) can be used.

Table 5.6 and Table 5.7 apply to bicycle paths and shared paths, however the application of superelevation on a shared path needs to consider the suitability of the crossfall for pedestrians, refer to Section 5.6.1.

5.4 Path Gradients

As a general principle longitudinal gradients on paths for cycling should be as flat as possible. The potential hazard for cyclists due to high speeds on steep downgrades is as important as the difficulty of riding up the grade when determining maximum gradients on two-way paths.

AS 1428.1:2009 and AS 1428.2:1992 have specific requirements for pedestrians, including wheelchair users, and require level rest areas at a specific spacing (see Table 5.8). While these standards were developed for pedestrian and wheelchair access to buildings and premises there is a need to consider their requirements with respect to the design of pedestrian inclusive paths. Where it is considered appropriate to provide compliant path gradients and flat landings the requirements of AS 1428.1 – 2000 should be incorporated into the path design.

Designers should consult any jurisdictional guidelines; however, in the absence of such guides the following approach is suggested:

- Where a path is proposed for a relatively short transverse pedestrian/cyclist overpass (e.g. across a road, creek or railway), it may be appropriate for it to be a shared path. For a shared path, the ramps should be provided with landings at a spacing that complies with AS 1428.1:2009. However, because these landings result in a reduction in cyclist comfort and convenience they may only be acceptable to cyclists if used over a relatively short length.
- Where a gradient that requires landings under AS 1428.1:2009 is proposed on a path (including a longitudinal path on a road bridge) that has to provide for ramps greater than 200 m in length, the provision of standard landings may present an inconvenience or hazard for cyclists, particularly those travelling downhill. If there is a need for pedestrian landings in this situation they should be provided on a separated facility or outside the shared path, on both sides.

5.4.1 Universal Access

Where the topography of the road or area where a path is to be located does not allow path grades to meet the requirements of AS 1428.1:2009, designers, in Australia, may refer to the Australian Human Rights Commission's Advisory note on streetscape, public outdoor areas, fixtures, fittings and furniture (Australian Human Rights Commission 2013).

5.4.2 Ease of Uphill Travel

Figure 5.6 shows the maximum lengths of uphill gradient acceptable to cyclists. The figure is based on a review of the ease of uphill travel (Andrew O'Brien & Associates 1996).

In using the figure designers should understand that:

- Above 3% the acceptable length reduces rapidly and it is considered this is the desirable maximum gradient for use on paths. However, in practice there are cases where it is not feasible to achieve a 3% maximum and the designer has no choice but to adopt a steeper gradient.
- In cases where 3% cannot be achieved consideration should be given to limiting gradient to a maximum of about 5% and providing short flatter sections (say 20 m long) at regular intervals to give cyclists travelling both uphill and downhill some relief from the gradient.

It is sometimes difficult to achieve these gradients where a path follows streets with driveways or a creek or river and a connection between paths must be achieved in the vicinity of a steep escarpment. It should also be noted that a long, uphill grade preceded by a downgrade is more acceptable than one preceded by a flat or slightly rising grade.

For uphill gradients consideration should also be given to:

- cyclist speeds on approach to an uphill section
- exposure to wind
- width of path – where the recommended gradient cannot be achieved it may be desirable to widen the path to cater for slower cyclists to be passed, the sideways displacement of bicycles being ridden uphill, or to allow for cyclists walking side by side.

Figure 5.6: Desirable uphill gradients for ease of cycling

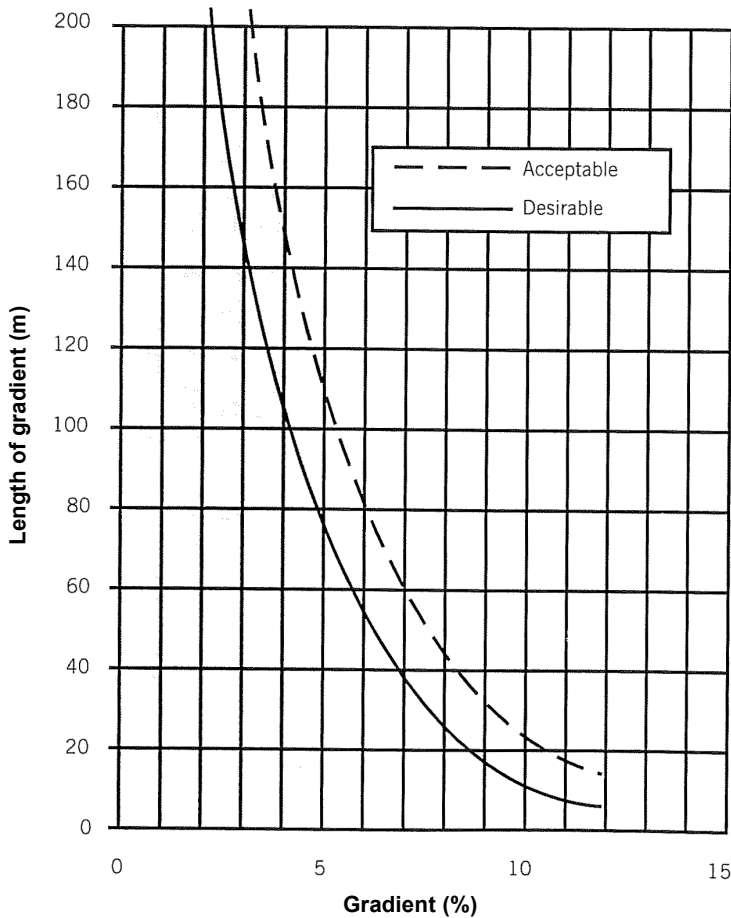

Notes:

Gradients and the associated length would normally be based on the distance between the tangent points for an isolated steep section. However, where there are consecutive grades of varying steepness (all uphill) or large radius vertical curves, these should be calculated based on the intersection points of the respective vertical curves.

In general, the 'acceptable' line in the figure would be satisfactory for paths with a high proportion of regular or physically fit cyclists, which in most instances would include commuter and sporting cyclists. Otherwise, the 'desirable' line in the figure is recommended.

Source: Based on a review by Andrew O'Brien and Associates (1996).

5.4.3 Safety and Downhill Travel on Paths

Gradients steeper than 5% should not be provided unless it is unavoidable. It is most important that sharp horizontal curves or fixed objects do not exist near the bottom of hills, particularly where the approach gradient is steep (greater than 5%) and relatively straight. If a curve must be provided at the bottom of a steep grade then consideration should be given to providing additional path width, and a clear escape route or recovery area adjacent to the outside of the curve.

Many cases where gradients are in excess of 5% occur on the approaches to grade-separated facilities (e.g. underpasses) and in these situations the provision of widened paths or clear escape routes is not practicable. In these cases adequate sight distance should be provided together with appropriate delineation and warning signs.

There may be existing bicycle facilities that have gradients which require riding skills beyond inexperienced and young cyclists when they are riding down the grade. As a guide, a gradient greater than 10% over 50 m with horizontal curves or a gradient of 12% over 50 m on a straight path should be avoided. Steep grades must not be combined with sharp horizontal curvature (i.e. curves < 20 m radius).

Intersecting paths, underpass access points and other circumstances that may result in conflict for cyclists should not be provided at the bottom of steep grades, except where there is no alternative. If an intersection must be provided then it is important that adequate sight distances are provided on all approaches.

5.5 Clearances, Batters and Need for Fences

5.5.1 Clearances

The clearances (Figure 5.7) may be used to construct the appropriate width of the facility required for paths that cyclists use. The envelope based on Figure 3.5, is assumed to be consistent over the range of operating conditions and allowance for higher speeds is provided through larger clearances to other cyclists and fixed objects beside the path.

Figure 5.7: Clearances between cyclist envelope and potential path hazards

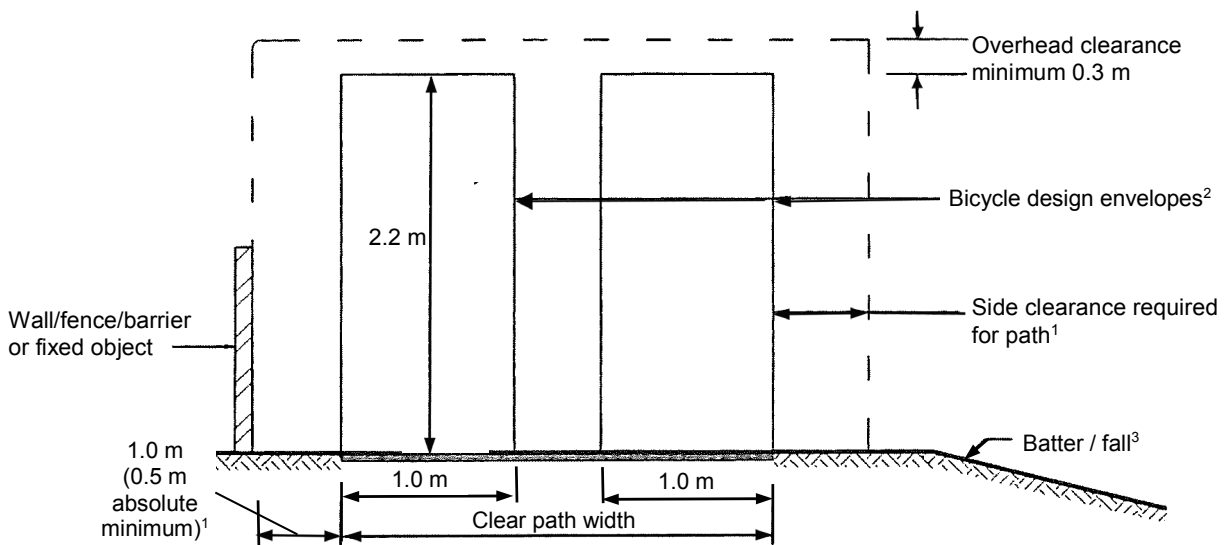

1 This may be reduced to 0.3 m where a fence or obstacle has smooth features.

2 Refer to Section 3.2.2 for guidance on bicycle design envelopes.

3 Refer to Section 5.5.3 for guidance on batters and need for a fence.

5.5.2 Bicycle paths

It is important for safe operation that adequate clearance is provided between bicycle operating spaces for cyclists travelling in opposite directions and between the cyclist operating spaces, and potential hazards beside paths (e.g. fixed objects, vertical drops, steep batters).

The clearance between cyclist operating spaces varies according to the type of use and operating speeds as follows:

A minimum lateral clearance of 1.0 m is required between opposing bicycle operating spaces where the path caters for higher speeds e.g. 30 km/h, because of the high relative speed which exists when cyclists approach one another from opposite directions (e.g. closing speed of 60 km/h).

On paths where the speeds of cyclists are not likely to exceed 20 km/h a minimum lateral clearance of 0.5 m is necessary between opposing bicycle operating spaces.

Consideration should be given to the provision of a centreline on all two-way paths that have a minimal clearance between opposing flows in order to provide guidance and certainty regarding the opposing travel path.

The following guidelines should be applied for clearances between the cyclist operating spaces and potential hazards beside paths:

- Where the areas beside the path and the path alignment are both relatively flat a lateral clearance of at least 1.0 m (0.5 m absolute minimum) should be provided between the edge of any path for cycling and any obstacle, which if struck may result in cyclists losing control or being injured. However, on high-speed paths it is most desirable to have a clearance considerably greater than 1.0 m. This is particularly important on small radius horizontal curves where cyclists may lean in when travelling around the curve.
- Where it is considered that an obstacle or hazard beside the path has attributes that could cause serious injury to cyclists (e.g. sharp surfaces such as the rear side of the posts and rails of steel W-beam road safety barrier), designers should assess the risk of cyclists losing control on the particular section of path, and consider either increasing the lateral clearance or shielding cyclists from the hazard. Depending on the situation a rub rail behind the posts or a cyclist fence near the edge of the path could be provided.
- Where a vertical drop or a steep batter exists or must be provided adjacent to the path the guidance in Section 5.5.2 should be applied.

Obstacles beside paths include bushes, culvert end walls, trees and large rocks used in landscaping. Provided the design and end treatments are appropriate, or where extenuating circumstances exist, a lesser clearance may be acceptable for fences and other obstacles that have smooth features and are aligned parallel to the path (0.3 m absolute minimum).

These horizontal clearances are partially illustrated in Appendix A.

In urban arterial road related areas it is recommended that where practicable paths are to be located with adequate clearance from both road traffic and the property line so that adequate sight distance is achieved for vehicles and pedestrians leaving driveways and gateways (Figure 5.8). A related consideration is that a path too far from the adjacent carriageway may decrease the likelihood of path users being seen because they are outside the peripheral vision of turning drivers. Wider clearances or physical barriers, including low profile landscaping, may be appropriate where:

- the kerbside lane is heavily trafficked
- high speed limits exist (e.g. 80 km/h and above)
- children on bicycles or inexperienced cyclists regularly use the path.

For this reason it is recommended that where practicable, paths in urban arterial road related areas be located with adequate clearance from both road traffic and the property line so that adequate sight distance is achieved for vehicles and pedestrians leaving driveways (Figure 5.8).

In addition, it is necessary for the path to be located with sufficient distance from the kerb that it enables driveways to be formed without adversely affecting the profile of the path, necessary road furniture to be located near the kerb and errant cyclists to recover without encroaching onto the road. However, where the only option is for the path to be located close to the kerb, consideration should be given to extending the path to the roadside as a sealed shoulder in order to avoid maintenance where it is difficult to access with machinery.

Figure 5.8: Location of path in road reserve

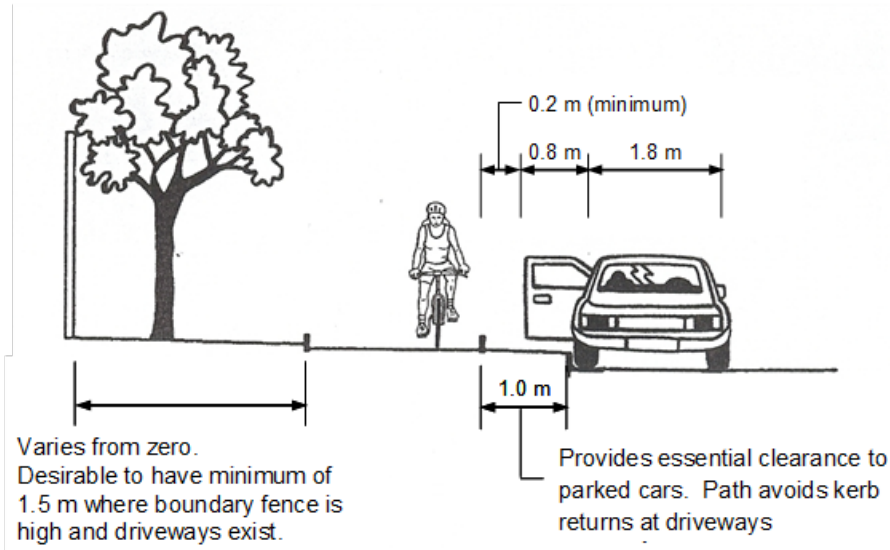

Note: Further information on path locations in road related areas is contained in Section 4.2.1.

Pedestrian path vertical clearance

An adequate vertical clearance should be provided over the full width of the pedestrian path, completely free of overhanging projections and obstructions (Figure 5.9). Clause D2.3.5 of AS 1742.2:2009 requires that the vertical clearance to a sign that overhangs a footway or bicycle path is no less than 2.5 m.

For urban areas AS 1742.2:2009 (Clause D2.3.5) requires a minimum vertical clearance to a sign of 2.0 m above the top of the kerb to prevent obstruction to an occasional pedestrian. It is considered that this should be interpreted to mean a sign that is located outside of the limits of the path and recommended clearances. It should be noted that AS 1428.2:1992 also requires a minimum vertical clearance of 2.0 m to fixtures and fittings to buildings (e.g. lights, awnings, opening windows) and that this is a minimum provision. Some municipalities require trees overhanging pedestrian paths to be trimmed to a clearance of 3.0 m.

Figure 5.9: Envelope of height requirements

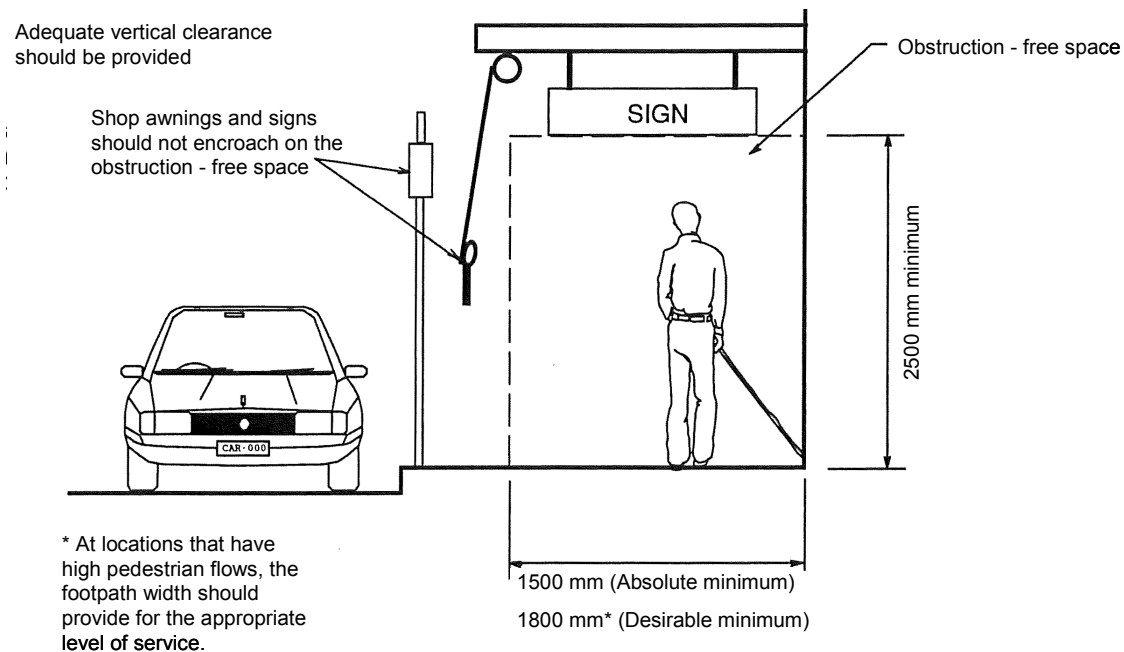

Note: The vertical clearance to an obstruction (e.g. sign), shown as 2500 mm, is required by AS 1742.2:2009.

Bicycle path vertical clearance

The minimum vertical clearance required by cyclists is 2.5 m, (i.e. 0.3 m above the cyclist design envelope) measured above the riding surface (Figure 5.7). This applies to tree branches, underpasses, doorways, sign structures and any other overhead structure. Where it is absolutely necessary to use the minimum clearance (e.g. at sites where space is constrained and the achievement of a greater clearance would have significant implications regarding the cost of a facility or impacts on other infrastructure) the designer should obtain the agreement of the relevant authority/agency.

5.5.3 Batters and Fences

General

The installation of a fence at the side of a path used by cyclists is desirable where:

- there is a steep batter or large vertical drop located in close proximity to the path
- the path is adjacent to an arterial road and it is necessary to restrict cyclist access to the road
- a bridge or culvert exists on a path
- a hazard exists adjacent to a particular bicycle facility
- cyclists are likely to be 'blazing a separate trail' at an intersection between paths or around a path terminal.

Fences may also be needed where the path geometry, e.g. a downhill grade followed by a sharp curve in the path may be a location where cyclists misjudge the speed the curve can accommodate and run off the path. In these locations a recovery area is needed for the cyclists if they travel off the path and the criteria in Figure 5.10 may not be appropriate. Treatments in these situations should be guided by a risk assessment.

There may be some locations where a treatment such as a vegetation fence could be used. Depending on the severity of the hazard (as determined from a risk assessment) the provision of dense shrubbery that prevents cyclists from reaching a hazard may be suitable.

Steep batter or vertical drop

Figure 5.10 provides a specific recommendation for the provision of a fence on a path in close proximity to a steep batter or vertical drop. In addition to those referred to in the figure, other circumstances may exist where it may be desirable to erect fences even if provision is not required by the figure (e.g. a curving path alignment, located in the vicinity of batters or a drop-off, bridges).

Figure 5.10 highlights the circumstances in which either a partial barrier fence (Figure 5.11), or a full barrier fence (Figure 5.12) or equivalent form of protection should be used. These barriers are intended to prevent access to a slope or to a fall away from a path or other riding surface, where injury might otherwise be expected in the event of a cyclist riding inadvertently off the line of a path. Examples of these fences are provided in the *Guide to Road Design Part 6B: Roadside Environment* (Austroads 2015b).

The minimum height of a fence should be 1.2 m (Figure 5.11 and Figure 5.12) and should be used only where the severity of the hazard is considered to be low. A higher fence ≥ 1.4 m, should be considered where the fence is protecting path users from a very severe hazard (e.g. high vertical drop from a structure to a body of water or rocks) or at a location where there is a risk of cyclists being vaulted off their bicycle if they collide with the fence, such as on a sharp curve following a steep downhill grade. The fence heights suggested should be verified by a risk assessment for each location that considers the type of hazard and its location near the path.

After determining what type of barrier fence is required, care must be taken in selecting the form of either partial or full barrier fencing so to not cause a hazard to cyclists. Where barrier fencing is provided directly adjacent a path with vertical components or balusters, consideration should be given to including a cyclist deflection rail (Figure 5.12). Cyclists deflection rails are design to enable a cyclist to deflect off the smooth horizontal rail striking the rail between the cyclists shoulder and elbow (i.e. between 1.2 m and 1.4 m from path surface) so that handlebars (typically 1.0 m from surface level) do not get caught in the vertical components of the fence. Infill panels as show in Figure 5.12 may also be considered as an alternative to deflection rails so to remove the hazard of vertical components of a barrier fencing however care must be taken to not restrict sight lines (Section 5.7). The infill panels of a fence should also have a fine weave mesh or similar to prevent bicycle wheels from being trapped or catching in the fence panel.

The terminal treatment of the fence also needs to be considered to avoid it being a hazard to cyclists. An example of a terminal treatment which has been flared away from the line of the rail to reduce the likelihood of a cyclist colliding into the end of the rail is shown in Figure 5.13.

Similar or even more stringent measures may be required adjacent to roads. Where a batter or fall is located in close proximity to a road, designers should have regard for the requirements of Figure 5.10, particularly where no kerb exists at the edge of a road. However, the measures required should be decided upon with consideration of all road users and of the particular circumstances

Figure 5.10: Requirement for fence barriers at batters and vertical drops

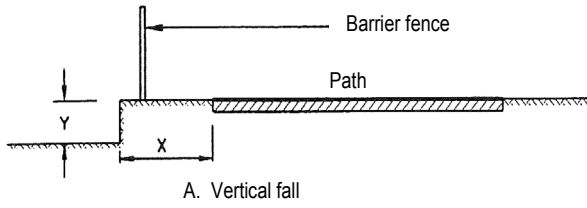

	X (m)	Y (m)
Fence not required*	<2	<0.25
Partial barrier fence required	<5	0.25 to 2
Full barrier fence required	<5	>2

* Batter off the surface where fall is within 1 m of path.

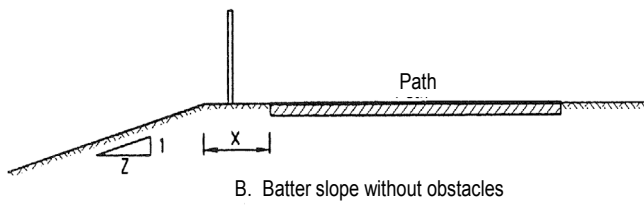

	X (m)	Z (m)
Fence not required	<1 1 to 5	>8 >3
Partial barrier fence required	<5	1 to 3
Full barrier fence required	<5	<1

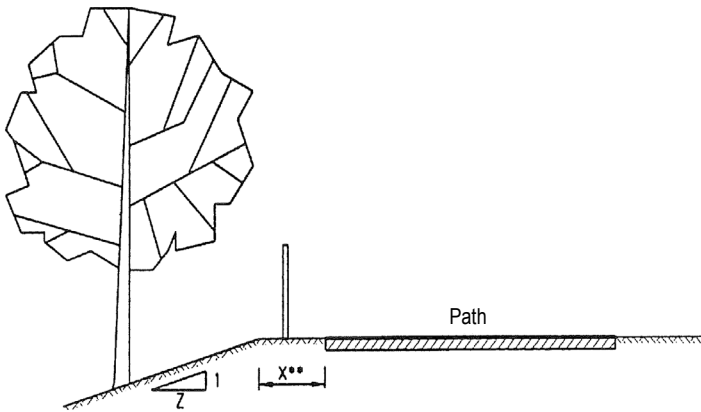

	X (m)	Z (m)
Fence not required	<1 1 to 5	>8 >4
Partial barrier fence required	<5	3 to 4
Full barrier fence required	<5	<3

** Barrier fence required if obstacle within 1 m of path.

Figure 5.11: Example of a partial barrier fence

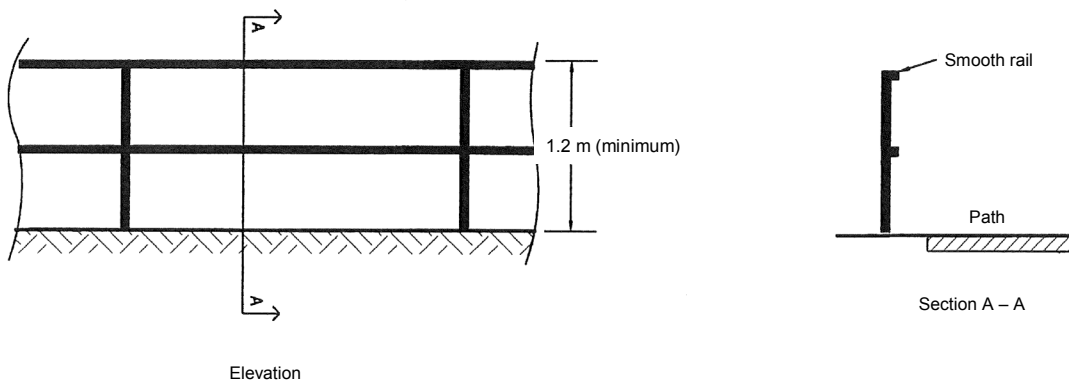

Notes: Any fence placed in road-related area should also be assessed for roadside suitability.

Figure 5.12: Example of a full barrier fence

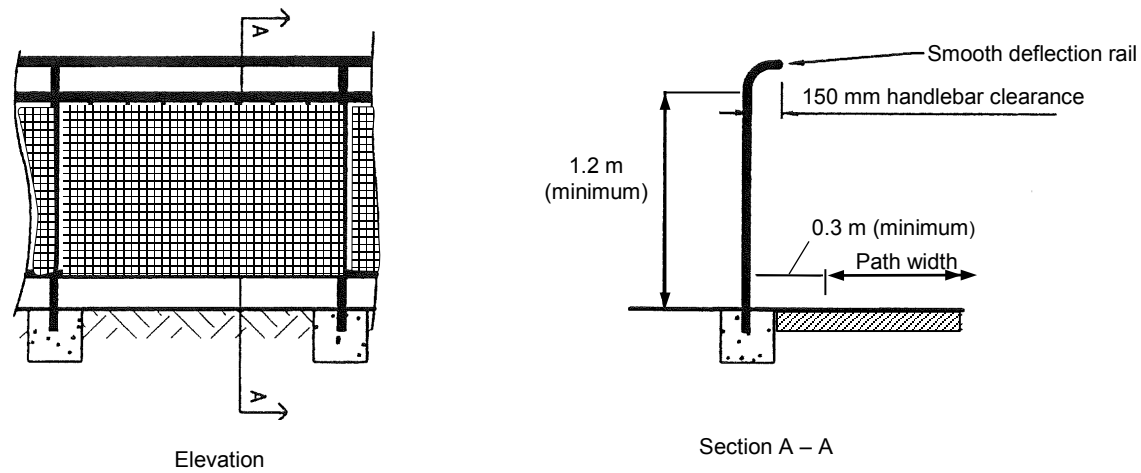

1 This may be reduced to 0.3 m where a fence has smooth features.

Notes:

Cyclist deflection rails should be placed between 1.2 m and 1.4 m above path surface so that cyclists are able to use the part of the arm between the shoulder and elbow to glance against the smooth longitudinal rail. This prevents the cyclist handle bar located approximately 1.0 m above the path surface from being caught in the vertical components of the fence.

Any fence placed in road related area should also be assessed for roadside suitability.

Figure 5.13: Example of flared bicycle rail terminal

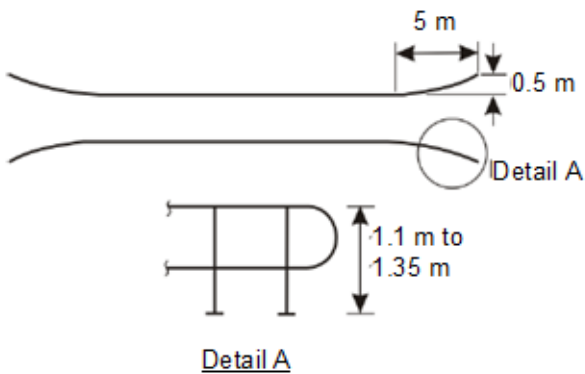

Source: Queensland Department of Transport and Main Roads (2015a).

5.6 Crossfall and Drainage

5.6.1 Crossfall

Water ponding on paths has a significant impact on the level of service provided to cyclists as spray leads to grit on both bicycle and rider and pedestrians, who may have to travel off the path to avoid the ponded water. On straight sections crowning of the pavement is preferable as it results in less accumulation of debris. On sealed surfaces a crossfall of 2–4% should be adequate to effectively dispose of surface water whereas unsealed surfaces may require 5% to prevent puddles of water from developing.

The crossfall of a paved pedestrian path may vary from flat (but achieving an adequately drained surface) to 2.5%. Provided that drainage is satisfactory, a lower crossfall is preferred (i.e. 1.0%) as a higher crossfall may cause problems for some people. Where paths are for pedestrian use or shared use, the needs of other path users (e.g. mobility impaired pedestrians) should be considered. In particular, AS 1428.1:2009 specifies that a path crossfall should not exceed 2.5% (1 in 40) or 3.3% (1 in 33) if the path has an asphalt surface.

A two-way crossfall on a path with a central crown, may provide an opportunity for wheelchair users to obtain relief from one-way crossfalls.

Section 5.3 provides information on the horizontal radius of curves and the corresponding superelevation that is required. With reference to Table 5.7 there is limited value in using higher rates of superelevation, and as such it is generally preferable to use a low path crossfall and thereby accommodate the needs of a range of path users.

5.6.2 Drainage

Paths should be constructed so that water does not pond on the surface and debris does not wash onto the path during heavy rain. The path should therefore have adequate crossfall and catch drains to collect water and prevent water and litter from flowing onto the path. In flat terrain it may be adequate to simply elevate the path above the adjacent land, but designers should ensure that the path shoulders are matched to the path surface level and graded with a suitable crossfall (preferably on a slope flatter than 1 in 8).

Catch drains will often be required on the inside of curves and pipes will often be needed to carry water under the path. On large radius curves (e.g. 100 m) an adverse superelevation of 2% may be provided to avoid the need for the catch drain and pipes. However, this should only be done where the catchment area above the path is relatively small and has a surface stable enough that debris is unlikely to wash over the path. Figure 5.14 shows typical cross-sections and drainage requirements of paths for cycling.

Regional paths should be designed for an equivalent flood immunity as that adopted for local roads unless suitable safe alternative routes can be easily accessed from the path. Regional paths that follow watercourses will have to satisfy the requirements of the responsible drainage authority. For most regional paths adjacent to freeways and arterial roads, an average recurrence interval of at least five years should be adopted whereas a two-year average recurrence interval should be satisfactory for paths that have a lesser function and/or have readily accessible alternative routes. In addition, for safety of path users, the water flow depth and velocity need to be assessed, refer to *Australian rainfall and runoff: revision project 10: appropriate safety criteria for people: stage 1 report*, (Engineers Australia 2010).

Where sections of a path are likely to be subjected to inundation (e.g. along a linear trail adjacent to a watercourse, less important routes) it is important that signs should be erected to warn users of any risk (e.g. flooding, slippery surface after inundation, accumulation of debris on the path) and that maintenance measures are in place to assist cyclists and pedestrians (e.g. well-signed detours, barricades). In such situations the drains should be designed to minimise the likelihood of blockages and the consequent ponding of water at low points in the alignment.

Where paths have to pass under the abutments of structures and headroom is limited, necessitating the level of the path being below the flood level, it may be possible to construct a flood wall between the path and the river to hold back water during minor flood events. In extreme conditions the water can overtop the wall and flow along the path.

Designers should also:

- check to ensure that water follows minimal flow-path distances on the path surface
- consider potential problems of water flowing either from the path or other sources, through landscaped areas, to deposit debris over the path surface
- consider the use of fencing or other treatment details that trap debris so that it accumulates clear of the path edge
- ensure that drains are of an adequate size to avoid them being blocked by roadside litter.

The same principles that are applied in the design of road cross-sections should be used in the design of path cross-sections, namely the need to prevent water from flowing across the path, flooding the path or causing damage to the pavement. Figure 5.14 shows four typical cross-sections that are used on regional paths and that illustrate these principles:

- Example a shows a path in flat terrain where the pavement is elevated above the natural surface and water is shed into the flat areas beside the path where it can flow to an outlet.
- Example b shows a case where a path is located on a cross-slope with the pavement cut into the high side so that the surface is coincident with the natural surface. This approach is not generally satisfactory as water and possibly debris would be shed across the path and water could seep into and cause damage to a flexible pavement on the high side. Consequently, this option should only be used where the upper 'non-eroding surface' has a porous, free-draining sub-surface such that run-off (regardless of the extent of debris) does not encroach onto the path; otherwise Example c should be used.
- Example c illustrates the provision of an open drain on the high side of the path to cut off water and carry it to a discharge point, possibly via pits and lateral pipes. In this case water from the path is shed to the low side.
- Example d again shows a path on a cross-slope but with the path on a curve and superelevated toward the high side. In this case the open drain collects water from the path and the high side of the path.

Figure 5.14: Drainage and crossfall requirements

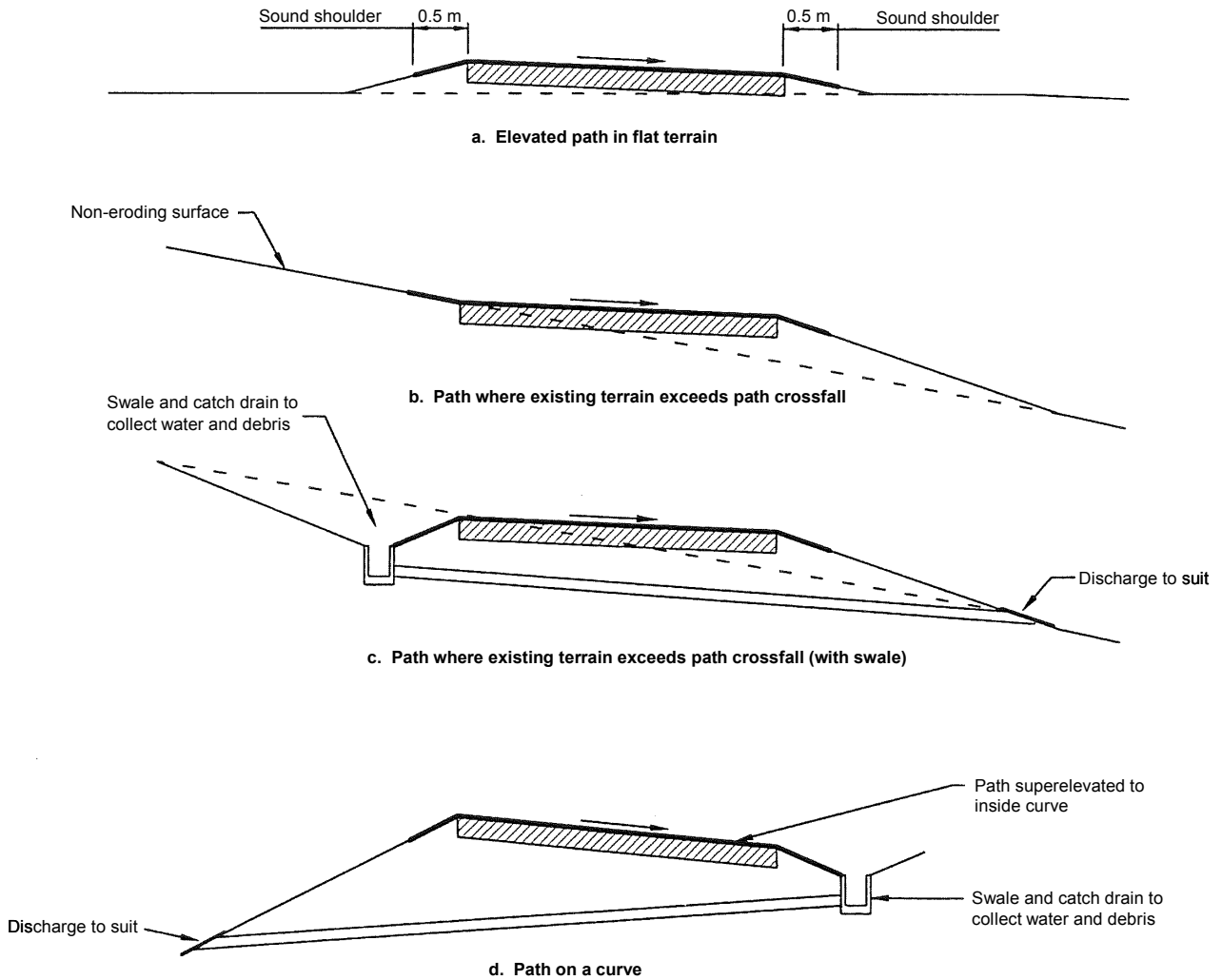

Note: For guidance on swales and catch drains, refer to Guide to Road Design Part 5B: Drainage: Open Channels, Culverts and Floodways (Austroads 2013b).

5.7 Sight Distance

For safe travel pedestrians and cyclists must be able to see other approaching path users. Locations where the available sight distance is needed to be assessed are at structures, such as:

- at intersections of paths
- across the inside of horizontal curves
- at the top and bottom of stairways
- under overhead obstructions
- culvert entries and exits
- in sag curves (e.g. where a path passes under a road) and over vertical crest curves.

The available sight distance needs to enable path users to stop or take evasive action if necessary in order to avoid another cyclist, pedestrian, or an obstacle in their path.

5.7.1 Bicycle Path Stopping Sight Distance

The stopping sight distances that should be provided to enable a cyclist to stop for various combinations of bicycle design speeds and gradients can be determined using Equation 1. Equation 1 is based on a perception/reaction time of 2.5 seconds, an eye height of the cyclist is assumed to be 1.4 m and the object height is assumed to be zero to recognise that impediments to bicycle travel exist at pavement level (e.g. potholes or stones). The coefficient of friction varies and typically is 0.32 for dry conditions and 0.16 for wet conditions (AASHTO 2012).

$$S = \frac{V^2}{254 \times (f \pm G)} + \frac{V}{1.4} \quad 1$$

where

- S = stopping sight distance (m)
- V = speed (km/h)
- f = coefficient of friction (typically 0.16 for a bicycle in wet conditions)
- G = grade of path (+ for uphill and – for downhill)

Paths should be designed and constructed to provide the greatest sight distance possible at any given location.

The stopping sight distance to be used in the geometric design of paths should be at least equal to that determined from Equation 1, and should be used:

- for intersection design
- in setting out the alignment of paths
- in relation to the positioning of terminals and handrails
- at entries to underpasses
- to locate landscaping in the field
- otherwise as required to ensure the safety of path users.

All two-way bicycle paths should be designed to provide a sight distance between opposing cyclists (i.e. as shown across a horizontal curve in Figure 5.15) at least equivalent to twice the stopping sight distance determined from Equation 1. This is to ensure that cyclists who are overtaking can avoid a head-on collision.

Path sight distances can be drastically reduced by the growth of vegetation and hence the location and maintenance of vegetation is critical to safe path operation.

Figure 5.15 illustrates the relationship between stopping sight distance, radius of the curve and the lateral clearance to enable clear visibility of obstructions such as extensive vegetation or an earth embankment. Isolated features including trees do not necessarily constitute a significant obstruction if cyclists can see most of the curve beyond them.

While the graph is provided for use by designers, it is suggested that it, or a simple tabular representation, should be supplied to works staff to be used in construction and routine maintenance operations.

Where an existing path is narrow, the level of use of the path is high, such that cyclists may be expected to travel in both directions at the same time (i.e. 'non-tidal' flow), and widening is not feasible, because of physical or financial constraints, it is recommended vegetation should be set back as shown in Figure 5.15. This setback is to prevent the possibility of head-on crashes. If such a setback is not possible then consideration should be given to any one or a combination of:

- local widening of the path around the curve
- warning signs
- tactile lines.

Figure 5.15: Lateral clearances on horizontal curves

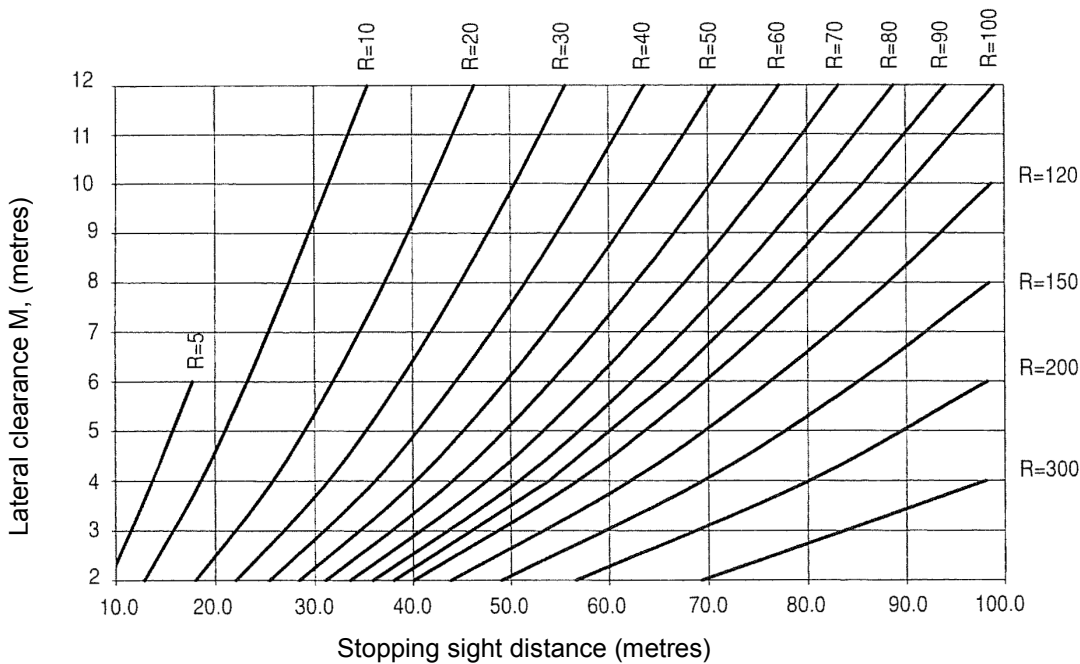
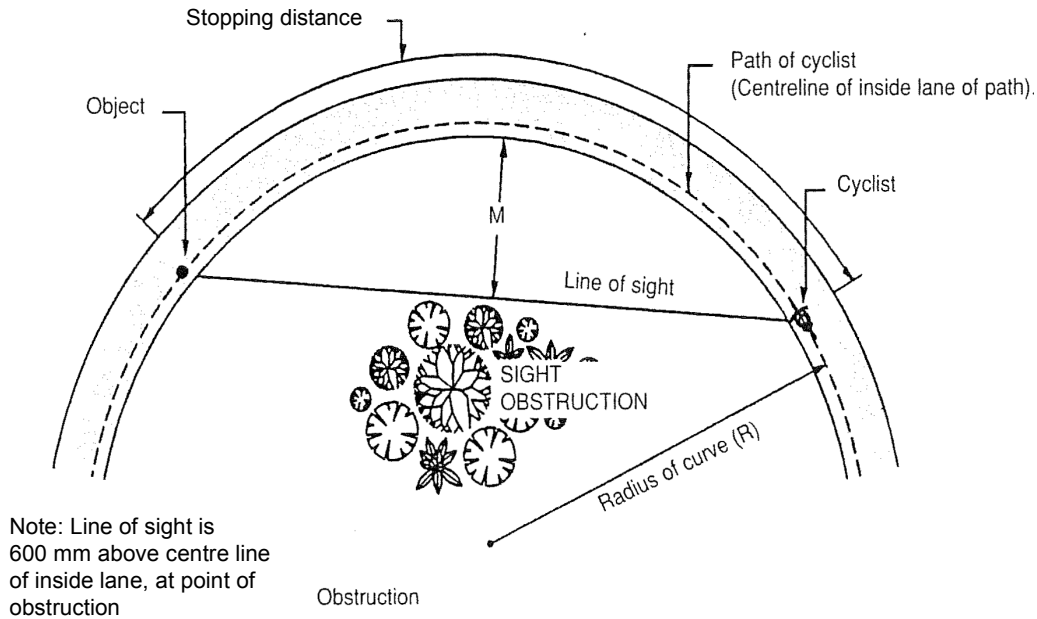

Source: AASHTO (1991).

Where a path has a change in grade, a vertical curve should be incorporated to provide a smooth transition between the grades. Crest vertical curves must be of sufficient length to give the cyclist the stopping sight distance as determined from Equation 2 (AASHTO 2012). Where practicable, sag curves should be the same length as equivalent crest curves to ensure comfort and an aesthetically pleasing path alignment.

$$\text{For } S > L, L = 2S - \frac{200 \times (\sqrt{h_1} + \sqrt{h_2})^2}{A} \quad 2$$

$$\text{For } S < L, L = \frac{A \times S^2}{100 \times (\sqrt{2} h_1 + \sqrt{2} h_2)^2}$$

where

- L = minimum length of vertical curve (m)
- A = algebraic grade difference (%)
- S = stopping sight distance (m)
- h_1 = eye height (m) (1.4 m typical for a cyclist)
- h_2 = object height (m)

5.8 Changes in Level

Changes in level, such as at kerbs, have to be designed to allow pedestrians and cyclists to move safely and efficiently along the road or path network. Factors relating to changes in level for pedestrians and treatments are summarised in Table 5.8.

Wherever practicable, a high level of service should be provided for pedestrians with respect to convenience and safety. As a general principle the dominant flow should claim priority and maintain a level surface. In situations where the volume of pedestrians and vehicles is high and the speed environment is relatively low it may be appropriate to allow pedestrians to have priority and cross the road without a change in level (i.e. not have to use ramps). This will not only reduce trip hazards for pedestrians but will also reduce vehicular speeds at the conflict points. However, where this type of treatment is installed it will require the use of formal crossings (e.g. pedestrian crossing with regulatory signs, pedestrian signalised crossing), to establish priority for pedestrians.

In locations where there is a low volume of vehicles on the side street and very few heavy vehicles, a continuous pedestrian path treatment could be used to provide priority to pedestrians. This treatment extends the pedestrian path across the road pavement on the same grade and without any colour or texture change. Further information on this type of treatment can be found in Roads and Maritime Services (2013).

Where a path crosses a property access driveway, the path should have a continuous grade across the driveway and preferably, the same crossfall as the path. Where property access cannot be achieved without altering the level or crossfall of the path, such as at a constrained site, the longitudinal grade on the path should provide a smooth change in level with relatively small changes in grade or if this is not able to be achieved ramps, similar to kerb ramps leading onto the driveway section of the path should be provided.

Table 5.8: Considerations relating to changes in level

Facility	Considerations
Kerbing and kerb ramps	<ul style="list-style-type: none"> • Level differences between a roadway and an adjacent pedestrian path pose difficulties for pedestrians, particularly those with mobility or vision impairments. • Provide kerb ramps with a smooth change in the level between the pedestrian path and road pavement to allow safe and easy access for pedestrians including people in personal mobility devices and those with a mobility impairment. • Align kerb ramps in the direction of travel to guide pedestrians who are blind or have vision impairment directly across the road and not out into the intersection. • A typical kerb ramp is illustrated in <i>AGRD Part 4</i> (Austroads 2017a). • A minimum pedestrian path width of 1330 mm should be provided beyond the top of the ramp. • A gradient of maximum of 1:8 quoted in AS 1428.1:2009, should be considered as an absolute maximum ramp gradient and only be used in extenuating circumstances. Providing a flatter kerb ramp grade, e.g. 1:10 with tactile ground surface indicators (TGSIs) may provide a smoother transition between the road pavement and the path. Designers should also consult with disability groups on the design of the kerb ramp. • A vertical lip should not be provided at the edge of the drainage channel as it inhibits the free movement of wheelchairs. • Design surface drainage to avoid low points and the accumulation of water where pedestrian crosswalks are to be located. For example, on-road drainage inlets should be placed immediately upstream of ramps to minimise the water that passes through the channel at ramp crossings. • Refer also to AS 1428.1:2009 for guidance regarding the design of kerb ramps.
Steps, stairs and ramps	<ul style="list-style-type: none"> • An abrupt change in level can be a problem for pedestrians particularly for those who have vision impairments and need to be warned of the presence of a kerb, a flight of stairs or a ramp. • Ramps should be provided where possible as an alternative or in addition to steps or stairs that are a barrier to people with disabilities and necessary for people in wheelchairs or with prams. On the other hand some people with impaired mobility cannot use ramps and need shallow steps (AS 1428.2:1992). • Rest areas (i.e. flat sections) should be provided at each change in direction and at intermediate points along ramps to break up long flights. AS 1428.2:1992 suggests that the spacing of rest areas range from 9 m for ramp grades of 1:14 to 15 m for grades of 1:20. This is a most important consideration in the design of overpasses and underpasses. • Provide handrails to assist pedestrians, including those in wheelchairs <ul style="list-style-type: none"> – on both sides of a set of stairs, or steps, or a ramp – wherever people may need support (e.g. continuously around rest areas and changes of direction). • Generally, two rails at different levels will be required to meet the need of both wheelchair users and other groups. • Ensure inter-visibility between the end of stairs or ramps and intersecting pedestrian paths (e.g. sight distance not obscured by a wall) and an area at the foot of the stairs to minimise the risk of collision. • Provide in all areas used by pedestrians (i.e. above stairs or ramps) a vertical clearance (i.e. headroom) no less than 2.5 m unless significant constraints exist. • Ramp surfaces and treads of stairs should be stable, even and slip resistant. • Tactile ground surface indicators (TGSIs) should be provided at the top of stairs and foot of stairs to indicate these hazards. • The provision of seating clear of the walking space should be considered on long ramps. Other features such as observation decks should be considered if the path provides tourist/social opportunities. • Recommended maximum crossfall is 1:40 (AS 1428.1:2009).

Facility	Considerations
Gradients	<ul style="list-style-type: none"> • Australian Standard AS 1428.1:2009 lists requirements for the design of sloped pedestrian paths. • Where the gradient is 1:33 level rest areas 1.2 m long should be provided at not greater than 25 m intervals whereas at 1:20 the interval should not exceed 15 m. Between gradients of 1:33 and 1:20 the interval should be interpolated. Landings are not required on gradients less than 1:33. Paths with a gradient steeper than 1:20 are to be considered as ramps for design purposes. • Adjacent ground for all pedestrian paths should be within 25 mm of the level of the pedestrian path. • If the adjacent ground has a steep slope, a kerb between 65 mm and 75 mm high should be provided to protect prams and wheelchairs and to guide those people with impaired vision. Handrails may also be provided. • The provision of seating clear of the walking space should be considered on long gradients. Other features such as observation decks should be considered if the path provides tourist/social opportunities. • Consideration should be given to the provision of an alternative shorter route via a staircase if such an alternative can be identified.
Crossfall	<ul style="list-style-type: none"> • Crossfall on pedestrian paths should be as flat as practicable consistent with achieving an adequately drained surface. Excessive crossfall causes problems for some people. • Crowning of the pedestrian path can benefit people using personal mobility devices as they can travel along the middle of the path, experiencing no crossfall. • AS 1428.1:2009 specifies that any crossfall should not exceed 1:40 (2.5%). A flatter crossfall may be adopted provided that drainage is facilitated to avoid any ponding of water within the path.

5.9 Surface Treatments

Surface treatments should be stable, firm, even, relatively smooth but slip resistant. The choice of surface treatment depends on:

- the grade of the surface and the coefficient of friction required
- whether the surface is also to provide guidance regarding use of the path or priority (i.e. maintaining contrast with the intersecting road surface)
- the physical environment, climate and demands placed on the surface.

It is important for many people that surfaces be flat. This is particularly so for people in wheelchairs, on crutches or who are unsteady on their feet as small ridges and protrusions as small as 6 mm can cause these people to stumble and fall.

Wherever possible pits for utilities or other purposes should not be located in paths as the covers can be hazardous for pedestrians (e.g. misaligned or broken covers form a trip hazard), particularly for physically impaired persons, people on crutches or using other walking aids. Additionally, metal manhole covers can become slippery, particularly when wet.

Another significant disadvantage of locating pit covers in paths is that the path is unable to be used when works are required to maintain the underground service that passes through the pit.

The use of some common paving materials is discussed in Appendix C.

5.10 Surface Tolerances

The surface of a new path pavement should be shaped to match existing features such as pit covers, edgings or driveways, to within 5 mm. It is desirable that the finished surface of a new path does not deviate from a 3 m straight edge by more than 5 mm at any point.

Existing paths often develop surface imperfections over their operational life such as:

- pavement deformation that results in undulating pavements with relatively smooth bumps
- tree roots creating sharp bumps
- service trenches that subside to create grooves or steps.

In addition, the hazards associated with such surface imperfections can be compounded by other features beside the path, such as an edge drop-off or fixed objects (e.g. trees, poles, rocks).

The surface of an existing path should not exceed the tolerances nominated in Table 5.9, however, conditions and requirements vary between agencies and so when assessing a path, the requirements of the relevant local agency should be obtained. The figures in the table are applicable to discontinuities in the surface of concrete and other sealed pavements, at the pavement/gutter interface, at interfaces between the pavement surface and service covers, at failures and at subsidence and the like. However, the values in the table may be used as a guide for the other surface imperfections described previously.

The table requirements may be difficult to achieve where a pavement abuts an unsealed surface. However, agencies should make every effort to limit the height of steps in these locations as the effect on pedestrians and cyclists travelling along or across a step can be severe.

While no dimension is provided in relation to a groove perpendicular to the direction of travel, this circumstance should be treated as two steps if greater than 100 mm wide.

Table 5.9: Suggested surface tolerances – existing surfaces

	Not to exceed (mm)	
	Width of groove ⁽¹⁾	Height of step ⁽²⁾
Parallel to direction of travel	12	10
Perpendicular to direction of travel	–	20

¹ A narrow slot in the surface that could catch a bicycle wheel, such as a gap between two concrete slabs.

² A ridge in the pavement, such as that which might exist between the pavement and a concrete gutter or manhole cover; or that might exist between two sections of pavement when the top level does not extend to the edge of the roadway.

Note: It is suggested that a height of 20 mm, may be excessive for many bicycles. This value should be considered as a maximum intervention level for an existing facility rather than a design or construction tolerance. It is suggested that individual jurisdictions should consider a lower intervention level (e.g. 10 mm for perpendicular to direction of travel) depending on local circumstances and the importance of the path within the bicycle path network. Designs and specifications should require smooth flat surfaces.

5.11 Lighting

The objectives of providing lighting of paths are to:

- enable cyclists and pedestrians to perceive hazards such as unusual or uneven surfaces or obstacles such as steps or street furniture, and to enable them to orientate themselves and find their way about
- enhance personal security by enabling potential threats from other people to be recognised in time to take appropriate action.

These objectives are particularly important for elderly people and people with impaired vision who may be more vulnerable to trip hazards or feel insecure or uncomfortable in poorly lit environments.

Where a path is located adjacent to a carriageway, the road lighting should also cater for the path (Austroads 2015b, AS/NZS 1158.1.1:2005, AS/NZS 1158.1.2:2010). Designers should consider all aspects of the design that may influence the effectiveness of the lighting, such as the presence of overhanging trees and low-profile hedges that may create significant shadowing which, when combined with adjacent headlights (from the roadway), could make the silhouettes of path users extremely difficult to see.

Areas associated with pedestrian paths that may require a relatively high level of lighting are at-grade road crossings, because of the potential for conflict with motor vehicles and pedestrian underpasses that are often perceived to be unsafe in terms of personal security.

Paths away from roads

Where paths are heavily used during periods of darkness (i.e. dawn, dusk and at night) consideration should be given to the provision of path lighting. The decision to provide lighting is a matter for the relevant agency.

A path considered for lighting will usually form part of a principal path network. Key issues to be considered are that:

- Cyclists require greater sight distance in order to avoid conflict with other cyclists or pedestrians and the outcome of such a crash is often severe.
- Bicycle head lamps may enable a cyclist to be seen but some may not illuminate the path surface sufficiently to enable cyclists to avoid hazards (e.g. rough surface, debris, obstacles).

Lighting assists in delineating the alignment of the path.

A level of lighting higher than that provided generally along a path should be considered for locations where conflict occurs with other path users or motor vehicles, or where there is greater concern for personal security, for example:

- path/path intersections on regional paths
- path/road intersections
- road crossings and refuges
- path terminal treatments
- cyclist/pedestrian underpasses
- tight curves.

If it is decided to light a path the lighting should be designed in accordance with relevant standards, which include:

- AS/NZS 1158.1.1:2005: Lighting for Roads and Public Spaces: Vehicular Traffic (Category V) lighting: Performance and Design Requirements
- AS/NZS 1158.1.2:2010: Lighting for Roads and Public Spaces: Vehicular Traffic (Category V) lighting: Guide to Design, Installation, Operation and Maintenance
- AS/NZS 1158.3.1:2005: Lighting for Roads and Public Spaces: Pedestrian Area (Category P) Lighting: Performance and Design Requirements.

Designers should also refer to the relevant jurisdiction for the local lighting requirements.

5.12 Underground Services

The location and design of paths should be coordinated with the many other features and infrastructure that need to be accommodated within road related areas and which are covered in the *Guide to Road Design Part 6B: Roadside Environment* (Austroads 2015b).

Above ground utility services that have to be located near paths should be placed so that they do not constitute a hazard for pedestrians and cyclists using the path. However, aside from the permanent fixtures located near the path it is important to ensure that underground services do adversely influence the design of the path or the future operation of the path. For example, future operation could be significantly impeded if:

- Utility pits are located within the path as maintenance staff and vehicles would be required to work on the path.
- The path is ripped up to access services.
- Maintenance vehicles associated with the utility provider drive or park along the path.

6. Intersections of Paths with Paths

6.1 General

In general, the intersections of paths with paths should be constructed and controlled in accordance with the established principles of codes of practice for roads. For instance, at path junctions, the controls and layout should favour the predominant flow on the major through route and meet geometric requirements such as sight distance and gradients. Also, designers must ensure that the construction and controls are consistent with any local requirements.

6.2 Intersection Priority

The designer or path manager should nominate which path is to have priority at intersections between paths. Priority should normally be given to the path that has the highest daily volume of cyclists and pedestrians. Where path volumes are low or similar on both paths the choice should be made on the basis of its function within the network, or by providing priority to the traffic stream that will be most disadvantaged through having to stop and accelerate to speed (e.g. one path may have a steep upgrade on the departure).

A similar approach can be applied to the determination of priority where a bicycle path or shared path intersects with a pedestrian path, which cyclists are not allowed to use, or infrequently use. In considering which path has priority, the path users which are impacted to a greater extent by having to give way should be given priority.

As a general rule, where volumes are low to moderate, cyclists will be disadvantaged more than pedestrians because of the effort required to brake and accelerate up to operating speed and cyclists would benefit in having priority. At higher volumes some pedestrians (e.g. elderly or mobility impaired) may have difficulty in crossing a shared path or bicycle path due to the speed of cyclists in which case priority may be given to the pedestrian path.

To ensure that priority requirements are clear, consideration should be given to the construction of additional controls (see Section 6.3.1) at the intersections of exclusive paths or separated paths with pedestrian paths, where either:

- paths are well used
- the pedestrian path is used regularly by people who have a vision impairment
- sight distance constraints exist.

6.3 Intersection Signs

6.3.1 Control Devices

On the intersections of paths where bicycles are permitted, give-way markings, which are preferred, and/or give-way signs can be used to establish priority. The use of give-way markings avoid the use of a pole which may become a hazard to cyclists. Give way signs should only be used where a particular safety issue is identified or where the intersection has a history of near misses or crashes. Stop signs should never be required.

6.3.2 Wayfinding Signs

Wayfinding signs should be provided at path intersections. Guidance on bicycle wayfinding signs can be found in:

- *Bicycle Wayfinding* (Austroads 2015c)
- *Guide to Traffic Management Part 10: Traffic Control and Communication Devices* (Austroads 2016d).

A further source for information on methods of providing wayfinding information can be found in the Pavement Marking Manual (Department of Planning, Transport and Infrastructure 2015).

Information relating to standard elements of signs can be found in:

- Manual of Traffic Signs and Markings (MOTSAM) Part 1: Traffic Signs (NZ Transport Agency 2010a) and Part 2: Markings (NZ Transport Agency 2010b)
- AS 1742.9:2000, Manual of Uniform Traffic Control Devices Part 9: Bicycle Facilities
- AS 1743:2001, Road Signs: Specifications.

6.4 Treatments for Intersections of Paths with Paths

Factors that should be considered in relation to intersections where bicycles are permitted are that:

- Pavement markings should include centre lines and give-way holding lines.
- Pavement splays in the corners should have a minimum radius of 2.5 m. The path intersection should also assist a cyclist undertaking a turn on a radius of ≥ 5 m to maintain their upright position through the turn.
- T-junctions, at busy locations, should be widened to allow for through cyclists to pass a turning cyclist as the extra space reduces the number and intensity of conflicts. Where hold rails are used in the side path the width should cater for turning cyclist envelopes plus an additional lean allowance.
- The area around path intersections should be kept clear of hazardous obstacles, such as log barriers, to provide cyclists with a recovery zone. However, it should be noted that landscaping is useful in deterring cyclists who may attempt to travel the shortest path between path junctions or at sharp curves, which, if it occurs, inevitably results in maintenance problems. Any landscaping should be soft and of low height.
- Care should also be exercised in the location of intersections on paths adjacent to watercourses so that water holes and steep embankments do not present a hazard to cyclists. The treatment at the sides of paths should provide a forgiving environment in terms of cyclist safety.

The treatment at the intersections of shared paths, establishing priority is shown in Figure 6.1 and Figure 6.2.

Figure 6.1: Intersection of shared paths

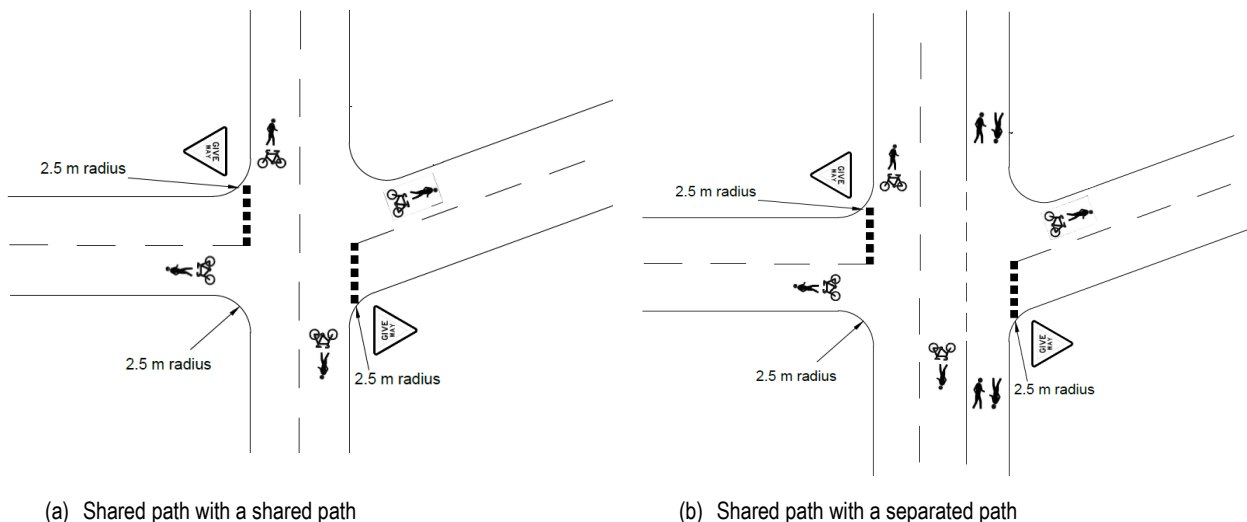

Note: Give way signs are optional and should only be used where there is a demonstrated need.

Figure 6.2: Example of a shared path intersection



Source: City of Adelaide (n.d.).

Figure 6.3 and Figure 6.4 show four arrangements where a bicycle path or shared path intersects with a pedestrian path and priority is reinforced through delineation and traffic control devices. Figure 6.3 illustrates cases where cyclists have priority and demonstrates how pedestrian ramps can be provided (Figure 6.3a) or a contrasting surface material (Figure 6.3b) on the pedestrian path can be used to provide an interface between the paths.

Figure 6.3: Intersection of bicycle path and pedestrian path where cyclists have priority

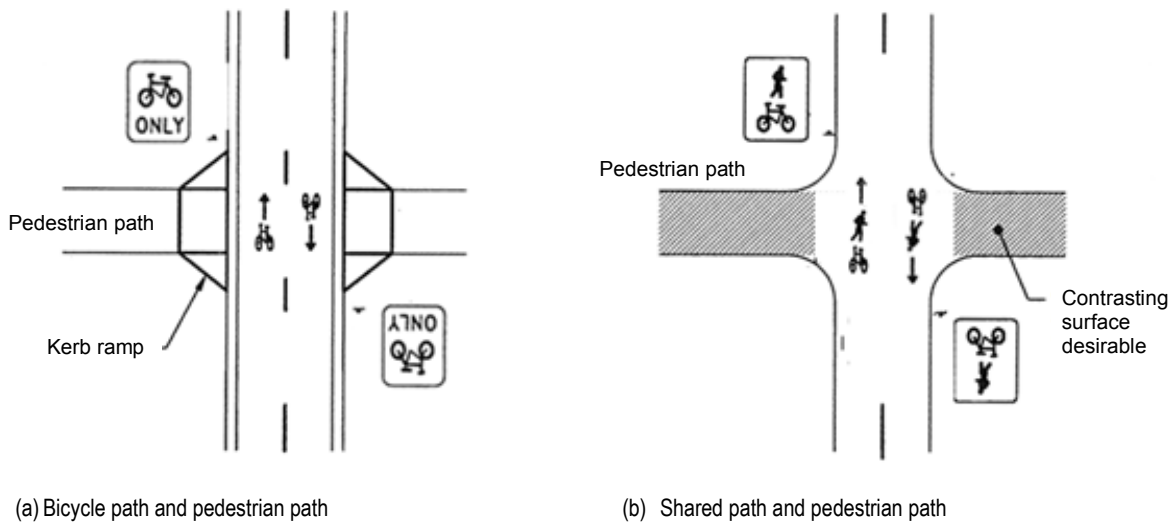
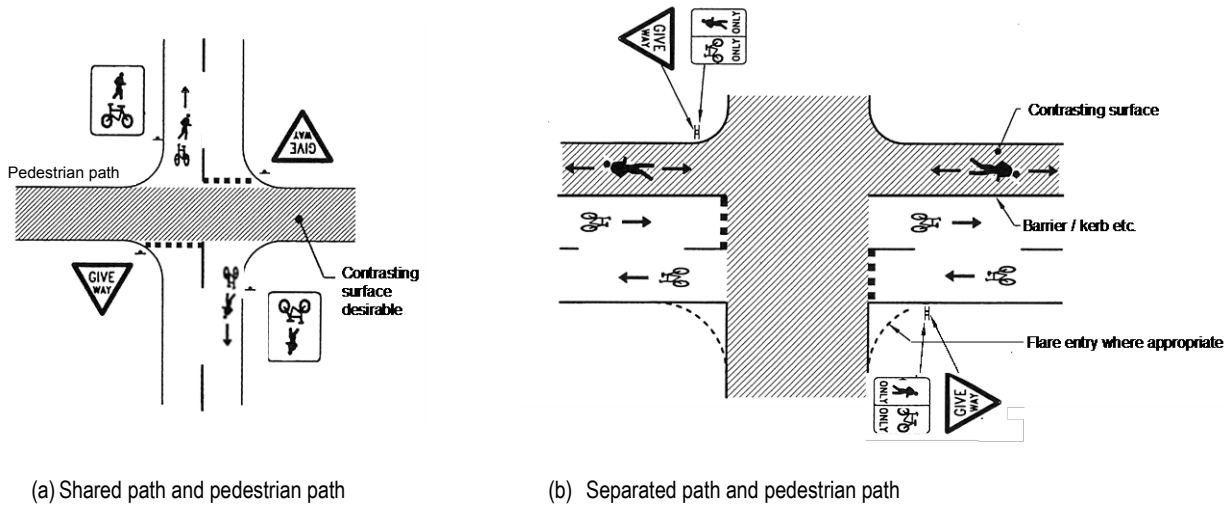

Figure 6.4 shows cases where pedestrians have priority at an intersection with a shared path (Figure 6.4a) and a separated path (Figure 6.4b) and shows the use of give-way signs to control cyclists and contrasting surfaces to emphasise that pedestrians have priority.

Figure 6.4: Intersection of a shared path and separated path where pedestrians have priority



Note: Give way signs are optional and should only be used where there is a demonstrated need.

6.5 Special Treatments for Intersections of Paths with Paths

At locations where there is a proven record of conflict or where there are other specific safety challenges such as short sight distances, the use of cross intersections between intersecting bicycle paths or shared paths may not be appropriate. At these intersections, a staggered T arrangement should be adopted to prevent high crossing speeds as shown in Figure 6.5.

Figure 6.5: Example of a staggered T-intersection

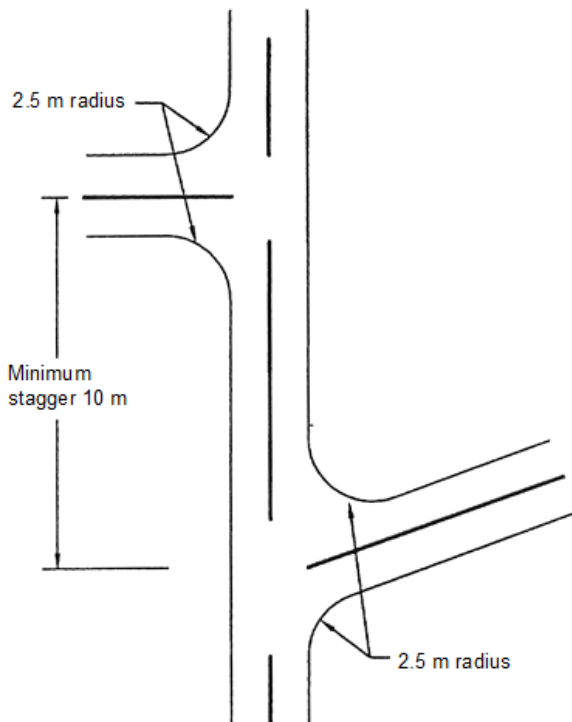

Note: Consider provision of holding rails on side of paths where main path volumes are high.

7. Intersections of Paths with Roads

7.1 General

Off-road paths must be readily accessible in order to be well utilised by the community. Access should always be provided where paths cross local streets and arterial roads. Accessibility should be improved further by providing regular connections to local roads or cul-de-sacs.

Where a path is located on one side of a road, kerb ramps should be provided opposite every intersecting street to enable access for local users. The path design should aim to provide an attractive appearance that enhances the streetscape. All connections and crossings should be designed and constructed so as to encourage safe and correct use by pedestrians and cyclists.

It is important that cyclists travelling along off-road paths are provided with sufficient visual and/or physical cues, such as warning signs or pavement markings, to advise them that they are approaching a road crossing. Cyclists will then be able to assess the situation and slow to an appropriate speed or stop if necessary.

Cycling at a consistent speed is significantly easier than cycling with frequent changes in speed. Therefore, cyclists prefer to keep moving and maintaining their momentum, unless there is a good reason for them to stop.

Treatments that allow cyclists to regulate their own speed and that are fairly direct are preferred because they do not unduly inconvenience cyclists. Therefore, treatments discussed in Section 7.5.4 which aim to slow cyclists down should only be used where there is a proven safety issue (e.g. history of ride-out incidents, near misses or crashes), and where the device itself does not pose a greater risk than the dangers it is designed to ameliorate.

The intersection of paths with roads and crossing of roads by paths is generally covered in the *Guide to Traffic Management Part 6: Intersections, Interchanges and Crossings* (Austroads 2013a) and *Parts 4, 4A, 4B and 4C of the Guide to Road Design* (Austroads 2017a, 2017b, 2015d and 2015e respectively).

7.2 Intersection Signs

7.2.1 Traffic Control Devices

The use of traffic control devices such as give-way signs and give-way holding lines will depend on the priority of the path with respect to the road. Section 7.3 provides guidance on the use of traffic control devices under various situations.

7.2.2 Wayfinding Signs

Wayfinding signs should be provided at the intersection of paths with roads. For guidance on bicycle wayfinding signs, refer to *Guide to Traffic Management Part 10: Traffic Control and Communication Devices* (Austroads 2016d) and *Bicycle Wayfinding* (Austroads 2015c). For standard elements of bicycle wayfinding signs, refer to AS 1742.9:2000 and AS 1743:2001 or in New Zealand the Land Transport Rule: Traffic Control Devices 2004 (Land Transport New Zealand 2005).

7.3 Treatments for Intersections of Paths with Roads

Where a path intersects or crosses a road mid-block, in general, the intersection should allow pedestrians and cyclists to freely access the roadway. In most instances it is unnecessary to use restrictive devices to slow cyclists down before they cross a road. If the slowing of cyclists is needed treatments such as path curves in advance of the intersection could be implemented.

Where a path connects to a path on a road, the preferred treatment is just a connection without the use of other devices (Figure 7.1). Where there is a safety issue identified, it may be necessary to add give-way holding lines and give-way signs at the path termination to emphasise priority. If this proves to be insufficient to overcome the safety issue, it may be necessary to add special termination treatments designed to slow cyclists (Section 7.5).

Figure 7.1: Example of a simple path connection at an on-road path



Source: Tony Arnold (personal communication 2016).

7.3.1 Road Crossings where the Path has Priority over the Road

It may be appropriate to provide a path with priority across a road where the path carries higher traffic volumes than the road it crosses and where either:

- the path crosses a low-speed street, or
- the path runs adjacent to a road that has priority over a minor intersecting street.

Designers should refer to *AGRD Part 4* (Austroads 2017a) and *Guide to Traffic Management Part 8: Local Area Traffic Management* (Austroads 2016c) for more information on appropriate treatments such as wombat crossings.

Examples of these types of crossings are shown in Figure 7.2 and Figure 7.3.

Figure 7.2: Example of an intersection where a separated pedestrian path crossing and a separated bicycle path crossing has priority across a local street



Source: Tony Arnold (personal communication 2016).

Figure 7.3: Example of an intersection where a path crossing has priority over a side street



Source: Tony Arnold (personal communication 2016).

7.3.2 Road Crossings in a Shared Environment Intersection

Where a path crosses a minor side street or other low-speed, low-volume street, it may be appropriate to provide a shared environment intersection. Shared environment intersections are recommended where the traffic volume of pedestrians, cyclists and motor vehicles are all fairly similar and traffic speed, including bicycle speeds, are low. See the *AGRD Part 4* (Austroads 2017a) and *Guide to Traffic Management Part 8: Local Area Traffic Management* (Austroads 2016c) for more information on appropriate treatments.

7.4 Ancillary Devices for Intersections of Paths with Roads

7.4.1 Push Buttons at Signalised Intersections

A push button may be required where a path meets a road at a signalised intersection and where the users of the path are required to activate a dedicated signal phase.

Push buttons should be located to the left of the path, where practical, in a location that is easily accessible for path users who are waiting to cross in alignment with the kerb ramp. For shared paths, where pedestrian and bicycle lanterns operate together, only one push button is required. For separated paths, where pedestrian and bicycle lanterns operate independently, a push button is required for each phase, pedestrian and bicycle.

Push buttons should be placed on existing traffic signal pedestals, to reduce the number of poles on and near the path. Where traffic signal pedestals are not available or appropriately positioned, a separate post should be installed such that the height of the push button is between 1.0 and 1.2 m. This height provides reasonable access for a range of users including pedestrians, wheelchair users and cyclists.

7.4.2 Holding Rails

A holding rail is a U-shaped rail that is similar to a U-rail but placed in close proximity to both the edge of a path on the approach to an intersection with a road or another path. Its purpose is to provide a support for cyclists to hold onto whilst they await an acceptable gap in the conflicting traffic stream. Holding rails may also be provided in central refuges and medians. An example of a holding rail is shown in Figure 7.4.

Holding rails should only be provided where there is a likelihood that cyclists will have to stop at intersections with roadways. For example, they should not be provided at the intersections of paths with other paths or at the intersection of a path with a local street where it is unlikely cyclists will have to stop and wait. In some jurisdictions holding rails also serve as a support for pedestrians who have a mobility impairment and use the rails to rest upon while waiting to cross roads.

Holding rails must be placed within easy reach of cyclists, on the left side of the path, to ensure that they:

- enable cyclists to stop without having to dismount or move their feet off the pedals (which can require cyclists to unclip or disengage from pedal retention devices such as toe clips)
- encourage cyclists to stop when appropriate
- assist the cyclists as they move off, reducing the time spent travelling through an intersection and aiding balance, thus improving safety
- in addition to other clues, provide a useful warning of the existence of an intersection.

Holding rails should be placed so that the cyclists using them can easily see approaching traffic and safely cross or enter the intersecting carriageway. If possible, holding rails should be located about 600 mm from the kerb line or edge of the intersecting roadway, and 300 mm from paths.

A sign-post extension on a holding rail has benefit in that it helps to minimise the number of posts near terminals. The sign should be located with a sufficient clearance to the intersecting road and high enough that it is not hazardous for cyclists.

Figure 7.4: Example of holding rail

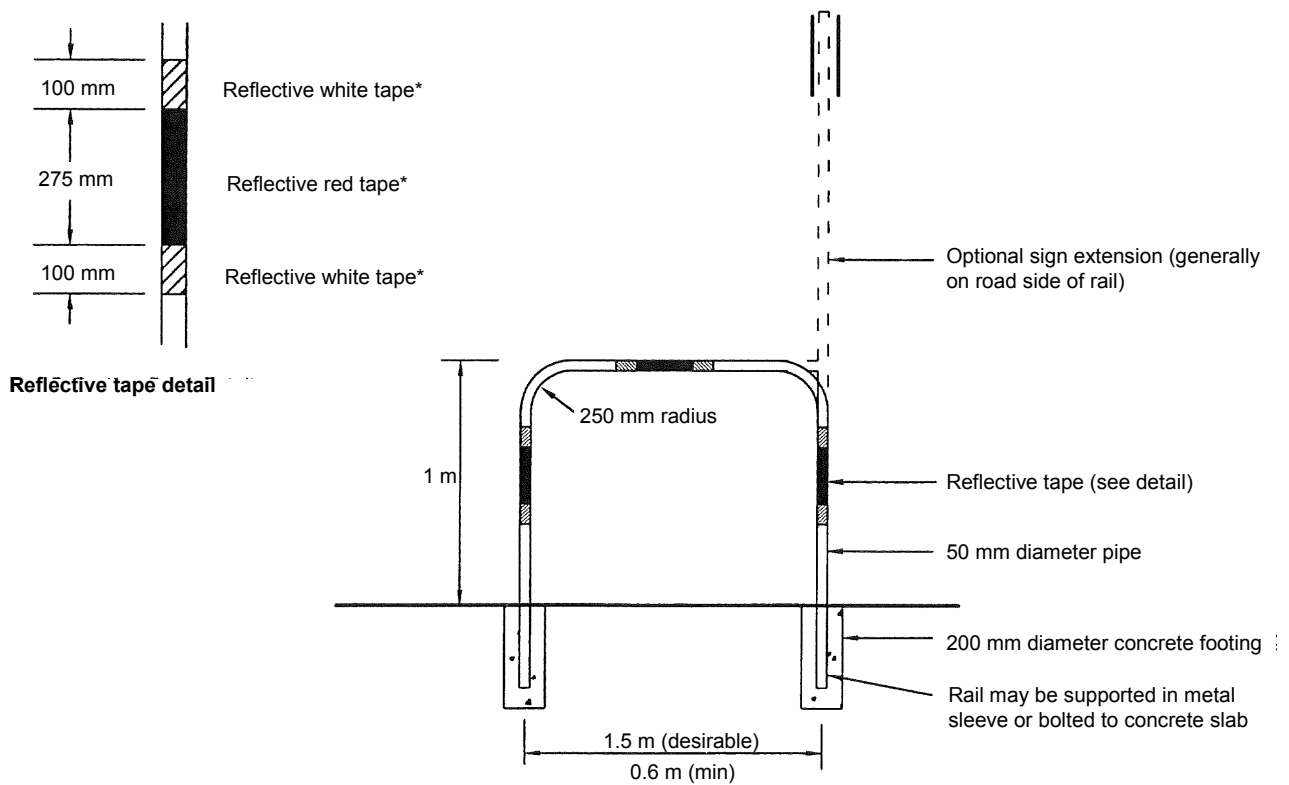

To avoid the unnecessary proliferation of holding rails, they should not be installed at the traffic islands or approaches to signalised intersections unless specifically sought by users. Furthermore, holding rails should not be placed centrally on paths due to the narrow section tubing used for holding rails making them less conspicuous. In addition, holding rails should not be installed where cyclists are required to dismount.

7.5 Special Treatments for Intersections of Paths with Roads

7.5.1 General

A path terminal treatment may be required where a shared path or bicycle path intersects with a road, e.g. when a path crosses a road from a road related area or parkland.

Path terminal treatments are provided to restrict illegal access by drivers of motor vehicles to road reserves and parkland to prevent damage to path structures (such as lightweight bridges) that have been designed only for bicycle and pedestrian use.

These devices can be hazardous to cyclists and as such they generally should not be installed unless:

- unauthorised motor vehicle access may result in damage to path structures
- there is clear evidence of unauthorised and undesirable motor vehicle access
- the device is effective at excluding such vehicles and not readily circumvented.

Where installed, terminal treatments should be designed and installed in such a way that they serve their intended purpose and do not cause an unacceptable hazard to cyclists. Cyclists must be able to:

- negotiate path entrances with ease
- concentrate on other traffic, pedestrians, pavements and ramps
- not be distracted by overly restrictive barriers.

It should be noted that not every jurisdiction permits the use of physical barriers to slow or advise cyclists of an approaching road. Physical barriers may be a hazard to other road users and any treatment should have a risk assessment undertaken.

7.5.2 Terminal Design Principles

The design of terminal treatments should meet certain criteria as outlined below. If local authorities choose to use or develop terminal devices that are not illustrated or described in this Part, the designs should consider the requirements outlined below.

Clearance

The design should:

- provide an opening width between 1.4 m and 1.6 m where restriction of motor vehicle access is warranted
Terminal devices should have sufficient width to accommodate the anticipated path traffic.
- be located with at least 1.4 m clearance to adjacent fixtures and so that cyclists can pass conveniently.

Access

The terminal treatment should:

- seek to enhance the safety of cyclists accounting for factors such as gradients, the proximity of roads and the approach alignment of the path
- be accessible to a range of path users including pedestrians and people with disabilities
In relation to bicycles, they should accommodate the common bicycle types as well as tandem bicycles, bicycles with trailers, and other human-powered vehicles.
- be constructed so that small passenger cars cannot pass easily through or under horizontal rail sections where a primary objective of the terminal is to restrict access for motor vehicles
It should be noted that it is generally impractical to restrict motorcycles and to do so may result in a hazard for cyclists.
- not be easily circumvented by unauthorised vehicles, such that either the device is rendered ineffective, or that alternative paths of access are created in adjacent reserve areas resulting in higher maintenance demands
- accommodate emergency or maintenance vehicle access where this is not available elsewhere in the vicinity of the terminal (in the event that the path will be relied upon by such vehicles). Note that wherever terminal device elements are removable the connections (or sockets) should be flush at the connecting surface and not present a hazard to path users.

Geometry

The terminal treatment should:

- be located with consideration for other design features in the immediate section of the path e.g. in general it would be inappropriate to locate terminals at or near curves, within a distance of less than 5 m of kerb ramps or within a manoeuvring zone of cyclists
- not be located too close to an intersection (e.g. 5–10 m) to enable storage and final braking to occur beyond the device where cyclists may wait for other path users to pass through the terminal device
- have clearances at the terminal device and parallel roads that are sufficient in the event of cyclists failing to properly negotiate the device
- if consisting of a frame be
 - at least 1.0 m high above the riding surface
 - shaped so that on the approach side of the frame, the minimum radius of the frame is 250 mm
 - constructed of individual frame elements that are rounded, without sharp edges, and having a minimum diameter of 100 mm
- if consisting of isolated vertical poles (e.g. bollards)
 - be at least 1.0 m high above the riding surface
 - have a minimum diameter of 300 mm.

Safety

The terminal treatment should:

- not present a hazardous feature for any pedestrian group (e.g. visually impaired pedestrians)
- include adequate protection where the sides grade away from the path at a steep angle or where obstructions exist
- have regard for other (conflicting) paths, other paths of access and for sight lines
Terminals should be located in such a way that existing paths are not obstructed in any way. Similarly sight lines should not be restricted due to the terminal device or to users (as a result of the terminal device).
- not be located at mid-block locations where speeds are likely to exceed 20 km/h.

Delineation

In order to operate safely under all light conditions it is important that terminal treatments and devices should:

- be painted in a contrasting colour (white or yellow) and be fitted with quality reflective tape on horizontal and vertical elements to ensure they are visible from all directions
Barriers etc., on both sides of paths should be painted and delineated in this manner. Similarly, reflective tape should be fully wrapped around the elements to which it is attached to ensure that it is clearly visible from all directions.
- be illuminated in accordance with AS/NZS 1158 (Set):2010, or with the lighting requirements of this Part, as appropriate
- where necessary include signs or pavement markings, generally on the path approach to the device, warning of the presence of devices
- be preceded by tactile linemarking, or a tactile path surface and a painted unbroken line, where cyclists need to deviate from their line of approach. Similarly, as a further means of warning to approaching cyclists, it is desirable for the device to be visible to one cyclist whilst following immediately behind another.

There are numerous reports of collisions of cyclists on group rides with isolated vertical poles (e.g. bollards) located within paths. Therefore, it may be appropriate to consider the use of poles that are not less than 1.8 m high where narrow poles (minimum 100 mm diameter) are used, to increase the likelihood of observation of poles above the form of a leading cyclist.

7.5.3 Terminal Treatments for Excluding Vehicles

Separate entry and exit treatment

The preferred terminal treatment to restrict access and warn cyclists to slow down is shown in Figure 7.5. This treatment is the bicycle path equivalent of providing a median island at a road intersection with similar benefits with respect to warning cyclists and channelising traffic movements. It provides sufficient guidance to cyclists that they are approaching a road and does not place an obstacle (such as a bollard) in the path of cyclists.

In order to restrict unauthorised access it is critical that the fence extends to the edge of the path. If access is required for authorised vehicles removable posts may be placed within the fence line.

Figure 7.5: Separate entry and exit terminal

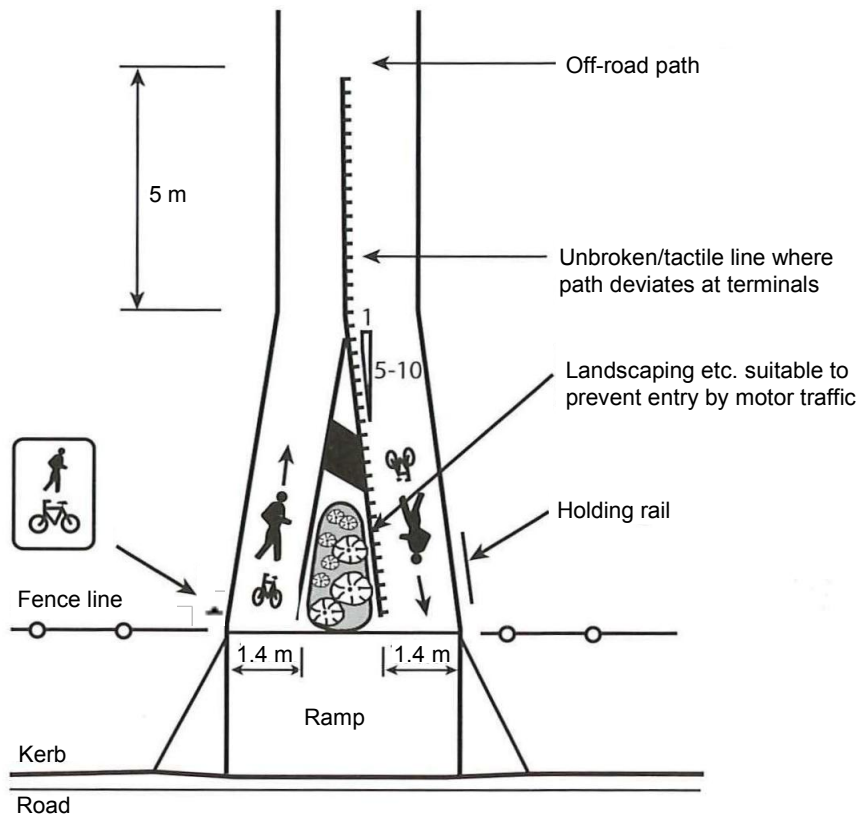

Source: Based on VicRoads (2005).

Bollard terminal treatments

A common method of restricting access to paths is to install a bollard in the centre of the path. This type of treatment can create an unacceptable risk to cyclists and should only be used where provision of the preferred treatments is not practicable. While opinions vary, there is considerable concern (and growing evidence in the form of injury compensation claims by cyclists) that the construction of these devices in the centre of paths is hazardous to cyclists.

If bollards are to be used on paths they must be used in conjunction with a feature on the sides of the path to provide openings of no more than 1.6 m wide. They should also be conspicuous to cyclists and include linemarking to direct cyclists away from the bollard. Figure 7.6 illustrates the layout of a bollard treatment while Figure 7.7 shows an installation without lighting, and Figure 7.8 shows an installation with lighting.

Figure 7.6: Preferred layout for the use of a central bollard

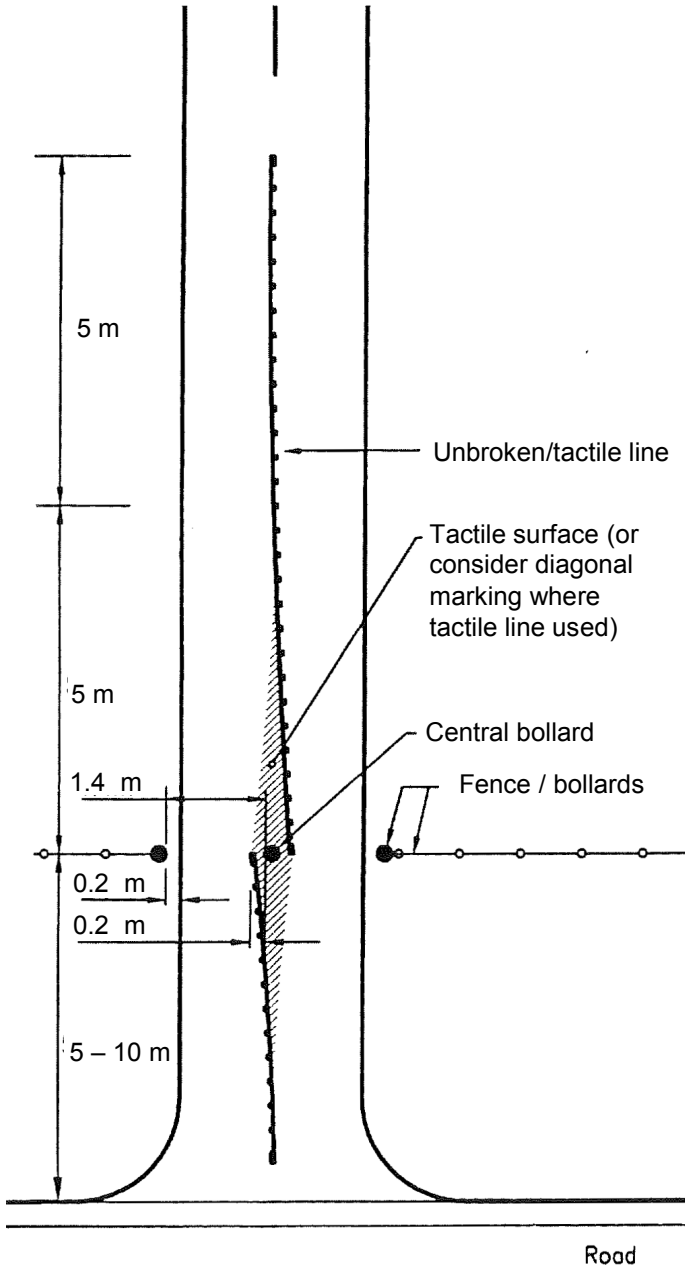

Source: VicRoads (2005).

Figure 7.7: Example of a bollard treatment



Source: Roads and Traffic Authority (2005).

Figure 7.8: Example of a bollard treatment with lighting



Note: The light should and fitting should be located outside of the clear height requirements, refer to Section 5.5.1.

Source: Queensland Department of Transport and Main Roads (n.d.).

U-rail terminal treatments

For paths that are 4 m wide or more, consideration could be given to the installation of a U-rail instead of a bollard. This arrangement shown in Figure 7.9 includes a hazard marker that provides a larger surface area and hence greater conspicuity for the treatment.

Figure 7.9: Example of U-rail and hazard board treatment



Source: Roads and Traffic Authority (2005).

Details of bollards and U-rails

Many instances exist where bollards are located in the centre of paths and no feature exists at the sides of the paths that would prevent access by motor vehicles and as such the devices serve no particular purpose. Where agencies are determined to maintain or construct central fixtures in the centre of paths the need must be justified in every instance; they should be effective in meeting their purpose, and should be provided with a high level of delineation. In particular, the locating of bollards and other fixtures centrally on paths is considered to be inappropriate at or near curves, or at intersections in the manoeuvring area of cyclists.

An example of the details of a bollard and U-rail used in New South Wales is shown in Figure 7.10.

Figure 7.10: Details of a bollard and U-rail

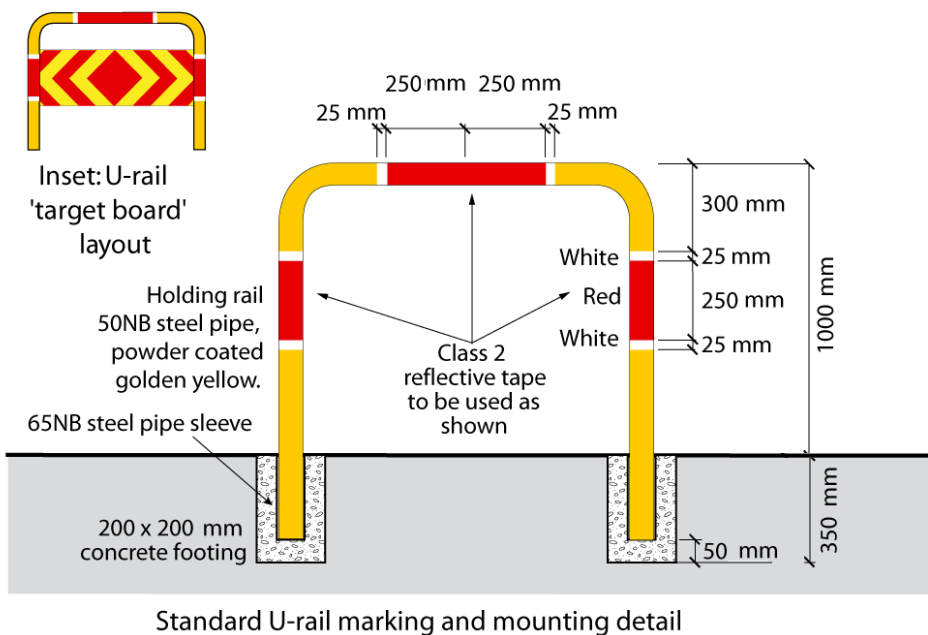
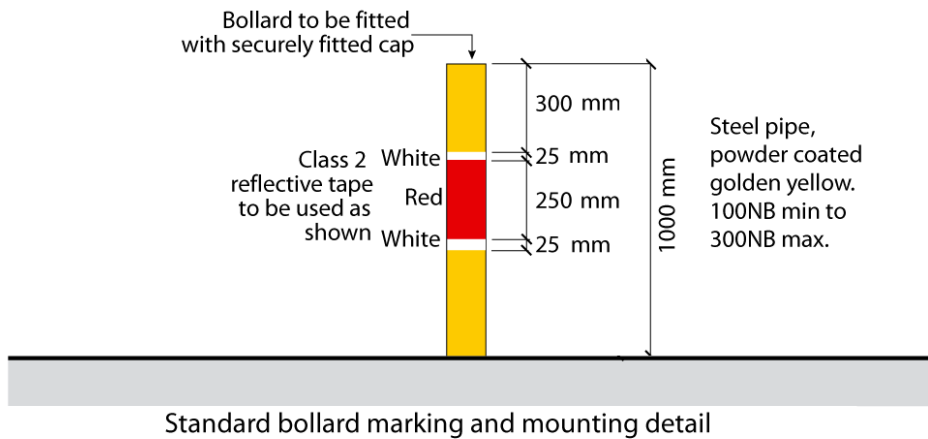

Notes:

- 1 Length of U-rail can be varied to suit path width. A minimum of 600mm and a maximum of 1500mm should be adopted. Detail shown above has used 1200mm.
- 2 Bollards and U-rails can be fixed to path by using either a bolt system or pipe sleeve and concrete as shown. If a pipe sleeve is used, a metal wedge is to be used to secure the U-rail in the sleeve.
- 3 Where a U-rail is mounted at right angles to a path a 'target board' shall be fitted. If the U-rail is mounted longitudinally along the path a target board is not used. See inset for 'target board' detail.

Source: Roads and Traffic Authority (2005).

7.5.4 Terminal Treatments for High-conflict Locations

Where there is a history of conflict (i.e. ride-out incidents, near misses or crashes), it may be necessary to install terminal treatments that are designed to enforce a reduction in cycling speed at the approach to a roadway. This should only be considered where it has been clearly demonstrated that other treatments have not worked and the device itself does not pose a greater risk than the dangers it is designed to ameliorate.

Where this is the case, designers should ensure that:

- the device is no more restrictive than is necessary and allows easy access for wheeled devices such as wheelchairs, motorised mobility scooters, standard bicycles, cargo bicycles, tandem bicycles etc.
- the device is light in colour and fitted with retro-reflective material to increase its conspicuity at night
- street lighting is adequate
- the fencing has no sharp protrusions.

Some road agencies do not favour these devices as they may:

- distract cyclists from concentrating on the task of processing more important information relating to surrounding traffic conditions
- create unnecessary conflict points and hazards for path users.

Staggered fence treatment

A staggered fence treatment should only be used where there is a very good reason to slow cyclists down (e.g. history of ride-out incidents, near misses or crashes). This type of treatment involves the installation of two U-rails or two sections of mesh fence as shown in Figure 7.11. It is important that the treatment has adequate lighting and is constructed of materials that are inherently conspicuous (i.e. all posts and mesh colours should contrast with the surrounding environment as viewed by the approaching cyclists) as total reliance on fitted delineation devices poses a risk to safety if the device is vandalised or poorly maintained.

The staggered fence should be designed so that the:

- left barrier fence is closest to approaching path users
- left barrier fence does not overlap the right barrier (reduces required deviation)
- distance between the two barrier fences is at least 3 m to provide an adequate clearance and turning path for larger bicycles such as cargo bicycles.

The materials that are suitable for mesh fence treatments are generally not retroreflective and hence the treatment should be delineated, for example, with a hazard board on each fence section facing approaching cyclists as shown in Figure 7.11.

Figure 7.11: Example of a staggered fence treatment



Source: G. Veith (n.d.).

Offset path treatment

An alternative to the staggered fence treatment, which is based on a similar principle, is to provide an offset path treatment as shown in Figure 7.12. This treatment has similar issues as those relating to the staggered fence treatment.

Figure 7.12: Example of an offset path treatment



Source: VicRoads (2005).

8. Paths at Structures

8.1 General

The design of structures is very important to pedestrians and cyclists. Existing road bridges are often narrower than the road on the approaches thus creating a squeeze point for pedestrians and cyclists. Because of the high relative cost of new bridges there can be a tendency for designers to be as economical as possible in the widths provided for the various users. It is important, however, that road managers look for ways to better cater for pedestrians and cyclists at all existing structures and that designers and planners ensure that adequate provision is made for them in the design of all new structures.

The primary requirements for using bridges and underpasses are that:

- adequate path width and horizontal clearances to objects (walls, safety barriers, kerbs, fences, poles, street furniture etc.) is provided
- adequate vertical clearance is provided, particularly in underpasses
- good sight lines are provided into and through structures
- the surface is smooth and not slippery under any conditions; a particular issue can arise with expansion joints that can provide a rough ride and be slippery when wet and designers should seek better methods and materials to address this issue.

8.2 Road Bridges

Where a bicycle or pedestrian facility is provided on the approach to a road bridge it is important that a similar facility be continued across (or under) the structure. This should always be possible in the case of new structures. In the case of existing structures it will not always be possible but in brownfield locations consideration should be given to implementing measures that will improve the facility e.g. reduce the width of motor traffic lanes to make space available for pedestrians and cyclists; utilise pedestrian paths as shared paths.

The characteristics of pedestrians and cyclists at a site may require that an on-road bicycle lane is provided for experienced cyclists and a shared path is provided for other cyclists and pedestrians.

For information relating to on-road facilities designers should refer to *Guide to Road Design Part 3: Geometric Design* (Austroads 2016b).

8.2.1 Use of Pedestrian Paths on Narrow Bridges

If the width between kerbs on a two-lane two-way bridge is less than 7.4 m and pedestrian paths exist on both sides of the bridge then ramps should be provided on both sides of the bridge so that cyclists can also use the pedestrian path to avoid the squeeze point. Where a pedestrian path exists on only one side of the bridge it may be possible to utilise the path for one direction and provide a wide kerbside lane in the opposite direction.

8.2.2 Shared Path Structures

Where a shared path is to be provided on only one side of a road, safe access to the path should be provided via appropriate at-grade crossings or by providing paths beneath any bridges near the abutments as illustrated in Figure 8.1. An example of a similar crossing is shown in Figure 8.2.

Figure 8.1: Illustration of a shared path crossing under a bridge abutment

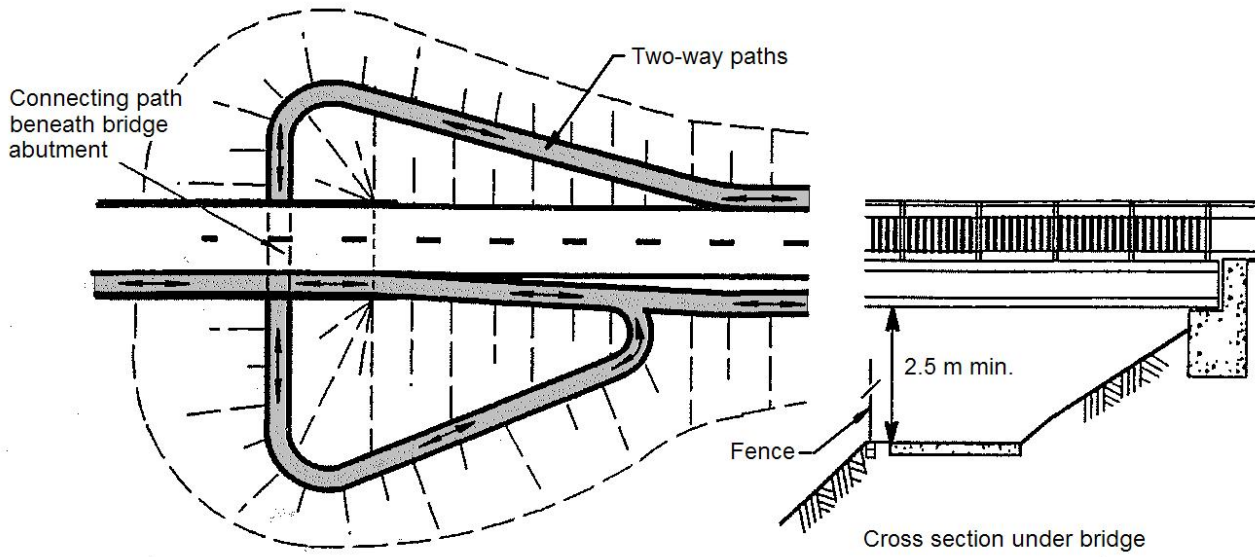

Figure 8.2: Shared path under a bridge abutment



Source: Gary Veith (personal communication 2009).

It is desirable that the width of shared path where it is located on one side of a bridge only accord with Section 5.1.4. If a width of less than 2.0 m is available then it may be necessary to erect warning signs advising cyclists not to overtake or pass on the pedestrian path.

If a path for cycling is provided on a road structure the path on the approaches should be at least 1.2 m from the edge of the traffic lane and concrete kerb installed along the length of the structure and on the immediate approach. Pedestrian fencing having a height of 1.4 m (Figure 5.12), preferably set back at least 450 mm from the line of kerb, should be considered for installation on the pedestrian path of the bridge to separate the cyclists from the motor vehicles in the adjacent traffic lane. The same treatment should be installed where for network reasons two-way shared paths, (which are of adequate width and used by young cyclists), are installed on structures along very busy roads. However, such fences should not be installed where they are located on the inside of horizontal curves and would impede the required stopping sight distance for motorists.

Where it is considered that cyclists and pedestrians would be at an unacceptable level of risk due to the speed of traffic, alignment of the road and any other contributing factors, consideration should be given to the installation of a safety barrier to shield path users.

Further information on the design of bridges is contained in *Guide to Bridge Technology* (Austroads 2009–2012).

8.3 Underpasses

8.3.1 General

Grade separated crossings such as bicycle bridges, underpasses and overpasses may be provided to achieve a safe crossing of roads (Figure 8.3), rivers or railways. General guidance on the use of grade separations for use by pedestrians and cyclists is provided in the *Guide to Traffic Management Part 6: Intersections, Interchanges and Crossings* (Austroads 2013a).

Although often provided as part of a shared path network grade separations may be provided as a safe alternative adjacent to narrow road bridges or through the fill behind a bridge abutment. In difficult terrain a structure, such as a box culvert, may be used to continue a shared path along the bank of a river.

When using culverts as part of a path network, the following principles in the design and operation of the culvert and the approaches should be applied (based on de Groot 2007):

- Culvert length – keep the length of the culvert as short as possible to minimise the distance a path user is in the closed space.
- Visible entry – approaching path users are able to observe the path enters a culvert well before entering the culvert.
- Vegetation – at the entry and exit, vegetation is managed to ensure that it does not create any hiding places.
- Approach embankments – are not too steep, e.g. 1:1 embankment slope, to reduce the perception of being closed in, also assists with casual surveillance of the section of path.
- Culvert dimensions – a height to width ratio of 1:1.5 is preferable to reduce the perception of entering a narrow space.
- Drainage – the floor of the culvert drains quickly and is shaped to reduce the build-up of debris.
- Maintenance – the culvert size facilitate the maintenance operations to enable the culvert to be readily cleaned.

These principles also support the crime prevention through environmental design principles, which assist in creating comfortable spaces for people to use.

Figure 8.3: Example of a pedestrian/bicycle path underpass



Source: Queensland Department of Transport and Main Roads (n.d.).

8.3.2 Use of Existing Culverts

The desirable vertical clearance within an underpass is 2.5 m. However, this height is problematic in that a standard height of 2.4 m has been used in many existing drainage culverts constructed with crown units and is adequate. In relation to severely constrained sites, culverts with a vertical clearance of only 2.0 m have been successfully utilised to accommodate paths for cycling under roads and this is considered to be acceptable when utilising existing structures.

The relative advantages and disadvantages of using a culvert with limited clearance rather than an at-grade crossing should be evaluated. If it is decided to use a culvert of limited height, signs should be erected to warn cyclists of the reduced headroom. Other steps should also be considered including some form of external (to the culvert) roof transition (from a height of 2.5 m to the height of the culvert roof) to negate the chance of a cyclist colliding with the abrupt low roof face of a culvert. Where a square corner cannot be avoided on the culvert ceiling at the entrance to the culvert some form of cushioning should be provided on the headwall to minimise injury to cyclists who may impact their head against it.

A drainage culvert should not cater for cyclist or pedestrian use unless it satisfies the recommendations in Section 5.6 for drainage, whilst providing adequate vertical clearance. Appropriate warning signs should be installed advising of alternative crossing points for use during higher water flows. A connecting path between the recreational path and the road is always provided to facilitate access to the path and is generally suitable for use as a bypass during high water flows. It is essential that good sight distance is provided to the culvert entrances so that cyclists have adequate warning and can see any debris, silt, etc. that may have built up around and in the culvert during and after these conditions.

If an underpass is used the alignment of the path on the approach should be designed such that users can see through the culvert. Vandal-proof lighting should also be provided in underpasses for shared paths.

Underpasses of roads should be constructed with minimal cover between the top of the underpass and the road. Whilst this may necessitate the relocation of services it has the advantage that shorter approach ramps can be used requiring less overall space. Also better opportunities for the provision of adequate sight lines may be possible in order to enhance personal security.

The gradients on approach ramps to shared path overpasses and underpasses should be in accordance with the requirements of AS 1428.1:2009, which are summarised in Section 5.4 and Table 5.8. Where the facility is an exclusive bicycle path a steeper gradient is permissible in accordance with Figure 5.6.

On existing structures that incorporate right angle landings in the alignment of the approach ramps, or where adequate sight distance cannot be provided, warning signs advising cyclists and other users of the hazards should be erected.

8.4 Bicycle Wheeling Ramps

Where it is not possible to locate a path for cycling so that an acceptable gradient is achieved a bicycle wheeling ramp (Figure 8.4) may be provided to accommodate a significant change in level over a short distance.

Figure 8.4: Example of a bicycle wheeling ramp



Source: ARRB Group (2009).

Wheeling ramps should be used as a last resort and should not necessarily be regarded as a treatment that serves the needs of cyclists well. They can be as unsatisfactory to cyclists (i.e. carrying children) as for pedestrians (due to inconvenience). They are generally regarded as inappropriate where used in association with new path facilities if alternative path access is possible.

Existing stairs can often be readily modified to provide for cyclists by the addition of a ramp formed by concrete infill or steel plate. Ramps may be either on the sides or within a median of the stairs.

Also:

- Wheeling ramps should be provided on both sides of stairways where significant bicycle volumes exist.
- The gradient of ramps should not exceed about 25°.
- Narrow channels (75 mm to 150 mm wide) or channels that are rounded at the base should be used to improve the ease of wheeling for cyclists. A channel designed to accommodate what is on average the widest bicycle tyre (i.e. that of a mountain bicycle) would be ideal.
- The channel should be constructed approximately 0.4 m from a fence or wall, or so as to avoid the catching of pedals or handle bars.
- Handrails should be constructed as close as practical to the fence or wall, when erected adjacent to a wheeling ramp.
- Wheeling ramps should be constructed with a smooth transition onto and off of the ramp.
- It may be desirable to construct the ramp with a kerb (Figure 8.5) to limit the possibility of pedestrians inadvertently stepping onto the ramp section.
- It would be prudent to construct the ramp so as to minimise the possibility that it may be cycled on.

Figure 8.5: Bicycle wheeling ramp key dimensions

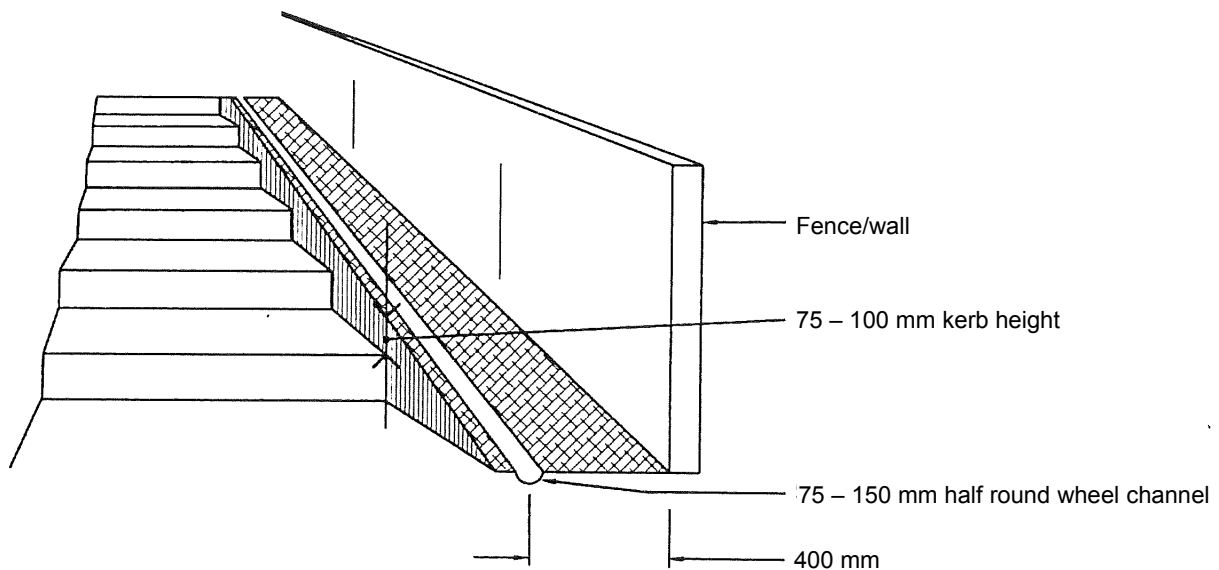

9. Construction and Maintenance Considerations for Paths

9.1 General

If paths are not adequately constructed and maintained, pedestrians and cyclists are not likely to use them, or may deviate to avoid surface irregularities thus creating a hazardous situation. Smooth, debris free surfaces are a fundamental requirement for providing safe paths.

On a path used by cyclists, the cyclist may reach speeds up to 50 km/h on downhill grades, a rough surface or pothole can cause a cyclist to fall, leave the path and crash or come into conflict with other path users. Most bicycles have no suspension or shock absorbers and many bicycles have relatively thin tyres inflated to high pressures. Consequently, when a cyclist hits a pothole at speed it is most uncomfortable, difficult to maintain control and potentially hazardous for the cyclist.

In order to gain an appreciation of the problems faced by pedestrians and cyclists it is suggested that maintenance supervisors should walk or ride over the path. This enables a more detailed examination of the surface to be made and defects detected.

A substantial capital investment is often made in providing paths and agencies should also have an effective management regime to define responsibilities and to ensure that these facilities are adequately maintained.

Reference should also be made to Appendix C regarding construction and maintenance considerations.

9.2 Bicycle Safety Audits

Appendix D presents the concept of a bicycle safety audit as part of a quality system. Bicycle safety audits are as important as safety audits that relate to other road users and should also comply with guidelines presented in the *Guide to Road Safety Part 6: Road Safety Audit* (Austroads 2009).

Bicycle safety audits should be applied to both on-road and off-road facilities, existing and proposed facilities, and all stages of the development of proposals from feasibility studies to pre-opening of the facility. An example of a bicycle safety checklist is provided in Appendix D. Such lists should be used in conjunction with Austroads lists that relate to road design, transportation and traffic in general.

References

- AASHTO 1991, *Guide for the development of bicycle facilities*, American Association of State Highway and Transportation Officials, Washington DC.
- AASHTO 2012, *Guide for the development of bicycle facilities*, 4th edn, American Association of State Highway and Transportation Officials, Washington, DC, USA.
- Andrew O'Brien & Associates 1996, 'Review of guide to traffic engineering practice: part 14: bicycles', State Bicycle Committee of Victoria & Ministry of Transport, Melbourne, Vic.
- Australian Asphalt Pavement Association 1990, *A guide to asphalt for lightly trafficked streets*, Advisory Note 5, AAPA, Kew, Vic, viewed 8 April 2016, <<http://www.aapa.asn.au/documents/item/119>>.
- Australian Human Rights Commission 2013, *Advisory note on streetscape, public outdoor areas, fixtures, fittings and furniture*, Australian Human Rights Commission, Sydney, NSW.
- Austrroads 2006, *Pedestrian-cyclist conflict minimisation on shared paths and footpaths*, AP-R287-06, Austrroads, Sydney, NSW.
- Austrroads 2009-2012, *Guide to bridge technology – set*, Austrroads, Sydney, NSW.
- Austrroads 2009, *Guide to road safety part 6: road safety audit*, 3rd edn, AGRS06-09, Austrroads, Sydney, NSW.
- Austrroads 2010a, *Guide to road design part 6: roadside design, safety and barriers*, 2nd edn, AGRD06-10, Austrroads, Sydney, NSW.
- Austrroads 2010b, *Australian national cycling strategy 2011-2016: gearing up for active and sustainable communities: national cycling strategy: 2011-2016*, AP-C85-10, Austrroads, Sydney, NSW.
- Austrroads 2013a, *Guide to traffic management part 6: intersections, interchanges and crossings*, 2nd edn, AGTM06-13, Austrroads, Sydney, NSW.
- Austrroads 2013b, *Guide to road design part 5B: drainage: open channels, culverts and floodways*, AGRD05B-13, Austrroads, Sydney, NSW.
- Austrroads 2014, *Guide to traffic management part 5: road management*, 2nd edn, AGTM05-14, Austrroads, Sydney, NSW.
- Austrroads 2015a, *Guide to road design part 1: introduction to road design*, 4th edn, AGRD01-15, Austrroads, Sydney, NSW.
- Austrroads 2015b, *Guide to road design part 6B: roadside environment*, 2nd edn, AGRD06B-15, Austrroads, Sydney, NSW.
- Austrroads 2015c, *Bicycle wayfinding*, AP-R492-15, Austrroads, Sydney, NSW.
- Austrroads 2015d, *Guide to road design part 4B: roundabouts*, 3rd edn, AGRD04B-15, Austrroads, Sydney, NSW.
- Austrroads 2015e, *Guide to road design part 4C: interchanges*, 2nd edn, AGRD04C-15, Austrroads, Sydney, NSW.
- Austrroads 2015f, *Level of service metrics (for network operations planning)*, AP-R475-15, Austrroads, Sydney, NSW.
- Austrroads 2016a, *Guide to traffic management part 4: network management*, 4th edn, AGTM04-16, Austrroads, Sydney, NSW.
- Austrroads 2016b, *Guide to road design part 3: geometric design*, 3rd edn, AGRD03-16, Austrroads, Sydney, NSW.
- Austrroads 2016c, *Guide to traffic management part 8: local area traffic management*, 2nd edn, AGTM08-16, Austrroads, Sydney, NSW.
- Austrroads 2016d, *Guide to traffic management part 10: traffic control and communication devices*, 2nd edn, AGTM10-16, Austrroads, Sydney, NSW.

- Austrroads 2017a, *Guide to road design part 4: intersections and crossings: general*, AGRD04-07, Austrroads, Sydney, NSW.
- Austrroads 2017b, *Guide to road design part 4A: unsignalised and signalised intersections*, 2nd edn, AGRD04A-17, Austrroads, Sydney, NSW.
- Austrroads 2017c, *Cycling aspects of Austrroads guides*, 3rd edn, AP-G88-17, Austrroads, Sydney, NSW.
- Cairney, P & King, K 2003, *Development of a performance based specification for a major bicycle facility*, ARR 358, ARRB Transport Research, Vermont South, Vic.
- Cement and Concrete Association of Australia 2004, *Guide to residential streets and paths*, Cement and Concrete Association of Australia, Sydney, NSW.
- Cross, KD & Fisher, GA 1977, *A study of bicycle/motor-vehicle accidents: identification of problem types and countermeasure approaches*, DOT-HS-4-00982, National Highway Transport Safety Administration, Washington, DC, USA.
- de Groot, R 2007, *Design manual for bicycle traffic*, CROW, Ede, The Netherlands.
- Department of Planning, Transport and Infrastructure, 2015, *Pavement marking manual*, DPTI, Adelaide, SA.
- Engineers Australia 2010, *Australian rainfall and runoff: revision project 10: appropriate safety criteria for people: stage 1 report*, Engineers Australia, Barton, ACT.
- Land Transport New Zealand 2005, *Land transport rule: traffic control devices 2004*, Wellington NZ.
- Land Transport New Zealand 2008, *Estimating demand for new cycling facilities in New Zealand*, report 340, Land Transport New Zealand, Wellington, NZ, viewed 30 May 2016, <<https://www.nzta.govt.nz/resources/research/reports/340>>.
- Ministry of Transport 2005, *Getting there: on foot, by cycle: a strategy to advance walking and cycling in New Zealand transport*, Ministry of Transport, Wellington, NZ.
- NZ Transport Agency 2009, *Pedestrian planning and design guide*, NZTA, Wellington, New Zealand, viewed 12 January 2016, <<https://www.nzta.govt.nz/assets/resources/pedestrian-planning-guide/docs/pedestrian-planning-guide.pdf>>.
- NZ Transport Agency 2010a, *Manual of traffic signs and markings (MOTSAM): part 1: traffic signs*, NZTA, Wellington, New Zealand.
- NZ Transport Agency 2010b, *Manual of traffic signs and markings (MOTSAM): part 2: markings*, NZTA, Wellington, New Zealand.
- Queensland Department of Transport and Main Roads 2015a, *Road planning and design manual: edition 2: volume 3: supplement to Austrroads Guide to Road Design Part 6A: Pedestrian and Cyclist Paths*, TMR, Brisbane, Qld.
- Queensland Department of Transport and Main Roads 2015b, *Technical note 128: selection and design of cycle tracks*, TMR, Brisbane, Qld.
- Queensland Transport 2005, *Easy steps: a tool kit for planning, designing and promoting safe walking*, Queensland Transport, Brisbane, Qld, viewed 18 January 2016, <<http://www.tmr.qld.gov.au/Travel-and-transport/Pedestrians-and-walking/Easy-Steps.aspx>>.
- Roads and Traffic Authority 2002, *How to prepare a pedestrian access and mobility plan: an easy three stage guide*, RTA/PUB.02.024, RTA, Sydney, NSW.
- Roads and Traffic Authority 2005, *NSW bicycle guidelines*, version 1.2, RTA, Sydney, NSW.
- Roads and Maritime Services 2013, *Continuous footpath treatments*, technical direction TDT 2013-05, RMS, Sydney, NSW.
- Shepherd, R 1994, 'Road and path quality for cyclists', *Australian Road Research Board (ARRB) conference, 17th, Gold Coast, Queensland*, Australian Road Research Board, Vermont South, Vic, vol. 17, no. 5, pp. 133-47.
- VicRoads 2005, *Terminal treatments for off-road paths*, cycle note no. 17, VicRoads, Kew, Vic.

Australian and New Zealand Standards

AS/NZS1158 (Set):2010, Lighting for roads and public spaces, set.

AS/NZS 1158.1.1:2005, Lighting for roads and public spaces: vehicular traffic (category V) lighting: performance and design requirements.

AS/NZS 1158.1.2:2010, Lighting for roads and public spaces: vehicular traffic (category V) lighting: guide to design, installation, operation and maintenance.

AS/NZS 1158.3.1:2005, Lighting for roads and public spaces: pedestrian area (category P) lighting: performance and design requirements.

AS/NZS 3695.1:2011, Wheelchairs: requirements and test methods for manual wheelchairs.

AS/NZS 3695.2:2013, Wheelchairs: requirements and test methods for electrically powered wheelchairs (including mobility scooters).

Australian Standards

AS 1428.1:2009, Design for access and mobility: part 1: general requirements for access: new building work.

AS 1428.2:1992 (R2015), Design for access and mobility: part 2: enhanced and additional requirements: buildings and facilities.

AS 1742.2:2009, Manual of uniform traffic control devices: part2: traffic control devices for general use.

AS 1742.3:2009, Manual of uniform traffic control devices: part 3: traffic control for works on roads.

AS 1742.9:2000, Manual of uniform traffic control devices: part 9: bicycle facilities.

AS 1743:2001, Road signs: specifications.

AS 2890.3:2015, Parking facilities: part 3: bicycle parking.

Appendix A Application of Envelopes and Clearances to Determine the Widths of Paths

Various common path operational scenarios are shown in Figure A 1, Figure A 2 and Figure A 3. These form the basis of the widths provided for paths in Section 5 of the guide. Designers should review the likely operational characteristics of paths during the design process to determine the appropriate path width.

A.1 Bicycle Paths

For a bicycle path (Figure A 1):

- 3.0 m is the desirable width for a path where high speeds are possible.
- 2.5 m is the acceptable minimum path width for paths with a predominant purpose of commuting, during periods of peak use.
- 2.0 m is the absolute minimum path width where paths experience very low use at all times and on all days or where significant constraints exist limiting the construction of a wider path, and may be acceptable for a commuting path where the path user flows are tidal in nature.

Whilst unlikely, it is technically possible that situations exist where wider paths may be justified i.e. where there are high speeds, and where high ‘concurrent’ bicycle volumes exist for both directions, such that passing within the lane in each direction is necessary.

Figure A 1: Bicycle path operation

Scenario	Overall width of path	Predominant path purpose
A	2.0 m	Typical circumstances of use Local access <ul style="list-style-type: none"> • Constrained conditions • ‘Tidal’ flow • Low use
B	2.5 m	Commuting and local access <ul style="list-style-type: none"> • Regular use • 20 km/h
C	3.0 m	Commuting <ul style="list-style-type: none"> • Frequent and concurrent use in both directions • 30 km/h+

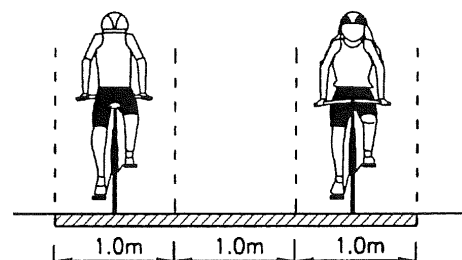
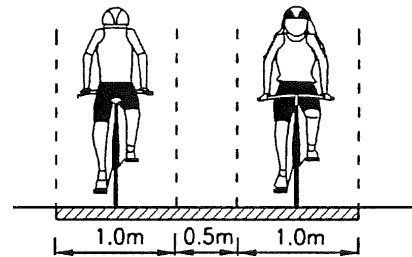
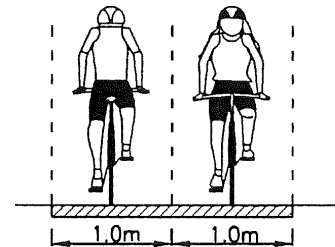

A.2 Shared Paths

For a shared path (Figure A 2):

- Regional paths should be 4.0 m wide to permit the cyclist groups/couples to pass pedestrian couples or other cyclist groups, or to permit cyclists travelling in opposite directions to pass pedestrians with convenience and safety. However, it should be noted that in some jurisdictions cyclists may be prohibited from riding side-by-side on shared paths.
- 2.5 m and 3.0 m are the absolute minimum widths for paths having a predominant purpose of commuting and recreation respectively, during periods of peak use.
- 2.0 m is an acceptable path width where the path has a very low use at all times and on all days, where significant constraints exist limiting the construction of a wider path.
- 3.0 m is the minimum path width for a path where high speeds occur.

A.3 Separated Paths

Figure A 3 illustrates the operation of a one-way separated path.

The width for this path is:

- 1.5 m desirable width (overall path width of 3.0 m) and is appropriate for paths used by experienced cyclists, and where there are relatively high cyclist speeds.
- 1.2 m absolute minimum width (overall path width ≥ 2.4 m) and should only be used for local access paths (where higher speed cyclists are a small proportion of all users), where cyclist speeds are relatively low, and where the path abuts an adjoining pedestrian path not less than 1.2 m wide.
- 2.0 m is the width of the bicycle path (overall width of 3.5 m) required where passing within the cyclists' path section occurs or where it is desirable that passing manoeuvres by cyclists occur outside of the pedestrian path section of the facility.

A barrier separating the bicycle and pedestrian path sections is not usually required for separated one-way paths. However, physical separation should be considered in situations such as where path conditions are congested or where there are unsafe conditions due to path users.

In the event that a barrier is used to separate the bicycle and pedestrian path sections, then a wider pedestrian path section may be required to allow passing manoeuvres on that section of the path, amongst other reasons (e.g. pedestrian volumes).

Figure A 2: Shared path operation

Scenario Overall width of path

Predominant path purpose

A 2.0 m Typical circumstances of use
Local access

- constrained conditions
- 'tidal' flow
- low use

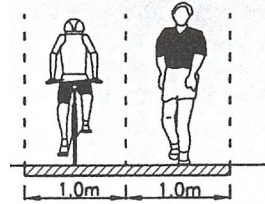

B 2.5 m Commuting and local access

- Regular use
- 20 km/h

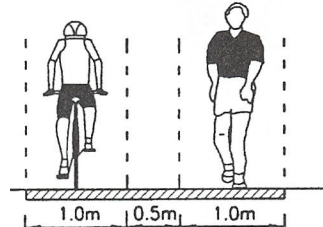

C 3.0 m Commuting

- Frequent and concurrent use in both directions
- 30 km/h+

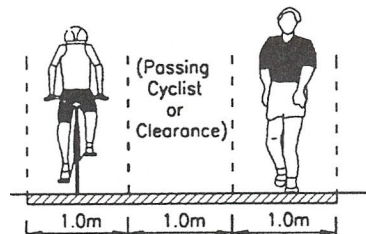

D 3.0 m Recreation

- Regular use
- 20 km/h

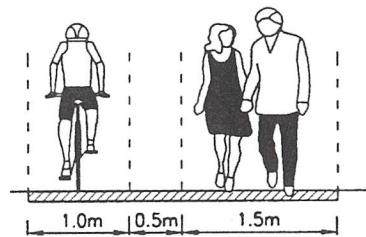

E 3.5 m Commuting and recreation (concurrent)

- Frequent and concurrent use in both directions
- 30 km/h+

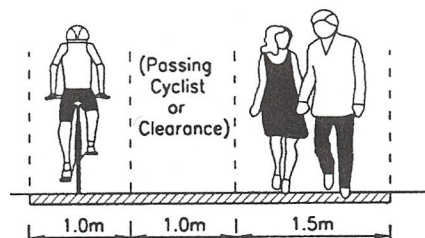

F 4.0 m Major recreation

- High and concurrent use in both directions
- 20 km/h

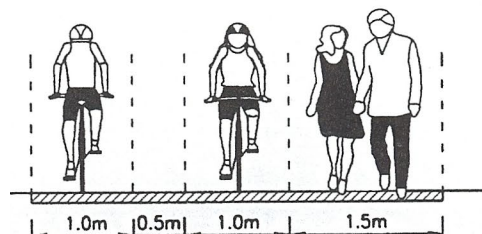

G 4.0 m Major recreation

- Regular group rides
- High and concurrent use in both directions
- Generally low speed due to congestion

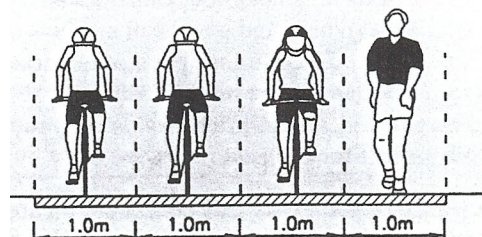
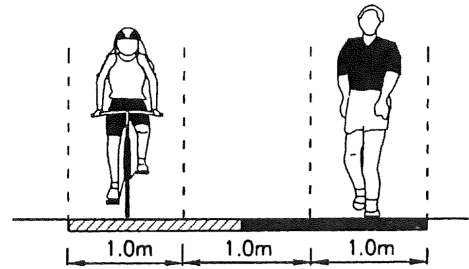
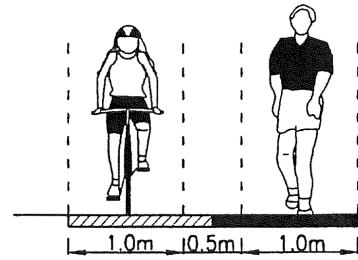

Figure A 3: Separated one-way path operation

Scenario	Overall width of path	Predominant path purpose
A	2.5 m	<p>Typical circumstances of use</p> <p>Commuting and local access</p> <ul style="list-style-type: none"> • Constrained conditions • 20 km/h
B	3.0 m	<p>Commuting</p> <ul style="list-style-type: none"> • Frequent and concurrent use in both path sections • 30 km/h+



Appendix B Speed Limiting Treatments

The use of speed limiting treatments on paths, either a bicycle path or a shared path, should follow the same principles as used when speed reducing treatments are placed on roads. The devices must provide a clear unambiguous direction to the path user, must not add a hazard and must be supported by necessary regulatory signage and linemarking.

Table B 1 sets out speed limiting treatments for bicycle path and shared path terminations.

Table B 1: Suggested path speed limiting treatments

Treatment	Use	Comments
Speed humps	Appropriate	Can destabilise riders and increase hazards if poorly sited or inadequately marked. Warning signs and linemarking similar to road humps.
Path narrowing	Appropriate	Minimum one-way width of 1.4 m. Warning signage and linemarking required.
Path deflection	Appropriate	Maximum deflection angle 10° for high-speed path and 20° for low-speed path.
Warning signs	Appropriate	Used to warn of an approaching hazard and to advise of a need to reduce speed. Used in conjunction with other methods.
Alternative paving	Appropriate	Use different materials and colours.
Path terminal deflection rails	Not appropriate	Can destabilise cyclists and increase hazards if used as a speed limiting treatment. Used only to prevent unauthorised vehicle entry when other methods have not succeeded.
Holding rails	Not appropriate	Only used at intersections to provide a temporary support for a cyclist.
Bollards	Not appropriate	Not considered an appropriate speed control treatment.

Source: Adapted from Roads and Traffic Authority (2005) and Queensland Department of Transport and Main Roads (2015a).

Appendix C Path Construction and Maintenance

C.1 General Requirements

Careful location, design and construction of paths for cycling can reduce future maintenance requirements. Careful attention to drainage, the location of vegetation and the type of vegetation planted can assist in minimising maintenance. A large amount of maintenance can be prevented if debris is not washed onto paths, and if appropriate plant species are selected so they do not cause pavement damage and trimming of overhead branches is not required.

The path alignment and cross-section should be designed to minimise the amount of debris, which can wash onto the path surface. Paths adjacent to watercourses should be located so that the likelihood of inundation and the resulting slippery surface is reduced.

Bushes that will not grow tall enough to obstruct sight distance should be planted on the inside of curves. Trees should be chosen and planted away from the edge of paths so as to minimise the likelihood of roots causing deformation and cracking of the path surface.

Paths for bicycles should be included in asset management programs in a similar manner to roads, to ensure a safe and useable riding surface and also to avoid the increasing cost of maintenance or reconstruction as a result of the asset degradation.

It is essential for effective maintenance operations that all aspects of the design allow for ease of access for all necessary maintenance plant (i.e. truck, backhoe, and mowers), not only to the path but abutting reservations that do not have alternate access. As the construction may not be performed by the agency performing the maintenance, consultation should be undertaken throughout the design process in order to determine maintenance requirements.

C.2 Path Maintenance Requirements

Regular maintenance activities on paths should include:

- filling of cracks (Figure C 1)
- trimming or removal of grass so that it does not intrude into the path (Figure C 2)
- sweeping of paths to remove debris such as broken glass and fine gravel (including that arising from construction and maintenance activities such as crack sealing)
- re-painting of pavement markings
- cleaning of signs
- trimming of trees and shrubs to maintain safe clearances and sight distances.

Figure C 1: Maintenance operations on asphalt path



Figure C 2: Asphalt path requiring maintenance



C.3 Pavements

C.3.1 Pavements for Bicycle Paths

The pavement of paths for cycling must be designed and constructed to a standard that ensures a satisfactory level of service for cyclists throughout the life of the facility.

The maintenance activities discussed previously require the use of a truck and other substantial machinery. If paths are not designed to carry the live loads imparted by this equipment then pavements will suffer structural damage, which will affect use of the facility, and be expensive to repair. All paths should therefore be designed to withstand at least a fully laden small truck.

Most paths should have a hard weatherproof surface. Primarily they can be constructed as a flexible pavement of crushed rock surfaced with asphalt or a bituminous seal, or as a rigid concrete pavement.

It is important that the sub-grades of both flexible and rigid pavements are compacted to a satisfactory standard and soft areas are treated. It may be necessary in some cases to assess sub-grade conditions along the line of the proposed path.

Typical cross-sections of flexible and rigid pavements are shown in Figure C 3. Individual road agencies will have a preference for particular types of pavement based on experience using local materials that should result in economical pavements. Appropriate pavement design advice should be sought in every instance.

Figure C 3: Typical pavements for paths

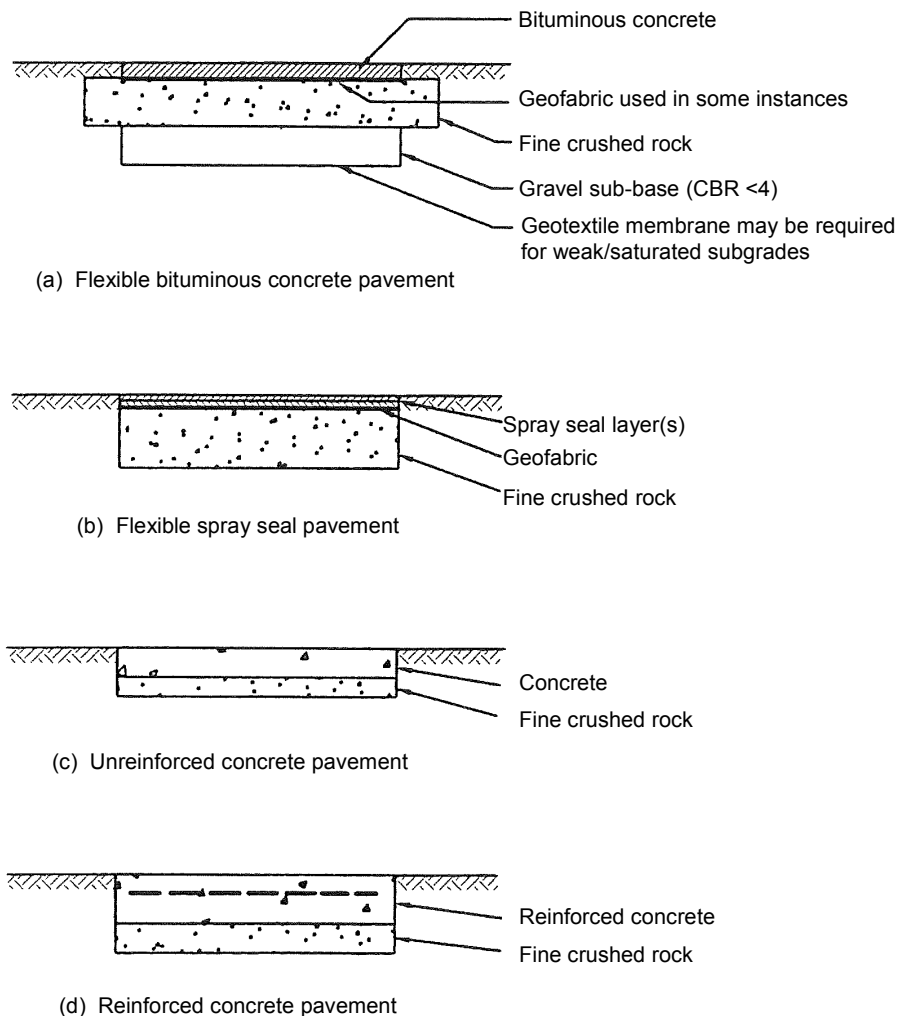

Where paths are located on river banks and likely to become inundated they should be constructed of concrete to provide greater resistance to scour by flood water.

Coloured pavement surfaces are used in some instances (refer to the *Guide to Traffic Management Part 10: Traffic Control and Communication Devices* (Austroads 2016d)).

Some road agencies have detailed specifications for the construction of bicycle path and shared path pavements. Figure C 4 shows examples of different pavement types and transverse joint types for concrete pavements.

Skid resistance

The surface of a path needs to provide a skid resistant surface to minimise the occurrence of cyclists and pedestrians slipping or uncontrolled skidding on the path. As a guide information on the performance of various types of path surfaces is available in *Development of a performance based specification for a major bicycle facility* (Cairney & King 2003).

Figure C 4: Examples of bicycle path pavements

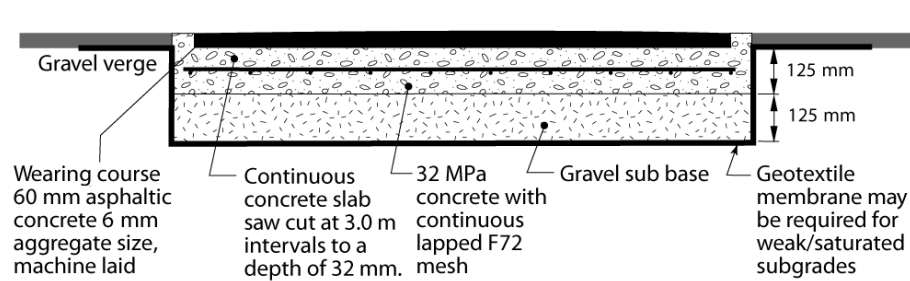

(a) Reinforced concrete path with asphalt surface and gravel sub base

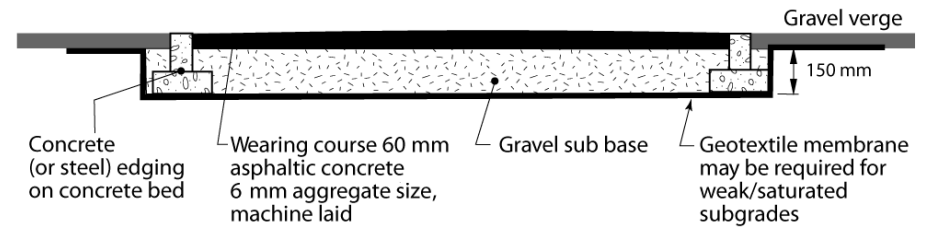

(b) Asphaltic concrete path with concrete or steel edging and gravel sub base

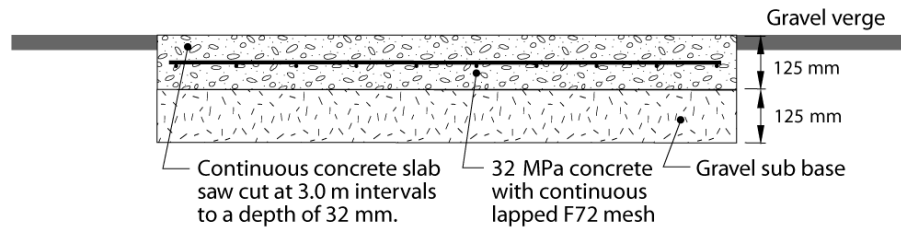

(c) Reinforced concrete path with gravel sub base

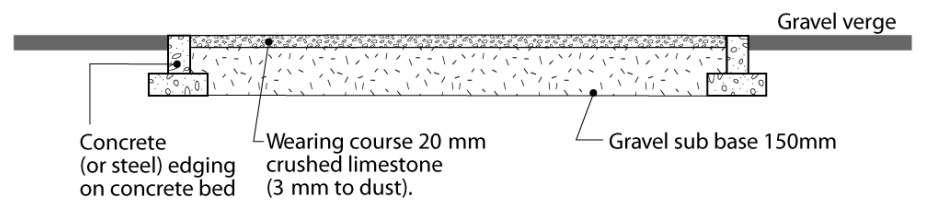

(d) Unsealed path with concrete or steel edging

Path cross sections

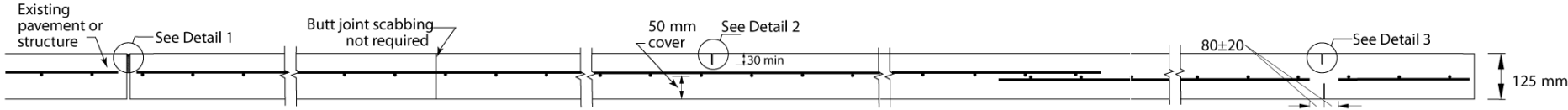

Isolation joint (without beam)
Used where new path joins to existing path or other structure.

Construction joint
Used when path is poured in two or more sections. This joint should be applied at 1.3 m (min) spacing to adjacent hinge-tied & sawn joint. Alternative option: break the mesh and place tiebars across the joint. Y2 ties 1000 long at 600 centres.

Hinge tied & sawn joint
The most commonly used path joint. Apply these joints at 3.0 m spacings.

Reinforcing lapped splice
Mesh must be placed so that the two outermost wires on the top sheet overlap the two outermost wires on the bottom sheet.

Sawn contraction joint provided at the second joint away from terminal anchors and junctions with existing flexible pavements.

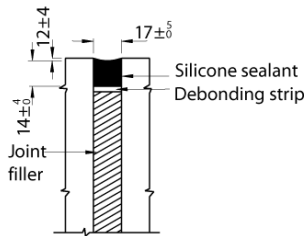

Detail 1

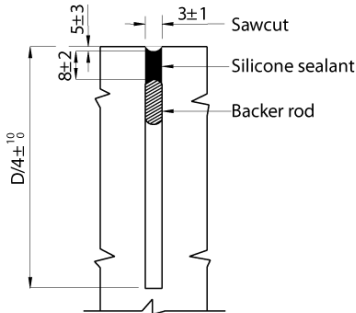

Detail 2

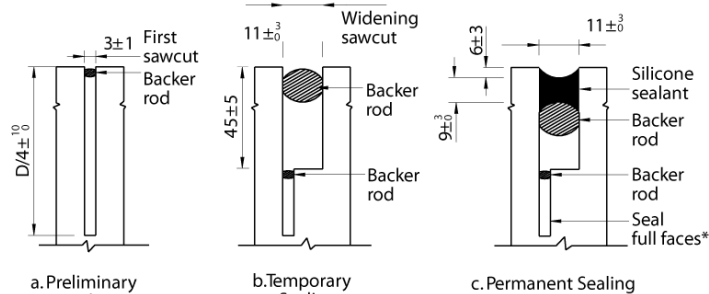

Detail 3

* Sealants must extend down the vertical edge of the slab at all joints (for the depth of the sawcut) to prevent the ingress of incompressibles.

Jointing notes

- 1 Slab lengths may be varied $\pm 10\%$ as required to suit local conditions.
2. Transverse joints are to be aligned square to the longitudinal edge with a tolerance of $\pm 5^\circ$
3. Where dowels are used on joints these are to be galvanised and fixed.
Dowels must be supported in such a way that no steel crosses the joint except for the dowel.
4. Saw cuts should be made within 12 hrs of concrete placement or as soon as the concrete is strong enough to support the sawing equipment.

Concrete path transverse jointing types (longitudinal section)

Source: Adapted from Roads and Traffic Authority (2005).

C.3.2 Bituminous Surface Pavements

Flexible pavements have in the past been favoured in some jurisdictions because they are usually cheaper to construct than concrete and have in general provided superior riding qualities.

Asphalt mixes should be similar to those used for lightly trafficked streets. For a path a 5 mm aggregate size is commonly used. The asphalt aggregate size should not exceed 10 mm nominal size and when a sprayed seal is used, the aggregate size should not exceed 7 mm as larger aggregates may result in an unacceptably rough surface.

More information on asphalt surfaces is contained in *A Guide to Asphalt for Lightly Trafficked Streets*, (Australian Asphalt Pavement Association 1990) available at <<http://www.aapa.asn.au/technology-and-publications/advisory-notes>>.

Due to the high pressure in many bicycle tyres it is desirable that sprayed sealed surfaces have a stone size less than 14 mm in order to provide a comfortable ride for cyclists.

C.3.3 Concrete Pavements

The use of concrete paths can be beneficial on the basis of whole-of-life costs, but only where appropriate construction methods are employed. In general, concrete paths have a longer life and are relatively unaffected by:

- inundation and should therefore be preferred for paths close to watercourses
- the deleterious effects of vegetation either at cracks or along the path edges
- low levels of maintenance
- the absence of motor traffic (important to the condition of bituminous pavements)
- poor sub-grade conditions in some instances
- occasional heavy traffic (in the case of reinforced paths).

Concrete paths should be of sufficient strength to resist cracking and differential vertical movement. A skid-resistant surface finish should be provided by transverse brooming of the wet concrete. Similar attention should be given to the smoothness of path sections both at joints and in between.

The development of concrete path construction techniques and products has resulted in significant improvements in rider comfort. It is critical that such techniques (Cement and Concrete Association of Australia 2004) are employed. They include:

- preformed or saw-cut contraction joints
As a consequence bull floating, trowelling and broom finishing can be extended right up to the joints resulting in a considerably improved riding surface. In particular, wet formed contraction joints made using a grooving tool, should be avoided. The sealing of contraction joints may be important to minimise the ingress of dirt and to limit weed growth amongst other benefits.
- the use of extended bull floats (up to 4 m wide) to avoid long wave corrugations that affect cyclists travelling at speed
- narrower and fewer joints.

It is sometimes perceived that the contrast between the colour of lines and concrete surfaces is insufficient. Conversely, concrete paths are thought to offer a higher standard of delineation for cycling in dark conditions. As for other path surface types, it is important that pavement markings are maintained on concrete paths to a high standard.

C.3.4 Unsealed Paths

Consideration may be given to the provision of a stabilised unsealed surface as the first stage of development where:

- it is necessary to reduce construction costs
- the path is unlikely to flood to the extent that excessive damage to an unsealed path or excessive maintenance costs will result
- the volume of cyclists initially using the path is expected to be low
- flat gradients exist (e.g. less than 3%)
- costs need to be reduced
- the environmental amenity of an area will be reduced by a sealed path.

The second stage would be the provision of an asphalt, or bituminous surface, or possibly a concrete surface.

Care should be taken in the selection of the (unsealed) surface material to ensure that the riding surface is smooth and well bound, as cyclists will not be attracted to a path that has a poor surface. Well graded river gravels are most suitable. Materials that result in loose surfacing should not be used under any circumstances. Good drainage is also an important factor in the success of gravel paths.

C.3.5 Timber Surfaces

Gaps between longitudinal planks in timber decks can trap bicycle wheels and cause serious injuries to cyclists. Consideration should therefore be given to remedial treatment of existing timber bridges such as through an asphalt overlay of the outer 1.0 m sections of deck to provide a smooth, safe ride for cyclists. At the very least warning signs should be provided on the approaches to bridges that have longitudinal gaps in the deck.

On new timber bridges the planks should be placed perpendicular to the direction of travel of cyclists. In constructing and maintaining bridges it is important to ensure that the deck joints at abutments and piers provide a smooth and hence safe passage for cyclists.

Drainage should not be a problem when one considers the number of gaps in the decks of timber bridges. However, individual planks have the potential to warp and collect small, localised pools of water. Timber surfaces can be slippery in wet or shady conditions. Where these circumstances are common the application of a non-slip finish is also desirable, regardless of the alignment of planks.

Further information on pavement materials is contained in Commentary 3.

[\[see Commentary 3\]](#)

C.4 Life Cycle Costing

When selecting a pavement for a path, consideration should be given to the costs, the initial capital cost, annual maintenance costs and renewal costs so that the constructing agency is able to determine a pavement with the knowledge of the financial, initial and future requirements for the path. An example of a life cycle costing for path surfaces is shown in Table C 1.

Table C 1: Example of life cycle costs

Material	Construction cost ⁽¹⁾ (\$)	Annual maintenance cost ⁽²⁾ (\$)	Life cycle cost (\$)
Decomposed granite	105 000	27 000	391 000
Asphalt	120 000	3000	152 000
Concrete	195 000	1500	210 000
Boardwalk	1 200 000	2000	1 221 000

1 Assumes a 20 year period.

2 Assumes regular rain and flooding, requiring 30% replacement of surface annually.

Note:

The construction costs and annual maintenance costs are indicative only for the nominated section of path and have been provided to show the development of the life cycle costs. For other paths, these costs should be determined using jurisdiction information.

Source: Adapted from Road and Traffic Authority (2005).

C.5 Provision at Works

C.5.1 General

When construction and maintenance work is carried out involving trenching or other construction work across roads and paths, access for cyclists and pedestrians should be maintained to a satisfactory quality to avoid the use of alternative routes which may be hazardous or inconvenient.

Construction and maintenance works should be undertaken in such a way that these activities do not place cyclists and pedestrians at risk during the works period. This is particularly important, for instance, where a sealed shoulder is closed for maintenance on freeways or other high speed roads where cyclists may be permitted.

C.5.2 Signing and Delineation at Work Sites on or Adjacent to Paths

The signing and delineation of construction and maintenance works on roads and paths should be performed in accordance with AS 1742.3:2009 and any relevant local codes of practice and regulations. In general, provision for works on paths should be made in accordance with the principles of these standards.

A principal objective of providing for cyclists and pedestrians adjacent to works site, the surface should be maintained in a clean and smooth state.

Figure C 5, Figure C 6 and Figure C 7 highlight the desired level of provision required in the vicinity of works, depending on the circumstances. The actual provisions to be made are dependent on the conditions that exist, including:

- presence of a traffic controller
- existing level of bicycle use, and also of pedestrian use in the case of shared path diversions
- available opportunities to provide for cyclists
- road or path alignment
- traffic speeds and volumes
- duration of work
- surface material and condition
- environmental impacts.

Provision for cyclists on roads should be made in the following circumstances:

- where bicycle lanes exist
- arterial roads
- collector roads, with an AADT in excess of 3000 vehicles per day
- strategic and other significant bicycle routes.

Safety barriers should be provided where required by AS 1742.3:2009, and are generally appropriate where cyclists or pedestrians are detoured onto roads. Temporary (lower) speed limits may also be appropriate in this circumstance.

Figure C 5 provides guidance where adequate provision for cyclists is not possible on a road, access along a path in the area of the roadside verge may be appropriate. Provided adequate separation from the work area can be maintained, it is generally acceptable to initiate and terminate the roadside verge bicycle access within the road lane transition zones either side of the work area.

For paths, reference should be made to Section 2 and Section 3 for guidance relating to paths located away from road reserves where temporary roadside verge access is required. The controls highlighted in these sections are applicable to temporary paths.

Containment fences should be provided in accordance with the requirements of AS 1742.3:2009, and otherwise as required by the *Guide to Road Design Part 6B: Roadside Environment* (Austroads 2015b). These may be appropriate to separate pedestrians and cyclists where a pedestrian path is to be used for access by cyclists, and where:

- significant pedestrian or bicycle volumes exist
- safety issues may arise due to the unexpected use of a pedestrian path by cyclists.

Examples of provisions for paths located adjacent to roads and in reserves are shown in Figure C 6 and Figure C 7.

Temporary paths should be sealed. Whilst dependent on circumstances, such as bicycle volumes, safety and the extent of inconvenience to cyclists, this may be unnecessary where:

- the works are carried out over a short period (e.g. less than two or three weeks duration)
- the temporary path surface is firm, smooth and free of thorns
- the works are carried out during dry weather conditions
- path traffic is minimal.

However, it is very desirable that temporary paths are sealed and delineated where works are carried out over longer periods. Separated paths should be suitably delineated regardless of the period of construction.

Where works on paths are carried out for a period exceeding one day, the works should be made sufficiently visible for night-time path travel, so that path users are able to observe conditions under low ambient light conditions including temporary access paths, and take appropriate action. In addition, as a general principle, lighting on temporary access paths should not be less than the existing level on the original path.

Specific consideration may need to be given to the intersections of paths and roads. The measures taken to protect traffic should be balanced with consideration to all of the potential users and movements at such locations.

Where containment fences are used, to avoid catching the pedals of cyclists the fence should be set back from paths by at least 0.3 m and fine weave mesh should be used to prevent bicycle handlebars or pedals from catching on the fence.

Surface tolerances for bicycle riding surfaces are provided in Section 5.10. Where steel road plates are used to cover excavated or damaged pavement surfaces, appropriate steps should be taken to ensure that any steps and grooves are within the permissible tolerances.

Figure C 5: Works on roads – exclusive bicycle path diversion

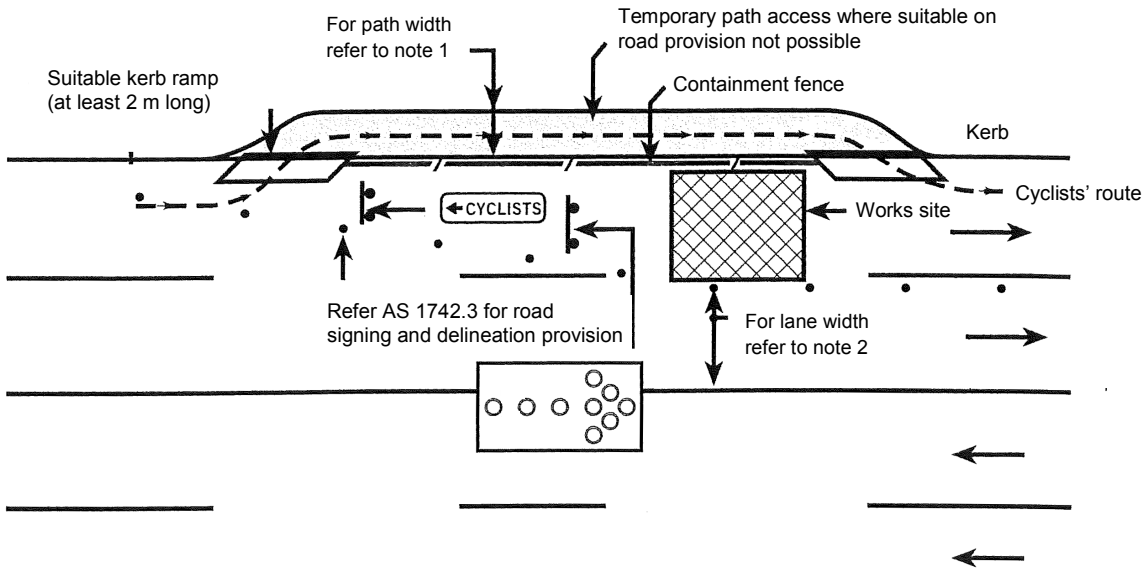

- 1 For path width refer to Section 5.1.3.
- 2 For lane width refer to AGRD Part 3 (Austroads 2016b).

Figure C 6: Works on paths adjacent roads – shared path diversion

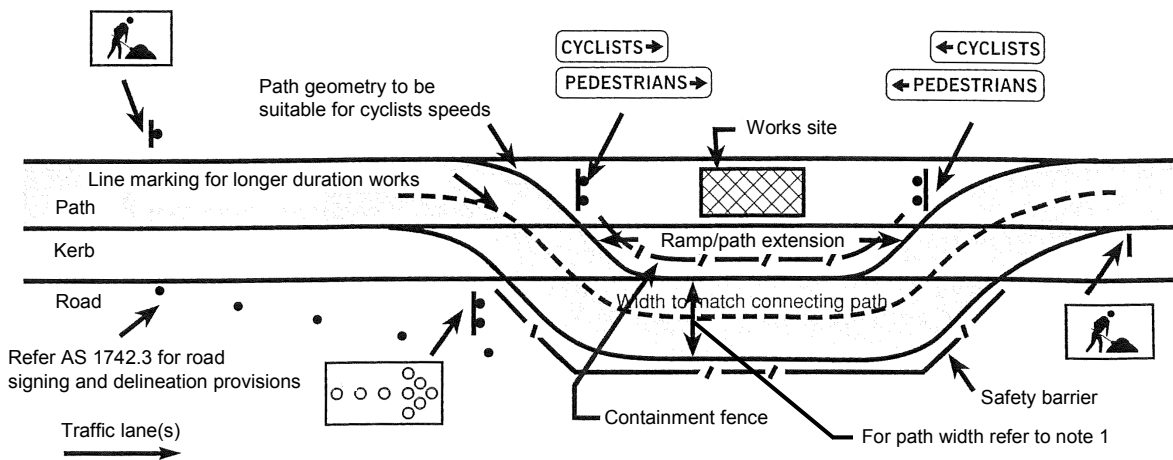

- 1 For path width refer to Section 5.1.4.

Figure C 7: Works on paths – shared path diversion

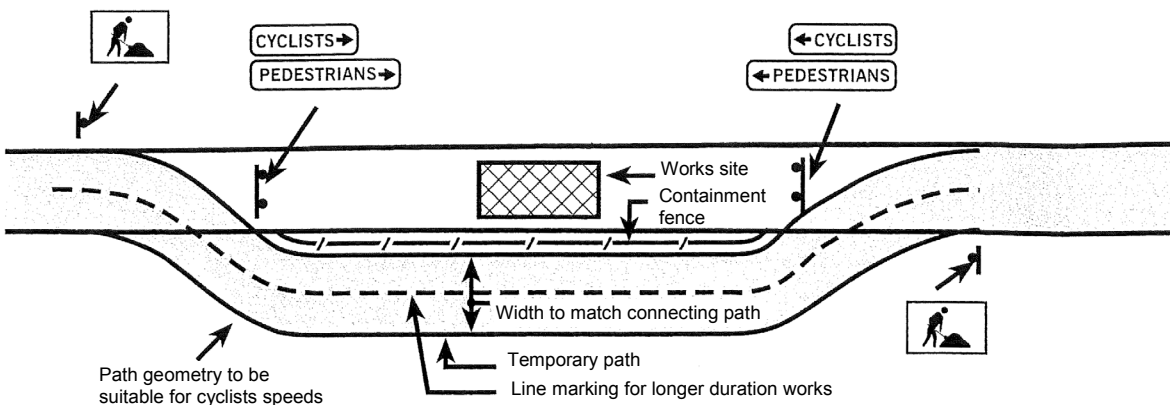

Appendix D Bicycle Safety Audit Checklist

D.1 Introduction

The implementation of a system of auditing of the infrastructure, which includes cycling facilities, either integrated with a similar process for roads, or otherwise, is recognised as the most appropriate means of undertaking these assessments.

In accordance with the Austroads road safety audit process (Austroads 2009a), it is appropriate that audits of bicycle routes and other facilities are conducted at various stages from planning through to construction, and in relation to existing infrastructure.

The lists of items in the sections below represent the possible contents of a checklist to assist the identification of relevant safety issues or concerns associated with bicycle facilities. It is unlikely that they include all of the issues that are of relevance or concern to cyclists, particularly given the wide variation in construction and design practice, and the conditions that exist.

It is therefore essential that personnel conducting audits of bicycle facilities are experienced in and knowledgeable about the provision of bicycle facilities.

Individual items provided in the lists may be applicable during several audit stages or may only relate to existing infrastructure.

Where existing infrastructure is to be audited, it is important that to some degree the audit is performed on a bicycle and on foot. The type of bicycle used should be representative of the most common type in the region of the audit, but should not have a suspension system or tyres wider than 32 mm.

Similarly, it is important that safety audit personnel ride at speeds typical of most users – which may be in excess of 25 km/h. Riding at slower speeds may not reveal potential problems such as geometric limitations or pavement surface defects.

Section D.2 is generally applicable to roads, paths and intersections. The requirements that relate mainly to either paths or roads are provided in Section D.9 and Section D.10 respectively.

In so far as roads are concerned, it is assumed that general road safety auditing processes exist, and hence the lists below represent additional considerations for bicycles.

D.2 General Requirements for Roads and Paths

- Are the designated crossing points and routes appropriate and acceptable to meet the required cyclist volumes?
- Are the characteristic bicycle use patterns accommodated (i.e. categories of cyclists, volumes, times of travel)?
- Do the proposals account for surrounding bicycle network deficiencies and opportunities?
- Do consistent and suitable provisions exist for the respective categories of cyclists anticipated along the route, or can they be achieved; for instance, is a path required for children and inexperienced cyclists?
- Are grade separated or controlled crossings required?
- Are traffic calming or local area traffic management measures required? (refer to the *Guide to Traffic Management Part 8: Local Area Traffic Management*) (Austroads 2016c).
- Are the requirements of local codes of practice met?

D.3 Alignment and Cross-section

- Does the cross-section of the lane/path facility safely accommodate the anticipated cyclists?
- Are stopping sight distances adequate for all traffic, accounting for paths, roads, driveways, railways etc.?
- Are sight lines applicable to the operation of cyclists obscured by obstacles such as signs, trees, pedestrian fences and parked cars?
- Is the horizontal and vertical alignment suitable? If not, are warning signs installed?
- Are there any sections of riding surface which may cause confusion for users, e.g.
 - Is alignment of the riding surface clearly defined, particularly at unexpected bends or for dark conditions?
 - Have disused pavement sections been removed or treated?
- Is sufficient route information or guidance provided?
- Does the design avoid or minimise the need for cyclists to slow or stop?
- Do hazardous conditions (e.g. concealed intersecting paths, curves) exist at the bottom of steep gradients?

D.4 Signs, Delineation and Lighting

- Are all necessary pavement markings provided?
- Are there any redundant pavement markings? Have redundant pavement markings been properly removed?
- Are all necessary regulatory, warning and direction signs provided and located appropriately? Are they conspicuous and clear in their intent? Are they at a safe distance/height with respect to the riding surface?
- Are signs in good condition and of an appropriate standard?
- Are there any redundant signs?
- Are fixed objects close to or on the path (trees, fences, holding rails, etc.) treated to ensure visibility at night (e.g. painted white and fitted with reflectors or reflective tape)?
- Are pavement markings clearly visible and effective for all likely conditions (e.g. day, night, rain, fog, rising or setting sun, oncoming headlights, light coloured pavement surface, poor lighting)?
- Are user movements obvious or delineated through intersections?
- Is public lighting of facilities required? Is the lighting design satisfactory, particularly at tunnels, underpasses and areas of high pedestrian activity? Is it operating satisfactorily?
- Are raised pavement markers recessed flush with the surface or located outside of the paths of travel of cyclists, or outside of bicycle lanes?
- Are thermoplastic markings chamfered?

D.5 Riding Surface

- Is the riding surface suitable for cycling?
- Are the riding surface and edges smooth and free of defects (e.g. grooves, ruts or steps) which could affect the stability of cyclists or cause wheel damage?
- Is the pavement design/construction of a satisfactory standard?
- Can utility service covers, grates, drainage pits etc. be safely negotiated by cyclists?

- Are smooth and flat gutters/channels provided at stormwater drainage pit inlets?
- Is the riding surface free of loose materials (e.g. sand, gravel, broken glass, concrete spills)?
- Is there suitable protection to prevent sand or other debris from depositing on the riding surface?
- Does the riding surface have adequate skid resistance, particularly at curves, intersections, bridge expansion joints and railway crossings?
- Is the riding surface generally free of areas where ponding or flow of water may occur?
- Is special protection required to prevent cyclists from running off the riding surface?

D.6 Vegetation, Maintenance and Construction

- Is suitable access for cycling available during maintenance and construction activities? (Appendix C).
- Are all locations free of construction or maintenance equipment?
- In the absence of an appropriate and regular maintenance program
 - Is there a possibility of the encroachment of grasses into bituminous riding surfaces (e.g. kikuyu) or similar circumstances that could result in poor edge conditions or pavement degradation?
 - Do thorn-bearing grasses (e.g. caltrop) exist, or are they likely to be introduced adjacent to the riding surface?
 - Are channels, kerb slots or similar treatments over which cyclists ride, located under deciduous trees etc. or otherwise likely to experience a build-up of debris due to poor drainage conditions?
- Will crack sealing processes or the application of spray seals result in the presence of loose/granular material/sand on the riding surface?
- Does landscaping allow adequate clearances, sight distance etc. and will these be maintained given mature plant growth?
- Could personal security of path users be adversely affected due to the position of bushes and other landscape features?
- Is landscaping required as a wind break?
- Will the positioning of trees and the species used contribute to the degradation of the pavement (e.g. through undermining or moisture variation)?

D.7 Traffic Signals

- Are separate pedestrian and/or bicycle phases provided where necessary?
- Do traffic signals operate correctly? Are signal displays located appropriately for all users?
- Does the design of the signals prevent conflicting motor vehicle movements during crossing phases for pedestrians and cyclists?
- Where a permanent demand for individual phases does not exist, have suitable detection facilities been provided for cyclists? Are these operating satisfactorily?
- Are inductive detector loops provided for bicycle users, are they located appropriately, of a suitable design and do they operate correctly for bicycles in the various stopping positions?
- If push-button actuators have been provided, are they located to allow convenient and legal operation from the normal stopping position (e.g. on the left of the riding surface or kerb ramp, behind the stop line)? Do they operate correctly?
- Are phasing and phase times acceptable? Are suitable warning signs or guidance for cyclists erected where intersection crossing times are insufficient?

D.8 Physical Objects

- Are fences, safety barrier or other objects located within 1.0 m of the path(s) of cyclists
 - free of sharp edges, exposed elements or corners so as to minimise the risk of injury to cyclists in the event of the feature/object being struck by a bicycle?
 - designed to minimise the potential for bicycle handle bars or pedals to become caught in the feature should an errant bicycle collide with it?
- If there are any obstructions located adjacent to the paths of cyclists, are they adequately delineated?
- Are clearances to the operating space of cyclists acceptable?

D.9 Paths

This section should be read in conjunction with Section D.2.

D.9.1 General

- Are automatic reticulation systems timed to avoid periods of significant path use? Do sprinklers spray away from the path (rather than across it)?
- Do irrigation hoses need to be placed across path surfaces?
- Are provisions for car parking in the vicinity of the path satisfactory in relation to the operation and safety of path users?
- Are there any potential problems of conflict between the various path users (e.g. pedestrians and cyclists)?
- Is the path subject to flooding? If so, are warning signs provided and located appropriately?

D.9.2 Alignment and Cross-section

- Where paths are located adjacent to roads, is there sufficient separation and/or protection from the carriageway?
- Are adequate overtaking opportunities provided?
- Is the path width, at structures or otherwise, adequate for the likely usage levels of pedestrians and cyclists?
- Is the geometric alignment and gradient satisfactory?
- Is the design speed appropriate?
- Is path crossfall suitable for the anticipated path users?
- Is the crossfall steep enough to adequately drain the path and prevent ponding on the surface, while being flat enough to be comfortable for pedestrians?

D.9.3 Intersections

- If justified, is path priority assigned to path users at road crossings?
- At intersections with busy roads, are appropriate facilities provided, e.g. traffic signals, underpass, overpass or median refuge, to allow path users to safely cross? Are the intersection controls satisfactory?
- Is the location of road/path or path/path intersections satisfactory and obvious with respect to horizontal and vertical alignment?
- Is the presence of intersections obvious to road/path users?
- Is a refuge required at road crossings? Would it adversely affect (e.g. squeeze) cyclists travelling along the road?

- In relation to path entry controls
 - Are terminal devices required? If so, does the device design meet the requirements of this Part?
 - If central holding rails or bollards exist, is there a legitimate reason why they are needed, and if so is there sufficient pavement width either side?
- Are kerb ramps adequate and suitable for all users (width, slope, flush surface)? Are turning radii adequate?
- Are holding rails provided? Are they positioned so as to not unduly interfere with access for cyclists and other users (consider tandem bicycles, bicycles with trailers etc.)?
- Are the controls associated with path/path intersections satisfactory?

D.10 Roads

Whilst this Part relates to paths it is often the case that road and path treatments interface therefore this section contains some information relating to roads that may impact on path users.

D.10.1 General

- Are bicycle lanes required?
- Are bicycle lane widths or the left traffic lane widths adequate to accommodate cyclists?
- Can sufficient space be obtained? Are there any squeeze points for cyclists?
- Does the construction of the lane facility conform to this Part and other relevant standards?
- Are special provisions required along curving roads?
- Are road markings for cyclists suitable and adequate, and do they meet relevant standards?
- On controlled access roads, is a path for experienced riders required within the reservation?
- Are local area traffic management treatments appropriate for bicycles?
- Are drainage pit covers flush with the surface or are there level differences that could be hazardous to cyclists and pedestrians?
- Is the positioning of bicycle pavement symbols potentially hazardous to motorcyclists?
- Are sealed shoulders at least as smooth as traffic lanes?

D.10.2 Intersections

- Are the intersection treatments appropriate?
- Are there any common cyclist movements (legal or otherwise) that differ from typical traffic movements? Are these likely to be anticipated by other traffic? Can these movements be made safely and if not what remedial measures are required?
- Are 'head start' storage areas required due to conflicting manoeuvres of bicycles and other traffic, or due to high cyclist volumes?
- Are special provisions for cyclists required at roundabouts?
- Are there continuity lines marked where appropriate?
- Are grated drainage pits that are potentially hazardous to cyclists and pedestrians located within the road/path intersection or within the turning path of cyclists (i.e. radii in the corners of the intersection)?
- Are grated pits on paths or in close proximity to paths properly designed so that they cannot trap bicycle wheels?

Commentary 1

C1.1 Planning and Need for a Path

C1.1.1 Planning

Cycling and walking have significant roles in transport systems throughout Australia and New Zealand and are expected to make an important contribution to the well-being and transportation of people in future.

The *Australian National Cycling Strategy 2011–2016* (Austroads 2010b) recognises that more and more people are cycling in Australia and whilst there have been many initiatives undertaken there is a need to provide greater progress. To support and encourage this progress the Strategy has the following priorities and objectives, in part:

- **Cycling promotion:** promote cycling both as a viable and safe mode of transport and an enjoyable recreational activity.
- **Infrastructure and Facilities:** create a comprehensive network of safe and attractive routes to cycle and end-of-trip facilities.
- **Integrated Planning:** consider and address cycling needs in all relevant transport and land use planning activities.
- **Safety:** enable people to cycle safely.
- **Monitoring and Evaluation:** improve monitoring and evaluation of cycling programs and develop decision-making processes for investment in cycling.
- **Guidance and Best Practice:** develop nationally consistent technical guidance for stakeholders to use and share best practice across jurisdictions.

The type of on-road bicycle facility should also align with the functional road hierarchy. An example of the alignment of a bicycle facility and road function, for urban roads, has been developed by Queensland Department of Transport and Main Roads (2015b) and is shown in Table C1 1.

Table C1 1: Example of an urban road bicycle facility selection depending on road function

Road function	Vehicle operating speed (km/h)		Cycle tracks appropriate?	Explanation
Local access road with or without parking	Up to 30 km/h		No	Mixed traffic is appropriate. Cycle track with limited vehicle access may be appropriate (refer 3.2.1).
			Maybe	Bicycle lanes/cycle tracks may be appropriate on primary bicycle route.
Collector/distributor road	Up to 50 km/h	No kerbside parking		Bicycle lanes with no kerbside parking are most appropriate.
		With kerbside parking	Yes	Bicycle lanes <u>not</u> preferred due to door zone conflicts (refer 3.3.1).
Arterial road	More than 50 km/h		Yes	Bicycle lanes <u>not</u> preferred due to high speed difference.
Urban motorway	More than 70 km/h		No	High quality parallel off-road bicycle path with grade separated, signalised or priority crossings at intersections is appropriate.

Source: Queensland Department of Transport and Main Roads (2015b).

The national strategy in New Zealand is *Getting there – on foot, by bicycle: A strategy to advance walking and cycling in New Zealand transport* (Ministry of Transport 2005). This strategy aims to ensure that supportive walking and cycling environments are provided in New Zealand communities, that safety is improved for pedestrians and cyclists, and that people walk and cycle more as part of their day-to-day transport mix. The development of walking and cycling is integral to achieving the five key objectives of this strategy:

- improving access and mobility
- protecting and promoting public health
- ensuring environmental sustainability
- assisting economic development
- assisting safety and personal security.

When planning or designing a path in a road, rail, river or coastal reservation it is important that designers have a broad view of the transport network and identify connections to other paths and facilities that should be provided as part of the design or accommodated in plans for the future.

It is important also to recognise the broad range of performance and skill that exists among pedestrians and cyclists due to factors such as age, experience, physical ability, cognitive skill and vision, and the need to provide paths to satisfy the needs of various users and demands.

Bicycle paths and facilities are generally designed for a normal bicycle. However, it is important to understand that there are other forms of human-powered vehicles that have a broad range of performance characteristics that may have to be considered. For example, tandem bicycles are generally the least manoeuvrable human-powered vehicle, which may have implications for path terminal design.

Planners and designers should establish early in the process whether the path is likely to carry a significant number of human powered vehicles other than bicycles so that paths and facilities are designed to safely accommodate the appropriate design vehicle. Commentary 2 provides operational characteristics for examples of human-powered vehicles and this information may assist designers in providing for them where necessary.

[\[see Commentary 2\]](#)

Designers should be aware of local pedestrian or cycling planning and design guides. These guides generally provide the policy and network planning context in which pedestrian facilities are provided within a jurisdiction. With respect to pedestrians examples of these guides include:

- How to Prepare a Pedestrian Access and Mobility Plan: An easy three stage guide (Roads and Traffic Authority 2002)
- Easy Steps: a toolkit for planning, designing and promoting safe walking (Queensland Transport 2005)
- Pedestrian Planning and Design Guide (NZ Transport Agency 2009).

Traffic management aspects and road user considerations in relation to pedestrian and cycling paths are provided in Austroads (2013a) and Austroads (2014a).

C1.2 Need for a Path

C1.2.1 General

The provision of coherent networks of pedestrian and bicycle paths is important because they

- encourage exercise which improves public health and reduces the strain on health services and hospital systems
- can assist in causing a shift from car to other forms of transport (walking, cycling and public transport) thereby reducing air pollution, greenhouse emissions and other forms of environmental pollution, as well as assisting in the management of traffic congestion
- benefit businesses through healthier employees who enjoy a better quality of life.

Designers have a role in achieving these important outcomes by ensuring that paths and associated facilities are appropriately located and designed.

Traffic management aspects and road user considerations in relation to pedestrian and cycling paths are provided in Austroads (2017c) and Austroads (2013a).

C1.2.2 Pedestrian Paths

The most common type of pedestrian path is used by pedestrians and young cyclists (depending on local road rules). The general principles relating to provision of pedestrian paths include:

- In general, all roads should have some type of walking facility out of the vehicle path. An exception may be categories of road that have a very low volume and low operating speed such as minor access roads.
- Pedestrian path installation warrants based solely on pedestrian volumes are not practical, except in the central business districts of cities and at event locations.

The need for pedestrian paths should also be related to the pedestrian network functional requirements. For example, the presence of pedestrians on many rural roads is a rare event and the provision of paths is not economically justified. In this situation the provision of shoulders will provide space for a pedestrian who happens to use the road.

On all roads that have a moderate to high speed and significant pedestrian activity should be provided with pedestrian paths because of the high risk of serious injury should a pedestrian be struck by a vehicle.

A higher road functional classification in urban areas generally means higher traffic speeds and volumes, and hence a need to provide for pedestrian mobility and safety. However, some roads classified as local streets also function as traffic routes and have similar needs.

Collector and arterial roads in the vicinity of schools should be provided with pedestrian paths and desirably off-road cycle paths, shared or segregated pedestrian paths, to increase safety for children travelling to and from school. Safe routes to school can also reduce reliance on car travel for school trips and have health and environmental benefits.

Many people with disabilities undertake much of their travel either on foot, in wheelchairs or on personal mobility devices (e.g. scooters) and so the development of a network of adequate pedestrian paths is important for their mobility. The provision of pedestrian paths that meet recommended dimensions, surface requirements, and which are free of obstructions is important to ensure that they do not represent a hazard for people who have difficulty in detecting or manoeuvring around obstacles.

The use of mobility scooters has emerged as an alternative means of transport for people with mobility impairment or other health issues and is likely to grow as the population ages. It is therefore important that paths and associated facilities can accommodate this type of use. The characteristics of these vehicles can be obtained from specifications on suppliers web sites. Dimensions for width, length and turning radii vary depending on model (e.g. length is often in the range 1.2 m to 1.6 m). Designers should source typical dimensions for products used in Australia and New Zealand and ensure that they can be accommodated within path and facility designs. For example mobility scooters should be able to:

- use kerb ramps and cross-channels without the device becoming unstable or the undercarriage impacting the path or road pavement
- turn within intersections and pass through chicanes and other devices in a continuous forward motion
- store safely within refuges without overhanging into the adjacent traffic lane.

Table C1 2 is an example of when pedestrian paths may be required based on the general abutting land use, and illustrates the way in which the principles are applied in New Zealand.

Table C1 2: New Zealand example of when to provide urban and rural pedestrian paths

Land use	Pedestrian path provision			
	New roads		Existing roads	
	Preferred	Minimum	Preferred	Minimum
Commercial and industrial	Both sides		Both sides	
Residential (on arterial roads)				
Residential (on collector roads)				
Residential (on local streets)	Both sides	One side	Both sides	One side
Three to ten dwellings per hectare	Both sides	One side	One side	Shoulders on both sides
Fewer than three dwellings per hectare	One side	Shoulders on both sides		

Source: NZ Transport Agency (2009).

C1.2.3 Paths for Cycling

The flow chart in Figure C1 1 is a basic guide to assist designers to choose an appropriate type of path treatment. The flow chart only considers the primary factors needed to determine the type of treatment required. Prior to this chart being applied a decision will have been taken as to whether an on-road lane or an off-road path, or both, are required. Also, there may be other issues, constraints and practices that will have a bearing on the decision-making process.

Figure C1 1: Guide to the choice of path treatment for cyclists

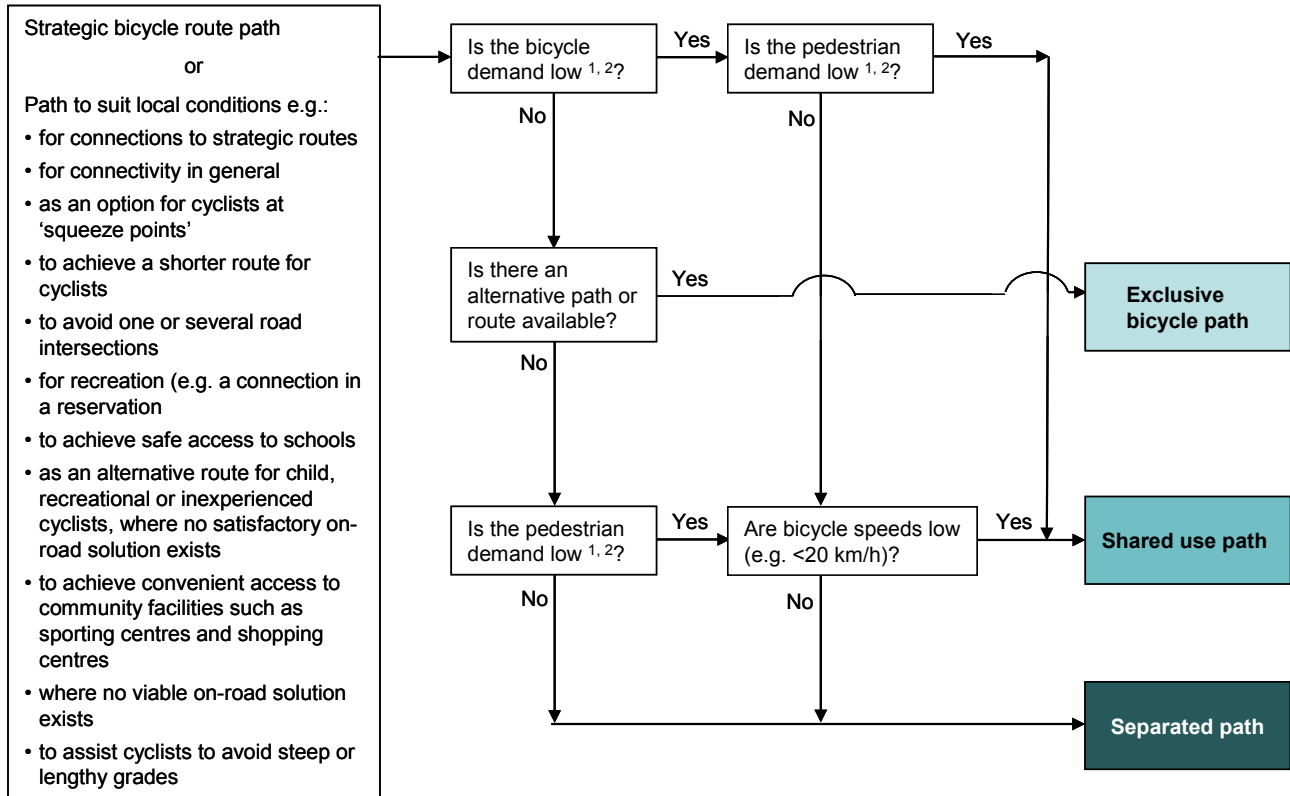

1 The level of demand can be assessed generally on the basis of the peak periods of a typical day as follows:

- a. Low volume: Infrequent use of path (say less than 10 users per hour)
- b. High volume: Regular use in both directions of travel (say more than 50 users per hour).

2 These path volumes are suggested in order to limit the incidence of conflict between users, and are significantly lower than the capacity of the principal path types.

C1.2.4 Operation Characteristics

Where sufficient volumes exist, separate paths should be provided for the exclusive use of cyclists and pedestrians. Separated paths may reduce the potential for conflict and allow the bicycle path section to operate at a reasonable speed.

An indication of the extent of other users normally found on shared paths is shown in Table C1 3.

Table C1 3: Categories of users of shared paths

Category of user	Specific users within category
Pedestrians	Children Elderly People pushing prams & strollers Family groups Dog walkers Joggers
Cyclists	Children Families Adults Individuals & groups Power assisted bicycles
Users with disabilities (vision, hearing mobility, & cognitively impaired users)	Pedestrians Sporting users Manual wheelchair users Electric wheelchair/scooter users
Small-wheeled vehicle users	Children's pedal/motorised/electric cars In-line skaters Skate boarders Foot scooters
Others	Organised events Maintenance workers Horse riders Anglers

If the facility is intended for use by experienced cyclists then it should follow a direct route to a popular destination, be wide and have a horizontal and vertical alignment which allows safe, high speed bicycle travel. Rail reserves and river banks can offer an opportunity to provide a high quality path. Provision of an exclusive bicycle path can often, but not always, mean that a separate parallel facility has to be provided to meet the volume of pedestrians and other potential users.

Because cyclist volumes are often relatively low, the cost of paths significant and many paths provide useful and attractive links for pedestrians, there has been a tendency for shared-use paths to be provided rather than exclusive bicycle paths. Whilst this enables the maximum benefit to be derived from these facilities, conflict does occur between cyclists and other users, particularly pedestrians, and this has become an issue on some busy paths. For this reason a separated path which divides the operating space for each use, or where completely separate facilities are provided, may be appropriate where both cyclist and pedestrian (or other user) volumes are heavy.

In some jurisdictions cyclists are permitted to ride on pedestrian paths whereas in others pedestrian paths must be signed as shared paths before cyclists are able to use them legally. The issue of cycling on pedestrian paths is one that must be addressed by the authorities responsible for traffic regulation.

Although they can be designed for high speeds, many paths are not used by inter-suburb distance cyclists. This is mainly due to cyclists inability to travel constantly at the relatively high speed attainable on the road system, and because paths often do not lead to useful destinations. Indirect paths bring cyclists into conflict with other users, and cause them to have to yield at side streets.

These factors can result in speeds being low and overall travel times being relatively long, and unattractive to cyclists. Thus paths should not be regarded as a substitute for adequately designing roads for travel by bicycle.

In designing an off-carriageway facility for bicycles, the designer should first determine the purpose of the cycling path. The purpose of a path is best assessed through consideration of the potential, likely and desired use of the path amongst the various categories of cyclists. Predominantly, a path for cycling may either lead to specific destinations or offer a pleasant ride. Therefore the detailed designs of commuter and recreational paths can be quite different.

Crashes and even fatalities occur on paths and may be the result of high-density use or as a result of mixed use which results in a large differential in speeds. Careful consideration of separated paths for differing user needs may be required to minimise risk within limited budgets.

[\[Back to body text\]](#)

Commentary 2

Although the bicycle is the standard vehicle for the design of facilities, the use of other human-powered vehicles (HPVs) such as tandem bicycles, tricycles and other ‘pedal powered vehicles’ may be popular in some areas and an allowance for these vehicles may be appropriate in the design of some facilities.

There is limited information available on the needs and operating characteristics of these vehicles, and in particular on their performance from the perspective of road and path design, or in relation to traffic management and safety. Therefore, designers should make their own assessment of the required measures that need to be taken to account for the use of these vehicles.

Consideration of the issues in Table C2 1 relating to HPVs and elderly or impaired cyclists may be relevant to the design of bicycle facilities that have significant use by these vehicles and path users.

Table C2 1: Human powered vehicles – facility design considerations

Issue	Details
Sight distance	Consider low cyclist eye height (as low as 0.7 m above riding surface in some instances)
Braking performance	Due to factors such as the low centre of gravity and braking system, performance of a recumbent tricycle can be significantly more effective than a standard bicycle. Conversely, a tandem bicycle may have a lesser performance
Medians or refuge width	The additional length of some HPVs may necessitate special consideration
Turning paths	Refer to Table C2 2
Width of road and path facilities	Use a vehicle design envelope equal to the difference in inner and outer turning path radii, plus 0.3 m (0.4 m for tandem bicycle). If this is greater than the standard bicycle envelope width then increase path space in road or path treatments accordingly
Path terminals	Give due consideration and allowance for lesser turning capabilities and in particular avoid chicanes
Speed	May be relatively high for tandem bicycles. May be lower for elderly cyclists or cyclists who have impairments
Gradients	Path gradients may have to be flatter for elderly cyclists, or cyclists who have impairments
Education	Make relevant advice available (e.g. conspicuity of low HPVs)

Operating dimensions of specific HPVs that may be of assistance to designers are shown in Table C2 2. Photographic examples of HPVs are shown in Figure C2 1, Figure C2 2 and Figure C2 3.

Table C2 2: Examples of HPV dimensions

Examples of human powered vehicles (HPVs)	Overall vehicle width (m)	Inner turning path radius (m)	Outer turning path radius (m)	Length (m)
Recumbent touring tricycle (Greenspeed)	0.9	1.4	2.3	1.95
Tandem recumbent touring tricycle (Greenspeed)	1.0	3.1	4.1	3.5
Tandem bicycle (Cannondale)	0.56	1.85	2.55	2.45
Bicycle with two wheel trailer (Coolstop)	0.82	0.7	1.85	2.67
Bicycle with BOB trailer (i.e. baby on board)	0.56	0.9	1.6	2.8
Bicycle with hitch-bicycle (Thorogood)	0.56	1.7	2.55	1.7

Figure C2 1: Examples of recumbent tricycles



Source: ICE Trikes (personal communication 2017)

Figure C2 2: Example of tandem bicycle



Figure C2 3: Example of bicycle with a hitch-bicycle attached



[\[Back to body text\]](#)

Commentary 3

C3.1 Concrete and Asphalt

Hard surfaces, such as concrete and asphalt, are generally the most functionally appropriate. They are preferred where the pedestrian path is on a gradient, especially where it can become wet. Concrete and other light coloured surfaces are preferred in hot climates as they radiate less heat. However, a disadvantage of concrete surfaces can be increased glare for pedestrians who may congregate adjacent to the path (e.g. cafes, general seating, and bus stops).

In order to provide a safer facility for cyclists and pedestrians, expansion/contraction joints should be no wider than 13 mm and the concrete surfaces should be finished to provide a non-slip surface (e.g. wooden floated or sponged finish may be satisfactory). Brushed or broomed finishes can have a disadvantage in that they cause increased abrasions for cyclists in the event of a fall, but may be necessary to enhance traction on steep grades. In some jurisdictions, there is a preference for saw-cut expansion joints.

C3.2 Pavers and Bricks

Glazed surfaces can become very slippery when wet and so pavers and bricks used on pedestrian paths in external areas should not be glazed. Joints should be as flush as possible and should not be wider than 13 mm. Unless they are laid on a firm base, small paving units tend to move independently and form an uneven surface. The provision of a firm, well-compacted base, or preferably a concrete base is essential where this type of paving is to be used for pedestrian paths.

Bluestone pavers are sometimes used as pavers in threshold local area traffic management treatments. They often fail the flatness test noted above and are difficult to negotiate for people in wheelchairs and some others. Bluestone pavers should therefore not be used on pedestrian routes or pedestrian paths. People with sight impairments frequently use differences in pavement colour as a means of guidance. They can find the variation of colour that occurs in surfaces composed of pavers confusing.

C3.3 Loose Surface Materials

Avoid the use of exposed aggregate, gravel, soil, sand, grass and tanbark surfacing on pedestrian routes, other than recreational routes. Even though they can be less expensive, and more aesthetic, some people find them difficult to walk on and they can impose severe difficulties for people in wheelchairs.

Where unsealed surfaces are used adequate crossfall should be provided to ensure that good drainage occurs. Unsealed surfaces may require an increase in crossfall (up to 5%) to prevent puddles of water from developing, though AS 1428.1:2009 specifies that a path crossfall should not exceed 2.5% to cater for people who have a disability.

[\[Back to body text\]](#)

Guide to Road Design Part 6A: Paths for Walking and Cycling provides guidance for designers and other practitioners on the design of paths for safe and efficient walking and cycling, both within and outside the road corridor. The guide provides information on considerations that should be given in providing a path, describes the types of paths and covers the requirements of path users, e.g. operating spaces, factors that influence path locations, and geometric design criteria for a path and related facilities such as intersections between paths, and terminal treatments. Detailed guidance is provided on path location, alignment, width, clearances, crossfall, drainage and sight distance requirements.

Guide to Road Design Part 6A



Austroads

Austroads is the association of Australasian road and transport agencies.

www.austroads.com.au