

# Pelvis and Perineum M1 Tutorial

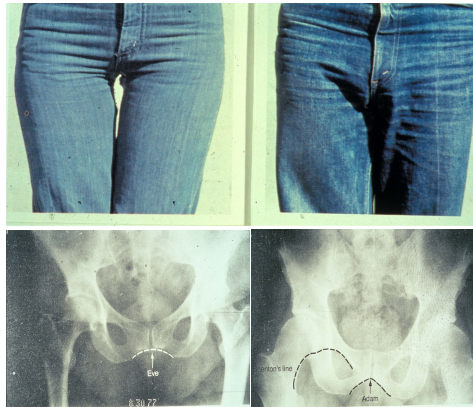

E.T ANG  
Anatomy Tutor,  
NUS YLLSoM



JEAN INGRES, *Le Source* 1820-1856, oil on canvas

# X-ray of the Pelvis

Female

vs

Male

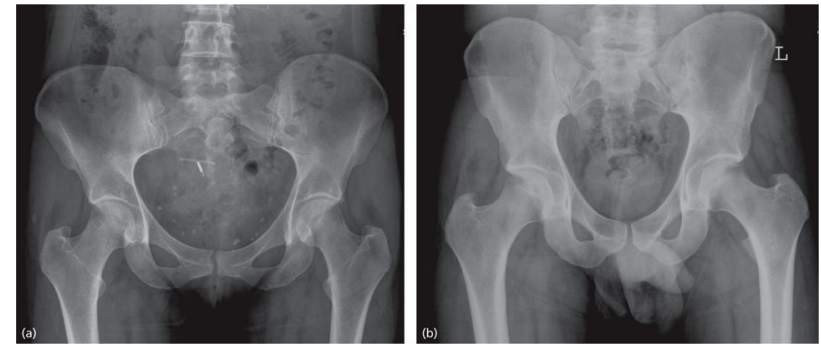

Public angle (Arch)?

Lateral dimensions?

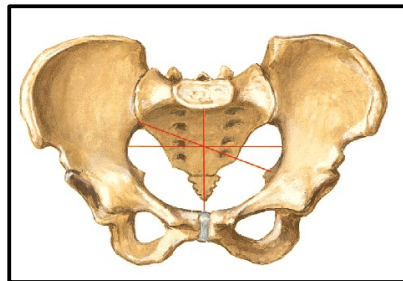

Relevant for O&G placement

Revise the pelvic bone

Know the Sacroiliac joint

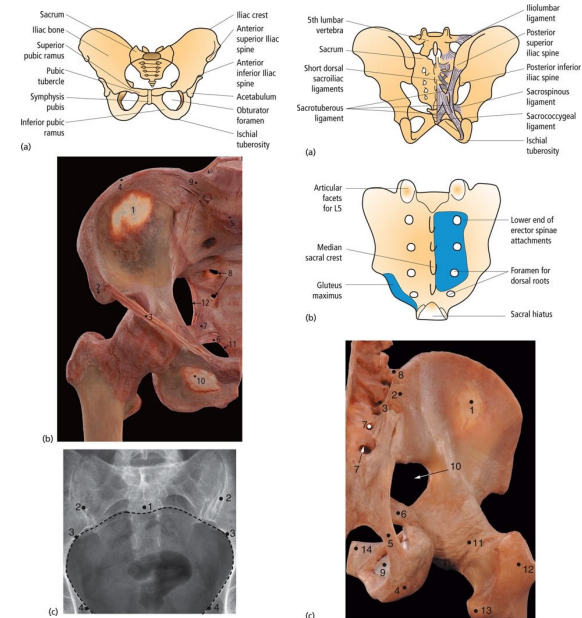
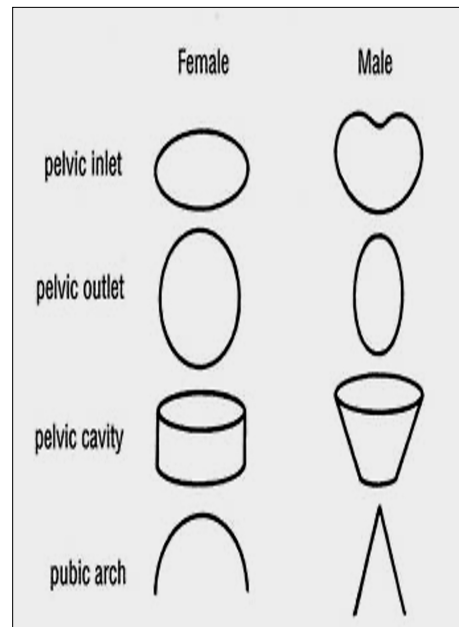

Revise all these structures! + sacrum

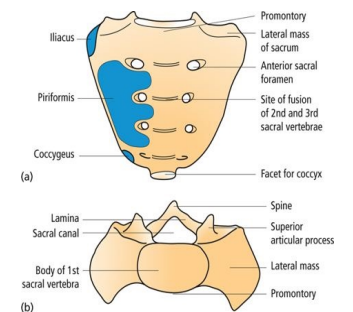

## Pointers for the wet lab

Pelvic floor (muscles) – **Levator Ani** (what are the components?)

With prosections, most of the muscles are dried up and hence difficult to differentiate the components of the **Levator Ani** muscles.

These are:

**iliococcygeus, pubococcygeus, puborectalis**

**Pelvic diaphragm** = Levator Ani + Coccygeus

### Further confusions for the student:

Need to separate female from male features, what are the homologs?

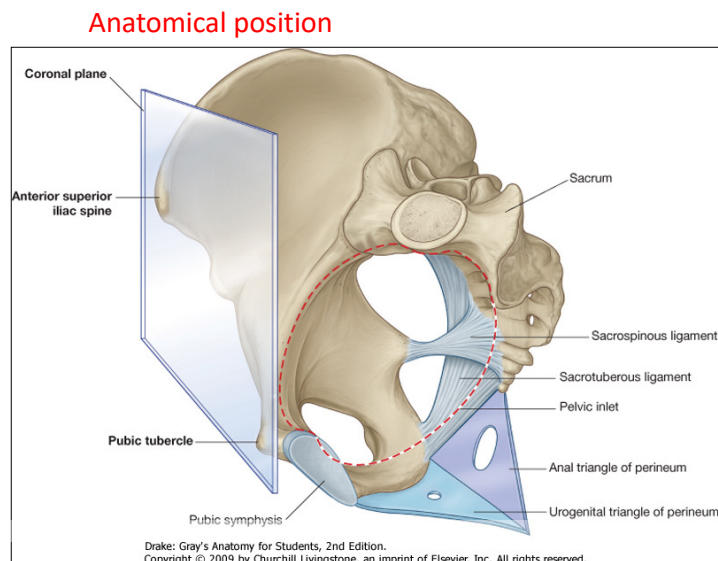

Downloaded from: StudentConsult (on 8 February 2012 01:55 AM)  
© 2005 Elsevier

## Obvious features are the perineal perforations:

Female = 3  
Male = 1 (excluding the urethra)

Need to know these structures to be great clinicians, why?

Finger into the anus, vaginal, palpate the perineal body.....

## Other matters

Difficult to appreciate the **Perineal pouches** (Deep + superficial) and perineal membrane etc. (all dried up).

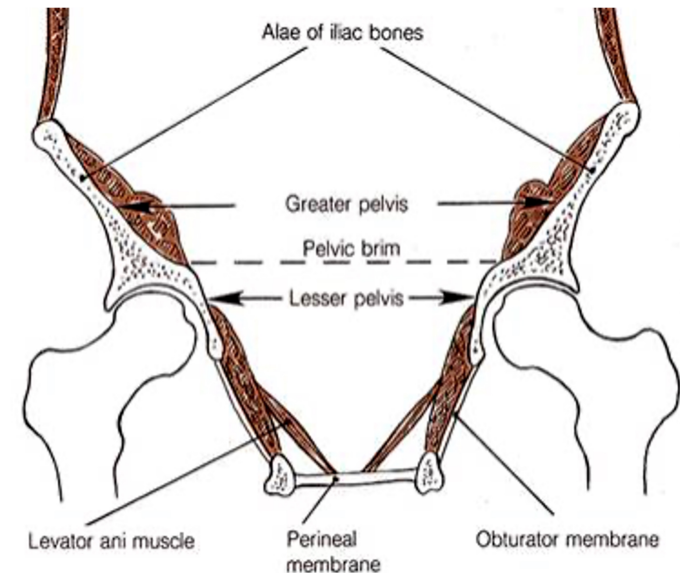



**Pelvic Brim Diameters**

**Transverse  
Anteroposterior ( true  
Conjugate)**

**Bony Pelvic Inlet  
(Brim)**

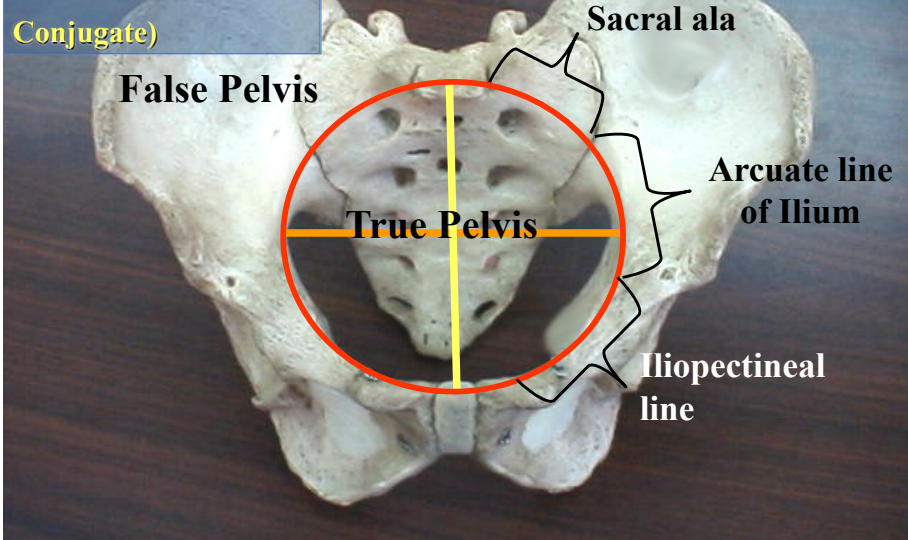

**Bony Pelvic Outlet**

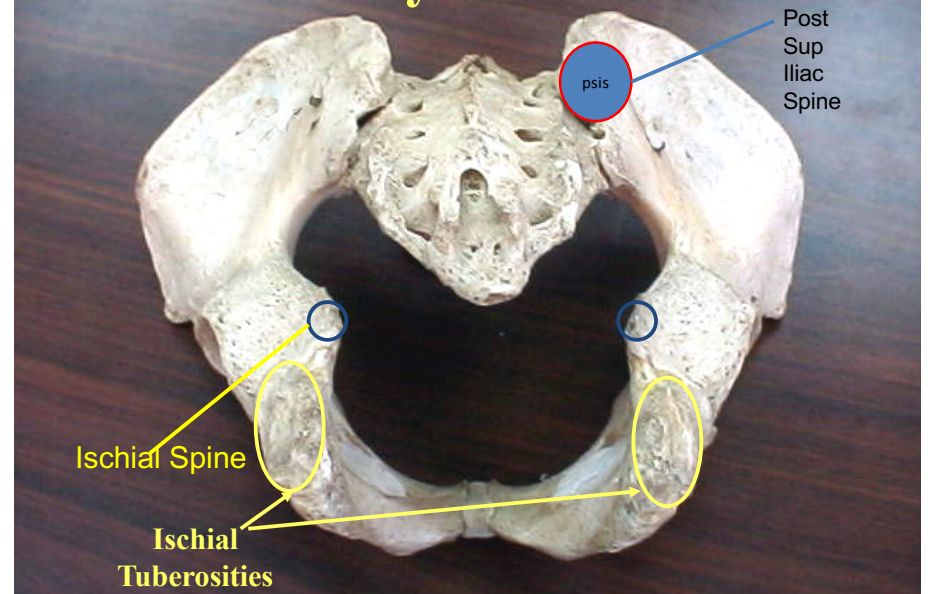

**Uterus**

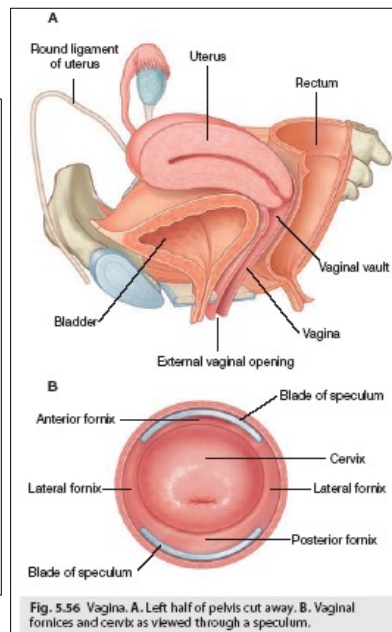
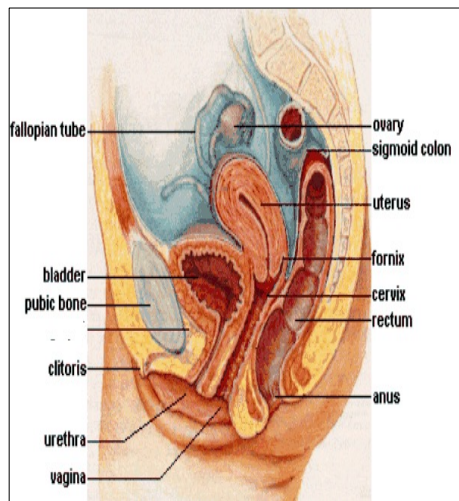
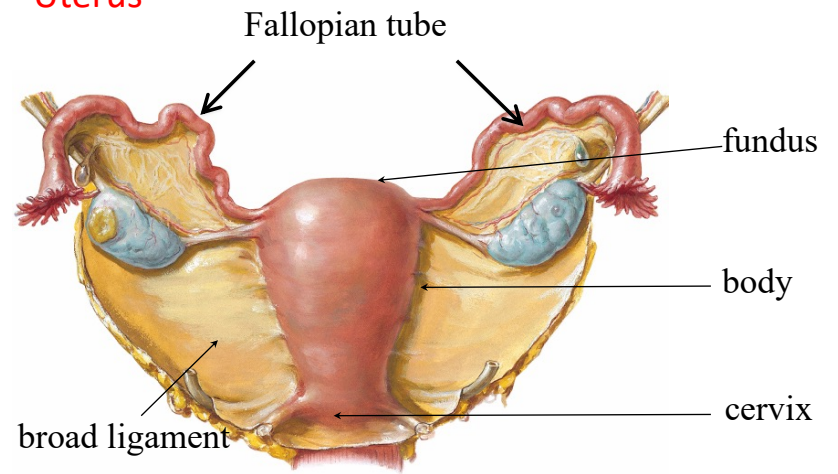
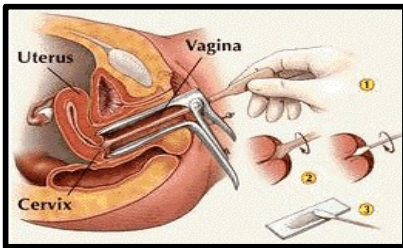
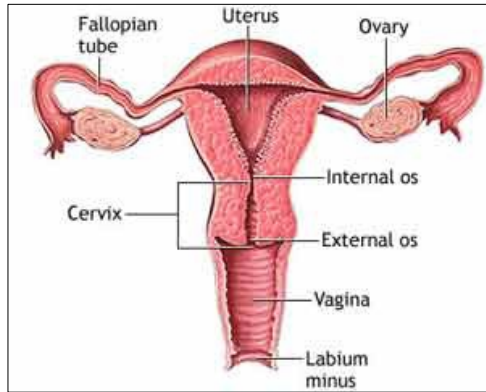

Fig. 5.56 Vagina. A. Left half of pelvis cut away. B. Vaginal fornices and cervix as viewed through a speculum.

**Uterus**



Content of the broad ligament?



**Prolapsed Uterus**



**Uterus**

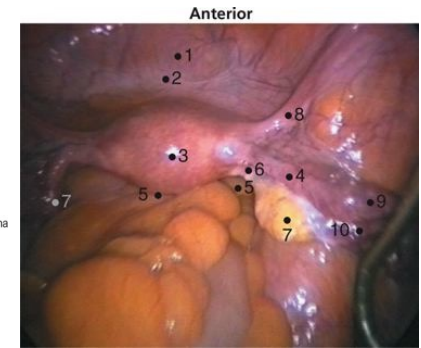
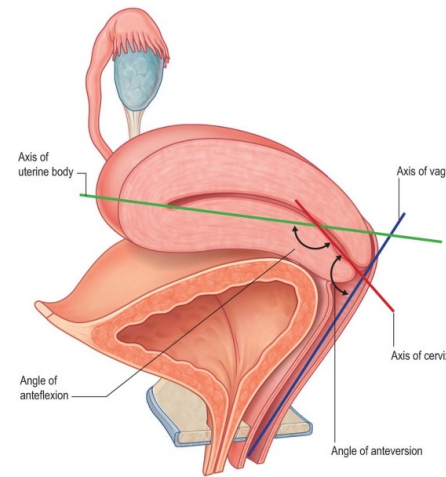

8 – Round ligament

4- Fallopian tube

Anteverted versus Retroverted position?

**Uterus – Blood supply**

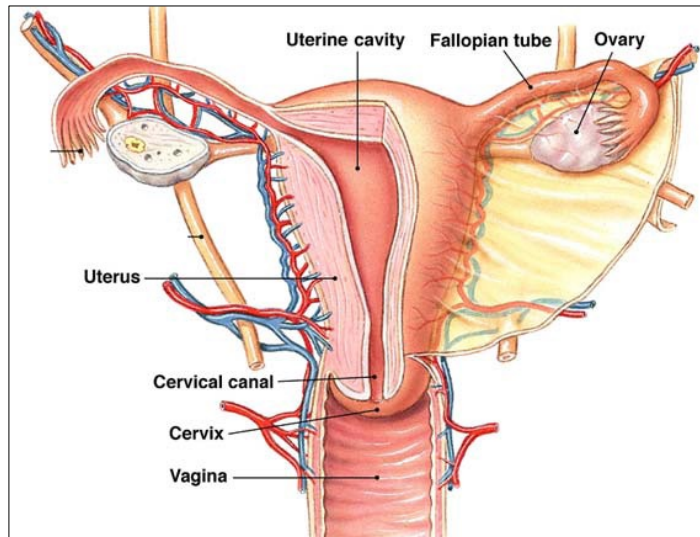

**Support for the uterus**

What are they?

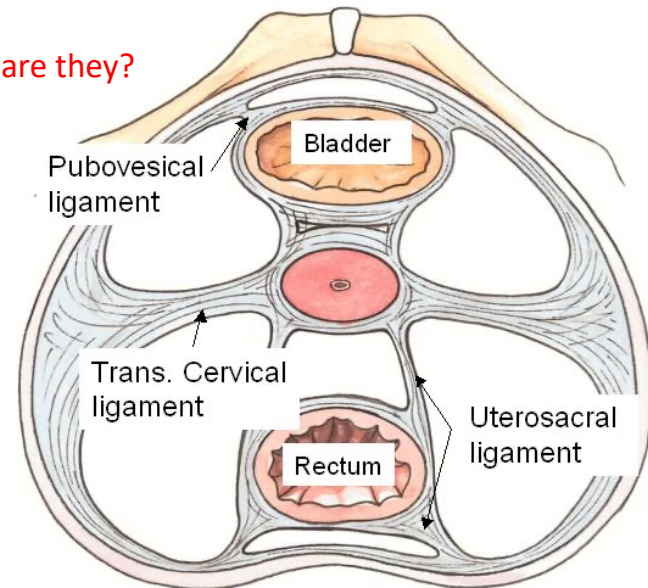



## In summary, you must know these:

- Parts of the Uterus
- Blood Supply
- Nerve Supply
- Relations
- Ligaments
  - Broad Ligament

## The Uterus

- Hollow
- Pear-shaped organ
- Thick muscular walls
- Young **nulliparous** adult: 8 cm long, 5 cm wide, 2.5 cm thick

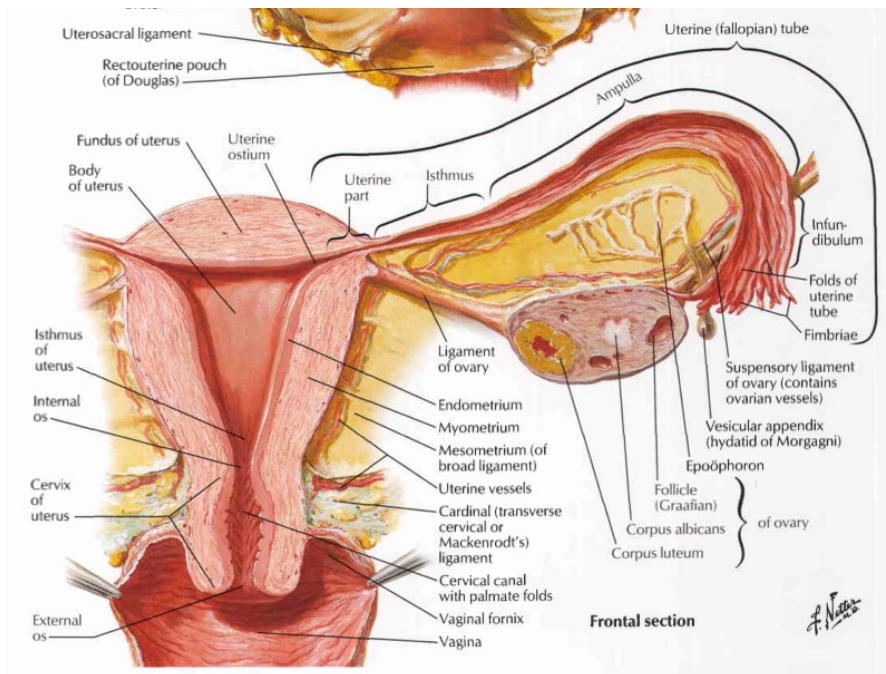

## Blood Supply

- Mainly: Uterine artery
  - Branch of internal iliac artery
  - Crosses over the ureter at base of broad ligament
  - Reaches cervix at the level of the internal os
  - Ascends along the lateral margin of the uterus
  - **Ends by anastomosing with the ovarian artery**
  - Small descending branch supplying cervix and vagina

## Blood Supply

- Ovarian artery
  - Arises from the abdominal aorta
  - In the suspensory ligament of the ovary
- Uterine vein
  - Drains into internal iliac vein
- Ovarian vein
  - Right: drains into IVC
  - Left: drains into left renal vein

## Relations

- Anteriorly: Uterovesical pouch, Superior surface of bladder
- Posteriorly: Rectouterine Pouch of Douglas, Ileum/Sigmoid colon
- Laterally: Broad ligament, Uterine vessels, Ureter, Round ligaments of ovary and uterus

## Nerve Supply

- Sympathetic and Parasympathetic nerves from branches of the inferior hypogastric plexuses (Mixed).

## Broad Ligament of the Uterus

- Two-layered fold of peritoneum
- Extend from lateral margins of uterus to lateral pelvic walls
- Superiorly: two layers are continuous
- Inferiorly: layers separate to cover the pelvic floor
- Ovary attaches to posterior layer by mesovarium



# Broad Ligament of the Uterus

Superior

## Contents:

- Uterine Tube
- Suspensory ligament of ovary/Ovarian blood vessels
- Round ligament of the ovary
- Round ligament of the uterus
- Uterine blood vessels

Inferior

# Other Ligaments

- Round ligament of the uterus
- Transverse cervical/cardinal ligaments
- Pubocervical ligaments
- Sacrocervical ligaments

# Bicornuate Uterus

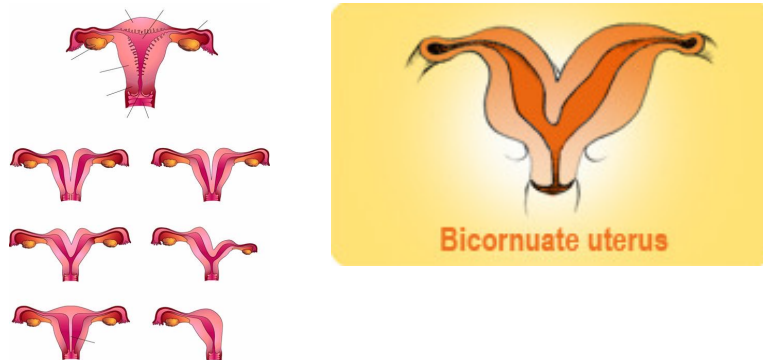

# Pelvic /Inferior Hypogastric Plexus

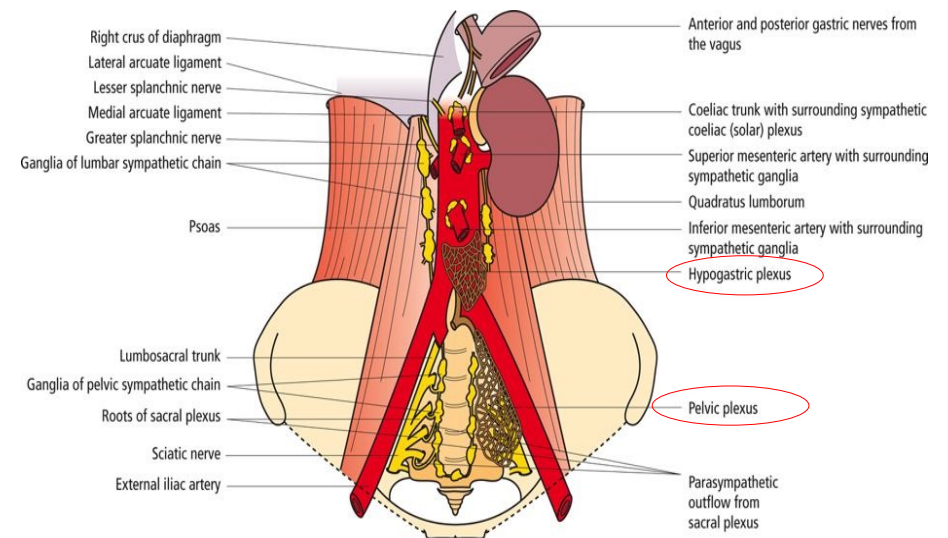

# Pelvic Autonomic Plexuses

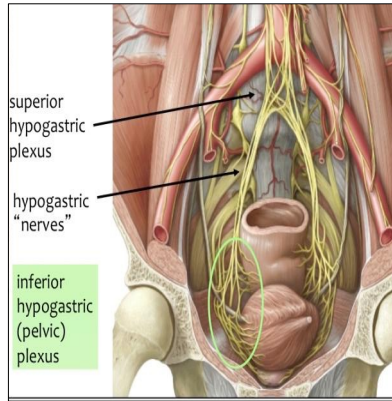

# Pelvic Pain Line

- Inferior limit of peritoneum
- In contact with peritoneum is superior to pain line
- Significance in anesthesia
- E.g. Childbirth

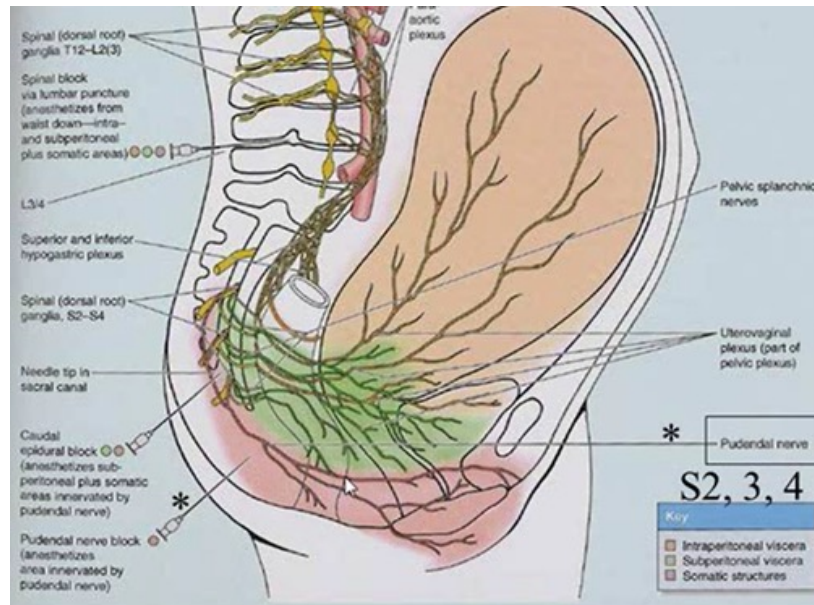
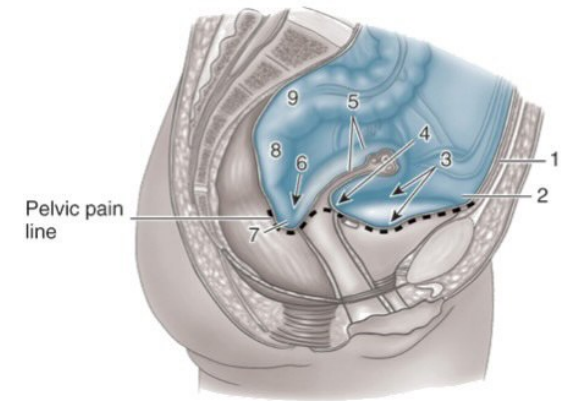

# Autonomic innervations of pelvic viscera

Viscera	Main autonomic innervation
Urinary bladder	<p><b>Sympathetic fibers</b> from inferior thoracic to upper lumbar spinal cord levels through hypogastric plexus (T10-L2)</p> <p><b>Parasympathetic</b> from pelvic splanchnic (S2-S4) and inferior hypogastric plexus; motor to detrusor, inhibitory to internal sphincter</p> <p>Reflex afferent &amp; inferior bladder follow parasympathetic</p> <p>Superior bladder follows sympathetic (pain line)</p>
Rectum	<p><b>Sympathetic</b> from lumbar splanchnic nerves (L1, L2) and hypogastric plexuses and peri-arterial plexus (inferior mesenteric and superior rectal arteries)</p> <p><b>Parasympathetic</b> from pelvic splanchnic (S2-S4) and inferior hypogastric plexus</p> <p><b>Afferent Pain</b> follows para (inf to pain line)</p>



## Autonomic innervations of pelvic viscera

Viscera	Main autonomic innervation
Male Genitalia	Sympathetic (T12-L2) lumbar splanchnic, hypogastric, pelvic plexuses Parasympathetic (S2, S3) pelvic splanchnic, inf hypogastric
Female Genitalia	-Inferior ¼ somatic innervation by deep perineal nerve -Autonomic nerves to rest of vagina and uterus derived from uterovaginal nerve plexus (*pelvic plexus from inf hypo plexus) -Sympathetic (T12-L2) pass through lumbar splanchnic nerves -Parasympathetic (S2-S4) pelvic splanchnic and inf hypo -Visceral afferent follow sympathetic for fundus and body of uterus

## Distribution of pelvic autonomic plexuses

- Superior hypogastric plexus: located inferior to bifurcation of aorta on sacral promontory
- Inferior hypogastric plexus: on either side of rectum, accompanies branches of internal iliac artery
- Ganglion impar: anterior to coccyx

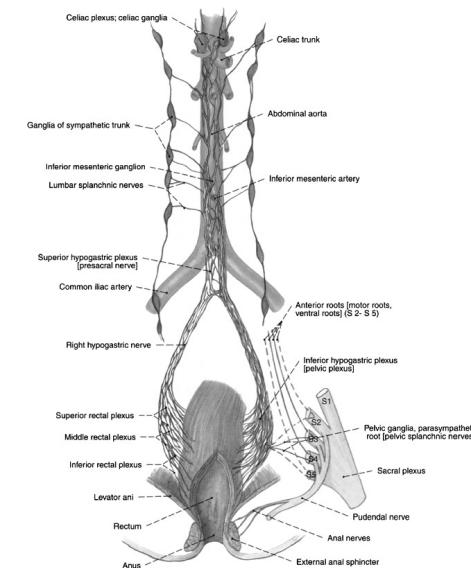
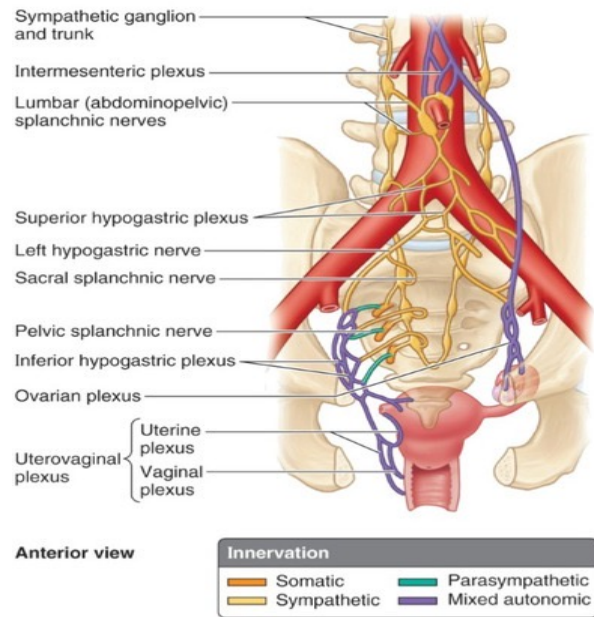

# Lymphatic drainage to pelvic viscera

Viscera	Main Lymphatic drainage
Urinary bladder	<b>External iliac nodes:</b> superior part of pelvic part of ureters, superolateral aspect of bladder <b>Internal iliac nodes:</b> inferior part of pelvic part of ureters, fundus & neck of bladder, female urethra, proximal male urethra
Rectum	<b>Pararectal nodes:</b> superior rectum <b>Sacral nodes:</b> inferior rectum <b>Internal iliac nodes:</b> distal ampulla
Male Genitalia	<b>External iliac nodes:</b> vas deferens, ejaculatory ducts <b>Internal iliac nodes:</b> inferior part of seminal glands, prostate
Female Genitalia	<b>Lumbar nodes:</b> ovaries, uterus fundus, superior body <b>Superficial inguinal nodes:</b> entrance of uterine tubes to uterus (via round ligaments), vagina (external orifice) <b>External iliac nodes:</b> uterine body, vagina (superior) <b>Internal iliac nodes:</b> cervix (via transverse cervical ligaments), vagina (middle) <b>Sacral nodes:</b> cervix (via uterosacral ligaments), vagina (inferior)

- Rule of thumb: more medial – internal iliac mostly
- Lymphatic vessels follow venous system in pelvis, drain into internal and external iliac nodes

# Lymphatic drainage of Pelvis

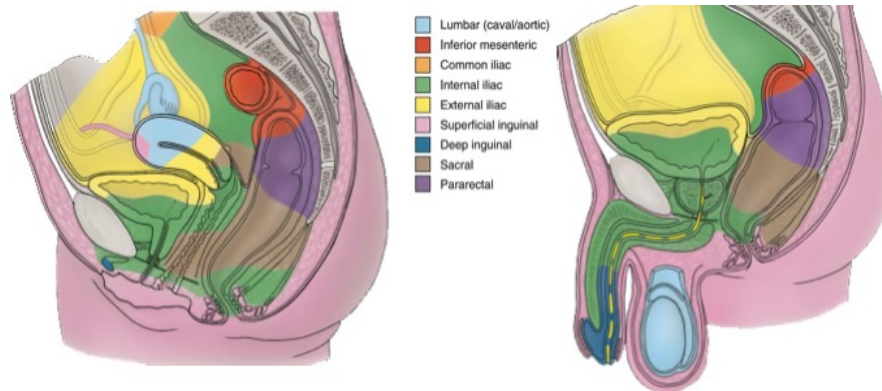
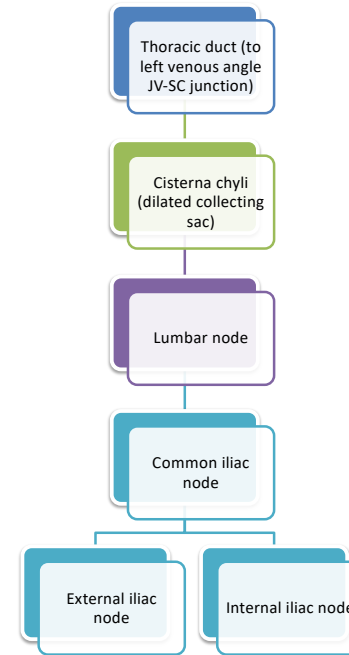

- Zones of drainage

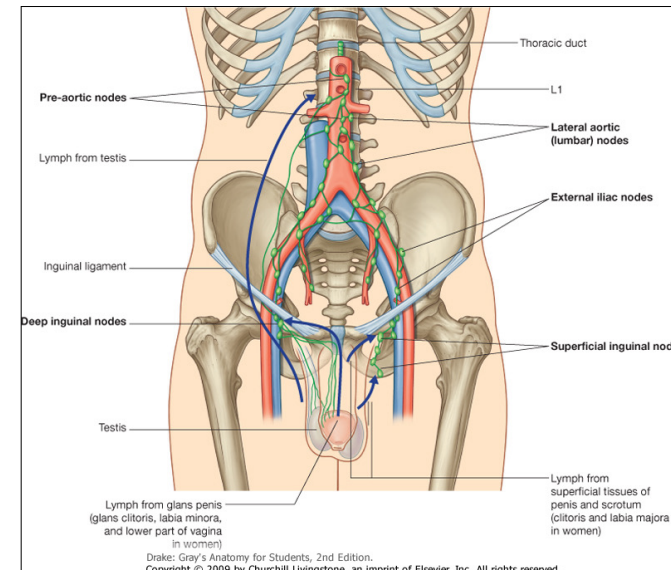

Drake: Gray's Anatomy for Students, 2nd Edition. Copyright © 2009 by Churchill Livingstone, an imprint of Elsevier, Inc. All rights reserved.



Break time !

## Prostate

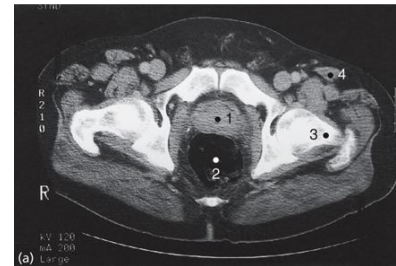
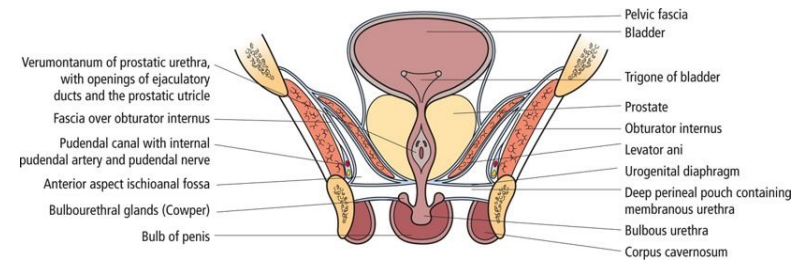

## Seminal vesicles

### Features

- (1) The seminal vesicles are paired lobulated glands situated behind the bladder.
- (2) They secrete 60% of the volume of semen. The secretion contains nutrients for the spermatozoa.

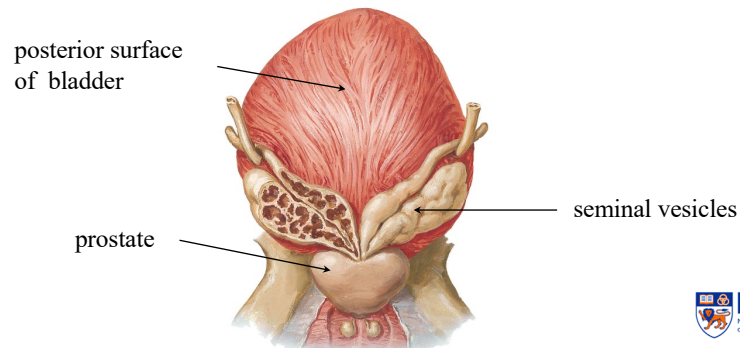

## Prostate gland

### Features

The prostate gland is a chestnut shaped fibromuscular organ which encircles the upper part of the urethra.

The prostate gland produces about 20-30% of the volume of semen. The prostate secretes seminal plasmin (an antibiotic) into the semen which helps to prevent infection.

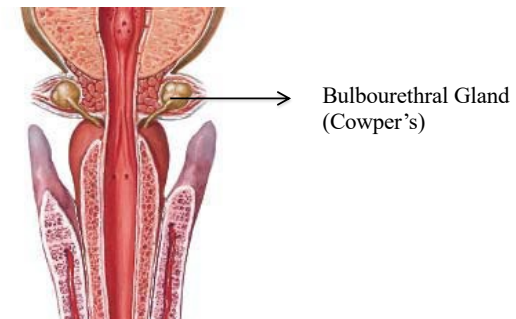

Male: Sagittal section

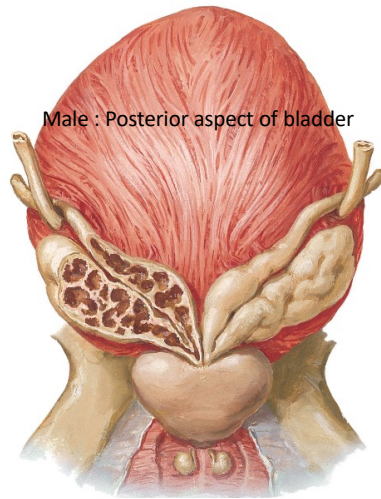
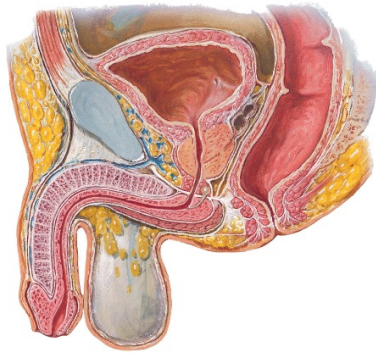

Male : Posterior aspect of bladder

Semen

Volume: 2-5 mls

Spermatozoa: 20-100 million per ml

Seminal fluid: mixture of glandular secretions with distinctive ionic and nutrient composition (fructose)

Enzymes: help to dissolve mucus secretions in vagina and have antibacterial functions



# Rectum

- Split into thirds: upper 1/3, middle 1/3 and lower 1/3
- Peritoneum covers entire upper 1/3 and only **anterior** portion of middle 1/3
- Length- 12cm long
- Course between Sigmoid colon and Anal Canal  
Pierces pelvic diaphragm (levator Ani + coccygeus) anterior of coccyx

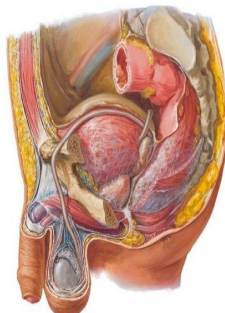

Pelvic Diaphragm of Female  
Inferior View

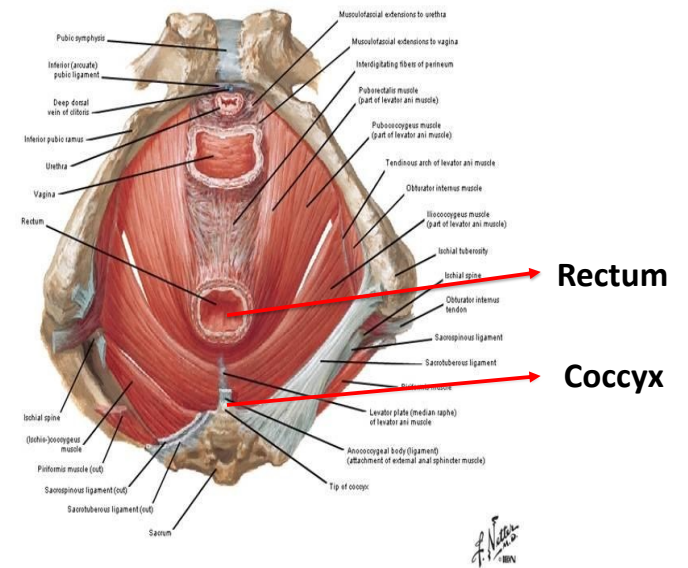

F. Netter M.D.



## Relations for males

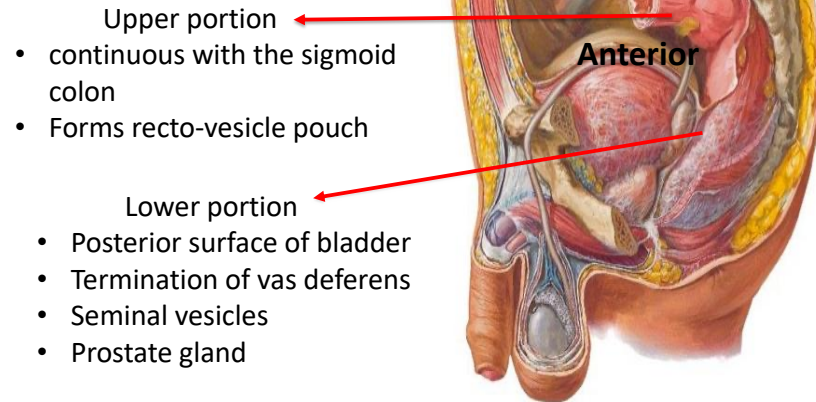

## Relations for females

- Upper portion**
- Continuous with sigmoid colon
  - Recto-uterine pouch i.e Pouch of Douglas

- Lower portion**
- Posterior surface of vagina
  - Posterior fornix

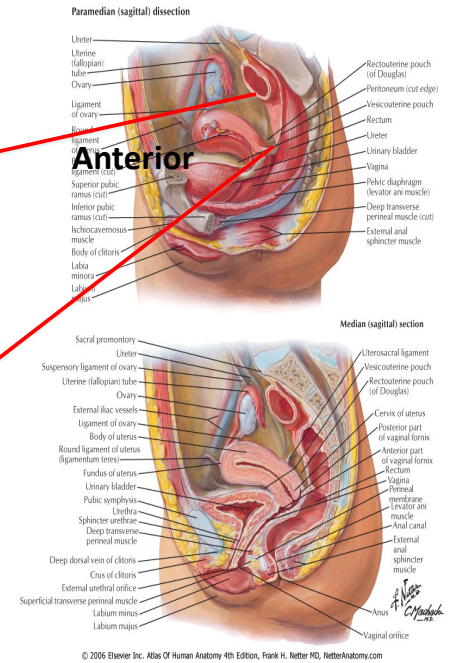

## Posterior relations

- Similar for both men and women
- Sacrum
- Coccyx
- Coccygeus
- Levator ani → **Pelvic diaphragm**  
(pubococcygeus, iliococcygeus and puborectalis)
- Sacral plexus
- Pelvic splanchnic nerves (S2-S4)
- Sympathetic trunk ( starts at T1 ends at L2)
- Median sacral & rectal vessels

## Internal features of rectum

- Lower part dilated to form rectal ampulla
- Transverse folds-formed by mucous membrane of rectum and circular muscle layer

# Blood supply of rectum

- Arterial supply
- Superior rectal artery (branch of inferior mesenteric artery)
- Middle rectal artery (branch of internal iliac artery)
- Inferior rectal artery (branch of internal iliac artery)

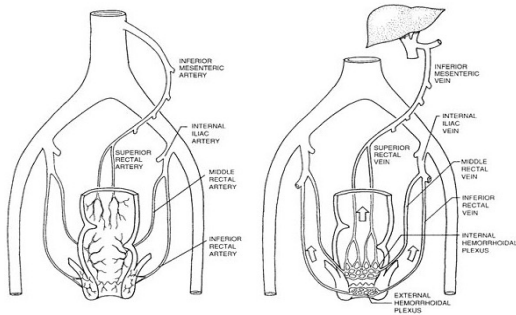

Contrast this to the blood supply to the anal canal

# Blood supply

Venous drainage mirrors the arteries

Anastomosis between systemic and portal system !!

Contrast this to the blood supply to the anal canal.....

The anal canal above the pectinate line is supplied by the terminal branches of the superior rectal (hemorrhoidal) artery, which is the terminal branch of the inferior mesenteric artery. The middle rectal artery (a branch of the internal iliac artery) and the inferior rectal artery (a branch of the internal pudendal artery) supply the lower anal canal.

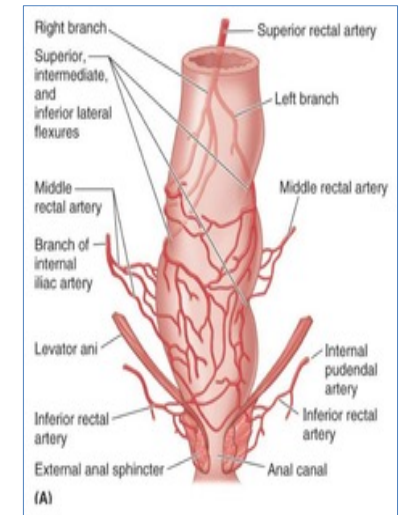

# Clinical application

- Haemorrhoids what are they?

Vascular structures in the anal canal.

(Many people have haemorrhoids!)

They are made up of connective tissue and arterio-venous channels.

(Superior rectal vein)

Pathology occurs only when they become inflamed or enlarged

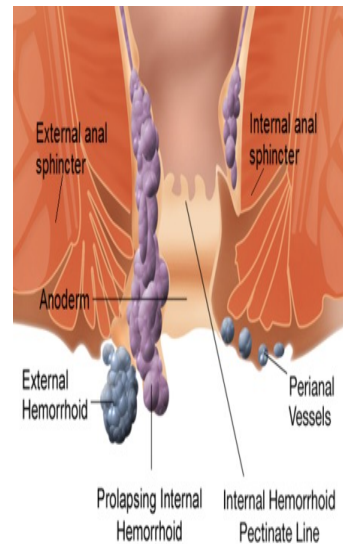

# Clinical application

- Classification:
- can be internal (inside the rectum) or external (outside the rectum)

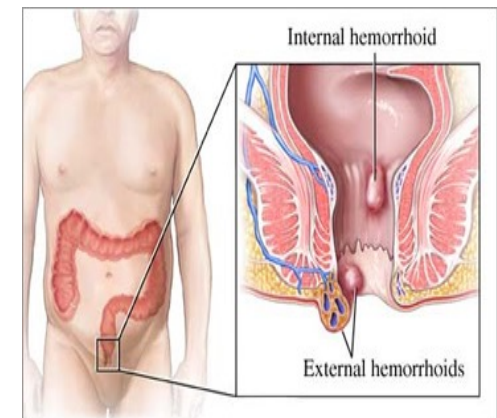



## Anal Canal (4cm)

Passes downwards and backwards from the rectal ampulla to the anus

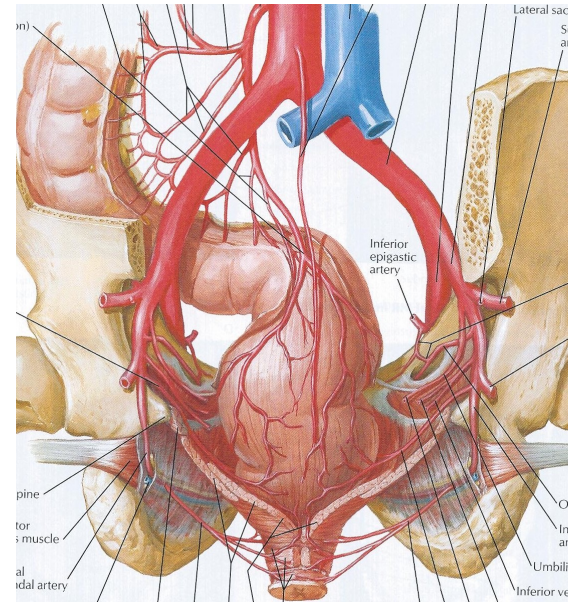
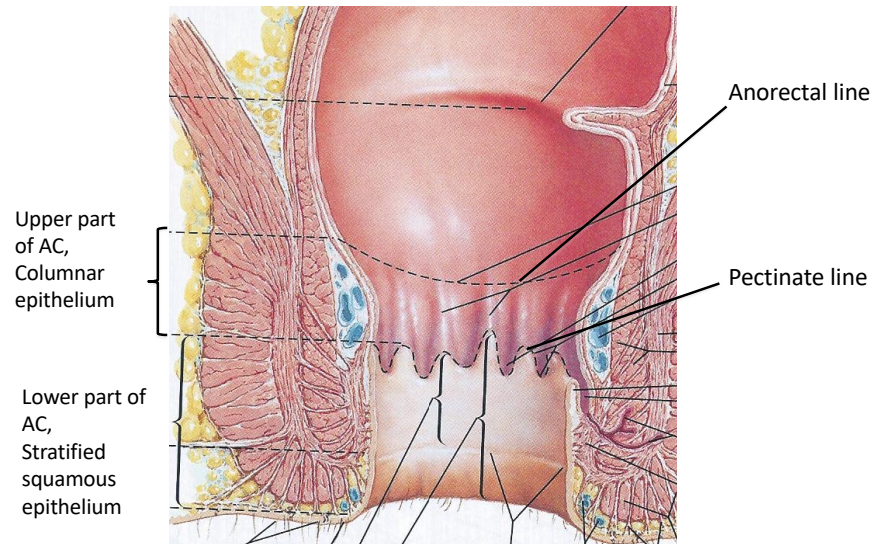

## Arterial supply

The anal canal above the pectinate line is supplied by the terminal branches of the superior rectal (hemorrhoidal) artery, which is the terminal branch of the superior mesenteric artery. The middle rectal artery (a branch of the internal iliac artery) and the inferior rectal artery (a branch of the internal pudendal artery) supply the lower anal canal.

## Anal sphincters

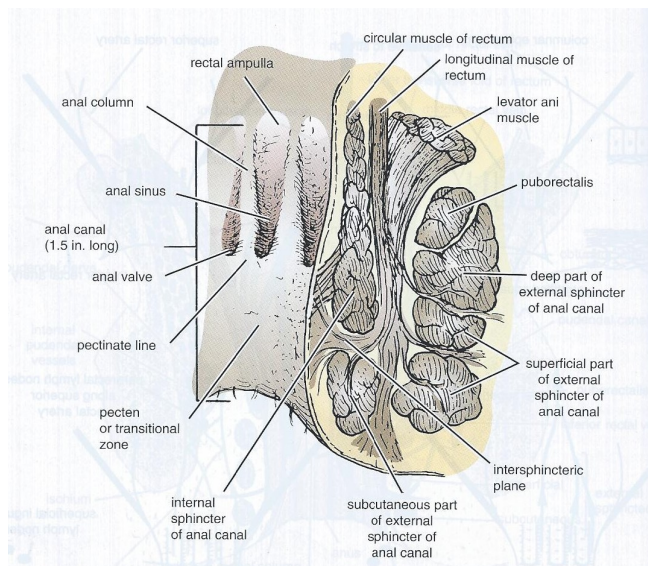

### Internal sphincter

- involuntary
- Thickening of smooth muscle of circular coat

### External sphincter

- voluntary
- 3 parts (subcutaneous, superficial, deep)
- puborectalis (part of levator ani/ pelvic diaphragm) joins with deep part to form a sling around the junction btw rectum and anal canal

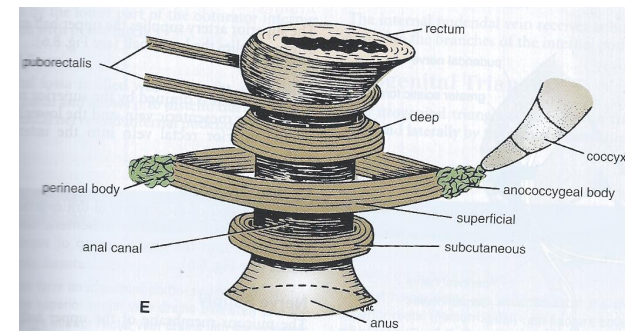



# Terminal rectum and anal canal

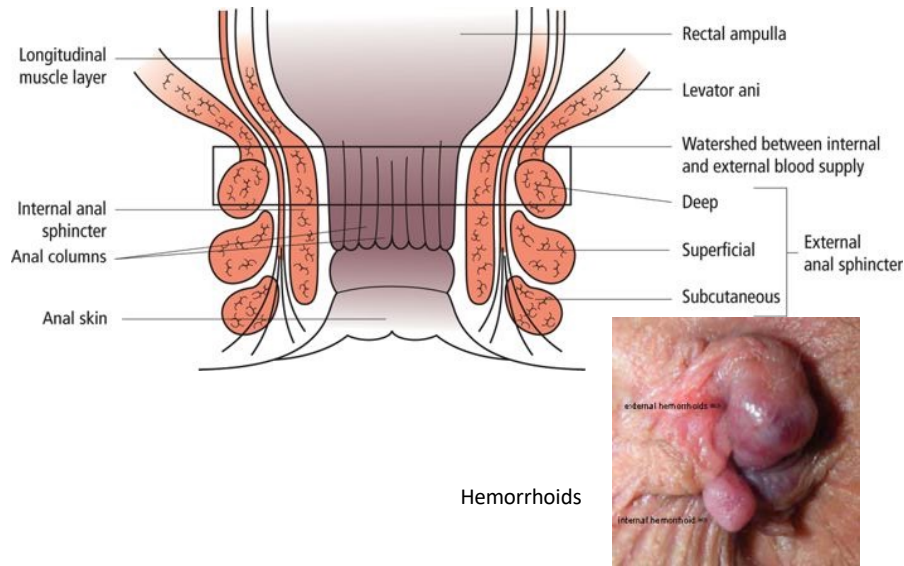

# Haemorrhoids (Piles)

- Venous varicosities, covered with mucous membrane.
- Internal – superior rectal vein, varying degrees, often aching rather than pain (autonomic innervation), causes include strains + constipation, pregnancy, Portal hypertension due to liver cirrhosis.
- External – Inferior rectal veins, may be associated with int. haemorrhoids, innervated by internal rectal nerves (somatic) therefore is painful.

## Arteries

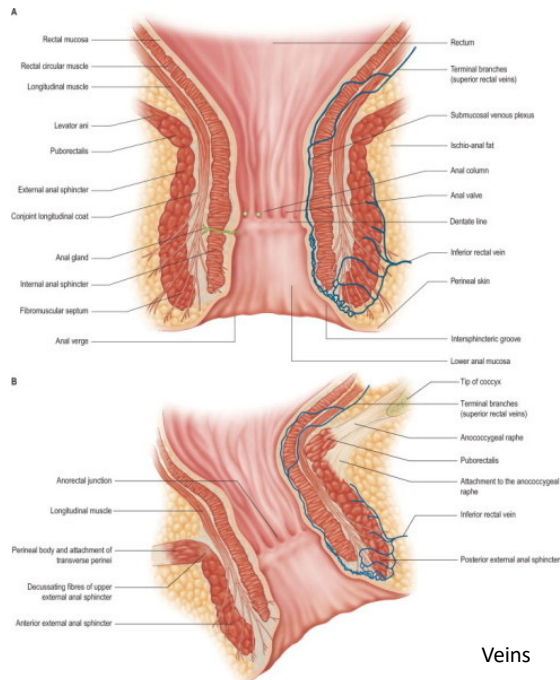
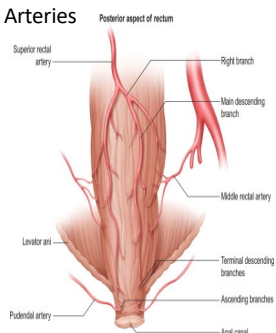

## Veins

Clinically, what you see.....



## Clinical application

- Causes: Excessive force due to defecation or parturition(giving birth) causing strain on the bowel. (things that increase intra-abdominal pressure, think constipation.....)
- Blocked blood flow enlarges the vessels!



## Staging the cancer

- **T**: describes how far the main (primary) tumour has grown into the wall of the intestine and whether it has grown into nearby areas.
- **N**: describes the extent of spread to nearby (regional) lymph nodes.
- **M**: indicates whether the cancer has spread (metastasized) to other organs of the body. (Colorectal cancer can spread almost anywhere in the body, but the most common sites of spread are the liver and lungs.)

## Colorectal cancer!

- Most prevalent form of cancer in men in Singapore!
- Staging of colorectal cancer (TNM system)
- Risk factors (meat heavy diet, physical inactivity, genetics, smoking, alcohol)

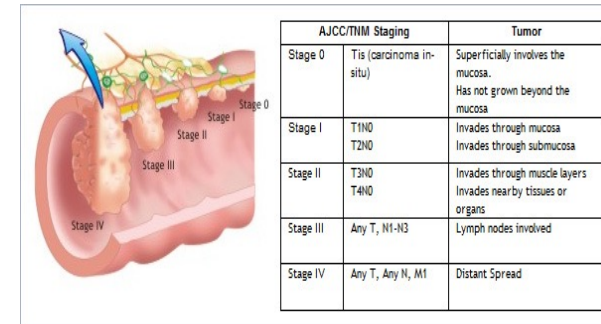

## Diagnosis

- Colonoscopy (tube inserted into the anus)
- Stool test (check for blood caused by polyps)

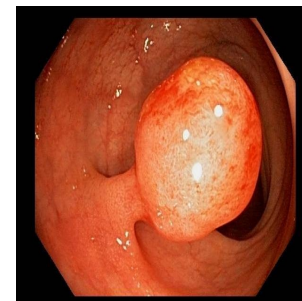

## Treatment

- By the stage of the cancer
- Stage 0 (tumour contained within mucosa): surgical removal of tumour)
- Stage 1 (tumour spread through the walls of the intestine): surgical removal with possibility of recurrence
- Stage 2 (spread to nearby tissues): surgery with chemotherapy to prevent recurrence.
- Stage 3 (spread top lymph nodes): Surgical removal of everything nearby + chemotherapy
- Stage 4 (spread to other organs e.g lungs, liver) : Surgery, chemotherapy + “Pray”

Rectum (lymphatic's) – follow the blood vessels!!

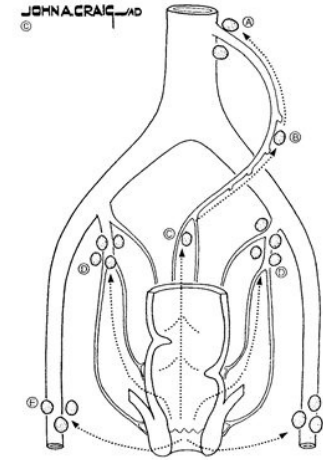

## PELVIC DIAPHRAGM

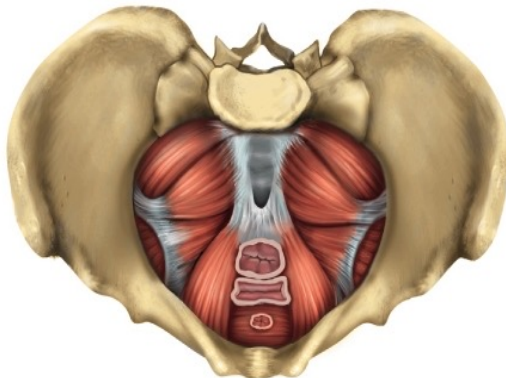

## IMPORTANCE OF PELVIC DIAPHRAGM

Forms the muscular part of pelvic floor, which separates the pelvic cavity from the perineum.

Provides support for pelvic viscera (eg. Bladder) – think of consequences if it is weak.

Think of pelvic organs prolapse.



## COMPONENTS OF PELVIC DIAPHRAGM

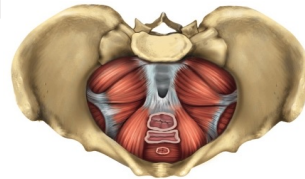

LEVATOR ANI

Pubococcygeus

Puborectalis

Iliococcygeus

Originates from body of pubis and courses posteriorly to attach along the midline until the coccyx

Originates from pubis and passes inferiorly on each side to form a sling around the terminal part of the GI tract, creating the perineal flexure at anorectal junction

Originates from fascia covering the obturator externus muscle

## COMPONENTS OF PELVIC DIAPHRAGM

INNERVATION: BRANCHES FROM ANT RAMUS OF S4,

INF RECTAL BRANCH OF PUDENDAL NERVE(S2-S4)

PART OF THE PELVIC FLOOR, SUPPORTING PELVIC VISCERA

MAINTAINS ANGLE BETWEEN RECTUM AND ANAL CANAL

REINFORCES EXT ANAL SPHINCTER, ACTS AS VAGINAL SPHINCTER

## COMPONENTS OF PELVIC DIAPHRAGM

### Levator Ani

-Originates from a line around the pelvic wall, post to pubic bone and extending across obturator internus muscle, to ischial spine

-Ant part attached to sup surface of perineal membrane

-Post part attached to perineal body, around the anal canal and along anococcygeal ligament

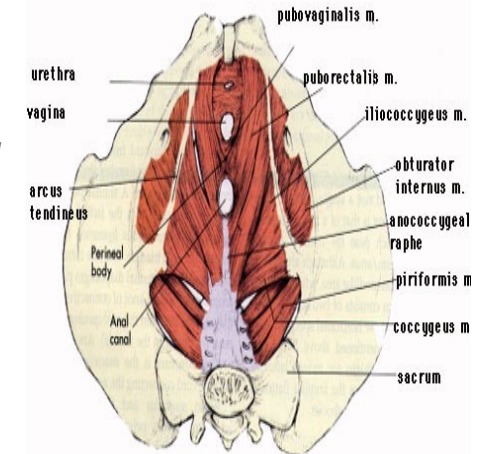

## COMPONENTS OF PELVIC DIAPHRAGM

COCCYGEUS

TRIANGULAR SHAPED, OVERLYING SACROSPINOUS LIGAMENT, FORMING POST PART OF DIAPHRAGM  
ORIGINATES FROM ISCHIAL SPINE(L&R) AND PELVIC SURFACE OF SACROSPINOUS LIGAMENT  
INSERTS INTO LATERAL MARGIN OF COCCYX AND RELATED BORDER OF SACRUM

## COMPONENTS OF PELVIC DIAPHRAGM

INNERVATED BY BRANCHES OF ANT RAMI OF S3  
AND S4  
ESSENTIAL IN SUPPORTING POST ASPECT OF  
PELVIC FLOOR  
PULLS COCCYX FORWARD DURING DEFECTION

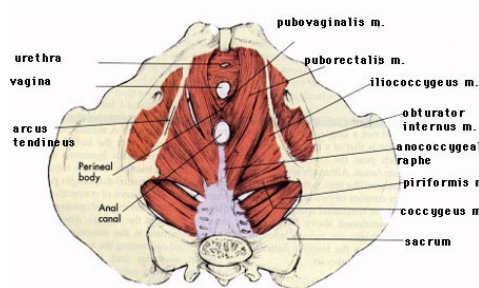

## Perineum

Thank you !

Will cover the Perineum  
next lesson

## 4 Parts

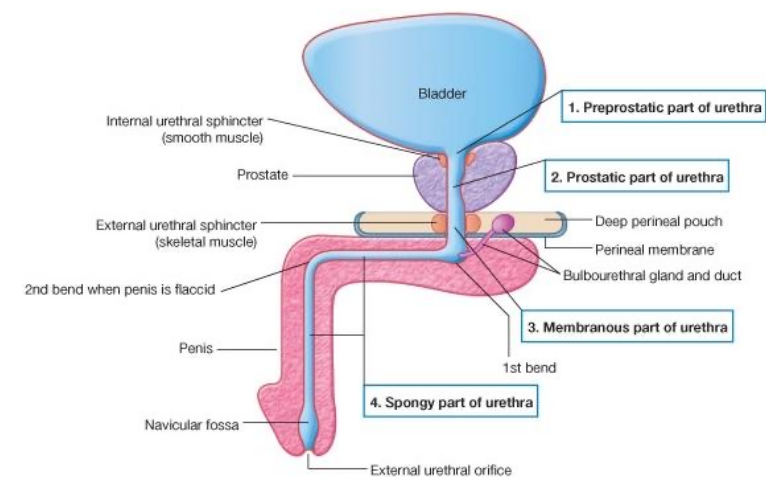

Where are the bends?

## Preprostatic Part

- Base of bladder → Prostate
- About 1cm
- Surrounded by Internal Urethral Sphincter (Circular cuff of smooth muscle) → Contraction of sphincter prevents retrograde movement of semen into bladder during ejaculation

## Prostatic Part

- Surrounded by prostate from base to apex
- About 3 to 4 cm

## Prostatic Part

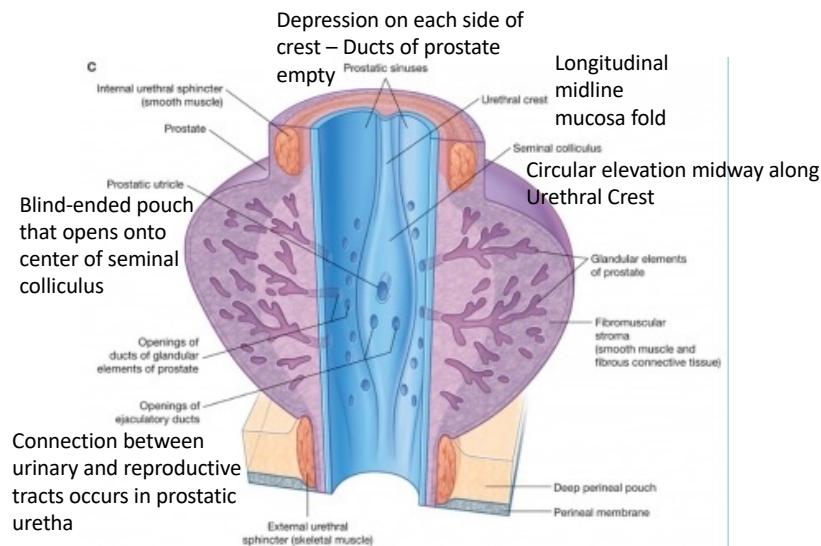

## Membranous Part

- Passes through deep perineal pouch
- About 1.25cm
- Surrounded by External Urethral Sphincter (Skeletal muscle)



## Penile/Spongy Part

- Surrounded by erectile tissue of penis
- About 15.75cm

## Penile/Spongy Part

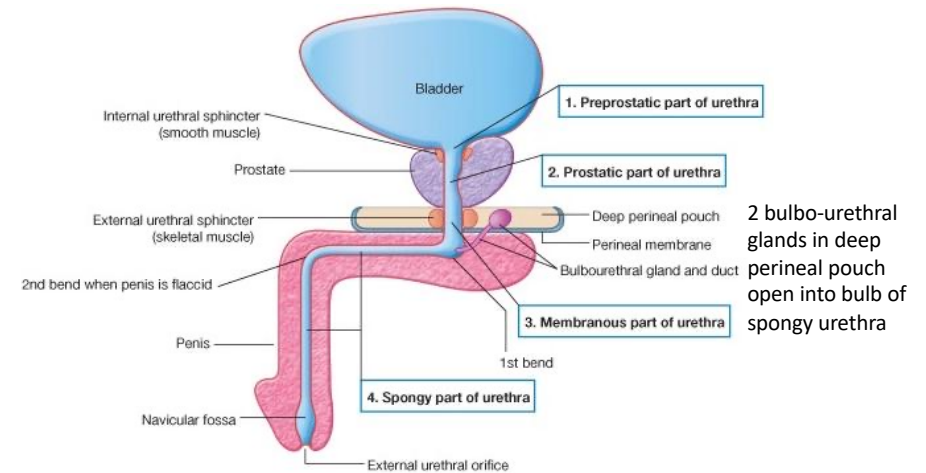

## Internal Urethral Sphincter

- Constricts internal urethral orifice (Junction of urethra and bladder)
- Smooth muscle → Involuntary control
- Sympathetic: Inferior Hypogastric plexus
- Parasympathetic: Pelvic plexus S2 to S4
- During micturition → Relax via parasympathetic NS
- Not urinating → Contract via sympathetic NS
- During ejaculation → Contract to prevent reflux of semen into bladder

## External Urethral Sphincter

- Somatic: Perineal branch of Pudendal nerve
- During micturition → Relax voluntarily
- Not urinating → Contract, Can voluntarily stop micturition

How does urine leaking from ruptured urethra spread (from the superficial perineal pouch)?

Common site for rupture: Within bulb of penis just below perineal membrane

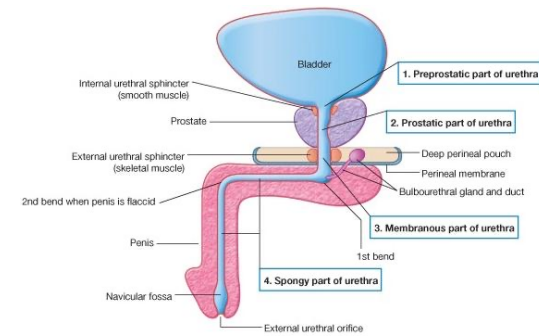

If bulb of penis just below perineal membrane ruptures:

- Urine flows into superficial perineal pouch → And then passes forward over scrotum beneath membranous layer of superficial fascia

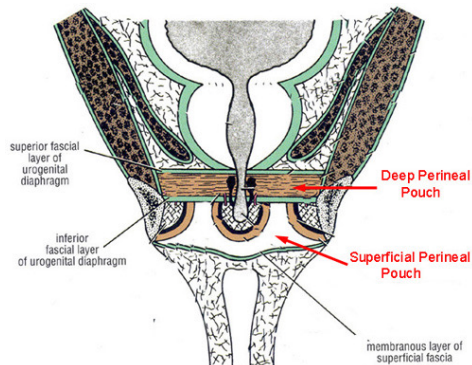

If membranous part of urethra ruptures:

Urine escapes into deep perineal pouch and flows upward around prostate and bladder OR downward into superficial perineal pouch

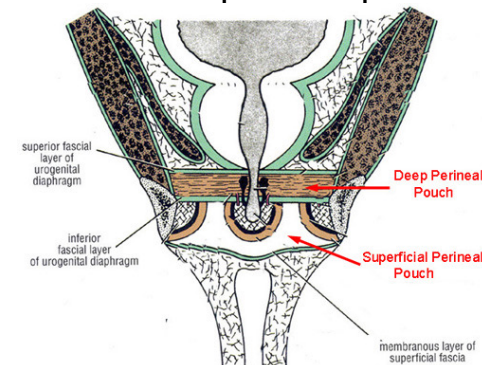

## Innervation of the perineum

Which nerves are responsible for sensory innervations of the perineum?

- Pudendal Nerve
- Inferior hypogastric plexuses

## Pudendal Nerve

- Main nerve of perineum
- Chief sensory nerve to external genitalia
- Branch of sacral plexus (anterior rami of S2-S4)
- Supplies Structures in perineum:
  - Perineal muscles
  - External Urethral sphincter
  - External anal sphincter
  - Skin of perineum

## Perineal Muscles

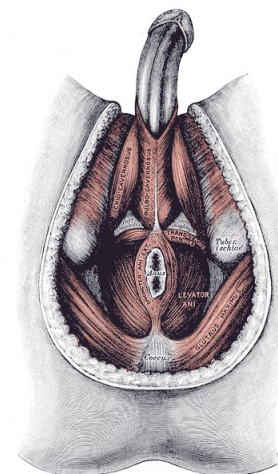

- Deep Transverse Perineal Muscles
- Superficial Transverse Perineal Muscles
- Bulbospongiosus
- Levator Ani



# Perineal Muscles

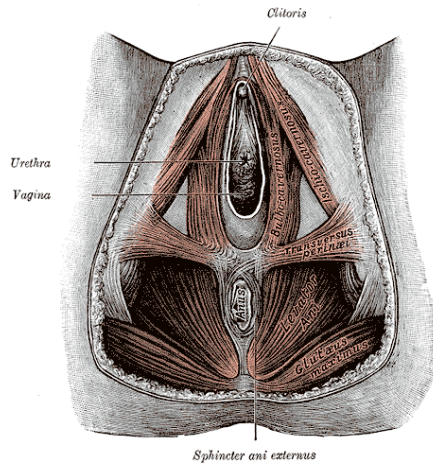

- Deep Transverse Perineal Muscles
- Superficial Transverse Perineal Muscles
- Bulbospongiosus
- Levator Ani

# Perineal Muscles

Fig. 5.36 Muscles in the deep perineal pouch. A. In women. B. In men

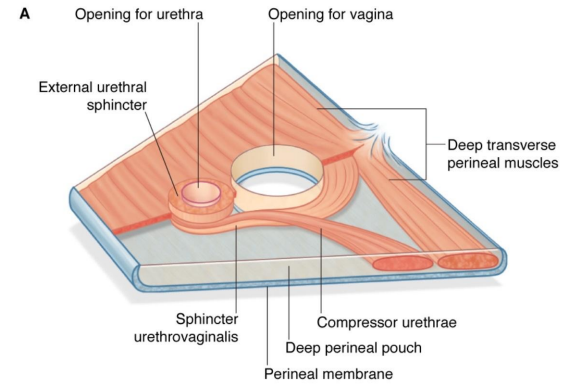

# Perineal Muscles

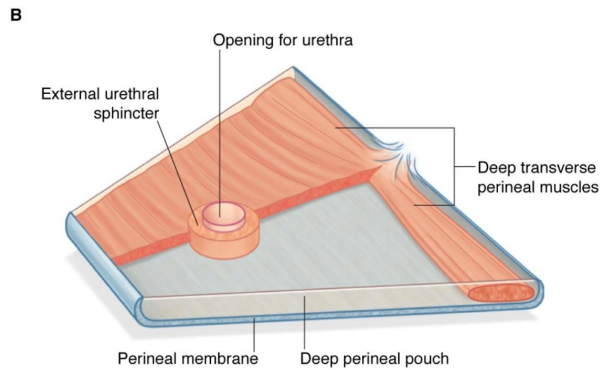

# Outline the course and distribution of the pudendal nerve

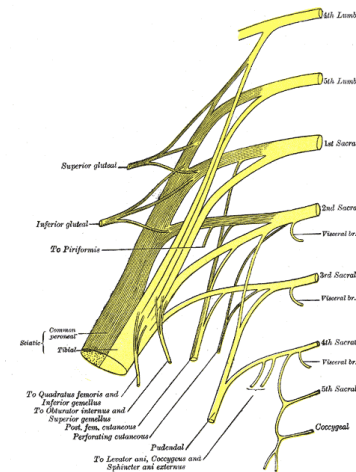

- Branch of sacral plexus
- Anterior division of ventral rami of S2-S4

## Course and distribution of the pudendal nerve

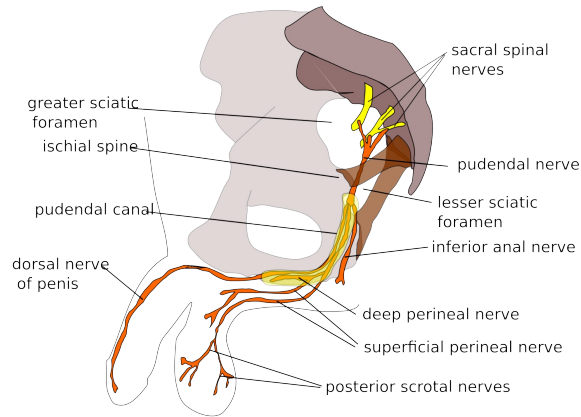

- Leaves main pelvic cavity through greater sciatic foramen
- Briefly courses through gluteal region

## Course and distribution of the pudendal nerve

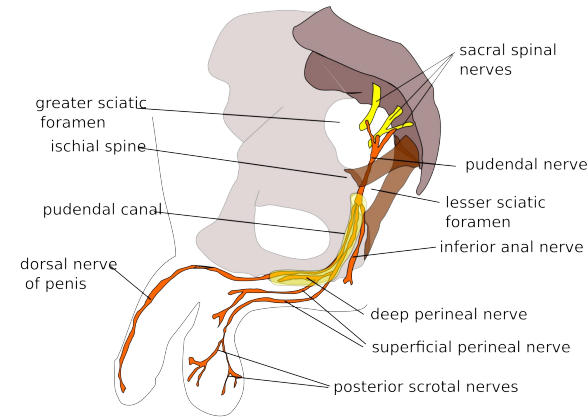

- Enters perineum through lesser sciatic foramen
- Passes through pudendal canal
- Accompanied by internal pudendal vessels
- Branches

## Pudendal Canal

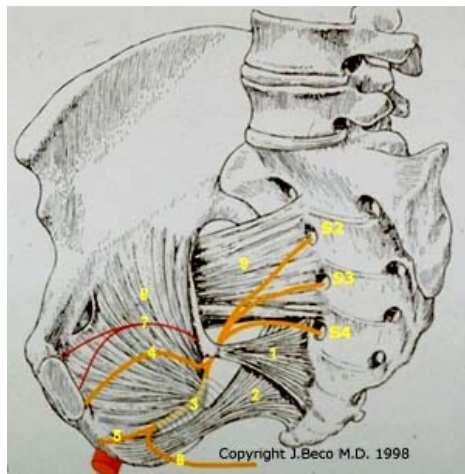

- 3
- Obturator membrane

## Distribution of the pudendal nerve

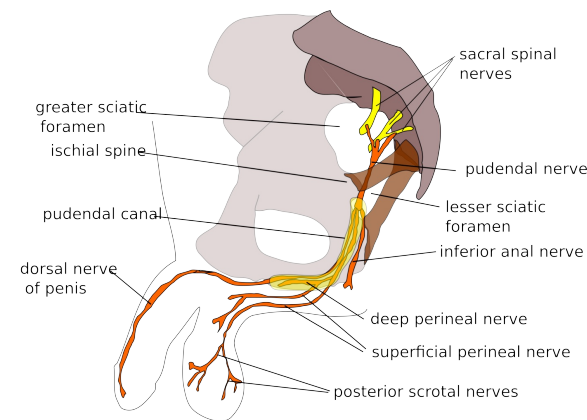

- Inferior rectal nerve
- Runs medially across ischiorectal fossa
- Supplies external anal sphincter, lower half of anal canal, perianal skin

## Distribution of the pudendal nerve 1

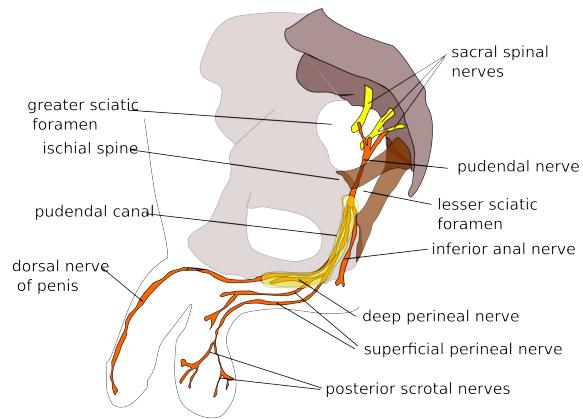

- Inferior rectal nerve
- Runs medially across ischiorectal fossa
- Supplies external anal sphincter, lower half of anal canal, perianal skin

## Distribution of the pudendal nerve 2

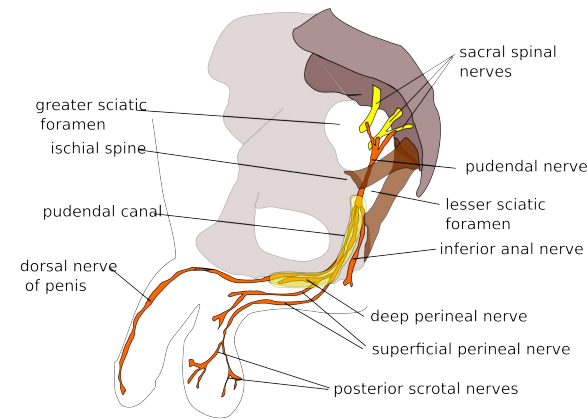

- Superficial & deep perineal nerve
- Innervate superior and deep perineal muscles, external urethral sphincter, bulbospongiosus
- Posterior scrotal branch: supply scrotal skin

## Distribution of the pudendal nerve 3

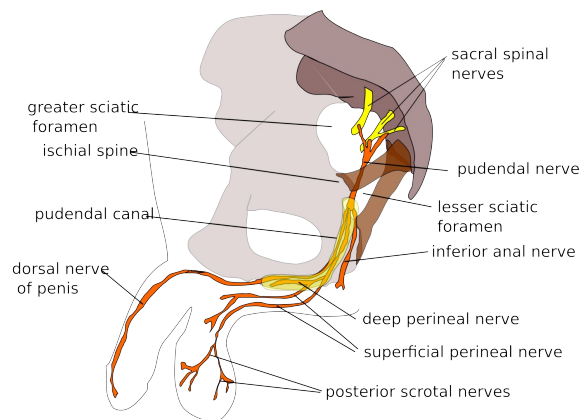

- Dorsal nerve of penis (or clitoris)
- Supplies skin of penis and glans (or clitoris)
- Supplies corpora cavernosum

## Distribution of the pudendal nerve 3

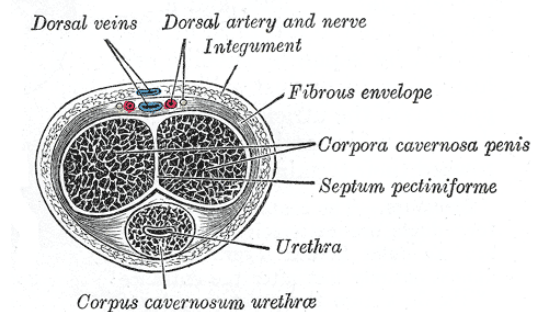

- Dorsal nerve of penis (or clitoris)
- Supplies skin of penis and glans (or clitoris)
- Supplies corpora cavernosum

The perineal region often requires to be anaesthetised for repair of tears, circumcision and haemorrhoidectomy.

- Pudendal Block Anesthesia
- Injection is given where the pudendal nerve crosses the sacrospinous ligament near the ischial spine
- Finger inserted into the vagina to palpate the ischial spine
- Infiltration is performed and the perineum is anaesthetised.

Superficial  
inguinal nodes

Follow superficial external pudendal blood vessels

Lie in superficial fascia, deep to Camper's fascia

Parallel inguinal ligament, extends inferiorly along great saphenous vein

## Lymphatic Drainage of Perineal Structures

Superficial  
inguinal nodes

Receive lymph from:  
Skin of perineum  
♂ Superficial tissues of penis and scrotum  
♀ Superficial tissues of clitoris and labia majora  
Anal canal inferior to pectinate line

Drain into deep inguinal nodes



## Deep inguinal nodes

Located medial to femoral vein  
in the femoral triangle

Receive lymph from:

♂ Glans penis

♀ Glans clitoris, labia minora,  
terminal inferior end of vagina

Drain into the external iliac  
nodes

## Swollen Inguinal Lymph Nodes

2) Anal cancer

Anal squamous cell carcinoma near  
squamocolumnar junction

Often linked to Human Papillomavirus  
(HPV) infection

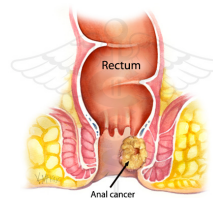

3) Vulvar cancer

Typically affects older women

Mostly labia majora affected, followed  
by labia minora

90% squamous cell carcinoma

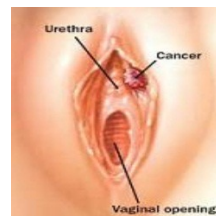

## Swollen Inguinal Lymph Nodes

1) Infection in lower extremities

Eg. orchitis in males –inflammation of the testes

Caused by:

- STDs chlamydia  
and gonorrhoea
- Active mumps
- Epididymis infection

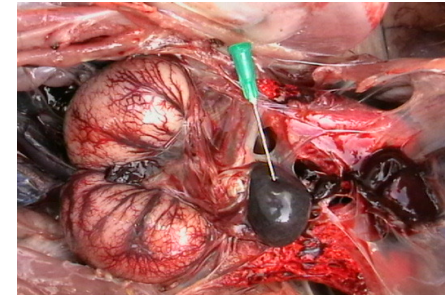

## Internal iliac nodes

Surround internal iliac artery

Receive lymph from:

Pelvic viscera

Deep structures of  
penis ♂ /clitoris ♀

## Lateral aortic (lumbar) nodes

Receive lymph from testes

Through channels that ascend  
in spermatic cord → inguinal  
canal

→ posterior abdominal wall

→ lateral aortic (lumbar)  
nodes and pre-aortic nodes (LI-  
LII)

## Perineum

- Lowest part of the trunk
- The roof is the pelvic diaphragm (pelvic floor)
- The borders are the symphysis pubis, the inferior ischiopubic rami, the ischial tuberosity, the sacrotuberous ligament, and the tip of coccyx.
- Anteriorly is the urogenital triangle and posteriorly, the anal triangle.

## Testicular Cancer

Symptoms:

- Lump in one testes (may or may not be painful)
- Sharp pain or dull ache in lower abdomen (spread to preaortic lymph nodes) or scrotum
- Breast enlargement (from elevated  $\beta$ -hCG hormone)

May be mistaken as:

- Epididymitis
- Hematocele
- Varicocele

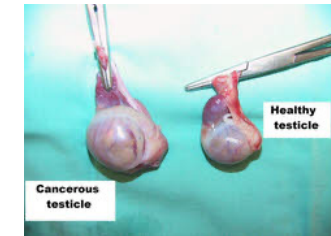

## Pelvic floor exercise

Also known as KEGEL exercises

Can be done discreetly, anytime ,  
anywhere and in any position.

Clinically, able to manage urinary  
incontinence, prevent prolapse of  
pelvic viscera (Cystocele,  
Rectocele, enterocele etc) or  
reduce its severity.



## Ischiorectal (Ischioanal) fossa

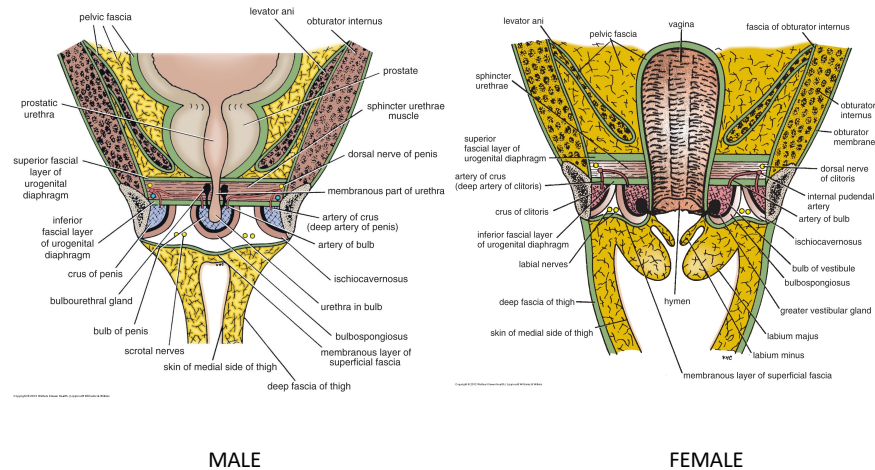

MALE

FEMALE

## Vagina

- 3 inches long
- Superiorposteriorly from vulva to uterus
- Upper half within pelvis
- Lower half within perineum
- Collapsed except at superior end
- Presence of fornix

## Major relations of vagina

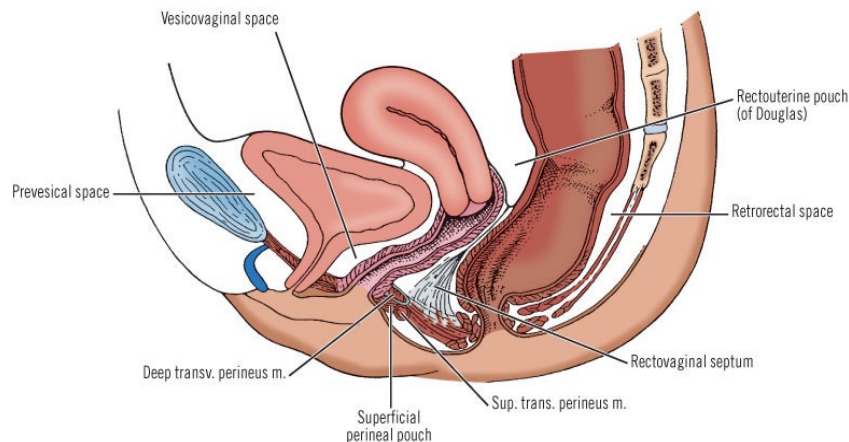

Copyright ©2006 by The McGraw-Hill Companies, Inc. All rights reserved.

## Major relations

Anterior	Bladder, urethra
Posterior	Upper 1/3: Pouch of Douglas Middle 1/3: Rectal ampulla Lower 1/3: Perineal body; anal canal
Lateral	Upper: Ureter Middle: Ant. fibers of levatores ani Lower part: Urogenital diaphragm and bulb of vestibule

## Others

- Blood supply- Vaginal artery, vaginal branch of uterine artery; vaginal vein
- Lymphatic drainage- internal and external iliac nodes, superficial inguinal nodes
- Innervation- Inferior hypogastric nerve

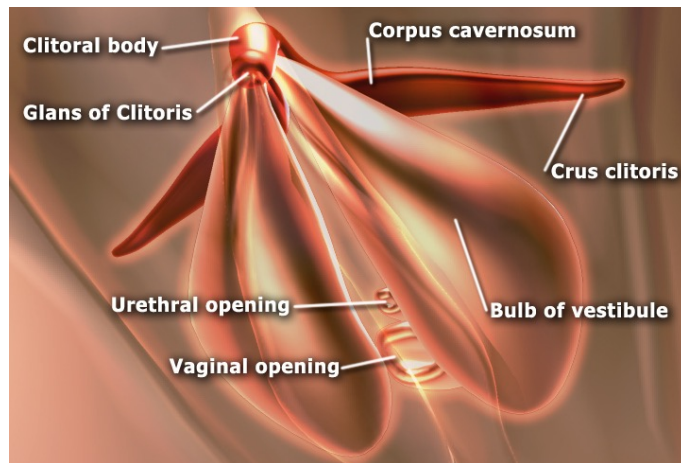

## Salient features of female external genitalia (Components)

Vulva (Collective term for female external genitalia)  
Includes:

- mons pubis
- labia majora and minora
- clitoris
- vestibule of vagina
- vestibular bulb
- greater vestibular glands
- vaginal orifice

## clitoris

Root

- Bulb (covered by bulbospongiosus muscle)
- Crura (covered by ischiocarvenosus muscle)

Body

- 2 corpora cavernosa

Glans

- Numerous sensory endings
- Partly hidden by prepuce



## Clitoris

- Blood supply- deep artery of clitoris, artery of the bulb, dorsal artery of clitoris (branches of internal pudendal artery; internal pudendal vein)
- Lymphatic drainage- skin: superficial inguinal nodes; deep structures: internal iliac nodes
- Innervation- Pudendal nerve, pelvis plexus

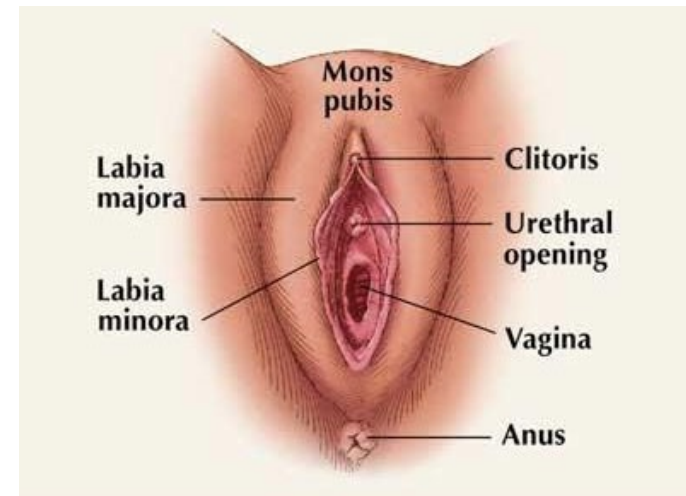

## Others

- Mons pubis- skin anterior to pubis
- Labia majora- hair bearing folds of skin posterior to mons pubis
- Labia minora- hairless folds of skin between labia majora, anterior prepuce (lateral fold), posterior frenulum (medial fold), posterior unite to form fourchette
- Vestibule- bounded laterally by labia minora
- Vaginal orifice- protected in virgins by hymen
- Greater vestibular gland- under posterior parts of bulb of vestibule and labia majora

## Imperforate hymen

A half moon of thin membrane normally surrounds the opening of a young girl's vagina.

?????? extends all the way across the area of the hymen, blocking the vaginal opening.

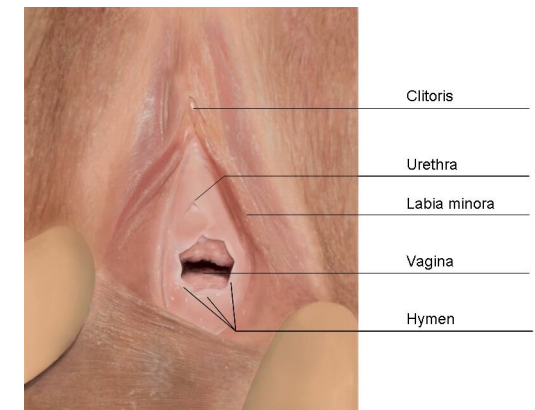

# Nerve supply

## For upper part:

- autonomic supply from inferior hypogastric plexus
- sensitive only to stretch

## For lower part:

- somatic supply from inferior rectal nerve, which is a branch of the pudendal nerve
- sensitive to normal sensations of pain, temperature, touch, pressure.

In the beginning .....

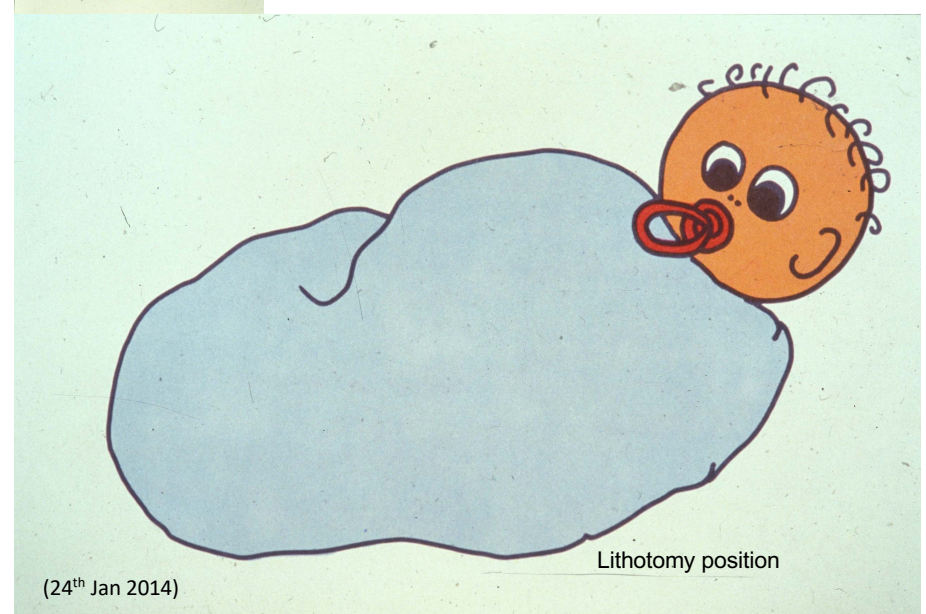

Sexual Intercourse (Coitus) captured by MRI

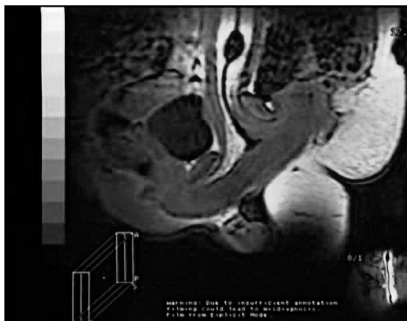

Papers

### Magnetic resonance imaging of male and female genitals during coitus and female sexual arousal

Willefried Weijner, Schult, P.A. van Amstel, Ida Sobels, Eduard Meuwart

**Abstract**  
**Objective:** To find out whether taking images of the male and female genitalia during coitus is feasible and to find out whether female and current ideas about the anatomy during sexual intercourse and during female sexual arousal are based on assumptions or on facts.  
**Design:** Observational study.  
**Setting:** University hospital in the Netherlands.  
**Methods:** Magnetic resonance imaging was used to study the female sexual response and the male and female genitalia during coitus. Eleven experiments were performed with eight couples and three single women.  
**Results:** The images obtained showed that during intercourse in the "missionary position" the penis has the shape of a horseshoe and 1/3 of its length is inserted into the vagina. The urethra was raised and the anterior vaginal wall invaginated. The size of the penis did not increase during sexual arousal.  
**Conclusions:** Using magnetic resonance imaging of the male and female genitalia during coitus is feasible and contributes to understanding of anatomy.

**Introduction**  
 "It appears to me the origin of their first and perhaps second, reason for existing." Leonardo da Vinci (1452-1519) wrote these words about the device "The Copulator" in about 1475 (Fig. 1). The Renaissance artist, whose a transparent view of the anatomy of sexual intercourse as envisaged by the anatomists of his time. The uterus was supposed to come down from the brain through a channel which can be seen in the spine of the man. In the woman the right half of the duct is depicted as originating in the right female breast and ending in the genital area. It was given the name of Vena ductus uterini and sometimes bodies were even cut in the duct of this vein and in the situation of the uterine tube in the genital area.  
 The first careful study since the sketch by Leonardo da Vinci of the intercourse of male and female genitalia during coitus was published by DeMeijere in 1753 (Fig. 2). The illustration shows a penis in erection inserted into the vagina of female subjects who were sexually aroused by direct stimulation (not necessarily with a vibrator) placed in its connection to the uterine appendages.  
 In the 1960s Masters and Johnson made their observations with an artificial penis that could mechanically imitate natural coitus and by "direct observation" the introduction of a speculum and "intentional palpation." Their most remarkable observations regarding sexual arousal in the woman were the backwards and upwards movements of the anterior vaginal wall (vaginal tenting) and a 30-100% greater volume of the uterus. This increase disappeared 10-20

## FEMALE PELVIC FLOOR – Superior View

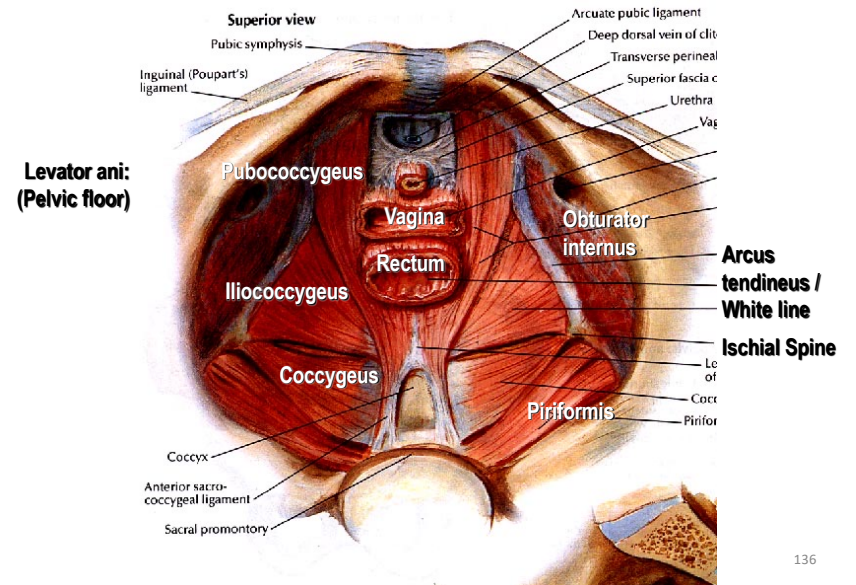



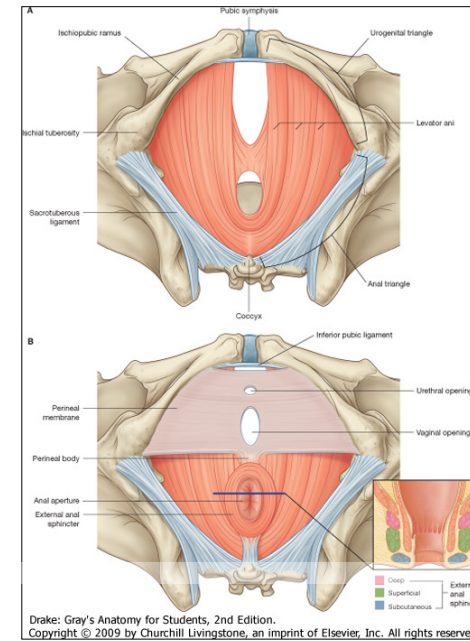
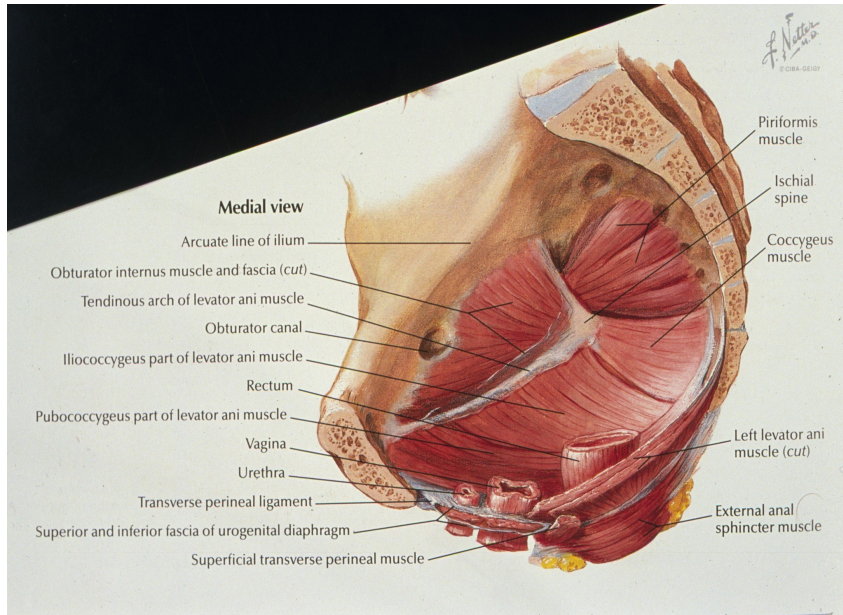

Know all the outlets and sphincters!

Downloaded from: StudentConsult (on 8 February 2012 01:55 AM)  
© 2005 Elsevier

## Pelvic diaphragm/ Pelvic Floor

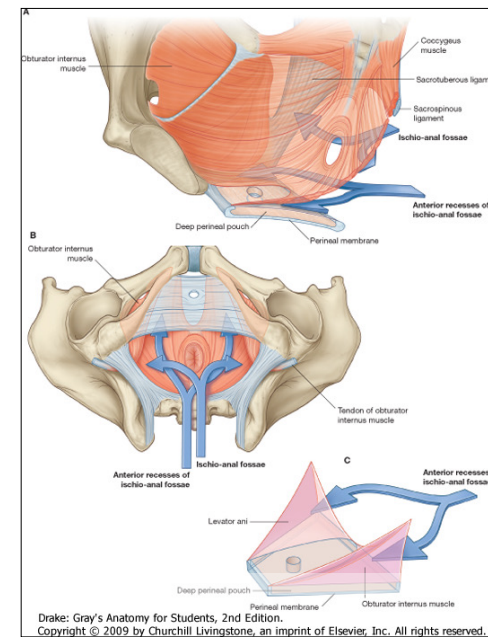
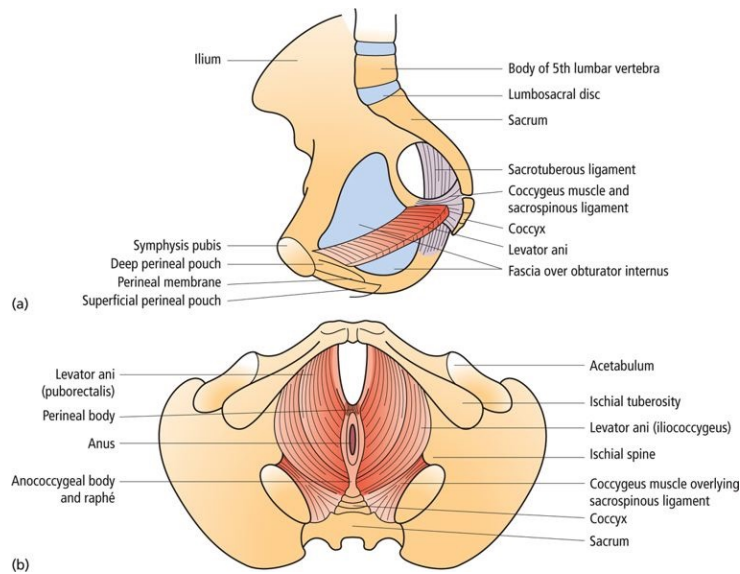

## Ischioanal (Ischioanal) fossa

How may pus track from side to side?

Communication at the posterior aspect but nil anteriorly.

Downloaded from: StudentConsult (on 8 February 2012 01:55 AM)  
© 2005 Elsevier

## Female Perineum

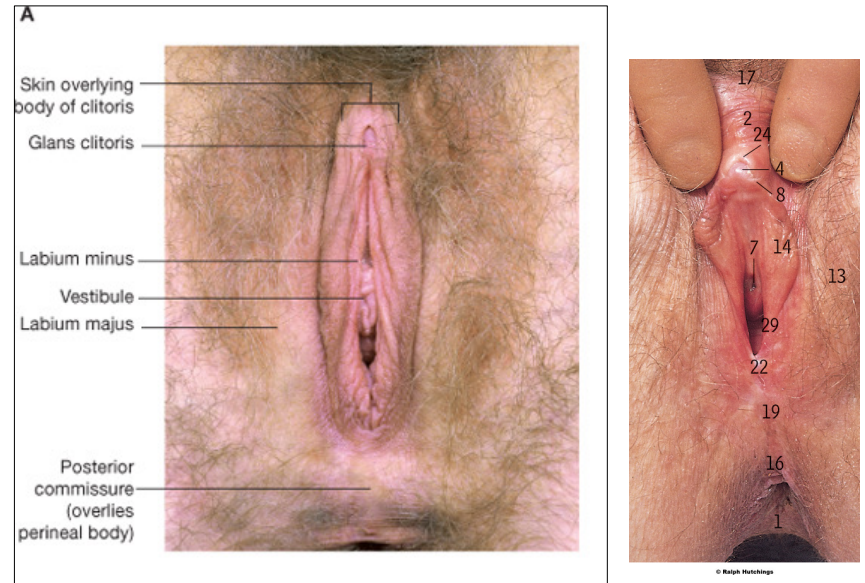
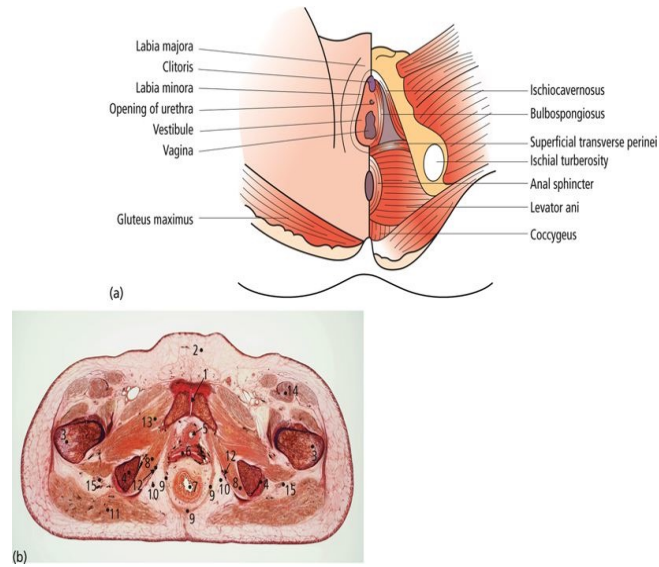

## Examination of the Vulva

- INSPECTION see Female circumcision
- Palpation



## Male Perineum

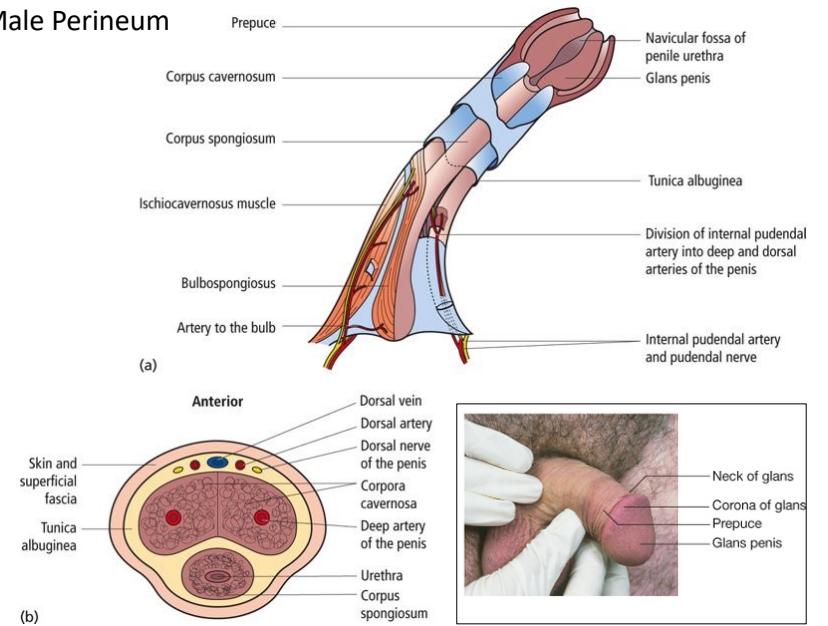



## Female vs Male urethra

### What is hypospadias?

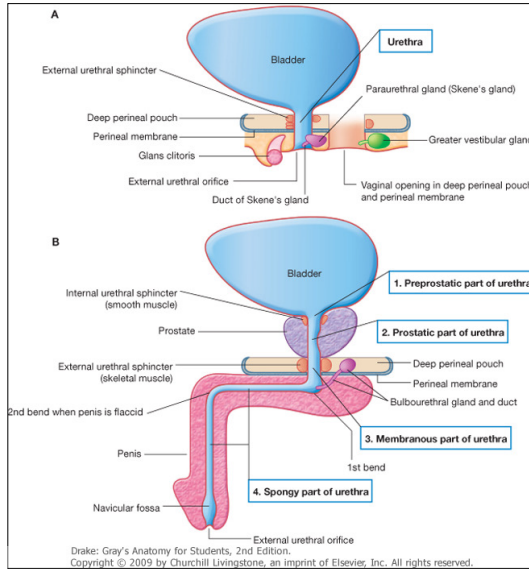
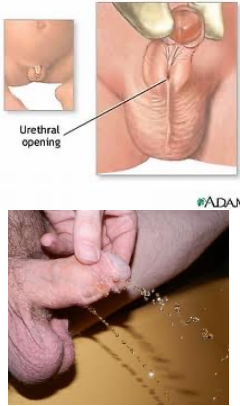

Downloaded from: StudentConsult (on 8 February 2012 01:55 AM)  
© 2005 Elsevier

## Male perineum & Pudendal nerve

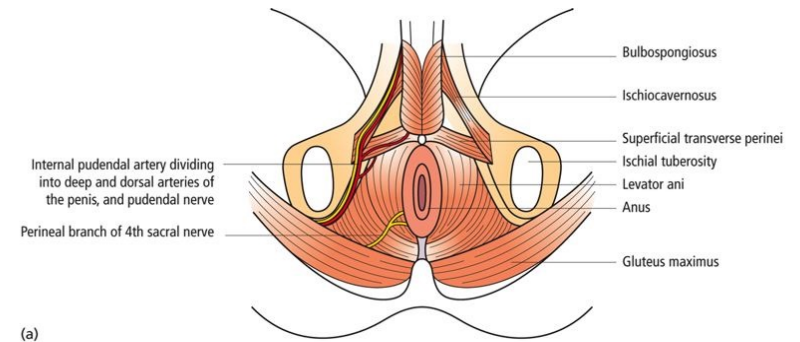

(a)

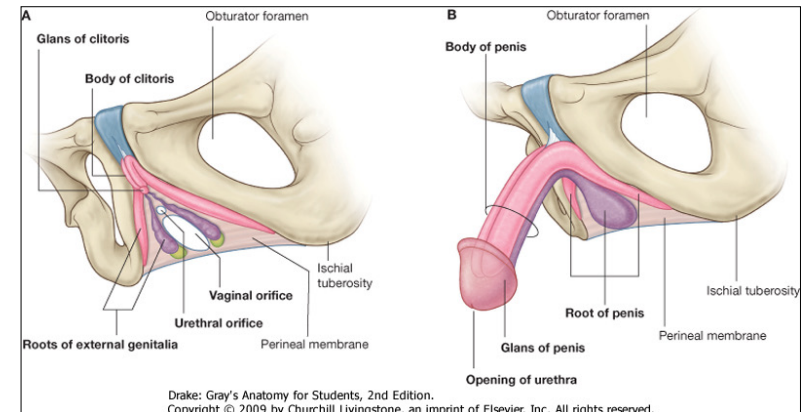
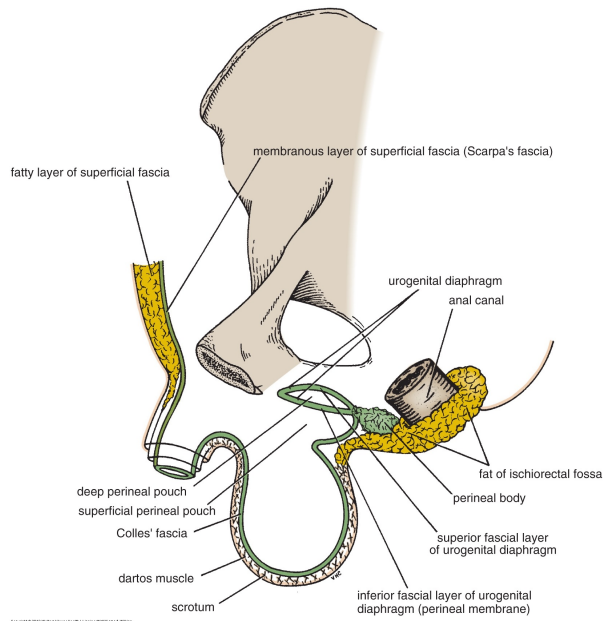

Drake: Gray's Anatomy for Students, 2nd Edition.  
Copyright © 2009 by Churchill Livingstone, an imprint of Elsevier, Inc. All rights reserved.

Compare female and male external genitalia.

Where is the bulbospongiosus muscle? Function?

Where are the ischiocavernosus muscles? Function?

Downloaded from: StudentConsult (on 8 February 2012 01:55 AM)  
© 2005 Elsevier

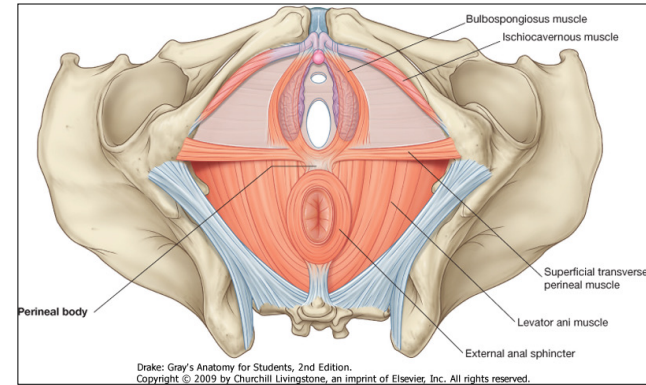
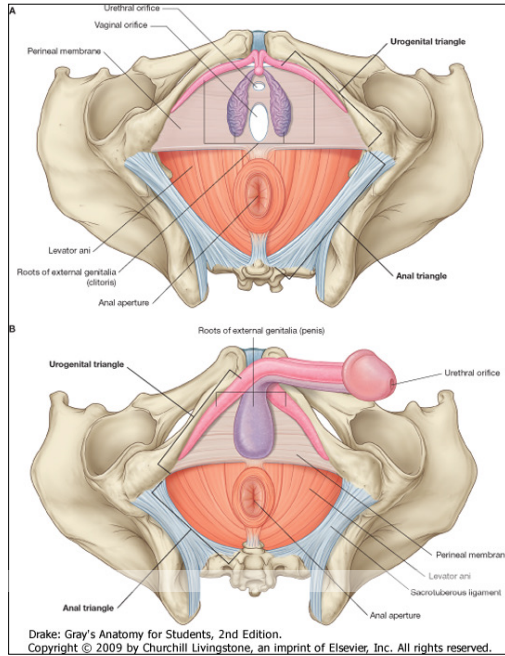

Where is the urogenital diaphragm?

Downloaded from: StudentConsult (on 8 February 2012 01:55 AM)  
© 2005 Elsevier

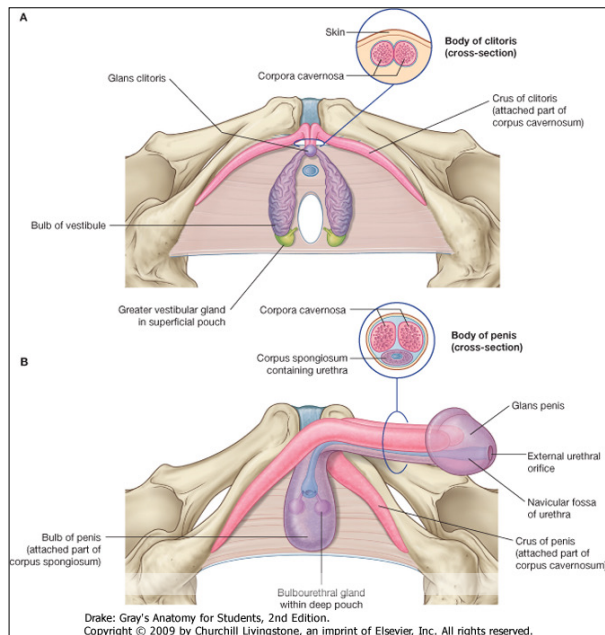

Downloaded from: StudentConsult (on 8 February 2012 01:55 AM)  
© 2005 Elsevier

## Lymphatic drainage of anal canal

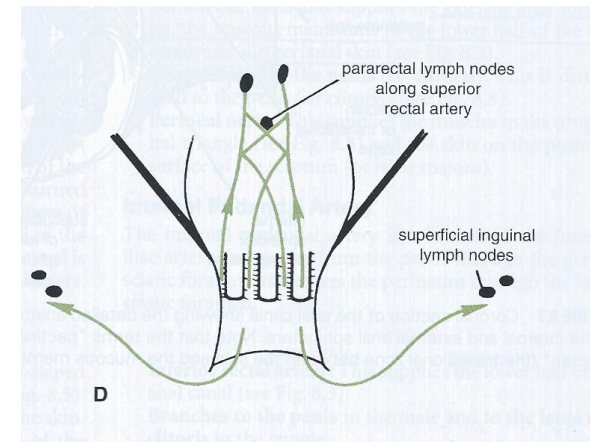

# Erectile Dysfunction

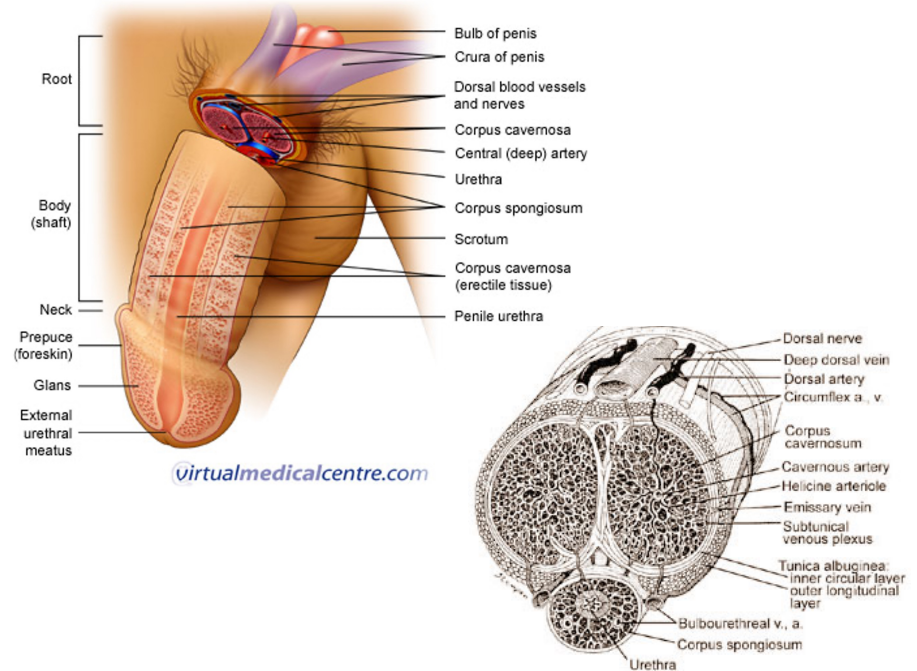

## Erection

- Stimuli ;)
- Afferent stimuli through somatic fibres in pudendal nerve
- Parasympathetic outflow from efferent fibres of S2-S4 (Neurotransmitter: NO)
- Vasodilation of arteries -> Erectile tissues engorged with blood
- Penis increases in length and diameter

## Ejaculation

- Bulbourethral (Cowper's) glands secrete viscous pre-ejaculate for lubrication purposes
- Friction on glans penis stimulates sympathetic fibres
- Contraction of smooth muscle of epididymis, vas deferens, seminal vesicles, prostate -> secretions and spermatozoa enter prostatic urethra
- Rhythmic contraction of bulbospongiosus muscle -> eject semen out of penile urethra
- Contraction of urethral sphincter prevents reflux of semen into urinary bladder (retrograde ejaculation)



# Erectile Dysfunction

- Inability to develop or maintain an erection
- Causes:
  - Psychological: stress, performance anxiety
  - Surgery: nerve damage, disrupt blood supply
  - Lifestyle: Smoking (constriction of arteries)
- Treatment
  - Medication: Phosphodiesterase type 5 inhibitors – block PD5, degradation of cGMP (cGMP = stimulates relaxation of smooth muscle)
  - Penis Pump – uses negative pressure to draw blood into penis
  - Surgery: Prostatic implants (insertion of artificial rods)

## Pudendal nerve

Arising from the anterior rami (S2,3,4)

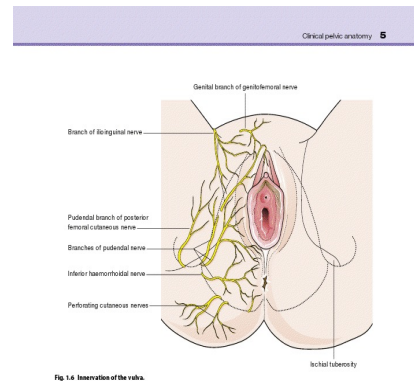
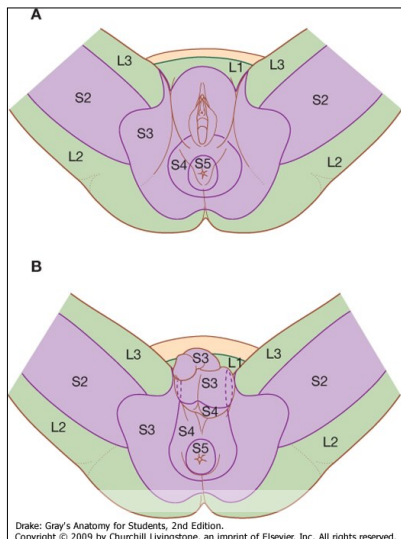
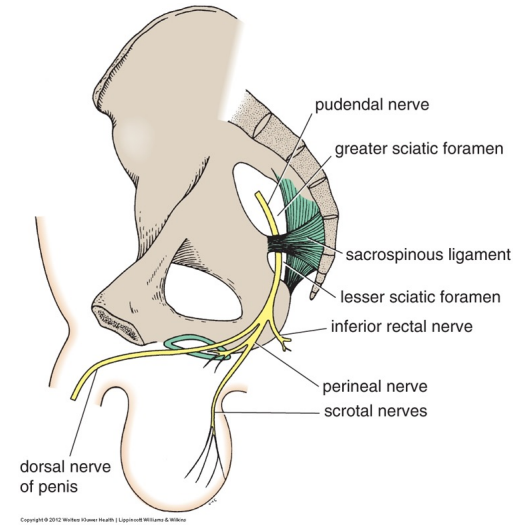

Fig. 1.6 Innervation of the vulva.



Pudendal block



KEY LANDMARK -- ISCHIAL SPINE



# Branches of internal iliac artery

A useful **mnemonic** to remember the branches

I Love Going Places In My Very Own Underwear!

Mnemonic

- I - iliolumbar artery
- L - lateral sacral artery
- G - gluteal (superior and inferior) arteries
- P - (internal) pubic artery
- I - inferior vesicle (uterine in females) artery
- M - middle rectal artery
- V - vaginal artery
- O - obturator artery
- U - umbilical artery

Testes and scrotum

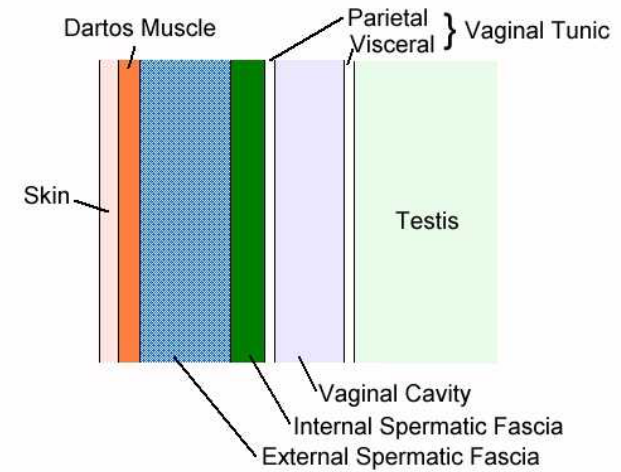

Testes and scrotum

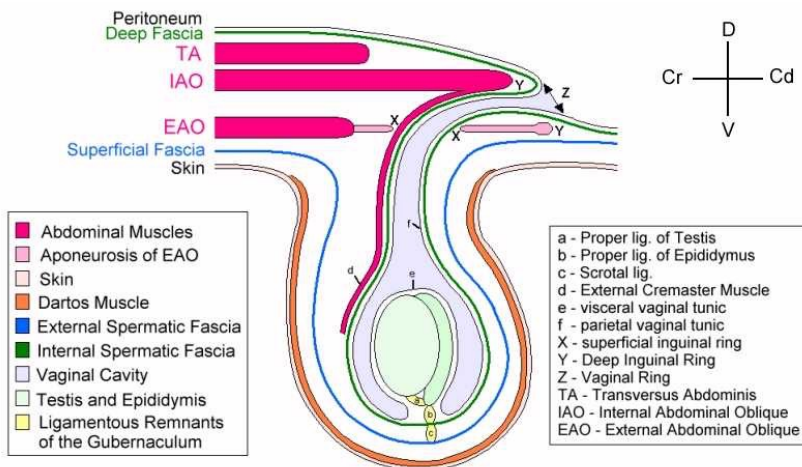

Vasectomy

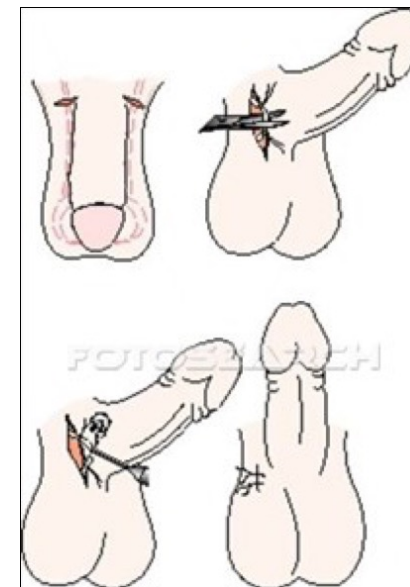

Thank you !