



Sierra M6-4 SAS/SATA Protocol Analyzer

User Manual



For Software Version 4.30
Document Version 3.0

March 2012

LeCroy Protocol Solutions Group
Copyright © 2012 LeCroy Protocol Solutions Group. All rights reserved.

Trademarks and Servicemarks:

LeCroy, LeCroy Protocol Solutions Group, CATC, SASSuite, SATASuite, SASTracer, SATracer, SASTrainer, SATrainer, SASTracker and Avalanche are trademarks of LeCroy. Microsoft, Windows, Windows 2000, Windows XP, Windows Vista and Windows 7 are registered trademarks of Microsoft Inc.

Intel and Pentium are registered trademarks of Intel Corporation.

All other trademarks and registered trademarks are property of their respective owners.

THE SPECIFICATIONS AND INFORMATION REGARDING THE PRODUCTS IN THIS MANUAL ARE SUBJECT TO CHANGE WITHOUT NOTICE. ALL INFORMATION, EXAMPLES AND RECOMMENDATIONS IN THIS MANUAL ARE BELIEVED TO BE ACCURATE BUT ARE REPRESENTED WITHOUT WARRANTY OF ANY KIND, EXPRESS OR IMPLIED. USERS ARE FULLY RESPONSIBLE FOR THEIR APPLICATION OF ANY PRODUCTS.

THE SOFTWARE LICENSE AND LIMITED WARRANTY FOR THE ACCOMPANYING PRODUCT ARE SET FORTH IN INFORMATION THAT SHIPPED WITH THE PRODUCT AND ARE INCORPORATED HEREIN BY THIS REFERENCE. IF YOU ARE UNABLE TO LOCATE THE SOFTWARE LICENSE OR LIMITED WARRANTY, CONTACT LeCroy FOR A COPY.

Copyright © 2012, LeCroy Corporation; All rights reserved.

This document may be printed and reproduced without additional permission, but all copies should contain this copyright notice.

WEEE Program



LeCroy Corporation
3385 Scott Blvd.
Santa Clara, CA 95054
TEL: 800-909-7112 (USA and Canada)
TEL: 408-653-1260 (worldwide)

Contents

Chapter 1: Introduction	17
Analyzer Overview	17
Features	18
Receiving Your Analyzer	18
Unpacking Your Analyzer	19
Analyzer Features	19
LEDs	19
Status and Configuration Display	20
Installing Your Analyzer	20
Software Installation	20
System restart	21
Error Message	21
Hardware Setup	21
Separate Systems	21
Connecting in General	21
Cables to Use	22
Expandability	23
Cascading with STX SYNC Expansion Cards	24
Cascading	24
Select Device	27
Cascading with CATC SYNC Expansion Cards	31
Using the Power Expansion Card	31
Removing Expansion Cards	32
Connecting via Ethernet	35
Connecting to a Network	35
Connecting over Different Subnets	35
TCP and UDP Ports Must be Open to Connect over Ethernet	36
Launching Your Analyzer	36
Operating in Simulation Mode	36

Using the Software 36

Getting Started with the Protocol Analyzer..... 37

Protocol Analyzer Initiator Emulator or Host Emulator 38

Performance Analyzer 38

Target Emulator or Device Emulator 38

LeCroy SAS and SATA Protocol Suite Menu Options and Toolbars..... 39

 File39

 Setup.....40

 Session.....40

 Analysis.....41

 Viewing Captured Data42

 Navigation43

 View44

 Window.....45

 Help.....45

 Toolbars45

Port Status..... 46

InFusion..... 46

Trainer..... 47

Chapter 2: Protocol Analysis 49

Easy Mode (Pre-Defined Setups) 49

 Main Window.....49

 Project Tree.....51

SAS/SATA Software Menus and Toolbars 53

 SAS Main Toolbar53

 SATA Main Toolbar53

 Run Hardware54

 Launch Jammer55

 Launch Trainer.....55

 CrossSync Control Panel55

 Launching the CrossSync Control Panel56

 Save Workspace56

 Saving a Trace Capture.....57

 Exporting.....58

 Export to Text/Excel58

 Export to Initiator Emulator (SAS) or Host Emulator (SATA)59

 Export to Trainer.....60

 Export Read/Write Command Report61

 Export Paired SAS Address Report.....61

Trace Properties62

Edit Comment62

Projects62

New Default Project62

Last Project62

Project File Types62

Run an Example Analysis Project64

Patterns and Data Capture Setup65

Pre- and Post-Trigger Data Capture67

Defining Patterns68

Protocol Errors70

FIS Types75

Trigger Setup79

Snapshot Mode80

Manual Trigger Mode80

Any Trigger Mode80

Bus Condition84

Symbol85

Primitive85

ATA Command87

Data Pattern88

Protocol Errors89

ATAPI90

Address Frame (SAS only)90

STP Frame (SAS only)91

SMP Frame (SAS only)92

SSP Frame (SAS only)92

SCSI Command (SAS only)93

Timeout (SATA only)94

ATA Command Pattern (SATA only)95

Soft Reset (SATA only)96

FIS (SATA only)96

FIS Pattern (SATA only)97

Sequential Trigger Mode99

Timer99

Defining Patterns99

Triggering Order100

Pre-Trigger101

Project Settings102

Memory Settings102

Sample File Name103

Memory Size103

Partial Memory103

Upload Manager	103
Analyzer Settings	104
Primitive Response Timeout	104
Disable Scrambling	104
Show XXXX value	105
ALIGN Transmission Period (differs for SAS and SATA)	105
Protocol Error Mask	105
External Trig Out Setting	105
External Trig In Setting	105
Choose Port Speed	106
Ports Configuration	106
Port Configuration and Projects	107
MUX Setting (SAS only)	110
Add a Project Note	111
Advanced Mode (User-Defined)	112
Working in Advanced Mode	112
State Number for Complex Trigger Sequences	114
Setting Trigger Conditions	115
Multi - Link Triggering.....	116
Set Timers	116
Timeout.....	117
Useful Key Sequences.....	119
Project Settings	119
Notes.....	120
Exercise and Capture	120
Programming the Initiator or Host Emulator	120
Add Program Lines	121
Adding Initiator or Host Emulator Commands	122
Adding an ATA Command	122
Smart Commands (SATA only)	122
Adding a User-Defined ATA Command.....	123
Adding a SCSI Command (SAS only)	123
Adding a User-Defined SCSI Command (SAS only).....	124
Adding a TASK Command (SAS only).....	124
Adding an SMP Command (SAS only)	125
Adding a Frame	126
Adding an Event	127
PHY Setting Dialog	129
Inserting Instructions.....	130
Start Loop	130
Loop Count	130
End Loop	130
Add a Goto	130

Add an If	131
Add Wait for Any Frame	132
Add Wait for PS (SAS only)	132
Add Wait for Power Management (SATA only)	132
Insert Delay	132
Add Stop	132
Add a Label	133
Instruction insert	133
Phy Reset Sequence and Identification	133
Sample Host Emulator Program (SATA only).....	133
Sample Initiator Emulator Program (SAS only).....	134
Data Blocks	134
Exercising Specific Addresses	134
Record and Play	136
Error and Command Settings.....	138
ATA Error and Command Settings	138
Outgoing ATA Frame Settings	141
Incoming ATA Frame Settings	143
SCSI Error and Command Settings (SAS only).....	144
Outgoing SCSI Frame Settings	146
Incoming SCSI Frame Settings	148
FIS Options (SATA only).....	148
Initiator Setting Tab (SAS only).....	149
Host Setting Tab (SATA).....	154
Project Settings	158
Creating a Data Block	159
Naming a Data Block	160
Editing a Data Block	161
Creating and Editing Data Blocks as Text	163
Load Data	164
Save As	164
Performance Analysis	164
Performance Analysis with Analyzer Only.....	164
New Performance Analysis Project	164
Last Saved Performance Analysis Project	164
Performance Analysis Project.....	165
Define Performance	166
Settings	167
Run Hardware	169
Target and Device Emulation	170
Pages Tab.....	170
Writable Buffer Size Field	171

Error Injection Tab.....	172
Setting General Errors	173
Identify Errors (SAS only)	175
Connection Management (SAS only).....	176
Open Connection Definition	177
Close Connection Definition	177
SAS Commands Errors (SAS only).....	178
ATA Commands Errors (SATA only)	183
Outgoing Frame Settings.....	184
Incoming Frame Settings.....	185
SATA Signature (SATA only).....	186
SATA Signature Errors	187
User-Defined Commands Tab	188
Target Emulator Settings (SAS).....	189
Notes Tab	192
Run Target Emulation	192
Device Emulator Settings (SATA only).....	193
Project Note	200
Using the Power Expansion Card	200
Run Device Emulation.....	200
Chapter 3: Display Manipulation	201
Viewer Display	201
Quick View	202
Using the Viewer Display	203
Trace Properties	203
Analysis	204
Show Analysis Toolbar	204
Decoding Assignments.....	206
Packet View.....	206
Packet View Metrics	207
Changing the Default View	208
Spreadsheet View	208
Save As Text/Excel	209
Change Format of Logical Block Address (LBA)	209
Column View	209
Text View	211
Field List View.....	212
Field List View Displayed in a Separate Window	212
Field List View Embedded in Packet or Spreadsheet Views	213
Waveform Display	214
Making a timing Measurement	214
Expanded Waveform View	215

Statistical Report	215
Generating Statistical Read/Write Report	216
Report Between Cursors	216
Report Between Events	217
Statistical Report Content	217
Report Options	218
General Report	218
Primitive Report	219
Bus Condition Report	219
ATA Command Report	220
ATAPI Report	221
Protocol Error Report	221
Others Report	222
SSP Transport Report (SAS)	222
SMP Transport Report (SAS)	223
STP Transport Report (SAS)	223
SCSI Command Report (SAS)	223
SMP Command Report (SAS)	224
Task Command Report (SAS)	224
SAS Address Report (SAS)	225
Lanes Report (SAS)	225
Read/Write Command Report (SAS)	226
Performance Report (SAS)	227
Performance Report (SATA)	227
FIS Report (SATA)	228
Queue Command Report (SATA)	229
PM Statistic Report (SATA)	229
PM Performance Report (SATA)	230
Read Write Command Report (SATA)	230
Statistical Report Toolbar	231
Export as Microsoft® Excel file	231
Save as Text file	231
Print Statistical Report	231
Print Preview	231
Report Display Settings	232
Link With Sample View	233
Formatting the Statistical Report View	234
Filtering Column Content	234
Sorting Column Content	236
Hiding Columns	236
Histogram View	237
Hide Frames	237

Hide Error Frames	237
User Defined	238
Primitives	238
Zoom	239
Bus Utilization View	239
Bus Utilization Buttons	240
Data Report	240
Data Payload View	241
Find Data Pattern	242
Compare Two Data Payloads	243
SAS Verification (SAS).....	244
Using the Power Expansion Card	245
Compliance Test (SATA).....	246
Using the Power Expansion Card	247
Running Verification Script Engine (VSE).....	248
Navigation + View Toolbar	251
Go To Menu.....	252
Locate Cursors	252
Go to Time Stamp	253
Bookmarks	253
Editing a Bookmark	254
Finding a Bookmark	254
Bookmark Description	255
Set Time Stamp Origin	256
Filtering	256
Filter Setup.....	257
Filter Type	258
Filtering Direction	258
Filter Idle	258
Save Filter Setup	259
Filter Logic	259
Multilevel Filtering in SAS	259
Filter descending packets from trace highlight bar	261
Selectable Filter Options for SAS	262
Bus Condition	262
Incomplete Frames	262
ATA Command	262
Protocol Error	262
ATAPI SCSI Command	262
Filter Check Condition	263
Filter by Tag Number	263
Filter Miscellaneous	264

Use Pair SAS Addresses	265
Selectable Filter Options for SATA	265
Bus Condition	266
Incomplete Frames	266
FIS	266
ATA Command	266
Protocol Error	266
Port	266
ATAPI SCSI Command	266
Miscellaneous	266
Enable Filter	266
Filter Idle.....	267
Search.....	267
Save Search Setup	268
Search By	268
Search Direction	268
Search From	268
Search Logic	269
Search For	269
Search Domain	269
Search Sub Items	270
Show/Hide Ports	271
Show/Hide Single Port	271
Show/Hide Multiple Ports	271
Packet View Toolbar.....	272
CATC Navigation View	273
Spec View	274
Decode Icons	276
Customize Display.....	276
Rename Port	276
Select and Apply Show/Hide Port Mode	277
Show/Hide Single Port	277
Show/Hide Multiple Ports	277
Show/Hide Field	278
Related Frames	278
Byte Order	279
Choose Data Format	280
Show All Data	280
Port Status.....	281
Toolbars.....	282
Enabling Tool Bars.....	282
Cursor Position Status Bar.....	282

Status Bar	283
Search Status.....	283
Using the Cursors and Bookmarks	283
Cursors.....	283
Positioning the X Cursor	283
Positioning the Y Cursor	283
Time	283
Display Configuration	284
Trace Viewer Configuration.....	284
Field Settings	286
Field Header Setting	287
Viewer Setting	287
Data Payload	287
Time Stamp Origin	287
Start Time and Port	287
Packet View Condense Mode	287
Time Stamp Format	287
Font	288
Save/Load Settings	288
Set Port Alias	288
Set As Default	289
SAS Address Alias (SAS only).....	289
Set As Default	290
Tx Vout & Preemphasis	290
Software Settings	291
General Tab.....	292
Paths	292
Template Files	292
Other	292
Found Device List Mode	293
Browse Default Path	293
Trace Viewer Tab.....	294
Open Trace file In	294
Optimization	294
Spread Sheet View Tab.....	296
Color Setting	296
Anchor the Selection Bar	296
Other	297
Column View Tab.....	297
Other	297
Field List View Tab	298
Update Field List Based On	298

Mode of Frame Field List:	298
Other	298
Sampling Memory Usage Optimization	299
If the Sampling Memory Usage Optimization Option is Checked	299
If the Sampling Memory Usage Optimization Option is Not Checked	300
Floating License	301
External Trig Setting	302
Update STX Board Interface	302
Update Device	303
User-Defined Decoding.....	304
Help Menu.....	306
Help Topics	306
VSE Help Topics	306
Update License	306
Display License Information.....	306
Check for Updates	308
About	308
Self Test.....	308
Clock Check	309
Test Result: OK or Error	309
Saving.....	309
Number of Runs Each Test.....	310
Run All Tests Sequentially	310
Memory Check.....	310
Serdes Check.....	311
Crosspoint Check.....	312
Main FPGA Check (SATA only)	313
Expansion Check.....	314
LED/Buzzer Check.....	315
Find DUT.....	316
Aliasing.....	318
Exporting.....	318
Compliance Test (SATA only)	318
Chapter 4: InFusion Overview	321
Key Features	322
Interface.....	323
Buttons	323
Menus	324
File	324
Setup	324
View	324
Configuration	324

Tools	324
Help	325
Main Library	325
File Library	326
Device Ports	327
Using the Device Ports Dialog	327
Port Configuration for InFusion	328
InFusion Scenarios.....	331
Scenarios Overview	331
InFusion Scenario Parameters	332
Global Rules.....	334
Sequences.....	334
Scenario Libraries	336
Main Library	336
File Libraries	336
Device Libraries.....	337
Scenario Properties.....	338
SATA Smart Hold Option	339
Scenario Events.....	341
DWORD Matcher	343
SAS Data Pattern	343
SATA Data Pattern.....	344
Scenario Actions	344
Using Counters in Events and Actions	347
Capturing a Data DWORD.....	348
Using Captured Data DWORDs	349
Summary of Scenario Creation	350
Creating Global Rules	351
Example 1: Creating a Single Event and Action that Removes a Primitive	352
Example 2: Wait for a Primitive and Replace It with an Error	355
Example 3: Creating OR Conditions	356
Example 4: Multiple Triggers and Actions	357
Example 5: Multiple Actions on a Single Event.....	359
Example 6: Using Timers.....	360
Creating a Sequence	362
Example 7: Creating Two Sequences and Global Rules	363
Example 8: Creating a Sequence With Many States #1	370
Example 9: Creating a Sequence With Many States #2	373
Downloading Scenarios	376
Running Scenarios	376

Scenario Batch Files 377

- Script Workspace 377
- Error Checking..... 380
- Log 380
- Statements 380
 - ifIsStopped 380
 - Goto Label 382
 - Run 383
 - Stop 383
 - WaitForStop 384
 - Sleep 385
 - Beep 385

Chapter 5: Sierra Trainer Traffic Generation 387

Sierra Trainer Menus 388

- File Menu 388
- Setup Menu 389
- Generate Menu..... 390
- Search Menu 390
- View Menu 391
- Tools Menu..... 392
- Window Menu 392
- Help Menu 392

Sierra Trainer Main Toolbar 393

Setting Up for Generating Initiator Traffic..... 394

Setting Up for Generating Target Traffic 394

Creating a Traffic Generation File 394

- Creating a New Generator File 395
- Editing an Example Generation File 396
- Converting an SATrainer Traffic Generation File 397
- Opening a Traffic Generation File..... 397
- Layout..... 398

Overview of Generation and Global Settings Files 398

- Traffic Generation (*.ssg) Files 398
- Settings.inc File 399
 - The Global Setting “AutoAlign” 400
 - Placing Global Settings in the Generation Block 401

Primitive and Frame Definitions..... 402

- Special Conditions for Frames..... 402
- Primitives Decl.inc File 403
- Address FramesDecl.inc File 403

SSPframes.inc File403

SMPframes.inc File.....403

STPframes.inc File403

Starting the Script Editor 404

 Script Editor Toolbar.....405

 View Options Menu406

 Pop-up Menu406

 File Tabs406

 Error Log407

 Tooltips407

Multi-Port Trainer Script Assignments to Links 407

Generating Traffic..... 409

 Stop Traffic Generation.....409

 Resume Traffic Generation.....409

Sierra Trainer Generation Language 410

 File Structure410

 Language.....410

 Comments410

 Includes410

 Settings411

 Constants411

 Predefined Constants411

 Data Patterns411

 Primitives412

 Packets/ Frames412

 Generation Block.....414

 Definitions415

 Field Variable Declarations415

 Changing Frame Fields415

 Preprocessor Integer Arithmetic415

 Loops416

 Trainer Script Enhancements.....417

 Variable Definition418

 Assigning Variable Values418

 Expression on Variables419

 If/While in Logical Expressions419

 Using Variable Values in Creating Patterns on Bus420

 Timer421

 PATTERN Counter421

 Procedure Definition422

 Sierra Trainer Generation Commands.....423

 General Commands423

SATA Commands	424
Primitive Commands	425
Primitive Category	427
Wait Commands	428
Wait Command Groups	433
Predefined Constants	435
Generation Settings	436
Generation Options	445
Generation Rules Toolbar.....	446
Generation Rules Page: How It Works	447
Creating Event Buttons.....	447
Dragging a Button to the Main Display Area	448
Assigning an Action.....	449
Generation Rules Pop-Up Menus.....	450
Cell Pop-up Menu	450
Action Pop-up Menu	450
Event Pop-up Menu	450
Events and Event Properties.....	451
Setting Complex “Wait For” Conditions	452
Setting Conditions with the Generation Options Dialog	452
Find.....	454
Data Pattern Mask and Match.....	456
Find Next	456
Search Direction	456
Display Options	457
Color/Format/Hiding Display Options	457
Color Display Options	458
Formats Display Options	459
Hiding Display Options	460
Level Hiding Options	460
Headers Options	461
Saving Display Options	462
Connection Parameters	463
Resetting the Toolbar.....	464
Appendix A: Creating a Pattern Generator File.....	467
Key words.....	467
Comment format.....	467
Primitive definition format	467
Loop definition format.....	467
Scramble definition format	467

Role definition format.....	467
END_OF_FILE definition	467
Appendix B: China Restriction of Hazardous Substances Table	469
WAN Operation	470
Appendix C: How to Contact LeCroy	471
Index:.....	473

Chapter 1

Introduction

This manual describes installation and operation of the LeCroy Sierra M6-4™ Protocol Analyzer and includes examples of typical applications.

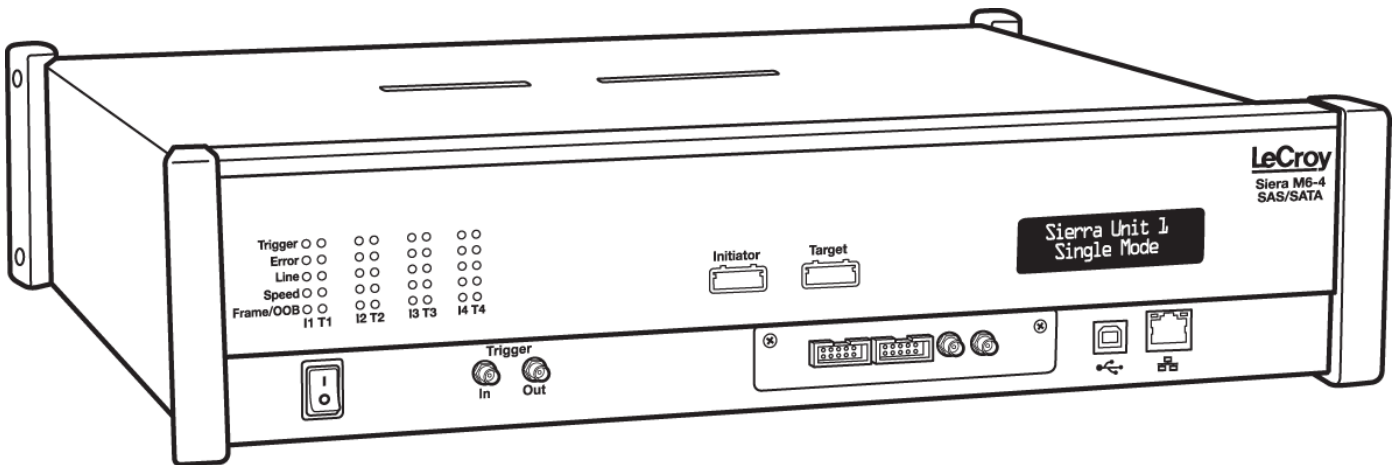

Figure 1.1: LeCroy Sierra M6-4 Protocol Analyzer

Analyzer Overview

The Sierra M6-4 SAS/SATA Protocol Analyzer is a serial bus analyzer, supports host and device emulation, and provides error injection functionality. The SAS analyzer software performs serial bus analysis for Serial Attached SCSI (SAS) data transfers, as well as Serial ATA (SATA) data transfers through STP data transfers. The SATA analyzer software performs serial bus analysis for Serial ATA (SATA) data transfers.

The Sierra M6-4 Analyzer helps Hardware, Firmware, Design, and Application Engineers troubleshoot and diagnose SAS and SATA problems within their product. The analyzer supports the following:

- ❑ Capture, triggering, and filtering of Serial Attached SCSI packets or Serial ATA packets
- ❑ Generation of bus traffic as a SAS Initiator Emulator or a SATA Host Emulator, while monitoring and analyzing results
- ❑ SAS target emulation and SATA device emulation

- ❑ Running a Pattern Generator
- ❑ TX Vout on transmitters for test and characterization
- ❑ CATC API

The analyzer provides for bi-directional trigger and capture of commands, primitives, patterns and all bus conditions. You can capture all frames and/or exclude traffic.

The Sierra M6-4 Analyzer has a USB port and an Ethernet port to connect to a computer. You can cascade analyzer units for higher port counts. The analyzer allows you to select frames to include and exclude for capture. Capturing can be triggered based on a specific event or manually.

The Sierra M6-4 Analyzer provides a full range of views and statistical reports.

Features

- ❑ 6 Gb/s SAS/SATA protocol analysis or error injection
- ❑ Native PHY for fast lock time
- ❑ Easy mode triggering
- ❑ Cascade up to 8 analyzers
- ❑ Sync with LeCroy Sierra and STX family products
- ❑ CrossSync Control Panel
- ❑ Hardware filtering
- ❑ Automatic error detection
- ❑ Comprehensive decoding of SAS and SATA data traffic
- ❑ Logical and chronological traffic displays
- ❑ Statistical reporting
- ❑ Trace memory of 8 GB or 16 GB
- ❑ GbE & USB 2.0 host interfaces
- ❑ Capture, triggering, and filtering of Serial Attached SCSI packets or Serial ATA packets
- ❑ TX Vout on transmitters for test and characterization
- ❑ Automation API
- ❑ Error Injection Functionality (Jammer)
- ❑ Emulation support
- ❑ Trainer traffic generation

Receiving Your Analyzer

The analyzer package includes the following components:

- ❑ 1 Sierra M6-4 Analyzer identified in the packing list
- ❑ 1 MiniSAS to 4-x1 SATA straight cable, 1 meter
- ❑ 1 MiniSAS to 4-x1 SATA crossover cable, 1 meter
- ❑ 2 mSAS to mSAS cables, 1 meter
- ❑ 2 mSAS to SAS x4 cables, 1 meter
- ❑ 1 USB A-B 2.0 cable, 1.8 meter
- ❑ 1 Ethernet cable, 10 feet
- ❑ 1 10-position ribbon cable, 6 inches
- ❑ 1 SMB RA to SMB RA cable, 6 inches
- ❑ 1 Three-Prong AC power cord

- ❑ 1 Installation CD ROM with software and documentation
- ❑ 1 Sierra M6-4 Getting Started manual

Unpacking Your Analyzer

Inspect the received shipping container for any damage. Unpack the container and account for each of the system components listed on the accompanying packing list. Visually inspect each component for absence of damage. In the event of damage notify the shipper and LeCroy Corporation. Retain all shipping materials for shipper’s inspection.

Analyzer Features

The Analyzer has the following features:

- ❑ Power Switch
- ❑ Frame, Speed, Link, Error, and Trigger LEDs
- ❑ External Trigger Input and Output
- ❑ Initiator and Target mini-SAS connectors (4)
- ❑ Expansion In/Out data ports and Clock In/Out connectors
- ❑ Status and Configuration LCD Display
- ❑ USB port for host connectivity
- ❑ Gigabit Ethernet port for network connectivity
- ❑ Power In (on back)

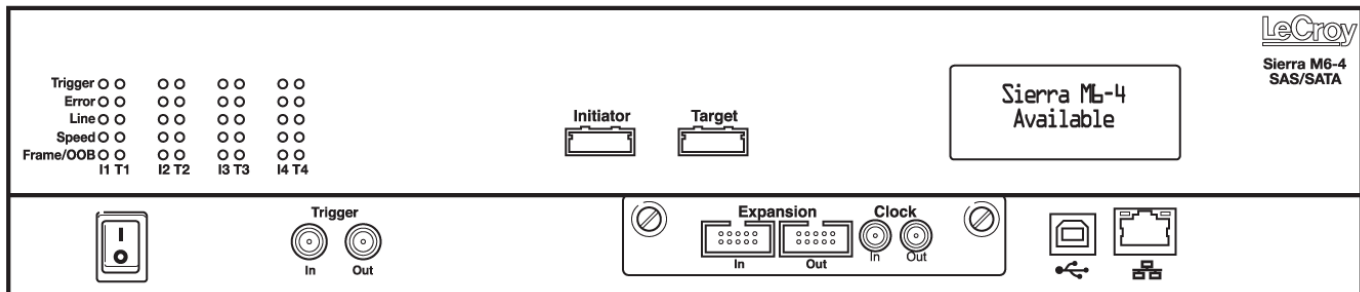

Figure 1.2: Front Panel

LEDs

Each link is supported by LEDs with the following functionality:

Green This LED is illuminated during the OOB (Out of Bound) sequence before the link is established and after link is established it indicates traffic on the bus.

Orange This LED is illuminated as follows:

Speed	Initiator	Target
1.5G	Off	Off
3.0G	On	Off
6.0G	On	On

Yellow This LED is illuminated when a link is established.

- Red** This LED illuminates when an error occurs.
- Blue** This LED is illuminated when a trigger occurs.

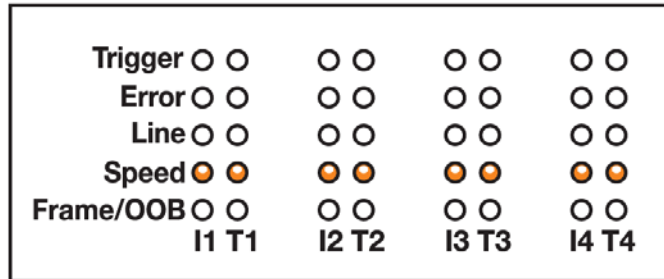

Figure 1.3: LEDs

Status and Configuration Display

The Analyzer front LCD display indicates the configuration and status of operations. For example, during initialization, the LCD panel displays boot status messages.

Installing Your Analyzer

Software Installation

The SAS and SATA software works on systems using the Windows® XP, Windows Vista, Windows 7, Windows Server 2003, and Windows Server 2008 operating systems. 64-bit Windows OS is recommended because it allows using more RAM memory. Other Operating Systems limit the RAM to 3GB.

Note on the Windows Vista Operating System: If the SAS or SATA software does not open, right-click the **SAS Protocol Suite** or **SATA Protocol Suite** icon and select **Properties** to display the Properties dialog. Select the **Compatibility** tab. Check to **Run this program in compatibility mode for Windows XP**.

1. Insert the Installation CD ROM into the CD/DVD drive on the host machine.
2. The installation automatically starts setup, unless Auto Run is off. In that case, select the CD ROM from "My Computer" and click **Setup**.
3. After the warning to close all other programs and before starting the installation, the Install component selection opens.
4. Select components for installation.
5. Click **Next** to complete the installation.

System restart

You must restart your computer before you can use your Analyzer software.

Error Message

If you get an error message during installation of the drivers for Window, consult your system administrator. Your system may allow only administrator-level users to copy such driver files.

Hardware Setup

Separate Systems

When using the analyzer, it is recommended to use a system to generate bus traffic and a second system to run the software, to avoid characterization of traffic generated by the analyzer.

Connecting in General

Note: You must install the software before connecting the analyzer to the host machine for the first time.

To set up the analyzer:

1. Plug the power adapter into the unit, and then plug the power adapter into a 100V–240V, 50Hz–60Hz, power outlet. Turn on the Power switch.
At power on, the analyzer will go through initialization as shown on the LCD display.
2. Connect the USB cable between the Sierra M6-4 USB port and a USB port on the Host PC. The host PC operating system detects the analyzer and driver files.
3. Connect the analyzer as shown in Figure 1.4.

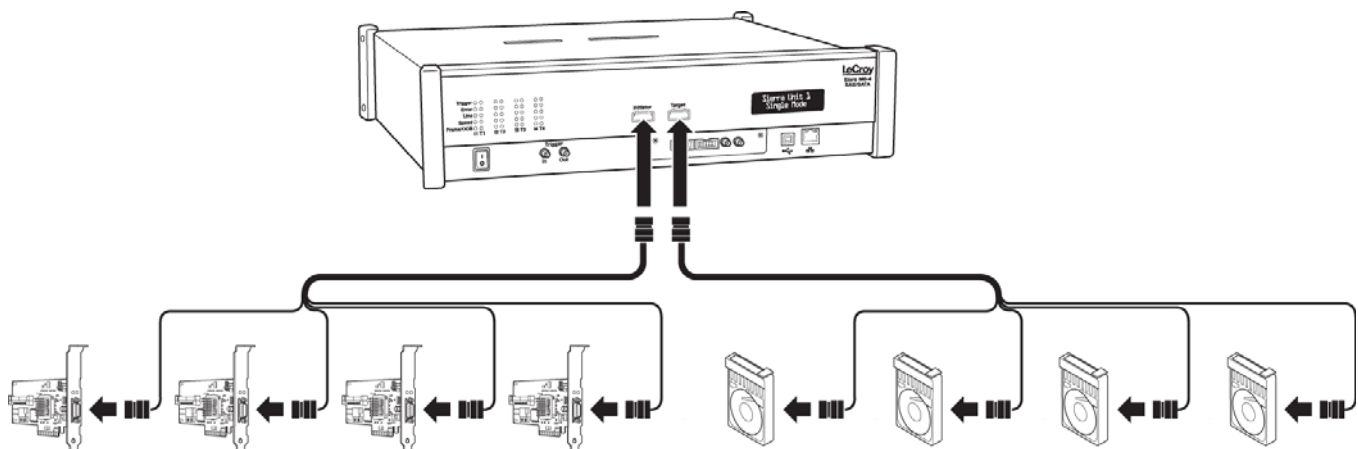

Figure 1.4: Analyzer Connections

Cables to Use

When using Sierra as a Host Emulator, connect from Target to hard drives using an iPass to SATA octopus Crossover cable.

When using Sierra as a Device Emulator, connect from Initiator to HBAs using an iPass to SATA octopus Straight cable.

When connecting between a HBA and a disk drive, use a crossover MiniSAS (iPASS) from the initiator port on the Sierra to MiniSAS or SAS4X cable depending on the HBA connector, and a MiniSAS from the target port to SATAx4, connecting the SATA connector to the disk drive.

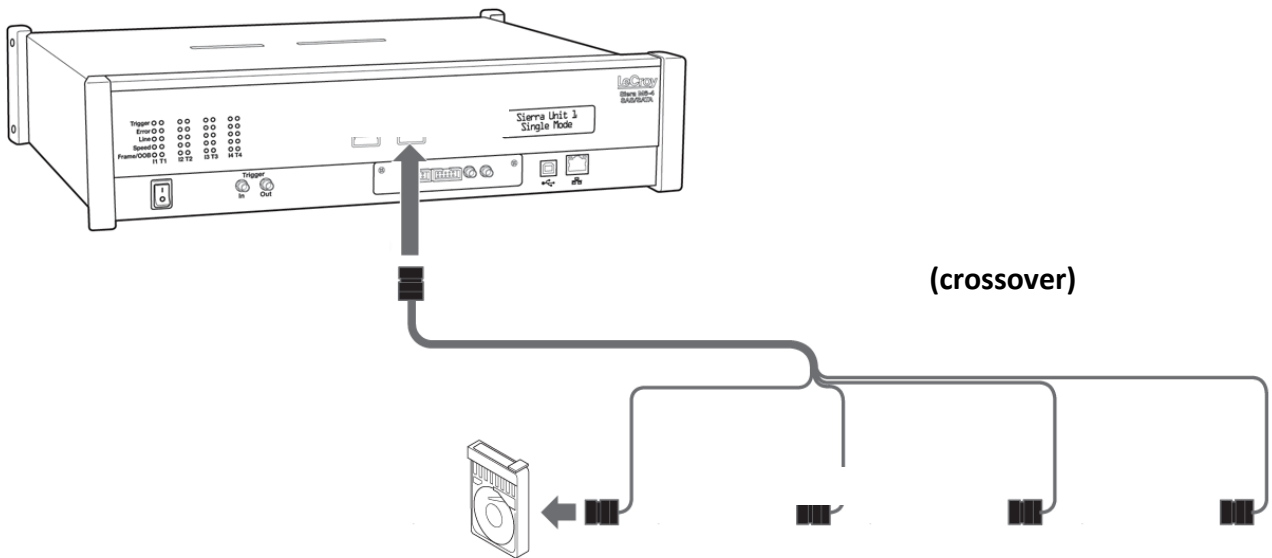

Figure 1.5: Sierra M6-4 Host Emulator Connected to DUT

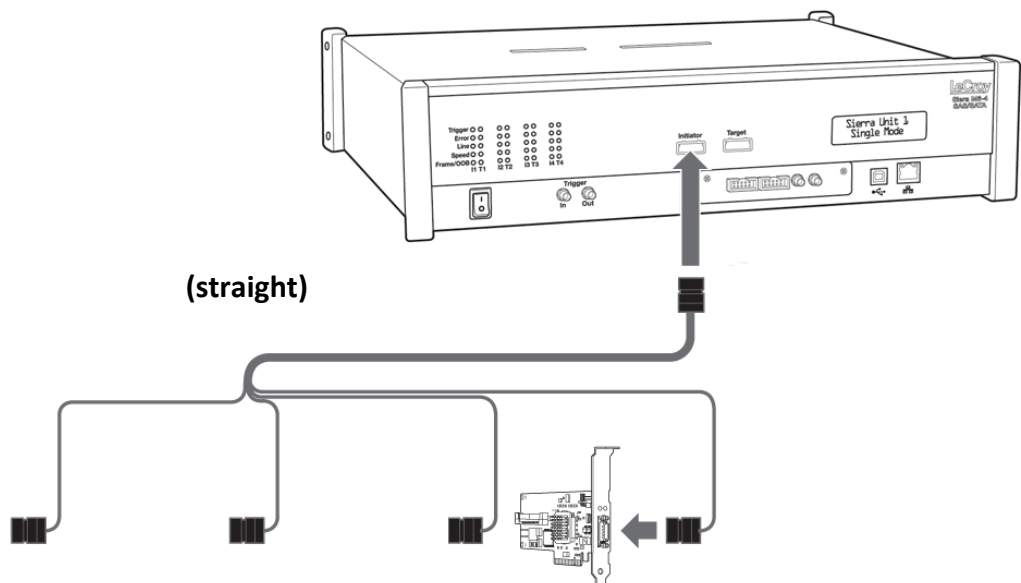

Figure 1.6: Sierra M6-4 Device Emulator Connected to DUT

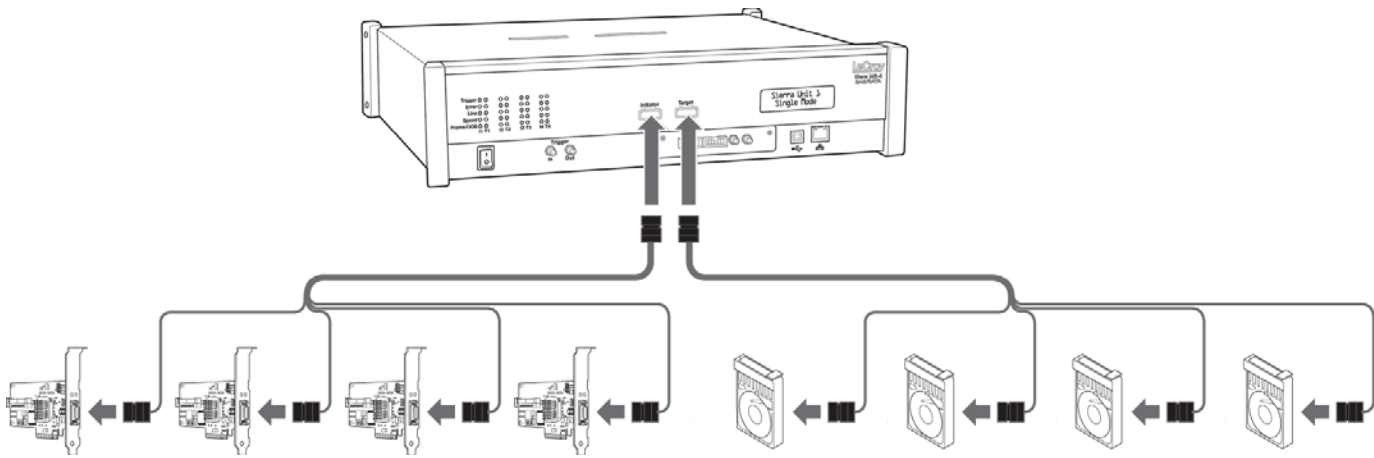

Figure 1.7: Sierra M6-4 Single Lane Connections

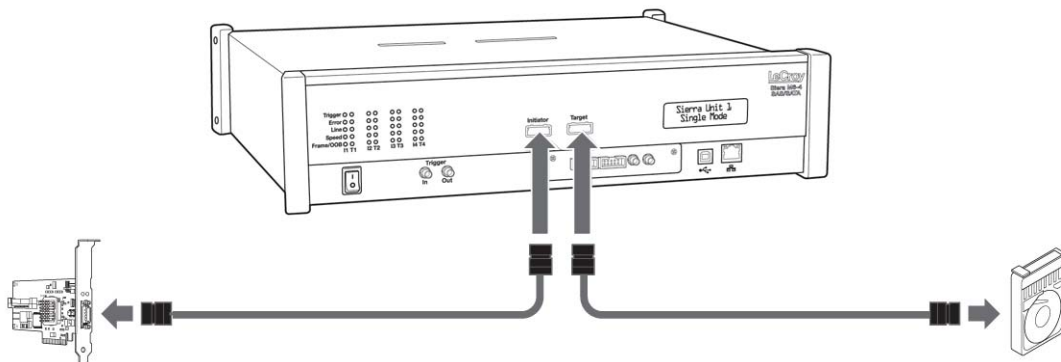

Figure 1.8: Sierra M6-4 Connections

Expandability

You can expand by:

- Cascading with STX SYNC Expansion Cards
- Cascading with CATC SYNC Expansion Cards
- Using the Power Expansion Card

You can remove expansion cards with two simple tools.

Cascading and Memory Size

For example, you have two units. The first one has 2 GB memory. The second one has 4 GB memory. The system shows the entire memory as 6 GB. If you set buffer size to 6 GB, the system programs the first board for 2 GB and the second board for 4 GB. You can consider this ratio when you set buffer size to any value. For example, if you set buffer size to 2 GB, the system programs the first board for $(2 \cdot 2) / 6$ GB and the second board for $(2 \cdot 4) / 6$ GB. Any unit that has more memory will have larger buffer size.

Cascading with STX SYNC Expansion Cards

You can use cascading of analyzer units for higher port count, by daisy chaining the units through the provided Expansion and Clock In/Out interfaces on the analyzer front. Connect “Out” connectors to “In” connectors of the next unit in the chain, for both Signal and Clock interfaces. You must provide external hubs for connecting the host PC to these units using USB or Ethernet. You can cascade up to eight units.

If you mix Sierra M6-4, Sierra M6-2, and STX A6-4 analyzers/emulators, put Sierra boards first, then STX.

Note: Because chain connections for cascading boards cause delay of signals, traffic on different boards is not completely time synchronized, with about one DWORD difference between consecutive boxes.

Cascading

To set up the units in a cascade:

1. Connect all units to the Host PC using either USB or Ethernet cables. You can use hubs.
2. Locate the Expansion and Clock ports on the front of each unit.

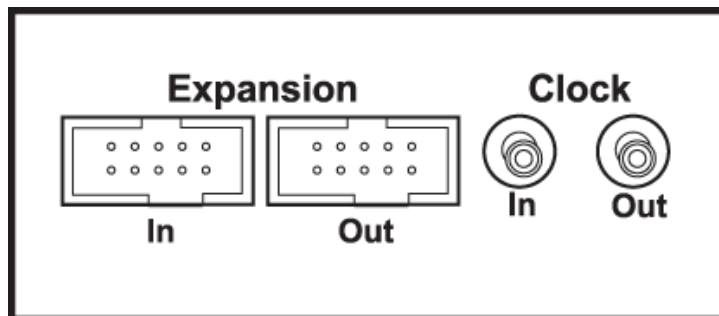

Figure 1.9: Expansion and Clock Ports on Front Panel

3. Connect the OUT Clock connector of Unit 1 to the IN Clock connector of Unit 2 using the supplied stacking cables. Similarly connect any additional units.
4. Connect the OUT 10-pin connector of Unit 1 to the IN 10-pin connector of Unit 2 using the supplied stacking cables. Similarly connect any additional units.

Note: Unit 1 must be the unit that has the first out connection

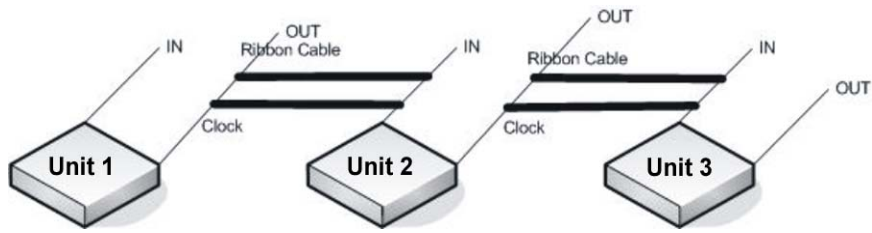
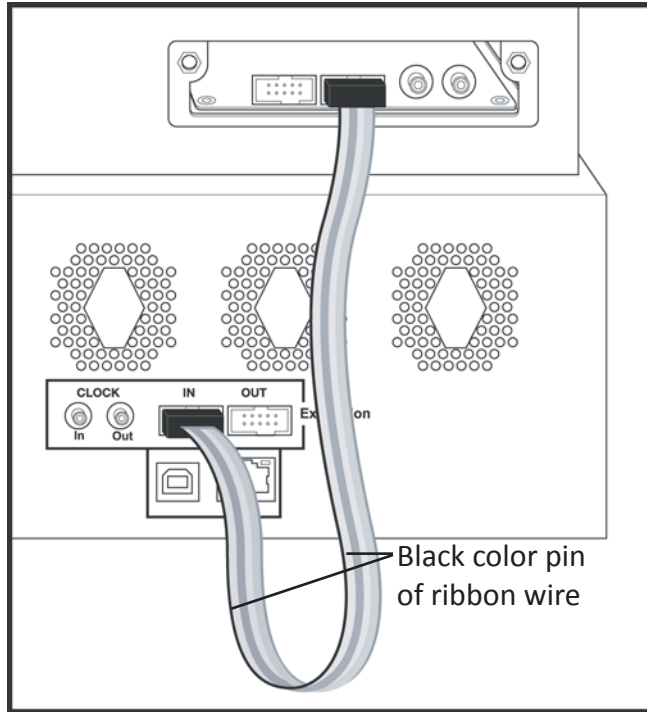

Figure 1.10: Cascading



Correct way to connect:
The black color pin of the ribbon wire is connected the same way between 2 connectors.

Cascading works correctly in this case.

Figure 1.11: Cascading Correctly

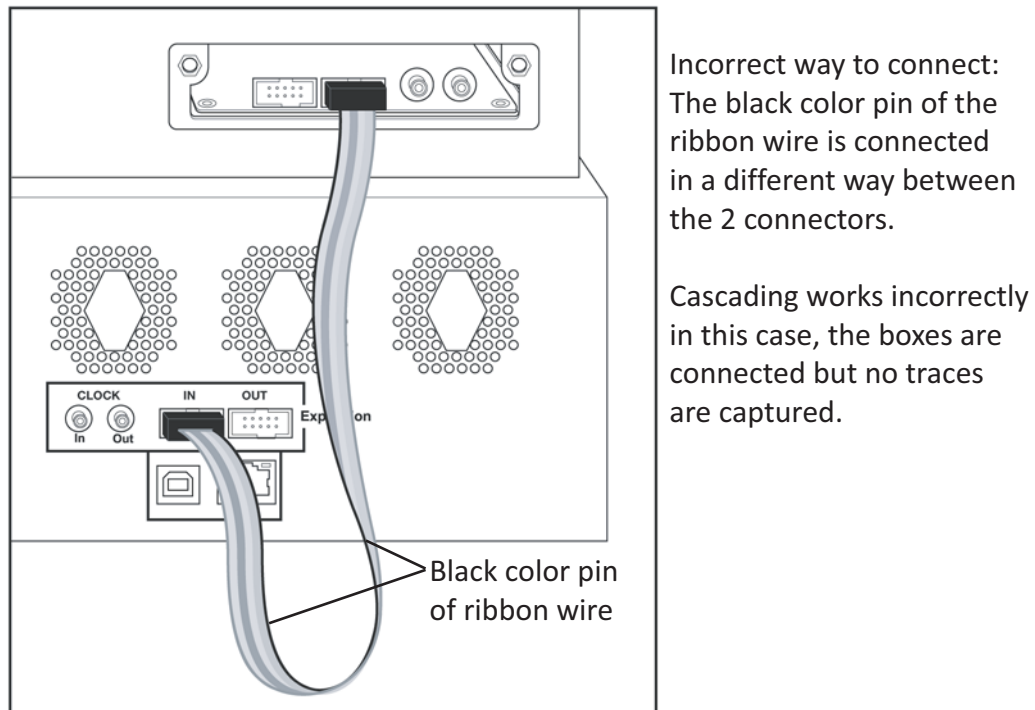

Figure 1.12: Cascading Wrongly

5. Make a note of the last four digits of the MAC address of the unit designated as Unit 1 and the last four digits of the other units, in order of connection.

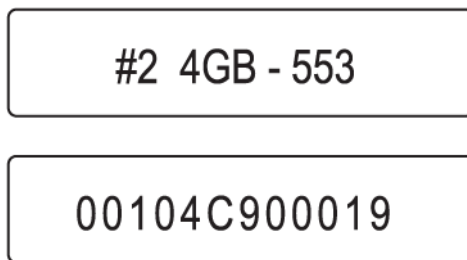

Figure 1.13: Address Digits

Important! Power up all units before starting the software.

Select Device

After starting the software, click on **Setup** and select **All Connected Devices** (see the following screen capture).

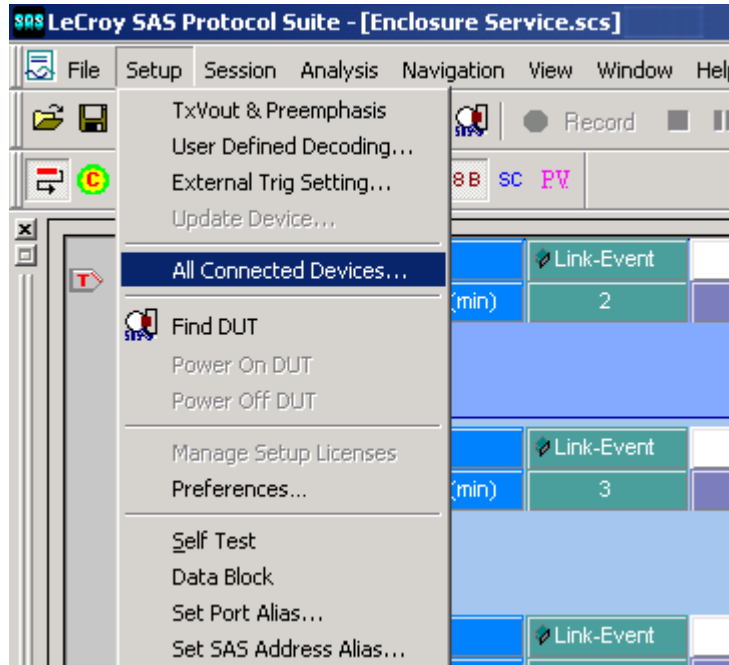

Figure 1.14: Connecting to All SAS Device(s)

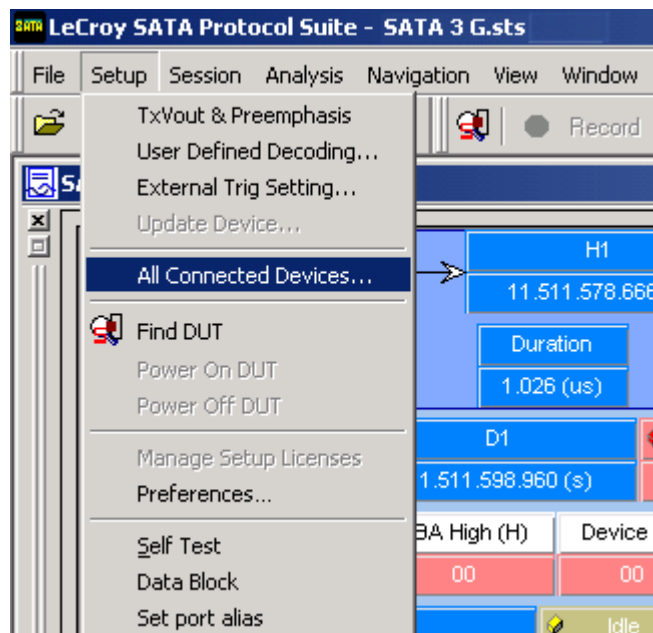

Figure 1.15: Connecting to All SATA Device(s)

The **Select Device** dialog allows connecting and disconnecting analyzers on the fly, without restarting the application.

The new Device List (introduced in version 4.10) mandates using updated firmware in order to detect the analyzer over Ethernet. Thus, the analyzer must be updated over USB before it can be used remotely over Ethernet. This is applicable for any update from version 4.00 or earlier to any version from 4.10 or later.

The following **Select Device** dialog displays. The colors in the 'Location' column mean the following:

- Red: Firmware and/or BusEngine components need to be updated to the latest version
- Light Blue: The device is ready to be connected.
- Yellow: The device is locked.
- Green: The software is connected and ready to run.

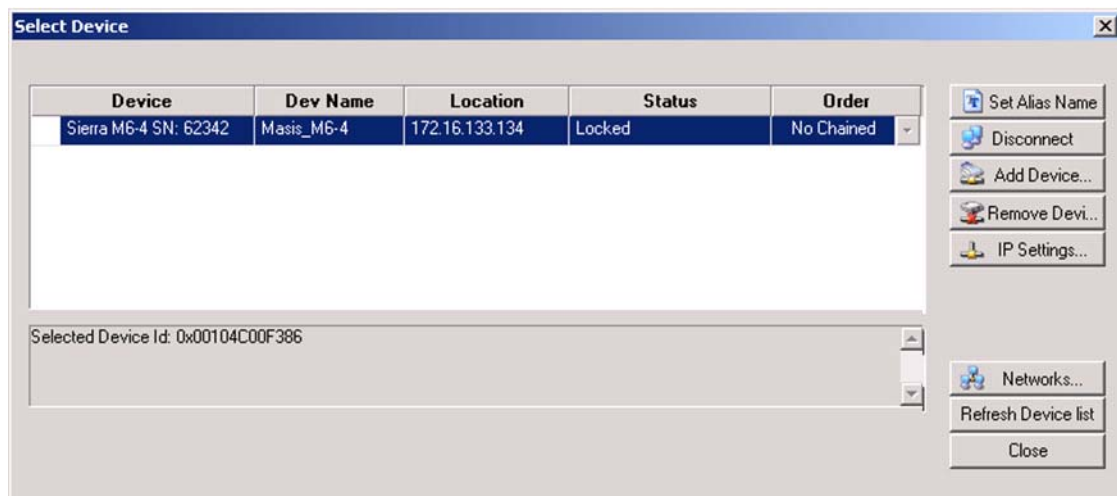

Figure 1.16: Select Device Dialog

Note: Click **Refresh Device List** to display all the devices on the network.

The Select Device dialog displays the following buttons:

Set Alias Name

Click **Set Alias Name** to display the Set device alias name dialog as shown below.

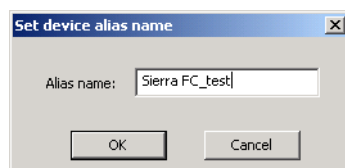

Figure 1.17: Set Device Alias Name Dialog

Disconnect

Click **Disconnect** to disconnect a device.

Add Device...

Click **Add Device** to add a device with a static IP address.

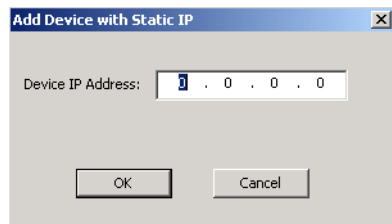

Figure 1.18: Add Device with Static IP Dialog

Remove Device

Click **Remove Device** to remove a previously added device.

IP Settings...

Click **IP Setting** to reset IP settings of a device. The following IP Setting dialog displays.

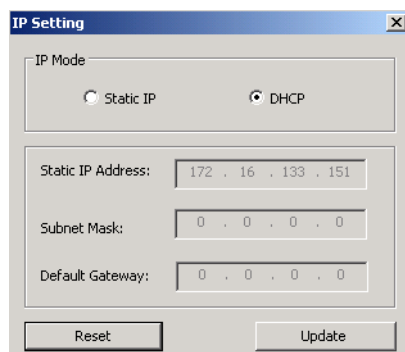

Figure 1.19: IP Setting Dialog

Networks...

Click **Networks** to select a network adapter. The following dialog displays.

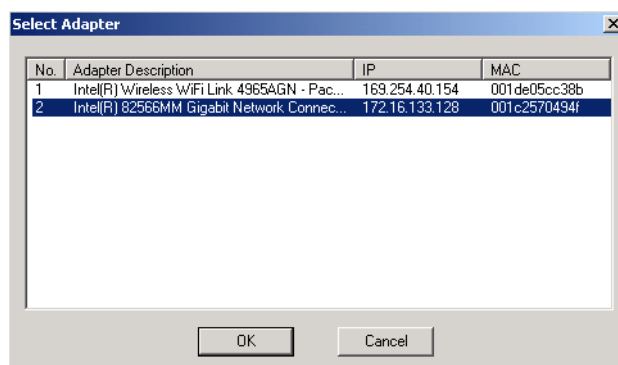

Figure 1.20: Select Adapter Dialog

Refresh Device List

Click **Refresh Device List** to refresh the device list.

To connect to a device, select a device which is Ready to Connect and click the **Connect** button on the right. The Connection Properties dialog is displayed (see the following screen capture).

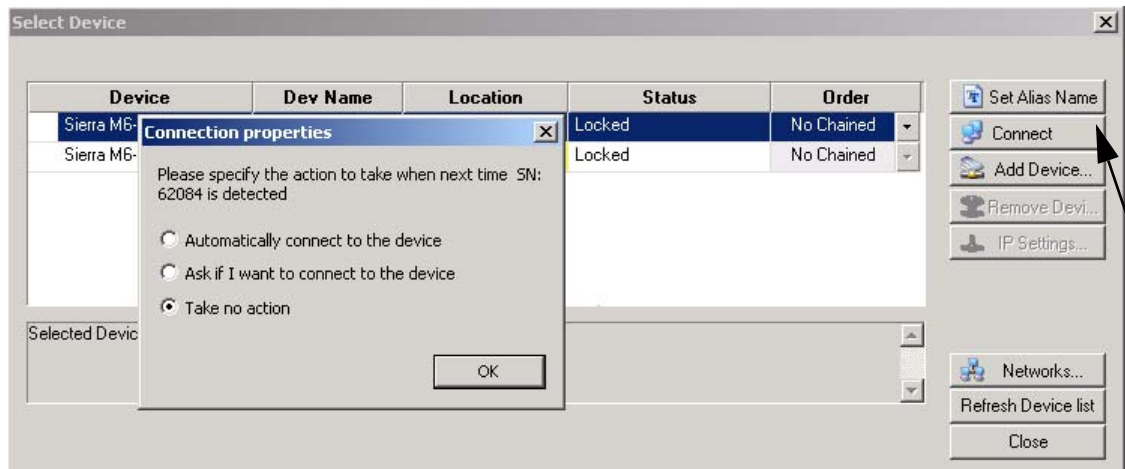

Figure 1.21: Connection Properties Dialog

Specify one of the actions from the following:

- Automatically connect to the device
- Ask if I want to connect to the device
- Take no action

If 'Automatically connect to the device' is selected, the next time the application opens the device will be automatically connected.

In the **Select Device** dialog chained or cascaded units are displayed in the **Device** column with a [(square bracket) icon. The sequence of the units is displayed in the **Order** column. See the following screen capture.

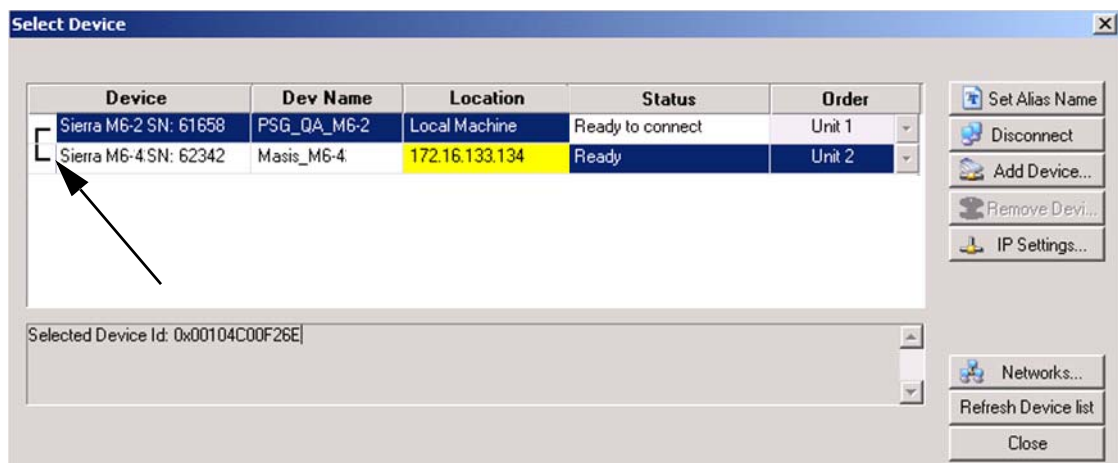

Figure 1.22: Select Device Dialog Displaying Unit 1 and Unit 2 Chained

Note: When using STX Sync cards, you need to manually specify the order of the chained units. To match your unit sequence to the address for each unit in the Select Device dialog, click the pull down tab under the Order heading (on the right side) and select unit numbers: 1 for Unit 1, 2 for Unit 2, and so on. This determines the order in which the cascaded ports appear in the trace. When using the CATC Sync cards the order is automatically detected.

IMPORTANT! Power up all units before starting the software.

Cascading with CATC SYNC Expansion Cards

You can cascade up to eight Sierra Analyzers, if they all have a CATC SYNC expansion card.

Note: If Sierra M6-4 has a CATC SYNC Expansion Card, you can cascade with Sierra M6-1. If Sierra M6-4 has an STX SYNC Expansion Card, you cannot cascade with Sierra M6-1.

Using the Power Expansion Card

You can use the Power Expansion Card to power the drives to test for Emulation, SATA Compliance, and SAS Verification. The Power Expansion Card can supply 5 V or 12 V.

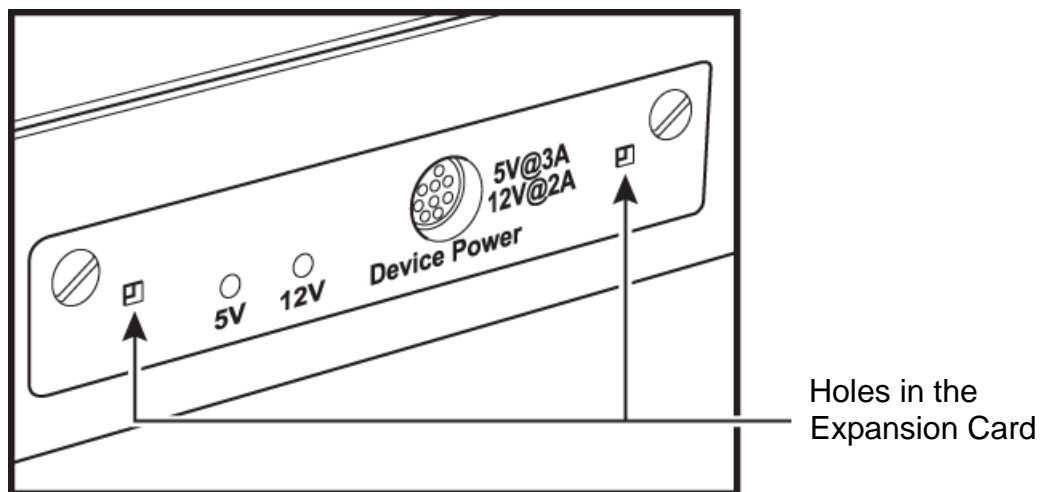

You can turn the card on or off through the software during SATA Compliance and SAS Verification tests.

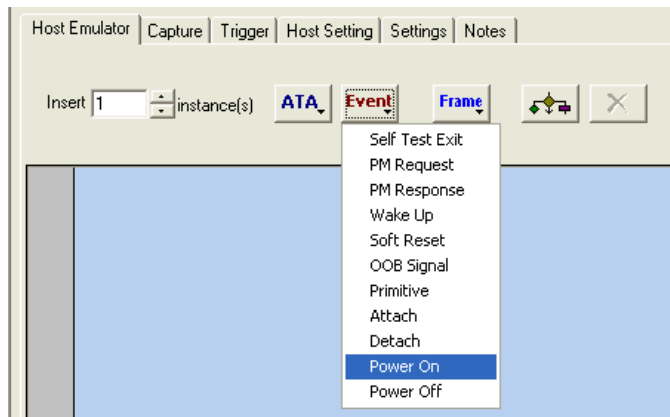

You can turn the card on or off through the BusEngine by user-emulation scripts during Emulation.

Removing Expansion Cards

You can remove expansion cards using two tools:

- Standard (flat blade) 3/16" screwdriver
- LeCroy Extraction Tool (part number 230-0160-00)

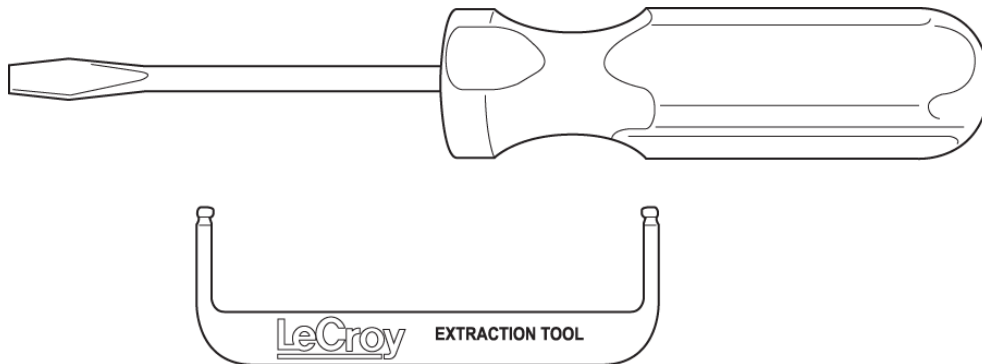

To remove an expansion card, follow these steps:

1. Unplug the system from AC power and turn the system so the expansion port is facing you. Note the two retaining screws and the holes for the extraction tool that are located on the panel of the expansion card.

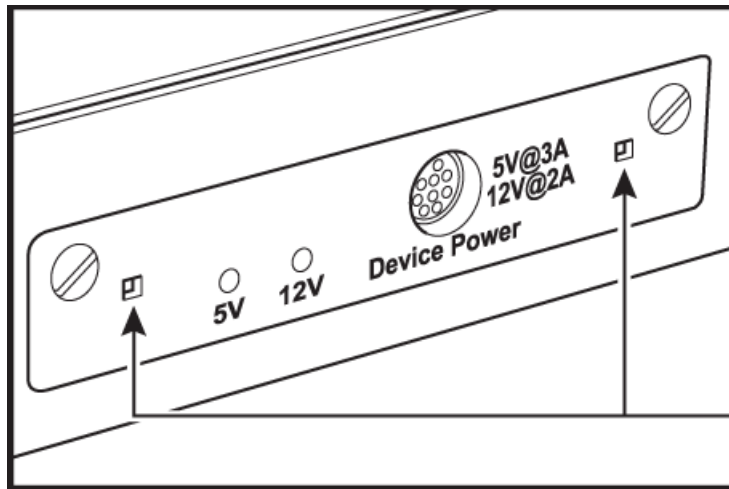

Holes in the
Expansion Card

2. Insert the extraction-tool prongs into the holes in the expansion card panel.

Note: If the prongs do not slip easily into the holes, use a small nail file or similar device to remove paint from the prongs.

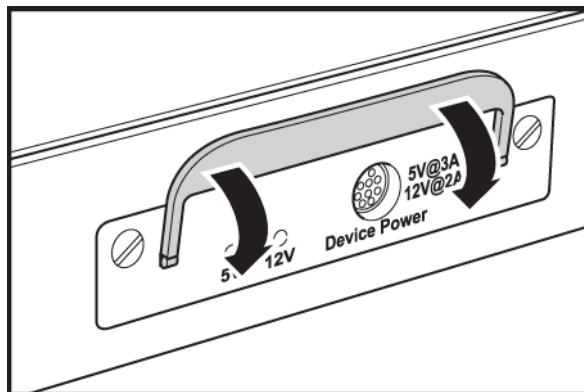

3. Rotate the extraction tool to a horizontal position to lock the prongs into place and make a handle.

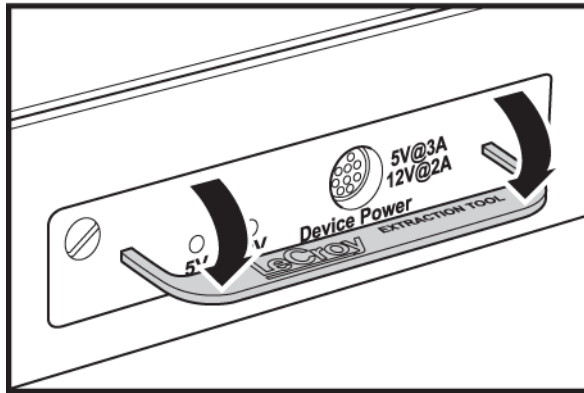

4. Using the screwdriver, loosen both retaining screws by rotating them counter-clockwise approximately two full turns, until feeling slight resistance. **Do not force the retaining screws** after two turns.

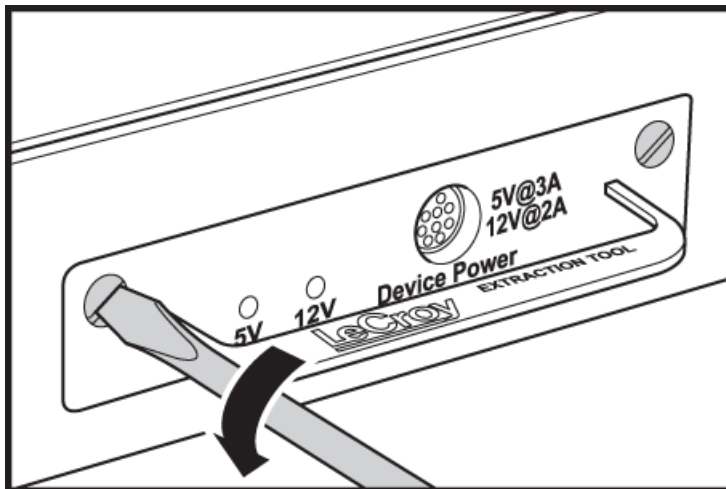

5. Using the extraction tool as a handle, gently wriggle the expansion card forward about 1/8".

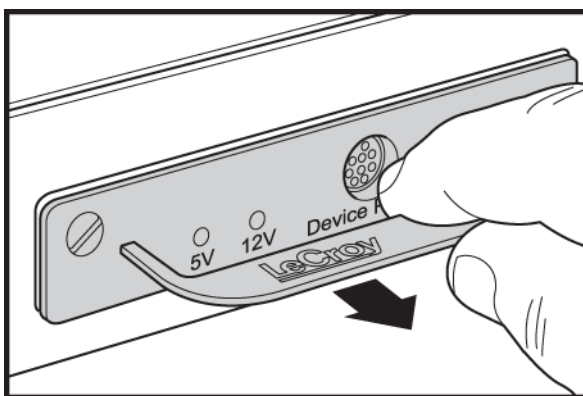

6. Repeat steps 4 and 5 approximately three times, until the card is free from the retaining screws and you can remove the card from the system.

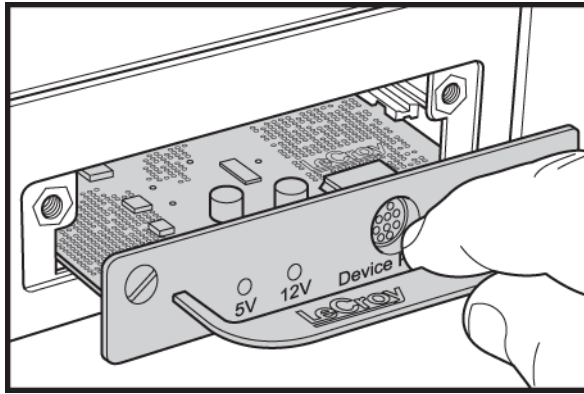

Connecting via Ethernet

The Ethernet connection can have any of these configurations:

1. Analyzer connected to a network using a hub or switch, Gigabit Ethernet interface, or similar device.
2. Analyzer connected to the host computer (machine running the application software), using a hub or switch, Gigabit Ethernet interface, or similar device.
3. Analyzer connected directly to the host computer using a crossover cable.

Connecting to a Network

When connected to a network, the analyzer can communicate with the DHCP server to obtain IP address configuration information in order to establish a connection. Refer to [“Select Device” on page 27](#).

Connecting over Different Subnets

If the Host PC (with the Sierra software) and Sierra M6-4 are on the same subnet, they will see each other's broadcasts, and the Sierra M6-4 application will automatically appear in the Select Device dialog, from which you can select a device (as described in the previous section).

If the Host PC and Sierra M6-4 do not reside on the same subnet, they will not see each other automatically. You must add the Sierra M6-4 IP address manually. To add the IP address, use the Add Device button (see [Figure 1.18 on page 29](#))

TCP and UDP Ports Must be Open to Connect over Ethernet

WARNING: Check your firewall settings before making Ethernet connections. Incorrect firewall settings can prevent LeCroy applications from detecting analyzers on the network, though Ping works correctly. Consult your Firewall documentation to allow LeCroy applications access to the network.

The following TCP and UDP ports must be open to connect over the Ethernet:

- ❑ **TCP Port:** 4000 to 4003
- ❑ **UDP Ports:** 4015 to 4017

Launching Your Analyzer

To launch the software, double-click the **SAS** or **SATA** Icon in the Program Manager Window.

Operating in Simulation Mode

The SAS/SATA applications operate in the Simulation Mode by default if the hardware is not detected.

The Analyzer software launches and displays the appropriate tool bar, but with the limitation that the Analyzer operates only on static, previously captured, bus data.

Limitations The Simulation mode lets you try all of the available functions, but keep in mind that the system is not capturing any real data and is displaying only pre-captured results.

Using the Software

The Sierra M6-4 application has the LeCroy SAS Protocol Suite and the LeCroy SATA Protocol Suite.

The LeCroy SAS Protocol Suite can be a:

- ❑ **Protocol Analyzer:** Captures data, triggers on events, and saves. **Easy Mode** allows standard Trigger and Data capture. **Advanced Mode** allows you to program custom triggering in and out, capturing, state jumps, and timers (see [“Protocol Analysis” on page 49](#)).
- ❑ **Jammer:** The InFusion™ Error Injector and Traffic Modifier is an error injector and traffic modification tool that allows you to verify real-world fault handling (see [“InFusion Overview” on page 321](#)).
- ❑ **Protocol Analyzer Initiator Emulator:** Generates bus traffic for capture. It also has Easy Mode and Advanced Mode (see [“Exercise and Capture” on page 120](#)).
- ❑ **Target Emulator:** Acts as target (see [“Target and Device Emulation” on page 170](#)).

The LeCroy SATA Protocol Suite can be a:

- ❑ **Protocol Analyzer:** Captures data, triggers on events, and saves. **Easy Mode** allows standard Trigger and Data capture. **Advanced Mode** allows you to program custom triggering in and out, capturing, state jumps, and timers (see [“Protocol Analysis” on page 49](#)).
- ❑ **Jammer:** The InFusion™ Error Injector and Traffic Modifier is an error injector and traffic modification tool that allows you to verify real-world fault handling (see [“InFusion Overview” on page 321](#)).
- ❑ **Protocol Analyzer Host Emulator:** Generates bus traffic for capture. It also has Easy Mode and Advanced Mode (see [“Exercise and Capture” on page 120](#)).
- ❑ **Device Emulator:** Acts as device (see [“Target and Device Emulation” on page 170](#)).

Getting Started with the Protocol Analyzer

To use the software for protocol analysis, first select **File > New > Protocol Analyzer** for a new project or **File > Open** an existing protocol analysis file: **.sac** for a SAS file or **.stc** for a SATA file (see [“Protocol Analysis” on page 49](#)). You can also open a **.scs** SAS Sample file or **.sts** SATA Sample file. Example files are in the Examples folder. You can also use **Project Setup > Last Protocol Analyzer**.

On the Capture tab, select to capture **Everything** or **Pattern**. For Pattern, select a Pattern. You can exclude patterns and frames. You can use different patterns for pre-trigger and post-trigger.

On the Trigger tab, select the trigger type. For Pattern, select the pattern.

On the Settings tab, select trigger position and memory use.

Change the Analyzer settings if necessary. Change the port Speed if necessary.

Use Advanced Mode only after you become familiar with the hardware and software and have special needs.

Protocol Analyzer Initiator Emulator or Host Emulator

To use the software for protocol analysis to generate host traffic, first select **File > New > Protocol Analyzer Initiator Emulation** or **Protocol Analyzer Host Emulation** for a new project or **File > Open** an existing Pattern Generator file: **.spg** for a single-role file (see [“Exercise and Capture” on page 120](#)).

In Easy Mode, on the Initiator Emulator or Host Emulator tab, insert instances of ATA, SCSI, TASK, SMP, Frame, or Event. Select the type of each from the drop-down lists. You can also loop, go to, wait, delay, if...then, and stop.

In Easy Mode, on the Capture tab, select to capture **Everything** or **Pattern**. For Pattern, select a Pattern. You can exclude patterns and frames. You can use different patterns for pre-trigger and post-trigger.

In Easy Mode, on the Trigger tab, select the trigger type. For Pattern, select the pattern.

In Easy Mode, on the Initiator Setting or Host Setting tab, select the port and speed. Select to run the Pattern Generator or Initiator Emulator or Host Emulator.

In Easy Mode, on the Settings tab, select trigger position and memory use. Also change the Analyzer settings if necessary. Specify addresses, stops, times, and sizes, if necessary.

Use Advanced Mode only after you become familiar with the hardware and software and have special needs.

Performance Analyzer

To do a Performance Analysis, select **File > New > Performance Analyzer**. Choose settings in the Performance Analysis dialog. Click Run Hardware (see [“Performance Analysis” on page 164](#).)

Target Emulator or Device Emulator

To use the software as a target or device emulator, first select **File > New > Target Emulator** or **Device Emulator** for a new project or **File > Open** an existing Emulator file: **.std** Target Emulator file or **.sde** Device Emulator file (see [“Target and Device Emulation” on page 170](#)). You can also use **Project Setup > Last Target Emulator** or **Last Device Emulator**.

In the Pages tab, change settings for the supported pages if necessary.

In the Error Injection tab, select General periodic errors, Identify frames, Connection Management open and close connection errors, SAS Commands and events errors, ATA Commands errors, or SATA Signature content.

Use the User-defined Commands tab only after you have become familiar with operations.

In the Settings tab, select addresses, sizes, times, and ports, if necessary.

You can capture traffic when using an Analyzer project (but not a Target Emulator project). With a Protocol Analyzer open, open a **Target Emulator**. After checking the settings, click the **Activate/Deactivate (Active)** device button. or select **Project Setup > Active Device**. If you change Target Emulator settings, **Deactivate** and then **Activate Device**.

LeCroy SAS and SATA Protocol Suite Menu Options and Toolbars

This section lists all the SAS and SATA Protocol Suite application menu options and the toolbars.

File

The File menu options allows you to perform common tasks such as open, close, save, export, print, send files and exit the application (see Figure 1.23).

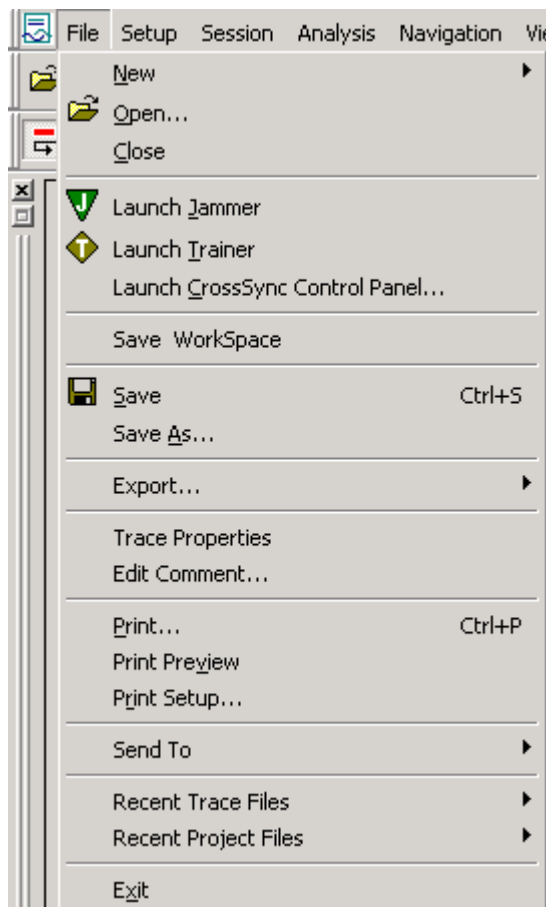

Figure 1.23: File Menu Option

Setup

For special work, you can use the Setup menu (see the following figure) to perform the following actions:

- Configure TxVout & Pre-emphasis (see [“Tx Vout & Preemphasis”](#) on page 290)
- User Defined Decoding (see [“User-Defined Decoding”](#) on page 304)
- External Trig Setting (see [“External Trig Setting”](#) on page 302)
- Update Device (see [“Update Device”](#) on page 303)
- All Connected Devices (see [“Select Device”](#) on page 27)
- Find and Power On/Off DUT (see [“Find DUT”](#) on page 316)
- Manage Setup Licences (see [“Floating License”](#) on page 301)
- Set Preferences (see [“Software Settings”](#) on page 291)
- Perform a Self Test (see [“Self Test”](#) on page 308)
- Creating a Data Block (see [“Data Blocks”](#) on page 134)
- Set Port Alias (see [“Set Port Alias”](#) on page 288)
- Set SAS Address Alias (see [“SAS Address Alias \(SAS only\)”](#) on page 289)

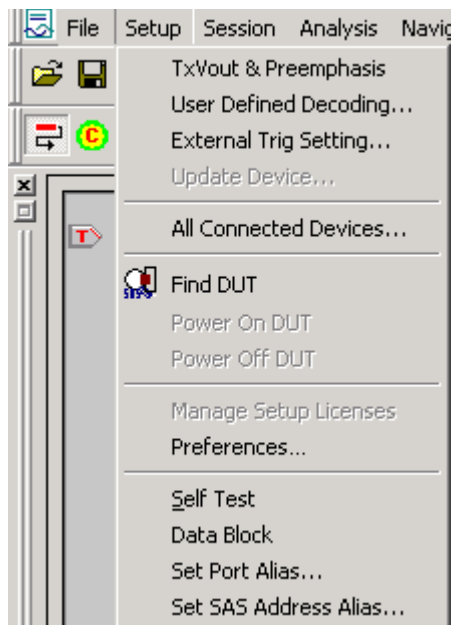

Figure 1.24: Setup Menu Option

Session

The Session menu has the following options:

- Start Capture/Record - Start capture or record a trace
- Pause Capture/Record - Aborts the capture without saving
- Stop Capture/Record - Stops the hardware
- Start Target Emulator - Starts the target emulator (SAS)
- Stop Target Emulator - Stops the target emulator (SAS)
- Start Device Emulator - Starts the device emulator (SATA)
- Stop Device Emulator - Stops the device emulator (SATA)

Analysis

The Analysis menu allows you to view captured data (see the following screen capture).

Menu items and toolbar options enabled and/or displayed are based on the type of window open. The following types of windows can be displayed:

- No active window
- Project file open
- Trace file open

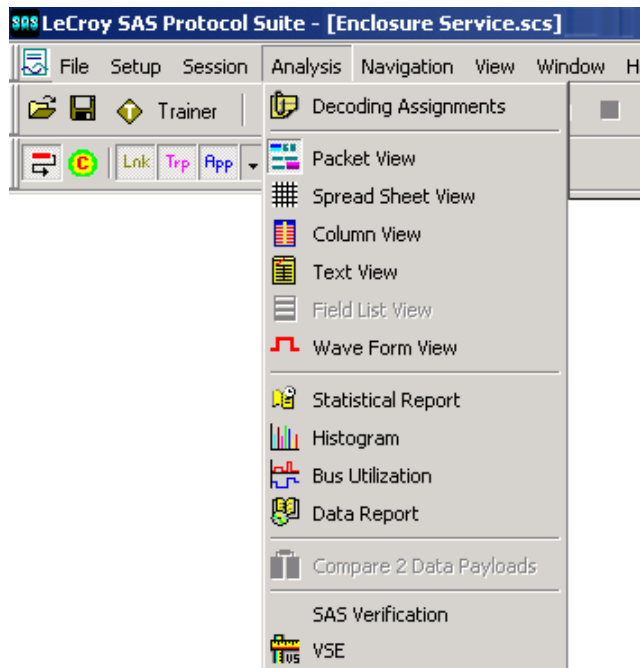

Figure 1.25: SAS Analysis Menu

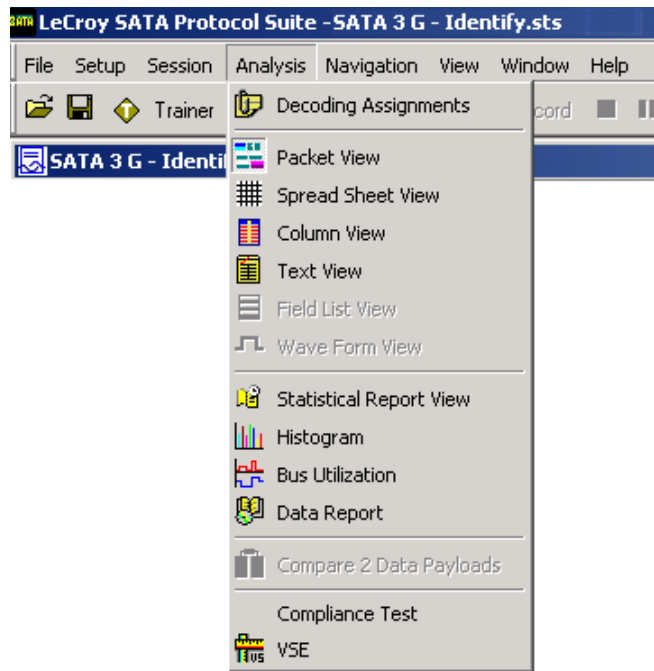

Figure 1.26: SATA Analysis Menu

Viewing Captured Data

After data capture, you can view the captured data in the Viewer by selecting **Analysis** see ("[Analysis](#)" on page 204). You can display the same data in:

- Packet View:** Displays packets
- Spreadsheet View:** Displays Packet View fields by time
- Column View:** Shows DWORDs in columns by port
- Text View:** Shows transaction frames, grouped in columns by port
- Field List View:** Displays field information in a list format
- Waveform Display:** Shows waveform display for all active ports, on which you can perform timing measurements
- Statistical Report:** generate statistics for all transports, commands, primitives, bus conditions, addresses, lanes, and errors
- Histogram View:** Shows frame-type transfers
- Bus Utilization:** Displays the utilization of the bus
- Data Reports:** Displays data payloads
- Compare 2 Data Payloads:** Compare two data payloads
- SAS Verification:** Verifies compliance with the SAS specification
- VSE:** Perform custom post-process analysis of the open trace by running a verification script over the trace

Navigation

The Navigation menu has the following options to navigate through the application (see the following screen capture).

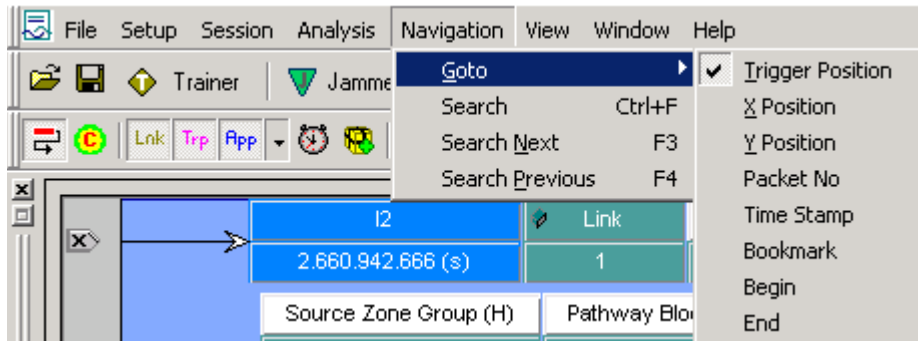

Figure 1.27: Navigation Menu Option

- Goto
 - Trigger Position
 - X Position
 - Y Position
 - Packet No
 - Time Stamp
 - Bookmark
 - Begin
 - End
- Search
- Search Next
- Search Previous

View

The View menu options allows the user to zoom in and out, enable/disable filtering and toolbars among other actions. It has the following options.

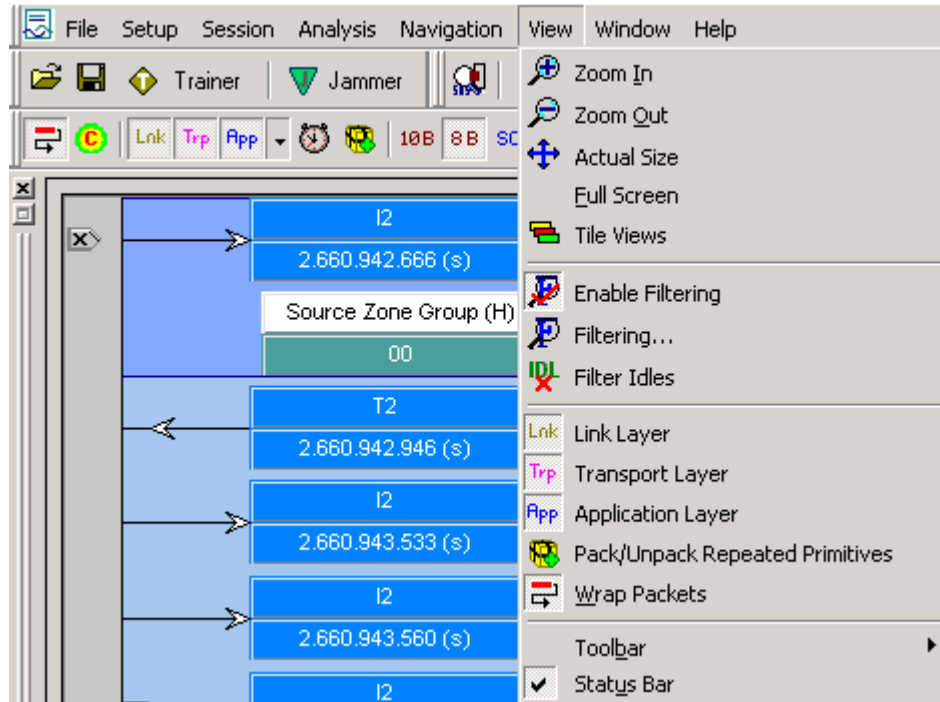

Figure 1.28: View Menu Option

- Zoom In (refer to “Navigation + View Toolbar” on page 251)
- Zoom Out (refer to “Navigation + View Toolbar” on page 251)
- Actual Size (refer to “Navigation + View Toolbar” on page 251)
- Full Screen (refer to “Navigation + View Toolbar” on page 251)
- Tile Views (refer to “Navigation + View Toolbar” on page 251))
- Enable Filtering (refer to “Filter Setup” on page 257)
- Filtering (refer to “Filter Setup” on page 257)
- Filter Idles (refer to “Filter Setup” on page 257)
- Link Layer-SAS only (refer to “Packet View Toolbar” on page 272)
- Transport Layer-SAS only (refer to “Packet View Toolbar” on page 272)
- Application Layer-SAS only (refer to “Packet View Toolbar” on page 272)
- Pack/Unpack Repeated Primitives-SAS only (refer to “Packet View Toolbar” on page 272)
- Physical Layer-SATA only (refer to “Packet View Toolbar” on page 272)
- FIS Layer-SATA only (refer to “Packet View Toolbar” on page 272)
- Command Layer-SATA only (refer to “Packet View Toolbar” on page 272)
- Wrap Packets (refer to (refer to “Packet View Toolbar” on page 272))

- Toolbar (allows you to customize the toolbar with the options given below)
 - Main
 - Record+Capture
 - Analysis
 - Navigation+View
 - Column View
 - Cursor position
 - Target Emulator
- Status Bar (refer to [“Cursor Position Status Bar”](#) on page 282)

Window

The Window menu has the following options:

- Cascade:** Displays all open windows in an overlapping arrangement.
- Tile Horizontal:** Displays all open windows in a above-below arrangement.
- Tile Vertical:** Displays all open windows in a side-by-side arrangement.
- Arrange Icons:** Arranges minimized windows at the bottom of the display.
- Close All:** Closes all windows.

Help

For more information see [“Help Menu”](#) on page 306.

Toolbars

The toolbars enable you to perform several actions, some of which are listed below.

- Show or hide fields and ports, change port names, and change data format.
- Show the layers and channels using their toolbars.
- Decode using the Decode toolbar.
- Search and Filter.

There are four sets of toolbars:

- Main Toolbar - For details on the Main Toolbar refer to [“SAS Main Toolbar”](#) on page 53 and [“SATA Main Toolbar”](#) on page 53.
- Record Capture Toolbar - For additional information see [“SAS Main Toolbar”](#) on page 53 and [“SATA Main Toolbar”](#) on page 53.
- Target/Device Emulator Toolbar - For additional information see [“SAS Main Toolbar”](#) on page 53 and [“SATA Main Toolbar”](#) on page 53.
- Navigation + View Toolbar - For additional information see [“Navigation + View Toolbar”](#) on page 251.
- Show Analysis Toolbar - For additional information see [“Show Analysis Toolbar”](#) on page 204.
- Packets View Toolbar - For additional information see [“Packet View Toolbar”](#) on page 272.

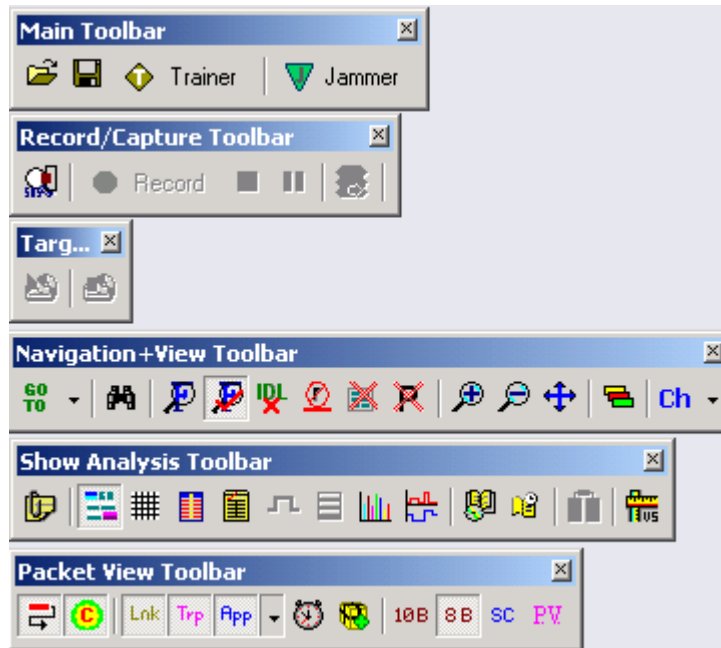

Figure 1.29: SAS/SATA Protocol Suite Toolbars

Port Status

You can display an overview of the active ports by clicking the buttons at the bottom right of the main window (see [“Port Status” on page 281](#)).

InFusion

The LeCroy InFusion™ Error Injector and Traffic Modifier is an error injector and traffic modification tool that allows you to verify real-world fault handling for Serial Attached SCSI (SAS) and Serial ATA (SATA) systems. Click on the Jammer icon

 Jammer to invoke the LeCroy SAS or SATA InFusion, see [“InFusion Overview” on page 321](#).

You can toggle between the InFusion and Analyzer panes by using the Alt+Tab keys, the Windows Task Bar or by pressing the respective toolbar button in each pane.

Trainer

SAS *Trainer* is a traffic generator that can emulate a SAS initiator/target or SATA host/device. Traffic generation enables engineers to test designs under realistic conditions and to transmit known errors, allowing engineers to observe how devices handle faulty link conditions.

Traffic generation is performed via the execution of text-based scripts. These traffic generation files (*.ssg) contain statements about the types of traffic to be generated. These script files can be edited with either a simple text editor such as Notepad or with the Script Editor utility provided by the application.

Click on the Trainer icon  to invoke the LeCroy SAS or SATA Trainer, see [“Sierra Trainer Traffic Generation” on page 387](#).

You can toggle between the Trainer and Analyzer panes by using the Alt+Tab keys, the Windows Task Bar or by pressing the respective toolbar button in each pane.

Chapter 2

Protocol Analysis

The system performs Protocol Analysis by defining and running an analysis project. An analysis project definition defines what to capture, what the analyzer triggers on, and the memory settings. You can save defined projects as project *.sac files for later use.

Easy Mode (Pre-Defined Setups)

After you install the Analyzer software (see [“Software Installation” on page 20](#)) and set up the Analyzer (see [“Hardware Setup” on page 21](#)), launch the Analyzer software (see [“Launching Your Analyzer” on page 36](#)) to display the default Protocol Analyzer in Easy Mode at the Capture tab.

This mode allows you to operate the analyzer with minimum setup. In this mode, you can perform only a Trigger and Data capture, or you can program the SAS Initiator Emulator or SATA Host Emulator to generate bus traffic for triggering and data capture.

Main Window

Use Easy Mode to get a comprehensive overview of your analyzer’s capabilities:

SAS: On the Analyzer Menu Bar, click **File > New > Protocol Analyzer** to open a SAS Protocol Analyzer dialog.

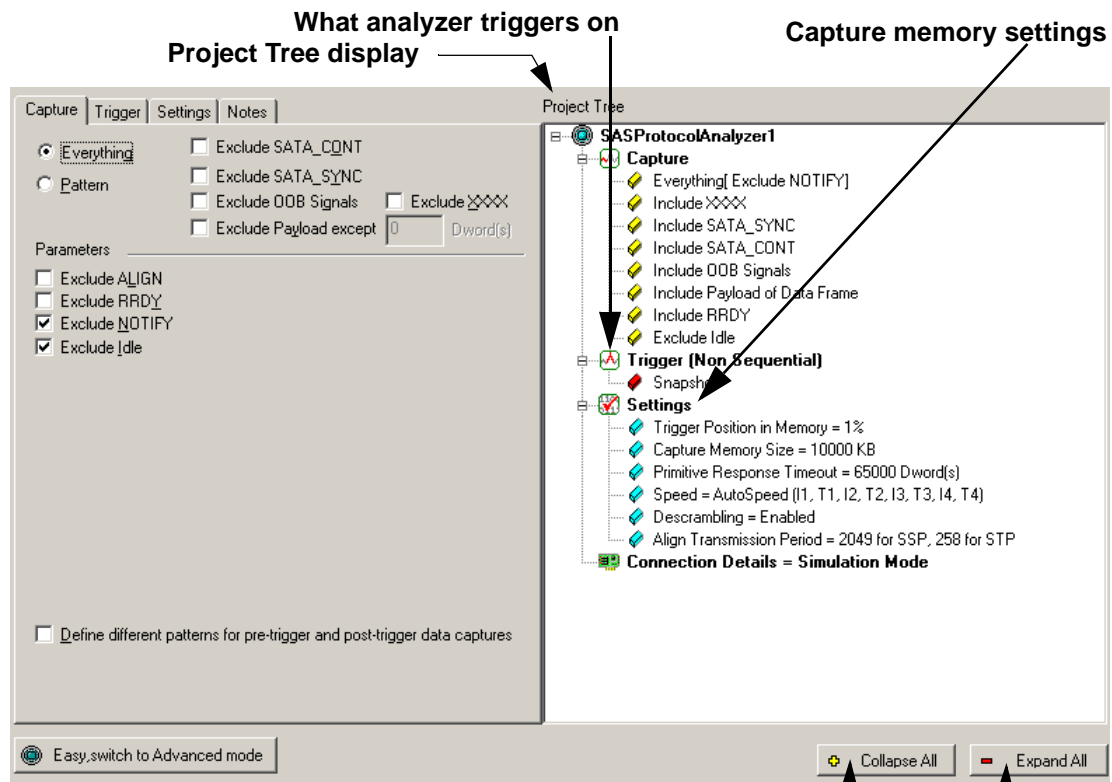

Collapse All button hides details in Project Tree
Expand All button expands collapsed Project Tree

Figure 2.1: SAS: New Analysis Project Dialog

The New Project dialog opens with default settings to capture Everything on the bus and to Trigger On on Snapshot. (The analyzer captures everything immediately without triggering on anything in particular.)

SATA: On the Analyzer Menu Bar, click **File > New > Protocol Analyzer** to open a SATA Protocol Analyzer dialog.

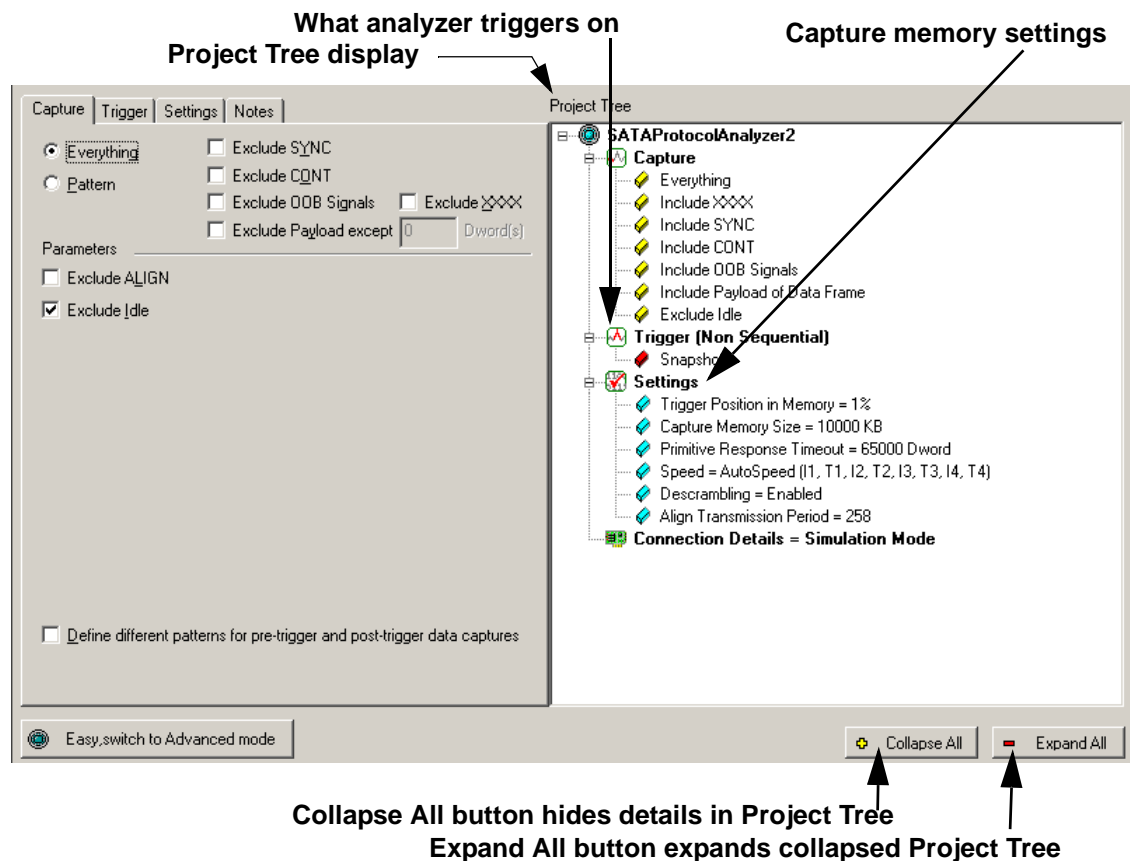

Figure 2.2: SATA: New Analysis Project Dialog

SAS vs. SATA: SATA Dialog does not show “Exclude RRDY” or “Exclude NOTIFY”. SATA Dialog replaces “Exclude SATA_CONT” with “Exclude CONT” and “Exclude SATA_SYNC” with “Exclude SYNC”.

Project Tree

The Project Tree on the right side of the main window displays a comprehensive tree structured overview of the project. The project tree shows what to capture, on what the analyzer triggers, and the capture memory settings.

Capture Tab Fields

The Capture tab has the following fields:

Exclude SATA_CONT (SAS) or Exclude CONT (SATA)

Check this to exclude SATA_CONT primitives from the data capture.

Exclude SATA_SYNC (SAS) or Exclude SYNC (SATA)

Check this to exclude SATA_SYNC primitives from the data capture.

Exclude OOB Signals

Check this to exclude OOB signals from the data capture.

Exclude XXXX

Check this to exclude XXXX patterns from the data capture.

Note: The validity of time stamps during Idles is traded off against good buffer memory utilization when using 'Exclude XXXX'.

Exclude Payload except

Check this to exclude Payload of Data Frames from the data capture. You can except a number of DWORD(s).

Note: The Data Report does not reflect excluded Payload of Data Frames.

Note: When showing truncated data in the Data Payload View, the truncation points are marked with a separator placed between payloads. You can get more information about the data exclusion using the tooltip over the separator.

Exclude ALIGN

Check this to exclude ALIGN primitives from the data capture.

Exclude RRDY (SAS only)

Check this to exclude RRDY primitives from the data capture.

Exclude NOTIFY (SAS only)

Check this to exclude NOTIFY primitives from the data capture.

Exclude Idle

Check this to exclude Idles from the data capture.

Define different patterns for pre-trigger and post-trigger data captures

Replaces the Capture tab with a Pre-Trigger Capture tab and a Post-Trigger Capture tab.

SAS/SATA Software Menus and Toolbars

The SAS and SATA software has the following menus and toolbars.

SAS Main Toolbar

The following figure displays the SAS main toolbar.

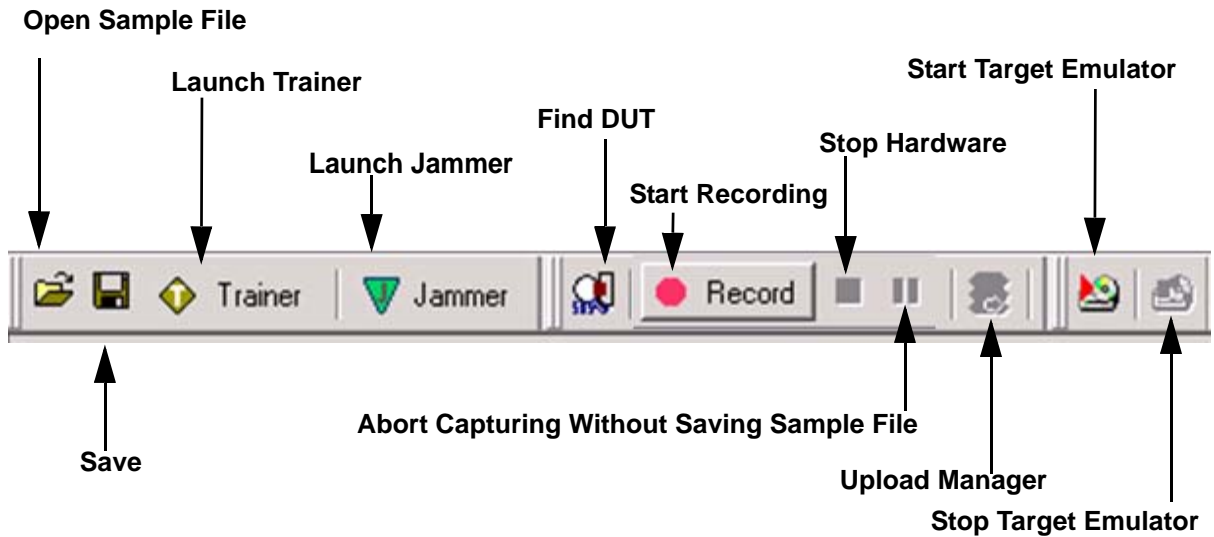

Figure 2.3: SAS: Software Menus and Toolbar

SATA Main Toolbar

The following figure displays the SATA main toolbar.

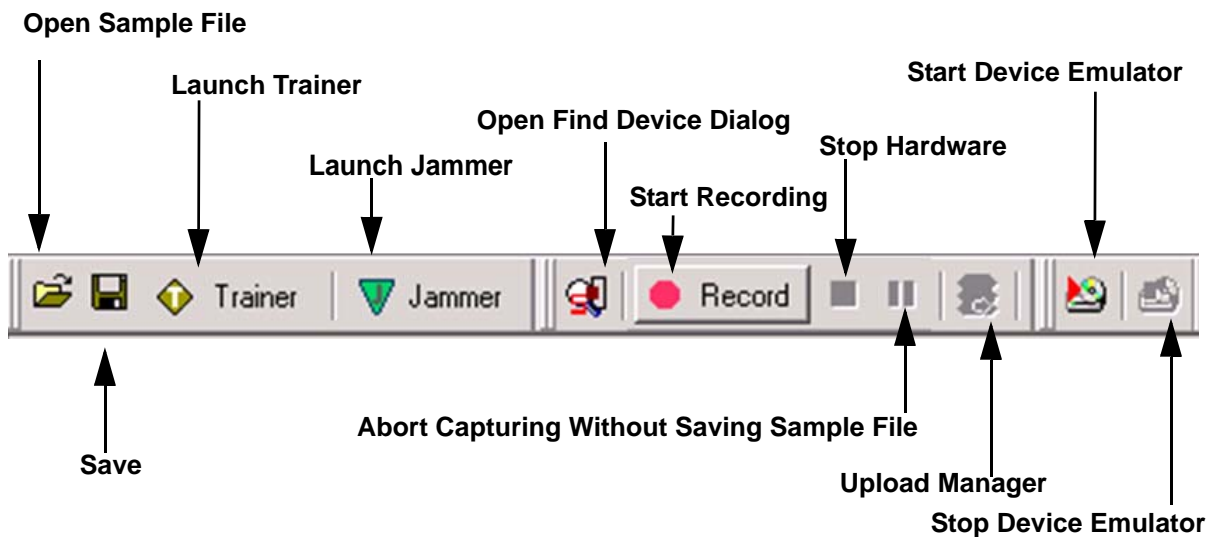



Figure 2.4: SATA: Software Menus and Toolbar

Run Hardware

To get an immediate overview of the bus traffic to and from your Analyzer:

1. Click the  **Record** button.
2. The analyzer begins filling the defined memory buffer with traffic on the bus. After the traffic fills the memory buffer, the traffic is uploaded to the viewer and the Packet View display opens. Packet View is the default display. However, you can view results in any of the different views by selecting **View** on the menu bar and choosing the desired View.

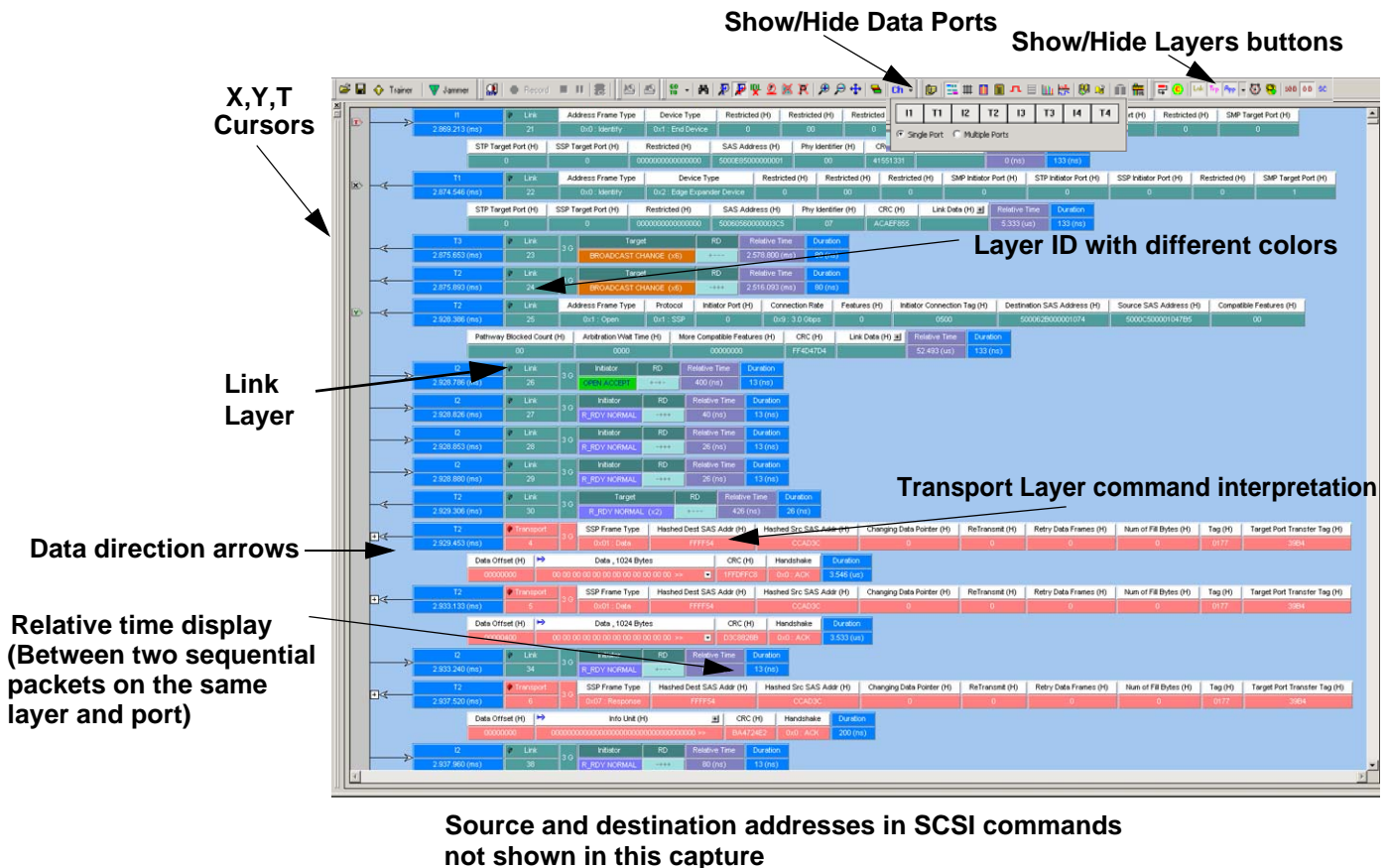

Figure 2.5: SAS: Typical Packet View Results Display

Note: When using the Advanced Mode sequencer, the analyzer logs the state transitions in the trace, with the name the user gives to the state.

In the Packet View, right-click on any packet and select **Show->State**, to display these states and their transitions in the trace.

SAS: In case of an STP interface, the expander displays STP addresses provided to the SATA drive and the SAS software integrates the STP addresses in the ATA command.

The results display shows each transaction for every layer identified in a different color and the data direction identified with data direction arrows. Upstream traffic has an arrow from right to left: ←. Downstream traffic has an arrow left to right: ⇒.

You can hide any layer by clicking the corresponding **Show/Hide** button on the menu bar. The system retains all captured data, but the display has only some data layers for simpler viewing.

You can configure the viewer display for test and viewing preferences (see [“Viewer Display” on page 201](#) for details about configuring the viewer display).

The Analysis Project dialog offers you a comprehensive set of choices to create a trigger and capture project satisfying some specific need. You can set the Analyzer to:

- Capture specific patterns (see [“Patterns and Data Capture Setup” on page 65](#)).
- Capture different patterns pre- and post-trigger.
- Exclude parameters from capture.
- Trigger on a pattern or sequence of patterns (see ["Trigger Setup" on page 79](#)).
- Configure trace capture memory (Settings tab).
- Select file to save trace capture in memory (Settings tab).
- Include a project note (Notes tab).

Launch Jammer

The Launch Jammer option invokes InFusion. For more information refer to [“InFusion Overview” on page 321](#).

Launch Trainer

The Launch Trainer option invokes Trainer. For more information refer to [“Sierra Trainer Traffic Generation” on page 387](#).

CrossSync Control Panel

The CrossSync Control Panel allows you to select analyzers for synchronization and manage the recording process.

CrossSync is LeCroy’s analyzer synchronization solution that enables time-aligned display of protocol traffic from multiple daisy-chained analyzers showing packet traffic from multiple high-speed serial busses. A lightweight software control panel allows users to select analyzers for synchronization and manage the recording process. Captured traffic is displayed using the latest analyzer software (in separate windows) with all the protocol specific search and reporting features.

Captured packets are displayed in separate windows that share a common time scale. Navigating the traffic in either direction will scroll to the same timestamp in a synchronized window. When using the CrossSync option, users can access the full complement of analysis capabilities available within the individual LeCroy software. Search, reporting, and decoding all operate normally.

This feature is available with the LeCroy SAS/SATA Protocol Suite application.

Launching the CrossSync Control Panel

To launch CrossSync from the SAS/SATA Protocol Suite software application, click on **File** and select **Launch CrossSync Control Panel** (see the screens below). Or, you can launch CrossSync from the **'Start'** menu.

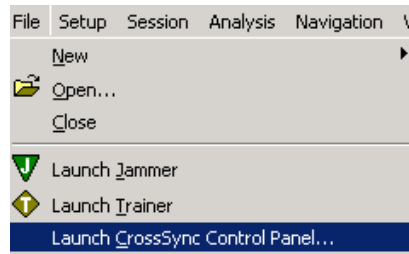

Figure 2.6: Launching CrossSync from the SAS Protocol Suite Application

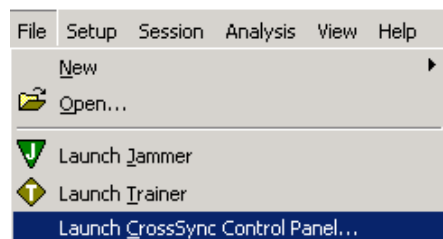

Figure 2.7: Launching CrossSync from the SATA Protocol Suite Application

Please refer to the ***CrossSync Control Panel User Manual*** for more information.

Save Workspace

The workspace **.wss** file sets viewing parameters.

After you open a trace and select views, you can save the viewing parameters in a workspace file. Select **File > Save Workspace** to open a Save As dialog. Save the current workspace as a **.wss** file.

To set a default workspace, select **Setup > Preferences > Software Settings** to open the Software Settings dialog. In the Default Workspace field, enter the path and name of a saved workspace **.wss** file.

After you open a trace, you can use a different workspace. Select **File > Open** to open another trace. Select a **.wss** file to open it.

Saving a Trace Capture

You can save a Trace Capture by selecting **Save** from the **File** menu, or select **Save As** to save as the trace capture for review at a later time using the following dialog.

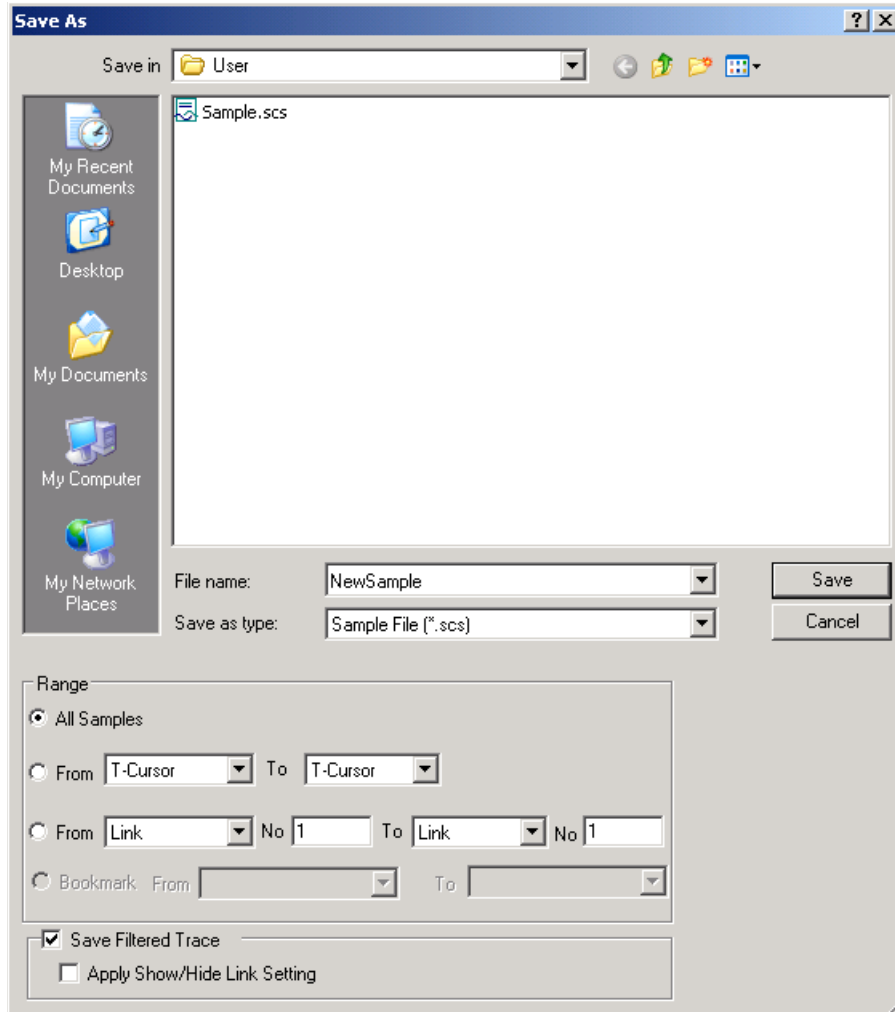

Figure 2.8: Save As Dialog

You can limit the range of the saved file. You can save:

- All Samples
- Range between selected cursors
- Range between selected Idle, link, commands
- Range between bookmarks

Save Filtered Trace checkbox saves a trace file without filtered data. You can **Apply Show/Hide Link Setting**.

Note: If you deselect a port using the buttons on the toolbar, and then save the trace, on reopening the trace the deselected port will still display if you select the **Save Filtered Trace** checkbox and then check **Apply Show/Hide Link Setting** in save as dialog.

Exporting

From the File menu, you can Export to Text/Excel, Export to Initiator Emulator, Export to Trainer, Export Read-Write Command Report, or Export Paired SAS Address Report.

Export to Text/Excel

From the File menu, you can export to Text/Excel, using the **Export to Text/Excel**. The **Save as Text** dialog displays.

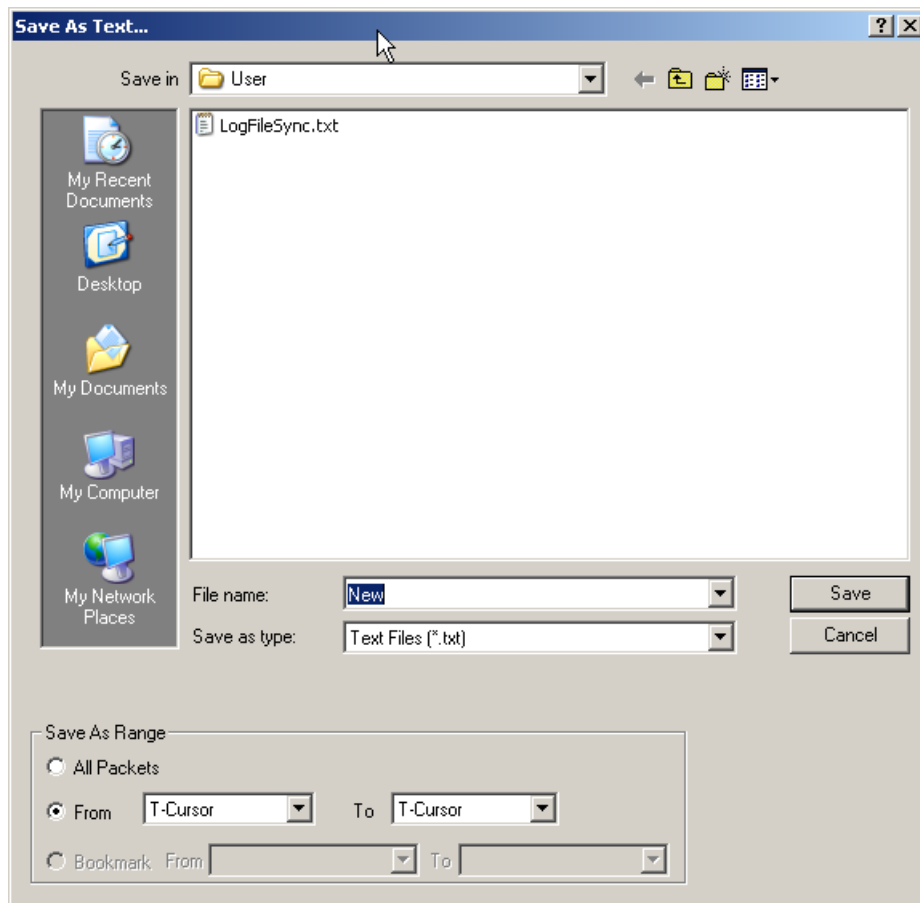

Figure 2.9: Save As Text Dialog

You can limit the range of the saved file. You can save:

- All Packets
- Range between selected cursors
- Range between bookmarks

Export to Initiator Emulator (SAS) or Host Emulator (SATA)

From the File menu, you can Export to Initiator Emulator (SAS) or Export to Host Emulator (SATA), using the Extract Sample File dialog (see following figures).

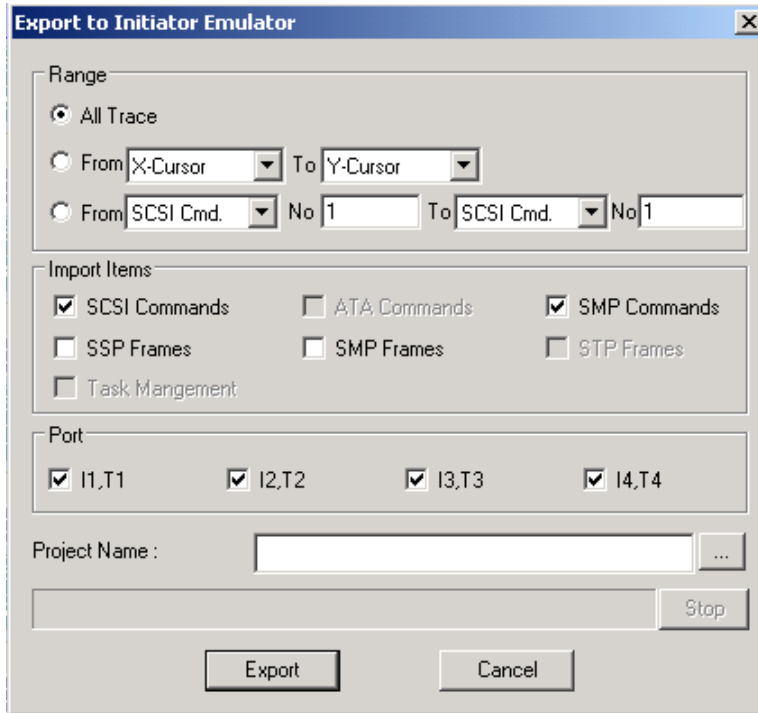

Figure 2.10: Export to Initiator Emulator (SAS) Dialog

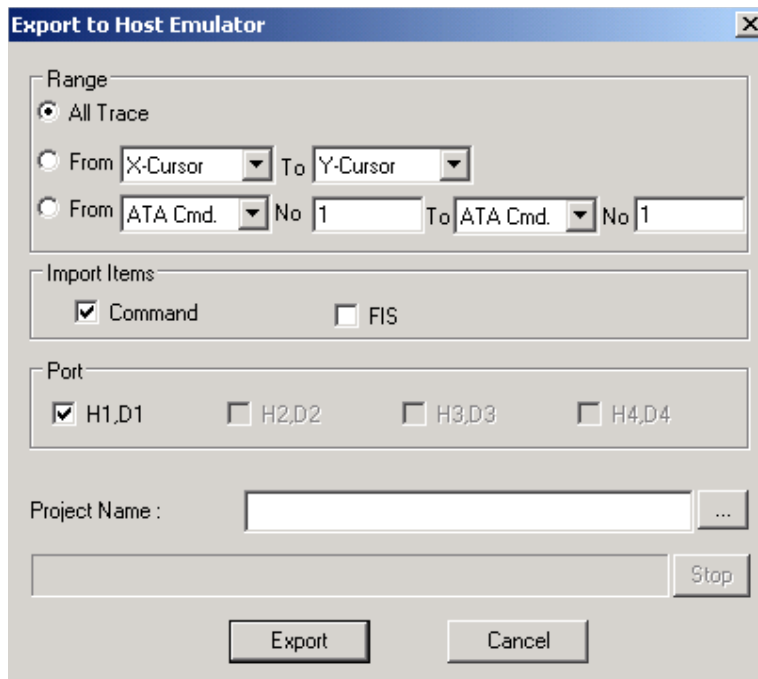

Figure 2.11: Export to Host Emulator (SATA) Dialog

You can limit the range of the saved file. You can save:

- All Trace
- Range between selected cursors
- Range between SCSI Commands or Transport

You can import **SCSI Commands**, **Task Management**, **ATA Commands**, **SSP Frames**, **SMP Frames**, **SMP Commands**, or **STP Frames**.

You can select the **Port**.

In the **Project Name**, enter a valid file.

Export to Trainer

From the File menu, you can Export to Trainer, using the Export to Trainer dialog.

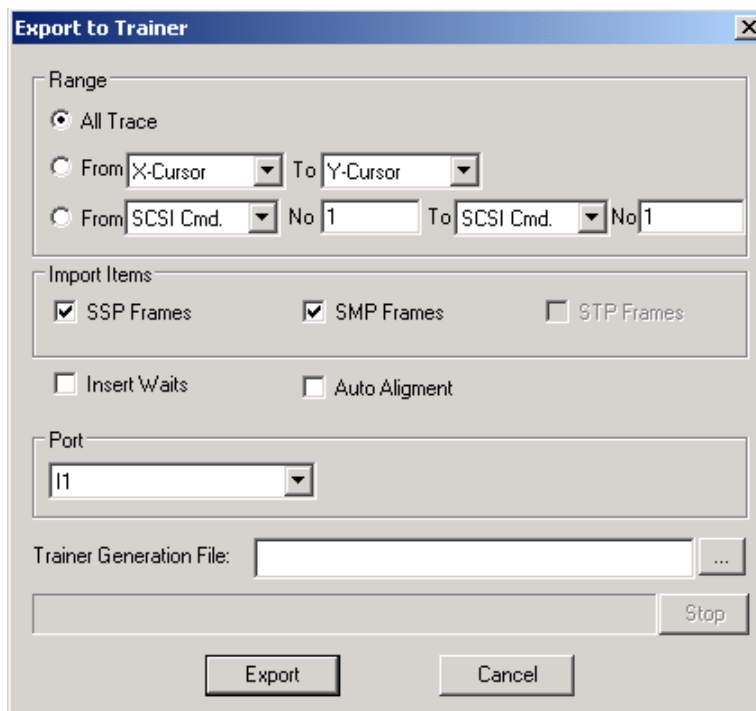

Figure 2.12: Export to Trainer Dialog

In the Export to Trainer dialog you can

- Limit the range of the saved file. You can save:
 - All Traces
 - Range between selected cursors
 - Range between SCSI Commands, SMP Commands or Transport
- Import **SSP Frames**, **SMP Frames**, or **STP Frames** (see [“Events and Event Properties” on page 451](#)).
- Insert Waits** (see [“Wait Commands” on page 428](#)).
- Use **Auto Alignment** (see [“The Global Setting “AutoAlign”” on page 400](#)).
- Select the **Port** (see [“Setup Menu” on page 389](#)).
- Indicate **Trainer Generation File Name** and click **Export** to export the trainer generation file.

Note: The resulting Trainer Generation file cannot exceed 2 MB or 1,000,000 packets.

Export Read/Write Command Report

From the File menu, you can Export Read/Write Command Report as an Excel file, using the Save As dialog.

Export Paired SAS Address Report

If Text View is activated, from the File menu you can save a Paired SAS Address Report as an Excel file, using the Export Paired SAS Address Report dialog.

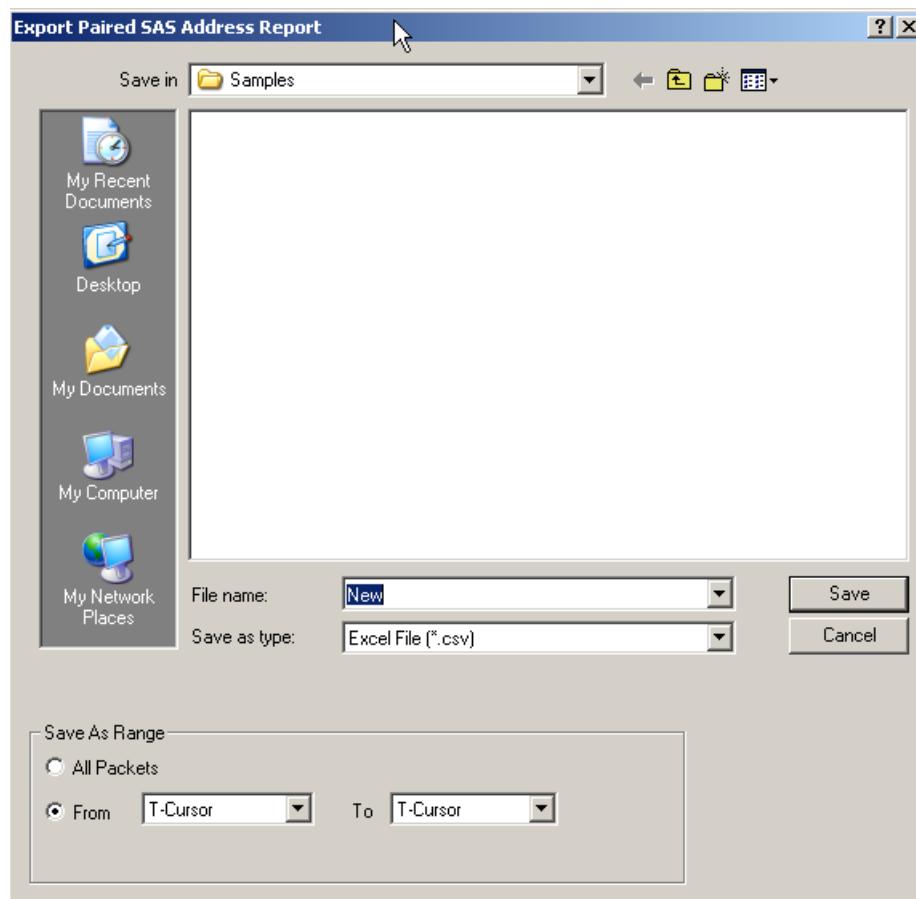

Figure 2.13: Export Paired SAS Address Report Dialog

You can limit the range of the saved file. You can save:

- All Packets
- Range between selected cursors

You can view expander traffic (particularly during discovery) in a spreadsheet format. You can use column headers with SAS Address Pairs. For example, instead of I1, T1, I2, T2, and so on, the columns are Source/Destination SAS Address pairs, such as S1:SEP or S2:EXP 0.

Trace Properties

Select **File > Trace Properties** to see the properties of the trace as shown below. For more information refer to [“Trace Properties” on page 203](#).

Edit Comment

You can write comments and edit them for a trace for future use. Select **File > Edit Comment** to view the edit window. Key in the comments and close the window.

Projects

You can define a new project, starting with the default project definition, or modify the settings for the last project run.

New Default Project

To start a New project, select File > New on the main menu bar and choose Protocol Analyzer to open a new project with default settings that you can modify (see [“Main Window” on page 49](#)).

Last Project

Clicking the Green button  opens the last project run, so you can modify it.

Project File Types

Projects have the following file types:

- *.asl Decoding script file (in the Examples folder “User Define Decoding Script” subfolder)
- *.cfg Display Configuration file (in the System folder “Config” subfolder)
- *.dat DataBlock file (in the System folder “DataBlock” subfolder)
- *.sac SAS Protocol Analyzer/Capture Project/Viewer file (in the Examples folder “EasyCaptr”, “AdvanceCaptr”, or “Exerciser” subfolders)
- *.saf Device Identifier file
- *.scs SAS Sample file (in the SAS Examples folder “Sample” subfolder)
- *.sde Device Emulator file (in the System folder “Compliance” subfolder)
- *.sfl Filter configuration file
- *.spg Single-role Pattern Generator file (in the Examples folder SAS “PatternGenerator\Single role (spg files)” subfolder and SATA “PatternGenerator\Single Role” subfolder). Single role means the file is for a Device or Host.
- *.ssh SAS Search configuration File

- *.stc SATA Protocol Analyzer/Capture Project/Viewer file (in the Examples folder “EasyCaptr”, “AdvanceCaptr”, or “Exerciser” subfolders)
- *.std Target Emulator file (in the Examples folder “Target Emulator” subfolder)
- *.sts SATA Sample file (in the SATA Examples folder “Sample” subfolder)
- *.tsh SATA Search configuration file
- *.wss SAS Workspace file (in the SAS System folder “Predefined\Workspace” subfolder)
- *.wst SATA Workspace file (in the SATA System folder “PreDefined\Workspace” subfolder)

Example Projects

The Analyzer includes example projects that you can use to perform an immediate analysis without any setup.

The Analyzer system software has a pre-defined folder (directory) structure for storing all files. All example files are in the Examples folder under the Sierra M6-4 folder.

It is strongly recommended that you open some example files to see types of projects that you can create.

Run an Example Analysis Project

To run an example project:

1. Select **File > Open**.
2. Locate example analysis projects by looking in the Examples folder. Examples are available for AdvanceCaptr, EasyCaptr, Exerciser, PatternGenerator, Samples, Target Emulator, and User Define Decoding Script.
3. In the EasyCaptr folder, choose an example *.sac file and click **Open** to display the example project dialog.

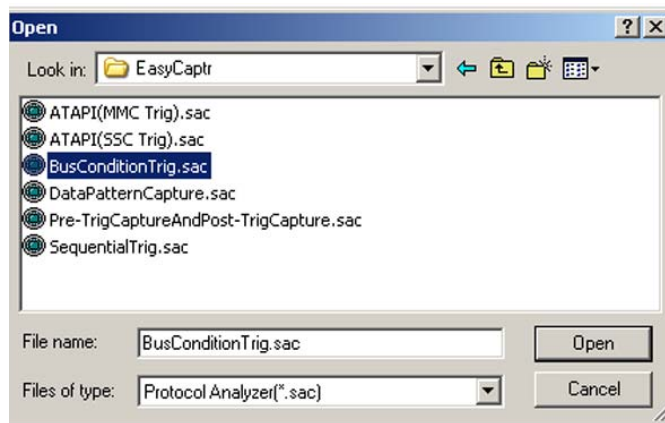

Figure 2.14: File Open Dialog

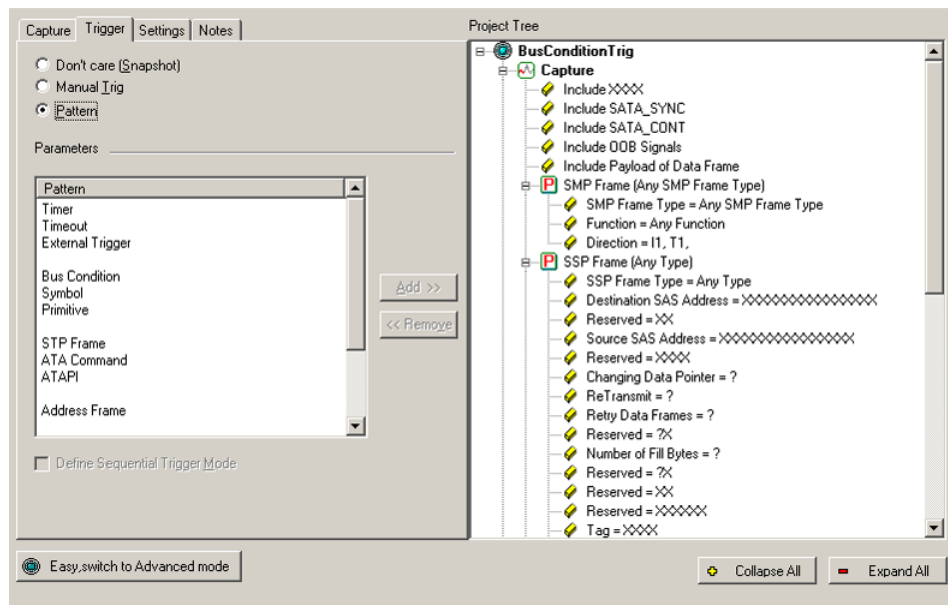

Figure 2.15: SAS: Sample Protocol Analysis Project

SAS vs. SATA: For Pattern Parameters, SATA Dialog adds FIS, FIS Pattern, and ATA Command Pattern and does not have STP Frame, SSP Frame, SMP Frame, and Address Frame.

4. Click the **Record** button to execute the pre-defined example.
5. After the project runs, you see an analyzer trace capture display similar to the one shown in Figure 2.16

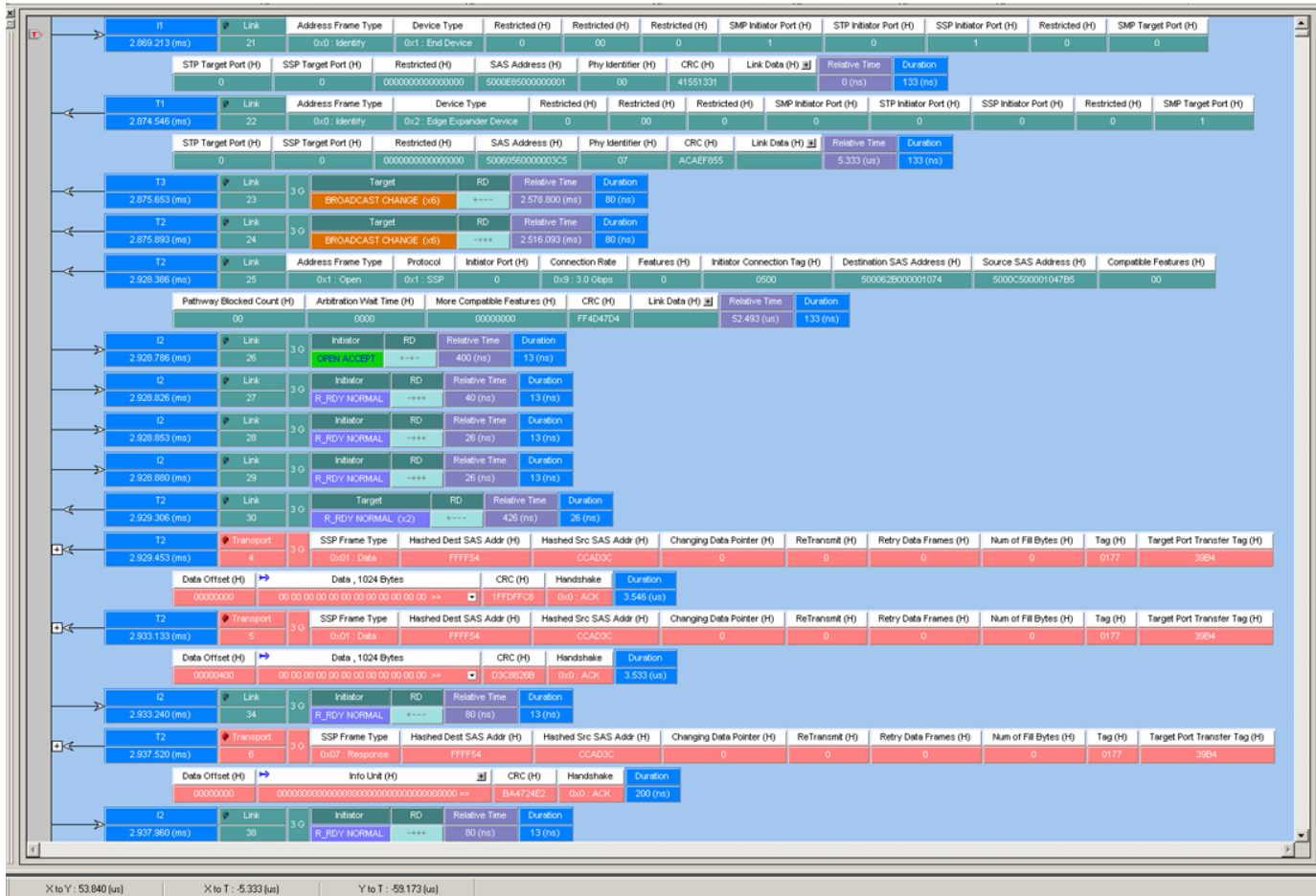

Figure 2.16: SAS: Analyzer Trace Capture Display

For details about the results display, See “Display Manipulation” on page 201. and See “Display Configuration” on page 284.

Patterns and Data Capture Setup

You can refine data capture by choosing Pattern and then selecting specific patterns for capture. Additionally, you can define a different set of patterns to capture after trigger.

To define specific patterns for capture, click the **Pattern** button (see Figure 2.17 on page 66.)

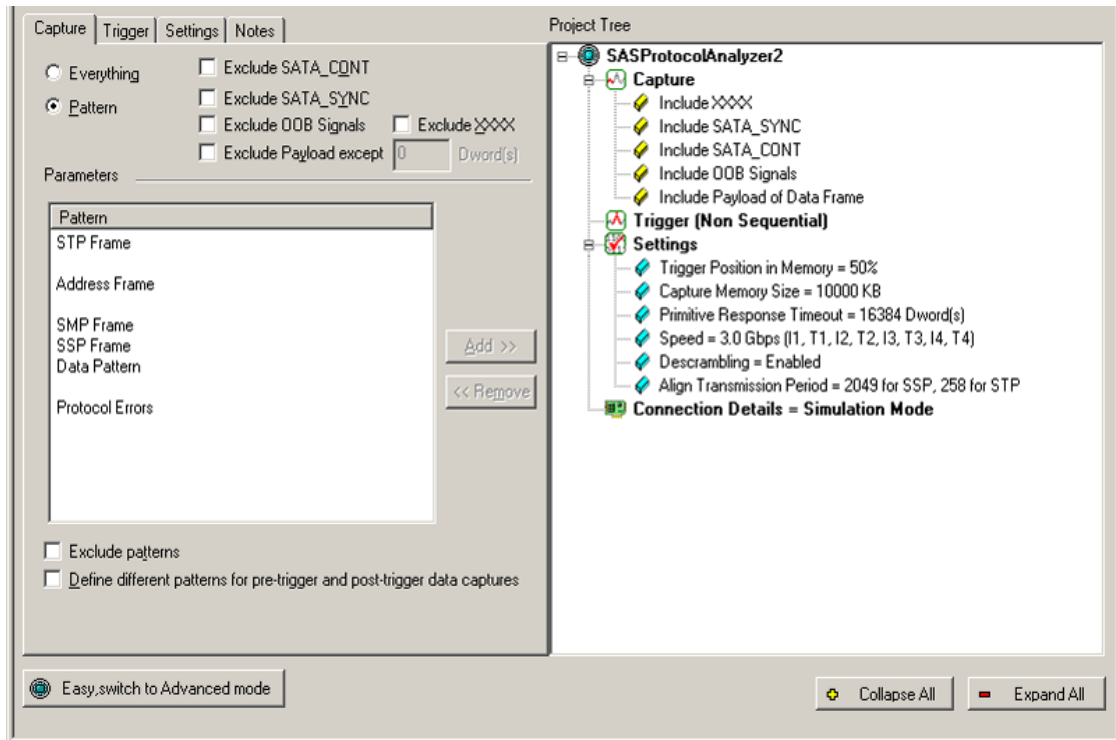

Figure 2.17: SAS: Choosing Capture Patterns

SAS vs. SATA: SATA Dialog replaces “Exclude SATA_CONT” with “Exclude CONT” and “Exclude SATA_SYNC” with “Exclude SYNC”.

The SAS Parameters window displays the following pattern capture choice categories:

- STP Frame
- Address Frame
- SMP Frame
- SSP Frame
- Data Pattern
- Protocol Errors

The SATA Parameters window displays the following pattern capture choice categories:

- FIS
- FIS Pattern
- Data Pattern
- Protocol Errors

Choose a Parameter

To choose a parameter for capture from any of these categories, highlight the category in the parameter window and click the **Add>>** button. This opens selection dialogs for each of the categories, displaying all parameters for that category. All of the patterns added appear in the project tree.

Exclude Patterns

Check this box to allow capture of everything **except** the patterns added to the Project Tree. When you check this box, the system adds the Primitive category to the parameter window and enables Exclude Idle.

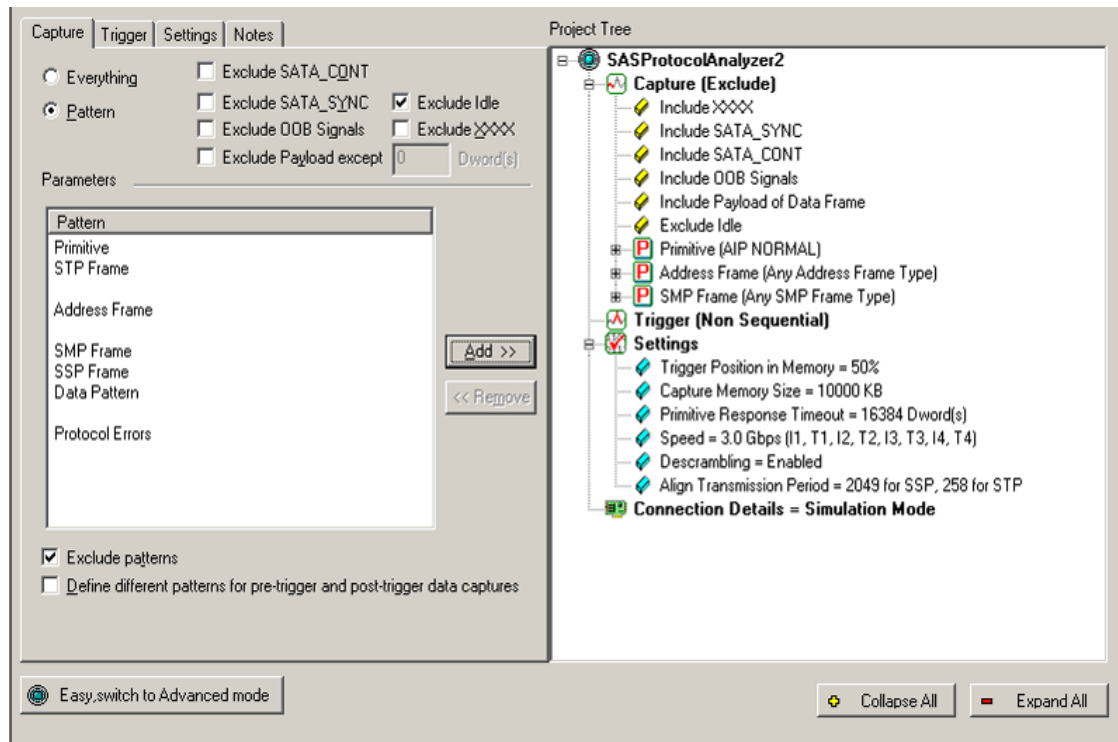

Figure 2.18: SAS: Exclude Patterns Checked

SAS vs. SATA: SATA Dialog replaces “Exclude SATA_COUNT” with “Exclude COUNT” and “Exclude SATA_SYNC” with “Exclude SYNC”. SATA Dialog has different Pattern Parameters (see [“Patterns and Data Capture Setup”](#) on page 65.)

To remove an item from capture, highlight it in the Project Tree and click the **<<Remove** button.

Pre- and Post-Trigger Data Capture

You can define one set of patterns for capture prior to the occurrence of a trigger and another set of patterns for capture after the occurrence of a trigger. The selections and setup procedure is the same for both, the Pre-Trigger capture and the Post-Trigger capture. To define different patterns for pre-trigger and post-trigger data capture, check **Define different patterns for pre-trigger and post-trigger data capture** to enable the Post-Trigger Capture tab. See the following figure.

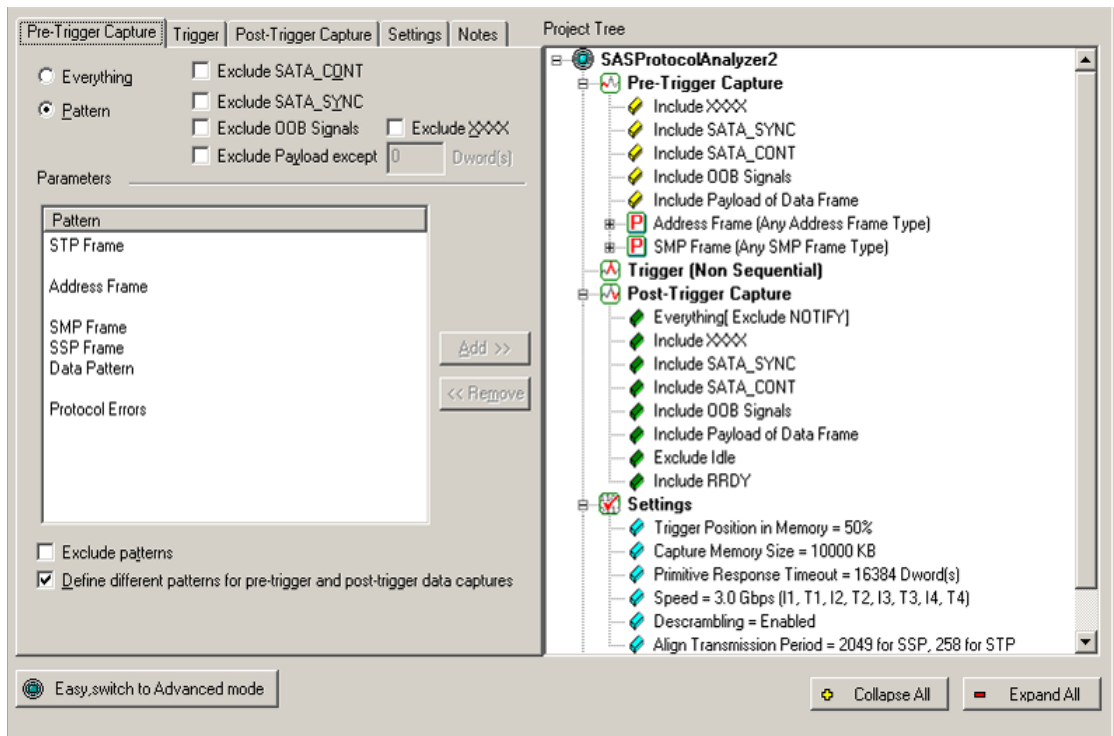

Figure 2.19: SAS: Post-trigger Capture Dialog Enabled

SAS vs. SATA: SATA Dialog replaces “Exclude SATA_CONT” with “Exclude CONT” and “Exclude SATA_SYNC” with “Exclude SYNC”. SATA Dialog has different Pattern Parameters (see “Patterns and Data Capture Setup” on page 65.)

Defining Patterns

To select an item for capture, either highlight the category and click the **Add>>** button or double-click the category to open a corresponding definition dialog. You can define patterns for specific ports by checking or unchecking Port ID.

Primitive

Double-click **Primitive** (available only if you check Exclude Patterns) to open the Primitive selection dialog.

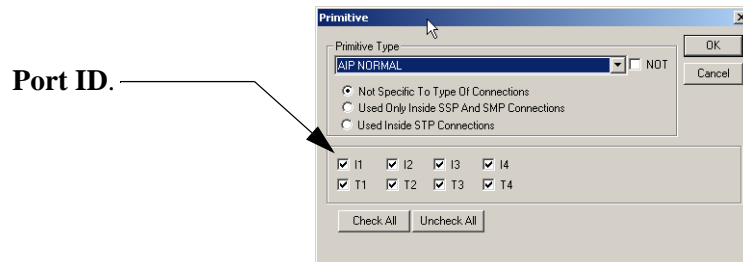

Figure 2.20: SAS: Primitive Dialog

SAS vs. SATA: SATA Dialog has no radio buttons and has different drop-down options.

Click the down arrow next to the Primitive drop-down list box, choose a Primitive to exclude, and click **OK**. Repeat for additional Primitives.

Data Pattern

Double-click **Data Pattern** to open the Data Pattern definition dialog.

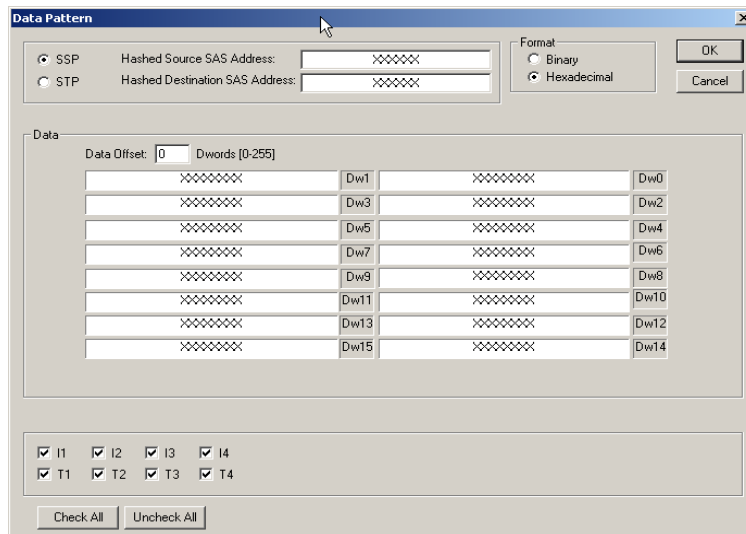

Figure 2.21: SAS: Data Pattern Dialog

SAS vs. SATA: SATA Dialog shows Port at the top and does not show SSP or STP.

Define the data pattern for capture or exclusion from capture and click **OK**.

Note: When entering the data pattern in the “data” section of this screen, if you are reading the data pattern from a recorded trace, you must reverse the order of the bytes listed for each DWORD entered. For example, if you want to capture (or exclude) “00 01 02 03” (as displayed in the trace), you must enter this pattern as “03 02 01 00”.

Protocol Errors

Double-click **Protocol Errors** to open the Protocol Errors selection dialog.

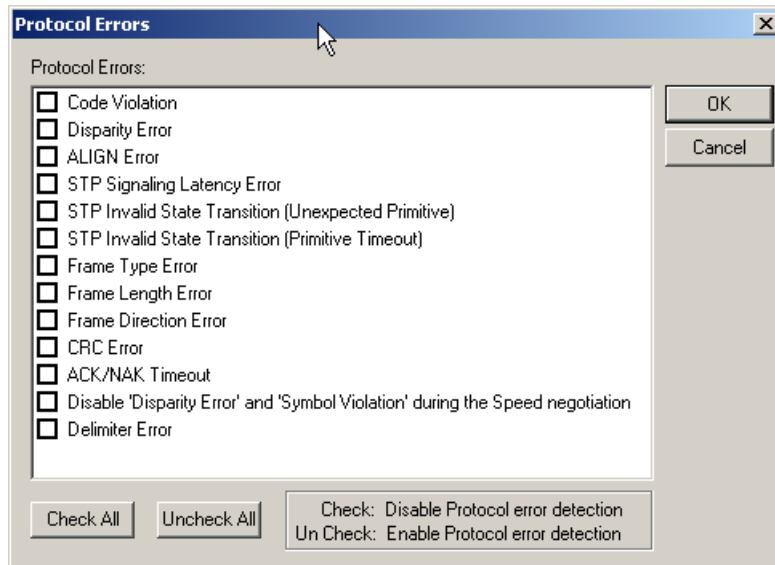

Figure 2.22: SAS: Protocol Errors Dialog

SAS vs. SATA: SATA dialog does not show ACK/NAK Timeout and has FIS signal-latency and state-transition errors, not STP ones.

Check protocol error(s) to omit or not capture, then click **OK**.

Protocol Errors

Code Violation: Wrong 10b symbol detected.

Disparity Error: Wrong disparity detected.

ALIGN Error: ALIGN primitive frequency is outside the specification requirements.

STP Signaling Latency Error [SAS only] or FIS Signaling Latency Error [SATA only]: DWORD difference between HOLD and HOLDA is greater than entered value in the HOLD/HOLDA Response Timeout field.

STP Invalid State Transition (Unexpected Primitive) [SAS only] or FIS Invalid State Transition (Unexpected Primitive) [SATA only]: Second SATA_SOF is encountered before SATA_EOF, and other unexpected primitives.

STP Invalid State Transition (Primitive Timeout) [SAS only] or FIS Invalid State Transition (Primitive Timeout) [SATA only]: Timeout between two paired primitives is above entered value. 65000 DWORDs is default. For example, it can occur between WTRM and R_OK, or X_RDY and R_RDY. It expects device (or host) to send a response, but response is not received after 65000 DWORDs. You set Primitive Response Timeout and HOLD/HOLDA Response Timeout in the Settings tab Analyzer Settings section.

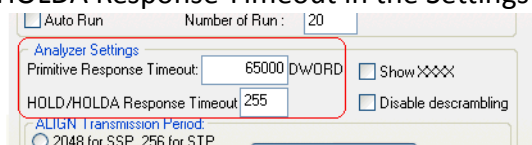

Frame Type Error: Wrong frame type.

Frame Length Error: Reported frame length is different than actual frame length.

Frame Direction Error: Wrong frame direction. For example, Register Device to Host coming from the Host.

CRC Error: CRC error detected.

ACK/NAK Timeout [SAS only]: ACK or NAK primitive missing or encountered unexpectedly.

Disable “Disparity Error” and “Symbol Violation” during the Speed negotiation: No longer detects Code Violation or Disparity Error.

Delimiter Error: Detects two SOF primitives without an EOF between them. Also detects two EOF primitives without an SOF between them.

STP Frame (SAS only)

Double-click **STP Frame** to open the FIS Type dialog.

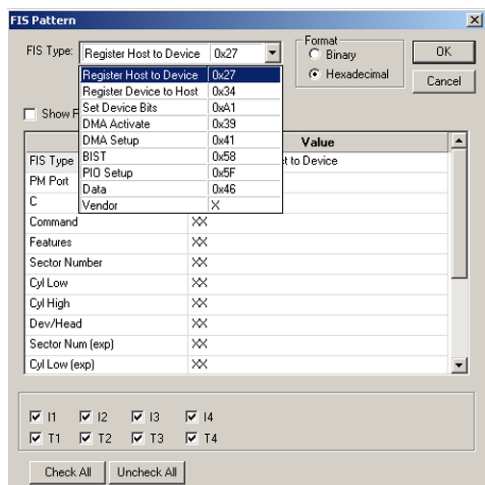

Figure 2.23: FIS Pattern Dialog

SAS vs. SATA: Not available in SATA.

Click the down arrow next to the Type drop-down list box, choose an FIS type to capture or exclude, and click **OK**. Repeat for additional types.

Available FIS Types:

- Register Host to Device
- Register Device to Host
- Set Device Bits
- DMA Activate
- DMA Setup
- BIST
- PIO Setup
- Data
- Vendor

Address Frame (SAS only)

Double-click **Address Frame** to open the Address Frame Type Pattern dialog.

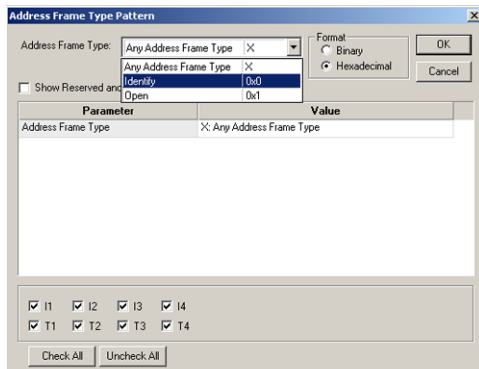

Figure 2.24: Address Frame Type Pattern Dialog

SAS vs. SATA: Not available in SATA.

Click the down arrow next to the Address Frame Types list box and choose an address frame type.

SMP Frame (SAS only)

Double-click **SMP Frame** to open the SMP Frame Pattern dialog.

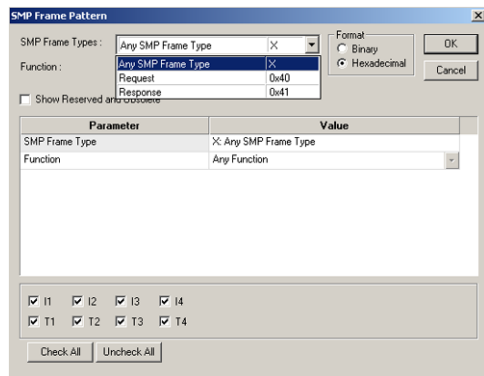

Figure 2.25: SMP Frame Pattern Dialog

SAS vs. SATA: Not available in SATA.

Click the down arrow next to the SMP Frame Type list box and choose a frame type. Assign a specific function to the frame by clicking the down arrow next to the Function list box and choose a function.

SSP Frame (SAS only)

Double-click **SSP Frame** to open the SSP Frame Pattern dialog.

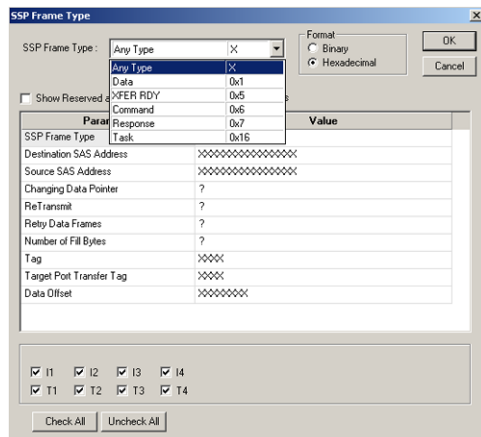

Figure 2.26: SSP Frame Type Dialog

SAS vs. SATA: Not available in SATA.

Click the down arrow next to the SSP Frame Type list box and choose an SSP Frame type.

FIS (SATA only)

Double-click **FIS (Frame Information Structure)** to open the FIS Type selection dialog.

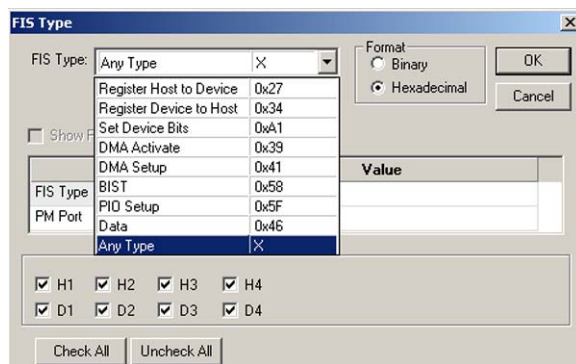

SAS vs. SATA: Not available in SAS.

Click the down arrow next to the Type drop-down list box, choose a FIS type to capture, and click **OK**. Repeat for additional types.

Available FIS Types:

- Register Host to Device
- Register Device to Host
- Set Device Bit
- DMA Activate
- DMA Setup
- BIST
- PIO Setup
- Data
- Any Type

FIS Pattern (SATA only)

Double-click **FIS Pattern** to open the FIS Pattern selection dialog.

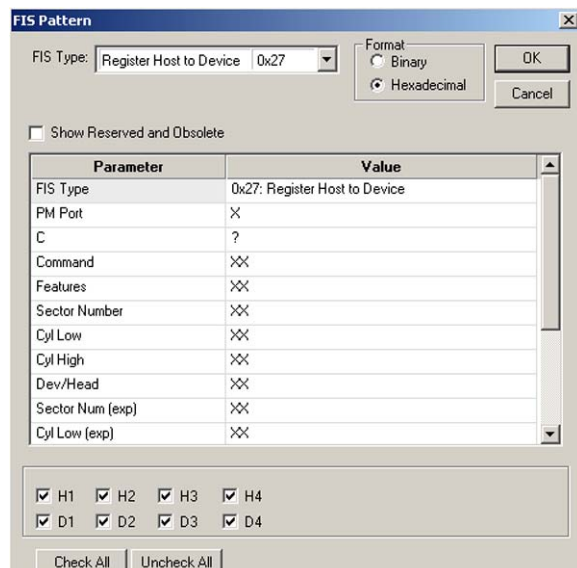

Figure 2.27: FIS Pattern Dialog

SAS vs. SATA: Not available in SAS.

The FIS Pattern dialog opens with the default FIS Type as **Register Host to device**. To choose another available FIS Type, click the down arrow next to the FIS Type list box.

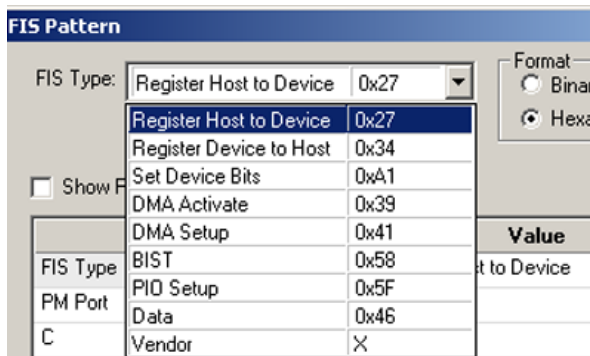

Figure 2.28: FIS Pattern Dialog Dropdown

SAS vs. SATA: Not available in SAS.

Choose a FIS Type and complete the corresponding dialog.

FIS Types

If you select STP Frame (SAS) or FIS Pattern (SATA) for the Pattern, the FIS Pattern window opens. You can select the FIS Type in this window from among the following types.

Register Host to Device

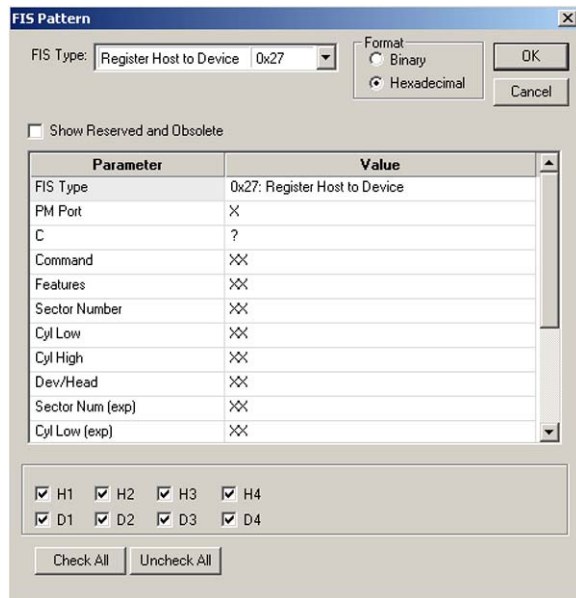

Figure 2.29: FIS Pattern - Register Host to Device Dialog

Register Device to Host

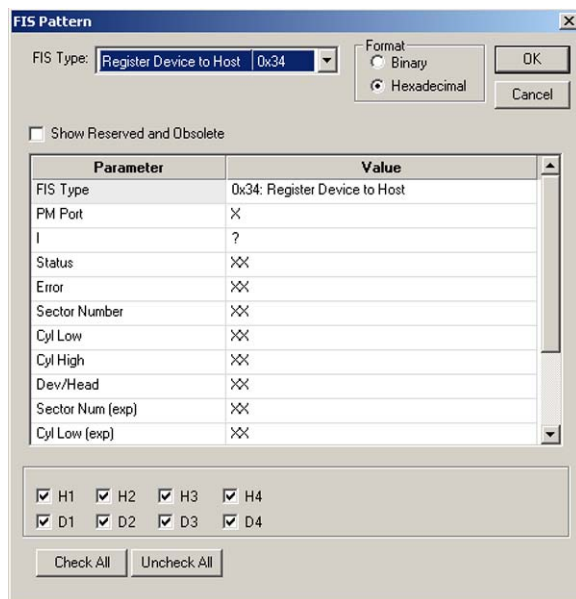

Figure 2.30: FIS Pattern - Register Device to Host Dialog

Set Device Bits

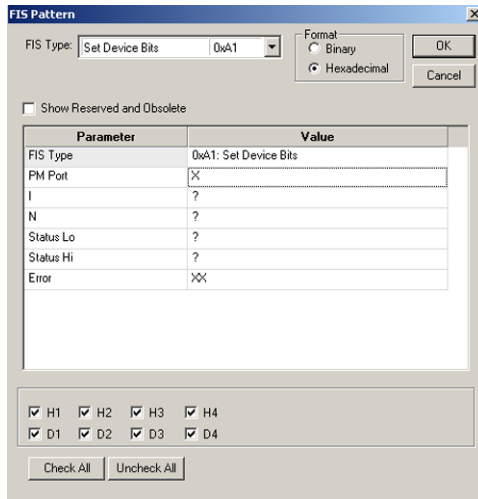

Figure 2.31: FIS Pattern - Set Device Bits Dialog

DMA Activate

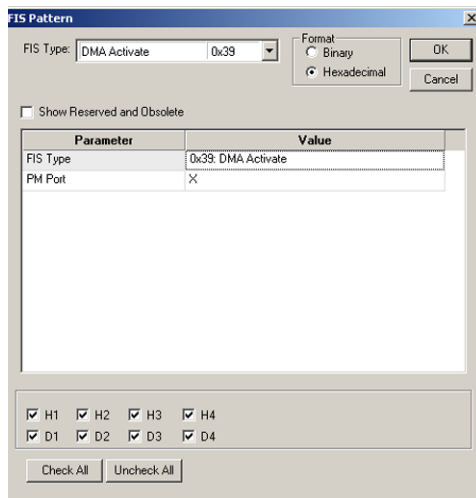

Figure 2.32: FIS Pattern - DMA Activate Dialog

DMA Setup

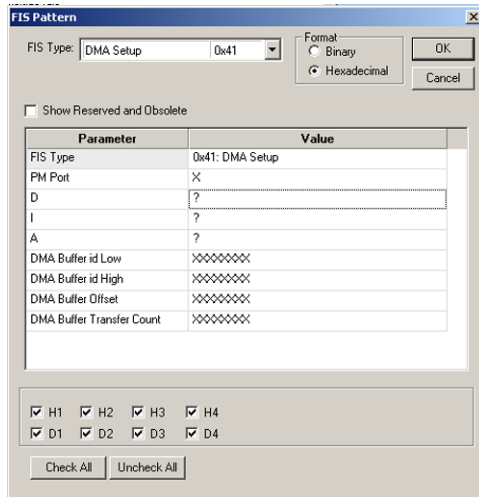

Figure 2.33: FIS Pattern - DMA Setup Dialog

BIST

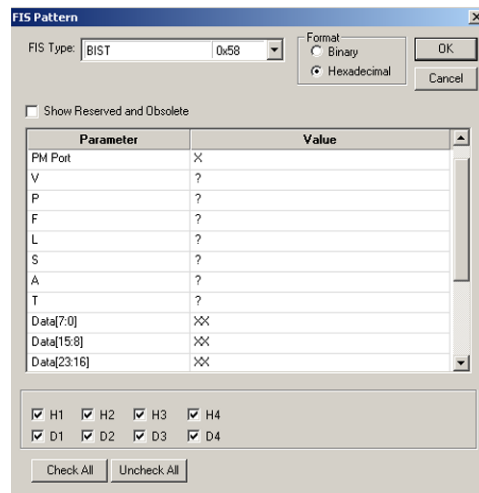

Figure 2.34: FIS Pattern - BIST Dialog

PIO Setup

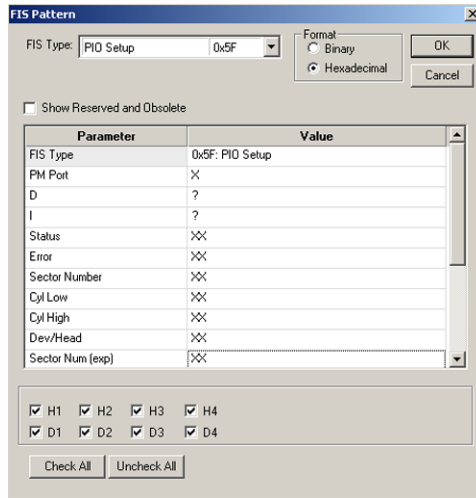

Figure 2.35: FIS Pattern - PIO Setup Dialog

Data

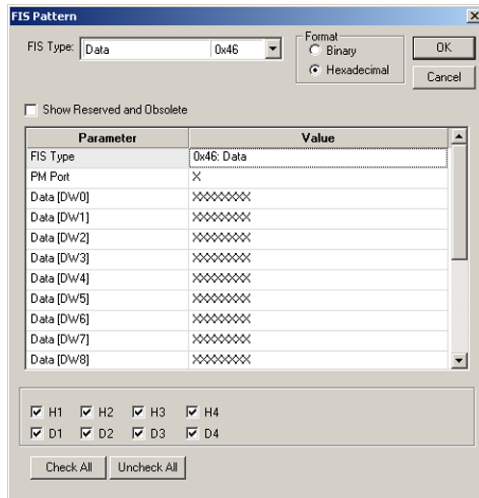

Figure 2.36: FIS Pattern - Data Dialog

Vendor

Vendor is for FIS Pattern.

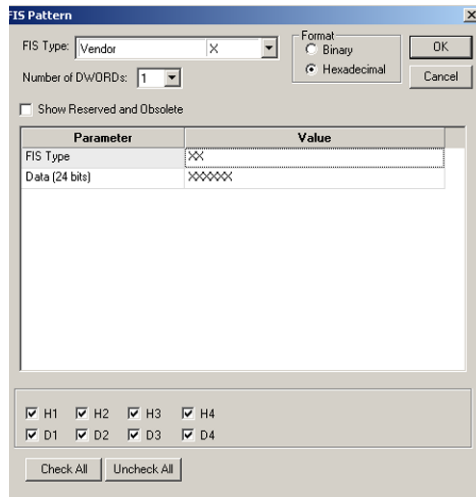

Figure 2.37: FIS Pattern - Vendor Dialog

Trigger Setup

The **Trigger** tab in the analysis project dialog allows you to specify when the analyzer completes a data capture. Three trigger modes are available: The default **Don't care (Snapshot)**, **Manual Trig**, and **Pattern**.

When data capture starts with **Don't care (Snapshot)** selected, the analyzer triggers on the first data pattern on the bus.

Starting a data capture with **Pattern** selected triggers when specific pattern(s) are detected in the captured data stream. The following three ways can trigger the analyzer with **Pattern** selected.

- Trigger on any pattern (Any Trigger Mode)
- External Trigger
- Trigger on a sequence of patterns (Sequential Trigger Mode)

Snapshot Mode

To trigger immediately on any pattern, check the **Don't care (Snapshot)** button.

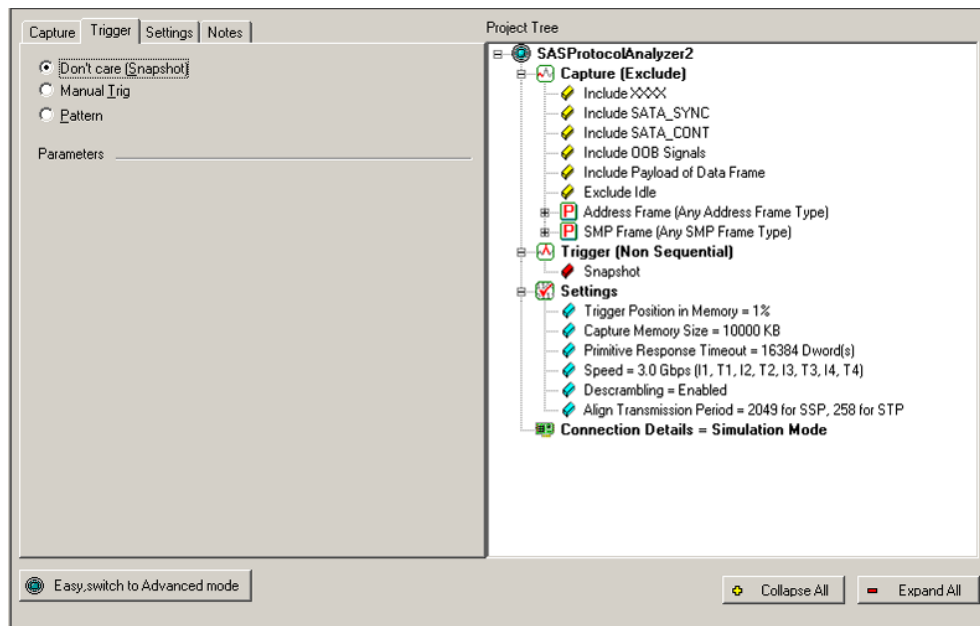

Figure 2.38: Default Trigger Selected

Manual Trigger Mode

In the **Manual Trigger** mode, the analyzer captures bus traffic continually from when you use the Manual Trigger until you click the **Stop Hardware** button (on the analyzer toolbar), which triggers the analyzer. To perform a manual trigger, check the **Manual Trig** button.

Any Trigger Mode

In **Any Trigger** mode, the Analyzer triggers whenever any of the patterns selected for triggering occurs (an OR condition). The procedure for selecting trigger parameters is identical to that for selecting capture parameters. All items selected for triggering appear in the Project Tree.

To define patterns for triggering, check the **Pattern** button in the Trigger dialog (see [Figure 2.39 on page 81.](#))

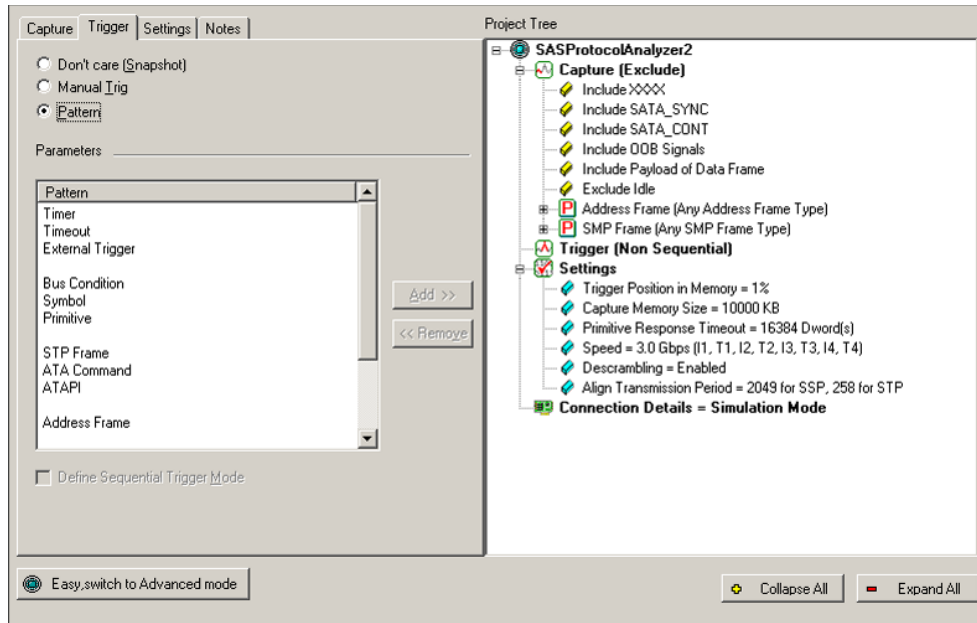

Figure 2.39: SAS: Select Patterns for Trigger

The SAS **Parameters** window displays the following trigger pattern categories:

- Timer
- Timeout
- External Trigger
- Bus Condition
- Symbol
- Primitive
- STP Frame
- ATA Command
- ATAPI
- Address Frame
- SMP Frame
- SSP Frame
- SCSI Command
- Data Pattern
- Protocol Errors

The SATA **Parameters** window displays the following trigger pattern categories:

- Timer
- Timeout
- External Trigger
- Bus Condition
- Symbol
- Primitive
- FIS
- FIS Pattern
- ATA Command
- ATA Command Pattern
- ATAPI
- Soft Reset
- Data Pattern
- Protocol Errors

Note: In packet view, you can right-click on any frame, select **Add to Trigger**, and add the pattern to **DataPatternCapture** to make it a trigger pattern.

Choosing a Parameter

Either highlight the category and click the **Add>>** button, or double-click the category, to open a corresponding definition dialog.

To remove an item, highlight it in the Project Tree, then click the **<<Remove** button.

Triggering on a Timer

Selecting a timer for a trigger in the **Any Trigger Mode** limits the time that the analyzer looks for selected triggering conditions before triggering. The timer activates when the Project runs. If none of the selected triggering conditions occurs during the timer's active time, the Analyzer triggers at the end of the time set for the timer.

You can set a timer independently of any other trigger selection, to cause an unconditional trigger after a set time.

To set the timer value, double-click **Timer** in the Pattern window to open the Timer dialog.



Figure 2.40: Timer Dialog

Check a Time Unit, enter the Timer Value, and click OK.

Timeout

Selecting **Timeout** for the pattern opens the Timeout Pattern dialog.

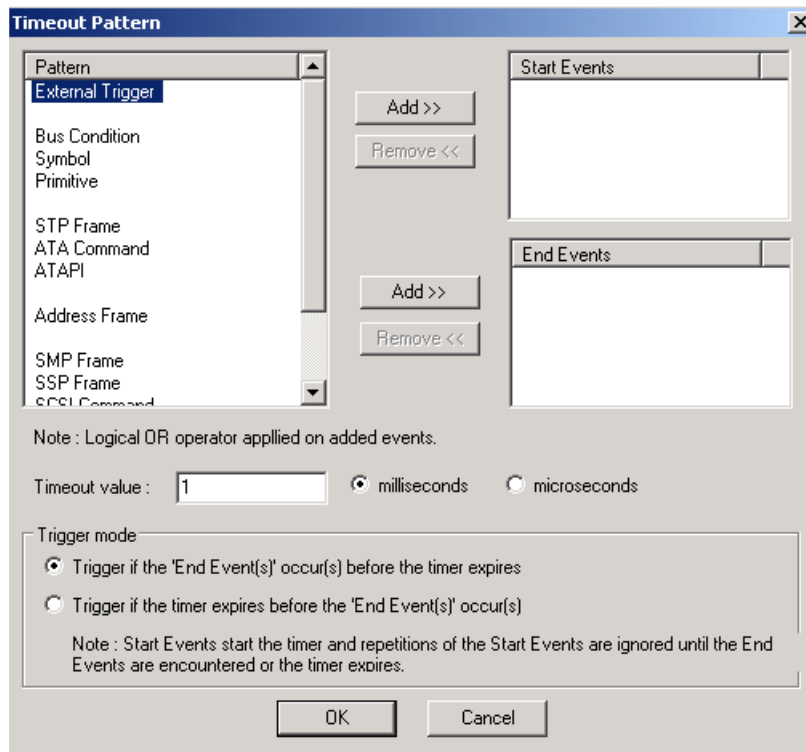

Figure 2.41: Timeout Dialog

"Start Events" starts the timer in Timeout Trigger and "End Events" triggers the analyzer (if first trigger mode is selected) or resets the trigger (if second trigger mode is selected). Repetitions of the Start Events are ignored until the End Event is encountered or the timer expires.

Select a pattern for Start Events or End Events, enter a Timeout value, then select Trigger Mode:

- If End Events occur before timer expires
- If timer expires before End Events

Note: You cannot select a Timeout pattern if you select any other pattern as the trigger condition.

External Trigger

You can trigger on an external trigger. To set up the trigger, click the **External Trigger** category.

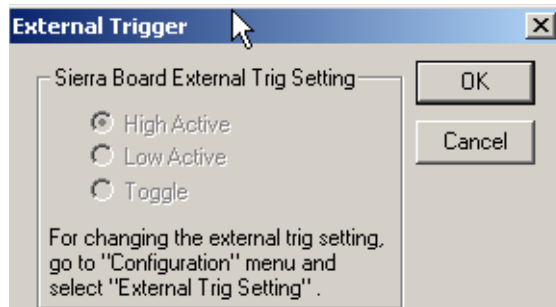

Figure 2.42: External Trigger Dialog

You cannot select an External Trigger Setting, so click **OK**.

Bus Condition

Double-click **Bus Condition** in the Patterns window of the Capture Project dialog to open the Bus Conditions dialog.

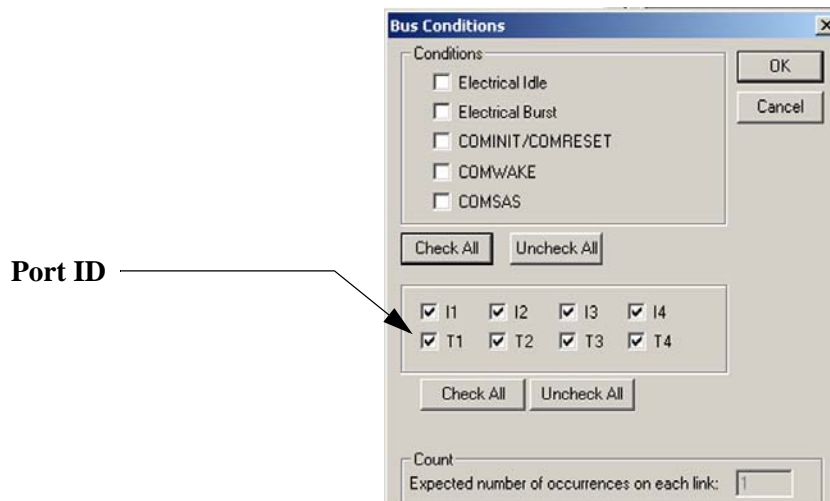

Figure 2.43: SAS: Bus Condition Dialog

SAS vs. SATA: SATA Dialog separates the COMINIT and COMRESET check boxes and replaces COMWAKE with Host COMWAKE and COMSAS with Device COMWAKE.

Check the Conditions to trigger on and click **OK**.

Note: You can define triggering for specific ports by checking or unchecking Port IDs.

Symbol

Double-click **Symbol** in the Patterns window of the Capture Project dialog to open the Symbol dialog.

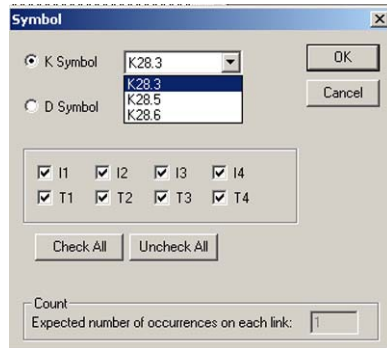

Figure 2.44: SAS: Symbol Dialog

Choose a symbol type by checking either the K Symbol or D Symbol option, then click the down arrow in the Symbol dropdown list, choose a symbol to trigger on, and click **OK**. Note that the D Symbol choice does not have a down arrow.

To choose a **D symbol**, click the D symbol option button and enter a Hex value.

Primitive

Double-click Primitive in the Patterns window of the Trigger dialog to open the Primitive dialog.

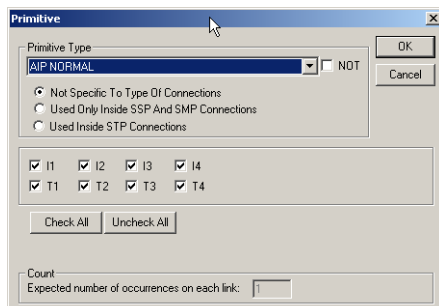

Figure 2.45: SAS: Primitive Dialog

SAS vs. SATA: SATA Dialog has no radio buttons and has different drop-down options.

Click the down arrow next to the Primitive dropdown list, scroll the list to choose a primitive on which to trigger, and click **OK**.

Note: Check the box to the right of the Primitive Type to use the logical NOT.

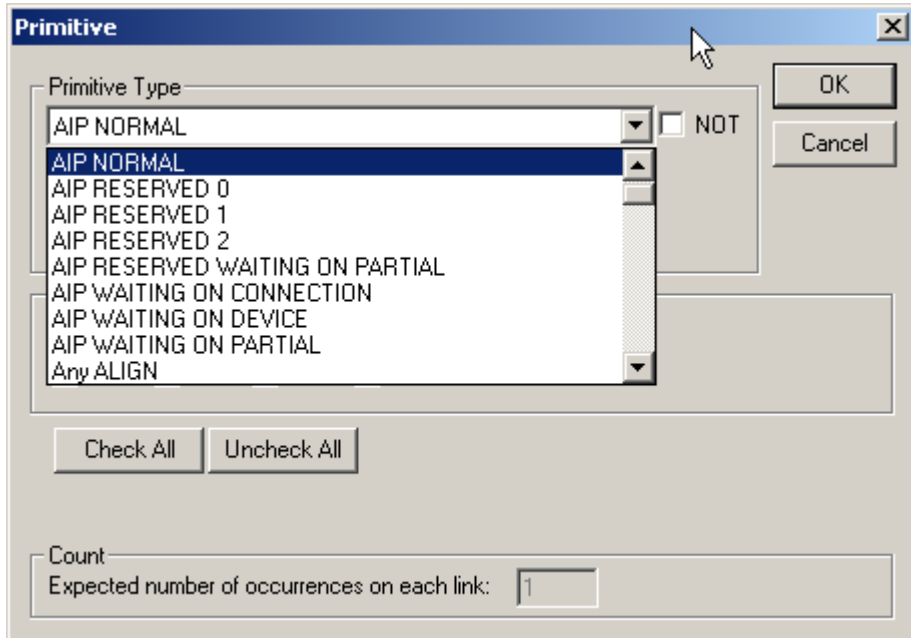

Figure 2.46: SAS: Primitive Selection Choices

SAS vs. SATA: SATA Dialog has different choices.

ATA Command

Double-click **ATA Command** in the Patterns window of the Trigger dialog to open the ATA Command dialog.

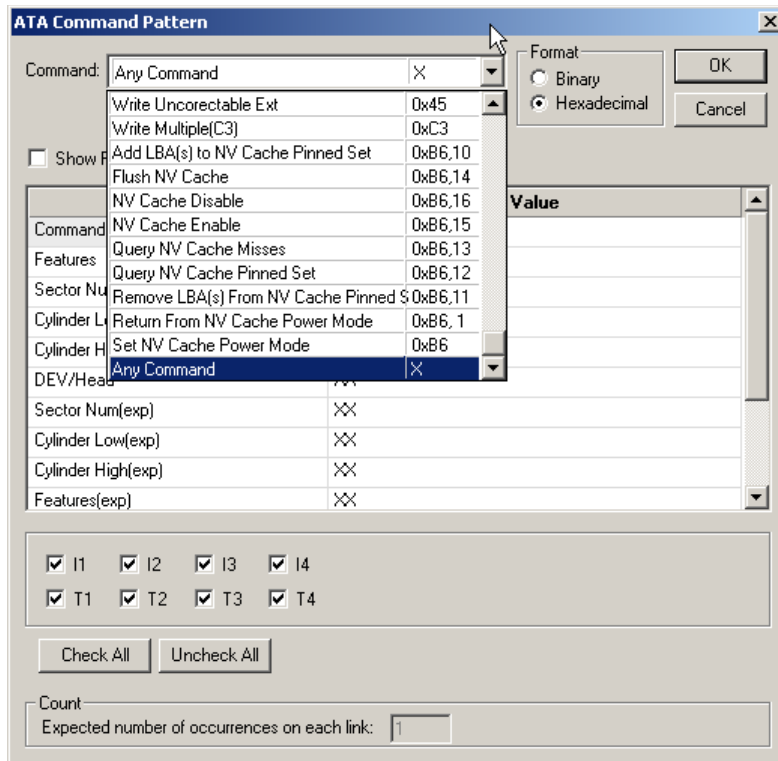

Figure 2.47: SAS: ATA Command Pattern Dialog

SAS vs. SATA: SATA Dialog has different dropdown options.

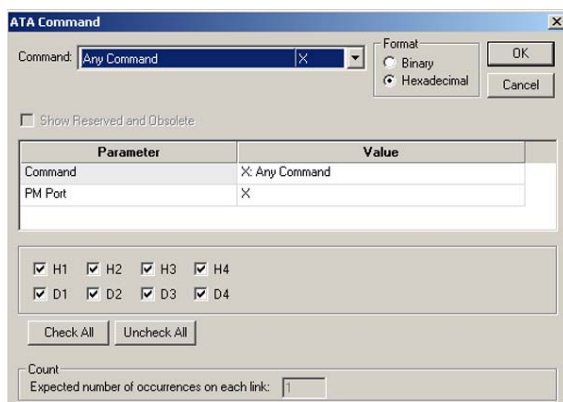

Figure 2.48: SATA: ATA Command Dialog

Click the down arrow next to the Command dropdown list, scroll the list to choose a command to trigger on, and click **OK**.

A powerful triggering choice is **Any Command**, which causes the analyzer to trigger on any ATA command.

Note: The command code and feature set are not the only parameters that describe an ATA command. For parameters such as LBA and sector count, you must use the **ATA Command Pattern** dialog.

Data Pattern

Double-click **Data Pattern** in the Patterns window of the Trigger dialog to open the Data Pattern dialog.

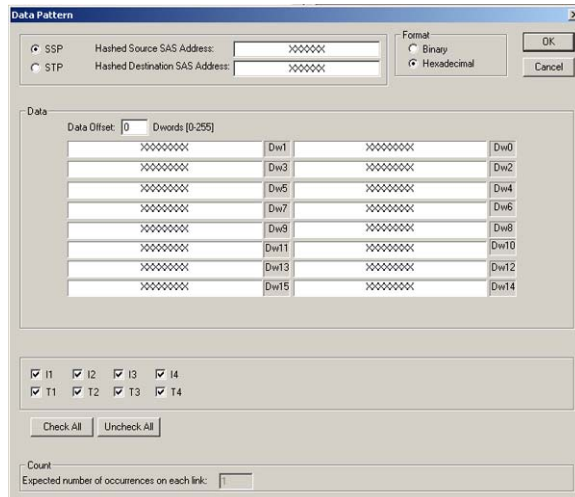

Figure 2.49: SAS: Data Pattern Dialog

SAS vs. SATA: SATA Dialog shows Port at the top and does not show SSP or STP.

Define the data pattern for triggering and click **OK**.

Note: When entering the data pattern in the “Data” section of this screen, if you are reading the data pattern from a recorded trace, you must reverse the order of the bytes listed for each DWORD entered. For example, if you want to trigger on “00 01 02 03” (as displayed in the trace), you must enter this DWORD pattern as “03 02 01 00”.

Protocol Errors

Double-click **Protocol Errors** in the Patterns window of the Trigger dialog to open the Protocol Errors dialog.

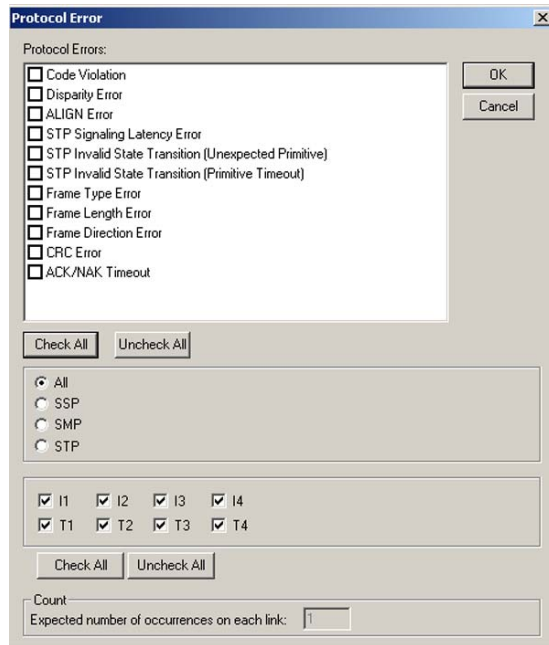

Figure 2.50: SAS: Protocol Errors Dialog

SAS vs. SATA: SATA Dialog shows Port and does not show SSP, SMP, or STP radio buttons.

Check the protocol error(s) on which to trigger and click **OK**.

ATAPI

Double-click **ATAPI** in the Patterns window of the Trigger dialog to open the ATAPI Patterns dialog.

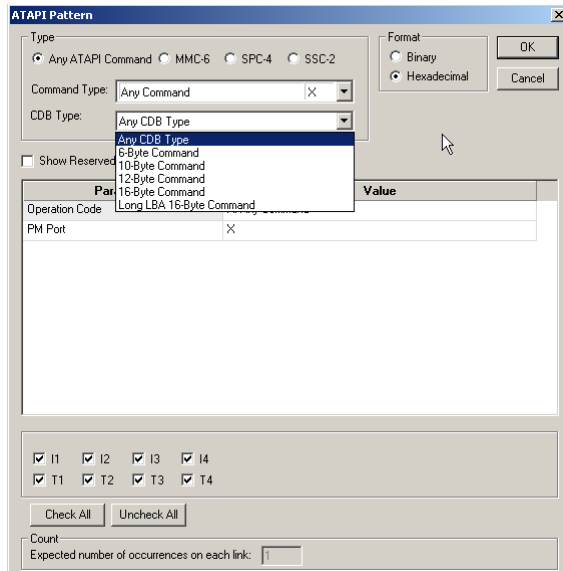

Figure 2.51: SAS: ATAPI Patterns Dialog

SAS vs. SATA: SATA Dialog has different dropdown options.

Click the down arrow next to the CDB dropdown list, scroll the list to choose a CDB Type, and click **OK**.

Address Frame (SAS only)

Double-click **Address Frame** in the Patterns window of the Trigger dialog to open the Address Frame Type Pattern dialog.

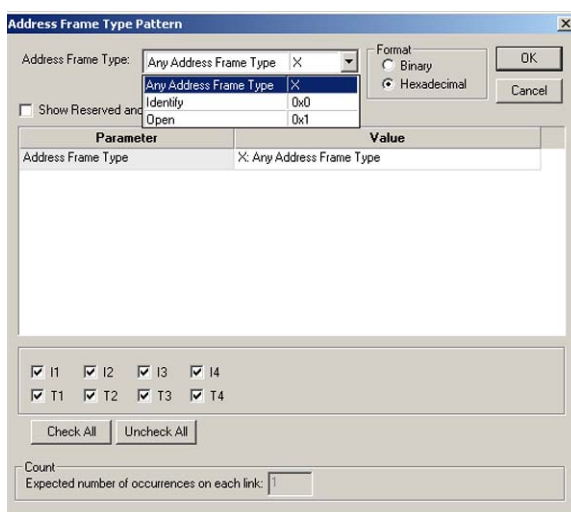

Figure 2.52: SAS: Address Frame Type Pattern Dialog

SAS vs. SATA: Not available in SATA.

Click the down arrow next to the Address Frame Type dropdown list, scroll the list to choose an address frame type on which to trigger, and click **OK**.

STP Frame (SAS only)

Double-click **STP Frame** in the Patterns window of the Trigger dialog to open the FIS Type dialog.

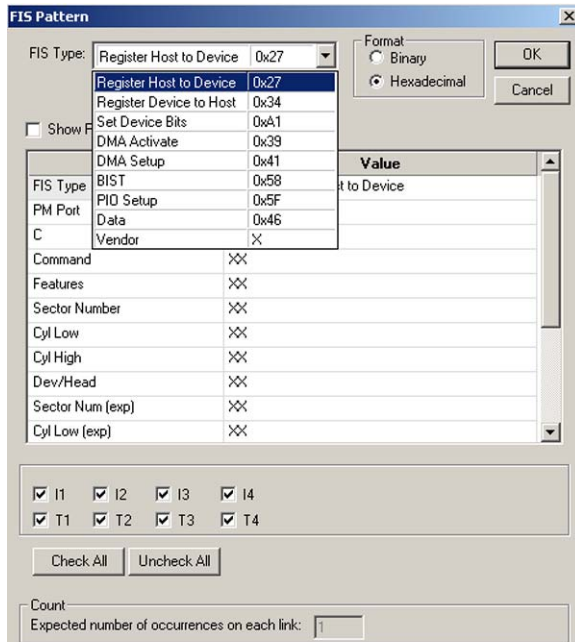

Figure 2.53: SAS: FIS Pattern Dialog

SAS vs. SATA: Not available in SATA.

Click the down arrow next to the FIS type dropdown list, scroll the list to choose an FIS type on which to trigger, and click **OK**.

SMP Frame (SAS only)

Double-click **SMP Frame** in the Patterns window of the Trigger dialog to open the SMP Frame Pattern dialog.

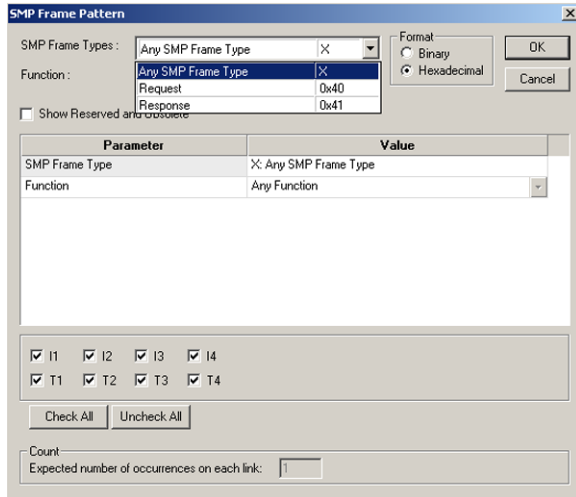

Figure 2.54: SAS: SMP Frame Pattern Dialog

SAS vs. SATA: Not available in SATA.

Click the down arrow next to the SMP Frame Types dropdown list and scroll the list to choose an SMP frame type on which to trigger. Then click the down arrow next to the Function dropdown list, choose a function, and click **OK**.

SSP Frame (SAS only)

Double-click **SSP Frame** in the Patterns window of the Trigger dialog to open the SSP Frame Pattern dialog.

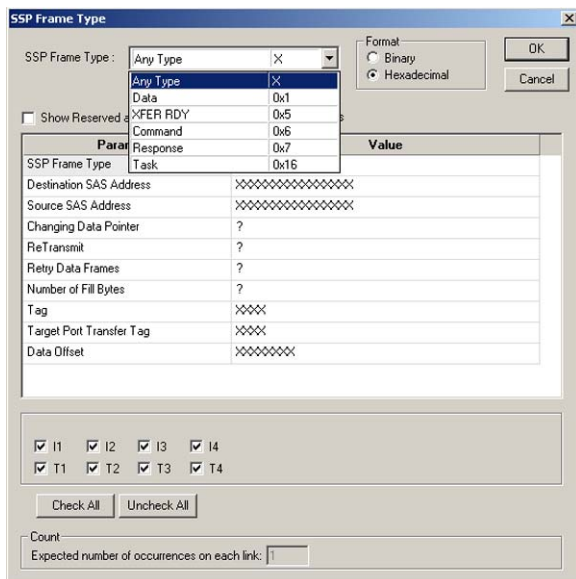

Figure 2.55: SAS: SSP Frame Type Dialog

SAS vs. SATA: Not available in SATA.

Click the down arrow next to the SSP Frame Type dropdown list, scroll the list to choose an SSP frame type on which to trigger, and click **OK**.

SCSI Command (SAS only)

Double-click **SCSI Command** in the Patterns window of the Trigger dialog to open the SCSI Command Pattern dialog.

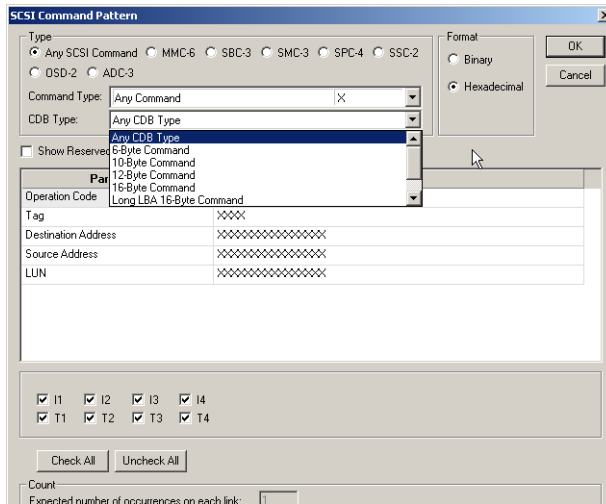

Figure 2.56: SAS: SCSI Command Pattern Dialog

SAS vs. SATA: Not available in SATA.

Click the down arrow next to the CDB dropdown list, scroll the list to choose a CDB Type, and click **OK**.

Timeout (SATA only)

Choosing timeout as a trigger condition allows you to define a timer with a timeout value that is reset to 0 and starts by occurrence of any events that you add to the Start Events list. You can then add one or more events to the End Events list and then choose a trigger to occur if an End event occurs before the timer expires, or if the timer expires before the occurrence of an end event.

You add and define the Start and End events identically to the way that you define and add patterns to capture.

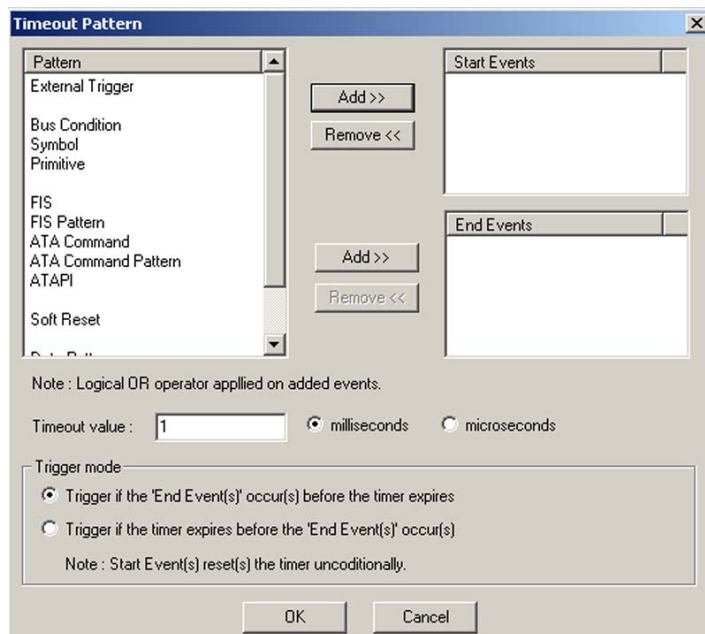

Figure 2.57: Timeout Pattern Dialog

ATA Command Pattern (SATA only)

Double-click **ATA Command Pattern** to open the ATA command pattern selection dialog.

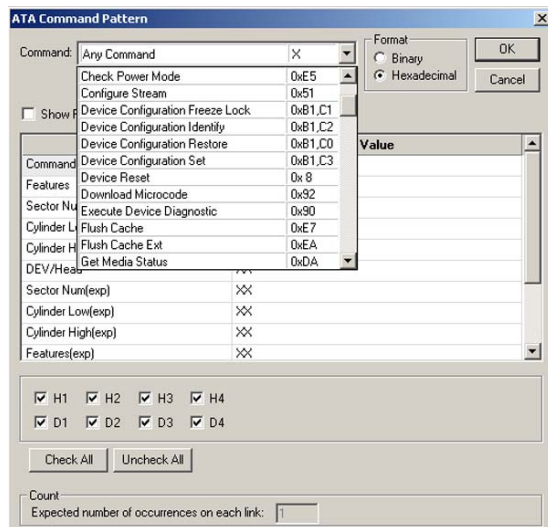

Figure 2.58: SATA: ATA Command Pattern Dialog

SAS vs. SATA: Not available in SAS.

Click the down arrow next to the Command list box, choose an ATA command, and click **OK**.

Soft Reset (SATA only)

Double-click **Soft Reset** to open the Soft Reset dialog.

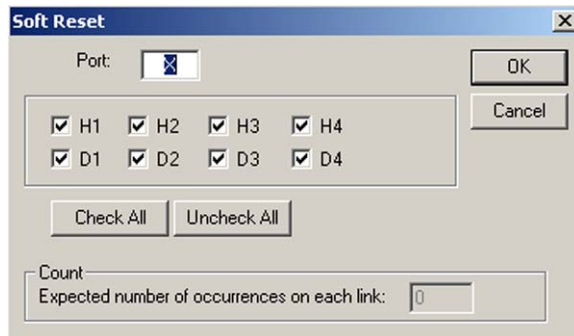

SATA: Soft Reset Dialog

SAS vs. SATA: Not available in SAS.

FIS (SATA only)

Double-click **Frame Information Structure (FIS)** to open the FIS Type selection dialog.

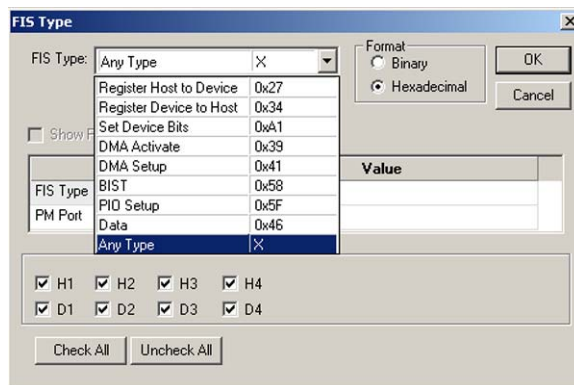

Figure 2.59: SATA: FIS Type Dialog

SAS vs. SATA: Not available in SAS.

Click the down arrow next to the Type drop-down list box, choose a FIS type on which to trigger, and click **OK**. Repeat for additional types.

Available FIS Types

- | | |
|--|------------------------------------|
| <input type="checkbox"/> Register Host to Device | <input type="checkbox"/> DMA Setup |
| <input type="checkbox"/> Register Device to Host | <input type="checkbox"/> BIST |
| <input type="checkbox"/> Set Device Bit | <input type="checkbox"/> PIO Setup |
| <input type="checkbox"/> DMA Activate | <input type="checkbox"/> Data |
| <input type="checkbox"/> Any Type | |

Note: You cannot trigger on a Vendor FIS.

FIS Pattern (SATA only)

Double-click **FIS Pattern** to open the FIS Pattern selection dialog.

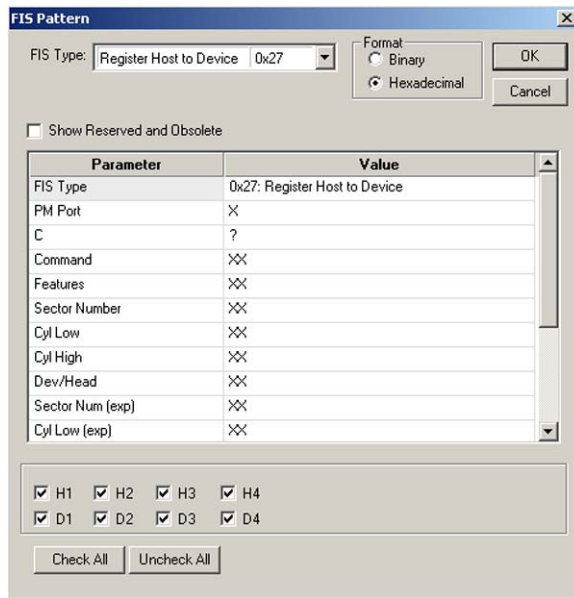
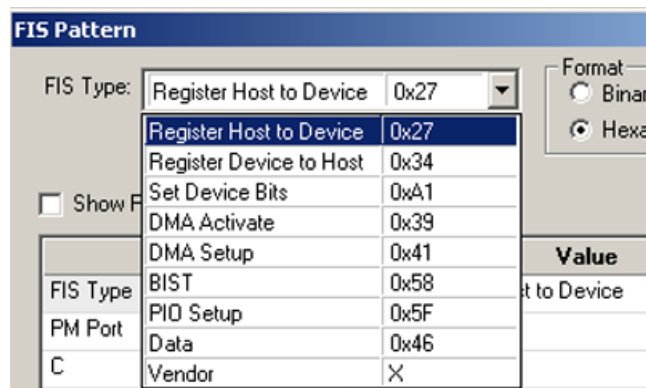

Figure 2.60: SATA: FIS Pattern Dialog

SAS vs. SATA: Not available in SAS.

The FIS Pattern dialog opens with the default FIS Type as **Register Host to device**. To choose another available FIS Type, click the down arrow next to the FIS Type list box.



SATA: FIS Pattern Dialog Choices

SAS vs. SATA: Not available in SAS.

Choose a FIS Type and complete the corresponding dialog.

ATA Command Pattern (SATA only)

Double-click **ATA Command** to open the ATA Command Pattern selection dialog.

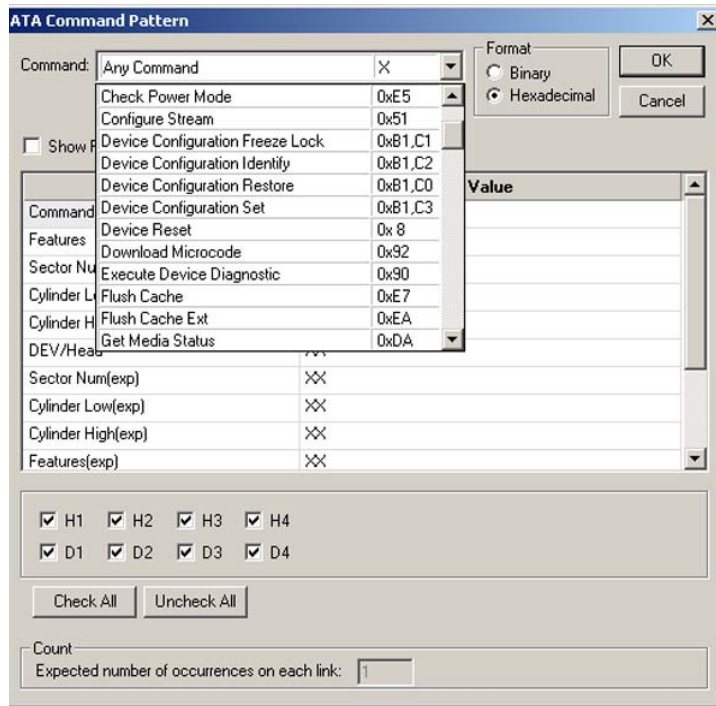

Figure 2.61: SATA: ATA Command Pattern Dialog

SAS vs. SATA: Not available in SAS.

Click the down arrow next to the Command list box, choose an ATA command, and click **OK**.

Soft Reset (SATA only)

Double-click **Soft Reset** to open the Soft Reset dialog.

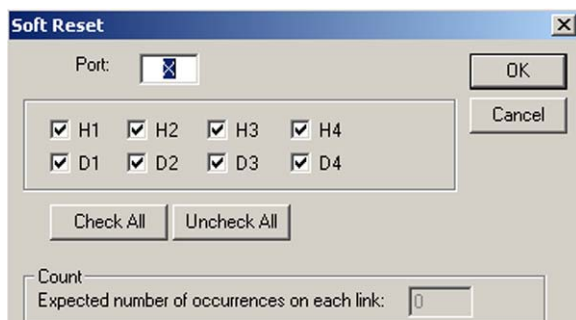

Figure 2.62: SATA: Soft Reset Dialog

SAS vs. SATA: Not available in SAS.

Sequential Trigger Mode

In the Sequential Trigger mode, triggering occurs whenever the system detects a specific sequence of patterns. The order in which you define triggering patterns establishes the sequence. You must define at least two patterns to enable the selection of the sequential trigger mode.

Note: Primitives and Symbols or Frames occurring very close together on different ports cause an error in triggering.

To define a triggering sequence, select more than one pattern, then check the **Define Sequential Trigger Mode** check box.

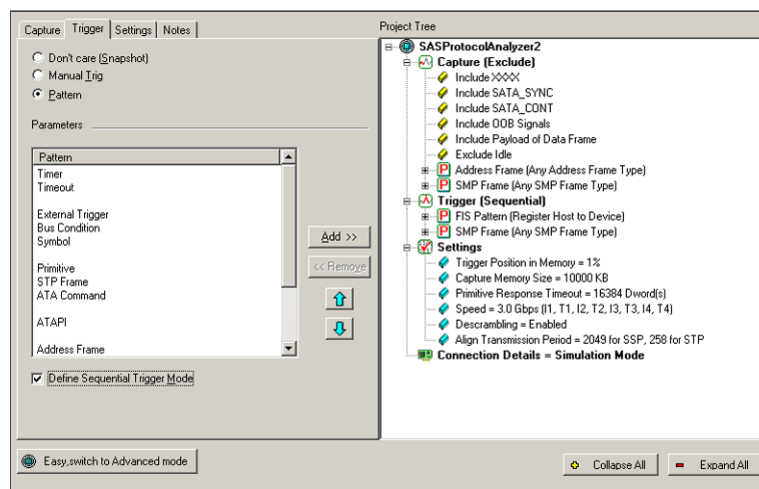

Figure 2.63: SAS: Select Sequential Trigger Mode

SAS vs. SATA: SATA Dialog has different patterns.

Timer

The sequential triggering mode offers the option of triggering on a timer or inserting a timer in the triggering sequence to delay detection of the next pattern in the sequence. To insert a timer in the trigger list, double-click **Timer** to open the Timer definition dialog.



Enter a **Time Value**, choose the **Time Unit**, and click **OK**.

Defining Patterns

The definition of patterns for the sequential trigger mode is identical to the Any Trigger mode, with the following exception:

In the sequential triggering mode, the definition dialogs for these triggering patterns have an additional setting, to count the number of occurrences. This setting allows you to

specify the number of times that the pattern must occur before triggering or proceeding in the trigger sequence.



Figure 2.64: Number of Occurrences Dialog

Note: The system counts events on each link independently, causing a trigger whenever the number of occurrences on any link equals the specified value.

Triggering Order

As you define and add triggering patterns, they display under the Trigger category in the Project Tree sequentially, in the order in which you entered them. When the project runs, the Analyzer detects the occurrence of each pattern in order and triggers on the last one.

You can reorder the sequence of triggering patterns. To change the sequence order, highlight a trigger pattern and use the **Up** or **Down** arrow to move it to a new position.

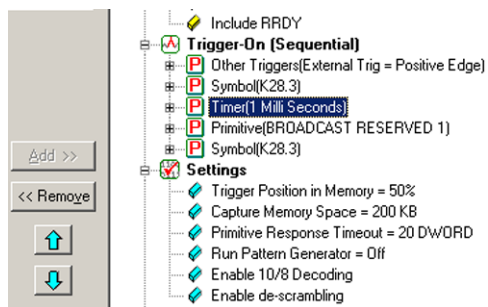

Figure 2.65: Triggering Order

Pre-Trigger

You can set the amount of data to capture before and after the trigger, as a percentage of pre-trigger, between 1% and 99%. Position the pre-trigger slider to a percentage. This feature allows the evaluation of bus activity leading up to and after the triggering event. Figure 2.66 illustrates the operation of pre-trigger in data memory.

Pre-trigger data is capture of the specified percentage of data prior to the triggering event. It cannot be guaranteed and may be 0. This can occur when the triggering event occurs before storing the required amount of pre-trigger event data. In such a case, the data display shows fewer than the specified data points prior to the triggering event.

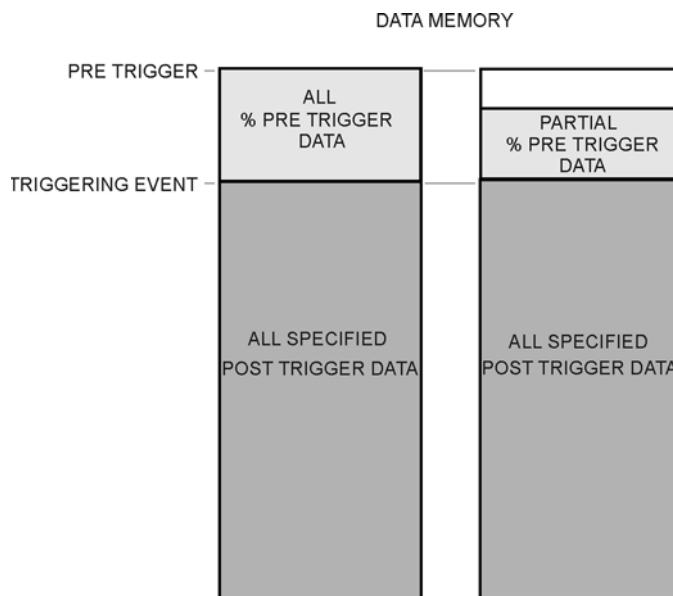

Figure 2.66: Pre-Trigger Example, 20% Pre-Trigger

Project Settings

To set project options, click the **Settings** tab.

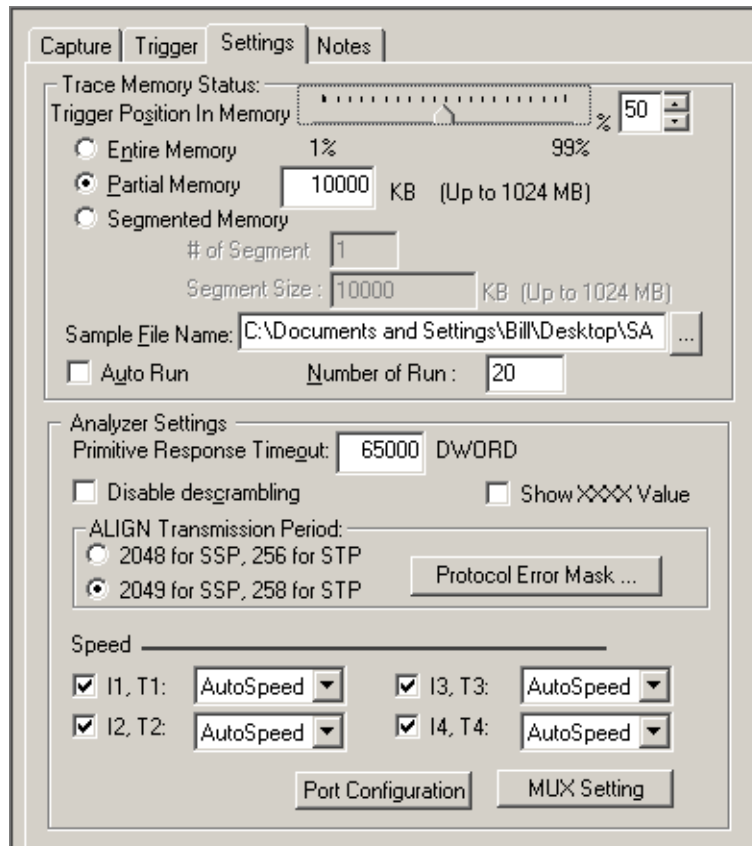

Figure 2.67: SAS: Setting Project Options

SAS vs. SATA: For the ALIGN Transmission Period section, SATA Dialog shows options 256 and 258, and does not show 2048 or 2049.

For Speed, SATA Dialog shows H1, D1 to H4, D4 and does not show I1, T1 to I4, T4.

SATA Dialog does not show MUX Setting button.

Memory Settings

The Trace Memory Status section has the following fields.

Trigger Position

Pre-Trigger defaults to 50%, which defines the percentage of data to capture before and after the triggering event. You can change this percentage by dragging the slider.

Capture of the specified percentage of the data prior to the triggering event cannot be guaranteed and may be 0. This can occur if the triggering event occurs before storing the required amount of pre-trigger event data. In such a case, the data display shows fewer than the specified data points prior to the triggering event. For more detail, (see [“Pre-Trigger” on page 101.](#))

Note: Trigger Position only works when the triggering option is Pattern.

Sample File Name

Click the ellipses next to the Sample File Name text box and choose a file name and location for the results of your current project.

Auto Run

To repeat the current capture and trigger setup automatically, check the Auto Run checkbox and enter the number of times in the Number of Run text box. The capture and trigger repeat automatically for the specified number of times, and the results are saved in consecutively numbered Sample.scs files.

Memory Size

In the Protocol Analyzer Settings tab, you can allot memory for the trace recording. Check **Entire Memory** to allow recording to use the whole memory, to capture the maximum amount of trace data. (Minimum size of memory is 2 GB. Maximum size of memory is 16 GB.)

Partial Memory

To reduce the memory size, check **Partial Memory** and enter a buffer size in kilobytes, up to the memory size in megabytes.

Note: If the size of a data packet exceeds the buffer memory allocation, the project runs, but no data capture occurs. You must increase buffer memory size to a value greater than the packet size.

Segmented Memory

Alternatively, you can use **Segmented Memory**. Enter an integer **# of Segment**, from 1 to 32, then enter an integer **Segment Size** in kilobytes, up to the memory size in megabytes divided by the number of segments. The default segment size is 10 MB.

Each time a trigger condition occurs, the system records a new segment. You can use a Snapshot or Pattern trigger, but not Manual Trigger. As the same trigger automatically repeats, the system makes the number of segments that you entered.

Upload Manager

To upload segments manually in the Upload Manager, select the **Don't upload segments and open upload manager automatically** checkbox.

To upload segments automatically for display as the system creates them, do not select the checkbox.

To view segmented trace files, click the **Upload Manager**  button, beside the Record button, to display the Upload Manager dialog (see [Figure 2.68 on page 104.](#))

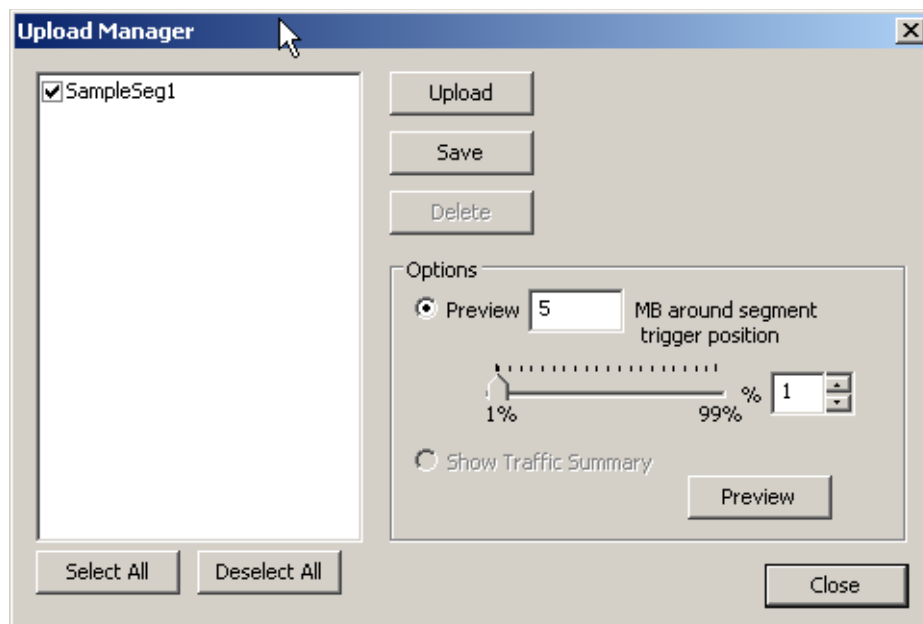

Figure 2.68: Upload Manager Dialog

The dialog displays the segments in the format Segment1, Segment2, and so on.

Select segments by clicking the checkbox. You can also **Select All** or **Deselect All** segments.

You can **Upload** segments for display, **Save** segments as sample files, and **Delete** segments.

The **Preview** radio button allows a preview of an integer number of megabytes around the trigger position. You can set the trigger position as a percentage and select the segment number. Click the radio button to **Show Traffic Summary** with the preview. To show the preview, click the **Preview** button.

Analyzer Settings

Primitive Response Timeout

The Primitive Response Timeout parameter specifies the number of DWORDs between two pair primitives after which the analyzer detects a protocol error. Default value is 65000. When host or device sends a primitive, such as X_RDY, HOLD, or WTRM, it expects device or host to reply with a primitive, such as R_RDY, HOLDA, or R_OK. This parameter detects FIS Signaling Latency error, between HOLD and HOLDA, and FIS State Transition error, between X_RDY and R_RDY, between SOF and EOF, or between WTRM and R_OK or R_ERR. You can set a trigger on these protocol errors.

Disable Scrambling

If checked, causes the Analyzer to assume that no traffic is scrambled. By default, the Analyzer assumes the scrambling state of the devices under test

Show XXXX value

Check this option to display XXXX values.

ALIGN Transmission Period (differs for SAS and SATA)

Choose the ALIGN Transmission Period for SSP and STP by clicking the corresponding option button, then open the Protocol Error Mask dialog.

Protocol Error Mask

Click the Protocol Error Mask button to open the Protocol Error Mask dialog.

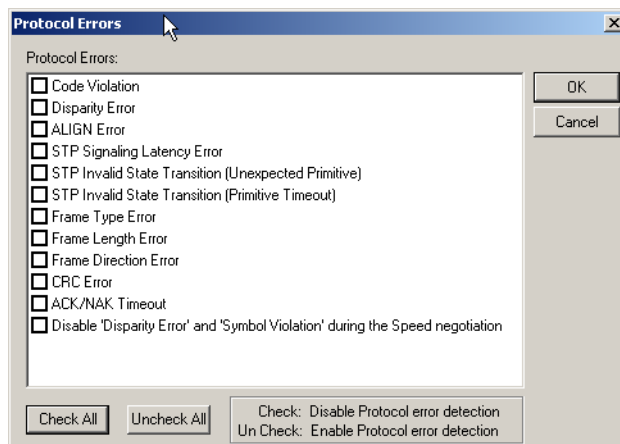

Figure 2.69: Protocol Errors Dialog

Check the Protocol Errors that you want the Analyzer to ignore.

When “RD Error” and “Code violation Error” are set as trigger events:

“RD Error” or “Code violation Error” can occur right after the OOB sequence.

“RD Error” or “Code violation Error” can occur right after the recovery from the PM state.

These errors are mainly caused by the long synchronization time of the analyzer. If these errors, caused by the Analyzer, become triggers, you cannot detect some other errors that you really need to detect. To NOT detect the above two errors, enable the software setting **Disable ‘Disparity Error’ and ‘Symbol Violation’ during Speed negotiation**. After this, the code violation is not triggered during the speed negotiation phase, but is triggered if the violation happens after the speed negotiation phase.

External Trig Out Setting

The Analyzer can send a Low or High external signal anytime a trigger occurs. Select the External Trig Out Setting: High Active, Low Active, or Toggle from High to Low or Low to High once (3.3 V output).

Enter the External TrigOut pulse width.

External Trig In Setting

An external Low or High input signal can cause triggering. Select the External Trig In Setting: High Active, Low Active, or Toggle from High to Low or Low to High once (3.3 V output).

Choose Port Speed

The default speed is Autospeed. You can also select the port speed from the drop-down list: 1.5 Gbps, 3.0 Gbps, or 6.0 Gbps.

Note: If a Port ID check box has no check, the analyzer does not capture any patterns for that port. The system allocates trace memory for that port to its adjacent port, for example: I1, T1 <-> I2, T2 or I3, T3 <-> I4, T4.

Ports Configuration

Select the **Port Configuration** button to display the Set Port Configuration dialog.

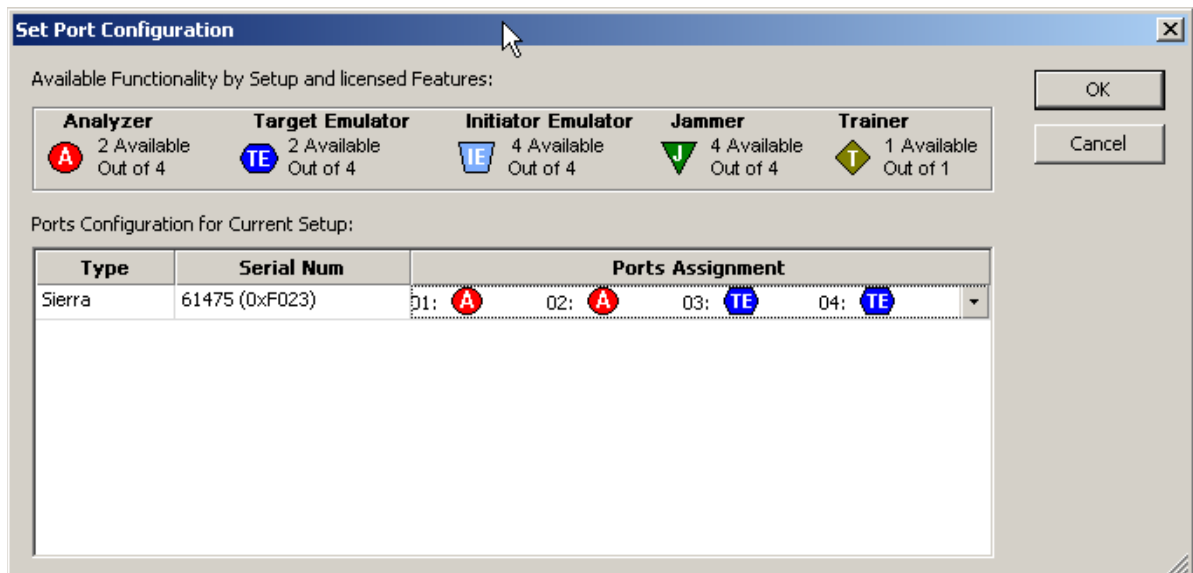

Figure 2.70: SAS: Set Port Configuration Dialog

The dialog shows the current port configuration. To select a port configuration, click the down arrow to display the Select Port Configuration dialog.

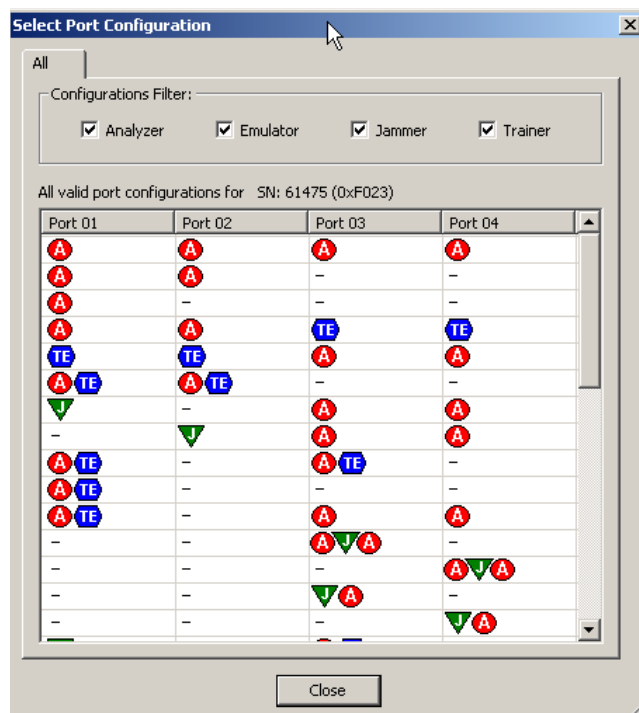







Figure 2.71: SAS: Select Port Configuration Dialog

Port configuration depends on the application you run.

- ❑ To act as analyzer, select the  **Analyzer** port configuration.
- ❑ To activate a Device emulator on a port, select the  **TargetEmulator** port configuration.
- ❑ To activate the Initiator Emulator on a port and run the Analyzer on the same port, select   **InitiatorEmulator/Analyzer**.
- ❑ To activate the InFusion on a port, select  **Jammer**.
- ❑ To activate the Trainer on a port, select  **Trainer**.

Sierra M6-2 can have Analyzer and Trainer or Analyzer and Jammer on the same port.

Note: To display the current Port Configuration, click the green button in the lower right corner to display the Port Status window (see [“Port Status” on page 281](#)).

Port Configuration and Projects

Port Configuration depends on Project selected.

Performance Analyzer and Performance Analyzer with Initiator Emulator do not use ports.

Protocol Analyzer, Protocol Analyzer with Initiator Emulator, and Target Emulator can have the following port configurations.

Project	Number			
	One analyzer and/or one emulator	Two analyzers and/or two emulators	Three analyzers and optionally one emulator	Four analyzers or emulators
Protocol Analyzer	Port 1.	One analyzer each on 1 and 2.	One each on 1, 2, and 3.	One each on 1, 2, 3, and 4.
Protocol Analyzer with Initiator Emulator	Port 1. Pair on Port 1.	One analyzer each on Port 1 and Port 2. One emulator each on Port 1 and Port 2.	Pair on 1 and one analyzer on 3 and one analyzer on 4.	NA
		One analyzer each on Port 1 and Port 3.		
		One emulator each on Port 1 and Port 3.		
		One analyzer each on 1 and 2, and One emulator each on 3 and 4.		
		One emulator each on 1 and 2, and One analyzer each on 3 and 4.		
		Pair on Port 1 and pair on Port 2. Pair on Port 1 and pair on Port 3.		

Project	Number			
Target Emulator	Port 1.	One emulator each on	Pair on Port 1 and	One each on
	Pair on Port 1	Port 1 and Port 2.	one analyzer each on	Port 1, 2, 3, and 4.
		One emulator each on	Port 3 and Port 4.	
		Port 1 and Port 3.		
		One emulator each on Port 1 and 2 and one analyzer each on Port 3 and 4.		
		One analyzer each on Port 1 and 2 and one emulator each on Port 3 and 4.		
		Pair on Port 1 and pair on Port 2.		
		Pair on Port 1 and pair on Port 3.		

Analyzers work with Emulators, Jammer, and Trainer (see below).

One Initiator Emulator can work by itself or work with one Analyzer.

One Target Emulator can work by itself or work with one Analyzer.

(Note that Host Emulator and Analyzer can be on one port and Analyzer and Device Emulator can be on another port at the same time.)

Emulators do not work with Trainer.

Emulators work with Jammer (see below).

Note: Ports 1 and 2 are a pair, and Ports 3 and 4 are a pair. Put related hardware on one pair. For example, put two analyzers on ports 1 and 2, and two emulators on Ports 3 and 4.

Jammer can pair with one or two analyzers on a port.

Jammer can go on the other pair from the analyzers pair.

Jammer can go on the other pair from the emulators pair or analyzers/emulators pair.

Jammer does not work with Trainer.

Trainer can pair with one analyzer on a port
 Trainer can go on the other pair from the analyzers pair.
 Trainer does not work with emulators.
 Trainer does not work with Jammer.

MUX Setting (SAS only)

Enable Muxing on port combinations.

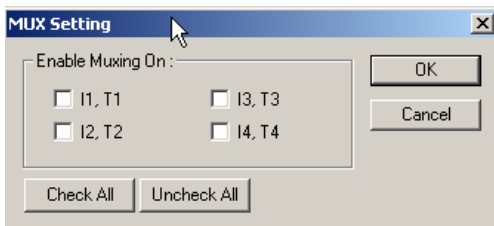

Figure 2.72: MUX Setting Dialog Box

If you enable this option on two ports, the data of both ports transfers on one physical link, whose speed is twice the speed of each link, and the data of two links multiplexes on one physical link. For example, two 3 G ports together make one 6 G port. Note the following:

- ❑ The muxing check boxes are usable only if two or more emulator channels are selected.
- ❑ The initiator emulator check box is greyed out if only one emulator channel is selected.

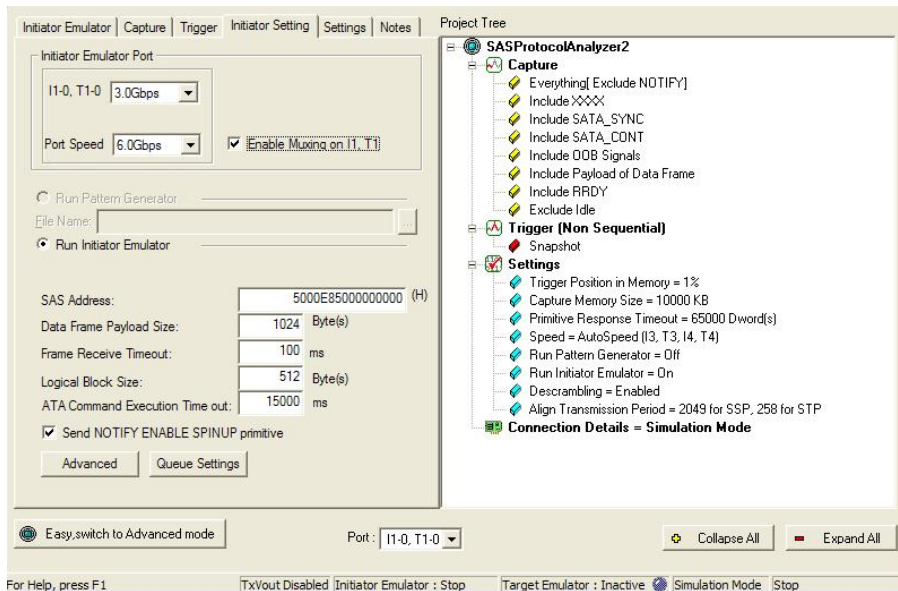

Figure 2.73: Initiator Emulator Check Box and Channel Speeds

- ❑ The target emulator check box is not displayed at all until two or more emulator channels are selected.

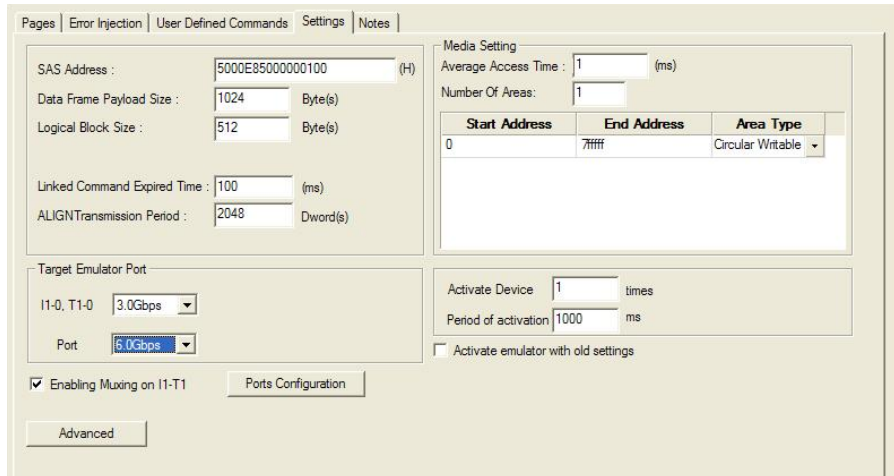

Figure 2.74: Target Emulator Check Box and Channel Speeds

Note: Analyzer must detect MUX primitives from both host and device sides to capture traffic correctly in Muxing mode.

Add a Project Note

To enter and save information about the current project, click the **Notes** tab and enter the data about the project.

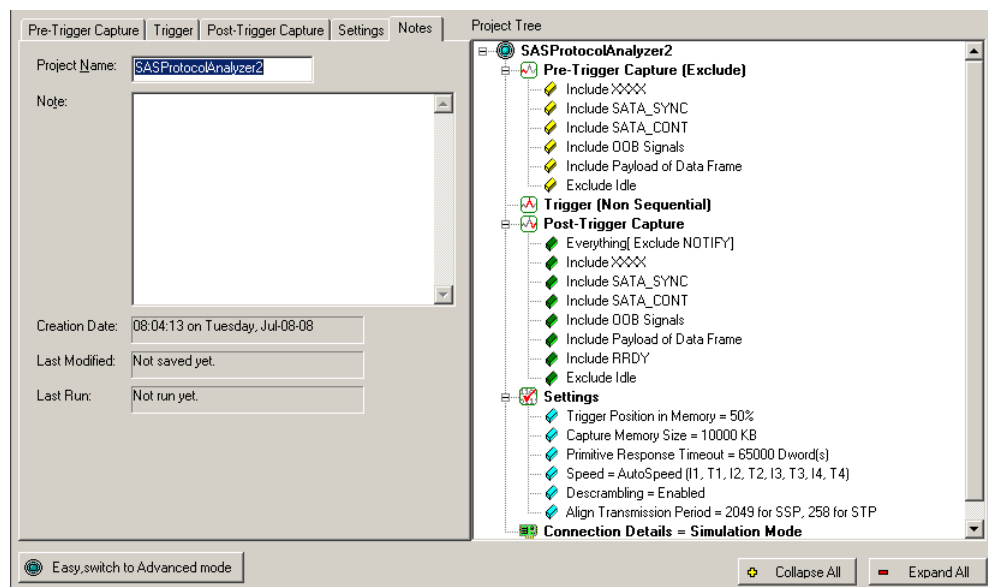

Figure 2.75: Project Notes Tab

Advanced Mode (User-Defined)

Advanced Mode expands Analysis capability by allowing you to program complex triggering and data capture projects.

The Advanced Mode is a state machine with up to 23 different states. You can program each state individually to:

- Trigger on a different event or trigger unconditionally.
- Capture Everything, Nothing, or a user-defined pattern.
- Include up to three ELSE IF statements, allowing a jump to any other state based on a user definition.
- Use up to three timers, which you can set to a maximum value of 42949 ms. You can set a timer in the state or continue the timer set in the previous state.
- Output an external trigger High or Low.

Note: In Advanced Mode, events on each link are counted independently. A condition is met if the number of events on a link equals the defined occurrence.

Working in Advanced Mode

To start working in the Advanced Mode, click the **Easy, Switch to Advanced Mode** button in an open Analyzer window.

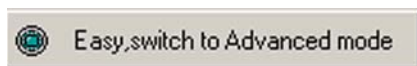

You can:

- Display the state definition
- Set Output Trigger level
- Select up to three timers
- Define the If condition and up to three Else If conditions
- Set number of occurrences before trigger
- Set captured data
- Set excluded data
- Go to next state
- Add state
- Choose link for Sequencer setup

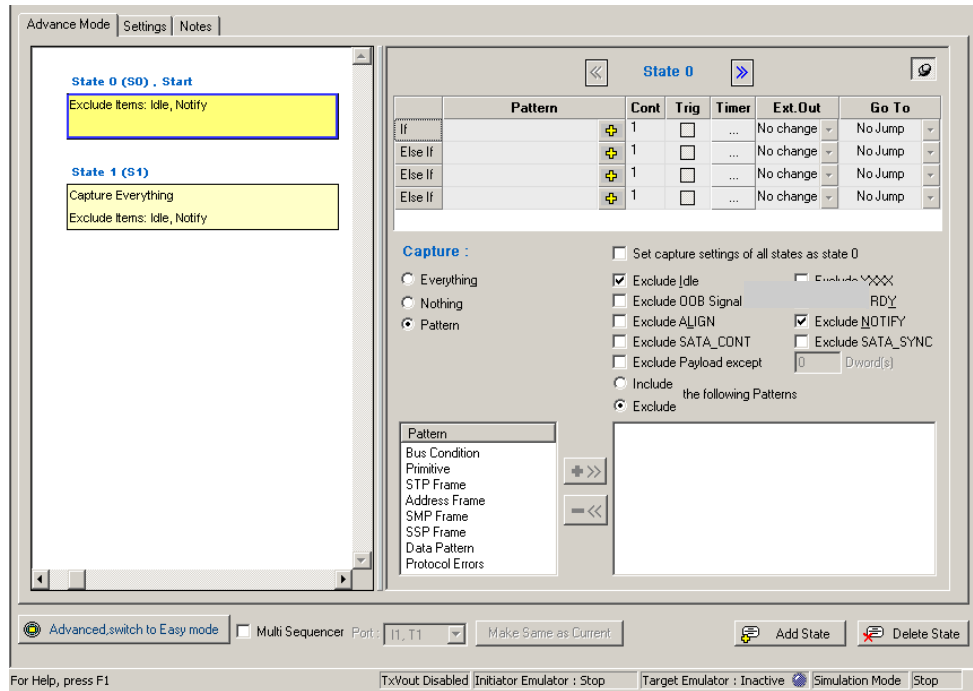

Figure 2.76: SAS: State Programming Dialog

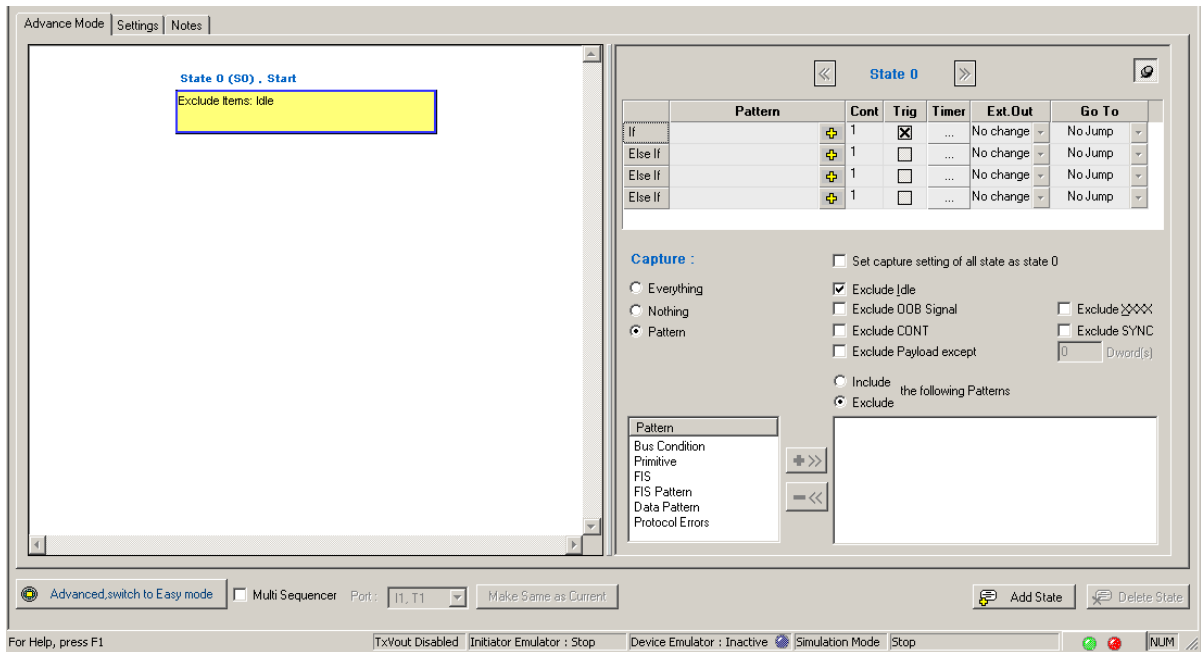

Figure 2.77: SATA: State Programming Dialog

SAS vs. SATA: SATA Dialog removes Exclude ALIGN, Exclude RRDY, and Exclude NOTIFY. SATA Dialog replaces Exclude SATA_CONT with Exclude CONT and Exclude SATA_SYNC with Exclude SYNC.

SATA Dialog has patterns Bus Condition, Primitive, FIS, FIS Pattern, Data Pattern, and Protocol Errors and does not have STP Frame, SMP Frame, STP Frame, or Address Frame.

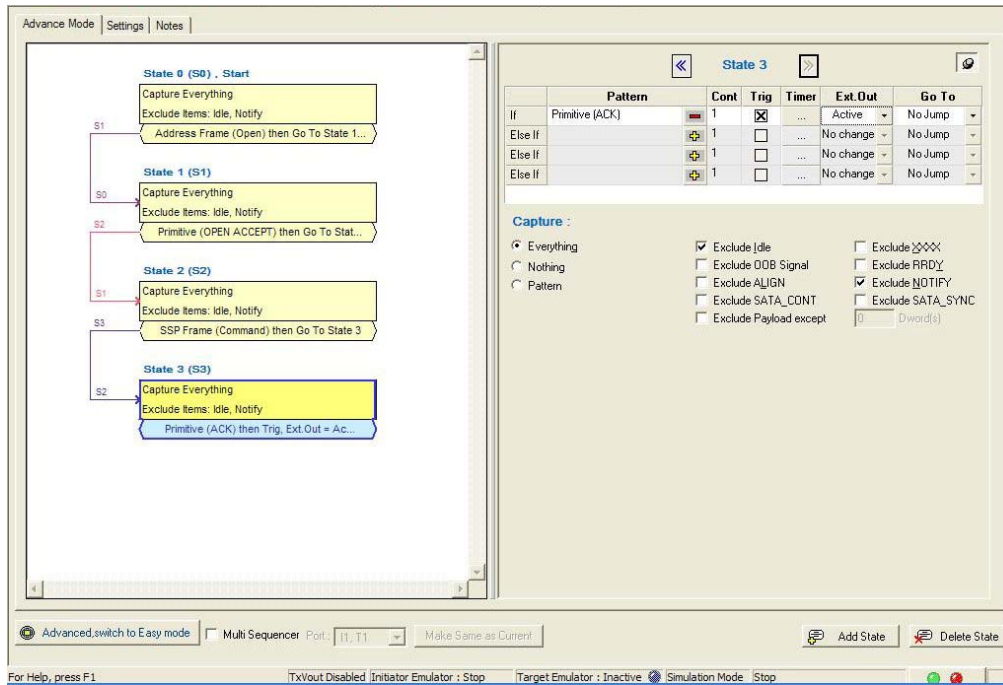

Figure 2.78: SAS: Advanced Trigger with Multiple Branches

State Number for Complex Trigger Sequences

To follow the path of complex trigger sequences, you can display state number.

To see state number, in Packet View right-click a link layer packet, show field, and select state number.

Setting Trigger Conditions

To set the If and Else If trigger condition:

1. Click the **Add Pattern** button  for a Pattern field and choose a trigger condition from the drop-down list.

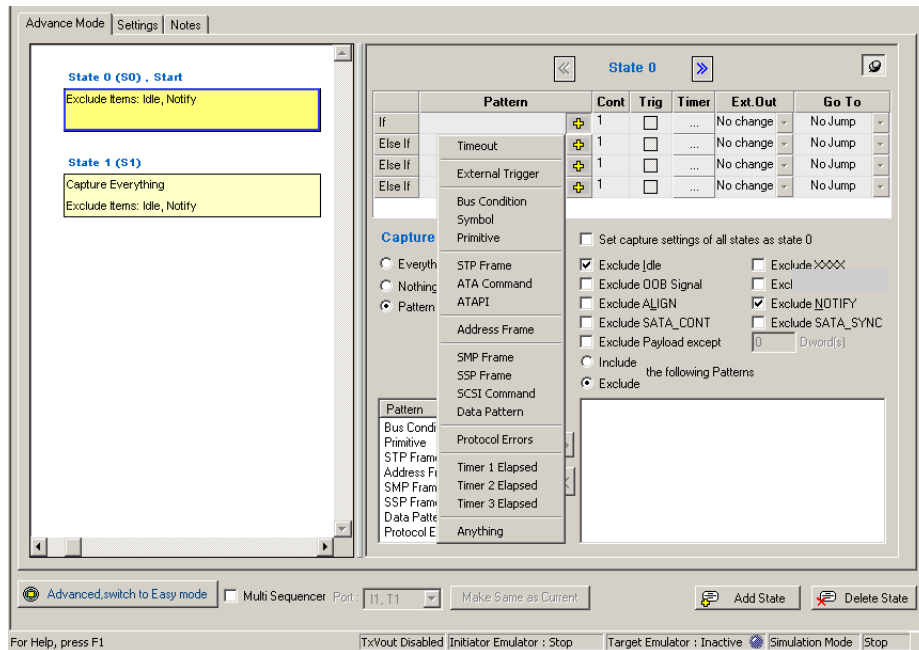

Figure 2.79: SAS: Choosing a Trigger Condition

2. Define each selected pattern in the same way as in Easy Mode, as described starting on [page 68](#). To use a timer, define it first.

Note: You can set a timer for any If or Else If condition.

3. Enter a value for the number of occurrences before trigger in the **Cont** field, up to a maximum of 65535 occurrences.
4. Choose a capture option: **Everything**, **Nothing**, or **Pattern**.
5. If you choose Pattern, you can select patterns for inclusion or exclusion. Clicking the **Pattern** option enables a pattern definition dialog.

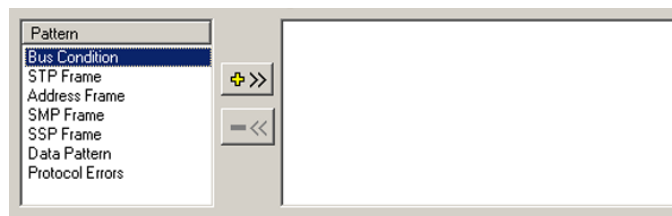

Figure 2.80: SAS: Choosing a Pattern

6. Choose pattern(s) and click the +>> button to add them for capture or exclusion. You define each pattern the same way as in Easy mode (see [“Defining Patterns” on page 68](#)).
7. For an output trigger, click the down arrow in the **Ext. Out** field and choose an output trigger level. **Note:** Do not use the LOW setting in Advanced Mode.
8. To go to another state, click the down arrow in the **Go To** field and select a state. If no other state has been defined, choose **New State** to add a state.

Multi - Link Triggering

You can set different triggering for each link. To set different trigger conditions for a link, check the **Multi Sequencer** check box and select the link for setup from the Port drop-down list.

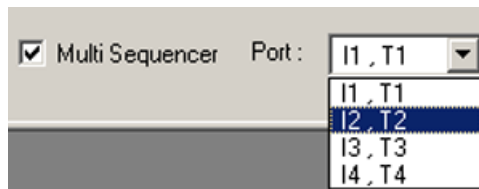

Figure 2.81: SAS: Multi - Link Triggering Setup

Set Timers

You can set and use up to three timers for triggering. You can set each timer for each state, or set it to continue from one set in the previous state. The timer defined for a particular state starts when the system enters that state. You can set a timer for any IF or ELSE IF condition. To set up the timers, click the **ellipses** in the **Timer** field next to the IF or ELSE IF condition in each state and define each of the timers in the Set Timers dialog.

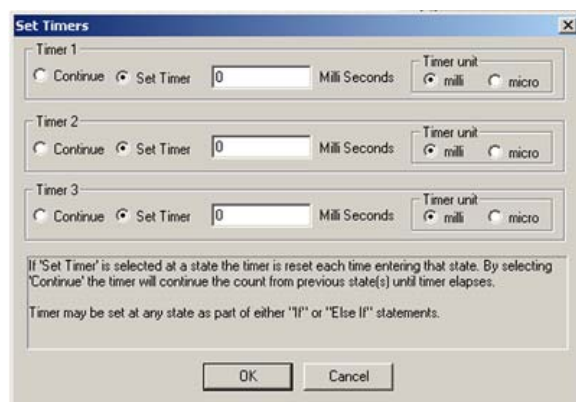

Figure 2.82: Set Timers Dialog

Note: Three timers are available. You have to set and start each timer in order to continue the next timer. For example, you have to start Timer 1, continue it, then set Timer 2 in order to continue it. It will not allow you to continue Timer 2 until you first set it.

Timeout

In the Timeout Pattern dialog you can do the following:

- Set a Timeout.
- Select a Pattern for the Start Event. (Start Event resets the timer.)
- Select a Pattern for the End Event.
- Enter the Timeout Value in milliseconds or microseconds.
- Select a Trigger Mode:
 - If End Event occurs before timer expires.
 - If timer expires before End Event occurs.

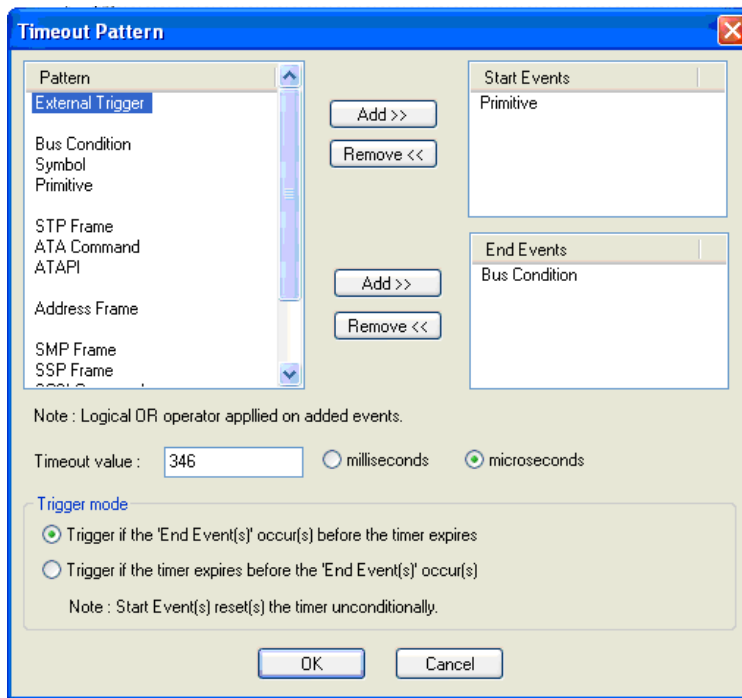

Figure 2.83: Timeout Dialog

WARNING: In Advanced Mode, Short State Jump Intervals Can Cause Hardware Queue Overflow and Corrupt Frames.

When using Advanced Mode, if too many state jumps occur in a short time, the hardware queue can overflow, which may corrupt frames. For example, an infinite loop can cause many state jumps in a short time. Hardware overflow can occur if interval between state jumps is less than 60 DWORDs.

In Advanced Mode, infinite loops are usually used to check if an event occurs before a timeout. In this case, you can use the Timeout dialog to avoid hardware queue overflow.

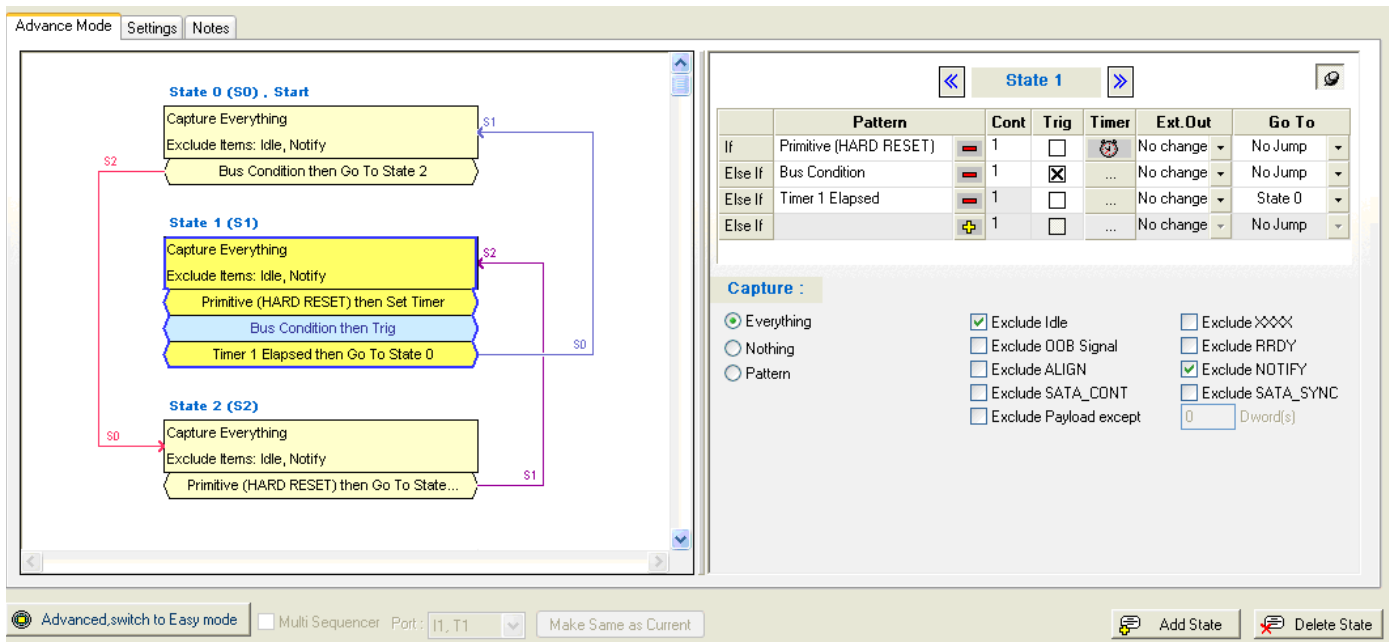

Figure 2.84: State Machine with Multiple Patterns and Timer Elapse

In Figure 2.84, the port detects HARD_RESET, which starts the Timer. When the timer expires, it jumps to another state. If a trigger occurs between timer start and end, the captured trace will have corrupt frames because of hardware queue overflow.

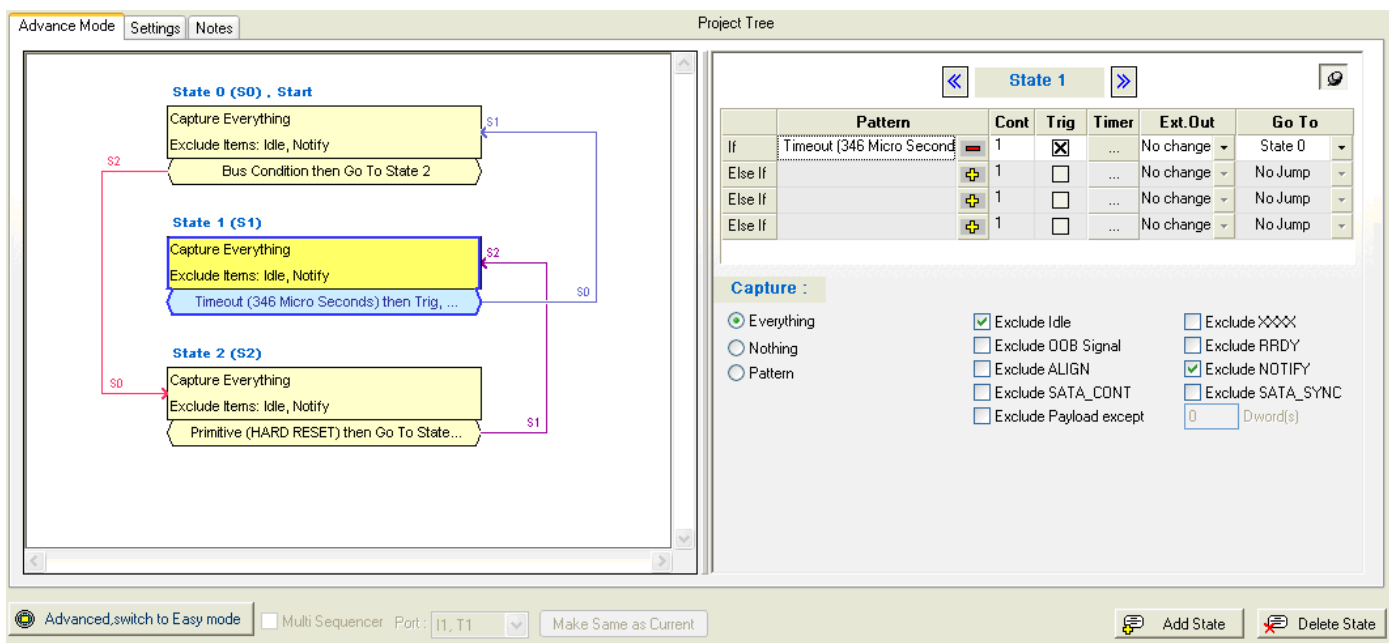

Figure 2.85: State Machine with Timeout Pattern to Replace Timer

To overcome this limitation, use a Timeout Pattern instead of Timer. Figure 2.85 shows the state machine using Timeout instead of Timer.

Figure 2.86 on page 119 shows the Timeout settings.

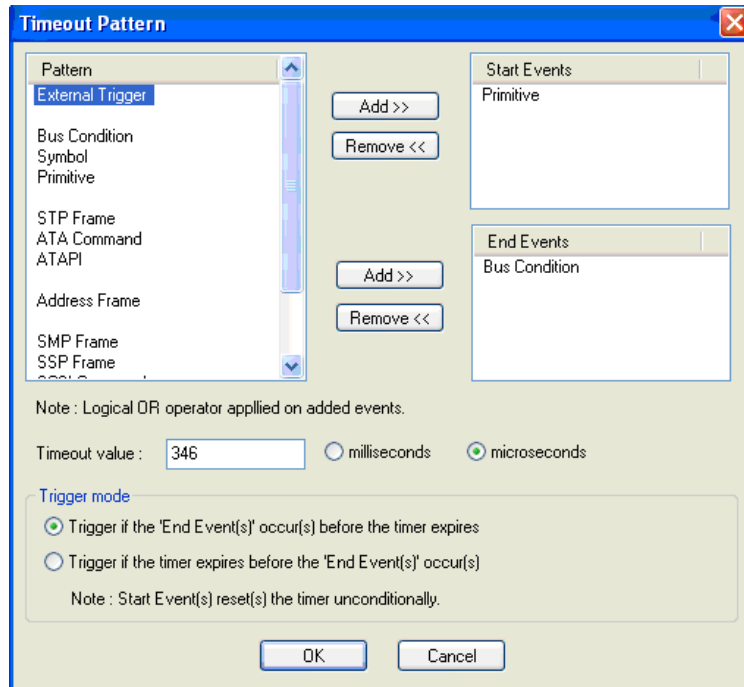

Figure 2.86: Timeout Settings

Timeout begins when the port detects the Start Event. Timer begins when the port detects the Hard RESET primitive. In the Trigger Mode window, set the Trigger to trigger when the port detects the End Event, before the Timeout occurs. In our example, this is the Bus Condition. Capture begins when the ports detects the Bus Condition before the Timeout occurs. If the port does not detect the Bus Condition until the Timeout occurs, the State Machine in [Figure 2.85 on page 118](#) jumps to State 0.

Useful Key Sequences

The following key sequences are active to assist you in navigating a defined state machine:

Ctrl+a	Add State
Insert	Insert State
Del	Delete State
Ctrl+c/Ctrl+Ins	Copy
Ctrl+v/Shift+Ins	Paste
Up/Down arrow keys	Moves selection between states
Page Up/Page Down	Page Up and Page Down states
Home	Go to first page
End	Go to end page

Project Settings

Prior to running the Advanced mode project, click the **Settings** tab. The options in the Settings dialog are the same as for the Easy Mode, described starting on [page 102](#).

SAS vs. SATA: For the ALIGN Transmission Period section, SATA Dialog shows options 256 and 258, and does not show 2048 or 2049.

For Speed, SATA Dialog shows H1, D1 to H4, D4 and does not show I1, T1 to I4, T4. SATA Dialog does not show MUX Setting button.

Notes

To include some descriptive information about the project, click the **Notes** tab and enter a brief descriptive note (see [“Add a Project Note” on page 111](#)).

Exercise and Capture

SAS: To perform a capture with SAS Initiator Emulator generated bus traffic, click **File > New > Protocol Analyzer (Initiator Emulator)**.

SATA: To perform a capture with SATA Host Emulator generated bus traffic, click **File > New > Protocol Analyzer (Host Emulator)**.

Program the Initiator Emulator or Host Emulator, then set up a capture, as described in [“Protocol Analysis” on page 49](#).

Programming the Initiator or Host Emulator

SAS: Click the **Initiator Emulator** tab to program the Initiator or Emulator.

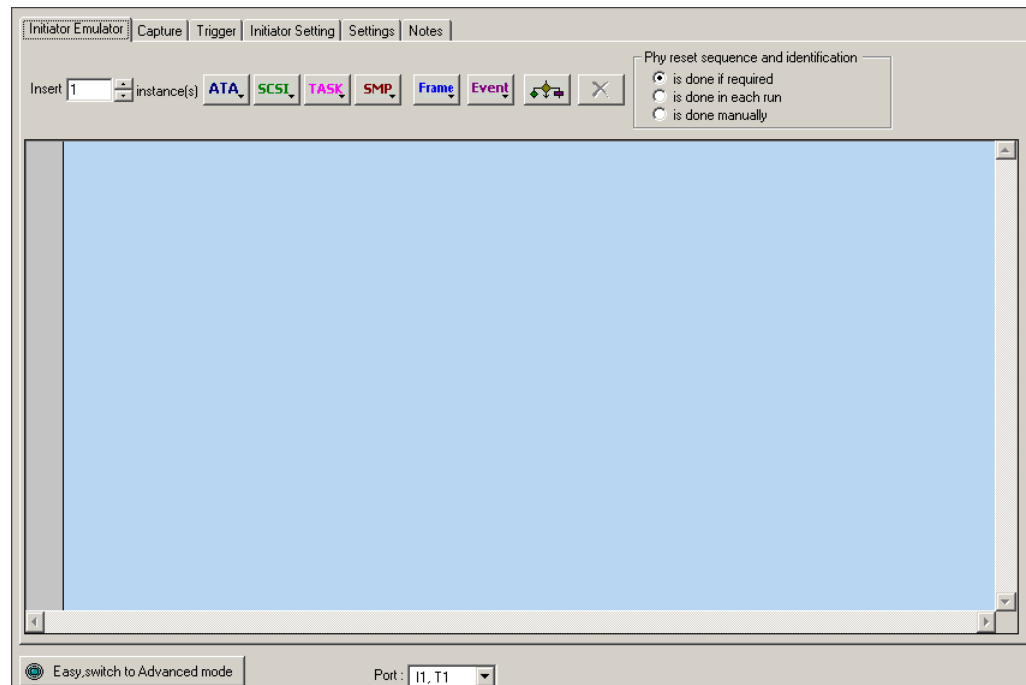

Figure 2.87: SAS: Initiator Emulator Program Dialog

SATA: Click the **Host Emulator** tab to program the Initiator or Emulator.

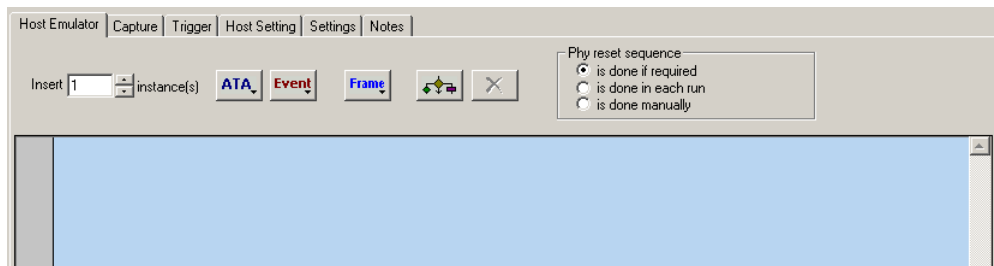

Figure 2.88: SATA: Host Emulator Program Dialog

SAS vs. SATA: SATA Dialog removes the SCSI, Task, and SMP buttons and replaces the Initiator Setting tab with the Host Setting tab.

SAS: You can create an Initiator program using ATA, SCSI, Task, and SMP commands; Frames; and/or Events. These commands can execute in a program loop or be subject to user-specified conditions.

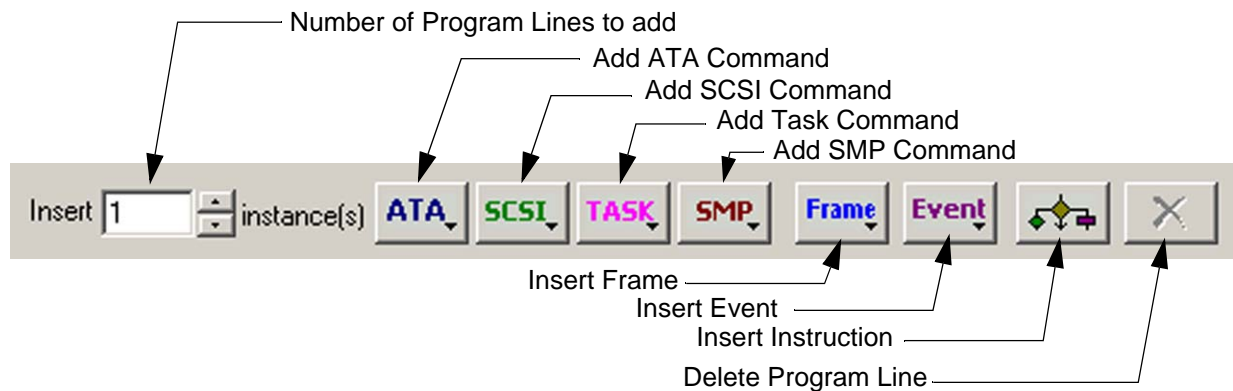

Figure 2.89: SAS: Host Emulator Program Dialog

SATA: You can create a Host program using ATA, Frames, and/or Events.

Add Program Lines

To add program lines, enter the number of lines to add in the Insert field, then click a command button: ATA, SCSI, TASK, SMP, Frame, or Event.

Note: SAS Initiator Emulator supports a queue depth of 32 commands.

Adding Initiator or Host Emulator Commands

Adding an ATA Command

Click the **Insert ATA Command** button, click one of the command categories, and choose a command.

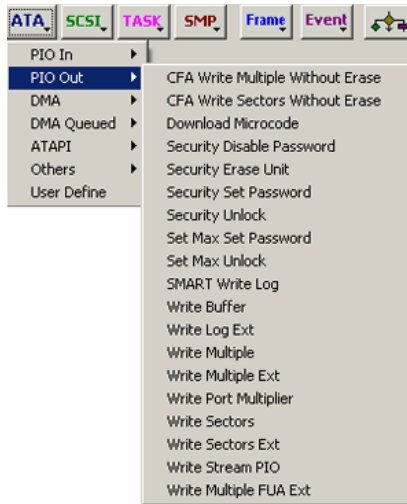

Figure 2.90: ATA Dropdown List

ATA Commands:

- PIO In
- PIO Out
- DMA
- DMA Queued
- NCQ
- ATAPI
- Smart (see below)
- Non-Data
- Others
- User Defined

Smart Commands (SATA only)

To enable smart commands, click the **Settings** tab to open the Settings dialog, click the **Advanced** button to open the Advanced Target Setting dialog, go to the Miscellaneous Feature tab, check **Support smart feature set**, and check the specific features to enable them (see [“Miscellaneous Features Tab” on page 199](#)).

Note about Payload Data file: The software refreshes the Payload Data file automatically, so when you select a Payload Data file, you get the latest version.

For the SPC4 SEND DIAGNOSTIC command, if you have selected the non-default path to the development directory on the Software Settings page, that path is shown when you select a Payload Data file.

Adding a User-Defined ATA Command

Click the **Insert ATA Command** button and choose **User Defined**. This enters an ATA command line with editable fields to define your own custom command.

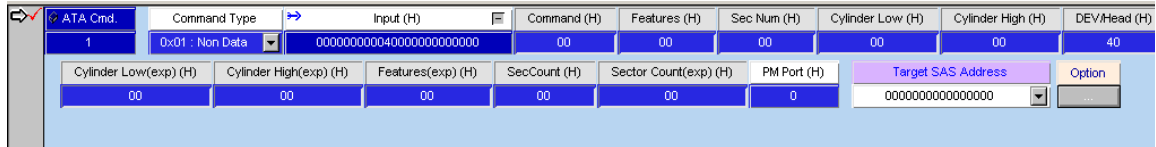

Figure 2.91: Insert ATA Command

Adding a SCSI Command (SAS only)

Click the **Insert SCSI Command** button, click one of the command categories, and choose a command.

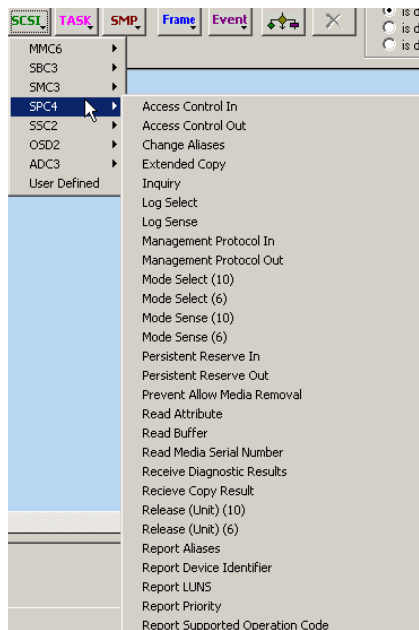

Figure 2.92: SAS: SCSI Dropdown List

SCSI Commands:

MMC6

SBC3

SMC3

SPC4

SSC2

OSD2

ADC3

User Defined

Adding a User-Defined SCSI Command (SAS only)

Click the **Insert SCSI Command** button and choose **User Defined**. This enters an SCSI command line with editable fields to define your own custom command.

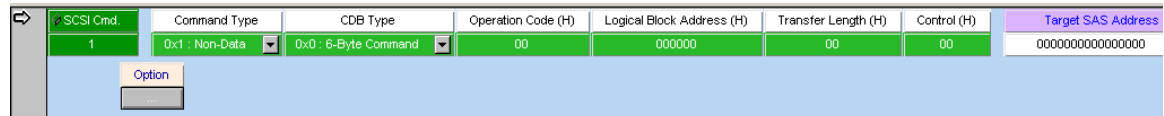

Figure 2.93: Insert SCSI Command

User-defined SCSI commands are Non-Data, Read from Block Device, Read from Non-Block Device, Write to Block Device, Write to Non-Block Device, Bi-Directional from Block, Skip_Write, and Skip_Read.

Adding a TASK Command (SAS only)

Click the **Insert Task Command** button and choose the command to insert.

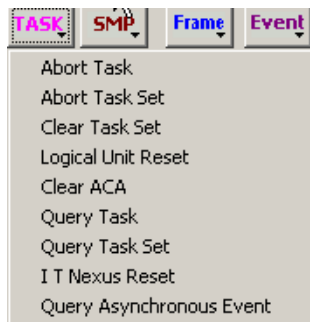

Figure 2.94: SAS: TASK Dropdown List

Task Commands:

- Abort Task
- Abort Task Set
- Clear Task Set
- Logical Unit Reset
- Clear ACA
- Query Task
- Query Task Set
- I T Nexus Reset
- Query Asynchronous Event

Adding an SMP Command (SAS only)

Click the **Insert SMP Command** button and choose the command to insert.

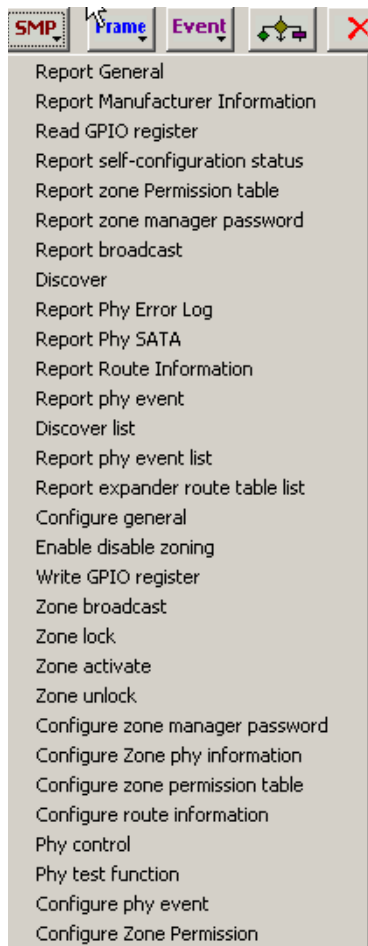

Figure 2.95: SAS: SMP Dropdown List

SMP Commands:

Report General
 Report Manufacturer Information
 Read GPIO Register
 Report self-configuration status
 Report zone permission table
 Report zone manager password
 Report broadcast
 Discover
 Report Phy Error Log
 Report Phy SATA
 Report Route Information
 Report phy event
 Discover list
 Report phy event list

Report expander route table list
 Configure general
 Enable disable zoning
 Write GPIO register
 Zone broadcast
 Zone lock
 Zone activate
 zone unlock
 Configure zone manager password
 Configure zone phy information
 Configure zone permission table
 Configure route information
 Phy control
 Phy test function
 Configure phy event
 Configure Zone Permission

Adding a Frame

SAS: Click the **Insert Frame** button and choose the frame type to insert.

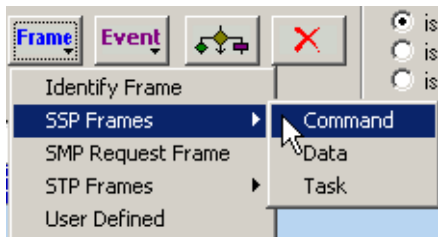

Figure 2.96: SAS: Frame Dropdown List

Note: SSP and STP frames offer additional options.

SAS Insert Frame Command:

Identify Frame
 SSP Frames (Command, Data, Task)
 SMP Request Frame
 STP Frames (Host to Device, DMA Setup, Data)
 User Defined

SATA: Click the **Insert Frame** button and choose the frame type to insert.



Figure 2.97: SATA: Frame Dropdown List

SATA Insert Frame Commands:

- Self Test
- Host to Device
- DMA Setup
- Data
- User Defined

Adding an Event

Click the **Insert Event** button and choose the event to insert.

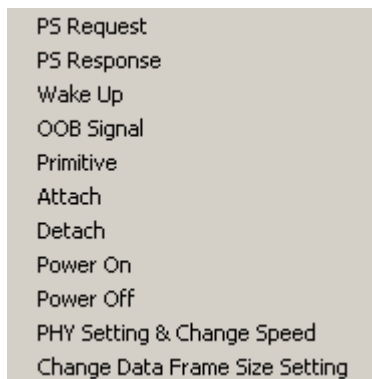

Figure 2.98: SAS: Event Dropdown List

SAS Event Commands:

- PS Request
- PS Response
- Wake Up
- OOB Signal
- Primitive
- Attach
- Detach
- Power On
- Power Off
- PHY Setting & Change Speed
- Change Data Frame Size Setting

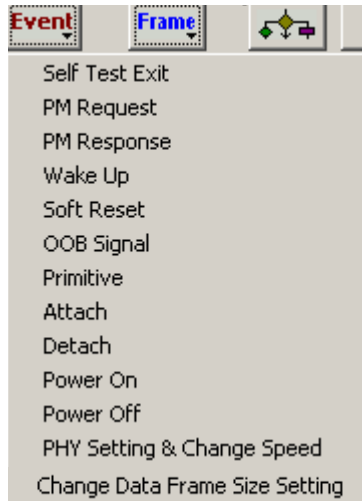

Figure 2.99: SATA: Event Dropdown List

SATA Event Commands:

Self Test Exit
PM Request
PM Response
Wake Up
Soft Reset
OOB Signal
Primitive
Attach
Detach
Power On
Power Off
PHY Setting & Change Speed
Change Data Frame Size Setting

PHY Setting Dialog

Sierra M6-4 and Sierra M6-2 only: The PHY Setting & Change Speed command supports 1.5, 3, and 6 Gbps speed changing. You can run commands for different speeds, which is especially useful for device checking. The Analyzer should support the Auto-Speed mode. Click the ... button to display the PHY Setting dialog.

Bit/Byte	7	6	5	4	3	2	1	0
0	Start	TX SSC Type	Reserved		Requested Logical Link Rate			
	1	0	00		0000			
1	G1 Without SSC	G1 With SSC	G2 Without SSC	G2 With SSC	G3 Without SSC	G3 With SSC	Reserved	
	1	0	1	0	1	0	00	
2	Reserved							
	00000000							
3	Reserved							PARITY
	0000000							0

Figure 2.100: SAS: PHY Setting Dialog

Select **Speed Negotiation Window 1 (1.5 Gbps)** or **2 (3 Gbps)**.

For SNW-3 PHY Capabilities, you can select **Calculate PARITY bit** or not.

For Line 0, enter Start, TX SSC Type, and/or Requested Logical Link Rate.

For Line 1, enter G1 without SSC, G1 with SSC, G2 without SSC, G2 with SSC, G3 without SSC, and G3 with SSC.

Inserting Instructions

Instructions are logical program elements that allow the definition of how the Initiator Emulator program executes. Using instructions, you can define program loops, make conditional jumps, and insert delays and stops.

To insert an instruction, click a command in the Initiator Emulator program where you want the instruction inserted, then click the **Insert Instruction** button, then choose the instruction to insert.

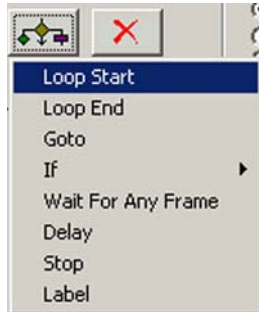

Figure 2.101: Insert Instructions Dropdown List

Start Loop

Click the command at which to start the loop, and then insert the Loop Start instruction.



Figure 2.102: Start Loop

Loop Count

Enter the number of times to run the loop in the number text box, or click the down arrow on the Count Drop-down combo box and choose Infinite.

End Loop

Click the command at which to stop the loop, and then insert the Loop End instruction.



Figure 2.103: End Loop

Add a Goto

To insert an unconditional jump to a previously labeled command, insert a Goto instruction. Then click the down arrow on the Drop-down combo box and choose the label to designate the destination command.



Figure 2.104: Goto

Add an If

To insert a conditional jump to a previously labeled command, insert an If instruction. Choose a specialized condition for the If from the If flyout.

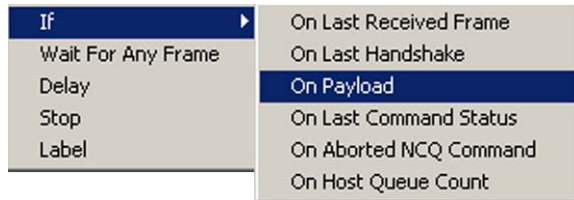

Figure 2.105: If

Then click the down arrow on the If Drop-down combo box, choose the condition for the jump and then the down arrow on the Goto Drop-down combo box, and choose the label to designate the destination of the jump.



Figure 2.106: If on Payload

For commands with incoming payloads, you can specify patterns for a condition by clicking the options button on a payload instruction and defining pattern(s).

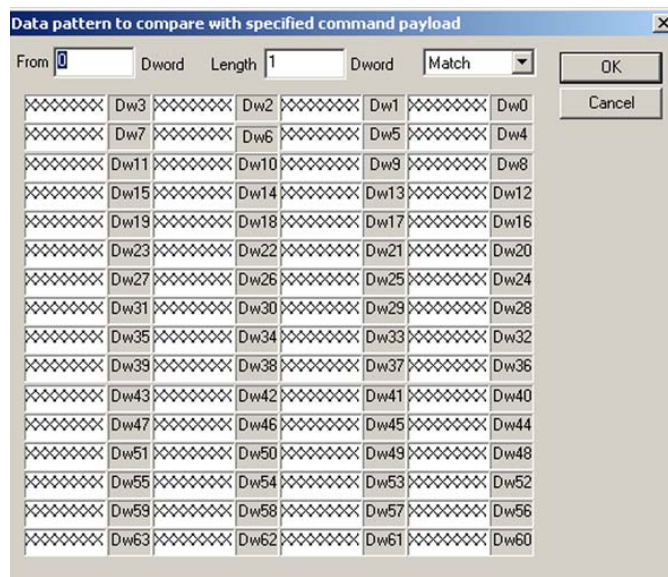

Figure 2.107: Specify Patterns

Add Wait for Any Frame

Insert this instruction and set an expiration time and a label for the Goto. This instruction causes the emulator to go to the specified label if any frame occurs prior to the expiration time. If the expiration time occurs first, the Initiator program goes to the next step.

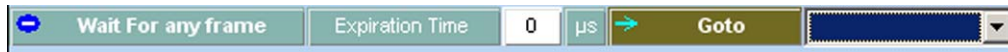

Figure 2.108: Wait for Any Frame

Add Wait for PS (SAS only)

Insert this instruction and select PS_ACK or PS_NAK. Set an expiration time and a label for the Goto. This instruction causes the emulator to go to the specified label if any frame occurs prior to the expiration time. If the expiration time occurs first, the emulator goes to the next step.

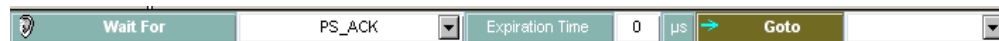

Figure 2.109: SAS: Wait for PS

Add Wait for Power Management (SATA only)

Insert this instruction and select PM_ACK or PM_NAK. Set an expiration time and a label for the Goto. This instruction causes the emulator to go to the specified label if any frame occurs prior to the expiration time. If the expiration time occurs first, the emulator goes to the next step.



Figure 2.110: SATA: Wait for Power Management

Insert Delay

To delay program execution, insert a Delay instruction. Enter the delay value (in microseconds) in the number text box to define a delay.



Figure 2.111: Delay

Add Stop

To define the end of the Initiator Emulator program, insert the Stop Initiator Exerciser instruction.

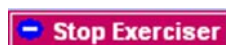

Figure 2.112: Stop

Add a Label

Add a label to any command, to use for conditional and unconditional jumps. Click the command to label, and insert the Label instruction. You can also insert a label by right-clicking a command and choosing Add Label.



Figure 2.113: Label

Labels are automatically labeled as Label# sequentially as they are added. However, you can assign them meaningful names such as STOP and START.

Instruction insert

You can set the instruction to insert before or after a command by setting the insertion mode. To set the insertion mode, right-click in the initiator page and choose Insert before current position or Insert after current position.

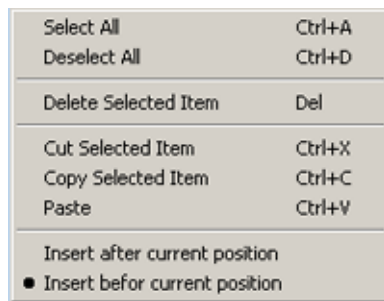

Figure 2.114: Instruction Insert

Phy Reset Sequence and Identification

The system performs this when required, by default, but you can perform it manually or on each run.

Sample Host Emulator Program (SATA only)

Figure 2.115 shows a simple completed SATA Host Emulator program.

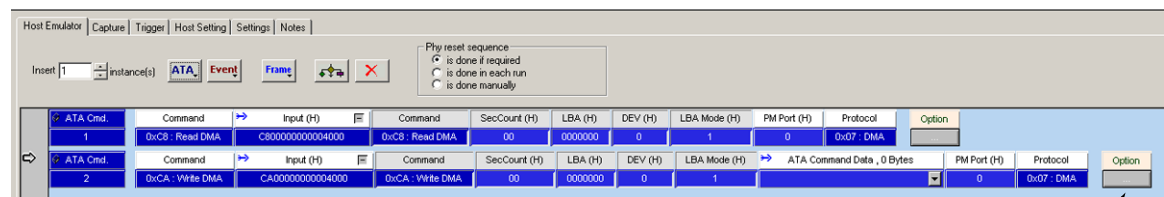

Option button

Figure 2.115: SATA: Sample Host Emulator Program

Sample Initiator Emulator Program (SAS only)

Figure 2.116 shows a simple completed SAS Initiator Emulator program.

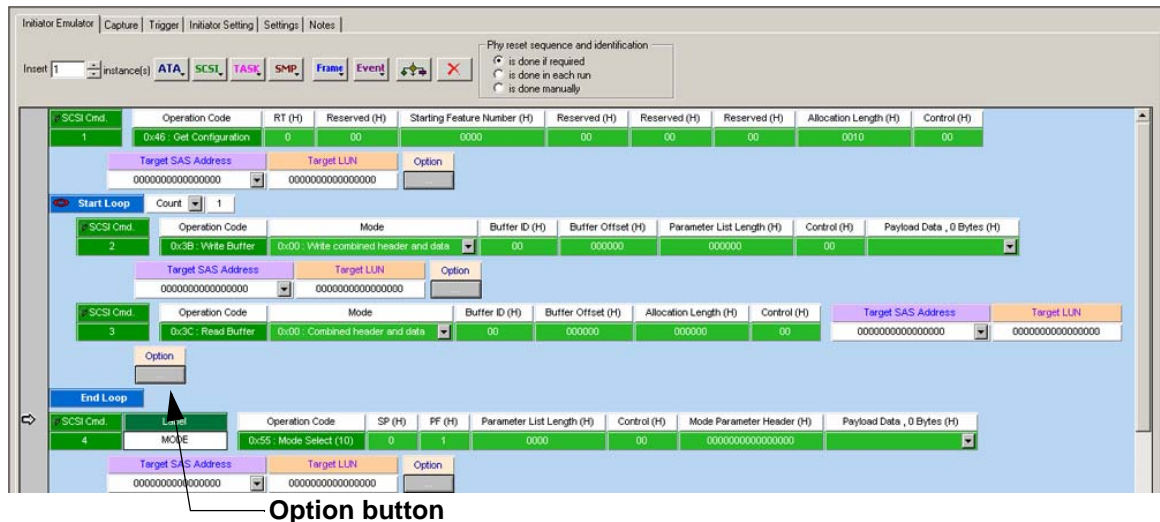



Figure 2.116: SAS: Sample Initiator DMA Emulator Program

Data Blocks

For commands requiring data blocks, click the down arrow of the **Payload Data** drop-down combo box and choose from a set of pre-defined data blocks. If

you need a new data block, select **Configuration > Data Block** or click the  **Data Block** icon on the tool bar to open a data block definition dialog (see [“Creating a Data Block” on page 159](#) for instructions on creating data blocks).

Exercising Specific Addresses

Since more than one device can be active at any given time, you can specify specific commands to send to an address. To assign commands to an address:

1. Click the down arrow on a **Target SAS Address** block in a completed Initiator Emulator program, then choose **Find New Device**.

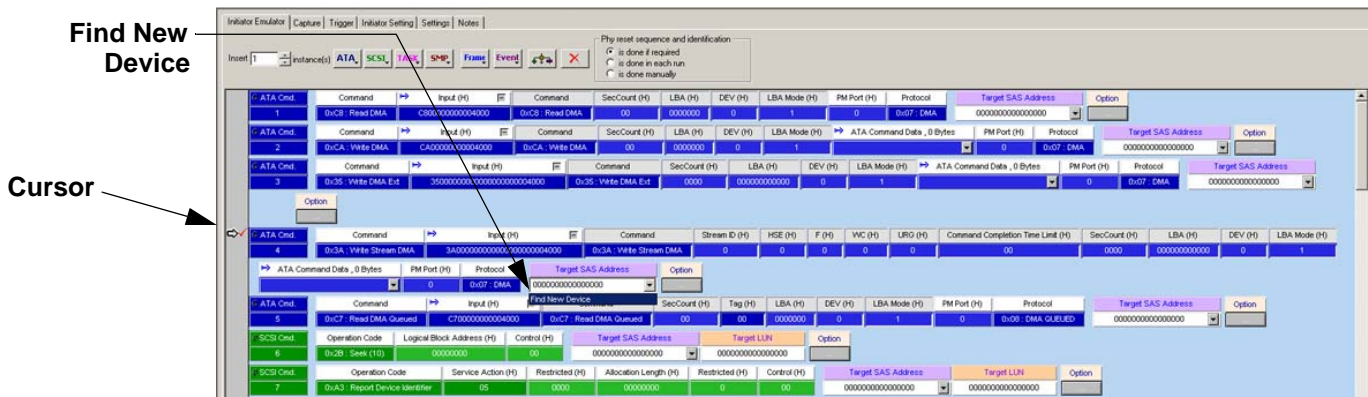

Figure 2.117: SAS: Find SAS Devices Select

Choosing **Find New Device** opens the Device Identifier dialog.

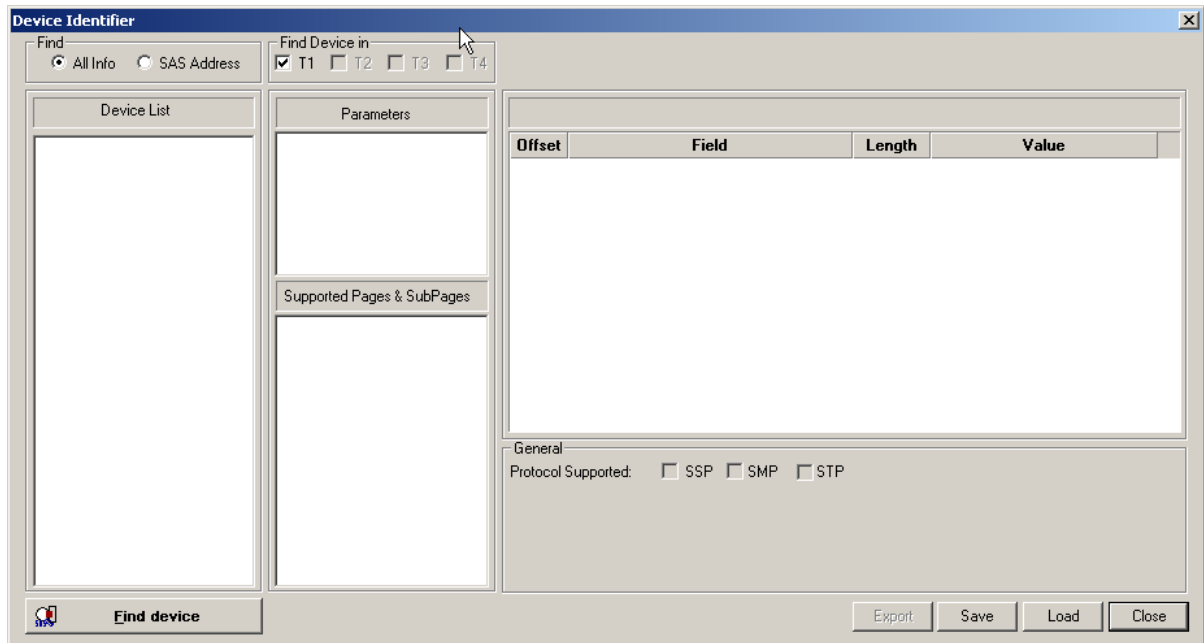

Figure 2.118: SAS: Device Identifier Dialog

SAS vs. SATA: SATA dialog does not show Find section (All Info and SAS Address).

SATA dialog has devices D1 to D4 and does not show T1 to T4.

SATA dialog does not show Supported Pages and Subpages.

SATA dialog lists Word, Description and Value, not Offset, Field, Length, and Value.

SATA dialog lists Device Type, Serial Number, and Spec Version, not Protocol Supported (SSP, SMP, STP)

2. Click the **Find device** button to display all active addresses.

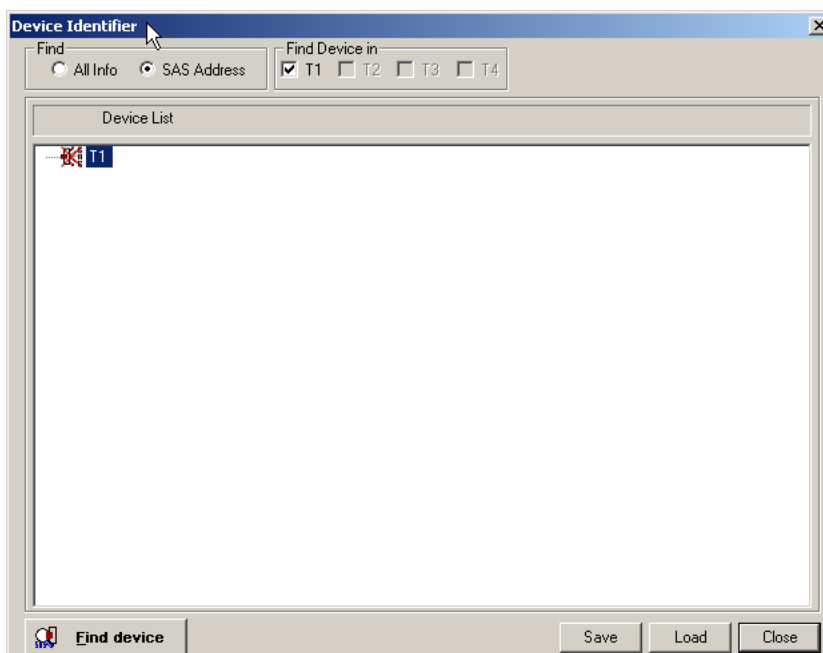

Figure 2.119: SAS: Active SAS Addresses

- To assign commands to an active address, right-click an address and choose:
 - Insert To Cursor** assigns all commands up to the cursor to the chosen address.
 - Insert: To All** assigns all commands to the chosen address.

Record and Play

This feature allows the selection of a range of commands in a trace and exports them to a previously saved *.sac file for execution by the SAS Initiator Emulator or *.stc file for execution by the SATA Host Emulator. You can export commands from all available samples, between X and Y cursors, or between designated commands.

To perform this action:

- Run a capture project or open a previously run and saved a captured trace file.
- Set X and Y cursors to export between cursors.

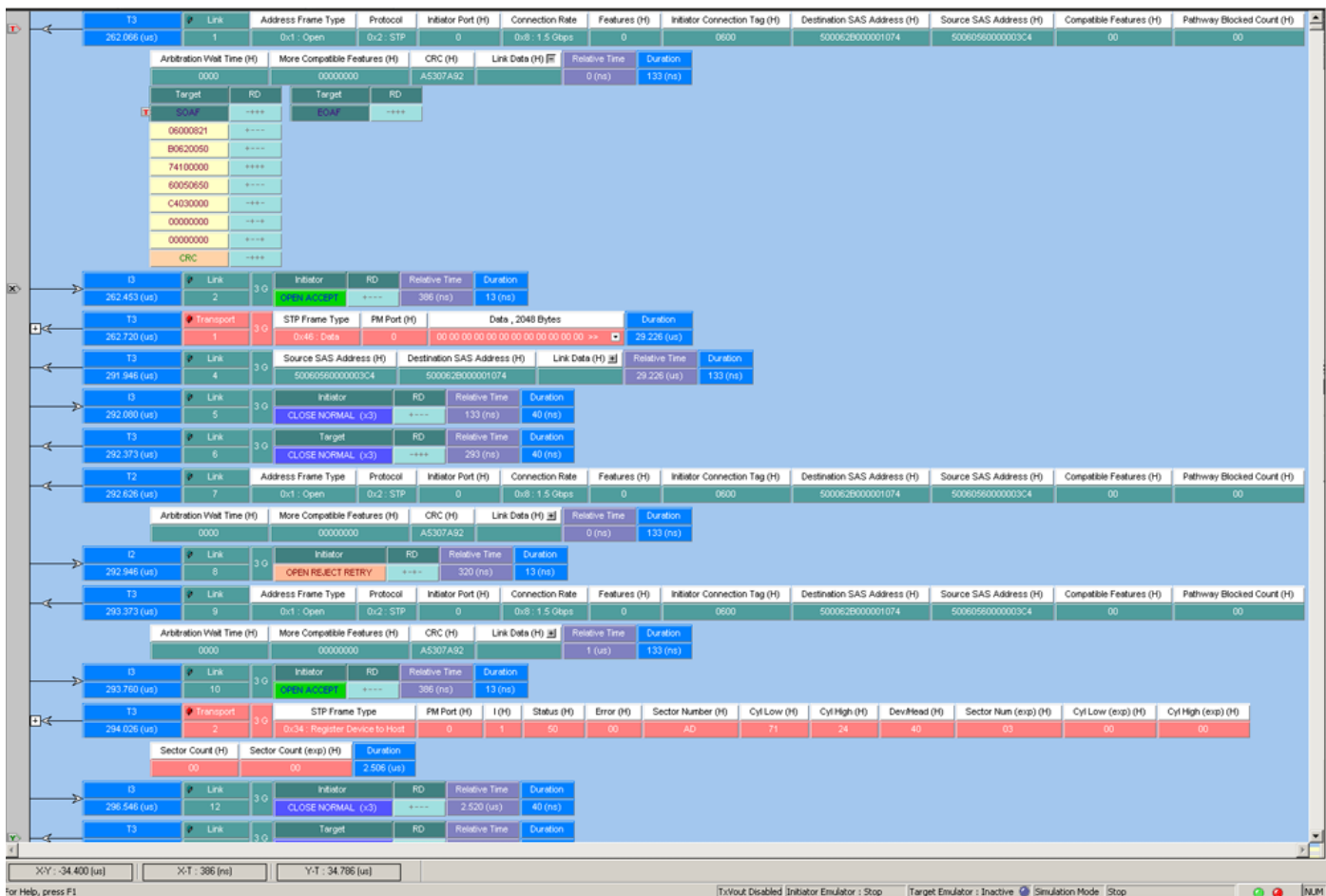

Figure 2.120: SAS: Captured Trace Display With Cursors Set

3. Click **File** and then choose **Export to Initiator Emulator** or **Export to Host Emulator**.

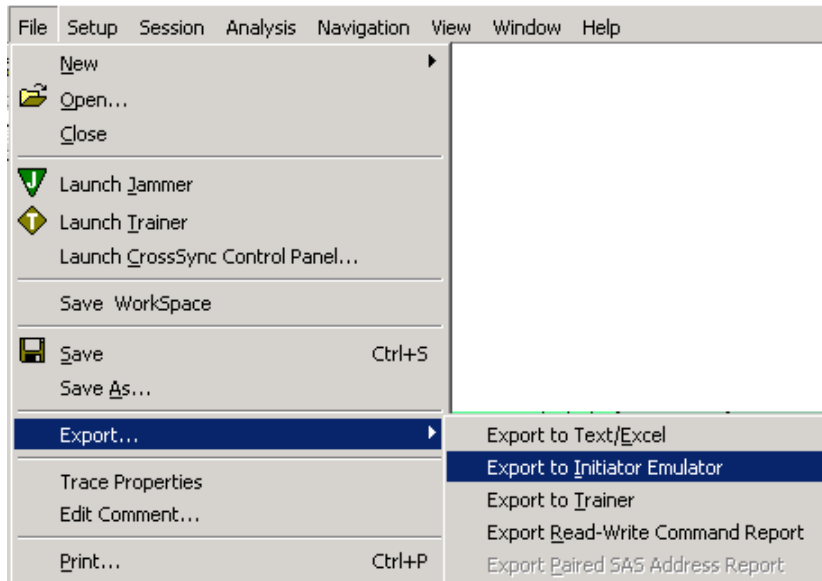

Figure 2.121: SAS: Export to Initiator Emulator

This displays the Export to Initiator Emulator dialog.

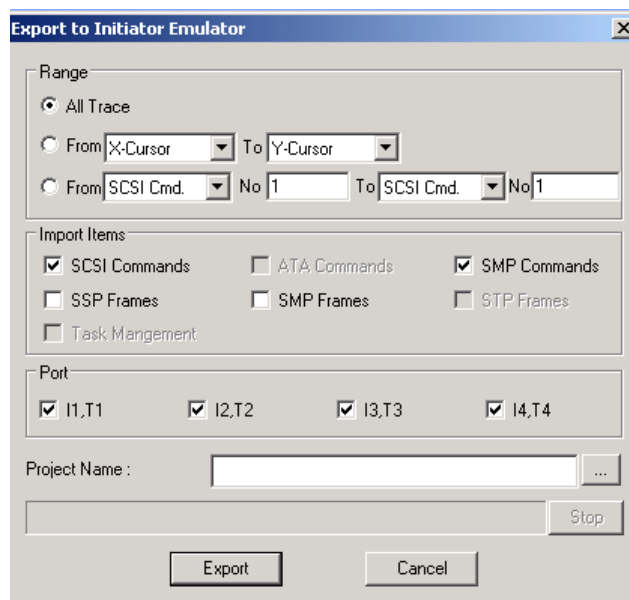

Figure 2.122: Export to Initiator Emulator Dialog

4. Click the ellipses next to the Project Name address bar and select an existing ***.sac** or ***.stc** file.
5. Choose an export range and item, Command, or FIS, then click **Export**.

6. After the export action completes, open the exported *.sac or *.stc file.

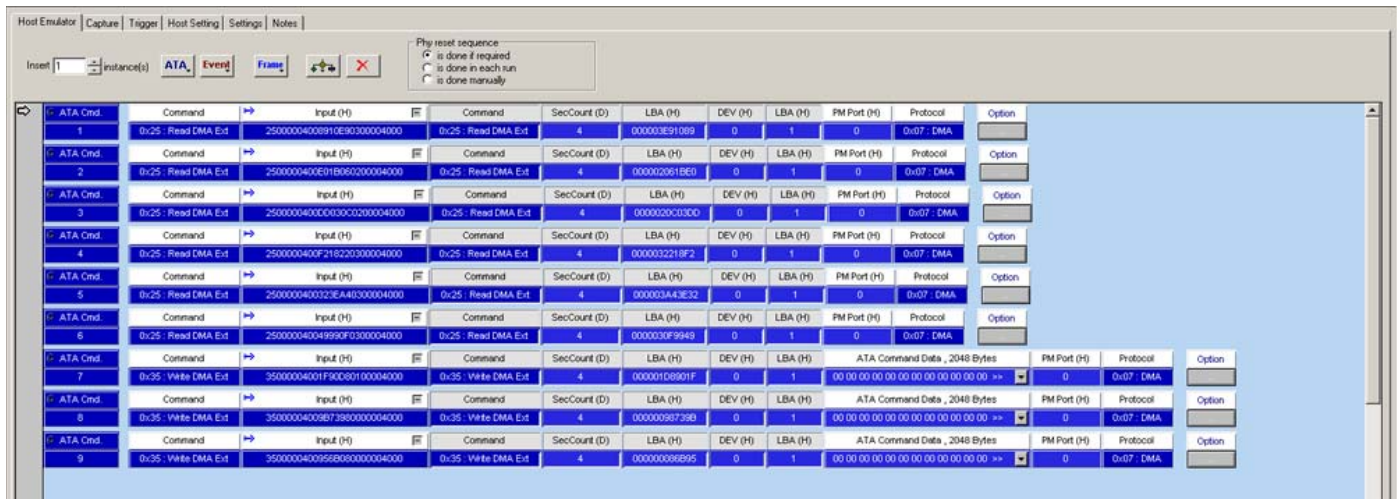

Figure 2.123: SATA: Host Emulator Program With the Exported Commands

You can run this set of commands immediately, or you can modify it by inserting instructions and/or additional commands.

Error and Command Settings

Each command type allows you to set a variety of command settings and to introduce errors. Click the **Option** button on a command line to display the corresponding Protocol Error and Command Settings dialog.

ATA Error and Command Settings

The Protocol Errors and Command Settings screen capture is shown below.

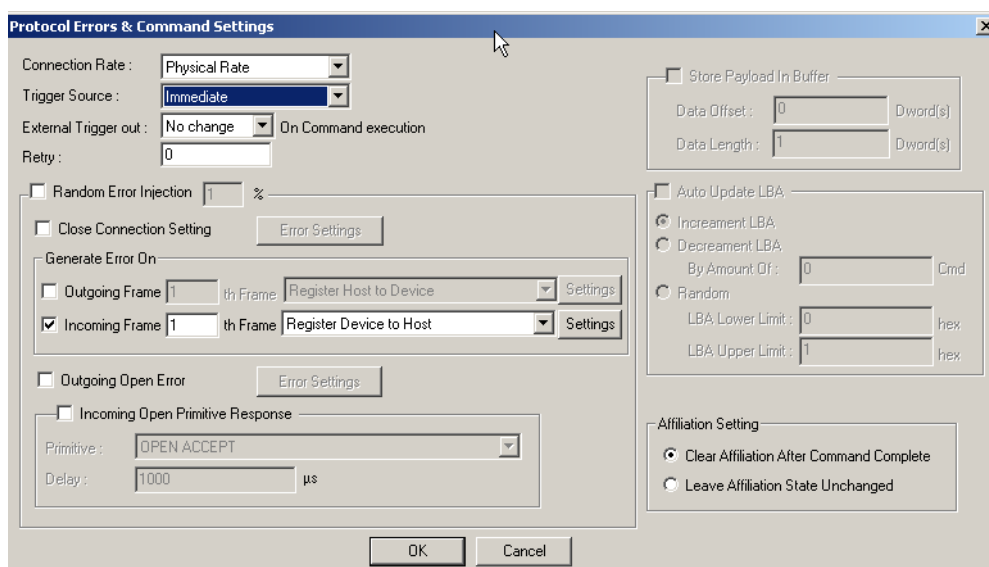

Figure 2.124: SAS: Protocol Error and Command Settings for ATA Dialog

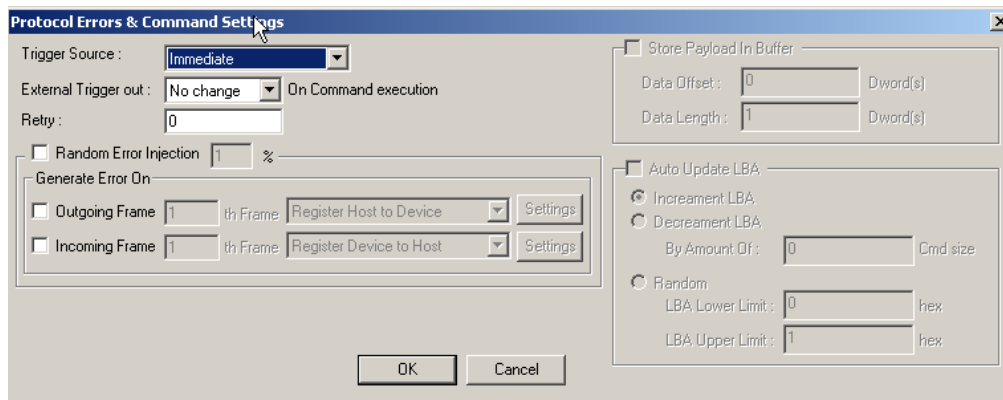

Figure 2.125: SATA: Protocol Error and Command Settings for ATA Dialog

Connection Rate

Select the Connection Rate to allow a higher speed port to communicate with a lower speed port: Physical Rate, 1.5 G, 3, or 6.

Trigger Source

Click the down arrow on the Trigger Source combo box to choose trigger type: Immediate, Wait for external trig, or Wait for Analyzer trig.

External Trigger Out

Click the down arrow on the External Trigger out combo box to choose the external trigger level: High, Low, or No change on command execution.

Retry

Enter a value for the number of command retries when a command failed in the Retry text box.

Store Payload in Buffer

Check the Store Payload in Buffer check box and enter values for Data Offset and Data Length.

Auto Update LBA

Check the Auto Update LBA check box and check an auto update option button.

Random Error Injection

Random Error Injection specifies the probability of Error Injection on the command. The probability percentage that you select applies to all Error Injection items.

Close Connection Setting

Checking Close Connection Setting enables the Error Settings button. Click this button to display the Close Connection Setting dialog.

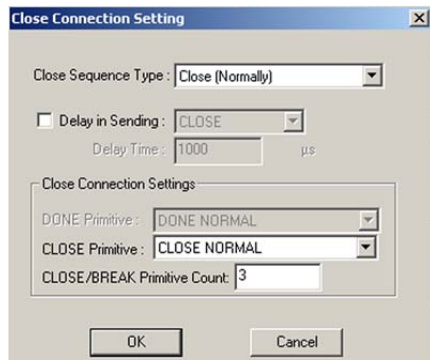

Figure 2.126: Close Connection Dialog

Select the **Close Sequence Type** from the drop-down list. Selecting **Delay in sending** allows you to specify the delay in sending Done, Close, or Break.

Select the **Close Connection Settings** from the drop-down lists.

Outgoing Open Error

Check Outgoing Open Error and then the enabled Error Settings button to display the Open Frame Setting dialog.

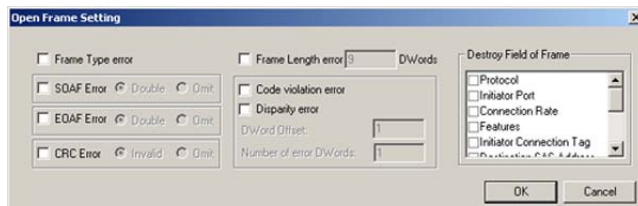

Figure 2.127: Open Frame Setting Dialog

Check errors to introduce.

Scroll through the available choices in the Destroy Field of Frame list box and check the field to destroy.

Incoming Open Primitive Response

Check this box, then click the down arrow next to the Primitive list box and choose a response type. Enter a Delay value.



Figure 2.128: Incoming Open Primitive Response Dialog

Affiliation Setting

Check Clear Affiliation After Command Complete to release device to commands from other sources, or check Leave Affiliation State Unchanged to retain control of device.

Enable First Burst

Check Enable First Burst to allow first burst.

Task Attribute

Choose Simple, Head of Queue, Ordered, or ACA.

Outgoing ATA Frame Settings

Before selecting Outgoing Frame Settings, select the Types Of Frames and the Frame Number on which to inject an error. Then check Outgoing Frame in the Generate Error On area and then the enabled Settings button to display the Outgoing Frame Settings dialog.

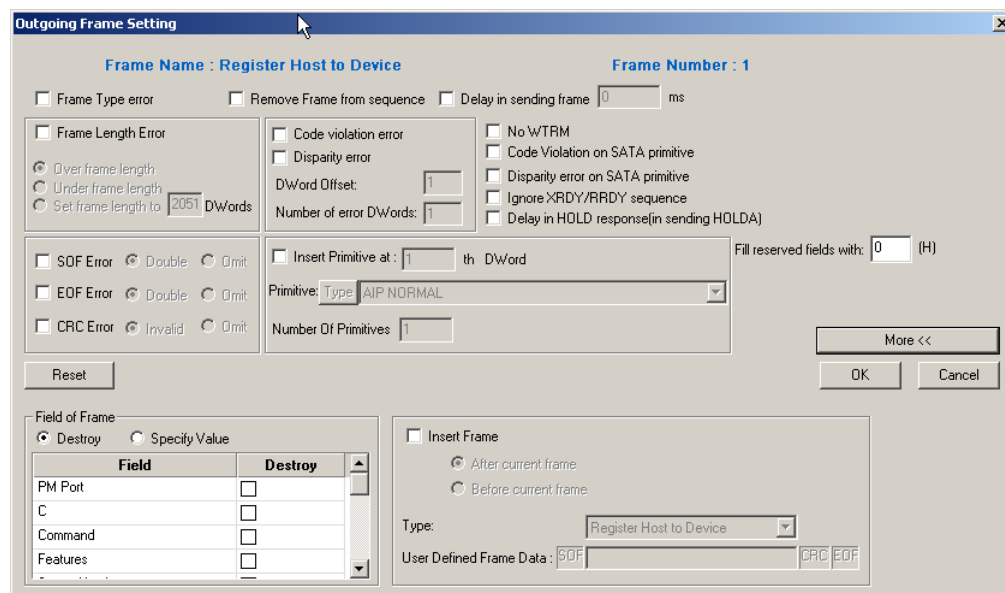

Figure 2.129: Outgoing Frame Settings

Frame Type Error

Check this to introduce a frame type error.

Remove Frame from sequence

Check this to remove frame from sequence.

Delay in sending frame

Check this to delay sending frame and enter a value for the delay.

Frame Length Error

Check Frame Length Error and choose the type of error to introduce.

Code violation and Disparity error

Check these and specify DWORD offset and number of error DWORDs.

Additionally check:

- No WTRM
- Code Violation on SATA primitive
- Disparity error on SATA primitive
- Ignore XRDY/RRDY sequence
- Delay in HOLD response (in sending HOLDA)

SOF, EOF and CRC errors

Check these and specify Double or Omit by checking the corresponding option button.

Insert Primitive

Check Insert Primitive and then click the Type button to open the Primitive Type dialog and select the primitive type.



Figure 2.130: Primitive Type Dialog

Click the down arrow on the Primitive combo box, choose a primitive, then click OK.

Fill reserved fields with

Enter a value for which reserved fields to change, if other than 0.

Field of Frame

Select Destroy, scroll through the available choices in the Field of Frame list box, and choose a field to destroy. Alternatively, select Specify Value to fill the chosen field with a pre-defined value.

Insert Frame

Check Insert Frame, click the down arrow on the Type combo box, and choose the frame type. Then choose to insert it before or after an outgoing frame command. Make sure that you have clicked More.

Note: In addition to the pre-defined frame types, you can scroll down the list to **User Defined** and enter your own frame data between SOF and EOF.

Incoming ATA Frame Settings

Before selecting Incoming Frame Settings, select the Types Of Frames and the Frame Number on which to inject an error. Then check Incoming Frame in the Generate Error On area and then the enabled Settings button to display the Incoming Frame Settings dialog.

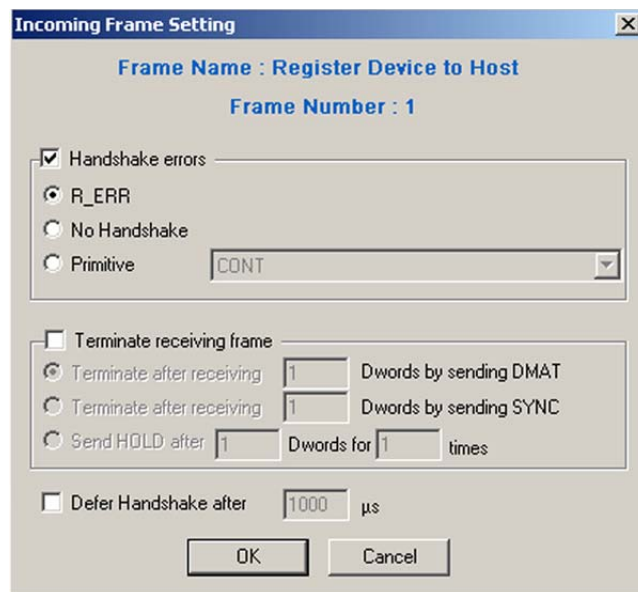

Figure 2.131: Incoming Frame Setting Dialog ATA

Handshake Error

Check Handshake Errors to enable selection of errors and primitives. Check R_ERR or select Primitive to send as an incoming frame response. Check No Handshake to send no response.

Terminate Receiving Frame

Check **Terminate Receiving Frame**, then choose the termination type.

Defer Handshake

Check the Defer Handshake after check box and enter a value for the time to defer the handshake.

SCSI Error and Command Settings (SAS only)

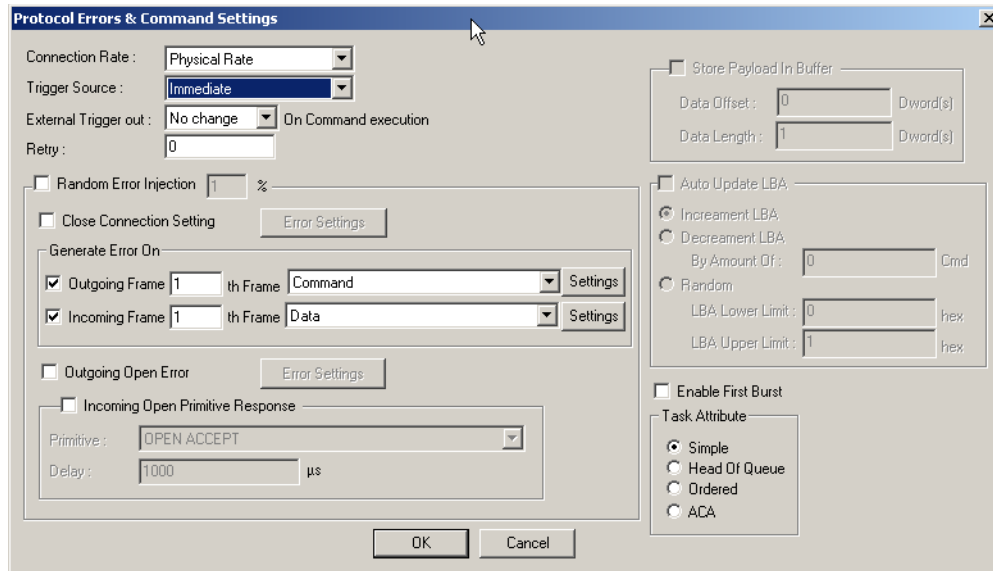

Figure 2.132: SAS: Protocol Error and Command Settings for SCSI Dialog

Connection Rate

Select the **Connection Rate** to allow a higher speed port to communicate with a lower speed port: Physical Rate, 1.5 G, 3, or 6.

Trigger Source

Click the down arrow on the Trigger Source combo box, and choose trigger type: Immediate, Wait for external trig, or Wait for Analyzer trig.

External Trigger Out

Click the down arrow on the External Trigger out combo box to choose the external trigger level: High, Low, or No change on command execution.

Retry

Enter a value for the number of command retries for failed commands in the Retry text box.

Random Error Injection

Random Error Injection specifies the probability of Error Injection on the command. The probability percentage that you select applies to all Error Injection items.

Close Connection Setting

Checking **Close Connection Settings** enables the Error Settings button. Click this button to display the Close Connection Setting dialog.

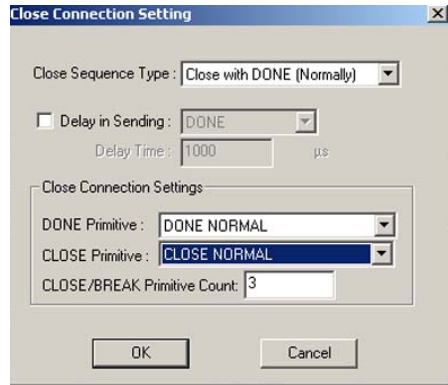

Figure 2.133: SAS: Close Connection Settings

Select a **Close Sequence Type** from the drop-down list.

Check **Delay in Sending** to specify the delay in sending Done, Close, or Break.

Select **Close Connection Settings** from the drop-down lists.

Store Payload in Buffer

This option is available for read type commands. Choose and specify **Data Offset** and **Data Length**.

Auto Update LBA

Check to enable Auto Update of LBA, then specify the update by checking the option.

Outgoing Open Error

Check **Outgoing Open Error** and then the enabled Error Settings button to display the Open Frame Setting dialog.

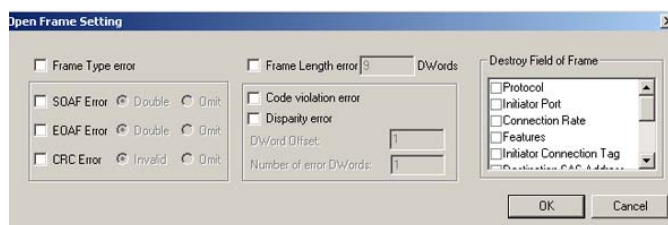

Figure 2.134: SAS: Open Frame Settings

Check the errors to introduce.

Scroll through the available choices in the **Destroy Field of Frame** list box and check the destroy field.

Incoming Open Primitive Response

To set a response to an incoming Open frame, check **Incoming Open Frame Response**, select a Primitive, and enter a value for Delay.

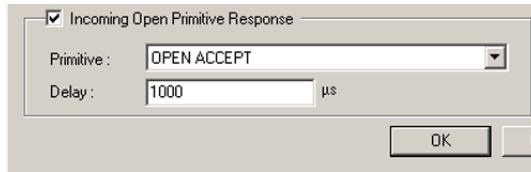

Figure 2.135: SAS: Open Primitive Response

Enable First Burst

Check the **Enable First Burst** box to specify to transfer the first burst data as defined by the First Burst Size field in the Advanced Initiator Setting dialog. See Figure 2.143: on page 152.

Task Attribute

Choose a task attribute of Simple, Head of Queue, Ordered, or ACA by checking the corresponding option button.

Outgoing SCSI Frame Settings

Before selecting Outgoing Frame Settings, select the Types Of Frames and the Frame Number on which to inject an error. Then check **Outgoing Frame** in the Generate Error On area and then the **Settings** button to display the Outgoing Frame Setting dialog.

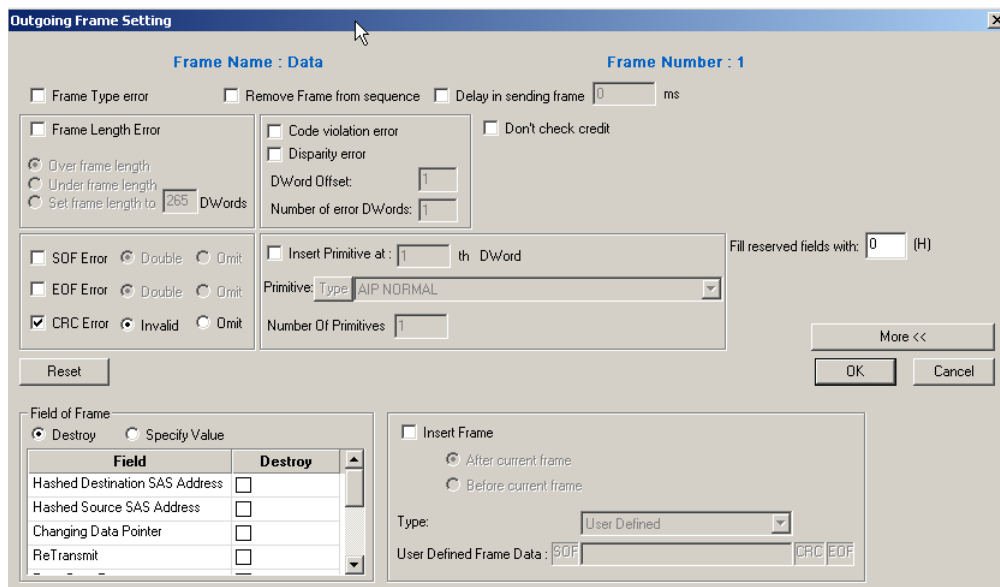

Figure 2.136: SAS: Outgoing Frame Setting Dialog SCSI

Frame Type Error

Check this to introduce a frame type error.

Remove Frame from sequence

Check this to remove frame from sequence.

Delay in sending frame

Check this to delay sending frame and enter a value for the delay.

Frame Length Error

Check **Frame Length Error**, then choose the type of error to introduce.

Code violation and Disparity error

Check these and specify DWORD offset and the number of error DWORDs.

Don't check credit

Check this to disable credit checking.

SOF, EOF and CRC errors

Check these and specify Double or Omit by checking the corresponding option button.

Insert Primitive

Check **Insert Primitive**, click the **Type** button to open the Primitive Type dialog, then select the primitive type.

Field of Frame

Select **Destroy**, scroll through the available choices in the Field of Frame list box, and choose a field to destroy. Alternatively, you can select **Specify Value** to fill the chosen field with a pre-defined value.

Insert Frame

You can insert a frame before or after the current frame. To insert a frame, check **Insert Frame**, check the option button at which to insert the frame, and choose a Frame Type.

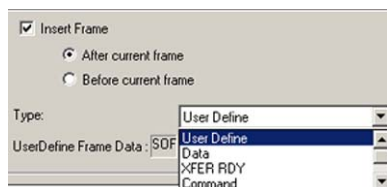

Figure 2.137: SAS: Insert Frame

Incoming SCSI Frame Settings

Before selecting Incoming Frame Settings, select the Types Of Frames and the Frame Number on which to inject an error. Then check Incoming Frame in the Generate Error On area and then the enabled Settings button to display the Incoming Frame Setting dialog.

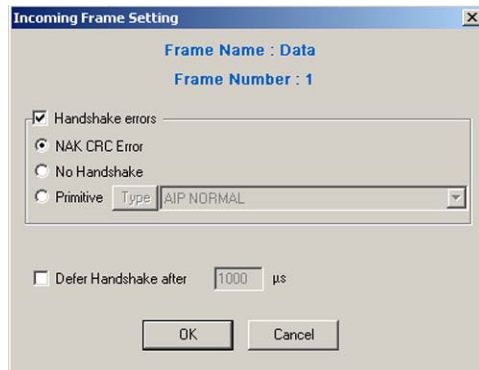

Figure 2.138: SAS: Incoming Frame Setting Dialog (SCSI)

Handshake Error

Check **Handshake Error** and select **NAK CRC Error**, **No Handshake**, or **Primitive** and a Primitive Type.

Defer Handshake

Check the **Defer Handshake after** check box and enter a value for the time to defer the handshake.

FIS Options (SATA only)

If you select **Frame > Host to Device**, **Frame > DMA Setup**, or **Frame > Data**, the system adds an FIS line. At the end of the line is an **Options** button that opens an Outgoing Frame Setting dialog.

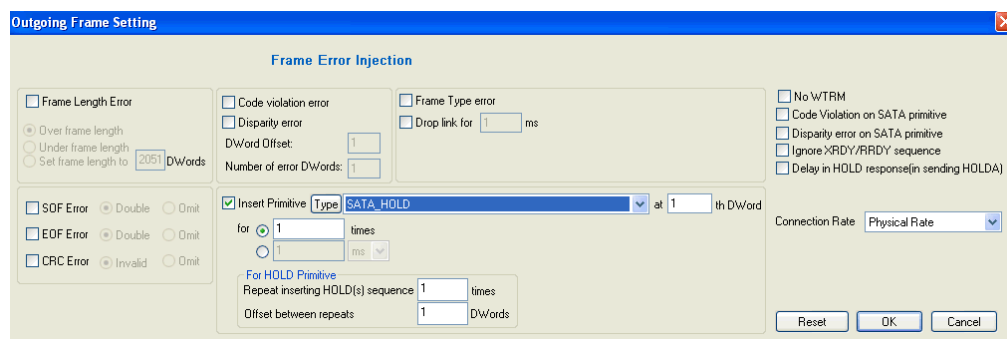

Figure 2.139: SATA: FIS Options Outgoing Frame Setting Dialog

Frame Length Error

Check **Frame Length Error**, then choose the type of error to introduce.

SOF, EOF and CRC errors

Check these and specify Double or Omit by checking the corresponding option button.

Code violation and Disparity error

Check these and specify DWORD offset and the number of error DWORDS.

Insert Primitive

Check **Insert Primitive**, click the **Type** button to open the Primitive Type dialog, then select the primitive type.

The host can send multiple bursts of HOLD primitives during a single data frame. You can repeat the HOLD sequence up to 999 times. You can enter the offset between repeats, up to 99999 DWORDs.

Frame Type Error

Check this to introduce a frame type error.

Drop Link for ... ms

Check this to drop link for the specified milliseconds.

Additionally check:

- No WTRM
- Code Violation on SATA primitive
- Disparity error on SATA primitive
- Ignore XRDY/RRDY sequence
- Delay in HOLD response (in sending HOLDA)

Initiator Setting Tab (SAS only)

The Initiator Setting tab allows you to select the Port(s) for generating SAS traffic and to specify SAS Address, Data Frame Payload size, Frame Receive Timeout, Logical Block size, and ATA Command Execution Time out (see [Figure 2.140 on page 150](#)).

You can run a Pattern Generator. To run the Pattern generator, check the **Run Pattern Generator** option button and select a **Pattern Generator File**. You can create Pattern Generator Files, see [“Creating a Pattern Generator File” on page 467](#).

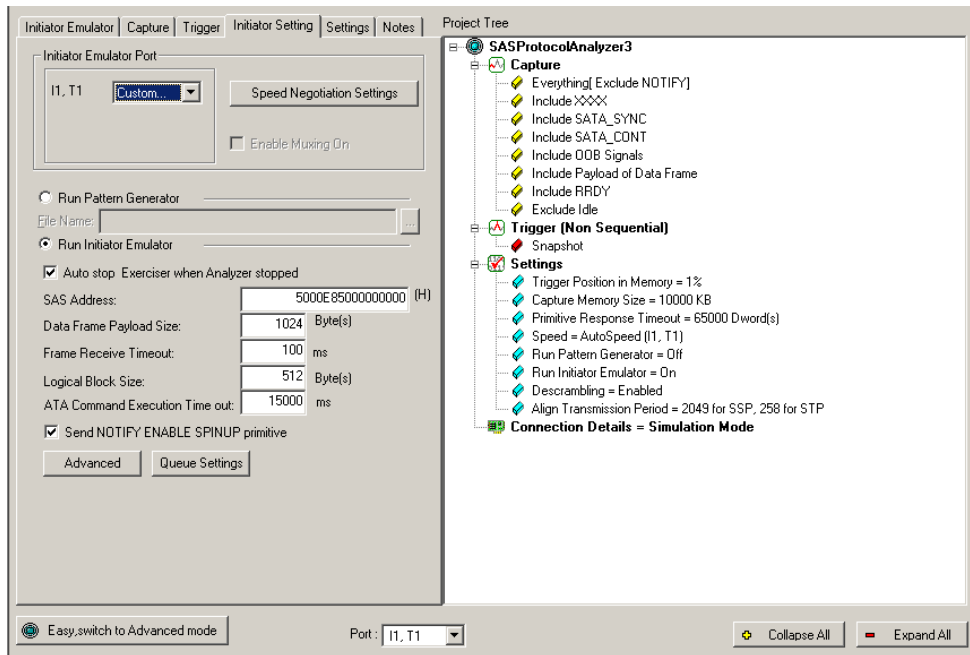

Figure 2.140: SAS: Initiator Setting Tab

Choose Initiator Emulator Port

For each port, select a speed, then click the **Speed Negotiation Setting** button.

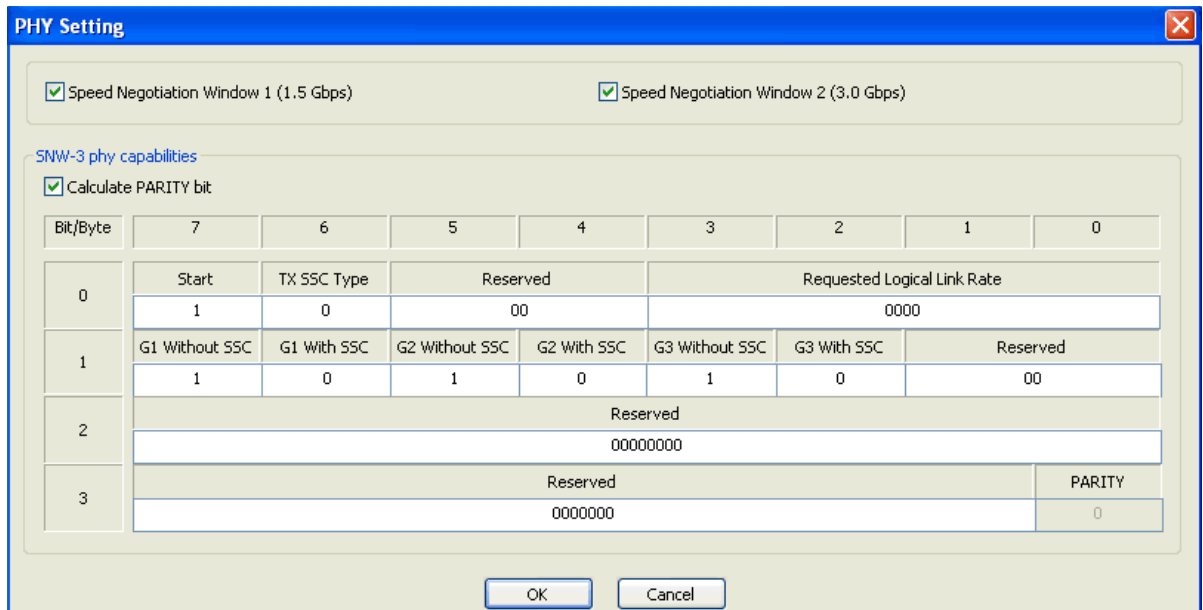

Figure 2.141: SAS: PHY Setting Dialog

Select the port speed settings (see “PHY Setting Dialog” on page 129).

After you click **OK**, you can **Enable Muxing On**.

Pattern Generator

You can select a Pattern Generation file.

Initiator Emulator

You can run an Initiator Emulator while setting:

- Auto stop exerciser when Analyzer stops
- SAS Address
- Data Frame Payload Size
- Frame Receive Timeout
- Logical Block Size
- ATA Command Execution Timeout
- Send NOTIFY ENABLE SPINUP primitive

Check **Autostop exerciser when Analyzer Stopped** to halt the Initiator Emulator when the Analyzer stops. If unchecked, the Exerciser continues to run even after the Analyzer stops.

Queue Settings

Click the **Queue Settings** button to display the Queue Settings dialog and specify:

- Queue Depth
- NCQ Error Recovery
- Queued/Non-Queued Items Status
- NCQ/Queue Command Timeout

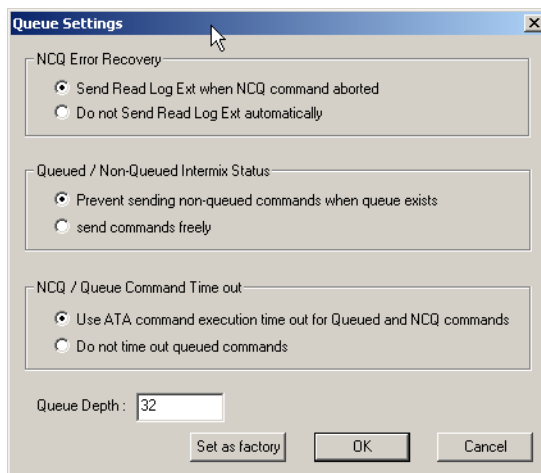

Figure 2.142: Queue Setting Dialog

Advanced Initiator Settings

- Click the **Advanced** button to display additional settable options:
- Align Transmission Period
- STP Initiator ALIGN Transmission Period
- Bus Inactivity Time Limit
- Maximum Connect Time Limit
- First Burst Size
- I_T nexus loss time
- Max Credits in each Connection
- Delay between getting HOLD and Sending HOLDA

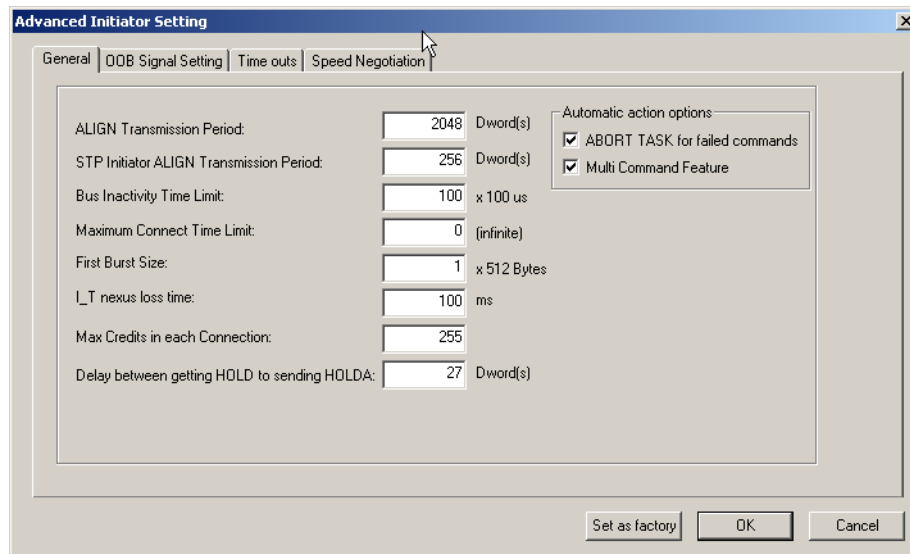

Figure 2.143: Advanced Initiator Settings Dialog General Tab

In the Advanced Initiator Setting dialog, choose **Automatic action** options from

- ABORT TASK for Failed Commands
- Multi Command feature.

OOB Signal Setting Tab

Click the **OOB Signal Setting** tab in the Advanced Host Setting dialog to specify OOB parameters in the enabled editable fields:

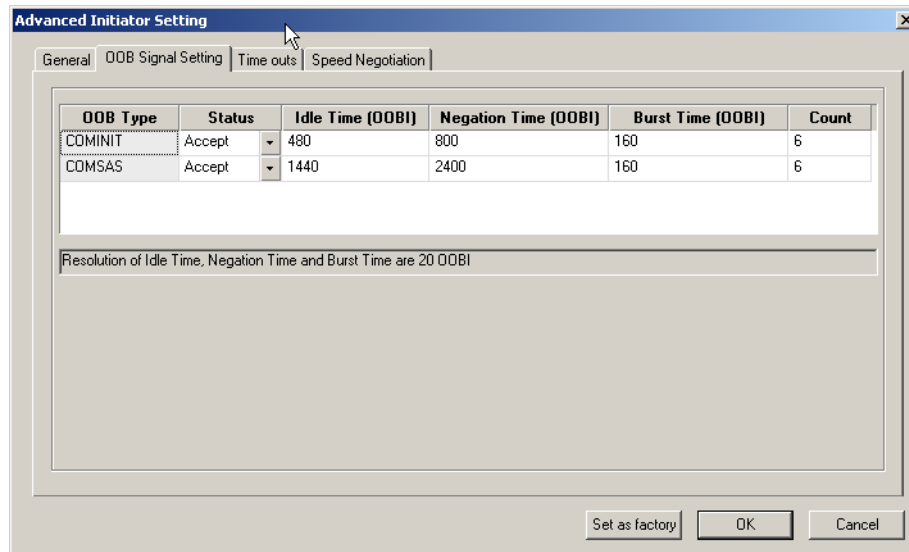

Figure 2.144: OOB Signal Setting Tab

Timeouts Tab

Click the **Timeouts** tab in the Advanced Host Setting dialog to specify timeouts for connection, CREDIT, ACK/NAK, ATA Command, OOB Signal and Identify frame. You can also edit the speed negotiation parameters.

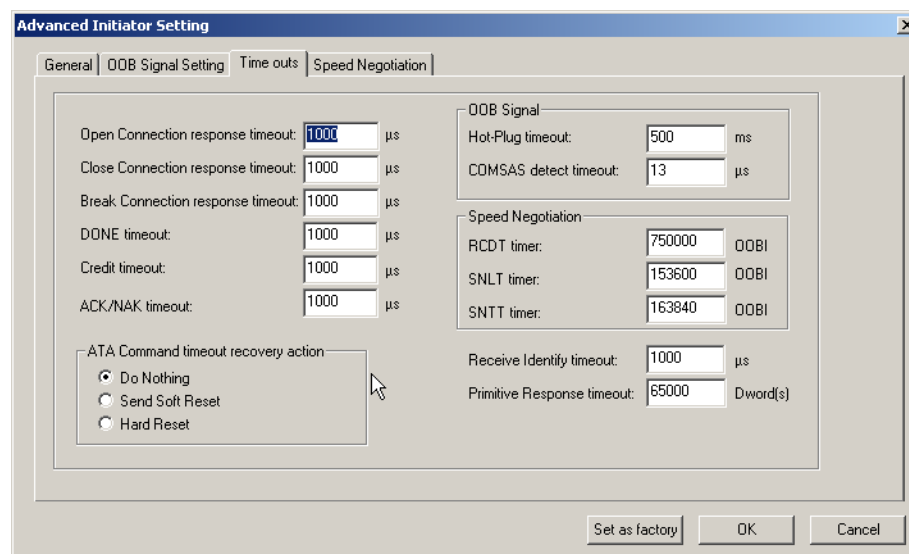

Figure 2.145: Timeouts Tab

Speed Negotiation Tab

Use the Speed Negotiation tab to inject errors during speed negotiation.

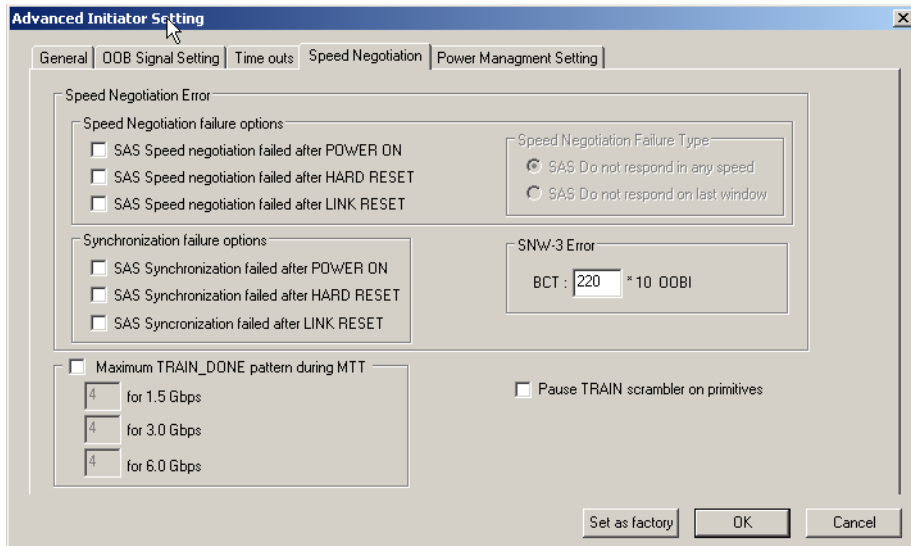

Figure 2.146: Speed Negotiation Tab

Host Setting Tab (SATA)

The Host Emulator Setting dialog allows you to select the Port(s) for exercising, choose to use the Host Emulator or Pattern generator and specify Host Emulator characteristics.

Click the **Host Setting** tab:

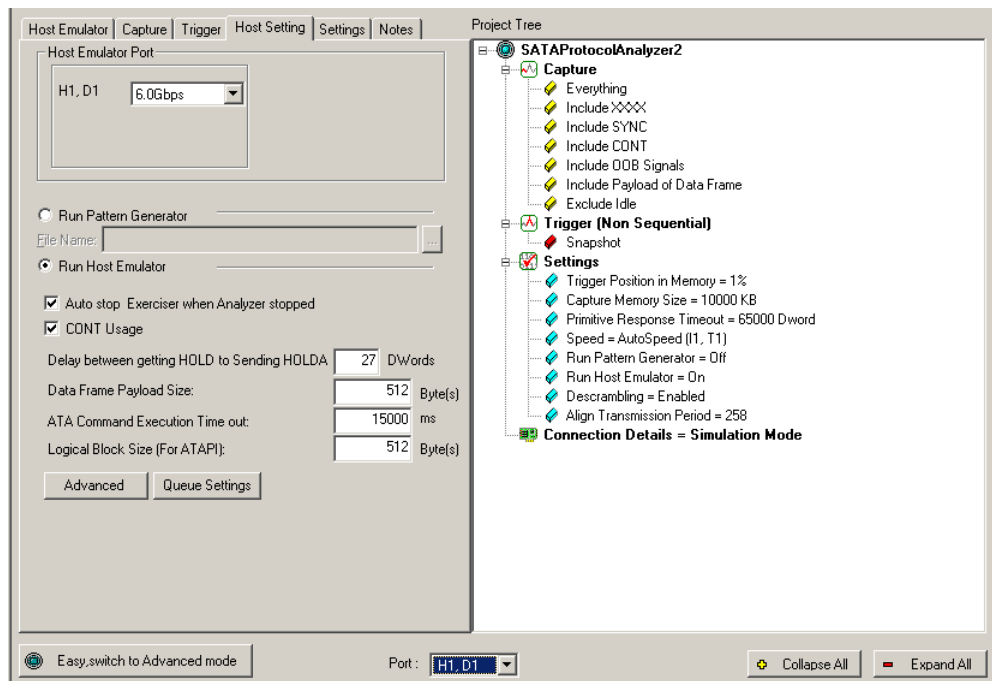

Figure 2.147: SATA: Host Setting Tab

Choose Host Emulator Port

For each port, select a speed.

Pattern Generator

You can select a Pattern Generation file. To perform a capture with a Pattern Generator, enter a path to a pattern generator *.spg file in the File Name dialog. See [“Creating a Pattern Generator File” on page 467](#) for instructions how to create a Pattern Generator file.

Host Emulator

You can run an Host Emulator while setting:

- Auto stop exerciser when Analyzer stops
- CONT usage
- Delay between getting HOLD to Sending HOLDA
- Data Frame Payload Size
- ATA Command Execution Timeout
- Logical Block Size (for ATAPI)

Check **Autostop exerciser when Analyzer Stopped** to halt the Host Emulator when the Analyzer stops.

Check **CONT Usage** to enable the specification of **Delay between getting HOLD to sending HOLDA**, **Data Frame Payload Size**, and **ATA Command Execution Timeout**.

ATA Command Execution Timeout

The ATA Command Execution Timeout is a timeout for ATA commands. When the host sends an H2D frame (i.e., it issues a command) and receives an R_OK from the device, it starts this timer. If the execution of the command takes more than the timeout specified (15 seconds is the default), the host emulator performs the action specified in the Advanced/General/ ATA command timeout recovery action settings. The options are Nothing, Send Soft Reset and Hard Reset. See the following figure.

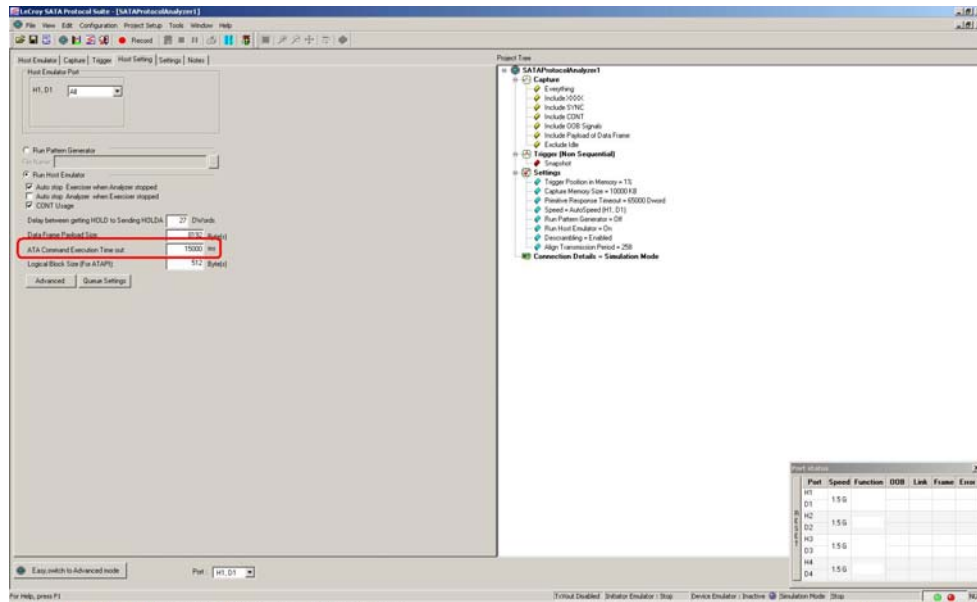

Figure 2.148: ATA Command Execution Timeout

Queue Settings

Click the **Queue Settings** button to display the Queue Settings dialog and specify:

- Queue Depth
- NCQ Error Recovery
- Queued/Non-Queued Items Status
- NCQ/Queue Command Timeout

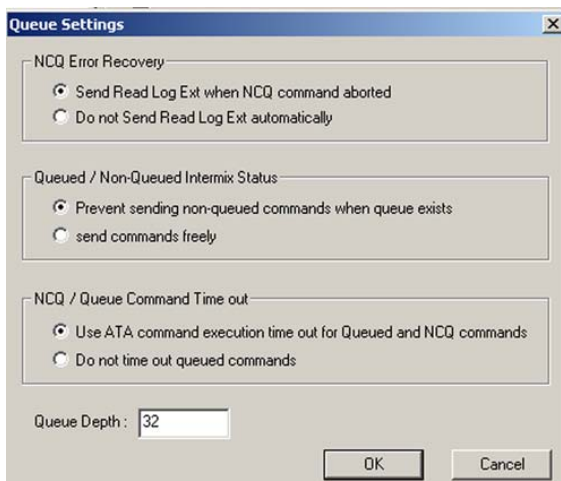

Figure 2.149: SATA: Queue Settings Dialog

Advanced Host Setting Dialog

Click the **Advanced** button to display all settable options.

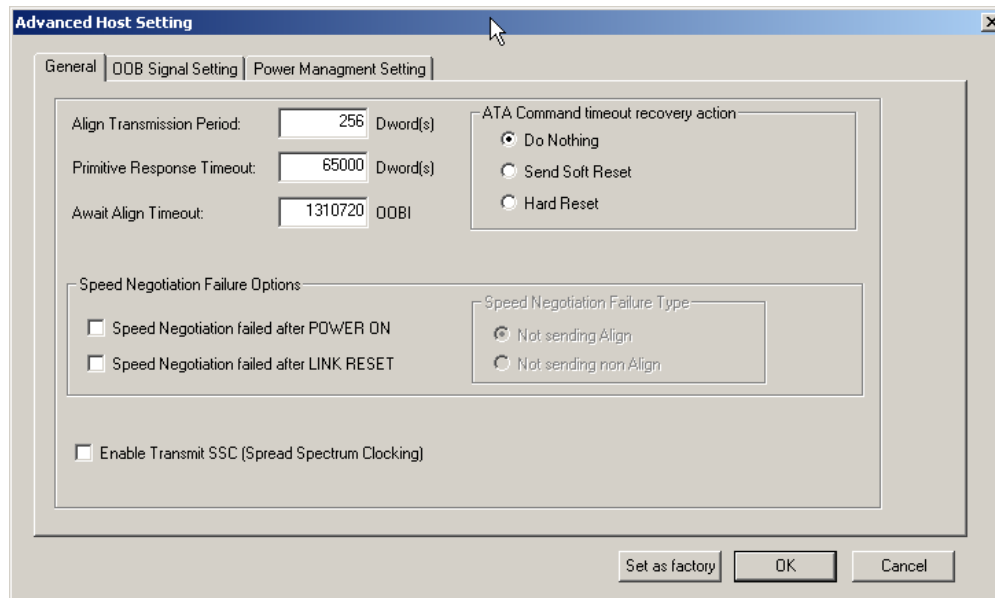

Figure 2.150: SATA: Advanced Host Setting Dialog General Tab

Settable options are:

- Set **Align Transmission Period**, **Primitive Response Timeout** and **Await Align Timeout**.
- Choose **ATA Command timeout recovery action** by checking the corresponding option button.
- Specify **Speed Negotiating Failure Option(s)** and a **Speed Negotiation Failure Type**.

OOB Signal Setting Tab

Click the **OOB Signal Setting** tab in the Advanced Host Setting dialog to specify OOB parameters in the enabled editable fields.

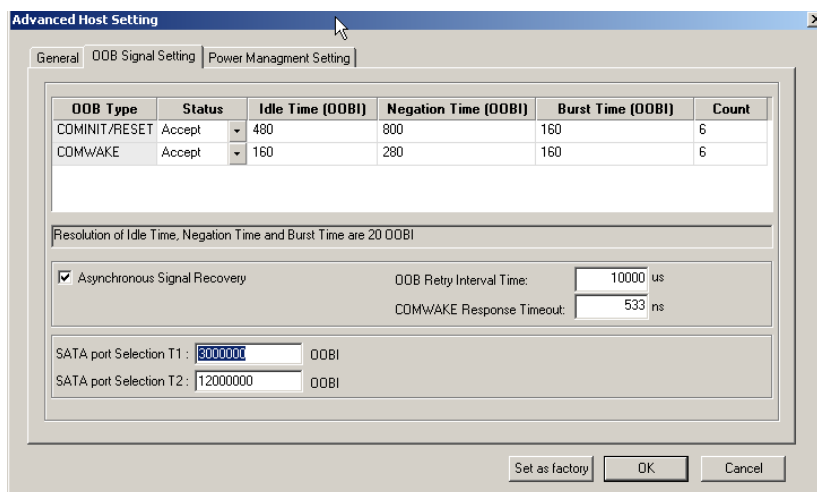

Figure 2.151: SATA: OOB Signal Setting Tab

Asynchronous signal recovery

Set the OOB Retry Interval Time, check the Asynchronous signal recovery option check box and enter a value for the time.

Inter-reset Delay Settings

Enter a value for **SATA port Selection T1** to specify the inter-reset- assertion delay for the first event of the selection sequence and **SATA port Selection T2** to specify the inter-reset- assertion delay for the second event of the selection sequence.

Power Management Settings

Click the **Power Management Setting** tab in the Advanced Host Setting dialog to specify the settings in the editable fields.

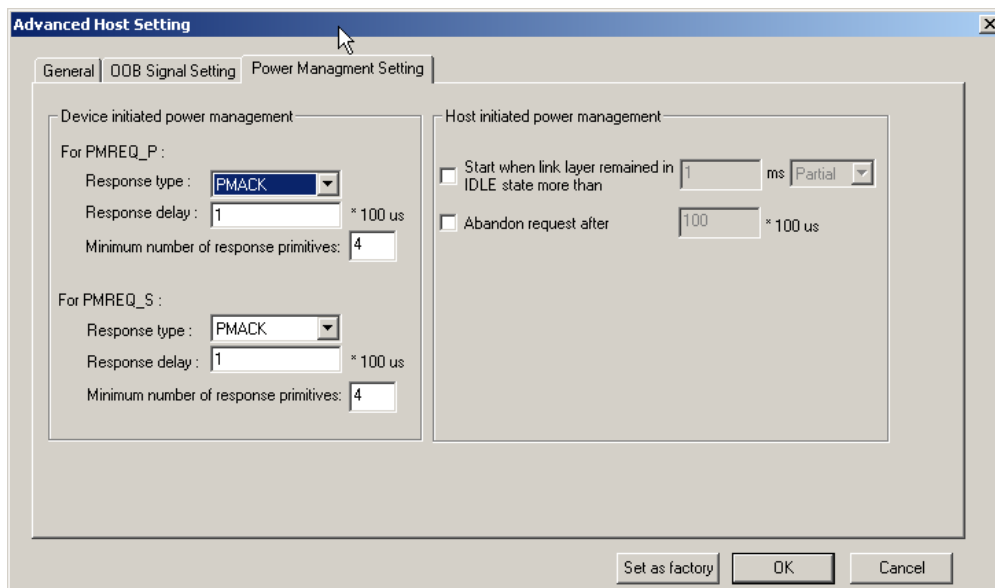

Figure 2.152: SATA: Power Management Settings

Set parameters for Host and/or Device initiated power management.

Project Settings

Set project settings in the Project Settings tab (see [“Project Settings” on page 102](#)).

Note: When using the Exerciser, channel 2 is not available and is grey.

Creating a Data Block

You can create the following types of data blocks, for use with data fields:

- Random data pattern
- Custom data pattern specifically for your application
- Counter data pattern
- Walking bit pattern



To create a data block, click the **Default Data Block** button on the Main toolbar, or select **Setup > Data Block** to open the Data Block dialog box as shown in [Figure 2.153](#)

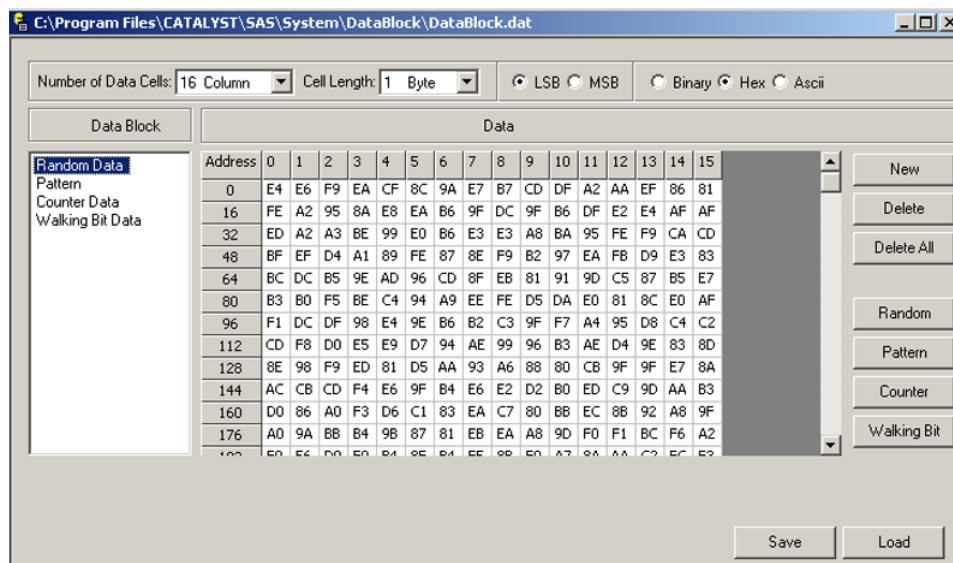

Figure 2.153: Default Data Block Dialog Box

To add another data block:

1. Click the **New** button in the Data Block dialog box.

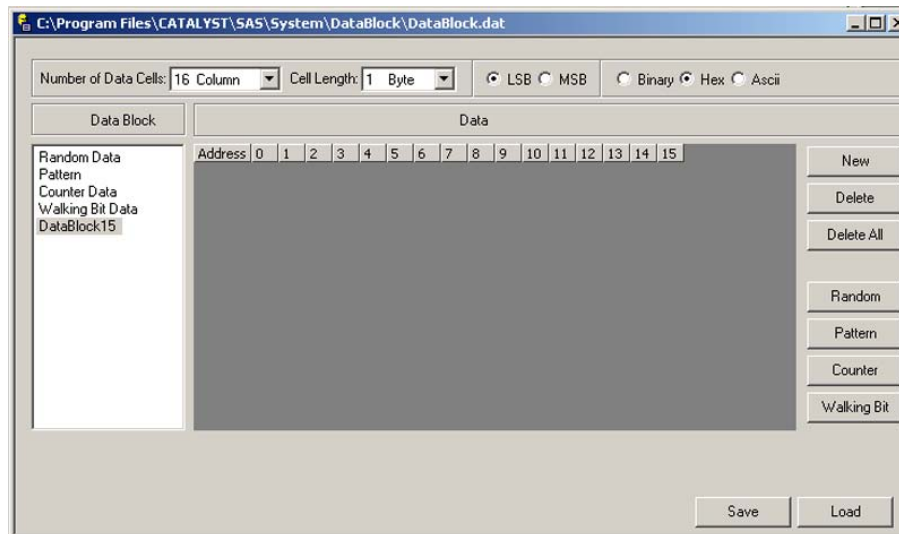

Figure 2.154: New Data Block Dialog Box

2. Choose the number of data cells (up to 16 data cells/row) and the cell length (up to 16 bytes/cell). This is a display function only.
3. Click either the **Bin**, **Hex**, or **Ascii** option button to choose a number format.
4. Click either the **LSB** or **MSB** option button to choose a bit order.

Naming a Data Block

Each new data block automatically receives a sequential data block number. To assign a unique descriptive name to a data block, right-click the data block name to open the Data Block Edit menu.

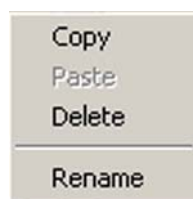

Figure 2.155: Data Block Edit

Choose **Rename**.

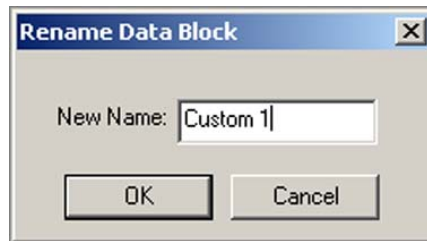

Figure 2.156: Rename Data Block

Enter a descriptive name in the New Name edit box and click **OK**.

Editing a Data Block

You can enter data in the defined cell structure by these methods:

- Define your own pattern
- Set a counter
- Choose a Random Pattern
- Choose a Walking Bit Pattern

Define Your Own Pattern

To define a pattern:

1. Click **Pattern** to open the Define Pattern dialog box as shown in [Figure 2.157](#)
2. Enter a data pattern in the Data Pattern edit box.
3. Choose the number of times to repeat that pattern, and click **OK**.

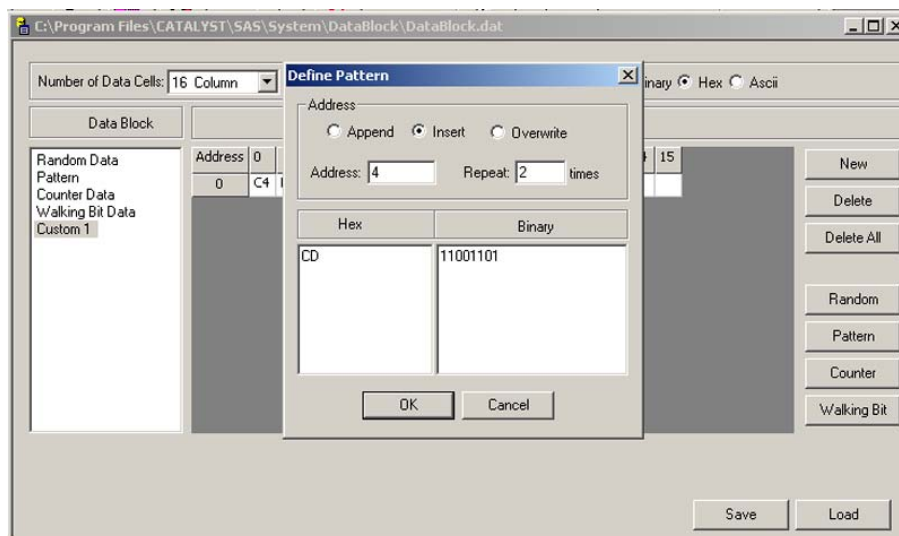

Figure 2.157: Define Your Own Data Pattern

Address

The cell address starts at 0 for the first data entry and automatically increments to the next available address. You can set it to a previously defined address to modify its content or insert additional data.

Insert/Overwrite Data

To define whether to overwrite data in a previously defined cell or insert new data after that cell, toggle the Insert/Overwrite button.

Save

When you have completed a data block definition, click the Save button to save the newly created data block.

Counter

To use a counter as data, click the **Counter** button, enter a Starting Number for the counter and the data address to count to, and click **OK** (See [Figure 2.158 on page 162.](#))

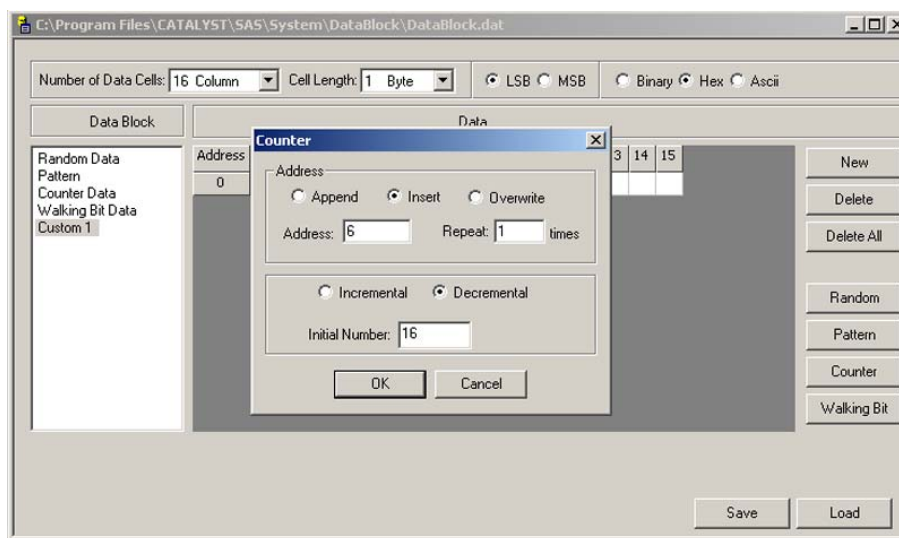

Figure 2.158: Set Counter as Data

Random Data Pattern

To use a random data pattern, click the **Random** button, enter the number of times to repeat the pattern, and click **OK** see ([Figure 2.159 on page 163.](#))

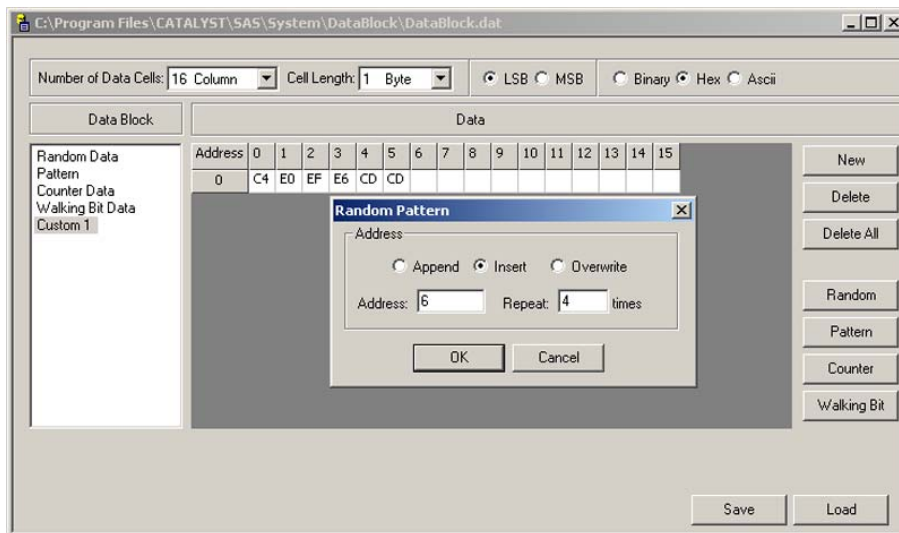

Figure 2.159: Choose a Random Pattern

Walking Bit Pattern

To use a walking bit pattern, click the **Walking Bit** button, then choose either a walking bit of “0” or “1”, the walk direction, the start position, and the number of times to repeat the pattern.

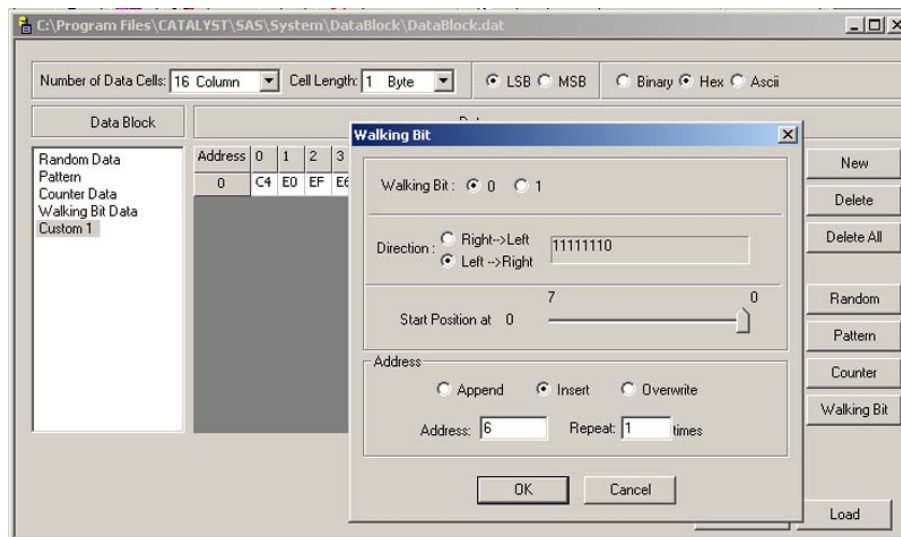

Figure 2.160: Define a Walking Bit Pattern

Creating and Editing Data Blocks as Text

You can create and edit data blocks using a text editor such as Windows[®] Notepad. To create a data block in Notepad, launch Notepad. Enter a header consisting of [Item1, Item2, Item3, Item4, Item5] where:

Item1 is the name of the Data Block.

Item2 is the size of the Data Block or the number of bytes in the format.

Item3 is the format of the data (HEX, BIN, ASCII).

Item4 is the group of bytes defined (1, 2, 4, 8 or 16).

Item5 is the direction (LSB or MSB).

Then enter the data in space delimited Hex format and save as a ***.txt** text file.

Load Data

To import Text Editor created data, click the **Load** button in the data block definition dialog to open the Load dialog. Choose a file and click **Load**. Modify existing data.

Save As

To create a new data block from an existing data block using a text editor, select the data block to edit from the **Data Block Name** list, then click **Save As** to open the Save As dialog.

Assign a name to the new data block text file and click **Save**.

You can now edit the newly created text file using Notepad or any other text editor, then import it into the data block definition, as described above.

Performance Analysis

An Analyzer incorporates a real-time Performance Analysis capability, to allow you to quickly measure performance parameters. You can select the format for the results display. You can set the Area and Column. You can use Bar, Line, or Pie charts with 3D and Grid enhancement options.

Performance Analysis with Analyzer Only

Note: Only Performance Analysis with Analyzer is supported. Performance Analysis with Emulation, Trainer, or InFusion is not supported.

New Performance Analysis Project

To perform a Performance Analysis on bus traffic and start a **New** project, click **File > New > Performance Analyzer** (Analyzer Only).

Last Saved Performance Analysis Project

To open the last saved Performance Analysis project, click the

Open Last Saved Performance Analyzer  button.

Performance Analysis Project

The Performance Analyzer dialog opens.

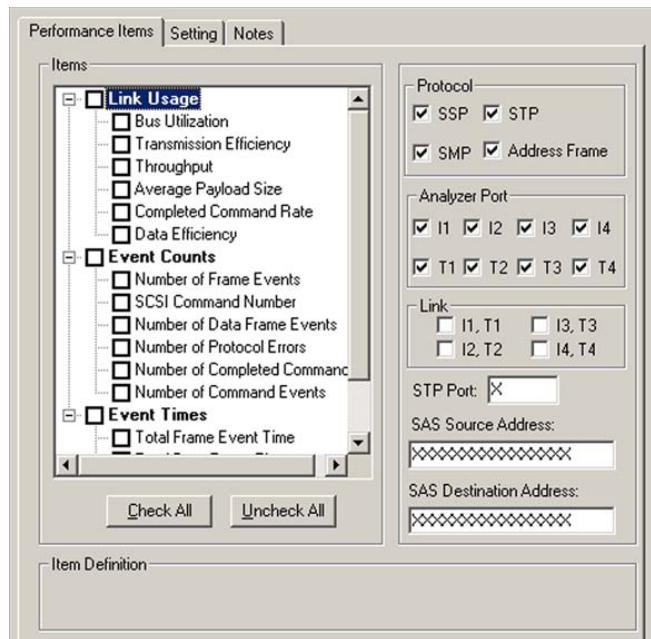

Figure 2.161: SAS: Performance Analysis Definition Dialog

Note: When you use the Exerciser, channel 2 is not usable and is greyed out.

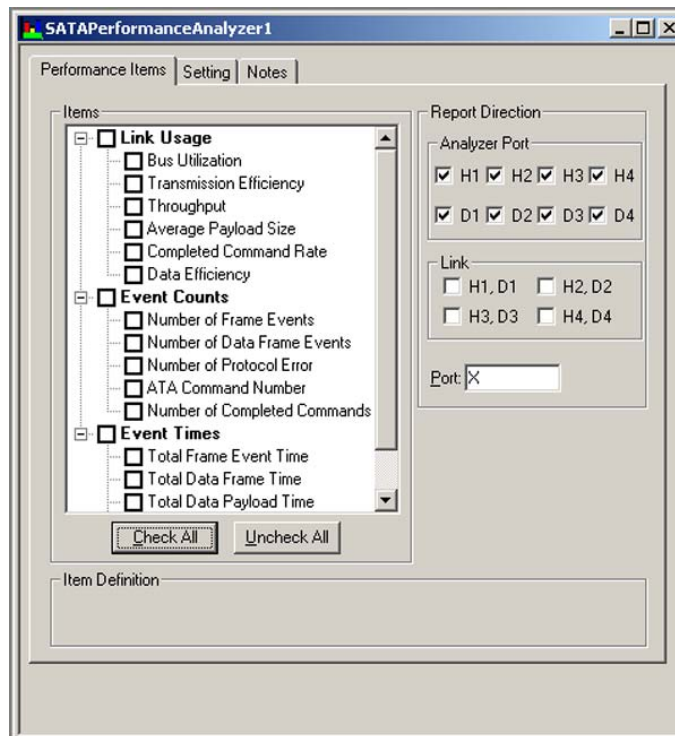

Figure 2.162: SATA: Performance Analysis Definition

Choose Protocol (SAS only)

Check the protocol check box(es) to select the protocol category:

- SSP for SCSI Commands
- STP for SATA Commands
- SMP for Management Commands
- Address Frame for Open and Identify

Analyzer Port

Check the Analyzer Port(s) to include in the performance calculation.

Link

Check the Link(s) to include in the performance calculation.

STP Port

Enter the STP port number for the STP port to include in the performance calculation.

SAS Source Address (SAS only)

Enter a SAS Source Address to include in the performance calculation.

SAS Destination Address (SAS only)

Enter a SAS Destination Address to include in the performance calculation.

Define Performance

Click the **Performance Item** check box in the Performance Items tab. Performance measurement has the following categories:

- Link Usage:
 - Bus Utilization (Ratio of frame time to update interval)
 - Transmission Efficiency (Ratio of payload time to frame time)
 - Throughput (Quantity of payload or useful data transferred during update interval)
 - Average Payload Size (Ratio of overall payload size to number of data frame)
 - Completed Command Rate (Ratio of completed commands to total commands)
 - Data Efficiency (Ratio of data payload time to data frame time)
- Event Counts:
 - Number of Frame Events
 - SCSI Command Number
 - Number of Data Frame Events
 - Number of Protocol Errors
 - Number of Completed Commands
 - Number of Command Events
- Event Times:
 - Total Frame Event Time
 - Total Data Frame Time
 - Total Data Payload Time
 - Total Idle Time

Settings

Click the **Setting** tab to display the settings dialog.

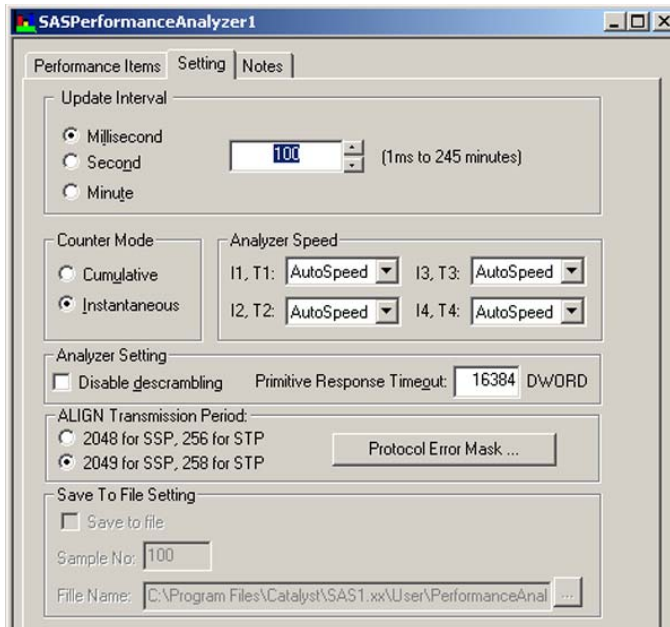

Figure 2.163: SAS: Settings Dialog

Note: When you use the Exerciser, channel 2 is not usable and is greyed out.

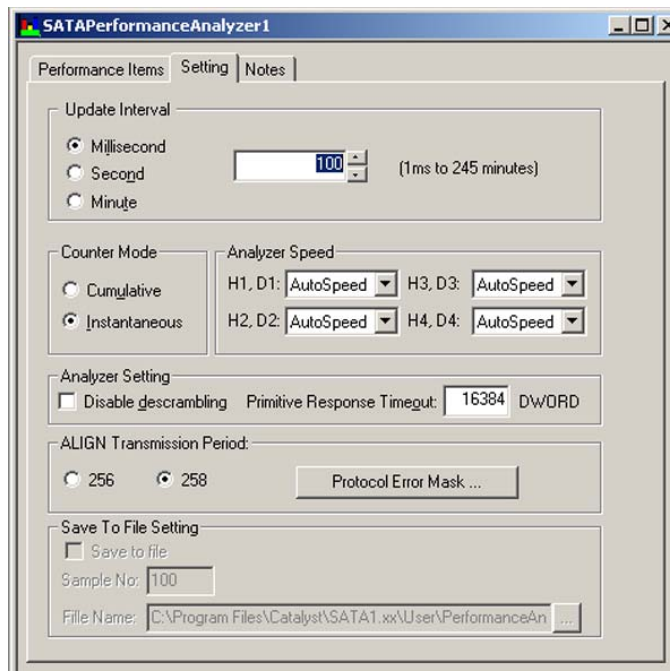



Figure 2.164: SATA: Settings Dialog

The settings dialog allows you to set the Analysis update interval and define the counter mode.

1. Choose the **Update Interval** in the range of 1 ms to 245 minutes.
2. Set the **Counter Mode** to either Cumulative or Instantaneous.
Cumulative causes the measurement counters to continually increment>
Instantaneous causes the measurement counters to reset for each Update interval.
3. Set the **Analyzer Speed** for each port used.
4. To disable descrambling, check the **Disable Descrambling** check box or check **Disable Scrambling**.
5. Enter a value for **Primitive Response Timeout**.
6. Choose the **Align Transmission Period** by checking the corresponding option button.
7. To select **Protocol Errors** to exclude from the analysis, click the **Protocol Error Mask** button and check any or all of the protocol errors to exclude. See [“Protocol Errors” on page 70](#).
8. To save the analysis result for later review, check **Save to file** and enter the path in which to save the result.
9. To include a descriptive note about the project, click the **Notes** tab and enter information in the **Notes** dialog. See [“Add a Project Note” on page 111](#).



To perform the Performance Analysis, click the  **Run Hardware** button and wait for the real time analysis for the selected items to display.

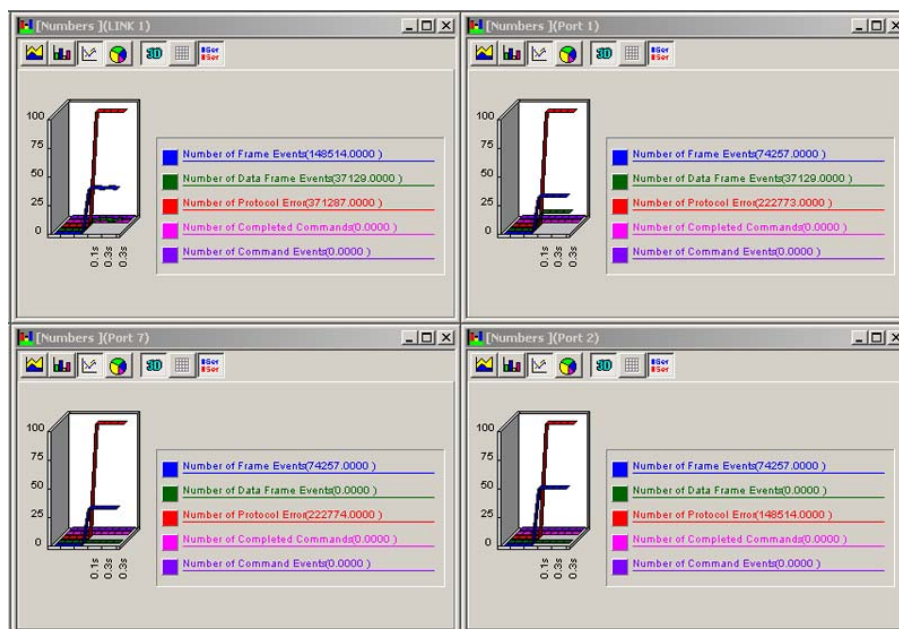

Figure 2.165: SAS: Performance Analysis Real Time Display

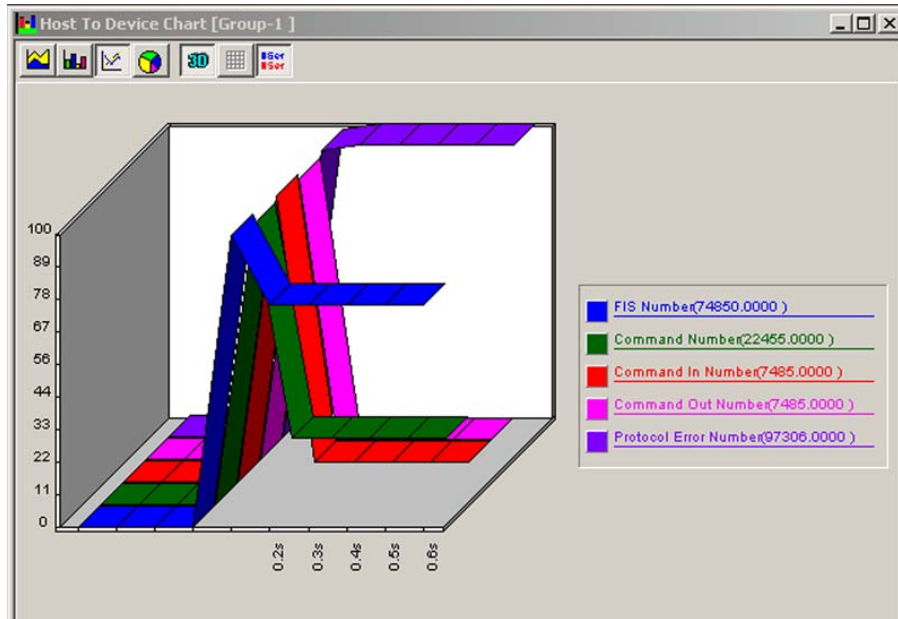
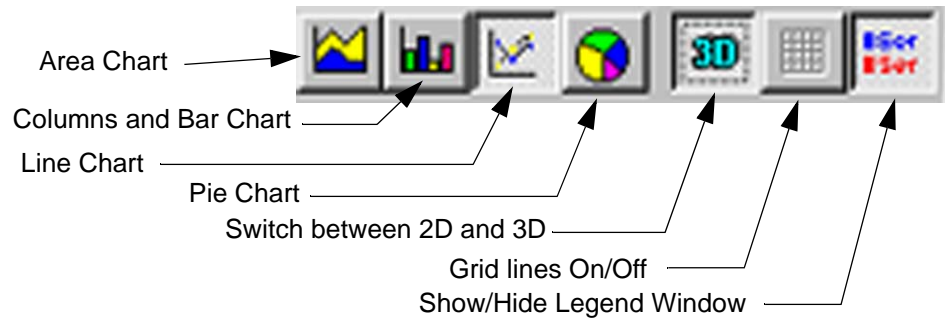

Figure 2.166: SATA: Performance Analysis Results Display

Alternate Display Format

You can display the result as 2D, 3D, and so on, by clicking the corresponding **Graphics Setting** on the Performance Analysis toolbar.



Run Hardware



To perform the defined analysis, click the **Run Hardware** button and wait for the result to display.

Target and Device Emulation

You can run the analyzer while device emulation is active to monitor bus traffic.

Pages Tab

SAS: To set up SAS Target Emulation, click **File > New > Target Emulator** to display the target emulator with the Pages tab selected.

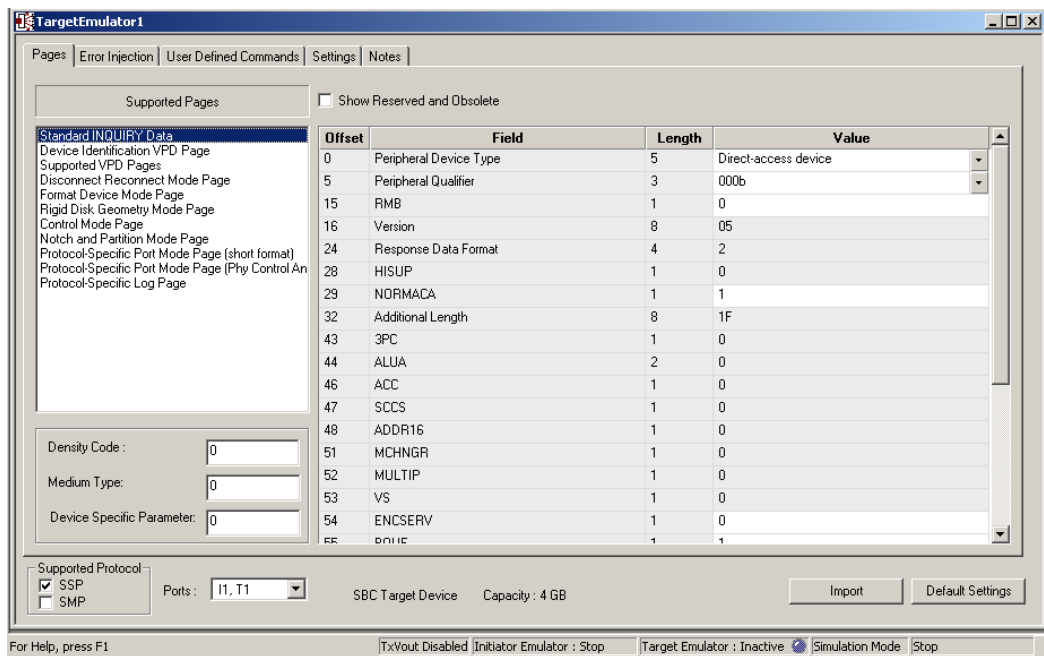

Figure 2.167: SAS: Target Emulation Project Pages Tab

The Target Emulator pages open with default settings for each page. To change settings for your application:

1. Select a page in the Supported Pages box and set values for each of the enabled (white) Value fields.
2. Enter values for Density Code, Medium Type, and Device Specific Parameter for the target emulator.
3. Check **SSP** or **SMP** to specify the protocol to support.
4. To reset the pages to the default settings, click the **Default Settings** button.
5. To use a previously defined Target, click the **Import** button and choose a previously defined Device Identifier *.saf file.

Note: Clicking the **Import** button on any of the Target Emulation dialogs sets all the parameters for the current emulation, including User-Defined Commands.

SATA: To set up a Device Emulation, click **File > New > Device Emulator**.
The Device Emulation project opens with the Pages tab selected.

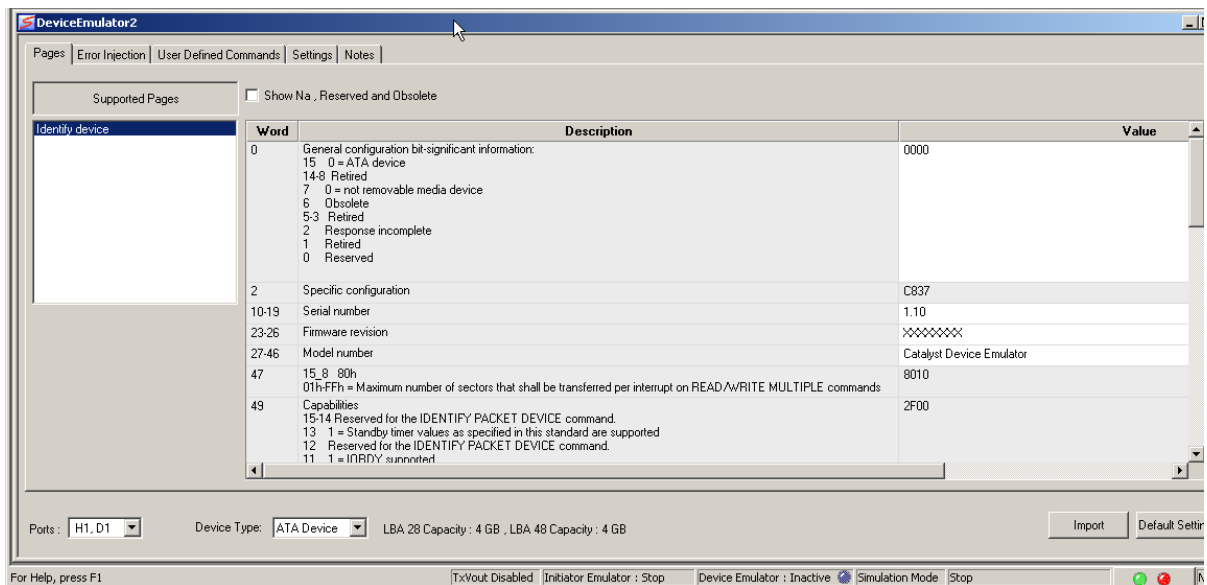

Figure 2.168: SATA: Device Emulation Project Pages Tab

The Device Emulator pages open with default settings for each page. To change settings for your application:

1. Set the Device Type of either ATA or ATAPI
2. Set values for each of the enabled (White) Value fields on the Identify page.
3. To reset the pages to the default settings, click the **Default Settings** button.
4. To use a previously defined emulation, click the **Import** button and select an emulation.

Writable Buffer Size Field

Writable buffer size field is about 3.5 GB.

Error Injection Tab

Clicking the **Error Injection** tab opens the General Errors dialog.

SAS: In addition to specifying general errors, you can also set errors for Identify, Connection Management, and SAS Commands by clicking the corresponding icon in the Errors window.

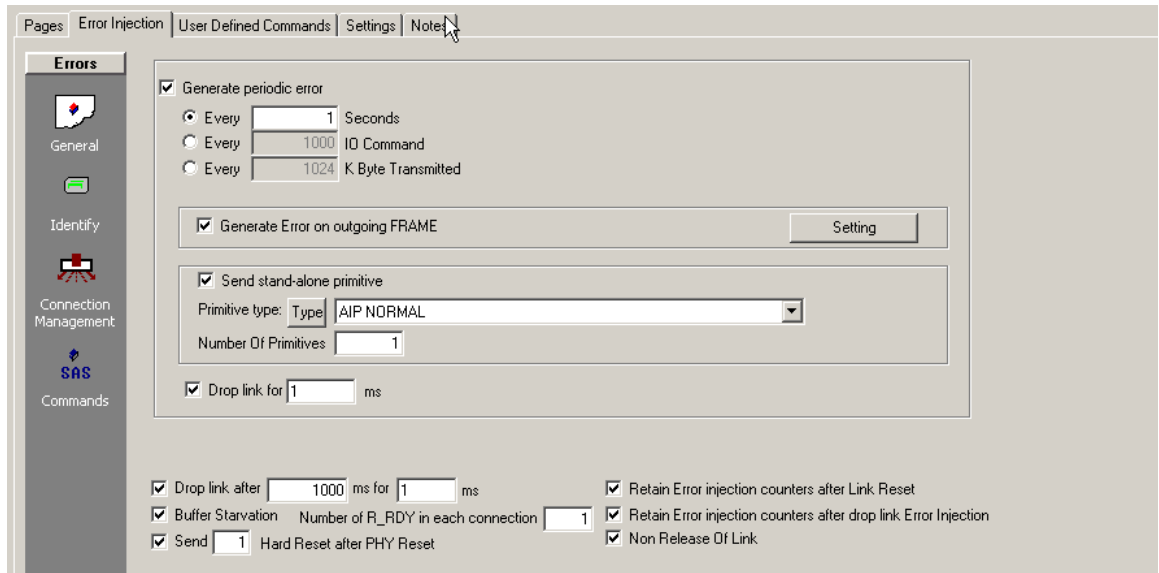

Figure 2.169: SAS: Setting General Errors

SATA: In addition to specifying general errors, you can also set errors for ATA Commands and SATA Signature by clicking the corresponding icon in the Errors window.

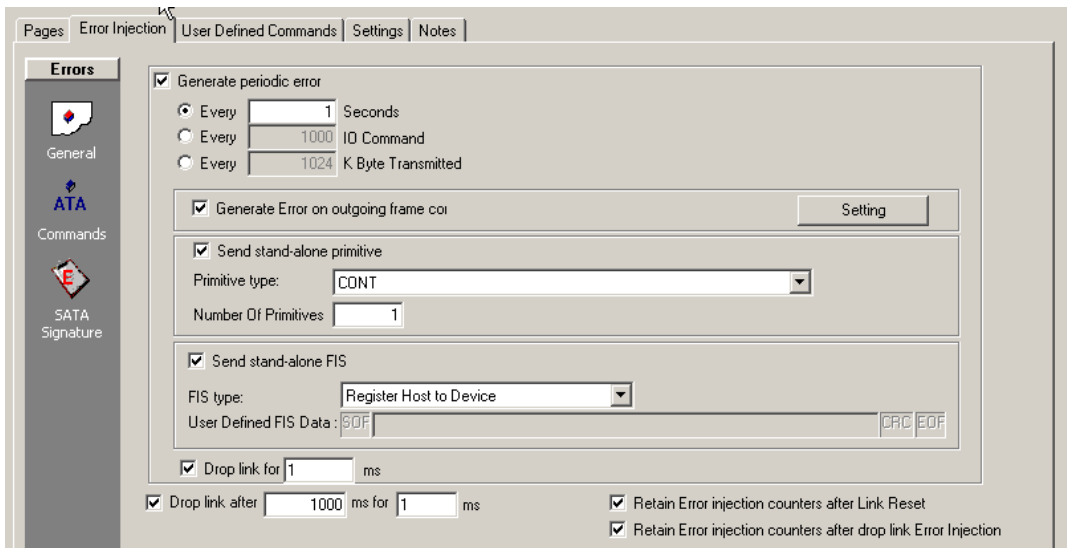

Figure 2.170: SATA: Setting General Errors

Setting General Errors

Generate Periodic Error

Generate Periodic Error allows you to inject periodic error on Command frame, FIS frame, stand alone primitive, and stand alone FIS. Check **Generate Periodic Error** and select the period unit of time, number of IO commands, or number of kilobytes transferred, by checking the corresponding option button.

Outgoing FIS Command Error or Outgoing Frame Command Error

SAS: Check **Generate Error on outgoing FIS commands**, then click the **Setting** button to open the error setting dialog.

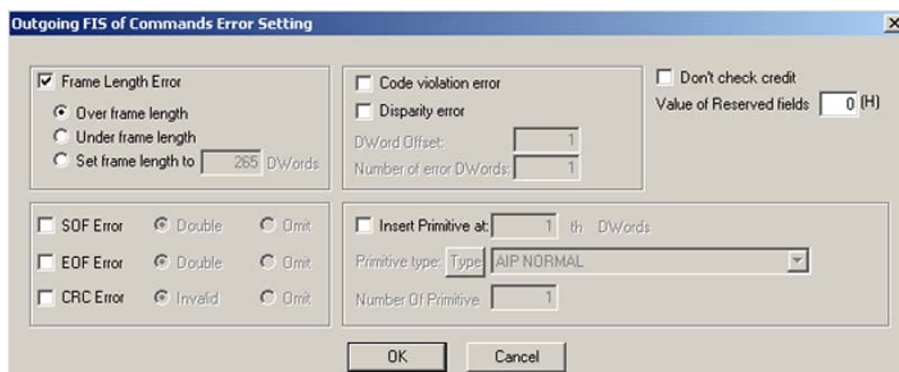

Figure 2.171: SAS: Outgoing FIS of Command Error Setting

SATA: Check **Generate Error on outgoing frame commands**, then click the **Setting** button to open the error setting dialog.

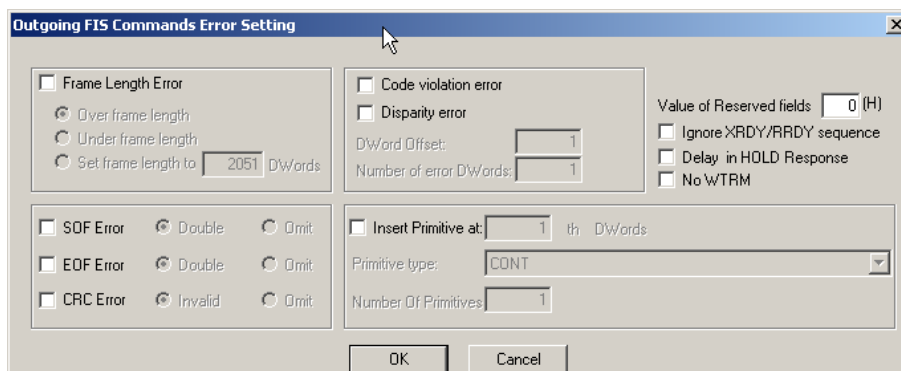

Figure 2.172: SATA: Outgoing FIS of Command Error Setting

Frame Length Error

Check Frame Length Error and choose the type of error to introduce.

- Under frame length:** Data frame payload returned by the DE is 0 bytes.
- Set data frame length to xxxx DWORDS:** Sets the frame length and not the payload length. You need to consider the frame header in the calculations.
- Over frame length:** 2049 DWORD payloads are sent instead of 2048, because four 00 bytes are added to the payload.

Code violation and Disparity errors

Check these and specify the DWORD offset and the number of error DWORDs.

Don't check credit (SAS only)

Check this to disable credit checking.

Value of Reserved Fields

Enter a value.

Ignore XRDY/RRDY sequence (SATA only)

Check or not.

Delay in HOLD Response (SATA only)

Check or not.

No WTRM (SATA only)

Check or not.

SOF, EOF & CRC Errors

Check any or all and choose the criteria for introduction.

Insert Primitive

Check Insert Primitive, click the Type button to open the Primitive Type dialog, then select the primitive type.

Send Primitive

Check **Send stand-alone primitive**, click the Type button to open the Primitive Type dialog, select the primitive type, and click **OK**.



Figure 2.173: Primitive Type

Click the down arrow on the Primitive list box, choose a primitive, enter a value for the number of primitives to send, and click **OK**.

Drop link for ... ms

Check and enter time value for which to drop the link.

Drop link after ... ms for ... ms

Check and enter time value for which to wait before dropping the link and time value for which to drop the link.

Retain Error Injection Counters after Link Reset

If unchecked, after every Link Reset, the Emulator resets its internal Command Number/Counters and re-initializes the Error injection core. If checked, the Emulator keeps the state.

Retain Error Injection Counters after drop link error injection

If unchecked, after every Link Reset, the Emulator resets its internal Command Number/Counters and re-initializes the Error injection core. If checked, the Emulator keeps the state.

Buffer Starvation (SAS only)

Enter **Number of R_RND** in each connection.

Send ... Hard Reset after PHY Reset (SAS only)

Specify number of resets to send.

Send FIS (SATA only)

Check **Send stand-alone FIS**, select the FIS Type button, and optionally enter User Defined FIS Data.

Identify Errors (SAS only)

Click the **Identify** icon in the Errors window to display the Identify Error Setting dialog

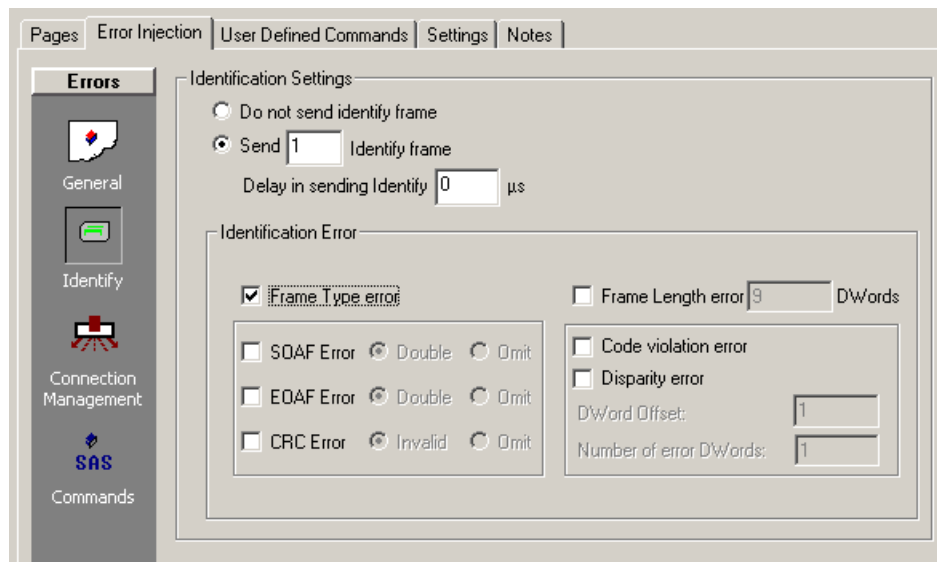

Figure 2.174: SAS: Identify Error Setting Dialog

Sending Identify Frame

Check the **Send** option button, then specify the number of Identify frames to send (and a delay, if needed).

Not to send Identify frames, check the **Do not send identify frames** option button.

Frame Type Error

Check this to send a Frame Type error.

Frame Length Error

Check **Frame Length error** and enter the number of DWORDs in the corresponding text box.

SOAF, EOAF and CRC

Check any or all and check the criteria for introduction.

Code violation and Disparity

Check either or both and specify DWORD offset and Number of DWORDs in the corresponding text boxes.

Connection Management (SAS only)

Click the **Connection Management** icon in the Errors window to display the Connection Management Setting dialog.

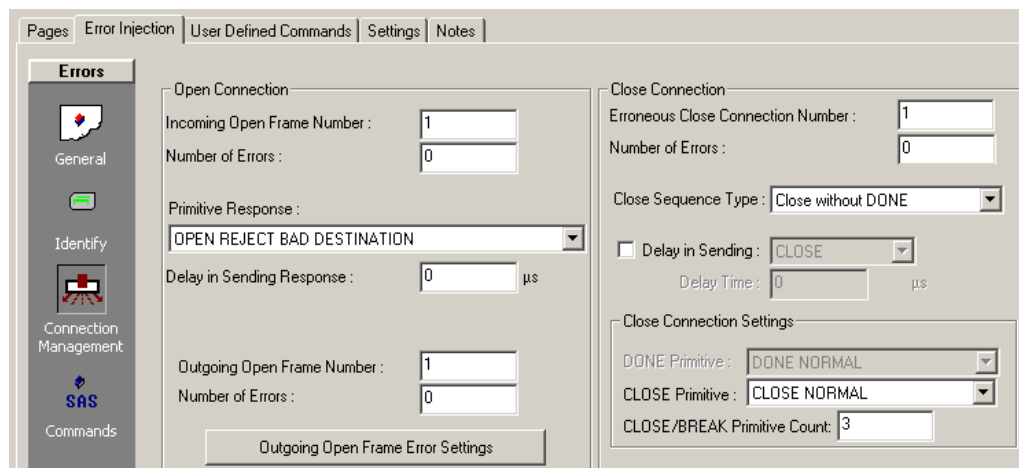

Figure 2.175: SAS: Connection Management Setting Dialog

Open Connection Definition

Incoming Frame Settings

1. In the **Open Connection** dialog, enter a value for the **Incoming Open Frame Number** and the **Number of Errors** in the corresponding text box.
2. Click the down arrow next to the **Primitive Response:** drop down list box, choose a primitive response, and enter a value for the **Delay in Sending Response** text box.
3. Enter a value for **Outgoing Open Frame Number** and **Number of Errors** in the corresponding text box.

Outgoing Frame Settings

Click **Outgoing Open Frame Error Settings** to display the **Open Frame Setting** dialog. Check the errors to introduce and click **OK**.

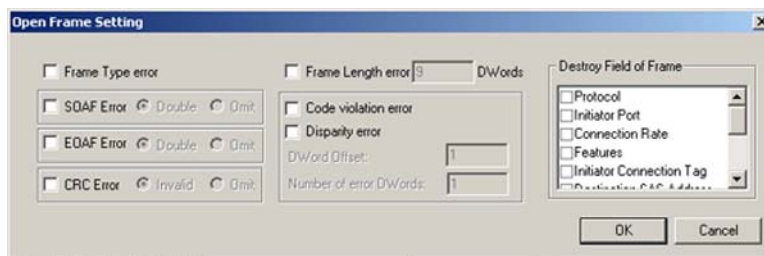

Figure 2.176: SAS: Open Frame Setting

Close Connection Definition

1. In the **Close Connection** dialog, enter a value for the **Erroneous Close Connection Number** and the **Number of Errors** in the corresponding text box.
2. Click the down arrow next to the **Close Sequence Type** drop down list box, then choose a closing sequence.
3. For a delay in sending, click the **Delay in Sending** check box, click the down arrow on the associated drop down list box, choose what to delay, and enter a value for the **Delay Time**.

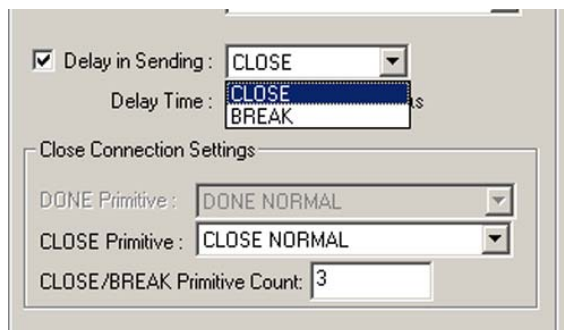

Figure 2.177: SAS: Delay in Sending

- Click the down arrow on the **CLOSE Primitive** or **DONE Primitive** dropdown list box in the **Close Connection Settings** dialog, then choose a Close or Done Primitive.
- Enter a value in the **CLOSE/BREAK Primitive Count** text box.

SAS Commands Errors (SAS only)

Click the **SAS Commands** icon in the Errors window to display the Commands Error Setting dialog.

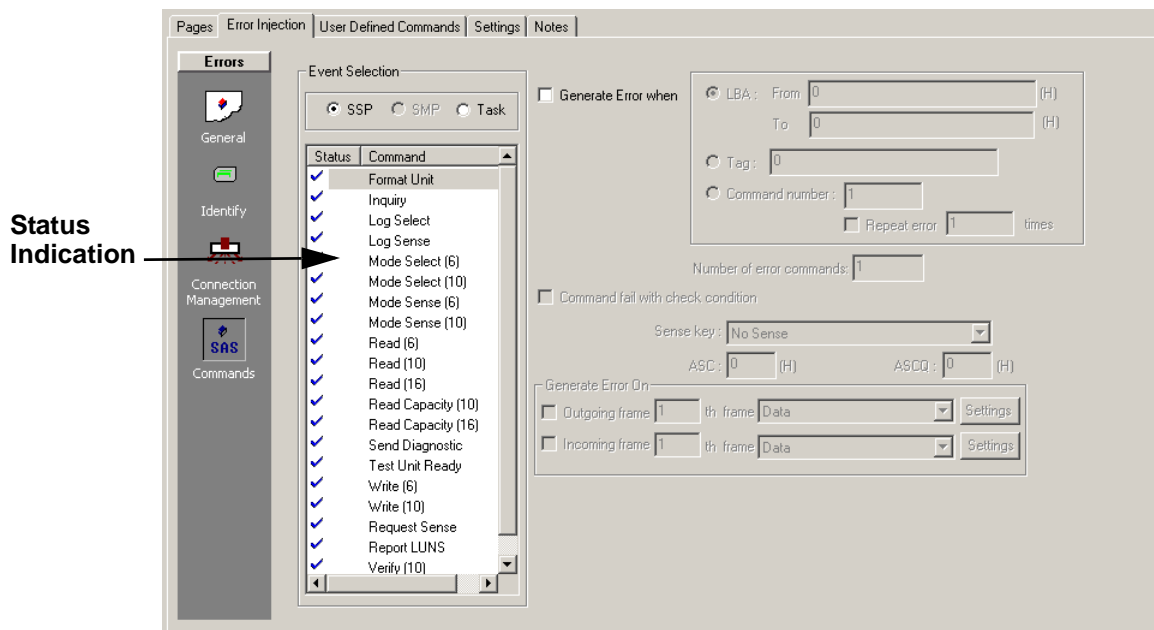

Figure 2.178: SAS: SAS Commands Error Setting Dialog

- Click the **SSP**, **SMP** or **Task** option button to display the commands available for each of these categories in the Event Selection window.
- Click a command for which to set an error, check the **Generate Error when:** check box, then enter values for **LBA**, **TAG**, or **Command number** in the corresponding text box.

Command number specifies the number of the command for which you want to inject error. For example, if you select the **Inquiry** command, then enter **2** for the Command Number, you inject error on the 2nd Inquiry command.

Number of error commands specifies the number of commands for which you want to inject error. For example, if you select the **Inquiry** command, then enter **2** for the Command Number, and enter **3** for Number of Error Commands, the target emulator injects error on the 2, 3, and 4 Inquiry commands, because you want to inject on 2nd command and continue error injection as much as 3 times.

When using Command Number as the Error Injection filter, you can repeat the erring-command sets by checking **Repeat error**. The default value is 1, which injects error only once, with no repeats. In the above example, the system injects error on the 2, 3, and 4 Inquiry commands and does not inject error for other commands. If you enter 2 for Repeat Error, the system injects error on the 2nd, 3rd, 4th, 6th, 7th, and 8th commands.

If you enter 3 for Repeat Error, target emulator injects error on the 2nd, 3rd, 4th, 6th, 7th, 8th, 10th, 11th, and 12th commands.

If you set Repeat Error to 0, it means infinity, and the system injects error on the 2nd, 3rd, 4th, 6th, 7th, 8th, 10th, 11th, 12th, 14th, 15th, 16th, 18th, 19th, 20th, 22th, 23th, 24th, and so on commands.

Note: Repeat error resets the target emulator received command counter.

In the API, use the following functions:

- ❑ **ErInjSetSCSICommandGenerateError:** Enable error injection on a command. Specify Command Number and Number of Error Commands in the 4th and 6th parameters. See API reference manual (section 5.5.139, page 748).
 - ❑ **ErInjSetSCSICommandRepeatedErrorOnCommandNumber (int nCommand, BOOL bEnable, short iCountOfRepeatedErrorsOnCommands):** **nCommand** specifies SCSI command. See 6.52 SCSI Command type definition in API manual. **bEnable:** TRUE means you want repeat error as much as iCountOfRepeatedErrorsOnCommands.
3. Click the **Command fail with check condition** check box, click the down arrow on the **Sense Key** drop down list box, choose an error type, and then enter values for **ASC** and **ASCQ** in the corresponding text boxes.
- Some Check Condition Sense Key and ASC/ASCQ values are (see [Figure 2.179 on page 180](#)):
- ❑ 01, 1807 (soft error, RECOVERED DATA WITH ECC - DATA REWRITTEN)
 - ❑ 0b, 1103 (aborted command, MULTIPLE READ ERRORS)
 - ❑ 0b, 4b06 (aborted command, INITIATOR RESPONSE TIMEOUT)
 - ❑ 04, 4100 (hardware errors, DATA PATH FAILURE)

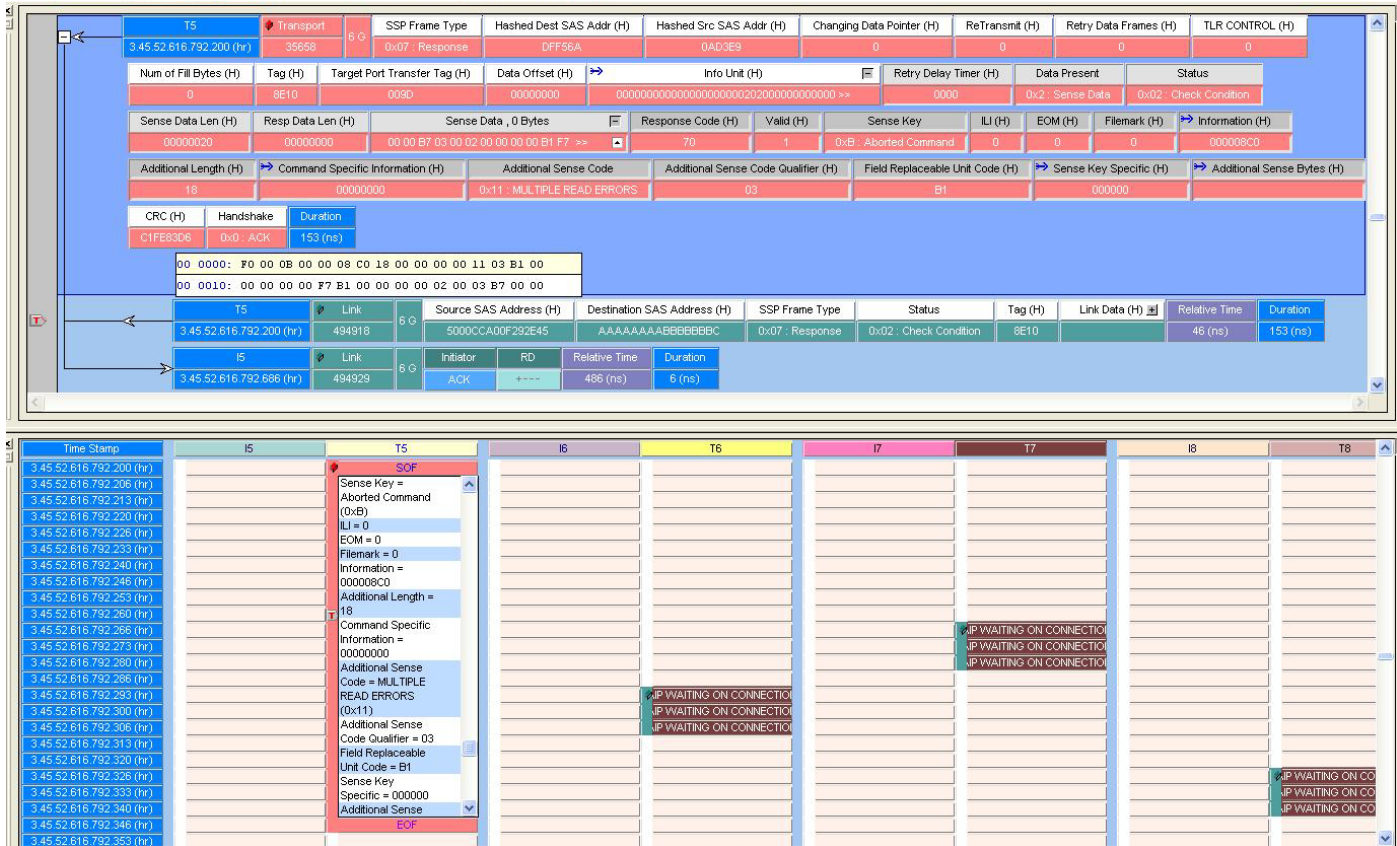

Figure 2.179: Sense Key Codes

4. Set up Outgoing and Incoming frame errors.

Note: Once you check the **Generate Error On:** check box for a command, a red status indication appears next to the command, indicating an error condition.

Outgoing Frame Settings

Before selecting Outgoing Frame Settings, select the Types Of Frames and the Frame Number on which to inject an error. Then check **Outgoing Frame** in the Generate Error On area and then the enabled **Settings** button to display the Outgoing Frame Setting dialog. See [Figure 2.180 on page 181](#).

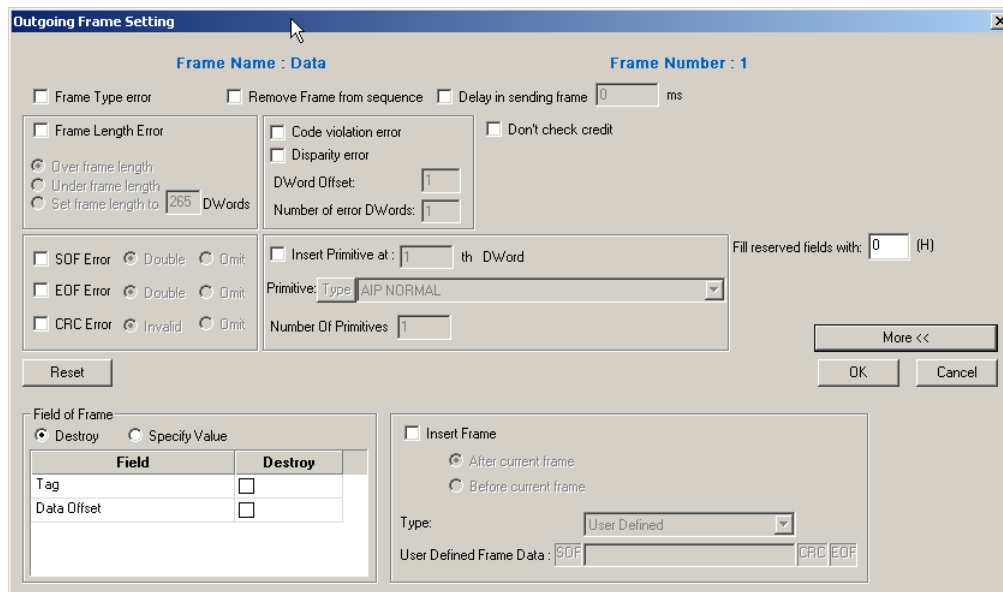

Figure 2.180: Outgoing Frame Setting Dialog

Frame Type Error

Check this to introduce a frame type error.

Remove Frame from sequence

Check this to remove frame from sequence.

Delay in sending frame

Check this to delay sending frame and enter a value for the delay.

Frame Length Error

Check Frame Length Error and choose the type of error to introduce.

Code Violation and Disparity error

Check these and specify DWORD offset and the number of error DWORDs.

Don't check credit

Check this to disable credit checking.

SOF, EOF, and CRC errors

Check these and specify Double or Omit by checking the corresponding option button.

Insert Primitive

Check Insert Primitive, click the Type button to open the Primitive Type dialog, select the primitive type, and click OK.

Destroy Field of Frame

Make sure to click the More button and then check the field to destroy.

Insert Frame

Check Insert Frame, click the down arrow on the Type combo box, and choose the frame type. Make sure that you have clicked More.

Incoming Frame Settings

Before selecting Incoming Frame Settings, select the **Types Of Frames** and the **Frame Number** on which to inject an error. Then check **Incoming Frame** in the Generate Error On area and then the enabled **Settings** button to display the Incoming Frame Settings dialog.

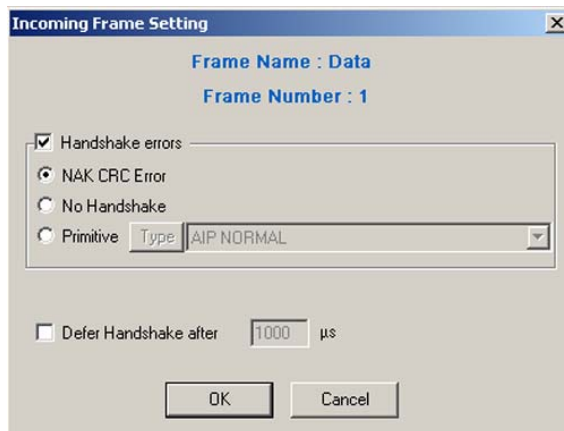

Figure 2.181: Incoming Frame Setting Dialog

Handshake Error

Check Handshake Errors to enable selection of error on handshake. Check NAK, CRC, or any other Primitive to send as an incoming frame response. Check No Handshake to send no response.

Defer Handshake Errors

Check **Defer Handshake** and enter a value for the time to defer the handshake.

ATA Commands Errors (SATA only)

Click the **ATA Commands** icon in the Errors window to display the ATA Commands Error Setting dialog.

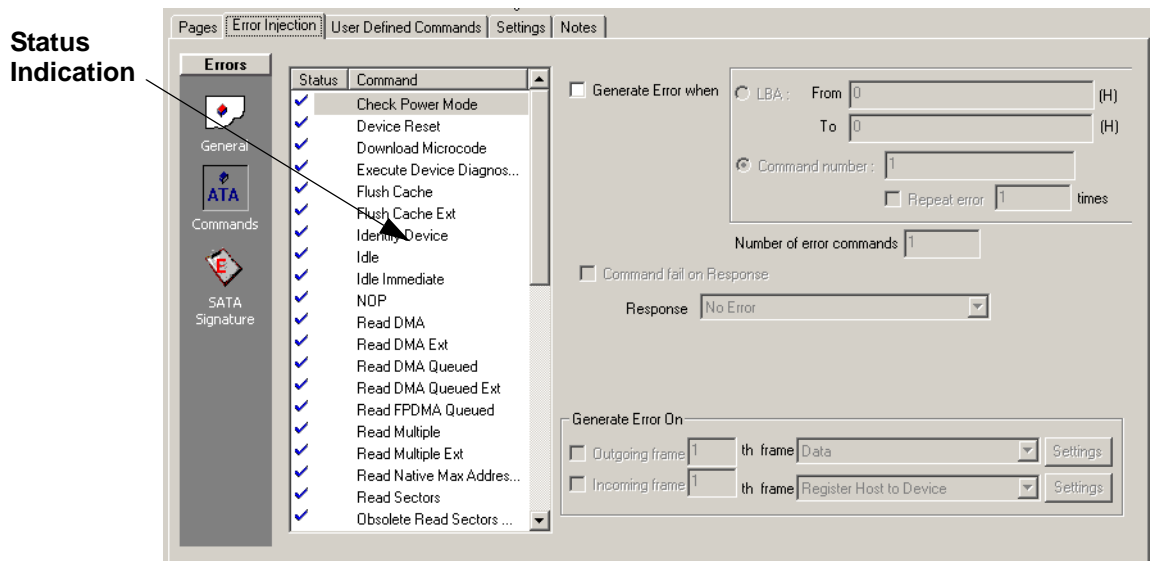

Figure 2.182: SATA: SAS Commands Error Setting Dialog

To set errors for ATA commands:

1. Click a command for which to set an error and then check the **Generate Error when** check box and chose **LBA or Command number** with a value in the corresponding text box.

Note: Hard-drive password security commands (as described in ATA8) are Data Set Management, Write Uncorrectable Ext, Security Disable Password, Security Erase Password, Security Erase Unit, Security Freeze Lock, Security Set Password and Security Unlock.

2. When you choose Command Number, you can use **Repeat error** for periodic series of errors in commands. Set the number of times to repeat the error, by entering a value in the **Number of Error Commands** text box.

Note: Once you check the **Generate Error when:** check box for a command, a red status indication appears next to the command selected indicating an error condition.

3. To force the system to send a defined response frame to the host, check the **Command fail on Response** check box and then choose a pre-defined response.
4. Repeat for every command for which to set an error.

Outgoing Frame Settings

Before selecting Outgoing Frame Settings, select the Types Of Frames and the Frame Number on which to inject an error. Then check **Outgoing Frame** in the **Generate Error On** area and then the enabled **Settings** button to display the Outgoing Frame Setting dialog.

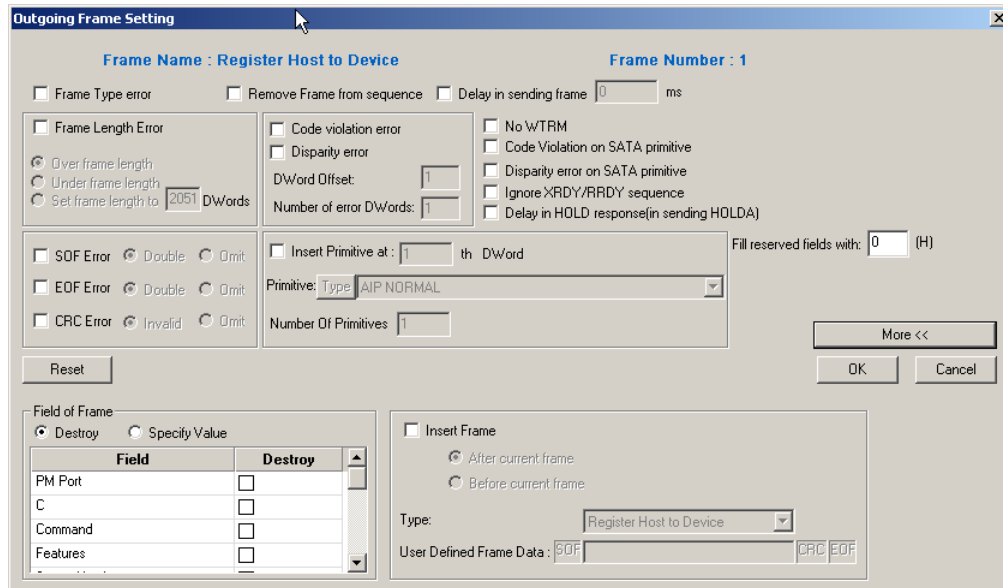

Figure 2.183: Outgoing Frame Setting Dialog

Frame Type Error

Check this to introduce a frame type error.

Remove Frame from sequence

Check this to remove frame from sequence.

Delay in sending frame

Check this to delay sending frame and enter a value for the delay.

Additionally check:

- No WTRM
- Code Violation on SATA primitive
- Disparity error on SATA primitive
- Ignore XRDY/RRDY sequence
- Delay in HOLD response (in sending HOLDA)

Frame Length Error

Check **Frame Length Error**, choose the type of error to introduce and click **OK**.

Code violation and Disparity error

Check these and specify DWORD offset and the number of error DWORDS.

SOF, EOF and CRC errors

Check these and specify **Double** or **Omit** by checking the corresponding option button.

Insert Primitive

Check **Insert Primitive** to enable the Primitive Type dialog, select the primitive type and number of primitives, and click **OK**.

Destroy Field of Frame

Click the **More** button to display the Field of Frame area, check **Destroy**, and check the fields to destroy. Alternatively, check **Specify Value** to choose from a predefined list of values.

Set Value of Field

Check **Fill Out** in the **Field of Frame** area and enter values for fields.

Insert Frame

Check **Insert Frame** and then click the down arrow on the **Type** combo box and choose the frame type. Make sure that you have clicked **More**.

Note: In addition to the pre-defined frame types, you can scroll down the list to **User Defined** and then enter your own frame data between SOF and EOF.

Incoming Frame Settings

Before selecting Incoming Frame Settings, select the Types Of Frames and the Frame Number on which to inject an error. Then check **Incoming Frame** in the **Generate Error On** area and then the enabled **Settings** button to display the Incoming Frame Settings dialog.

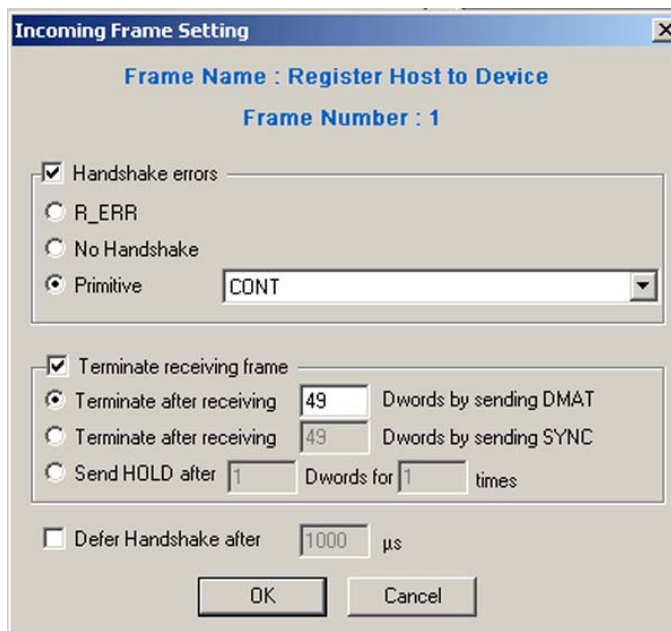

Figure 2.184: Incoming Frame Setting Dialog

Handshake Errors

Check **Handshake Errors** to enable selection of error on handshake. Check **NAK**, **CRC**, or any other **Primitive** to send as an incoming frame response. Check **No Handshake** to send no response.

Defer Handshake Errors

Check **Defer Handshake** and enter a value for the time to defer the handshake.

Primitive

Check **Insert Primitive** then click the down arrow on the **Primitive** drop down combo box and choose a primitive.

Terminate receiving frame

Check **Terminate receiving frame** and choose the termination condition.

SATA Signature (SATA only)

Click the **SATA Signature** icon in the Errors window to display the SATA Signature dialog.

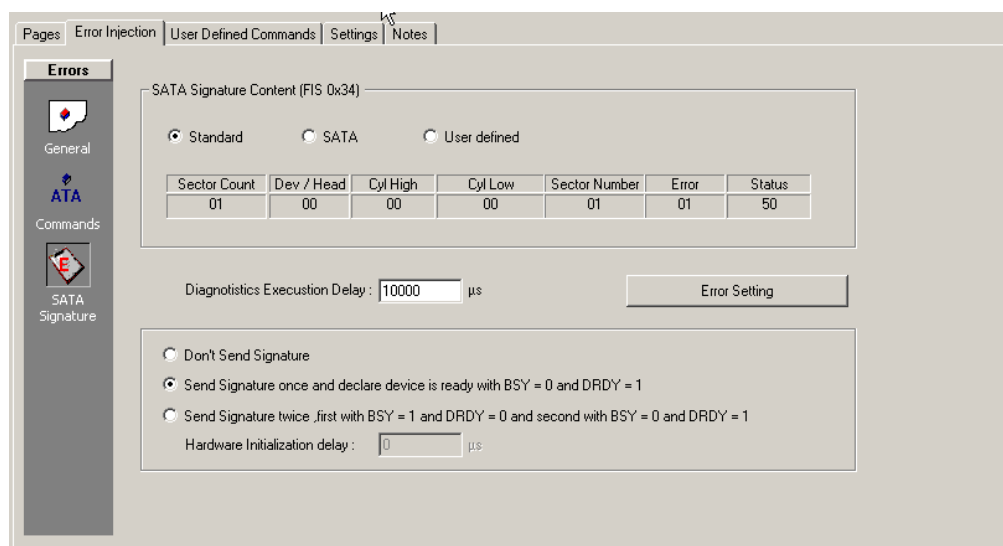

Figure 2.185: SATA: SATA Signature Dialog

Choose SATA Signature Content

Choose either the pre-defined **Standard** or **SATA**. Alternatively, you can define your own signature by checking the **User Defined** option button and then entering values in the enabled fields.

Specify when to send Signature

You can choose from **Don't Send Signature**, **Send Signature once** and declare device is ready with BSY=0 and DRDY=1, or **Send Signature twice**, first with BSY=1 and DRDY=0 and second with BSY=0 and DRDY=1, by checking the corresponding option button.

Note: If you choose **Send Signature twice**, first with BSY=1 and DRDY=0 and second with BSY=0 and DRDY=1, the system enables the Hardware initialization delay text box, allowing you to set the hardware initialization delay.

SATA Signature Errors

You can define errors to introduce when sending a SATA Signature. To define the errors, click the **Error Setting** button to open the SATA Signature Error Setting dialog.

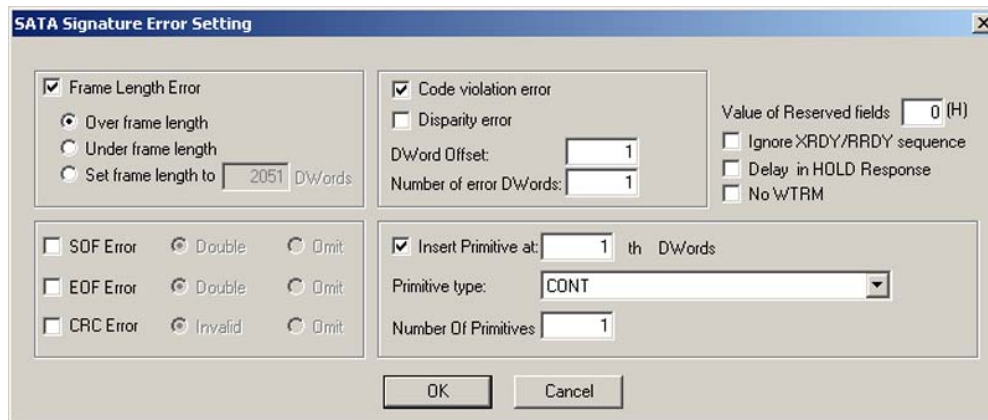

Figure 2.186: SATA: SATA Signature Error Setting

Frame Length Error

Choose the Frame Length Error type to introduce.

SOF, EOF and CRC Errors

Check any or all and check the criteria for introduction.

Code Violation and Disparity errors

Check and specify DWORD offset and Number of DWORD errors for Disparity error.

Additional Settings

Set and check:

- Value for Reserved fields
- Ignore XRDY/RRDY Sequence
- Delay in HOLD Response
- No WTRM

Insert Primitive

Check **Insert Primitive**, click the down arrow on the **Primitive** list box, choose a primitive type and enter a value for the Number of Primitive.

User-Defined Commands Tab

To create command(s) specifically for your application, click the **User Defined Commands** tab to display the command definition dialog.

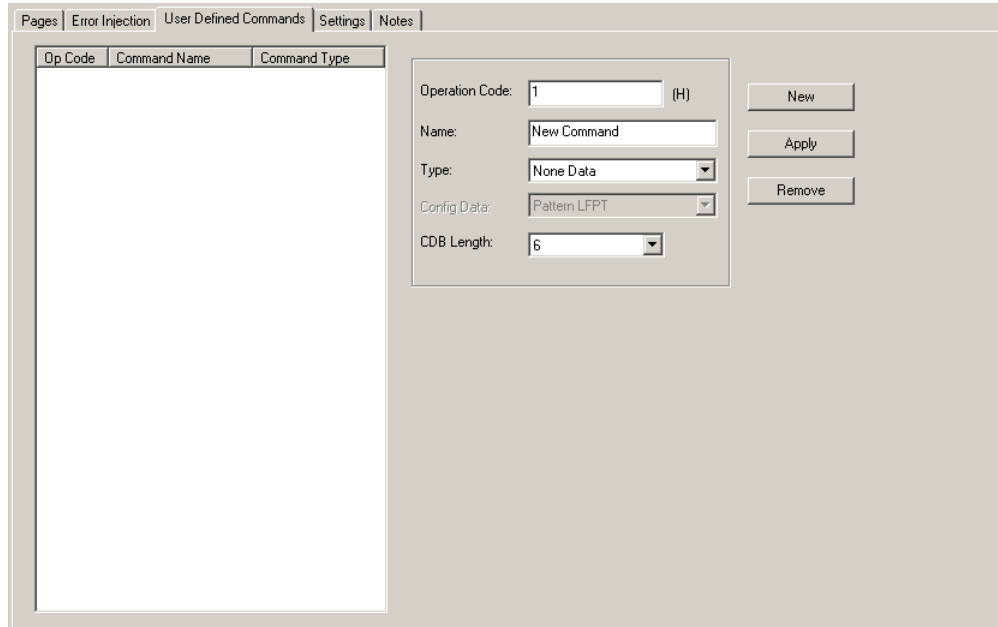

Figure 2.187: SAS: Command Definition Dialog

To define a command:

1. Enter an **Operation Code** and a **Name** in the corresponding text boxes.
2. Click the down arrow on the **Type** combo box and choose a command type.
3. For command types requiring configuration data, click the down arrow on the enabled **Config data:** combo box and choose appropriate configuration data.
4. Enter the **CDB length:** 6, 10, 12, or 16.
5. When done, click the **New** button.
6. The defined command appears in the command name window.
7. To make changes to a previously defined command, highlight the command, make the changes, and click **Apply**.

Note: After creation, the User-Defined commands appear in the Event Selection dialog.

Target Emulator Settings (SAS)

Click the **Settings** tab to display the Target Emulator Settings dialog.

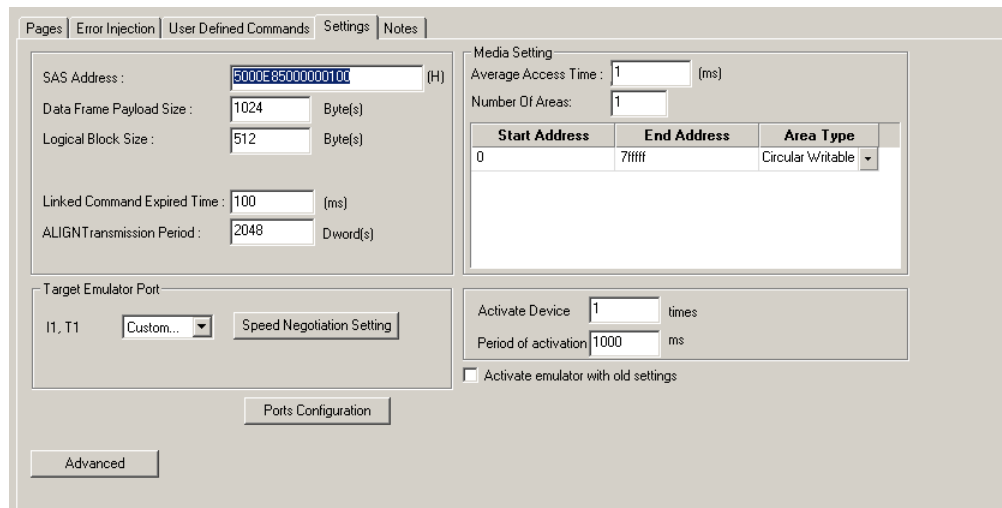

Figure 2.188: SAS: Target Emulator Settings Dialog

The Settings page opens with a default set of values, which you can modify. To return to these values, click the **Default Settings** button.

Define the Target

Enter a **SAS Address**, **Data Frame Payload Size**, **Logical Block Size**, **Linked Command Expired Time**, and **ALIGN Transmission Period** in the corresponding text box.

Media Settings

Enter a value for Average Access Time to simulate Seek/Access time delay of a real device.

Enter a Number of Writable Areas. **Define a Start** and an **End Address**, click the down arrow under the **Area Type**, and choose **Normal Writable**, **Circular Writable**, or **Non-Writable**.

Note: To set and get the settings of Media Settings Area Types, use these two functions:

```
SetMediaAreaAttribute(int nAreaIndex, int nStartAddress, int nEndAddress,
TrgEmulMediaAreaTypeEnum eAreaType, int* pnErrorCode)
GetMediaAreaAttribute(int nAreaIndex, int* pnStartAddress, int* pnEndAddress,
TrgEmulMediaAreaTypeEnum* peAreaType)
```

nAreaIndex: Specifies the (zero base) index of the Area.

Note: The Number of Areas should be set by the **SetNumberOfMediaArea** function prior to calling these functions.

nStartAddress: Specifies the start address of the Area.

nEndAddress: Specifies the End address of the Area.

eAreaType: Specifies the Area Type. This parameter should be in **TrgEmulMediaAreaTypeEnum** format. Its possible values are:

```
typedef enum {eNORMAL_WRITABLE = 0, eCIRCULAR_WRITABLE = 1,
eNONE_WRITABLE = 2} TrgEmulMediaAreaTypeEnum;
```

Choose Target Emulator Port

Click a port option button, then click the **Speed Negotiation Setting** button (see [“Speed Negotiation Tab” on page 154](#)). Select the port speed settings, all by default.

Ports Configuration

Click the **Port Configuration** button to display the Ports Configuration dialog (see [“Ports Configuration” on page 106](#)).

Device Activation

Enter a number of times in the **Activate Device** field. If **Activate Device** = 1, the software activates Target Emulator until you deactivate it. This is the default behavior. (**Period of Activation** has no effect.)

If **Activate Device** = n, where n > 1, the software activates and deactivates Target Emulator n times, with activation period specified in the **period of activation** field. For example, if **Activate Device** = 10 and **period of activation** = 2000 ms, the software activates Target Emulator for 2000 ms and then deactivates it, and then repeats activation and deactivation 9 times, for a total of 10 times. (You must enter **Period of Activation**.)

Advanced Settings

Click the **Advanced Button** to display additional setting options. The dialog opens displaying the OOB Signal Setting tab.

OOB Signal Setting

Edit the default values displayed in the white editable fields.

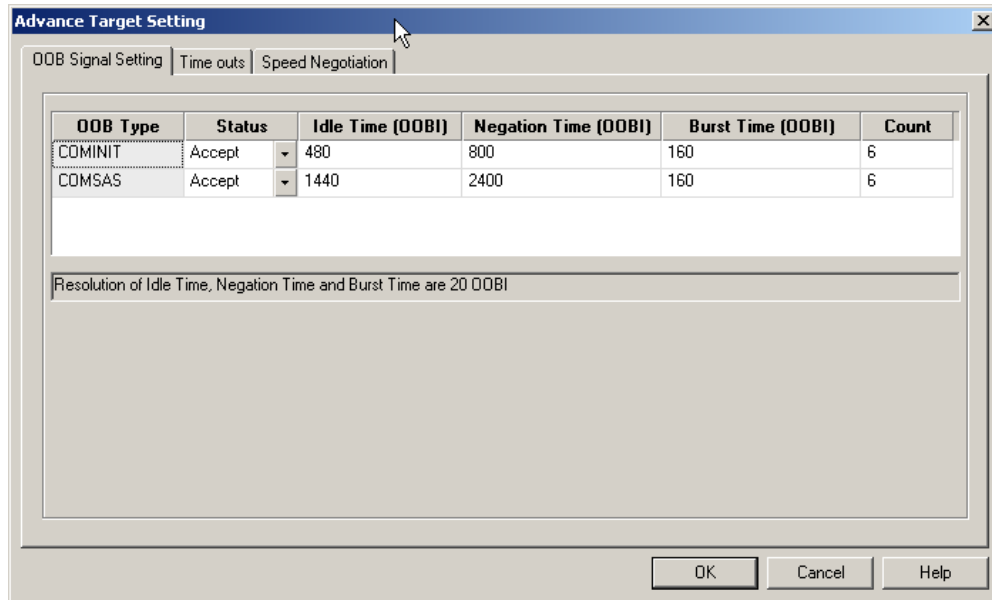

Figure 2.189: OOB Signal Setting Dialog

Set Timeouts

Click the **Timeouts** tab to display the Timeouts setting dialog.

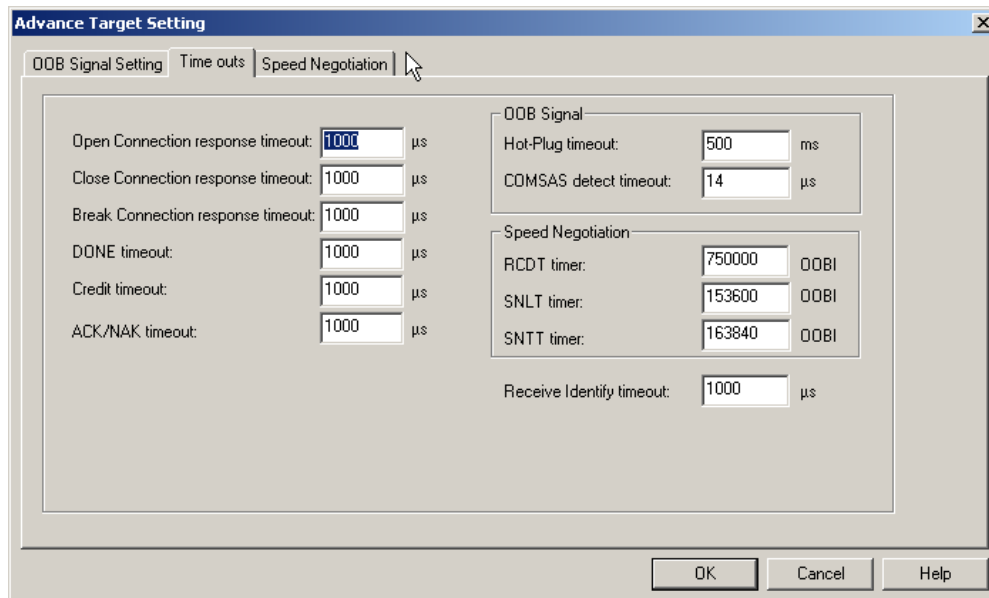

Figure 2.190: Timeout Setting Dialog

Edit the default values displayed in the white editable fields and click **OK**.

Set Speed Negotiating error

Click the **Speed Negotiation** tab to display the Speed Negotiation dialog.

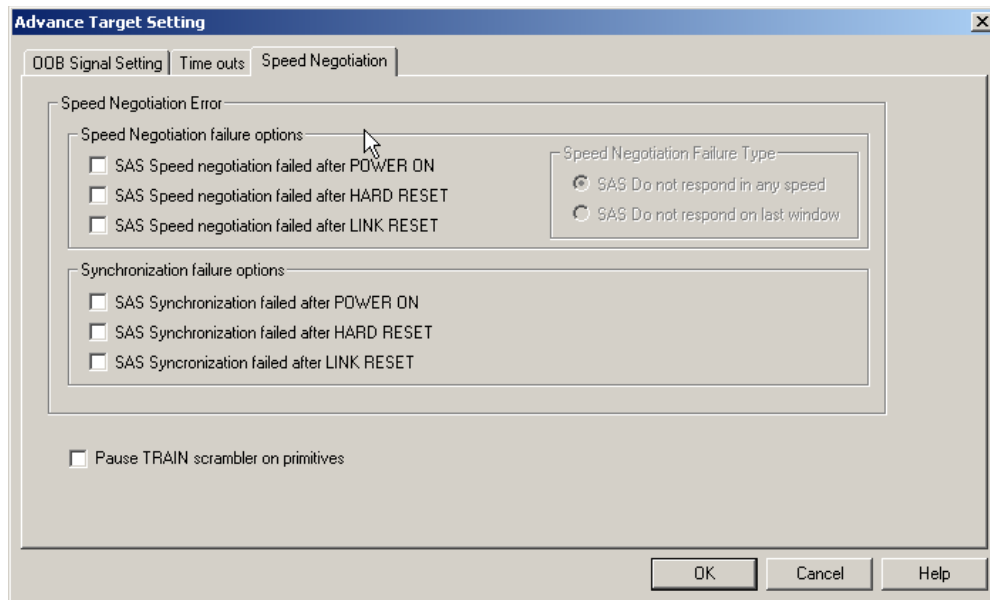

Figure 2.191: Speed Negotiating Error Setting Dialog

Check a **Speed Negotiation Error** check box and choose a failure type by checking a corresponding option button. Additionally, you can choose the **Synchronization failure** option.

Notes Tab

Click the **Notes** tab and enter a Project Name and a brief description of the Target Emulation project (see [“Add a Project Note” on page 111](#)).

Run Target Emulation



Click the **Activate Device** button or select **Project Setup > Active Device** to start emulation.

Note: You can run the analyzer while device emulation is active to monitor bus traffic.

Device Emulator Settings (SATA only)

Click the **Settings** tab to display the Device Emulator Settings dialog.

The Settings tab opens with a default set of values, which you can modify. To return to these values, click the **Default Settings** button.

The screenshot shows the 'Settings' tab of the Device Emulator Settings dialog. The 'PHY / Link layer settings' section contains the following fields: 'ALIGN Transmission Period' (256 Dword(s)), 'Primitive Response Time out' (65000 Dword(s)), 'Device send ALIGN Time' (110 μs), and 'Delay between getting HOLD to Sending HOLDA' (27 DWords). A checkbox for 'CONT Usage' is checked. The 'General' section has 'Data Frame Payload Size' (8192 Byte(s)). The 'Target Emulator Port' section shows 'H1, D1' and a dropdown menu set to '3.0/1.5Gbps'. The 'Media Setting' section includes 'Average Access Time' (1 ms) and 'Number Of Areas' (1). Below this is a table with columns 'Start Address', 'End Address', and 'Area Type', containing one row with values '0', '7ffff', and 'Circular Writable'. At the bottom, there are fields for 'Activate Device' (1 times) and 'Period of activation' (1000 ms), and a checkbox for 'Activate emulator with old settings'. Buttons for 'Advanced', 'Ports configuration', and a 'Default Settings' button are also visible.

Figure 2.192: SATA: Device Emulator Settings

PHY/Link layer settings

Enter values for **Align Transmission Period**, **Primitive Response Timeout**, and **Standby Timeout**, **Device send Align Time** and **Delay between getting HOLD to Sending HOLDA** and specify a delay. Check **CONT usage**.

Delay Between Getting HOLD to Sending HOLDA

To enable the **Delay between getting HOLD to Sending HOLDA** feature perform the following steps:

1. Enter the value in the **Delay between getting HOLD to Sending HOLDA** field in the **Settings** tab as shown in the figure above.
2. Select the **Error Injection** tab (see [Figure 2.193 on page 194.](#))

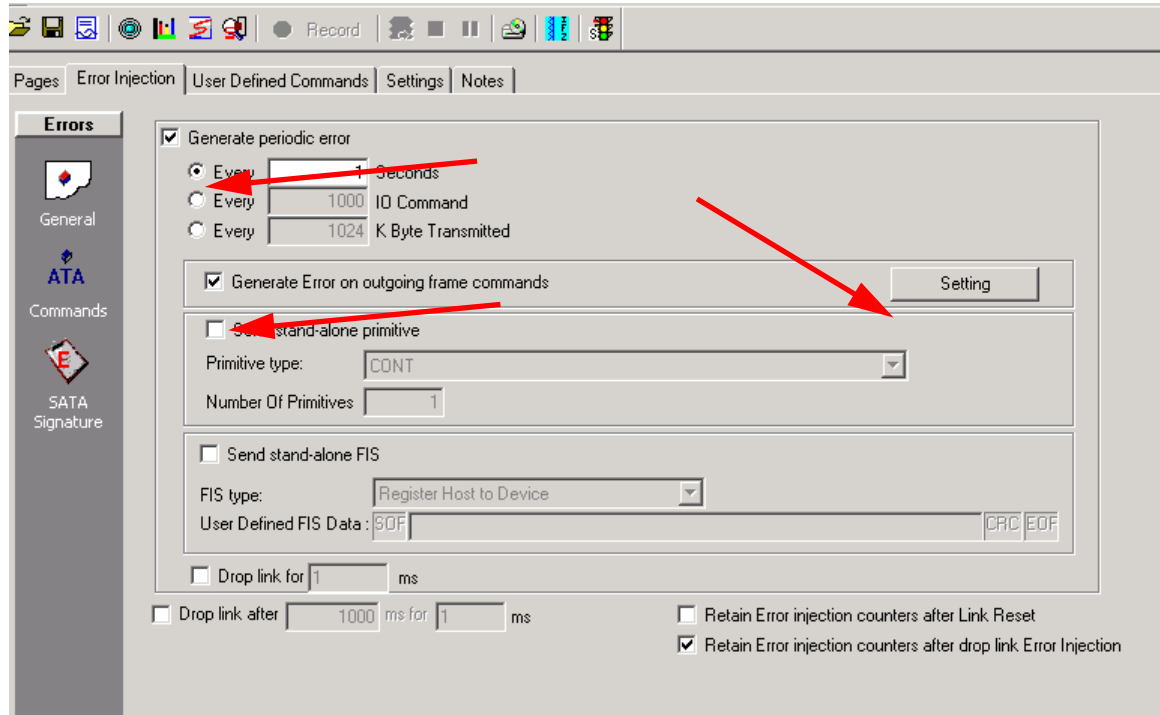

Figure 2.193: SATA: Error Injection Tab

3. Click the **Generate periodic error** check box.
4. Click the **Generate Error on outgoing frame commands** check box.
5. Click the **Settings** button.

The Outgoing FRAME Error Setting dialog displays.

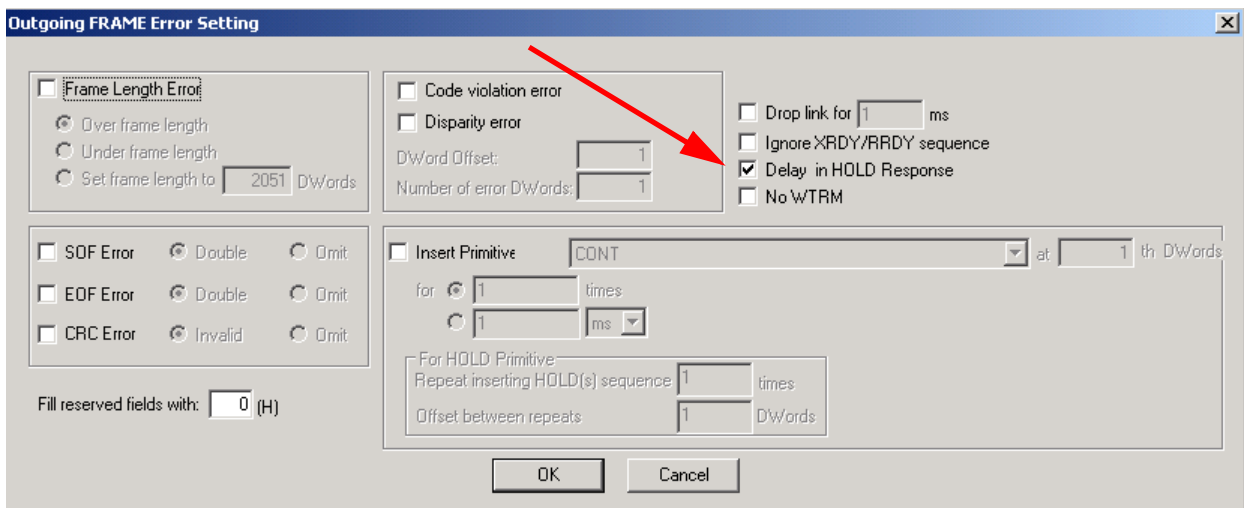

Figure 2.194: SATA: Outgoing FRAME Error Setting Tab

6. Click the **Delay in HOLD Response** check box.
7. Click **OK**.

Media Settings

Enter a value for **Average Access time** to simulate Seek/Access time delay of a real device.

Enter a **Number of Areas**. Define a **Start** and an **End Address**, click the down arrow under the **Area Type** and choose **Normal Writable**, **Circular Writable**, or **Non Writable**.

Payload Size

Enter a value for **Data Frame Payload Size** in the General area.

Choose Target Emulator Port

Click a port option button and click the down arrow next to the **Speed** list box and choose a port speed. Use the **Speed Negotiation Setting** button to open the dialog (see [“Speed Negotiation Tab” on page 154](#)).

Note: If you have made some changes to a defined emulation and want to return to the original definition, check the **Activate the emulator with old settings**.

Ports Configuration

Click the **Port Configuration** button to display the Ports Configuration dialog (see [“Ports Configuration” on page 106](#)).

Activation

Enter **number of times** and **period of activation**.

Advanced Options

Click the **Advanced** button to display the OOB Signal Setting, Power Management setting, Speed Negotiation, NCQ Command setting and Miscellaneous additional setting dialogs.

OOB Signal Setting

Edit the default values displayed in the white editable fields. (see [Figure 2.195 on page 196](#).)

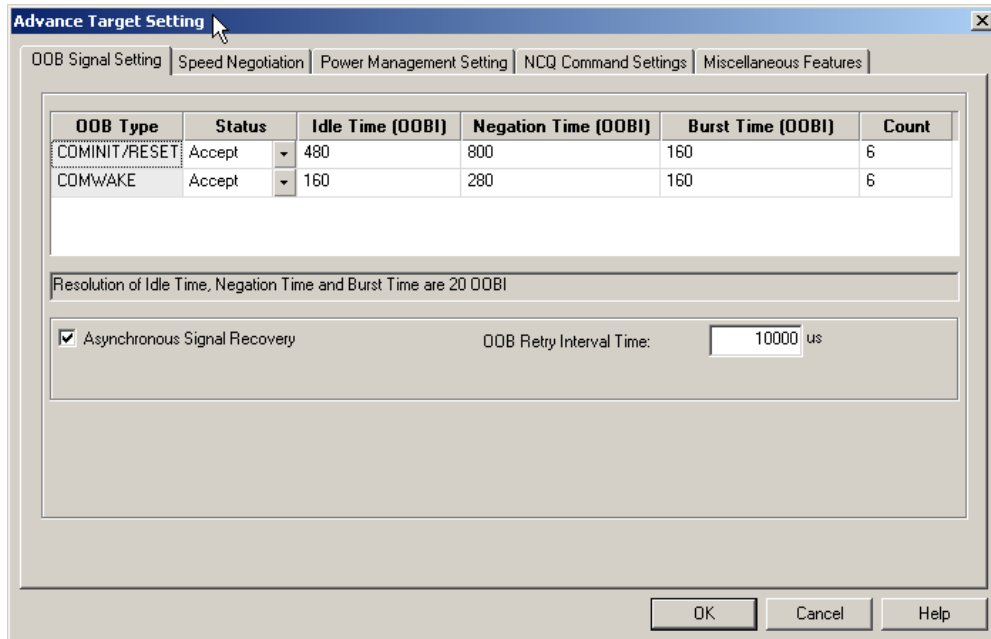

Figure 2.195: OOB Signal Setting Dialog

Speed Negotiation

Click the **Speed Negotiation** tab to display the Speed Negotiation dialog. Specify **Speed Negotiating Failure Option(s)** and a **Speed Negotiation Failure Type**.

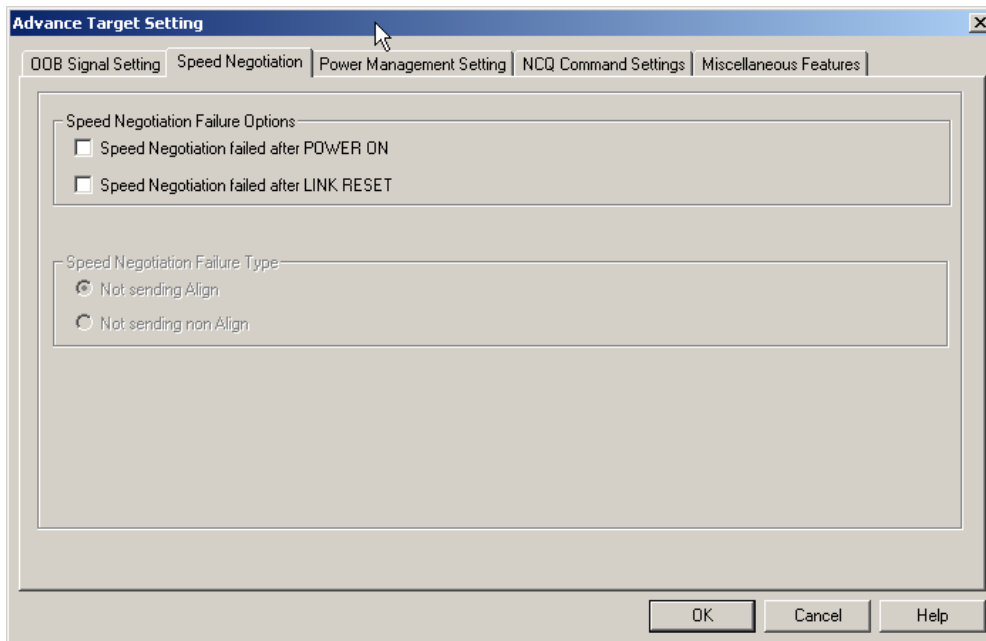

Figure 2.196: Speed Negotiation Dialog

Power Management Settings Tab

The following screen capture shows the Power Management Settings tab in the Advanced Target Settings dialog.

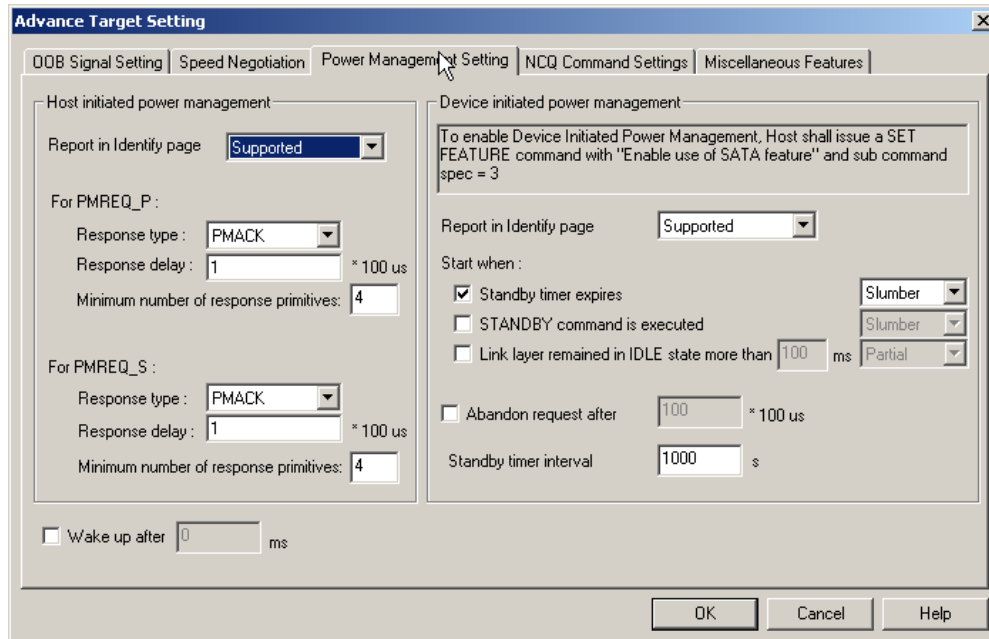

Figure 2.197: Power Management

1. In the **Host Initialized Power Management** area, choose whether to support the report in the Identify page.
2. Specify the response type for PMREQ_P and PMREQ_S, the delay, and **Minimum Number of Response Primitives**.
3. In the **Device Initiated Power Management** area choose whether to support the report in the Identify page.
4. Define start event by choosing **Standby timer expires**, **STANDBY command executes**, or **Link layer remains in IDLE state** more than [XXX] ms.
5. Specify time for **Abandon request** and **Wake up after** and enter the **Standby timer interval**.

NCQ Command Settings Tab

The following screen capture shows the NCQ Command Settings tab in the Advanced Target Settings dialog.

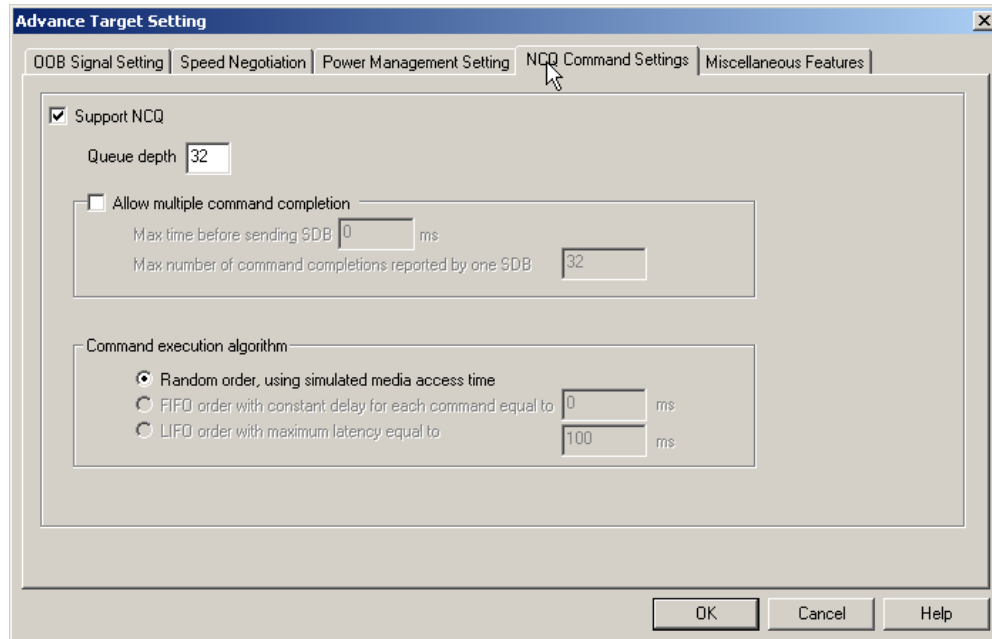

Figure 2.198: NCQ Commands

To enable **NCQ** commands, perform the following steps:

1. Check **Support NCQ** and specify **Queue depth**.
2. Optionally check **Allow multiple command completion** and enter values for **Max time before sending SDP** and **Max number of command completions reported by one SDB**.

Miscellaneous Features Tab

The following screen capture shows the Miscellaneous Features tab in the Advanced Target Settings dialog.

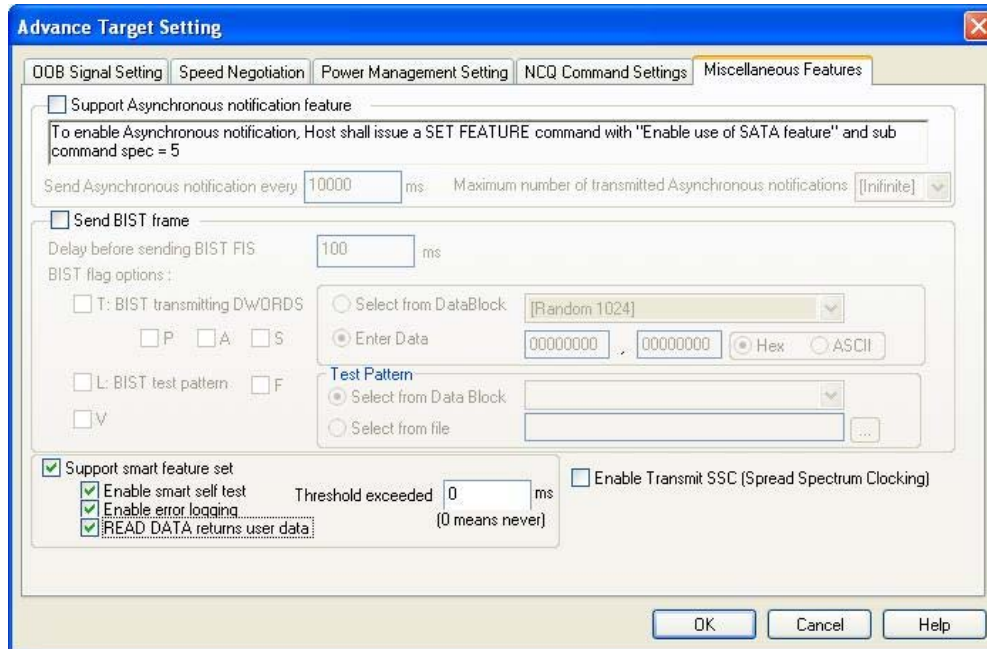

Figure 2.199: Miscellaneous Features

To enable Asynchronous notification, perform the following steps:

1. Check the **Support Asynchronous notification feature**, and then specify the millisecond **Asynchronous notification interval** and the **Maximum number of transmitted Asynchronous notifications**.
2. To send a BIST frame, check **Send BIST frame** and enter a value for the millisecond **Delay before sending BIST FIS**. Choose BIST flag options and enter or select DATA or test pattern.
3. To support smart features, check **Support smart feature set**.
For self test, check **Enable smart self test**.
For error logging, check **Enable error logging**.
To return user data for READ DATA, check **READ DATA returns user data**.
To set threshold, enter an integer in **Threshold exceeded**. To never exceed threshold, enter **0**.
4. To enable Transmit Spread Spectrum Clocking, check **Enable Transmit SSC**.

Project Note

Click the **Notes** tab and enter a **Project Name** and a brief description of the Device Emulation project (see [“Add a Project Note” on page 111](#)).

Using the Power Expansion Card

You can use the Power Expansion Card for Emulation. See [“Using the Power Expansion Card” on page 31](#).

Run Device Emulation



Click the **Activate Device** button to start emulation.

You can run the analyzer while device emulation is active to monitor bus traffic.

Chapter 3

Display Manipulation

Viewer Display

After data is captured (Recorded), the Viewer displays a sample file (.scs for SAS and .sts for SATA) in Packet View.

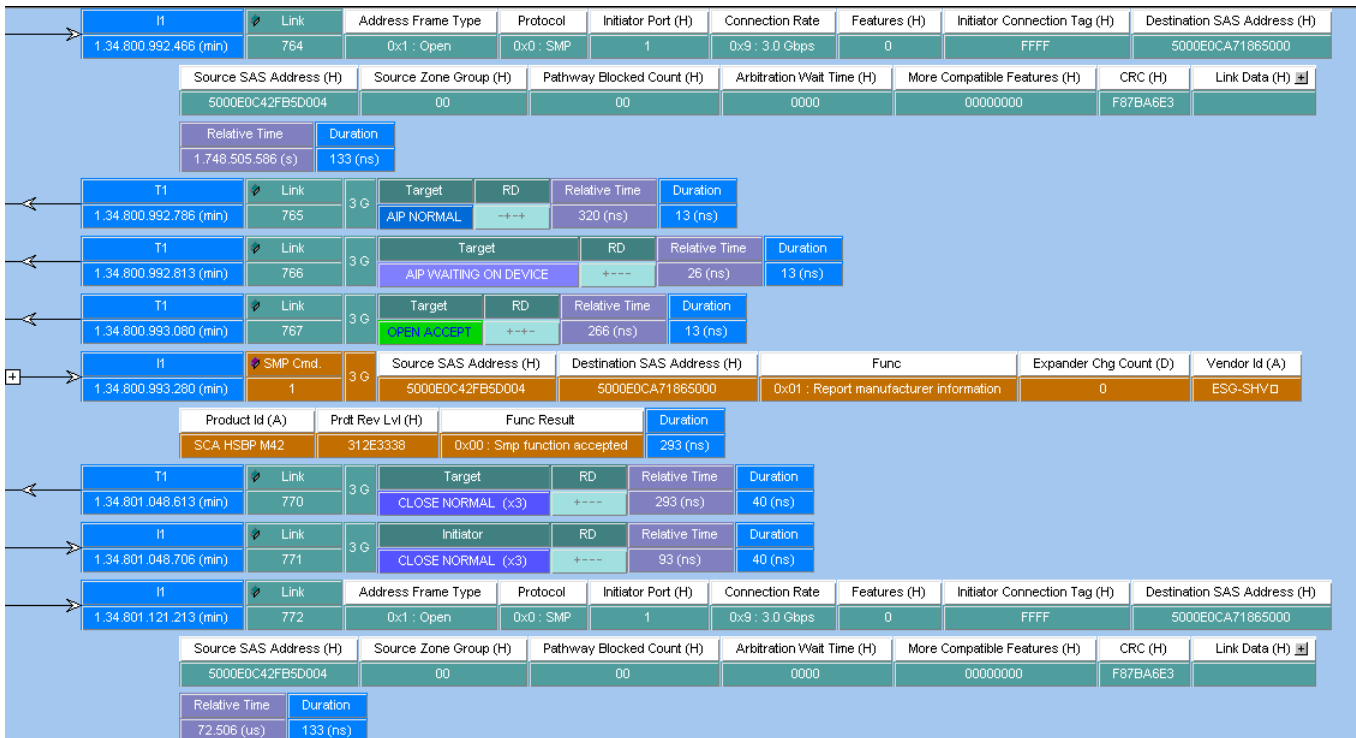

Figure 3.1: SAS: Packet View of .scs Sample File

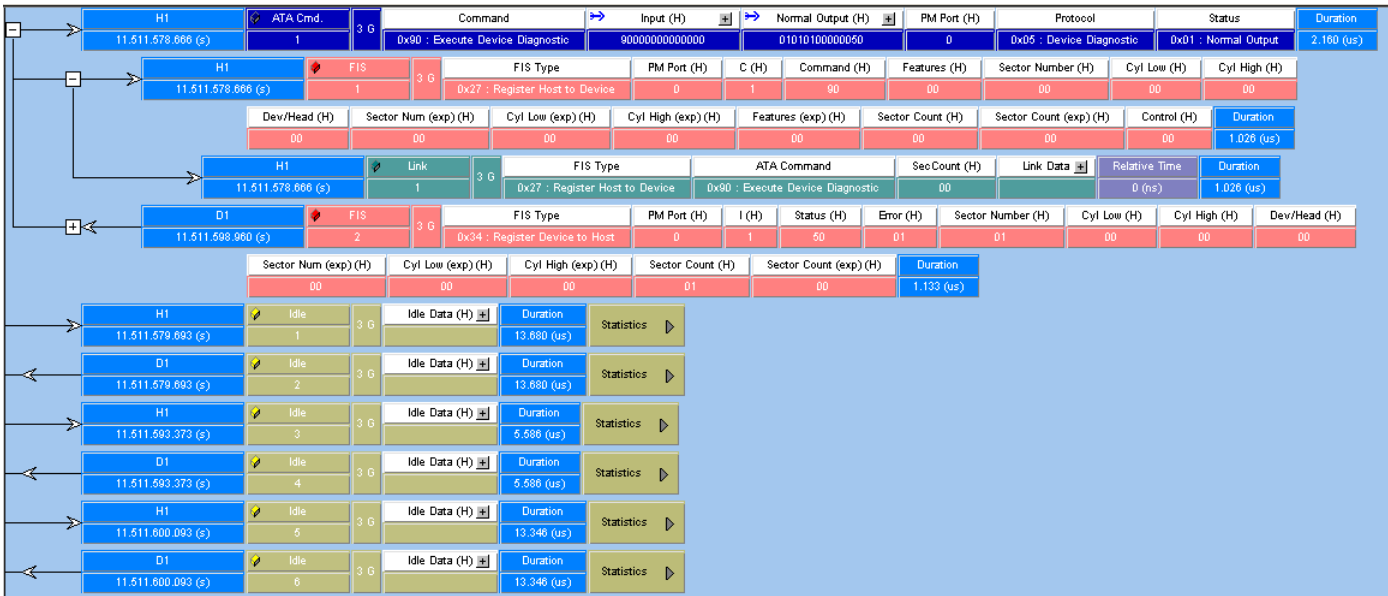

Figure 3.2: SATA: Packet View of .sts Sample File

Quick View

By default, the Software Settings enable **Quick View**. Quick View allows full access to the whole trace more quickly, especially when using a Gigabit Ethernet connection. However, the trace is NOT written to the Host PC hard drive. To save the trace, you must manually click **Save**.

If you uncheck **Quick View** in the Software Settings to disable Quick View, the trace loads more slowly, but is automatically saved to the Host PC hard drive. When Quick View is disabled, the Viewer displays successive parts of trace data as they upload. As soon as a trace part uploads, it is available in all trace views.

If you only need quick successive traces, and do not need to save them, keep the default setting to enable Quick View.

If you need to save all captured traces, unchecking the Quick View setting loads traces faster, especially for larger traces and slower connections than Gigabit Ethernet.

To refresh the viewer display with more uploaded data, scroll to the end of the trace, using scroll bars, page down, arrow down, or CTRL-End. Newly uploaded data then appears there.

Note: High-level decoding and statistics are available only after the whole trace has uploaded.

The software automatically switches to full trace view after trace uploading finishes.

Note: Users must press **CTRL Home** to go to the beginning of an uploaded trace, and **CTRL End** to go to the end of an uploaded trace.

Using the Viewer Display

To configure the data viewer display, use the toolbars. You can display the same data in:

- Packet view
- Spreadsheet view
- Column view, with transactions grouped for each active port
- Text view, with transactions grouped for each active port
- Waveform view
- Field List view
- Histogram view
- Bus Utilization view
- Data Report
- Statistical Report view

To change the view type when opening a sample, change the default workspace or save options in the Software Settings dialog.

To toggle among open windows, use **CTRL - TAB**.

To reverse toggle order, use **CTRL - SHIFT - TAB**.

To make a frame a trigger pattern, in Packet View, right-click any frame, select **Add to Trigger**, and add the pattern to **DataPatternCapture**.

Viewer Display enables you to also perform the following:

- Decode Assignments (Refer to [“Decoding Assignments” on page 206](#) for more details.)
- Compare Two Data Payloads (Refer to [“Compare Two Data Payloads” on page 243](#) for more details.)
- Run Verification Scripts (Refer to [“Running Verification Script Engine \(VSE\)” on page 248](#) for more details.)

Trace Properties

You can view the Trace Properties from the File menu. Click **File > Trace Properties**, the Trace Properties dialog displays with the following information:

- Software version
- Sample file version
- Grouping Type
- Hardware bin file version
- Analyzer armed at
- Analyzer triggered at
- Sample saved at
- Original Capture Project: **Open** displays the project settings used to capture the sample.
- Licensing Information
- Simpass Information

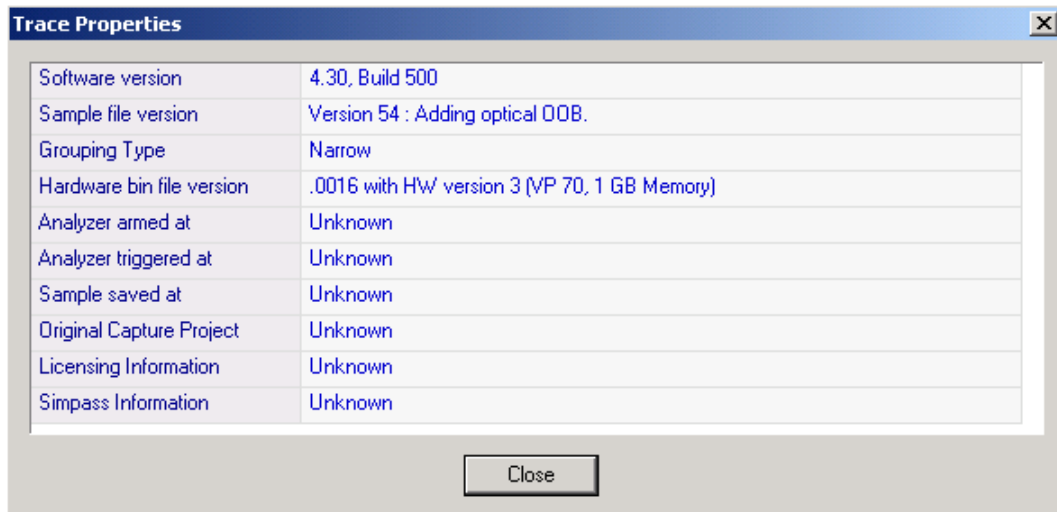

Figure 3.3: Trace Properties Dialog

Analysis

The Analysis menu options allows you to see the trace in various views and switch views.

Show Analysis Toolbar

To display the capture in any of the other available views you can make the selection on the View Type toolbar as shown below or select the menu option under Analysis as shown in [Figure 3.5 on page 205](#).

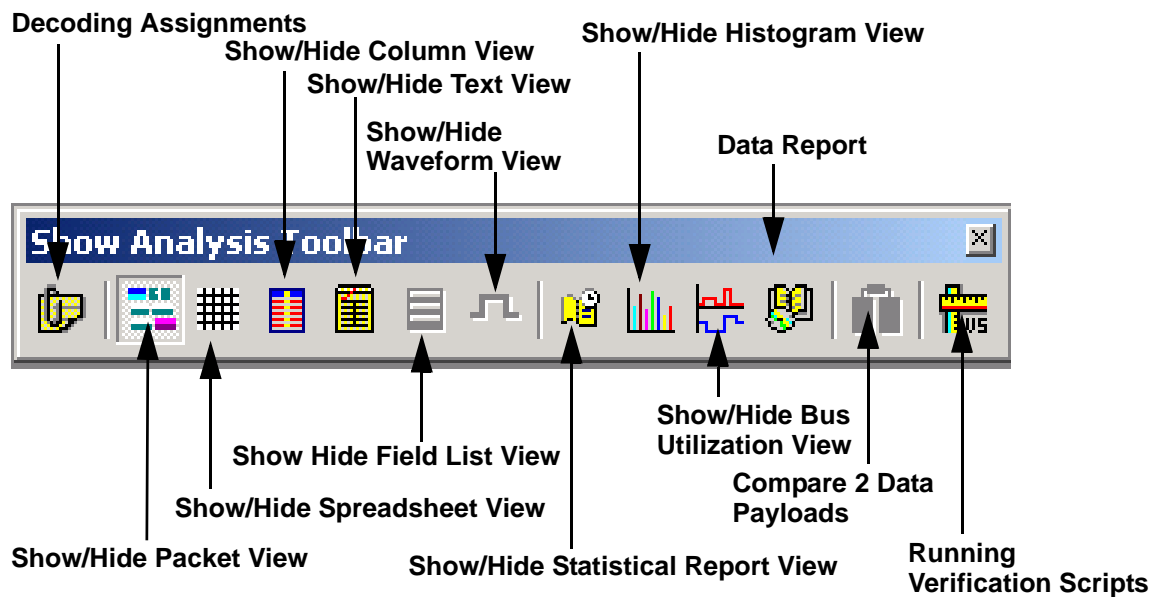

Figure 3.4: View Type Toolbar

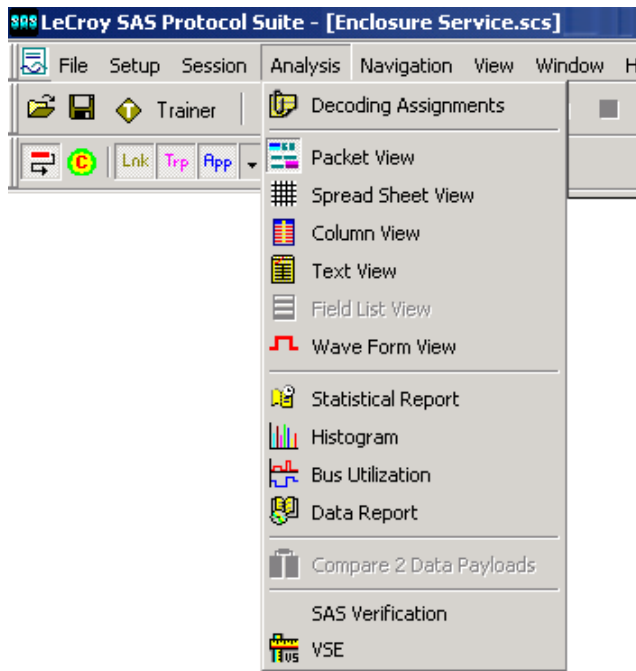

Figure 3.5: SAS Analysis Menu

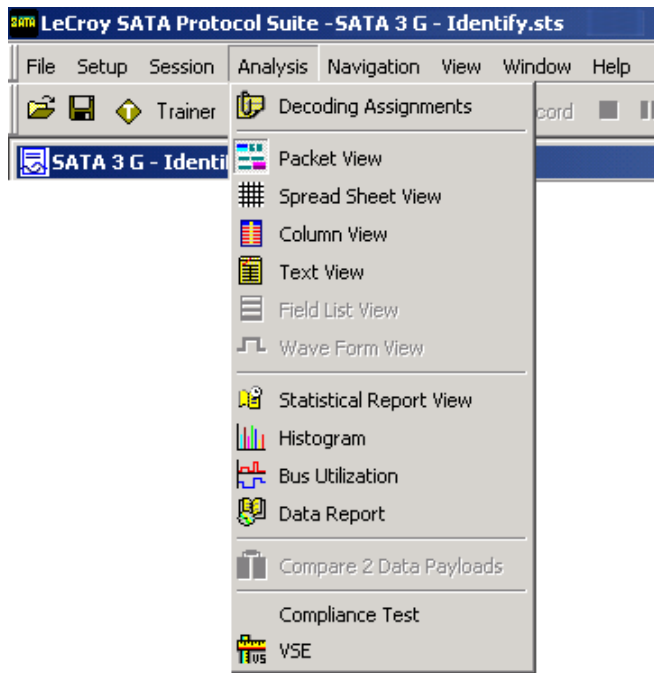

Figure 3.6: SATA Analysis Menu

Decoding Assignments



Click on the Decoding Assignments icon to display the Decoding Assignment dialog. Check a **Hash Destination SAS Address** checkbox to select it and select a **SCSI Spec(s)**. Click the **Add to Assigned List** button to decode. Select a spec and click **Remove it** or click on **Remove All** to remove all the specs.

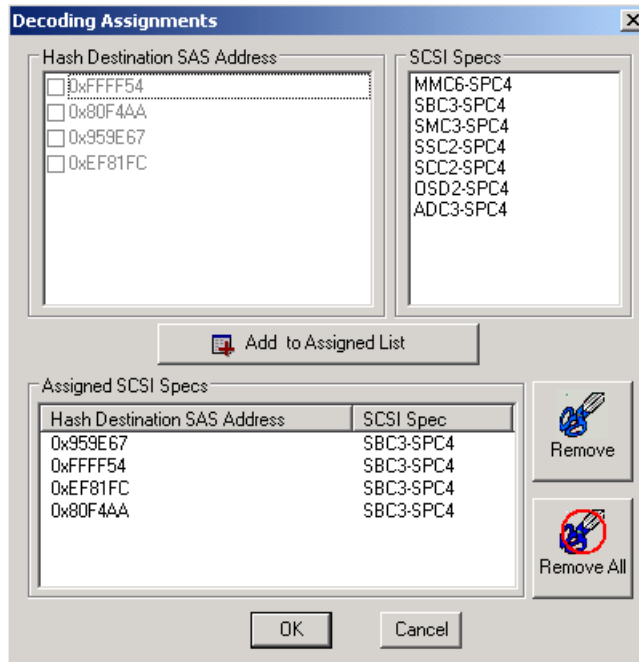

Figure 3.7: Decoding Assignments Dialog for SAS

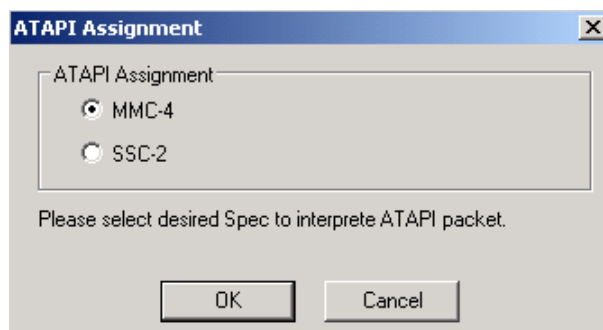

Figure 3.8: ATAPI Assignment Dialog for SATA

Packet View

After you select a view, it appears in a separate window. To increase the new window



display size, select **Analysis > Packet View** or, click the **Show/Hide Packet View** button.

When scrolling through either display using the scroll bar, the corresponding display in the other view scrolls with it.

You can rearrange the tiling by clicking **Window** and choosing **Vertical** or **Horizontal** tiling.

Packet View Metrics

The Metrics feature provides quick access to additional information about the packet data. Click the Metrics + icon as shown in Figure 3.9 to display the details.

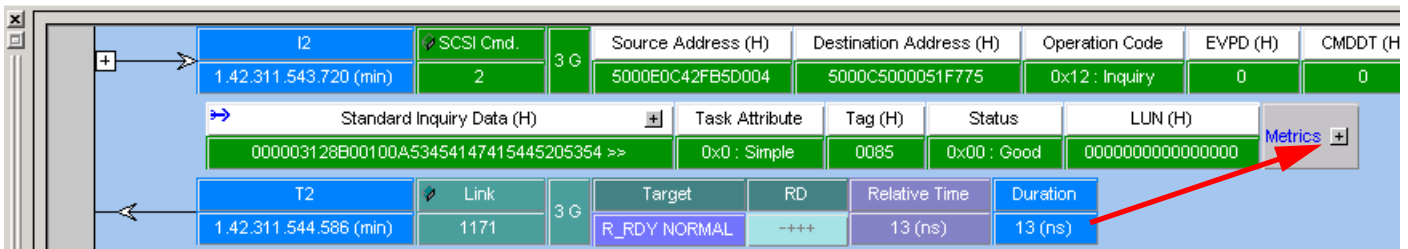

Figure 3.9: Packet View Metrics

The following additional information of the packet is displayed when the Metrics field is expanded. Refer to [Figure on page 208](#).

Trp. No. - Number of Transports

The total number of transports that compose this exchange.

Resp. Time - Response Time

The time taken to transmit this command on the link(s) from the beginning of the first frame in the command to the end of the last frame in the command.

Pld. Bytes - Payload Bytes

The number of payload bytes this operation transferred.

Latency Time

The time measured from the transmission of the command to the first data transmitted for this IO operation.

Data-Stat. Time - Data to Status Time

The time between the end of data transmission for this command and the Status frame.

Thrpt MB/s- Data Throughput

The payload divided by response time expressed in MB per second.

Duration

The time taken from the first DWord to the last DWord in a line.

Id.	3 G	Source Address (H)	Destination Address (H)	Operation Code	EVPD (H)	CMDDT (H)	Page or OpCode (H)	Allocation Length (H)	Contr	
		5000E0C42FB5D004	5000C5000051F775	0x12 : Inquiry	0	0	00	0060	0	
a (H)		Task Attribute	Tag (H)	Status	LUN (H)	Metrics	Trp. No.	Resp. Time	Pld. Bytes	Duration
5445205354 >>		0x0 : Simple	0085	0x00 : Good	0000000000000000	<input checked="" type="checkbox"/>	3	527.093 (us)	96	866 (ns)
3 G		Target	RD	Relative Time	Duration					
		R_RDY NORMAL	----	13 (ns)	13 (ns)					

Packet View Metrics Expanded

Changing the Default View

Perform the following steps to change the default view of all trace files to Packet View:

1. Open a trace file.
2. Select the **Packet View**. Close all other views.
3. Select **File > Save Workspace** to open a Save As dialog. Save the current workspace as a **.wss** file.
4. Select **Setup > Preferences > Software Settings** to open the Software Settings dialog.
5. In the Default Workspace field, enter the path and name of the workspace **.wss** file that you saved in step 3.

Because the default workspace contains only Packet View, the software opens trace files in Packet View.

Spreadsheet View

Spreadsheet View displays all of the Packet View fields in a time sequential spreadsheet format. To display the Spreadsheet View of the current capture, click

Analysis > Spreadsheet View or click the  button on the toolbar.

Time Stamp	Relative Time	Port	Src. SAS Address	Dest. SAS Address	Frame	Command
1.24.697.690.040 (min)	0 (ns)	T2			COMINT	
1.24.698.072.533 (min)	0 (ns)	T1			COMINT	
1.24.737.286.480 (min)	0 (ns)	T4			COMINT	
1.24.737.670.253 (min)	0 (ns)	T3			COMINT	
1.24.768.795.986 (min)	70.723.453 (ms)	T1			COMINT	
1.24.780.391.293 (min)	82.701.253 (ms)	T2			COMINT	
1.24.819.716.960 (min)	82.430.480 (ms)	T4			COMINT	
1.24.820.100.733 (min)	82.430.480 (ms)	T3			COMINT	
1.24.850.983.493 (min)	70.592.200 (ms)	T2			COMINT	
1.24.851.367.266 (min)	82.571.280 (ms)	T1			COMINT	
1.24.890.916.026 (min)	71.199.066 (ms)	T4			COMINT	
1.24.891.299.813 (min)	71.199.080 (ms)	T3			COMINT	

Figure 3.10: SAS: Spreadsheet View

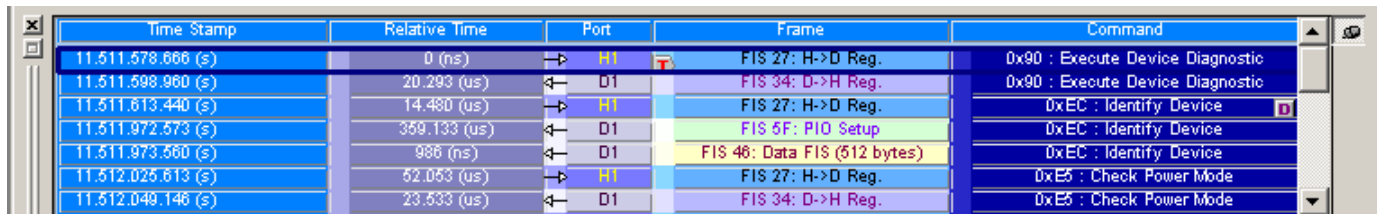

Time Stamp	Relative Time	Port	Frame	Command
11.511.578.866 (s)	0 (ns)	H1	FIS 27: H->D Reg.	0x90 : Execute Device Diagnostic
11.511.598.960 (s)	20.293 (us)	D1	FIS 34: D->H Reg.	0x90 : Execute Device Diagnostic
11.511.613.440 (s)	14.480 (us)	H1	FIS 27: H->D Reg.	0xEC : Identify Device
11.511.972.573 (s)	369.133 (us)	D1	FIS 5F: PIO Setup	0xEC : Identify Device
11.511.973.560 (s)	986 (ns)	D1	FIS 46: Data FIS (512 bytes)	0xEC : Identify Device
11.512.026.613 (s)	52.053 (us)	H1	FIS 27: H->D Reg.	0xE5 : Check Power Mode
11.512.049.146 (s)	23.533 (us)	D1	FIS 34: D->H Reg.	0xE5 : Check Power Mode

Figure 3.11: SATA: Spreadsheet View

Right-click a column heading to go to **Software Settings**, make all columns the same width, choose **Time Stamp Format**, or **Goto** a position.

Right-click a column heading to **Hide** or **Show** the column. To show the same columns permanently, select **Setup>Preferences > Software Settings> Trace Viewer > As Previously Saved**.

Right-click the column to **Add Bookmark** or **Edit Bookmark**, **Set Time Stamp Origin**, go to **Software Settings**, choose **Time Stamp Format**, **Change Background (or Foreground) Color**, or **Goto** a position.

Note: You can double-click a data frame to display the data payload view.
The Status column can show ABRT and UNC status.

Save As Text/Excel

Select **File > Save As Text/Excel** to open the Save As Text dialog.

For Save As Type, select **Text Files** or **Excel Files**.

For Save As Range, select **All Packets** or enter a cursor range.

Enter a **File Name** and click **Save**.

Note: The Save As Excel option is available only for Column View and Spreadsheet View.

Change Format of Logical Block Address (LBA)

You can set different LBA formats in Packet View and Spreadsheet View. To change the LBA format, right-click the LBA column to display the popup menu, select **Format**, and change the format to **Decimal**, **Hexadecimal**, or **Binary**.

In Spreadsheet View, you can also click the **Trace Viewer Configuration** icon to display the Trace Viewer Configuration dialog. Expand the **Frame List/Spread Sheet View**, select **LBA/Sector#**, and change the **Format**. If you cannot change the format there, select the **Link Fields**, **Transport Fields**, **ATA Cmd. Fields**, or **SCSI Cmd. Fields** node, select the field (such as "LBA High"), and then change the **Format**.

Column View

Column View displays the captured data grouped in columns by port. Each row shows captured DWORDs on different ports related to the timestamp. It also shows different speed (1.5G, 3G, 6G) DWORDs. Different DWORD cell height shows the duration of the

DWORD. To display Column View of the current capture, click **Analysis > Column View** or

click the  button on the toolbar.

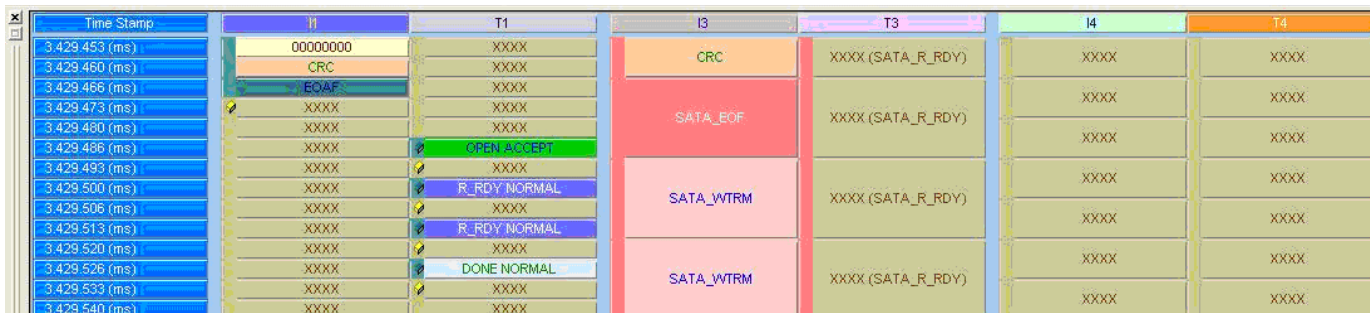

Time Stamp	I1	T1	I3	T3	I4	T4
3.429 453 (ms)	00000000	XXXX	CRC	XXXX (SATA_R_RDY)	XXXX	XXXX
3.429 460 (ms)	CRC	XXXX				
3.429 466 (ms)	EOAF	XXXX				
3.429 473 (ms)	XXXX	XXXX	SATA_EOF	XXXX (SATA_R_RDY)	XXXX	XXXX
3.429 480 (ms)	XXXX	XXXX				
3.429 486 (ms)	XXXX	OPEN_ACCEPT				
3.429 493 (ms)	XXXX	XXXX				
3.429 500 (ms)	XXXX	R_RDY NORMAL	SATA_WTRM	XXXX (SATA_R_RDY)	XXXX	XXXX
3.429 506 (ms)	XXXX	XXXX				
3.429 513 (ms)	XXXX	R_RDY NORMAL				
3.429 520 (ms)	XXXX	XXXX				
3.429 526 (ms)	XXXX	DONE NORMAL	SATA_WTRM	XXXX (SATA_R_RDY)	XXXX	XXXX
3.429 533 (ms)	XXXX	XXXX				
3.429 540 (ms)	XXXX	XXXX				

Figure 3.12: SAS: Column View

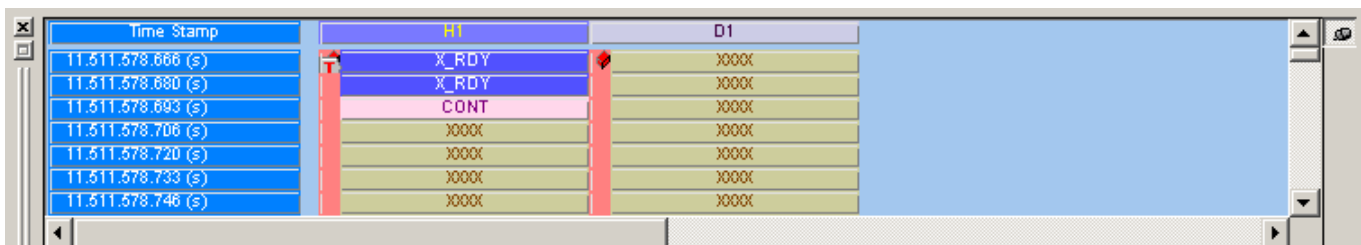

Time Stamp	I1	D1
11.511.578.666 (s)	X_RDY	XXXX
11.511.578.680 (s)	X_RDY	XXXX
11.511.578.693 (s)	CONT	XXXX
11.511.578.706 (s)	XXXX	XXXX
11.511.578.720 (s)	XXXX	XXXX
11.511.578.733 (s)	XXXX	XXXX
11.511.578.746 (s)	XXXX	XXXX

Figure 3.13: SATA: Column View

Right-click in the Column View to display commands:

- Software Settings
- Time Stamp Format (LeCroy Format, Milli Second, Micro Second)
- Go to (Trigger Position, X Position, Y Position, Packet Number, Time Stamp, Bookmark, Begin, End)
- Bookmark
- Goto within Packet (SOF, EOF, Next HOLD, Previous HOLD, Next HOLDA, Previous HOLDA, Next Align, Previous Align, Next R_IP, Previous R_IP)

Note: The Column View displays the CRC value. To see different formats (10b, 8b, scrambled, and so on), select a format by clicking its Tool menu button.

Resize Columns

You can resize the columns in Column View by clicking in the column boundary and dragging the boundary to a new position.

Rearrange Columns

You can rearrange columns by left-clicking in the column title and then dragging the drag-and-drop icon  to a new position.

Save As Text/Excel

Select **File > Save As Text/Excel** to open the Save As Text dialog.

For Save As Type, select **Text Files** or **Excel Files**.

For Save As Range, select **All Packets** or enter a cursor range.

Enter a **File Name** and click **Save**.

Note: The Save As Excel option is available only for Column View and Spreadsheet View.

Text View

Text View displays the captured data interpreted as transaction frames, grouped in columns by port.



To display Text View, select **Analysis > Text View** or click the button on the toolbar.

Time Stamp	Port	All Lanes	H	T1	I2	T2	I3
1.24.697.690.040 (min)	T2	COMINIT				COMINIT	
1.24.698.072.533 (min)	T1	COMINIT		COMINIT			
1.24.737.286.480 (min)	T4	COMINIT					
1.24.737.670.253 (min)	T3	COMINIT					
1.24.768.795.986 (min)	T1	COMINIT		COMINIT			
1.24.780.391.293 (min)	T2	COMINIT				COMINIT	
1.24.819.716.960 (min)	T4	COMINIT					
1.24.820.100.733 (min)	T3	COMINIT					
1.24.850.983.493 (min)	T2	COMINIT				COMINIT	
1.24.851.367.266 (min)	T1	COMINIT		COMINIT			
1.24.890.916.026 (min)	T4	COMINIT					
1.24.891.299.813 (min)	T3	COMINIT					

Figure 3.14: SAS: Text View

Time Stamp	Port	All Lanes	H1	D1	Speed
11.511.578.666 (s)	H1	Execute Device Diagnostic	Execute Device Diagnostic		3 G
11.511.598.960 (s)	D1	D->H Reg. (FIS 34)		D->H Reg. (FIS 34)	3 G
11.511.613.440 (s)	H1	Identify Device	Identify Device		3 G
11.511.972.573 (s)	D1	PID Setup (FIS 5F)		PID Setup (FIS 5F)	3 G
11.511.973.580 (s)	D1	Data FIS (FIS 46)		Data FIS (FIS 46)	3 G
11.512.025.613 (s)	H1	Check Power Mode	Check Power Mode		3 G
11.512.049.146 (s)	D1	D->H Reg. (FIS 34)		D->H Reg. (FIS 34)	3 G
11.512.061.666 (s)	H1	Set Features	Set Features		3 G
11.512.094.506 (s)	D1	D->H Reg. (FIS 34)		D->H Reg. (FIS 34)	3 G
11.512.106.480 (s)	H1	Set Features	Set Features		3 G
11.512.145.720 (s)	D1	D->H Reg. (FIS 34)		D->H Reg. (FIS 34)	3 G
11.512.158.573 (s)	H1	Set Features	Set Features		3 G
11.512.199.373 (s)	D1	D->H Reg. (FIS 34)		D->H Reg. (FIS 34)	3 G
11.512.213.306 (s)	H1	Set Features	Set Features		3 G
11.512.247.613 (s)	D1	D->H Reg. (FIS 34)		D->H Reg. (FIS 34)	3 G
11.512.258.480 (s)	H1	Set Features	Set Features		3 G
11.512.298.053 (s)	D1	D->H Reg. (FIS 34)		D->H Reg. (FIS 34)	3 G
11.525.087.600 (s)	D1	D->H Reg. (FIS 34)		D->H Reg. (FIS 34)	3 G

Figure 3.15: SATA: Text View

Note: The LBA and Tag Number value are shown in the All Lanes column.

Field List View

Whenever an additional view (such as Text View) displays, you can display a Field List View, which displays field information in a list format. The information of this view is shown in the Packet View under the Transport layer. Expand the Info Unit, then expand the Sense Data, refer to the screen capture below.

To open a Field List View of the current capture, select **Analysis > Field List View** or click

the  button on the toolbar.

Note: This icon will appear in the top tool bar only if the spreadsheet view is displayed.

T5	Transport	6 G	SSP Frame Type	Hashed Dest SAS Addr (H)	Hashed Src SAS Addr (H)	Changing Data Pointer (H)
3.45.52.616.792.200 (hr)	35658		0x07 : Response	DFF56A	0AD3E9	0
ReTransmit (H)	Retry Data Frames (H)	TLR CONTROL (H)	Num of Fill Bytes (H)	Tag (H)	Target Port Transfer Tag (H)	Data Offset (H)
0	0	0	0	8E10	009D	00000000
Info Unit (H)			Retry Delay Timer (H)	Data Present	Status	Sense Data Len (H)
00000000000000000000000000000000 >>			0000	0x2 : Sense Data	0x02 : Check Condition	00000020
Resp Data Len (H)	Sense Data , 0 Bytes		CRC (H)	Handshake	Duration	
00000000	00 00 B7 03 00 02 00 00 00 00 B1 F7 >>		C1FE83D6	0x0 : ACK	153 (ns)	

Figure 3.16: Packet Decode Information

Field List View Displayed in a Separate Window

Click **Setup > Preferences > Software Settings** and select the **Field List View** tab, refer to [Figure 3.134 on page 298](#) to see the default settings of the Field List View dialog. The **Show Field List in Column View** checkbox is selected as the default setting. In order to view the Field List View in a separate window the Spreadsheet View needs to be open.

Click on the Field List View icon to view it in a separate window as shown in the following figure.

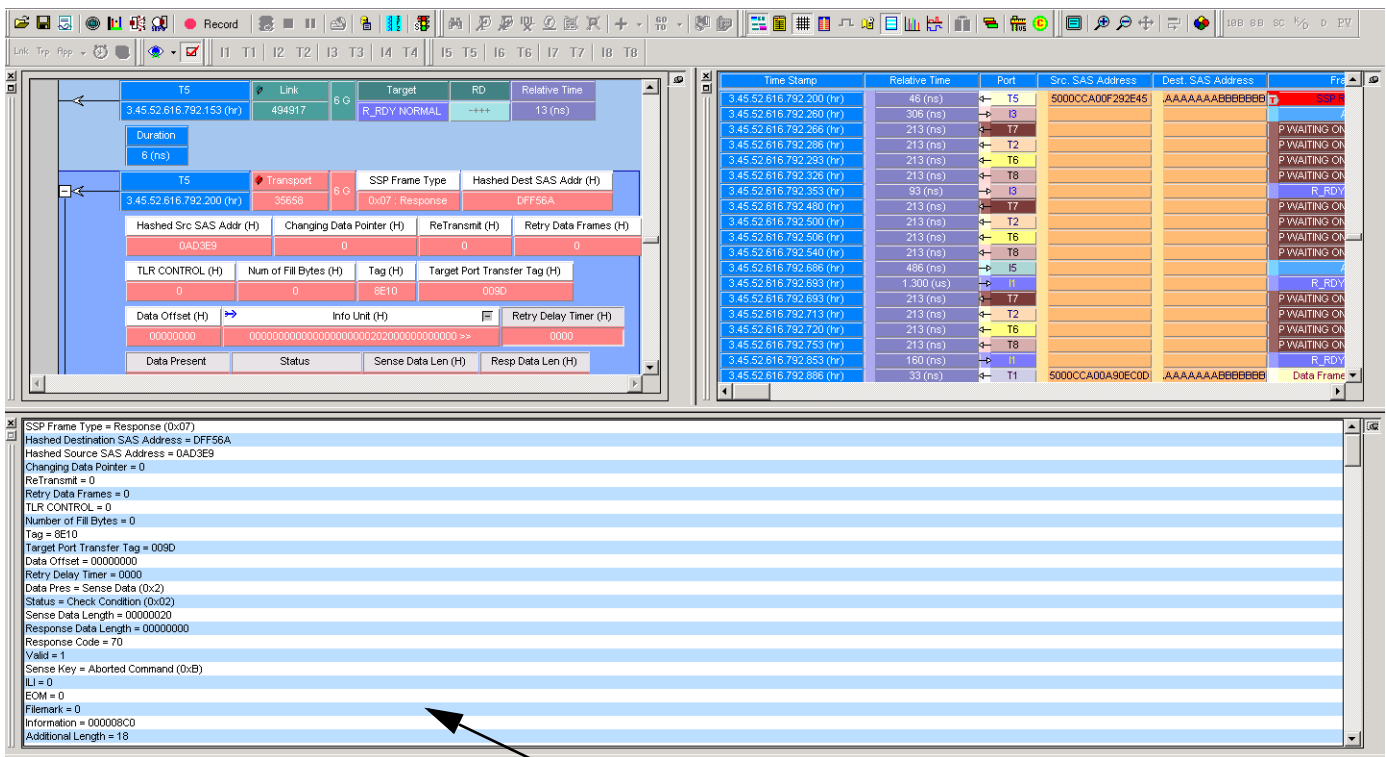

Field List View in a separate window

Figure 3.17: Field List View Displayed in a Separate Window

Field List View Embedded in Packet or Spreadsheet Views

Click **Analysis > Software Settings** and select the **Field List View** tab, refer to [Figure 3.134 on page 298](#) to see the default settings of the Field List View dialog. The **Show Field List in Column View** checkbox is selected as the default setting. Select the **Show Field List as Embedded in frame/spreadsheet views** checkbox in order to view the Field List View embedded in the Frame or Spreadsheet View.

Refresh the spreadsheet view to see the Field List View embedded as a column as shown in the following screen capture.

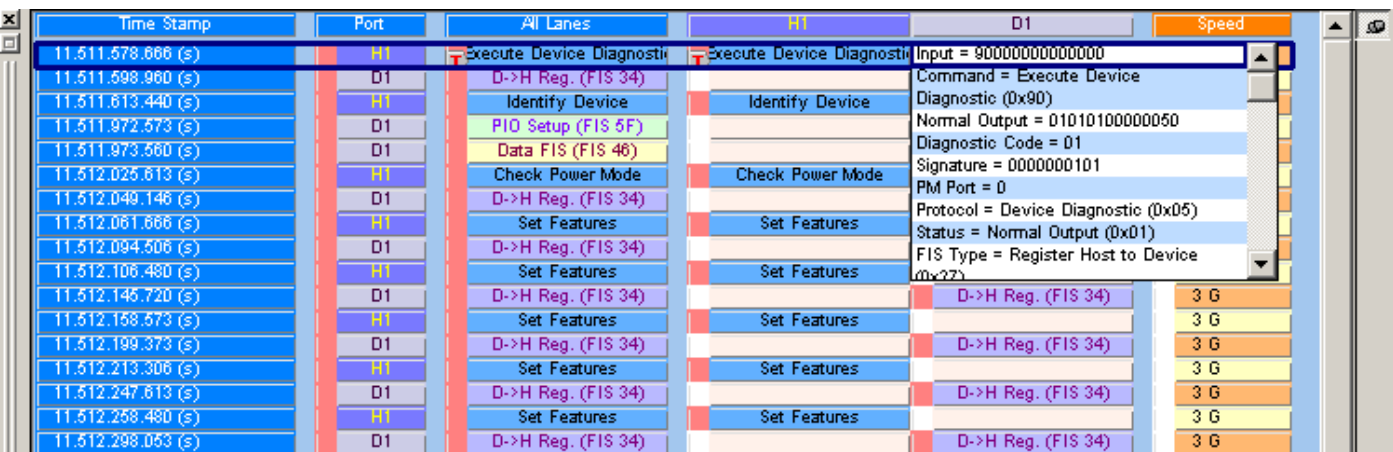

Figure 3.18: Field List View

In the Column View, check the **Show Field View in Column View** checkbox in the **Software Settings** dialog under the **Setup > Preferences** file menu, then display Field View while the Column View is open.

Waveform Display

You can enable a waveform display for all active ports, and perform timing measurements, by positioning timing cursors within the waveform display.



Select **Analysis > Wave Form View** or click the **Show/Hide Waveform** button on the toolbar to enable the waveform display.

The Compact View shows the OOB Sequence with speed negotiation.

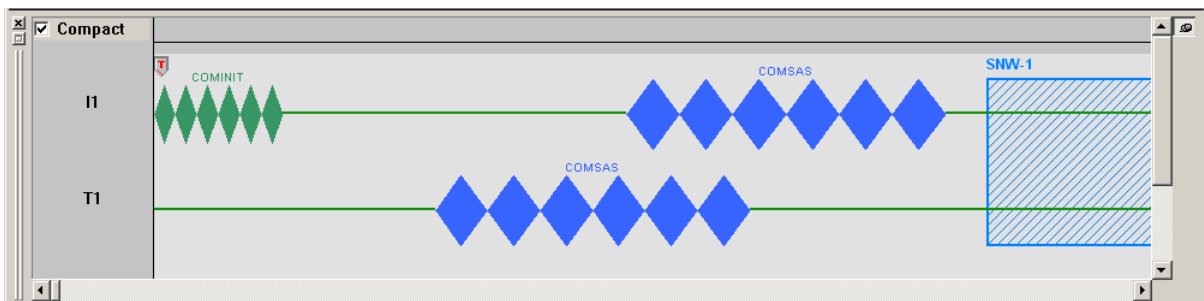

Figure 3.19: SAS: Waveform View

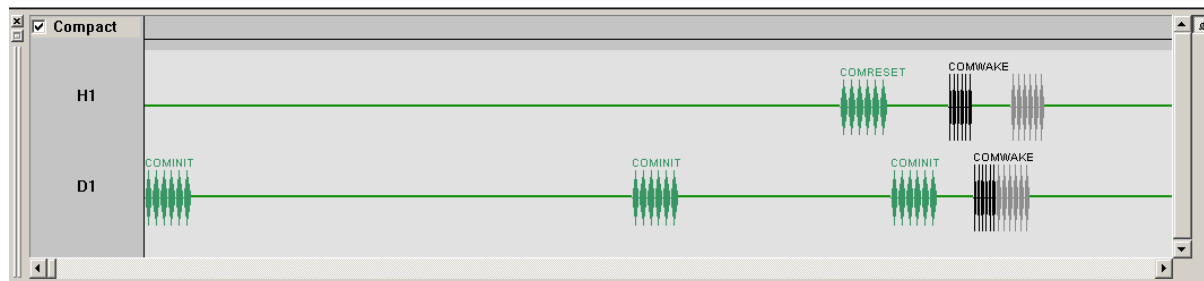

Figure 3.20: SATA: Waveform View

Making a timing Measurement

Timing measurements are made with two timing cursors T1 and T2. Click the left mouse button in the gray bar on the top of the waveform display at a point for the T1 cursor, and the right mouse button at a point for the T2 cursor. The time difference between the cursors is on a line connecting the two cursors (see [Figure 3.21 on page 215](#)).

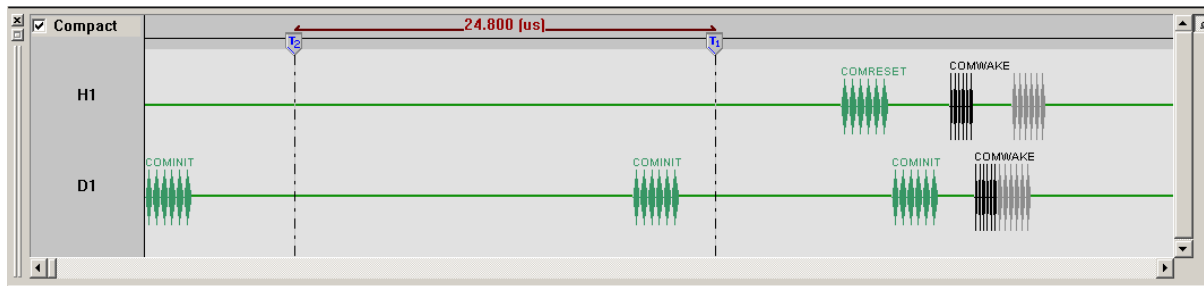

Figure 3.21: SATA: Timing Cursors Enabled

Expanded Waveform View

To see a 10x time scale expansion of the waveform, uncheck the **Compact View** checkbox in the Waveform View window. The OOB Sequence has speed negotiation (Hardware version 4 or later).

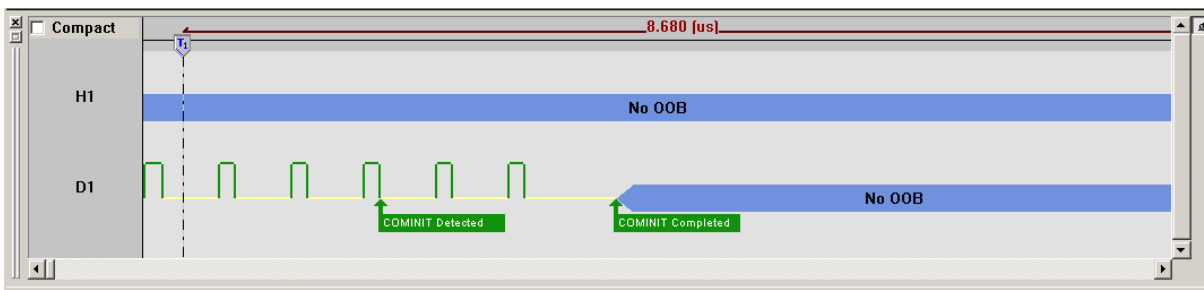

Figure 3.22: SATA: Expanded Waveform View

Statistical Report

Whenever a captured sample is in the Sample Viewer, a **Statistical Report** selection in the **Report** menu and a **Statistical Report Button** on the viewer toolbar are enabled. You can create a Statistical Report for the entire capture or select a portion of it.



To display a Statistical Report, click the **Statistical Report** button on the viewer toolbar or select **Report > Statistical Report** to display the Select Statistical Report Range dialog.

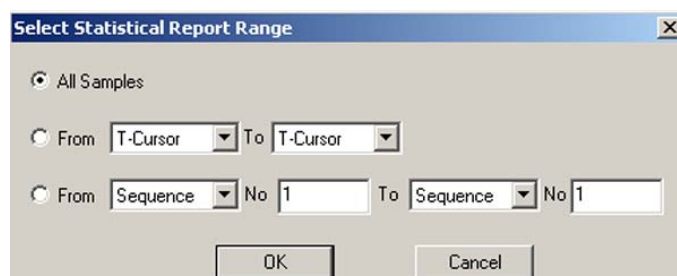

Figure 3.23: Statistical Report Range Dialog

The default statistical report has All Samples. You can set a specific Statistical report range between defined cursor positions or events.

Generating Statistical Read/Write Report

To create a statistical read/write page perform the following steps:

1. Click on the **Setup > Preferences** menu option and select **Software Settings**.
2. Click on the **Sample Viewer** tab.
3. Check the box **Create statistical report read/write page** (see [Figure 3.24 on page 216.](#))

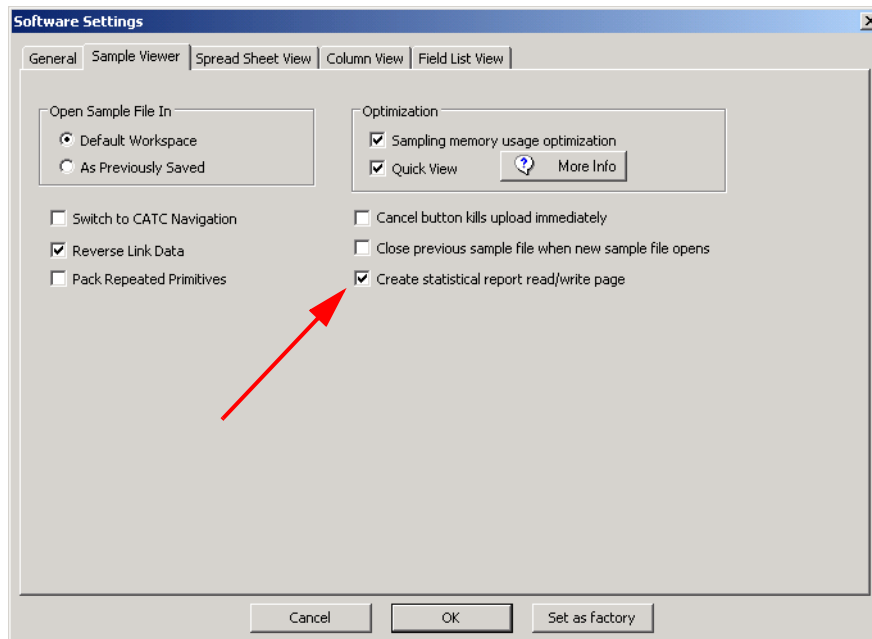

Figure 3.24: Enabling Read/Write Statistical Report

Note: This settings should be enabled before you capture the trace file.

If you have already captured a trace file and want to create a read/write statistical report for the sample, perform the following steps:

1. Enable the read/write settings as mentioned above.
2. Open the trace file.
3. Set the X pointer on the first packet in the viewer.
4. Set the Y pointer on last packet in the viewer.
5. Save as the trace file using the X to Y option.

Now the saved trace file will contain the read/write statistical report.

Report Between Cursors

Click the option button next to the **From** cursor selection drop down list. Then click the **From** down arrow and choose the 1st cursor, click the **To** down arrow to choose the 2nd cursor, and click **OK**. The resulting report has only the capture between the cursors (see [Figure 3.25 on page 217.](#))

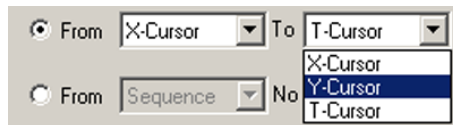

Figure 3.25: Report between Cursors

Report Between Events

Click the option button next to the **From** the event selection dropdown list, click the **From** down arrow to choose the 1st event, then enter the number of its occurrence. Next click the **To** down arrow to choose the 2nd event, then enter the number of its occurrence.

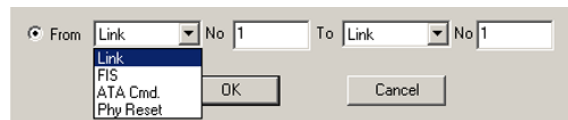

Figure 3.26: SATA: Report between Events

Click **OK**. The resulting report are limited to the capture between the defined events.

SAS vs. SATA: SAS adds Transport, SCSI Cmd, SMP Cmd, and Task Mng to the drop-down list and deletes FIS and Phy Reset.

Statistical Report Content

SAS: A complete SAS statistical report consists of the following reports, accessed by clicking the corresponding tab in the dialog:

- General
- Bus Condition
- Primitive
- SSP Transport
- SMP Transport
- STP Transport
- ATA Command
- SCSI Command
- SMP Command
- Task Command
- SAS Address
- Read/Write Command
- Protocol Error
- Performance
- Lanes
- Others

SATA: A complete SATA statistical report consists of the following reports, accessed by clicking the corresponding tab in the dialog:

- General
- Bus Condition
- Primitive

- FIS
- ATA Command
- ATAPI Command
- Read/Write Command
- Protocol Error
- Performance
- Others
- PM Statistic
- PM Performance

Note: Results are displayed only for items that have been captured in the sample.

Report Options

Some report categories offer options to display only specific items. These report categories incorporate drop-down list boxes offering pre-defined and custom options. For details see [“Formatting the Statistical Report View” on page 234.](#)

General Report

To display the General Report, click the **General** tab. The General Report displays the report data in columns with the following information. See the following screen capture:

- Type: All, Custom, Bus Condition, FIS, Identify Address Frame, Open Address Frame, SMP Frame, SSP Frame, STP Frame
- Direction:** All, H->D, D->H, I->T, T->I, or Custom
- Duration:** All, Custom, or time unit
- Count:** All, Custom, or a number of occurrences
- %:** of total count

Type	Direction	Duration	Count	%
All	All	All	All	---
FIS	H->D	9.191 893 58 ms	1748	29.70
FIS	D->H	122.484 352 11 ms	4054	68.88
Bus Condition	H->D	62.213 333 13 us	32	0.54
Bus Condition	D->H	93.506 668 09 us	52	0.88
		0.13183196	5886	100.00

Figure 3.27: General Statistical Report

Primitive Report

To display the Primitive Report, click the **Primitive** tab. The Primitive Report displays information in the following columns:

- Primitive:** All, Custom, Unknown
For SATA: CONT, EOF, HOLD, HOLDA, R_IP, R_OK, R_RDY, SOF, SYNC, WTRM, X_RDY, ALIGN
FOR SAS: SATA_CONT, SATA_EOF, SATA_R_IP, SATA_R_OK, SATA_R_RDY, SATA_SOF, SATA_SYNC, SATA_WTRM, SATA_X_RDY, ACK, EOF, SOF, EOPF, SOAF, AIP_WAITING_ON_DEVICE, AIP_NORMAL, DONE_NORMAL, READY_NORMAL, CLOSE_NORMAL, OPEN_ACCEPT, ALIGN0, ALIGN1, NOTIFY_ENABLE_SPINUP
- Direction:** All, H->D, D->H, I->T, T->I, or Custom
- Count:** All, Custom, or a number of occurrences
- %:** of total count



Primitive	Direction	Count	%
All	All	All	---
CONT	H->D	1748	2.99
CONT	D->H	4054	6.95
EOF	H->D	1748	2.99
EOF	D->H	4054	6.95
HOLD	H->D	415	0.71
HOLD	D->H	887	1.52
HOLDA	H->D	415	0.71

Figure 3.28: Primitive Report

Bus Condition Report

To display the Bus Condition Report, click the **Bus Condition** tab. The Bus Condition Report displays information in the following columns.

- Bus Condition:** All, Custom, Activity On, COMININT/COMRESET, COMSAS, COMWAKE, Keep Alive Activity
- Direction:** All, H->D, D->H, I->T, T->I, or Custom
- Count:** All, Custom, or a number of occurrences
- %:** of total count

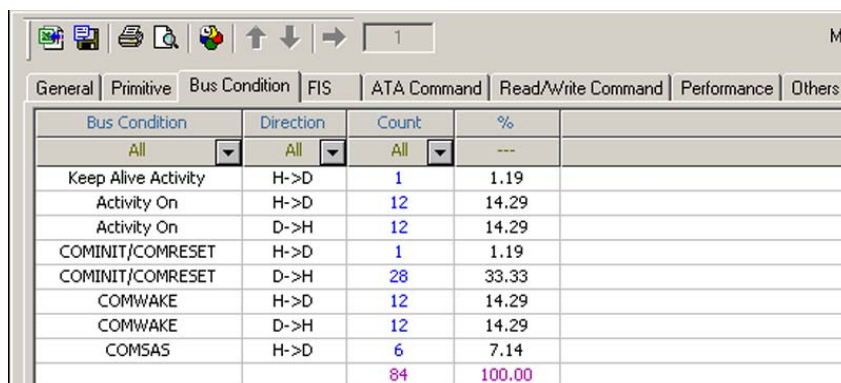

Bus Condition	Direction	Count	%
All	All	All	---
Keep Alive Activity	H->D	1	1.19
Activity On	H->D	12	14.29
Activity On	D->H	12	14.29
COMINIT/COMRESET	H->D	1	1.19
COMINIT/COMRESET	D->H	28	33.33
COMWAKE	H->D	12	14.29
COMWAKE	D->H	12	14.29
COMSAS	H->D	6	7.14
		84	100.00

Figure 3.29: Bus Condition Report

ATA Command Report

To display the ATA Command Report, click the **ATA Command** tab. The ATA Command Report displays information in the following columns:

- Command: All, Custom, Check Power Mode, Execute Device Diagnostic, Flush Cache, Identify Device, Read DMA Ext, Read FPDMA Queue, Set Feature, Write DMA Ext, Write FPDMA Queue
- PM Port
- Direction: All, H->D, D->H, I->T, T->I, or Custom
- Number of FIS: All, Custom, or a number
- Payload Size**: All, Custom, or a number of DWORDs
- Status: All, Custom, Incomplete, Normal Output
- Timeout: such as All, Custom, N/A, Yes, No (see [“Time out of ATA Command Report” on page 220](#))
- Duration**: All, Custom, or time unit
- Count**: All, Custom, or a number of occurrences
- %**: of total count

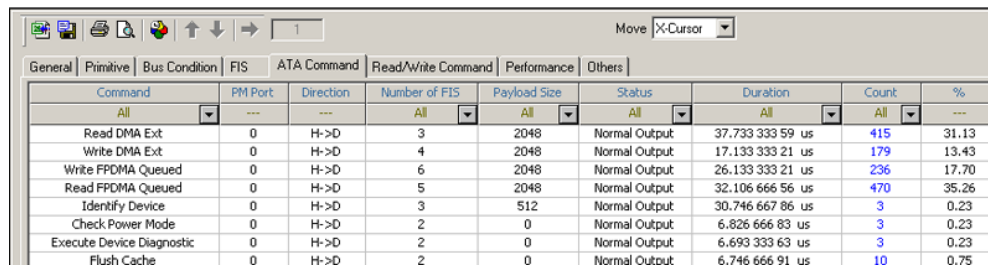

Command	PM Port	Direction	Number of FIS	Payload Size	Status	Duration	Count	%
All	---	---	All	All	All	All	All	---
Read DMA Ext	0	H->D	3	2048	Normal Output	37.733 333 59 us	415	31.13
Write DMA Ext	0	H->D	4	2048	Normal Output	17.133 333 21 us	179	13.43
Write FPDMA Queued	0	H->D	6	2048	Normal Output	26.133 333 21 us	236	17.70
Read FPDMA Queued	0	H->D	5	2048	Normal Output	32.106 666 56 us	470	35.26
Identify Device	0	H->D	3	512	Normal Output	30.746 667 86 us	3	0.23
Check Power Mode	0	H->D	2	0	Normal Output	6.826 666 83 us	3	0.23
Execute Device Diagnostic	0	H->D	2	0	Normal Output	6.693 333 63 us	3	0.23
Flush Cache	0	H->D	2	0	Normal Output	6.746 666 91 us	10	0.75

Figure 3.30: SATA: ATA Command Report

Time out of ATA Command Report

The Time out shows the NCQ time out. It is applicable for only NCQ commands. A threshold can be set in the "NCQ commands Timeout Threshold", the default value is 1000 μ sec (the user can change it to any value). The statistical report provides a "Time out" report based on this threshold. Any NCQ command that takes more than the given threshold is flagged as "yes", which means that a timeout occurred for that command.

ATAPI Report

To display the ATAPI Report, click the **ATAPI** tab. The ATAPI Report displays information in the following columns:

- Command:** All, Custom, Inquiry, Mode Sense 10, Read10, Request Sense
- Direction:** All, H->D, D->H, or Custom
- Number of FIS** or **Number of Transport:** All, Custom, or a number
- Payload Size:** All, Custom, or a number of DWORDs
- Status:** All, Custom, Check Condition, Good
- Duration:** All, Custom, or time unit (accumulative)
- Count:** All, Custom, or a number of occurrences
- %:** of total count

Command	Direction	Number of FIS	Payload Size	Status	Duration	Count	%
All	---	All	All	All	All	All	---
Mode Sense10	H->D	1	0	Check Condition	37.733 333 59 us	2	40.00
Request Sense	H->D	3	20	Good	86.213 333 13 us	2	40.00
Inquiry	H->D	3	36	Good	47.439 998 63 us	1	20.00
					0.00017139	5	100.00

Figure 3.31: SATA: ATAPI Report

Protocol Error Report

To display the Protocol Error Report, click the **Protocol Error** tab. The Protocol Error Report displays the report data in columns with the following information:

- Protocol Error:** All, Custom, Code Violation, CRC Error, Disparity Error, Align-Notify Error
- Direction:** All, H->D, D->H, I->T, T->I, or Custom
- Count:** All, Custom, or a number of occurrences
- %:** of total count

Protocol Error	Direction	Count	%
All	---	---	---
Code Violation	I->T	1	50.00
CRC Error	I->T	1	50.00
		2	100.00

Figure 3.32: SAS: Protocol Error Report

Others Report

To display the Others Report, click the **Others** tab. The Others Report displays information in the following columns:

- Items
 - Idle No: Number of idle packets
 - Payload Size: Total number of payloads in trace files (SCSI + ATA commands)
 - Sample Time: Sample time
 - Idle (Initiator): Host idle time
 - Idle (Target): Device idle time (total)
 - SSP Bus Utilization: SSP bus utilization time (SSP frames)
 - SMP Bus Utilization: SSP bus utilization time (SMP frames)
 - STP Bus Utilization: SSP bus utilization time (STP frames)
- Report
 - Count or Time

General		Primitive		SSP Transport		SCSI Command		Task Command		SAS Address		Performance		Lanes		Pending ID		Others	
Items		Report																	
---		---																	
Idle No		0																	
Payload Size		3168																	
Sample Time		13.333 866 12																	
Idle		0.000 000 00																	
Idle		0.000 000 00																	
SSP Bus		2.746 666 67																	
SMP Bus		0.000 000 00																	
STP Bus		0.000 000 00																	

Figure 3.33: Others Report

SSP Transport Report (SAS)

To display the SSP Transport Report, click the **SSP Transport** tab. The SSP Transport Report displays the report data in columns with the following information:

- Type: All, Custom, Command, Data, Response, XFER_RDY
- Direction: All, I->T, T->I, or Custom
- Duration: All, Custom, or time unit
- Count: All, Custom, or a number
- %: of total count

General		Primitive		SSP Transport		SMP Transport		STP Transport		ATA Command		SCSI Command		SMP Command		Task Command		SAS Address		Protocol Error		Performance		Lanes		Others	
Type	Direction	Duration		Count	%																						
All	All	All	All	All	---																						
Data	I->T	765.000 000 00 us		458	15.15																						
Data	T->I	1.515 053 39 ms		921	30.47																						
XFER_RDY	T->I	17.280 000 69 us		229	7.58																						

Figure 3.34: SAS: SSP Transport Report

SMP Transport Report (SAS)

To display the SMP Transport Report, click the **SMP Transport** tab. The SMP Transport Report displays the report data in columns with the following information:

- Type: All, Custom, Request, Response
- Direction: All, I->T, T->I, or Custom
- Duration: All, Custom, or time unit
- Count: All, Custom, or a number
- %: of total count

Type	Direction	Duration	Count	%
All	All	All	---	---
Request	I->T	1.973 333 36 us	25	50.00
Response	T->I	4.293 333 53 us	25	50.00
		0.00000627	50	100.00

Figure 3.35: SAS: SMP Transport Report

STP Transport Report (SAS)

To display the STP Transport Report, click the **STP Transport** tab. The STP Transport Report displays the report data in columns with the following information:

- FIS Type: All, Custom, Data, PIO Setup, Register Host To Device, Register Device To Host
- PM Port
- Direction: All, I->T, T->I, or Custom
- Duration: All, Custom, or time unit
- Count: All, Custom, or a number
- %: of total count

FIS Type	PM Port	Direction	Duration	Count	%
All	---	All	All	All	---
Register Host to Device	0	I->T	340.293 334 96 us	301	30.16
Register Device to Host	0	T->I	352.640 014 65 us	300	30.06
DMA Activate	0	T->I	102.239 997 86 us	95	9.52

Figure 3.36: SAS: STP Transport Report

SCSI Command Report (SAS)

To display the SCSI Command Report, click the **SCSI Command** tab. The SCSI Command Report displays the report data in columns with the following information:

- Command: All, Custom, Inquiry, Mode Sense6, Pause Resume, Play Audio 10, Read Capacity, Read10, Receive Diagnostic Results, Send Diagnostic, Write10, Start Stop Unit, Test Unit Ready, Report Luns, Synchronize Cache10
- Direction: All, I->T, T->I, or Custom
- Number of Transport: All, Custom, or a number
- Payload Size: All, Custom, or a number of DWORDs
- Status: All, Custom, Good, Incomplete, Response Data Present

- Task Attribute: Simple
- Duration: All, Custom, or time unit
- Count: All, Custom, or a number
- %: of total count

Command	Direction	Number Of Transport	Payload Size	Status	Task Attribute	Duration	Count	%
All	---	All	All	All	---	All	All	---
Write10	I->T	5	2048	Good	Simple	1.756 386 64 ms	229	34.24
Inquiry	I->T	3	128	Good	Simple	960.000 000 00 ns	1	0.02
Read10	I->T	4	2048	Good	Simple	3.351 399 90 ms	447	65.33

Figure 3.37: SAS: SCSI Command Report

SMP Command Report (SAS)

To display the SMP Command Report, click the **SMP Command** tab. The SMP Command Report displays the report data in columns with the following information:

- Function: All, Custom, Discover, Report General, Report Manufacture Information, Report PHY Error Log
- Function Result: SMP Function Accepted
- Direction: All, I->T, T->I, or Custom
- Duration: All, Custom, or time unit
- Count: All, Custom, or a number
- %: of total count

Function	Function Result	Direction	Duration	Count	%
All	---	---	All	All	---
Report General	SMP Function Accepted	I->T	186.666 671 75 ns	1	4.00
Discover	SMP Function Accepted	I->T	3.519 999 98 us	12	48.00
Report Phy Error Log	SMP Function Accepted	I->T	2.559 999 94 us	12	48.00
			0.00000627	25	100.00

Figure 3.38: SAS: SMP Command Report

Task Command Report (SAS)

To display the Task Command Report, click the **TASK Command** tab. The Task Command Report displays the report data in columns with the following information:

- Function
- Status
- Direction: All, I->T, T->I, or Custom
- Duration: All, Custom, or time unit
- Count: All, Custom, or a number
- %: of total count

Function	Status	Direction	Duration	Count	%
---	---	---	---	---	---
Abort Task	Good	I->T	426.666 656 49 ns	1	100.00
			0.00000043	1	100.00

Figure 3.39: SAS: TASK Command Report

SAS Address Report (SAS)

To display the SAS Address Report, click the **SAS Address** tab. The SAS Address Report displays the report data in columns with the following information. See the following screen capture:

- Source SAS Address: All, Custom, or an address
- Destination SAS Address: All, Custom, or an address
- Protocol Type: SMP, SSP, STP
- Frame Type: All, Custom, Command, Data, DMA Activate, Register Host To Device, Register Device To Host, Response, XFER_RDY
- Count:** All, Custom, or a number

Source SAS Address	Destination SAS Address	Protocol Type	Frame Type	Count
All	All	All	All	All
5006056000003C4	5000628000001074	STP	Data	206
5006056000003C4	5000628000001074	STP	Register Device to Host	300
5000628000001074	5006056000003C4	STP	Register Host to Device	301

Figure 3.40: SAS: SAS Address Report

Lanes Report (SAS)

To display the Lanes Report, click the **Lanes** tab. The Lanes Report displays the report data in columns with the following information:

- Port
- Open Accept: All, Custom, or a number
- Open Reject: All, Custom, or a number
- AIP Waiting on Con.
- Break
- SCSI Command: All, Custom, or a number
- ATA Command: All, Custom, or a number
- SMP Command: All, Custom, or a number
- Out Standing Command: All, Custom, or a number
- Transfer Bytes: All, Custom, or a number
- Link Utilization (time)
- Link Utilization%

Port	Open Accept	Open Reject	AIP Waiting on Con.	Break	SCSI Command	ATA Command	SMP Command	Out Standing Cmd	Transfer Bytes	Link Utilization	Link Utilization
All	All	All	---	---	All	All	All	All	All	---	---
I1	9	0	0	0	6	0	0	1	0	4.293 334 us	0.03
T1	7	0	0	0	0	0	0	0	172	5.360 000 us	0.03
I2	776	102	0	0	700	300	25	2	661504	4.552 893 ms	29.1

Figure 3.41: SAS Lanes Report

Read/Write Command Report (SAS)

To display the Read/Write Command Report, click the **Read/Write Command** tab. You can enable or disable creation of this page under Software Settings (see [“Software Settings” on page 291](#)). The Read/Write Command report displays the report data in columns with the following information:

- Source SAS Address
- Destination SAS Address
- Protocol Type
- OpCode/Command
- Tag
- LBA
- Sector Count
- Xfer Length
- Payload Size: All, Custom, or a number of DWORDs
- Status: All, Custom, Good
- Completion Time
- Performance
- Standard Deviation
- Count:** All, Custom, or a number

Source SAS Address	Destination SAS Address	Protocol Type	OpCode / Command	Tag	LBA	Sector Count	Xfer Length	Payload size	Status	Completion T
---	All	All	All	---	All	All	All	All	All	All
500062B000001074	50060560000003C4	STP	Read DMA Ext		0x80e215	0x4		2048	Normal Output	26.891 679 76
500062B000001074	5000C500001047B5	SSP	Write10	0x182	0xae6aa6		0x4	2048	Good	352.266 662 64
500062B000001074	5000C500001047B5	SSP	Read10	0x17C	0x1e65352		0x4	2048	Good	14.481 987 00
500062B000001074	5000C500001047B5	SSP	Write10	0x17B	0x2a206a5		0x4	2048	Good	968.693 359 3i

Figure 3.42: SAS: Read Write Command Report

Performance Report (SAS)

To display the Performance Report, click the **Performance** tab. The Performance Report displays the report data in columns with the following information:

- Minimum Completion Time
- Average Completion Time
- Maximum Completion Time
- Initiator Bus Utilization
- Target Bus Utilization
- Efficiency
- Total Read Cmd
- Total Read (Bytes)
- Total Read Duration
- Cmd Minimum Read (MB/S)
- Cmd Average Read (MB/S)
- Cmd Maximum Read (MB/S)
- Total Write Cmd
- Total Write (Bytes)
- Total Write Duration
- Cmd Minimum Write (MB/S)
- Cmd Average Write (MB/S)
- Cmd Maximum Write (MB/S)
- Average Byte per SSP Frame
- Average Byte per STP Frame

General	Primitive	SSP Transport	SMP Transport	STP Transport	ATA Command	SCSI Command	SMP Command	Task Command	SAS Address	Protocol Error	Performance	Lanes	Others
Min. Compl. Time	Avg. Compl. Time	Max. Compl. Time	Init. Bus Util	Target Bus Util	Efficiency	Total Read Cmd	Total Read(Bytes)						
---	---	---	---	---	---	---	---						
69.293 334 96 us	10.442 747 12 ms	50.291 065 22 ms	4.66 ms	10.97 ms	43.57	659	1331728						

Figure 3.43: SAS: Performance Report

Performance Report (SATA)

To display the Performance Report, click the **Performance** tab. The Performance Report displays information in the following columns:

- Minimum Completion Time
- Average Completion Time
- Maximum Completion Time
- Host Bus Utilization
- Device Bus Utilization
- Efficiency (%)
- Total Read Cmd
- Total Read (Bytes)
- Total Read Duration
- Cmd Minimum Read (MB/S)
- Cmd Average Read (MB/S)
- Cmd Maximum Read (MB/S)
- Total Write Cmd

- Total Write (Bytes)
- Total Write Duration
- Cmd Minimum Write (MB/S)
- Cmd Average Write (MB/S)
- Cmd Maximum Write (MB/S)
- Average Byte Per FIS
- FIS Minimum Difference Time
- FIS Average Difference Time
- FIS Maximum Difference Time

Min. Compl. Time	Avg. Compl. Time	Max. Compl. Time	Host Bus Utilization	Device Bus Utilization	Efficiency	Total Read Cmd	Total Read(Byte)
363.626 678 47 us	363.626 678 47 us	363.626 678 47 us	8.16 us	13.40 us	29.34	1	512

Figure 3.44: SATA: Performance Report

FIS Report (SATA)

To display the FIS Report, click the **FIS** tab. The FIS Report displays information in the following columns:

- FIS Type:** All, Custom, Data, PIO Setup, Register Host To Device, Register Device To Host
- PM Port
- Direction:** All, H->D, D->H, or Custom
- Duration:** All, Custom, or time unit (accumulative)
- Count:** All, Custom, or a number of occurrences
- %:** of total count

FIS Type	PM Port	Direction	Duration	Count	%
All	---	All	All	All	---
Register Host to Device	0	H->D	695.826 660 16 us	1333	22.97
Register Device to Host	0	D->H	761.133 361 82 us	1332	22.96
Set Device Bits	0	D->H	487.066 680 91 us	706	12.17
DMA Activate	0	D->H	214.080 001 83 us	415	7.15
DMA Setup	0	D->H	574.346 679 69 us	706	12.17
PIO Setup	0	D->H	8.426 667 21 us	5	0.09
Data	0	H->D	2.350 293 40 ms	415	7.15
Data	0	D->H	50.023 921 97 ms	890	15.34
			0.05511509	5802	100.00

Figure 3.45: SATA: FIS Report

Queue Command Report (SATA)

To display the Queue Command Report, click the **Queue Command** tab. The Queue Command Report displays information in the following columns:

- Command:** All, Custom, Read DMA Queued
- PM Port
- Status:** All, Custom, Normal Output
- Payload Size:** All, Custom, or a number of DWORDs
- Direction:** All, H->D, D->H, or Custom
- Duration:** All, Custom, or time unit (accumulative)
- Count:** All, Custom, or a number of occurrences
- %:** of total count

Command	Direction	Number of FIS	Payload Size	Status	Duration	Count	%
All	---	All	All	All	All	All	---
Mode Sense10	H->D	1	0	Check Condition	37.733 333 59 us	2	40.00
Request Sense	H->D	3	20	Good	86.213 333 13 us	2	40.00
Inquiry	H->D	3	36	Good	47.439 998 63 us	1	20.00
					0.00017139	5	100.00

Figure 3.46: SATA: Queue Command Report

PM Statistic Report (SATA)

To display the PM Statistic Report, click the **PM Statistic** tab. The PM Statistic Report displays information in the following columns:

- Request Type: PMREQ_P
- Request Port
- Response Type: All, Custom, PMACK
- Response Time
- Request Entering Delay
- Response Entering Delay
- Wakeup Type
- Request DC Idle Time
- Response DC Idle Time
- Request Wakeup Time
- Response Wakeup Time
- Count:** All, Custom, or a number

Request Type	REQ. Port	Response Type	Response Time	REQ. Entering Delay	RESP. Entering Delay	Wakeup Type	REQ. DC Idle Time	RESP. DC Idle Time	REQ. Wakeup Time	RESP. Wakeup Time	Count
---	---	---	---	---	---	---	---	---	---	---	---
PMREQ_P	H1	PMACK	293.333 344 ns	1.813 333 us	1.066 667 us		1.037 973 ms	1.059 227 ms	24.160 000 us	23.066 668 us	1
											1

Figure 3.47: SATA: PM Statistic Report

PM Performance Report (SATA)

To display the PM Performance Report, click the **PM Performance** tab. The PM Performance Report displays information in the following columns:

- Port
- Partial Request
- Partial ACKed
- Partial NACKed
- Slumber Request
- Slumber ACKed
- Slumber NACKed
- Partial Time / Slumber Time %
- Partial Time / Total Time %
- Slumber Time / Total Time %

Port	Partial Request	Partial ACKed	Partial NACKed	Slumber Request	Slumber ACKed	Slumber NACKed	Partial Time / Slumber Time %	Partial Time / Total Time %	Slumber Time / Total Time %
H1	1	1	0	0	0	0	N/A	0.03	N/A

Figure 3.48: SATA: PM Performance Report

Read Write Command Report (SATA)

To display the Read/Write Command Report, click the **Read/Write Command** tab. You can enable or disable creation of this page under Software Settings (see [page 291](#)). The Read/Write Command Report displays information in the following columns:

- Time Stamp
- OpCode/Command
- LBA
- Sector Count
- Payload Size: All, Custom, or a number of DWORDs
- Status: All, Custom, Good
- Completion Time
- Count:** All, Custom, or a number

Time Stamp	OpCode / Command	LBA	Sector Count	Payload size	Status	Completion Time	Count
7.086 733 ms	Read DMA Ext	0x3e91089	0x4	2048	Normal Output	23.616 920 47 ms	1
36.192 829 ms	Read DMA Ext	0x2061be0	0x4	2048	Normal Output	24.622 480 39 ms	1
79.374 199 ms	Read DMA Ext	0x20c03dd	0x4	2048	Normal Output	5.868 813 51 ms	1
87.538 506 ms	Read DMA Ext	0x32218f2	0x4	2048	Normal Output	16.218 040 47 ms	1
103.870 239 ms	Read DMA Ext	0x3a43e32	0x4	2048	Normal Output	18.062 200 55 ms	1
122.003 601 ms	Read DMA Ext	0x30f9949	0x4	2048	Normal Output	16.309 919 36 ms	1
138.406 189 ms	Write DMA Ext	0x1d8901f	0x4	2048	Normal Output	6.931 439 88 ms	1
145.384 949 ms	Write DMA Ext	0x98739b	0x4	2048	Normal Output	7.563 373 57 ms	1

Figure 3.49: SATA: Read Write Command Report

Statistical Report Toolbar

- The Statistical Report toolbar provides the following functions accessible by buttons on the toolbar:
- Export to Excel
- Save as Text
- Print Report
- Print Preview
- Report Display Settings
- Move to **X-Cursor**, **Y-Cursor**, or **None**



Export as Microsoft® Excel file



The **Export to Excel** button opens the Export to Excel dialog. Choose a folder in which to save the Excel file, choose an appropriate file name, and click **Save**.

Save as Text file



The **Save as Text** button opens the Export to Text dialog. Choose a folder in which to save the Text file, choose an appropriate file name, and click **Save**.

Print Statistical Report



The **Print** button opens the select printer dialog. Choose an available printer and click **OK**.

Print Preview



The **Print Preview** button displays a preview of the report to print (see [Figure 3.50 on page 232](#)).

Catalyst Enterprises Inc.		Serial ATA		Apr 14, 2006		
General:						
Type	Direction	Duration	Count			
FIS	H->D	633.186 706 54 us	1000			
FIS	D->H	399.720 001 22 us	999			
		0.00103291	1999			
Primitive:						
Primitive	Direction	Count				
CONT	H->D	1000				
CONT	D->H	999				
EOF	H->D	1000				
EOF	D->H	999				
HOLD	H->D	1000				
HOLDA	H->D	500				
R_IP	H->D	1000				
R_IP	D->H	999				
R_OK	H->D	1000				
R_RDY	H->D	1000				
R_RDY	D->H	999				
SOF	H->D	1000				
SOF	D->H	999				
SYNC	H->D	1000				
SYNC	D->H	999				
WTRM	H->D	1000				
WTRM	D->H	999				
X_RDY	H->D	1000				
X_RDY	D->H	999				
ALIGN	H->D	500				
		18992				
FIS:						
FIS Type	PM Port	Direction	Duration	Count		
Register Host to Device	0	H->D	313.266 662 60 us	500		
Register Device to Host	0	D->H	309.693 328 86 us	749		
Set Device Bits	0	D->H	90.026 664 73 us	250		
Data	0	H->D	319.920 013 43 us	500		
			0.00103291	1999		
ATA Command						
Command	PM Port	Direction	Number of FIS	Payload Size	Status	Time
Write DMA Queued	0	H->D	2	0	Normal Output	N/A

Figure 3.50: Sample Print Preview of Report

Report Display Settings



The **Setting** button opens the Setting dialog.

You can set up the report columns for display to suit a particular analysis need, eliminating the need to show/hide columns individually. Use the **Setting** dialog to configure the display for each page (see [Figure 3.51 on page 233](#) and [Figure 3.52 on page 233](#)).

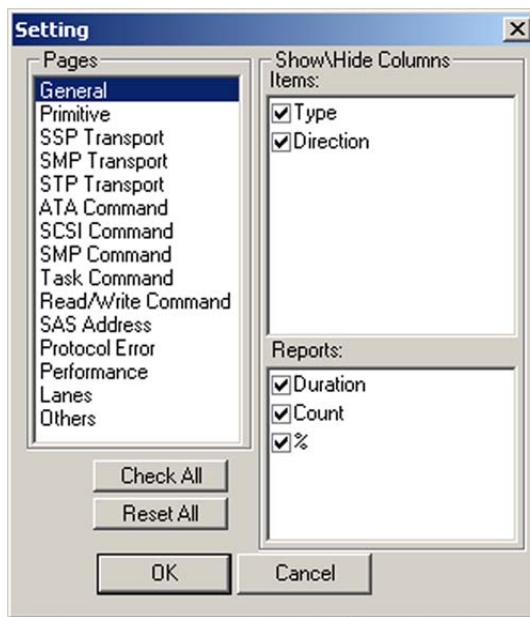

Figure 3.51: SAS: Statistical Report Column Setting

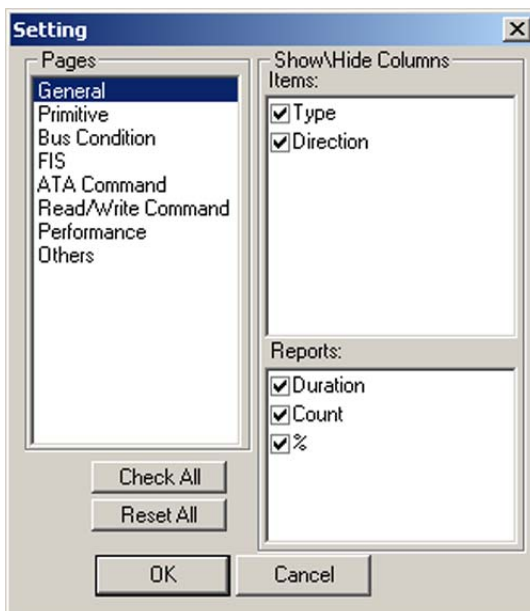

Figure 3.52: SATA: Statistical Report Column Setting

Link With Sample View

When you select a type on any page of the Statistical Report, a set of navigation buttons allows you to examine each instance of that type in the Sample Viewer.





The **Jump to Previous** button goes to the previous instance of the selected type in the Sample Viewer.



The **Jump to Next** button goes to the next instance of the selected type in the Sample Viewer.



The **Jump to Specific** button goes to the instance specified as N of M items on the Statistical Report toolbar.



The **Move** drop-down list moves to the X-Cursor, Y-Cursor, or None.

Formatting the Statistical Report View

Initially the Statistical Report View contains all of the information in columns, but you can customize the display by:

- Filtering columns by item
- Sorting items by column
- Hiding any column on the display

Filtering Column Content

To filter column content, click the down arrow in the heading for that column and choose the items to display. The default is All. By checking a specific item, you exclude everything but that item for display.

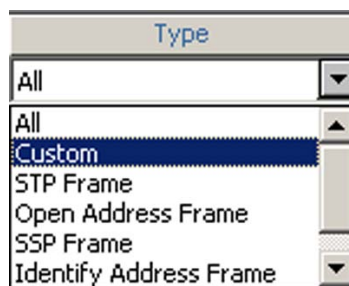

Figure 3.53: SAS: Type

Choosing **Custom** allows you to specify more than one item for display (see [Figure 3.54 on page 235](#)).

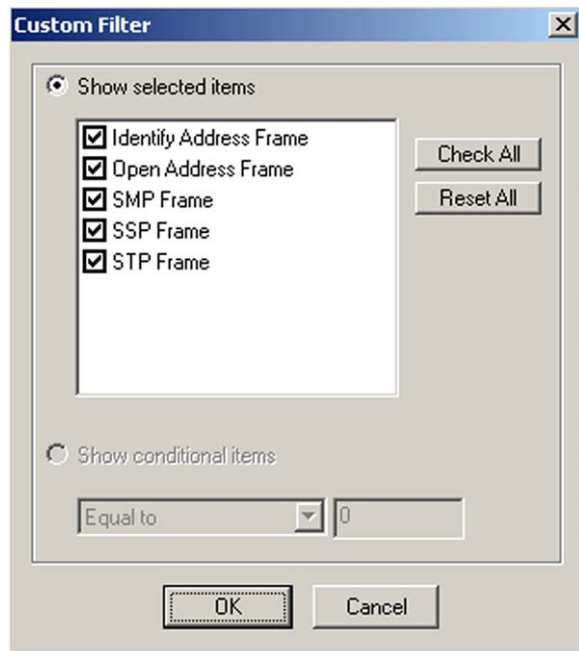

Figure 3.54: SAS: Custom Filter



Figure 3.55: SATA: FIS Type

Choosing **Custom** allows you to specify more than one item for display (see [Figure 3.56 on page 236](#)).



Figure 3.56: SATA: Custom Filter

Check the items to display and click **OK**.

Sorting Column Content

To sort column content, click the **heading** for that column. Repeated clicking of the column heading sorts the column in ascending or descending order.

Type	Direction	Duration	Count	%
All	All	All	All	---
Open Address Frame	I->T	18.39999962 us	69	28.51
SMP Frame	T->I	4.53333330 us	17	7.02
SMP Frame	I->T	1.81333339 us	17	7.02
SSP Frame	T->I	23.12000084 us	53	21.90
SSP Frame	I->T	14.48000050 us	35	14.46
STP Frame	T->I	85.89333344 us	34	14.05
STP Frame	I->T	7.03999996 us	17	7.02
		0.00015528	242	100.00

Type	Direction	Duration	Count	%
All	All	All	All	---
STP Frame	I->T	7.03999996 us	17	7.02
STP Frame	T->I	85.89333344 us	34	14.05
SSP Frame	I->T	14.48000050 us	35	14.46
SSP Frame	T->I	23.12000084 us	53	21.90
SMP Frame	I->T	1.81333339 us	17	7.02
SMP Frame	T->I	4.53333330 us	17	7.02
Open Address Frame	I->T	18.39999962 us	69	28.51
		0.00015528	242	100.00

Figure 3.57: Toggling Type Sort Order

Hiding Columns

To hide a column, right-click in the column and choose **Hide**. To unhide a column, right-click any column and choose **Unhide**.

Histogram View

The Histogram View displays a histogram of frame-type transfers.

To display the Histogram View of the current capture, click **Analysis > Histogram View** or

click the  button on the toolbar.

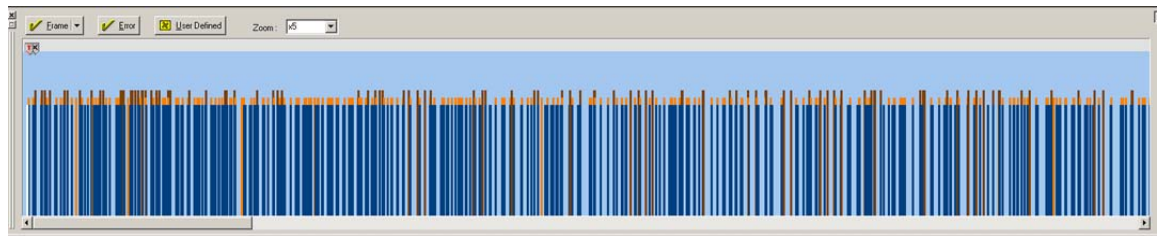

Figure 3.58: Histogram View

Hide Frames

You can customize the histogram by including only frame types that you want.

To choose frame types to include in the display, click the down arrow on the **Frame** button on the Histogram toolbar and check frame types:

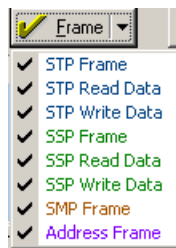

Figure 3.59: SAS: Histogram Frames

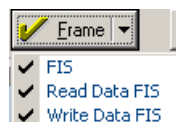

Figure 3.60: SAS: Histogram Frames

Hide Error Frames

Frames with errors are displayed in red. To hide error frames from the histogram, click the



Note: To display the error code of a protocol error, click the error icon (with the red 'x').

User Defined

You can define additional items for inclusion in the Histogram by clicking the

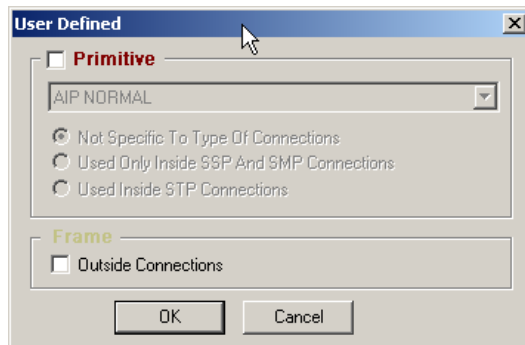
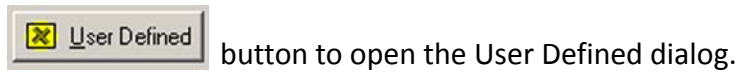

Figure 3.61: SAS: Histogram User Defined Dialog

You can include Primitive and/or Outside Connections frames.

Primitives

To include Primitives, check the **Primitive** check box, click the down arrow on the Primitive list box, and choose a Primitive.

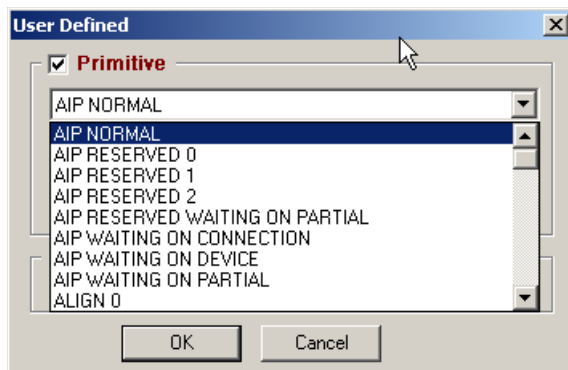

Figure 3.62: SAS: Choosing a Primitive



Figure 3.63: SATA: Choosing a Primitive

Check a Connection Type option radio button, if available, and click **OK**.

Zoom

You can Zoom from x1 to x256.

Bus Utilization View

The Bus Utilization View displays information on pending IO. To display the Bus Utilization View of the current capture,

click **Analysis > Bus Utilization View** or click the  button on the toolbar.

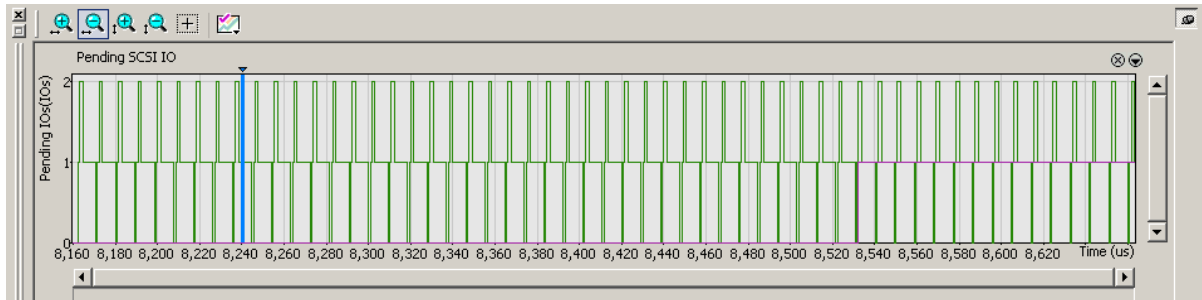

Figure 3.64: SAS: Bus Utilization View for Pending SCSI IO

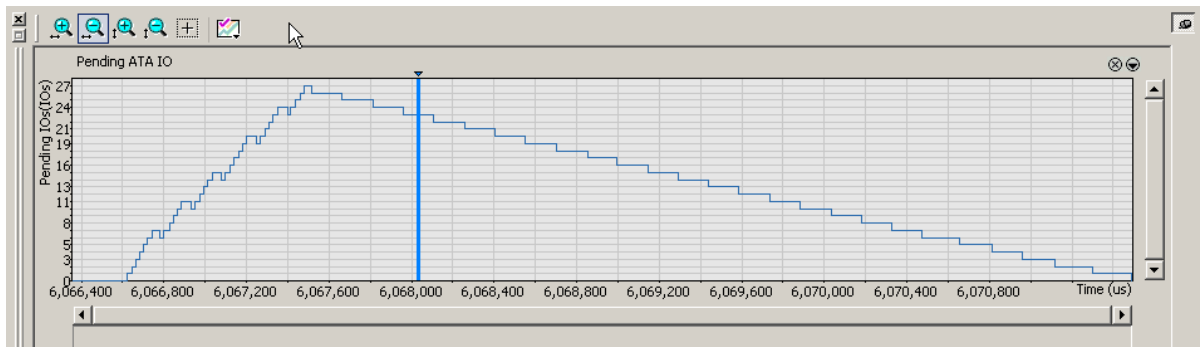

Figure 3.65: SATA: Bus Utilization View for Pending ATA IO

Available Bus Utilization Views are:

- Pending SCSI IO (for SAS)
- Pending ATA IO (for SATA)









Hovering the mouse over the graph heading displays the graph legend:

- Go to ATA/SCSI Cmd. #:** Jump to command.
- Synchronize with Trace View:** Synchronize all open views to that location in the trace.
- Fit to Graph Area:** Zoom to fit.
- Hide:** Do not display the graph.

To synchronize all open views to that location in the trace, double-click the graph.

Bus Utilization Buttons

The Bus Utilization window has a row of buttons for changing the format of the displayed data. The buttons have the following functions:

	Horizontal zoom in		Vertical zoom in
	Horizontal zoom out		Vertical zoom out
	Graph Areas Presents options for displaying additional graphs.		Click and Drag zoom Click diagonally to select and zoom in on part of the graph.
	Hide graph.		Graph legend (see previous page)

Data Report

When a captured sample is in the Sample Viewer, the Data Report button is on the Viewer toolbar, and Data Report is in the Report menu.

The data report displays all the data sent from the host to the device and from the device to the host. All PIO In =>In commands are grouped as a data packet until the occurrence of a PIO Out =>Out command, creating a new data packet.



To display a Data Report, click the

Data Report button on the Viewer toolbar or select **Report > Data Report**.

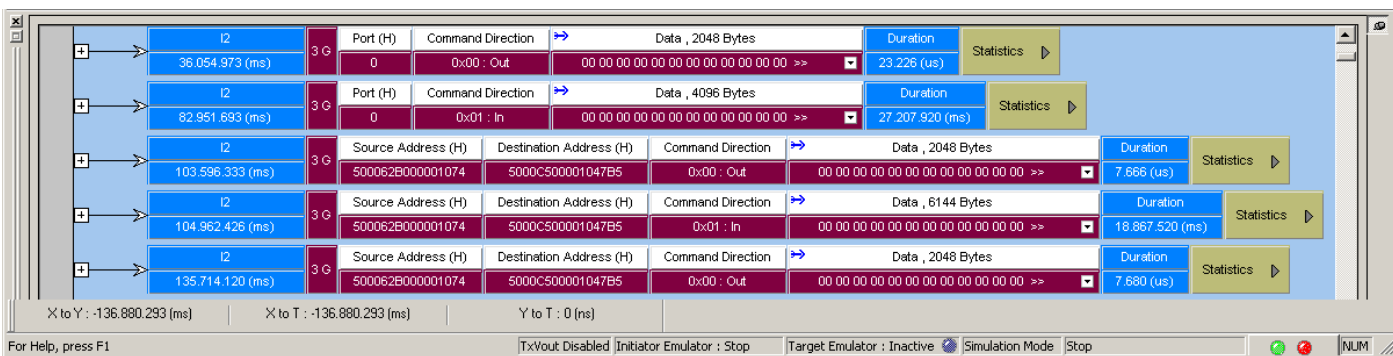

Figure 3.66: SAS: Data Report

Click the **Down Arrow** in a data field to display Data Report details (see [Figure 3.67 on page 241](#))..

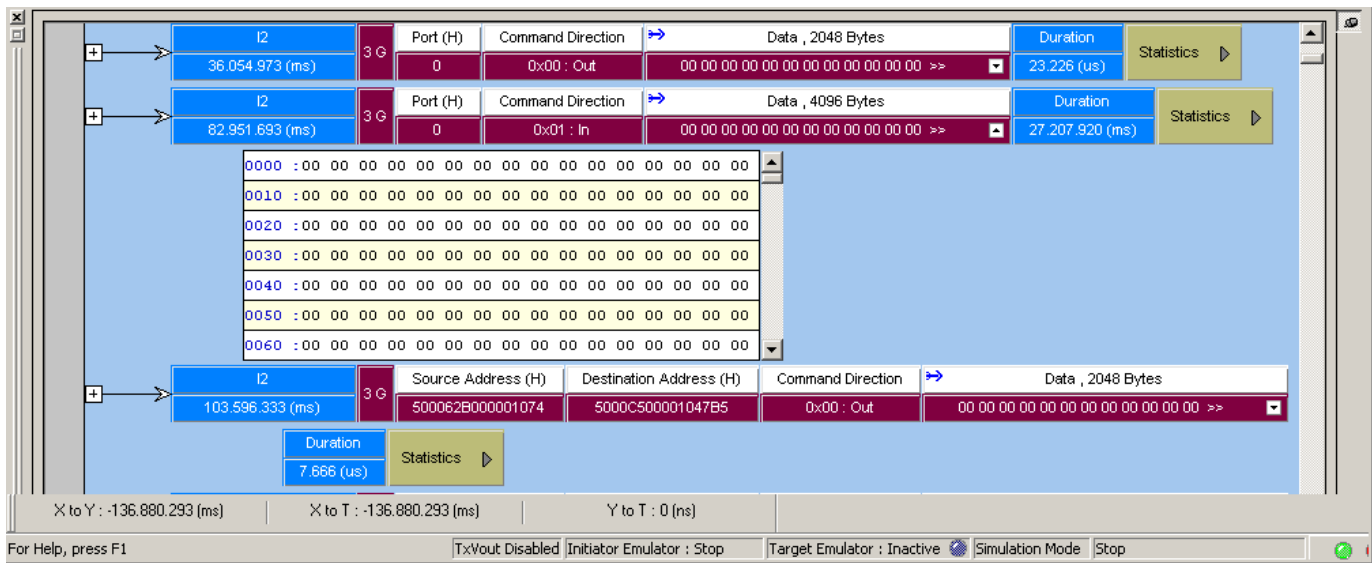
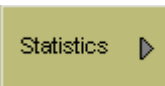

Figure 3.67: SAS: Data Report Details

Click the **Statistics** button  at the end of a row to display data report statistics.

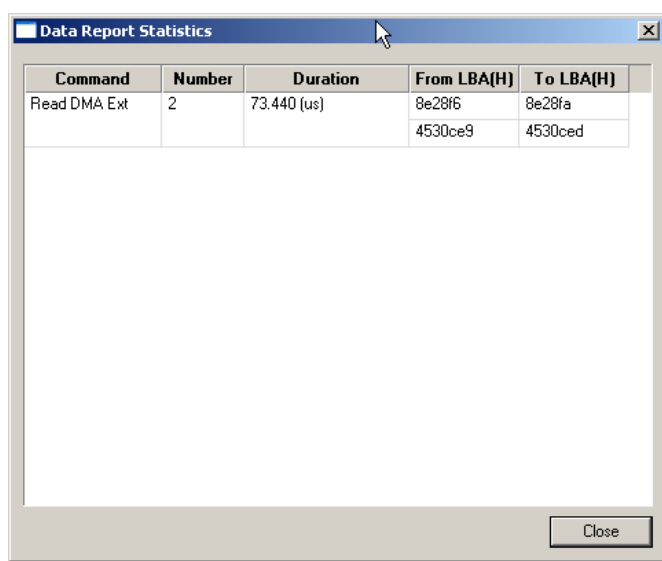

Figure 3.68: SAS: Data Report Statistics

Data Payload View

To display the Data Payload View, double-click a data payload field in a Packet or Spreadsheet view, or right-click a data payload field and select **Open as Data View**. See the following screen capture:

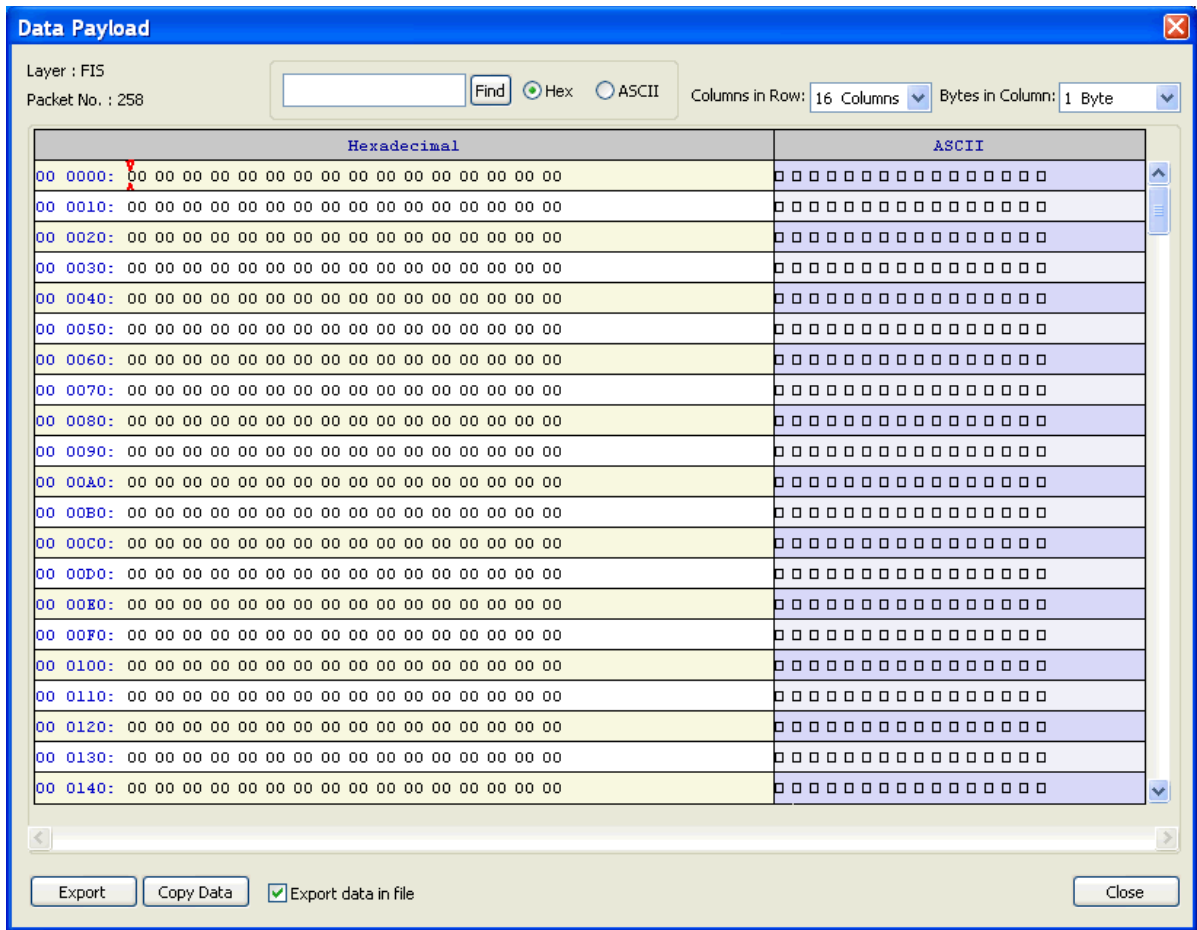

Figure 3.69: Data Payload View

Note: When showing truncated data in the Data Payload View, the truncation points are marked with a separator placed between payloads. You can get more information about the data exclusion using the tooltip over the separator.

Note: You can control the number of bytes per line.

Find Data Pattern

To quickly locate a data pattern in the current frame, enter the pattern in the Text Box and click the **Find** button.

Compare Two Data Payloads

To compare two data payloads, select two different payload packets, one as reference. Right-click a payload field in Packet View or a related frame in Text View or Spreadsheet View to display a menu, then select **Set As Reference Data Payload**.

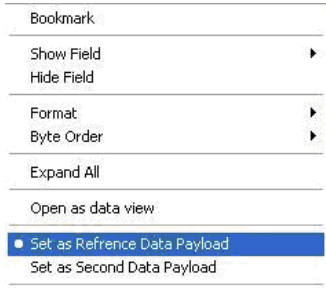

Right-click a payload field in Packet View or a related frame in Text View or Spreadsheet View to display a menu, and choose **Set as Second Data Payload**.



To compare data payloads, click the **Show/Hide Compare 2 Data Payloads** button on the toolbar:

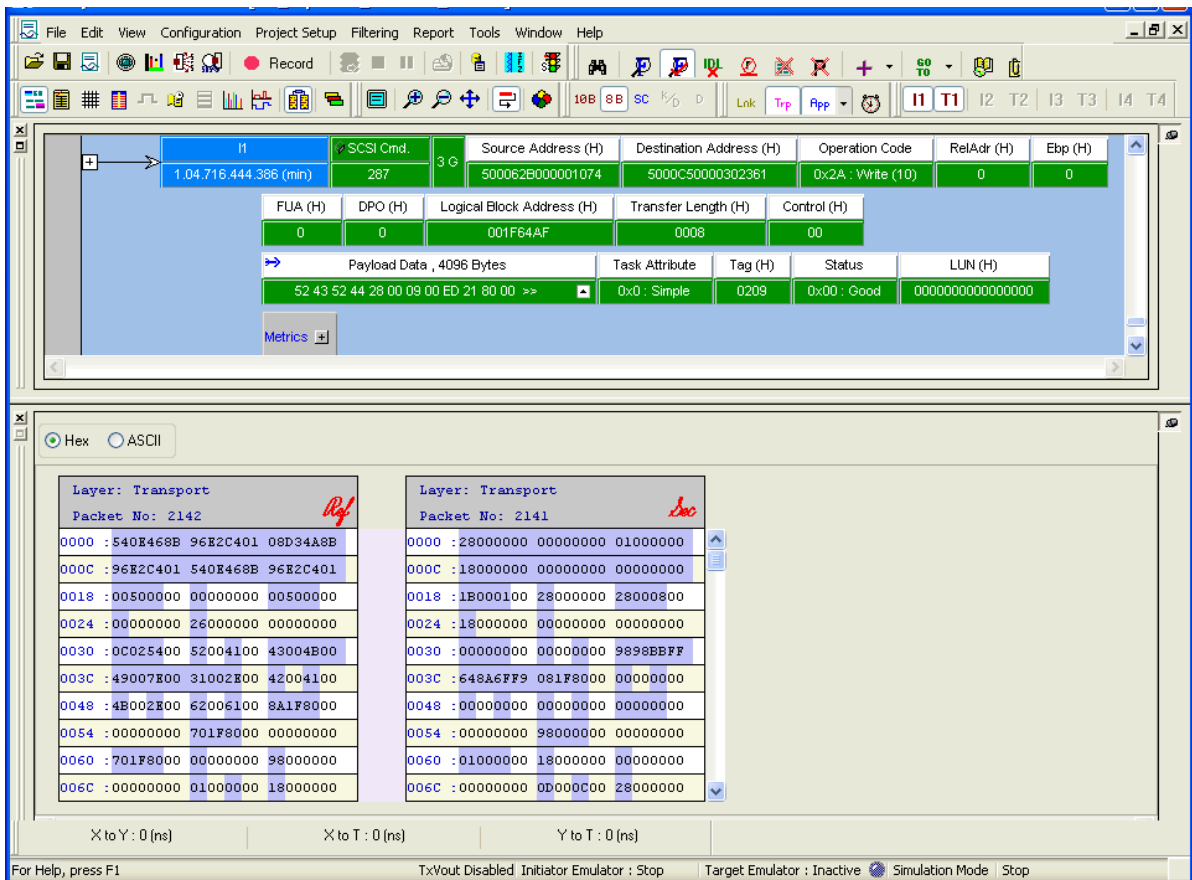

Figure 3.70: Compare Two Data Payloads

SAS Verification (SAS)

SAS Verification consists of a set of selectable tests to verify compliance with the SAS specification.

Note: Speed Negotiation and all other SAS tests are documented in the *SAS Verification Test Descriptions.pdf* file in the installed Documents directory.

To run a SAS Verification Test:

1. Select **Tools** on the main toolbar and choose **SAS Verification** to open the SAS Verification dialog.

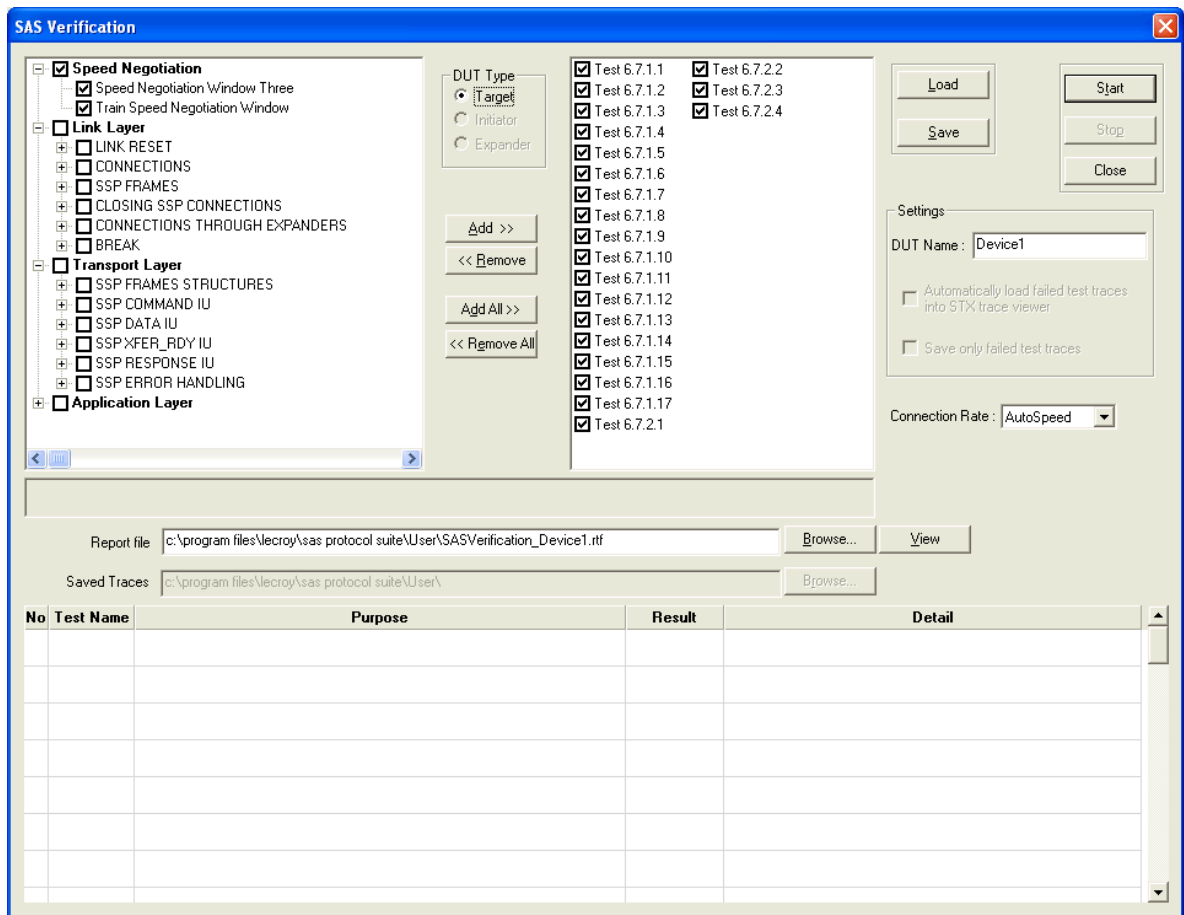

Figure 3.71: SAS Verification Dialog

Speed Negotiation has Speed Negotiation Window Three and Train Speed Negotiation Window.

The Link Layer has Link Reset, Connections, SSP Frames, Closing SSP Connections, Connections through Expanders, and Break.

The Transport Layer has SSP Frames Structures, Command IU, Data IU, XFER_RDY IU, Response IU, and Error Handling.

The Application Layer has SCSI CDB and STP Operations.

2. Choose the tests in the left pane of the dialog and click the **Add>>** button.
3. Enter a value for **DUT Type**: Target, Initiator, or Expander.
4. Enter the **DUT Name**.
5. Enter the **Connection Rate** as Autospeed or a value.
6. To view failed test traces in the sample viewer, check the **Automatically load failed test traces into STX trace viewer** check box.
7. To save the failed test traces only, check the **Save only failed test traces** check box.
8. Enter a path and file name for **Report file**, or use the default file name and path:
c:\program files\lecroy\sas protocol suite\User\SASVerification_Device1.rtf
9. Enter a path and file name for **Saved Traces**, or use the default folder:
C:\Program Files\LeCroy\SAS Protocol Suite\User\
10. After you select tests, click **Start**.
11. The test runs and, after a brief period, displays the result.
12. To save the current compliance setup for later use, click the **Save** button to open the Save As dialog. Assign a meaningful name to the setup and save it as a ***.cst** compliance file.
13. To run a previously defined setup, click the **Load** button and choose a previously defined setup to run.

Note: For the NACA test, both ports of the SAS device must be connected to two Host Emulation ports, I1 and I2, using two SATA cables.

Note: When you are running SAS Verification, you cannot work with Trainer and Emulator while device is connected to D connector and HBA is connected to H connector.

Using the Power Expansion Card

You can use the Power Expansion Card for SAS Verification. See [“Using the Power Expansion Card” on page 31](#).

Compliance Test (SATA)

SATA Verification consists of a set of selectable tests to verify compliance with the SATA specification.

Note: The Digital Tests and the Phy Tests are documented in the *SATA_Digital-Device_MOI_LeCroy_1.00_UTD1.4.pdf* file in the installed Documents directory.

To run a SATA Compliance Test:

1. Select **Analysis** on the main toolbar and choose **Compliance Test** to open the SATA Compliance Test dialog.

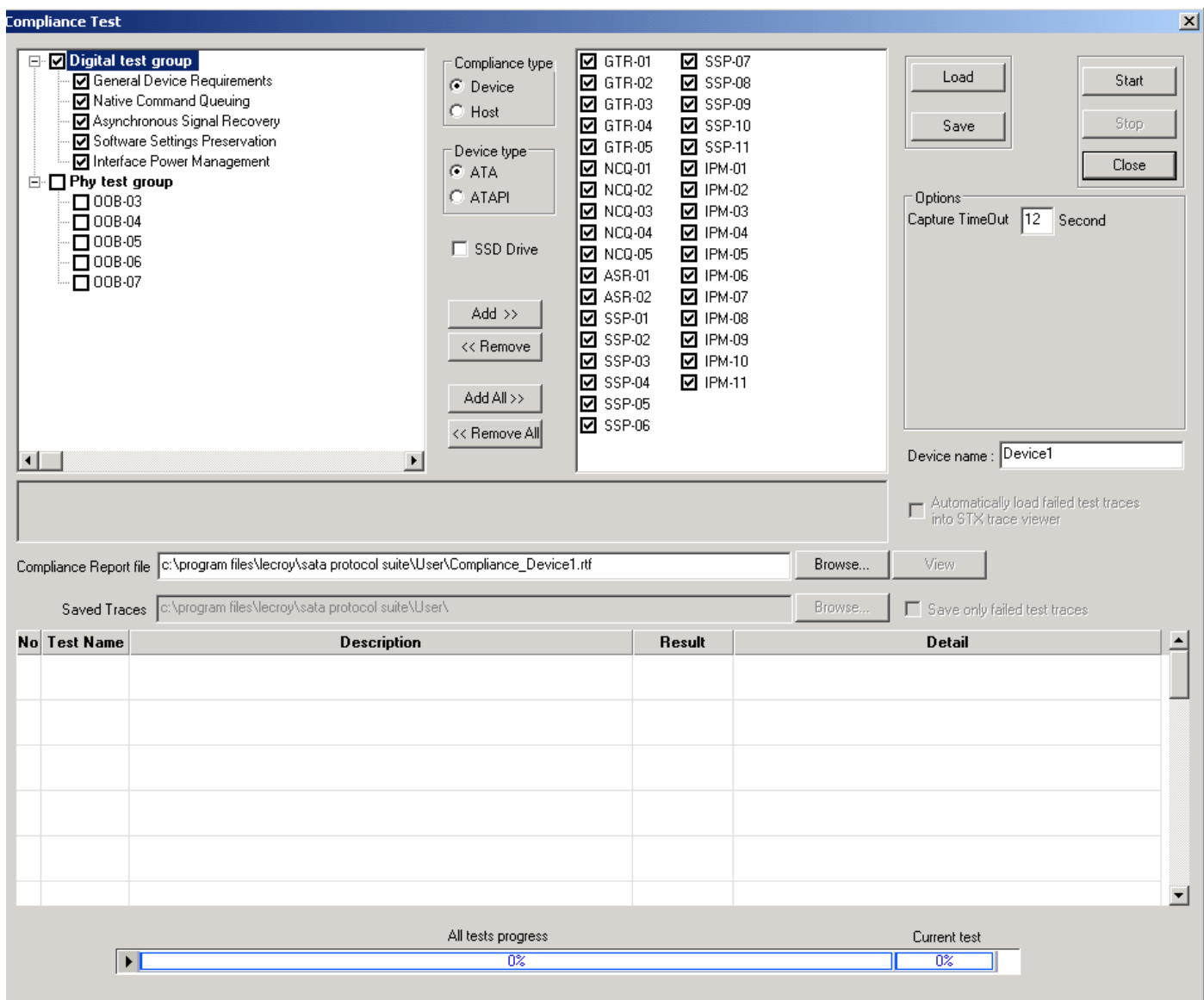

Figure 3.72: Compliance Test Dialog

The Phy Test and Digital Test groups are displayed in the left column. The Digital Tests comprise of the following:

- General Device Requirements
 - Native Command Queuing
 - Asynchronous Signal Recovery
 - Software Settings Preservation
 - Interface Power Management
2. Choose the tests in the left pane of the dialog by clicking on the checkboxes and click the **Add>>** button.
You can add all or remove all by clicking **Add All** or **Remove All**.
 3. Select a Compliance Type: Device or Host
 4. Select a Device Type: ATA or ATAPI
 5. Enter the **Capture Timeout** value in seconds.
 6. To view failed test traces in the sample viewer, check the **Automatically load failed test traces into STX trace viewer** check box.
 7. To save the failed test traces only, check the **Save only failed test traces** check box.
 8. Enter a path and file name for **Report file**, or use the default file name and path:
c:\program files\lecroy\sas protocol suite\User\Compliance_Device1.rtf
 9. Enter a path and file name for **Saved Traces**, or use the default folder:
c:\Program Files\LeCroy\SAS Protocol Suite\User\
 10. After you select tests, click **Start**.
 11. The test runs and, after a brief period, displays the result.
 12. To save the current compliance setup for later use, click the **Save** button to open the Save As dialog. Assign a meaningful name to the setup and save it as a ***.cst** compliance file.
 13. To run a previously defined setup, click the **Load** button and choose a previously defined setup to run.

Note: When you are running the Compliance Test, you cannot work with Trainer and Emulator while the device is connected to a D connector and HBA is connected to an H connector.

Using the Power Expansion Card

You can use the Power Expansion Card for the SATA Compliance Test. See [“Using the Power Expansion Card” on page 31](#).

Running Verification Script Engine (VSE)

You can perform custom post-process analysis of the open trace by running a verification script over the trace. A verification script instructs the application to send trace and analysis information to the script. A verification script also contains script code, written using CATC Script Language (CSL) (see the **CSL_RefManual.pdf** document in the **docs** directory of the installation), used to process trace data and output that data in different formats.

Note: You may write your own verification scripts to perform custom verification and analysis. For information on how to write a verification script, see the *Verification Script Engine Reference Manual*.

To run a verification script over a trace:

1. Select the main menu item **Analysis > Verification script** or click the

Running verification scripts button  on the main tool bar. The Run Verification Scripts dialog opens, from which you choose and then run one or several verification scripts.

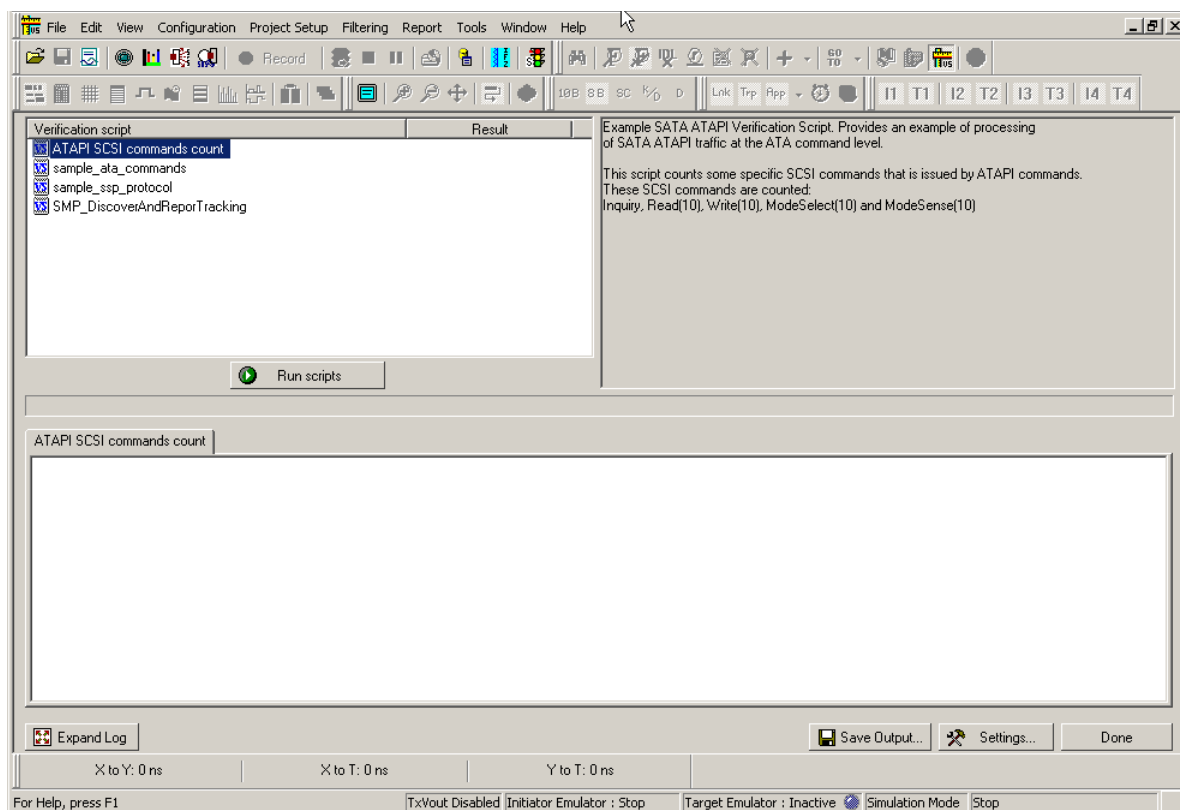

Figure 3.73: Run Verification Scripts Dialog

To expand the Log window, click the **Expand Log** button. The Log window fills the whole window. To see the Verification Scripts window again, click the Collapse Log button.

To save output, click the **Save Output** button.

2. After choosing **Settings** from the drop-down list or the button, the Settings dialog appears:

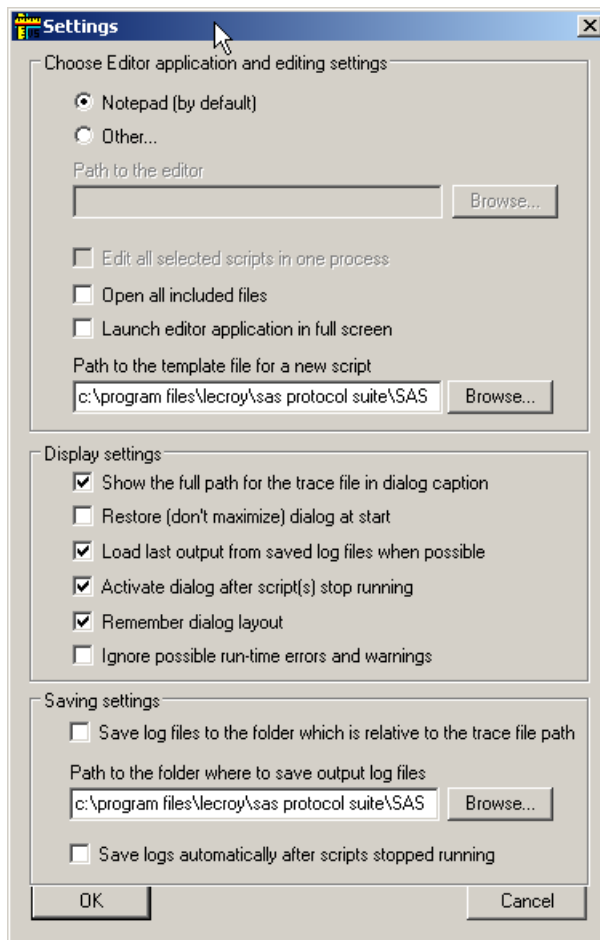

Figure 3.74: Run Verification Scripts - Settings Dialog

Choose the editor application: Notepad or other.

Edit all selected scripts in one process: If the editor supports multiple documents, you can edit all scripts in the editor.

Open all included files: You can edit included files, as well as the main script.

Launch editor application in full screen: You can use whole screen.

Path to the template file for a new script: You can use a template for the script.

Display Settings can show full trace-file path, restore dialog at start, load last output from save log files, activate dialog after scripts have run, remember dialog layout, and ignore errors and warnings.

Saving Settings can save log files to relative file folder, indicate output-log-file path, and save logs automatically.

- Click the **Run scripts** button after you select scripts to run. VSE starts running the selected verification scripts, shows script report information in the output windows, and presents the results of verifications in the script list:

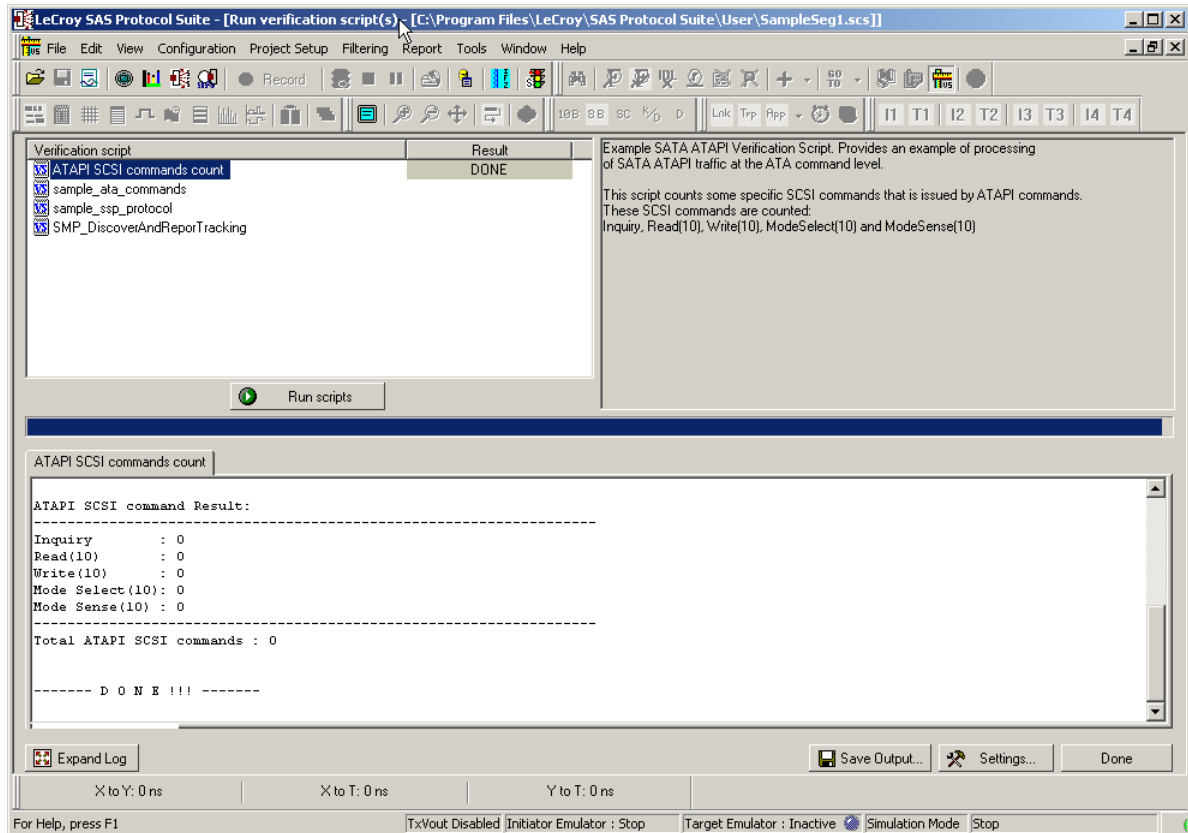

Figure 3.75: Run Verification Scripts Dialog

- Right-clicking in the script list displays some additional operations over selected scripts:

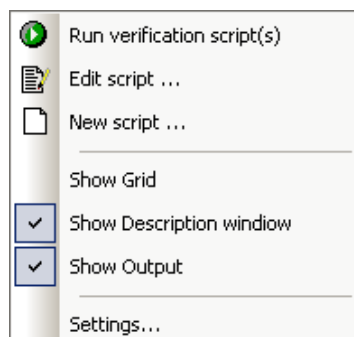

Figure 3.76: Run Verification Scripts - Menu

Run verification script(s): Start running selected script(s).

Edit script: Edit selected scripts in the editor application specified in Editor settings.

New script: Create a new script file using the template specified in Editor settings.

Show Grid: Show/hide a grid in the verification script list.

Show Description window: Show/hide the script description window (Shortcut key F2).

Show Output: Show/hide the script output windows (Shortcut key F3).

Settings: Open a special Setting dialog to specify different settings for VSE.

Navigation + View Toolbar

The Navigation + View toolbar allows you to navigate, search filter, hide RRDY/all primitives and unassociated traffic, zoom, tile views and select ports.

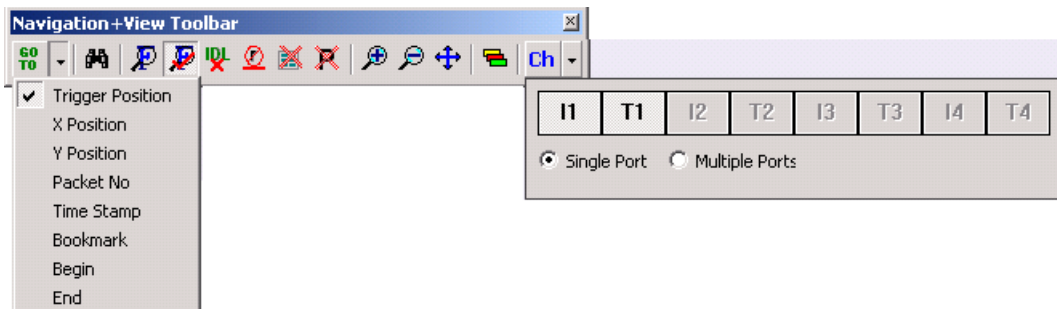

	The down arrow on the Go To button allows location of cursors or specific packets: Trigger Position, X Position, Y Position, Packet Number, Timestamp, Bookmark, Begin, and End.
	The Search button opens the search dialog (see “Search” on page 267).
	The Filtering Setup button opens the Filter dialog (see “Filtering” on page 256) and allows you to specify the criteria for filtering the result.
	The Enable Disable Filtering button toggles the result between a filtered and unfiltered view (see “Filtering” on page 256).
	The Filter Idle button toggles the display to show/hide idle packets (see “Filtering” on page 256).
	The Hide RRDY Primitives button toggles the display to show/hide RRDY primitives (see “Filtering” on page 256).
	The Hide Unassociated Traffic button toggles the display to show/hide unassociated traffic (see “Filtering” on page 256).



The **Hide All Primitives** button toggles the display to show/hide all primitives (see “[Filtering](#)” on page 256). **Note:** When capturing PM traces, you need the ability to filter the PM primitives so you can find commands quicker.



The **Zoom In** button on the Viewer Setting Toolbar magnifies the data display area on the screen. Clicking this button in Column or Text View increases column width only.



The **Zoom Out** button on the Viewer Setting Toolbar scales the data display area to display more data lines on the screen. Clicking this button in Column or Text View decreases column width only.



The **Normal Zoom** button on the Viewer Setting Toolbar resets the zoom to default normal on the screen. Clicking this button in Column or Text View resets column width only.



You can use **Tile Horizontally All Views icon** or select **View > Tile Views** to revert any unintended window docking or sizing, or maximize screen utilization. This function only tiles views inside a trace window.

Note that there is no command to tile views vertically.

Go To Menu

Locate Cursors

To quickly locate any cursor within the data viewer display, click the **Go To** button and choose the cursor to locate. You can also locate a cursor by selecting **Go To** from the Edit menu and choosing the cursor to locate.

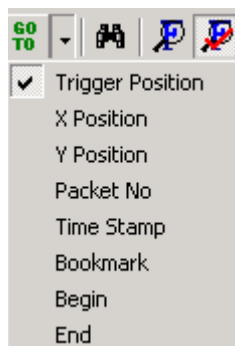

Figure 3.77: Locate Cursor

Go to Time Stamp

To locate a timestamp, click the **Go To** button and choose **Timestamp** (see the following screen capture.)

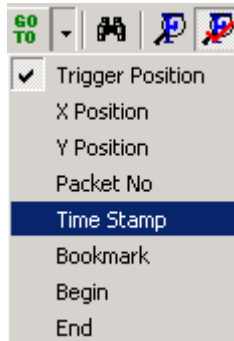

Figure 3.78: Time Stamp

Enter a time stamp value in the Go To Timestamp dialog and click **OK**.

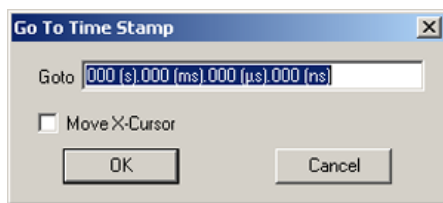

Figure 3.79: Go to Time Stamp

Bookmarks

Bookmarks are a convenient way to mark a point in the data viewer display by name, so that you can rapidly return to that point. To create a bookmark, right-click the mouse in the data viewer area on a packet in which to place the bookmark.

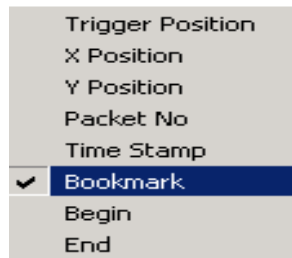

Figure 3.80: Bookmark

Click **Bookmark** from the fly out menu to open the Bookmark Comment Dialog.

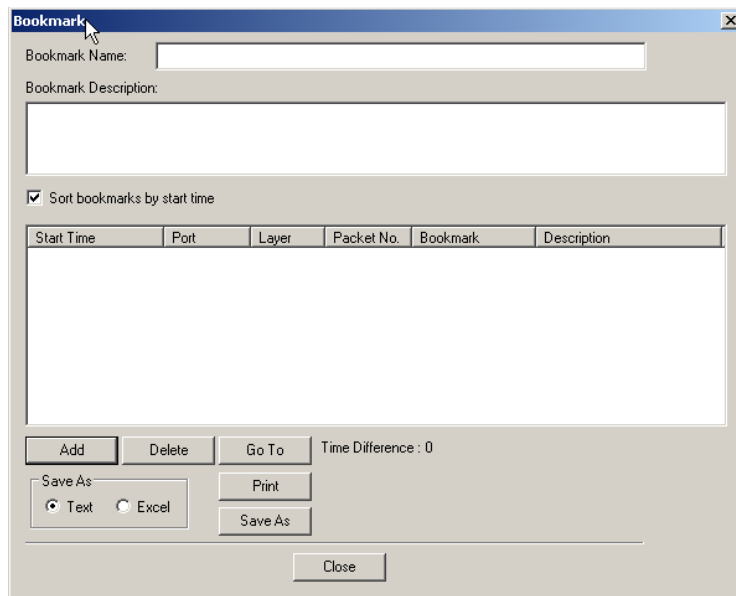

Figure 3.81: Bookmark Dialog

Enter a description for the bookmark and click the **Add** button. Repeat for additional **bookmarks**.

You can save the bookmark as a text file or Excel CSV file.

Note: Column View has a different bookmark mechanism than other views, and you can set a bookmark on each DWORD in the view. This makes Column View bookmarks unavailable in other views and vice versa.

Editing a Bookmark

If a packet has a bookmark, you can edit the bookmark by right-clicking the data viewer area of the packet, selecting the **Edit Bookmark** command from the pop-up menu, and changing the information in the Bookmark dialog (see above).

Finding a Bookmark

To find a bookmark in the data viewer display, right-click the mouse in the sample viewer and select **Bookmark** (see [Figure 3.82 on page 255](#)).

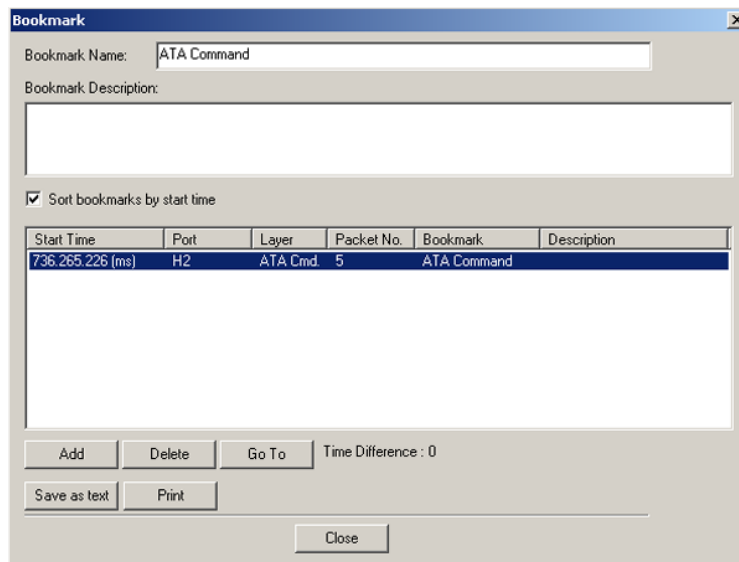

Figure 3.82: Go To Bookmark Dialog Box

Highlight the bookmark to which to go, then click the **Go To** button, or double-click the selection.

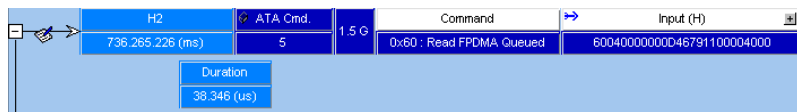

Figure 3.83: Bookmark Found Example in Data Viewer Display

Bookmark Description

To get a quick description of a displayed bookmark, position the tool tip over a bookmark. The name and description of the bookmark display.

Set Time Stamp Origin

Right-click in the sample viewer to open the fly out menu:

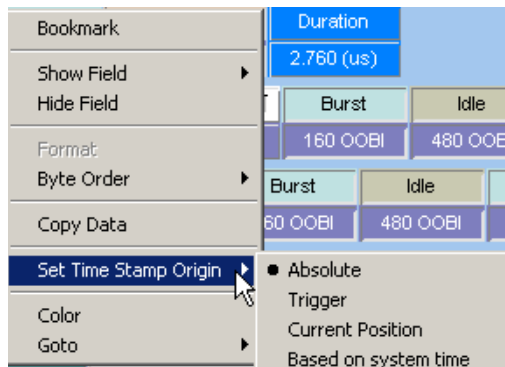

Figure 3.84: Bookmark Found Example in Data Viewer Display

Highlight **Set Time Stamp Origin** and choose either Absolute, Trigger, Current Position, or Based on system time.

Filtering

The Filtering menu and options allow you to modify data in the sample viewer display to exclude packets with a set of user-defined patterns and show the results in all views.

To set up filtering, you must have a viewer display open.

The Filtering menu has the options:

- Enable Filtering (see [“Enable Filter” on page 266](#))
- Filtering (see [“Filter Setup” on page 257](#))
- Link Layer (SAS)
- Transport Layer (SAS)
- Application Layer (SAS)
- Physical Layer (SATA)
- FIS Layer (SATA)
- Command Layer (SATA)
- Filter Idles (see [“Filter Idle” on page 267](#))

Filter Setup



To display the Filter setup dialog, click the **Filter** button on the Viewer toolbar or select **Filtering > Filtering**.

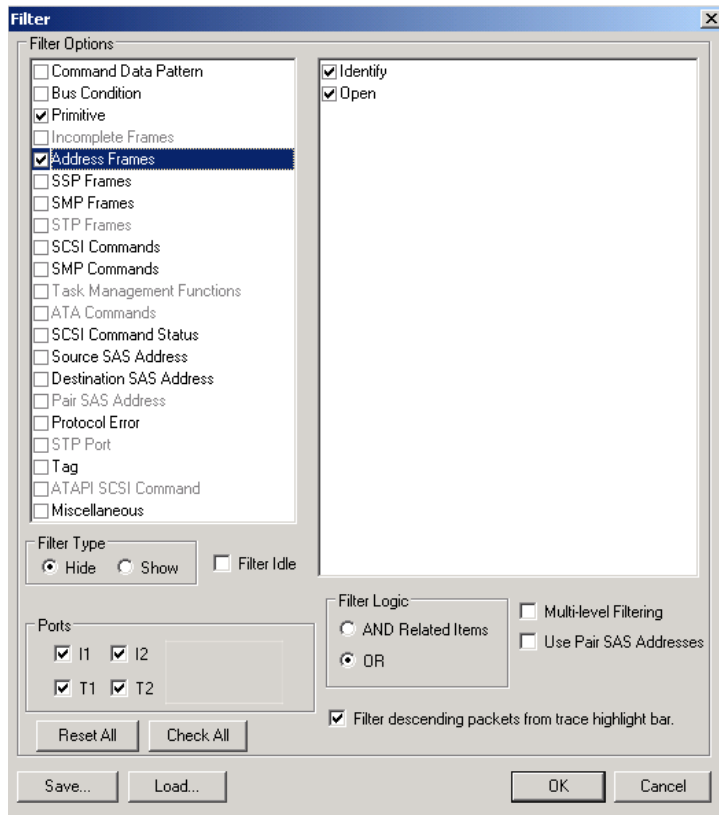

Figure 3.85: SAS: Filter Setup Dialog

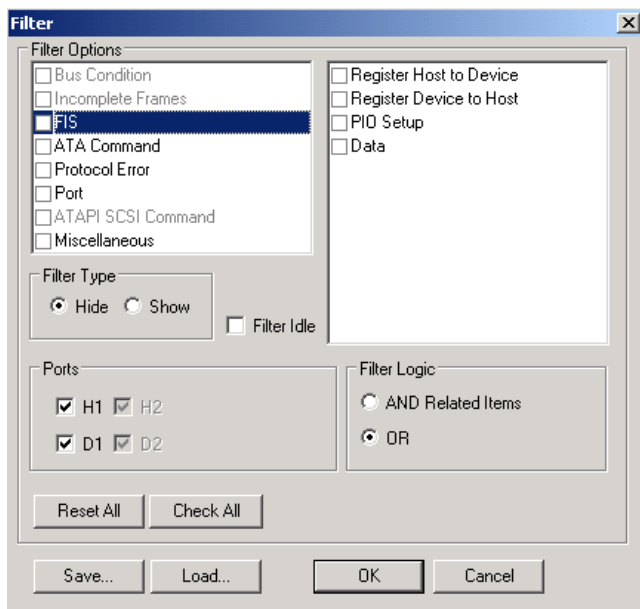

Figure 3.86: SATA: Filter Setup Dialog

You can select or deselect each of the items shown in the Filter Options window for filtering, by checking or unchecking a corresponding check box. Items not in the current sample are in shade.

Note: If you select a group, that also selects all child items.

Note: Only packets captured at run time are available for selection for filtering.

Filter Type

You can choose to show or hide the Filter Type items by checking the **Show** or **Hide** option button.

Note: When capturing PM traces, you need the ability to filter the PM primitives so you can find commands quicker.

Filtering Direction

You can select items for filtering in a single direction or both directions by checking the corresponding Port. By default, all ports are enabled. Uncheck the port check boxes for ports not to include in the filter.

Filter Idle

Depending on the Filter Type (Hide/Show), Idle packets in the Sample Viewer are shown or hidden.

Save Filter Setup

After you have set up a Filter configuration, you can save it as an SAS Filter file (*.sfl) or SATA Filter file (*.tfl) by clicking **Save**. You can then use it on a different capture by clicking **Load** in the Filter dialog.

Filter Logic

After you have set up Filter options, you can set filter logic to **And Related Items** to apply “AND” logic on related selected options (for example, SCSI commands and SAS Addresses) or **OR** to apply “OR” logic on all selected options.

Multilevel Filtering in SAS

You can set up a filter in a sequential steps by **Multi level filtering**. In each level, you can select specific items to “AND” to the previous level. The results of all levels show in views.

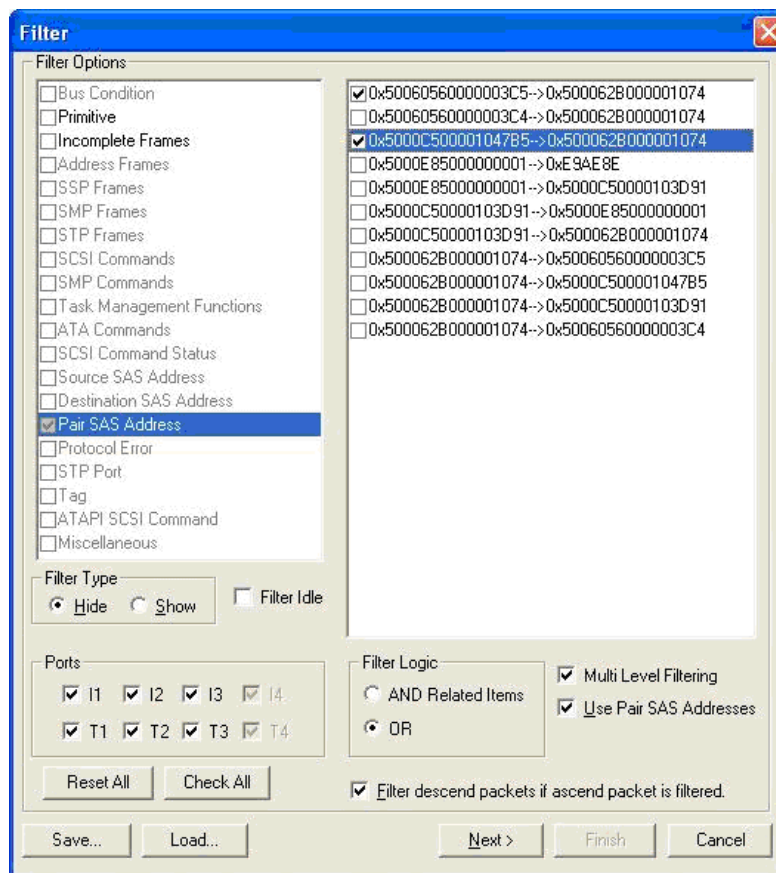

Figure 3.87: First Level of Multilevel Filtering

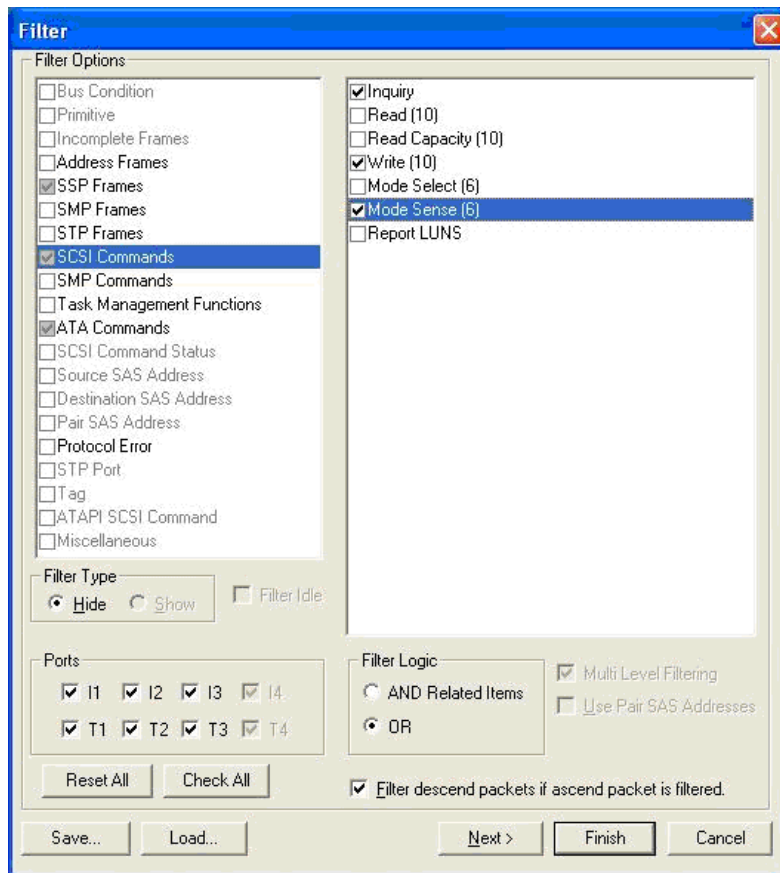

Figure 3.88: Second Level of Multilevel Filtering

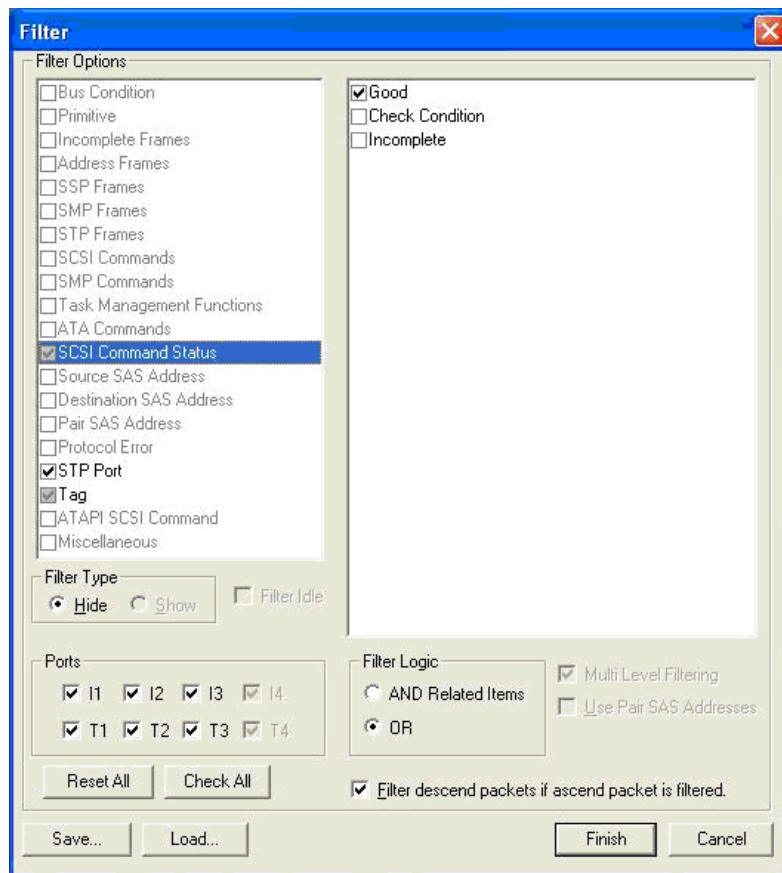

Figure 3.89: Third Level of Multilevel Filtering

Filter descending packets from trace highlight bar

If you check the **Filter descending packets from trace highlight bar** checkbox, the application will only filter onward from the highlighted trace selection bar.

If you uncheck this option, the software only filters the filtered packet. For example, if this option is checked and any SCSI command is selected, all transport and link packets of this command are filtered. If you unchecked this option, only selected SCSI commands are filtered.

Selectable Filter Options for SAS

The SAS Filter Options are:

- Bus Condition
- Primitive
- Incomplete Frames
- Address Frames
- SSP Frames
- SMP Frames
- STP Frames
- SCSI Commands
- Task Management Functions
- ATA Commands
- SCSI Command Status (see [“Filter Check Condition” on page 263](#))
- Source SAS Address
- Destination SAS Address
- Pair SAS Address
- Protocol Error
- STP Port
- Tag (see [“Filter by Tag Number” on page 263](#))
- ATAPI SCSI Command
- Miscellaneous (see [“Filter Miscellaneous” on page 264](#))

Bus Condition

When selected, depending on the Filter Type, the Hide/Show selection shows or hides captured Bus Conditions in the Sample Viewer.

Incomplete Frames

When selected, depending on the Filter Type, the Hide/Show selection shows or hides Incomplete Frames in the Sample Viewer.

ATA Command

When selected, depending on the Filter Type, the Hide/Show selection shows or hides captured ATA commands in the Sample Viewer.

Protocol Error

When selected, depending on the Filter Type, the Hide/Show selection shows or hides captured packets with the specified Protocol Errors in the Sample Viewer.

ATAPI SCSI Command

When selected, depending on the Filter Type, the Show/Hide selection shows or hides ATAPI SCSI commands.

Filter Check Condition

Checking the **SCSI Command Status** check box enables Check Condition for filtering.

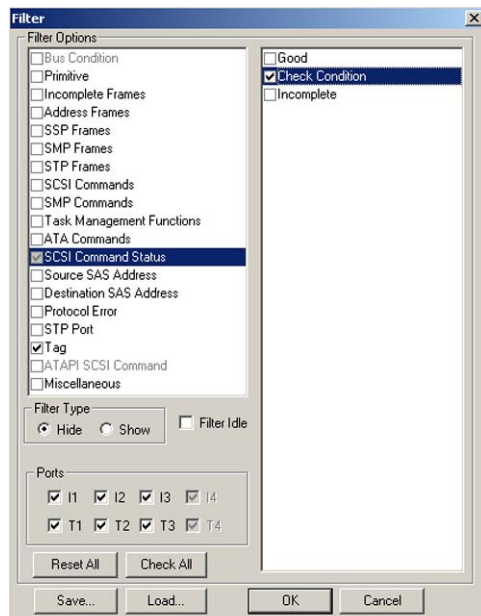

Figure 3.90: SAS: Filter Check Condition

Filter by Tag Number

Checking the **Tag** check box displays tags available for filtering. Check the corresponding check boxes for tags to filter.

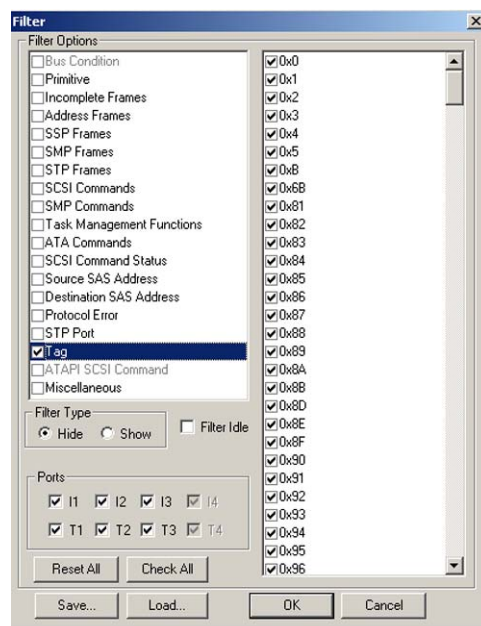

Figure 3.91: SAS: Filter by Tag Number

Filter Miscellaneous

When you choose **Miscellaneous**, an additional dialog displays, allowing you to specify the filtering of State Range and/or External Signal In.

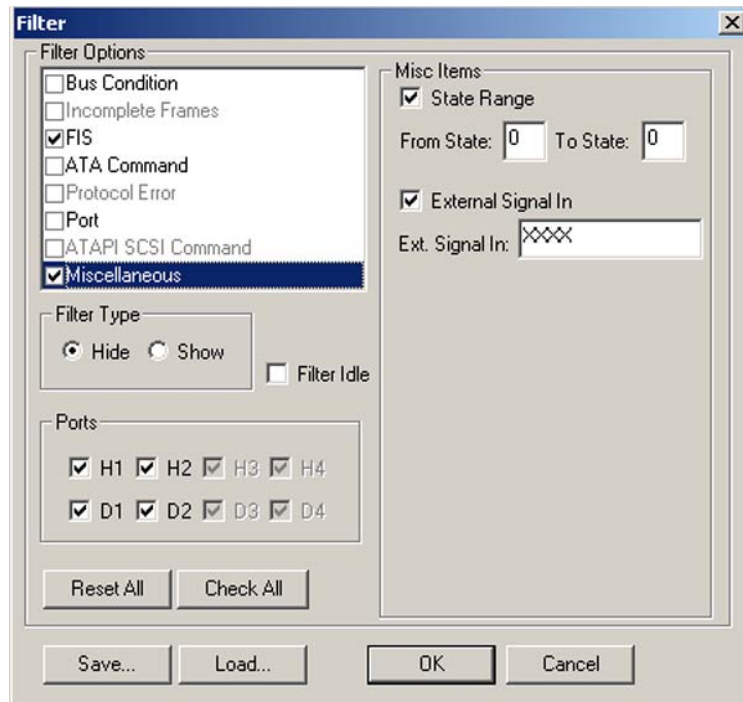

Figure 3.92: Filter State and/or External Signals

Use Pair SAS Addresses

You can use all available pair SAS addresses (Source -> Destination) instead of using SAS source and destination addresses. To enable the pair SAS address filter option, check **Use Pair SAS Addresses** check box in the Filter dialog.

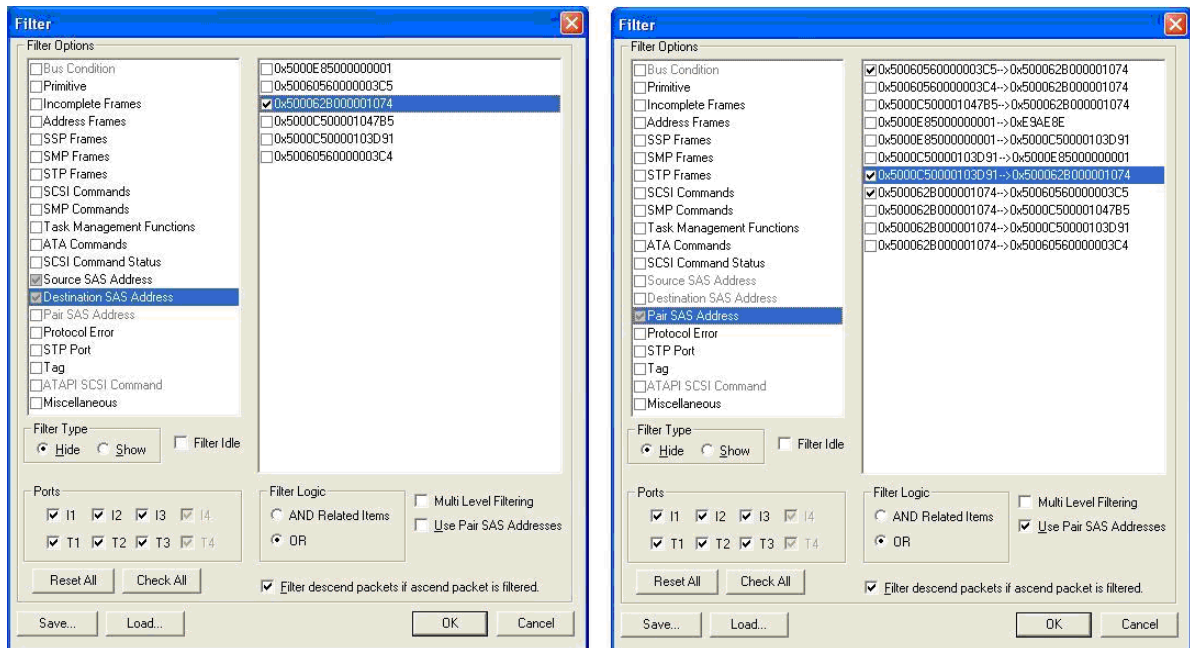

Figure 3.93: SAS: SAS Address Filtering before and after Using Pair SAS Addresses

Note: If you enable pair SAS addresses, the source/destination SAS addresses options are disabled and filtering on them is ignored at filtering time. If you disable pair SAS addresses, the pair SAS address option is disabled and filtering on it is ignored at filtering time.

Selectable Filter Options for SATA

The SATA filter options are:

- Bus Condition
- Incomplete Frames
- FIS
- ATA Command
- Protocol Error
- Port
- ATAPI SCSI Command
- Miscellaneous
- Filter Idle

Bus Condition

When selected, depending on the Filter Type, the Hide/Show selection shows or hides captured Bus Conditions in the Sample Viewer.

Incomplete Frames

When selected, depending on the Filter Type, the Hide/Show selection shows or hides Incomplete Frames in the Sample Viewer.

FIS

When selected, depending on the Filter Type, the Hide/Show selection shows or hides captured FIS items in the Sample Viewer.

ATA Command

When selected, depending on the Filter Type, the Hide/Show selection shows or hides captured ATA commands in the Sample Viewer.

Protocol Error

When selected, depending on the Filter Type, the Hide/Show selection shows or hides captured packets with the specified Protocol Errors in the Sample Viewer.

Port

When selected, depending on the Filter Type, the Show/Hide selection shows or hides packet traffic for the selected port.

ATAPI SCSI Command

When selected, depending on the Filter Type, the Show/Hide selection shows or hides ATAPI SCSI commands.

Miscellaneous

When you choose Miscellaneous, an additional dialog displays, allowing you to specify the filtering of State Range and/or External Signal In (see [“Filter Miscellaneous” on page 264](#)).

Enable Filter

Select **Filtering > Enable Filtering** or click the  **Filter Enable** button on the display menu bar to toggle between Filtered and Unfiltered display.

Filter Idle

Depending on the Filter Type (Hide/Show), Idle packets in the Sample Viewer are shown or hidden.



You can quickly filter idles by clicking the **Filter Idle** button. This button toggles between Show and Hide items.

Search

The Search menu and toolbar options permit you to examine any data capture file to quickly locate the packet or data pattern.



To perform an initial search, select **Edit > Search** or click the **Search** button to open the Search setup dialog (see [Figure 3.94 on page 267](#)).

Note: Only items captured in the sample file are enabled for search.

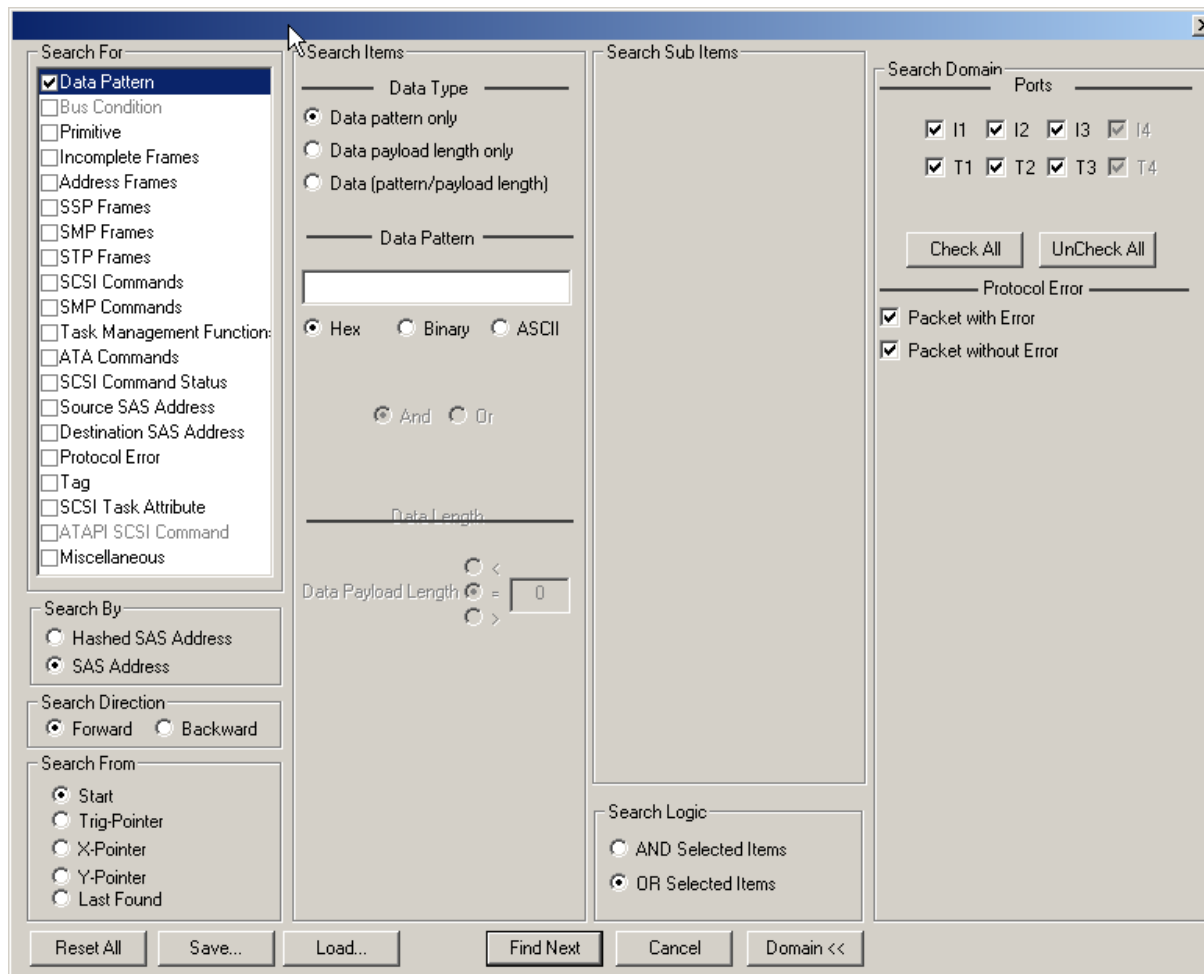

Figure 3.94: SAS: Search Data Pattern

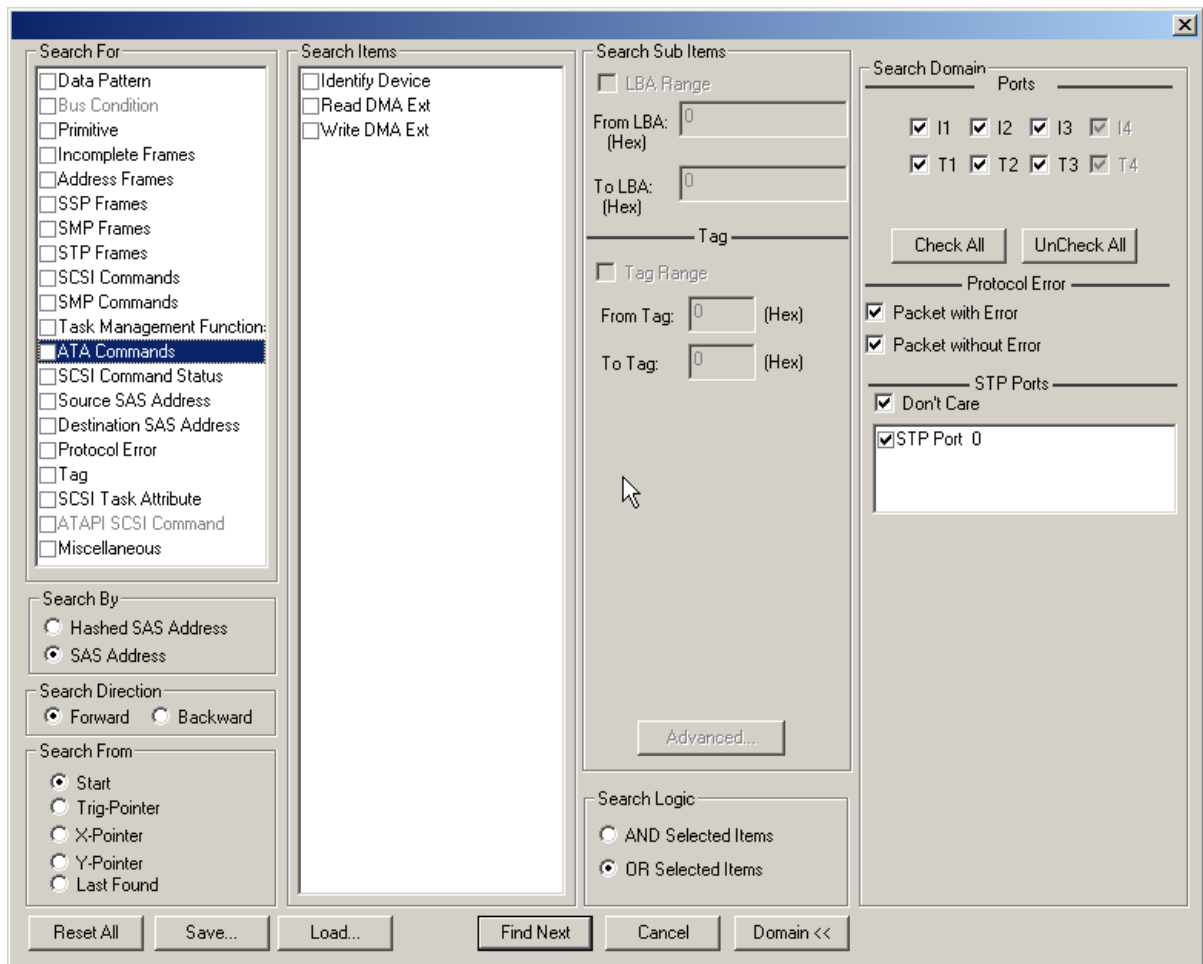

Figure 3.95: Search Parameter Definition Dialog

You can continue to search the output file using **Next Search (F3)** or **Previous Search (F4)** for the same pattern, until you redefine the data capture search parameters.

Save Search Setup

After you have set up a Search configuration, you can save it as a SAS Search configuration file (*.ssh) or a SATA Search configuration file (*.tsh) by clicking **Save**. You can then use it on a different capture by clicking **Load** in the Search dialog.

Search By

Choose **Hashed SAS Address** to search on hash address, or choose **SAS Address** to search for address.

Search Direction

Choose either **Forward** or **Backward** direction in which to perform the search.

Search From

Choose a starting point to begin or continue a search: Start of the sample file, Trigger Pointer, X Pointer, Y Pointer, or Last Found.

Search Logic

The default setting is **Or Selected Items**. With this setting, clicking **Find Next** locates all selected items in turn. If you choose **And Selected Items**, you can set a logical AND combination of items to find. Both options allow setting Advanced search features.

Search For

Choose a category to search in the **Search For** window. Each of the search categories offers additional choices in the **Search Items window** to refine the search. Check items for the selected category.

Data Pattern

Search for Data Pattern allows you to search for a specific Data Type, Pattern, and Length (see [Figure 3.94 on page 267](#)).

- Data Pattern Only
- Data Payload Length Only
- Data Pattern and Data Payload Length

Advanced options

Some of the Search For categories offer advanced options for search. To set these options, highlight the search item in a category and click the **Advanced** button to open the Advanced options dialog.

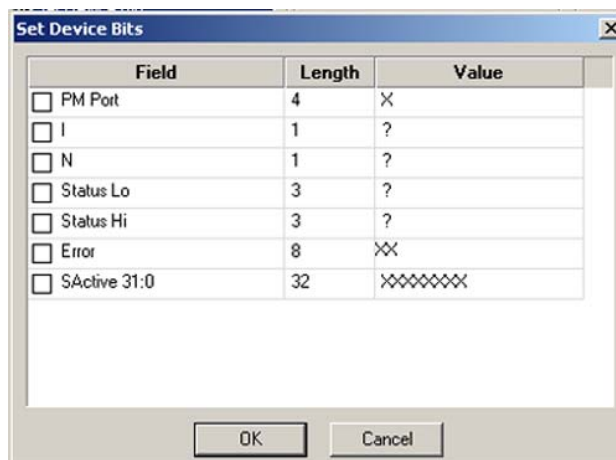

Figure 3.96: Advanced Options Dialog Example: Set Device Bits

Set the options and click **OK**.

Search Domain

Click the **Domain** button and choose a search domain from all ports or a specific port.

Protocol Error

You can refine the search to locate packets with an error or without an error.

Note: When searching for Protocol Errors in Column View, you cannot search for a specific Protocol Error type. Search returns any protocol error.

Search Sub Items

When searching SCSI Command Status, you can refine the search by selecting from a list of Sub Items.

Note: Some of the search categories allow you to refine the search by specifying specific SAS addresses and STP ports to search.

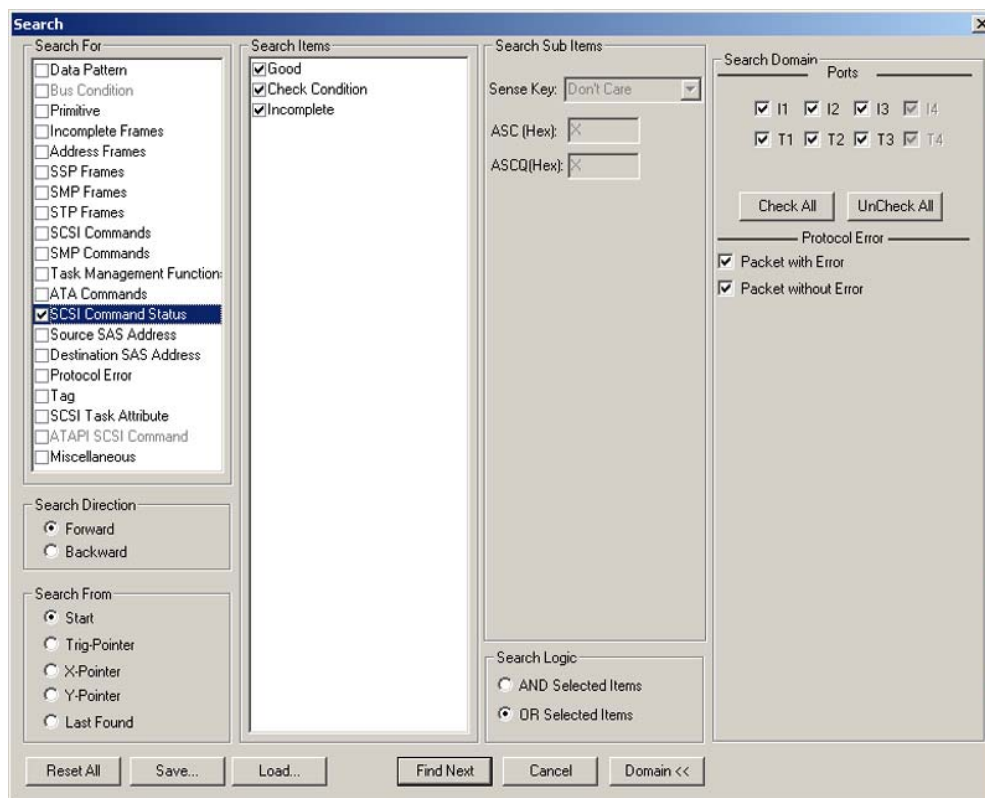

Figure 3.97: Search Sub Items

When you check the **SCSI Command Status**, the **Check Condition** item appears in the Search Items Window, if a check condition has occurred. Clicking this enables **Search Sub Items**, allowing you to refine the search by specifying **Sense Key**, **ASC**, and **ASCQ**.

Search by Tag Number

To search by Tag Number, check the **Tags** box in the Search For window and then check the Tag(s) for which to search in the Search Items window. See the following screen capture.

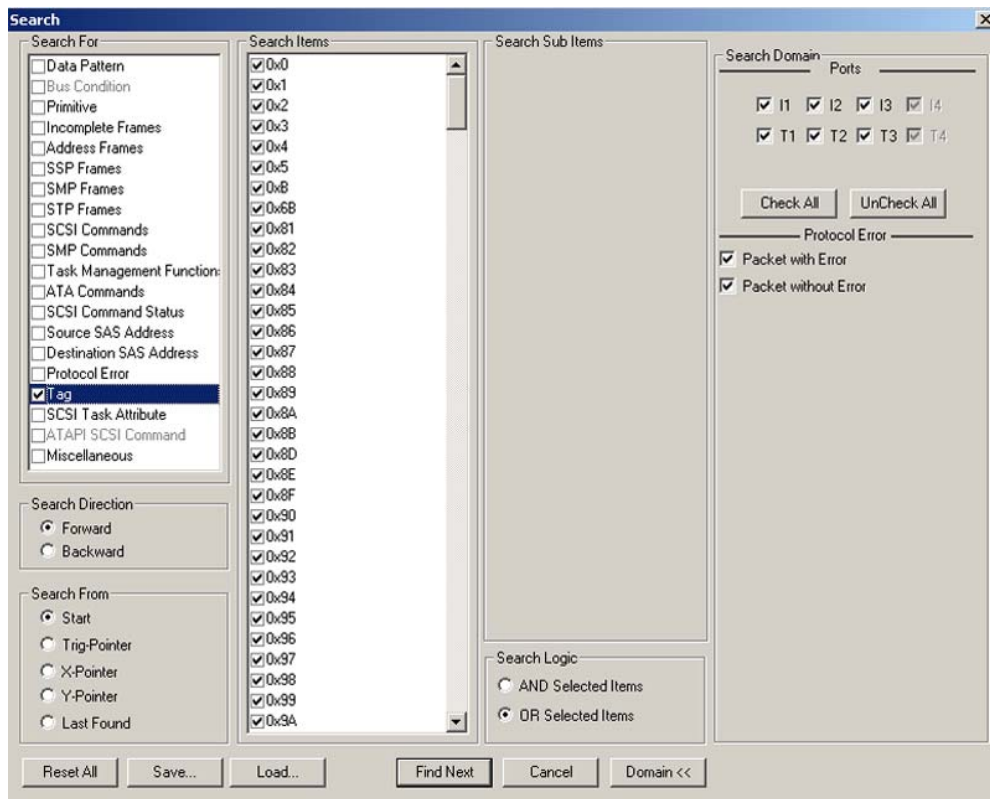

Figure 3.98: Search by Tag Number

Show/Hide Ports

You can **Show/Hide a Single Port** or you can **Show/Hide Multiple Ports**. To do so click on the **Ch Down Arrow**.

Show/Hide Single Port

If Show/Hide Single Port is selected, you can click on one port button at a time to show/hide the capture for that port. Show/Hide Single Port is time consuming as it shows or hides one port at a time.

Show/Hide Multiple Ports

If Show/Hide Multiple Ports is selected, you can click on multiple ports to show or hide them. This mode is much faster. Click on multiple ports to show or hide them.



Figure 3.99: SAS: Show/Hide Ports Toolbar





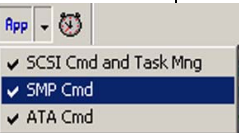

Figure 3.100: SATA: Show/Hide Ports Toolbar





You can also show or hide a port by right-clicking a **Port ID** in Text View or Column View and choosing **Show** or **Hide** (see Figure 3.104).

Packet View Toolbar

The Packet View toolbar allows wrapping, zooming, and configuration.

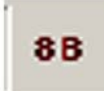

	<p>The Wrap Packets button on the Viewer Toolbar wraps the packet data in the display to eliminate the need for horizontal scrolling.</p>
	<p>Go to CATC Navigation View. Click this button to change the trace display to a CATC Trace™. You can change the colors, fonts, and so on, in the Trace Viewer Configuration (see “Trace Viewer Configuration” on page 284).</p>
	<p>The Show/Hide Link Packet button displays/hides the Link layer (SAS only).</p>
	<p>The Show/Hide Transport Packet button on the Layers Toolbar displays/hides the Transport layer and below (SAS only).</p>
 	<p>The Show/Hide All Commands Packet button shows/hides the Command layer and all layers below: SCSI Cmd and Task Mng, SMP Cmd, and ATA Cmd (SAS only). Click the down arrow on the Show/Hide All Commands Packet button to choose command types to show/hide.</p>
	<p>The Show/Hide Physical Packet button toggles the display of physical layer packets (SATA only).</p>
	<p>The Show/Hide FIS packet button toggles the display of FIS layer packets. When “OFF”, the FIS layer and its links are hidden (SATA only).</p>
	<p>The Show/Hide CMD packet button toggles the display of the CMD packets. When “ON”, only the command layer displays (SATA only).</p>
	<p>The Show/Hide Command Queue button displays queued commands. (SATA only)</p>

	The Order/Reorder button toggles the time order of packets.
	The Pack/Unpack Repeated Primitives toggles packing repeated primitives in one port. (SAS only)
	The 10B button displays the payload data as 10-bit encoded data.
	The 8B button displays the payload as 8-bit scrambled or unscrambled data, depending on the Scrambled setting.
	The SC button selects scramble/unscramble for the 8-bit payload data.

CATC Navigation View

To change the trace display to a CATC Trace™, click the **CATC Navigation**  button. You can change the colors, fonts, and so on, in the Trace Viewer Configuration (see [“Trace Viewer Configuration” on page 284](#)).

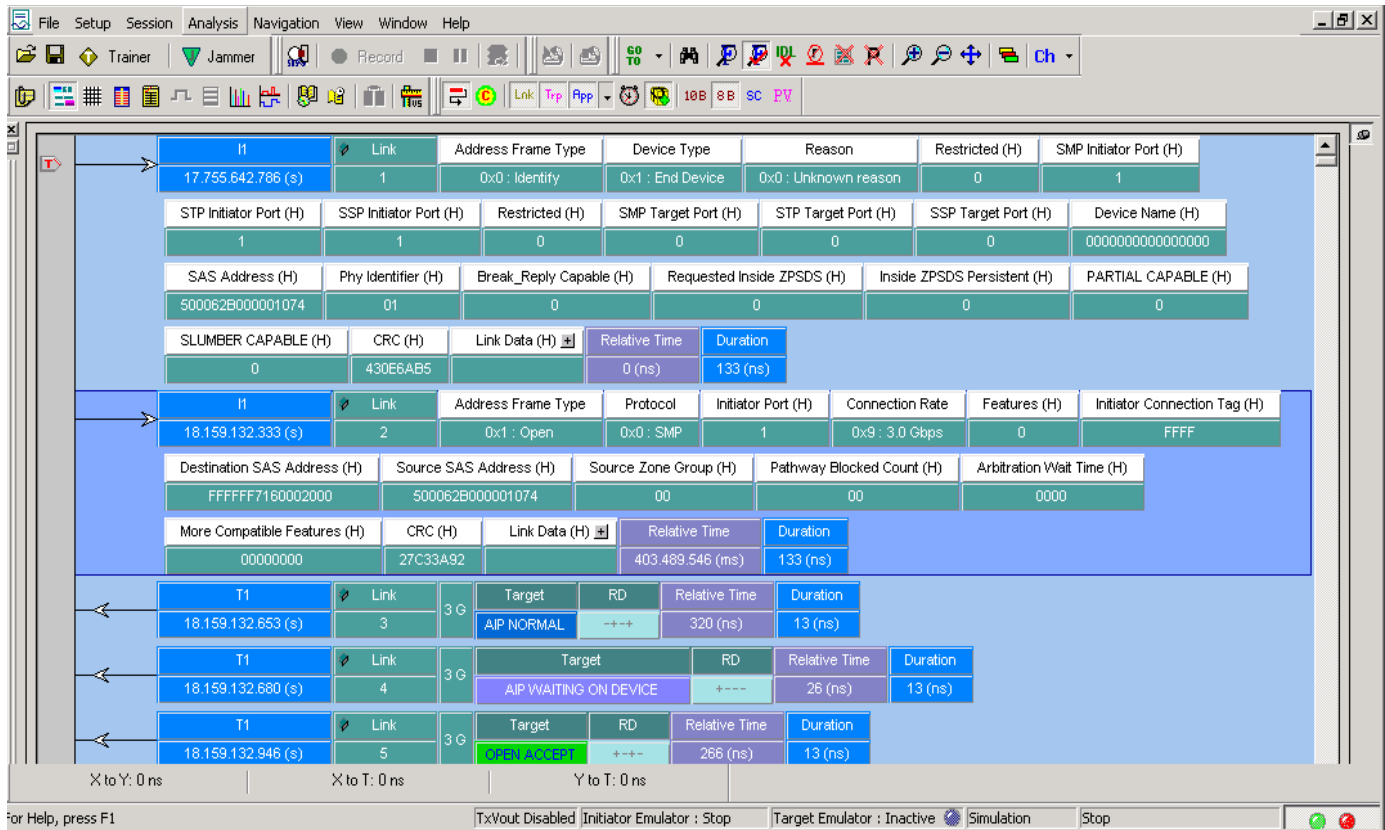

Figure 3.101: CATC Navigation View

Spec View

Spec View shows packet header information.

To obtain the Spec View from the CATC View, left-click to display a popup menu, then select the **View Field** option (see [Figure 3.102 on page 275.](#))

To obtain the Spec View from the Catalyst View, right-click to display a popup menu, then select the **View Field** option.

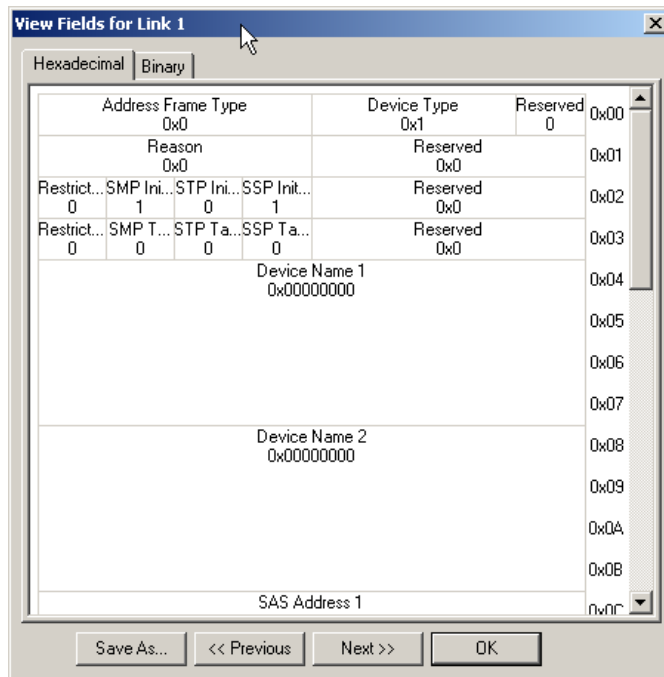

Figure 3.102: Spec View

The tabs allows you to display **Hexadecimal** or **Binary**.

The buttons allow you to go to **Previous** or **Next**.

You can **Save As** a text file.

Decode Icons

The **Decode Toolbar** controls encoding and scrambling features.

To view corresponding Unscrambled and Scrambled payload data values instantaneously, position the mouse pointer over a data field.

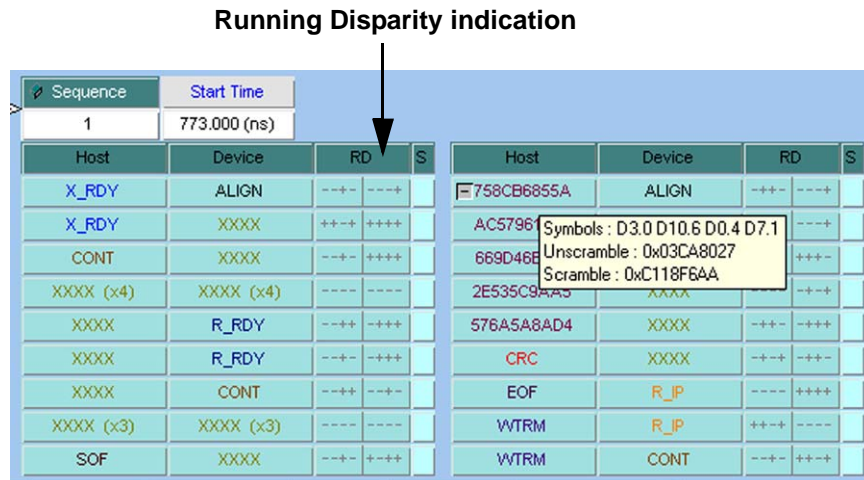

Figure 3.103: Payload Data Display

Customize Display

You can customize the display as explained below.

Rename Port

You can rename each port for easy identification. To rename a port, right-click the **port ID** in Text View or Column View.

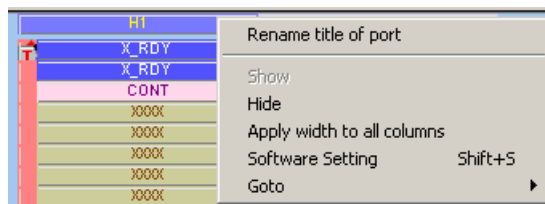

Figure 3.104: Rename Port

Choose **Rename title of port** to open the Rename Title of Port dialog.



Figure 3.105: Rename Title of Port

Select and Apply Show/Hide Port Mode

You can simplify the viewer display by hiding the captures of ports. All active ports are highlighted on the Show/Hide Ports toolbar.

You can **Show/Hide a Single Port** or you can **Show/Hide Multiple Ports**. Click on the drop-down arrow and select from the two options as shown in the following figure:

- Show/Hide Single Port
- Show/Hide Multiple Ports

Click on the **Apply show/hide port** button to apply the specific mode.

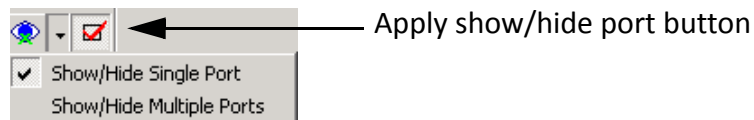

Figure 3.106: Show/Hide Single or Multiple Ports

Show/Hide Single Port

If Show/Hide Single Port is selected, you can click on one port button at a time to show/hide the capture for that port. Show/Hide Single Port is time consuming as it shows or hides one port at a time.

Show/Hide Multiple Ports

If Show/Hide Multiple Ports is selected, you can click on multiple ports to show or hide them. This mode is much faster. Click on multiple ports to show or hide them.



Figure 3.107: SAS: Show/Hide Ports Toolbar



Figure 3.108: SATA: Show/Hide Ports Toolbar

You can also show or hide a port by right-clicking a **Port ID** in Text View or Column View and choosing **Show** or **Hide** (see Figure 3.104).

Show/Hide Field

You can simplify the Viewer display by hiding some fields. You can hide the **Duration**, **Relative Time**, **External Signals**, and **Packet number** fields by right-clicking the corresponding field title and choosing **Hide Field**.

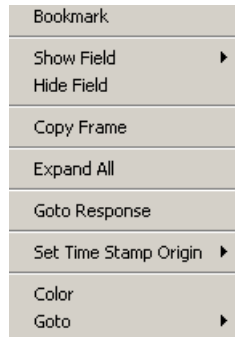

Figure 3.109: Hide Field

To restore a field to the display, right-click a **Port ID** field and choose the hidden field to restore

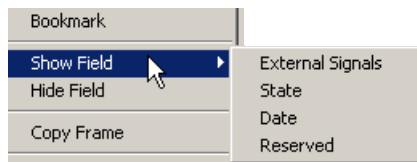

Figure 3.110: Show Field

Note: Only the fields previously hidden appear in the restore list.

Related Frames

Right-click a **Command frame** for an SSP frame, or **Register Device to Host** for an STP frame, to open a short-cut menu, then choose **Goto Response** to jump to the corresponding Response frame in the viewer.

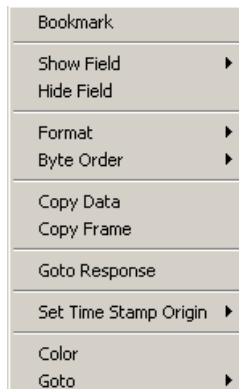

Figure 3.111: Goto Response

Similarly, right-click a **Response frame** for an SSP Frame, or **Register Device to Host** for an STP frame, to open a short-cut menu, then choose **Goto Command** to jump to the corresponding Command frame in the viewer.

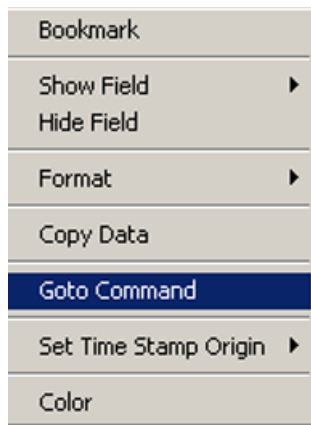

Figure 3.112: Goto Command

In Column View, you can right-click a DWORD inside a frame to display the **Goto Within Packet** command. You can jump to an SOF, EOF, HOLD, or R_IP.



Figure 3.113: Goto Within Packet Command

Byte Order

You can change the byte order in fields marked by an arrow and other fields.

Right-click in the field, select **Byte Order**, and choose the ordering.

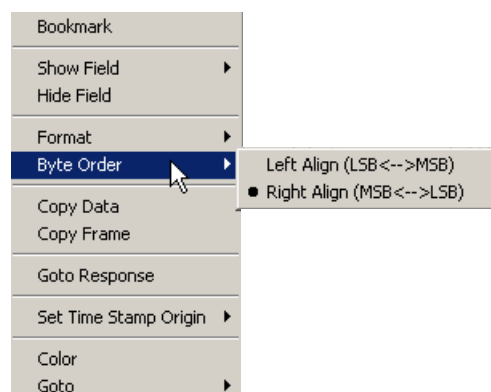

Figure 3.114: Byte Order

Note: A blue arrow in the byte order field indicates that it has been changed.

Choose Data Format

You can display data values either in hexadecimal (default) or binary. To choose data format, right-click the mouse over a data field, and choose **Format** and the format.

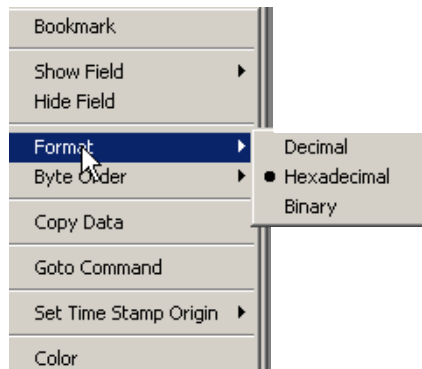

Figure 3.115: Format

Show All Data

To display all captured data, click the **data expand** toggle arrow in a data field, to examine the data in detail.

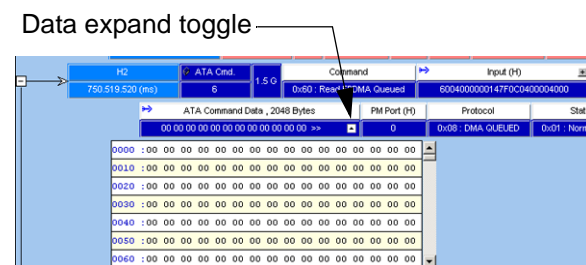

Figure 3.116: Show All Data

You can expand or collapse all data fields globally. To expand all data fields, right-click the mouse in a data field and choose **Expand All**.

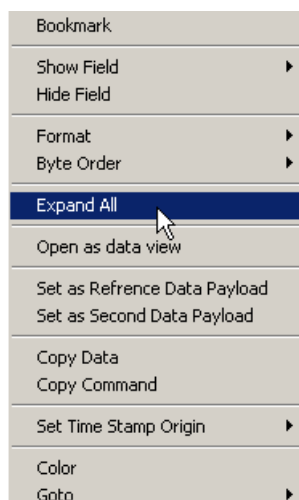
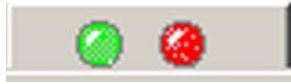

Figure 3.117: Expand All

To collapse all fields, right-click the mouse in a data field and choose **Collapse All**.

Port Status

You can get an overview of the active ports by clicking the **Port Status** button at the bottom right of the application window.



The Port Status displays the Port, Speed, and Analyzer.

In addition to displaying OOB, Link, Frame, and Error, a display showing the % buffer full opens when a trigger occurs.

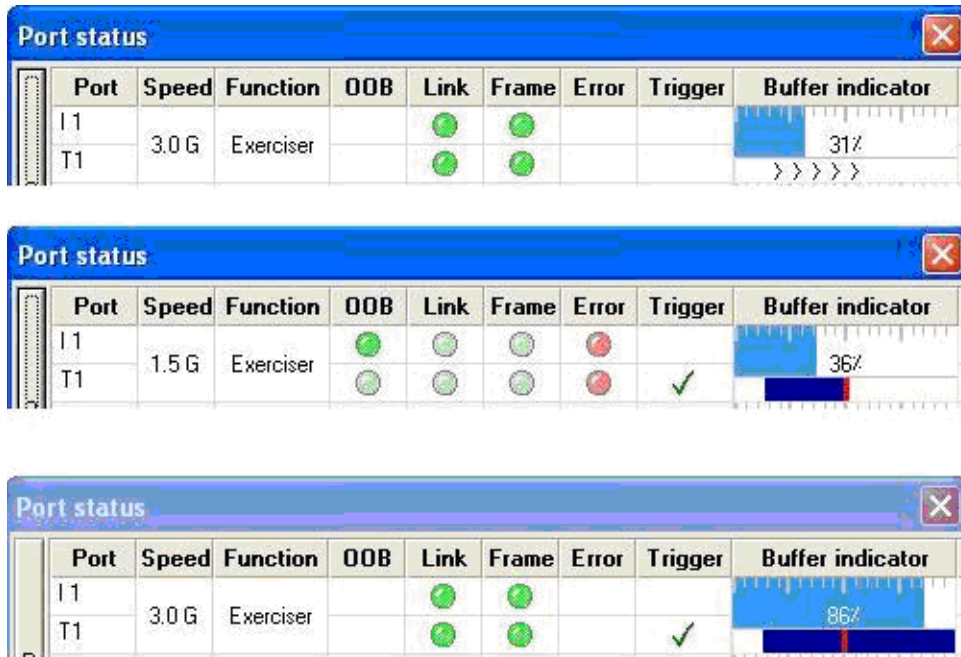

Figure 3.118: Port Status Window and Capturing Time

1. Pre-trig capturing (trig is 50%)
2. Trig point (shown by red bar; 36% pre trig was captured)
3. Post-trig capturing (50% post-trig was captured and capturing has stopped)

Note: If sample capture occurs with more than one unit active, additional Port Status windows display.

The OOB, Link, Frame and Error LEDs in the Port Status dialog mimic/follow the LEDs on the Front panel of the unit.

Reset button

LEDs illuminated

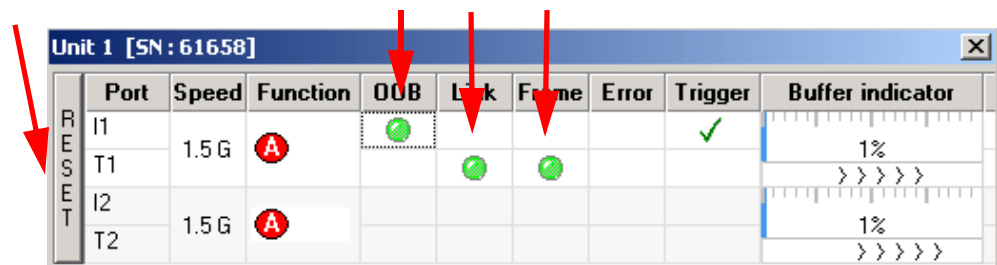

When the LEDs are dim, it indicates they were lit in the past. Pressing the Reset button erases this history and the illuminated LEDs are removed from the dialog.

Toolbars

Enabling Tool Bars

To customize the Viewer Display workspace, you can enable and reposition the available toolbars. To display or hide toolbars, select **View > Toolbar**, then check or uncheck toolbars.



Toolbars are:

- Main
- Record + Capture
- Analysis
- Navigation + View
- Packet View
- Column View
- Cursor Position
- Device/Target Emulator

Once enabled, the toolbars can dock at the Viewer Display window or float on the windows desktop.

Cursor Position Status Bar

To display the cursor position status bar, select **View > Status Bar**.

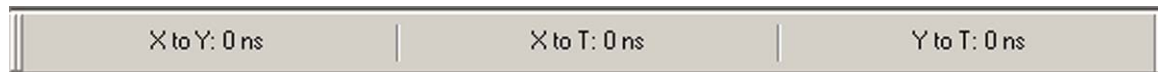

Figure 3.119: Cursor Position Toolbar

See [“Using the Cursors and Bookmarks” on page 283](#).

Status Bar

The Status bar is located at the bottom of the main display window.

Search Status

The right most segment displays the current search direction: **Fwd** (forward) or **Bwd** (backward). Change the search direction from the Search Menu or double-click the Search Status segment.

Using the Cursors and Bookmarks

Cursors

The data viewer display incorporates three cursors labeled **X**, **Y**, and **T**. All cursors are initially overlaid and positioned at location 0, which is the trigger position of the display. The Trigger, or **T**, cursor is the measurement reference and is always at location 0 in the display.

Positioning the X Cursor

To position the X-Cursor within the viewer data display, click the left mouse button in the gray bar on the left side of the sample viewer next to the line in which to place the cursor.

Positioning the Y Cursor

To position the Y-cursor within the viewer data display, click the right mouse button in the gray bar on the left side of the sample viewer next to the line in which to place the cursor.

Note: You can also left-click to set the X-cursor and right-click to set the Y cursor in the Frame and Column View by clicking in the narrow strip on the very left side of a cell. Similarly, you can set the cursors in the Waveform View by left and right clicking at the beginning of a waveform.

Time

Time differences between the cursors are displayed in the Cursor Position toolbar. To display the cursor position toolbar, select **Toolbar** from the view menu and choose Cursor Position.



Figure 3.120: Cursor Position Toolbar

Display Configuration

The Analyzer ships with a default display configuration of field and viewer settings. You can define your own field and viewer settings for a particular testing scenario. Right-click in the Packet View and select **Display Option**. The Trace Viewer Configuration dialog displays (see [Figure 3.121 on page 285](#)).

Trace Viewer Configuration

The Trace Viewer Configuration dialog allows you to change the following display settings:

- Field Setting
 - Format (Decimal, Hexadecimal, Binary)
 - Visible
 - Byte Order (Right Align, Left Align)
- Field Header Setting
 - Text (color)
 - Name
 - Abbreviation
 - Foreground (color)
- Viewer Setting
 - Wrap Packet
 - Enable Tooltips
- Data Payload
 - Columns in Row (1, 2, 4, 8, 16)
 - Bytes in Column (1, 2, 4, 8, 16)
- Time Stamp Origin: Absolute, Trigger, User Defined, Based on System Time
- Same color for start time and port
- Enable Packet View Condense Mode
- Time Stamp Format (LeCroy, Milli, Micro)
- Save Trace Viewer Configuration in a file
- Load Trace Viewer Configuration from a file
- Factory Setting (restores default settings)
- Font (opens Font dialog)

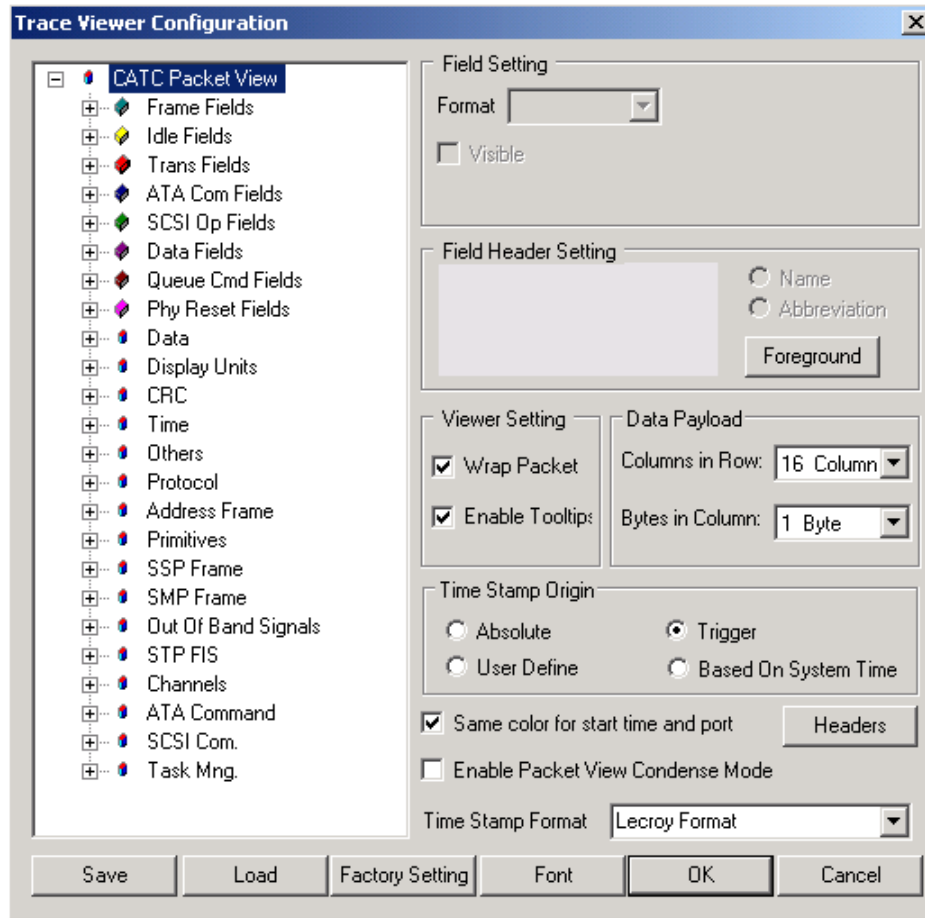

Figure 3.121: Trace Viewer Configuration

Field Settings

To view a packet field, select a field from the packet field tree and check the **Visible** box. Uncheck it to hide the field. To change the data format of a packet field, select the field and choose a data format from the Format drop-down list.

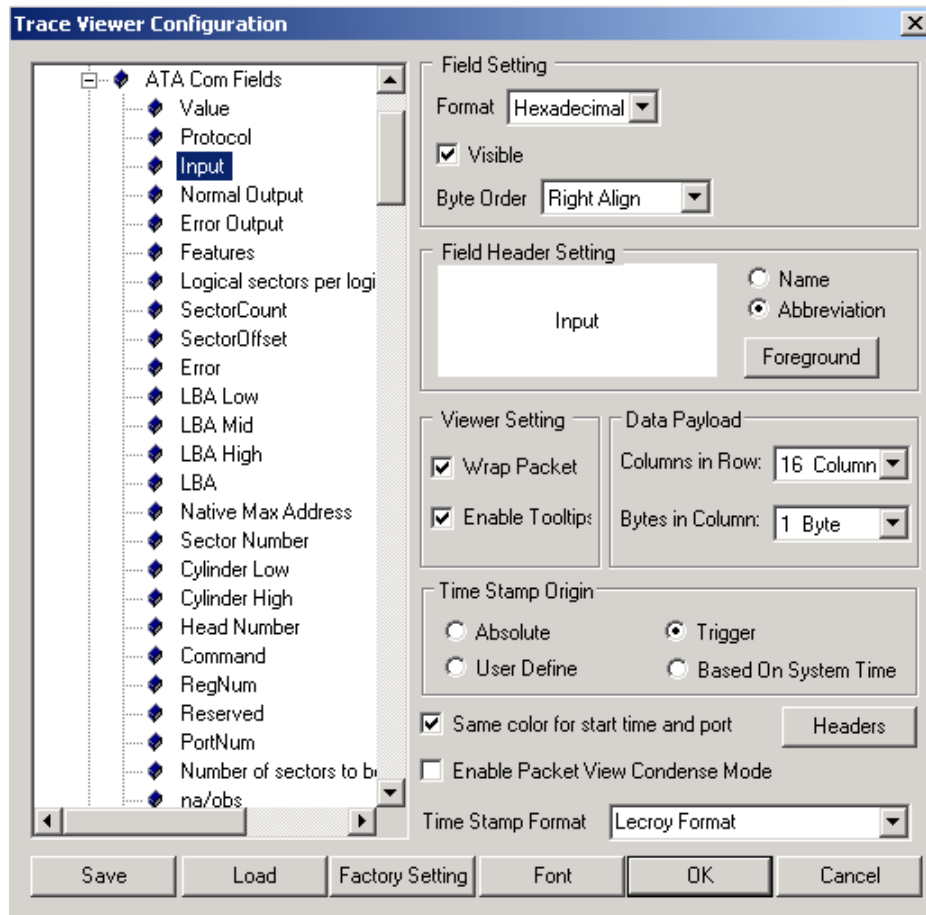

Figure 3.122: ATA Command Fields

Field Header Setting

You can use the Name or Abbreviation.

To change the color of the text in a packet field header, select a field from the packet field tree and click the **Foreground** button.



Figure 3.123: Color

Choose an appropriate color and click **OK**.

Viewer Setting

Check the **Wrap Packet** box to enable the wrapping of packets in the display.

Check the **Enable Tooltip** box to enable tool tips for packet fields.

Data Payload

You can format the Data Payload display.

For Columns in Row, select 1, 2, 4, 8, or 16.

For Bytes in Column, select 1, 2, 4, 8, or 16.

Time Stamp Origin

Select Absolute, User DEfined, Trigger, or Based on System Time.

Start Time and Port

You can use the same color for the start time and port.

Packet View Condense Mode

You can enable Packet View Condense Mode to minimize Packet View rows.

Time Stamp Format

Select LeCroy, Milliseconds, or Microseconds.

Font

To change display fonts, click the **Font** button to open the Font dialog box.

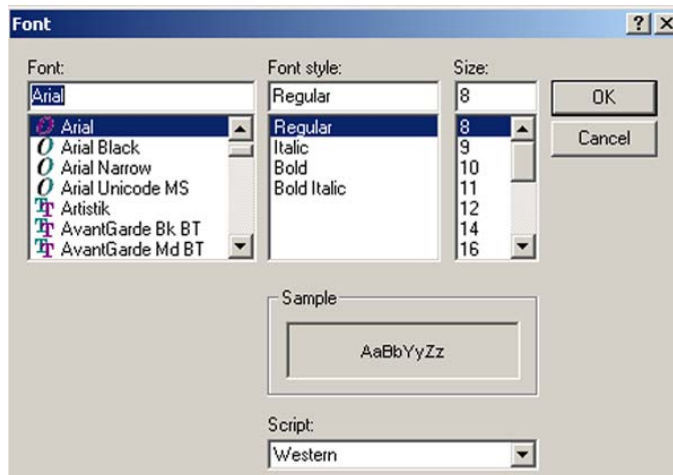

Figure 3.124: Font

Choose the font, font style, and size, and click **OK**.

Save/Load Settings

You can save the customized configuration settings in a ***.cfg** file by clicking the **Save** button and completing the Save As procedure. To load a previously saved configuration file, click **Load** and choose an appropriate file.

Set Port Alias

Port Alias allows you to assign a meaningful name to each port to assist in interpreting the results displayed in the sample view (see [Figure 3.125 on page 289](#)).

To assign port names in an open sample view, select **Setup > Set Port Alias**.

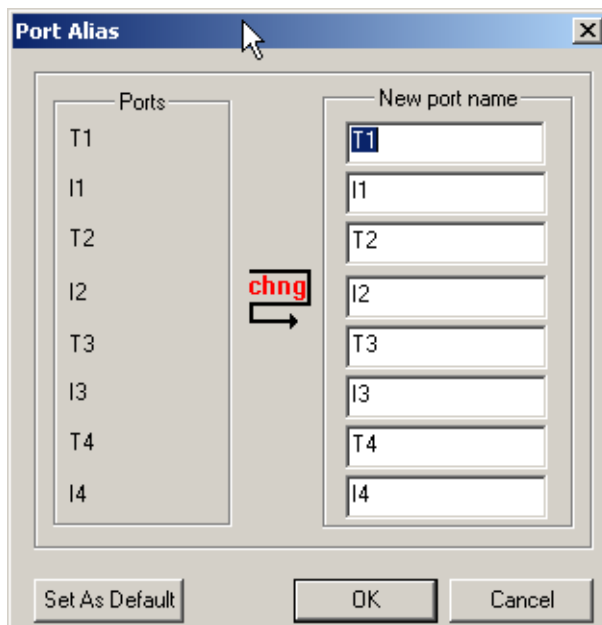

Figure 3.125: SAS: Assign Port Alias

Assign a meaningful name to each port in use and click **OK**. The assigned names replace the port numbers in the sample view.

←	Host	↗	Link
	33.426.666 (us)		306
	Device 1	↗	Link
→	33.453.333 (us)		307

If you elect to save the capture sample file, the assigned port names are saved together with the result, so that when you open the sample file later, the assigned names are retained.

Set As Default

If you want to set these port aliases for sample files that will be captured later, you can set them as default, and new samples will be opened by these default port aliases.

SAS Address Alias (SAS only)

SAS Address Alias allows you to assign a meaningful name to each SAS address to assist in interpreting the results displayed in the sample view. To assign SAS address names in an open sample view, select **Setup > Set SAS Address Alias**. See the following screen capture.

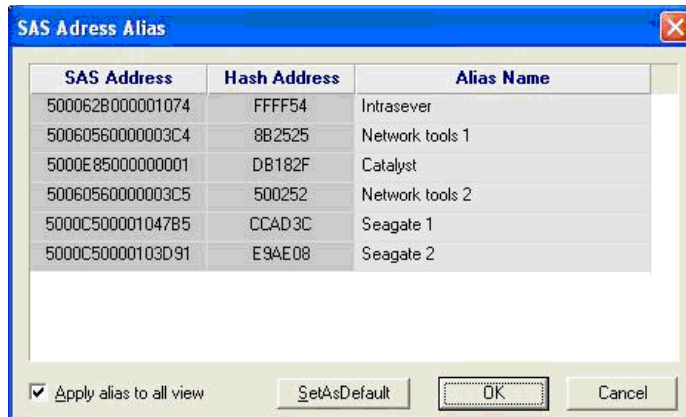

Figure 3.126: SAS: Assign SAS Address Alias

Assign a meaningful name to each SAS address in use and click **OK**. The assigned names replace the SAS address in the sample view, Search, filter, and Statistical report.

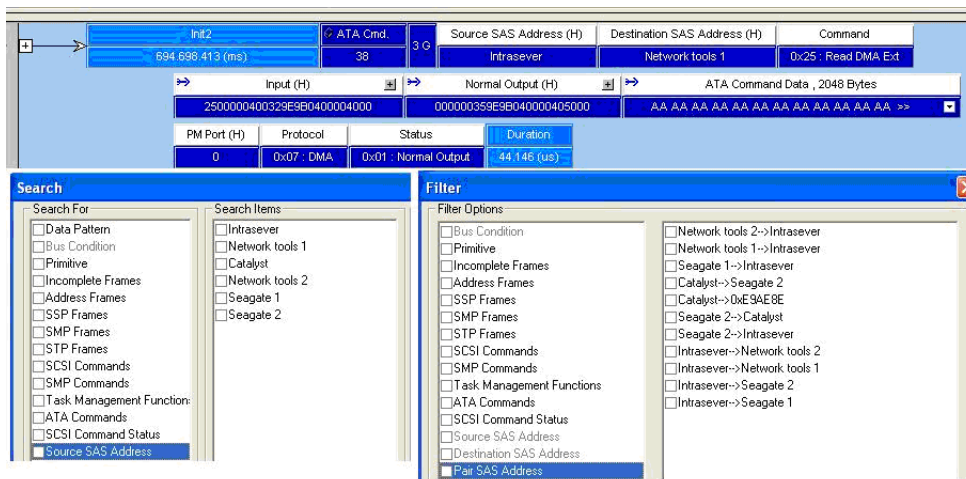

Figure 3.127: SAS: SAS Address Alias

If you elect to save the captured sample file, the assigned SAS address names are saved together with the result, so that when you open the sample file later, the assigned names are retained.

Set As Default

If you want to set these SAS address aliases for sample files that will be captured later, you can set them as default, and new samples will be opened by these default SAS address aliases.

Tx Vout & Preemphasis

The analyzer incorporates the ability to select TX Vout for the transmitter on each port. Selecting TX Vout increases the output voltage swing above the nominal value, for test and characterization purposes. This feature is also useful to compensate for line loss when driving long cables.

To select TX Vout, select **Setup > Tx Vout & Preemphasis** to display the Rx/Tx Settings dialog:

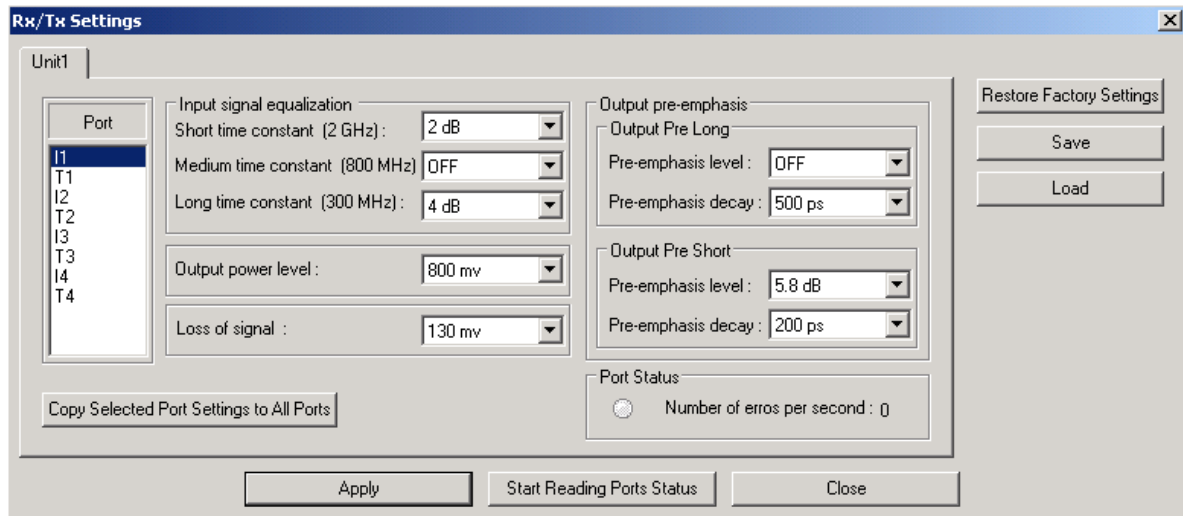

Figure 3.128: Choose Port for TX Vout

Copy Selected Port Settings to All Ports implements one port's setting into all other port settings.

Port Status displays number of errors per second.

Start Reading Port Status implements reading of number of errors displayed in Port Status.

Restore Factory Settings restores default values.

Save saves the new values as a *.sng file.

Load loads back the saved *.sng file.

Software Settings

Software settings allows you to define template files for new Analyzer projects, to specify how sample files appear when opened, and to set ATAPI and SCSI Spec Assignments.

To perform software settings in an open sample view, click **Setup** on the toolbar and choose **Preferences**.

General Tab

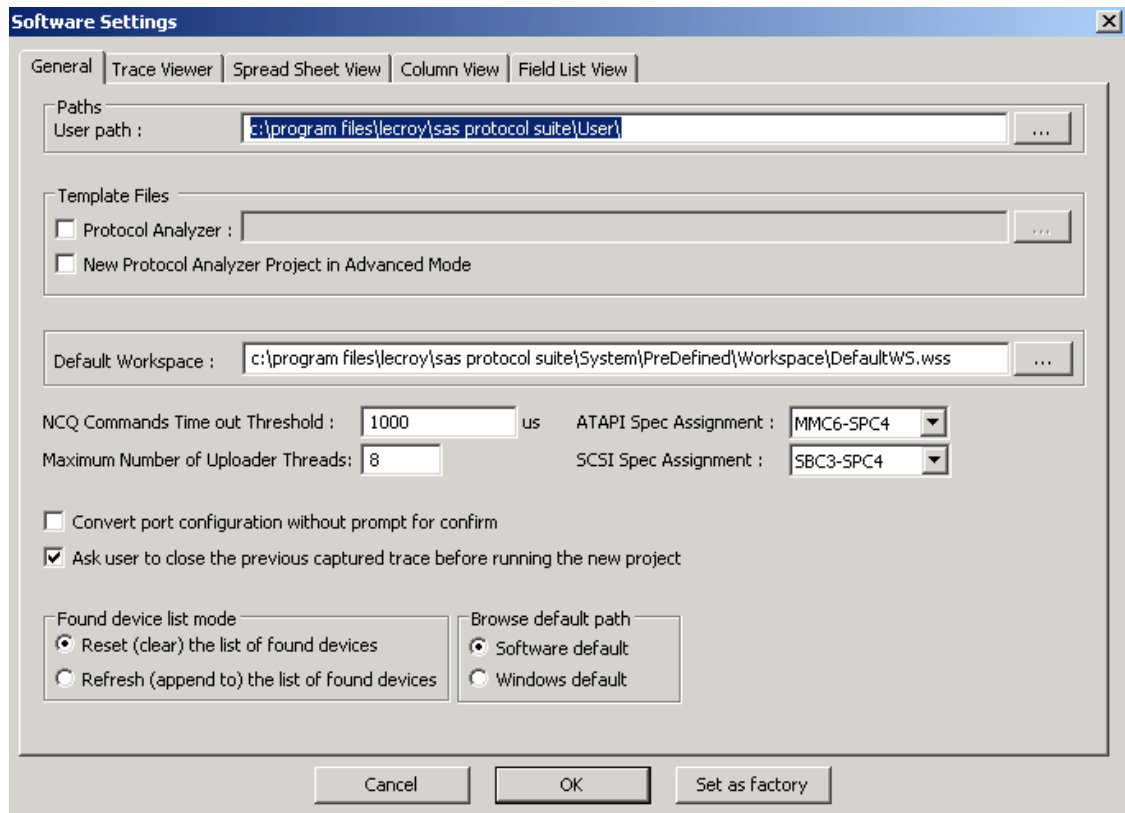

Figure 3.129: SAS: Software Settings Dialog General Tab

The SATA Software Settings dialog has the same options, except that it does not have “SCSI spec assignment”.

Paths

User Path specifies the “User” folder path, used by the software after launching the Open dialog.

Template Files

Protocol Analyzer: You can use a pre-saved analyzer and/or analyzer/emulator project file as a template. Whenever you make a new project file, the software uses the template to initialize the project file.

New Protocol Analyzer Project in Advanced Mode: When you use the New menu item to create a new project file, the software switches to Advanced mode automatically.

Other

Default Workspace specifies the default workspace file for opening a sample file. You can save any viewer configuration as a workspace and then specify it as the default workspace. The software always open a trace file based on the default workspace file.

NCQ Commands Time out Threshold: The software uses this setting in the statistical ATA command page for NCQ commands. If the time out exceeds this setting, the software reports an error.

Maximum Number of Uploader Threads: If Quick View is not enabled, during cascading, specifies the number of concurrent processes for uploading a sample file.

ATAPI spec assignment: Specifies the ATAPI default spec.

SCSI spec assignment (SAS only): Specifies the SCSI default spec.

Convert port configuration without prompt for confirm: If the current attached board does not support the project file port configuration, the software converts it to a supported port configuration without asking for confirmation. If this setting is unchecked, the software asks for confirmation

Ask user to close the previous captured sample before running the new project: When you start to run a new project, the software prompts you to close the current sample.

Found Device List Mode

Reset (clear) the list of found devices: Lists only the currently found devices.

Refresh (append to) the list of found devices: Adds new devices to the list of devices found previously.

Browse Default Path

Software default: After you select **File > Open**, the Open dialog shows the default user folder.

Windows default: After you select **File > Open**, the Open dialog shows the path selected when the Open dialog was last used.

Trace Viewer Tab

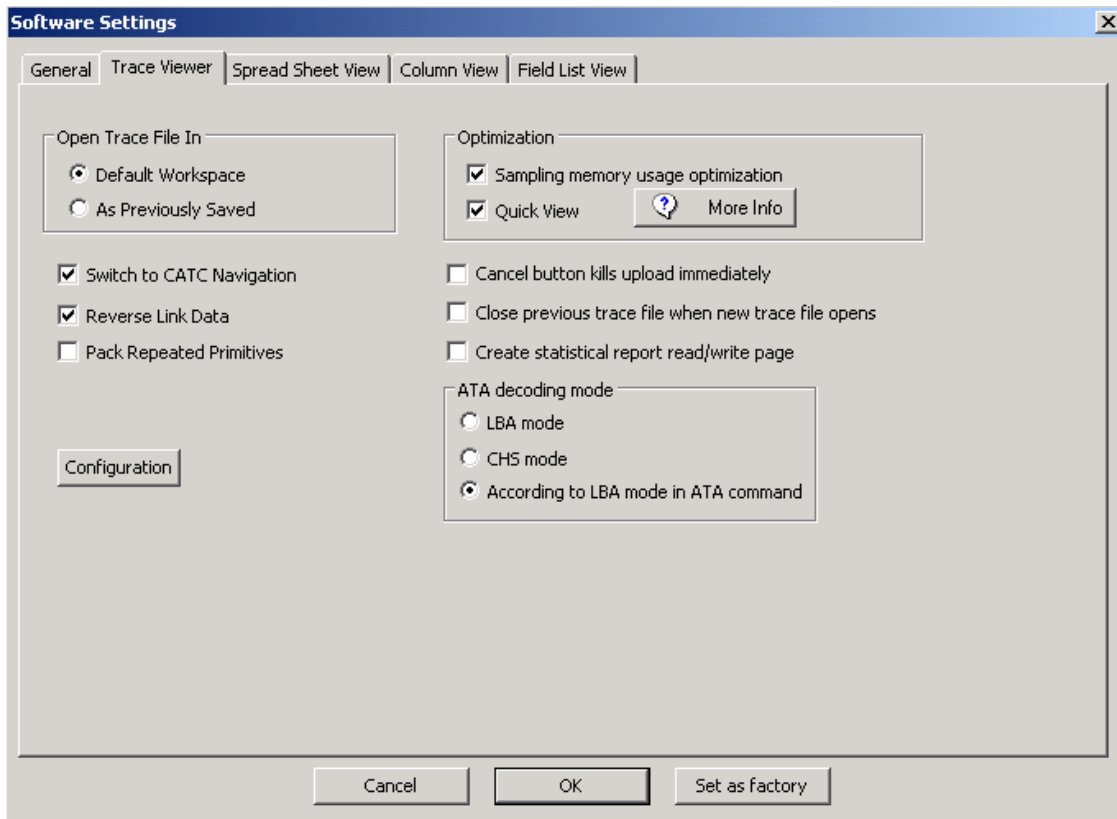

Figure 3.130: SAS: Software Settings Dialog Trace Viewer Tab

The SATA Software Settings dialog has the same options.

Open Trace file In

Default Workspace: The software opens a **trace** file in view(s) based on the specified default workspace.

As previously saved: The software opens a trace file in view (views) based on the last saved configuration for the **trace** file.

Optimization

Sampling memory usage optimization: Enables memory cascading for two ports. The analyzer will use memory of another port if there is not data on another port. (see [“Sampling Memory Usage Optimization” on page 299](#))

Quick View: Quick View allows full access to the whole trace more quickly, especially when using a Gigabit Ethernet connection. However, the trace is NOT written to the Host PC hard drive. To save the trace, you must manually click **Save**.

If you do not check Quick View, the trace loads more slowly but is automatically saved to the Host PC hard drive.

Other

Switch to CATC Navigation: Packet view will open in CATC mode.

Reverse Link Data: The software shows DWORDs of link data as reversed.

Pack Repeated Primitives: The software packs repeated primitives just after opening a sample file.

Cancel button kills upload immediately: The software kills the uploading process if you press **Cancel**.

Close previous sample file when new sample file opens: When you want to open a new sample file, the software closes any open sample files.

Create statistical report read/write page: The software creates a Read/Write page in the statistical report. Enabling this setting displays the **Read/Write Stream DMA** command in the Read/Write page.

LBA mode: Checking this box enables LBA mode for ATA decoding.

CHS mode: Checking this box enables CHS mode for ATA decoding.

According to LBA mode in ATA command: Checking this box enables decoding according to LBA mode in ATA command for ATA decoding.

Configuration: Clicking **Setup** displays the Trace Viewer Configuration dialog (see below).

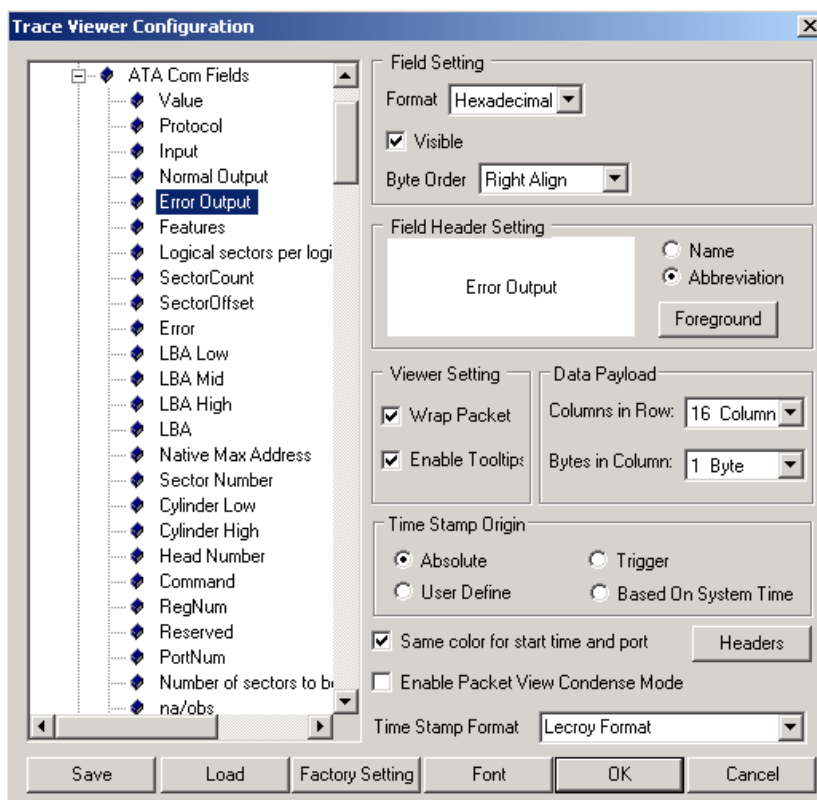

Figure 3.131: SATA: Software Settings Dialog Spread Sheet View Tab

Select a view in the left pane and set the trace viewer display options in the right pane.

Spread Sheet View Tab

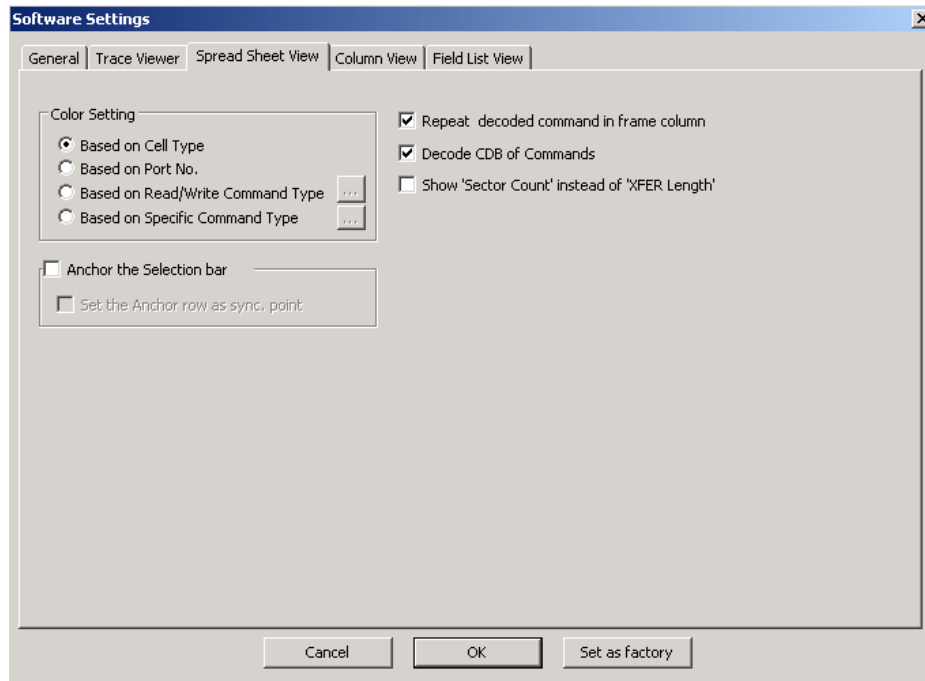

Figure 3.132: SATA: Software Settings Dialog Spread Sheet View Tab

The SAS Software Settings dialog has the same options, except that it does not have “Show ‘Sector Count’ instead of ‘Xfer Length’”.

Color Setting

Based on Cell Type: Each column has its own color.

Based on Port No.: Data of each row are shown based on the specified color for its port. You can set the color of ports in the Viewer settings.

Based on Read/Write Command Type: You can specify a color for Read commands, another color for Write commands, and other color for other commands. The software shows each row based on the command type: Read, Write, or others.

Based on Specific Command Type: You can specify a color for each command. The software applies the setting on the Command column.

Anchor the Selection Bar

You can anchor the selection bar of the Spreadsheet View.

Set the Anchor row as sync. point: Other views synchronize based on the contents of the anchor row.

Other

Repeat decoded command in frame column: The spreadsheet shows the name of the command in front of all frames in the Command column. Otherwise, it will show the name of the command only in front of the SSP command frame.

Decode CDB of Commands: The spreadsheet shows name of command in command column, otherwise shows CDB of command in command column.

Show 'Sector Count' instead of 'Xfer Length' (SATA only): Display sector count.

Column View Tab

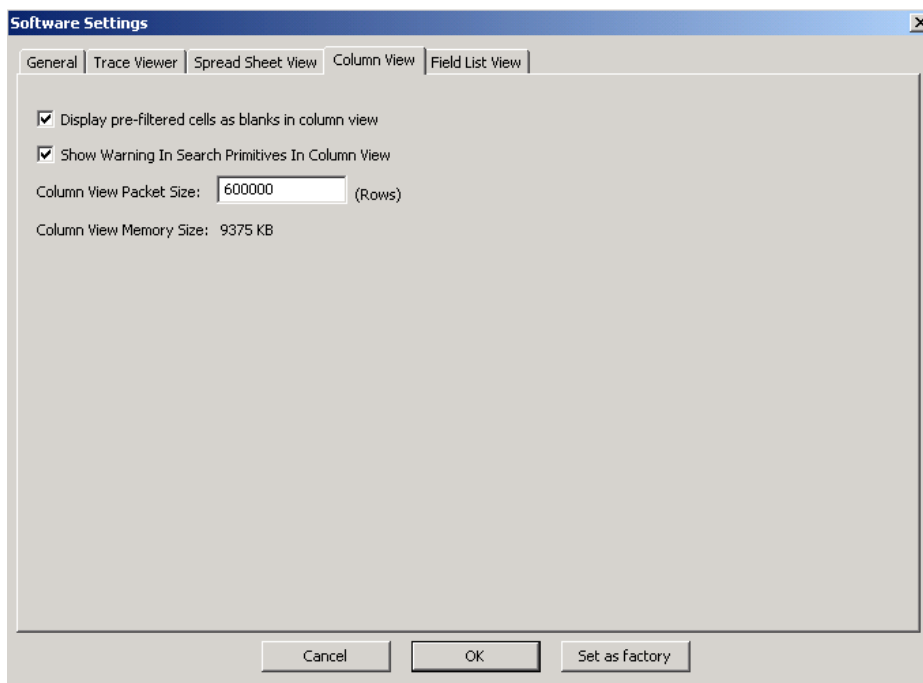

Figure 3.133: SAS: Software Settings Dialog Column View Tab

The SATA Software Settings dialog has the same options.

Other

Display pre-filtered cells as blank in column view: The software shows pre-filtered data (already filtered in the capture project), as blank cells. Otherwise, it will show them as “pre-filtered” cells.

Show Warning in Search Primitive In Column View: If searching in Column View takes a long time, the software asks if you want to continue search. Otherwise, the software continues searching with no pause.

Column View Packet Size: Specifies the allocated buffer for showing rows of a packet in Column View: When you see “Too Large” in a Column-View cell, the current allocated buffer is not enough and you should increase it by changing this setting.

Column View Memory Size: Displays the memory buffer.

Field List View Tab

The Field List View tab has the default settings as shown below.

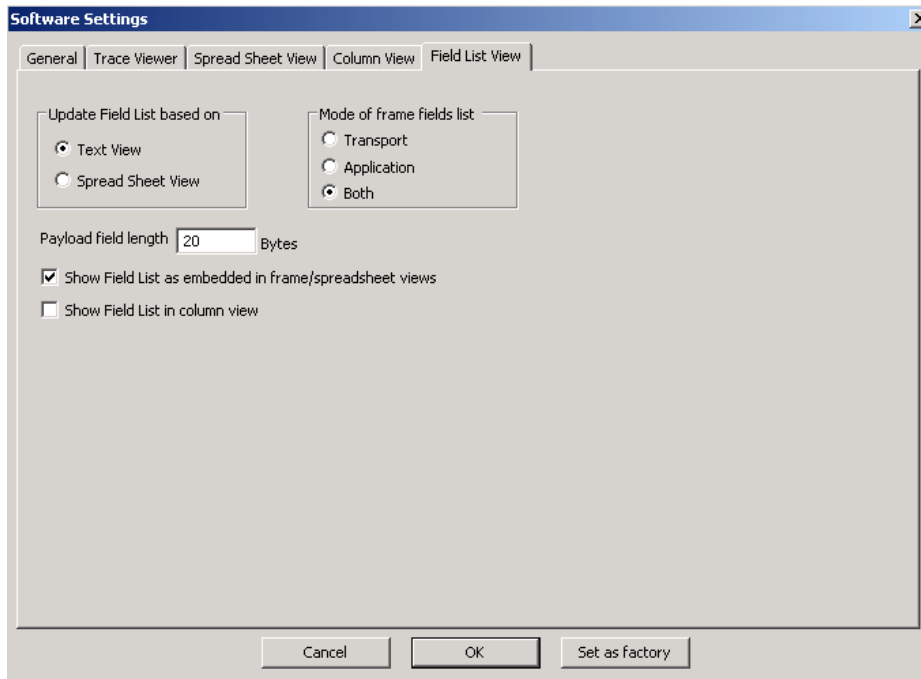

Figure 3.134: SAS: Software Settings Dialog Field List View Tab

The SATA Software Settings dialog has the same options.

For additional information on Field List View, refer to [“Field List View” on page 212](#)

Update Field List Based On

Text view: The software updates the contents of the Field List based on the current Text View.

Spreadsheet view: The software updates the contents of the Field List based on the current Spreadsheet View.

Mode of Frame Field List:

Transport: Shows decoding of transport layer.

Application: Shows decoding of Application layer.

Both: Shows decoding of both transport and application layers.

Other

Payload Field Length: Specifies the number of bytes that are shown in the field list for payload fields.

Show Field List as Embedded In Frame/Spreadsheet Views: The Field List is embedded in frame/spreadsheet views. Otherwise, it will open as a separated view.

Show Field List in Column View: The software embeds the Field List in the column. Otherwise, the Field List is not in Column View.

Sampling Memory Usage Optimization

The Software Settings dialog has a Sampling Memory Usage Optimization option in the **Trace Viewer** tab. This Memory Assignment (MA) feature optimizes sampling memory utilization.

If the Sampling Memory Usage Optimization Option is Checked

The system tries to use empty space in all memory banks to prevent any memory bank from filling completely. Each physical link is not necessarily assigned to a specific memory bank. The system can capture more sample data than if the MA option is unchecked, and sample file size is closer to the user-defined Sampling Memory Size.

Memory Assignment efficiency varies with Port Configuration and Trigger Position:

- ❑ **FPGA:** The Memory Assignment feature works for a pair of ports connected to one FPGA, for example ports 1 and 2 (or ports 3 and 4). Memory Assignment does not work for two ports connected to different FPGAs, for example ports 1 and 3.
- ❑ **Triggering:** Memory Assignment only starts after the trigger point. During pre-trigger, each physical link is always assigned to a specific memory bank. Post-trigger, the system can try to use empty space in all memory banks, if you check the MA option. Therefore, Memory Assignment efficiency is maximum when Trigger Position is set to 0% (snap-shot trigger) and is minimum when Trigger Position is set to 99% or when there is no triggering (you stop recording manually).
- ❑ **MUX:** When MUX is enabled, each segment has four memory banks, limiting Memory Assignment somewhat.

Here are examples of different Port Configurations and Trigger Positions:

- **One port configuration (A - -):** Sample size is user-specified sample size.
- **Two port configuration (AA - -):** Ports 1 and 2 are on the same FPGA, so Memory Assignment has an effect. If you use snapshot triggering, the sample size is near specified size.
- **Two port configuration (AA - -):** If you use manual stop, Memory Assignment has no effect. Sample size depends on port traffic loads.
- **Two port configuration (AA - -):** If trigger is set at 50%, and there is enough data to fill pre-trigger, Memory Assignment has an effect. Sample size is typically near specified size.
- **Two port configuration (AA - -):** If trigger is set at 50%, but there is not enough data to fill pre-trigger, Memory Assignment has an effect. Sample size is typically more than half specified size, with size determined by the amount of data captured before trigger.
- **Two port configuration (A - A -):** Ports 1 and 3 are not on the same FPGA, so Memory Assignment has no effect. If one port has heavy traffic, it may fill its memory bank and stop recording, resulting in smaller sample size than specified.

Note: Checking this option does not affect the sample. It only allows larger sample sizes.

Note: If traffic is balanced on ports, sample size is the same whether you check or uncheck the Sampling Memory Usage Optimization option.

Note: Memory Assignment depends on traffic load distribution at the time when the system tries to re-assign physical links to memory banks. Therefore, if you repeat a capture with the same Sampling Memory Size and Segment Number parameters, the resulting sample size may not be the same. However, if traffic load distribution is similar, sample size will be similar.

Note: The buffer status indicator shows buffer by FPGA, not by port.

If the Sampling Memory Usage Optimization Option is Not Checked

Each physical link (or logical link if MUX is enabled) is assigned to a specific memory space (memory bank), depending on the Sampling Memory Size and Segment Number parameters.

Important: If **any** physical link fills its memory bank, the recording process stops. Other memory banks will typically be less than full (and can be empty). The sample file might be smaller than the user-defined Sampling Memory Size. You might even think that the Analyzer malfunctioned.

Floating License

Note: License Manager is only available when in Cascading mode. For example, if one unit is licensed only for JJJ and a second unit is licensed only for AAAA, cascading the two units and using the License Manager allows each unit to do JJAA.

To manage the license, select **Setup > Manage Setup Licenses**.

The Floating License dialog displays the available functionality by Function, Total Ports, Assigned To ports, and Not Used. It also displays the Current License Configuration by License Type, Serial Number, Analyzer, Device Emulator, Host Emulator, and InFusion.

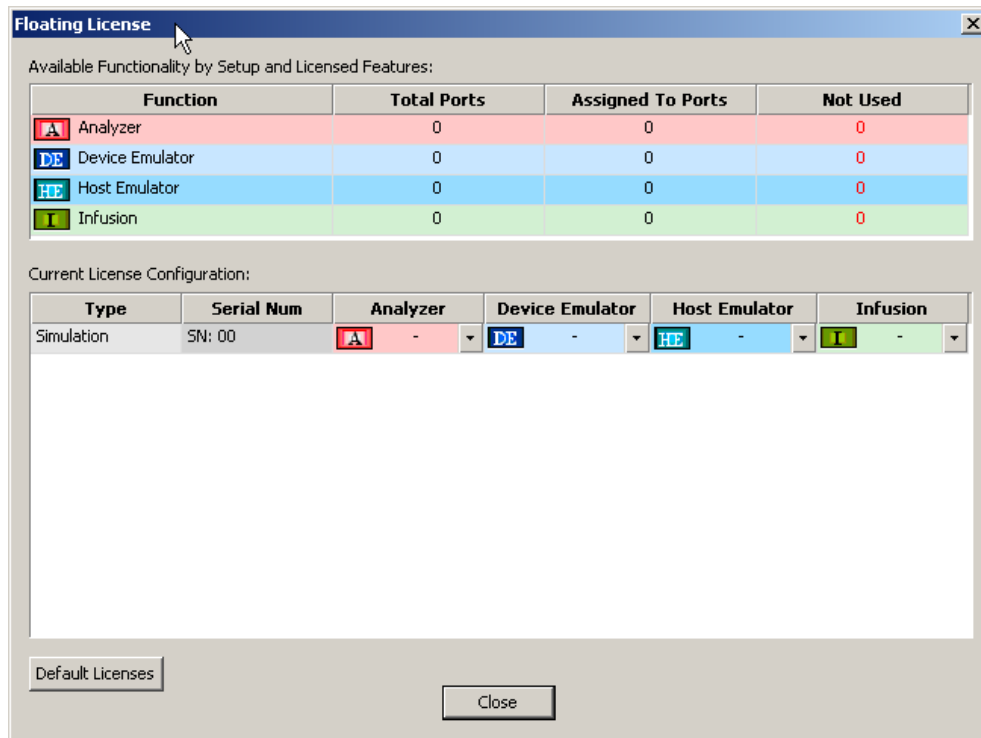

External Trig Setting

The External Trig Setting dialog displays the External Trig Out Setting and External Trig In Setting as High Active, Low Active, or Toggle.

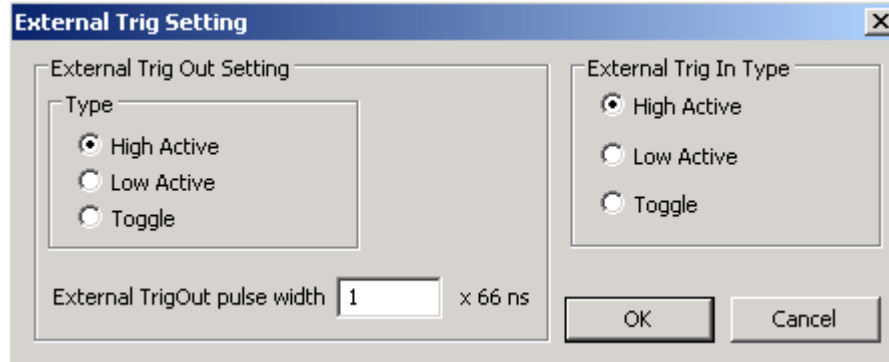

Figure 3.135: External Trigger Setting Dialog

To display the External Trig Setting dialog, select **Setup > External Trig Setting**.

External Trig Out Setting

The Analyzer can send a Low or High external signal anytime a trigger occurs. Select the External Trig Out Setting: High Active, Low Active, or Toggle from High to Low or Low to High once (3.3 V output).

Enter the External TrigOut pulse width.

External Trig In Setting

An external Low or High input signal can cause triggering. Select the External Trig In Setting: High Active, Low Active, or Toggle from High to Low or Low to High once (3.3 V output).

Note: The nominal External Trigger voltage is 0.818 volts. Trigger In can work with 1 volt to 5 volts input voltage.

Update STX Board Interface

The Update STX Board Interface dialog allows you to update the STX Board Interface.

Update Device

The Update Device command allows you to update a Sierra M6-4 Analyzer or CATC-Sync expansion card whose current version is incorrect.

1. Click **Setup > Update Device** to display the Device Setup dialog.

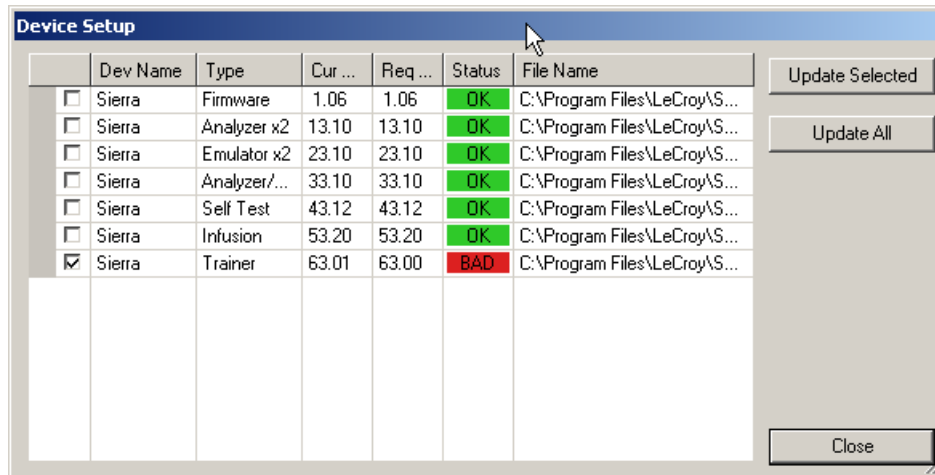

Figure 3.136: Device Setup Dialog with BAD Device Status

Devices whose version is correct have an OK status.

A device whose version is incorrect has a BAD status.

Note: You can click the ellipses (...) at the end of a file path and name to display an Open dialog, in which you can browse for files.

2. Click the checkbox to the left of a device with BAD status, then click **Update Selected** to begin the process that will make the Analyzer version correct.

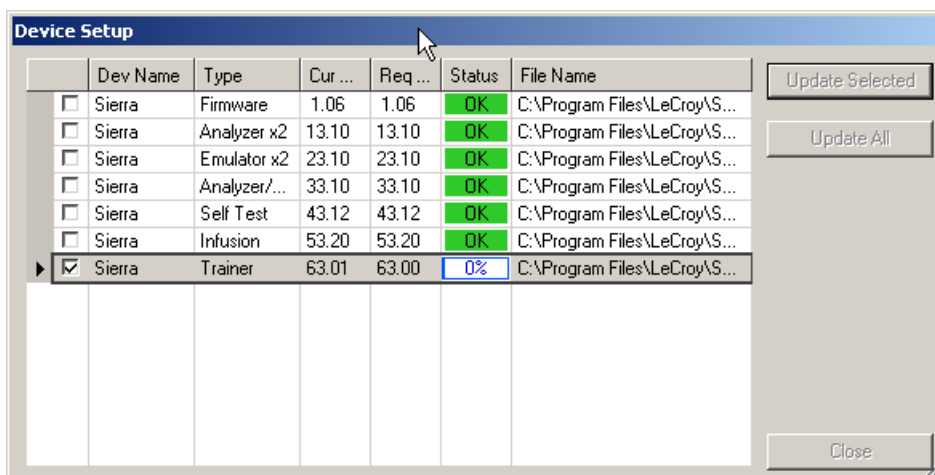

Figure 3.137: Device Setup Dialog Beginning to Update Status of a Device

After the update, the device must restart.

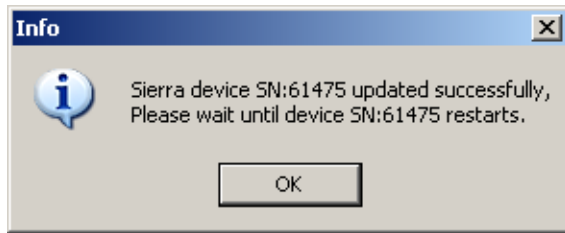

Figure 3.138: Info Dialog

Then the update is complete.

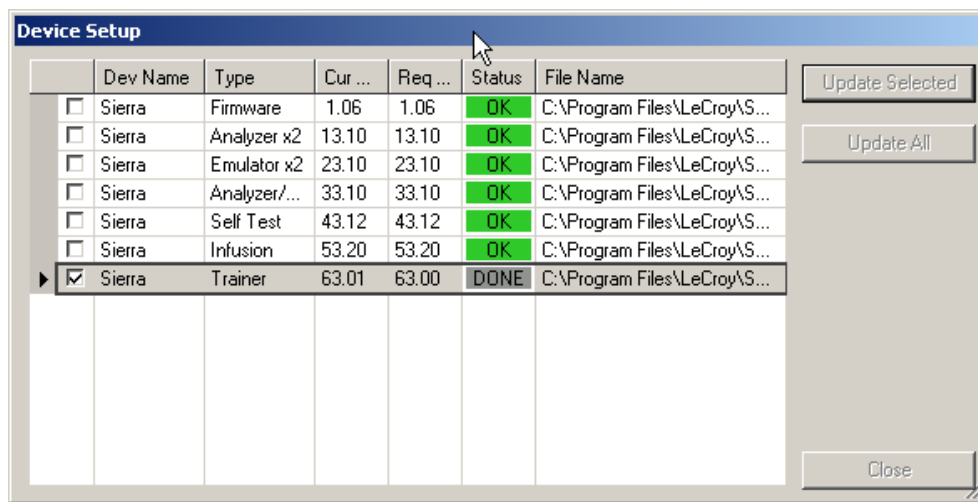

Figure 3.139: Device Setup Dialog with DONE Device Status

User-Defined Decoding

User-defined decoding allows you to create a definition file to interpret commands and frames that are not in the standard set recognized by the software.

Select **Setup > User Defined Decoding** to open the User Defined Decoding dialog.

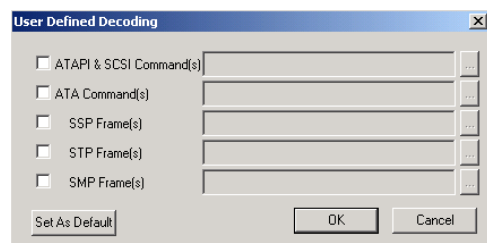

Figure 3.140: SAS: User Defined Decoding

SAS vs. SATA: SAS adds SCSI Commands, SSP Frames, and SMP Frames.

Check **ATA Commands** and/or **STP frames**. Click the ellipses next to a command type text box to display the **Open** dialog. Choose an appropriate script file and click **Open**.

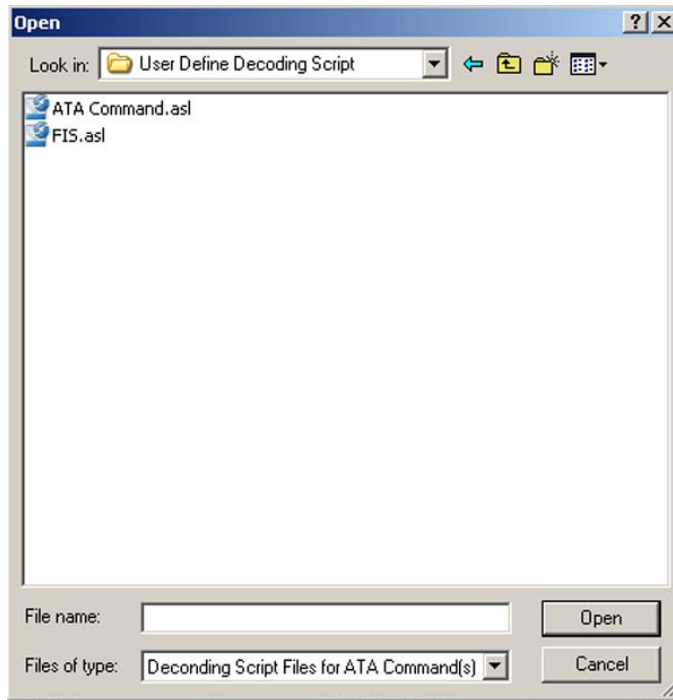

Figure 3.141: Choosing a Script File

Help Menu

Help Topics

Displays online help. You can also select F1.

VSE Help Topics

Displays VSE online help. You can also select F1.

Update License

A current license agreement with LeCroy entitles the Analyzer owner to continued technical support and access to software updates as they are published on the LeCroy website. When you obtain a license key, from the Help menu select Update License to display the Select License Key File dialog box. Enter the path and filename for the license key, or browse to the directory that contains the license key and select the *.lic file. Click Open.

Display License Information

Open a license information dialog to display a list of named features supported by the current software version (see [Figure 3.142 on page 307](#)). Named features that are not enabled on your system are indicated by No in the Purchased column. Whether or not named features are enabled depends on the license key stored in your analyzer. If you try to use a feature for which you do not yet have a license, the program displays the License Protection Message. To use the feature, you must purchase a license.



Figure 3.142: Licensing Dialog

Check for Updates

Check whether a new software version is available. If so, you can download from the LeCroy web site.

You can select to Check for updates at application startup.

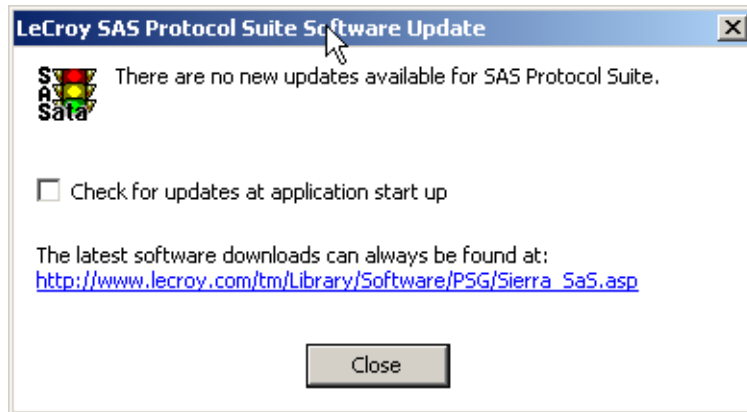

Figure 3.143: Check for Updates

About

Displays version information.

Self Test

You can use the built-in RAM self-test utility. Select **Setup** on the main menu bar and choose **Self Test** to open the Self Test dialog

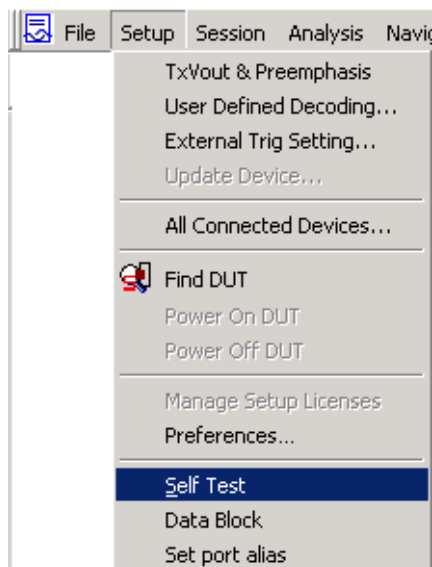

Figure 3.144: Self Test Command

Clock Check

To perform a Clock check, choose the clock to test and click the **Start Clock Check** button. After a short time, the Test Result appears to the right of the selected line.

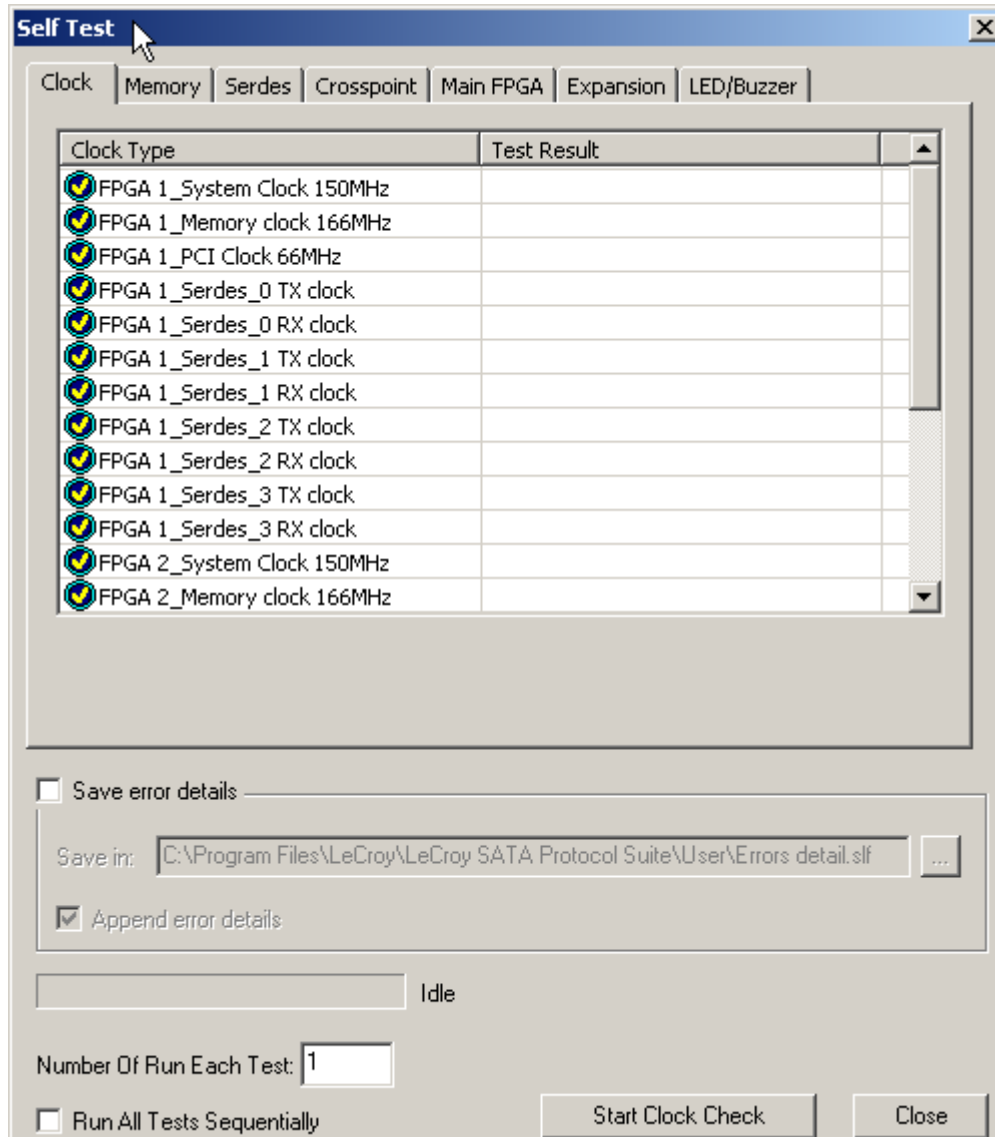

Figure 3.145: SATA: Self Test Dialog Clock Tab

Test Result: OK or Error

If a test is OK and you specified one run, the Test Result is **OK: 1 times**.

If a test has an error and you specified one run, the Test Result is **Error: 1 times**.

Saving

You can save any check result by checking the **Save error details** check box and specifying a destination file name.

Number of Runs Each Test

You can specify to run a test more than once.

Run All Tests Sequentially

This option runs all items in the Clock, Memory, Serdes, Crosspoint, Main FPGA, Expansion, and LED/Buzzer tests in order. After you check this check box, the command button becomes **Start All Tests**. You must click the **Stop Test** button on the LED/Buzzer tab to stop the check.

Memory Check

To perform a SDRAM or Exerciser RAM memory check, select the **Memory** tab.

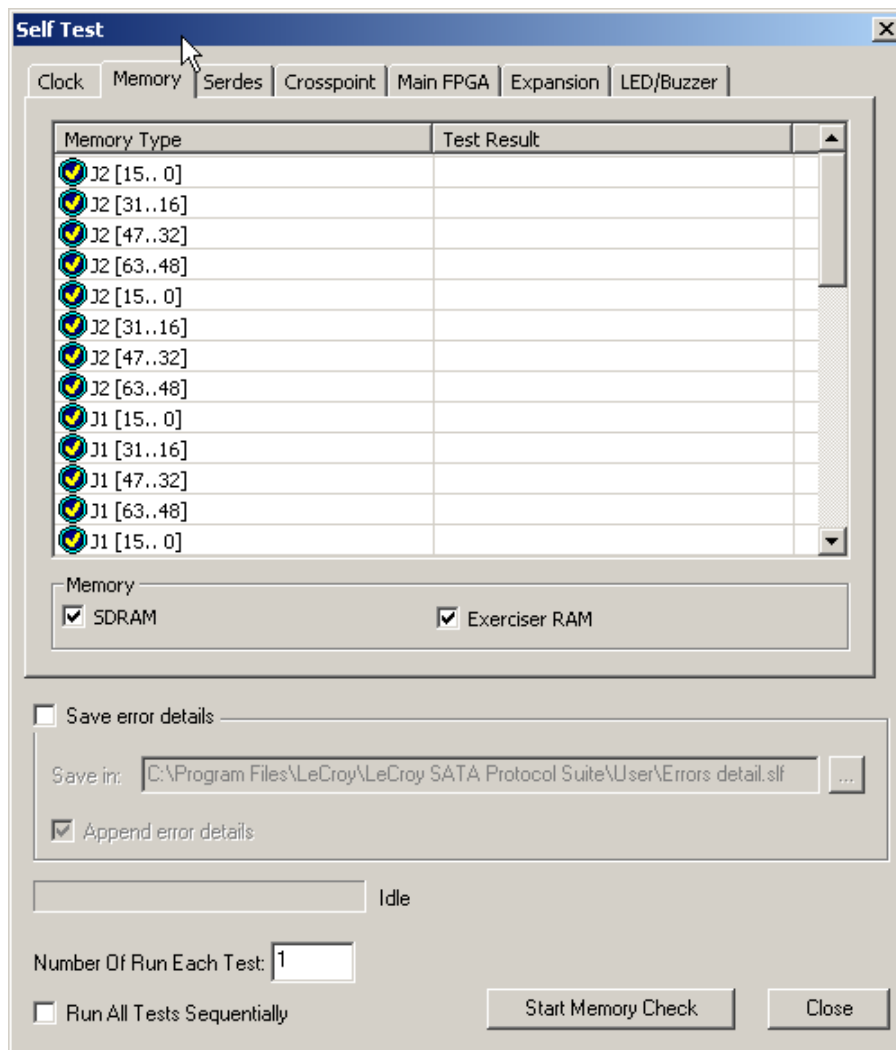

Figure 3.146: SAS: Self Test Dialog Memory Tab

Choose the SDRAM, Exerciser Data, or Exerciser Instruction to test and click the **Start Memory Check** button. After a short time, the Test Result appears to the right of the selected line.

Serdes Check

To perform an FPGA 1 or 2 Serdes Chip check, select the **Serdes** tab.

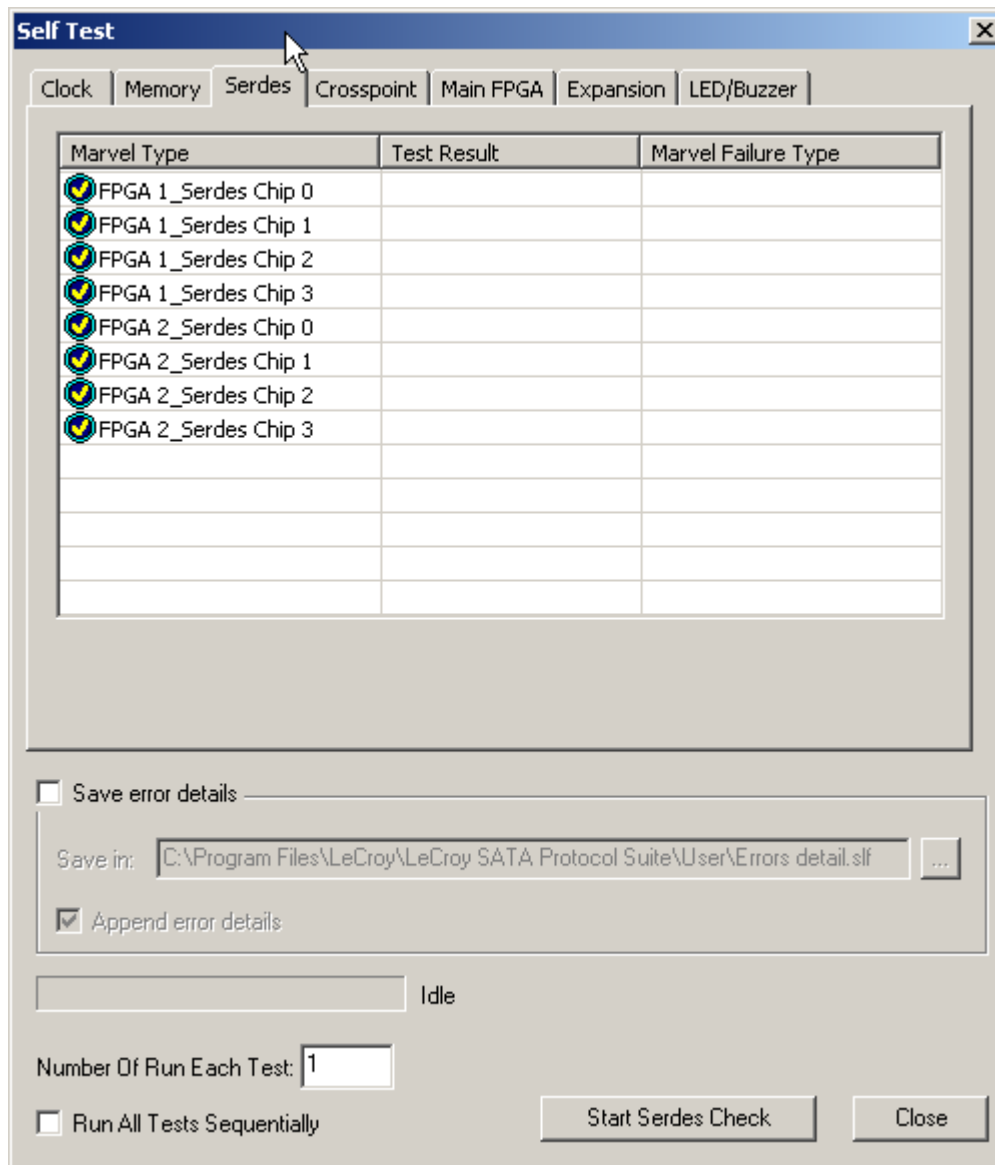

Figure 3.147: SATA: Self Test Dialog Serdes Tab

Choose the n FPGA 1 or 2 Serdes Chip to test and click the **Start Serdes Check** button. After a short time, the Test Result and Marvel Failure Type appear to the right of the selected line. Marvel Failure Type indicates the error type.

Crosspoint Check

To perform a Crosspoint-Crosspoint bus test or Crosspoint external loop back, select the **Crosspoint** tab.

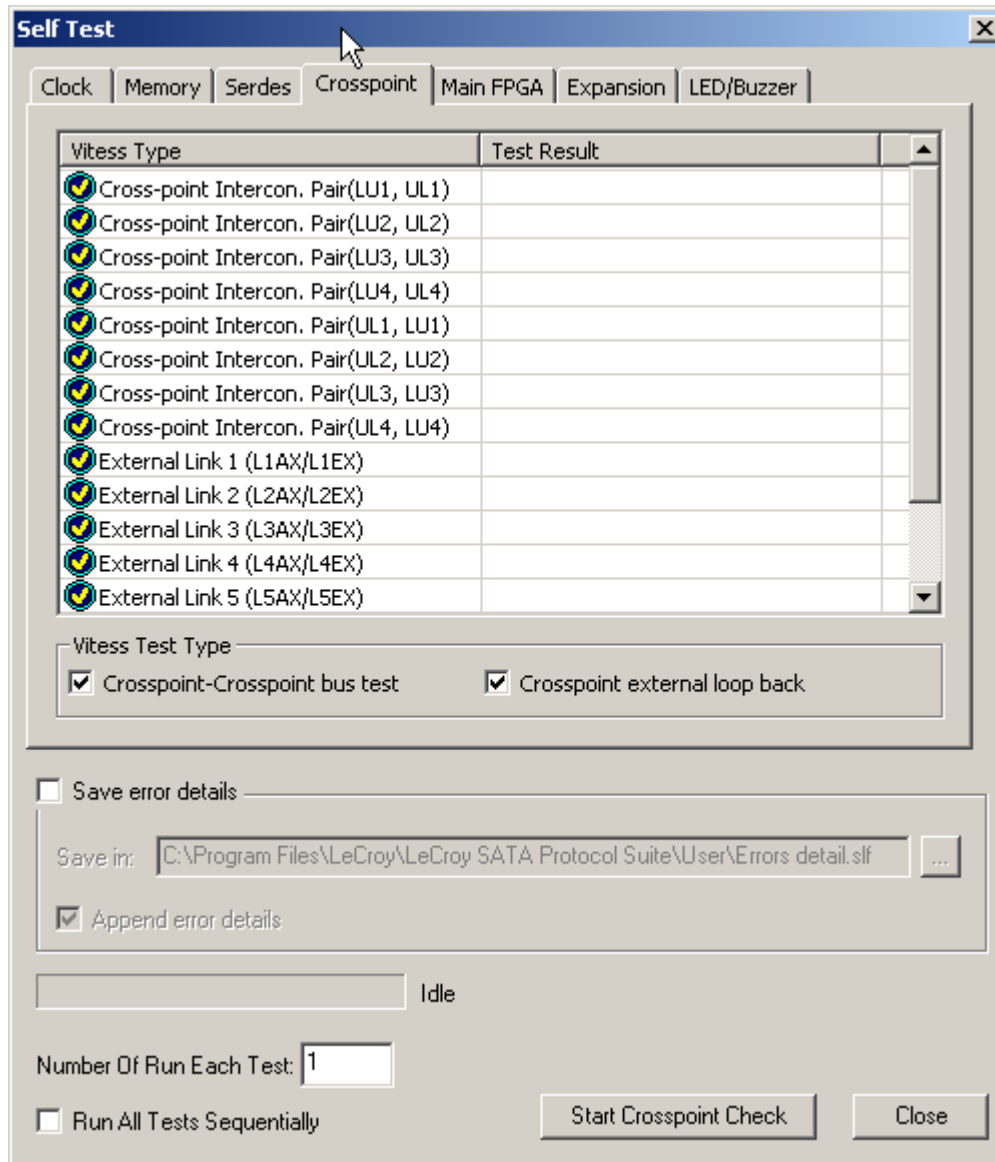

Figure 3.148: SATA: Self Test Dialog Crosspoint Tab

Choose the Crosspoint Interconnection Pair or External loop back to test and click the **Start Crosspoint Check** button. After a short time, the Test Result appears to the right of the selected line.

Main FPGA Check (SATA only)

To perform an Inter-FPGA Connection check, select the **Main FPGA** tab.

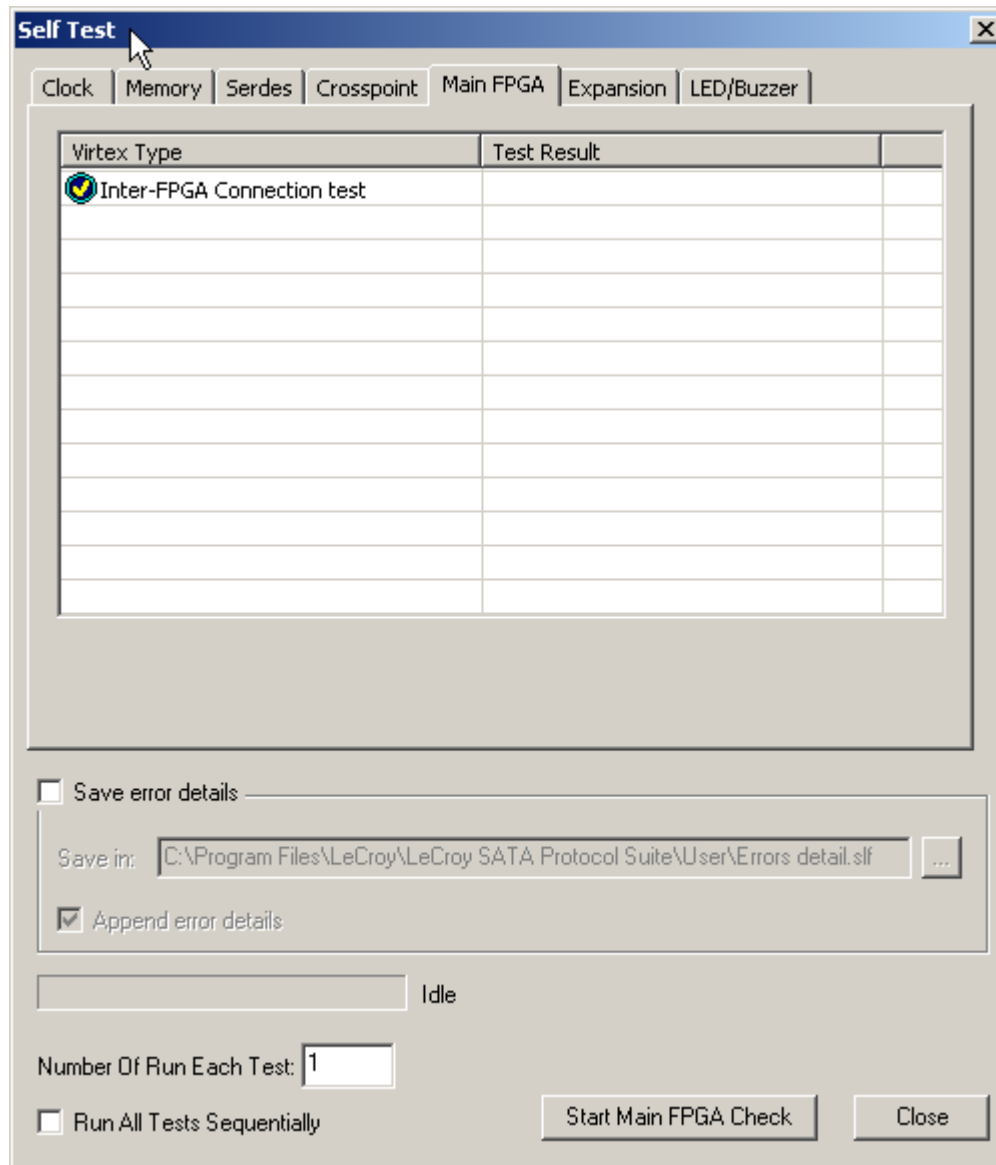

Figure 3.149: Self Test Dialog Main FPGA Tab

Choose the Inter-FPGA Connection test and click the **Start Main FPGA Check** button. After a short time, the Test Result appears to the right of the selected line.

Expansion Check

To perform a Expansion Card Data Status or Clock Status check, select the **Expansion** tab.

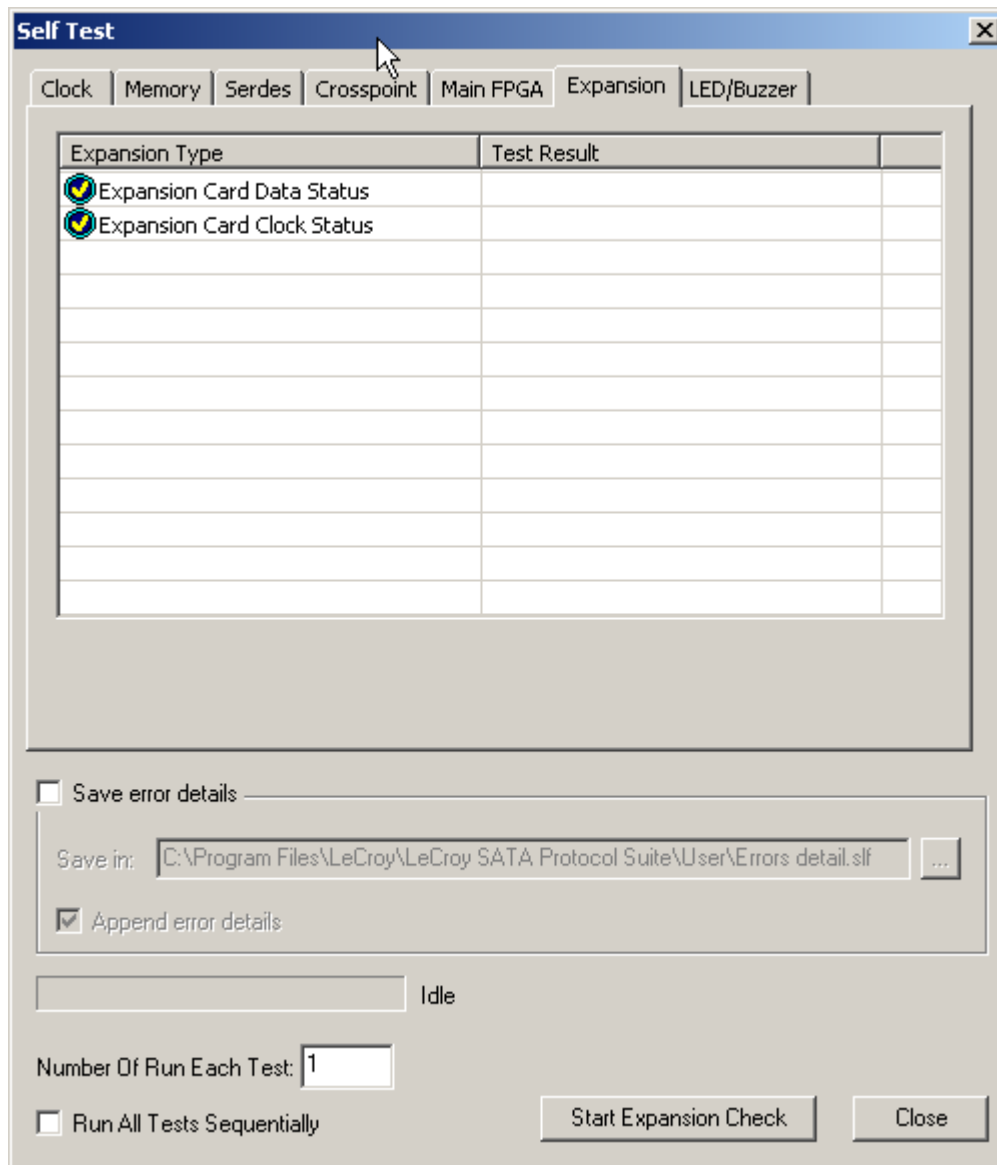

Figure 3.150: Self Test Dialog Expansion Tab

Choose the Expansion Card Data Status or Clock Status to test and click the **Start Expansion Check** button. After a short time, the Test Result appears to the right of the selected line.

LED/Buzzer Check

To perform a LED or Buzzer check, select the **LED/Buzzer** tab.

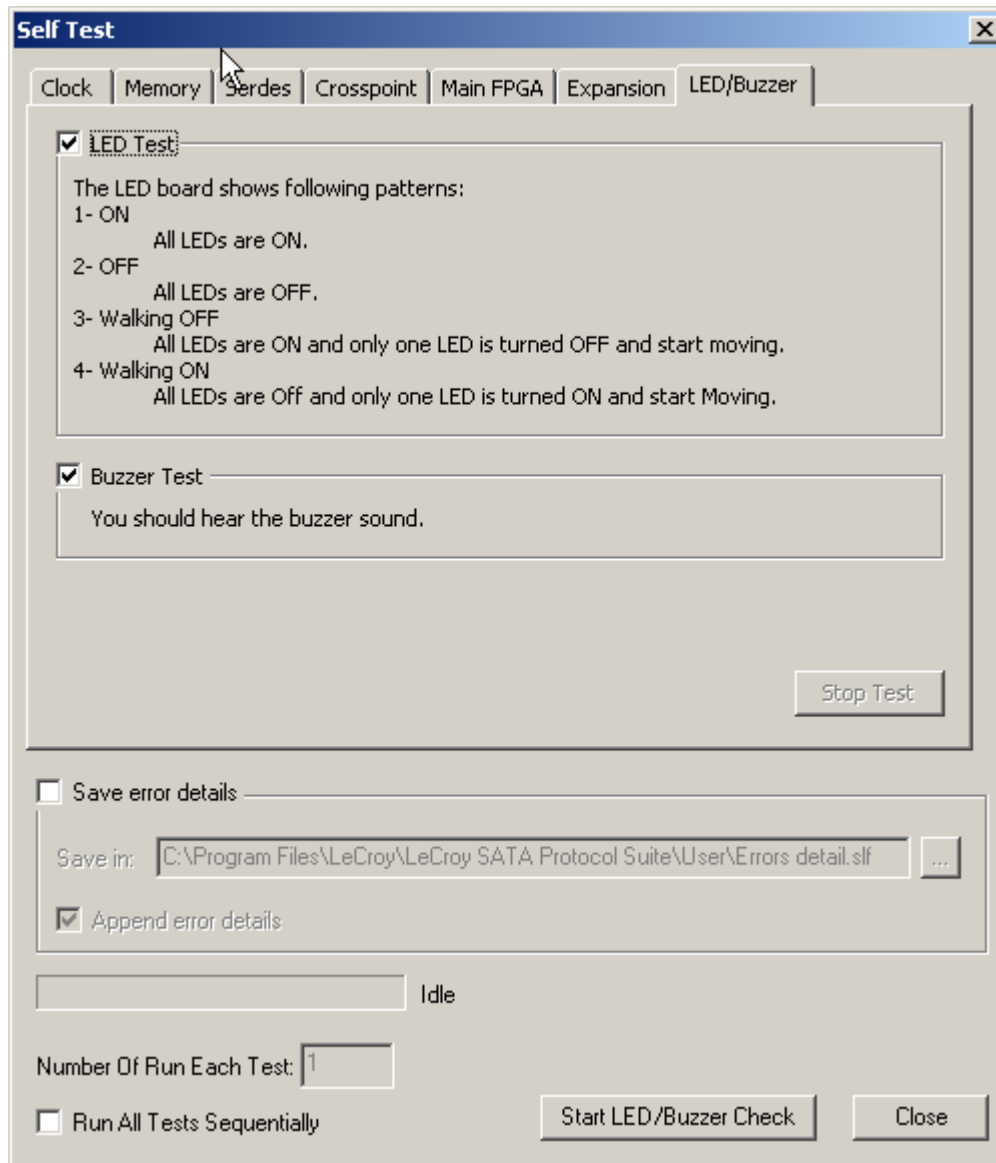

Figure 3.151: Self Test Dialog LED/Buzzer Tab

Check **LED Test** or **Buzzer Test** and click the **Start LED/Buzzer Check** button. For the LED, you should see the LED pattern. For the buzzer, you should hear it sound. You must click the **Stop Test** button to stop the check.

Find DUT

Saving device information allows you to import the specific device information into the Target/Device emulator.

The Find DUT utility obtains all vendor-specific information and detailed device parameters.

Find device finds any devices that are attached to any port.

Select **Setup** on the main menu bar and choose **Find DUT**.

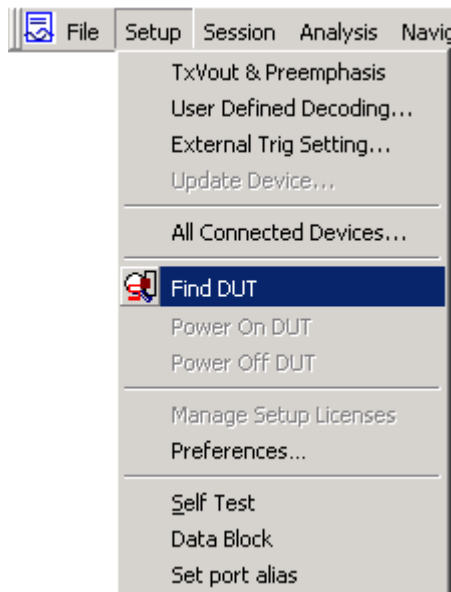

Figure 3.152: Find DUT

The Find DUT dialog opens. See following screen capture.

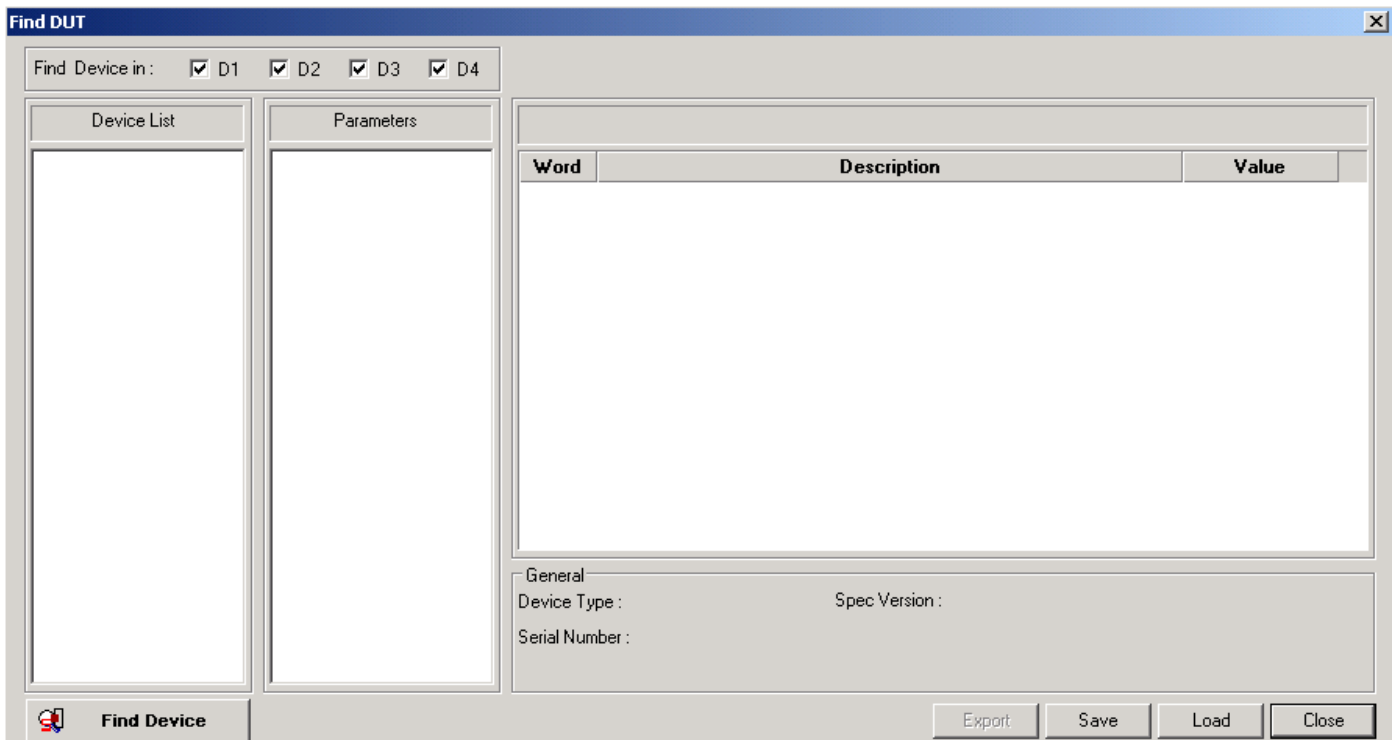

Figure 3.153: Find DUT Dialog

Click the **Find Device** button to search for connected devices. After a brief period, the dialog displays all device information.

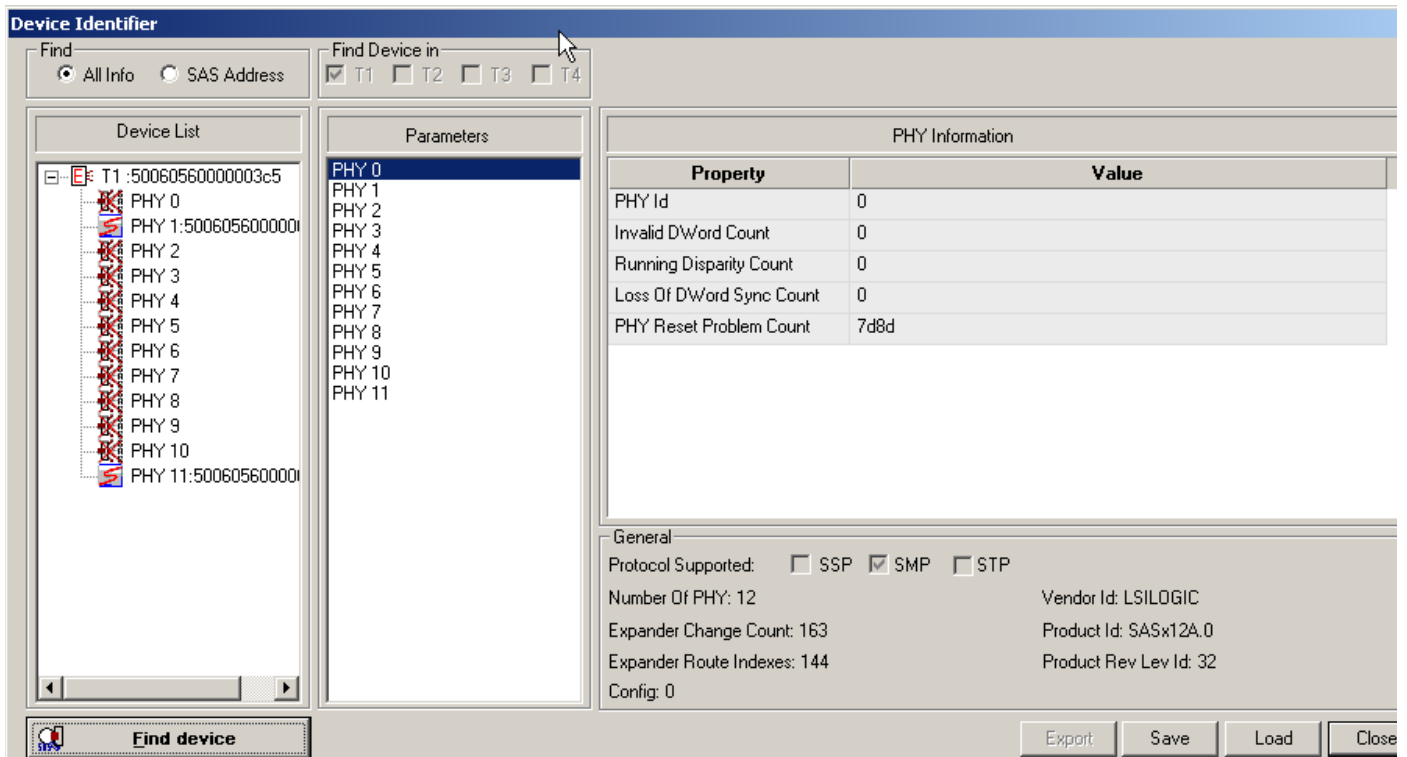

Figure 3.154: SAS: Identified Devices

Click a device in the Device List to display information about that device.

Aliasing

You can enter a 16-character alias name for a device. In the Device List, right-click the device name and enter an alias after the colon.

The alias name appears in the Device List.

Exporting

You can export a device specification to a text file. Click the **Export** button to open the Export dialog.

Compliance Test (SATA only)

The Compliance Test consists of a set of selectable tests to verify compliance with the SATA specification. SATA compliance is at UTD Rev 1.4

Note: The tests follow the LeCroy MOI, which is described in the **SATA_Digital-Device_MOI_LeCroy_1.00_UTD1.4.pdf** file in the installed Documents directory.

Note: You can start tests using the command line. The SAS/SATA Protocol Suite API Reference Manual, Section 2.12, starting on page 153, explains how to write VB scripts to automate compliance tests and generate results as RTF files.

To run a Compliance Test:

1. Click **Analysis** on the main toolbar and choose **Compliance Test** to open the Compliance Test dialog. See following screen capture.

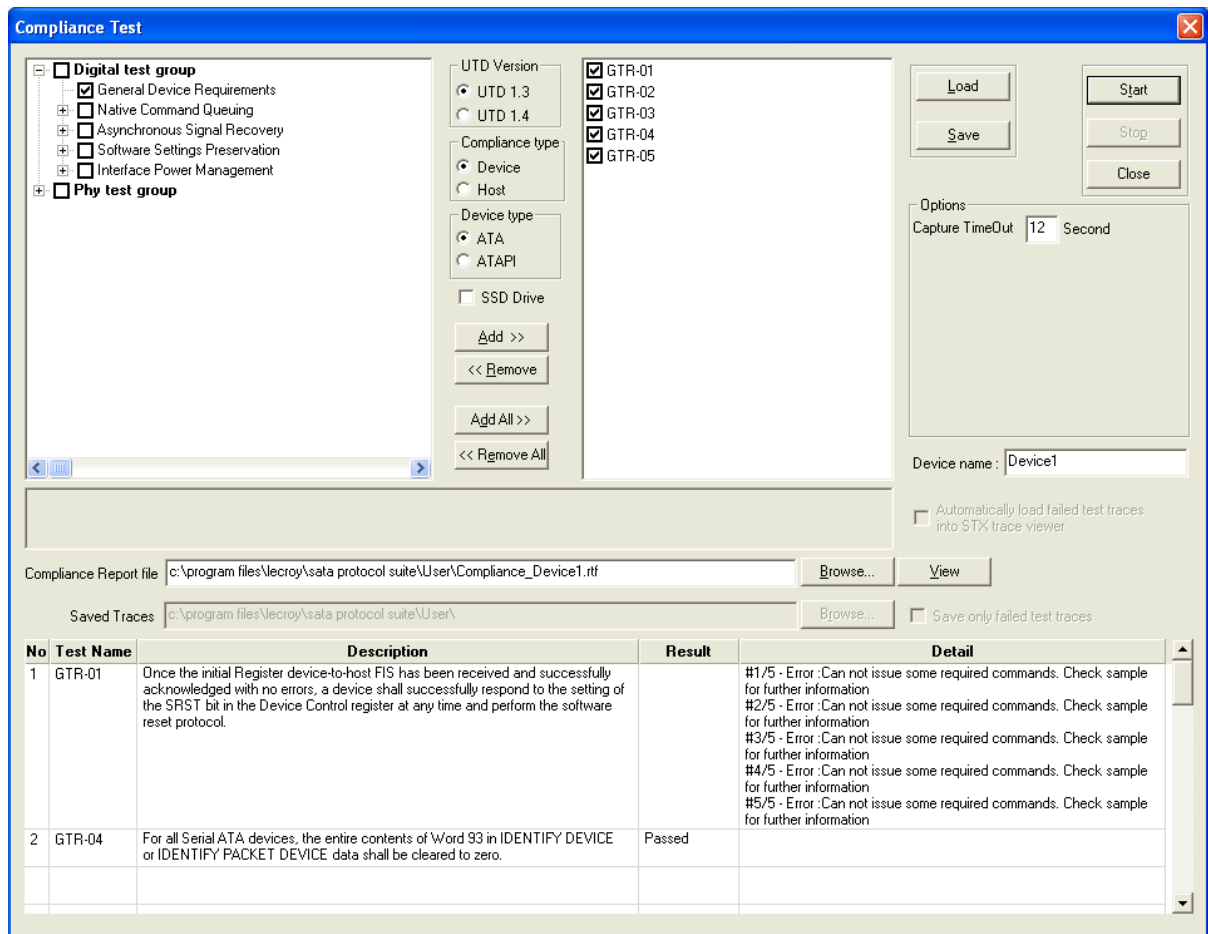

Figure 3.155: SATA: Compliance Test Selection

The Digital Test Group has:

- General Device Requirements:** GTR-01 through GTR-05
- Native Command Queuing:** NCQ-01 through NCQ-05
- Asynchronous Signal Recovery:** ASR-01 and ASR-02
- Software Settings Preservation:** SSP-01 through SSP-12
- Interface Power Management:** IPM-01 through IPM-11
- Digital Optional Features:** DOF-01 and DOF-02

The PHY Test Group has tests OOB-03 through OOB-07.

2. Choose tests in the left pane and click the **Add>>** button.
3. Enter a value for **Capture Timeout**.

Note: If test running time exceeds the Capture Timeout value, the test terminates.

4. Enter the **Device Name**.
5. Select the UTD Version as **UTD 1.3** (for devices supporting up to SATA 2.6 specification) or **UTD 1.4** (for devices supporting up to SATA 3.0 specification).
6. Select the Compliance Type as **Host** or **Device**.

7. Select the Device Type as **ATA** or **ATAPI**.
8. When testing SSD devices, select the **SSD Drive** checkbox, to ensure correct test results.
9. To view failed test traces in sample viewer check, the **Automatically load failed test traces** check box.
10. To save the failed test traces only, check the **Save only failed test traces** check box.
11. Enter a path and file name for the **Compliance Report file**, or use the default file name and path:
C:\Program Files\LeCroy\SATA Protocol Suite\User\Compliance_Device1.rtf
12. Enter a path and file name for the **Saved Traces**, or use the default folder:
C:\Program Files\LeCroy\SATA Protocol Suite\User\
13. After you select tests, click **Start**.
14. The test runs and after a brief period of time displays the result.

No	Test Name	Description	Result	Detail
1	GTR-01	Once the initial Register device-to-host FIS has been received and successfully acknowledged with no errors, a device shall successfully respond to the setting of the SRST bit in the Device Control register at any time and perform the software reset protocol.		#1/5 - Error : Can not issue some required commands. Check sample for further information #2/5 - Error : Can not issue some required commands. Check sample for further information #3/5 - Error : Can not issue some required commands. Check sample for further information #4/5 - Error : Can not issue some required commands. Check sample for further information #5/5 - Error : Can not issue some required commands. Check sample for further information
2	GTR-04	For all Serial ATA devices, the entire contents of Word 93 in IDENTIFY DEVICE or IDENTIFY PACKET DEVICE data shall be cleared to zero.	Passed	

Figure 3.156: SATA: Compliance Test Result

15. To save the current compliance setup for later use, click the **Save** button to open the Save As dialog. Assign a meaningful name to the setup and save it as a ***.cst** compliance file.
16. To run a previously defined setup, click the **Load** button and choose a setup.

Note: When you are running Compliance Test, do not connect the analyzer to the Host if testing a Device. Do not connect the analyzer to the Device if testing Host. Such improper connections can impact compliance-test result validity.

Chapter 4

InFusion Overview

The LeCroy InFusion™ Error Injector and Traffic Modifier is an error injector and traffic modification tool that allows you to verify real-world fault handling for Serial Attached SCSI (SAS) and Serial ATA (SATA) systems. InFusion can sit unobtrusively in the data path on a live system to programmatically alter or corrupt traffic. InFusion is the ideal tool for stress-testing systems using actual workloads.

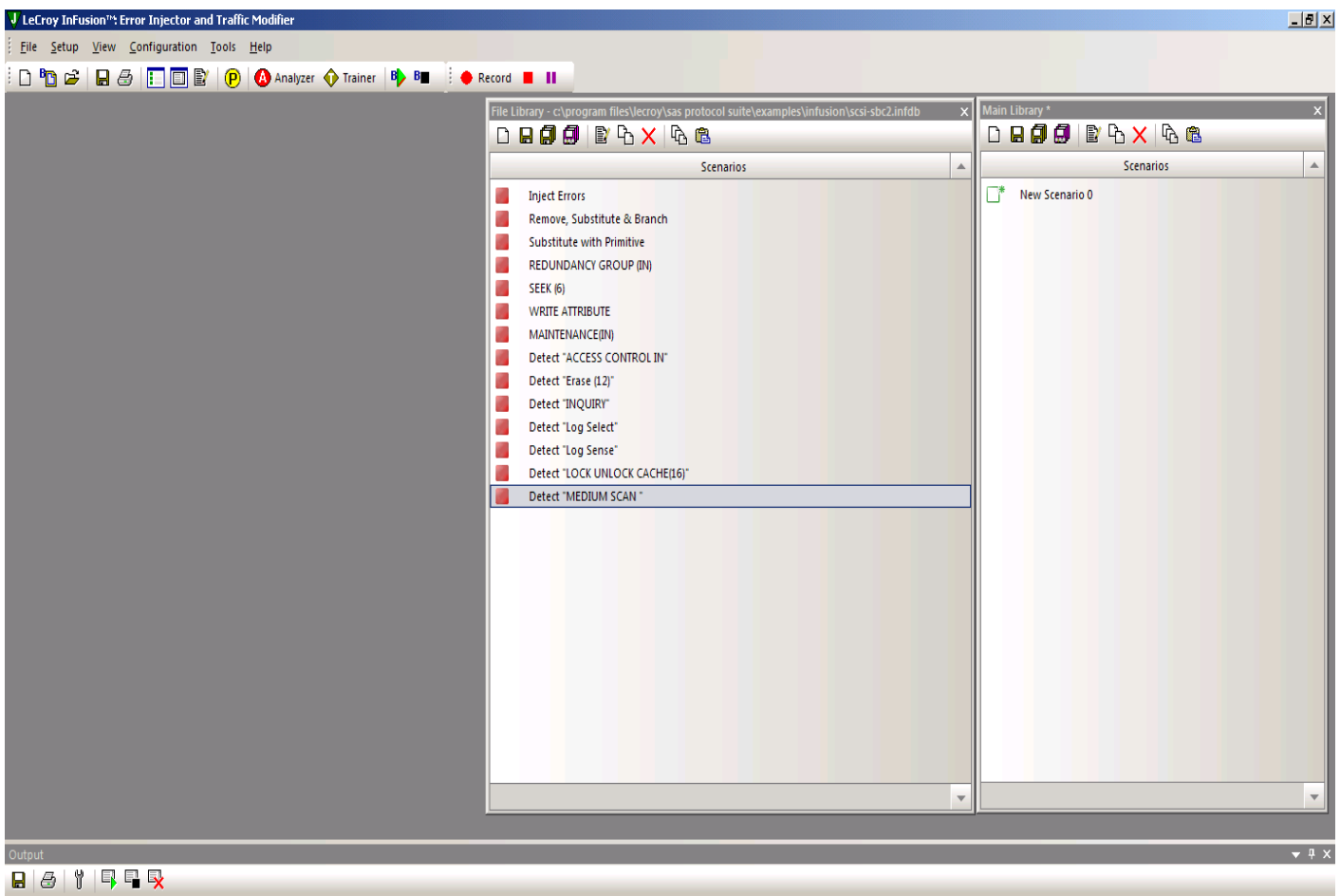

Figure 4.1: InFusion Windows

InFusion supports SAS SSP, SMP, STP, and SATA-based protocols operating across a single SAS or SATA link up to 6 G. InFusion monitors traffic from both directions in real-time and relies on predefined rules to replace any bit, primitive, or parameter with one you specify. InFusion can change traffic when it detects a specific sequence or reaches a designated time interval, yet it requires no complicated scripts, programming, or simulation tools.

InFusion can monitor traffic in both directions and act on events occurring in either direction of the communications link. InFusion can modify traffic in only one direction within a given test scenario, but that direction can be either from the Initiator or from the Target.

InFusion is specifically designed to verify recovery characteristics within a subsystem. An easy pop-up menu interface allows you to create specific test scenarios in just minutes.

Once a InFusion session starts, the system automatically handles protocol handshaking between devices. InFusion transmits a faithful copy of the original data stream down to the CRC value which, if needed, it recalculates. InFusion allows test engineers to systematically verify error recovery in ways not possible with other test platforms.

An InFusion event can trigger an analyzer.

InFusion supports all commands in the SATA 3.0 specification.

Key Features

The key features of InFusion are:

- ❑ **Error Injection:** Injects CRC, disparity, 8b/10b encoding, framing, and coding errors.
- ❑ **Break Link Recovery:** Programmatically breaks the connection to test link recovery.
- ❑ **Value Replacement:** Monitors the link for specific values, patterns, or primitives (as low as bit level) and replace with user-defined values. You can replace values on every occurrence, after a specified number of occurrences, or after a specified time interval.
- ❑ **Packet Drop:** Removes individual primitives, address frames, or data frames from the stream to verify retry behavior.
- ❑ **Primitive Manipulation:** Replaces handshaking and flow control primitives to help validate robustness of a design.
- ❑ **Traffic Monitoring:** Operates as a traffic monitor, collecting statistical data on user-specified parameters. In this mode, data passes unchanged in both directions.
- ❑ **Menu-Driven Interface:** Allows easy set-up of test scenarios.
- ❑ **API based on C++:** Allows development of custom test applications.
- ❑ **Scenario Batch Files:** Allows scenario scripts.

With respect to traffic modification, in the Link Layer you can modify primitives, CRC, scrambled traffic, and SSP, SMP, and STP connection events. You cannot modify clock skew management, OOB and power management, and signal integrity.

InFusion consists of a hardware device that connects to the line under test and a Windows-based software application used to create and download test scripts to the device. You also can use the software application to configure and control the device across an Ethernet link.

InFusion test scripts are called scenarios. Scenarios determine how the hardware device monitors and modifies line traffic. You must use the application to create and download scenarios.

For the InFusion connections, the device is connected between the SAS/SATA host and the PHY of the test target (DUT).

Interface

Buttons

The InFusion interface has the following command buttons:

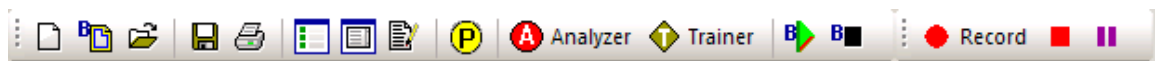

New Scenario: Begins the scenario creation process by listing Scenario Name, Direction for traffic changes, and Global Rules in the scenario window.

New Batch Script: Starts a scenario batch file in Batch Script window.

Open Library: Lists the InFusion Library Files (**.infdb**), which contain the available scenarios, in an Open dialog.

Save: Saves the current scenario in the UserData folder.

Print: Prints the current scenario.

Show Library: Displays/hides the Main Library window (on the right), which displays the available scenarios. You can create a new scenario, save a selected scenario, save the library, save a copy of the library, display the selected scenario, insert a copy of the selected item, or delete the selected scenario.

Show Output: Displays/hides the Output window (at the bottom), which displays InFusion output. Use the buttons to save output, print output, display options (automatically save the log file, with a path and size), start logging, stop logging, and clear the Output window.

Show Port Assignment: Displays/hides the current port assignment.

Port Configuration: Displays the port configuration dialog. See [“Port Configuration for InFusion” on page 328](#).

Launch Analyzer: Returns to the Protocol Analyzer or Target/Host Emulator window.

Launch Trainer: Goes to the Trainer window.

Run Batch Script: Runs a scenario batch file.

Stop Batch Script: Stops a running scenario batch file.

Record: Starts recording on the current analyzer, using the current project.

Stop: Stops recording on the current analyzer.

Abort: Aborts recording.

Menus

The InFusion interface has the following menus:

File

(see command descriptions in the “Buttons” section above)

- New Scenario, Open Scenario (File Library or Main Library)
- Open an InFusion database (.infdb file)
- Launch Analyzer
- Launch Trainer
- New Batch Script, Save Batch Script As
- New Library, Close Library (File Library or Main Library), Save Library, Save Copy of Library As
- Open Log File
- Print Setup
- Recent Trace Files
- Recent Project Files
- Close

Setup

- External Trig Setting (see [“External Trig Setting” on page 302](#))
- Update Device (see [“Update Device” on page 303](#))
- All Connected Devices
- Status Bar

View

- Views (Library, Output, Port Assignment, Customize - commands, Toolbars, Keyboard, Menu and Options)
- Smart Docking
- Toolbar
- Status Bar

Configuration

- Port Configuration (see [“Port Configuration for InFusion” on page 328](#))
- Batch Script Setting (see [“Scenario Batch Files” on page 377](#))

Tools

Browse UserData, System, or InFusion folder.

Help

Help Topics and About InFusion.

Main Library

You can **Show Main Library**.

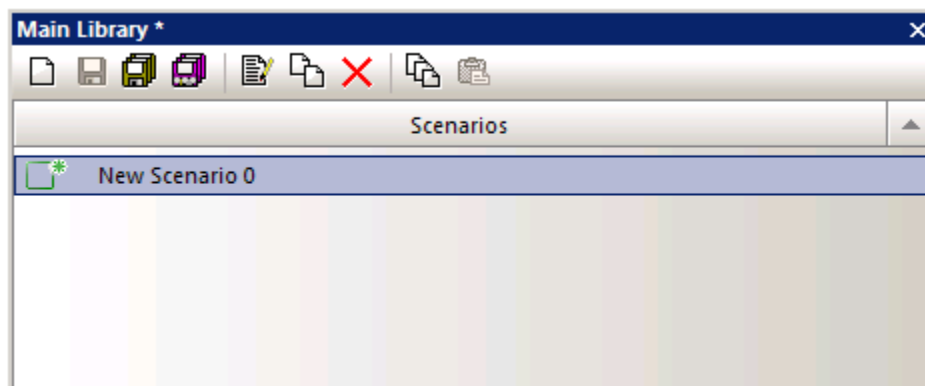

Figure 4.2: Main Library

The Main Library has Scenarios.

Using the buttons from left to right, you can:

- Create a new scenario and save a scenario.
- Save a library and save a copy of a library.
- View/edit a scenario, insert copy of a scenario and delete scenario.
- Copy and paste.

File Library

You can display the File Library.

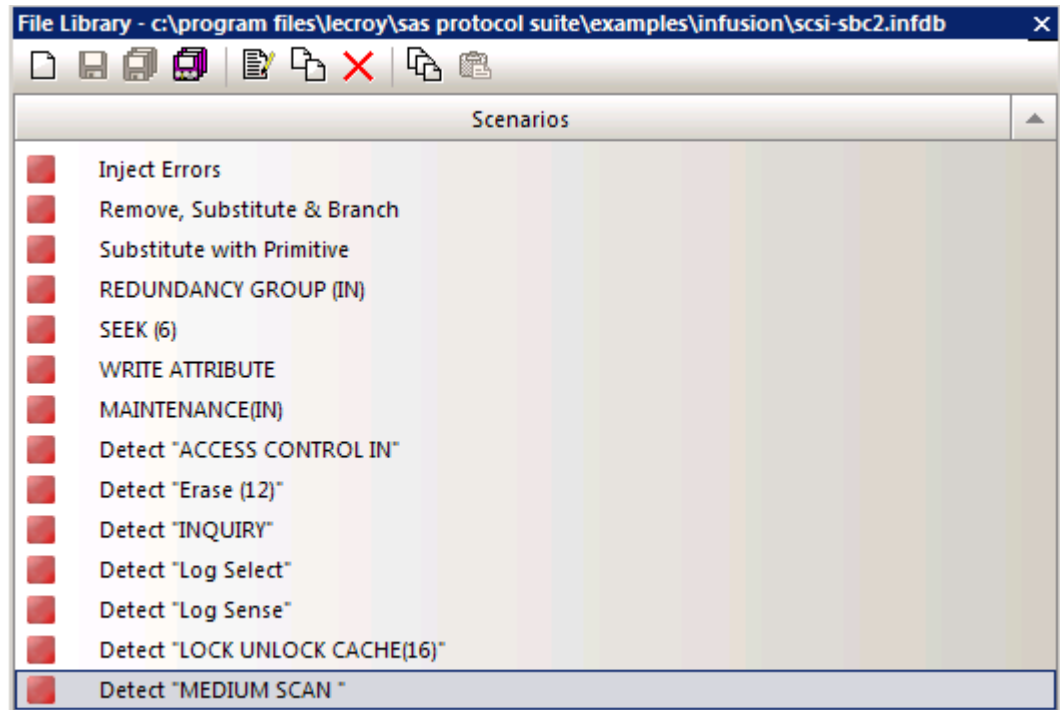

Figure 4.3: File Library

A File Library has Scenarios currently available in the device.

Using the buttons from left to right, you can:

- New scenario.
- Save selected scenario.
- Save library.
- Save a copy of the library as.
- View/edit a selected item.
- Insert a copy.
- Delete a selected scenario.
- Copy
- Paste

Device Ports

If a device is connected, the software displays the Device Ports.

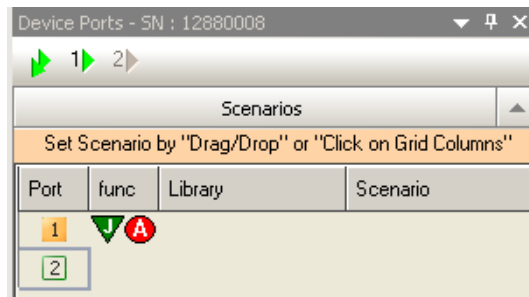

Figure 4.4: Device Ports

Using the first row of icons, you can Run/Stop All Ports or Run/Stop individual ports. The columns display the Port, Function/Configuration, Library, and Scenario. You can Float, Dock, Auto-Hide, or Hide the window.

Note: A port row is grayed-out when that port has not been configured to be a Jammer in the Port Configuration dialog (see [“Port Configuration for InFusion” on page 328](#)).

Using the Device Ports Dialog

After you have finished Port Configuration (see [“Port Configuration for InFusion” on page 328](#)), you use the Device Ports dialog to assign specific scenarios to ports, so that different scenarios can run on different ports.

To assign a scenario to a port, drag and drop the scenario from any library window to the port. The Device Ports dialog then displays the Library and Scenario on the row for that Port/Configuration.

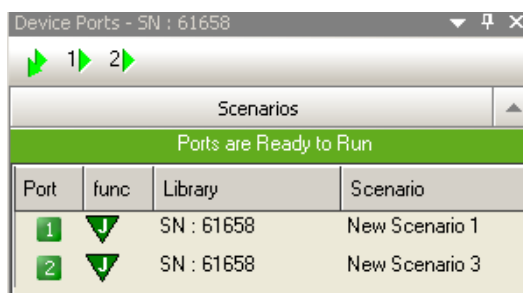

Figure 4.5: Device Ports Dialog

Alternatively, assign the scenario using the Library and Scenario drop-down lists.

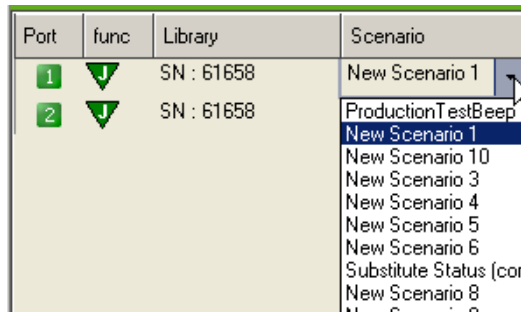

Figure 4.6: Scenario Drop-down List

After you have assigned scenarios to ports, in the first row of icons, use the first green arrow icon to **Run/Stop All Ports**, or use the numbered green arrows to **Run/Stop an individual port**.

Note: A port row is grayed-out when that port is running a scenario.

Port Configuration for InFusion

The InFusion (Jammer) port configurations must match the Analyzer port configurations for the infusion-analyzer to work.

Select **Configuration > Port Configuration** to display the Set Port Configuration dialog.

To record traffic both before and after the InFusion modifies (jams) it, select **Analyzer/Jammer/Analyzer** on the port that you want to jam. In the following figure, there is a match on Port3.

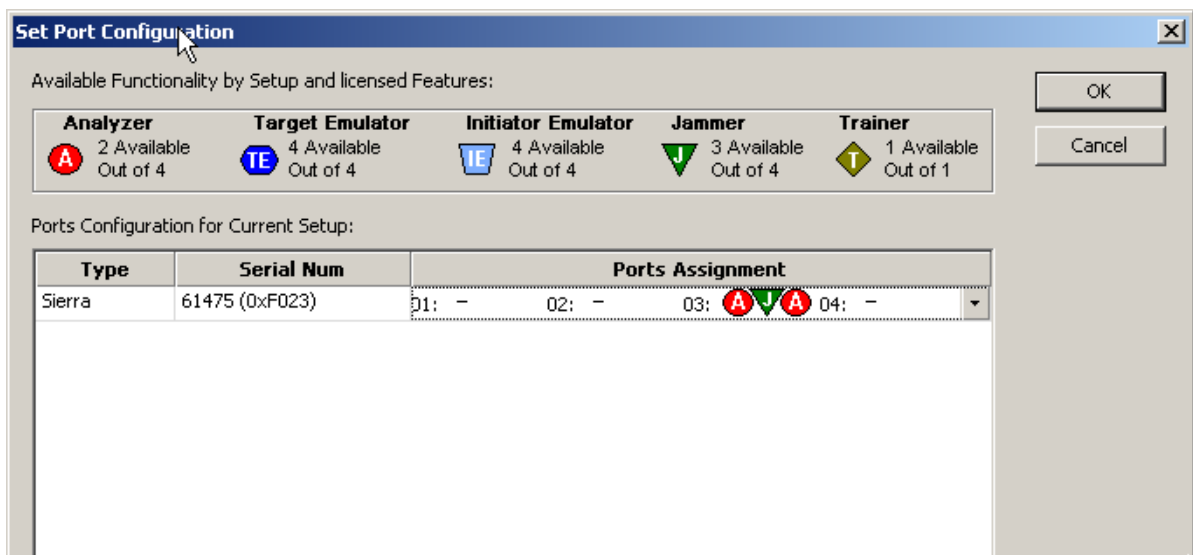

Figure 4.7: Ports Configuration Dialog with InFusion/Analyzer Port Match

Note: You can select only one Jammer port at a time with this configuration.

To record traffic from two ports after the InFusion modifies (jams) them, select a combination of ports that have **Jammer/Analyzer** specified under them. The different configurations accommodate different possible user setups and requirements.

Note: To display the current Port Configuration, click **Show Analyzer** to go to the analyzer application, then click the green button in the lower right corner to display the Port Status window (see [“Port Status” on page 281](#)).

Important Information for Jammer and Analyzer

Jammer intercepts and delays traffic on both directions simultaneously, so Host sends to Jammer, Jammer delays and sends to Host, Device sends to Jammer, Jammer delays and sends to Device. However, Jammer modifies traffic in one direction only: from Host to Device, or from Device to Host.

When using Jammer and Analyzer, the Select Port Configuration dialog has options JA as shown in [Figure 4.8](#).

(After Jammer)	-
-	(After Jammer)
	-
-	
(Host Side)	-
-	(Host Side)
(Device Side)	-
-	(Device Side)

Figure 4.8: Select Port Configuration Options with Jammer and Analyzer

The following figures illustrate the available setup options.

- **JA (After Jammer):** Analyzer captures Jammer to Host and Jammer to Device. Analyzer is after Jammer on both paths. See [Figure 4.9](#).

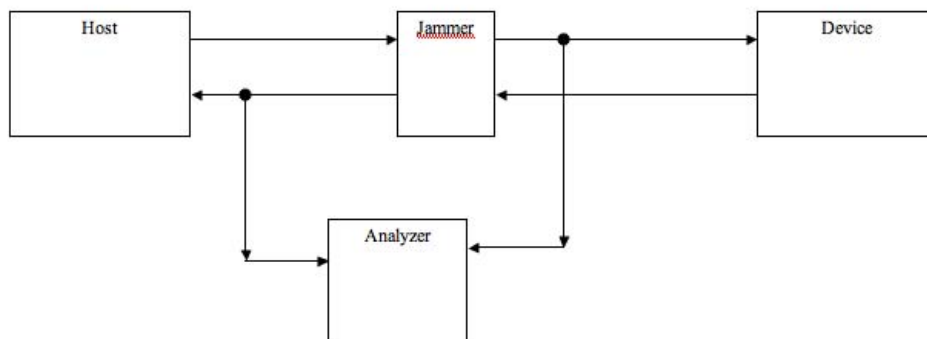

Figure 4.9: Jammer and Analyzer with Analyzer after Jammer

- **JA (Host Side):** Analyzer captures Host to Jammer and Jammer to Host. Analyzer is before and after Jammer on Host side. See [Figure 4.10](#).

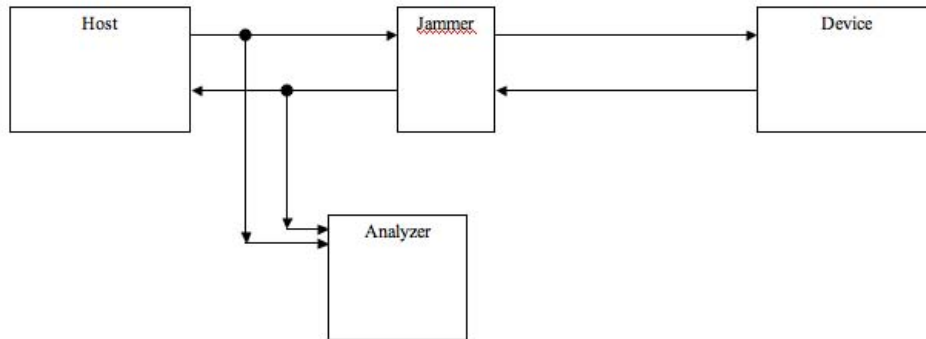

Figure 4.10: Jammer and Analyzer Host Side

- **JA (Device Side):** Analyzer captures Jammer to Device and Device to Jammer. Analyzer is before and after Jammer on Device side. See [Figure 4.11](#).

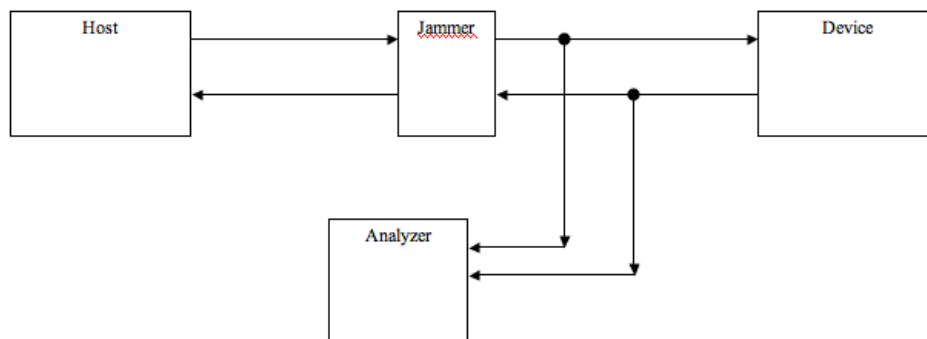

Figure 4.11: Jammer and Analyzer Device Side

The setup options are the same whether Jammer modifies traffic from Host to Device or from Device to Host.

Note: When the Unit Under Test (UUT) is the Host, using JA (Host Side) (see [Figure 4.10](#)) will give the most accurate recordings of Host behavior, though the Jammer delays will accumulate in the round trip. When the Unit Under Test (UUT) is the Device, using JA (Device Side) (see [Figure 4.11](#)) will give the most accurate recordings of Device behavior, though the Jammer delays will accumulate in the round trip. The After Jammer configuration (see [Figure 4.9 on page 329](#)) is useful when debugging a system, as the tapping points are balanced to account for Jammer delays. Note that when SATA traffic is recorded, this configuration might show out of order HOLD/HOLDA primitives, due to the special handling of these primitives by the Jammer.

Note: When running InFusion in an AJ port configuration a "FIS Signalling Latency Error" message displays due to the delay through the InFusion Jammer. This can be prevented by turning off the detection of this error using the Protocol Error Mask dialog from the Settings tab.

InFusion Scenarios

You can create and execute InFusion scenarios. A scenario is a test script that defines how InFusion monitors and modifies line traffic.

Scenarios Overview

You create scenarios on a PC running the InFusion application. You then assign the scenarios for execution to a desired port on an InFusion device. You can also download up to ten scenarios to each InFusion device.

The InFusion application provides a menu-driven interface for building scenarios. The interface prompts you for simple decisions and choices from drop-down menus. As you make your selections, the script takes shape automatically in the scenario window. The script is in the form of simple English sentences. You need not understand any formal scripting language.

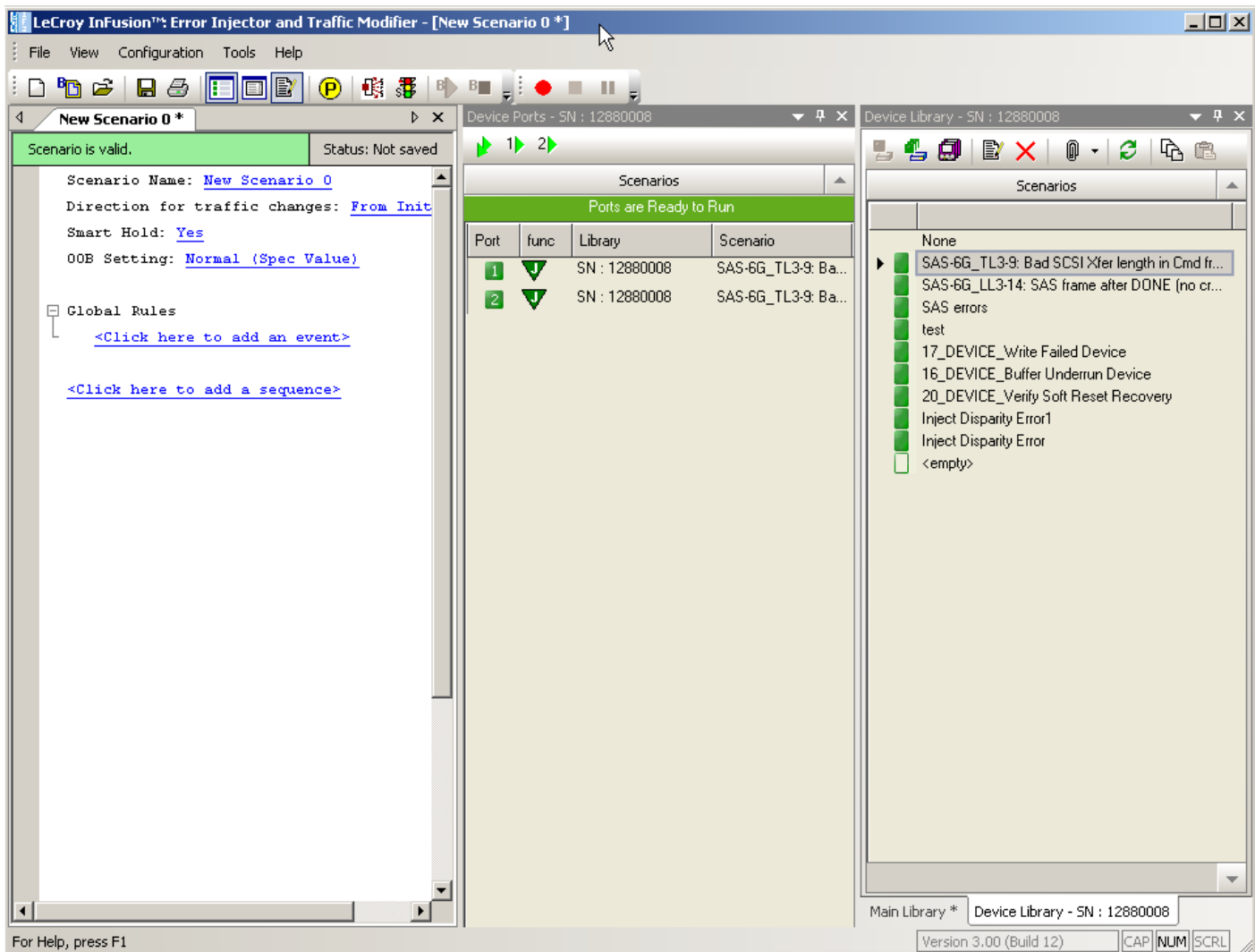

Figure 4.12: New Scenario in InFusion Window

InFusion Scenario Parameters

Timers

Timers allowed per state/sequence/scenario:

2 timers per state and 6 timers per scenario are allowed.

Events

Events allowed to be used per state/sequence/scenario:

For combined events, there is virtually no limit per state/sequence/scenario.

Actions

Actions allowed per state/sequence/scenario:

A maximum of 8 actions per state, 2048 actions per sequence (8*256 state), 4104 actions per scenario (2*2048 + 8 more in the Global Rules "state").

Monitors

Monitors allowed to be used per state/sequence/scenario:

InFusion can keep an account of 8/12 Monitor/Count events per scenario.

Random change of use of count and count randomly:

In Global Rules, if a Counter is used for Event counting, 2 extra actions are consumed. 2 more actions are required for "Every Nth occurrence" option.

In Sequences, If a Counter is used for Event counting, 3 extra actions are consumed. 3 more actions are required for "Every Nth occurrence" option.

Regarding limits on any of the above mentioned connections, i.e., x timers + y monitors are allowed per state where $x+y=n$:

There are a lot of big/small rules checked by the scenario compiler, but as a rule of thumb:

8 actions per state are available

12 counters globally are available, each assigned permanently to a certain job

6 available timers per scenario

12 programmable multi-purpose resources for DWORD comparison/substitution/capture are available. If a pattern detector uses 3 of these resources to trigger on a specific frame on the bus, only 9 more resources are available for other tasks. Frame/FIS type detectors are excluded from this rule, because they use their own dedicated resources.

8 primitive detectors are available

If you want to trigger on a pattern (Frame/FIS) and change/capture a dword(s) before the last offset of a detected pattern (e.g., changing the Frame Type of a SAS Frame with Data Offset == 11223344), you are limited to a maximum of 9 dword offset (i.e., if you trigger on the 20th payload of a Data FIS, you can change/capture the 12th dword onwards. 11th payload dword and preceding dwords are not accessible for change/capture)

You can not change a state based on back-to-back events. At 6G speed, there should be at least one dword between the triggering event of two consecutive states. At other speeds, back-to-back dword state transitions might rarely be missed, so best practice is to never assume back-to-back dword events.

As described later in this chapter, you can create any number of scenarios and store them in libraries on the PC hard drive. Scenario library files names are in the following format:

<filename>.infdb

Creating InFusion scenarios is easy, but it requires an understanding of the following terms defined in Table 4.1 on page 334.

TABLE 4.1: Key Scenario Terms

Term	Definition
Action	InFusion response to an event.
Event	Condition that is detectable by InFusion.
Combined Event	Logical OR association of events (for example, event A OR event B).
Global Rules	Portion of a scenario that can define a single InFusion test state. You can think of the Global Rules and each sequence as a separate test routine or program operating within the scenario. Each operates independently and in parallel with the others. The purpose of each is to detect events and then respond with the appropriate action or set of actions. In essence, you can operate up to three test states simultaneously within InFusion.
Sequence	Portion of a scenario that can define multiple InFusion test states. More flexible than the Global Rules, a sequence allows more powerful scenarios that include branching and looping between test states (Global Rules can define only a single test state, so there is no branching).
State	“Behavior” of the Global Rules or a sequence at any point in time. In terms of InFusion testing, behavior is “waiting” for a set of events and responding with a set of actions.

Global Rules

Global Rules are a portion of the scenario that can define only one test state. To create the Global Rules, you use the menu-driven interface to enter an event or combined event and the corresponding action or set of actions (the response of InFusion hardware to the event).

In the case of a combined event, the action is taken upon occurrence of any of the events stated for the event combination. It is a logical OR association, meaning any of the events can trigger the action.

After you enter the event or combined event, the interface prompts you for actions. An action might be, for example, injecting a particular primitive or error into the traffic stream. You can enter multiple actions, which take place simultaneously.

After defining the event and actions within the Global Rule area, you can save the scenario and download it to a InFusion device.

Sequences

The Global Rules are all you need for simple test scenarios. However, a scenario also can contain one or two sequences, which can define multiple states and allow branching between states. With a sequence, you also can do looping, which allows you to repeat a test state or to execute a test for a specified period of time.

As with Global Rules, the menu-driven interface guides you in building a sequence. Some of the prompts are different, however, because you now are encapsulating groups of

events and actions as distinct states. Recall that a state is a combination of events and actions at a specific point in time. If the event or combined event defined by a state occurs, the corresponding action or set of actions follows.



Figure 4.13: Global Rules and Sequence Areas of a Scenario

InFusion hardware provides the capacity to have up to two sequences co-existing in a scenario in addition to the Global Rules. Recall that both the Global Rules and any sequences are active at all times. Each is a separate “state machine,” having the behavior of a particular test state at any point in time. Because the Global Rules has the capacity for only one state, you can view it as a “degenerative state machine.”

Scenario Libraries

You can create any number of scenarios, which you then can archive on your PC hard drive. You also can download up to ten scenarios to each InFusion device for test execution. You can think of the libraries as windows that hold scenarios.

Recall that each library is a separate ***.infdb** file.

Main Library

When you launch the InFusion application, it opens a window called the Main Library. The main library is the default workspace for creating and storing new scenarios. The main library corresponds with the following file in the InFusion folder on the PC hard drive:

```
default.infdb
```

File Libraries

You can save the main library with a name other than default (while still using the **.infdb** file extension). The new file becomes a file library that is functionally equivalent to the main library with the following exception: It does not open by default in the Main Library window. You can navigate to other file libraries using the File Manager of the InFusion application.

In this manual, the main library and other **.infdb** file libraries are collectively called **general libraries**.

If you select **Open Library**, you see a window similar to the following:

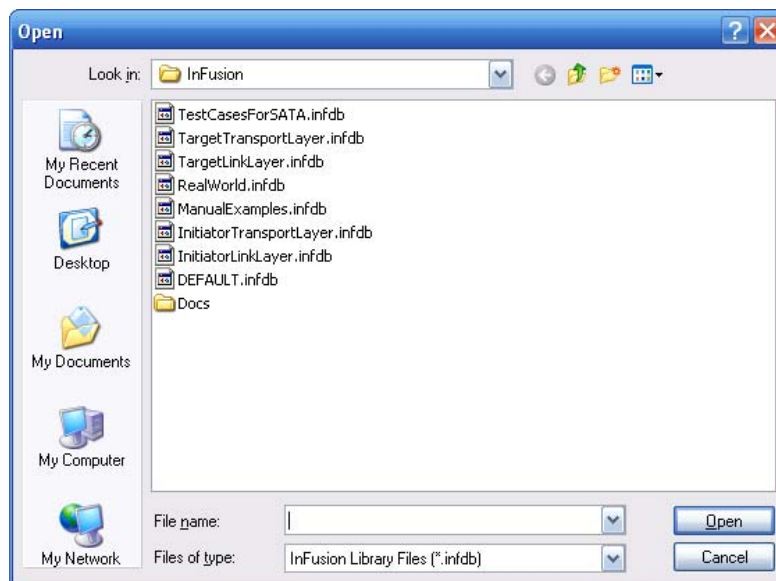

Figure 4.14: Open Library File List

By selecting the **TestCasesForSATA.infbd** file, you get an additional library window with predefined SATA test cases, similar to the following:

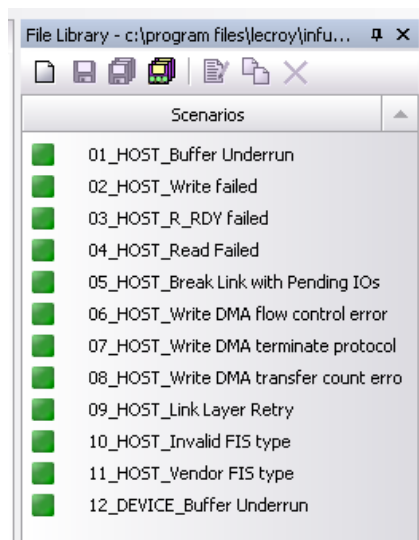

Figure 4.15: Test Cases for SATA Library

Device Libraries

In addition to general libraries, the application defines device libraries. Each device library is associated with a specific InFusion device. Each device library opens in a separate Device Library window and holds up to ten InFusion scenarios for the device. When you connect to the device and click the entry for that device in the Device List, the device library for the device opens automatically.

The scenarios that appear in the device library are those currently stored on the corresponding device. They were uploaded from the device to your PC when you opened the device library. You can click any of the scenarios listed to open it for editing. When you are finished with your edits, you can use the buttons on the Device Library toolbar to download the revised scenario to the device.

The None scenario is an empty and undefined scenario to allow you to assign port(s) to None.

The Multiport feature allows you to run a scenario by more than one port in a Device Library and to assign different ports to different scenarios and run them together. Each scenario in a library can run by more than one port.

Scenario Properties

To begin the scenario creation process, you click the **New Scenario** button in a library window or on the InFusion application toolbar. As the first step in creating a scenario, the application prompts you for scenario name, a short description (optional), and the direction of traffic to which any traffic changes apply. Changes are, for example, injection or removal of data or a primitive.

You identify direction of traffic change, or modification, in terms of traffic origin. The application uses the following conventions:

- ❑ **From Initiator:** Change is made to traffic coming from test host (for example, CRC error is injected into traffic stream sent from initiator to target).
- ❑ **From Target:** Modification is made to traffic coming from the target (for example, CRC error is injected into traffic stream sent from target to initiator).

The following figure shows the first prompt in the scenario creation process.

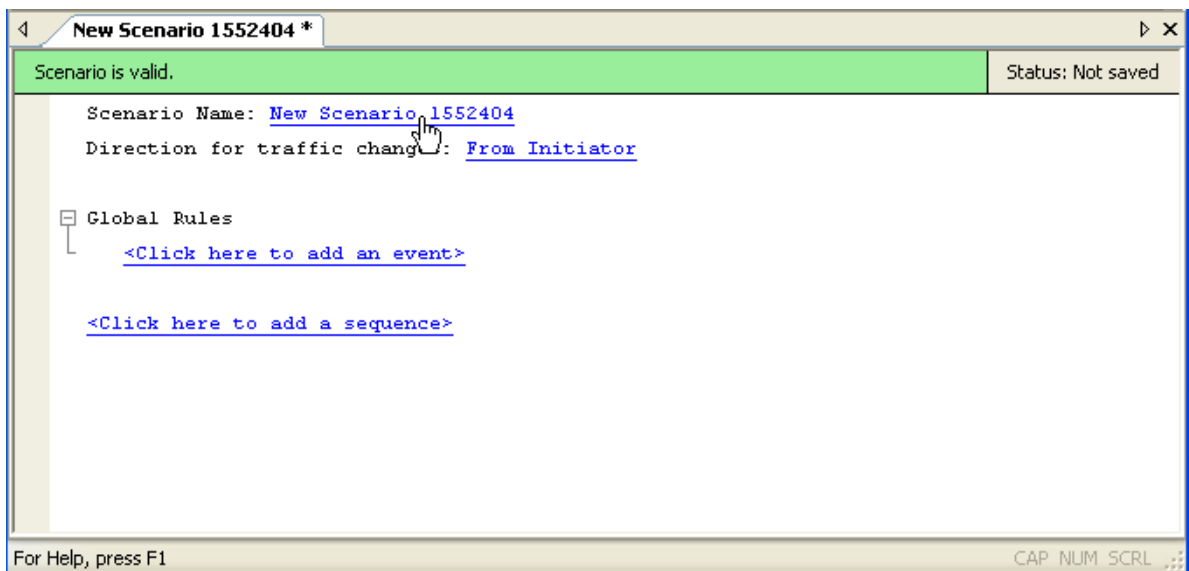

Figure 4.16: Entering Basic Scenario Information

To copy an event or action, right-click on the event or action and select **Copy**. Right-click **Click here to add another event** or **Click here to add an action** and then select **Paste**.

To copy a sequence or state, right-click on the sequence or state and select **Copy**. Right-click **Click here to add another sequence** or **Click here to add another state** and then select **Paste**.

You can also cut, delete, and edit a selected sequence, state, event, or action.

When you click the Scenario Name or the Direction For Traffic Changes, the Scenario Properties dialog box appears, allowing you to enter the scenario name, a short description, and direction of traffic change.

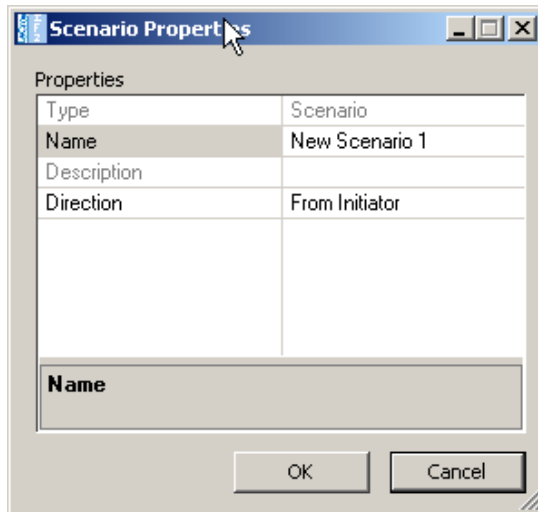

Figure 4.17: SAS Scenario Properties Dialog Box

In the Scenario Properties screen, the direction for traffic modification is defined on a global basis for the entire scenario. In other words, any scenario action that modifies line traffic only affects the traffic flowing in the direction established at the top of the scenario, in the Scenario Properties. Scenario events can be monitored in either direction, and therefore the parameters for events provide the ability to specify the intended direction for monitoring traffic for that event.

SATA Smart Hold Option

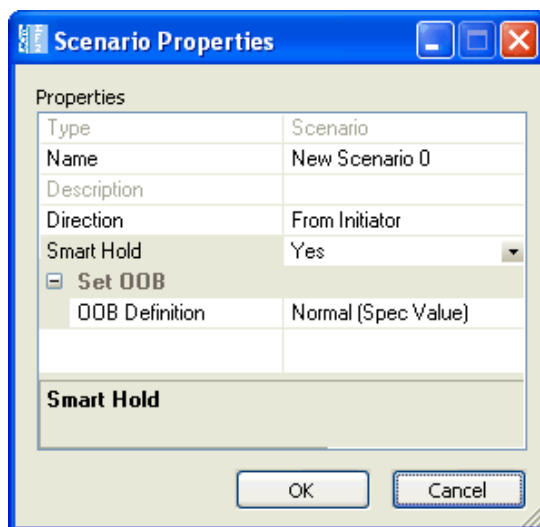

Figure 4.18: SATA Scenario Properties Dialog Box

SATA Scenario Properties have a Smart Hold option, which is on by default.

Each port monitors incoming data, which originated with the other device's receiver, as close as possible to where it enters the bus engine. If a port detects a HOLD primitive during a SATA frame, the port stops reading data from the FIFO and generates HOLDA. The HOLD propagates through the bus engine and eventually goes to the other device, where the HOLD causes the other device to send HOLDA. (The bus engine FIFOs must be deep enough to hold all the traffic that the other device sends while the HOLD propagates. The port drops all incoming HOLDA conditions, so HOLDAs are never put in the FIFOs or made visible to the sequencers.)

After this, the port that had been receiving the HOLD stops sending HOLDA and attempts to read data from the FIFO. The termination of HOLD propagates through the bus engine and then causes the other device to restart transmission, which puts data into the FIFO.

Note: If both sides send HOLD primitives that overlap, the receivers drop the HOLD conditions to avoid overflowing the FIFOs. If you turn off the Smart Hold option, the port does not send HOLDA when it detects a HOLD primitive during a SATA frame.

Scenario Events

A scenario is a script you create using simple mouse clicks and text entries. As you work, the script takes shape in the scenario area of the application display. You can think of the scenario area itself as consisting of two subareas: A Global Rules area at the top, where you create the Global Rules, and a Sequence area beneath the Global Rules, where you create any sequences. Whether you are creating Global Rules or a Sequence, the menu-driven interface prompts you to specify the event(s) for which you want to trigger actions.

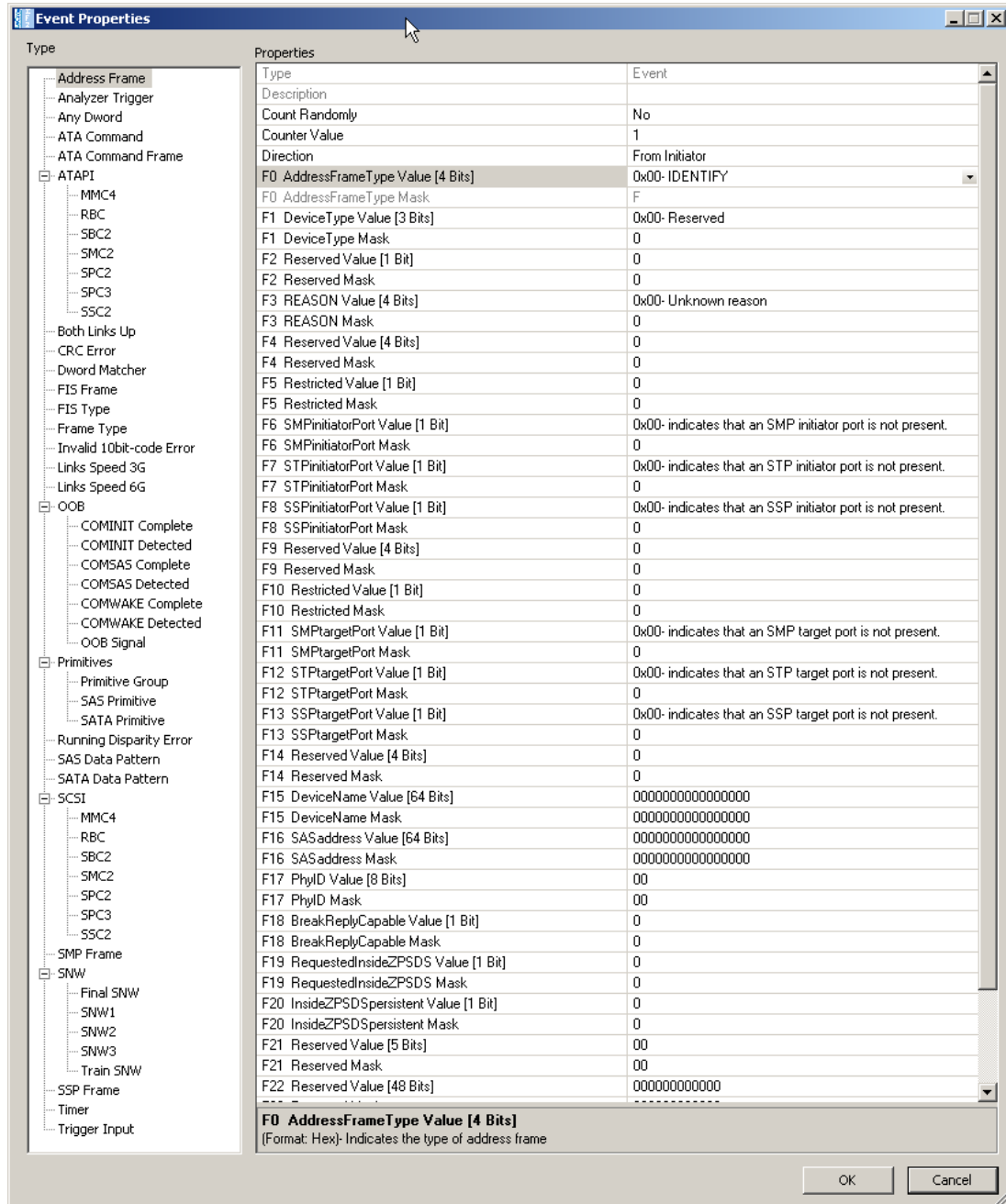

Figure 4.19: Event Properties Dialog

While many events are line conditions, an event also can be a condition that occurs within a InFusion device (for example, detection of a trigger signal from another device). The following table lists supported events. Note that some events are applicable only in the context of creating sequences (those events appear on the drop-down list only if you are creating a sequence). Sequences can have multiple states, and they allow branching between states.

TABLE 4.2: Events

Event	Description
Address Frame	Occurrence of a specified address frame.
Analyzer Trigger	<p>Trigger on Analyzer when its event matches. You can see the trigger on the Status Bar, but the Port Status dialog does not display any mark in the Trigger column.</p> <p>Note: This is different than the external trigger mechanism. You do not need an external trigger cable.</p> <p>Note: The Trigger on Analyzer feature functions when the trigger pattern is set to "Pattern/Infusion" and running a scenario which will trigger analyzer after a 5s timer. A message "Triggered, Post-Trig Capturing" displays on the Software Status bar.</p> <p>Note: When the analyzer triggers, it triggers on a packet before the actual trigger event occurs. The trace triggers more than 1us before the event actually occurs. The trigger is on the Initiator side instead of the Target side as set in the scenario.</p>
Any DWORD	Occurrence of any DWORD.
ATA Command	Occurrence of a particular ATA command.
ATA Command Frame	Occurrence of a particular ATA command frame.
[+] ATAPI	Occurrence of a particular ATAPI command from the list: MMC4, RBC, SBC2, SMC2, SPC2, SPC3, or SSC2.
Both Links Up	Occurrence of both line ports active (not idling).
CRC Error	Occurrence of a CRC error.
DWORD Matcher	Occurrence of a particular DWORD.
FIS Frame	Occurrence of a particular FIS frame.
FIS Type	Occurrence of a particular SATA FIS type.
Frame Type	Occurrence of a particular frame type.
Invalid 10bit-code Error	Occurrence of an invalid 10b code.
Links Speed 3G	Both lines operating at 3 Gbps.
Links Speed 6G	Both lines operating at 6 Gbps.
OOB Signal	Occurrence of OOB signal.
[+] Primitives	Occurrence of Primitive Group, SAS Primitive, or SATA Primitive.
Running Disparity Error	Occurrence of Running Disparity (RD) error.

Event	Description
SAS Data Pattern	Occurrence of a particular data pattern in a SAS frame.
SATA Data Pattern	Occurrence of a particular data pattern in a SATA frame.
{+} SCSI	Occurrence of a particular SCSI command from the list: MMC4, RBC, SBC2, SMC2, SPC2, SPC3, or SSC2.
SMP Frame	Occurrence of a particular SMP frame.
SNW	Occurrence of Final SNW, SNW1, SNW2, SNW3, Train SNW
SSP Frame	Occurrence of a particular SSP frame.
Timer	Occurrence of a particular elapsed time (time period).
Trigger Input	Occurrence of input trigger.

The following sections provide some additional details about three of the above events.

DWORD Matcher

DWORD Matcher is a DWORD pattern matcher that presents match and mask fields and a K-Code Mask field. K-Codes are control characters that are always used in the first byte of a four-byte primitive. Of the K-Code masks listed in the menu, D-D-D-D is used for data bytes, and K-D-D-D is used for all primitives.

When you create a DWORD match, keep the following in mind:

- The pattern can be inside or outside of frames (it does not matter if the pattern is inside a frame or not).
- Because the pattern can be inside or outside of frames, there is no offset.
- You can make user-defined primitives. (This is the reason this feature was created.)
- You can use any K/D pattern.

SAS Data Pattern

When you create a SAS data pattern, keep the following in mind:

- The pattern must be defined inside a frame that starts with a SOF or SOAF.
- The pattern must be data only (no K-codes/primitives).
- The pattern must be defined at a specific offset in the frame.
- The pattern and mask must be specified in the same format as specified in the SAS standard:
0x12345678 (hex)
where "1" is the first digit on the cable and is the MSB as given in the SAS Standard.

For example, for an SMP Request:

```
Pattern: 0x40000000
Mask: 0xFF000000
Offset: 0
SOF Type: SOF
```

SATA Data Pattern

When you create a SATA data pattern, keep the following in mind:

- ❑ The pattern must be defined inside a frame that starts with a SATA_SOF.
- ❑ The pattern must be data only (no K-codes/primitives).
- ❑ The pattern must be defined at a specific offset in the frame.
- ❑ The pattern and mask must be specified in the same format as specified in the SATA Standard.

For example, for Register H -> D FIS:

```
Pattern: 0x00000027
Mask: 0x000000FF
Offset: 0
SOF Type: SATA_SOF
```

Scenario Actions

After you enter the set of events for a test state, the menu-driven interface prompts you for the corresponding action or set of actions. If you define multiple actions, the actions occur simultaneously (see [Figure 4.20 on page 345.](#))

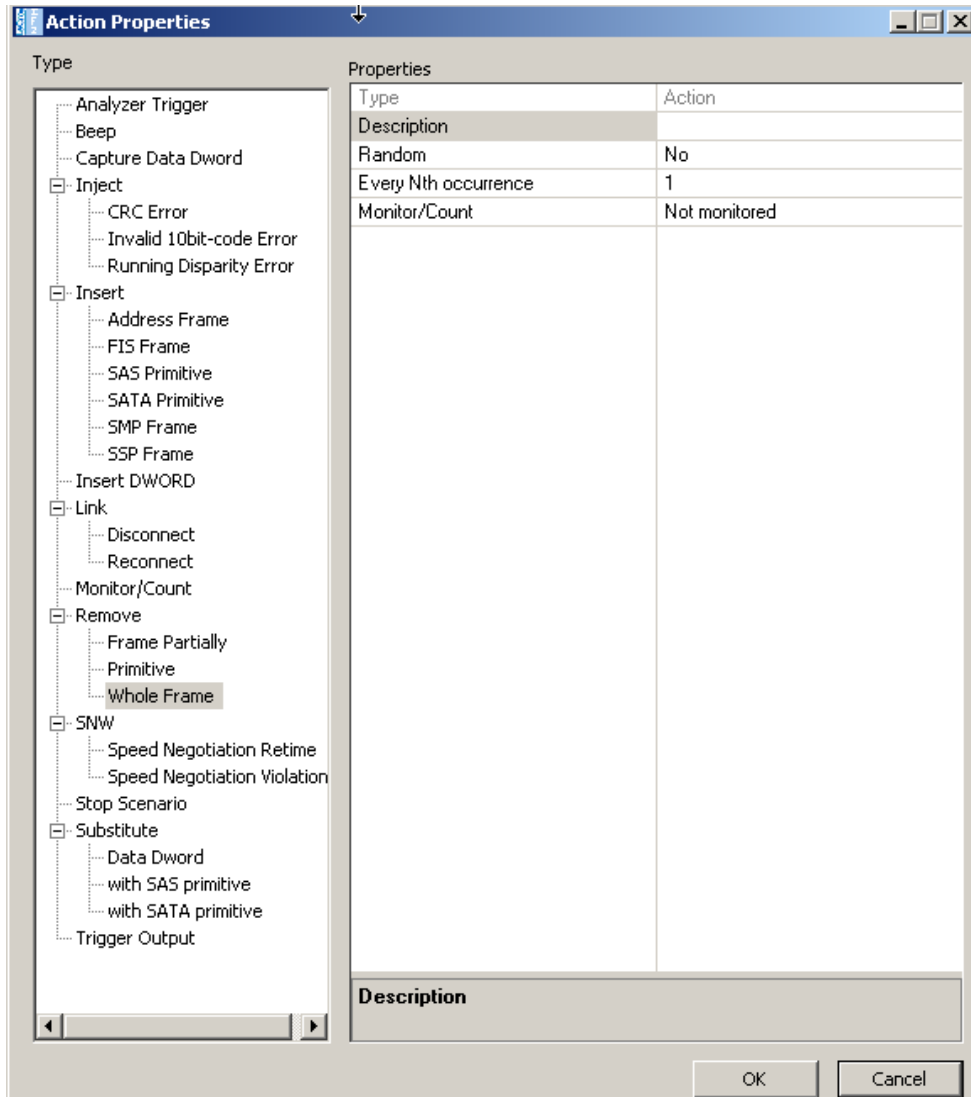

Figure 4.20: Action Properties Dialog

The following table lists supported actions. Note that some of these actions only apply to creating sequences.

TABLE 4.3: Test State Actions

Action		Description
Analyzer Trigger		The Jammer sends a trigger to the Analyzer.
Beep		Emits audible sound of duration selectable via drop-down list.
Branch to	Existing State ¹	Go to a state in this sequence that is already defined. ¹
	New State ¹	Go to a state in this sequence that is not yet defined (you need to define it). ¹
Capture Data DWORD		Captures a data DWORD into one of four registers.
Inject	CRC Error	Injects a CRC error into the line.
	Invalid 10bit-code Error	Injects invalid 10b code into the line.
	Running Disparity Error	Injects a Running Disparity (RD) error into traffic.
Insert	Address Frame	Inserts a frame or primitive.
	FIS Frame	
	SAS Primitive	
	SATA Primitive	
	SMP Frame	
	SSP Frame	
Insert DWORD		Inserts DWORD.
Link	Disconnect	Puts both InFusion SAS ports at electrical idle immediately.
	Reconnect	Starts traffic pass-through immediately. This action restarts traffic after a previous disconnect command. Once traffic is passing through, the initiator and target resume OOB signaling.
Monitor/Count		Opens a window to count the number of events that occur during a session. A session is a time interval during which a scenario runs.
Remove	Frame Partially	Removes the targeted event from the traffic. In InFusion. A Remove primitive action is implemented by replacing the primitive with an idle data DWORD. A Remove frame action is implemented by replacing the start-of-frame and end-of-frame primitives with an idle data DWORD.
	Whole Frame	
Restart	All Sequences ¹	Restart all sequences in the scenario. ¹
	Current Sequence ¹	Restart the sequence that contains this action definition. ¹

Action	Description
SNW	Speed Negotiation Retime
	Speed Negotiation Violation
Stop Scenario	
Substitute Data DWORD	
	with SAS Primitive
	with SATA Primitive
Trigger Output	

¹ Only shown in Action Properties dialog box when creating a sequence.

Note:

Using Counters in Events and Actions

Many of the events and actions supported by InFusion also support counters that can control functions.

Within events, counters determine how many times the event must occur before the associated actions are triggered. Event counters typically have two properties:

- Count Randomly:** Can be set to “Yes” or “No” (default value is “No”). If set to “Yes”, the event repeats a random number of times (between 1 and the value set in the property **Max Random Count**, which replaces the property **Counter Value** when “Yes” is selected), before the action is triggered.
- Counter Value:** Number of repeats required when **Count Randomly** is set to “No”. The default value is 1.

Within actions, counters determine how many times the system calls the action before it acts. Action counters typically have two properties:

- Random:** Can be set to “Yes” or “No” (default value is “No”). If set to “Yes”, the action triggers a number of occurrences before the action takes place. That number ranges randomly between 1 and the value set in the property **At least every Nth occurrence**, which replaces the property **Every Nth occurrence** when “Yes” is selected.
- Every Nth occurrence:** Number of times the system calls the action before it acts.

Note that there is some overlap in the way these counters can be used. For example, in the simple case of a single event leading to a single action, it makes no difference whether you specify the event to require five repeats before triggering the action, or the action to require five occurrences before it acts.

However, in the case of combined events and/or actions, the separate counters provide flexibility in designing test cases. For example, consider the case where Event_1 OR

Event_2 leads to Action. If Event_1 has a counter of 5, then the Action triggers either when Event_1 has repeated five times or when Event_2 happens the first time, whichever occurs first.

But if the event counters are set to 1 and the Action counter is set to 5, then the Action happens after five occurrences of EITHER Event_1 or Event_2.

Capturing a Data DWORD

InFusion provides the ability to capture individual data DWORDs and provides four different registers to store captured DWORDs (DWORD #0, #1, #2 and #3).

To capture a data DWORD, select **Capture Data DWORD** from the Action Properties screen, as shown below. Select the register to be used to store the DWORD from the drop-down menu under the **Capture Register** property.

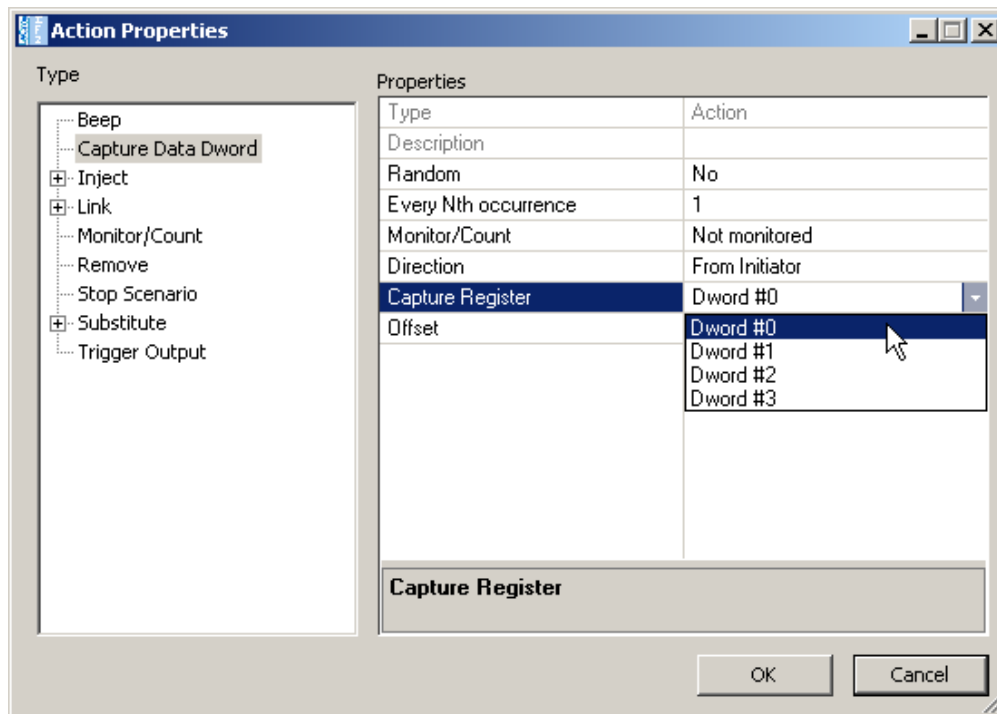

Figure 4.21: Capture Data DWORD Action

Using Captured Data DWORDs

Captured data DWORDs can be used in creating events for data that match the captured DWORD(s), or in creating actions to substitute the captured DWORD(s) into the data stream.

To create an event using the captured DWORD, in the Event Properties menu, select **SAS Data Pattern** (or **SATA Data Pattern**), and then select any of the 12 DWORDs (**DWORD 0 Type** through **DWORD 11 Type**). The drop-down menu provides the choice of a custom DWORD or any of the four captured DWORDs. If you select a captured DWORD, the **Value** field beneath this selection is hidden (the **Value** field is only used for specifying custom DWORDs). Note that choice of a mask and an offset are still available when using captured DWORDs.

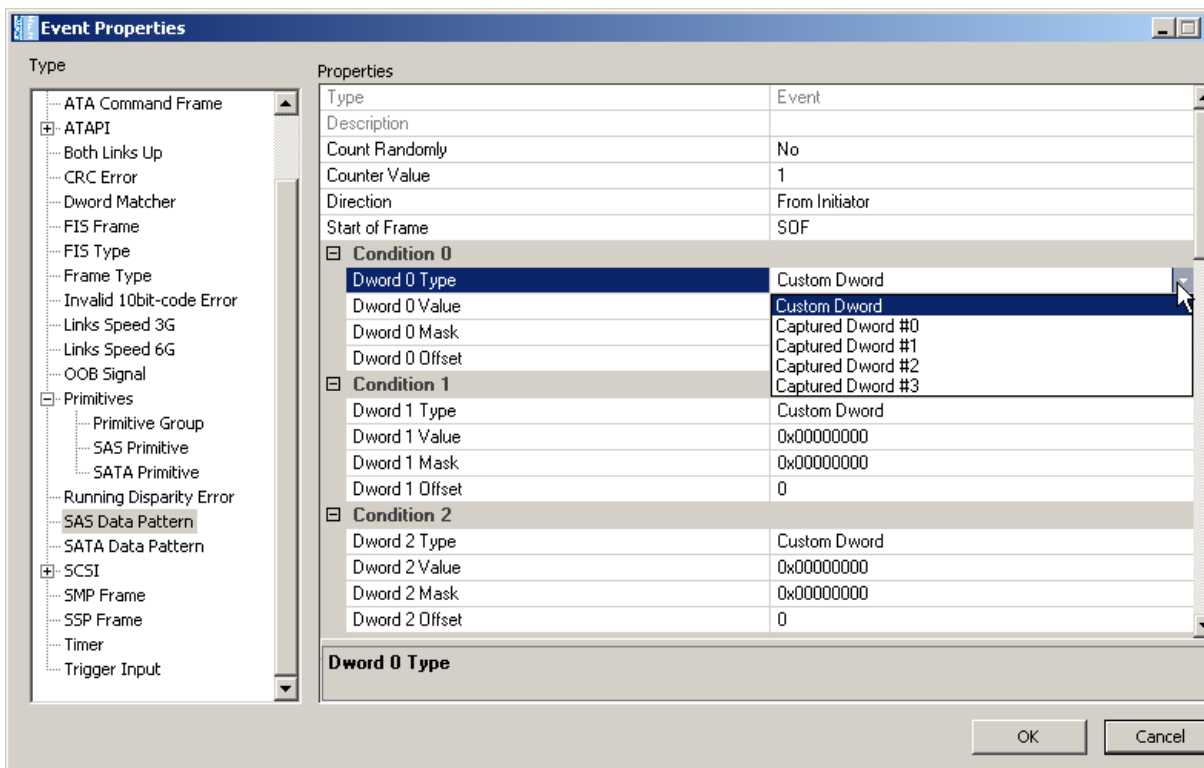

Figure 4.22: Using a Captured DWORD in a SAS Data Pattern

Captured data DWORDs may also be used in the **Substitute Data DWORD** test state action. From the Action Properties screen, choose **Substitute Data DWORD** and then select the **Substitute for** property. A drop-down menu is provided (see below) that allows the choice of a custom DWORD or any of the four captured DWORD registers.

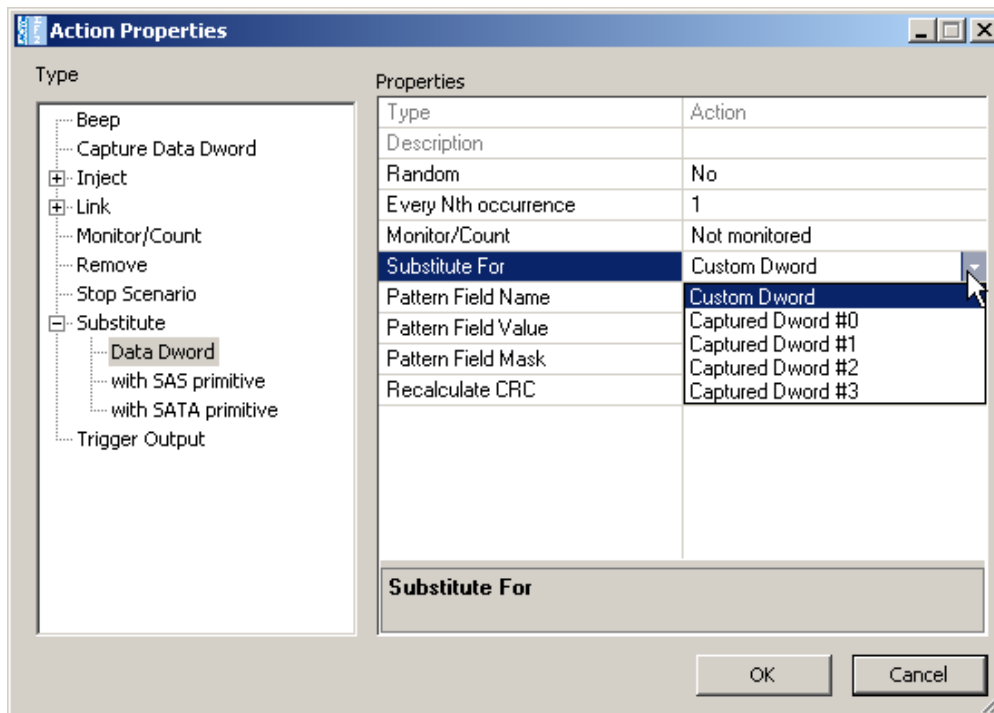

Figure 4.23: Using a Captured Data DWORD in Substitute DWORD Test Action

Summary of Scenario Creation

The suggested process of creating and executing a scenario is as follows:

1. Create a scenario in the main library.
2. Copy the scenario from main library to a device library by drag-and-drop with a mouse. (Each device library is associated with a specific InFusion device.)
3. Download all scenarios in the device library to a InFusion device.
4. Select the scenario in the device library that you want to run on the device.
5. To run the scenario, click the **Start Scenario** button from the Device Library toolbar. The device starts to monitor/modify traffic.

Note: Step 1 is described in detail for each example in following sections. Steps 2 to 5 are described in detail at the end of this chapter.

Creating Global Rules

This section gives examples for creating the Global Rules area of a scenario. Recall that the Global Rules area defines a single test state. The Global Rules do not have the capacity for multiple states, so that area of a scenario cannot change state.

In terms of InFusion testing, a state defines test “behavior.” In this context, behavior is “waiting” for an event and responding with an action or set of actions that happen simultaneously.

Keep in mind that a test state you implement with the Global Rules operates in parallel with the active test state of each sequence in the scenario.

In effect, InFusion lets you do up to three line tests at the same time. You can do one test with the Global Rules and a separate test with each sequence you create. You can have up to two sequences in a scenario.

The following table summarizes the Global Rules examples that follow.

TABLE 4.4: Global Rules Examples

Example	Description
1	Creating a single event and action (removes a primitive).
2	Creating a single event and action (replaces a primitive).
3	Creating a combined event (a logical OR association of multiple events) and an action.
4	Creating multiple triggers and actions.
5	Creating multiple actions on a single event.
6	Using timers.

Example 1: Creating a Single Event and Action that Removes a Primitive

In this example, the Global Rules area of the scenario waits for each RRDY Normal primitive from the initiator and removes it.

1. Click the **New Scenario** button in the main library or one of the device libraries.
2. In the Scenario Properties dialog, enter the scenario name, description, and direction of traffic change (see [Figure 4.17 on page 339](#)).
3. In the Global Rules area, click the prompt to **add an event**.

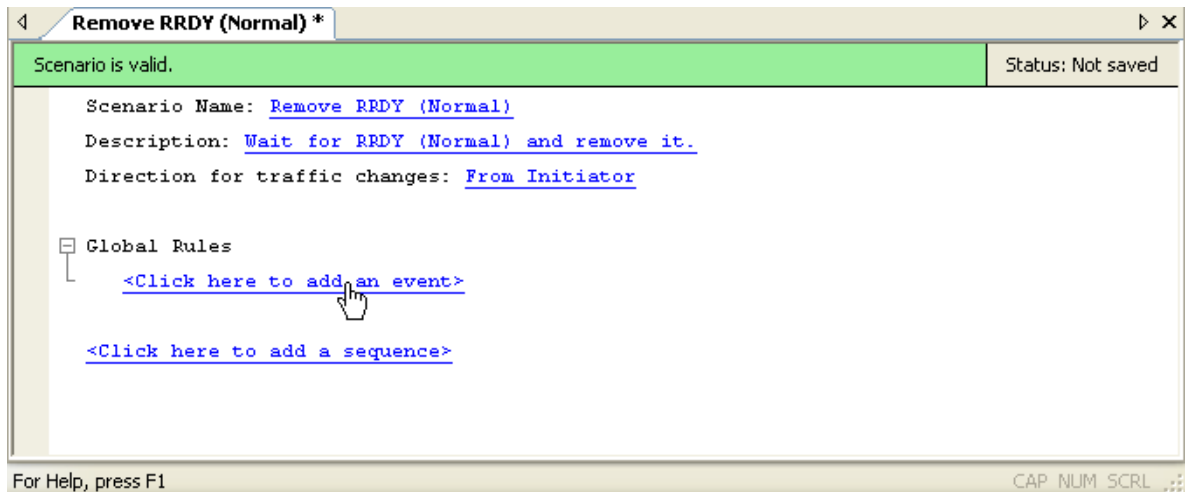

Figure 4.24: Example 1: Adding an Event

The Event Properties dialog box appears (see [Figure 4.19 on page 341](#)).

4. In the Type column of the Event Properties dialog, choose **Primitive > SAS Primitive**.
5. In the Type column in the middle of the dialog box, click **Description** if you want to add a description of the event.
6. Click **Direction** to choose the direction of traffic to monitor for the selected event (the default is **From Initiator**, which is what you want for this example).

7. Still in the middle column of the Event Properties dialog box, click **Primitive** to display a drop-down menu that lets you choose the type of primitive for which you want to wait in this scenario. In this example, it is **RRDY (Normal)**.

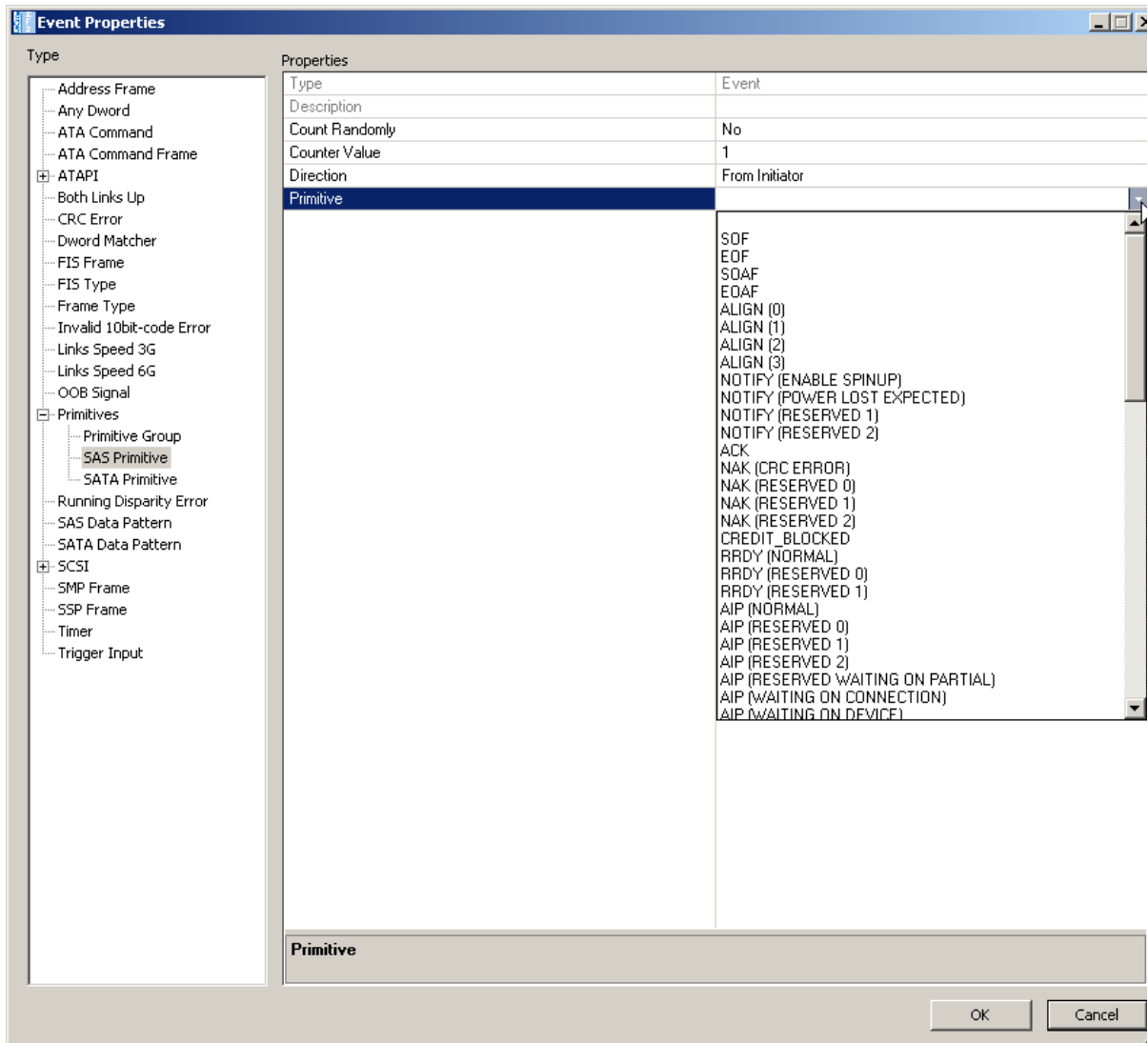

Figure 4.25: Example 1: Event Drop-Down List

8. Click **OK** to close the Event Properties dialog box.

- In the Global Rules area, click the prompt to **add an action**.

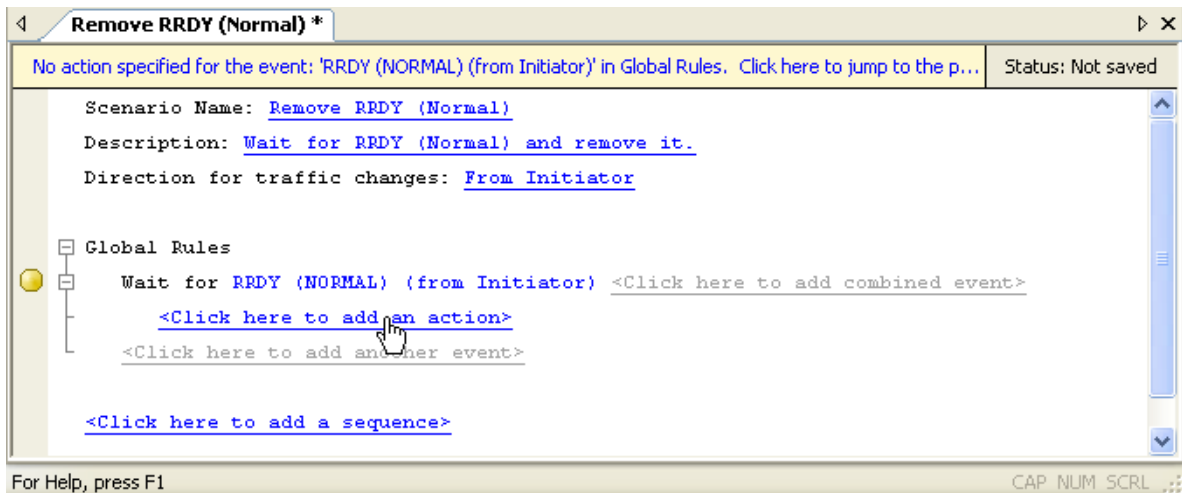

Figure 4.26: Example 1: Entering an Action

The Action Properties dialog box appears (see [Figure 4.20 on page 345](#)).

- In the Type column on the left, choose the action that you want to occur when an RRDY is detected. In this example, it is the **Remove Primitive** action. Select Random **Yes** or **No**, **N** for Every Nth occurrence, and Monitor/Count as **Monitored** or **Not Monitored**.
- Click **OK** to close the Action Properties dialog box.

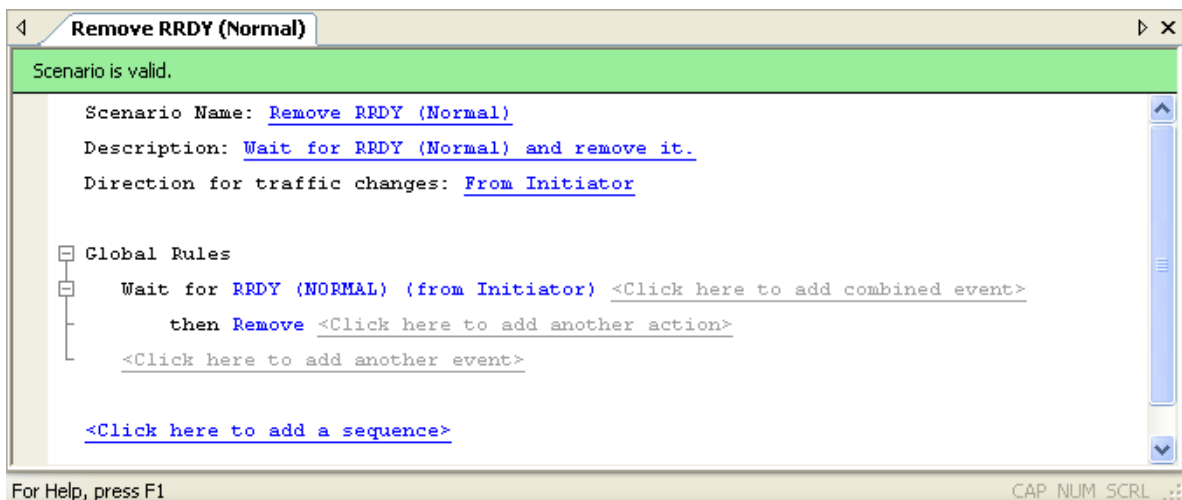

Figure 4.27: Example1: Complete Scenario

- In the File menu, select **Save Scenario** to save the scenario.

Example 2: Wait for a Primitive and Replace It with an Error

In this example, the Global Rules portion of the scenario waits for each RRDY Normal primitive and replaces it with an ERROR primitive.

1. Click the **New Scenario** button in the main library or one of the device libraries. In the Scenario Properties dialog, enter the scenario name, description, and direction of traffic change.
2. In the Global Rules area, click the prompt to **add an event** to display the Event Properties dialog box.
3. As you did in the previous example, choose **RRDY (Normal)** as the type of primitive to monitor.
4. In the Global Rules area, click the prompt to **add an action** to display the Action Properties dialog box.
5. In the Type column on the left, choose **Substitute > with SAS Primitive** as the action that you want when an RRDY (Normal) occurs.
6. In the middle column of the dialog box, click **Description** if you want to add a description of the action.
7. Still in the middle column of the Event Properties dialog box, click **Primitive** to display a drop-down menu that lets you choose the type of primitive for which to substitute for RRDY (Normal) (see Figure 4.25 on page 353). Choose **ERROR**.
8. Click **OK** to close the Action Properties dialog box.
9. In the File menu, select **Save Scenario** to save the scenario.

In this example, you set the substitution action to happen at every occurrence of an RRDY (Normal) (as shown in the figure, the action is set for every occurrence). However, you can set an action to happen at other multiples of event occurrence (for example 5, 25, 1000 and so on). You also can set the action to happen at random, within a specified number of event occurrences.

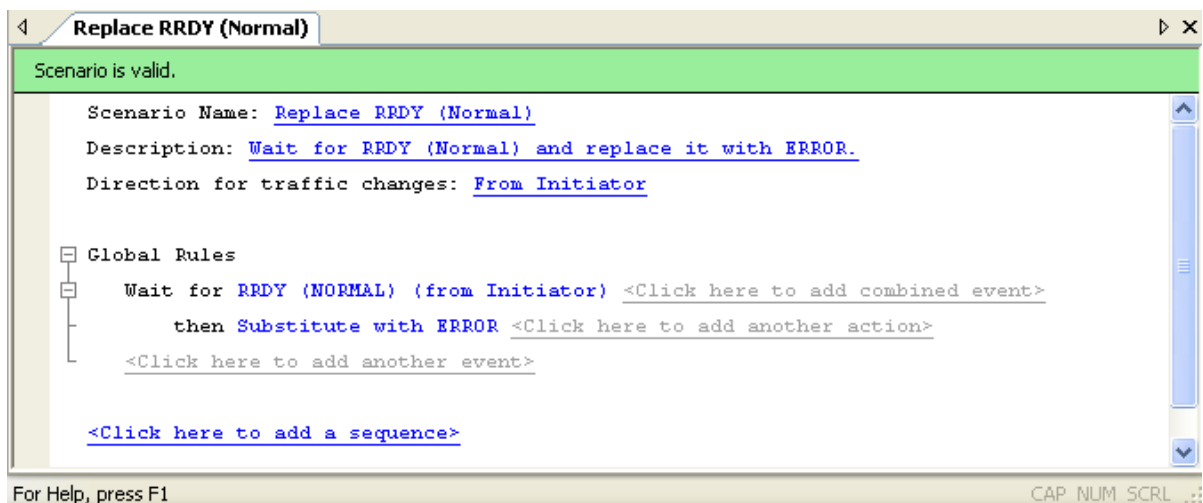

Figure 4.28: Example 2: Complete Scenario

Example 3: Creating OR Conditions

In this example, the Global Rules area of the scenario waits for either of two types of RRDY primitive and replaces them with an ERROR primitive.

This example includes a combined event (a logical OR association of two or more single events). Here, the combined event consists of any occurrence of RRDY (Normal) or RRDY (Reserved 0).

1. Click the **New Scenario** button in the main library or one of the device libraries. In the Scenario Properties dialog, enter the scenario name, description, and direction of traffic change.
2. In the Global Rules area, click the prompt to **add an event** to display the Event Properties dialog box.
3. As you did in example 1 of this chapter, choose **RRDY (Normal)** as the first primitive that you want to monitor.
4. Click the **add combined event** prompt to add a second event.

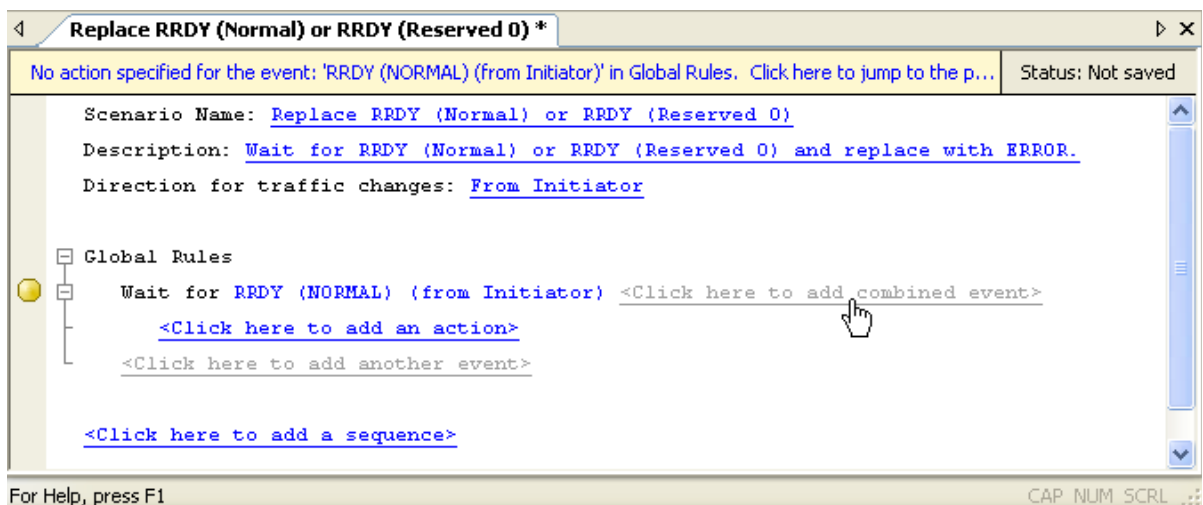

Figure 4.29: Example 3: Entering the Second Event

The Event Properties dialog box appears.

5. Choose **RRDY (Reserved 0)** as the second primitive that you want to monitor.
6. Click **OK** to close the Event Properties dialog box.
7. In the Global Rules area, click the prompt to **add an action** to display the Action Properties dialog box.
8. In the Type list on the left, choose **Substitute SAS Primitive** as the action that you want when either RRDY Reserved 0 or RRDY Normal occurs.
9. Click **OK** to close the Action Properties dialog box.

10. In the File menu, select **Save Scenario** to save the scenario.

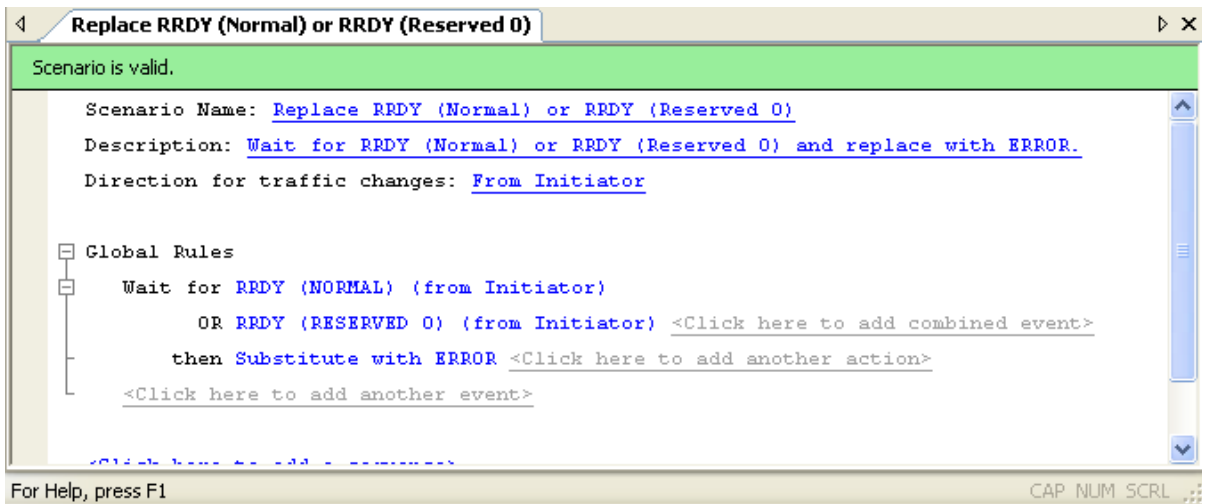

Figure 4.30: Example 3: Complete Scenario

Example 4: Multiple Triggers and Actions

In this example, the Global Rules area of the scenario waits for two events, each of which triggers a different action.

1. Click the **New Scenario** button in the main library or one of the device libraries. In the Scenario Properties dialog, enter the scenario name, description, and direction of traffic change.
2. As you did in example 2, choose **RRDY (Normal)** as the first event to monitor, and substitute with the SAS primitive **ERROR** as action.
3. In the Global Rules area, click the prompt to **add the next event** (keep in mind this is not a combined event).

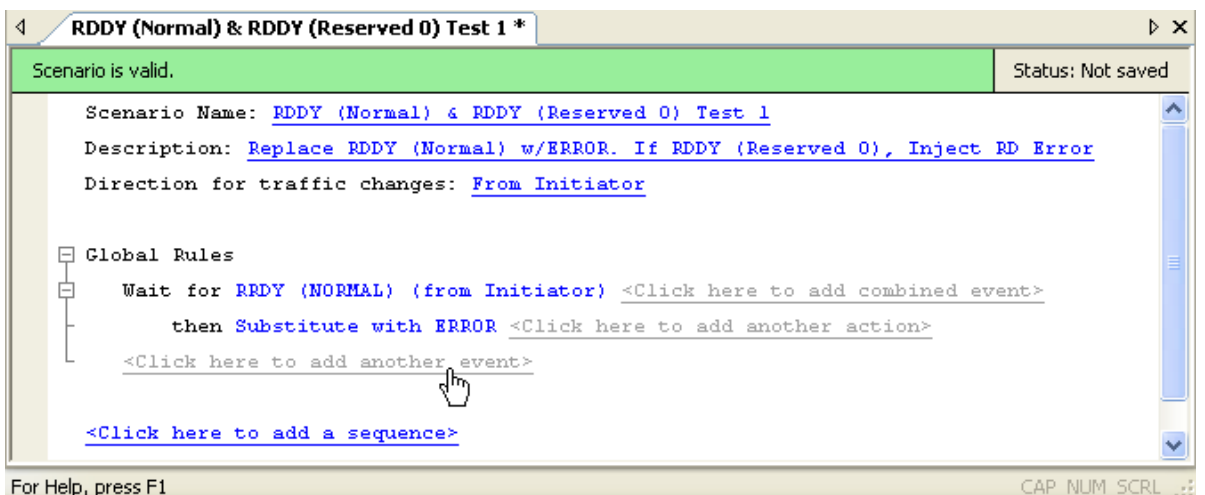

Figure 4.31: Example 4: Entering Second Event

The Event Properties dialog box appears.

In this example, there is a parallel set of events, but each event is associated with its own action. In a combined event, there is a parallel set of events sharing the same action.

4. Using the drop-down menu, choose **RRDY (Reserved 0)** as the second event to monitor.
5. Click **OK** to close the Event Properties dialog box.
6. In the Global Rules area, click the prompt to **add an action** to be triggered by the RRDY (Reserved 0).

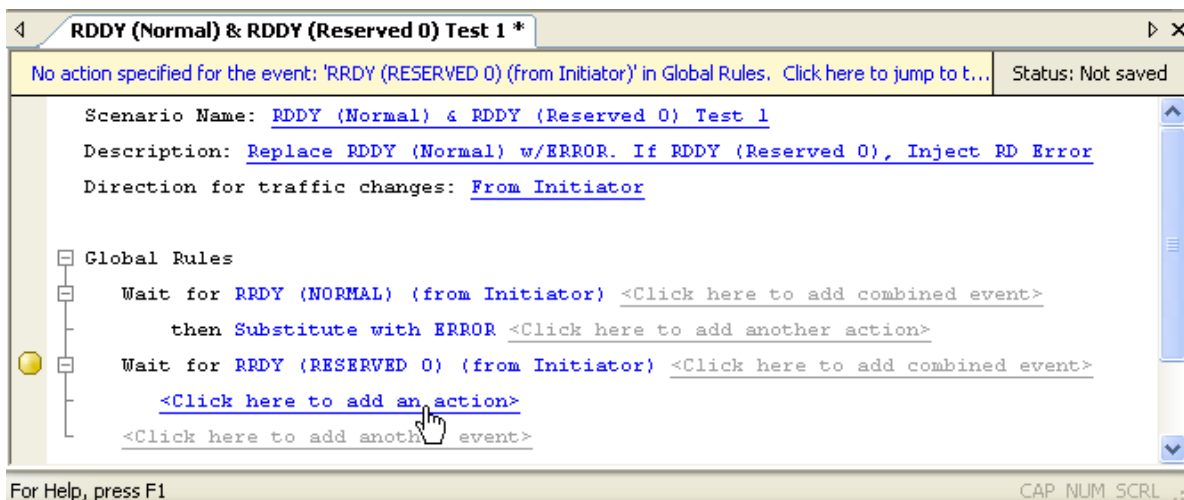

Figure 4.32: Example 4: Entering Second Action

The Action Properties dialog box appears.

7. Use it to choose **Inject RD Error** as the action triggered by RRDY (Reserved 0).
8. Click **OK** to close the Action Properties dialog box.

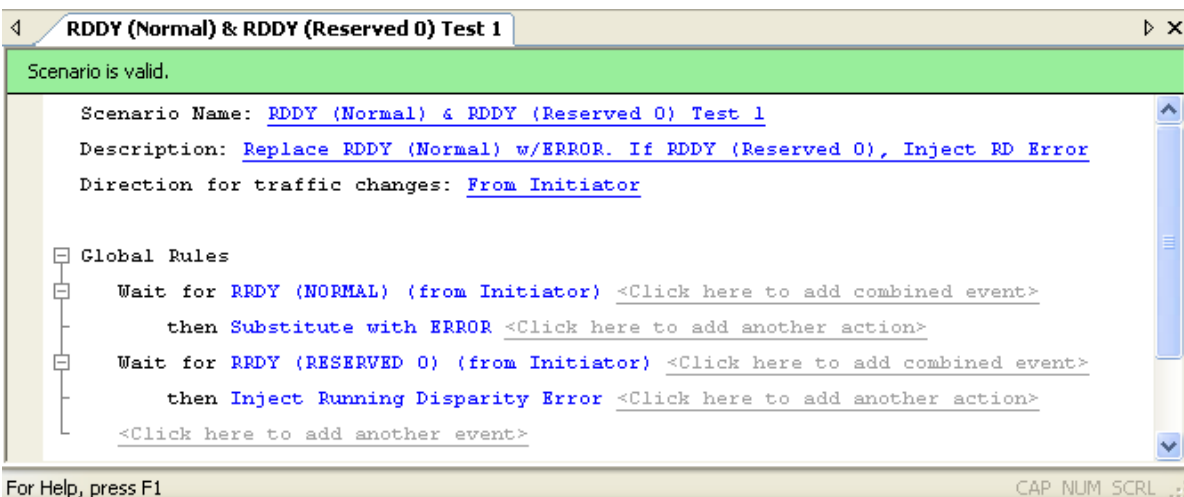

Figure 4.33: Example 4: Complete Scenario

9. In the File menu, select **Save Scenario** to save the scenario.

Example 5: Multiple Actions on a Single Event

In this example, an event triggers a set of actions. The actions occur at the same time. The device waits for an ACK from the initiator. When it occurs, the device beeps, injects an RD error, and increments a counter monitoring for that event (ACK from initiator).

1. Click the **New Scenario** button in the main library or one of the device libraries. In the Scenario Properties dialog, enter the scenario name, description, and direction of traffic change.
2. As in previous examples, configure the first event and its response in the Global Rules area. Choose **ACK** primitive as the event and **Beep** as the action. From the Action Properties drop-down menu, enter **500 ms** as the duration of the beep.
3. Click the **add another action** prompt to add a second action.

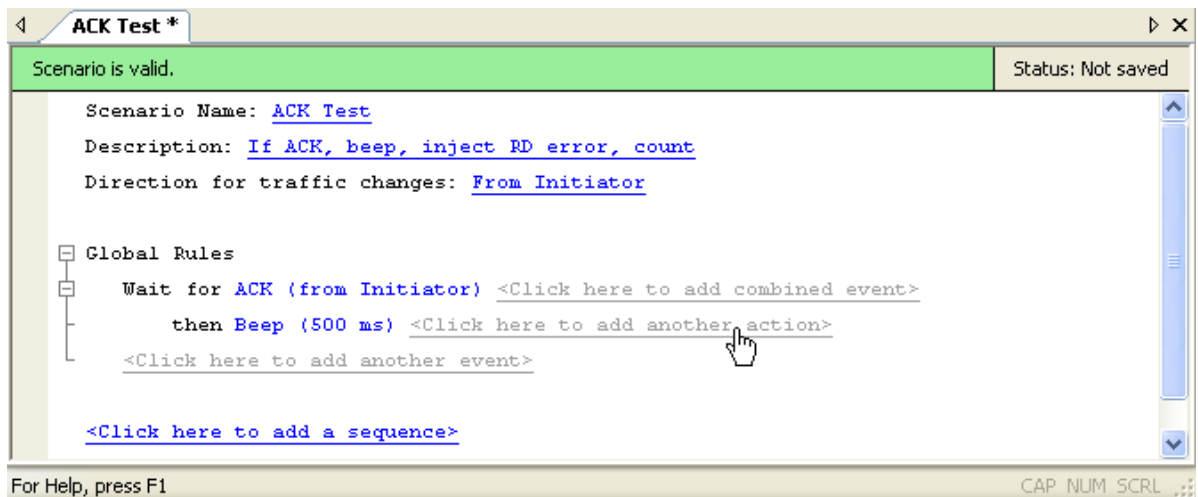

Figure 4.34: Example 5: Entering the Second Action

The Action Properties dialog box appears.

4. Choose **Inject RD Error** as the second action.
5. Click the **add another action** prompt to add a third action.
6. The Action Properties dialog box appears.
7. Choose **Monitor/Count** as the third action.

- Click **OK** to close the Action Properties dialog box.

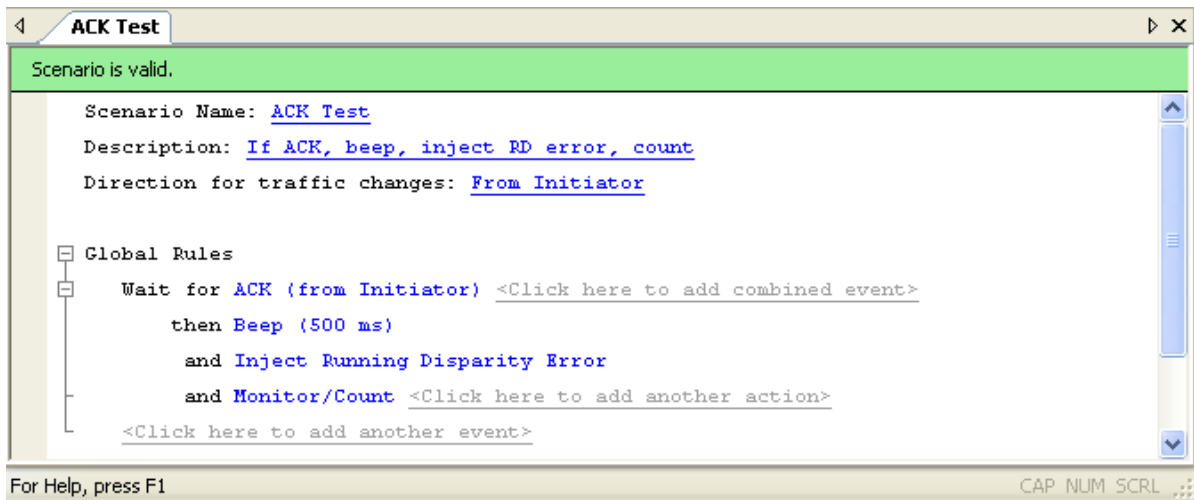

Figure 4.35: Example 5: Complete Scenario

- In the File menu, select **Save Scenario** to save the scenario.

This example sets the counter to increment at each occurrence of an ACK (every 1 ACK).

Example 6: Using Timers

In this example, the Global Rules portion of the scenario waits for an ACK primitive from the initiator. Each time the device detects an ACK, it injects an RD Error into the traffic stream. This state continues for a random period of time, not to exceed 1.790 seconds. After the time period has elapsed (timer times out), the scenario stops.

Although this example sets the timer for a random period, you also can set the timer for known values (2 ms., 5 mins., 1 hr., and so on).

- Click the **New Scenario** button in the main library or one of the device libraries. In the Scenario Properties dialog, enter the scenario name, description, and direction of traffic change.
- As in previous examples, configure the first event and its response in the Global Rules area. Choose **ACK** primitive as the event and **Inject RD Error** as the action.

3. Click the prompt to **add another event** (keep in mind this is not a combined event).



Figure 4.36: Example 6: Entering the Second Event

The Event Properties dialog box appears.

4. In the Type column on the left, choose **Timer**. Set the timer for random timing with a maximum time limit of 1.790 seconds.
5. Click **OK** to close the Event Properties dialog box.
6. Click the prompt to **add an action** to correspond with the second event.

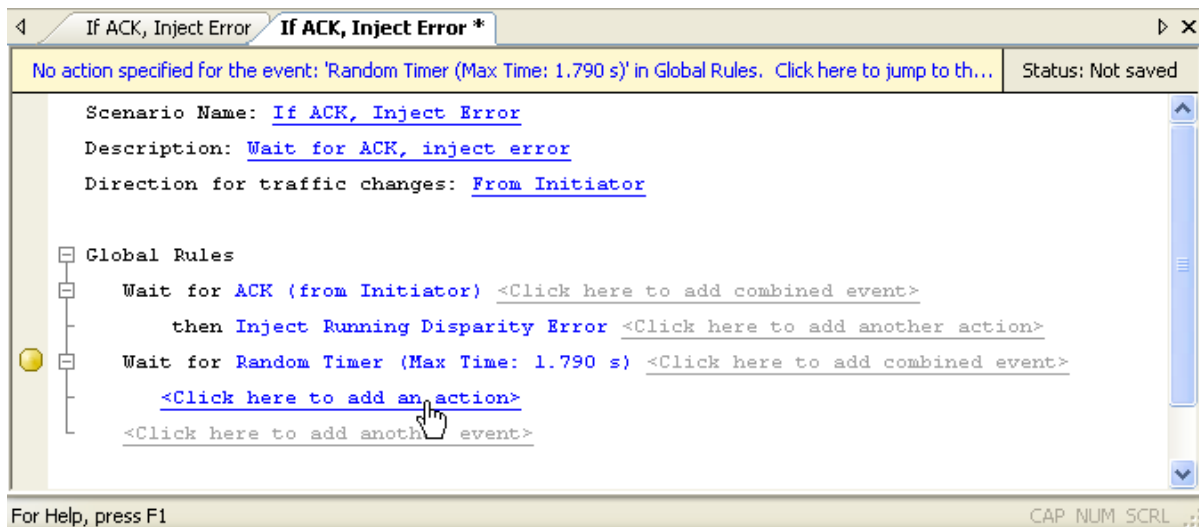

Figure 4.37: Example 6: Entering Second Action

The Action Properties dialog box appears.

7. In the Type list on the left, choose **Stop Scenario** as the action that you want after the timer has expired.

- Click **OK** to close the Action Properties dialog box.

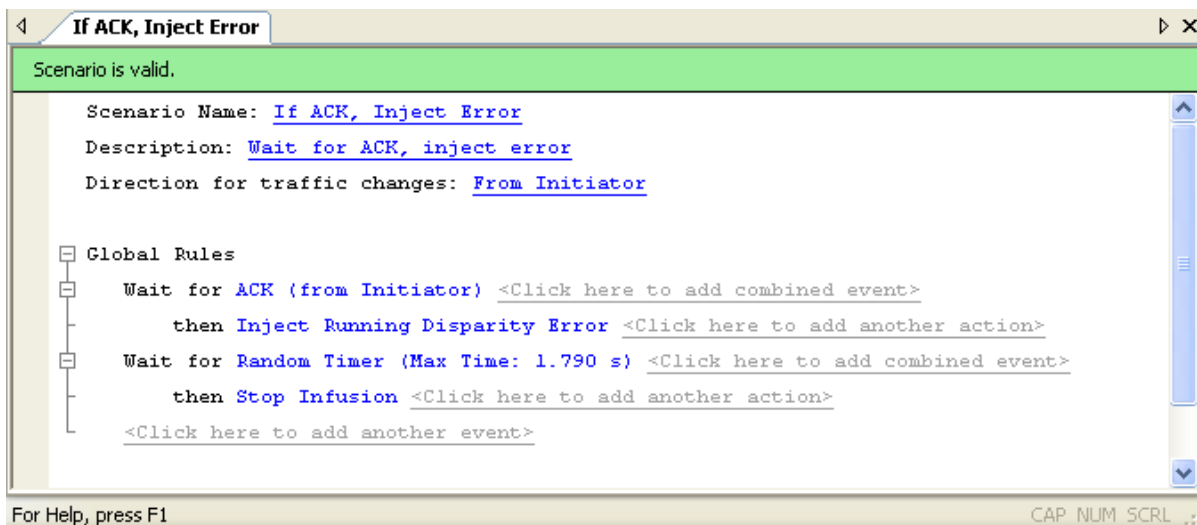

Figure 4.38: Example 6: Complete Scenario

- In the File menu, select **Save Scenario** to save the scenario.

Creating a Sequence

This section gives several examples for creating sequences. Recall that a sequence can have multiple states, but only one state is active at any time. In other words, at any point in time, a sequence “waits” for one event (or combined event) and responds with the corresponding action or set of actions when the event occurs.

A sequence is more powerful than Global Rules, because you can create branching or looping test logic with a sequence. You can include up to two sequences in a scenario, but each is completely independent of the other. There is no branching or other interaction between the two, except through the Restart All Sequences action.

You must follow some simple rules when creating sequences:

TABLE 4.5: Sequence Rules

You can use only two branch actions per state.

When you specify actions for a state, you can only use two instances of **Branch to an Existing State** or **Branch to a New State**. If you try to use more than two, a red error message appears in the status area of the application that says “Too Many Actions.”

You can use only one restart sequence action per state.

When you specify actions for a state, you can only use one instance of **Restart Current Sequence** or **Restart All Sequences**. If you try to use more than one, a red error message appears in the status area of the application that says “Too Many Actions.”

You can use a maximum of 255 states per sequence.

If you try to use more than 255 states, a red error message appears in the status area of the application.

The following table summarizes the examples that follow.

TABLE 4.6: Sequence Examples

Example	Description
7	Creating two sequences and Global Rules: This scenario has two objectives that you implement with Global Rules and two sequences. 1) You use Global Rules to replace any of three types of primitives. 2) You use two sequences to detect the order in which a type of frame is received from initiator and target.
8	Creating a sequence with many states #1: The objective of this scenario is to detect an incorrect order of primitives and to cause the device to beep when it happens. You implement this scenario with a single five-state sequence.
9	Creating a sequence with many states #2: This scenario is an enhancement of example 8. In this scenario, the objective is to detect an incorrect order of primitives, fix it, and cause the device to beep when this happens. As with example 8, you implement this scenario with a single five-state sequence.

Example 7: Creating Two Sequences and Global Rules

In this example, Global Rules substitute an Align (0) primitive for each of the following received from the initiator: Align (1), Align (2), and Align (3). As a separate test operation, two sequences determine the order in which each Identify Address frame is received from initiator and target.

The following tables summarize the logic implemented by each of the sequences.

TABLE 4.7: Example 7: Logic of Sequence 0

State	Description
State 0	If Address Frame is detected from initiator, go to State 1; otherwise, continue to check incoming frames (do not change state).
State 1	If next Address Frame detected is from target, beep 1 second.

TABLE 4.8: Example 7: Logic of Sequence 1

State	Description
State 0	If Address Frame is detected from target, go to State 1; otherwise, continue to check incoming frames (do not change state).
State 1	If next Address Frame detected is from initiator, beep 2 seconds.

There is no interaction between the two sequences. Each of them operates independently (and is independent of the Global Rules). However, the two sequences complement each other with their logic. In this sense, they both combine to implement a test objective.

1. Click the **New Scenario** button in the main library or one of the device libraries. In the Scenario Properties dialog, enter the scenario name, description, and direction of traffic change.
2. As in previous examples, create the Global Rules area.
3. Click the prompt to **add a sequence**. Prompts for the sequence appear beneath the Global Rules area. You create a sequence one state at a time. The application numbers states consecutively from 0 up (1, 2, 3, and so on).

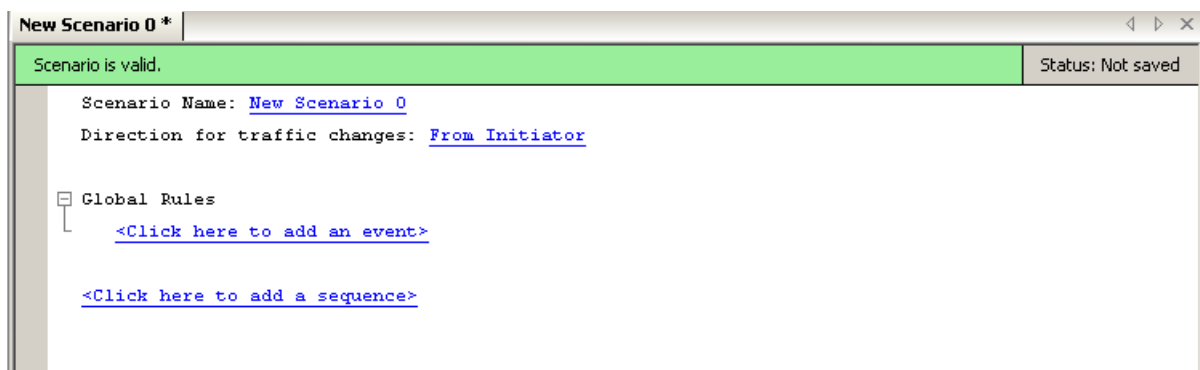

Figure 4.39: Example 7: Adding a Sequence

By default, the name of the first sequence in a scenario is Sequence 0. The name of the first state is State 0. To change the name of a sequence or state, or to associate a description with it, click the name of the sequence or state. A dialog box appears that allows you to enter that information.

Note: The description does not appear on screen, but you can bring it up by clicking the name of the sequence or state.

4. In the State 0 area, click the prompt to **add an event**.



Figure 4.40: Example 7: Adding an Event for the First State

The Event Properties dialog box appears.

5. In the Event Properties dialog box, select **Address Frame** as the event.
6. Click **OK** to close the Event Properties dialog box.

- In the State 0 area, click the prompt to **add an action**.

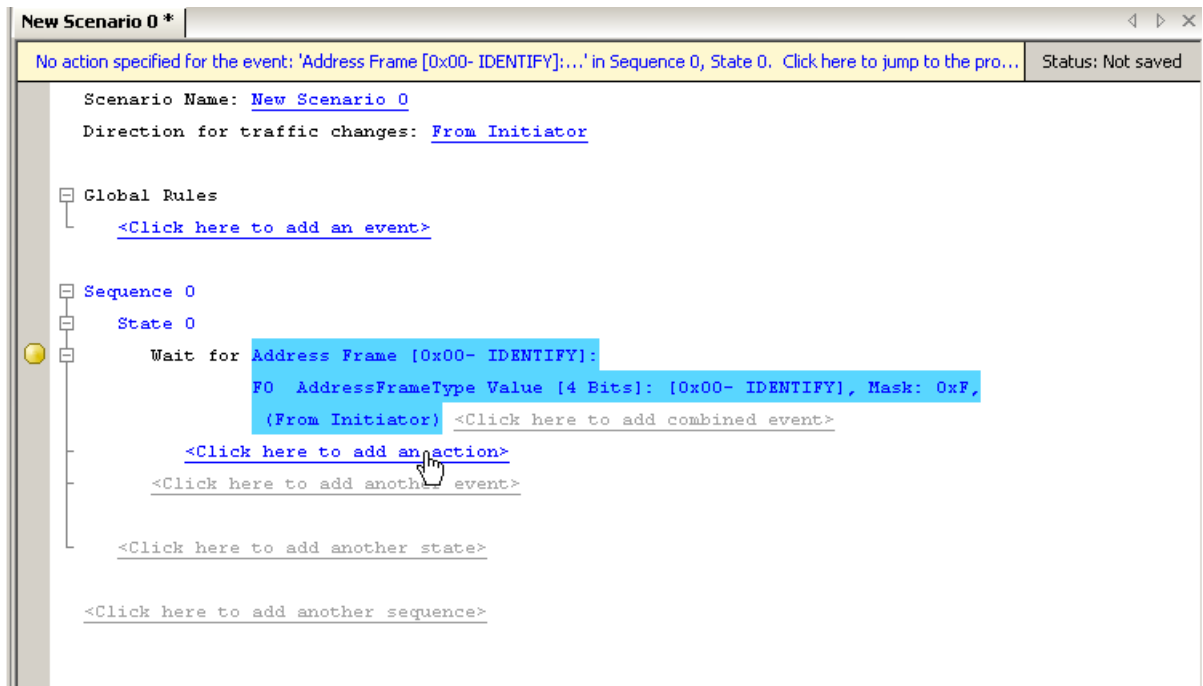

Figure 4.41: Example 7: Adding an Action for the First State

The Action Properties dialog box appears

- For the action, select **Branch to > New State**.
- Click the **OK** button to close the Action Properties dialog box.
- This saves the action and automatically creates an area for State 1 in the scenario.
- In the State 1 area, click the prompt to **add an event**. The Event Properties dialog box appears.
- Choose the **Address Frame** event. In the Direction column, select **From Target** (you want State 1 to trigger on an Identify Address frame received from the target).
- Click **OK** to close the Event Properties dialog box.

14. Click the prompt to **add an action** for State 1.



Figure 4.42: Example 7: Adding an Action to the Second State

The Action Properties dialog box appears.

15. In this example, you enter the action **Beep**, and you set the duration of the beep for 1 second.
16. Click **OK** to close the Action Properties dialog box.

17. You are finished creating the first sequence. Click the **add another sequence** prompt to create an area in the scenario for the second sequence (Sequence 1).



Figure 4.43: Example 7: Adding a Second Sequence

18. Create two states in the second sequence with the characteristics shown in the following table.

TABLE 4.9: Example 7: States for Second Sequence

State	Event	Action
0	Address Frame from Target	Branch to State 1
1	Address Frame from Initiator	Beep for 2 seconds.

19. In the File menu, select **Save Scenario** to save the scenario.

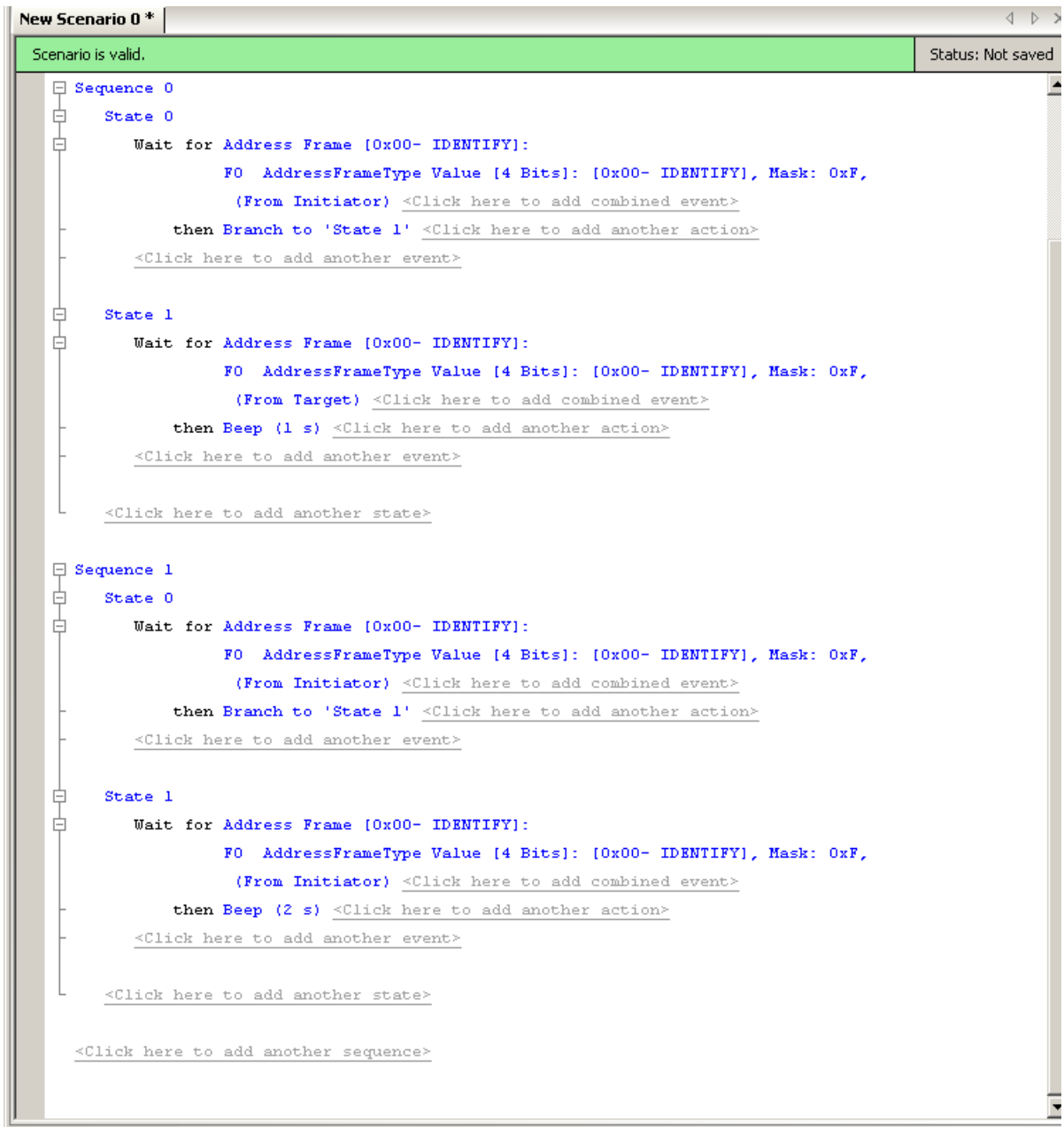

Figure 4.44: Example 7: Sequence Area of Scenario

Example 8: Creating a Sequence With Many States #1

In this example, a five-state sequence detects if a group of primitives is received out-of-order from the initiator. The expected order is: Align (0), Align (1), Align (2), Align (3). If this scenario detects any other order of these primitives, it causes the device to beep and the scenario to restart.

This example is designed to give you an idea of the powerful logic that you can implement with sequences.

Note that the states in this sequence have been renamed (do not have their default names). The following table summarizes the sequence logic.

TABLE 4.10: Example 8: Logic of Sequence 0

State	Description
Wait for Align (0)	When an Align (0) is received, go to Wait for Align (1).
Wait for Align (1)	If an Align (1) is received next, go to Wait for Align (2); otherwise, go to Indicate Error.
Wait for Align (2)	If an Align (2) is received next, go to Wait for Align (3); otherwise, go to Indicate Error.
Wait for Align (3)	If an Align (3) is received next, restart test; otherwise go to Indicate Error.
Indicate Error	Indicate error and restart test.

1. Click the **New Scenario** button in the main library or one of the device libraries. In the Scenario Properties dialog, enter the scenario name, description, and direction of traffic change.
2. As in previous examples, create the five states for this sequence.

3. In the File menu, select **Save Scenario** to save the scenario.

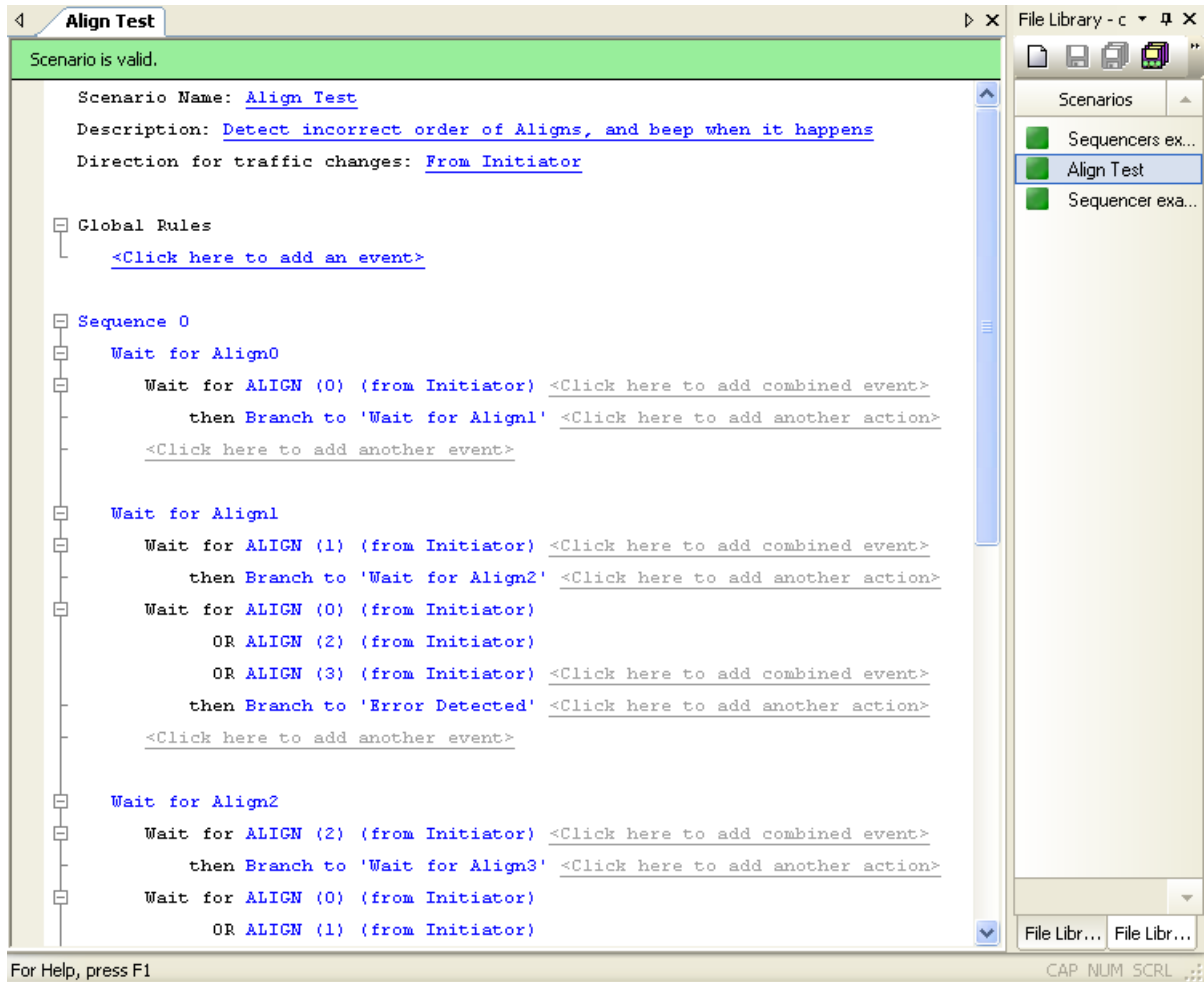

Figure 4.45: Example 8: Top Half of Scenario

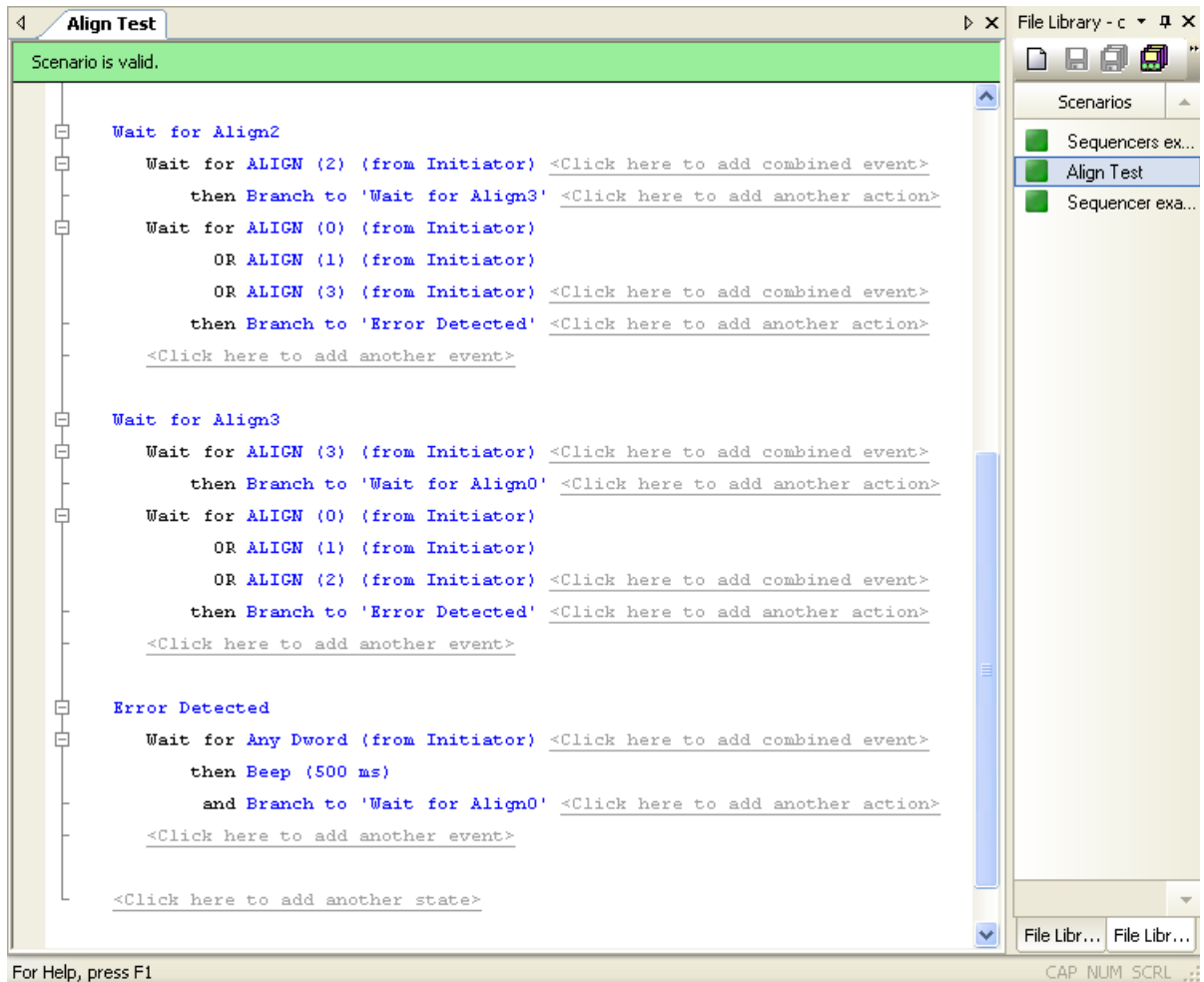

Figure 4.46: Example 8: Bottom Half of Scenario

Example 9: Creating a Sequence With Many States #2

In this example, a five-state sequence not only detects if a group of primitives is received out-of-order, but it fixes any incorrect order. The logic is similar to that of example 8 with a few small changes. The following table summarizes each state.

TABLE 4.11: Example 9: Logic of Sequence 0

State	Description
Wait for Align (0)	When an Align (0) is received, go to Wait for Align (1).
Wait for Align (1)	If an Align (1) is received next, go to Wait for Align (2); otherwise, replace primitive with Align (1) and go to Indicate Error.
Wait for Align (2)	If an Align (2) is received next, go to Wait for Align (3); otherwise, replace primitive with Align (2) and go to Indicate Error.
Wait for Align (3)	If an Align (3) is received next, restart test; otherwise, replace primitive with Align (3) and go to Indicate Error.
Indicate Error	Indicate error and restart test.

1. Click the **New Scenario** button in the main library or one of the device libraries. In the Scenario Properties dialog, enter the scenario name, description, and direction of traffic change.
2. As in previous examples, create the five states for this sequence.

3. In the File menu, select **Save Scenario** to save the scenario.

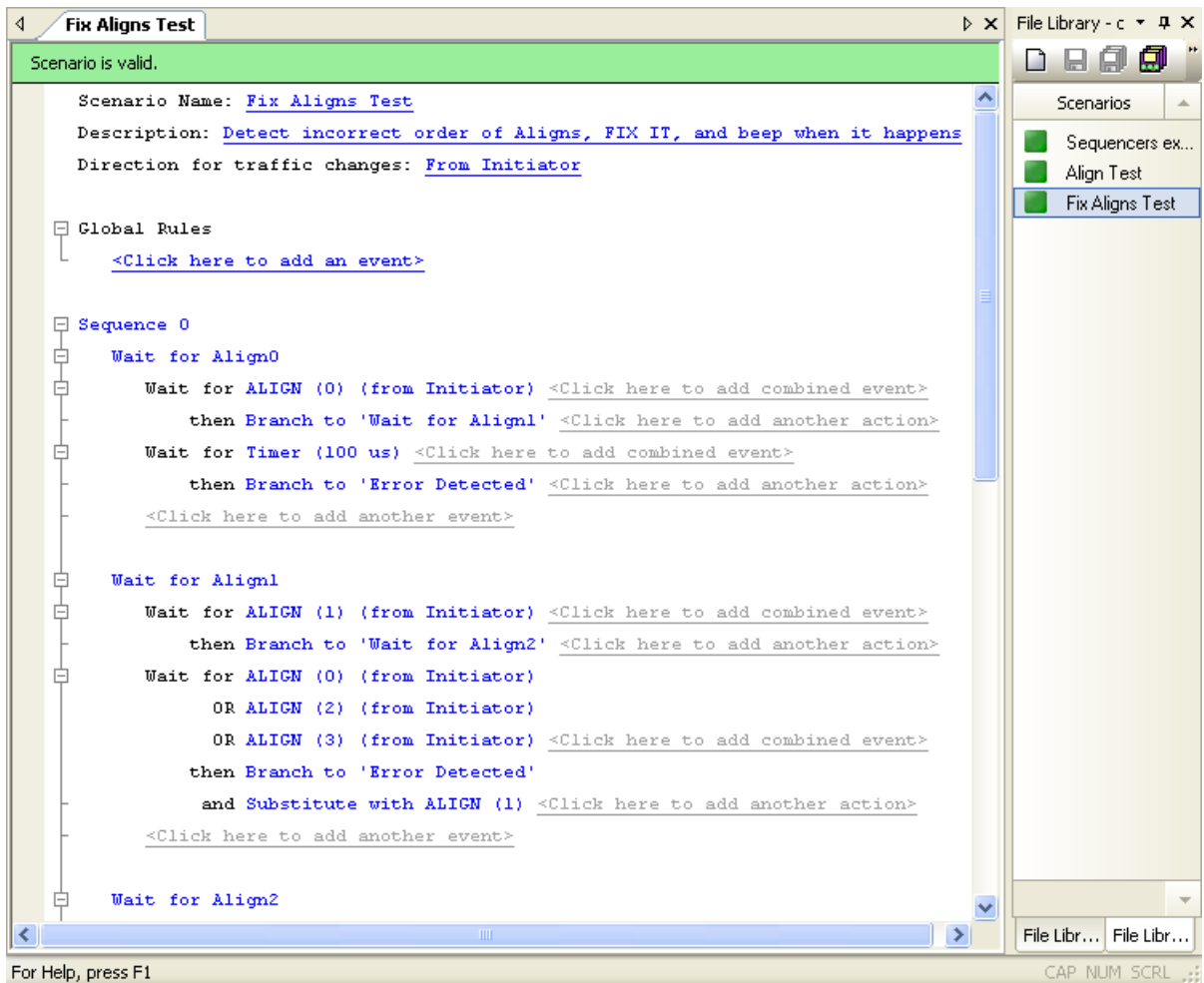

Figure 4.47: Example 9: Top Half of Scenario

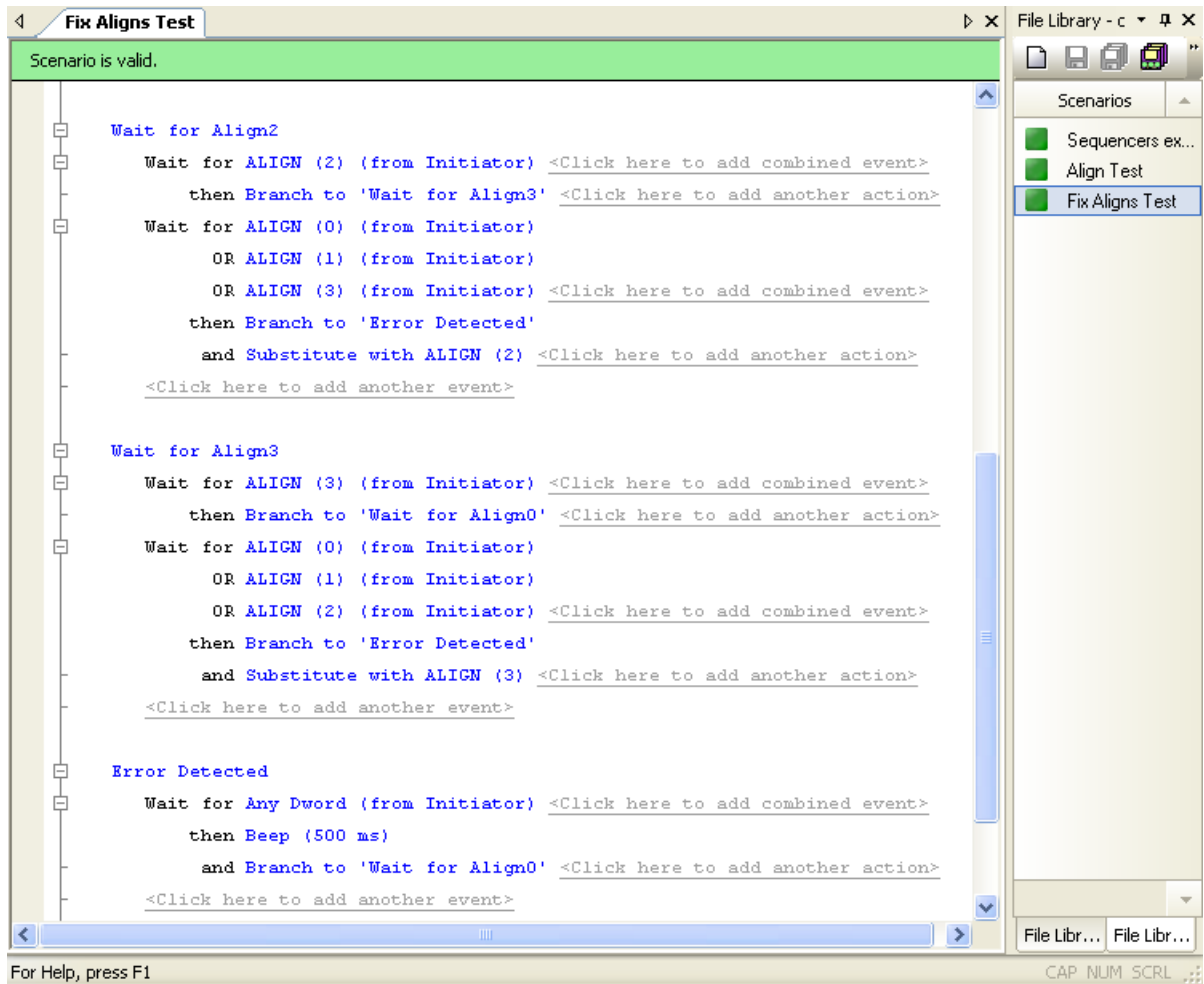

Figure 4.48: Example 9: Bottom Half of Scenario

Downloading Scenarios

After you have created a scenario, you need to download it to the InFusion device for execution.

If you use a general library as a scenario archive, then the process of creating and downloading a scenario is as follows:

1. Open the general library (Main library or a File library). Scenarios in the library are listed in the Main Library window.
2. Open the Device Library window by clicking the **Show Device Library** button on application toolbar.
3. Open the Device Library for the device to which you want to download a scenario or scenarios. You can open the device library in two ways: by clicking the **Device Library icon** in the device list window or by double-clicking the **device name**.
4. Copy the scenario from general library to device library by dragging it with the mouse.
5. Download all scenarios in the device library to the InFusion device. To do so, click the **Download all Scenarios** button on the Device Library toolbar (second button from left).

Running Scenarios

If you use a general library as a scenario archive, then the process of executing a scenario is as follows:

1. Select the scenario to run by clicking it.
2. To run the scenario, click the **Run Scenario** button on the Device Library toolbar (second button from the right). The InFusion device then begins its session.

Scenario Batch Files

You can write a script with commands to run a sequence of executable scenarios automatically. A Scenario Batch file is a text file with a list of commands to run in sequence when you execute the file. A batch script can manage scenarios and their assigned ports and hardware in sequence, using conditions. The system checks for accuracy of inputs and commands.

Note: Before you run a Scenario Batch file that requests scenarios, you must download the scenarios to the Scenarios box.

To start a batch script, click the **New Batch Script** button or select **File > New Batch Script**.



Script Workspace

In the Script Workspace, add a command and make a batch file.

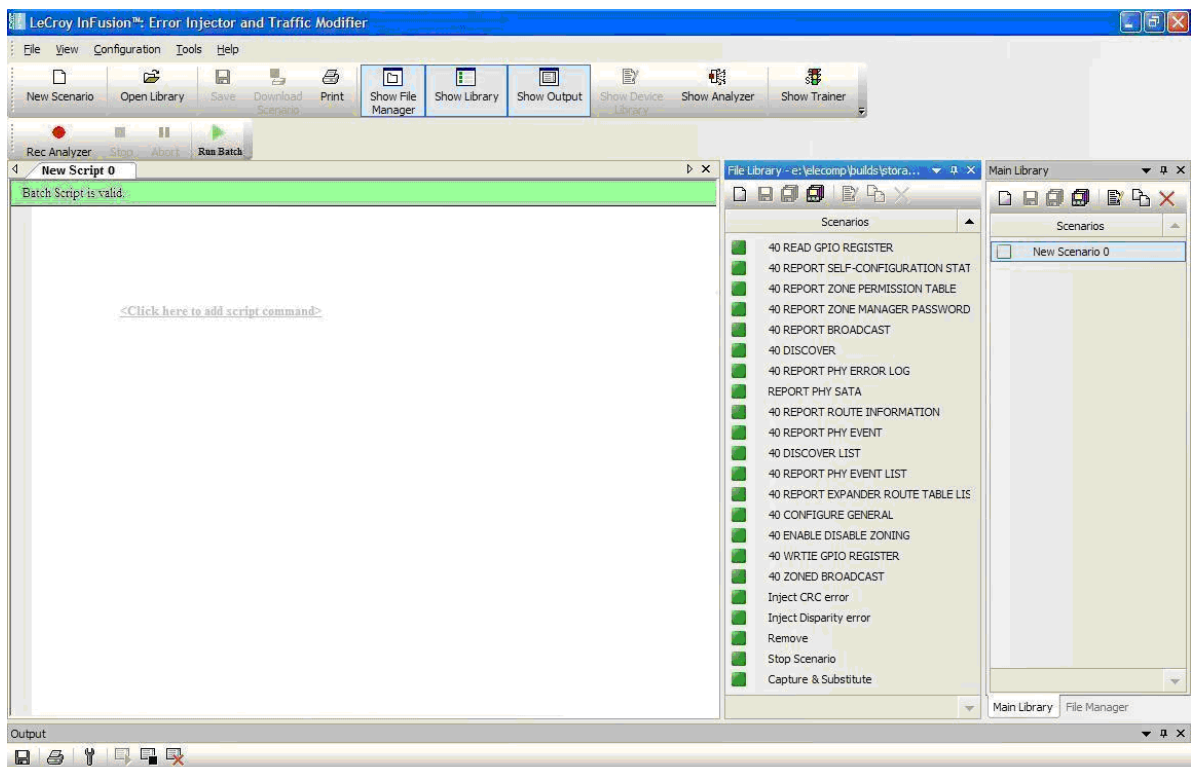

Figure 4.49: Script Workspace

In this window, you can enter a script command by clicking **Click here to add script command**.

3. First, click **Click here to add script command** to open the Command Parameters dialog.

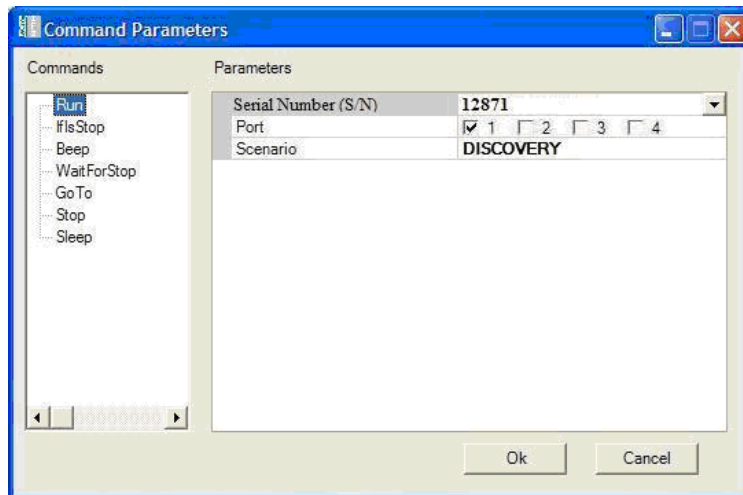

Figure 4.50: Command Parameters Dialog

The Command Parameters Dialog contains the list of available commands and their parameters from which to build scenarios and connected hardware and available ports.

4. Select appropriate parameters for the command and click **OK** to display the script in the Script Workspace.



Note: You can select ports from the port list, depending on number of ports licensed.

Note: The hardware Serial Number can already exist or not. If the Serial Number exists, the Serial Number (for example, S/N: 12871) is shown. In Offline and Simulation mode, you can enter a Serial Number. In Online mode, you can only enter an existing Serial Number.

5. To add another command, click **Click here to add another script command**.



To copy a script command, right-click on the command and select **Copy**. Right-click **Click here to add another script command** and then select **Paste**.

You can also cut, delete, and edit a selected script command.

6. To edit batch commands, click the command, or right-click the command and select **Edit** from popup menu.



7. **To delete a command**, right-click and select **Delete** from popup menu, or select command and press **Delete** key on keyboard.

After finishing, if everything is correct, push the **Run Batch** button to execute scenario and save result in the log file.

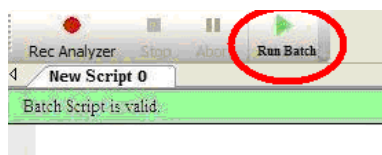

Note: Before you run a Scenario Batch file that requests scenarios, you must download the scenarios to the Scenarios box.

Error Checking

The Script Workspace shows errors by red color. The program reports all errors in the log file.

If you use a script from other InFusion hardware, it may cause an error, for example, mismatch in hardware Mac addresses, or scenarios that are not already in current hardware.

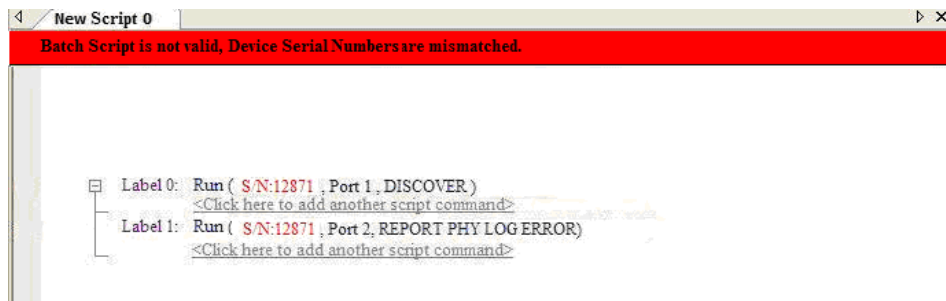

Log

Results of executable batch commands are saved automatically into a log file with user-specified name. The status of executable commands is shown in log area.

Statements

Statements can be conditional statements or non-conditional statements.

IfIsStopped

Shows whether a scenario is already stopped or not.

Format

```
IfIsStopped (Serial Number, Target Port)
```

Parameters

- Serial Number:** Serial number of hardware
- Target Port:** Port number in port map

Example

```
IfIsStopped(ox01267, 1) Then
{
  Beep (750, 300)
  Run (ox01267, " Detect AddressFrame Open", 5)
}
```

The value of second parameter is 5 and shows check stopping mode of combination of port number 1 and port number 3.

After filling parameters from the Command Parameters Dialog, the program makes the IF-ELSE structure in the Script workspace. The ELSE statement is optional. To add an ELSE body, click **Click here to add else body**.

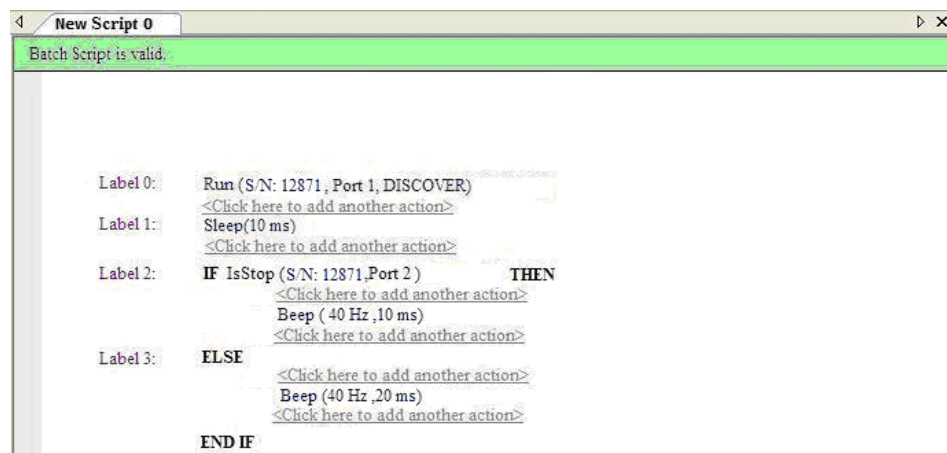
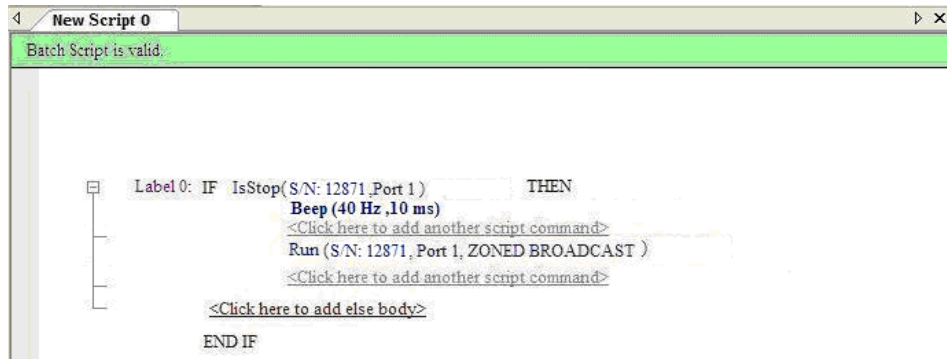

Goto Label

Goes to specified label. Labels can be assigned to each script line.

Format

```
Goto Label3
```

Parameters

none

Example

```
Label3: WaitForStop(0x83456, 2, 100)
Run (ox01267," Inject CRC000", 4)
Goto Label7
```

Note: You can use a **Label** and a **Goto Label** to make loops. First make the label, then make Goto Label. The Command Parameters window shows only enabled Labels. Labels are disabled by default and are in gray color. To enable them, click them to make purple color.

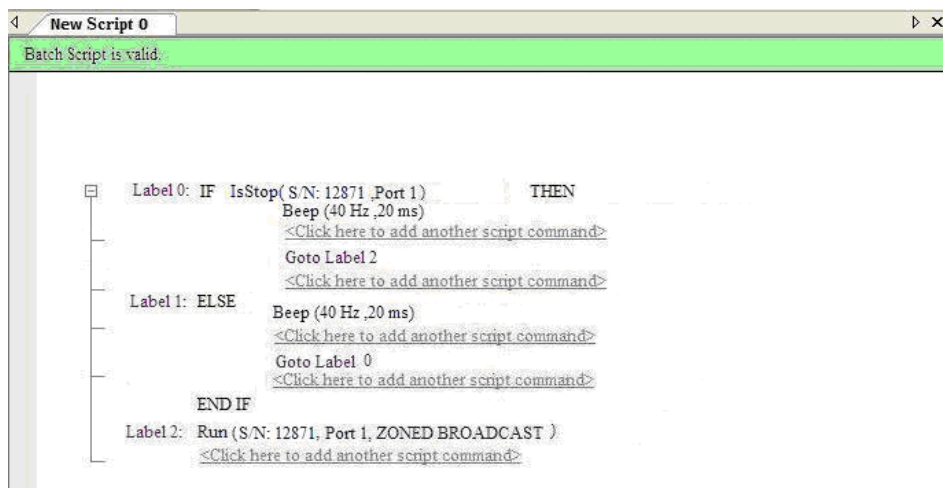
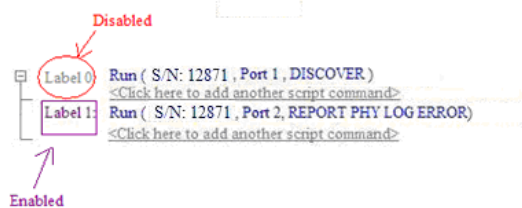
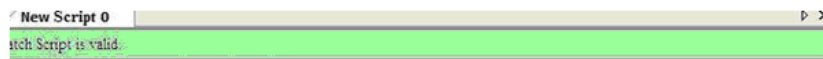
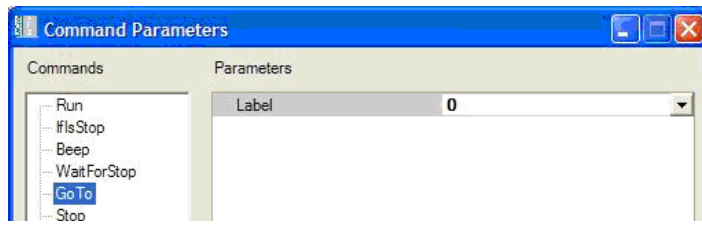

Run

Runs the scenario on hardware on specified ports. If you call this command for the first time and the scenario was not assigned to the hardware and ports before, the scenario is assigned to specified hardware and ports and then scenario runs on the hardware.

Format

```
Run (Serial Number, Scenario Name, Target Port)
```

Parameters

- Serial Number:** Serial number of hardware
- Scenario Name:** Name of scenario
- Target Port:** Port number in port map

Example

```
Run (ox841200," Substitute address frame", 4)
Beep(800, 400)
Run (ox841200," CRC Inject _ Play CD", 8)
WaitForStop(0x63463, 1, 150)
Run (ox841200," Remove Send Cue Sheet", 2)
Goto Label6
Run (S/N: 12871, Port 1, DISCOVER)
```

Note: If the selected ports are busy, scenario cannot run, and the command will be skipped. The result will be written in Log area.

Stop

Stops running scenario by hardware and port name.

Format

```
Stop (Serial Number, Target Port)
```

Parameters

- Serial Number:** Serial number of hardware
- Target Port:** Port number in port map

Example

```
Run (ox00820,"Inject CRC000", 2)
Beep(700, 500)
Stop (ox00820, 2)
Goto Label3
...
Label3 : Run(ox005007,"Detect DATA", 8)
Sleep(40)
```

WaitForStop

Used to wait for occurrence of specified condition.

Format

```
WaitForStop(SerialNumber, Target Port, Duration)
```

Parameters

- Serial Number:** Serial number of hardware
- Target Port:** Port number in port map
- Duration:** Integer or random duration in milliseconds. In the Command Parameters Window, WaitForStop duration has three options:
- Infinite:** Wait until **Stop** command.
- Random:** Stop after a random time.
- Finite time:** Stop after specified time in milliseconds.

Example

```
Run (ox001267, "Detect AddressFrame Open", 2)
WaitForStop (0x348790, 2, Forever)
Run (ox005007, "Detect DATA", 4)
WaitForStop(ox005007, 4, 100)
Stop (ox001267, 2)
```

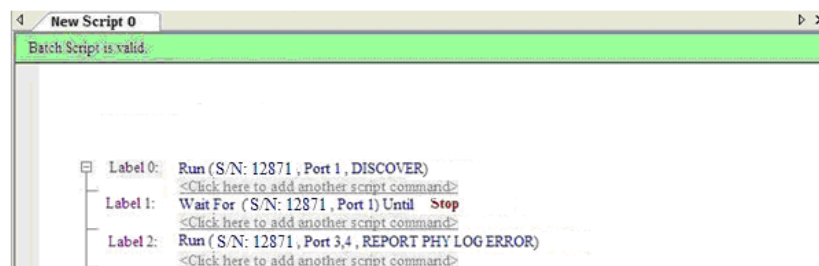
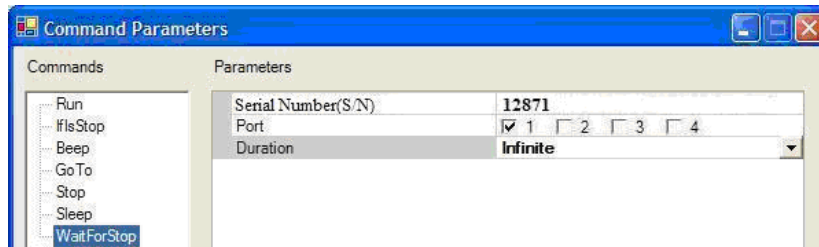

Sleep

Used to sleep for a few seconds.

Format

```
Sleep(Duration)
```

Parameters

- ❑ **Duration:** Integer or random duration in milliseconds

Example

```
Sleep(100)
```



Beep

If specified condition is satisfied, the system beep for specified duration.

Format

```
Beep (Duration, Frequency)
```

Parameters

- ❑ **Duration:** Integer or random duration in milliseconds
- ❑ **Frequency:** Frequency in hertz

Example

```
IfIsStopped(0x83456, 4) then  
{  
  Beep (2, 20)  
  Run (0x83456, "Identify_Disparity error", 8)  
}
```

Chapter 5

Sierra Trainer Traffic Generation

The Sierra Trainer is a traffic generator that can emulate a SAS initiator/target or SATA host/device. Traffic generation enables engineers to test designs under realistic conditions and to transmit known errors, allowing engineers to observe how devices handle faulty link conditions.

Traffic generation is performed via the execution of text-based scripts. These traffic generation files (*.sbg) contain statements about the types of traffic to be generated. These script files can be edited with either a simple text editor such as Notepad or with the Script Editor utility provided by the application.

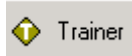
To open the Traffic Generation window, click the **Launch Trainer Icon**  in the SAS Protocol Suite or SATA Protocol Suite window:

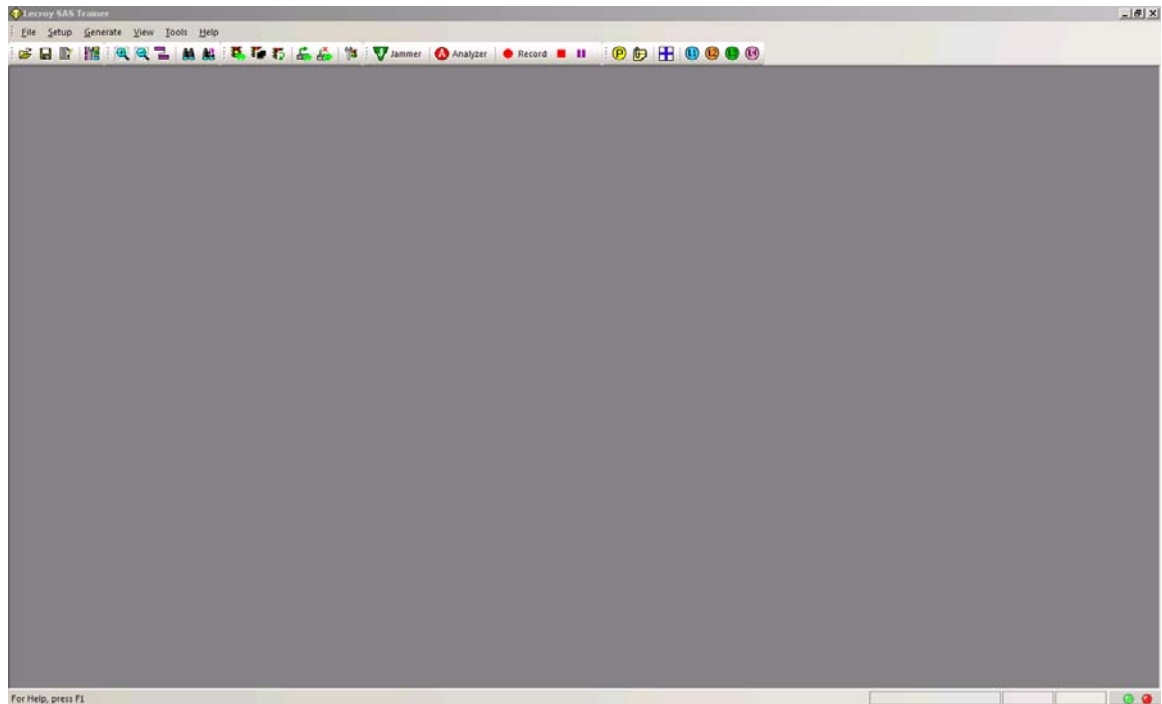

Figure 5.1: SAS: Sierra Trainer Window

SATA: Replaces the SAS icon with the SATA icon for Show Analyzer Frame.

Note: Trainer has Power On and Power Off commands to control External Power Expansion Card.

Sierra Trainer Menus

The Sierra Trainer menus are:

File Menu

New GenFile: Starts a new Generation File.

Open: Opens a file.

Close: Closes the current window.

Launch Analyzer: Displays Analyzer Window.

Launch Analyzer: Displays Jammer (Infusion) Window.

Save As: Saves the current file with a new name.

Print: Prints part or all of the current traffic data file.

Print Preview: Produces an on-screen preview before printing.

Print Setup: Sets the options for the current or new printer.

Edit Comment: Allows you to enter a comment in a dialog.

Export: Saves trace as text file in Packet View Format.

Convert: Converts an SATrainer Generation File (**.stg** file) to a Generation File (**.ssg** file).

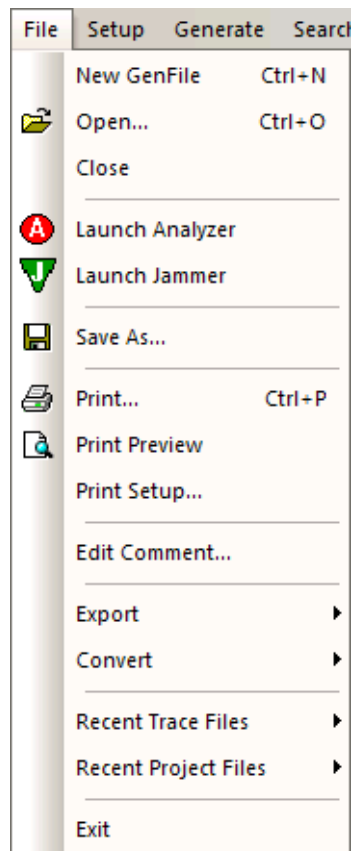

Figure 5.2: Trainer File Menu

Setup Menu

- ❑ **Update Sierra Device:** See [“Update Device” on page 303](#).
- ❑ **Port Configuration:**

You can select different combinations of Trainer with Analyzer and Jammer. When running two different applications on the ports, you must set the same port configuration in both of them. See [“Ports Configuration” on page 106](#). The following describes possible configurations:

- **Analyzer and Trainer on same port:** You can generate initiator/target traffic and also capture the traffic generated.
- **Analyzer and Trainer on same port, and Analyzer and Trainer on another port:** You can generate initiator/target traffic and also capture the traffic generated on two ports.
- **Trainer on one port, Analyzer on another port, and Analyzer on a third port:** Trainer is run on a port generating initiator/target traffic and two port Analyzers run on two other ports capturing the traffic of those ports.
- **Trainer on two ports, and Analyzer on two ports:** Two Trainers run on two ports generating initiator/target traffic and two Analyzers run on two other ports capturing the traffic of those ports.
- **Trainer and Jammer on same port:** You can generate initiator/target traffic and also inject errors on the traffic between initiator and target on the port.

Note: See [“Multi-Port Trainer Script Assignments to Links” on page 407](#).

Display Options: Selects what information to display. See [“Display Options” on page 457](#).

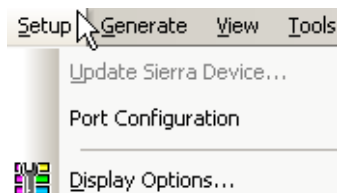

Figure 5.3: Trainer Setup Menu

Generate Menu

Start Generation: Causes the Generator to begin generation.

Stop Generation: Causes the Generator to stop generation.

Resume Generation: Causes the Generator to resume generation after a stop.

Connect Link: Automatically bring the linkup to the Host, Device, Initiator, or Target connected to the Generator.

Disconnect Link: Disconnect link.

Connect Parameters: Set the “Identify” frame parameter settings to keep the link connected. See [“Connection Parameters” on page 463](#).

Generation Options: Setup the Generation Rules. See [“Generation Options” on page 445](#).

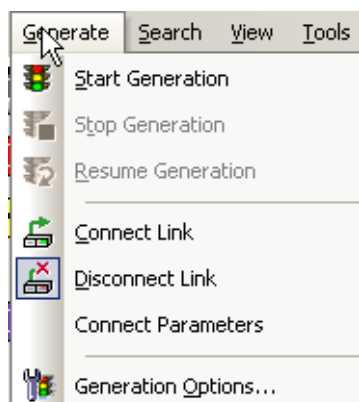

Figure 5.4: Trainer Generate Menu

Search Menu

Go to Event: Opens a dialog that allows you to go to a frame and time.

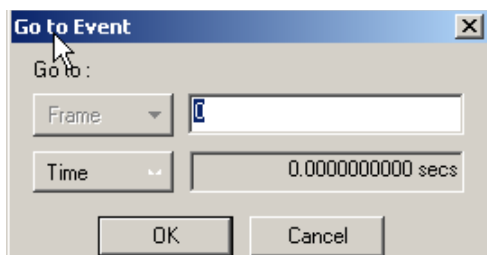

Figure 5.5: Go to Event Dialog

Go to Marker: Positions the display to the selected marked packet.

Go to: Packet Types, SSP Frames, SMP Frames, Primitives, Errors, Data Lengths, Speed, SATA FIS Type, SATA FIS Port, or Hash Address (Source or Destination). See [Figure 5.6 on page 391](#).

Find: Displays the Find dialog. See [“Find” on page 454](#).

Find Next: Applies the previous **Find** parameters to the next search.

Search Direction: Toggles the search forward or backwards. The current direction is indicated in the menu.

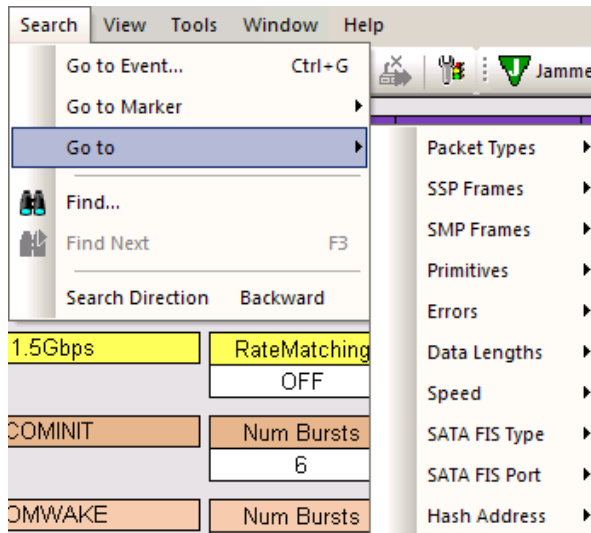

Figure 5.6: Trainer Search Menu

View Menu

See [Figure 5.7 on page 392](#).

Zoom In: Increases the size of the displayed elements.

Zoom Out: Decreases the size of the displayed elements.

Toolbars: Displays list of available toolbars: Standard, Frequently Used, Generator, Analyzer, Ports, or Customize. See [“Resetting the Toolbar” on page 464](#).

Status Bar: Toggles the Sierra Trainer Status Bar, at the bottom of the window, which shows help messages and the search direction. The right most segment displays the current search direction: Fwd (forward) or Bwd (backward). Change the search direction from the Search menu or double-click the Search Status segment.

Wrap: Wraps displayed packets within the window.

Compact: Displays each row on one line only, with no wrapping.

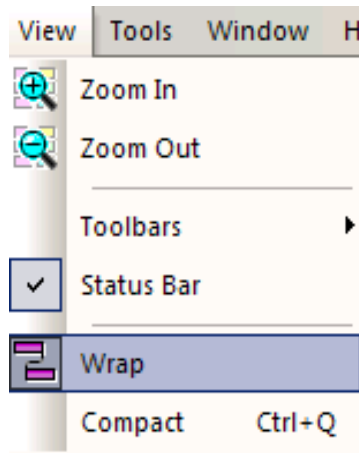

Figure 5.7: Trainer View Menu

Tools Menu

Hash Address Utility: Opens a dialog that allows you to enter an eight-byte SAS Address to display a Hashed Address.

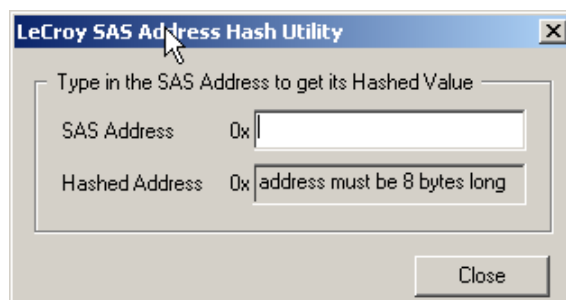

Figure 5.8: Address Hash Utility Dialog

Window Menu

Cascade: Displays all open windows in an overlapping arrangement.

Tile Horizontal: Displays all open windows in a above-below arrangement.

Tile Vertical: Displays all open windows in a side-by-side arrangement.

Arrange Icons: Arranges minimized windows at the bottom of the display.

Windows: Displays a list of open windows.

Help Menu

Help Topics: Displays online help. You can also select F1.

Check for Updates: Check whether a new software version is available. If so, you can download from the LeCroy web site. You can select to Check for updates at application startup.

About: Displays version information.

























Sierra Trainer Main Toolbar

The Sierra Trainer toolbar contains the following buttons:



Figure 5.9: Sierra Trainer Toolbar

The buttons have the following functions:

	Open Document.		Save As. Opens a dialog in which you can save your edits in the appropriate file type.
	Edit as Text. Edit the text file for the document.		Setup Display Options. Opens the Display Options window.
	Zoom In.		Zoom Out.
	Wrap.		Find.
	Find Next.		Start All Generation.
	Stop All Generation.		Resume All Generation.
	Connect All Link.		Disconnect All Link.
	Setup Generation Options. Opens the Generation Options window.		Launch Jammer (Infusion).
	Launch Analyzer.		Start Recording.
	Stop Recording.		Abort Recording.
	Show Port Configuration Dialog. (See “Ports Configuration” on page 106.)		Show Script Assignment Dialog. (See section below.)
	Tile Windows		Assign Active Script/ Remove Assigned Script for Link 1, 2, 3, or 4 See “Multi-Port Trainer Script Assignments to Links” on page 407.

Setting Up for Generating Initiator Traffic

Connect the SAS cable from the **Target** port of the Sierra Analyzer to the Target port on the unit under test. This transmits the Traffic Generator stream from the **Target** port to the target-side port on the unit under test.

Setting Up for Generating Target Traffic

Connect the SAS cable from the **Initiator** port of the Sierra Analyzer to the Initiator-side port on the unit under test. This transmits the Traffic Generator stream from the **Initiator** port to the initiator-side port on the unit under test.

Creating a Traffic Generation File

Generating traffic is a two-step process.

First, create a text-based Sierra Trainer Traffic Generator file. This text file has an **.ssg** extension. You can create this file by creating a new generator file or editing an existing file.

Note: **.ssg** files created in other applications run in the Sierra Trainer.

After the file has been created, it can be opened and displayed in the application. You can invoke the application to transmit the traffic generation file by using the **Start Generation**

button .

Note: For details about traffic generation files, see [“Sierra Trainer Generation Language” on page 410](#).

Creating a New Generator File

You can create a new Sierra Trainer Traffic Generator **.ssg** file.

To create an **.ssg** file:

1. In the Sierra Trainer window, select **File > New GenFile** to display the Global Settings of a new **.ssg** file in a trace view.

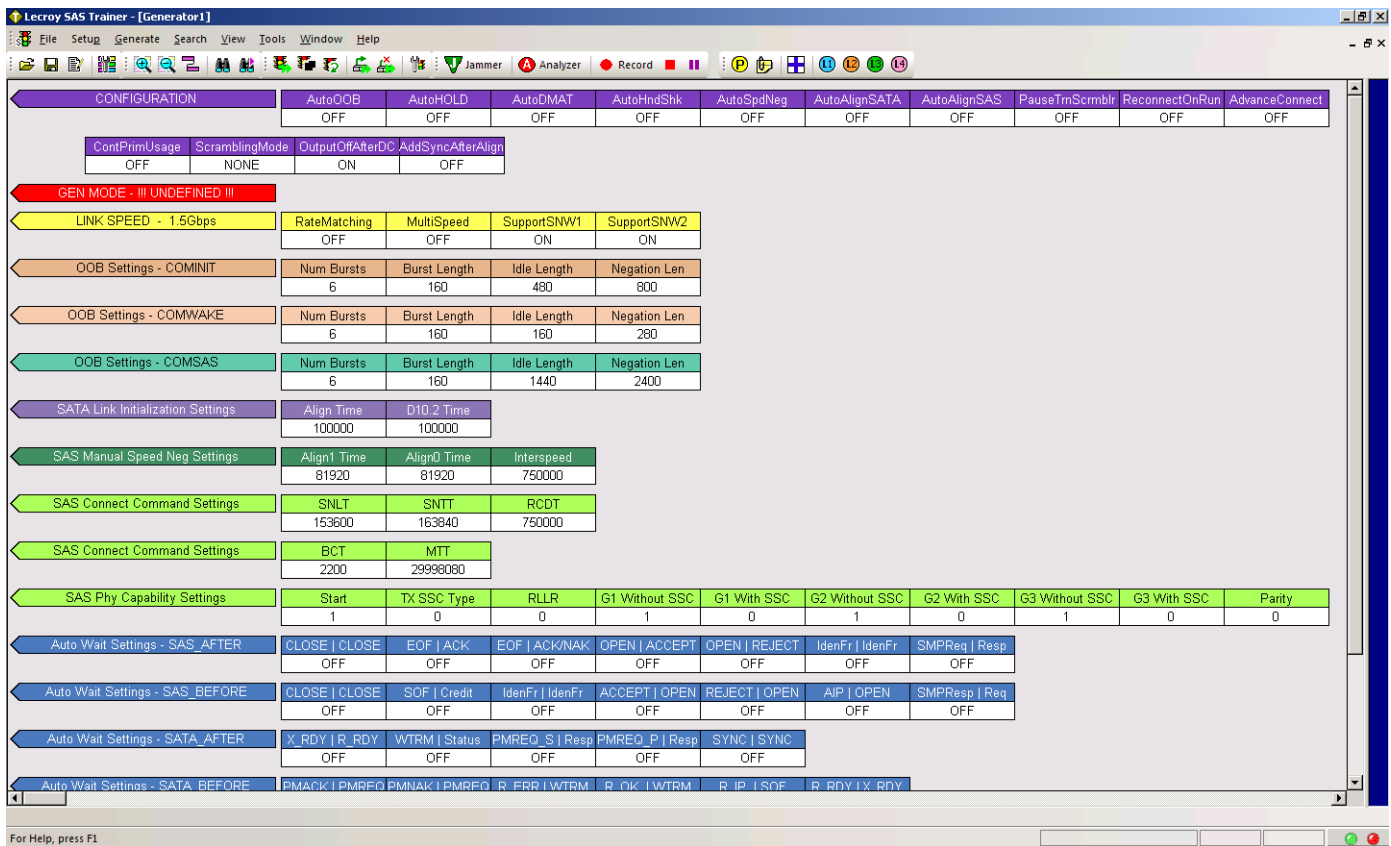



Figure 5.10: New GenFile

2. Click the **Edit as Text**  button to enter Generation Block or Change Settings instructions in the Generation Script Editor. See [“Starting the Script Editor”](#) on page 404.

Editing an Example Generation File

The easiest way to generate traffic is to start with one of the example generation files and edit the settings to see how the script file behaves. As you make and save changes, the trace view of the generation file is automatically updated.

The following screenshots show an example file as it appears in the script editor and trace window.

```

Generation
{
  # SendSSPFrameData
  # {
  #   Data = { 21223344 55667788 99AABBCC }
  # }

  SendSSPFrameXferRdy
  {
    Data = { 51223344 55667788 99AABBCC }
  }

  SendSSPFrameCommand

  SendSSPFrameResponse

  SendSSPFrameTask
  {
    Data = { 51223344 55667788 99AABBCC }
  }

  SendSSPFrameVendor
}
    
```

The screenshot shows a configuration window with several sections:

- GEN MODE - SATA Host, SSC is ON** (Pink bar)
- LINK SPEED - 1.5Gbps** (Yellow bar)
- CONFIGURATION** (Purple bar) with a table:

AutoOOB	AutoHOLD	AutoDMAT	AutoALIGN	AutoHndShk	AutoSpdNeg
ON	OFF	OFF	ON	OFF	ON
- OOB Settings - COMINIT** (Orange bar) with a table:

Num Bursts	Burst Length	Idle Length	Negation Len
1	2	3	4
- OOB Settings - COMWAKE** (Light Orange bar) with a table:

Num Bursts	Burst Length	Idle Length	Negation Len
5	6	7	8
- OOB Settings - COMSAS** (Light Green bar) with a table:

Num Bursts	Burst Length	Idle Length	Negation Len
9	10	11	12
- SATA Link Initialization Settings** (Purple bar) with a table:

Align Count	D10.2 Count
13	14
- Speed Negotiation Settings** (Light Green bar) with a table:

SNLT	SNIT	RCDT
15	16	17
- Frame Trace** (Bottom section) showing a table of frames:

Frame	Rate	SOE	Tag	Data	CRC	EOF	Idle	Time Stamp
13	1.5	G	XFER_RDY	0x0000	12 bytes	0x669F7A95	0.000 ns	00.000 000 000
13	1.5	G	COMMAND	0x0000	0 bytes	0x74258E55	0.000 ns	00.000 000 320
13	1.5	G	RESPONSE	0x0000	0 bytes	0x5340ABD4	0.000 ns	00.000 000 560
13	1.5	G	TASK	0x0000	12 bytes	0xC486DB10	0.000 ns	00.000 000 800
13	1.5	G	UNKNOWN	0x0000	0 bytes	0xBCF96B0F	0.000 ns	00.000 001 120

In the screenshot, global settings make up the eight bars at the top of the window. Below that are five frames. If you look at the script itself, there are six frame commands, five active and one commented out.

The following sections describe how to open and edit traffic generation files.

Converting an SATrainer Traffic Generation File

If you have old 2500-based SATrainer Generator **.stg** files, you can convert them to Sierra Trainer Traffic Generator **.ssg** files using the legacy **Convert** function.

To convert an **.stg** file into an **.ssg** file:

1. In the Sierra Trainer window, select **File > Convert > Convert .stg to .ssg** to display an Open dialog.
2. Use Files of Type **SATrainer Generator Files (.stg)**.
3. Select an SATrainer Generator ***.stg** file.
4. Click **Open**. The application creates a Sierra Trainer Traffic Generator file (***.ssg**).

Opening a Traffic Generation File

After the Traffic Generator file (***.ssg**) file has been created, you can open it in the application.

To open a Traffic Generator file:

1. Select **File > Open** on the Menu Bar, or click  on the Toolbar, to display an Open dialog.
2. Select a Generator text file (***.ssg**) and click **Open** to display the file. (The install directory contains example files.)

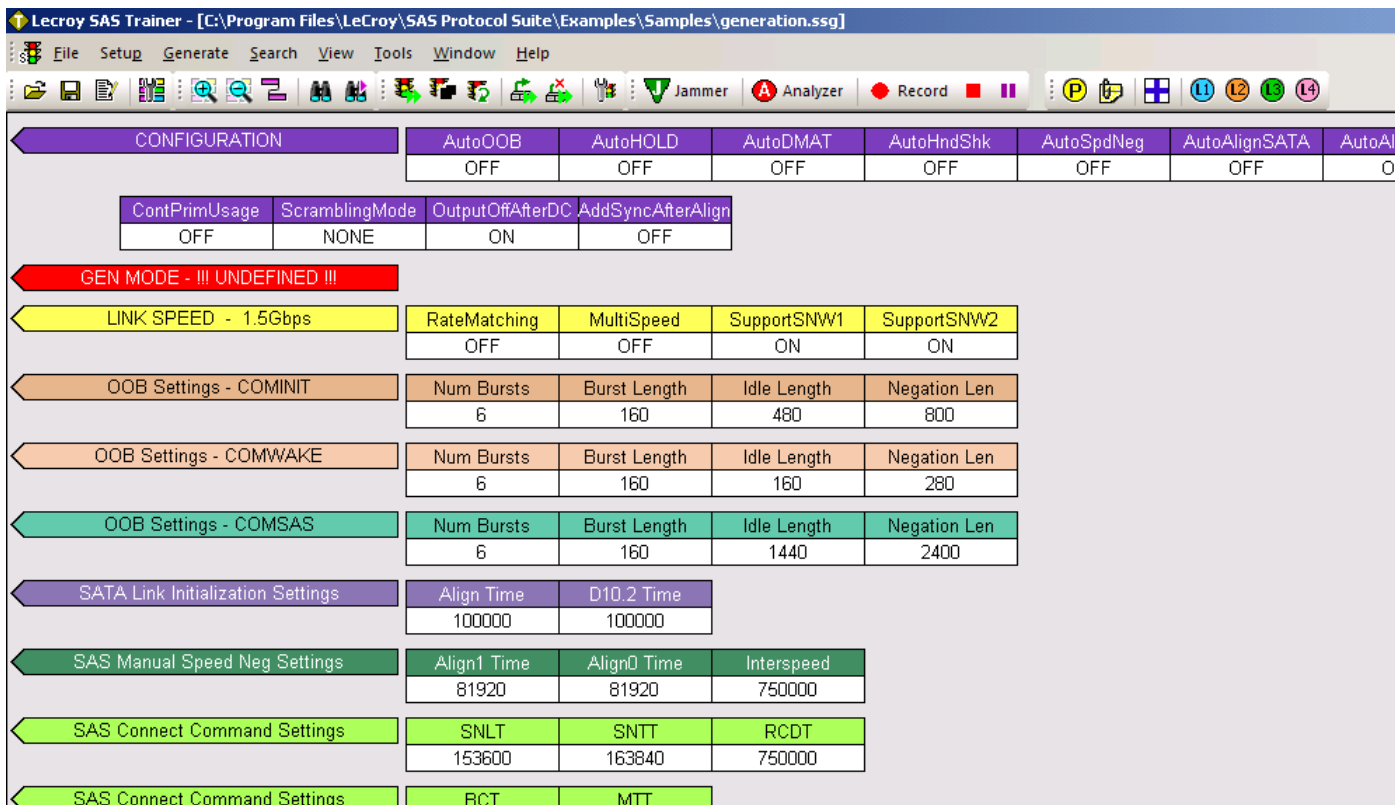

Figure 5.11: Sierra Trainer Generator File

Layout

The **.ssg** file has several colored bars that represent global settings. The bars show the current configuration of the generation file. Example settings are:

- Configuration
- GenMode (SAS or SATA, SSC On or Off)
- Link speed (1.5 Gbps, 3.0 Gbps, or 6.0 Gbps)
- Type of device (Initiator or Device)
- COMINIT
- COMWAKE
- Scrambling Mode

As changes are made and saved to the traffic generation file, the bars immediately update. The traffic pattern to generate appears below the bars as a series of frames. You can edit the traffic generation file to add, edit or remove frames.

Overview of Generation and Global Settings Files

Example **.ssg** files and **Include** files are in two directories called **\Samples** and **\Include** that are typically installed in: **C:\Program Files\LeCroy\SAS Protocol Suite\Generation**.

Traffic Generation (*.ssg) Files

The **.ssg** traffic generation files are text files consisting of **include** statements, a generation block, and optionally global statements.

The generation block is the code responsible for the actual traffic generation. It is marked by the tag **Generation**. The composition and format of the generation block is described later.

```
%include "Generation\Include\Settings.inc"

Generation
{
}

```

The **include** statements provide links to the **Include** files, which provide the definitions for primitives, frames, and settings that hold for most or all of the generation session (global settings).

The definitions for SAS and SATA traffic are contained in LeCroy-provided **Include** files: **Settings.inc**, **PrimitivesDecl.inc**, **AddressFramesDecl.inc**, **SSPFrames.inc**, **SMPFrames.inc**, and **SSPFrames.inc**.

Settings.inc File

The **Settings.inc** file contains global statements about the link, the type of device being emulated, and other conditions that are to exist throughout part or all of the traffic generation. This file must be included in the traffic generation file.

There are fifteen groups of settings in this file:

- AutoMode
- COMINIT/COMRESET OOB Signal
- COMWAKE OOB Signal
- COMSAS OOB Signal
- Generation Commands
- Link Speed
- SATA Link Initialization
- SAS Speed Negotiation
- SATA Speed Negotiation
- Autowait:
 - SAS After
 - SAS Before
 - SATA After
 - SATA Before
- Wait Command Timeout
- Scrambling Mode

Details about each group of settings are described in the **Traffic Generation Language** section.

Editing Settings.inc

Text in the **Settings.inc** file can be edited directly or copied into the beginning of the traffic generation file and edited there.

```
%include "Generation\Include\PrimitivesDecl.inc"
%include "Generation\Include\Settings.inc"

Set GenerationMode = GEN_MODE_SATA_HOST

Generation
{
}
}
```

When editing global settings, keep in mind the following rule: The last line encountered before the generation block takes precedence. Thus, if the following two lines about the device emulation were added just above the generation block, the second would take effect:

```
set GenerationMode = GEN_MODE_SATA_HOST
set GenerationMode = GEN_MODE_SAS_INITIATOR
```

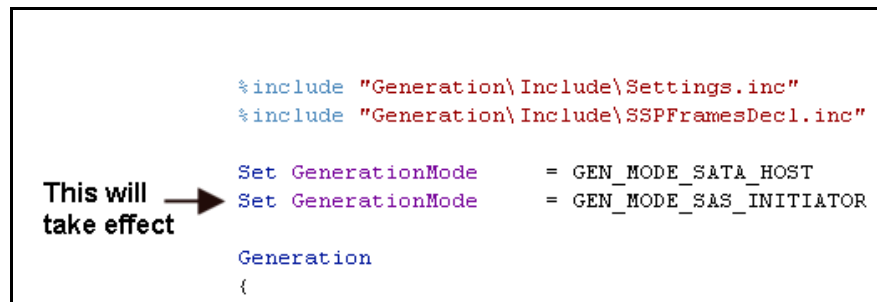

```

%include "Generation\Include\Settings.inc"
%include "Generation\Include\SSPframesDecl.inc"

Set GenerationMode = GEN_MODE_SATA_HOST
Set GenerationMode = GEN_MODE_SAS_INITIATOR

Generation
{

```

The Global Setting “AutoAlign”

AutoAlign is a global setting that may be on or off depending on the type of device you are emulating. There is an AutoAlign setting for SAS and one for SATA, for example, “set AutoAlignSAS = ON” and “set AutoAlignSATA=OFF.”

- ❑ SAS: Sends AutoAligns every 2048 DWORDs.
- ❑ SATA: Sends AutoAligns every 256 DWORDs.

If you plan to set and reset AutoAlign in the middle of traffic generation, you need to know what the defaults are for AutoAlign. The defaults are as follows:

For SATA host/device emulation,:

- ❑ AutoAlignSATA is assumed to be ON.
- ❑ AutoAlignSAS is assumed to be OFF.

For SAS emulation, the assumptions are opposite:

- ❑ AutoAlignSATA is assumed to be OFF.
- ❑ AutoAlignSAS is assumed to be ON.

For STP:

- ❑ AutoAlignSAS and AutoAlignSATA are assumed to be ON.

Placing Global Settings in the Generation Block

Some global settings such as AutoAlign = On/Off can be set and reset in the generation block. For example, you might want to set SASAutoAlign = ON prior to traffic generation, and then change to OFF halfway through the generation session.

```

%include "Generation\Include\Settings.inc"
%include "Generation\Include\SSPFramesDecl.inc"

Generation
{
  # SendSSPFrameData
  # {
  #   Data = { 21223344 55667788 99AABBCC }
  # }

  SendSSPFrameXferRdy
  {
    Data = { 51223344 55667788 99AABBCC }
  }

  Set AutoAlignSAS = OFF ← Global Setting added to generation block

  SendSSPFrameCommand

  SendSSPFrameResponse

  SendSSPFrameTask
  {
    Data = { 51223344 55667788 99AABBCC }
  }

  SendSSPFrameVendor
}
    
```

When placed within the generation block and then viewed in the trace window, global settings appear as colored bars interspersed amidst the traffic.

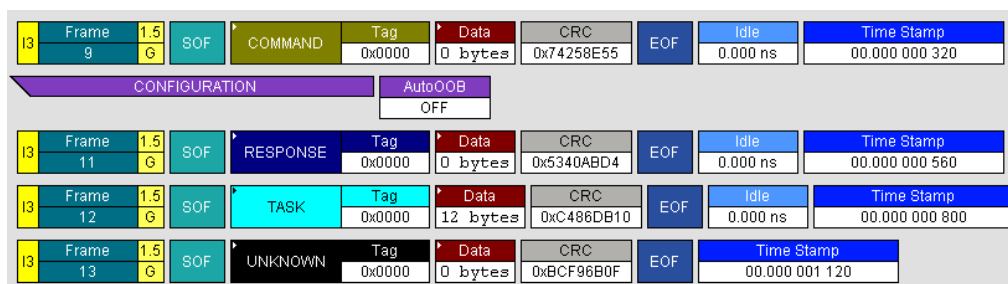

While most global settings can be set in the generation block, three will be ignored if placed within the generation block:

- set Link Speed =
- set GenerationMode =
- set SSC =

These commands should be configured either in the **Setting.inc** file or at the beginning of the traffic generation file as a global statement.

Primitive and Frame Definitions

Five other **Include** files are provided that define the most of the known templates for Primitives and Frames. The five are:

- ❑ PrimitivesDecl.inc
- ❑ AddressFramesDecl.inc
- ❑ SSPFramesDecl.inc
- ❑ SMPFramesDecl.inc
- ❑ STPFramesDecl.inc

Each of the Frame templates defines header and field structure.

The default value for all Frame fields is zero.

Special Conditions for Frames

There are three conditions about Frames that need to be kept in mind when configuring Frame generation:

1. Frame delimiters need to agree - At the present time, when defining a Frame, make sure that the Frame Prologue and Frame Epilogue agree. Do not mix types. For example, do not mix a SAS Start of Frame (SOF) with a SAS End of Address Frame (EOAF).

A SAS SOF should be matched to a SAS EOF. A SAS SOAF should be matched to a SAS EOAF. If generating SATA traffic, a SATA_SOAF should be matched to a SATA_EOF.

At the present time, if you mix different types of prologues and epilogues for any given Frame, the Frame is ignored.

2. Data Length Fields can be fixed-length or variable - By default, data frames are of a fixed length. If you want to generate variable length frames, place an asterisk in the Data definition field in the **SSPFramesDecl.inc** file:

Data : *

```

39|
40| ##### DATA #####
41| Data          : *      # Variable length field, can be assigned to an array of DWORDs
42|
43|

```

If you replace the asterisk with a value, then the field becomes fixed length.

3. CRC Calculations are calculated unless told otherwise - If the CRC is not explicitly set in the traffic generation file, the application assumes that you want it and calculates and displays it in front of the generated frames.

If you provide a CRC value, the application uses that value, even if it is incorrect. This gives you the option of configuring the generator to create errors.

If the generation file was created through the Export command (File > Export > To Generator File Format ...), the CRC is calculated but commented out. If the source trace has a bad CRC, the CRC is exported into the generation file and is not commented out.

Primitives Decl.inc File

The **PrimitivesDecl.inc** file defines Primitives. The file consists of declarations (left) and the corresponding byte streams (right).

```
6 Primitive SOAF = kBC 18 1E 81
7 Primitive EOAF = kBC 18 67 9F
8
9 Primitive "ALIGN (0)" = kBC 4A 4A 7B
10 Primitive "ALIGN (1)" = kBC 07 07 07
11 Primitive "ALIGN (2)" = kBC 61 61 61
12 Primitive "ALIGN (3)" = kBC 7B 7B 7B
```

To generate Primitives, copy relevant portions of text on the left (not the bytes shown right) from this file into the generator block section of the **.ssg** file.

Address FramesDecl.inc File

The **AddressFramesDecl.inc** file defines Address frames.

SSPFrames.inc File

The **SSPFrames.inc** file defines SSP frames.

SMPFrames.inc File

The **SMPFrames.inc** file defines SMP frames.

STPFrames.inc File

The **STPFrames.inc** file defines STP frames.

Starting the Script Editor

To edit an **.ssg** file, use the Script Editor. The Script Edit editing tool displays the **.ssg** file and its supporting **Include** files. The Script Editor utility has several aids to simplify the process of writing and editing scripts: tool-tips, drop-down menus, and colored fields. The Script Editor example below shows several commented lines followed by some instructions. The Script Editor has three areas: toolbar (top), script window, and file tabs (at the bottom of the window). If errors occur, a log opens at the bottom of the window. **Note:** If more than one port of Trainer is licensed, you can assign scripts to one or more ports. See [“Multi-Port Trainer Script Assignments to Links”](#) on page 407.

To launch the Script Editor, click the **Script Editor**  button on the toolbar or right-click in the trace window and choose **Edit as Text**.

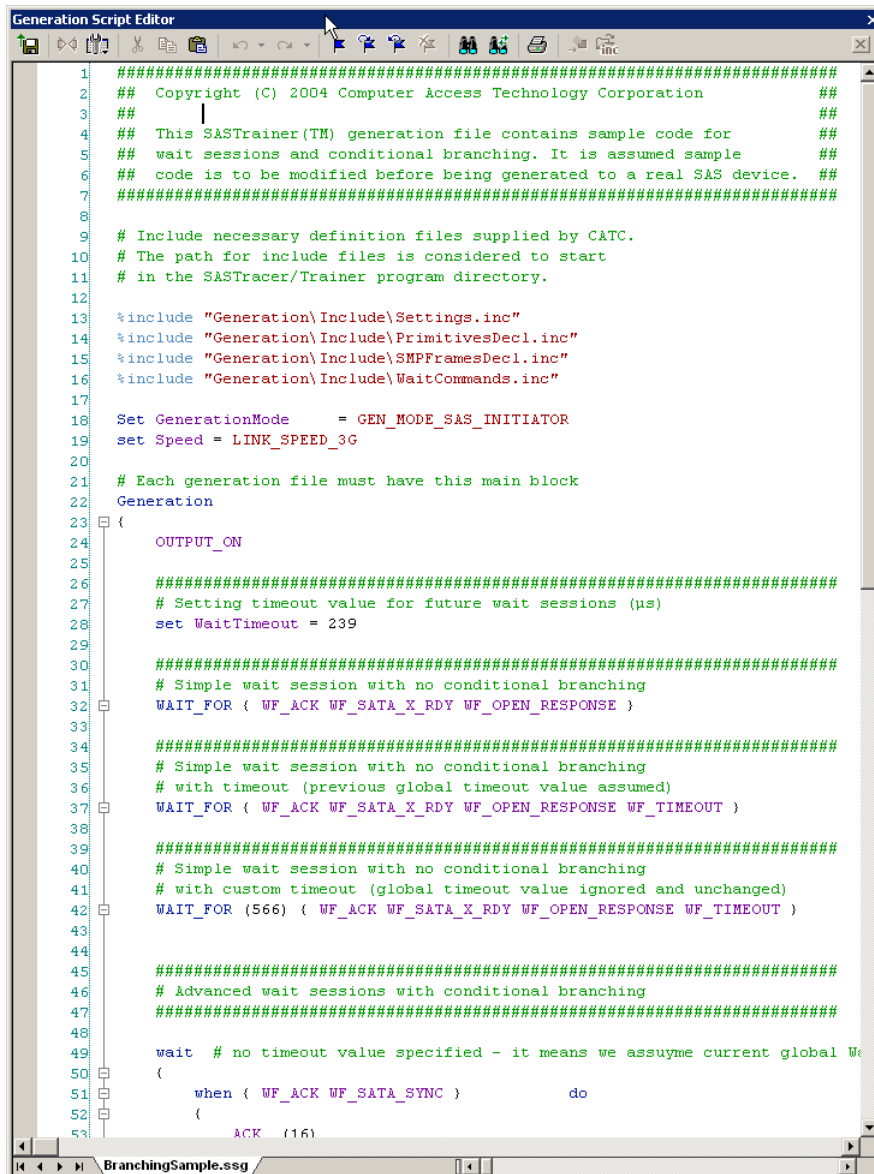

```

1 #####
2 ## Copyright (C) 2004 Computer Access Technology Corporation ##
3 ## | ##
4 ## This SASTrainer(TM) generation file contains sample code for ##
5 ## wait sessions and conditional branching. It is assumed sample ##
6 ## code is to be modified before being generated to a real SAS device. ##
7 #####
8
9 # Include necessary definition files supplied by CATC.
10 # The path for include files is considered to start
11 # in the SASTracer/Trainer program directory.
12
13 %include "Generation\Include\Settings.inc"
14 %include "Generation\Include\PrimitivesDecl.inc"
15 %include "Generation\Include\SMPPframesDecl.inc"
16 %include "Generation\Include\WaitCommands.inc"
17
18 Set GenerationMode = GEN_MODE_SAS_INITIATOR
19 set Speed = LINK_SPEED_3G
20
21 # Each generation file must have this main block
22 Generation
23 {
24     OUTPUT_ON
25
26     #####
27     # Setting timeout value for future wait sessions (µs)
28     set WaitTimeout = 239
29
30     #####
31     # Simple wait session with no conditional branching
32     WAIT_FOR { WF_ACK WF_SATA_X_RDY WF_OPEN_RESPONSE }
33
34     #####
35     # Simple wait session with no conditional branching
36     # with timeout (previous global timeout value assumed)
37     WAIT_FOR { WF_ACK WF_SATA_X_RDY WF_OPEN_RESPONSE WF_TIMEOUT }
38
39     #####
40     # Simple wait session with no conditional branching
41     # with custom timeout (global timeout value ignored and unchanged)
42     WAIT_FOR (566) { WF_ACK WF_SATA_X_RDY WF_OPEN_RESPONSE WF_TIMEOUT }
43
44     #####
45     # Advanced wait sessions with conditional branching
46     #####
47
48     wait # no timeout value specified - it means we assume current global W
49     {
50         when { WF_ACK WF_SATA_SYNC } do
51         {
52             ACK (16)
53

```

Figure 5.12: Script Editor

















Script Editor Toolbar

The Script Editor toolbar contains buttons for saving your edits, navigating, searching, and other functions.



Figure 5.13: Script Editor Toolbar

The buttons have the following functions:

	Save. Saves your edits and immediately updates the setting bars and Frames shown in the trace window.		Add/Remove bookmark. Allows markers to be set or removed to aid in navigation.
	View Options. Opens a menu with three options: Enable Outlining, Toggle Outlining, and Show Line Numbers. See View Options Menu below.		Go to next bookmark.
	Cut.		Go to previous bookmark.
	Copy.		Clear all bookmarks.
	Paste.		Find.
	Undo.		Find and Replace.
	Redo.		Go to Trace View
	Print.		Go to Definition of Selected Keyword.
			Open File under Cursor. Opens the file pointed to with the mouse in the script. This command works with Include statements.

View Options Menu

The View Options button displays a menu with the following options:

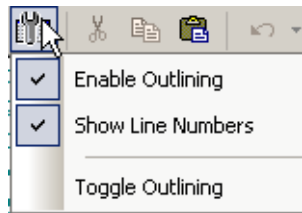

- Enable Outlining:** Adds an expandable/collapsible tree structure to the left side of the Script Editor showing the hierarchical relationships of the script lines.
- Show Line Numbers:** Adds line numbers to the left side of the Script Editor window.
- Toggle Outlining:** Switches between collapsed and expanded states.

Pop-up Menu

Left-click anywhere in the script window to open a pop-up menu with the following options:

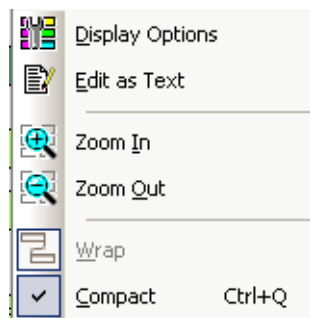

- Display Options:** Selects what information to display. See [“Display Options” on page 457](#).
- Edit as Text:** Opens the Script Editor.
- Zoom In:** Increases the size of the displayed elements
- Zoom Out:** Decreases the size of the displayed elements
- Wrap:** Wraps displayed packets within the window.
- Compact:** Displays each row on one line only, with no wrapping

File Tabs

At the bottom of the window is a tab that shows the name of the **.ssg** file. If your **.ssg** file has an Include statement in it, the supporting Include files automatically open when the **.ssg** file is first opened. Tabs for the opened Include files appear at the bottom of this window.



Figure 5.14: File Tab

Error Log

Whenever you create a scripting error, a log opens at the bottom of the application window. When the error is corrected, the window automatically closes.

File (Line)	Description
C:\Program Files\CATC\SASTracer\Ge...\Primitives.ssg (-1)	Undefined identifier 'NotTodayThanks' used for setting 'ssc'

Figure 5.15: Log

Tooltips

The Script Editor window includes extensive tooltips for each keyword. To see a tooltip, hold the mouse pointer over a keyword.

Multi-Port Trainer Script Assignments to Links

If more than one port of Trainer is licensed, after you open a generator file (.ssg) or create a new generator file ([“Creating a Traffic Generation File” on page 394](#)), you can assign the script to one or more ports.

Click the  Port Configuration button to open the Set Port Configuration dialog (see [“Ports Configuration” on page 106](#)). Select a port configuration. For example, Trainer may be on Port1 and Port 2 or Port3 and Port4.

After you select port configuration, the Assign Active Script/Remove Assigned Script for Link 1, 2, 3, or 4 buttons have colors. For example, for Trainer on Ports 1 and 2, the buttons are .

After you open or create a script in the Trainer window, click the L1 or L2 button to assign the script to Port 1 or Port 2. A display appears to the left of the script in the Trainer window:



That link now has link-specific Start, Stop, Resume, Connect, and Disconnect buttons. (See the previous page for the button descriptions.)

Use the link-specific buttons to control each link separately.

You can click the L1 or L2 button again to remove the script from the link.

After you select port configuration, the Trainer toolbar changes to display the Generation buttons Start All Generation, Stop All Generation, Resume All Generation, Connect All Link, and Disconnect All Link:



Use these buttons to control all links.

You can click  to open the Link Script Selection script assignment dialog.

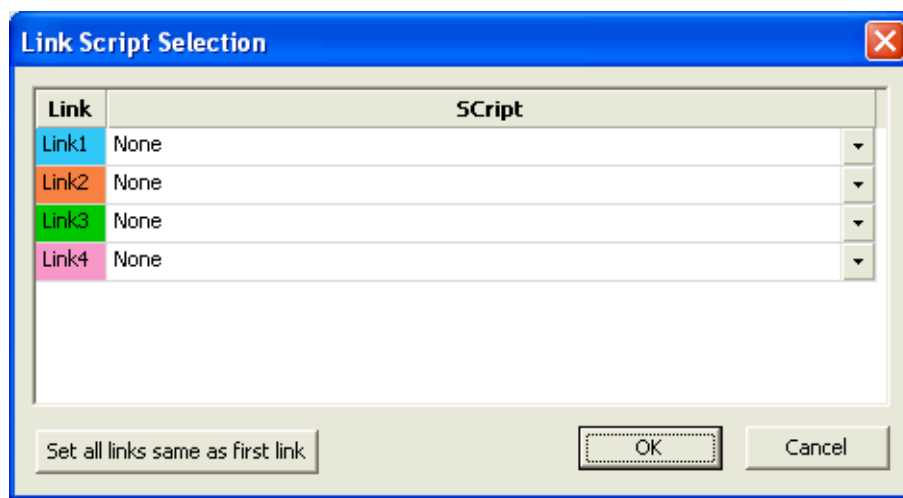

For any available Link, you can select any open script from the Script drop-down list.

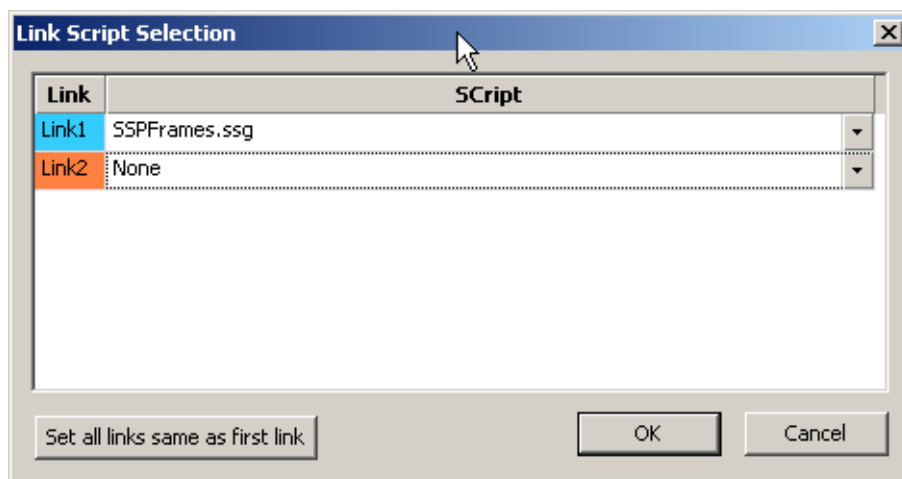



After you select an open script, you can assign or remove a link for that script by clicking **Assign Active Script/Remove Assigned Script for Link**.

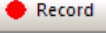

Generating Traffic

After the `.ssg` file has been opened onscreen, recording and traffic generation can begin at any time.

1. (optional) Click  **Record** to begin the recording.
2. If the script does not have a connect block built into it, connect the exerciser to the DUT by clicking the **Connect Link** button . Clicking this button causes the generator to invoke the various settings in your script (for example, the global settings) and then establish a connection.
3. Click the **Start Generation** button  on the Toolbar.

While generating traffic, a bar appears on the right of the trace view, indicating that traffic generation is taking place. (The green light on the Traffic signal button also blinks during traffic generation).

Stop Traffic Generation

Normally, traffic generation stops automatically when the application reaches the end of the Generator file.

To manually stop traffic generation, click the **Stop Generation** button .

Resume Traffic Generation

If traffic generation is stopped prior to the end of the script, it can be resumed.

To resume traffic generation, click the **Resume Generation** button .

Sierra Trainer Generation Language

The Sierra Trainer File Generation Language is an API that allows you to separate traffic into text commands. These commands are used construct primitives and frames that are sent to the host or the device.

File Structure

Traffic Generation files (*.sbg) should have the following structure:

Declarations

- Global generation settings
- Constants
- Data patterns
- Chain of symbols (primitives, raw data)
- Packet templates

Note: Some declared objects could be used in further declarations as long as they are previously declared. No forward declarations are allowed at this time.

Generation Blocks

- List of generation instructions

Note: It is possible to create many generation blocks, but currently only a block with the name 'Generation' executes. (Calls of some blocks from another blocks are not currently allowed.)

Language

Comments

#' is the Comment symbol. The line remainder after this symbol is ignored.

/* */' is a Comment Block. All the text between '/' '*' and '*' '/' is ignored.

```
/*
  This is an example of a block of comments.
*/
```

Includes

The directive **%include "FileName.inc"** includes the file **FileName.inc**. This lets you add common definitions and templates into new scripts.

The language parser makes sure the same file is not included more than once.

Example:

```
%include "SomeInc.inc"
# This directive actually includes file 'SomeInc_1.inc'.
```

%inline is the same as **%include**, but without the Language parser check.

Settings

The **Set "Constant Name" = Value** statement sets different constants/modes using the following value types:

- Predefined constants (TRUE, FALSE, ON, OFF, INFINITE)
- Numbers

Examples:

```
Set AutoAlignSATA=ON
Set WaitTimeOut=239
```

Constants

Only unsigned integers can be defined as constants. Some constants are predefined in Sierra Trainer.

Examples:

```
Const SOME_HEX_DATA = 0xAABBFFEE #defines hexadecimal constant
Const SOME_DEC_DATA = 12        # defines decimal constant
Const "SOME DEC DATA" = 64     # defines decimal constant
Const "Some Hex Data" = 0xCDCDBEBE
```

Predefined Constants

- TRUE
- FALSE
- ON
- OFF
- INFINITE

Data Patterns

Data patterns are streams of hexadecimal values. Using '['' lets the user include constants or predefined data pattern in another pattern.

Examples:

```
DataPattern PATTERN_1 = AAAABBBB [SOME_HEX_DATA] EEEEEFFF 1210ABB1
AAAABBBB 1210ABB1 AAAABBBB 1210ABB1 AAAABBBB 1210ABB1 ["SOME DEC
DATA"] 1210AB
DataPattern PATTERN_2 = 00000000 11111111 22222222 33333333 AAAABBBB
55556666 FEFEFEFE CDCDCDCD 9999BBBB 12343434 6767676B 56BBFF
DataPattern PATTERN_3 = [PATTERN_1] FFFFFFFF EEEEEEEE [SOME_HEX_DATA]
DataPattern SOME_PATTERN = BBBBBBBB DDDDDDDD
```

Primitives

Primitives can be defined using the following:

- ❑ Byte values ('k' indicates control symbol). The 10b codes are calculated based on the current running disparity
- ❑ Primitives are completely interchangeable with SymChains.

Example:

```
Primitive "CHAIN (ONE)" = kBC 1E 1E 1E kBC 1A 0F
SymChain ChainTwo = k28.5 D12.3 D10.2 D11.6
SymChain ChainThree = k28.3 3EA 25 k18 IFA
Primitive SOF = kBC 18 E4 67
Primitive EOF = kBC 18 F0 9B
```

- ❑ Raw 10 bits codes. This definition might cause running disparity errors.

Example:

```
Primitive "CHAIN (TWO)" = 305 2D4 1E4 362
```

- ❑ Mixed bytes and 10b codes. This definition might cause running disparity errors.

Example:

```
Primitive "CHAIN (TWO)" = 305 2D4 1E4 362 ["CHAIN (ONE)"]
```

Packets/ Frames

Using the “Frame” or “Packet” keyword, you can define a frame of traffic to use in the generation stream. Declarations of prolog and epilog may be mixed with field declarations.

```
Frame "name" : "parent name"
{
Field Definition 0: "Field Name : Field Length = Default Value"
...
Field Definition n: "Field Name : Field Length = Default Value"
Primitive Definition 0: "Primitive name, offset, count"
...
Primitive Definition m: "Primitive name, offset, count"
Prolog = "primitive name"
Epilog = "primitive name"
}
```

Field Definition

- ❑ Field length is in bits. '*' means that the length is variable and is set based on the assigned value.
- ❑ Field starting offset is calculated from frame start based on the length of the previous fields.

Examples:

```
Field32      : 32 = 0xAABBFFEE
FrameType    : 8  = 12
HashedDest   : 24 = HEX_DATA
Reserved1    : 8  = 0xDA
Field16      : 16 = 0xAAAA
Reserved2    : 8  = 0xAD
CRC          : 32
```

Data field Definition

- **Data = { pattern }**: Pattern is assigned to Data.
- **Data = count, value**: A pattern of “count” times “value” is assigned to Data.
- **Data = count, start value, step**: A pattern of values starting with “start value” with steps of “step” and a length of “count” is assigned to Data.

Primitive definition. Primitives are inserted into the frame payload. Primitive definitions are inherited by descended frame templates.

- ❑ Assigning '*' clears all previous settings (maybe from parent frame template).
- ❑ Offset specifies the DWORD offset where this primitive is inserted in the Frame.
- ❑ Count specifies how many times to repeat the primitive.

Examples:

```
Primitive : *
Primitive : SOF, 48 # where 48 = offset
Primitive : "CLOSE (NORMAL)", 36, 5 # where 5 = repeat
```

Prolog and Epilog define Primitive chains to be used at the beginning and end of the frame.

Examples:

```
Prolog = SOF # For this frame primitive 'SOF' is a Prolog.
Epilog = EOF # For this frame primitive 'EOF' is an Epilog.
```

Frames can be derived from other Frames, therefore inheriting the layout of the parent Frame. In this case, the user may:

- ❑ Change Prolog and Epilog.
- ❑ Change default field values.
- ❑ Add new fields.

Frame Examples

```

Frame Some_Frame
{
    Field32      : 32 = 0xAABBBFFEE
    FrameType    : 8  = 12
    HashedDest   : 24 = HEX_DATA
    Reserved1    : 8  = 0xDA
    Field16      : 16 = 0xAAAA
    Reserved2    : 8  = 0xAD
    Data         : *  = PATTERN_1
    CRC          : 32

    Primitive : *
    Primitive : SOF, 48
    Primitive : SOF, 96
    Primitive : "CLOSE (NORMAL)", 36, 5

    Prolog = SOF
    Epilog = EOF
}
Frame Some_Frame_1 : Some_Frame
{
    Field32 = "Some Hex Data"
    Data    = { 11111111 22222222 33333333 44444444 55555555 }
    Opcode  : 128, 8, 0x2A
    LBA     : 64

    Primitive : *
    Primitive : "CLOSE (NORMAL)", 24, 48

    Prolog = "CHAIN (ONE)"
    Epilog = "CHAIN (ONE)"
}

```

Generation Block

Sierra Trainer generates the stream that is defined in this block.

```

Generation
{
    Chain Definition (Repeat = N, Idle = M)
    Chain Definition (N, M)
    Chain Definition
    Frame Definition
    Frame Definition (RunningDisp = ON/OFF)
    Frame Definition
    {
    Field Definition
    Data Definition
    } (Repeat = N, Idle = M, RunningDisp = ON/OFF)
}

```

Definitions

Chain Definition:

- ❑ Without any parameters, the chain is sent once.
- ❑ With “Repeat” and “Idle” parameters, the chain is sent N times and then nothing is sent (idle) M times. “Repeat” and “Idle” are optional.

Frame Definition

- ❑ Without any parameters, send the frame based in default values.
- ❑ With “RunningDisp” ON, send the frames based on default values and insert a running disparity error.
- ❑ With parameters overriding or adding to a template frame, with or without injection of an overriding or adding to a template frame, with or without injection of running disparity error.

Field Variable Declarations

You can declare a variable (var_name) as a frame of type (frame_type):

```
$var_name = frame_type
```

Note: Frame variables can be declared/re-declared and used many times.

Changing Frame Fields

You can change some fields in a frame variable.

```
Change var_name { field_name = value }
```

Preprocessor Integer Arithmetic

You can declare DWORD variables, make arithmetic operations, and use them in field and parameters assignments.

Note: Arithmetic expressions are allowed only in numeric variable assignments.

Examples:

Legal Operations

```
x = 2
y = ( z = 12 ) + ( SOME_DEC_DATA + 36 ) / 8
z = 0x1 << 5
s = "Some Hex Data" # constant may be used in operations
```

```
x++
y--
z += ( x + y )
x = ( ( y & 0xFF ) >> 5 ) / 12
```

```
SOF ( Repeat = x, Idle = y )
```

```

X
{
Field16 = 0xEEEE # Example of the data payload assignment which
usesbothintegervariables,constants,hexliteralsanddatapatterns
Data = { y y y y 7a7a7a7a "Some Hex Data" "Some Hex Data" 8b8b8b8b
z z z z [PATTERN_3] }
}
( Repeat = 10, Idle = y ) # uses integer variable for parameter/
setting.

Illegal operations

x = y + 2
SOF ( Repeat = (x+y)*7 )
# - illegal, use z = (x+y)*7 SOF ( Repeat = z ) instead

```

Loops

Loops can be used in two modes:

1. Using an integer number, loop a specified number of loops. This number has to be smaller than 64,000.
2. Using the word "infinite", loops for ever.

```

Loops ( loop_count/Infinite )
{
send instructions
assignments
change values
send instructions
}

```

Example:

```

LOOP( 50 )
{
    "CHAIN (ONE)"
    "CHAIN (TWO)"
    Some_Frame
    $Y = Some_Frame { Data = 256, 0xFEFEFEFE }
    Y
    Change Y { Field32 = x }
    Y
    Y
}

```

Trainer Script Enhancements

The Trainer script language can already produce SAS/SATA Primitive Sequences and Frames.

The Trainer script enhancements described in this section allow generation of Commands and Application Layer sequences (as in the Exerciser), by processing received frames, making complex decisions, and generating the contents of frame in run-time, for both RX and TX. Variables can keep the run-time state of the bus. Low-level commands can manipulate variables and use variables to create patterns.

Trainer language can perform SATA compliance tests with fast SSD devices and provide a SSD performance test tool with limited output data patterns. Trainer has sequential/random LBA command generation and full NCQ support.

Trainer can be programmed to act as SAS Initiator, SAS Target, SATA Host, or SATA Device.

SAS Initiator

As an Initiator, Trainer can send commands in all protocols (SSP/STP/SMP) and interact with its peer to complete the command in normal conditions and some popular error conditions. Limitations are:

- ❑ Uses only one command at a time.
- ❑ Does not save Read data or reuse bulk read data for next commands.
- ❑ Sends only limited Write data patterns.
- ❑ Has tight flow control, due to limited RX frame processing.

SAS Target

As a Target, Trainer can receive commands in all protocols (SSP/STP/SMP) and respond to them in normal conditions or some popular error conditions. Limitations are:

- ❑ Uses only one command at a time. Command queuing is not supported.
- ❑ Does not save incoming write data. Sends back data for all LBAs or generates counter/random data. Cannot be used as a real formatted partition.
- ❑ Has tight flow control, due to limited RX frame processing.

SATA Host

As a Host, Trainer can send commands and complete them in normal or some popular error conditions. SATA Host can issue NCQ commands, necessary for SATA compliance tests on SSD devices. Limitations are:

- ❑ Does not save Read data or reuse bulk read data for next commands.
- ❑ Sends only limited Write data patterns.

SATA Device

As a Device, Trainer can receive commands and respond to them in normal or some popular error conditions. Limitations are:

- ❑ Uses only one command at a time. Command queuing is not supported.
- ❑ Does not save incoming write data. Sends back data for all LBAs or generates counter/random data. Cannot be used as a real formatted partition. To use the Trainer as a SATA Device in real configurations, only tools like IO-METER (that can work with un-partitioned and un-formatted drives) can be used.

Variable Definition

Variable definition is like definitions in programming languages. You can define up to 512 DWORD (32-bit) variables. There is no constraint on variable names, except you cannot use keywords. Variable scopes are general and you should define them in the script header before the generation block.

The syntax of variable definition is:

```
VAR32 @VariableName1, @VariableName2, ...
VAR64 @VariableName
```

VAR64 holds field values greater than 32 bits, such as SASAddress.

Note: Variable names should start with @.

Assigning Variable Values

You can set variable values in different ways:

Constant value:

```
@varName1 = 1234
```

Other variable value:

```
@varName1 = @varName2
```

Result of expression on other variables:

```
@varName1 = @varName1 + @varName2
```

Fields of last received frame:

```
@varName1 = (SSPFrame) LRF::FrameType,
```

where LRF is Last Received Frame

Note: Specifying packet type (SSPFrame) before LRF causes last received frame to be this packet type, and field start-bit position is calculated according to the packet-type definition.

Part of last received frame:

```
@varName1 = LRF[stratBitOffset:endBitOffset],
where offsets are bit based
```

Random values:

```
@varName1 = Random
```

Expression on Variables

Mathematical expressions, such as sum, subtract, and shift:

```
@varName1 + @varName2
@varName1 - @ varName2
@varName1 & @varName2
@varName1 | @varName2
@varName1 << 2
```

Logical expressions, such as compare, equal, not, and, and or:

```
@varName1 > @varName2
@varName1 < @ varName2
@varName1 == @varName2
@varName1 != @ varName2
(logical expression1) && (logical expression2)
(logical expression1) || (logical expression2)
```

Complex expressions (combination of different operators) with prioritizing supported:

```
(@varName1 + @varName2) > @varName3
```

If/While in Logical Expressions

Like programming languages, scripts allow conditional statements.

The **if/while** syntaxes are:

```
If (expression)
{
    ...
}
else
{
    ...
}

While(@VarName)
{
    .....
}
```

Note: In this release, **while** condition is limited to simple variable values only. Combining operators is not allowed in **while** expressions. You should move such expressions inside **while** block.

Note: Nested **while** and **if** are supported.

Using Variable Values in Creating Patterns on Bus

In creating patterns to send on bus, trainer script allows using variables. In these cases, because the created pattern is dynamic, it is not possible to do scrambling and calculating in software code. These tasks are done in the hardware engine. To activate, set “Auto scramble mode” in “on” state.

The following examples show uses of variables in creating patterns.

Use variable for field value:

```
SendOpenAddressFrameSSP
{
  InitiatorPort = 0x1
    InitiatorConnectionTag = @variableName1
  .....
}
```

The constraints are:

- Field Length bigger than 64 bit is not supported.
- Field StartBitOffset and EndBitOffset should be in same DWORD, except for length bigger than 32.

Use LRF directly for field value:

```
SendSSPFrameCommand_Initiator
{
  Data = LRF[startBitOffset:endBitOffset]
  Tag = 0x101
}
```

The constraints are:

- Length bigger than 64 bit is not supported.
- Offsets (StartBitOffset and EndBitOffset) should be in same DWORD, except for length bigger than 32.

```
SendSSPFrameCommand
{
  #Data = {00112233 @variableName1 @variableName2 44556677}
}
```

```
RawData {
  K28.5 D24.0 D30.0 D01.4
    @variableName1
      50    00    62    B0
      00    00    00    30
      50    08    05    EF
      $C
      00    00    00    01
      00    00    00    00
      SendCRC
      K28.5 D24.0 D07.3 D31.4 }
}
```

When there are variable values in RawData, you must include **SendCRC** command instead of last DWORD. Otherwise, wrong CRC value will be sent.

The constraints are:

- ❑ Variables are not allowed on First and LAST DWORD (instead of start/end frames).
- ❑ **SendCRC** is only supported on last DWORD before end of frame.

```
SendSATAFrame
{
  SATA_SOF
  SATA_DATA ( 0x11223344 )
  SATA_DATA (@variableName1)
  SATA_DATA ( 0x55667788 )
  #SATA_CRC ( 0x99AACCB ) # good crc - can be changed to bad
  SATA_EOF
}
```

If **SATA_CRC** command is not included, trainer engine computes and inserts correct CRC in pattern.

Timer

Trainer script syntax allows using some timers. You can start a timer anywhere. The timer current value is loadable on variable to be used in expressions and conditions on this expression. There are four timers, named A, B, C, and D.

Starting timer (setting timer value to zero) syntax is:

```
CLEAR_TIMER_A
CLEAR_TIMER_B
CLEAR_TIMER_C
CLEAR_TIMER_D
```

Loading timer current value in variables:

```
@varName1 =TIMER_A
@varName1 =TIMER_B
@varName1 =TIMER_C
@varName1 =TIMER_D
```

PATTERN Counter

Trainer script syntax allows you to use counters on a number of defined events in generation settings.

Syntax for loading counters in variables is:

```
@varName1 = COUNT_REC_RESOURCE_OUTPUT_A
@varName1 = COUNT_REC_RESOURCE_OUTPUT_B
@varName1 = COUNT_REC_RESOURCE_OUTPUT_C
@varName1 = COUNT_REC_RESOURCE_OUTPUT_D
@varName1 = COUNT_REC_RESOURCE_OUTPUT_E
@varName1 = COUNT_REC_RESOURCE_OUTPUT_F
```

Syntax for clearing (resetting) counters is:

```
CLEAR_REC_RESOURCE_OUTPUT_A  
CLEAR_REC_RESOURCE_OUTPUT_B  
CLEAR_REC_RESOURCE_OUTPUT_C  
CLEAR_REC_RESOURCE_OUTPUT_D  
CLEAR_REC_RESOURCE_OUTPUT_E  
CLEAR_REC_RESOURCE_OUTPUT_F
```

Procedure Definition

Procedures allow creating simple syntaxes for complex reusable parts in scripts. You can write such code once as a procedure and use everywhere required.

Procedure definition syntax is:

```
procedure procedureName  
{  
  ...  
}
```

Calling procedure syntax is:

```
Call procedureName
```

Sierra Trainer Generation Commands

General Commands

IDLE (n)	Generator will insert n idle DWORDs into the generation stream.
CLEAR_CREDIT_AVAIL	This commands clears the credit established with the command WF_CREDIT_AVAIL. (See WF_CREDIT_AVAIL in following section on Wait Commands for explanation).
RD_ERROR	Generator will insert one idle DWORD into the generation stream, which will intentionally break RD sequence creating RD error.
CONNECT	Generator will go through connection sequence using current GenFile settings (gen mode, speed, and so on). Generation will not resume until connection is established.
DISCONNECT	Generator will break existing connection to DUT.
PAUSE	Generator will come to a break and the user will be able to resume generation by pressing Resume button on Generation toolbar. Generator shall transmit idle DWORDs while in the Pause.
OUTPUT_ON	Takes the Trainer out of Electric Idle state. If it is already out of Electric Idle, this is a NOP.
OOB Commands	
COMINIT	Generator will send COMINIT OOB signals using current COMINIT settings.
COMRESET	Generator will send COMRESET OOB signals using current COMRESET settings.
COMWAKE	Generator will send COMWAKE OOB signals using current COMWAKE settings.
COMSAS	Generator will send COMSAS OOB signals using current COMSAS settings.
SATA_ALIGN	Generator will go through SATA_ALIGN stage of SATA SpeedNeg process using current SATA_ALIGN settings.
SATA_D10_2	Generator will go through SATA_D10_2 stage of SATA SpeedNeg process using current SATA_D10_2 settings.
SPEED_NEG_RCDT	Generator will go through SPEED_NEG_RCDT stage of SAS SpeedNeg process using current SPEED_NEG_RCDT settings.
SPEED_NEG_ALIGN0	Generator will go through SPEED_NEG_ALIGN0 stage of SAS SpeedNeg process using current SPEED_NEG_ALIGN0 settings.

SPEED_NEG_ALIGN1	Generator will go through SPEED_NEG_ALIGN1 stage of SAS SpeedNeg process using current SPEED_NEG_ALIGN1 settings.
Set Speed = LINK_SPEED_1_5G	Generator will change speed to 1.5G (if MultiSpeed is enabled). This settings is not applied when Advanced Connect is set.
Set Speed = LINK_SPEED_3G	Generator will change speed to 3G (if MultiSpeed is enabled). This settings is not applied when Advanced Connect is set.
Set Speed = LINK_SPEED_6G	Generator will change speed to 6G (if MultiSpeed is enabled). This settings is not applied when Advanced Connect is set.
Send_Phy_Capability	Generator will send PHY Capability Bits. (this command is used in SNW3).
Send_Train_TrainDone	Generator will send Train/Train Done Patterns. (This Command is used in Train Windows).
Delay (#)	Generator will wait until # ns before executing next command.
Power_Expansion_On	Switch on power expansion card.
Power_Expansion_Off	Switch off power expansion card
Exit (ExitCode)	Call this command in any branch of the Trainer program to stop execution. After exit, the Port Status dialog displays the exit code.

Note: The Trainer GUI has LED indicators:
Green is for pass.
Red is for fail.
No color is for unknown or for user to review.

SATA Commands

Look at STP sample file for syntax.

- SEND_SATA_FRAME
- SendSATAFrame
- SATAData
- SATA_Data
- SATACRC
- SATA_CRC
- SATAXXXX
- SATA_XXXX

Primitive Commands

The following is a list of SAS and SATA primitives declared in **Primitives.Decl.inc** as Symbol Chains. If you want to use these primitives in your script, you must also include **Primitives.Decl.inc** in your script.

- SOF
- EOF
- SOAF
- EOAF
- ALIGN (0)
- ALIGN (1)
- ALIGN (2)
- ALIGN (3)
- NOTIFY (ENABLE SPINUP)
- NOTIFY (RESERVED 0)
- NOTIFY (RESERVED 1)
- NOTIFY (RESERVED 2)
- ACK
- NAK (CRC ERROR)
- NAK (RESERVED 0)
- NAK (RESERVED 1)
- NAK (RESERVED 2)
- CREDIT_BLOCKED
- RRDY (NORMAL)
- RRDY (RESERVED 0)
- RRDY (RESERVED 1)
- SATA_SOF
- SATA_EOF
- SATA_CONT
- SATA_DMAT
- SATA_HOLD
- SATA_HOLDA
- SATA_PMACK
- SATA_PMNAK
- SATA_PMREQ_P
- SATA_PMREQ_S
- SATA_R_ERR
- SATA_R_IP
- SATA_R_OK
- SATA_R_RDY
- SATA_SYNC
- SATA_WTRM
- SATA_X_RDY
- SATA_ERROR
- AIP (NORMAL)
- AIP (RESERVED 0)
- AIP (RESERVED 1)

- AIP (RESERVED 2)
- AIP (RESERVED 3)
- AIP (WAITING ON CONNECTION)
- AIP (WAITING ON DEVICE)
- AIP (WAITING ON PARTIAL)
- BREAK
- BROADCAST (CHANGE)
- BROADCAST (RESERVED 0)
- BROADCAST (RESERVED 1)
- BROADCAST (RESERVED 2)
- BROADCAST (RESERVED 3)
- BROADCAST (RESERVED 4)
- BROADCAST (RESERVED CHANGE 0)
- BROADCAST (RESERVED CHANGE 1)
- CLOSE (CLEAR AFFILIATION)
- CLOSE (NORMAL)
- CLOSE (RESERVED 0)
- CLOSE (RESERVED 1)
- ERROR
- HARD_RESET
- OPEN_ACCEPT
- OPEN_REJECT (BAD DESTINATION)
- OPEN_REJECT (CONNECTION RATE NOT SUPPORTED)
- OPEN_REJECT (NO DESTINATION)
- OPEN_REJECT (PATHWAY BLOCKED)
- OPEN_REJECT (PROTOCOL NOT SUPPORTED)
- OPEN_REJECT (RESERVED ABANDON 0)
- OPEN_REJECT (RESERVED ABANDON 1)
- OPEN_REJECT (RESERVED ABANDON 2)
- OPEN_REJECT (RESERVED ABANDON 3)
- OPEN_REJECT (RESERVED CONTINUE 0)
- OPEN_REJECT (RESERVED CONTINUE 1)
- OPEN_REJECT (RESERVED INITIALIZE 0)
- OPEN_REJECT (RESERVED INITIALIZE 1)
- OPEN_REJECT (RESERVED STOP 0)
- OPEN_REJECT (RESERVED STOP 1)
- OPEN_REJECT (RETRY)
- OPEN_REJECT (STP RESOURCES BUSY)
- OPEN_REJECT (WRONG DESTINATION)
- DONE (ACK/NAK TIMEOUT)
- DONE (CREDIT TIMEOUT)
- DONE (NORMAL)
- DONE (RESERVED 0)
- DONE (RESERVED 1)
- DONE (RESERVED TIMEOUT 0)
- DONE (RESERVED TIMEOUT 1)
- SAS Specific Script-Defined Constants
- SAS_AF_DT_NO_DEVICE_ATTACHED

- SAS_AF_DT_END_DEVICE
- SAS_AF_DT_EDGE_EXPANDER_DEVICE
- SAS_AF_DT_FANOUT_EXPANDER_DEVICE
- SAS_AF_FT_IDENTIFY
- SAS_AF_FT_OPEN
- SAS_AF_PROTOCOL_SMP
- SAS_AF_PROTOCOL_SSP
- SAS_AF_PROTOCOL_STP
- SAS_AF_PROTOCOL_UNKNOWN
- SAS_AF_RATE_1_5_GBPS
- SAS_AF_RATE_3_GBPS
- SMP_FRAME_TYPE_REQUEST
- SMP_FRAME_TYPE_RESPONSE
- SMP_REPORT_GENERAL
- SMP_REPORT_MANUFACTURER_INFO
- SMP_DISCOVER
- SMP_REPORT_PHY_ERROR_LOG
- SMP_REPORT_PHY_SATA
- SMP_REPORT_ROUTE_INFO
- SMP_CONFIGURE_ROUTE_INFO
- SMP_PHY_CONTROL
- SSP_FRAME_TYPE_DATA
- SSP_FRAME_TYPE_XFER_RDY
- SSP_FRAME_TYPE_COMMAND
- SSP_FRAME_TYPE_RESPONSE
- SSP_FRAME_TYPE_TASK
- SSP_FRAME_TYPE_VENDOR
- MUX (LOGICAL 0)
- MUX (LOGICAL 1)
- BREAK_REPLY
- TRAIN
- TRAIN_DONE
- PS_ACK
- PS_NAK
- PS_REQ_PARTIAL
- PS_REQ_SLUMBER

Primitive Category

- ALIGN:** 0, 1, 2, or 3
- NOTIFY:** ENABLE SPINUP, RESERVED 0, RESERVED 1, or RESERVED 2
- ACK
- NAK:** CRC ERROR, RESERVED 0, RESERVED 1, or RESERVED 2
- RRDY:** NORMAL, RESERVED 0, RESERVED 1
- AIP:** NORMAL, RESERVED 0, RESERVED 1, RESERVED 2, RESERVED 3, WAITING ON CONNECTION, WAITING ON DEVICE, or WAITING ON PARTIAL
- BREAK
- CLOSE:** CLEAR AFFILIATION, NORMAL, RESERVED 0, RESERVED 1

- ❑ CREDIT BLOCKED
- ❑ OPEN ACCEPT
- ❑ **OPEN REJECT:** BAD DESTINATION, CONNECTION RATE NOT SUPPORTED, NO DESTINATION, PATHWAY BLOCKED, PROTOCOL NOT SUPPORTED, RESERVED ABANDON 0, RESERVED ABANDON 1, RESERVED ABANDON 2, RESERVED ABANDON 3, RESERVED CONTINUE 0, RESERVED CONTINUE 1, RESERVED INITIALIZE 0, RESERVED INITIALIZE 1, RESERVED STOP 0, RESERVED STOP 1, RETRY, STP RESOURCES BUSY, or WRONG DESTINATION
- ❑ **BROADCAST:** CHANGE, RESERVED 0, RESERVED 1, RESERVED 2, RESERVED 3, RESERVED 4, RESERVED CHANGE 0, or RESERVED CHANGE 1
- ❑ **DONE:** ACK/NAK TIMEOUT, CREDIT TIMEOUT, NORMAL, RESERVED 0, RESERVED 1, RESERVED TIMEOUT 0, or RESERVED TIMEOUT 1
- ❑ SATA FLOW CTRL PRIMITIVE
- ❑ SATA IDLE PRIMITIVE
- ❑ **SAS PS PRIMITIVE:** PS_REQ_PARTIAL, PS_REQ_SLUMBER, PS_ACK, or PS_NAK

Wait Commands

Syntax:

```
WAIT_FOR { <command1> <command2> ... <group1> <group2> ... }
```

Wait Command Name	Description
WF_TIMEOUT	<p>Timeout Credit Available</p> <p>When WF_TIMEOUT is requested in WAIT_FOR command, the wait session will be released after timeout has elapsed.</p> <p>The Timeout value can be set two different ways:</p> <ol style="list-style-type: none"> 1. Through the global WaitTimeout setting that can appear anywhere in generation. Default value is 1000 microseconds. <p>Syntax:</p> <p>Set WaitTimeout = <value> (in microseconds)</p> <ol style="list-style-type: none"> 2. Through local WaitTimeout value for this specific wait session. <p>Syntax:</p> <pre>WAIT_FOR (<number_of_microseconds> {WF_TIMEOUT <other_wait_commands>}</pre> <p>In this case wait for other commands will be released no later then after number_of_microseconds, but global WaitTimeout value remains unchanged for future use.</p> <p>See Generation\Include\WaitCommands.inc in the program folder for the samples of syntax.</p>

Wait Command Name	Description
WF_SOF	primitive
WF_EOF	primitive
WF_SOAF	primitive
WF_EOAF	primitive
WF_ACK	primitive
WF_NAK_CRC_ERROR	primitive
WF_NAK_RESERVED_0	primitive
WF_NAK_RESERVED_1	primitive
WF_NAK_RESERVED_2	primitive
WF_CREDIT_AVAIL	<p>Credit Available</p> <p>This function is based on a 10-bit counter whose value can range from -512 to +511 (twos-complement). This counter is cleared by sending or receiving an OPEN_ACCEPT primitive, or by execution of a CLEAR_CREDIT_AVAIL command in the script.</p> <p>This counter is incremented by receiving any SAS RRDY primitive and is decremented by sending SAS SOF. The wait_for command will wait for this counter to have a positive value between +1 and +511. This wait_for condition is intended to be used before sending a SAS frame within a connection.</p> <p>CLEAR_CREDIT_AVAIL clears this credit function.</p>
WF_CREDIT_BLOCKED_RECEIVED	<p>CreditBlocked Received</p> <p>This function is based on a flip-flop which is cleared by sending or receiving an OPEN_ACCEPT primitive. It is set by receiving a CREDIT_BLOCKED primitive. It is intended to be used in conjunction with wf_credit_avail to prevent script hangs in those cases where there is not going to be any more credit granted.</p>
WF_CREDIT_BLOCKED	primitive
WF_RRDY_NORMAL	primitive
WF_RRDY_RESERVED_0	primitive
WF_RRDY_RESERVED_1	primitive
WF_BREAK	primitive
WF_CLOSE_CLEAR_AFFILIATION	primitive
WF_CLOSE_NORMAL	primitive
WF_CLOSE_RESERVED_0	primitive
WF_CLOSE_RESERVED_1	primitive

Wait Command Name	Description
WF_DONE_ACK_NAK_TIMEOUT	primitive
WF_DONE_CREDIT_TIMEOUT	primitive
WF_DONE_NORMAL	primitive
WF_DONE_RESERVED_0	primitive
WF_DONE_RESERVED_1	primitive
WF_DONE_RESERVED_TIMEOUT_0	primitive
WF_DONE_RESERVED_TIMEOUT_1	primitive
WF_ERROR	primitive
WF_HARD_RESET	primitive
WF_AIP_NORMAL	primitive
WF_AIP_RESERVED_0	primitive
WF_AIP_RESERVED_1	primitive
WF_AIP_RESERVED_2	primitive
WF_AIP_RESERVED_WAIT_ON_PART	primitive
WF_AIP_WAIT_ON_CONN	primitive
WF_AIP_WAIT_ON_DEVICE	primitive
WF_AIP_WAIT_ON_PARTIAL	primitive
WF_IDENTIFY_FRAME	Identify Address Frame
WF_OPEN_FRAME	Open Address Frame
WF_SMP_REQUEST	SMP Request Frame
WF_SMP_RESPONSE	SMP Response Frame
WF_REC_RESOURCES_OUTPUT_A	Advanced Wait Condition A This command causes generation to wait for Event "A" to occur that you defined in the Generation Options dialog described at the end of this chapter.
WF_REC_RESOURCES_OUTPUT_B	Advanced Wait Condition B This command causes generation to wait for Event "B" to occur that you defined in the Generation Options dialog described at the end of this chapter.
WF_REC_RESOURCES_OUTPUT_C	Advanced Wait Condition C This command causes generation to wait for Event "C" to occur that you defined in the Generation Options dialog described at the end of this chapter.
WF_REC_RESOURCES_OUTPUT_D	Advanced Wait Condition D This command causes generation to wait for Event "D" to occur that you defined in the Generation Options dialog described at the end of this chapter.

Wait Command Name	Description
WF_REC_RESOURCES_OUTPUT_E	Advanced Wait Condition E This command causes generation to wait for Event "E" to occur that you defined in the Generation Options dialog described at the end of this chapter.
WF_REC_RESOURCES_OUTPUT_F	Advanced Wait Condition F This command causes generation to wait for Event "F" to occur that you defined in the Generation Options dialog described at the end of this chapter.
WF_COMRESET_COMINIT	COMRESET OOB Signals
WF_COMSAS	COMSAS OOB Signals
WF_COMWAKE	COMWAKE OOB Signals
WF_BLOCK1_MISC_RESERVED_0	reserved
WF_BLOCK1_MISC_RESERVED_1	reserved
WF_BLOCK1_MISC_RESERVED_2	reserved
WF_BLOCK1_MISC_RESERVED_3	reserved
WF_BLOCK1_MISC_RESERVED_4	reserved
WF_SATA_CONT	primitive
WF_SATA_DMAT	primitive
WF_SATA_EOF	primitive
WF_SATA_ERROR	primitive
WF_SATA_HOLD	primitive
WF_SATA_HOLDA	primitive
WF_SATA_PMACK	primitive
WF_SATA_PMNAK	primitive
WF_SATA_PMREQ_P	primitive
WF_SATA_PMREQ_S	primitive
WF_SATA_R_ERR	primitive
WF_SATA_R_IP	primitive
WF_SATA_R_OK	primitive
WF_SATA_R_RDY	primitive
WF_SATA_SOF	primitive
WF_SATA_SYNC	primitive
WF_SATA_WTRM	primitive
WF_SATA_X_RDY	primitive
WF_OPEN_ACCEPT	primitive
WF_OPEN_REJECT_BAD_DESTINATION	primitive
WF_OPEN_REJECT_CONN_RATE_NOT_SUPPOR TED	primitive
WF_OPEN_REJECT_NO_DESTINATION	primitive

Wait Command Name	Description
WF_OPEN_REJECT_PATHWAY_BLOCKED	primitive
WF_OPEN_REJECT_PROTOCOL_NOT_SUPPORTED	primitive
WF_OPEN_REJECT_RETRY	primitive
WF_OPEN_REJECT_STP_RESOURCES_BUSY	primitive
WF_OPEN_REJECT_WRONG_DESTINATION	primitive
WF_OPEN_REJECT_RESERVED_ABANDON_0	primitive
WF_OPEN_REJECT_RESERVED_ABANDON_1	primitive
WF_OPEN_REJECT_RESERVED_ABANDON_2	primitive
WF_OPEN_REJECT_RESERVED_ABANDON_3	primitive
WF_OPEN_REJECT_RESERVED_CONTINUE_0	primitive
WF_OPEN_REJECT_RESERVED_CONTINUE_1	primitive
WF_OPEN_REJECT_RESERVED_INITIALIZE_0	primitive
WF_OPEN_REJECT_RESERVED_INITIALIZE_1	primitive
WF_OPEN_REJECT_RESERVED_STOP_0	primitive
WF_OPEN_REJECT_RESERVED_STOP_1	primitive
WF_ALIGN_0	primitive
WF_ALIGN_1	primitive
WF_ALIGN_2	primitive
WF_ALIGN_3	primitive
WF_NOTIFY_ENABLE_SPINUP	primitive
WF_NOTIFY_RESERVED_0	primitive
WF_NOTIFY_RESERVED_1	primitive
WF_NOTIFY_RESERVED_2	primitive
WF_BROADCAST_CHANGE	primitive
WF_BROADCAST_RESERVED_0	primitive
WF_BROADCAST_RESERVED_1	primitive
WF_BROADCAST_RESERVED_2	primitive
WF_BROADCAST_RESERVED_3	primitive
WF_BROADCAST_RESERVED_4	primitive
WF_BROADCAST_RESERVED_CHANGE_0	primitive
WF_BROADCAST_RESERVED_CHANGE_1	primitive
WF_BLOCK2_MISC_RESERVED_0	reserved
WF_BLOCK2_MISC_RESERVED_1	reserved
WF_TRAIN	primitive
WF_TRAIN_DONE	primitive
WF_BREAK_REPLY	primitive
WF_MUX_LOGICAL_0	primitive
WF_MUX_LOGICAL_1	primitive
WF_PS_REQ_PARTIAL	primitive

Wait Command Name	Description
WF_PS_REQ_SLUMBER	primitive
WF_PS_ACK	primitive
WF_PS_NAK	primitive

Wait Command Groups

Wait Command Group	Group Contents
WF_TIMEOUT	WF_TIMEOUT_BLOCK_ONE WF_TIMEOUT_BLOCK_TWO
WF_ALL_SOF	WF_SOF WF_SOAF
WF_ALL_EOF	WF_EOF WF_SOAF
WF_NAK	WF_NAK_CRC_ERROR WF_NAK_RESERVED_0 WF_NAK_RESERVED_1 WF_NAK_RESERVED_2
WF_RRDY	WF_RRDY_NORMAL WF_RRDY_RESERVED_0 WF_RRDY_RESERVED_1
WF_CREDIT_OK	WF_CREDIT_AVAIL WF_CREDIT_BLOCKED_RECEIVED
WF_CLOSE	WF_CLOSE_CLEAR_AFFILIATION WF_CLOSE_NORMAL WF_CLOSE_RESERVED_0 WF_CLOSE_RESERVED_1
WF_DONE	WF_DONE_ACK_NAK_TIMEOUT WF_DONE_CREDIT_TIMEOUT WF_DONE_NORMAL WF_DONE_RESERVED_0 WF_DONE_RESERVED_1 WF_DONE_RESERVED_TIMEOUT_0 WF_DONE_RESERVED_TIMEOUT_1

Wait Command Group	Group Contents
WF_AIP	WF_AIP_NORMAL WF_AIP_RESERVED_0 WF_AIP_RESERVED_1 WF_AIP_RESERVED_2 WF_AIP_RESERVED_WAIT_ON_PART WF_AIP_WAIT_ON_CONN WF_AIP_WAIT_ON_DEVICE WF_AIP_WAIT_ON_PARTIAL
WF_REC_RESOURCES	WF_REC_RESOURCES_OUTPUT_A WF_REC_RESOURCES_OUTPUT_B WF_REC_RESOURCES_OUTPUT_C WF_REC_RESOURCES_OUTPUT_D WF_REC_RESOURCES_OUTPUT_E WF_REC_RESOURCES_OUTPUT_F
WF_RCV_STATUS	WF_SATA_R_ERR WF_SATA_R_OK
WF_PM_REQ	WF_SATA_PMREQ_P WF_SATA_PMREQ_S
WF_PM_STATUS	WF_SATA_PMACK WF_SATA_PMNAK
WF_OPEN_REJECT	WF_OPEN_REJECT_BAD_DESTINATION WF_OPEN_REJECT_CONN_RATE_NOT_SUPPORTED WF_OPEN_REJECT_NO_DESTINATION WF_OPEN_REJECT_PATHWAY_BLOCKED WF_OPEN_REJECT_PROTOCOL_NOT_SUPPORTED WF_OPEN_REJECT_RETRY WF_OPEN_REJECT_STP_RESOURCES_BUSY WF_OPEN_REJECT_WRONG_DESTINATION WF_OPEN_REJECT_RESERVED_ABANDON_0 WF_OPEN_REJECT_RESERVED_ABANDON_1
WF_OPEN_REJECT (continued...)	WF_OPEN_REJECT_RESERVED_ABANDON_2 WF_OPEN_REJECT_RESERVED_ABANDON_3 WF_OPEN_REJECT_RESERVED_CONTINUE_0 WF_OPEN_REJECT_RESERVED_CONTINUE_1 WF_OPEN_REJECT_RESERVED_INITIALIZE_0 WF_OPEN_REJECT_RESERVED_INITIALIZE_1 WF_OPEN_REJECT_RESERVED_STOP_0 WF_OPEN_REJECT_RESERVED_STOP_1

Wait Command Group	Group Contents
WF_OPEN_RESPONSE	WF_OPEN_ACCEPT
	WF_OPEN_REJECT
WF_ALIGN	WF_ALIGN_0
	WF_ALIGN_1
	WF_ALIGN_2
	WF_ALIGN_3
WF_NOTIFY	WF_NOTIFY_ENABLE_SPINUP
	WF_NOTIFY_RESERVED_0
	WF_NOTIFY_RESERVED_1
	WF_NOTIFY_RESERVED_2
WF_BROADCAST	WF_BROADCAST_CHANGE
	WF_BROADCAST_RESERVED_0
	WF_BROADCAST_RESERVED_1
	WF_BROADCAST_RESERVED_2
	WF_BROADCAST_RESERVED_3
	WF_BROADCAST_RESERVED_4
	WF_BROADCAST_RESERVED_CHANGE_0
	WF_BROADCAST_RESERVED_CHANGE_1
WF_SAS_PS_REQ	WF_PS_REQ_PARTIAL
	WF_PS_REQ_SLUMBER
WF_SAS_PS_STATUS	WF_PS_ACK
	WF_PS_ACK

Predefined Constants

Predefined Constant	Internal Value
GEN_MODE_ERROR	0
GEN_MODE_SATA_HOST	1
GEN_MODE_SATA_DEVICE	2
GEN_MODE_SAS_INITIATOR	3
GEN_MODE_SAS_TARGET	4
GEN_LINK_SPEED_1_5G	00
GEN_LINK_SPEED_3G	01
GEN_LINK_SPEED_6G	10
SCRAMBLING_MODE_NONE	0
SCRAMBLING_MODE_SAS	1
SCRAMBLING_MODE_SATA	2

Generation Settings

Setting	Default Value	Description
Global Settings		
GenerationMode	>>>>>	Generation Mode - must be defined or no generation will take place. Possible Values: GEN_MODE_SATA_HOST GEN_MODE_SATA_DEVICE GEN_MODE_SAS_INITIATOR GEN_MODE_SAS_TARGET Default Value: GEN_MODE_ERROR - undefined mode
SSCEnable	0	Spread Spectrum Clocking (SSC) In SATA software, turns SSC on or off. Can only be set outside Generation block. In SAS software, when you turn on SSC, Trainer PHY can turn on SSC on the PHY. In the SAS protocol, during speed negotiation, when both sides of a link agree to turn on their SSC, SSC will turn on, with the SSC Type and SSC Amplitude parameters.
SSCType		Specifies SSC type as midsread.
SSCAmplitude		Specifies SSC Amplitude. Possible values are: SSC_AMP_500 SSC_AMP_1000 SSC_AMP_1500 SSC_AMP_2000 SSC_AMP_2500 SSC_AMP_3000
MultiSpeedMode	0	When set, the change of speed within Generation block is allowed with following syntax: set Speed = LINK_SPEED_1_5G / LINK_SPEED_3G / LINK_SPEED_6G
Output Disable	0	This very poorly named register bit forces the Trainer to output data. It is a little like the output_on script command except that its effect cannot be undone for the duration of the script. If this is turned on, none of the out-of-band commands will work, as the output enable is forced on.
SupportSNW1	1	When set, in "Connect command" SNW1 will be tried in Speed Negotiation phase Can only be set outside Generation block.
SupportSNW2	1	When set, in "Connect command" SNW2 will be tried in Speed Negotiation phase. Can only be set outside Generation block.

Setting	Default Value	Description
PauseTrnScramblr.	0	When set, the generator pauses the Idle scrambler of Train/TrainDone pattern.
ReconnectOnRun	0	When “AdvanceConnect” and “ReconnectOnRun” are set, the “Connect” command forces the Trainer to disconnect the physical link before executing the “Connect” command. When “AdvanceConnect” is not set, this setting does not affect the Trainer.
AdvanceConnect	0	When set, the Trainer uses the “PHY Capability” and “SupportSNW” settings, instead of the “Set Speed” settings, for executing the “Connect” command.
OutputOffAfterDC	On Off	If set to On, Trainer puts DC Idle on line when it detects sync lost on the link.

Setting	Default Value	Description
AutoMode Settings		
AutoOOBMode	On	When set, the generator will go through the stages of bringing up the link automatically, including waiting for and responding to the device or host it is connected to.
AutoHoldMode	0	When set, the generator will respond automatically to Hold requests. Not supported for version 1.1 (reserved).
AutoDMAT	0	When set, the generator will respond automatically to DMAT requests. Not supported for version 1.1 (reserved).
AutoHandshake	0	When set, the generator will respond automatically to TBD commands. Not supported for version 1.1 (reserved).
AutoSpeedNeg	On	When set, the generator will automatically go through the speed negotiation process, for the speed set in the PINTERFACEC_SERDES register for the Trainer.
AutoAlignSATA	0	When set, the generator will automatically inserting the stream 2 Align(0) primitives every 254 DWORDS, as specified in the SATA spec.
AutoAlignSAS	On	When set, the generator will automatically inserting the stream Align primitives every 2048 DWORDS, as specified in the SAS spec. Two Align modes can be turned on simultaneously, to support STP
COMINIT Settings		
COMINIT_NegLen	800	The number of bursts to send as part of this OOB type. Each Burst is followed by an Idle. The Burst-Idle pairs are repeated the requested number of times, and then followed by the Negation_length of Idle.
COMINIT_IdleLen	480	Burst time between each OOB idle in OOBIs. During the specified period, the generator will send ALIGN(0) at the specified speed.
COMINIT_BurstLen	160	Idle time between each OOB burst in OOBIs. During the specified period, the generator will keep the line at electric idle.
COMINIT_NumBursts	6	Negation time at the end of the OOB signal in OOBIs. During the specified period, the generator will keep the line at electric idle.

Setting	Default Value	Description
COMWAKE Settings		
COMWAKE_NegLen	280	The number of bursts to send as part of this OOB type. Each Burst is followed by an Idle. The Burst-Idle pairs are repeated the requested number of times, and then followed by the Negation_length of Idle.
COMWAKE_IdleLen	160	Burst time between each OOB idle in OOBIs. During the specified period, the generator will send ALIGN(0) at the specified speed.
COMWAKE_BurstLen	160	Idle time between each OOB burst in OOBIs. During the specified period, the generator will keep the line at electric idle.
COMWAKE_NumBursts	6	Negation time at the end of the OOB signal in OOBIs. During the specified period, the generator will keep the line at electric idle.
COMSAS Settings		
COMSAS_NegLen	2400	The number of bursts to send as part of this OOB type. Each Burst is followed by an Idle. The Burst-Idle pairs are repeated the requested number of times, and then followed by the Negation_length of Idle.
COMSAS_IdleLen	1440	Burst time between each OOB idle in OOBIs. During the specified period, the generator will send ALIGN(0) at the specified speed.
COMSAS_BurstLen	160	Idle time between each OOB burst in OOBIs. During the specified period, the generator will keep the line at electric idle.
COMSAS_NumBursts	6	Negation time at the end of the OOB signal in OOBIs. During the specified period, the generator will keep the line at electric idle.
SATA Link Init Settings		
OOB_SATA_D102_Time	100000	D10.2 time for SATA link synchronization in OOBIs. During the specified period, the generator will transmit D10.2 symbols.
OOB_SATA_Align_Time	100000	ALIGN(0) time for SATA link synchronization in OOBIs. During the specified period, the generator will transmit ALIGN(0) primitives.

Setting	Default Value	Description
SAS Speed Negotiation Settings		
OOB_SAS_Align1_Time	81920	ALIGN(1) time for SAS speed negotiation in OOBIs. During the specified period, the generator will transmit ALIGN(1) primitives.
OOB_SAS_Align0_Time	81920	ALIGN(0) time for SAS speed negotiation in OOBIs. During the specified period, the generator will transmit ALIGN(0) primitives.
OOB_SAS_Interspeed_Time	750000	Interspeed time for SAS speed negotiation in OOBIs. During the specified period, the generator will keep the line at electric idle.
OOB_SpeedNeg_MTT.	29998080 OOBI	The maximum time in OOBIs during which training phase of speed negotiation should be completed in Train-SNW.
OOB_SpeedNeg_SNTT.	2200 OOBI	The time in OOBIs during which generator transmits phy capability bits in SNW-3. In Automatic connection This value is also used for the time during which generator sends Align0 and Align1 in SNW1 and SNW2.
OOB_SpeedNeg_BCT.	2200 OOBI	The time in OOBIs during which generator transmits COMWAKE or D.C. idle during SNW-3.

Setting	Default Value	Description
Phy Capabilities Settings		
OOB_SpeedNeg_Phy_start		The START bit shall be set to one. The phy's receiver shall use this bit to establish the timing for the subsequent bits.
OOB_SpeedNeg_Phy_txSSCtype		A TX SSC TYPE bit set to one indicates that the phy's transmitter uses center-spreading SSC when SSC is enabled. A TX SSC TYPE bit set to zero indicates that the phy's transmitter uses down-spreading SSC when SSC is enabled or that the phy does not support SSC.
OOB_SpeedNeg_Phy_RLLR		The REQUESTED LOGICAL LINK RATE field indicates if the phy supports multiplexing and, if so, the logical link rate that the phy is requesting.
OOB_SpeedNeg_Phy_g1WithoutSSC		A G1 WITHOUT SSC bit set to one indicates that the phy supports G1 (i.e., 1.5 Gbps) without SSC. A G1 WITHOUT SSC bit set to zero indicates that the phy does not support G1 without SSC.
OOB_SpeedNeg_Phy_g1WithSSC		A G1 WITH SSC bit set to one indicates that the phy supports G1 (i.e., 1.5 Gbps) with SSC. A G1 WITH SSC bit set to zero indicates that the phy does not support G1 with SSC.
OOB_SpeedNeg_Phy_g2WithoutSSC		A G2 WITHOUT SSC bit set to one indicates that the phy supports G2 (i.e., 3 Gbps) without SSC. A G2 WITHOUT SSC bit set to zero indicates that the phy does not support G2 without SSC.
OOB_SpeedNeg_Phy_g2WithSSC		A G2 WITH SSC bit set to one indicates that the phy supports G2 (i.e., 3 Gbps) with SSC. A G2 WITH SSC bit set to zero indicates that the phy does not support G2 with SSC.
OOB_SpeedNeg_Phy_g3WithoutSSC		A G3 WITHOUT SSC bit set to one indicates that the phy supports G3 (i.e., 6 Gbps) without SSC. A G3 WITHOUT SSC bit set to zero indicates that the phy does not support G3 without SSC.
OOB_SpeedNeg_Phy_g3WithSSC		A G3 WITH SSC bit set to one indicates that the phy supports G3 (i.e., 6 Gbps) with SSC. A G3 WITH SSC bit set to zero indicates that the phy does not support G3 with SSC.
OOB_SpeedNeg_Phy_Parity		The PARITY bit provides for error detection of all the SNW-3 phy capabilities bits. The PARITY bit shall be set to one or zero such that the total number of SNW-3 phy capabilities bits that are set to one is even, including the START bit and the PARITY bit.

Setting	Default Value	Description
SATA Speed Negotiation Settings		
OOB_SpeedNeg_RCDT	750000	Maximum time in OOBIs during the speed negotiation window for a transmitter to reply with ALIGN(1).
OOB_SpeedNeg_SNTT	163840	Time in OOBIs during which ALIGN(0) or ALIGN(1) is transmitted at each physical link rate during the speed negotiation sequence.
OOB_SpeedNeg_SNLT	153600	Time in OOBIs during which the transmitter shall transmit idle between rates during speed negotiation.
Speed Settings		
Speed	>>>>>	Link Speed Possible Values: LINK_SPEED_1_5G LINK_SPEED_3G LINK_SPEED_6G Default Value: LINK_SPEED_1_5G
RateMatching	0	When set, the generator will automatically inserting the stream Align(0) primitive after every DWORD.
Scrambling Mode Settings		
Scrambling	>>>>>	<p>Raw Data Scrambling Mode - Only those raw DWORDs will be scrambled that contain only data bytes (no 10-bit symbols or 'K' bytes. Scrambling is reset by changing ScramblingMode or by any valid SAS or SATA frame.</p> <p>When Scrambling is on, scrambling is done by Trainer engine. It automatically detects scrambling type (SAS or SATA) by start frame primitive.</p> <p>When Scrambling is off, data is sent without any scrambling.</p> <p>Possible Values: SCRAMBLING_MODE_NONE SCRAMBLING_MODE_SAS SCRAMBLING_MODE_SATA SCRAMBLING_MODE_AUTO Default Value: SCRAMBLING_MODE_AUTO</p>

Setting	Default Value	Description
Wait Timeout Settings		
WaitTimeout	1000	Sets global WaitTimeout value in microseconds
AUTO_WAIT_SAS_AFTER Settings		
AUTO_WAIT_SAS_AFTER_CLOSE_FOR_CLOSE	FALSE	When set, the generator will insert WAIT_FOR CLOSE command immediately after each CLOSE primitive.
AUTO_WAIT_SAS_AFTER_EOF_FOR_ACK	FALSE	When set, the generator will insert WAIT_FOR ACK command immediately after each EOF primitive.
AUTO_WAIT_SAS_AFTER_EOF_FOR_ACK_OR_NAK	FALSE	When set, the generator will insert WAIT_FOR ACK or NAK command immediately after each EOF primitive.
AUTO_WAIT_SAS_AFTER_OPEN_FOR_OPEN_ACCEPT	FALSE	When set, the generator will insert WAIT_FOR OPEN_ACCEPT command immediately after each Open Address Frame.
AUTO_WAIT_SAS_AFTER_OPEN_FOR_OPEN_REJECT	FALSE	When set, the generator will insert WAIT_FOR OPEN_REJECT command immediately after each Open Address Frame.
AUTO_WAIT_SAS_AFTER_IDENTIFY_FOR_IDENTIFY_FRAME	FALSE	When set, the generator will insert WAIT_FOR Identify Frame command immediately after each Identify Address Frame.
AUTO_WAIT_SAS_AFTER_SMP_REQ_FOR_RESP	FALSE	When set, the generator will insert WAIT_FOR SMP Response Frame command immediately after each SMP Request Frame.
AUTO_WAIT_SAS_BEFORE Settings		
AUTO_WAIT_SAS_BEFORE_CLOSE_FOR_CLOSE	FALSE	When set, the generator will insert WAIT_FOR CLOSE command right before each CLOSE primitive.
AUTO_WAIT_SAS_BEFORE_SOF_FOR_CREDIT	FALSE	When set, the generator will insert WAIT_FOR CREDIT command right before each SOF primitive.
AUTO_WAIT_SAS_BEFORE_IDENTIFY_FOR_IDENTIFY_FRAME	FALSE	When set, the generator will insert WAIT_FOR Identify Frame command right before each Identify Address Frame.
AUTO_WAIT_SAS_BEFORE_OPEN_ACCEPT_FOR_OPEN	FALSE	When set, the generator will insert WAIT_FOR Open Frame command right before each OPEN_ACCEPT primitive.
AUTO_WAIT_SAS_BEFORE_OPEN_REJECT_FOR_OPEN	FALSE	When set, the generator will insert WAIT_FOR Open Frame command right before each OPEN_REJECT primitive.
AUTO_WAIT_SAS_BEFORE_AIP_FOR_OPEN	FALSE	When set, the generator will insert WAIT_FOR Open Frame command right before each primitive of AIP group.
AUTO_WAIT_SAS_BEFORE_SMP_RESP_FOR_REQ	FALSE	When set, the generator will insert WAIT_FOR SMP Request Frame command right before each SMP Response Frame.

Setting	Default Value	Description
AUTO_WAIT_SATA_AFTER Settings		
AUTO_WAIT_SATA_AFTER_X_RDY_FOR_R_RDY	FALSE	When set, the generator will insert WAIT_FOR SATA_R_RDY command immediately after each case of SATA_CONT primitive following SATA_X_RDY primitive.
AUTO_WAIT_SATA_AFTER_WTRM_FOR_STATUS	FALSE	When set, the generator will insert WAIT_FOR SATA_R_ERR or SATA_R_OK command immediately after each case of SATA_CONT primitive following SATA_WTRM primitive.
AUTO_WAIT_SATA_AFTER_PMREQ_S_FOR_RESPONSE	FALSE	When set, the generator will insert WAIT_FOR SATA_PMACK or SATA_PMNAK command immediately after each case of SATA_CONT primitive following SATA_PMREQ_S primitive.
AUTO_WAIT_SATA_AFTER_PMREQ_P_FOR_RESPONSE	FALSE	When set, the generator will insert WAIT_FOR SATA_PMACK or SATA_PMNAK command immediately after each case of SATA_CONT primitive following SATA_PMREQ_P primitive.
AUTO_WAIT_SATA_AFTER_SYNC_FOR_SYNC	FALSE	When set, the generator will insert WAIT_FOR SATA_SYNC command immediately after each case of SATA_CONT primitive following SATA_SYNC primitive.
AUTO_WAIT_SATA_BEFORE Settings		
AUTO_WAIT_SATA_BEFORE_PMACK_FOR_PMREQ	FALSE	When set, the generator will insert WAIT_FOR SATA_PMREQ_S or SATA_PMREQ_P command right before each SATA_PMACK primitive.
AUTO_WAIT_SATA_BEFORE_PMNAK_FOR_PMREQ	FALSE	When set, the generator will insert WAIT_FOR SATA_PMREQ_S or SATA_PMREQ_P command right before each SATA_PMNAK primitive.
AUTO_WAIT_SATA_BEFORE_RERR_FOR_WTRM	FALSE	When set, the generator will insert WAIT_FOR SATA_R_ERR command right before each SATA_WTRM primitive.
AUTO_WAIT_SATA_BEFORE_ROK_FOR_WTRM	FALSE	When set, the generator will insert WAIT_FOR SATA_R_OK command right before each SATA_WTRM primitive.
AUTO_WAIT_SATA_BEFORE_RIP_FOR_SOF	FALSE	When set, the generator will insert WAIT_FOR SATA_R_IP command right before each SATA_SOF primitive.
AUTO_WAIT_SATA_BEFORE_R_RDY_FOR_X_RDY	FALSE	When set, the generator will insert WAIT_FOR SATA_X_RDY command right before each SATA_R_RDY primitive.

Generation Options

Use the Generation Rules to set triggers and filters.

To display the Generation Options dialog, select **Generate > Generation Options** or click

the **Setup Generation Options**  button.

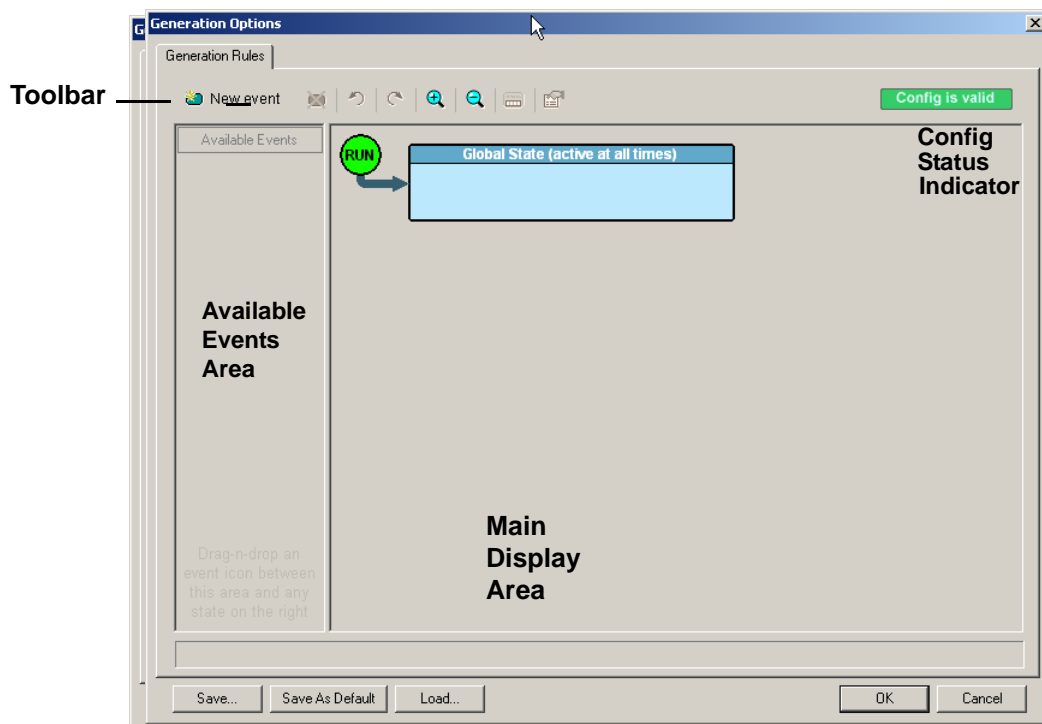

Figure 5.16: Generation Options Window

The page has the following areas:

- ❑ **Toolbar:** Contains buttons that control the Generation Rules page.
- ❑ **Available Events Area:** Area where you can park Event buttons that you intend to use in the Main Display area.
- ❑ **Main Display Area:** Area where you configure trigger and filter rules. You configure rules by dragging Event buttons from the Available Events area and then assigning actions to those buttons.
- ❑ **Config Status Indicator:** A button that indicates if the rule is valid or invalid. If a trigger or filter rule is configured correctly, the button is green and indicates Config is Valid. If a rule is not configured correctly, the button is red and indicates Config is Invalid.

Pop-Up Menus: When you right-click a button or area in the Generation Rules page, a context-sensitive pop-up menu appears that lets you do operations that relate to that button or area.

Properties Dialogs: When you click the Show/Hide Properties Dialog button for an event, action, or state, a dialog allows you to perform the same operations as in the pop-up menus.

Generation Rules Toolbar

The Generation Rules toolbar buttons control the Generation Rules page.

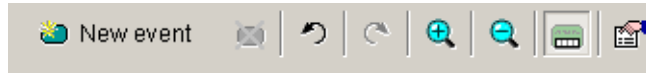
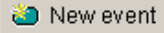











Figure 5.17: Generation Rules Toolbar

TABLE 5.12: Recording Rules Buttons

	New Event. Creates a new event in the Available Events area.		Zoom Out. Makes the display appear smaller.
	Delete Event. Deletes the selected event.		Show/Hide Channels. Shows or hides the channel icon on the Event button.
	Undo. Undoes the change made to Recording Rules page. The Undo buffer has unlimited size.		Show/Hide Properties Dialog. Shows or hides the properties dialog of the selected event, action, or state.
	Redo. Restores changes done to the Recording Rules page.		This display appears when the current Recording Rules configuration can be executed by the hardware.
	Zoom In. Enlarges the display (see note). There are five zoom levels. The default level is the middle one.		This display appears when the current Recording Rules configuration cannot be executed by the hardware.

Note: If you have a wheel on the mouse, you can zoom by holding down the CTRL key and rolling the mouse wheel.

Generation Rules Page: How It Works

You can think of the Generation Rules page as a workspace for creating rules (rules that determine how the analyzer generates traces). Rules are combinations of events and actions.

An event and the action or actions associated with it form a rule state.

Briefly, creating a rule involves the following steps:

1. Creating Event buttons in the Available Events area.
2. Drag-and-drop of Event buttons to the appropriate areas (cells) in the Main Display area.
3. Assigning an action or actions to each Event button.

Creating Event Buttons

To create a rule, first create one or more Event buttons. As you create Event buttons, they appear in the Available Events area. You then can drag-and-drop them into the Main Display area.

To create event buttons:

1. Click the **New Event** button at the left side of the toolbar to display the New Event pop-up menu.



Figure 5.18: New Event Menu

2. Select an event, such as Primitive. The event appears in the Available Events area.



Figure 5.19: Available Events Area

Dragging a Button to the Main Display Area

After you create an Event button in the Available Events area, you can drag the button to the Main Display area and drop it in the appropriate cell (a cell is a grayed-out rectangle with a dashed line around it). You can think of each cell as a target for drag-and-drop of an Event button.

To drag-and-drop the Event button:

1. Place the mouse cursor on the Event button in the Available Events area. Click the left mouse button.
2. Drag the button to the cell. When the button is in the cell, a dashed highlight line appears around the cell. Drop the button in the cell (release the left mouse button). The Event button appears in the cell.

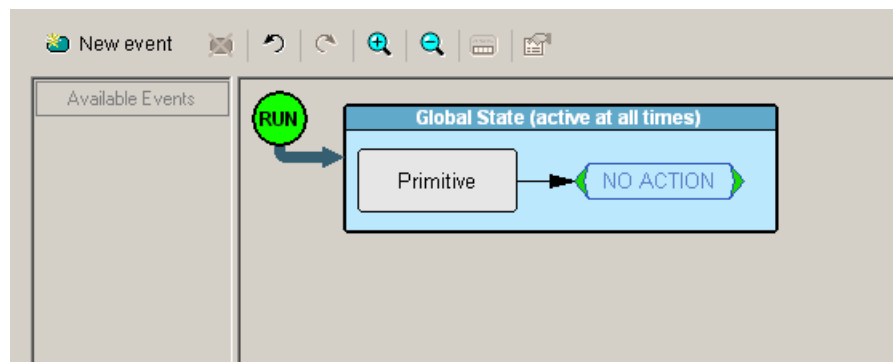

Figure 5.20: Event in Main Display

The default label for the first cell is Global State, which is active at all times.

Assigning an Action

After you have dropped the Event button in a cell in the Main Display area, you can assign an action to the event.

Note: If you do not assign an action to an Event button, the Generator ignores the event.

To assign an action to an Event button:

1. Right-click the **Event** button to display a pop-up menu.

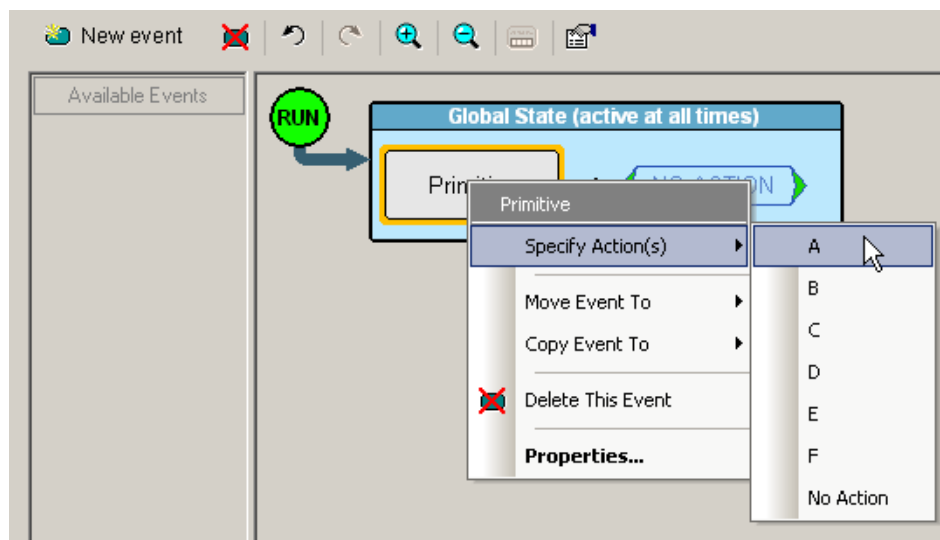

Figure 5.21: Action Menu

2. Select **Specify Action**, and then choose an action from the submenu. The menu closes, and the action is assigned.

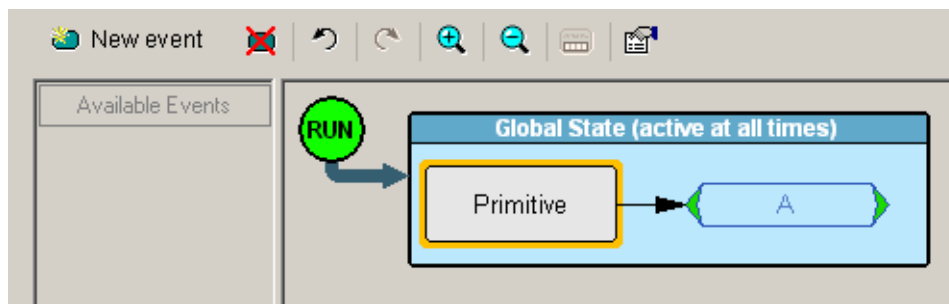

Figure 5.22: Action in Main Display

Note: You can also set actions within the Properties dialog for each event. Double-click the Event button to open the Properties dialog, then select the Actions tab and set your actions.

Generation Rules Pop-Up Menus

The Generation Rules window has context-sensitive pop-up menus that are associated with the following types of object: cells, events, and actions.

Cell Pop-up Menu

If you right-click a cell in the Main Display area that has an Event button contained in it, the Cell pop-up menu appears. The Cell pop-up menu has the following options.

- ❑ **New Event:** Displays the same menu that you get when you click the New Event button on the toolbar.
- ❑ **Properties:** Displays the Properties dialog for the selected cell.

Action Pop-up Menu

If you click an Action button in the Main Display area, the Action pop-up menu appears with the options **A** through **F** and **No Action**.

Event Pop-up Menu

If you click an Event button in the Main Display area, the Event pop-up menu appears. The Event pop-up menu has the following options:

- ❑ **Specify Action(s):** Opens the Actions submenu, allowing you to assign an action to the event. Options on this submenu are the same as those on the Action pop-up, described previously.
- ❑ **Move Event to:** Moves the selected event to a different position in the Recording Rules window.
- ❑ **Copy Event to:** Copies the selected event to a different position in the Recording Rules window.
- ❑ **Delete This Event:** Deletes the selected Event. Alternatively, you can use the Delete button on the toolbar or keyboard to delete events.
- ❑ **Properties:** Displays the Event Properties dialog for the selected event.

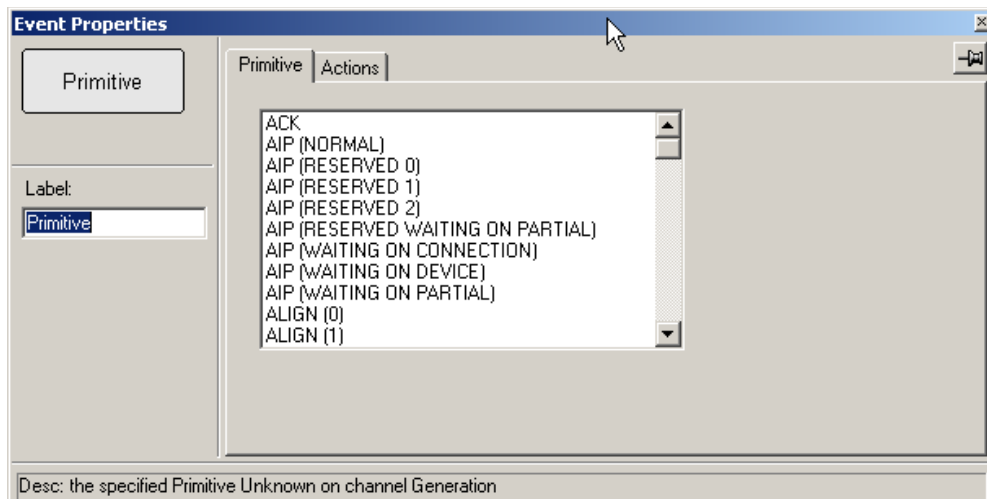

Figure 5.23: Event Properties

The dialog lists the Properties and their Values.

Events and Event Properties

Generation rules are associations between events and actions. These associations determine how trace recording occurs. The supported events are:

- ❑ **Primitives:** Primitive Categories or Primitive
- ❑ **Frames:** Open Address Frames, Identify Address Frames, Zone Broadcast Address Frames, SSP Frames, or SMP Frames
- ❑ SCSI Commands
- ❑ SCSI Status
- ❑ **SATA FIS:** Register Host to Device, Register Device to Host, Set Device Bits, DMA Activate, DMA Setup, BIST Activate, PIO Setup, Data, Route, or Vend FIS
- ❑ **SSP Frame Header:** DATA, XFER_RDY, COMMAND, RESPONSE, TASK, VENDOR, or RESERVED
- ❑ **SSP Information Unit:** Command IU, Task IU, XFER_RDY IU, or Response IU
- ❑ **SMP Request/Response:** RPT_GENERAL, RPT_MFG_INFO, DISCOVER, RPT_PHY_ERR_LOG, RPT_PHY_SATA, RPT_RT_INFO, CONFIG_RT_INFO, PHY_CONTROL, PHY_TEST_FUNCTION, CONFIG_PHY_ZONE, CONFIG_ZONE_PERM, RPT_ZONE_PERM, or RPT_ZONE_RT_TBL
- ❑ ATA Commands
- ❑ ATAPI Commands
- ❑ SATA Data Pattern
- ❑ SAS Data Pattern

Data Pattern Mask and Match

If you select Data Pattern as the Event, you can set Data Pattern event properties in the Event Properties dialog.

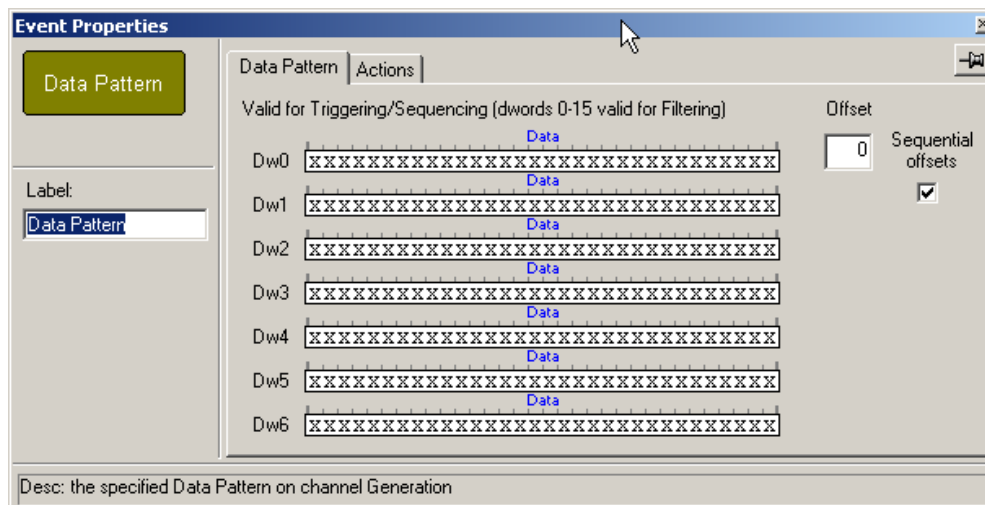

Figure 5.24: Event Properties for Data Pattern Event

In the Data Pattern dialog, you can set the DWORD. You can set the **Offset** by entering an integer. Optionally click the **Sequential Offsets** checkbox.

Setting Complex “Wait For” Conditions

The Generation Options dialog lets you define complex “Wait For” events and assign a letter value (“A” through “F”) to the definition, so that you can refer to the definition by letter instead of by textual name.

After a letter value has been assigned to an event, the letter is referred to in your generation script using the following command syntax:

```
Wait_For {WF_REC_RESOURCES_OUTPUT_A}
```

where “A,” in this case, is the defined condition.

Setting Conditions with the Generation Options Dialog

To set a complex condition, open the Generation Options dialog:

1. Select **Generate > Generation Options** from the menu to open the Generation Options dialog.

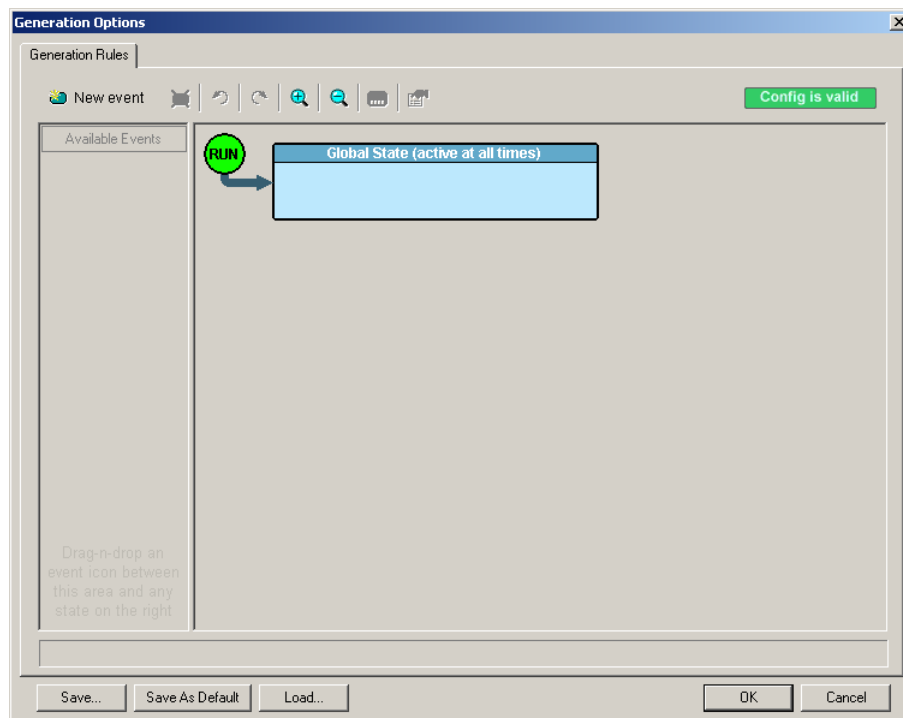

2. Click the **New Events** button and select an event from the menu. The selected event should appear in the **Available Events** area along the left side of the dialog box.
3. Drag the new event button to the **Global State** cell.

- Right-click the new event button and select **Specify Action(s)**. A menu appears showing the letters A through F and the option “No action.”

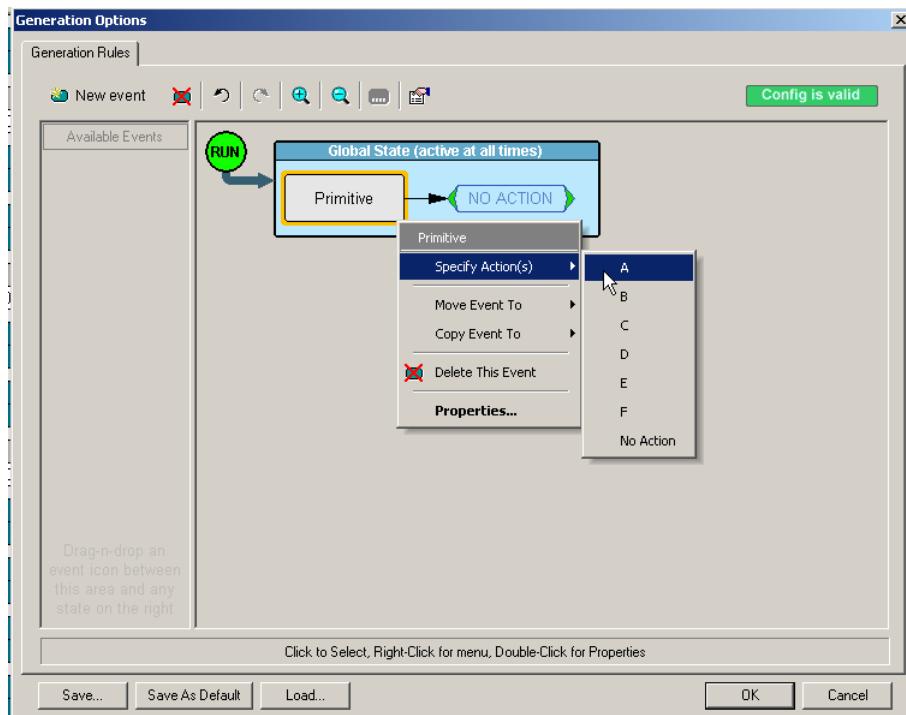

- Select a letter from the menu. The menu closes. The event button should now point to a neighboring button that has the letter value you assigned.

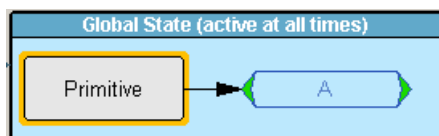

- After the condition has been defined, you can then add the **Wait For** command line (with whatever letter you assigned) to your script. For example:

```
Wait_For {WF_REC_RESOURCES_OUTPUT_A}
```

Find

Find allows searches on an open trace using one or more criteria. You can search by packet, transactions, split transaction, transfer, packet type, and fields within packets.

To run **Find**, select **Search > Find** or by click  on the toolbar.

Searches can combine criteria using the options **Intersection** and **Union**.

Intersection creates AND statements such as “Find all packets with x and y.”

Union creates OR statements such as “Find all packets with x OR y.”

You can also perform searches in which packets or events are excluded from a trace, using the **Exclusion** option.

To perform a search:

1. Select **Find...** under **Search** on the Menu Bar.
OR

Click  in the Toolbar.

You see the User-Defined Find Events screen:

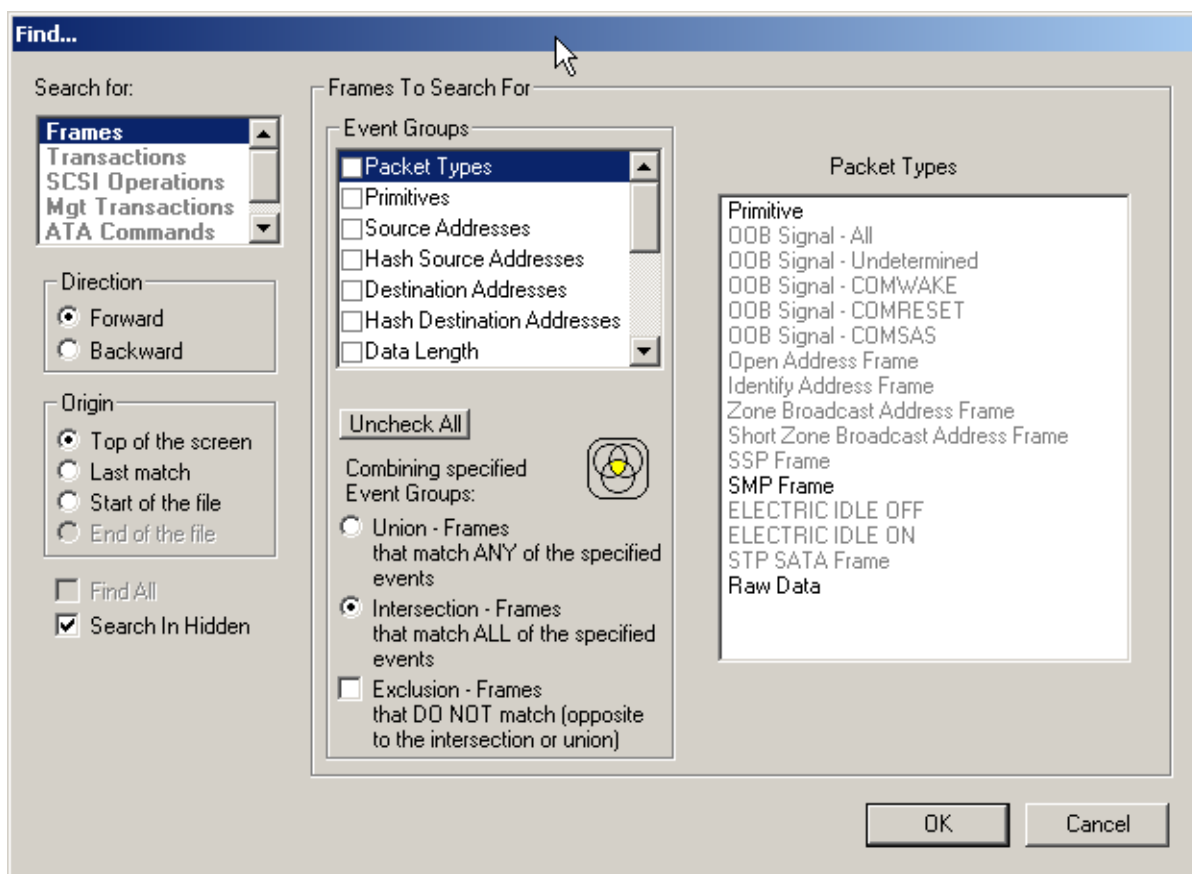

Figure 5.25: Find Dialog

2. Select **Frames, Transactions, SCSI Operations, Management Transactions, ATA Commands**, or **OOBs** from the top left list box to list that type of event in the Events Group box.
3. Select one or more events from the **Events Group** box:
 - Packet Types (Header, PHY, Event, Transaction)
 - Primitives
 - Source Addresses
 - Hash Source Addresses
 - Destination Addresses
 - Hash Destination Addresses
 - Data Length
 - SMP Frames
 - SSP Frames
 - Errors
 - FIS Types
 - FIS Port Number
 - Channel
 - Data Pattern
 - Completion Time
4. Select one of the following options:
 - Union:** Find all packets matching ANY of the specified events.



- Intersection:** Find packets matching ALL of the specified events.



- Exclusion:** Exclude packets matching any of the specified events.
Exclusion works with the other two options:
Select Union *AND* Exclusion
(=Exclude packets with ANY of the following fields) or
Intersection *AND* Exclusion
(=Exclude packets with ALL of the following fields.)



5. Optionally set the search **Direction** and **Origin**.
6. Optionally check to **Search in Hidden** or **Find All**.
7. Click **OK**.

After the search finishes, the program displays the packets meeting the search criteria.

Data Pattern Mask and Match

If you select Data Pattern as the Event Group in the Find dialog, you can set the Bitmask, Mask, and Match for each bit.

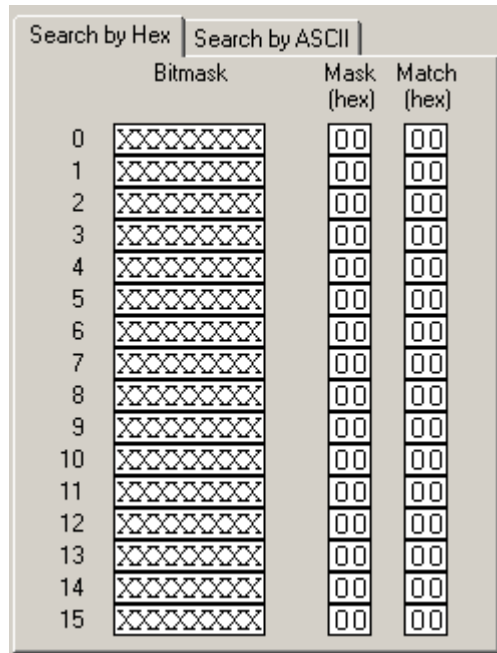

Figure 5.26: Data Pattern

Bitmask and Match always correlate. When you set Bitmask or Match, the other changes to maintain their correlation.

Note: If you set Bitmask/Match before setting Mask, the Mask changes to the default mask. You must change to the Mask that you want.

Note: If you set an appropriate Mask before setting Bitmask/Match, the Mask does not change automatically to a default mask if you change Bitmask/Match.

Find Next

To apply the previous **Find** parameters to the next search:

- Select **Find Next** under **Search** on the Menu Bar.

OR

- Click  on the Toolbar.

Search Direction

Toggles the search forward or backwards. The current direction is indicated in the menu.

Display Options

You can select what information to display using the Display Options window.

To open the Display Options window:

- Select **Display Options** under Setup on the Menu Bar.

OR

- Click  on the Toolbar.

You can select Color/Format/Hiding, Level Hiding, and Headers display options. The following sections describe these display options.

Restore Factory Presets sets all Display Options values to the installed values.

Color/Format/Hiding Display Options

To modify the colors, formats, and hiding options, select the **Color/Format/Hiding** tab.

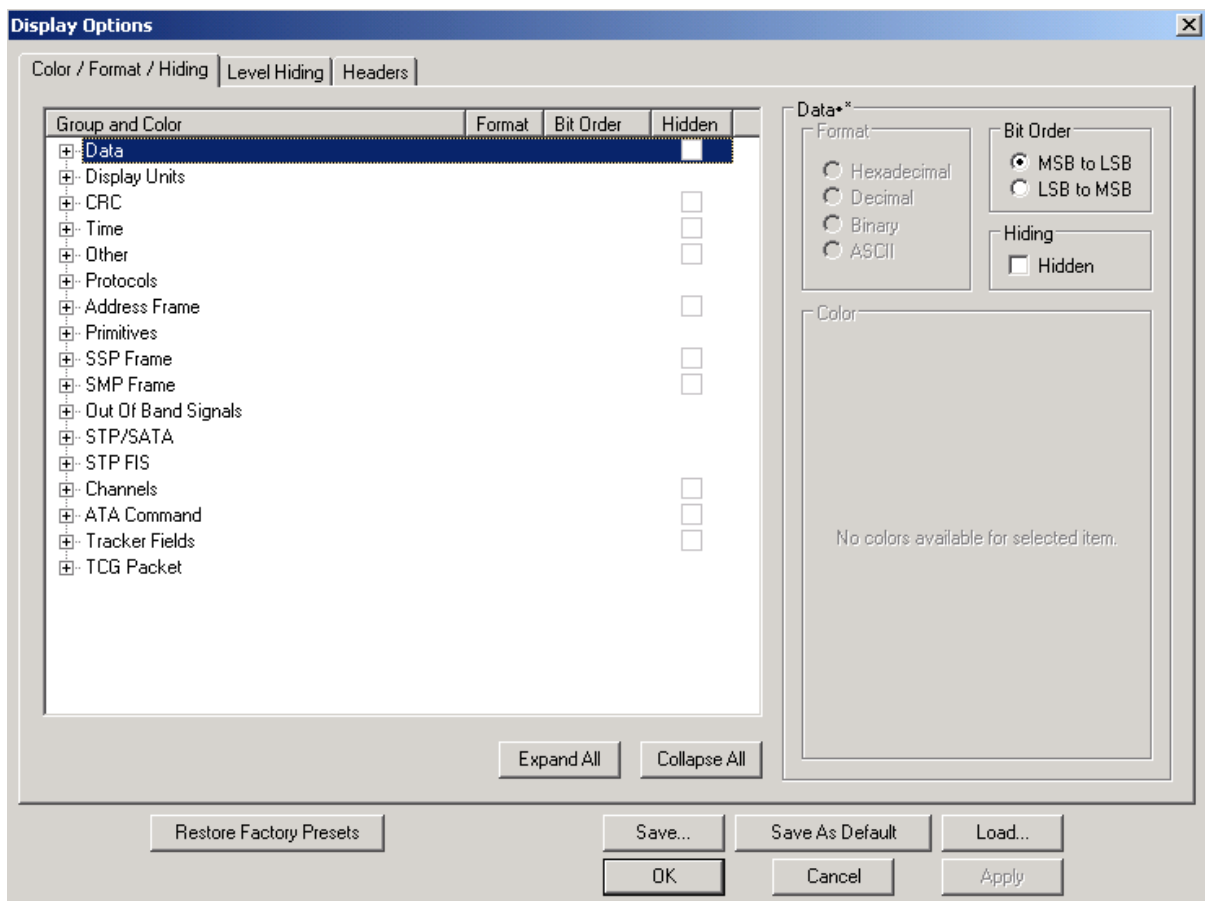

Figure 5.27: Display Options Dialog - Color, Format, Hiding Tab

Color Display Options

The program uses a default set of colors for each type of data in each group of data. The colors and color combinations are appropriate for most graphic systems. You can alter any color.

To specify a color for an information type, in the Color/Format/Hiding tab, select a row (such as Data) in the Group and Color column and expand it.

Select a data type (such as Data Length) in the Group, then select a color in the Color section, using Standard or Custom colors. Use a bright color for each important field.

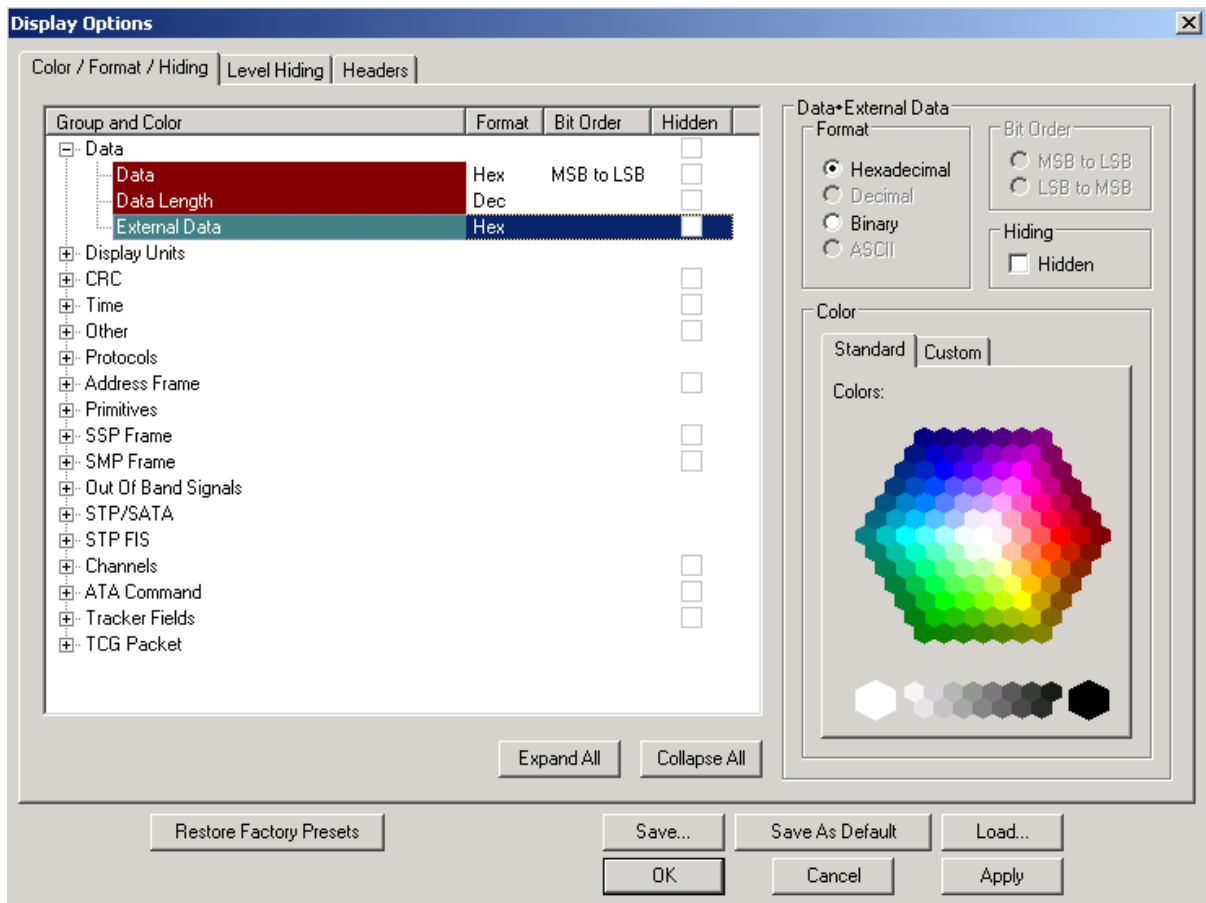

Figure 5.28: Display Options Dialog - Color

To customize colors, use the Custom tab.

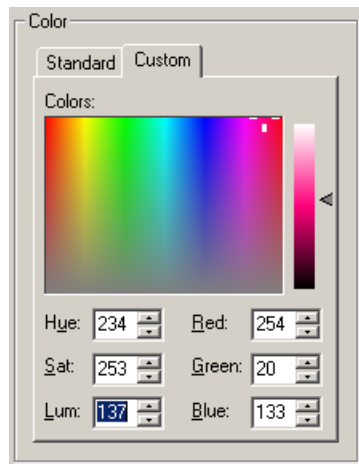

Figure 5.29: Custom Colors

Note: You cannot change the color of an Invalid Data (packet error) field. It is permanently set to red.

Formats Display Options

For each type of data in each group of data, the program has a default data format. Examples of number data formats are Binary, Decimal, and Hexadecimal. An example of a text data format is ASCII.

To specify a data format for an information type, in the Color/Format/Hiding tab, select a row (such as Data) in the Group and Color column and expand it.

Select a data type in the Group.

Select a format in the Format section. The following formats are available:

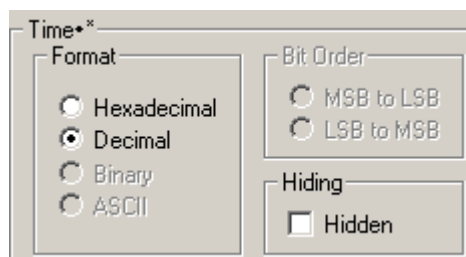

Figure 5.30: Formats

If available, select **Bit Order** in the Format section. The options are MSB to LSB or LSB to MSB.

Hiding Display Options

By default, no data is hidden. You can hide any group of data and any type of data.

To hide one or more fields, select the Group and Data type in the Group and Color column, then click the **Hidden** checkbox in the display or the **Hidden** checkbox in the Hiding section of the Format section.

Level Hiding Options

By default, nothing is hidden. You can hide:

- Packet Types
- Primitives
- Source Addresses
- Destination Addresses
- Data Length
- SMP Frames
- SSP Frames
- Channels
- FIS Types
- FIS Ports
- Gen Global Settings

Select the **Level Hiding** tab, then select the data types to hide.

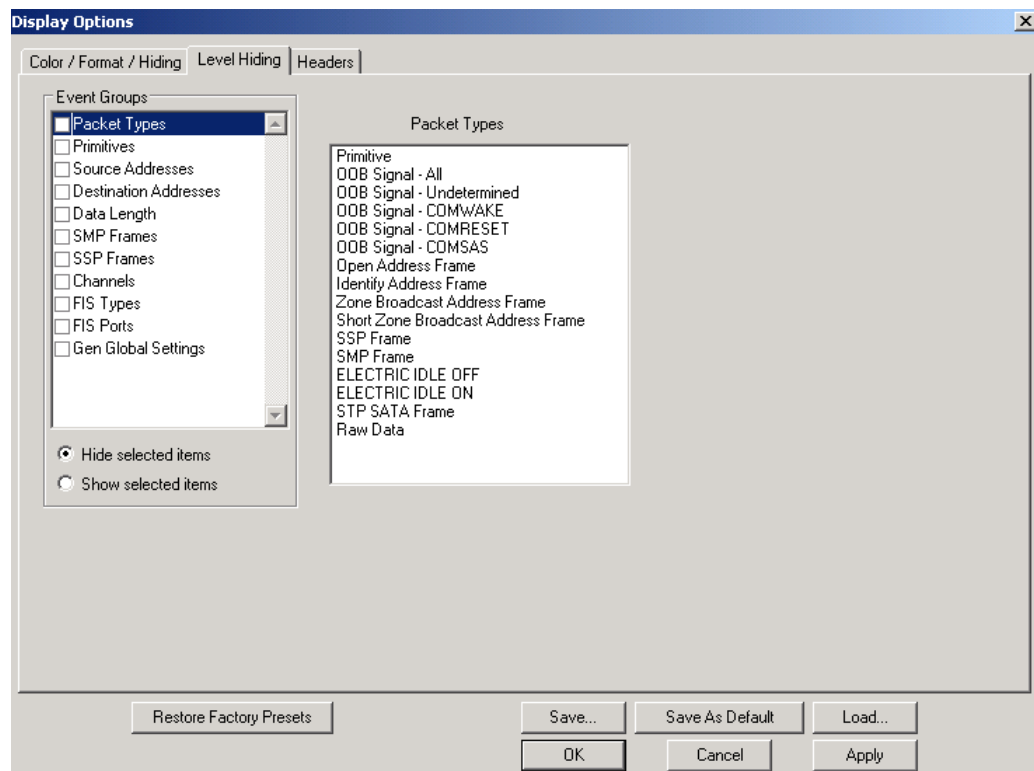

Figure 5.31: Level Hiding Tab

You can select to **Hide selected items** or **Show selected items**.

Headers Options

You can choose the appearance of header fields. Select the **Header** tab, then select the header.

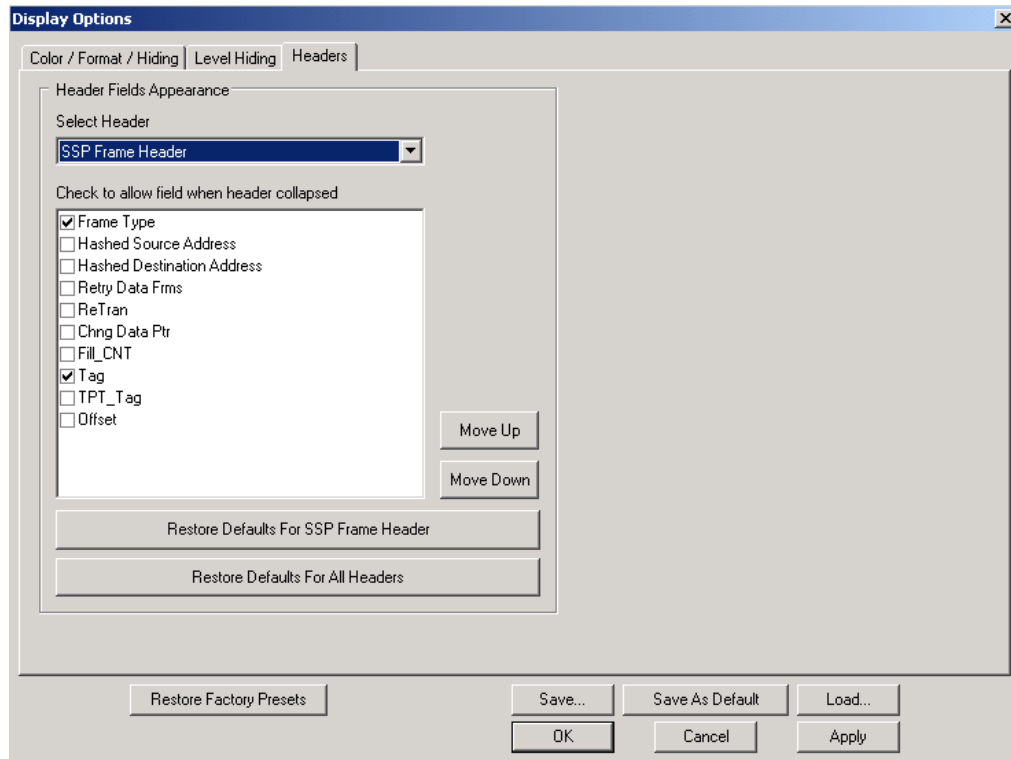

Figure 5.32: Level Hiding Tab

Available headers are:

- SSP Frame Header
- SMP Report General (Request or Response)
- SMP Report Mfg Info (Request or Response)
- SMP Discover (Request or Response)
- SMP Report Phy Error Log (Request or Response)
- SMP Report Route Info (Request or Response)
- SMP Configure Route Info (Request or Response)
- SMP Phy Control (Request or Response)
- SMP Phy Test Function (Request or Response)
- SMP Configure Phy Zone (Request or Response)
- SMP Configure Zone Permission (Request or Response)
- SMP Report Zone Permission (Request or Response)
- SMP Report Zone Routing Table (Request or Response)
- STP Register Host to Device FIS
- STP Register Device to Host FIS
- STP Register Device Bits Device to Host FIS
- STP DMA Activate Device to Host FIS
- STP DMA Setup FIS

- STP BIST Activate FIS
- STP PIO Setup Device to Host FIS
- STP Data FIS
- STP Frame Summary Header
- SATA Frame Summary Header
- SAS Delta Time

Check boxes to allow a field when the selected header is collapsed. Example header fields are:

- Frame Type
- Function
- Result
- Offset
- FIS Type

You can move items up and down.

You can select to **Restore Defaults** for the selected header or all headers.

Saving Display Options

You can save a set of Display Options values, make a set the default settings, or use a saved set of values with the commands at the bottom of the **Display Options** window:

- To save the current Display Options values in an options file for use in future sessions, click **Save**. Enter a file name without a file name extension. The program adds the **.opt** extension. (The file must have an **.opt** file name extension.)
- To load a previously saved **.opt** file, click **Load** and select a file name.
- To save the current Display Options values in the **default.opt** options file for use as the default display options, click **Save as Default**. (Do not delete the **default.opt** file.)
- To apply the current Display Options values, click **Apply**. The Display Options window remains open.
- To apply the current Display Options values and close the Display Options window, click **OK**.
- To cancel unsaved changes to display values and exit the Display Options window, click **Cancel**.

Connection Parameters

To display the connection parameters, select **Generate > Connect Parameters**.

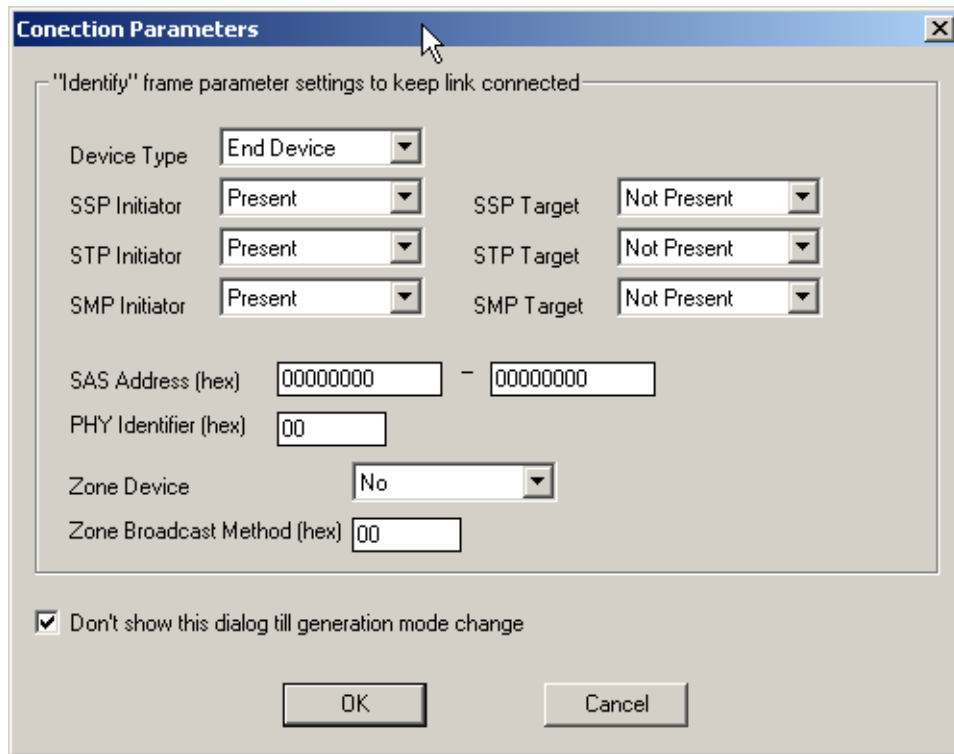

Figure 5.33: Connection Parameters Dialog

You can set the “Identify” frame parameter settings to keep the link connected:

- Device Type:** End Device, Edge Expander, or Fanout Expander
- SSP Initiator:** Present or Not Present
- STP Initiator:** Present or Not Present
- SMP Initiator:** Present or Not Present
- SSP Target:** Present or Not Present
- STP Target:** Present or Not Present
- SMP Target:** Present or Not Present
- SAS Address (hex):** eight digits - eight digits
- PHY Identifier (hex):** two digits
- Zone Device:** Yes or No
- Zone Broadcast Method (hex):** two digits

You can select to not show the dialog until there is a generation mode change.

Resetting the Toolbar

The Analyzer Toolbar has the following:

- Launch Jammer:** Switches to InFusion frame.
- Launch Analyzer :** Switches to Analyzer frame.
- Start Recording:** Start Analyzer without switching to Analyzer frame.
- Stop Recording:** Stop Analyzer without switching to Analyzer frame.
- Abort Recording:** Abort Analyzer without switching to Analyzer frame.

The Generator Toolbar has the following:

- Start Generation**
- Stop Generation**
- Resume Generation**
- Connect Link**
- Disconnect Link**
- Generation Options**

From time to time (such as following a software upgrade), it is possible for the buttons on the toolbar to not match their intended function. You can reset the toolbar by performing the following steps:

1. Select **View > Toolbars** from the menu bar.
2. Select **Customize** from the submenu to display the Customize dialog box.

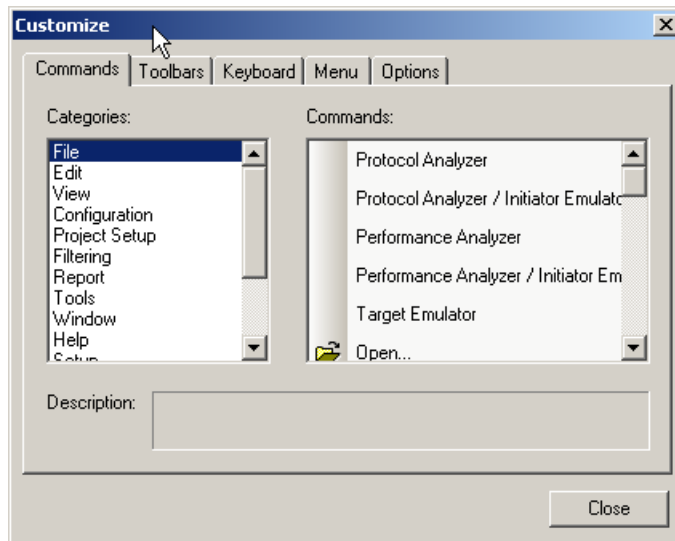

Figure 5.34: Customize Commands

3. Select the **Toolbars** tab to display the Toolbars page of the Customize dialog box.

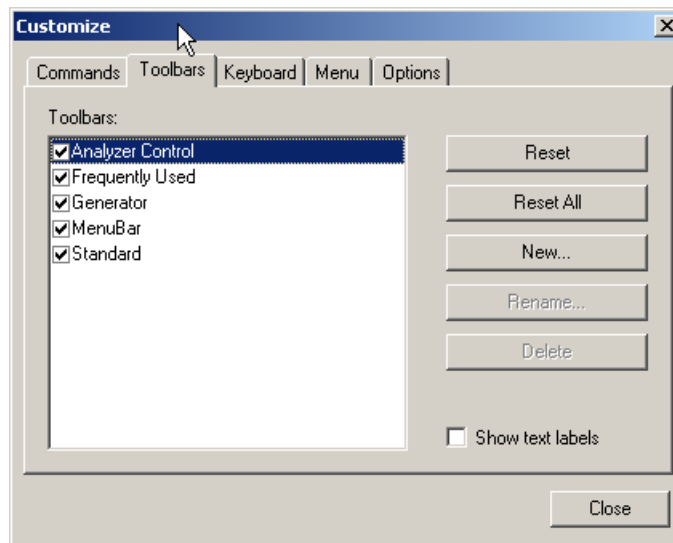

Figure 5.35: Customize Toolbars

4. Click the **Reset All** button.

The toolbar resets to the factory defaults.

Appendix A

Creating a Pattern Generator File

You may use any text editor or word processor to create a pattern generator file (*.spg) using the following conventions:

Key words

ALIGN, CONT, DMAT, EOF, HOLD, HOLDA, PMACK, PMNAK, PMREQ_P, PMREQ_S, R_ERR, R_IP, R_OK, R_RDY, SOF, SYNC, WTRM, X_RDY, XXXX, LOOP, Enable, Disable, Host, Device, Scramble, Role, END_OF_FILE.

Comment format

```
/*Comment text*/
```

Primitive definition format

To add an ALIGN primitive, use ALIGN or 27.3 10.2 10.2 K28.5

To add a CONT primitive, use CONT or 25.4 25.4 10.5 K28.3

Loop definition format

You may write a defined pattern into memory repeatedly by enabling a loop.

Loop definition allows either “Enable” or Disable”. To enable looping use: Loop=Enable

Scramble definition format

Scramble definition allows either “Enable” or Disable”. To enable scramble use:
Scramble=Enable

Role definition format

To specify SATA hardware role: Role=Host or Role=Device

END_OF_FILE definition

A pattern generator file must include END_OF_FILE as the last statement in the file.

Figure A-1 illustrates a typical Pattern Generator file.

```

DeviceRole.spig - Notepad
File Edit Format View Help
/* Target */
27.3 10.2 10.2 K28.5          /* Align */
27.3 10.2 10.2 K28.5          /* Align */
XXXX
XXXX
/* -----Open Address Frame----- */
/* -----Open SSP Connection----- */
01.4 30.0 24.0 K28.5          /* SOAF */
FF FF 08 91
44 33 22 11
88 77 66 55
cc dd ee ff
88 99 aa bb
80 01 06 00
00 00 00 00
00 00 00 00
31.4 07.3 24.0 K28.5          /* EOAF */ /* CRC */
/* -----Read DMA Command----- */
/* -----Register Host to Device----- */
XXXX
XXXX
XXXX
XXXX
XXXX
XXXX
10.2 10.2 21.4 K28.3          /* R_RDY */
10.2 10.2 21.4 K28.3          /* R_RDY */
25.4 25.4 10.5 K28.3          /* CONT */
XXXX
XXXX
XXXX
27.3 10.2 10.2 K28.5          /* Align */
27.3 10.2 10.2 K28.5          /* Align */
XXXX /* XXXX */
XXXX /* XXXX */
XXXX /* XXXX */
XXXX /* XXXX */
21.2 21.2 21.5 K28.3          /* R_IP */
21.2 21.2 21.5 K28.3          /* R_IP */
25.4 25.4 10.5 K28.3          /* CONT */
XXXX
XXXX
XXXX
XXXX
21.1 21.1 21.5 K28.3          /* R_OK */
21.1 21.1 21.5 K28.3          /* R_OK */
25.4 25.4 10.5 K28.3          /* CONT */
XXXX
XXXX

```

Figure A.1: Sample Pattern Generator File *.spig

Appendix B

China Restriction of Hazardous Substances Table

The following tables are supplied in compliance with China's Restriction of Hazardous Substances (China RoHS) requirements:

部件名称	有毒有害物质和元素					
	铅 (Pb)	汞 (Hg)	镉 (Cd)	六价铬 (Cr ⁶⁺)	多溴联苯 (PBB)	多溴二苯醚 (PBDE)
PCBAs	X	O	X	X	X	X
机械硬件	O	O	X	O	O	O
金属片	O	O	X	O	O	O
塑料部件	O	O	O	O	X	X
电源	X	X	X	O	X	X
电源线	X	O	X	O	X	X
保护外壳(如有)	O	O	O	O	X	X
电缆组件(如有)	X	O	X	O	X	X
风扇(如有)	X	O	X	O	X	X
交流滤波器和熔丝组件(如有)	X	O	X	O	O	O
外部电源(如有)	X	X	X	O	X	X
探头(如有)	X	O	X	O	X	X
O: 表明该有毒有害物质在该部件所有均质材料中的含量均在 SJ/T11363-2006 标准规定的限量要求之下。						
X: 表明该有毒有害物质至少在该部件的某一均质材料中的含量超过 SJ/T11363-2006 标准规定的限量要求。						

EFUP (对环境友好的使用时间) 使用条件:

温度: 5摄氏度到40摄氏度

湿度: 5% - 95%最大相对湿度 (无冷凝)

高度: 最高2000米

Part Name	Toxic or Hazardous Substances and Elements					
	Lead (Pb)	Mercury (Hg)	Cadmium (Cd)	Hexavalent Chromium (Cr ⁶⁺)	Polybrominated Biphenyls (PBB)	Polybrominated Diphenyl Ethers (PBDE)
PCBAs	X	O	X	X	X	X
Mechanical Hardware	O	O	X	O	O	O
Sheet Metal	O	O	X	O	O	O
Plastic Parts	O	O	O	O	X	X
Power Supply	X	X	X	O	X	X
Power Cord	X	O	X	O	X	X
Protective Case (if present)	O	O	O	O	X	X
Cable Assemblies (if present)	X	O	X	O	X	X
Fans (if present)	X	O	X	O	X	X
AC Filter/Fuse Assy (if present)	X	O	X	O	O	O
Ext Power Supply (if present)	X	X	X	O	X	X
Probes (if present)	X	O	X	O	X	X
O: Indicates that this toxic or hazardous substance contained in all of the homogeneous materials for this part is below the limit requirement specified in SJ/T11363-2006.						
X: Indicates that this toxic or hazardous substance contained in at least one of the homogenous materials used for this part is above the limit requirement specified in SJ/T11363-2006.						

EFUP (Environmental Friendly Use Period) Use Conditions:

Temperature 5C to 40C

Humidity 5% to 95% max RH (non-condensing)

Altitude Up to 2000 meters

WAN Operation

WAN connected operation is supported. Contact factory for details of operation. Refer [“How to Contact LeCroy” on page 471](#) for contact information.

Appendix C

How to Contact LeCroy

Type of Service	Contact
Call for technical support	US and Canada: 1 (800) 909-7112 Worldwide: 1 (408) 653-1260
Fax your questions	Worldwide: 1 (408) 727-6622
Write a letter	LeCroy Protocol Solutions Group Customer Support 3385 Scott Blvd. Santa Clara, CA 95054-3115 USA
Send e-mail	psgsupport@lecroy.com
Visit LeCroy's web site	http://www.lecroy.com/

Index

Symbols

.cfg file 288
.cst compliance file 320
.infdb file 336
.sac files 49
.stg files 47, 387

Numerics

10 bit payload data display 273
10-pin connector 24
8 bit payload data display 273

A

Abort Analyzer button 393
About 308, 392
Action 334
 button 450
 pop-up menu 450
action
 counter 347
 scenario 344
Action Properties dialog 347
actions
 assigning 449
 events 449, 451
Actions submenu 450
Activate Device button 192, 200
Activation 195
Active Device command 192
Add Device... 29
Add Pattern button 115
Add to Trigger 203
address 471
address frame 72
Address Frame Type Pattern dialog 90
Address FramesDecl.inc 403
Advanced button 152
Advanced Host Settings 156
Advanced Initiator Settings 152
Advanced Mode 36, 112
Advanced Settings 190
Affiliation 141
affiliation setting 141
alias name 318
ALIGN Transmission Period 105
Analysis Project dialog 55
analyzer
 connecting 21
analyzer overview 17
Anchor the Selection bar 296
Any Trigger mode 80
application overview 36
Apply Show/Hide Link Setting 57
As previously saved 294
Ask user to close the previous captured sample
 before running the new project 293
assigning actions 449
Asynchronous notification 199
Asynchronous signal recovery 158
ATA Command 122
ATA Command Pattern dialog 98
ATA command pattern dialog 95
ATA Command Report 220
ATA Commands Error Setting dialog 183
ATA Commands icon 183
ATAPI Report 221
ATAPI spec assignment 293
Auto Run 20, 103
Auto Update LBA 145
Auto Update LBA check box 139
AutoAlign 400
Autostop exerciser when Analyzer Stopped 151, 155
Available Events Area 445

B

Based on Cell Type 296
Based on Port No. 296
Based on Read/Write Command Type 296
Based on Specific Command Type 296

- batch command editing 379
 - batch script 377
 - Batch Script Setting 324
 - Beep statement 385
 - BIST (FIS) 77
 - bookmarks 253
 - finding 254
 - Break Link Recovery 322
 - Browse Default Path 293
 - buffer
 - % full 281
 - Buffer Starvation 175
 - bus condition report 219
 - Bus Utilization
 - buttons 240
 - Bus Utilization View 239
 - buttons
 - bus utilization 240
 - Main toolbar 393
 - Script Editor 405
 - Buzzer check 315
 - Byte Order 279
 - Bytes in Column 287
- C**
- cables 18
 - usage 22
 - Cancel button kills upload immediately 295
 - capture
 - pre and post trigger 67
 - Capture tab 51
 - captured data 42
 - cascading 24
 - cascading STX-430's & STX-460's 24
 - CATC Script Language 248
 - CATC Technical Support 471
 - cell address 161
 - Cell pop-up menu 450
 - cells 448
 - highlight 448
 - Check for Updates 308, 392
 - Choose Port Speed 106
 - Choose SATA Signature Content 186
 - Click here to add another script command 379
 - Click here to add script command 378
 - Clock check 309
 - Clock ports 24
 - Close Connection Definition 177
 - Close Connection dialog 177
 - Close Connection Setting 140, 145
 - Close previous sample file when new sample file opens 295
 - Code violation and Disparity 176
 - Code Violation and Disparity error 181
 - Code violation and Disparity error 142, 147, 149, 184
 - Code Violation and Disparity errors 187
 - Code violation and Disparity errors 174
 - Collapse All 280
 - Collapse Log button 248
 - color 287
 - colors
 - Display Options 458
 - column
 - hiding 236
 - rearrange 210
 - resize 210
 - column content
 - filtering 234
 - sorting 236
 - Column View 42
 - column view 209
 - Column View Memory Size 297
 - Column View Packet Size 297
 - Columns in Row 287
 - Combined Event 334
 - Command Parameters dialog 378
 - Command Properties dialog 378
 - Commands Error Setting dialog 178
 - Compact 391
 - compensate
 - for line loss 290
 - Complex "Wait For" Conditions 452
 - compliance test 318
 - Compliance Test dialog 318
 - components 18
 - conditional statements 380
 - Config Status Indicator 445
 - configuration 284
 - Configuration menu (InFusion) 324
 - Configure Device 324
 - Connect Link 390
 - Connect Link button 393
 - Connect Parameters 390
 - Connect Parameters command 463
 - Connection Management icon 176
 - Connection Management Setting dialog 176
 - Connection Parameters dialog 463
 - Connection Rate 139, 144
 - CONT Usage 155
 - contact 471
 - Convert 388
 - Convert port configuration without prompt for confirm 293
 - Copy Event to option 450
 - copying events 450

- Count Randomly 347
- counter
 - as data 162
- Counter button 162
- Counter Value 347
- counters 347
- CRC Calculations 402
- Create statistical report read/write page 295
- crossover MiniSAS 22
- Current License Configuration field 301
- cursor position status bar 282
- cursors
 - locating 252
 - positioning 283
 - timing 214
- Customize
 - command 464
 - dialog box 464
- D**
- data 42
 - pattern 69
 - show 280
- DATA (FIS) 78
- data block
 - counter data 162
 - custom pattern 161
 - defining 159
 - editing 161
 - editing as text 163
 - naming 160
 - random pattern 162
 - walking bit 163
- Data Block dialog box 159
- Data Block Edit menu 160
- Data Block icon 134
- Data Block Name list 164
- data blocks 134
- data format 280
- Data Pattern definition dialog 69
- Data Pattern edit box 161
- Data Pattern Mask and Match 451, 456
- Data Payload View 241
- data report 240
- Data Report button 240
- Data View 42
- DataPatternCapture 203
- Decode CDB of Commands 297
- Decode Toolbar 276
- Decode toolbar 45
- Default Data Block button 159
- Default Workspace 292, 294
- default workspace 292
- default.infdb file 336
- Defer Handshake 144, 148
- Defer Handshake Errors 182, 186
- Define different patterns for pre-trigger and post-trigger data captures 52
- Define Pattern dialog 161
- Delay in HOLD Response 174
- Delay in sending frame 142, 147, 181, 184
- Delay instruction 132
- Delete button 450
- Delete This Event option 450
- deleting events 450
- Destroy Field of Frame 181, 185
- Device Activation 190
- device emulation 171
- Device Emulator 37
- device emulator
 - settings 193
- Device Emulator Settings dialog 193
- Device Identifier dialog 135, 316
- device library 337
- Device Library window 337, 376
- Device List 317
- Device Setup dialog 303
- Device Type field 463
- DHCP server 35
- direction
 - search 391, 456
- Disconnect 28
- Disconnect Link 390
- Disconnect Link button 393
- disparity indication 276
- display
 - fonts 288
- display Configuration 284
- display configuration 284
- Display License Information 306
- display manipulation 203
- Display Options 389
 - Color/Format/Hiding tab 457
 - factory settings 457
 - level hiding 460
 - loading 462
 - saving 462
 - values 457
 - window 457
- Display pre-filtered cells as blank in column view 297
- DMA activate (FIS) 76
- DMA setup (FIS) 77
- Don't care (Snapshot) 79
- Don't check credit 147, 174, 181
- downloading a scenario 376
- dragging buttons 448
- Drop Length for ... ms 149

Drop link after ... ms for ... ms 175
 Drop link for ... ms 174
 Dword Matcher 343

E

Easy Mode 36, 49
 Edit as Text button 393
 Edit Comment 388
 Edit script 251
 e-mail 471
 Email CATC Support 471
 Enable Outlining command 406
 Enable Tooltip box 287
 Entire Memory 103
 error
 connection management 176
 Error Injection 322
 Error Injection tab 172
 error log 407
 error message
 startup 21
 errors 380
 SAS commands 183
 Ethernet
 connecting with 35
 Ethernet port 19
 Event 334
 event
 counter 347
 scenario 341
 Event button 127
 Event buttons
 creating 447
 dragging 448
 Event pop-up menu 450
 Event Properties dialog 450
 events 451
 actions 449, 451
 buttons 447
 copying 450
 deleting 450
 moving 450
 Events Group box 455
 example files 63
 exclude from capture
 Align 52
 Idles 52
 Notify 52
 OOB Signals 51
 patterns 67
 Payload of Data Frame 52
 RRDY 52
 SATA_CONT 51
 SATA_SYNC 51
 XXXX 52
 Exclusion search 455

exercise
 specific addresses 134
 Expand All 280
 Expand Log button 248
 expandability 24
 Expanded Waveform View 215
 Expansion Card Data Status or Clock Status
 check 314
 Expansion module 19
 Expansion ports 24
 Export 388
 Export command 137
 Export Paired SAS Address Report 61
 Export Read/Write Command Report 61
 Export to Excel button 231
 Export to Generator 60
 Export to Initiator Emulator 58, 59
 External Trig In Setting 105, 302
 External Trig Out Setting 105, 302
 External Trig Setting 324
 External Trig Setting dialog 302
 external trigger 19, 105
 External Trigger dialog 84
 External Trigger Out 144
 External Trigger out combo box 139
 Extract Sample File dialog 59, 137

F

fax number 471
 features 19
 field
 show/hide 278
 Field List Settings 298
 field list view 212
 Field of Frame 143, 147
 Field Settings 286
 file library 336
 File Manager 336
 File Menu 388
 File menu (InFusion) 324
 file type
 definition 62
 files
 .utg 47, 387
 tabs 406
 Fill reserved fields with 142
 filter 256
 by tag number 263
 check condition 263
 options 262
 save setup 259
 type 258
 filter enable 266
 filter idle 251, 267

- filtering 256
 - direction 258
- filtering column content 234
- Filtering menu 256
- filters 445
- Find
 - command 454
 - utility 454
- Find and Replace button 393
- Find button 393
- Find command 390
- Find Device 316
- Find Device button 317
- Find New Device command 134
- Find Next 391
- Find Next command 456
- first burst 141
 - enable 146
- FIS Pattern selection dialog 74
- FIS Report 228
- FIS Type selection dialog 73
- Fit to Graph Area 239
- Floating License dialog 301
- format
 - display options 459
- Found Device List Mode 293
- FPGA 1 or 2 Serdes Chip 311
- Frame button 126
- Frame Length Error 142, 147, 149, 173, 176, 181, 184, 187
- frame settings
 - incoming ATI 143
 - incoming SCSI 148
 - outgoing ATI 141
 - outgoing SCSI 146, 180, 184
- Frame Type 147
- Frame Type Error 141, 147, 149, 176, 181, 184
- frames
 - hide 237
- From Initiator 338
- From Target 338

G

- General Errors dialog 172
- general report 218
- Generate Error On area 141
- Generate Menu 390
- Generate Periodic Error 173
- Generating Traffic 394, 409
- Generation Commands 423
- Generation Files 396
- Generation Language 410
- Generation Options 390
- Generation Rules 445

- Generation Rules page 445
- Generation Rules toolbar 446
- Getting Started manual 19
- Gigabit Ethernet interface 35
- Global Rules 334
 - examples 351
- Go to ATA/SCSI Cmd. 239
- Go To button 251
- Go to command 390
- Go to Event 390
- Go to Event dialog 390
- Go to Marker 390
- Go To Timestamp dialog 253
- Goto Command 278
- Goto instruction 130
- Goto Label statement 382
- Goto Response 278
- Goto Within Packet command 279
- grouping
 - by port 104

H

- Handshake Error 143, 148, 182
- Handshake Errors 186
- hardware
 - run 54
- hardware setup 21
- Hash Address Utility 392
- Hashed Address field 392
- Help Menu 392
- Help Topics 306, 392
- Hide All Primitives 252
- Hide RRDY Primitives 251
- Hide Unassociated Traffic 251
- hiding
 - display options 460
 - levels 460
- hiding options 460
- Histogram View 42
- histogram view 237
- Host Emulator 120, 155
- Host Emulator Port 155
- Host Emulator Setting dialog 154

I

- Identify Error Setting dialog 175
- Identify frame parameter settings 463
- Identify icon 175
- If instruction 131
- IfIsStopped statement 380
- Ignore XRDY/RRDY sequence 174
- Include statement 406

Incoming Frame Setting dialog 148
Incoming Frame Settings 177, 182, 185
Incoming Frame Settings dialog 143, 182, 185
Incoming Open Primitive Response 140, 146
InFusion 321
Infusion 46
InFusion scenarios 331
initiator
 add a frame 126
 add an event 127
 add ATA command 122
 add program lines 121
 add SCSI command 123
 add SMP command 125
 add Task command 124
 adding commands 122
 exercise specific addresses 134
 program instructions 130
 programming 120
Initiator Emulation 394
Initiator Emulator 120, 151
Initiator Setting tab 149
Insert ATA Command button 122
Insert Event button 127
Insert Frame 143, 147, 182, 185
Insert Frame button 126
Insert Instruction button 130
Insert Primitive 142, 147, 149, 174, 181, 185, 187
Insert SCSI Command button 123
Insert SMP Command button 125
Insert Task Command button 124
Install component selection 20
Installation CD ROM 19
installing the analyzer 20
Instruction button 130
Inter-FPGA Connection 313
Inter-reset Delay Settings 158
Intersection search 455
IP Settings... 29
iPass to SATA octopus Crossover cable 22
iPass to SATA octopus Straight cable 22

J

Jammer 328
Jump to Next button 234
Jump to Previous button 234
Jump to Specific button 234

K

K-Codes 343

L

label 133
lanes report 225
launching 36
Launching the CrossSync Control Panel 56
LCD display 20
LED check 315
LEDs
 description 19
library 336
 device 337
 main 336
License Configuration 301
License Manager 301
line condition 342
line numbers 406
link layer
 command interpretation 54
Link Script Selection dialog 408
Link With Sample View 233
Load command 462
Load dialog 164
log
 error 407
log file 380
Loop End instruction 130
Loop Start instruction 130

M

MAC address 26
Main Display Area 445
Main FPGA tab 313
Main Library window 336
Main Window 49
Manual Trig 79
Manual Trig button 80
manual trigger 80
Maximum Number of Uploader Threads 293
Memory Assignment 299
memory check 310
Memory Size 103
MiniSAS 22
mini-SAS connectors 19
Mode 298
Mode of frame field list 298
Move drop-down list 234
Move Event to option 450
moving events 450
MUX Setting 110
MUX Setting dialog 110
Muxing 110

N

- NCQ commands 198
- NCQ Commands Time out Threshold 293
- network 35
- Networks... 29
- New Batch Script command 323
- New Event
 - button 447
 - option 450
 - pop-up menu 447
- New GenFile 388
- New Protocol Analyzer Project in Advanced Mode 292
- New Scenario button 338
- New Scenario command 323
- New script 251
- No WTRM 174
- normal zoom
 - reset 252
- Notes tab 111
- Number of Run text box 103
- Number of Runs Each Test 310

O

- OOB Signal Setting 191
- OOB Signal Setting tab 153, 157
- Open as Data Vie 241
- Open Connection Definition 177
- Open Connection dialog 177
- Open Document button 393
- Open Frame Setting dialog 140, 145, 177
- Open Library command 323
- Open Sample file In 294
- operating system 20
- opt files 462
- order reorder
 - in results display 273
- Others Report view 222
- Outgoing FIS Command Error 173
- Outgoing Frame Command Error 173
- Outgoing Frame Setting dialog 146, 148, 180, 184
- Outgoing Frame Settings 177, 180, 184
- Outgoing Frame Settings dialog 141
- Outgoing Open Error 140, 145
- output trigger 116

P

- Pack Repeated Primitives 295
- Packet Drop 322
- Packet View 42, 201
- packing list 18
- Partial Memory 103

- Paths settings 292
- pattern definition
 - in sequential trigger mode 99
- Pattern field 115
- Pattern Generation file 151, 155
- Pattern Generator 149
- pattern generator 149, 155
 - file creation 149
- Pattern triggers 79
- Payload Data drop-down combo box 134
- Payload field length 298
- Payload Size 195
- Pending ATA IO 239
- Pending SCSI IO 239
- performance analysis 38, 164
 - analyzer only 164
 - defining 164
- Performance Report 227
- performance report 227
- Periodic Error 173
- Phy
 - reset sequence and initiation 133
- PHY Identifier field 463
- PHY Setting & Change Speed command 129
- PHY/Link layer settings 193
- PIO Setup (FIS) 78
- PM Performance Report 230
- PM Statistic Report 229
- pop-up menu
 - Script Editor 406
- pop-up menus
 - Recording Rules 445
- port
 - renaming 276
 - status 281
- port alias 288
- Port Configuration 323, 324, 389
- Port Configuration button 106
- port ID 276
- Port Speed 106
- Port Status 46
- power management
 - device initiated 197
 - host initiated 197
- Power Management Setting tab 158
- pre-trigger 101
 - data 102
- Primitive 186
- Primitive and Frame Definitions 402
- Primitive Manipulation 322
- primitive report 219
- primitive response timeout 104
- Primitive selection dialog 68

Primitive Type dialog 142, 147, 149, 174
 Primitives Decl.inc 403
 Print Preview button 231
 program lines 121
 Program Manager Window 36
 project
 examples 63
 file type definition 62
 notes 111
 settings 102, 119
 project note 111
 Project Settings tab 158
 Project Tree 51
 projects 62
 Properties
 option 450
 Properties options
 events 450
 protocol
 error mask 105
 Protocol Analysis 49
 Protocol Analyzer 36
 Protocol Analyzer Initiator Emulator 36
 Protocol Analyzer setting 292
 Protocol Error and Command Settings dialog 138
 protocol error report 221
 protocol errors 70
 Protocol Errors dialog 89

Q

Queue Command Report 229
 Queue Settings dialog 151, 156
 Quick View 202, 294

R

random data pattern 162
 Random Error Injection 139, 144
 rate matching 139, 144
 Read/Write Command Report 230
 read/write command report 226
 Rec Analyzer command 324
 record and play 136
 Refresh (append to) the list of found devices 293
 Refresh Device List 30
 register device to host (FIS) 75
 relative time display 54
 Remove Device 29
 Remove Frame from sequence 141, 147, 181, 184
 Rename Title of Port dialog 276
 renaming port 276
 Repeat decoded command in frame column 297
 Reset (clear) the list of found devices 293

Reset All button 465
 resetting
 Toolbar 464
 Response frame 278
 Restore Factory Presets button 457
 Restore Factory Presets option 457
 Resume Generation 390
 Resume Generation button 393
 Retain Error Injection Counters after Link Reset 175
 Retry 144
 Retry text box 139
 Reverse Link Data 295
 rules
 validity 445
 Run All Tests Sequentially 310
 Run Batch button 379
 Run Batch Script command 323
 run hardware 54
 Run Pattern Generator button 149
 Run Scenario button 376
 Run scripts button 250
 Run statement 383
 Run Verification Scripts dialog 248
 running disparity 276
 Running verification scripts button 248
 Rx/Tx Settings dialog 291

S

Sample File Name 103
 Sample View link 233
 Sample View Settings 294
 Sampling memory usage optimization 294
 Sampling Memory Usage Optimization option 299
 SAS Address 392
 SAS Address Alias 289
 SAS Address field 463
 SAS address report 225
 SAS Commands icon 178
 SAS data pattern 343
 SAS Parameters window 81
 SAS Protocol Suite 36
 SAS Verification 244
 SAS4X cable 22
 SATA data pattern 344
 SATA Parameters window 82
 SATA Protocol Suite 36
 SATA Signature 186
 SATA Signature dialog 186
 SATA Signature Error Setting dialog 187
 SATA Signature Errors 187

- save
 - Display Options 462
 - partial trace capture 57, 58, 59, 60, 61
 - trace capture 57
- Save as Text button 231
- Save As Text dialog 209, 211
- Save button 393
- Save Filtered Sample 57
- Save Output button 248
- scenario 331
 - action 344
 - creation 350
 - downloading 376
 - event 341
 - overview 331
 - properties 338
 - running 376
- Scenario Batch file 377
- Scenario Properties dialog 339
- scramble/unscramble payload data 273
- scrambling
 - disable 104
- Script Assignment dialog 408
- Script Editor 404
 - buttons 393, 405
 - pop-up menu 406
 - toolbar 405
- Script Workspace 377
- SCSI Command 93, 123
- SCSI Command report 223
- SCSI commands
 - address display 54
- SCSI spec assignment 293
- SDRAM or Exerciser RAM memory check 310
- search 267
 - by tag 270
 - complex 454
 - Direction 455
 - direction 391, 456
 - domain 269
 - Exclusion 455
 - for data pattern 268, 269
 - Intersection 455
 - logic 269
 - Origin 455
 - SAS address 270
 - save setup 268
 - status 283
 - STP port 270
 - sub items 270
 - Union 455
- Search Direction 391
- search direction 268
- search from 268
- search items 269
- Search Menu 390
- select
 - item for capture 68
- Select Device 27
- Select Port Configuration dialog 107
- selecting components for installation 20
- self test 308
- Self Test dialog 308
- Send BIST frame 199
- Send FIS 175
- Send stand-alone primitive 174
- Sending Identify Frame 176
- separate systems 21
- sequence 334
 - examples 362
- sequential triggering 99
- Serial ATA (SATA) data transfers 17
- Serial Attached SCSI (SAS) data transfers 17
- session 346
- Set Alias Name 28
- Set as Second Data Payload 243
- set device bits (FIS) 76
- Set Port Configuration dialog 106
- Set Speed Negotiating error 192
- Set the Anchor row as sync. point 296
- Set Time Stamp Origin 256
- Set Timers dialog 116
- Set Value of Field 185
- Setting button 232
- Setting dialog 232
- settings
 - advanced mode 119
- Settings button 141
- Settings command 249
- Settings dialog 249
- Settings tab 102, 119, 189
- Settings.inc File 399
- Setup command 20
- Setup Display Options button 393
- Setup Generation Options button 393
- Setup Menu 389
- show
 - all data in data field 280
- Show Description window 251
- Show Device Library button 376
- Show Device Library command 323
- Show Field List as embedded In frame/spreadsheet views 298
- Show Field List in Column View 299
- Show Grid 251
- Show Library command 323
- Show Line Numbers command 406
- Show Output 251
- Show Output command 323
- Show Sector Count instead of Xfer Length 297

- Show Warning in Search Primitive In Column
 - View 297
- Show XXXX value 105
- Show/Hide CMD packet
 - in results display 272
- Show/Hide Command queue
 - in results display 272
- Show/Hide Compare 2 Data Payloads button 243
- Show/Hide DLLP packet
 - in results display 272
- Show/Hide Field 278
- Show/Hide Link Packet button 272
- Show/Hide Physical Packet
 - in results display 272
- Show/Hide TLP packet
 - in results display 272
- Show/Hide Transport Packet button 272
- Sierra M6-4 Protocol Analyzer 17
- Sierra Trainer menus 388
- Sierra Trainer toolbar 393
- simulation mode 36
- Sleep statement 385
- smart features 199
- SMP Command 125
- SMP Command report 224
- SMP frame 72
- SMP Initiator field 463
- SMP Target field 463
- SMP Transport report 223
- SMPFrames.inc 403
- Snapshot mode 80
- SOAF, EOAF and CRC 176
- SOF, EOF & CRC Errors 174
- SOF, EOF and CRC Errors 187
- SOF, EOF and CRC errors 142, 147, 149, 185
- SOF, EOF, and CRC errors 181
- Soft Reset dialog 98
- Software default 293
- software installation 20
- software overview 36
- software settings 291
- sorting column content 236
- Spec View 274
- Specify Action option 450
- Specify when to send Signature 186
- Speed Negotiation Setting button 150
- Speed Negotiation tab 154, 192
- Spread Sheet Color Setting 296
- Spread Spectrum Clocking 199
- Spreadsheet View 42
- spreadsheet view 208
- SSP Frame 73

- SSP Initiator field 463
- SSP Target field 463
- SSP Transport Report 222
- SSPFrames.inc 403
- Start Analyzer button 393
- Start Generation 390
- Start Generation button 393
- State 334
- statements 380
- statistical report
 - column setting 232
 - content (SATA) 217
 - options 218
 - save as text 231
- Statistical Report toolbar 231
- Statistical Report View 234
- statistical reports 42
- Statistics button 241
- Status bar 283
- Status Bar command 391
- Stop Analyzer button 393
- Stop Batch Script 323
- Stop Generation 390
- Stop Generation button 393
- Stop Hardware button 80
- Stop Initiator Exerciser instruction 132
- Stop statement 383
- Store Payload in Buffer 145
- Store Payload in Buffer check box 139
- STP Initiator field 463
- STP Target field 463
- STP Transport report 223
- STPFrames.inc 403
- subnet 35
- support 471
- Switch to CATC Navigation 295
- Synchronize with Trace View 239

T

tabs

- file 406

Target

- define 189

- Target Emulation 394

- target emulation 170

- Target Emulator 36

- target emulator

- media settings 189, 195

- port selection 190, 195

- settings 189

- Target Emulator Settings dialog 189

- target OOB signal setting 195

- target power management 197

- Target SAS Address block 134
 - target speed negotiation 196
 - Task Attribute 146
 - task attribute 141
 - Task Command 124
 - task command report 224
 - Technical Support 471
 - telephone number 471
 - Template Files 292
 - Terminate receiving frame 186
 - Termination
 - receiving frame 143
 - Test Result 309
 - Text View 42
 - text view 211
 - Tile Views 252
 - time
 - relative display 54
 - Time Stamp Origin 256
 - Timeout Pattern dialog 83
 - Timeouts tab 153, 191
 - timer 82
 - setup advanced mode 116
 - Timer definition dialog 99
 - Timer dialog 82
 - timers 360
 - timing
 - cursors 214
 - measurement 214
 - tool bar 282
 - Toolbar
 - command 464
 - Recording Rules 445
 - resetting 464
 - tab 465
 - Toolbar command 282
 - Toolbars 391
 - Tools Menu 392
 - Tools menu (InFusion) 324
 - tooltips 407
 - Trace Capture 57
 - Trace Memory Status section 102
 - Traffic Generation 47, 387
 - Traffic Generation (*.sng) Files 394, 397, 398
 - Traffic Generation window 387
 - Traffic Monitoring 322
 - Trainer toolbar 393
 - tree 406
 - trigger
 - condition 115
 - external 84
 - manually 80
 - multi link 116
 - on address frame 90
 - on ATA command 87
 - on ATA command pattern 95, 98
 - on ATAPI 90
 - on bus condition 84
 - on data pattern 88
 - on FIS 96
 - on FIS pattern 97
 - on pattern 80
 - on primitive 85
 - on protocol errors 89
 - on SCSI Command 93
 - on SMP Frame 92
 - on soft reset 96, 98
 - on SSP Frame 92
 - on STP frame 91
 - on symbol 85
 - on timer 82
 - position in memory 102
 - setting advanced 115
 - setup 79
 - snapshot 80
 - Trigger Source 144
 - Trigger Source combo box 139
 - Trigger tab 79
 - triggering
 - on timer sequential 99
 - order 100
 - triggers
 - setting 445
 - Tx Vout 290
 - Tx Vout & Preemphasis command 291
 - Type combo box 143
- ## U
- Union search 455
 - unpacking 19
 - Update Field List based on 298
 - Update License 306
 - Update Sierra Device 324, 389
 - Update Sierra Device command 303
 - Update STX Board Interface dialog 302
 - Upload Manager dialog 103
 - USB port 19
 - User Defined Commands tab 188
 - user defined decoding 304
 - User Defined Decoding dialog 304
 - User Path 292
 - User-Defined Find Events screen 454
 - using the cursors 283
- ## V
- Value of Reserved Fields 174
 - Value Replacement 322
 - VENDOR (FIS) 79
 - Verification script command 248
 - Verification Script Engine Reference Manual 248

View Field option 274
View Menu 391
View menu (InFusion) 324
View Options
 button 406
 menu 406
View Type toolbar 211
Viewer 42, 201
Viewer Setting toolbar 272
views 42
Visible box 286

W

Wait for Any Frame 132
Wait for Power Management 132
Wait for PS 132
WaitForStop statement 384
walking bit pattern 163
Waveform Display 42
waveform display 214
web site 471
Website, CATC 471
Window Menu 392
Windows default 293
Wrap 391
Wrap button 393
Wrap Packet box 287
wrap packets
 in results display 272

Z

Zone Broadcast Method field 463
Zone Device field 463
Zoom In 391
 results display 252
Zoom In button 393
Zoom Out 391
 results display 252
Zoom Out button 393