



Cave Rock and Skyland Water System Evaluation

Preliminary Engineering Report

Douglas County, Nevada

October 27, 2016

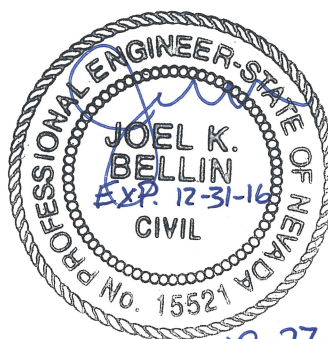

10-27-16





Contents

1	Executive Summary	3
1.1	Need for Project	3
1.1.1	Lake Intake	3
1.1.2	Distribution and Storage	3
1.1.3	Water Treatment Plant	3
1.2	Project Alternatives	4
1.3	Alternatives Analysis	5
1.4	Prioritization of Improvements and Cost Summary	5
2	Project Planning Area	7
2.1	Project Location	7
2.2	Environmental Resources Present	7
2.2.1	Geology and Land Capability	7
2.2.2	Air Quality	14
2.2.3	Water Quality and FEMA Flood Zones	14
2.2.4	Biological Resources	15
2.2.5	Noise	20
2.2.6	Land Use	20
2.2.7	Transportation	22
2.2.8	Hazards	23
2.2.9	Public Utilities and Services	23
2.2.10	Scenic Resources	24
2.2.11	Cultural Resources	26
2.3	Population Trends	29
2.4	Community Engagement	30
3	Existing Facilities & Deficiencies	31
3.1.1	Location Map	31
3.2	History	32
3.3	Lake Intake	33
3.3.1	Condition	33
3.3.2	Regulatory Compliance	34
3.4	Lake Intake Pump Station	34
3.4.1	Condition	35
3.4.2	Operational Issues	35
3.5	Cave Rock/Skyland Water Treatment Plant	35
3.5.1	Condition	36
3.5.2	Electrical	36
3.5.3	Controls/SCADA	36
3.5.4	Regulatory Compliance	37
3.6	Distribution System	37
3.6.1	Regulatory Compliance	37
3.6.2	Fire Flow Requirements	38
3.6.3	Water Meters	43
3.6.4	Piping Condition	43
3.7	Water System Modeling	46
3.7.2	Water System Demands	48
3.7.3	Evaluation Criteria	48
3.7.4	Pressure and Velocity	48
3.7.5	Existing System Analysis	49

3.8	Water Storage Tanks	51
3.8.1	Condition	51
3.8.2	Regulatory Compliance.....	52
3.9	Booster Pump Stations.....	54
3.9.1	General Overall Pumping Strategy	54
3.9.2	Condition/Regulatory Compliance.....	55
3.10	Water Treatment Plant	56
3.11	Sanitary Surveys	57
3.12	Financial Status of Existing Facilities	57
3.12.1	Audit Information	57
3.12.2	Income.....	58
3.12.3	Rate Schedule.....	58
3.12.4	Metering Customers	60
3.12.5	Annual O&M Cost.....	62
3.12.6	Energy Costs.....	62
3.12.7	Capital Improvements Program	64
3.12.8	Debt Repayments.....	65
3.12.9	Reserve Funds	66
4	Need for Project	68
4.1	Summary of Need for Project.....	68
4.1.1	Fire Flow and Storage Deficiency	69
4.1.2	Pumping Stations	70
4.1.3	Piping Leaks.....	70
4.1.4	Water Treatment	70
4.1.5	Water Meters.....	70
5	Project Alternatives	72
5.1	Summary	72
5.2	Deficiencies 1-9 – Fire Flow, Pressure, Velocity, Line Size, Line Leaks, and Pump Stations.....	73
5.2.1	Alternative 1 – Modified Existing System Configuration	73
5.2.2	Alternative 2 – High Pressure Main & Zone Pumping.....	88
5.3	Deficiency 10 – Storage Volume.....	97
5.3.1	Alternative 1 – Upsize Tanks in Existing Locations	97
5.3.2	Alternative 2 – Supplemental Tanks	99
5.4	Deficiency 11 – Water Treatment.....	100
5.4.1	Alternative 1 – Redundant/ Peak Demand Membrane Skid	101
5.5	Deficiency 12 –Water Conservation.....	106
5.5.1	Alternative 1 – Installation of Water Meters	106
5.6	Deficiency 13 – Lake Intake Pump Station	107
5.6.1	Alternative 1 – Lower Pumps by 4 Feet.....	107
5.6.2	Alternative 2 – Replace Intake Pipe	110
5.6.3	Alternative 3 – Add Booster Pump in the Lake	114
6	Alternatives Analysis	117
6.1	Deficiency 1-9 – Fire Flow, Pressure, Velocity, Line Size, Line Leaks, and Pump Stations.....	117
6.1.1	Rankings and Capital Cost Summary	117
6.1.2	Implementation.....	118
6.1.3	Reliability	118
6.1.4	Operability/Maintenance	118
6.1.5	Environmental/Permitting	119



6.1.6	Recommended Alternative	119
6.2	Deficiency 10 – Storage Volume	119
6.2.1	Rankings and Capital Cost Summary	119
6.2.2	Implementation	120
6.2.3	Reliability	120
6.2.4	Operability/Maintenance	120
6.2.5	Environmental/Permitting	120
6.2.6	Recommended Alternative	120
6.3	Deficiency 13 – Lake Intake Pump Station	120
6.3.1	Rankings and Capital Cost Summary	120
6.3.2	Implementation	121
6.3.3	Reliability	121
6.3.4	Operability/Maintenance	121
6.3.5	Environmental/Permitting	122
6.3.6	Recommended Alternative	122
7	Prioritization of Improvements and Cost Summary	123
7.1	Discussion of Priorities	123
7.1.1	Priority 1 Projects	123
7.1.2	Priority 2 Projects	123
7.1.3	Priority 3 Projects	123
7.1.4	Priority 4 Projects	124
7.2	Project Priority Summary and Costs	124
8	References	125

Tables

Table 1-1	Summary of Deficiencies and Alternatives	4
Table 1-2	Project Priority and Cost Summary	6
Table 2-1.	NRCS Soils in the Cave Rock and Skyland WSA	8
Table 2-2.	NNHP Species List for the Cave Rock and Skyland WSA Project Area	16
Table 2-3.	USFWS Species List for the Skyland WSA Project Area	19
Table 2-4	Cultural Resources	26
Table 2-5	Historic Resources	28
Table 3-1	Water System Components	32
Table 3-2	Intake Pump Station	35
Table 3-3	SCADA Master Plan Improvement Summary	37
Table 3-4	Code Comparison Criteria	38
Table 3-5.	Leak History and Associated Costs	45
Table 3-6	Facility Inventory	47
Table 3-7	Pipe Inventory	47
Table 3-8	Model Demands	48
Table 3-9.	Evaluation Criteria	48
Table 3-10.	Tank Levels during Model Scenarios	49
Table 3-11	Cave Rock Water Storage Tank Capacity and Base Elevation	51
Table 3-12.	Storage Requirements by Zone	53
Table 3-13	Surplus/ Deficit Storage Requirement by Zone	54
Table 3-14	Microfiltration Equipment Parameters	56
Table 3-15	Summary of Sanitary Survey Deficiencies	57
Table 3-16	FY 13/14 CAFR Summary (July 1, 2013 – June 30, 2014)	57

Table 3-17 Summary of Annual Income (FY 14/15 Budget).....	58
Table 3-18. Summary of Cave Rock Current Monthly Water Rates.....	59
Table 3-19 Summary of Skyland Current Monthly Water Rates.....	60
Table 3-20. Summary of Annual O&M Costs.....	62
Table 3-21 Annual Energy Costs ⁽¹⁾	62
Table 3-22 Cave Rock Capital Improvement Budget (\$000s).....	64
Table 3-23 Skyland Capital Improvement Budget (\$000s).....	64
Table 3-24 Cave Rock Debt Obligations (\$000s).....	65
Table 3-25 Skyland Debt Obligations (\$000s).....	65
Table 3-26 Beginning Reserve Fund Balances (\$000s).....	67
Table 4-1 Summary of System Deficiencies.....	68
Table 5-1. Needs and Alternatives Matrix.....	72
Table 5-2. Alternative 1 Pipeline Summary.....	74
Table 5-3. Alternative 1 Pressure Reducing Station Summary.....	75
Table 5-4. Cost Opinion for Deficiency 1-9: Alternative 1.....	88
Table 5-5 Alternative 2 Pipeline Summary.....	89
Table 5-6 Alternative 2 Pressure Reducing Station Summary.....	92
Table 5-7. Alternative 2: High Pressure Main & Zone Pumping.....	96
Table 5-8. Tank Summary - Alternative 1.....	97
Table 5-9. Cost Opinion – Alternative 1.....	99
Table 5-10 Tank Summary - Alternative 2.....	100
Table 5-11. Cost Opinion – Alternative 2.....	100
Table 5-12. Supplemental Membrane Skid: Design Summary.....	102
Table 5-13. Cost Opinion - Cave Rock/Skyland Water Treatment Plant Modifications.....	106
Table 5-14. Cost Opinion - Cave Rock Residential Water Meters.....	106
Table 5-15 Cost Opinion - Skyland Residential Water Meters.....	107
Table 5-16. Cost Opinion Alternative 1 – Lake Intake Pump Station.....	110
Table 5-17. Cost Opinion Alternative 2 – Lake Intake Pump Station.....	114
Table 5-18. Cost Opinion Alternative 3 – Lake Intake Pump Station.....	116
Table 6-1. Deficiency 1-9 Capital Cost Summary.....	117
Table 6-2. Deficiency 1-9 Alternative Rankings.....	118
Table 6-3 Deficiency 10 Capital Cost Summary.....	119
Table 6-4 Deficiency 10 Alternative Rankings.....	119
Table 6-5. Capital Cost Summary.....	120
Table 6-6. Deficiency 13 Alternative Rankings.....	121
Table 7-1. Project Priority Summary and Costs.....	124

Figures

Figure 2-1 Cave Rock and Skyland WSA Land Capability Map	11
Figure 2-2 Skyland Soils Map	12
Figure 2-3 Cave Rock Soils Map	13
Figure 3-1. Cave Rock/Skyland Water System Location Map.....	32
Figure 3-2. IFC Table B105.1	39
Figure 3-3 Cave Rock Fire Flow Requirements.....	40
Figure 3-4 North Skyland Fire Flow Requirements.....	41
Figure 3-5 Central Skyland Fire Flow Requirements.....	42
Figure 3-6 South Skyland Fire Flow Requirements	43
Figure 3-7 Leak Repair Map	44
Figure 3-8. Cave Rock/Skyland Historical Leak Repair County	46
Figure 3-9 Fire Flow & Pressure Deficiencies.....	50
Figure 3-10 Cave Rock/ Skyland Water System Schematic.....	55
Figure 3-11. Monthly Energy Usage – Cave Rock	63
Figure 3-12. Monthly Energy Usage – Skyland	64
Figure 5-1 Alt 1 Zone A1 Improvements	77
Figure 5-2 Alt 1 Zone A1-2 Improvements.....	78
Figure 5-3 Alt 1 Zone B1 Improvements	79
Figure 5-4 Alt 1 Zone C1 Improvements.....	80
Figure 5-5 Alt 1 Hidden Woods Zone Improvements.....	81
Figure 5-6 Alt 1 Skyland 1 Zone Improvements	82
Figure 5-7 Alt 1 Skyland 2 Zone Improvements	83
Figure 5-8 Alt 1 Skyland 3 Zone Improvements	84
Figure 5-9 Alt 2 Cave Rock Zone A1 Improvements	90
Figure 5-10 Alt 2 Hidden Woods Zone Improvements.....	91
Figure 5-11 Alternative 2 Pumping Schematic.....	94
Figure 5-12 Alt 2 WTP Plan Pumping Modifications.....	95
Figure 5-13 Alt 2 WTP Section Pumping Modifications.....	95
Figure 5-14 Cave Rock WTP Equipment Plan.....	104
Figure 5-15 Preliminary Pump Plan	108
Figure 5-16 Existing Lake Intake Pipe Plan	111
Figure 5-17 Lake Intake Pipe Modification Plan	112
Figure 5-18 Booster Pump and Intake Screen Layout.....	114

Appendices

- A – COST OPINIONS
- B – FIGURES
- C – EQUIPMENT CUT SHEETS
- D – REPORTS

This page is intentionally left blank.

1 Executive Summary

The objective of the Cave Rock/Skyland Preliminary Engineering Report (PER) is to:

- Identify water system deficiencies
- Develop and compare project alternatives to address those deficiencies
- Identify and evaluate environmental impacts of the project alternatives
- Prioritize recommended alternatives
- Provide preliminary costs for the recommended project alternatives

1.1 Need for Project

The system was evaluated based on the following criteria:

- Nevada Administrative Code (NAC) 445A
- Douglas County design standards
- Overall condition of facilities based on previous County reports and field visits

The results of the assessment are summarized in the following general areas.

1.1.1 Lake Intake

The following deficiencies were noted for the Lake intake and the Pump Station:

1. Unable to meet summer water system demands at low Lake Tahoe water surface levels.
2. Intake screen location less than 1,000-ft from shore which violates NAC 445A requirements.
3. Intake screen depth less than 15-ft during low Lake Tahoe water surface levels which violates NAC 445A requirements.

1.1.2 Distribution and Storage

The following deficiencies were noted for the water distribution and storage components:

1. Excessive line leaks due to old piping with poor installation.
2. Insufficient fire flows and system pressures.
3. Most services are not metered.
4. Access restrictions to Hidden Woods Storage Tank.

1.1.3 Water Treatment Plant

The Cave Rock/Skyland Water Treatment Plant (WTP) is generally in good condition, and meets all applicable treatment standards. However, the WTP lacks a

backup water treatment skid thus there is no redundancy in the plant's production of treated water.

1.2 Project Alternatives

Table 1-1 summarizes the identified water system deficiencies and project alternatives:

Table 1-1 Summary of Deficiencies and Alternatives

No.	Deficiency	Relevant Code	Alternative 1	Alternative 2	Alternative 3
1	Fire Flow	Fire Authority/NFC County 4.1.3	Modified Existing System Configuration	High Pressure Main & Zone Pumping	N/A
2	Min Distribution Pressure – FF + Max Day Demand (MDD)	NAC 445A 6672 County 4.1.1	Modified Existing System Configuration	High Pressure Main & Zone Pumping	N/A
3	Min Distribution Pressure – Peak Hour Demand	NAC 445A 6672 County 4.1.1	Modified Existing System Configuration	High Pressure Main & Zone Pumping	N/A
4	Min Distribution Pressure – MDD	NAC 445A 6672 County 4.1.1	Modified Existing System Configuration	High Pressure Main & Zone Pumping	N/A
5	Max Velocity (all conditions except fire flow)	NAC 445A 6672/County 4.1.4	Modified Existing System Configuration	High Pressure Main & Zone Pumping	N/A
6	Max Velocity (fire flow + ADD)	County 4.1.4	Modified Existing System Configuration	High Pressure Main & Zone Pumping	N/A
7	Min Main Line Size (All)	County 4.5	Modified Existing System Configuration	High Pressure Main & Zone Pumping	N/A
8	Line Leaks	NAC 445A 6727	Modified Existing System Configuration	High Pressure Main & Zone Pumping	N/A
9	Cave Rock/Hidden Woods Booster Pumping Station	NAC 445A 7055	Modified Existing System Configuration	High Pressure Main & Zone Pumping	N/A
10	Storage Volume & Access (Hidden Woods)	NAC 445A.6674, 6708	Upsize tanks in current location	Supplemental Tanks	N/A
11	Supply Redundancy	NAC 445A 6678	Redundant treatment skid	N/A	N/A
12	Water Conservation	NRS 540.131/ County 4.5.6	Installation of water meters	N/A	N/A



No.	Deficiency	Relevant Code	Alternative 1	Alternative 2	Alternative 3
13	Lake Intake Pump Station	N/A	Lower pumps by 4 feet	Replace intake pipe	Add booster pumps in Lake

1.3 Alternatives Analysis

The alternatives were evaluated based on the following weighted criteria, and ranked accordingly.

- Implementation (20%) – Is the alternative feasible to implement? Is the alternative constructible?
- Reliability (25%) – Will the alternative provide reliable results?
- Operability/Maintenance (40%) – Does the alternative require large quantities of time in terms of operator attention? Does the alternative require specialized maintenance requirements that cannot be performed in-house, or does it require frequent calibration, cleaning, tuning, etc.? Does it require an ongoing contract for maintenance?
- Environmental Consideration (15%) – Will the alternative be difficult to permit? Can TRPA thresholds be met? Are there short-term or long-term effects on the environment?

1.4 Prioritization of Improvements and Cost Summary

The recommended alternatives were prioritized based on the following criteria:

- Priority 1 – These deficiencies represent public health and safety risks. Consequence of failure is included potential loss of life and property.
- Priority 2 – Represent deficiencies which may result in temporary disruption of water service or compliance, but generally minimal public health and safety impacts.
- Priority 3 – Represent deficiencies which may result in less efficient operations, but are not likely to cause loss or disruption of service or compliance.
- Priority 4 – Represent projects which may result in further gains in efficiency from priority 3, but are not directly needed for operations. Projects in this category represent “wants” more than “needs”, and do not address code violations.

The following table summarizes the overall project priorities and costs.

Table 1-2 Project Priority and Cost Summary

No.	Deficiency Description	Priority	Recommended Alternative	Cave Rock Capital Cost (x\$1,000)	Skyland Capital Cost (x\$1,000)
1-9	Fire Flow, Pressure, Velocity, Leaks, Booster Pumping	1	1 – Modified Existing System	\$ 10,329	\$ 8,849
10	Hidden Woods, Lower and Upper Cave Rock Storage Volume Deficiencies	1	2 – Add Supplemental Tanks	\$ 1,840	\$ 0
11	Water Treatment Plant Redundancy	2	Redundant Treatment Skid	\$ 1,420	\$ 1,420
12	Water Conservation	3	Installation of Water Meters	\$ 920	\$ 770
13	Lake Intake Pump Station	2	3 – Add booster pumps in Lake	\$ 139	\$ 139
Total				\$14,648	\$11,178
Grand Total				\$ 25,826	

2 Project Planning Area

The project Planning Area includes the Cave Rock and Skyland Water System Areas (WSA) located on the east shore of the Lake Tahoe Basin within Douglas County, Nevada. Both WSAs are primarily residential intermixed with undeveloped and Forest Service land.

2.1 Project Location

The Cave Rock and Skyland WSAs are depicted in the Figure 3-1 Location Map. As shown in the location map, the boundary for the Cave Rock WSA runs from Lake Tahoe to the west, to Forest Service land to the east, and from just south of Pittman Terrace in the north to just north of Lakeside Cove Resort at the southern boundary. The eastern boundary is approximately 3,250 feet from US Highway 50, or roughly 625 feet east of the northeast end of Crane Court in the northern portion of the WSA and roughly 2,000 feet from the end of Hidden Woods Drive in the southern portion of the WSA.

The boundary for the Skyland WSA runs from Lake Tahoe to the west, to Forest Service land to the east, and from the South Zephyr Creek outlet into Lake Tahoe at the southern boundary to Lakeside Cove Resort at the northern boundary, north of Mason Court. From U.S. 50, the eastern boundary is approximately 2,750 feet at Ray Way to 3,250 feet at Warrior Way in the southern portion of the WSA.

Both WSAs are located in Douglas County, Nevada within the Glenbrook, NV United States Geological Survey (USGS) 7.5-minute quadrangle, township 13 North, Range 18 East, Section 3, and Township 14 North, Range 18 E, Section 34 and 27.

2.2 Environmental Resources Present

2.2.1 Geology and Land Capability

Under the Bailey Land Scoring System, soil types are classified into categories 1 through 7, with subcategories 1a, 1b (stream environment zone), and 1c being the most environmentally sensitive and 7 being the least sensitive. Development is prohibited on capability 1 through 3 lands, with allowable base coverage limited to 1% for capability 1 and 2 lands and up to 5% on capability 3 lands. Allowable coverage increases to 20% and 25% for capability 4 and 5 land, respectively, and up to 30% for capability 6 and 7 land.

The majority of the Cave Rock WSA consists of “other environmentally sensitive areas,” which are lands within capability 1a, 1c, 2 and 3. Small pockets of non-sensitive land capability classes (4-7) are located at the southwest corner and central portion of the WSA. The Cave Rock WSA also includes 1b SEZ land east and south of Bedell Way along Lincoln Creek and along the tributary north of Crane Court.

Roughly half of the Skyland WSA consists of “other environmentally sensitive areas,” which are lands within capability 1a, 1c, 2 and 3 (Figure 2-1). These areas are located on the eastern half of the WSA. The western half is primarily non-sensitive

land capability classes (4-7). The Skyland WSA also includes 1b SEZ land. One pocket of 1b SEZ is located just north of Tall Pines Road around Mehrten Road. Another area of 1b SEZ follows a drainage that extends from Willow Drive near Red Fir Drive southwest to the lake. Located north of George Whittell High School, a larger area of 1b SEZ follows the Zephyr Creek and North Zephyr Creek drainage to the lake. Another large area of 1b SEZ is located at the southern boundary of the WSA and includes the South Zephyr Creek drainage. 1b SEZ area is also located along the entire shoreline from the Zephyr Creek outlet into the lake south to the South Zephyr Creek outlet into the lake.

According to the NRCS Web Soil Survey (accessed 8/18/15 and 8/19/15), the soil units in the Cave Rock and Skyland WSA (Figure 2-2 and Figure 2-3) include:

Table 2-1. NRCS Soils in the Cave Rock and Skyland WSA

NRCS Soils in the Cave Rock and Skyland WSA								
Soil Type ¹	Parent Material ²	Surface Runoff Class ³	Slowest Permeability ⁴	Shrink-Swell Potential ⁵	Corrosivity ⁶	Drainage Class ⁷	Available Water Capacity ⁸	Hydrologic Soil Group ⁹
Caverock sandy loam, 9-50% slopes (7101)	Colluvium over residuum weathered from latite	High	Rapid	Low	Moderate/Low	Somewhat excessively drained	Low (4.0 in.)	C
Cagwin-Rock outcrop complex, 5-15% slopes, extremely stony (7411)	Colluvium over grus derived from granodiorite	Low	Rapid	Low	Moderate/Low	Somewhat excessively drained	Very Low (2.1 in.)	B
Cagwin-Rock outcrop complex, 15-30% slopes, extremely stony (7412)	Colluvium over grus derived from granodiorite	Medium	Rapid	Low	Moderate/Low	Somewhat excessively drained	Very Low (2.1 in.)	B
Cagwin-Rock outcrop complex, 30-50% slopes, extremely stony (7413)	Colluvium over grus derived from granodiorite	Medium	Rapid	Low	Moderate/Low	Somewhat excessively drained	Very Low (2.1 in.)	B
Cagwin-Rock outcrop complex, 50-70% slopes, extremely stony (7414)	Colluvium over grus derived from granodiorite	Medium	Rapid	Low	Moderate/Low	Somewhat excessively drained	Very Low (2.1 in.)	B
Cassenai gravelly loamy coarse sand, 5-15% slopes, very stony (7421)	Colluvium derived from granodiorite	Low	Rapid	Low	Moderate/Low	Somewhat excessively drained	Low (4.5 in.)	A
Cassenai gravelly loamy coarse sand, 15-30% slopes, very stony (7422)	Colluvium derived from granodiorite	Medium	Rapid	Low	Moderate/Low	Somewhat excessively drained	Low (4.5 in.)	A
Cassenai gravelly loamy coarse sand, 30-50%	Colluvium derived from granodiorite	Medium	Rapid	Low	Moderate/Low	Somewhat excessively drained	Low (4.5 in.)	A



NRCS Soils in the Cave Rock and Skyland WSA								
Soil Type ¹	Parent Material ²	Surface Runoff Class ³	Slowest Permeability ⁴	Shrink-Swell Potential ⁵	Corrosivity ⁶	Drainage Class ⁷	Available Water Capacity ⁸	Hydrologic Soil Group ⁹
slopes, very stony (7423)								
Cassenai gravelly loamy coarse sand, 50-70% slopes, very stony (7424)	Colluvium derived from granodiorite	Medium	Rapid	Low	Moderate/Low	Somewhat excessively drained	Low (4.5 in.)	A
Christopher-Gefo complex, 0-5% slopes (7444)	Outwash derived from granodiorite	Very Low	Rapid	Low	Moderate/Low	Somewhat excessively drained	Moderate (6.6 in.)	A
Jabu coarse sandy loam, 0-9% slopes (7461)	Outwash derived from granodiorite	Low	Rapid	Low	Moderate/High	Well drained	Low (4.5 in.)	A
Meeks gravelly loamy coarse sand, 15-30% slopes extremely bouldery (7485)	Till derived from granodiorite	Low	Rapid	Low	Moderate/Low	Somewhat excessively drained	Very low (2.9 in.)	A
Meeks gravelly loamy coarse sand, 30-70% slopes extremely bouldery (7486)	Till derived from granodiorite	Low	Rapid	Low	Moderate/Low	Somewhat excessively drained	Very low (2.9 in.)	A
Oxyaquic Cryorthents-Aquic Xerothents-Tahoe complex, 0-15% slopes (9011)	Alluvium and/or colluvium derived from mixed	High	Rapid	Low	Moderate/High	Somewhat poorly drained	Very low (2.5 in.)	A

Source: NRCS 2015 Soil Survey Maps

Table Notes:

1. See Figure 2-2 and Figure 2-3 for locations
2. Parent material. The unconsolidated and chemically weathered mineral and organic material in which the solum of a soil is formed as a result of pedogenic processes.
3. Runoff. The precipitation discharged into stream channels from an area. The water that flows off the surface of the land without sinking into the soil is called surface runoff. Water that enters the soil before reaching surface streams is called ground-water runoff or seepage flow from ground water.
4. Permeability. The quality of the soil that enables water or air to move downward through the profile. The rate at which a saturated soil transmits water is accepted as a measure of this quality.
5. Shrink/Swell Potential provides criteria for determination of expansive soil properties.
6. Ratings are for Concrete/Steel. The ratings provided are the most conservative and based on the highest % representative aggregate. Site-specific soil resistivity analysis will be necessary prior to site development.
7. Drainage class (natural). Refers to the frequency and duration of wet periods under conditions similar to those under which the soil formed. Alterations of the water regime by human activities, either through drainage or irrigation, are not a consideration unless they have significantly changed the morphology of the soil. Seven classes of natural soil drainage are recognized—excessively drained, somewhat excessively drained, well drained, moderately well drained, somewhat poorly drained, poorly drained, and very poorly drained. These classes are defined in the “Soil Survey Manual.”
8. Available water capacity (AWC) (available moisture capacity). The volume of water that should be available to plants if the soil, inclusive of fragments, were at field capacity. It is commonly estimated as the difference between the amount of water at field capacity and the amount at wilting point with adjustments for salinity, fragments, and rooting depth. It is commonly expressed as inches of water per inch of soil. The capacity, in inches, in a 60-inch profile or to a limiting layer is expressed as: Very low 0 to 2.5; Low 2.5 to 5.0; Moderate 5.0 to 7.5; High 7.5 to 10.0; Very high more than 10.0.

9. Hydrologic soil groups. Refers to soils grouped according to their runoff potential. The soil properties that influence this potential are those that affect the minimum rate of water infiltration on a bare soil during periods after prolonged wetting when the soil is not frozen. These properties are depth to a seasonal high water table, the infiltration rate and permeability after prolonged wetting, and depth to a very slowly permeable layer. The slope and the kind of plant cover are not considered but are separate factors in predicting runoff. Hydrologic Soils Group Definitions: A =low runoff potential (0.30 to 0.45 in/hr); B=moderate runoff potential (0.15 to 0.30 in/hr); C=moderately high runoff potential (0.05 to 0.5 in/hr); D=high runoff potential (less than 0.05 in/hr)

Geologic hazards in the area include earthquakes, seiche, tsunami, and erosion. The primary north-south fault zone that separates the eastern edge of the Sierra Nevada from the parallel fault block mountains of Nevada and Utah is located about six miles east of the Lake Tahoe Basin. Significant fault movement along the Sierra Nevada frontal fault could occur in the future with resultant ground failure and severe ground shaking within the Lake Tahoe Basin. Fault lines, including the Incline Village Fault, Stateline Fault, East Tahoe Fault, and West Tahoe Fault, traverse the lake and numerous earthquakes have occurred in the Lake Tahoe Basin within the past 100 years. Due to an earthquake in 1966, a seiche occurred on the lake measuring 0.4 feet. Both seiche and tsunami events could occur if triggered by an earthquake event in or near the lake. The Lake Tahoe Basin is classified as Zone III for earthquake intensity, which is the highest intensity zone and one in which structural damage may occur. Runoff from roadways and urban development, as well as ground disturbance, can result in erosion. Due to the slopes within the area, erosion caused by runoff and storm events can occur. While EIP programs are implemented to address surface runoff in the area and control erosion and siltation, some erosion can continue to occur.

A unique rock formation, Cave Rock, is located within the WSA; however water system improvements and repairs would not affect its continued presence or current state.

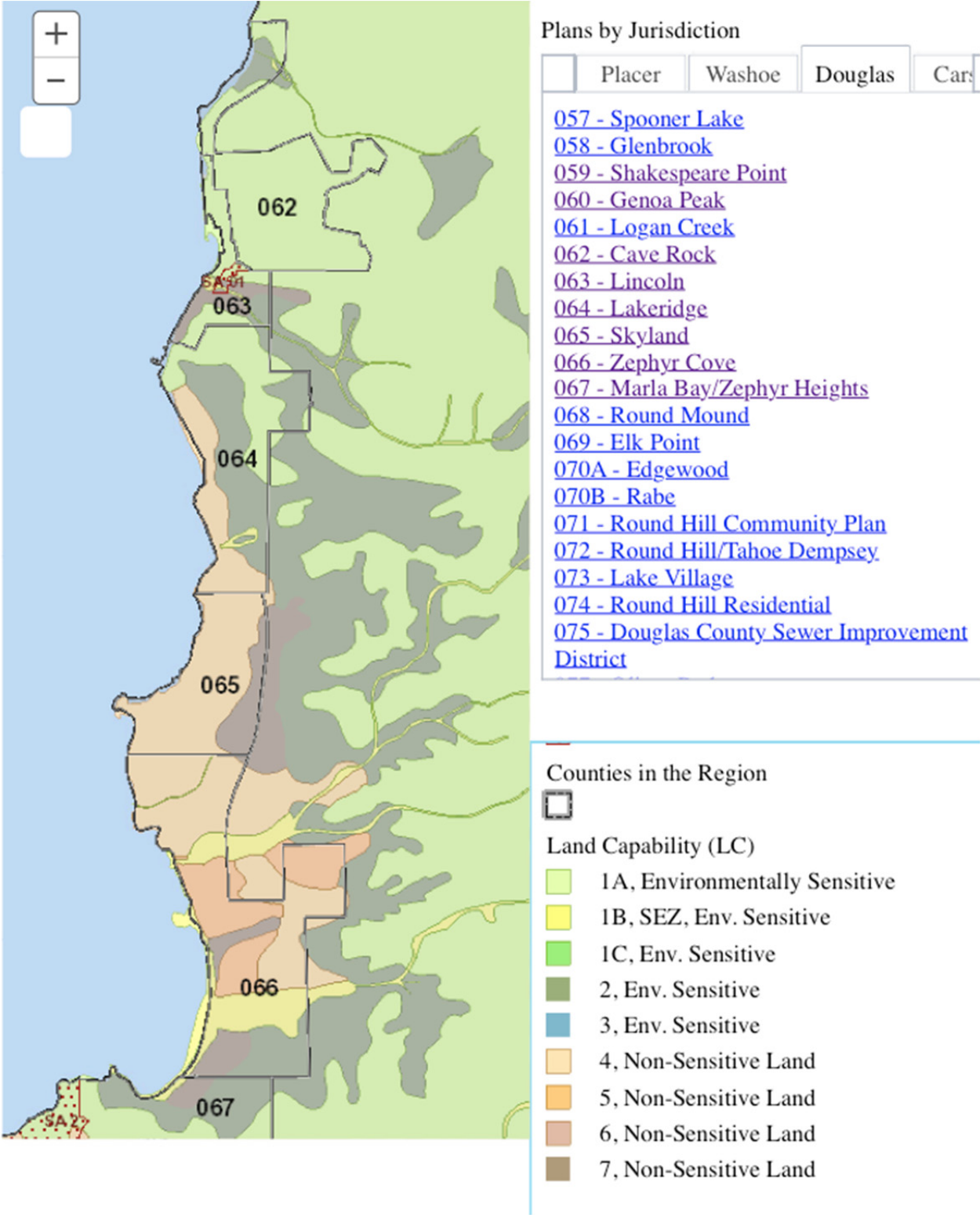

Figure 2-1 Cave Rock and Skyland WSA Land Capability Map

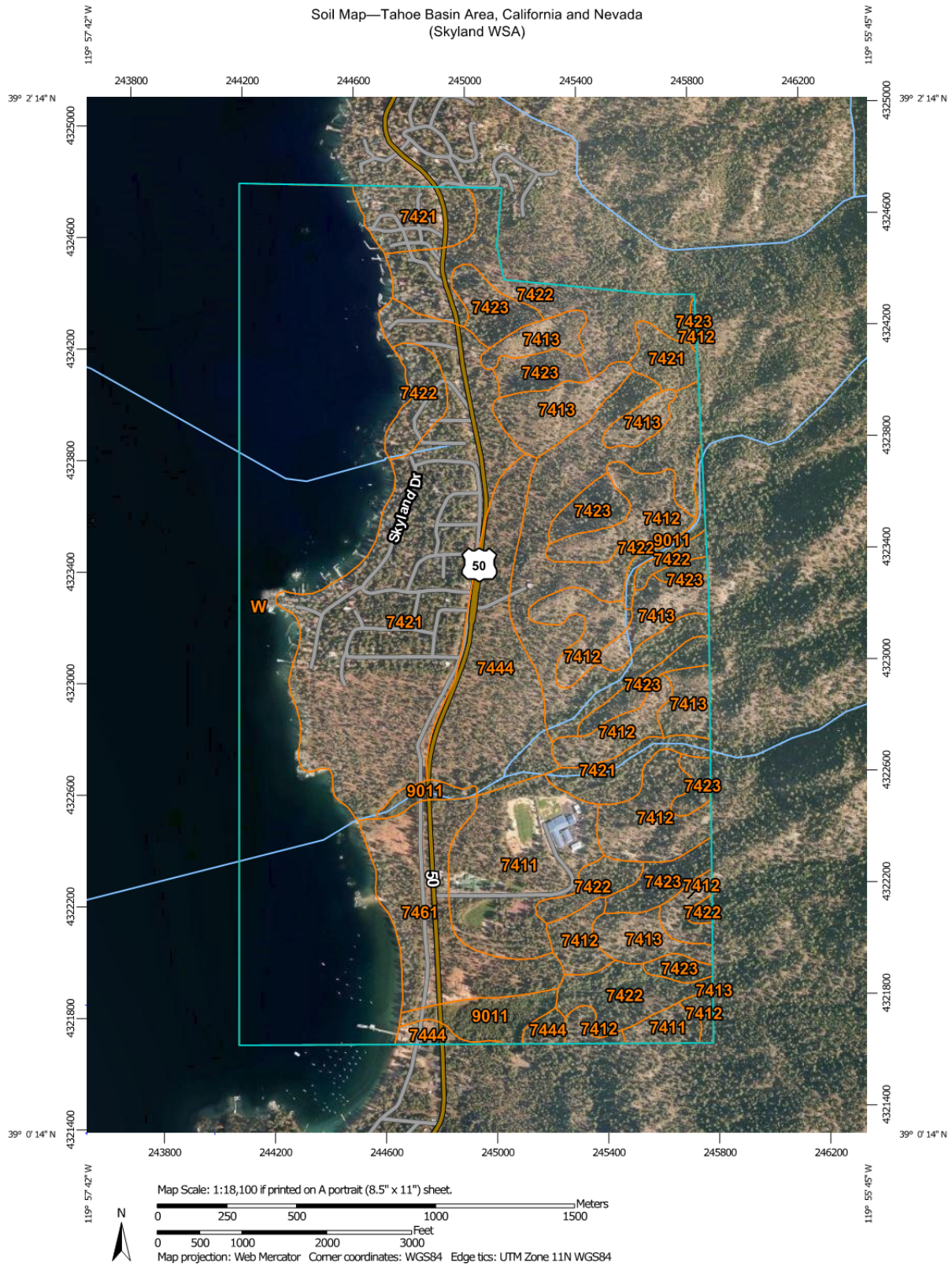
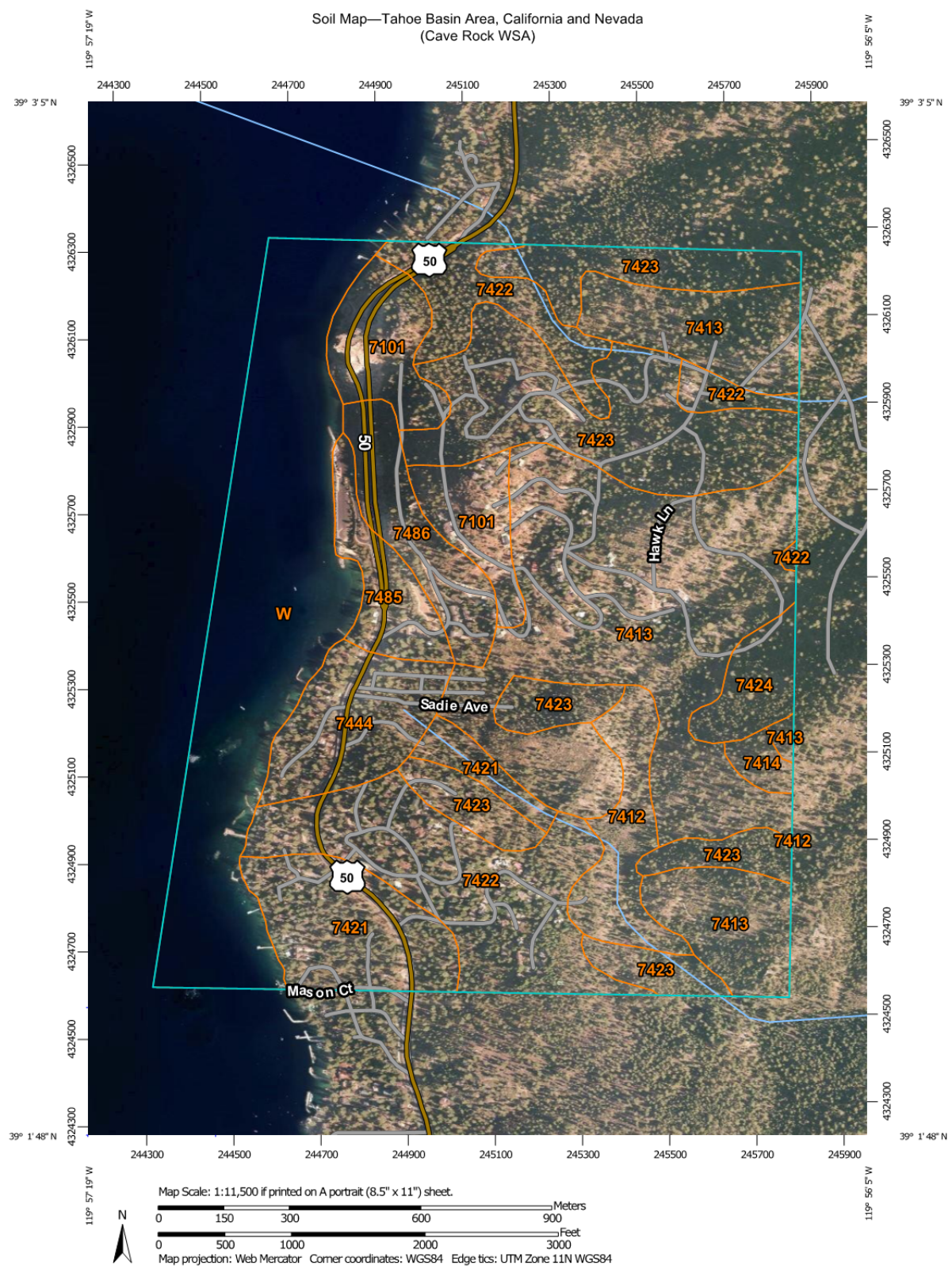

Figure 2-2 Skyland Soils Map



Natural Resources Conservation Service

Web Soil Survey
 National Cooperative Soil Survey

10/28/2015
 Page 1 of 3

Figure 2-3 Cave Rock Soils Map

2.2.2 Air Quality

The only Nevada Division of Environmental Protection air monitoring station in the basin is located in Stateline and monitors only carbon monoxide (CO) emissions. According to the TRPA 2011 Threshold Evaluation, improvements in CO emission reductions result in attainment of threshold standards for 1-hour and 8-hour CO emissions. The region is also in attainment with ozone (O₃), nitrogen oxides (NO_x), and particulate matter (PM₁₀ and PM_{2.5}). Improvements to the water system may result in a temporary increase in emissions during the active construction period as a result of vehicle and equipment fuel combustion and ground disturbance, but would not affect long-term emissions levels. Likewise odors from construction equipment idling would be temporary and limited to the area of active construction activity.

2.2.3 Water Quality and FEMA Flood Zones

The majority of the Cave Rock WSA is FEMA undetermined flood hazard area. The undetermined flood hazard is primarily undeveloped Forest Service land within the eastern portion of the WSA, although there are patches within the developed area. Most of the developed areas within the western and central portions of the WSA are within the FEMA Zone X 500-year flood zone, including the US 50 corridor and areas near the shoreline. The portions of the WSA within Lake Tahoe and at the shoreline are in FEMA Zone A of the 100-year flood zone. Base flood elevations have not been determined by FEMA within Zone A. A portion of Zone A stretches from the lake around Sadie Lane, Tahoe Glen Drive, and Tahoe Glen Court, following Lincoln Creek and its outfall into the lake. An unnamed tributary is located at the northeast corner of the Cave Rock WSA, but is not associated with Zone A within the boundary of the WSA.

The majority of the Skyland WSA is FEMA undetermined flood hazard area. The undetermined flood hazard is primarily undeveloped Forest Service land east of U.S. 50 and the undeveloped areas south of Myron Drive and Willow Drive, although there are patches west of U.S. 50 in the northern portion of the WSA near Mason Court. Most of the developed areas within the western and northern portions of the WSA are within the FEMA Zone X 500-year flood zone, including the area between U.S. 50 and the shoreline. The portions of the WSA within Lake Tahoe and along the entire shoreline, including the properties west of Skyland Drive are in FEMA Zone A of the 100-year flood zone. Base flood elevations have not been determined by FEMA within Zone A. In addition to Lake Tahoe, a portion of South Zephyr Creek is located in the southeast corner of the WSA and Zephyr Creek, North Zephyr Creek, and their tributaries are located within the southern portion of the WSA, none of which are associated with Zone A outside of the Lake Tahoe shorezone.

According to the Draft Tahoe Douglas Area Plan (2014), the Douglas County portion of the basin contributes three percent of the Basin-wide fine sediment particle load. Various water quality and erosion control projects have been completed in the area through the County, NDOT and the TRPA EIP. TMDL reductions are planned through various erosion control and drainage improvement projects in the area, some of which have been completed and some of which are planned for future EIP projects. The Tahoe Douglas Area Plan and 2012 Douglas County Master Plan

indicate a number of private parcels in the area have BMP certification. In all of the Tahoe-area of Douglas County in 2012, including areas outside the Water System Areas, there were 946 BMP-certified single-family residential units (36%), 751 BMP-certified multi-family residential units (43%) and 71 BMP-certified commercial units (51%) (Douglas County Master Plan, 2012).

2.2.4 Biological Resources

The Cave Rock and Skyland WSAs are located within the U.S. Forest Service Carson Range Ecological Subsection. Predominant vegetation types within the Carson Range include Jeffrey pine (*Pinus jeffreyii*) and white fir (*Aibes concolor*). Sedge meadow communities and willow thickets can occur in wet areas, with lodgepole pine (*Pinus contorta*) occurring around the margins of wet areas. The Carson Range also includes shrubs such as big sagebrush (*Artemisia tridentata*), bitterbrush (*Purshia tridentata*), greenleaf manzanita (*Arctostaphylos patula*), rabbitbrush (*Ericameria nauseosa*), and tobacco brush (*Ceanothus velutinus*). In the Cave Rock WSA, the predominant vegetation communities include Jeffrey pine, montane chaparral, Sierran mixed conifer, and urban. In the Skyland WSA, the predominant vegetation communities include Jeffrey pine, montane chaparral, and urban, with some small parches of Sierran mixed conifer, perennial grassland, eastside pine and wet meadow.

Vegetation

According to the TRPA 2011 Threshold Evaluation, the dominant vegetation associations in the Cave Rock and Skyland WSAs are yellow pine and some areas of shrub. Yellow pine forest typically includes Jeffrey pine, white fir, incense cedar (*Calocedrus decurrens*), and sugar pine (*Pinus lambertiana*), and is the most common vegetation association in the basin. Shrub association includes greenleaf and pinemat manzanita (*Arctostaphylos nevadensis*), tobacco brush, Sierra chinquapin (*Chrysolepis sempervirens*), huckleberry oak (*Quercus vacciniifolia*), and mountain whitethorn (*Ceanothus cordulatus*). The WSAs do not provide suitable habitat to support populations of Galena Creek rockcress (*Arabis rigidissima* var. *demota*), Cup Lake draba (*Draba asterophora* var. *macrocarpa*), Long-petaled lewisia (*Lewisia longipetala*), and Tahoe Draba (*Draba asterophora* var. *asterophora*), although Tahoe yellow cress has been identified along the lake's sandy beaches within the Skyland WSA boundary.

Wildlife

Species in Douglas County listed by the Nevada Natural Heritage Program (heritage.nv.gov, Accessed 7/16/2015) include the following:

Table 2-2. NNHP Species List for the Cave Rock and Skyland WSA Project Area

NNHP Species List for the Cave Rock and Skyland WSA Project Area				
Common Name	Species	G Rank	S Rank	Status (NNHP/Federal/NV Protection/USFS/NNPS)
Amphibian				
northern leopard frog	Lithobates pipiens	G5	S2S3	Watch List/C/PA
Sierra Nevada yellow-legged frog	Rana sierrae	G1G2	SH	At-Risk List/USFS S
Bird				
Tricolored Blackbird	Agelaius tricolor	G2G3	S1B	At-Risk List
Golden Eagle	Aquila chrysaetos	G5	S4	Watch List
Short-eared Owl	Asio flammeus	G5	S4	Watch List
Ferruginous Hawk	Buteo regalis	G4	S2	At-Risk List
Western Snowy Plover	Charadrius nivosus nivosus	G3T3	S3B	Watch List
Olive-sided Flycatcher	Contopus cooperi	G4	S2B	Watch List
Prairie Falcon	Falco mexicanus	G5	S4	Watch List
Peregrine Falcon	Falco peregrinus	G4	S2	At-Risk List/USFS S
Pinyon Jay	Gymnorhinus cyanocephalus	G5	S3S4	Watch List
Loggerhead Shrike	Lanius ludovicianus	G4	S4	Watch List
Lewis's Woodpecker	Melanerpes lewis	G4	S3	Watch List
Mountain Quail	Oreortyx pictus	G5	S3	Watch List/GB/USFS S
Sage Thrasher	Oreoscoptes montanus	G5	S5B	Watch List
American White Pelican	Pelecanus erythrorhynchos	G4	S2B	Watch List
Flammulated Owl	Psiloscops flammeolus	G4	S4B	Watch List/USFS S
Brewer's Sparrow	Spizella breweri	G5	S4B	Watch List
Fish				
mountain whitefish	Prosopium williamsoni	G5	S3	Watch List/GF
Mammal				
mountain beaver	Aplodontia rufa	G5	S1	At-Risk List
big brown bat	Eptesicus fuscus	G5	S4	Watch List
spotted bat	Euderma maculatum	G4	S2	At-Risk List/TM/USFS S
northern flying squirrel	Glaucomys sabrinus	G5	S3	Watch List
silver-haired bat	Lasionycteris noctivagans	G5	S3B	Watch List
hoary bat	Lasiurus cinereus	G5	S3N	Watch List
sagebrush vole	Lemmiscus curtatus	G5	S3	Watch List
Sierra Nevada snowshoe hare	Lepus americanus tahoensis	G5T3T4Q	S3	Watch List/GM
American marten	Martes americana	G5	S2S3	At-Risk List/FM
California myotis	Myotis californicus	G5	S4	Watch List
western small-footed myotis	Myotis ciliolabrum	G5	S3	Watch List
long-eared myotis	Myotis evotis	G5	S4	Watch List
little brown myotis	Myotis lucifugus	G5	S3	Watch List
fringed myotis	Myotis thysanodes	G4	S2	At-Risk List/PM
long-legged myotis	Myotis volans	G5	S4	Watch List
Yuma myotis	Myotis yumanensis	G5	S3S4	Watch List
Allen's chipmunk	Neotamias senex	G5	S2S3	Watch List
American pika	Ochotona princeps	G5	S2	At-Risk List/PM
American water	Sorex palustris	G5	S2	At-Risk List



NNHP Species List for the Cave Rock and Skyland WSA Project Area				
Common Name	Species	G Rank	S Rank	Status (NNHP/Federal/NV Protection/USFS/NNPS)
shrew				
Trowbridge's shrew	<i>Sorex trowbridgii</i>	G5	S2	Watch List
Mexican free-tailed bat	<i>Tadarida brasiliensis</i>	G5	S3S4B	Watch List/PM
Douglas's squirrel	<i>Tamiasciurus douglasii</i>	G5	S5	Watch List/PM
mountain pocket gopher	<i>Thomomys monticola</i>	G5	S3	Watch List
western jumping mouse	<i>Zapus princeps</i>	G5	S2	At-Risk List
Reptile				
northern rubber boa	<i>Charina bottae</i>	G5	S3S4	Watch List
Sierra alligator lizard	<i>Elgaria coerulea palmeri</i>	G5T4	S2S3	At-Risk List/PR
Sierra gartersnake	<i>Thamnophis couchii</i>	G4	S3	Watch List
Invertebrate				
endemic Tahoe annelid	<i>Varichaeta nevadana</i>	GNR	SNR	Watch List
Tahoe cave obligate amphipod	<i>Stygobromus laticolus</i>	G1	SNR	Watch List
Tahoe cave obligate amphipod	<i>Stygobromus tahoensis</i>	G1	SNR	Watch List
Tahoe benthic stonefly	<i>Capnia lacustra</i>	G1	S1	At-Risk List
Carson Valley wood nymph	<i>Cercyonis pegala carsonensis</i>	G5T1T2	S2	At-Risk List
Mono checkerspot	<i>Euphydryas editha monoensis</i>	G5T2T3	S1	At-Risk List
northern Sierra endemic ant	<i>Formica microphthalma</i>	G2?	S1	At-Risk List
Carson Valley sandhill skipper	<i>Polites sabuleti genoa</i>	G5T3T4	S1	At-Risk List
Carson wandering skipper	<i>Pseudocopaeodes eunus obscurus</i>	G3G4T1	S1	At-Risk List/LE
Apache silverspot butterfly	<i>Speyeria nokomis apacheana</i>	G3T2	S2	At-Risk List
Carson Valley silverspot	<i>Speyeria nokomis carsonensis</i>	G3T1	S1	At-Risk List
Nevada water mite	<i>Thermacarus nevadensis</i>	GH	SH	Watch List
western Lahontan pyrg	<i>Pyrgulopsis longiglans</i>	G2G3	S2S3	At-Risk List
Wongs pyrg	<i>Pyrgulopsis wongi</i>	G2G3	S1	At-Risk List
Plant				
Shevock bristlegrass	<i>Orthotrichum shevockii</i>	G2	S1	Watch List/USFS S/NNPS M
Washoe tall rockcress	<i>Arabis rectissima</i> var. <i>simulans</i>	G4G5T1Q	S1	At-Risk List/USFS 4/NNPS T
Margaret's Rushy milkvetch	<i>Astragalus convallarius</i> var. <i>margaretiae</i>	G5T2	S2	At-Risk List/NNPS D
Lavin eggvetch	<i>Astragalus oophorus</i> var. <i>lavinii</i>	G4T2	S2	At-Risk List/USFS S/NNPS W
Nevada suncup	<i>Camissonia nevadensis</i>	G3	S3	Watch List/NNPS D
Steamboat monkeyflower	<i>Diplacus ovatus</i>	G1G2Q	S1S2	At-Risk List/NNPS T

NNHP Species List for the Cave Rock and Skyland WSA Project Area				
Common Name	Species	G Rank	S Rank	Status (NNHP/Federal/NV Protection/USFS/NNPS)
Tahoe draba	Draba asterophora var. asterophora	G2T2	S1S2	At-Risk List/USFS S/NNPS T
Slide Mountain buckwheat	Eriogonum ovalifolium var. eximium	G5T3	S2	At-Risk List/NNPS W
sand cholla	Grusonia pulchella	G4	S2S3	At-Risk List/CY/NNPS D
Webber ivesia	Ivesia webberi	G2	S2	At-Risk List/LT/CE/USFS S/NNPS T
soft lupine	Lupinus malacophyllus	G3?	S3?	Watch List/NNPS D
Wassuk beardtongue	Penstemon rubicundus	G2G3	S3	At-Risk List/USFS S/NNPS D
tuni	Perideridia lemmonii	G4?	S3?	Watch List
Williams combleaf	Polyctenium williamsiae	G2Q	S2	At-Risk List/CE/USFS S/NNPS T
Tahoe yellowcress	Rorippa subumbellata	G1	S1	At-Risk List/C/LTBMU S/NNPS T
Tiehm peppercress	Stroganowia tiehmii	G2	S2	At-Risk List/NNPS W
Leichtlin mariposa lily	Calochortus leichtlinii	G4	S3	Watch List

G - Refers to the **global** population of a species.

T - Refers to the subspecific or variety **taxonomic** level (used in conjunction with G-rank); uses numeric ranks 1-5 in the same way that G and S ranks are applied.

S - Refers to the **subnational** (state) population of a species, subspecies, or variety.

X - Presumed Extinct or extirpated (S-rank) – Not located despite intensive searches and virtually no likelihood of rediscovery.

H - Possibly Extinct – Known from only historical occurrences but still some hope of rediscovery.

1 - Critically Imperiled – At very high risk of extirpation in the jurisdiction due to very restricted range, very few populations or occurrences, very steep declines, severe threats, or other factors.

2 - Imperiled – At high risk of extirpation in the jurisdiction due to restricted range, few populations or occurrences, steep declines, severe threats, or other factors.

3 - Vulnerable – At moderate risk of extirpation in the jurisdiction due to a fairly restricted range, relatively few populations or occurrences, recent and widespread declines, threats, or other factors.

4 - Apparently Secure – At fairly low risk of extirpation in the jurisdiction due to an extensive range and/or many populations or occurrences, but with possible cause for some concern as a result of local recent declines, threats, or other factors.

5 - Secure – At very low or no risk of extirpation in the jurisdiction due to a very extensive range, abundant populations or occurrences, with little to no concern from declines or threats.

S#S# - Range Rank – A numeric range rank (e.g., S2S3 or S1S3) is used to indicate uncertainty about the exact status of a taxon. Ranges cannot skip more than two ranks (e.g., SU is used rather than S1S4). A range rank could also be applied at the global scale as well (e.g., G2G3).

NR - Taxon Not Ranked – rank not yet assessed.

NA - Conservation status rank is **Not Applicable** because element is not a suitable target for conservation activities (often used for non-native species or hybrids).

U - Unrankable – Currently unrankable due to lack of information or due to substantially conflicting information about status or trends.

Q - Questionable taxonomy – taxonomic distinctiveness of the entity at the current level is questionable or currently being reviewed; resolution of this uncertainty may result in change from a species to a subspecies, variety or hybrid, or the inclusion of this taxon in another taxon, with the resulting taxon having a lower-priority conservation status.

B - Breeding – Conservation status refers to the breeding population of the element in the nation or state/province.

N - Non-breeding – Conservation status refers to the non-breeding population of the element in the nation or state/province (e.g., wintering bird populations).

M - Migrant – Migrant species occurring regularly on migration at particular staging areas or concentration spots where the species might warrant conservation attention. Conservation status refers to the aggregating transient population of the species in the nation or state/province.

C – USFWS Candidate for listing as Threatened or Endangered

LT – USFWS Listed Threatened



- LE** – USFWS Listed Endangered
- CE** – Critically Endangered Plant (State of NV Protection and Designation)
- CY** – Protected as a cactus, yucca, or Christmas tree (State of NV Protection and Designation)
- GF** – Game Fish (State of NV Protection and Designation)
- PA** – Protected Amphibian (State of NV Protection and Designation)
- PR** – Protected Reptile (State of NV Protection and Designation)
- GM** – Game Mammal (State of NV Protection and Designation)
- FM** – Fur-bearing Mammal (State of NV Protection and Designation)
- PM** – Protected Mammal (State of NV Protection and Designation)
- TM** – Threatened Mammal (State of NV Protection and Designation)
- USFS S** – Region 4 (Humboldt-Toiyabe National Forest) Sensitive
- LTBMU** – USFS LTBMU listed species
- NNPS M** – Marginal/disjunct, rare and/or possibly distinct, and potentially vulnerable in the NV portion of its range, but more widespread and secure outside NV.
- NNPS T** – Threatened, believed to meet the ESA definition of Threatened but not formally listed.
- NNPS D** – Delisted, dropped from consideration, no longer of concern.
- NNPS W** – Watch list species, potentially vulnerable to becoming Threatened or Endangered.

Species listed by the US fish and Wildlife Service for the project area include:

Table 2-3. USFWS Species List for the Skyland WSA Project Area

USFWS Species List for the Skyland WSA Project Area		
Type	Species	Federal Status
Fishes	Cui-ui (<i>Chasmistes cujus</i>)	Endangered
Fishes	Lahontan cutthroat trout (<i>Oncorhynchus clarkii henshawi</i>)	Threatened

While northern goshawk (*Accipiter gentilis*) are not known to occur in the area the area adjacent to the WSA contains suitable habitat for this species. Osprey (*Pandion haliaetus*) nests, which are protected under the Migratory Bird Treaty Act, have been recorded in the Cave Rock WSA (Shay Zanetti, Personal Communication 28 Sept. 2015). Although there are no known bald eagle (*Haliaeetus leucocephalus*) nesting sites within the WSA (TRPA 2011 Threshold Evaluation) wintering bald eagle protection areas are located nearby in the Uppaway WSA. Fragmented areas appropriate for mule deer summer fawning and foraging habitat occur in the area. Each WSA includes some area subject to TRPA’s disturbance (free) zone for listed species and species groups. Additionally, willow flycatcher (*Empidonax traillii*) habitat may be present in the wet meadow area located at the southern edge of the WSA.

According to the LTBMU Forest Plan, there are no Protected Activity Centers (California Spotted Owl (*Strix occidentalis*) and Northern goshawk) or Home Range Core Areas (Spotted Owl), Whitebark pine (*Pinus albicaulis*) species refuge area, or species refuge area for Sierra Nevada yellow-legged frog (*Rana sierrae*) or Lahontan cutthroat trout within the WSAs. However, there are species refuge areas for Tahoe yellow cress within Skyland WSA, along the shores of Zephyr Cove.

Pre-construction surveys for nesting bird species will be required in order to conform with the Migratory Bird Treaty Act of 1918. As noted above, no known Protected Activity Centers for either northern goshawk or California spotted owl are known to occur in the area, however creation of a new roadway, pipeline or tank site would likely require protocol surveys to be performed. Willow flycatcher habitat will also

likely require surveys for the presence of this species in the wet meadow area at the southern edge of the WSA.

2.2.5 Noise

Since the Cave Rock and Skyland WSAs are residential and recreation areas, the primary noise source is U.S. Highway 50, although some noise may be generated by the Zephyr Cove Marina and Resort and the Cave Rock Water Treatment Plant. The maximum community noise equivalent level for PAS 060, 062, 065, and 066 is 50 CNEL, with a maximum of 65 CNEL for the US 50 corridor. In PAS 060, the maximum community noise equivalent decreases to 25 CNEL within the Lincoln Park roadless area. The maximum community noise equivalent level for PAS 063 and 064 is 55 CNEL, with a maximum of 65 CNEL for the US 50 corridor.

The TRPA 2011 Threshold Evaluation Report indicates that noise levels along U.S. Highway 50 are at or somewhat better than targets. Noise studies indicate that roadway noise levels are below 65 CNEL, ranging between 58 and 65 A-weighted decibels (dBA), for an average of 61 dBA.

2.2.6 Land Use

The Cave Rock and Skyland WSAs are located within the Tahoe Douglas Area Plan. According to the Area Plan and the Regional Plan Land Use map, land uses in the Skyland WSA are residential, conservation, and recreation, while in the Cave Rock WSA, they include conservation and backcountry in addition to residential. Douglas County Zoning in the Cave Rock WSA consists of Residential (PAS 064, 063, and 062), and Managed Resources (PAS 060). The Skyland WSA consists of Residential (PAS 065 and 064), Managed Resource (PAS 060), and Commercial (PAS 066).

The Cave Rock WSA includes Plan Area Statement 063 Lincoln, 062 Cave Rock, the northern portion of 064 Lakeridge, and a portion of 060 Genoa Peak. The Skyland WSA includes Plan Area Statement 065 Skyland, 066 Zephyr Cove, the southern portion of 064 Lakeridge, and a portion of 060 Genoa Peak. Potable water service facilities are considered a special use in each of the Plan Area Statements within the Cave Rock and Skyland WSAs.

Plan Area Statement 060 Genoa Peak has a land use classification of conservation and management strategy of mitigation with no special designations. According to the Plan Area Statement, "This area should be managed for low level resource use with special management emphasis on the protection of water and visual qualities." Most of the Plan Area is managed by the U.S. Forest Service for primitive recreation, including dirt roads for off-highway vehicle use, cross country skiing and hiking access. Planning considerations and special policies address recreation and wilderness management, and watershed protection, among others.

Plan Area Statement 062 Cave Rock has a land use classification of residential and management strategy of mitigation with no special designations. According to the Plan Area Statement, "This area should continue to be residential with improvements made to upgrade the area." At 55% build out, existing uses in this area includes

mostly low-density residential with a small condominium development. Planning considerations and special policies address infrastructure improvements, drainage and erosion control, landscape screening improvements, and SEZ treatment, among others.

Plan Area Statement 063 Lincoln has a land use classification of residential and management strategy of mitigation with no special designations. According to the Plan Area Statement, “This area should continue the existing land use pattern with the primary use being residential.” Existing uses in the area includes the Cave Rock boat ramp, a trailer park, the Lincoln Park subdivision and some small commercial establishments, and is 70% built out. Planning considerations and special policies address the commercial area, improvements to character and infrastructure, among others.

Plan Area Statement 064 Lakeridge has a land use classification of residential and management strategy of mitigation with no special designations. According to the Plan Area Statement, “This area should continue to be residential, maintaining the existing character of the neighborhood.” At 75% build out, this area includes three low-density subdivisions and large residential estates with private ownership of the shoreline.

Plan Area Statement 065 Skyland has a land use classification of residential and management strategy of mitigation with no special designations. According to the Plan Area Statement, “This area should continue to be residential, maintaining the existing character of the neighborhood.” Existing uses in the area includes a low-density residential subdivision. The shorezone is privately owned and the area is approximately 85% built out. Planning considerations and special policies address highway runoff, access to adjacent USFS land, and man-made structures within the shorezone.

Plan Area Statement 066 Zephyr Cove has a land use classification of recreation, a management strategy of mitigation, and is a TDR receiving area for existing development. According to the Plan Area Statement, “This area should continue to serve as a recreation/education center with limited opportunities for recreation expansion consistent with the need to improve the quality of the recreation experience.” At 50% build out, existing uses in this area includes the federally owned Zephyr Cove Resort and Marina (M.S. Dixie Tour Boat), a library, senior citizen center, elementary school, high school, a Douglas County park, and a large estate. Approximately 50% of the shoreline is in public ownership. Planning considerations and special policies address traffic congestion and pedestrian and vehicular safety in relation to the resort, beach accessibility, fish migration barriers on Zephyr Creek, runoff water quality, and protection of Rorippa in certain beach areas. Water intake lines are an allowed use within the shorezone.

Review of the LTBMU Forest Plan Land Management Plan (2015) indicates that a portion of LTBMU Backcountry area may be within the Cave Rock and Skyland WSAs. Within Backcountry areas, natural ecological processes are free of human influence and activity, leaving natural processes to shape the environment. These areas include dispersed recreation and include few roads, with existing roads being unpaved. Permanent roads and urban development are not suitable uses in this

area, and the area is managed to maintain forest health, habitat, watersheds, and healthy soils. The Management Concept within Backcountry Management Areas is natural landscapes, dispersed recreation use, and limited management.

The Cave Rock and Skyland WSAs also include LTBMU General Conservation Management Area where the management concept includes roaded landscapes, active management, dispersed and developed recreation uses. These areas are actively managed to meet various social, economic, and ecological goals and most uses allowed on Forest Service land may occur in this management area. Recreation in the General Conservation Management Area includes beaches, resorts, historic sites, streams, and trails, among others, although dispersed recreation such as hiking trails, also occurs in this area. Forest management is implemented to enhance watershed conditions, address fire and disease risk, control invasive species, and maintain unique habitat.

Santini-Burton/Urban Forest Parcels Management Area can also be found within the Cave Rock and Skyland WSAs. These area protected and undeveloped landscapes and active management areas that are generally smaller in size and located in or near urban and suburban areas or adjacent to General Conservation and Backcountry Management Areas. Santini-Burton lands were acquired under the 1980 Santini-Burton Act and use and development of these lands is restricted to activities that do not compromise the watershed or environmental quality of the area such as dispersed recreation.

Utilities are considered suitable within the General Conservation Management Area, but face restrictions in Backcountry, Santini-Burton, and Urban Forest Management Areas. Soil and Water Restoration activities are considered suitable in these management areas.

2.2.7 Transportation

The primary roadway through the area is U.S. Highway 50, which is a 4 lane rural undivided highway through the WSAs. Nevada Department of Transportation and the 2012 Regional Plan EIR indicate traffic volumes on U.S. 50 range from 15,100 ADT west of Meyers to 12,000 ADT east of SR 28. SR 28 intersects U.S. 50 just northeast of the Uppaway WSA near Glenbrook. Summer 2010 traffic counts indicate between 27,000 to 33,000 ADT on U.S. 50 between South Stateline and Zephyr Cove, while counts dropped to 14,900 on U.S. 50 at Glenbrook near SR 28. SR 28 experienced an ADT of 7,200, indicating a majority of the trips on U.S. 50 in this area continued on out of the basin and into the Carson Valley.

Transit service is available within the WSAs along U.S. 50 through the Tahoe Transportation District BlueGo/Valley and Lake Express Service that operates one route (Stateline to Carson City) along this stretch of U.S. 50. There are no stops in the Cave Rock WSA. The nearest transit stops are located in Zephyr Cove near Whittell High School (Skyland WSA), Zephyr Cove Stables, and Zephyr Cove Resort (Zephyr WSA). Although no bike path is located in the area, a bikeway is planned to include this portion of U.S. 50, and encircle the lake.

Water utility system improvements and repair would have no long-term effect on traffic and circulation, although some temporary construction delays on U.S. 50 and neighborhood streets may occur during the active construction period.

2.2.8 Hazards

The nearest active Leaking Underground Storage Tank (LUST) sites are the Round Hill Shell located at 199 U.S. 50 in Zephyr Cove and Zephyr Cove Resort at 760 U.S. 50 in Zephyr Cove, both of which have confirmed release of gasoline and are actively monitored (Nevada Division of Environmental Protection, 7/15/15).

The entire WSA areas are within the Wildland Urban Interface (WUI) as shown in the LTBMU Forest Plan Map (Map 4, Forest Plan, 2015).

U.S. 50 is the primary evacuation route through this area, as well as the Uppaway WSA, and Zephyr Water Utility District.

2.2.9 Public Utilities and Services

Utility and service providers within the Cave Rock and Skyland WSAs include Douglas County, Cave Rock Estates General Improvement District (GID), Lakeridge GID, Skyland GID, Douglas County School District, Douglas County Sewer Improvement District, Douglas County Sheriff's Office, Tahoe Douglas Fire Protection District, South Tahoe Refuse, NV Energy, Southwest Gas, and Frontier Communications (Douglas County Master Plan, 2012).

Douglas County provides water service within the Uppaway, Cave Rock, and Skyland WSAs, and Zephyr Water Utility District. These areas were consolidated under the County. The County is currently evaluating the existing system, planning for repairs and improvements, and assessing future needs. With little growth anticipated, efforts focus on system improvements and repairs.

Tahoe Douglas Sewer Improvement District provides collection of wastewater and conveys it to Douglas County Sewer Improvement District No.1 for treatment. All treated effluent is pumped out of the Tahoe Basin into the Carson Valley for irrigation use.

The Lakeridge and Cave Rock Estates GIDs are located in the Cave Rock WSA. The Cave Rock Estates GID maintains roads, curb and gutter, sidewalks, storm drains, water systems and street lighting within the Cave Rock Estates development (caverockgid.org, 7/22/15). The Lakeridge GID also maintains infrastructure within the Lakeridge development, such as storm drains and catch basins, road maintenance, snow removal, and has developed a Fire Safe Project to protect homes within the Lakeridge development from fire hazards (homeintahoe.com, 7/22/15). The Skyland GID is responsible for paving and plowing of streets, maintaining curbs and gutters, sidewalks, storm runoff vaults, the fence along U.S. 50, street lighting, and water and sewer improvements within the 245 home Skyland subdivision (skylandgid.com, 7/22/15).

South Tahoe Refuse provides solid waste service under a franchise agreement with Douglas County. Refuse and recyclables are transported to a material recovery

facility and transfer station in South Lake Tahoe, California, and then transported to the Lockwood Landfill in Storey County.

The Douglas County Sheriff's Office has a substation at Kingsbury Grade and U.S. 50 south of the WSAs, with County law enforcement support services centered in the South Shore area.

The Tahoe Douglas Fire Protection District provides fire protection, emergency response, and rescue services. The nearest fire stations are the Glenbrook Station #25 south of the Uppaway WSA, and the Zephyr Cove Station #24 in the Skyland WSA.

The Douglas County School District operates Zephyr Cove Elementary (K-6) and George Whittell High School (7-12), located within the Skyland WSA. Due to declining enrollment, Kingsbury Middle School was closed in 2008 and may be redeveloped into commercial and residential uses. Library services are provided by the County at the Library in Zephyr Cove, located in the Skyland WSA on Warrior Way.

Recreation in the area includes U.S. Forest Service land and trails for hiking, biking, and other recreation activities, while other recreation resources in the vicinity of the WSAs includes the Glenbrook golf course, the Zephyr Cove marina, Spooner Lake, and the Tahoe Rim Trail. Area schools also provide recreational facilities; however few developed recreation facilities are located within or near the WSAs. The LTBMU Forest Plan identifies the Cave Rock and Skyland WSAs as an area with Urban, Rural, and Roaded Natural Recreation Spectrums.

Nevada Energy and Southwest Gas provide electricity and natural gas services to the area, and Frontier Communications provides communication services.

2.2.10 Scenic Resources

The Skyland WSA includes Roadway Unit 30 and Scenic Shoreline Units 27 and 28, while the Cave Rock WSA includes Roadway Units 29 and 30 and Scenic Shoreline Units 26 and 27 (Wagstaff and Brady 1983).

Scenic Roadway Unit 29 – Cave Rock stretches from north of Lincoln Park up to the Glenbrook area north of the Uppaway WSA. Within the Cave Rock WSA, views include panoramas of pine forest along the shoreline, distant views of the lake and mountains, and shoreline development and residences, as well as Cave Rock. The scenic quality is defined as high in this area with a rating of 3. The TRPA 2011 Threshold Report indicates the threshold composite rating has increased from 23 in 1982 to 23.5 in 2011, with improvement in roadway distractions. Improved roadway safety features and residential features affected the increase in rating. Overall, the ratings include: man-made features – 3; roadway distractions – 4.5; road structure – 3; lake views – 5; landscape views – 5; and variety – 3.

Scenic Roadway Unit 30 – Zephyr Cove-Lincoln Park is located within both the Cave Rock and the Skyland WSAs. The northern portion of Scenic Roadway Unit 30 is located within the Cave Rock WSA. Views within the Cave Rock WSA include Cave Rock, forested area and intermittent lake vistas, and some residential development

visible in the foreground. Views within the Skyland WSA include intermittent views of the lake through the natural forest area, unobtrusive residential development, riparian and meadow vegetation around Zephyr Creek, and views of Zephyr Cove and distant mountains to the west. The overall scenic quality is defined as high with a rating of 3; however views within the Cave Rock WSA range from low to high quality with ratings ranging from 1 to 3 and views within the Skyland WSA range from moderate to high quality with ratings ranging from 2 to 3. In 2001, Unit 30 was separated into four units with the portion in the Cave Rock WSA being Unit 30A and the portion in the Skyland WSA being Units 30A and 30B. The TRPA 2011 Threshold Report for Unit 30A indicates a threshold composite rating of 16, with overall ratings of: man-made features – 2.5; roadway distractions – 2; road structure – 3.5; lake views – 4; landscape views – 2; and variety – 2. Contrasting fencing, inadequate landscaping around a water treatment structure, and residences detract from the scenic quality of the area. Unit 30B has a threshold composite rating of 16.5 with overall ratings of: man-made features – 3; roadway distractions – 3.5; road structure – 2; lake views – 2.5; landscape views – 3; and variety – 2.5. Roadside parking near the Zephyr Cove Resort persists and distracts from the visual quality of the area.

The Cave Rock WSA includes portions of Scenic Shoreline Unit 26 – Cave Rock. Shoreline views include Cave Rock. While the overall scenic quality is defined as moderate with a rating of 2, the views within the WSA has a high scenic quality and rating of 3. According to the 2011 TRPA Threshold Report, the composite rating has slightly decreased from 10 in 1982 to 9.5 due to the development of highly visible large new homes with high reflectivity and poor screening, as well as piers and boatlifts. Although some structural improvements have been made, they were not sufficiently widespread to improve the rating and the area is at risk as it is not in threshold attainment. Ratings include: composite – 9.5; man-made features – 2.5; background views – 4; and variety – 3.

The Cave Rock and Skyland WSAs include Scenic Shoreline Unit 27 – Lincoln Park, which has an overall low scenic quality and rating of 1. Within the Cave Rock WSA, background views include road scars and residences, while shoreline views include steep, rocky, and sparsely vegetated areas with a breakwater, road scars, parking lot, and boat landing, as well as Cave Rock. Within the Skyland WSA, background views include forested ridges, along with peaks and ski runs at Heavenly. Shoreline views include forested areas and housing with small sandy beaches and offshore boulders. The presence of some large homes at the shoreline detract from the visual quality of the area. Unit 27 is out of threshold attainment and is considered at risk. Ratings for Unit 27 include: Threshold composite – 7; man-made features – 1; background views – 4; and variety – 2. The rating is primarily due to the addition of noticeable new and rebuilt residential structures that have poor setbacks and screening with large window areas. The domination of residences within the viewshed creates high contrast with the forest and detracts from variety and man-made features.

Scenic Shoreline Unit 28 – Tahoe School has an overall moderate scenic quality and rating of 2. Background views include forested steep hills, while shoreline views

include rocky, forested, natural shore with willows and other vegetation near the creeks. Some housing and roadway are visible. Offshore views include rocks and boulders within the lake. Unit 28 remains at-risk of non-attainment with threshold composite score of 11; man-made features – 4; background views – 4; and variety – 3. Although this unit is in attainment, residential remodeling in the area can threaten the current score.

Scenic Recreation Area 3 – Cave Rock is located within the Cave Rock WSA. Views from Scenic Recreation Area 3 include views of the lake and distant peaks across the lake, distinctive Cave Rock, vegetated slopes, beach area, a boat ramp and restroom facility, and parking. While Cave Rock and the surrounding rock outcroppings and vegetation lend scenic value to the area, visible structures and paved areas detract from the visual quality. According to the 2011 Threshold Report, this area is not in attainment with ratings of 2.5 for coherence, 5 for condition, 3 for compatibility, and 4 for design quality, for a total rating of 14.5.

Scenic Recreation Area 2 – Zephyr Cove is also located within the Skyland WSA. Views from Scenic Recreation Area 2 include views of the lake, distant peaks across the lake, sandy beaches, forests, area streams, the pier and concessions, parking, and picnic areas. Development within the recreation area as well as nearby residential subdivisions affect the scenic value of this area. According to the 2011 Threshold Report, this area is in attainment with ratings of 4 for unity, vividness, and intactness and 3 for variety for a total rating of 15.

The LTBMU Forest Plan indicates USFS portions of the cave Rock and Skyland WSAs have a minimum scenic integrity of “high”. The Forest Plan Scenic Stability rating for both WSAs is mostly moderate, with some area of high stability around Lincoln Creek and Zephyr Creek, and some area of low stability near Zephyr Cove on both sides of U.S. 50.

U.S. 50 is a National Scenic Byway within each of the Douglas County Water System areas.

2.2.11 Cultural Resources

Approximately 20-25% of the Skyland WSA and less than 25% of the Cave Rock WSA have been the subject of cultural resources survey and inventory. Thirteen inventories have been completed within the Skyland WSA. Eight of the inventories were completed for the U.S. Forest Service, three for the Nevada Department of Transportation, and two for private entities. None of these inventories covered the entire Skyland WSA. Eight inventories have been completed within the Cave Rock WSA. Five of the inventories were completed for the U.S. Forest Service, two for the Nevada Department of Transportation, and one for a private entity.

Table 2-4 Cultural Resources

SHPO Report Number	Lead Agency	Title	Author	Report Year
DBI_NV_2007_19	USFS	Cave Rock Urban Lots Fuels Reduction, Douglas County, Nevada	Godin, Terry	2006



SHPO Report Number	Lead Agency	Title	Author	Report Year
3722	USFS	Cultural Resource Inventory for the Spooner Hazardous Fuels Reduction Project Douglas County, Nevada	Dexter, S	1994
DBI_NV_2007_20	USFS	Archaeological Inventory Report, Hidden Woods Erosion Control Project, Douglas County, Nevada	Zeier, Charles	2000
DBI_NV_2007_198	NDOT	Cultural Resources Inventory Report Lower US 50 Erosion Control -- Storm Water Management Master Plan Douglas County, Nevada	Reno, Ronald and Charles D. Zeier	2000
	Unknown	Cultural Resources Report: M. S. Dixie Turn Lane, W.O. 20727 (from NADB)	Matranga, P. and J. McNeil	1982
3-143	USFS HT Carson	USDAFS Short Form Cultural Resources Report: Zephyr Cove Forest Health, Douglas County, Nevada	O'Brien, S.	1992
3-155	USFS HT Carson	USDAFS Lake Tahoe Basin Management Unit Heritage Resource Report: Urban Fringe Management Project (Nevada Portion), Douglas County, Nevada	Dexter, S.	1994
3-162	USFS HT Carson	Lake Tahoe Basin Management Unit Short Form Cultural Resources Report: Zephyr Cove Campground Retrofit, Douglas County, Nevada	Dexter, S.	1996
18-315	Unknown	Cultural Resources Inventory and Evaluation Report For The Proposed Spooner Summit and East Shore Project (Big Gulp) Timber Sales	Lindstrom, Susan G. and Jeffery T. Hall	1994
3286	FHWA	A Class III Cultural Resources Inventory for the Elk Point Unit #3 Fuel Treatment Project Douglas County, Nevada	Matranga, Peter	2009
DBI_NV_2007_20	USFS	Archaeological Inventory Report, Hidden Woods Erosion Control Project, Douglas County, Nevada	Zeier, Charles	2000
6665	USFS	Zephyr Cove Stables BMP Project	Blom, Devin	2011
5949	NDOT	Archaeological Inventory Report State Route 207, Kingsbury Grade Erosion Control / Archaeological Inventory Lower US 50 Erosion Control - Storm Water Management Master Plan Douglas County, Nevada	Zeier, Charles D.	2006
3-163-1	USFS	USDAFS Cultural Resource Report Douglas County Land Exchange Lake Tahoe Basin Management Unit, Douglas County, Nevada	Berrien, G.L.	1992

There are thirteen previously recorded historic era cultural resources within or adjacent to the Skyland WSA, three of which, the Lincoln Highway or Highway 50 and two Chinese camps/cabins, have been recommend eligible for listing on the National Register of Historic Places (nvcris.shpo.nv.gov, accessed on 10/19/15 and 10/20/15). The other cultural resources consist primarily of historic roads, tree stumps, the Skyland Telephone line, and domestic refuse from historical logging and mining. There are eight recorded historical resources within and adjacent to the Cave Rock WSA. Two sections of the Lincoln Highway/U.S. Highway 50 and Cave Rock are recommended as eligible for the NRHP. The other 5 historical resources consist of two roads, a logging complex, and historical lumber camps. None of the sites are listed on the National Register of Historical Places (NRHP) or otherwise protected by the state of Nevada (National Register of Historic Places Research Database, nps.gov/nR/research/index, accessed on 10/20/15). Historical resources further from the project area include a large historical timber-harvest landscape, and numerous resources associated with historical agricultural and mining practices.

Table 2-5 Historic Resources

Trinomial	Age	Description	Site Record NRHP Evaluation
DO901	Historic	Road	Ineligible
DO803	Historic	Road	Ineligible
DO804	Historic	Road	Ineligible
DO895	Historic	Road	Ineligible
DO896	Historic	Road	Ineligible
DO8	Prehistoric	Cave Rock	Eligible
DO607	Historic	Chinese camp/cabin	Eligible
DO608	Historic	Chinese camp/cabin	Eligible
DO654	Historic	Logging Complex	Unevaluated
DO902	Historic	Can scatter	Ineligible
DO903	Historic	Tree stumps	Ineligible
DO451	Historic	Section of Hwy 50/Lincoln Hwy	Eligible
DO621	Historic	Section of Hwy 50/Lincoln Hwy	Eligible
DO452	Historic	Zephyr Cove Riding Stables	Unevaluated
DO697	Historic	Water conveyance	Ineligible
DO698	Historic	Cedar stumps	Ineligible



Trinomial	Age	Description	Site Record NRHP Evaluation
DO696	Historic	Skyland Telephone Line	Ineligible

Cave Rock is a large prehistoric site recorded within the Cave Rock WSA. No additional prehistoric archaeological resources have been recorded in the Cave Rock WSA (nvcris.shpo.nv.gov, accessed on 10/20/15 and 10/21/15). There are no previously recorded prehistoric archaeological sites located within the Skyland WSA (nvcris.shpo.nv.gov, accessed on 10/19/15 and 10/20/15). Prehistoric sites would most likely be ethnographically associated with the Washoe Tribe of Nevada and California. The closest archaeological sites to the Cave Rock and Skyland WSAs are located along the lakeshore. The prehistoric sites are primarily food preparation areas surrounding bedrock mortar (grinding hole) stations.

The Cave Rock WSA has a high cultural resource sensitivity due to Cave Rock. The Skyland WSA has a medium to low cultural resources sensitivity. Resources would most likely be associated with historical timber harvesting and forestry practices. Large complex prehistoric or historic resources requiring costly mitigation measures are not anticipated. This assessment is based solely on a records search conducted electronically with the Nevada Cultural Resources Information System (nvcris.shpo.nv.gov, accessed on 10/19/15 and 10/20/15). There is always the possibility that previously unrecorded cultural resources are present near and around the Cave Rock and Skyland WSAs.

2.3 Population Trends

According to the 2011 Douglas County Master Plan, population trends in the Lake Tahoe region of Douglas County indicate the full-time permanent population declined between 2000 and 2010 as a result of an increase in second and vacation home ownership. The number of active vacation home rentals in the area is expected to continue to increase. The population in the Tahoe area decreased between 2000 and 2010 the Zephyr Cove/Roundhill CDP experiencing a population decrease of 373 persons or -20% for a total population of 1,324. Similar trends occurred in other portions of the Lake Tahoe area such as Kingsbury and Stateline, while the portions of Douglas County outside of the Lake Tahoe Basin experienced population growth. TRPA socioeconomic data for 2010 indicates that percentage of primary residences in Douglas County versus secondary residences is 51/49 (TRPA 2011 Threshold Evaluation – Appendix A). Overall, the population increased by 14% between 2000 and 2010 in Douglas County, with a 2010 population of 46,997 persons.

Nevada County Population Projections 2014-2033 prepared by the Nevada State Demographer’s Office (October 1, 2014), project the population of Douglas County will be approximately 49,620 persons in 2032, as compared to 48,478 persons in 2013. Overall, population trends indicate a population decrease in Douglas County through 2018, with an average annual increase of 0.3% through 2033. The 2014-2033 Projections also indicate most job growth will occur in the fields of construction

(1.2%), accommodation and food services (1.8%), and professional, scientific, and technical services (0.8%), among others.

Redevelopment employment along US 50 is unlikely to result in population growth despite employment gains as workforce housing has not increased. In addition, wages corresponding to the employment growth areas in the Lake Tahoe Basin do not afford employees residence within the Lake Tahoe area. Those employed by new jobs will continue to commute to the area from more affordable areas in Douglas County. Therefore, population growth trends will continue to decrease or remain stagnant in the Lake Tahoe Basin area.

In 2012, there were 102 vacant developable residential parcels (Individual Parcel Evaluation System [IPES] score above zero) in the Tahoe Planning Area of Douglas County. At a development rate of eight allocations per year, the area would be built-out within 13 years. There are 10 vacant lots in the Uppaway WSA, and 2 with active connection permits.

2.4 Community Engagement

Community engagement will occur through a series of workshops, where the County will share the findings of the PER, and solicit input from the rate payers. The exact format of the workshops have not been determined at this time, but they will include discussion of the system deficiencies, proposed alternatives, and probable funding sources.

3 Existing Facilities & Deficiencies

The intent of this section is to describe the existing condition of the water system and identify deficiencies based on County, NAC, and other industry standard codes and references.

3.1.1 Location Map

The Cave Rock/Skyland water system, located on the west shore of Lake Tahoe, serves the residents in the Cave Rock, Lakeridge, Hidden Woods, and Skyland subdivisions as shown in the location map (Figure 3-1). The Cave Rock subdivision is located approximately 5.7 miles north of Stateline, Nevada, and approximately 1.7 miles south of Logan Creek Estates. Lakeridge and Hidden Woods are located immediately south of the community of Cave Rock, and Skyland is located approximately one mile further south.

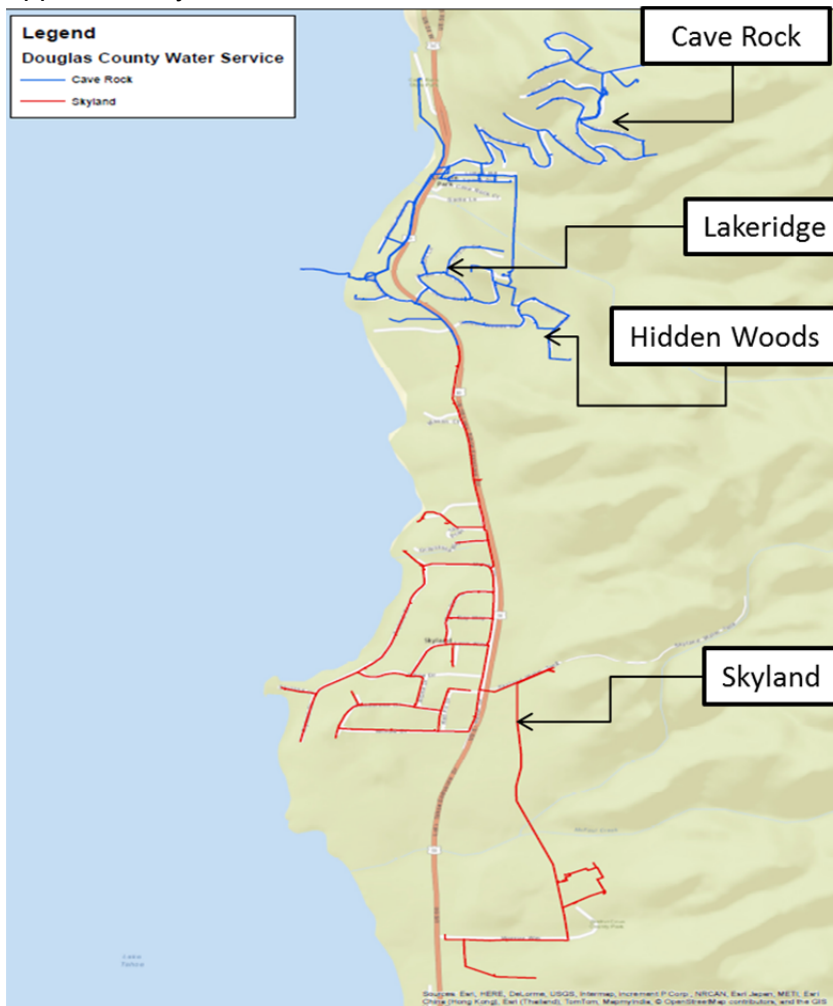

Figure 3-1. Cave Rock/Skyland Water System Location Map

3.2 History

The Cave Rock/Skyland water system is operated as a single system, but the Cave Rock area and the Skyland area have their own rate schedules. A water system map that shows the existing piping, tank and pump station configuration is included as Figure 3-1. The system currently serves approximately 601 Equivalent Dwelling Units (EDUs). The approximate customer count for the two areas is as follows

- Cave Rock customers: 334 connections
- Skyland customers: 267 connections

The Cave Rock/Skyland water system is comprised of the following major system components listed in Table 3-1.

Table 3-1 Water System Components

Water Storage Tanks	Storage Tank Capacity (gallons)	Storage Tank Base Elevation (feet)	Year Constructed
Lakeridge Tank	335,800	6,531	1996
Hidden Woods Tank	121,600	6,596	Not Known
Lower Cave Rock Tank	186,800	6,768	2007
Skyland Tank	782,000	6,431	2003
Upper Cave Rock Tank	196,000	6,937	1995
TOTAL	1,642,400		
Water Treatment Plant	Water Source	Treatment Method	Year Constructed
Cave Rock/Skyland WTP, 875 gpm rated capacity	Surface Water – Lake Tahoe	Microfiltration	1997
	Material(s)	Size/Capacity	Length (feet)
Lake Intake	HDPE	10-inch	1,726
Lake Intake Pump Station	-	606 gpm	-
Distribution Piping	Ductile Iron	6-Inch	29,113
	Ductile Iron	>8 inch	19,901
	PVC, Ductile Iron, Galvanized Iron	1-inch to 4-inch	7,258

Source: (Douglas County Record Drawings)

3.3 Lake Intake

Lake Tahoe is the sole water source for Cave Rock/Skyland Water System. A 10-inch diameter High Density Polyethylene (HDPE) pipeline extends approximately 1,726-feet into Lake Tahoe. The line is buried near the shore and the submerged and anchored to the Lake floor via concrete blocks.

The Cave Rock lake intake has of two intake locations. The near shore intake location is 6,205.9-feet in elevation, making it 16.9-feet below the current water level (6,222.8). The far shore intake is at 6161.3-feet in elevation, making it 61.5 feet below the current water level (6,222.8).

3.3.1 Condition

The intake is inspected every 2-5 years by a commercial diving company using scuba equipment. The last inspection was performed October 17th, 2014 by Blue Locker Commercial Diving Services. Overall, the intake pipeline is in good condition. The details of the most recent condition assessment is in Appendix B and summarized below:

- No visible damage to majority of pipeline. Stainless steel protection bands added to sections showing wear from rubbing on rock as a result of wave action.
- No penetrations or holes found in the pipeline
- Concrete anchor blocks are secure and in place
- Marine growth covers the entire pipeline and debris is present in isolated areas through out the inspection

The following photos show the condition of the lake intake pipe, concrete anchor blocks and the clean intake screen.



Photo 3-1 Pipeline and Anchor Block

The intake screen was cleaned by the diver to remove marine growth. Asian clams, an invasive species to Lake Tahoe which can clog screens, have not been a problem so far.

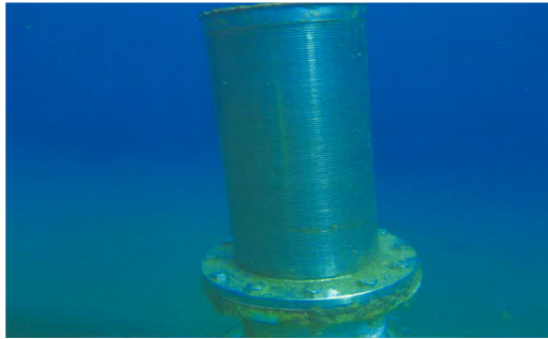

Photo 3-2 Clean Intake Screen

The check valve cap on the intake line has rusted bolts but is securely fastened as shown in Photo 3-3.

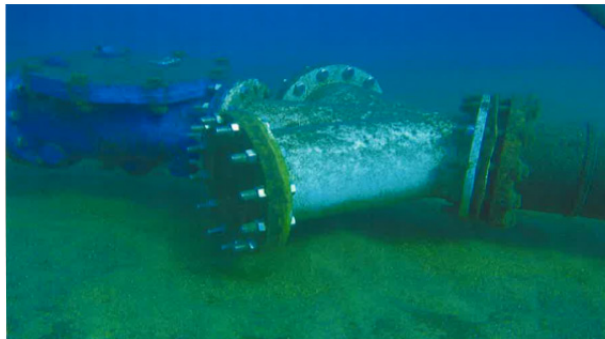

Photo 3-3 Tilted Check Valve

3.3.2 Regulatory Compliance

NAC 445A.6698 and 445A.860 requires the intake to extend at least 1,000-feet into the Lake, 15-feet below the surface, and 4-feet above the bottom. The near shore intake does not comply with the 1,000-feet from shore criteria and does not comply with the 15-foot submergence requirement when the Lake drops below elevation 6,220.9 feet. Nevada Division of Environmental Protection (NDEP) has provided an exemption for the 1,000-feet from shore requirement for the near shore intake. Currently the water system utilizes the near shore intake only and the far shore screen location has a flange installed due to Net Positive Suction Head (NPSH) issues the lake intake pumps when pumping from this location.

3.4 Lake Intake Pump Station

Cave Rock utilizes two centrifugal, end suction pumps located in a building on the lakeshore to pump raw water from Lake Tahoe directly to the Cave Rock/Skyland Water Treatment Plant.

Three (3) intake pumps were initially installed on a submerged skid in the Lake, with a maximum of two pumps to operate simultaneously and the third for standby. In 2010, the water system's lake intake pumps were moved from a submerged skid in Lake Tahoe into an existing intake pump building on the shore of the lake after one



of the submerged pumps failed leaving the water system without redundancy in supply during summer demands.

Table 3-2 Intake Pump Station

	Design Conditions	
	Value	Units
Number of Submersible Pumps	2	
Design Flow, Firm	606	gpm
Design Total Dynamic Head	282	ft
Electric Motor	40	HP
Piping Discharge Size	8	inch

Source: Douglas County Record Drawings

The intake pumps operate on variable frequency drives (VFDs) that are set to operate at a set flow rate. The intake pumps currently operate to deliver 452 gpm or 606 gpm to the WTP. Delivery of higher flows can be limited by Net Positive Suction Head Available (NPSH_a) when the Lake Tahoe water surface elevation is low.

3.4.1 Condition

Overall the pump station is in fair condition. The pumps and piping are approximately 5 years old and are in good condition.

The CMU pump building is in fair condition.

3.4.2 Operational Issues

At low Lake Tahoe water surface levels, suction side hydraulics cause cavitation of the pumps due to reductions in NPSH_a which limits pumping capacity to the Cave Rock/Skyland WTP.

3.5 Cave Rock/Skyland Water Treatment Plant

The Cave Rock/Skyland Water Treatment Plant is a 1.25 MGD (875 gpm) microfiltration plant that was placed into operation in 1997. Raw water is pumped from the Lake directly through the microfilters and then into a chlorine contact tank, from where it is pumped to the distribution system. The existing turbine pumps that pump effluent out of the WTP operate at 452 gpm or 607 gpm, to match the flow that the WTP receives through the intake pumps.

Two microfiltration skids were furnished by Memcor (now a division of US filter). The two skids consist of a 90 module unit (Model 90M10C) and a 6 module unit (Model 6M10C). The 90M10C has a capacity of 1.25 MGD based on a maximum flux rate of approximately 0.07 gallons per minute per square feet (gpm/ft²) of membrane area. The 6M10C was designed to process backwash water from the 90 module skid, with

the finished water (filtrate) discharged to the plant chlorine contact tank. Only backwash water from the 6 module unit is discharged to the sewer.

The Cave Rock WTP is served by a 277/480 Volt, 3 phase, 4 wire, 600 amp service. The existing standby generator is a Caterpillar Model 3306 diesel engine with a 230 kW, 288 kVA generator installed indoors. The generator capacity is about 210 kW at station altitude.

3.5.1 Condition

The WTP has no redundant or excess treatment capacity. The plant was designed for a capacity of 1.25 MGD (875 gpm) utilizing microfiltration. The plant operates at 607 gpm during summer demands and there is no backup or redundancy in the plant's production of treated water. The plant is limited in its treatment capacity due to the maximum capacity that can be provided by the intake pump station. Nolte prepared a reliability study for Douglas County in 2002 and provided recommendations for installation of a second microfiltration skid that would provide a back up to maintain operation if the present skid failed or needed service.

The effluent pumps flow match the treatment plant via variable frequency drive (VFD) control.

3.5.2 Electrical

Generally speaking the electrical systems are in good working order. The plant has adequate power supply from the 480V, 600 amp service. The service is overhead, which is more susceptible to outages due to downed trees. However, backup power is provided by a 200kW standby diesel generator.

Lightning storms are common in Lake Tahoe in the summer, which can cause voltage surges. The Motor Control Center (MCC) is protected by Transient Voltage Surge Suppression (TVSS). However, this cannot guarantee protection against a direct lightning strike.

Voltage fluctuations, sometimes referred to as "dirty power" are also somewhat common in Lake Tahoe. Voltage drops may result in control equipment shutdowns, which are a nuisance. Uninterrupted Power Supply (UPS) protects control equipment such as PLCs from nuisance shut downs due to voltage fluctuations.

3.5.3 Controls/SCADA

The WTP is the hub of the County's SCADA system at the Lake. Data from remote sites including ZWUD WTP, tanks, and booster stations is transmitted to Cave Rock. The County uses Wonderware SCADA software on a PC. Data is stored on the PC and backed up on a hard drive.

The County's SCADA Master Plan (*SCADA Master Plan Technical Memorandum*, CH2MHill, June 1, 2015) identified and prioritized the improvements as shown in the following table. Priority definitions are as follows:

- Priority 1 – RTU replacement should be planned as soon as possible.

- Priority 2 – Non Ethernet capable SCADAPack RTUs. Should be replaced to simplify and better utilize a telemetry upgrade.
- Priority 3 – Non-obsolete SCADAPack RTUs that should be replaced when they fail.

Table 3-3 SCADA Master Plan Improvement Summary

Site	RTU	Replacement Priority
Cave Rock Upper Tank	TeleSafe VS/3	1
Cave Rock Lower Tank	See Cave Rock Upper Booster	N/A
Cave Rock Upper Booster	SCADAPack 350 (5209)	3
Cave Rock Lower Booster	SCADAPack Micro 16 (5203)	2
Cave Rock Treatment Plant	SCADAPack 32 (5232)	3
Cave Rock Intake	TESCO L2000 RTU	1
Lakeridge Tank	Not Identified	1
Lakeridge Booster	TeleSafe VS/3	1
Hidden Woods Tank	TeleSafe VS/3	1
Hidden Woods Booster	SCADAPack Micro 16 (5203)	2
Skyland Tank	SCADAPack Light (5203)	2

Source: CH2MHill SCADA Master Plan, June 1, 2015

3.5.4 Regulatory Compliance

Currently, the treatment plant meets all applicable state and federal water quality regulations except for redundancy requirements.

3.6 Distribution System

The existing distribution system is primarily constructed of 1-inch to 12-inch ductile iron, steel, PVC, and galvanized iron pipe. Pipe replacement is on-going; however, large portions of the distribution system are over 50 years old.

Due to the large range in elevation of the system, there are currently seven pressure zones in Cave Rock. The distribution system analysis revealed that the velocities exceed the County and NAC standards. Also, the most of the domestic pipes are old and failing, and will require replacement.

3.6.1 Regulatory Compliance

The distribution system must meet State and Federal regulations, as documented in the Nevada Administrative Code (NAC) section 445A. In addition to the criteria in

NAC 445A, Douglas County has its own Design Criteria, some of which are stricter than the NAC. Lastly, fire flow requirements are ultimately governed by the local fire authority, the Tahoe Douglas Fire District.

The following table summarizes the general water distribution requirements for both Douglas County and the State of Nevada. In the few instances where County code criteria were stricter than NAC (as shown in italicized red font), the stricter code governs.

Table 3-4 Code Comparison Criteria

	NAC 445A	County
System Residual Pressure		
Fire Flow & Max Day	20 psi	20 psi
Max Day	40 psi	40 psi
Peak Hour	30 psi	30 psi
Max Static	100 psi	100 psi
Pipe Velocity		
All Conditions (except Fire Flow)	8 fps	8 fps
Fire Flow & Ave Day Demand	None	<i>10 fps</i>
Minimum Pipe Size	6-inch	<i>8-inch</i>
Pipe Material	As per Orange Book/AWWA	<i>Ductile Iron or C900 PVC</i>

Source: NAC and Douglas County Design Criteria

3.6.2 Fire Flow Requirements

The County met with Tahoe Douglas Fire District (TDFD) on February 25, 2015 to discuss fire flow requirements for Zephyr Water Utility District, which is a part of Douglas County. The County requirement for fire flow is 1,500 gpm minimum. Historically, this fire flow requirement has been applied “across the board” with respect to residential fire flow requirements for water system modeling and analysis for water systems in Douglas County. However, at this meeting, TDFD as represented by Eric Guevin, Fire Marshall, stated that fire flow requirements were governed by the International Fire Code (IFC). In the IFC, fire flow is determined based on building size and construction, as summarized in Table B105.1.



**TABLE B105.1
 MINIMUM REQUIRED FIRE-FLOW AND FLOW DURATION FOR BUILDINGS**

FIRE-FLOW CALCULATION AREA (square feet)					FIRE-FLOW (gallons per minute) ^b	FLOW DURATION (hours)
Type IA and IB*	Type IIA and IIIA*	Type IV and V-A*	Type IIB and IIIB*	Type V-B*		
0-22,700	0-12,700	0-8,200	0-5,900	0-3,600	1,500	2
22,701-30,200	12,701-17,000	8,201-10,900	5,901-7,900	3,601-4,800	1,750	
30,201-38,700	17,001-21,800	10,901-12,900	7,901-9,800	4,801-6,200	2,000	
38,701-48,300	21,801-24,200	12,901-17,400	9,801-12,600	6,201-7,700	2,250	
48,301-59,000	24,201-33,200	17,401-21,300	12,601-15,400	7,701-9,400	2,500	
59,001-70,900	33,201-39,700	21,301-25,500	15,401-18,400	9,401-11,300	2,750	
70,901-83,700	39,701-47,100	25,501-30,100	18,401-21,800	11,301-13,400	3,000	3
83,701-97,700	47,101-54,900	30,101-35,200	21,801-25,900	13,401-15,600	3,250	
97,701-112,700	54,901-63,400	35,201-40,600	25,901-29,300	15,601-18,000	3,500	
112,701-128,700	63,401-72,400	40,601-46,400	29,301-33,500	18,001-20,600	3,750	
128,701-145,900	72,401-82,100	46,401-52,500	33,501-37,900	20,601-23,300	4,000	
145,901-164,200	82,101-92,400	52,501-59,100	37,901-42,700	23,301-26,300	4,250	
164,201-183,400	92,401-103,100	59,101-66,000	42,701-47,700	26,301-29,300	4,500	4
183,401-203,700	103,101-114,600	66,001-73,300	47,701-53,000	29,301-32,600	4,750	
203,701-225,200	114,601-126,700	73,301-81,100	53,001-58,600	32,601-36,000	5,000	
225,201-247,700	126,701-139,400	81,101-89,200	58,601-65,400	36,001-39,600	5,250	
247,701-271,200	139,401-152,600	89,201-97,700	65,401-70,600	39,601-43,400	5,500	
271,201-295,900	152,601-166,500	97,701-106,500	70,601-77,000	43,401-47,400	5,750	
295,901-Greater	166,501-Greater	106,501-115,800	77,001-83,700	47,401-51,500	6,000	
—	—	115,801-125,500	83,701-90,600	51,501-55,700	6,250	
—	—	125,501-135,500	90,601-97,900	55,701-60,200	6,500	
—	—	135,501-145,800	97,901-106,800	60,201-64,800	6,750	
—	—	145,801-156,700	106,801-113,200	64,801-69,600	7,000	
—	—	156,701-167,900	113,201-121,300	69,601-74,600	7,250	
—	—	167,901-179,400	121,301-129,600	74,601-79,800	7,500	
—	—	179,401-191,400	129,601-138,300	79,801-85,100	7,750	
—	—	191,401-Greater	138,301-Greater	85,101-Greater	8,000	

For SI: 1 square foot = 0.0929 m², 1 gallon per minute = 3.785 L/m, 1 pound per square inch = 6.895 kPa.

a. Types of construction are based on the *International Building Code*.

b. Measured at 20 psi residual pressure.

Figure 3-2. IFC Table B105.1

The County used building information obtained from County GIS records to determine the fire flow criteria for each parcel in the water system. This information is shown on the following figure. The required parcel fire flows were allocated to nearby hydrants, as indicated by the colored circles shown in Figure 3-3. These flows were used as the basis for water system modeling to verify the system meets pressure and flows under the various demand scenarios.

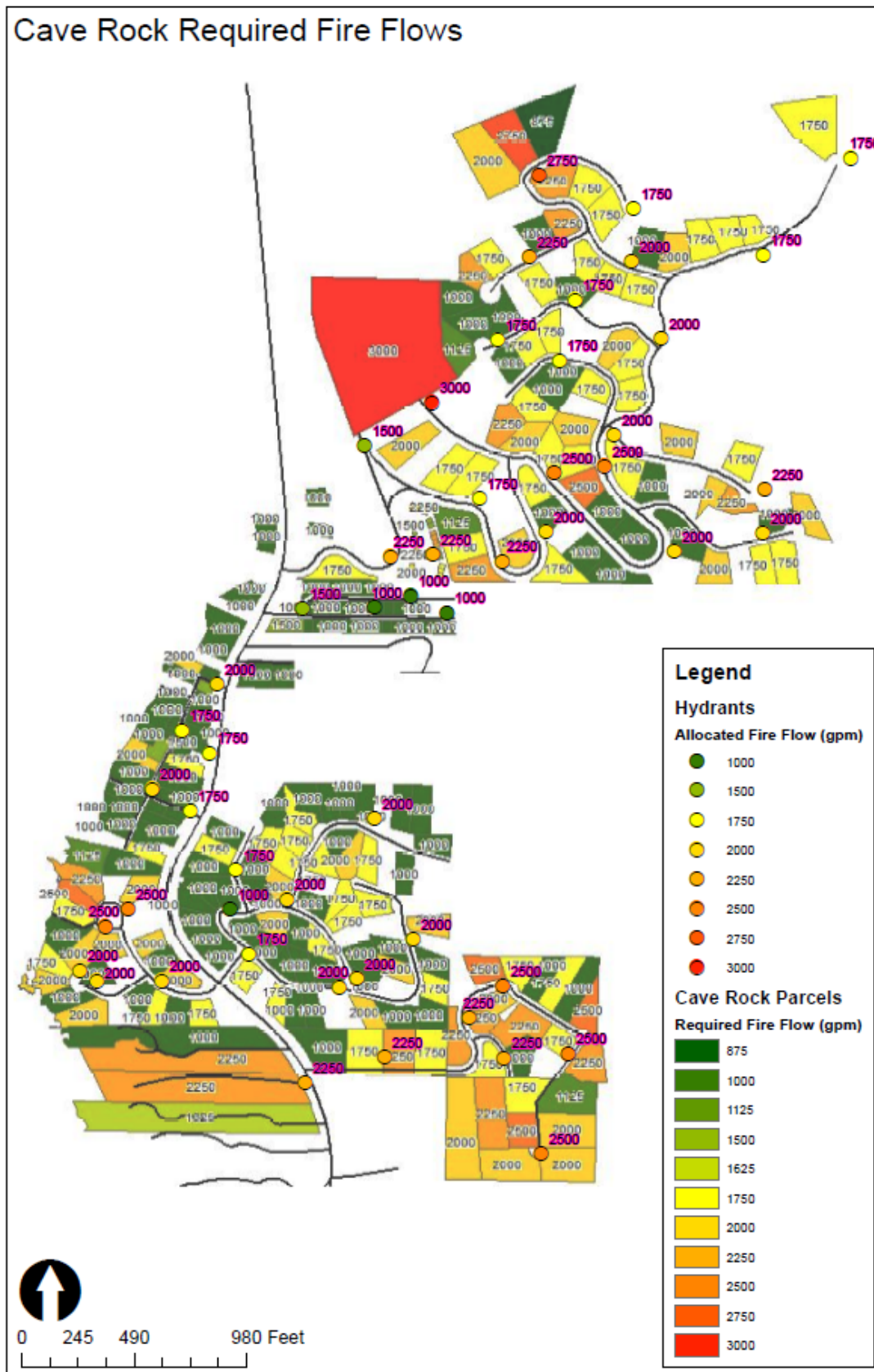

Figure 3-3 Cave Rock Fire Flow Requirements

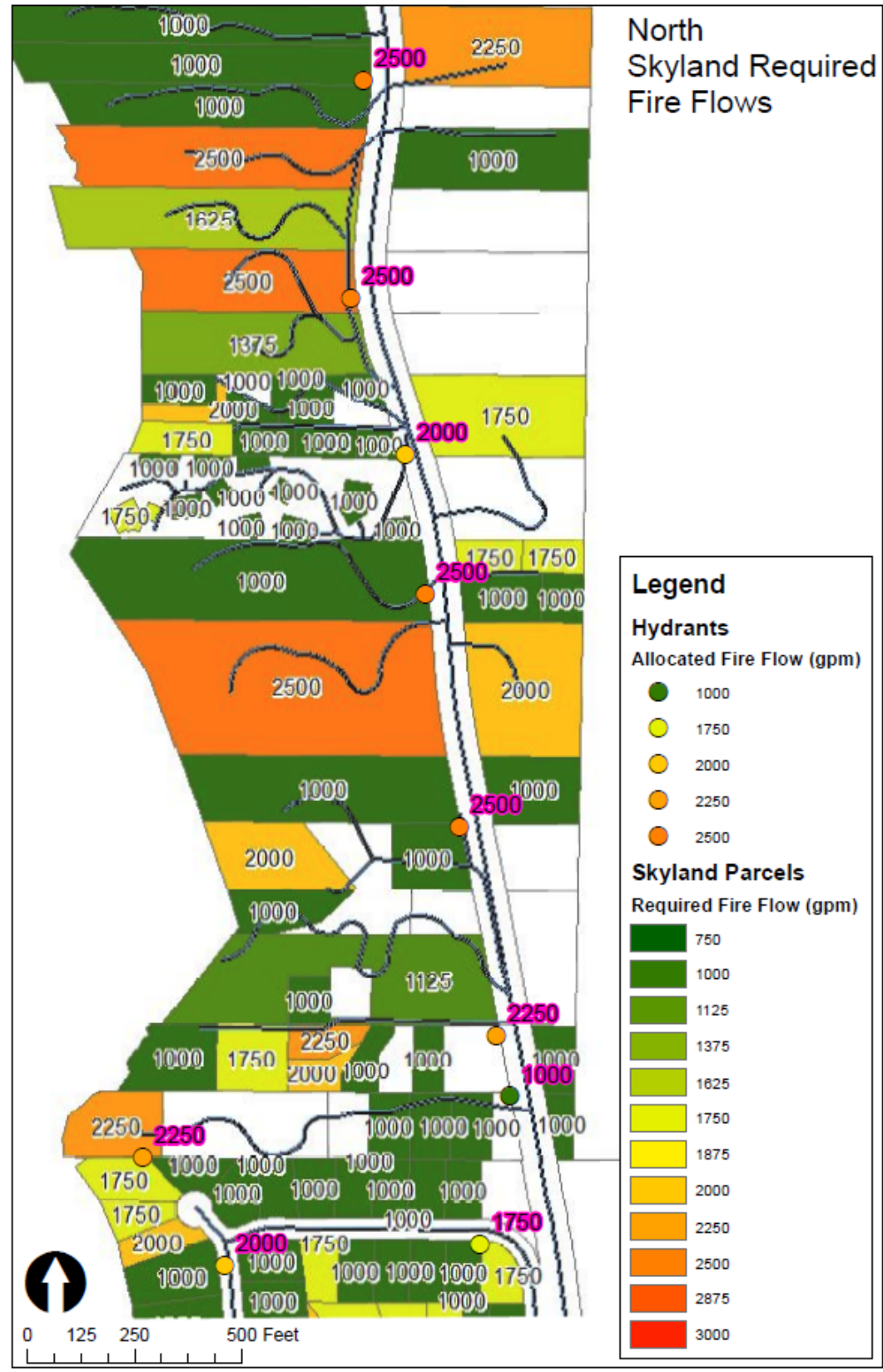

Figure 3-4 North Skyland Fire Flow Requirements

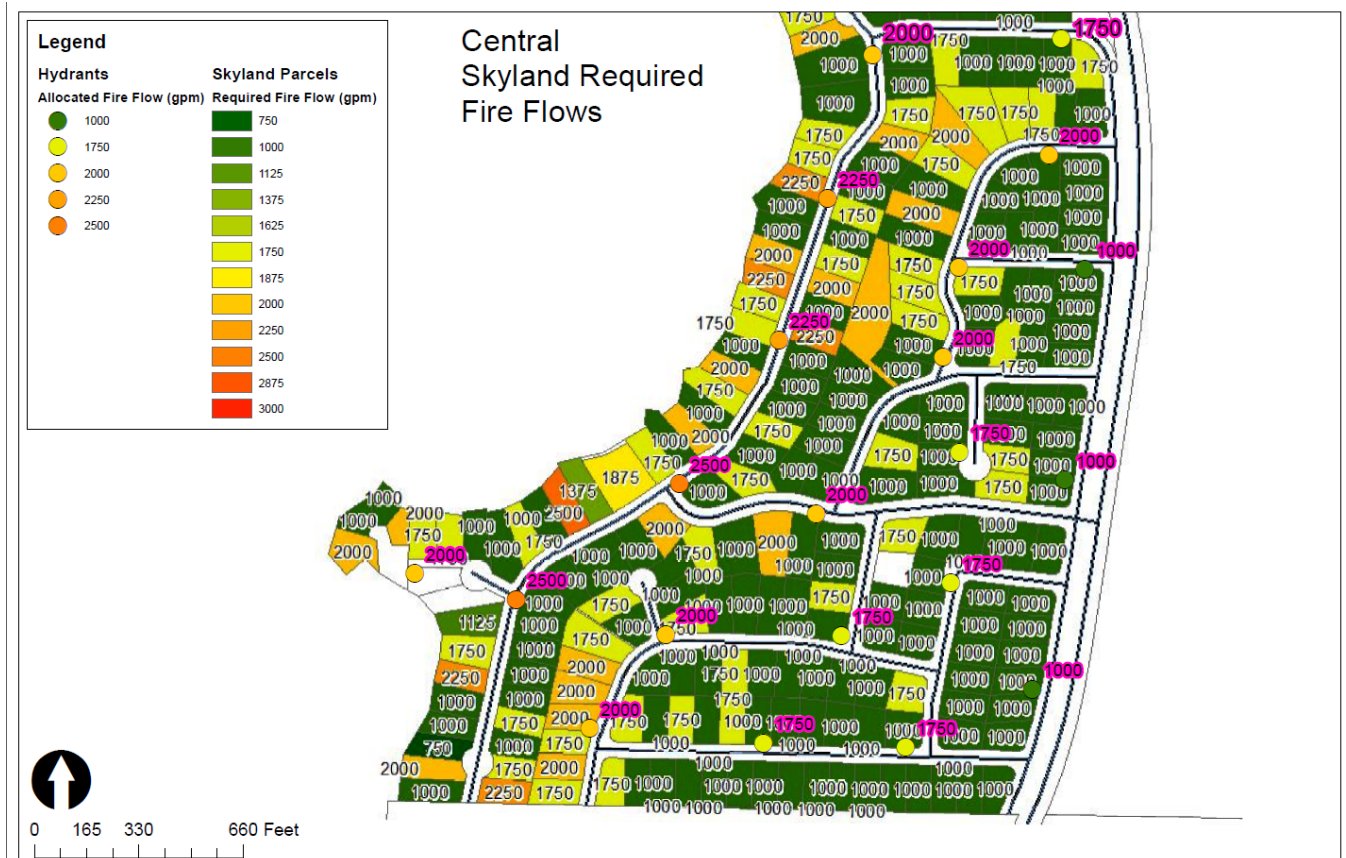

Figure 3-5 Central Skyland Fire Flow Requirements

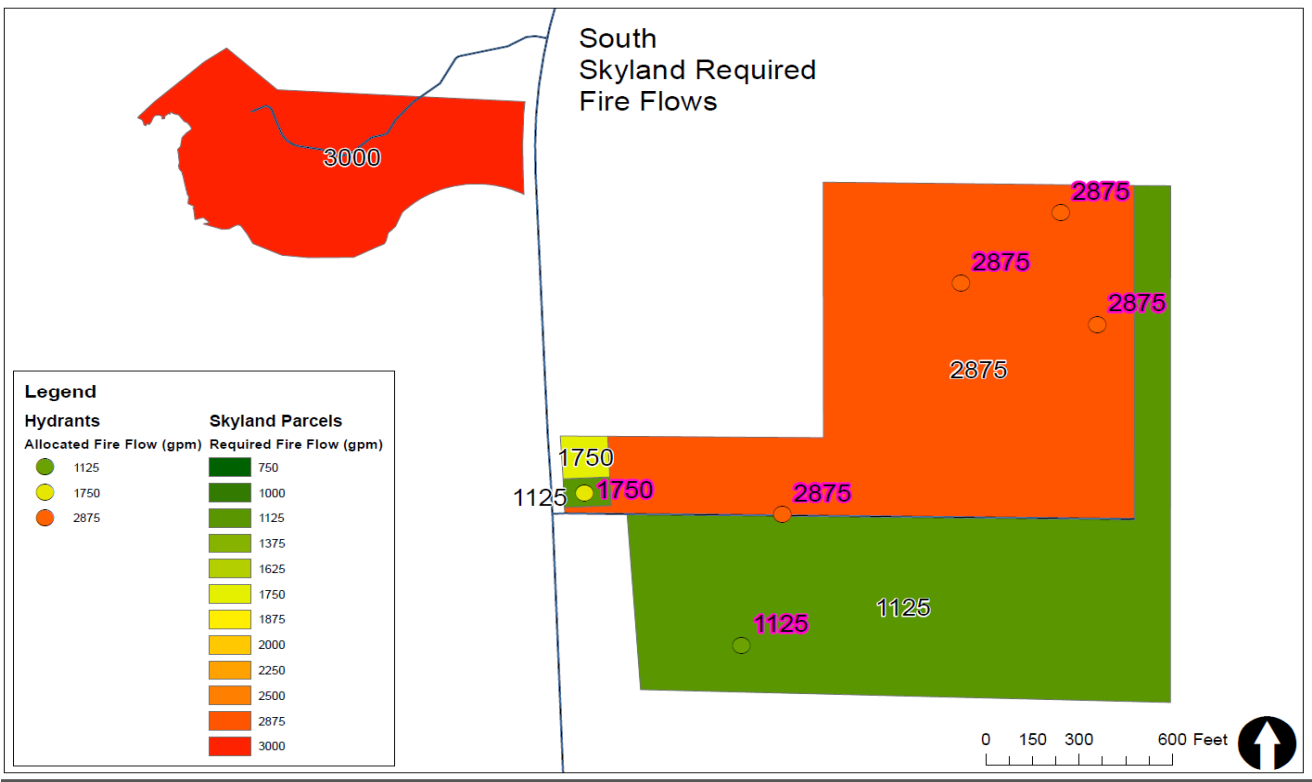

Figure 3-6 South Skyland Fire Flow Requirements

3.6.3 Water Meters

Currently only about 14 of the 300, or 4.7% of the services, are metered. Non-metered services are charged a flat rate, which does not promote water conservation. A water conservation plan is required under NRS 540.131, and the County has a water conservation plan. However, metering of all services is not listed under the Recommendations section of the plan.

3.6.4 Piping Condition

The original remaining distribution piping is in poor condition, as evidenced by the large number of leaks over the last 10 years. Original piping installation was very poor, and likely did not include much, if any, construction inspection. Pipe bedding and backfill was substandard, as it is not uncommon to find large rocks in the pipe bed zone. The following figure shows the location of leak repairs and replaced pipelines.

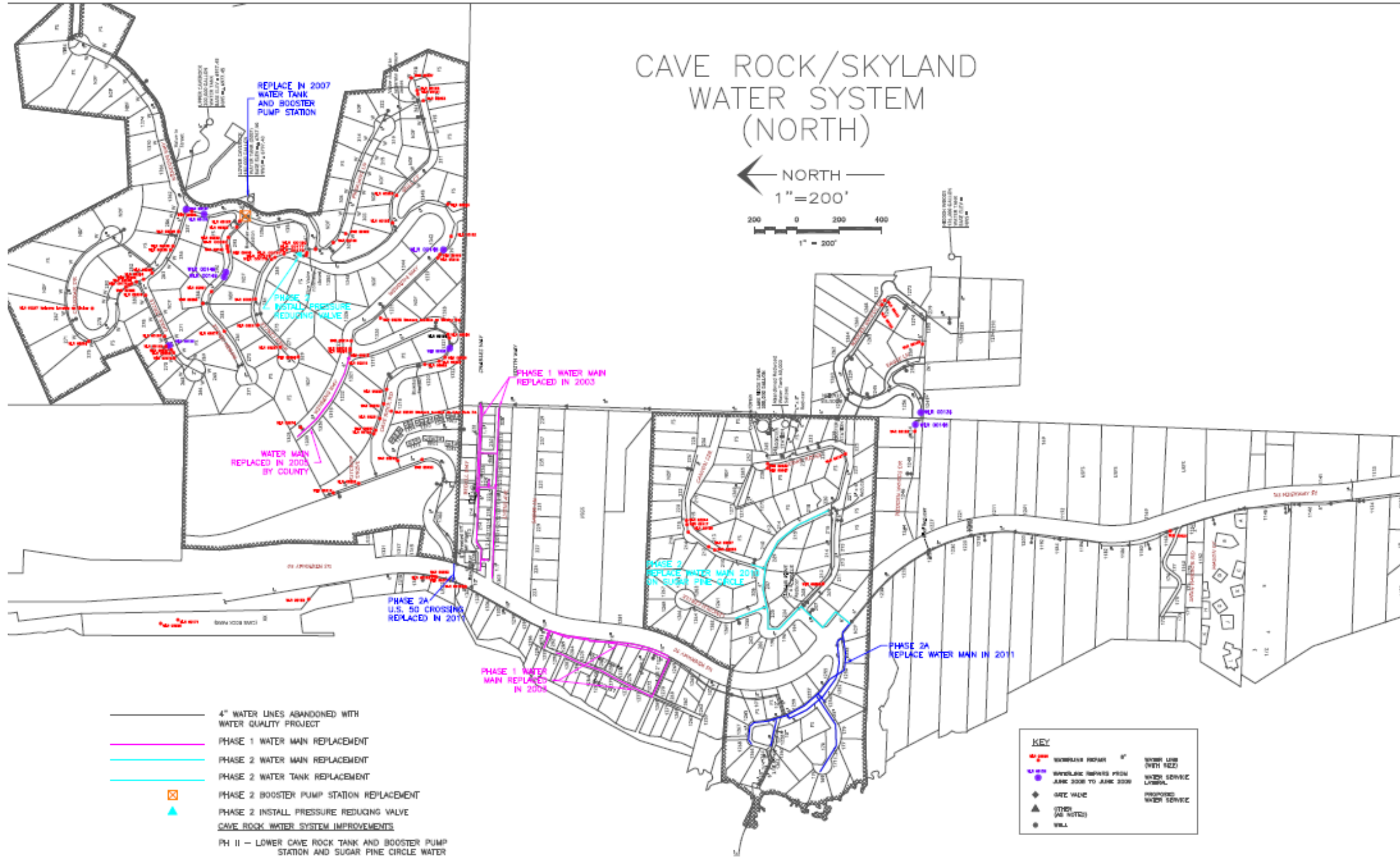

Figure 3-7 Leak Repair Map



Photo 3-4 Typical Failed Pipes

The County has documented the extensive leak history at Cave Rock, which is summarized in the following table:

Table 3-5. Leak History and Associated Costs

Year	Number of Identified Leaks		Leak Repair Cost ⁽¹⁾
	Cave Rock	Skyland	
2009	14	4	-
2010	8	0	\$ 32,043 (FY 2009-2010)
2011	15	0	\$ 66,017 (FY 2010-2011)
2012	19	2	\$ 117,495 (FY 2011-2012)

Year	Number of Identified Leaks		Leak Repair Cost ⁽¹⁾
	Cave Rock	Skyland	
2013	10	6	\$ 71,445 (FY 2012-2013)
2014	9	0	\$ 49,527 (FY 2013-2014)
2015	8	2	Not Available
Totals	83	14	-
Annual Avg.	12	2	\$ 67,305

Source: Douglas County Records

(1) Leak Repair Costs include Cave Rock, Skyland, and Uppaway

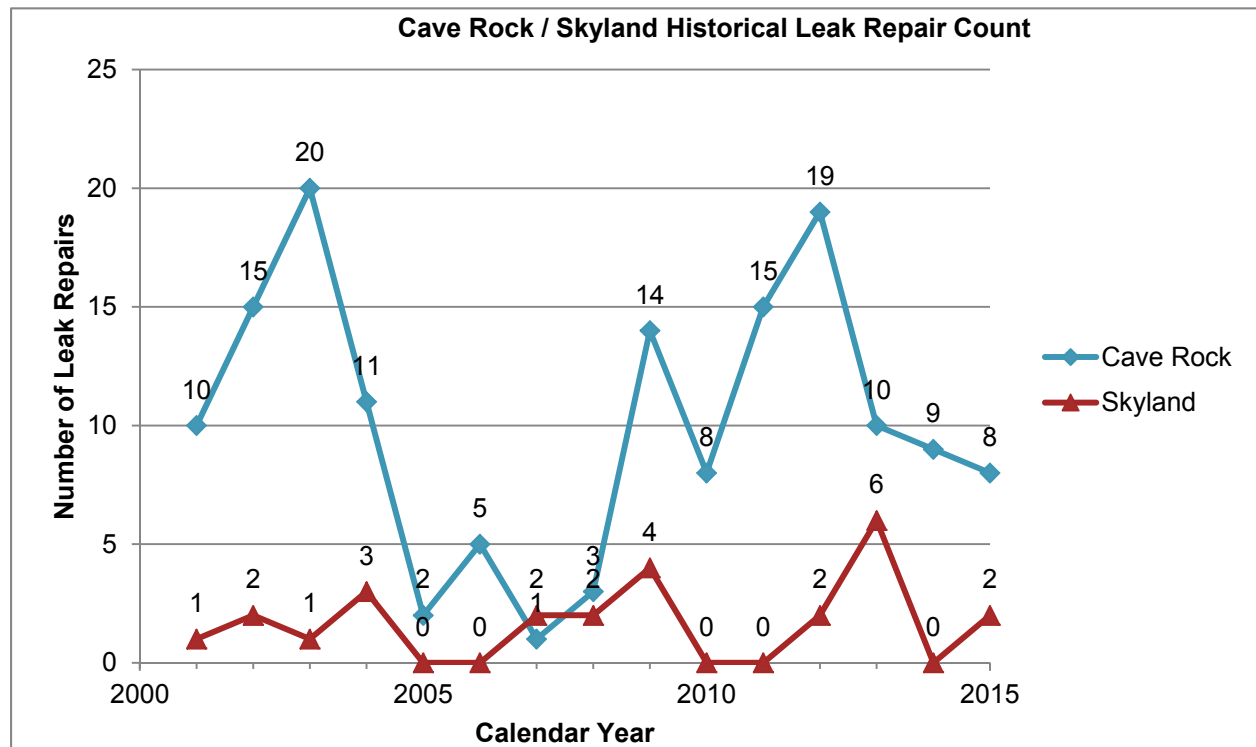

Figure 3-8. Cave Rock/Skyland Historical Leak Repair County

3.7 Water System Modeling

Douglas County provided a hydraulic model of the Cave Rock water distribution to HDR for modeling fire flows and system pressures. The model was analyzed and updated based on County water distribution system evaluation criteria. The modeling software package Bentley® WaterGEMS® V8i was used for this analysis.



Model Infrastructure

The County model contains the entire Cave Rock/Skyland water system including the Lake intake pumps, WTP, and distribution system. The model contains 518 facilities which are summarized in Table 3-6. The pipes are summarized in Table 3-7.

Table 3-6 Facility Inventory

Facility	Quantity
Pipes Segments	269
Pipe Junctions	228
Pumps	6
Pressure Reducing Valves (PRVs)	6
Pressure Sustaining Valve (PSV)	1
Flow Control Valve (FCV)	1
Tanks	5
Reservoirs	1

Table 3-7 Pipe Inventory

Material	Diameter (inch)	Length (feet)
Ductile Iron	2	300
Ductile Iron	3	58
Ductile Iron	4	4,208
Ductile Iron	6	31,094
Ductile Iron	8	15,898
Ductile Iron	10	472
Galvanized Iron	2	1,063
Polyvinyl Chloride	8	2,559
Polyvinyl Chloride	10	3,104
	Total	58,756

3.7.2 Water System Demands

In designing and analyzing water systems, a careful consideration of customer demand for water is crucial. It is standard engineering practice to evaluate three demand periods: Average Daily Demand (ADD), Maximum Daily Demand (MDD), and Peak Hour Demand (PHD). Table 3-8 provides a summary of the estimated ADD, MDD, and PHD rates used in the various model scenarios.

Table 3-8 Model Demands

Demand Scenario	Average Day Demand (gpm)	Maximum Day Demand (gpm)	Peak Hour Demand (gpm)
Total	292	564	1,379
Peaking Factor	1.0	1.4	5.0

Since growth in the service area is currently negative and there is very limited room for expansion of the system, current demands are considered adequate for representing future conditions.

3.7.3 Evaluation Criteria

Evaluation criteria for analyzing the model are based on the Nevada Administrative Code Section 445A, and Douglas County Design Standards, and are summarized in Section 3.6.1.

3.7.4 Pressure and Velocity

These criteria include minimum/ maximum pressures and velocities for the following flow conditions:

- Maximum Day Demand (MDD)
- Peak Hour Demand (PHD)
- MDD plus Fire Flow (MDD + FF)
- Average Day Demand (ADD)

Table 3-9. Evaluation Criteria

Criteria	Value	Units
MDD Min Pressure	40	psi
PHD Min Pressure	30	psi
MDD + FF	20	psi
ADD Max Pressure	100	psi
ADD Max Velocity	8	ft/s



Criteria	Value	Units
ADD + FF Max Velocity	10	ft/s

Fire Flow

Fire flow requirements were determined based on parcel data provided by the County, as summarized in Section 3.6.2. The resulting map and list of fire flow requirements per hydrant and model node are shown in Figure 3-3.

3.7.5 Existing System Analysis

The existing system was analyzed based on the evaluation criteria. Model simulations were run for ADD, ADD+FF, MDD, MDD+FF, and PHD. Tank levels were adjusted based on the type of analysis being run. For high pressure sensitive simulations, for example, ADD maximum pressure analysis, the level of the tanks were set to approximately 75 percent full.

All PRVs were allowed to open for fire flow simulations based on the assumption PRVs in the real world system are set to fully open in the event of a major pressure gradient is experienced in the direction of flow.

Table 3-10. Tank Levels during Model Scenarios

Tank	Elevation (Base) (ft)	Diameter (ft)	Percent Full (%)	Level (Initial) (ft)	Level (Maximum) (ft)	Level (Minimum) (ft)
Upper Cave Rock	6,937.45	29.66	75	28.5	38	0
Lower Cave Rock	6,767.50	33	75	21.9	29.2	0
Lakeridge	6,531.00	58	75	13.5	18	0
Skyland Tank	6,431.00	65	75	23.63	31.5	0
Hidden Woods	6,596.00	30	75	17.25	23	0

Results

Average Day Demand

Nineteen (19) model nodes were above 100 psi. Nodes with high pressure were located in the Cave Rock as shown in Figure 3-9.

Max Day Demand & Fire Flow

Eighty three (83) fire flow deficiencies were located throughout the Cave Rock and Skyland systems as shown in Figure 3-9.

Figure 3-9 Fire Flow & Pressure Deficiencies

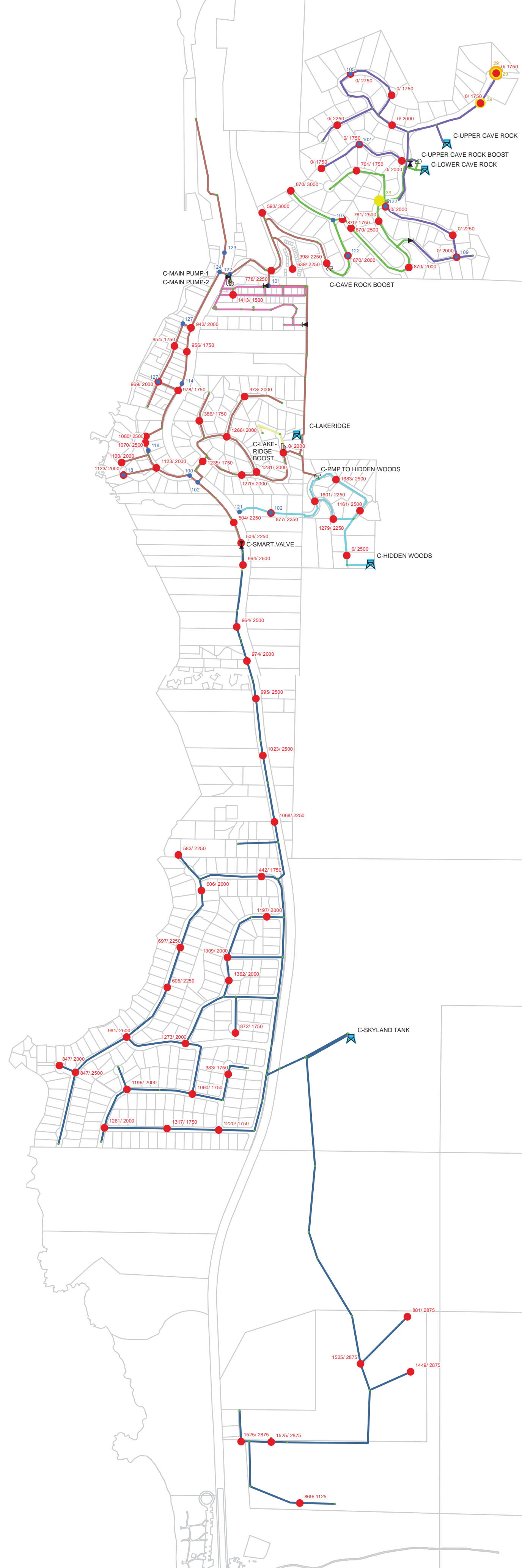

Legend

Deficiencies

- Average Day Demand Pressure > 100 psi
- Hydrants Not Meeting Criteria: Available/ Required Flow
- Max Day Demand Pressure < 40 psi
- Peak Hour Demand Pressure < 30 psi

Pipes by Zone

- C-ZONE-1a
- C-ZONE-1b
- C-ZONE-1c
- C-ZONE-1d
- C-ZONE-2
- C-ZONE-6
- New Subdivision

Facilities

- Tanks
- Pumps
- Flow Control Valve
- Pressure Reducing Valve
- Model Junctions

Max Day Demand

Two (2) model nodes have less than 40 psi pressure. These nodes are located in the far north eastern area of the Cave Rock system in Zone 1C, as shown in Figure 3-9.

Peak Hour Demand

One (1) model node has less than 30 psi pressure. This node is located in the far northeastern area of the Cave Rock system in Zone 1C, as shown in Figure 3-9.

- The model results indicate that the existing system as modeled does not meet the evaluation criteria

3.8 Water Storage Tanks

Cave Rock has five water storage tanks to meet the system demands including required fire flows, and domestic demands. Table 3-11 summarizes the volume and base elevation of these five tanks.

Table 3-11 Cave Rock Water Storage Tank Capacity and Base Elevation

	Tank Volume, gallons	Base Elevation, ft	Year of Construction
Lakeridge Tank	355,800	6,531	1996
Hidden Woods Tank	121,600	6,596	Not Known
Lower Cave Rock Tank	186,800	6,768	2007
Skyland Tank	782,000	6,431	2003
Upper Cave Rock Tank	196,000	6,937	1995

3.8.1 Condition

The Hidden Woods Tank was constructed of bolted steel and has base tank elevation of 6,596 ft. Inspection of the tank has not been possible due to access restrictions. The 2007 NDEP survey noted that the tank is not constructed to provide access for inspection and cleaning and the channel for the overflow is not properly air-gapped. The corrective action recommended to the County is to provide information on life expectancy and develop a plan to replace the tank.

The Skyland Tank was constructed in 2003 of welded steel and has base tank elevation of 6,431 ft. On October 16th, 2014, Blue Locker Commercial Diving Services, L.L.C. Performed a Cleaning and Inspection of the Skyland Tank for Douglas County Public Works. The condition assessment revealed that the tank is in good condition. The details of the assessment are in Appendix D.

The Lakeridge Tank was constructed in 1996 of welded steel and has a base tank elevation of 6,531 ft. On September 9th, 2013, Blue Locker Commercial Diving Services, L.L.C. performed a cleaning and inspection of the Lakeridge Tank. The

condition assessment revealed that the tank is in very good condition. The details of the assessment are in Appendix D.

The Upper Cave Rock tank was constructed in 1998 of welded steel and has a base tank elevation of 6,937 ft. On June 16th, 2015, Blue Locker Commercial Diving Services, L.L.C. performed a cleaning and inspection of the Upper Cave Rock Tank. The condition assessment revealed that the tank is in very good condition. A liner was installed in the tank in 2014/2015 to mitigate leaks. The details of the assessment are in Appendix D.

The Lower Cave Rock tank was constructed in 2007 of bolted steel and has a base tank elevation of 6,768 ft. On June 16th, 2015, Blue Locker Commercial Diving Services, L.L.C. performed a cleaning and inspection of the Lower Cave Rock Tank. The condition assessment revealed that the tank is in good condition. The inspection report notes that there may be possible compliance issues with overflow pipe that should be investigated and addressed. The details of the assessment are in Appendix D.

3.8.2 Regulatory Compliance

Tank Volume

Storage volume is covered under the following sections of the NAC 445A:

- 6674 – Storage Capacity
- 66745 – Operating Storage
- 6675 – Emergency Reserve

Douglas County shares the NAC 445A requirements for total storage volume, which for *new* systems is comprised of:

- Total Storage = Operating Storage + Emergency Reserve + Fire Demand.

Where:

- Operating Storage = Max day demand based on historical data, minus the system capacity to treat and pump water. Max day demand occurs in July and is approximately 574 gpm (1993 to 2014 data).
- Emergency Reserve = 75% of Operating Storage
- Fire Storage = 2,500 to 3,000 gpm for 2 hours

However, for *existing* systems, NAC 445A.6674 says “*An existing public water system maintains a storage capacity that, as determined by an engineer on the basis of historical data, accepted engineering judgment and a network hydraulic analysis, is sufficient to ensure that the total capacity of the public water system will meet current and anticipated demands for water while maintaining the pressures indicated in NAC 445A.6711.*”

Accepted practice for sizing storage tanks is to provide the greater of either;

- Equalization Storage (EQ) + Fire Flow Storage

Or

- 2 x EQ

Equalization storage refers to the volume needed to meet peak hour demands while production facilities are operating at design capacity. This is typically calculated as the difference between peak hour demand and max day demand for a period of 6 hours.

Fire flow storage is the required fire flow and duration, based on the Fire District requirements. In this case it is either 2,500 or 3,000 gpm for 2 hours. Table 3-12 shows the calculated storage volume required for each zone. The bold numbers represent the governing storage requirement.

Table 3-12. Storage Requirements by Zone

Zone	MDD ¹ (gpm)	MHD ² (gpm)	EQ ³ (gal)	Fire Vol ⁴ (gal)	2EQ ⁵ (gal)	EQ + Fire ⁶ (gal)
Skyland	311	398	31,368	360,000	62,736	422,736
Lakeridge	159	204	16,035	300,000	32,070	332,070
Hidden Woods	25	32	2,540	300,000	5,080	305,080
Lower Cave Rock	24	30	2,381	360,000	4,763	364,763
Upper Cave Rock	55	71	5,557	330,000	11,113	341,113
TOTAL	574	735	57,881	1,650,000	115,761	1,765,761

1 – Based on May to Sept pumpage data, 1992 to 2014

2 – Assumed 1.28 Peaking Factor on MDD

3 – Difference between MHD and MDD for 6 hours

4 – Per Fire District, 2,500 or 3,000 gpm for 2 hours

5 – 2 x EQ

6 – EQ + Fire Vol

Zone Transfers

Assuming there is no more than one fire in occurring in the system at a time, water can be transferred from the upper to the lower zones within the system. For example, water can be transferred from Upper Cave Rock to Lower Cave Rock, and from Lakeridge and Hidden Woods to Skyland tank.

Table 3-13 shows the surplus or deficit in storage for each zone, examined two different ways. Column 5 shows the surplus or deficit without considering water transfers between zones. As a whole, the system is 123,250 gallons deficient in storage capacity. This deficiency is primarily driven by the recent higher fire flow requirements. Using the historic 1,500 gpm fire flow results in a surplus of storage.

Column 6 shows the surplus and deficit considering zone transfers. For the purposes of this analysis, it is assumed that only half the total potential storage in the upper zone would be available to transfer to the lower zone. This accounts for the out of

zone demands and emergency reserves. Using this criteria, the system as a whole has a surplus of 274,400 gallons, but Hidden Woods, Lower and Upper Cave Rock zones are still deficient.

Table 3-13 Surplus/ Deficit Storage Requirement by Zone

Zone/Base EI	Existing Storage	Required Storage ¹	Other Available Storage ²	Surplus/ (Deficit) ³	Surplus/ (Deficit) ⁴
Skyland (6,431)	781,914	422,736	238,685	359,178	597,863
Lakeridge (6,531)	355,754	332,070	60,808	23,684	84,492
Hidden Woods (6,596)	121,616	305,080	0	(183,464)	(183,464)
Lower Cave Rock (6,766)	186,824	364,763	98,202	(177,939)	(79,737)
Upper Cave Rock (6,937)	196,403	341,113	0	(144,710)	(144,710)
TOTAL	1,642,511	1,765,761		(123,250)	274,444

All volumes in gallons.

1 – Per Table 3-12

2 – Based on transfer from higher connected zones, assumed half of total potential storage available.

3 – Assuming no zone transfers.

4 – Assuming zone transfers.

3.9 Booster Pump Stations

The following four booster pump stations are in service in the Cave Rock water distribution system:

- Lower Cave Rock Booster Station (underground)
- Upper Cave Rock Booster Station replaced in 2008
- Hidden Woods Booster Station (underground)
- Cedar Ridge Hydro-Pneumatic Station (above-ground)

3.9.1 General Overall Pumping Strategy

The treated water from the Cave Rock WTP is pumped to the Lakeridge Tank by the existing treatment plant high service pumps. A portion of the water pumped to Lakeridge Tank is conveyed to the Lower Cave Rock Tank by the Lower Cave Rock Booster Pumping Station. Some of this water is boosted again by the Upper Cave Rock Booster Pumping Station to the Upper Cave Rock Tank. Another portion of the water that is pumped to the Lakeridge Tank is conveyed to the Hidden Woods Tank by Hidden Woods Booster Pumping station. The Cedar Ridge Booster provides domestic pressure to homes on Cedar Ridge off the Lakeridge Tank.

The final portion of water that is not retained in Lakeridge Tank or pumped to the Lower Cave Rock or Hidden Woods Tanks flows into the Skyland Tank, controlled by the smart valve in Highway 50. This Flow Control Valve (FCV) modulates flow to the Skyland tank and prevents it from overflowing. It can also allow flow from Skyland tank back the other direction to feed Lincoln Park. Figure 3-10 illustrates the basic water system schematic.

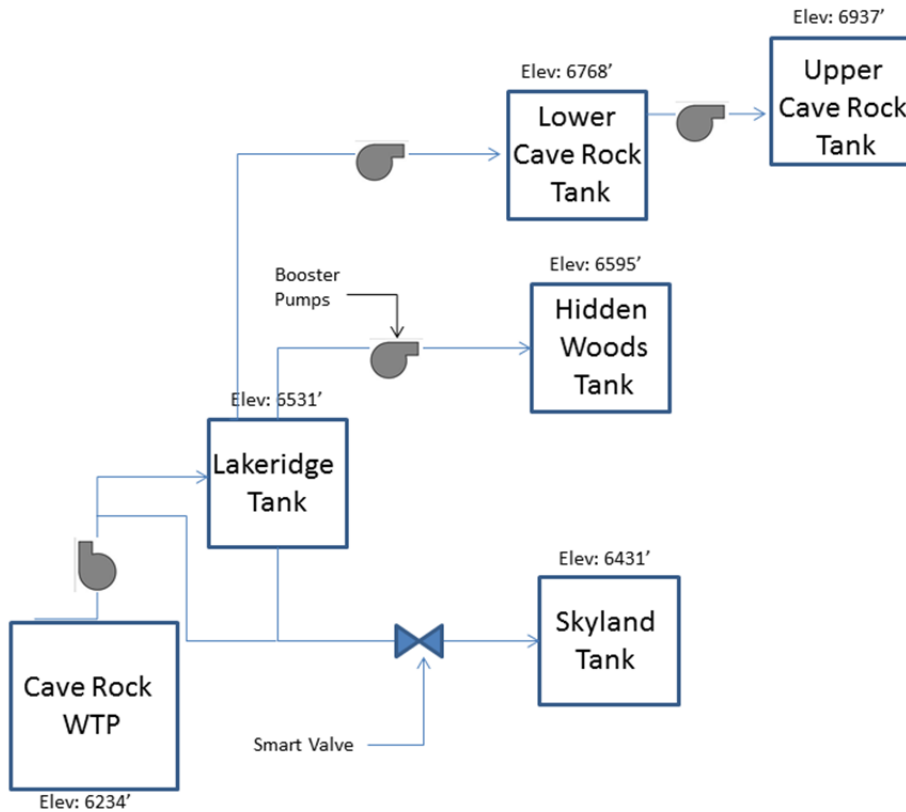

Figure 3-10 Cave Rock/ Skyland Water System Schematic

3.9.2 Condition/Regulatory Compliance

Lower Cave Rock and Hidden Woods booster stations are located in underground vaults. Based on a State of Nevada Sanitary Survey (2007, see Appendix D), these facilities do not meet state regulations and need to be replaced or eliminated. New facilities that meet current codes could be located either above or below ground.

The Cedar Ridge Booster Station consists of a hydro-pneumatic tank with a pump that pressurizes the tank and serves the upper Cedar Ridge area. This hydro-pneumatic station has limited capacity and provides no fire flow. This facility also needs to be replaced to meet current standards, or eliminated.

3.10 Water Treatment Plant

The Cave Rock-Skyland Water Treatment Plant (WTP) was built in 1997, and serves both the Cave Rock and Skyland water systems. The plant has a design capacity of 1.25 mgd (875 gpm) and utilizes microfiltration in addition to chlorine contact to meet all State and Federal requirements under the Surface Water Treatment Rules.

The microfiltration equipment consists of one large primary treatment skid , and one smaller skid to treat the backwash water, for a higher overall yield , and greater treatment efficiency. Only waste from the backwash water skid is released to the sewer.

The membranes installed are manufactured of polypropylene, which is not resistant to chlorine. They were replaced in kind in approximately 2012. Evoqua’s new “N” series membranes are constructed of PVDF, which is chlorine resistant and operates at a lower feed and backwash pressure. The result is lower power costs and less BW waste. However, converting to the new membranes would require new feed and backwash equipment.

The plant has two flow set points, which are maintained by a modulating valve on the filtrate discharge. The low setpoint, approximately 500 gpm, is used during the winter months. The high setpoint of 800 gpm is used for summer demands. The controls will automatically switch between low and high modes based on Lakeridge tank level setpoints.

The following table summarizes the microfiltration equipment design parameters.

Table 3-14 Microfiltration Equipment Parameters

Parameter	Value
Primary Treatment Skid	Memcor 90M10C
Filtrate Flow	1.25 MGD
Backwash Water Skid	Memcor 6M10C
Filtrate Flow	22 gpm
Maximum Design Flux	7.5 gpd/SF
Clean Membrane TMP	8.5 psi
Backwash Interval	Every 70 minutes
Clean-in-Place (CIP) Interval	30 days, or as required by TMP, which ever occurs first.
Clean-in-Place (CIP) Chemicals	0.5 – 1% Citric Acid



3.11 Sanitary Surveys

Nevada Division of Environmental Protection (NDEP) last conducted a sanitary survey of the water system on 10 September, 2015. A subsequent letter from NDEP dated September 29, 2015 identified 3 items as an observation/recommendation. The following table summarizes the deficiencies noted by NDEP. It should be noted that the County has a Cross-Connection Control Program, reference Title 20 Backflow and Cross-Connection Control Ordinance.

Table 3-15 Summary of Sanitary Survey Deficiencies

No.	Area	Relevant Codes	Description
1	System Management and Operation	NAC 445A.671 85	System must have and implement a current cross-connection control program
2	Distribution System	-	Observations of frequent rate of leak repair, particularly in old steel mains
3	Intake	-	Discussed lowering lake levels and intake screen depth

NDEP sanitary surveys from 2007 through 2015 are included in Appendix D.

3.12 Financial Status of Existing Facilities

3.12.1 Audit Information

A Comprehensive Annual Financial Report (CAFR) is completed annually for the County which outlines the financial activities over the past fiscal year. The details of the utilities financial review are included as part of the CAFR as a major enterprise fund. The CAFR provides a summary of the Cave Rock & Skyland’s financial position. The full CAFR is available on the County’s website. For the analysis completed for the plan, the FY 2013/14 CAFR was reviewed which was the most recent year available at the beginning of the study. Shown below in Table 3-14 is a summary of the FY 2013/14 CAFR review for the County’s Cave Rock and Skyland water systems.

Table 3-16 FY 13/14 CAFR Summary (July 1, 2013 – June 30, 2014)

	Budget		Actual		Variance	
	Cave Rock ^[1]	Skyland	Cave Rock ^[1]	Skyland	Cave Rock ^[1]	Skyland
Operating Revenues	\$771,000	\$420,500	\$773,759	\$423,861	\$ 2,759	\$3,361
Operating Expenses	<u>\$735,551</u>	<u>\$420,545</u>	<u>\$650,826</u>	<u>\$364,705</u>	<u>\$84,725</u>	<u>\$55,840</u>

	Budget		Actual		Variance	
Operating Bal/(Def)	\$35,449	(\$45)	\$122,933	\$59,156	\$87,484	\$59,201
Plus: Non-Op Rev/(Exp)	(\$76,508)	(\$19,800)	(\$53,516)	(\$11,619)	\$22,992	\$8,181
Plus: Contributed Capital	\$0	\$0	\$27,508	\$43,779	\$110,476	\$43,779
Plus: Transfers In	<u>\$1,750</u>	<u>\$1,245</u>	<u>\$1,750</u>	<u>\$1,245</u>	<u>\$0</u>	<u>\$0</u>
Change in Net Position	(\$39,309)	(\$18,600)	\$98,675	\$92,561	\$137,984	\$111,161

3.12.2 Income

The primary source of income for both systems is through user rates. The budgeted water user fees are based on the current rate schedules for the water system and the number of metered and unmetered customers. In addition to user rates, additional sources of income include late charges, loan proceeds and rent/lease income along with interest on current investments. Shown below in Table 3-17 is a summary of Cave Rock & Skyland's current budgeted FY 2014/15 O&M expenses.

Table 3-17 Summary of Annual Income (FY 14/15 Budget)

Account #	Account Description	Cave Rock Budget ^[1]	Skyland Budget
344.850	Water User Fees	<u>\$713,400</u>	<u>\$359,000</u>
	Charges for Service Totals	\$713,400	\$359,000
360.810	Late Charges	\$1,000	\$500
360.750	Loan Proceeds	\$135,726	\$194
362.100	Rent/Lease Income	<u>\$31,680</u>	<u>\$0</u>
	Other Financing Sources Totals	\$168,406	\$694
361.200	Interest on Investment	<u>\$800</u>	<u>\$400</u>
	Totals Revenues	\$882,606	\$360,788

[1] – Budget includes Uppaway system costs as system financials are combined

3.12.3 Rate Schedule

HDR reviewed the current water rate schedule for the Cave Rock and Skyway Water Utilities. Currently, residential customers have a flat monthly charge and are not charged any volumetric component. Cave Rock has 292 residential customers and consumption is unknown as customers are unmetered. For commercial customers, there is a monthly fixed charge and volumetric consumption charge on a per 1,000



gallon basis. For Cave Rock, there are 4 metered commercial customers with approximately 703,000 gallons of consumption (in FY 2013/14) and 3 metered irrigation customers that are charged similarly to commercial metered with a fixed monthly charge and a volumetric consumption charge. For irrigation, annual consumption is approximately 571,000 gallons.

For the Skyland system, there are 242 residential customers and again consumption is unknown as they are not metered. For commercial customers, there are 11 which had a combined annual consumption of 3,101,000 gallons (in FY 2013/14) and for irrigation customers there are 5 with an annual water consumption of 4,481,000 gallons. A summary of the current water rates (as of July 1, 2015) for the Cave Rock and Skyland water systems are shown below in Table 3-18 and Table 3-17, respectively.

Table 3-18. Summary of Cave Rock Current Monthly Water Rates

Meter Size	Residential – Flat	Commercial - Metered	Irrigation – Metered
5/8 inch	\$195.37	\$89.12	\$51.39
3/4 inch	\$195.37	\$89.12	\$51.39
1 inch	\$488.42	\$222.80	\$128.51
1-1/2 inch	\$976.83	\$445.59	\$256.99
2 inch	\$1,562.93	\$712.96	\$411.18
3 inch	N/A	\$1,425.91	\$822.37
4 inch	N/A	\$2,227.98	\$1,284.96
<u>Volumetric Charge</u>			
\$ per 1,000 gallons Used		\$6.56	\$6.56
# of Customers	292	4	3
Consumption (1,000 gallons)	n/a	703	571

Table 3-19 Summary of Skyland Current Monthly Water Rates

Meter Size	Residential – Flat	Commercial - Metered	Irrigation – Metered
5/8 inch	\$84.56	\$44.04	\$41.21
3/4 inch	\$84.56	\$44.04	\$41.21
1 inch	\$196.73	\$94.46	\$76.39
1-1/2 inch	\$383.65	\$178.52	\$135.02
2 inch	\$607.98	\$279.38	\$205.39
3 inch	N/A	\$548.35	\$393.03
4 inch	N/A	\$850.94	\$304.11
<u>Volumetric Charge</u>			
\$ per 1,000 gallons Used		\$2.73	\$2.37
# of Customers	242	11	5
Consumption (1,000 gallons)	n/a	3,101	4,481

3.12.4 Metering Customers

A key component of rate setting is the ability to provide the customer with a price signal that reflects the impacts (costs) placed on the system by their consumption. This is typically accomplished through the use of metered rates. However, not all utilities have meters on all customers, and as a result charge a flat rate that reflects the average customer use based on metered customers. Given the recent drought in the western United States, which has highlighted water resource management, a renewed interest in metering customers has been emphasized. Although the transition to metered water service and rates can be costly and demanding, it can be a process that ends with the utility and the customer understanding the cost impacts placed on the system during peak use periods and the infrastructure necessary to provide service. Given the increased visibility of metered rates, the County has been considering a transition to metered rates and has started to evaluate the alternatives.

Capital Cost and Rate Adjustments

The first item to consider would be the initial capital investment as it is the first step in implementation and there is a substantial financial burden at onset. Many utilities will be challenged by the cost of the metering program but this can be mitigated by strategic planning. It is most likely to be a phasing in approach where meters are replaced over a period of years, not necessarily in a single year. The final meter implementation plan typically reflects the available funding for the capital investment in meters. With the advent of meters comes the necessity of a residential metered

rate, similar to commercial and irrigation. The structure would be designed to meet the County's rate design goals and objectives (i.e. conservation, revenue stability, etc.).

Also, there would need to be rate adjustments to provide the additional funding to finance the meter purchases and installation. Reserve funds can also play a pivotal role in storing up funds and then dispersing them as the program requires them. The reserves are then typically restored over time to maintain prudent minimum reserve levels.

Conservation

Currently, the amount of water used is not apparent to customers as there is no volumetric component. This can lead to a greater use of water, and some may argue, wasteful use. However, the "waste" may be inadvertent because customers do not have an avenue to monitor their own use.

Reduction in Use

Another key aspect to include in the analysis is the anticipated reduction in per capita water usage as customer's transition to metered rates and reduces consumption. This can impact rate revenue but it can also provide for additional available capacity for the District's system which may defer future capital needs for water supply and push them out a number of years which results in cost savings for the utility in the short term. It can also save money in the area of source of supply. The reduced use can result in the delay of source of supply projects or the avoidance of purchasing water from other purveyors, depending on the water supply portfolio of the District.

System Leaks

Another aspect of metering customers is the ability to detect leaks in the system. As meters are placed in service the County will be able to compare total production to total metered sales and begin to gain an understanding of the unaccounted for water on the system and develop a plan to minimize the water loss. These losses may occur on the distribution system or on the customer owned facilities.

Funding

Finally, the metering of water customers is becoming a "mandatory" requirement as many grant and low interest loan applications are requesting the utility to note if customers are billed on a metered rate. By metering customers the ability to obtain future low interest loans or grants may be enhanced. It should be noted that there are additional funding sources that may be utilized in order to minimize rate impacts from the cost of metering customers. The lowest cost funding available are grant and low interest loan programs. However, these programs are becoming more difficult to obtain given availability of funds, the 'competition' for them with other utilities, as well as the County's eligibility to meet the requirements. Each program has different eligibility requirements and projects that can be funded from the program. It should also be noted that the full project cost will most likely not be funded through grants or low interest loans and other sources of funding will be necessary. These can be

other low interest loan programs, existing reserves, rate funded, or additional long-term debt. Other utilities in the Tahoe Basin have recently been successful in receiving grant and low interest loan funding to assist in funding the installation of meters over the next several years.

3.12.5 Annual O&M Cost

The goal of all utilities is to operate the system in a way that provides service to it's customers into perpetuity. A large component of this is the annual operations and maintenance (O&M) expense to maintain and operate the water system. As with all costs, the O&M costs will typically increase with time due to inflationary measures. Costs can also increase due to additions like new FTE's, programs, or other. Because the annual O&M costs are anticipated to increase with time, it is important to model this trend as best as possible and then plan accordingly by adjusting rates to have the capacity to adequately fund the utility's budgeted O&M. Shown below in Table 3-18 is a summary of Cave Rock and Skyland's budgeted FY 2014/15 O&M expenses.

Table 3-20. Summary of Annual O&M Costs

	Salaries & Wages	Employee Benefits	Services & Supplies	Total O&M Expenses
Cave Rock ^[1] - O&M Expenses	\$121,534	\$48,478	\$333,286	\$503,298
Skyland - O&M Expenses	\$77,185	\$30,408	\$166,415	\$274,008

[1] – Cave Rock O&M costs include Uppaway's costs

3.12.6 Energy Costs

When reviewing Cave Rock & Skyland's historical energy costs, it was noted that they had a slight decrease for Cave Rock in kWh in CY 2013 and the 11 months of CY 2014 are showing the same downward trend from CY 2012 levels. For the Skyland system, it appears to have bounced back to the CY 2012 levels after decreasing in CY 2013. For FY 2015/16, energy costs are budgeted at \$46,350 for Cave Rock and \$30,900 for Skyland. Shown in Table 3-21 is a summary of the energy costs.

Table 3-21 Annual Energy Costs ⁽¹⁾

Year	Annual Usage (kWh)		Annual Energy Costs	
	Cave Rock ^[1]	Skyland	Cave Rock ^[1]	Skyland
CY 2012	608,140	334	\$50,320	\$467
CY 2013	569,749	273	\$47,740	\$462
CY 2014 ⁽²⁾	539,005	347	\$44,142	\$609



Year	Annual Usage (kWh)	Annual Energy Costs
(1)	Dated from the NVEnergy billing Jan 2012 – Nov 2014	
(2)	2014 uses the 11 months as provided by the County and the average for December from the previous 2 years	

[1] – Cave Rock energy usage and costs include Uppaway’s portion

In additional to the summary shown above, the monthly power usage is shown below to further aide in analyzing power costs. Shown in the Figure below is a summary of the monthly power use for CY 2012 – CY 2014 for both water systems.

Figure 3-11. Monthly Energy Usage – Cave Rock

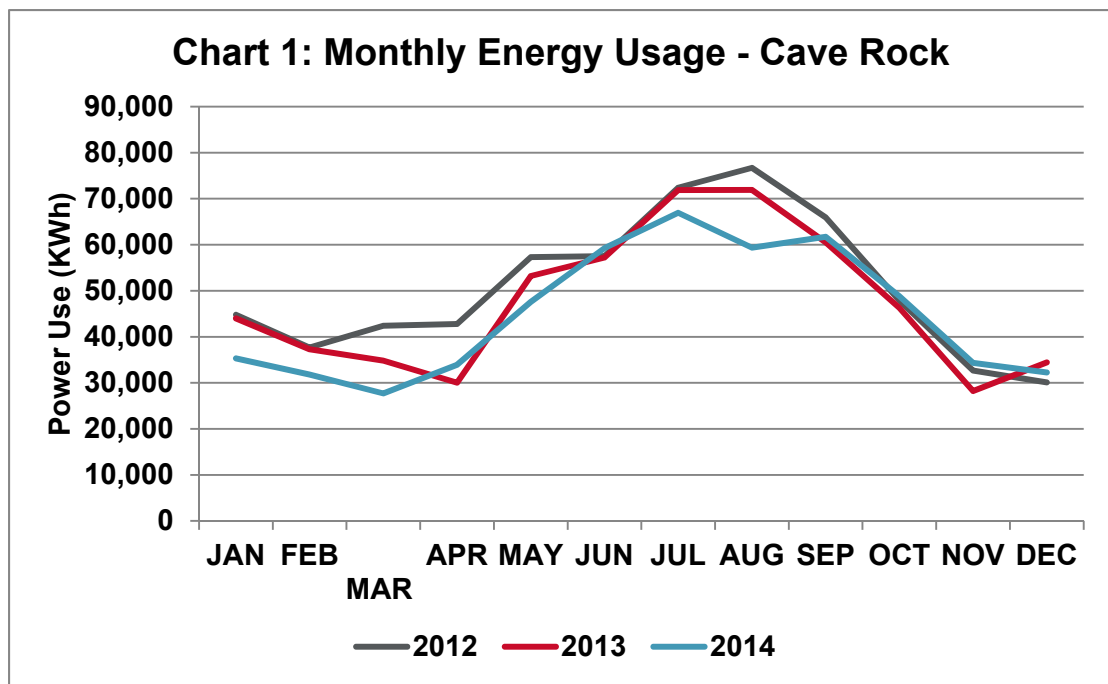
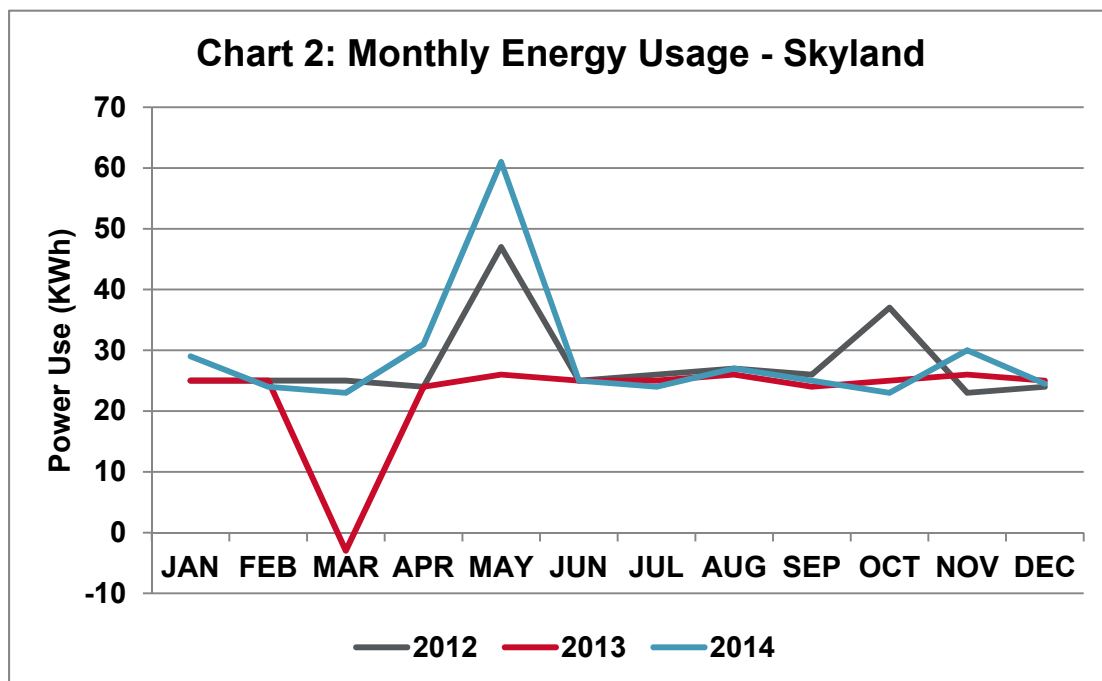

Figure 3-12. Monthly Energy Usage – Skyland



3.12.7 Capital Improvements Program

The County’s Cave Rock and Skyland water system’s CIP for FY 2015/16 through FY 2020/21 is summarized in the Tables below.

Table 3-22 Cave Rock Capital Improvement Budget (\$000s)

	FY 14/15	FY 15/16	FY 16/17	FY 17/18	FY 18/19	FY 19/20
Treatment Plant – Redundancy ^[1]	\$0	\$0	\$39	\$527	\$0	\$0
Water System Improv. Phase 2B	\$0	\$0	\$128	\$1,187	\$1,083	\$0
Water Distribution System Improv.	\$0	\$0	\$0	\$264	\$1,354	\$3,501
Replace Hidden Woods Tank	<u>\$0</u>	<u>0</u>	<u>\$0</u>	<u>\$0</u>	<u>\$0</u>	<u>\$1,669</u>
Total Capital Projects	\$0	\$0	\$167	\$1,978	\$2,437	\$5,170

[1] – Project contains only Cave Rock’s proportion (50%)

Table 3-23 Skyland Capital Improvement Budget (\$000s)

	FY 14/15	FY 15/16	FY 16/17	FY 17/18	FY 18/19	FY 19/20
Treatment Plant – Redundancy ^[1]	\$0	\$0	\$39	\$527	\$0	\$0
Budgeted Capital Projects	\$77	\$0	\$0	\$0	\$0	\$0



	FY 14/15	FY 15/16	FY 16/17	FY 17/18	FY 18/19	FY 19/20
Water Distribution System Improv.	<u>\$0</u>	<u>\$0</u>	<u>\$0</u>	<u>\$0</u>	<u>\$271</u>	<u>\$3,615</u>
Total Capital Projects	\$77	\$0	\$39	\$527	\$271	\$3,615

[1] – Project contains only Skyland’s proportion (50%)

3.12.8 Debt Repayments

Currently, Cave Rock has three debt obligations: 2005 revenue bond, 2009 SRF loan, and 2012 revenue bond. Skyland, on the other hand, has just two obligations, the 2005 revenue bond and the 2009 SRF loan. For both systems, the 2005 revenue bond is retired in FY 2015/16 which results in a reduction of annual debt service of approximately \$16,000 and \$24,000 for Cave Rock and Skyland, respectively. Table 3-229, shows a summary of the current debt service for the current budget year and a 5-year projected period for Cave Rock and Table 3-23 shows the same detail for Skyland.

Table 3-24 Cave Rock Debt Obligations (\$000s)

	FY 14/15	FY 15/16	FY 16/17	FY 17/18	FY 18/19	FY 19/20
2005A Water Refunding Bond	\$15	\$16	\$0	\$0	\$0	\$0
2009 SRF Loan	\$151	\$155	\$155	\$154	\$154	\$154
2012A Water Refunding Bond	<u>\$106</u>	<u>\$147</u>	<u>\$148</u>	<u>\$149</u>	<u>\$149</u>	<u>\$149</u>
Total Capital Projects	\$273	\$318	\$302	\$303	\$303	\$303

Table 3-25 Skyland Debt Obligations (\$000s)

	FY 14/15	FY 15/16	FY 16/17	FY 17/18	FY 18/19	FY 19/20
2005A Water Refunding Bond	\$24	\$24	\$0	\$0	\$0	\$0
2009 SRF Loan	<u>\$29</u>	<u>\$29</u>	<u>\$29</u>	<u>\$29</u>	<u>\$29</u>	<u>\$29</u>
Total Capital Projects	\$53	\$54	\$29	\$29	\$29	\$29

Table 3-22 shows that the 2009 SFR Loan and the 2012A Bond continue throughout the review period. This means shows that a significant portion of the current debt for Cave Rock will need to be serviced and care should be taken to maintain strong Debt Service Coverage (DSC) ratios. For the Skyland system debt shown in Table 3-23, the 2009 SRF Loan continues over the review period and represents approximately half of the system’s debt service. As shown in Tables 3-22 & 3-23, it can be seen that the 2005A Water Refunding Bond is retired in FY 2016. This would allow the County the ability to fund future capital improvements through means that the County can add addition new long-term borrowing up to the level that of the annual debt service payment of the 2005A bond, or does not exceed approximately

\$40,000, and there would be no net impact to current rate levels. However, if additional long-term borrowing is necessary to fund the project(s) in the future and the annual debt service exceeds that amount, the balance would most likely need to be funded through increases in user rates. The County should proactively manage the retirement of the existing long-term debt with regards to timing large capital projects to maximize available funding sources and leverage capital funding prudently.

3.12.9 Reserve Funds

An important component of a utility financial health is maintaining prudent reserve ending balances. There are many different types of reserve funds and numerous objectives that can be accomplished with them. Currently, the Cave Rock and Skyland water systems have three financial reserves: operating, capital, and emergency. The County also has a set of existing financial policies to guide the maintenance of the reserve funds for the operating reserve, the capital reserve, and the emergency reserve.

For the operating fund, the County currently has a minimum level at 60 days of O&M expenses with a goal of 90 days. This figure is targeted in order to provide funding for the utilities operations, should there be a shortfall due to perhaps a wetter summer than normal or decreased rate revenues. The target for Cave Rock for FY 2015 is \$124,000 which is currently being met and exceeded by the ending fund balance. For Skyland, the targeted is approximately \$67,000 for FY 2015 and this is also being met and exceeded.

Next is the County's capital reserves for the two systems, which holds loan and bond proceeds as well as other capital-related revenues such as connection fee revenue. Currently, the County's policy for the capital reserve ending balance is 2.0% of the total (original) cost of utility fixed assets. Again this is to provide funding should an anomaly occur for the utility but with regards to capital infrastructure. For instance, if a major water main bursts and a sudden need for a large amount of cash for repairs is required. This allows the utility greater resiliency during those times and to limit the loss of service for the customers as a result of cash flow issues.

The final reserve is for emergencies. This reserve, as the name implies is to cover unexpected emergencies and is similar in nature to the objective of the capital fund but is more intended for small scale equipment failures rather than system-wide. The minimum emergency reserve balance is \$50,000 with a goal of \$75,000. The County is currently meeting the minimum balance for both the Cave Rock and Skyland systems.

Shown below is the beginning reserve fund balances from the current FY 2014/15 budget (beginning reserve balance July 1 2014) for Cave Rock and Skyland.



Table 3-26 Beginning Reserve Fund Balances (\$000s)

	Cave Rock	Skyland
Operating Reserves	\$393	\$291
Capital Reserves	\$573	\$185
Emergency Reserves	\$50	\$50

4 Need for Project

The evaluation of the existing system in Section 3 identified various needs or deficiencies for the water system. These needs are categorized under the following general categories. Note that some needs could be classified under more than one category.

4.1 Summary of Need for Project

Based on the results of the condition assessment, operational issues, and water model results described in Section 3.7, the treatment, distribution, and storage systems have the following deficiencies which need to be addressed.

Table 4-1 Summary of System Deficiencies

No.	Deficiency	Relevant Codes	Requirement/ Goal	Existing Condition ⁽¹⁾
1	Fire Flow	Fire Authority/ NFC County 4.1.3	1,500 to 3,000 gpm	<3,000 gpm
2	Minimum Distribution Pressure – FF + Max Day Demand (MDD)	NAC 445A.6672 County 4.1.1	20 psi	<20 psi
3	Minimum Distribution Pressure – Peak Hour Demand	NAC 445A.6672 County 4.1.1	30 psi	<30 psi
4	Minimum Distribution Pressure – MDD	NAC 445A.6672 County 4.1.1	40 psi	<40 psi
5	Maximum Velocity (All conditions except fire flow)	NAC 445A.6672/ County 4.1.4	8 fps	>8 fps
6	Maximum Velocity (Fire Flow + ADD)	County 4.1.4	10 fps	>10 fps
7	Minimum Main Line Size (All)	County 4.5	8 inch	2 inch
8	Line Leaks	NAC 445A.6727	Minimize repair costs	97 leaks since 2009
9.1	Lower Cave Rock Booster	NAC 445A.66965, 67055, 6697 Applicable OSHA and Building Codes	Comply with NAC, OSHA, and Building Codes	Non-compliance for: below grade, ingress/egress, ventilation, flood elevation.
9.2	Hidden Woods Booster	NAC 445A.66965, 67055, 6697 Applicable OSHA and Building Codes	Comply with NAC, OSHA, and Building Codes	Non-compliance for: below grade, ingress/egress, ventilation, flood elevation.



No.	Deficiency	Relevant Codes	Requirement/ Goal	Existing Condition ⁽¹⁾
9.3	Cedar Ridge Booster	Fire Authority/ NFC County 4.1.3	Varies ~2,000 gpm	Varies ~1,200 gpm
10.1	Hidden Woods Tank	NAC 445A.6674, 6708	305,080 gal. Inspection and cleaning access	121,616 gal No Inspection access
10.2	Lower Cave Rock Tank	NAC 445A.6674	364,763 gal	285,026 gal ²
10.3	Upper Cave Rock Tank	NAC 445A.6674	341,113 gal	196,403 gal
11	Water Treatment	NAC 445A.6678	Redundant Membrane Skid at WTP. Expand capacity for peak demands.	No redundant membrane skid. Running at peak capacity in summer.
12	Water Conservation	NRS 540.131/ County 4.5.6	100% Metered	4.7% Metered
13	Lake Intake Pump Station	N/A	Meet changing system demands throughout year	Suction side hydraulics cause cavitation at low water levels in Lake Tahoe

- (1) Refer to modeling results in Section 3.7.
- (2) Includes zone transfer storage

4.1.1 Fire Flow and Storage Deficiency

Fire flow, storage, and the related minimum pressure requirements are the largest drivers for improvements to the distribution and storage system. These requirements result in increases to the pipe sizes, and increases to the storage and/or pumping requirements. Fire protection is an especially important function of the water system given the drought conditions and changing climate. Historically, water systems in the Lake Tahoe area have been undersized for fire protection, in large part due to the development of smaller individual water systems to serve general improvement districts, rather than a regional approach to water service.

Increases in both fire flow capacity, and fire storage are needed to meet the National Fire Code requirements, which are based on building size and construction. The trend over the last 15 years has been to tear down smaller original structures, and build large homes in Lake Tahoe. This translates directly into increased fire flow and storage requirements the system must provide. Figure 3-9 summarizes the fire flow and pressure deficiencies.

4.1.2 Pumping Stations

Lower Cave Rock and Hidden Woods Stations are under ground in vaults, and do not meet current code requirements for ingress/egress, ventilation, electrical, flooding, etc. These stations need to be replaced or eliminated by consolidating the pumping system.

Cedar Ridge Booster has limited capacity and does not provide fire flow to homes on Cedar Ridge. It needs to be eliminated or reconfigured to meet current codes.

4.1.3 Piping Leaks

Piping leaks need to be addressed to minimize the costs of repairing the original failing distribution system and for public health and safety concerns. A large leak can take out a road, cause significant erosion, and endanger structures. Large leaks also take a portion of the water system out of service, and associated fire protection.

Line replacements to address leaks should be combined with replacements for fire flow and pumping system reconfiguration, wherever possible.

4.1.4 Water Treatment

Currently there are two operational issues at the water treatment plant:

- No membrane redundancy
- Capacity limitations at peak demand

Membrane Redundancy

Should the primary treatment skid fail due to a controls issue, valve malfunction, or piping brake, there is no redundant skid, and the plant would be unable to produce water. NAC 445A requires redundancy in treatment unit processes, typically 100% for two treatment units, and 50% for three or more.

Treatment Capacity/ Efficiency

During peak summer demands, the plant runs near or at capacity, and at a higher TMP. Colder water and higher membrane flux (flow per surface area) results in higher Trans-Membrane Pressure (TMP). Higher TMPs result in shorter runs between backwashes, which increases waste to sewer, decreasing plant efficiency.

The addition of a second primary treatment skid would both increase the plant capacity, and reduce the operating TMP. This results in a more efficient plant operation.

4.1.5 Water Meters

The 1991 Nevada State Legislature passed a law requiring public water systems to adopt a Plan of Water Conservation (NRS 540.131). The Board for Financing Water Projects deems that: "Metering of all water services is an essential element of a water conservation program." As such, water meters are required for AB198 grant funding, and the Board would likely question the lack of water meters for DWSRF



loans. The DWSRF program remains solvent and is planned to disperse approximately \$24.2 million in project funding for fiscal year 2015. Grants, as outlined by AB 198 (assembly bill), are available under NRS 349.980 – 349.987 for installation of water meters as part of a water conservation program. The funding source for the grant program is based on property tax revenue and has dwindled in recent years as a result of decreased real estate values and therefore, property tax revenue. The Nevada Division of Environmental Protection reviews the available funding for this program annually and determines if funds will be available.

During this time of sustained drought, water production is impacted as pump heads decrease in response to a lower lake level. Water meters have been proven to reduce water usage in public water systems. Installation of meters ensures that available resources are conserved, which lowers overall operation and maintenance costs.

5 Project Alternatives

Deficiencies 1 through 9 are not interrelated, since fire flows and pressures are affected by the pumping configuration and vice versa, and leak repairs may be covered by line upsizing or reconfigured pumping. Therefore, deficiencies 1 - 9 will all be covered under the same alternative, rather than as mutually exclusive items.

5.1 Summary

The following Table 5-1 summarizes the project alternatives to address system deficiencies described in Section 3 and 4.

Table 5-1. Needs and Alternatives Matrix

No.	Deficiency	Alternative 1	Alternative 2	Alternative 3
1	Fire Flow	Modified Existing Pumping Configuration	Zone Pumping Configuration	N/A
2	Minimum Distribution Pressure – FF + Max Day Demand (MDD)	Modified Existing Pumping Configuration	Zone Pumping Configuration	N/A
3	Minimum Distribution Pressure – Peak Hour Demand	Modified Existing Pumping Configuration	Zone Pumping Configuration	N/A
4	Minimum Distribution Pressure – MDD	Modified Existing Pumping Configuration	Zone Pumping Configuration	N/A
5	Maximum Velocity (All conditions except fire flow)	Modified Existing Pumping Configuration	Zone Pumping Configuration	N/A
6	Maximum Velocity (Fire Flow + ADD)	Modified Existing Pumping Configuration	Zone Pumping Configuration	N/A
7	Minimum Main Line Size (All)	Modified Existing Pumping Configuration	Zone Pumping Configuration	N/A
8	Line Leaks	Replace lines in conjunction with FF and pumping improvements	Replace lines in conjunction with FF and pumping improvements	N/A
9.1	Lower Cave Rock Booster	New above ground station	Eliminate Station by adding new pumps at WTP and high pressure main.	N/A
9.2	Hidden Woods Booster	Replaced by new Lakeridge Booster	Eliminate Station by adding new pumps at WTP and high pressure main.	

No.	Deficiency	Alternative 1	Alternative 2	Alternative 3
9.3	Cedar Ridge Booster	Replaced by new Lakeridge Booster	Eliminate Station by adding new pumps at WTP and high pressure main.	
10.1	Hidden Woods Tank	Replace in current location	N/A	N/A
10.2	Lower Cave Rock Tank	Replace in current location	Add Second Tank	
10.3	Upper Cave Rock Tank	Replace in current location	Add Second Tank	
11	Water Treatment	Provide redundant membrane treatment skid, and replace backwash skid with larger unit.	N/A	N/A
12	Water Conservation	Installation of Water Meters	N/A	N/A
13	Lake Intake Pump Station	Lower intake pumps by 4 feet	Replace intake pipe in Lake Tahoe	Add booster pumps in Lake

5.2 Deficiencies 1-9 – Fire Flow, Pressure, Velocity, Line Size, Line Leaks, and Pump Stations

Given the number of tanks, pump stations, and pressure zones, many different system alternatives could be considered to address these deficiencies. Douglas County evaluated 5 such alternatives in a comprehensive analysis (*Cave Rock Water System – Facility Planning (Technical Memorandum No.1, April 2008)*). The TM included water system modeling, code requirements, operational issues, and net present value of each alternative. The recommended alternative was D - “Modified High Pressure Main (Zone Pumping, One Set of Pumps at New Treatment Plant Booster Station)”. A slightly modified version of this alternative will be considered as Alternative 2. This alternative is also described in the 2008 *10% Design Report, Cave Rock Water System Improvements*, HDR.

Alternative 1 is based on a slightly modified existing system configuration, similar to Alternative A in the County study.

5.2.1 Alternative 1 – Modified Existing System Configuration

General Description

This alternative is based on the existing system configuration and Alternative A of the 2008 Douglas County TM. The primary changes to the system are as follows:

- New Booster near Lakeridge Tank to replace both the Hidden Woods and Cedar Ridge stations.
 - New station has 2 sets of pumps, one to boost to the Hidden Woods tank, and one to provide domestic service to Cedar Ridge.
 - Cedar Ridge fire flow will come from the Hidden Woods tank.
- Various new PRVs
- Replace Lower Cave Rock Booster

Piping

Improvements include installation of approximately 24,737 lineal feet of new pipe. This includes line upsizing to meet pressure and velocity criteria for the various flow scenarios:

- Fire Flow + ADD
- PHD
- MDD

In addition, 15,923 lineal feet of new pipe are required for replacement of lines in leak prone areas. Table 5-2 summarizes the line upsizing and replacements required for this alternative.

Table 5-2. Alternative 1 Pipeline Summary

Diameter	Quantity Criteria (ft)		Total
	Cave Rock	Skyland	
8-inch Pipeline	4,368	8,650	13,018
10-inch Pipeline	11,583	2,947	14,530
12-inch Pipeline	4,076	6,820	10,896
14-inch Pipeline	-	2,417	2,417
Total	20,027	20,833	40,861



Pressure Reducing Stations

Nine (9) additional pressure reducing stations are required for this alternative. The existing PRVs remain in place. Table 5-3 shows the existing and additional PRVs needed to address this deficiency. All the PRVs are located within the Cave Rock system as shown in the following figures.

Table 5-3. Alternative 1 Pressure Reducing Station Summary

Model ID	Location	Status	Elevation (ft)	Hydraulic Grade Setting (ft)	Pressure Setting (psi)
381	Bedell Ave	Existing	6,323	6,480	68
382	Lower Cave Rock Tank	Existing	6,770	6,788	8
383	Water Treatment Plant	Existing	6,260	6,458	86
811	New Subdivision near Sadie Lane	Existing	6,351	6,478	55
823	Gull Ct	New	6,660	6,752	40
888	WTP to Lincoln Hwy	New	6,258	6,443	80
891	Cedar Ridge to Lincoln Hwy	New	6,309	6,447	60
895	Hidden Woods Dr	New	6,436	6,551	50
900	Lower Cave Rock to Pheasant Dr	New	6,692	6,890	86
903	Chukkar Dr	New	6,703	6,908	50
906	Chukkar Dr	New	6,788	6,903	50
916	Robin Circle	New	6,758	6,943	80
979	Cedar Ridge to Sugar Pine Cir	New	6,384	6,545	70

Booster Stations

The Lower Cave Rock Booster Station and Hidden Woods Booster Stations are demolished and replaced with above ground stations that comply with code requirements. Cedar Ridge pneumatic station is removed and replaced by the new Lakeridge Booster.

Lower Cave Rock Booster will be located on vacant parcel 1-418-27-810-049 owned by the US Forest Service. It will not functionally change from the existing.

The new Lakeridge Booster will be located next to Lakeridge tank on vacant parcel 1-418-34-112-022 off Cedar Ridge. This station will have 2 different sets of pumps. One set will be sized to pump to the Hidden Woods Tank. The other set will be sized to provide domestic service pressure to the area previously served by the Cedar Ridge Booster. Fire flow to Cedar Ridge will come off the 10-inch from the Lake Ridge Booster Station.

Figures

The following figures show the proposed Alternative 1 improvements.

Alternative 1 Cave Rock Zone A1 Improvements

Figure 5-1

Legend

Distribution Pipe

- Replaced (Red line)
- Existing (Black line)

Pumps

- Existing (Black circle with arrow)
- Added (Red circle with arrow)

Pressure Reducing Valve

- Existing (Black triangle with arrow)
- Added (Red triangle with arrow)

Other Facilities

- Tanks (Blue trapezoid)

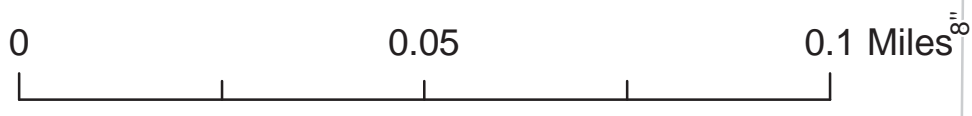
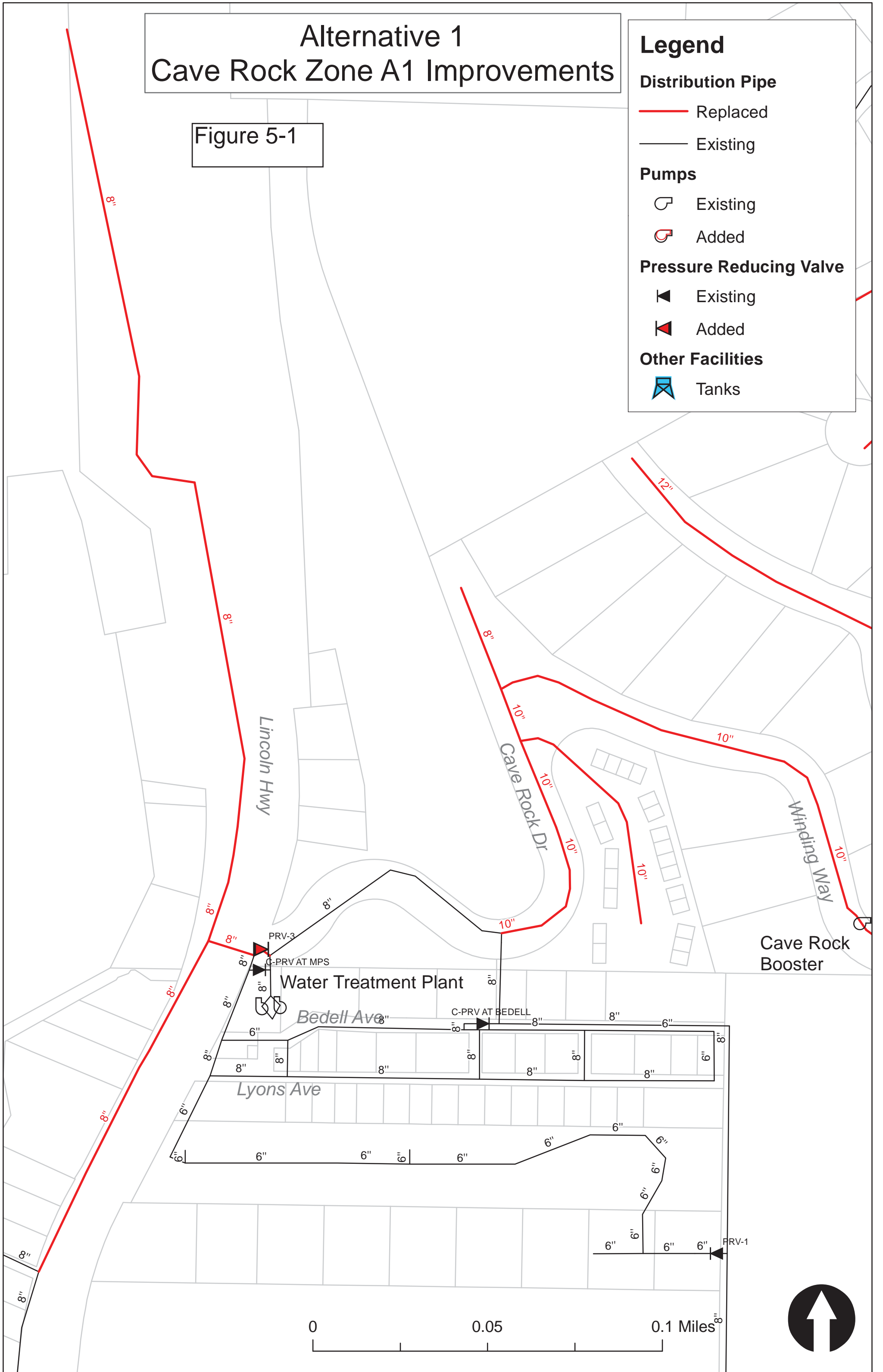

Alternative 1 Cave Rock Zone A1 Improvements

Figure 5-2

Legend

Distribution Pipe

- Replaced (Red line)
- Existing (Black line)

Pumps

- Existing (Black circle with arrow)
- Added (Red circle with arrow)

Pressure Reducing Valve

- Existing (Black triangle with arrow)
- Added (Red triangle with arrow)

Other Facilities

- Tanks (Blue trapezoid)

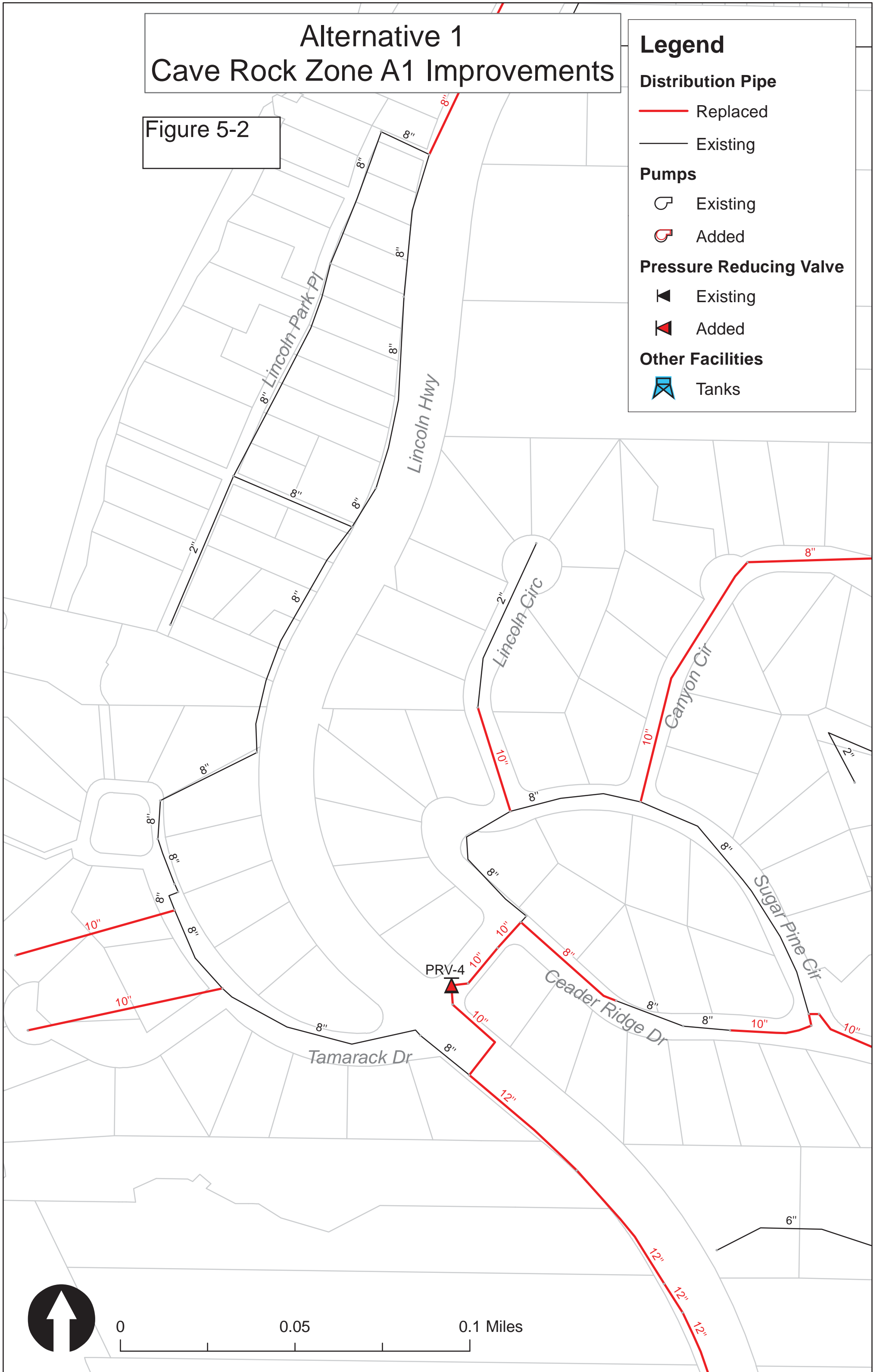

0 0.05 0.1 Miles

Alternative 1: Cave Rock Zone B1 Improvements

Figure 5-3

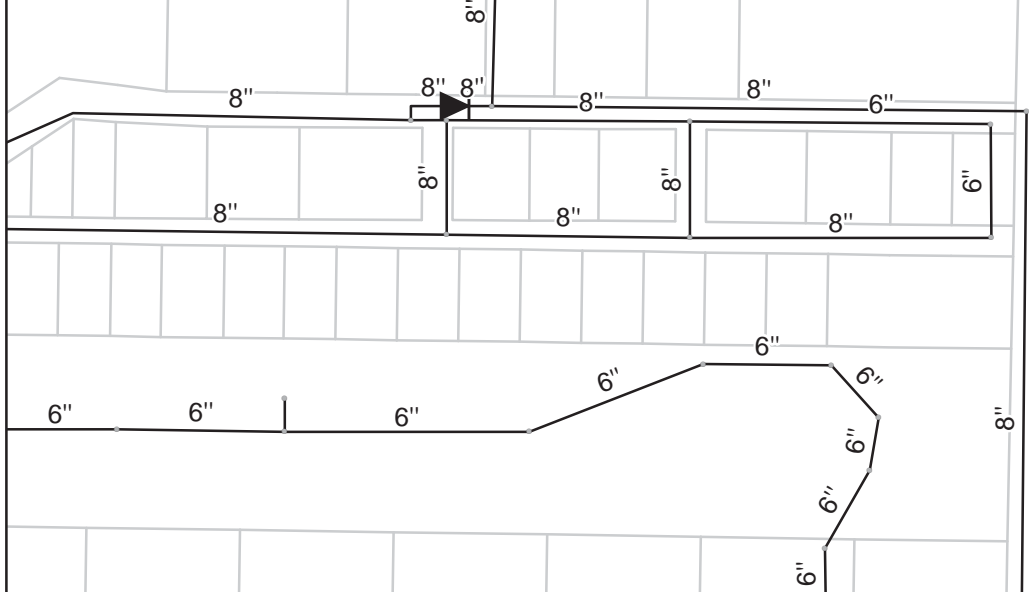
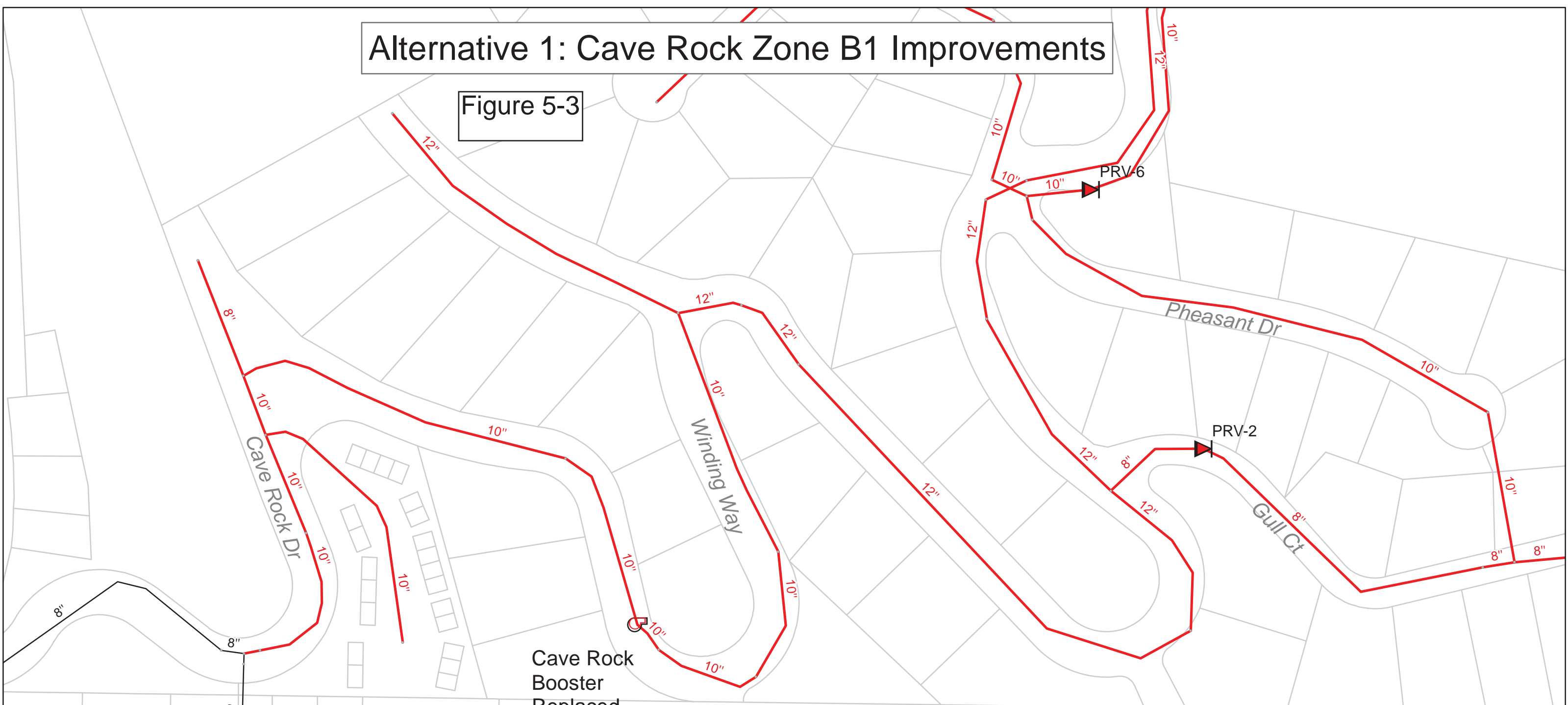

Cave Rock
Booster
Replaced

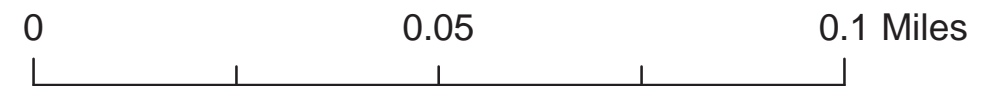

Legend

Distribution Pipe	Pumps	Pressure Reducing Valve	Other Facilities
Replaced	Existing	Existing	Tanks
Existing	Replaced	Added	



Alternative 1: Cave Rock Zone C1 Improvements

Figure 5-4

Total of Four PRVs Added to Zone C1

Booster pump added for non-fire demands
Check valve bypass added to allow fire flows

Legend

Distribution Pipe
— Replaced
— Existing

Pumps
⊕ Existing
⊕ Added

Pressure Reducing Valve
◀ Existing
◀ Added

Other Facilities
⊕ Tanks

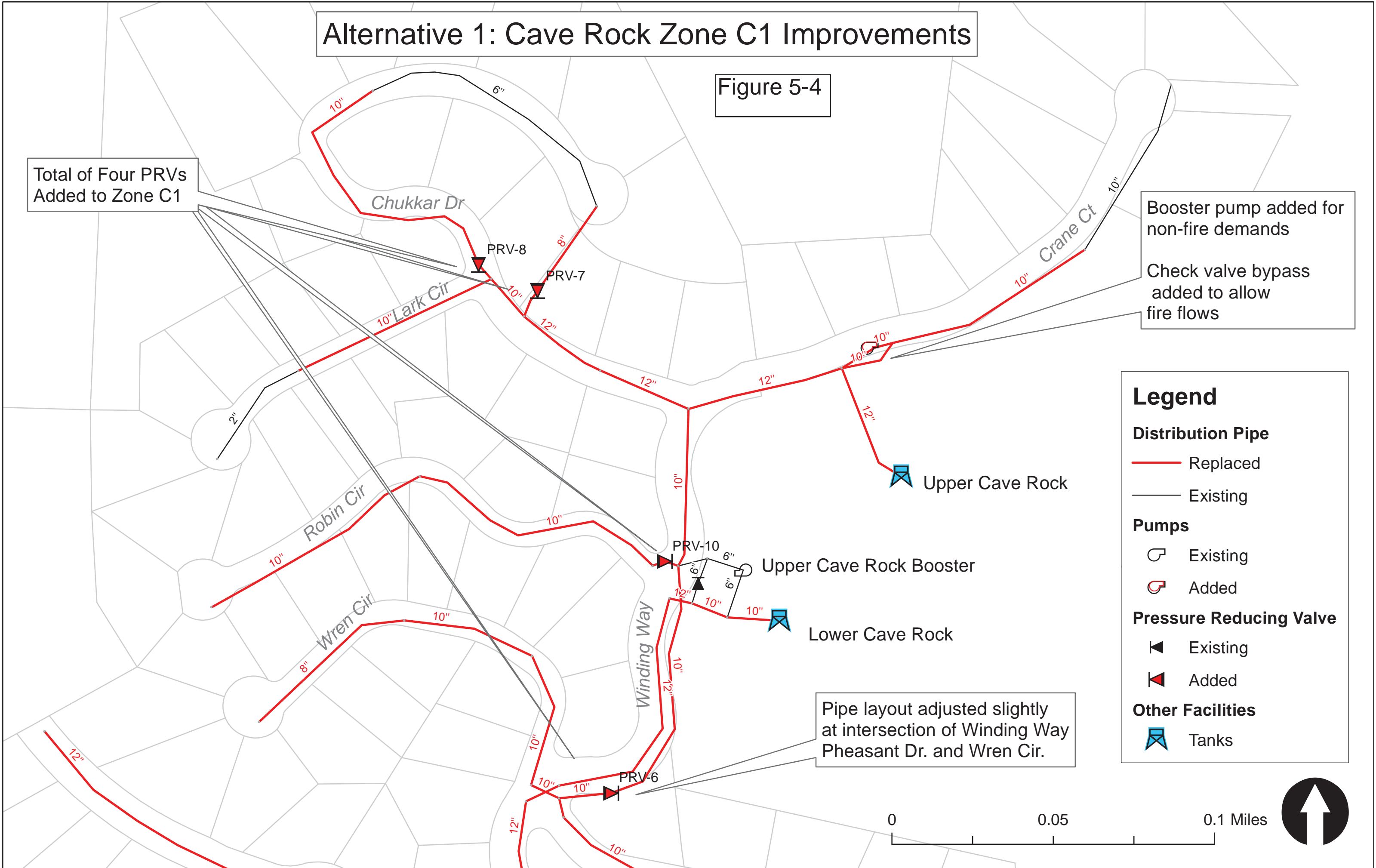

Pipe layout adjusted slightly at intersection of Winding Way Pheasant Dr. and Wren Cir.

Alternative 1 Cave Rock Hidden Woods Improvements

Figure 5-5

New Cedar Ridge and Hidden Woods combination pump station added

Existing Cedar Ridge hydro pneumatic station removed

Existing Hidden Woods pump station removed

PRV added for lower elevation Sugar Pine Cir

PRV added for homes to the west

Legend

Distribution Pipe

- Replaced
- Existing

Pumps

- Existing
- Added
- Removed

Pressure Reducing Valve

- Existing
- Added

Other Facilities

- Tanks
- Flow Control Valve

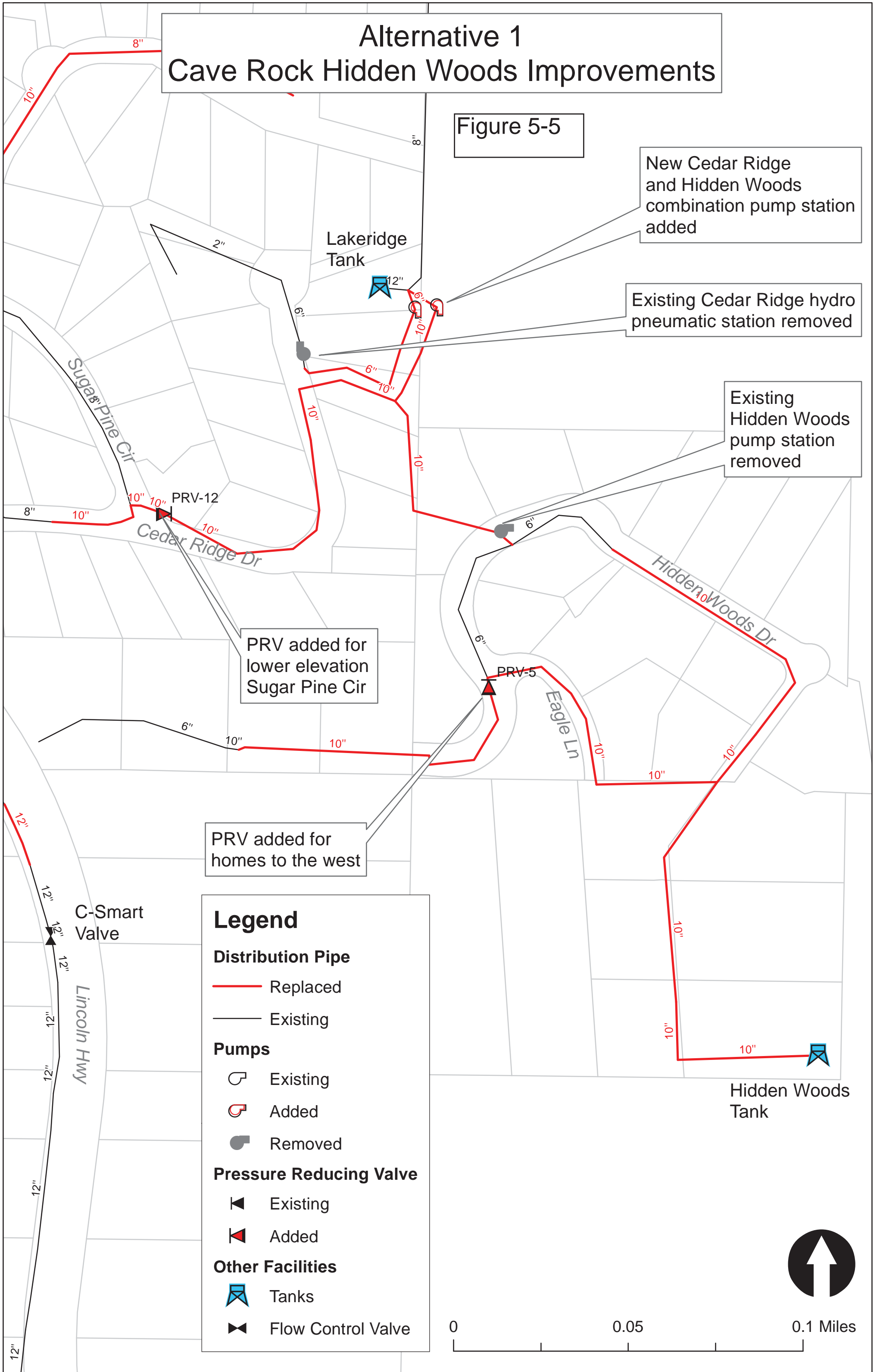

Alternative 1: Skyland Improvements

Figure 5-6

Legend

Distribution Pipe

- Replaced
- Existing



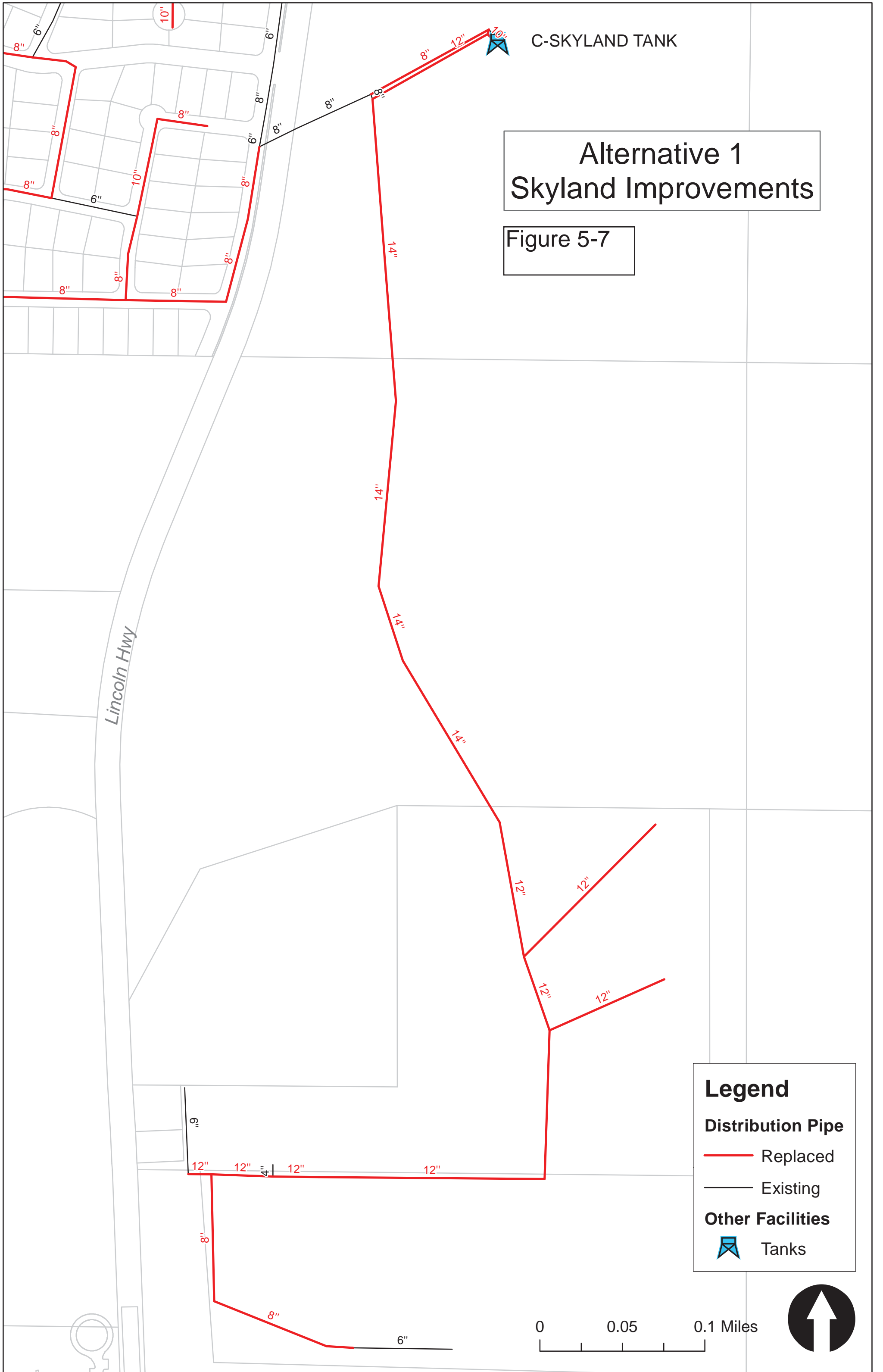

Alternative 1 Skyland Improvements

Figure 5-7

Legend

Distribution Pipe

- Replaced
- Existing

Other Facilities

- ⚙ Tanks

0 0.05 0.1 Miles

Alternative 1: Skyland Improvements

Figure 5-8

C-Smart Valve

Lincoln Hwy

Tahoe Dr

Legend

Distribution Pipe

- Replaced
- Existing

0 0.05 0.1 Miles

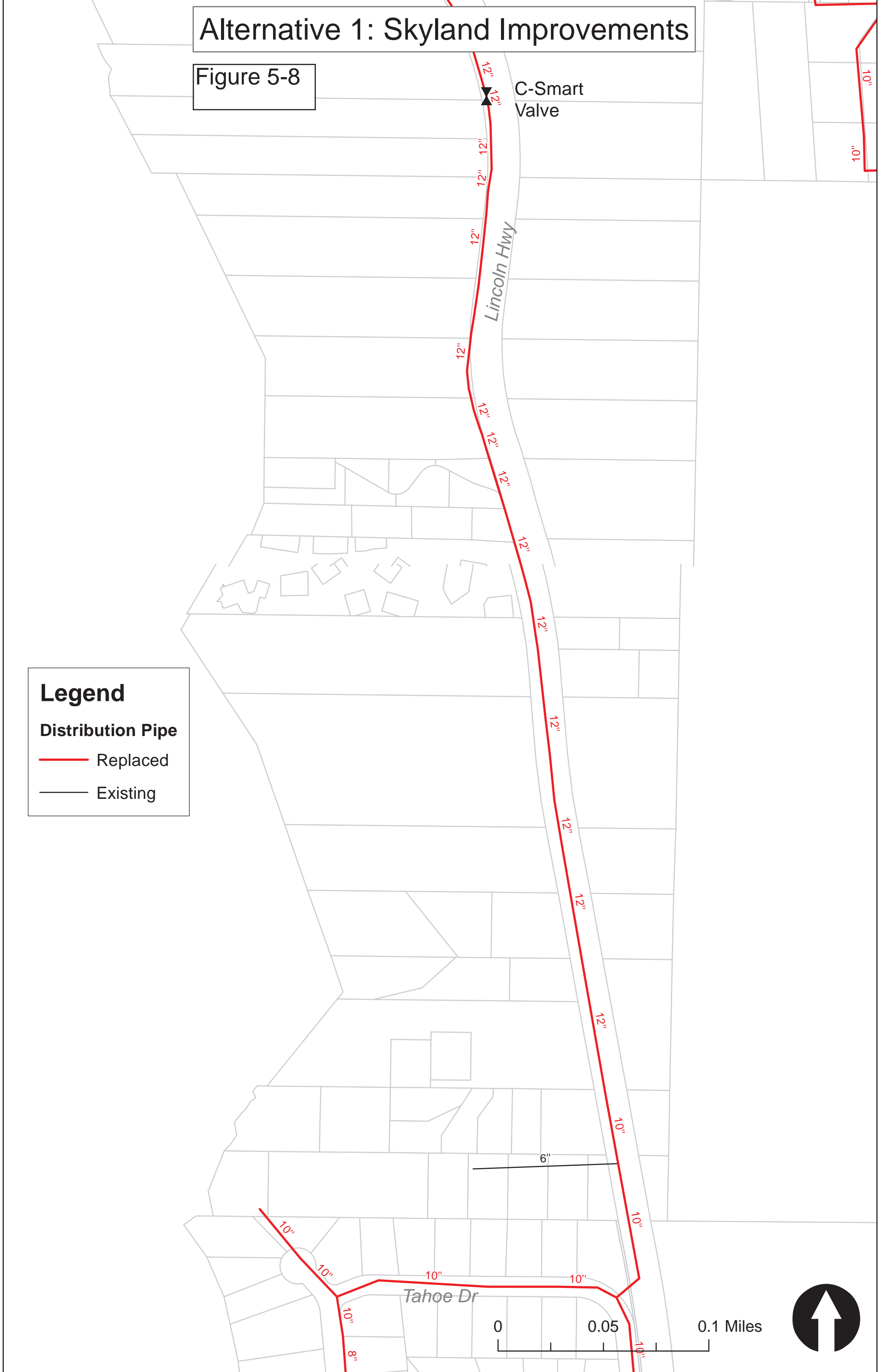

Environmental Impacts

Development of new pipeline and pressure reducing stations, raising the Lower Cave Rock and Hidden Woods Booster Stations above ground, and the replacement of existing pipeline will not adversely affect population rates or housing resources, operation noise, circulation systems, public services, utilities, minerals, agriculture or forestry, or recreation, or create significant hazards. The new pipelines and pressure reducing stations and replacement pipelines would be located beneath existing pavement, where feasible, or in line with existing pipeline. In areas where the pipe is upsized, additional easement may be required. Mitigable impacts may occur in relation to construction noise, air emissions, and traffic, geology and land coverage, hydrology and water quality, aesthetics, biological resources, and cultural resources.

The purpose of the booster stations is to lift water, which will benefit fire flows and result in compliance with current regulations for fire flow. Access to the booster stations would occur directly from Hidden Woods Drive and Cave Rock Drive to allow operation and maintenance access to the booster pump stations, and access would not generate traffic or alter circulation patterns.

Operation of the pipelines and PRVs would not create noise levels that exceed threshold limits. Construction noise is expected to occur; however BMPs such as heavy equipment muffling, limiting construction hours to TRPA's construction noise exemption hours (8 AM to 6:30 PM), and compliance with TRPA Code of Ordinances Section 68.9 Noise will ensure noise levels are not significant. BMPs may include, but are not limited to equipment muffling, use of temporary sound barriers, alternate backup warning systems, and pre-construction building inspection and monitoring during construction, among other methods. Emergency pressure relief valves and other similar emergency control devices are exempt from noise limitations per TRPA Code of Ordinances (Section 68.9).

Some temporary air emissions may occur during construction as a result of construction activity, however standard BMPs for the Tahoe Basin would be employed to limit construction emissions. No long-term operational or traffic-related emissions would occur. BMPs include those listed in the TRPA Code of Ordinances (33.3.3 and Chapter 65), such as limits on diesel engine vehicle idling, covering exposed soils and stored materials with a chemical dust suppressant or water, removing track out, and limiting construction vehicle speeds, among others. Operation of the pipelines and PRVs would not result in an increase in daily vehicle trip ends, congestion, or other traffic related changes that would increase air emissions. Construction VMT is expected to be below threshold limits.

Pipeline upgrades along U.S. 50 and local roadways may result in temporary traffic events, but construction within the interstate and neighborhood roadways would meet NDOT and County traffic control requirements including signage, implementation of safety devices and other controls as determined necessary.

Construction of the pipelines, boosters, and PRVs will result in ground disturbance, which can affect erosion and water quality. Implementation of BMPs, including those

listed in TRPA's Water Quality Management Plan for the Lake Tahoe Region, Volume II, Handbook of Best Management Practices (TRPA, May 2014) and the TRPA Code of Ordinances Section 60.4 would reduce water quality impacts and erosion to a less than significant level. These BMPs include, but are not limited to, infiltration devices, slope stabilization, revegetation of disturbed areas, and runoff controls. The Project will incorporate standard practices to comply with TRPA regulations to avoid, reduce, minimize and mitigation water quality impacts, including implementation of: an Erosion Control Plan, onsite monitoring, a Storm Water Pollution Prevention Plan (SWPPP), a dewatering plan, tree protection measures, a revegetation plan, and operations BMPs and monitoring. The Bureau of Water Pollution Control within the Nevada Department of Environmental Planning is responsible for regulating discharges into the waters of the State and will require a site-specific SWPPP to prevent debris, soil, silt, oil, or other earthen or construction materials from entering into the SEZ. The SWPPP will describe, locate, and implement the BMPs specific to each area in which construction and operation occurs, will designate areas for construction staging and access, and will include a spill response and groundwater management plan. Construction shall also occur in the dry season to minimize siltation. Consultation with the USFS will also occur to ensure the appropriate measures as implemented on USFS property.

The new and replacement pipelines and PRVs would be located below ground, primarily beneath existing area roadway pavement, and would not result in additional coverage. The new upsized pipeline in the area around Warrior Way and extending up to the existing pipeline on the east side of U.S. 50 in the vicinity of Red Fir Way would result in additional ground disturbance and would not be located underneath existing or proposed roadway pavement. New ground disturbance associated with each PRV would measure approximately 10 feet by 15 feet or 150 square feet. If excess land coverage occurs, mitigation would include 1) coverage reduction onsite; 2) offsite coverage reduction; 3) payment of excess coverage mitigation fee; 4) findings for excess land coverage; or 5) a combination of these options. As stated in TRPA Code of Ordinances Section 30.4.2.D, "The maximum land coverage for linear public facilities and public health and safety facilities is limited to the minimum amount needed to achieve its public purpose." Section 30.4.2.F states, "The maximum land coverage for other public service facilities located outside of an approved community plan is 50 percent of the project area." According to Section 30.5.1.C, "Land coverage and disturbance for public service facilities may be permitted in Land Capability Districts 1a, 1c, 2, and 3 if TRPA finds that: The project is necessary for public health, safety... There is no reasonable alternative... The impacts are fully mitigated..." Since the majority of the Cave Rock and Skyland area is located within land capability 1b and 2, locating the tank and pipelines within a higher land capability is not feasible, particularly given the location of the existing infrastructure. Repair of linear public facilities and minor utility projects (replacement, repair, interconnection of existing utilities) is not subject to excess land coverage mitigation (TRPA Code of Ordinances Section 30.6.2.E and F).

New or replaced pipelines and pressure reducing valves would be located below existing pavement and would not result in an aesthetic change.

There are no known wildlife resources in the area; however pre-construction surveys for nesting bird species will be required in order to conform with the Migratory Bird Treaty Act of 1918. No known Protected Activity Centers for either northern goshawk or California spotted owl are known to occur in the area, however construction activity on US Forest Service land would likely require protocol surveys to be performed. Once final design occurs, the plan detail will be able to indicate potential tree or vegetation removal. Implementation of vegetation protection BMPs during construction will ensure no significant impacts occur (TRPA Code of Ordinances Chapter 33.6) and the project will be required to comply with resource protection actions required by the USFS and resource agencies.

There are no known cultural resources within the area where new or replacement pipeline is proposed. If previously undiscovered human remains or archaeological resources are discovered during construction, construction activity shall temporarily cease in the vicinity of the discovery until the TRPA Cultural Resources staff (or their qualified consultant) evaluates the resource for NRHP eligibility, Native American (Washoe) values, and compliance with TRPA Code, and consults with the Nevada SHPO, TRPA, and the Washoe Tribe, as appropriate (TRPA Code of Ordinances, 33.3.7, 67.3, and 67.4).

Cost Opinion

The cost opinion provided is a level 4, or feasibility level cost opinion. The level or accuracy for feasibility level estimates typically ranges between +40% and -20%, with a recommended contingency of 20% to 30%. Costs include 25% for administrative costs such as engineering, legal, and construction management. Detailed cost break downs are included in Appendix A.

Cost allocations between Cave Rock and Skyland are based on where the infrastructure is located. Pipelines, PRVs, and pump stations located in and serving the respective areas are assigned to those areas. Cost for shared facilities such as the water treatment plant, are based on the *Memorandum of Understanding for Cost Sharing, Cave Rock/Skyland Regional Water Treatment Plant*. The MOU states that in general, all costs are split on a 50/50 basis between Cave Rock and Skyland.

Table 5-4. Cost Opinion for Deficiency 1-9: Alternative 1

Item	Cave Rock(x\$1,000)	Skyland (x\$1,000)
Division 1	\$ 862	\$ 739
Demo	\$ 23	
Pipelines	\$ 4,624	\$ 4,924
PRVs	\$ 492	
Lower Cave Rock Booster	\$ 265	
Lake Ridge Booster	\$ 345	
Contingency (25%)	\$ 1,653	\$ 1,416
Administrative (25%)	\$ 2,066	\$ 1,770
Total Capital	\$ 10,329	\$ 8,849
Grand Total	\$ 19,178	

Notes:

1. Cost does not include associated easements.

5.2.2 Alternative 2 – High Pressure Main & Zone Pumping

General Description

This alternative eliminates the Lower Cave Rock, Hidden Woods, and Cedar Ridge Booster Stations. These are replaced with a new medium/high pressure zone pump station in the treatment plant. The pumps would be sized to pump to the Lower Cave Rock Tank (high zone), and Hidden Woods Tanks (medium zone). A pressure reducing valve would control flow to the medium pressure zone. Lakeridge tank will need a flow control valve to prevent over-filling. This pumping configuration is detailed in the 2008 *10% Design Report, Cave Rock Water System Improvements*, HDR, in Appendix D.

A new high pressure water main is required on Cave Rock Drive to serve the Lower Cave Rock Tank. The existing WTP booster pumps are repurposed to pump to Skyland Tank, and the existing Smart Valve is removed.

Piping

The piping is similar to Alternative 1, with the following exceptions:

- 8-inch and 10-in high pressure line to Lower Cave Rock Tank
- Abandon existing 8-inch main
- New services and PRVs off HP main



Additional modeling is required during detailed design to confirm the fire flows and pressures for this alternative since the pumping is different from Alternative 1.

Table 5-5 Alternative 2 Pipeline Summary

Diameter	Quantity Criteria (ft)		Total
	Cave Rock	Skyland	
8-inch Pipeline	6,510	8,648	15,158
10-inch Pipeline	11,644	2,946	14,590
12-inch Pipeline	4,032	6,821	10,853
14-inch Pipeline	-	2,418	2,418
Total	22,186	20,833	43,019

Figures



The following figures show the proposed piping, pumping, and PRV changes to the system for Alternative 2.



Alternative 2 Cave Rock Zone A1 Improvements

Figure 5-9

Legend

Distribution Pipe
— Replaced
 — Existing

Pumps
 Existing
 Added

Pressure Reducing Valve
 Existing
 Added

Other Facilities
 Tanks

High pressure main installed from treatment plant to intersection of Winding Way

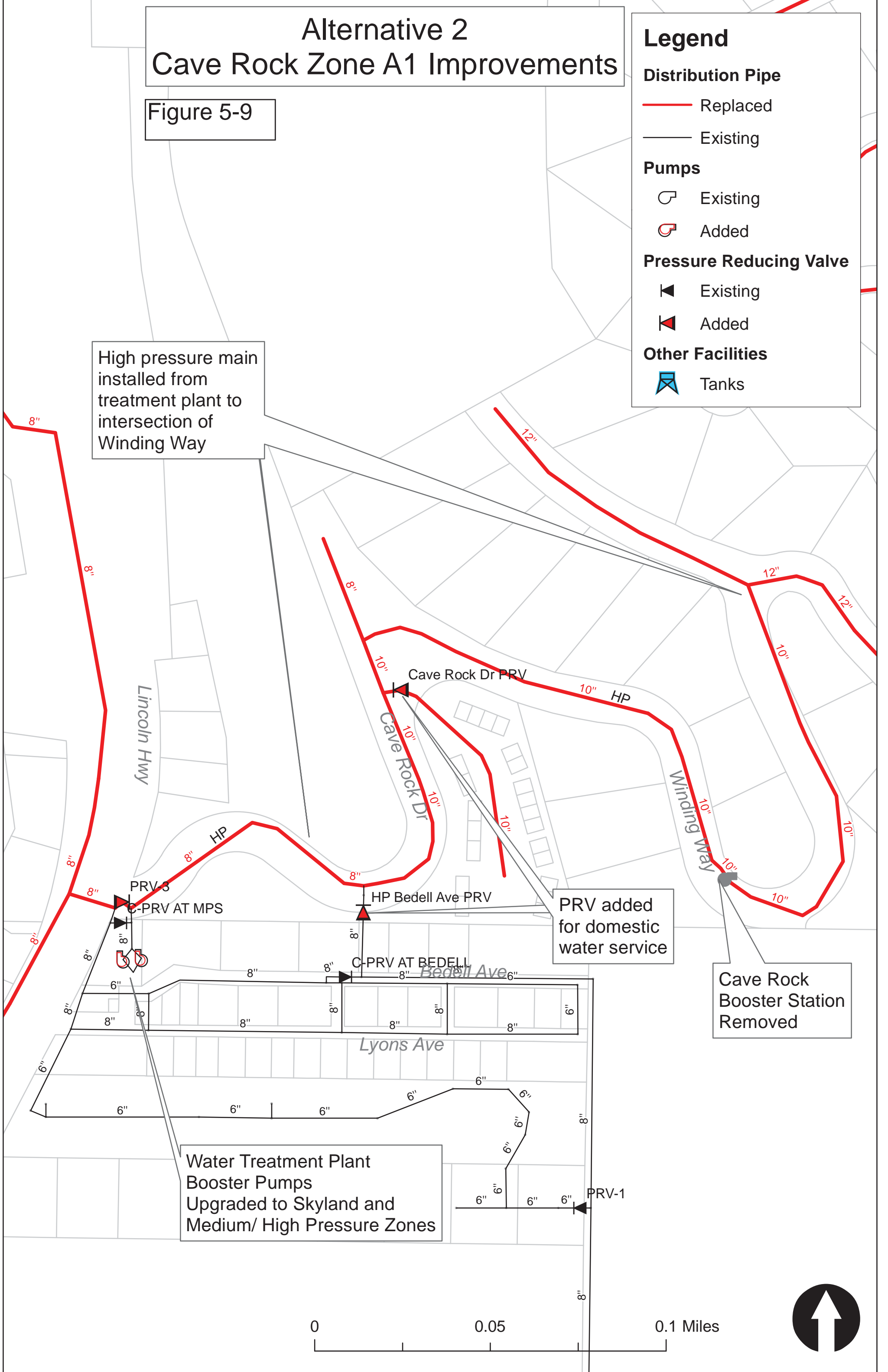

Water Treatment Plant
Booster Pumps
Upgraded to Skyland and
Medium/ High Pressure Zones

PRV added
for domestic
water service

Cave Rock
Booster Station
Removed

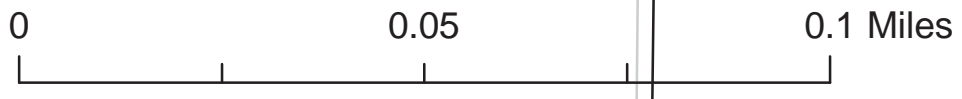

Alternative 2 Cave Rock Hidden Woods Improvements

Figure 5-10

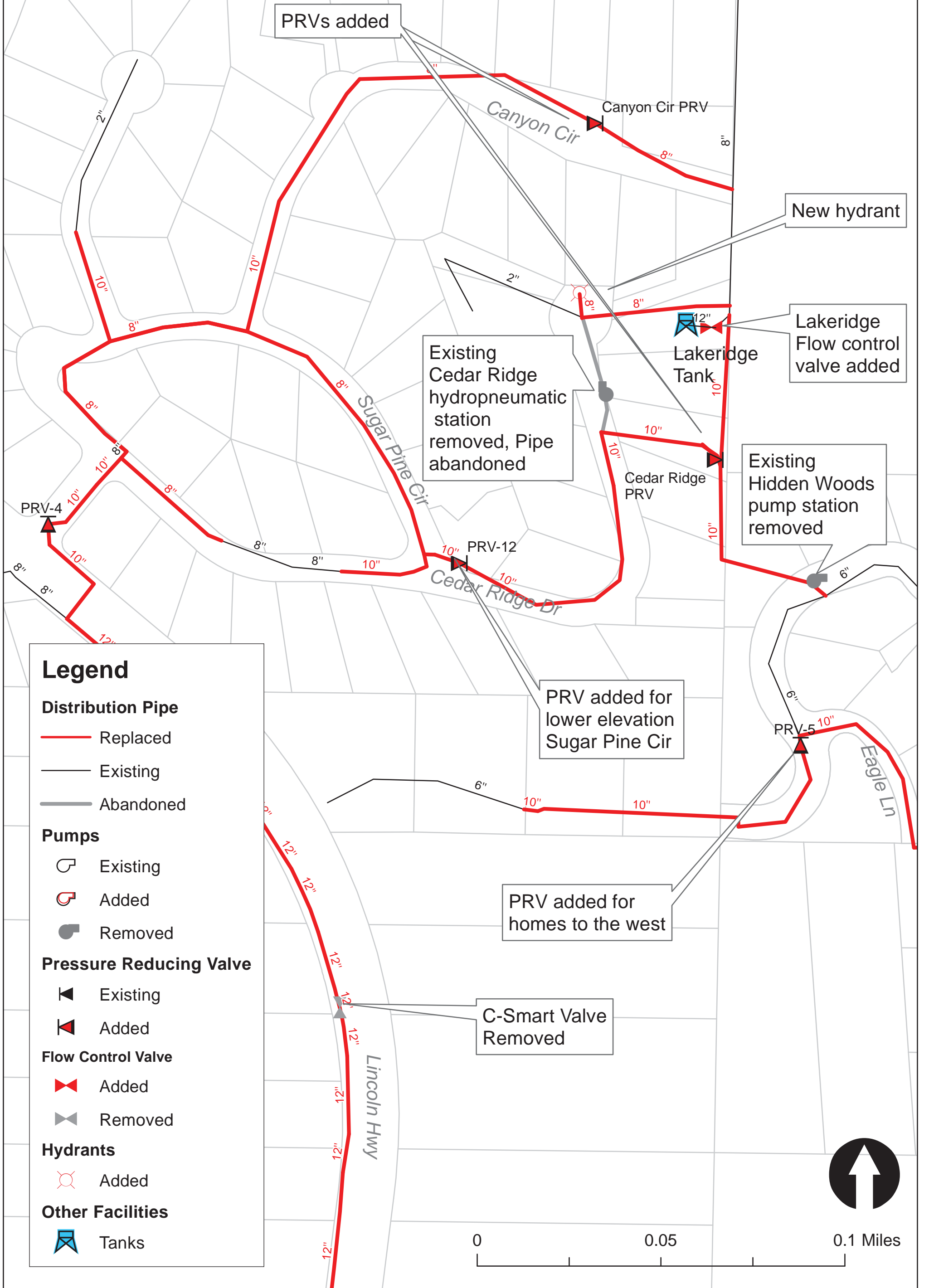

PRVs added

Canyon Cir PRV

New hydrant

Lakeridge Flow control valve added

Existing Cedar Ridge hydropneumatic station removed, Pipe abandoned

Lakeridge Tank

Existing Hidden Woods pump station removed

Cedar Ridge PRV

PRV-4

PRV-12

PRV added for lower elevation Sugar Pine Cir

PRV-5

PRV added for homes to the west

C-Smart Valve Removed

Legend

Distribution Pipe

- Replaced
- Existing
- Abandoned

Pumps

- Existing
- Added
- Removed

Pressure Reducing Valve

- Existing
- Added

Flow Control Valve

- Added
- Removed

Hydrants

- Added

Other Facilities

- Tanks

0 0.05 0.1 Miles



Pressure Reducing Stations

A total of fourteen (14) new pressure reducing stations are required in this alternative, which includes a flow control valve at the Lake Ridge Tank. Alternative 2 requires five (5) additional stations over Alternative 1, as summarized in the following table.

Table 5-6 Alternative 2 Pressure Reducing Station Summary

Model ID	Location	Status	Elevation (ft)	Hydraulic Grade Setting (ft)	Pressure Setting (psi)
381	Bedell Ave	Existing	6,323	6,480	68
382	Lower Cave Rock Tank	Existing	6,770	6,788	8
383	Water Treatment Plant	Existing	6,260	6,458	86
811	New Subdivision near Sadie Lane	Existing	6,351	6,478	55
823	Gull Ct	New	6,660	6,752	40
888	WTP to Lincoln Hwy	New	6,258	6,443	80
891	Cedar Ridge to Lincoln Hwy	New	6,309	6,436	55
895	Hidden Woods Dr	New	6,436	6,551	50
900	Lower Cave Rock to Pheasant Dr	New	6,692	6,890	86
903	Chukkar Dr	New	6,703	6,908	50
906	Chukkar Dr	New	6,788	6,903	50
916	Robin Circle	New	6,758	6,943	80
979	Cedar Ridge to Sugar Pine Cir	New	6,384	6,545	70
–	Canyon Cir to Lake Ridge Tank Zone	New	6,436	6,575	60
–	Lake Ridge/Hidden Woods Zone to Cedar Ridge	New	6,493	6,678	80

Model ID	Location	Status	Elevation (ft)	Hydraulic Grade Setting (ft)	Pressure Setting (psi)
-	Cave Rock Dr to Bedell Ave off High Pressure Line	New	6,316	6,630	136
-	Cave Rock Dr to Domestic Services	New	6,371	6,532	70
-	Lake Ridge Tank FCV	New	6,531	6,551	N/A

Booster Stations

Alternative 2 eliminates the Lower Cave Rock, Hidden Woods, and Cedar Ridge Booster Stations by replacing them with a new medium/high pressure zone pump station in the water treatment plant, and a high pressure water line.

The new pump station at the treatment plant would pump directly into the Lower Cave Rock and Hidden Woods Tank, as shown in Figure 5-11. A pressure reducing valve is needed to regulate pressure to the Hidden Woods zone, as well as a control valve at Lakeridge tank to prevent over filling.

Fire flow to Cedar Ridge will come from the Hidden Woods tank and a new PRV. The 2-inch Cedar Ridge line will be abandoned and served from a new 8-inch with a hydrant added at the end.

The existing WTP booster pumps would be modified or replaced for reduced head to pump to the Skyland Tank. The existing smart valve that currently controls flow to Skyland Tank would be removed. This alternative is detailed in the *10% Design Report Cave Rock Water System Improvements*, HDR 2008. Refer to Appendix D.

This alternative also includes piping improvements in the Sugar Pine Circle and Canyon Circle areas.

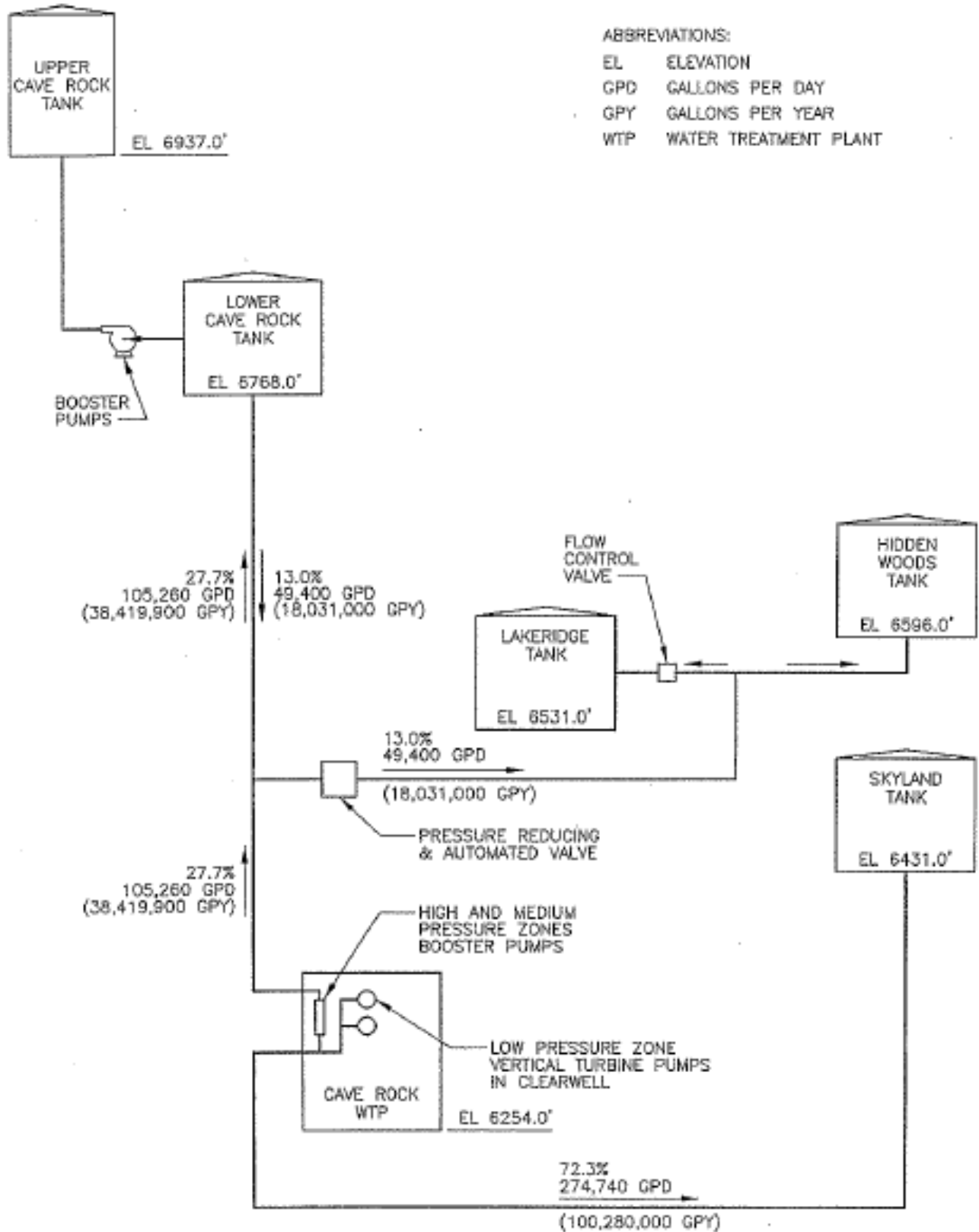

Figure 5-11 Alternative 2 Pumping Schematic

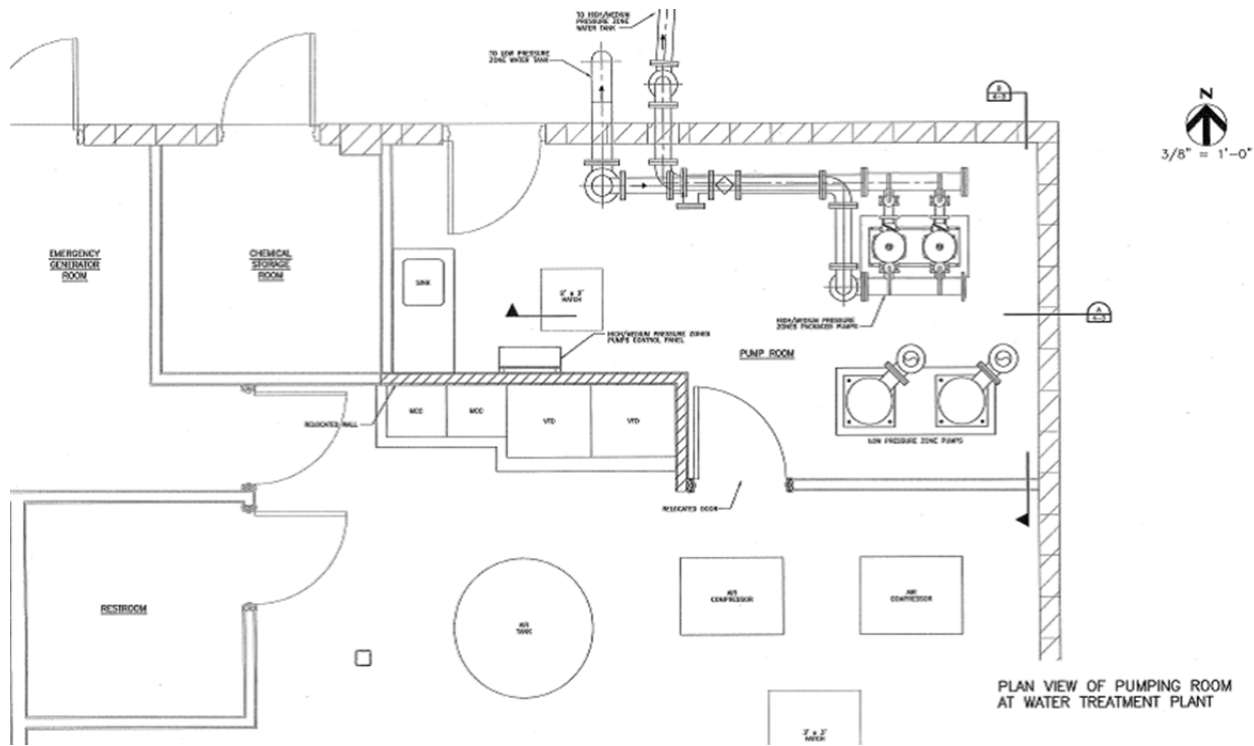

Figure 5-12 Alt 2 WTP Plan Pumping Modifications

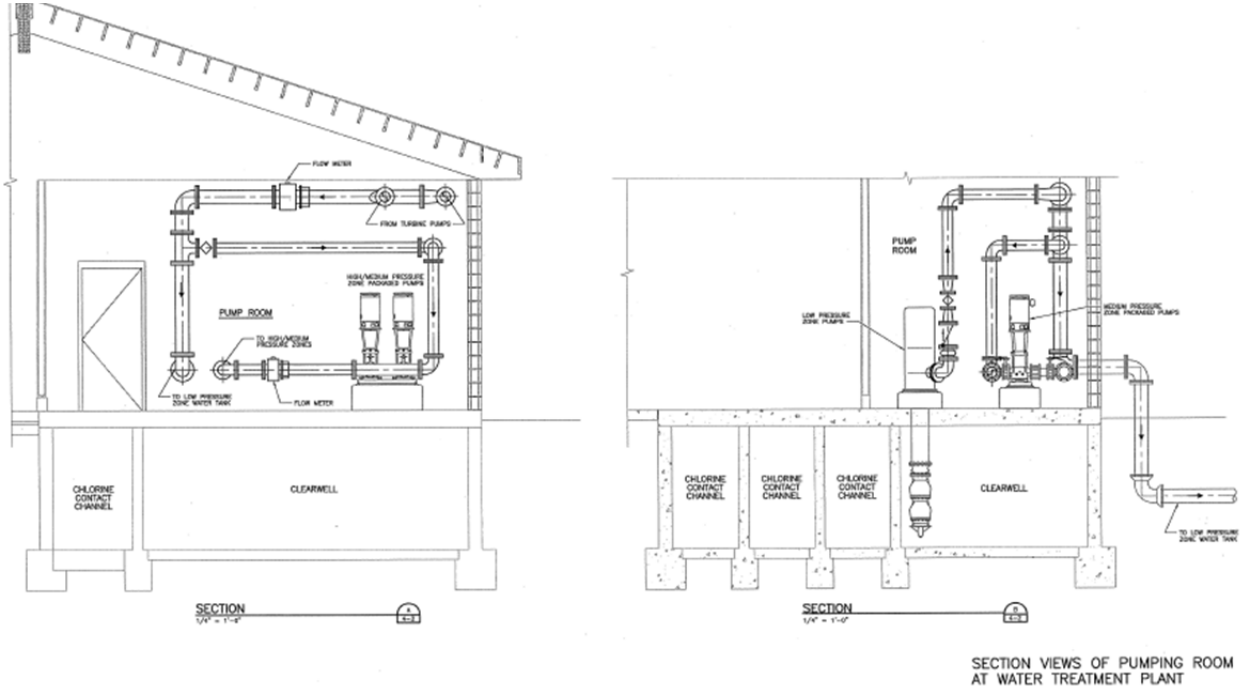

Figure 5-13 Alt 2 WTP Section Pumping Modifications

Environmental Impacts

The WTP modifications would remove the existing treatment plant pumps and install new vertical turbine pumps, along with high/medium pressure zone pumps in the WTP pumping room. This action would not result in new disturbance, rather the upgrade of mechanical systems within an existing utility structure. No new coverage, excavation, or ground disturbance would occur and work would be completed within the existing WTP so construction disturbance would be confined to the interior of the WTP. This would not cause new disturbance to the environment and would serve to improve existing water service. Service improvements would not result in new population or housing demands as the modification treats an existing system deficiency.

Cost Opinion

Table 5-7. Alternative 2: High Pressure Main & Zone Pumping

Item	Cave Rock(x\$1,000)	Skyland (x\$1,000)
Division 1	\$ 947	\$ 803
Demo	\$ 33	\$ 18
Pipelines	\$ 5,048	\$ 4,924
PRVs	\$ 796	
High Pressure Services	\$ 21	
WTP Pumping Modifications	\$ 410	\$ 410
Contingency (25%)	\$ 1,814	\$ 1,539
Administrative (25%)	\$ 2,268	\$ 1,924
Total Capital	\$ 11,338	\$ 9,618
Grand Total	\$ 20,956	

Notes:

1. Cost does not include associated easements.



5.3 Deficiency 10 – Storage Volume

The storage analysis in Section 3.8.2 showed the following tanks to be undersized:

- Hidden Woods
- Lower Cave Rock
- Upper Cave Rock

In addition, the 121,600 gallon Hidden Woods Tank does not meet code criteria for proper access and cleaning and the overflow does not have the proper air-gap. The corrective action recommended that the County provide information on life expectancy and a plan to replace the tank.

5.3.1 Alternative 1 – Upsize Tanks in Existing Locations

Larger welded steel tanks will be constructed at the existing tank locations. The tanks will be constructed to AWWA D-100 standards, with a concrete ring foundation, and NSF-61 certified epoxy coating.

Table 5-8. Tank Summary - Alternative 1

Tank Location	Existing Size (Gal)	Proposed Size (Gal)
Hidden Woods	121,600	306,000
Lower Cave Rock	186,800	267,000
Upper Cave Rock	196,400	342,000

Environmental Impacts

Development of a new water storage tank will not adversely affect population rates or housing resources, circulation systems, public services, utilities, minerals, agriculture or forestry, or recreation, or create significant hazards. Mitigable impacts may occur in relation to operation noise, construction air emissions, traffic, geology and land coverage, hydrology and water quality, aesthetics, biological resources, and cultural resources.

Since an existing storage tank would be replaced by the proposed tank in the same or nearly the same location, operation would not create new noise or exceed threshold limits. Construction noise is expected to occur; however BMPs such as heavy equipment muffling, limiting construction hours to TRPA’s construction noise exemption hours (8 AM to 6:30 PM), and compliance with TRPA Code of Ordinances Section 68.9 Noise will ensure noise levels are not significant. As stated above, construction would be limited to TRPA’s construction noise exemption hours and BMPs would be implemented to reduce construction noise disturbance. BMPs may include, but are not limited to equipment muffling, use of temporary sound barriers, alternate backup warning systems, and pre-construction building inspection and monitoring during construction, among other methods.

Some temporary air emissions may occur during construction as a result of construction activity, however standard BMPs for the Tahoe Basin would be employed to limit construction emissions. No long-term operational or traffic-related emissions would occur. BMPs include those listed in the TRPA Code of Ordinances (33.3.3 and Chapter 65), such as limits on diesel engine vehicle idling, covering exposed soils and stored materials with a chemical dust suppressant or water, removing track out, and limiting construction vehicle speeds, among others. As discussed above, the access to and operation of the storage tank would not result in an increase in daily vehicle trip ends, congestion, or other traffic related changes that would increase air emissions. Construction VMT is expected to be below threshold limits.

Construction of the storage tank will result in some ground disturbance, which can affect erosion and water quality. Implementation of BMPs, including those listed in TRPA's Water Quality Management Plan for the Lake Tahoe Region, Volume II, Handbook of Best Management Practices (TRPA, May 2014) and the TRPA Code of Ordinances Section 60.4 would reduce water quality impacts and erosion to a less than significant level. These BMPs include, but are not limited to, infiltration devices, slope stabilization, revegetation of disturbed areas, and runoff controls. Permanent BMPs would be included to address runoff from any new storage tank coverage. The Project will incorporate standard practices to comply with TRPA regulations to avoid, reduce, minimize and mitigation water quality impacts, including implementation of: an Erosion Control Plan, onsite monitoring, a Storm Water Pollution Prevention Plan (SWPPP), a dewatering plan, tree protection measures, a revegetation plan, and operations BMPs and monitoring. The Bureau of Water Pollution Control within the Nevada Department of Environmental Planning is responsible for regulating discharges into the waters of the State and will require a site-specific SWPPP to prevent debris, soil, silt, oil, or other earthen or construction materials from entering into the SEZ. The SWPPP will describe, locate, and implement the BMPs specific to each area in which construction and operation occurs, will designate areas for construction staging and access, and will include a spill response and groundwater management plan. Construction shall also occur in the dry season to minimize siltation. Consultation with the USFS will also occur to ensure the appropriate measures as implemented on USFS property.

Since the storage tank will replace the existing large above-ground structure, it will be visible within the area, but would not result in a substantial visual change. The existing tank will be removed and the new tank would not be visible from U.S. 50 and Lake Tahoe, due to intervening vegetation and development. Once design is complete, a more detailed plan would need to be prepared to ensure compliance with TRPA height limitations and design standards (TRPA Code of Ordinances Chapters 37 and 36). To ensure no adverse impacts occur, the project may require mitigation in accordance with the height and design standards such as, lowering the height of the tank, landscape screening, color blending, and other methods to reduce visibility and maintain the visual character. No public roadway signage is associated with the structure.



There are no known wildlife resources in the area; however pre-construction surveys for nesting bird species will be required in order to conform with the Migratory Bird Treaty Act of 1918. No known Protected Activity Centers for either northern goshawk or California spotted owl are known to occur in the area, however creation of a new roadway and associated tank site on US Forest Service land would likely require protocol surveys to be performed. Once final design occurs, the plan detail will be able to indicate potential tree or vegetation removal. Implementation of vegetation protection BMPs during construction will ensure no significant impacts occur (TRPA Code of Ordinances Chapter 33.6) and the project will be required to comply with resource protection actions required by the USFS and resource agencies.

There are no known cultural resources within the area of the water storage tank or affected neighborhood roadways. If previously undiscovered human remains or archaeological resources are discovered during construction, construction activity shall temporarily cease in the vicinity of the discovery until the TRPA Cultural Resources staff (or their qualified consultant) evaluates the resource for NRHP eligibility, Native American (Washoe) values, and compliance with TRPA Code, and consults with the Nevada SHPO, TRPA, and the Washoe Tribe, as appropriate (TRPA Code of Ordinances, 33.3.7, 67.3, and 67.4).

Cost Opinion

Table 5-9. Cost Opinion – Alternative 1

Item	Quantity	Unit Cost	Cave Rock Cost (x\$1,000)
Division 1	LS		\$178
Hidden Woods Tank	306,000 Gal	\$1.50	\$ 459
Lower Cave Rock Tank	267,000 Gal	\$1.50	\$ 401
Upper Cave Rock Tank	342,000 Gal	\$1.50	\$ 513
Contingency (25%)			\$ 388
Administrative (25%)			\$ 485
Total Capital			\$ 2,424

5.3.2 Alternative 2 – Supplemental Tanks

This alternative would involve adding a supplemental tank to the Lower and Upper Cave Rock tanks, to provide the required storage. Hidden Woods tank does not meet current codes for access, and as such is not considered for this alternative. The tanks would be located in the vicinity of the existing tanks, at the same elevation. Sizing of the supplemental tanks is per the following table.

Table 5-10 Tank Summary - Alternative 2

Supplemental Tank	Proposed Size (Gal)
Lower Cave Rock	80,000
Upper Cave Rock	145,000
Hidden Woods (Replacement)	306,000

Cost Opinion

Table 5-11. Cost Opinion – Alternative 2

Item	Quantity	Unit Cost	Cave Rock Cost (x\$1,000)
Division 1	LS		\$135
Lower Cave Rock Tank	80,000 Gal	\$2.75	\$ 220
Upper Cave Rock Tank	145,000 Gal	\$2.50	\$ 363
Hidden Woods Tank (Replacement)	306,000 Gal	\$1.50	\$ 459
Contingency (25%)			\$ 295
Administrative (25%)			\$ 368
Total Capital			\$ 1,840

5.4 Deficiency 11 – Water Treatment

The treatment plant has one microfiltration skid that produces treated water. The plant operates at capacity during peak summer demand and there is no backup or redundancy in the plant’s production of treated water. During the summer, the plant operates at high Trans-Membrane Pressure (TMP) which results in less efficient operation.

The 2002 Nolte report (Appendix D) recommended installation of a redundant 48M10C skid to provide redundancy, and increased treatment flow up to 950 gpm. A 12M10C skid was also recommended to process potentially increased backwash flows. Since that report was written, new low pressure membranes have been developed which provide higher recovery rates with a smaller footprint. The existing membranes on the 90M10C skid were replaced in kind in approximately 2012.

5.4.1 Alternative 1 – Redundant/ Peak Demand Membrane Skid

A new skid for filtrate capacity expansion is recommended to increase capacity and provide redundancy in the treatment plant. Refer to the floor plan of the WTP shown in

Figure 5-14.

Preliminary analysis indicates a redundant 48 module skid can be fit inside the existing treatment plant building. Space will be tight between the existing 90M10C skid and the redundant skid.

A new backwash skid is recommended to treat the potential higher backwash flows resulting from the additional treatment. An 18 module skid is recommended to replace the existing 6M10C used for backwash, which can accommodate the flow from both primary treatment skids.

Membrane Selection

Evoqua/Memcor has developed a new N membrane constructed of chlorine resistant PVDF, which increases membrane life.

A new Evoqua CPII MR1 48L40N Trirack skid will double the existing membrane surface area. Each module has 721 SF of surface area versus the 361 SF for the existing M10C modules. The proposed skid layout is 3 racks of 16 modules (48 total), which would provide an additional 1.25 MGD of treatment capacity. This will provide 100% system redundancy, and can be operated under peak flows or cold water conditions if needed to reduce TMP.

The newer membranes Clean-In-Place (CIP) procedure requires different chemicals than the existing system. 12.5% hypochlorite and citric or mineral acid are required for the CIP, in addition to a hot water tank to heat the solution that is recirculated through the membranes. Hypochlorite is already delivered to the WTP, and the usage required is only about 200 gallons per year.

Air requirements are 2.5 scfm at 125 psi, which should be handled by the existing compressor and receiver.

A second backwash tank is required to handle the potential increased waste volume.

Backwash Skid

Backwash waste from the new skid is estimated to be 30,877 gallons per day, based on a 45 minute backwash interval. The existing skid produces 31,680 gpd based on the Nolte report. If operated together, the total would be approximately 62,500 gpd. An Evoqua XPsr 18L10N system could recover this waste operating at just under 19 GFD (~92% recovery) and produce an estimated 4,726 gpd of backwash waste. In addition, a second backwash tank would be added.

Table 5-12. Supplemental Membrane Skid: Design Summary

Design Parameter	Value
SUPPLEMENTAL MEMBRANE SKID	
Manufacturer & Model	Memcor CPII MR1 48L40N
No. of Membrane Modules	48
Skid Size (LxWxH)	13'-2"x5'-9"x8'-9"
Feed Pressure	30 – 50 psi
Filtrate Flow	1.25 MGD
Maximum Design Flux	39 gfd
Recovery	≥ 97%
Backwash Interval	45 minutes
Chlorine Maintenance Wash Interval	168 hours
Acid Maintenance Wash Interval	168 hours
Chlorine Maintenance Wash Concentration	75 – 200 ppm free chlorine
Clean-in-Place (CIP) Interval	30 days, or as required by TMP, which ever occurs first.
Clean-in-Place (CIP) Chemicals	500 ppm free chlorine, 0.5 – 1% Citric
Air Scour Requirements	10 SCFM at 125psi, 500 gal receiver tank
BACKWASH MEMBRANE SKID	
Manufacturer & Model	Memcor XPsr 18L10N
No. of Membrane Modules	18
Skid Size (LxWxH)	10'x4'-5"x7'-2"
Feed Capacity	62,500 gpd
Flux	19 gfd
Recovery	≥ 92%
Feed Pressure	30 – 50 psi
CIP Interval	30 days
Chlorine Maintenance Wash Interval	168 hours



Design Parameter	Value
Acid Maintenance Wash Interval	168 hours
Backwash Interval	22 minutes

Ancillary Equipment

The proposed system includes the following assumptions:

- The feed pumps would be replaced to provide the increased flow (if the skids will be run in parallel). The new CPII will require 955 gpm to produce 1.25 mgd and 1,025 gpm during backwash during the short sweep step.
- Assume the existing strainer can be reused.
- The existing compressed air capacity and receiver volume are sufficient for both systems. The new CPII requires 10 scfm and 500 gallons of volume.
- New CIP system consisting of 850 gallon tank, 15 hp pump, and chemical dosing pumps.
- Turbidimeters for each filtrate line.
- Block and bleed valves
- New control panel and PLC for the new system.

The complete Evoqua proposal is included in Appendix C.

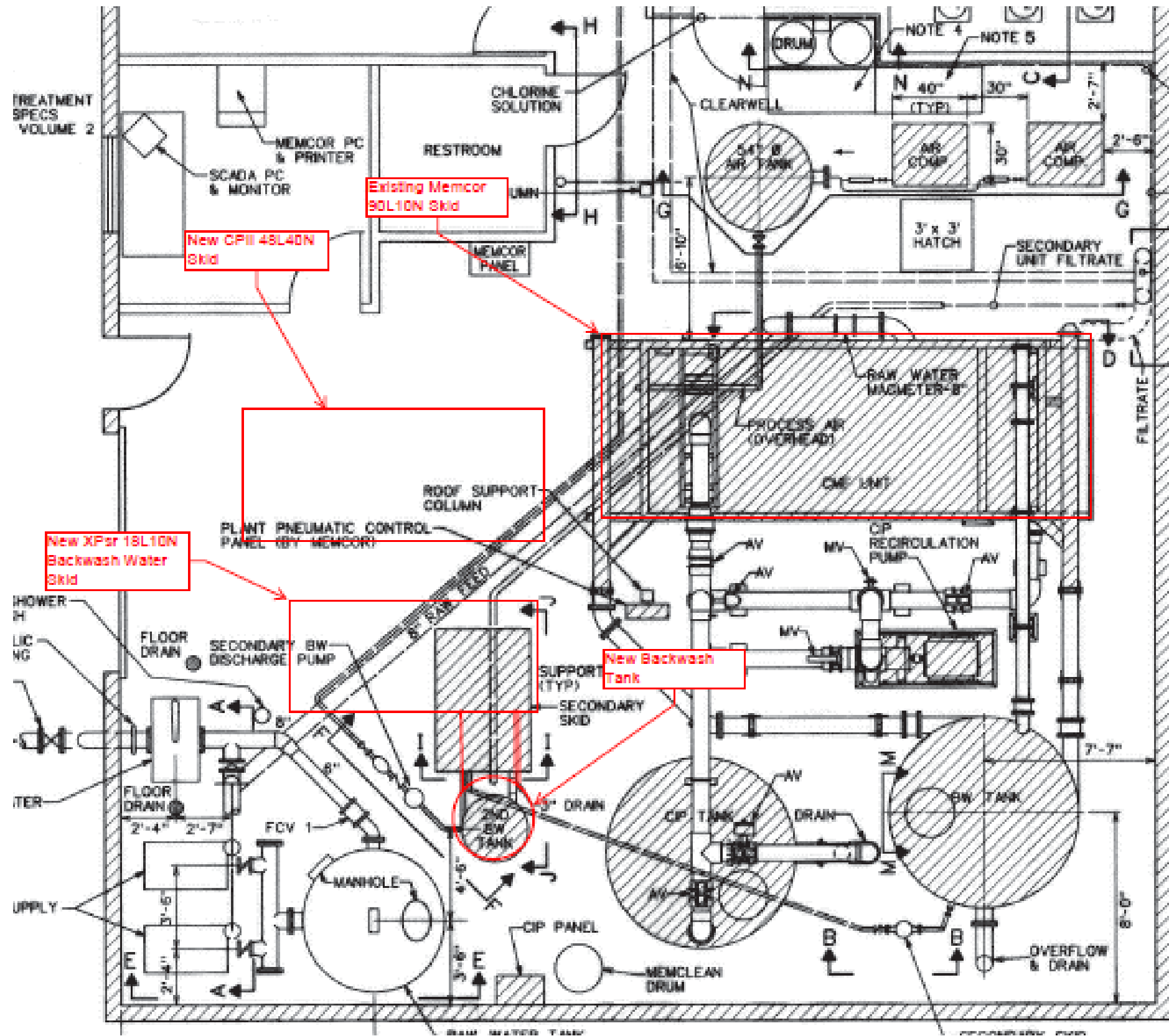

Figure 5-14 Cave Rock WTP Equipment Plan

Environmental Impacts

This action would not result in new land disturbance, rather the upgrade of devices within an existing utility structure. No new excavation, grading, or coverage would result. It will not adversely affect population rates or housing resources, circulation systems, public services, utilities, minerals, agriculture or forestry, or recreation, or create significant hazards. No significant impacts would occur in relation to operation noise, construction air emissions, traffic, geology and land coverage, hydrology and water quality, aesthetics, biological resources, or cultural resources, as the system would replace an existing system within the existing WTP and no new changes outside the structure would occur. Modifications would occur within the existing structure resulting in no additional coverage, expansion of facilities, new uses, or other substantial change to the operations that would create environmental impacts. This would not cause new disturbance to the environment and would serve to improve existing water service.

Operation would not create new noise or exceed threshold limits. Construction noise is expected to occur; however BMPs such as heavy equipment muffling, limiting construction hours to TRPA's construction noise exemption hours (8 AM to 6:30 PM), and compliance with TRPA Code of Ordinances Section 68.9 Noise will ensure noise levels are not significant. As stated above, construction would be limited to TRPA's construction noise exemption hours and BMPs would be implemented to reduce construction noise disturbance. BMPs may include, but are not limited to equipment muffling, use of temporary sound barriers, alternate backup warning systems, and pre-construction building inspection and monitoring during construction, among other methods.

Some temporary air emissions may occur during construction as a result of construction activity, however standard BMPs for the Tahoe Basin would be employed to limit construction emissions. As discussed above, the access to and operation of the storage tank would not result in an increase in daily vehicle trip ends, congestion, or other traffic related changes that would increase air emissions. Construction VMT is expected to be below threshold limits and activity would not cause substantial disturbance to traffic along U.S. 50.

Cost Opinion

Cost for the WTP redundancy improvements is split 50/50 between Cave Rock and Skyland per existing agreements.

Table 5-13. Cost Opinion - Cave Rock/Skyland Water Treatment Plant Modifications

Item	Cave Rock Cost (x\$1,000)	Skyland Cost (x\$1,000)
Division 1	\$ 143	\$ 143
Water Treatment Plant Modifications	\$ 794	\$ 794
Contingency (25%)	\$ 199	\$ 199
Administrative (25%)	\$ 284	\$ 284
Total Capital	\$ 1,420	\$ 1,420
Grand Total	\$ 2,840	

5.5 Deficiency 12 –Water Conservation

5.5.1 Alternative 1 – Installation of Water Meters

Description

To comply with NRS requirements for a Water Conservation Plan, this alternative includes the installation of approximately 292 residential water meters in Cave Rock and 242 residential water meters in Skyland.

Environmental Impacts

No significant environmental impacts are associated with this alternative.

Cost Opinion

Table 5-14. Cost Opinion - Cave Rock Residential Water Meters

Item	Quantity	Unit Cost	Cost (x\$1,000)
Division 1	LS		\$ 75
Residential 3/4 & 1-Inch Meter Assemblies	292	\$1,800	\$ 526
Contingency (25%)	LS		\$ 132
Administrative (25%)	LS		\$ 183
Total Capital			\$ 920



Table 5-15 Cost Opinion - Skyland Residential Water Meters

Item	Quantity	Unit Cost	Cost (x\$1,000)
Division 1	LS		\$ 64
Residential 3/4 & 1-Inch Meter Assemblies	242	\$1,800	\$ 436
Contingency (25%)	LS		\$ 109
Administrative (25%)	LS		\$ 153
Total Capital			\$ 770

5.6 Deficiency 13 – Lake Intake Pump Station

Three options were considered to address low intake pressure, as evaluated in the 2015 Cave Rock Lake Intake Improvements Alternatives TM which is included as Appendix A to this PER.

- Lower the pumps by 4 feet in elevation
- Replace the intake pipe
- Add booster pumping in the lake

5.6.1 Alternative 1 – Lower Pumps by 4 Feet

Alternative 1 proposes lowering the existing intake pumps elevation by 4 feet. This alternative requires construction of an addition onto the west side of the existing pump building and modifications to piping and electrical to facilitate the lower pump location.

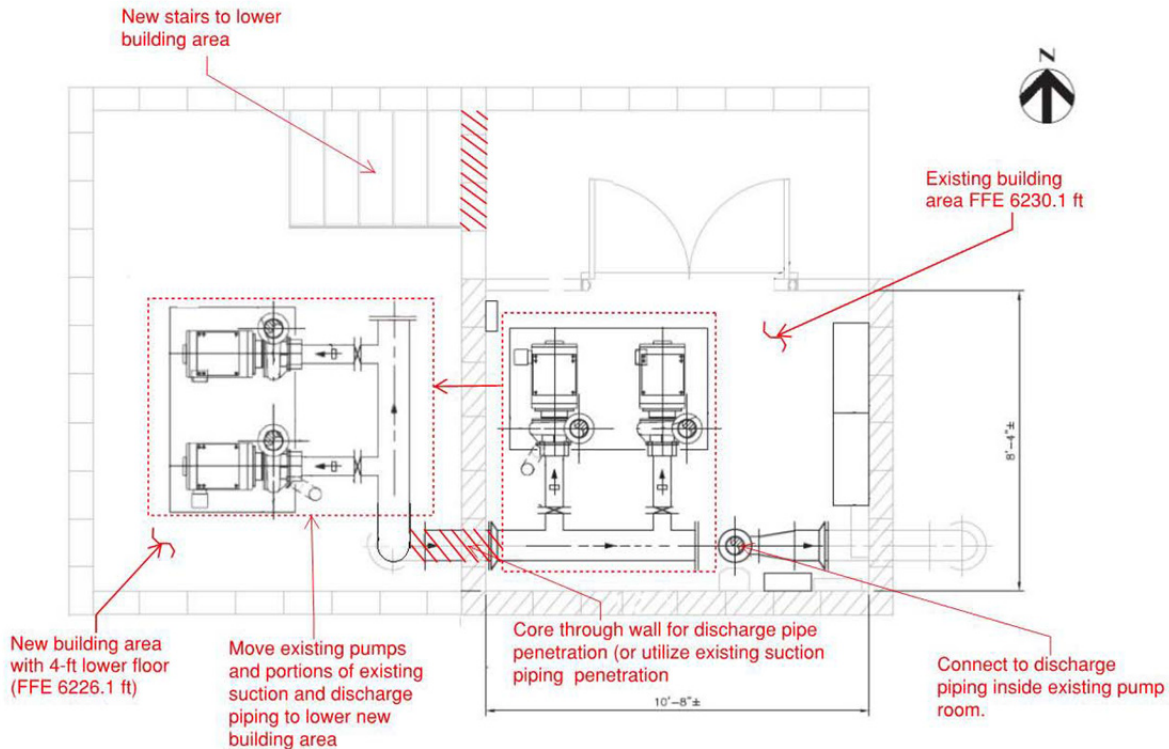

Figure 5-15 Preliminary Pump Plan

Environmental Impacts

Lowering the intake pumps at the existing pump building will result in 180 square feet of new floor area at the pump building and 2 feet of excavation. This action will not adversely affect population rates or housing resources, traffic and circulation systems, cultural resources, public services, utilities, minerals, agriculture or forestry, or recreation, or create significant hazards. The new pipelines and pressure reducing stations and replacement pipelines would be located beneath existing pavement, where feasible, or in line with existing pipeline. Mitigable impacts may occur in relation to construction air emissions and noise, geology and land coverage, hydrology and water quality, aesthetics, and biological resources.

Operation of the pumps would not increase existing noise levels or exceed threshold limits. Construction noise is expected to occur; however BMPs such as heavy equipment muffling, limiting construction hours to TRPA's construction noise exemption hours (8 AM to 6:30 PM), and compliance with TRPA Code of Ordinances Section 68.9 Noise will ensure noise levels are not significant.

Some temporary air emissions may occur during construction as a result of construction activity, however standard BMPs for the Tahoe Basin would be employed to limit construction emissions. No long-term operational or traffic-related emissions would occur. BMPs include those listed in the TRPA Code of Ordinances (33.3.3 and Chapter 65), such as limits on diesel engine vehicle idling, covering exposed soils and stored materials with a chemical dust suppressant or water, removing track out, and limiting construction vehicle speeds, among others. Construction and operations VMT is expected to be below threshold limits.

Construction will result in ground disturbance, which can affect erosion and water quality. Excavation would be approximately 2 feet in depth, however, the lowered pump elevation would be below the high water elevation of 6,229.1, and would therefore affect Waters of the U.S. and may require additional geotechnical studies and mitigation to ensure stability. Implementation of BMPs, including those listed in TRPA's Water Quality Management Plan for the Lake Tahoe Region, Volume II, Handbook of Best Management Practices (TRPA, May 2014) and the TRPA Code of Ordinances Section 60.4 would reduce water quality impacts and erosion to a less than significant level. These BMPs include, but are not limited to, infiltration devices, slope stabilization, revegetation of disturbed areas, and runoff controls. Permanent BMPs would be included to address runoff from the additional coverage at the pump building. The Project will incorporate standard practices to comply with TRPA regulations to avoid, reduce, minimize and mitigation water quality impacts, including implementation of: an Erosion Control Plan, onsite monitoring, a dewatering plan, a revegetation plan, and operations BMPs and monitoring. Since the final floor elevation would be below the high water mark, additional measures will be required to address interference and water quality. Based on proximity to the lake, the Bureau of Water Pollution Control within the Nevada Department of Environmental Planning, responsible for regulating discharges into the waters of the State, and the US Army Corps of Engineers (USACE) may require a site-specific SWPPP and other mitigation actions to prevent debris, soil, silt, oil, or other earthen or construction materials from entering the lake. The SWPPP will describe, locate, and implement the BMPs specific to each area in which construction and operation occurs, will designate areas for construction staging and access, and will include a spill response and groundwater management plan. The project will be required to comply with the terms and conditions established by the USACE. Construction shall also occur in the dry season to minimize siltation.

The addition to the pump building would result in 180 square feet of new coverage, requiring coverage transfer. If excess land coverage occurs, mitigation would include 1) coverage reduction onsite; 2) offsite coverage reduction; 3) payment of excess coverage mitigation fee; 4) findings for excess land coverage; or 5) a combination of these options. As stated in TRPA Code of Ordinances Section 30.4.2.D, "The maximum land coverage for linear public facilities and public health and safety facilities is limited to the minimum amount needed to achieve its public purpose." Section 30.4.2.F states, "The maximum land coverage for other public service facilities located outside of an approved community plan is 50 percent of the project area." According to Section 30.5.1.C, "Land coverage and disturbance for public service facilities may be permitted in Land Capability Districts 1a. 1c. 2. And 3 if TRPA finds that: The project is necessary for public health, safety...There is no reasonable alternative...The impacts are fully mitigated...."

Locating the additional pump house area within the shoreline will require permitting and easement with the TRPA. The pump house is located on parcel APN 141834201018 (12.4 acres). The Project will be required to comply with the permit terms and conditions.

Since the pump building is an above-ground structure, the addition will be visible within the area, and may be visible from Lake Tahoe, due to the height of the structure and footprint elevation. Once design is complete, a more detailed plan would need to be prepared to ensure compliance with TRPA height limitations, shoreline standards and building design standards (TRPA Code of Ordinances Chapters 37 and 36). To ensure no adverse impacts occur, the project may require mitigation in accordance with the design standards such as landscape screening, color blending, and other methods to reduce visibility and maintain the visual character. No public roadway signage is associated with the structure.

There are no known wildlife resources in the area; however pre-construction surveys for nesting bird species will be required in order to conform with the Migratory Bird Treaty Act of 1918. No known Protected Activity Centers for either northern goshawk or California spotted owl are known to occur in the area. Implementation of vegetation protection BMPs during construction will ensure no significant impacts occur (TRPA Code of Ordinances Chapter 33.6) and the project will be required to comply with resource protection actions required by the USFS and resource agencies. Since the pumps would be below the ordinary high water mark, consultation with the resource agencies, including the USACE will be required to ensure impacts are fully mitigated.

There are no known cultural resources within the area of the pump building.

Cost Opinion

Table 5-16. Cost Opinion Alternative 1 – Lake Intake Pump Station

Item	Cost (x\$1,000)
Division 1	
Planning Level Opinion of Probable Construction Cost for lowering pumps by 4 feet	\$ 69
Contingency (25%)	\$ 17
Administrative (25%)	\$ 22
Total Capital	\$ 108

5.6.2 Alternative 2 – Replace Intake Pipe

Alternative 2 proposes replacing the existing intake pipe with larger diameter high dimension ratio (DR) (i.e. thin wall) HDPE pipe. Replacing the existing 10 inch DR 9 intake pipe with the new pipe would reduce the suction piping losses by about 4 feet according to hydraulic calculations calibrated with pump testing, and therefore reduce the NPSH_a by the same amount.

Leaving the existing pipe in place and installing a second intake pipe was also considered in the Cave Rock Lake Intake Improvements project. However, this was



not preferred since this may not fall under the existing memorandum of understanding (MOU) with Tahoe Regional Planning Agency (TRPA) and would result in additional infrastructure in Lake Tahoe that is not required.

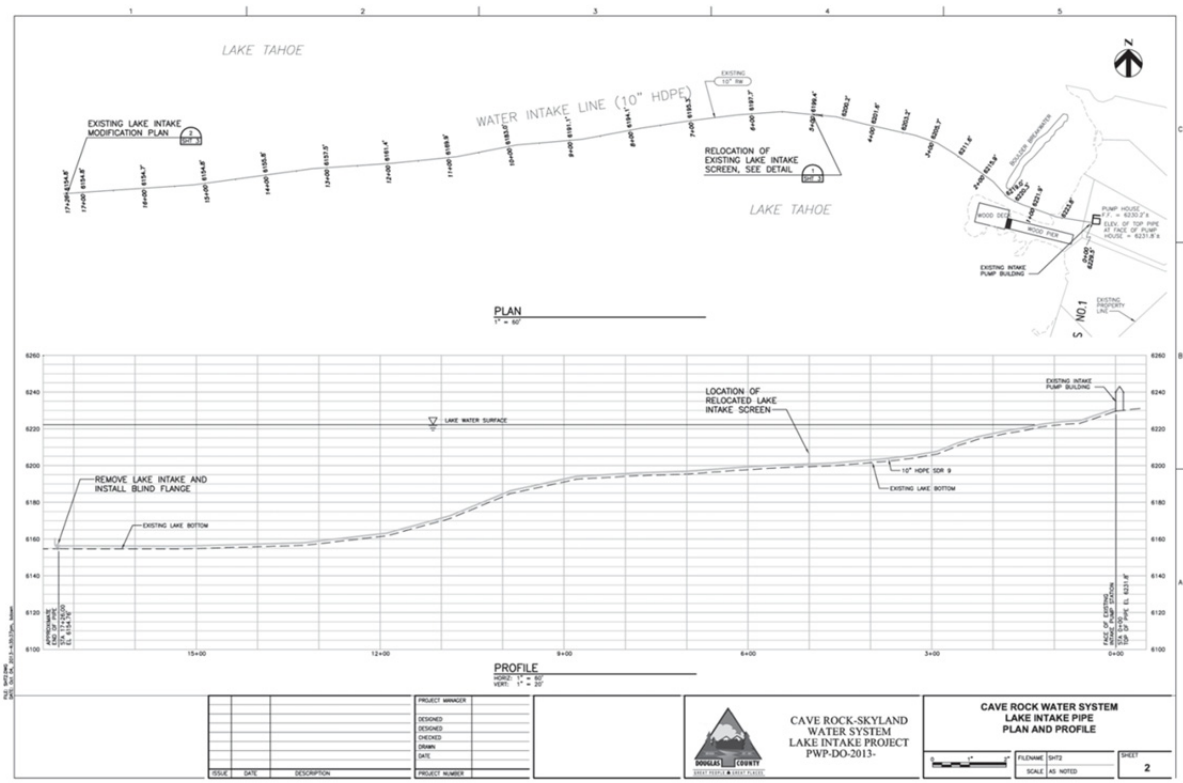

Figure 5-16 Existing Lake Intake Pipe Plan

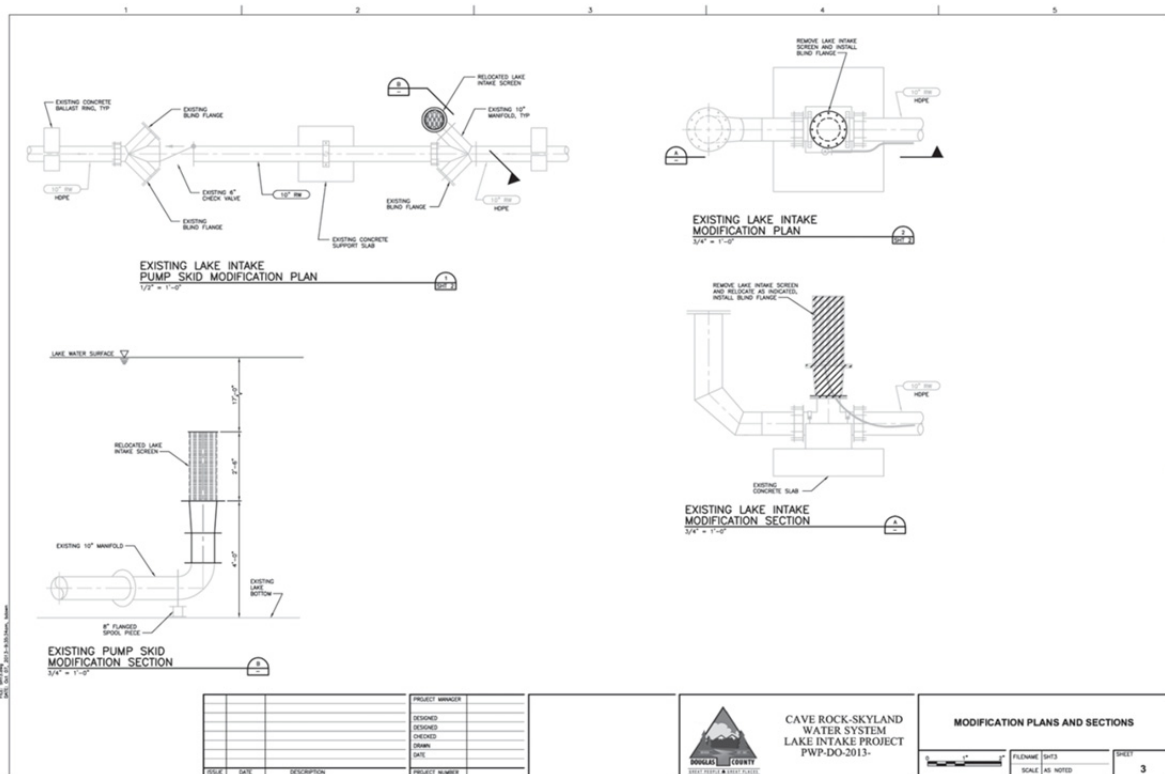

Figure 5-17 Lake Intake Pipe Modification Plan

Environmental Impacts

Development of new 14-inch diameter pipeline will not adversely affect population rates or housing resources, traffic or circulation systems, public services, utilities, minerals, aesthetics, agriculture or forestry, cultural resources, recreation, or create significant hazards. The new pipeline would be located within Lake Tahoe, which may require amendment to the MOU with TRPA and would require coordination with various state and federal regulatory agencies. Mitigable impacts may occur in relation to construction air emissions and noise, geology, hydrology and water quality, and biological resources.

Operation of the pipeline would not create new noise emissions or noise levels that exceed threshold limits. Construction noise is expected to occur, with construction occurring by barge within the lake; however BMPs such as equipment muffling, limiting construction hours to TRPA’s construction noise exemption hours (8 AM to 6:30 PM), and compliance with TRPA Code of Ordinances Section 68.9 Noise will ensure noise levels are not significant.

Some temporary air emissions may occur during construction as a result of construction activity, however standard BMPs for the Tahoe Basin would be employed to limit construction emissions. No long-term operational or traffic-related emissions would occur. Construction VMT is expected to be below threshold limits.

Installation of the 500 linear feet pipeline will occur by barge within the lake and hand-digging within the shoreline to the pump house, and will result in some

disturbance to the lake bed and shorezone, which can affect water quality. Implementation of BMPs, including those listed in TRPA's Water Quality Management Plan for the Lake Tahoe Region, Volume II, Handbook of Best Management Practices (TRPA, May 2014) and the TRPA Code of Ordinances Section 60.4 would reduce water quality impacts and erosion to a less than significant level. The Bureau of Water Pollution Control within the Nevada Department of Environmental Planning is responsible for regulating discharges into the waters of the State and will require consultation and mitigation measures based on the extent of impact, as will the U.S. Army Corps of Engineers.

Water intake lines are an allowed use. According to Section 82.3 of the TRPA Code of Ordinances, an increase in the pipeline diameter would be considered an expansion of an existing structure. Such activity may be allowed if compliance with development standards and design standards occurs and if appropriate BMPs as established in section 60.4 are installed. In accordance with Section 85.5, construction within the backshore must show no reasonable alternatives and that coverage and disturbance impacts are mitigated.

The replacement pipeline may be able to reuse the existing pipe anchors to avoid additional disturbance within the lakebed. Some disturbance would occur within the shoreline area due to hand-digging of a trench to remove the old line and install the new line between the lake and the pump house. While this would result in disturbance, it would not result in new coverage. Repair of linear public facilities and minor utility projects (replacement, repair, interconnection of existing utilities) is not subject to excess land coverage mitigation (TRPA Code of Ordinances Section 30.6.2.E and F).

Pre-construction surveys for nesting bird species will be required in order to conform with the Migratory Bird Treaty Act of 1918. No known Protected Activity Centers for either northern goshawk or California spotted owl are known to occur in the area. Implementation of vegetation protection BMPs during construction will ensure no significant impacts occur (TRPA Code of Ordinances Chapter 33.6) and the project will be required to comply with resource protection actions required by the USFS, USACE, and other resource agencies. Due to the location of the pipe within the lake, potential construction related impacts on fish habitat and spawning would need to be addressed and appropriate BMPs established at the time of final design.

Placement of the pipeline in the lake and construction activities will require coordination with the Coast Guard. Coast Guard permits and conditions of approval would be required for the project.

Cost Opinion

Table 5-17. Cost Opinion Alternative 2 – Lake Intake Pump Station

Item	Cost (x\$1,000)
Division 1	
Planning Level Opinion of Probable Construction Cost for replacing intake pipe	\$ 199
Contingency (25%)	\$ 50
Administrative (24%)	\$ 62
Total Capital	\$ 312

5.6.3 Alternative 3 – Add Booster Pump in the Lake

This alternative proposes the addition of a submersible inline booster pump at the existing pump intake screen that would run in series with the existing lake intake pumps at lower lake levels. This alternative would boost the suction pressure to the existing lake intake pumps and eliminate NPSH_a issues that can cause cavitation of the existing pumps. The additional pump would be vertical turbine, submersible pump, installed horizontally in a can. The alternative also includes installing a new low profile intake screen at the near shore intake. Water will be drawn from this intake screen when the new booster pump is not operating. The existing intake screen will be moved to the end of the intake pipe.

This was the recommended option in the *Cave Rock Lake Intake Improvements Alternatives TM*, HDR 2015 and is currently under construction.

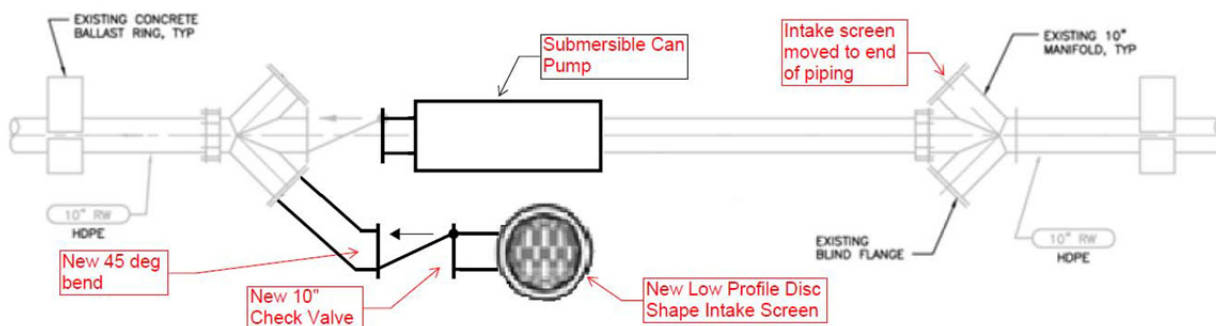

Figure 5-18 Booster Pump and Intake Screen Layout

Environmental Impacts

The addition of the new booster pump and screen on the existing pipeline, as well as replacement of the existing damaged pipe segment, will result in the least amount of

disturbance and would not adversely affect population rates or housing resources, traffic or circulation systems, public services, utilities, minerals, aesthetics, agriculture or forestry, cultural resources, recreation, or create significant hazards. The new pipeline would be located within Lake Tahoe, which may require amendment to the MOU with TRPA and would require coordination with various state and federal regulatory agencies. Placement of the pipeline in the lake and construction activities will require coordination and permitting with the Coast Guard, particularly in relation to the additional electrical line required to operate the booster pump. Mitigable impacts may occur in relation to construction air emissions and noise, geology, hydrology and water quality, and biological resources.

Operation of the booster pump would not result in noise levels that exceed threshold limits. Construction noise is expected to occur, with construction occurring by barge within the lake; however BMPs such as equipment muffling, limiting construction hours to TRPA's construction noise exemption hours (8 AM to 6:30 PM), and compliance with TRPA Code of Ordinances Section 68.9 Noise will ensure noise levels are not significant.

Some temporary air emissions may occur during construction as a result of construction activity, however standard BMPs for the Tahoe Basin would be employed to limit construction emissions. No long-term operational or traffic-related emissions would occur. Construction VMT is expected to be below threshold limits.

Installation of the booster pump and screen and replacement of the damaged pipe segment will occur by barge and result in some disturbance to the lake bed, which can affect water quality. Implementation of BMPs, including those listed in TRPA's Water Quality Management Plan for the Lake Tahoe Region, Volume II, Handbook of Best Management Practices (TRPA, May 2014) and the TRPA Code of Ordinances Section 60.4 would reduce water quality impacts and erosion to a less than significant level. The Bureau of Water Pollution Control within the Nevada Department of Environmental Planning is responsible for regulating discharges into the waters of the State and will require consultation and mitigation measures based on the extent of impact, as will the U.S. Army Corps of Engineers.

Installation of the booster pump will occur by barge within the lake, as well as hand-digging within the shoreline to the pump house to install electrical feeds to the booster pump, and will result in some disturbance to the lake bed and shorezone, which can affect water quality. Implementation of BMPs, including those listed in TRPA's Water Quality Management Plan for the Lake Tahoe Region, Volume II, Handbook of Best Management Practices (TRPA, May 2014) and the TRPA Code of Ordinances Section 60.4 would reduce water quality impacts and erosion to a less than significant level. The Bureau of Water Pollution Control within the Nevada Department of Environmental Planning is responsible for regulating discharges into the waters of the State and will require consultation and mitigation measures based on the extent of impact, as will the U.S. Army Corps of Engineers.

Water intake lines are an allowed use. According to Section 82.3 of the TRPA Code of Ordinances, the addition of the booster pump would be considered an expansion of an existing structure. Such activity may be allowed if compliance with development standards and design standards occurs and if appropriate BMPs as

established in section 60.4 are installed. In accordance with Section 85.5, construction within the backshore must show no reasonable alternatives and that coverage and disturbance impacts are mitigated.

The booster pump may be able to reuse the existing pipe anchors to avoid additional disturbance within the lakebed, although new anchors will be needed for the replaced section of pipe. Some disturbance would occur within the shoreline area due to hand-digging of a trench for the electrical feed line to the booster pump. This would result in disturbance, and a small increase in new coverage within the lake. Repair of linear public facilities and minor utility projects (replacement, repair, interconnection of existing utilities) is not subject to excess land coverage mitigation (TRPA Code of Ordinances Section 30.6.2.E and F)

Pre-construction surveys for nesting bird species will be required in order to conform with the Migratory Bird Treaty Act of 1918. No known Protected Activity Centers for either northern goshawk or California spotted owl are known to occur in the area. Implementation of vegetation protection BMPs during construction will ensure no significant impacts occur (TRPA Code of Ordinances Chapter 33.6) and the project will be required to comply with resource protection actions required by the USFS, USACE, and other resource agencies. Due to the location of the booster pump, screen, and replacement pipe within the lake, as well as the electrical feed, potential construction related impacts on fish habitat and spawning would need to be addressed and appropriate BMPs established at the time of final design.

Placement of the booster pump and electrical feed in the lake and construction activities will require coordination with the Coast Guard. Coast Guard permits and conditions of approval would be required for the project. Although the electrical line results in an increase in potential boat anchor snags, it would not limit aquatic use of the lake.

Cost Opinion

Table 5-18. Cost Opinion Alternative 3 – Lake Intake Pump Station

Item	Cave Rock Cost (x\$1,000)	Skyland Cost (x\$1,000)
Planning Level Opinion of Probable Construction Cost for adding booster pumps in the lake	\$ 89	\$ 89
Contingency (25%)	\$ 22	\$ 22
Administrative (25%)	\$ 28	\$ 28
Total Capital	\$ 139	\$ 139
Grand Total	\$ 278	

Detailed description of each Lake Intake alternative and respective cost estimates are attached in Appendix D.



6 Alternatives Analysis

For the purpose of evaluating the alternatives proposed for deficiencies 9 and 13, four weighted criteria will be used to develop an overall score. The criteria will be ranked on a scale of one (1) to four (4), with one being the highest (best) ranking, and 4 being the lowest (worst). The overall lowest score is considered the best alternative. Cost will be a stand alone criterion, which is not factored into the weighted score. The following criteria and weighting will be used to score the alternatives:

- Implementation (20%) – Is the alternative feasible to implement? Is the alternative constructible?
- Reliability (25%) – Will the alternative provide reliable results?
- Operability/Maintenance (40%) – Does the alternative require large quantities of time in terms of operator attention? Does the alternative require specialized maintenance requirements that cannot be performed in-house, or does it require frequent calibration, cleaning, tuning, etc.? Does it require an ongoing contract for maintenance?
- Environmental Consideration (15%): Will the alternative be difficult to permit? Can TRPA thresholds be met? Are there short-term or long-term effects on the environment?

6.1 Deficiency 1-9 – Fire Flow, Pressure, Velocity, Line Size, Line Leaks, and Pump Stations

6.1.1 Rankings and Capital Cost Summary

Table 6-1. Deficiency 1-9 Capital Cost Summary

Alternative	Capital Cost (x\$1,000)
1 – Modified Existing System Configuration	\$ 19,178
2 – High Pressure Main and Zone Pumping	\$ 20,956

Table 6-2. Deficiency 1-9 Alternative Rankings

Criterion	Weight	Alternative Rank		Weighted Score	
Alternative		1	2	1	2
Implementation	20%	1	2	0.20	0.40
Reliability	25%	1	1	0.25	0.25
Operability/Maintenance	40%	1	2	0.40	0.80
Environmental/Permitting	15%	2	1	0.30	0.15
Net Score				1.2	1.6
Net Rank				1	2

Notes:

1. Ranking 1 – 4.1 is highest (best), 4 is lowest (worst).
2. Lowest net score is considered best alternative.

6.1.2 Implementation

Since Alternative 1 is based on the existing system configuration, it is easier to implement. This is especially true considering the limited working space at the WTP to add new pumps.

6.1.3 Reliability

Reliability is expected to be about the same for both alternatives. Alternative 1 has fewer PRVs but 1 extra booster station. Alternative 2 has a high pressure main with additional PRVs.

6.1.4 Operability/Maintenance

Alternative 1 Pros:

1. Alternative 1 does not significantly change pressure zones and has fewer total PRVs in the system.
2. No high pressure mains.
3. Time tested operations.

Alternative 1 Cons:

1. One additional pump station compared to Alternative 2.

Alternative 2 Pros:

1. Fewer booster pumps and brings almost the entire booster pumping (all except the Upper Cave Rock BPS) into the existing WTP.
2. Lower O&M costs

Alternative 2 Cons:



1. Makes the pumping room in the WTP very tight and access for maintenance difficult.
2. Unproven pumping configuration.
3. Higher capital cost.

Overall Alternative 1 has more pros than cons and is ranked higher than Alternative 2.

6.1.5 Environmental/Permitting

Permits, easements, and/or land acquisition will be required for Alternative 1 as it requires new building for housing the relocated pumps above ground. Installation of booster pumps at the WTP will only require a County building permit. Hence, Alternative 2 is ranked higher.

6.1.6 Recommended Alternative

Alternative 1 scored the highest and is the preferred Alternative. Alternative 2 has lower power and Operations and Maintenance costs by about \$17,000 per year¹. However, given the \$1.8M capital cost difference, the simple payback for Alternative 2 is over 100 years. Thus, Alternative 1 is preferred.

6.2 Deficiency 10 – Storage Volume

6.2.1 Rankings and Capital Cost Summary

Table 6-3 Deficiency 10 Capital Cost Summary

Alternative	Description	Capital Cost (x\$1,000)
1	Replace Existing Tanks	\$ 2,424
2	Add Supplemental Tanks	\$ 1,840

Table 6-4 Deficiency 10 Alternative Rankings

Criterion	Weight	Alternative Rank		Weighted Score	
		1	2	1	2
Implementation	20%	3	1	0.60	0.20
Reliability	25%	1	1	0.25	0.25
Operability/Maintenance	40%	2	1	0.80	0.40
Environmental/Permitting	15%	1.5	1	0.23	0.15
Net Score				1.9	1.0

Criterion	Weight	Alternative Rank	Weighted Score
		Net Rank	2
			1

Notes:

1. Ranking 1 – 4.1 is highest (best), 4 is lowest (worst).
2. Lowest net score is considered best alternative.

6.2.2 Implementation

Alternative 2 is easier to implement since the existing tanks can be kept online during the construction of the supplemental tanks. This eliminates the need for temporary tanks during construction, and the associated problems with providing fire flow and storage.

6.2.3 Reliability

Both alternatives are equally reliable.

6.2.4 Operability/Maintenance

Alternative 2 provides more operational flexibility since a tank can be taken offline for maintenance without the need for a temporary tank. The supplemental tank provides increased system redundancy.

6.2.5 Environmental/Permitting

Assuming the supplemental tank is located in the same area as the existing tank, Alternative 2 is ranked slightly higher since a temporary tank isn't needed during construction. If the supplemental tank must be located in a new undisturbed area, then Alternative 1 would be ranked higher.

6.2.6 Recommended Alternative

Alternative 2 is recommended for being easier to implement, providing increased operational flexibility, and lower cost.

6.3 Deficiency 13 – Lake Intake Pump Station

6.3.1 Rankings and Capital Cost Summary

Table 6-5. Capital Cost Summary

Alternative	Capital Cost (x\$1,000)
1 – Lower the pumps by 4 feet in elevation	\$ 108
2 – Replace the intake pipe	\$ 312
3 – Add booster pumping in the lake	\$ 277



Table 6-6. Deficiency 13 Alternative Rankings

Criterion	Weight	Alternative Rank			Weighted Score		
		1	2	3	1	2	3
Alternative		1	2	3	1	2	3
Implementation	20%	3.0	2.5	2.5	0.60	0.50	0.50
Reliability	25%	2.0	2.0	1.0	0.50	0.50	0.25
Operability/Maintenance	40%	3.0	3.0	2.0	1.20	1.20	0.80
Environmental/Permitting	15%	2.0	3.0	3.0	0.30	0.45	0.45
Net Score					2.6	2.7	2.0
Net Rank					2	3	1

Notes:

1. Ranking 1 – 4.1 is highest (best), 4 is lowest (worst).
2. Lowest net score is considered best alternative.

6.3.2 Implementation

Implementation of Alternative 1 is difficult due to the several factors including the following:

- Significant Geotechnical permitting and Tahoe Regional Planning Agency (TRPA) mitigation and coverage transfer issues are expected for Alternative 1. This would add design costs and could delay bid documents.
- Also for Alternative 1, Foundation and geotechnical requirements for new slab in this area are unknown and may cause additional costs.

For these reasons, Alternative 1 was ranked lower than Alternatives 2 and 3. While Alternatives 2 and 3 do not have these issues, they have more difficult mobilization as they require divers, barge, line lifting and replacing.

6.3.3 Reliability

Alternative 3 has the highest reliability since it provides relatively constant pumping rates to be maintained at low lake levels. Alternatives 1 and 2 are equally reliable, but do not provide protection for drought conditions.

6.3.4 Operability/Maintenance

Alternative 3 involves a second set of pumps, which require eventual replacement and not easily accessible. However, it does offer the advantage of increased operational flexibility since suction pressure can be maintained at lower lake levels. Overall, the upsides outweigh the downside for this category. Alternatives 1 and 2 are equal in this category.

6.3.5 Environmental/Permitting

Alternatives 2 and 3 are about equal with respect to this category, as both will require TRPA and Army Corps permits and BMPs associated with working in the Lake. Alternative 1 does not involve work in the lake, but still requires a TRPA permit due to the excavation volume that is required. Since the area has already been disturbed, Alternative 1 has a higher ranking.

6.3.6 Recommended Alternative

While the construction cost is the lowest for Alternative 1, additional engineering, geotechnical and permitting costs due to geotechnical and TRPA permitting concerns will likely offset the construction savings. Alternative 2 will provide a new pipe into the lake, reduce head losses on the suction side of the pumps, and keep equipment out of Lake Tahoe. However, Alternative 2 does not offer the flexibility and performance of Alternative 3. Alternative 3 offers the benefit of being able to pump 800+ gpm at lake levels down to elevation 6,219 and lower and replaces 100-ft of damaged piping in the lake. Alternative 3 also enables drawing water from the end of the intake pipe during low lake levels to provide compliance with NDEP requirements for screen submergence at all lake levels. Alternative 3 is also less expensive than Alternative 2. As per the analysis performed in this report, Alternative 3 is recommended and this is in agreement with the 2015 *Cave Rock Lake Intake Improvements Alternatives TM*. Alternative 3 is currently in construction.

7 Prioritization of Improvements and Cost Summary

7.1 Discussion of Priorities

Prioritization of projects is based on risk. System deficiencies with higher associated risk consequences will be given higher priority. The projects are grouped into four priority categories as follows:

- Priority 1 – These deficiencies represent public health and safety risks. Consequence of failure includes potential loss of life and property.
- Priority 2 – Represent deficiencies which may result in temporary disruption of water service or compliance, but generally minimal public health and safety impacts.
- Priority 3 – Represent deficiencies which may result in less efficient operations, but are not likely to cause loss or disruption of service or compliance.
- Priority 4 – Represent projects which may result in further gains in efficiency from priority 3, but are not directly needed for operations. Projects in this category represent “wants” more than “needs”, and do not address code violations.

7.1.1 Priority 1 Projects

Priority 1 projects address direct threats to public health and safety.

Fire flow represents potential threats to public health and safety. Potential results of insufficient fire flow include loss of property and life. As such, project(s) that address Deficiencies 1-7 and 10 were deemed the only Priority 1 projects.

7.1.2 Priority 2 Projects

Priority 2 project address deficiencies which result in system shutdown downs and minor compliance issues. These deficiencies generally do not pose threats to public health.

Line leaks result in partial system shutdowns, and risk distribution system contamination. Treatment redundancy is a code requirement, and may result in temporary loss of production water should a failure occur. Booster station replacement is also a code compliance issue.

7.1.3 Priority 3 Projects

Priority 3 projects generally address deficiencies which result in less efficient system operation, but no threats to public health or safety.

7.1.4 Priority 4 Projects

Priority 4 projects are not related directly to code requirements, but may provide benefits to the system reliability and efficiency. These projects are more “wants” than “needs”.

7.2 Project Priority Summary and Costs

Table 7-1. Project Priority Summary and Costs

No.	Deficiency Description	Priority	Recommended Alternative	Cave Rock Capital Cost (x\$1,000)	Skyland Capital Cost (x\$1,000)
1-9	Fire Flow, Pressure, Velocity, Leaks, Booster Pumping	1	1 – Modified Existing System	\$ 10,329	\$ 8,849
10	Hidden Woods, Lower and Upper Cave Rock Storage Volume Deficiencies	1	2 – Add Supplemental Tanks	\$ 1,840	\$ 0
11	Water Treatment Plant Redundancy	2	Redundant Treatment Skid	\$ 1,420	\$ 1,420
12	Water Conservation	3	Installation of Water Meters	\$ 920	\$ 770
13	Lake Intake Pump Station	2	3 – Add booster pumps in Lake	\$ 139	\$ 139
Total				\$14,648	\$11,178
Grand Total				\$ 25,826	

8 References

1. *Cave Rock/Skyland Water System Model and Needs Assessment Report*, March 20, 2008
2. Blue Locker Commercial Diving Services – Douglas County Cave Rock – Steel Reservoir Inspection, 2014-2015
3. *Cave Rock Water System Improvements 10% Design Report*, HDR, October, 2008
4. *Cave Rock Water System – Facility Planning, Technical Memorandum No.1*, Douglas County, April 2008
5. *Cave Rock Lake Intake Improvement Alternatives, Technical Memorandum*, HDR September 2015
6. *Operational Assessment and Reliability Study Cave Rock-Skyland Water Treatment Plant*, Nolte Associates, Inc., September 2002

APPENDIX A – COST OPINIONS

Job No.					Calc. No.	
Computation					FDR	
Project: Cave Rock Skyland Water System Preliminary Engineering				Computed: PD		
Subject: Fire Flow, Pressure, and Booster Pumping				Date: 10/27/2016		
Task: Deficiency 1-9 Alternative - 1				Reviewed: JB		
File Name: C:\Users\bellin\Desktop\Projects\Douglas County\Lake Water PER\PERs\Cave Rock\Costs\Cave Rock _ Costs_2-26 (Autosaved).xlsx\Def 1-9 Alt 1					Date:	
DESCRIPTION	QUANTITY	UNITS	UNIT COST	TOTAL COST	Cave Rock	Skyland
General Requirements						
Mobilization	1	LS	3.00%	\$330,100		
Demobilization	1	LS	1.00%	\$107,900		
Bonds and Insurance	1	LS	2.50%	\$273,700		
Construction Facilities/Fencing	1	LS	0.50%	\$53,700		
General Conditions	1	LS	4.00%	\$444,700		
Shop Drawings and O&M Manuals	1	LS	2.00%	\$217,900		
Facilities Start-up & Testing	1	LS	2.00%	\$217,900		
Traffic Control		LS		\$25,000		
SUBTOTAL			15.0%	\$1,670,900		
Demolition						
Demolition of Hidden Woods Booster Station		LS		\$7,500		
Demolition of Cedar Ridge Hydropneumatic Tank		LS		\$7,500		
Demolition of Lower Cave rock Booster Station		LS		\$7,500		
SUBTOTAL				\$22,500	\$22,500	
Cave Rock Pipelines (includes patch paving)						
8" DIP	4368	LF	\$193	\$843,171		
8" Gate Valve	6	EA	\$2,900	\$17,400		
10" DIP	11583	LF	\$227	\$2,630,480		
10" Gate Valve	15	EA	\$3,200	\$48,000		
12" DIP	4076	LF	\$261	\$1,063,836		
12" Gate Valve	6	EA	\$3,500	\$21,000		
14" DIP		LF	\$295	\$0		
14" Gate Valve	0	EA	\$4,000	\$0		
SUBTOTAL				\$4,623,887	\$4,623,887	
Skyland Pipelines (includes patch paving)						
8" DIP	8648	LF	\$193	\$1,669,355		
8" Gate Valve	11	EA	\$2,900	\$31,900		
10" DIP	2946	LF	\$227	\$669,032		
10" Gate Valve	4	EA	\$3,200	\$12,800		
12" DIP	6821	LF	\$261	\$1,780,281		
12" Gate Valve	9	EA	\$3,500	\$31,500		
14" DIP	2418	LF	\$295	\$713,310		
14" Gate Valve	4	EA	\$4,000	\$16,000		
SUBTOTAL				\$4,924,178		\$4,924,178
Cave Rock Pressure Reducing Stations						
8" PRV	9	EA	\$54,700	\$492,300		
SUBTOTAL				\$492,300	\$492,300	
Booster Stations						
<i>Lower Cave Rock Booster Station - Above Ground</i>						
Sitework	1	LS	\$25,000	\$25,000		
Booster Pump Station Building	300	SF	\$175	\$52,500		
Booster Pump Station Mechanical	1	LS	\$50,000	\$50,000		
Horizontal Split Case Pumps	2	EA	\$25,000	\$50,000		
Electrical, Controls, & Telemetry	1	LS	\$87,000	\$87,000		
SUBTOTAL				\$264,500	\$264,500	
<i>Lakeridge Booster Station - Above Ground</i>						
Sitework	1	LS	\$25,000	\$25,000		
Booster Pump Station Building	400	SF	\$175	\$70,000		
Booster Pump Station Mechanical	1	LS	\$50,000	\$50,000		
Horizontal Split Case Pumps	2	EA	\$35,000	\$70,000		
Cedar Ridge Domestic Pumps	2	EA	\$15,000	\$30,000		
Electrical, Controls, & Telemetry	1	LS	\$100,000	\$100,000		
SUBTOTAL				\$345,000	\$345,000	
SUBTOTAL				\$10,672,365	\$5,748,187	\$4,924,178
(ADDITIVE FOR) DIVISION 1 (ABOVE)				\$1,600,855	\$862,228	\$738,627
SUBTOTAL 2				\$12,273,220	\$6,610,415	\$5,662,804
CONTINGENCY (25%)				\$3,069,000	\$1,653,000	\$1,416,000
SUBTOTAL 3				\$15,342,000	\$8,263,000	\$7,079,000
ADMINISTRATIVE (25%)				\$3,836,000	\$2,066,000	\$1,770,000
TOTAL				\$19,178,000	\$10,329,000	\$8,849,000

Job No.					Calc. No.		
Computation					HDR		
Project: Cave Rock Skyland Water System Preliminary Engineering					Computed: PD		
Subject: Fire Flow, Pressure, and Booster Pumping					Date: 10/27/2016		
Task: Cave Rock Deficiency 1-9 Alternative - 2					Reviewed: JB		
File Name: C:\Users\bellin\Desktop\Projects\Douglas County\Lake Water PER\PERs\Cave Rock\Costs\Cave Rock_Costs_2-26 (Autosaved).xlsx\Def 1-9 Alt 2					Date:		
DESCRIPTION	QUANTITY	UNITS	UNIT COST	TOTAL COST	Cave Rock	Skyland	
General Requirements							
Mobilization	1	LS	3.00%	\$360,700			
Demobilization	1	LS	1.00%	\$117,800			
Bonds and Insurance	1	LS	2.50%	\$299,000			
Construction Facilities/Fencing	1	LS	0.50%	\$58,600			
General Conditions	1	LS	4.00%	\$485,900			
Shop Drawings and O&M Manuals	1	LS	2.00%	\$238,000			
Facilities Start-up & Testing	1	LS	2.00%	\$238,000			
Traffic Control		LS		\$25,000			
SUBTOTAL			15.0%	\$1,823,000			
Demolition							
Demolition of Hidden Woods Booster Station		LS		\$7,500	\$7,500		
Demolition of Cedar Ridge Hydropneumatic Tank		LS		\$7,500	\$7,500		
Demolition of Lower Cave rock Booster Station		LS		\$7,500	\$7,500		
Demolition of Skyland Smart Valve		LS		\$7,500		\$7,500	
WTP Misc Demo		LS		\$20,000	\$10,000	\$10,000	
SUBTOTAL				\$50,000	\$32,500	\$17,500	
Cave Rock Pipelines (includes patch paving)							
8" DIP	6510	LF	\$193	\$1,256,649			
8" Gate Valve	9	EA	\$2,900	\$26,100			
10" DIP	11644	LF	\$227	\$2,644,333			
10" Gate Valve	15	EA	\$3,200	\$48,000			
12" DIP	4032	LF	\$261	\$1,052,352			
12" Gate Valve	6	EA	\$3,500	\$21,000			
14" DIP		LF	\$295	\$0			
14" Gate Valve	0	EA	\$4,000	\$0			
SUBTOTAL				\$5,048,434	\$5,048,434		
Skyland Pipelines (includes patch paving)							
8" DIP	8648	LF	\$193	\$1,669,355			
8" Gate Valve	11	EA	\$2,900	\$31,900			
10" DIP	2946	LF	\$227	\$669,032			
10" Gate Valve	4	EA	\$3,200	\$12,800			
12" DIP	6821	LF	\$261	\$1,780,281			
12" Gate Valve	9	EA	\$3,500	\$31,500			
14" DIP	2418	LF	\$295	\$713,310			
14" Gate Valve	4	EA	\$4,000	\$16,000			
SUBTOTAL				\$4,924,178		\$4,924,178	
Cave Rock Pressure Reducing Stations							
8" PRV	13	EA	\$54,700	\$711,100			
SUBTOTAL				\$711,100	\$711,100		
Lake Ridge Tank Level Control Valve							
Vault		LS		\$25,000			
Valve		LS		\$20,000			
Misc Mech		LS		\$15,000			
Electrical		LS		\$15,000			
Excavation/Backfill		LS		\$10,000			
SUBTOTAL				\$85,000	\$85,000		
High Pressure Services							
Type 1 - Single Meter Pit with PRV per New Service Detail	6	EA	\$3,500	\$21,000			
SUBTOTAL				\$21,000	\$21,000		
WTP Pumping Modifications							
Concrete		LS		\$25,000			
Painting & Coatings		LS		\$50,000			
Doors & Windows		LS		\$25,000			
Vertical Turbine Pumps	2	EA	\$65,000	\$130,000			
VFDs for Vertical Turbine Pumps	2	EA	\$35,000	\$70,000			
Variable Speed Packaged Pump including VFD	1	EA	\$100,000	\$100,000			
Mechanical	50%			\$150,000			
Installation	50%			\$150,000			
Electrical & Instrumentation	40%			\$120,000			
SUBTOTAL				\$820,000	\$410,000	\$410,000	
SUBTOTAL				\$11,659,712	\$6,309,000	\$5,352,000	
(ADDITIVE FOR) DIVISION 1 (ABOVE)				\$1,750,000	\$947,000	\$803,000	
SUBTOTAL 2				\$13,409,712	\$7,256,000	\$6,155,000	
CONTINGENCY (25%)				\$3,353,000	\$1,814,000	\$1,539,000	
SUBTOTAL 3				\$16,764,000	\$9,070,000	\$7,694,000	
ADMINISTRATIVE (25%)				\$4,192,000	\$2,268,000	\$1,924,000	
TOTAL				\$20,956,000	\$11,338,000	\$9,618,000	

Job No.

Calc. No.

Computation**Project:** Cave Rock Skyland Water System Preliminary Engineering**Computed:**

PD

Subject: Storage Tank Replacements**Date:**

10/27/2016

Task: Cost Estimate - Deficiency 10 Alt 1 - New Upsized Storage Tanks**Reviewed:**

JB

File Name: C:\pwworking\phx\ld0466632\Cave Rock _ Costs_2-18.xlsx\Def 10 Hidden Wood.**Date:**

DESCRIPTION	QUANTITY	UNITS	UNIT COST	TOTAL COST
General Requirements				
Mobilization	1	LS	3.00%	\$41,175
Demobilization	1	LS	1.00%	\$13,725
Bonds and Insurance	1	LS	2.50%	\$34,313
Construction Facilities/Fencing	1	LS	0.50%	\$6,863
General Conditions	1	LS	2.00%	\$27,450
Shop Drawings and O&M Manuals	1	LS	2.00%	\$27,450
Facilities Start-up & Testing	1	LS	2.00%	\$27,450
SUBTOTAL			13.0%	\$178,425
Hidden Woods Storage Tank				
Steel Tank	306,000	Gal	\$1.50	\$459,000
Lower Cave Rock Tank				
Steel Tank	267,000	Gal	\$1.50	\$400,500
Upper Cave Rock Tank				
Steel Tank	342,000	Gal	\$1.50	\$513,000
SUBTOTAL				\$1,372,500

SUBTOTAL	\$1,372,500
(ADDITIVE FOR) DIVISION 1 (ABOVE)	\$178,425
SUBTOTAL 2	\$1,550,925
CONTINGENCY (25%)	\$388,000
SUBTOTAL 3	\$1,938,925
ADMINISTRATIVE (25%)	\$485,000
TOTAL	\$2,424,000

Job No.

Calc. No.

Computation

Project:	Cave Rock Skyland Water System Preliminary Engineering	Computed:	PD
Subject:	Storage	Date:	10/27/2016
Task:	Cost Estimate - Deficiency 10 Alt 2 - Supplemental Storage	Reviewed:	JB
File Name:	C:\pwworking\phx\ld0466632\Cave Rock _ Costs_ 2-18.xlsx\Def 10 Hidden Wood. Date:		

DESCRIPTION	QUANTITY	UNITS	UNIT COST	TOTAL COST
General Requirements				
Mobilization	1	LS	3.00%	\$31,245
Demobilization	1	LS	1.00%	\$10,415
Bonds and Insurance	1	LS	2.50%	\$26,038
Construction Facilities/Fencing	1	LS	0.50%	\$5,208
General Conditions	1	LS	2.00%	\$20,830
Shop Drawings and O&M Manuals	1	LS	2.00%	\$20,830
Facilities Start-up & Testing	1	LS	2.00%	\$20,830
SUBTOTAL			13.0%	\$135,395
Hidden Woods Storage Tank				
Steel Tank	306,000	Gal	\$1.50	\$459,000
Lower Cave Rock Tank				
Steel Tank	80,000	Gal	\$2.75	\$220,000
Upper Cave Rock Tank				
Steel Tank	145,000	Gal	\$2.50	\$362,500
SUBTOTAL				\$1,041,500

SUBTOTAL	\$1,041,500
(ADDITIVE FOR) DIVISION 1 (ABOVE)	\$135,395
SUBTOTAL 2	\$1,176,895
CONTINGENCY (25%)	\$295,000
SUBTOTAL 3	\$1,471,895
ADMINISTRATIVE (25%)	\$368,000
TOTAL	\$1,840,000

Job No.					Calc. No.		
Computation					HDR		
Project: Cave Rock Skyland Water System Preliminary Engineering					Computed: PD		
Subject: Water Treatment Plant Redundant Skid and Capacity Expansion					Date: 10/27/2016		
Task: Deficiency 11 - WTP Redundancy					Reviewed: JB		
File Name: C:\Users\jbellin\Desktop\Projects\Douglas County\Lake Water PERPERS\Cave Rock\Costs\Cave Rock _ Costs_ 2-26 (Autosaved).xlsx\Def 11 - WTP					Date:		
DESCRIPTION	QUANTITY	UNITS	UNIT COST	TOTAL COST	Cave Rock	Skyland	
General Requirements							
Mobilization	1	LS	5.00%	\$83,600			
Demobilization	1	LS	2.00%	\$32,400			
Bonds and Insurance	1	LS	2.50%	\$40,800			
Construction Facilities/Fencing	1	LS	1.00%	\$16,100			
General Conditions	1	LS	2.00%	\$32,400			
Shop Drawings and O&M Manuals	1	LS	2.00%	\$32,400			
Facilities Start-up & Testing	1	LS	3.00%	\$49,100			
SUBTOTAL			17.5%	\$286,800	\$143,400	\$143,400	
WTP modifications							
Demo		LS		\$20,000			
Redundant and Backwash Skids and ancillary equipment		LS		\$850,000			
Equipment Installation		LS	25%	\$212,500			
Process/ Mechanical Piping		LS	30%	\$255,000			
Building modifications		LS		\$80,000			
Electrical/Control modifications		LS	20%	\$170,000			
		LS					
SUBTOTAL				\$1,587,500	\$793,750	\$793,750	
				SUBTOTAL	\$1,587,500	\$793,750	\$793,750
				(ADDITIVE FOR) DIVISION 1 (ABOVE)	\$286,800	\$143,400	\$143,400
				SUBTOTAL 2	\$1,874,300	\$937,150	\$937,150
				CONTINGENCY (25%)	\$397,000	\$198,500	\$198,500
				SUBTOTAL 3	\$2,271,000	\$1,136,000	\$1,136,000
				ADMINISTRATIVE (25%)	\$568,000	\$284,000	\$284,000
				TOTAL	\$2,840,000	\$1,420,000	\$1,420,000

Job No.

Calc. No.

Computation**FDR****Project:** Cave Rock Skyland Water System Preliminary Engineering**Computed:** PD**Subject:** Water Conservation - Water Meters**Date:** 10/27/2016**Task:** Deficiency 12 - Cave Rock Water Meters**Reviewed:** JB**File Name:** C:\Users\jbellin\Desktop\Projects\Douglas County\Lake Water PER\PERs\Cave Rock\Costs\Cave Rock _ Costs**Date:**

DESCRIPTION	QUANTITY	UNITS	UNIT COST	TOTAL COST
General Requirements				
Mobilization	1	LS	3.00%	\$16,300
Demobilization	1	LS	1.00%	\$5,400
Bonds and Insurance	1	LS	2.50%	\$13,500
Construction Facilities/Fencing	1	LS	0.50%	\$2,700
General Conditions	1	LS	2.00%	\$10,800
Shop Drawings and O&M Manuals	1	LS	2.00%	\$10,800
Traffic Control		LS		\$15,000
SUBTOTAL			11.0%	\$74,500
Cave Rock Residential Meters				
Install Meter, Yolk, and Pit Assembly	292	EA	\$1,800	\$525,600
Commercial Meters				
Install 3/4" Meter, Yolk, and Pit Assembly	0	EA	\$1,570	\$0
Install 1" Meter, Yolk, and Pit Assembly	0	EA	\$2,280	\$0
Install 2" Meter, Yolk, and Pit Assembly	0	EA	\$3,530	\$0
SUBTOTAL				\$0

SUBTOTAL	\$525,600
(ADDITIVE FOR) DIVISION 1 (ABOVE)	\$74,500
SUBTOTAL 2	\$600,100
CONTINGENCY (25%)	\$132,000
SUBTOTAL 3	\$732,000
ADMINISTRATIVE (25%)	\$183,000
TOTAL	\$920,000

Job No.		Calc. No.		
Computation		FDR		
Project: Cave Rock Skyland Water System Preliminary Engineering		Computed: PD		
Subject: Water Conservation - Water Meters		Date: 10/27/2016		
Task: Deficiency 12 - Skyland Water Meters		Reviewed: JB		
File Name: C:\Users\jbellin\Desktop\Projects\Douglas County\Lake Water PER\PERs\Cave Rock\Costs\Cave Rock _ Costs		Date:		
DESCRIPTION	QUANTITY	UNITS	UNIT COST	TOTAL COST
General Requirements				
Mobilization	1	LS	3.00%	\$13,500
Demobilization	1	LS	1.00%	\$4,400
Bonds and Insurance	1	LS	2.50%	\$11,200
Construction Facilities/Fencing	1	LS	0.50%	\$2,200
General Conditions	1	LS	2.00%	\$8,900
Shop Drawings and O&M Manuals	1	LS	2.00%	\$8,900
Traffic Control		LS		\$15,000
SUBTOTAL			11.0%	\$64,100
Skyland Residential Meters				
Install Meter, Yolk, and Pit Assembly	242	EA	\$1,800	\$435,600
Commercial Meters				
Install 3/4" Meter, Yolk, and Pit Assembly	0	EA	\$1,570	\$0
Install 1" Meter, Yolk, and Pit Assembly	0	EA	\$2,280	\$0
Install 2" Meter, Yolk, and Pit Assembly	0	EA	\$3,530	\$0
SUBTOTAL				\$0
SUBTOTAL				\$435,600
(ADDITIVE FOR) DIVISION 1 (ABOVE)				\$64,100
SUBTOTAL 2				\$499,700
CONTINGENCY (25%)				\$109,000
SUBTOTAL 3				\$609,000
ADMINISTRATIVE (25%)				\$153,000
TOTAL				\$770,000

Job No.					Calc. No.		
Computation					FDR		
Project: Cave Rock Skyland Water System Preliminary Engineering					Computed: PD		
Subject: Lake Intake Pump Station, Alternatives 1,2,3.					Date: 10/27/2016		
Task: Deficiency 13					Reviewed: JB		
File Name: C:\Users\jbellin\Desktop\Projects\Douglas County\Lake Water PER\PERs\Cave Rock\Costs\Cave Rock_Costs_2-26 (Autosaved).xlsx\Def 13_Lake Intake PS					Date:		
DESCRIPTION		QUANTITY	UNITS	UNIT COST	TOTAL COST		
Alternative 1							
General Requirements							
General conditions	1	LS	\$	10,000.00	\$10,000		
Concrete slab foundation	13	CY	\$	1,200.00	\$16,000		
CMU walls	310	SF	\$	50.00	\$16,000		
Metal roof structure	180	SF	\$	50.00	\$9,000		
Metal Stairs	1	LS	\$	3,000.00	\$3,000		
Pipe modifications	1	LS	\$	10,000.00	\$10,000		
Electrical and Instrumentation	1	LS	\$	5,000.00	\$5,000		
SUBTOTAL					\$69,000		
SUBTOTAL					\$69,000		
CONTINGENCY (25%)					\$17,250		
SUBTOTAL 3					\$86,000		
ADMINISTRATIVE (25%)					\$21,500		
TOTAL					\$108,000		
Alternative 2							
General Requirements							
General conditions	1	LS	\$	10,000.00	\$10,000		
Lake Mobilization/Demobilization	1	LS	\$	15,000.00	\$15,000		
Removal and disposal of existing 10"	1	LS	\$	42,000.00	\$42,000		
New 14" HDPE w/ Concrete Collars every 20' +/-	500	LF	\$	180.00	\$90,000		
Hand Dig Trench to Pump House	1	LS	\$	30,000.00	\$30,000		
New intake structures	1	LS	\$	12,000.00	\$12,000		
SUBTOTAL					\$199,000		
SUBTOTAL					\$199,000		
CONTINGENCY (25%)					\$49,750		
SUBTOTAL 3					\$249,000		
ADMINISTRATIVE (25%)					\$62,250		
TOTAL					\$312,000		
Alternative 3							
General Requirements							
General conditions	1	LS	\$	10,000.00	\$10,000		
Lake mobilization/demobilization	1	LS	\$	15,000.00	\$15,000		
Conduit to Pump in Hand Dug Trench	1	LS	\$	25,000.00	\$25,000		
Conduit to Pump Anchored to Blocks	1	LS	\$	15,000.00	\$15,000		
10" HDPE Pipe w/ Concrete Anchors	100	LF	\$	200.00	\$20,000		
Demo 10" HDPE Pipe and Anchors	100	LF	\$	100.00	\$10,000		
Booster Pump	1	EA	\$	25,000.00	\$25,000		
Pump installation	1	LS	\$	8,000.00	\$8,000		
Check Valve	1	EA	\$	7,000.00	\$7,000		
Piping and Pipe Support Modifications	1	LS	\$	15,000.00	\$15,000		
Low profile intake screen	1	EA	\$	12,000.00	\$12,000		
Electrical and Instrumentation	1	LS	\$	15,000.00	\$15,000		
SUBTOTAL					\$177,000	\$ 88,500	\$ 88,500
SUBTOTAL					\$177,000		
CONTINGENCY (25%)					\$44,250	\$ 22,125	\$ 22,125
SUBTOTAL 3					\$221,000		
ADMINISTRATIVE (25%)					\$55,250	\$ 27,625	\$ 27,625
TOTAL					\$277,000	\$139,000	\$139,000

APPENDIX B – FIGURES

North Skyland Required Fire Flows

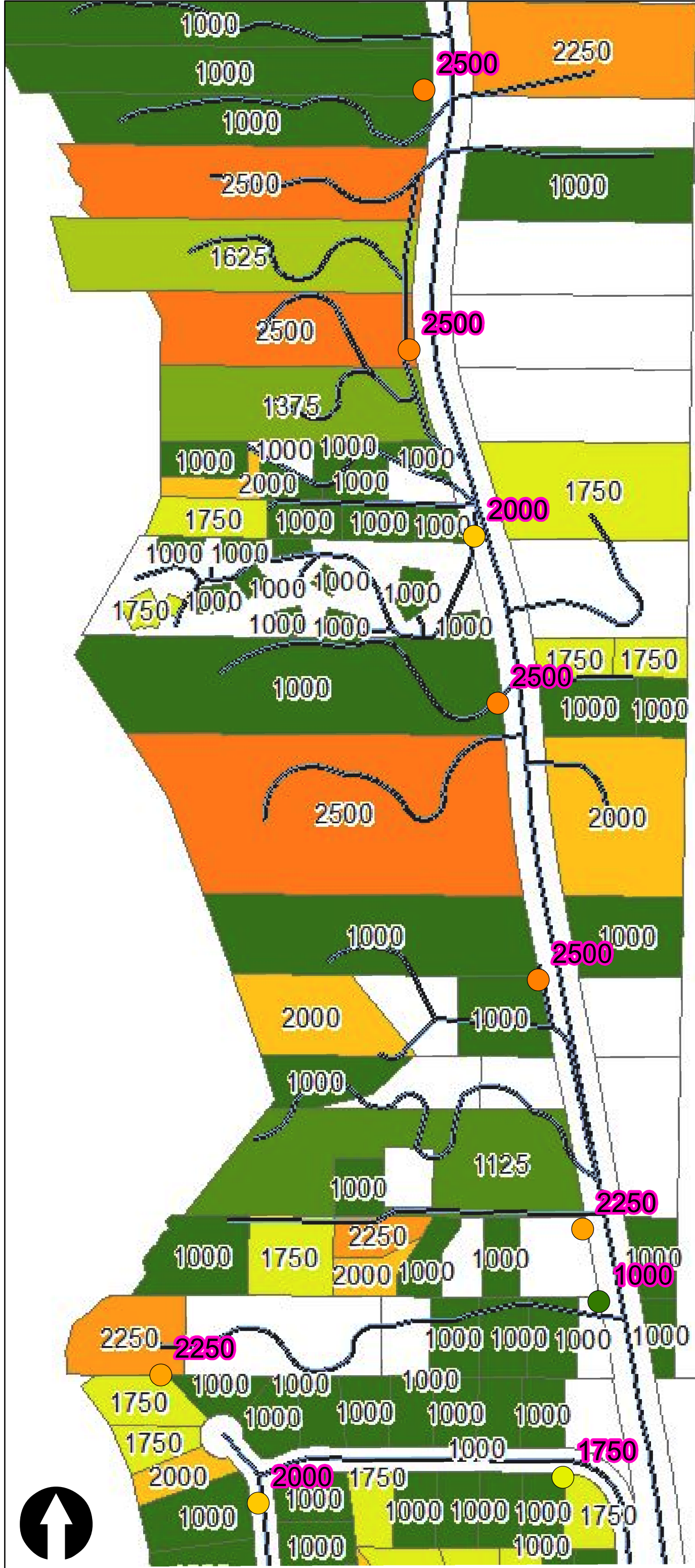

Legend

Hydrants

Allocated Fire Flow (gpm)

- 1000
- 1750
- 2000
- 2250
- 2500

Skyland Parcels

Required Fire Flow (gpm)

- 750
- 1000
- 1125
- 1375
- 1625
- 1750
- 1875
- 2000
- 2250
- 2500
- 2875
- 3000

South Skyland Required Fire Flows

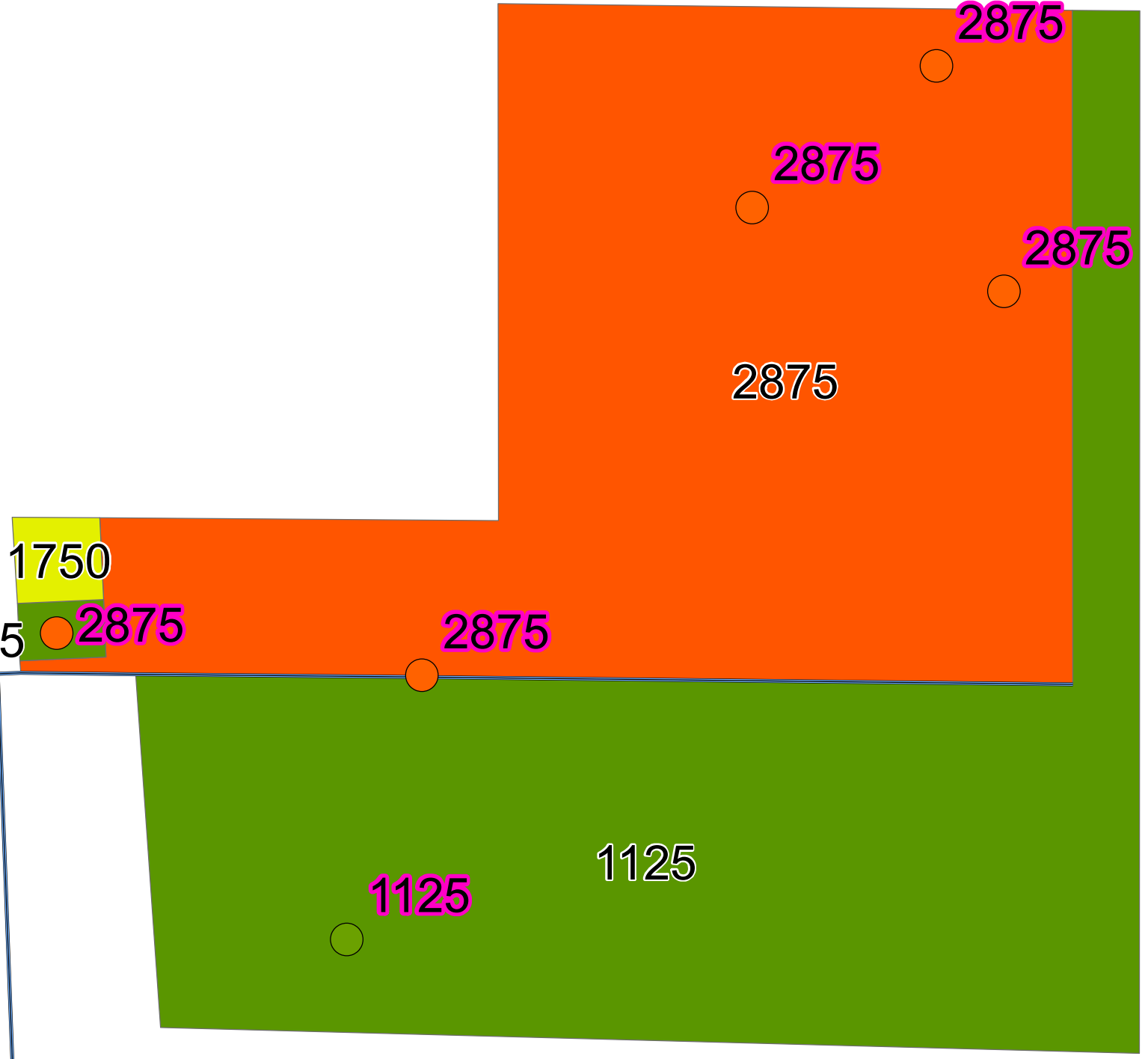
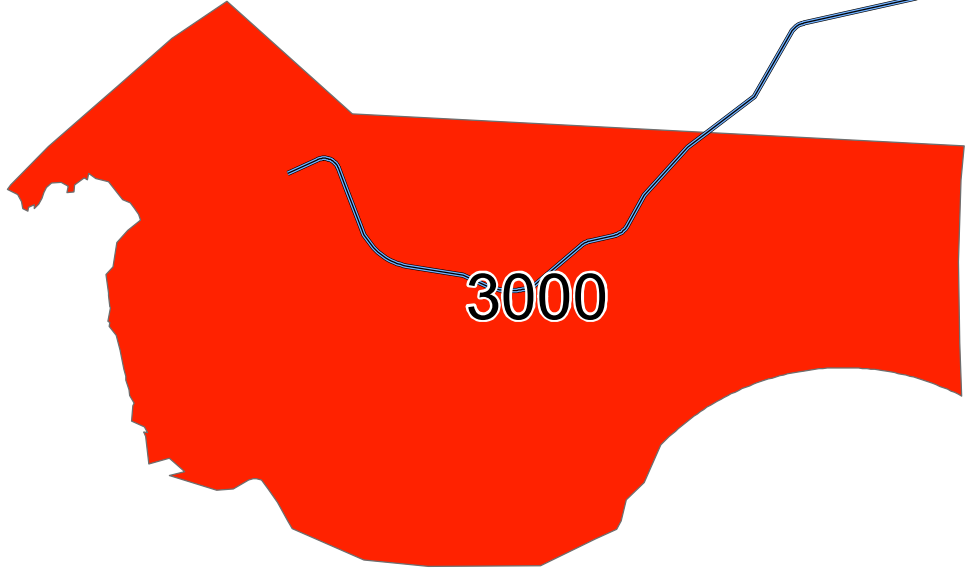

Legend

Hydrants		Skyland Parcels	
Allocated Fire Flow (gpm)		Required Fire Flow (gpm)	
1125		750	
2875		1000	
		1125	
		1375	
		1625	
		1750	
		1875	
		2000	
		2250	
		2500	
		2875	
		3000	

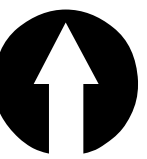
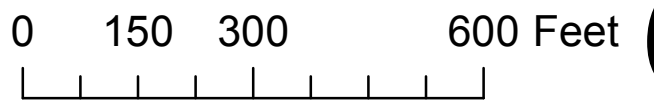

Legend

Hydrants		Skyland Parcels	
Allocated Fire Flow (gpm)		Required Fire Flow (gpm)	
● 1000	● 1000	■ 750	■ 750
● 1750	● 1750	■ 1000	■ 1000
● 2000	● 2000	■ 1125	■ 1125
● 2250	● 2250	■ 1375	■ 1375
● 2500	● 2500	■ 1625	■ 1625
		■ 1750	■ 1750
		■ 1875	■ 1875
		■ 2000	■ 2000
		■ 2250	■ 2250
		■ 2500	■ 2500
		■ 2875	■ 2875
		■ 3000	■ 3000

Central Skyland Required Fire Flows

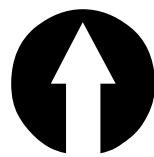
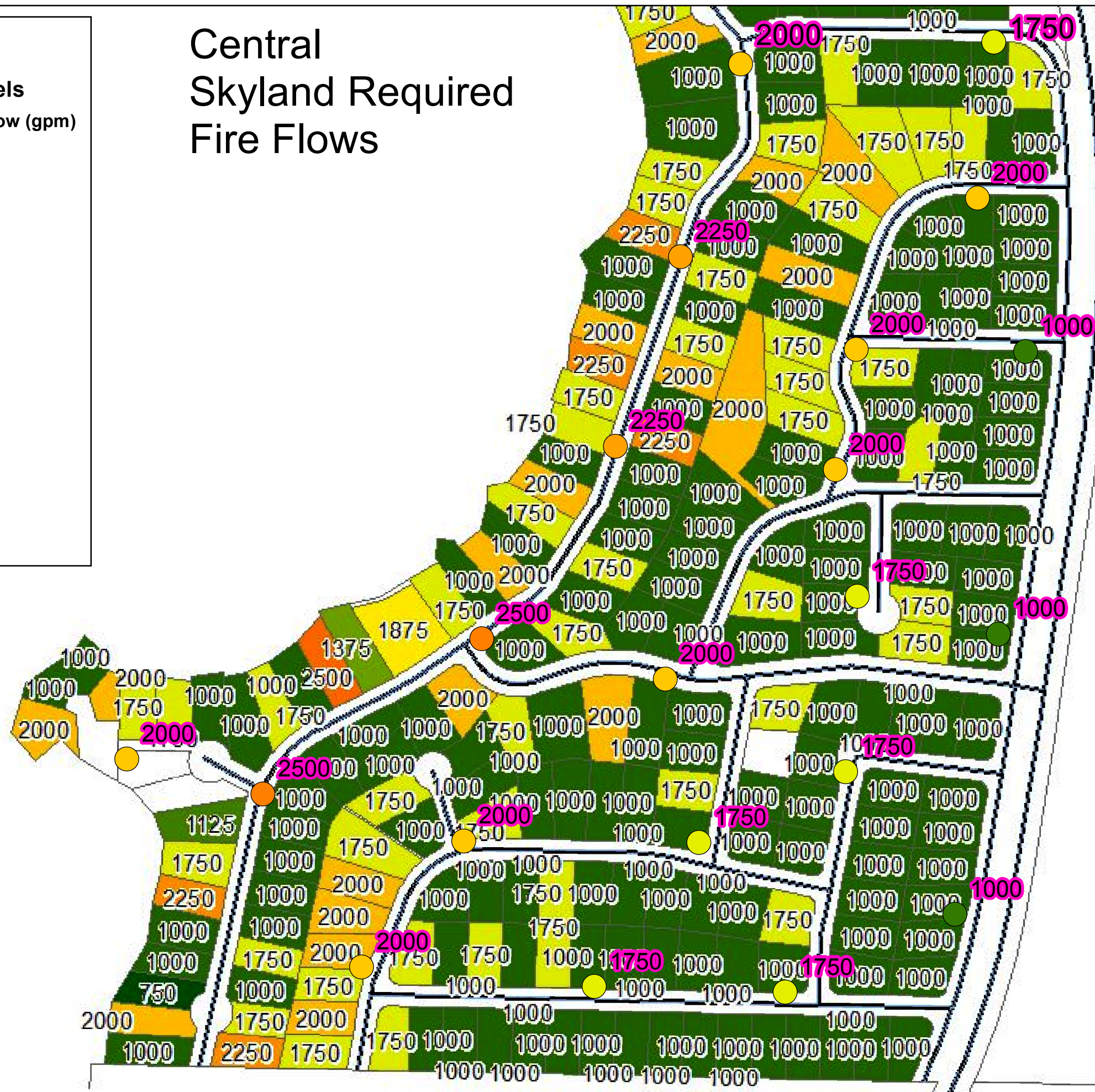

0 165 330 660 Feet



Cave Rock/ Skyland Initial Model Results

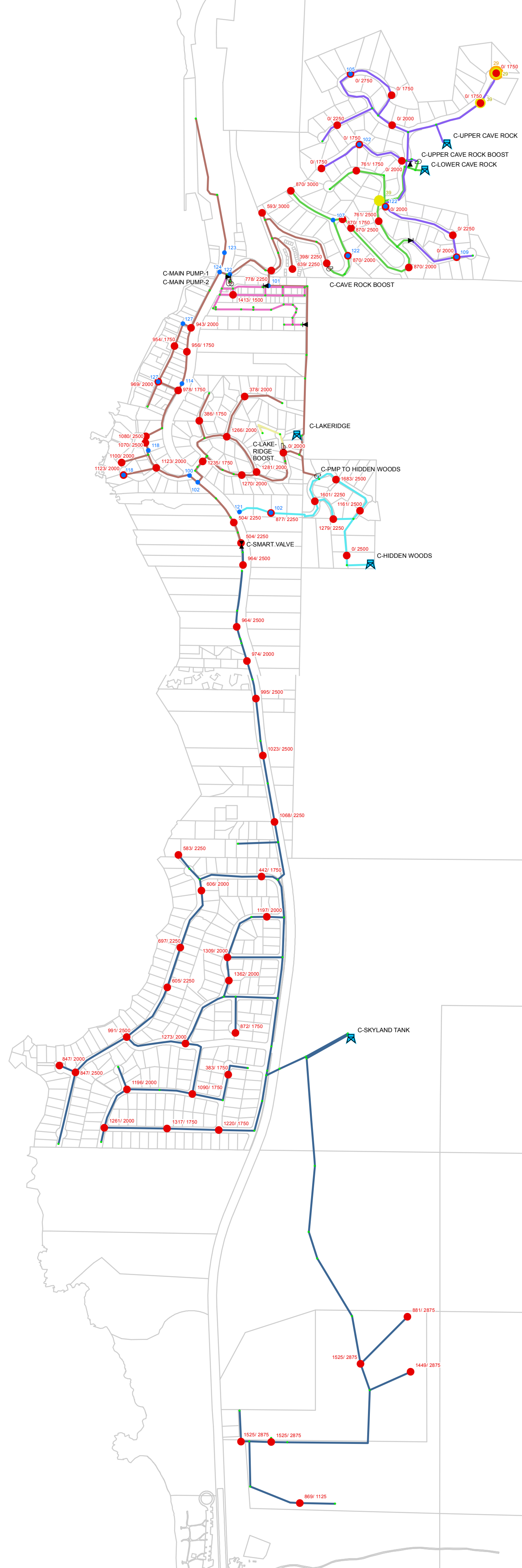

Legend

Deficiencies

- Average Day Demand Pressure > 100 psi
- Hydrants Not Meeting Criteria: Available/ Required Flow
- Max Day Demand Pressure < 40 psi
- Peak Hour Demand Pressure < 30 psi

Pipes by Zone

- C-ZONE-1a
- C-ZONE-1b
- C-ZONE-1c
- C-ZONE-1d
- C-ZONE-2
- C-ZONE-6
- New Subdivision

Facilities

- Tanks
- Pumps
- Flow Control Valve
- Pressure Reducing Valve
- Model Junctions

Alternative 1 Cave Rock Zone A1 Improvements

Legend

Distribution Pipe

- Replaced (Red line)
- Existing (Black line)

Pumps

- Existing (Black circle with arrow)
- Added (Red circle with arrow)

Pressure Reducing Valve

- Existing (Black triangle with arrow)
- Added (Red triangle with arrow)

Other Facilities

- Tanks (Blue trapezoid)

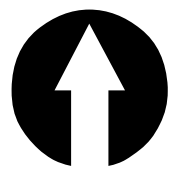
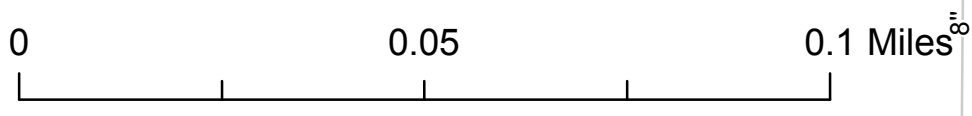
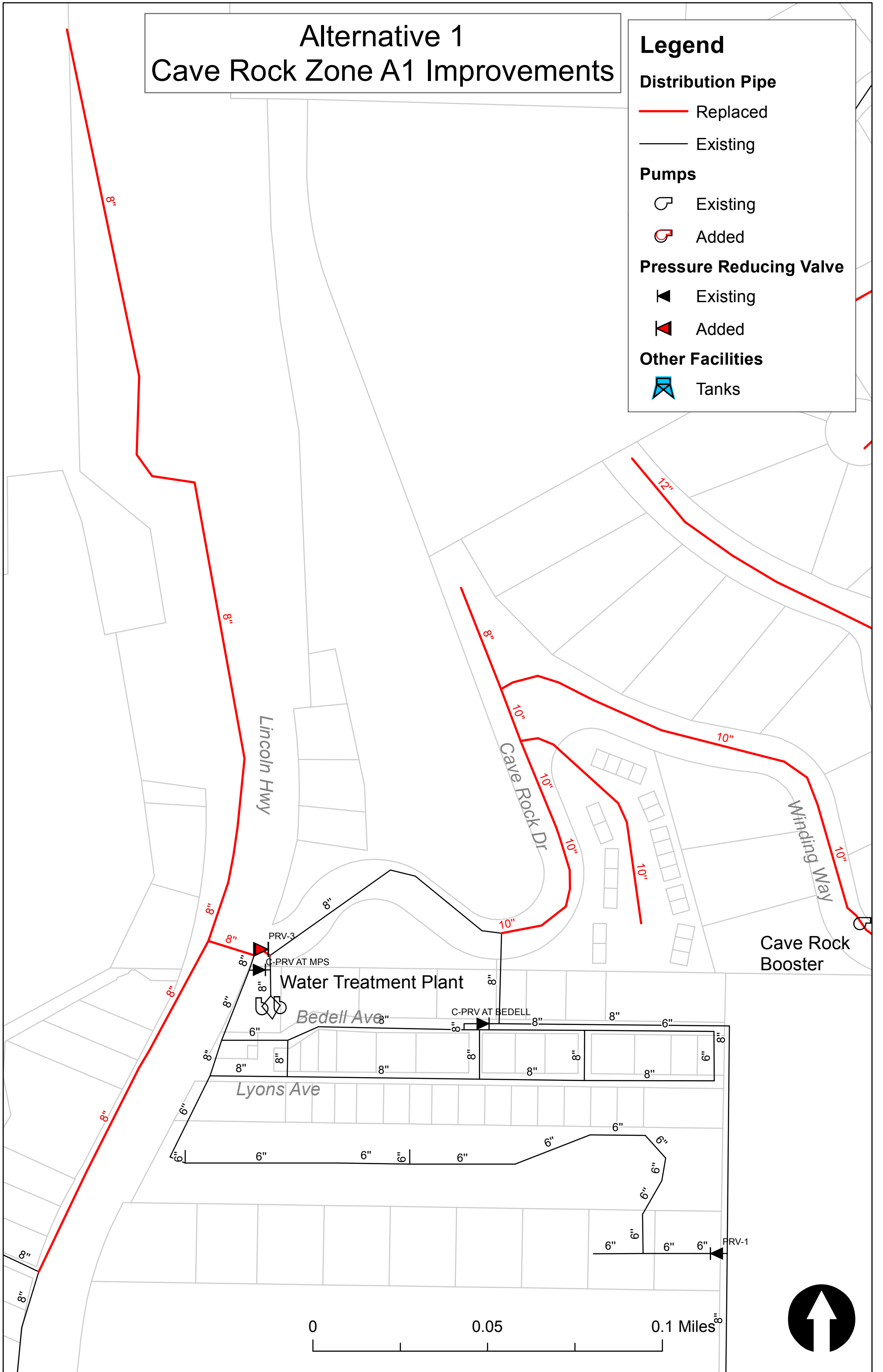

Alternative 1 Cave Rock Zone A1 Improvements

Legend

Distribution Pipe

- Replaced (Red line)
- Existing (Black line)

Pumps

- Existing (Black circle with arrow)
- Added (Red circle with arrow)

Pressure Reducing Valve

- Existing (Black triangle with arrow)
- Added (Red triangle with arrow)

Other Facilities

- Tanks (Blue trapezoid)

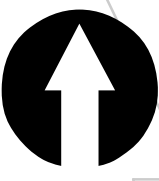
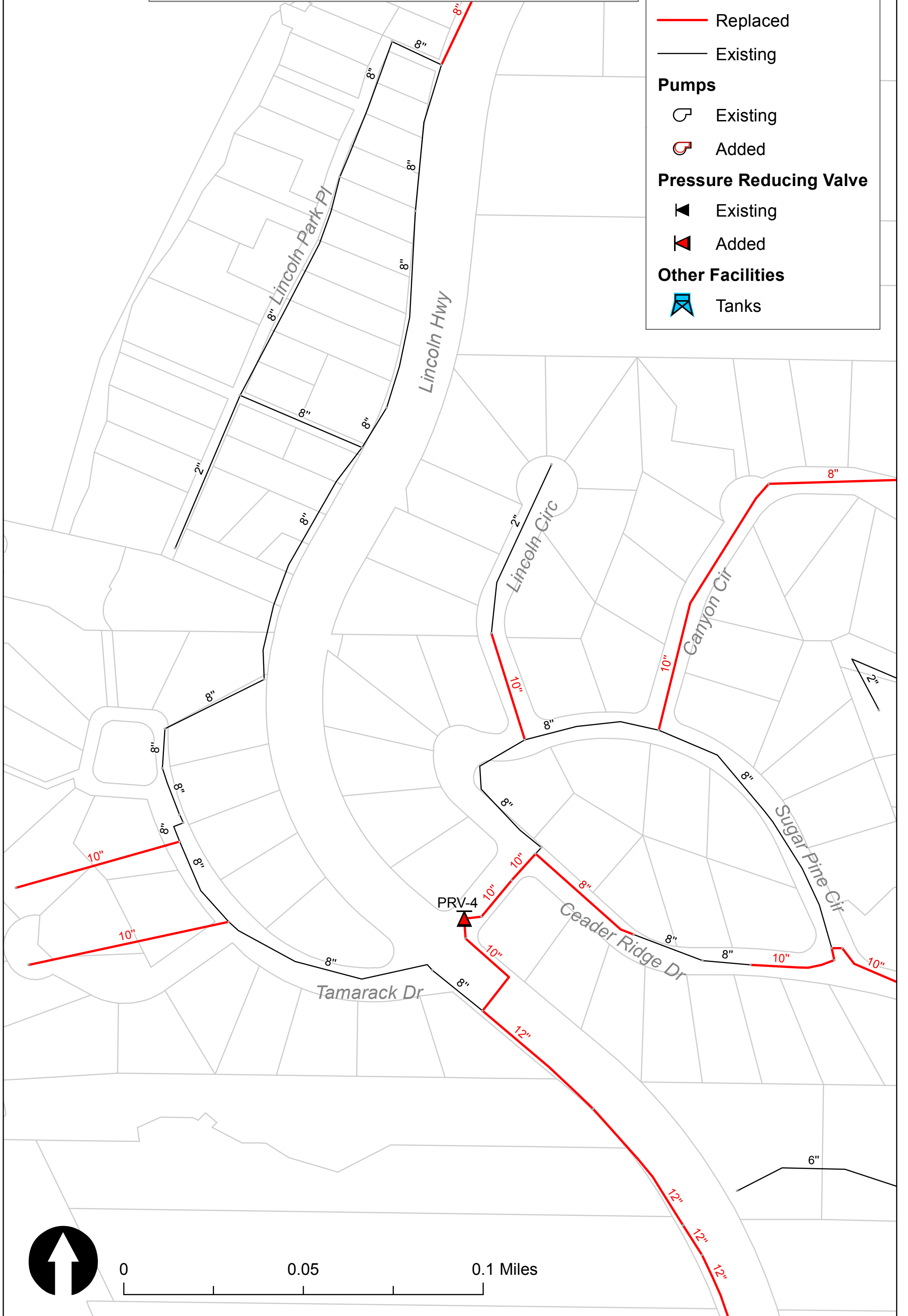

0 0.05 0.1 Miles

Alternative 1: Cave Rock Zone B1 Improvements

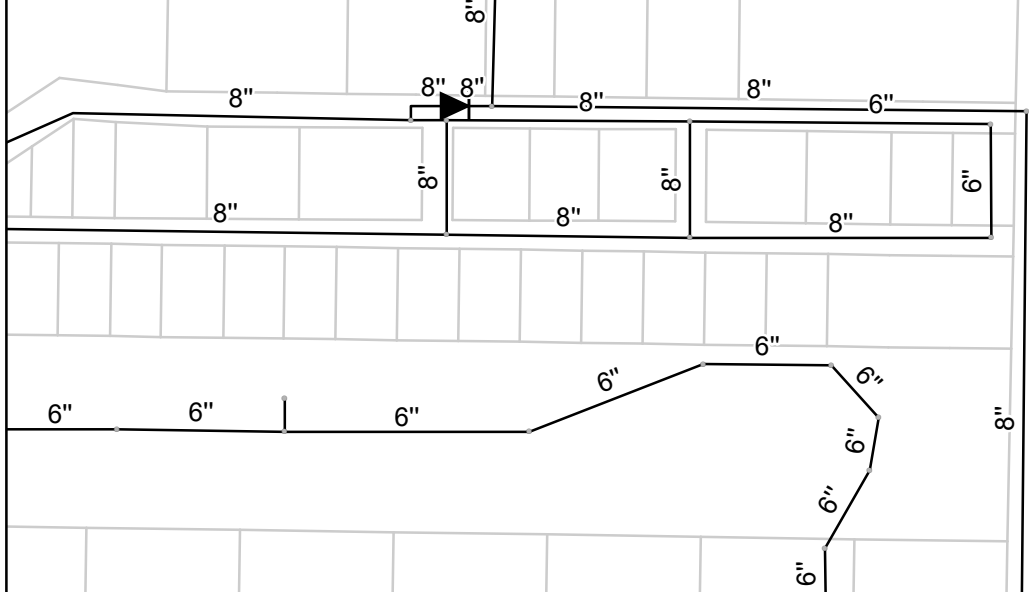
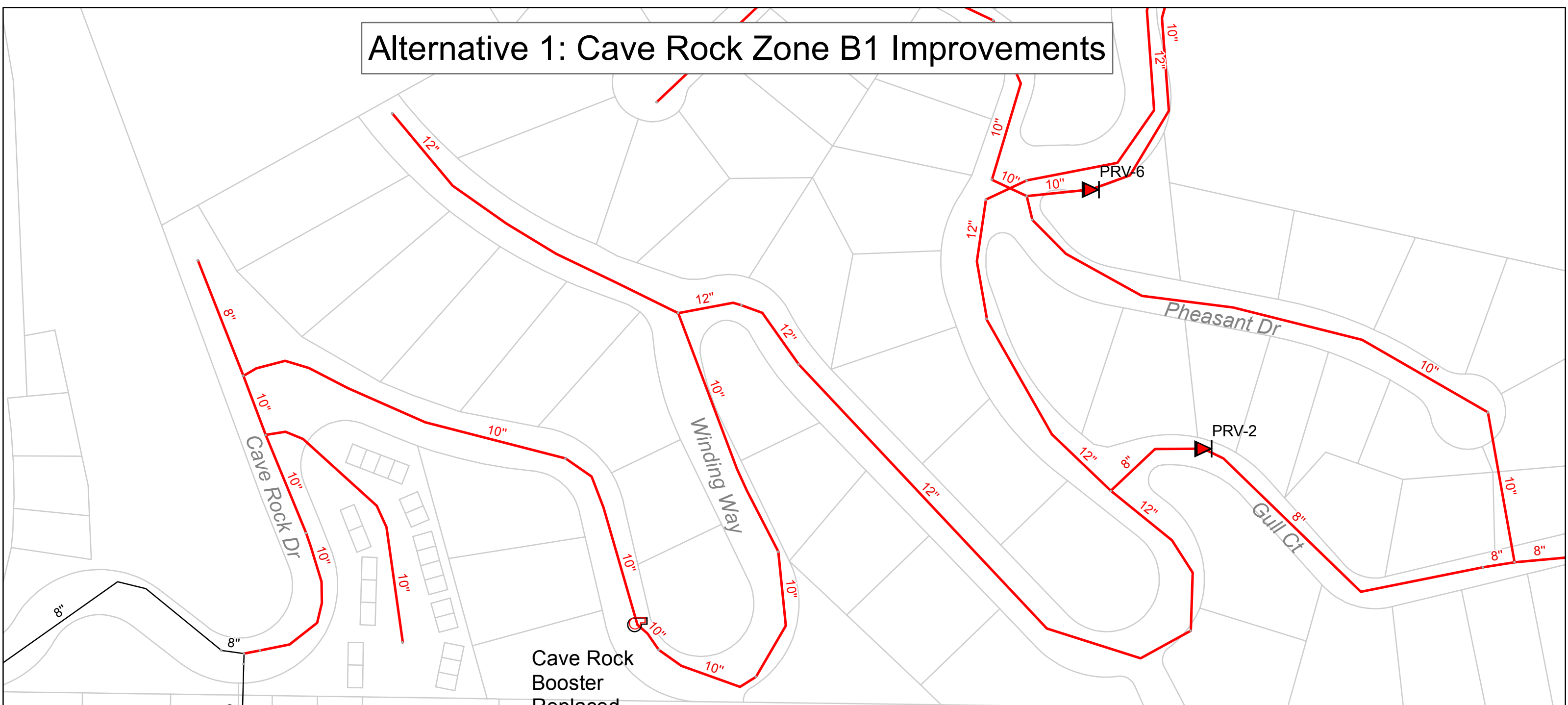

Cave Rock
Booster
Replaced

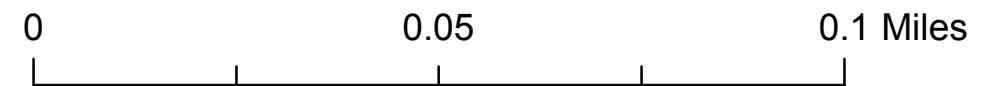

Legend

Distribution Pipe	Pumps	Pressure Reducing Valve	Other Facilities
Replaced	Existing	Existing	Tanks
Existing	Replaced	Added	

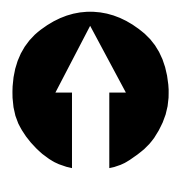





Alternative 1: Cave Rock Zone C1 Improvements



Total of Four PRVs Added to Zone C1

Booster pump added for non-fire demands
 Check valve bypass added to allow fire flows

Legend

Distribution Pipe
 Replaced
 Existing

Pumps
 Existing
 Added

Pressure Reducing Valve
 Existing
 Added

Other Facilities
 Tanks

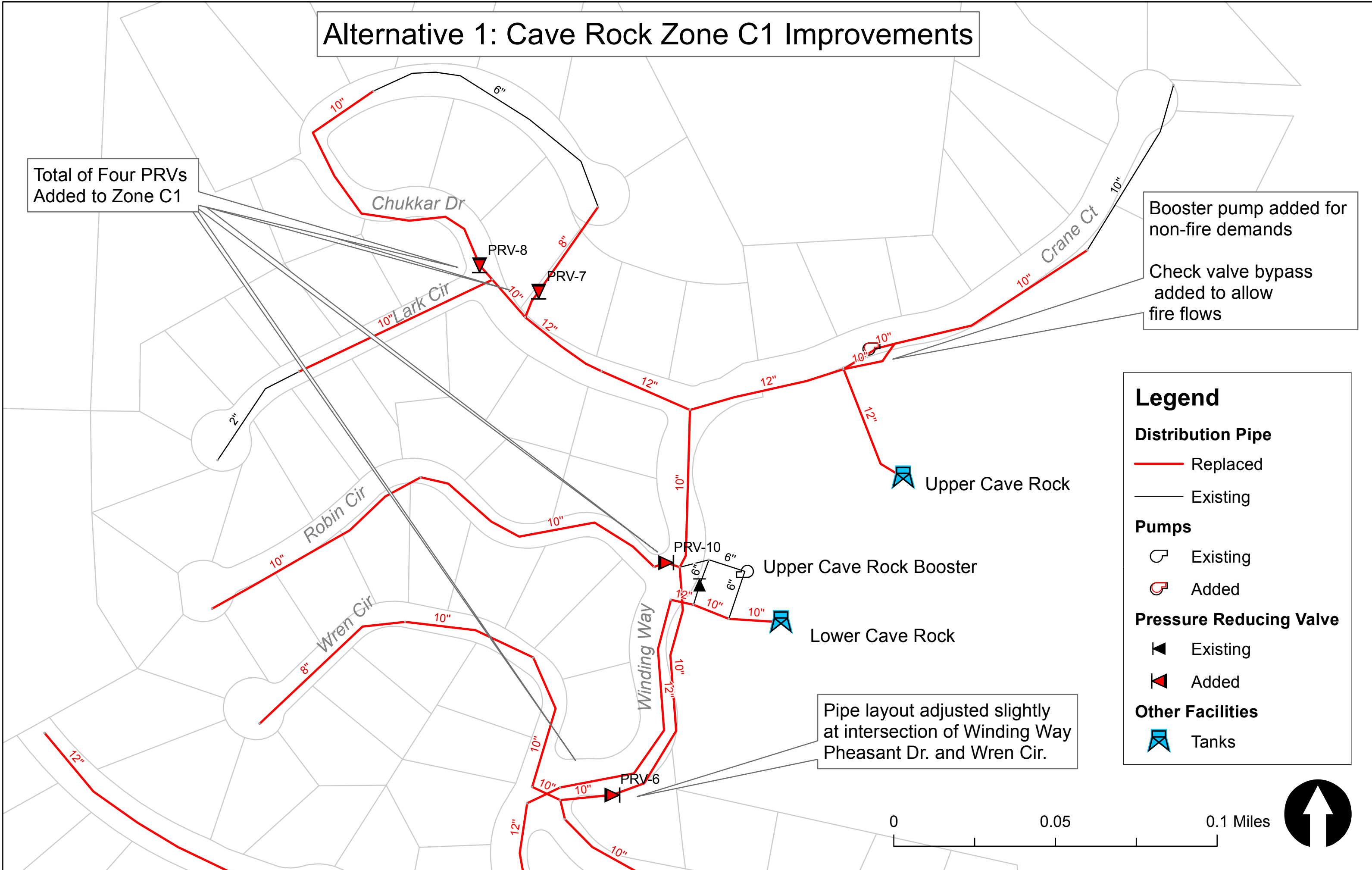

Pipe layout adjusted slightly at intersection of Winding Way Pheasant Dr. and Wren Cir.

0 0.05 0.1 Miles

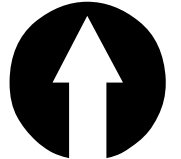

Alternative 1: Skyland Improvements

C-Smart Valve

Lincoln Hwy

Tahoe Dr

Legend

Distribution Pipe

- Replaced
- Existing

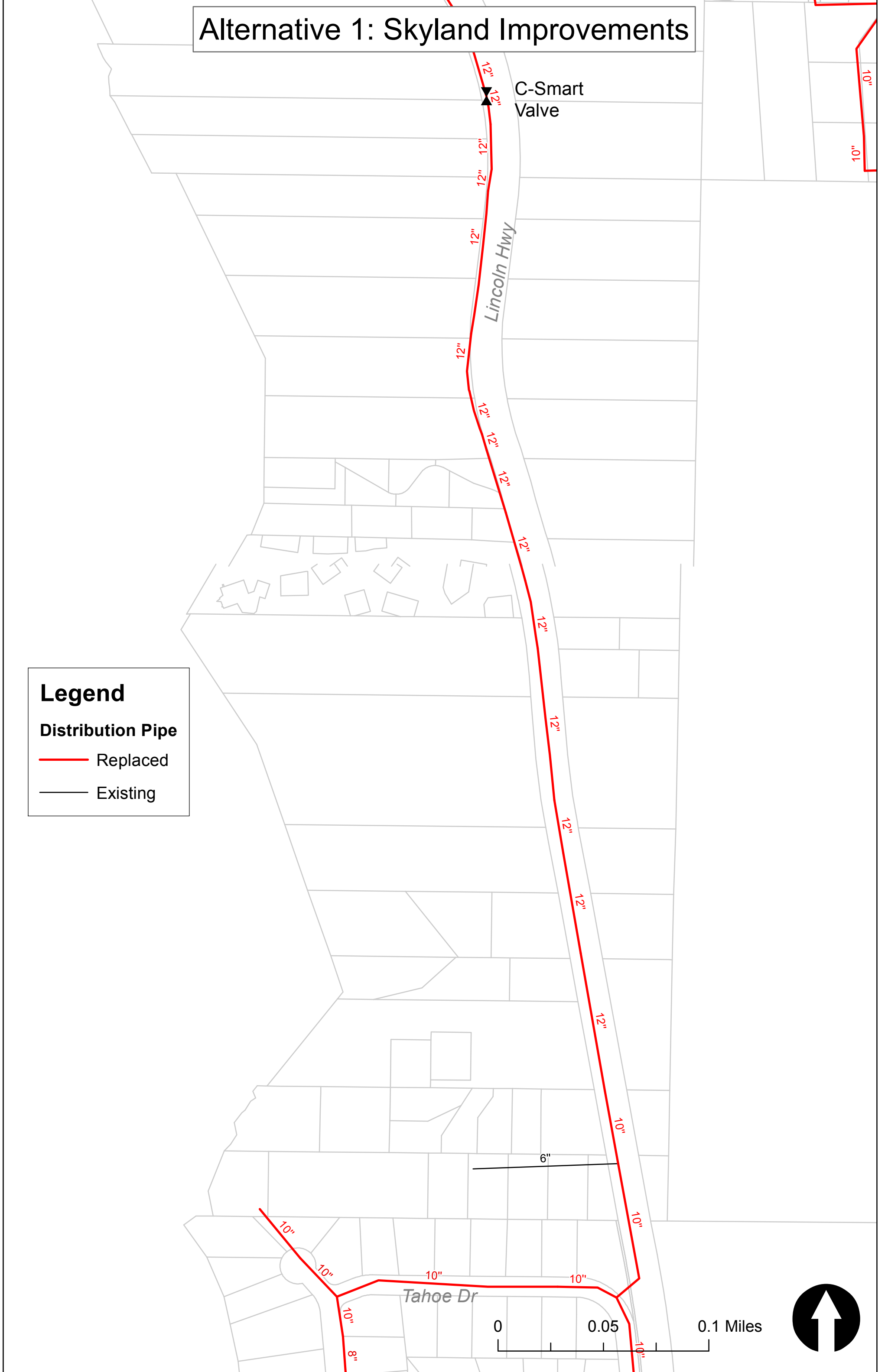
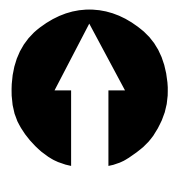
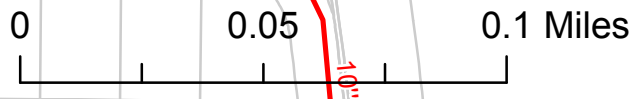

C-SKYLAND TANK

Alternative 1 Skyland Improvements

Lincoln Hwy

Legend

Distribution Pipe

- Replaced
- Existing

Other Facilities

- Tanks

0 0.05 0.1 Miles

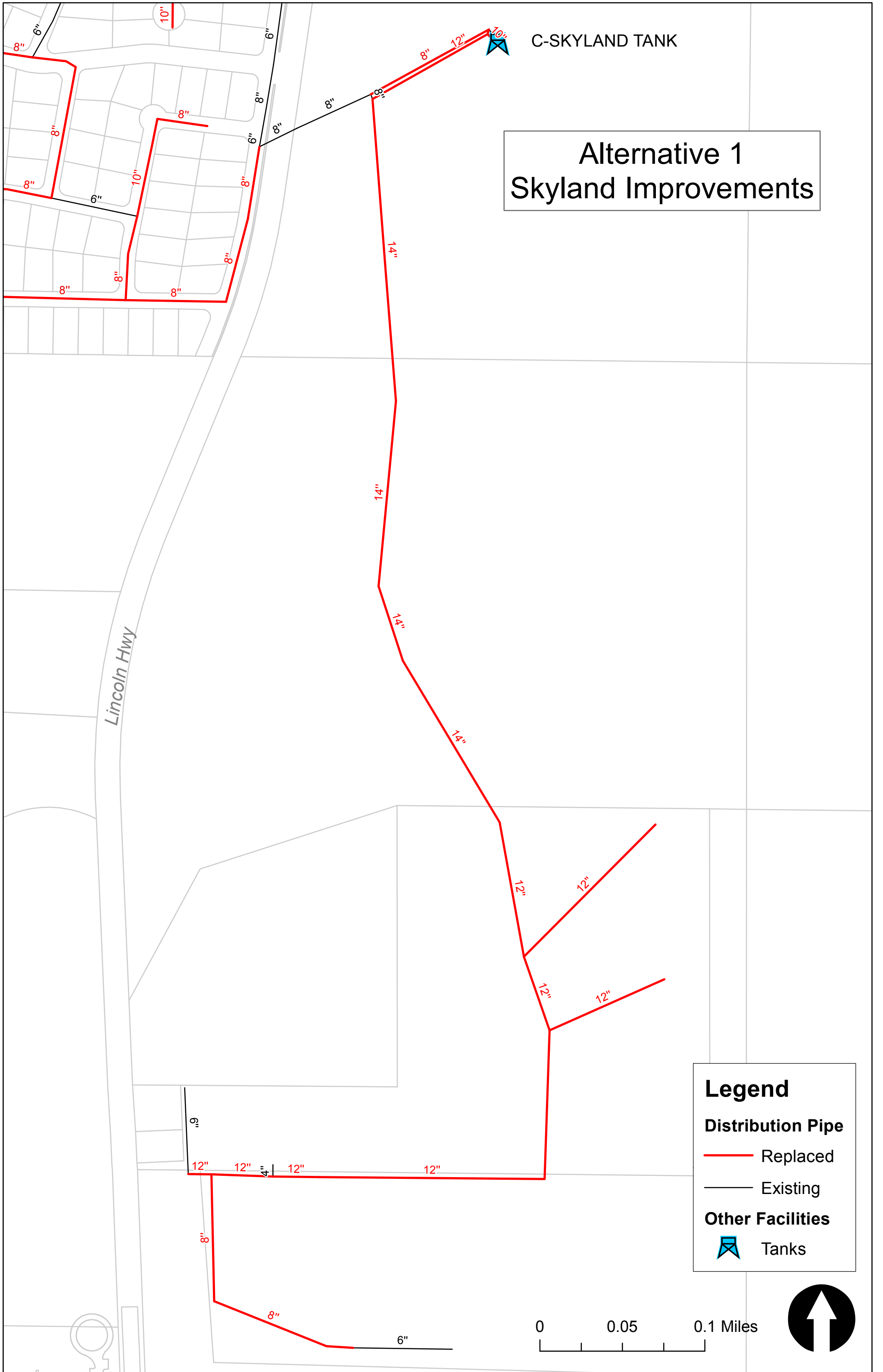
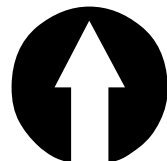

Alternative 1: Skyland Improvements

Legend

Distribution Pipe

- Replaced
- Existing

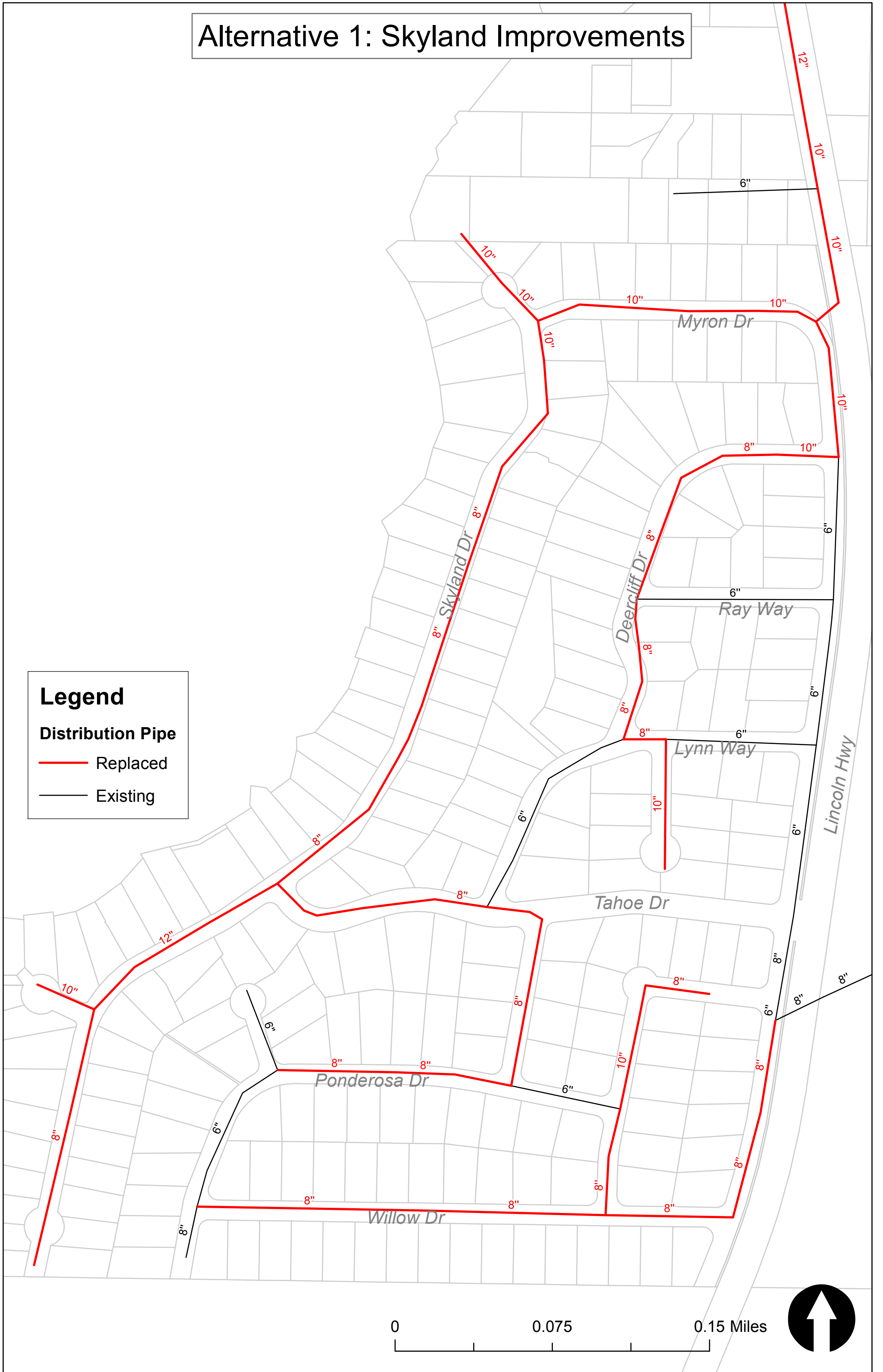

0 0.075 0.15 Miles

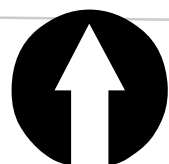

Alternative 1 Cave Rock Hidden Woods Improvements

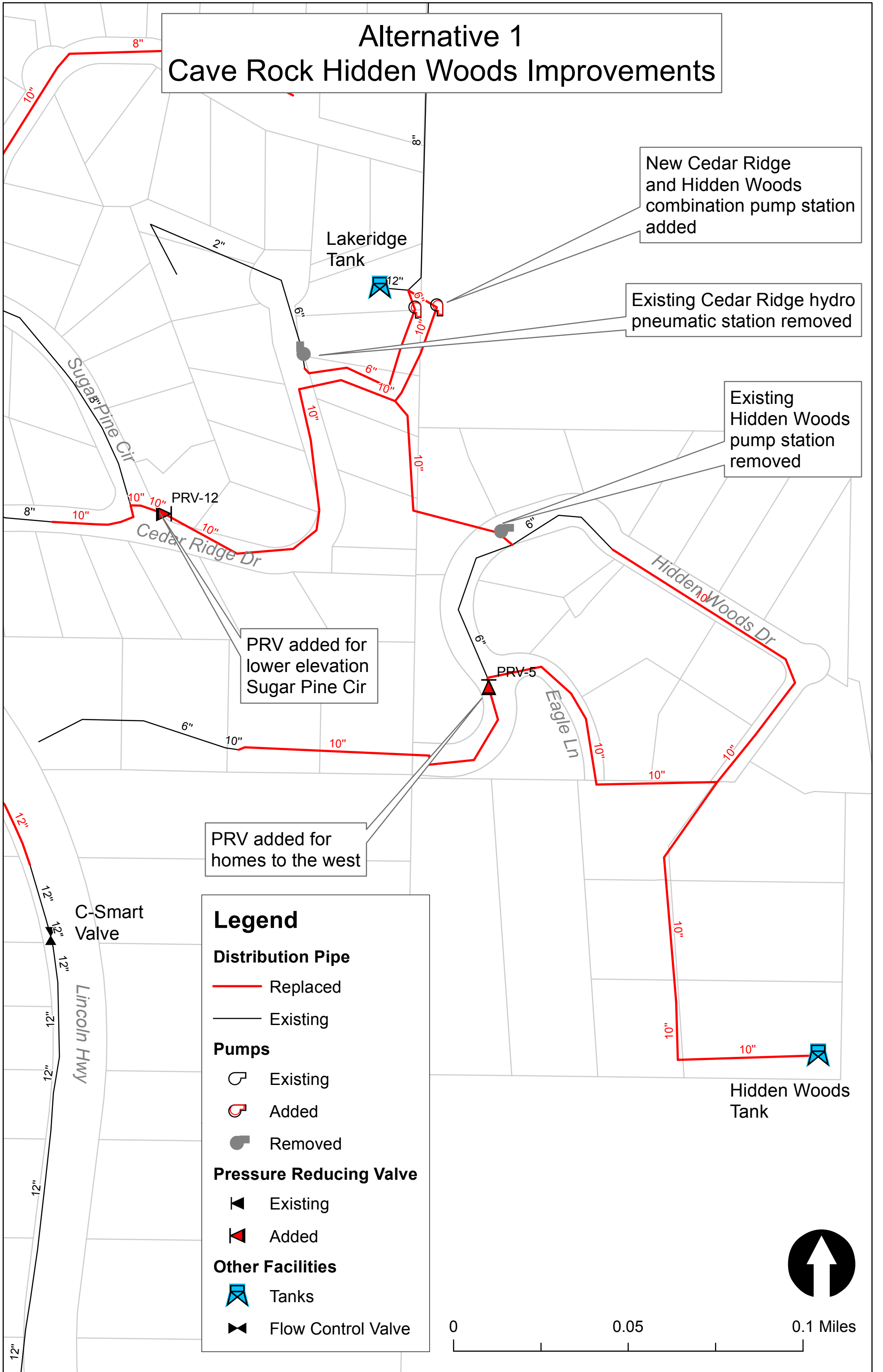

New Cedar Ridge and Hidden Woods combination pump station added

Existing Cedar Ridge hydro pneumatic station removed

Existing Hidden Woods pump station removed

PRV added for lower elevation Sugar Pine Cir

PRV added for homes to the west

Legend

Distribution Pipe

- Replaced
- Existing

Pumps

- ⊕ Existing
- ⊕ Added
- Removed

Pressure Reducing Valve

- ◀ Existing
- ◀ Added

Other Facilities

- ⊕ Tanks
- ⊕ Flow Control Valve

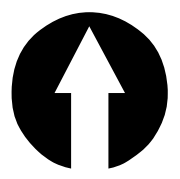

0 0.05 0.1 Miles





Alternative 2 Cave Rock Zone A1 Improvements

Legend

Distribution Pipe
— Replaced
 — Existing

Pumps
 Existing
 Added

Pressure Reducing Valve
 Existing
 Added

Other Facilities
 Tanks

High pressure main installed from treatment plant to intersection of Winding Way

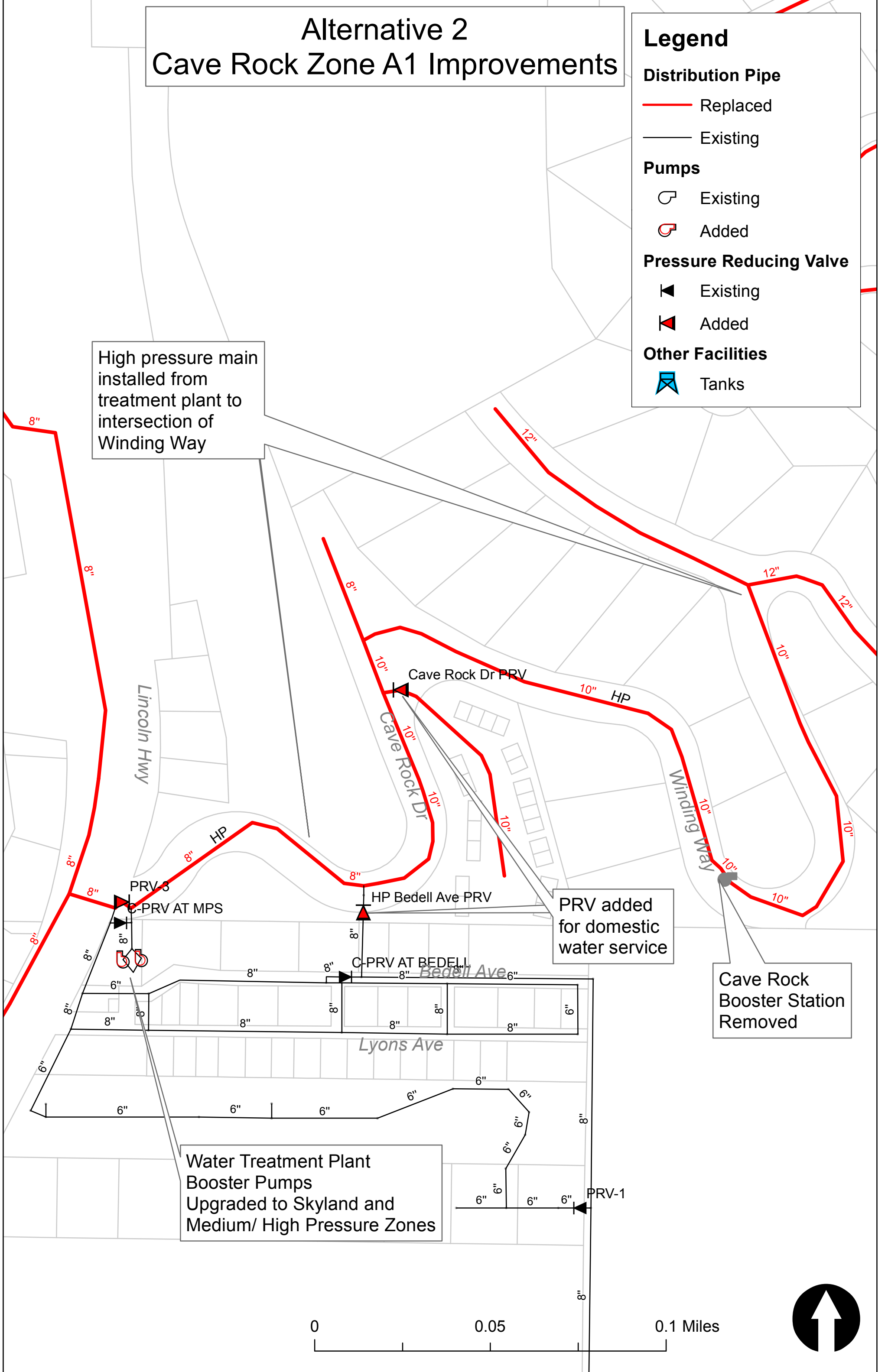

Water Treatment Plant
Booster Pumps
Upgraded to Skyland and
Medium/ High Pressure Zones

PRV added
for domestic
water service

Cave Rock
Booster Station
Removed

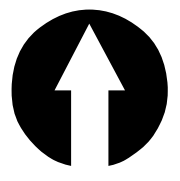
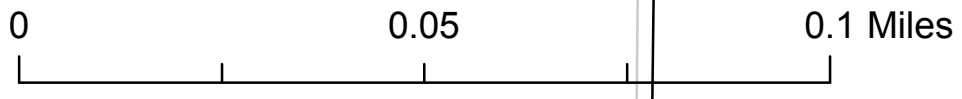

Alternative 2 Cave Rock Hidden Woods Improvements

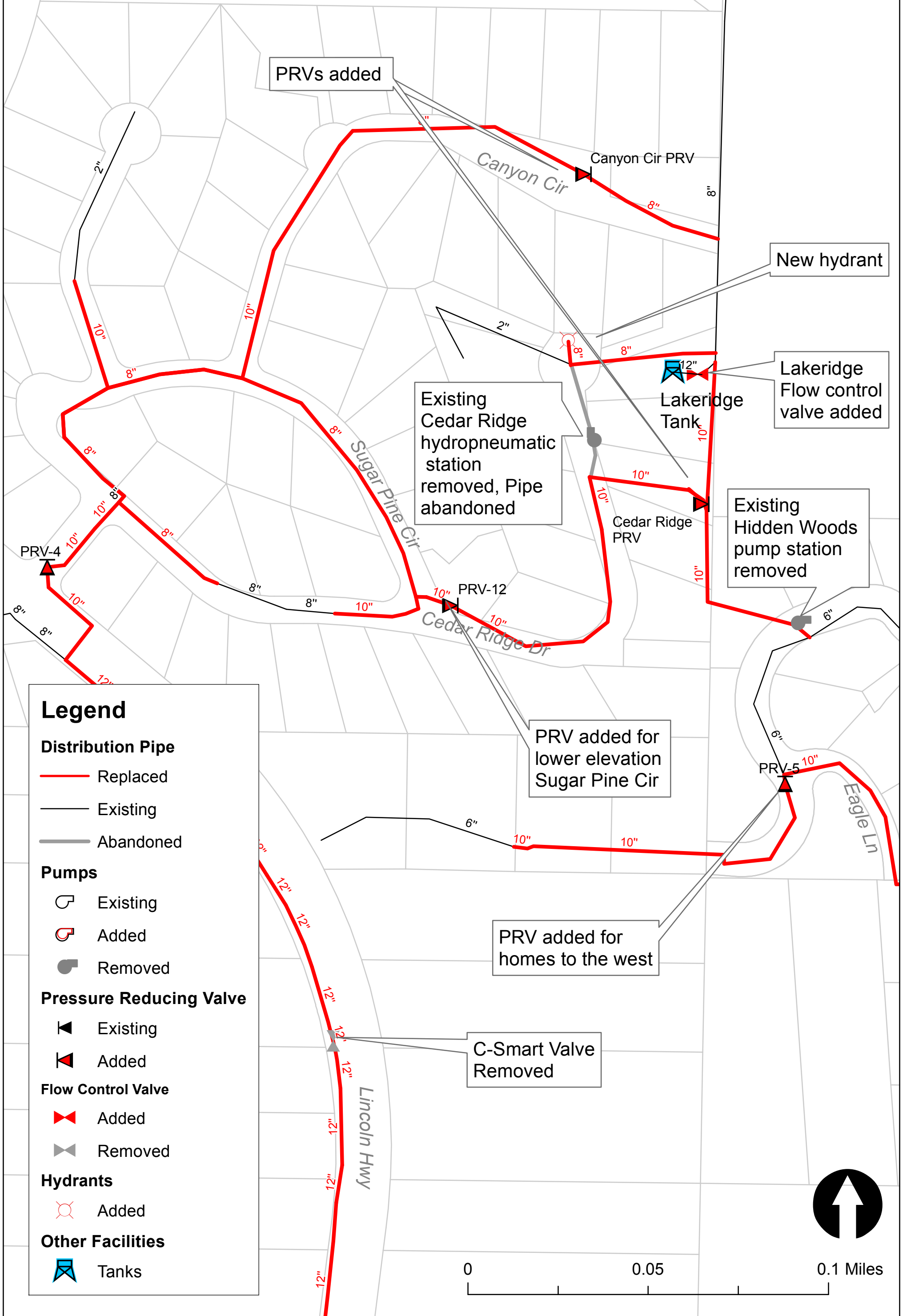

PRVs added

Canyon Cir PRV

New hydrant

Lakeridge Flow control valve added

Existing Cedar Ridge hydropneumatic station removed, Pipe abandoned

Lakeridge Tank

Existing Hidden Woods pump station removed

PRV-4

PRV-12

Cedar Ridge PRV

PRV added for lower elevation Sugar Pine Cir

PRV-5

PRV added for homes to the west

C-Smart Valve Removed

Legend

Distribution Pipe

- Replaced
- Existing
- Abandoned

Pumps

- Existing
- Added
- Removed

Pressure Reducing Valve

- Existing
- Added

Flow Control Valve

- Added
- Removed

Hydrants

- Added

Other Facilities

- Tanks

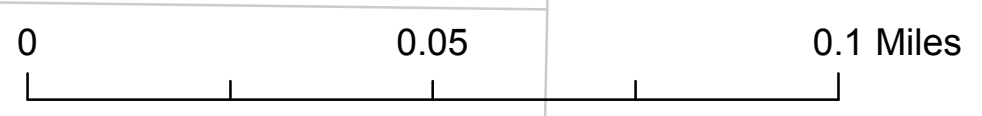

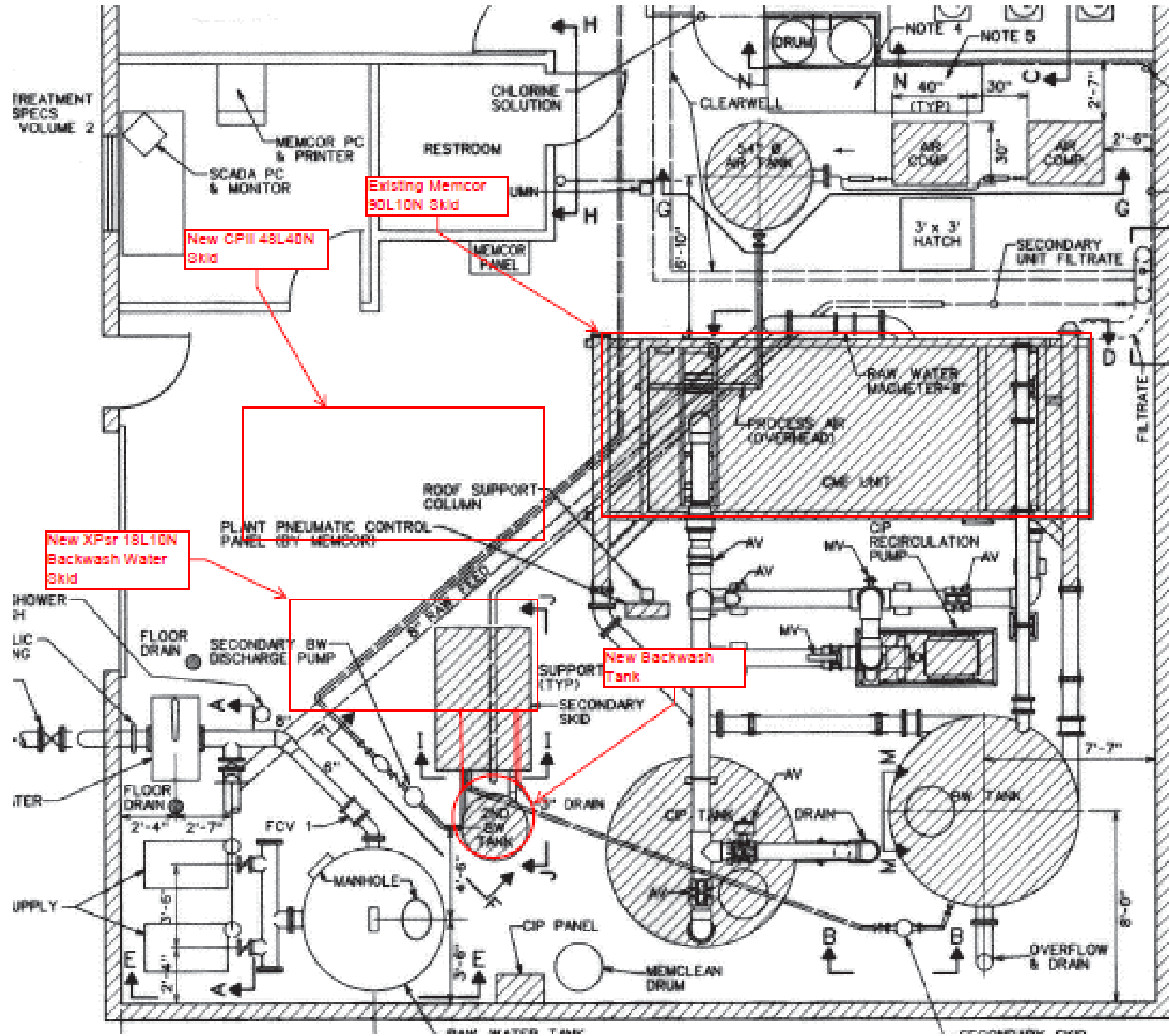

Figure 5-14 Cave Rock WTP Equipment Plan

APPENDIX C – EQUIPMENT CUT SHEETS



eVOQUA
WATER TECHNOLOGIES

MEMCOR[®] CII MEMBRANE FILTRATION SYSTEM

DOUGLAS COUNTY, NV; CAVE ROCK SKYLAND

Budgetary Proposal # 16P1310CPD

September 28th, 2016

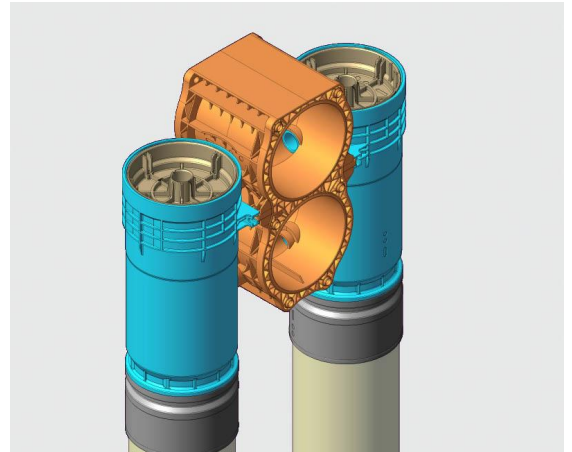

EXECUTIVE SUMMARY

Thank you for your interest in Evoqua Water Technologies' new MEMCOR® CPII low-pressure ultrafiltration (UF) system. The MEMCOR CPII represents the latest evolution of UF systems from the first company to commercialize them. It represents the best aspects of our design heritage and combines small footprint, ease of access, process simplicity, and a robust membrane technology into a single package.

The N Fiber and L40N Module

At the heart of the new technology is the new 'N' membrane fiber. The N fiber is manufactured from robust and chlorine-resistant PVDF polymer, with specific improvements to the membrane morphology to impart a more consistent, break-resistant fiber. Evoqua has also improved the potting formulation of the new N module to provide more consistent performance under a variety of operating conditions.

Each L40N module contains 721 square feet of surface area, with a nominal pore size of 0.04 micron. The L40N module operates in an outside-in flow path, providing better treatability of high-solids feeds.

There are over 13,000 membrane modules in operation today using the 'N' fiber in a wide variety of applications from surface water, tertiary wastewater, to desalination.

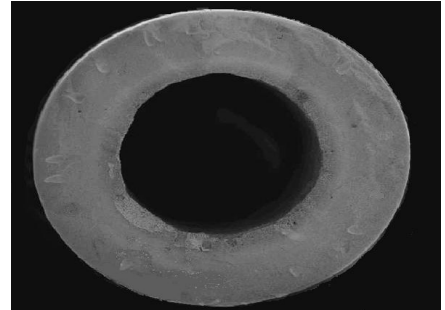

The MemRACK and CPII System

The heart of the new system is the MemRACK. Designed for modular flexibility and process simplicity, it incorporates the best features of previous UF designs while building on new innovations developed by the Evoqua team.

The MemRACK and CPII System offer the following benefits:

- Delivered to Site Assembled – not an Erector Set
- Easy Side and Top Module Access
- In-place repair capability
- Integral module isolation
- Decreased footprint
- Increased production uptime by 5% compared to other designs

We would like to thank you again for your interest in Evoqua's line of MEMCOR Products. We believe that every MEMCOR product comes with more than just equipment – it includes the expansive knowledge of MEMCOR's dedicated team of membrane scientists, engineers, and technicians who stand behind every installation. We are eager to share this expertise with those responsible for providing the world with clean, consistent, and high-quality water.



Should you have any questions regarding this quotation, or would like to request any additional information please contact us the Technical Sales Manager or the Evoqua Regional Representative listed below.

Evoqua Water Technologies LLC:

John Kutilek
Technical Sales Manager, MEMCOR Products
Technical Sales Manager
Telephone: 619-887-1674
Facsimile: 978-323-0854
John.Kutilek@evoqua.com

TABLE OF CONTENTS

Project Overview.....	4
Detailed Engineering and Technical Information.....	5
1 Design Basis	5
1.1 Feed and Filtrate Quality.....	5
1.2 Process Design	6
1.3 Design Requirements and Assumptions.....	8
2 MEMCOR® Scope of Supply.....	9
2.1 3 X CPlI 16 L40N Primary System Scope of Supply.....	9
2.2 1, XPsr 18L10N Backwash Recovery System Scope of Supply	18
3 Controls Description	22
4 Process Description	23
5 Service.....	26
Evoqua Water Technologies LLC – Standard Terms of Sale	27
Extended Low Pressure Membrane Module Warranty	30

Project Overview

The following table summarizes the contents of this quotation:

MEMCOR® System:	3 x CPII 16 L40N & XPsr Backwash Recovery
Skid mounted pressurized membrane units with local piping	Membrane Integrity Test
48 L40N Modules	PLC Master Controller System
Clean-in-Place (CIP) System	Manufacturing Services (Commissioning / Training)
Chemical Transfer System	O&M Manuals
XPsr Backwash Recovery System	Custom Tool Package
Standard Terms of Sale	Warranties
Budgetary Proposal Price:	USD \$850,000

Please note that the pricing above does not include insurance, bonds, or any applicable taxes.

The scope of supply and pricing are based on Evoqua's standard equipment selection, standard terms of sale and warranty terms as described herein. Any variations from these standards may affect this budgetary quotation. Additionally, please note that this budgetary quotation is for review and informational purposes only and does not constitute an offer for acceptance.

Payment Terms: 10% on Order, net 30
 15% on Engineering Submittals, staged submittals allowed, net 30
 25% on Order of major rotating equipment, net 30
 45% on Delivery, partial deliveries accepted, net 30
 5% on Start-up, net 30
 Full payment not to exceed 120 days after shipment

Freight: F.O.B. shipping point, with freight prepaid to the jobsite.

Shipments: Estimated 12 - 14 weeks after receipt of full information and approved drawings when required.

Drawings: Three (3) sets of submittal drawings, if required, will be issued approximately 6 - 8 weeks after receipt and approval of purchase order.

Manuals: Three (3) copies of English language owner's manuals are included. Additional manuals will cost \$150 each.

Detailed Engineering and Technical Information

1 DESIGN BASIS

This section contains engineering and technical information on the design of the proposed MEMCOR® CPII system. This includes redundancy, cleaning intervals, as well as key process parameters such as recovery and flux. It also includes important information on mechanical design requirements before and after the UF system that will make the overall plant design a success.

If you have questions after reviewing this information, our engineers are available to provide more detailed analyses to assist with your water treatment needs.

1.1 Feed and Filtrate Quality

In general, PVDF membranes are resistant to oxidizing feeds. Specific resistances can be found on the module data sheet. The feed water shall not contain (i) any polar organic solvents (such as acetone); or (ii) any cationic water treatment polymers. If the presence of oil and grease or fibrous material is suspected, consult MEMCOR®. Iron and Manganese must be properly oxidized to ensure compliance with water quality limits and avoid membrane fouling. The feed water must be pre-screened to prevent fiber damage due to solids from building up in the fiber bundles.

This proposed design is based on the feed water having the following characteristics:

Table 1.1 – Raw Water Quality Specifications

PARAMETER ¹	UNITS	AVERAGE	MAX OR RANGE
Temperature	Deg C	*	10 – 25
pH ²		*	6 – 9
Total Organic Carbon	mg/L	*	< 1.0
Turbidity	NTU	*	< 5
LSI	SU	*	+0.5
Alkalinity	mg/L as CaCO ₃	*	*
Hardness	mg/L as CaCO ₃	*	< 100
Iron	mg/L	*	< 0.3
Dissolved Iron	mg/L	*	< 0.1
Manganese	mg/L	*	< 0.05
Dissolved Manganese	mg/L	*	< 0.025

1 Customer must confirm all assumed parameters and values, and provide any missing information.

2 For applications where feed water undergoes chemical pretreatment, such as oxidation, direct coagulation, or settled feeds, the pH range shall be adjusted to 7 – 8.

The equipment offered will provide the following filtrate quality:

Table 1.2 – Filtrate Quality Specifications¹

PARAMETER	UNITS	QUALITY
Turbidity ²	NTU	< 0.1
Particle Removal ³	Log Removal	> 4.0

1 The Filtrate Quality Specifications identified in Table 1.2 above are for reference purposes only. Please see “Extended Low Pressure Membrane Module Warranty” for any and all guarantees and warranties provided with this proposal.

2 Filtrate turbidity shall be <0.1 NTU 95% of the time and <0.3 NTU 100% of the time.

3 As measured by MEMCOR’s standard Air Hold Test for removal of particles 3.0+ microns in size.

1.2 Process Design

The proposed system has been designed based on the following process parameters:

Table 1.3 – Process Design Parameters for the Primary System

PARAMETER	UNITS	VALUE
System Size	N/A	3 x CPII 16 L40N
Filtrate Capacity	MGD (nominal)	1.25
Instantaneous Flux	gfd	39
System Recovery	%	≥ 97
CIP Interval	Days	30
System Operation	N/A	N
Chlorine MW Interval	Hours	168
Acid MW Interval	Hours	168
Backwash Interval	Minutes	45

Table 1.4 – Process Design Parameters for the Backwash Recovery System

PARAMETER	UNITS	VALUE
System Size	N/A	1 x XPsr 18L10N
Feed Capacity	GPD (nominal)	62,500
Instantaneous Flux	gfd	19
System Recovery	%	≥ 92
CIP Interval	Days	30
System Operation	N/A	N
Chlorine MW Interval	Hours	48
Acid MW Interval	Hours	48
Backwash Interval	Minutes	22

1 The Process Design Parameters identified in Table 1.3 above are for reference purposes only. Please see “Process Performance Warranty”, if provided, and/or “Extended Low Pressure Membrane Module Warranty” for any and all guarantees and warranties provided with this proposal.

Operation Mode

“N” designates the number of units supplied.

N Operation

All the units participate to make the required flow on an average daily basis over a CIP interval.

1.3 Design Requirements and Assumptions

The table below lists the design requirements for the proposed system:

Table 1.4 – MEMCOR® CPII Design Requirements

REQUIREMENT	VALUE
Feed water pre-screening	≤ 250 micron
Feed water pressure	30 - 50 psi
Filtrate terminal point back pressure	3 – 5 psi
Filtrate Exhaust	Gravity drain to waste – dedicated line separate from backwash outlet
Compressed air supply pressure ¹	125 psi
Compressed air supply flow ¹	≥ 10 SCFM
Compressed air receiver volume	500 gallons
Site layout drawings	Reviewed by Evoqua

¹ The quality requirement for the compressed air to be supplied to the CPII unit is (1) having a dew point ten (10) degrees C below the lowest ambient temperature and (2) meeting the Compressed Air Contaminant and Purity Class two standard set forth in ISO 8573-1:2001(E).

In addition to the design requirements provided above, the proposed system design is based on the following design assumptions.

1. Design calculations are based on the plant being available for operation 100% of the time.
2. Design calculations are based on one (1) air hold test per unit per day.
3. External site hydraulics shall allow for backwash waste drain without any backpressure in the line. The backwash sweep with aeration step will need to drain at a flow rate of 13.2 gpm/module for 10 seconds, following be the backwash shell sweep that will need to drain at a flow rate of 24.2 gpm/module for 30 seconds.
4. Cleaning frequencies, including backwash, MW, and CIP intervals, are based on a properly maintained and operated pretreatment system (if applicable). Improper operation or bypassing of the pretreatment system will result in more frequent cleaning or lowered system performance.
5. The minimum flow is based on 50% of the maximum unit flow.
6. Heater sizing is based on a heat time of 6 hours.
7. The recoveries stated are based on the maximum unit flow (excluding strainer waste). As flow decreases through the unit, the recovery may also be reduced while cleaning intervals remain constant.
8. The design capacity is based on an average daily flow over the CIP interval. On the days where CIPs are conducted the net production flow will be reduced. Conversely, production flow will exceed the design capacity on non-CIP days.
9. RO permeate or a dedicated water softening system (by others) is required for CIP and MW makeup water if the average hardness of the membrane feed water is known to exceed 150 ppm as CaCo₃.
10. It is essential that the pneumatic distribution system (not provided by EWT) include a proper supply of moisture traps, automatic drains, isolation valves, and other accessories. Undue moisture buildup in the distribution system could damage critical operating components.

2 MEMCOR® SCOPE OF SUPPLY

2.1 3 X CPII 16 L40N PRIMARY SYSTEM SCOPE OF SUPPLY

The following represents the standard scope of supply to provide a MEMCOR CPII Low Pressure Membrane Filtration System. The system uses third generation “N” Series hollow fiber polyvinylidene fluoride (PVDF) membrane modules.

The sub-systems that encompass the scope for a fully operable system, described in detail below, include the following:

System	P&ID Number	# of Sheets
1. MEMCOR® CPII MR1 Unit – Standard	MGS92040002-FD	2
2. MEMCOR® CPII MR1 Feed Water System – Pressurized Feed	MGS92040003-FD	1
3. MEMCOR® CPII MR1 System Interconnection – Standard	MGS92040004-FD	1
4. MEMCOR CPII Clean-In-Place System – MR1 MR2	MGS92070006-FD	2
5. MEMCOR® CPII MR Chemical Transfer System – MR1 Simple	MGS92070009-FD	1
6. MEMCOR® CPII MR Compressed Air System – MR1 & MR2	MGS 92070007-FD	1
7. MEMCOR® CPII MR Neutralization System – MR1 & MR2	MGS 92070008-FD	1

Also included in the scope of supply for the MEMCOR CPII system are the following:

Additional Scope not Listed in P&IDs

8. Custom Tools
9. Control System
10. Manufacturer’s Engineering Support and Services

The following equipment selection can change without notice.

1. **MEMCOR® CPII Unit**

Each MEMCOR® CPII unit forms an individual filter that is operated independently of the other units in the system. Each unit is controlled by the plant PLC from the plant Process Control Panel via remote I/O. The following equipment is included for each MEMCOR CPII unit:

QTY.	PER UNIT	COMMON FOR PLANT	DESCRIPTION	MANUFACTURER / MODEL
48	ü		Membrane Modules fabricated of polyvinylidene fluoride (PVDF) membrane material.	Evoqua / L40N
3	ü		MemRACK. Includes integral headers and membrane housings, and support frame.	Evoqua / MEMCOR MemRACK 16
1	ü		Fabricated carbon steel piping frame, with zinc plated steel bolting, powder-coated per Evoqua standard.	Evoqua
1	ü		HDPE, Nylon and ABS pipework, including shipped loose spools as part of the block and bleed assemblies.	Multiple

1	Ü	Filtrate water turbidimeter, panel mounted with bubble trap, isolation valves and accessories, shipped loose for installation by others.	Hach Company / Model 1720E with SC200 Controller
12	Ü	Automatic butterfly valves, lug style, resilient seated with cast iron body, nylon coated ductile iron disc, 416SS stem, EPDM seat, and pneumatic actuators. The valve configuration includes the shipped loose block valves as part of the double block and bleed assemblies at the following unit terminal connections: feed, filtrate, CIP in and drain, and CIP feed and filtrate return.	Bray / Valve: Series 31 Actuator: Series 92
4	Ü	Automatic right angle seat bleed valves, with 316 L SS body and EPDM seat. All bleed to be shipped loose as part of the block and bleed assemblies at the following unit terminal connections: feed, filtrate, CIP in and drain, and CIP feed and filtrate return.	Schubert & Salzer / Type 7050
3	Ü	Sample manual polypropylene ball valves.	John Guest / Series PPSV
1	Ü	Control air inlet manual brass ball valves with PTFE seat, full port, BSPP threaded connections.	Parker Hannifin / Series BVGC
1	Ü	Tool air inlet manual brass ball valves with RPTFE seat, full port, and threaded connections.	Flow-Tek (Bray) / Series S51
1	Ü	Feed flow control valve, lug style, resilient seated with cast iron body, nylon coated ductile iron disc, 416SS stem, EPDM seat, and pneumatic actuators, with electro-pneumatic positioner.	Bray with Valve Related Controls / Valve: Series 31 Actuator: Series 92 Positioner: Model VE
1	Ü	Feed water magnetic flow sensor, with EPDM liner, Hastelloy-C electrodes, and integrally mounted flow transmitter.	Siemens / Magflo 5100W Series with Mag 6000 Series transmitter
1	Ü	Filtrate vibrating fork level switches.	Siemens / Sitrans LVL100
1	Ü	Unit manual drain butterfly valve, lug style, resilient seated with cast iron body, nylon coated ductile iron disc, 416SS stem, and EPDM seat.	Bray / Series 31
1	Ü	Scour air inlet swing check valve with polypropylene body and EPDM seal.	Praher / K4 Series
1	Ü	Process air inlet wafer type swing check valve with 316SS body, disc and trim, and EPDM seal.	Ritepro (Bray) / Check Rite Model 210

2	ü	Filtrate pressure transmitters.	Siemens / Sitrans P DS III Series
1	ü	Control Air pressure switch low.	SMC Pneumatic / Series ISE70

2. **MEMCOR® Feed Water System**

The feed water system to the MEMCOR CPII units consists of equipment and instrumentation that is important to ensure that the system is protected from contamination. The following equipment is included as part of the feed system:

QTY.	PER UNIT	COMMON FOR PLANT	DESCRIPTION	MANUFACTURER / MODEL
1 Lot		ü	Miscellaneous manual stainless steel ball valves, with RPTFE seat, full port, and threaded connections.	Flow-Tek (Bray) / Series S85
1		ü	Common feed water pressure transmitter.	Siemens / Sitrans P DS III Series
1		ü	Common feed water temperature transmitter with 100 Ohm platinum RTD and 316SS thermowell.	Siemens / Sitrans TS500 Series

3. **MEMCOR® System Interconnection**

The interconnection system collects filtrate from each unit and includes the following equipment:

QTY.	PER UNIT	COMMON FOR PLANT	DESCRIPTION	MANUFACTURER / MODEL
1		ü	Automatic butterfly valves, for CIP sweep line isolation, lug style, resilient seated with cast iron body, nylon coated ductile iron disc, 416SS stem, EPDM seat, and pneumatic actuators.	Bray / Valve: Series 31 Actuator: Series 92
1		ü	Manual stainless steel ball valves, for filtrate sample, with RPTFE seat, full port, and threaded connections.	Flow-Tek (Bray) / Series S85

4. **MEMCOR® Clean-In-Place System**

Membrane systems need to be chemically cleaned periodically to remove foulants that are not removed by the air/liquid backwash. Membrane fouling is the primary cause of loss of productivity and downtime for a membrane system. Each CPlI unit is chemically cleaned individually while the other units in the system remain on line.

The cleaning program includes both recirculation and soaking periods and is completed within 4 to 6 hours. At the end of the cleaning period, the cleaning solution is directed to the optional neutralization system prior to disposal. Once the unit is drained, raw water is introduced and a backwash sequence followed by a filter-to-waste cycle is initiated. The filter-to-waste and backwash volumes are sent to the optional neutralization system prior to discharge. This process is known as a Clean-In-Place operation (CIP). A shorter version of this cleaning process without a soaking period, which is completed in approximately 45 minutes, is called a Maintenance Wash. In the Maintenance Wash process a dilute cleaning solution is recirculated through the membranes.

The following equipment is included in the Chemical Cleaning System:

QTY.	PER UNIT	COMMON FOR PLANT	DESCRIPTION	MANUFACTURER / MODEL
Pump Components – Shipped Loose Equipment				
1		ü	Vertical multistage in-line centrifugal CIP Pump (1 duty / 0 standby) with 316 stainless steel wetted parts, premium efficiency TEFC motor (460VAC/3ph/60Hz).	Grundfos / Model CRN 90-1-1
1		ü	ORP sensor and pH sensor with one shared SC200 controller/transmitter and insertion mounting hardware (sensors are inline mounted in the CIP return piping).	Hach Company / Model RD2P5 and PD2P1 with SC200 Controller
1		ü	Air release valve, 316SS body and trim.	Val-Matic / Model 22.15
6		ü	Automatic butterfly valves, for automatic control of the cleaning process, lug style, resilient seated with cast iron body, nylon coated ductile iron disc, 416SS stem, EPDM seat, and pneumatic actuators.	Bray / Valve: Series 31 Actuator: Series 92
4		ü	Automatic diaphragm valves for chemical injection isolation, with CPVC body and pneumatic actuator.	Chemline / Type 710
2		ü	Manual stainless steel ball valves, with RPTFE seat, full port, and threaded connections.	Flow-Tek (Bray) / Series S85
1		ü	Control air inlet manual brass ball valves with PTFE seat, full port, BSPP threaded connections.	Parker Hannifin / Series BVGC
1		ü	Control air isolation manual brass ball valves with RPTFE seat, full port, and threaded connections.	Flow-Tek (Bray) / Series S51
4		ü	Corporation stops (Injection quills) with integral check valve, 1" ball valve, 1/2" NPT inlet connection, and 1/2" NPT solution tube, CPVC.	Saf-T-Flow / EB-164 Series

1	ü	Flow control valve, lug style, resilient seated with cast iron body, nylon coated ductile iron disc, 416SS stem, EPDM seat, and pneumatic actuators, with electro-pneumatic positioner.	Bray with Valve Related Controls / Valve: Series 31 Actuator: Series 92 Positioner: Model VE
1	ü	CIP pump discharge line flow probe and switch.	Magnetrol / Model TD1
2	ü	Manual butterfly valves for isolation of the CIP pump, lug style, resilient seated with cast iron body, nylon coated ductile iron disc, 416SS stem, and EPDM seat, manufactured by Bray Controls.	Bray / Series 31
1	ü	CIP pump discharge swing check valves, with polypropylene body and EPDM seals.	Praher / K4 Series
2	ü	Pressure indicating gauge with diaphragm seal, on CIP pump suction and discharge.	Ashcroft / Duralife Type 1009 with Type 100 seal
1	ü	Pressure relief valve, CPVC body and viton seal.	Plast-O-Matic / Series RVT
1	ü	Control air pressure switch low.	SMC Pneumatic / Series ISE70
1	ü	CIP line temperature transmitter with 100 Ohm platinum RTD and 316SS thermowell.	Siemens / Sitrans TS500 Series
Tank Components - Shipped Loose Equipment			
1	ü	730 gallon (working volume) fiberglass reinforced plastic (FRP) hot water tank for use in the CIP process (this tank will only be exposed to chemical-free filtrate water).	TBD
1	ü	30 kW immersion type heater with stainless steel sheath elements and flange, J-type thermocouple, moisture resistant enclosure.	Watlow / WATROB ANSI Flange
1	ü	Automatic butterfly valves, for service water tank fill isolation, lug style, resilient seated with cast iron body, nylon coated ductile iron disc, 416SS stem, EPDM seat, and pneumatic actuators.	Bray / Valve: Series 31 Actuator: Series 92
1	ü	CIP tank level transmitter.	Siemens / Sitrans P DS III Series
2	ü	CIP tank vibrating fork level switches.	Siemens / Sitrans LVL100

1	ü	Manual butterfly valves for CIP tank drain, lug style, resilient seated with cast iron body, nylon coated ductile iron disc, 416SS stem, and EPDM seat.	Bray / Series 31
1	ü	CIP tank temperature transmitter with 100 Ohm platinum RTD and 316SS thermowell.	Siemens / Sitrans TS500 Series

5. MEMCOR® Chemical Transfer System

The chemical transfer system delivers chemicals such as acid and sodium hypochlorite for cleaning and maintenance washing. The following equipment is included in the chemical transfer system:

QTY.	PER UNIT	COMMON FOR PLANT	DESCRIPTION	MANUFACTURER / MODEL
1		ü	Cleaning chemical: 12.5% sodium hypochlorite electronic diaphragm metering pump, with PVDF head and diaphragm, PVDF manual prime/degassing valve, ceramic valve balls and teflon valve ball seats. Clear PVC suction tubing and PVDF foot valve with polypropylene screen shipped loose. Day tanks or chemical storage totes with to be provided by others.	Pulsafeeder
1		ü	Cleaning chemical: 50% citric acid electronic diaphragm metering pump, with PVDF head and diaphragm, PVDF manual prime/degassing valve, ceramic valve balls and teflon valve ball seats. Clear PVC suction tubing and PVDF foot valve with polypropylene screen shipped loose. Day tanks or chemical storage totes with to be provided by others.	LMI
1		ü	Cleaning chemical: 50% sulfuric acid electronic diaphragm metering pump, with PVDF head and diaphragm, PVDF manual prime/degassing valve, ceramic valve balls and teflon valve ball seats. Clear PVC suction tubing and PVDF foot valve with polypropylene screen shipped loose. Day tanks or chemical storage totes with to be provided by others.	Pulsafeeder

6. MEMCOR® Compressed Air System

The compressed air system provides air for valve actuation, air-assisted liquid backwash and integrity testing. The air-assisted liquid backwash is a key patented feature of the MEMCOR CPlI system, assisting with solids removal from the membrane modules during backwash by re-directing filtrate water in the filtrate manifold back towards the lumen of the membrane fiber. Compressed air is also used in the system for the Membrane Integrity Test, various plant instruments and controls, and other steps in the cleaning processes. In order to ensure an appropriate supply of air to perform all of the functions required, the following equipment has been provided:

QTY.	PER UNIT	COMMON FOR PLANT	DESCRIPTION	MANUFACTURER / MODEL
Compressor and Air Receiver Components – Shipped Loose Equipment				
1 lot		Ü	Manual brass ball valves with RPTFE seat, full port, and threaded connections.	Flow-Tek (Bray) / Series S51
1		Ü	Manual butterfly valves, lug style, resilient seated with cast iron body, nylon coated ductile iron disc, 416SS stem, and EPDM seat.	Bray / Series 31
2		Ü	Pressure relief valves to protect the system from over pressurization, brass body with stainless steel ball.	Kingston / Series 119CSS
Air Regulator Components - Shipped Loose Equipment				
1 Lot		Ü	Manual brass ball valves with RPTFE seat, full port, and threaded connections.	Flow-Tek (Bray) / Series S51
1		Ü	Air velocity transmitter.	E+E Elektronik Corp / Series EE75
8		Ü	Manual butterfly valves, lug style, resilient seated with cast iron body, nylon coated ductile iron disc, 416SS stem, and EPDM seat.	Bray / Series 31
1		Ü	Pressure transmitters.	Siemens / Sitrans P DS III Series
1 Lot		Ü	Pressure indicating gauge.	Ashcroft / Duralife Type 1009
3		Ü	Pressure relief valves to protect the system from over pressurization, brass body with stainless steel ball.	Kingston / Series 119CSS
2		Ü	Control air regulators set at 90 psi.	SMC Pneumatic / Series AR
4		Ü	Elector-Pneumatic air regulators.	SMC Pneumatic / Series ITV
4		Ü	Process air regulators set at various pressures for process air and backwash scour air.	Fisher (Emerson) / Series 299H

7. Custom Tools

The following custom tools will be provided as standard with each MEMCOR CPII system:

QTY.	PER UNIT	COMMON FOR PLANT	DESCRIPTION	MANUFACTURER / MODEL
1		ü	Sonic Analyzer for onsite diagnostic analysis of membrane modules.	MEMCOR / Evoqua
1		ü	Membrane pin repair kit.	MEMCOR / Evoqua
1		ü	Lot of hand tools including, filtrate isolation valve tool, top cap removal/installation tool, and module removal (lifting) tool.	MEMCOR / Evoqua

8. Control System

The control system provided for the MEMCOR CPII system includes the following equipment:

QTY.	PER UNIT	COMMON FOR PLANT	DESCRIPTION	MANUFACTURER / MODEL
1		ü	Process Control Panel, to coordinate operation of all MEMCOR supplied equipment including, a PLC, local I/O, panel door mounted 15" color touch screen Operator Interface Terminal (OIT), and Remote Access Server.	Allen Bradley / Compact Logix PLC w/ Panelview Plus 1500
1	ü		Modular I/O, mounted directly to the skid unit, used to relay information to/from the Process Control Panel and the individual MEMCOR CPII unit(s) via an Ethernet/IP communications link.	Balluff / Distributed Modular I/O with IO-Link
1		ü	Modular I/O, mounted directly on a backpanel for installation by the Contractor, used to relay information to/from the Process Control Panel and the CIP system via an Ethernet/IP communications link.	Balluff / Distributed Modular I/O with IO-Link

9. Manufacturer’s Engineering Support and Services

The entire execution process from design to start-up will be overseen by MEMCOR personnel. A certified project manager will act as a single contact point between MEMCOR and the customer. The following services will be provided during the execution of this project:

QTY.	PER UNIT	COMMON FOR PLANT	DESCRIPTION
3 copies		ü	<p>Standard MEMCOR CII system submittal including:</p> <ul style="list-style-type: none"> - Submittal Approval Form - Process Overview - Valve, Equipment and Instrumentation List - Manufacturer’s Cut Sheets - Mechanical Drawings <ul style="list-style-type: none"> o Membrane System P&ID (showing Evoqua supplied equipment) o CII Unit P&ID o CII Unit General Arrangement (including location of termination points) o Drawings and data for tanks supplied by Evoqua - I/O List - Electrical Bill of Materials - Electrical Drawings <ul style="list-style-type: none"> o Control Single Line o Three Phase Power Single Line o Field Interface Connections o Process Control Panel diagrams
3 copies		ü	<p>Operation and maintenance manuals are included. Manuals will be to Evoqua’s commercial standards. This shall include detailed project specific manufacturer drawings, equipment, valves, instruments and pipe schedules. No drawings, except those used internally by consultant/customer are to be reproduced without the expressed, written permission of Evoqua.</p>
35		ü	<p>Eight hour service-days for manufacturer’s services at regular intervals during the project to ensure proper installation and assembly procedures are followed as well as commissioning and training of the MEMCOR CII system. Additional services may be retained at MEMCOR scheduled rates of US\$1650.00 per day, per person plus travel expenses at cost plus 5% mark up. The services included are:</p> <ul style="list-style-type: none"> - On-site supervision that includes MEMCOR CII installation support and plant pre-commissioning, - On-site services for plant commissioning which includes startup, completion of functional test and initial performance test, - Training of operators and technical staff in conjunction of startup. Training will include; equipment description, field instrumentation, control panels, detailed component description, preventive maintenance and troubleshooting.

2.2 1, XPSR 18L10N BACKWASH RECOVERY SYSTEM SCOPE OF SUPPLY

1. Feed Water System

The feed water system to the MEMCOR® XPsr units consists of equipment and instrumentation that is important to ensure that the system is protected from contamination. The following equipment is included as part of the feed system:

QUANTITY	PER UNIT	COMMON FOR PLANT	DESCRIPTION
1		a	Simplex Strainer with cast iron body and 316SS 250 micron basket
1		a	Common feed water Turbidimeter with controller, isolation valves, sample pump, and accessories, for installation by others
2		a	Manual butterfly valves for isolation of the strainer(s), wafer or lug style, resilient seated with cast iron body, nylon coated ductile iron disc, 416SS stem, and EPDM seat

2. *MEMCOR® XPsr Unit*

Each MEMCOR® XPsr unit forms an individual filter that is operated independently of the other units in the system. Each unit is controlled by the plant PLC from the plant Process Control Panel via remote I/O. Each unit can be fully isolated from the rest of the system (using automatic block and bleed valves) for cleaning processes and shares common resources such as the air and clean-in-place (CIP) systems. The following equipment is included for each MEMCOR® XPsr unit:

QUANTITY	PER UNIT	COMMON FOR PLANT	DESCRIPTION
1	a		Painted carbon steel frame
1	a		Schedule 80 PVC pipework
18	a		Membrane Modules fabricated of polyvinylidene fluoride (PVDF) membrane material manufactured by MEMCOR
1	a		Centrifugal end suction horizontal Feed/CIP pump with 316L stainless steel wetted parts, TEFC motor (460VAC/3ph/60Hz)
1	a		Lot of automatic butterfly valves, wafer style, resilient seated with cast iron body, 316SS disc and stem, EPDM seat, and double acting pneumatic actuators
1	a		Lot of automatic butterfly valves, lug style, resilient seated with cast iron body, nylon coated ductile iron disc, 416SS stem, EPDM seat, and double acting pneumatic actuators. The valve configuration includes the block valves (shipped loose) as part of the double block and bleed isolation at the following unit terminal connections: feed, filtrate, and CIP in
3	a		Automatic globe valves, right angle seated with stainless steel body, EPDM seat, and chrome plated brass actuator, for bleed valve (shipped loose) in the block and bleed configuration at the following unit terminal connections: feed, filtrate and CIP in

QUANTITY	PER UNIT	COMMON FOR PLANT	DESCRIPTION
1	a		Manual ball valve for high pressure air inlet isolation, with bronze body, RPTFE seat, full port, and threaded connection
2	a		Feed and filtrate sample manual ball valves
1	a		Manual ball valve for turbidimeter isolation, with PVC body, EPDM elastomer, full port, and threaded connection
1	a		Air filter, with aluminum body and 0.01 micron rating
1	a		Feed water magnetic flow sensor, with Ebonite liner, Hastelloy-C electrodes, and integrally mounted flow transmitter
1	a		Air scour inlet float style flow meter
1	a		Manual butterfly valves for pump isolation, wafer or lug style, resilient seated with cast iron body, nylon coated ductile iron disc, 416SS stem, and EPDM seat
1	a		Check valve for test air inlet, straight type insert style
3	a		Low pressure check valve for unit process air inlet feed and filtrate, and unit air scour inlet, with 316SS body and spring, and viton sea
1	a		Feed inlet in-line disc style check valve with 316SS body and trim, and EPDM seat
4	a		Pressure indicating gauge
4	a		Process air regulators set at various pressures for controls, integrity testing, and backwash
1	a		Air scour pressure relief valve to protect the system from over pressurization
2	a		Shell air and AHT air pressure relief valves to protect the system from over pressurization
1	a		Pressure switch
2	a		Pressure transmitters
4	a		Solenoid valves, zero differential pressure type, pilot operated
1	a		Unit feed temperature transmitter with 100 Ohm platinum RTD and 316SS thermowell

All equipment will be shipped as one pre-assembled skid to be installed on site. (except for items marked "shipped loose").

3. Interconnection System

The interconnection system collects filtrate from each unit and includes the following equipment:

Quantity	Per Unit	Common for Plant	Description
1	a		Filtrate water turbidimeter with controller, panel mounted with bubble trap, isolation valves and accessories
1	a		Lot of automatic butterfly valve, wafer or lug style, resilient seated with cast iron body, nylon coated ductile iron disc, 416SS stem, EPDM seat, and double acting pneumatic actuators
1	a		Lot of waste diversion valves
1		a	Air release valve, 316SS body and trim

4. Custom Tools

The following custom tools will be provided as standard with each MEMCOR® XPsr system:

Quantity	Per Unit	Common for Plant	Description
1		a	Sonic Analyzer for onsite diagnostic analysis of membrane modules, manufactured by MEMCOR
1		a	Membrane pin repair kit, including test cylinder, basin, and pins, manufactured by MEMCOR
1		a	Lot of hand tools including filtrate clip tool, isolation valve tools, c-spanner, and strap wrench, manufactured by MEMCOR

5. Control System

The control system provided for the MEMCOR® XPsr system includes the following equipment:

Quantity	Per Unit	Common for Plant	Description
1	a		Unit Panel, mounted directly to the skid unit, used to relay information to/from the Process Control Panel and the individual MEMCOR® XPsr via Ethernet communication, including, digital and analog I/O modules, and 24 VDC power supply
1	a		Variable frequency drive (NEMA 1) for feed pump flow control
1		a	CIP dosing panel (shipped loose)

Equipment and Services Provided by Others

All other works and equipment necessary to complete the project and not shown as being supplied by EVOQUA shall be supplied by others, including but not limited to:

- Civil works and any and all building modifications or construction to house the MEMCOR membrane filtration system equipment including all concrete work related with construction, grouting of equipment and else as applicable.
- Unloading, unpacking, storage (according to EVOQUA's recommendation), installation, assembly and field erection of the MEMCOR system.
- Interconnecting pipework between the MEMCOR units, between the MEMCOR units and the ancillary equipment (including air scour, compressed air, and chemical cleaning systems), between the MEMCOR units or ancillary equipment and equipment Supplied By Others and between the ancillary equipment.
- Pipe support including pipe hangers for all piping supplied outside the MEMCOR units.
- Pneumatic lines supplying air to the pneumatic actuators.
- Floor drains.
- Safety showers.
- Neutralization system to process the chemical cleaning waste prior to disposal (if applicable)
- Backwash waste holding tank or connection of the backwash outlet of each MEMCOR unit to sewer or other appropriate receiving system.
- Feed pumps, strainers and turbidimeter
- Chemical transfer systems for services other than related to the chemical cleaning of the membrane modules, specifically coagulant transfer systems.
- Supply and storage of all chemicals required for MEMCOR membrane filtration system cleaning, maintenance, and/or operation.
- SCADA system.
- Supply and installation of all VFDs, motor control centers, and disconnects, unless otherwise specified.
- Supply and installation of all control wiring, power cabling including cabling tray, conduits, fittings and supports as necessary.
- Installation of control panels not mounted on the MEMCOR units.
- Building power, lighting, main disconnect, power distribution.
- Instrumentation not specifically listed in the MEMCOR scope as specified herein.
- Spare Parts.
- Pump alignment and vibration analysis.
- Lubricants.
- Engineering services other than listed in the MEMCOR scope above including structural or foundation design.
- Supervision of installation.
- Permits and approvals.
- Anchor bolt and anchor bolt calculations (if required by the Engineer) for all equipment supplied in the MEMCOR scope.
- Walkways, handrail, stairways and ladders as required.
- Grouting.

3 CONTROLS DESCRIPTION

Our controls architecture is based on a single Master Control Panel (MCP) working with distributed input/output (I/O) modules located at key application points in the system. Specifications for our control system are indicated in the table below.

Table 3.1 – Control System Elements

ELEMENT	DESCRIPTION
MCP PLC	Allen Bradley Compact Logix
Operator Interface Terminal (OIT)	Allen Bradley Panelview Plus 6 1500 15" color touch screen
Communications Protocol	Allen Bradley Ethernet I/P
Membrane Skid and CIP Remote I/O Modules	Baluff IO-Link module I/O
Remote Monitoring Capability	Remote Access Server (RAS) Modem

Master Control Panel (MCP)

All operations including filtration, backwashing, chemical cleans, and standby are controlled from the MCP. The MCP can also share operating information to plant-wide monitoring systems such as a SCADA system. Control of non membrane equipment such as High Service Pumps, Chemical Feed, and Raw Water Pumps can be optionally added as required to accommodate project-specific needs.

The MCP is operated via the Operator Interface Terminal (OIT) mounted in the door of the MCP. The OIT provides for a graphical interface for monitoring and full operator control of the membrane system.

Remote maintenance and monitoring capability is provided by a Remote Access Server (RAS modem) via a telephone interface for direct connection to the Ethernet network. A MEMCOR process engineer can directly access system operating data via this connection to provide online support and assistance for the operation of the plant.

Membrane Unit

Membrane skids are configured Baluff IO-Link modular I/O. The I/O modules are mounted direct to the skid unit. The I/O includes a SMC pneumatic solenoid manifold for control of the on unit valves. The master PLC communicates with the unit mounted I/O via an Ethernet/IP communications link. Skid I/O are completely factory wired minimizing customer installation costs. The customer skid electrical connections are limited to the communications cable and 24VDC power cable.

Clean-In-Place System

The CIP system will also include Baluff IO-Link modular I/O. The I/O modules will be mounted directly on a backpanel for installation by the Contractor. The I/O includes a SMC pneumatic solenoid manifold for control of the CIP system valves. The master PLC communicates with the unit mounted I/O via an Ethernet/IP communications link.

4 PROCESS DESCRIPTION

All normal plant operation and process sequences are automatically controlled by the PLC and control system. Most sequences can also be triggered manually by the operator and some sequences such as chemical cleaning (CIP) can be manually initiated by the operator but automatically carried out once initiated.

The main operating states are as follows:

Shutdown

SHUTDOWN is the normal power up and shutdown state of a unit. In this sequence, no active cycles are running and no solenoid valves are energized. A unit remains in this state until the operator starts the unit.

Standby

STANDBY is an active state that a unit enters when the unit is available to run but no run command exists. One or more units can enter the STANDBY state when there is no, or insufficient demand. A unit in standby can return to filtration automatically.

Startup

During this sequence, the membrane array is filled with water. First, the air on the shell side is expelled out through the upper backwash outlet while the feed valve is open. Next, the filtrate side is primed by opening the filtrate exhaust while feed pressure continues to be applied to the membrane fibers.

Filtration

In Filtration, the feed pumps and unit feed valves maintain the filtration flow set point as the transmembrane pressure increases.

Backwash

Over time, particles rejected by the membranes build up on the outside of each fiber. As a result, the resistance to flow increases until a backwash is performed. The backwash sequence is used to reduce the build up of solids and reduce the transmembrane pressure. The backwash uses mechanical action only to remove solids - no chemicals are used during the backwash. A backwash is typically initiated after a pre-set period of time but can also be initiated when the change in resistance to flow exceeds a pre-set limit.

The backwash is fully automated and typically takes approximately 1.5 minutes. The backwash sequence includes the following steps:

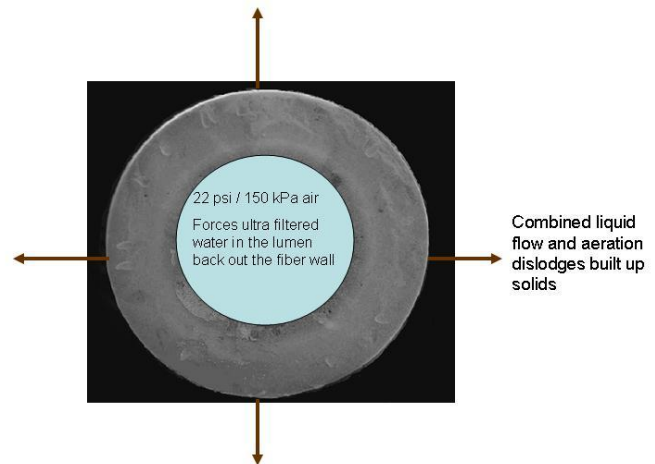

1. Pre-Aeration – Low pressure air enters the shell side at the bottom of the CPlI rack to provide air scouring to loosen/remove foulants from the membrane fibers. The flow meter downstream of the air scour pressure regulator is used to monitor the backwash air scour flow. The shell is vented via the upper backwash waste manifold.
2. Aeration and air driven liquid backwash – Air scouring continues. Low pressure process air is used to push the filtrate in the lumen side to the shell side of the unit thus creating the backwash effect.
3. Sweep with Aeration – Air scouring continues, while feed water enters the shell side via the lower feed manifold and exits the unit via the backwash waste manifold through the upper backwash valve.

4. Sweeping with Lumen Vent – Feed water continues to enter the shell side via the lower feed manifold and exit the unit via the backwash waste manifold through the upper backwash valve, while the filtrate exhaust valve is opened to vent the lumens.
5. Fill Lumen – Feed water continues to enter the shell side via the lower feed manifold, however, the upper backwash valve is closed and the unit filtrate exhaust valve remains opened. By closing the shell side of the unit to atmosphere and opening the lumen side of the unit, fill water entering the unit is forced through the membranes and refills the lumen side of the unit.

Clean-In-Place (CIP) / Maintenance Wash (MW)

The Clean-In-Place sequence is used to maintain long-term membrane performance. The CIP is manually initiated by the operator based either on transmembrane pressure (TMP), operational time, or calendar time. Under normal operating conditions, the CIP will be initiated based on operational time or calendar time, whichever occurs first. The maintenance wash sequence is similar to the CIP, but will have shorter recirculation and soak sequences along with different chemical concentrations. The maintenance washing is used to increase the time between Clean-In-Place events. Maintenance washes typically take about 45 minutes. The CIP is semi-automated and takes about 2.5 hours for each of the two chemical cleans. The operator manually initiates the CIP and MW, and permits it to continue after certain steps; however it is fully automated aside from that.

The steps of the MW and CIP are outlined below:

1. CIP Hot Water Tank Fill – the CIP Hot Water tank is filled from one of the units in operation or from the common filtrate piping header. Alternatively, the CIP Hot Water tank is filled from the external fill valve from either RO permeate or city water. This step is performed in preparation of conducting a CIP and does not require a CPII unit to be removed from operation.
2. CIP Hot Water Tank Heating – for acid CIPs, the water in the CIP tank is heated (typically to 30°C). For chlorine CIPs, the water in the CIP tank may be heated (typically to 20°C) if the water temperature reaches low temperatures for prolonged periods of time. MWs are not typically heated. This step also does not require removing a CPII unit from operation.
3. Backwash –The unit is backwashed to remove excess solids and maximize the chemical cleaning efficiency. The backwash waste is drained to the regular waste outlet.
4. Unit Hot Water Fill – The unit is filled with water from the CIP Hot Water tank.
5. Filtrate Recirculation and Chemical Dosing – The CIP transfer/recirculation pump starts to recirculate the water to the unit in a closed loop. The unit is fully isolated from the rest of the system. Acid or chlorine (as sodium hypochlorite) is added in the loop at the beginning of the recirculation sequence until the appropriate quantity of cleaning chemical is added.
6. Recirculation – The cleaning solution is recirculated through the membranes.
7. Soak – The modules are left to soak for a preset time.
8. Unit Drain – The cleaning solution is drained away from the unit to the neutralization system or sump.
9. Rinse CIP – The unit is refilled with feed water and rinsed to remove residual chemical. All rinse water is directed to the neutralization system or chemical waste disposal system.
10. Filtration to Waste – The unit is put into filtration but the filtrate with chemical residue is sent to the neutralization system or chemical waste disposal system.

Chemical Neutralization

Upon completion of a Maintenance Wash or CIP sequence, the dilute chemical solution from the unit is transferred to the neutralization tank. Neutralization is a fully automated batch process which occurs at the conclusion of either a CIP or MW.

The neutralization pump is started either automatically via the MCP or manually by an operator, which starts recirculation within a piping loop. An inline pH and ORP probe signals to the PLC which neutralization chemical (typically sodium bisulfite for chlorine neutralization or sodium hydroxide for acid neutralization) should be dosed into the circulation loop. The neutralization pump continues to run, turning over the tank through mixing eductors until a neutral condition is detected. Upon detecting a neutral condition, the tank contents are gravity drained to a discharge location (i.e. sewer).

Direct Integrity Test (DIT) (Referred to by Evoqua as an Air Hold Test)

The direct integrity test procedure is similar to that used on all of the other MEMCOR systems. The principal process steps include draining down the lumen, pressurizing the inside of the module fibers with integrity air while the unit is vented via the upper backwash valve to atmospheric pressure, shutting down the air supply and monitoring the pressure over time using the filtrate pressure transmitter supplied with each unit.

The result is logged and displayed on the OIT. The test confirms integrity when the rate of pressure decay remains lower than a pre-determined value which is used to determine the log removal value of the system. Each MEMCOR CPII unit is tested at regular time interval adjustable by the operator.

5 SERVICE

In an effort to ensure project support and customer satisfaction, 24/7 phone support can be reached anytime day or night by dialing 1-800-MEMCOR4. During working hours there are eight telephone support personnel available and after working hours the Service Department is on a rotating schedule to ensure that someone is always available to assist our customers.

Evoqua maintains a vast network of local service branches. Each branch has a team of technicians who are trained to assist in the maintenance and support of water and wastewater treatment plants across the country. Our technicians can reach 85% of the North American population in two hours or less. So you can rest assured that there will always be someone close at hand if you should need support after the sale.

The map below shows the location of each Evoqua service branch.



EVOQUA can offer a one-time or an ongoing Service Agreement to assist with the maintenance of your new system. Our ongoing service agreements are designed as preventive maintenance programs to help minimize your total plant operating cost.

A variety of levels of service are available to suit your needs from infrequent check-ups to almost complete takeover of your maintenance requirements. We can provide more information and discuss this further at your convenience.

Evoqua Water Technologies LLC – Standard Terms of Sale

1. **Applicable Terms.** These terms govern the purchase and sale of equipment, products, related services, leased products, and media goods if any (collectively herein "Work"), referred to in Seller's proposal ("Seller's Documentation"). Whether these terms are included in an offer or an acceptance by Seller, such offer or acceptance is expressly conditioned on Buyer's assent to these terms. Seller rejects all additional or different terms in any of Buyer's forms or documents.
2. **Payment.** Buyer shall pay Seller the full purchase price as set forth in Seller's Documentation. Unless Seller's Documentation specifically provides otherwise, freight, storage, insurance and all taxes, levies, duties, tariffs, permits or license fees or other governmental charges relating to the Work or any incremental increases thereto shall be paid by Buyer. If Seller is required to pay any such charges, Buyer shall immediately reimburse Seller. If Buyer claims a tax or other exemption or direct payment permit, it shall provide Seller with a valid exemption certificate or permit and indemnify, defend and hold Seller harmless from any taxes, costs and penalties arising out of same. All payments are due within 30 days after receipt of invoice. Buyer shall be charged the lower of 1 ½% interest per month or the maximum legal rate on all amounts not received by the due date and shall pay all of Seller's reasonable costs (including attorneys' fees) of collecting amounts due but unpaid. All orders are subject to credit approval by Seller. Back charges without Seller's prior written approval shall not be accepted.
3. **Delivery.** Delivery of the Work shall be in material compliance with the schedule in Seller's Documentation. Unless Seller's Documentation provides otherwise, delivery terms are ExWorks Seller's factory (Incoterms 2010). Title to all Work shall pass upon receipt of payment for the Work under the respective invoice. Unless otherwise agreed to in writing by Seller, shipping dates are approximate only and Seller shall not be liable for any loss or expense (consequential or otherwise) incurred by Buyer or Buyer's customer if Seller fails to meet the specified delivery schedule.
4. **Ownership of Materials and Licenses.** All devices, designs (including drawings, plans and specifications), estimates, prices, notes, electronic data, software and other documents or information prepared or disclosed by Seller, and all related intellectual property rights, shall remain Seller's property. Seller grants Buyer a non-exclusive, non-transferable license to use any such material solely for Buyer's use of the Work. Buyer shall not disclose any such material to third parties without Seller's prior written consent. Buyer grants Seller a non-exclusive, non-transferable license to use Buyer's name and logo for marketing purposes, including but not limited to, press releases, marketing and promotional materials, and web site content.
5. **Changes.** Neither party shall implement any changes in the scope of Work described in Seller's Documentation without a mutually agreed upon change order. Any change to the scope of the Work, delivery schedule for the Work, any Force Majeure Event, any law, rule, regulation, order, code, standard or requirement which requires any change hereunder shall entitle Seller to an equitable adjustment in the price and time of performance.
6. **Force Majeure Event.** Neither Buyer nor Seller shall have any liability for any breach or delay (except for breach of payment obligations) caused by a Force Majeure Event. If a Force Majeure Event exceeds six (6) months in duration, the Seller shall have the right to terminate the Agreement without liability, upon fifteen (15) days written notice to Buyer, and shall be entitled to payment for work performed prior to the date of termination. "**Force Majeure Event**" shall mean events or circumstances that are beyond the affected party's control and could not reasonably have been easily avoided or overcome by the affected party and are not substantially attributable to the other party. Force Majeure Event may include, but is not limited to, the following circumstances or events: war, act of foreign enemies, terrorism, riot, strike, or lockout by persons other than by Seller or its sub-suppliers, natural catastrophes or (with respect to on-site work), unusual weather conditions.
7. **Warranty.** Subject to the following sentence, Seller warrants to Buyer that the (i) Work shall materially conform to the description in Seller's Documentation and shall be free from defects in material and workmanship and (ii) the Services shall be performed in a timely and workmanlike manner. Determination of suitability of treated water for any use by Buyer shall be the sole and exclusive responsibility of Buyer. The foregoing warranty shall not apply to any Work that is specified or otherwise demanded by Buyer and is not manufactured or selected by Seller, as to which (i) Seller hereby assigns to Buyer, to the extent assignable, any warranties made to Seller and (ii) Seller shall have no other liability to Buyer under warranty, tort or any other legal theory. The Seller warrants the Work, or any components thereof, through the earlier of (i) eighteen (18) months from delivery of the Work or (ii) twelve (12) months from initial operation of the Work or ninety (90) days from the performance of services (the "Warranty Period"). If Buyer gives Seller prompt written notice of breach of this warranty within the Warranty Period, Seller shall, at its sole option and as Buyer's sole and exclusive remedy, repair or replace the subject parts, re-perform the Service or refund the purchase price. Unless otherwise agreed to in writing by Seller, (i) Buyer shall be responsible for any labor required to gain access to the Work so that Seller can assess the available remedies and (ii) Buyer shall be responsible for all costs of installation of repaired or replaced Work. If Seller determines that any claimed breach is not, in fact, covered by this warranty, Buyer shall pay Seller its then customary charges for any repair or replacement made by Seller. Seller's warranty is conditioned on Buyer's (a) operating and maintaining the Work in accordance with Seller's instructions, (b) not making any unauthorized repairs or alterations, and (c) not being in default of any payment obligation to Seller. Seller's warranty does not cover (i) damage caused by chemical action or abrasive material, misuse or improper installation (unless installed by Seller) and (ii) media goods (such as, but not limited to, resin, membranes, or granular activated carbon media) once media goods are

installed. THE WARRANTIES SET FORTH IN THIS SECTION 7 AND THE WARRANTY SET FOR IN THE “EXTENDED LOW PRESSURE MEMBRANE MODULE WARRANTY” SECTION OF EVOQUA’S PROPOSAL ARE THE SELLER’S SOLE AND EXCLUSIVE WARRANTIES AND ARE SUBJECT TO THE LIMITATION OF LIABILITY PROVISION BELOW. SELLER MAKES NO OTHER WARRANTIES OF ANY KIND, EXPRESS OR IMPLIED, INCLUDING WITHOUT LIMITATION, ANY WARRANTY OF MERCHANTABILITY OR FITNESS FOR PURPOSE.

8. Indemnity. Seller shall indemnify, defend and hold Buyer harmless from any claim, cause of action or liability incurred by Buyer as a result of third party claims for personal injury, death or damage to tangible property, to the extent caused by Seller’s negligence. Seller shall have the sole authority to direct the defense of and settle any indemnified claim. Seller’s indemnification is conditioned on Buyer (a) promptly, within the Warranty Period, notifying Seller of any claim, and (b) providing reasonable cooperation in the defense of any claim.

9. Assignment. Neither party may assign this Agreement, in whole or in part, nor any rights or obligations hereunder without the prior written consent of the other party; provided, however, the Seller may assign its rights and obligations under these terms to its affiliates or in connection with the sale or transfer of the Seller’s business and Seller may grant a security interest in the Agreement and/or assign proceeds of the agreement without Buyer’s consent.

10. Termination. Either party may terminate this agreement, upon issuance of a written notice of breach and a thirty (30) day cure period, for a material breach (including but not limited to, filing of bankruptcy, or failure to fulfill the material obligations of this agreement). If Buyer suspends an order without a change order for ninety (90) or more days, Seller may thereafter terminate this Agreement without liability, upon fifteen (15) days written notice to Buyer, and shall be entitled to payment for work performed, whether delivered or undelivered, prior to the date of termination.

11. Dispute Resolution. Seller and Buyer shall negotiate in good faith to resolve any dispute relating hereto. If, despite good faith efforts, the parties are unable to resolve a dispute or claim arising out of or relating to this Agreement or its breach, termination, enforcement, interpretation or validity, the parties will first seek to agree on a forum for mediation to be held in a mutually agreeable site. If the parties are unable to resolve the dispute through mediation, then *any dispute, claim or controversy arising out of or relating to this Agreement or the breach, termination, enforcement, interpretation or validity thereof, including the determination of the scope or applicability of this agreement to arbitrate, shall be determined by arbitration in Pittsburgh, Pennsylvania before three arbitrators who are lawyers experienced in the discipline that is the subject of the dispute and shall be jointly selected by Seller and Buyer. The arbitration shall be administered by JAMS pursuant to its Comprehensive Arbitration Rules and Procedures. The Arbitrators shall issue a reasoned decision of a majority of the arbitrators, which shall be the decision of the panel. Judgment may be entered upon the arbitrators’ decision in any court of competent jurisdiction. The substantially prevailing party as determined by the arbitrators shall be reimbursed by the other party for all costs, expenses and charges, including without limitation reasonable attorneys’ fees, incurred by the prevailing party in connection with the arbitration. For any order shipped outside of the United States, any dispute shall be referred to and finally determined by the International Center for Dispute Resolution in accordance with the provisions of its International Arbitration Rules, enforceable under the New York Convention (Convention on the Recognition and Enforcement of Foreign Arbitral Awards) and the governing language shall be English.*

12. Export Compliance. Buyer acknowledges that Seller is required to comply with applicable export laws and regulations relating to the sale, exportation, transfer, assignment, disposal and usage of the Work provided under this Agreement, including any export license requirements. Buyer agrees that such Work shall not at any time directly or indirectly be used, exported, sold, transferred, assigned or otherwise disposed of in a manner which will result in non-compliance with such applicable export laws and regulations. It shall be a condition of the continuing performance by Seller of its obligations hereunder that compliance with such export laws and regulations be maintained at all times. BUYER AGREES TO INDEMNIFY AND HOLD SELLER HARMLESS FROM ANY AND ALL COSTS, LIABILITIES, PENALTIES, SANCTIONS AND FINES RELATED TO NON-COMPLIANCE WITH APPLICABLE EXPORT LAWS AND REGULATIONS.

13. LIMITATION OF LIABILITY. NOTWITHSTANDING ANYTHING ELSE TO THE CONTRARY, SELLER SHALL NOT BE LIABLE FOR ANY CONSEQUENTIAL, INCIDENTAL, SPECIAL, PUNITIVE OR OTHER INDIRECT DAMAGES, AND SELLER’S TOTAL LIABILITY ARISING AT ANY TIME FROM THE SALE OR USE OF THE WORK, INCLUDING WITHOUT LIMITATION ANY LIABILITY FOR ALL WARRANTY CLAIMS OR FOR ANY BREACH OR FAILURE TO PERFORM ANY OBLIGATION UNDER THE CONTRACT, SHALL NOT EXCEED THE PURCHASE PRICE PAID FOR THE WORK. THESE LIMITATIONS APPLY WHETHER THE LIABILITY IS BASED ON CONTRACT, TORT, STRICT LIABILITY OR ANY OTHER THEORY.

14. Rental Equipment / Services. Any leased or rented equipment (“Leased Equipment”) provided by Seller shall at all times be the property of Seller with the exception of certain miscellaneous installation materials purchased by the Buyer, and no right or property interest is transferred to the Buyer, except the right to use any such Leased Equipment as provided herein. Buyer agrees that it shall not pledge, lend, or create a security interest in, part with possession of, or relocate the Leased Equipment. Buyer shall be responsible to maintain the Leased Equipment in good and efficient working order. At the end of the initial term specified in the order, the terms shall automatically renew for the identical period unless canceled in writing by Buyer

or Seller not sooner than three (3) months nor later than one (1) month from termination of the initial order or any renewal terms. Upon any renewal, Seller shall have the right to issue notice of increased pricing which shall be effective for any renewed terms unless Buyer objects in writing within fifteen (15) days of issuance of said notice. If Buyer timely cancels service in writing prior to the end of the initial or any renewal term this shall not relieve Buyer of its obligations under the order for the monthly rental service charge which shall continue to be due and owing. Upon the expiration or termination of this Agreement, Buyer shall promptly make any Leased Equipment available to Seller for removal. Buyer hereby agrees that it shall grant Seller access to the Leased Equipment location and shall permit Seller to take possession of and remove the Leased Equipment without resort to legal process and hereby releases Seller from any claim or right of action for trespass or damages caused by reason of such entry and removal.

15. Miscellaneous. These terms, together with any Contract Documents issued or signed by the Seller, comprise the complete and exclusive statement of the agreement between the parties (the "Agreement") and supersede any terms contained in Buyer's documents, unless separately signed by Seller. No part of the Agreement may be changed or cancelled except by a written document signed by Seller and Buyer. No course of dealing or performance, usage of trade or failure to enforce any term shall be used to modify the Agreement. To the extent the Agreement is considered a subcontract under Buyer's prime contract with an agency of the United States government, in case of Federal Acquisition Regulations (FARs) flow down terms, Seller will be in compliance with Section 44.403 of the FAR relating to commercial items and those additional clauses as specifically listed in 52.244-6, Subcontracts for Commercial Items (OCT 2014). If any of these terms is unenforceable, such term shall be limited only to the extent necessary to make it enforceable, and all other terms shall remain in full force and effect. The Agreement shall be governed by the laws of the Commonwealth of Pennsylvania without regard to its conflict of laws provisions. Both Buyer and Seller reject the applicability of the United Nations Convention on Contracts for the international sales of goods to the relationship between the parties and to all transactions arising from said relationship.

Extended Low Pressure Membrane Module Warranty

1. Term of the Low Pressure Membrane Module Warranty
 - a. This Warranty shall commence (“Commencement Date”) on the earlier of:
 - i) wet start up of the equipment, or
 - ii) 6 months after the delivery of the final low pressure membrane skid/rack to the Buyer.
 - b. This Warranty shall continue for a period of 7 years from the Commencement Date (the “Module Warranty Period”).
2. Repair and Replacement Conditions
 - a. In the event an individual low pressure membrane module exhibits defects in material or workmanship, as defined in Paragraph 2.b. below, the Seller shall, at its sole option and as the Buyer’s sole remedy, conduct either of the following:
 - i) Repair the low pressure membrane module at no cost to Buyer; or
 - ii) Provide replacement low pressure membrane modules per the warranty replacement schedule listed in Paragraph 5 below.
 - b. Low pressure membrane modules shall be deemed to be exhibiting defects in material or workmanship under the following conditions:
 - i) If the low pressure membrane module fails Seller’s standard integrity test and cannot be repaired by the Buyer; or
 - ii) If a low pressure membrane module fails Seller’s standard integrity test and requires pin repair by Buyer on more than three occasions in any three month period or more than six occasions in any twelve month period after commencement of the Module Warranty Period, it may be repaired or replaced by Seller under the terms of low pressure membrane module warranty.
 - c. Buyer will return to Seller the end of each low pressure membrane module with the serial number to qualify for a replacement module.
3. Low Pressure Membrane Module Warranty Exclusions: The Buyer recognizes that damage resulting from any of the following shall be excluded from coverage under the low pressure membrane module warranty:
 - a. Alteration or faulty installation of membrane system equipment, components or low pressure membrane modules by any person other than an employee or representative of Seller without the Seller’s prior written consent.
 - b. Buyer causing or permitting any low pressure membrane modules to dry or to have a moisture content below that specified in the operating instructions.
 - c. Chemical or physical conditions such as (but not limited to) pH, temperature or climatic factors outside recommended operating parameters in the appropriate section of the Operating and Maintenance Manual even where Seller is aware of the existence of these conditions.
 - d. Supply of influent water exhibiting parameters inconsistent with the parameters determined or specified at the time of bid and/or pilot testing. Deviance from any specified influent parameters may diminish or, in certain cases, void this warranty.
 - e. Exposure of the low pressure membrane modules to oil, organic solvents and other substances not normally present in water. In particular, waste water from oil filters and/or compressors shall not be permitted to come in contact with the low pressure membrane modules at any time.
 - f. Permanent or temporary exposure of the low pressure membrane modules to sand, grit or other particulate that may result in fiber damage or abrasion.
 - g. Improper maintenance of the equipment (including failure to perform general pinning maintenance) as

defined in Seller supplied Operating and Maintenance Manual.

- h. Use of water treatment chemicals or cleaning procedures other than chemicals, cleaning solutions and procedures approved by the Seller.
 - i. Use of cationic polymer in the Buyer's water treatment process without the prior written consent of Seller.
4. Warranty Conditions: This warranty is conditioned upon Buyer:
- a. Not being in default of any payment obligations to Seller; and
 - b. Maintaining hand-written or electronic operational logs and providing such logs to Seller in the event of a warranty claim.
5. Warranty Replacement Schedule
- a. **First 12 Months:** If a low pressure membrane module shall require replacement under the repair and replacement conditions described in section 2 above during the first twelve (12) months of the "Module Warranty Period", a replacement will be supplied by Seller at no charge.
 - b. **Next 72 Months:** If a low pressure membrane module shall require replacement under the repair and replacement conditions described in section 2 above during the next seventy-two (72) months of the Module Warranty Period, a replacement will be supplied by Seller and invoiced based upon a pro-rata value of a total of eighty-four (84) months. The pro-rata value shall be determined using a replacement price of US\$1,850.00 per module adjusted by the increase in the North American Consumer Price Index (CPI) All Urban Consumers (US City Average), and reducing this price by 1/84th for each month remaining in the 84-month period.
 - c. Replacement modules supplied by the Seller to Buyer under warranty shall assume the balance of the low pressure membrane module warranty that remained on the defective low pressure membrane module that was replaced under warranty.
 - d. Freight costs associated with the furnishing of replacement modules provided under the low pressure membrane module warranty is not included in the warranty replacement price. Accordingly, the shipping/delivery terms for replacement modules supplied under the low pressure membrane module warranty shall be "Ex Works Seller's Facility" and Seller shall arrange, and Buyer shall pay for, transportation of replacement membrane modules to Buyer's facility.
6. IN NO EVENT SHALL SELLER BE LIABLE FOR ANY INDIRECT, CONSEQUENTIAL, INCIDENTAL, SPECIAL, PUNITIVE OR OTHER DAMAGES AND SELLER'S TOTAL LIABILITY UNDER THIS EXTENDED LOW PRESSURE MEMBRANE MODULE WARRANTY, WHEN ADDED TO ALL LIABILITY OF SELLER TO THE BUYER AND ANY END USER OF THE SYSTEM, IF DIFFERENT FROM THE BUYER, UNDER THE SYSTEM SALE CONTRACT, SHALL NOT EXCEED THE LIMITATION ON LIABILITY SET FORTH IN THE SYSTEM SALE CONTRACT. THE FOREGOING LIMITATIONS APPLY REGARDLESS OF WHETHER THE LIABILITIES OR DAMAGES ARISE OR ARE ALLEGED TO ARISE UNDER CONTRACT, TORT, STRICT LIABILITY OR ANY OTHER THEORY.



evoqua
WATER TECHNOLOGIES

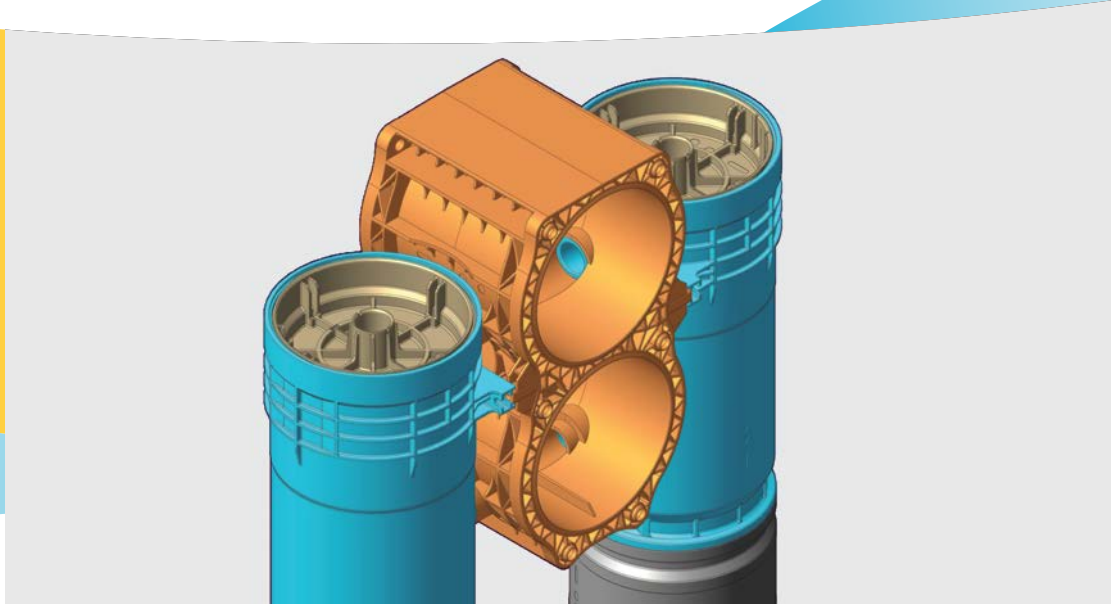

MEMCOR® CP II ULTRAFILTRATION SYSTEM

**THE LATEST IN UF TECHNOLOGY
LOWERING THE COST OF TREATED WATER**



MEMCOR® CP II SYSTEM ASSEMBLY RACK

A NATURAL EVOLUTION IN MEMBRANE TECHNOLOGY

Introducing the MEMCOR® CP II system, a pressurized, pre-engineered membrane system with a modular building-block configuration and ultra-compact footprint.

Building on 25 years of experience in supplying membranes and membrane systems, the MEMCOR CP II system is the next evolution of the MEMCOR® product family. The system utilizes the latest enhanced PVDF UF membrane technology, and features design enhancements which reduce installation costs, improve system performance, and simplify operations.

The MEMCOR CP II system is ideal for new installations and upgrades of existing facilities. By combining durable materials and reusable housings with easy module access, it reduces maintenance requirements and delivers exceptional value over the entire system lifecycle.

A SIMPLE, MORE EFFICIENT PROCESS

In the MEMCOR CP II filtration system, feed water is pumped through the feed header and into modules comprised of thousands of membrane fibers with microscopic pores on the membrane surface. As the water passes through the fibers, particles greater than 0.04 μm are rejected by the membrane.

The system provides greater flexibility, with options for high and low solids backwash timed at routine intervals, which minimizes system downtime and results in more production from each membrane module. Material not removed by the backwash is removed by regularly timed chemical cleaning.

INNOVATIVE DESIGN FOR ENHANCED PERFORMANCE

MEMCOR CP II systems utilize an innovative assembly which combines the feed, filtrate, air, and waste headers with the membrane housings to form the MemRACK™ array. The integral headers within the MemRACK array are designed to optimize flow distribution within the system, delivering greater long-term process stability.

Self-supporting MemRACK arrays reduce membrane array footprint by up to 50% compared to previous MEMCOR system offerings. MemRACK arrays also fit in standard shipping containers allowing MEMCOR CP II systems to be quickly delivered and deployed anywhere in the world.



THE L40 MODULE HOUSING,
WASTE HEADER AND FILTRATE HEADER

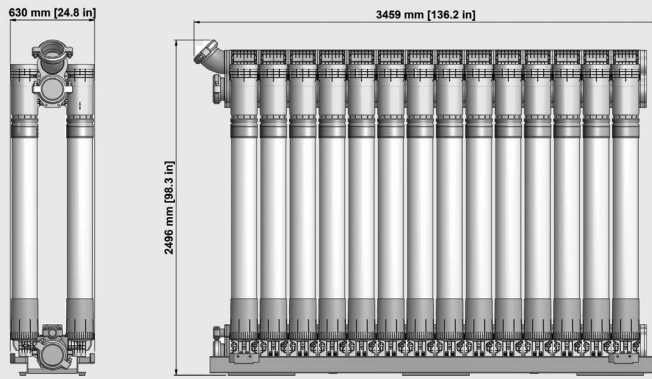

MEMCOR® CP II SYSTEM ASSEMBLY DETAILS

FLEXIBILITY FOR A WIDE RANGE OF APPLICATIONS

The enhanced modularity of the MEMCOR® CP II system speeds implementation and delivers greater design flexibility. The number of modules in each MemRACK™ array is flexible up to 28 modules. MemRACK arrays are manifolded together to form functional units designed to fit an operator's application and available footprint, and racks can be combined in a variety of configurations. The MemRACK array's ultra-compact footprint enables designers to maximize access to each membrane module without having to add to building size. The MEMCOR CP II system allows for in-place maintenance, eliminating the need to remove modules.

All MEMCOR CP II systems are backed by the superior technical ability, experience, application knowledge and expert resources of Evoqua Water Technologies, an industry leader with more than 1,800 installations and 400,000 modules in operation worldwide.

MEMCOR CP II SYSTEM FEATURES

- Durable L40N PVDF UF membrane module
- Fully assembled, integral MemRACK array with optimized system hydraulics for long term process stability
- Multiple access routes to the L40N modules within the MemRACK array
- Industry leading UF system footprint
- Feed, air, filtrate, and waste headers integrate into a single, cost-saving component

THE MEMCOR® CP II SYSTEM LOWERS THE COST OF WATER PRODUCED

- MEMCOR CP II system's 90-second backwash results in more productivity from each module, which reduces the number of modules required to produce a given capacity, and drives down capital cost
- Modular building-block configuration allows for faster implementation and lower costs
- Maximum filtration performance in half the footprint of previous MEMCOR membrane arrays, which reduces the cost of new construction
- Simplifies operations and maintenance with access to membrane modules from the side or the top of the MemRACK array
- Scalable to meet wide range of plant capacities

MEMCOR CP II system can be supplied in a complete system or as MemRACK arrays and L40 modules only.

Step into a MEMCOR CP II system today.
Visit www.evoqua.com/cp2 to learn more.



181 Thorn Hill Road, Warrendale, PA 15086

+1 (866) 926-8420 (toll-free) +1 (978) 614-7233 (toll)

www.evoqua.com

MEMCOR and MemRACK are trademarks of Evoqua, its subsidiaries or affiliates in some countries.

The information provided in this literature contains merely general descriptions or characteristics of performance which in actual case of use do not always apply as described or which may change as a result of further development of the products. An obligation to provide the respective characteristics shall only exist if expressly agreed in the terms and of the contract.

© 2014 Evoqua Water Technologies LLC Subject to change without notice MC-CP11-BR-0414

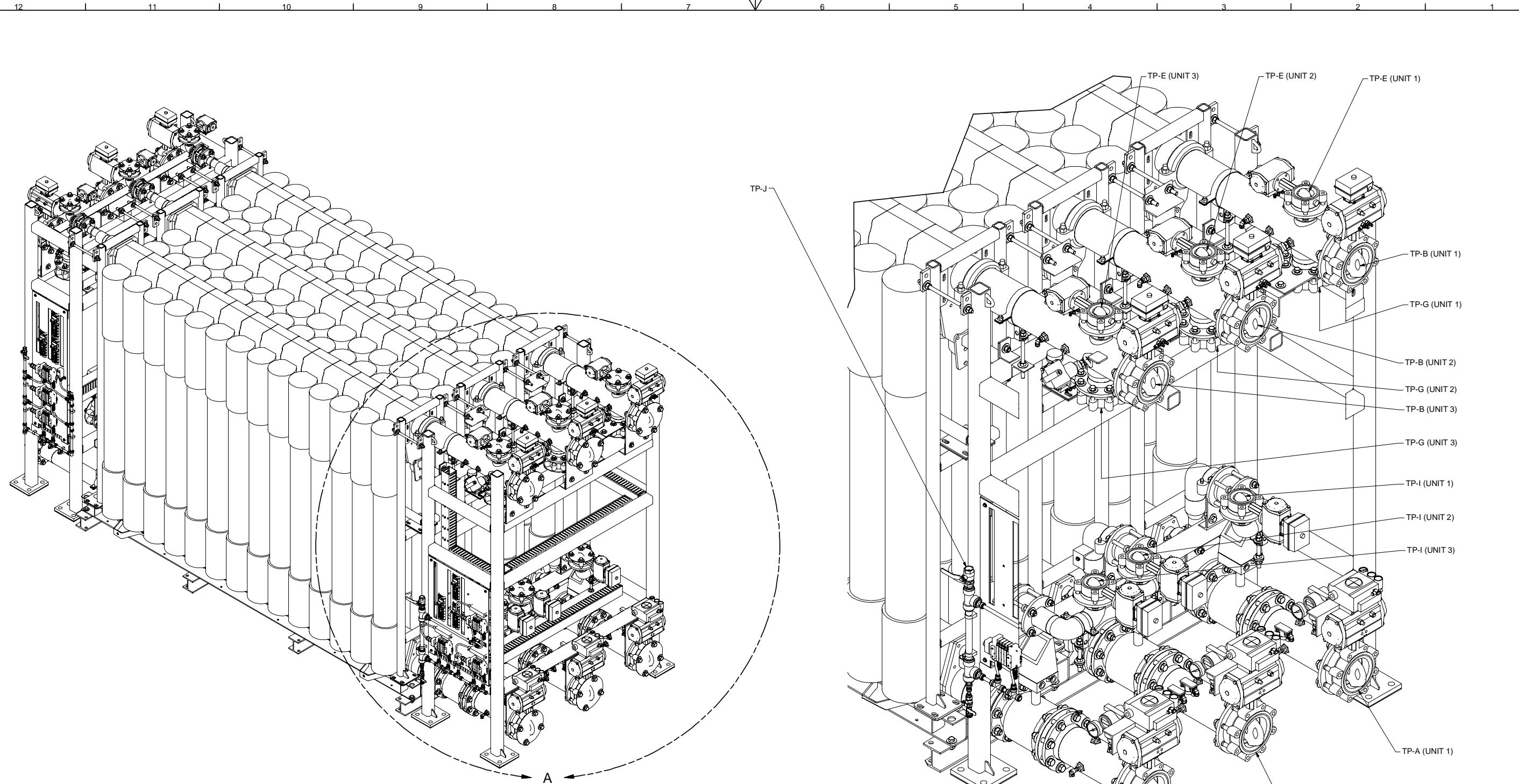

DETAIL A
FRAME CUT OUT FOR CLARITY

<p>COMPANY CONFIDENTIAL DOCUMENT AND ALL INFORMATION CONTAINED HEREIN ARE THE PROPERTY OF EVOQUA AND/OR ITS AFFILIATES. THE DESIGN CONCEPTS AND INFORMATION CONTAINED HEREIN ARE PROPRIETARY TO EVOQUA AND ARE SUBMITTED IN CONFIDENCE. THEY ARE NOT TRANSFERABLE AND MUST BE USED ONLY FOR THE PURPOSE FOR WHICH THE DOCUMENT IS EXPRESSLY LOANED. THEY MUST NOT BE DISCLOSED, REPRODUCED, LOANED OR USED IN ANY OTHER MANNER TO THE INTEREST OF EVOQUA. ALL PATENT RIGHTS ARE RESERVED UPON THE REQUEST OF EVOQUA. THIS DOCUMENT, ALONG WITH ALL COPIES AND EXTRACTS, AND ALL RELATED NOTES AND ANALYSES, MUST BE RETURNED TO EVOQUA OR DESTROYED, AS INSTRUCTED BY EVOQUA. ACCEPTANCE OF THIS DELIVERY OF THIS DOCUMENT CONSTITUTES AGREEMENT TO THESE TERMS AND CONDITIONS.</p>										DRAWN R. VALENTIN DATE 02 APRIL 2015	TITLE TRI-RACK GENERAL ARRANGEMENT MEMCOR CPII MR1														
										CHECKED DATE DRM 25 JUN 2015	CLIENT MEMCOR GLOBAL STANDARD PRODUCT														
										APPROVED DATE ST 26 JUN 2015	U.S.A. 558 CLARK ROAD TEWKSBURY, MA 01876-1631 1-800-856-2674 (1-800-MEMCOR-4)	AUSTRALIA 1 MEMTEC PARKWAY, SOUTH WINDSOR, NSW 2756 TEL +61 (0) 2 4577 6800	U.K. OUTRAMS WHARF, LITTLE EATON, DERBY, ENGLAND, DE21 5EL TEL +44 (0) 1332 387300												
A 0 ORIGINAL ISSUE										26 JUN 2015	RV	DRM	ST	---	U.K./AUS U.S.A.	DESCRIPTION	DATE	DWN	CHKD	APVD	ECR	PROJECT MGS9207	DRAWING MGS92094000-GA	SHEET 1 OF 3	STATUS REL

12 11 10 9 8 7 6 5 4 3 2 1

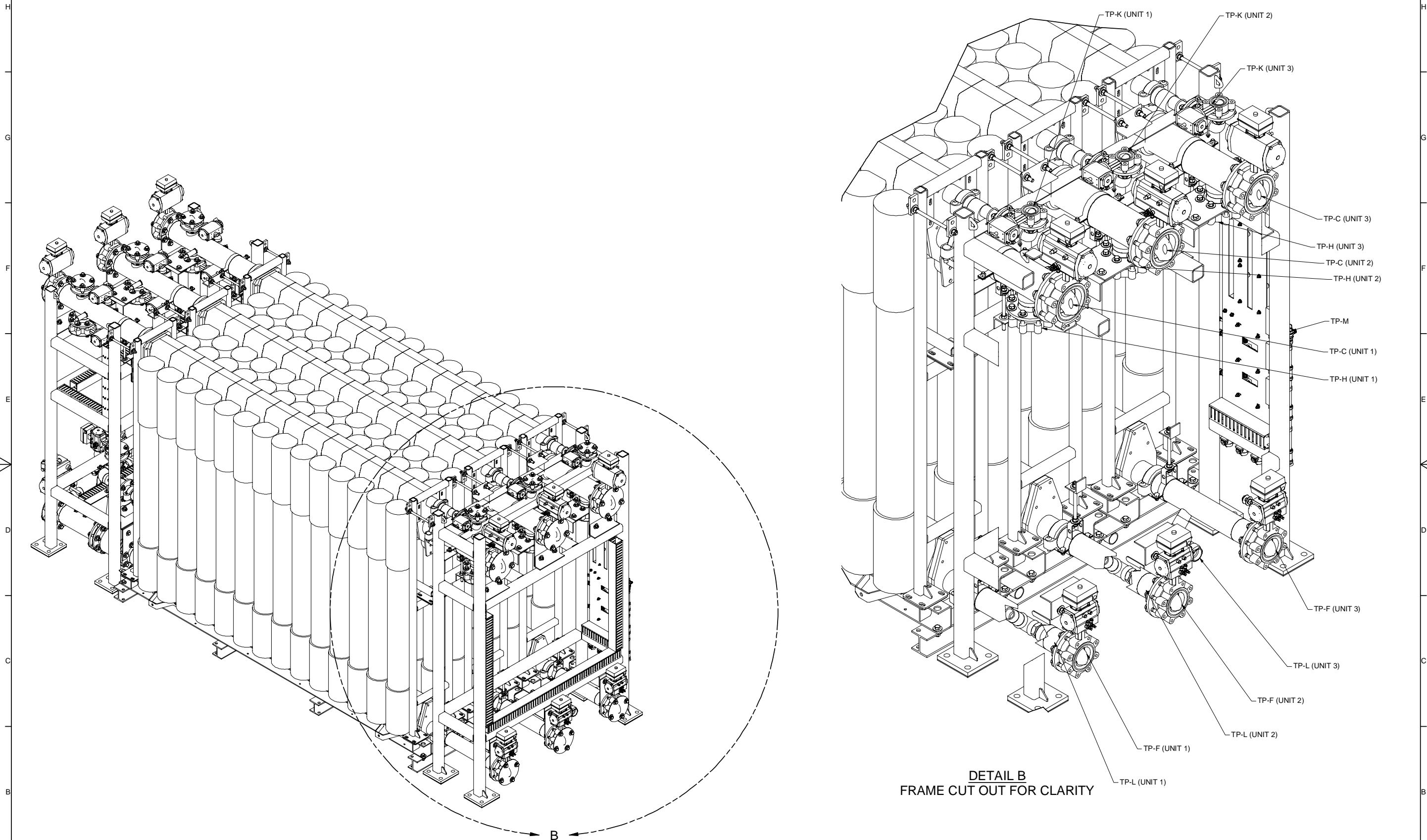

DETAIL B
FRAME CUT OUT FOR CLARITY

<p>COMPANY CONFIDENTIAL DOCUMENT AND ALL INFORMATION CONTAINED HEREIN ARE THE PROPERTY OF EVOQUA AND/OR ITS AFFILIATES. THE DESIGN CONCEPTS AND INFORMATION CONTAINED HEREIN ARE PROPRIETARY TO EVOQUA AND ARE SUBMITTED IN CONFIDENCE. THEY ARE NOT TRANSFERABLE AND MUST BE USED ONLY FOR THE PURPOSE FOR WHICH THE DOCUMENT IS EXPRESSLY LOANED. THEY MUST NOT BE DISCLOSED, REPRODUCED, LOANED OR USED IN ANY OTHER MANNER WITHOUT EXPRESS WRITTEN CONSENT OF EVOQUA. IN NO EVENT SHALL THEY BE USED IN ANY MANNER DETRIMENTAL TO THE INTEREST OF EVOQUA. ALL PATENT RIGHTS ARE RESERVED UPON THE REQUEST OF EVOQUA. THIS DOCUMENT, ALONG WITH ALL COPIES AND EXTRACTS, AND ALL RELATED NOTES AND ANALYSES, MUST BE RETURNED TO EVOQUA OR DESTROYED, AS INSTRUCTED BY EVOQUA. ACCEPTANCE OF THIS DELIVERY OF THIS DOCUMENT CONSTITUTES AGREEMENT TO THESE TERMS AND CONDITIONS.</p>										DRAWN R. VALENTIN DATE 02 APRIL 2015	TITLE TRI-RACK GENERAL ARRANGEMENT MEMCOR CPII MR1				
CHECKED DATE DRG 25 JUN 2015										CLIENT MEMCOR GLOBAL STANDARD PRODUCT					
APPROVED DATE ST 26 JUN 2015										U.S.A. 558 CLARK ROAD SOUTH WINDSOR, NSW 2756 01878-1631 1-800-836-2674 (1-800-MEMCOR-4) TEL +61 (0) 2 4577 6800	AUSTRALIA 1 MEMTEC PARKWAY, SOUTH WINDSOR, NSW 2756 TEL +61 (0) 2 4577 6800	U.K. OUTRAMS WHARF, LITTLE EATON, DERBY, ENGLAND, DE21 5EL TEL +44 (0) 1332 387300			
A 0 ORIGINAL ISSUE										26 JUN 2015	RV	DRM	ST	---	
U.K./AUS U.S.A.										DESCRIPTION	DATE	DWN	CHKD	APVD	ECR

12 11 10 9 8 7 6 5 4 3 2 1

TERMINATION POINTS			
LABEL	DESCRIPTION	SIZE	CONNECTION TYPE
TP-A	FEED WATER	6" [150mm]	FLANGE ANSI DRILLED
TP-B	FILTRATE	6" [150mm]	FLANGE ANSI DRILLED
TP-C	BACKWASH	6" [150mm]	FLANGE ANSI DRILLED
TP-E	FILTRATE EXHAUST	3" [80mm]	FLANGE ANSI DRILLED
TP-F	CIP INLET/DRAIN	4" [100mm]	FLANGE ANSI DRILLED
TP-G	CIP FILTRATE RETURN	4" [100mm]	FLANGE ANSI DRILLED
TP-H	CIP FEED RETURN	4" [100mm]	FLANGE ANSI DRILLED
TP-I	AIR SCOUR INLET	3" [80mm]	FLANGE ANSI DRILLED
TP-J	CONTROL AIR INLET	1" [25mm]	THREADED (NPT)
TP-K	PROCESS AIR INLET	2" [50mm]	FLANGE ANSI DRILLED
TP-L	DRAIN	2" [50mm]	THREADED (NPT)
TP-M	CONTROL AIR INLET	1/2" [12mm]	THREADED (NPT)

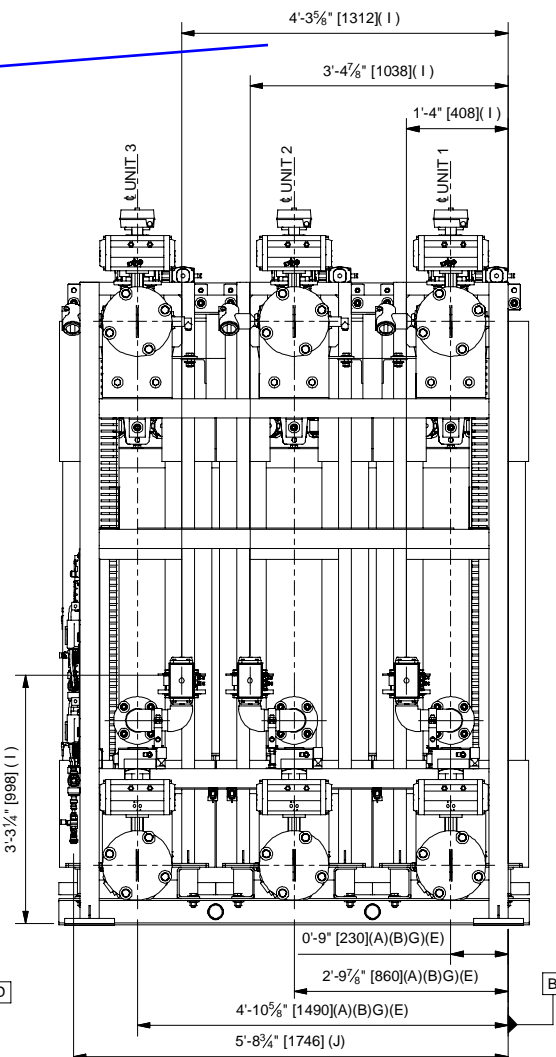
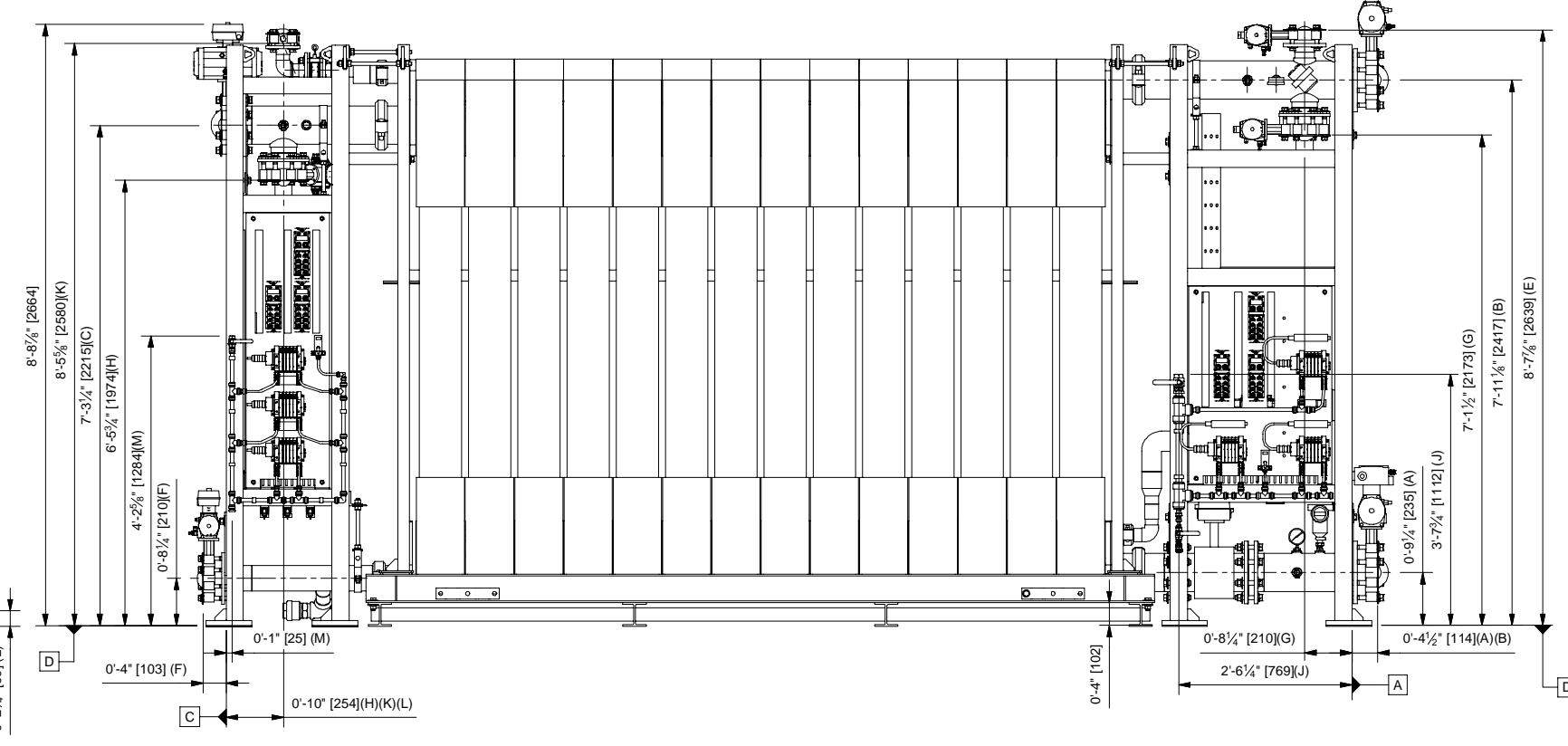
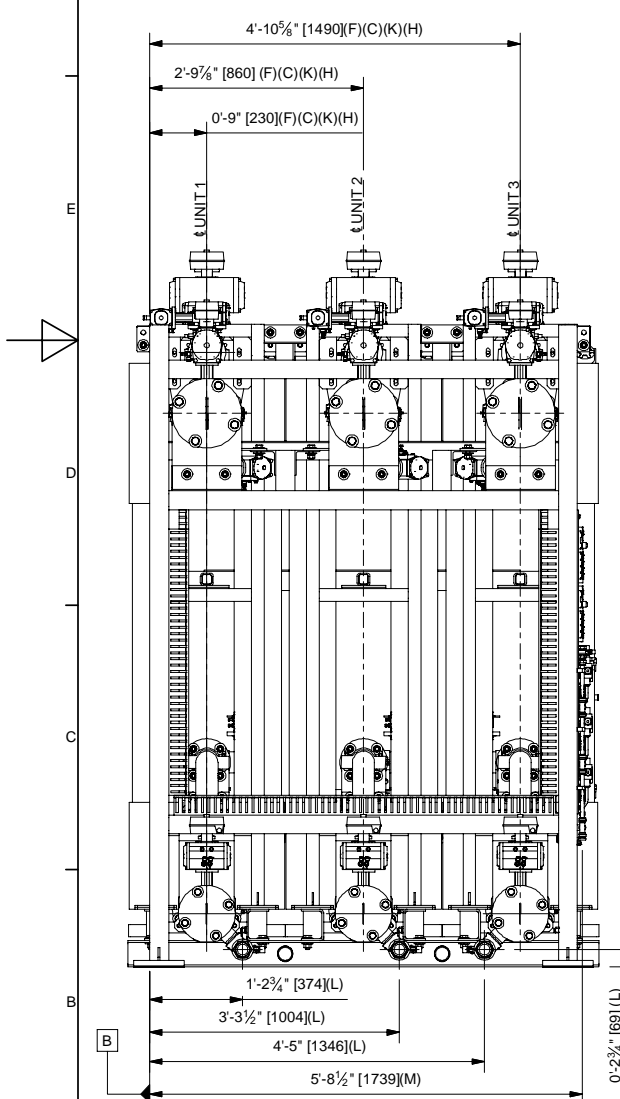
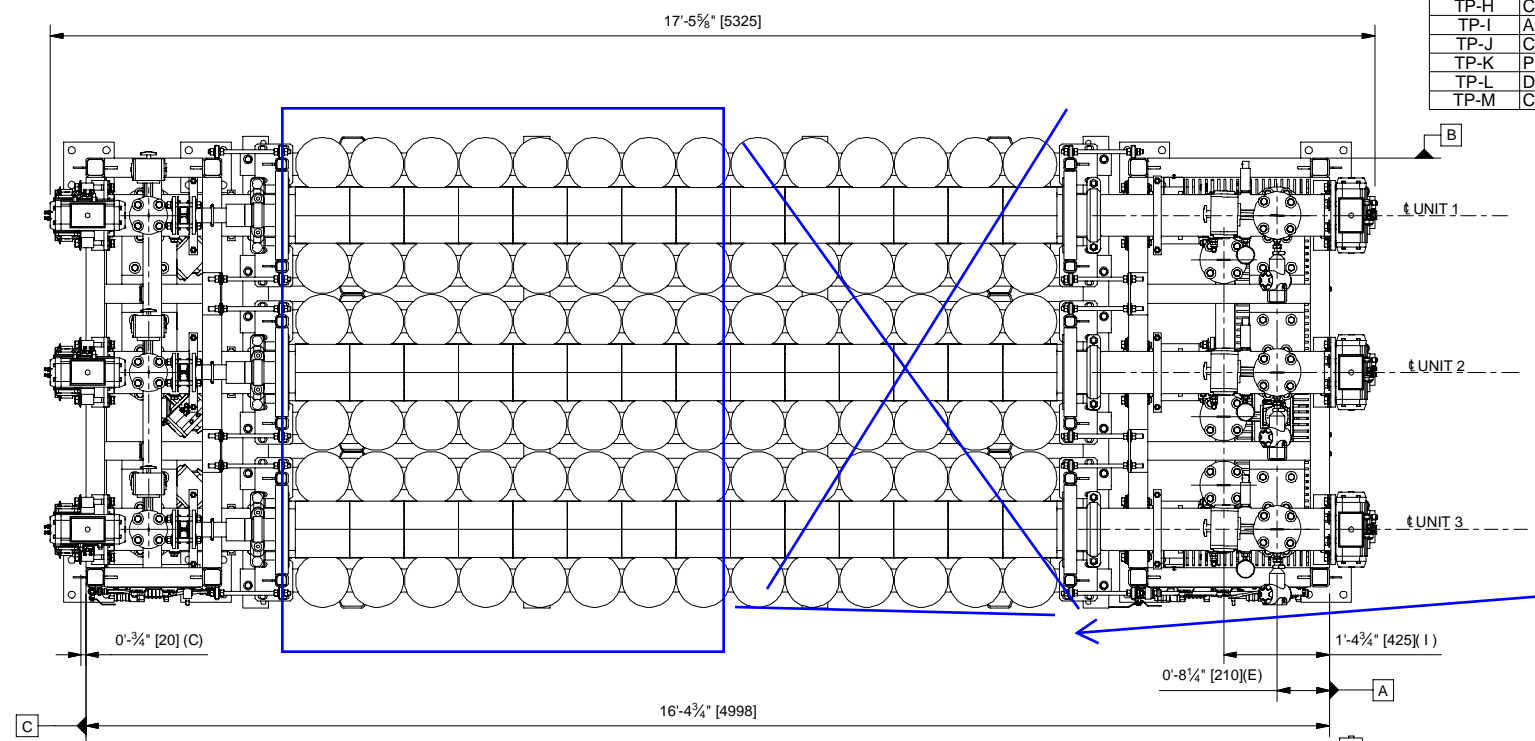

NOTES:
 1. APPROXIMATE WEIGHTS:
 CPII 28 RACKS:
 SHIPPING (EACH RACK) - 2,720 LBS (1,235 KG) SHIPPING (BASE FRAME) - 410 LBS (185 KG)
 SHIPPING (PER RACK) - 5,580 LBS (2,500 KG) OPERATING TOTAL (3 RACKS & BASE) - 17,200 LBS (7,800 KG)
FRONT PIPING SKID:
 SHIPPING - 2,100 LBS (950 KG) OPERATING - 2,370 LBS (1,075 KG)
REAR PIPING SKID:
 SHIPPING - 1,250 LBS (570 KG) OPERATING - 1,380 LBS (625 KG)

TOLERANCES	
UNLESS OTHERWISE SPECIFIED	
STANDARD LINEAR:	HDPE PIPE LINEAR:
.XX = ±.06	.XX = ± 1/8
.XXX = ±.031	.XXX = ± 1/16
X/XX = ±1/16	
ANGULAR:	ANGULAR:
0° = ±.50°	0° = ±.50°

COMPANY CONFIDENTIAL
 DOCUMENT AND ALL INFORMATION CONTAINED HEREIN ARE THE PROPERTY OF EVOQUA AND/OR ITS AFFILIATES. THE DESIGN CONCEPTS AND INFORMATION CONTAINED HEREIN ARE PROPRIETARY TO EVOQUA AND ARE SUBMITTED IN CONFIDENCE. THEY ARE NOT TRANSFERABLE AND MUST BE USED ONLY FOR THE PURPOSE FOR WHICH THE DOCUMENT IS EXPRESSLY LOANED. THEY MUST NOT BE DISCLOSED, REPRODUCED, LOANED OR USED IN ANY OTHER MANNER WITHOUT EXPRESS WRITTEN CONSENT OF EVOQUA. IN NO EVENT SHALL THEY BE USED IN ANY MANNER DETRIMENTAL TO THE INTERESTS OF EVOQUA. ALL PATENT RIGHTS ARE RESERVED UPON THE REQUEST OF EVOQUA. THIS DOCUMENT, ALONG WITH ALL COPIES AND EXTRACTS, AND ALL RELATED NOTES AND ANALYSES, MUST BE RETURNED TO EVOQUA OR DESTROYED, AS INSTRUCTED BY EVOQUA. ACCEPTANCE OF THIS DELIVERY OF THIS DOCUMENT CONSTITUTES AGREEMENT TO THESE TERMS AND CONDITIONS.

DRAWN	DATE	TITLE
R VALENTIN	02APRIL2015	TRI-RACK GENERAL ARRANGEMENT
CHECKED	DATE	MEMCOR CPII MR1
DRM	25JUN2015	CLIENT
APPROVED	DATE	MEMCOR GLOBAL STANDARD PRODUCT
ST	26JUN2015	

U.S.A.	AUSTRALIA	U.K.
558 CLARK ROAD	1 HEMTEC PARKWAY,	OUTRAMS WHARF,
TEWKSBURY, MA	SOUTH WINDSOR,	LITTLE EATON,
01876-1631	NSW 2756	DERBY, ENGLAND, DE21 5EL
1-800-636-2674 (1-800-MEMCOR-4)	TEL +61 (0) 2 4577 6800	TEL +44 (0) 1332 387300

SCALE:	PROJECT	DRAWING	STATUS
NONE	MGS9207	MGS92094000-GA	3 OF 3

GENERAL ABBREVIATIONS

ADD'L	ADDITIONAL	NC	NORMALLY CLOSED
A TO C	AIR TO CLOSE	ND	NOMINAL DIAMETER
A TO O	AIR TO OPEN	NO	NORMALLY OPEN
AVG	AVERAGE	OPR CAP	OPERATING CAPACITY
BC	BOLT CIRCLE	OD	OUTSIDE DIAMETER
B/EL	BOTTOM ELEVATION	OAL	OVERALL LENGTH
CAL	CALIBRATION	ORP	OXIDATION REDUCTION POTENTIAL
CAP	CAPACITY	PA	PLANT AIR
CIP	CLEAN IN PLACE	PW	PLANT WATER
CL	CENTER LINE	POS	POSITION
CW	CITY WATER (POTABLE)	PSIG	POUNDS PER SQUARE INCH - GAUGE
CONT'D	CONTINUED	PCP	PROCESS CONTROL PANEL
CFM	CUBIC FEET PER MINUTE	RED	REDUCER
REQ	DEVICE REQUIRED TO RUN	RPM	REVOLUTIONS PER MINUTE
DIA	DIAMETER	SP	SAMPLE POINT
DWG	DRAWING	SCH	SCHEDULE
EL	ELEVATION	SW	SEAL WATER
FC	FAIL CLOSED	SWD	SIDE WATER DEPTH
FO	FAIL OPEN	EWT	EVOQUA WATER TECHNOLOGIES
FT	FEET OF WATER	SPT	SETPOINT
FRL	FILTER/REGULATOR/LUBRICATOR	SG	SPECIFIC GRAVITY
GAL	GALLONS	SSH	STRAIGHT SIDE HEIGHT
GPD	GALLONS PER DAY	CNTRL	SPEED CONTROL
GPH	GALLONS PER HOUR	STD	STANDARD
GPM	GALLONS PER MINUTE	SCFM	STANDARD CUBIC FEET PER MINUTE
HB	HOSE BIB	TP	TERMINATION POINT
HG	INCHES OF MERCURY	T/T	TIP-TO-TIP
HOA	HAND/OFF/AUTO	TBA	TO BE ASCERTAINED
HI	HIGH	TDH	TOTAL DYNAMIC HEAD (FT OF FLUID)
HA	HIGH ALARM	T/EL	TOP ELEVATION
HP	HORSEPOWER	TURB	TURBIDITY
ID	INSIDE DIAMETER	TYP	TYPICAL
IA	INSTRUMENT AIR	VAC	VACUUM
IAS	INSTRUMENT AIR SUPPLY	VSD	VARIABLE SPEED DRIVE
INV	INVERT	WC	WATER COLUMN
LO	LOW	WD	WATER DEPTH
LA	LOW ALARM	WL	WATER LEVEL
MH	MANHOLE	W/	WITH
MW	MANWAY	W/O	WITHOUT
MAT	MATERIAL	WV	WORKING VOLUME (DOES NOT INCLUDE FREEBOARD OR HEEL)
MGD	MILLION GALLONS PER DAY		
MCC	MOTOR CONTROL CENTER		

PIPING AND TUBING MATERIAL ABBREVIATIONS

ABS	ACRYLONITRILE BUTADIENE STYRENE TRUSS PIPE
ALM	ALUMINUM PIPE OR TUBING
ARP	ALUMINUM REINFORCED PLASTIC PIPE
BL	BLACK IRON PIPE
BPT	BRAIDED PLASTIC TUBING-PVC
CS	CARBON STEEL PIPE
MI	CARBON STEEL PIPE W/MALLEABLE IRON FITTINGS
CI	CAST IRON PIPE
CISP	CAST IRON SOIL PIPE
CMH	CHEMICAL HOSE
CPVC	CHLORINATED POLYVINYL CHLORIDE PIPE
CMCP	CORRUGATED METAL CULVERT PIPE
CMP	CORRUGATED METAL PIPE
COP	COPPER PIPE
DI	DUCTILE CAST IRON PIPE
ERP	EPOXY RESIN PIPE
FRP	FIBERGLASS REINFORCED PLASTIC PIPE
HOSE	FLEXIBLE HOSE
GS	GALVANIZED STEEL PIPE
HSI	HIGH SILICON IRON PIPE
NLS	NEOPRENE LINED STEEL PIPE
NEO	NEOPRENE HOSE
NI	NICKEL ALLOY PIPE
KLS	PVDF LINED STEEL PIPE (KYNAR LINED TYPICAL)
KYN	PVDF (KYNAR)
KYP	PHENOLIC RESIN PIPE
PEP	POLYETHYLENE PIPE
PETB	POLYETHYLENE TUBING
PLS	POLYPROPYLENE LINED STEEL PIPE
POP	POLYPROPYLENE PIPE
PVC	POLYVINYL CHLORIDE PIPE
PVC HOSE	POLYVINYL CHLORIDE HOSE
PVDF	POLYVINYLIDENE FLUORIDE PIPE
RCP	REINFORCED CONCRETE PIPE
RCCP	REINFORCED CONCRETE CULVERT PIPE
RBR	RUBBER
SLH	SARAN TUBING
SLS	SARAN LINED STEEL PIPE
SAR	SLUDGE HOSE
SS	STAINLESS STEEL PIPE OR TUBING
TEF	TEFLON
TLF	TEFLON LINED STEEL PIPE
TI	TITANIUM ALLOY PIPE
TYB	TYGON TUBING-BRAIDED
TYG	TYGON TUBING-UNBRAIDED

INSTRUMENT SYMBOLS

	PRIMARY LOCATION ***NORMALLY ACCESSIBLE TO OPERATOR	FIELD MOUNTED	AUXILIARY LOCATION ***NORMALLY ACCESSIBLE TO OPERATOR
DISCRETE INSTRUMENTS	1	2	3
SHARED DISPLAY, SHARED CONTROL	4	5	6
COMPUTER FUNCTION	7	8	9
PROGRAMMABLE LOGIC CONTROL	10	11	12

* SYMBOL SIZE MAY VARY ACCORDING TO THE USER'S NEEDS AND THE TYPE OF DOCUMENT. A SUGGESTED SQUARE AND CIRCLE SIZE FOR LARGE DIAGRAMS IS SHOWN ABOVE. CONSISTENCY IS RECOMMENDED.
 ** ABBREVIATIONS OF THE USER'S CHOICE SUCH AS IP1 (INSTRUMENT PANEL #1), IC2 (INSTRUMENT CONSOLE #2), CC3 (COMPUTER CONSOLE #3), ETC., MAY BE USED WHEN IT IS NECESSARY TO SPECIFY INSTRUMENT OR FUNCTION LOCATION.
 *** NORMALLY INACCESSIBLE OR BEHIND-THE-PANEL DEVICES OR FUNCTIONS MAY BE DEPICTED BY USING THE SAME SYMBOL BUT WITH DASHED HORIZONTAL BARS, I.E.



FLows AND PROCESS LINE DESIGNATIONS

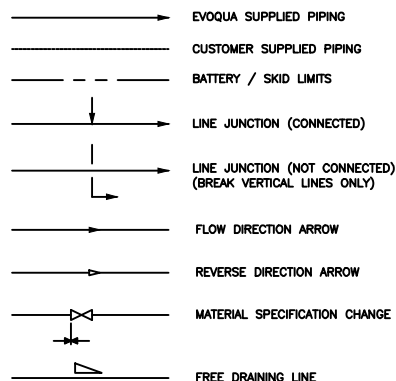

INSTRUMENT AND CONTROL LINE RELATED DESIGNATIONS

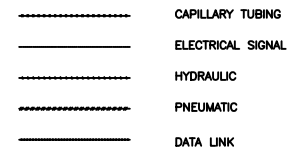

PROCESS LINE CONTINUATIONS

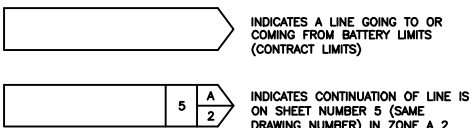

LINE NUMBER IDENTIFICATION

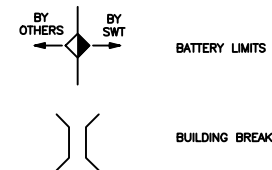
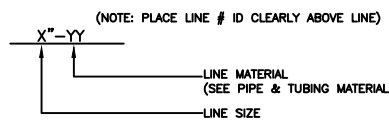

ISA INSTRUMENT IDENTIFICATION TABLE

FIRST LETTER	SUCCEEDING LETTERS		
	PROCESS VARIABLE	MODIFIER (IF NEEDED)	READOUT OR COMPUTER FUNCTION
A	ANALYSIS		ALARM
B	BURNER, COMBUSTION		USER'S CHOICE
C	USER'S CHOICE		CONTROL
D	USER'S CHOICE	DIFFERENTIAL	
E	VOLTAGE		SENSOR (PRIMARY ELEMENT)
F	FLOW RATE	RATIO (FRACTION)	
G	USER'S CHOICE		GLASS, VIEWING DEVICE
H	HAND		
I	CURRENT (ELECTRICAL)		INDICATE
J	POWER	SCAN	
K	TIME, TIME SCHEDULE	TIME RATE OF CHANGE	CONTROL STATION
L	LEVEL		LOW
M	USER'S CHOICE	MOMENTARY	MIDDLE, INTERMEDIATE
N	USER'S CHOICE		USER'S CHOICE
O	USER'S CHOICE		ORIFICE (RESTRICTION)
P	PRESSURE, VACUUM		POINT (TEST CONNECTION)
Q	QUANTITY	INTEGRATE, TOTALIZE	
R	RADIATION		RECORD
S	SPEED, FREQUENCY	SAFETY	SWITCH
T	TEMPERATURE		TRANSMIT
U	MULTIVARIABLE		MULTIFUNCTION
V	VIBRATION, MECH. ANALYSIS		VALVE, DAMPER, LOUVER
W	WEIGHT, FORCE		WELL
X	UNCLASSIFIED	X-AXIS	UNCLASSIFIED
Y	EVENT, STATE OR PRESENCE	Y-AXIS	RELAY, COMPUTE, CONVERT
Z	POSITION, DIMENSION	Z-AXIS	DRIVER, ACTUATOR, UNCLASSIFIED FINAL CONTROL ELEMENT

LEGEND BASED ON ISA STANDARD S 5.1

TYPICAL INSTRUMENT TAG NUMBERS

SEE ISA 55.1 TABLE ABOVE FOR MORE DETAILED INFORMATION

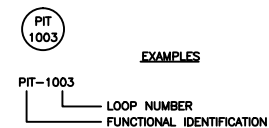

NOTE: HYPHENS ARE OPTIONAL AS SEPARATORS

AEXXX	ANALYSIS ELEMENT	P100X	PRESSURE GAUGE
AITXXX	ANALYSIS INSTRUMENT TRANSMITTER	PITXXX	PRESSURE INDICATOR TRANSMITTER
DPXXX	DIFFERENTIAL PRESSURE	PSXXX	PRESSURE SWITCH
FXXXX	FLOW ELEMENT	TI000X	TEMPERATURE INDICATOR
FITXXX	FLOW INDICATOR TRANSMITTER	TI100X	TEMPERATURE INDICATOR TRANSMITTER
LITXXX	LEVEL INDICATOR TRANSMITTER	TSXXX	TEMPERATURE SWITCH
LSXXX	LEVEL SWITCH		

EQUIPMENT TAG NUMBERS

BXXXX	AIR HANDLING-BLOWERS	MXXXX	MIXER, AERATOR, AGITATOR
BTXXX	BUBBLE TRAP	MOXX	MOTOR
CCXXX	CALIBRATION COLUMN	PDXXX	PULSATION DAMPENER
ROXXXTOR	CLARIFIER, THICKENER, SEPERATOR	PXXX	PUMP
CXXX	COMPRESSOR	ROXXX	REVERSE OSMOSIS UNIT
DSXXX	DOSING SKID	SKXXX	SKID
DXXX	DRYER	IXXXX	SOFTENER, DEMINERALIZER
EDXXX	EDUCTOR/EJECTOR	SBXXX	SPECTACLE BLIND
EJXXX	EXPANSION JOINT	SGXXX	STEAM GENERATOR
FXXX	FILTER	STXXX	STEAM TRAP
HEXXX	HEAT EXCHANGER/ELEMENT	STROXX	STRAINER
HTROXX	HEATER	TKXXX	TANK
LPXXX	LOCAL PANEL		

VALVE & ACCESSORY TAG NUMBERS

AVXXX	AVXXX AUTOMATIC VALVE	FCVXXX	FLOW CONTROL VALVE
ARVXXX	AIR RELIEF VALVE	MANVXX	MANUAL VALVE
BPVXXX	BACK PRESSURE VALVE	NRVXXX	NON RETURN VALVE
BVXXX	BALL VALVE (MANUAL)	PRVXXX	PRESSURE REGULATOR
CQVXXX	CHEMICAL QUILL	PRRVXX	PRESSURE RELIEF VALVE
CSXXX	CORPORATION STOP	SVXXX	SOLENOID VALVE

PRELIMINARY
NOT FOR CONSTRUCTION

<p>COMPANY CONFIDENTIAL THIS DOCUMENT AND ALL INFORMATION CONTAINED HEREIN ARE THE PROPERTY OF EVOQUA AND/OR ITS AFFILIATES. THE DESIGN CONCEPTS AND INFORMATION CONTAINED HEREIN ARE PROPRIETARY TO EVOQUA AND ARE SUBMITTED IN CONFIDENCE. THEY ARE NOT TRANSFERABLE AND MUST BE USED ONLY FOR THE PURPOSE FOR WHICH THE DOCUMENT IS EXPRESSLY ISSUED. THEY MUST NOT BE DISCLOSED, REPRODUCED, LOANED OR USED IN ANY OTHER MANNER WITHOUT THE EXPRESS WRITTEN CONSENT OF EVOQUA. IN NO EVENT SHALL THEY BE USED IN ANY MANNER DETRIMENTAL TO THE INTEREST OF EVOQUA. ALL PATENT RIGHTS ARE RESERVED. UPON THE DEMAND OF EVOQUA, THIS DOCUMENT, ALONG WITH ALL COPIES AND EXTRACTS, AND ALL RELATED NOTES AND ANALYSES, MUST BE RETURNED TO EVOQUA OR DESTROYED AS INSTRUCTED BY EVOQUA. ACCEPTANCE OF THE DELIVERY OF THIS DOCUMENT CONSTITUTES AGREEMENT TO THESE TERMS.</p>				DESIGNER JAM	DATE 09/17/15	TITLE PROCESS AND INSTRUMENTATION DIAGRAM LEGEND SHEET ONE
				CHECKER	DATE	CLIENT STANDARD PRODUCT
				ENGINEER	DATE	
				MANAGER	DATE	
				FILE: 15Q15XXXPX	SCALE: NONE	
				<p>PROJECT CODE 15Q15XXXPX</p>		<p>DRAWING SHEET 15Q15XXXPX 1 OF 12</p>
				<p>REVISIONS</p>		<p>REV A</p>

MISCELLANEOUS EQUIPMENT

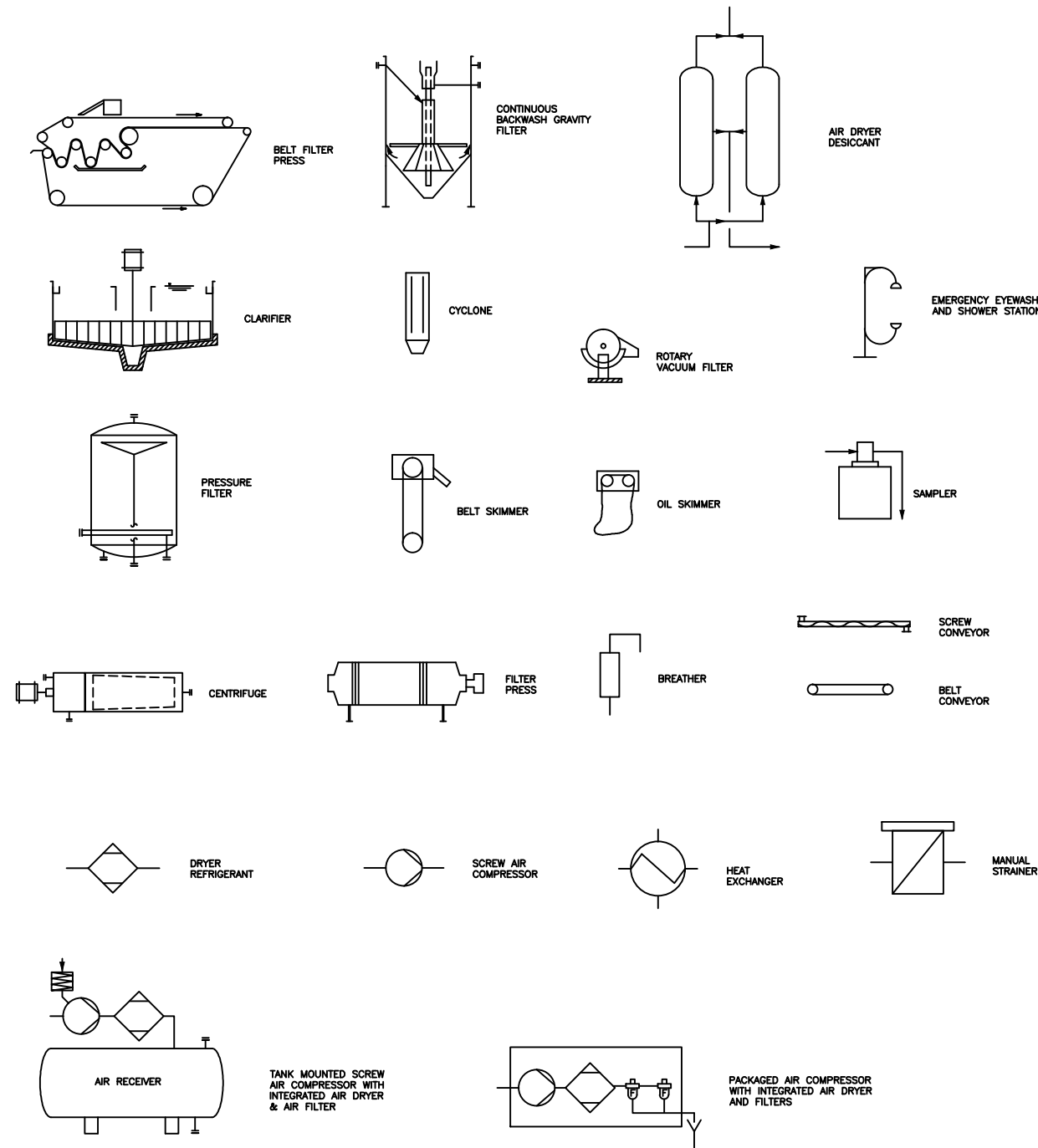

TANKS AND ACCESSORIES

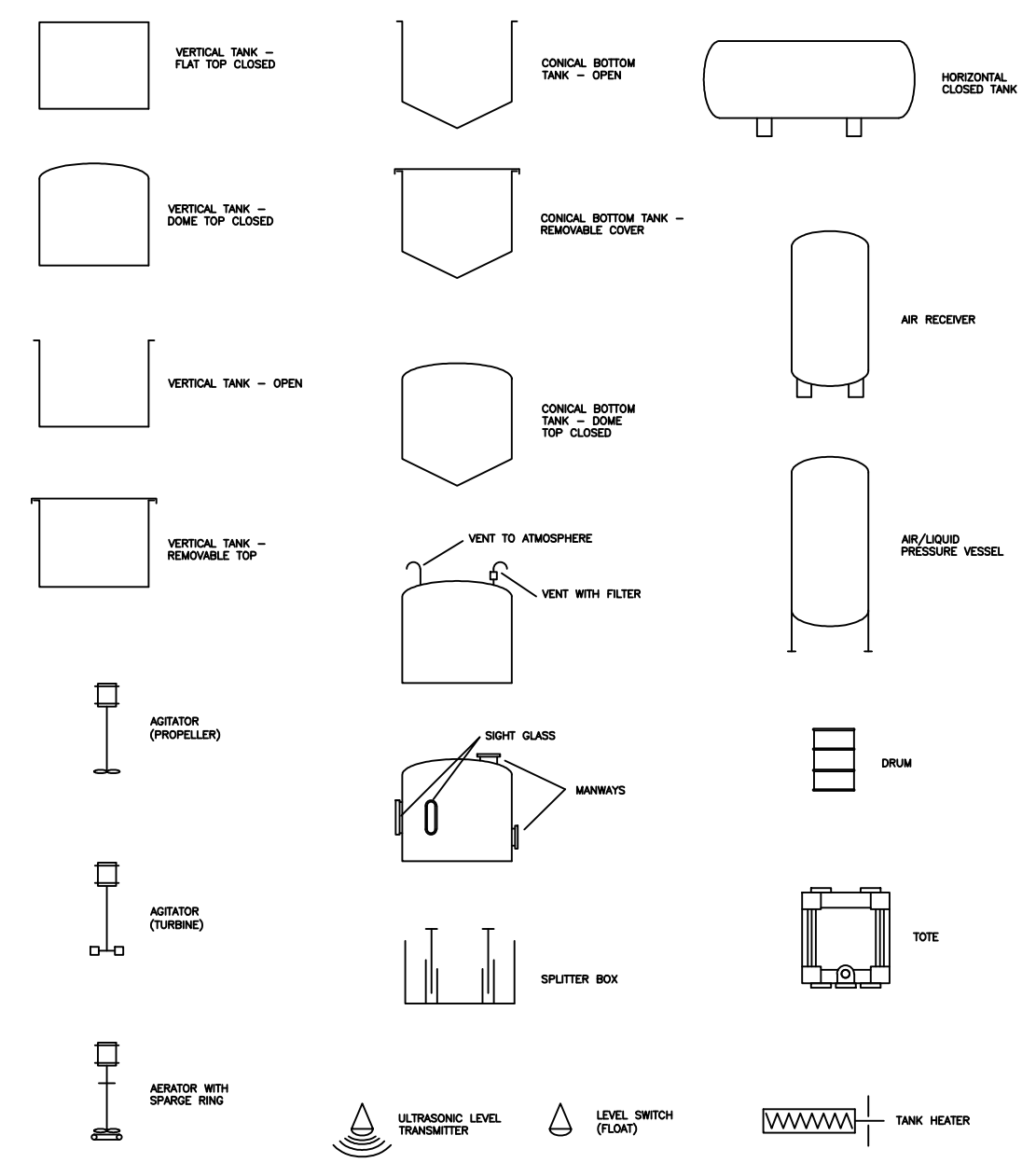

PRELIMINARY
NOT FOR CONSTRUCTION

STD: BORDER-0106-24X36D1	INTL REF:	BAR = 1" AT PLOT SCALE	REV	DESCRIPTION	DATE	DWN	CHKD	APVD	ECN	COMPANY CONFIDENTIAL THIS DOCUMENT AND ALL INFORMATION CONTAINED HEREIN ARE THE PROPERTY OF EVOQUA AND/OR ITS AFFILIATES. THE DESIGN CONCEPTS AND INFORMATION CONTAINED HEREIN ARE PROPRIETARY TO EVOQUA AND ARE SUBMITTED IN CONFIDENCE. THEY ARE NOT TRANSFERABLE AND MUST BE USED ONLY FOR THE PURPOSE FOR WHICH THE DOCUMENT IS EXPRESSED. REPRODUCED, LOANED OR USED IN ANY OTHER MANNER WITHOUT THE EXPRESS WRITTEN CONSENT OF EVOQUA. IN NO EVENT SHALL THEY BE USED IN ANY MANNER DETRIMENTAL TO THE INTEREST OF EVOQUA. ALL PATENT RIGHTS ARE RESERVED. UPON THE DEMAND OF EVOQUA, THIS DOCUMENT, ALONG WITH ALL COPIES AND EXTRACTS, AND ALL RELATED NOTES AND ANALYSES, MUST BE RETURNED TO EVOQUA OR DESTROYED AS INSTRUCTED BY EVOQUA. ACCEPTANCE OF THE DELIVERY OF THIS DOCUMENT CONSTITUTES AGREEMENT TO THESE TERMS.	DESIGNER JAM	DATE 09/17/15	TITLE PROCESS AND INSTRUMENTATION DIAGRAM LEGEND SHEET TWO	CLIENT STANDARD PRODUCT	PROJECT 15Q15XXXPX	CODE 15Q15XXXPX	DRAWING 2 OF 12	SHEET 2 OF 12	REV A
- SEE SHEET ONE											CHECKER	DATE	ENGINEER	DATE	MANAGER	DATE	SCALE NONE		

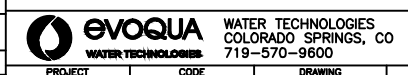

PIPING ACCESSORIES

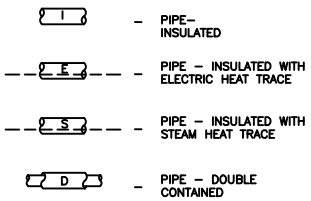
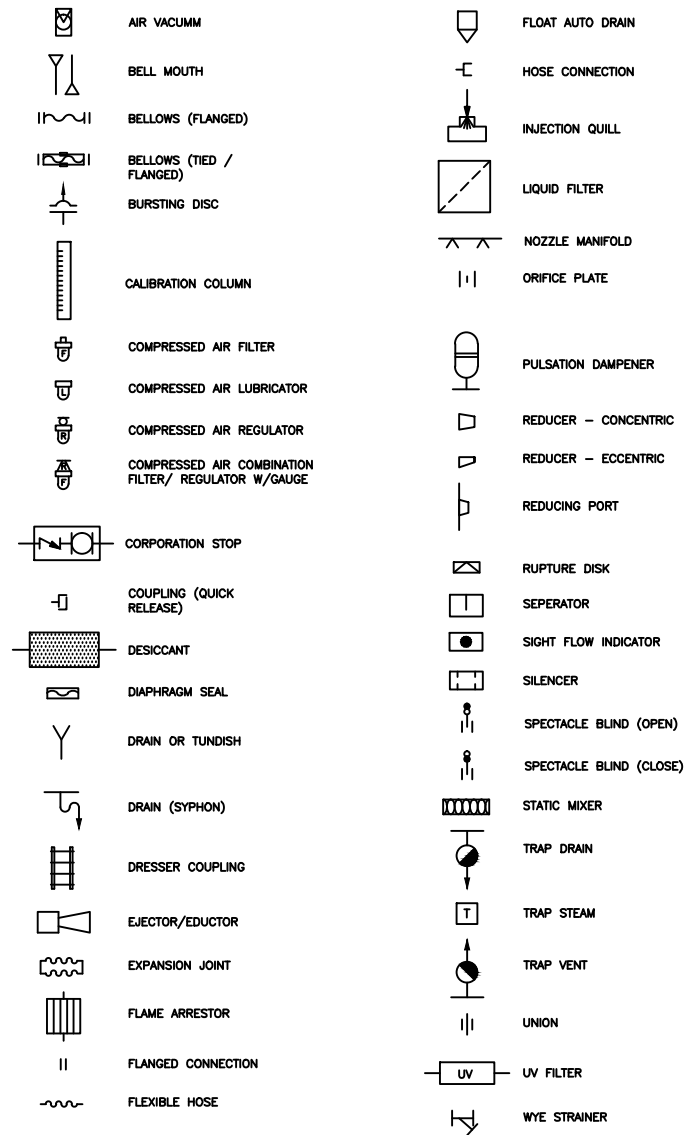

VALVE SYMBOLS

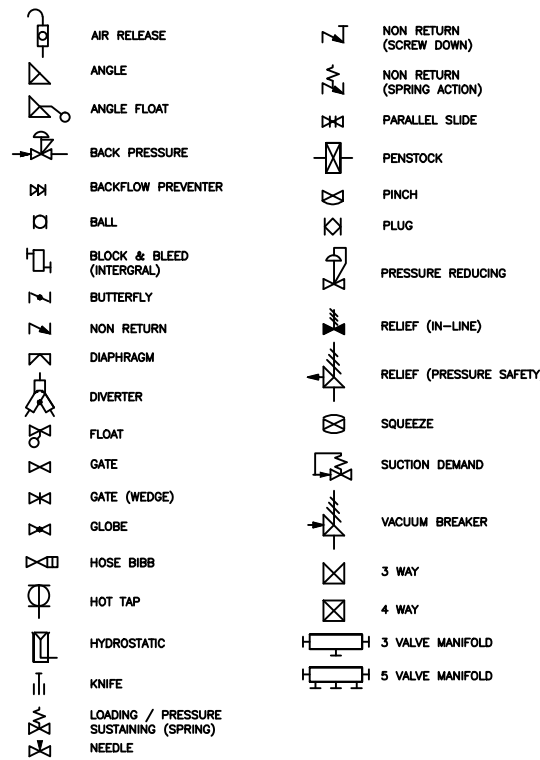

ACTUATORS

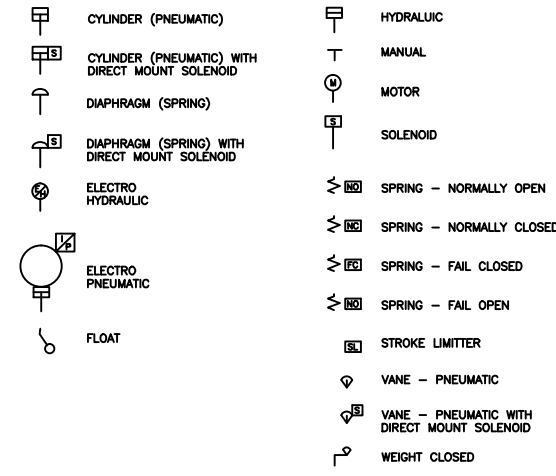

POWER SOURCE & ELECTRICAL RELATED

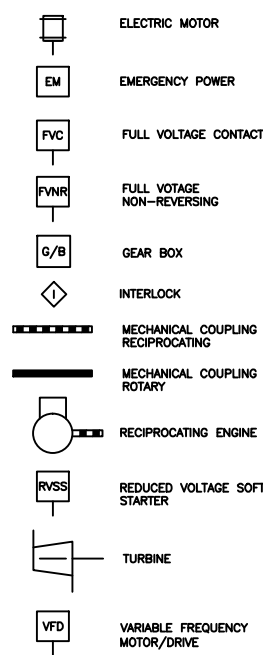

INSTRUMENT AND RELATED ITEMS

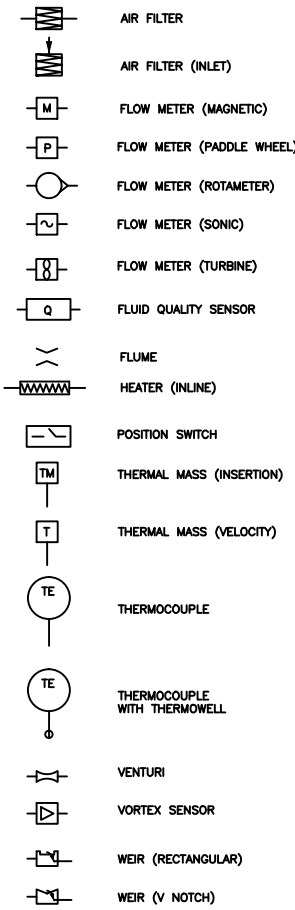

PUMPS

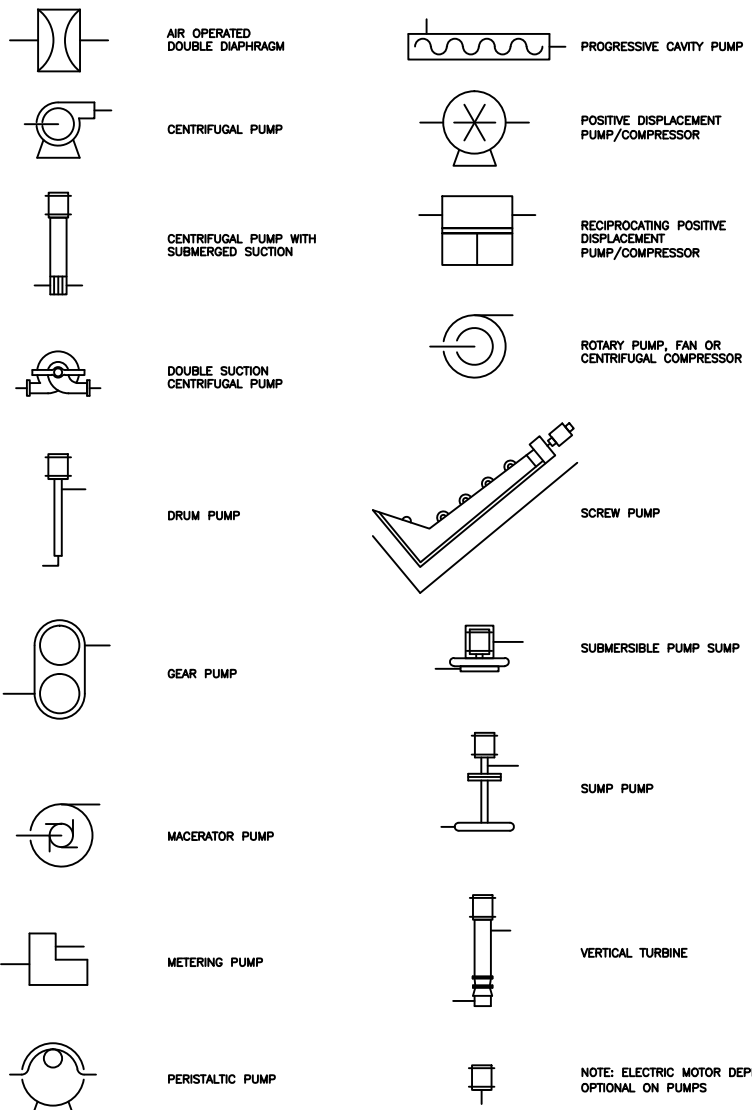

BLOWERS

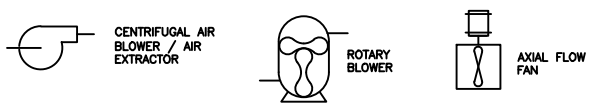

PRELIMINARY
NOT FOR CONSTRUCTION

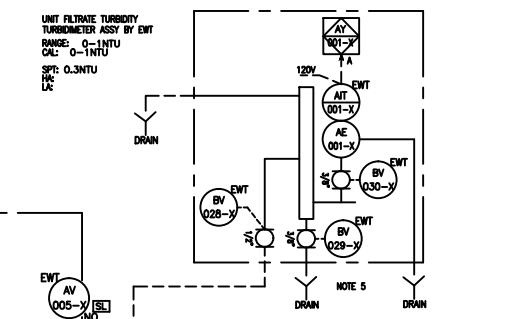
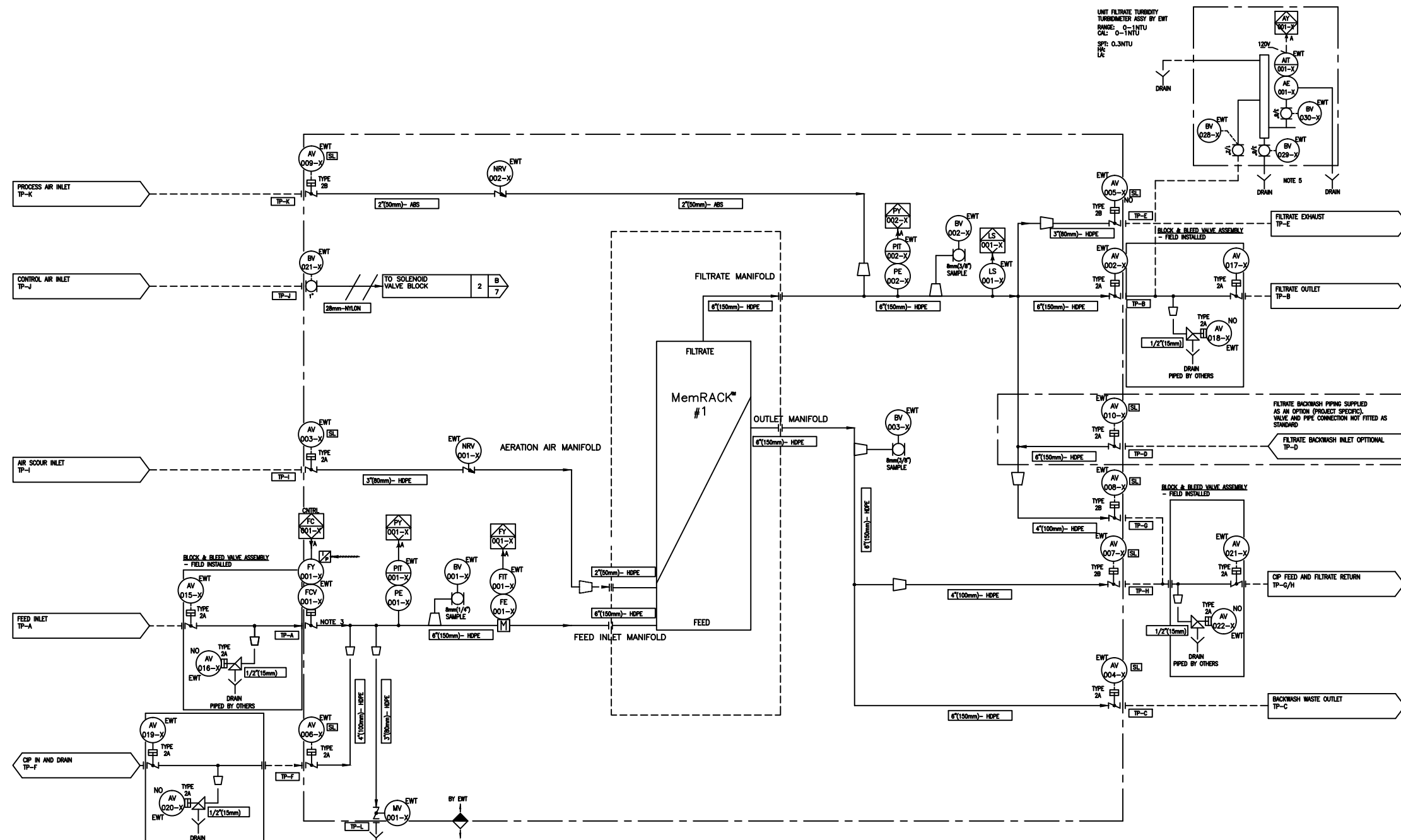
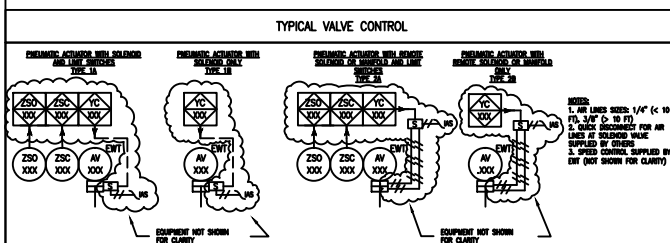

TABLE 1 TERMINATION POINTS

TABLE	DESCRIPTION	SIZE - INCHES (mm)	CONNECTION TYPE
TP-A	FEED INLET	6" (150mm)	FLANGE ANSI DRILLED
TP-B	FILTRATE OUTLET	6" (150mm)	FLANGE ANSI DRILLED
TP-C	BACKWASH WASTE OUTLET	6" (150mm)	FLANGE ANSI DRILLED
TP-D	FILTRATE BACKWASH (optional)	6" (150mm)	FLANGE ANSI DRILLED
TP-E	FILTRATE EXHAUST	3" (80mm)	FLANGE ANSI DRILLED
TP-F	CIP IN/UNIT DRAIN	4" (100mm)	FLANGE ANSI DRILLED
TP-G	CIP RETURN FILTRATE	4" (100mm)	FLANGE ANSI DRILLED
TP-H	CIP RETURN FEED	4" (100mm)	FLANGE ANSI DRILLED
TP-I	AIR SCOUR INLET	3" (80mm)	FLANGE ANSI DRILLED
TP-J	CONTROL AIR INLET	1" (25mm)	THREADED BSP
TP-K	PROCESS AIR INLET	2" (50mm)	FLANGE ANSI DRILLED
TP-L	UNIT MANUAL DRAIN	3" (80mm)	FLANGE ANSI DRILLED



NOTES:
 1- EQUIPMENT MARKED WITH "EWT" IS SUPPLIED BY EVOQUA WATER TECHNOLOGIES FOR INSTALLATION BY OTHERS
 2- ALL INTERCONNECTING PIPEWORK (EXCEPT WHEN INDICATED) IS SUPPLIED BY OTHERS
 3- VALVE TAGGED FV001-X HAS ELECTRO-PNEUMATIC POSITIONER. IN THE CASE OF A SYSTEM WITH A DEDICATED VFD CONTROLLED FEED PUMP PER UNIT, FEED VALVE TO BE TAGGED AV001-X AND ON/OFF CONTROLLED (TYPE 2A).
 4- FOR DRAIN CONNECTIONS & SIZES NOT SHOWN, SEE MECHANICAL DRAWINGS.
 5- PNEUMATIC ACTUATED VALVES SHOWN OUTSIDE THE UNIT BOX ARE SHIPPED LOOSE TO BE INSTALLED BY OTHERS
 6- SOLENOIDS FOR PNEUMATIC ACTUATED VALVES SHOWN OUTSIDE THE UNIT BOX ARE LOCATED IN SOLENOID VALVE BLOCK MOUNTED ON THE UNIT
 7- PNEUMATIC TUBING AND ELECTRICAL WIRES FOR THE VALVES SHOWN OUTSIDE THE UNIT BOX ARE WIRED BACK TO THE I/O SOLENOID BLOCK ON THE UNIT BY OTHERS.

INTL REF:
 BAR = 1" AT PLOT SCALE

REV	DESCRIPTION	DATE	DWN	CHKD	APVD	ECH
-	SEE SHEET ONE					

COMPANY CONFIDENTIAL
 THIS DOCUMENT AND ALL INFORMATION CONTAINED HEREIN ARE THE PROPERTY OF EVOQUA AND/OR ITS AFFILIATES. THE DESIGN CONCEPTS AND INFORMATION CONTAINED HEREIN ARE PROPRIETARY TO EVOQUA AND ARE SUBMITTED IN CONFIDENCE. THEY ARE NOT TO BE REPRODUCED, COPIED, OR USED IN ANY OTHER MANNER WITHOUT THE EXPRESS WRITTEN CONSENT OF EVOQUA. IN NO EVENT SHALL THEY BE USED IN ANY MANNER DETRIMENTAL TO THE INTEREST OF EVOQUA. ALL PATENT RIGHTS ARE RESERVED. UPON THE DEMAND OF EVOQUA, THIS DOCUMENT, ALONG WITH ALL COPIES AND EXTRACTS, AND ALL RELATED NOTES AND ANALYSES, MUST BE RETURNED TO EVOQUA OR DESTROYED AS INSTRUCTED BY EVOQUA. ACCEPTANCE OF THE DELIVERY OF THIS DOCUMENT CONSTITUTES AGREEMENT TO THESE TERMS.

DESIGNER: JAM DATE: 09/17/15
 CHECKER: DATE:
 ENGINEER: DATE:
 MANAGER: DATE:
 FILE: 1501500XPX
 SCALE: NONE

PRELIMINARY
 NOT FOR CONSTRUCTION

TITLE: PROCESS AND INSTRUMENTATION DIAGRAM MEMCOR CPIIMR1 UNIT
 CLIENT: STANDARD PRODUCT

PROJECT: 15Q15XXXPX
 CODE: 15Q15XXXPX
 DRAWING: 15Q15XXXPX
 SHEET: 4 OF 12
 REV: A

WATER TECHNOLOGIES COLORADO SPRINGS, CO 719-570-9600

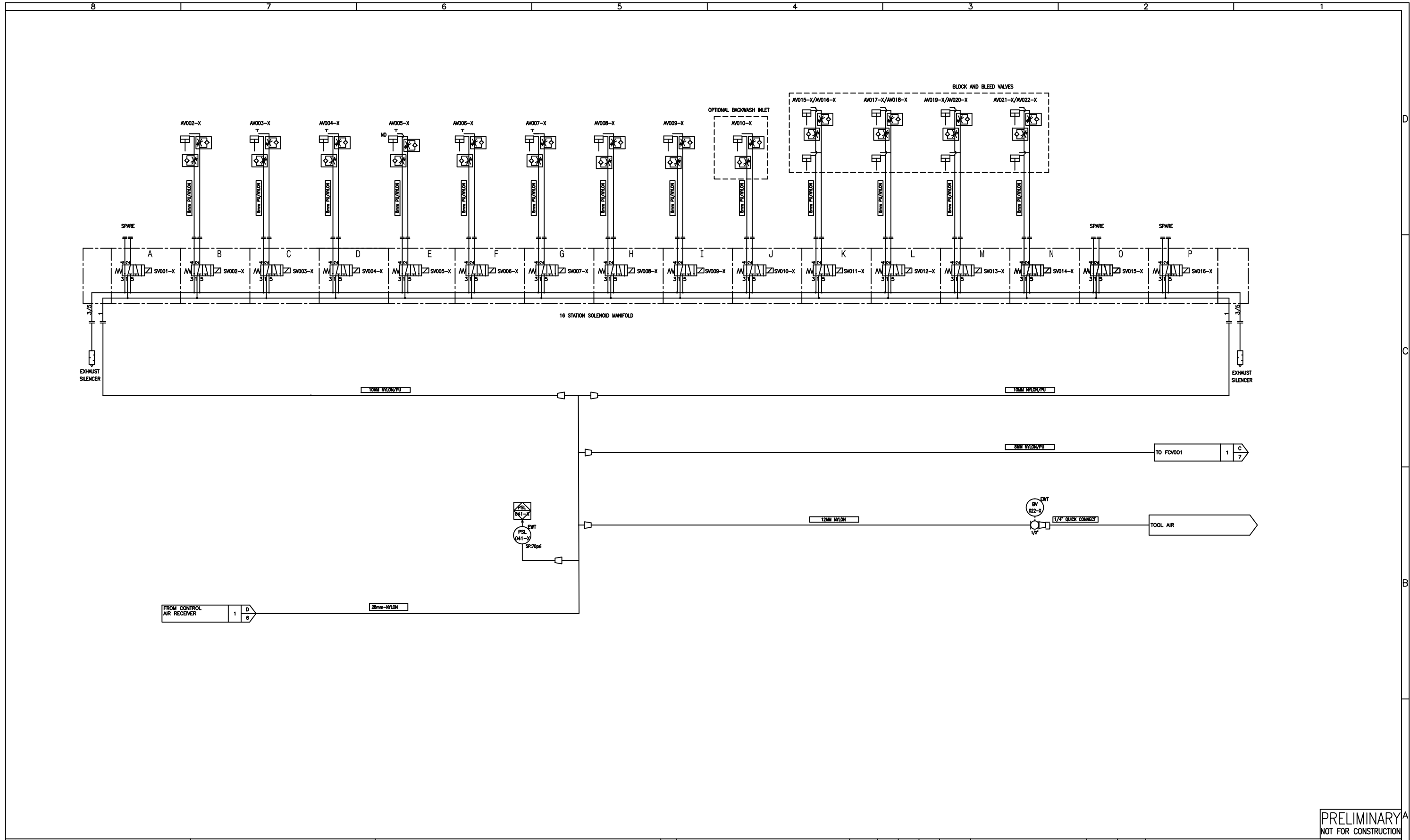

PRELIMINARY
NOT FOR CONSTRUCTION

NOTES:
1. ALL EQUIPMENT SHOWN ON THIS SHEET IS INCLUDED ON THE MEMCOR UNIT.

REV	DESCRIPTION	DATE	DWN	CHKD	APVD	ECN
-	SEE SHEET ONE					

COMPANY CONFIDENTIAL
THIS DOCUMENT AND ALL INFORMATION CONTAINED HEREIN ARE THE PROPERTY OF EVOQUA AND/OR ITS AFFILIATES. THE DESIGN CONCEPTS AND INFORMATION CONTAINED HEREIN ARE PROPRIETARY TO EVOQUA AND ARE SUBMITTED IN CONFIDENCE. THEY ARE NOT TRANSFERABLE AND MUST BE USED ONLY FOR THE PURPOSE FOR WHICH THE DOCUMENT IS EXPRESSLY PREPARED. THEY MUST NOT BE DISCLOSED, REPRODUCED, LOANED OR USED IN ANY OTHER MANNER WITHOUT THE EXPRESS WRITTEN CONSENT OF EVOQUA. IN NO EVENT SHALL THEY BE USED IN ANY MANNER DETRIMENTAL TO THE INTEREST OF EVOQUA. ALL PATENT RIGHTS ARE RESERVED. UPON THE DEMAND OF EVOQUA, THIS DOCUMENT, ALONG WITH ALL COPIES AND EXTRACTS, AND ALL RELATED NOTES AND ANALYSES, MUST BE RETURNED TO EVOQUA OR DESTROYED AS INSTRUCTED BY EVOQUA. ACCEPTANCE OF THE DELIVERY OF THIS DOCUMENT CONSTITUTES AGREEMENT TO THESE TERMS.

DESIGNER JAM DATE 09/17/15
CHECKER DATE
ENGINEER DATE
MANAGER DATE
FILE: 15Q15XXXPX
SCALE: NONE

TITLE PROCESS AND INSTRUMENTATION DIAGRAM MEMCOR CPIIMR1 UNIT
CLIENT STANDARD PRODUCT
PROJECT CODE 15Q15XXXPX
DRAWING SHEET 5 OF 12
REV A
eVOQUA WATER TECHNOLOGIES
COLORADO SPRINGS, CO
719-570-9600

STD: BORDER-0106-24X36D1 INTL REF:

BAR = 1" AT PLOT SCALE

AUTOMATIC STRAINERS STR1001 THRU STR1002
 2 X 100 % CONFIGURATION (1 DUTY/1 STANDBY)
 970 GPM EACH (DESIGN)
 1165 GPM EACH (DURING BACKWASH SWEEP)
 250 MICRON SCREEN
 1/4HP 120VAC/1PH/60HZ

FEED WATER SUPPLY
 MINIMUM PRESSURE: 35 PSI
 MAXIMUM PRESSURE: <50 PSI
 (NOTE 11)
 DESIGN FLOW RATE: 970 GPM
 BW SWEEP FLOW RATE: 1165 GPM

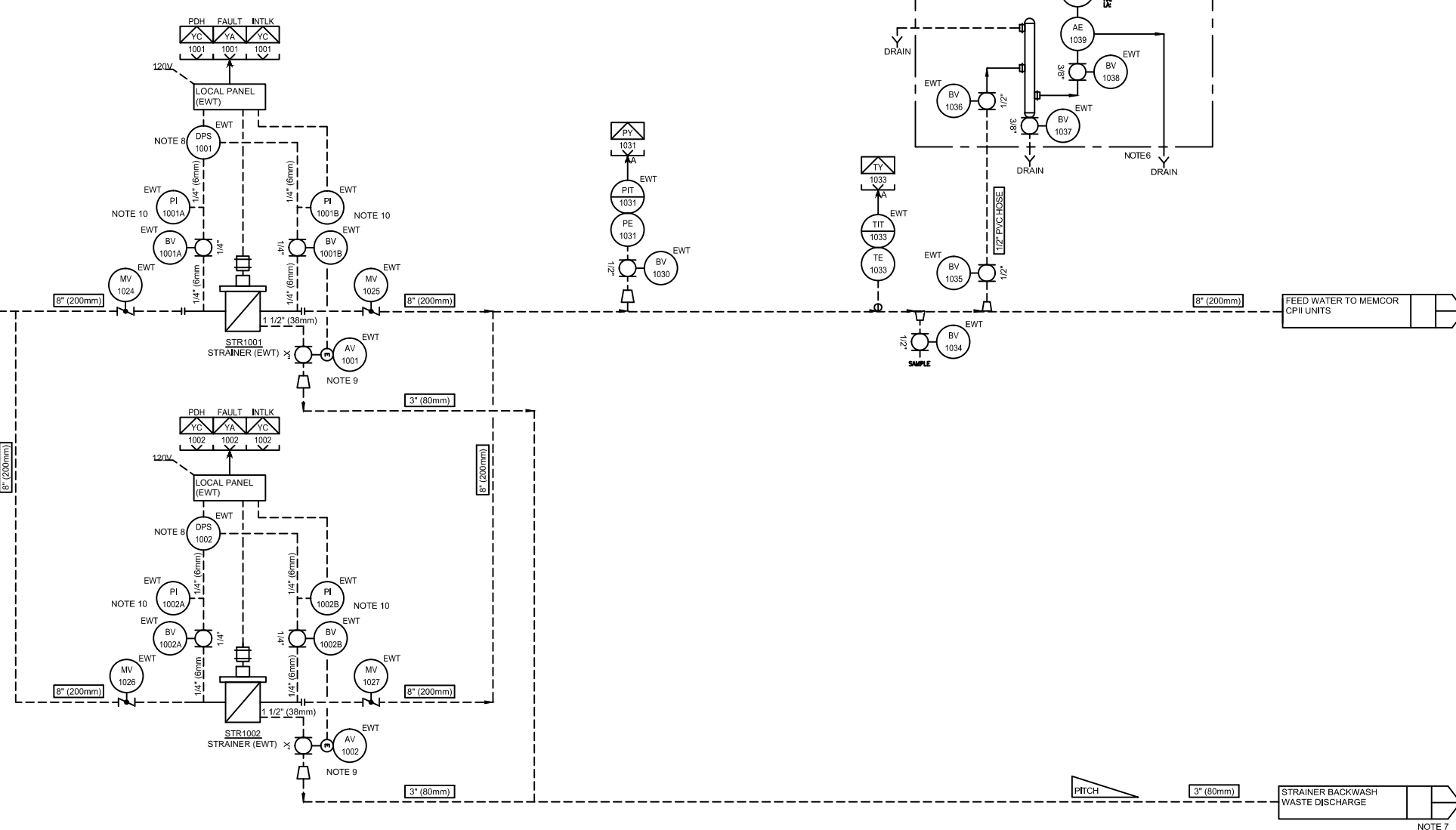

MATERIALS AND SERVICE (SEE NOTES)									
DESCRIPTION	DI	CS	ABS	PVC	CPVC	HDPE	304SS	316SS	COPPER
RAW/FEED WATER	Y	Y	Y	Y	Y	Y	Y	Y	N
FILTRATE WATER	Y	Y	Y	Y	Y	Y	Y	Y	N
WASTE (BACKWASH OUTLET)	Y	Y	Y	N	N	Y	Y	Y	N
WASTE/FILTRATE EXHAUST	Y	Y	Y	N	N	Y	Y	Y	N
CIP	N	N	N	N	N	N	N	N	N
PROCESS & CONTROL AIR	N	N	Y	N	N	N	N	Y	Y
AIR SCOUR AIR	N	N	Y	N	N	N	Y	Y	Y

Y = SUITABLE
 N = NOT RECOMMENDED

NOTES:
 A. TABLE IS PROVIDED FOR REFERENCE ONLY. CHECK WITH THE PIPE VENDOR FOR SERVICE SUITABILITY.
 B. IF PLASTIC PIPE IS USED FOR COMPRESSED AIR SERVICE, CHECK WITH THE PIPE VENDOR TO ENSURE PIPE IS RATED FOR COMPRESSED AIR SERVICE. DO NOT USE PVC/CPVC ON COMPRESSED AIR LINES.
 C. LIST OF MATERIALS IS NOT COMPREHENSIVE. CONTACT EWT FOR USING MATERIALS NOT LISTED.
 D. CHECK WITH APPROPRIATE REGULATORY AGENCIES AND REQUIREMENTS ON USE OF MATERIALS LISTED.
 E. AVOID CONCRETE-MORTAR COATED/LINED PIPES ON THE RAW/FEED WATER TO THE MEMBRANE UNITS.
 F. EPOXY COATED/LINED DI OR CS IS ACCEPTABLE ON RAW/FEED SIDE PROVIDED MEASURES ARE TAKEN TO PREVENT COATING/LINING CHIPPING DURING CONSTRUCTION AND OPERATION.
 G. ACCOUNT FOR THERMAL EXPANSION AND CONTRACTION IN DESIGN AND SUPPORT FOR HDPE PIPING (IF USED) IN CIP SYSTEM.

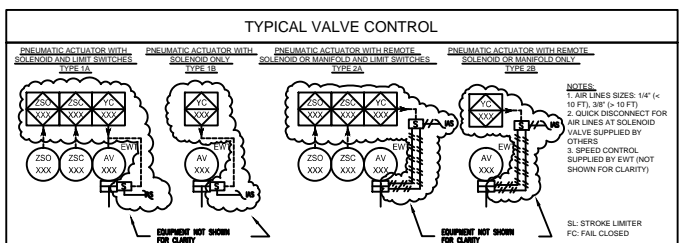

NOTES:
 1- EQUIPMENT MARKED WITH "EWT" IS SUPPLIED BY EVOQUA WATER TECHNOLOGIES FOR INSTALLATION BY OTHERS.
 2- ALL INTERCONNECTING PIPEWORK (EXCEPT WHEN INDICATED) IS SUPPLIED BY OTHERS.
 3- INSTRUMENTS 24VDC OR LOOP POWERED UNLESS OTHERWISE INDICATED.
 4- POWER SUPPLY TO INSTRUMENTS REQUIRING SEPARATE POWER SUPPLY IS PROVIDED BY OTHERS.
 5- MCC AND VFD(S) SUPPLIED BY OTHERS UNLESS OTHERWISE NOTED.

6- FOR DRAIN CONNECTIONS AND SIZES NOT SHOWN, SEE MECHANICAL DRAWINGS.
 7- SELF DRAINING. PROVIDE SLOPE TO DRAIN THE LINE. NO BACK PRESSURE IN THE LINE.
 8- DIFFERENTIAL PRESSURE SWITCHES DPS 1001 THRU DPS 1002 ARE SHIPPED LOOSE WITH THE STRAINER. THESE ARE INSTALLED AND WIRED TO THE STRAINER CONTROL PANELS BY OTHERS.
 9- ELECTRIC ACTUATED VALVES AV 1001 THRU AV 1002 ARE SHIPPED LOOSE WITH THE STRAINER. THESE ARE INSTALLED AND WIRED TO THE STRAINER LOCAL PANELS BY OTHERS.

10- BALL VALVES BV 1001A/1001B THRU BY 1002A/1002B, PRESSURE GAUGES PI 1001A/1001B THRU PI 1002A/1002B, AND TWO SETS OF TEES ARE SHIPPED LOOSE WITH THE STRAINER. THESE ARE INSTALLED BY OTHERS.
 11- PRESSURE RELIEF AND/OR PRESSURE SUSTAINING VALVE(S) PROVIDED BY OTHERS TO PROTECT STRAINER AND MEMBRANE SYSTEM FROM OVER PRESSURIZING AND/OR TO KEEP WITHIN MAXIMUM DESIGN PRESSURE OF MEMBRANE SYSTEM. DESIGN BY OTHERS. PIPE TO WASTE/SUMP AS REQUIRED.

REV	DESCRIPTION	DATE	DWN	CHKD	APVD	ECN
-	SEE SHEET ONE					

COMPANY CONFIDENTIAL
 THIS DOCUMENT AND ALL INFORMATION CONTAINED HEREIN ARE THE PROPERTY OF EVOQUA AND/OR ITS AFFILIATES. THE DESIGN CONCEPTS AND INFORMATION CONTAINED HEREIN ARE PROPRIETARY TO EVOQUA AND ARE SUBMITTED IN CONFIDENCE. THEY ARE NOT TRANSFERABLE AND MUST BE USED ONLY FOR THE PURPOSE FOR WHICH THE DOCUMENT IS EXPRESSLY PREPARED. THEY MUST NOT BE DISCLOSED, REPRODUCED, LOANED OR USED IN ANY OTHER MANNER WITHOUT THE EXPRESS WRITTEN CONSENT OF EVOQUA. IN NO EVENT SHALL THEY BE USED IN ANY MANNER DETRIMENTAL TO THE INTEREST OF EVOQUA. ALL PATENT RIGHTS ARE RESERVED. UPON THE DEMAND OF EVOQUA, THIS DOCUMENT, ALONG WITH ALL COPIES AND EXTRACTS, AND ALL RELATED NOTES AND ANALYSES, MUST BE RETURNED TO EVOQUA OR DESTROYED AS INSTRUCTED BY EVOQUA. ACCEPTANCE OF THE DELIVERY OF THIS DOCUMENT CONSTITUTES AGREEMENT TO THESE TERMS.

DESIGNER JAM	DATE 09/17/15	TITLE PROCESS AND INSTRUMENTATION DIAGRAM MEMCOR 2XCPIIMR1 FEED WATER SYSTEM -- PRESSURIZED FEED
CHECKER	DATE	CLIENT STANDARD PRODUCT
ENGINEER	DATE	WATER TECHNOLOGIES COLORADO SPRINGS, CO 719-570-9600
MANAGER	DATE	
FILE: 1501500XPX	SCALE: NONE	PROJECT 15Q15XXXPX
		DRAWING 15Q15XXXPX
		SHEET 6 OF 12
		REV A

PRELIMINARY
 NOT FOR CONSTRUCTION

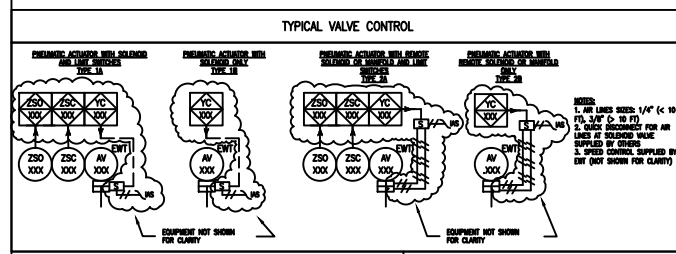
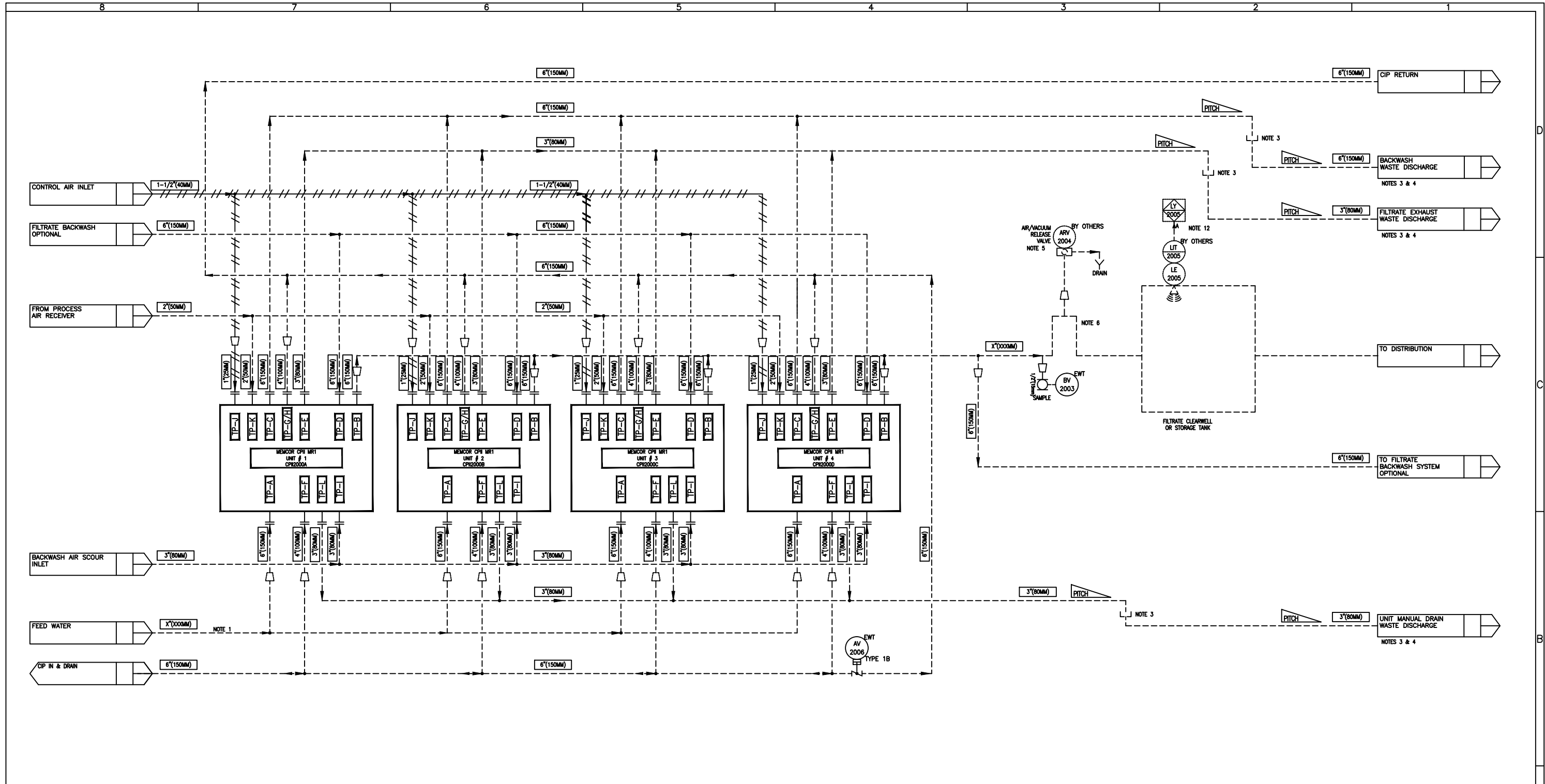

FIELD CONNECTION TABLE			
LABEL	DESCRIPTION	SIZE	CONNECTION
TP-A	FEED	6" (150MM)	FLANGE
TP-B	FILTRATE	6" (150MM)	FLANGE
TP-C	BACKWASH WASTE OUTLET	6" (150MM)	FLANGE
TP-D	FILTRATE BACKWASH IN (OPTIONAL)	6" (150MM)	FLANGE
TP-E	FILTRATE EXHAUST	3" (80MM)	FLANGE
TP-F	CIP IN/LIMIT DRAIN	4" (100MM)	FLANGE
TP-G/H	CIP FEED AND FILTRATE RETURN	4" (100MM)	FLANGE
TP-I	AIR SCOUR INLET	3" (80MM)	FLANGE
TP-J	CONTROL AIR INLET	1" (25MM)	NPT
TP-K	PROCESS AIR INLET	2" (50MM)	FLANGE
TP-L	UNIT MANUAL DRAIN	3" (80MM)	FLANGE

- NOTES:**
- 1- FEED AND FILTRATE SIZED FOR THE REQUIRED FLOW
 - 2- INSTRUMENTS 24VDC UNLESS OTHERWISE NOTED.
 - 3- PROVIDE POSITIVE AIR BREAK OR OPEN (FREE) DISCHARGE. SELF DRAINING. PROVIDE SLOPE TO DRAIN THE LINE. NO BACKPRESSURE IN LINE.
 - 4- RUN SEPARATE LINES FOR BACKWASH OUTLET AND FILTRATE EXHAUST
 - 5- INSTALL AIR RELEASE/VACUUM BREAKER VALVE AT THE HIGH POINT IN THE LINE.
 - 6- PROVIDE A MINIMUM OF 7 FT (2 METERS) OF BACKPRESSURE FOR INSTRUMENTS (CREATE A LOOP IF NEEDED).
 - 7- FOUR UNITS SHOWN AS TYPICAL ONLY. THE NUMBER OF UNITS WILL VARY WITH THE PARTICULAR SYSTEM DESIGN.
 - 8- EQUIPMENT MARKED WITH "EWT" IS SUPPLIED BY EVOQUA WATER TECHNOLOGIES FOR INSTALLATION BY OTHERS.
 - 9- ALL INTERCONNECTING PIPEWORK (EXCEPT WHEN INDICATED) IS SUPPLIED BY OTHERS.
 - 10- POWER SUPPLY TO INSTRUMENTS REQUIRING SEPARATE POWER SUPPLY IS PROVIDED BY OTHERS.
 - 11- MCC AND VFD(S) SUPPLIED BY OTHERS.
 - 12- LEVEL INFORMATION IS TO BE PROVIDED TO EVOQUA'S PCP STD: BORDER-0106-24X36D1

INTL REF: _____

BAR = 1" AT PLOT SCALE

REV	DESCRIPTION	DATE	DWN	CHKD	APVD	ECH
-	SEE SHEET ONE					

COMPANY CONFIDENTIAL

THIS DOCUMENT AND ALL INFORMATION CONTAINED HEREIN ARE THE PROPERTY OF EVOQUA AND/OR ITS AFFILIATES. THE DESIGN CONCEPTS AND INFORMATION CONTAINED HEREIN ARE PROPRIETARY TO EVOQUA AND ARE SUBMITTED IN CONFIDENCE. THEY ARE NOT TRANSFERABLE AND MUST BE USED ONLY FOR THE PURPOSE FOR WHICH THE DOCUMENT IS EXPRESSLY ISSUED. THEY MUST NOT BE DISCLOSED, REPRODUCED, LOANED OR USED IN ANY OTHER MANNER WITHOUT THE EXPRESS WRITTEN CONSENT OF EVOQUA. IN NO EVENT SHALL THEY BE USED IN ANY MANNER DETRIMENTAL TO THE INTEREST OF EVOQUA. ALL PATENT RIGHTS ARE RESERVED. UPON THE DEMAND OF EVOQUA, THIS DOCUMENT, ALONG WITH ALL COPIES AND EXTRACTS, AND ALL RELATED NOTES AND ANALYSES, MUST BE RETURNED TO EVOQUA OR DESTROYED AS INSTRUCTED BY EVOQUA. ACCEPTANCE OF THE DELIVERY OF THIS DOCUMENT CONSTITUTES AGREEMENT TO THESE TERMS.

DESIGNER: JAM DATE: 09/17/15
 CHECKER: DATE:
 ENGINEER: DATE:
 MANAGER: DATE:
 FILE: 15Q15XXXPX
 SCALE: NONE

PRELIMINARY
NOT FOR CONSTRUCTION

TITLE: PROCESS AND INSTRUMENTATION DIAGRAM
MEMCOR CPI/MR1 SYSTEM INTERCONNECTION
MR1

CLIENT: STANDARD PRODUCT

evoqua WATER TECHNOLOGIES
WATER TECHNOLOGIES
COLORADO SPRINGS, CO
719-570-9600

PROJECT: 15Q15XXXPX
CODE: _____
DRAWING: 15Q15XXXPX
SHEET: 7 OF 12
REV: A

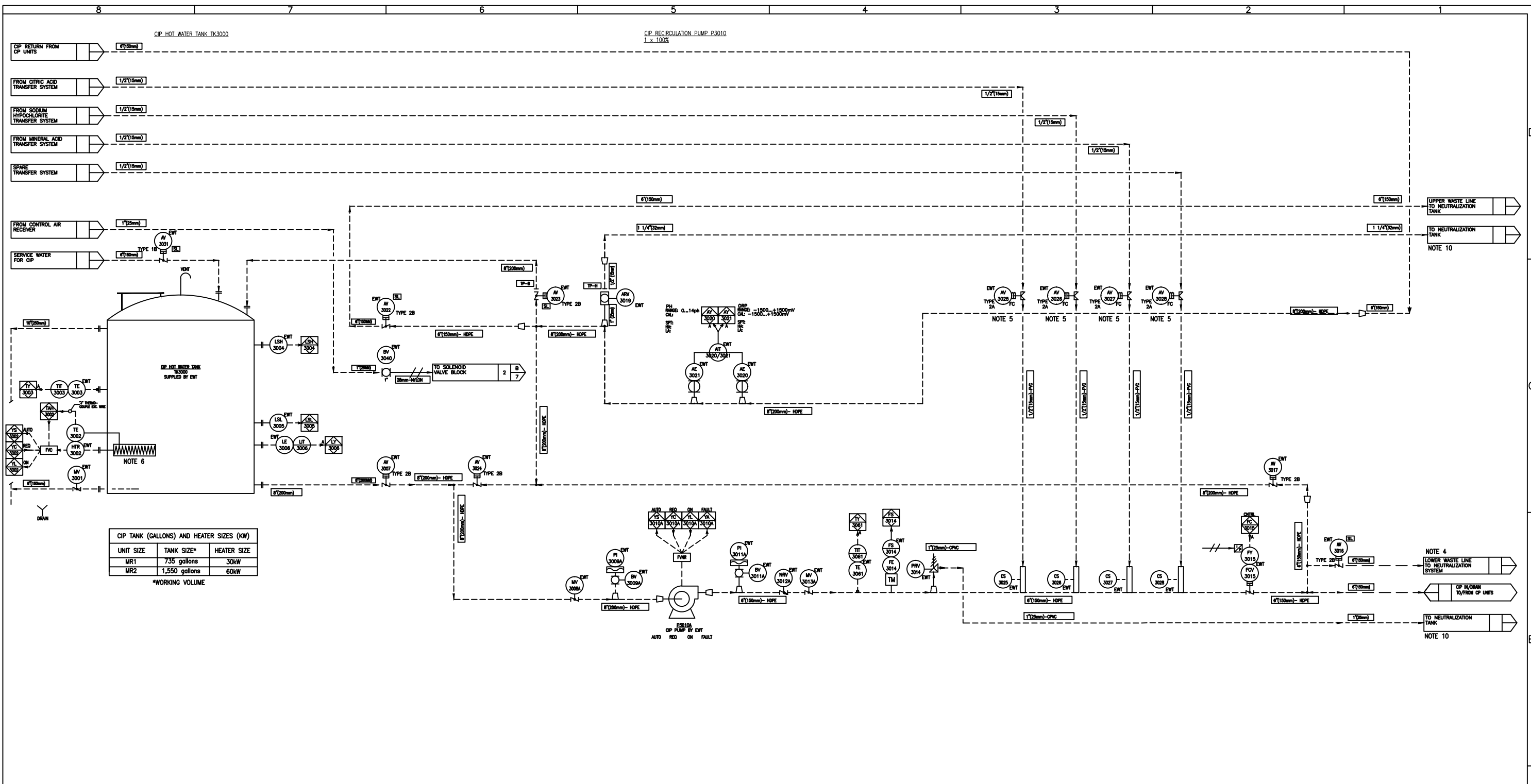

CIP TANK (GALLONS) AND HEATER SIZES (KW)

UNIT SIZE	TANK SIZE*	HEATER SIZE
MR1	735 gallons	30kW
MR2	1,550 gallons	60kW

*WORKING VOLUME

CIP PUMPS

UNIT SIZE	FLOW (GPM)	PRESSURE (FT)	MOTOR (hp)	MODEL
MR1	370 GPM	80 FT	15hp @ 60Hz	CRN 90-1-1
MR2	740 GPM	60 FT	25hp @ 60Hz	CRN 150-1-1
MR1	80 M3/Hr	22 M	7.5kW @ 50Hz	CRN 90-1
MR2	160 M3/Hr	17 M	15kW @ 50Hz	CRN 150-1

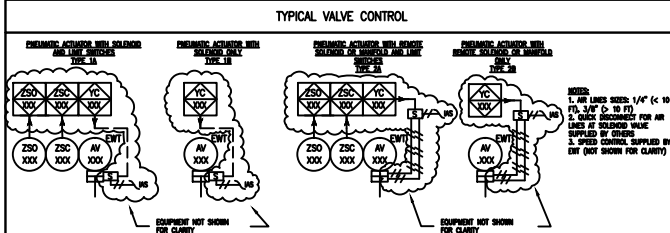

NOTES:

- EQUIPMENT MARKED WITH "EWT" IS SUPPLIED BY EVOQUA WATER TECHNOLOGIES FOR INSTALLATION BY OTHERS.
- ALL INTERCONNECTING PIPEWORK (EXCEPT WHEN INDICATED) IS SUPPLIED BY OTHERS.
- INSTRUMENTS 24VDC UNLESS OTHERWISE INDICATED.
- PROVIDE SLOPE TO DRAIN THE LINE IF WASTE COLLECTION BELOW GRADE. PROVIDE POSITIVE AIR BREAK OR OPEN (FREE) DISCHARGE FOR SELF DRAINING. ENSURE NO BACKPRESSURE IN LINE.
- TYPE 2A FAILED CLOSE VALVE WITH CLOSE LIMIT SWITCH ONLY.
- CIP WATER STORAGE TANK HEATER NOT USUALLY REQUIRED WHERE THE MINIMUM WATER TEMPERATURE IS GREATER THAN 77 °F (25 °C).

7-CIP MAKE-UP WATER SHOULD BE THE BEST QUALITY AVAILABLE. EXTERNAL CIP MAKE-UP WATER CONNECTION IS USUALLY ONLY REQUIRED WHEN CP UNIT FILTRATE DOES NOT MEET QUALITY REQUIREMENTS TYPICALLY - SI <15 PPM, TOTAL HARDNESS <150 mg/l AND CONDUCTIVITY <1000 µS/cm. WHERE FILTRATE QUALITY DOES NOT MEET GUIDELINES, BETTER QUALITY WATER SUCH AS TOWNS WATER OR RO PERMEATE SHOULD BE USED FOR CIP MAKE-UP.

8-POWER SUPPLY TO INSTRUMENTS REQUIRING SEPARATE POWER SUPPLY IS PROVIDED BY OTHERS.

9-MCC AND VFD(S) SUPPLIED BY OTHERS.

10-AIR RELIEF AND RELEASE VALVE PIPED SEPARATELY TO NEUTRALIZATION SYSTEM.

INTL. REF:

REV	DESCRIPTION	DATE	DWN	CHKD	APVD	ECN
-	SEE SHEET ONE					

COMPANY CONFIDENTIAL

THIS DOCUMENT AND ALL INFORMATION CONTAINED HEREIN ARE THE PROPERTY OF EVOQUA AND/OR ITS AFFILIATES. THE DESIGN CONCEPTS AND INFORMATION CONTAINED HEREIN ARE PROPRIETARY TO EVOQUA AND ARE SUBMITTED IN CONFIDENCE. THEY ARE NOT TRANSFERABLE AND MUST BE USED ONLY FOR THE PURPOSE FOR WHICH THE DOCUMENT IS EXPRESSLY LOANED. THEY MUST NOT BE DISCLOSED, REPRODUCED, LOANED OR USED IN ANY OTHER MANNER WITHOUT THE EXPRESS WRITTEN CONSENT OF EVOQUA. IN NO EVENT SHALL THEY BE USED IN ANY MANNER DETRIMENTAL TO THE INTEREST OF EVOQUA. ALL PATENT RIGHTS ARE RESERVED. UPON THE DEMAND OF EVOQUA, THIS DOCUMENT, ALONG WITH ALL COPIES AND EXTRACTS, AND ALL RELATED NOTES AND ANALYSES, MUST BE RETURNED TO EVOQUA OR DESTROYED AS INSTRUCTED BY EVOQUA. ACCEPTANCE OF THE DELIVERY OF THIS DOCUMENT CONSTITUTES AGREEMENT TO THESE TERMS.

DESIGNER: JAM
CHECKER: DATE
ENGINEER: DATE
MANAGER: DATE

FILE: 1501500XPX
SCALE: NONE

PRELIMINARY
NOT FOR CONSTRUCTION

TITLE: PROCESS AND INSTRUMENTATION DIAGRAM MEMCOR CPIIMR CLEAN-IN-PLACE SYSTEM MR1 & MR2

CLIENT: STANDARD PRODUCT

PROJECT CODE: 15Q15XXXPX
DRAWING CODE: 15Q15XXXPX
SHEET: 8 OF 12
REV: A

EVOQUA WATER TECHNOLOGIES
COLORADO SPRINGS, CO
719-570-9600

8 7 6 5 4 3 2 1

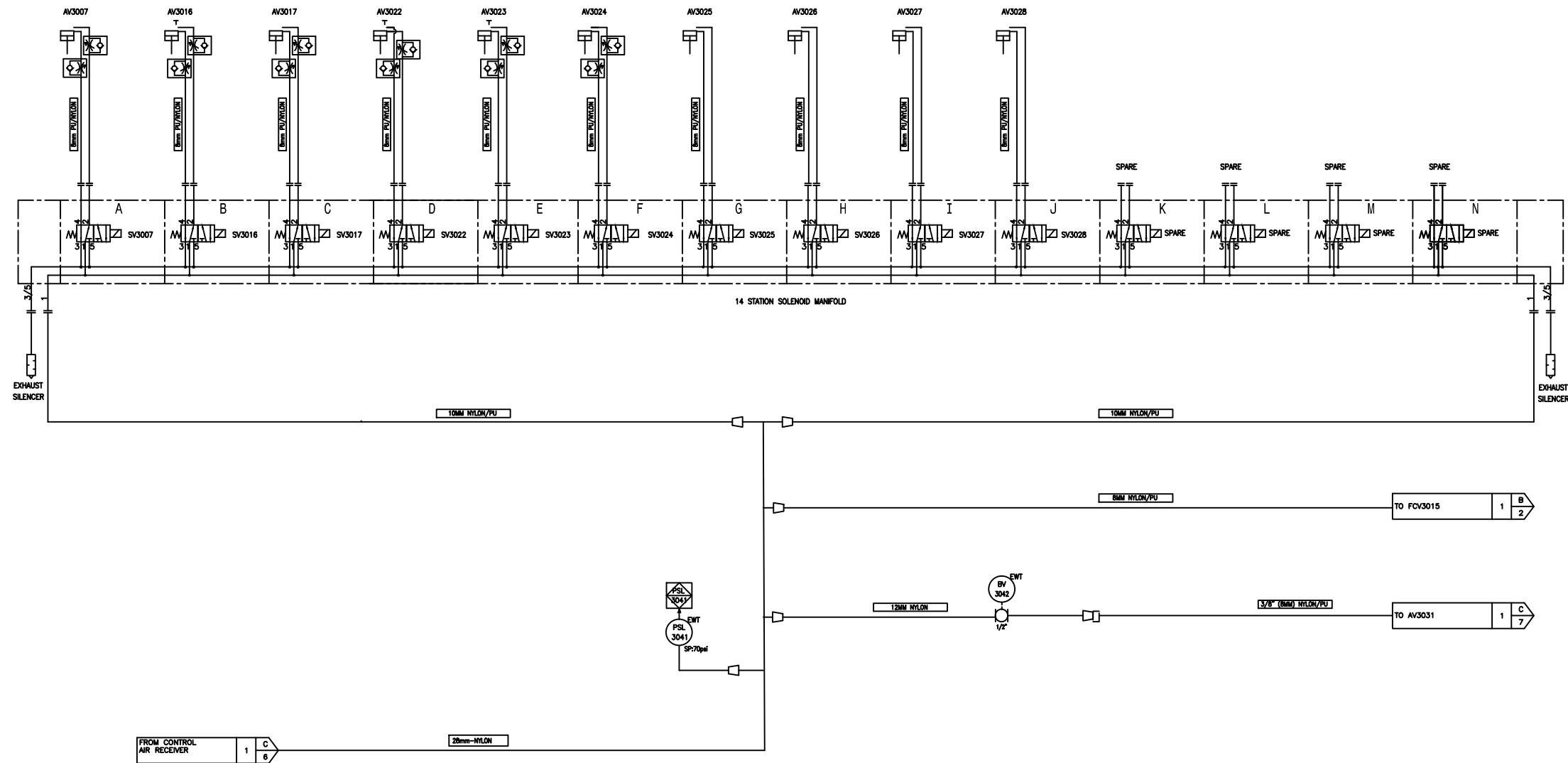

PRELIMINARY
NOT FOR CONSTRUCTION

NOTES:
1. ALL EQUIPMENT SHOWN ON THIS SHEET IS INCLUDED ON THE MEMCOR UNIT.

STD: BORDER-0106-24X36D1

INTL REF:

BAR = 1" AT PLOT SCALE

REV	DESCRIPTION	DATE	DWN	CHKD	APVD	ECN
-	SEE SHEET ONE					

COMPANY CONFIDENTIAL
THIS DOCUMENT AND ALL INFORMATION CONTAINED HEREIN ARE THE PROPERTY OF EVOQUA AND/OR ITS AFFILIATES. THE DESIGN CONCEPTS AND INFORMATION CONTAINED HEREIN ARE PROPRIETARY TO EVOQUA AND ARE SUBMITTED IN CONFIDENCE. THEY ARE NOT TRANSFERABLE AND MUST BE USED ONLY FOR THE PURPOSE FOR WHICH THE DOCUMENT IS EXPRESSLY REPRODUCED, LOANED OR USED IN ANY OTHER MANNER WITHOUT THE EXPRESS WRITTEN CONSENT OF EVOQUA. IN NO EVENT SHALL THEY BE USED IN ANY MANNER DETRIMENTAL TO THE INTEREST OF EVOQUA. ALL PATENT RIGHTS ARE RESERVED. UPON THE DEMAND OF EVOQUA, THIS DOCUMENT, ALONG WITH ALL COPIES AND EXTRACTS, AND ALL RELATED NOTES AND ANALYSES, MUST BE RETURNED TO EVOQUA OR DESTROYED AS INSTRUCTED BY EVOQUA. ACCEPTANCE OF THE DELIVERY OF THIS DOCUMENT CONSTITUTES AGREEMENT TO THESE TERMS.

DESIGNER	DATE
JAM	08/17/15
CHECKER	DATE
ENGINEER	DATE
MANAGER	DATE
FILE:	15015000PX
SCALE:	NONE

TITLE	PROCESS AND INSTRUMENTATION DIAGRAM MEMCOR CPIIMR CLEAN-IN-PLACE SYSTEM MR1 & MR2 DUTY/STANDBY PUMP SKID
CLIENT	STANDARD PRODUCT
PROJECT	15Q15XXXPX
CODE	
DRAWING	15Q15XXXPX
SHEET	9 OF 12
REV	A



WATER TECHNOLOGIES
COLORADO SPRINGS, CO
719-570-9600

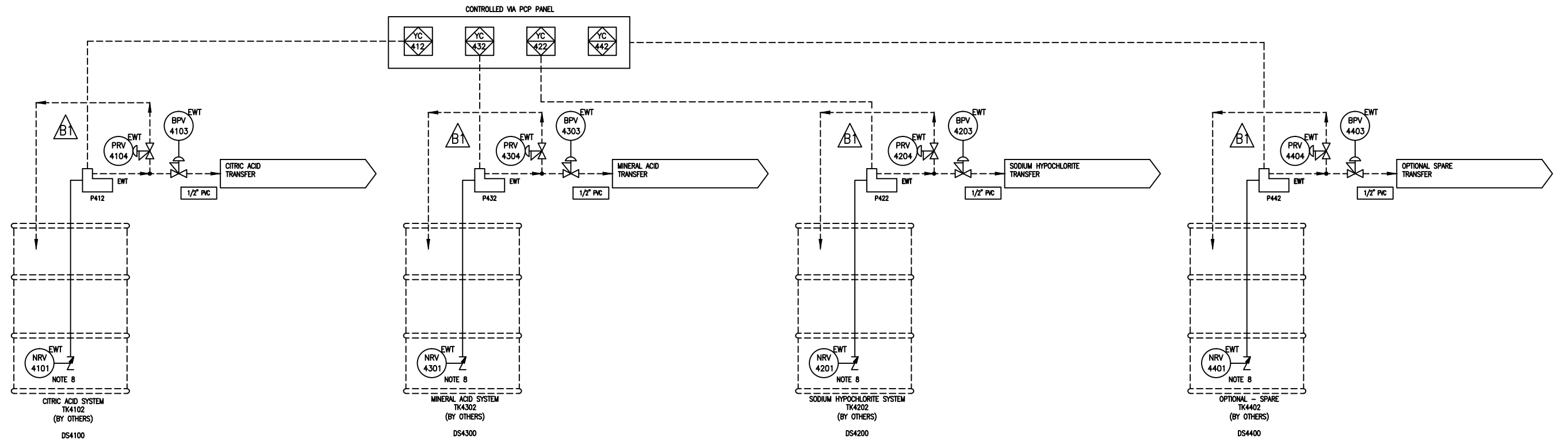

CHEMICAL TRANSFER SYSTEM - PUMP ON SHELF OPTION

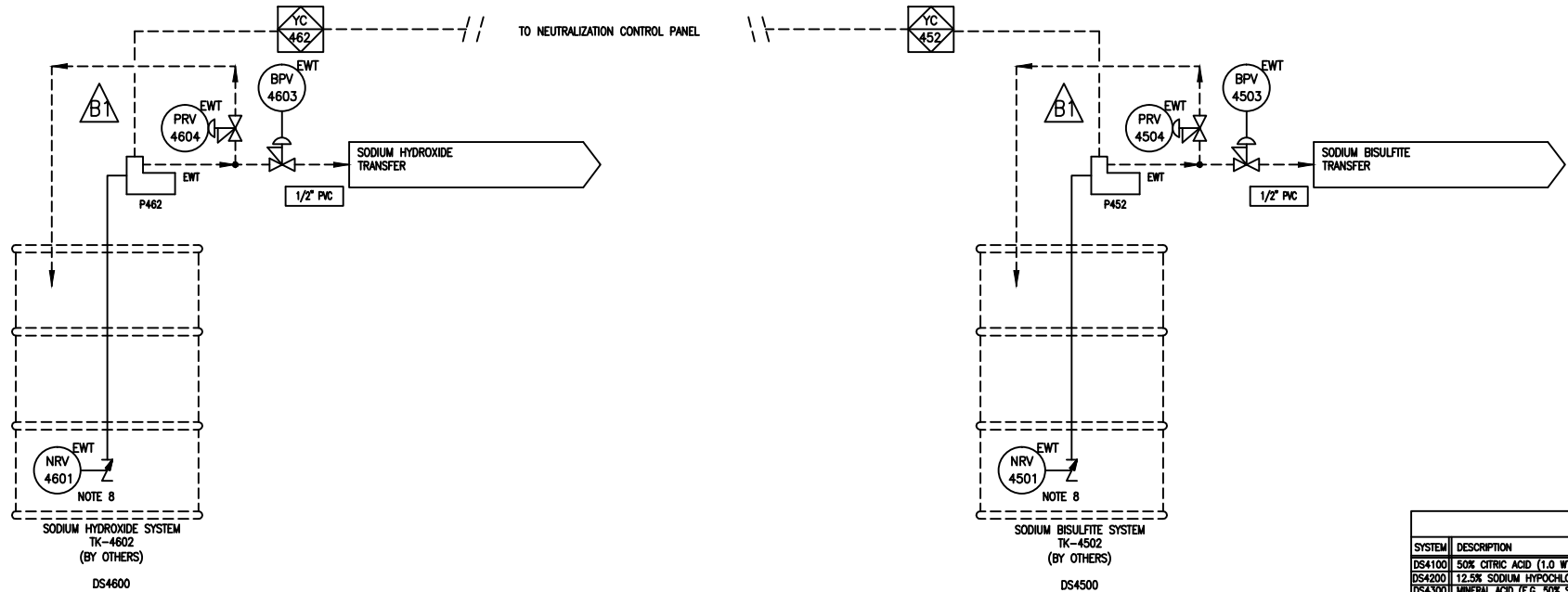

CHEMICAL DOSAGE REQUIREMENTS			
SYSTEM	DESCRIPTION	PUMP MR1	DOSING TIME
DS4100	50% CITRIC ACID (1.0 WT%) (FOR CIP)	40 GPH	45 PSIG 20 MIN
DS4200	12.5% SODIUM HYPOCHLORITE (500 PPM CIP/100 PPM MW)	10 GPH	45 PSIG 15/3 MIN
DS4300	MINERAL ACID (E.G. 50% SULFURIC ACID (0.08WT%)) CIP/MW	9 GPH	45 PSIG 5 MIN
	MINERAL ACID (E.G. 75% PHOSPHORIC ACID (0.08WT%)) CIP/MW	40 GPH	45 PSIG 8 MIN
	MINERAL ACID (E.G. 32% HYDROCHLORIC ACID (0.08WT%)) CIP/MW	16 GPH	45 PSIG 5 MIN
DS4400	SPARE CIP (E.G. 38% SODIUM BISULFITE (0.02WT%)) CIP/MW	5 GPH	45 PSIG 5 MIN
DS4500	38% SODIUM BISULFITE (FOR NEUTRALIZATION)	3 GPH	30 PSIG 20/4 MIN
DS4600	50% SODIUM HYDROXIDE (FOR NEUTRALIZATION)	27 GPH	30 PSIG 27/2 MIN

- NOTES:
- 1-ALL INTERCONNECTING PIPEWORK IS BY OTHERS
 - 2-ALL ITEMS IN EVOQUA SCOPE NOTED BY "EWT". EVOQUA OPTIONS FOR THE CPIMR ARE LABELLED BY "OPTION".
 - 3-POWER TO OFF SKID ITEMS BY CUSTOMER UNLESS NOTED.
 - 4-INSTRUMENTS LOOP POWERED UNLESS OTHERWISE INDICATED.
 - 5-ALL DISCRETE INSTRUMENTS 24VDC UNLESS OTHERWISE INDICATED.

6-PIPING & TUBING OUTSIDE OF SKIDS PROVIDED BY OTHERS. SELECTION OF SINGLE TUBING OR DOUBLE CONTAINED PIPING BY OTHERS. LEAK DETECTION & INSULATION NOT INCLUDED IN EWT SCOPE OF WORK

REV	DESCRIPTION	DATE	DWN	CHKD	APVD	ECN
-	SEE SHEET ONE					

REV	DESCRIPTION	DATE	DWN	CHKD	APVD	ECN

COMPANY CONFIDENTIAL

THIS DOCUMENT AND ALL INFORMATION CONTAINED HEREIN ARE THE PROPERTY OF EVOQUA AND/OR ITS AFFILIATES. THE DESIGN CONCEPTS AND INFORMATION CONTAINED HEREIN ARE PROPRIETARY TO EVOQUA AND ARE SUBMITTED IN CONFIDENCE. THEY ARE NOT TRANSFERABLE AND MUST BE USED ONLY FOR THE PURPOSE FOR WHICH THE DOCUMENT IS EXPRESSED. LOANED, REPRODUCED, LOANED OR USED IN ANY OTHER MANNER WITHOUT THE EXPRESS WRITTEN CONSENT OF EVOQUA. IN NO EVENT SHALL THEY BE USED IN ANY MANNER DETRIMENTAL TO THE INTEREST OF EVOQUA. ALL PATENT RIGHTS ARE RESERVED. UPON THE DEMAND OF EVOQUA, THIS DOCUMENT, ALONG WITH ALL COPIES AND EXTRACTS, AND ALL RELATED NOTES AND ANALYSES, MUST BE RETURNED TO EVOQUA OR DESTROYED AS INSTRUCTED BY EVOQUA. ACCEPTANCE OF THE DELIVERY OF THIS DOCUMENT CONSTITUTES AGREEMENT TO THESE TERMS.

DESIGNER: JAM DATE: 09/17/15
 CHECKER: DATE:
 ENGINEER: DATE:
 MANAGER: DATE:
 FILE: 1501500XPX
 SCALE: NONE

TITLE: PROCESS AND INSTRUMENTATION DIAGRAM MEMCOR CPIIMR CHEMICAL TRANSFER SYSTEM MR1 SIMPLE

CLIENT: STANDARD PRODUCT

PROJECT: 15Q15XXXPX

CODE: 15Q15XXXPX

DRAWING: 10 OF 12

SHEET: 10 OF 12

REV: A

PRELIMINARY NOT FOR CONSTRUCTION

COMPRESSOR PACKAGE
 CS000A, CS000B
 2 x 100% CONFIGURATION (1 DUTY/1 STANDBY)
 OIL LUBRICATED (FOOD GRADE)
 WITH INTEGRAL REFRIGERATED DRYER

NOTE 5

COALESING AIR FILTERS
 FS060A, FS061A, FS060B, FS061B
 2 x 100% CONFIGURATION (2 DUTY/2 STANDBY)
 MAYBE SUPPLIED INTEGRAL WITH COMPRESSOR (SEE NOTE 2)
 INTEGRAL HEADLOSS & AUTODRAIN
 1ST STAGE: 1 um PARTICLES
 2ND STAGE: 0.01 um PARTICLES
 FINAL CONNECTION LINE SIZE DEPENDENT ON COMPRESSOR SELECTION

CONTROL AIR RECEIVER TK500B
 ASME CODE
 PRIMED OUTSIDE, POWDERED COATED INSIDE
 120 GALLON (450 LITRES)

PROCESS AIR RECEIVER TK5032
 ASME CODE
 PRIMED OUTSIDE, POWDERED COATED INSIDE

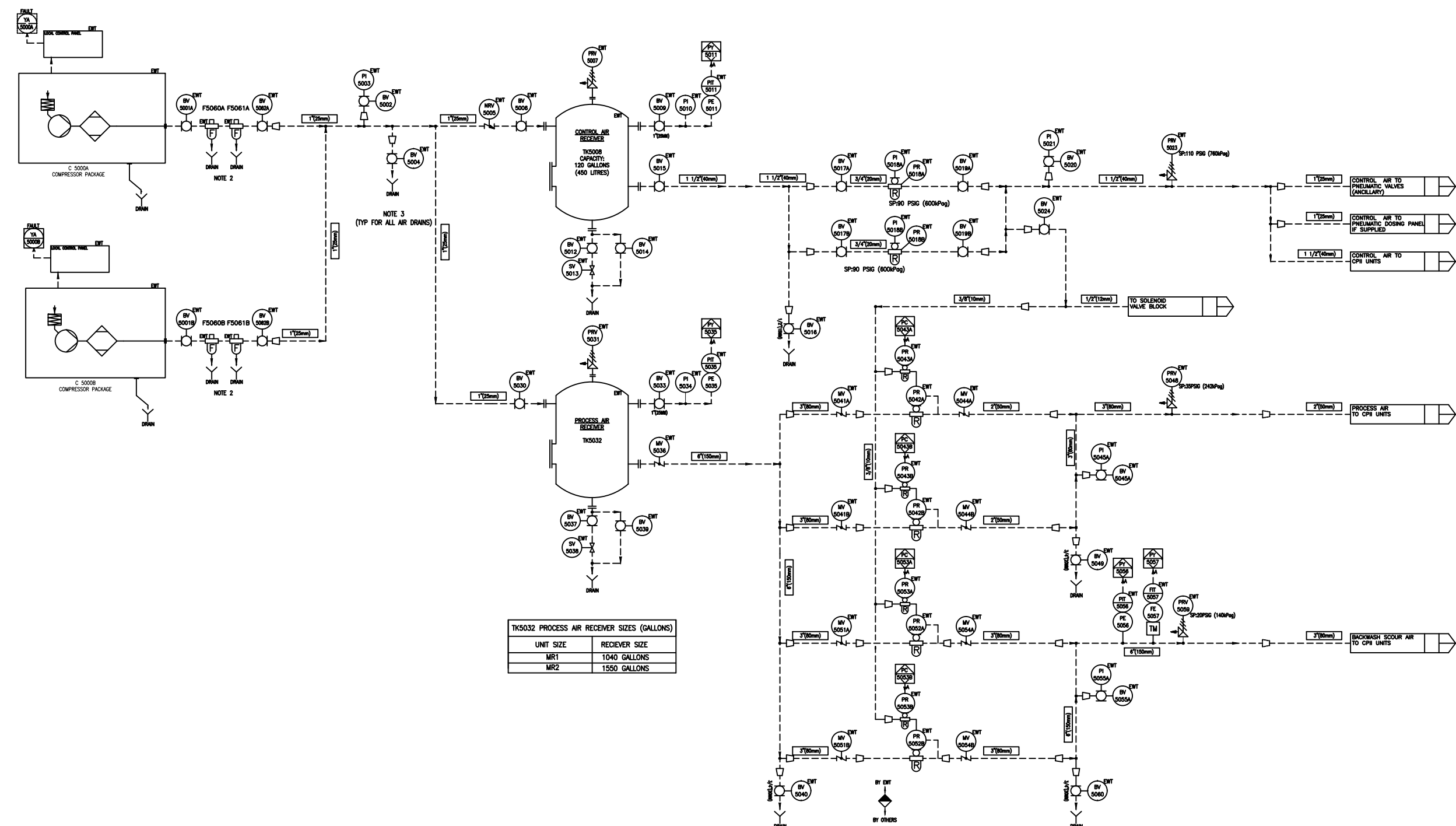

UNIT SIZE	RECEIVER SIZE
MR1	1040 GALLONS
MR2	1550 GALLONS

PRELIMINARY
 NOT FOR CONSTRUCTION

NOTES:
 1-INSTRUMENTS 24VDC UNLESS OTHERWISE NOTED.
 2-FILTERS MAYBE SUPPLIED AS PART OF THE COMPRESSOR PACKAGE. IF INTEGRAL WITH COMPRESSOR VALVES BV5062A/B NOT SUPPLIED.
 3-KEEP AIR SYSTEM DRAINS SEPARATE FROM WATER DRAINS.
 4-AIR LINE SYMBOL NOT USED FOR CLARITY
 5-COMPRESSORS SUPPLIED WITH OR WITHOUT AIR RECEIVER DEPENDING ON SIZE OF SYSTEM.
 6-AIR REGULATOR SYSTEM DUTY/STANDBY CONFIGURATION.
 7-ALL ITEMS IN EVOQUA SCOPE NOTED BY "EWT".

INTL REF:

BAR = 1" AT PLOT SCALE

REV	DESCRIPTION	DATE	DWN	CHKD	APVD	ECH
-	SEE SHEET ONE					

COMPANY CONFIDENTIAL
 THIS DOCUMENT AND ALL INFORMATION CONTAINED HEREIN ARE THE PROPERTY OF EVOQUA AND/OR ITS AFFILIATES. THE DESIGN CONCEPTS AND INFORMATION CONTAINED HEREIN ARE PROPRIETARY TO EVOQUA AND ARE SUBMITTED IN CONFIDENCE. THEY ARE NOT TRANSFERABLE AND MUST BE USED ONLY FOR THE PURPOSE FOR WHICH THE DOCUMENT IS EXPRESSLY PREPARED. THEY MUST NOT BE DISCLOSED, REPRODUCED, LOANED OR USED IN ANY OTHER MANNER WITHOUT THE EXPRESS WRITTEN CONSENT OF EVOQUA. IN NO EVENT SHALL THEY BE USED IN ANY MANNER DETRIMENTAL TO THE INTEREST OF EVOQUA. ALL PATENT RIGHTS ARE RESERVED. UPON THE DEMAND OF EVOQUA, THIS DOCUMENT, ALONG WITH ALL COPIES AND EXTRACTS, AND ALL RELATED NOTES AND ANALYSES, MUST BE RETURNED TO EVOQUA OR DESTROYED AS INSTRUCTED BY EVOQUA. ACCEPTANCE OF THE DELIVERY OF THIS DOCUMENT CONSTITUTES AGREEMENT TO THESE TERMS.

DESIGNER JAM
 CHECKER
 ENGINEER
 MANAGER

DATE 09/17/15
 DATE
 DATE
 DATE

TITLE PROCESS AND INSTRUMENTATION DIAGRAM
 MR1 AN MR2 UNITS
 MEMCOR CPIIMR COMPRESSED AIR SYSTEM
 CLIENT STANDARD PRODUCT
 PROJECT CODE 15Q15XXXPX
 DRAWING SHEET 11 OF 12
 SCALE NONE
 REV A



WATER TECHNOLOGIES
 COLORADO SPRINGS, CO
 719-570-9600

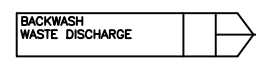

NOTES 8 & 9



NOTES 8 & 9

LINE 1

LINE 2

LINE 1

LINE 2

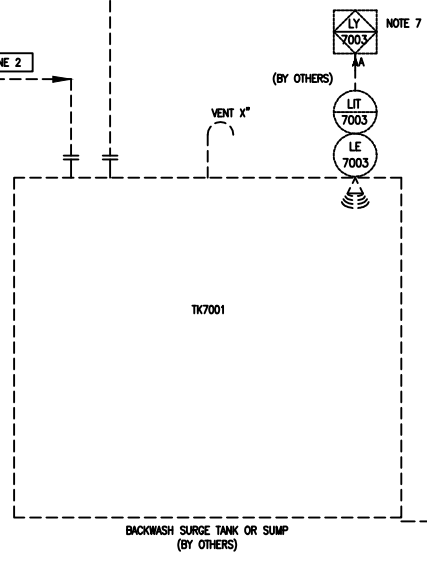

BACKWASH SUMP OR TANK	
UNIT SIZE	TANK SIZE
MR1	1500 GALLONS
MR2	3000 GALLONS
MR4	6000 GALLONS

LINE SIZES FOR DIFFERENT UNITS			
PROCESS LINE #	MR1	MR2	MR4
LINE 1	6" (150MM)	8" (200MM)	12" (300MM)
LINE 2	3" (80MM)	3" (80MM)	4" (100MM)

PRELIMINARY
NOT FOR CONSTRUCTION

NOTES:
 1-EQUIPMENT MARKED WITH "EMT" IS SUPPLIED BY EVOQUA INDUSTRY FOR INSTALLATION BY OTHERS.
 2-ALL INTERCONNECTING PIPEWORK (EXCEPT WHEN INDICATED) IS SUPPLIED BY OTHERS.
 3-INSTRUMENTS LOOP POWERED UNLESS OTHERWISE INDICATED.
 4-POWER SUPPLY TO INSTRUMENTS REQUIRING SEPARATE POWER SUPPLY IS PROVIDED BY OTHERS.
 5-MCC AND VFD SUPPLIED BY OTHERS.
 6-ALL DISCRETE INSTRUMENTS 24Vdc UNLESS OTHERWISE INDICATED.

7-TO EVOQUA VIA NETWORK
 8-PROVIDE POSITIVE AIR BREAK OR OPEN (FREE) DISCHARGE. SELF DRAINING. PROVIDE SLOPE TO DRAIN THE LINE. NO BACKPRESSURE IN LINE.
 9-RUN SEPARATE LINES FOR BACKWASH OUTLET AND FILTRATE EXHAUST

REV	DESCRIPTION	DATE	DWN	CHKD	APVD	ECN
-	SEE SHEET ONE					

DESIGNER	DATE	TITLE
JAM	09/17/15	PROCESS AND INSTRUMENTATION DIAGRAM MEMCOR CPIIMR BACKWASH WASTE SYSTEM
CHECKER	DATE	CLIENT
		STANDARD PRODUCT
ENGINEER	DATE	MANAGER
FILE:	SCALE:	PROJECT
15Q15XXXPX	NONE	15Q15XXXPX

COMPANY CONFIDENTIAL
 THIS DOCUMENT AND ALL INFORMATION CONTAINED HEREIN ARE THE PROPERTY OF EVOQUA AND/OR ITS AFFILIATES. THE DESIGN CONCEPTS AND INFORMATION CONTAINED HEREIN ARE PROPRIETARY TO EVOQUA AND ARE SUBMITTED IN CONFIDENCE. THEY ARE NOT TRANSFERABLE AND MUST BE USED ONLY FOR THE PURPOSE FOR WHICH THE DOCUMENT IS EXPRESSED. LOANED, THEY MUST NOT BE DISCLOSED, REPRODUCED, LOANED OR USED IN ANY OTHER MANNER WITHOUT THE EXPRESS WRITTEN CONSENT OF EVOQUA. IN NO EVENT SHALL THEY BE USED IN ANY MANNER DETRIMENTAL TO THE INTEREST OF EVOQUA. ALL PATENT RIGHTS ARE RESERVED. UPON THE DEMAND OF EVOQUA, THIS DOCUMENT, ALONG WITH ALL COPIES AND EXTRACTS, AND ALL RELATED NOTES AND ANALYSES, MUST BE RETURNED TO EVOQUA OR DESTROYED AS INSTRUCTED BY EVOQUA. ACCEPTANCE OF THE DELIVERY OF THIS DOCUMENT CONSTITUTES AGREEMENT TO THESE TERMS.

evoqua WATER TECHNOLOGIES
 COLORADO SPRINGS, CO
 719-570-9600

PROJECT	CODE	DRAWING	SHEET	REV
15Q15XXXPX		15Q15XXXPX	12 OF 12	A

STD: BORDER-0106-24X36D1

INTL REF:

BAR = 1" AT PLOT SCALE

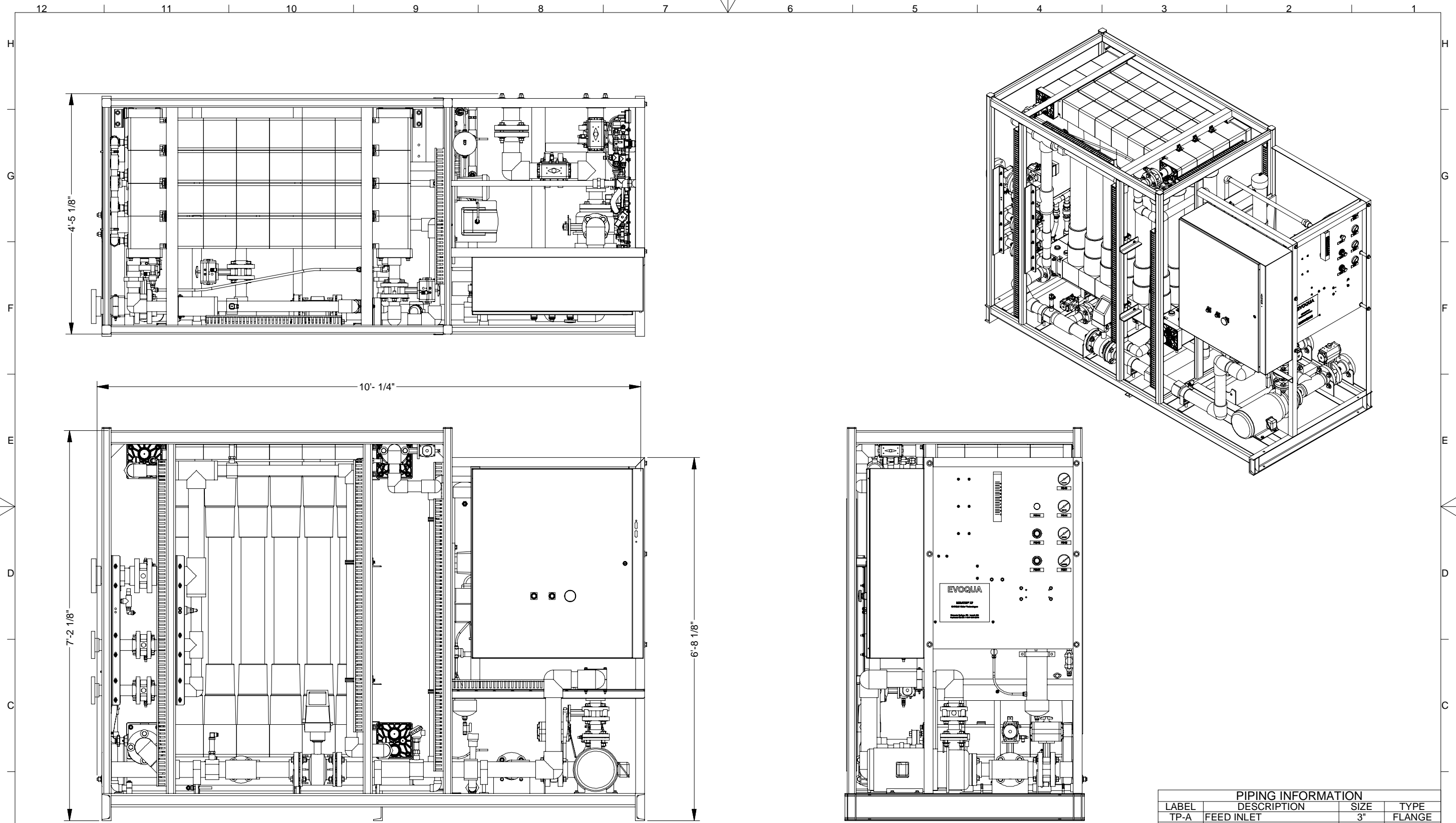

CONTROL PANEL SIDE VIEW

PNEUMATIC PANEL END VIEW

PIPING INFORMATION			
LABEL	DESCRIPTION	SIZE	TYPE
TP-A	FEED INLET	3"	FLANGE
TP-B	FILTRATE OUTLET	3"	FLANGE
TP-C	CIP IN	3"	FLANGE
TP-D	CIP RETURN	2"	FLANGE
TP-E	FILTRATE EXHUAUST	2"	FLANGE
TP-F	BACKWASH OUTLET	3"	FLANGE
TP-G	CONTROL AIR INLET	1"	NPT
TP-H	WASTE DRAIN	1"	SOCKET

- NOTES:
- WEIGHTS (APPROXIMATE):
SHIPPING:
XP24: 2750 LBS XP18: 2400 LBS
OPERATING:
XP24: 3800 LBS XP18: 3200 LBS
UNIT TO SHIP AS ONE COMPLETE ASSEMBLY.
TO BE INSTALLED IN THE FIELD BY CONTRACTOR.
 - ELECTRICAL TERMINATIONS AND 120 VOLT POWER SUPPLY TO UNIT BY INSTALLATION CONTRACTOR

TOLERANCES
UNLESS OTHERWISE SPECIFIED

LINEAR:

.XX	=±.06
.XXX	=±.031
X/XX	=±1/16

ANGULAR:

0°	=±.50°
----	--------

REV	DATE	BY	CHKD	APVD	ECR	DESCRIPTION
3	10/13/2014	GDC	SMKB	JBT	2032-1391	UPDATE DRAWINGS AND RE-BRANDING NAME
2	3/5/2013	RV	ST	ST	2032-1278	UPDATE VIEWS, TERMINATION POINTS A, C & F ELEVATION DIMENSION CHANGED, ADDED TP-H
1	9/16/2011	SMKB	SJT	TPO	1012-767	UPDATED WITH STRUCTURAL CHANGES TO FRAME
0	5/3/2011	RV	W.McL	STJ		INITIAL ISSUE

COMPANY CONFIDENTIAL
DOCUMENT AND ALL INFORMATION CONTAINED HEREIN ARE THE PROPERTY OF EVOQUA AND/OR ITS AFFILIATES. THE DESIGN CONCEPTS AND INFORMATION CONTAINED HEREIN ARE PROPRIETARY TO EVOQUA AND ARE SUBMITTED IN CONFIDENCE. THEY ARE NOT TRANSFERABLE AND MUST BE USED ONLY FOR THE PURPOSE FOR WHICH THE DOCUMENT IS EXPRESSLY LOANED. THEY MUST NOT BE DISCLOSED, REPRODUCED, LOANED OR USED IN ANY OTHER MANNER WITHOUT EXPRESS WRITTEN CONSENT OF EVOQUA. IN NO EVENT SHALL THEY BE USED IN ANY MANNER DETRIMENTAL TO THE INTEREST OF EVOQUA. ALL PATENT RIGHTS ARE RESERVED UPON THE REQUEST OF EVOQUA. THIS DOCUMENT, ALONG WITH ALL COPIES AND EXTRACTS, AND ALL RELATED NOTES AND ANALYSES, MUST BE RETURNED TO EVOQUA OR DESTROYED, AS INSTRUCTED BY EVOQUA. ACCEPTANCE OF THIS DELIVERY OF THIS DOCUMENT CONSTITUTES AGREEMENT TO THESE TERMS AND CONDITIONS.

DRAWN	RV	DATE	5/2/2011	TITLE	XPsr 18-24 PUMPED AND PRESSURIZED FEEDS GENERAL ARRANGEMENT
CHECKED	SJT	DATE	5/3/2011	CLIENT	MEMCOR STANDARD
APPROVED	W.McL	DATE	5/3/2011		

evoqua
WATER TECHNOLOGIES

U.S.A.
55 TECHNOLOGY DRIVE, SUITE 201
LOWELL,
MA 01851-5203
1-800-896-2674 (1-800-MEMCOR-4)

AUSTRALIA
1 MEMTEC PARKWAY,
SOUTH WINDSOR,
NSW 2756
TEL +61 (0) 2 4577 6800

U.K.
OUTRAMS WHARF,
DERBY, ENGLAND, DE1 5EL
TEL +44 (0) 1332 387300

SCALE:	NONE	PROJECT:	920077	DRAWING:	9200770500
DO NOT SCALE ALL DIMENSIONS UNLESS SPECIFIED		SHEET:	1 OF 4	STATUS:	REL

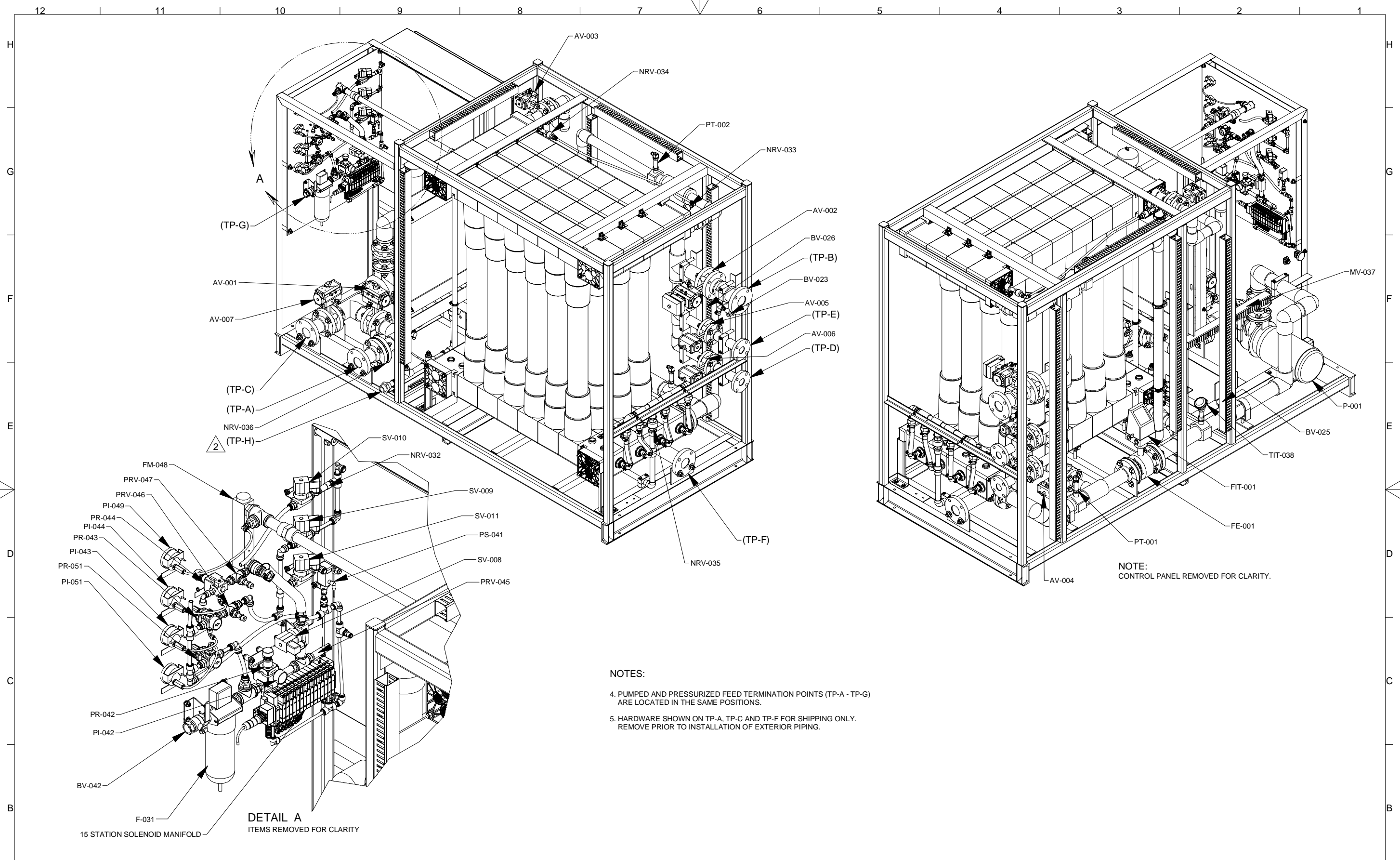

- NOTES:
4. PUMPED AND PRESSURIZED FEED TERMINATION POINTS (TP-A - TP-G) ARE LOCATED IN THE SAME POSITIONS.
 5. HARDWARE SHOWN ON TP-A, TP-C AND TP-F FOR SHIPPING ONLY. REMOVE PRIOR TO INSTALLATION OF EXTERIOR PIPING.

ITEM BALLOON KEY

ITEM #
 QTY ITEM QTY
 FOR
 # REFERENCE

#	DESCRIPTION	DATE	DWN	CHKD	APVD	ECR
3	UPDATE DRAWINGS AND RE-BRANDING NAME	10/13/2014	GDC	SMKB	JBT	2032-1391
2	UPDATE VIEWS, TERMINATION POINTS A, C & F ELEVATION DIMENSION CHANGED, ADDED TP-H	3/5/2013	RV	ST	ST	2032-1278
1	UPDATED WITH STRUCTURAL CHANGES TO FRAME	9/16/2011	SMKB	SJT	TPO	1012-767
0	INITIAL ISSUE	5/3/2011	RV	W.McL	STJ	

COMPANY CONFIDENTIAL
 DOCUMENT AND ALL INFORMATION CONTAINED HEREIN ARE THE PROPERTY OF EVOQUA AND/OR ITS AFFILIATES. THE DESIGN CONCEPTS AND INFORMATION CONTAINED HEREIN ARE PROPRIETARY TO EVOQUA AND ARE SUBMITTED IN CONFIDENCE. THEY ARE NOT TRANSFERABLE AND MUST BE USED ONLY FOR THE PURPOSE FOR WHICH THE DOCUMENT IS EXPRESSLY LOANED. THEY MUST NOT BE DISCLOSED, REPRODUCED, LOANED OR USED IN ANY OTHER MANNER WITHOUT EXPRESS WRITTEN CONSENT OF EVOQUA. IN NO EVENT SHALL THEY BE USED IN ANY MANNER DETRIMENTAL TO THE INTEREST OF EVOQUA. ALL PATENT RIGHTS ARE RESERVED UPON THE REQUEST OF EVOQUA. THIS DOCUMENT, ALONG WITH ALL COPIES AND EXTRACTS, AND ALL RELATED NOTES AND ANALYSES, MUST BE RETURNED TO EVOQUA OR DESTROYED, AS INSTRUCTED BY EVOQUA. ACCEPTANCE OF THIS DELIVERY OF THIS DOCUMENT CONSTITUTES AGREEMENT TO THESE TERMS AND CONDITIONS.

DRAWN RV	DATE 5/2/2011	TITLE XPsr 18-24 PUMPED AND PRESSURIZED FEEDS GENERAL ARRANGEMENT
CHECKED SJT	DATE 5/3/2011	CLIENT MEMCOR STANDARD
APPROVED W.McL	DATE 5/3/2011	

evoqua WATER TECHNOLOGIES	U.S.A. 55 TECHNOLOGY DRIVE, SUITE 201 LOWELL, MA 01851-5203 1-800-836-2674 (1-800-MEMCOR-4)	AUSTRALIA 1 MEMTEC PARKWAY, SOUTH WINDSOR, NSW 2756 TEL +61 (0) 2 4577 6800	U.K. OUTRAMS WHARF, LITTLE EATON, DERBY, ENGLAND, DE21 5EL TEL +44 (0) 1332 387300
SCALE: NONE	PROJECT 920077	DRAWING 9200770500	SHEET 2 OF 4
DO NOT SCALE ALL DIMENSIONS IMPERIAL			STATUS REL

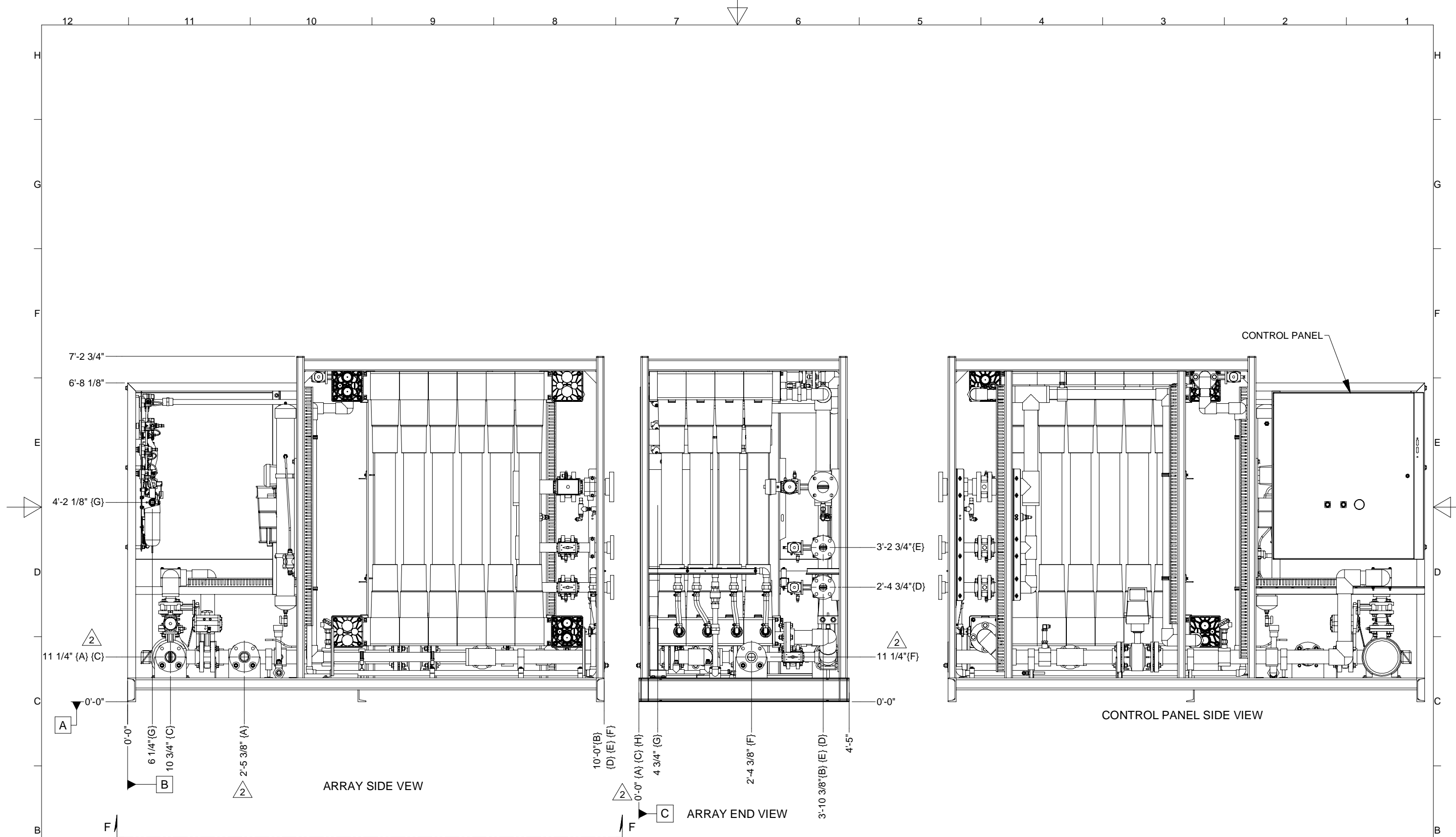

ARRAY SIDE VIEW

ARRAY END VIEW

CONTROL PANEL SIDE VIEW

TOLERANCES
UNLESS OTHERWISE SPECIFIED
LINEAR:
.XX = ±.06
.XXX = ±.031
X/XX = ±1/16
ANGULAR:
0° = ±.50°

U.K./AUS	U.S.A.	DESCRIPTION	DATE	DWN	CHKD	APVD	ECR		
		3	UPDATE DRAWINGS AND RE-BRANDING NAME	10/13/2014	GDC	SMKB	JBT	2032-1391	
		2	UPDATE VIEWS, TERMINATION POINTS A, C & F ELEVATION DIMENSION CHANGED, ADDED TP-H	3/5/2013	RV	ST	ST	2032-1278	
		1	UPDATED WITH STRUCTURAL CHANGES TO FRAME	9/16/2011	SMKB	SJT	TPD	1012-767	
		0	INITIAL ISSUE	5/3/2011	RV	W.McL	STJ		

COMPANY CONFIDENTIAL
DOCUMENT AND ALL INFORMATION CONTAINED HEREIN ARE THE PROPERTY OF EVOQUA AND/OR ITS AFFILIATES. THE DESIGN CONCEPTS AND INFORMATION CONTAINED HEREIN ARE PROPRIETARY TO EVOQUA AND ARE SUBMITTED IN CONFIDENCE. THEY ARE NOT TRANSFERABLE AND MUST BE USED ONLY FOR THE PURPOSE FOR WHICH THE DOCUMENT IS EXPRESSLY LOANED. THEY MUST NOT BE DISCLOSED, REPRODUCED, LOANED OR USED IN ANY OTHER MANNER WITHOUT EXPRESS WRITTEN CONSENT OF EVOQUA. IN NO EVENT SHALL THEY BE USED IN ANY MANNER DETRIMENTAL TO THE INTEREST OF EVOQUA. ALL PATENT RIGHTS ARE RESERVED UPON THE REQUEST OF EVOQUA. THIS DOCUMENT, ALONG WITH ALL COPIES AND EXTRACTS, AND ALL RELATED NOTES AND ANALYSES, MUST BE RETURNED TO EVOQUA OR DESTROYED, AS INSTRUCTED BY EVOQUA. ACCEPTANCE OF THIS DELIVERY OF THIS DOCUMENT CONSTITUTES AGREEMENT TO THESE TERMS AND CONDITIONS.

DRAWN RV	DATE 5/2/2011	TITLE XPsr 18-24 PUMPED AND PRESSURIZED FEEDS GENERAL ARRANGEMENT			
CHECKED SJT	DATE 5/3/2011	CLIENT MEMCOR STANDARD			
APPROVED W.McL	DATE 5/3/2011				
		<table border="0"> <tr> <td>U.S.A. 55 TECHNOLOGY DRIVE, SUITE 201 LOWELL, MA 01851-5203 1-800-836-2674 (1-800-MEMCOR-4)</td> <td>AUSTRALIA 1 MEMTEC PARKWAY, SOUTH WINDSOR, NSW 2756 TEL +61 (0) 2 4577 6800</td> <td>U.K. OUTRAMS WHARF, LITTLE EATON, DERBY, ENGLAND, DE1 5EL TEL +44 (0) 1332 387300</td> </tr> </table>	U.S.A. 55 TECHNOLOGY DRIVE, SUITE 201 LOWELL, MA 01851-5203 1-800-836-2674 (1-800-MEMCOR-4)	AUSTRALIA 1 MEMTEC PARKWAY, SOUTH WINDSOR, NSW 2756 TEL +61 (0) 2 4577 6800	U.K. OUTRAMS WHARF, LITTLE EATON, DERBY, ENGLAND, DE1 5EL TEL +44 (0) 1332 387300
U.S.A. 55 TECHNOLOGY DRIVE, SUITE 201 LOWELL, MA 01851-5203 1-800-836-2674 (1-800-MEMCOR-4)	AUSTRALIA 1 MEMTEC PARKWAY, SOUTH WINDSOR, NSW 2756 TEL +61 (0) 2 4577 6800	U.K. OUTRAMS WHARF, LITTLE EATON, DERBY, ENGLAND, DE1 5EL TEL +44 (0) 1332 387300			
DO NOT SCALE ALL DIMENSIONS IMPERIAL	SCALE: NONE	DRAWING 920077 9200770500			
		SHEET 3 OF 4 STATUS REL			

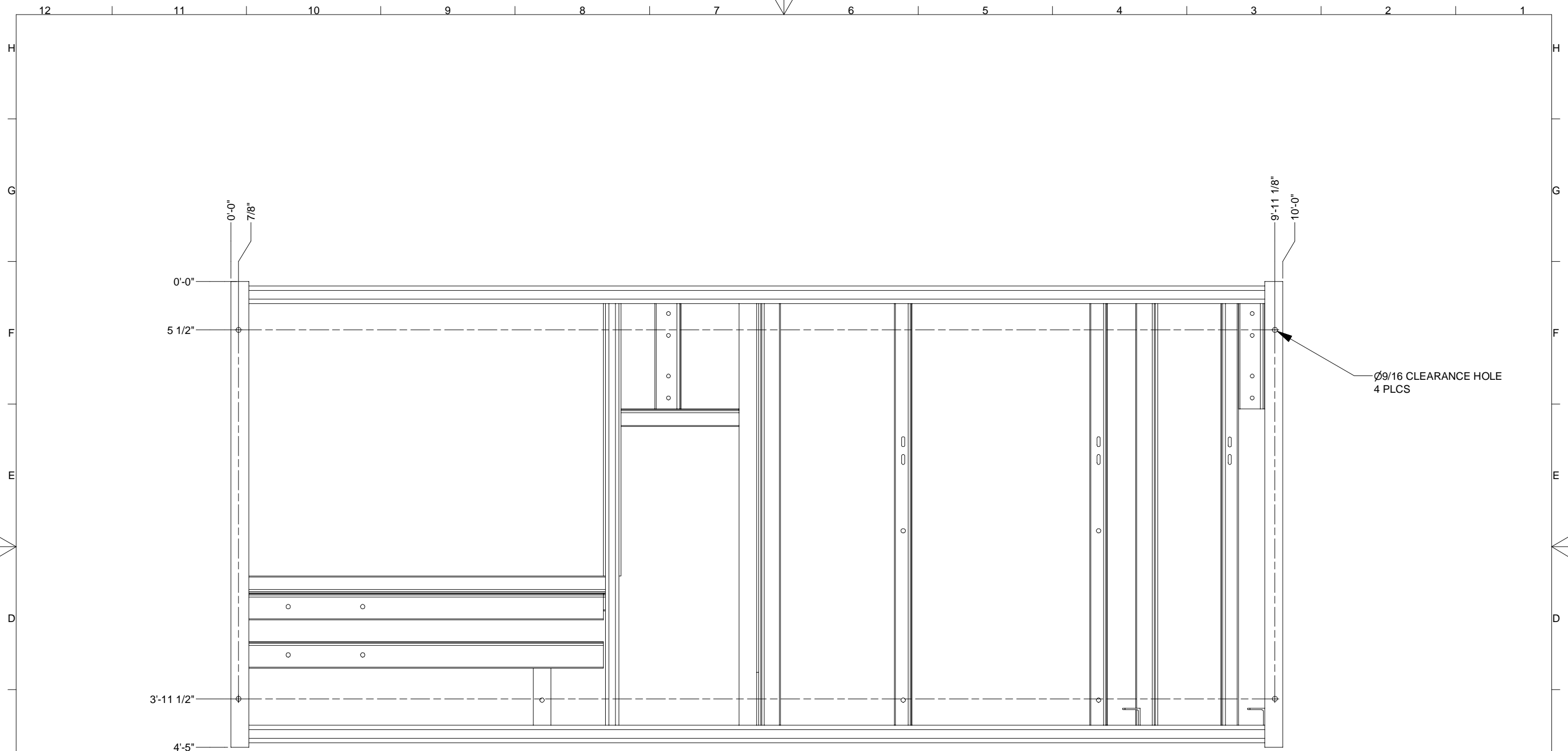

VIEW F-F
ANCHOR BOLT LOCATION

2 NO CHANGES THIS SHEET

TOLERANCES
UNLESS OTHERWISE SPECIFIED
LINEAR:
.XX = ±.06
.XXX = ±.031
X/XX = ±1/16
ANGULAR:
0° = ±.50°

NO.	DESCRIPTION	DATE	DWN	CHKD	APVD	ECR
3	UPDATE DRAWINGS AND RE-BRANDING NAME	10/13/2014	GDC	SMKB	JBT	2032-1391
2	UPDATE VIEWS, TERMINATION POINTS A, C & F ELEVATION DIMENSION CHANGED, ADDED TP-H	3/5/2013	RV	ST	ST	2032-1278
1	UPDATED WITH STRUCTURAL CHANGES TO FRAME	9/16/2011	SMKB	SJT	TPD	1012-767
0	INITIAL ISSUE	5/3/2011	RV	W.McL	STJ	

COMPANY CONFIDENTIAL
DOCUMENT AND ALL INFORMATION CONTAINED HEREIN ARE THE PROPERTY OF EVOQUA AND/OR ITS AFFILIATES. THE DESIGN CONCEPTS AND INFORMATION CONTAINED HEREIN ARE PROPRIETARY TO EVOQUA AND ARE SUBMITTED IN CONFIDENCE. THEY ARE NOT TRANSFERABLE AND MUST BE USED ONLY FOR THE PURPOSE FOR WHICH THE DOCUMENT IS EXPRESSLY LOANED. THEY MUST NOT BE DISCLOSED, REPRODUCED, LOANED OR USED IN ANY OTHER MANNER WITHOUT EXPRESS WRITTEN CONSENT OF EVOQUA. IN NO EVENT SHALL THEY BE USED IN ANY MANNER DETRIMENTAL TO THE INTEREST OF EVOQUA. ALL PATENT RIGHTS ARE RESERVED UPON THE REQUEST OF EVOQUA. THIS DOCUMENT, ALONG WITH ALL COPIES AND EXTRACTS, AND ALL RELATED NOTES AND ANALYSES, MUST BE RETURNED TO EVOQUA OR DESTROYED, AS INSTRUCTED BY EVOQUA. ACCEPTANCE OF THIS DELIVERY OF THIS DOCUMENT CONSTITUTES AGREEMENT TO THESE TERMS AND CONDITIONS.

DRAWN RV	DATE 5/2/2011	TITLE XPsr 18-24 PUMPED AND PRESSURIZED FEEDS GENERAL ARRANGEMENT
CHECKED SJT	DATE 5/3/2011	CLIENT MEMCOR STANDARD
APPROVED W.McL	DATE 5/3/2011	
		U.S.A. 55 TECHNOLOGY DRIVE, SUITE 201 LOWELL, MA 01851-5203 1-800-836-2674 (1-800-MEMCOR-4)
AUSTRALIA 1 MEMTEC PARKWAY, SOUTH WINDSOR, NSW 2756 TEL +61 (0) 2 4577 6800		U.K. OUTRAMS WHARF, LITTLE EATON, DERBY, ENGLAND, DE21 5EL TEL +44 (0) 1332 387300
DO NOT SCALE ALL DIMENSIONS IMPERIAL	SCALE: NONE	PROJECT 920077
		DRAWING 9200770500
		SHEET 4 OF 4
		STATUS REL

APPENDIX D – REPORTS

10% Design Report

Cave Rock Water System Improvements

Douglas County

DOUGLAS COUNTY

NOV 03 2008

October 2008

PUBLIC WORKS

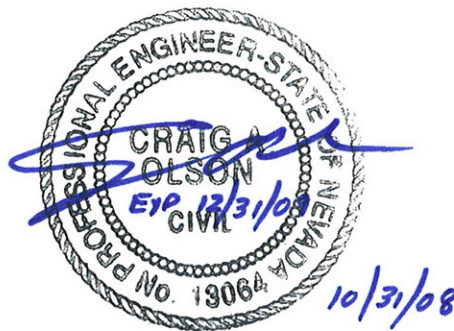

Prepared under the responsible charge of

Craig A. Olson
13064

HDR

2365 Iron Point Road, Suite 300
Folsom, CA 95630

Contents

- Chapter 1 - Executive Summary..... 1
 - Introduction..... 1
 - Basis for Design 1
 - Recommended Project..... 2
 - Project Implementation..... 2
- Chapter 2 - Introduction 3
 - Purpose 3
 - Scope..... 3
 - Background Information 3
 - Project Personnel 6
 - Owner 6
 - Consulting Engineer 6
 - Permitting 7
 - Surveying 7
 - Geotechnical 7
 - State Agencies 7
- Chapter 3 - Basis for Design..... 8
 - Pressure Zone Breakdowns 8
 - Water Usage Demands 8
 - Design Flow Design Criteria 10
 - Pressure Head Design Criteria..... 11
 - Low Pressure Zone Booster Pumps Design Criteria (Current Peak Flow of 875 GPM)..... 12
 - High/Medium Pressure Zone Booster Pumps Design Criteria 12
 - Pipe Size Design Criteria..... 12
 - Flow and Pressure Design Criteria..... 12
 - Fire Supply Criteria..... 12
- Chapter 4 - Recommended Project..... 13
 - Booster Pumps Removal and Reconfiguration 13
 - System Description and Layout..... 13
 - Low Pressure Zone Pumps 13
 - Medium and High Pressure Zone Pumps 18
 - Water Treatment Plant Flow Controls 21
 - Water Treatment Plant Flow Controls 21
 - Upper Cave Rock Booster Station Pumps 21
 - Cave Rock Water Treatment Plant Modifications..... 21
 - Water Main Replacements, Installations and Modifications..... 23
 - Cave Rock Road and Winding Way High Pressure Main..... 23
 - Sugar Pine Circle Area..... 23
 - Canyon Circle Area 23
 - Water Mains, Flow Control Valve, and PRV in Cedar Ridge Drive 27
 - Water Mains, Flow Control Valve, and PRV in Cedar Ridge Drive 27
 - Water Main between Pheasant Drive and Gull Court 27
 - Waterline under Highway 50 at Lakeridge 27
 - Pressure Reducing Valves (PRV's) and Control Valves 31
 - Pipe Materials 31
 - Utility Coordination 31
 - Electrical 31
 - Pavement Repair and Site Restoration 33
 - TRPA Permitting..... 33
 - Geotechnical..... 33

Demolition Work 33

Chapter 5 - Project Implementation..... 34

 Construction Documents 34

 Sheet List 34

 Specifications List..... 35

Appendix A - Project Schedule 39

Appendix B - Project Cost..... 40

Figures

Figure 2-1. Cave Rock Area Scope Summary..... 4

Figure 2-2. Lakeridge Area Scope Summary 5

Figure 3-1. Pressure Zones 9

Figure 4-1. New Project Pumping Strategy Schematic 14

Figure 4-2. Plan View of Pumping Room at Water Treatment Plant 15

Figure 4-3. Section Views of Pumping Room at Water Treatment Plant 16

Figure 4-4. Vertical Turbine Pump Flow Range for Low Pressure System 17

Figure 4-5. Pump Flow Range for High/Medium Pressure Zones..... 19

Figure 4-6. Pump Flow Range for High/Medium Pressure Zones..... 20

Figure 4-7. Treatment Plant Modifications 22

Figure 4-8. Cave Rock Drive High Pressure Transmission Main 24

Figure 4-9. Sugar Pine Circle Water Main 25

Figure 4-10. Canyon Circle Modifications..... 26

Figure 4-11. Cedar Ridge Drive Water Main and Modifications 28

Figure 4-12. Pheasant Drive to Gull Court Waterline 29

Figure 4-13. U.S. Highway 50 Water Main Crossing..... 30

Tables

Table 1-1. Design Head and Flow Conditions 1

Table 3-1. Summary of 1996-2006 Water Usage Data 8

Table 3-2. Water System Connections 10

Table 3-3. Average Summer Water Demand per Zone 10

Table 3-4. Water Demand Percentages per Zone..... 10

Table 3-5. Design Flows 11

Table 3-6. Pressure Head Conditions..... 11

Table 3-7. Required Residual Pressures..... 12

Table 4-1. Medium and High Pressure Zone Pump Suction Pressures 18

Table 4-2. Cave Rock WTP Electrical Loads..... 32

Chapter 1 - Executive Summary

The recommendations of the 10% Design Report for the Cave Rock Water System Improvements project are presented in this report. Descriptions of the existing water system, project design requirements, the basis for design, and the implementation of the recommended project are presented herein.

Introduction

In January 2007, Douglas County prepared a fiscal year 2006/2007 rate study for the Cave Rock / Skyland Water System to incorporate estimated costs for capital improvements over the next five years. The rate study addressed the critical needs and deficiencies in the water system, including deficient booster pumping stations, undersized water lines with excessive repair history, and water tank storage deficiencies. From this rate study and capital improvement project, five alternatives were developed by Douglas County in a Technical Memorandum completed by Ron Roman on April 10, 2008. This project addresses the water system's most critical and immediate needs.

Basis for Design

Water usage demand data for the Cave Rock and Skyland areas from 1996 through 2006 was used to determine the average usage in the each of the three pressure zones. The new pumping system is sized to operate up to a flow rate of to 1,000 gpm. The 1,000 gpm maximum flow rate is broken down by percentage into the pressure zones below.

Table 1-1 shows the design flow and head conditions for each pressure zone.

Table 1-1. Design Head and Flow Conditions

Pumps	Design Flow	Primary Design Head	Secondary Design Head
High/Medium Pressure Zone Pumps	277 gpm	208 ft	384 ft
Low Pressure Zone Pumps ¹	1000 gpm	323 ft	--

Note: A pipe coefficient of 120 was used in these calculations. The high/medium pressure zones pump off of the pressure created by the low pressure zone. The two design heads for the high and medium pressure zones are created by the low pressure zone pumps being ON or OFF. ON creates the primary design head. OFF creates the secondary design head.

¹ The Low Pressure Zone pumps are sized to deliver 723 gpm to the low pressure zone under future conditions. The current pumping strategy would deliver a maximum of 598 gpm to the low pressure zone. A pumping capacity of 1,000 gpm provides future flow to all the zones simultaneously. Further explanation of this configuration is in Chapter 3 – Basis of Design.

Recommended Project

The recommended project includes the following components:

- ◆ Installation of a high pressure transmission main in Cave Rock Drive.
- ◆ Pressure reducing valve modifications.
- ◆ Replacement of water mains in Sugar Pine Circle and Lincoln Circle
- ◆ Replacement of the water main and the installation of a fire hydrant and PRV station at Canyon Circle.
- ◆ Installation of a water main, flow control valve, fire hydrant and PRV in the Cedar Ridge area.
- ◆ Installation of a water main between Pheasant Drive and Gull Court.
- ◆ Installation of a water line and casing pipe under Highway 50 at Lake Ridge Drive.
- ◆ Modification of the Cave Rock Water Treatment Plant (WTP) to house new pumps and facilitate a new pumping strategy.
- ◆ Removal of the existing Lower and Upper Cave Rock, Hidden Woods, and Cedar Ridge booster stations.
- ◆ Installation of baffling in the chlorine contact basin in Cave Rock WTP.
- ◆ Install pressure reducing valve and flow control valve station between high pressure zone and medium pressure zone.
- ◆ Demolition work, as required.

Project Implementation

The construction documents for this project are scheduled to be completed by the end of 2008, with construction complete by the end of 2009. The opinion of probable construction cost for the recommended facilities is approximately \$2.8 million.

Chapter 2 - Introduction

Purpose

The purpose of this Preliminary Design Report is as follows:

- ◆ Define the basis and scope of detailed design.
- ◆ Describe modifications and their purpose in the water system piping and pumping. This information will serve as the basis for the preparation of contract construction documents.
- ◆ Present a tentative schedule of activity for the project, including a timeline for both the design and construction of the project.
- ◆ Provide an opinion of the probable construction cost for the recommended project.

Scope

This report includes both the general and conceptual information and basic details regarding the design of Cave Rock/Skyland Water System improvements. The system improvements include the installation of new booster pumps, the removal of existing booster stations, waterline replacements and installations, PRV and control valve installations, and wet well baffling at the water treatment plant (WTP). These improvements will reduce system maintenance costs and energy usage, and improve fire protection, reliability, and redundancy.

Figure 2-1 and Figure 2-2 show the locations of the improvements.

Background Information

The Cave Rock water system is located near the eastern shore of Lake Tahoe, approximately seven miles north of the California/Nevada state line on U.S. Highway 50. The water system pumps water via turbine pumps (lake pumps) that are currently installed along a 1500 foot pipe line on the bottom of Lake Tahoe. This water is conveyed to the 875 gpm capacity membrane WTP, located just across U.S. Highway 50 from Lake Tahoe. The lake pumps currently operate to deliver 520 gpm or 875 gpm to the WTP. The existing turbine pumps that pump effluent flow out of the WTP also operate at 520 gpm or 875 gpm, to match the flow that the WTP receives.

Cave Rock WTP treated water is pumped to Lakeridge Tank by the existing treatment plant high service pumps. A portion of the water pumped to Lakeridge Tank is conveyed to the lower Cave Rock tank by the Lower Cave Rock Booster Pumping Station. Some of this water is boosted again by the Upper Cave Rock Booster Pumping Station to the Upper Cave Rock Tank. Another portion of the water that is pumped to the Lakeridge Tank is conveyed to the Hidden Woods Tank by Hidden Woods Booster Pumping Station. The final portion of water that is not retained in Lakeridge Tank or pumped to the Lower Cave Rock or Hidden woods tanks flows into the Skyland tank by gravity.



LAKE
TAHOE

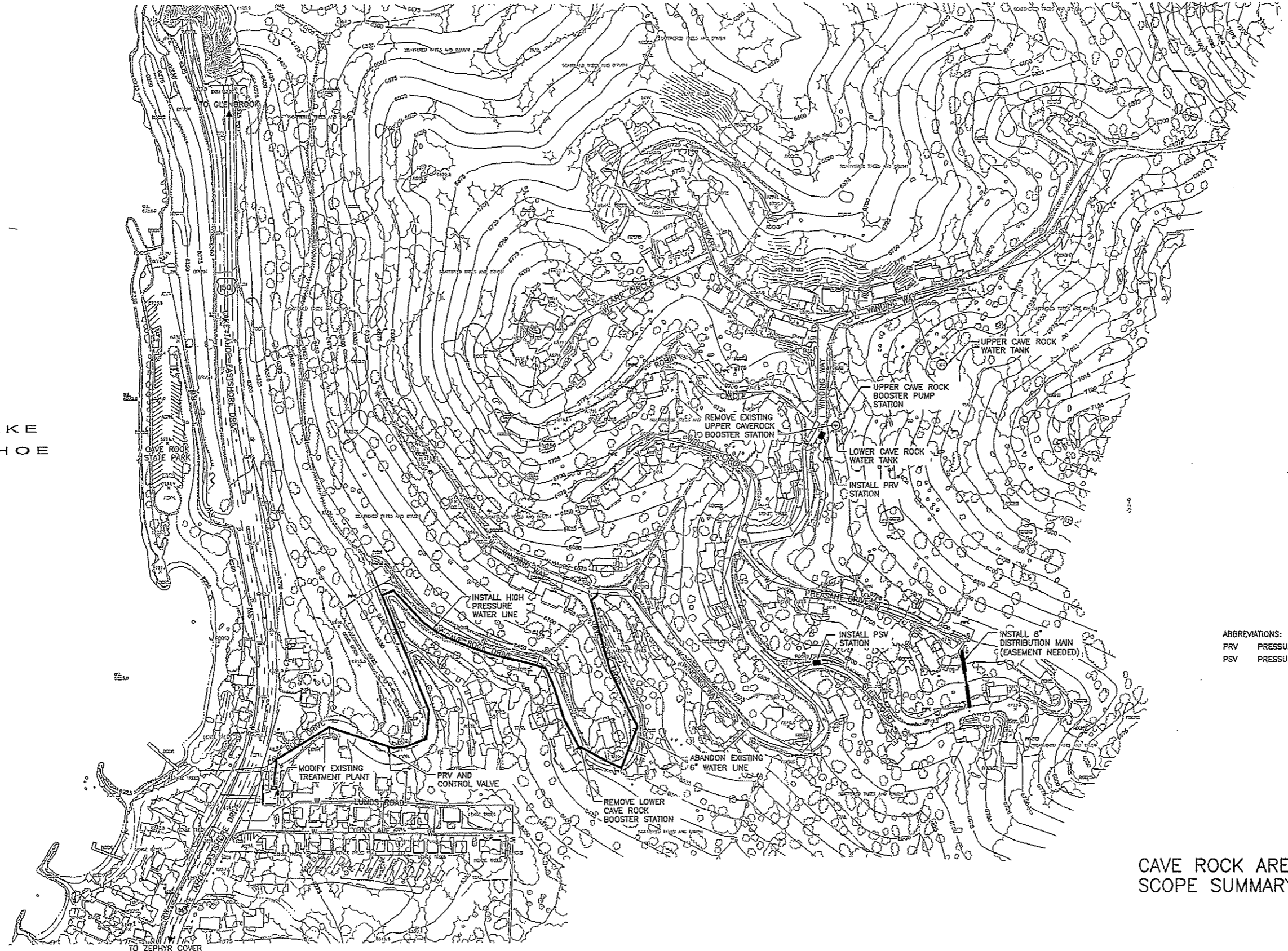

ABBREVIATIONS:
PRV PRESSURE REDUCING VALVE
PSV PRESSURE SUSTAINING VALVE

CAVE ROCK AREA
SCOPE SUMMARY



FILE: RDR-F2-01.dwg
DATE: Oct 27, 2008 - 11:47:27am bdown

Figure 2-1

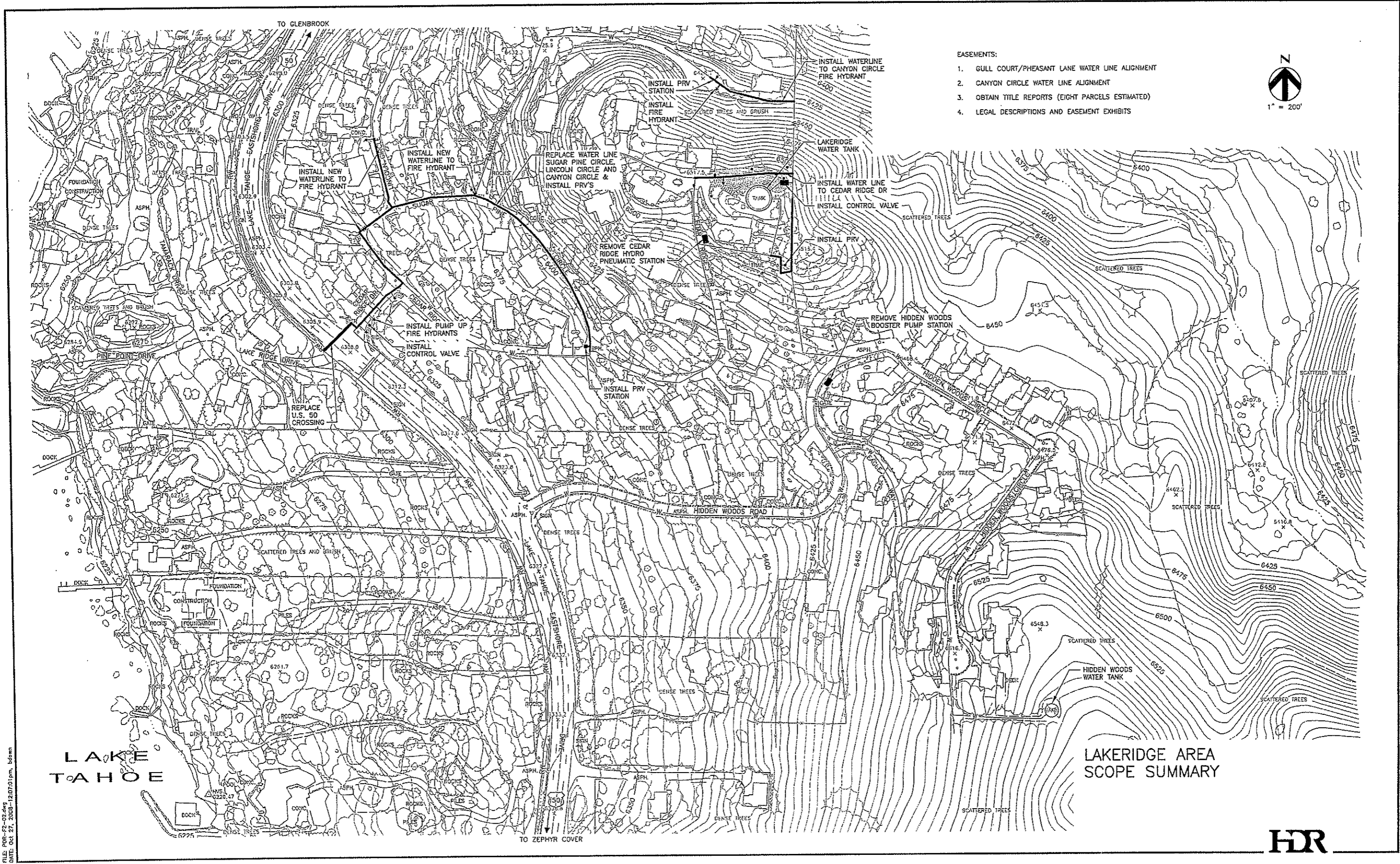

- EASEMENTS:
1. GULL COURT/PHEASANT LANE WATER LINE ALIGNMENT
 2. CANYON CIRCLE WATER LINE ALIGNMENT
 3. OBTAIN TITLE REPORTS (EIGHT PARCELS ESTIMATED)
 4. LEGAL DESCRIPTIONS AND EASEMENT EXHIBITS



LAKERIDGE AREA
SCOPE SUMMARY



FILE: P06-F2-02.dwg
DATE: Oct 27, 2003 - 12:07:01 pm, bdevn

Figure 2-2

The following summary presents the issues in the existing water system:

- ◆ Fire flow requirements are not met in the system. The system relies on tank storage to provide the required fire flow capacities. This leaves large areas, especially homes close to tanks, with very little, if any, fire protection.
- ◆ The water system contains old and leaking lines that have an extensive repair history. These waterlines decrease the system's reliability, are inefficient, and drive up the system's maintenance costs.
- ◆ Existing booster pumping stations do not meet code requirements. Currently, three of the four booster pump stations are located in underground vaults. This does not meet the State of Nevada's Sanitary Survey regulations.
- ◆ Currently, all of the water that is used in the low pressure service area, (72 percent of the total water usage) is being pumped to the Lakeridge Tank, which is located 100 feet above Skyland Tank.

Project Personnel

Owner

Douglas County

US Mail Address
1594 Esmeralda Ave.
P.O. Box 18
Minden, NV 89423

Overnight Address
1120 Airport Toad, Bldg. F-2
Minden, NV 89423

Telephone Number (775) 782-6230
FAX Number (775) 782-9007

Contacts

Carl Ruschmeyer, Public Works Director
Ron Roman, Senior Civil Engineer

Consulting Engineer

HDR Engineering, Inc.

2365 Iron Point Road
Folsom, CA 95630

Telephone Number (916) 817-4700
FAX Number (916) 817-4747

Contacts

Robert Williams, Principal-in-Charge
Craig Olson, Project Manager
Bill Ettlich, Electrical Engineer
Robert Natoli, Project Engineer

Permitting**Resource Concepts, Inc.**

340 N. Minnesota Street

Carson City, NV 89703

Contact

Kathy Canfield

Telephone Number (775) 883-1600

FAX Number (775) 883-1656

Surveying**Turner & Associates**

308 Dorla Court, #203

Zephyr Cove, NV 89448

Contact

Ron Turner

Telephone Number (775) 588-5658

FAX Number (775) 588-9296

Geotechnical**Pezonella Associates, Inc.**

520 Edison Way

Reno, NV 89502

Contact

Chris Betts

Telephone Number (775) 856-5566

FAX Number (775) 856-6042

State Agencies**Tahoe Regional Planning Agency (TRPA)**

128 Market Street

P.O. Box 5310

Stateline, NV 89449

Telephone Number (775) 588-4547

FAX Number (775) 588-4527

Nevada Division of Environmental Protection (NDEP)

901 S. Stewart Street, Suite 4001

Carson City, NV 89701-5249

Telephone Number (775) 687-9444

FAX Number (775) 687-5856

Chapter 3 - Basis for Design

This section presents a summary of the design criteria, assumptions, water usage data and system pressure zones that were used to establish the basis of design for the Cave Rock Water System pumping and piping improvements.

Pressure Zone Breakdowns

The Cave Rock/Skyland Water System will be broken into three zones for design purposes. These zones will be referred to as the high pressure, medium pressure, and low pressure zones. The high pressure zone contains the Lower Cave Rock and Upper Cave Rock tanks. Houses along Cave Rock Road and the streets branching from Cave Rock Road are serviced from this zone. The medium pressure zone contains the Lakeridge and Hidden Woods tanks. Houses in the Lakeridge development on the east side of U.S. Highway 50 are serviced from this zone. The low pressure zone contains Skyland Tank. It services homes in the Skyland, Bedell, and Lyons areas, the Lakeridge development on the west side of U.S. Highway 50, as well as two schools, a library, Lincoln Park and some commercial buildings.

Figure 3-1 provides a visual delineation of these three pressure zones.

Water Usage Demands

Douglas County recorded water usage data from 1996 to 2006 for the Cave Rock/Skyland system. This data was recorded for two portions of the system, labeled Cave Rock and Skyland as shown in Table 3-1. Water usage increases in summer months, requiring summer usage data to be used as the basis of design.

Table 3-1. Summary of 1996-2006 Water Usage Data

Water Usage Data – Average Summer Usage	
Cave Rock System	186 gpm
Skyland System	267 gpm
Total	454 gpm

The data labeled as the Cave Rock system includes all of the high and medium pressure zones and a portion of the low pressure zone. The data labeled as the Skyland system includes the remainder of the low pressure zone. To determine the portions of the Cave Rock and Skyland usage data that will be used in the new pressure zones, it was necessary to know the number of connections in each pressure zone. This information is shown in Figure 3-1 and summarized again in Table 3-2. This data was gathered from sheets CRS1 through CRS4 that were received from Douglas County.

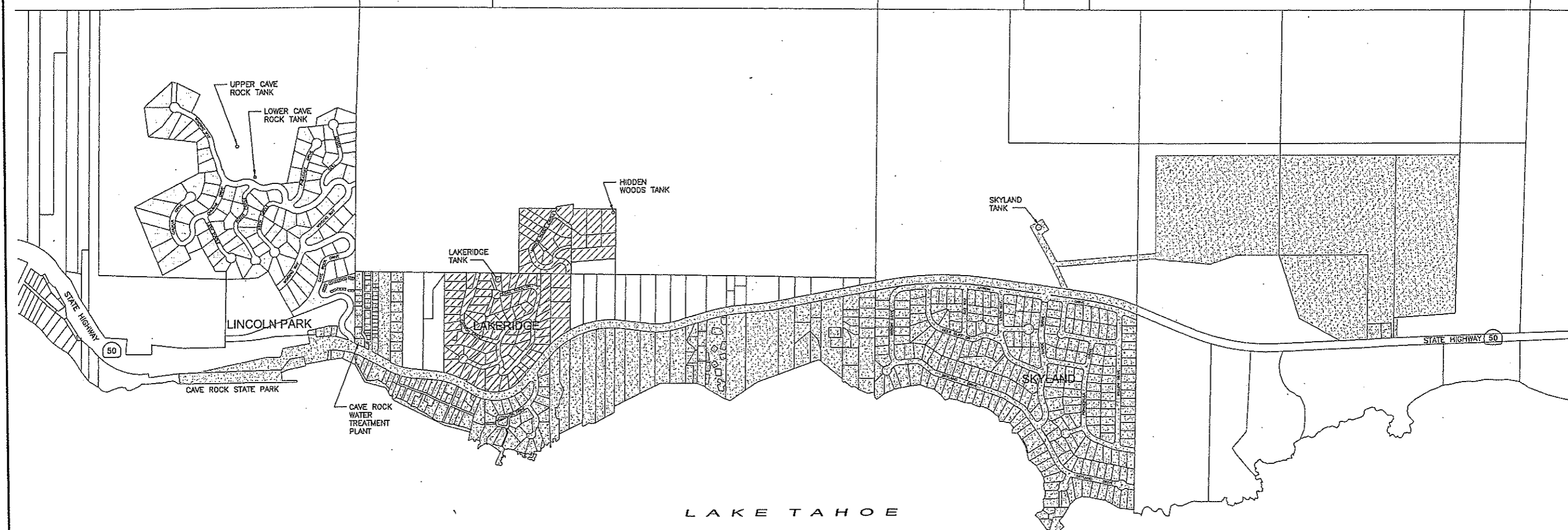
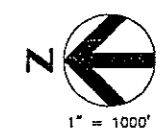

CONNECTIONS SUMMARY		
	EXISTING	BUILD OUT
HIGH PRESSURE ZONE	89	94
MEDIUM PRESSURE ZONE	79	87
LOW PRESSURE ZONE	325	406
TOTAL	493	587

LEGEND:

- LOW PRESSURE ZONE
- MEDIUM PRESSURE ZONE
- HIGH PRESSURE ZONE

PRESSURE ZONES



FILE: PDR-F3-01.dwg
DATE: Oct 27, 2008 - 1:25:56pm - bdown

Figure 3-1

Table 3-2. Water System Connections

CONNECTIONS SUMMARY		
	Existing	Build Out
High Pressure Zone	89	94
Medium Pressure Zone	79	87
Low Pressure Zone	325	406
Total	493	587

HDR used this information to determine how much water from the WTP each zone demands. Table 3-3 shows the water usage per zone and Table 3-4 shows the percentage of the total water flow used in each zone.

Table 3-3. Average Summer Water Demand per Zone

Zone	Flow
High Pressure Zone	67 gpm
Medium Pressure Zone	59 gpm
Low Pressure Zone	328 gpm
Total Existing Summer Usage	454 gpm

Table 3-4. Water Demand Percentages per Zone

Zone	Flow Percentage
High Pressure Zone	14.7%
Medium Pressure Zone	13.0%
Low Pressure Zone	72.3%

Design Flow Design Criteria

The design flows were determined by considering the water usage demands at the three pressure zones, the existing Cave Rock WTP standby generator capacity, the capacity of the Cave Rock WTP, and flow rates provided to the WTP by the lake pumps that draw water from Lake Tahoe. The previous section discusses water usage demands in the pressure zones; a further discussion of the effects of the generator, WTP capacity and lake pumps is included in this section.

The existing standby generator at the Cave Rock WTP is loaded close to its maximum capacity. There is no room in the generator room to increase its capacity. If the new pumps cannot be sized within the existing generator capacity, the load shedding of non-essential electrical equipment, (i.e. HVAC equipment) would be necessary.

Another limiting factor is the current 875 gpm WTP capacity. Pumping at rates above the WTP capacity will draw down the wet well and eventually shut down the pumps when the water level drops too low.

Ultimately, the low pressure pumps will need to be designed to operate by flow-matching the Cave Rock WTP's influent flow. Those flows are currently 520 gpm when one lake pump is operating and 875 gpm when two lake pumps are operating. These two influent flow rates can be adjusted by the valves on the influent side of the WTP.

In order to accommodate some growth in demand for the entire service area, a design flow rate of 1,000 gpm was selected for the low pressure zone pumps. In order to reach this design flow, the capacity of the Cave Rock WTP would have to be increased.

The flows listed in Table 3-5 divide the 1,000 gpm low pressure pumps design flow among the pressure zones using the percentages listed in Table 3-4. These flows provide a peaking factor of 2.20 for average summer day flows of 454 gpm, derived from the 1996 – 2006 water usage data.

Table 3-5. Design Flows

Design Flows	
High/Medium Pressure Zone	277 gpm
Low Pressure Zone	723 gpm
Total	1,000 gpm

All pumps will operate with a variable frequency drive (VFD) to allow operation at multiple points to accommodate current and future conditions.

Pressure Head Design Criteria

The low pressure zone pumps will be designed to provide flow to the entire system, but only provide the pressure head of the low pressure zone. The high/medium pressure zone pump will boost the pressure of the low pressure zone pump. This pumping strategy will create two pressure head conditions for the high/medium pressure zone pumps. If the low pressure zone pump is off, the high/medium pressure zone pumps will boost pressure from the static head provided by the low pressure zone water tank (Skyland water tank). If the low pressure zone pump is on the high/medium pressure zone pump will boost pressure from the low pressure zone pumps. The high/medium pressure zone pumps will operate at a reduced speed to account for the lower total dynamic head (TDH) required when the low pressure pumps are on.

Table 3-6 below summarizes these pressure head conditions.

Table 3-6. Pressure Head Conditions

Pumps	Primary Design Head ²	Secondary Design Head ³
High/Medium Pressure Zone Pumps	208 ft	384 ft
Low Pressure Zone Pumps	323 ft	--

² With low pressure zone pumps ON pumping 875 gpm total, 538 gpm to low pressure zone and 277 gpm for boosting to the high/medium pressure zones

³ With low pressure zone pumps OFF

Low Pressure Zone Booster Pumps Design Criteria (Current Peak Flow of 875 GPM)

Average Summer Water Demand: 328 gpm
 Pump Station Design Flow: 875 gpm
 Pump Station Design TDH: 323 feet (598 gpm being pumped to low pressure zone)

High/Medium Pressure Zone Booster Pumps Design Criteria

Average Summer Water Demand: 126 gpm
 Pump Station Design Flow: 277 gpm
 Primary Pump Station Design TDH: 384 feet (low pressure zone pump off)
 Secondary Pump Station Design TDH: 208 feet (low pressure zone pump on)

Pipe Size Design Criteria

Douglas County Design Criteria and Improvement Standards require a minimum 8-inch pipe diameter (Section 4.5 Distribution Mains). NAC 445A requires a minimum 6-inch diameter for all mains of a public water system (NAC 445A.67115)

Flow and Pressure Design Criteria

NAC 445A and the Douglas County Design Criteria and Improvement Standards require that water velocities remain below 8 feet per second during all flow conditions other than fire flow, and remain below 10 feet per second under fire flow conditions.

NAC 445A and the Douglas County Design Criteria and Improvement Standards for pressures in public water systems are summarized in Table 3-7.

Table 3-7. Required Residual Pressures

System Condition	Required Residual Pressure in the Distribution System
Fire flow during maximum day demand	Greater than 20 psi
Peak Hour Demand	Greater than 30 psi
Maximum Day Demand	Greater than 40 psi
All conditions	Must not exceed 100 psi

Water pressures in the Lincoln Park Area are in excess of 100 psi under existing conditions. With the recommended project, pressures in Lincoln Park will remain in excess of 100 psi when the low pressure zone pumps are on.

Fire Supply Criteria

The Tahoe-Douglas County Fire Protection District requires a fire flow of 1,500 gallons per minute for two hours.

Chapter 4 - Recommended Project

This section presents a summary of the design features developed for the Cave Rock water systems improvement project. These features were developed from the design criteria described in the previous section.

Booster Pumps Removal and Reconfiguration

Three of the four existing booster stations are located in underground vaults. Based on the State of Nevada Sanitary Survey, these facilities do not meet state regulations and need to be removed or relocated above ground. The Upper Cave Rock Booster Station will be relocated, and the remaining three existing booster stations (Lower Cave Rock, Hidden Woods, and Cedar Ridge Hydro-Pneumatic Station) will be removed. The removed booster stations will be replaced by booster pumps located inside the pump room in the existing Cave Rock WTP. Walls and access to the pump room will be adjusted to optimize space to fit the new pumps in the treatment plant.

System Description and Layout

Figure 4-1 shows the pumping and flow strategy of the new system. More discussion on the operation of the Low and High/Medium pressure zone pumps are included the following paragraphs.

Low Pressure Zone Pumps

The three existing vertical turbine pumps at the Cave Rock WTP will be removed and replaced with two new vertical turbine pumps installed over the clear well in the same location as the existing vertical turbine pumps.

Figure 4-2 and Figure 4-3 shows the location of these pumps.

The low pressure zone pumps will be sized to deliver a future peak flow of 1,000 gpm to the entire system. The pumps will operate on a VFD to accommodate current system flows. The low pressure zone pumps will be designed to reach the head requirements of the low pressure zone. This will enable the high/medium pressure zone pumps to operate by pulling portions of the flow from the low pressure zone pumps while the low pressure zone pumps simultaneously fill the Skyland Tank.

Figure 4-4 shows the pump flow range for the low pressure zone pumps.

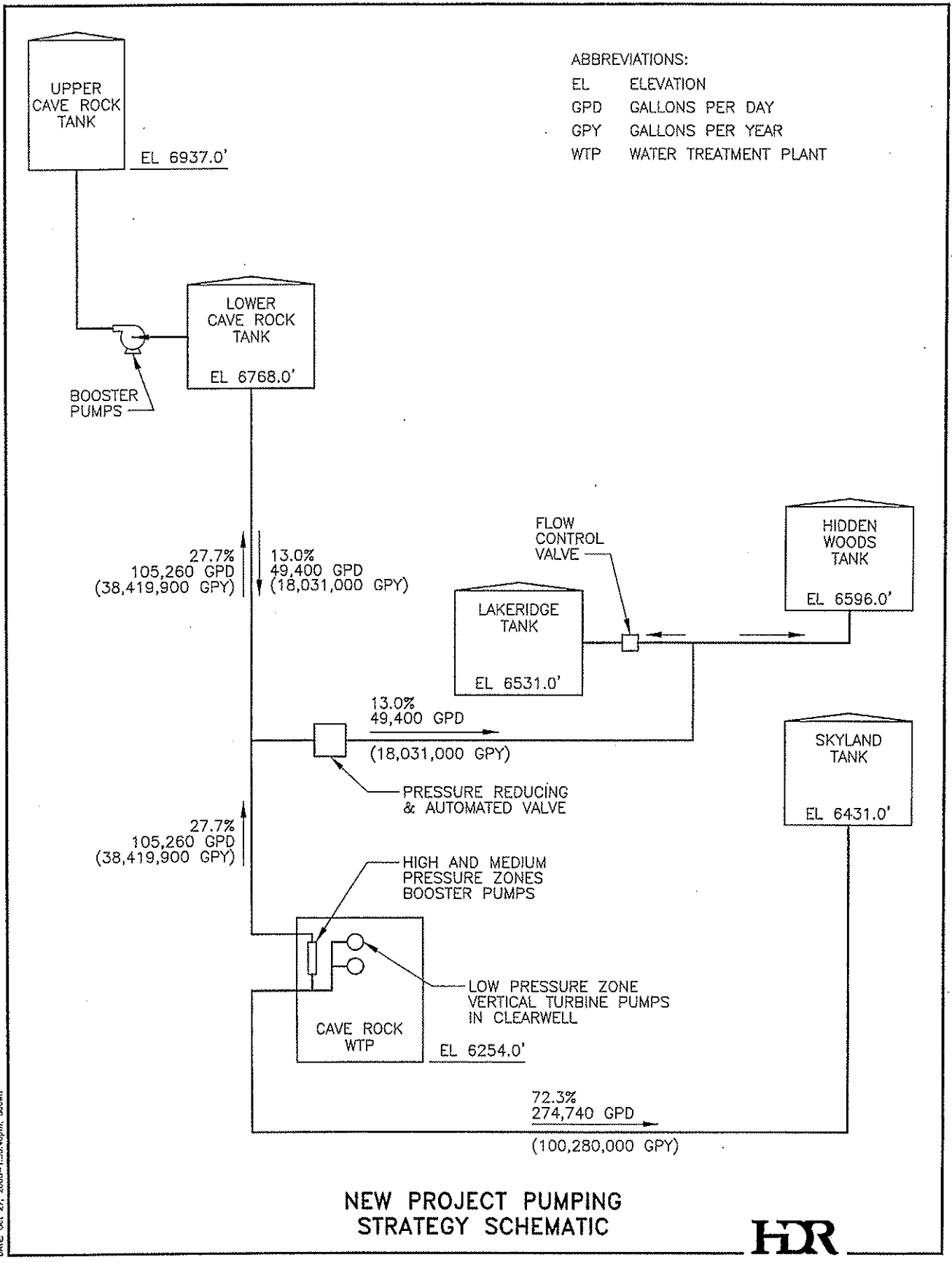

FILE: PDR-FA-01.dwg
 DATE: Oct 27, 2008 1:38:40pm bdeven



Figure 4-1

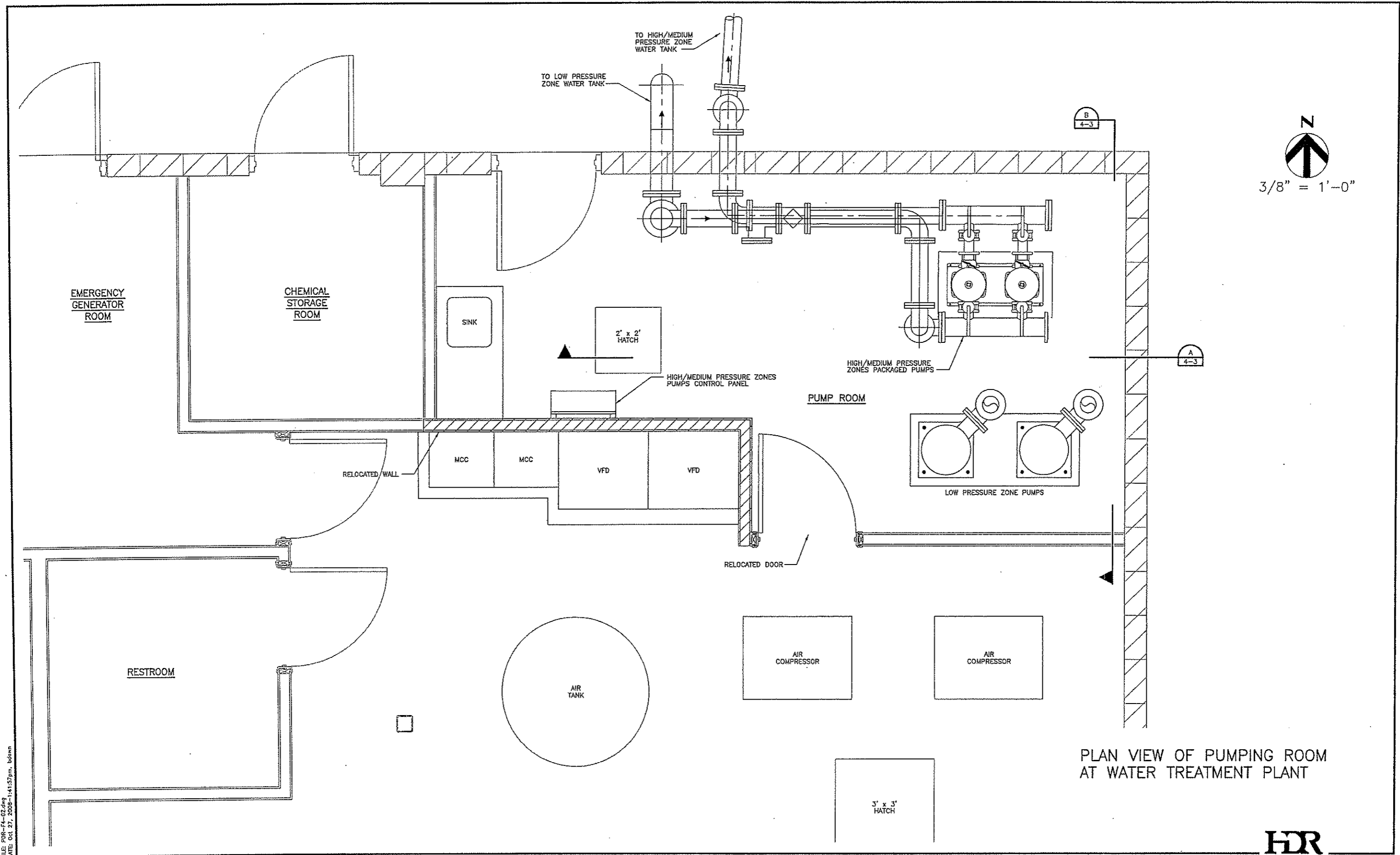

FILE: PDR-F4-02.dwg
DATE: OCT 27, 2009 - 1:11:57 PM, b4dmm

Figure 4-2

FILE: P08-F4-03.dwg
DATE: Oct 27, 2008-14:35pm, sdown

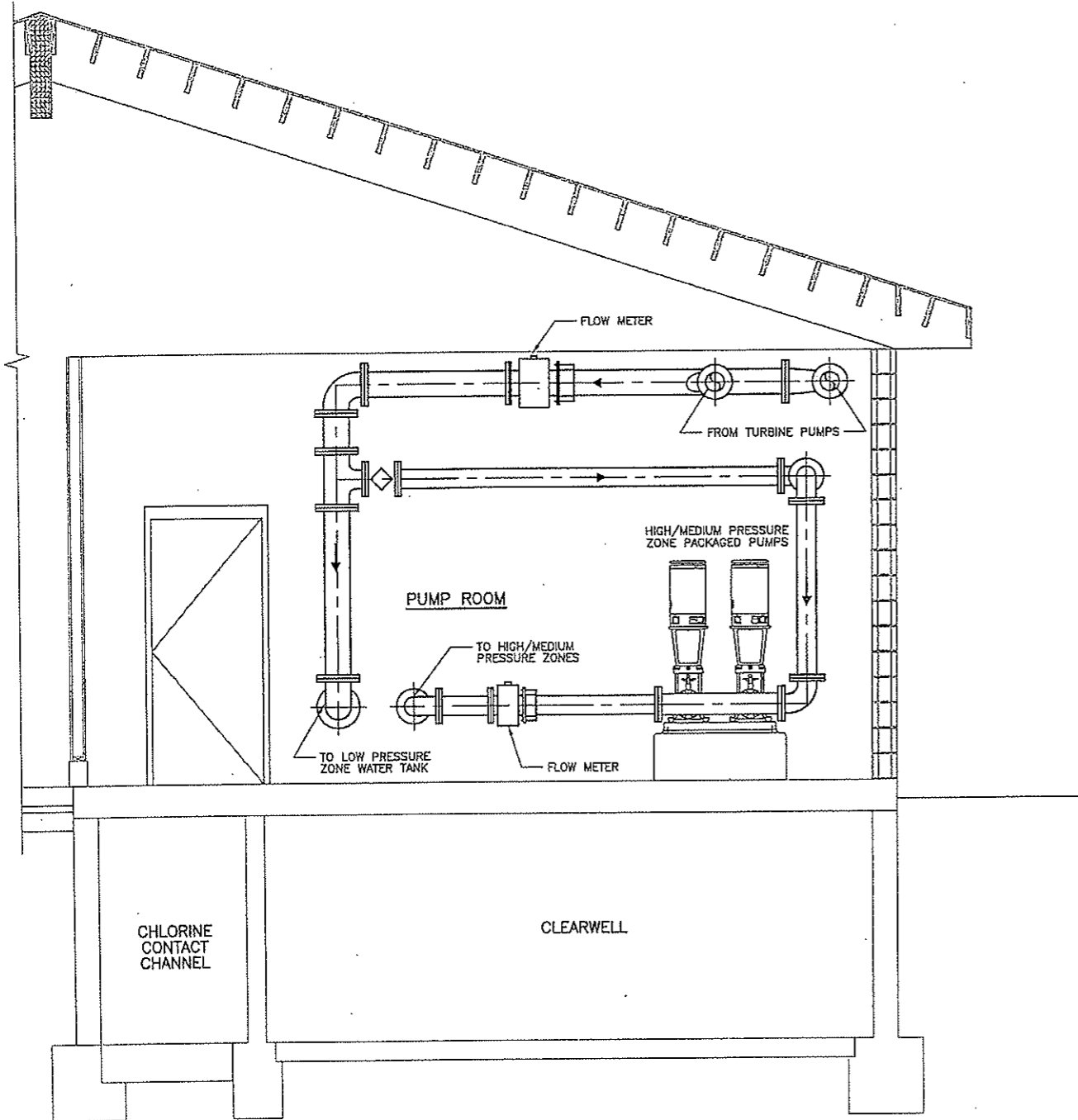

SECTION A
1/4" = 1'-0"

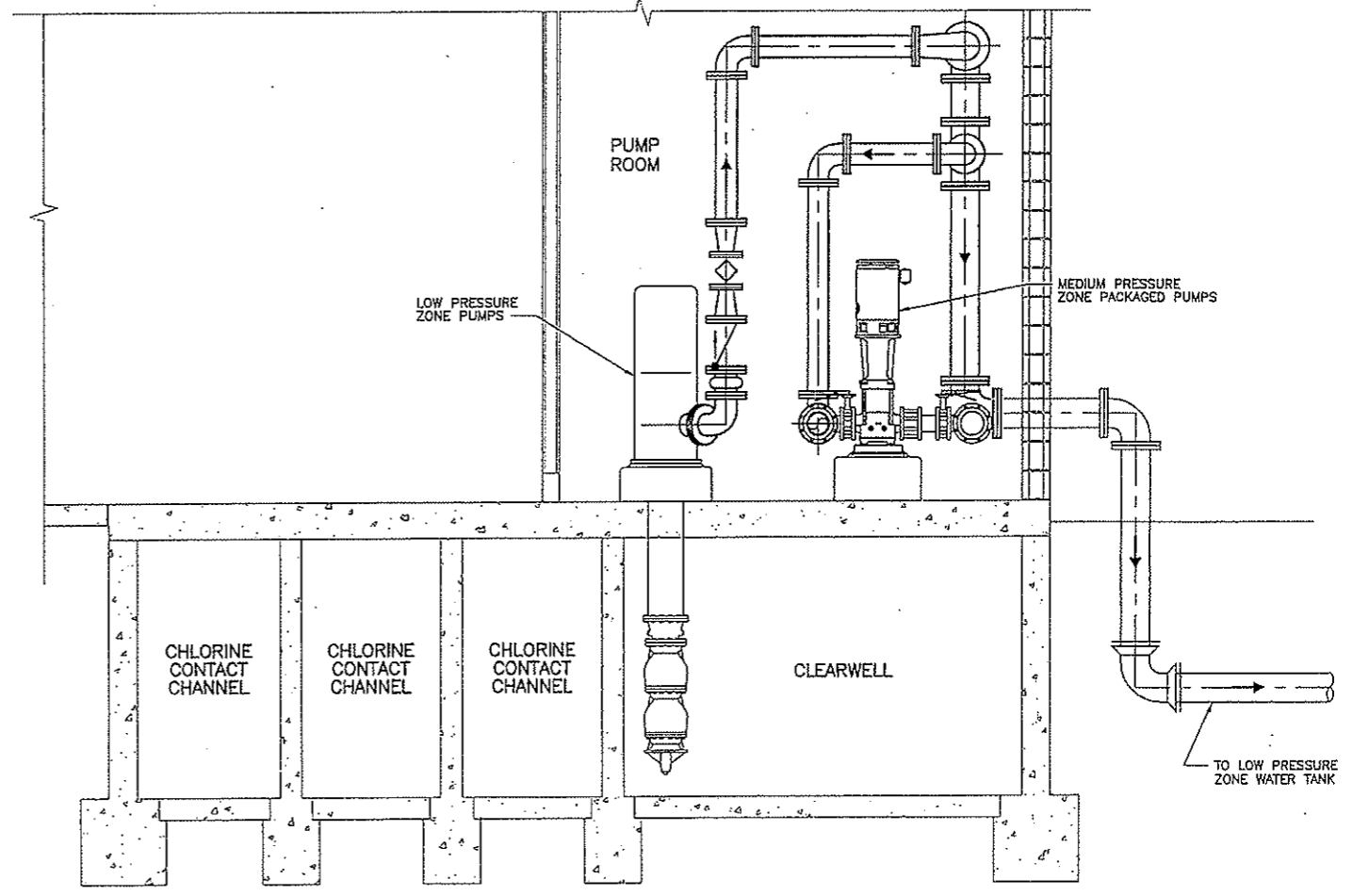

SECTION B
1/4" = 1'-0"

SECTION VIEWS OF PUMPING ROOM
AT WATER TREATMENT PLANT



Figure 4-3

Vertical Turbine Pump Flow Range for Low Pressure System

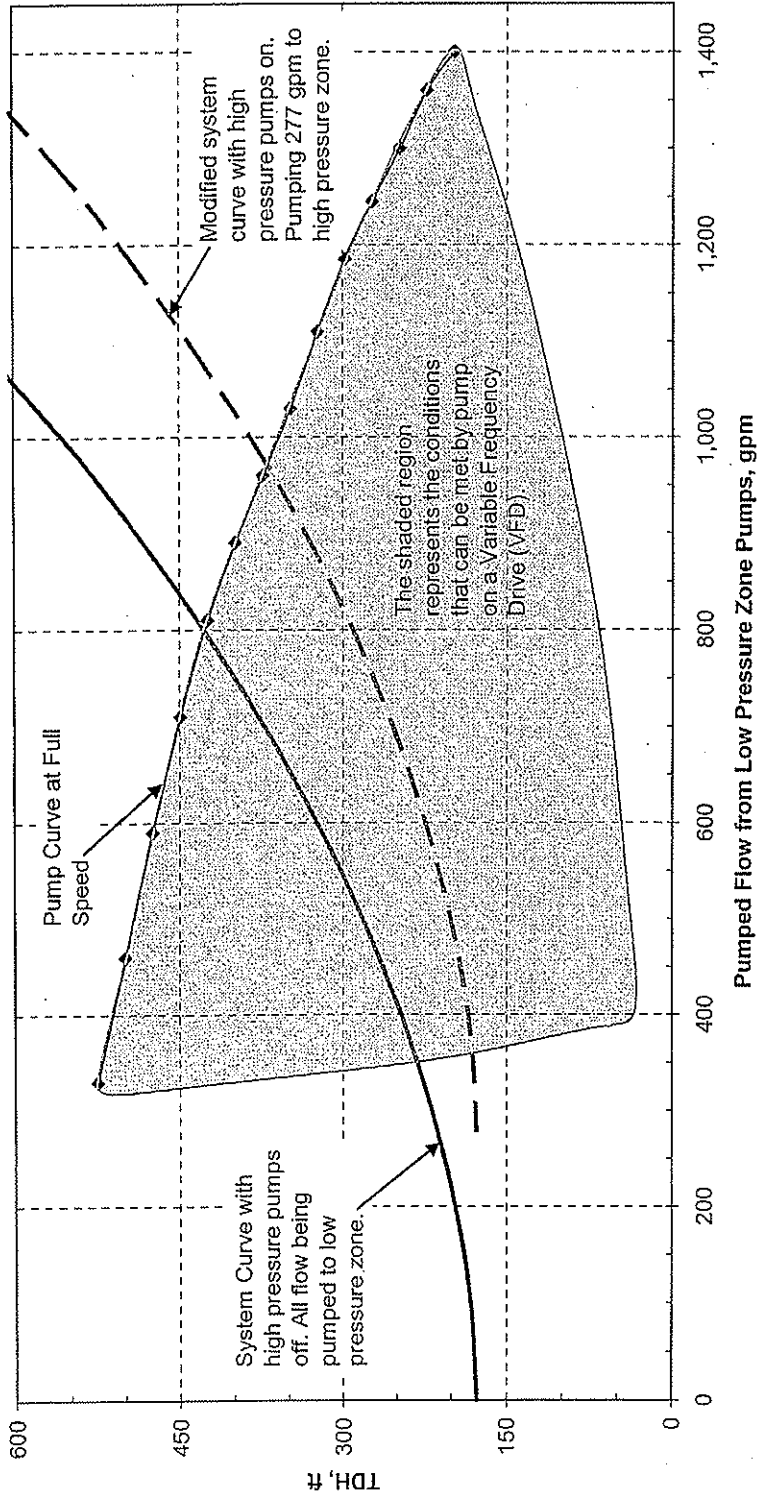

— Low Pressure System Curve, c=120 - - - Modified Low Pressure System Curve, c=120 —◆— 100 HP Vertical Turbine Pump

Figure 4-4

Medium and High Pressure Zone Pumps

Ron Roman’s Technical Memorandum No. 1, dated April 10, 2008, outlined the design of one set of pumps to pump to the high and medium pressure zones with a smart valve/PRV station to control flows to the different tanks on a demand basis. This set of pumps will be sized to deliver high and medium pressure zone water demands and to meet the head demands of the high pressure zone. The water that is sent to the medium pressure zone will pass through a pressure reducing valve (PRV) station that lowers the water pressure for conveyance to the medium pressure zone. Additionally, an electrically actuated control valve will be located in the PRV station. This valve will open to allow flow to the medium pressure zone when called by the Hidden Woods or Lakeridge water tank.

The high/medium pressure zone pump will boost water from the low pressure zone. This will be possible at any time, either by the system pressure created by the static head of the Skyland tank or by the system pressure generated when the low pressure zone pumps are in operation.

The suction pressure experienced by the high/medium pressure zone pumps will be the static head of the Skyland tank or the pressure head created by the low pressure zone pumps. These pressures are not equivalent. The pressure created by the pumps will be greater because the dynamic head and static head losses must be met by the pumps. These different suction pressures create the primary and secondary design head conditions for the pressure zones.

Table 4-1 summarizes this information.

Table 4-1. Medium and High Pressure Zone Pump Suction Pressures

Condition	Static Head	Dynamic Head	Total Suction Pressure high/medium pressure zone pumps see from Low Pressure Zone
Low Pressure Zone Pumps OFF	177 ft	-30 ft	147 ft
Low Pressure Zone Pumps ON	177 ft	146 ft	323 ft

Due to a spatial constraint in the Cave Rock WTP pumping room, the new pumps will be packaged pump systems. They will come equipped with all necessary fittings and a control cabinet.

VFDs will be provided for both high/medium pressure zone pumps. Figure 4-5 shows the pump range of the high/medium pressure zone pumps.

Figure 4-6 is an analysis of the extra costs associated with pumping medium pressure zone flows to the high pressure zone. The extra power cost will be approximately \$2,000.00 per year for the medium and high pressure zone pumps. However, the project will realize a net savings in power costs since low pressure zone supply is no longer being pumped to the medium pressure zone.

Pump Flow Range for High/Medium Pressure Zones

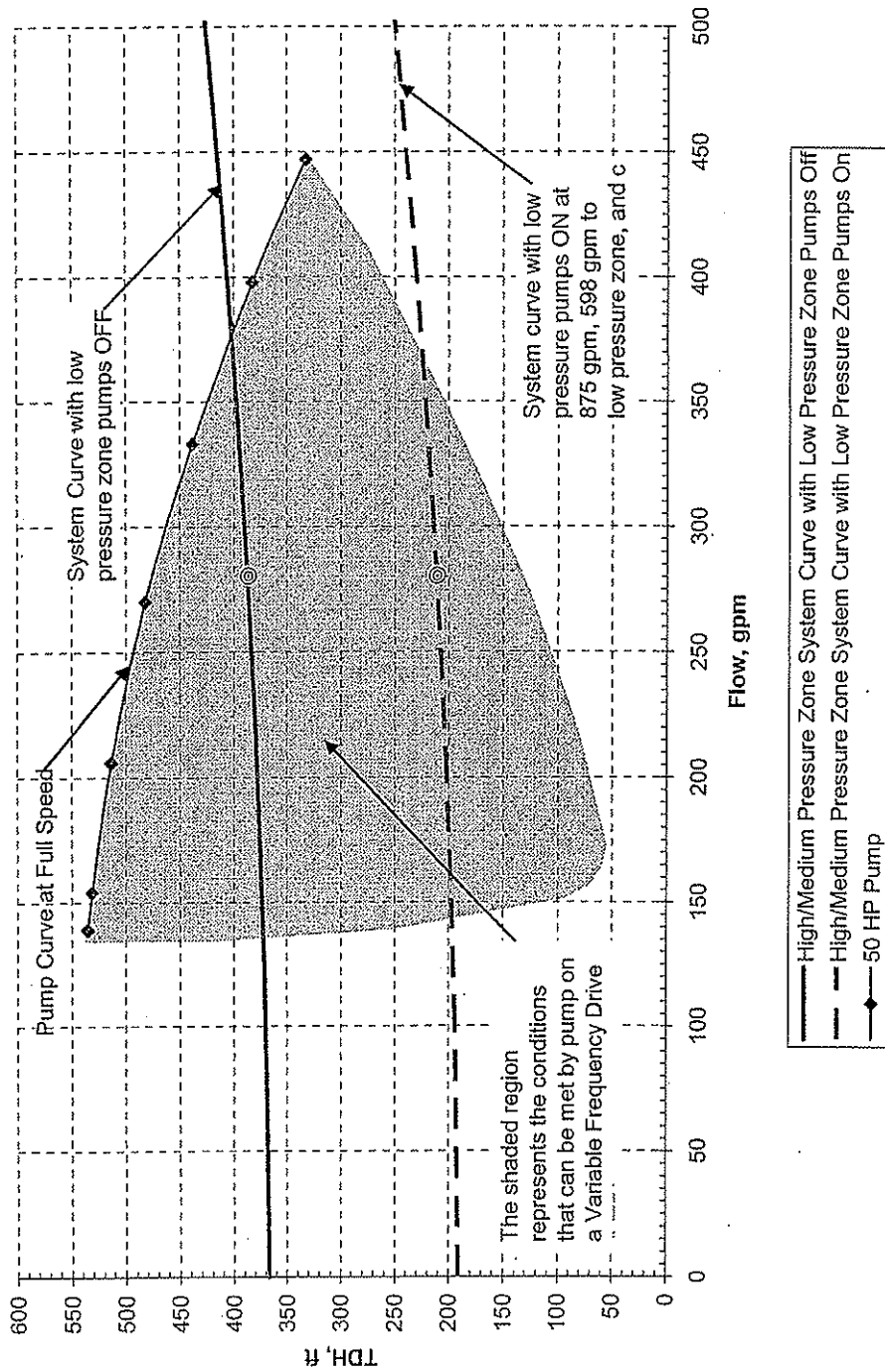

Figure 4-5

Cost Analysis for Pumping Medium Pressure Zone Flow to High Pressure Zone

Assumptions:

- Low Pressure pumps OFF
- Assume that 360,000 gallons per day of water will be used in entire Cave Rock Skyland Water System in 2009 (same assumption that Douglas County has made in past reports).
- The entire water systems usage will break down to the three pressure zones at the following percentages: 72.3% to Low Pressure Zone (LP - Skyland), 14.7% to High Pressure Zone (HP - Cave Rock), 13.0% to Medium Pressure Zone (MP - Lakeridge and Hidden Woods).
- All of the Medium Pressure (MP) zone water will be pumped to the Hidden Woods Tank in the pumping directly to the MP zone scenario.

Cave Rock Skyland Usage in Gallons

Year	Gallons of Usage
1992	110110201
1993	120565275
1994	129339043
1995	117553387
1996	139149472
1997	131776079
1998	123456817
1999	136027900
2000	144060100
2001	145484000
2002	134182000
2003	147621000
2004	154408100
2005	128542600
2006	136231500
Total	1998507474
Years of Data	15
Avg. Annual Usage	133233832 gal/year
Avg. Daily Usage	365024 gpd

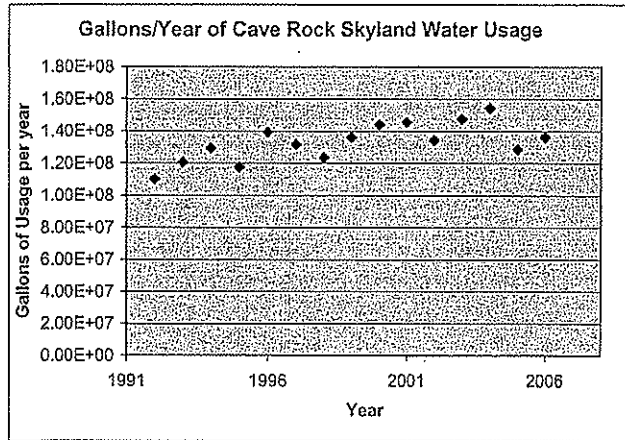

Pumping directly to the MP Zone

138,700,000 2009 Estimate Usage in gallons
 13.0% Percent of Usage to MP zone
 18,031,000 gallons to pump to MP zone

165 gpm pumping by pump using 9.7 HP
 109,278.8 minutes operation/year
 1,821.3 hours of operation/year
 9.7 HP used by pump
 7.2 KW used by pump
 13,161.7 KW-hrs per year
 \$0.14 \$/KW-hr

\$1,842.64 Cost of Pumping/Year

Pumping to the HP zone and burning head/allowing backflow

138,700,000 2009 Estimate Usage in gallons
 13.0% Percent of Usage to MP zone
 18,031,000 gallons to pump to MP Zone

210 gpm pumping by pump using 26.8 HP
 85,861.9 minutes of operation/year
 1,431.0 hours of operation/year
 26.8 HP used by pump
 20.0 KW used by pump
 28,572.0 KW-hrs per year
 \$0.14 \$/KW-hr

\$4,000.08 Cost of Pumping/Year

Costs Break Down

Cost to Pump to the HP zone and burn head per year	\$4,000.08
Cost to Pump to the MP zone directly per year	\$1,842.64
Estimated Additional Annual Pumping Costs	\$2,157.44

Approximate Capital Cost Savings

650 foot 8-inch Water Main not needed	\$65,000.00
One set of pumps not needed	\$35,000.00
Electrical, Instrumentation Savings	\$20,000.00
Total Savings	\$120,000.00

Assuming:

Discount Rate @ 4%
 Life (years) 20
 Net Present Cost(NPC)

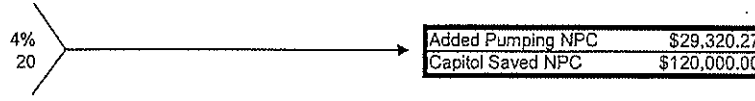

Figure 4-6

Water Treatment Plant Flow Controls

The maximum influent flow to the water treatment plant is 520 gpm with one lake pump operating and 875 gpm with two lake pumps operating. These flows can be modulated and controlled to lesser flows by the filtrate flow control loop in the membrane treatment system. The only limit on throttling this raw water flow is that at approximately 600 gpm the PRV valve at the lake starts opening and discharging to the lake. Consideration should be given to setting this PRV at a higher pressure to prevent this premature discharge when throttling.

Under the new pumping strategy, more water will travel through the low pressure zones pipeline to the Skyland tank. 875 gpm cannot be pumped through this water line without experiencing excessive dynamic head losses. Controls will need to be implemented so that when two lake pumps are on, both the high/medium pressure zone pumps and the low pressure zone pumps must also be on. This will limit the flow through the low pressure zone pipeline to 598 gpm when the WTP is receiving 875 gpm (277 gpm will be pumped to the high/medium pressure zones). 598 gpm is the approximate flow rate that the low pressure zone pipeline can accommodate without experiencing excessive system headloss and pressure. When the WTP plant is receiving 520 gpm, the low pressure pumps can operate with or without the high/medium pressure zone pumps on.

Upper Cave Rock Booster Station Pumps

The existing Upper Cave Rock Booster Station is located underneath Winding Way in an underground vault. As mentioned in the booster pumps removal section, this does not meet State of Nevada Sanitary Survey standards.

A new structure on the north side of Lower Cave Rock tank has been built to house the Upper Cave Rock Booster Station. Douglas County will complete the installation of the pumps, as well as the mechanical and electrical work in this building. The removal of the existing booster station will be performed under the scope of this project.

Cave Rock Water Treatment Plant Modifications

The Cave Rock WTP modifications will include pump replacements, pump installations, baffling installation, and wall and equipment relocations. The existing treatment plant pumps will be removed and new vertical turbine pumps will be installed. These pumps will be reconfigured to pump to Skyland Water Tank, which services the low pressure zone. The high/medium pressure zone pumps will also be added to the Cave Rock WTP pumping room. Below the pumping room, baffling will be installed in the chlorine contact basin and clear well. The baffling will be added to increase the holding time of the plant effluent and ensure chlorine residuals requirements are met. Information regarding the location of baffling has been obtained from the county. Figure 4-7 shows all treatment plant modifications, including associated demolition and relocation work around the pumping room and the location of the baffling.

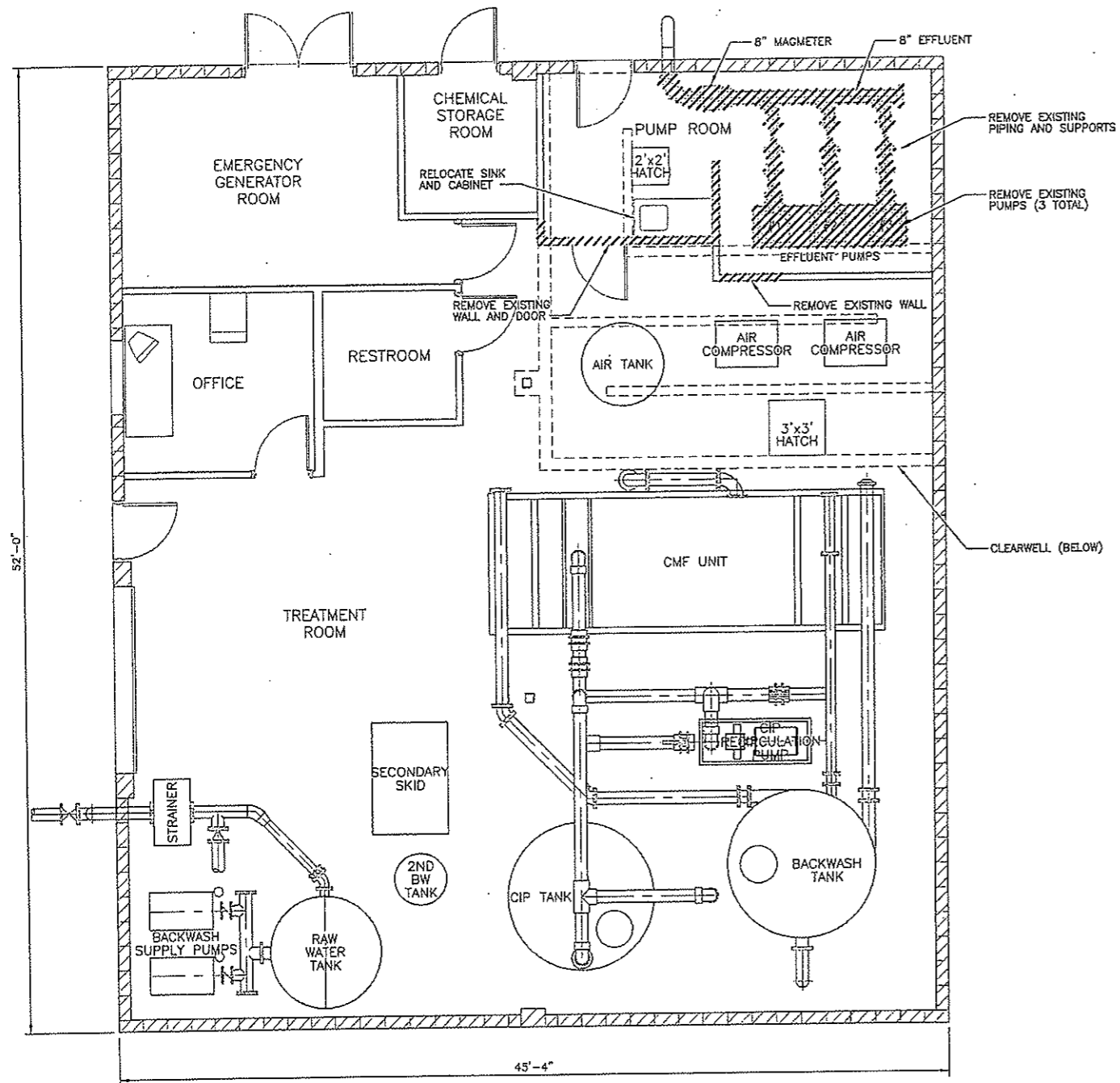

FLOOR PLAN MODIFICATIONS
1/8" = 1'-0"

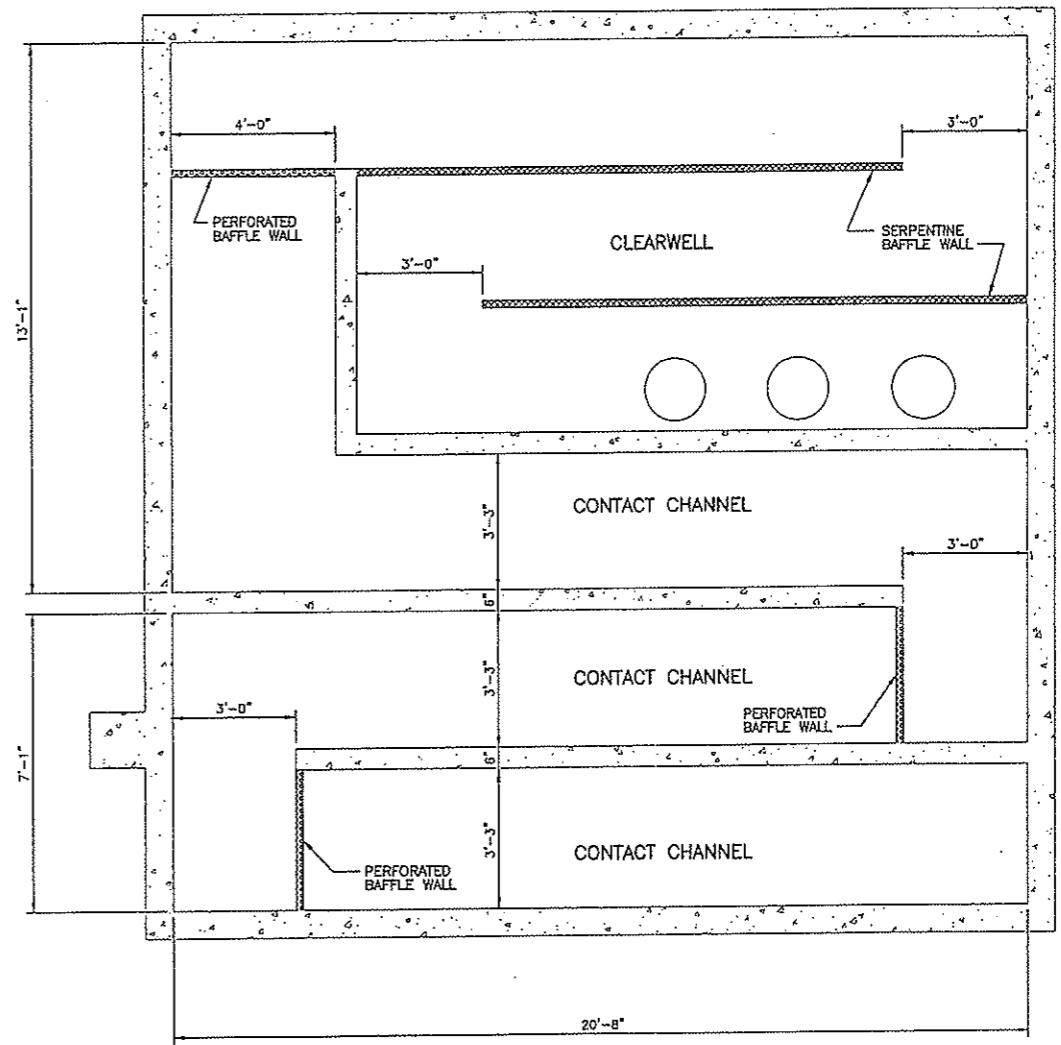

CLEARWELL: PLAN MODIFICATIONS
1/4" = 1'-0"

TREATMENT PLANT MODIFICATIONS



Figure 4-7

FILE: PDR-F4-07.DWG
DATE: Oct 27, 2009-11:42:29am, D:\denn

Water Main Replacements, Installations and Modifications

Cave Rock Road and Winding Way High Pressure Main

2,700 linear feet of 8-inch diameter, high pressure transmission main will be installed on Cave Rock Road and continue up Winding Way, eventually connecting to the existing pipeline. The installation of this waterline will occur in a separate trench while the existing waterline remains in service. After the line is completely installed, a shutdown will occur to change the system over to the new pipe line.

With the new pumping configuration, this high pressure line will experience pressures in excess of 250 psi. The existing line needs to be replaced because it is old, leaky, has an excessive repair history and because it can not handle these new higher pressures. This modification will improve the systems reliability and efficiency.

Four water service connections with PRVs will need to be installed on this water main. This will enable services in the area to receive water at pressures below the maximum allowable 100 psi pressure. The water service connection locations are shown in Figure 4-8, which also shows the location of the high pressure main in Cave Rock Road.

Sugar Pine Circle Area

Waterlines in the Sugar Pine Circle area of Cave Rock are undersized and have experienced excessive repairs due to age and poor construction. The waterlines in Sugar Pine Circle, Canyon Circle, and Lincoln Circle will be replaced to improve fire flows and system reliability, and to decrease maintenance costs. A flow control valve will need to be installed in this area to enable water to flow from the medium pressure zone to the low pressure zone without over-filling the Skyland tank.

Due to the road width of Sugar Pine Circle and the quantity of existing utilities in Sugar Pine Circle, the new water lines will be placed in the same trench as the existing line. This installation will occur by removing the existing pipeline, then replacing it in 200 foot pipe segments. Water service will be shut down to homes serviced by the pipe segment that is being replaced, but will be returned to affected homes within eight hours of the shutdown.

Figure 4-9 shows the location of these waterlines.

Canyon Circle Area

Canyon Circle will require two waterline installations. One line will run to the fire hydrant on the corner of Canyon Circle and Sugar Pine Circle. The other line will connect the existing line in Canyon Circle to the pipe that runs from the Cave Rock WTP to the Lakeridge tank. A pressure reducing valve station will be needed in this connecting line due to high pressures in the line from the WTP. These modifications will improve fire protection and water service to the homes in the Canyon Circle area.

Figure 4-10 shows the location of these modifications.

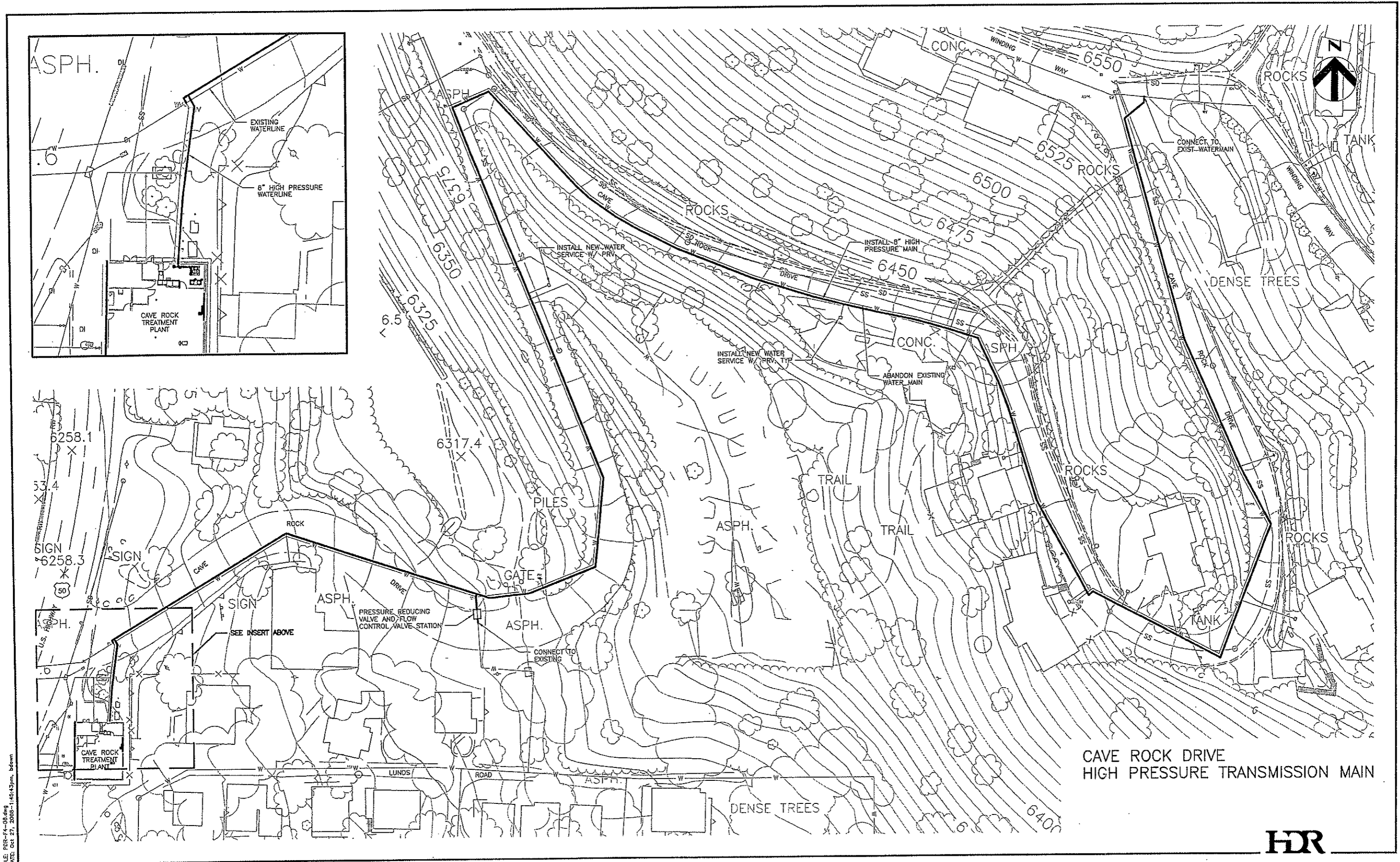

FILE: PDR-74-08.dwg
 DATE: Oct 27, 2009 1:45:43pm. Inform

CAVE ROCK DRIVE
HIGH PRESSURE TRANSMISSION MAIN



Figure 4-8

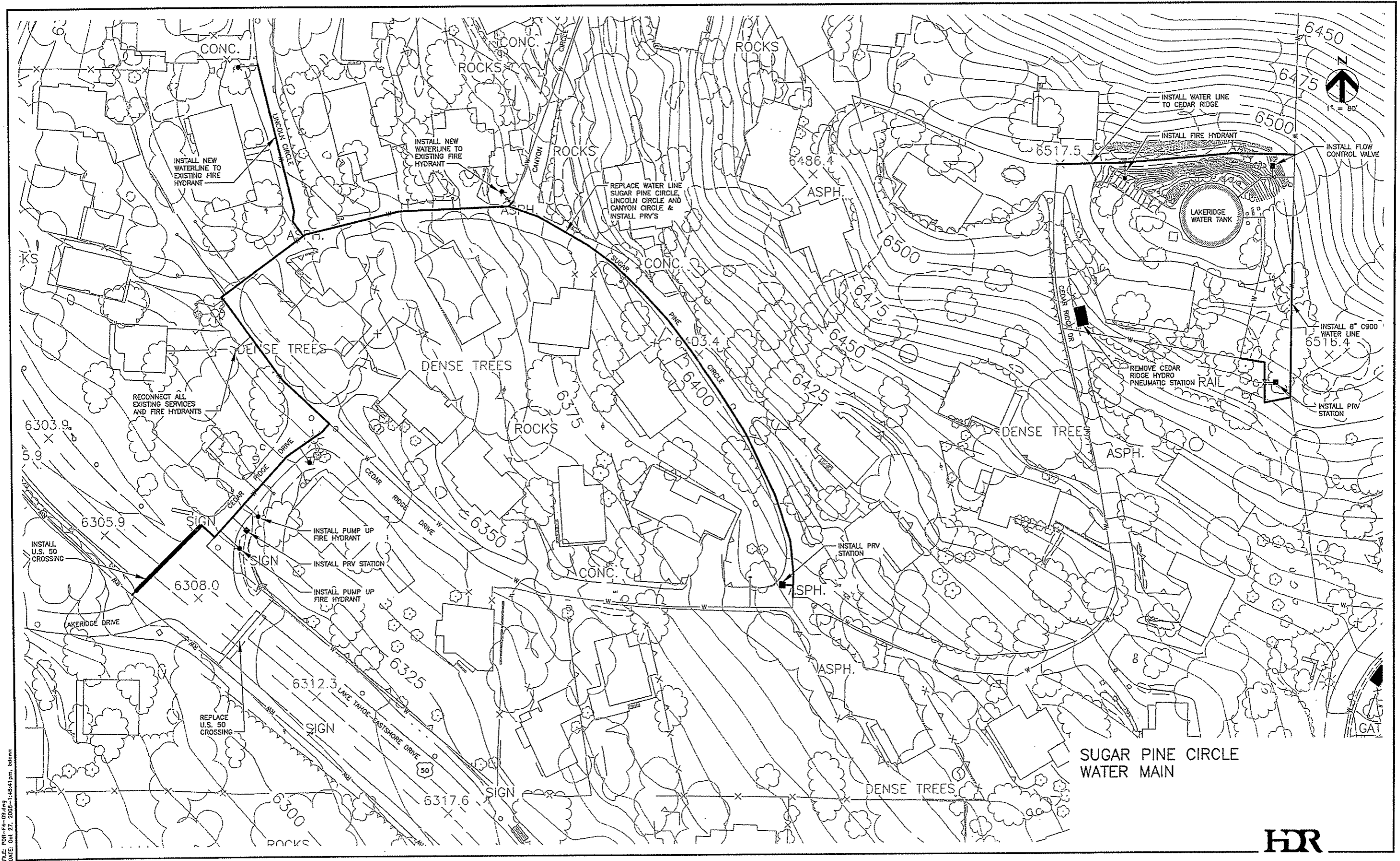

P.L.E. PDR-F4-03.dwg
 DATE: Oct 27, 2008-1:48:41 pm, mblmrr



Figure 4-9

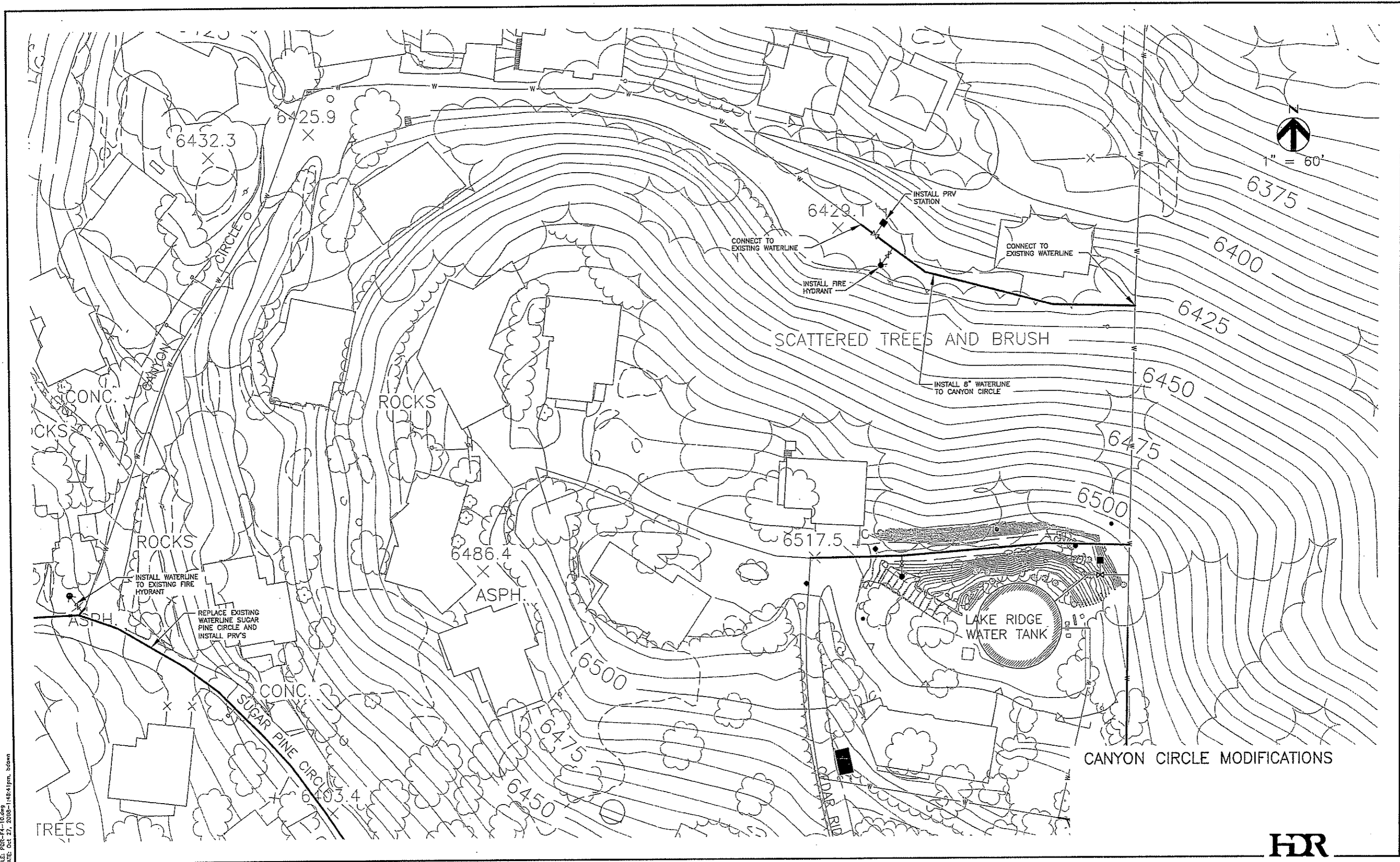

FILE: PUR-F4-10.dwg
DATE: Oct 27, 2008-1:45:11pm, bdam

HDR

Figure 4-10

Water Mains, Flow Control Valve, and PRV in Cedar Ridge Drive

Three pipes will be at the top of Cedar Ridge Drive. One of these waterlines will connect the water line in Cedar Ridge Drive into the water main that travels from the Cave Rock WTP to Lakeridge Tank. A fire hydrant will be installed on this line. The second of these water lines will connect the line that travels from the Cave Rock WTP to Lakeridge Tank with the piping leading to the Hidden Woods Tank. The new pumping strategy will be designed to pump to the Hidden Woods Tank. A control valve will be installed on the inlet line to Lakeridge Tank to allow it to fill as needed. The third water line will connect the pipeline that travels to the Hidden Woods tank with the Lakeridge medium pressure zone. A PRV be installed on this waterline.

These pipelines, PRV stations, and the fire hydrant will improve fire protection to the Cedar Ridge area and will allow for water to travel properly between the Hidden Woods and Lakeridge tanks. Figure 4-11 shows the location of these modifications.

Water Main between Pheasant Drive and Gull Court

The installation of a waterline between Pheasant Drive and Gull Court will improve system redundancy and fire flows. This line will be 8 inches in diameter and be approximately 200 linear feet in length. Figure 4-12 shows the location of this waterline.

Waterline under Highway 50 at Lakeridge

The line under U.S. Highway 50 at the entrance to Lakeridge is a critical water line. The existing 6-inch steel line is the primary supply to the lower portion of the Lakeridge development and is a connection point into the low pressure system. This pipe does not meet Douglas County pipe size requirements and utility coordinators have reported that this line is corroded and in poor condition. Replacement of this line will improve system reliability.

A conductor casing will be installed near the entrance of Lakeridge under U.S. Highway 50. This casing will hold the new water line and other utility lines. Figure 4-13 shows the location of this casing and waterline.

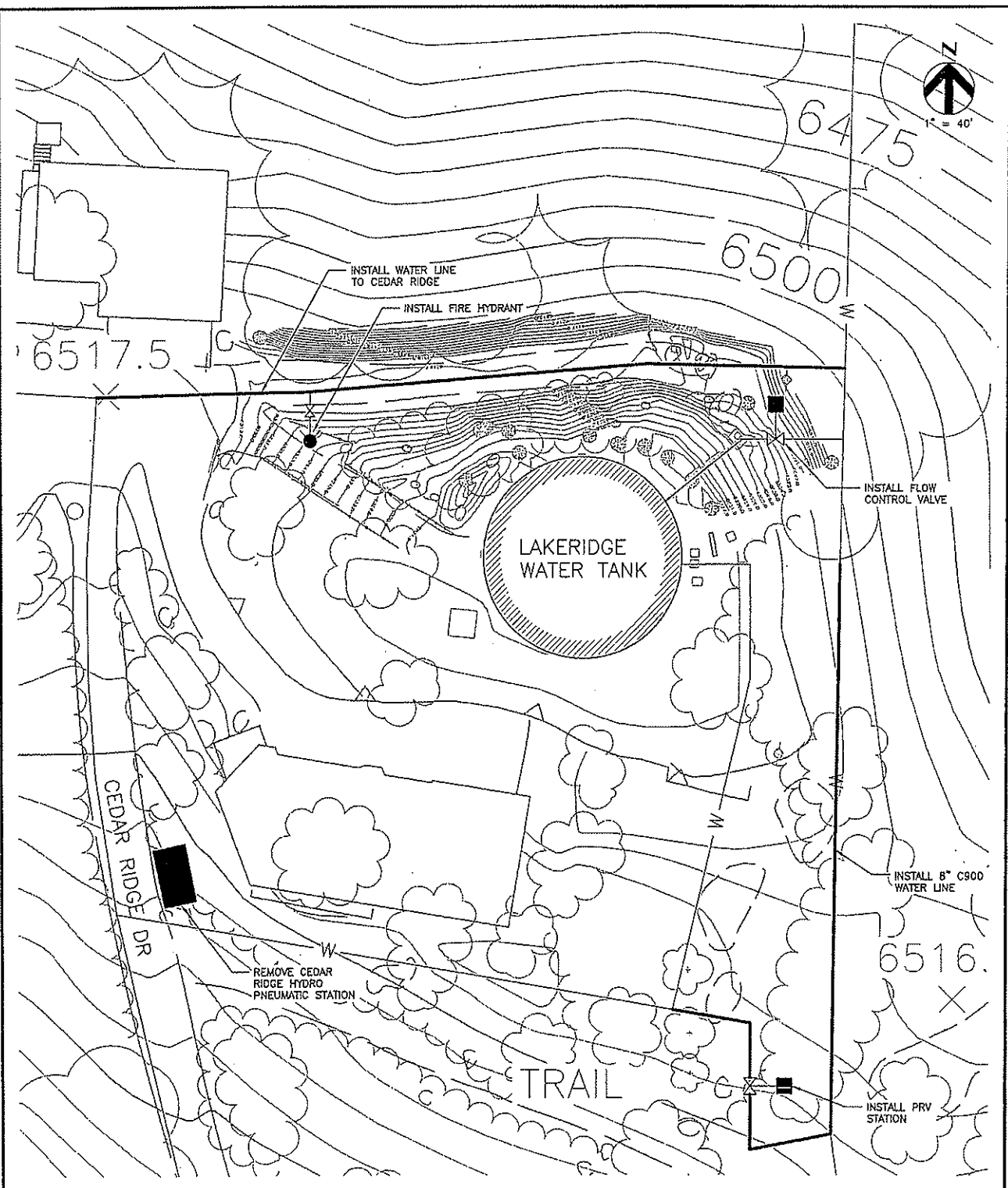

CEDAR RIDGE DRIVE
WATER MAIN AND MODIFICATIONS



FILE: PDR-F4-11.dwg
DATE: Oct 27, 2008 - 1:48:41pm, bdean

Figure 4-11

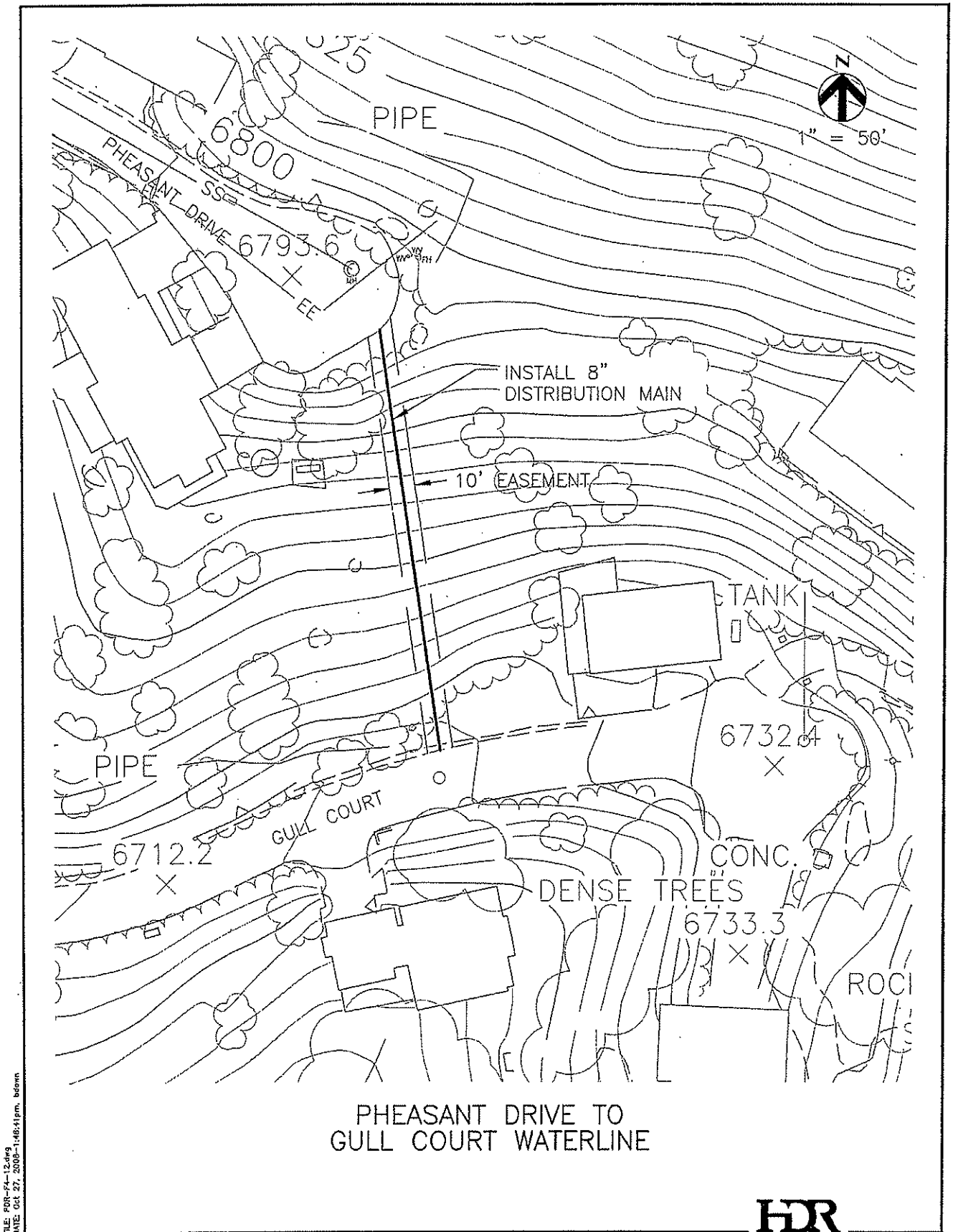

FILE: PDR-PA-12.dwg
 DATE: Oct 27, 2008 - 1:48:41pm. bdown

HDR

Figure 4-12

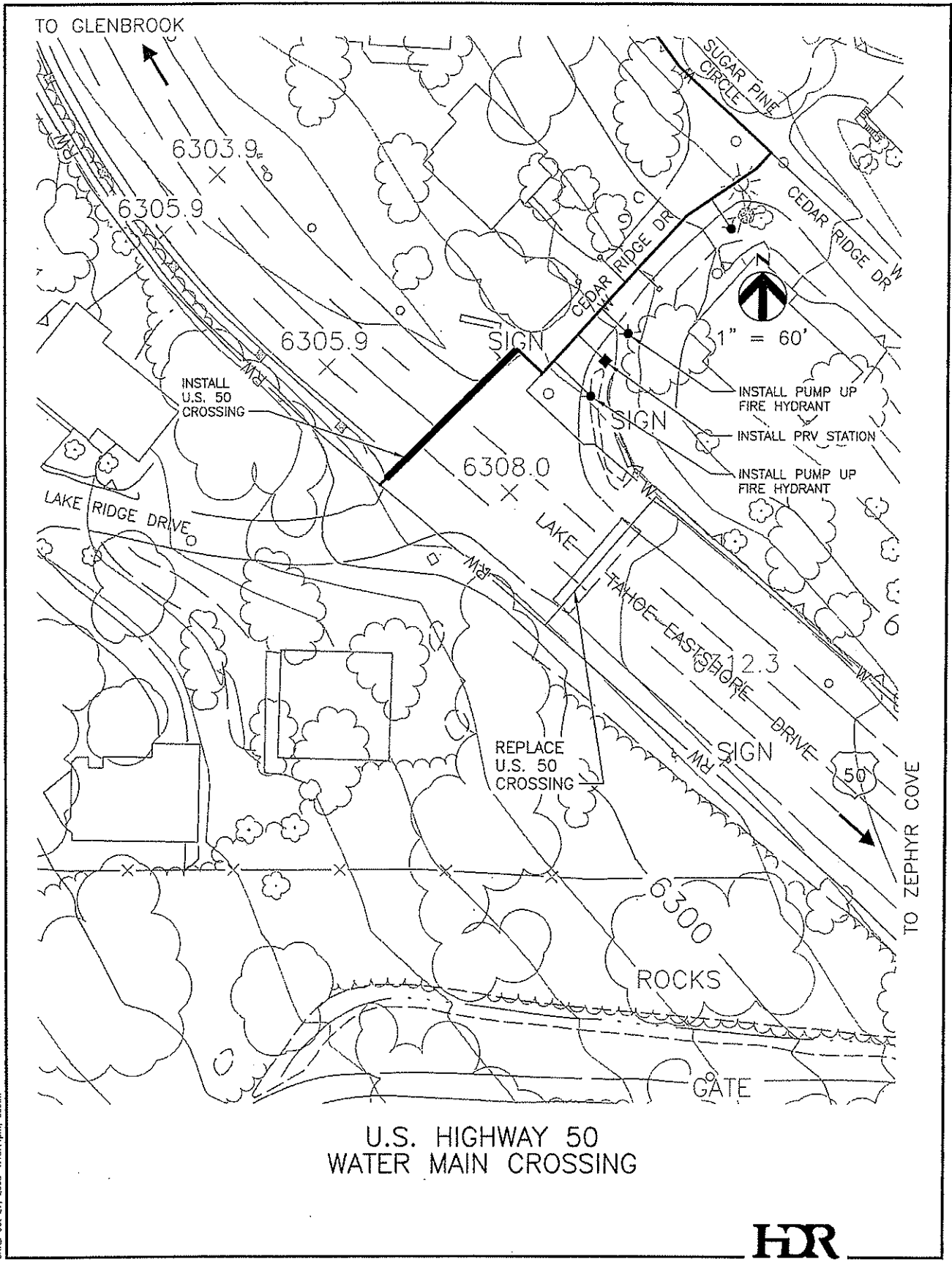

U.S. HIGHWAY 50
WATER MAIN CROSSING



FILE: R09-F4-13.dwg
DATE: Oct. 27, 2009-11:48:41pm, bdean

Figure 4-13

Pressure Reducing Valves (PRV's) and Control Valves

It is estimated that eight pressure reducing valve stations will be needed on new connections and piping. One is to be located on the top of Cedar Ridge, four on Cave Rock Road, one on Winding Way, and two in the Sugar Pine Circle area. These pressure reducing valves will keep residual system pressures below the 100 psi maximum system pressure. A pressure sustaining control valve station will be needed at Gull Court and Cedar Ridge to maintain the required pressures.

Pipe Materials

The types of pipes used to distribute water under pressure include ductile iron, plastic, concrete and steel. For water mains, ductile iron and PVC (polyvinyl chloride) pipe are regularly used and are the two main pipe types used in the Cave Rock/Skyland water system.

Ductile iron is known for its long life, toughness, imperviousness, ease of tapping and its ability to withstand internal pressure and external loads. PVC pipes are not subject to corrosion and are exceptionally smooth, minimizing friction losses in water flow. PVC is the preferred plastic for water distribution because of its strength and its resistance to internal pressures. However, PVC does have a lower Modulus of Elasticity than ductile iron, and is therefore less resistant to pressure surges.

PVC plastic will be the preferred pipe material for this project, but there will be exceptions to this preference, especially where line pressures exceed 200 psi.

Utility Coordination

As needed, a letter will be written to the following utility companies to obtain data regarding the location of existing utilities:

- ◆ Verizon.
- ◆ Sierra Pacific Power Company.
- ◆ Southwest Gas.
- ◆ Charter.
- ◆ Underground Service Alert (for additional utility potential).

Electrical

The Cave Rock WTP is served by a 277/480 Volt, 3 phase, 4 wire, 600 amp service. The existing standby generator is a Caterpillar Model 3306 diesel engine with a 230 KW, 288 KVA generator installed indoors. The actual generator capacity is about 210 KW at station altitude. The generator room is very small and there is no room to install a larger generator.

The plan is to remove the three existing 50 HP vertical turbine pumps (P300, P301, P302) and install two variable speed (VFD) 100 HP pumps to pump to the low pressure zone. In addition, two variable speed (VFD) 50 HP pumps will be installed to service the high and medium pressure zones. There will be no other plant changes that will impact electrical loads.

The new electrical loads are shown in Table 4-2 for connected, demand, and standby generator loads. The maximum demand on the utility service will be 451 amps, which is within the 600 amp capacity of the utility service. The existing motor control center (MCC) is full and can not be expanded. We will subfeed from this MCC to a new MCC for the low pressure zone pumps (P300, P301) at a new location in the pump station. This new MCC will serve all of the new pumps.

The load on the standby generator with the 40 KW of electrical heat in Panelboard P3 exceeds the generator capacity. The plan is to load shed Panelboard P3 heat and the clean-in-place heater for the WTP process to allow the existing generator to carry the load during power outages. The load on the generator with Panelboard P3 heat and the clean-in-place heater shed is about 229 KW as compared to the generator capacity of 210 KW at the station altitude.

The 100 HP and 50 HP pumps in this report exceed the standby generator capacity at the plant even with load shedding all of the electrical heating loads. Current electrical calculations show that pumps of 75 HP and 50 HP would be the largest pump combination that the existing standby generator would be able to power. As the design continues, the pumps and electrical capacity of the standby generator will be further evaluated to determine the correct sizing to deliver the maximum flow under these load constraints.

Table 4-2. Cave Rock WTP Electrical Loads

Load	KVA		
	Connected	Demand	Standby Generator
Panel board P1	166	120	70
Panel board P3	40	40	0
P400 Feed Pump	3/4	3/4	3/4
P600 b/w discharge	1/2	1/2	1/2
P300 Low Pressure Pump	100	100	100
P301 Low Pressure Pump	100	--	--
P302 High/Medium Pressure Pump	50	50	50
P303 High/Medium Pressure Pump	50	--	--
P500 b/w Pump	20	20	20
P501 b/w Pump	20	--	--
P400 Air Comp	15	15	15
P401 Air Comp	15	--	--
P100 CIP Pump	30	30	30
Total	667.25	376	286
Amps at 480 Volts		451	343
x 1.25		563	
KW (0.8 PF)			229

Pavement Repair and Site Restoration

Pavement repair will be done in compliance with the Douglas County standard street cut repair detail. The street repair detail will be included in the construction drawings. In locations where water lines do not run under existing roads, re-vegetation work will be performed as required.

TRPA Permitting

Resource Concepts, Inc. will assist Douglas County with TRPA permitting for the project. The full extent of the scope of work and associated costs for this task will be based on discussions and determinations made by TRPA staff at the pre-application meeting and upon completion of the research of TRPA files. Revisions to the work under this subtask as a result of the pre-application meeting and research completion will be identified, and a modified scope of work will be presented to Douglas County for consideration and approval.

Geotechnical

Pezonella Associates, Inc., will perform a geotechnical investigation and a soils/hydrology scoping report for the project. Preliminary data will be available as it develops.

The geotechnical investigation will be performed to determine the subsurface soil conditions along the water line alignments and to provide an opinion and recommendations concerning:

- ◆ Potential geological hazards.
- ◆ Opinions concerning the presence of historic groundwater levels.

Demolition Work

Demolition work will include:

- ◆ Hidden Woods Booster Station, Cedar Ridge Hydro-Pneumatic Booster Station, Lower Cave Rock Booster Station, and Upper Cave Rock Booster Station.
- ◆ Removing walls and relocating equipment above the wet well at Cave Rock WTP.
- ◆ The smart valve in route to the Skyland tank.
- ◆ Pipe replacement at any location (particularly Sugar Pine Circle) where spatial constraints require the placement of new pipe in the same location as existing pipe.

Chapter 5 - Project Implementation

Construction Documents

Sheet List

General

G1	Cover Sheet, Location/Vicinity/Key Maps, and List of Sheets
G2	General Abbreviations
G3	General Symbols
G4	Hydraulic Profile and Design Criteria
G5	Douglas County Standards I
G6	Douglas County Standards II
G7	Douglas County Standards III
G8	Douglas County Standards IV
G9	Standard Details I
G10	Standard Details II
G11	Standard Details III

Environmental

E1	Best Management Practices Notes and Details
E2	Best Management Practices Details

Demolition

D1	Cave Rock Site Demolition Plan
D2	Cave Rock Site Demolition Sections and Details
D3	Lakeridge Site Demolition Plan
D4	Lakeridge Site Demolition Sections and Details

Civil

C1	Overall Site Plan
C2	Site Plan Easements, BMP's, and Right-of-Ways
C3	Treatment Plant Enlarged Site Plan
C4	Plan and Profile I - Cave Rock Drive
C5	Plan and Profile II - Cave Rock Drive
C6	Plan and Profile III - Cave Rock Drive
C7	Plan and Profile IV - Winding Way
C8	Plan and Profile V - Winding Way
C9	Plan and Profile VI - Sugar Pine Circle
C10	Plan and Profile VII - Sugar Pine Circle
C11	Plan and Profile VIII - Sugar Pine Circle
C12	Plan and Profile IX - Sugar Pine Circle
C13	Plan and Profile X - Canyon Circle
C14	Lakeridge Water Tank - Plan and Details
C15	U.S. Highway 50 Waterline Crossing - Plan, Section, and Details

- C16 Miscellaneous Site Details I
- C17 Miscellaneous Site Details II

Structural/Process

- S1 Existing Treatment Plant Modification Plan
- S2 Existing Treatment Plant Modification Sections and Details I
- S3 Existing Treatment Plant Modification Sections and Details II
- S4 Existing Treatment Plant Modification Sections and Details III
- S5 Existing Treatment Plant Clearwell Modification Plan and Sections
- S6 Existing Treatment Plant Clearwell Modification Sections and Details

Electrical

- E1 Electrical Symbols
- E2 Electrical Abbreviations
- E3 One-Line Diagram and MCC Elevation
- E4 Control Schematic and Control System Block Diagrams
- E5 Existing Treatment Plant - Partial Site Plan
- E6 Existing Treatment Plant - Power Plan
- E7 Existing Treatment Plant - Lighting and Grounding Plan
- E8 Details

Instrumentation

- Y1 Instrumentation Symbols and Abbreviations
- Y2 Process and Instrumentation Diagram

Specifications List

**Division 0 - Bidding Requirement, Contract Forms, and Conditions of the Contract
(Provide by Client)**

- Advertisement for Bids
- Instructions to Bidders
- Bid Form
- Agreement
- Performance and Payment Bonds
- General Conditions
- Supplementary Conditions
- Exhibits

Division 1 - General Requirements

- 01060 Special Conditions
- 01340 Submittals
- 01560 Environmental Protection and Special Controls
- 01600 Product Delivery, Storage, and Handling

- 01650 System Startup
- 01710 Cleaning
- 01800 Openings and Penetrations in Construction

Division 2 - Site Work

- 02072 Demolition, Cutting and Patching
- 02110 Site Clearing
- 02200 Earthwork
- 02221 Trenching, Backfilling, and Compacting for Utilities
- 02224 Pipeline Undercrossings
- 02270 Soil Erosion and Sediment Control
- 02271 Stone Revetment (Rip Rap)
- 02444 Chain Link Fence and Gates
- 02513 Asphaltic Concrete Vehicular Paving and Repair
- 02515 Precast Concrete Manhole Structures
- 02528 Concrete Curb and Gutter
- 02660 Water Main Construction
- 02930 Seeding, Sodding and Landscaping

Division 3 - Concrete

- 03002 Concrete
- 03431 Precast and Prestressed Concrete

Division 4 - Masonry

- 04200 Segmental Retaining Wall

Division 5 - Metals

- 05505 Metal Fabrications

Division 6 - Wood and Plastics

- 06100 Rough Carpentry
- 06200 Finish Carpentry
- 06410 Architectural Cabinetwork (Millwork)

Division 7 - Thermal and Moisture Protection

- 07120 Fluid Applied Waterproofing
- 07176 Liquid Water Repellent
- 07900 Joint Sealants

Division 8 - Doors and Windows

08110	Metal Doors and Frames
08305	Access Doors
08700	Finish Hardware
08800	Glass and Glazing

Division 9 - Finishes

09250	Gypsum Board
09905	Painting and Protective Coatings

Division 10 - Specialties

10400	Identification Devices
10970	Clearwell Baffling System

Division 11 - Equipment

11005	Equipment: Basic Requirements
11060	Pumping Equipment: Basic Requirements
11061	Pumping Equipment: Non-Clog Centrifugal
11072	Pumping Equipment: Vertical Turbine (Line Shaft)
11077	Pumping Equipment: Inline Centrifugal Pumps

Division 13 - Special Construction

13440	Instrumentation for Process Control
13448	Control Panels and Enclosures

Division 14 - Conveying Systems

14301	Hoists, Trolleys, and Monorails
-------	---------------------------------

Division 15 - Mechanical

15060	Pipe and Pipe Fittings: Basic Requirements
15061	Pipe: Steel
15062	Pipe: Ductile Iron
15063	Pipe: Copper
15064	Pipe: Plastic
15090	Pipe Support Systems
15100	Valves: Basic Requirements
15101	Gate Valves
15103	Butterfly Valves

15104	Ball Valves
15106	Check Valves
15114	Miscellaneous Valves
15440	Plumbing Fixtures and Equipment
15510	Fire Hydrant

Division 16 - Electrical

16010	Electrical: Basic Requirements
16012	Seismic Bracing Systems
16060	Grounding
16120	Wire and Cable: 600 Volt and Below
16130	Raceways and Boxes
16135	Electrical: Exterior Underground
16140	Wiring Devices
16265	Variable Frequency Drives - Low Voltage
16270	Power Transformers
16430	Switchgear
16440	Switchboards
16441	Panelboards
16442	Motor Control Equipment
16460	Dry-type Transformers
16490	Overcurrent and Short Circuit Protective Devices

Appendix A - Project Schedule

Project Schedule

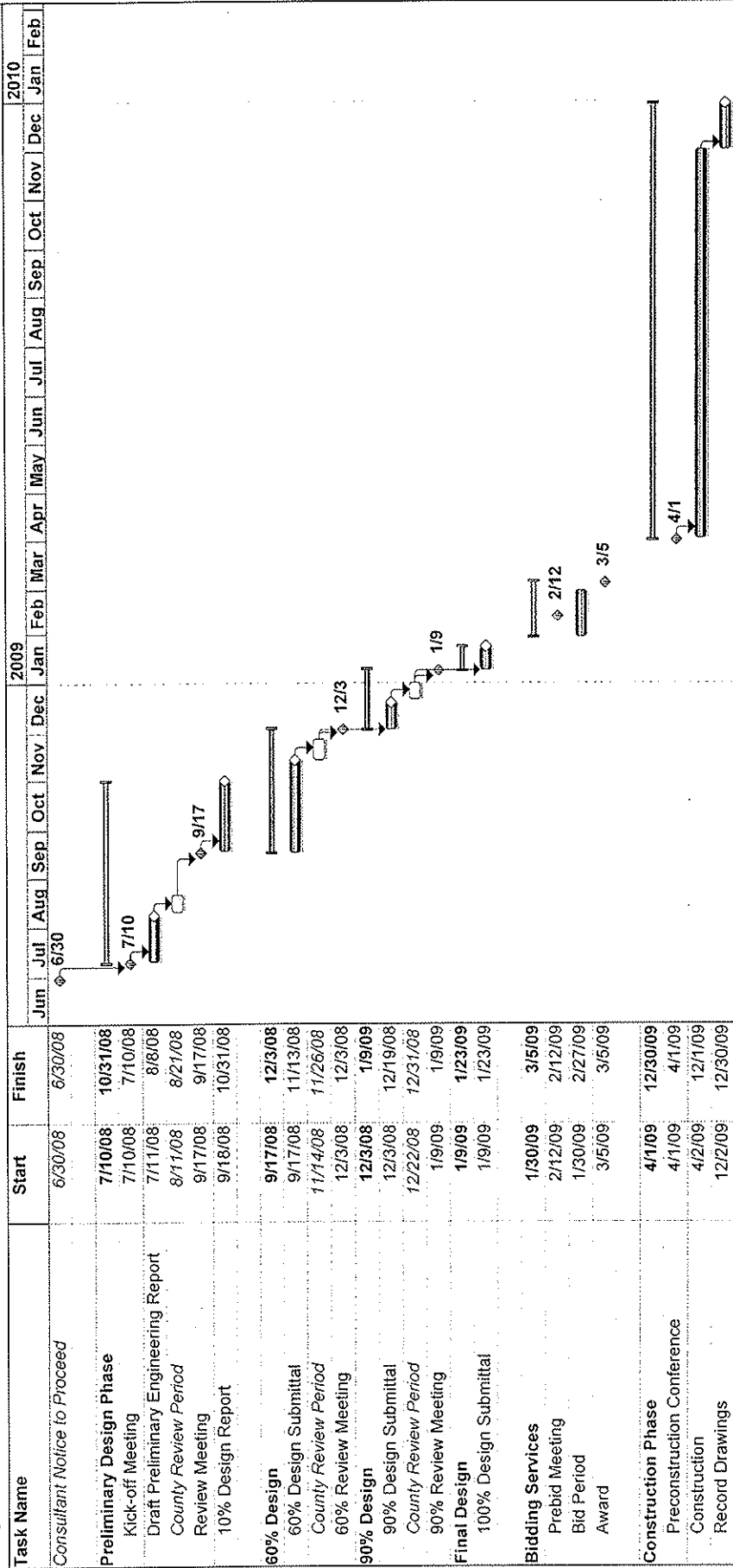

Douglas County
Cave Rock Water System Improvements

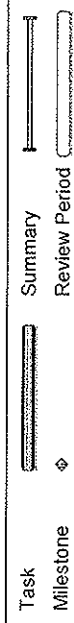

Appendix B - Project Cost

Job No. 08363-87037

Calc. No.

Computation**HDR****Project:** Cave Rock Skyland Water System Improvements**Subject:** Preliminary Cost Estimate**Task:** Preliminary Cost Estimate**File Name:** C:\PW\working\SAC\dms94729\Cave Rock PDR Cost Estimate.xls\HDR Estimate**Date:** 8/1/2008

DESCRIPTION	QUANTITY	UNITS	UNIT COST	TOTAL COST
DIVISION 1 - GENERAL REQUIREMENTS				
Mobilization	1	LS	1.50%	\$35,300
Demobilization	1	LS	1.00%	\$23,500
Bonds and Insurance	1	LS	1.00%	\$23,500
Construction Facilities/Fencing/Offices	1	LS	2.00%	\$47,300
Permitting (incl SWPPP)	1	LS	0.50%	\$11,700
General Conditions	1	LS	2.00%	\$47,300
Shop Drawings and O&M Manuals	1	LS	2.00%	\$47,300
Facilities Start-up & Testing	1	LS	3.00%	\$71,700
DIVISION SUBTOTAL				\$308,000
DIVISION 2 - SITE WORK				
<i>Site</i>				
Excavation for Piping	2300	CY	\$15	\$34,500
Piping Backfill	1700	CY	\$20	\$34,000
CDF Backfill	600	CY	\$80	\$48,000
Demolition of Hidden Woods Booster Station	1	LS	\$5,000	\$5,000
Demolition of Cedar Ridge Hydro-pneumatic Tank	1	LS	\$5,000	\$5,000
Demolition of Lower Cave rock Booster Station	1	LS	\$5,000	\$5,000
Pavement Repair	16000	SF	\$3.50	\$56,000
Remove Skyland Smart Valve	1	LS	\$5,000	\$5,000
Potholing	1	LS	\$7,500	\$7,500
Tie into existing systems	1	LS	\$50,000	\$50,000
Revegetation	8700	SF	\$4.50	\$39,150
<i>Water Treatment Plant</i>				
Wall re-alignment	1	LS	\$25,000	\$25,000
Demolition of concrete pad	1	LS	\$2,500	\$2,500
Equipment relocations	1	LS	\$5,000	\$5,000
Miscellaneous Site Work	1	LS	\$10,000	\$10,000
DIVISION SUBTOTAL				\$331,650
DIVISION 3 - CONCRETE				
<i>Water Treatment Plant</i>				
Bollards	3	LS	\$700	\$2,100
Concrete pad for High/Medium Zone Pumps	4	CY	\$800	\$3,200
DIVISION SUBTOTAL				\$5,300
DIVISION 5 - MISCELLANEOUS METALS				
<i>Water Treatment Plant</i>				
Pipe Access Equipment (ladder/cat walk)	1	EA	\$1,500	\$1,500
Pipe Supports, Miscellaneous metals	1	LS	\$15,000	\$15,000
DIVISION SUBTOTAL				\$16,500
DIVISION 6 - WOOD AND FIBERGLASS				
<i>Water Treatment Plant</i>				
New Wall Framing	200	SF	\$45	\$9,000
DIVISION SUBTOTAL				\$9,000
DIVISION 8 - DOORS AND WINDOWS				
<i>Water Treatment Plant</i>				
3 x 8 Door	1	EA	\$2,500	\$2,500
DIVISION SUBTOTAL				\$2,500

DIVISION 9 - FINISHES				
<i>Water Treatment Plant</i>				
Painting and Protective Coatings (Piping and Equipment)	1	LS	\$50,000	\$50,000
DIVISION SUBTOTAL				\$50,000
DIVISION 10 - SPECIALTIES				
<i>Water Treatment Plant</i>				
Baffling in Chlorine Contact Basin	1	LS	\$40,000	\$40,000
Identification, Stenciling and Tagging System	1	LS	\$5,000	\$5,000
DIVISION SUBTOTAL				\$45,000
DIVISION 11 - EQUIPMENT				
<i>Water Treatment Plant</i>				
Vertical Turbine Pumps	2	EA	\$65,000	\$130,000
VFDs for Vertical Turbine Pumps	2	EA	\$35,000	\$70,000
BoosterpaQ to High/Medium Pressure Zone	1	EA	\$40,000	\$40,000
VFD for BoosterpaQ	1	EA	\$25,000	\$25,000
DIVISION SUBTOTAL				\$265,000
DIVISION 13 - SPECIAL CONSTRUCTION				
<i>Water Treatment Plant</i>				
Instrumentation	5.0%	LS	\$83,698	\$83,698
DIVISION SUBTOTAL				\$83,698
DIVISION 14 - CONVEYING SYSTEMS				
<i>Water Treatment Plant</i>				
Miscellaneous Conveying Equipment	1	LS	\$5,000	\$5,000
DIVISION SUBTOTAL				\$5,000
DIVISION 15 - MECHANICAL				
<i>Water Meters/Services Replacement</i>				
Type 1 - Single Meter Pit with PRV per New Service Detail	6	EA	\$2,500	\$15,000
<i>Site</i>				
8" High Pressure Water Main (Cave Rock Rd.)	2500	LF	\$120	\$300,000
8" Water Main (Cedar Ridge)	850	LF	\$120	\$102,000
8" Water Mains (Sugar Pine Lines)	1200	LF	\$120	\$144,000
8" Water Main (Pheasant to Gull Ct)	200	LF	\$120	\$24,000
Pressure Sustaining Control Valves	2	EA	\$30,000	\$60,000
Pressure Reducing Valve Station	8	EA	\$15,000	\$120,000
Fire Department Connection	7	EA	\$3,000	\$21,000
Highway 50 Casing	1	LS	\$80,000	\$80,000
Fire Hydrant	7	EA	\$4,000	\$28,000
<i>Water Treatment Plant</i>				
Misc. Fittings and Piping	1	LS	\$50,000	\$50,000
DIVISION SUBTOTAL				\$944,000
SUBTOTAL DIVISIONS 2 - 15 (Not including Division 13)				\$1,673,950
DIVISION 16 - ELECTRICAL				
Misc. Electrical (% of Divisions 2 - 15)	15%	LS	\$251,093	\$251,093
SUBTOTAL				\$251,093
DIVISION SUBTOTAL				\$251,093
SUBTOTAL				\$2,316,740
CONTINGENCY (20%)				\$463,348
TOTAL				\$2,790,000

Notes:

1. This cost opinion does not include any County administrative costs.
2. This cost opinion does not include costs for engineering, and/or construction management.
3. The contingency is for unknown items left out of the estimate because the design is not yet completed.

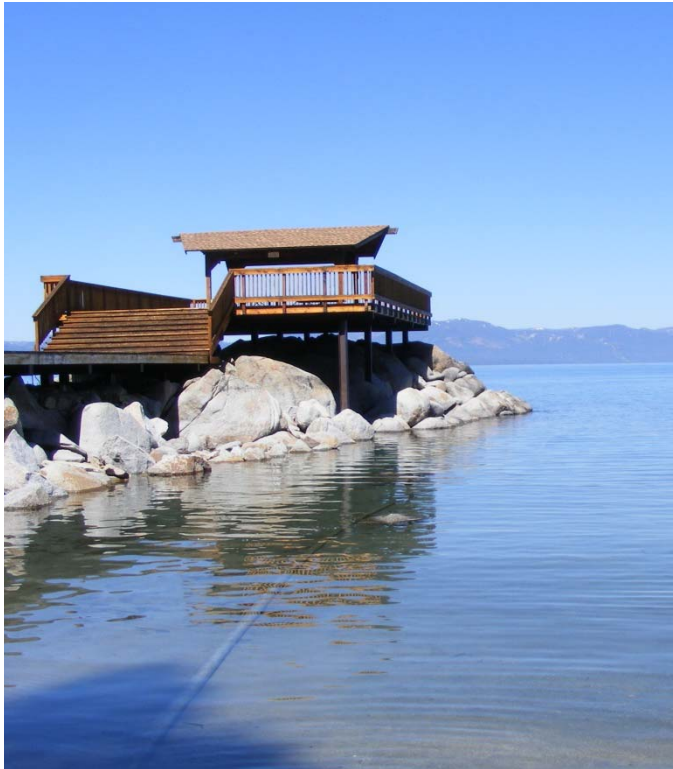

Technical Memorandum Cave Rock Lake Intake Improvement Alternatives

Cave Rock Water System Lake Improvement

Douglas County, NV
September 10th, 2015

Table of Contents

List of Appendices	1
List of Tables	1
List of Figures	1
1. Introduction & Purpose	2
2. Background	2
3. Design Criteria	2
4. Alternatives	2
Alternative 1 – Lower Pumps by 4 Feet	3
Alternative 2 – Replace Intake Pipe	4
Alternative 3 – Add Booster Pumps in the Lake.....	6
5. Recommended Alternative	8

List of Appendices

Appendix A – System Information Documents
 Appendix B – Alternative 3 – Pump Information
 Appendix C – Engineering Contractor Construction Quotes

List of Tables

Table 1 : Alternative 1 Advantages and Disadvantages	4
Table 2 : Alternative 1 Planning Level Opinion of Probable Construction Cost	4
Table 3: NPSH _a improvement at 606 gpm from Replacing 400 ft of Intake Pipe.....	5
Table 4: NPSH _a improvement at 606 gpm from Replacing 500 ft of Intake Pipe.....	5
Table 5 : Alternative 2 Advantages and Disadvantages	5
Table 6 : Alternative 2 Planning Level Opinion of Probable Construction Cost	6
Table 7 : Alternative 3 Advantages and Disadvantages	7
Table 8 : Alternative 3 Planning Level Opinion of Preliminary Construction Cost.....	8

List of Figures

Figure 1: Alternative 1 Preliminary Plan to Lower Pumps by 4 Feet.....	3
Figure 2: Alternative 3 Booster Pump and Intake Screen Preliminary Layout	7

1. Introduction & Purpose

This Technical Memorandum (TM) provides design criteria and alternatives for the Cave Rock Water System Lake Intake Improvement Project (Project) in Glenbrook, Nevada. The TM has the following objectives:

- Provide background & design criteria
- Describe, evaluate and provide preliminary costs estimates of 3 design alternatives.
- Provide a recommended alternative.

2. Background

The Cave Rock Water System in Glenbrook, Nevada is owned and operated by Douglas County. In 2010, the water system's two lake intake pumps were moved from a submerged skid in Lake Tahoe into an existing intake pump building on the shore of the lake. Due to low water levels in Lake Tahoe this year and the potential for even lower water levels next year, suction side hydraulics may cause cavitation issues due to reduced Net Positive Suction Head available (NPSH_a) limitations of the pump system. HDR Engineering Inc. (HDR) was contracted to develop and evaluate alternatives for modifying the Cave Rock Water System Lake Intake system. These alternatives shall meet the changing system demands throughout the year in order to transport the water demand necessary to the Cave Rock water treatment plant.

Appendix A includes documentation of the Cave Rock Water System lake intake system.

3. Design Criteria

Three design alternatives were evaluated to provide the water system with a minimum flow of 606 gpm to the Cave Rock Water System Water Treatment Plant (WTP) at a minimum Lake Tahoe water surface elevation of 6,219 feet¹.

HDR's hydraulic analysis of the system was based on 2010 through 2015 pump testing. The analysis determined that the NPSH_a of the system needed to be increased by a minimum of 4-feet to meet the design criteria requirement of 606 gpm at a Lake Tahoe water surface elevation of 6,219 feet.

4. Alternatives

The three design alternatives for consideration are presented below:

- Lower the pumps by 4 feet in elevation
- Replace the intake pipe
- Add booster pumping in the lake

¹ Elevations in this TM are all on Lake Tahoe Datum.

Alternative 1 – Lower Pumps by 4 Feet

Alternative 1 proposes lowering the intake pump elevation by 4 feet. This alternative requires construction of an addition onto the west side of the existing pump building and modifications to piping and electrical to facilitate the lower pump location. These modifications can be seen in Figure 1.

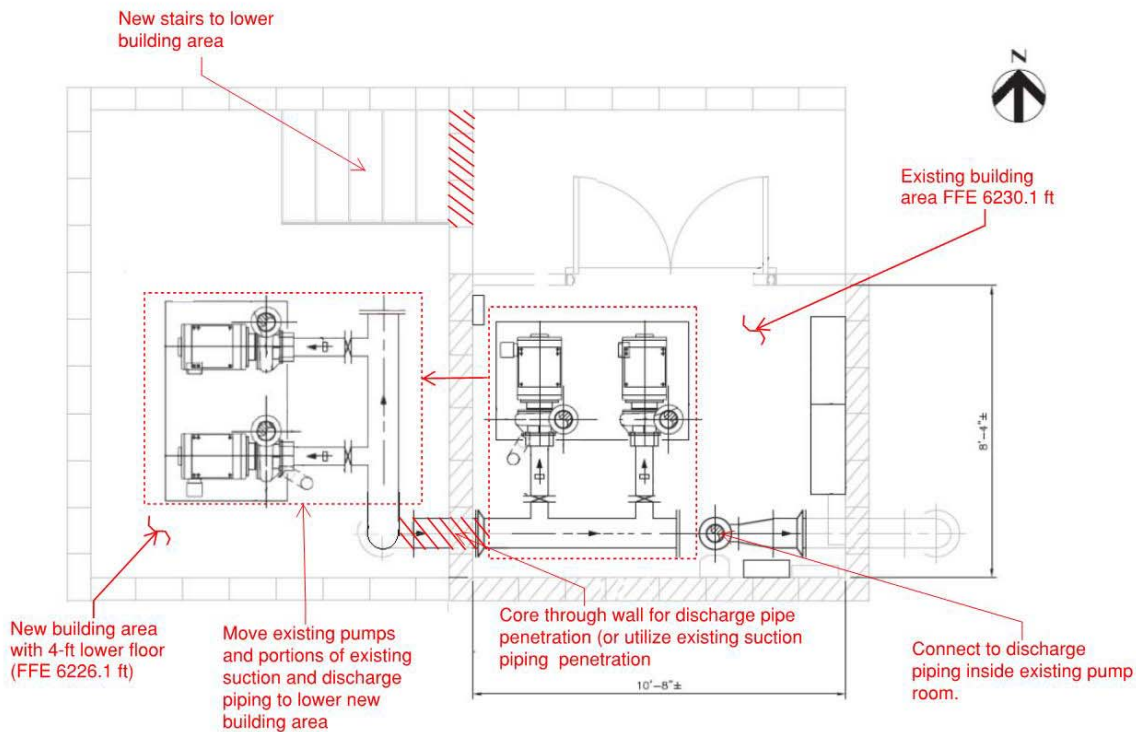

Figure 1: Alternative 1 Preliminary Plan to Lower Pumps by 4 Feet.

The advantages and disadvantages of Alternative 1 are shown in Table 1. The planning level opinion of probable construction cost is shown in Table 2.

Table 1 : Alternative 1 Advantages and Disadvantages

ADVANTAGES	DISADVANTAGES
<ul style="list-style-type: none"> No work in the Lake. Can design for more space around pumps Could improve inlet conditions into pumps with more space in new portion of building. Keeps pumps and electrical conduits out of Lake Tahoe. 	<ul style="list-style-type: none"> Significant Tahoe Regional Planning Agency (TRPA) mitigation and coverage transfer issues expected. This would add design costs and could delay bid documents. Lowers pumps below Lake Tahoe high water elevation (6,229.1). Access for pump removal and/or replacement would still be difficult to remedy. Foundation and geotechnical requirements for new slab in this area are unknown and may cause additional costs.

Table 2 : Alternative 1 Planning Level Opinion of Probable Construction Cost

DESCRIPTION	QUANTITY	UNITS	UNIT COST	COST
General conditions	1	LS	\$10,000	\$10,000
Concrete slab foundation*	13	CY	\$1,200	\$16,000
CMU walls	310	SF	\$50	\$16,000
Metal roof structure	180	SF	\$50	\$9,000
Metal Stairs	1	LS	\$3,000	\$3,000
Pipe modifications	1	LS	\$10,000	\$10,000
Electrical and Instrumentation	1	LS	\$5,000	\$5,000
Total				\$69,000
Contingency	-	-	30%	\$21,000
			Total	\$90,000**

*Assume slab on grade for planning level estimate

**Cost estimate does not include engineering, geotechnical investigation, permitting, or county administrative costs.

Alternative 2 – Replace Intake Pipe

Alternative 2 proposes replacing the existing intake pipe with larger diameter high dimension ratio (DR) (i.e. thin wall) HDPE pipe. Replacing the existing 10 inch DR 9 intake pipe with the new pipe would reduce the suction piping losses by about 4 feet according to hydraulic calculations calibrated with pump testing, and therefore reduce the $NPSH_a$ by the same amount. Leaving the existing pipe in place and installing a second intake pipe was also considered. This is not preferred over the proposed Alternative 2 since this may not fall under the existing memorandum of understanding (MOU) with Tahoe Regional Planning Agency (TRPA) and would result in additional infrastructure in Lake Tahoe that is not required.

Three pipe sizes were evaluated to determine if 4-feet of headloss reduction could be achieved at 606 gpm. A minimum wall thickness of 0.75" was utilized to determine pipe DR. Table 3 shows NPSH_a improvements from replacing 400 feet of pipe from STA 1+00 to 5+00 to reduce shoreline construction. Table 4 shows NPSH_a improvements from replacing 500 feet of pipe from STA 0+00 to 5+00.

Table 3: NPSH_a improvement at 606 gpm from Replacing 400 ft of Intake Pipe

SIZE (IN.)	DR	I.D. (IN.)	LENGTH (FT.)	C VALUE	V (FT/S)	PIPING H _L (FT.)	NPSH _A IMPROVEMENT (FT.)
10*	9	8.22	400	110	3.66	3.58	0.00
14	19	12.44	400	130	1.60	0.35	3.23
16	21	14.39	400	130	1.20	0.17	3.41
18	21	16.18	400	130	0.95	0.10	3.48

*Existing pipe

Table 4: NPSH_a improvement at 606 gpm from Replacing 500 ft of Intake Pipe

SIZE (IN.)	SDR	I.D. (IN.)	LENGTH (FT.)	C VALUE	V (FT/S)	PIPING H _L (FT.)	NPSH _A IMPROVEMENT (FT.)
*10	9	8.22	500	110	3.66	4.48	0.00
14	26	12.86	500	130	1.50	0.38	4.10
14	19	12.44	500	130	1.60	0.44	4.04
16	21	14.39	500	130	1.20	0.22	4.26
18	21	16.18	500	130	0.95	0.12	4.36

Higher SDR pipes with wall thickness below 0.75" were not considered.

*Existing pipe

The advantages and disadvantages of Alternative 2 are shown in Table 5. The planning level opinion of probable construction cost is shown in Table 6.

Table 5 : Alternative 2 Advantages and Disadvantages

ADVANTAGES	DISADVANTAGES
<ul style="list-style-type: none"> Minimal work on shore. Updates/upgrades old piping in lake. Alternative with least amount of permitting concerns, with minimal TRPA permitting; potentially falls under existing Cave Rock Water System MOU with TRPA May be able to utilize the existing pipe anchors and transfer them to the new 14-inch HDPE intake pipe. 	<ul style="list-style-type: none"> Requires barge and lifting line/replacing. More difficult mobilization than Alternative 1. Larger piping reduces the velocity in the pipe to below 2 ft/s allowing for some sediment to settle within the pipe. If the c value of the intake pipe is higher than 110 or if c values of new pipe drops below 130, 4-ft of NPSH_a improvement is not achieved.

Table 6 : Alternative 2 Planning Level Opinion of Probable Construction Cost

DESCRIPTION	QUANTITY	UNITS	UNIT COST	COST
General conditions	1	LS	\$10,000	\$10,000
Lake Mobilization/Demobilization	1	LS	\$15,000	\$15,000
Removal and disposal of existing 10" HDPE	1	LS	\$42,000	\$42,000
New 14" HDPE w/ Concrete Collars every 20' +/-	500	LF	\$180	\$90,000
New intake structures	1	LS	\$12,000	\$12,000
Hand Dig Trench to Pump House	1	LS	\$30,000	\$30,000
Total				\$199,000
Contingency			15%	\$30,000
Estimate based on a quote from Pacific Built Inc. on August 25, 2015. Quote included in Appendix C.			Total	\$229,000*
*Cost estimate does not include engineering, permitting, or county administrative costs.				

Alternative 3 – Add Booster Pumps in the Lake

Alternative 3 proposes the addition of a submersible inline booster pump at the existing pump intake screen that would run in series with the existing lake intake pumps at lower lake levels. This alternative would boost the suction pressure to the existing lake intake pumps and eliminate NPSH_a issues that can cause cavitation of the existing pumps. The additional pump would be vertical turbine, submersible pump, installed horizontally in a can. A preliminary pump selection cutsheet is included in Appendix B. Due to electrical constraints of the lake intake system, the maximum horsepower for the additional pumps is 10 HP. Alternative 3 also includes installing a new low profile intake screen at the near shore intake. Water will be drawn from this intake screen when the new booster pump is not operating. The existing intake screen will be moved to the end of the intake pipe. Additionally, approximately 100 feet of damaged pipe between STA 1+00 and 2+00 will be replaced. Additional anchorage will be provided for this segment of pipe to protect from wave action and rocks causing damage to the new segment of pipe. Figure 2 shows the preliminary booster pump and intake screen layout for Alternative 3.

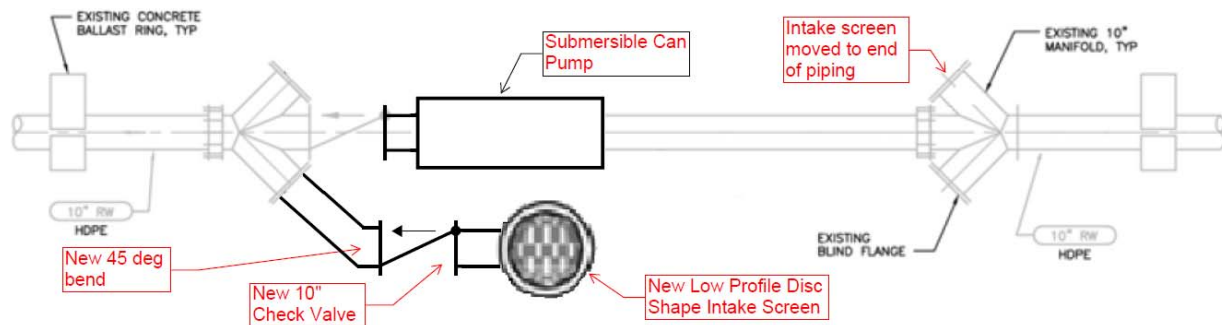

Figure 2: Alternative 3 Booster Pump and Intake Screen Preliminary Layout

The advantages and disadvantages of Alternative 3 are shown in Table 7. The planning level opinion of probable construction cost is shown in Table 8.

Table 7 : Alternative 3 Advantages and Disadvantages

ADVANTAGES	DISADVANTAGES
<ul style="list-style-type: none"> • Minimal TRPA concerns, work may fall under Cave Rock Water Systems MOU with TRPA. • Can provide additional $NPSH_a$ to pump treatment plant capacity of 800+ gpm at low lake levels. • New piping and anchors between STA 1+00 and 2+00 will replace and protect damaged segment of pipe. • Pumping from the far intake will provide compliance with NDEP intake screen depth requirements when lake levels are low. 	<ul style="list-style-type: none"> • Requires barge and lifting line/replacing. • Requires electrical feeds into the lake to power new booster pumps. This requires hand digging trench on shoreline. • Puts pumps back into the lake which will require monthly exercising if not operated. • Increase in O&M costs to the County to maintain additional pumps in the lake. • Additional energy consumption from double pumping raw water. • More complex intake pump system with multiple pumps. • The electrical line in lake increases likelihood of a boat anchor snag.

Table 8 : Alternative 3 Planning Level Opinion of Preliminary Construction Cost

DESCRIPTION	QUANTITY	UNITS	UNIT COST	COST
General conditions	1	LS	\$10,000	\$10,000
Lake mobilization/demobilization	1	LS	\$15,000	\$15,000
Conduit to Pump in Hand Dug Trench	1	LS	\$25,000	\$25,000
Conduit to Pump Anchored to Blocks	1	LS	\$15,000	\$15,000
10" HDPE Pipe w/ Concrete Anchors	100	LF	\$200	\$20,000
Demo 10" HDPE Pipe and Anchors	100	LF	\$100	\$10,000
Booster Pump*	1	EA	\$25,000	\$25,000
Pump installation	1	LS	\$8,000	\$8,000
Check Valve	1	EA	\$7,000	\$7,000
Piping and Pipe Support Modifications	1	LS	\$15,000	\$15,000
Low profile intake screen	1	EA	\$12,000	\$12,000
Electrical and Instrumentation	1	LS	\$15,000	\$15,000
Total				\$177,000
Contingency			20%	\$35,000
Estimate based off Alternative 2 quote provided by Pacific Built Inc. See Appendix C.				
*Based on budgetary quote from pump representative.				
**Cost estimate does not include engineering, permitting, or county administrative costs.				
			Total	\$212,000**

5. Recommended Alternative

HDR recommends Alternative 3 for final design and construction. Alternative 1 geotechnical and TRPA permitting concerns remove it from consideration if final design needs to be completed by December 2015. While the construction cost is the lowest for Alternative 1, additional engineering, geotechnical and permitting costs will likely offset the construction savings. Alternative 2 will provide a new pipe into the lake, reduce headlosses on the suction side of the pumps and keep equipment out of Lake Tahoe. However, Alternative 2 does not offer the flexibility and performance of Alternative 3. Alternative 3 offers the benefit of being able to pump 800+ gpm at lake levels down to elevation 6,219 and lower and replaces 100-ft of damaged piping in the lake. Alternative 3 also enables drawing water from the end of the intake pipe during low lake levels to provide compliance with NDEP requirements for screen submergence at all lake levels. Alternative 3 is also less expensive than Alternative 2.

Engagement of the following jurisdictional agencies will be required for any of the design alternatives as they all include work below the high water level (6,229.1) of Lake Tahoe.

1. Nevada State Lands
2. United State Army Corp of Engineers
3. US Coast Guard
4. Tahoe Regional Planning Agency
5. Nevada Department of Environmental Protection (NDEP)

Appendix A – System Information Documents

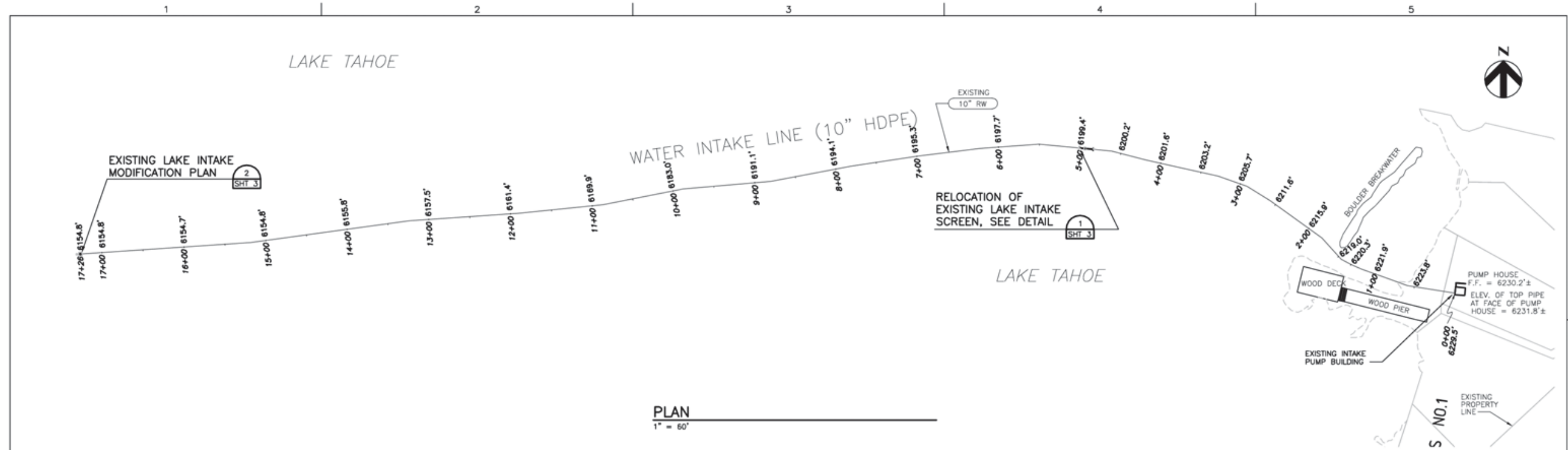

PLAN
1" = 60'

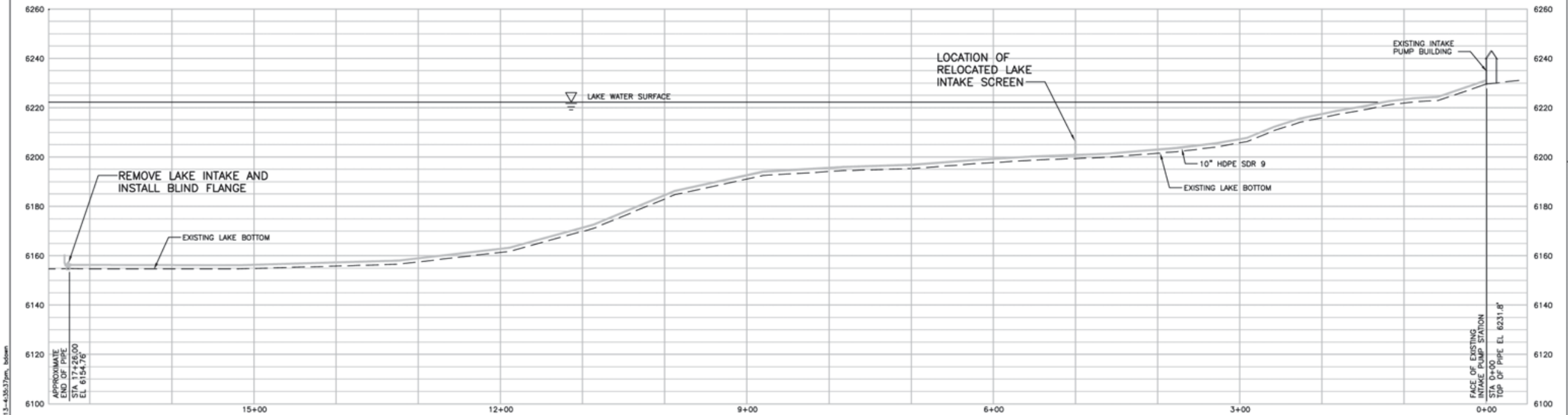

PROFILE
HORIZ: 1" = 60'
VERT: 1" = 20'

FILE: SWITZ.DWG
 DATE: 08/14/2013 4:35:37pm bldmm

ISSUE	DATE	DESCRIPTION

PROJECT MANAGER	
DESIGNED	
CHECKED	
DRAWN	
DATE	
PROJECT NUMBER	



CAVE ROCK-SKYLAND
WATER SYSTEM
LAKE INTAKE PROJECT
PWP-DO-2013-

**CAVE ROCK WATER SYSTEM
LAKE INTAKE PIPE
PLAN AND PROFILE**

	FILENAME: SHT2 SCALE: AS NOTED	SHEET <p style="text-align: center; font-size: 24pt;">2</p>
--	-----------------------------------	---

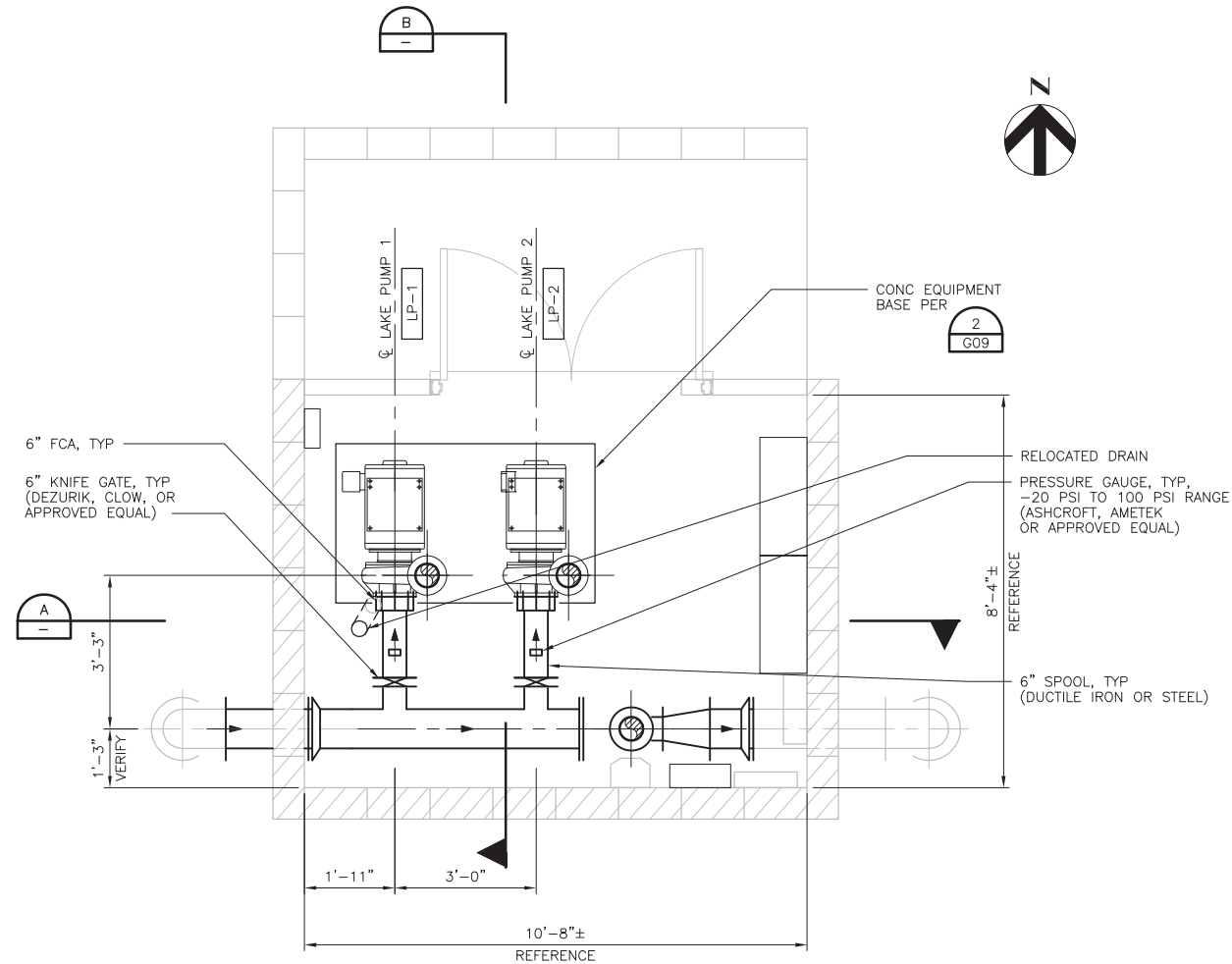

MODIFIED PUMP STATION PLAN
1/2" = 1'-0"

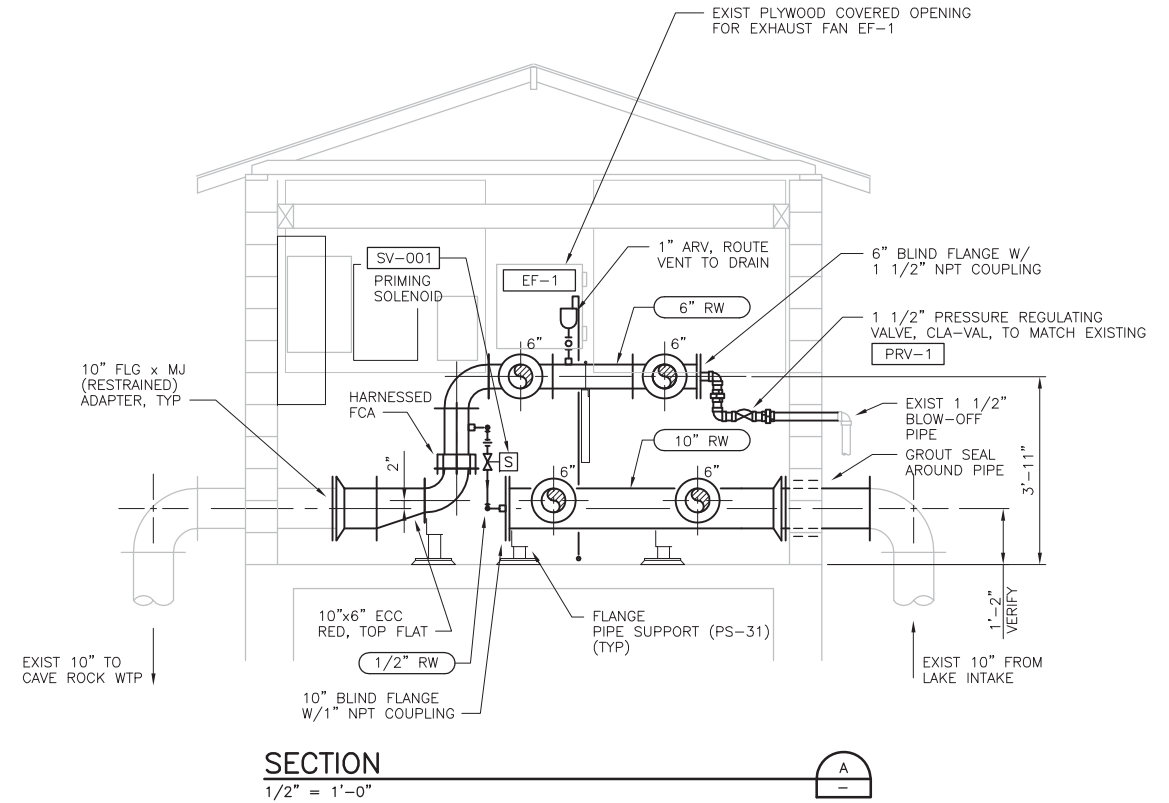

SECTION
1/2" = 1'-0"

NOTES:

1. A FIRE DEPARTMENT KNOX KEY BOX SHALL BE PROVIDED AND INSTALLED FOR EMERGENCY ACCESS (IFC 506.1). ORDER FORMS FOR KNOX KEY BOX AVAILABLE AT:

http://www.knoxbox.com/store/or/the_TDFPD_Station_#3,193_Elks_Point_Road,_Zephyr_Cove.
2. DURING DEMOLITION AND CONSTRUCTION (INTAKE PUMP BUILDING) AN EXTINGUISHER WITH A MINIMUM 2A 10 BC RATING SHALL BE PROVIDED.
3. CONTRACTOR TO REMOVE AND REPLACE EXISTING PLYWOOD ON EAST WALL. REPLACE WITH 3/4-INCH EXTERIOR GRADE PLYWOOD. ATTACH TO WALL WITH 1/4" x 4" LONG STAINLESS STEEL EXPANSION ANCHOR BOLTS AT 2'-0" ON CENTER EACH DIRECTION. PLYWOOD TO SUPPORT NEW ELECTRICAL PANELS.
4. CONTRACTOR TO REMOVE AND REPLACE EXISTING INSULATION ON CEILING, WEST WALL, EAST WALL, SOUTH WALL, AND NORTH WALL. NEW INSULATION TO BE 1" RIGID INSULATION (JOHNS MANSVILLE INSUL-SHIELD PSK FACED BOARDS, MINIMUM R OF 4.2 (HR x FT² x °F)/BTU OR APPROVED EQUAL). ATTACH DIRECTLY TO WALL (MASONRY OR WOOD STUDS) PER MANUFACTURER'S RECOMMENDATIONS. CONTRACTOR TO NEATLY FIX NEW INSULATION AROUND EXISTING FACILITIES NOT REQUIRING REMOVAL/MODIFICATION, AND AROUND NEW IMPROVEMENTS. HOLD NEW INSULATION 2'-FEET ABOVE FINISHED FLOOR.

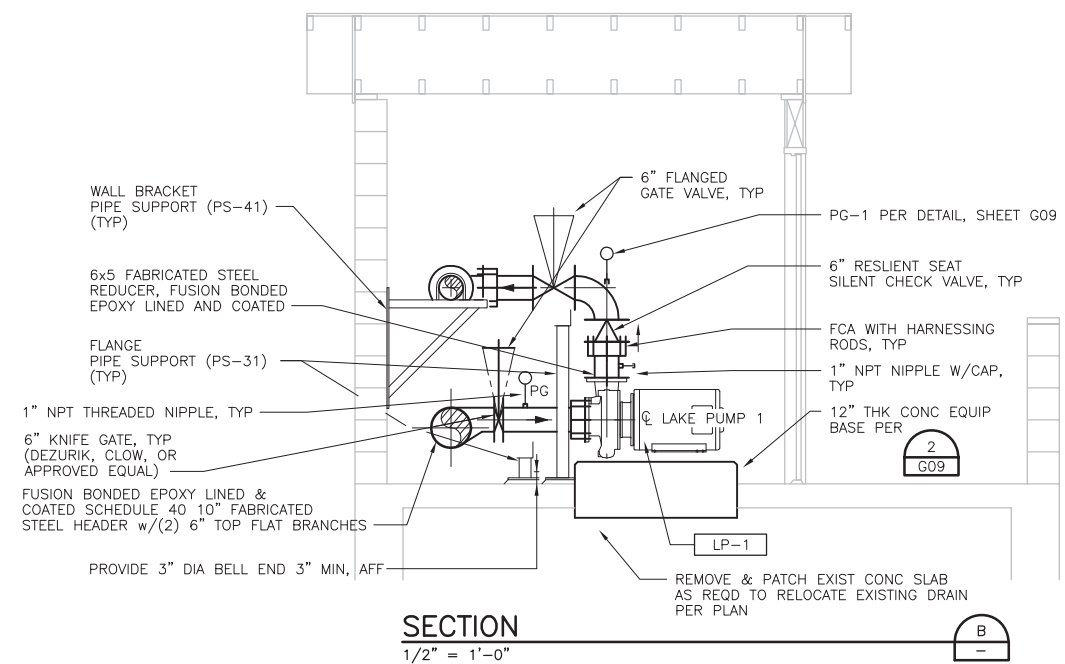

SECTION
1/2" = 1'-0"

FILE: 87037-4SP02.dwg
DATE: Jun 10, 2011 12:12:26pm pvomneu

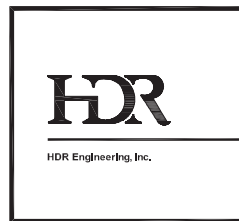

ISSUE	DATE	DESCRIPTION
1	6/13/11	CORRECTED PER CONSTRUCTION RECORDS

PROJECT MANAGER	C. OLSON
DESIGNED	R. NATOLI
CHECKED	C. OLSON
DRAWN	P. VAN MEURS
DATE	Jun 10, 2011
PROJECT NUMBER	08363-87037



**CAVE ROCK-SKYLAND
WATER SYSTEM
IMPROVEMENTS PROJECT
PHASE 1
PWP-DO-2009-354**

**RAW WATER PUMP STATION
MODIFICATION PLAN AND SECTIONS**

0 1" 2"

FILENAME	B7037-4SP02	SHEET	SP02
SCALE	AS NOTED		

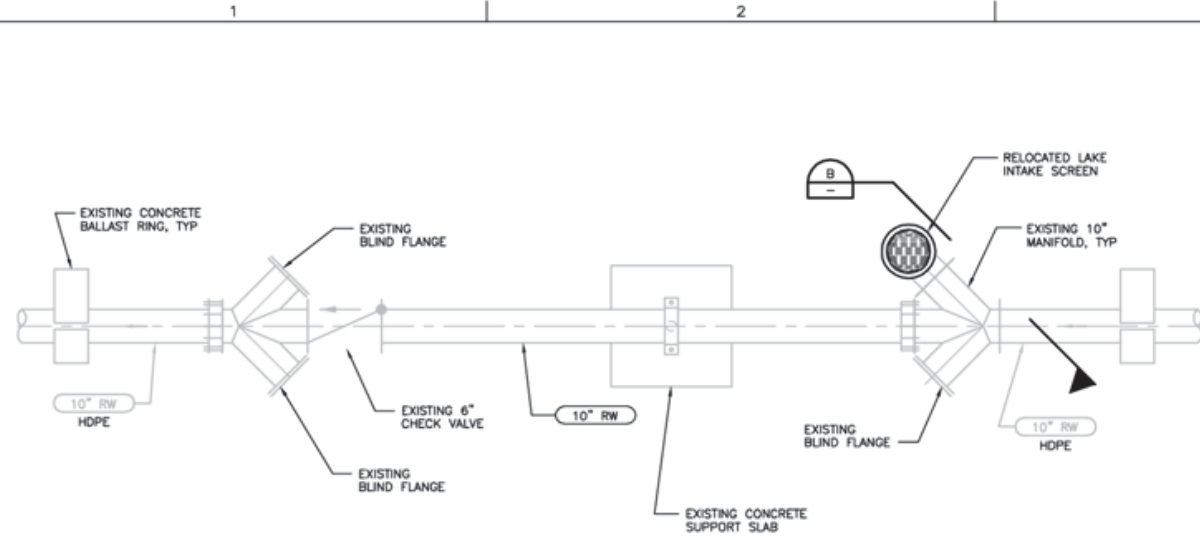

EXISTING LAKE INTAKE PUMP SKID MODIFICATION PLAN
 1/2" = 1'-0" 1 SHT 2

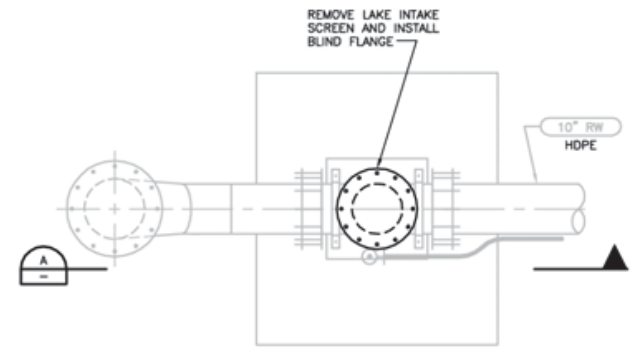

EXISTING LAKE INTAKE MODIFICATION PLAN
 3/4" = 1'-0" 2 SHT 2

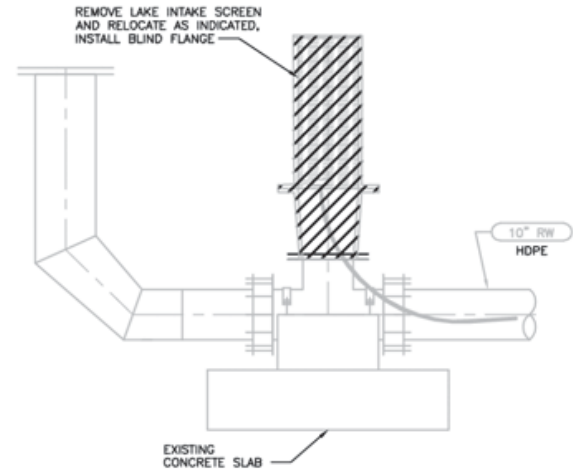

EXISTING LAKE INTAKE MODIFICATION SECTION
 3/4" = 1'-0" A

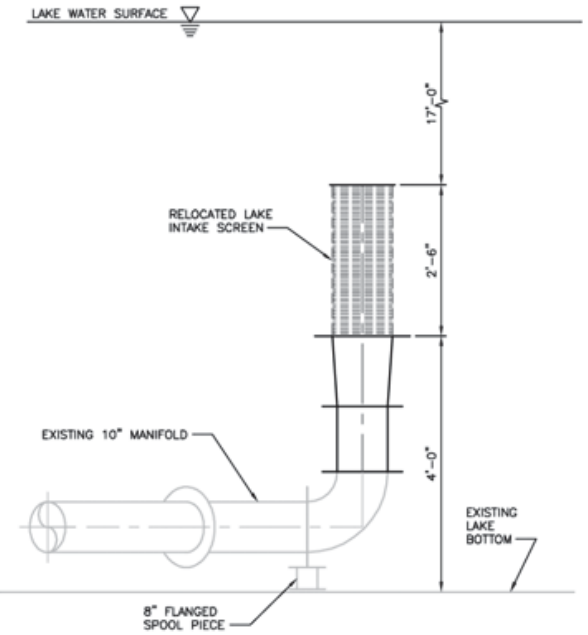

EXISTING PUMP SKID MODIFICATION SECTION
 3/4" = 1'-0" B

FILE: SHT3.dwg
 DATE: 05/17/2013 9:35:34am bshen

			PROJECT MANAGER	
			DESIGNED	
			CHECKED	
			DRAWN	
			DATE	
			PROJECT NUMBER	
ISSUE	DATE	DESCRIPTION		



CAVE ROCK-SKYLAND
 WATER SYSTEM
 LAKE INTAKE PROJECT
 PWP-DO-2013-

MODIFICATION PLANS AND SECTIONS

FILENAME	SHT3	SHEET
SCALE	AS NOTED	3

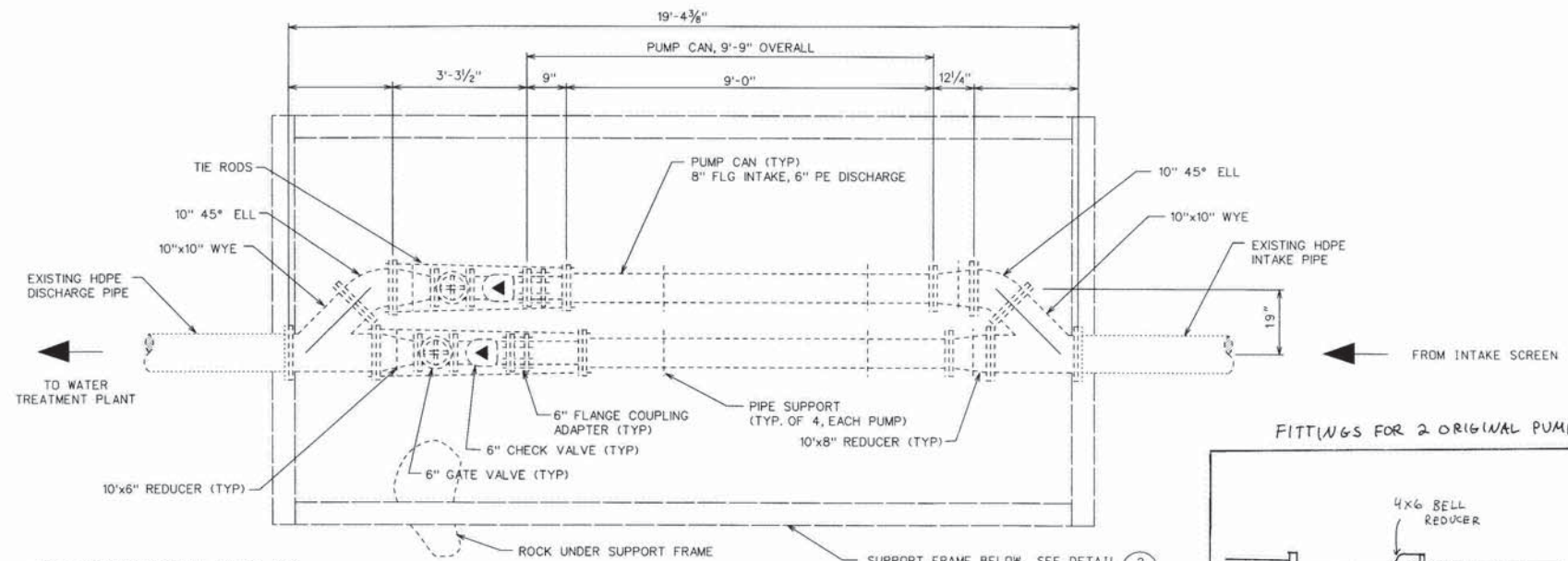

NOTE: CONTRACTOR SHALL ADJUST AND RELOCATE PUMP STATION OFF OF EXISTING ROCK AND POSITION SUPPORT FRAME FLAT ON THE BOTTOM.

EXISTING

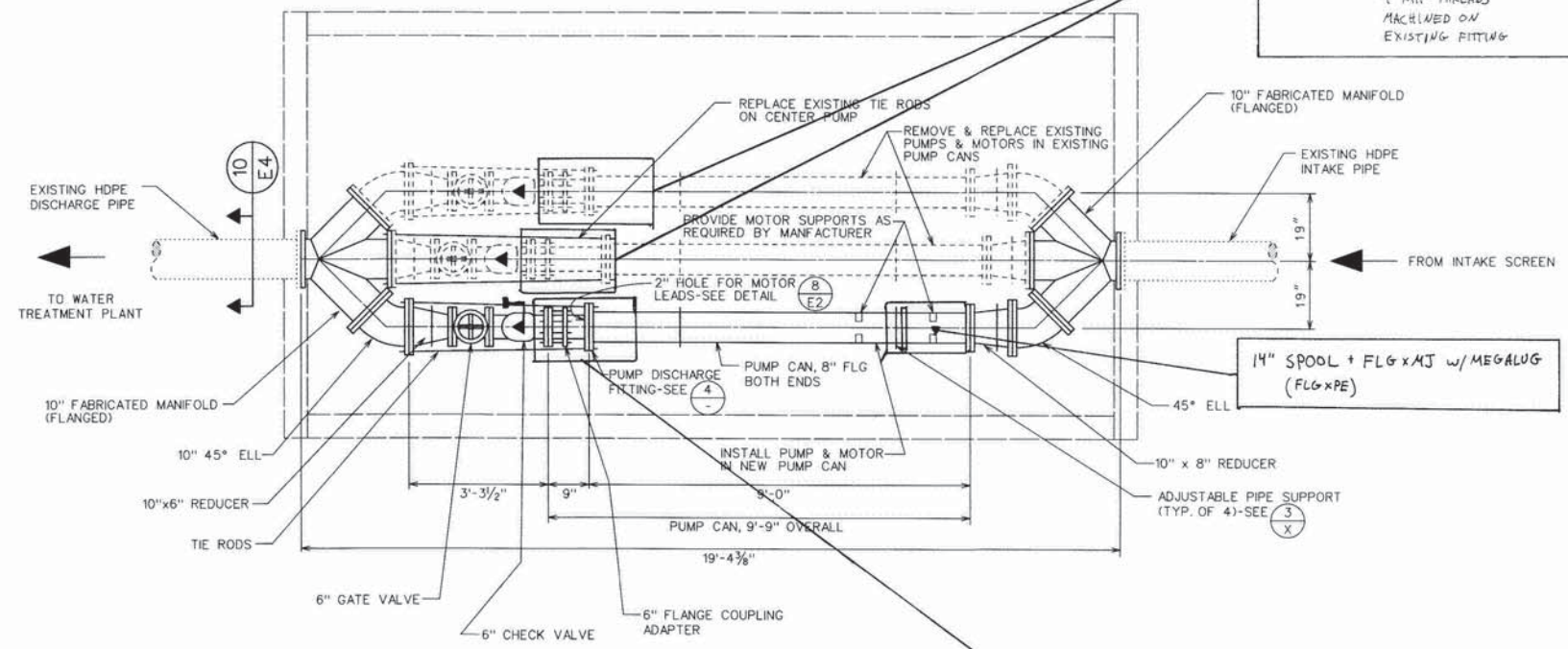

PROPOSED

RAW WATER PUMP STATION 1
SCALE: 1"=2'-0"

- NOTES:
- FABRICATED MANIFOLDS, ELL'S, REDUCERS, NEW PUMP CAN & PUMP DISCHARGE FITTING TO BE FUSION EPOXY COATED.
 - SUPPORT BEAM & PIPE SUPPORTS TO BE SANDBLASTED & PAINTED PER SPECIFICATIONS.
 - REMOVE EXISTING PUMPS & MOTORS, REPLACE WITH NEW PUMPS & MOTORS PER SPECIFICATIONS. CONNECT NEW PUMPS & MOTORS TO EXISTING PUMP DISCHARGE FITTINGS & VALVES.

FITTINGS FOR 2 ORIGINAL PUMP CANS

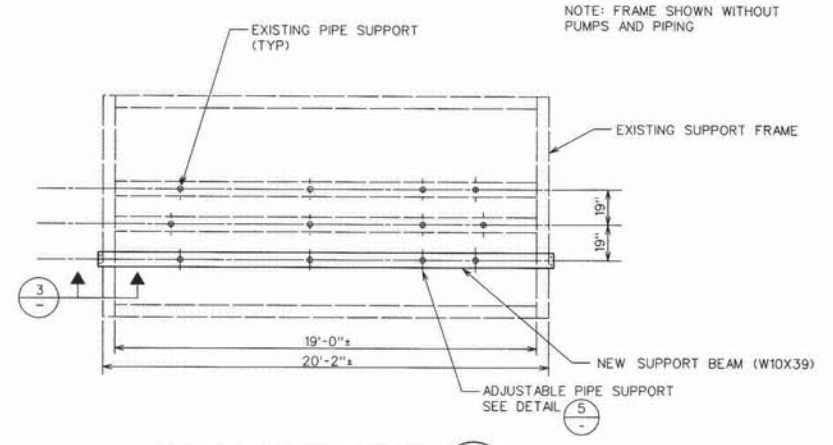
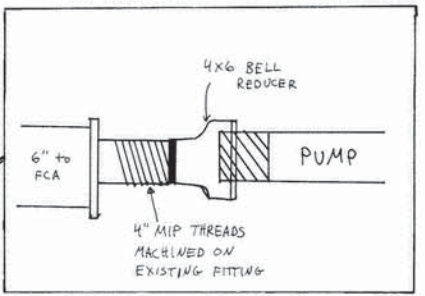

PUMP FRAME SUPPORT 2
SCALE: 1"=4'-0"

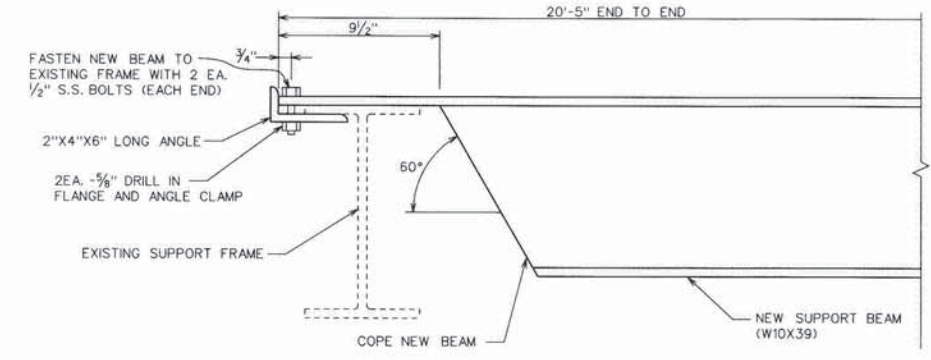

CONNECTION 3
NO SCALE

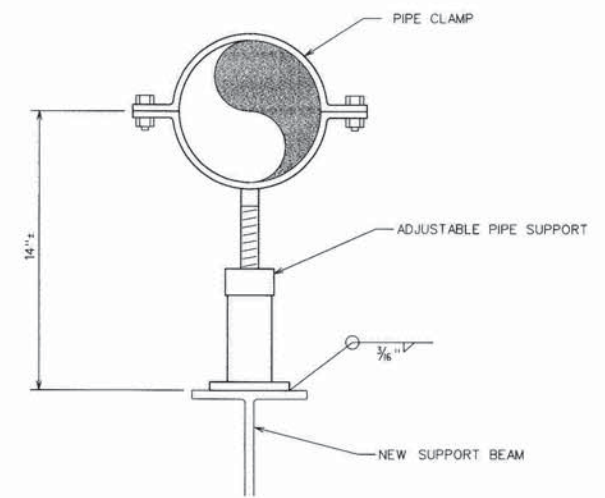

ADJUSTABLE PIPE SUPPORT 5
NO SCALE

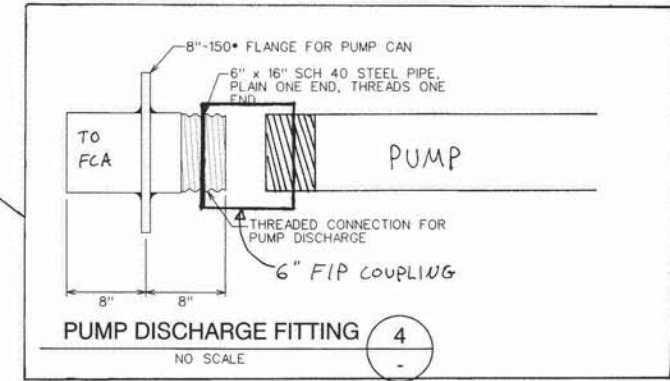

PUMP DISCHARGE FITTING 4
NO SCALE

XG/97
KASL
5/16/96

DESIGNED BY:	REVISION	DATE	DESCRIPTION	BY	APP'D	BENCH MARK :	ELEV :	6222.73
DRAFTED BY:		8/98	RECORD DRAWING	JTB		DESCRIPTION :	DATUM :	LAKE TAHOE DATUM
CHECKED BY:						WATER SURFACE ELEVATION FOR LAKE TAHOE RECORDED IN THE OFFICE OF THE LAKE TAHOE WATER MASTER, TAHOE CITY, CALIFORNIA ON 6/8/94		
DESIGN FILE:								

**CAVEROCK/SKYLAND WATER SYSTEM
IMPROVEMENT PROJECT FOR
WATER MAINS, PUMP STATION & STORAGE TANKS**
DOUGLAS COUNTY, NEVADA

SCALE AS SHOWN
JOB NO. 3005-02
DATE :

**RAW WATER PUMP STATION
IMPROVEMENTS**
Gilmore Engineering
101 River Ridge Court
Folsom, California 95630
(916) 987-7124

KASL
CONSULTING ENGINEERS, INC.
Civil-Environmental-Surveying
(916) 929-8127 FAX (916) 929-0621
4200 NORTH FREEWAY BLVD., SUITE 1
SACRAMENTO, CA. 95834

Appendix B – Alternative 3 Pump Information

Pump Performance Datasheet

Customer	: HDR	Quote number	: 455530
Customer reference	:	Size	: 10DKH
Item number	: 001	Stages	: 1
Service	:	Based on curve number	: 10DKH 1770 Rev. 0
Quantity	: 1	Date last saved	: 13 Aug 2015 4:30 PM

Operating Conditions		Liquid	
Flow, rated	: 700 USgpm	Liquid type	: Water - Potable
Differential head / pressure, rated (requested)	: 30.00 ft	Additional liquid description	:
Differential head / pressure, rated (actual)	: 30.38 ft	Solids diameter, max	: 0.00 in
Suction pressure, rated / max	: 0.00 / 0.00 psi.g	Solids concentration, by volume	: 0.00 %
NPSH available, rated	: Ample	Solids concentration, by weight	: 0.00 %
Frequency	: 60 Hz	Temperature, max	: 68.00 deg F
Performance		Fluid density, rated / max	: 1.000 / 1.000 SG
Speed, rated	: 1,770 rpm	Viscosity, rated	: 1.00 cP
Impeller diameter, rated	: 6.09 in	Vapor pressure, rated	: 0.00 psi.a
Impeller diameter, maximum	: 6.47 in	Material	
Impeller diameter, minimum	: 5.50 in	Material selected	: Cast Iron/Bronze
Efficiency (bowl / pump)	: 73.22 / 69.73 %	Pressure Data	
NPSH required / margin required	: 10.71 / 0.00 ft	Maximum working pressure	: See the Additional Data page
Ns (imp. eye flow) / Nss (imp. eye flow)	: 3,282 / 7,680 US Units	Component pressure limit	: See the Additional Data page
MCSF	: 197 USgpm	Maximum allowable suction pressure	: N/A
Head, maximum, rated diameter	: 50.91 ft	Hydrostatic test pressure	: See the Additional Data page
Head rise to shutoff	: 62.68 %	Driver & Power Data	
Flow, best eff. point (BEP)	: 686 USgpm	Driver sizing specification	: ISO 5199
Flow ratio (rated / BEP)	: 102.08 %	Margin over specification	: 0.00 %
Diameter ratio (rated / max)	: 94.20 %	Service factor	: 1.15
Head ratio (rated dia / max dia)	: 82.79 %	Power, hydraulic	: 5.5 hp
Cq/Ch/Ce/Cn [ANSI/HI 9.6.7-2010]	: 1.00 / 1.00 / 1.00 / 1.00	Power (bowl / pump)	: 7.6 / 7.6 hp
Selection status	: Acceptable	Power, maximum, rated diameter	: 7.6 hp
		Minimum recommended motor rating	: 10.0 hp / 7.5 kW

Pump and bowl (dashed) performance. Bowl adjusted for construction and viscosity.
Pump further adjusted for friction and power losses of lineshaft and thrust bearings. Pump is not adjusted for any static lift.
The duty point represents the pump performance head.

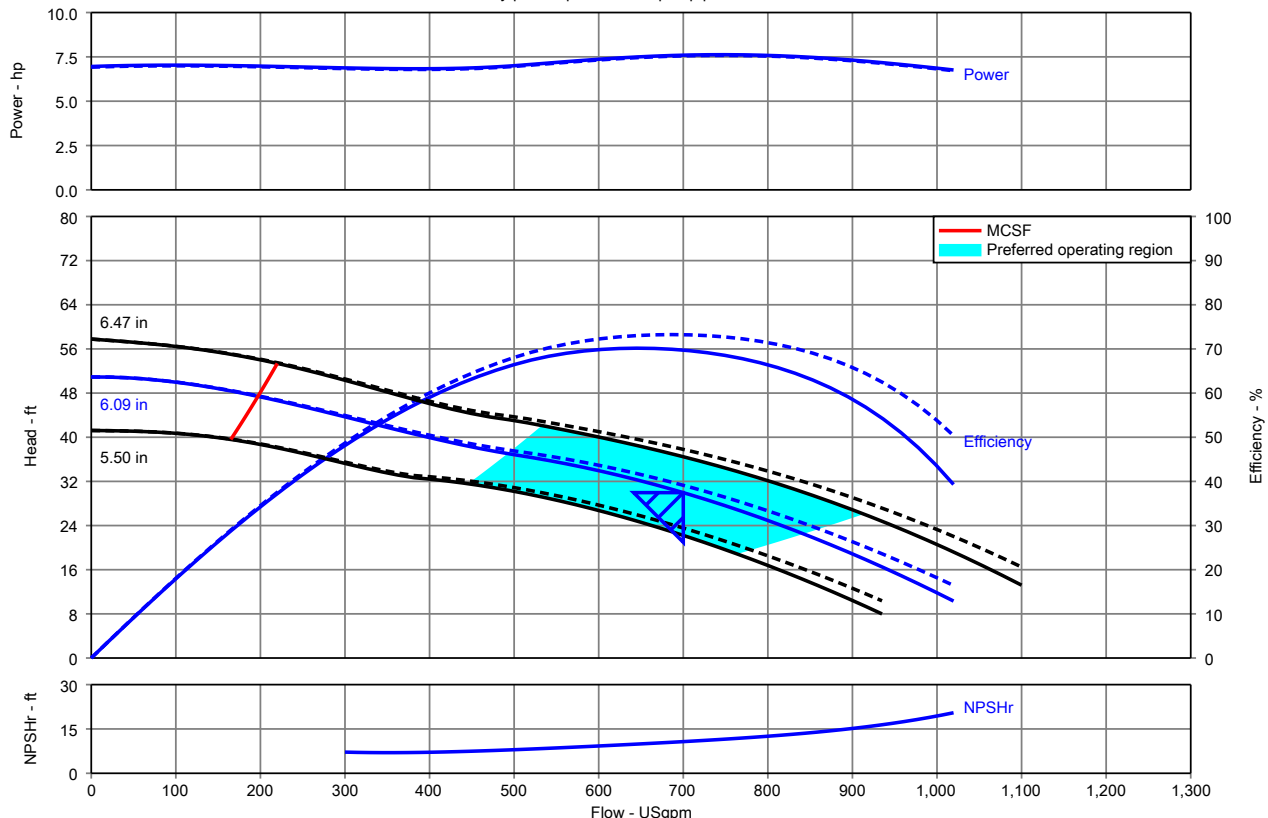



TURBINE TYPE, HORIZONTAL BOOSTER SUBMERSIBLE PUMP

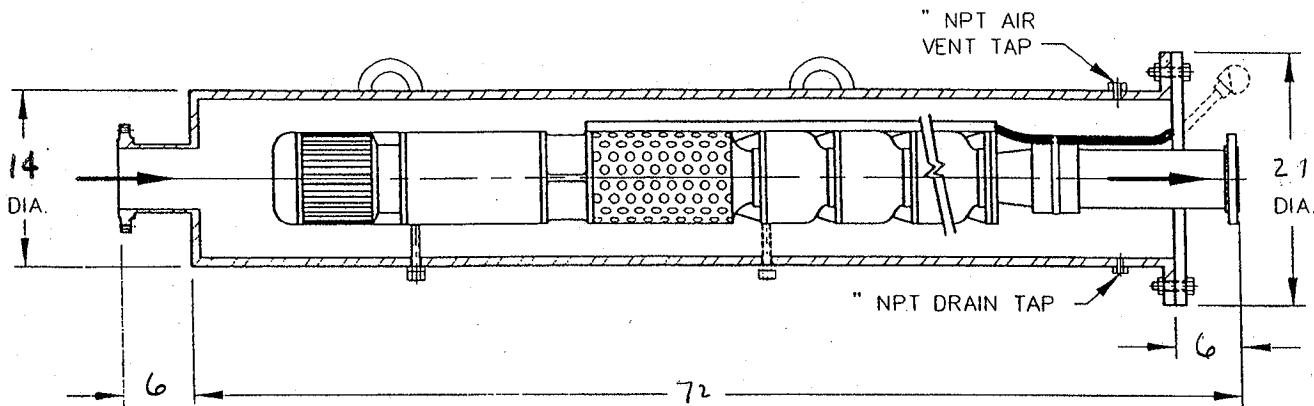

10" 150# -R.F.ANSI. SUCTION FLG.
 _____ DIA. HOLES *
 _____ DIA. BOLT CIRCLE
 _____ DIA. FLANGE

8" 150# -R.F.ANSI. DISCH. FLG.
 _____ DIA. HOLES *
 _____ DIA. BOLT CIRCLE
 _____ DIA. FLANGE

MOTOR

MAKE HITACHI
 HP 10 RPM 1760
 PHASE 3 HERTZ 60
 VOLTAGE 460
 FRAME NO. _____

CABLE

SIZE _____
 LENGTH _____
 TYPE _____

PUMP

TYPE 10DKH STAGE 1
700 GPM 30 BOWL HD

MATERIAL

SURFACE PLATE _____
 BARREL _____
 PUMP BOWL _____
 IMPELLER _____
 BEARINGS _____
 BOWL SHAFT _____
 STRAINER _____
 BOWL W/R _____
 IMPELLER W/R _____

CUSTOMER H.R.
DOUGLAS COUNTY P.W.

Dimensions in Inches

FLUID WATER
 SPEC. GRAVITY _____
 VISCOSITY _____
 TEMPERATURE _____
 PH _____

ORDER NO. _____
 SUPPLIER _____

REMARKS
 NO. UNITS REQ'D. _____

DWG. NO. _____
 SERIAL NO. _____

By: [Signature] Date: 9/13/14

NOT TO BE USED
 FOR CONSTRUCTION
 UNLESS CERTIFIED

A **WEBB** COMPANY

Appendix C – Engineering Contractor Construction Quotes

Not A Proposal – For Budgetary Purposes Only

Pacific Built Inc.

Engineering Contractor

P.O. Box 6694

Tahoe City, CA 96145

Phone: (530) 583-3447

Fax: (530) 583-2528

E-mail address: pacificbuilt@yahoo.com

California Contractors License: # A - 797068 – Nevada Contractors License #0053611– A

PROPOSAL DATE: 25 August 2015

Owner: CAVE ROCK / SKYLAND WATER SYSTEM – Douglas County Public Works

Project Location: Lakeridge Subdivision Area

Consultant/Contact: Rob Natoli, PE, CDT of HDR Inc.

Pacific Built, Inc. hereby submits specifications and estimates for the following project:

LAKE INTAKE RELOCATION PROJECT

- | | |
|---|-----------------|
| 1. Mobilization to Jobsite w/ Equipment & Materials | \$ 6,000 |
| 2. Removal and Disposal of existing 10” HDPE | \$42,000 |
| 3. Install New 14” HDPE Line with Concrete Collars every 20’ +/- | \$90,000 |
| 4. Build & Install Steel Framed Intake Structure with Sun Screen (to inhibit algae growth) | \$12,000 |
| 5. Hand Dig Trench to Pump House (Can’t Access with Equipment) | \$30,000 |
| 6. Jobsite Clean-up & Demobilization | \$ 6,000 |

* Price based upon the pipe being fused @ Cave Rock Boat Ramp, brought to jobsite in one piece.

** Prices are strictly estimates given on information of project provided.

*** **Price Does not include Plans, Permits, Engineering and/or Testing**

Pacific Built, Inc. hereby proposes to furnish material and labor – complete in accordance with above specifications, for the sum of:

One hundred fifty-five thousand dollars & no/100 \$ 186,000.00

Authorized Signature of Contractor:

Luke T. Ragan

Luke T. Ragan / President / RMO

Proposal
Pacific Built Inc.
Engineering Contractor

P.O. Box 6694
Tahoe City, CA 96145
Phone: (530) 583-3447
Fax: (530) 583-2528
E-mail address: pacificbuilt@yahoo.com

California Contractors License: # A - 797068 – Nevada Contractors License #0053611– A

PROPOSAL DATE: 10/03/12

**Owner: Douglas County Public Works, P.O. Box 218, Minden, NV 89423
Attn: Nick Charles ncharles@co.douglas.nv.us**

Project Location: Lakeridge Water Intake - Modification

Pacific Built, Inc. hereby submits specifications and estimates for the following project:

SHORTEN WATER INTAKE LINE - LAKERIDGE

1. Mobilization of Equipment to Jobsite
2. Locate Intake
3. Remove Intake Structure
4. Removal of 750' of Pipe and Anchors
5. Re-Attach Intake Structure
6. Disposal of 750' of Pipe
7. Inspect Leak Bands and Re-Install
8. Assist with Testing of Intake Line: Removal of Temp. Intake and/or Cap Off @ Old Skid Location
9. Demobilization of Equipment

** All Employees of Pacific Built, Inc. have NV OSHA 10/30 Certifications

Pacific Built, Inc. hereby proposes to furnish material and labor – complete in accordance with above specifications, for the sum of:

Fifty-five thousand seven hundred seventy-five dollars & no/100 \$ 55,775.00

Progress Payments

Progress payments for the above project shall be made in accordance with the following schedule:

- | | |
|--|--------------|
| 1. Deposit Due Upon Signing Of Proposal | \$ 1,000.00 |
| 2. Payment Due Prior to Mobilization | \$ 25,000.00 |
| 3. Progress Payment Due Upon Completion of Removal of Pipe | \$ 15,000.00 |
| 4. Payment Due Upon Completion of Re-Attachment of Intake | \$ 10,000.00 |
| 5. Final Payment Due Upon Release of Retainage | \$ 4,775.00 |

Options

Pacific Built, Inc. may, upon mutual agreement of the Owner and Contractor, provide certain Options to the Owner. The Option(s) available to the Owner and the additional costs for said Option(s) in addition to the proposed sum for material and labor set forth above are as follows:

No Options Given At This Time.

Should Owner wish for Contractor to perform Option(s) outlined above, Owner shall sign on the lines indicated above. The cost of each Option shall be borne by the Owner in addition to the proposed sum for material and labor set forth above. Should Owner approve of an Option(s) in the instant Proposal, Contractor shall for purposes of the Owner Contractor Agreement add to the original proposal price the cost of said Option(s) and reference provide in Article 4.1 of the Owner Contractor Agreement a final contract price including the costs for performance by Contractor of the Option(s). Should Owner approve of an Option(s) in the instant Proposal, Contractor shall also outline in Article 5.1.2 of the Owner Contractor Agreement, the work required for such Option(s) and shall reference the work in the stages outlined in that Article.

Any alteration or deviation from the above specifications involving extra cost will only be executed upon written change orders and will become an extra charge over the sum mentioned in this contract. All agreements must be in writing. This proposal shall be binding upon the contractor for a period of thirty (30) days.

Upon acceptance of the instant Proposal, Contractor shall promptly provide to Owner Contractor's standard Owner-Contractor Agreement (AIA Document A101-2007) along with related General Conditions and addenda for review and execution by Owner. Said Agreement shall be executed by Owner and Contractor prior to commencement of the project.

Authorized Signature of Contractor:

Luke T. Ragan

Luke T. Ragan / Vice President / RMO

***Note:** This proposal may be withdrawn by Pacific Built, Inc. if not accepted within thirty (30) days.

Owner's Acceptance of Proposal – The above Proposal is hereby accepted by Owner and Owner hereby requests that Contractor promptly forward Contractor's standard Owner-Contractor agreement for review and execution by Owner.

Signature: _____

Date of Acceptance: _____

Signature: _____

Date of Acceptance: _____