



# City of Pleasant Ridge Eave Detail Requirements

The entire City of Pleasant Ridge is designated as a federal historic district. The City does not have a design review board, but it does have an Exterior Design Standards document which new construction and renovations in the City must meet. The design standards are online at: <https://cityofpleasantridge.org/wp-content/uploads/2018/01/Exterior-Design-Standards.pdf>

The following is a summary of eave design considerations by architect Marianne Cusato. She is the author of [Get Your House Right: Architectural Elements to Use and Avoid](#). Drawings by the author.

## Simple Eaves Without a Return

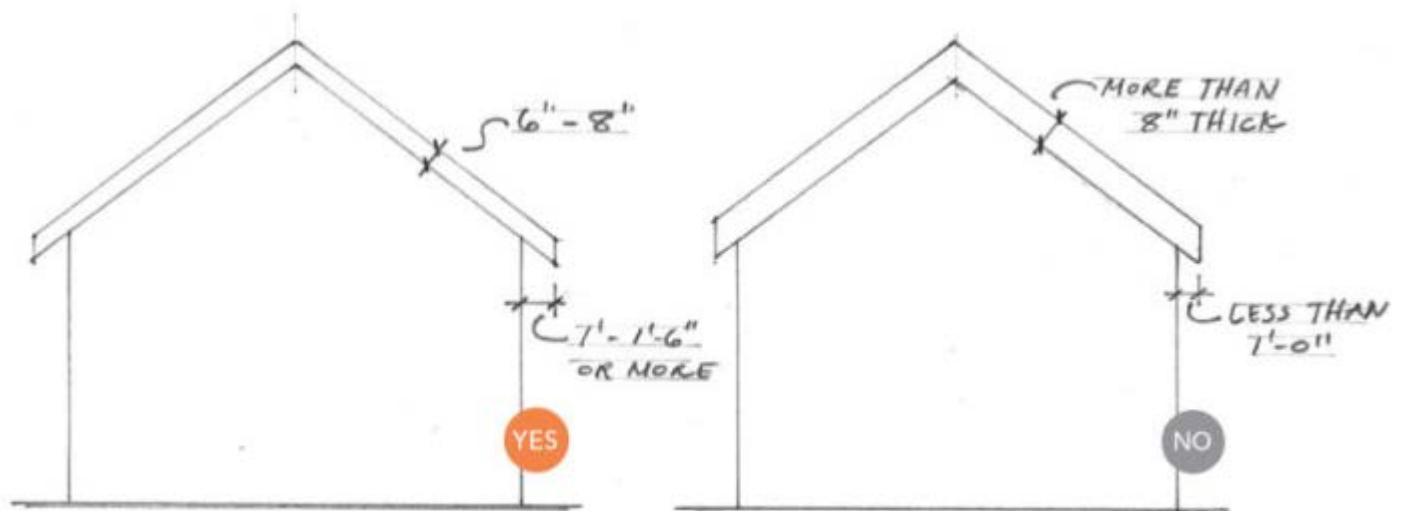

## General rules of thumb

Eave design starts with looking at the overall building composition and proportion. When designing a gable-end eave without a return, the dimensions to look at are the width of the trim (set between 6 in. and 8 in. thick) and the overhang from the side wall (set between 12 in. to 18 in., depending on the style of the building). avoid gable ends that are over 8 in. wide, especially when the eave overhang is less than 12 in.

## Start with roof framing

The design of your eave is dictated by the construction of your roof. before manufactured trusses, the simplest roof construction involved extending exposed rafter tails beyond the walls of the house. Trusses streamline construction, but it's important when using them to make sure the resulting eave works with the design of your building.

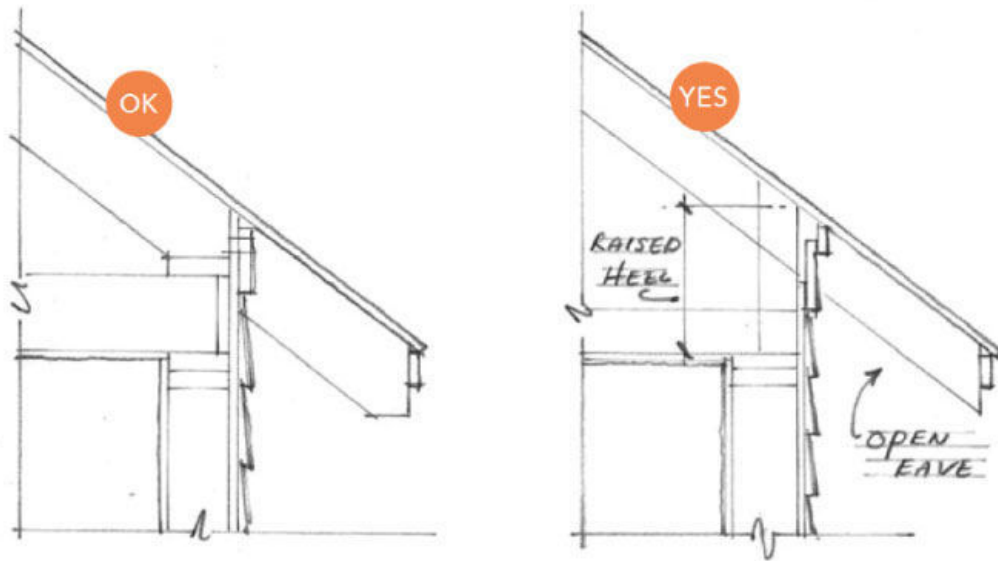

*Left:* Open eaves with roof rafters, *Right:* Open eaves with trusses

### Open eaves with roof rafters

before roof trusses, the exposed rafter tails were an extension of the roof framing. The ceiling joists pushed the rafters up and gave extra height to the building.

### Open eaves with trusses

When designing an open eave with roof trusses, make sure that you raise the heel of the truss and use a thicker top chord. doing so raises the eave, which prevents it from conflicting with the window head height.

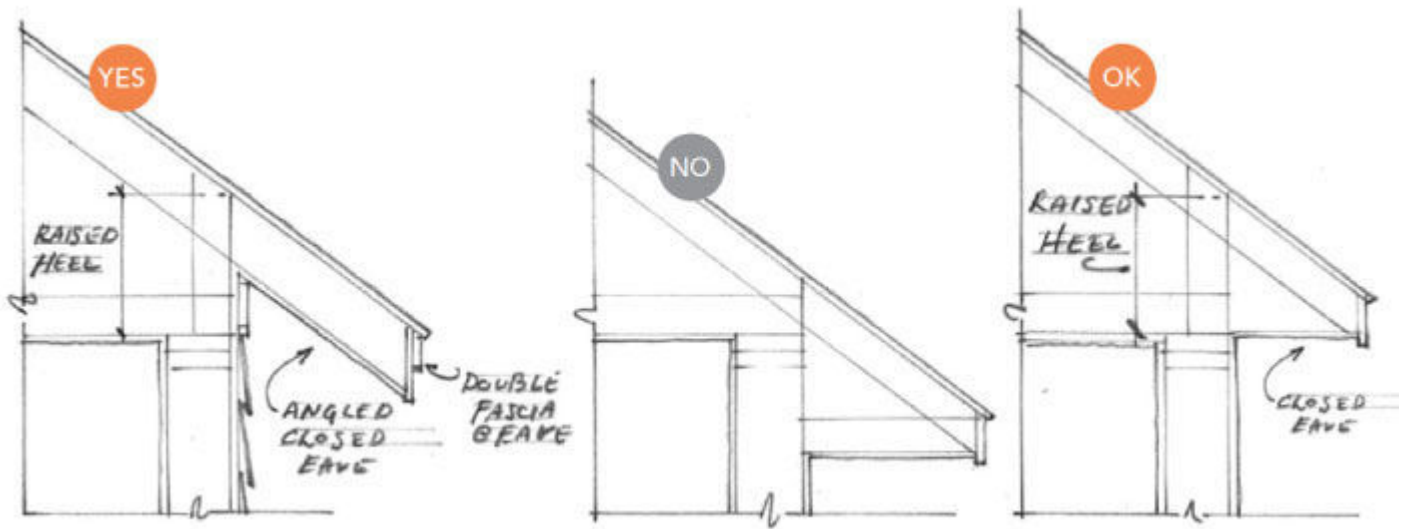

*From left to right:* Closed eaves with angled soffit, Closed eaves with flat soffit and no raised heel, Closed eaves with flat soffit and raised heel

### Closed eaves with angled soffit

Exposed rafter tails are more work to install and maintain over time. Moreover, as homes have shifted increasingly to conditioned attics, closed eaves have become more popular. With a closed eave, you still want to raise the heel height of the truss. Also, make the extra effort to install an angled soffit. It looks substantially better than a flat soffit.

### Closed eaves with flat soffit and no raised heel

The default in eave design is a flat soffit. While flat soffits work well in some situations, in most, they result in pork-chop eave returns. Proceed with extreme caution when using a flat soffit.

### Closed eaves with flat soffit and raised heel

When you do use a flat soffit, make sure to include a raised heel on the truss. This pulls the eave up, giving height to the roofline as well as keeping the eave clear of the window head height.

## Gable-end details for closed eaves

### Angled soffit

The cleanest look for a gable end with a closed eave is to angle the soffit, therefore eliminating the need to resolve the eave at the gable end. This configuration gives the look of an open eave, but it has the same benefits—ease of maintenance and energy performance—as a closed eave.

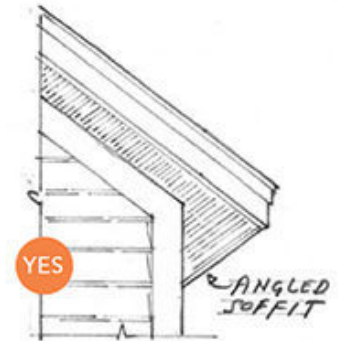

### Pork-chop eave

The much-derided pork-chop eave has been covered in depth in many articles. It is the unfortunate result of connecting the geometry of a flat soffit on the side eave with the angle of the gable end. This is a detail to avoid at all costs. If you are not able to use an angled soffit, use one of the two flat-soffit details illustrated below. There is no reason to use a pork-chop eave.

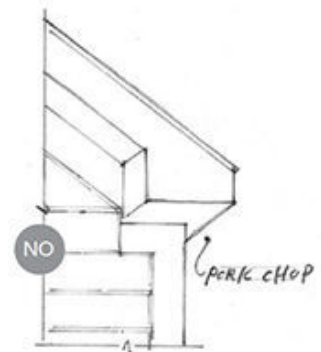

### Flat soffit, stopping at end wall

If you must use a flat soffit, stop the flat portion of the soffit at the wall to align with the corner board. This allows the gable projection of the eave to extend down and look like an angled soffit at a glance.



### Flat soffit with bracket

While flat soffits are not ideal, one way to mask them is to stop the horizontal soffit at the gable-end wall, as in the previous example, and then add a decorative bracket at the gable end to hide the transition from flat to angled.

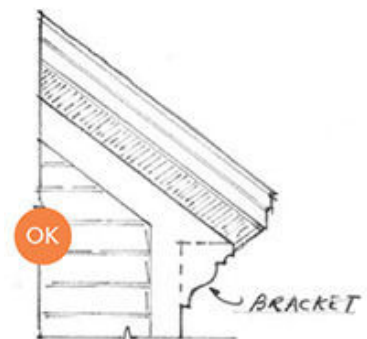

### Plumb- vs. square-cut eaves

Plumb-cut eaves are perpendicular to the ground, while square-cut eaves are perpendicular to the angle of the roof.

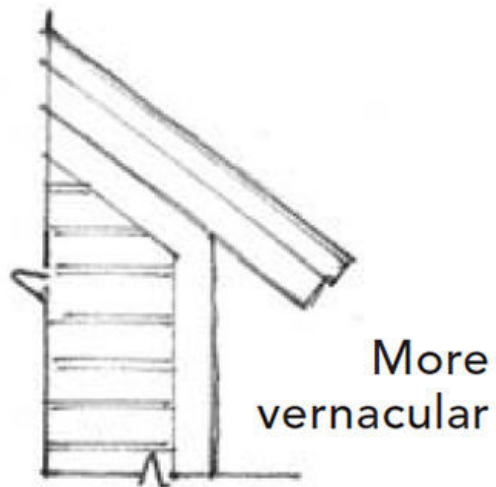
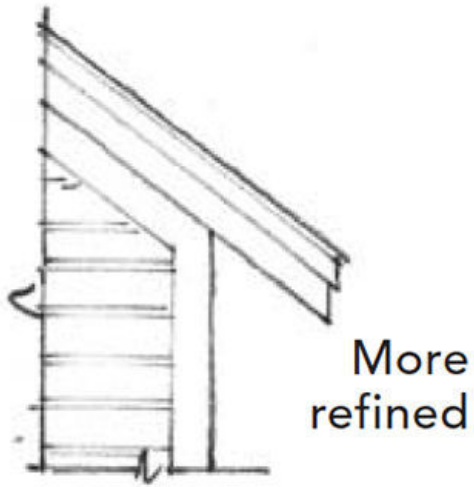

## Boxed Eaves with a Return

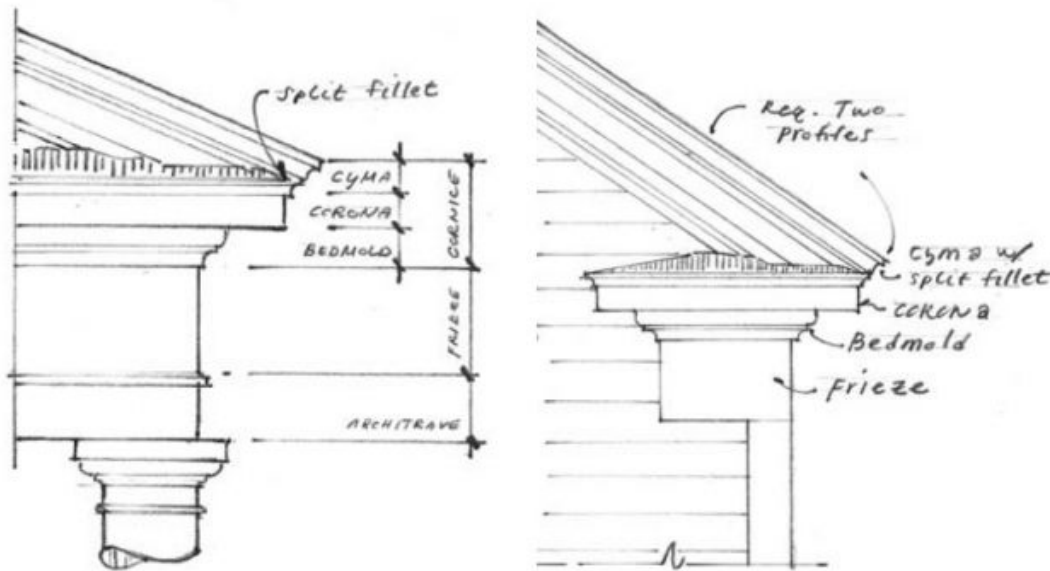

Classical cornice

In the first section we looked at simple eaves, with a focus on the eave detail at a gable end. In this installment, we will focus on returns for boxed eaves. The architecture of boxed-eave returns are based on the classical orders, in which the entablature is made of three elements: the architrave (beam), frieze (ceiling joists), and cornice (transition to the roof). The cornice is broken down into three parts: the bedmold (which evolved from the plate that holds the rafters), the corona (the ends of rafters that form a drip edge), and the cyma (traditionally the gutter).

These elements translate directly to modern classical eaves, with a full cornice over a frieze. If you are using a full cornice, the angled profile of the cyma and the horizontal profile of the cyma will not be the same. Commercially available molding profiles set for a limited range of roof slopes used to be an option; they allowed the cornice to be installed with stock moldings. Today, if you are planning to install a classical cornice, it will most likely require custom cutting.

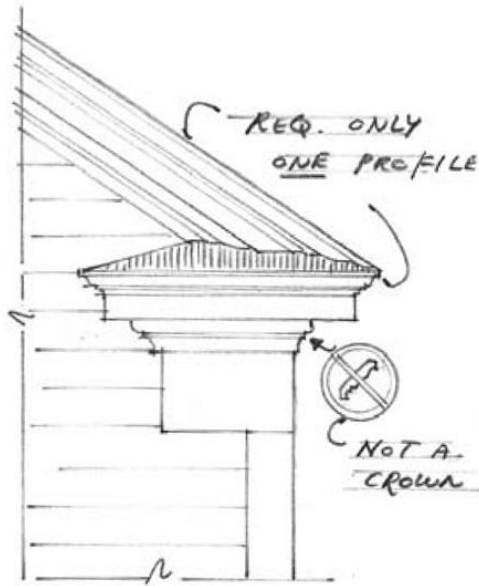

Poor man's cornice

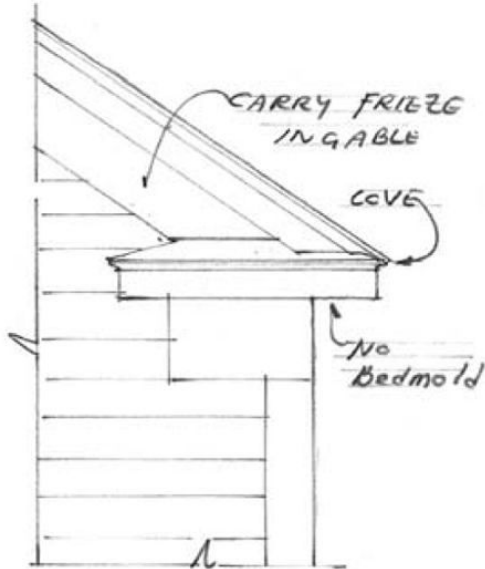

Simple boxed-eave return

To avoid needing to use custom moldings, you can install what has been termed a “poor man’s cornice.” For this detail, you need only one cyma profile, and rather than splitting the cyma to match the classical orders, the entire cornice runs into the eave return; and the angled cornice from the gable end resolves into the horizontal cornice. A common mistake is to substitute a cyma for the bedmold.

It is better to omit the molding under the corona altogether than to use a terminating molding in place of a supporting molding. If profiled moldings are not in the budget or are the wrong fit for the look of your home, a simple boxed-eave return provides a universal solution. The following is a step-by-step guide to proportioning your simple boxed eaves.

One key note: do not confuse the simple boxed eave with a pork chop eave, which was addressed in the first section.

### Step 1: Setting out a simple boxed-eave return

The corona height start with a corona between 4 in. and 6 in. avoid coronas that are overly tall (in the range of 8 in.). While this height works for a hip roof or eave with an angled soffit, it will be too heavy for a boxed-eave return on a gable end.

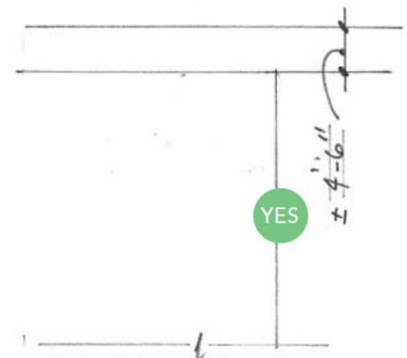

## Step 2: The eave depth, frieze size, and return depth

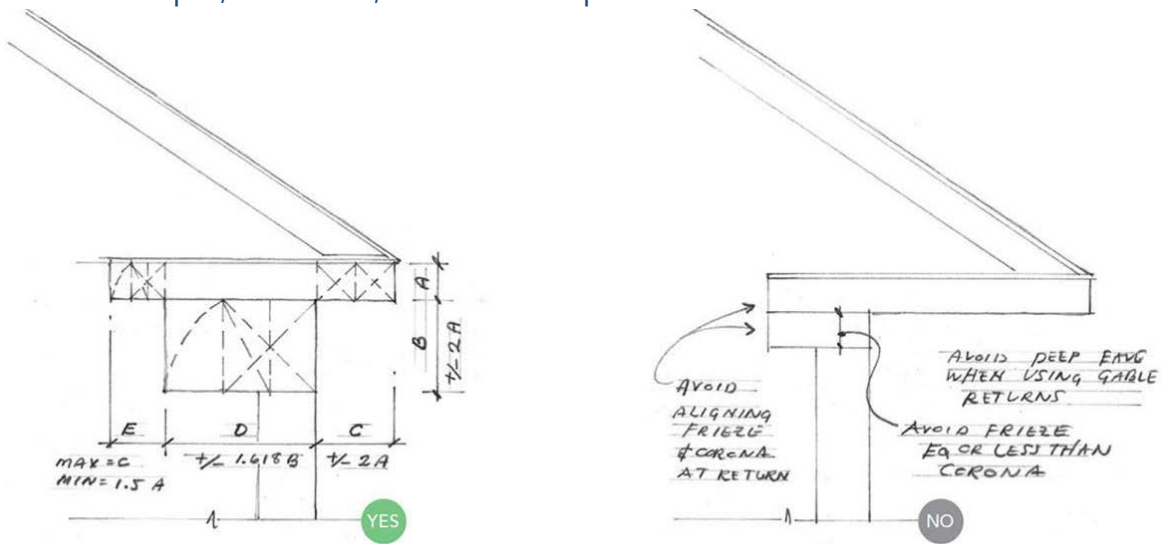

This diagram illustrates one possible proportioning system for the eave return. In this case, the depth of the eave ( $C$ ) is set by overlaying a double square on the projecting corona ( $A$ ). The frieze height ( $B$ ) is set a little over the projection of the eave. The width of the frieze ( $D$ ) is set by inscribing a golden rectangle (a ratio of 1:1.618) on the frieze. The depth of the return ( $e$ ) is also set by a golden rectangle.

This is just one of many ways to proportion eave returns, and it's a good point of departure. As you experiment with your design, here are the pitfalls to avoid: As with deep coronas, eaves over 12 in. deep work well on hip roofs and gable ends with an angled soffit, but with a boxed-eave return they look too heavy.

Also, when sizing your frieze, make sure it is at least two steps up in dimensional lumber from and ideally double the height of the corona. Finally, when setting the depth of the return, be sure it is at least one-and-a-half times the height of the corona and no more than the extension of the eave from the building. More refined details will have the return on the gable end smaller than the eave overhang, but there still needs to be a return.



### Step 3: The eave roof and gable

The final step is putting the “roof” on the eave and addressing what happens in the gable itself. Remember, the “roof” on the return is there just to shed a small amount of water. Do not set it to match the main roof slope of the house. A slight return—just enough to keep water from pooling—is all you need.

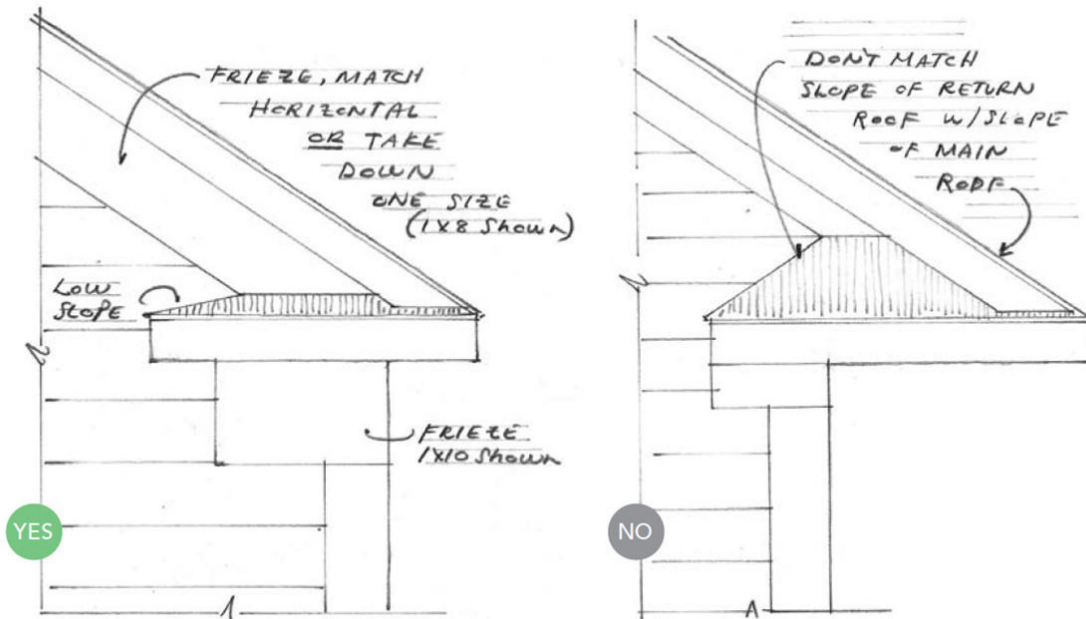

In the gable, the frieze can either match the horizontal frieze on the rest of the building, or it can be reduced one step in dimensional lumber. The step-down works because the angle of the gable will make the element feel larger.