

GENETIC DETERMINISM, INDUCIBLE MORPHOLOGY
AND PHENOTYPIC PLASTICITY IN THE MARINE
BRYOZOAN 'ELECTRA PILOSA' (L.)

Micha Bayer

A Thesis Submitted for the Degree of PhD
at the
University of St Andrews



1998

Full metadata for this item is available in
St Andrews Research Repository
at:

<http://research-repository.st-andrews.ac.uk/>

Please use this identifier to cite or link to this item:

<http://hdl.handle.net/10023/14623>

This item is protected by original copyright

**Genetic Determinism, Inducible Morphology and Phenotypic
Plasticity in the Marine Bryozoan Electra pilosa (L.)**

by Micha Bayer

**Submitted for the Degree of a Doctor of Philosophy at the University of
St. Andrews**



School of Environmental and Evolutionary Biology

June 1998

ProQuest Number: 10171251

All rights reserved

INFORMATION TO ALL USERS

The quality of this reproduction is dependent upon the quality of the copy submitted.

In the unlikely event that the author did not send a complete manuscript and there are missing pages, these will be noted. Also, if material had to be removed, a note will indicate the deletion.



ProQuest 10171251

Published by ProQuest LLC (2017). Copyright of the Dissertation is held by the Author.

All rights reserved.

This work is protected against unauthorized copying under Title 17, United States Code
Microform Edition © ProQuest LLC.

ProQuest LLC.
789 East Eisenhower Parkway
P.O. Box 1346
Ann Arbor, MI 48106 – 1346

th D 208.

ABSTRACT

The marine bryozoan *Electra pilosa* typically inhabits ephemeral substrata in the intertidal and shallow subtidal, and is probably the ecologically most successful bryozoan species in British waters. Modular organisms like *E. pilosa* frequently evolve pronounced phenotypic plasticity to cope with the ecological challenges resulting from passive larval dispersal into unpredictable habitats, and temporal variability of the environment colonized by the immobile adult stage. *E. pilosa* colonies on wave-exposed shores differ morphologically from those found on sheltered shores in possessing numerous long-spined zooids. The present study demonstrates that spine formation in *E. pilosa* is environmentally inducible by wave-related abrasion by macroalgae; additionally, the spines also have a fortuitous anti-predator effect in discouraging predation by the nudibranchs *Adalaria proxima* and *Polycera quadrilineata*. It is suggested that the inducible spines of *E. pilosa* constitute an adaptation for the protection of feeding polypides in high-energy environments, and that plasticity for the trait is of adaptive value in this organism which exploits a diverse range of habitats.

Although a number of traits in this species clearly are subject to considerable phenotypic plasticity, other attributes apparently are highly deterministic, heritable and genotype-specific. *Electra pilosa* displays pronounced among-genotype variation in colony growth rate, and the present study shows that this variation is due to proximate factors which affect growth rate and covary with genotype. This study also presents the first evidence of senescence at the zooid level in *E. pilosa*: Zooids deteriorate systematically over time, as indicated by decreasing polypide life spans and increasing polypide regeneration times, but in contrast to this, whole-organism senescence does not appear to occur in this species.

DECLARATIONS

(i) I, Micha Bayer, hereby certify that this thesis, which is approximately 53,000 words in length, has been written by me, that it is the record of work carried out by me and that it has not been submitted in any previous application for a higher degree.

date...29/6/98... signature of candidate...

(ii) I was admitted as a research student in June 1994 and as a candidate for the degree of Ph.D. in Sept. 1996; the higher study for which this is a record was carried out in the University of St. Andrews between 1994 and 1998.

date...29/6/98... signature of candidate..

(iii) I hereby certify that the candidate has fulfilled the conditions of the Resolution and Regulations appropriate for the degree of Ph.D. in the University of St. Andrews and that the candidate is qualified to submit this thesis in application for that degree.

date...3 June 1998... signature of supervisor.....

Unrestricted Copyright Declaration

In submitting this thesis to the University of St. Andrews I understand that I am giving permission for it to be made available for use in accordance with the regulations of the University Library for the time being in force, subject to any copyright vested in the work not being affected thereby. I also understand that the title and abstract will be published, and that a copy of the work may be made and supplied to any bona fide library or research worker.

date...29/6/98... signature of candidate.....

ACKNOWLEDGEMENTS

I would like to thank all those who have directly or indirectly contributed to this project. Many thanks go to my supervisor, Dr Chris Todd, for his guidance and the excellent scientific training that I have received in doing this project. I am indebted to a number of people for their technical support and advice: the staff of the Bute workshop, for building the wave tank; Peter "I need a chitty" Baxter, for his day-to-day technical support and sense of humour; Janette Duck and Clare Bird, for laboratory assistance with bryozoan and algal culture; Irvine Davidson, for SEM photographs; the Bute Photographic Unit, for their professional and prompt assistance in all photographic matters; Steve Smart, for help with scanning and Photoshop; the staff of the Reprographics Unit, particularly Catherine McIntyre, for help with the editing and printing of my photographic material; Prof. Richard Cormack at the School of Mathematical and Computational Sciences, for advice on statistics and the use of the dreaded GLIM package, and John Henderson at IT Services, for patiently explaining the use of CLUSTAN.

Above all, I would like to thank the people that have supported me throughout this at times Sisyphean project; Lynsey, for her love and for her humour which was much appreciated on many occasions; finally, my parents, without who I could have never come to Scotland in the first place, and who have supported me morally throughout the whole project, and financially during the latter stages.

TABLE OF CONTENTS

<u>Chapter 1: General Introduction</u>	1
1.1 The biology of modular organisms: an overview	1
1.2 Introduction to the Bryozoa	5
1.3 <i>Electra pilosa</i> : A species profile	12
1.4 Evolutionary strategies of organisms inhabiting heterogeneous environments	13
1.5 Outline of thesis objectives	18
<u>Chapter 2: Methodology</u>	20
2.1 Laboratory culture of <i>Electra pilosa</i>	20
2.2 Image analysis	23
2.3 Statistical analysis	24
<u>Chapter 3: An investigation into factors affecting the variability of colony growth in <i>Electra pilosa</i></u>	26
3.1 Introduction	26
3.2 Material and Methods	29
3.3 Results	33
3.4 Discussion	38
<u>Chapter 4: The occurrence of extended median proximal spines in <i>Electra pilosa</i></u>	42
4.1 Introduction	42
4.2 Material and Methods	45
4.2.1 Spinosity of <i>Electra pilosa</i> colonies at different field sites	45
4.2.2 EMPS: a discrete character	47
4.2.3 Assessment of the formation of EMPSs in the laboratory	48
4.2.4. Phenetic comparison of morphological characters of long-spined and short-spined morphs	49
4.2.5 Spontaneous EMPS formation and influence of genotype on spinosity	51
4.2.6 Promotion of EMPS development by inter- and intraspecific overgrowth encounters	51
4.3 Results	54
4.3.1 Spinosity of <i>Electra pilosa</i> colonies at different field sites	54

4.3.2 EMPS: a discrete character	54
4.3.3 Assessment of the formation of EMPSs in the laboratory	55
4.3.4 Phenetic comparison of morphological characters of long-spined and short-spined morphs	57
4.3.5 Spontaneous EMPS formation and influence of genotype on spinosity	58
4.3.6 Effect of inter- and intraspecific overgrowth encounters on EMPS development	59
4.4 Discussion	60
<u>Chapter 5: A new type of inducible morphology and its effects on nudibranch predators</u>	64
5.1 Introduction	64
5.2 Material and Methods	76
5.2.1 Effects of water flow and wave action on EMPS development	76
5.2.2 Effects of wave-related abrasion on EMPS development	79
5.2.3 The effect of EMPSs on the feeding behaviour of nudibranch mollusc predators	80
5.3 Results	82
5.3.1 Effects of water flow and wave action on EMPS development	82
5.3.2 Effects of wave-related abrasion on EMPS development	84
5.3.3 The effect of EMPSs on the feeding behaviour of nudibranch mollusc predators	85
5.4 Discussion	87
<u>Chapter 6: General Discussion</u>	95
6.1 Variation of colony growth rate and the occurrence of zooid senescence	95
6.2 The EMPS formation response	104
<u>References</u>	122
<u>Appendix</u>	162

LIST OF ACRONYMS

ANCOVA	Analysis of Variance
ANOVA	Analysis of Covariance
DD	Distal Distance
DLD	Distolateral Distance
EMPS	Extended Median Proximal Spine
GL	Gymnocyst Length
GLIM	Generalized Linear Interactive Modelling
MPS	Median Proximal Spine
OprL	Operculum Length
OprW	Operculum Width
OpsA	Opesial Area
OpsL	Opesial Length
OpsW	Opesial Width
PLD	Proximolateral Distance
PLS	Polypide Life Span
PLSD	Protected Least Significant Difference
RCP	Relative Colony Perimeter
RT	Regeneration Time
s. d.	Standard Deviation
s. e.	Standard Error
SEM	Scanning Electron Microscope
UPGMA	Unweighted Pair-Group Method Using Arithmetic Averages
WPGMA	Weighted Pair-Group Method Using Arithmetic Averages
ZA	Zooid Area
ZL	Zooid Length
ZW	Zooid Width

LIST OF UNITS

atm	atmospheres
C	Celsius
cm	centimetres
d	days
h	hours
l	litres
min	minutes
ml	millilitres
mM	micromoles
mo	months
rpm	revolutions per minute
s	seconds
wk	weeks
μ l	microlitres
μ m	micrometres

CHAPTER 1: GENERAL INTRODUCTION

1.1 THE BIOLOGY OF MODULAR ORGANISMS: AN OVERVIEW

Modular organisms are defined by Harper (1977) as multicellular units which either are physiologically connected (as for the zooids of bryozoan colonies, or the polyps of corals) or separate (e.g. ramets of a clone of plants). The term module originally was coined by the architect Le Corbusier in the 1940s, but now it is widely employed to denote a structure used repetitively in the construction of a larger edifice (Chapman 1981). Chapman redefined Harper's definition by excluding physically separate entities, which generally are now referred to as clone members (*sensu* Hughes 1990) or ramets (*sensu* Begon *et al.* 1990). A more recent view (Hughes 1990) defined modular organisms as characterized by an iterated body plan and multiplication of modules by means of agametic reproduction (that is, fission or budding). The range of modular organisms is extremely diverse: representatives are found among plants, protists, fungi and 19 of the metazoan phyla (Begon *et al.* 1990, Hughes 1990), with most of the latter being marine.

Morphology and physiology

Modular animals usually can be categorized as one of six basic morphologies (Jackson 1979): 'runners', 'sheets', 'mounds', 'plates', 'vines', or 'trees'. It appears that physical factors determine largely which morphology may occur in which environment(s); thus, for example, 'tree' forms will perform poorly in, or even be excluded from, high energy environments such as the shallow sublittoral of exposed shores (Ryland 1970). Due to the iterative nature of colony development, growth in modular animals often is indeterminate (Sebens 1987), and continuous lateral expansion on hard substrata frequently results in colonial organisms outcompeting unitary organisms (Jackson 1977). The rules of self-organization of modular

organisms have been subject to considerable investigation and several authors have found that pattern formation apparently is by means of relatively simple qualitative and quantitative mechanisms which are amenable to modelling (Waller & Steingraeber 1985, Bell 1986, Kaandorp 1991, 1994).

Buss (1983) showed that taxa in which ramet production occurs (including modular organisms) are characterized by a lack of germ cell sequestration and preformistic development; reproduction in these taxa is by means of somatic embryogenesis, and thus somatic mutations in individual modules may be passed on to budding/fission products and gametes produced by the module. As a consequence of this, selection acts not only upon the whole organism ("genet" *sensu* Begon *et al.* 1990), but also at the level of the module. Other authors since have attempted to model the extent to which module and whole-organism interact when subject to selection (Tuomi & Vuorisalo 1989a,b, Pedersen & Tuomi 1995), with the preliminary conclusion that no level of organization should be chosen *a priori* to describe the selection process in modular organisms (Pedersen & Tuomi 1995).

Polymorphism at the level of the module is a widespread phenomenon in modular organisms, particularly in colonial invertebrates (Harvell 1994). Polymorphs are thought to evolve under the following conditions (Harvell 1994): (i) units within a colony are identical; (ii) colony development is iterated and thus there is potential for novelty as new modules arise; (iii) abnormal modules can be supported in integrated colonies and thus survive, and (iv) signal transduction pathways for the development of polymorphs often depend on a combination of extrinsic and intrinsic signals and are thus highly complex and malleable. With respect to condition (i), it has been argued that the retention of zooid individuality in cheilostomatid bryozoans has been a major contributory factor to the evolution of polymorphs in this taxon (Ryland 1979). There is also some suggestion that polymorphism in cheilostomatid bryozoans is more frequent in higher latitudes than in tropic regions (Schopf 1973), but it has been

argued that simple latitudinal clines of complexity are an oversimplification of the actual situation (Hughes & Jackson 1990).

The extent to which modules are integrated within colonies varies greatly among taxa and has important implications for a number of ecological characteristics. Modular organisms have evolved a number of physiological mechanisms which are indicative of the integration of modules into “superorganisms”. They include (i) resource sharing, by means of exchange of nutrients across a colony, (ii) behavioural coordination through colonial nervous systems, and (iii) coordinated defensive responses to mechanical disturbance and/or predation (Ryland 1979, Mackie 1986). There also is evidence of a number of morphological evolutionary trends towards increasing integration of modules in colonies (McKinney & Jackson 1991).

The modules of modular organisms are generally small when compared to related unitary organisms, and possess a large feeding surface relative to body mass which is energetically favourable because it generates a metabolic surplus (Ryland & Warner 1986). Modularization also removes the allometric metabolic constraint on whole-organism growth, because, in contrast to unitary organisms, respiration rate does not increase with body size (Hughes & Hughes 1986b). Thus, growth in many modular organisms is — at least theoretically — indeterminate, in that it is not genetically limited by an upper maximum value (Sebens 1987).

Life history and demography

Life histories of modular animals typically are more complex than those of unitary organisms, and are seemingly fundamentally different. Many life history traits are size- rather than age-related (Jackson & Coates 1986). Partial mortality due to predation, injury, fragmentation or fission may confound the relationship between age and size in modular organisms, and in some cases these events may lead to a rejuvenation of the affected colony part, resetting the developmental process at the whole-organism level (Jackson & Coates 1986). Fragmentation of modular

organisms, combined with continuing survival of the fragments, also can be adaptive in enhancing genet growth rates (Stoner 1989) and/or propagation of the genet (Highsmith 1982).

Recruitment of new individuals in modular marine invertebrates can be by means of sexually or asexually produced larvae, fragmentation of existing colonies, or even by expulsion of individual modules, as recently demonstrated for corals (Kramarsky-Winter *et al.* 1997). For the majority of species, dispersal is predominantly by means of short-lived planktonic larvae, but realized potential for dispersal appears to be small (Jackson 1986, Jackson & Coates 1986).

The demography of some species is further complicated by their potential for fusion with conspecifics (Hughes & Jackson 1980, Grosberg 1988, Feldgarden & Yund 1992, Shapiro 1992, Craig 1994, Shapiro 1996). The ecology and evolution of fusion are not well understood: evidence for benefits is scant, but may include reduced risks of mortality due to larger colony size, while costs include somatic and germ cell parasitism (Grosberg 1988, Hughes 1990). It is thought that in the absence of allorecognition, fusion would be common and unrestricted (Grosberg 1988); thus, fusion can probably best be viewed as a consequence of the breakdown of allorecognition in individual cases.

Modular organisms often are able to avoid, or at least markedly delay, senescence at the level of the genet (Jackson & Coates 1986, Begon *et al.* 1990). More specifically, whole-organism senescence may not evolve in species where reproduction is primarily clonal and sexual reproduction is rare (Caswell 1985) because the pattern of selective pressure on different stages in the life cycle may be very different from that found in non-clonal organisms. Instead, senescence frequently occurs at the module level, with each module passing through the life history phases characteristic of unitary organisms (Begon *et al.* 1990; see also Chapter 3).

1.2 INTRODUCTION TO THE BRYOZOA

Morphology

Bryozoan colonies have been adequately described as “modular machines” by McKinney and Jackson (1991). With the exception of a single genus (Ryland 1970), all bryozoan species are colonial, and the vast majority are sessile and marine. Colonies consist of modules termed “zooids”; the most basic type of zooid, a feeding autozooid, consists of the cystid — the zooid’s skeleton — and a feeding organ called the polypide (Fig. 1.1). Polypides essentially are large digestive tracts which support a feeding structure called the lophophore, a circular corona of tentacles. Most zooids are small (< 1 mm length), and zooid numbers within colonies, and thus colony sizes, range over seven orders of magnitude for different species (McKinney & Jackson 1991).

The morphology of zooids within the same colony is subject to considerable variation. Boardman and Cheetham (1973) identified four different sources of zooid morphological variation: (i) ontogenetic development of zooids; (ii) astogenetic development of the colony; (iii) zooid polymorphism within colonies, and (iv) microenvironmentally induced variation. Astogeny is the process of colony formation (Boardman & Cheetham 1973), which typically is accompanied by early generational changes in zooid morphology. The first generations of zooids budded from the ancestrula, the postlarval founder zooid (Fig. 1.2), display systematic variation in a proximal-distal direction (“zone of astogenetic change”); after several generations of zooids have been formed, the astogenetic effect on zooid morphology ceases and morphology becomes repetitive (“zone of astogenetic repetition”).

Macroenvironmental variation also affects zooid morphology (Okamura 1987b, Hunter & Hughes 1994), and as a result, regionalization of zooid morphology within colonies may occur (Hageman 1995). Zooids of the same generation then will

Figure 1.1: Generalized structure of autozooids in an anascan bryozoan (modified from McKinney & Jackson 1991).

Fig. 1.1

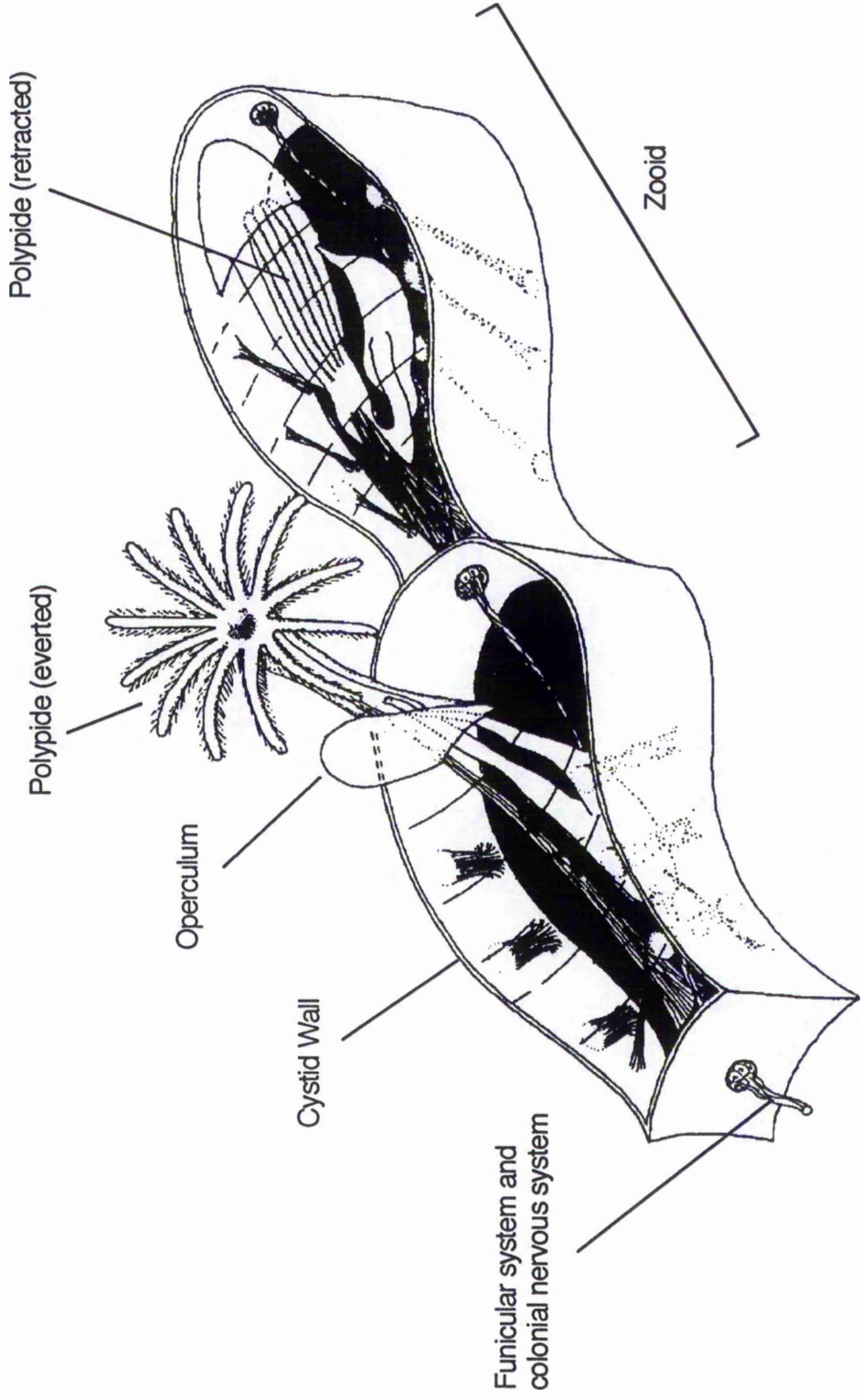
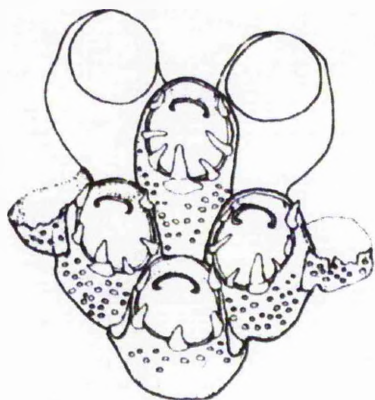
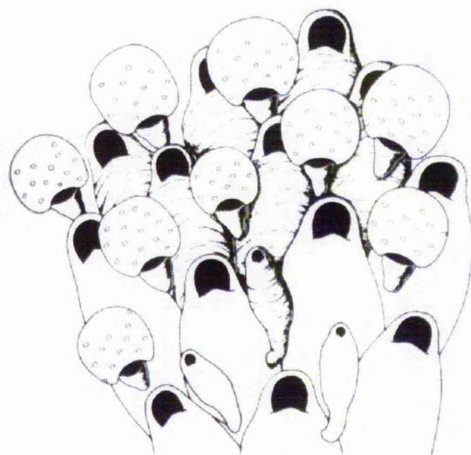

Figure 1.2: Polymorphism in the Bryozoa. A. Ancestrula and periancestrular zooids (*Electra pilosa*). B. Dwarfed androzooids and gynozooids with ovicells (*Celleporella hyalina*). C. Circumopesial spinozooids (*Membraniporella aragoi*). D. Lateral and axial vibracula, and giant avicularium (laterally, left; *Scrupocellaria varians*). Illustration A from Ryland and Hayward 1977; illustrations B-D from Silén 1977.



A



B

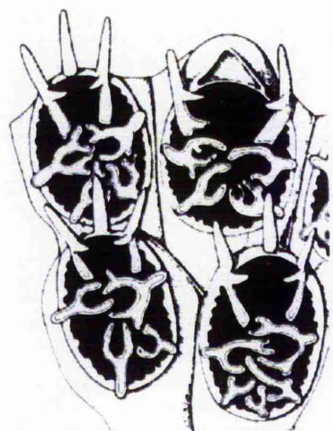

C

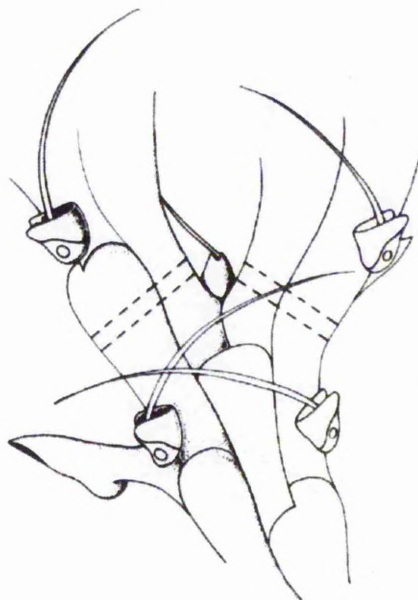

D

express the morphology induced by the environmental conditions present at the time of zooid formation.

Species identification of bryozoans is largely based on zooid skeletal characters, and although there are cases of cryptic speciation (Thorpe *et al.* 1978a,b, D'Hondt & Goyffon 1992, Lidgard & Buckley 1994), it has been argued that, generally, zooid morphology is an adequate means of species description and that most bryozoan species are indeed “good” species (Jackson 1990). There are, however, instances where zooidal characters can be misleading due to zooid polymorphism (see below): for example, periancestrular zooids in the cheilostomatid *Membraniporella nitida* are morphologically distinct from zooids formed at a later stage in astogeny (Ryland and Hayward 1977).

Zooid polymorphism

Polymorphs — also known as heterozooids — are a common phenomenon in bryozoan colonies. Heterozooids are characterized by the loss of feeding and budding functions; thus, in vibracula and avicularia, the operculum — which allows the evagination of the polypide in autozooids — have respectively been modified to form a mobile seta or a jaw (Fig. 1.2). The function of these heterozooids has been subject to presumption and speculation, but present opinion is that avicularia are defensive structures, whereas vibracula serve a cleaning function (McKinney & Jackson 1991). Gonozooids (Fig. 1.2) are specialized for sexual reproduction, and some are categorized as heterozooids while others have retained their feeding and budding functions and thus qualify as autozooids (Silén 1977). Brood chambers (ovicells), which accommodate developing embryos in cheilostomatids, also are thought to be heterozooids. In spinozooids (Fig. 1.2), the basic autozooid morphology has been reduced to a spine-bearing structure which is assumed to serve a function of passive defence (Silén 1977).

Colony integration

Zooids in bryozoan colonies are connected by a network of tissue strands — the so-called funicular system — which provides continuity among the coelomic cavities of zooids within a colony (Silén 1944, Ryland 1979) and allows the exchange of metabolites among zooids (Best & Thorpe 1985, Miles *et al.* 1995). It has been shown that gradients of free protein concentration exist between the colony centre and the periphery (Best & Thorpe 1985), and it has been suggested that an active pumping mechanism translocates metabolites to the growing edge of the colony (Miles *et al.* 1995). Although the mechanism mediating metabolite transport remains to be established, it is clear that translocation of resources is a necessary prerequisite for the growth of developing, non-feeding zooids at the growing margin of a bryozoan colony.

Integration of zooids within colonies also occurs at the level of the nervous system (Lutaud 1977, Ryland 1979), and behavioural integration has been shown for the retractor reflex of polypides (Thorpe *et al.* 1975a,b) as well as for coordinated feeding behaviour (reviewed by Ryland 1979).

Bryozoan nutrition

Feeding in bryozoans is effected by means of the tentaculate lophophore; beating cilia on the tentacles generate a water current which transports suspended food particles towards the mouth of the lophophore. Both morphology of the polypide and feeding behaviour vary considerably among taxa (Winston 1978): lophophore diameters of 56 species studied differed by an order of magnitude (187-1012 μm), and tentacle numbers ranged from 8 to 31. Species can be categorized into four different types on the basis of their polypide feeding behaviour (Winston 1978): (i) “filterers” strain food particles almost passively from the feeding current, with little movement of the tentacles; (ii) “tentacle feeders” capture individual particles by means of tentacle flicking and directing of them towards the mouth; (iii) “scanners” (mostly species

characterized by uniserial growth pattern and/or wide spacing of zooids) have polypides which bend at the base and scan the water for food particles in a circle; (iv) “cage captors” appear to actively catch mobile zooplankton, such as ciliates, by using the tentacles to form a cage around the particle and then ingesting it. It is, therefore, clearly inadequate to simply describe the Bryozoa as a whole as filter feeders.

The qualitative composition of food sources utilized by bryozoans in the natural environment is poorly documented, possibly due to the technical difficulties involved in gut contents analysis of these microscopic organisms. Best and Thorpe (1994) carried out a qualitative analysis of food sources available to the intertidal bryozoan *Flustrellidra hispida* growing on the macroalga *Fucus serratus*. Their findings show that the available food supply is dominated by diatoms, flagellates and algal spores, but the food sources which are actually utilized by individual bryozoan species probably are a function of particle sizes, and possibly food preferences. There are, however, a number of studies that describe diets which have been successfully employed in laboratory studies involving bryozoans (Winston 1976, Jebram 1977, Jebram & Rummert 1978, Jebram 1979, 1980a,b, Kitamura & Hirayama 1984, 1985, Cancino *et al.* 1991, Hunter & Hughes 1991, 1993a,b, Bayer *et al.* 1994, Bayer 1994).

Distribution

Bryozoans occur in virtually all types of marine habitat, and at almost all depths, although the majority of species occur in the shallower waters of the continental shelves (Ryland 1970, 1976). There appears to be a strong correlation between colony form (Fig. 1.3) and the type of habitat occupied: rocky shores and the continental shelves show a prevalence of two-dimensional, encrusting species, whereas deep sea species mostly are of three-dimensional, arborescent morphology (Ryland 1970). Thus, it would appear that the increased levels of hydraulic energy in shallower habitats restrict the occurrence of three-dimensional growth forms, which

Figure 1.3: Colony morphology in gymnolaemate bryozoans (modified from Ryland 1970). A. Fleshy, encrusting (*Flustrellidra hispida*). B, C. Erect, arborescent (*Bugula* sp. and *Cellaria* sp.). D. Calcified, encrusting (*Cupuladria* sp.). E. Fleshy, frondose (*Alcyonidium diaphanum*). F. Erect, plumose (*Bugula* sp.). G. Erect, frondose (*Flustra foliacea*). H. Erect, foliose (*Pentapora* sp.). I. Encrusting, fenestrate (*Sertella* sp.). J. Erect, branching (*Myriapora* sp.).

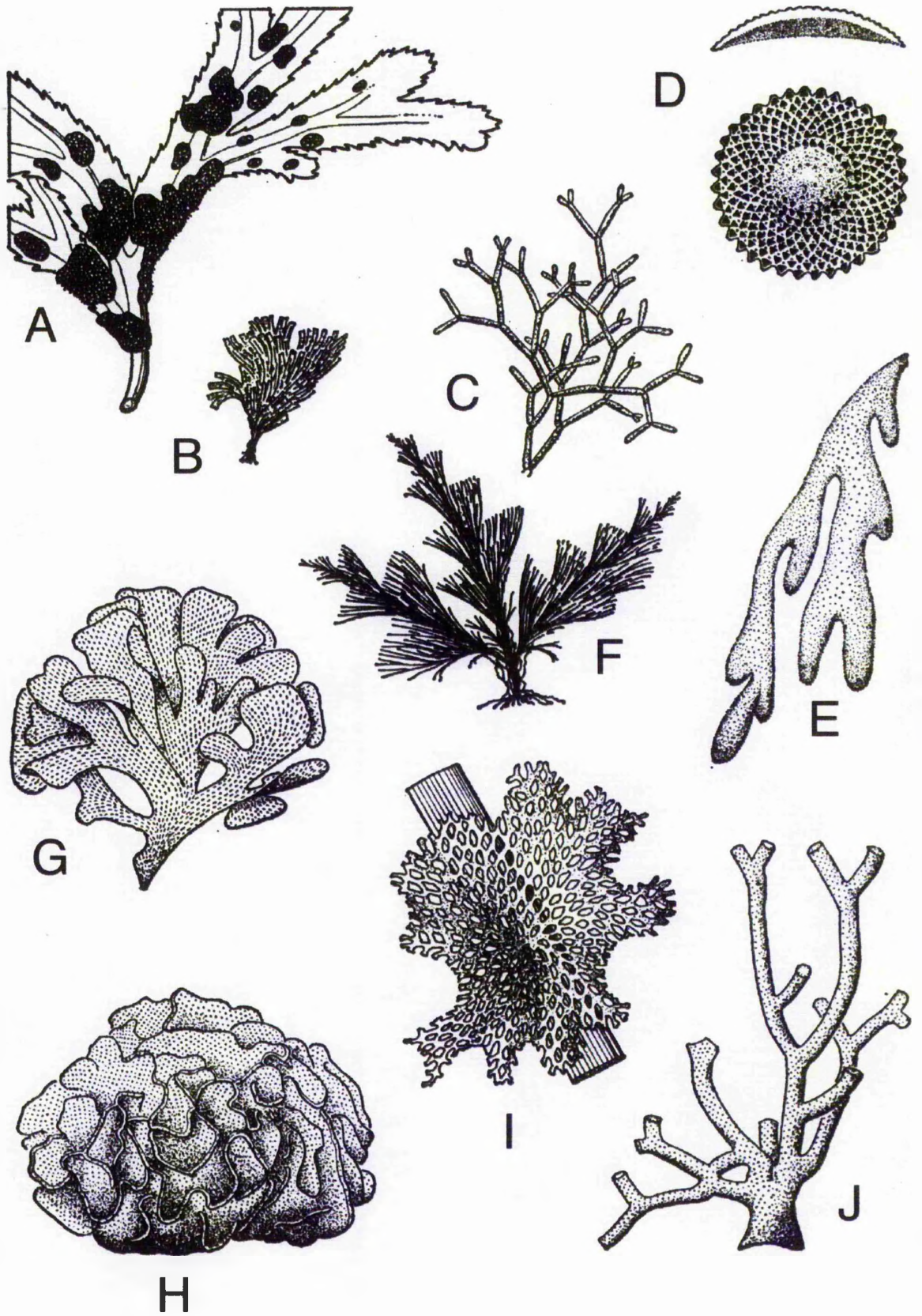

are more fragile but unaffected by the allometric restriction of colony growth rates (*cf.* Chapter 3).

Many bryozoans inhabit macroalgal substrata in the intertidal and subtidal (Ryland 1976, Seed & Hughes 1992), and a number of authors have investigated the relationships between bryozoans and their macroalgal substrata (reviewed in Williams & Seed 1992). Encrusting bryozoans can reduce the photosynthetic rate of their macroalgal substrata by up to 95%, by reducing the amount of light available to the alga for photosynthesis (Oswald *et al.* 1984, Oswald & Seed 1986), although this need not necessarily translate into reduced growth of the alga (Cancino *et al.* 1987). There is evidence to suggest that algae can compensate for the reduction in light levels by increasing their photosynthetic efficiency (Munoz *et al.* 1991). Bryozoans also may reduce the rate of nitrogen acquisition of their host macroalgal substratum, but, again, algae can compensate for this by uptaking ammonia excreted by the bryozoan (Hurd *et al.* 1994). Further deleterious effects of encrusting bryozoans on their substratum include (i) reduced flexibility of the algal frond which, in turn, may lead to increased frond loss, (ii) inhibition of sporulation, and (iii) an increase in plant weight, which may translate into increased risk of detachment through wave action (Dixon *et al.* 1981, Williams & Seed 1992). Conversely, bryozoans may benefit from their substratum by assimilating dissolved organic matter produced by the alga (de Burgh & Fankboner 1978); this presumably enhances colony growth and also may account for the reduced mortality rates and extended polypide life spans observed in some species (Manriquez & Cancino 1996).

Sexual reproduction

All described bryozoan species are hermaphroditic, at least at the level of the colony (Reed 1991); male and female reproductive organs either may be situated within the same zooid (zooidal hermaphroditism) or in separate zooids within the same colony (zooidal gonochorism). Until the 1960s it was assumed that self-fertilization was

obligatory in bryozoans, but an investigation by Silén (1966) showed that the cheilostomatids *Electra crustulenta* and *E. posidoniae* are free-spawning and that outcrossing is possible. Notwithstanding that, self-fertilization does indeed occur in a number of bryozoans, albeit at low frequencies (Maturó 1991, Hunter & Hughes 1993c).

Spermatozoa release in bryozoans is from two dorsomedial polypide tentacles and spermatozoa then drift to other polypides where they become trapped in the feeding current. Until recently, fertilization in the non-brooding Bryozoa was believed to be external (Silén 1966), with sperm-egg fusion occurring shortly after the release of the egg into the water, but Temkin (1994, 1996) showed that fertilization actually occurs in the ovary. The majority of bryozoans brood embryos in brood chambers (Reed 1991, Ryland & Bishop 1993), but embryonic development in non-brooding species is external (Ström 1977) and thus presumably planktonic.

In most bryozoan species, embryos develop into lecithotrophic larvae, which, upon release, are planktonic for a short period and then settle and metamorphose on a suitable substratum (Reed 1991). The larvae of non-brooding species are of the cyphonautes type (Ström 1977), planktotrophic, and generally have a pelagic period of several weeks or months before settlement (Reed 1991). Following settlement, larvae metamorphose into the ancestrula, the founder zooid, which gives rise to the colony by means of asexual budding (Ryland 1970).

Systematics

A recent review of bryozoan diversity accounted for approximately 3,800 living species (Horowitz & Pachut 1996), but it has been estimated that only 50 to 75% of all Recent bryozoan species have been described (Winston 1988). Given the recent upsurge in numbers of Antarctic bryozoan species described (Hayward & Thorpe 1989, Winston & Hayward 1994, Hayward 1995, Peck *et al.* 1995), it is likely that a major proportion of undescribed species will be endemic to the polar regions; the

number of species reported from the Arctic Ocean is even higher than that for Antarctica (Winston & Hayward 1994).

The comparatively small number of living species contrasts with a fossil record of approximately 15,000 species which dates back to the Ordovician (Pechenik 1996), rendering the Bryozoa one of the three dominant fossil phyla of the Palaeozoic (McKinney & Jackson 1991). Approximately 12% of Recent bryozoan species have a fossil record (Horowitz & Pachut 1996), some of which are exceptionally extensive and complete (McKinney & Jackson 1991). This has attracted interest from evolutionary biologists, who have used the bryozoan fossil record to corroborate the Punctuated Equilibrium Theory (Cheetham *et al.* 1993, 1994).

A classification of the Bryozoa formulated by Ryland (1970) can be summarized as follows. The Bryozoa comprise three classes, the Phylactolaemata, the Stenolaemata and the Gymnolaemata (Fig. 1.4). The Phylactolaemata form the smallest class and includes 12 genera, all of which are unmineralized, and found in freshwater only. The Stenolaemata is a large group with 550 genera, but almost all of its representatives are fossil; some species of the order Cyclostomatida are Recent. The Gymnolaemata is the largest class and comprise the vast majority of all living species (650 genera); all gymnolaemates and stenolaemates are marine. The Gymnolaemata include two orders, the soft-bodied Ctenostomatida (about 40 genera) and the calcified Cheilostomatida, the latter of which comprises 610 genera and thus the majority of all living bryozoans. The Cheilostomatida appeared late in the fossil record, but underwent a major radiation in the Cretaceous (N.B. a completely revised classification of the order Cheilostomatida is currently being prepared by D. P. Gordon).

The evolutionary origin of the Bryozoa has been subject to much debate. A division introduced in the 19th century distinguished two groups within the Bryozoa, the Bryozoa Entoprocta and the Bryozoa Ectoprocta (Ryland 1970). However, a recent analysis of ribosomal RNA indicates that they are not, in fact, sister taxa

Figure 1.4: Generalized phylogeny of the Bryozoa.

Fig. 1.4

PHYLUM

Bryozoa

CLASS

Phylactolaemata
12 genera

Stenolaemata
550 genera

Gymnolaemata
650 genera

ORDER

Cyclostomatida

Cystoporatida

Cryptostomatida

Trepostomatida

Ctenostomatida

Cheilostomatida

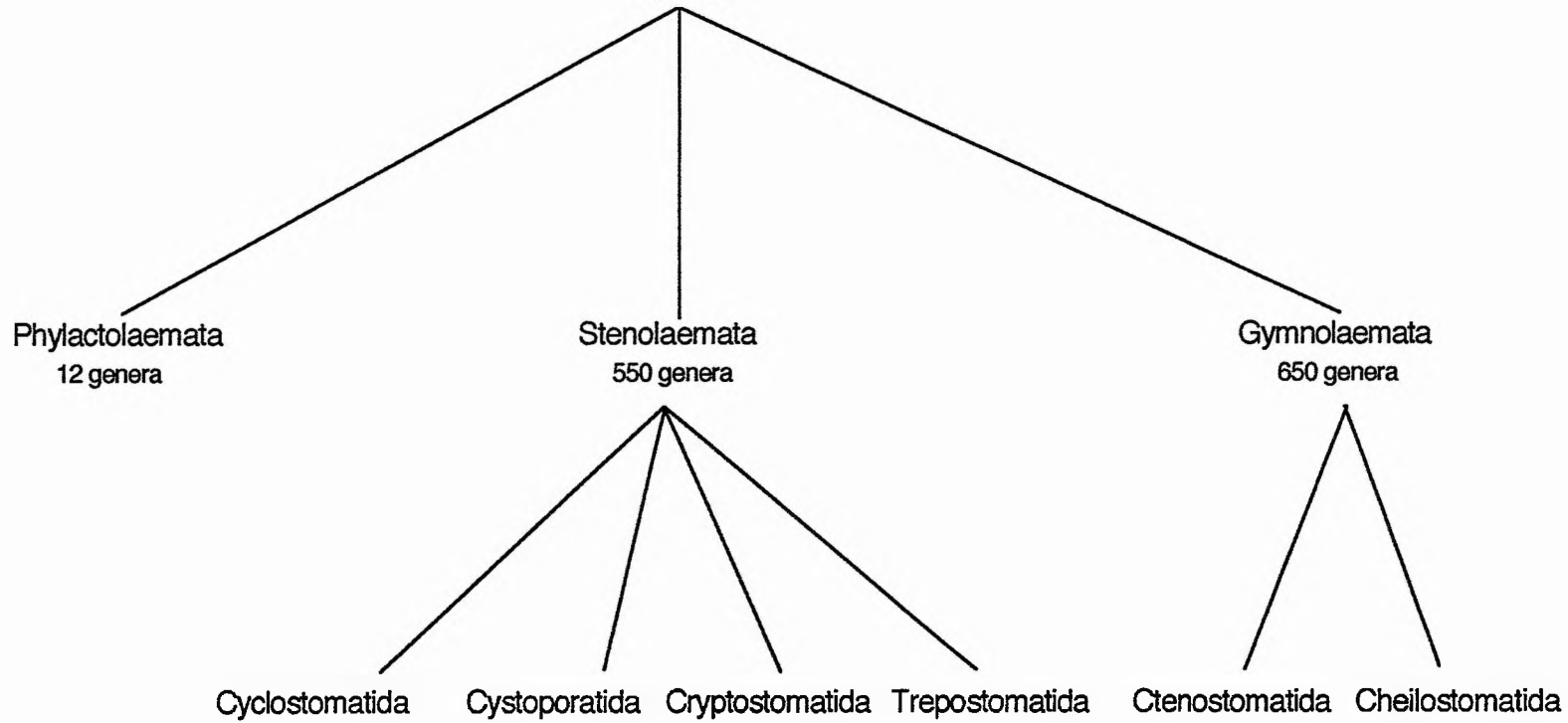

(Mackey *et al.* 1996). Entoprocta and Ectoprocta now form separate phyla, with the respective synonyms Kamptozoa and Bryozoa generally being used. Relationships of the Bryozoa with other phyla also are still under revision; Hyman (1959) suggested a placement of the Bryozoa in the group “Lophophorates”, together with the Phoronida and the Brachiopoda, but Nielsen (1995) states that “their phylogenetic position cannot at present be stated with certainty” (p. 206), and he argues that a placement in the “Lophophorates” would be based on largely circumstantial evidence and probably cannot be upheld. However, recent molecular evidence suggests strong affinities of the Bryozoa, Phoronida and Brachiopoda with Protostomes rather than Deuterostomes (Cohen *et al.* 1998).

1.3 *ELECTRA PILOSA*: A SPECIES PROFILE

Electra pilosa (L.), an anascan cheilostomatid, was first described as *Flustra pilosa* in 1767. Zooids of *E. pilosa* are approximately oval in shape (Fig. 1.2), with a well developed gymnocyst which covers approximately half the zooid (Ryland & Hayward 1977). The gymnocyst bears numerous pores, which is the main taxonomic criterion for the distinction of *E. pilosa* from congeners. The distal half of the zooid is dominated by an uncalcified opesial area, surrounded by a margin bearing four to twelve marginal spines, in addition to a well developed median proximal spine.

Colony form of *Electra pilosa* typically is encrusting (Fig. 1.5), but erect growth of colonies is possible around substratum cores such as filamentous algae (Ryland & Hayward 1977), and there also is a self-supporting arborescent morph which, some authors have argued, may be a separate species (*Electra* “*verticillata*”, Bobin & Prenant 1960). Current opinion, however, is that all morphs are conspecific (Ryland & Hayward 1977), and Jebram (1970) has argued that erect colony growth is inducible by water currents. Remarkably, arborescent morphs attached to small substratum cores can form ball-shaped aggregates, which episodically are washed up

Figure 1.5: Top: Colony of *Electra pilosa*, grown on glass plate in the laboratory. Maximum diameter of colony approximately 20 mm. Bottom: *E. pilosa* on its natural substratum, the phaeophyte *Fucus serratus*, growing on a small rock. Scale increments on ruler 1 cm.

Fig. 1.5

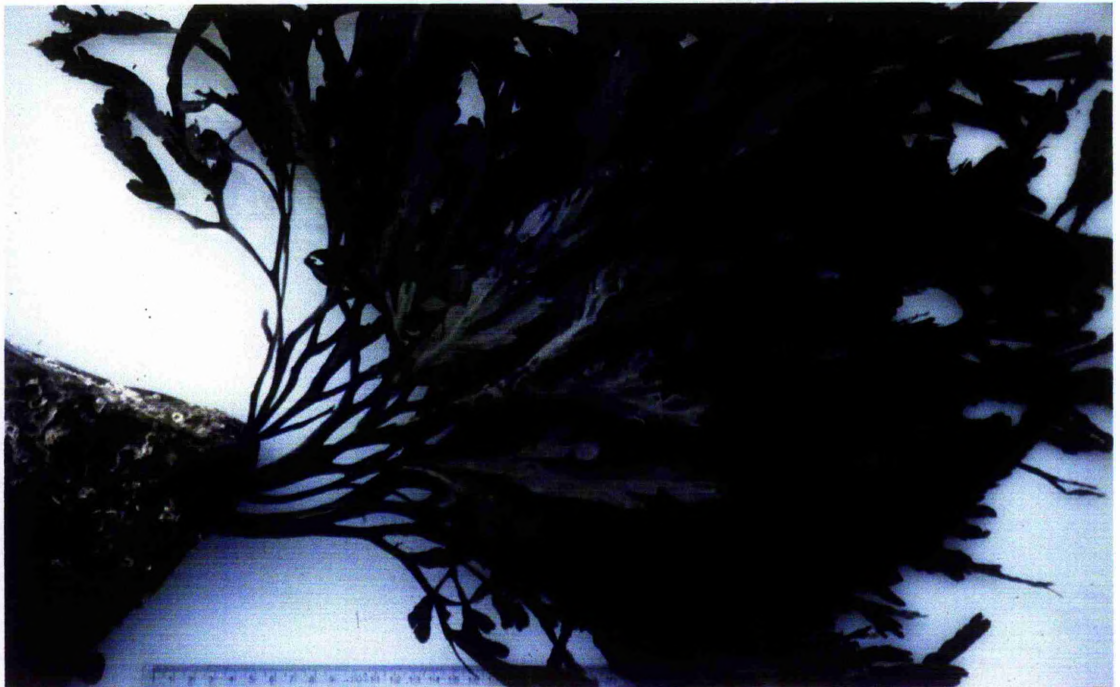
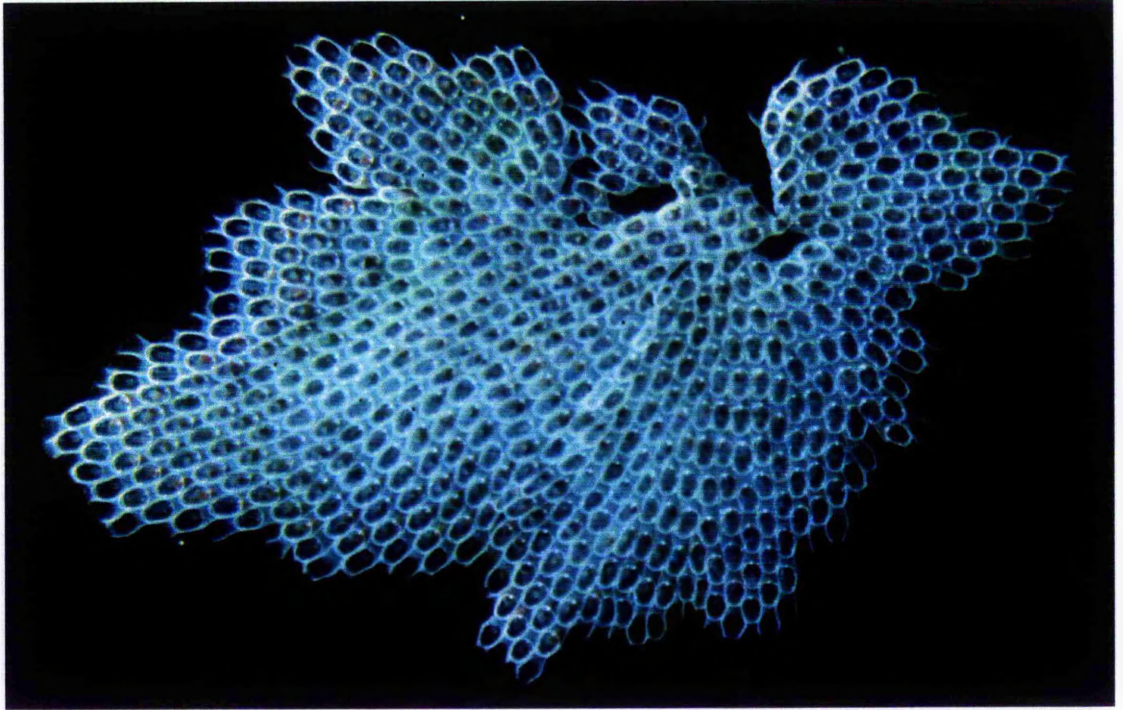

in large numbers on sandy North Sea shores (Prigge 1967), where they can form deposits of more than 1 m deep. The origin of these aggregates is not known, but it is likely that they occur in large numbers on the seafloor from where they become detached in heavy swells.

Electra pilosa is a protandric hermaphrodite with internal fertilization and external egg development (Temkin 1996). Embryos develop into shelled larvae of the cyphonautes type, which have a pelagic period of approximately two months before settlement (Marcus 1926). *E. pilosa* has a near cosmopolitan distribution; it has been recorded from Labrador, Greenland, the Mediterranean, the Red Sea and the Indian Ocean (Marcus 1926). In British waters it probably is the most common and abundant bryozoan species (Ryland & Hayward 1977). It occupies a variety of substratum types, but its greatest abundance is on macroalgal substrata (Fig. 1.5) in the intertidal and subtidal of rocky shores. *E. pilosa* frequently occurs in dense aggregations, rather than being randomly distributed (Ryland & Sykes 1972). Whether or not this is due to gregarious settling behaviour of larvae remains to be shown, but gregarious settling has been reported for other bryozoan species (Ryland 1976), and probably enhances fertilization success.

1.4 EVOLUTIONARY STRATEGIES OF ORGANISMS INHABITING HETEROGENEOUS ENVIRONMENTS

Phenotypic plasticity

Most modular organisms are sessile, or at least sedentary (Hughes 1990), and thus they are subject to spatial and temporal variation of both biotic and abiotic factors. Also, dispersal is passive in the majority of epifaunal taxa and, consequently, active choice of habitat on a larger scale is frequently very limited. As a result of this, a

number of strategies have evolved which allow modular organisms to adapt to unpredictable environmental conditions.

Probably the most widespread strategy employed is the modification of phenotypic characters in response to environmental cues, also known as phenotypic plasticity. Plasticity is generally accepted to be associated with spatially and/or temporally variable environments (Adler & Harvell 1990, de Jong 1995, Via *et al.* 1995); it appears to be widespread (Tables 1.1 - 1.3) and has been reported for all major taxonomic groups (Schlichting 1986, West-Eberhard 1989, Scheiner 1993a). There has, however, been much controversy over whether (i) phenotypic plasticity is itself a selectable trait, or (ii) it is a by-product of selection on phenotypic values, and (iii) over its molecular regulation (Scheiner 1993a,b, Schlichting & Pigliucci 1993, Via 1993a,b, Pigliucci 1996).

A recent synthesis of conflicting theory has resolved some of the controversy (Via *et al.* 1995), with the conclusion that phenotypic plasticity can itself be an adaptive trait. Gotthard and Nylin (1995), however, have warned that existing terminology can be misleading, because plasticity for a trait may be adaptive, but it need not necessarily constitute an adaptation. In their terminology, plasticity for a trait is only an adaptation if it is likely to have arisen as a result of selection for this specific function. Thus, for example, the structural reinforcement of conifer needles, induced by wind exposure, is adaptive also in discouraging herbivory (Ennos 1997), but it is not a specific adaptation to the latter.

Plasticity for a trait need not always be adaptive. Depending on the reliability and timing of environmental cues, plasticity for a trait may be maladaptive under certain circumstances (reviewed by DeWitt *et al.* 1998) if, for example, cue and selective agent are not reliably linked (Gotthard & Nylin 1995) or if there is an extended lag phase between cue detection and expression of the phenotype (Padilla & Adolph 1996). A frequently quoted example for a potential cost of plasticity is the metabolic expense involved in the upkeep of the sensory and regulatory mechanisms

Table 1.1: Examples of phenotypic plasticity of continuously varying traits. This table is not exhaustive, and shows only selected illustrative examples representing a range of different taxa.

TAXONOMIC AFFILIATION	SPECIES	ENVIRONMENTAL CUE	AFFECTED TRAIT	SOURCE
Angiospermae: Dicotyledones	<i>Brassica rapa</i>	shading	hypocotyl growth	Schmitt <i>et al.</i> 1995
Angiospermae: Dicotyledones	<i>Cakile edentula</i>	water supply	leaf size	Dudley 1996
Angiospermae: Dicotyledones	<i>Impatiens capensis</i>	shading	hypocotyl growth	Dudley & Schmitt 1996
Porifera	<i>Halichondria panicea</i>	wave exposure	morphology and tissue stiffness	Palumbi 1984b
Mollusca: Gastropoda	<i>Placida dendritica</i>	diet algal host	ceratal morphology, body shape	Trowbridge 1997
Arthropoda: Diptera	<i>Simulium hundstromi</i>	water current velocity	morphology of primary fan	Zhang & Malmqvist 1997
Arthropoda: Coleoptera	<i>Harmonia axyridis</i>	diet type	developmental rate, body size, coloration	Grill <i>et al.</i> 1997
Arthropoda: Coleoptera	<i>Stator limbatus</i>	host plant type	egg size	Fox <i>et al.</i> 1997
Arthropoda: Crustacea	<i>Cancer productus</i>	diet toughness	claw size and morphology	Smith & Palmer 1994
Echinodermata: Echinoidea	<i>Strongylocentrotus purpuratus</i>	food supply	gonad mass, morphology of Aristotle's lantern	Ebert 1996
Echinodermata: Echinoidea	<i>Dendraster excentricus</i>	food supply	length of ciliated bands in larvae	Hart & Strathmann 1994
Chordata: Osteichthyes	<i>Gambusia affinis</i>	temperature, crowding	age and size at maturity	Stearns 1983
Chordata: Amphibia	<i>Scaphiopus couchii</i>	pond drying	rate of larval development	Newman 1988
Chordata: Reptilia	<i>Lacerta vivipara</i>	habitat altitude	growth, survival rate	Sorci <i>et al.</i> 1996

Table 1.2: Examples of inducible defences, induced by predators or competitors. This table is not exhaustive, and shows only selected illustrative examples representing a range of different taxa.

TAXONOMIC AFFILIATION	SPECIES	INDUCTIVE CUE	RESPONSE	SOURCE
Ciliophora	<i>Onichodromus quadricornutus</i>	predation by cannibalistic conspecifics	formation of defensive spines	Wicklow 1988
Ciliophora	<i>Sterkiella</i> sp.	predation by <i>Onichodromus quadricornutus</i> , <i>Styloynchia mytilus</i> , <i>Urostyla grandis</i> , <i>Lembadion magnum</i> (Ciliophora)	formation of defensive dorsal keels	Wicklow 1997
Ciliophora	<i>Aspidisca turrita</i>	predation by <i>Urostyla grandis</i> , <i>Lembadion magnum</i> (Ciliophora)	formation of a dorsal thorn	Wicklow 1997
Phaeophyta	<i>Fucus distichus</i>	grazing by gastropods and isopods	production of polyphenolic compounds	van Alstyne 1988
Phaeophyta	<i>Fucus distichus</i>	grazing by <i>Littorina</i> spp. (Mollusca: Gastropoda)	adventitious branching	van Alstyne 1989
Angiospermae: Monocotyledones	<i>Triticum uniaristatum</i>	predation by <i>Rhopalosiphum padi</i> (Arthropoda: Homoptera)	production of hydroxamic acid	Gianoli & Niemeyer 1997
Angiospermae: Dicotyledones	<i>Vaccinium myrtillius</i>	predation by <i>Clethrionomys rufocanus</i> (Chordata: Rodentia)	production of phenol	Oksanen <i>et al.</i> 1987
Angiospermae: Dicotyledones	<i>Acacia tortilis</i>	grazing by domestic ungulates	spine formation	Gowda 1996
Cnidaria: Hydroidea	<i>Hydractinia symbiolongicarpus</i>	physical contact with competitors for space (conspecifics)	formation of hyperplastic stolons	Buss & Grosberg 1990
Cnidaria: Gorgoniacea	<i>Erythropodium caribaeorum</i>	physical contact with competitors for space (various taxa)	formation of sweeper tentacles	Sebens & Miles 1988

Cnidaria: Scleractinia	<i>Agaricia agaricites</i>	physical contact with competitors for space: <i>Erythropodium caribaeorum</i> (Cnidaria: Gorgoniaceae), <i>Palythoa caribbea</i> (Cnidaria: Zoanthiidea)	formation of sweeper tentacles	Chomesky 1983
Mollusca: Bivalvia	<i>Mytilus edulis</i>	predation by <i>Asterias rubens</i> (Echinodermata: Asteroidea)	reinforced morphology	Reimer & Tedengren 1996
Mollusca: Gastropoda	<i>Nucella lamellosa</i>	predation by <i>Cancer productus</i> (Arthropoda: Crustacea)	formation of larger apertural teeth	Appleton & Palmer 1988
Mollusca: Gastropoda	<i>Physella virgata</i>	predation by <i>Orconectes virilis</i> (Arthropoda: Crustacea)	delayed reproduction	Crowl & Covich 1990
Mollusca: Gastropoda	<i>Littorina obtusata</i>	predation by <i>Carcinus maenas</i> (Arthropoda: Crustacea)	reinforced shell	Trussell 1996
Rotifera	<i>Keratella slacki</i>	predation by <i>Asplanchna</i> spp. (Rotifera)	posterior spine development	Gilbert & Stemberger 1984
Arthropoda: Crustacea	<i>Daphnia pulex</i>	predation by larvae of <i>Chaoborus cristallinus</i> (Arthropoda: Diptera)	formation of defensive neck spines	Walls & Kettola 1989
Arthropoda: Crustacea	<i>Chithalamus anisopoma</i>	predation by <i>Acanthina angelica</i> (Mollusca: Gastropoda)	reinforced shell	Lively 1986b
Bryozoa	<i>Schizoporella serialis</i>	physical contact with competitor for space, <i>Celleporaria aperta</i> (Bryozoa)	giant bud formation	Nandakumar & Tanaka 1994
Bryozoa	<i>Schizoporella unicornis</i> , <i>Hippopodina feegensis</i>	physical contact with competitors for space (intra- and interspecific competition)	stolon formation	Tzioumis 1994
Bryozoa	<i>Membranipora membranacea</i>	physical contact with competitors for space (conspecifics)	stolon formation	Harvell & Padilla 1990
Bryozoa	<i>Membranipora membranacea</i>	predation by <i>Doridella steinbergae</i> (Mollusca: Gastropoda)	spinozoid formation	Yoshioka 1982, Harvell 1984

Chordata: Amphibia	<i>Hyla chrysoscelis</i>	predation by <i>Anax junius</i> (Arthropoda: Odonata)	induction of tailfin coloration	McCollum & Van Buskirk 1996
Chordata: Amphibia	<i>Agalychnis callidryas</i>	predation by <i>Leptodeira septentrionalis</i> (Chordata: Reptilia)	early hatching of larvae	Warkentin 1995
Chordata: Osteichthyes	<i>Carassius carassius</i>	predation by <i>Esox lucius</i> (Chordata: Osteichthyes)	deeper body	Brönmark & Miner 1992

Table 1.3: Examples of seasonally induced polyphenisms. This list is not exhaustive, and contains selected examples illustrating the variety of inductive cues and phenotypic responses.

TAXONOMIC AFFILIATION	SPECIES	ENVIRONMENTAL CUE	AFFECTED TRAIT	SOURCE
Arthropoda: Lepidoptera	<i>Pararge aegeria</i>	rearing temperature	developmental period, body size	Sibly <i>et al.</i> 1997
Arthropoda: Lepidoptera	<i>Bicyclus anynana</i>	rearing temperature	wing melanin pattern	Brakefield <i>et al.</i> 1996
Arthropoda: Lepidoptera	<i>Bicyclus anynana</i>	rearing temperature, photoperiod	rate of larval development, pupal weight	Brakefield & Kesbeke 1997
Arthropoda: Lepidoptera	<i>Pontia occidentalis</i>	photoperiod	wing melanin pattern	Kingsolver 1995a,b
Arthropoda: Lepidoptera	<i>Papilio polyxenes</i>	photoperiod	pupal coloration	Hazel <i>et al.</i> 1987
Arthropoda: Lepidoptera	<i>Nemoria arizonia</i>	seasonally available diet types	caterpillar morphology (mimicry type)	Greene 1989

required for the plastic expression of a trait (DeWitt *et al.* 1998); however, there is, as yet, no empirical evidence to corroborate this, and costs may well be trivial. It also has been suggested that plasticity may be an ancestral trait in some species, and may be present in a species simply because of evolutionary constraints (Gotthard & Nylin 1995).

A number of studies show that phenotypic plasticity for a trait is a heritable character and that genetic variation for plasticity within populations is common (Cook & Johnson 1968, Newman 1988, Sultan & Bazzaz 1993, Brakefield *et al.* 1996, Grill *et al.* 1997, Sibly *et al.* 1997). In experiments using cloned genotypes subjected to different environments, this variation may manifest itself as genotype x environment (G x E) Interaction (Via 1994). G x E interaction is defined as non-parallel reaction norms, the range of phenotypic values that a genotype can assume in different environments (Stearns 1992). Theoretically, parallel reaction norms are conceivable, with the trait affected being phenotypically plastic, and genotypes all expressing plasticity in the same fashion. In practice, however, it appears that G x E interaction (= crossing reaction norms) is found in practically all taxa examined, and it thus appears to be pervasive (review in Stearns 1992). It should be noted though that reaction norms do not need to cross within the range of environmental values examined in order for a G x E interaction term to be statistically significant.

Genetic control of phenotypic plasticity may be by means of two fundamentally different mechanisms (Schlichting & Pigliucci 1993, 1995): First, allelic sensitivity is the direct control of gene expression by environmental factors; for example, transcription of a structural gene may be increased as a direct result of elevated temperatures. Second, under regulatory plasticity, on the other hand, gene expression is controlled indirectly by means of a secondary mechanism, activated by an external stimulus. The two mechanisms correspond to two differing types of phenotypic responses (Smith-Gill 1983): (i) phenotypic modulation, whereby a trait shows continuous variation proportional to the magnitude of the external stimulus, and

(ii) developmental conversion, in which a trait is expressed in a deterministic fashion if a threshold value of the external cue is exceeded. The latter results in the coexistence of discrete phenotypes, a situation also referred to as polyphenism (Moran 1992).

To explain the phenomenon of developmental conversion, Schlichting and Pigliucci (1993) invoked regulatory genes, which they referred to as plasticity genes. These they defined as "...genes that control phenotypic expression and are independent of trait means..." (Schlichting & Pigliucci 1993, p. 367). Thus, plasticity genes form a separate class of loci, in addition to structural genes. In an ensuing dispute (Scheiner 1993b, Via 1993a,b, 1994), Via (1993a) argued that plasticity was determined by the same loci that express the trait itself. This controversy has since been resolved (de Jong 1995, Via *et al.* 1995), and it is now agreed that plasticity genes do indeed exist (Weber & Scheiner 1992, Jasienski *et al.* 1997). There is a wealth of experimental evidence for the existence of such loci (reviewed by Pigliucci 1996), the two most prominent examples being the heat shock response and the associated family of heat shock proteins (Maresca *et al.* 1988, Nagao *et al.* 1990, Hübel & Schöffl 1994), and the hypocotyl elongation response in plants which is mediated by a family of phytochrome enzymes (Clack *et al.* 1994, Santoni *et al.* 1994, Schmitt *et al.* 1995).

Inducible defences are a separate class of phenotypically plastic responses. The majority of inducible defences fall into the category of developmental conversion (see above), where specific cues trigger all-or-nothing responses resulting in discrete phenotypes (= polyphenism). The formation of inducible defences is mediated by biotic cues (predators or competitors; Adler & Harvell 1990), rather than physical factors, and in most cases involves the formation of structures or substances which are not normally found in the organism. Inducible defences reduce the risk of mortality due to predation or, in sessile organisms, overgrowth by competitors, and thus generally are adaptive. This type of plasticity is fundamentally different from the mostly abiotically induced, continuous plasticity displayed by many organisms in

response to continuously varying environments (Table 1.1), which affects existing traits and may or may not be adaptive. Inducible defences are widespread, particularly among clonal organisms (Harvell 1990), and a list describing selected examples from a range of taxa has been provided (Table 1.2). A further category of phenotypically plastic response concerns the seasonal polyphenisms that are found mostly in insects (Table 1.3) and which share characteristics with both of the other types of plasticity. Seasonal polyphenisms are controlled by abiotic physical factors which affect larval development and thus lead to the expression of discrete, seasonally adapted morphs in the imago (Kingsolver & Wiernasz 1991, Kingsolver 1995a,b, Brakefield *et al.* 1996, Roskam & Brakefield 1996, Brakefield & Kesbeke 1997).

Alternatives to phenotypic plasticity

It has been shown that phenotypic plasticity may not always evolve in organisms inhabiting heterogeneous environments: local conditions may be a poor indicator of actual selective agents, organisms may simply not be able to detect cues linked to selective agents (Warner 1997), or there may be a cost to the maintenance of the “developmental switch” (Moran 1992). In these situations, generalist phenotypes may provide higher fitness when averaged over the whole dispersive range of a species (Moran 1992, Warner 1997). Generalist phenotypes are characterized by intermediate fitness with respect to the range of possible environments, but are fitter than alternative phenotypes in the respective “wrong” environment (Moran 1992).

Another strategy employed by organisms in heterogeneous environments is bet-hedging, whereby offspring of different phenotypes are assigned to environments at random; thus, this strategy is based on fortuitous adaptedness and survival of at least some of the offspring. However, there are constraints on the evolution of bet-hedging in different situations. Moran (1992) demonstrated that bet-hedging will only evolve in a spatially heterogeneous environment if there is competitive interaction among related individuals; in a temporally fluctuating environment, bet-hedging only

will be favoured over a monophenic strategy if the probability of correct assignment of monophenic individuals to environments is considerably less than 1.

Lively (1986a) showed in a simple two-environment model that canalization, — i.e. genetically deterministic development — can be an alternative to phenotypic plasticity under certain conditions: two morphs, each adapted to one of two differing environments, can coexist in a stable state (= balanced polymorphism; Futuyma 1986) if their frequencies are at equilibrium and their fitnesses equal. Ironically, Lively's model requires for the two morphs to competitively interact in order to coexist. His model also predicts that a mixture of strategies is possible within the same population: genetically fixed morphs and phenotypically plastic morphs, which can attain either morphology by means of developmental conversion, may coexist in a stable combination under the same conditions as above, but, as an additional condition, the probability of the plastic genotype correctly choosing the appropriate morphology must be more than 50%. This latter scenario does not appear to be supported by empirical data, whereas the former is (Futuyma 1986, Begon *et al.* 1990).

It has been argued that phenotypic plasticity will only evolve in an organism if at least some exchange between alternative habitats can occur (reviewed by Sibly 1996). In the absence of gene flow among populations, adaptation of a population to local conditions may occur as the result of selection; however, Warner (1997) argued that even if gene flow leads to panmixia, localized adaptation and the establishing of a metapopulation structure may occur if selection is intense and if there is at least partial retention of offspring in the population.

1.5 OUTLINE OF THESIS OBJECTIVES

The present study focuses on genetic determinism and phenotypic plasticity in the marine bryozoan *Electra pilosa*. There are two main topics: the extent of genetic determinism in the naturally occurring variation of colony growth rates (Chapter 3), and the occurrence of a morphological polyphenism at the level of the zooid (Chapters

4 and 5). It is shown that what superficially appears to be purely genotypic variation of colony growth performance, is, in fact, the result of the interaction of biological parameters that covary with genotype (Chapter 3). It also is shown that the coexistence of two distinct phenotypes of *E. pilosa*, which has puzzled bryozoologists for more than 100 years, is an environmentally induced polyphenism which is triggered by an abiotic cue (Chapters 4 and 5).

CHAPTER 2: GENERAL METHODOLOGY

2.1 Laboratory culture of *Electra pilosa*

2.1.a) Cloning method

Electra pilosa, like many other bryozoans, has a remarkable potential for regeneration after injury, in that lesions and damaged colony parts usually are repaired within hours or days of the damage occurring. The present methodology exploits this in physically splitting colonies that will then form autonomous replicates of the same genotype, thus allowing the simultaneous subjection of replicate colonies of the same genotype to different experimental treatments. In order to minimize any previous environmental effects on colony performance or development, all clonal experimental material was ongrown from undifferentiated ancestrulae.

Following collection, ancestrulae were transferred to the laboratory where they were kept in a circular 6-l glass trough with 3 μm filtered seawater. The water temperature was then increased from ambient by 3°C every 24h until a temperature of 18°C was established.

Ancestrulae were excised together with a surrounding piece of *Fucus serratus* L. thallus tissue from the algal substratum. This was clipped onto a microscope slide by means of slit pieces of PVC tubing and a sandwich of two microscopic coverslips (Fig. 2.1). The uppermost coverslip onto which the colonies were allowed to grow had been prescored by means of a diamond pencil. The top half of the algal thallus adjacent to the coverslip sandwich was removed to provide a continuous, flush surface for the colony to grow on. Colonies then grew from the algal thallus onto the uppermost coverslip. Once colonies were established on coverslips, the algal pieces were removed and the coverslips split by means of a scalpel, thus giving a number of fragments of the same colony (= genotype). Fragments (= "replication strips") then were clipped onto glass plates by means of glass strips and slit PVC tubing, and

Figure 2.1: Diagram of cloning methodology used. A. Ancestrula prepared for growth off algal substratum and onto prescored coverslip. B. Young colony on coverslip prior to the fragmentation procedure. C. Replication strips clipped to experimental glass plates. D. Colonies growing onto experimental plates. E. Clamps and replication strips removed and colonies cut back to starter clusters of nine zooids (three rows; three columns) each. F. Starter group; note change in scale. G. Secondary growth of colonies from starter clusters during experiment proper.

Figure 2.1

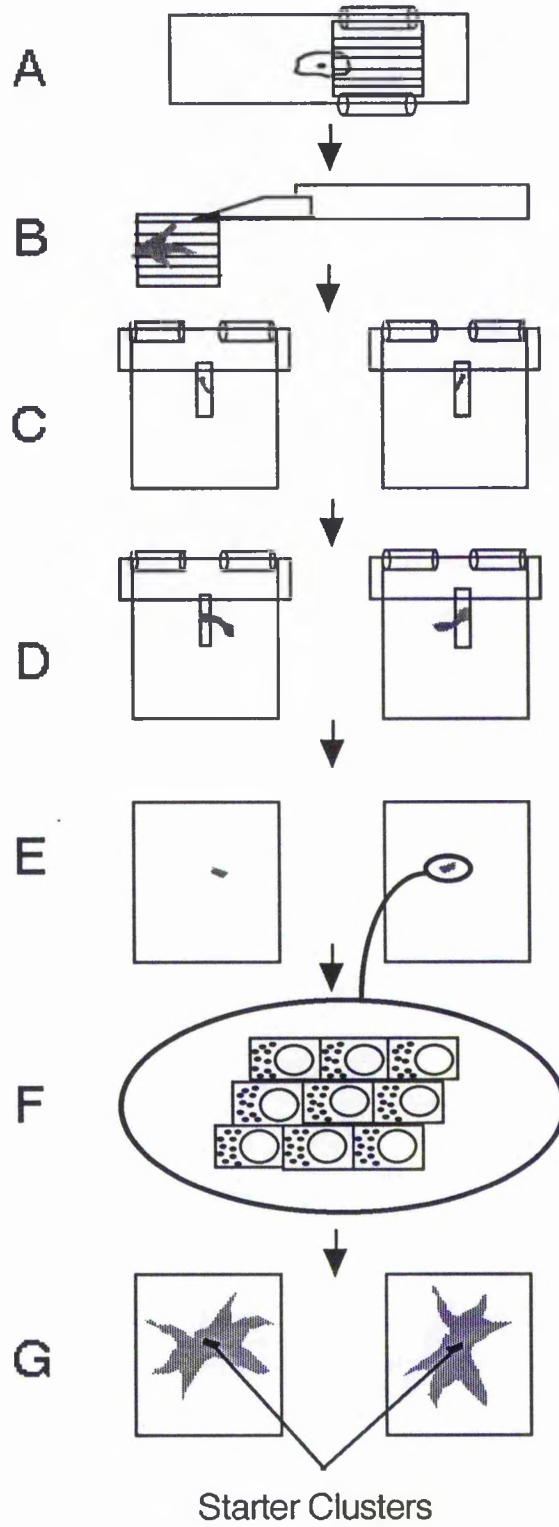

colonies were allowed to grow onto the plates. Prior to the experiment proper, glass strips and replication strips were removed and the newly formed colony parts on the glass plate cut and reduced to starter clusters of nine zooids in a standard 3x3 array.

2.1.b) Culture conditions

Unless stated otherwise, colonies were kept in circular pneumatic glass troughs containing 6-l of 3 μm filtered seawater, maintained in a large waterbath at a temperature of $18^{\circ}\text{C} \pm 0.1^{\circ}$. Each culture trough was continuously aerated by a centrally positioned airstone. Colonies on their glass plates were held upright in a removable circular perspex rack; they all faced the same way and were spaced at equal distances. To preclude any positional effects, the arrangement of colonies in the trough was randomized by assigning numbers to positions in the rack and then allocating colonies to positions by means of random numbers obtained from statistical tables (Zar 1984).

The water in the culture dishes was replaced twice a week prior to feeding; colonies were cleaned with a soft paint brush to prevent the build-up of microfouling organisms and faeces on the colony surface, either of which can lead to non-evagination of polypides and thus a cessation of feeding (Marcus 1926).

2.1.c) Diet

The food source chosen for this experiment was the flagellate cryptophyte *Rhodomonas* sp. which has proved to be an excellent monoculture diet both for a wide variety of molluscan larvae (C.D. Todd, pers. comm.) and for bryozoan culture (Kitamura & Hirayama 1984, Hunter & Hughes 1991, 1993a,b). Although species mixtures in bryozoan laboratory culture have been employed by some workers, with mixed results (Winston 1976, Jebram & Rummert 1978, Jebram 1979, 1980a,b, Kitamura & Hirayama 1984, Cancino *et al.* 1991), bryozoan nutrition, particularly in

the field, is still a poorly understood phenomenon (Best & Thorpe 1994). Based on the relative success of most monofood diets (reviewed in Jebram 1977), and due to their ease of use, many studies involving bryozoan laboratory culture now use monofood diets (Kitamura & Hirayama 1985, Hunter & Hughes 1991, 1993a,b, Bayer *et al.* 1994, Bayer 1994).

Rhodomonas sp. was grown in batch culture in 3-l Erlenmeyer flasks, using Provasoli's Enriched Seawater (PES) as culture medium (Provasoli 1968). The only modification employed was a doubling of the nitrate concentration. This has proven necessary to prevent cultures from turning green in the log phase of growth. All glassware and seawater were autoclaved prior to use to minimize the risk of contamination with foreign material. Cultures were thus not axenic, in that although they contained only a single species of flagellate there were bacteria present at all times. Microalgal cultures were grown to an optimal population size (approximately $2,500 \text{ cells} \cdot \mu\text{l}^{-1}$) within 5-6 d and then harvested. *Rhodomonas* sp. cells were separated from the PES culture medium by centrifugation prior to their use in feeding and resuspended in autoclaved seawater: this minimized growth both of algae and bacteria in the bryozoan cultures.

The concentration of the resulting *Rhodomonas* sp. suspension was determined immediately before daily feeding by establishing absorbance on a Dynatech MR 5000 photospectrometer (filter wavelength 550 nm). To establish an absorbance/cell count calibration curve, five repeat haemocytometer counts were made for each of 10 concentrations of *Rhodomonas* suspension; the concentrations ranged from 1×10^3 to $7 \times 10^3 \text{ cells} \cdot \mu\text{l}^{-1}$. Five 200 μl aliquots of each of the test suspensions were then pipetted into a 96-well plate and absorbance measured on the photospectrometer. The obtained values were plotted against manually obtained cell counts and a simple linear regression applied. The resulting regression equation was transformed and then used daily to establish cell counts from absorbance readings.

Prior to adding food to a bryozoan culture trough, a water sample was obtained and a cell count was made on a Sedgwick-Rafter counting chamber to establish the present *Rhodomonas* concentration; food then was replenished as required. Unless stated otherwise, all colonies were given *Rhodomonas* sp. at a concentration of 100 cells · μl^{-1} .

2.2 Image Analysis

In most experiments, measurement of colony growth rates was required; this was accomplished by means of photographing colonies using a video camera on a WILD M8 stereomicroscope; measurements were taken on the resulting images using image analysis software (*analySIS 2.0*, Soft-Imaging Software GmbH, Münster, Germany, 1994). Colony outlines were binarized and smoothed using a morphological filter, set at a fixed level of one iteration. A repeat series of measurements of the same colony showed that the inherent measurement error of this method was low (approximately $\pm 0.1\%$). Zooid counts were made by photographing whole colonies, binarizing the image, and separating any contiguous zooids using a morphological erosion filter set at one iteration. Zooids could then be detected and counted.

Some experiments necessitated the measurement of zooid spine lengths (MPSSs and EMPSSs); this was accomplished by photographing zooids in side view on the set-up described above, and then measuring spine length on the resulting image using a simple distance measurement function. Zooids were sampled in randomly chosen transects a single column of zooids wide from the colony centre to the periphery. In experiments where repeat observations of colonies/zooids were required, a *camera lucida* mounted on a WILD M8 stereomicroscope was used to draw colonies/zooids which then allowed their subsequent re-identification, due to the unique and irreversible arrangement of zooids in colonies.

2.3 Statistical analysis

Unless stated otherwise, data were examined for deviations from normality (z-scores histograms, *StatView 4.01*, Abacus Concepts Inc., Berkeley, California, 1992) and homoscedasticity (*F*-max tests, Sokal & Rohlf 1981) and analysed by ANOVA using *SuperANOVA* (Abacus Concepts Inc., 1991). Data transformation, rather than non-parametric statistics, were employed where significant violations of ANOVA assumptions were found. Percentage data tend to be binomially, rather than normally, distributed (Zar 1984), and accordingly transformation was required prior to analysis. The standard method employed in this case is arcsine transformation (Zar 1984) of the square root of proportions, rather than percentages; data in degrees have to be converted to radians thereafter by multiplication with a constant of 57.296. However, the deviation from normality is trivial for percentages between 30 and 70 % and in those cases transformation is unnecessary. Other cases where transformation is required are: positive skewness, an asymmetrical deviation from normality, and/or heteroscedasticity with standard deviations being proportional to group means, requiring logarithmic transformation; negative skewness, and/or heteroscedasticity with standard deviations decreasing as group means increase, requiring logarithmic transformation, and Poisson distributed data (e.g. counts), with group variances being proportional to means, requiring square root transformation. Data transformations employed are indicated in each individual section.

The hierarchical organization of modular organisms has important implications for experimental design and statistical analysis. There has been some debate over the adequacy of "tailor-made" ANOVA designs used in the study of morphological variation in bryozoans (Schopf 1976, Brande & Bretsky 1982), and it has been argued that studies of morphological variation — which by necessity involve measurements at the zooid level — should employ standard two-level nested ANOVA (Brande & Bretsky 1982). Independence of observations is one of the fundamental assumptions made in using ANOVA (Sokal & Rohlf 1981, Zar 1984), and it is debatable whether

zooids within colonies form truly independent entities, particularly given the extent of colonial integration in some species (reviewed by Ryland 1979). Despite individual zooids being able to survive and bud new zooids, regional morphological differentiation within colonies (Hageman 1995) and the existence of astogenetic gradients in colonies (Boardman & Cheetham 1973), are just two examples of complications that may arise from treating zooids as being independent; thus, it has to be emphasized that both the sampling of zooids within colonies and the subsequent analysis of data must be carried out with great care and consideration. Comparative analyses, employing both colony means and zooid level observations can help here in elucidating the patterns of variation encountered (e.g. Bayer *et al.* 1994).

**CHAPTER 3: AN INVESTIGATION INTO FACTORS
AFFECTING THE VARIABILITY OF COLONY GROWTH
IN *ELECTRA PILOSA***

3.1 INTRODUCTION

Colony growth performance probably is the most important component of genotypic fitness in bryozoans. None the less, a multitude of fitness concepts is currently in use and their definitions vary considerably. One widely used definition pertains to reproductive rate; that is, the expectation of lifetime reproductive success (de Jong 1994). In many bryozoans, fecundity is positively correlated with colony size (Hayward 1973, Hayward & Harvey 1974, Thorpe 1979, Wood & Seed 1992) and thus maximization of colonial growth rate should result in maximal genotypic fitness. Maximization of colony size also can provide a refuge from competitive overgrowth by neighbouring organisms (Sebens 1982a). Similarly, regenerative capacity and resistance to predators, diseases and catastrophes generally increase with colony size (Jackson & Coates 1986).

Growth of modular colonial organisms is indeterminate, in that it is not genetically limited to a maximum size (Sebens 1982b). There are several types of indeterminate growth (Sebens 1987); growth in encrusting bryozoans such as *Electra pilosa* is of the "plastic attenuating" type, in which the full potential for plasticity of growth is retained throughout the life span of an organism and growth has to slow due to allometric constraints (see below). Colony size does not, however, necessarily reach an asymptotic value. In contrast to this, unitary organisms (*sensu* Hughes 1990) are subject to an energetic constraint resulting from the allometric relationship between feeding surface area and body mass. Thus, growth is limited by a critical size at which metabolic expenditure exceeds the net energy gain possible through continued food capture. Modularization frees an organism from this constraint because whole-

organism (= colony) area and the number of feeding modules generally increase isometrically (Sebens 1982b, Hughes & Hughes 1986b).

Importantly, the specific growth rate of encrusting species is restricted because new zooids can be only produced by the (linearly growing) perimeter of the colony whilst colony area increases quadratically (Hughes & Hughes 1986b). Thus, colony growth is exponential during the early phase of astogeny, but then levels off asymptotically at a later stage (Menon 1972, Hayward & Ryland 1975, Winston 1976, Hughes & Hughes 1986a, Cancino & Hughes 1987, Hughes 1989, Hunter & Hughes 1993b). Adaptations for overcoming this allometric constraint — at least in part — include (i) increasing colony perimeter relative to colony area, either by adopting stellate growth morphologies (Hughes & Hughes 1986b) or by fragmentation (Jackson & Winston 1981, Stoner 1989), and/or (ii) increasing zooidal budding rates as the colony grows (Hughes & Hughes 1986b).

In marine invertebrates, the genetic component of growth often is less relevant than the effect of environmental parameters if growth performance is environmentally modulated (Sebens 1987). Bryozoans are no exception and a number of studies show that colony growth is affected by various exogenous factors. Food type and quantity both show pronounced effects on colony growth rates (Winston 1976, Jebram & Rummert 1978, Hunter & Hughes 1993a,b, Bayer 1994, Hunter & Hughes 1995; see also review in Ch. 2). Colony growth in *Electra pilosa* is positively correlated with temperature (Menon 1972), probably due to increased filtration rates and gut passage times (Menon 1974). Water flow has varying effects on growth in bryozoans: “intermediate” flow rates appear to stimulate colony growth (Hughes & Hughes 1986a, Hughes 1989, Hughes 1992), presumably through increased food supply, whilst “higher” flow rates can reduce, or even prevent, feeding and thus compromise colony growth (Cancino & Hughes 1987, Okamura 1992, Eckman & Duggins 1993). Larval delay during the pelagic phase also can have a detrimental effect on subsequent

development and growth of young colonies (Woollacott *et al.* 1989, Orellana & Cancino 1991, but see also Hunter & Fusetani 1996, Wendt 1996).

Despite the apparent importance to fitness of maximization of colony growth, there is widespread evidence for pronounced genotypic variation of growth rates (Hayward 1973, Hayward & Harvey 1974, Thorpe 1979, Keough 1986, Keough & Chernoff 1987, Keough 1989, Hughes 1992, Wood & Seed 1992, Hunter & Hughes 1995). A recent review (Arendt 1997) of the existing work on intrinsic growth rates highlighted the fact that most organisms appear to grow at submaximal rates, presumably as a consequence of trade-offs with other parameters; these may include development, maintenance and repair, defence and sexual reproduction. Trade-offs occur both at the inter-individual (Stearns 1992) and inter-species level (Herrera *et al.* 1996).

In the present study an explanation was sought for the considerable genetic variation of colony growth rates in *Electra pilosa* (Bayer 1994, Bayer *et al.* 1994) in terms of trade-offs and proximate, heritable factors that might exert a direct influence on the growth performance of a colony (or ramet). Figure 3.1 shows a summary of the factors that might be expected to be of especial importance to colony growth.

Foremost, interest was focused on the phenomenon of polypide regression and its possible implications for colony growth. Best & Thorpe (1985) and Miles *et al.* (1995) have shown that active nutrient translocation amongst zooids in a proximal-distal direction causes metabolite gradients between the centre and the periphery of a colony; this provides evidence of the individual contribution made by zooids to the overall growth of the colony. This contribution will be a function of (i) the polypide's filtration performance (which itself might be affected by lophophore morphology, Fig. 3.1) and (ii) the amount of time available for filtration. The latter is a function of lophophore evagination time as well as polypide life span and the time required to form a new polypide after regression (polypide regeneration time).

Figure 3.1: Schematic representation of parameters of putative importance in affecting colony growth rates in *Electra pilosa*. Ticks on arrows indicate mechanisms that had been confirmed in previous studies, “test” indicates the relationships to be explored here.

Fig. 3.1

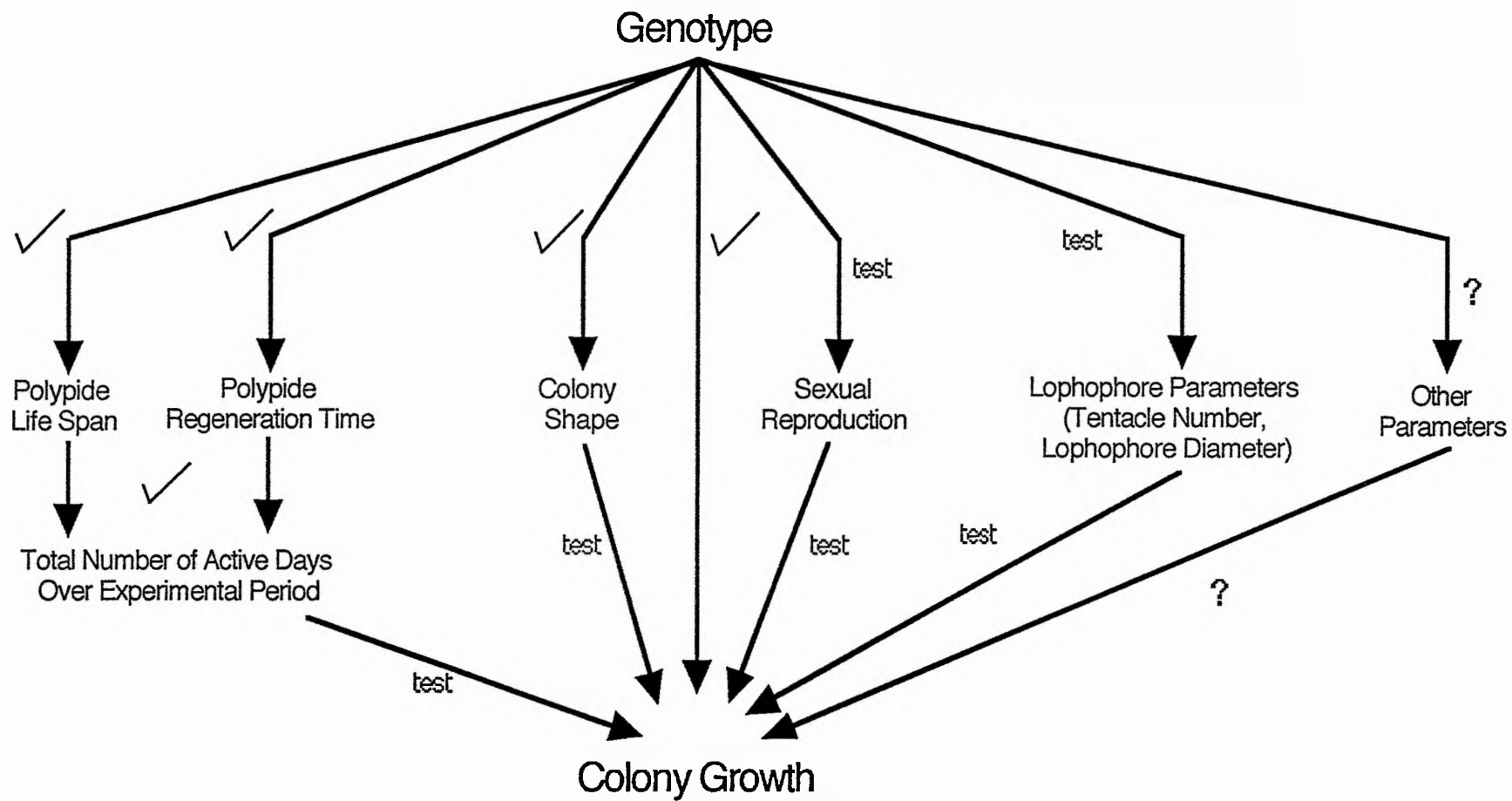

The second question asked was whether colony shape affects colony growth performance in any way. It has been argued that species with stellate growth morphologies, such as *Electra pilosa*, can maintain higher growth rates than do more lobate species (Rubin 1987). This arises from colony growth being constrained by the absolute perimeter length (see above), and stellate colony shapes having longer perimeters relative to their area. Intuitively, if this were the case, then a relationship between colony shape and growth rate would be expected to be expressed at an intraspecific level also, with stellate genotypes achieving faster growth than lobate conspecifics.

Finally, the question as to whether sexual reproduction affects colony growth in *Electra pilosa* was addressed. Is there any evidence of trade-offs between somatic and sexual investment which might vary among genotypes? Trade-offs of this kind are commonplace among a variety of organisms and well documented (reviewed in Stearns 1992). Here, five different genotypes of *E. pilosa* were replicated and the resulting colonies reared together under constant conditions in a common garden experiment, to test for the effects of the above factors on colony growth.

3.2 MATERIAL AND METHODS

3.2.1 Bryozoan culture

Ancestrulae of *Electra pilosa* were collected from a single plant of the intertidal macrophyte *Fucus serratus*, from St Andrews Bay, Fife, Scotland. Colonies were then prepared for replication as described in section 2.1. Four replicate colonies of each of five genotypes were used in the experiment. The duration of the experiment was determined by the size of the glass plates used as artificial substrata; when the first colony had grown to the edge of its glass plate the experiment had to be discontinued. This occurred after a period of 103 d. Throughout the experiment, colonies were

maintained at $18 \pm 0.1^\circ\text{C}$ and fed with *Rhodomonas* sp. at a final trough concentration $42.5 \text{ cells}\cdot\mu\text{l}^{-1}$.

3.2.2 Data collection

The determination of polypide life spans and regeneration times required daily repeat observations of individual zooids. For this purpose, the first eight zooids budded by each 3 x 3 zooid starter cluster were utilized, giving a total of 160 observational zooids (5 genotypes x 4 colonies per genotype x 8 zooids per colony). These zooids were mapped by *camera lucida* on a Wild M8 stereomicroscope to allow their subsequent re-identification. Because zooids do not change shape once they have fully developed, and because each cluster had its own characteristic pattern, this method ensured reliable re-identification of clusters at any subsequent stage. Polypide condition in each of the zooids was recorded daily, with polypides being scored either as actively feeding or as being in the process of regression and subsequent regeneration. Records were made also non-invasively of visible evidence of sexual maturation (release of spermatozoa into the coelom and oocyte development) for each of the zooids throughout the experiment. Individual colonies were transferred from the main trough to an observation dish, where they were kept for short periods only (< 30 sec), and a cold light source was used for illumination to minimize handling stress on colonies. There did not appear to be any adverse effects of the daily handling procedure.

Polypide regression and regeneration in *Electra pilosa* follows the same pattern as that described by Gordon (1977) for *Cryptosula pallasiana*. The onset of polypide regression appears to be closely correlated with the termination of ciliary movement in the stomach (Bayer *et al.* 1994); polypides were classified as actively feeding when ciliary activity was detectable in the pylorus region of the stomach. A polypide was considered to be regressing or regenerating from the incidence of the cessation of ciliary activity in the stomach, to the point of first evagination of the newly formed polypide. Although regression of the old polypide and the formation of a new

polypide overlap to some extent, in some cases there were extended periods of “dormancy”, with the new polypide forming long after regression was complete. These cases were still scored as regressing or regenerating, because it would be arbitrary to distinguish between a “typical” case with marginal overlap between regression and regeneration, and an “atypical” case in which there is a very brief gap between the completion of regression and the onset of regeneration. After an undetermined number of polypide cycles, zooids eventually die. Zooid death is easily observed by the detachment and loss of the frontal membrane, the uncalcified part of the frontal surface of the zooid, which leaves the zooid devoid of soft tissue.

Colony area/perimeter and incremental growth were measured weekly from *camera lucida* drawings of the colonies, using an image analyzer (see Ch. 2). Lophophore parameters (tentacle number, lophophore diameter) were measured only at the end of the experiment, for samples of ten randomly chosen polypides for each colony. Colony shape was quantified by using the relative colony perimeter, RCP (Jebram 1980a), obtained from the weekly area and perimeter measurements. Colony area at the end of the experiment (= final colony area) was used as measure of growth performance of a colony.

3.2.3 Data analysis

The variation in growth (= final colony area) within and between genotypes was modelled in GLIM (Generalized Linear Interactive Modelling, v. 3.77; Royal Statistical Society, 1987); the model fitted here was a multiple regression model with both fixed and continuous factors.

Owing to the marked between-genotype differences in polypide life spans (PLS) and regeneration times (RT), the available numbers of observational polypide cycles varied considerably. Although a maximum of 11 cycles was recorded in some cases, cycle 11 had to be excluded from the polypide life span analysis due to

insufficient replication ($n = 3$, out of 160 zooids possible): similarly, cycles 10 ($n = 9$) and 11 ($n = 2$) had to be deleted from the analysis of polypide regeneration times.

Throughout the analyses, colony means of parameters were used where observations on individual zooids were involved. Strictly, nested ANOVA would apply to data of this type; however, in the case of bryozoans, physiological data on individual zooids are likely to be non-independent due to their colony-wide physiological integration (Ryland 1979). Thus, the analytical assumption of independence is violated and individual zooid data should not be used.

The structure of the data is, in analytical terms, somewhat problematic; repeated measures ANOVA was not applicable in the present case because the data of interest will, in all likelihood, be subject to temporal autocorrelation. Similarly, fitting different curvilinear models to individual genotypes will not provide biologically meaningful information, and, at least for some of the genotypes, was not possible. In considering further the influence of PLS and RT on colony growth/size, it was deemed appropriate to choose a parameter that describes the integrated net metabolic input to the colonial nutrient pool, rather than simply either PLS or RT in isolation. Assuming that net metabolic input will be a composite both of PLS and RT, the percentage was calculated of days throughout the experiment for which a zooid had an active intact polypide. This accounted both for PLS and RT, whilst also overcoming the problem of temporal patterns differing between genotypes. Hereafter, this parameter is referred to as 'zooid activity'. Colony means for (percentage) zooid activity, final colony area, colony shape and lophophore parameters were analysed by Oneway ANOVA, followed by Fisher's PLSD *post hoc* test.

3.3 RESULTS

3.3.1 Colony Growth

Colony growth rate — as expressed by final colony area — varied very significantly between genotypes ($p < 0.001$; Tables 3.1, 3.2), resulting in an almost sixfold difference in mean colony area between the fastest and slowest growing genotypes (numbers 1 and 3, respectively; Figs. 3.2, 3.3). Individual replicates showed striking similarity in growth performance within a genotype, whilst there were marked differences among genotypes. Fisher's PLSD *post hoc* test showed all possible combinations between genotypes, except 1 and 5, to be significantly different. Genotype means of final colony area are given in Table 3.1.

3.3.2 Colony Shape

As observed for colony growth rate, colony RCP proved to be significantly different between genotypes ($p < 0.001$; Tables 3.1, 3.2, Figs. 3.2, 3.4). Colony shape ranged from rather stellate (high RCP) in Genotypes 2 and 5, to more lobate (low RCP), in Genotypes 1, 3 and 4 (Fig. 3.2). Again, there was a surprising degree of similarity among replicate colonies within genotypes, suggesting that, like colony growth performance, colony shape may be highly heritable.

RCP also changed over time, at least for some of the genotypes: Figure 3.5 shows that Genotypes 2 and 5 became distinct from the remainder of genotypes over weeks 2, 3 and 4 and then continued to become increasingly stellate over the duration of the experiment, whereas RCP in the other genotypes remained relatively constant throughout. This would suggest that the expansion of the colony perimeter relative to colony area is not necessarily a feature of late colony development, but an apparently deterministic feature which is expressed early in astogeny.

Table 3.1: Genotype means of colony parameters measured in the experiment. Means are for observations from four replicate colonies per genotype (RCP = relative colony perimeter).

Genotype	Final Colony Area (mm ²)		Final RCP		Zooid Activity (%)		Lophophore Diameter (μ m)		Tentacle Number	
	Mean	s.e.	Mean	s.e.	Mean	s.e.	Mean	s.e.	Mean	s.e.
1	1758.30	67.79	1.481	0.061	52.17	1.07	485.71	19.75	11.95	0.05
2	968.57	24.10	2.236	0.148	38.92	1.47	423.80	29.01	12.80	0.33
3	311.65	16.10	1.411	0.051	33.32	1.66	487.49	25.99	12.35	0.15
4	639.35	34.99	1.307	0.044	41.97	1.05	444.04	5.71	12.72	0.14
5	1689.17	121.62	2.091	0.100	38.92	0.92	474.99	2.83	12.77	0.18

Table 3.2: Summary statistics of separate Oneway ANOVAs and Fisher's PLSD *post hoc* test of colony characters, using Genotype as factor. Where appropriate, colony means were used which were calculated from ten observations on individual polypides per colony (lophophore diameter, tentacle number). A total of 20 colonies was used in the analysis (four replicates of each of five genotypes). Significant differences in the *post hoc* test are denoted by group letters: allocation of genotypes to different groups indicates significant differences ($p < 0.05$).

Source	Numerator df	Denominator df	F	p
Final Area	4	15	94.85	< 0.001
Final RCP	4	15	22.59	< 0.001
Zooid Activity	4	15	29.94	< 0.001
Lophophore Diameter	4	15	2.02	0.142
Tentacle Number	4	15	3.49	0.033

Fisher's Protected LSD

	Genotype 1	Genotype 2	Genotype 3	Genotype 4	Genotype 5
Final Area	d	c	a	b	d
Final RCP	a	b	a	a	b
Zooid Activity	c	b	a	b	b
Loph. Diam.	b	a	b	a,b	a,b
Tent. No.	a	b	a,b	b	b

Figure 3.2: The colonies at the end of the experiment, after a growth period of 103 d. Replicates of genotypes are arranged in columns, and genotypes are arranged 1 to 5 from left to right. The size of the glass plates was 8 x 8 cm.

Fig. 3.2

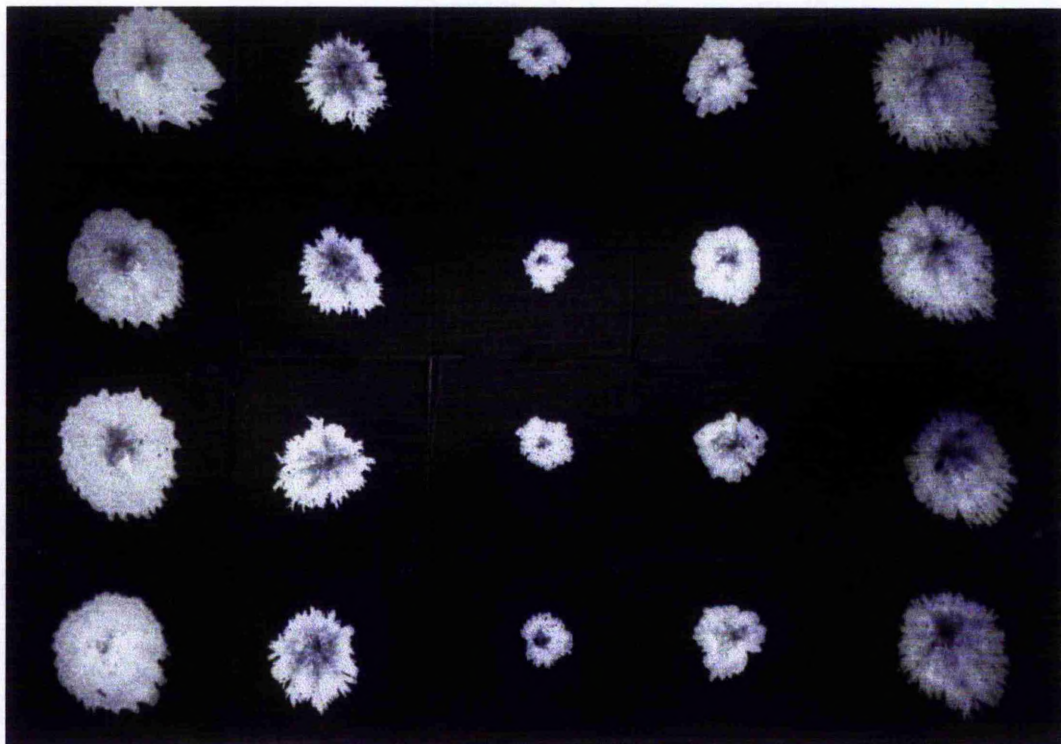

Figure 3.3: Genotype means of colony area (mm²) at the end of the experiment (t = 103 d). Error bars are + 1 s.e. Genotypes are arranged 1 to 5 from left to right. Means are based on observations from four replicate colonies per genotype.

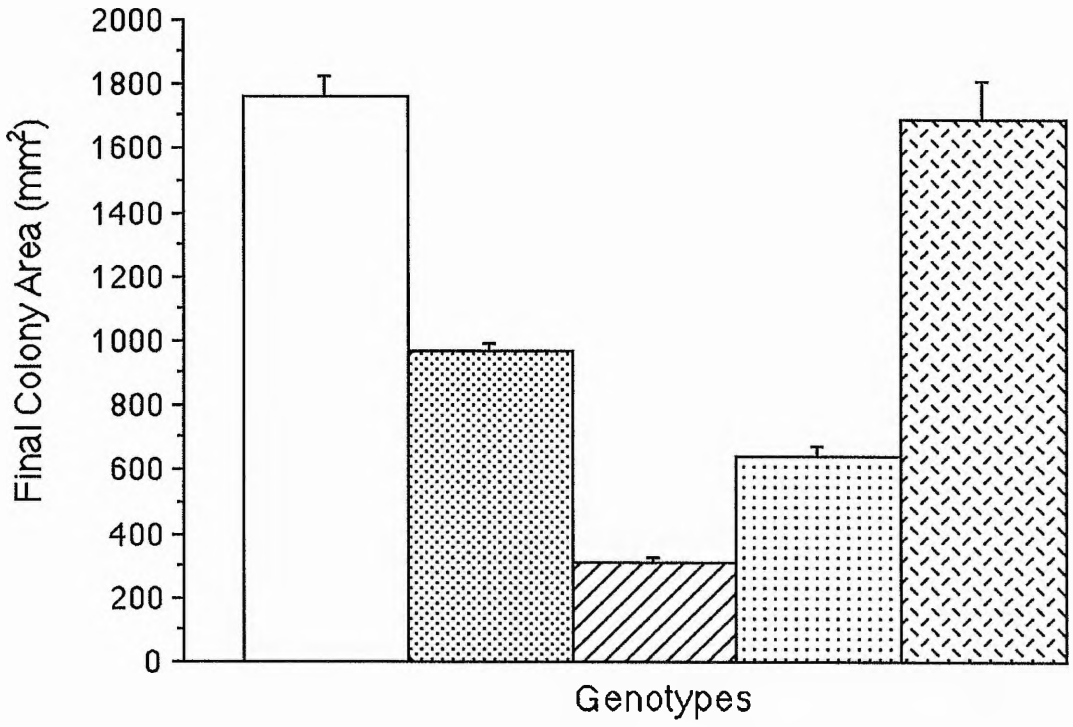
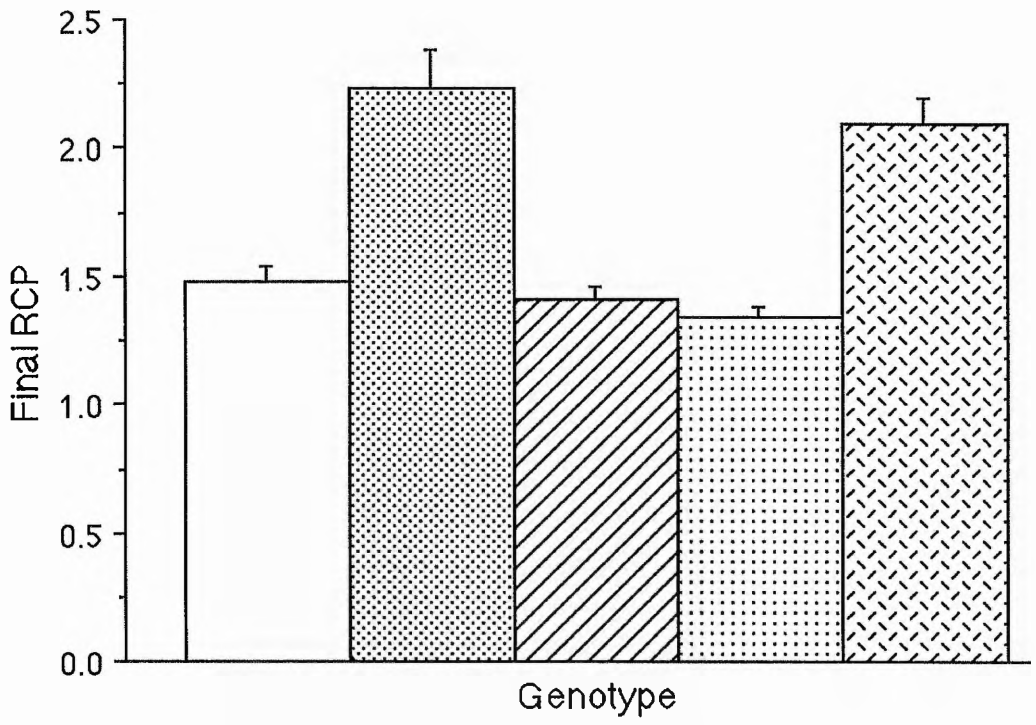

Figure 3.4: Genotype means of colony shape, as measured by the relative colony perimeter RCP ($= \text{perimeter}^2 / 4 \pi \text{ area}$) at the end of the experiment ($t = 103 \text{ d}$). Error bars are $+ 1 \text{ s. e.}$ Genotypes are arranged 1 to 5 from left to right. Means are based on observations from four replicate colonies per genotype.

Fig. 3.4



3.3.3 Polypide Life Span (PLS) and Polypide Regeneration Time (RT)

Polypide life spans (PLS) and regeneration times (RT) varied markedly, both over time and with cycle number; polypide life spans (PLS) decreased sharply over the first three cycles, and then levelled off in an approximately hyperbolic fashion, whereas regeneration times (RT) increased asymptotically over the duration of the experiment (Fig. 3.6). Because the observational zooids were essentially central in position, as the colony grows they become progressively more distant from the growing distal (peripheral) zooids. Notwithstanding this positional effect, the observed changes in both PLS and RT indicate a systematic, and possibly age-specific, decline of these fundamental parameters at the zooid level. PLS ranged from 1 to 14 d, while RT varied between 2 and 69 d. The extreme range of RT values reflected extended periods of dormancy, which occurred with increasing frequency towards the end of the experiment.

The combined effect of polypides degenerating after increasingly shorter periods and the zooids also taking longer to regenerate new polypides was reflected in the asymptotically declining proportion of functional polypides in the observational sample of zooids (Fig. 3.7). The data show a moving average, superimposed initially by a cyclical element; this gradually decreased as the experiment progressed, probably because of the increasing variability in PLS and RT among genotypes. By the end of the experiment, the proportion of zooids with functional polypides in the observational clusters (total 160) was approximately one quarter (final colony sizes varied between 1,861 and 13,926 zooids) although there is no indication of what the actual asymptote value might have been had the experiment been continued. Although many zooids entered a state of dormancy towards the end of the experiment, with no new polypides being formed after regression, none of the observational zooids died during the course of the experiment.

Individual genotypes followed seemingly characteristic temporal patterns of both PLS and RT (Fig. 3.8). PLS for Genotype 3 appeared to be the least variable

Figure 3.5: Temporal pattern of changes in colony shape and size over the experiment. Data shown are genotype means of colony area in mm² (top) and relative colony perimeter (RCP, = $\text{perimeter}^2 / 4 \pi \text{ area}$; bottom) plotted against time in weeks. Genotype 1: filled squares; Genotype 2: crosses; Genotype 3: open triangles; Genotype 4: filled triangles; Genotype 5: open diamonds. Error bars are ± 1 standard error. Means are based on four replicate colonies per genotype.

Fig. 3.5

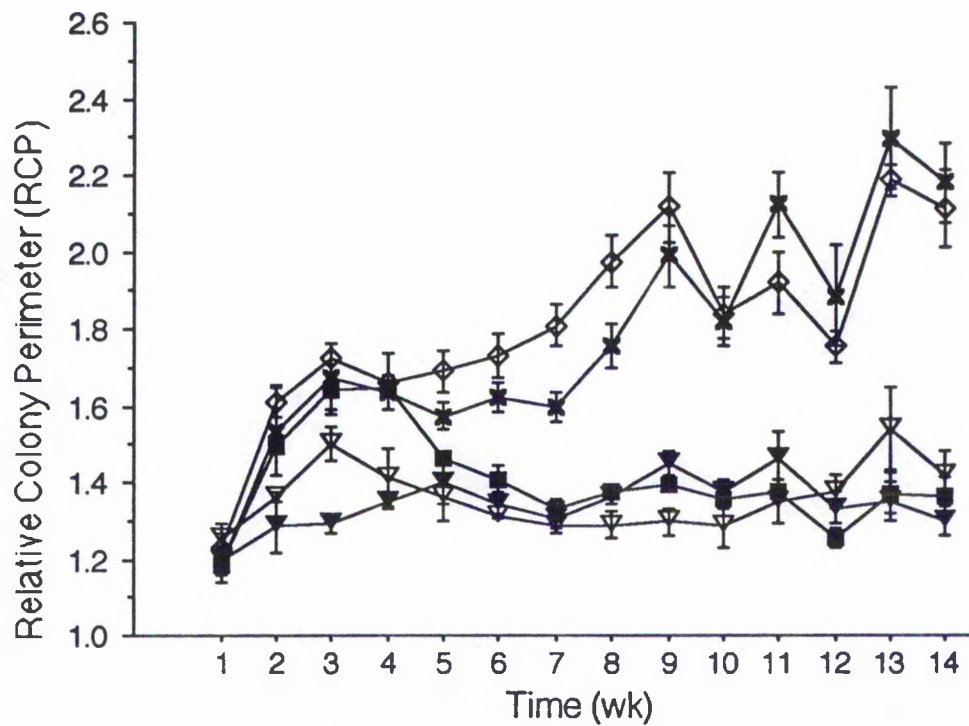
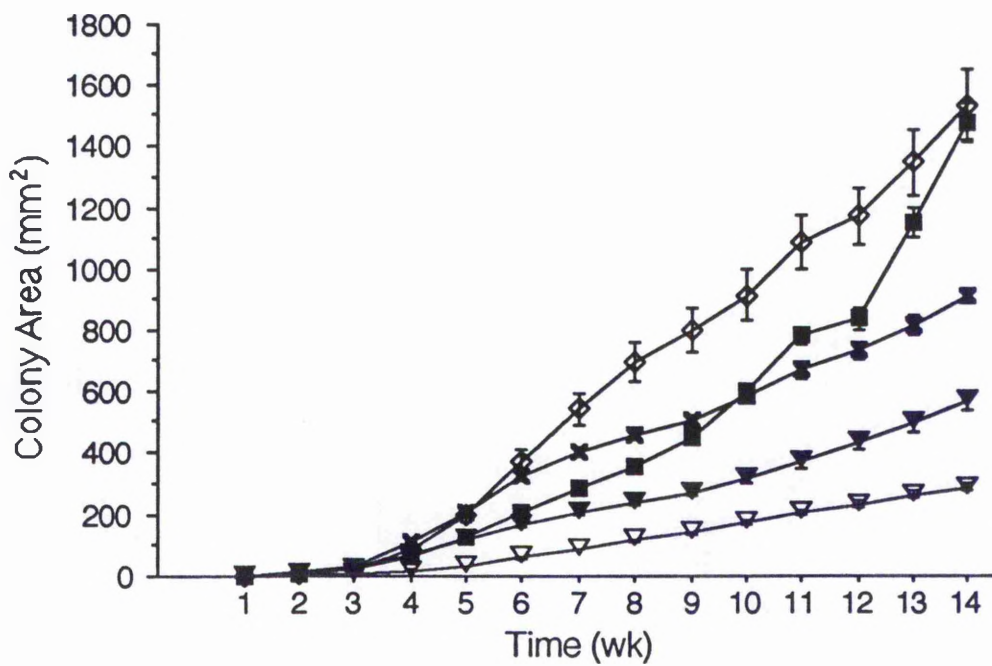

Figure 3.6: Polypide life spans (PLS, filled squares) and polypide regeneration times (RT, open squares) as a function of regression-regeneration cycle number. Data shown are overall means \pm 1 s. e., calculated from genotype means ($n = 5$). Five genotypes were replicated fourfold each to give a total of 20 colonies. For each colony, daily observations were made on a cluster of 8 zooids (total $n = 160$), and polypides were classed as functional or regressing/regenerating. Data were obtained over 103 d.

Fig. 3.6

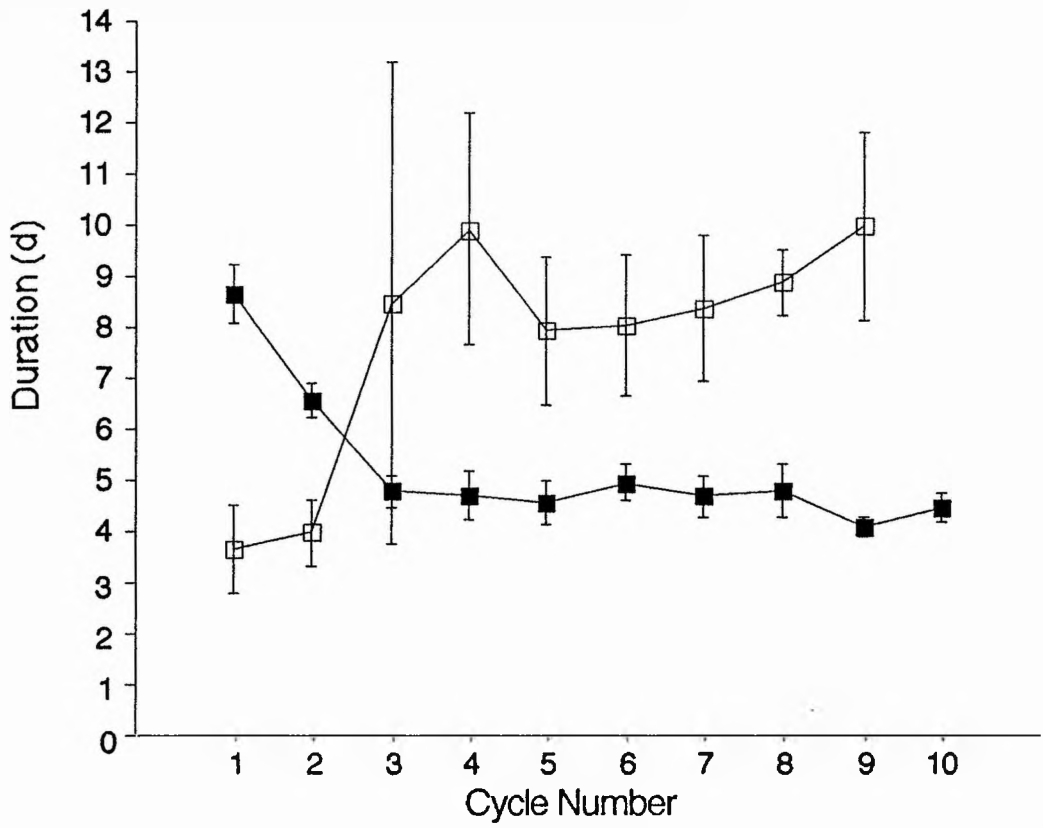

Figure 3.7: Percentage of zooids with “functional” polypides over the experimental period. Observations were obtained for 160 zooids, with eight observational zooids in each of 20 colonies (five genotypes, four replicate colonies each). Data plotted are grand means ± 1 s.e. (n = 20).

Fig. 3.7

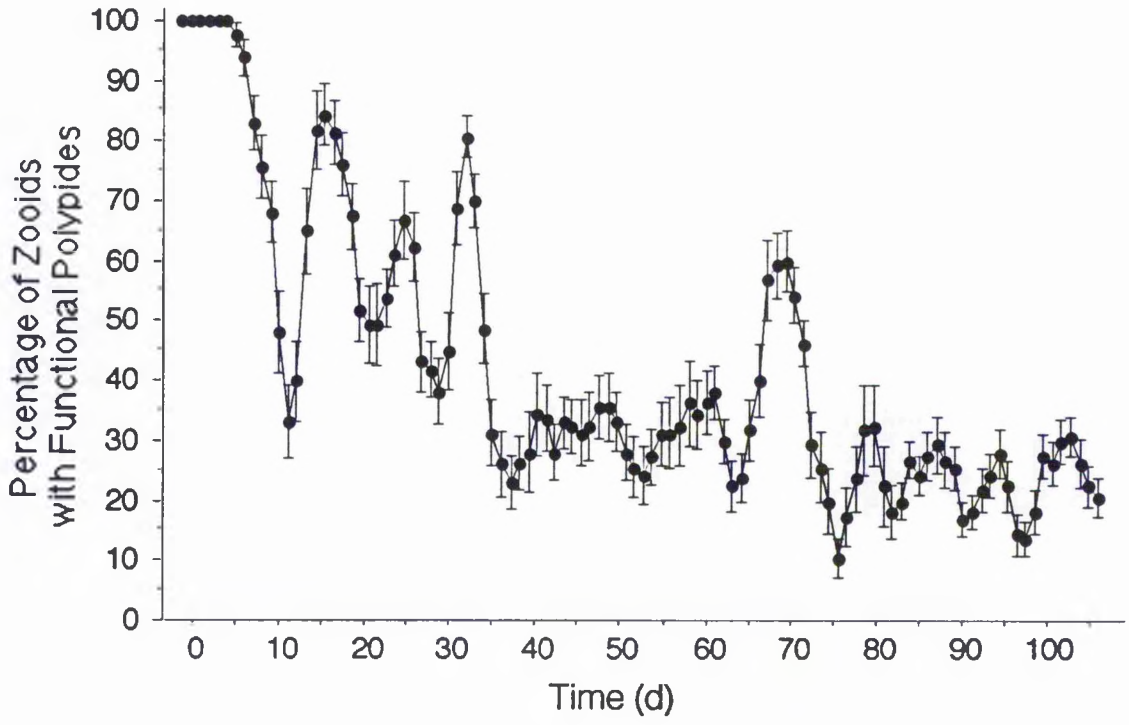
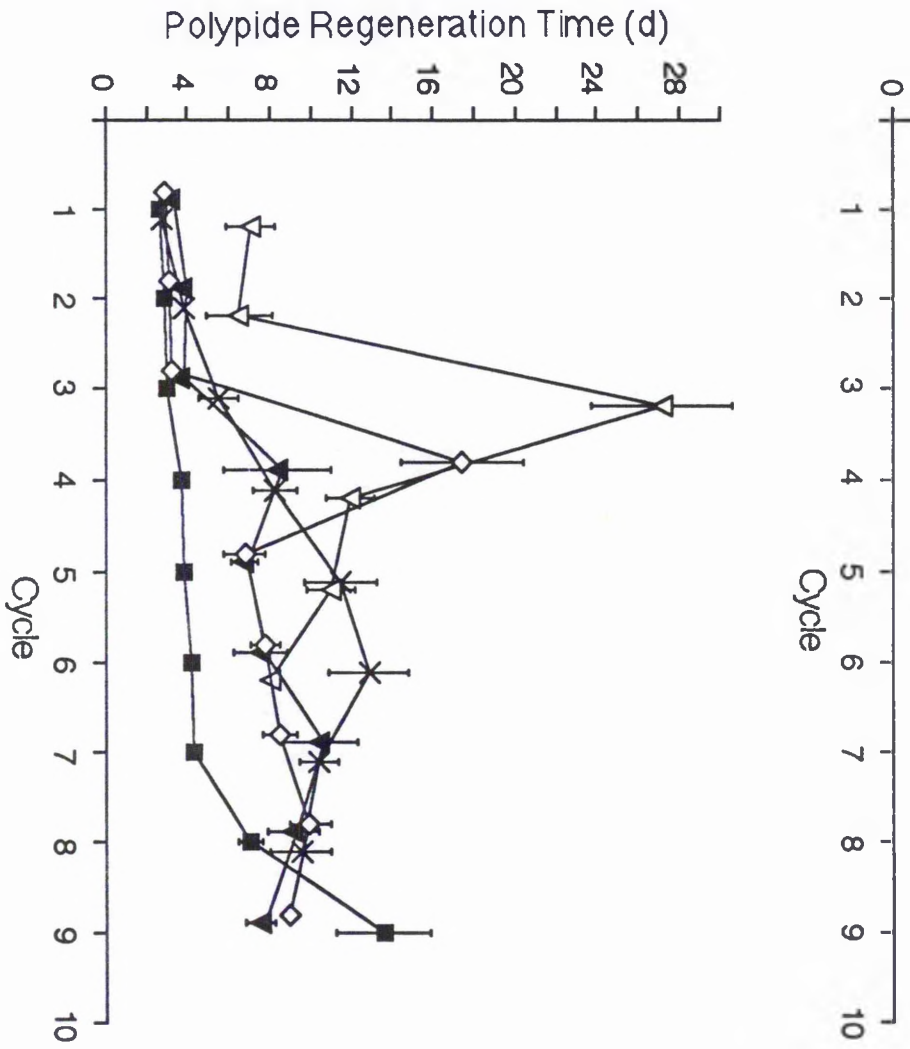

Figure 3.8: Top: Genotype means of polypide life spans in days, plotted against polypide cycle number. Means are based on 160 observational zooids among 20 colonies of five different genotypes (four replicate colonies per genotype). Bottom: Genotype means of polypide regeneration times in days, plotted against polypide cycle number. Genotype 1: filled squares; Genotype 2: crosses; Genotype 3: open triangles; Genotype 4: filled triangles; Genotype 5: open diamonds. Error bars represent ± 1 s.e. Note difference in ordinate scales.



Polypide Life Span (d)

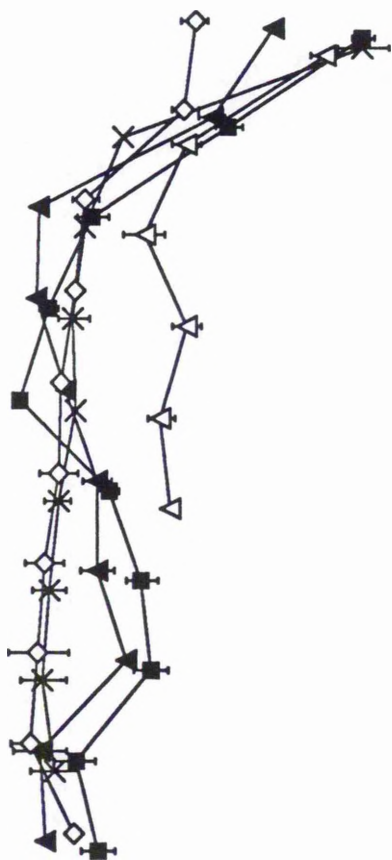

Fig. 3.8

among cycles, with little apparent temporal pattern. The remainder showed a homogeneous pattern but diverged strongly in cycles 7 and 8. Genotypic patterns of regeneration times were even more pronounced, resulting in considerable differences, particularly for cycles 3 and 4. Accordingly, ANOVA of zooid activity revealed the genotypes to be highly significantly different from one another ($p < 0.001$, Fig. 3.9, Table 3.1).

From the asynchrony of genotypes in the temporal pattern of polypide cycling (Fig. 3.10) it is evident that the different peaks both in PLS and RT were caused not by extrinsic disturbances or perturbation, but were largely deterministic events taking place at the genotype level. A particularly clear illustration of this was the extended period of regeneration for the zooids of Genotype 3 after the third polypide cycle. This deterministic element also was reflected later in the experiment, in that polypides often degenerated well before the stomach epithelia had reached their normal pre-regression level of waste product build-up, which usually is indicated by a dark brown coloration of the digestive tract.

3.3.4 Sexual reproduction

The incidence of sexual maturation of zooids within colonies was erratic and incomplete in all cases. Although developing oocytes were observed they never developed fully and were apparently resorbed. All colonies consistently developed sperm morulae but only for Genotypes 1 and 3 were mature spermatozoa released into the coelom. The male resource 'investment' of all colonies probably was very similar, despite the genotypic differences in final maturation. Sperm maturation — where present — commenced among zooids at the colony centre, and then proceeded in an approximately concentric fashion towards the colony periphery. This implies that zooids undergo sexual maturation at a certain stage in their ontogeny, somewhat independently of whole-colony development and/or external influences. Importantly, almost all of the observational zooids of Genotype 1 completed spermatogenesis, and

Figure 3.9: Genotype means of zooid activity, expressed as percent of the whole experimental period. Error bars are + 1 s.e. Genotypes are arranged 1 to 5 from left to right. Means are based on observations from 160 observational zooids among 20 colonies (four replicate colonies in each of the five genotypes).

Fig. 3.9

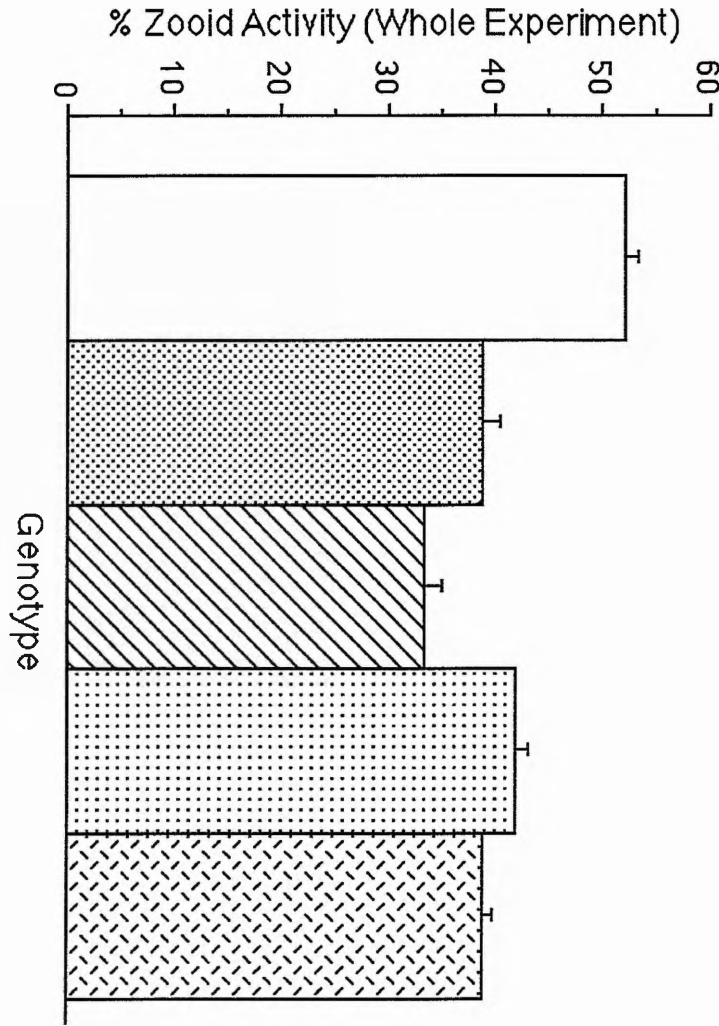
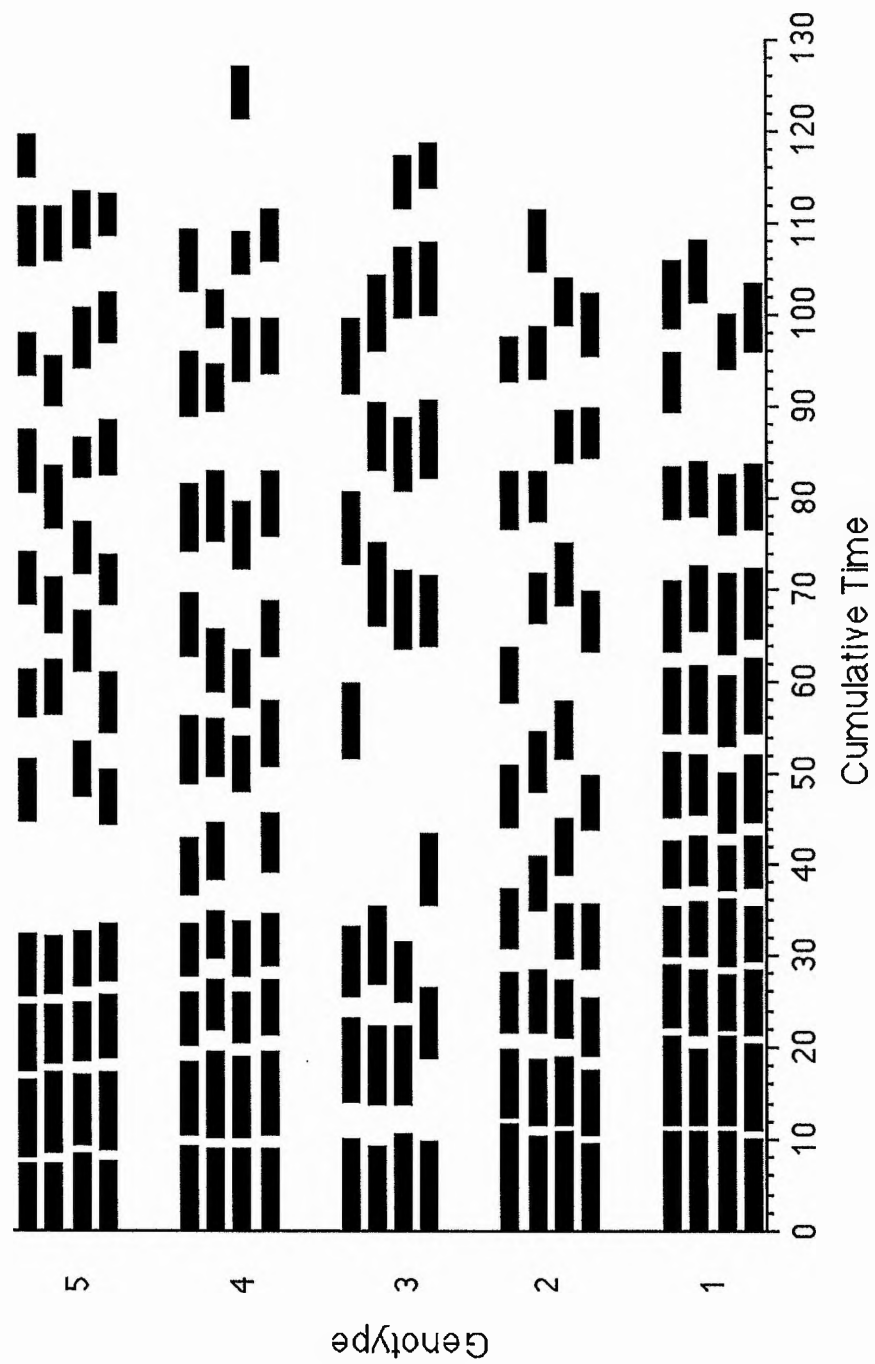

Figure 3.10: Graphic representation of the polypide regression pattern over time. Solid bars represent periods when a zooid had a functional polypide, gaps represent periods of regression and/or regeneration. For ease of illustration, data plotted are cumulative colony means, calculated from observations on eight zooids per colony. Genotypes are numbered 1 to 5 on the ordinate, with replicate colonies arranged in blocks of four. Because data are colony means, rather than observations from individual zooids, they are not strictly additive and in some cases total more than the duration of the experimental period (103 d).

Fig. 3.10



most zooids initiated the first period of coelomic sperm release within only 2-3 d of one another (days 20-23, Fig. 3.11). A second period of sperm release occurred from days 74 and 75 onwards in a number of zooids in three of the four replicates of that genotype. Genotype 3 also produced mature spermatozoa in all replicate colonies, but here only one to four of the eight observational zooids per colony produced sperm and there was no second sperm release in this genotype. As for Genotype 1, coelomic release was initiated within a comparatively short period (5 d) in all affected zooids, albeit at a later stage (days 28-33). The failure of complete sexual maturation of colonies in this experiment precluded further analyses, but for the purposes of modelling colony growth it was assumed that the differences between genotypes in sexual development were negligible.

3.3.5 Lophophore morphology

Oneway ANOVA showed no significant differences between genotypes for lophophore diameter (range 347-559 μm ; $p = 0.142$, Tables 3.1, 3.2), whilst tentacle number (range 10-14 per polypide) was marginally significant among genotypes ($p = 0.033$, Tables 3.1, 3.2).

3.3.6 Modelling colony growth rate

The outcome of fitting the generalized linear model to the data for final colony area is presented in Table 3.3. Two separate analyses were undertaken, with each involving the fitting of factors to the data in a different order. This is of great importance both to the outcome, and interpretation, of generalized linear models (Crawley 1993). The two analyses provide different approaches to the one problem and have to be interpreted in conjunction.

For Analysis 1, the between-genotype factor was fitted first, followed by the factors within-genotype RCP and zooid activity. The between-genotype factor here reflects the overall variation between genotype means: fitting RCP and zooid activity

Figure 3.11: Temporal pattern of sperm maturation among colonies of Genotype 1. Data are arranged in four blocks (one for each replicate colony of Genotype 1), represented by different plot symbols. Individual zooids within the replicate colonies are arranged in horizontal lines (maximum eight per colony). Data points represent days on which observational zooids contained mature spermatozoa released into the coelom.

Fig. 3.11

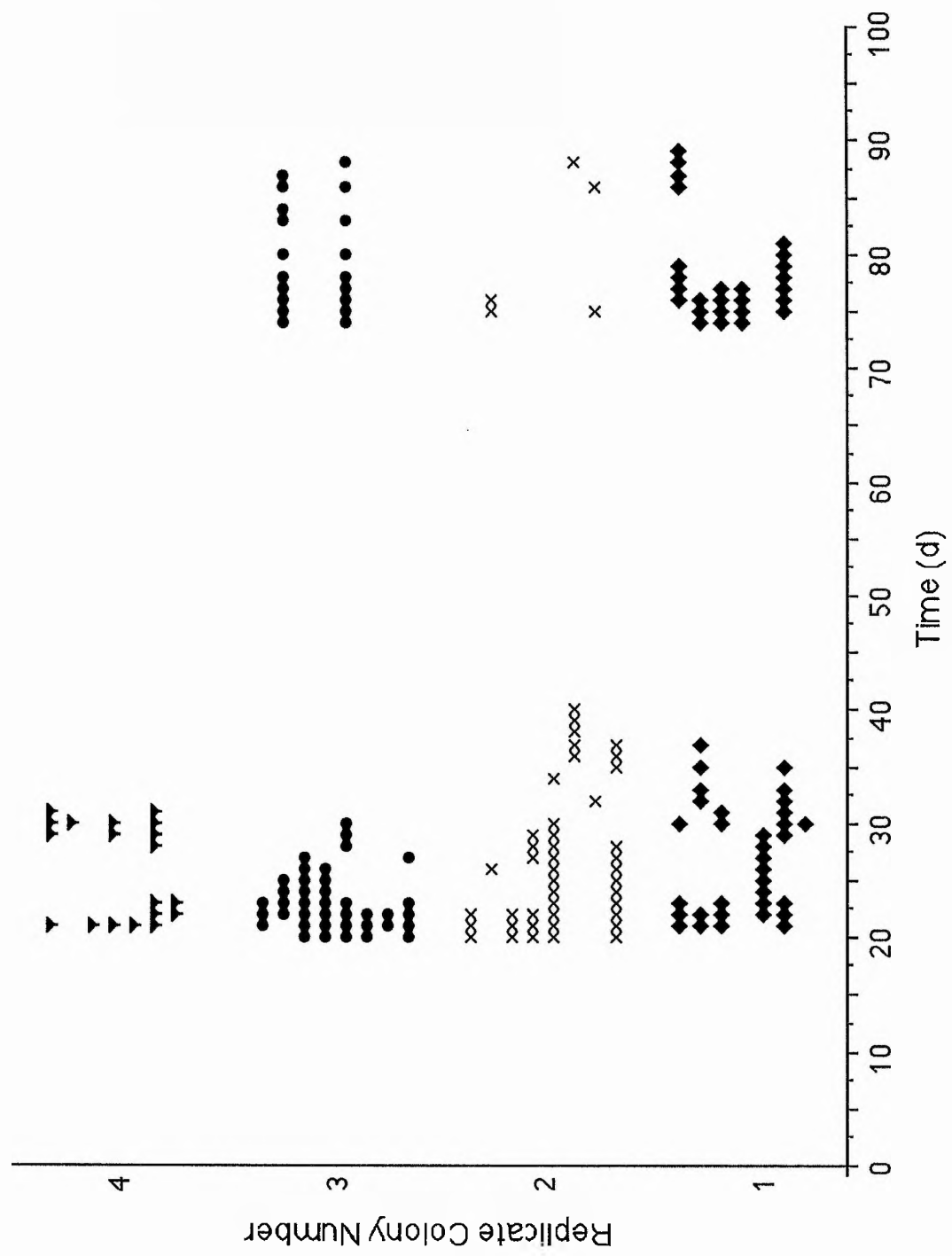

Table 3.3: ANOVA of generalized linear model of parameters affecting colony growth in *Electra pilosa*. Factors were fitted to the model in two different orders; for Analysis 1, the order was Genotype, RCP and Zooid Activity, for Analysis 2 the order was RCP, Zooid Activity and Genotype.

ANALYSIS 1

Source	df	SS	MS	F	p
Between Genotypes	4	8.363	2.097	211.18	< 0.001
Within Genotype RCP	1	0.024	0.024	2.42	> 0.100
Within Genotype Activity	1	0.000	0.000	0.04	> 0.500
Residual	13	0.129	0.009		
Total	19	8.516			

ANALYSIS 2

Source	df	SS	MS	F	p
Overall RCP	1	1.743	1.743	176.06	< 0.001
Overall Activity	1	4.474	4.474	451.91	< 0.001
Between Genotypes	4	2.169	0.542	59.78	< 0.001
Residual	13	0.129	0.009		
Total	19	8.516			

after the genotype means explores the relationship between these variables and colony area among the four replicates of each genotype separately. This resulted in the factor genotype emerging as highly significant ($p < 0.001$, Table 3.3), and accounting for almost all of the observed variation. Within genotypes, the relationship between colony area and RCP/zooid activity was not significant, possibly as result of insufficient replication within genotypes.

For Analysis 2, factors were fitted in the reverse order (RCP, Zooid Activity, Genotype), permitting investigation of the relationships between colony area, RCP and zooid activity for all of the colonies first, irrespective of genotype, before adding the genotypic component to the model. In this case, all three factors were highly significant, suggesting a marked effect both of zooid activity and colony shape on colony growth; their relative contributions to the overall variation were 70.4 and 27.3 % respectively (added variance components, Sokal & Rohlf 1981, p.216; see also Table 3.4). In contrast to zooid activity and colony shape, genotype accounted for only a minor component of variation in colony growth (2.1 %). This analysis differed from the previous model in that it investigated overall contribution of the three parameters, independent of within-group structure. Neither lophophore parameter nor tentacle number significantly improved the fit of the model and, as required by convention (Crawley 1993), they were omitted from the final model.

A plot of the ln-transformed final colony area against final RCP (Fig. 3.12, top) showed a significant positive correlation ($r = 0.452$, $p < 0.05$) when all colonies were included; within genotypes, the relationship between the two variables is unclear, because Genotypes 3 and 4 apparently displayed a negative correlation, whilst Genotypes 1, 2 and 5 all showed positive correlations. A plot of ln final colony area against zooid activity (Fig. 3.12, middle) showed an even more significant correlation ($r = 0.644$, $p < 0.002$), but, again, the within-genotype patterns were inconsistent, with Genotypes 2, 3 and 5 being positive and 1 and 4 negative. From these data, Genotypes 1, 3 and 4 appear to fall more or less on the same line, whilst Genotypes 2

Table 3.4: Variance components of factors included in the generalized linear growth rate model (Analysis 2); these represent the relative contribution of factors in the model as well as that of the residual term. Variance components were calculated according to Sokal and Rohlf (1981, p. 216).

Factor	% Contribution to Overall Variation
Colony Shape (RCP)	27.34
Zoooid Activity	70.40
Genotype	2.10
Residual (Error)	0.16

Figure 3.12: Top: Plot of ln-transformed colony area at the end of the experiment ($t = 103$ d) against colony shape, as measured by RCP, at the end of the experiment. Correlation coefficient, $r = 0.452$. Middle: Plot of ln-transformed colony area at the end of the experiment against percent zooid activity for the whole experimental period. Correlation coefficient, $r = 0.644$. Bottom: Plot of colony area at the end of the experiment, scaled by colony shape (RCP), against percent zooid activity for the whole experimental period. Correlation coefficient, $r = 0.832$. Genotype 1, filled squares; Genotype 2, crosses; Genotype 3, open triangles; Genotype 4, filled triangles; Genotype 5, open diamonds.

Fig. 3.12

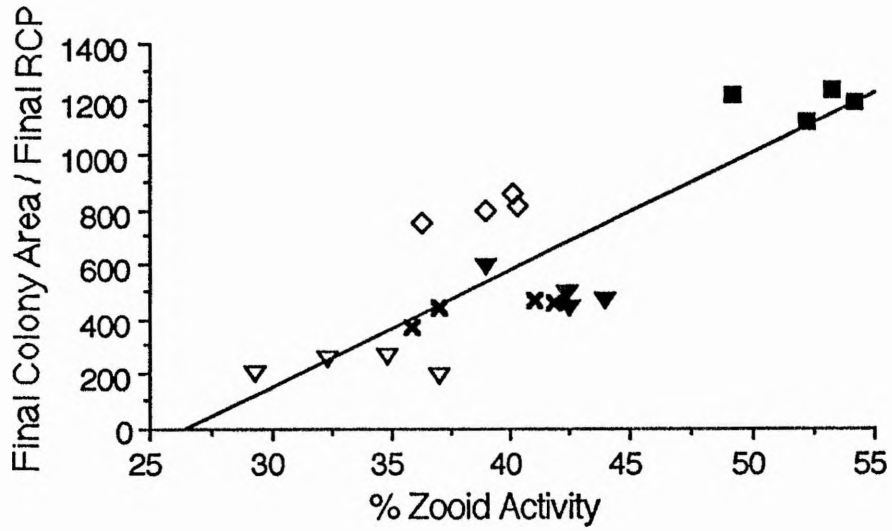
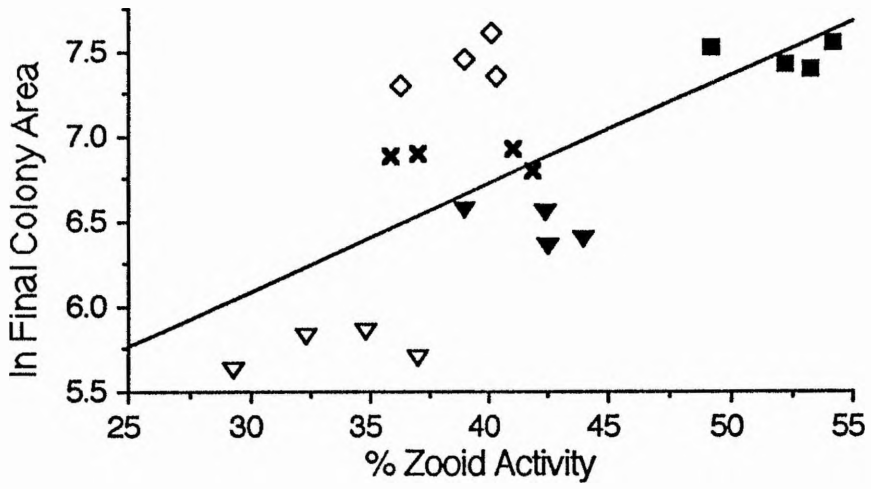
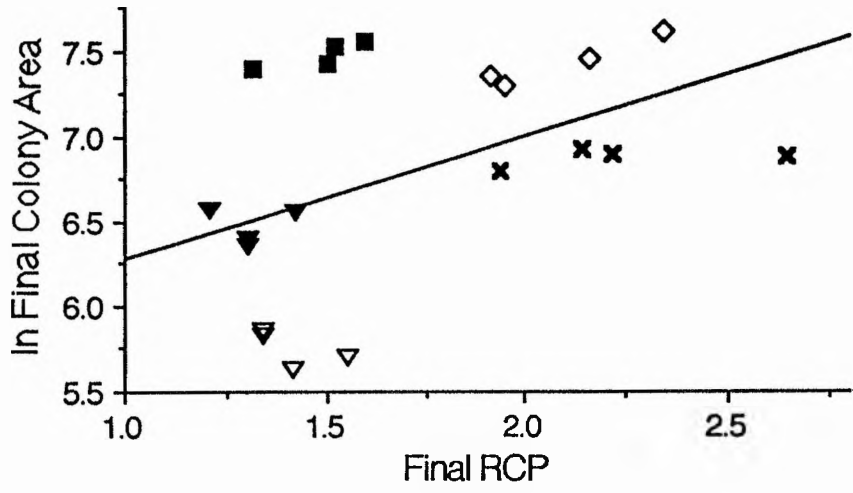

and 5 differ considerably. In terms of colony shape, however, Genotypes 2 and 5 clearly are more stellate than 1, 3 or 4, which may well account for the enhanced colony growth. Scaling colonies by their shape (by dividing final colony area by final RCP) and plotting this against zooid activity results in a much higher correlation coefficient ($r = 0.832$, $p < 0.001$; Fig. 3.12, bottom), confirming the assumption that much of the total variation in colony area was due to variation in colony shape and zooid activity.

3.4 DISCUSSION

Colony shape and zooid activity

The present model demonstrated the relative importance of two parameters (colony shape, polypide regression/regeneration) that so far have attracted little attention in explaining the frequently observed variation of colony growth rates among bryozoans. Colonies with higher levels of zooid activity and/or more stellate shapes displayed increased growth rates. Both parameters appear to be strongly heritable and covary with genotype: this can lead to misinterpretation of genotypic effects on growth rate variation in isolation. None the less, it has to be acknowledged that sample sizes in the present study were small, both at the colony and the genotype level, due to logistic constraints and the necessity to monitor large numbers of zooids on an extended daily basis. Most of the evidence for linear relationships between colony growth and the explanatory variables was derived from two of the five genotypes (Fig. 3.12).

Stellate genotypes outperformed their more lobate counterparts in terms of colony growth, thus confirming existing theory which predicts that colonies with “runner” morphologies (i.e. elongate or stellate colony shape) should display increased growth rates because “runner” morphology reduces the allometric constraint of two-dimensional growth (Buss 1979, Rubin 1987, Bishop 1989). Genotypes differed significantly in their morphology, ranging from rather stellate to almost

circular (Fig. 3.2). The range of RCP values observed in the present study was not dissimilar to that observed in a comparable previous experiment (Bayer 1994). Differentiation of colony shape occurred relatively early in the experiment (weeks 2 to 4) after which the two most stellate genotypes continued to increase in RCP, whereas the remainder of genotypes did not show any significant changes in colony shape and remained lobate to circular. This clearly suggests a deterministic pattern at the genotype level. It is also noteworthy in this context that the growth trajectories of the two fastest growing genotypes, 1 and 5, differed markedly. Genotype 5, which was rather stellate but had low zooid activity, began to outgrow the remainder of genotypes early in the experiment, but then continued growing at a relatively constant rate (Fig. 3.5). Genotype 1, which was relatively lobate but had the highest zooid activity value, diverged from the remainder of the genotypes much later than did Genotype 5 but then rapidly grew to approximately the same size. This apparently reflects the mechanisms by which the two main determinants of colony growth — colony shape and zooid activity — affect the growth performance of a colony. Expansion of the colony perimeter into lobes at an early stage of astogeny reduces the allometric constraint of two-dimensional growth and thus allows a colony to grow at faster rates from early on, as observed in Genotype 5. In comparison, the effect of increased zooid activity (increased feeding time potential) will be minor early on in astogeny but relatively pronounced when integrated over the whole duration of the growth period; this would be consistent with a later gain in growth as was observed for Genotype 1. This pattern is further evidence of the importance of zooid activity and colony shape for colony growth.

A minor, but statistically significant, genotypic component of variation in growth rates remained unexplained by the present model (2.1 % of the total variance). This could either simply be a purely genetic background or it could be explained by other genotype-specific factors that were not measured in this study. The latter might include, for example, behavioural factors, such as lophophore evagination times or

sensitivity to stimulation or perturbation, that are genotype-specific and thus masked as genetic variation in the model. Notwithstanding this, it would be profitable to complement data such as those presented here with observations of whole-colony filtration rate. Overall filtration rates in themselves will be affected by numerous behavioural and/or physiological factors, but they probably constitute the most likely source of the presently unexplained variation in growth rates among genotypes.

Sexual reproduction

Sexual parameters could not be included in the present model, because maturation was incomplete in all cases. At present, there are no data available that would suggest the existence of such trade-offs in a non-brooding bryozoan, where sexual investment is presumably less than in brooding species. However, trade-offs between somatic and sexual investment have been reported for brooding bryozoan species (Hughes 1989, Hunter & Hughes 1995, Herrera *et al.* 1996, Hunter *et al.* 1996); here, reproductive allocation is determined both by genotypic and environmental components (reviewed by Seed & Hughes 1992).

The failure of sexual maturation in the present experiment might well have been due to a dietary deficiency and/or the artificially high temperature in cultures (18°C). Although *Rhodomonas* sp. has been used in several studies involving bryozoans (Hunter & Hughes 1991, 1993a,b), and even though monoculture diets often have produced better growth than mixed diets (Winston 1976, Jebram & Rummert 1978, Hunter & Hughes 1991), the likelihood is that monoculture diets are nutritionally suboptimal. Even simple deficiencies in single essential amino acids could, for example, exert marked effects on the success of vitellogenesis and hence colony growth and fitness. That the present culture technique results in striking within-genotype consistency both in growth rate and colony shape would suggest, however, that dietary deficiencies or suboptimalities are comparatively trivial. Overall, colonies appeared healthy throughout all experiments in this study, and, except for

sexual reproductive parameters, did not appear to differ from colonies growing in the field in any way. A more likely explanation for the failure of oocyte maturation in this experiment may be that the constant environment of the laboratory might have lacked environmental cues required for the timing and activation of sexual reproduction.

Zooid senescence

The data do suggest evidence of senescence at the level of the zooid; both polypide life spans (PLS) and polypide regeneration times (RT) showed signs of a programmed physiological deterioration at the level of the zooid, resulting in a declining proportion of actively feeding polypides in the observational sample of zooids in each colony, and in the colony centres in general (Fig. 3.13). Towards the end of the present experiment, polypides in the observational clusters frequently degenerated long before the typical levels of waste product accumulation had been achieved. This was apparent from the pink (rather than dark brown) coloration of the digestive tracts of polypides immediately prior to degeneration. It is conceivable that, at this stage, polypide regression is affected primarily by the age of the zooid rather than the amount of food ingested by its polypide (for a full discussion of zooid senescence see Chapter 6).

Figure 3.13. Colony of *Electra pilosa* grown on a glass plate under laboratory conditions. The peripheral section of the colony shows a clear preponderance of zooids with functional polypides (as indicated by a filled stomach and caecum, visible as a large dark mass in a zooid), whereas the central (= proximal) section is dominated by zooids containing brown bodies rather than functional polypides (visible as a small dark mass within the zooid). Maximum colony width ~ 16 mm.

Fig. 3.13

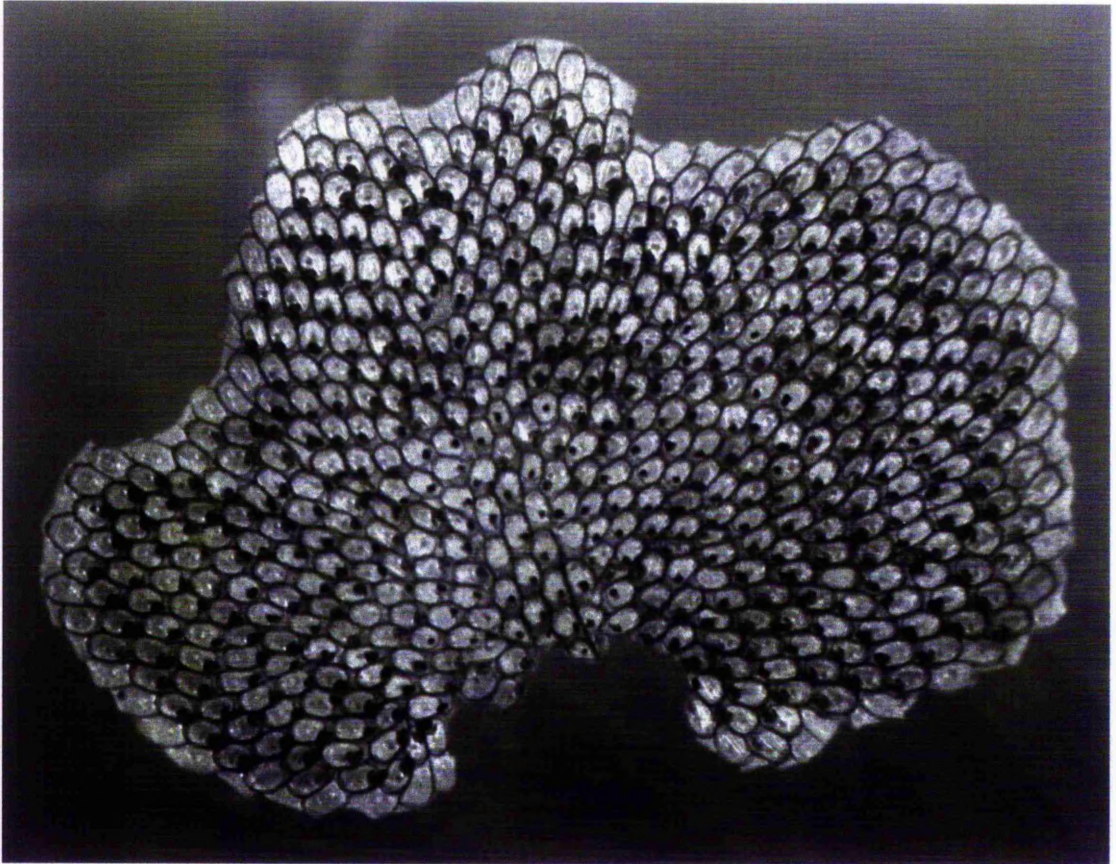

CHAPTER 4:
THE OCCURRENCE OF EXTENDED MEDIAN
PROXIMAL SPINES IN *ELECTRA PILOSA*

4.1 INTRODUCTION

Electra pilosa displays a particularly strong degree of morphological plasticity (Hincks 1880, Norman 1894) and amongst cheilostomatid bryozoans in general the problem of cryptic species is particularly marked (McKinney & Jackson 1991; Lidgard & Buckley 1994). Numerous varieties, forms and subspecies of *E. pilosa* have been described (Hincks 1880, Norman 1894, Bobin & Prenant 1960). Zooids of *E. pilosa* generally have up to 11 short (~100 μm) marginal spines and a single short (~200 μm) median proximal spine (MPS) (Ryland & Hayward 1977). In a long-spined zooid morph, however, the MPS is greatly elongated (up to 2100 μm ; Fig. 4.1). These extended median proximal spines (EMPSs) also are described for the erect form of *E. pilosa* (Bobin & Prenant 1960, Prigge 1967, Janke & Kremer 1988) and have been suggested by Bobin & Prenant (1960) to be diagnostic of this morph, the putative species *Electra* “*verticillata*”. Colonies growing around vertical cylindrical algal substrata such as *Gracilaria* spp. or *Plocamium* spp., and also the tufted stipes of *Chondrus crispus* Stackhouse, display the extended spines characteristic of *E. “verticillata”*, as do colonies forming three-dimensional tufts on flat surfaces — such as mollusc shells, kelp blades or rocks (pers. obs.). This applies also to unattached *E. pilosa* “balls” (Prigge 1967) which may form around substratum cores such as fragments of hydroid colonies. Despite the inconsistent incidence of EMPSs it is striking that the basal parts of the tuft-forming morphs grow in the sheet-like form typical of *E. pilosa* (Ryland 1959, Bobin & Prenant 1960, Ryland & Hayward 1977). Vertical extension of the colony into the water column presumably renders the zooids much more susceptible to physical

Figure 4.1: Feeding polypides of *Electra pilosa* in field-collected short-spined colony (top) and long-spined colony (bottom). Height of extended polypides approximately 500 μm .

Fig.4.1

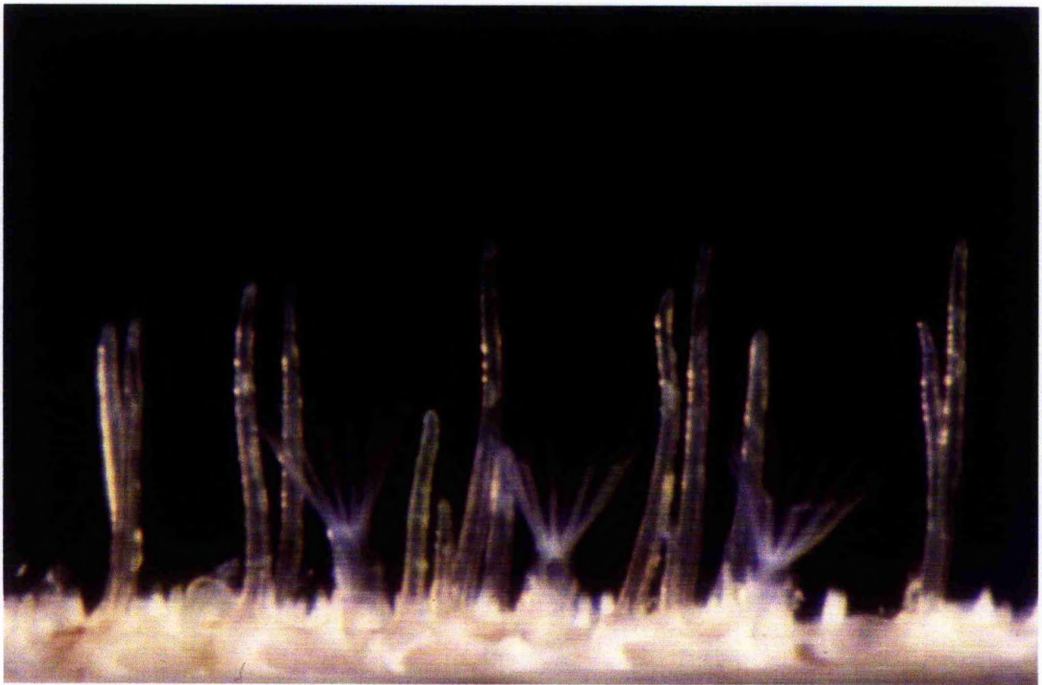
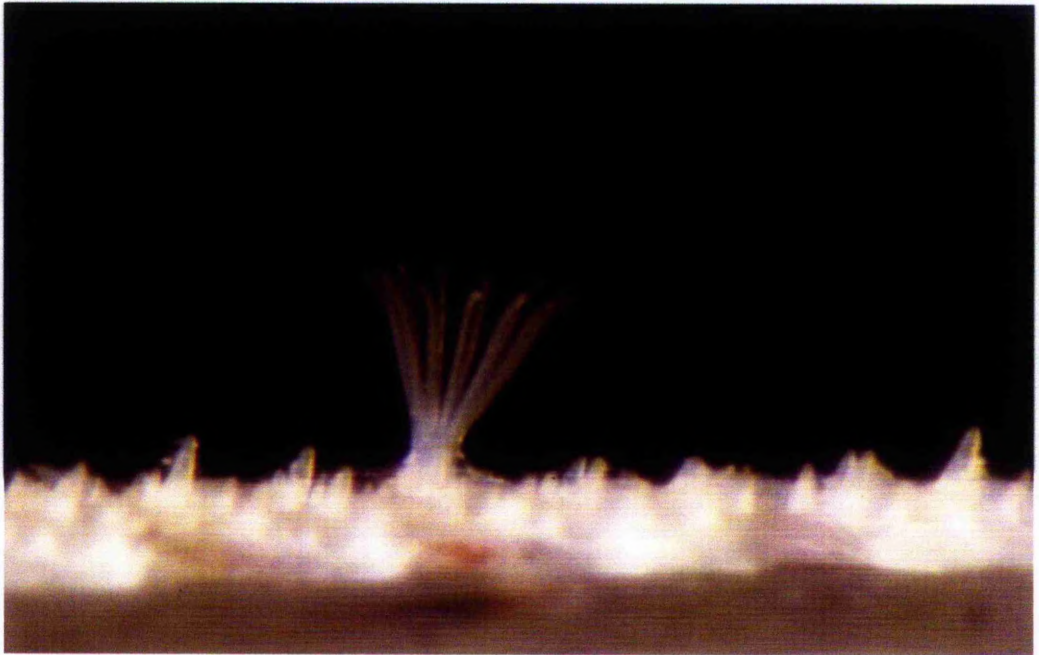

disturbances from wave action and abrasion; therefore, EMPSs might comprise some form of protection for polypides and the delicate frontal surface of zooids (Figs. 4.1, 4.2).

The morphological characters described for the variants all fall within the range of characters observed in *Electra pilosa*, and can occasionally even be observed within a single colony. The present consensus is that there are no cryptic species present in *E. pilosa* (Ryland & Hayward 1977), and molecular evidence appears to confirm this finding (d'Hondt & Goyffon 1993). However, there is a lack of experimental data identifying the origin of “spiny” morphs of *E. pilosa*, and their distinctness — or otherwise — from “unspiny” *E. pilosa*. Thus, the primary questions to be addressed in this study were as follows:

- 1). Are the morphs bearing EMPSs —
 - a) a distinct species, separate from *E. pilosa*?
 - b) phenotypic responses of colonies of *E. pilosa* to specific environmental challenges?
- 2.) Does the EMPS —
 - a) form spontaneously, under controlled laboratory conditions, and in the absence of environmental fluctuations?
 - b) occur in all colonies, or is its formation restricted to certain genotypes?
 - c) constitute a discrete character or simply a continuous extension of normal MPSs?
 - d) continue to form in colonies which have demonstrated the ability to form the character but subsequently have been transferred to the laboratory to grow in constant conditions?
 - e) form as a result of competition with other bryozoan colonies, as postulated by Stebbing (1973b)?

The important question of whether or not EMPSs are inducible by predators, in a manner analogous to the spinozooids of the bryozoan *Membranipora membranacea* (Harvell 1984a), was not addressed in this study but has been covered elsewhere

Figure 4.2: Cross section of long-spined *Electra pilosa* colonies growing on both sides of a *Fucus serratus* frond (Kingsbarns, E Scotland). Length of extended spines approximately 1200 μm .

Fig. 4.2

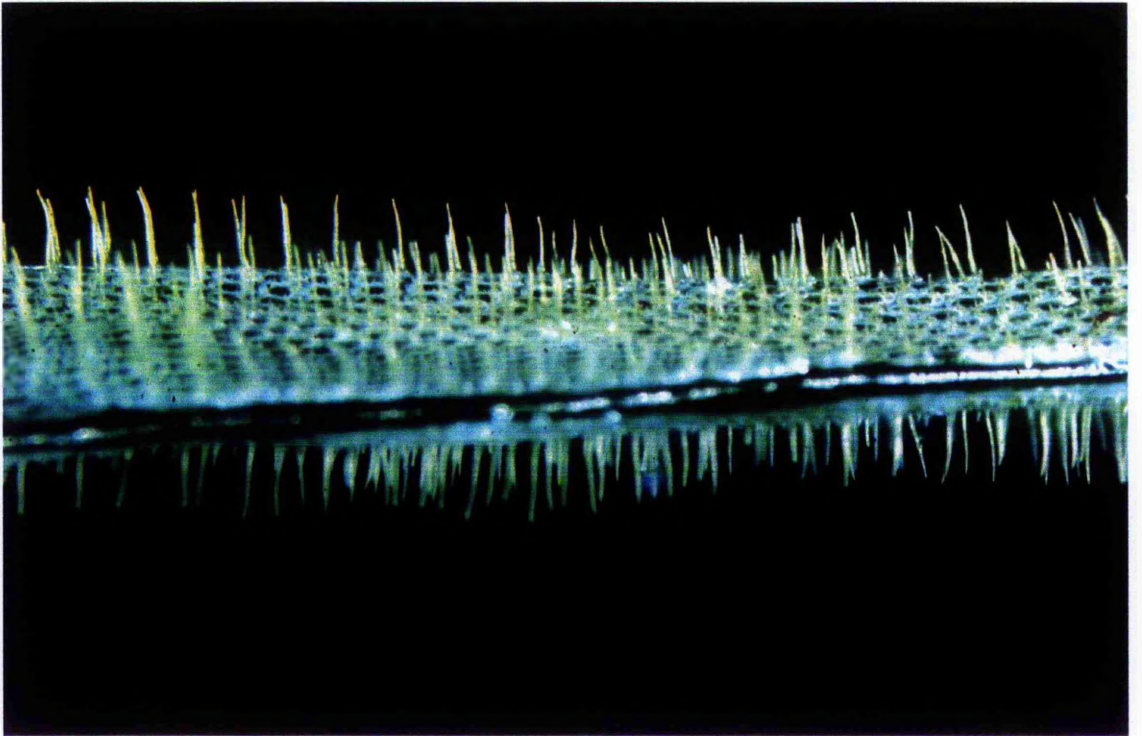

(Shaw 1994, Graham 1996). Both of these studies showed that, unlike the spinozooids of *M. membranacea*, extended spines in *Electra pilosa* are clearly not inducible by the presence of predators or predation itself.

Preliminary observations suggested that the incidence of EMPSs in *Electra pilosa* showed a considerable amount of variation among field sites; there also was an indication of a potential correlation between wave crash exposure of shores and a) the proportion of colonies bearing EMPSs, and b) percentages of EMPS-bearing zooids present in “spiny” colonies. Stebbing (1973a,b) suggested their incidence to be inducible both by space competitor overgrowth and by the effects of wave action. He also found an increased incidence of EMPSs among older/larger colonies and some seasonal variation of EMPS incidence in natural populations. Given the general seasonal pattern of larval settlement (Todd & Turner 1986), however, it is unclear as to whether this pattern is attributable to season alone or size/age of the colony. The first part of this study thus aimed at quantifying both incidence of “spiny” colonies and spinosity of colonies at a variety of sites of differing exposure. The study also aimed to establish whether the EMPS is a) simply a “normal” median proximal spine of greater length than an unextended MPS, but in a continuum with MPS lengths, or b) a separate, discrete character, with separate mean and mode, and thus subject to selection independently of MPS.

In order to test whether a history of exposure to certain environments might stimulate the formation of EMPSs, colonies of *Electra pilosa* were grown under controlled laboratory conditions after previous exposure to their normal environment. This was intended to demonstrate the possible presence of an environmental switch at the whole-colony level, which might cause continuous expression of EMPSs after exposure to an environmental stimulus. This part of the study also aimed to investigate whether all genotypes possess the potential to form EMPSs, by replicating colonies collected at different sites.

Various authors have assigned “spiny” and “unspiny” morphs of *Electra pilosa* the status of separate subspecies or varieties (Hincks 1880, Norman 1894). It was therefore of importance to clarify the taxonomic status of the two morphs. A phenetic approach was chosen to accomplish this; phenetics as a taxonomic method is still popular and useful in bryozoan taxonomy, despite the recent increase in the number of modern molecular techniques also now available.

Furthermore, it was of interest whether colonies grown from ancestrulae under controlled laboratory conditions form EMPs spontaneously, without previous exposure to environmental stimuli, and, if so, whether all genotypes in a population are capable of doing so. This was addressed by collecting ancestrulae on their natural substratum at two sites of differing wave crash exposure (Dundonnell/Gruinard Bay, see below), propagating them and then growing colonies in an undisturbed environment under constant controlled conditions.

Stebbing (1973b) had argued that EMPs may be inducible by direct overgrowth competition with other bryozoan species; *Electra pilosa* is competitively inferior and almost invariably overgrown by a wide variety of other bryozoan species in intertidal and infralittoral assemblages (Stebbing 1973b, Turner & Todd 1994). Here, this question was addressed by subjecting replicated genotypes of *E. pilosa* to direct competition for space both by conspecifics and by colonies of *Flustrellidra hispida* (Fabricius), a sympatric ctenostomatid bryozoan which specializes on *Fucus serratus* as a substratum.

4.2 MATERIAL AND METHODS

4.2.1 Spinosity of *Electra pilosa* colonies at different field sites

4.2.1.a) Study sites and site classification

Several workers have employed simple devices for the measurement of wave energy and even abrasion at a given site (Craik 1980, Palumbi 1984a, Bell & Denny 1994);

however, accurate long term *in situ* measurements of wave exposure pose considerable logistic and analytical problems in the field, and may misrepresent average conditions at a given site if the measurement period coincides with a spell of exceptionally calm or stormy weather. The fetch of a site — the distance between a shore and the nearest obstruction in a perpendicular direction — can give some approximation of the mean wave exposure to which a shore is subject, and a method has been devised allowing calculation of a theoretical exposure value from fetch indices (Hummon 1989). The most reliable and practical methods for the classification of shores are, however, based on biological factors; biological exposure indices provide the advantage of yielding more representative time-averaged measures of exposure than can *in situ* measurements or theoretical measures of exposure. A variety of biological exposure indices are currently in use, but probably the most commonly used in Britain is Lewis' Biological Exposure Scale (Lewis 1964), which is based on presence/absence and relative abundance of particular species as well as the extent of their vertical distribution. This scale was used in the present study for the classification of sites (Table 4.1).

The sites chosen for this study covered a wide geographic range and differed markedly in their exposure to wave action (Table 4.1; for latitude/longitude coordinates and grid references of field sites see Appendix 6). Clachan Seil, W Scotland, is a narrow tidal channel running in a north-south direction, separating the island of Seil from the mainland. It is unique in providing almost complete shelter from the prevailing westerly winds, and wave action at this site is negligible. By contrast, Kingsbarns, E Scotland, is an east-northeast facing, gently sloping rocky shore with a fetch of several hundred kilometres, which regularly experiences substantial wave action and severe winter storms typical of the east coast of Britain. Gruinard Bay and Dundonnell, NW Scotland, both located at Little Loch Broom, are two sites of contrasting exposure, in spite of their relative proximity (11 km). The west-facing Gruinard Bay shore, although partly protected by several islands to the

Table 4.1: Classification of study sites by wave exposure; high Lewis indices indicate shelter, low values exposure (Lewis 1964). Data of incidence of EMPSs at sites are shown also. For latitude/longitude coordinates and grid references of field sites see Appendix 6.

Study Site	Degree of Exposure	Lewis Index	% "spiny" colonies at site	% long-spined zooids in "spiny" colonies (\pm s.e.)
Clachan Seil	sheltered to very sheltered	4-5	36.60	0.94 \pm 0.24
Dundonnell	sheltered	4	24.13	0.68 \pm 0.22
Gruinard Bay	semi-exposed	3	96.66	12.08 \pm 1.79
Kingsbarns	exposed to semi-exposed	2-3	83.33	9.07 \pm 1.47

Table 4.2: Nested ANOVA of percentage of long-spined zooids in colonies from four sites (Dundonnell, Clachan Seil, Kingsbarns, Gruinard Bay), with "Shore Type" either "sheltered" (Dundonnell, Clachan Seil) or "exposed" (Kingsbarns, Gruinard Bay). Data were arcsine transformed prior to analysis. Error terms used in F -tests are specified in the far right hand column. Nested factors are denoted by the subgroups factor followed by the groups factor in parentheses.

	df	SS	MS	F	p	Error Term
Shore Type	1	2125.4	2125.4	40.45	0.024	Site (Shore Type)
Site (Shore Type)	2	105.0	52.5	1.05	0.353	Residual
Residual	68	3379.6	49.7			

west, frequently experiences severe westerly winds, whilst the north-facing shore at Dundonnell is well protected by the northerly shore of Little Loch Broom and has a fetch of only several hundred metres. *Electra pilosa* is abundant at all study sites and occupies a variety of substratum types, but the present study focused on colonies epibiotic on *Fucus serratus*, where its abundance is greatest.

4.2.1.b) Data Collection

30 colonies were collected haphazardly from each of the four sites. EMPS counts were obtained using a stereomicroscope, whilst zooid counts were established using image analysis as described in section 2.2. The *a priori* distinction between MPS and EMPS can be made on the basis of the basal boss from which the spine forms: for EMPSs, the boss is large and has a clearly visible lumen which remains uncalcified throughout; in unextended MPS, the boss is small and rudimentary and the lumen is absent, i.e. the boss is generally fully calcified (Fig. 4.3).

4.2.2 EMPS: a discrete character?

In order to determine whether EMPSs and MPSs constitute separate, discrete characters *Electra pilosa* colonies were collected on *Fucus serratus* from Kingsbarns, E Scotland (see above), an exposed to semi-exposed shore. A square of 1 cm² was cut out with a scalpel from each of five colonies and split with a razor blade into five strips of approximately equal size. The sectioned strips then were examined with the stereomicroscope/image analyzer set-up (section 2.2). A single transect of zooids was photographed in side view along one edge of each colony strip, and lengths of all MPSs, forming EMPSs and fully formed EMPSs were measured using a distance measurement function.

Forming EMPSs are easily distinguished from fully formed EMPSs by the conical tip which is present only in the latter (Bobin 1968), whereas the tip of forming EMPSs is blunt (Fig. 4.4) and appears rectangular in side view. MPS and EMPS can

Figure 4.3: Short-spined (A) and long-spined zooids (B) of *Electra pilosa*, showing the difference in size and shape of the boss basal to the median proximal spine: in short-spined zooids, the boss is rudimentary and internally calcified, whereas in long-spined zooids it is enlarged and bulbous and has a clearly visible lumen (after Ryland & Hayward 1977).

A

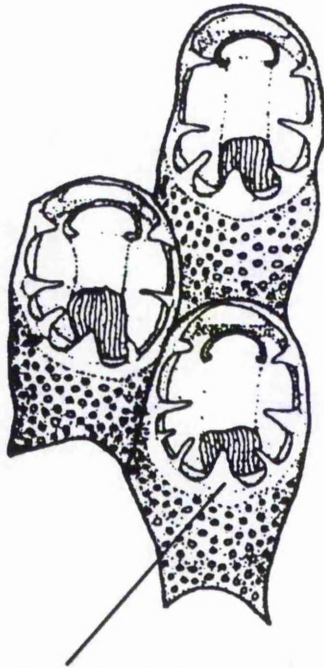

boss (unextended
median proximal spine)

B

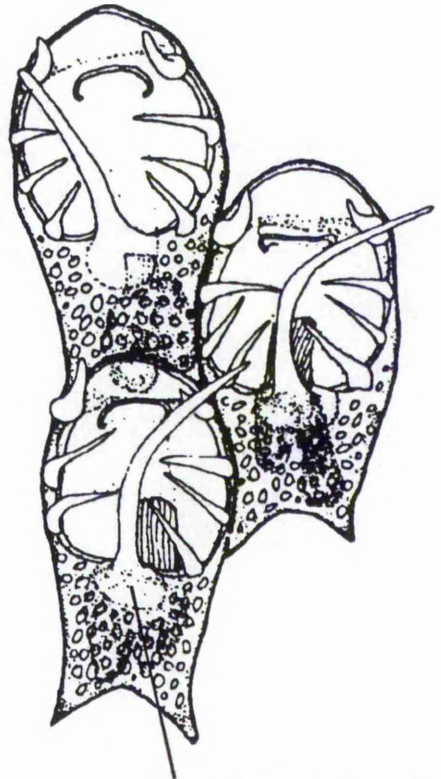

boss (extended median
proximal spine)

Figure 4.4 Top: SEM micrograph of laboratory-grown colony of *Electra pilosa*. The two EMPSs shown are in the process of formation and the apical meristem is visible as a blunt tip with a central depression. The remainder of zooids in the picture are short-spined.

Bottom: SEM micrograph showing two fully developed EMPSs; the depression in the tip of the spine has filled in as spine growth ceased, and the spine has the conical tip indicative of completed growth. Zooid length approximately 600 μm (both figures).

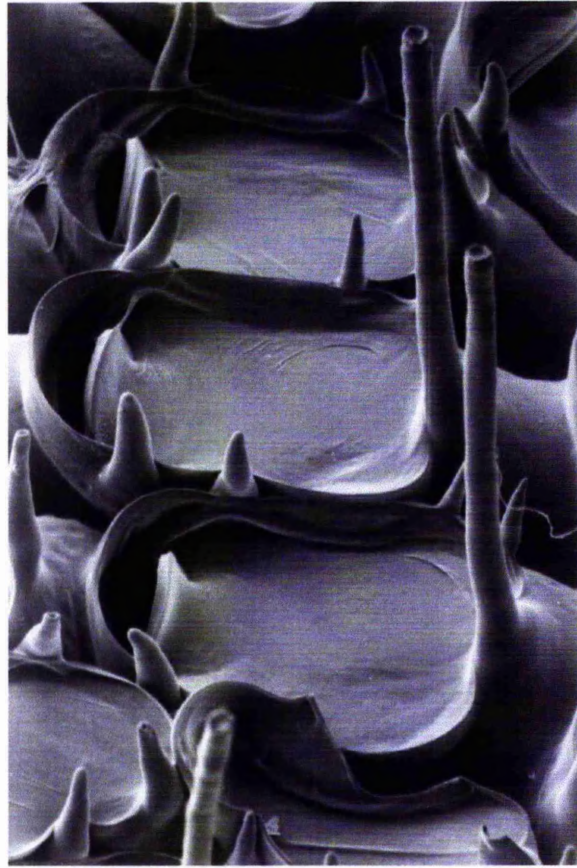

be distinguished *a priori* on the basis of the basal boss from which they form (see above), and thus all spines measured in the experiment could be categorized prior to measuring their lengths. For the purposes of statistical analysis, it was assumed that the transects represented random samples and the five transects taken from each colony were pooled in the analysis.

4.2.3 Assessment of the formation of EMPSs in the laboratory

Colonies of *Electra pilosa* were collected from the two rocky shores at Dundonnell and Gruinard Bay, NW Scotland (see above), in April 1995. To avoid the risk of sampling several fragments of the same genotype, only intact colonies were used, i.e. colonies bearing an ancestrula and showing no signs of fragmentation. Ancestrulae of *E. pilosa* are easily identified as such: the early budding pattern in this species is strictly deterministic and follows a fixed sequence of budding locus activation (Silén 1987). With the exception of one pair of zooids immediately adjacent to the ancestrula, budding from the proximal locus is observed only in the ancestrula itself, and its location can thus be identified reliably. Fragmentation of colonies is a common phenomenon in colonial organisms (Jackson 1979, Jackson & Winston 1981, Jackson & Coates 1986), and particularly frequent in *E. pilosa*; colonies tend to break up easily upon attaining a certain age or size, a consequence of proximal senescence at the zooid level (*cf.* Chapter 3). Aggregations of *E. pilosa* colonies found on *Fucus serratus* often consist of numerous colony fragments, with ancestrulae and surrounding central zooids missing (*pers. obs.*).

13 colonies from each site were prepared for replication and grown onto prescored coverslips. Of these, five colonies (= genotypes) from each of the two sites were selected haphazardly for experimental propagation (see Chapter 2), with six replicates per genotype being used in the experiment (total $n = 60$ colonies). Colonies which did not grow during the preparatory phase and/or showed signs of abnormal development were discarded. Colonies were allocated to trough positions in a

complete randomized block design, with one complete set of colonies to each of two glass troughs. Each trough contained three replicate colonies of each of the ten genotypes, allowing calculation of within-trough and between-trough error terms.

The total duration of the experiment was 10 wk. At the end of the experiment, colonies were cleaned and air dried for skeletal examination. Counts were made of the number of zooids and EMPS in each colony. MPS lengths were measured in single transects (one column of zooids wide) from colony centres to their peripheries; due to the small number of EMPSs available, lengths were measured for all EMPSs present, rather than using transect samples. The same set of measurements was also taken from the original colonies collected from the two sites, prior to their replication.

4.2.4. Phenetic comparison of morphological characters of long-spined and short-spined morphs

Colonies used in this part of the study were those ongrown from adult colonies for the assessment of formation of EMPSs in the laboratory (section 4.2.3 above). To simplify data collection, only two replicate colonies from each of the ten genotypes (five from each of two sites, Dundonnell and Gruinard Bay) were selected for examination; all colonies were from the same trough (replicates IV and V of each genotype). 15 zooids per colony were sampled in a single, randomly chosen straight line transect in a distal-proximal direction from the colony periphery (15 zooids x 20 colonies = 300 zooids total).

Zooids were photographed individually using the stereomicroscope/image analyzer set-up. All morphological characters that could be reliably measured were used; in all, 12 zooid characters were measured (all maximum measurements; Fig. 4.5): zooid area (ZA), opesia area (OpsA), operculum length and width (OprL, OprW), gymnocyst length (GL), zooid length and width (ZL, ZW), opesia length and width (OpsL, OpsW), distance between opercula in distal, distolateral and proximolateral direction (DD, DLD, PLD).

Figure 4.5: Schematic representation of zooid morphological characters used in phenetic comparison of “spiny” and “unspiny” morphs of *Electra pilosa*. A) Length and width measurements: operculum length and width (OprL, OprW), gymnocyst length (GL), zooid length and width (ZL, ZW), opesia length and width (OpsL, OpsW). B) Area measurements: opesia area (OpsA) and zooid area (ZA, includes opesia area). C) Measurements of neighbouring zooids’ spatial relationship: distance between opercula in distal, distolateral and proximolateral direction (DD, DLD, PLD).

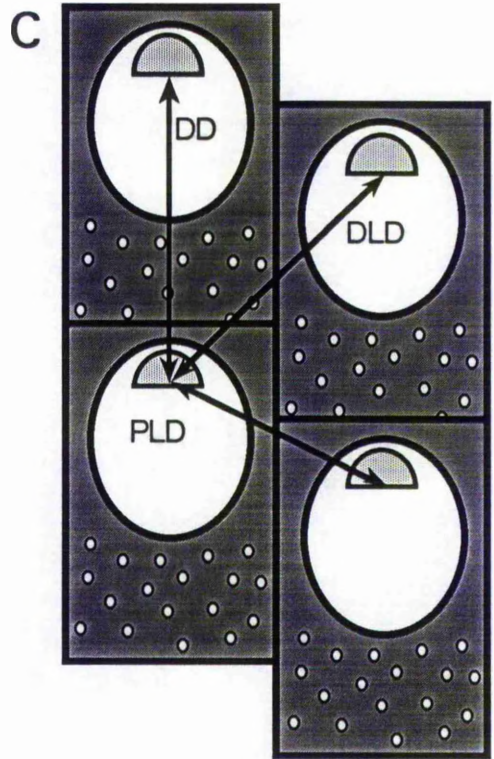
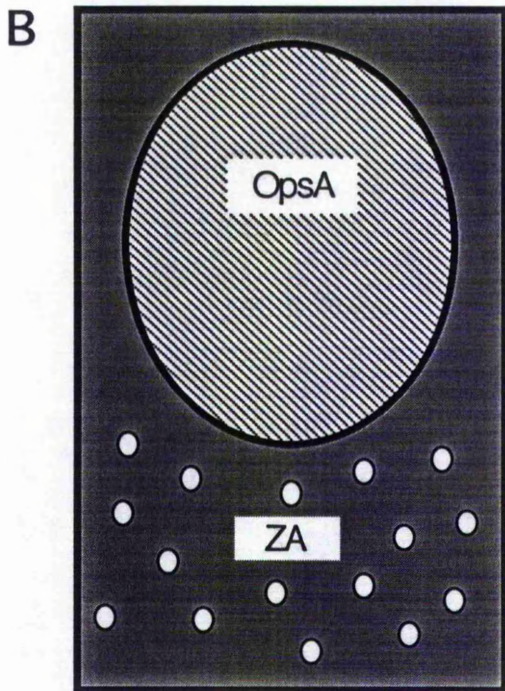
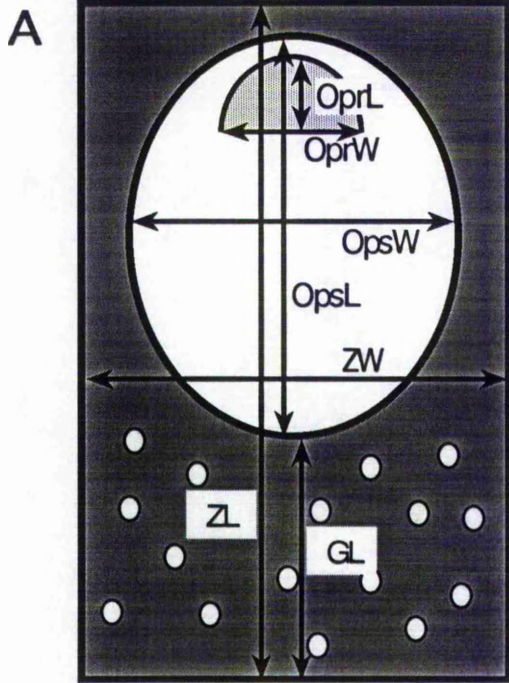

Data were analyzed using multivariate cluster analysis. The use of morphological data in conjunction with cluster analysis and other classification methods (also referred to as phenetics) can be problematic (De Queiroz & Good 1997) and generally is regarded as unsuitable for classification or phylogenetic analyses (Quicke 1993); nowadays phenetic techniques are mostly used for the determination of cryptic groups in a sample of specimens. Cluster analysis is based on measures of similarity/dissimilarity which take into account all variables measured, and uses hierarchical diagrams of relatedness (*tree diagrams* or *dendrograms*) to investigate the existence of natural groups (Sneath & Sokal 1973). The outcome of cluster analysis can be highly dependent on the type of similarity/dissimilarity measure and clustering method used (reviewed by Cormack 1971); consequently, a variety of different indices and clustering methods was employed in the present study to allow comparison of outcomes.

Data were standardized to a mean of zero and standard deviation units by subtracting the character grand mean from each value and dividing by its standard deviation; this removes both size differences within variables and unit/magnitude differences among variables (Wishart 1987). Data were analyzed using *Clustan 3.2 - Sun 4 Version* (D. Wishart, Computing Laboratory, University of St Andrews, 1991) on a Sun Microsystems mainframe computer.

Two different analyses were carried out: the main analysis was based on means of all observations collected for a given character in a colony; thus, only 20 cases (from the 20 colonies) were analyzed, simplifying considerably the interpretation of outcomes. A total of five different clustering methods and four different similarity/dissimilarity coefficients were used in the colony means analysis (UPGMA, Ward's Method, Complete Linkage, Median Linkage, Centroid Clustering; Squared Euclidean Distance, Euclidean Sum of Squares, Average Squared Distance, Similarity Ratio). Two colony level characters (colony size and shape) were used in addition to the zooid morphological characters, thus increasing the total number of

characters employed to 14. Colony shape was expressed as relative colony perimeter (RCP, see Chapter 3); colony size was measured as total colony area.

Analysis of zooid data was carried out using three clustering methods (Ward's method, UPGMA and WPGMA; all with squared Euclidean Distance). Due to the large number of observations ($n = 300$), the dataset had to be reduced to allow analysis, and only the first 8 observations from each colony were used, giving a total of 160 observations. However, resulting dendrograms were still analyzable only under considerable magnification and consequently dendrograms have not been included here.

4.2.5 Spontaneous EMPS formation and influence of genotype on spinosity

Post-metamorphic ancestrulae of *Electra pilosa* were collected on *Fucus serratus* from the shores of Gruinard Bay and Dundonnell (see above), in July 1995. Ten ancestrulae (= genotypes) from each site were grown, replicated and reared under standard culture conditions. Three replicate colonies per genotype were used, with 20 colonies in each of three circular troughs, in complete randomized blocks (one colony per genotype per trough = 60 colonies). Colony growth was measured at 2 wk intervals. Colonies were grown for a period of 10 wk, and then examined for EMPSs as above.

4.2.6 Promotion of EMPS development by inter- and intraspecific overgrowth encounters

4.2.6.a) Intraspecific Competition

Ancestrulae of *Electra pilosa* were collected from Clachan Seil, Argyll, W Scotland, in July 1994. Following a replication period of ~ 6 wk, five genotypes were haphazardly chosen for use in the experiment and replicated. Three treatments were used in the experiment:

- 1) Allogenic encounter (colony presented with a competitor of a different genotype)

2) Isogenic encounter (colony presented with a competitor of the same genotype)

3) Negative control (no competitor)

For (1) five different genotype combinations were used, resulting in each genotype encountering two other genotypes. Each genotype combination and single genotype treatment was replicated threefold, giving a total of 45 experimental plates. Plates were kept in three 6-l glass troughs, with a complete, randomized set of 15 plates in each. Colony growth was measured at 2 wk intervals. The experiment was terminated after a period of 12 wk, after which colonies were examined for EMPSs. Colonies in the allogenic and isogenic treatment also were tested for colony fusion immediately before the end of experiment; this was achieved by observing the response to a mechanical stimulus, applied to frontal membranes of zooids with a blunt metal probe.

An increasing number of studies suggest that colony fusion is as widespread a phenomenon in the Bryozoa (Humphries 1979, Shapiro 1992, Craig 1994, Shapiro 1996) as in other colonial marine invertebrates (review by Grosberg 1988), but fusion has not been reported for *Electra pilosa*. Mechanical stimulation of both frontal membranes and polypide tentacles has been shown to elicit polypide retraction in several species of bryozoan including the present species (Thorpe *et al.* 1975a,b) and stimulation of the frontal membrane specifically induces a coordinated localized response involving the colonial nervous system. Thus, stimulus transduction should be evident across contact interfaces after colony fusion. Here, the stimulus was applied to zooids in both colonies, immediately either side of the contact interface; three testing points were chosen in each colony, one at either end of the contact interface, and one approximately intermediate to the two endpoints. This was intended to confirm whether colonies had fused over the whole or only part of the contact area. Only zooids with functional polypides were used. Zooids were stimulated three times each, with an interval of several seconds between stimulation, allowing for a recovery period. A response was scored as positive when at least two

polypides in the other colony retracted simultaneously or, in the case of withdrawn polypides, displayed twitching of the polypide retractor muscle. During all testing, colonies were kept in isolation in a 200 ml plastic dish containing filtered seawater, and responses were observed using a WILD M8 stereomicroscope.

4.2.6.b) Interspecific Competition

Gravid colonies of the ctenostomatid bryozoan *Flustrellidra hispida* were collected from the intertidal at Kingsbarns, east Scotland (see above), in July 1997 and transferred to the laboratory. Colonies were kept in darkness for a period of 12 h after which larvae were released by lightshock treatment in 6-l circular glass troughs. Hatched larvae then were pipetted into a 50 x 50 cm settlement tank; the bottom of the tank was entirely covered with 8 x 8 cm glass plates. Prior to the experiment, glass plates had been exposed to running unfiltered seawater for a period of 10 d to facilitate the formation of biofilms, and subsequently coated with extract from *Fucus serratus* obtained by conditioning filtered seawater with finely cut fronds overnight. The settlement dish contained 6-l of 0.2 μm filtered seawater which contained added KCl to give a concentration elevated by 10 mM; KCl has been shown to artificially induce metamorphosis in other bryozoan species (Wendt & Woollacott 1995) and was used here to enhance settlement success. The settlement dish was kept at room temperature (18-19° C) on a dark background, and larvae were allowed to settle over a 48 h period.

The glass plates then were transferred to a single 6-l glass trough and reared under standard *Electra pilosa* culture conditions. Growth of *Flustrellidra hispida* in the laboratory was slow and colonies required 12 wk to reach a size sufficient for use in the experiment. Ten colonies of *F. hispida* were used in the experiment and a replication strip bearing zooids of *E. pilosa* was clipped onto each of the experimental plates approximately 5 mm from the *F. hispida* colony; excess colonies of *F. hispida* were removed with a scalpel. Ten colonies of *E. pilosa* were set up on glass plates

bearing perspex dummy colonies to control for the effects of obstacle encounter alone; dummy colonies were cut from 3 mm perspex, edges were rounded on a grinding machine, and finished colonies attached to glass plates by means of perspex glue. Ten colonies of *E. pilosa* were grown on glass plates with neither dummy colonies nor competitors (negative control). A total of five genotypes of *E. pilosa* was used, with two replicate colonies per treatment (total $n = 30$). Colonies then were grown for a period of 7 wk. Colony area was measured on a weekly basis. At the end of the experiment, colonies were examined for EMPSs as above.

4.3 RESULTS

4.3.1 Spinosity of *Electra pilosa* colonies at different field sites

On wave-exposed shores (Kingsbarns, Gruinard Bay), significantly higher proportions of colonies on *Fucus serratus* had long-spined zooids than on the sheltered shores (Dundonnell, Clachan Seil) (t-test, $p = 0.037$; means: exposed shores $72.7\% \pm 6.78$, s.e.; sheltered $33.3\% \pm 3.90$; Table 4.1, Fig. 4.6). Within “spiny” colonies from exposed shores there was a significantly higher proportion of long-spined zooids than in “spiny” colonies from sheltered shores ($p = 0.024$; Table 4.2; Fig. 4.6).

Linear regression analysis of the data from all colonies ($n = 120$) revealed a significant relationship between colony size (measured as number of zooids) and the number of long-spined zooids in the colony ($p < 0.001$; Table 4.3, Fig. 4.7), whereas regression of the percentage of long-spined zooids in colonies on colony size was non-significant ($p = 0.770$; Table 4.3). Thus, the number of long-spined zooids in colonies is a function of colony size, but relative spinosity (independent of colony size) is not, in fact, increased in larger colonies.

4.3.2 EMPS: a discrete character

Table 4.3: Least squares linear regression analysis of EMPS number and percent long-spined zooids, respectively, on colony size, measured as zooid number.

Number of long-spined zooids in colony on zooid number:

Source	df	SS	MS	F	p
Regression	1	49,071	49,071	17.38	< 0.001
Residual	117	330,410	2,824		
Total	118	379,482			

Regression equation: $y = 0.8 + 0.05 x ; r^2 = 0.100$

Percentage of long-spined zooids in colony on zooid number:

Source	df	SS	MS	F	p
Regression	1	4.87	4.87	0.08	0.780
Residual	117	7265.0	62.09		
Total	118	7269.9			

Regression equation: $y = 5 + 0.0005 x ; r^2 = 0.0007$

Figure 4.6: Differences in spinosity of *Electra pilosa* colonies from four sites of varying wave exposure. Top: Percentages of colonies including long-spined zooids at each site (“spiny” colonies). Bottom: Percentages of long-spined zooids within “spiny” colonies at the same sites. Data shown are back-transformed arcsine means + 1 s.e. Note difference in ordinate scales. Sites shown: CS = Clachan Seil, W Scotland, sheltered to very sheltered, Lewis Biological Exposure Scale 4-5 (Lewis 1964); DD = Dundonnell, NW Scotland, sheltered, Lewis Scale 4; GB = Gruinard Bay, NW Scotland, semi-exposed, Lewis Scale 3; KB = Kingsbarns, E Scotland, exposed to semi-exposed, Lewis Scale 2-3.

Fig. 4.6

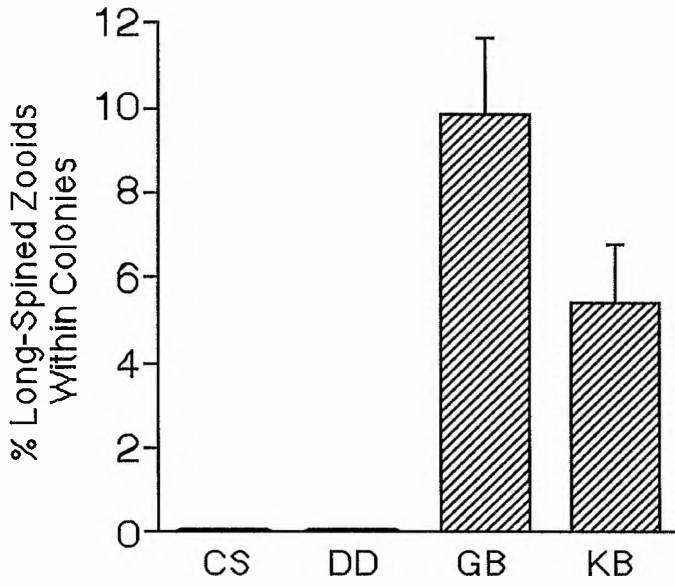
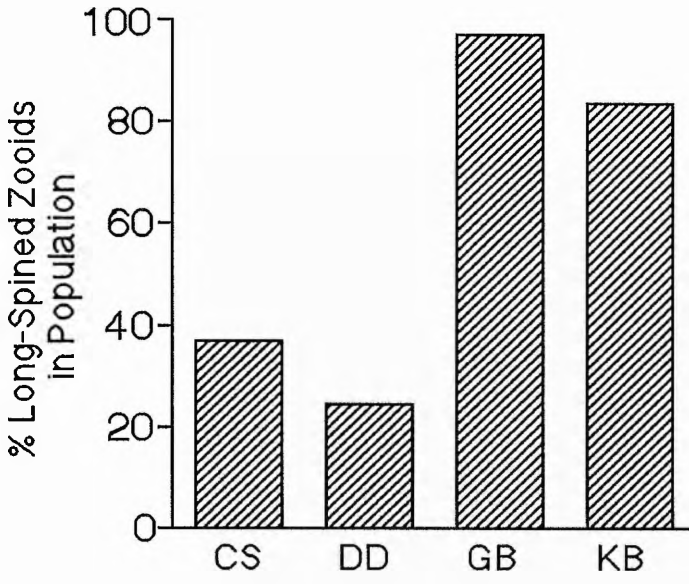

Figure 4.7: Relationship between colony size and colony spinosity in *Electra pilosa*. Top: Regression of number of EMPSs on number of zooids in colony; $p < 0.001$, $r^2 = 0.10$. Bottom: Regression of percentage of long-spined zooids on number of zooids in colony; $p = 0.780$, $r^2 = 0.0007$. Note difference in ordinate scales. Sample size $n = 119$.

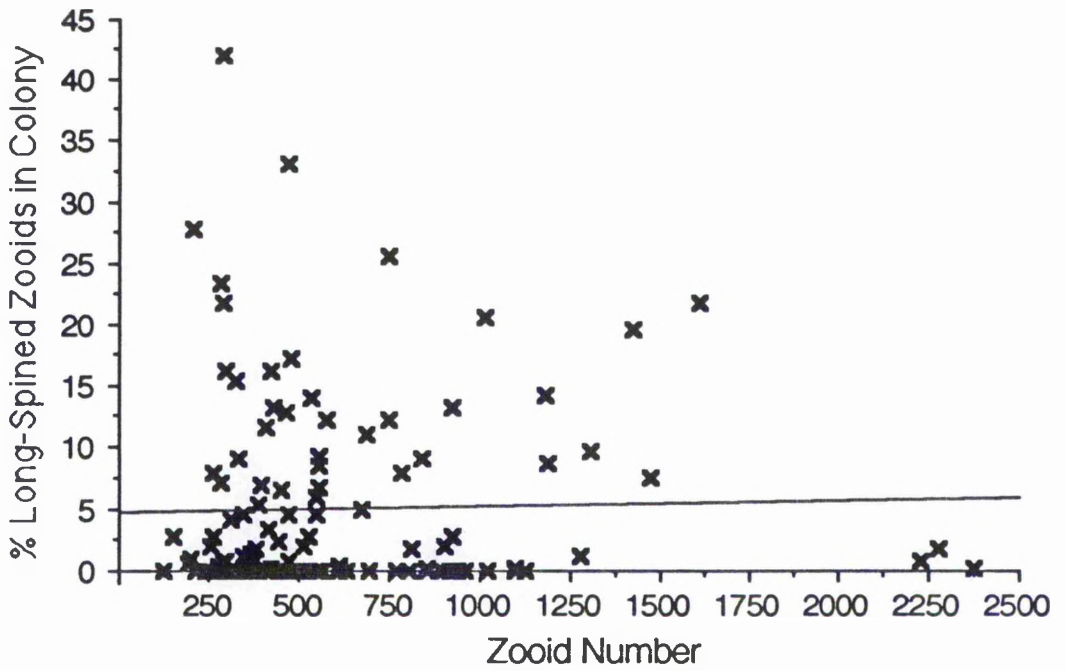
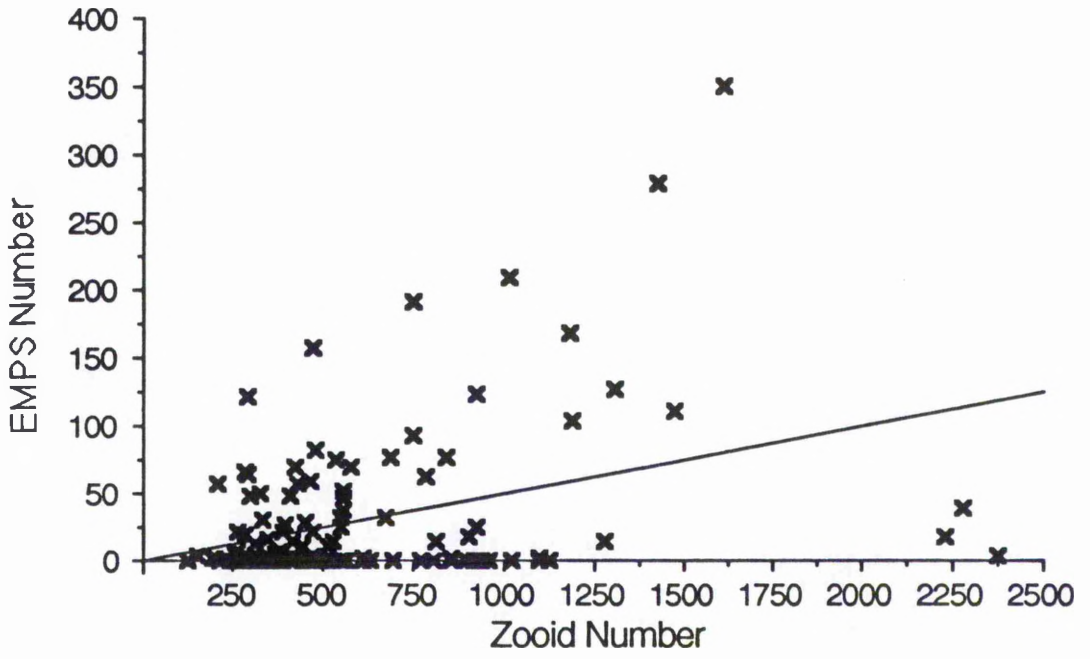
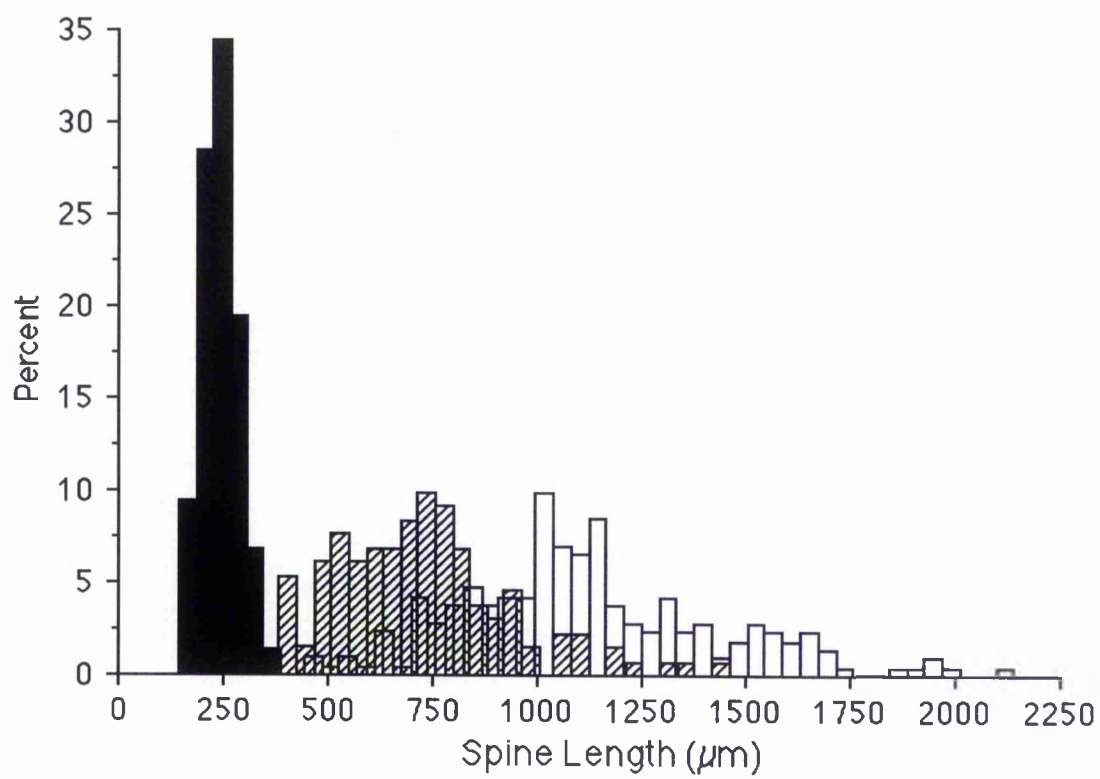

Figure 4.8: Frequency distribution of spine lengths (in μm) measured in five colonies of *Electra pilosa* collected at Kingsbarns, E Scotland. Counts comprise data from MPSs (black fill), fully formed EMPSs (no fill) and forming EMPSs (hatched fill). Total sample size $n = 566$.



The frequency distribution of spine lengths of all three categories of spine showed an essentially trimodal pattern (Fig. 4.8). Frequency distribution plots of the separate spine types (Fig. 4.9) supported the finding that MPSs, fully formed EMPSs and forming EMPSs fall into three distinct, separate categories, showing approximately normally distributed data with three separate modes at $\sim 250 \mu\text{m}$ (MPSs), $\sim 750 \mu\text{m}$ (forming EMPSs) and $\sim 1000 \mu\text{m}$ (fully formed EMPSs). In a boxplot of spine lengths separated by categories, MPS and EMPS did not show any overlap in range (Fig. 4.10), whilst forming EMPSs clearly overlapped with fully formed EMPSs and, to a minor extent, with MPSs. Spine lengths ranged from 145 - 387 μm for MPS, and 219 - 1459 μm and 442 - 2140 μm for forming and fully formed EMPSs respectively (Table 4.4).

Two-way ANOVA of the pooled data showed highly significant overall differences among colonies and among spine types (Fig. 4.11, Table 4.5); Fisher's PLSD *post hoc* comparison revealed all three types of spine to be significantly different from each other. Separate Oneway ANOVAs for each category showed highly significant among-colonies differences for MPSs and EMPSs, but not for forming EMPSs (Table 4.6).

4.3.3 Assessment of the formation of EMPSs in the laboratory

Colony sizes in the original colonies collected in the field ranged from 26 - 521 zooids. Between 3.8 and 53.1 % of zooids were long-spined in colonies from Gruinard Bay (Fig. 4.12), and all colonies in the sample possessed long-spined zooids; in colonies from Dundonnell, only one colony possessed long-spined zooids (2.94 %). In colonies grown in the laboratory experiment, EMPSs formed only in colonies of three genotypes (G1, G2, G3), all of which originated from Gruinard Bay. Numbers of EMPSs formed were extremely low compared to the original colonies from that site; the percentage of long-spined zooids ranged between 0.02 and 0.48 (Fig. 4.13). Only one genotype, G2, formed EMPSs in all of its six replicate

Table 4.4: Descriptive statistics of lengths of MPS, forming EMPSs and fully formed EMPSs (in μm).

Spine Type	Mean	s.e.	Minimum	Maximum	n
MPS	241.7	3.08	144.7	386.9	221
fully formed EMPSs	1120.1	21.35	442.4	2140.2	214
forming EMPSs	715.8	19.18	218.9	1458.7	131

Table 4.5: Twoway ANOVA of pooled spine length data (MPSs, forming EMPSs and fully formed EMPSs).

Source	df	SS	MS	F	p
Colony	4	3,606,007	901,501	32.94	< 0.001
Spine Type	2	66,308,095	33,150,000	1211.49	< 0.001
Colony x Spine Type	8	7,979,762	997,470	36.45	< 0.001
Residual	551	15,078,858	27,366		

Table 4.6: Summary statistics of separate Oneway ANOVAs of each category of spine, Factor "Colony".

Spine Type	Numerator df	Denominator df	F	p
MPSs	4	216	18.30	< 0.001
Fully Formed EMPSs	4	209	71.35	< 0.001
Forming EMPSs	4	126	1.67	0.161

Table 4.7: Summary data for laboratory-grown colonies which developed EMPS during the experimental period; all three genotypes in which EMPSs were observed came from Gruinard Bay. Replicate colonies i-iii and iv-vi were respectively accommodated in separate troughs.

Genotype	Replicate Colony	Number of EMPSs Formed	Number of Zooids Formed	% Long-Spined Zooids
G1	i	0	4,903	0.000
G1	ii	0	4,478	0.000
G1	iii	1	4,851	0.021
G1	iv	2	4,404	0.045
G1	v	0	3,393	0.000
G1	vi	1	4,006	0.025
G2	i	21	14,136	0.149
G2	ii	30	13,664	0.220
G2	iii	18	11,840	0.152
G2	iv	77	15,955	0.483
G2	v	59	14,955	0.395
G2	vi	54	14,005	0.386
G3	i	0	562	0.000
G3	ii	0	622	0.000
G3	iii	0	630	0.000
G3	iv	0	279	0.000
G3	v	1	739	0.135
G3	vi	0	635	0.000

Figure 4.9: Frequency distribution of spine lengths (in μm) measured in five colonies of *Electra pilosa* collected at Kingsbarns, E Scotland. Distributions are shown separately for MPS (top, n = 221), fully formed EMPS (centre, n = 214) and forming EMPS (bottom, n = 131). Normal curve comparisons are shown also.

Fig. 4.9

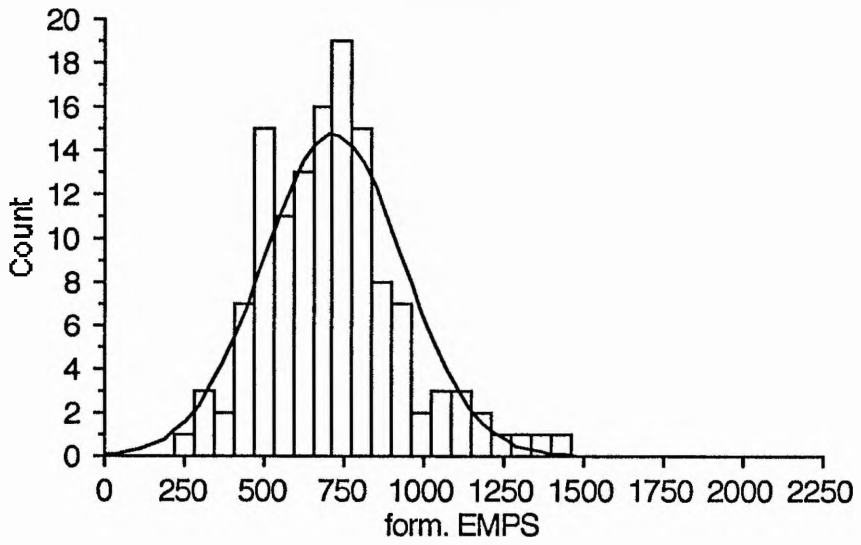
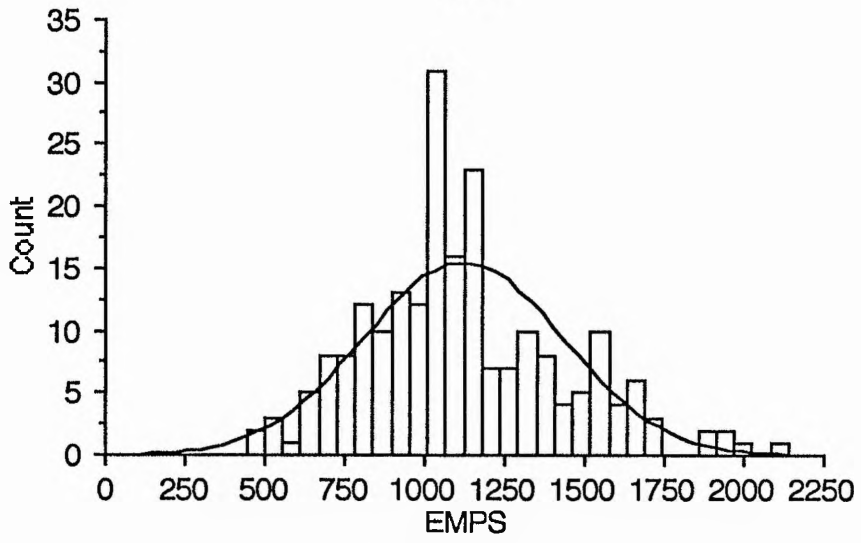
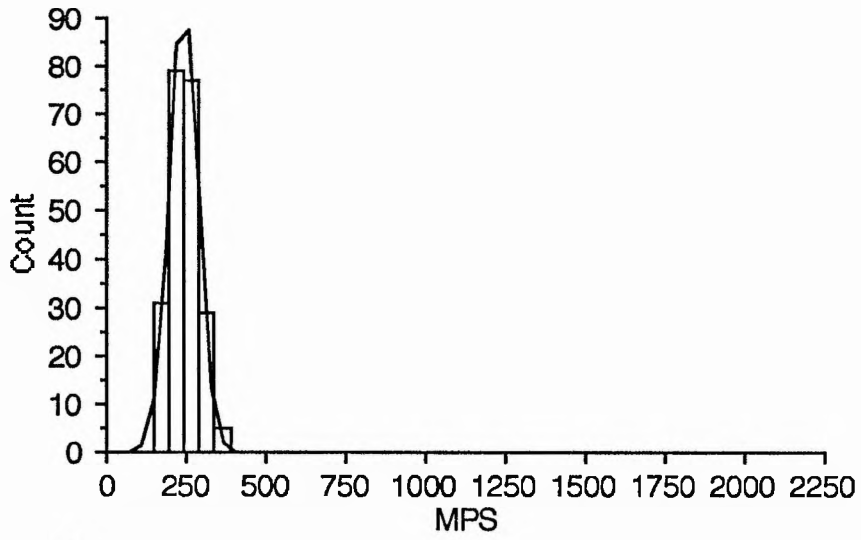

Figure 4.10: Boxplot of ranges of spine lengths (μm) for MPSs, fully formed EMPSs and forming EMPSs in five colonies of *Electra pilosa* collected at Kingsbarns, E Scotland. The five horizontal lines in each boxplot represent the 10th, 25th, 50th, 75th and 90th percentile of each variable, with values above the 90th and below the 10th percentile plotted separately. Sample sizes: MPS, $n = 221$; fully formed EMPS, $n = 214$; forming EMPS, $n = 131$.

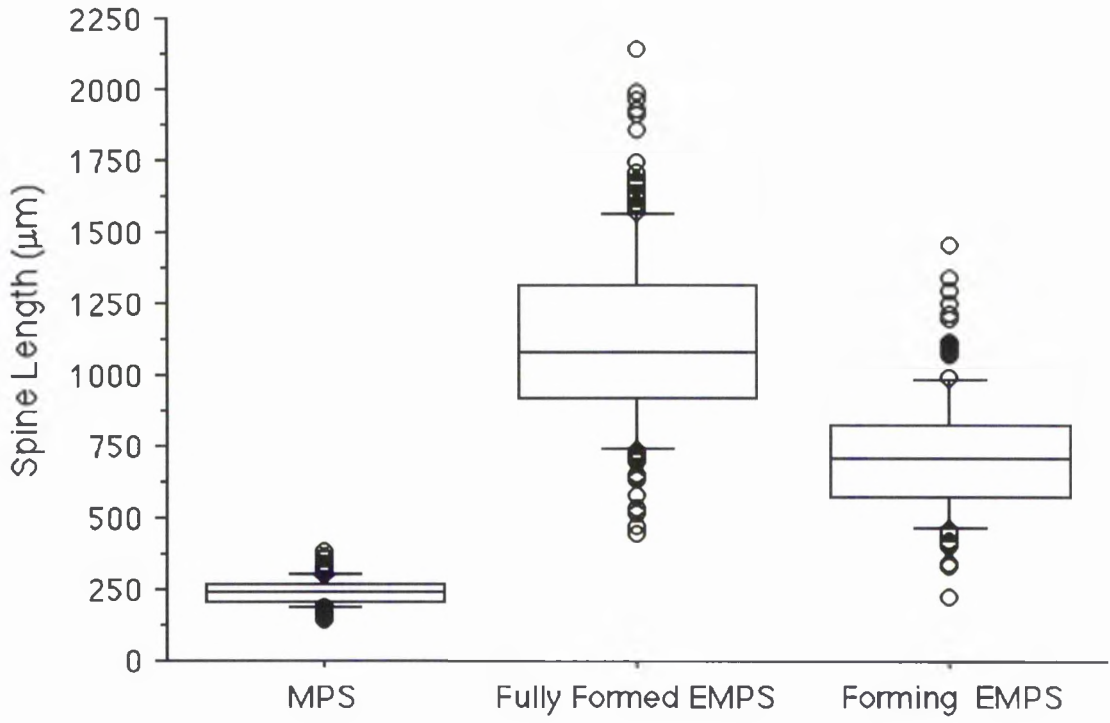

Figure 4.11: Spine lengths (μm) for MPS (top) and fully formed EMPS (bottom) in five colonies of *Electra pilosa* collected at Kingsbarns, E Scotland. Data shown are colony means + 1 s.e. Colonies are arranged 1 to 5 left to right and fill patterns in top and bottom graph correspond to the same colony. Note difference in ordinate scales (sample sizes: MPS n = 221; fully formed EMPS n = 214).

Fig. 4.11

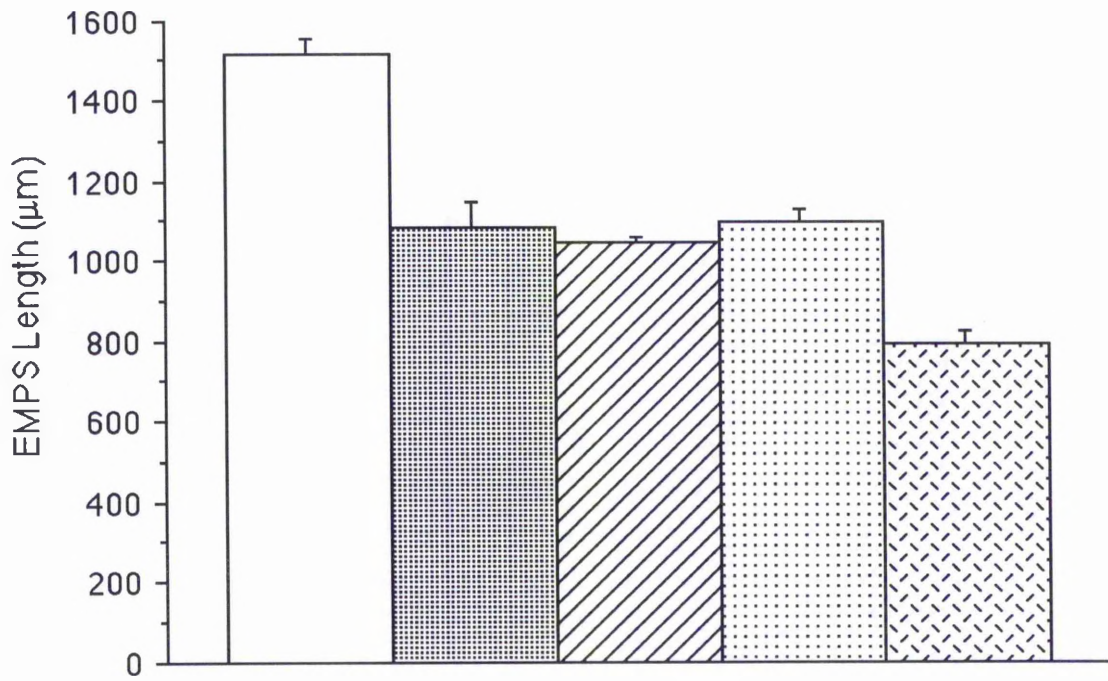
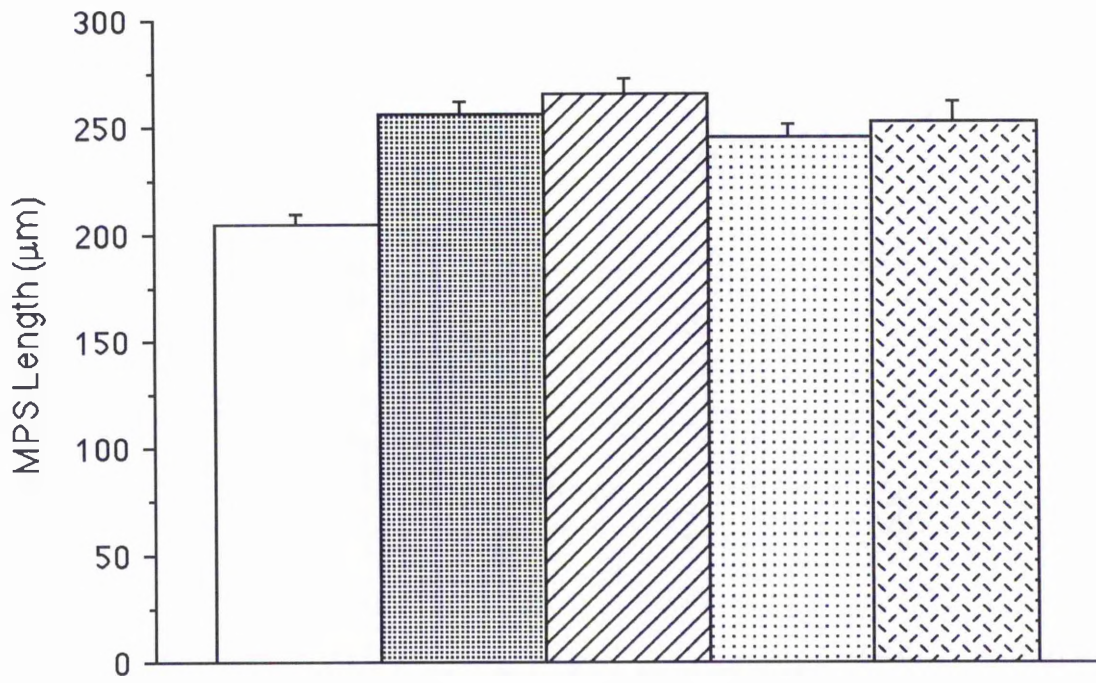

Figure 4.12: Top: Percentages of long-spined zooids in field-collected colonies of *Electra pilosa* from two sites, Dundonnell (white fill) and Gruinard Bay (stippled fill). 14 colonies were used per site. Note that the values for all colonies but one are zero for Dundonnell. Bottom: Colony size of the same colonies, expressed as zooid number.

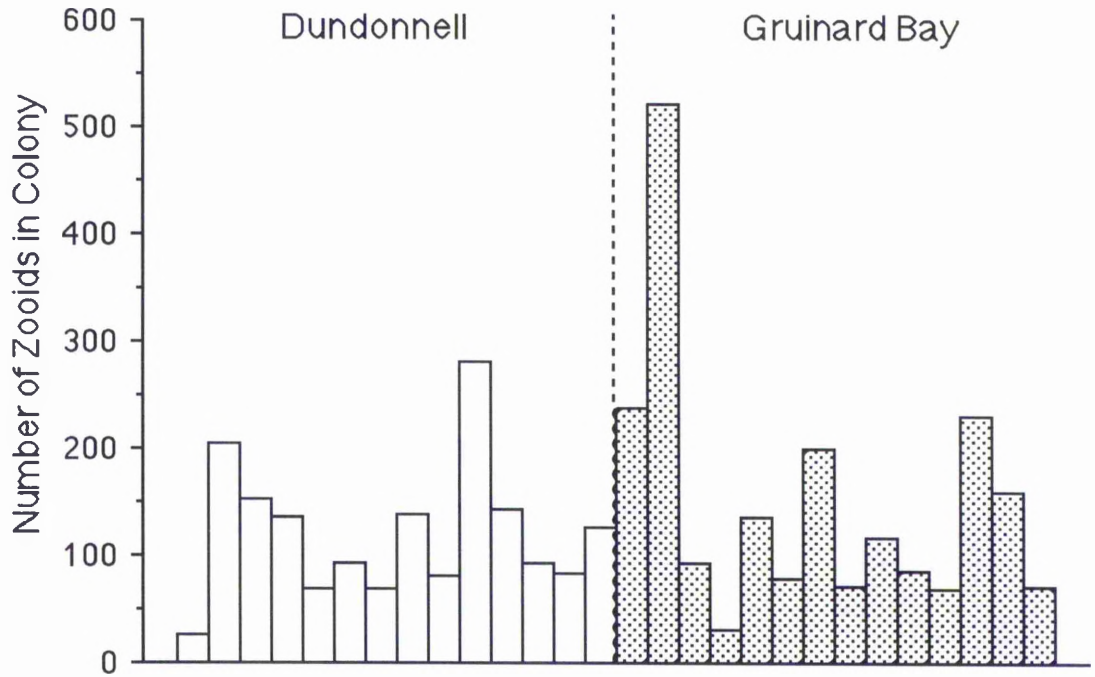
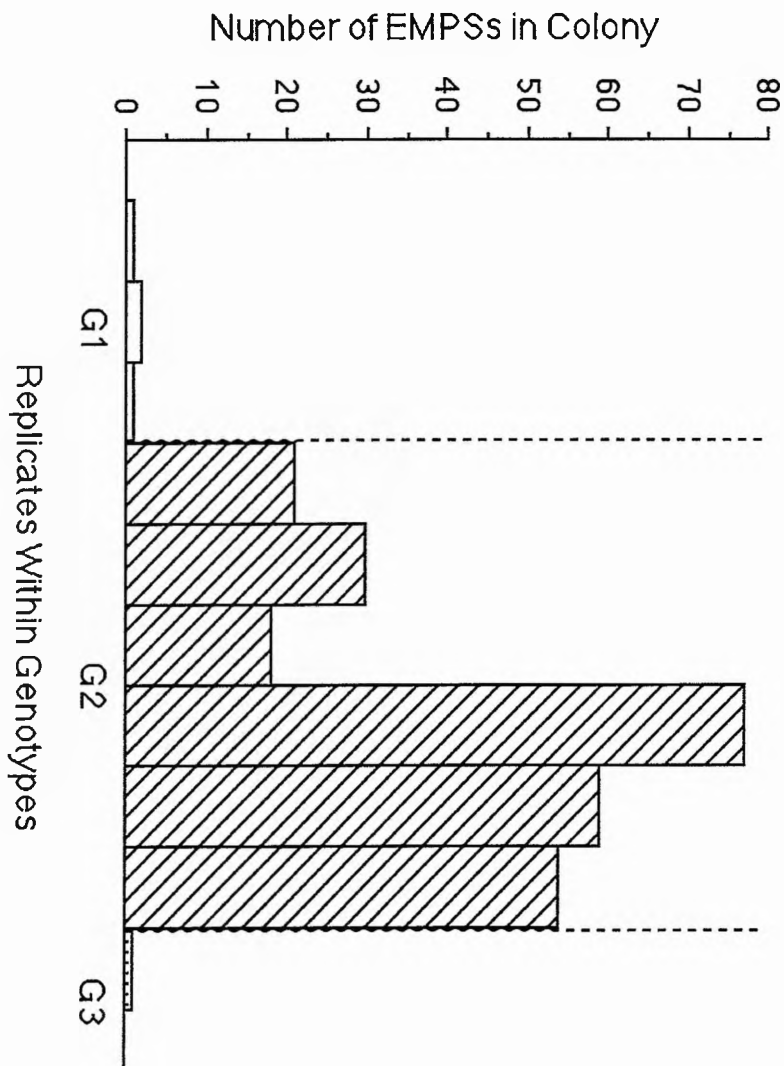

Figure 4.13: Top: Percentages of long-spined zooids in colonies of *Electra pilosa* reared in the laboratory. Only those genotypes which produced EMPSs during the experimental period are shown (G1, white fill; G 2, hatched fill; G 3, stippled fill; all from Gruinard Bay). Six replicate colonies per genotype were used in the experiment. Bottom: Numbers of EMPSs for the same colonies (matched by fill).



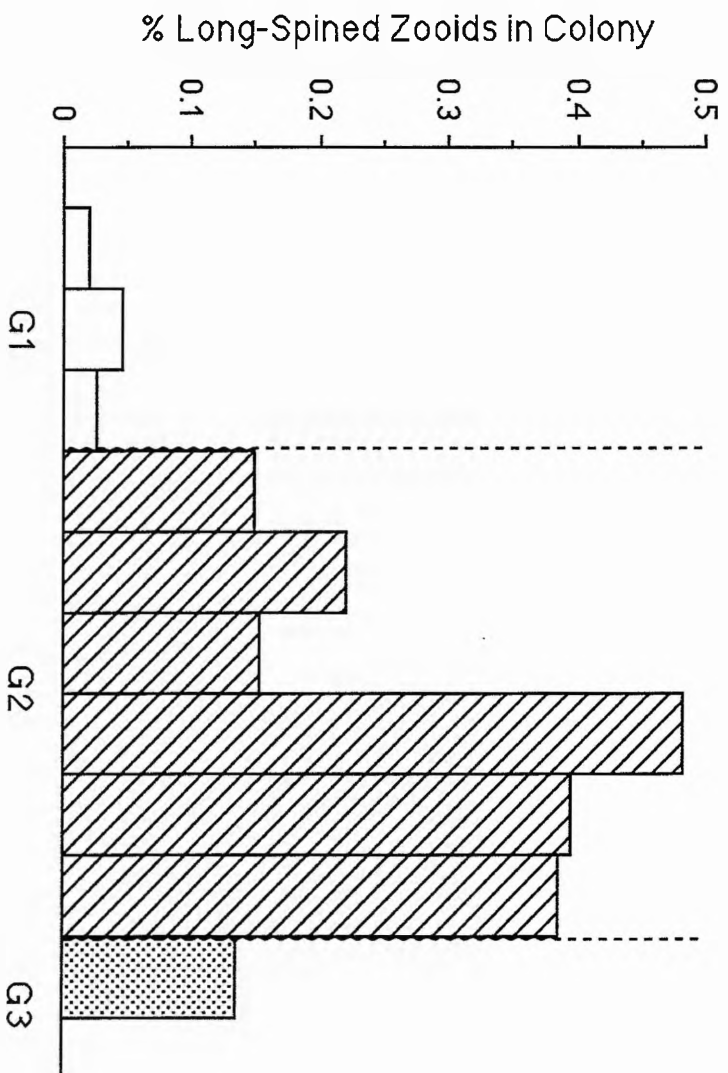

Fig. 4.13

colonies (Fig. 4.13, Table 4.7); the other two genotypes produced EMPSs in three out of six and one out of six replicate colonies only, and in very low numbers (one to two EMPSs per replicate colony).

The frequency distribution of lengths of MPSs and EMPSs in the laboratory-grown colonies of Genotype G2 was bimodal (Fig. 4.14), supporting the findings of section 4.3.2 in which it was shown that MPSs and EMPSs are discrete characters with normal distributions (data from Genotypes G1 and G3 are not included here due to the small number of EMPSs produced). Separate plots of spine length frequency distributions of the two spine types (Fig. 4.15) and a plot of length ranges of MPSs and EMPSs (Fig. 4.16) showed patterns very similar to those observed in the field-collected colonies of section 4.3.2 (see also Table 4.8 for descriptive statistics). Nested ANOVA of lengths of MPSs in the laboratory-grown colonies revealed highly significant differences among genotypes and among replicate colonies (Table 4.9), although there was no significant difference between sites ($p = 0.184$; see also Table 4.10 for descriptive statistics).

Colony growth in Genotype G3 was extremely slow during the preparatory phase of the experiment, and three of its six replicate colonies had to be excluded when advanced growth of the remainder of colonies prevented further postponement of the experiment. The three replicates were set up with a delay of 3 wk, and data pertaining to colony growth in Genotype G3 are hence excluded from graphs and analyses. Colony growth was exponential in all genotypes in weeks 1 to 4 but approximately linear for the rest of the experiment in all genotypes but one (G2; Fig. 4.17). In Genotype G2, colony growth remained exponential for the whole of the experimental period and final colony area in G2 colonies was thus considerably higher than for any other genotype (Fig. 4.18). Overall, genotypes from Gruinard Bay grew at higher rates than those from Dundonnell and attained larger final sizes (Fig. 4.18); however, variability of final colony size of Gruinard Bay genotypes exceeded that found in Dundonnell genotypes, resulting in a non-significant p -value of the between-

Figure 4.14: Frequency distribution of spine lengths (μm) in laboratory-reared colonies of Genotype G2. Data shown are for MPS (black fill) and EMPS lengths (white fill). Total sample size $n = 460$.

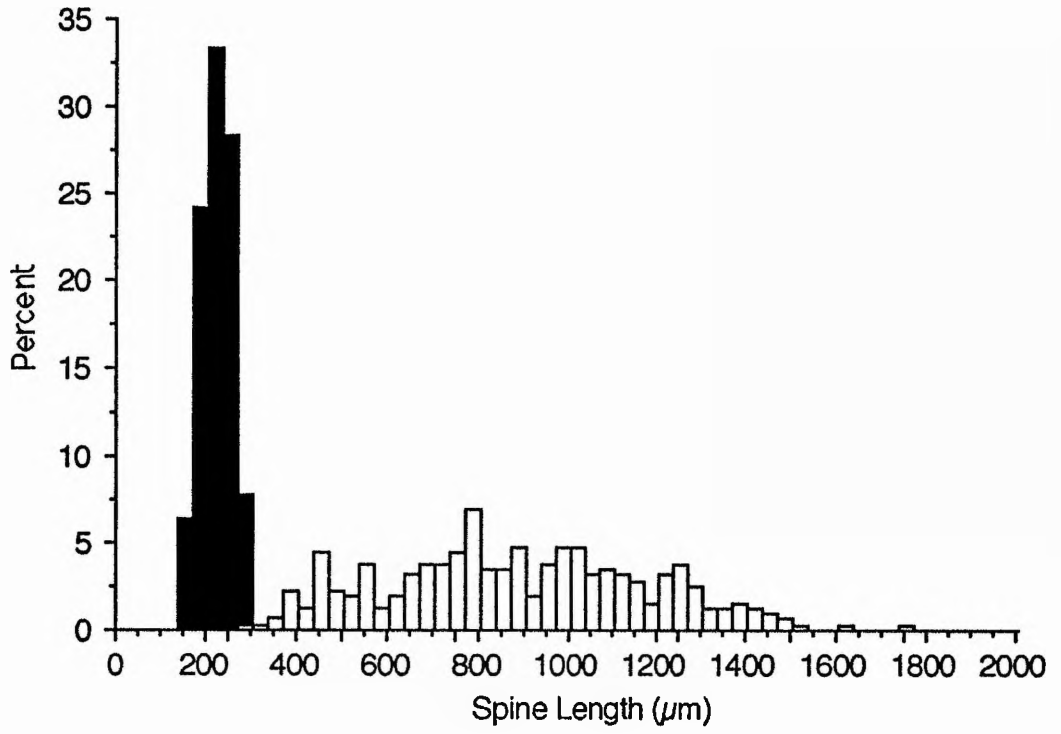

Figure 4.15: Frequency distributions of (top) MPS and (bottom) EMPS lengths (μm) in laboratory-reared colonies of Genotype G2. Sample sizes: MPS $n = 141$, EMPS $n = 319$. Note difference in ordinate scales.

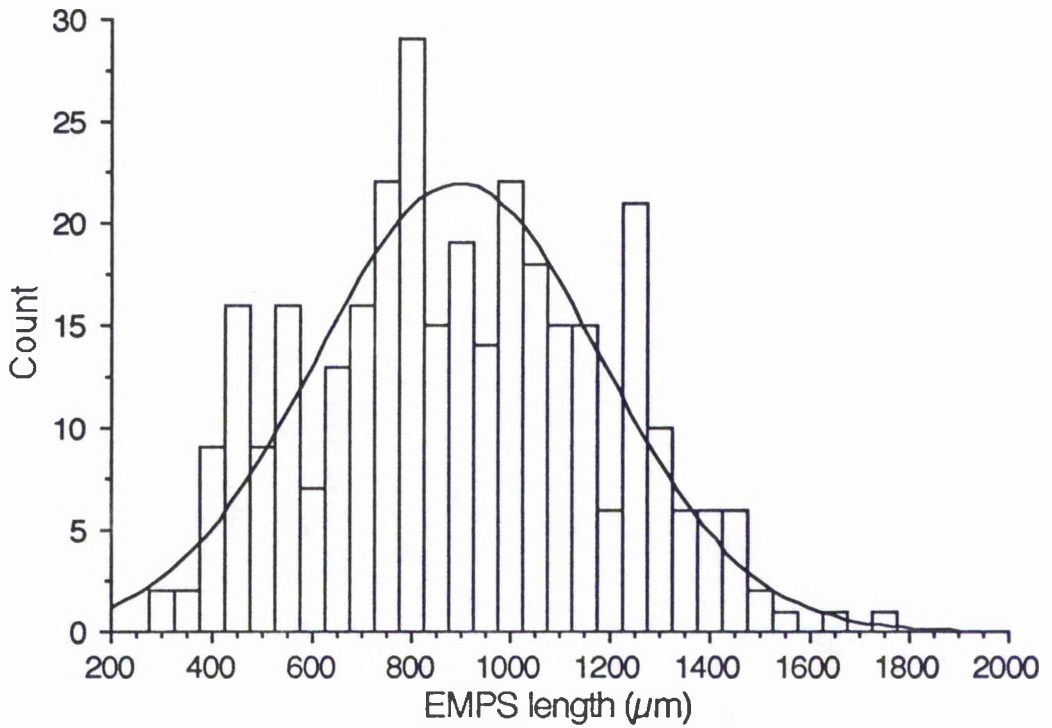
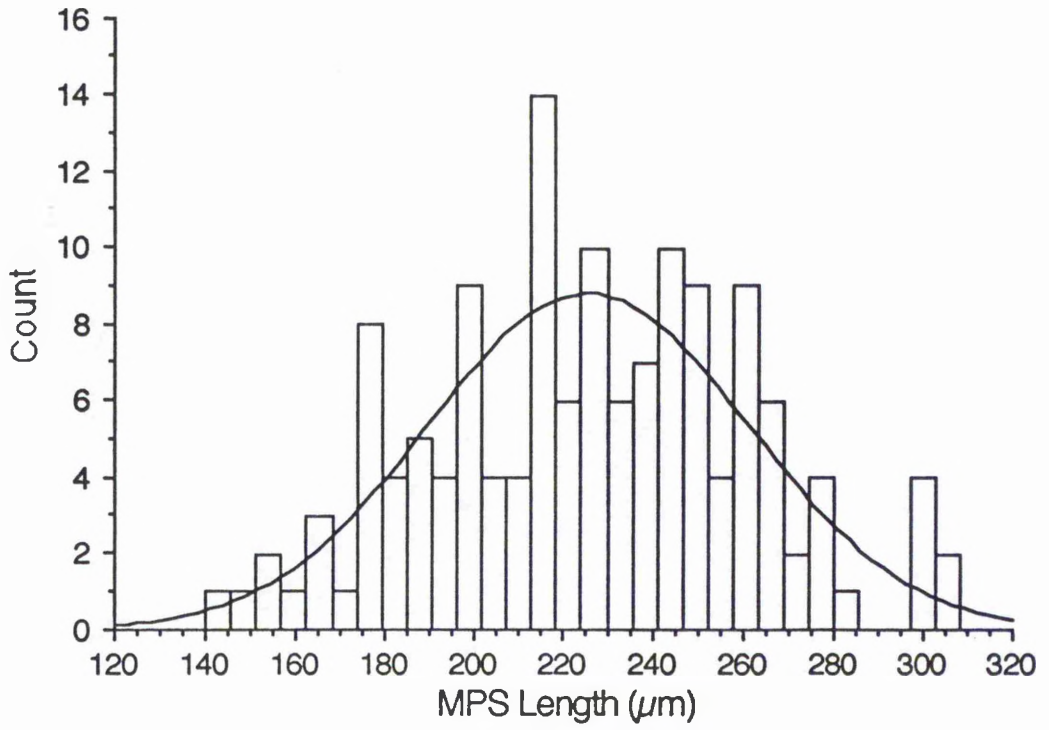

Figure 4.16: Comparison of ranges of spine lengths for MPS (left) and EMPS (right). Data pertain to zooids from six replicate colonies of Genotype G2 from Gruinard Bay. The five horizontal lines in each boxplot represent the 10th, 25th, 50th, 75th and 90th percentile of each variable, with values above the 90th and below the 10th percentile plotted separately. Sample sizes: MPS $n = 141$, EMPS $n = 319$.

Fig. 4.16

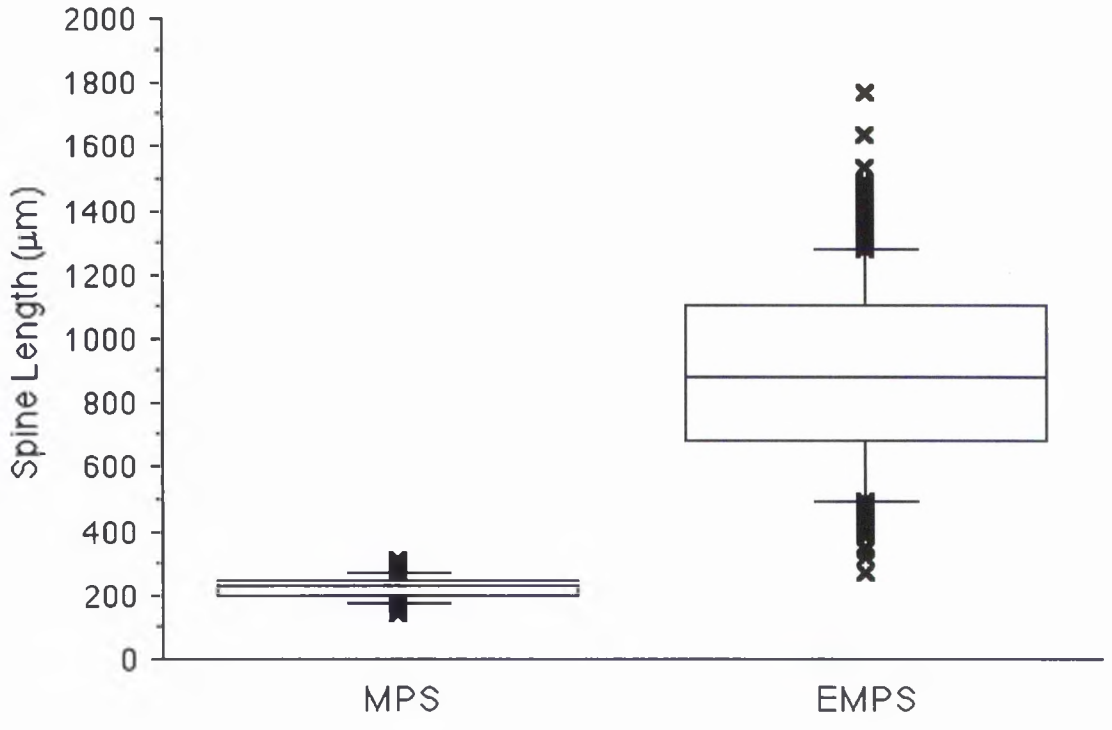

Table 4.8: Comparative statistics of MPS and EMPS lengths (in μm) in six laboratory-reared colonies of Genotype G2 from Gruinard Bay.

Spine Type	Mean	s.d.	s.e.	n	Minimum	Maximum
MPS	225.32	35.76	3.01	141	140.06	308.23
EMPS	894.82	289.96	16.23	319	273.17	1773.77

Table 4.9: Nested ANOVA of MPS length of laboratory-grown colonies (all colonies); untransformed data were used. Nested factors are denoted by the subgroups factor followed by the groups factor in parentheses. Sample size $n = 1253$.

Source	df	SS	MS	F	p	Error Term
Site	1	142,835	142,835	2.11	0.184	Genotype (Site)
Genotype (Site)	8	540,561	67,570	24.00	< 0.001	Replicate
Replicate (Genotype)	50	140,766	2,815	4.06	< 0.001	Residual
Residual	1193	827,174	693			

Figure 4.17: Colony growth of the laboratory-grown colonies over the experimental period. Data shown are genotype means \pm 1 s.e., based on six replicate colonies per genotype. Genotypes from Dundonnell (D1-D5) are shown as open plot symbols, genotypes from Gruinard Bay (G1, 2, 4, and 5) as filled plot symbols. The colonies of Genotype G3 from Gruinard Bay entered the experimental period with a delay and are hence excluded from the graph.

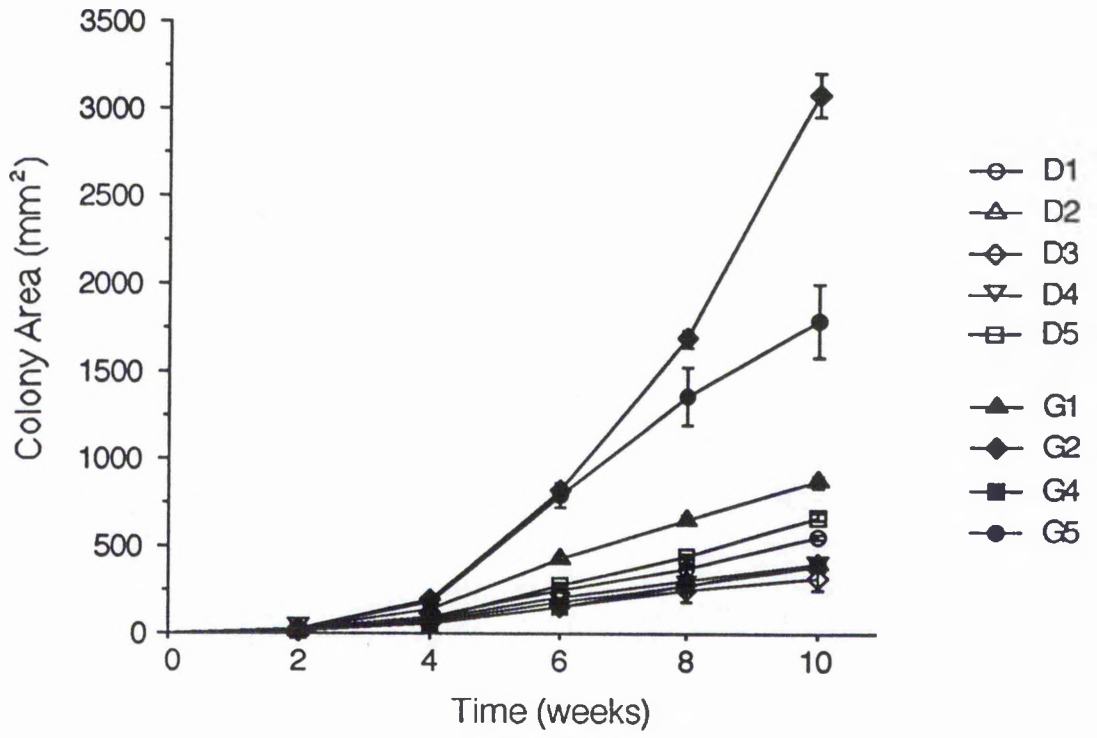

Figure 4.18: Colony area (mm²) of the laboratory-grown colonies at the end of the experiment. Top: Genotype means (+ 1 s.e.), based on six replicate colonies each. Genotypes from Dundonnell are labelled D1-D5, genotypes from Gruinard Bay G1, 2, 4 and 5. Bottom: Grand means (+ 1 s.e.) for Dundonnell (white fill) and Gruinard Bay (hatched fill), averaged across all replicate colonies and genotypes. Sample sizes: Dundonnell n = 30, Gruinard Bay n = 24. Note difference in ordinate scales.

Fig. 4.18

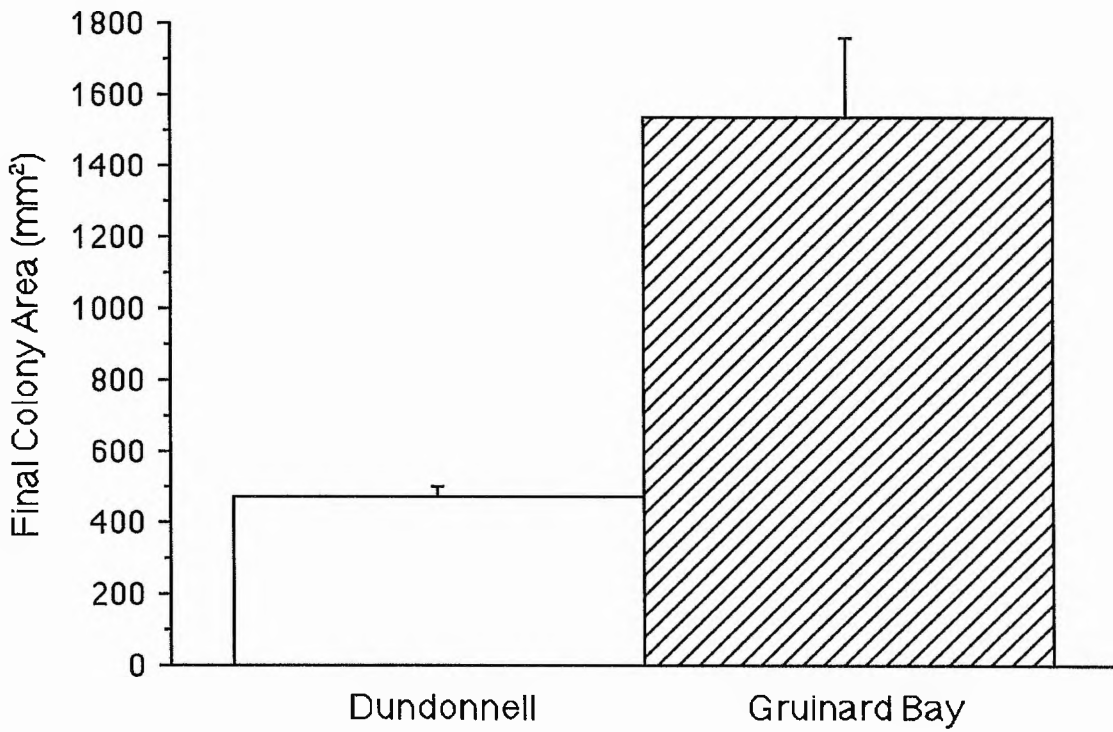
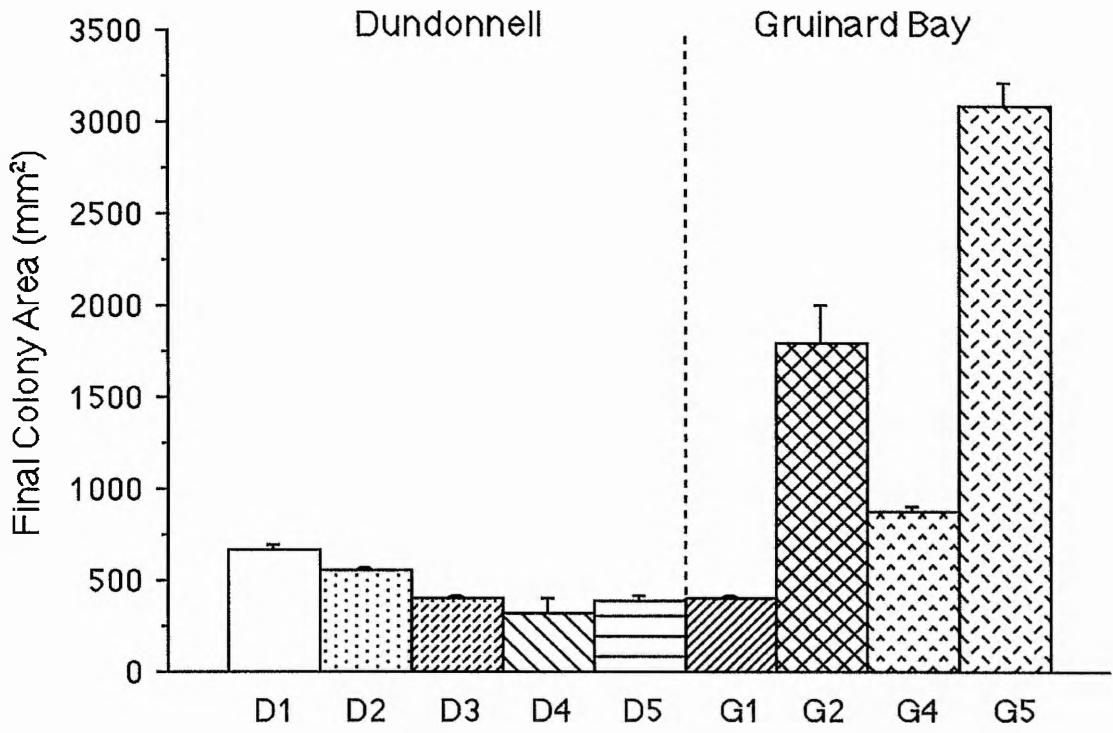

Table 4.10: Descriptive statistics of MPS length (in μm), measured in laboratory-grown colonies replicated from five genotypes per site.

MPS Length	Mean	s.d.	s.e.	n	Minimum	Maximum
Total	179.39	36.64	1.03	1,253	89.79	308.23
Gruinard Bay	189.26	35.80	1.38	672	99.85	308.23
Dundonnell	167.98	34.23	1.42	581	89.79	279.58

Table 4.11: Nested ANOVA of colony area at the end of the experiment, after a 10 wk growth period. Data were \log_{10} -transformed prior to analysis. Nested factors are denoted by the subgroups factor followed by the groups factor in parentheses. Error terms used in F -tests are specified in the last column.

Source	df	SS	MS	F	p	Error Term
Trough	1	0.009	0.009	0.45	0.502	Residual
Site	1	2.438	2.438	5.19	0.056	Genotype (Site)
Genotype (Site)	7	3.284	0.469	24.90	< 0.001	Residual
Residual	44	0.829	0.019			

sites factor in a nested ANOVA ($p = 0.057$, Table 4.11). There were no significant differences between troughs ($p = 0.502$), but the Genotype factor (nested in the Between-Sites factor) was highly significant at $p < 0.001$. Final colony sizes ranged from 53.1 - 3572.2 mm² (equivalent to approximately 320 - 21,780 zooids).

4.3.4. Phenetic comparison of morphological characters of long-spined and short-spined morphs

In the colony means cluster analysis, replicate colonies of the same genotype generally clustered at the highest level of similarity, except for Genotypes G4 and D3 whose replicate colonies tended to separate, depending on the clustering method and similarity/dissimilarity coefficient employed. A combination of Squared Euclidean Distance and UPGMA (Fig. 4.19) produced a dendrogram largely representative of all others (see Appendices 1-5); Euclidean Sum of Squares/UPGMA and Average Squared Distance/UPGMA produced dendrograms identical to the former.

Differences among dendrograms were negligible, and did not qualitatively affect the overall outcome of the analysis. In all analyses two larger clusters formed: cluster 1 always consisted of all colonies from Genotypes G3 and D1, and colony G4V; G4 IV either clustered with this group peripherally or with a subcluster containing all colonies of Genotypes G1 and G2. Cluster 2 consisted of one subcluster formed by G5, D4, D5, D3IV (and, in some cases, D3V), and another subcluster which consistently comprised G1 and G2 and one other colony (either D3V or G4IV, depending on method). Genotype D2 was consistently separate from the two main clusters, except in the case of Similarity Ratio/UPGMA, where it was included in cluster 2. It has to be noted here that D1, the only "spiny" genotype from Dundonnell, consistently clustered with the "spiny" Genotypes G3 and G4 from Gruinard Bay. However, it appears that generally there was considerable overlap and mixing between the two groups from Dundonnell (all "unspiny" except Genotype D1) and Gruinard Bay (all "spiny"). Thus, there did not appear to be any distinct clusters which might suggest

Figure 4.19: Dendrogram of colony means cluster analysis, using Squared Euclidean Distance as a dissimilarity measure and the Unweighted Pair Group Average Method (UPGMA) as a clustering method. Colony means were based on 15 zooid level observations per character from each of 20 colonies (two replicate colonies from each of ten genotypes). Genotypes originated from two sites, Gruinard Bay (G; black circles) and Dundonnell (D; white circles); five genotypes were used per site. The dissimilarity index was based on colony means of 12 zooid morphological characters and two colony level measurements, colony shape (as relative colony perimeter, RCP) and colony size (as colony area).

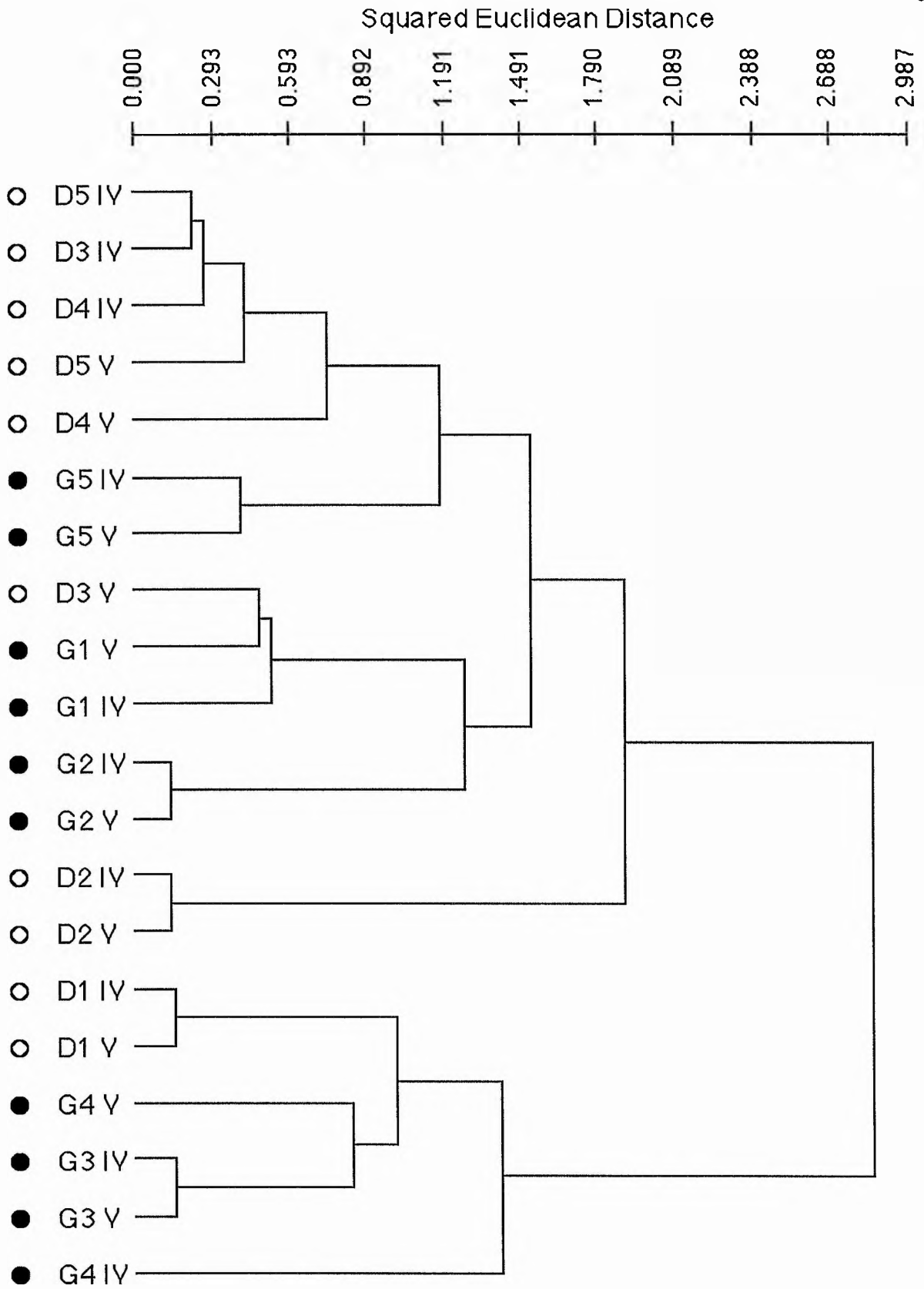

D = Dundonnell; G = Gruinard Bay

either population differentiation or a possible distinction between “spiny” and “unspiny” morphs of *Electra pilosa*.

In the analysis of the zooid data, Ward’s method produced the clearest classification, with results generally matching those of the same analysis using colony means. Mixing of zooids from different genotypes in the same cluster occurred with all three clustering methods. Zooids of some genotypes (e.g. D2) tended to form clusters more than those of others, with zooids from both replicate colonies even falling into single clusters; this suggested pronounced differences among genotypes in the extent of within-genotype and within-colony variation. Generally, four or five distinct clusters formed, all of which were similar to clusters in the colony means analyses, underlining the validity of both classifications.

4.3.5 Spontaneous EMPS formation/Influence of genotype on spinosity

No EMPSs formed in any of the colonies during either the preparatory replication period or the experimental period itself. The conclusion is, therefore, that EMPS formation will not occur in the laboratory under constant environmental conditions and that the formation of EMPSs in the previous experiment was probably artefactual. Note that, in contrast to section 4.3.3 above, the colonies used here all were derived from newly-metamorphosed ancestrulae.

Genotype growth rates differed strongly in this experiment: two genotypes, both from Gruinard Bay, grew at considerably greater rates than the remainder, resulting in pronounced among-genotype differences in final colony size (Fig. 4.20; Table 4.12). There were no significant differences between sites in final colony area ($p = 0.294$). At the end of the experiment (after 10 wk), colony sizes ranged from 74.6 to 3724.1 mm² (equivalent to approximately 450 to 22,700 zooids).

Figure 4.20: Colony area (in mm²) over the experimental period in the spontaneous EMPS formation experiment. Data plotted are means \pm 1 s.e. of three replicate colonies per genotype. Genotypes originated from two locations, Gruinard Bay (filled diamonds) and Dundonnell (open circles). Ten genotypes were used per site.

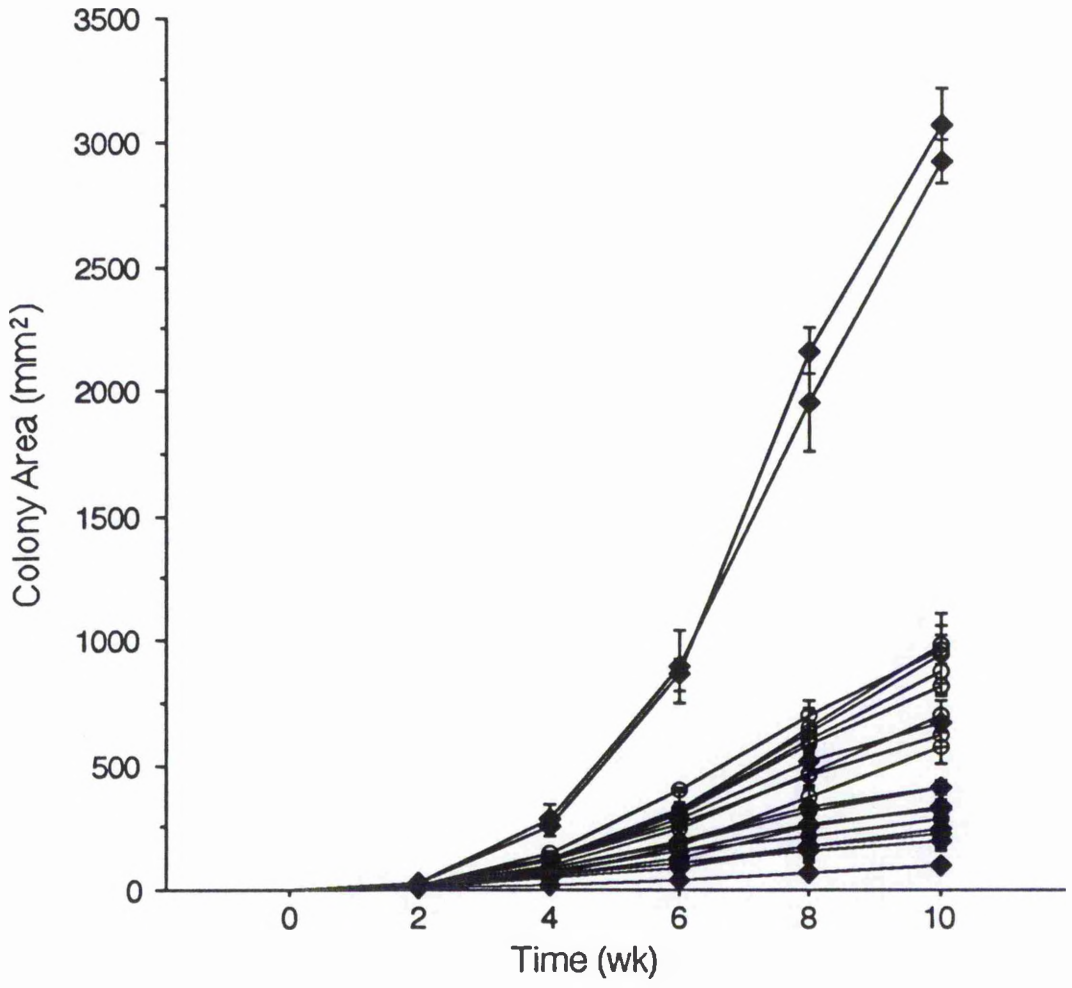

Table 4.12: Nested ANOVA of colony area at the end of the experiment, after a 10 wk growth period. Data were \log_{10} -transformed prior to analysis. Nested factors are denoted by the subgroups factor followed by the groups factor in parentheses. Error terms used in F -tests are specified in the last column.

Source	df	SS	MS	<i>F</i>	<i>p</i>	Error Term
Trough	2	0.081	0.040	4.99	0.011	Residual
Site	1	0.520	0.520	1.16	0.294	Genotype (Site)
Genotype (Site)	18	8.050	0.447	55.21	< 0.001	Residual
Residual	38	0.308			0.008	

Table 4.13: Oneway ANOVA of percentages of long-spined zooids in the nine replicate colonies of Genotype 5 from the intraspecific competition experiment. Three replicate colonies were used in each treatment (allogenic/isogenic encounters and control). Data were arcsine-transformed prior to analysis.

Source	df	SS	MS	<i>F</i>	<i>p</i>
Treatment	2	7.68	3.84	1.90	0.229
Residual	6	12.11	2.02		

4.3.6 Promotion of EMPS development by inter- and intraspecific overgrowth encounters

4.3.6 .a) Intraspecific competition

In this experiment, EMPSs formed only in one out of five genotypes. All replicate colonies of that genotype expressed the character (including negative controls), albeit at very low levels (between 0.34 and 1.92 % of zooids in each colony). Oneway ANOVA of percentages of long-spined zooids in the nine replicates of that genotype showed no significant differences among treatments ($p = 0.229$, Table 4.13).

Contact between colonies in the isogenic and allogenic treatments occurred for periods of 3 to 9 wk.

Colony growth was extremely slow in three cases during the preparatory phase of the experiment (2 x Genotypes 3+5 allogenic encounter and 1 x Genotype 5 isogenic encounter), and consequently, these colonies could not be cut back to starter clusters on the date when advanced growth of the remainder of colonies prevented further postponement of the experiment. These colonies were set up with a delay of 2 wk, and data pertaining to colony growth in these cases are hence excluded from graphs and analyses. Final colony sizes ranged from 132.5 - 1079.8 mm² (equivalent to approximately 810 - 6,580 zooids). There were significant differences in final colony area among genotypes and among treatments (Table 4.14); a *post hoc* test showed controls and both the allogenic and isogenic treatment to be significantly different but there were no significant differences between the allogenic and isogenic treatment. Thus, the presence of competing colonies on the same glass plate led to reduced colony growth in this experiment, irrespective of their genotypic identity.

Stimulation of zooid frontal membranes resulted in 100% positive responses in the isogenic treatment (retraction of polypides on the other side of contact interfaces), indicating colony fusion in all cases and demonstrating full self-compatibility in this species. In the allogenic treatment, however, no positive responses were observed, i.e. no fusion had occurred among any of the different genotype combinations tested.

Table 4.14: Twoway ANOVA of colony area at the end of the intraspecific competition experiment, and *post hoc* comparison (Fisher's PLSD) of treatment means. Data were \log_{10} -transformed prior to analysis.

Source	df	SS	MS	F	p
Genotype	4	1.201	0.300	24.40	< 0.001
Treatment	2	0.308	0.154	12.50	< 0.001
Genotype x Treatment	8	0.088	0.011	0.89	0.526
Residual	54	0.665	0.012		

Treatment Comparison	Mean Diff.	Critical Diff.	p
Allogenic - Control	- 0.189	0.072	< 0.001
Allogenic - Isogenic	- 0.020	0.061	0.504
Isogenic - Control	0.169	0.071	< 0.001

4.3.6 .b) Interspecific competition

Contact between colonies of *Electra pilosa* and *Flustrellidra hispida* occurred for periods of 4 to 6 wk. No EMPSs formed in colonies of *E. pilosa*, showing that the formation of EMPSs in *E. pilosa* is unrelated to the presence of this and presumably other space competitors. Final colony sizes ranged from 124.2 - 816.3 mm² (equivalent to approximately 760 - 4,980 zooids); there were significant differences in final colony area among genotypes ($p < 0.001$) and treatments ($p = 0.018$; Table 4.15). A *post hoc* comparison (Fisher's PLSD) among treatments revealed a significant difference between control and dummy colonies ($p = 0.031$), with mean colony size in the dummy treatment greatly reduced (Table 4.15). Thus, dummy colonies slowed growth of *E. pilosa* whilst the presence of *F. hispida* colonies did not exert a significant effect on growth of *E. pilosa*, possibly due to the small size of *F. hispida* colonies. Overgrowth of dummy colonies occurred in eight out of ten cases, whereas all *F. hispida* colonies were overgrown, to varying extents, by *E. pilosa* colonies (Fig. 4.21). Dummy colonies were overgrown to varying extent, but no pattern was apparent which could have explained the observed variation. Overgrowth of *F. hispida* colonies induced a change in the colony growth pattern of *E. pilosa* from multiserial to uniserial, and in some cases the overgrown colony was covered almost completely by *E. pilosa* zooids. No instances of *F. hispida* overgrowing *E. pilosa* were observed.

4.4 DISCUSSION

The variable incidence of EMPSs among colonies and sites (section 4.3.1) indicates that the classification of colonies into "long-spined" and "short-spined" morphs of *Electra pilosa* is not strictly valid; although exclusively "short-spined" morphs were present at all sites examined, exclusively (i.e. 100%) "long-spined" morphs were not

Table 4.15: Twoway ANOVA of final colony area (untransformed data) of colonies in the interspecific competition experiment, *post hoc* comparison (Fisher's PLSD) of treatment means and descriptive statistics (*F. hispida* = *Flustrellidra hispida*).

Source	df	SS	MS	F	p
Genotype	4	1,349,286	337,321	104.95	< 0.001
Treatment	2	33,780	16,890	5.25	0.018
Genotype x Treatment	8	10,858	1,357	0.422	0.889
Residual	15	48,208	3,213		

Treatment Comparison	Mean Diff.	Crit. Diff.	p
Control - Dummy	75.31	68.80	0.031
Control - <i>F. hispida</i>	9.14	68.80	0.937
Dummy - <i>F. hispida</i>	- 66.16	68.80	0.060

Treatment	Mean Area	s.d.	s.e.	n	Minimum	Maximum
Control	449.81	239.09	75.60	10	234.56	800.97
Dummy	374.49	234.50	74.15	10	124.19	751.76
<i>F. hispida</i>	440.66	210.53	66.57	10	260.07	816.32

Figure 4.21: Overgrowth of *Flustrellidra hispida* by *Electra pilosa* on glass plate substratum in the laboratory. The spines of *F. hispida* disrupt the growth pattern of *E. pilosa*, inducing uniserial growth morphology in the overgrowing colony. Diameter of *F. hispida* colony approximately 10 mm.

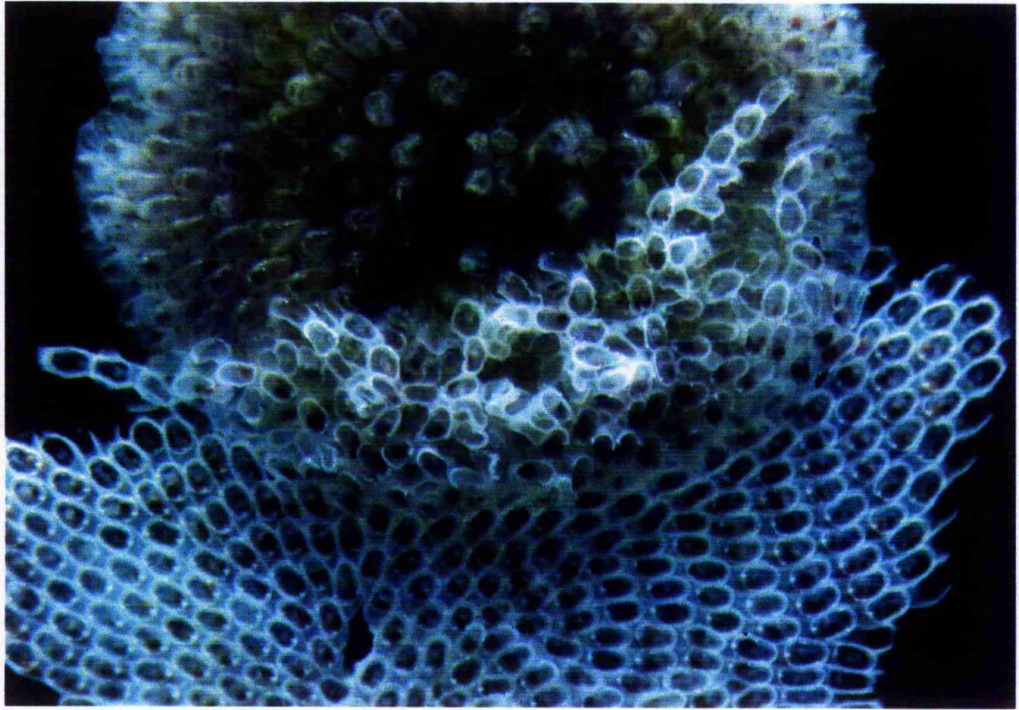

observed and probably are extremely rare. A recent, similar study showed that spinosity of *E. pilosa* colonies varies not only among sites but also among different algal substratum types within sites (Gamwell 1996): there was an indication of increased spinosity on cylindrical substratum types such as filamentous red algae, but a laboratory experiment carried out as part of the same study showed that cylindrical substratum morphology alone is insufficient to promote the formation of EMPSs. The variability observed would suggest that the incidence of EMPSs is not a genotypically fixed character, but environmentally determined and thus phenotypically plastic, a finding with important implications for the further course of this investigation.

Here, there appeared to be a clear correlation between incidence of EMPSs and wave exposure at a given site. Numerous biotic and abiotic parameters may covary with wave exposure itself, such as species composition of the community (e.g. Lewis 1964, Denny 1988), or the quantity and qualitative composition of available nutrients (e.g. Leigh *et al.* 1987). The focus of the remainder of this study hence was on isolating the factor(s) responsible for the observed variation in incidence of EMPSs.

Analysis of frequency distributions of lengths of MPSs and EMPSs in field-collected colonies (section 4.3.2) indicated clearly that the EMPS is indeed a discrete, deterministic character, thus supporting the *a priori* categorization used here in spine length measurement: MPS and EMPS lengths in this study were normally distributed, a feature characteristic of morphological traits maintained at an optimum mean by stabilizing selection (Futuyma 1986). The five field-collected colonies (representing different genotypes) sampled here differed significantly from each other both in MPS and EMPS lengths, but it is unclear whether this variability was exclusively genotypic or also environmentally induced: phenotypic variance contains a genetic variance component but may also contain an environmental and a genotype x environment interaction variance component (Futuyma 1986), and in the absence of environmental data (and/or replication of genotypes) the determination of variance components is impossible. Although colonies were collected from one site these may well have been

subject to different microenvironments during colony development, which may, in turn, have been reflected in zooid morphology. However, it is clear that the EMPS is a character separate from unextended, “normal” MPS. The two characters may well be subject to selection independently of each other: rank orders of colonies were different for length of EMPSs and MPSs respectively (Fig. 4.11) which might be a result of selection acting differentially on the two traits.

A small number of EMPSs formed spontaneously in colonies ongrown in the laboratory from “spiny” genotypes previously exposed to natural environmental conditions (section 4.3.3). It remains unclear whether the formation of these spines was simply artefactual and a result of laboratory culture or whether it was caused by the previous exposure of these genotypes to their natural habitat. It should be noted here that all three genotypes which produced EMPSs in the laboratory experiment originated from Gruinard Bay, the exposed sampling site, and that none of the colonies derived from “unspiny” genotypes from Dundonnell, the sheltered sampling site, formed EMPSs during the experiment. However, in view of the small numbers of EMPSs produced it would be unjustified to interpret the formation of EMPSs in the “spiny” genotypes as being due to a developmental “switch” which, once activated during exposure of original colonies to natural conditions, might continue to promote EMPS expression thereafter. Results from the spontaneous EMPS formation experiment (section 4.3.5) were somewhat clearer, in that no EMPSs formed in any of the 60 colonies grown; all of the genotypes used had been reared from post-metamorphic ancestrulae and thus had been exposed to their respective habitats and environmental conditions for a very brief period only, perhaps only a few hours. This result is in agreement with observations on batches of ancestrulae reared in the laboratory in pilot studies and previous experiments (Bayer 1994): under standard laboratory conditions as described here, colonies of *Electra pilosa* generally do not develop EMPSs.

Cluster analyses of both colony means and zooid data (section 4.3.4) showed replicate colonies of the same genotype and zooids of the same genotype/colony to generally form clusters, but failed to demonstrate any convincing clustering of either genotypes from the same site or of “spiny” and “unspiny” genotypes. Thus, on the simple basis of overall morphological similarity it would seem that the two morphs are, in fact, conspecific. However, the *a priori* absolute classification of genotypes as “spiny” or “unspiny” is not possible if it is assumed that EMPSs are indeed inducible by an environmental cue: EMPSs form at some stage in astogeny but an “unspiny” colony might well be a potentially “spiny” colony that has yet to experience exposure to the inductive environmental cue(s).

In contrast to the hypothesis put forward by Stebbing (1973b), direct competition for space with conspecifics and with colonies of one other bryozoan species (section 4.3.6) failed to induce EMPS formation in this study. In the intraspecific competition experiment (4.3.6.a), one genotype developed EMPSs in all its replicates, albeit in very small numbers; there were no significant differences among treatments, again suggesting that EMPS formation here may well have been artefactual. No EMPSs were formed in the interspecific competition experiment; however, there were no instances of overgrowth of *Electra pilosa* by the competitor, *Flustrellidra hispida*, which, in the field, regularly overgrows *E. pilosa* (Stebbing 1973b, Turner & Todd 1994). It would appear that culture conditions for *F. hispida* were suboptimal in this experiment, leading to reduced colony growth and hence reduced potential for overgrowth of competing colonies. Thus, conditions for the induction of EMPSs may not have been adequate here.

CHAPTER 5: A NEW TYPE OF INDUCIBLE MORPHOLOGY AND ITS EFFECTS ON NUDIBRANCH PREDATORS

5.1 INTRODUCTION

The investigation of the occurrence of extended median proximal spines under natural conditions suggested strongly that EMPSSs are environmentally inducible and that their occurrence may be related to wave action, water movement or related parameters (Ch. 4). The further course of the investigation thus demanded a detailed inquiry into the effects of water flow, wave action and associated physical factors. Wave action is a physically complex phenomenon and its effects on marine organisms inhabiting the intertidal are numerous and complex; several reviews have addressed this topic (Vogel 1981, Koehl 1984, Denny *et al.* 1985, Denny 1987, 1988) and their findings are summarized briefly below.

Biomechanics of the intertidal zone

Depending on wave height and shore topography, breaking waves and their run-up on the shore can produce water velocities of up to 14 ms^{-1} and acceleration in excess of 400 ms^{-2} (Denny *et al.* 1985). Forces exerted on intertidal organisms as a consequence of this are threefold: (1) drag, the longitudinal retarding force exerted by water, (2) lift, the upward pressure that water exerts on an object to counteract the force of gravity, and (3) the acceleration reaction, the response of an object to a change in water velocity (Denny 1988). These forces, particularly the latter, set physical limits to the size and shape of organisms inhabiting the wave-swept environment, beyond which dislodgement or breakage will occur (Denny 1985, Denny *et al.* 1985, Gaylord *et al.* 1994, Utter & Denny 1996). Flexible organisms such as seaweeds are subject to a reduced amount of force due to a delayed response brought about by

bending (Koehl 1984, Friedland & Denny 1995). There are two other forces which occur in exceptional circumstances (Denny 1987): (1) sudden localized build-ups of pressure, sometimes in excess of several hundred atm, can result from water jets impacting flat surfaces perpendicularly, but under normal circumstances these are greatly attenuated by air pockets; (2) suspended objects ranging in size from sand grains to logs can be projected at the substratum and associated organisms, causing mechanical damage of varying extent (e.g. Shanks & Wright 1986).

Exposure to wave crash and community organization

Wave exposure probably is the single most important structuring factor in intertidal community organization, and a number of texts on intertidal ecology are available which discuss the subject in its full breadth (e.g. Lewis 1964, Boaden & Seed 1985, Little & Kitching 1996). Effects of wave action on distribution, abundance and vertical zonation of intertidal organisms can be direct or indirect (Lewis 1964): immediate, biomechanical factors (see above) may set upper limits to the wave exposure an organism can actually tolerate, whilst other physical factors (such as oxygen availability, sedimentation, water chemistry, salinity and temperature) and biological factors (occurrence of predators/competitors) may covary with wave exposure and thus define a framework within which species can occur. Wave action also affects community structure by influencing dispersal and input of propagules such as larvae of invertebrates or macroalgal spores. In combination, wave exposure and shore topography may determine the height of zonal boundaries on the shore. Thus, community composition and structure of the intertidal of a given site can be used to obtain a measure of the long term average exposure of the shore; several biological exposure indices are in use, but the most commonly applied is that developed by Lewis (1964).

Wave exposure also can have a profound effect on the productivity of a shore community; for example, the increased productivity of seaweeds on exposed shores is

attributed to a rich CO₂ and nutrient supply, reduced boundary layer resistance and constant removal of metabolic waste products (Boaden & Seed 1985). There are numerous studies which have documented the increased productivity of exposed environments at a variety of levels (e.g. Jokiel 1978, McQuaid & Branch 1984, 1985, Leigh *et al.* 1987, Levin & Mathieson 1991, Hurd *et al.* 1996).

Disturbance resulting from storm waves is a major structuring agent of intertidal communities; disturbance-mediated mortality can free up primary substratum space and allow recruitment of, for example, competitively inferior species (Sousa 1984). Disturbance at intermediate frequencies and intermediate intensities can act to maintain diversity by allowing recruitment and persistence of species that would otherwise become locally extinct.

Moving water and the Bryozoa

Effects of wave-related physical stress on bryozoans have largely been ignored.

Herrera and Jackson (1992) investigated the extent of environmental variation in seven species of reef bryozoans from Panama and found that lophophore parameters varied systematically among sites of differing exposure, and that colonies from exposed shores had smaller lophophores than their counterparts from sheltered sites.

Whitehead *et al.* (1996) correlated spinosity (as number of spines per zooid) in the ctenostomatid *Flustrellidra hispida* to wave exposure at sample sites and experimentally manipulated colonies to grow in high- and low-turbulence regimes.

Their findings suggest that spinosity in this species is genetically controlled but that some variation is inducible by the effects of water turbulence, with colonies reared in high-turbulence conditions producing an increased number of zooidal spines.

Whitehead *et al.* (1996) proposed that spines in *F. hispida* extend the boundary layer vertically and thus facilitate feeding.

In comparison to the paucity of studies on wave crash, a wealth of studies exists on the effects of water flow on bryozoans. Post-breaking waves are

characterized by fast, turbulent water flows perpendicular to the shore, referred to as run-up (Denny 1988). The consequential turbulent mixing has important implications for sessile suspension feeders because laminar, non-turbulent flows lead to the build-up of essentially impenetrable boundary layers in which availability of nutrients/food may become a limiting factor (Nowell & Jumars 1984, Denny 1988). However, most of the existing studies on Bryozoa and water flow appear to be based on laminar flow, which typically is associated with non-turbulent water currents rather than wave action, and results may not be applicable in a wave crash context. Okamura (1987a, 1990) examined the feeding behaviour of two species of bryozoan, *Bugula neritina* and *Bugula stolonifera*, and found that faster flow regimes caused a switch in particle selection from smaller to larger particles in *B. stolonifera*, whereas feeding behaviour in *B. neritina* was unaffected by faster flows. In two other studies, Okamura (1984, 1985) compared feeding success in two bryozoan species with contrasting colony morphologies (encrusting *versus* arborescent) and found that — irrespective of colony morphology — faster flow speeds generally reduced feeding success, particularly in smaller colonies. Similarly, Eckman and Duggins (1993) subjected several species of suspension feeder, including the bryozoan *Membranipora membranacea*, to a number of water flow speeds and compared growth rates as well feeding behaviour among treatments. They showed that *M. membranacea* is unable to feed at flow speeds greater than 25 cms⁻¹, which was reflected in reduced colony growth in the faster flow regimes. *M. membranacea* typically inhabits large, sheet-like macroalgae in the sublittoral which bend in flow and thus are subject to formation of extensive boundary layers; it appears that this encrusting species, which inhabits the low flow environment of the lower boundary layer, is not adapted to feeding in fast-moving water. Similarly, Cancino and Hughes (1987) investigated the effect of water flow on *Celleporella hyalina* and they found that restricted water flow — in their study possibly covarying with a restricted food supply — had a negative effect on colony growth and on reproductive output.

Moving water and other taxa

Gastropoda

Exposure to wave action affects organisms across a wide range of phyla on a range of different levels. The Gastropoda appears to be the taxon that has received the most attention with respect to morphological studies. Several studies on intertidal snails (Brown & Quinn 1988, Boulding & Van Alstyne 1993, Etter 1996) have found that growth rates differ markedly between exposed and protected shores, with molluscs from exposed shores attaining smaller body sizes, and that the effect is phenotypically plastic, rather than due to genetic differentiation. Differences in growth rates presumably result from the reduction of feeding rates on exposed shores, mediated by reduced foraging time available, or from increased prey handling time due to the hydromechanical forces encountered.

Shell shape of intertidal snails also can differ in relation to wave exposure (Kitching 1976, Vermeij 1978, Crothers 1983, Frid & Fordham 1994), with snails from exposed locations displaying squatter shell morphologies than snails from sheltered shores. However, inferences about the mechanism responsible can not be made on the basis of this alone, because such patterns may be brought about by selection, genetic differentiation, phenotypic plasticity or even behavioural adaptations leading to assortment of individuals in certain areas (Janson 1982, Moreno *et al.* 1993, Hobday 1995). A study by Johannesson and Tatarenkov (1997) of allozyme variation in the snail *Littorina saxatilis* demonstrated that genetic differentiation at the microhabitat (within-site) level can indeed take place. Theoretical models indicate that genetic differentiation at sites of differing wave exposure can be maintained even if rates of gene flow between populations are high (Boulding 1990). Selective pressures acting differentially at sites of varying wave exposure include the risk of dislodgement, desiccation during emersion, or the (covarying) presence of predators; on some shores the interaction of these selective agents may lead to within-shore differentiation of ecotypes and the resulting hybrid zones (Rolan-Alvarez *et al.* 1997).

Trussell (1997) demonstrated that variation in foot size and shell morphology in *Littorina obtusata* was due to phenotypic plasticity and that snails reared in high velocity flows develop squatter shells and larger pedal areas. Both of these characteristics are assumed to reduce the risk of dislodgement in wave crash environments and it has been argued that differences in foot size between species of the *Littorina* complex may reflect the extent to which they exploit different ecological niches in terms of wave exposure of shores (Grahame & Mill 1986). Similarly, Etter (1988) conducted a study on the sources of variation in pedal surface area in *Nucella lapillus* in relation to environmental factors, and found the trait to be highly phenotypically plastic, with pedal surface area increasing as a function of wave exposure.

Superficially, morphology of snail shells may correlate with wave exposure but need not be related to wave action itself; instead, morphology may be related to factors that covary with exposure such as the presence or absence of a predators: Trussell (1996) noted a trend of increasing shell thickness in relation to wave exposure in the snail *Littorina obtusata*; however, most of this variation proved to be inducible by the presence of a crab predator, although a component did indeed seem to be related to wave exposure. The dogwhelk *Nucella lapillus* also responds to perceived risk of crab predation, with a reduction in feeding and in growth as well as changes in shell morphology (Palmer 1990). It has been shown for *Littorina saxatilis* that a crab predator offered a choice of snails from exposed and from sheltered shores will select small snails (i.e. those with the morphology characteristic of exposed shores) for which there is a higher attack success rate than for the larger morphs from sheltered shores (Johannesson 1986).

Behavioural adaptations of intertidal snails to wave-exposed shores include the temporal cessation of feeding activity during exposure to wave action (Hughes & Taylor 1997) or a shift to smaller prey size (Richardson & Brown 1990), pursuit of prey by means of passive transport in wave-generated flow (Odendaal *et al.* 1992) and

migration to a tidal height where the risk of dislodgement and that of desiccation are balanced (Hobday 1995).

Cnidaria

For scleractinian corals, exposure to wave action, particularly during storms, can be a major source of partial or whole-colony mortality through breakage (e.g. Tunnicliffe 1981, 1982, Massel & Done 1993), although fragmentation of colonies without ensuing mortality can also be beneficial as a means of asexual propagation (Tunnicliffe 1981, Highsmith 1982). Scoffin *et al.* (1992) described how linear extension rate in the massive scleractinian *Porites lutea* from South Thailand was negatively correlated with wave exposure, resulting in greater skeletal bulk and thus possibly greater robustness in colonies from exposed sites. However, there was some uncertainty about the mechanism responsible and the authors tentatively suggested that abrasion by suspended inorganic matter might account for reduced polyp feeding time and thus reduced growth. Similarly, a study by Brown *et al.* (1985) of *Acropora aspera* showed that colony growth (measured as linear extension rate) and skeletal accretion were negative correlated with wave exposure while skeletal density was positively correlated.

Graus *et al.* (1977) found a number of adaptations to wave crash in colonies of the branching reef coral *Acropora palmata* at wave-exposed locations. These included orientation of branches parallel to the current, lower branch inclinations on the seaward facing side of the colony, and spear-like colony morphology (as opposed to palmate in sheltered locations). Whether or not this morphology is the result of selection or a consequence of phenotypic plasticity, however, remained unclear. Although colony morphology is clearly phenotypically plastic in some species (Foster 1979, Bruno & Edmunds 1997), this need not be the case for all scleractinians. The coral *Pavona cactus* displays an apparent lack of phenotypic plasticity, because most of the morphological variation within the species is explained by genotypic identity

(Willis & Ayre 1985, Ayre & Willis 1988). Similarly, there is no evidence of an association between habitat and morphology in the genus *Platygyra* (Miller 1994).

Jokiel (1978) showed that increased water motion favoured planulation rates and colony growth in the scleractinian *Pocillopora* spp. from Hawaii, presumably as a consequence of enhanced photosynthetic activity of zooxanthellae due to an increased nutrient supply and enhanced oxygen removal from the boundary layer. This appears to be supported by the findings of Dennison and Barnes (1988) who showed that net photosynthesis, respiration and calcification in both light and dark conditions all are enhanced in stirred water, as compared to unstirred conditions. Another mechanism by which water movement benefits coral growth is through increased rates of phosphate uptake, which is linearly positively correlated with current speed (Atkinson & Bilger 1992). It is assumed that the uptake of phosphate, which is critical for the growth of the symbiotic zooxanthellae of hermatypic corals, is limited by diffusive sublayers which are progressively broken down as current speed increases and flow becomes turbulent. A detailed study of the physiological implications of water movement on the scleractinian *Pocillopora damicornis* was carried out by Lesser *et al.* (1994). *P. damicornis* from two Hawaiian reef sites were morphometrically analysed and specimens transplanted to a flow tank in the laboratory. Colonies from the exposed, windward facing site were shorter and had a more compact morphology than did those from the sheltered side of the reef. Transplanted colonies showed a trend of net and gross photosynthetic rates increasing with increasing water flow. Colonies from sites differing in exposure differed in morphology but not in Reynolds numbers, and the authors argue that, as a by-product of morphological plasticity, the thickness of the diffusional boundary layer is minimized, which in turn maximizes carbon delivery.

Coral clearance rates also may be enhanced by water currents: Lewis (1976) showed that a more than twofold increase in current speed (from 1.4 to 3.4 cm s^{-1}) led to an approximately 70% increase in clearance rates in *Agaricia agaricites*. However,

like for many other suspension feeders (sea pens: Best 1988, crinoids: Leonard *et al.* 1988, bryozoans: see above), total food capture in scleractinians appears to be maximal at intermediate flow rates (Helmuth & Sebens 1993, Sebens *et al.* 1997) although in some cases feeding efficiency (capture rate adjusted for particle flux) is actually greatest at lower flow speeds (Sebens *et al.* 1997).

Free-living scleractinians may possess complex adaptations to life in exposed conditions: the solitary coral *Fungia scutaria* possesses a discoid skeleton which largely prevents overturning in currents but facilitates self-righting (Jokiel & Cowdin 1976). Furthermore, the situation of the stomodeum in a depression on the apex of the animal causes an area of low pressure to form in currents which facilitates feeding.

Both plate-like scleractinians and gorgonian octocorals tend to orient perpendicular to water currents, thus maximizing their rates of prey capture (Rees 1972, Leversee 1976, Helmuth & Sebens 1993). Leversee (1976) also found a prevalence of flatter, more fan-shaped colonies of the gorgonian *Leptogorgia* in current-swept areas. Colony morphology in the Mediterranean gorgonian *Eunicella cavolini* is phenotypically plastic in relation to the degree of wave exposure (Velirimov 1976, Weinbauer & Velirimov 1995). However, colonies from sheltered habitats display higher levels of porosity (a measure of compactness of colony morphology) than do colonies from exposed habitats; a finding in contrast to predictions, because low porosity generally increases drag forces and hence the risk of dislodgment (Weinbauer & Velirimov 1995).

Sebens (1984) showed that feeding success in the soft coral *Alcyonium siderium* — which translates into increased colony growth rates — is positively correlated with water flow and exposure, but colony size may be limited by a critical value at which metabolic cost of whole-colony maintenance exceeds the net energy gain and/or feeding becomes physically impossible.

Porifera

Morphology of sponges may also be affected by wave crash: Palumbi (1986) showed how skeletal morphology in the demosponge *Halichondria panicea* is reinforced at high-energy sites, with spicule density and sponge thickness increasing as a function of exposure. Costs of the structural reinforcements include a loss in pumping efficiency due to decreased bore of piping systems and slower growth.

Macroalgae

As sessile organisms with often complex morphologies, seaweeds are amongst those organisms most strongly affected by wave exposure. A variety of morphological responses to wave exposure has been reported: Sjøtun and Fredriksen (1995) reported increased, presumably phenotypically plastic, investment in holdfasts in the kelp *Laminaria hyperborea* at exposed locations in Norway. Similarly, the South African kelp *Laminaria schinzii* displays morphological variability in relation to wave exposure, with plants from more exposed sites possessing thicker, longer stipes and stronger fronds (Molloy & Bolton 1996). A study of the knotted wrack *Ascophyllum nodosum* showed that internode growth rates are greatest at intermediate wave exposure, and that both receptacle size and pigmentation are positively correlated with exposure (Cousens 1982). The rhodophyte *Chondrus crispus* exists in two different morphs which are associated with exposed and sheltered habitats respectively (Gutierrez & Fernández 1992): plants from exposed habitats have narrow fronds with circular transverse sections, whilst fronds of plants from sheltered habitats are generally broad with flattened sections. It has to be noted that none of the studies reviewed here include analyses of the possible causes for the variation observed, and that, as for the work carried out on molluscs (see above), the mechanisms responsible for the observed patterns are conjectural. Likely sources of variation include (i) selection, (ii) differentiation through random genetic drift, (iii) phenotypic plasticity or

(iv) proximate mechanisms such as tattering of fronds on exposed shores (Blanchette 1997).

Effects of EMPSs on predators

The present study also addressed the potential significance of extended spines to predator behaviour. Spines as anti-predator devices have evolved in a number of phyla (reviewed in Adler & Harvell 1990, Begon *et al.* 1990). Apart from fish and echinoids, bryozoans are preyed upon mainly by nudibranch molluscs (Ryland 1970, McKinney & Jackson 1991) for which they constitute a major prey group (Todd 1981, McDonald & Nybakken 1991). Nudibranch predators often form close trophic relationships with prey species, in which specialization to the point of stenophagy appears to be widespread (Thompson 1964, Chadwick & Thorpe 1981, Todd 1981, Barnes & Bullough 1996). Variation in prey preferences can arise from ingestive conditioning, the modification of prey preference due to previous experience (Hall *et al.* 1982, 1984), and in some cases dietary specialization is reflected by the radular morphology of the molluscs (Bloom 1976, Nybakken & McDonald 1981).

A number of defensive mechanisms have evolved in prey species of nudibranch molluscs. In the hydroid *Cordylophora lacustris* predation by a nudibranch predator induces a change in colony morphology by means of an increase in stolonal budding rate, resulting in denser colonies which are thought to render settlement of the predators' larvae more difficult (Gaulin *et al.* 1986). Anthozoans display a variety of anti-predator behaviours against attack by the nudibranchs, including tentacle retraction, deployment of nematocysts, column bulging, crawling and even release from the substratum (Edmunds *et al.* 1976, Harris & Howe 1979). In the bryozoan *Membranipora membranacea*, the formation of spines (as spine-bearing specialist zooids in which feeding and budding functions have been lost) is inducible through a soluble waterborne cue emanating from a nudibranch predator (Harvell 1984a), and the spines significantly reduce predation by the mollusc.

Electra pilosa is preyed upon by a variety of organisms, but in British waters it is predominantly exploited by the nudibranch molluscs *Adalaria proxima* (Alder & Hancock) (Fig. 5.1), a stenophagous specialist (Todd 1981), *Onchidoris muricata* and, to a minor extent, the sublittoral species *Polycera quadrilineata* (Müller, 1776) (Fig. 5.1), which is preferentially associated with *Membranipora membranacea* (Thompson & Brown 1976). The relationship between *A. proxima* and *E. pilosa* is intimate to the extent that larval metamorphosis in *A. proxima* is specifically induced by the presence of the bryozoan (Lambert & Todd 1994, Lambert *et al.* 1997). However, two recent unpublished studies (Shaw 1994, Graham 1996) have shown unambiguously that, in contrast to the case of *M. membranacea* (Harvell 1984a), the extended spines of *E. pilosa* zooids are not inducible by *Adalaria proxima*, its main specialist predator.

Inducible morphology generally is adaptive with respect to a primary causative agent, but does not preclude the existence of a fortuitous adaptive function with respect to other secondary agents. For example, structural reinforcements in conifer needles, induced by wind exposure, may also be adaptive in increasing resistance to herbivory and frost (Ennos 1997). It thus seemed conceivable that EMPSs in *Electra pilosa*, although not inducible by its main predator *Adalaria proxima*, might still have a secondary, fortuitous function with minor adaptive effects in reducing or even preventing predation on a given colony. Zooidal spines and specialist spinozooids in other bryozoan species have been shown to be an effective means of hindering or disrupting predation (Harvell 1984a, Cook 1985, Harvell 1986). It was expedient, therefore, to ascertain whether extended spines in this species can either discourage predators from attacking a given colony, or perhaps increase prey handling times and thus reduce predation rates.

The primary objectives of this part of the study were thus —

1. To assess whether or not water flow, wave crash or wave crash-related abrasion are involved in inducing the formation of extended median proximal spines (EMPSs).

Figure 5.1: Nudibranch predators of *Electra pilosa*. Top: *Adalaria proxima*, a specialist predator of *E. pilosa*. Adult *A. proxima* can reach up to 17 mm in length. Bottom: *Polycera quadrilineata*, another nudibranch predator of *E. pilosa*, feeding on its preferred diet *Membranipora membranacea*. Length of individuals approximately 20 mm (both pictures from Picton & Morrow 1994).

Fig. 5.1

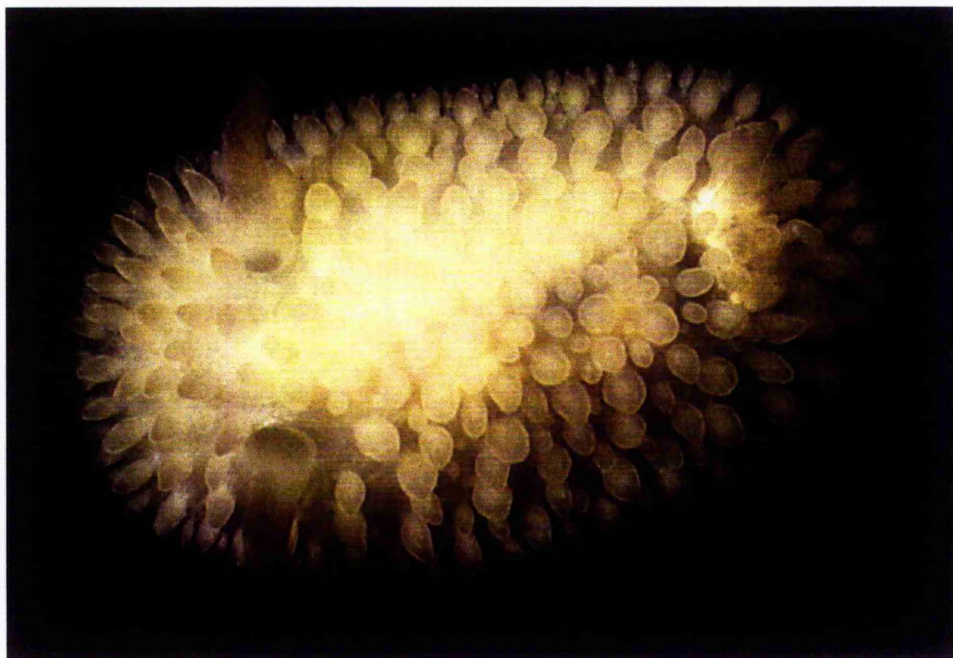

2. To investigate the effect of EMPSs on the feeding behaviour and feeding efficiency of two species of nudibranch predators of *Electra pilosa*.

The simulation of wave action and its associated parameters in the laboratory is a logistically complex and expensive undertaking (Denny 1988). Generating waves comparable to those encountered under natural conditions generally involves large scale, purpose-built basins which were unavailable for the present study. Thus, an inexpensive small scale wave tank was commissioned which generated at least some of the biomechanical forces associated with wave crash (see section 5.2.1). The objective was not to recreate the natural environment but to generate water movement mimicking wave crash in a controlled and manipulable fashion.

To experimentally assess the effect of extended spines on predation, short-spined, long-spined and de-spined *Electra pilosa* were offered to both *Adalaria proxima*, a suctorial predator which removes only the soft tissues of individual zooids, and to *Polycera quadrilineata*, a raptorial predator which consumes the soft tissues of the zooids and also the skeletal components. In a series of experiments, preference patterns were established for prey types and predation rates recorded in relation to the prey type consumed.

5.2 MATERIAL AND METHODS

5.2.1 Effects of water flow and wave action on EMPS development

5.2.1.a) Effects of wave action

This part of the study was intended to provide a first test of the effects of vertical water discharge/wave action on EMPS formation. Recently settled ancestrulae (post-larval "founder" zooids) of *Electra pilosa* were collected on *Fucus serratus* from the shore of Kingsbarns, E Scotland (see above) in November 1995. Colonies were propagated from the ancestrulae, grown onto glass plates and replicated by fragmentation. Six replicate colonies from each of eight genotypes (total n = 48) were used in this

experiment, with triplicates of each genotype in each of two treatments (“exposure”/“shelter”). Glass plates with colonies were held back to back horizontally in randomly allocated slots in two rows in a purpose-built perspex rack (Fig. 5.2). The rack was installed ~2 cm below the water surface in the purpose-built wave tank (Fig. 5.3); to mimic wave action throughout the experiment, a tipping tank mounted 30 cm above the rack discharged 7.2 l of internally pumped water every 20 s. Colonies facing upwards (“exposure” treatment) were subject to vertical water discharge at regular intervals; colonies facing downwards (“shelter” treatment) experienced little water movement, although some mixing of the water surrounding these colonies occurred due to the comb-like base of the rack. The use of an uneven number of replicates within a treatment made a complete randomized block design impossible, but in this experiment the emphasis was primarily on maximizing the number of genotypes tested. Hence, genotypes were represented in each of the two rows by either one or two replicate colonies, with the remainder of the respective replicates in the opposing row. Within rows, colonies were allocated at random using random number tables (Zar 1984). The wave tank was itself situated in thermostatted waterbath at 18°C which was kept in a 10°C constant temperature room. *Rhodomonas* sp. was given at a concentration of 50 cells · μl^{-1} . The experiment was conducted over a period of 6 wk; growth measurements and inspection for EMPS formation were carried out on a weekly basis.

5.2.1.b) Effects of water flow

The experimental set-up described above provided a test of the effects of vertical water discharge/turbulent flow across colonies. In a subsequent experiment, this was contrasted by subjecting colonies to laminar flow. Laminar flow in laboratory set-ups is usually generated by means of linear flumes with water recirculation systems; however, flumes are large, expensive and mechanically complex and were not available for the present study. A simple, small scale construction made from a

Figure 5.2: Schematic representation of the perspex rack used in the wave tank. The rack accommodated 48 glass plates bearing bryozoans, 24 each facing up and facing down. For ease of illustration fewer are shown. Treatment colonies (facing upwards) are subject to direct vertical water discharge from the tipping tank and the resulting turbulence, whereas control colonies (facing downwards) are kept in water showing little movement. Dimensions of rack approximately 60 x 20 x 15 cm.

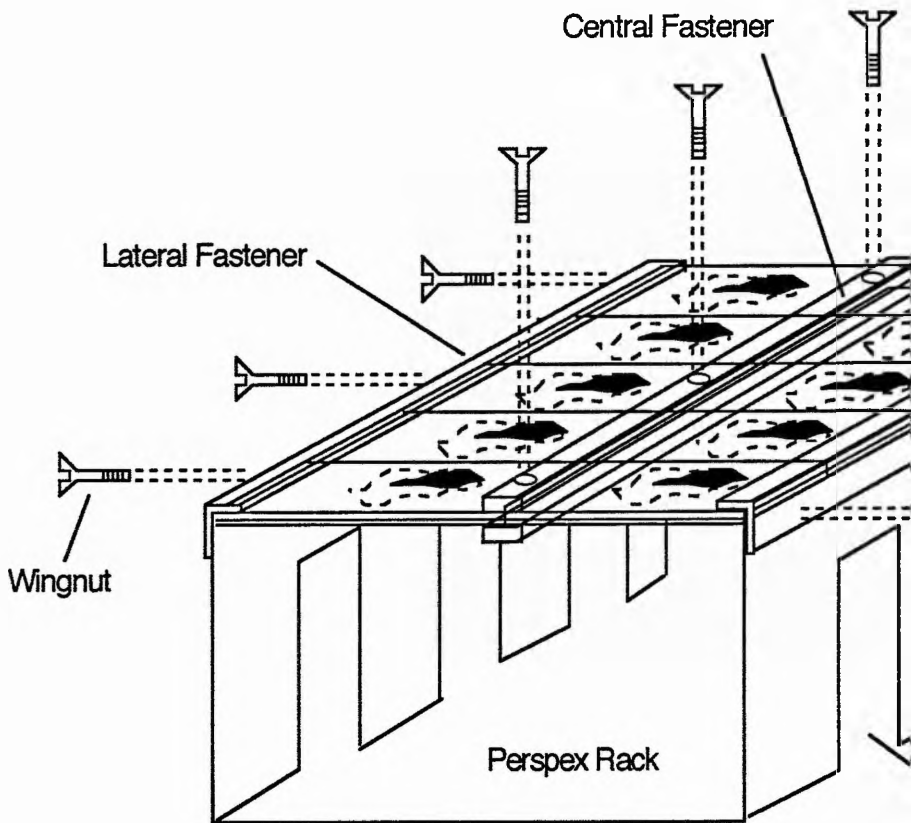

Fig. 5.2

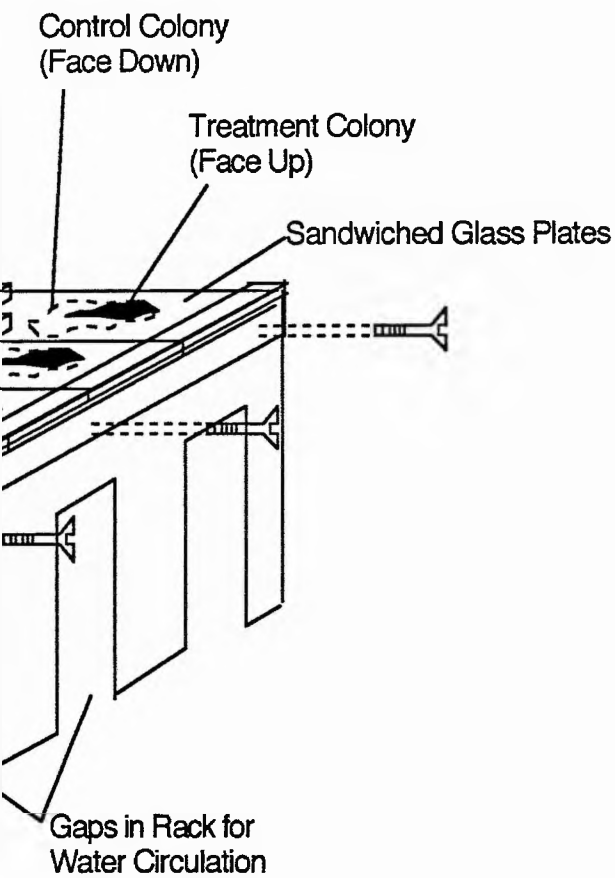

Figure 5.3: Purpose-built wave tank used in the laboratory experiments. The glass tank itself was situated in a water bath at 18° C, kept in a 10° C constant temperature facility. Water pumped from the bottom of the tank constantly flows into the excentric tipping tank which, once full, tips over at intervals of 20 s and discharges approximately 7.2 litres of water onto the rack below. Treatment colonies facing upwards on the rack are thus exposed to constant water motion and wave crash similar to that experienced in the intertidal during immersion periods. Approximate dimensions of tank 70 x 70 x 70 cm.

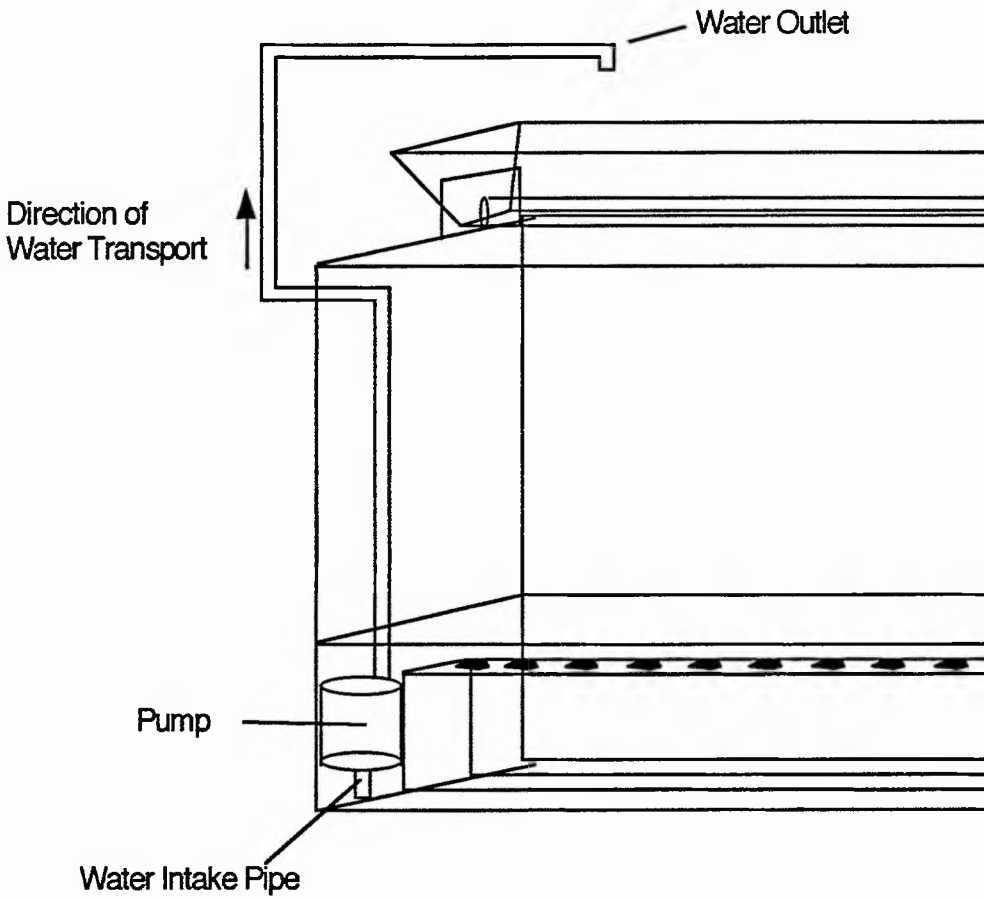
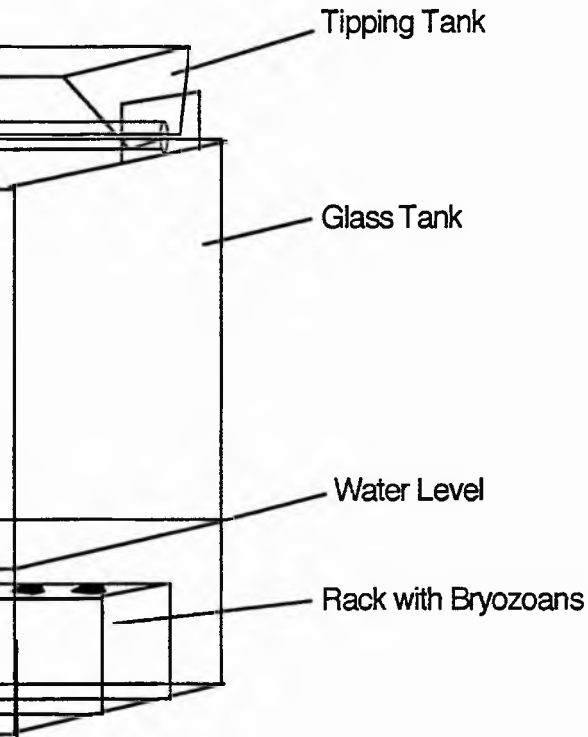

Fig. 5.3



circular pneumatic glass trough (see above) and an electric paddle stirrer was therefore employed (Fig. 5.4). The paddle stirrer, held above the centre of the trough, was fitted with a 8 x 8 cm PVC paddle; holes in the paddle reduced water drag and mechanical load on the stirrer motor. The stirrer rotated at a constant speed of approximately 220 rpm. This provided an approximately laminar, circular flow around the periphery of the glass trough. Colonies of *Electra pilosa* were held horizontally on glass plates attached to the bottom of the trough by means of individual perspex racks. Two glass plates per position were held back to back, with one colony facing up and one facing down. Due to the formation of a boundary layer at the bottom of the trough, colonies on the underside experienced no, or very little, water movement and served as negative controls, whilst colonies facing upwards were subject to fast water flow and served as treatment colonies. A total of eight positions were available in the trough, accommodating 16 colonies in total; four genotypes were used for the experiment, each replicated fourfold (two treatment colonies, two controls). All genotypes were collected at Kingsbarns (see above) in May 1996 and replicated following standard protocol; standard culture conditions (18°C, 50 cells · μl^{-1} *Rhodomonas*) were applied throughout the experiment. Colonies were drawn for growth measurements on a weekly basis. The experiment was terminated after 3 wk and colonies were examined for EMPSs as above.

5.2.1.c) Effects of water flow using colonies on their natural substratum

To further investigate the effects of water flow on formation of EMPS, ancestrulae of *Electra pilosa* were collected from the shore of Kingsbarns (see above) in June 1996 on *Fucus serratus* for a second experiment in the wave tank. Sixty ancestrulae on frond sections approximately 10 cm long were used in the experiment. Frond sections were sewn onto slit pieces of silicone tubing 4 cm in length; these then were attached to the wave tank perspex rack described above by clipping the tubing end into the rack fasteners (Fig. 5.5). This provided the advantage of algal fronds not being damaged

Figure 5.4: Schematic representation of set-up used in the water flow experiment. The trough accommodated 16 colonies (eight each in flow and no flow treatment) in eight positions (for ease of illustration only six are shown). The motion of the paddle causes a circular, approximately laminar flow in the trough. Treatment colonies face up into the moving water, whilst control colonies face down into the boundary layer at the bottom of the trough where water motion is negligible. Trough dimensions approximately 30 cm diam. x 15 cm height.

Fig. 5.4

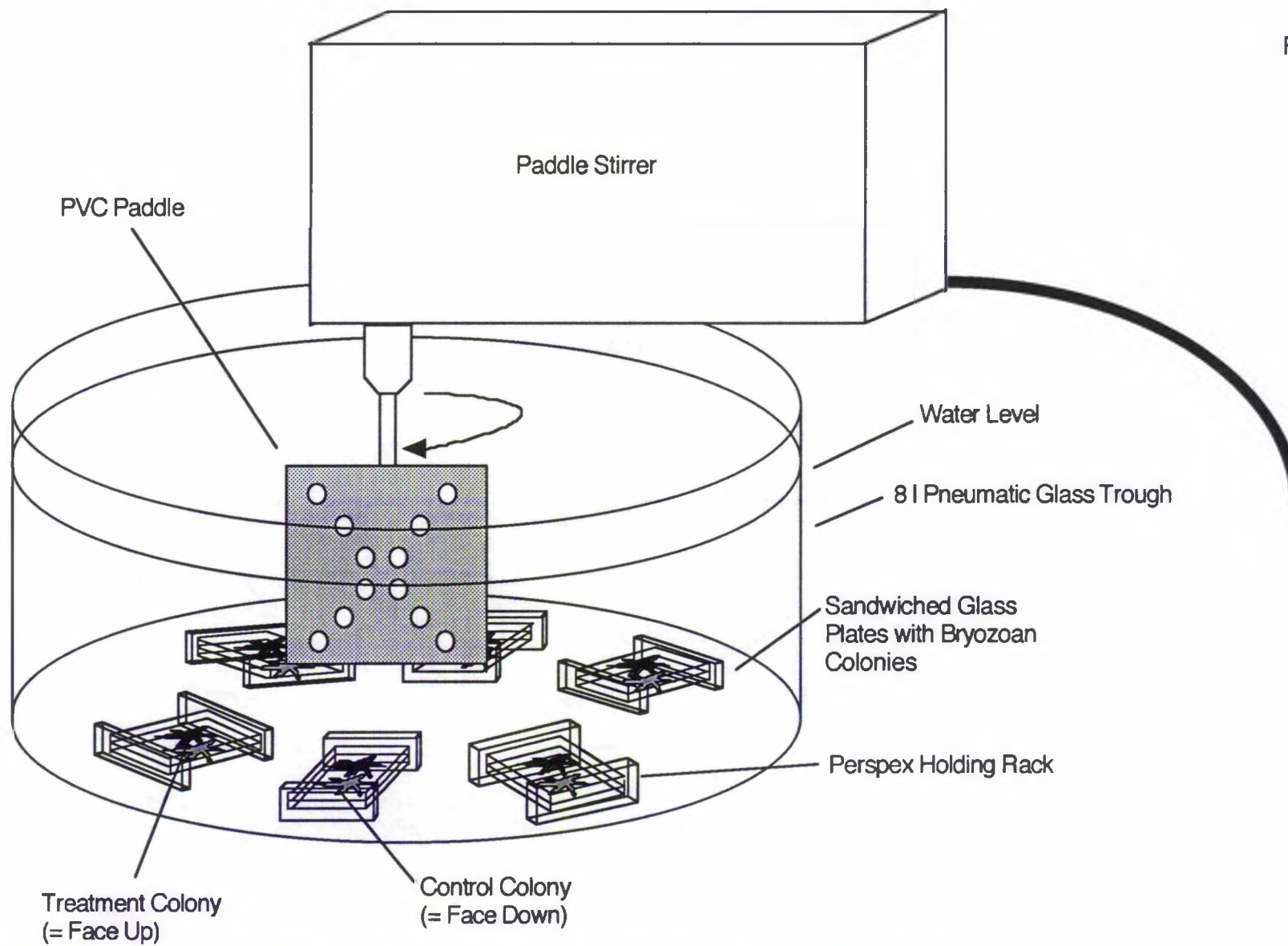
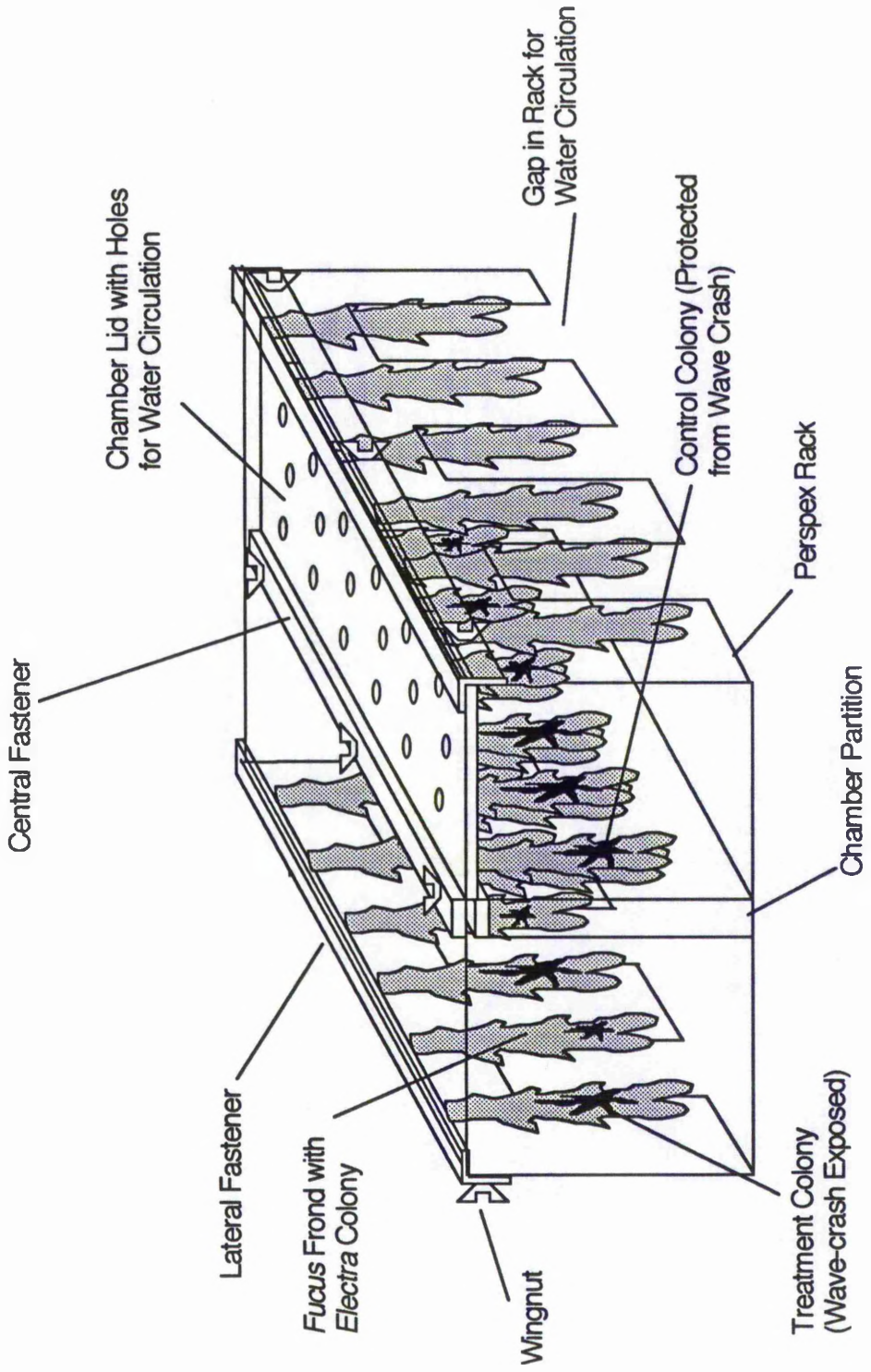

Figure 5.5: Diagram of perspex rack set-up used in water flow/natural substratum experiment. A central partition allowed one half of the rack to be protected from the water impact by closing it off with a perspex lid. This accommodated control colonies (= no water movement), whilst treatment colonies in the other half of the rack were subject to water discharge from the tipping tank. In flowing past the algal fronds bearing the bryozoan colonies, the water discharge generated a mixture of laminar and turbulent flow. Thirty colonies were used in each treatment. The whole rack was placed in the wave tank (see Fig. 5.3). Dimensions of rack as in Fig. 5.2.

Fig. 5.5



by the attachment process which might have resulted in reduced life spans of fronds. The rack was then placed in the wave tank. To provide a negative control, half of the rack, accommodating 30 of the colonies, was sealed off by means of a perspex lid; the other half with the remaining 30 colonies was left open and thus exposed to the vertical water discharge generated by the tipping tank. Thus, treatment colonies experienced a mixture of turbulent and laminar flow during tipping tank discharge, whilst control colonies were not subject to water movement. *Rhodomonas* sp. was given at a concentration of $50 \text{ cells} \cdot \mu\text{l}^{-1}$; the remainder of culture conditions was as described above (section 5.2.a). Colony growth was measured once a week and colonies were examined for EMPSs as before.

5.2.2 Effects of wave-related abrasion on EMPS development

Ancestrulae of *Electra pilosa* were collected on *Fucus serratus* from the shore of Kingsbarns (see above) in July 1996 and replicated by fragmentation. Six replicate colonies from each of four genotypes (total $n = 24$) were randomly allocated to slots in two complete randomized blocks on the wave tank perspex rack. There were two treatments ("intermittent" and "permanent" abrasion) and one control ("no abrasion") group. The experiment was subdivided into three periods: Period 1 provided a phase of undisturbed growth, allowing colonies to attain a size sufficient to prevent whole-colony mortality during abrasion; at the beginning of Period 2, specimens of the filamentous red macroalga *Ceramium rubrum* (Hudson) were attached to the edges of plates allocated to the two treatments ("intermittent" and "permanent" abrasion) to provide wave-generated mechanical stimulation or abrasion of the underlying colony. The algae were removed from the "intermittent" treatment at the end of Period 2, whereas colonies in the "permanent" treatment remained abraded during Period 3. The lengths of periods were determined arbitrarily on the basis of colony growth and hence varied (Period 1 = 18 d, Period 2 = 8 d, Period 3 = 8 d). Throughout the experiment, colonies were drawn on alternate days using a *camera lucida* mounted on a

stereomicroscope to provide a detailed temporal record of colony growth and of EMPS formation. Additionally, colonies were drawn on the last day of each experimental period, thus allowing a direct comparison of the pre- and post-induction status of colonies. At the end of the experiment, colonies were removed from the tank, cleaned with a paint brush in fresh water and air dried. Colonies were then examined under a stereomicroscope, and numbers of short- and long-spined zooids in each colony were counted.

5.2.3 The effect of EMPSs on the feeding behaviour of nudibranch mollusc predators

5.2.3. a) Preliminary preference experiments: *Adalaria proxima*

Adult *Adalaria proxima* were collected from the shore of Clachan Seil, W Scotland (see Ch. 4) in July 1994. Fifteen molluscs were used per treatment; animals were starved for 24 h prior to experiment and then placed in individual 200 ml polypropylene dishes containing either long-spined or short-spined *Electra pilosa*. To standardize the size of colonies offered to predators, discs of 4 mm diameter (equivalent to ~ 40 zooids) were punched out with a cork borer from *E. pilosa* colonies growing on *Fucus serratus*. In all cases, discs were cut from immediately proximal to the distal growing margin to avoid possible variation in zooid palatability (Harvell 1984b). Prey types offered to the molluscs in this experiment were "long-spined" and "short-spined" *E. pilosa*. Due to the patchiness of extended spines within colonies, discs categorized as long-spined rarely consisted exclusively of long-spined zooids; accordingly, the criterion adopted here was a minimum of 50% long-spined zooids. Short-spined discs comprised exclusively of zooids with unextended MPS.

The molluscs were then allowed to feed on the prey for a period of 21 h. Throughout the experiment, dishes were kept in a constantly illuminated room at ambient temperature. Three repeats of the experiment were carried out, using the same molluscs. Mollusc sizes ranged from 2.23 - 5.83 mm (mantle length). At the end of each experiment, *Electra pilosa* discs were removed from the dishes and the numbers

of zooids consumed were counted directly. Data were analysed by ANCOVA (Minitab Version 8.2,1991), using mollusc length as the covariate.

5.2.3.b) Preliminary preference experiments: *Polycera quadrilineata*

Adult *Polycera quadrilineata*, of between 11 and 20 mm body length were collected from the subtidal at Kingsbarns (see above) in August 1994. The design of this experiment was identical to that of the previous, except for a third treatment in which long-spined discs of *Electra pilosa* were artificially de-spined to control for factors that might covary with spinosity. To prepare de-spined discs, extended spines were clipped basally with iridectomy scissors, to render the median spines comparable in length to unextended median spines. Fifteen molluscs were used per treatment (total n = 45). *P. quadrilineata* is a raptorial predator and removes whole zooids which necessitated the measurement of colony area consumed; this was accomplished by means of drawings made by *camera lucida*, which were measured using image analysis. Data were analysed as for *Adalaria proxima* (see above).

5.2.3.c) Finalized preference experiments: *Polycera quadrilineata*

Adult *Polycera quadrilineata* were collected from the subtidal at Kingsbarns (see above) in September 1994 and in July 1996. Short-spined, long-spined and de-spined *Electra pilosa* discs were impaled horizontally through the algal thallus onto short pieces of fuse wire (three to each piece of wire, one of each prey type), which was then bent to produce a trefoil array of the three discs. The trefoil array eliminated the need for randomization of discs and enabled each individual predator to be in contact with all three discs at the same time, thus offering a choice of the three prey type options. Animals were starved for 24 h prior to experiment and then weighed; this provided additional resolution compared to the more inaccurate measuring of body length which varies with body posture. Slugs weighed between 9 and 201 mg when damp dried. The disc arrays and molluscs then were introduced at random

orientations into separate wells of Corning six-well plates containing 3 μm -filtered sea water. Plates were kept at room temperature (21° C) for the duration of the experiment.

Feeding molluscs' positions on the disc arrays were recorded at 1 min intervals for the first 6 h of the experiment; the extent of predation was recorded on a Wild M8 stereomicroscope, fitted with a *camera lucida*, at varying intervals during the experiment, depending on the feeding activity of molluscs (see above). A final observation was made after 24 h. Two repeats of the experiment were carried out. Data from the two experimental repeats were pooled, with experimental repeat as a factor in the model. Feeding rate data were analysed by ANCOVA (SuperANOVA, Abacus Concepts Inc., 1991), using mollusc weight as the covariate. Prey choice data were analysed using *G*-tests for goodness of fit (Sokal & Rohlf 1981).

5.3 RESULTS

5.3.1 Effects of water flow and wave action on EMPS development

5.3.1.a) Effects of wave action

Neither the treatment (= wave crash) colonies nor control (= shelter) colonies developed extended spines in this experiment; the formation of EMPSs is thus unrelated to the effect of wave crash/vertical water discharge alone. Colonies exposed to wave crash grew faster than did control colonies situated in static water conditions, resulting in a significant between-treatment difference in final colony area ($p < 0.001$; Table 5.1, Fig. 5.6). Final colony area ranged from 154.3 - 1150.3 mm² (equivalent to approximately 940 - 7,010 zooids). Genotypes also differed significantly in final colony sizes attained ($p < 0.001$; Table 5.1, Fig. 5.6).

Table 5.1. Twoway ANOVA and descriptive statistics of colony area (in mm²) at the end of the wave action experiment. Six replicate colonies from each of eight genotypes (total n = 48) were used, with triplicates of each genotype being used in each of two treatments (“exposure”/“shelter”). Untransformed data were used in the analysis.

Source	df	SS	MS	F	p
Genotype	7	2231172.03	318738.86	45.93	< 0.001
Treatment	1	266809.98	266809.98	38.45	< 0.001
Genotype x Treatment	7	70332.40	10047.49	1.45	0.221
Residual	32	222055.93	6939.25		

	Mean	s.d.	s.e.	n	Min.	Max.
Control	540.39	217.13	44.32	24	154.33	1045.71
Treatment	689.50	250.15	51.06	24	178.84	1150.25

Figure 5.6: Colony area at the end of the wave action experiment. Six replicate colonies from each of eight genotypes (total $n = 48$) were used, with triplicates of each genotype in each of two treatments (“exposure”/“shelter”). Top: Treatment means (+ 1 s.e.), averaged across genotypes. Bottom: Genotype means (+ 1 s.e.), averaged across treatments. Note differences in ordinate scales.

Fig. 5.6

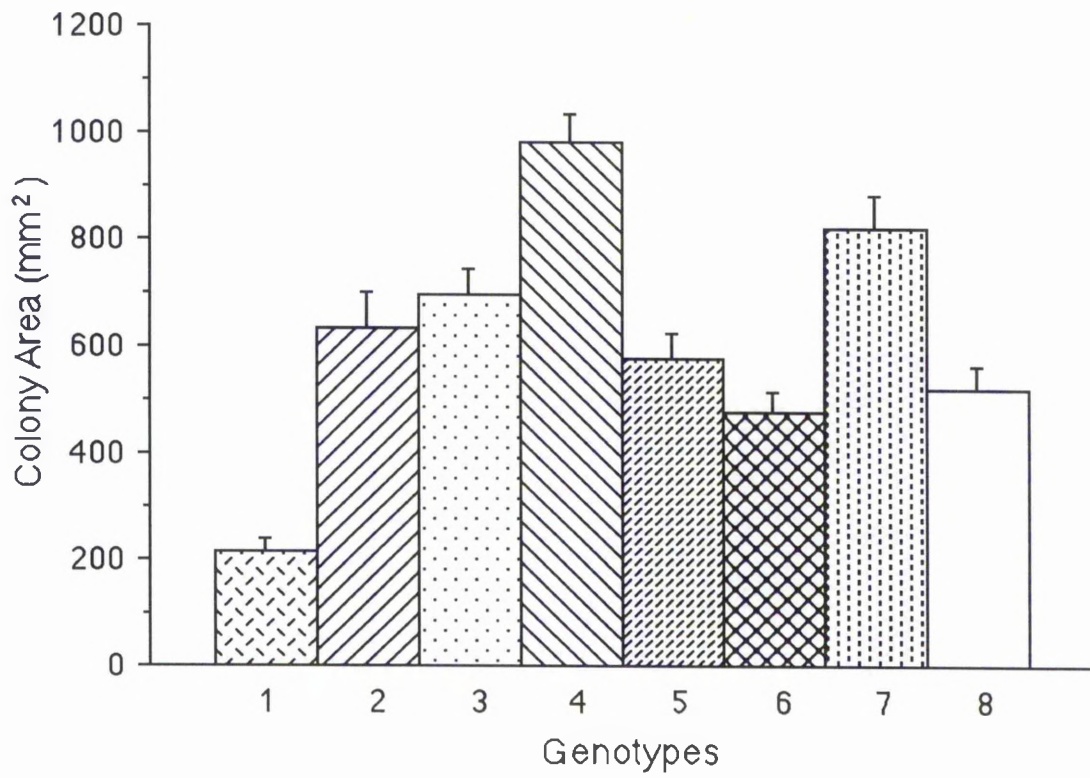
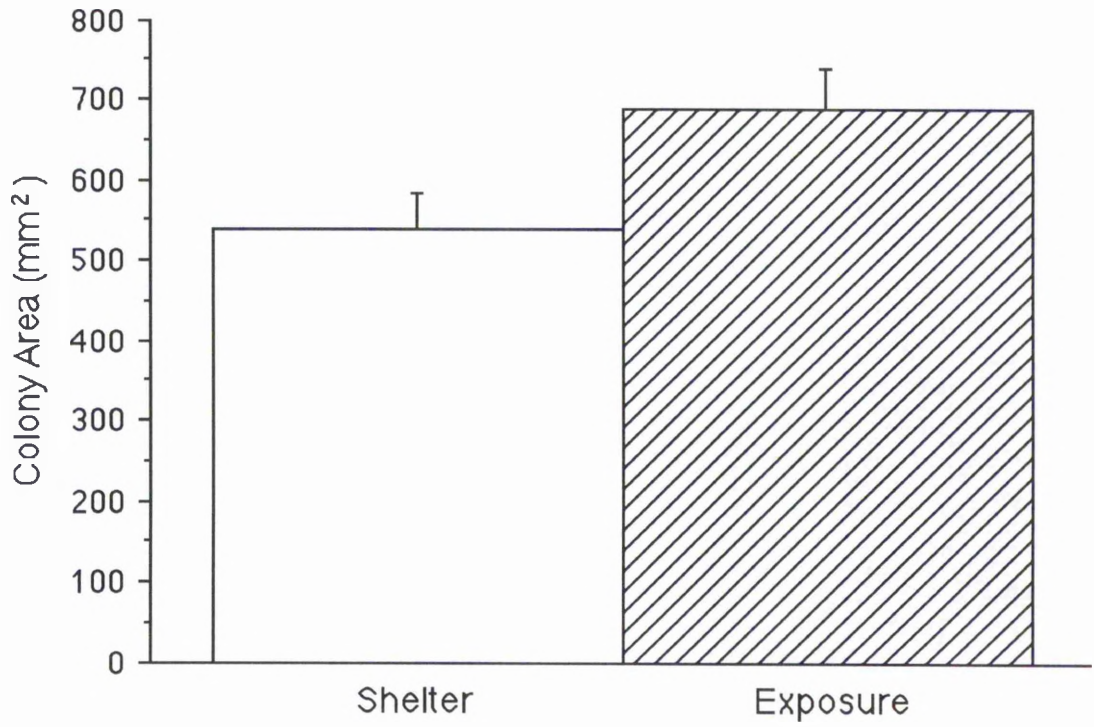

5.3.1.b) Effects of water flow

Colonies in the flow tank grew well and attained normal sizes for their age; final colony areas after 3 wk ranged from 20.7 - 68.7 mm². Again, there were significant differences in growth performance among genotypes ($p < 0.001$; Table 5.2, Fig. 5.7), but no differences between the flow and the no flow treatments ($p = 0.947$; Table 5.2, Fig. 5.7). No EMPSs were formed in either of the two treatments during the experimental period; thus, laminar water flow does not appear to be implicated in the formation of extended spines.

5.3.1.c) Effects of water flow using colonies on their natural substratum

Treatment colonies in this experiment were strongly affected by the water discharge from the tipping tank: within several days a number of colonies were lost due to abrasion caused by contact with the perspex rack. The remainder of colonies, however, grew exceptionally well and attained sizes of 4.6- 849.7 mm² over the experimental period (equivalent to approximately 30 - 5,180 zooids; Fig. 5.8, Table 5.3). Differences among colonies in growth rate were pronounced, and visual examination of colonies suggested that at least some of the slow-growing colonies had failed to bud zooids from one or two of the four budding loci of the ancestrula, thus causing a major delay in colony development. The budding pattern of the ancestrula in *Electra pilosa* is strictly deterministic and all four budding loci are normally activated in a well defined order (Silén 1987). The differences in growth performance among colonies were reflected in a non-significant p -value in a comparison of final colony area between treatments ($p = 0.661$; unpaired t -test; Table 5.3), but mean final area of colonies in the “exposed” treatment was still greater than that of colonies in the “sheltered” treatment (Table 5.3, Fig. 5.8).

None of the control colonies developed EMPSs over the duration of the experiment; however, one of the treatment colonies formed a total of 14 EMPSs during weeks 5 and 6 of the experiment. All EMPSs in that colony developed in

Table 5.2. Twoway ANOVA and descriptive statistics of colony area at the end of the water flow experiment. A total of 16 colonies were used in the experiment; four genotypes were replicated fourfold each (two treatment colonies, two control colonies). Treatment colonies were situated in laminar flow, whilst control colonies were not subject to water movement.

Source	df	SS	MS	F	p
Genotype	3	3268.17	1089.39	52.23	< 0.001
Treatment	1	0.10	0.10	0.00	0.947
Genotype x Treatment	3	38.78	12.93	0.62	0.622
Residual	8	166.86	20.86		

	Mean	s. d.	s. e.	n	Min.	Max.
Total	39.08	15.22	3.80	16	20.66	68.72
Flow	39.16	16.14	5.71	8	21.28	68.72
No Flow	39.00	15.36	5.43	8	20.66	62.02

Figure 5.7: Growth of colonies in the water flow experiment. Data show colony area in mm^2 at the end of the experiment. Four genotypes were used, with two replicates in each of the two treatments (flow/no flow; total $n = 16$). Top: Genotype means (+ 1 s.e.), averaged across treatments. Bottom: Treatment means (+ 1 s.e.), averaged across genotypes. Note differences in ordinate scales.

Fig. 5.7

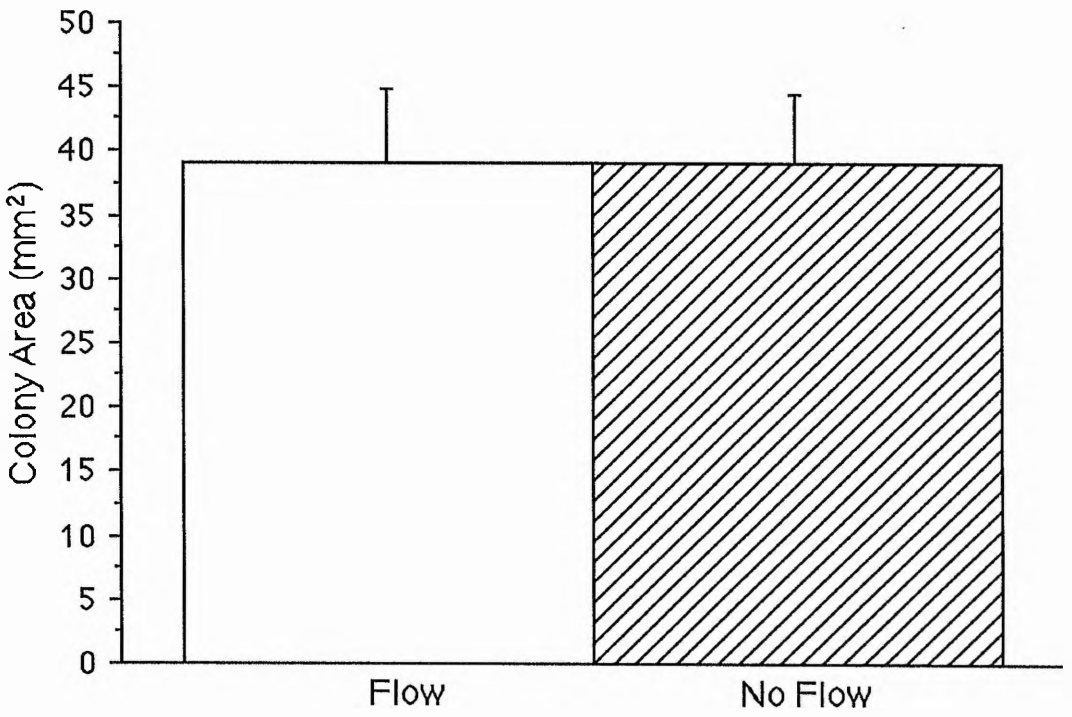
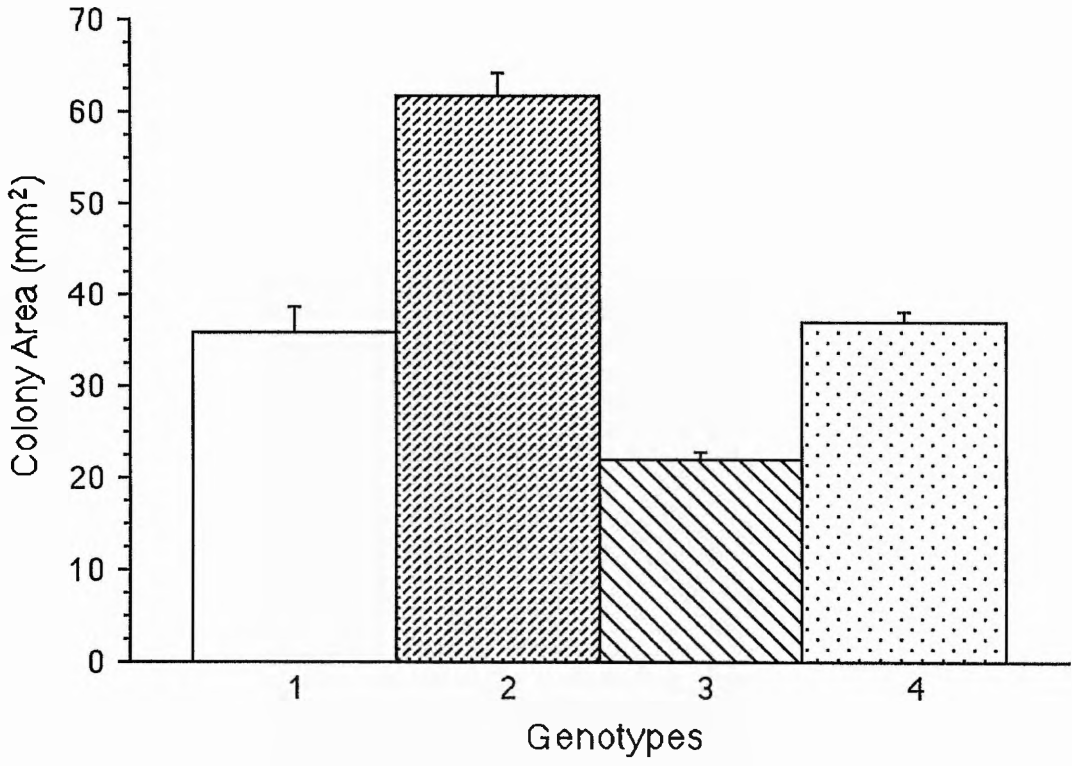

Figure 5.8: Growth of colonies in the water flow/natural substratum experiment. Thirty unreplicated genotypes were used in each of two treatments (flow/no flow). Data show mean colony area in mm² at the end of the experiment, averaged across colonies. The five horizontal lines in each boxplot represent the 10th, 25th, 50th, 75th and 90th percentile of each variable, with values above the 90th and below the 10th percentile plotted separately.

Fig. 5.8

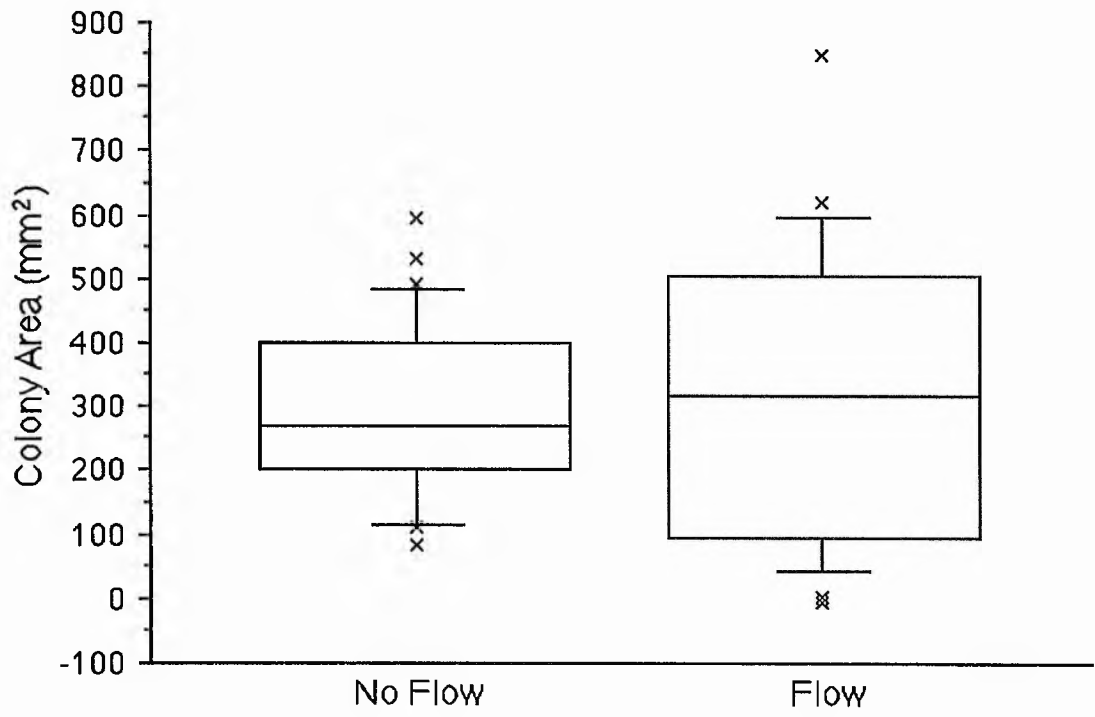

Table 5.3. Unpaired *t*-test and descriptive statistics of colony area (in mm²) at the end of the water flow/natural substratum experiment. 60 colonies on fronds of *Fucus serratus* were used, 30 each in the flow treatment and a negative control (no flow).

	Mean Difference	df	<i>t</i>	<i>p</i>
Control, Treatment	- 22.02	52	- 0.44	0.661

	Mean	s.d.	s.e.	n	Min.	Max.
Total	305.6	181.4	24.7	54	4.9	849.7
Control	295.4	132.9	24.7	29	81.0	593.3
Treatment	317.4	227.6	45.5	25	4.6	849.7

zooids on the edge of the algal frond which had been overgrown by the colony (Fig. 5.9), and closer examination revealed that the frond had been in contact with a neighbouring frond. Thus, water flow mediated by the tipping tank discharge had caused the edges of the two fronds to continually brush along each other, resulting in mechanical abrasion of zooids growing on the frond edge. This strongly suggested that EMPS formation might be inducible not necessarily by water movement alone, but by repeated mechanical stimulation of a colony or abrasion of the colony surface. This finding had important consequences for the further course of this investigation.

5.3.2 Effects of wave-related abrasion on EMPS development

This part of the study was intended to test the hypothesis that EMPS formation can be induced by mechanical abrasion, for example by seaweeds, as suggested by the findings from the previous section. Here, extended spines did indeed form in all colonies that received algal abrasion, but only for zooids budded and fully formed during the treatment periods (Figs. 5.10, 5.11). Some colonies in the “intermittent” treatment did produce a small number of EMPSs following the removal of algal abrasion (Period 3, Fig. 5.11), but zooid maps showed that these all were peripheral buds that were forming whilst still being subject to the stimulus up to the end of Period 2.

Extended spine formation was observed to be a two stage process; initially there is formation of a large basal boss on the zooid wall and the boss then either develops an extended spine, or, in exceptional circumstances, calcifies and forms a spine of length intermediate to unextended and fully extended MPSs. The development of EMPSs commenced within 24 h of exposure to the abrasion stimulus, and was completed within a minimum of 4 d. No EMPSs were formed in control colonies subject only to wave crash. ANOVA revealed significant differences in the percentage of induced zooids among periods, genotypes and treatments in the experiment (Table 5.4); as expected, there also was significant Treatment x Period

Figure 5.9: Formation of EMPSs on edge of *Fucus serratus* frond, induced by accidental scouring of neighbouring fronds in the water flow/natural substratum experiment. Length of individual zooids approximately 600 μm .

Fig. 5.9

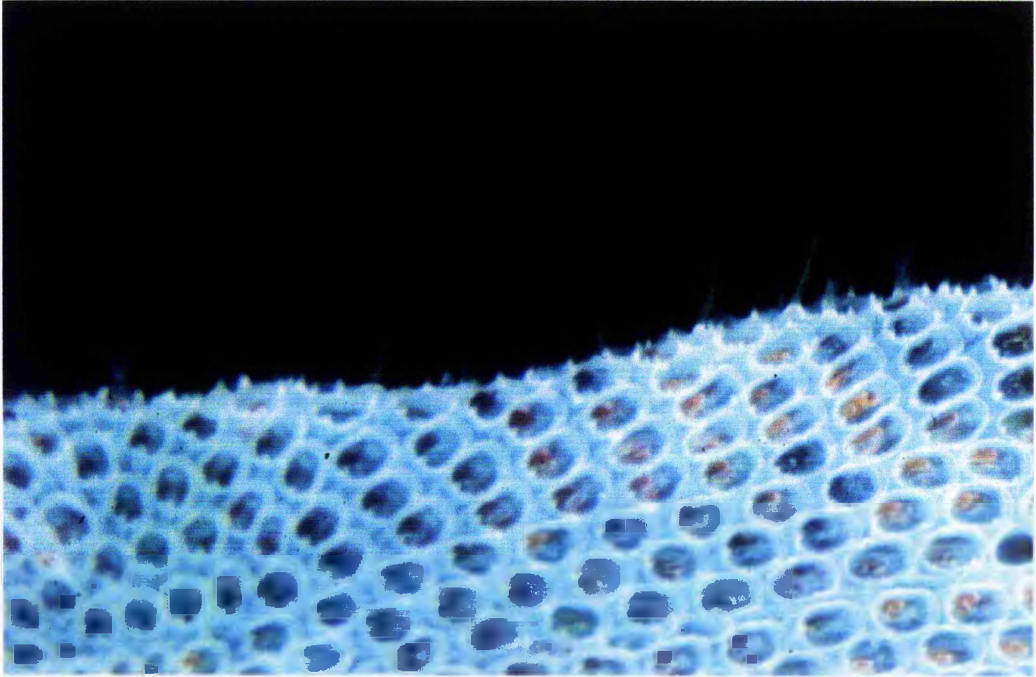

Figure 5.10: Induction of EMPS formation in the abrasion experiment. Top: colony from “intermittent” treatment, showing extensive EMPS formation. Zooids in the centre and right hand section of the picture were formed during exposure to seaweed abrasion (between days 19 and 26 of the experiment), and the majority display the inducible morphology. Zooids which formed before (not shown here) and after (left hand section) the abrasion period are short-spined. Length of individual zooids approximately 600 μm . Bottom: control colony, showing short-spined zooids only; no EMPS formed in any of the control colonies. Zooid length as above.

Fig. 5.10

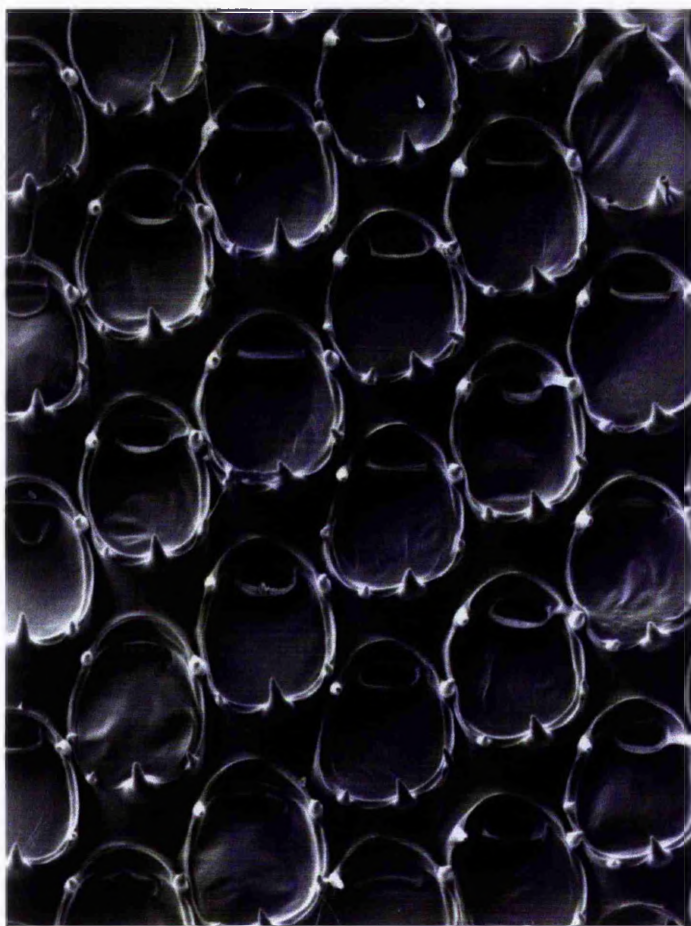

Figure 5.11: Induction of EMPS formation in *Electra pilosa*. Data are percentages of zooids newly formed in each period of the abrasion experiment which displayed the inducible morphology (EMPSs, bosses and calcified EMPS-bosses):

a) control: wave crash throughout, no abrasion (all values zero).

b) permanent abrasion: wave crash throughout, abrasion in Periods 2 and 3 (white fill).

c) intermittent abrasion: wave crash throughout, abrasion in Period 2 only (hatched fill).

Data shown are backtransformed arcsine percentages from 24 colonies (six replicates from each of four genotypes, with two replicates in each treatment).

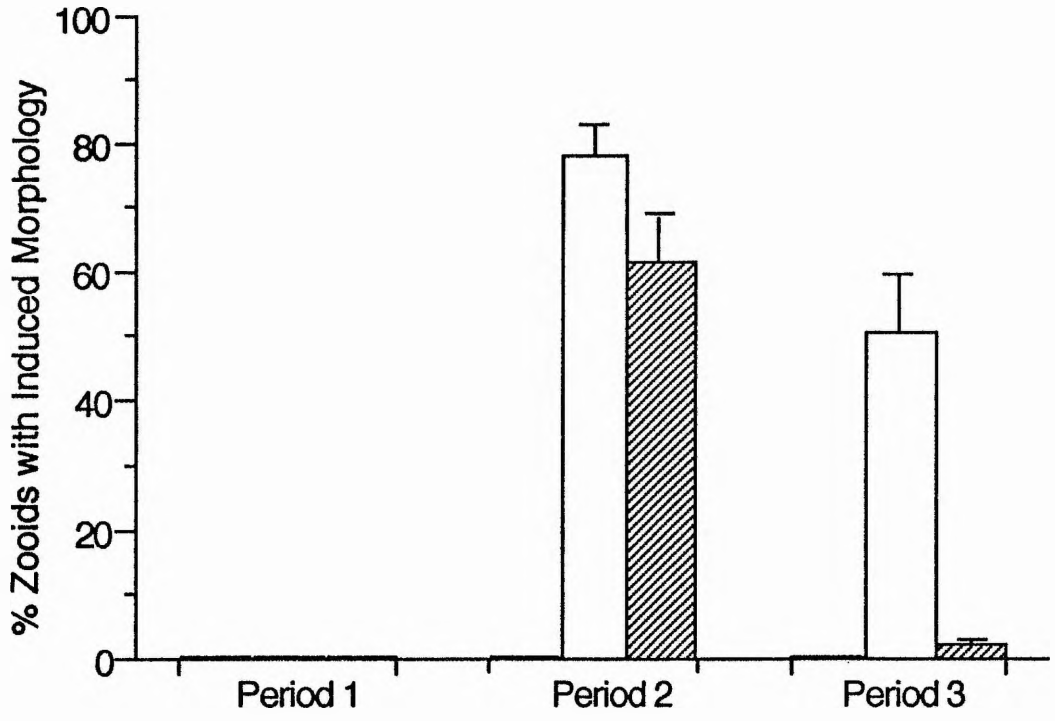

Table 5.4. ANOVA of the percentage of zooids displaying the inducible morphology (EMPSs, bosses and calcified bosses) formed in Periods 2 and 3 of the abrasion experiment. Data were arcsine transformed prior to analysis. Six replicate colonies from each of four genotypes (total n = 24) were used in two complete randomized blocks. There were two treatments (“intermittent” and “permanent” abrasion) and one control (“no abrasion”) group. Data from Period 1 of the experiment and from the control group were excluded from the analysis (all values zero).

Source	df	SS	MS	F	p
Genotype	3	890.57	296.86	4.10	0.032
Treatment	1	4092.75	4092.74	56.57	< 0.001
Block	1	181.56	181.56	2.51	0.139
Period	1	6939.74	6939.74	95.93	< 0.001
Genotype x Treatment	3	56.12	18.71	0.26	0.854
Genotype x Block	3	216.06	72.02	0.99	0.428
Treatment x Block	1	3.27	3.27	0.05	0.835
Genotype x Period	3	468.44	156.15	2.16	0.146
Treatment x Period	1	1267.46	1267.46	17.52	< 0.001
Block x Period	1	0.04	0.04	0.00	0.982
Residual	12	868.13	72.35		

interaction. Despite the pronounced block effect for colony growth (see below) there was no significant block effect on the percentage of induced zooids.

The final size range of colonies was 80 to 2506 zooids (Fig. 5.12, Table 5.5). As expected, final colony size varied strongly with genotype, but there also were block and treatment effects (Table 5.6); growth of colonies in the “permanent” treatment was significantly reduced when compared to that of control colonies, with control colonies attaining approximately twice the final size of “permanent” treatment colonies (Table 5.5). This possibly was attributable to a reduction in the availability of suspended *Rhodomonas* cells to feeding zooids of the treatment colonies, due to a simple screening effect of the algal tufts; alternatively, the observed reduction in colony growth might have been attributable to the energetic costs of EMPS production. Additional sources of variation in colony growth might be increased frequencies or durations of feeding polypide retraction in abraded colonies, but alternative experimental designs will be necessary to distinguish these sources of variation.

5.3.3 The effect of EMPSs on the feeding behaviour of nudibranch mollusc predators

5.3.3.a) Preliminary preference experiments: *Adalaria proxima*

In all three experiments, significantly more short-spined *Electra pilosa* were consumed than long-spined (Table 5.7; Fig. 5.13); mollusc length did not have a significant effect on the number of zooids eaten in any of the experiments. Thus, *Adalaria proxima* did appear to prefer short-spined *E. pilosa*, resulting in molluscs in the short-spined treatment spending more time feeding than individuals in the long-spined treatment. Alternatively, individuals in both treatments may have spent the same amount of time feeding but prey handling time when consuming long-spined prey might have been greater than for the short-spined prey. The numbers of molluscs feeding varied among repeats and ranged from 19 to 27 per experiment.

Figure 5.12: Growth of colonies in the wave abrasion experiment. Data show the number of zooids in colonies the end of the experiment. Six replicates from each of four genotypes were used, with two replicates in each of three treatments (total $n = 24$). Top: treatment means (+ 1 s.e.), averaged across genotypes and blocks. Bottom: block means (+ 1 s.e.), averaged across treatments and genotypes. Note differences in ordinate scales.

Fig. 5.12

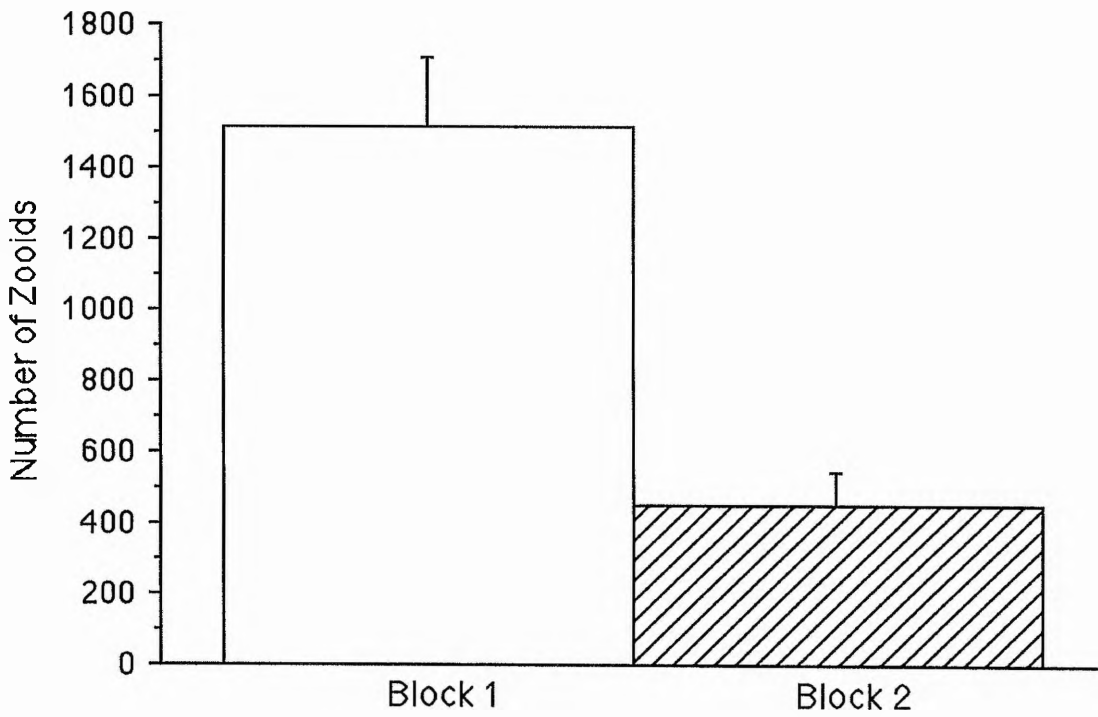
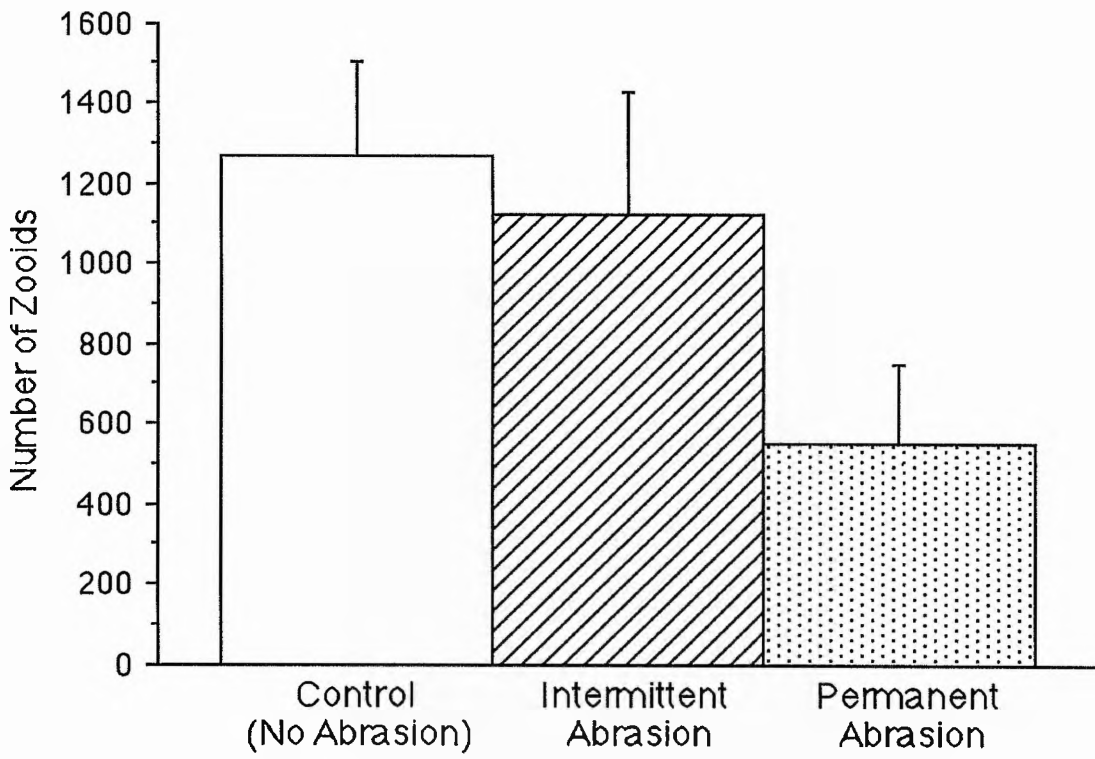

Table 5.5. Descriptive statistics of zooid counts at the end of the abrasion experiment. Data are split by treatment (upper) and by block (lower).

Split by TREATMENT

Treatment	Mean	s.d.	s.e.	n	Min.	Max.
Control	1271.00	657.72	232.54	8	396	2506
Permanent	550.75	570.14	201.58	8	80	1655
Intermittent	1125.00	857.15	303.05	8	149	2200

Split by BLOCK

Block	Mean	s.d.	s.e.	n	Min.	Max.
Block 1	1512.58	672.41	194.11	12	211.00	2506
Block 2	451.92	307.87	88.88	12	80.00	970

Table 5.6. ANOVA of zooid counts at the end of the abrasion experiment. Data were \log_{10} -transformed prior to analysis. Six replicate colonies from each of four genotypes (total $n = 24$) were used in two complete randomized blocks. There were two treatments (“intermittent” and “permanent” abrasion) and one control (“no abrasion”) group. Treatments with the same group labels are not significantly different from each other.

Source	df	SS	MS	F	p
Genotype	3	0.157	0.052	1.09	0.423
Treatment	2	1.062	0.531	11.08	0.010
Block	1	1.885	1.885	39.34	< 0.001
Genotype x Treatment	6	0.344	0.057	1.19	0.417
Genotype x Block	3	0.259	0.086	1.80	0.247
Treatment x Block	2	0.162	0.081	1.69	0.262
Residual	6	0.287	0.048		

Fisher’s Protected LSD

Treatment	Count	Mean	Group Labels
Permanent	8	2.546	a
Intermittent	8	2.893	b
Control	8	3.050	b

Table 5.7. Data summary of preliminary preference experiments (*Adalaria proxima*). Response variable was number of zooids consumed over the duration of each experiment. Data were analysed for each of three experimental repeats separately, using ANCOVA (Minitab Version 8.2, 1991), with mollusc length as the covariate.

	Treatment	Mollusc Length	Number of Molluscs Used	Number of Molluscs Feeding
Experiment 1	$p < 0.001$	$p = 0.099$	30	27
Experiment 2	$p = 0.028$	$p = 0.767$	30	19
Experiment 3	$p = 0.003$	$p = 0.793$	30	27

Table 5.8. ANCOVA of colony area (in mm²) consumed in preliminary preference experiments for *Polycera quadrilineata*. Data were analysed as for *Adalaria proxima* above, using mollusc length as the covariate.

Source	df	SS	MS	F	p
Mollusc Length	1	172.32	172.32	4.19	0.051
Treatment	2	2.27	1.13	0.03	0.973
Error	27	1110.49	41.13		
Total	30				

Figure 5.13: Preliminary comparison of short-spined and long-spined *Electra pilosa* as prey offered to the nudibranch *Adalaria proxima*. Data shown are the mean numbers of zooids (+ 1 s.e.) taken in each of three experiments, split by prey type (hatched = long-spined *E. pilosa*; white = short-spined *E. pilosa*). Fifteen molluscs were used per treatment (n = 30 per repeat).

Fig. 5.13

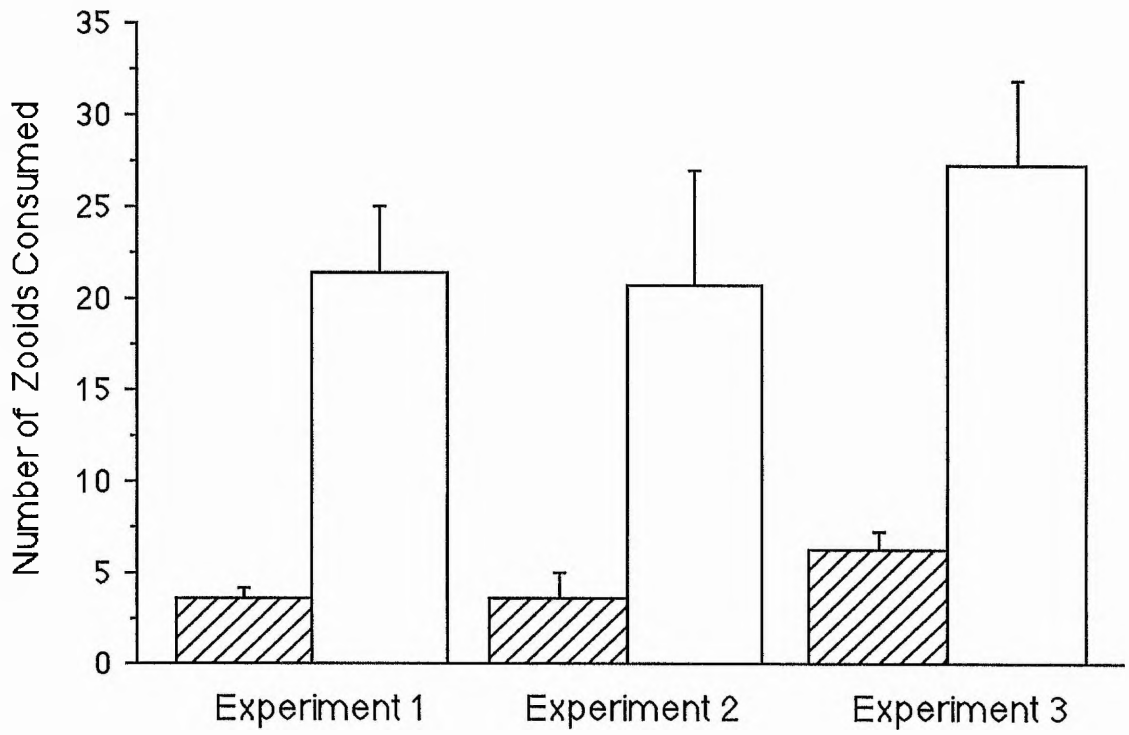

5.3.3.b) Preliminary preference experiments: *Polycera quadrilineata*

For the larger *Polycera quadrilineata* there was no significant effect of either treatment ($p = 0.973$, ANCOVA, as above) or mollusc length ($p = 0.051$) on colony area consumed (Table 5.8, Fig. 5.14), although the latter p -value for mollusc length was close to significance. Thus, there did not appear to be a preference for either of the prey types or a difference in prey handling times among prey types. Colony area consumed ranged between 0.89 and 25.17 mm² (Fig. 5.14). Fourteen out of the 45 molluscs did not feed during the experimental period; most of these had been offered long-spined *Electra pilosa* (de-spined: 3, short-spined: 3, long-spined: 8).

5.3.3.c) Finalized choice experiments: *Polycera quadrilineata*

For this experiment, *Polycera quadrilineata* predation was reduced by EMPSs, as indicated by the significantly lower number of long-spined discs attacked over the duration of the experiment (G -test for goodness of fit, $p < 0.025$, Fig. 5.15). Subdividing tests for planned comparisons between treatments showed that there was no significant difference between de-spined and short-spined discs (G -test, $p > 0.10$), but de-spined and short-spined treatments were significantly different from the long-spined treatment (G -test, $p < 0.025$). An analysis of the proportion of discs attacked during the first feeding bout revealed that significantly fewer long-spined discs were attacked (G -test, $p < 0.025$; Fig. 5.15), again with no significant differences in a de-spined *versus* short-spined comparison (G -test, $p > 0.75$), but pronounced, significant differences between de-spined and short-spined *versus* long-spined treatments (G -test, $p < 0.01$).

There were significant differences in feeding rates among treatments (ANCOVA, $p = 0.034$; Table 5.9, Fig. 5.16), and Fisher's PLSD *post hoc* comparison showed that these were due to a significant difference ($p < 0.05$) between the short-spined treatment and the remainder. Mean feeding rates of *Polycera quadrilineata* feeding on short-spined *Electra pilosa* were almost double that of

Figure 5.14: Preliminary comparison of short-spined, long-spined and de-spined *Electra pilosa* as prey offered to the nudibranch *Polycera quadrilineata*. Data shown are the mean colony areas consumed (+ 1 s.e.) of each of three prey types (hatched = long-spined *E. pilosa*; white = short-spined *E. pilosa*; stippled = de-spined *E. pilosa*). Fifteen molluscs were used per treatment (total n = 45).

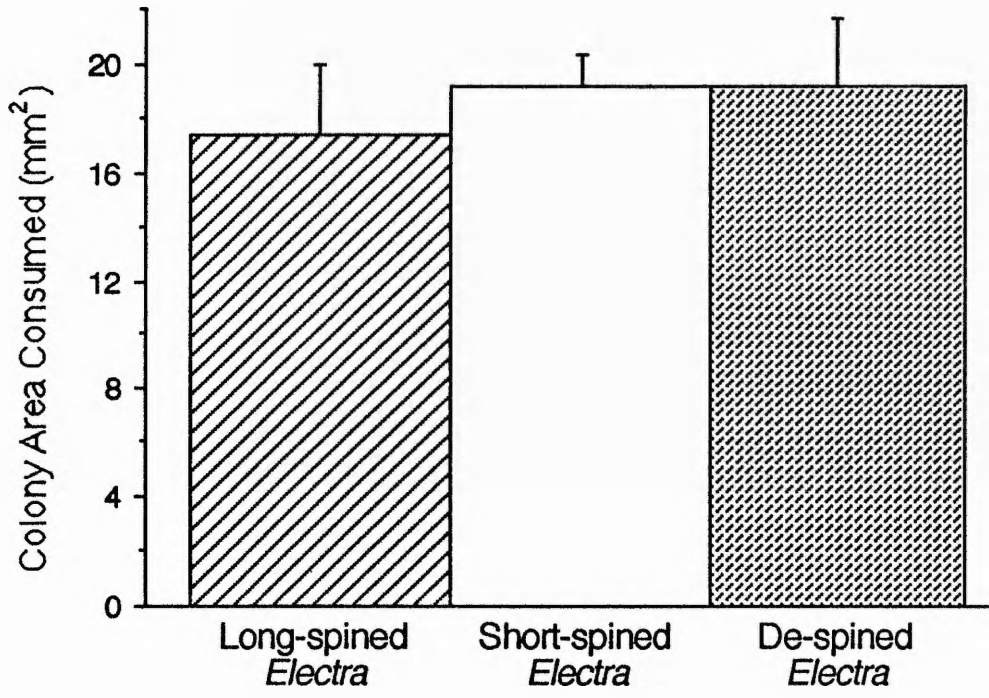

Figure 5.15: Finalized prey choice experiments. Three prey types were offered simultaneously to each mollusc: long-spined *Electra pilosa* (hatched); short-spined *E. pilosa* (white) and de-spined *E. pilosa* (stippled). Data shown are the number of *E. pilosa* discs attacked in the initial feeding period (top) and the total number of discs in each category that had been fed upon by the end of the experiment (bottom), for each of two experimental repeats. Mollusc sample size $n = 34/40$, for repeats 1/2 respectively. Note differences in ordinate scales.

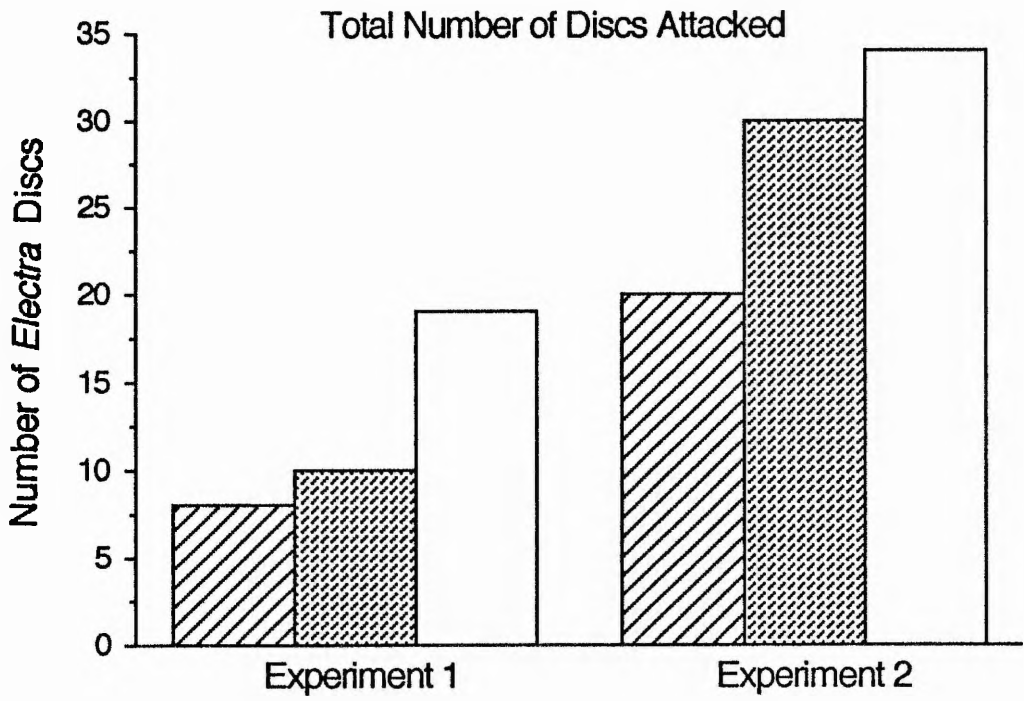
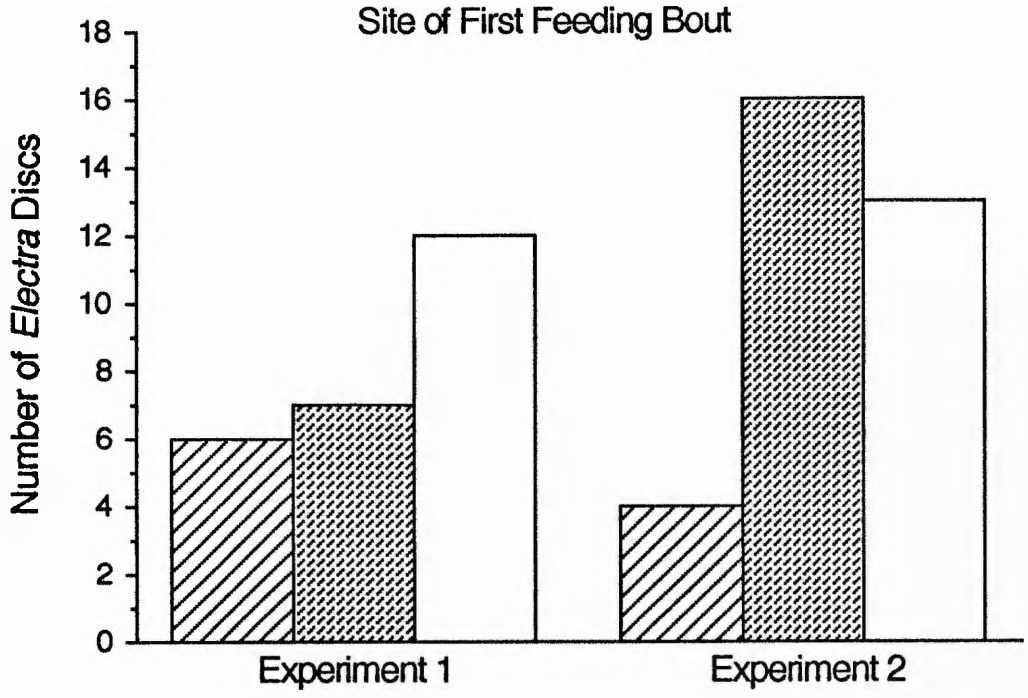

Table 5.9. ANCOVA and Fisher's PLSD *post hoc* test of feeding rates from finalized preference experiments. Untransformed data were used in the analysis. Data are pooled from experimental repeats 1 and 2, using experimental repeat as a factor and mollusc weight as a covariate. Treatments with the same group labels are not significantly different from each other.

Source	df	SS	MS	F	p
Mollusc Weight	1	960.8	960.8	8.51	0.004
Experimental Repeat	1	135.4	135.4	1.20	0.276
Treatment	2	793.9	396.9	3.51	0.034
Repeat x Treatment	2	101.5	50.8	0.45	0.639
Error	91	10279.7	113.0		
Total	97				

Fisher's Protected LSD

Treatment	Count	Mean	Group Labels
long-spined	22	9.698	a
de-spined	35	12.553	a
short-spined	41	18.053	b

Figure 5.16: Feeding rates in finalized prey choice experiments. Data shown are the feeding rates in mm² of colony area per hour (+ 1 s.e.) for each of three types of prey consumed (long-spined *Electra pilosa*, hatched; short-spined *E. pilosa*, white; de-spined *E. pilosa*, stippled), for each of two experimental repeats. For sample sizes see Table 5.3.3.IV.

Fig. 5.16

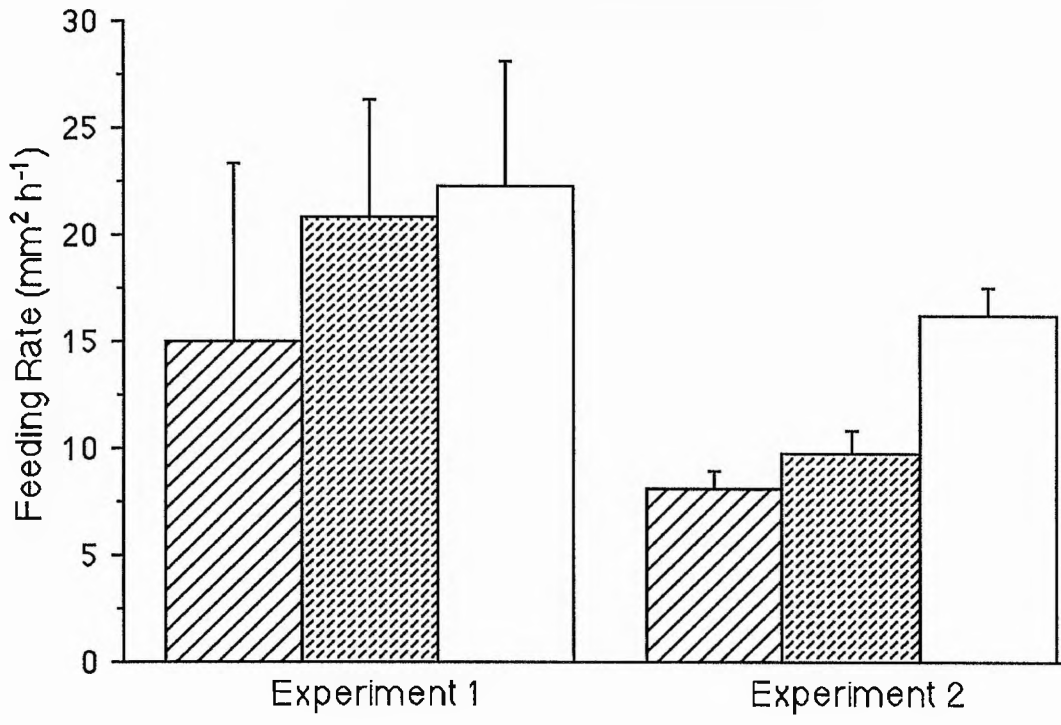

molluscs feeding on long-spined discs (Table 5.10); de-spined discs were consumed at rates intermediate to those in the other two treatments. Feeding rates showed pronounced variation among individuals, with standard deviations ranging between 73 and 93% of the mean depending on the treatment, but differences between treatments were still sufficiently pronounced to produce a significant effect. Feeding rates were not significantly different between the long-spined and de-spined treatments.

5.4 DISCUSSION

Effects of wave action

Exposure of *Electra pilosa* colonies to wave crash/vertical water discharge alone was insufficient to induce the formation of EMPs. None of the colonies in this experiment produced extended spines over the experimental period, although colonies attained sizes comparable to those of long-spined colonies growing under natural conditions in the field. However, it should be noted that the differences between treatments were sufficient to affect colony growth rates significantly: colonies exposed to wave crash grew to larger sizes than did control colonies maintained in still water. The possibility of an artefact cannot be ruled out here, as the experimental design required placement of control colonies in a block separate from treatment colonies, facing downwards. The physics of suspension feeding in an inverted position (for example in cryptic reef environments) have not been investigated experimentally, but it is conceivable that feeding in this position is less effective due to food particles being lost from feeding currents through sinking. However, there are numerous examples of increased productivity of sessile organisms in exposed environments (Jokiel 1978, McQuaid & Branch 1984, 1985, Leigh *et al.* 1987, Levin & Mathieson 1991, Hurd *et al.* 1996) and it is possible that colonies did indeed benefit from the water motion in terms of increased food supply and reduced microfouling, which may translate into enhanced colony growth. Thus, assuming that EMPs are adaptive and that they

Table 5.10. Descriptive statistics of feeding rates from finalized preference experiments.

Experiment 1

Treatment	Mean	s.d.	s.e.	n	Min.	Max.
Short-spined Discs	22.19	20.80	5.77	13	5.00	84.60
Long-spined Discs	15.02	18.62	8.33	5	2.82	48.00
De-spined Discs	20.72	16.38	5.46	9	7.20	60.00

Experiment 2

Treatment	Mean	s.d.	s.e.	n	Min.	Max.
Short-spined discs	16.13	7.40	1.40	28	2.03	35.02
Long-spined Discs	8.13	3.20	0.78	17	2.80	14.00
De-spined Discs	9.73	5.91	1.16	26	1.90	28.42

Experiments 1 and 2 (pooled data)

Treatment	Mean	s.d.	s.e.	n	Min.	Max.
Short-spined discs	18.05	13.22	2.07	41	2.03	84.60
Long-spined Discs	9.70	9.09	1.94	22	2.80	48.00
De-spined Discs	12.55	10.61	1.79	35	1.90	60.00

possibly serve a protective function, it would be difficult to envisage a role for EMPSs in what are already favourable environmental conditions.

Effects of water flow

Laminar water flow — as opposed to the turbulent flow in the previous experiment — also failed to induce the formation of extended spines in *Electra pilosa*. None of the colonies produced EMPSs over a period of three weeks, after which the experiment was terminated. In this experiment, there were no significant differences in colony growth between the flow and no flow environments; thus, enhanced water flow did not appear to exert any effect on colony growth rates. A number of studies suggest that fast laminar flows actually decrease feeding efficiency in bryozoans (Okamura 1984, 1985, Eckman & Duggins 1993). However, the duration of this experiment was less than that of previous experiments and differences in growth rates might well have developed over a longer experimental period. Furthermore, the actual amount of water flow experienced by colonies in the two treatments was not determined. It appeared from observations on the behaviour of particulate matter suspended in the trough that an extensive boundary layer existed at the bottom of the trough which contained the control colonies, and in which there appeared to be little to no flow, whilst treatment colonies were held above the boundary layer in a fast-flowing area.

Thus, it appears that laminar flow is not implicated in the formation of EMPSs, a finding in keeping with the low incidence of long-spined colonies from Clachan Seil, one of the field sites investigated as part of the spinosity study (section 4.3.1). There is virtually no wave action at this location, but as a narrow channel it experiences strong tidal currents of up to 0.87 ms^{-1} a few tens of centimetres above the substratum in peak flows during spring tides (C. D. Todd, pers. comm.; Fig. 5.17). *Electra pilosa* is abundant at this location and occupies a variety of substratum types, but short-spined colonies are particularly prevalent on the large *Laminaria digitata* specimens growing in the high flow areas of the site.

Figure 5.17: Current velocity over a tidal cycle at Clachan Seil, W Scotland.

Measurements of flow velocity were taken in a narrow, shallow part of the tidal channel among the *Laminaria digitata* canopy. Data were collected by deployment of an InterOcean SA current meter which was attached to a concrete block. Time zero here denotes the commencement of the flood tide at the observation site. Data courtesy of C. D. Todd.

Fig. 5.17

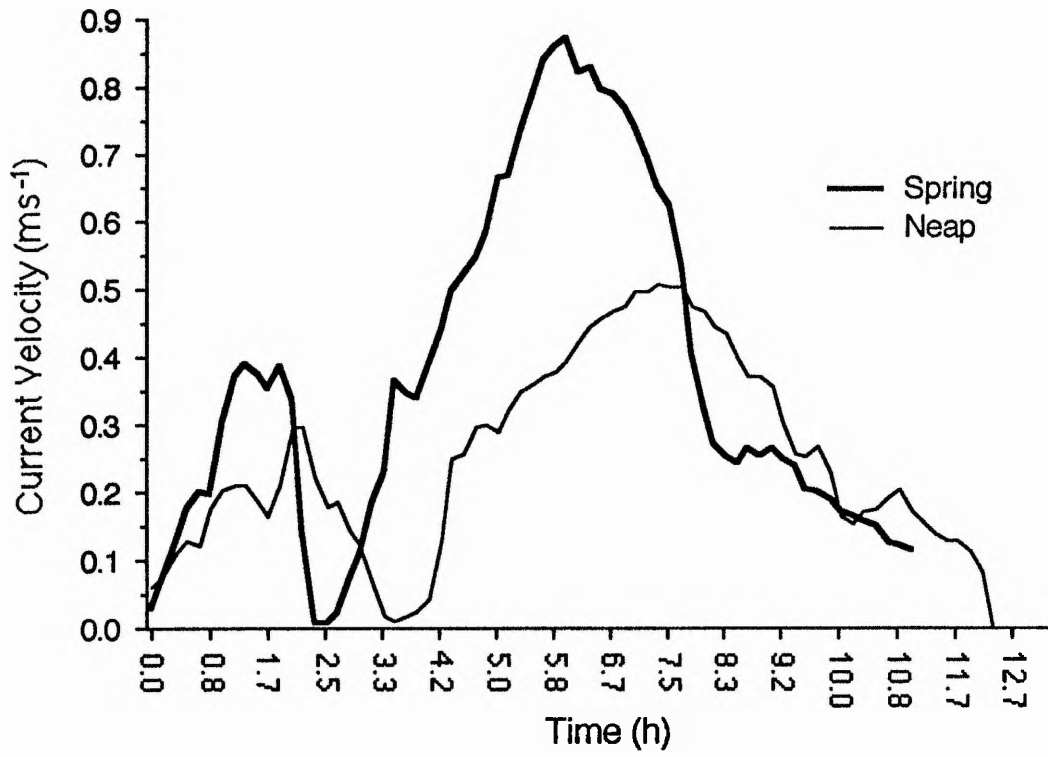

Effects of water flow using colonies on their natural substratum

In this experiment, colonies were reared from ancestrulae on their natural substratum *Fucus serratus* in the wave tank. Colonies growing under protected conditions did not develop EMPSs; however, there was an instance of seemingly “accidental” induction of EMPSs which occurred in a single colony in the “exposed” treatment, in zooids growing on the edge of the *Fucus serratus* frond. It was apparent that two neighbouring fronds had been in physical contact over a period of 7 d, and that zooids growing on the edge of one of the thalli had been subject to scouring/abrasion by the neighbouring frond. All 14 EMPSs formed in this colony can thus be assumed to have formed as a consequence of scouring by an algal frond. None of the remainder of colonies in the “exposed” treatment developed EMPSs over the experimental period, and there was no evidence for physical contact between fronds other than those mentioned above. Again, there appeared to be a trend for colonies in the “exposed” treatment to grow to bigger final sizes, but this trend was not statistically significant, probably due to the pronounced variability in colony growth performances. The experimental design employed here was different from that of other experiments in that unreplicated genotypes were used, thus greatly increasing the variance among genotypes, which may mask real trends. None the less, it was considered expedient to manipulate a wide variety of genotypes to see whether spine induction were possible by this means.

Effects of wave-related abrasion on EMPS development

The accidental induction of EMPS formation by abrasion in the previous experiment had provided a clear indication for the further course of the investigation; in the following experiment, wave-related abrasion was provided by seaweeds on a larger and systematic scale. Here, extended spines formed in all treatment colonies, but only in zooids that were formed and had received the stimulus during the treatment periods.

Control colonies exposed to wave crash only did not form EMPSSs, again confirming results from the previous experiments.

As a consequence of the recording method, in which zooids were recorded only when they were fully formed, a small percentage of long-spined zooids emerged as having formed after the removal of seaweeds, but it was apparent from zooid maps that these had all started to form during the treatment period. Thus, there appears to be a period only early in their ontogeny when zooids are competent to form EMPSSs. This is in keeping with the findings of Harvell (1991) who showed that zooids of the bryozoan *Membranipora membranacea*, induced to form spines by a waterborne cue from a predator nudibranch, have an ontogenetic "window" when they are competent to receive and respond to the stimulus. Older zooids that have not been subjected to the cue during their competent phase lose the ability to form spines.

The fact that EMPSSs were still developing in some zooids after the removal of the stimulus would suggest that there is a certain threshold which is required for the development of the character, and that once that threshold has been exceeded, development of the spine will continue even if the stimulus is removed thereafter. This finding has important implications for the ecology of the EMPSS induction response (for a full discussion of adaptive aspects of the trait see Chapter 6).

Occurrence of abrasion under natural conditions

Knowledge of the effects of scouring/abrasion on marine organisms is at present rather incomplete. Wave-related scour can be mediated by a variety of mechanisms. (i) Suspended particles varying in size from silt to cobbles can have abrasive effects, (ii) seaweeds — attached or unattached — can exert a similar effect, and, (iii) on a much larger scale, floating ice can have highly destructive effects on the sublittoral of polar and sub-polar regions (e.g. Barnes 1995). Only a single study has made mention of the fact that flexible seaweeds might experience abrasion under wave crash conditions (Jones & Demetropoulos 1968). In the only two studies available on

abrasion in bryozoans, Best (1985) and Best and Thorpe (1996) found that silt suspended in the water column caused polypides of *Electra pilosa* to retract, leading to sometimes prolonged periods on non-evagination. It is unclear, however, whether this was due to clogging of the feeding apparatus or simply to the polypide retractor reflex activated by mechanical stimulation of polypides or frontal membranes (Thorpe *et al.* 1975a,b).

Kennelly (1989) carried out a study on the effects of shading and scour of understory species by the kelp *Ecklonia radiata* in New South Wales; it was found that the absence of shading resulted in a mixed response, with some species increasing in abundance, while others showed a decrease. Removal of non-shading but scouring kelp showed little effect overall: only one species, the sea anemone *Cnidopus verrater*, showed a significant preference for unscoured areas. In contrast to this, Velimirov and Griffiths (1979) showed in their study of South African *Laminaria pallida* kelp forests that sweeping by algal fronds (also known as “whiplash effect”) can have a major effect on community structure: there, sweeping by kelp fronds maintained areas free from both mobile and sessile species at ranges of up to 80 cm from surrounding holdfasts. It was argued that this would provide primary substratum space and protection from predation for new *Laminaria* recruits (although this begs the question of how recently settled sporophytes themselves are protected from the sweeping action of fronds of adult plants). Similar findings emerged from two other studies investigating the effect of macroalgal sweeping on surrounding substratum space (Ha Kim & DeWreede 1996, Kiiirikki 1996). In a study on the effects of sand abrasion on colonization of rock surfaces by algal turfs in the Galapagos Islands, Kendrick (1991) found that whilst abrasion can actually enhance recruitment rates, it may also lead to reduced rates of biomass production in established plants. Van Tamelen (1996) showed that scouring by cobbles can reduce the abundance of organisms inhabiting tidepools and also lead to the zonal patterns observed. However, no work has

been carried out on the effects of scouring on the morphology of marine organisms, and the present work is novel in this respect.

EMPSs and predators

The results of the preliminary preference experiments involving the nudibranch predator *Adalaria proxima*, and the findings of a later unpublished study (Wilson 1997), suggest that feeding behaviour in this predator is clearly affected by the presence of EMPSs in colonies of *Electra pilosa*. Here, *A. proxima* given a choice of short-spined and long-spined *E. pilosa* consumed significantly greater amounts of the short-spined prey over the experimental period; this trend was consistent across three repeats of the experiment. However, a potential shortcoming of the present design was that it did not allow a distinction between real preference for short-spined *E. pilosa* or increased prey handling times when consuming long-spined *E. pilosa*. The final experimental design accounted for these sources of variation by recording actual time spent feeding on each prey type (see below).

The same preliminary experiment was also carried out using the nudibranch *Polycera quadrilineata*, a more generalist predator of *Electra pilosa*. This larger species did not show a significant preference for short-spined *E. pilosa* in this experiment, although a trend in this direction was apparent. Furthermore, feeding rates in this and in other nudibranch species appear to vary greatly over time and among individuals (see below), and it is possible that excessive variation of feeding rates may have produced the observed outcome in this experiment.

However, in the finalized, improved design experiments *Polycera quadrilineata* did show a significant preference for short-spined *Electra pilosa*, both in the number of discs attacked during the first feeding bout as well as in the total number of discs that were attacked over the duration of the experiment. This supports the possibility that the results in the preliminary experiments might have suffered from a lack of resolution. The improved design of the present experiments allowed a distinction

between preference for a given prey type and handling time effects, by recording actual time that the molluscs spent feeding. Here, feeding rates were clearly elevated on long-spined *E. pilosa*, suggesting increased prey handling times. Surprisingly, feeding rates also were elevated on de-spined prey, but were intermediate to those for short- and long-spined *E. pilosa*. This suggests either an artefact from the de-spining of zooids, resulting in sharp edges which may have discouraged predation, or, alternatively, covariance of another parameter with the presence of extended spines. Harvell (1984b) examined patterns of intracolony variation of palatability in the bryozoan *Dendrobeatia lichenoides* with respect to a nudibranch predator and found that the accumulation of brown bodies in zooids rendered zooids unattractive for predation. However, brown bodies in the present species are ejected and discarded with the formation of a new polypide (Bayer 1994, Bayer *et al.* 1994), and therefore cannot account for the observed pattern. Increasing calcification of zooids with age does occur in *Electra pilosa* (pers. obs.) but there is no evidence to suggest that zooids bearing EMPs should be of greater age than short-spined zooids.

Mean feeding rates were higher in experiment 1 than in experiment 2, but in the former fewer molluscs fed over the experimental period, resulting in pronounced variability of feeding rates. Molluscs for experiment 2 were collected slightly earlier in the season than for experiment 1 (July rather than September), and the variation in feeding rates in experiment 1 may well have been a consequence of individuals approaching reproductive state which is accompanied by a cessation of feeding in this species (C. D. Todd, pers. comm.); also, 26.5 % of molluscs did not feed in experiment 1 (9 out of 34) whereas only 7.5 % failed to feed in experiment 2 (3 out of 40).

The observed anti-predator function of the extended spines in *Electra pilosa* (although in this case probably fortuitous) is not the only example of a structural defence against nudibranch predation: Cook (1985) observed the feeding behaviour of (unspecified) nudibranchs from Ghana feeding on the putative species *Electra*

“*verticillata*” (= *E. pilosa* in Ryland & Hayward 1977) and reported that the extended spines present in *E. “verticillata”* clearly deterred the nudibranchs from feeding and in one case even caused injury to the mantle of one of the molluscs. Similarly, Harvell (1984a, 1986) showed that the spines induced by a nudibranch predator in the bryozoan *Membranipora membranacea* are effective means of significantly reducing predation by the nudibranch.

CHAPTER 6: GENERAL DISCUSSION

6.1 VARIATION OF COLONY GROWTH RATE AND THE OCCURRENCE OF ZOOID SENESCENCE

The observed genotypic variation in colony growth throughout this study was pronounced, as has been shown by previous studies (Bayer 1994, Bayer *et al.* 1994). Genotypes differed almost sixfold in growth performance over the experimental period; the standard deviation of genotype means was almost 60 % of the mean, compared to the expected 16 % of a standardized normal curve (Zar 1984). The question remains why a strongly fitness-related trait should be subject to this amount of genetic variation. Major components of fitness such as colony growth can be expected to be under directional selection (Via & Lande 1985) until an optimum is reached and stabilizing selection acts to maintain the trait at a narrow optimum, i.e. variation is minimal (Futuyma 1986). Quantitative traits generally are under polygenic control, in that many loci with small additive effects contribute to gene expression ("quantitative trait loci"; Mitchell-Olds 1995). Typical estimates of the number of contributing loci vary between five and 20, but cases of up to 100 such loci have been reported. Genetic variation in fitness-related traits can be maintained indefinitely if the traits are genetically correlated; such correlation can arise if loci pleiotropically affect both traits, particularly if they are negatively correlated (Futuyma 1986), with alleles coding for a positive value of one trait and a negative value of the other. Life history trade-offs, for example between flowering time and size at first reproduction in plants, are indeed frequently caused by genetic correlations between quantitative trait loci (Mitchell-Olds 1995). It is conceivable that both zooid activity and colony shape in the present species are under polygenic control and subject to genetic correlation. Colony growth itself probably is not genetically correlated with either feature but rather affected directly by them, as indicated here by the differing growth trajectories of Genotypes 1 and 5 (see above).

Variation of growth rate under natural conditions

Although it is clear from this study that genotype-related factors cause a major proportion of the among-colonies variation in *Electra pilosa*, it also has become evident that ancestrular budding is critical to the normal growth and development of unmanipulated colonies (section 5.3.1.c). In an experiment using ancestrulae on their natural substratum, *Fucus serratus*, size variation among the unreplicated colonies (= genotypes) was striking (Fig. 5.8), and closer examination revealed that some of the colonies had failed to activate ancestrular budding loci; all of those colonies had grown to sub-average sizes at the end of the experiment. The very early budding pattern of *E. pilosa* colonies is strictly deterministic (Silén 1987), with loci being activated in a prescribed sequence. As a consequence, any failure to activate a locus will result in the loss of one quarter of potential zooids per locus, at least in the early stages of colony development, and the colony may possibly not be able to compensate for this throughout its lifetime.

Adequacy of laboratory culture techniques

The bryozoan culture technique used here was modified from that originally employed by Jebram (1968, 1977); colonies growing on coverslips pre-scored with a diamond knife were split, and the coverslip fragments transferred to experimental plates onto which the fragmented colonies were allowed to grow. Although highly invasive in character, it appears that the present technique is successful and does not introduce any artefacts, as indicated by the high consistency of both colony form and growth rate among replicate colonies from the same genotype (Fig. 3.2). Another modification was made with regard to the collection of stock colonies from the field: the original technique utilized fully developed colonies which have been subject to environmental effects for some time prior to transfer to the laboratory. Here, bryozoans were collected as ancestrulae, to minimize any possible effects of previous exposure to environmental factors. Larval metamorphosis of bryozoans is rapid (~ 20 min), but is

followed by a period of polypide differentiation, which precedes ancestrular budding and lasts several days (Zimmer & Woollacott 1977). Thus, there appears to be a period when the developing ancestrula may be subject to environmental variation both on a temporal and spatial scale. Field observations of *Electra pilosa* support these findings: colonies settled on settlement panels over immersion periods of 26 - 54 d at Clachan Seil, W Scotland (see Chapter 4) show a distinctly leptokurtic size frequency distribution, with a clear prevalence of (presumably differentiating) ancestrulae (Fig. 6.1). This suggests a substantial delay between settlement and initiation of budding in this species, and that ancestrulae do experience at least some exposure to environmental cues. However, any effect of this on subsequent colony development is conjectural, and would require further experimental investigation.

Zooid senescence

Observational zooids in the long term experiment (Chapter 3) were among the earliest budded by the replicate colony fragments and showed clear signs of senescence, indicated by polypide life spans decreasing over the experiment while polypide regeneration times increased. It is a frequently suggested concept that modular organisms should be unaffected by senescence processes at the genet level (e.g. Begon *et al.* 1990, Hughes 1990); however, experimental evidence for this is rather scarce, and little is known about whether or not senescence could instead be expressed at the module (= zooid) level. Examples of module senescence have been reported for most modular phyla, including higher plants (Watt 1947, Hardwick 1986), ascidians (Millar 1971), scleractinian corals (Meesters & Bak 1995) and hydroids (Elmhirst 1922, Strehler 1961, Strehler & Crowell 1961, Brock 1974). Module senescence in the Bryozoa can occur at two levels: zooids may senesce and eventually die (Palumbi & Jackson 1983), but there also is the widespread phenomenon of repeated degeneration and regeneration of polypides within zooids (reviewed by Gordon 1977). Zooidal life span has been established for only a few species but it appears to

Figure 6.1: Size frequency distribution of *Electra pilosa* colonies settled on slate panels at Clachan Seil, W Scotland (see Chapter 4), between 1981 and 1985. Settlement was on the underside of 15 x 15 cm panels bolted in a 'sandwich' fashion, and held apart by 2.5 cm perspex spacers. Settlers were recorded at the end of intervals ranging from 28 to 57 d in length, and numbers of zooids budded by the ancestrula were noted. Note that these data are for ancestrulae which successfully recruited throughout the year and were accordingly subject to differing temperature regimes. Unbudded ancestrulae are indicated by the black fill. Data courtesy of Dr. C. D. Todd.

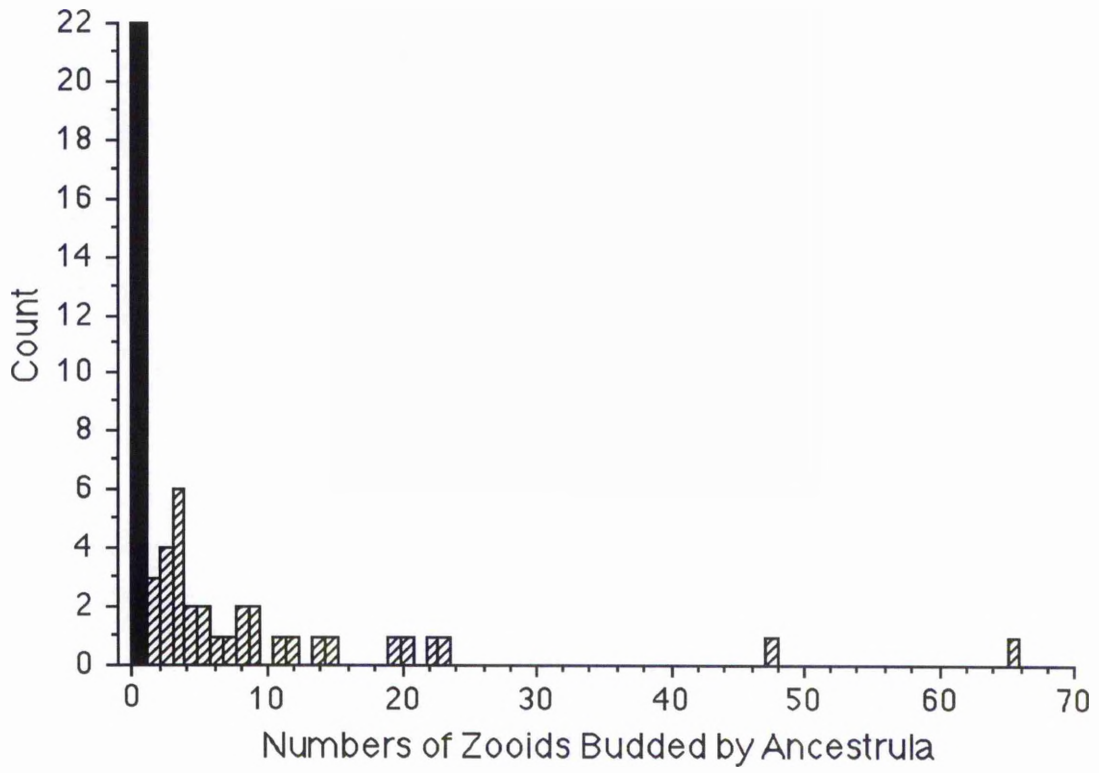

be of the order of several months to possibly years (Cancino & Hughes 1987, Munoz *et al.* 1990). Polypide life spans are highly plastic with respect to environmental conditions but generally range from weeks to months (Gordon 1977).

Here, observations of individual zooids did not encompass their potential longevity. From personal observations in the laboratory it is clear that zooids of *Electra pilosa* do die eventually. The duration of the present experiment was insufficient to establish zooid life spans as such because none of the observational zooids died during the experimental period of 103 d. However, from the long term laboratory culture of strains of *E. pilosa* for the present study it was apparent that zooids do eventually die, perhaps at ages of 6 - 12 months, with zooid death within the colony gradually spreading in a proximal-distal direction (see Fig. 3.13).

The reductions in polypide life span (PLS) and the increases of regeneration time (RT) described here were reflected as a rapidly decreasing proportion of zooids with functional polypides in the observed sample, but this was not the case for younger zooids nearer the periphery of a colony; this indicates that zooids decline in relation to either their age or their relative position within the colony. The rate of senescence probably is deterministic to a large extent and controlled at least in part by the genotype, as suggested by the significant genotype effect for zooid activity. Evidence from a number of bryozoan species suggests that zooids of the same age in a colony mature, reproduce, and senesce more or less simultaneously (Ryland 1979). There is, however, some suggestion that zooid position relative to colony periphery may affect bryozoan zooidal longevity: Muñoz *et al.* (1990) found in a study of three Chilean species that zooid cohorts nearer the periphery had significantly longer zooidal life spans than did those near the colony centre. This they interpreted as an effect of the reduction of zooid metabolic rate with increasing colony size, a finding in sharp contrast to that of Hughes and Hughes (1986b) who suggested that there is no effect of colony size on metabolic rate in *E. pilosa*.

Senescence in *Electra pilosa*, and in many other bryozoans, can also be observed at the level of the polypide (Gordon 1977). Polypides degenerate after periods of several days to weeks and usually are replaced rapidly. In *E. pilosa*, the rate of polypide turnover appears to be controlled by the amount of food ingested by a polypide as well as by the genotype (Bayer *et al.* 1994). Polypide senescence probably is best viewed as what has been termed “organ senescence” (Rose 1991) and may be analogous to, for example, leaf loss in plants or erythrocyte turnover in mammals, in which the replacement of specialized structures is metabolically less costly than their repair (Rose 1991).

In the case of *Electra pilosa*, colonies can be maintained in the laboratory for periods in excess of two years and probably longer and show no signs of whole-organism senescence: despite the senescence and death of proximal colony parts, colonies continue to bud healthy new zooids peripherally and show no signs of physiological deterioration. Senescence at the whole-organism (genet) level would be expected to be expressed in all zooids simultaneously, with death of the colony ensuing, but no evidence for this was observed either in the laboratory or in the field.

Distal investment as an adaptive strategy

In a number of modular organisms older, more proximal, colony parts display symptoms of senescence while growth continues in younger, peripheral parts of the organism. Examples for this can be found in corals, ascidians, hydroids and bryozoans (reviewed by Palumbi & Jackson 1983). The concept of senescence itself being favoured by selection has long since been abandoned (Hoekstra 1993), but it has been argued that rapid distal growth in modular organisms — at the cost of proximal senescence — can be adaptive under certain circumstances (Palumbi & Jackson 1983). The bryozoan *Steginoporella* sp. combines high metabolic investment in distal colony parts with senescence of proximal modules, thus achieving enhanced ‘mobility’ across the substratum (Jackson & Winston 1981) and overgrowth

capability, which in turn lead to relative space dominance in its habitat. Such features also are characteristic of staghorn coral, *Acropora cervicornis*, and bracken fern, *Pteridium aquilinum* (Palumbi & Jackson 1983). In communities dominated by sessile organisms, and hence likely to be subject to intense competition for primary substratum space, these characteristics might well provide a trade-off for the presumed reduction of ramet reproductive potential due to proximal module loss.

Patterns of resource allocation

Alternatively, the observed pattern of proximal deterioration could be brought about by a constraint of resource allocation within colonies, rather than being directly selected for. A source-sink model for the control of colony growth in bryozoans has been proposed by Harvell & Helling (1993), and metabolite transport within the colony, a prerequisite for the model, has been demonstrated in *Membranipora membranacea* (Best & Thorpe 1985, Miles *et al.* 1995). With respect to the present species, it is conceivable that the observed pattern of physiological deterioration of older, central colony parts may not be a result of selection for rapid peripheral expansion, but in itself an inevitable consequence of the active transfer of metabolites from the colony centre (= "source") to the actively growing edge of the colony (= "sink"). In this scenario, the amount of available metabolites required for the maintenance and replacement of polypides in central (= proximal) zooids would decrease with the addition of an increasing number of peripheral zooids, leading to decreased rates of regeneration in central parts, as observed in the present study. Reduced metabolite availability also might account for decreased polypide life spans. Further experimental work might help elucidate the underlying mechanisms here.

Evolutionary constraints

The evolutionary theory of aging predicts that senescence will evolve in any natural population as a result of the declining force of selection with age (Rose 1991). Also,

Kirkwood's disposable soma theory (Kirkwood 1977) states that the resource investment required for indefinite survival (= immortality) will always reduce fitness, and immortality will hence be selected against (Kirkwood & Rose 1991, Holliday 1995). Both theories would predict relative ubiquity of the phenomenon of senescence, at least for sexually reproducing unitary organisms. Assuming that colonial animals have evolved from a unitary ancestor (Buss 1987), it would appear plausible that senescence is an ancestral trait that did not evolve in modular taxa but rather in their unitary ancestors. This assumption is certainly testable empirically, but at present data on senescence in modular organisms are still greatly lacking (Rose 1991).

Can senescence evolve in a colonial organism?

The question still remains therefore whether 'true' senescence (*sensu* Williams 1957) could indeed evolve in a modular organism, rather than being an ancestral trait. Senescence (aging) is defined as a decline in the age-specific fitness components of an organism due to internal physiological degeneration (Rose 1991). Modern evolutionary theory of aging dates back to Medawar (1952), who predicted that the frequency of mutations with age-specific deleterious effects will increase with age for a given cohort. Williams (1957) further developed Medawar's ideas by invoking pleiotropic genes with positive effects early and negative effects late in the life of an organism, thus explaining how genes conferring senescence traits can actually be favored by natural selection. The key assumption in the antagonistic pleiotropy model of senescence is that reproductive probability decreases to zero as a function of age, which leads to the establishment of a "selection shadow" (Hoekstra 1993). Any character negatively affecting intrinsic mortality, expressed at an age where the reproductive probability of an organism is zero, will escape the scrutiny of natural selection because genes will already have been passed on by then, and this may lead to the establishment of senescence. Non-evolutionary theories of senescence are based

on the progressive breakdown of maintenance and repair systems (Holliday 1995) and are not necessarily mutually exclusive with evolutionary theory.

Weismann predicted that aging should occur only in species where there is a separation of soma and germ line (as discussed by Rose 1991). Accordingly, asexual reproduction should confer potential immortality to the genet (though not to the ramet), because the somatic embryogenesis of asexual taxa (see Hughes 1990) allows no clear distinction between germ line and soma. This has been confirmed for prokaryotes (Rose 1991), and also for invertebrates reproducing by fission (Bell 1984), although there also has been one reported instance of senescence in an asexual oligochaete (Martínez & Levinton 1992).

However, in applying a theoretical model to demographic data from three species of scleractinian coral, Orive (1995) showed that senescence can indeed evolve in modular organisms. The spread of alleles that pleiotropically affect early *versus* late life history parameters in a population of clonally reproducing organisms can still lead to the establishment of senescence, albeit at a later stage than for a population of unitary organisms with obligatory sexual reproduction. Orive's model does not specify whether the expression of senescence would occur as simultaneous senescence/death of all modules in a colony (= ramet/genet death) or as sequential senescence expressed at the module level, with modules senescing sequentially as a function of their age. Both scenarios are possible in theory; there is at least one case where the former has been observed in a colonial ascidian (Rinkevich *et al.* 1992), and theoretically it is possible that at least some of the numerous cases of proximal senescence in modular organisms may represent evolved senescence *sensu stricto*.

Traditional models of senescence generally have focused on unitary rather than modular organisms, and are based on the assumption that selection acts at the level of the individual (Buss 1983). There are, however, conflicting opinions on whether selection operates at the level of the genetic individual (genet) only: some authors have argued that because fitness-related characters in modular organisms are expressed at

the level of the module, selection will operate both at the genotype and the module level (Tuomi & Vuorisalo 1989a,b). Regrettably, at present there are no empirical data to support the latter proposition. Theoretical models developed by Gardner and Mangel (1997) predict that whether or not senescence will evolve in a clonal organism is a function of life history traits such as survival rates of individual modules or trade-offs between sexual and clonal reproduction. However, as in Orive's (1995) models, no prediction can be made for the circumstances under which senescence at the level of the module may evolve.

Whether the senescence phenomena observed in *Electra pilosa* can be categorized as evolved senescence or whether they are due to other mechanisms (see above) is a question that will be answered only with additional experimental data. In particular, experimental designs are required that will allow a distinction between age- and position-specific physiological deterioration at the level of the zooid within a given colony. If zooid senescence were indeed a function of the position of zooids within their colonies, then continuous resectioning of the colony periphery to a 'starter cluster' of zooids should lead to indefinite rejuvenation of zooids immediately proximal to the periphery, along with a resetting of the ontogenetic clock at the level of the zooid and a lack of the trends observed in PLS and RT in the present study. In contrast to this, zooids proximal of an unmanipulated part of colony periphery should senesce as the distance to the periphery increases. Under age-specific regulation of senescence, no difference between patches should be observed.

In this context the question emerges whether or not colonies of *Electra pilosa*, as well as other colonial organisms, may be potentially immortal at least at the level of the genet. Genotypes of *E. pilosa* have been maintained in the laboratory for periods of more than two years, showing constant distal growth combined with proximal death, but with no apparent signs of deterioration in zooids budded by the growing edge of the colony. Thus, colonies do not appear to age at the level of the genet, and

the possibility of indefinite propagation of the genotype (= immortality) cannot be ruled out.

6.2 THE EMPS FORMATION RESPONSE

Adaptive significance of EMPSs

The rapid — and presumably energetically costly — formation of extended spines raises questions about their function and potential adaptive significance. In the everted position (Fig. 4.1), lophophores of *Electra pilosa* project above the colony into the water column, and are essentially unprotected; lophophores comprise soft tissues only and have little resistance to shear stresses or impact by solid objects. It is probable that selective pressure for protection of the lophophore is high, as indicated by the extremely rapid lophophore retractor reflex, which is triggered by contact with solid objects (Thorpe *et al.* 1975a,b). The lophophore retractor muscle contracts at a rate of more than 20 muscle lengths per second and thus appears to be the fastest muscle described for any taxon (Thorpe *et al.* 1975a). Fully formed extended spines can be several times the length of everted lophophores (mean EMPS length approximately 1200 μm ; lophophore length approximately 470 μm) and, at least in clusters, may afford considerable protection against mechanical disturbances (Figs. 4.1, 4.2). Protection may not only be afforded to the polypides of EMPS-bearing zooids but also to those of neighbouring short-spined zooids, thus increasing the net fitness gain to the colony (= genotype). None the less, the extent to which long-spined zooids benefit the whole colony is unknown at present and will require further investigation.

EMPSs are uncalcified hollow projections of the chitinous cuticle of the bryozoan zooid (Ryland & Hayward 1977). Chitin is characterized by outstanding material properties, probably the main reason for its ecological success; it combines high stiffness, comparable to that of mussel shell and coral skeleton, with high extension values, resulting in a material of higher breaking energy (the force required

to break a material sample of a given size) than the former two (Koehl 1984, Denny 1987). Additionally, long thin structures such as the extended spines of *Electra pilosa* provide greater flexibility than do short squat structures (Denny 1987); thus, the combination of shape and material properties renders EMPSs extremely tough structures, which will withstand significant impact in a vertical direction whilst retaining the ability to bend when subject to horizontal forces. EMPSs of *E. pilosa* can be bent at the base by 90° in any direction without breakage occurring (pers. obs.).

Adaptive plasticity

The plastic expression of the trait begs the question of why it should not be expressed constitutively, rather than facultatively. Phenotypic plasticity is typical of organisms that inhabit environments that are unpredictably variable both spatially and temporally (Via *et al.* 1995). Adaptive functions of traits and adaptivity of plasticity for a trait have often been confused in the literature (Gotthard & Nylin 1995). Plastically expressed traits may be adaptive, in being beneficial in terms of phenotypic selection, but this need not necessarily apply to plasticity itself. Under certain circumstances, plasticity may not be adaptive, and may even be maladaptive, if, for example, inductive cues are not reliably linked to selective agents (Gotthard & Nylin 1995), or if lag phases between cue perception and trait expression are too long (Padilla & Adolph 1996). Experimentally, plasticity can be shown to be adaptive only if alternative phenotypes can be subjected to the respectively “wrong” and “right” environments, with phenotypes in the “right” environments outperforming their counterparts in the “wrong” environments (Gotthard & Nylin 1995, Schmitt *et al.* 1995, Dudley & Schmitt 1996). For inducible defences, a distinct class of plastic responses (see Chapter 1), conditions for adaptivity of plasticity have been summarized as follows (Adler & Harvell 1990):

- 1) The selective agent is unpredictable and carries a reduction in fitness for the organism.

- 2) Environmental cues tied to the selective agent are reliable and non-fatal.
- 3) There is a cost that partially offsets the fitness benefits of the inducible morphology.

Although not an inducible defence *sensu stricto* (see below), the EMPS formation response of *Electra pilosa* satisfies the above conditions to a large extent. In the following, the applicability of these conditions to the case of *E. pilosa* will be discussed.

Condition 1): The selective agent is unpredictable and carries a reduction in fitness for the organism.

Larval dispersal of *Electra pilosa* is passive and — except for larval microhabitat choice on successful encounter of a substratum — carries an element of unpredictability with respect to the quality of the habitat encountered at the time of larval competence to metamorphose. Spatially, wave exposure may vary at numerous levels: (i) among locations: variation at this level will largely be due to aspect of the site and associated fetch, but also by substratum slope; (ii) macroenvironmentally, i.e. bathymetrically or with respect to habitat level on the shore: this will affect both the degree of wave exposure and the amount of time that an organism is exposed to wave action; (iii) microenvironmentally, i.e. with respect to microhabitat quality (topography of substratum and associated potential for physical shelter): this will determine how much of the potential wave exposure an organism will actually be subject to.

Wave exposure can be variable not only spatially but also on a temporal scale, ranging from daily to seasonally. On the east coast of Scotland, for example, shores experience predominantly offshore winds during the summer, accompanied by a lack of wave action, whereas strong easterly winds may prevail for extended periods during the winter months, causing severe swells and significant physical disturbance in the intertidal of rocky shores. On a daily basis, intertidal and subtidal organisms are subject to short term variation in weather conditions and associated surface wind generated waves.

Exposure to wave-related abrasion probably reduces fitness of *Electra pilosa* through reduced colony growth, as indicated by the reduced growth rate of colonies exposed to abrasion in the present study (Chapter 5). This, in turn, may result in reduced reproductive value: in bryozoans, reproductive value is closely linked to colony growth due to their modular construction, with fecundity being a linear function of colony size or zooid number (Thorpe 1979).

Condition 2): Environmental cues tied to the selective agent are reliable and non-fatal.

In the case of the EMPS formation response, cues are indeed reliable predictors in that the cue and selective agent appear to be identical (= wave-related abrasion). However, in order for the cue to be representative of long term average conditions in a given habitat, there must be a delicately balanced system of thresholds for both intensity and frequency of the cue. Reliability of the cue ultimately is a function of accurate prediction of long term conditions on the basis of present stimuli. Preliminary range finding experiments to establish a minimum stimulation time for EMPS formation indicate that the stimulus must occur for between 1 and 24 h in order for an EMPS to form (data not shown). Accurate estimates of the time threshold rely on even and effective stimulation of all zooids in a colony, a logistically difficult undertaking given the small size of bryozoan zooids. Uneven stimulation of zooids within colonies also is the most likely explanation for the incomplete induction of zooids formed during exposure to abrasion in the present study: EMPS formation never exceeded values of 85% of forming zooids. However, comparable values obtained from field-grown colonies are consistently lower (~ 53% maximum, Fig. 4.12), but probably are affected to a greater extent by temporal variability of exposure than by uneven stimulation. Given the rapidity of zooidal budding it is inevitable that many zooids will form completely during periods of very low wave action and thus remain uninduced.

In the present example, cue and selective agent are seemingly identical, and thus the cue itself is presumably harmful. This is in contrast to, for example, the case of the bryozoan *Membranipora membranacea*, in which the selective agent (predation by a nudibranch predator) and the cue (a waterborne chemical) are separate entities (Harvell 1984a, 1986), and the cue itself is harmless. However, whole colony mortality as a result of physical disturbance generally is rare in modular organisms (Dyrynda 1986), and it thus can be assumed that the cue is at least non-fatal to the genotype as whole.

Condition 3): There is a cost that partially offsets the fitness benefits of the inducible morphology.

Costs may occur in terms of the metabolic expenses of EMPS formation and possibly increased risk of microfouling and siltation of the zooid skeleton. Marcus (1926) observed that EMPSs can entrap significant amounts of sand and silt, which may in turn prevent polypides from everting and feeding, and thus lead to a reduction in colony growth. Estimates of the metabolic expense involved in forming morphological features are difficult to obtain; however, the metabolic cost of the predator-induced helmet and spine of *Daphnia galeata* has been estimated to be only one seventh of the metabolic cost of a single parthenogenetic egg (Riessen 1984). The commonly made assumption that the cost of inducible defences is primarily that of forming the defence thus may be unfounded, as also has been shown for *Membranipora membranacea* (Grünbaum 1997). There, spine production in response to predation by a nudibranch predator causes a reduction in colony growth rate, which originally was assumed to be due to the metabolic cost of spine formation (Harvell 1986). However, Grünbaum (1997) showed that, at least at higher ambient flow speeds, the observed reduction in colony growth is actually caused by hydrodynamic interference of polypide feeding currents by spines. Highly integrated colony morphologies such as that of *M. membranacea* lead to the mutual interference of

polypide feeding currents; this is further aggravated by the presence of spinozooids, which increase the resistance to excurrent flow under the polypide canopy (Grünbaum 1997). There is, however, a transient cost to spinozoid production at the time of their formation, which is reflected in temporarily reduced colony growth and an allocation shift towards sexual reproduction (Harvell 1986, 1992). Thus, lifetime cost associated with spinozooids in that species includes both transient and extended effects, with the latter outweighing the former. It is conceivable that costs of EMPS production in *Electra pilosa* are similar to those of *M. membranacea*, although the nature and morphology of the spines differs considerably between the two species. EMPSs of *E. pilosa* penetrate through the canopy of extended lophophores and thus also form an obstruction in the area under the canopy, which may interfere with excurrent flow to some extent. Regardless, it must be stressed that the nature of the cost is critical to whether or not plasticity for a trait is adaptive; a “one-off” cost is likely to have a much smaller effect than even a minor lifetime cost.

Karban *et al.* (1997) have highlighted the apparently widespread lack of costs of predator-inducible toxins in plants, and has offered an alternative explanation for why a plastic strategy should be favoured over a constitutive response. They argued that plasticity, which leads to increased phenotypic variability within a species, will be favoured when herbivores avoid variable prey types and selective forces counteract the establishing of constitutively high levels of toxin, for example due to autotoxicity.

Evolution of plasticity in individual species

The rarity of wave crash-inducible structures in intertidal organisms is surprising but may reflect the limited range of dispersal in many epifaunal marine invertebrates (Jackson & Coates 1986). It has been argued that phenotypic plasticity will only evolve in an organism if at least some exchange between alternative habitats can occur (Sibly 1996). Many marine invertebrates reproduce by means of relatively short-lived larvae (Jackson 1986; see also Todd *et al.* 1998), and, accordingly, dispersal often

takes place on a scale of several metres. Thus, the range of physical environments available is limited, and in most species there is potential for local genetic adaptation to occur (Jackson & Coates 1986). *Electra pilosa* displays pronounced phenotypic plasticity at a number of levels (Hincks 1880, Norman 1894, Ryland & Hayward 1977), possibly as a consequence of its potential for wide-scale dispersal. Although several authors have argued that planktotrophic larvae are “for” dispersal (reviewed in Todd *et al.* 1998), it is difficult to argue a case for the adaptive significance of dispersal *per se* (Strathmann 1985), and it appears that there is as yet no consensus on the significance of dispersal as an evolutionary strategy. Strathmann (1985) also pointed out that planktotrophic larvae, such as that of *E. pilosa*, do not possess the potential for metamorphosis during the obligatory pelagic phase, and thus dispersal may be enforced, rather than a selected trait, and even may be maladaptive. If this was indeed the case, phenotypic plasticity in *E. pilosa* should be viewed as a consequence of its dispersive potential, rather than a prerequisite for it.

As predicted by theory, constraints on the evolution of phenotypic plasticity may be highly taxon-specific (Moran 1992), and, accordingly, it is difficult to predict where plasticity should evolve. Scleractinian corals, for example, generally are subject to environmental heterogeneity both spatially and temporally, and consequently widespread plasticity should be expected in this taxon. However, the coral *Pavona cactus* displays an apparent lack of phenotypic plasticity, as revealed by high correlation between genotype and colony morphology (Willis & Ayre 1985, Ayre & Willis 1988). Similarly, there is no evidence of an association between habitat and morphology in the genus *Platygyra* (Miller 1994).

All genotypes utilized in this study and the preliminary experiments not shown here, as well as the genotypes in a related study (Hoyle 1997), showed the potential for EMPSs induction after abrasion. It thus can be assumed that plasticity for this trait is widespread in this species, perhaps even to the extent of being an established character. The population genetics of bryozoans with long-lived planktotrophic larvae

have not been well investigated. All but thirty bryozoan species reproduce by means of short-lived lecithotrophic larvae (Jackson & Coates 1986), and it is assumed that genetically they form essentially "closed" populations, with little gene flow occurring among locations. *Electra pilosa* is typical in this respect, because its larval period is approximately 2 mo (Marcus 1926), and larvae presumably are dispersed over long distances, thus precluding small scale genetic differentiation. Population genetic studies of bryozoans with long-lived larvae are scarce, but preliminary proteinogram work has been carried out by Jaguin (1996) and d'Hondt and Goyffon (1993). Both studies suggest clinal variability in a number of loci among European populations of *E. pilosa* and *Membranipora membranacea*, which also has long-lived planktotrophic larvae. Thus, it would appear that local populations of these species are not genetically isolated, but rather differ continuously on a scale of hundreds of kilometres. Given this situation, it is clearly difficult to make predictions about the occurrence of plasticity for EMPS formation in *E. pilosa* in other parts of its distributional range; however, it is possible that the response is not pervasive and only occurs in part of the range of *E. pilosa*, although there is no evidence for this. In contrast to this, the bryozoan *Membranipora membranacea* shows within-population variation for inducibility of spines in relation to a nudibranch predator (Harvell 1998). There, a small proportion of the population (13%) is not capable of producing spines in response to the predator, and some genotypes (6%) produce the spines constitutively, whereas the majority of genotypes (80%) is of the inducible type.

Timing, perception and specificity of the inductive cue

In this study, the formation of EMPSs was observed to commence after as little as 24 h, and the minimum time required for completion of EMPSs was 4 d; in comparison, most other inducible morphologies require longer for complete formation (reviewed in Harvell 1990). It has been emphasized that plasticity can only be adaptive if the time lag between cue perception and phenotypic response is sufficiently short for a

mismatch of phenotype and environment to be avoided (Padilla & Adolph 1996). Wave-related abrasion can presumably be sufficiently rapid and severe in effect to demand a rapid adaptive response of the target organism.

The investigation of cue perception and signal transduction in EMPS formation did not form part of the present study. However, a likely pathway for the perception of the mechanical cues associated with wave-related abrasion is the zooidal nervous system of *Electra pilosa*, which has been studied in detail by Lutaud (1973). The marginal spines of *E. pilosa* zooids are innervated by sensory nerves, with the median proximal spine (MPS) receiving a double supply. Additionally, the cerebral ganglion is situated in the base of the median spine, and, interestingly, Lutaud (1973) has argued that marginal spines may serve a sensory function with respect to mechanical shock or water movement.

The present study utilized the macroalga *Ceramium rubrum* as an abrasive agent; this might prompt the question as to whether chemical cues from this species might be involved in the induction of EMPSs. However, control and treatment colonies were accommodated in immediate proximity of each other, and despite thorough mixing of the water in the wave tank throughout the experiment, none of the control colonies developed EMPSs. Furthermore, preliminary tests preparatory to the main experiment utilized a number of other abrasive agents (*Fucus serratus*, *Plocamium cartilagineum*, plastic sheets), and it became apparent that all of these have the capacity to induce the formation of EMPSs.

Zooid control over EMPS formation

In this study, there did not appear to be a minimum astogenetic age of colonies at which EMPSs may develop, nor was there an effect of colony size on relative spinosity (Fig. 4.7). Colonies as small as four zooids have been observed to possess long-spined zooids (pers. obs.), and EMPS development thus appears to be controlled entirely at the level of the zooid, and to be independent of astogenetic rules (Boardman

& Cheetham 1973). It also is clear that older, fully differentiated zooids have lost the ability to form EMPSs, and that EMPS formation is inducible only during a developmental window early in zooid ontogeny.

The present study clearly demonstrated that EMPS and MPS are discrete, separate characters, and that they thus evolve independently of each other: genotypes differed in rank order for MPS and EMPS length, thus apparently demonstrating an absence of any linkage of the characters. Also, frequency distributions of spine length of fully formed MPSs and EMPSs were bimodal, showing separate peaks for each character. Thus, it can be assumed that selection will act on each character independently. It has been shown that even plastic traits, such as the EMPS of *Electra pilosa*, can evolve rapidly, and that plasticity does not, as assumed previously, lead to the automatic uncoupling of genotype and phenotype (Stearns 1983).

Using existing definitions of zooid polymorphism in the Bryozoa (Silén 1977), long-spined zooids of *Electra pilosa* clearly cannot be defined as heterozooids, because they retain their feeding and budding functions and thus qualify as autozooids. In many cases, bryozoan spines are themselves heterozooids (Silén 1977), but the EMPSs of *E. pilosa* cannot be categorized as such because there is continuity between the coelom and the lumen of the spine (Bobin 1968), and thus EMPS are simply hollow protuberances of the cuticle. This also sets them aside from the specialized spinozooids of *Membranipora membranacea* (Harvell 1991).

Taxonomic implications

EMPSs have given rise to taxonomic controversy on more than one occasion.

Although many varieties of *Electra pilosa* have been described, it would appear that long-spined colonies of *E. pilosa* are so widespread and common that they have been recorded on several occasions as the typical variety (Hincks 1880, Norman 1894).

Their widespread occurrence also seems to have prompted Linnaeus, who first described the species in 1767 (as *Flustra pilosa*) to choose the specific name "*pilosa*"

(from Latin *pilosus* = hairy). Hincks (1880) described five varieties of *E. pilosa* (as “*Membranipora pilosa*”), of which he chose the long-spined morph as the “normal” form. Norman (1894) described no less than ten different varieties of *E. pilosa* (including four free-living forms), many of which included EMPSSs as a diagnostic character. Norman was so impressed by the morphological variation he encountered that he wrote: “The truly marvellous forms above described exhibit an amount of variation in *Electra pilosa*, to which I know no counterpart in the whole range of marine zoology, or, indeed, in any other animal.” (p.121). More than 80 years later, Ryland and Hayward (1977) argued that short-spined and long-spined morphs were conspecific, but an explanation for the coexistence of the morphs was not given. The present study shows that even a distinction between short-spined and long-spined morphs is untenable since the former is readily transformed into the latter (but not *vice versa*). Additionally, the present study also has shown that overall zooid morphology does not differ between morphs (section 4.2.4/4.3.4), as indicated by a lack of natural groups in cluster analysis (Fig. 4.19).

A new type of plastic response?

The combination of an abiotic inductive cue and an inducible morphological defence render the EMPSSs of *Electra pilosa* a unique case which is difficult to accommodate in any of the existing categories of plastic responses. By definition, inducible defences are responses to biotic agents such as predators and competitors (Adler & Harvell 1990, Harvell 1990), and typically they are characterized by the formation of an adaptive morphological structure which arises only in response to a specific cue and would otherwise be absent (Table 1.2). Thus, they fall into the category of developmental conversions (Smith-Gill 1983), which result in the occurrence of two or more discrete morphs within a species (= polyphenism). The remainder of phenotypically plastic responses are predominantly attributable to variation in physical factors, such as temperature, photoperiod or availability of resources (Table 1.1), and

result in continuous, rather than discrete, variation in the affected trait(s), which may or may not be adaptive (for the special case of seasonal polyphenism see Chapter 1). The developmental mechanism implicated in these responses is referred to as phenotypic modulation (Smith-Gill 1983), and is based on quantitative variation in gene expression. The EMPS formation response of *E. pilosa* clearly falls into the category of developmental conversion/polyphenism, because MPSs and EMPSs have been shown to be discrete characters (Chapter 4), and EMPSs probably can be assumed to be adaptive. Despite these similarities with inducible defences, however, EMPS formation cannot be easily be categorized as such, since the inductive cue for EMPS formation is abiotic (wave-related abrasion) and, at least superficially, continuously variable. It can only be assumed that mechanical stimulation of zooids is filtered through a threshold system and transduced as an all-or-nothing signal, making it qualitatively comparable to biotic cues (which are either present or absent). Threshold systems are thought to operate on the basis of hormonal levels exceeding critical values which thus — directly or indirectly — trigger gene expression (Roff *et al.* 1997).

EMPSs and interspecific overgrowth competition

In the light of the present findings, a re-evaluation of the data from Stebbing (1973b) appeared expedient. Stebbing analyzed large numbers of *Electra pilosa* growing on *Fucus serratus*, with respect to the occurrence of EMPSs and potential causal factors. He found a prevalence of long-spined zooids on convexities of the algal thallus, such as the mid rib and frond edges (statistically significant in analysis by M. Bayer, chi-square test, $p < 0.001$ for both categories), and argued that extended spines may afford protection from abrasion and buffeting by adjacent fronds. He also found that *E. pilosa* in competitive overgrowth encounters with the bryozoans *Flustrellidra hispida* and *Alcyonidium hirsutum* tended to be short-spined, whereas colonies in contact with *Alcyonidium polyoum* tended to be long-spined. The frequency of

overgrowth of *E. pilosa* by these competitors was inversely related to the proportion of long-spined colonies in each sample, but no statistical test was carried out to corroborate this (raw data unavailable). This was interpreted as being due to EMPSs halting overgrowth, although no data were collected to show that this was actually the case; thus, the effectiveness of EMPSs in halting overgrowth is largely anecdotal and experimentally unsubstantiated. Furthermore, interspecific overgrowth of competing bryozoan colonies usually is partial, rather than total, even in the absence of spines or similar structures: growth of the overgrowing colony usually stops several rows of zooids into the overgrown colony, and is frequently redirected to other colony parts (pers. obs.). An alternative explanation is that EMPS induction in *E. pilosa* adjacent to other species is a function of their height relative to that of *E. pilosa* colonies, with neighbouring colonies acting as “spacers” with regard to abrasion by algal fronds and thus affording at least partial protection from the inductive cue to *E. pilosa* colonies; the order of the relative height of colonies among species (*F. hispida* > *A. hirsutum* > *A. polyoum*) is inversely related to the proportional incidence of EMPSs in neighbouring *E. pilosa* in Stebbing’s (1973b) study (*A. polyoum* > *A. hirsutum* > *F. hispida*).

Hydrodynamic effects of bryozoan spines

An alternative interpretation for the adaptivity of bryozoan spines has been offered by Whitehead *et al.* (1996) for the ctenostomatid *Flustrellidra hispida*. There, numbers of zooidal spines vary in relation to both water flow and genotype, with genotypes from exposed shores having more spines than those from sheltered locations. Whitehead *et al.* (1996) argued that the adaptive significance of spines in *F. hispida* may be to vertically extend the boundary layer overlying the colony to facilitate feeding in flow. However, existing studies show that laminar boundary layers are generally detrimental to sessile suspension feeders due to the lack of turbulent mixing which is a requirement for the provision of food and nutrients, as well as for fertilization (Vogel

1981, Denny 1988). Consequently, most sessile suspension feeders have evolved adaptations to disrupt boundary layers and make flow turbulent (Denny 1988), and the spines of *F. hispida* may well fall into that category. Whether or not this may apply to the present species is at present open to conjecture, and requires experimental investigation.

Spontaneous formation of EMPSs

There were several instances of seemingly spontaneous formation of EMPSs in unmanipulated colonies in this study (sections 4.2.3/4.3.3 and 4.2.6/4.3.6) and, prior to this, in the ongoing culture of laboratory stocks of *Electra pilosa*. Their induction remains unclear, but a striking feature of EMPS formation was that in both cases it occurred systematically in the largest genotype (in section 4.2.3/4.3.3 two other genotypes also formed EMPSs, but numbers formed were negligible; see Table 4.7). The effective maintenance of colonies in the laboratory requires regular cleaning, which in the present study was undertaken twice a week using an artist's paintbrush. It is conceivable that EMPS formation was accidentally induced by brushing with the paintbrush, and that larger colonies, which required brushing for longer periods, may have received sufficient stimulation to induce EMPS formation.

Effects of substratum type on spinosity

The present study did not compare spinosity of *Electra pilosa* growing on different substratum types. A related study (Gamwell 1996), however, compared seven different substrata that are exploited by *E. pilosa*, and found that small macroalgae with complex morphologies generally bear *E. pilosa* with higher proportions of long-spined zooids than those growing on *Fucus serratus* and *Laminaria digitata*; the species studied included *Chondrus crispus*, *Mastocarpus stellatus*, *Palmaria palmata*, *Plocamium cartilagineum* and *Ceramium rubrum*. These species all share a more complex morphology than the frondose *F. serratus* and *L. digitata*, and it has been

argued that this type of macroalga has relatively high drag coefficients and consequently experiences severe accelerational forces (Gaylord *et al.* 1994). This might translate into increased rates of abrasion and thus may account for the increased spinosity of *E. pilosa* colonies associated with these substratum types. An alternative hypothesis — that a cylindrical substratum morphology alone, in the absence of water movement, might induce EMPS formation — was rejected (Gamwell 1996).

Fortuitous defence against predators

Although the extended spines of *Electra pilosa* can be an effective antipredator device against two mollusc species with contrasting feeding strategies, it has been demonstrated unambiguously that, in contrast to the spinozooids of *Membranipora membranacea*, EMPSs in *E. pilosa* zooids are not inducible by the predators themselves (Shaw 1994, Graham 1996). Their fortuitous, secondary function as a defence against predators can thus be viewed as adaptive *sensu* Gotthard and Nylin (1995), but not as an adaptation in itself. Gotthard and Nylin (1995) argued that a trait may be adaptive, i.e. beneficial, with respect to a function for which it was not “designed”, whereas an adaptation *sensu stricto* has been “designed” specifically for the function.

A full understanding of the effect of EMPSs on predators also requires an analysis of the distribution patterns of the species involved. *Adalaria proxima* occurs both intertidally and subtidally but intertidal populations show clear distributional variations in association with wave action. On the wave-exposed east and west coasts of Scotland the nudibranchs occur predominantly beneath stable rocks (where *Electra pilosa* is comparatively rare), whereas on the sheltered coasts (especially sealochs) of western Scotland the molluscs are found exclusively on *Fucus serratus* and *Laminaria digitata* plants (Todd *et al.* 1998). It is apparent, therefore, that in locations characterized by long-spined colonies (e.g. on macroalgae on wave-exposed shores) the bryozoan is only rarely exploited by *A. proxima* and that epibiotic populations of

the mollusc are most frequent in locations where short-spined colonies predominate. Selective pressure on the evolution of anti-predator defences, and, equally, beneficial effects of EMPSs in reducing predation, can thus be assumed to be of minor importance to *E. pilosa*.

Other responses to wave crash

The present study did not investigate other colony characteristics that might be affected by wave crash and/or abrasion, but two incidental observations emerged: (i) in some areas, zooids clearly increased their calcification rates when subject to wave crash only, and (ii) polypide behaviour was markedly different after a period of habituation to the abrasion stimulus. The retraction of feeding polypides of *Electra pilosa* after mechanical stimulation (Thorpe *et al.* 1975a,b) is usually followed by a recovery period of tens of seconds to minutes during which polypides do not evaginate (pers. obs.). In polypides habituated to wave crash and wave-related abrasion, this recovery period is strikingly reduced: retracted polypides re-evaginate almost instantly following retraction, and thus presumably maximize feeding success. It is conceivable that, despite this apparent adaptation to feeding in wave crash environments, overall feeding times may still be reduced when compared to sheltered habitats, but that the increased availability of suspended food in exposed environments compensates for this. The outcome of experiments in this study suggests that wave crash only, without the added complication of abrasion, does indeed stimulate colony growth, but does not induce EMPS formation (Chapter 5).

Outlook

The primary objective of any future research on the present topic should be to ascertain whether plasticity for the EMPS formation confers increased fitness (colony growth/reproductive performance) in this abundant epifaunal species. Most studies of phenotypic plasticity are confined either to laboratory or field experimentation, and

investigations of the adaptive aspects of plasticity by reciprocal experiments or reciprocal transplants are still greatly lacking (Gotthard & Nylin 1995). More important, the study of adaptive plasticity has yet to be extended to modular animals, although there is the well documented case of a predator-induced defence in the marine bryozoan, *Membranipora membranacea* (Harvell 1984a, 1986). There, the adaptive function of the character (spination of zooids) has been demonstrated, and costs of the production of the inducible character have been quantified (Harvell 1986, 1992), but the adaptive value of plasticity itself has not been tested.

The general questions arising from the present study are thus as follows:

- (1) Is plasticity for this trait truly of adaptive value, given the structural unpredictability of this generalist organism's habitats and its likelihood of extensive passive dispersal?
- (2) What is the resource investment/cost involved in producing/possessing EMPSs in terms of possibly compromised further colony growth and (assuming that fecundity is primarily determined by colony zooid number) subsequent reproductive output?
- (3) Is there an intensity/duration threshold for the perception of/response to the inductive stimulus? This will markedly influence the dynamics of colony spinosity in relation to colony growth and the seasonally varying intensity of environmental challenge from abrasion and predator attack.

To resolve the issue of plasticity as an adaptive trait, reciprocal experiments would have to be used (Gotthard & Nylin 1995), which involve the subjection of induced and uninduced phenotypes to both the "appropriate" and the "wrong" environment. Thus, long-spined morphs would be subjected to non-abrasion conditions, whilst other colonies would be artificially maintained short-spined under abrasion conditions. The performance of colonies in these treatments could then be compared against the performance of colonies in their appropriate environments. Assuming that plasticity for the trait is indeed adaptive in this regard, the prediction would be for phenotypes in their respective "appropriate" environment to outperform

these phenotypes in “wrong” environments (Schmitt *et al.* 1995, Dudley & Schmitt 1996).

REFERENCES

- Adler, F R & Harvell, C D. 1990. Inducible defenses, phenotypic variability and biotic environments. Trends in Ecology and Evolution, **5**: 407-410.
- Appleton, R D & Palmer, R P. 1988. Water-borne stimuli released by predatory crabs and damaged prey induce more predator-resistant shells in a marine gastropod. Proceedings of the National Academy of Sciences of the United States of America, **85**: 4387-4391.
- Arendt, J D. 1997. Adaptive intrinsic growth rates: an integration across taxa. The Quarterly Review of Biology, **72**: 149-177.
- Atkinson, M J & Bilger, R W. 1992. Effects of water velocity on phosphate uptake in coral reef-flat communities. Limnology and Oceanography, **37**: 273-279.
- Ayre, D J & Willis, B L. 1988. Population structure in the coral *Pavona cactus*: clonal genotypes show little phenotypic plasticity. Marine Biology, **99**: 495-505.
- Barnes, D K A. 1995. Sublittoral epifaunal communities of Signy Island, Antarctica. II. Below the ice-foot zone. Marine Biology, **121**: 565-572.
- Barnes, D K A & Bullough, L W. 1996. Some observations on the diet and distribution of nudibranchs at Signy Island, Antarctica. Journal of Molluscan Studies, **62**: 281-287.
- Bayer, M M. 1994. Genotypic variation of polypide regression, growth rate and colony form in the marine bryozoan *Electra pilosa* (L.). M. Sc. thesis, 95 pp. School of Biological and Medical Sciences, University of St Andrews, Scotland.
- Bayer, M M, Cormack, R M & Todd, C D. 1994. Influence of food concentration on polypide regression in the marine bryozoan *Electra pilosa* (L.) (Bryozoa: Cheilostomata). Journal of Experimental Marine Biology and Ecology, **178**: 35-50.

- Begon, M, Harper, J L & Townsend, C R. 1990. *Ecology: Individuals, Populations and Communities*. Blackwell Scientific Publications, London. 945 pp.
- Bell, A D. 1986. The simulation of branching pattern in modular organisms. Philosophical Transactions of the Royal Society of London, Series B, **313**: 143-159.
- Bell, E C & Denny, M W. 1994. Quantifying "wave exposure": a simple device for recording maximum velocity and results of its use at several field sites. Journal of Experimental Marine Biology and Ecology, **181**: 9-29.
- Bell, G. 1984. Evolutionary and nonevolutionary consequences of senescence. American Naturalist, **124**: 600-603.
- Best, B A. 1988. Passive suspension feeding in a sea pen: effects of ambient flow on volume flow rate and filtering efficiency. Biological Bulletin, **175**: 332-342.
- Best, M A. 1985. Some aspects of the ecology and physiology of feeding in marine Bryozoa. Ph.D. thesis, 471 pp., University of Liverpool, U.K.
- Best, M A & Thorpe, J P. 1985. Autoradiographic study of feeding and the colonial transport of metabolites in the marine bryozoan *Membranipora membranacea*. Marine Biology, **84**: 295-300.
- Best, M A & Thorpe, J P. 1994. An analysis of potential food sources available to intertidal bryozoans in Britain. Pages 1-7 in Hayward, P J S, Ryland, J S & Taylor, P D, eds. *Biology and Palaeobiology of Bryozoans*. Olsen & Olsen, Fredensborg, Denmark.
- Best, M A & Thorpe, J P. 1996. The effect of suspended particulate matter (silt) on the feeding activity of the intertidal ctenostomate bryozoan *Flustrellidra hispida* (Fabricius). Pages 39-45 in Gordon, D P, Smith, A M & Grant-Mackie, J A, eds. *Bryozoans in Space and Time*. National Institute of Water & Atmospheric Research Ltd, Wellington, New Zealand.
- Bishop, J D. 1989. Colony form and the exploitation of spatial refuges by encrusting Bryozoa. Biological Reviews, **64**: 197-218.

- Blanchette, C A. 1997. Size and survival of intertidal plants in response to wave action: a case study with *Fucus gardneri*. Ecology, **78**: 1563-1578.
- Bloom, S A. 1976. Morphological correlations between dorid nudibranch predators and sponge prey. Veliger, **18**: 289-301.
- Boaden, P J S & Seed, R. 1985. *An Introduction to Coastal Ecology*. Blackie, Glasgow and London. 218 pp.
- Boardman, R S & Cheetham, A H. 1973. Degrees of colony dominance in stenolaemate and gymnolaemate Bryozoa. Pages 121-220 in Boardman, R S, Cheetham, A H & Oliver, W A j, eds. *Animal Colonies: Development and Function Through Time*. Dowden, Hutchinson and Ross, Stroudsburg.
- Bobin, G. 1968. Morphogenese du termen et des épines dans les zooécies d'*Electra verticillata* (Ellis et Solander) (bryozoaire chilostome, Anasca). Cahiers de Biologie Marine, **9**: 53-68.
- Bobin, G & Prenant, M. 1960. *Electra verticillata* (Ellis et Solander, 1786) Lamouroux, 1816 (Bryozoaire Chilostome). Cahiers de Biologie Marine, **1**: 121-156.
- Boulding, E G. 1990. Are the opposing selection pressures on exposed and protected shores sufficient to maintain genetic differentiation between gastropod populations with high intermigration rates? Pages 41-52 in Johannesson, K, Raffaelli, D G & Hannaford Ellis, C J, eds. *Progress in Littorinid and Muricid Biology*. Kluwer Academic Publishers, Belgium.
- Boulding, E G & Van Alstyne, K L. 1993. Mechanisms of differential survival and growth of two species of *Littorina* on wave-exposed and on protected shores. Journal of Experimental Marine Biology and Ecology, **169**: 139-166.
- Brakefield, P M, Gates, J M, Keys, D, Kesbeke, F, Wijngaarden, P J, Monteiro, A, French, V & Carroll, S B. 1996. Development, plasticity and evolution of butterfly eyespot patterns. Nature, **384**: 236-242.

- Brakefield, P M & Kesbeke, F. 1997. Genotype-environment interactions for insect growth in constant and fluctuating temperature regimes. Proceedings of the Royal Society of London, Series B, : 717-723.
- Brande, S & Bretsky, S S. 1982. Avoid improper statistical analysis in bryozoans: analysis of variance is suitable for study of hierarchical variation. Journal of Paleontology, **56**: 1207-1212.
- Brock, M A. 1974. Growth, development and longevity rhythms in *Campanularia flexuosa*. American Zoologist, **14**: 757-771.
- Brönmark, C & Miner, J G. 1992. Predator-induced phenotypical change in body morphology in crucian carp. Science, **258**: 1348-1350.
- Brown, B E, Sya'rani, L & Le Tissier, M. 1985. Skeletal form and growth in *Acropora aspera* (Dana) from the Pulau Seribu, Indonesia. Journal of Experimental Marine Biology and Ecology, **86**: 139-150.
- Brown, K M & Quinn, J F. 1988. The effect of wave action on growth in three species of intertidal gastropods. Oecologia, **75**: 420-425.
- Bruno, J F & Edmunds, P J. 1997. Clonal variation for phenotypic plasticity in the coral *Madracis mirabilis*. Ecology, **78**: 2177-2190.
- Buss, L W. 1979. Habitat selection, directional growth and spatial refuges: why colonial animals have more hiding places. Pages 459-497 in Larwood, G P & Rosen, B R, eds. *Biology and Systematics of Colonial Organisms*. Academic Press, London and New York.
- Buss, L W. 1983. Evolution, development and the units of selection. Proceedings of the National Academy of Sciences of the United States of America, **80**: 1387-1391.
- Buss, L W. 1987. *The Evolution of Individuality*. Princeton University Press, Princeton, New Jersey. 201 pp.
- Buss, L W & Grosberg, R K. 1990. Morphogenetic basis for phenotypic differences in hydroid competitive behaviour. Nature, **343**: 63-66.

- Cancino, J M, Castaneda, B & Orellana, M C. 1991. Reproductive strategies in bryozoans: experimental test of the effects of conspecific neighbours. Pages 81-88 in Bigey, F P, ed. *Bryozoaires Actuels et Fossiles: Bryozoa Living and Fossil*. Bull. Soc. Sci. Nat. Ouest. Fr., Nantes, France.
- Cancino, J M & Hughes, R N. 1987. The effect of water flow on growth and reproduction of *Celleporella hyalina* (L.) (Bryozoa: Cheilostomata). Journal of Experimental Marine Biology and Ecology, **112**: 109-130.
- Cancino, J M, Muñoz, J, Muñoz, M & Orellana, M C. 1987. Effects of the bryozoan *Membranipora tuberculata* (Bosc.) on the photosynthesis and growth of *Gelidium rex* Santelices et Abbott. Journal of Experimental Marine Biology and Ecology, **113**: 105-112.
- Caswell, H. 1985. The evolutionary demography of clonal reproduction. Pages 187-224 in Jackson, J B C, Buss, L W & Cook, R E, eds. *Population Biology and Evolution of Clonal Organisms*. Yale University Press, New Haven and London.
- Chadwick, S R & Thorpe, J P. 1981. An investigation of some aspects of bryozoan predation by dorid nudibranchs (Mollusca: Opisthobranchia). Pages 51-58 in Larwood, G P & Nielsen, C, eds. *Recent and Fossil Bryozoa*. Olsen & Olsen, Fredensborg, Denmark.
- Chapman, G. 1981. Individuality and modular organisms. Biological Journal of the Linnean Society, **15**: 177-184.
- Cheetham, A H, Jackson, J B C & Hayek, L-A C. 1993. Quantitative genetics of bryozoan phenotypic evolution. I. Rate tests for random change versus selection in differentiation of living species. Evolution, **47**: 1526-1538.
- Cheetham, A H, Jackson, J B C & Hayek, L-A C. 1994. Quantitative genetics of bryozoan phenotypic evolution. II. Analysis of selection and random change in fossil species using reconstructed genetic parameters. Evolution, **48**: 360-375.

- Chornesky, E A. 1983. Induced development of sweeper tentacles on the reef coral *Agaricia agaricites*: a response to direct competition. Biological Bulletin, **165**: 569-581.
- Clack, T, Mathews, S & Sharrock, R A. 1994. The phytochrome apoprotein family in *Arabidopsis* is encoded by five genes: the sequences and expression of PHYD and PHYE. Plant Molecular Biology, **25**: 413-427.
- Cohen, B L, Stark, S, Gawthrop, A B, Burke, M E & Thayer, C W. 1998. Comparison of articulate brachiopod nuclear and mitochondrial gene trees leads to a clade-based redefinition of protostomes (Protostomozoa) and deuterostomes (Deuterostomozoa). Proceedings of the Royal Society of London, Series B, **265**: 475-482.
- Cook, P L. 1985. *Bryozoa from Ghana - a preliminary survey*. Musee Royale de l'Afrique Centrale, Tervuren, Belgique.
- Cook, S A & Johnson, M P. 1968. Adapation to heterogeneous environments I. Variation in heterophylly in *Ranunculus flammulus* (L.). Evolution, **22**: 496-516.
- Cormack, R M. 1971. A review of classification. Journal of the Royal Statistical Society, Series A General, **134**: 321-367.
- Cousens, R. 1982. The effect of exposure to wave action on the morphology and pigmentation of *Ascophyllum nodosum* (L.) Le Jolis in south-eastern Canada. Botanica Marina, **25**: 191-195.
- Craig, S F. 1994. Intraspecific fusion in the encrusting bryozoan *Fenestrulina* sp. Pages 51-54 in Hayward, P J S, Ryland, J S & Taylor, P D, eds. *Biology and Palaeobiology of Bryozoans*. Olsen & Olsen, Fredensborg, Denmark.
- Craik, G J S. 1980. Simple method for measuring the relative scouring of intertidal areas. Marine Biology, **59**: 257-260.
- Crawley, M J. 1993. *GLIM for Ecologists*. Blackwell Scientific Publications, Oxford. 379 pp.

- Crothers, J H. 1983. Variation in dog-whelk shells in relation to wave action and crab predation. Biological Journal of the Linnean Society, **20**: 85-102.
- Crowl, T A & Covich, A P. 1990. Predator-induced life-history shifts in a freshwater snail. Science, **247**: 949-951.
- D'Hondt, J-L & Goyffon, M. 1992. Electrophoretic variability of *Alcyonidium mytili* Dalyell, 1847 (Bryozoa, Ctenostomida) from European coasts. Bollettino di Zoologia, **59**: 465-470.
- d'Hondt, J-L & Goyffon, M. 1993. Observations sur le polymorphisme de quelques populations Européennes d'*Electra pilosa* (Linné, 1767) (Bryozoaires, Chilostomes). Bulletin de la Société Zoologique de France, **118**: 375-386.
- de Burgh, M E & Fankboner, P V. 1978. A nutritional association between the bull kelp *Nereocystis luetkeana* and its epizoic bryozoan *Membranipora membranacea*. Oikos, **31**: 69-72.
- de Jong, G. 1994. The fitness of fitness concepts and the description of natural selection. The Quarterly Review of Biology, **69**: 3-29.
- de Jong, G. 1995. Phenotypic plasticity as a product of selection in a variable environment. American Naturalist, **145**: 493-512.
- De Queiroz, K & Good, D A. 1997. Phenetic clustering in biology: a critique. The Quarterly Review of Biology, **72**: 3-30.
- Dennison, W C & Barnes, D J. 1988. Effect of water motion on coral photosynthesis and calcification. Journal of Experimental Marine Biology and Ecology, **115**: 67-77.
- Denny, M W. 1985. Wave forces on intertidal organisms: A case study. Limnology and Oceanography, **30**: 1171-1187.
- Denny, M W. 1987. Life in the maelstrom: the biomechanics of wave-swept rocky shores. Trends in Ecology and Evolution, **2**: 61-66.
- Denny, M W. 1988. *Biology and the Mechanics of the Wave-Swept Environment*. Princeton University Press, Princeton, New Jersey, USA. 329 pp.

- Denny, M W, Daniel, T L & Koehl, M A R. 1985. Mechanical limits to size in wave-swept organisms. Ecological Monographs, **55**: 69-102.
- DeWitt, T J, Sih, A & Wilson, D S. 1998. Costs and limits of phenotypic plasticity. Trends in Ecology and Evolution, **13**: 77-81.
- Dixon, J, Schroeter, S C & Kastendiek, J. 1981. Effects of the encrusting bryozoan *Membranipora membranacea* on the loss of blades and fronds by the giant kelp, *Macrocystis pyrifera* (Laminariales). Journal of Phycology, **17**: 341-345.
- Dudley, S A. 1996. Differing selection on plant physiological traits in response to environmental water availability: a test of adaptive hypotheses. Evolution, **50**: 92-102.
- Dudley, S A & Schmitt, J. 1996. Testing the adaptive plasticity hypothesis: density-dependent selection on manipulated stem length in *Impatiens capensis*. American Naturalist, **147**: 445-465.
- Dyrynda, P E J. 1986. Defensive strategies of modular organisms. Philosophical Transactions of the Royal Society of London, Series B, **313**: 227-243.
- Ebert, T A. 1996. Adaptive aspects of phenotypic plasticity in echinoderms. Oceanologica Acta, **19**: 347-355.
- Eckman, J E & Duggins, D O. 1993. Effects of flow speed on growth of benthic suspension feeders. Biological Bulletin, **185**: 28-42.
- Edmunds, M, Potts, G W, Swinfen, R C & Waters, V L. 1976. Defensive behaviour of sea anemones in response to predation by the opisthobranch mollusc *Aeolidia papillosa* (L.). Journal of the Marine Biological Association of the U.K., **56**: 65-83.
- Elmhirst, R. 1922. Cyclic conditions and rejuvenation in hydroids. Nature, **109**: 208-209.
- Ennos, A R. 1997. Wind as an ecological factor. Trends in Ecology and Evolution, **12**: 109-111.

- Etter, R J. 1988. Asymmetrical developmental plasticity in an intertidal snail. Evolution, **42**: 322-334.
- Etter, R J. 1996. The effect of wave action, prey type, and foraging time on growth of the predatory snail *Nucella lapillus* (L.). Journal of Experimental Marine Biology and Ecology, **196**: 341-356.
- Feldgarden, M & Yund, P O. 1992. Allorecognition in colonial marine invertebrates: does selection favour fusion with kin of fusion with self? Biological Bulletin, **182**: 155-158.
- Foster, A B. 1979. Phenotypic plasticity in the reef corals *Montastrea annularis* (Ellis & Solander) and *Siderastrea siderea* (Ellis & Solander). Journal of Experimental Marine Biology and Ecology, **39**: 25-54.
- Fox, C W, Thakar, M S & Mousseau, T A. 1997. Egg size plasticity in a seed beetle: an adaptive maternal effect. American Naturalist, **149**: 149-163.
- Frid, C L J & Fordham, E. 1994. The morphology of the sub-littoral gastropod *Gibbula cineraria* (L.) along a gradient of wave action. Ophelia, **40**: 135-146.
- Friedland, M T & Denny, M W. 1995. Surviving hydrodynamic forces in a wave-swept environment: consequences of morphology in the feather boa kelp, *Egregia menziesii* (Turner). Journal of Experimental Marine Biology and Ecology, **190**: 109-133.
- Futuyma, D J. 1986. *Evolutionary Biology*. Sinauer Associates Inc. Publishers, Sunderland, Massachusetts, USA. 600 pp.
- Gamwell, L. 1996. The effects of site and substratum type on the spinosity of the bryozoan *Electra pilosa*. Senior Honours Project thesis, 44 pp. School of Biological and Medical Sciences, University of St Andrews, St Andrews, Scotland.
- Gardner, S N & Mangel, M. 1997. When can a clonal organism escape senescence? American Naturalist, **150**: 462-490.

- Gaulin, G, Dill, L, Beaulieu, J & Harris, L G. 1986. Predation-induced changes in growth form in a nudibranch-hyroid association. Veliger, **28**: 389-393.
- Gaylord, B, Blanchette, C A & Denny, M W. 1994. Mechanical consequences of size in wave-swept algae. Ecological Monographs, **64**: 287-313.
- Gianoli, E & Niemeyer, H M. 1997. Lack of costs of herbivory-induced defenses in a wild wheat: integration of physiological and ecological approaches. Oikos, **80**: 269-275.
- Gilbert, J J & Stemberger, R S. 1984. *Asplanchna*-induced polymorphism in the rotifer *Keratella slacki*. Limnology and Oceanography, **29**: 1309-1316.
- Gordon, D P. 1977. The ageing process in bryozoans. Pages 335-376 in Woollacott, R M & Zimmer, R L, eds. *Biology of Bryozoans*. Academic Press, New York and London.
- Gotthard, K & Nylin, S. 1995. Adaptive plasticity and plasticity as an adaptation: a selective review of plasticity in animal morphology and life history. Oikos, **74**: 3-17.
- Gowda, J H. 1996. Spines of *Acacia tortilis*: what do they defend and how? Oikos, **77**: 279-284.
- Graham, T W. 1996. An investigation into aspects of the predation of the bryozoan *Electra pilosa* by the nudibranch *Adalaria proxima* and the subsequent regeneration process. Seniour Honours Project thesis, 55 pp. School of Biological and Medical Sciences, University of St Andrews, Scotland.
- Grahame, J & Mill, P J. 1986. Relative size of the foot of two species of *Littorina* on a rocky shore in Wales. Journal of Zoology, **208**: 229-236.
- Graus, R R, Chamberlain, J A & Boker, A M. 1977. Structural modification of corals in relation to waves and currents in Frost, S H, Weiss, M P & Saunders, J B, eds. *Reefs and Related Carbonates – Ecology and Sedimentology*. Am. Assoc. Petrol Geol., Tulsa, Oklahoma.

- Greene, E. 1989. A diet-induced developmental polymorphism in a caterpillar. Science, **243**: 643-646.
- Grill, C P, Moore, A J & Brodie, E D I. 1997. The genetics of phenotypic plasticity in a colonizing population of the ladybird beetle, *Harmonia axyridis*. Heredity, **78**: 261-269.
- Grosberg, R K. 1988. The evolution of allorecognition specificity in clonal invertebrates. The Quarterly Review of Biology, **63**: 377-412.
- Grünbaum, D. 1997. Hydromechanical mechanisms of colony organization and cost of defense in an encrusting bryozoan, *Membranipora membranacea*. Limnology and Oceanography, **42**: 741-752.
- Gutierrez, L M & Fernández, C. 1992. Water motion and morphology in *Chondrus crispus* (Rhodophyta). Journal of Phycology, **28**: 156-162.
- Ha Kim, J & DeWreede, R E. 1996. Effects of size and season of disturbance on algal patch recovery in a rocky intertidal community. Marine Ecology Progress Series, **133**: 217-228.
- Hageman, S J. 1995. Observed phenotypic variation in a Paleozoic bryozoan. Paleobiology, **21**: 314-328.
- Hall, S J, Todd, C D & Gordon, A D. 1982. The influence of ingestive conditioning on the prey species selection in *Aeolidia papillosa* (Mollusca Nudibranchia). Journal of Animal Ecology, **51**: 907-921.
- Hall, S J, Todd, C D & Gordon, A D. 1984. Prey-species selection by the anemone predator *Aeolidia papillosa* (L.): the influence of ingestive conditioning and previous dietary history, and a test for switching behaviour. Journal of Experimental Marine Biology and Ecology, **82**: 11-33.
- Hardwick, R C. 1986. Physiological consequences of modular growth in plants. Philosophical Transactions of the Royal Society of London, Series B, **313**: 161-173.
- Harper, J L. 1977. *Population Biology of Plants*. Academic Press, London. 892 pp.

- Harris, L G & Howe, N R. 1979. An analysis of the defensive mechanisms observed in the anemone *Anthopleura elegantissima* in response to its nudibranch predator *Aeolidia papillosa*. Biological Bulletin, **157**: 138-152.
- Hart, M W & Strathmann, R R. 1994. Functional consequences of phenotypic plasticity in echinoid larvae. Biological Bulletin, **186**: 291-299.
- Harvell, C D. 1984a. Predator-induced defense in a marine bryozoan. Science, **224**: 1357-1359.
- Harvell, C D. 1984b. Why nudibranchs are partial predators: intracolony variation in bryozoan palatability. Ecology, **65**: 716-724.
- Harvell, C D. 1986. The ecology and evolution of inducible defenses in a marine bryozoan: cues, costs and consequences. American Naturalist, **128**: 810-823.
- Harvell, C D. 1990. The ecology and evolution of inducible defenses. The Quarterly Review of Biology, **65**: 323-341.
- Harvell, C D. 1991. Coloniality and inducible polymorphism. American Naturalist, **138**: 1-14.
- Harvell, C D. 1992. Inducible defenses and allocation shifts in a marine bryozoan. Ecology, **73**: 1567-1576.
- Harvell, C D. 1998. Genetic variation and polymorphism in the inducible spines of a marine bryozoan. Evolution, **52**: 80-86.
- Harvell, C D. 1994. The evolution of polymorphism in colonial invertebrates and social insects. The Quarterly Review of Biology, **69**: 155-185.
- Harvell, C D & Helling, R. 1993. Experimental induction of localized reproduction in a marine bryozoan. Biological Bulletin, **184**: 286-295.
- Harvell, C D & Padilla, D K. 1990. Inducible morphology, heterochrony and size hierarchies in a colonial invertebrate culture. Proceedings of the National Academy of Sciences of the United States of America, **87**: 508-512.

- Hayward, P J. 1973. Preliminary observations on settlement and growth in populations of *Alcyonidium hirsutum* (Fleming). Pages 107-113 in Larwood, G P, ed. *Living and Fossil Bryozoa*. Academic Press, London.
- Hayward, P J. 1995. *A Synopsis of the Antarctic Cheilostomatous Bryozoa*. Oxford University Press, Oxford. 400 pp.
- Hayward, P J & Harvey, P H. 1974. Growth and mortality of the bryozoan *Alcyonidium hirsutum* (Fleming) on *Fucus serratus* (L.). Journal of the Marine Biological Association of the U.K., **54**: 677-684.
- Hayward, P J & Ryland, J S. 1975. Growth, reproduction and larval dispersal in *Alcyonidium hirsutum* (Fleming) and some other Bryozoa. Pubblicazioni de la Stazione Zoologica di Napoli, **39**: 226-241.
- Hayward, P J & Thorpe, J P. 1989. Systematic notes on some Antarctic Ascophora (Bryozoa, Cheilostomata). Zoologica Scripta, **18**: 365-374.
- Hazel, W, Brandt, R & Grantham, T. 1987. Genetic variability and phenotypic plasticity in pupal colour and its adaptive significance in the swallowtail butterfly *Papilio polyxenes*. Heredity, **59**: 449-455.
- Helmuth, B & Sebens, K. 1993. The influence of colony morphology and orientation to flow on particle capture by the scleractinian coral *Agaricia agaricites* (Linnaeus). Journal of Experimental Marine Biology and Ecology, **165**: 251-278.
- Herrera, A & Jackson, J B C. 1992. Environmental versus taxonomic variation in lophophore morphology of Panamanian cheilostome bryozoans. Marine Biology, **112**: 99-106.
- Herrera, A, Jackson, J B C, Hughes, D J, Jara, J & Ramos, H. 1996. Life-history variation in three coexisting cheilostome bryozoan species of the genus *Stylopoma* in Panama. Marine Biology, **126**: 461-469.
- Highsmith, R C. 1982. Reproduction by fragmentation in corals. Marine Ecology Progress Series, **7**: 207-226.

- Hincks, T. 1880. *A History of the British Marine Polyzoa*. John Van Voorst, London. 601 pp.
- Hobday, A. 1995. Body-size variation exhibited by an intertidal limpet: influence of wave exposure, tidal height and migratory behavior. Journal of Experimental Marine Biology and Ecology, **189**: 29-45.
- Hoekstra, R F. 1993. Senescence and evolution. Netherlands Journal of Zoology, **43**: 352-358.
- Holliday, R. 1995. *Understanding Ageing*. Cambridge University Press. 207 pp.
- Horowitz, A S & Pachut, J F. 1996. Diversity of Cenozoic Bryozoa: A preliminary report. Pages 133-138 in Gordon, D P, Smith, A M & Grant-Mackie, J A, eds. *Bryozoans in Space and Time*. National Institute of Water and Atmospheric Research, Wellington, NZ.
- Hoyle, J E. 1997. The induction of extended median proximal spines in the bryozoan *Electra pilosa* (L.) by wave-crash related seaweed abrasion. Senior Honours Project thesis, 61 pp. School of Biological and Medical Sciences, University of St Andrews, Scotland.
- Hübel, A & Schöffl, F. 1994. *Arabidopsis* heat shock factor: isolation and characterization of the gene and the recombinant protein. Plant Molecular Biology, **26**: 353-362.
- Hughes, D J. 1989. Variation in reproductive strategy among clones of the bryozoan *Celleporella hyalina*. Ecological Monographs, **59**: 387-403.
- Hughes, D J. 1992. Genotype- environment interactions and relative clonal fitness in a marine bryozoan. Journal of Animal Ecology, **61**: 291-306.
- Hughes, D J & Hughes, R N. 1986a. Life history variation in *Celleporella hyalina* (Bryozoa). Proceedings of the Royal Society of London, Series B, **228**: 127-132.

- Hughes, D J & Hughes, R N. 1986b. Metabolic implications of modularity: studies on the respiration and growth of *Electra pilosa*. Philosophical Transactions of the Royal Society of London, Series B, **313**: 23-29.
- Hughes, D J & Jackson, J B C. 1990. Do constant environments promote complexity of form? The distribution of bryozoan polymorphism as a test of hypotheses. Evolution, **44**: 889-905.
- Hughes, R N. 1990. *The Functional Biology of Clonal Organisms*. Chapman & Hall, London. 331 pp.
- Hughes, R N & Taylor, M J. 1997. Genotype-environment interaction expressed in the foraging behaviour of dogwhelks, *Nucella lapillus* (L.) under simulated environmental hazard. Proceedings of the Royal Society of London, Series B, **264**: 417-422.
- Hughes, T P & Jackson, J B C. 1980. Do corals lie about their age? Some demographic consequences of partial mortality, fission and fusion. Science, **209**: 713-715.
- Hummon, W D. 1989. The fetch-energy index: An *a priori* estimator of coastal exposure, applied to littoral marine Gastrotricha of the British Isles. Pages 387-393 in Ryland, J S & Tyler, P A, eds. *Reproduction, Genetics and Distributions of Marine Organisms*. Olsen & Olsen, Fredensborg, DK.
- Humphries, E M. 1979. Selected features of growth in *Parasmittina nitida*. Pages 195-218 in Larwood, G P & Abbott, M B, eds. *Advances in Bryozoology*. Academic Press, London and New York.
- Hunter, E & Fusetani, N. 1996. Studies on the effects of larval swimming time on settlement, metamorphosis and post-larval development of *Bugula neritina* (Cheilostomatida). Pages 139-148 in Gordon, D P, Smith, A M & Grant-Mackie, J A, eds. *Bryozoans in Space and Time*. National Institute of Water & Atmospheric Research Ltd, Wellington, New Zealand.

- Hunter, E & Hughes, R N. 1991. Growth of laboratory cultured colonies of *Celleporella hyalina* (L.). Pages 187-191 in Bigey, F P, ed. *Bryozoaires actuels et fossiles: Bryozoa living and fossil*. Bull. Soc. Sci. Nat. Ouest Fr., Nantes.
- Hunter, E & Hughes, R N. 1993a. The effect of cell concentration on colony growth and feeding in the bryozoan *Celleporella hyalina*. Journal of the Marine Biological Association of the U.K., **73**: 321-331.
- Hunter, E & Hughes, R N. 1993b. Effects of diet on life-history parameters of the marine bryozoan, *Celleporella hyalina* (L.). Journal of Experimental Marine Biology and Ecology, **167**: 163-177.
- Hunter, E & Hughes, R N. 1993c. Self-fertilisation in *Celleporella hyalina*. Marine Biology, **115**: 495-500.
- Hunter, E & Hughes, R N. 1994. The influence of temperature, food ration and genotype on zooid size in *Celleporella hyalina* (L.). Pages 83-86 in Hayward, P J, Ryland, J S & Taylor, P D, eds. *Biology and Palaeobiology of Bryozoans*. Olsen & Olsen, Fredensborg, Denmark.
- Hunter, E & Hughes, R N. 1995. Environmental and genetic components of variation in sexual allocation by an epialgal bryozoan. Marine Ecology Progress Series, **120**: 193-201.
- Hunter, E, Hughes, R N & Goldson, A. 1996. Environmental and genetic control of somatic and sexual performance in *Celleporella hyalina* (L.). Pages 149-156 in Gordon, D P, Smith, A M & Grant-Mackie, J A, eds. *Bryozoans in Space and Time*. National Institute of Water & Atmospheric Research Ltd, Wellington, New Zealand.
- Hurd, C L, Durante, K M, Chia, F-S & Harrison, P J. 1994. Effect of bryozoan colonization on inorganic nitrogen acquisition by the kelps *Agarum fimbriatum* and *Macrocystis integrifolia*. Marine Biology, **121**: 167-173.

- Hurd, C L, Harrison, P J & Druehl, L D. 1996. Effect of seawater velocity on inorganic nitrogen uptake by morphologically distinct forms of *Macrocystis integrifolia* from wave-sheltered and exposed sites. Marine Biology, **126**: 205-214.
- Hyman, L H. 1959. *The Invertebrates: Smaller Coelomate Groups*. McGraw-Hill, New York. 783 pp.
- Jackson, J B C. 1977. Competition on marine hard substrata: The adaptive significance of solitary and colonial strategies. American Naturalist, **111**: 743-767.
- Jackson, J B C. 1979. Morphological strategies of sessile animals. Pages 499-555 in Larwood, G P & Rosen, B R, eds. *Biology and Systematics of Colonial Organisms*. Academic Press, London and New York.
- Jackson, J B C. 1986. Modes of dispersal of clonal benthic invertebrates: consequences for species' distributions and genetic structure of local populations. Bulletin of Marine Science, **39**: 588-606.
- Jackson, J B C. 1990. Evolutionary significance of morphospecies: a test with cheilostome bryozoa. Science, **248**: 579-583.
- Jackson, J B C & Coates, A G. 1986. Life cycles and evolution of clonal (modular) animals. Philosophical Transactions of the Royal Society of London, Series B, **313**: 7-22.
- Jackson, J B C & Winston, J E. 1981. Modular growth and longevity in bryozoans. Pages 121-126 in Larwood, G P & Nielsen, C, eds. *Recent and Fossil Bryozoa*. Olsen & Olsen, Fredensborg.
- Jaguin, A. 1996. Observations sur la variabilité intraspécifique de *Membranipora membranacea* (Linné, 1767), Bryozoaires, Cheilostomes. Bulletin de la Société Zoologique de France, **121**: 363-374.
- Janke, K & Kremer, B P. 1988. *Dtne, Strand und Wattenmeer: Tiere und Pflanzen unserer Küsten*. Franckh, Stuttgart, Germany. 319 pp.

- Janson, K. 1982. Genetic and environmental effects on the growth rate of *Littorina saxatilis*. Marine Biology, **69**: 73-78.
- Jasienski, M, Ayala, F J & Bazzaz, F A. 1997. Phenotypic plasticity and similarity of DNA among genotypes of an annual plant. Heredity, **78**: 176-181.
- Jebram, D. 1968. A cultivation method for saltwater bryozoa and an example for experimental biology. Atti de la Societa Italiana di Scienze Naturali e Museo Civico di Storia Naturale, **108**: 119-128.
- Jebram, D. 1970. Preliminary experiments with Bryozoa in a simple apparatus for producing continuous water currents. Helgoländer wissenschaftliche Meeresuntersuchungen, **20**: 278-292.
- Jebram, D. 1977. Experimental techniques and culture methods. Pages 273-306 in Woollacott, R M & Zimmer, R L, eds. *Biology of Bryozoans*. Academic Press, New York.
- Jebram, D. 1979. Interrelations of nutrition, food uptake and growth in bryozoans. Pages 121-140 in Larwood, G P A, M.B., ed. *Advances in Bryozoology*. Academic Press, London and New York.
- Jebram, D. 1980a. Influences of the food on the colony forms of *Electra pilosa*. Zoologische Jahrbuecher der Systematik, **108**: 1-14.
- Jebram, D. 1980b. Prospection for a sufficient nutrition for the cosmopolitic marine bryozoan *Electra pilosa* (L.). Zoologische Jahrbuecher der Systematik, **107**: 368-390.
- Jebram, D & Rummert, H-D. 1978. Influences of different diets on growth and forms of *Conopeum seurati* (Bryozoa, Cheilostomata). Zoologische Jahrbuecher der Systematik, **105**: 502-514.
- Johannesson, B. 1986. Shell morphology of *Littorina saxatilis* Olivi: the relative importance of physical factors and predation. Journal of Experimental Marine Biology and Ecology, **102**: 183-195.

- Johannesson, K & Tatarenkov, A. 1997. Allozyme variation in a snail (*Littorina saxatilis*) - deconfounding the effects of microhabitat and gene flow. Evolution, **51**: 402-409.
- Jokiel, P L. 1978. Effects of water motion on reef corals. Journal of Experimental Marine Biology and Ecology, **35**: 87-97.
- Jokiel, P L & Cowdin, H P. 1976. Hydromechanical adaptation in the solitary free-living coral *Fungia scutaria*. Nature, **262**: 212-213.
- Jones, W E & Demetropoulos, A. 1968. Exposure to wave action: measurements of an important ecological parameter on rocky shores on Anglesey. Journal of Experimental Marine Biology and Ecology, **2**: 46-63.
- Kaandorp, J A. 1991. Modelling growth forms of the sponge *Haliclona oculata* (Porifera: Demospongiae) using fractal techniques. Marine Biology, **110**: 203-215.
- Kaandorp, J A. 1994. *Fractal Modelling: Growth and Form in Biology*. Springer-Verlag, Berlin. 208 pp.
- Karban, R, Agrawal, A A & Mangel, M. 1997. The benefits of induced defenses against herbivores. Ecology, **78**: 1351-1355.
- Kendrick, G A. 1991. Recruitment of coralline crusts and filamentous turf algae in the Galapagos archipelago: effect of simulated scour, erosion and accretion. Journal of Experimental Marine Biology and Ecology, **147**: 47-63.
- Kennelly, S J. 1989. Effects of kelp canopies on understorey species due to shade and scour. Marine Ecology Progress Series, **50**: 215-224.
- Keough, M J. 1986. The distribution of a bryozoan on seagrass blades: settlement, growth, and mortality. Ecology, **67**: 846-857.
- Keough, M J. 1989. Variation in growth rate and reproduction of the bryozoan *Bugula neritina*. Biological Bulletin, **177**: 277-286.
- Keough, M J & Chernoff, H. 1987. Dispersal and population variation in the bryozoan *Bugula neritina*. Ecology, **68**: 199-210.

- Kiirikki, M. 1996. Experimental evidence that *Fucus vesiculosus* (Phaeophyta) controls filamentous algae by means of the whiplash effect. European Journal of Phycology, **31**: 61-66.
- Kingsolver, J G. 1995a. Fitness consequences of seasonal polyphenism in western white butterflies. Evolution, **49**: 942-954.
- Kingsolver, J G. 1995b. Viability selection on seasonally polyphenic traits: wing melanin patterns in western white butterflies. Evolution, **49**: 932-941.
- Kingsolver, J G & Wiernasz, D C. 1991. Seasonal polyphenism in wing-melanin pattern and thermoregulatory adaptation in *Pieris* butterflies. American Naturalist, **137**: 816-830.
- Kirkwood, T B L. 1977. Evolution of ageing. Nature, **270**: 301-304.
- Kirkwood, T B L & Rose, M R. 1991. Evolution of senescence: late survival sacrificed for reproduction. Philosophical Transactions of the Royal Society of London, Series B, **332**: 15-24.
- Kitamura, H & Hirayama, K. 1984. Suitable food plankton for growth of a bryozoan *Bugula neritina* under laboratory conditions. Bulletin of the Japanese Society of Scientific Fisheries, **50**: 973-977.
- Kitamura, H & Hirayama, K. 1985. The effect of low salinity on the early growth of a bryozoan *Bugula neritina* in the sea and laboratory. Bulletin of the Japanese Society of Scientific Fisheries, **51**: 1401-1405.
- Kitching, J A. 1976. Distribution and changes in shell form of *Thais* spp. (Gastropoda) near Bamfield, B.C. Journal of Experimental Marine Biology and Ecology, **23**: 109-126.
- Koehl, M A R. 1984. How do benthic organisms withstand moving water? American Zoologist, **24**: 57-70.
- Kramarsky-Winter, E, Fine, M & Loya, Y. 1997. Coral polyp expulsion. Nature, **387**: 137.

- Lambert, W J & Todd, C D. 1994. Evidence for a water-borne cue inducing metamorphosis in the dorid nudibranch mollusc *Adalaria proxima* (Gastropoda: Nudibranchia). Marine Biology, **120**: 265-271.
- Lambert, W J, Todd, C D & Hardege, J D. 1997. Partial characterization and biological activity of a metamorphic inducer of the dorid nudibranch *Adalaria proxima* (Gastropoda: Nudibranchia). Invertebrate Biology, **116**: 71-81.
- Leigh, E G, Paine, R T, Quinn, J F & Suchanek, T H. 1987. Wave energy and intertidal productivity. Proceedings of the National Academy of Sciences of the United States of America, **84**: 1314-1318.
- Leonard, A B, Strickler, J R & Holland, N D. 1988. Effects of current speed on filtration during suspension feeding in *Oligometra serripinna* (Echinodermata: Crinoidea). Marine Biology, **97**: 111-125.
- Lesser, M P, Weis, V M, Patterson, M R & Jokiel, P L. 1994. Effects of morphology and water motion on carbon delivery and productivity in the reef coral, *Pocillopora damicornis* (Linnaeus): Diffusion barriers, inorganic carbon limitation, and biochemical plasticity. Journal of Experimental Marine Biology and Ecology, **178**: 153-179.
- Leversee, G J. 1976. Flow and feeding in fan-shaped colonies of the gorgonian coral, *Leptogorgia*. Biological Bulletin, **151**: 344-356.
- Levin, P S & Mathieson, A C. 1991. Variation in a host-epiphyte relationship along a wave exposure gradient. Marine Ecology Progress Series, **77**: 271-278.
- Lewis, J B. 1976. Experimental tests of suspension feeding in Atlantic reef corals. Marine Biology, **36**: 147-150.
- Lewis, J R. 1964. *The Ecology of Rocky Shores*. The English Universities Press Ltd., London. 323 pp.

- Lidgard, S & Buckley, G A. 1994. Towards a morphological species concept in cheilostomates: phenotypic variation in *Adeonellopsis yarraensis* (Waters). Pages 101-105 in Hayward, P J, Ryland, J S & Taylor, P D, eds. *Biology and Palaeobiology of Bryozoans*. Olsen & Olsen, Fredensborg, Denmark.
- Little, C & Kitching, J A. 1996. *The Biology of Rocky Shores*. Oxford University Press, Oxford. 240 pp.
- Lively, C M. 1986a. Canalization versus developmental conversion in a spatially variable environment. *American Naturalist*, **128**: 561-572.
- Lively, C M. 1986b. Predator-induced shell dimorphism in the acorn barnacle *Chthalamus anisopoma*. *Evolution*, **40**: 232-242.
- Lutaud, G. 1973. The great tentacle sheath nerve as the path of an innervation of the frontal wall structures in the cheilostome *Electra pilosa* (Linné). Pages 317-326 in Larwood, G P, ed. *Living and Fossil Bryozoa*. Academic Press, London and New York.
- Lutaud, G. 1977. The nervous system in bryozoans. Pages 329-337 in Woollacott, R M & Zimmer, R L, eds. *Biology of Bryozoans*. Academic Press, New York and London.
- Mackey, L Y, Winnepeninckx, B, Dewachter, R, Backeljau, T, Emschermann, P & Garey, J R. 1996. 18s ribosomal-RNA suggests that Entoprocta are protostomes, unrelated to Ectoprocta. *Journal of Molecular Evolution*, **42**: 552-559.
- Mackie, G O. 1986. From aggregates to integrates: physiological aspects of modularity in colonial animals. *Philosophical Transactions of the Royal Society of London, Series B*, **313**: 175-196.
- Manriquez, P H & Cancino, J M. 1996. Bryozoan-macroalgal interactions: do epibionts benefit? *Marine Ecology Progress Series*, **138**: 189-197.

- Marcus, E. 1926. Beobachtungen und Versuche an lebenden Meeresbryozoen. Zoologische Jahrbuecher, Abteilung Systematik, Oekologie und Geographie der Tiere, **52**: 1-102.
- Maresca, B, Patriarca, E, Goldenberg, C & Sacco, M. 1988. Heat shock and cold adaptation in Antarctic fishes: a molecular approach. Comparative Biochemistry and Physiology, **90B**: 623-629.
- Martínez, D E & Levinton, J S. 1992. Asexual metazoans undergo senescence. Proceedings of the National Academy of Sciences of the United States of America, **89**: 9920-9923.
- Massel, S R & Done, T J. 1993. Effects of cyclone waves on massive coral assemblages on the Great Barrier Reef: meteorology, hydrodynamics and demography. Coral Reefs, **12**: 153-166.
- Maturo, F J. 1991. Self-fertilization in gymnolaemate Bryozoa. Page 572 (abstract only) in Bigey, F P, ed. *Bryozoaires Actuels Et Fossiles: Bryozoa Living and Fossil*. Bull. Soc. Sci. Nat. Ouest. Fr., Nantes, France.
- McCollum, S A & Van Buskirk, J. 1996. Costs and benefits of a predator-induced polyphenism in the gray treefrog *Hyla chrysoscelis*. Evolution, **50**: 583-593.
- McDonald, G & Nybakken, J. 1991. A preliminary report on a world-wide review of the food of nudibranchs. Journal of Molluscan Studies, **57**: 61-63.
- McKinney, F K & Jackson, J B C. 1991. *Bryozoan Evolution*. The University of Chicago Press, Chicago and London. 238 pp.
- McQuaid, C D & Branch, G M. 1984. Influence of sea temperature, substratum and wave exposure on rocky intertidal communities: an analysis of faunal and floral biomass. Marine Ecology Progress Series, **19**: 145-151.
- McQuaid, C D & Branch, G M. 1985. Trophic structure of rocky intertidal communities: response to wave action and implications for energy flow. Marine Ecology Progress Series, **22**: 153-161.
- Medawar, P B. 1952. *An Unsolved Problem in Biology*. Lewis, London. 24 pp.

- Meesters, E H & Bak, R P M. 1995. Age-related deterioration of a physiological function in the branching coral *Acropora palmata*. Marine Ecology Progress Series, **121**: 203-209.
- Menon, N R. 1972. Heat tolerance, growth and regeneration in three North Sea bryozoans exposed to different constant temperatures. Marine Biology, **15**: 1-11.
- Menon, N R. 1974. Clearance rates of food suspension and food passage rates as a function of temperature in two North-Sea bryozoans. Marine Biology, **24**: 65-67.
- Miles, J S, Harvell, C D, Griggs, C M & Eisner, S. 1995. Resource translocation in a marine bryozoan: quantification and visualization of ^{14}C and ^{35}S . Marine Biology, **122**: 439-445.
- Millar, R H. 1971. The biology of ascidians. Advances in Marine Biology, **9**: 1-100.
- Miller, K J. 1994. Morphological variation in the coral genus *Platygyra*: environmental influences and taxonomic implications. Marine Ecology Progress Series, **110**: 19-28.
- Mitchell-Olds, T. 1995. The molecular basis of quantitative genetic variation in natural populations. Trends in Ecology and Evolution, **10**: 324-328.
- Molloy, F J & Bolton, J J. 1996. The effects of wave exposure and depth on the morphology of inshore populations of the Namibian kelp *Laminaria schinzii* Foslie. Botanica Marina, **39**: 525-531.
- Moran, N A. 1992. The evolutionary maintenance of alternative phenotypes. American Naturalist, **139**: 971-989.
- Moreno, C A, Reyes, A & Ascencio, G. 1993. Habitat and movements of the recruits of *Concholepas concholepas* (Mollusca: Muricidae) in the rocky intertidal of southern Chile. Journal of Experimental Marine Biology and Ecology, **171**: 51-61.

- Munoz, J, Cancino, J M & Molina, M X. 1991. Effect of encrusting bryozoans on the physiology of their algal substratum. Journal of the Marine Biological Association of the U.K., **71**: 877-882.
- Munoz, M R, Manriquez, P H, Castaneda, B & Cancino, J M. 1990. Es afectada la expectativa de vida de los modulos por su posicion en la colonia? Estudio comparativo en briozoos. Revista de Biologia Marina, Valparaiso, **25**: 35-46.
- Nagao, R T, Kimpel, J A & Key, J L. 1990. Molecular and cellular biology of the heat-shock response. Advances in Genetics, **28**: 235-274.
- Nandakumar, K & Tanaka, M. 1994. Formation of giant buds in the cheilostome bryozoan *Schizoporella serialis* (Heller, 1867) during its interaction with the bryozoan *Celleporaria aperta* (Hincks, 1882). Journal of Experimental Marine Biology and Ecology, **183**: 1-9.
- Newman, R A. 1988. Adaptive plasticity in development of *Scaphiopus couchii* tadpoles in desert ponds. Evolution, **42**: 774-783.
- Nielsen, C. 1995. *Animal Evolution: Interrelationships of the Living Phyla*. Oxford University Press, Oxford. 467 pp.
- Norman, C. 1894. A month on the Trondhjem Fjord. Annals and Magazine of Natural History Series 6, **13**: 112-133.
- Nowell, A R M & Jumars, P A. 1984. Flow environments of aquatic benthos. Annual Review of Ecology and Systematics, **15**: 303-328.
- Nybakken, J & McDonald, G. 1981. Feeding mechanisms of west American nudibranchs feeding on Bryozoa, Cnidaria and Ascidiacea, with special respect to the radula. Malacologia, **20**: 439-449.
- Odendaal, F J, Turchin, P, Hoy, G, Wickens, P, Wells, J & Schroeder, G. 1992. *Bullia digitalis* (Gastropoda) actively pursues moving prey by swash-riding. Journal of Zoology, **228**: 103-113.

- Okamura, B. 1984. The effects of ambient flow velocity, colony size, and upstream colonies on the feeding success of Bryozoa. I. *Bugula stolonifera* Ryland, an arborescent species. Journal of Experimental Marine Biology and Ecology, **83**: 179-193.
- Okamura, B. 1985. The effects of ambient flow velocity, colony size, and upstream colonies on the feeding success of Bryozoa. II. *Conopeum reticulum* (Linnaeus), an encrusting species. Journal of Experimental Marine Biology and Ecology, **89**: 69-80.
- Okamura, B. 1987a. Particle size and flow velocity induce an inferred switch in bryozoan suspension-feeding behavior. Biological Bulletin, **173**: 222-229.
- Okamura, B. 1987b. Seasonal changes in zooid size and feeding activity in epifaunal colonies of *Electra pilosa*. Pages 197-203 in Ross, J R P, ed. *Bryozoa: Present and Past*. Western Washington University, Bellingham, Washington.
- Okamura, B. 1990. Particle size, flow velocity, and suspension-feeding by the erect bryozoans *Bugula neritina* and *B. stolonifera*. Marine Biology, **105**: 33-38.
- Okamura, B. 1992. Microhabitat variation and patterns of colony growth and feeding in a marine bryozoan. Ecology, **73**: 1502-1513.
- Oksanen, L, Oksanen, T, Lukkari, A & Sirén, S. 1987. The role of phenol-based inducible defense in the interaction between tundra populations of the vole *Clethrionomys rufocanus* and the dwarf shrub *Vaccinium myrtillus*. Oikos, **50**: 371-380.
- Orellana, M C & Cancino, J M. 1991. Effects of delaying settlement on metamorphosis and early colonial growth in *Celleporella hyalina* (Bryozoa: Cheilostomata). Pages 309-316 in Bigey, F P, ed. *Bryozoa living and fossil*. Sci. Nat. Quest Fr., Nantes.
- Orive, M E. 1995. Senescence in organisms with clonal reproduction and complex life histories. American Naturalist, **145**: 90-108.

- Oswald, R C & Seed, R. 1986. Organisation and seasonal progression within the epifaunal communities of coastal macroalgae. Cahiers de Biologie Marine, **27**: 29-40.
- Oswald, R C, Telford, N, Seed, R & Happey-Wood, C M. 1984. The effects of encrusting bryozoans on the photosynthetic activity of *Fucus serratus* (L.). Estuarine, Coastal and Shelf Science, **19**: 697-702.
- Padilla, D K & Adolph, S C. 1996. Plastic inducible morphologies are not always adaptive: the importance of time delays in a stochastic environment. Evolutionary Ecology, **10**: 105-117.
- Palmer, A R. 1990. Effect of crab effluent and scent of damaged conspecifics on feeding, growth, and shell morphology of the Atlantic dogwhelk *Nucella lapillus* (L.). Pages 155-182 in Johannesson, K, Raffaelli, D G & Hannaford Ellis, C J, eds. *Progress in Littorinid and Muricid Biology*. Kluwer Academic Publishers, Belgium.
- Palumbi, S R. 1984a. Measuring intertidal wave forces. Journal of Experimental Marine Biology and Ecology, **81**: 171-179.
- Palumbi, S R. 1984b. Tactics of acclimation: Morphological changes of sponges in an unpredictable environment. Science, **225**: 1478-1480.
- Palumbi, S R. 1986. How body plans limit acclimation: responses of a demosponge to wave force. Ecology, **67**: 208-214.
- Palumbi, S R & Jackson, J B C. 1983. Ageing in modular organisms: ecology of zooid senescence in *Steginoporella* sp. (Bryozoa: Cheilostomata). Biological Bulletin, **164**: 267-278.
- Pechenik, J A. 1996. *Biology of the Invertebrates*. Wm. C. Brown Publishers, Dubuque, IA.
- Peck, L S, Hayward, P J & Spencer-Jones, M E. 1995. A pelagic bryozoan from Antarctica. Marine Biology, **123**: 757-762.

- Pedersen, B & Tuomi, J. 1995. Hierarchical selection and fitness in modular and clonal organisms. Oikos, **73**: 167-180.
- Picton, B E & Morrow, C C. 1994. *A Field Guide to the Nudibranchs of the British Isles*. Immel Publishing, London. 143 pp.
- Pigliucci, M. 1996. How organisms respond to environmental changes: from phenotypes to molecules (and vice versa). Trends in Ecology and Evolution, **11**: 168-173.
- Prigge, H. 1967. Über eine Massenanspülung kugelförmiger *Electra pilosa* - Kolonien an den Küsten der südlichen Nordsee in den Jahren 1965 und 1966. Abhandlungen und Verhandlungen. Naturwissenschaftlicher Verein Hamburg, N. F., **11**: 63-78.
- Provasoli, L. 1968. Media and prospects for the cultivation of marine algae. Pages 63-75 in Watanabe, A & Hattori, A, eds. *Cultures and Collections of Algae*. Japanese Society of Plant Physiologists, Hakone.
- Quicke, D L J. 1993. *Principles and Techniques of Contemporary Taxonomy*. Blackie Academic & Professional, London. 311 pp.
- Reed, C G. 1991. Bryozoa. Pages 85-245 in Giese, A C, Pearse, J S & Pearse, V B, eds. *Reproduction of Marine Invertebrates*. Boxwood Press, Pacific Grove, California.
- Rees, J T. 1972. The effect of current on growth form in an octocoral. Journal of Experimental Marine Biology and Ecology, **10**: 115-123.
- Reimer, O & Tedengren, M. 1996. Phenotypical improvement of morphological defences in the mussel *Mytilus edulis* induced by exposure to the predator *Asterias rubens*. Oikos, **75**: 383-390.
- Richardson, T D & Brown, K M. 1990. Wave exposure and prey size selection in an intertidal predator. Journal of Experimental Marine Biology and Ecology, **142**: 105-120.

- Riessen, H P. 1984. The other side of cyclomorphosis: Why *Daphnia* lose their helmets. Limnology and Oceanography, **29**: 1123-1127.
- Rinkevich, B, Lauzon, R J, Brown, B W M & Weissman, I L. 1992. Evidence for a programmed life span in a colonial protochordate. Proceedings of the National Academy of Sciences of the United States of America, **89**: 3546-3550.
- Roff, D A, Stirling, G & Fairbairn, D J. 1997. The evolution of threshold traits: a quantitative genetic analysis of the physiological and life-history correlates of wing dimorphism in the sand cricket. Evolution, **51**: 1910-1919.
- Rolan-Alvarez, E, Johannesson, K & Erlandsson, J. 1997. The maintenance of a cline in the marine snail *Littorina saxatilis*: the role of home site advantage and hybrid fitness. Evolution, **51**: 1838-1847.
- Rose, M R. 1991. *Evolutionary Biology of Aging*. Oxford University Press, New York and Oxford. 221 pp.
- Roskam, J C & Brakefield, P M. 1996. A comparison of temperature-induced polyphenism in African *Bicyclus* butterflies from a seasonal savannah-rainforest ecotone. Evolution, **50**: 2360-2372.
- Rubin, J A. 1987. Growth and refuge location in continuous, modular organisms: experimental and computer simulation studies. Oecologia, **72**: 46-51.
- Ryland, J S. 1959. Experiments on the selection of algal substrates by polyzoan larvae. Journal of Experimental Biology, **36**: 613-631.
- Ryland, J S. 1970. *Bryozoans*. Hutchinson University Library, London. 175 pp.
- Ryland, J S. 1976. Physiology and ecology of marine bryozoans. Advances in Marine Biology, **14**: 285-443.
- Ryland, J S. 1979. Structural and physiological aspects of coloniality in Bryozoa in Larwood, G P & Rosen, B R, eds. *Biology and Systematics of Colonial Organisms*. Academic Press, London.

- Ryland, J S & Bishop, J D D. 1993. Internal fertilisation in hermaphroditic colonial invertebrates. Oceanography and Marine Biology: An Annual Review, **31**: 445-477.
- Ryland, J S & Hayward, P J. 1977. *British Anascan Bryozoans*. Academic Press, London. 180 pp.
- Ryland, J S & Sykes, A M. 1972. The analysis of pattern in communities of bryozoa. I. Discrete sampling methods. Journal of Experimental Marine Biology and Ecology, **8**: 277-297.
- Ryland, J S & Warner, G F. 1986. Growth and form in modular animals: ideas on the size and arrangement of zooids. Philosophical Transactions of the Royal Society of London, Series B, **313**: 53-76.
- Santoni, V, Bellini, C & Caboche, M. 1994. Use of two-dimensional protein-pattern analysis for the characterization of *Arabidopsis thaliana* mutants. Planta, **192**: 557-566.
- Scheiner, S M. 1993a. Genetics and evolution of phenotypic plasticity. Annual Review of Ecology and Systematics, **24**: 35-68.
- Scheiner, S M. 1993b. Plasticity as a selectable trait: reply to Via. American Naturalist, **142**: 371-373.
- Schlichting, C D. 1986. The evolution of phenotypic plasticity in plants. Annual Review of Ecology and Systematics, **17**: 667-693.
- Schlichting, C D & Pigliucci, M. 1993. Control of phenotypic plasticity via regulatory genes. American Naturalist, **142**: 366-370.
- Schlichting, C D & Pigliucci, M. 1995. Gene regulation, quantitative genetics and the evolution of reaction norms. Evolutionary Ecology, **9**: 154-168.
- Schmitt, J, McCormack, A C & Smith, H. 1995. A test of the adaptive plasticity hypothesis using transgenic and mutant plants disabled in phytochrome-mediated elongation responses to neighbors. American Naturalist, **146**: 937-953.

- Schopf, T J M. 1973. Ergonomics of polymorphism: its relation to the colony as the unit of selection in species of the phylum Ectoprocta. Pages 247-294 in Boardman, R S, Cheetham, A H & Oliver, W A j, eds. *Animal Colonies: Development and Function Through Time*. Dowden, Hutchinson and Ross, Stroudsburg.
- Schopf, T J M. 1976. Environmental versus genetic causes of morphologic variability in bryozoan colonies from the deep sea. *Paleobiology*, **2**: 156-165.
- Scoffin, T P, Tudhope, A W, Brown, B E, Chansang, H & Cheeney, R F. 1992. Patterns and possible environmental controls of skeletogenesis of *Porites lutea*, South Thailand. *Coral Reefs*, **11**: 1-11.
- Sebens, K & Miles, J S. 1988. Sweeper tentacles in a gorgonian octocoral: morphological modifications for interference competition. *Biological Bulletin*, **175**: 378-387.
- Sebens, K P. 1982a. Competition for space: growth rate, reproductive output and escape in size. *American Naturalist*, **120**: 189-197.
- Sebens, K P. 1982b. Limits to indeterminate growth: an optimal size model applied to passive suspension feeders. *Ecology*, **63**: 209-222.
- Sebens, K P. 1984. Water flow and coral colony size: Interhabitat comparisons of the octocoral *Alcyonium siderium*. *Proceedings of the National Academy of Sciences of the United States of America*, **81**: 5473-5477.
- Sebens, K P. 1987. The ecology of indeterminate growth in animals. *Annual Review of Ecology and Systematics*, **18**: 371-407.
- Sebens, K P, Witting, J & Helmuth, B. 1997. Effects of water flow and branch spacing on particle capture by the reef coral *Madracis mirabilis* (Duchassaing and Michelotti). *Journal of Experimental Marine Biology and Ecology*, **211**: 1-28.
- Seed, R & Hughes, R N. 1992. Reproductive strategies of epialgal bryozoans. *Invertebrate Reproduction and Development*, **22**: 291-300.

- Shanks, A L & Wright, W G. 1986. Adding teeth to wave action: the destructive effects of wave-borne rocks on intertidal organisms. Oecologia, **69**: 420-428.
- Shapiro, D F. 1992. Intercolony coordination of zooid behaviour and a new class of pore plates in a marine bryozoan. Biological Bulletin, **182**: 221-230.
- Shapiro, D F. 1996. Size-dependent neural integration between genetically different colonies of a marine bryozoan. Journal of Experimental Biology, **199**: 1229-1239.
- Shaw, J P. 1994. The effects of suctorial and raptorial predation on the growth of the bryozoan *Electra pilosa*. Senior Honours Project thesis, 26 pp. School of Biological and Medical Sciences, University of St Andrews, Scotland.
- Sibly, R M. 1996. Life history evolution in heterogeneous environments: a review of theory. Philosophical Transactions of the Royal Society of London, Series B, **351**: 1349-1359.
- Sibly, R M, Winokur, L & Smith, R H. 1997. Interpopulation variation in phenotypic plasticity in the speckled wood butterfly, *Pararge aegeria*. Oikos, **78**: 323-330.
- Silén, L. 1944. On the formation of the interzooidal communications of the Bryozoa. Zoologiska Bidrag fran Uppsala, **22**: 433-488.
- Silén, L. 1966. On the fertilization problem in the gymnolaematous Bryozoa. Ophelia, **3**: 113-140.
- Silén, L. 1977. Polymorphism. Pages 183-231 in Woollacott, R M & Zimmer, R L, eds. *Biology of Bryozoans*. Academic Press, New York and London.
- Silén, L. 1987. Colony growth pattern in *Electra pilosa* and comparable encrusting cheilostome bryozoans. Acta Zoologica, **68**: 17-34.
- Sjøtun, K & Fredriksen, S. 1995. Growth allocation in *Laminaria hyperborea* (Laminariales, Phaeophyceae) in relation to age and wave exposure. Marine Ecology Progress Series, **126**: 213-222.

- Smith, L D & Palmer, A R. 1994. Effects of manipulated diet on size and performance of brachyuran crab claws. Science, **264**: 710-712.
- Smith-Gill, S J. 1983. Developmental plasticity: developmental conversion versus phenotypic modulation. American Zoologist, **23**: 47-55.
- Sneath, P H A & Sokal, R R. 1973. *Numerical Taxonomy*. W. H. Freeman and Company, San Francisco, California. 573 pp.
- Sokal, R R & Rohlf, F J. 1981. *Biometry*. W. H. Freeman and Company, New York. 859 pp.
- Sorci, G, Clobert, J & Belichon, S. 1996. Phenotypic plasticity of growth and survival in the common lizard *Lacerta vivipara*. Journal of Animal Ecology, **65**: 781-790.
- Sousa, W P. 1984. The role of disturbance in natural communities. Annual Review of Ecology and Systematics, **15**: 353-391.
- Stearns, S C. 1983. The evolution of life-history traits in mosquitofish since their introduction to Hawaii in 1905: rates of evolution, heritabilities, and developmental plasticity. American Zoologist, **23**: 65-75.
- Stearns, S C. 1992. *The Evolution of Life Histories*. Oxford University Press, Oxford, New York , Toronto. 249 pp.
- Stebbing, A R D. 1973a. Competition for space among the epiphytes of *Fucus serratus*. Journal of the Marine Biological Association of the U.K., **53**: 247-261.
- Stebbing, A R D. 1973b. Observations on colony overgrowth and spatial competition. Pages 173-183 in Larwood, P G, ed. *Living and Fossil Bryozoa*. Academic Press, London.
- Stoner, D S. 1989. Fragmentation: a mechanism for the stimulation of genet growth rates in an encrusting colonial ascidian. Bulletin of Marine Science, **45**: 277-287.

- Strathmann, R R. 1985. Feeding and nonfeeding larval development and life-history evolution in marine invertebrates. Annual Review of Ecology and Systematics, **16**: 339-361.
- Strehler, B L. 1961. Aging in Coelenterates. Pages 373-395 in Lenhoff, H M & Loomis, W F, eds. *The Biology of Hydra and of some other Coelenterates*. Univ. of Miami Press, Coral Gables, FL.
- Strehler, B L & Crowell, S. 1961. Studies on comparative physiology of ageing. I. Function vs. age of *Campanularia flexuosa*. Gerontologia, **5**: 1-8.
- Ström, R. 1977. Brooding patterns of bryozoans. Pages 23-55 in Woollacott, R M & Zimmer, R L, eds. *Biology of Bryozoans*. Academic Press, New York and London.
- Sultan, S E & Bazzaz, F A. 1993. Phenotypic plasticity in *Polygonum persicaria*. I. Diversity and uniformity in genotypic norms of reaction to light. Evolution, **47**: 1009-1031.
- Temkin, M H. 1994. Gamete spawning and fertilization in the gymnolaemate bryozoan *Membranipora membranacea*. Biological Bulletin, **187**: 143-155.
- Temkin, M H. 1996. Comparative fertilization biology of gymnolaemate bryozoans. Marine Biology, **127**: 329-339.
- Thompson, T E. 1964. Grazing and the life cycles of British nudibranchs. Pages 275-297 in Crisp, D J, ed. *Grazing in Terrestrial and Marine Environments*. Blackwell, Oxford.
- Thompson, T E & Brown, G H. 1976. *British Opisthobranch Molluscs*. Academic Press, London. 203 pp.
- Thorpe, J P. 1979. A model using deterministic equations to describe some possible parameters affecting growth rate and fecundity in Bryozoa. Pages 113-120 in Larwood, G P & Abbott, M B, eds. *Advances in Bryozoology*. Academic Press, London and New York.

- Thorpe, J P, Beardmore, J A & Ryland, J S. 1978a. Genetic evidence for cryptic speciation in the marine bryozoan *Alcyonidium gelatinosum*. Marine Biology, **49**: 27-32.
- Thorpe, J P, Ryland, J S & Beardmore, J A. 1978b. Genetic variation and biochemical systematics in the marine bryozoan *Alcyonidium mytili*. Marine Biology, **49**: 343-350.
- Thorpe, J P, Shelton, G A B & Laverack, M S. 1975a. Colonial nervous control of lophophore retraction in cheilostome bryozoa. Science, **189**: 60-61.
- Thorpe, J P, Shelton, G A B & Laverack, M S. 1975b. Electrophysiology and coordinated behavioural responses in the colonial bryozoan *Membranipora membranacea*. Journal of Experimental Biology, **62**: 389-404.
- Todd, C D. 1981. The ecology of nudibranch molluscs. Oceanography and Marine Biology: An Annual Review, **19**: 141-234.
- Todd, C D, Lambert, W J & Thorpe, J P. 1998. The genetic structure of intertidal populations of two species of nudibranch molluscs with planktotrophic and pelagic lecithotrophic larval stages: are pelagic larvae "for" dispersal? Journal of Experimental Marine Biology and Ecology, : in press.
- Todd, C D & Turner, S J. 1986. Ecology of intertidal and sublittoral cryptic epifaunal assemblages. I. Experimental rationale and the analysis of larval settlement. Journal of Experimental Marine Biology and Ecology, **99**: 199-231.
- Trowbridge, C D. 1997. Dietary induction of opisthobranch morphology: *Placida dendritica* (Alder & Hancock, 1843) on different green algal hosts. Journal of Molluscan Studies, **63**: 29-38.
- Trussell, G C. 1996. Phenotypic plasticity in an intertidal snail: the role of a common crab predator. Evolution, **50**: 448-454.
- Trussell, G C. 1997. Phenotypic plasticity in the foot size of an intertidal snail. Ecology, **78**: 1033-1048.

- Tunnicliffe, V. 1981. Breakage and propagation in the stony coral *Acropora cervicornis*. Proceedings of the National Academy of Sciences of the United States of America, **78**: 2427-2431.
- Tunnicliffe, V. 1982. The effects of wave-induced flow on a reef-coral. Journal of Experimental Marine Biology and Ecology, **64**: 1-10.
- Tuomi, J & Vuorisalo, T. 1989a. Hierarchical selection in modular organisms. Trends in Ecology and Evolution, **4**: 209-213.
- Tuomi, J & Vuorisalo, T. 1989b. What are the units of selection in modular organisms? Oikos, **54**: 227-233.
- Turner, S J & Todd, C D. 1994. Competition for space in encrusting bryozoan assemblages: the influence of encounter angle, site and year on outcome variability. Journal of the Marine Biological Association of the U.K., **74**: 603-622.
- Tzioumis, V. 1994. Bryozoan stolonial outgrowths: a role in competitive interactions? Journal of the Marine Biological Association of the U.K., **74**: 203-210.
- Utter, B D & Denny, M W. 1996. Wave-induced forces on the giant kelp *Macrocystis pyrifera* (Agardh): field test of a computational model. Journal of Experimental Biology, **199**: 2645-2654.
- van Alstyne, K L. 1988. Herbivore grazing increases polyphenolic defenses in the intertidal brown alga *Fucus distichus*. Ecology, **69**: 655-663.
- van Alstyne, K L. 1989. Adventitious branching as a herbivore-induced defense in the intertidal brown alga *Fucus distichus*. Marine Ecology Progress Series, **56**: 169-176.
- van Tamelen, P G. 1996. Algal zonation in tidepools: experimental evaluation of the roles of physical disturbance, herbivory and competition. Journal of Experimental Marine Biology and Ecology, **201**: 197-231.

- Velimirov, B. 1976. Variations in growth form of *Eunicella cavolinii* Koch (Octocorallia) related to intensity of water movement. Journal of Experimental Marine Biology and Ecology, **21**: 109-117.
- Velimirov, B & Griffiths, C L. 1979. Wave-induced kelp movement and its importance for community structure. Botanica Marina, **22**: 169-172.
- Vermeij, G J. 1978. *Biogeography and Adaptation*. Harvard University Press, Cambridge, Massachusetts. 332 pp.
- Via, S. 1993a. Adaptive phenotypic plasticity: target or by-product of selection in a variable environment? American Naturalist, **142**: 352-365.
- Via, S. 1993b. Regulatory genes and reaction norms. American Naturalist, **142**: 374-378.
- Via, S. 1994. The evolution of phenotypic plasticity: what do we really know? Pages 35-57 in Real, L A, ed. *Ecological Genetics*. Princeton University Press, Princeton, New Jersey, USA.
- Via, S, Gomulkiewicz, R, De Jong, G, Scheiner, S M, Schlichting, C D & Van Tienderen, P H. 1995. Adaptive phenotypic plasticity: consensus and controversy. Trends in Ecology and Evolution, **10**: 212-217.
- Via, S & Lande, R. 1985. Genotype-environment interaction and the evolution of phenotypic plasticity. Evolution, **39**: 505-522.
- Vogel, S. 1981. *Life in Moving Fluids*. Willard Grant Press, Boston, Massachusetts. 352 pp.
- Waller, D M & Steingraeber, D A. 1985. Branching and modular growth: Theoretical models and empirical patterns. Pages 225-257 in Jackson, J B C, Buss, L W & Cook, R E, eds. *Population Biology and Evolution of Clonal Organisms*. Yale University Press, New Haven and London.
- Walls, M & Kettola, M. 1989. Effects of predator-induced spines on individual fitness in *Daphnia pulex*. Limnology and Oceanography, **34**: 390-396.

- Warkentin, K M. 1995. Adaptive plasticity in hatching age: A response to predation risk trade-offs. Proceedings of the National Academy of Sciences of the United States of America, **92**: 3507-3510.
- Warner, R R. 1997. Evolutionary ecology: how to reconcile pelagic dispersal with local adaptation. Coral Reefs, **16**: S115-S120.
- Watt, A S. 1947. Pattern and process in the plant community. Journal of Ecology, **35**: 1-35.
- Weber, S L & Scheiner, S M. 1992. The genetics of phenotypic plasticity. IV. Chromosomal localization. Journal of Evolutionary Biology, **5**: 109-120.
- Weinbauer, M G & Velirimov, B. 1995. Morphological variations in the Mediterranean sea fan *Eunicella cavolini* (Coelenterata: Gorgonacea) in relation to exposure, colony size and colony region. Bulletin of Marine Science, **56**: 283-295.
- Wendt, D E. 1996. Effect of larval swimming duration on success of metamorphosis and size of the ancestrular lophophore in *Bugula neritina* (Bryozoa). Biological Bulletin, **191**: 224-233.
- Wendt, D E & Woollacott, R M. 1995. Induction of larval settlement by KCl in three species of *Bugula* (Bryozoa). Invertebrate Biology, **114**: 345-351.
- West-Eberhard, M-J. 1989. Phenotypic plasticity and the origins of diversity. Annual Review of Ecology and Systematics, **20**: 249-278.
- Whitehead, J W, Seed, R & Hughes, R N. 1996. Factors controlling spinosity in the epialgal bryozoan *Flustrellidra hispida* (Fabricius). Pages 367-375 in Gordon, D P, Smith, A M & Grant-Mackie, J A, eds. *Bryozoans in Space and Time*. National Institute of Water & Atmospheric Research Ltd, Wellington, New Zealand.
- Wicklow, B J. 1988. Developmental polymorphism induced by intraspecific predation in the ciliated protozoan *Onychodromus quadricornutus*. Protozoology, **35**: 137-141.

- Wicklow, B J. 1997. Signal-induced defensive phenotypic changes in ciliated protists: morphological and ecological implications for predator and prey. Journal of Eukaryotic Microbiology, **44**: 176-188.
- Williams, G A & Seed, R. 1992. Interactions between macrofaunal epiphytes and their host algae. Pages 189-211 in John, D M, Hawkins, S J & Price, J H, eds. *Plant-Animal Interactions in the Marine Benthos*. Clarendon Press, Oxford.
- Williams, G C. 1957. Pleiotropy, natural selection, and the evolution of senescence. Evolution, **11**: 398-411.
- Willis, B L & Ayre, D J. 1985. Asexual reproduction and genetic determination of growth form in the coral *Pavona cactus*: biochemical, genetic and immunogenic evidence. Oecologia, **65**: 516-525.
- Wilson, J F B. 1997. Variation in colony and zooid morphology of the bryozoan *Electra pilosa* (Linnaeus) and the resulting implications on the grazing characteristics of *Adalaria proxima* (Alder and Hancock). Senior Honours Project thesis, 78 pp. School of Biological and Medical Sciences, University of St Andrews, Scotland.
- Winston, J E. 1976. Experimental culture of the marine ectoproct *Conopeum tenuissimum* from Chesapeake Bay. Biological Bulletin, **150**: 318- 335.
- Winston, J E. 1978. Polypide morphology and feeding behaviour in marine ectoprocts. Bulletin of Marine Science, **28**: 1-31.
- Winston, J E. 1988. The systematist's perspective. Pages 1-6 in Fautin, D G, ed. *Biomedical Importance of Marine Organisms*. California Acad. Sci., San Francisco.
- Winston, J E & Hayward, P J. 1994. Bryozoa Of the United-States Antarctic Research-Program - Preliminary-Report. Pages 205-210 in Hayward, P J S, Ryland, J S & Taylor, P D, eds. *Biology and Palaeobiology of Bryozoans*. Olsen & Olsen, Fredensborg, Denmark.

- Wishart, D. 1987. *Clustan User Manual*. Computing Laboratory, University of St Andrews, St Andrews, Scotland. 250 pp.
- Wood, V & Seed, R. 1992. Reproduction and growth of *Alcyonidium hirsutum* (Fleming) and *Flustrellidra hispida* (Fabricius) (Bryozoa: Ctenostomata) within a *Fucus serratus* L. community. Cahiers de Biologie Marine, **33**: 347-363.
- Woollacott, R M, Pechenik, J A & Imbalzano, K M. 1989. Effects of duration of larval swimming period on early colony development in *Bugula stolonifera* (Bryozoa: Cheilostomata). Marine Biology, **102**: 57-63.
- Yoshioka, P M. 1982. Predator-induced polymorphism in the bryozoan *Membranipora membranacea*. Journal of Experimental Marine Biology and Ecology, **61**: 233-242.
- Zar, J H. 1984. *Biostatistical Analysis*. Prentice-Hall, Englewood Cliffs, New Jersey, USA. 718 pp.
- Zhang, Y & Malmqvist, B. 1997. Phenotypic plasticity in a suspension-feeding insect, *Simulium lundstromi* (Diptera: Simuliidae), in response to current velocity. Oikos, **78**: 503-510.
- Zimmer, R L & Woollacott, R M. 1977. Metamorphosis, ancestrulae, and coloniality in bryozoan life cycles. Pages 91-142 in Woollacott, R M & Zimmer, R L, eds. *Biology of Bryozoans*. Academic Press, New York.

APPENDIX

Appendix 1: Colony means cluster analysis, using Ward's Method and Squared Euclidean Distance

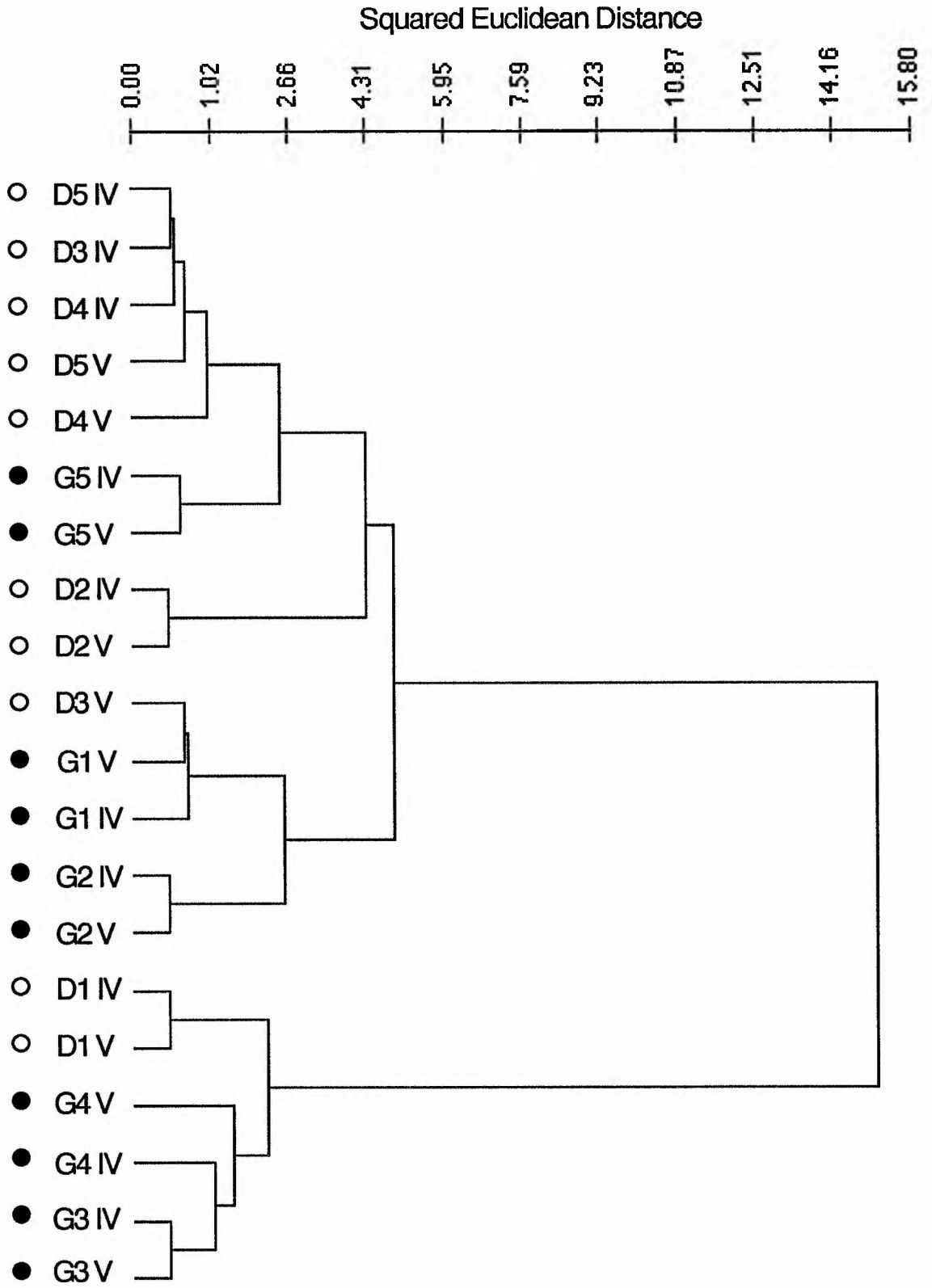

Appendix 2: Colony means cluster analysis, using UPGMA and Similarity Ratio

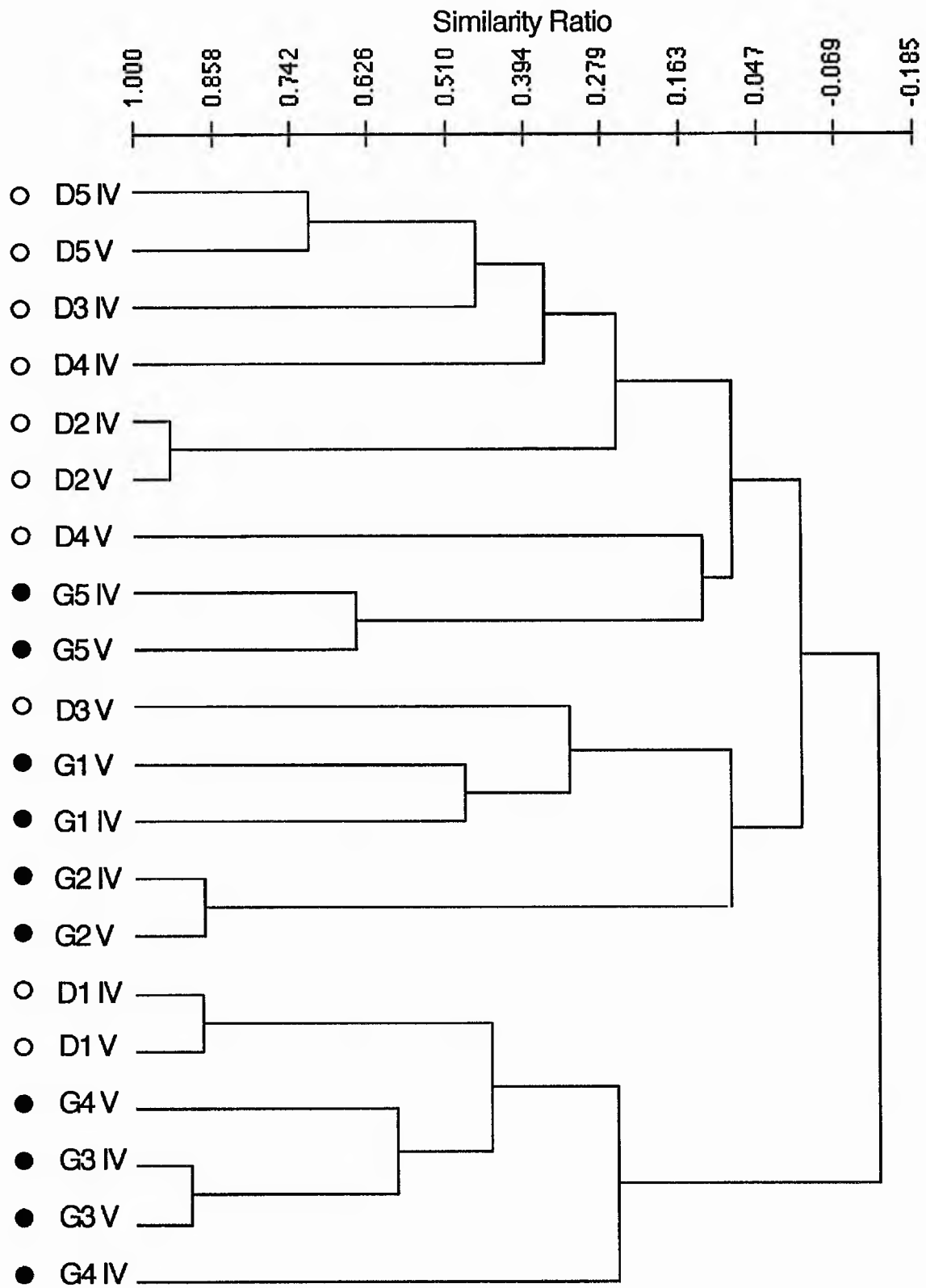

Appendix 3: Colony means cluster analysis, using Complete Linkage clustering and Squared Euclidean Distance

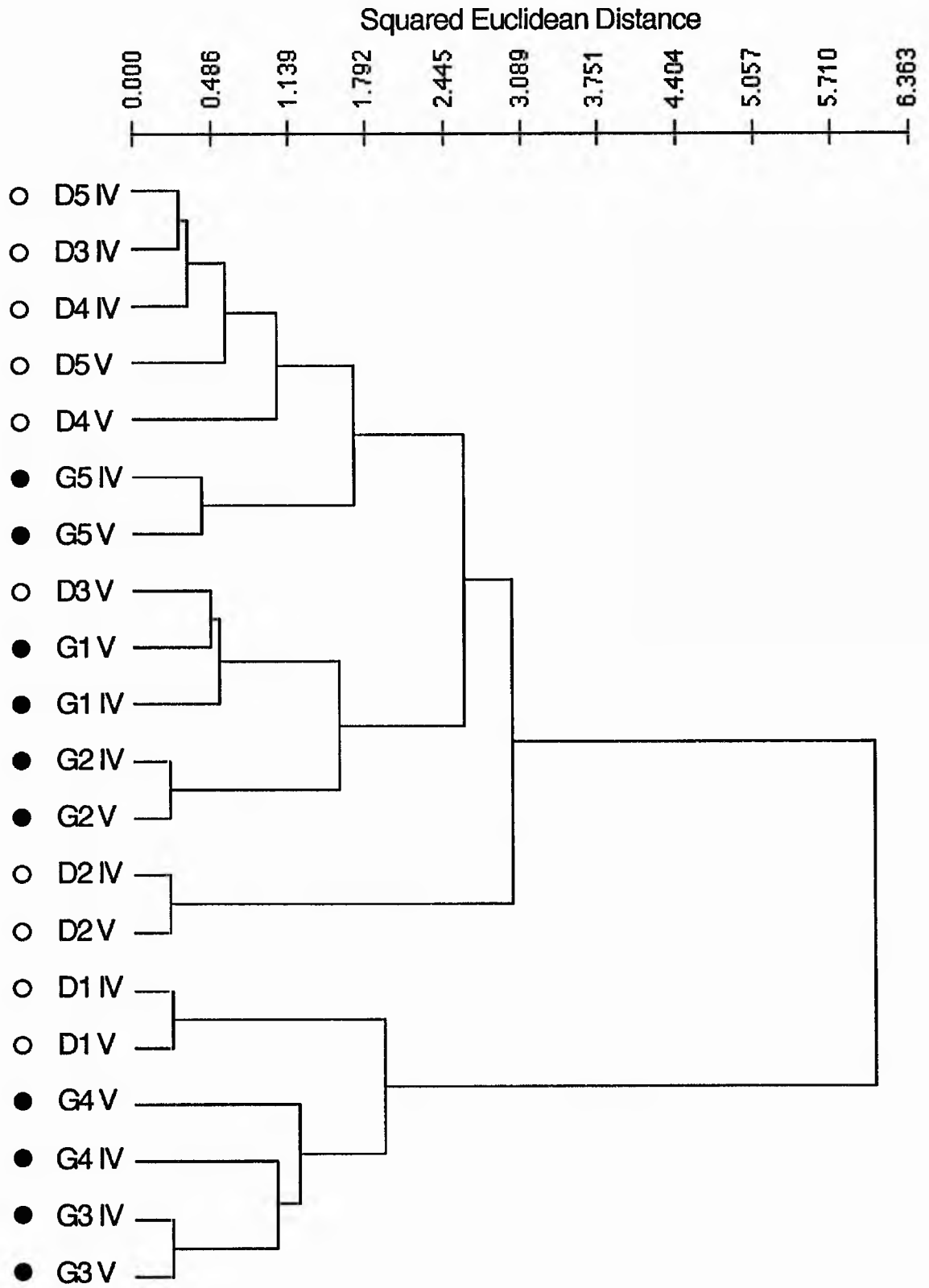

Appendix 4: Colony means cluster analysis, using Median clustering and Squared Euclidean Distance

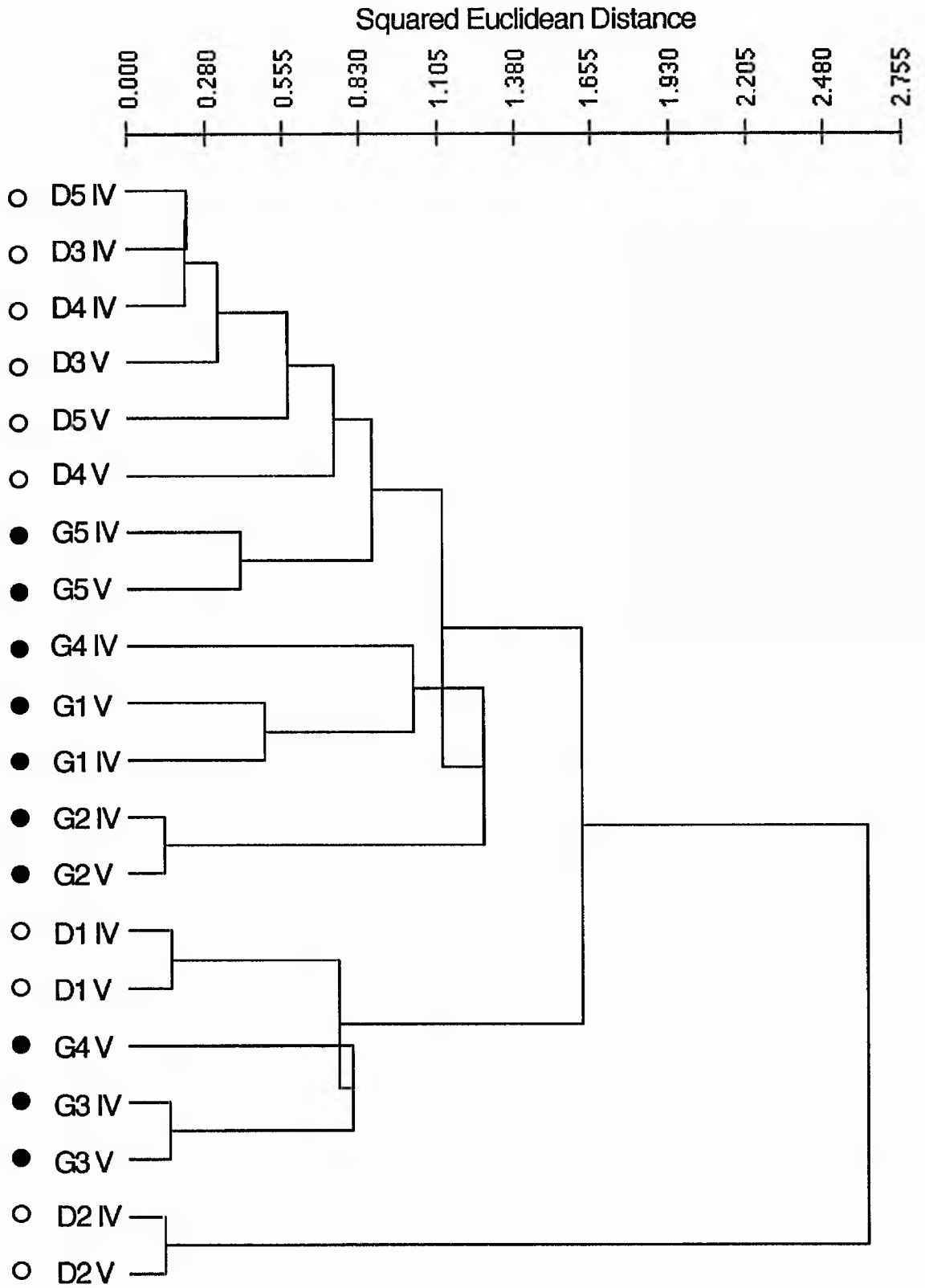

Appendix 5: Colony means cluster analysis, using Centroid clustering and Squared Euclidean Distance

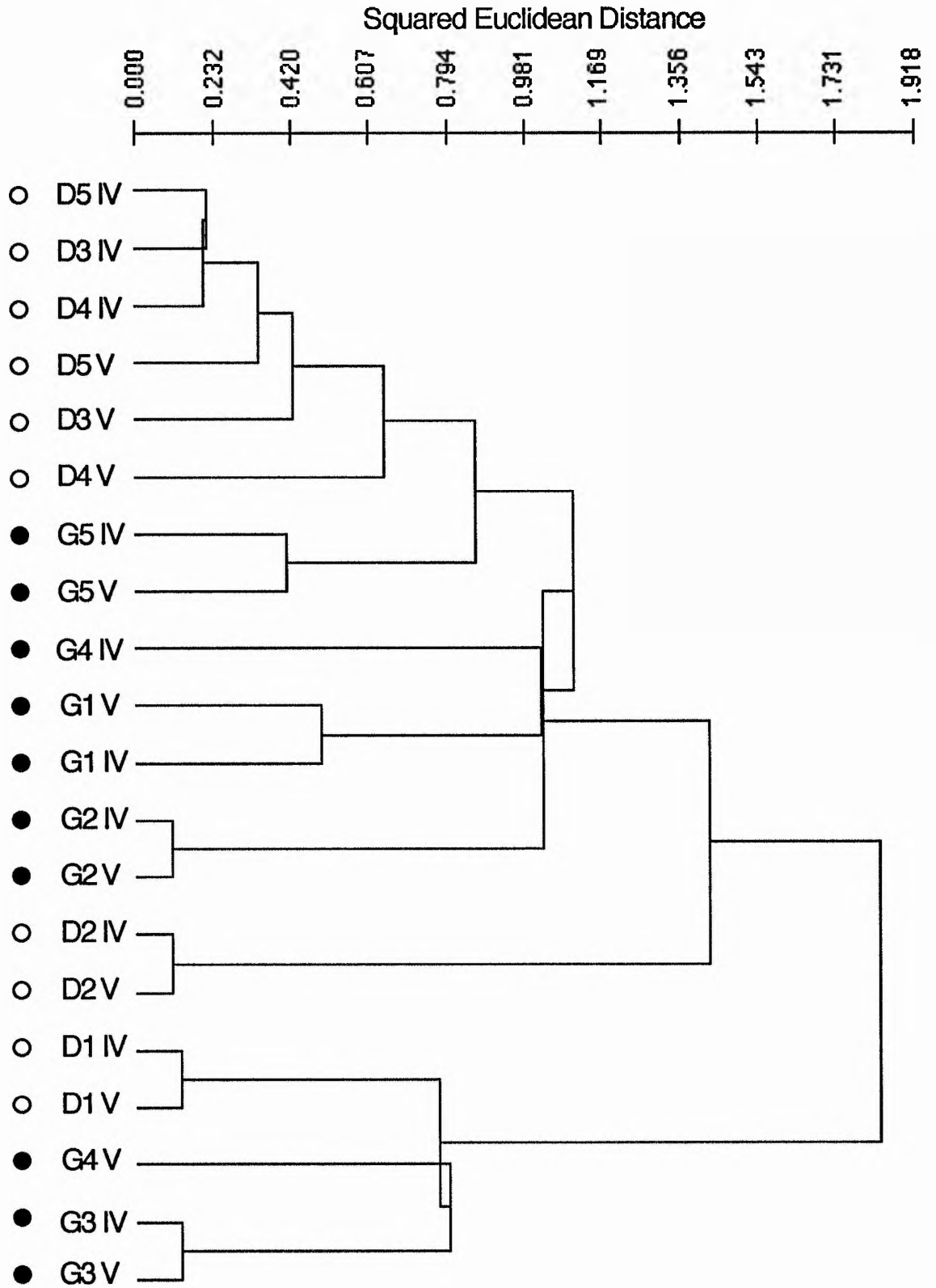

Appendix 6: Latitude/longitude coordinates and Ordnance Survey grid references of field sites used in this study.

Study Site	Area	Latitude/ Longitude Coordinates	Ordnance Survey Grid Reference
Clachan Seil	W Scotland	56° 19' N, 5° 35' W	NM 795197
Dundonnell	NW Scotland	57° 51' N, 5° 15' W	NH 085887
Gruinard Bay	NW Scotland	57° 53' N, 5° 27' W	NG 978932
Kingsbarns	E Scotland	56° 20' N, 2° 44' W	NO 532159

Appendix 7

Printed Publications Resulting From This Study

Wave-related abrasion induces formation of extended spines in a marine bryozoan

MICHA M. BAYER*, CHRISTOPHER D. TODD, JANE E. HOYLE
AND JOHN F. B. WILSON

Gatty Marine Laboratory, School of Environmental and Evolutionary Biology, University of St Andrews, St Andrews, Fife KY16 8LB, Scotland, UK (mmb@st-andrews.ac.uk)

SUMMARY

Inducible morphology, the conditional expression of morphological characters under certain environmental regimes, is a trait usually found in organisms subject to discrete environmental variability. In marine invertebrates, inducible changes in morphology are usually linked to unpredictable attack by predators or overgrowth competition. We present here evidence that extended spine formation in the marine bryozoan *Electra pilosa* is inducible by an abiotic cue, wave-related abrasion. In a laboratory experiment, we induced the formation of extended spines by subjecting colonies of *E. pilosa* to abrasion by seaweeds. We also investigated the potential role of *Adalaria proxima*, a specialist suctorial nudibranch predator of *E. pilosa*, in the formation of extended spines. While the presence of the predator does not itself induce extended spine formation, the spines do have a fortuitous anti-predator effect, discouraging predation both by *A. proxima* and another nudibranch, *Polycera quadrilineata*. We suggest that extended spines in *E. pilosa* constitute an adaptation for the protection of feeding polypides in high-energy environments, and that plasticity for the trait is of adaptive value in this passively dispersed organism, which exploits a diverse range of substrata and epifaunal habitats.

1. INTRODUCTION

Amongst invertebrate animals, inducible changes in discrete morphological characters have been reported to be mediated by biotic factors (Adler & Harvell 1990; Harvell 1990). These phenotypic plasticities include defensive structures such as spines (rotifers, bryozoans) or helmets (crustaceans), formed in response to predators, and sweeper tentacles (cnidarians) or stolons (bryozoans) arising from competition for space. We report here on the induction of a discrete morphology (extended median proximal spines, EMPS), which is novel in being mediated by an abiotic factor, wave-related abrasion. Typically, bryozoan colonies are encrusting and comprise interconnected zooids. The cosmopolitan marine bryozoan *Electra pilosa* L. is abundant in north-western Europe, and commonly grows epibiotically on the intertidal macro-alga *Fucus serratus* L. (Ryland & Hayward 1977). Zooids of *E. pilosa* generally have up to 11 short (*ca.* 100 µm) marginal spines and a single short (*ca.* 200 µm) median proximal spine (MPS). In a long-spined zooid morph, however, the MPS is greatly elongated (up to 2100 µm), a feature which is so distinctive that it has led some taxonomic authorities to assign this morph subspecific status (Hincks 1880). Nonetheless, three lines of evidence point to this morph being an ecophe-

notypic variant: (1) long- and short-spined zooids can occur within the same colony (figure 1); (2) the proportions of long- and short-spined colonies within populations vary seasonally (Stebbing 1973); and (3) on wave-exposed shores, there are higher proportions of colonies having long-spined zooids than occur on sheltered shores, and within colonies from exposed shores there is a higher proportion of long-spined zooids than in colonies from sheltered shores (figure 2). Colonies epibiotic on different seaweed species also differ in the percentage of long-spined zooids they display (C. D. Todd, unpublished data).

Given the above observations on the environmental correlation between wave exposure and the long-spined morph, we considered it likely that the formation of extended spines might be inducible by wave action, or perhaps by wave-related abrasion. We therefore subjected replicated genotypes to simulated wave action and algal abrasion in a laboratory experiment. Also, we aimed to investigate the role of a specialist nudibranch predator of *E. pilosa* as a potential inductive cue for the formation of extended spines. In the bryozoan *Membranipora membranacea* L., the formation of spines (as spine-bearing specialist zooids in which feeding and budding functions have been lost) is inducible through a water-borne cue from a nudibranch sea slug predator (Harvell 1984a). *E. pilosa* is preyed upon by a variety of organisms, but in British waters it is predominantly exploited by the nudibranch

*Author for correspondence.

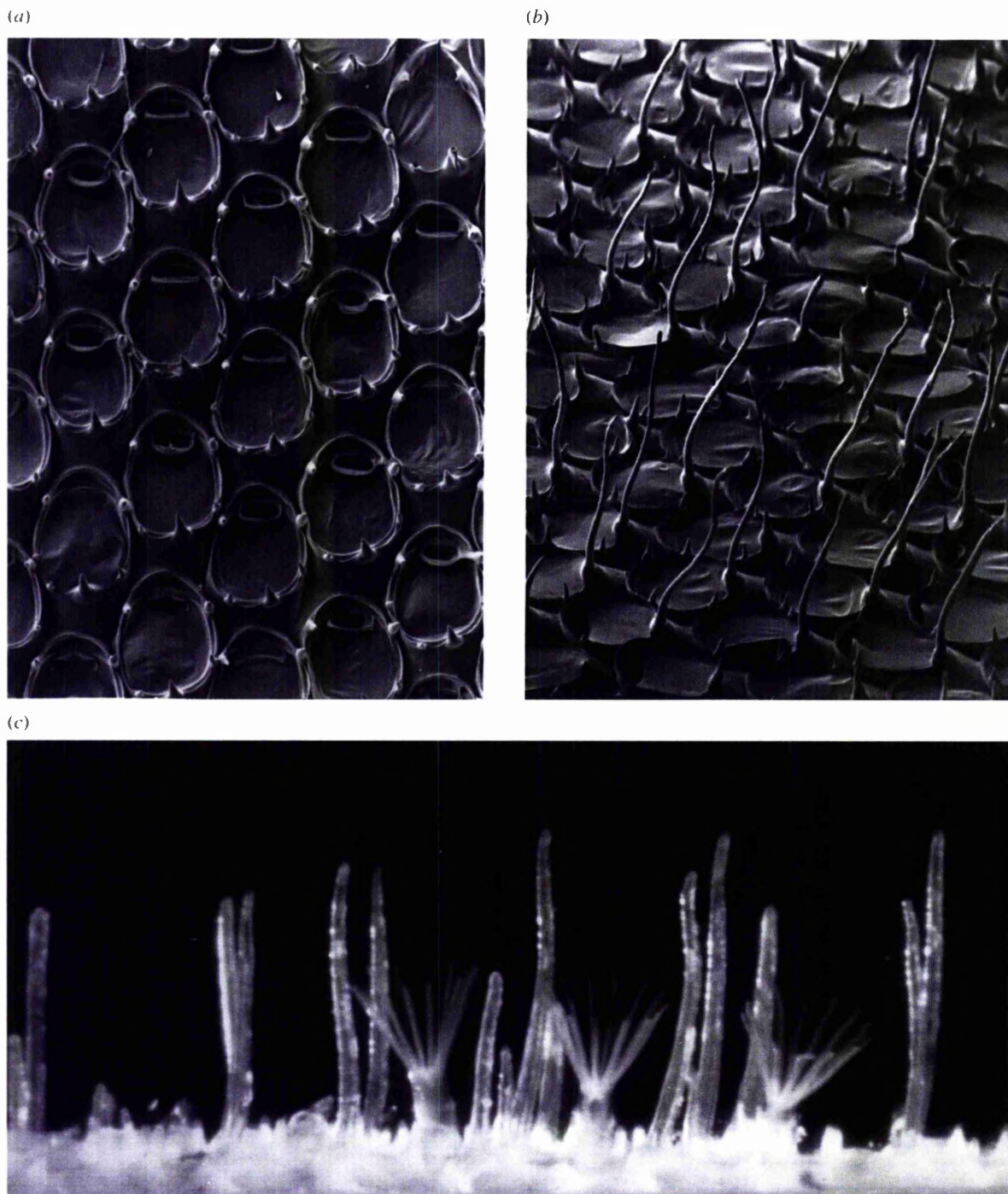

Figure 1. (a) Scanning electron micrograph (SEM) of a typical laboratory-grown, short-spined colony of *Electra pilosa*. Zooid length ca. 0.6 mm. (b) SEM of laboratory-grown induced colony of *E. pilosa*, showing long- and short-spined zooids. (c) Extended spines and feeding lophophores in a field-collected colony of *E. pilosa*. Fully formed extended spines (here ca. 1200 μ m) have a conical tip; spines of intermediate length shown here are blunt-ended and still forming. Short-spined zooids are also present.

mollusc *Adalaria proxima* (Alder & Hancock), a stenophagous specialist (Todd 1981), and, to a lesser extent, the sublittoral species *Polycera quadrilineata* (Müller), which is preferentially associated with *M. membranacea* (Thompson & Brown 1976). The relationship between the predator and its prey is intimate to the extent that larval metamorphosis in

A. proxima is specifically induced by the presence of the bryozoan (Lambert & Todd 1994; Lambert *et al.* 1997).

To investigate whether extended spines in *E. pilosa* zooids are inducible through predation by *A. proxima*, we subjected cloned replicate colonies of *E. pilosa* growing on glass plates to predation by *A. proxima*, and monitored colony development thereafter. We also

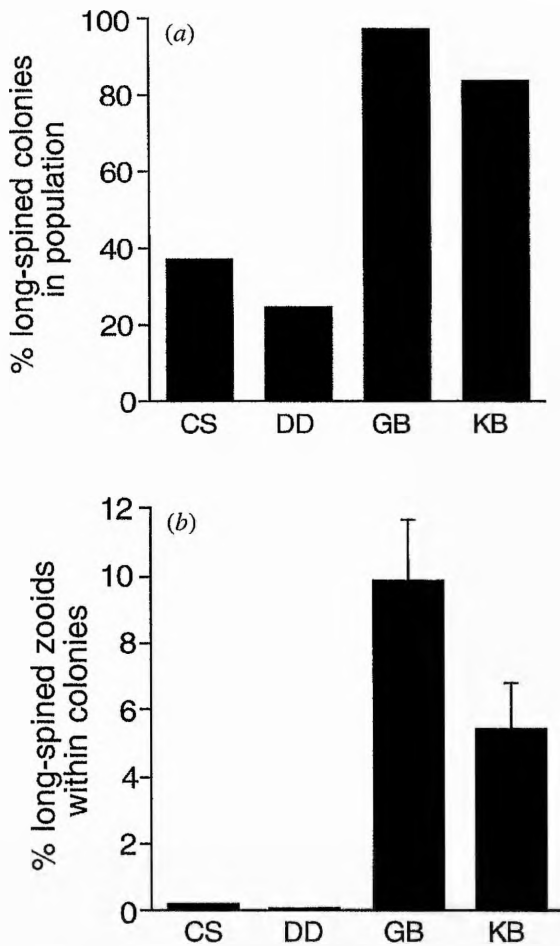

Figure 2. Differences in spinosity of *Electra pilosa* colonies from four sites of varying wave exposure. (a) Percentages of colonies including long-spined zooids at each site ('spiny' colonies). (b) Percentages of long-spined zooids within 'spiny' colonies at the same sites. Data shown are back-transformed arcsin means + s.e. Sites shown: CS, Clachan Seil, west Scotland, sheltered to very sheltered, Lewis Biological Exposure (LBE) scale 4–5 (Lewis 1964); DD, Dundonnell, north-west Scotland, sheltered, LBE scale 4; GB, Gruinard Bay, north-west Scotland, semi-exposed, LBE scale 3; KB, Kingsbarns, east Scotland, exposed to semi-exposed, LBE scale 2–3.

assessed the effectiveness of extended spines in reducing predation: zooidal spines or specialist spinozooids can be an effective means of hindering or disrupting predation (Cook 1985; Harvell 1984a, 1986). Here, we offered short-spined, long-spined and de-spined *E. pilosa* to both *A. proxima*, a suctorial predator which removes only the soft tissues of individual zooids, and *P. quadrilineata*, a raptorial predator which consumes the soft tissues of the zooids and also the skeletal components.

2. MATERIAL AND METHODS

(a) Abrasion experiments

Recently settled ancestrulae (post-larval 'founder' zooids) of *E. pilosa* were collected on *F. serratus*. Colonies were propagated from the ancestrulae, grown onto glass plates, and replicated by fragmentation (for details of methodology

see Bayer *et al.* (1994)). Six replicate colonies from each of four genotypes (total $n = 24$) were randomly allocated to slots in two complete randomized blocks on a horizontal rack which was held *ca.* 2 cm below the surface of the water in a purpose-built thermostatically controlled tank (18 °C). The flagellate *Rhodomonas* sp. was provided as food at a concentration of 50 000 cells ml⁻¹. The food concentration in the tank was established daily by counting cells in a water sample using a Sedgwick–Rafter counting chamber, and food was added as required to re-establish the above concentration. The water in the tank (75 l of 3 µm-filtered seawater) was changed once a week. To mimic wave action throughout the experiment, a tipping tank mounted 30 cm above the rack discharged 7.2 l of internally pumped water every 20 s.

There were two treatments ('intermittent' and 'permanent' abrasion) and one control ('no abrasion') group. The experiment was subdivided into three periods: period 1 provided a phase of undisturbed growth, allowing colonies to attain a size sufficient to prevent whole-colony mortality during abrasion; at the beginning of period 2, specimens of the filamentous red macroalgae *Ceramium rubrum* (Hudson) were attached to the edges of plates allocated to the two treatments ('intermittent' and 'permanent' abrasion) to provide wave-generated mechanical stimulation or abrasion of the underlying colony. The algae were removed from the 'intermittent' abrasion treatment at the end of period 2, whereas colonies in the 'permanent' abrasion treatment remained abraded during period 3. The experiment was carried out twice, with different sets of genotypes. The lengths of the periods were determined by colony growth and varied slightly between experimental repeats (period 1 = 18/12 d, period 2 = 8/9 d, period 3 = 8/8 d, for experiments 1/2, respectively). Throughout each experiment, colonies were drawn on alternate days, using a *camera lucida* mounted on a stereomicroscope, to provide a detailed temporal record of colony growth and of EMPS formation. In addition, colonies were drawn on the last day of each experimental period, thus allowing a direct comparison of the pre- and post-induction status of colonies. EMPS are easily recognizable from the early stages of their formation: a large boss with a visible lumen develops on the zooid bud, which then forms the base of the developing EMPS; in a non-extended MPS, the boss is rudimentary and has no visible lumen.

As a result of the water discharge from the tipping tank deviating slightly from vertical, colony growth was reduced in one of the blocks (i.e. rows in the rack) in experiment 1. Prior to experiment 2, settings on the tipping tank were adjusted slightly to reduce the block effect, and therefore the analysis of the experimental data was undertaken for each experiment separately.

At the end of each experiment, colonies were removed from the tank, cleaned with a paint-brush in fresh water and air-dried. Colonies were then examined under a stereomicroscope, and the numbers of short- and long-spined zooids in each colony were counted. Data were log₁₀-transformed where necessary, and then analysed using Multifactorial Analysis of Variance (SuperANOVA, Abacus Concepts, Inc., Berkeley, California, USA, 1991).

(b) Testing for inductive cues from *Adalaria proxima*

A total of 38 colonies of *E. pilosa* from four replicated genotypes were obtained by fragmentation and grown to a size of approximately 150 mm² (equivalent to *ca.* 915 zooids). Half of these were subjected to a 2–3 d period of continuous predation by *A. proxima* after which the mollusc was removed; during the predation period, colonies were kept in

individual 200 ml polypropylene dishes at 15 °C, the maximum temperature tolerable by the molluscs. Colony development was then monitored for a minimum of 20 d. Except for the period of predation, colonies on their glass plates were held vertically in a randomized array by a circular Perspex rack situated in a round 8 l glass trough. Colonies were fed the flagellate *Rhodomonas* sp. throughout the experiment; the filtered seawater in the tank was changed twice a week.

(c) Prey choice and feeding rate experiments

To standardize the size of colony pieces offered to predators, we punched out with a cork borer 5 mm diameter discs (equivalent to ca. 40 zooids) from *E. pilosa* colonies growing on *F. serratus*. In all cases, discs were cut from the area immediately proximal to the distal growing margin, to avoid possible variation in zooid palatability (Harvell 1984b). Due to the patchiness of extended spines, discs categorized as long-spined rarely consisted exclusively of long-spined zooids; accordingly, the criterion adopted here was a minimum of 50% long-spined zooids. To prepare de-spined discs, extended spines were clipped basally with iridectomy scissors to render the median spines comparable in length to unextended median spines. Short-spined discs comprised exclusively zooids with unextended median proximal spines. The algal discs were then impaled horizontally onto short pieces of fuse wire (three to each piece of wire, one of each prey type) which was then bent to produce a trefoil array of the three discs. The trefoil array eliminated the need for randomization of discs and enabled each individual predator to be in contact with all three discs at the same time, thus offering a choice of the three different types of prey. The disc arrays and molluscs were then introduced at random orientations into separate wells of Corning six-well plates containing filtered seawater.

Positions of feeding molluscs on the disc arrays were recorded at 1 min intervals for the first 6 h of the experiment. The extent of predation was recorded on a WILD M8 stereomicroscope, fitted with a *camera lucida*, at varying intervals during the experiment, depending on the feeding activity of molluscs. A final observation was made after 24 h. *P. quadrilineata* is a raptorial predator that removes whole zooids, and this necessitated measurement of the colony area consumed; this was accomplished by means of drawings made using the *camera lucida*, which were digitized using analySIS 2.0 image analysis software (Soft-Imaging Software GmbH, Münster, Germany). *A. proxima*, a suctorial predator, removes the soft parts of zooids only, leaving the hard skeleton; accordingly, the number of zooids consumed was counted and used in the analysis. Two repeats of the experiment were carried out for each predator species.

Feeding rate data were \log_{10} -transformed where necessary, and analysed by Analysis of Covariance (SuperANOVA) using mollusc weight or length as the covariate. Data from the choice experiments were analysed using *G*-tests for goodness of fit (Sokal & Rohlf 1981).

3. RESULTS

(a) Abrasion experiments

It appears that formation of EMPS is a deterministic process, as indicated by spine length frequency distributions: MPS and EMPS show strikingly different mean lengths, with normal distributions

(M. M. Bayer, unpublished data), suggesting that the extended spine is a discrete character rather than one that shows continuous variation.

Extended spine formation was observed to be a two-stage process. Initially, a large basal boss forms on the zooid wall, and the boss then either develops an extended spine, or, in exceptional circumstances, calcifies and forms a spine of length intermediate between the lengths of unextended and extended MPS. The development of EMPS commenced within 24 h of exposure to the abrasion stimulus, and was completed within a minimum of 4 d. Figure 3 shows the back-transformed arcsin mean (+s.e.) per cent of zooids that formed in each experimental period, and that displayed the induced morphology (bosses, intermediate length spines and EMPS). Extended spines formed in all colonies that received algal abrasion, but only for zooids budded and fully formed during the treatment periods (figure 3). Some colonies in the 'intermittent' abrasion treatment did produce a small number of EMPS following the removal of algal abrasion (period 3, figure 3), but zooid maps showed that these were all peripheral buds that were forming while still being subject to the stimulus up to the end of period 2. Thus, there appears to be a period only early on in their ontogeny when zooids can form EMPS. No EMPS were formed in control colonies subjected only to wave-crash: EMPS do not, therefore, form in response to water movement alone and in *E. pilosa* they probably are not an adaptation to modulating water flow over the colony surface (cf. Whitehead *et al.* 1996).

ANOVA revealed a significant difference ($p < 0.001$) in the percentage of induced zooids between the periods in experiment 1, but showed no significant period effect for experiment 2 ($p = 0.271$) due to an increase in the number of zooids induced during period 3 in the 'permanent' abrasion treatment. A significant block effect ($p = 0.015$) was also observed for experiment 2.

The final size range of colonies was 80–2506 zooids and 121–669 zooids for experiments 1 and 2, respectively. As expected, final colony size varied strongly with genotype, but there were also block and treatment effects; growth of colonies in the 'permanent' abrasion treatment was significantly reduced when compared to that of control colonies ($p = 0.003$, ANOVA), with control colonies attaining approximately twice the final size of 'permanent' abrasion treatment colonies. This was possibly attributable to a reduction in the availability of suspended *Rhodomonas* cells to feeding zooids of the treatment colonies, due to a simple screening effect of the algal tufts; alternatively, the observed reduction in colony growth might have been attributable to the energetic costs of EMPS production. Additional sources of variation in colony growth might be increased frequencies or duration of feeding polypide retraction in abraded colonies, but alternative experimental designs will be necessary to distinguish these sources of variation.

(b) Testing for inductive cues from *Adalaria proxima*

A. proxima is a major predator of *E. pilosa* in the intertidal and sublittoral, but none of the zooids in either the

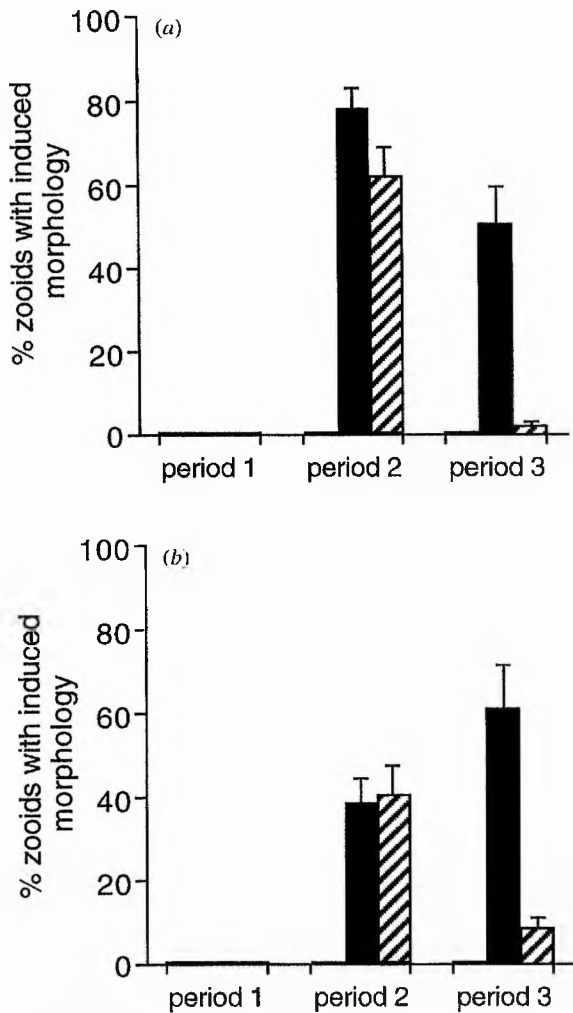

Figure 3. Induction of EMPS formation in *Electra pilosa*. Data are percentages of zooids newly formed in each period for two repeats. Experiment 1 (a) and experiment 2 (b) of the wave-crash abrasion experiment (two treatments and control): (i) control: wave-crash throughout, no abrasion (all values zero); (ii) permanent abrasion: wave-crash throughout, abrasion in periods 2 and 3 (black fill). (iii) intermittent abrasion: wave-crash throughout, abrasion in period 2 only (hatched fill).

treatment or the control colonies developed EMPS during predation or over the post-predation observation period. The formation of EMPS in *E. pilosa* is thus unrelated to predation by this major predator, and probably others. As expected, EMPS did not develop in pre-existing zooids, and thus colony growth is a requirement for the expression of this inducible character; here, colony growth rate was temporarily reduced during the predation period, possibly indicating a shock response to predation itself and/or an effect of the temperature reduction (see §2). Nonetheless, colonies in the predation treatments budded a total of approximately 1600 zooids during the predation period, none of which formed EMPS. Colonies also continued to bud new zooids after predation, with colony area increasing by 215–431% over the period between exposure to predation and the conclusion of

the experiment, and remained active and healthy throughout. There were no significant differences in colony area between treatments at the end of the experiment.

(c) Prey choice and feeding rate experiments

P. quadrilineata predation was reduced by EMPS, as indicated both by the significantly lower number of long-spined discs consumed over the duration of the experiment (*G*-test for goodness of fit, $p < 0.025$; figure 4), and the significantly lower proportion of long-spined discs attacked during the first feeding bout (*G*-test, $p < 0.025$; figure 4). In those cases where *P. quadrilineata* did consume long-spined discs, feeding rates were significantly lower than on short-spined and de-spined discs (ANCOVA, $p = 0.002$). Similarly, *A. proxima* showed a clear preference for short-spined and de-spined prey (figure 4), with a significantly lower number of long-spined discs attacked (*G*-test, $p < 0.001$) and a significant preference for short-spined and de-spined discs over long-spined discs during the first feeding bout (*G*-test, $p < 0.001$). *A. proxima* feeding rates were not significantly different amongst treatments (ANCOVA, covariate mollusc length), which was most likely due to only two nudibranchs feeding on long-spined discs, but the mean feeding rate on long-spined discs was still lower than that for short-spined and de-spined *E. pilosa* (long-spined: $1.52 \text{ zooids h}^{-1} \pm 1.40$, s.e.; short-spined: 2.20 ± 0.64 ; de-spined: 2.97 ± 1.10). Observed predation rates were lower than previously reported for adult *A. proxima* (Todd & Havenhand 1989) and can probably be explained by the present individuals being reproductive.

4. DISCUSSION

The rapid—and presumably energetically costly—formation of extended spines raises questions about the potential adaptive significance of this character in *E. pilosa*. Bryozoans are suspension feeders, and zooids capture particles by means of their tentaculate and ciliated lophophore. In the everted position (figure 1c), lophophores in *E. pilosa* project above the colony into the water column, and are essentially unprotected. It is probable that selective pressure for protection of the lophophore is high, as indicated by the fast lophophore retractor reflex, which is triggered by contact with solid objects (Thorpe *et al.* 1975). Fully formed extended spines can be several times the length of everted lophophores (EMPS length *ca.* 1200 μm ; lophophore length *ca.* 470 μm ; M. M. Bayer, unpublished data) and, at least in clusters, may afford considerable protection against mechanical disturbances. EMPS are uncalcified hollow projections of the chitinous cuticle (Ryland & Hayward 1977), a material which combines high mechanical strength with flexibility to the extent that they are essentially unbreakable (M. M. Bayer, personal observations).

The plastic expression of the trait begs the question why it should not be expressed constitutively, rather

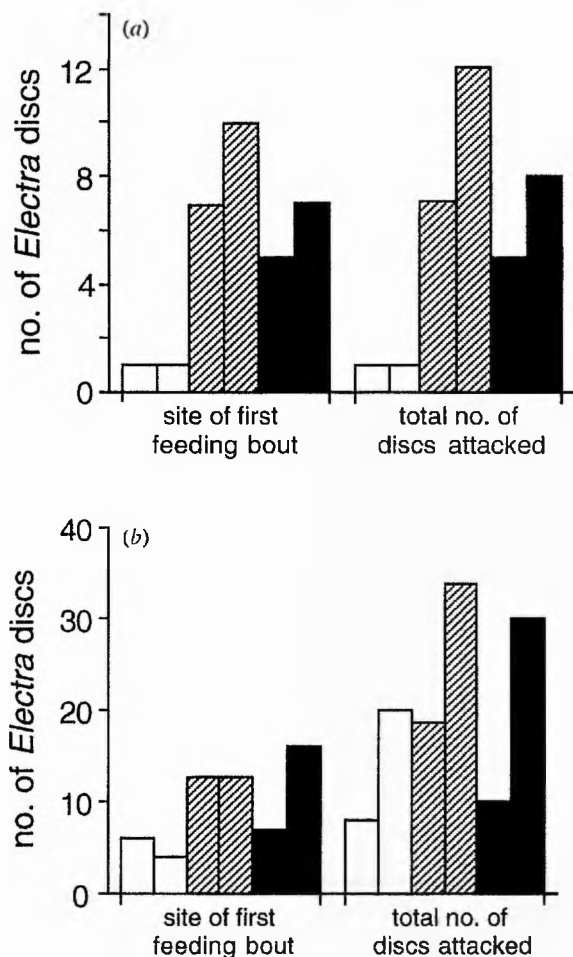

Figure 4. Feeding preferences of two nudibranchs, *Adalaria proxima* (a) and *Polycera quadrilineata* (b), preying upon *Electra pilosa*. Individuals were offered a choice of three different types of *E. pilosa* colony: long-spined discs (white fill); short-spined discs (hatched) and de-spined discs (black fill). Records were made of the molluscs' choice of prey in the initial feeding period (left-hand section of graphs) and the total number of discs in each category that had been fed upon by the end of the experiment (right-hand section of graphs). Data shown are from two experimental repeats, represented by left-hand and right-hand columns of each pair of bars (sample sizes: *A. proxima*, $n = 20/23$; *P. quadrilineata*, $n = 34/40$; for repeats 1/2, respectively).

than facultatively. Phenotypic plasticity is typically found in organisms that inhabit environments that are unpredictably variable both spatially and temporally (Adler & Harvell 1990). There has been considerable controversy over whether phenotypic plasticity is itself a selectable trait or a by-product of selection on phenotypic values. A recent synthesis of conflicting theory has resolved some of the controversy (Via *et al.* 1995), with the conclusion that phenotypic plasticity can itself be an adaptive trait. Adaptive plasticity appears to be a widespread phenomenon and has been reported for all major taxonomic groups (Dudley 1996; Dudley & Schmitt 1996; Ebert 1996; Gotthard & Nylin 1995; Hazel *et al.* 1987; Kingsolver & Wiernasz 1991; Stearns 1989; Vasseur & Aarsen 1992). The plastic expression of

traits is assumed to be adaptive under the following three conditions (Adler & Harvell 1990): (1) the selective agent is unpredictable and carries a reduction in fitness for the organism; (2) environmental cues tied to the selective agent are reliable and non-fatal; and (3) there is a cost that partly offsets the fitness benefits of the inducible morphology. With specific reference to *E. pilosa*, (1) larval dispersal is passive and, except for larval microhabitat choice, carries an element of unpredictability with respect to the quality of the habitat encountered at the time of larval competence to metamorphose; exposure to wave-related abrasion probably carries a cost in terms of reduced growth (see above) and possibly reduced reproductive value too. In bryozoans, reproductive value is closely linked to colony growth due to their modular construction (Thorpe 1979). Third, wave exposure can be variable not only spatially but also on a temporal scale, ranging from daily to seasonally. (2) Cues are reliable predictors in that the cue and the selective agent are identical in the present case (wave-related abrasion); although partial mortality is widespread amongst bryozoan colonies due to competition, predation or physical disturbance, the cue is potentially fatal to the genotype. This is in contrast to, for example, the case of the bryozoan *M. membranacea*, in which the selective agent (predation by a nudibranch predator) and the cue (a waterborne chemical) are separate entities (Harvell 1984a, 1986), and where the cue itself is harmless. (3) Costs may occur in terms of the metabolic expenses of EMPS formation and possibly increased risk of micro-fouling and siltation of the zooid skeleton: Marcus (1926) observed that EMPS can entrap significant amounts of sand and silt, which can in turn prevent polypides from everting and feeding.

Although extended spines can be an effective anti-predator device against two mollusc species with contrasting feeding strategies, it is clear that in contrast to the spinozooids of *M. membranacea*, the spines of *E. pilosa* zooids are not inducible by the predators themselves. *A. proxima*, a specialist predator of *E. pilosa*, occurs both intertidally and subtidally, but intertidal populations show clear distributional variations in association with wave action. On the wave-exposed east and west coasts of Scotland the nudibranchs occur beneath stable rocks (where *E. pilosa* is comparatively rare), whereas on the sheltered coasts (especially sealochs) of western Scotland the molluscs are found exclusively on *F. serratus* and *Laminaria digitata* (Todd *et al.* 1997). It is apparent, therefore, that in locations characterized by long-spined colonies (e.g. on macroalgae on wave-exposed shores), the bryozoan is not exploited by *A. proxima*, and that epibiotic populations of the mollusc are most frequent in locations where short-spined colonies predominate. Selective pressure on the evolution of anti-predator defences can thus be assumed to be of minor importance to *E. pilosa*. Although inducible morphology is generally adaptive with respect to a primary causative agent, this does not preclude the existence of a fortuitous adaptive function with respect to other, secondary agents: for example, just as spines in *E. pilosa* may also reduce predation, structural reinforcements in conifer needles, induced by wind exposure,

may also be adaptive in increasing resistance to herbivory and frost (Ennos 1997).

We thank Tara Graham, Jennifer Shaw and Laura Gamwell for laboratory assistance. Scott Lidgard, Keith Sillar, Anne Magurran and an anonymous reviewer provided valuable comments on the manuscript, and Janette Duck, Peter Baxter and the staff of the Bute Medical Building Workshop gave excellent technical assistance. This research was funded by Natural Environment Research Council grant GR3/9512 to C.D.T.

REFERENCES

- Adler, F. R. & Harvell, C. D. 1990 Inducible defenses, phenotypic variability and biotic environments. *Trends Ecol. Evol.* **5**, 407–410.
- Bayer, M. M., Cormack, R. M. & Todd, C. D. 1994 Influence of food concentration on polypide regression in the marine bryozoan *Electra pilosa* (L.) (Bryozoa: Cheilostomata). *J. Exp. Mar. Biol. Ecol.* **178**, 35–50.
- Cook, P. L. 1985 Bryozoa from Ghana—a preliminary survey. *Sciences zoologiques, Ann. vol. 238*. Tervuren, Belgique: Musee Royale de l'Afrique Centrale.
- Dudley, S. A. 1996 Differing selection on plant physiological traits in response to environmental water availability: a test of adaptive hypotheses. *Evolution* **50**, 92–102.
- Dudley, S. A. & Schmitt, J. 1996 Testing the adaptive plasticity hypothesis: density-dependent selection on manipulated stem length in *Impatiens capensis*. *Am. Nat.* **147**, 445–465.
- Ebert, T. A. 1996 Adaptive aspects of phenotypic plasticity in echinoderms. *Oceanol. Acta* **19**, 347–355.
- Ennos, A. R. 1997 Wind as an ecological factor. *Trends Ecol. Evol.* **12**, 109–111.
- Gotthard, K. & Nylin, S. 1995 Adaptive plasticity and plasticity as an adaptation: a selective review of plasticity in animal morphology and life history. *Oikos* **74**, 3–17.
- Harvell, C. D. 1984a Predator-induced defense in a marine bryozoan. *Science* **224**, 1357–1359.
- Harvell, C. D. 1984b Why nudibranchs are partial predators: intracolony variation in bryozoan palatability. *Ecology* **65**, 716–724.
- Harvell, C. D. 1986 The ecology and evolution of inducible defenses in a marine bryozoan: cues, costs and consequences. *Am. Nat.* **128**, 810–823.
- Harvell, C. D. 1990 The ecology and evolution of inducible defenses. *Quart. Rev. Biol.* **65**, 323–341.
- Hazel, W., Brandt, R. & Grantham, T. 1987 Genetic variability and phenotypic plasticity in pupal colour and its adaptive significance in the swallowtail butterfly *Papilio polyxenes*. *Heredity* **59**, 449–455.
- Hincks, T. 1880 *A history of the British marine polyzoa*. London: John Van Voorst.
- Kingsolver, J. G. & Wiernasz, D. C. 1991 Seasonal polyphenism in wing-melanin pattern and thermoregulatory adaptation in *Pteris* butterflies. *Am. Nat.* **137**, 816–830.
- Lambert, W. J. & Todd, C. D. 1994 Evidence for a water-borne cue inducing metamorphosis in the dorid nudibranch mollusc *Adalaria proxima* (Gastropoda: Nudibranchia). *Mar. Biol.* **120**, 265–271.
- Lambert, W. J., Todd, C. D. & Hardege, J. D. 1997 Partial characterization and biological activity of a metamorphic inducer of the dorid nudibranch *Adalaria proxima* (Gastropoda: Nudibranchia). *Invert. Biol.* **116**, 71–81.
- Lewis, J. R. 1964 *The ecology of rocky shores*. London: The English Universities Press Ltd.
- Marcus, E. 1926 Beobachtungen und Versuche an lebenden Meeresbryozoen. *Zool. Jahrb. Abt. Syst. Oekol. Geogr. Tiere* **52**, 1–102.
- Ryland, J. S. & Hayward, P. J. 1977 *British anascan bryozoans*. Synopses of the British Fauna (New Series). London: Academic Press.
- Sokal, R. R. & Rohlf, F. J. 1981 *Biometry*. New York: W. H. Freeman.
- Stearns, S. C. 1989 The evolutionary significance of phenotypic plasticity. *BioScience* **39**, 436–445.
- Stebbing, A. R. D. 1973 Observations on colony overgrowth and spatial competition. In *Living and fossil bryozoa* (ed. P. G. Larwood), pp. 173–183. London: Academic Press.
- Thompson, T. E. & Brown, G. H. 1976 *British opisthobranch molluscs*. Synopses of the British Fauna. London: Academic Press.
- Thorpe, J. P. 1979 A model using deterministic equations to describe some possible parameters affecting growth rate and fecundity in Bryozoa. In *Advances in bryozoology* (ed. G. P. Larwood & M. B. Abbott), pp. 113–120. London and New York: Academic Press.
- Thorpe, J. P., Shelton, G. A. B. & Laverack, M. S. 1975 Colonial nervous control of lophophore retraction in cheilostome bryozoa. *Science* **189**, 60–61.
- Todd, C. D. 1981 The ecology of nudibranch molluscs. *Oceanogr. Mar. Biol. A. Rev.* **19**, 141–234.
- Todd, C. D. & Havenhand, J. N. 1989 Nudibranch bryozoan associations: the quantification of ingestion and some observations on partial predation among Doridoidea. *J. Moll. Stud.* **55**, 245–259.
- Todd, C. D., Lambert, W. J. & Thorpe, J. P. 1997 The genetic structure of intertidal populations of two species of nudibranch molluscs with planktotrophic and pelagic lecithotrophic larval stages: are pelagic larvae 'for' dispersal? *J. Exp. Mar. Biol. Ecol.* (Submitted.)
- Vasseur, L. & Aarsen, L. W. 1992 Interpretation of adaptive plasticity in *Lemna minor*. *Oikos* **65**, 233–241.
- Via, S., Gomulkiewicz, R., De Jong, G., Scheiner, S. M., Schlichting, C. D. & Van Tienderen, P. H. 1995 Adaptive phenotypic plasticity: consensus and controversy. *Trends Ecol. Evol.* **10**, 212–217.
- Whitehead, J. W., Secd, R. & Hughes, R. N. 1996 Factors controlling spinosity in the epialgal bryozoan *Flustrellidra hispida* (Fabricius). In *Bryozoans in space and time* (ed. D. P. Gordon, A. M. Smith & J. A. Grant-Mackie), pp. 367–375. Wellington, New Zealand: National Institute of Water & Atmospheric Research Ltd.

Received 16 July 1997; accepted 8 August 1997

Effect of polypide regression and other parameters on colony growth in the cheilostomate *Electra pilosa* (L.)

Micha M. Bayer & Christopher D. Todd

Gatty Marine Laboratory, School of Biological and Medical Sciences, University of St Andrews, St Andrews, Fife KY16 8LB, Scotland, U.K.

ABSTRACT

Five randomly chosen genotypes of the anascan cheilostomate *Electra pilosa* (L.) were reared from ancestrulae, cloned and propagated under laboratory conditions. The definitive experimental colonies were reared on a diet of the flagellate *Rhodomonas* sp. for a period of 103 days. Throughout the experiment, daily observations of polypide regression/regeneration were made for a cluster of eight zooids in each colony. Colony growth/size, colony form (relative colony perimeter, RCP), tentacle number, and zooid activity — a combined measure of polypide life spans and polypide regeneration times — all differed significantly between genotypes. Stellate colonies (with higher RCP values) showed higher growth rates and there also was a significant correlation between growth rate and overall zooid activity. Neither tentacle number nor lophophore diameter, however, showed a significant correlation with colony growth rate/final size. That polypide life spans decreased over the duration of the experiment, whilst regeneration times increased, suggests the occurrence of senescence at the zooid level. One consequence of this was the progressive increase in the percentage of inactive zooids among the observed zooids. Nevertheless, much of the total between-genotype variation in colony size was not explained by either colony form or zooid activity.

Keywords: *Electra pilosa*, polypide regression, senescence, polypide regeneration, colony growth, model

INTRODUCTION

In modular organisms, growth probably constitutes the most important element of fitness. Size/area maximisation appears to have a direct effect on fecundity (e.g., Hayward & Ryland 1975; Thorpe 1979; Wood & Seed 1992), regenerative capacity, competitive ability, and also resistance to predators, diseases, and catastrophes (Jackson & Coates 1986). The likelihood of survival of colony parts increases as a function of their size and, with respect to overgrowth competition, colonial animals can have size refuges from overgrowth by exceeding a certain size limit (Sebens 1982). Colony growth can be affected by sexual-reproductive parameters; trade-offs between somatic investment and sexual allocation are not infrequent, and experimental evidence for these continues to accumulate (Stearns 1992).

Variation in growth rates at the genetic level is frequently observed in modular organisms and is well documented in bryozoans (Hughes & Hughes 1986; Cancino & Hughes 1987; Hughes 1989, 1992; Keough 1989). Despite the fact that such variation has repeatedly been observed, there still is a general lack of understanding of the underlying causes of the observed variability. In this study, we sought to explain the considerable genetic variation of colony growth rates in the cheilostomate *Electra pilosa* (L.) by means of other, genetically fixed, parameters that might bear a direct influence on the growth performance of a colony (or ramet). Figure 1 summarises the factors that might be expected to be of importance to colony growth.

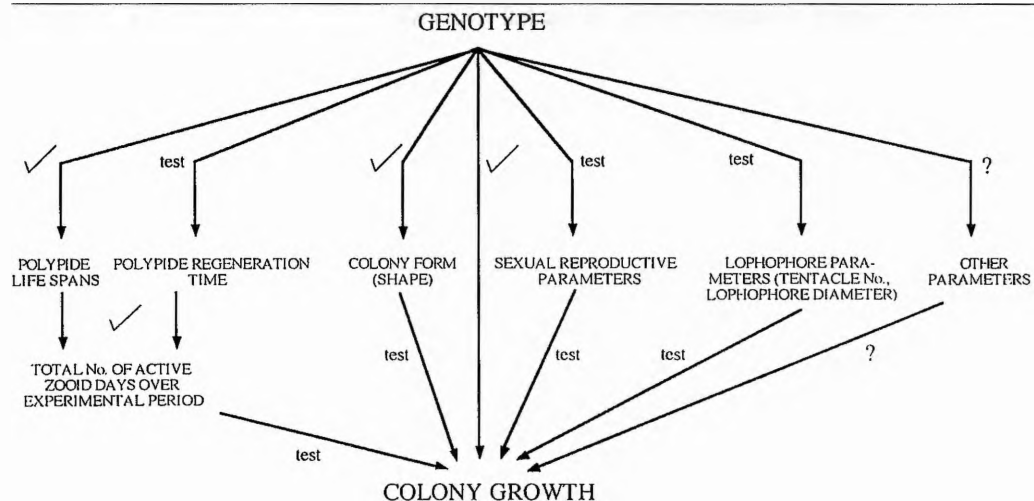

Fig. 1. Schematic representation of parameters of putative importance for colony growth rates in *Electra pilosa*. Ticks (checkmarks) on arrows indicate mechanisms that had been confirmed in previous studies, "test" indicates the relationships to be explored here.

Reprinted from:
Gordon, D.P., Smith, A.M.
& Grant-Mackie, J.A.
1996: *Bryozoans in Space and Time*. Proceedings of the 10th International Bryozoology Conference, Wellington, New Zealand. 1995. National Institute of Water & Atmospheric Research Ltd, Wellington. 442 p.

Foremost, our interest focuses on the phenomenon of polypide regression and its possible implications for colony growth. Best and Thorpe (1985) have shown that active nutrient translocation causes metabolic gradients from the centre to the periphery of a colony; this provides evidence of the individual contribution made by zooids to the overall growth of the colony. This contribution will be a function of (a) the polypide's filtration performance (which itself might be affected by lophophore morphology) and (b) the amount of time available for filtration. The latter is a function both of polypide life span and the time required to form a new polypide after regression.

Second, we ask the question whether colony form affects colony growth in any way. It has been argued that species with stellate growth morphologies, such as *Electra pilosa*, can maintain higher growth rates than do more lobate species (Rubin 1987). This arises from colony growth being limited by the absolute perimeter length and stellate colony shapes having longer perimeters relative to their area. Intuitively, if this were the case, then a relationship between colony form and growth rate would be expected to be expressed at an intraspecific level also, with stellate genotypes achieving faster growth than lobate conspecifics.

Electra pilosa is a hermaphroditic non-brooding species with a pelagic cyphonautes larva. In the present study, post-settlement ancestrulae were collected from the field and ongrown under controlled laboratory conditions. Our objective was to investigate within- and between-genotype variation in colony growth, polypide cycling, and sexual maturation.

MATERIAL & METHODS

Bryozoan culture

The methodology of bryozoan culture that we have developed is described in detail elsewhere (Bayer *et al.* 1994). Briefly, recently metamorphosed postlarval ancestrulae of *Electra pilosa* were collected from a single plant of the intertidal macrophyte *Fucus serratus* (L.), from St Andrews Bay, Fife, Scotland (56°20'N, 2°47'W) in June 1993. In the laboratory, small pieces of thallus bearing ancestrulae were excised and clipped onto separate microscope slides by means of slit PVC tubing. Apposition of a coverslip to the resectioned surface of the alga allows the ancestrula to bud and grow off the alga and onto the manipulable plane substratum. Once established on the coverslip the colony can be excised and transferred and clipped to another slide. Apposition of another coverslip, which is prescored with a diamond pencil, encourages the further growth of the colony onto these breakable strips. Once the colonies were well established on the final coverslip substratum, the colonies were broken up and replicate pieces clipped onto individual 8 x 8 cm glass plates. Broken colonies heal quickly and readily grow onto the experimental glass-plate substrata. The colony fragments were then allowed to heal and grow off the coverslip strips and onto the definitive experimental 8 x 8 cm plates. For the purposes of the present experiment, five genotypes were replicated fourfold each on separate glass plates. At the commencement of the experiment the coverslip on each plate was removed and each of the replicate colonies was carefully trimmed to a group of nine adjacent zooids. All colonies were treated contemporaneously and trimmed to the nine initial zooids on day 0. The first eight zooids budded from the starter group were used for observational purposes. These were inspected daily and records made of the cycles of polypide degeneration/regeneration and sexual maturation for each of the zooids throughout the experiment.

During the replication phase, and throughout the experiment itself, colonies were maintained in a thermostatted waterbath at 18°C and fed a monoculture diet ($4.25 \cdot 10^4$ cells·ml⁻¹) of the flagellate chrysophyte *Rhodomonas* sp. in 0.22 mm filtered seawater. The seawater and algal diet in the culture dishes was replaced every three days. The definitive experimental colonies were held upright by means of a slotted perspex annulus on the bottom of a single circular 7-litre glass trough. The positions of colonies within the trough were assigned at random to preclude positional effects. The experiment extended over 103 days. Daily observations on an individual zooid commenced when its first polypide had formed and initiated feeding; because of the unequal timing of the formation of the observed zooids, the duration of the observational period for individual zooids varied between 97 and 103 days. Colony area and incremental growth were measured weekly from digitised *camera lucida* drawings of the colonies. Lophophore parameters (tentacle number, lophophore diameter) were measured only at the end of the experiment, for samples of ten randomly chosen polypides for each colony.

Data analysis

Colony form was quantified by using the relative colony perimeter, RCP (= $\text{perimeter}^2 / 4\pi \text{area}$;

Jebam1980), obtained from the weekly area and perimeter measurements. Colony area at the end of the experiment (= final colony area) was used as measure of growth performance of a colony. Prior to analysis, the data were examined for non-normality and heteroscedasticity and transformed where necessary. The variation in growth (= final colony area), within and between genotypes was modelled in GLIM (Generalized Linear Interactive Modelling, v. 3.77; Royal Statistical Society 1987); the model fitted here was a multiple regression model with both fixed and continuous factors.

Owing to the marked between-genotype differences in polypide life spans (PLS) and/or regeneration times (RT), the available numbers of observed-polypide cycles varied considerably. Although a maximum of 11 cycles was recorded in some cases, cycle 11 had to be excluded from the polypide life-span analysis due to insufficient replication ($n = 3$, out of 160 (20 x 8) zooids possible): similarly, cycles 10 ($n = 9$) and 11 ($n = 2$) had to be deleted from the analysis of polypide regeneration times.

Throughout our analyses, colony means of parameters were used where observations on individual zooids were involved; strictly, nested ANOVA would apply to data of this type, but in the case of bryozoan zooids, with their colony-wide integration, the assumption of independence is violated and individual zooid data cannot be used. Colony means are, however, justifiable from a biological point of view, because the colony is the genetic individual and thus the unit upon which selection acts.

The structure of the data is, in analytical terms, somewhat problematic; repeated-measures ANOVA was not applicable in the present case because the data of interest will, in all likelihood, be subject to temporal autocorrelation. Similarly, fitting different curvilinear models to individual genotypes will not provide biologically meaningful information, and, at least for some of the genotypes, was not possible. In considering further the influence of PLS and RT on colony growth/size, we deemed it appropriate to choose a parameter that describes the net metabolic input to the colonial nutrient pool, rather than simply either PLS or RT in isolation. Assuming that net metabolic input will be a composite both of PLS and RT, we calculated the percentage of days throughout the experiment for which a zooid had an active intact polypide. This accounted both for PLS and RT, whilst also overcoming the problem of their temporal patterns differing between genotypes. Hereafter, this parameter is referred to as 'zooid activity'. Colony means for (percentage) zooid activity were analysed by one-way ANOVA, followed by Scheffé's multiple comparison procedure.

RESULTS

Colony growth

Colony growth rate — as expressed by final colony area — differed very significantly between genotypes (ANOVA, $F_{4,15} = 94.85$, $P < 0.0001$), resulting in an almost six-fold difference in mean colony area between the fastest- and slowest-growing genotypes (numbers 1 and 3, respectively) (Figs 2 and 3). Scheffé's multiple comparison test showed all possible combinations

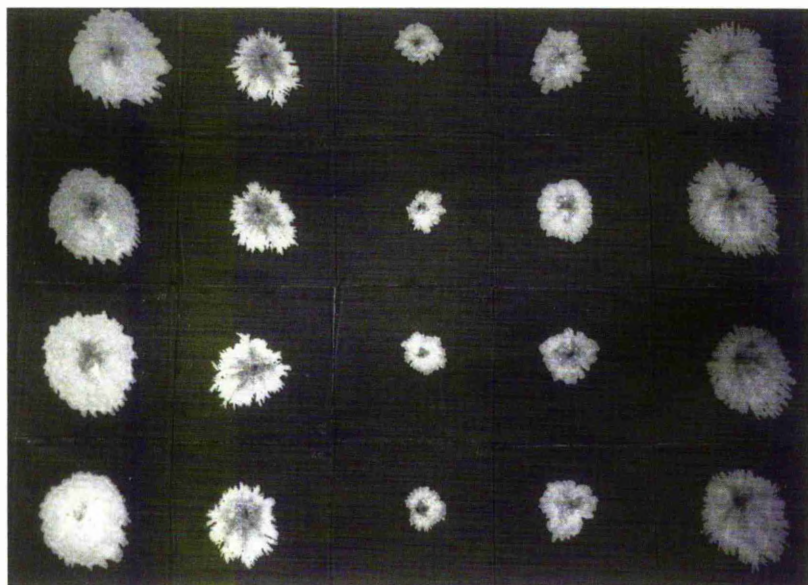
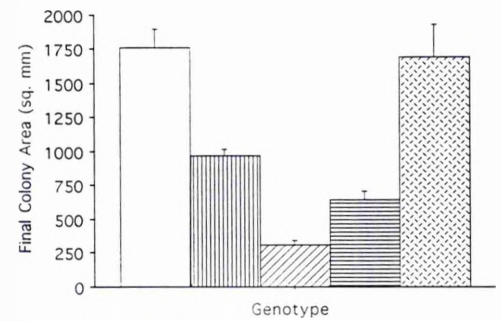

Fig. 2. The colonies at the end of the experiment, after a growth period of 103 days. Replicates of genotypes are arranged in columns, and genotypes are arranged 1 to 5 from left to right. The size of glass plates is 8 x 8 cm.

Fig. 3. Genotype means of colony area in square millimetres at the end of the experiment ($t = 103$ d). Error bars are $+1$ standard deviation. Genotypes are arranged 1 to 5 from left to right. Means are based on observations from four replicate colonies per genotype.



between genotypes, except 1 and 5, to be significantly different. Genotype means of final colony area are given in Table 1.

Table 1. Genotype means of parameters measured in the experiment. Means are based on observations from four replicate colonies per genotype (RCP = relative colony perimeter, Loph. diameter = diameter of extended lophophore, Tentacle no. = number of lophophore tentacles)

Genotype	Final Area (sq. mm)		Final RCP		Zooid Activity (%)		Loph. diameter (μm)		Tentacle no.	
	mean	SD	mean	SD	mean	SD	mean	SD	mean	SD
1	1758.3	135.5	1.481	0.122	52.17	2.14	485.7	39.5	11.9	0.10
2	968.5	48.2	2.236	0.297	38.92	2.95	423.8	58.0	12.8	0.67
3	311.6	32.2	1.411	0.101	33.32	3.32	487.4	51.9	12.3	0.30
4	639.3	69.9	1.307	0.088	41.97	2.10	444.0	11.4	12.7	0.35
5	1689.1	243.2	2.091	0.200	38.92	1.85	474.9	5.6	12.7	0.35

Colony form

As observed for colony growth rate, colony RCP proved to be significantly different between genotypes (ANOVA, $F_{4,15} = 22.59$, $P < 0.0001$) (Fig. 4). Colony form ranged from rather stellate (high RCP) in genotypes 2 and 5, to more lobate (low RCP), in genotypes 1, 3, and 4 (Fig. 2).

Fig. 4. Genotype means of colony form, as measured by the relative colony perimeter RCP ($= \text{perimeter}^2/4\pi \text{area}$) at the end of the experiment ($t = 103$ d). Error bars are $+1$ standard deviation. Genotypes are arranged 1 to 5 from left to right. Means are based on observations from four replicate colonies per genotype.

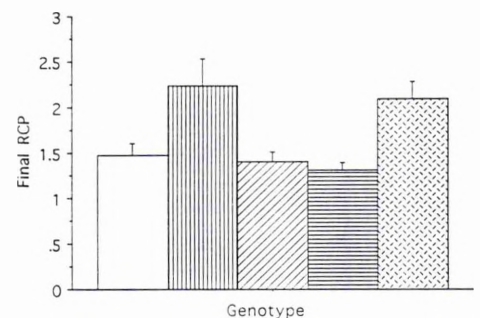

Polypide life span/polypide regeneration time

Polypide life spans (PLS) and regeneration times (RT) both varied markedly over time and with cycle number (Fig. 5). PLS showed a sharp decline over the first three cycles, stabilising at an apparently asymptotic level over the remaining seven cycles. Polypide regeneration times (RT)

Fig. 5. Overall means of polypide life spans (\circ) and regeneration times (\bullet) in days, plotted against polypide cycle number. Means are based on 160 observational zooids among 20 colonies of five different genotypes (four replicate colonies per genotype). Error bars represent ± 1 standard error.

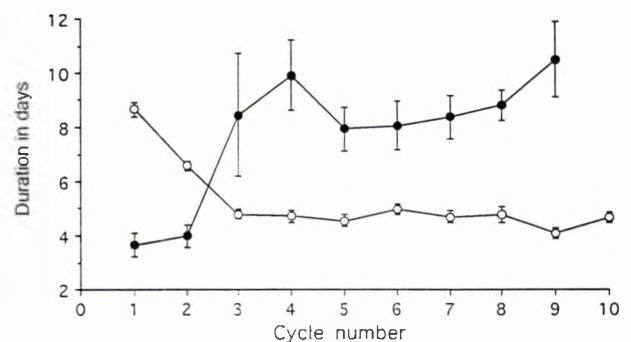

increased sharply over the first four cycles, fell after cycle 4, and increased again from cycle 5 onwards. PLS and RT ranged from 2–14 and 3–69 days respectively, and showed striking variation between genotypes and with cycle number.

The combined effects of decreasing PLS and increasing RT resulted in zooids spending an increased amount of time in an inactive non-feeding mode, that is, regressing or regenerating. This was reflected by the increasing proportion of inactive zooids in the observed-zooid clusters (Fig. 6). Individual genotypes followed seemingly characteristic temporal patterns of both PLS and RT (Figs 7 and 8). PLS for genotype 3 appeared to be the least variable among cycles, with little apparent temporal pattern. The remainder showed a homogeneous pattern but diverged strongly in cycles 7 and 8. Genotypic patterns of regeneration times were even more pronounced, resulting in considerable differences, particularly for cycles 3 and 4. Similarly, ANOVA of zooid activity revealed the genotypes to be highly significantly different from one another ($F_{4,15} = 29.94, P < 0.0001$) (Fig. 9).

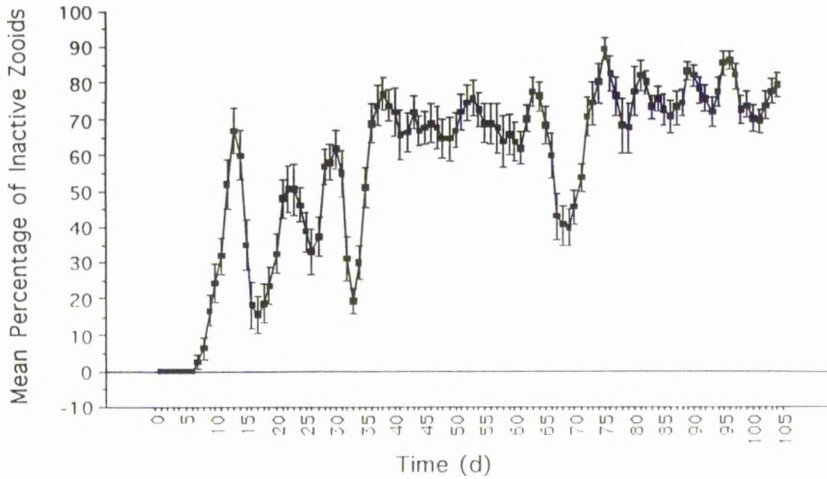

Fig. 6. Overall means of the percentage of inactive (= regressing or regenerating) zooids in the observed clusters, plotted against time in days. Means are based on 160 observed zooids among 20 colonies of five different genotypes (four replicate colonies per genotype). Error bars represent ± 1 standard error.

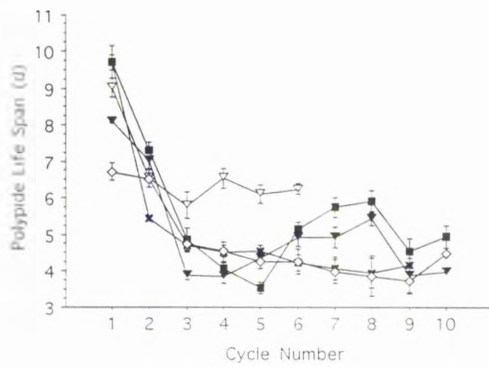

Fig. 7. (L) Genotype means of polypide life spans in days, plotted against polypide cycle number. Means are based on 160 observed zooids among 20 colonies of five different genotypes (four replicate colonies per genotype). Error bars represent ± 1 standard error.

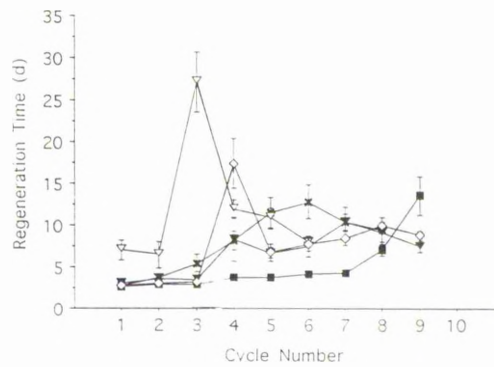

Fig. 8. (R) Genotype means of polypide regeneration times in days, plotted against polypide cycle number. Means are based on 160 observed zooids among 20 colonies of five different genotypes (four replicate colonies per genotype). Error bars represent ± 1 standard error.

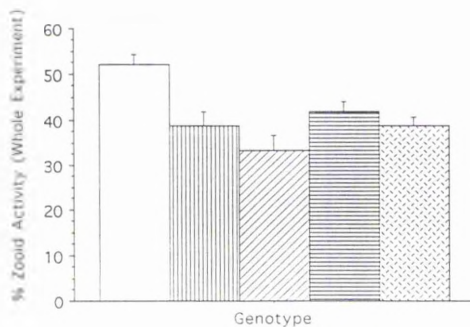
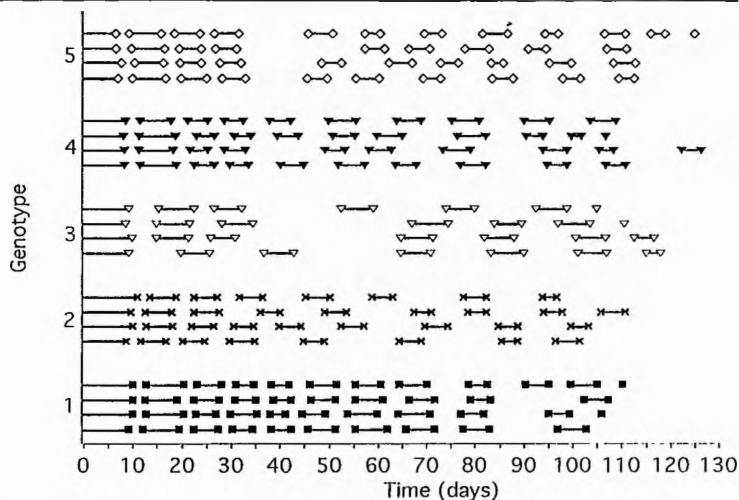

Fig. 9. Genotype means of zooid activity, expressed as percent of the whole experimental period. Error bars are ± 1 standard deviation. Genotypes are arranged 1 to 5 from left to right. Means are based on observations from 160 observed zooids among 20 colonies (four replicate colonies in each of the five genotypes).

The dynamic temporal pattern of polypide cycling within given genotypes raises the question whether some of the variation, such as the peaks in RT for cycles 3 and 4, may have been caused by external factors, or at least occurred contemporaneously in all affected genotypes. Cycle number represents only an approximate measure of time because, for example, cycle 3 in one genotype was not necessarily concurrent with cycle 3 in other genotypes. The real-time pattern of active feeding periods and RT is shown (Fig. 10), from which it is clear that prolonged RT occurred at different times in different genotypes, and that, where present, their occurrence was generally consistent within genotypes. This suggests regeneration to be a genetically programmed process, rather than a product of external perturbation or synchronisation. This appeared, however, to apply more to some genotypes than to others; genotypes 1, 3, and 5 showed generally clear patterns of polypide cycling, in contrast to genotypes 2 and 4.

Fig. 10. Temporal pattern of active (= feeding) and inactive (= regressing/regenerating) periods in all colonies (n = 20, from five genotypes, each replicated four-fold). Data presented are colony means from an observed cluster of eight zooids per colony. Lines connecting data points represent active periods; blanks are inactive periods. Because the data presented are colony means, they are not additive and, in some cases, add up to more than the 103 days observational period.



Sexual reproduction

The incidence of sexual maturation of zooids within colonies was strongly erratic and incomplete in all cases. Although developing oocytes were observed they never developed fully and were apparently resorbed. All colonies consistently developed sperm morulae but only in genotypes 1 and 3 were mature spermatozoa released into the coelom. The male resource "investment" of all colonies probably was very similar, despite the genotypic differences in final maturation. Sperm maturation (where present) commenced among zooids at the colony centre, and then proceeded in an approximately concentric fashion towards the colony periphery. This implies that zooids undergo sexual maturation at a certain stage in their ontogeny, rather independently of whole-colony development and/or external influences. Importantly, almost all of the observed zooids of genotype 1 completed spermatogenesis, and most zooids initiated the first period of coelomic sperm release within only two to three days of one another (Fig. 11, days 20–23). A second period of sperm release occurred from days 74 and 75 onwards in a number of zooids in three of the four replicates of that genotype. Genotype 3 also produced mature spermatozoa in all replicate colonies, but here only one to four of the eight observed zooids per colony produced sperm and there was no second sperm release in this genotype. As for genotype 1, coelomic release was initiated within a comparatively short period (5 days) in all affected zooids, albeit at a later stage (days 28–33). All other genotypes consistently developed sperm morulae but failed to release sperm into the coelom during the experimental period. The inconsistency, or complete failure, of sexual maturation of colonies in this experiment precluded further analyses, but, for the purposes of modelling colony growth, it was assumed that the differences between genotypes in sexual development were negligible.

Lophophore morphology

Oneway ANOVA showed no significant differences between genotypes for lophophore diameter (range 347–559 μm ; $F_{4,15} = 2.02, P = 0.142$), whilst tentacle number (range 10–14 per polypide) was marginally significant among genotypes ($F_{4,15} = 3.49, P = 0.033$). Genotype 1, once again, contributed most to the variation in tentacle number (see Table 1).

Modelling colony growth rate

The outcome of fitting the generalised linear model to the data for final colony area is presented

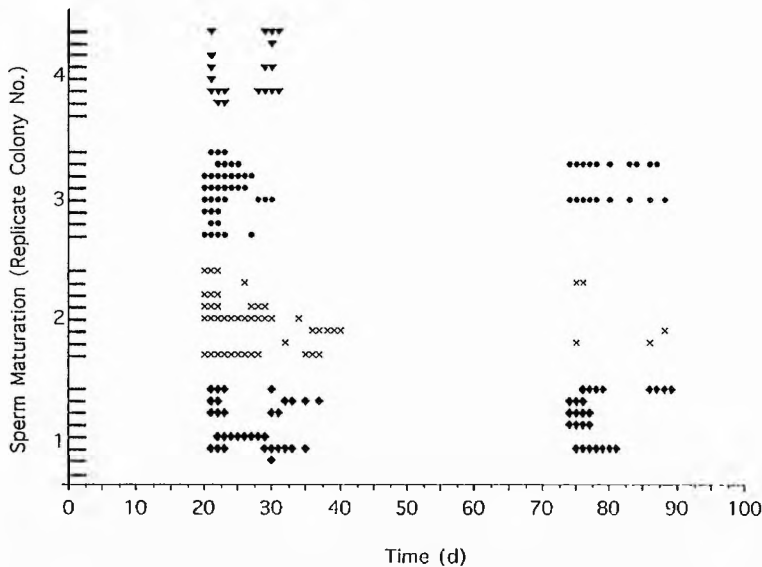

Fig. 11. Temporal pattern of sperm maturation among colonies of genotype 1. Data are arranged in four blocks (one for each replicate colony of genotype 1), represented by different plot symbols. Individual zooids within the replicate colonies are arranged in horizontal lines (maximum of eight per colony). Data points represent days on which zooids contained mature spermatozoa released into the coelom.

in Table 2. Two separate analyses were undertaken, with each involving the fitting of factors to the data in a different order. This is of great importance both to the outcome, and interpretation, of generalised linear models (R. M. Cormack pers. comm.). The two analyses provide different approaches to the one problem and have to be interpreted in conjunction.

	df	SS	MS	F	P
Analysis 1					
Between genotypes	4	8.363	2.0975	211.18	< 0.001***
Within-genotype RCP	1	0.024	0.024	2.42	> 0.100
Within-genotype activity	1	0.0004	0.0004	0.04	> 0.500
Residual	13	0.1294	0.0099		
Total	19	8.5161			
Analysis 2					
Overall RCP	1	1.743	1.743	176.06	< 0.001***
Overall activity	1	4.474	4.474	451.91	< 0.001***
Between genotypes	4	2.169	0.5425	59.78	< 0.001***
Residual	13	0.1294	0.0099		
Total	19	8.5161			

Table 2. ANOVA table of generalised linear model of parameters affecting colony growth in *Electra pilosa*. Factors were fitted to the model in two different orders; in analysis 1, the order was genotype, RCP and zooid activity; for analysis 2 the order was RCP, zooid activity, and genotype.

In analysis 1, the between-genotype factor was fitted first, followed by the factors within-genotype RCP and zooid activity. The between-genotype factor here reflects the overall variation between genotype means: fitting RCP and zooid activity after the genotype means explores the relationship between these variables and colony area, among the four replicates of each genotype separately. This resulted in the factor genotype emerging as overwhelmingly significant ($F_{4,13} = 211.18, p < 0.0001$), and accounting for almost all of the observed variation. Within genotypes, the relationship between colony area and RCP and zooid activity was not significant, possibly as result of insufficient replication within genotypes.

In analysis 2, factors were fitted in the reverse order (RCP, zooid activity, genotype), permitting investigation of the relationships between colony area, RCP, and zooid activity for all of the colonies first, irrespective of genotype, before adding the genotypic component to the model. In this case, all three factors were highly significant, suggesting a marked effect of both colony form and zooid activity on colony growth; genotype, however, still accounted for a considerable portion of the total variation in colony growth, even after fitting RCP and zooid activity. Neither lophophore parameter nor tentacle number significantly improved the fit of the model and, as required by convention (Crawley 1993), they were omitted from the final model.

A plot of final colony area against final RCP (Fig. 12) shows a significant positive correlation ($r = 0.452$) when all colonies are included; within genotypes, the relationship between the two variables is unclear, because genotypes 3 and 4 apparently displayed a negative correlation, whilst genotypes 1, 2, and 5 all showed positive correlations. Similarly, a plot of final colony area against zooid activity (Fig. 13) shows an even more significant correlation ($r = 0.644$), but,

again, the within-genotype patterns are inconsistent, with genotypes 2, 3, and 5 being positive and 1 and 4 negative. From these data, genotypes 1, 3, and 4 appear to fall more or less on the same line, while genotypes 2 and 5 differ considerably. In terms of colony form, however, genotypes 2 and 5 are clearly more stellate than 1, 3, or 4, which may well account for the enhanced colony growth. Scaling colonies by their form (by dividing final colony area by final RCP) and plotting this against zooid activity (Fig. 14) results in a much higher correlation coefficient ($r = 0.832$), confirming the assumption that much of the total variation in colony area is due to variation in colony form and zooid activity.

Fig. 12. (L) Plot of In-transformed colony area at the end of the experiment ($t = 103$ d) against colony form, as measured by RCP, at the end of the experiment. Data plotted are colony means. Genotype 1: filled squares; genotype 2: crosses; genotype 3: open triangles; genotype 4: filled triangles; genotype 5: open diamonds. Correlation coefficient, $r = 0.452$.

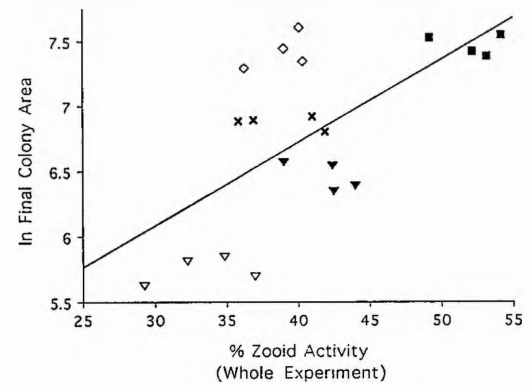
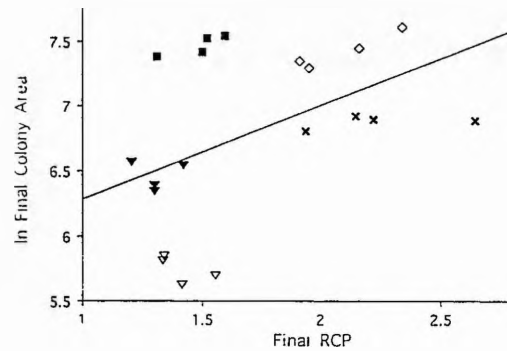
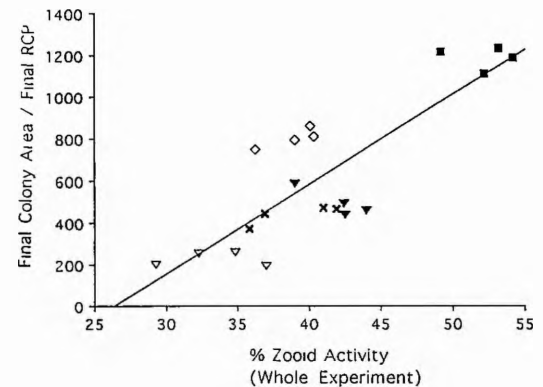

Fig. 13. (R) Plot of In-transformed colony area at the end of the experiment ($t = 103$ d) against percent zooid activity for the whole experimental period. Data plotted are colony means. Symbols as for Fig. 12. Correlation coefficient, $r = 0.644$.

Fig. 14. (R) Plot of colony area at the end of the experiment ($t = 103$ d), scaled by colony form (RCP), against percent zooid activity for the whole experimental period. Data plotted are colony means. Symbols as for Fig. 12. Correlation coefficient, $r = 0.832$.



DISCUSSION

In a previous study of replicated genotypes of *Electra pilosa*, Bayer *et al.* (1994) showed that polypide lifespans are determined not only by genotype, but also by the amount of food ingested and the accumulation of waste products by individual polypides. It could be shown that elevated food concentrations led to reduced PLS across genotypes. Data in that study were collected only over the first three polypide cycles; the present study is the more comprehensive in providing data for up to 10 polypide cycles.

Percentages of inactive (regressing or regenerating) zooids in the observed clusters increased over the experimental period. The data represent a typical example of a moving average, with a superimposed cyclical element due to polypide cycling; there were slow decreases in amplitude as the colonies became increasingly asynchronous in the later stages of the experiment (Fig. 10), but there also was a clear underlying trend of the percentage of inactive zooids increasing asymptotically (Fig. 6). The data do suggest evidence of senescence at the level of the zooid; indeed, towards the end of the present experiment, polypides in the observed clusters frequently degenerated long before the typical levels of waste-product accumulation had been achieved. This was apparent from the pink (rather than dark brown) coloration of the digestive tracts of polypides immediately prior to degeneration. It is conceivable that, at this stage, polypide regression is affected primarily by the age of the zooid rather than the amount of food ingested by its polypide.

It is a frequently suggested concept that modular organisms should be unaffected by

senescence processes at the genet level (e.g., Begon et al. 1990; Hughes 1990); however, experimental evidence for this is rather scarce, and little is known about whether or not senescence could instead be expressed at the module (= zooid) level. Our data imply senescence at the zooid level despite the fact that the observations for individual zooids did not encompass their potential longevity. Both from our own observations, and those of others, it is clear that *E. pilosa* zooids do die eventually. Under the experimental conditions used in our studies, zooid life spans appear to range from between approximately 6–12 months, whilst the genet lifespan is certainly in excess of two years (unpubl. obs.). Both the evidence for senescence at the zooid level, and the fact that zooids appeared to mature sexually at a certain ontogenetic age, suggest a high degree of zooid individuality, in contrast to evolutionary trends towards increasing zooid integration which occur at a whole range of morphological and physiological levels (McKinney & Jackson 1989).

The present model demonstrates the relative importance of two distinct parameters (colony form, polypide regression) that so far have attracted little attention in explaining the frequently observed variation of colony growth rates among bryozoans. Both parameters are strongly heritable and covary with genotype: this can lead to misinterpretation of genotypic effects on growth-rate variation in isolation. Nevertheless, it has to be acknowledged that sample sizes in the present study were small, both at the colony and the genotype level, due to logistic constraints and the necessity to monitor zooids on an extended daily basis.

Most of our evidence for linear relationships between colony growth and the explanatory variables is derived from two of the five genotypes but four replicates are certainly insufficient replication to confidently establish the within-genotype relationships between the parameters in question. Notwithstanding the foregoing, it is apparent that both colony form and zooid activity are of importance in determining colony growth rate, although a genetic component of variation in growth rates remains unexplained. This could either be a purely genetic background upon which other factors such as colony form and zooid activity are acting, or it could be explained by other genotype-specific factors that were not measured in this study. The latter might include, for example, behavioural factors, such as lophophore evagination times or sensitivity to perturbation, that are masked as genetic variation in the model.

Sexual parameters could not be included in the present model, because maturation was incomplete in all cases. This might well have been due to a dietary deficiency; although *Rhodomonas* sp. has been used in several studies involving bryozoans (Hunter & Hughes 1991, 1993a, b), and even though monoculture diets often have produced better growth than mixed diets (e.g., Winston 1976; Jebram & Rummert 1978; Hunter & Hughes 1991), the likelihood is that monoculture diets are nutritionally suboptimal. Even simple deficiencies in single essential amino acids could, for example, exert marked effects on the success of vitellogenesis and hence colony growth and fitness. That our culture techniques result in striking within-genotype consistency both in growth rate and colony form would lead us to suggest, however, that dietary deficiencies or suboptimalities are comparatively trivial. Notwithstanding this qualification, it would be profitable to complement data such as those presented here with whole-colony filtration-rate observations. Overall filtration rates in themselves will be affected by numerous behavioural and/or physiological factors, but we believe this is the most likely source of the as yet unexplained variation in growth rates among genotypes.

ACKNOWLEDGEMENTS

We are grateful to Richard M. Cormack at the School of Mathematical and Computational Sciences, St Andrews University, for his advice on analysing the data and use of the GLIM package.

REFERENCES

- BAYER, M.M.; CORMACK, R.M.; TODD, C.D. 1994: Influence of food concentration on polypide regression in the marine bryozoan *Electra pilosa* (L.) (Bryozoa: Cheilostomata). *Journal of Experimental Marine Biology and Ecology* 178 : 35–50.
- BEGON, M.; HARPER, J.L.; TOWNSEND, C.R. 1990: *Ecology: Individuals, populations and communities*. Blackwell Scientific Publications, London. 945 p.
- BEST, M.A.; THORPE, J.P. 1985: Autoradiographic study of feeding and the colonial transport of metabolites in the marine bryozoan *Membranipora membranacea*. *Marine Biology* 84 : 295–300.
- CANCINO, J.M.; HUGHES, R.N. 1987: The effect of water flow on growth and reproduction of *Celleporella hyalina* (L.) (Bryozoa: Cheilostomata). *Journal of Experimental Marine Biology and Ecology* 112 : 109–130.

- CRAWLEY, M.J. 1993: *GLIM for Ecologists*. Blackwell Scientific Publications, Oxford. 379 p.
- HAYWARD, P.J.; RYLAND, J.S. 1975: Growth, reproduction and larval dispersal in *Alcyonidium hirsutum* (Fleming) and some other Bryozoa. *Publicazioni de la Stazione Zoologica di Napoli* 39 Suppl. : 226–241.
- HUGHES, D.J.; HUGHES, R.N. 1986: Life history variation in *Celleporella hyalina* (Bryozoa). *Proceedings of the Royal Society of London, B*, 228 : 127–132.
- HUGHES, D.J. 1989: Variation in reproductive strategy among clones of the bryozoan *Celleporella hyalina*. *Ecological Monographs* 59 : 387–403.
- HUGHES, D.J. 1992: Genotype-environment interactions and relative clonal fitness in a marine bryozoan. *Journal of Animal Ecology* 61 : 291–306.
- HUGHES, R.N. 1990: *The functional biology of clonal organisms*. Chapman & Hall, London. 331 p.
- HUNTER, E.; HUGHES, R.N. 1991: Growth of laboratory cultured colonies of *Celleporella hyalina* (L.). In Bigey, F.P. (ed.) *Bryozoaires actuels et fossiles: Bryozoa living and fossil*. *Bulletin de la Société des Sciences Naturelles de l'Ouest de France (Nantes), Mémoire HS 1* : 187–191.
- HUNTER, E.; HUGHES, R.N. 1993a: Effects of diet on life-history parameters of the marine bryozoan, *Celleporella hyalina* (L.). *Journal of Experimental Marine Biology and Ecology* 167 : 163–177.
- HUNTER, E.; HUGHES, R.N. 1993b: The effect of cell concentration on colony growth and feeding in the bryozoan *Celleporella hyalina*. *Journal of the Marine Biological Association of the U.K.* 73 : 321–331.
- JACKSON, J.B.C.; COATES, A.G. 1986: Life cycles and evolution of clonal (modular) animals. *Philosophical Transactions of the Royal Society of London, B*, 313 : 7–22.
- JEBRAM, D.; RUMMERT, H.-D. 1978: Influences of different diets on growth and forms of *Conopeum seurati* (Bryozoa, Cheilostomata). *Zoologische Jahrbücher für Systematik* 105 : 502–514.
- JEBRAM, D. 1980: Influences of the food on the colony forms of *Electra pilosa*. *Zoologische Jahrbücher für Systematik* 108 : 1–14.
- KEOUGH, M.J. 1989: Variation in growth rate and reproduction of the bryozoan *Bugula neritina*. *The Biological Bulletin* 177 : 277–286.
- McKINNEY, F.K.; JACKSON, J.B.C. 1989: *Bryozoan evolution*. The University of Chicago Press, Chicago & London. 238 p.
- RUBIN, J.A. 1987: Growth and refuge location in continuous, modular organisms: experimental and computer simulation studies. *Oecologia* 72 : 46–51.
- RYLAND, J.S.; STEBBING, A.R.D. 1971: Settlement and oriented growth in epiphytic and epizoic bryozoans. Pp 105–123 in Crisp, D.J. (ed.) *Fourth European Marine Biology Symposium*. Cambridge University Press, London. 386 p.
- SEBENS, K.P. 1982: Competition for space: growth rate, reproductive output and escape in size. *American Naturalist* 120 : 189–197.
- STEARNS, S.C. 1992: *The evolution of life histories*. Oxford University Press, Oxford, New York & Toronto. 249 p.
- THORPE, J.P. 1979: A model using deterministic equations to describe some possible parameters affecting growth rate and fecundity in Bryozoa. Pp 113–120 in Larwood, G.P.; Abbott, M.B. (eds) *Advances in bryozoology. [Systematics Association Special Volume 13]* Academic Press, London & New York. xvi + 639 p.
- WINSTON, J.E. 1976: Experimental culture of the estuarine ectoproct *Conopeum tenuissimum* from Chesapeake Bay. *The Biological Bulletin* 150 : 318–335.
- WOOD, V.; SEED, R. 1992: Reproduction and growth of *Alcyonidium hirsutum* (Fleming) and *Flustrellidra hispida* (Fabricius) (Bryozoa: Ctenostomata) within a *Fucus serratus* (L.) community. *Cahiers de Biologie marine* 33 : 347–363.

Evidence for zooid senescence in the marine bryozoan *Electra pilosa*

Micha M. Bayer^a and Christopher D. Todd

Gatty Marine Laboratory, School of Environmental and Evolutionary Biology, University of St. Andrews,
St. Andrews, Fife, KY16 8LB, Scotland

Abstract. One of the commonly assumed consequences of modularity is that senescence may be avoided, or at least delayed, at the level of the genet, with senescence frequently being expressed at the level of the individual module. Here we present evidence from a laboratory study of senescence at the zooid (= module) level in the bryozoan *Electra pilosa*. Post-larval ancestrulae of this species were collected intertidally in St Andrews Bay, SE Scotland, on the macroalga *Fucus serratus*, and reared under constant conditions in the laboratory. Polypides in this species undergo repeated cycles of regression and regeneration. Zooid senescence was indicated here by polypide life spans decreasing over successive polypide cycles, while the period required to regenerate new polypides increased over time. Senescence *sensu stricto* may have evolved either in a unitary ancestor of the Bryozoa, or in the phylum itself, but the proximal deterioration of physiological parameters at the zooid level might not constitute evolved senescence *sensu stricto*. Rather, it may result from selection for rapid distal colony growth, with a concomitant decrease in proximal zooid investment and provisioning.

Additional key words: modular organisms, polypide life spans, polypide regression, regeneration time, proximal investment

Senescence (aging) is defined as a decline in the age-specific fitness components of an organism due to internal physiological degeneration (Rose 1991). Modern evolutionary theory of aging goes back to Medawar (1952), who predicted that the frequency of mutations with age-specific deleterious effects will increase with age for a given cohort. Williams' antagonistic pleiotropy hypothesis (Williams 1957) extended existing theory; it predicts that mutations having negative effects late in life, as well as positive effects before reproductive age is reached, will be passed on because their net effect on fitness is still positive. The accumulation of these negative effects then will be reflected in an age-specific intrinsic decline in fitness. Both hypotheses are well supported by experimental evidence (reviewed by Stearns 1992).

Modular organisms as defined by Harper (1977) comprise multicellular units which are either physiologically connected (as for the zooids of bryozoan colonies, or the polyps of corals) or separate, genetically identical individuals (e.g., ramets of a clone of plants). The range of modular organisms is extremely diverse and includes most plants, most protists, fungi, and members of 19 animal phyla. Modular organisms often

are able to avoid, or at least markedly delay, senescence at the level of the genet (Jackson & Coates 1986; Begon et al. 1990). More specifically, whole-organism senescence may not evolve in species where reproduction is primarily clonal and sexual reproduction is rare (Caswell 1985) because the pattern of selective pressure on different stages in the life cycle may be very different from that found in non-clonal organisms. Senescence frequently occurs at the module level, with each module passing through the life-history phases characteristic of unitary organisms. In sharp contrast to the volume of work on senescence in mammals, published work on senescence in modular organisms is scant and often anecdotal.

Many higher plants display organized senescence at the module level in the form of either sequential or simultaneous senescence and death of leaves (Hardwick 1986), while at the whole-organism level there are numerous strategies ranging from ephemeral (several weeks) to extended (>1000 yr) life spans (Woolhouse 1972). Partial, proximal senescence also has been reported for the bracken fern, *Pteridium aquilinum* (Watt 1947). Modular animals display a wide range of senescence strategies. In the colonial ascidian *Botryllus schlosseri*, zooids regularly degenerate and are replaced in a process known as takeover (Millar 1971), but deterministic, whole-organism senescence

^a Author for correspondence. E-mail: mmb@st-andrews.ac.uk

also has been observed (Rinkevich et al. 1992; Chadwick-Furman & Weissman 1995). Scleractinian corals have traditionally been viewed as being potentially immortal and free from senescence effects at the whole-organism level (Jackson & Coates 1986), although experimental work on *Acropora* spp. indicates that there is at least partial senescence of proximal regions in that genus (Meesters & Bak 1995). Even soft-bodied colonial anthozoans appear to have the potential for extreme longevity; in a recent study, the age of deep-sea specimens of the zoanthid *Gerardia* sp. was calculated as 1800 ± 300 yr (Druffel et al. 1995). Among hydroids, module senescence is observed as degeneration of the hydranths (Elmhirst 1922; Strehler & Crowell 1961; Brock 1974), followed usually by *in situ* regeneration of a new hydranth. Although replacement cycles in hydroids have been reported in a number of laboratory studies, this phenomenon is not necessarily expressed to the same extent under field conditions whereby hydranths and their supporting hydrocauli often succumb to predators or other disturbances (Hughes 1987).

Whole-colony life spans in Bryozoa are difficult to determine, and accordingly the available information is scarce and incomplete. Life spans of up to 12 years have been reported for *Flustra foliacea* (Stebbing 1971), and analysis of a large colony of *Pentapora foliacea* suggested a colony age of at least 3 years (Pätzold et al. 1987). Barnes (1995) calculated the age of large, living specimens of two antarctic species, *Cellarinella watersi* and *Alloeflustra tenuis*, to be 9 and 26 years respectively. Eggleston (1972) classified the bryozoan fauna of the Isle of Man into annual, subannual, and perennial species, but it is unclear how the data were collected, and no mention is made of potential external sources of mortality. In fact, it appears that whole-colony life spans usually are limited by substratum integrity rather than being intrinsically regulated (McKinney & Jackson 1991). Module senescence in the Bryozoa can occur at two levels: zooids may senesce and eventually die (Palumbi & Jackson 1983), but there also is the widespread phenomenon of repeated degeneration and regeneration of polypides within zooids (reviewed by Gordon 1977). Throughout its life span, a polypide continually accumulates waste products in its stomach epithelium; these epithelial cells cannot be replaced, and when the level of waste reaches a certain threshold, the whole polypide regresses. It then is replaced by a new polypide, formed inside the existing zooid.

Quantity of food ingested and rate of polypide turnover are positively correlated in the marine bryozoan *Electra pilosa* (Bayer et al. 1994), although polypide regression may be induced also by the absence of food

in *Membranipora isabelleana* (Manriquez & Cancino 1996). Zooidal life span has been established for only few species but it appears to be of the order of several months to possibly years (Cancino & Hughes 1987; Muñoz et al. 1990). Polypide life spans are highly plastic with respect to environmental conditions but generally range from weeks to months (Gordon 1977). In the case of bryozoans, and for many other modular organisms, the complexities of coloniality are further compounded by the modules being physiologically interconnected by the funicular system (Silén 1944), but the degree of zooid individuality varies considerably among different bryozoan taxa (Ryland 1979).

Here, we asked the question whether there was any evidence of senescence at the level of the zooid in *Electra pilosa* (LINNAEUS 1767). We also aimed to establish zooidal lifespans. Laboratory culture techniques make it possible to obtain data on clonal material grown on glass substrata under controlled conditions, in the absence of predation or physical disturbances. *E. pilosa* is an anascan cheilostomate bryozoan with an assumed cosmopolitan distribution (Ryland & Hayward 1977). Around the British Isles, it is generally very abundant in the intertidal and upper subtidal zone of rocky shores, occupying a variety of substratum types (e.g., seaweeds, rocks, and shells), although it is predominantly epibiotic on thalli of the fucoid *Fucus serratus* (LINNAEUS 1767).

Methods

Culture conditions

Post-metamorphic ancestrulae of *Electra pilosa* were collected intertidally on their natural substratum, *Fucus serratus*, in St. Andrews Bay, Fife, S. E. Scotland (56°20' N, 2°47' W) in June 1993. Each ancestrula was excised from the algal thallus together with a small piece of surrounding thallus tissue, and the algal fragment was clipped onto a glass microscope slide by means of a pre-scored and an un-scored glass coverslip and slit pieces of PVC tubing. The two coverslips were placed one on top of the other, with the pre-scored coverslip topmost, and were positioned so that a flush surface was provided distal to the ancestrula, onto which the young budding zooids could grow readily. This propagation method allows the establishment of colonies of this non-brooding species on artificial substrata with the minimum of previous exposure of the organism to variable field conditions.

After each bryozoan was established on its pre-scored coverslip, each colony (and the coverslip substratum) was split with a scalpel, and the resulting pieces clipped onto separate glass panels (80 × 80 mm). The high regenerative potential of this species

allowed for rapid healing of breakage lesions, and colonies quickly established zooids on the glass panels. In this fashion, colonies were propagated from ancestrulae of five genotypes, with each genotype replicated fourfold, giving a total of 20 colonies. A detailed account of the cloning and propagation methodology is given elsewhere (Bayer et al. 1994).

Immediately before the study period, the glass strip vectors were removed from the glass panels and the remaining zooids on each panel trimmed to a cluster of nine zooids in a 3×3 array. This provided equal starting conditions for all colonies, irrespective of their potential differences in growth rate. With this replication method, both colony growth rate and colony shape within genotypes are highly consistent (Bayer & Todd 1996) and colonies appeared healthy overall.

The colonies then were grown until the first colony reached the edge of its glass plate; when this occurred, after 103 days, the study was terminated. Throughout the study period, colonies were maintained in 2- μm filtered seawater, in a single circular 8-liter glass trough, held in a waterbath at a temperature of $18^\circ \pm 0.1^\circ \text{C}$. The glass plates were held upright in a circular perspex rack, with colonies allocated to positions at random to preclude positional effects. The colonies were fed a monoculture diet of the flagellate chrysophyte *Rhodomonas* sp.; food concentrations in the tank were monitored on a daily basis and maintained at $\sim 42,500$ cells ml^{-1} . Aeration and water circulation were provided by a central airstone, and the water in the tank was changed twice a week.

Data collection

The first eight zooids budded by each 3×3 zoid starter cluster were used, giving a total of 160 observed zooids (5 genotypes \times 4 colonies per genotype \times 8 zooids per colony). These zooids were mapped by *camera lucida* on a Wild M8 stereomicroscope to allow their subsequent re-identification; because zooids do not change shape once they have fully developed, and each cluster had its own characteristic pattern, this method ensured reliable re-identification of clusters at any subsequent stage. Polypide condition in each of the zooids was recorded daily, with polypides being scored either as functional (feeding) or as being in the process of regression and subsequent regeneration. Individual colonies were transferred from the main tank to an observation dish, where they were kept for short periods only (<30 sec), and a cold light source was used for illumination to minimize handling stress on colonies. No adverse effects of the daily handling procedure were detected.

Polypide regression and regeneration in *E. pilosa*

follows the same pattern as that described by Gordon (1977) for *Cryptosula pallasiana*. The onset of polypide regression appears to be closely correlated with the termination of ciliary movement in the stomach (Bayer et al. 1994); polypides were classified as actively feeding when ciliary activity was detectable in the pylorus region of the stomach. A polypide was considered to be regressing or regenerating from the cessation of ciliary activity in the stomach, to the point of first evagination of the newly-formed polypide. Although regression of the old polypide and formation of a new polypide overlap to some extent, in some cases there were extended periods of "dormancy," with the new polypide forming long after regression was complete. These cases were still scored as regressing or regenerating, because it would be arbitrary to distinguish between a "typical" case with marginal overlap between regression and regeneration, and an "atypical" case with a gap between the completion of regression and the onset of regeneration. After an undetermined number of polypide cycles, zooids eventually die. Zoid death is easily observed by the detachment and loss of the frontal membrane, the uncalcified part of the frontal surface of the zoid, which leaves the zoid devoid of soft tissue.

Results

Observations on polypide longevity were available for up to 11 regression-regeneration cycles over the duration of the study. Only 2 of the 160 observed zooids completed cycle 11, so results are shown only for the first 10 cycles. Polypide life spans (PLS) decreased sharply over the first 3 cycles, and then leveled off in approximately hyperbolic fashion, whereas regeneration times (RT) increased asymptotically over the duration of the study (Fig. 1). Because the observed zooids were essentially central in position, they became progressively more distant from the growing distal (peripheral) zooids as the colonies grew. The observed changes in both PLS and RT indicated a systematic and possibly age-specific decline of these parameters at the zoid level. PLS ranged from 1 to 14 days, while RT varied between 2 and 69 days. The extreme range of RT values reflected extended periods of dormancy, which occurred with increasing frequency towards the end of the study.

Pronounced differences were seen in ontogenetic patterns among genotypes, with most of the overall variability both in PLS and RT being due to genotype 3 (Figs. 1, 2). Most of the among-genotype variation in PLS and RT was observed in the later stages of the study, from cycle 3 onwards. ANOVA of PLS and RT revealed highly significant main effects for genotype

Fig. 1. Polypide life spans and polypide regeneration times as a function of regression-regeneration cycle number. Data shown are overall means ± 1 standard error, calculated from genotype means ($n=5$). Five genotypes were replicated fourfold each to give a total of 20 colonies. For each colony, a cluster of 8 zooids (total 160) were observed daily, and polypides were classed as functional or regressing/regenerating. Data were obtained over 103 days.

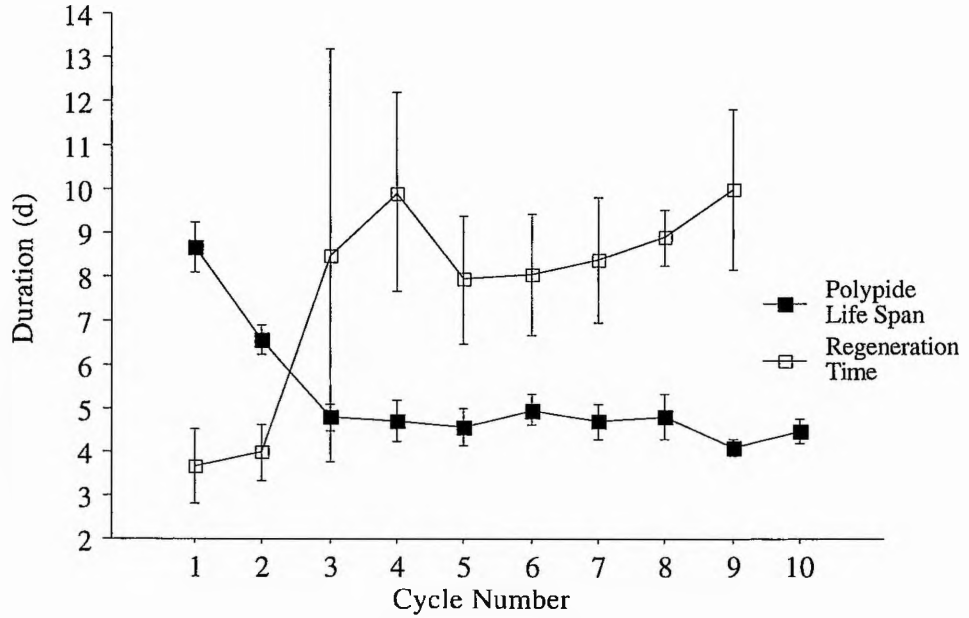

and cycle as well as genotype \times cycle interaction effects (Tables 1, 2). There was no significant effect of replicate colonies within genotypes ($p>.50$); that is, the variation between zooids exceeded that between replicate colonies of the same genotype, emphasizing the importance of genotype in the observed pattern.

From the asynchrony of genotypes in the temporal pattern of polypide cycling (Fig. 2) it is evident that the different peaks both in PLS and RT were not caused by extrinsic disturbances or perturbation, but were largely deterministic events taking place at the genotype level. A particularly clear illustration of this was the extended period of regeneration in the zooids of genotype 3 after the third polypide cycle. This de-

terministic element also was reflected later in the study, in that polypides often degenerated well before the stomach epithelia had reached their normal pre-regression level of waste-product build-up, which usually is indicated by a dark brown coloration of the digestive tract.

The combined effect of polypides degenerating at increasingly earlier stages and zooids taking longer to regenerate new polypides was reflected in the hyperbolically declining proportion of functional polypides in the sample of zooids studied (Fig. 3). The data show a moving average, superimposed initially by a cyclical element; this gradually decreased as the study progressed, probably because of the increasing variability

Fig. 2. Graphic representation of the polypide regression pattern over time. Solid bars represent periods when a zooid had a functional polypide; gaps represent periods of regression and/or regeneration. For ease of illustration, data plotted are cumulative colony means, calculated from observations on 8 zooids per colony. Genotypes are numbered 1 to 5 on the y-axis, with replicate colonies arranged in blocks of four. Because data are colony means, rather than observations from individual zooids, they are not strictly additive and in some cases total more than the duration of the study period (103 days).

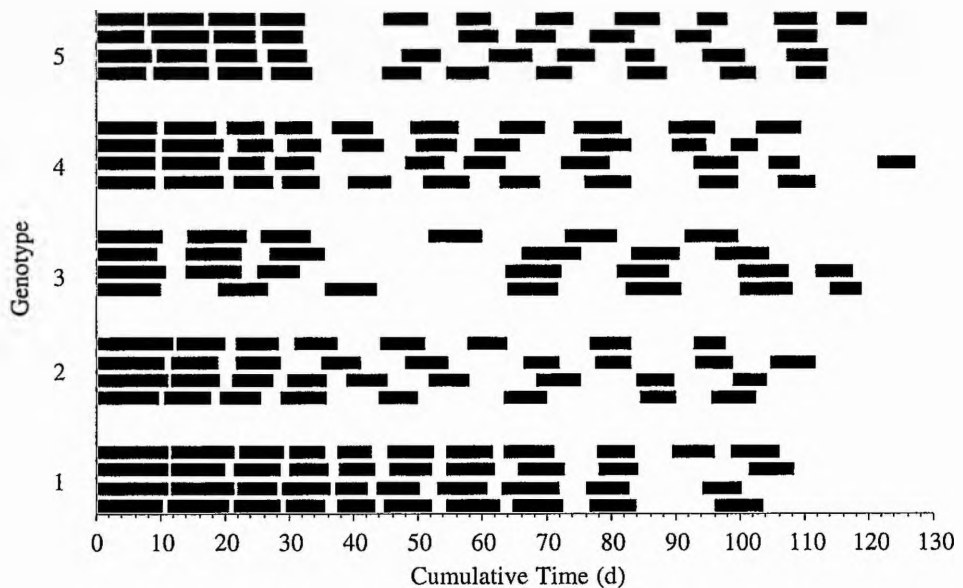

Table 1. ANOVA table of polypide life spans (PLS). Data analysed were duration (in days) of successive life spans of polypides within the same zoid. Observations were obtained for up to 11 regression-regeneration cycles. Before analysis, data were inspected for non-normality and heteroscedasticity, and no transformation was found to be necessary. Replicate colonies were nested within genotypes, and the genotype factor was crossed with cycle. Empty cells in some cycles necessitated the use of a generalized linear model (GLIM, Payne 1987).

Source	df	SS	MS	F	P
Genotype	4	427.7	106.92	93.14	<0.001
Replicate colony	15	17.2	1.14	0.72	>0.500
Cycle	10	2,303.0	230.30	144.84	<0.001
Genotype × Cycle	33	487.7	14.77	9.28	<0.001
Error	1,173	1,868.5	1.59		
Total	1,235	5,103.7			

in PLS and RT among genotypes. By the end of the study, the proportion of zooids with functional polypides in the study clusters (total 160) was approximately one quarter (final colony sizes varied between 1861 and 13,926 zooids) although there is no indication of what the actual asymptote value might have been had the study been continued. Although many zooids entered a state of dormancy towards the end of the study, with no new polypides being formed after regression, none of the observed zooids died during the course of the study.

Discussion

Levels of senescence in *Electra pilosa*

The duration of this study was insufficient to establish zoid life spans as such; none of the observed

Table 2. ANOVA table of polypide regeneration times (RT). Data analysed were duration (in days) of successive periods in which a zoid did not have a functional polypide, that is, when polypides either were regressing and/or regenerating. Before analysis, data were inspected for non-normality and heteroscedasticity, and a log-transformation was found to be necessary. Analysis as for Table 1.

Source	df	SS	MS	F	P
Genotype	4	12.27	3.067	80.71	<0.001
Replicate colony	15	0.58	0.038	1.02	>0.500
Cycle	10	31.43	3.143	84.94	<0.001
Genotype × Cycle	31	13.99	0.451	12.18	<0.001
Error	1,044	38.86	0.037		
Total	1,104	97.14			

zooids died during the study period of 103 days. It is, however, clear from other laboratory studies (unpubl. data) that zooids do eventually die, at an age of 6–12 months, with zoid death within the colony gradually spreading in a proximal-distal direction. The reduction in PLS and the increase of RT described here were reflected as a rapidly decreasing proportion of zooids with functional polypides in the study sample (160 zooids), but this was not the case for younger zooids nearer the periphery of a colony (Fig. 4). The present study did not include comparative observations of peripheral zooids, but senescent colony parts are immediately obvious due to a dramatically increased proportion of inactive zooids containing brown bodies, which was not observed in peripheral colony areas here. We thus are confident that the senescence observed in central colony parts in this study and in previous ones is not a laboratory artefact. We have also observed proximal senescence in colonies of *Electra pilosa* in the field: large, old colonies growing on macroalgae generally lack older, central zooids which, after a period of senescence, die and eventually break up, while the colony continues to bud new zooids at the periphery (M. Bayer, pers. obs.).

The above observations indicate that zooids decline in relation either to their age or to their relative position within the colony. The rate of senescence probably is deterministic to a large extent and controlled at least in part by the genotype, as suggested by the significant genotype effect for both parameters (Tables 1, 2). Evidence from a number of bryozoan species (reviewed by Ryland 1979) suggests that zooids of the same age in a colony mature, reproduce, and senesce simultaneously. There is, however, some suggestion that zoid position relative to colony periphery may affect bryozoan zooidal longevity. Muñoz et al. (1990) found in a study of three Chilean species that zoid cohorts nearer the periphery had significantly longer zooidal life spans than did those near the colony center. This they interpreted as an effect of a reduction of zoid metabolic rate with increasing colony size, a finding in sharp contrast to that of Hughes & Hughes (1986), whose data show that there is no effect of colony size on metabolic rate in *Electra pilosa*.

In this study—and in a previous laboratory study on the same species (Bayer et al. 1994)—oogenesis was not observed, possibly due to the absence of environmental cues in the laboratory or a lack of dietary essential nutrients. Sperm maturation did, however, occur in genotypes 1 and 3, but the temporal pattern of senescence did not seem to bear any relation to this, and was probably unaffected.

Senescence in *E. pilosa*, and in many other bryozoans (see Gordon 1977), can also be observed at the

Fig. 3. Percentage of zooids with functional polypides over the study period. Observations were obtained for 160 zooids, with 8 observed zooids in each of 20 colonies (five genotypes, four replicate colonies each). Data plotted are grand means ± 1 standard error ($n=20$).

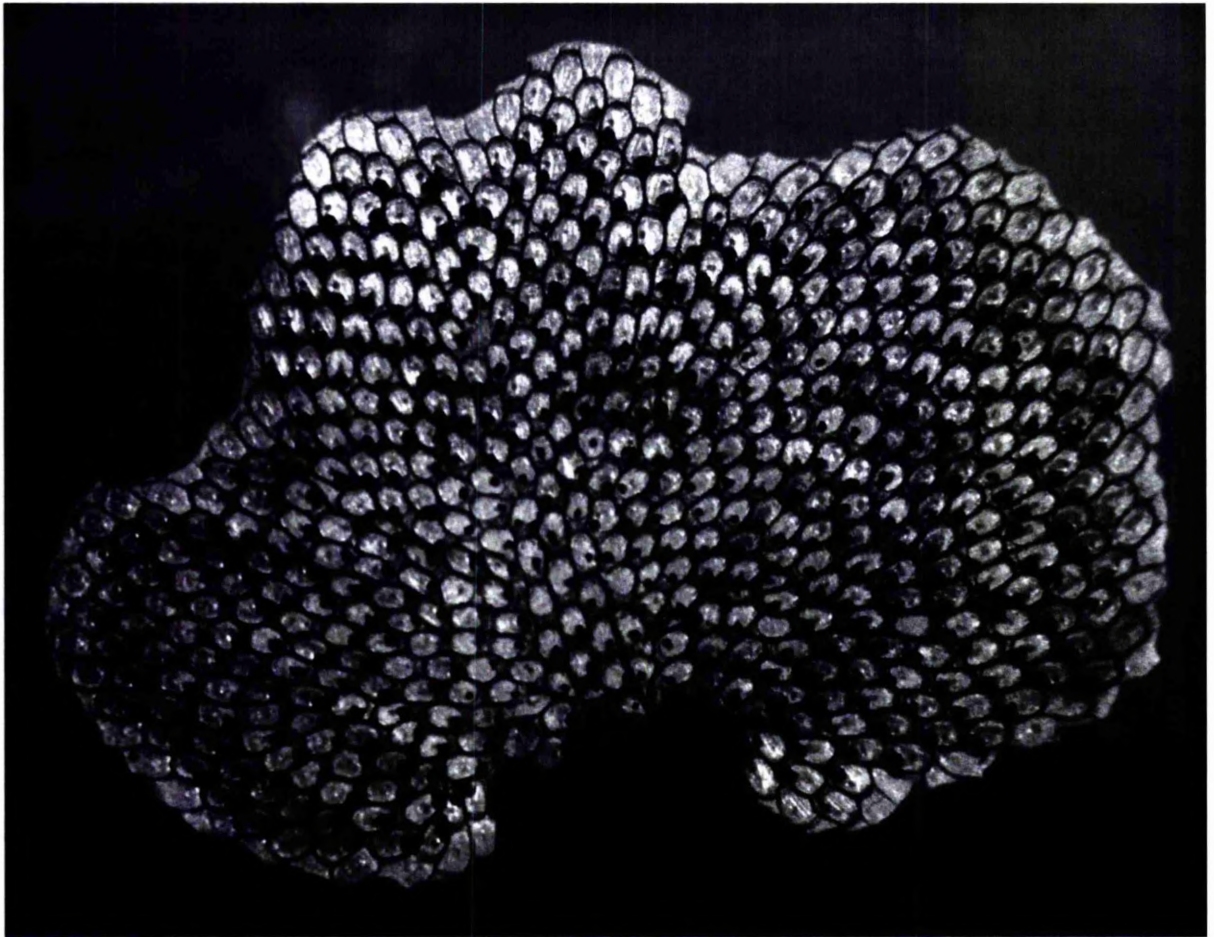
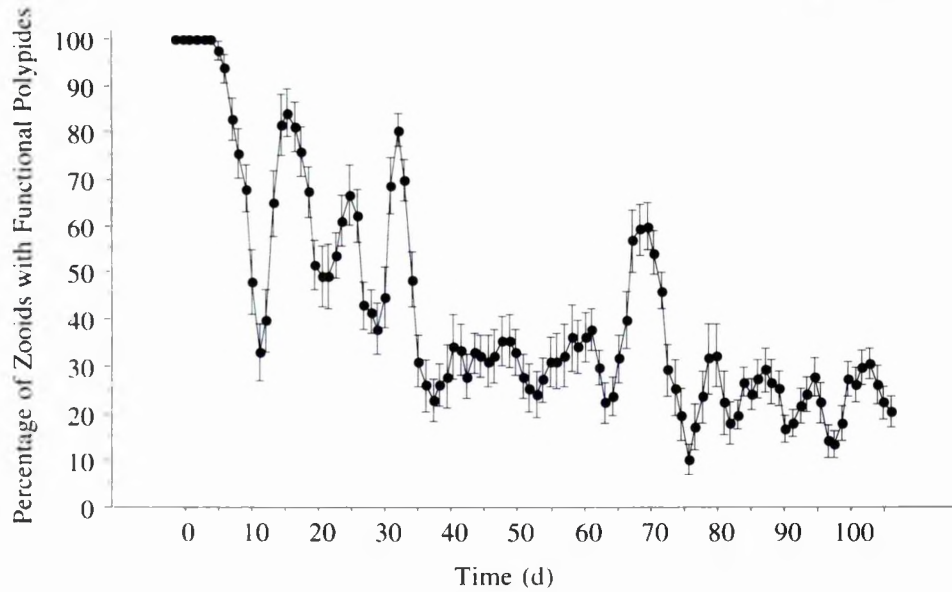

Fig. 4. Colony of *Electra pilosa* grown on a glass plate under laboratory conditions. The peripheral section of the colony shows a clear preponderance of zooids with functional polypides (as indicated by a filled stomach and caecum, visible as a large dark mass in a zooid), whereas the central section is dominated by zooids containing brown bodies rather than functional polypides (visible as a small dark mass in the zooid). Maximum colony width ~ 16 mm.

level of polypides. Polypides degenerate after periods of several days to weeks and usually are replaced rapidly. In *E. pilosa*, the rate of polypide turnover appears to be controlled by the amount of food ingested by a polypide as well as by the genotype (Bayer et al. 1994). Polypide senescence is probably best viewed as what has been termed "organ senescence" (Rose 1991) and may be analogous to, for example, leaf loss in plants, or erythrocyte turnover in mammals, in which the replacement of specialized structures is metabolically less costly than their repair (Rose 1991).

In the case of *E. pilosa*, colonies can be maintained in the laboratory for periods in excess of two years and probably longer; despite the senescence and death of proximal colony parts, colonies continue to bud healthy new peripheral zooids which show no signs of physiological deterioration. We would expect senescence at the whole-organism (genet) level to be expressed in all zooids simultaneously, with death of the colony ensuing, but as yet we have not observed any instances of this in the laboratory or in the field.

Distal investment as an adaptive strategy

In a number of modular organisms older, more proximal, colony parts display symptoms of senescence while growth continues in younger, peripheral parts of the organism. Examples of this can be found in hydroids (Campbell 1968), corals (Meesters & Bak 1995), ascidians (Sabbadin 1979), and bryozoans (Bronstein 1939; Ryland 1979; Palumbi & Jackson 1982, 1983). The concept of senescence itself being favored by selection has long since been abandoned (Hoekstra 1993), but it has been argued that rapid distal growth in modular organisms—at the cost of proximal senescence—can be adaptive under certain circumstances (Palumbi & Jackson 1983). The bryozoan *Steginoporella* sp. combines high metabolic investment in distal colony parts with senescence of proximal modules, thus achieving enhanced "mobility" (Jackson & Winston 1981) and overgrowth capability, which in turn lead to relative space dominance in its habitat. Such features also are characteristic of staghorn coral, *Acropora cervicornis*, and bracken fern, *Pteridium aquilinum* (Palumbi & Jackson 1983). In communities dominated by sessile organisms, and hence likely to be subject to intense competition for primary substratum space, these characteristics might well provide a trade-off for the presumed reduction of ramet reproductive potential due to proximal module loss.

Patterns of resource allocation

Alternatively, the observed pattern of proximal deterioration could be brought about by a constraint of

resource allocation within colonies, rather than being directly selected for. A source-sink model for the control of colony growth in bryozoans has been proposed by Harvell & Helling (1993), and metabolite transport within the colony, a prerequisite for the model, has been demonstrated in *Membranipora membranacea* (Best & Thorpe 1985; Miles et al. 1995). With respect to the present species, it is conceivable that the observed pattern of physiological deterioration of older, central colony parts may not be a result of selection for rapid peripheral expansion, but in itself an inevitable consequence of the active transfer of metabolites from the colony center (= "source") to the actively growing edge of the colony (= "sink"). In this scenario, the amount of available metabolites required for the maintenance and replacement of polypides in central (= proximal) zooids would decrease with the addition of an increasing number of peripheral zooids, leading to decreased rates of regeneration in central parts, as observed in the present study. Reduced metabolite availability might also account for decreased polypide life spans. Further work might help elucidate the underlying mechanisms here.

Evolutionary constraints

The evolutionary theory of aging predicts that senescence will evolve in any natural population as a result of the declining force of selection with age (Rose 1991). Also, Kirkwood's disposable soma theory (Kirkwood 1977) states that the resource investment required for indefinite survival (= immortality) will always reduce fitness, and immortality will hence be selected against (Kirkwood & Rose 1991; Holliday 1995). Both theories would predict relative ubiquity of the phenomenon of senescence, at least for sexually reproducing unitary organisms. Assuming that colonial animals have evolved from a unitary ancestor (Buss 1987), it would appear plausible that senescence is an ancestral trait that did not evolve in modular taxa but rather in their unitary ancestors. This assumption is certainly testable empirically, but at present data on senescence in modular organisms are still greatly lacking (Rose 1991).

Can senescence evolve in a colonial organism?

The question remains whether "true" senescence *sensu* Williams (1957) could indeed evolve in a modular organism, rather than being an ancestral trait (see above). Medawar (1952) recognized that the force of natural selection decreases with the age of an organism, as reproductive probability declines. Williams (1957) developed Medawar's ideas further by invoking pleiotropic genes with positive effects early and neg-

ative effects late in the life of an organism, thus explaining how genes conferring senescence traits can actually be favored by natural selection. The key assumption in the antagonistic pleiotropy model of senescence is that reproductive probability decreases to zero as a function of age, which leads to the establishment of a "selection shadow" (Hoekstra 1993). Any character negatively affecting intrinsic mortality, expressed at an age where the reproductive probability of an organism is zero, will escape the scrutiny of natural selection because genes will already have been passed on by then, and this may lead to the establishment of senescence.

Traditional models of senescence generally have focused on unitary rather than modular organisms, and are based on the assumption that selection acts at the level of the individual (Buss 1983). There are, however, conflicting opinions on whether selection operates at the level of the genetic individual (genet) only: some authors have argued that because fitness-related characters in modular organisms are expressed at the level of the module, selection will operate both at the genotype and the module level (Tuomi & Vuorisalo 1989a,b). There are, however, no empirical data to support the latter proposition.

Weismann predicted that aging should occur only in species where there is a separation of soma and germ line (as discussed by Rose 1991). Accordingly, exclusively asexual reproduction should confer potential immortality to the genet (though not to the ramet), because the somatic embryogenesis of strictly asexual taxa allows no clear distinction between germ line and soma. This has been confirmed for prokaryotes (Rose 1991), but the situation in taxa with alternating sexual/asexual modes of reproduction is less clear: Bell (1984) presented evidence for the apparent absence of senescence in two oligochaete species that reproduce predominantly by fission, whereas Martínez & Levinton (1992) clearly demonstrated that senescence can indeed occur in predominantly asexual oligochaete species.

However, in applying a theoretical model to demographic data from three scleractinian coral species, Orive (1995) showed that senescence can indeed evolve in modular organisms. The spread of alleles that pleiotropically affect early vs. late life-history parameters in a population of clonally reproducing organisms can still lead to the establishment of senescence, albeit at a later stage than for a population of unitary organisms with exclusively sexual reproduction. Orive's model does not specify whether the expression of senescence would occur as either simultaneous senescence/death of all modules in a colony (= ramet/genet death) or as sequential senescence expressed at the module lev-

el, with modules senescing sequentially as a function of their age.

Both scenarios are possible in theory; there is at least one case in which the former has been observed in a colonial ascidian (Rinkevich et al. 1992), and theoretically it is possible that at least some of the numerous cases of proximal senescence in modular organisms (see above) may represent evolved senescence *sensu stricto*. If senescence can indeed evolve in modular organisms, and if it can be expressed either at the whole-organism or the module level, then this could account for the occurrence of differing modes of senescence (whole-organism vs. module senescence) in modular taxa. However, whether the senescence phenomena observed in *E. pilosa* can be categorized as evolved senescence or whether they are due to other mechanisms (see above) is a question that will be answered only with additional experimental data.

Acknowledgments. We would like to thank Richard M. Cormack, School of Mathematical and Computational Sciences, University of St. Andrews, for his advice on statistical issues; Cynthia D. Trowbridge; one anonymous reviewer; and, in particular, Kerstin Wasson, for valuable comments and suggestions towards the manuscript.

References

- Barnes DKA 1995. Seasonal and annual growth in erect species of Antarctic bryozoans. *J. Exp. Mar. Biol. Ecol.* 188: 181–198.
- Bayer MM & Todd CD 1996. Effect of polypide regression and other parameters on colony growth in the cheilostomate *Electra pilosa* (L.). In: Bryozoans in Space and Time. Gordon DP, Smith AM, & Grant-Mackie JA, eds., pp. 29–38. National Institute of Water and Atmospheric Research, Wellington, NZ.
- Bayer MM, Cormack RM, & Todd CD 1994. Influence of food concentration on polypide regression in the marine bryozoan *Electra pilosa* (L.) (Bryozoa: Cheilostomata). *J. Exp. Mar. Biol. Ecol.* 178: 35–50.
- Begon M, Harper JL, & Townsend CR 1990. *Ecology: Individuals, Populations and Communities*. Blackwell Scientific Publ., London. 945 pp.
- Bell G 1984. Evolutionary and nonevolutionary consequences of senescence. *Am. Nat.* 124: 600–603.
- Best MA & Thorpe JP 1985. Autoradiographic study of feeding and colonial transport of metabolites in the marine bryozoan *Membranipora membranacea*. *Mar. Biol.* 84: 295–300.
- Brock MA 1974. Growth, development and longevity rhythms in *Campanularia flexuosa*. *Am. Zool.* 14: 757–771.
- Bronstein G 1939. Sur les gradients physiologiques dans une colonie de bryozoaires. *C. R. Hebd. Seances Acad. Sci.* 209: 602–603.

- Buss LW 1983. Evolution, development, and the units of selection. *Proc. Natl. Acad. Sci. USA* 80: 1387–1391.
- 1987. *The Evolution of Individuality*. Princeton University Press, Princeton, New Jersey. 201 pp.
- Campbell RD 1968. Colony growth and pattern in the two-tentacled hydroid, *Proboscoidactyla flavicirrata*. *Biol. Bull.* 135: 96–104.
- Cancino JM & Hughes RN 1987. The effect of water flow on growth and reproduction of *Celleporella hyalina* (L.) (Bryozoa: Cheilostomata). *J. Exp. Mar. Biol. Ecol.* 112: 109–130.
- Caswell H 1985. The evolutionary demography of clonal reproduction. In: *Population Biology and Evolution of Clonal Organisms*. Jackson JBC, Buss LW, & Cook RE, eds., pp. 187–224. Yale University Press, New Haven.
- Chadwick-Furman NE & Weissman IL 1995. Life histories and senescence of *Botryllus schlosseri* (Chordata, Ascidiacea) in Monterey Bay. *Biol. Bull.* 189: 36–41.
- Druffel ERM, Griffin S, Witter A, Nelson E, Southon J, Kashgarian M, & Vogel J 1995. *Gerardia*: Bristlecone pine of the deep-sea? *Geochim. Cosmochim. Acta* 59: 5031–5036.
- Eggleston D 1972. Patterns of reproduction in the marine Ectoprocta of the Isle of Man. *J. Nat. Hist.* 6: 31–38.
- Elmhirst R 1922. Cyclic conditions and rejuvenation in hydroids. *Nature* 109: 208–209.
- Gordon DP 1977. The aging process in bryozoans. In: *Biology of Bryozoans*. Woollacott RM & Zimmer RL, eds., pp. 335–376. Academic Press, New York.
- Hardwick RC 1986. Physiological consequences of modular growth in plants. *Phil. Trans. R. Soc. Lond. B313*: 161–173.
- Harper JL 1977. *Population Biology of Plants*. Academic Press, London. 892 pp.
- Harvell CD & Helling R 1993. Experimental induction of localized reproduction in a marine bryozoan. *Biol. Bull.* 184: 286–295.
- Hoekstra RF 1993. Senescence and evolution. *Neth. J. Zool.* 43: 352–358.
- Holliday R 1995. *Understanding Ageing*. Cambridge University Press. 207 pp.
- Hughes DJ & Hughes RN 1986. Metabolic implications of modularity: studies on the respiration and growth of *Electra pilosa*. *Phil. Trans. R. Soc. Lond. B313*: 23–29.
- Hughes RG 1987. The loss of hydranths of *Laomedea flexuosa* Alder and other hydroids, with reference to hydroid senescence. In: *Modern Trends in the Systematics, Ecology and Evolution of Hydroids and Hydromedusae*. Bouillon J, Boero F, & Cornelius PFS, eds., pp. 171–184. Univ. Lond. Queen Mary College.
- Jackson JBC & Coates AG 1986. Life cycles and evolution of clonal (modular) animals. *Phil. Trans. R. Soc. Lond. B313*: 7–22.
- Jackson JBC & Winston JE 1981. Modular growth and longevity in bryozoans. In: *Recent and Fossil Bryozoa*. Larwood GP & Nielsen C, eds., pp. 121–126. Olsen and Olsen, Fredensborg, Denmark.
- Kirkwood TBL 1977. Evolution of ageing. *Nature* 270: 301–304.
- Kirkwood TBL & Rose MR 1991. Evolution of senescence: late survival sacrificed for reproduction. *Phil. Trans. R. Soc. Lond. B332*: 15–24.
- Manriquez PH & Cancino JM 1996. Bryozoan-macroalgal interactions: do epibionts benefit? *Mar. Ecol. Prog. Ser.* 138: 189–197.
- Martínez DE & Levinton JS 1992. Asexual metazoans undergo senescence. *Proc. Natl. Acad. Sci. USA* 89: 9920–9923.
- McKinney FK & Jackson JBC 1991. *Bryozoan Evolution*, 2nd edition. University of Chicago Press, Chicago. 238 pp.
- Medawar PB 1952. *An Unsolved Problem in Biology*. H. K. Lewis, London. 24 pp.
- Meesters EH & Bak RPM 1995. Age-related deterioration of a physiological function in the branching coral *Acropora palmata*. *Mar. Ecol. Prog. Ser.* 121: 203–209.
- Miles JS, Harvell CD, Griggs CM, & Eisner S 1995. Resource translocation in a marine bryozoan: quantification and visualization of ¹⁴C and ³⁵S. *Mar. Biol.* 122: 439–445.
- Millar RH 1971. The biology of ascidians. *Adv. Mar. Biol.* 9: 1–100.
- Muñoz MR, Manriquez PH, Castaneda B, & Cancino JM 1990. Es afectada la expectativa de vida de los módulos por su posición en la colonia? Estudio comparativo en bryozoos. *Rev. Biol. Mar., Valparaíso* 25: 35–46.
- Orive ME 1995. Senescence in organisms with clonal reproduction and complex life histories. *Am. Nat.* 145: 90–108.
- Palumbi SR & Jackson JBC 1982. Ecology of cryptic coral reef communities. II. Recovery from small disturbance events by encrusting Bryozoa: the influence of “host” species and lesion size. *J. Exp. Mar. Biol. Ecol.* 64: 103–115.
- 1983. Aging in modular organisms: ecology of zoid senescence in *Steginoporella* sp. (Bryozoa: Cheilostomata). *Biol. Bull.* 164: 267–278.
- Pätzold J, Ristedt H, & Wefer G 1987. Rate of growth and longevity of a large colony of *Pentapora foliacea* (Bryozoa) recorded in their oxygen isotope profiles. *Mar. Biol.* 96: 535–538.
- Payne CD 1987. *The GLIM System—Release 3.77*. Numerical Algorithms Group, Oxford.
- Rinkevich B, Lauzon RJ, Brown BWM, & Weissman IL 1992. Evidence for a programmed life span in a colonial protochordate. *Proc. Natl. Acad. Sci. USA* 89: 3546–3550.
- Rose MR 1991. *Evolutionary Biology of Aging*. Oxford University Press, New York and Oxford. 221 pp.
- Ryland JS 1979. Structural and physiological aspects of coloniality in Bryozoa. In: *Biology and Systematics of Colonial Organisms*. Larwood GP & Rosen BR, eds., pp. 211–242. Academic Press, London.
- Ryland JS & Hayward PJ 1977. *British Anascan Bryozoans. Synopses of the British Fauna (New Series), No. 10*. Academic Press, London. 180 pp.
- Sabbadin A 1979. Colonial structure and genetic patterns in

- ascidians. In: *Biology and Systematics of Colonial Organisms*. Larwood GP & Rosen BR, eds., pp. 433–444. Academic Press, London.
- Silén L 1944. On the formation of the interzooidal communications of the Bryozoa. *Zool. Bidr. Uppsala* 22: 433–488.
- Stearns SC 1992. *The Evolution of Life Histories*. Oxford University Press, Oxford, New York and Toronto. 249 pp.
- Stebbing ARD 1971. Growth of *Flustra foliacea* (Bryozoa). *Mar. Biol.* 9: 267–72.
- Strehler BL & Crowell S 1961. Studies on comparative physiology of aging. I. Function vs. age of *Campanularia flexuosa*. *Gerontologia* 5: 1–8.
- Tuomi J & Vuorisalo T 1989a. Hierarchical selection in modular organisms. *Trends Ecol. Evol.* 4: 209–213.
- 1989b. What are the units of selection in modular organisms? *Oikos* 54: 227–233.
- Watt AS 1947. Pattern and process in the plant community. *J. Ecol.* 35: 1–22.
- Williams GC 1957. Pleiotropy, natural selection, and the evolution of senescence. *Evolution* 11: 398–411.
- Woolhouse HW 1972. *Aging Processes in Higher Plants*. Oxford Biology Readers, Head JJ & Lowenstein OE, series eds. Oxford University Press, London. 15 pp.