

1983

## **Ultrastructure and development of the flagellar apparatus and flagellar motion in the colonial green alga *Astrephomene gubernaculifera*.**

H.J. Hoops

G.L. Floyd

Follow this and additional works at: <https://knight scholar.geneseo.edu/biology>

---

### **Recommended Citation**

Hoops H.J., Floyd G.L. (1983) Ultrastructure and development of the flagellar apparatus and flagellar motion in the colonial green alga *Astrephomene gubernaculifera*.. *Journal of Cell Science* 63: 21-41. doi:

This Article is brought to you for free and open access by the Department of Biology at KnightScholar. It has been accepted for inclusion in Biology Faculty/Staff Works by an authorized administrator of KnightScholar. For more information, please contact [KnightScholar@geneseo.edu](mailto:KnightScholar@geneseo.edu).

## ULTRASTRUCTURE AND DEVELOPMENT OF THE FLAGELLAR APPARATUS AND FLAGELLAR MOTION IN THE COLONIAL GREEN ALGA *ASTREPHOMENE* *GUBERNACULIFERA*

HAROLD J. HOOPS\* AND GARY L. FLOYD†

*Botany Department, The Ohio State University, 1735 Neil Ave, Columbus, Ohio,  
U.S.A.*

---

### SUMMARY

Immediately following embryonic cleavage, the cells of *Astrephomene* have four equal-sized basal bodies, two of which are connected by a striated distal fibre and two striated proximal fibres. The four microtubular rootlets, which alternate between having 3/1 and 2 members, are arranged cruciately. The two basal bodies that are connected by the striated fibres then extend into flagella, while the two accessory basal bodies are now markedly shorter. At this stage the flagellar apparatus has 180° rotational symmetry and is very similar to the flagellar apparatus of the unicellular *Chlamydomonas* and related algae. Development proceeds with a number of concurrent events. The basal bodies begin to separate at their proximal ends and become nearly parallel. Each striated proximal fibre detaches at one end from one of the basal bodies. Each half of the flagellar apparatus, which consists of a flagellum and attached basal body, an accessory basal body, two rootlets and a striated fibre (formerly one of the proximal striated fibres), rotates about 90°, the two halves rotating in opposite directions. An electron-dense strut forms near one two-membered rootlet and grows past both basal bodies. During this time a fine, fibrous component appears between newly developed spade-like structures and associated amorphous material connected to each basal body. The basal bodies continue to separate as the distal fibre stretches and finally detaches from one of them. These processes result in the loss of the 180° rotational symmetry present in previous stages. Although the flagella continue to separate, there is no further reorganization of the components of the flagellar apparatus. In the mature cell of *Astrephomene*, the two flagella are inserted separately and are parallel. The four microtubular rootlets are no longer arranged cruciately. Three of the rootlets are nearly parallel, while the fourth is approximately perpendicular to the other three. A striated fibre connects each basal body to the underside of the strut. These fibres run in the direction of the effective stroke of the flagella and might be important either in anchoring the basal bodies or in the initiation of flagellar motion. Unlike the case in the unicellular *Chlamydomonas*, the two flagella beat in the same direction and in parallel planes. The flagella of a given cell may or may not beat in synchrony. The combination of this type of flagellar motion and the parallel, separate flagella appears to be suited to the motion of this colonial organism.

### INTRODUCTION

Colonial morphology of the multicellular members of the green algal order Volvocales varies considerably from genus to genus (Fritsch, 1935; Smith, 1950). These algae are often regarded as being evolutionarily derived from unicellular

\* Present address: Worcester Foundation of Experimental Biology, 222 Maple Ave, Shrewsbury, MA 01545, U.S.A.

† Author for correspondence.

Volvoclean representatives (Crow, 1918; Fritsch, 1935; Lang, 1963; Pickett-Heaps, 1975a; Ettl, 1976) such as *Chlamydomonas*, for which the structure of the flagellar apparatus and many aspects of flagellar motion have been described (Ringo, 1967; Hyams & Borisy, 1975, 1978; Schmidt & Eckert, 1976; Moestrup, 1978; Goodenough & Weiss, 1978; Katz & McLean, 1979). The transition from unicellular to colonial habit imposed a new set of opportunities and constraints on flagellar motion, which is presumably reflected in the construction of the flagellar apparatus. For example, a spherical colony with radially arranged cells could not move efficiently if all the cells composing the colony used the breaststroke-like motion characteristic of *Chlamydomonas*. Modification of the flagellar action necessary to permit directed colonial motion might therefore be accompanied by modification of the structure of the flagellar apparatus. There are indications that such structural modifications have occurred in the colonial Volvoclean algae. However, the flagellar apparatus has not been completely characterized for any spherical colony composed of radially arranged cells. Nor has any attempt been made to relate the fine-structural features of the flagellar apparatus to the features of flagellar or colonial motion.

Of the many species available for such a study, *Astrephomene gubernaculifera* Pocock is particularly suitable. All cells of the colony are similar, except for the presence in some colonies of a small group of rudder cells (Pocock, 1953; Stein, 1958). In addition, aspects of morphology and development have been characterized (Pocock, 1953; Stein, 1958). Ultrastructural features of the interphase cell and of mitosis and cytokinesis are consistent with placement of *Astrephomene* in the Volvocales (Hoops & Floyd, 1982a).

In this paper, the structure and development of the flagellar apparatus of *A. gubernaculifera* are described. The results are interpreted with respect to flagellar motion and colonial form and motion.

#### MATERIALS AND METHODS

*A. gubernaculifera* (LB1068) was obtained from the Culture Collection of Algae at the University of Texas. Non-axenic stocks were maintained in soil-water medium to which pea cotyledon had been added (Stein, 1958). These cultures grew slowly, but contained large colonies with both somatic rudder cells and vegetative cells. Axenic cultures were obtained by the spray plate method and grown in Modified Volvoclean Medium (Brooks, 1966). The axenic cultures grew rapidly, resulting in small, numerous cells and colonies. Rudder cells were not differentiated in the young colonies from these cultures. Axenic cultures 1–3 days old or non-axenic cultures 2 weeks old were fixed in 1% glutaraldehyde in culture medium for 10–15 min and transferred directly to 1% glutaraldehyde in 0.1–0.2 M-sodium cacodylate (pH 7.2) for about 2 h. After rinsing in buffer, the cells were collected on a millipore filter, embedded in 1% agar and postfixed in 1% OsO<sub>4</sub> in buffer for 1 h. The sample was washed in water, poststained overnight in 1% aqueous uranyl acetate, dehydrated in acetone and embedded in either Spurr's resin or Epon-Araldite. In some cases the cells were not embedded in the agar before processing, but a loose pellet was fixed, stained *en bloc* and dehydrated as above, and embedded between Teflon-coated glass slides. Serial sections were picked up on Formvar-coated slot grids, stained with lead citrate, and viewed on an Hitachi H300 transmission electron microscope. All diagrams and supporting figures are in the correct absolute orientation (Floyd, Hoops & Swanson, 1980).

Cinephotomicrographic analysis of flagellar motion was conducted using phase-contrast on a Zeiss Universal microscope, with Tri-X reversal movie film in a Redlake Locam model 51, 16 mm high-speed motion picture camera synchronized with a Chadwick-Helmuth Strobex power supply and

lamp. The framing rate was either 128 or 256 frames per second. To allow observation of flagellar motion, the colonies were held by gentle suction utilizing a micropipet, and held away from both the coverslip and the slide (Shapiro & Witman, unpublished).

## RESULTS

Like other colonial Volvocalean algae, each reproductive cell of *Astrephomene* divides several times to yield a new daughter colony. Asexual reproduction and colony structure have been adequately described (Pocock, 1953; Stein, 1958; Hoops & Floyd, 1982a) and will not be covered here. Since it is difficult to determine the cell number of an entire colony in thin section, it is uncertain whether the initial stage in the development of the flagellar apparatus represents the condition of the flagellar apparatus shortly before, or after, the last division. Nevertheless the appearance of early stages was quite consistent.

### *Early stages of development*

In the earliest stage, the flagellar apparatus includes four basal bodies (Figs 1–3), none of which extends into flagella. Two opposite basal bodies are connected by a broad, striated distal fibre (Figs 1, 7) and two proximal striated fibres (Figs 3, 6, 7). The other two basal bodies are further apart (Figs 1–3) and are attached to the first pair by fine projections (Fig. 2). Four cruciately arranged rootlets descend from the region of the basal bodies (Figs 2, 4, 5). The rootlets are more closely associated with the basal bodies that are connected by the distal and proximal striated fibres than the two widely separated basal bodies. The rootlets at this and later stages are of two types, and alternate between having four (3 over 1) and two microtubules each (Figs 2, 4, 5). In addition to the rootlets, numerous cytoplasmic microtubules lie just under the plasmalemma and extend towards the posterior end of the cell (not shown).

As the cells enlarge, the basal bodies that are connected by the distal and proximal striated fibres give rise to flagella. The structure of the flagellar apparatus at this stage is similar to that of certain other motile chlorophycean algal cells (see Discussion), but very different from the adult cell of *Astrephomene*. A diagrammatic reconstruction (Fig. 8) is provided to aid in interpretation, and for comparison with published information on the flagellar apparatus of other chlorophycean cells.

Two short accessory basal bodies are now located to the side of the functional ones (Fig. 8). The accessory basal bodies are lower in the cell than the functional pair, and they are not arranged in the V-shaped configuration characteristic of the functional basal bodies. It is not certain if this condition is due to the rearrangement and shortening of the original second pair, or if the accessory basal bodies are formed after the redistribution of the original two pairs to the daughter cells following division. Each accessory basal body has a complete set of triplets in addition to the cartwheel structure (not shown). The functional basal bodies are arranged in a V-shaped configuration about 90° apart (Figs 6–8). Each proximal striated fibre is triangular and possesses a distinctive striation pattern (Figs 6–8). One fibre is attached to the first functional basal body at the base of the triangle, but about half of the base extends

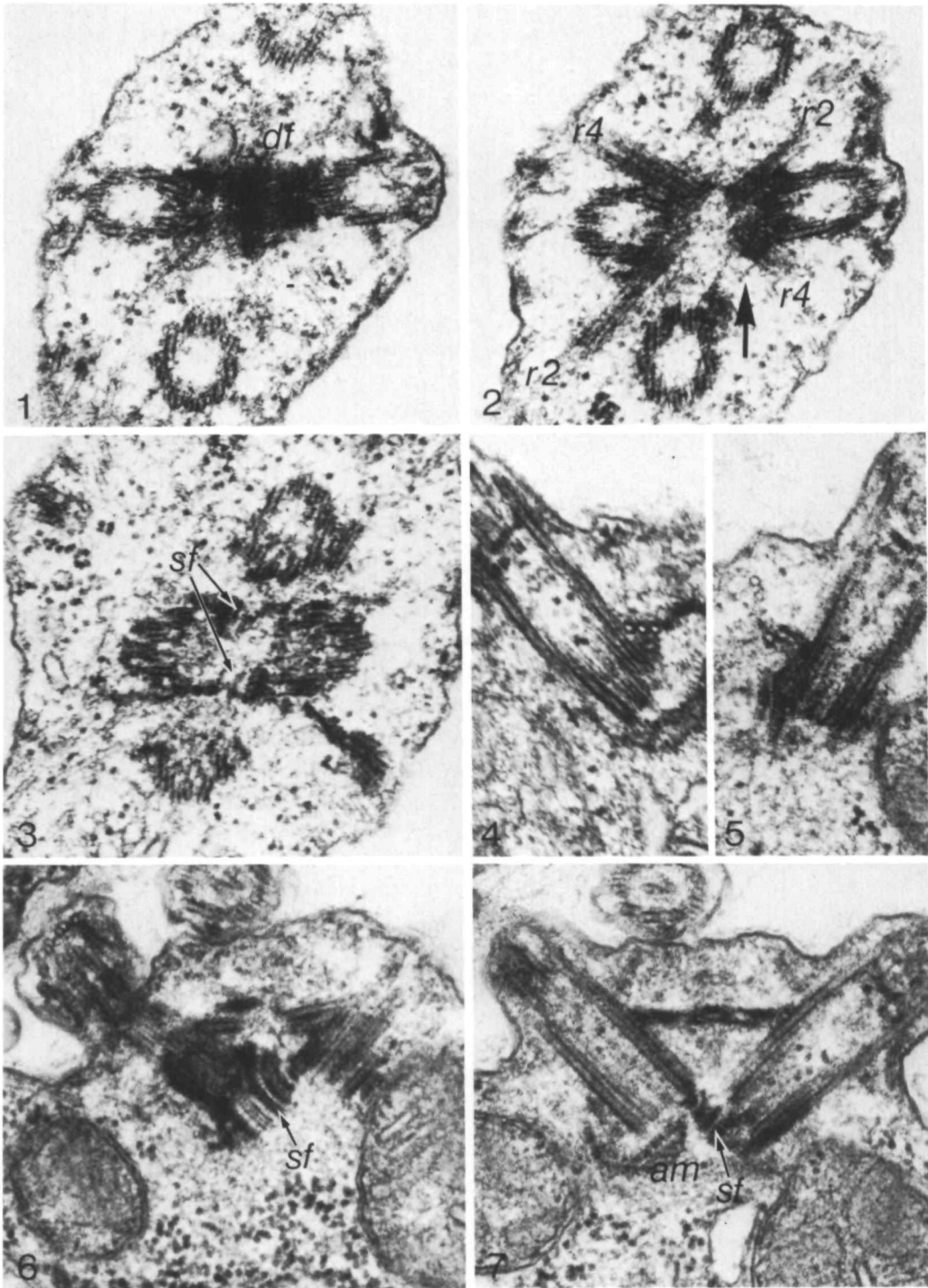

Figs 1-7

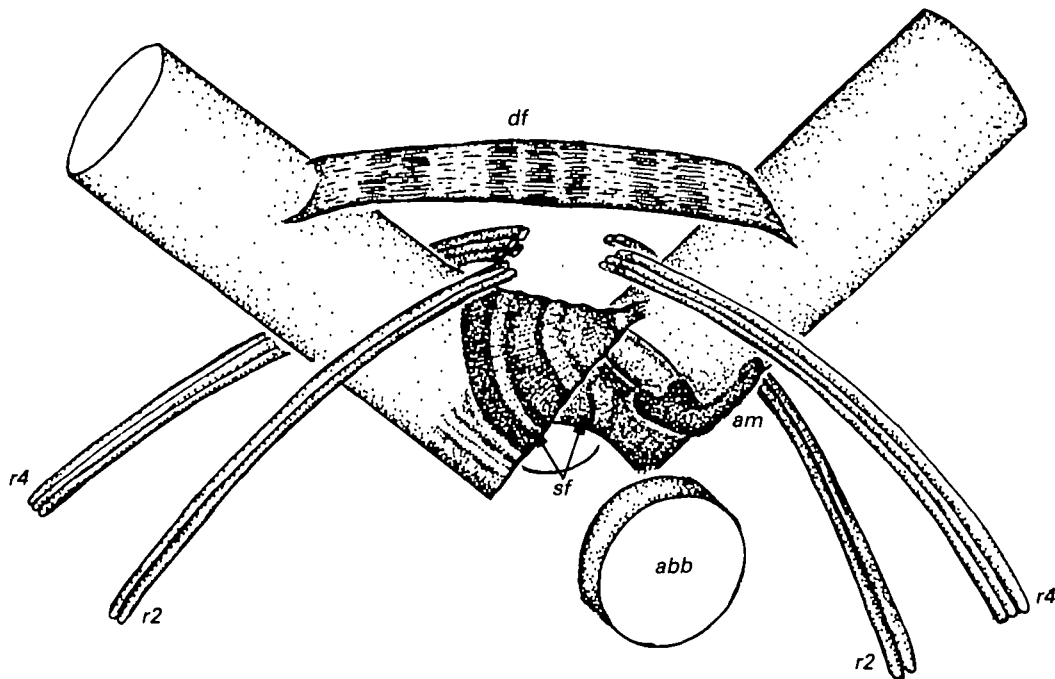

Fig. 8. Reconstruction of the early flagellated stage. The two functional basal bodies are connected by a distal striated fibre (*df*) and two proximal striated fibres (*sf*). The rootlets alternate between having four (*r4*) and two (*r2*) members. Note also the amorphous material (*am*) and one accessory basal body (*abb*).

below the proximal side of the basal body (Figs 6–8). The apex of the fibre is located to the outside of the second basal body, and toward the anterior of the cell (Figs 6–8). The second proximal striated fibre has its apex on the first basal body, and its base on the second, and is thus the reverse of the first fibre (Figs 6–8). Also associated with the proximal region of each basal body is a region of amorphous electron-dense material (Figs 6–8). This material is found in association with the posterior side of the basal body and partly occludes the lumen.

The next step in the development involves several concurrent changes (Figs 9–14). These are summarized in Fig. 27. An electron-dense 'strut' forms near one

---

Figs 1–3. Very early stages in development of *Astrephomene* flagellar apparatus (serial sections 1, 2, 5). Two of the basal bodies are connected by a striated distal fibre (*df*) and two striated proximal fibres (*sf*). Fine projections (arrow, Fig. 2) connect the other basal bodies to the first pair. None of the basal bodies extends into flagella. Four rootlets (*r2*, *r4*) descend from the flagellar apparatus in a cruciate arrangement.  $\times 55\ 000$ .

Fig. 4. Early flagellate stage. The larger rootlet is present in the 3/1 configuration near the basal bodies.  $\times 68\ 000$ .

Fig. 5. Early flagellated stage. The smaller rootlet is two-membered.  $\times 68\ 000$ .

Figs 6–7. Early flagellated stage (serial sections 1, 3). Each proximal striated fibre (*sf*) is triangular and extends past the proximal end of the basal body. Amorphous material (*am*) is associated with each of the basal bodies at their proximal ends.  $\times 65\ 000$ .

of the two-membered rootlets (Figs 9–11). The strut is not appressed to the rootlet near which it forms and it does not extend past the second functional basal body (Figs 10, 11). The striated distal fibre detaches from one edge of each functional basal body (Fig. 10). The rootlets are no longer arranged cruciately, but have become asymmetrical. One two-membered rootlet and one four-membered rootlet are closer together, while the other two- and four-membered rootlets diverge (Figs 10–12). The positions of the accessory basal bodies have also changed, so that one is between the inner pair of rootlets (Fig. 10), while the second appears under the two-membered rootlet and the forming strut (Figs 12, 13). These changes suggest that each half of the flagellar apparatus rotates, the two halves rotating in opposite directions.

Another change involves the proximal striated fibres. Each fibre dissociates at its pointed end from one of the two basal bodies (Figs 12, 13). Electron-dense material remains at the former site of attachment (Fig. 12). Since these fibres no longer extend from basal body to basal body in the manner of the chlamydomonad proximal fibres (Melkonian, 1980a), the use of the term proximal fibre would be misleading; therefore, they will be referred to as striated fibres after this stage. Initially, these striated fibres do not reattach to any structure, although in Figs 12–14, one fibre underlies the developing strut while the other terminates near that structure. A narrow spade-like structure extends from one (Fig. 14) or both (not shown) of the basal bodies at this stage. A fibrous component begins to develop between the spade-like structures (Fig. 14). The two halves of the flagellar apparatus continue to rotate until the inner rootlets are parallel. The functional basal bodies become parallel and continue to separate and the strut elongates until it passes beyond both basal bodies (Fig. 27). These processes result in the flagellar apparatus of the mature cell.

#### *Mature cell*

A detailed reconstruction of the mature flagellar apparatus is shown in Fig. 15. The flagella are nearly but not perfectly parallel (Figs 16–19). Although the internal structure of the flagella and basal bodies is similar to that reported for *Chlamydomonas* (Ringo, 1967), *Volvox* (Olson & Kochert, 1970), and *Eudorina* (Hobbs, 1971), and thus not described in detail here, the components that are associated with each of the basal bodies are arranged differently (Fig. 15). For convenience, we have arbitrarily labelled the basal body to the left in Fig. 15 as number 1, and the second as number 2. From sectioning colonies of known orientation, it has been determined that the structures in the foreground of Fig. 15 are directed anteriorly.

The strut extends beyond both basal bodies on one side of the flagellar apparatus

---

Figs 9–14. Flagellar apparatus during early development (serial sections 1, 3, 4, 5, 6, 8). The two functional basal bodies are becoming more nearly parallel. An electron-dense strut (*s*) is forming near one two-membered rootlet (*r2*), but does not yet extend past both basal bodies. The distal striated fibre (*df*) has detached from the basal bodies along two corners. The rootlets (*r2*, *r4*) and the accessory basal bodies (*abb*) are in the process of rotation. Both proximal striated fibres (*sf*) have detached at one end; the site of their former attachment is characterized by electron-dense material (arrow, Fig. 12). A spade-like structure (*ss*) is visible under one of the functional basal bodies.  $\times 49\,000$ .

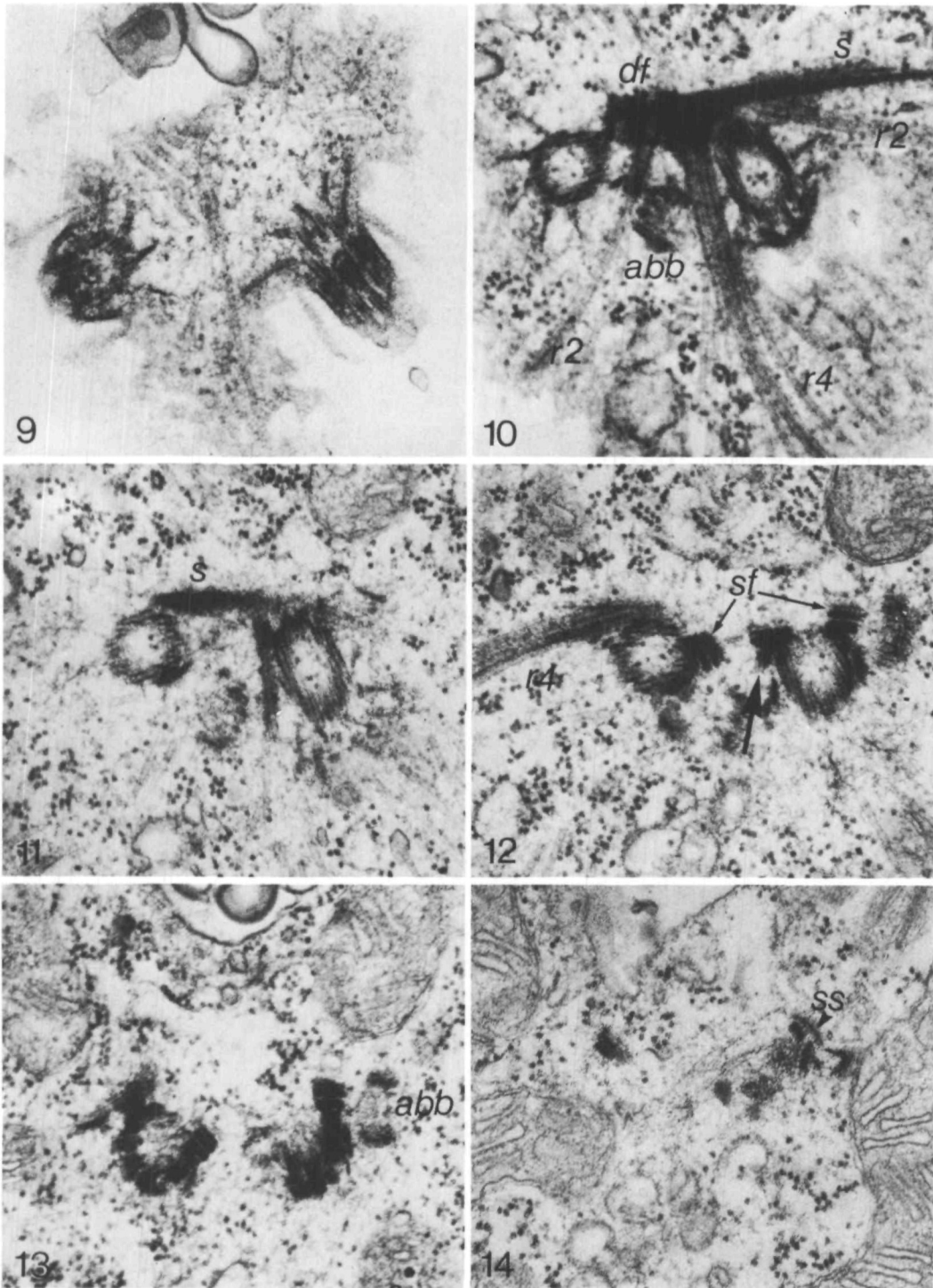

Figs 9-14



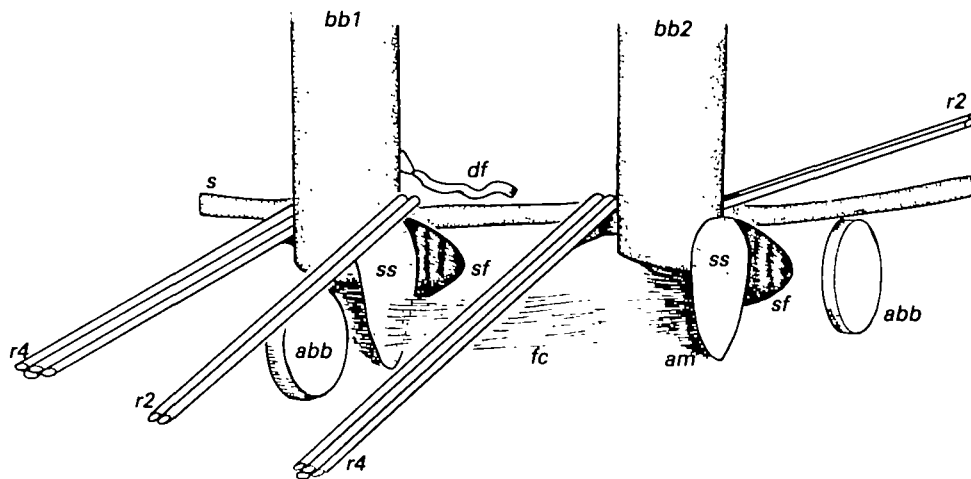

Fig. 15. Diagrammatic representation of the flagellar apparatus of the mature cell of *Astrephomene*. In this view basal body 1 (*bb1*) is on the left of basal body 2 (*bb2*). The strut (*s*) extends past both basal bodies. The striated fibres (*sf*) extend under the strut. Both four-membered (*r4*) and two-membered (*r2*) rootlets extend from the basal bodies. A fibrous component (*fc*) connects the spade-like structures (*ss*). An electron-dense 'flap' (*df*) is attached to basal body 1. An accessory basal body (*abb*) is near each of the smaller rootlets. *am*, amorphous material.

(Figs 16–18). This strut is striated at a periodicity of approximately 5–6 nm (not shown) and in cross-section, is semicircular (Figs 23, 24). It connects to each functional basal body by a series of thin shelf-like projections that arise from the flat side of the strut (Figs 22, 23 inset). These projections are present on the strut between the basal bodies (Fig. 22), but they are not associated with the strut when it extends beyond the basal bodies (Fig. 23). The plasmalemma curves down toward the strut leaving a cleft just to the outside of the basal bodies (Figs 22, 23); however, a direct connection of the strut to the plasmalemma was not observed.

The four rootlets extend just under the plasmalemma for an undetermined distance. Two rootlets, each of which inserts *between* the functional basal bodies, are parallel (Figs 15–18). These two inner rootlets alternate between having two and four members (Figs 15, 20, 21). The fourth rootlet, two-membered (Fig. 23), is approximately perpendicular to the other three and rises toward the cell surface at a rather steep angle (Figs 14, 22), so it is not obvious in the plane that shows the

---

Figs 16–18. Top views of the flagellar apparatus (serial sections 1, 2, 4). The electron-dense strut (*s*) extends past both basal bodies. Three of the rootlets (*r2*, two *r4*s) extend from the flagellar apparatus. A striated component is associated with the underside of one four-membered rootlet (arrow). One striated fibre (*sf*) is associated with a spade-like structure (*ss*) and extends under the strut (Fig. 18). Amorphous material (*am*) is located under the basal bodies near the spade-like structure. Other abbreviations as in Fig. 15.  $\times 51\,000$ .

Fig. 19. Basal body region. Note the fibrous component (*fc*) running between the spade-like structure (*ss*) attached to one basal body and the amorphous material (*am*) associated with the other. Also note membranes around the filaments.  $\times 71\,000$ .

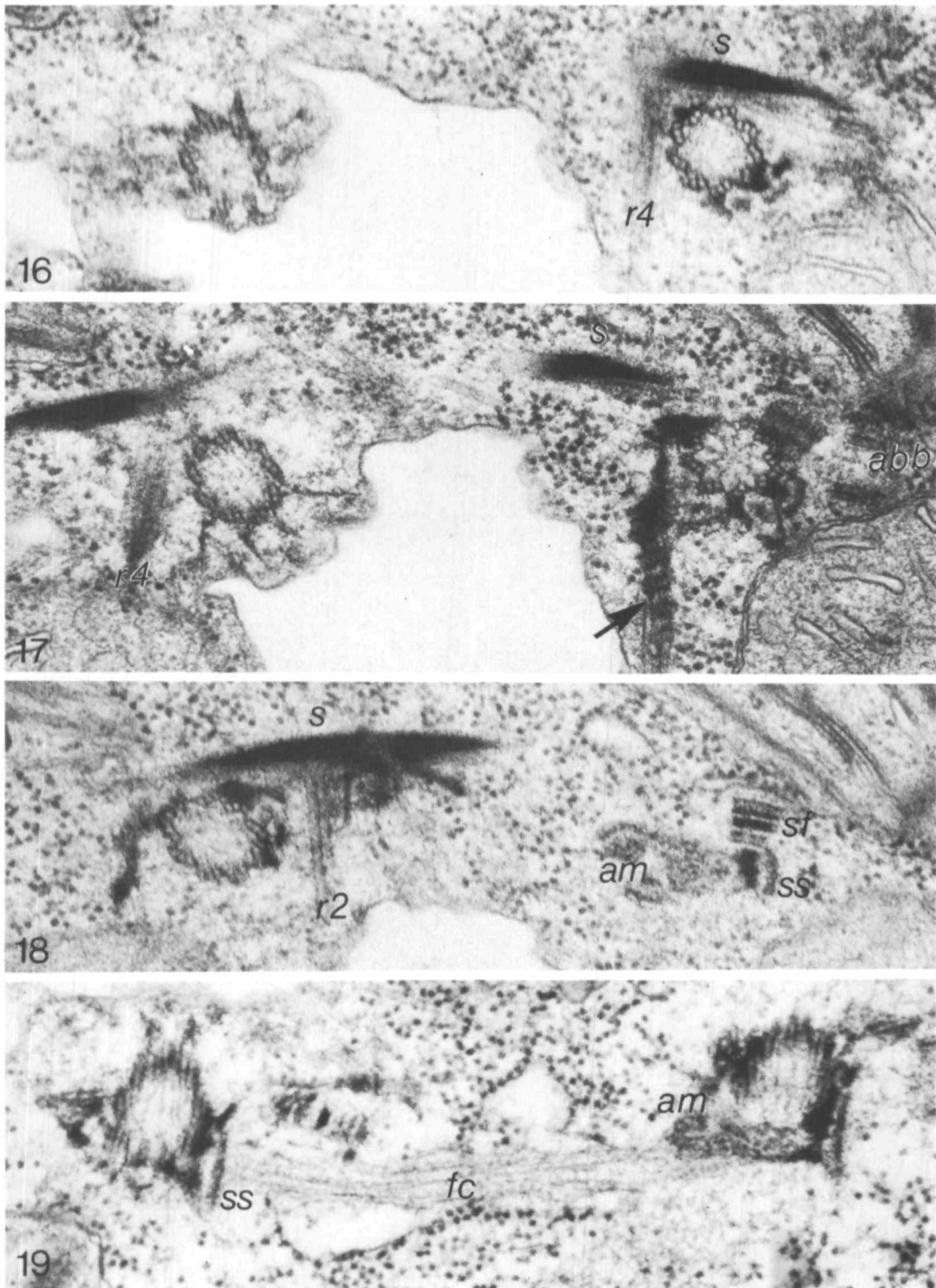

Figs 16-19

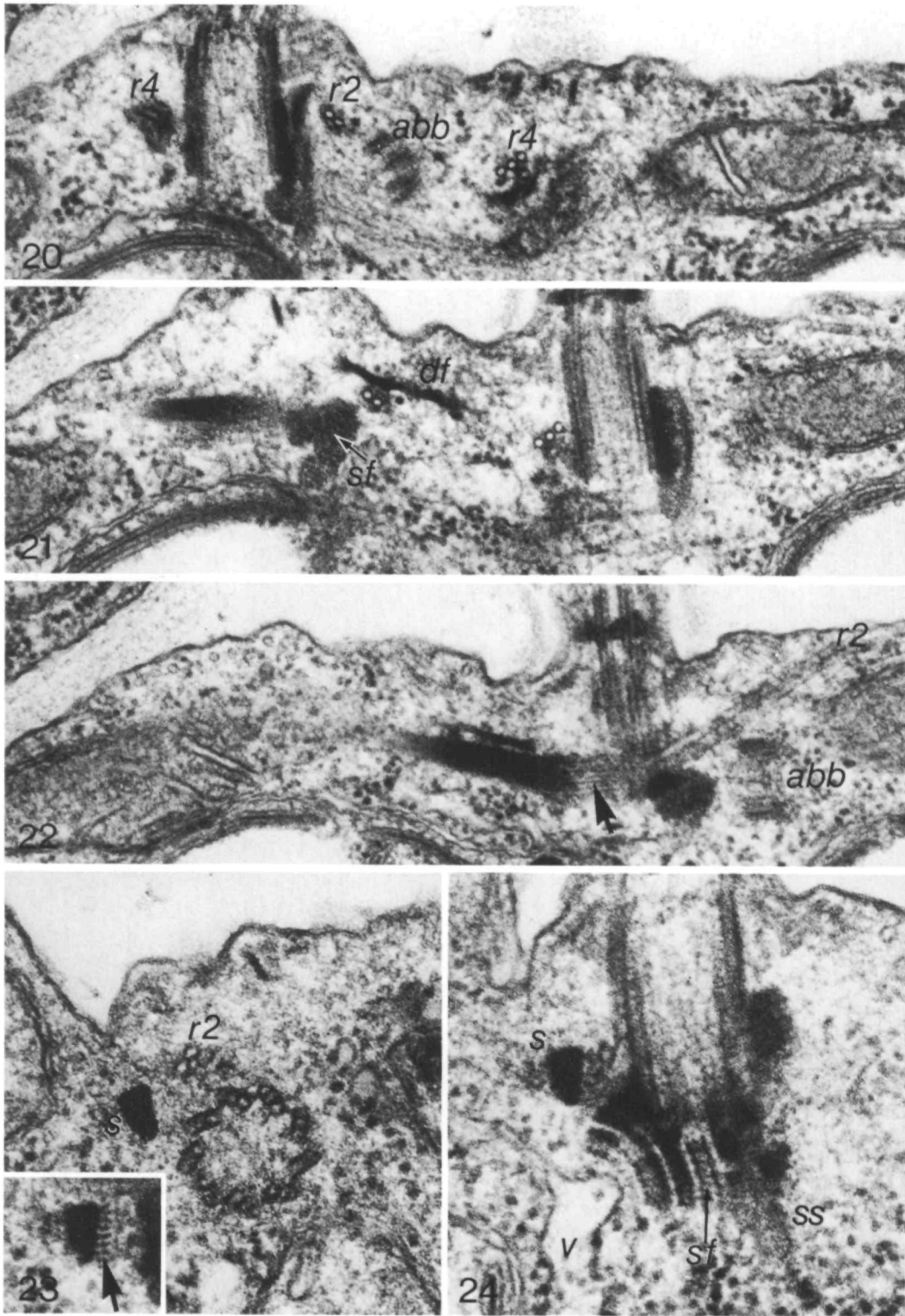

Figs 20-24

longitudinal views of the other rootlets (Figs 16–18). This rootlet runs in nearly the same direction as the strut, although it appears to attach to the strut only at the insertion of the rootlet near the basal body (Fig. 22). A periodic component runs under the 3/1 rootlet that is inserted into basal body 2 (Fig. 17). There does not appear to be a similar component associated with the second 3/1 rootlet (Figs 17, 18).

An accessory basal body occurs near the proximal end of each functional basal body and near a two-membered rootlet (Figs 15, 17, 20, 22, 23). The accessory basal bodies are always in the same position relative to the rest of the flagellar apparatus. One accessory basal body is located between the functional basal bodies, with its central axis pointing away from basal body 1 (Figs 15, 20; the position of this accessory basal body has been slightly altered in Fig. 15 to allow details of the proximal area of basal body 1 to be seen). The second accessory basal body, associated with and to the outside of functional basal body 2, has its central axis pointing in roughly the same direction as the first (Figs 15, 17, 22).

The large, triangular striated fibre is found on the same side of each functional basal body as the associated accessory basal body. From above, each striated fibre appears to attach directly to the strut (Figs 15–18). Sections in other planes, however, indicate that the pointed end of these fibres is below the strut (Fig. 24). These fibres have a characteristic striated pattern with fine filaments that run perpendicular to the striations. Approximately half of each fibre is under the proximal portion of its associated basal body (Figs 15, 24). Each fibre abuts the spade-like structure that also extends below the basal body (Figs 15, 18, 24). At the other (pointed) end of each striated fibre there is usually a membrane-bound vesicle of varying size (Fig. 24).

The distal fibre is reduced to a thin, electron-dense extension from basal body 1. It touches the strut, but it is not part of that structure (Figs 15, 21).

The spade-like structures are located to the side of the basal bodies opposite the strut (Figs 15, 18). They are associated with amorphous material that partially occludes the proximal region of each functional basal body (Figs 15, 18, 19). The fine fibrous component runs from the outside of the spade-like structure of basal body 1 to the amorphous material associated with the inside of the spade-like structure on basal body 2 (Fig. 19). This fibrous component is associated with membranes that look like endoplasmic reticulum, or vesicles (Fig. 19). Because of the irregular appearance of the membranes, it is difficult to determine their precise arrangement, but

Figs 20–22. Side-view of the flagellar apparatus (serial sections 1, 3, 5). Both inner rootlets (*r2*, *r4*) are in cross-section while one outer one (*r4*) is sectioned obliquely. The fourth rootlet (*r2*) is sectioned longitudinally. One striated fibre (*sf*) is seen in cross-section. Note the electron-dense flap (*df*, Fig. 21), shelf-like structures (arrow) on the strut, and accessory basal bodies (*abb*, Fig. 22).  $\times 63\,000$ .

Fig. 23. Cross-section of the accessory basal body associated with functional basal body 2. A rootlet (*r2*) is associated with the strut (*s*).  $\times 100\,000$ . Inset: strut near the vicinity of the basal body. Note the shelf-like structures (arrow) that extend from the strut toward material associated with the basal body.  $\times 100\,000$ .

Fig. 24. Striated fibre. This fibre (*sf*) is associated with the spade-like structure (*ss*) and the strut (*s*). A vesicle (*v*) is present at the apex of the fibre. Note the fine periodicity of the strut.  $\times 100\,000$ .

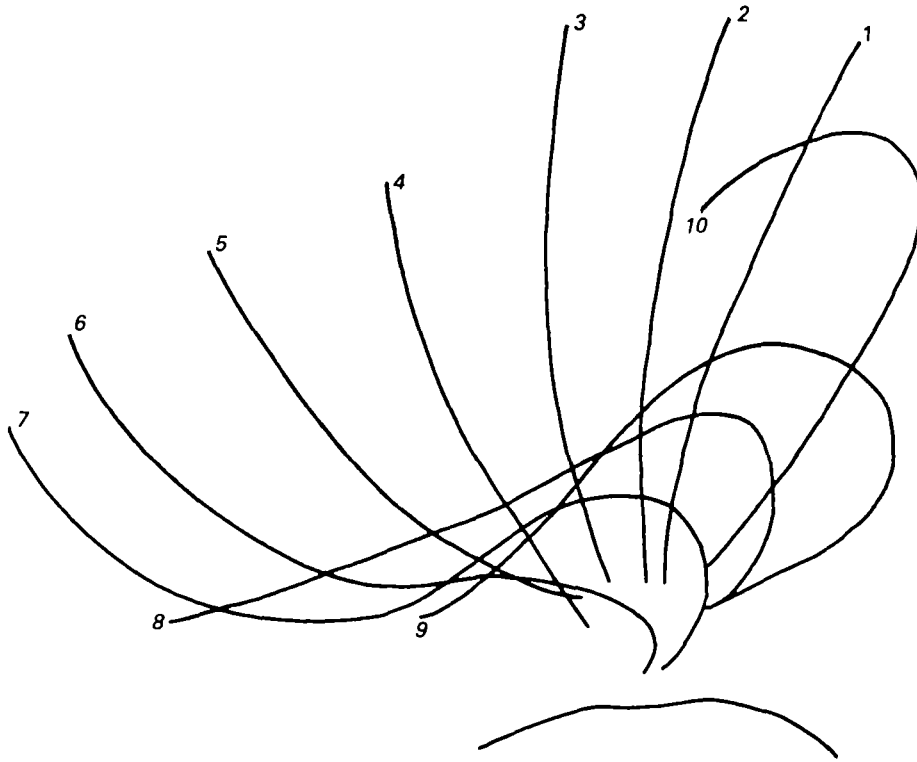

Fig. 25. Flagellar motion. From a tracing of cine film taken at 128 frames per second. In this case the flagellum did not pause at the beginning of the effective stroke. Numbers indicate the order from the beginning of effective stroke to the end of recovery stroke.

they do not seem to enclose the fibrous component completely (serial sections not shown).

#### *Analysis of flagellar motion:*

The flagella of *Astrephomene* beat in a ciliary manner (Figs 25, 26). Fig. 25 was obtained from tracings with an interval between the stages of about 7·8 ms. Unlike the case in many cilia, the effective stroke takes about as long as, or in some cases slightly longer than, the recovery stroke. A flagellum may stop or pause near the beginning of the effective stroke, sometimes for a considerable period. If both flagella of a given cell are in the same portion of the beat cycle (i.e. are synchronized) they are nearly parallel (Fig. 26). The direction of the effective stroke is towards the posterior of the colony, and varies little for a given flagellum over the period during which it was observed. Both of the flagella of a given cell beat in parallel planes in the same direction. The plane of the effective stroke is nearly perpendicular to the strut, but never reaches that position. The difference presumably represents the component of flagellar motion responsible for colony rotation rather than forward swimming. The flagella of each cell are not necessarily synchronized; frequently, one flagellum is in

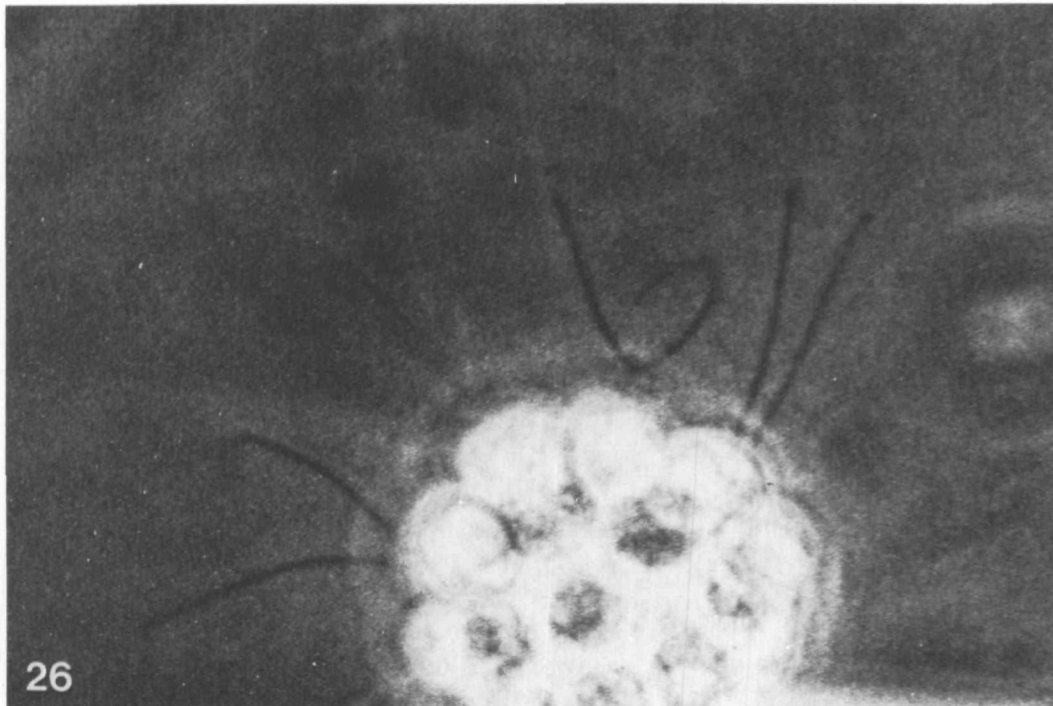

Fig. 26. Single frame from cine film. In one cell both flagella are in the parallel position at the beginning of the effective stroke. Note the lack of synchrony in the other cells, which have one flagellum in the effective stroke and the other in the recovery stroke.  $\times 1000$ .

the middle of the effective stroke while the second is in the middle of the recovery stroke (Fig. 26). At times both flagella may pause, then one flagellum will start the effective stroke, followed almost immediately by the second.

#### DISCUSSION

##### *Early stages of development*

During early stages of development the flagellar apparatus of *Astrephomene* supports two flagella in a V-shaped arrangement, which Pocock (1953) has reported to be capable of movement. In these early stages, the flagellar apparatus resembles the chlamydomonad type (Melkonian, 1980a). Specifically, it resembles the flagellar apparatus of *Chlamydomonas* (Ringo, 1967; Moestrup, 1978; Goodenough & Weiss, 1978; Katz & McLean, 1979) in possessing two functional basal bodies in a V-shaped configuration, one distal striated fibre, two proximal striated fibres and four cruciately arranged microtubular rootlets. In addition, the rootlets in each genus alternate between having two and four microtubules, with the latter in the 3/1 configuration in the region of the basal bodies. Although the vegetative cells of *Chlamydomonas reinhardtii* do not possess fully formed accessory basal bodies during most of interphase (Ringo, 1967; Cavalier-Smith, 1974; Gould, 1975), gametes in this species do

have accessory basal bodies (Friedmann, Colwin & Colwin, 1968) in a position similar to that of the flagellar apparatus in the immature cell of *Astrephomene*. Both the flagellar apparatus of *Chlamydomonas* and that of *Astrephomene*, at this stage, have 180° rotational symmetry (see Floyd *et al.* 1980). While a number of these features are present in a variety of green algae (Moestrup, 1978; Melkonian, 1980a; Floyd *et al.* 1980; Hoops, Floyd & Swanson, 1982), taken together the similarities suggest a close phylogenetic relationship between *Astrephomene* and the unicellular algae of the chlamydomonad type. The sperm cells of *Volvox carteri* (Birchem & Kochert, 1979), *V. aureus* (Deason, Darden & Ely, 1969; Deason & Darden, 1971) and *V. tertius* (Pickett-Heaps, 1975b) also resemble the chlamydomonad type of flagellar apparatus in having the two functional basal bodies in a V-shaped arrangement and connected by a distal fibre, and in possessing cruciate microtubular rootlets. This is in contrast to the mature vegetative cells of *Volvox*, in which the flagella are inserted separately and are approximately parallel. The ultrastructure of the flagellar apparatuses in mature vegetative cells of *V. carteri* f. *weismannia* and *V. rousseletii*, like that of *Astrephomene*, are significantly different from *Chlamydomonas*, but the flagellar apparatuses of the embryonic cells are of the chlamydomonad type (unpublished observations).

It has been suggested repeatedly that the colonial Volvocales evolved from unicellular members of the Order (Crow, 1918; Fritsch, 1935; Lang, 1963; Pickett-Heaps, 1975a; Ettl, 1976). The similarity of the flagellar apparatus of the immature cells of *Astrephomene*, as well as the sperm cells of *Volvox*, to the algae with the chlamydomonad type of flagellar apparatus, supports this view. However, some of the details of the flagellar apparatus of immature *Astrephomene* cells do differ from those noted in *Chlamydomonas*. In particular, the proximal striated fibres of *Astrephomene* appear unusual because they are triangular and much of the striated fibre is proximal to the base of the basal body. The similarity of flagellar apparatuses of immature cells and sperm cells in the colonial Volvocales to *Chlamydomonas* should not be taken as evidence that the ancestor of the colonial Volvocales was a present-day *Chlamydomonas*. Careful investigation of other unicellular algae may reveal species that have additional features in common with the immature flagellar apparatus of *Astrephomene* and the sperm cells of *Volvox*.

The flagellar apparatus of *Astrephomene* does not remain in the chlamydomonad configuration, but rather undergoes a major reorganization involving the separation, rotation and rejoining of certain structures. Others are newly developed. This is illustrated diagrammatically in Fig. 27. The strut forms in association with one of the two-membered rootlets and remains close to this rootlet during development to the mature state. The strut elongates during development. However, at present, the mechanism for this elongation is not understood. The association with a smaller rootlet, as well as the fine periodicity, indicates that it may be a derived form of the SMAC (striated microtubular-associated component; Floyd *et al.* 1980), which is present in association with the smaller microtubular rootlets in a variety of algae, including *Chlamydomonas* (see Goodenough & Weiss, 1978).

Another modification in the flagellar apparatus includes the formation of the spade-like structures and the associated fibrous component that runs between them. The

spade-like structures are not developed when the flagellar apparatus is in the chlamydomonad type of stage, although the amorphous material associated with these structures in the mature form is also present in the immature cells. The spade-like structures form during the early stages of reorganization, when the basal bodies are rotating and becoming more nearly parallel. Both the time of formation and the position of these structures suggest that they are involved in the reorganization movement.

In addition to the rearrangement that causes basal bodies to become separate and parallel, there is also rotation of the two halves of the flagellar apparatus. Although no internal markers were found associated with each basal body, the position of the

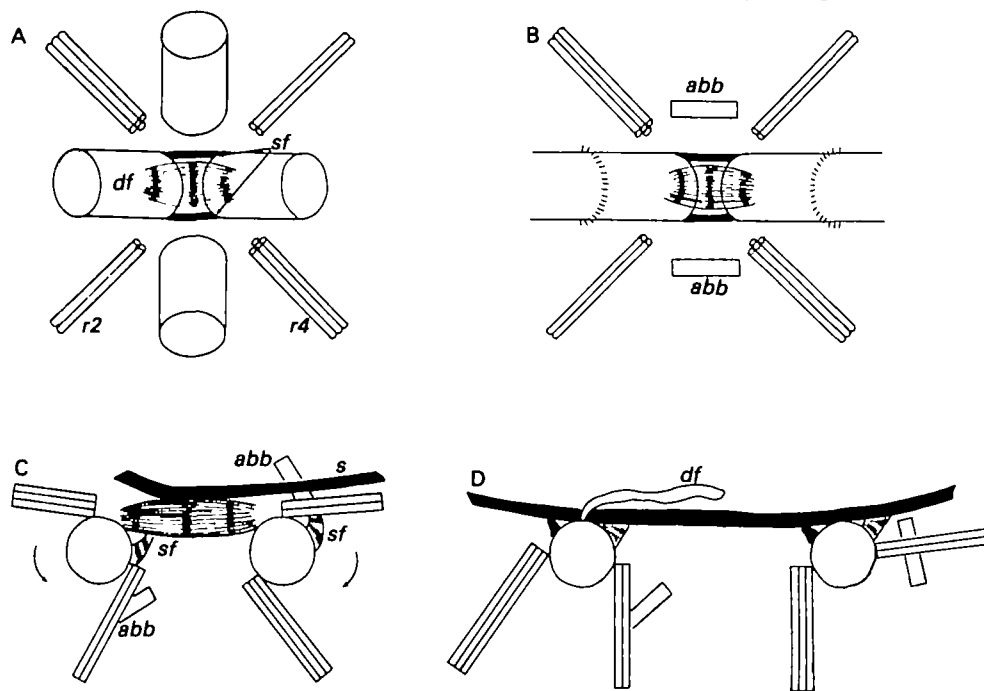

Fig. 27. Diagrammatic representation of the development of the flagellar apparatus in *Astrephomene*. A. In the earliest stage, four full-sized basal bodies are present, two of which are connected by the distal striated fibre (df) and two proximal striated fibres (sf). The microtubular rootlets (r2, r4) are cruciately arranged. B. Later the cells enter the chlamydomonad stage, as two basal bodies grow flagella, while two smaller accessory basal bodies (abb) are also present. C. During development the basal bodies become nearly parallel, the proximal striated fibres detach at one of the ends, and each half of the flagellar apparatus begins to rotate. This rotation is reflected in the position of the microtubular rootlets, the striated fibres (sf; formerly the proximal striated fibres), and the accessory basal bodies. In addition, an electron-dense strut (s) forms near one of the two rootlets and extends past one of the basal bodies. For simplicity, the fibrous component that extends between the basal bodies is not shown. Arrows indicate direction of rotation. D. In the mature stage the strut extends past both basal bodies and rotation of each half of the flagellar apparatus ceases. The striated fibres attach to the underside of the strut. The distal fibre has detached from one of the basal bodies. Again, the fibrous component between the basal bodies was omitted for clarity. Although the basal bodies will continue to separate, there is no further rearrangement of components.



striated fibre and its former attachment, as well as the position and attachments of the distal fibre during this process, suggest that each basal body and its attached flagellum rotate 90° from its original orientation. In addition, the other components of each half, including an accessory basal body, one small and one large rootlet, amorphous material at the proximal end of the basal body, the developing spade-like structure and one striated fibre (formerly one of the proximal striated fibres), rotate with the basal body. Together, these changes result in the flagellar apparatus present in the mature cell.

#### *Mature cells*

In *Astrephomene*, the structural details of the mature flagellar apparatus are different from those commonly associated with volvocalean motile cells. Unlike the situation in most of these algae, including *Gloeomonas* (Schnepf, Deichgraber & Ettl, 1976) and *Carteria* type II (Lembi, 1975), two unicellular organisms in which the basal bodies are also separated, the entire mature flagellar apparatus of *Astrephomene* does not show 180° rotational symmetry (see Floyd *et al.* 1980).

The rootlets are not arranged in a cruciate manner, but are spaced asymmetrically, with two rootlets in association with each of the functional basal bodies. The distance between basal bodies is considerable; presumably, the growth of either the fibrous component or the portion of the strut between the basal bodies, or both, is responsible for the increase in distance.

The triangular striated fibres are parallel to each other, but on the same side of their respective basal bodies. Each fibre has a small vesicle at the apex, and attaches to the strut on the proximal side. Striated fibres also attach the proximal ends of *Carteria* type II to the 'electron-dense rods' of the 'B' complex (Lembi, 1975). The relationship between the rods in *Carteria* and the strut in *Astrephomene* is uncertain, as is the relationship between the striated fibres of these two algae. A connecting band is present in *Gloeomonas* (Schnepf *et al.* 1976), but in this case the connecting band appears to be branched, with extensions that run past each of the basal bodies on both sides, a situation different from that in *Astrephomene*.

Of the colonial members of the Volvocales with radially arranged cells, the flagellar apparatuses of the vegetative cells have been partially characterized for *Eudorina illinoensis* (Hobbs, 1971) and *V. carteri* (Olson & Kochert, 1970). In *Eudorina* a single 'proximal band' was found connecting the separated basal bodies, while in *V. carteri* both proximal and distal 'kinetosome bridges' were observed. Work in progress on *V. rouseletii* and *V. carteri* indicates that the nature of the components of the flagellar apparatus, with the exception of the basal bodies and axonemes, is different from that of *Astrephomene*. Also, the flagellar apparatuses of two other colonial algae, *Pyrobotrys* and *Chlorcorona* (Hoops & Floyd, 1982*b,c*), are different from *Astrephomene*. These two, non-radial colonial forms have flagella that extend to the side of each cell toward the outside of the colony, even though the flagella are inserted in a V-shaped arrangement.

#### *Flagellar motion*

The flagella of *Astrephomene* beat with a ciliary type of motion, but unlike

*Chlamydomonas* the effective stroke of each flagellum is in the same direction. A transition to the 'flagellar' type of motion, such as occurs in *Chlamydomonas* (Ringo, 1967; Schmidt & Ekert, 1976; Hyams & Borisy, 1978), was never observed. Both flagella of a given cell, and the flagella of all cells in a colony, have the effective stroke toward the posterior of the colony, therefore generating effective colonial motion. In *Astrephomene*, the flagella do not beat continuously, nor do both flagella from a given cell necessarily beat synchronously. In *Volvox*, high light intensity is thought to prevent or slow flagellar beating in positive phototaxis (Huth, 1970; Hand & Haupt, 1971; Sakaguchi & Twada, 1977; Sakaguchi & Iwasa, 1979). A similar effect may occur in *Astrephomene*, which also has a well-developed phototactic response. Due to the high-intensity flash used in filming, the rate of flagellar beating and periods between the flagellar strokes may not represent the situation found typically in the swimming colony. This may account for the unusual length of time that a given flagellum is in the recovery stroke compared to the effective stroke. It is assumed, however, that the form of the flagellar beat observed is unchanged. Therefore, the flagella beat in a plane that is almost perpendicular to the strut and its associated two-membered rootlet, but nearly parallel to the other rootlets. The effective stroke is towards the three parallel rootlets and away from the position of the strut. Presumably, both the rootlets and the strut are involved in anchoring the basal bodies, as postulated for many types of flagellar rootlets (Ringo, 1967; Pitelka, 1974; Stephans, 1975; Goodenough & Weiss, 1978; Gardiner, Miller & Marsh, 1981).

The development of the flagellar apparatus described here is consistent with flagellar motion in this organism. Fig. 28 compares flagellar motion in *Chlamydomonas* and *Astrephomene* diagrammatically. The face-view of *Chlamydomonas* is defined here as the view in which flagellar motion is in the plane of the page, while in side-view the plane of flagellar motion is at right angles to the paper. Cell orientation of *Astrephomene* in the chlamydomonad stage is determined by comparison with *Chlamydomonas*, and does not change during flagellar reorientation. Note that each flagellum of *Astrephomene* beats in a plane that is rotated about 90° from that of *Chlamydomonas*. Since each half of the flagellar apparatus has rotated by a comparable amount, this implies that a structural component determines the plane of flagellar beat. Precisely what structural component is responsible continues to remain an important question. The striated proximal fibre is a possible candidate. This fibre appears to be in the right plane to initiate flagellar motion in both the chlamydomonad and mature stages. Some algal striated fibres are contractile (Salisbury & Floyd, 1978; Melkonian, 1980b), and it has been suggested that these or similar fibres might function in the initiation or control of flagellar motion (Salisbury & Floyd, 1978; Hyams & Borisy, 1975, 1978). Alternatively, the striated fibres might be important in initiating or maintaining the proper positioning of the basal bodies by means of a specific association with the developing strut, or by acting as shock absorbers during flagellar motion. Since the distal fibre does not rotate during development, or connect the basal bodies in the mature cell, it cannot be responsible for any of the above.

On the other hand, the structural component that determines the direction of the

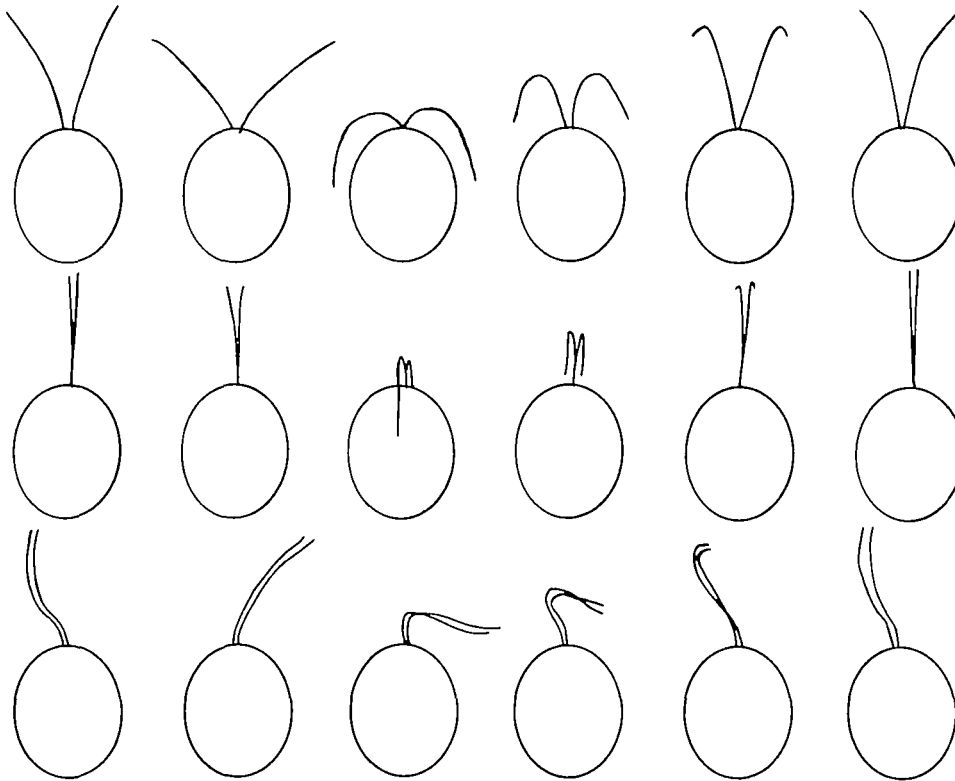

Fig. 28. Diagrammatic comparison of flagellar motion in *Chlamydomonas* and *Astrephomene*. The two top rows show the flagellar motion of *Chlamydomonas* in two different views. In the top row the flagellar motion is in the plane of the page, while the cells in the second row are views at the same stages, but at right angles to the plane of flagellar motion. The bottom row represents flagellar motion in *Astrephomene*. In this case the cell orientation is the same as that of the second row of *Chlamydomonas*. For simplicity the flagella in *Astrephomene* are shown as synchronous. Note that each flagellum in *Astrephomene* beats in a plane about  $90^\circ$  different from that of the *Chlamydomonas* cell with the same orientation. This appears to be correlated with the development of the flagellar apparatus in *Astrephomene*. The flagellar motion in *Chlamydomonas* was taken from Ringo (1967) and Hyams & Borisy (1978).

effective stroke might be located in the axoneme or basal body. Under certain conditions, isolated axonemes of *Chlamydomonas* beat with an asymmetric form, presumably equivalent to the ciliary type of motion characteristic of forward swimming (Bessen, Fay & Witman, 1980) and similar to flagellar motion in *Astrephomene*. Some green algae have one, two or three septations or beaks in the flagellar axoneme (see Hoops *et al.* 1982; Witman, Carlson, Berliner & Rosenbaum, 1972). When three such structures are present, they are in two adjacent doublets and the doublet directly opposite this pair. Although it is difficult to envisage how these structures would directly influence the directionality of flagellar beat, their presence might reflect a structural polarity, that may be difficult to observe directly. A further possibility involves the orientation of the central pair. These microtubules are thought to have

a particular relationship to the direction of flagellar beat (Satir, 1963, 1975; Tamm & Horridge, 1970). In a given organism, however, the orientation of the central pair is not necessarily fixed. In the ciliate *Opalina*, the plane of the central pair varies with the flagellar beat (Tamm & Horridge, 1970). There appears to be rotation during flagellar motion in *Paramecium* (Omoto & Kung, 1979, 1980) and in the green alga *Micromonas* (Omoto & Witman, 1981). The central pair also appears to rotate in disintegrating axonemes of *Chlamydomonas* (Kamiya, 1982; Kamiya, Nagai & Nakamura, 1983). In contrast, the central-pair orientation does not change during forward or reverse swimming in the ctenophore *Pleurobrachia* (Tamm & Tamm, 1981). Since the position of the central pair of microtubules is not always fixed, it seems unlikely that it would be necessary to rotate each half of the flagellar apparatus of *Astrephomene* solely to reorient the central pair.

It is also possible that even though the structural component that determines the plane of the effective stroke might be axonemal, the component responsible for the initiation of the stroke might be external to the axoneme. This theory is similar to that suggested by Tamm & Horridge (1970) for the ciliate *Opalina*. In *Opalina* the effective stroke is probably initiated by viscous-coupling. In the case of *Astrephomene*, where flagella are considerably further apart, initiation may be accomplished by other means, such as contraction of the striated fibre. This would explain why not only the flagellum, but associated components, in particular the proximal fibres, underwent rotation during development.

The combination of separate, nearly parallel flagella and the ciliary motion of both flagella in parallel planes is admirably suited to the type of movement in *Astrephomene*. First, both flagella of a given cell and all cells of the colony beat towards the posterior of the colony. This is necessary for efficient colonial motion. Secondly, the nearly parallel arrangement of the flagella minimizes detrimental interference of the flagella of neighbouring cells. Thirdly, the separation of the flagella of a single cell would minimize possible interference of the two, which otherwise might arise as a result of the nearly parallel arrangement. If the flagella remained close together, one flagellum could be mechanically hindered by the other, particularly if the flagella were beating asynchronously.

We thank George Witman for his assistance with the microcinematographic analysis, Charles O'Kelly for reviewing the manuscript, and Carol Stuessy for assisting in the preparation of the drawings. This research was supported by a Sigma Xi grant-in-aid and an Ohio State Research Award to H.J.H. and by NSF grant DEB-7911777 to G.L.F.

#### REFERENCES

- BESSEN, M., FAY, R. B. & WITMAN, G. B. (1980). Calcium control of waveform in isolated flagellar axonemes of *Chlamydomonas*. *J. Cell Biol.* **86**, 446–455.
- BIRCHEM, R. & KOCHERT, G. (1979). Development of sperm cells of *Volvox carteri* f. *weismannia*. *Phycologia* **18**, 409–419.
- BROOKS, A. E. (1966). The sexual cycle and intercrossing in the genus *Astrephomene*. *J. Protozool.* **13**, 367–375.
- CAVALIER-SMITH, T. (1974). Basal body and flagellar development during the vegetative cell cycle and the sexual cycle of *Chlamydomonas reinhardtii*. *J. Cell Sci.* **16**, 529–556.

- CROW, W. B. (1918). The classification of some colonial chlamydomonads. *New Phytol.* **17**, 151–159.
- DEASON, T. R. & DARDEN, W. H. JR (1971). The male initial and mitosis in *Volvox*. In *Contributions in Phycology* (ed. B. Parker & R. M. Brown), pp. 67–79. Lawrence: Allen Press.
- DEASON, T. R., DARDEN, W. H. JR & ELY, S. (1969). The development of sperm packets of the M5 strain of *Volvox aureus*. *J. Ultrastruct. Res.* **26**, 85–94.
- ETTL, H. (1976). Die Gattung *Chlamydomonas* Ehrenberg. *Beih. Nova Hedwigia* **49**, 1–1122.
- FLOYD, G. L., HOOPS, H. J. & SWANSON, J. A. (1980). Fine structure of the zoospore of *Ulothrix belkæ* with emphasis on the flagellar apparatus. *Protoplasma* **104**, 17–31.
- FRIEDMAN, I., COLWIN, A. L. & COLWIN, L. H. (1968). Fine-structural aspects of fertilization in *Chlamydomonas reinhardtii*. *J. Cell Sci.* **3**, 115–128.
- FRITSCH, F. E. (1935). *The Structure and Reproduction of the Algae*, vol. 1. Cambridge University Press.
- GARDINER, P. R., MILLER, R. M. & MARSH, M. C. D. (1981). Studies on the rhizoplast from *Naegleria gruberi*. *J. Cell Sci.* **47**, 277–293.
- GOODENOUGH, U. W. & WEISS, R. L. (1978). Interrelationships between microtubules, a striated fiber, and the gametic mating structure of *Chlamydomonas reinhardtii*. *J. Cell Biol.* **76**, 430–438.
- GOULD, R. R. (1975). The basal bodies of *Chlamydomonas reinhardtii*, formation from probasal bodies, isolation and partial characterization. *J. Cell Biol.* **65**, 65–74.
- HAND, W. G. & HAUPT, W. (1971). Flagellar activity of the colony members of *Volvox aureus* Ehrb. during light stimulation. *J. Protozool.* **18**, 361–364.
- HOBBS, M. J. (1971). The fine structure of *Eudorina illinoiensis* (Kofoid) Pascher. *Br. phycol. Bull.* **6**, 81–103.
- HOOPS, H. J. & FLOYD, G. L. (1982a). Mitosis, cytokinesis and colony formation in the colonial green alga *Astrephomene gubernaculifera*. *Br. phycol. Bull.* **17**, 297–310.
- HOOPS, H. J. & FLOYD, G. L. (1982b). Ultrastructure of the flagellar apparatus of *Pyrobotryx* (Chlorophyceae). *J. Phycol.* **18**, 455–462.
- HOOPS, H. J. & FLOYD, G. L. (1982c). Ultrastructure and taxonomic position of the rare volvoclean alga, *Chlorcorona bohemica*. *J. Phycol.* **18**, 462–466.
- HOOPS, H. J., FLOYD, G. L. & SWANSON, J. A. (1982). Ultrastructure of the biflagellate motile cells of *Ulvaria oxysperma* (Kütz) Bliding and phylogenetic relationships among ulvophyceean algae. *Am. J. Bot.* **69**, 150–159.
- HUTH, K. (1970). Bewegung und orientierung bei *Volvox aureus* Ehrb. I. Mechanismus der phototaktischen reaktion. *Z. PflPhysiol.* **62**, 436–450.
- HYAMS, J. S. & BORISY, G. G. (1975). Flagellar coordination in *Chlamydomonas reinhardtii*: isolation and reactivation of the flagellar apparatus. *Science, N.Y.* **189**, 891–893.
- HYAMS, J. S. & BORISY, G. G. (1978). Isolated flagellar apparatus of *Chlamydomonas*: characterization of forward swimming and alternation of waveform and reversal of motion by calcium ions *in vitro*. *J. Cell Sci.* **33**, 235–253.
- KAMIYA, R. (1982). Extrusion and rotation of the central-pair microtubules in detergent-treated *Chlamydomonas* flagella. *Cell Motil. (suppl.)* **1**, 169–173.
- KAMIYA, R., NAGAI, R. & NAKAMURA, S. (1983). Rotation of the central-pair of microtubules in *Chlamydomonas* flagella. In *Biological Functions of Microtubules and Related Structures* (ed. H. Sakai, H. Mohri & G. G. Borisy). London: Academic Press.
- KATZ, K. R. & McLEAN, R. J. (1979). Rhizoplast and rootlet system of the flagellar apparatus of *Chlamydomonas moewusii*. *J. Cell Sci.* **39**, 373–381.
- LANG, N. C. (1963). Electron microscopy of Volvocaceae and Astrephomenaceae. *Am. J. Bot.* **50**, 280–300.
- LEMBI, C. A. (1975). The fine structure of the flagellar apparatus of *Carteria*. *J. Phycol.* **11**, 1–9.
- MELKONIAN, M. (1980a). Ultrastructural aspects of basal body associated fibrous structures in green algae: a critical review. *BioSystems* **12**, 85–104.
- MELKONIAN, M. (1980b). Flagellar roots, mating structure and gametic fusion in the green alga *Ulva lactuca* (Ulvales). *J. Cell Sci.* **46**, 149–169.
- MOESTRUP, Ø. (1978). On the phylogenetic validity of the flagellar apparatus in green algae and other chlorophyll a and b containing plants. *BioSystems* **10**, 117–144.
- OLSON, L. W. & KOCHERT, G. (1970). Ultrastructure of *Volvox carteri* II. The kinetosome. *Arch. Mikrobiol.* **74**, 31–40.

- OMOTO, C. K. & KUNG, C. (1979). The pair of central tubules rotates during ciliary beat in *Paramecium*. *Nature, Lond.* **279**, 523–534.
- OMOTO, C. K. & KUNG, C. (1980). Rotation and twist of the central pair of microtubules in the cilia of *Paramecium*. *J. Cell Biol.* **87**, 33–46.
- OMOTO, C. K. & WITMAN, G. B. (1981). Functionally significant central pair rotation in a primitive eukaryotic flagellum. *Nature, Lond.* **290**, 708–710.
- PICKETT-HEAPS, J. D. (1975a). *Green Algae: Structure, Reproduction and Evolution in Selected Genera*. Sunderland: Sinauer Associates.
- PICKETT-HEAPS, J. D. (1975b). Structural and phylogenetic aspects of microtubular systems in gametes and zoospores of certain green algae. In *The Biology of the Male Gamete* (ed. J. G. Duckett & P. A. Racey), pp. 37–44. New York: Academic Press.
- PITELKA, D. R. (1974). Basal bodies and root structures. In *Cilia and Flagella* (ed. M. A. Sleight), pp. 437–469. New York, London: Academic Press.
- POCOCK, M. A. (1953). Two multicellular motile green algae, *Volvulina* Playfair and *Astrephomene*, a new genus. *Trans. R. Soc. S. Afr.* **34**, 103–127.
- RINGO, D. L. (1967). Flagellar motion and fine structure of the flagellar apparatus in *Chlamydomonas*. *J. Cell Biol.* **33**, 543–571.
- SAKAGUCHI, H. & IWASA, K. (1979). Two photophobic responses in *Volvox carteri*. *Pl. Cell Physiol.* **20**, 909–916.
- SAKAGUCHI, H. & TAWADA, K. (1977). Temperature effect on the photo-accumulation and phobic response of *Volvox aureus*. *J. Protozool.* **24**, 284–288.
- SALISBURY, J. L. & FLOYD, G. L. (1978). Calcium induced contraction of the rhizoplast of a quadriflagellate green alga. *Science, N.Y.* **202**, 975–978.
- SATIR, P. (1963). Studies on cilia. The fixation of the metachronal wave. *J. Cell Biol.* **18**, 345–365.
- SATIR, P. (1975). Ciliary and flagellar movement: An introduction. In *Molecules and Cell Movement* (ed. S. Inoue & R. E. Stephans), pp. 143–149. New York: Raven Press.
- SCHMIDT, J. A. & ECKERT, R. (1976). Calcium couples flagellar reversal to photostimulation in *Chlamydomonas reinhardtii*. *Nature, Lond.* **262**, 713–715.
- SCHNEFF, E., DEICHGRABER, G. & ETTL, H. (1976). *Gloeomonas* oder *Chlamydomonas*? Elektronenmikroskopische untersuchungen an *Gloeomonas simulans*. *Pl. Syst. Evol.* **125**, 109–121.
- SMITH, G. M. (1950). *The Freshwater Algae of the United States*, 2nd edn. New York: McGraw Hill.
- STEIN, J. R. (1958). A morphological study of *Astrephomene gubernaculifera* and *Volvulina steinii*. *Am. J. Bot.* **45**, 388–397.
- STEPHANS, R. E. (1975). The basal apparatus. Mass isolation from the molluscan ciliated gill epithelium and a preliminary characterization of striated roots. *J. Cell Biol.* **64**, 408–420.
- TAMM, S. L. & HORRIDGE, G. A. (1970). The relation between the orientation of the central fibrils and the direction of beat in cilia of *Opalina*. *Proc. R. Soc. London B*, **175**, 219–233.
- TAMM, S. L. & TAMM, S. (1981). Ciliary reversal without rotation of axonemal structure in Ctenophore comb plates. *J. Cell Biol.* **89**, 495–509.
- WITMAN, G. B., CARLSON, K., BERLINER, J. & ROSENBAUM, J. L. (1972). *Chlamydomonas* flagella. I. Isolation and electrophoretic analysis of microtubules, matrix, membranes and mastigonemes. *J. Cell Biol.* **54**, 507–539.

(Received 17 September 1982—Accepted, in revised form, 17 March 1983)