

Steenstrupia

ZOOLOGICAL MUSEUM
UNIVERSITY OF COPENHAGEN



Volume 20 (3): 73-95

September 10, 1994

North Atlantic and Caribbean species of *Sergia* (Crustacea, Decapoda, Sergestidae) and their horizontal and vertical distribution

A. L. VERESHCHAKA

Eleven North Atlantic and Caribbean species of the genus *Sergia* Stimpson, 1860, represented by 2081 specimens, are recognized and described: *Sergia tenuiremis* (Krøyer, 1855) (= *S. Krøyeri* Bate, 1881), *S. japonica* (Bate, 1881) (= *S. mollis* Smith, 1882), *S. laminata* (Burkenroad, 1940) (= *S. guineensis* Crosnier & Forest, 1973, syn. n.), *S. robusta* (Smith, 1882), *S. grandis* (Sund, 1920), *S. splendens* (Sund, 1920) (= *S. crassus* Hansen, 1922), *S. regalis* (Gordon, 1939) (= *S. creber* Burkenroad, 1940, syn. n.), *S. extenuata* (Burkenroad, 1940), *S. wolffi* sp. n., *S. talismani* (Barnard, 1947) (= *S. splendens* Hansen, 1920), and *S. hansjacobi* sp. n. New diagnoses and key to all known North Atlantic and Caribbean species are given. Analyses of geographical and vertical distribution are carried out, distribution maps represented. Ecology of the genus *Sergia* species is discussed.

Key words: Sergestidae, benthopelagic, pelagic, *Sergia*

A.L. Vereshchaka, Institute of Oceanology (Department of Plankton), Krasikova Street 23, 117218 Moscow, Russia.

INTRODUCTION

The North Atlantic and Caribbean region is one of the most explored ones, and its fauna seems to be well studied. At the same time, there are some groups of marine organisms which remain poorly examined due to difficulty of their systematics. The large family Sergestidae is one of these groups. About half of the described sergestid species belongs to the genus *Sergia* which is treated in this paper.

The genus demonstrates unusual individual variability in all known morphological features, including even structure of the petasma which is the most reliable taxonomic character in other peneids. This accounts for confusions in systematics of the genus, numerous synonyms and mistakes in reports on the species distribution. Some species described as new appear to belong to those which have been already described, while really new species are referred to others and thus remain

undescribed. Therefore, a revision of the genus *Sergia* and a study of its distribution seem to be necessary.

The study of the genus began in 1855 when Krøyer described the first species as *Sergestes tenuiremis*. Bate (1888), reporting on the scientific results of the "Challenger" Expedition, described a lot of new species found in the Atlantic Ocean. In our century appeared the outstanding papers by Hansen (1903, 1919, 1920, 1922) who sufficiently reduced the number of species described by Bate and found more new species, one representing a new species group, *S. challengeri*. His work is a headstone of recent systematics of sergestids. Later, papers by Kemp (1913), Sund (1920), Illig (1927), Kensley (1971), and Crosnier & Forest (1973) advanced knowledge of genus composition and geographical distribution in the Atlantic Ocean. Foxton (1970) described in detail vertical distribution of many North Atlantic species belonging to the genus *Sergia*. Apart from these,

smaller papers have dealt with selected species (description, luminophore structure, biology).

Burkenroad (1940) described 21 new species of Sergestidae from the "Dana" collection but provided no illustrations of these. Later, many of his holotypes were lost during a loan from the Zoological Museum of Copenhagen. This has led to appearance of younger synonyms and additional confusion in systematics of the genus *Sergia*.

Species of the genus *Sergia* resemble each other and seem to lack reliable morphological differences. The structure of the petasma is helpful in identification of the males and, anyway, remains the only feature which provides the final confirmation of species identity. The characters of the genital area in females are useless as a rule. Instead, the number and position of photophores which have proved to be the most conservative features, are proposed as diagnostic character. As specimens in museum collections usually have been preserved in alcohol or formalin for a long time, the photophores are very difficult to note and count. They are visible more or less only on the antennal scales and outer uropod rami. It is these organs which will be used in the present paper for identification of females. In addition, form of branchiae, eyes, and outer antennal flagella are useful in systematics of the genus *Sergia*.

The following abbreviations are used:

- Cp - carapace
- LA - lobus armatus
- LAc - lobus accessorius
- LC - lobus connectens
- LT - lobus terminalis
- LI - lobus inermis
- PV - processus ventralis
- PU - processus uncifer
- St. - station

MATERIAL AND METHODS

This study is based mainly upon material collected during the first "Dana" Expedition which took place between 1920 and 1922. The stations sampled by "Dana"-I (Schmidt 1929) cover a vast area of the North Atlantic and Caribbean regions. Animals have been caught at depths ranging from 0 to 2000 m. The ratio of the depth of the gear and wire out in meters is believed to be 1:3. Several types of

gear have been used: ring-trawl, closing net (200 cm in diameter), open conical stramin nets (100, 150, and 200 cm in diam.), open conical silk nets (100 and 150 cm in diam.), and open conical ring-trawl (300 cm in diam.). The "Dana" materials are kept in the Zoological Museum, University of Copenhagen (ZMUC).

In addition to the "Dana"-I material, specimens from the collection of the "Dana"-II Expedition have been examined in order to confirm conclusions of species identity, synonymy, and distribution. Specimens of *Sergia talismani* were taken from the collection sampled during the "Talisman" Expedition 1883 and the "Atlantide" Expedition 1945-46 (ZMUC).

The lists of material for each species includes list of stations, number of females and males from each station, limits of their carapace length, and total range of wire out in meter. Detailed specimen data are available from the author on request.

The material taken during the "Dana" Expeditions is rather representative: duration of each tow ranges from 2 to 6 hours, and volume of water filtered reaches thousands of cubic meter. This allows semi-quantitative estimations of the species distribution. As depths of sampling are numerous and irregular, all estimations of the species numbers have been averaged for the following intervals of depths: 0-200 m, 200-500 m, 500-1000 m, 1000-1500 m, 1500-2000 m, and 2000-2500 m. Concentration of animals in each layer (separately for the daytime and night) has been calculated as a quotient: number of all specimens in the region caught in the depth range in question/total volume of water filtered in this depth range at all those stations where the species was recorded. The average speed of a gear during sampling was believed to be 3 knots. Although this method seems to be conditional it may well give a general information about distribution of rare deep-water species.

SYSTEMATICS

Genus *Sergia* Stimpson, 1860

Sergia Stimpson, 1860: 46. Type species: *Sergia remipes* Stimpson, 1860, a mastigopus stage, without closer identification.

Sergestes M.-Edwards, 1830 (part).

Sergestes (*Sergia*): Yaldwyn, 1957.

Approximately 30 species are included in the genus *Sergia*.

Diagnosis

Sergestidae with pereopods I-III elongate and without chelae. Pereopods IV-V reduced, without dactyls. Branchiae present over pereopods IV. No organ of Pesta, a specialized modification of the gastrohepatic gland. PV not forked.

Distribution

Throughout all tropical and temperate zones of the World Ocean.

Identification key for the North Atlantic and Caribbean species of the genus *Sergia*

1. Dermal photophores absent. Integument membranous. PV much wider than LA; if not, the latter strongly curved in distal part, its tip directed proximally (*S. japonica* group) 2
- Dermal photophores present, usually notable on antennal scales and outer uropod rami. PV not wider than LA. LA never strongly curved in distal part, its tip directed distally 4
2. Length of eyestalk papilla exceeding its width. PV equal in width to LA. LA strongly curved in distal part, its tip directed proximally. Small LAc present at base of LA ..
..... *S. tenuiremis*
- Length of eyestalk papilla never exceeding its width. PV much wider than LA. LA never strongly curved in distal part, its tip directed distally. (LAc lacking) 3
3. Cornea equal in width to eyestalks. LC much longer than LT *S. japonica*.

present

- Cornea much wider than eyestalks. LC shorter than LT *S. laminata*
- 4. Photophores of lens-bearing type. LT divided into two parts. Well-marked LAc present (*S. challengeri* group) 5
- Photophores lacking lens, of the "opaque spot" type. LT never divided. No well-marked LAc (*S. robusta* group) 6
- 5. Antennal scale with 4 photophores, outer exopod ramus with 2 photophores. Antennal clasping organ reduced. LI straight. LA much longer than LAc *S. talismani*
- Antennal scale usually with 5 photophores, outer uropod ramus with 3 photophores. Antennal clasping organ developed. LI strongly curved. no longer than the LAc ..
..... *S. hansjacobi*
- 6. Maxillipeds III with dactylus and propodus entire. No LI *S. splendens*
- Maxillipeds III with dactylus and propodus divided into subjoints. LI present 7
- 7. Antennal scale with a single row of photophores. LC never divided 8
- Antennal scale with two rows of photophores or lacking them. LC divided into two lobules 10
- 8. Distal part of antennal scale lacking photophores. Outer uropod ramus with single group of photophores on proximal joint. LA straight *S. extenuata*
- Distal part of antennal scale with photophores. Outer uropod ramus with photophores 2 on proximal and on distal joint. LA curved 9
- 9. Antennal scale lacking photophores in proximal part. LA strongly curved at about 1/3 of its length creating orthogonal angle *S. regalis*
- Antennal scale with photophores in proximal part. LA curved slightly and gradually *S. robusta*
- 10. Antennal scale and outer uropod ramus with photophores. LA with hooks at its base *S. grandis*
- Antennal scale and outer exopod ramus lacking photophores. LA lacking hooks at its base *S. wolffi*

Table 1. Morphological patterns of North Atlantic and Caribbean *Sergia* species (memb - membranous, rud - rudimentary).

Species	inte-gument	hepatic spine	cornea compared with eyestalk	eye-stalk papilla	dermal photophores			
					pre-sence	type	antennal scale, rows/number	outer uropod ramus, rows/number
<i>S. tenuiremis</i>	firm	-	wider	+	-			
<i>S. japonica</i>	memb	-	equal	rud	-			
<i>S. laminata</i>	memb	-	wider	rud	-			
<i>S. robusta</i>	firm	-	wider	-	+	spot	1/6-14	1/3-9
<i>S. grandis</i>	firm	-	wider	rud	+	spot	2/9-18	1/2-3
<i>S. splendens</i>	firm	barb	wider	rud	+	spot	1/16-20	1/5-15
<i>S. regalis</i>	firm	-	wider	-	+	spot	1/9-13	2/6-13
<i>S. extenuata</i>	firm	-	wider	rud	+	spot	1/1	-
<i>S. wolffi</i>	firm	-	wider	rud	+	spot	-	-
<i>S. talismani</i>	firm	+	wider	-	+	lens	1/4	1/2
<i>S. hansjacobi</i>	firm	barb	wider	-	+	lens	1/5	1/3

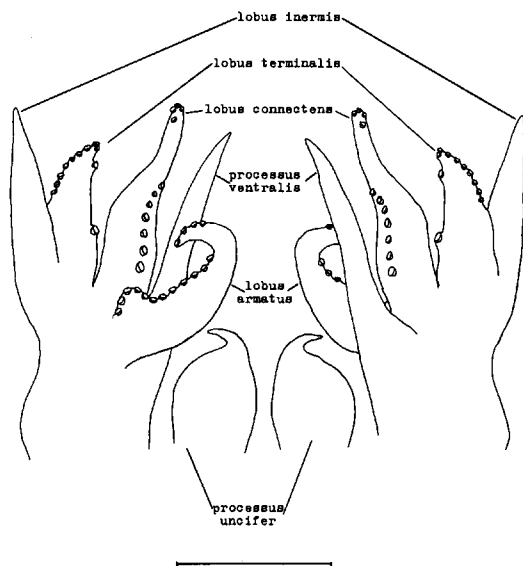

Fig. 1. *Sergia tenuiremis* (Krøyer, 1855). Right petasma, oral (left) and caudal (right) views. Scale: 1 mm.

The *S. japonica* species group

Integument membranous or firm, without hepatic spine/barb. No dermal photophores. Cornea wider or equal to eyestalk in width, the latter with well developed or somewhat rudimentary papilla.

Distributed throughout all Oceans, in subtropical and tropical zones, in deep waters. In the North Atlantic and Caribbean region 3 species have been found: *S. tenuiremis* (= *S. Krøyeri* = *S. tropicus*), *S. japonica* (= *S. mollis*), and *S. laminata* (= *S. guineensis*),

Sergia tenuiremis (Krøyer, 1855)

Figs. 1-3, 26.

Sergestes tenuiremis Krøyer, 1855: 255, tab. 4, fig. 1; Hansen 1920: 478; Sund 1920: 7; Illig 1927: 283, figs. 6-10; Yaldwyn 1957: 9.

Sergestes Krøyeri Bate, 1881: 193; Hansen 1920: 479; Illig 1927: 289, figs. 18-25; Burkenroad 1940: 50; Yaldwyn 1957: 9; Crosnier & Forest 1973: 308; Lagardere 1978: 7. Synonymized by Burkenroad (1940).

Sergestes junceus Bate, 1888: 416, pl. 76, fig. 1. Synonymized by Hansen (1903).

Sergestes longicollis Bate, 1888: 421, Pl. 421, fig. 1. Synonymized by Hansen (1903).

Sergestes tropicus Sund, 1920: 18, figs 27-8, 30-32. Synonymized by Hansen (1920).

Sergia tenuiremis: Omori 1974: 236 (by implication).

Sergia Krøyeri: Krygier & Wasmer, 1988: 72.

Material. "Dana"-I Exp.: St. 1142 (3 ♂, 1 ♀); St. 1152 (3 ♀); St. 1156 (2 ♂, 4 ♀); St. 1239 (1 ♀); St. 1365 (1 ♂, 2 ♀). Cp length: 12-21 mm (♂), 12½-20 mm (♀). Total "wire out" range 1500-6000 m.

Diagnosis. *Sergia* with firm integument missing hepatic spine or barb (Tab. 1). Cornea considerably wider than eyestalk, the latter with well defined eyestalk papilla. Dermal photophores absent. Petasma with all lobi well developed and never divided, LA strongly curved, its distal part directed proximally.

Remarks

The "Dana" specimens (Fig. 1) well correspond to Bate's holotype (Bate, 1888) and Hansen's detailed description (1922). *S. Krøyeri* has proved to be identical with *S. tenuiremis*: Hansen (1920) pointed out that "the single difference known is the shape of the rostrum which is rather feebly developed and... varying in shape in adult specimens of *S. tenuiremis*, so that in the present case the difference is perhaps of no value". He proposed the identity of these species but, having no specimens from the Pacific Ocean from where *S. Krøyeri* had been described, could not compare structures of the male petasma and confirm his conclusion. Having examined the "Dana" collections, I have compared these and found no significant difference. Illig (1927) kept both species as separate but had in possession no mature male of *S. tenuiremis*. Specimens referred to *S. Krøyeri* are the mature forms of *S. tenuiremis* with well developed petasma and long eyestalk papilla which are somewhat rudimentary in the specimens usually identified as *S. tenuiremis*. Burkenroad (1940) came to the conclusion that *S. tenuiremis* is the younger synonym of *S. Krøyeri*, and Crosnier & Forest (1973), Lagardere (1978), Krygier & Wasmer (1988) followed him. This is misleading, for the latter species has been described later. Therefore, the valid name of this species is *S. tenuiremis*, *S. Krøyeri* being a younger synonym.

Geographical distribution

S. tenuiremis occurs throughout tropical and temperate zones of all oceans. In the North Atlantic it has been recorded from 5 stations in the Western, Central, and Eastern parts (Fig. 2, dots refer to "Dana"-I material). Since this rare and deep-living species has been found in most of "Dana"-I's deepest samples, *S. tenuiremis* may well occur throughout the whole hatched area. This species

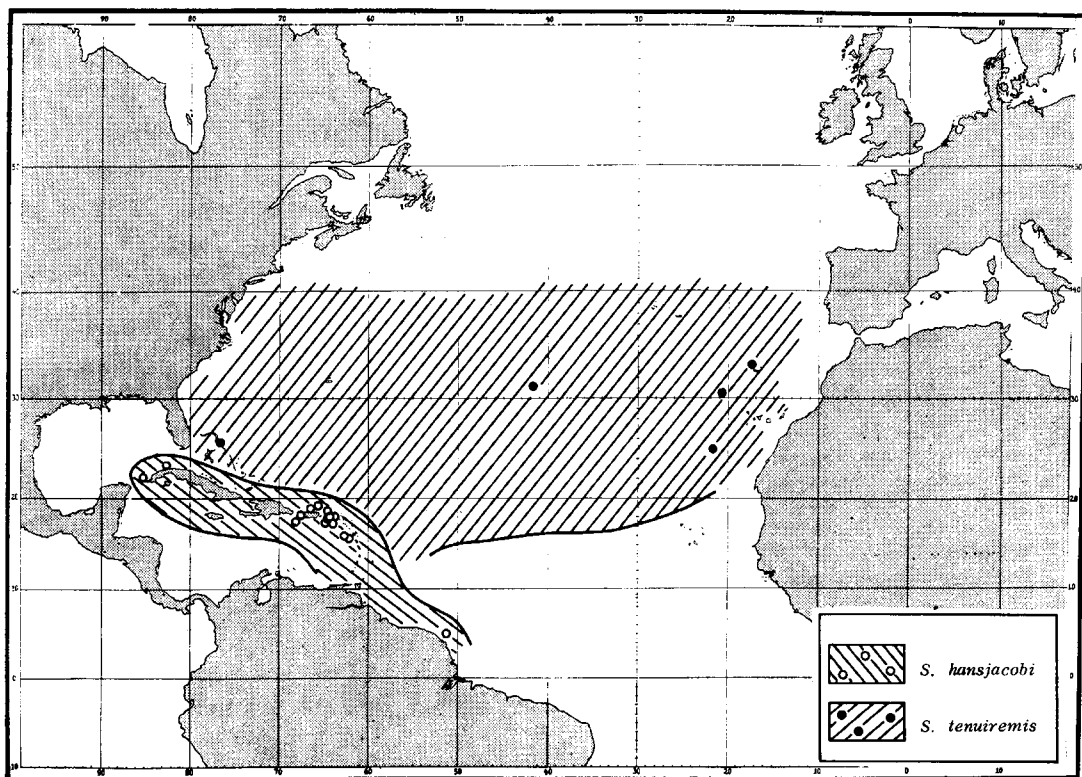

Fig. 2. Geographical distribution of *S. tenuiremis* and *S. hansjacobi* in the North Atlantic and Caribbean regions (dots and circles refer to "Dana"-I material).

has also been recorded from off Greenland (Bate, 1888, referring to Krøyer), Fuerteventura (Hansen 1920), Canaries and Azores (Hansen 1922). Illig (1927) found this species in the Indian Ocean as well. *S. krøyeri*, which is synonymous with *S. tenuiremis*, was described by Bate from the Pacific Ocean, at 29°55' S, 178°14' W, later recorded by Illig (1927) from different locations in the Atlantic and Indian Oceans, and by Krygier and Wasmer (1988) from the Northern Pacific.

Vertical distribution

At night, *S. tenuiremis* is found at depths of 500-2000 m. The density is highest in the layers 1000-1500 m and 1500-2000 m: 3.7 ind/100000 m³ (Fig. 3). In the daytime, all specimens have been caught at 1500-2000 m where their density reaches 3.0 ind/100000 m³. Probably, this species dwells also in the layer 1000-1500 m which has been poorly

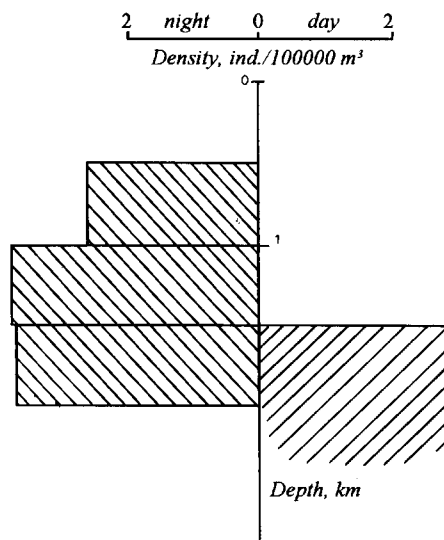

Fig. 3. Vertical distribution of *S. tenuiremis* in the North Atlantic and Caribbean regions.

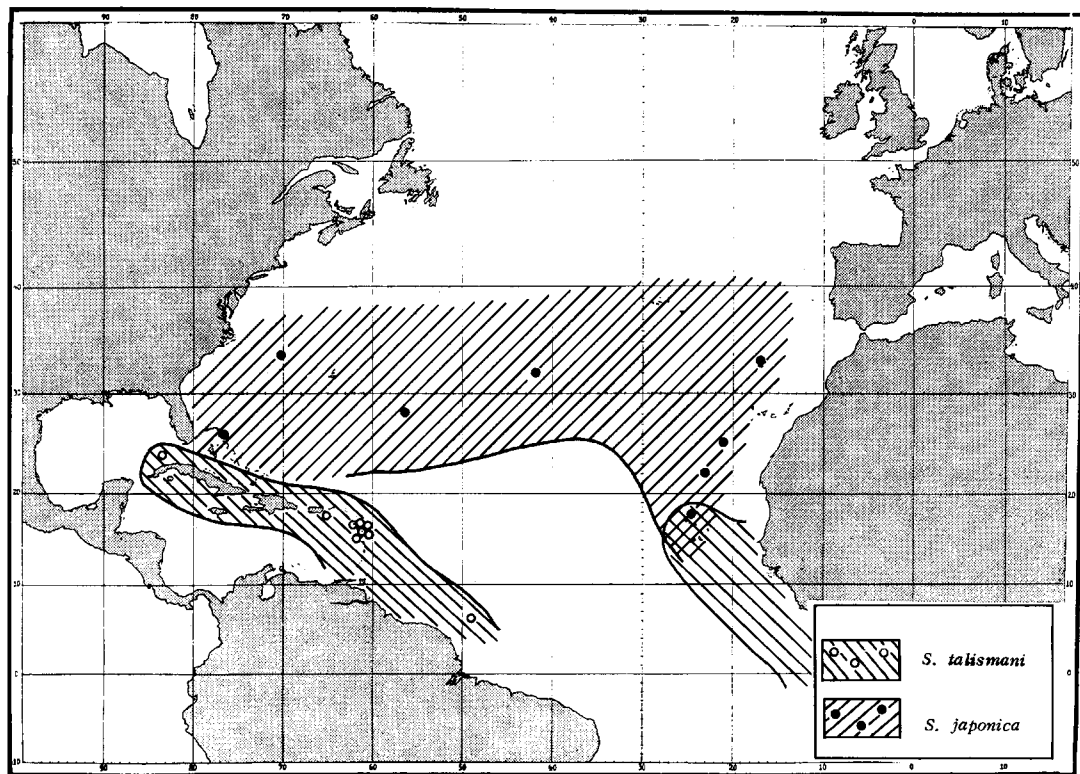

Fig. 4. Geographical distribution of *S. japonica* and *S. talismani* in the North Atlantic and Caribbean regions (dots and circles refer to "Dana"-I material).

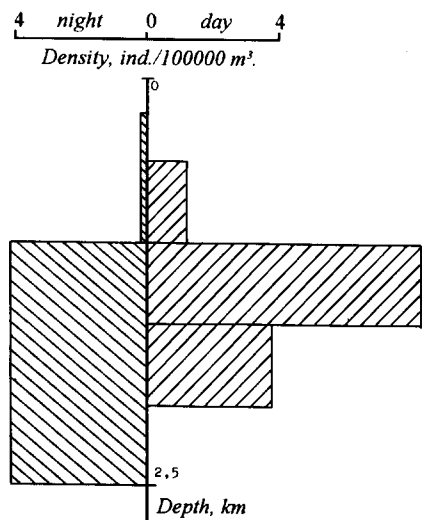

Fig. 5. Vertical distribution of *S. japonica* in the North Atlantic and Caribbean regions.

sampled during the daytime at those stations where *S. tenuiremis* is recorded. The results for the daytime agree with data of Foxton (1970) who pointed out that this species lives deeper than 900 m. Foxton found lesser depths of maximal numbers of the species at night, 570 m.

Sergia japonica (Bate, 1881)

Figs. 4-5, 26.

Sergestes japonicus Bate, 1881: 194; 1888: 387, pl. 70, figs. 1-2; Hansen 1896: 947; 1919: 6; Illig 1927: 292, figs. 26-29; Yaldwyn 1957: 22; Crosnier & Forest 1973: 341, figs. 113, 117.

Sergestes mollis Smith, 1882: 100; Hansen 1920: 478; Sund 1920: 20, fig. 34; Hansen 1922: 75, pl. 4, fig. 3. Synonymized by Hansen (1896, 1903) and Burkenroad (1940).

Sergia japonicus: Omori 1974: 236.

Sergia japonica: Krygier & Wasmer 1988: 74.

Material. "Dana"-I Exp.: St. 1142 (4 ♂); St. 1156 (4 ♂, 1 ♀); St. 1157 (29 ♂, 10 ♀); St. 1159 (12 ♂, 1 ♀); St. 1239 (3 ♀); St. 1342 (2 ♀); St. 1358 (1 ♂, 1 ♀); St. 1365 (1 ♀). Cp length:

6-22½ mm (♂), 12½-20 mm (♀). Total "wire out" range 1000-6000 m.

Diagnosis. *Sergia* with membranous integument missing hepatic spine or barb (Tab. 1). Cornea equal to eyestalk in width, the latter with rudimentary papilla. Dermal photophores absent. Petasma with all lobi undivided, LI and LT reduced, LC enlarged and exceeding wide PV.

Remarks

The "Dana" specimens confirm Hansen's view (1896) that *S. japonica* Bate and *S. mollis* Smith are synonyms. Specimens taken at the same station demonstrate gradual changes in the structure of petasma, and especially in the form and relative size of PV. Sund (1920), disputing with Hansen, referred to the distinctions in form of rostrum. However, this character seems to vary individually and is thus not reliable for distinction of *Sergia* species. Sakai & Nakano (1983) separated *S. mollis* and *S. japonica* on the basis of LT spinuation, LA and LI form, characters of PV and female coxa. The "Dana" specimens show variability of these characters as usual in *Sergia*; they are thus of no value and prove the conclusion of Hansen that both species are synonyms.

Geographical distribution

S. japonica seems to be a cosmopolitan species which occurs in tropical and temperate waters of all oceans. In the North Atlantic and Caribbean regions, it is known from 8 stations evenly covering a vast area to the North of about 15°N (Fig. 4). The species has been found in the South Atlantic, off Dakar, Praia, Gabon, Congo, and Angola (Hansen 1920; 1922; Crosnier & Forest 1973). *S. japonica* also lives in the Northern Pacific (Krygier & Wasmer 1988), off Japan, Philippines, Cook Strait (Bate 1888; Yaldwyn 1957). Illig (1927) recorded this species from the Indian Ocean as well.

Vertical distribution

At night, *S. japonica* is evenly distributed in the layer 1000-2500 where its density reaches 4.2 ind/100000 m³ (Fig. 5). Since the specimens are very few, their numbers have been averaged for the whole layer. In the daytime, *S. japonica* dwells at 500-2000 m. The density is highest in the layer 1000-1500 m, reaching 8.4 ind/100000 m³. The data agree with Foxton (1970) who found the

maximal concentrations of *S. japonica* in his deepest samples from depths 925-950 m.

Sergia laminata (Burkenroad, 1940)

Figs. 6-7, 26.

Sergestes laminatus Burkenroad, 1940: 53; Yaldwyn 1957: 9; Kensley 1971: 251, fig. 18. Holotype (ZMUC) examined. *Sergestes guineensis* Crosnier & Forest, 1973: 343, fig. 118. (Holotype, Museum National d'Histoire Naturelle, Paris, examined) **Syn. n.**

Sergia laminata: Omori 1974: 236 (by implication).

Material. "Dana"-I Exp.: St. 1157 (2 ♀); St. 1159 (2 ♂); St. 1163 (4 ♂, 3 ♀); St. 1172 (5 ♂, 1 ♀). Cp length: 7-10 mm (♂), 7-9 mm (♀). Total "wire out" range 1000-5000 m.

Diagnosis. *Sergia* with membranous integument missing hepatic spine or barb (Tab. 1). Cornea wider than eyestalk, the latter with rudimentary papilla. Dermal photophores absent. Petasma with all lobi undivided, LI reduced, LT enlarged and equal in length to PV. Latter extremely wide, leaf-shaped, LA strongly curved.

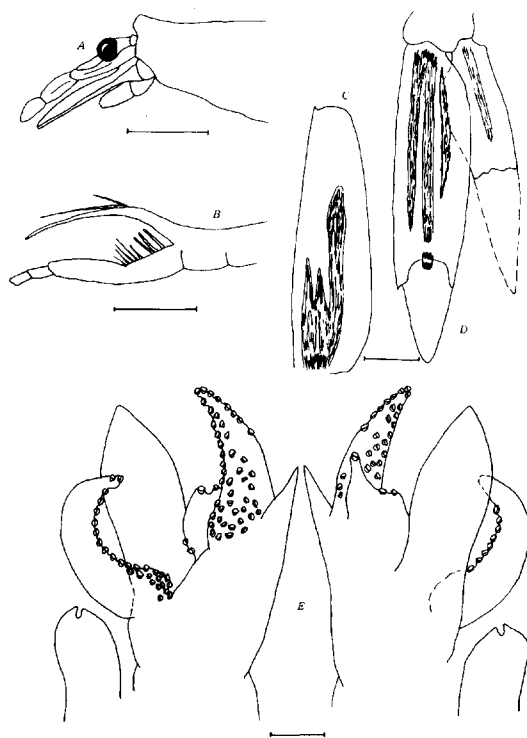

Fig. 6. *Sergia laminata* (Burkenroad, 1940) (holotype). A - anterior part of Cp, lateral view. B - outer antennular flagellum. C - antennular scale. D - uropods, D - right petasma, caudal (left) and oral (right) views. Scales: 3 mm (A), 0.4 mm (B), 1.0 mm (C, D), 0.2 mm (E).

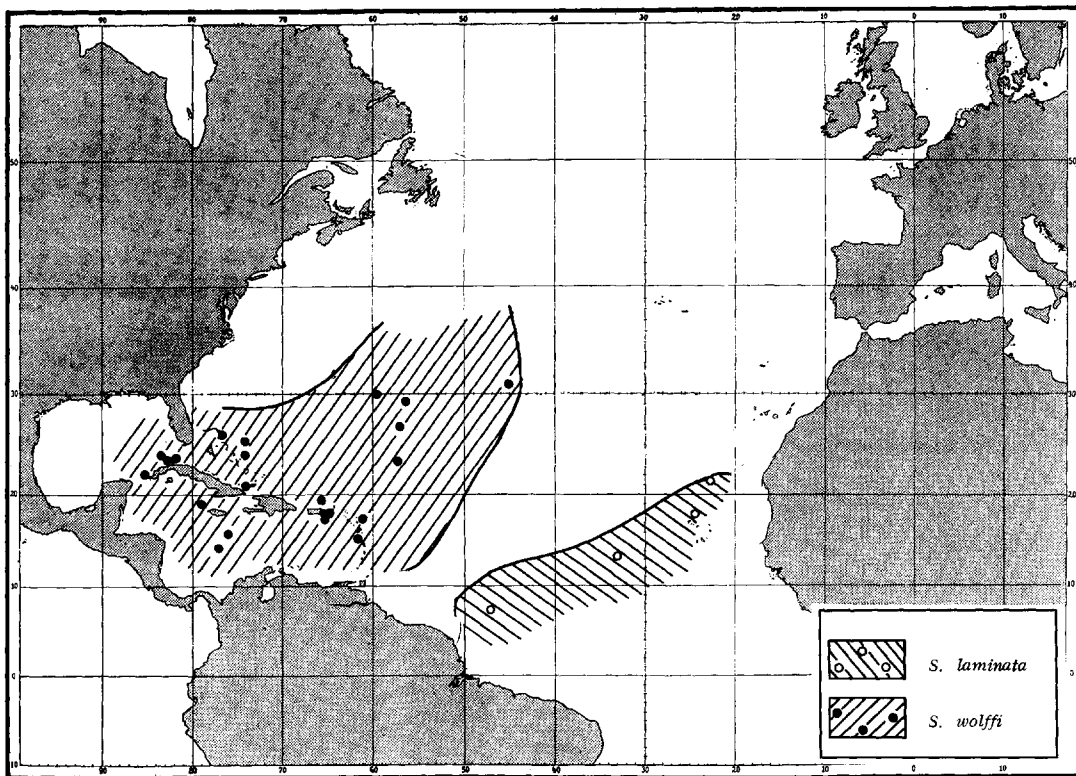

Fig. 7. Geographical distribution of *S. laminata* and *S. wolffi* in the North Atlantic and Caribbean regions (dots and circles refer to "Dana"-I material).

Remarks

The "Dana" specimens correspond well to Burkenroad's description (1940), and to the description and figures of Kensley (1971) except for some peculiarities of the petasma fine structure which may be due to the geographical isolation. The original description of *S. laminata* (Burkenroad 1940) was very brief and included no figure of the holotype which misled those carcinologists dealing with the *Sergia* species later. Crosnier & Forest (1973) described the new species *S. guineensis* from the East Atlantic and did not discuss differences between the new species and *S. laminata* although their figures and Burkenroad's description leave no doubt that both species are very similar at least. I have examined the holotype of *S. laminata* in the Copenhagen Museum and found no significant divergence between this and a paratype of *S. guineensis* as figured by Crosnier &

Forest (1973). In addition, I compared holotypes of *S. laminata* and *S. guineensis*, the latter had been kindly sent by Dr. Alain Crosnier. The only difference between the holotypes was the form of rostrum: convex in the former and acute in the latter, while the form of petasma was identical. Since the form of rostrum is of no taxonomic value in the genus *Sergia*, *S. guineensis* is a new, younger synonym of *S. laminata*. In this context, it seems reasonable to give the necessary figures of the type specimen's petasma, anterior part of carapace, antennal scale, and uropods (Fig. 6).

Geographical distribution

S. laminata seems to dwell in the lower latitudes of all three oceans. In the North Atlantic, this species has been recorded at 4 stations from a restricted area south of about 20°N, and it has never been found in the Caribbean region, North American

waters, and central part of the North Atlantic (Fig. 7). This species has also been found in the Equatorial Atlantic (Crosnier & Forest 1973, as *S. guineensis*), in the South Atlantic: from Congo to Angola (Crosnier & Forest 1973), and penetrates into the South-West Indian Ocean (Kensley 1971). *S. laminata* is distributed at least throughout the whole Western Indian Ocean, where I have found it during the 17th cruise of R/V "Vityaz", and it goes as far as the Malagasy Republic where the holotype was caught (Burkenroad 1940). It has also been found in the northern (Krygier & Wasmer 1988) and southeastern Pacific (Vereshchaka 1990b).

Vertical distribution

At those stations where *S. laminata* occurs, only two layers have been sampled at night: 0-200 and 200-500 m. The former lacks the species, while the latter has 2.6 ind/100000 m³. In the daytime, all layers have been sampled representatively, and the species has been found in the layer 1500-2000 m where its density reaches 0.7 ind/100000 m³. I suppose that *S. laminata* lives at great depths, and this agrees with conclusions on the synonymous *S. guineensis* by Crosnier & Forest (1973). *S. laminata* seems not to undertake extensive diurnal migration, and its day and night highest densities probably coincide, lying in the layer 1500-2000 m.

The *S. robusta* species group

Integument firm, with or without hepatic barb. Lens-less dermal photophores present, at least on pereopods. Cornea wider than eyestalk, the latter with papilla, if present, rudimentary.

Known from tropical and temperate waters of all oceans. In the North Atlantic and Caribbean regions 6 species have been found: *S. robusta*, *S. grandis*, *S. regalis* (= *S. crebra*), *S. extenuata*, *S. splendens* (= *S. crassus*), and *S. wolffi* sp. n.

Sergia robusta (Smith, 1882)

Figs. 8-9, 26.

Sergestes robustus Smith, 1882: 97, pl. 16, figs. 5-8; Hansen 1903: 480, figs. 6-7; Hansen 1920: 479; Sund 1920: 11, figs. 11-15; Hansen 1922: 106, pl. 1, figs. 4-5, pl. 6, figs. 2-3, pl. 7, fig. 1; Illig 1927: 301, fig. 44 (part); Yaldwyn 1957: 9; Crosnier & Forest 1973: 327, figs. 111-112.

Sergestes dissimilis Bate, 1888: 437. Synonymized by Hansen (1922).

Sergia robustus: Omori 1974: 236.

Material. "Dana"-I Exp.: St. 1142 (1 ♂, 1 ♀); St. 1152 (1 ♀); St. 1157 (1 ♂, 1 ♀); St. 1159 (1 ♀); St. 1342 (2 ♂, 1 ♀); St. 1353 (1 ♀); St. 1366 (1 ♂); St. 1367 (1 ♂); St. 1369 (4 ♂, 1 ♀); St. 1370 (2 ♀); St. 1371 (1 ♂, 1 ♀); St. 1374 (4 ♂, 2 ♀); St. 1377 (8 ♂); St. 1379 (12 ♂); St. 1380 (1 ♂ 10.0). Cp length: 6½-19 mm (♂), 8-18 mm (♀). Total "wire out" range 600-7000 m.

Diagnosis. *Sergia* with firm integument missing hepatic spine or barb (Tab. 1). Cornea wider than eyestalk, the latter without trace of papilla. Lens-less dermal photophores present, forming 1 row (6-14) on antennal scale and 1 row (3-9) on outer exopod ramus. Petasma with all lobi undivided, LI reduced; LC and LT, LA and PV nearly equal in length.

Remarks

S. robusta is a most variable species in such characters as form of rostrum and number of photophores which may be absent in the distal part of outer exopod ramus. Even the fine structure of petasma may be different in specimens taken at the same "Dana"-I station. In spite of this, photophore rows on antennal scale (6-14) and outer exopod ramus (3-9), as well as form and comparative length of lobi in petasma make it easy to refer all these specimens to a single species. Position of the photophores correspond to those described by Dennell (1955) and Crosnier & Forest (1973).

Geographical distribution

S. robusta seems to live only in the Atlantic Ocean. It prefers temperate waters and has been recorded mainly from stations north of 30° N (Fig. 8). At the same time, ascending to the upper water layers at night, this species can penetrate into the lower latitudes with the Canarian Stream. This species has also been found in the Mediterranean (Sund 1920), off Congo and Angola (Crosnier & Forest 1973). Illig's reports (1927) on *S. robusta* from the Indian Ocean are doubtful.

Vertical distribution

At night, *S. robusta* occurs below 200 m, its density being highest at 200-500 m where it reaches 2.6 ind/100000 m³ (Fig. 9). In the daytime, the species lives at depths 1000-2000 m, its maximal density is as high as 0.7 ind/100000 m³ in the layer 1500-2000 m. The data of night distribution agree with the previous studies of Foxtton (1970). But in the daytime Foxtton found the maximum lying at a level of 800 m which is considerably higher than shown by the "Dana" material. It

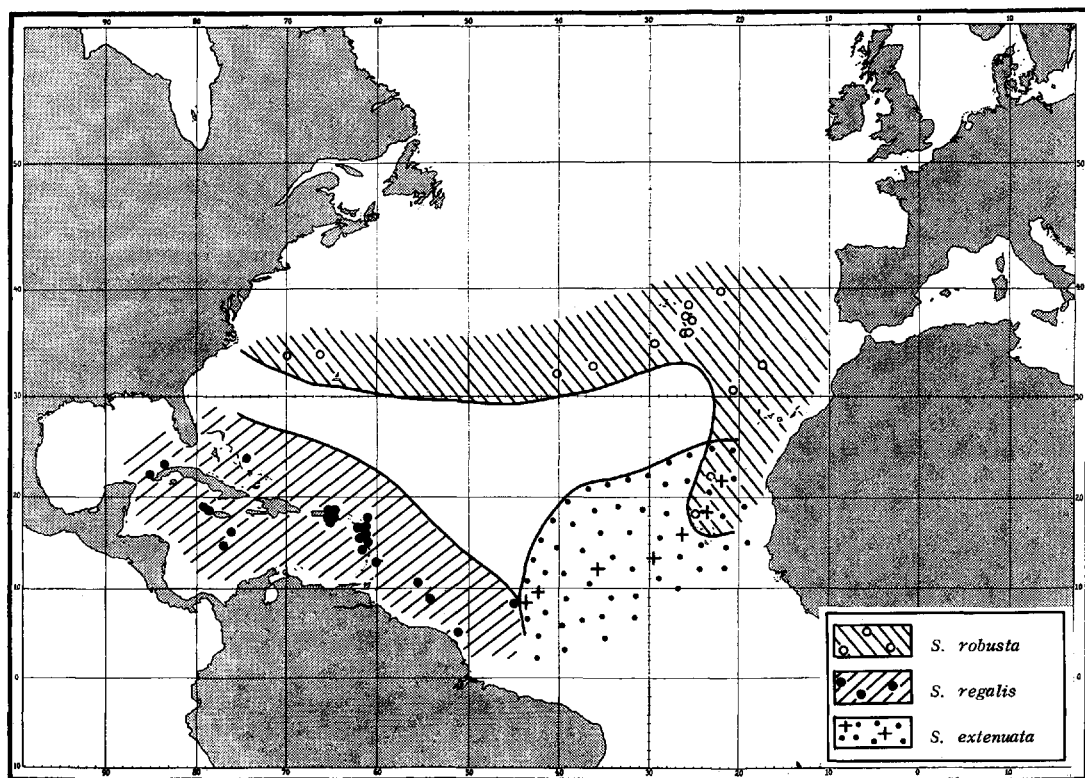

Fig. 8. Geographical distribution of *S. robusta*, *S. regalis*, and *S. extenuata* in the North Atlantic and Caribbean regions (larger dots, circles, and crosses refer to "Dana"-I material).

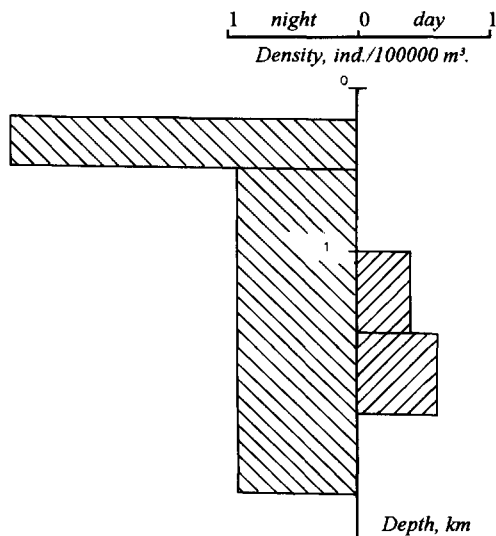

Fig. 9. Vertical distribution of *S. robusta* in the North Atlantic and Caribbean regions.

should, however, be pointed out that Foxton had samples only from the depths 0-950 m.

Sergia grandis (Sund, 1920)

Figs. 10-12, 26.

Sergestes grandis Sund, 1920: 16, figs. 22-26; Hansen 1922: 92, pl. 5, fig. 3; Kensley 1971: 249, fig. 17; Yaldwyn 1957: 9; Crosnier & Forest 1973: 331, figs. 113-116.

Sergia grandis: Omori 1974: 236 (by implication).

Material. "Dana"-I Exp.: St. 941 (2 ♂, 1 ♀); St. 947 (1 ♂); St. 1142 (1 ♀); St. 1163 (1 ♀); St. 1165 (1 ♀); St. 1177 (1 ♀); St. 1178 (1 ♂); St. 1183 (1 ♂); St. 1185 (4 ♂); St. 1188 (2 ♂, 1 ♀); St. 1202 (4 ♂); St. 1214 (3 ♂); St. 1215 (2 ♂); St. 1216 (2 ♂, 1 ♀); St. 1217 (5 ♂, 1 ♀); St. 1218 (2 ♂); St. 1223 (16 ♂, 6 ♀); St. 1225 (31 ♂, 4 ♀); St. 1228 (2 ♂); St. 1230 (16 ♂, 4 ♀); St. 1231 (20 ♂, 7 ♀); St. 1239 (5 ♂, 4 ♀); St. 1240 (1 ♂); St. 1241 (2 ♂); St. 1242 (8 ♂, 2 ♀); St. 1243 (5 ♂); St. 1245 (5 ♂); St. 1247 (1 ♀); St. 1250 (1 ♂, 1 ♀); St. 1261 (2 ♂); St. 1266 (3 ♂, 2 ♀); St. 1268 (1 ♂); St. 1269 (1 ♂); St. 1270 (1 ♂); St. 1276 (1 ♂); St. 1278 (1 ♀); St. 1279 (2 ♂); St. 1281 (2 ♀); St. 1287 (1 ♂); St. 1288 (1 ♀); St. 1289 (1 ♂); St. 1294 (1 ♂); St. 1322 (2 ♂, 1 ♀); St. 1323 (1 ♂); St. 1326 (1 ♀); St. 1327, (2 ♂); St. 1328 (1 ♂); St. 1334 (2 ♀); St. 1335 (1 ♂);

St. 1336 (1 ♂); St. 1337 (4 ♂, 1 ♀); St. 1339 (1 ♂, 1 ♀); St. 1341 (1 ♀); St. 1342 (3 ♂, 3 ♀); St. 1353 (2 ♂, 3 ♀); St. 1356 (2 ♂, 1 ♀); St. 1358 (1 ♂, 1 ♀); St. 1361 (2 ♀); St. 1363 (1 ♂, 1 ♀); St. 1365 (1 ♂); St. 1366 (1 ♂, 1 ♀); St. 1368 (1 ♀); St. 1369 (1 ♀); St. 1370 (1 ♂); St. 1371 (1 ♀). Cp length: 3-24½ mm (♂), 4½-25 mm (♀). Total "wire out" range 100-7000 m.

Diagnosis. *Sergia* with firm integument missing hepatic spine or barb (Tab. 1). Cornea wider than eyestalk, the latter with rudimentary papilla. Lens-less dermal photophores present, forming 2 rows (9-18) on antennal scale and 1 group (2-3) on outer exopod ramus. Petasma with LC divided into 2 nearly equal parts; LI and LT, LA and narrow PV approximately equal in length.

Remarks

S. grandis is very closely related to the Pacific *S. phorca* (Faxon, 1893). I found the following reliable differences between them (1-2 after Hansen (1922), modified):

(1) Relative length of LA (0.2-0.5 of PV length in the Atlantic specimens of *S. grandis*, the "Dana"-I collection, and 0.7-1.0 of PV length in the Eastern Pacific specimens of *S. phorca*, the "Dana"-II collection).

(2) Visibility of the lower half of posterior branchiae on XII segment (well visible in *S. grandis* and completely covered by anterior branchiae of XII segment in *S. phorca*).

(3) Photophore position on the outer uropod ramus (2-3 photophores forming a spot in *S. grandis* and 3-7 photophores forming a curve in *S. phorca* (Fig. 10)).

Other morphological characters: form of antennal scale, pereopods IV, uropods, PV, hook of PU (Sund 1920), form of LC (Hansen 1922), form of rostrum, LT, PU, eyes (Crosnier & Forest 1973), are subjective and have proved to be rather variable in the genus *Sergia*. This may be seen even in specimens caught at the same station.

S. grandis is also related to *S. potens* (Burkenroad, 1940) and to *S. maxima* (Burkenroad, 1940). From the former *S. grandis* differs in comparative length of LA and photophore position on outer uropod ramus, the mentioned characters in *S. potens* being similar to those in *S. phorca*. From *S. maxima* *S. grandis* differs in photophore pattern in the distal part of antennal scale (discrete spots in *S. grandis* and continuous line in *S. maxima*).

Geographical distribution

S. grandis is widely distributed in the tropical and Subtropical Atlantic waters. In the North Atlantic,

this species occurs throughout a vast area of the West and Central North Atlantic, while it seems to avoid the vicinities of the African and European Continents (Fig. 11). This species has also been found near the Cape Verde Isles (Hansen 1922), in the Central and South Atlantic (Crosnier & Forest 1973), and around South Africa (Kensley 1971).

Vertical distribution

At night, *S. grandis* dwells at depths of 0-2000 m, the density is highest in the layer 200-500m where it reaches 2.2 ind/100000 m³ (Fig. 12). During daytime, the species lives below 500 m, and its maximal density lies in the layer 500-1000 m characterized by the concentrations of 1.2 ind/100000 m³.

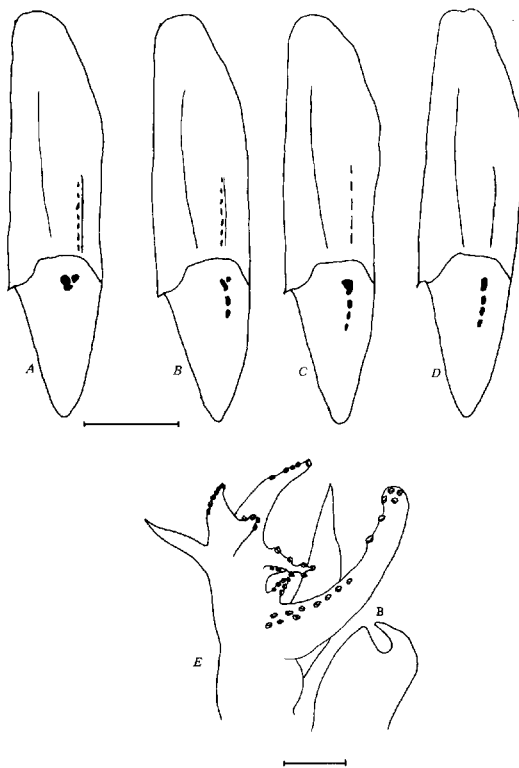

Fig. 10. *Sergia grandis* (Faxon, 1893). (male from "Dana"-I St. 1231, Cp length 20.0 mm). A - photophore position on the outer exopod ramus compared with this in *S. phorca* (B-D, males from "Dana"-I St. 1903, 1905, 1906, Cp length 19.0-21.5 mm). E - right petasma, oral view. Scales: 3.0 mm (A-D), 0.2 mm (B).

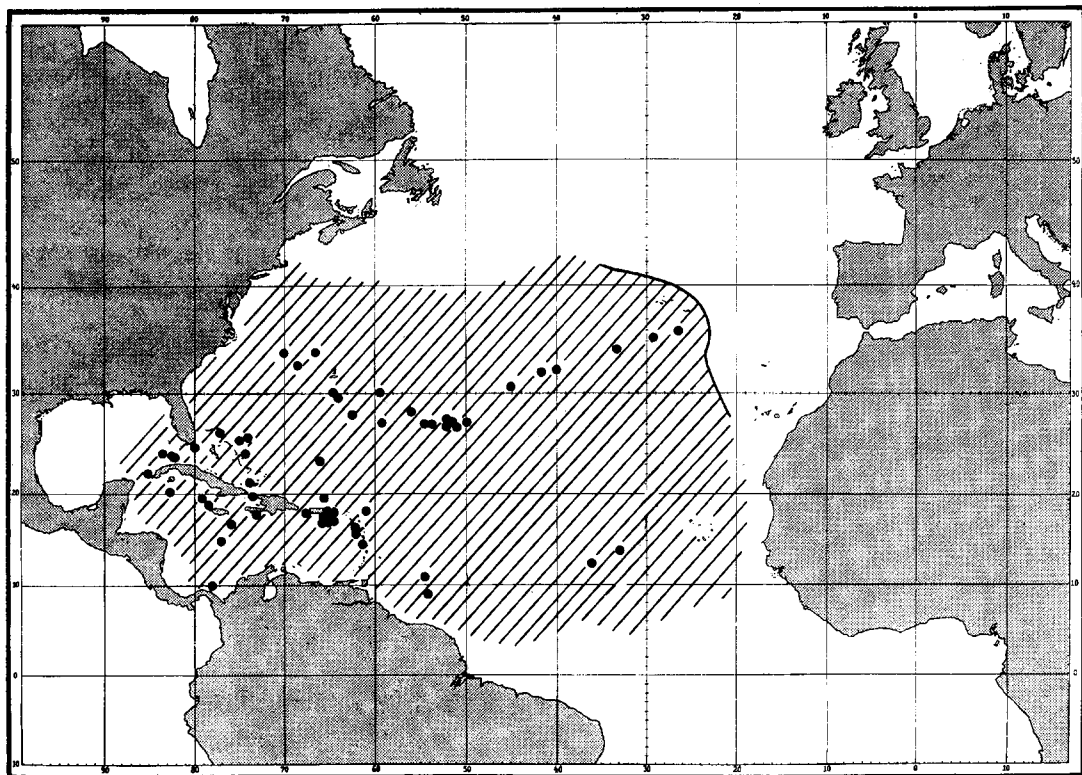

Fig. 11. Geographical distribution of *S. grandis* in the North Atlantic and Caribbean regions (dots refer to "Dana"-I material).

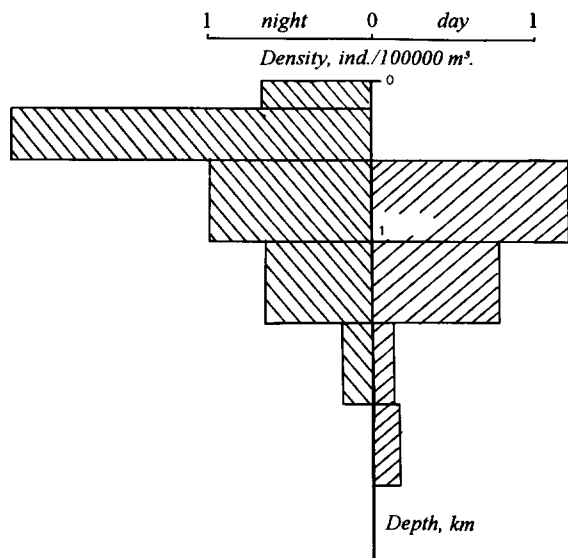

Fig. 12. Vertical distribution of *S. grandis* in the North Atlantic and Caribbean regions.

Sergia splendens (Sund, 1920)

Figs. 13-15, 26.

Sergestes splendens Sund, 1920: 14, figs. 16-18; Yaldwyn 1957: 9; Kensley 1971: 260, fig. 23.

Sergestes crassus Hansen, 1922: 98, pl. 5, fig. 4. Synonymized by Hansen (1922).

Sergia splendens: Omori 1974: 236.

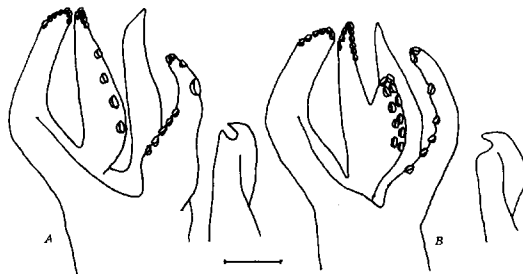

Fig. 13. *Sergia splendens* (Sund, 1920) ("Dana"-I St. 1217), right petasma, oral view. A - usual form (male, Cp length 9.0 mm). B - petasma with divided LC (male, Cp length 8.0 mm). Scale: 1 mm.

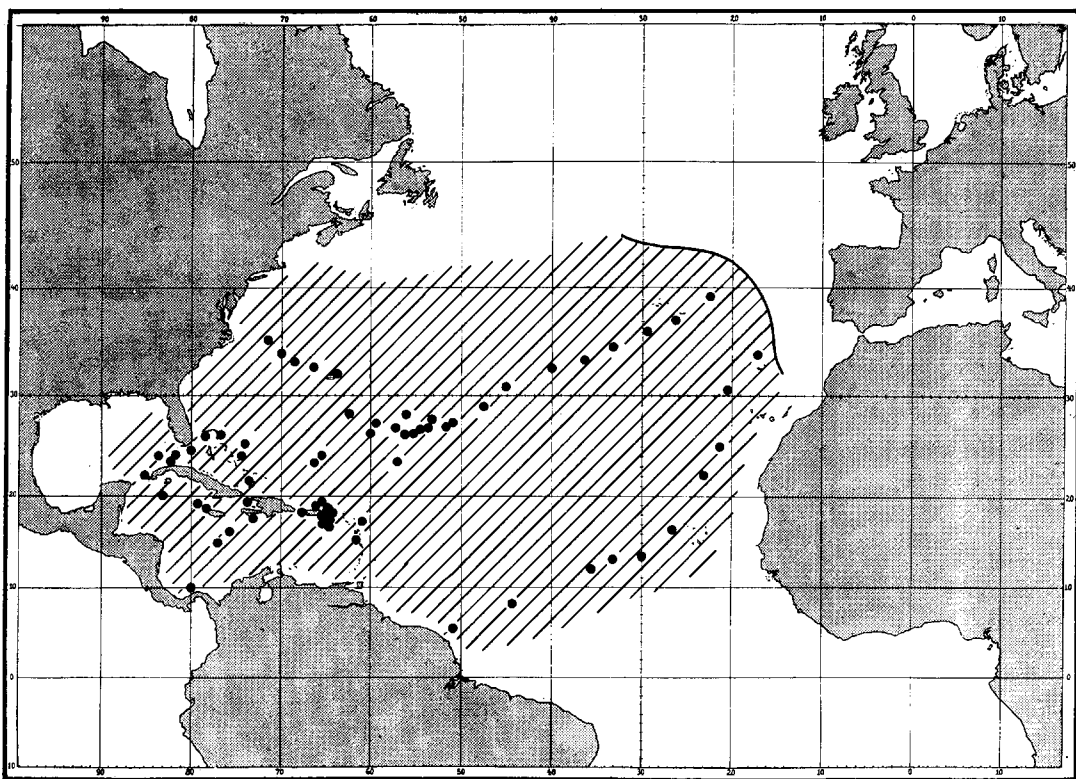

Fig. 14. Geographical distribution of *S. splendens* in the North Atlantic and Caribbean regions (dots refer to "Dana"-I material).

Material. "Dana"-I Exp.: St. 939 (6 ♂, 2 ♀); St. 941 (1 ♂); St. 946 (4 ♂, 3 ♀); St. 947 (8 ♂, 8 ♀); St. 952 (5 ♂, 8 ♀); St. 1142 (1 ♂, 1 ♀); St. 1150 (1 ♀); St. 1152 (1 ♂, 2 ♀); St. 1156 (1 ♀); St. 1157 (1 ♂, 3 ♀); St. 1160 (1 ♂); St. 1162 (1 ♀); St. 1163 (1 ♂, 1 ♀); St. 1165 (1 ♀); St. 1171 (2 ♂); St. 1174 (4 ♂); St. 1185 (4 ♂, 2 ♀); St. 1194 (1 ♂); St. 1198 (14 ♂, 3 ♀); St. 1202 (1 ♀); St. 1214 (8 ♂, 8 ♀); St. 1215 (2 ♂); St. 1216 (2 ♂); St. 1217 (26 ♂, 23 ♀); St. 1218 (5 ♂, 2 ♀); St. 1223 (39 ♂, 29 ♀); St. 1225 (79 ♂, 57 ♀); St. 1228 (1 ♂); St. 1230 (26 ♂, 24 ♀); St. 1231 (18 ♂, 14 ♀); St. 1239 (3 ♂, 3 ♀); St. 1241 (3 ♂, 4 ♀); St. 1242 (7 ♂, 1 ♀); St. 1243 (7 ♂); St. 1245 (4 ♂, 1 ♀); St. 1247 (2 ♂); St. 1250 (78 ♂, 41 ♀); St. 1256 (9 ♂, 9 ♀); St. 1260 (1 ♂); St. 1261 (19 ♂, 9 ♀); St. 1266 (1 ♀); St. 1267 (1 ♂, 1 ♀); St. 1268 (5 ♂); St. 1269 (9 ♂, 6 ♀); St. 1270 (1 ♂); St. 1274 (1 ♂, 1 ♀); St. 1281 (2 ♂, 1 ♀); St. 1286 (3 ♂); St. 1289 (1 ♂, 1 ♀); St. 1292 (9 ♂, 1 ♀); St. 1293 (2 ♂, 2 ♀); St. 1320 (2 ♂, 6 ♀); St. 1321 (10 ♂, 3 ♀); St. 1322 (7 ♂, 2 ♀); St. 1323 (2 ♂, 3 ♀); St. 1326 (1 ♂); St. 1330 (1 ♂); St. 1332 (14 ♂, 9 ♀); St. 1334 (3 ♂, 10 ♀); St. 1335 (3 ♂); St. 1341 (60 ♂, 31 ♀); St. 1342 (68 ♂, 46 ♀); St. 1345 (1 ♂, 3 ♀); St. 1352 (15 ♂, 5 ♀); St. 1353 (1 ♀); St. 1355 (4 ♂, 5 ♀); St. 1356 (11 ♂, 9 ♀); St. 1358 (14 ♂, 9 ♀); St. 1360 (4 ♂, 2 ♀); St. 1361 (1 ♂, 8 ♀); St. 1362 (8 ♂, 6 ♀); St. 1363 (4 ♀); St. 1366 (2 ♂, 1 ♀); St. 1367 (1 ♂, 2 ♀); St. 1368 (1 ♂, 10 ♀); St. 1369 (1 ♂); St. 1370 (1 ♂); St. 1380 (4 ♂). Cpl length: 2-11½ mm (♂), 3½-10 mm (♀). Total "wire out" range 50-7000 m.

Diagnosis. *Sergia* with firm integument having hepatic barb (Tab. 1). Cornea wider than eyestalk, the latter with rudimentary papilla. Lens-less dermal photophores present, forming 1 row (16-20) on antennal scale and 1 row (5-15) on outer exopod ramus. Petasma without LI, all lobi undivided and nearly equal in size.

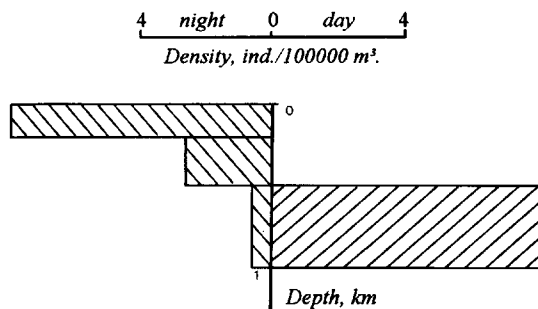

Fig. 15. Vertical distribution of *S. splendens* in the North Atlantic and Caribbean regions.

Remarks

Most of the "Dana"-I specimens agrees with the original description (Sund 1920). At the same time, they show considerable morphological variability in such characters as the photophore number and even in the structure of petasma. The number of photophores varies individually even in specimens taken at the same station and believed to belong to the single population. I have counted photophores on the outer exopod ramus of the specimens from "Dana"-I station 1217 (42 females and 22 males) and found their number ranging from 8 to 15 in females (average 11), and from 5 to 13 in males (average 10). Among numerous "Dana"-I specimens, I have met some with an usual form of LC (completely lacking tubercle (Fig. 13 A), and with LC thickened at its proximal part and bearing a lobule like in the closely related *S. gardineri* (Kemp, 1913). This lobule may reach about 0.3 of the LC entire length (Fig. 13 B), and transitional cases between these two terminal forms can easily be found.

Geographical distribution

S. splendens seems to live only in the Atlantic Ocean. This is the most common species of the genus *Sergia* in the North Atlantic where it occurs almost at every station (Fig. 14). *S. splendens* has also been recorded from the South Atlantic as far as 38° S. However, this species is absent from the Indian Ocean (Kensley 1971) being substituted by the closely related *S. gardineri*.

Vertical distribution

S. splendens appears to be the most superficially living species of the genus *Sergia*. At night, its density is highest in the layer 0-200 m where it reaches 8.0 ind/100000 m³ (Fig. 15). In the daytime, no specimen has been caught in the upper 500 m. The density maximum lies in the layer 500-1000 m where it reaches 8.3 ind/100000 m³. These data well correspond to those of Foxton (1970) who found the night and day maxima at depths of 110 and 925 m, respectively.

Sergia regalis (Gordon, 1939)

Figs. 8, 16-17, 26.

Sergestes regalis Gordon, 1939: 499, figs. 1-4; Yaldwyn 1957: 9; Kensley 1971: 256, fig. 21.

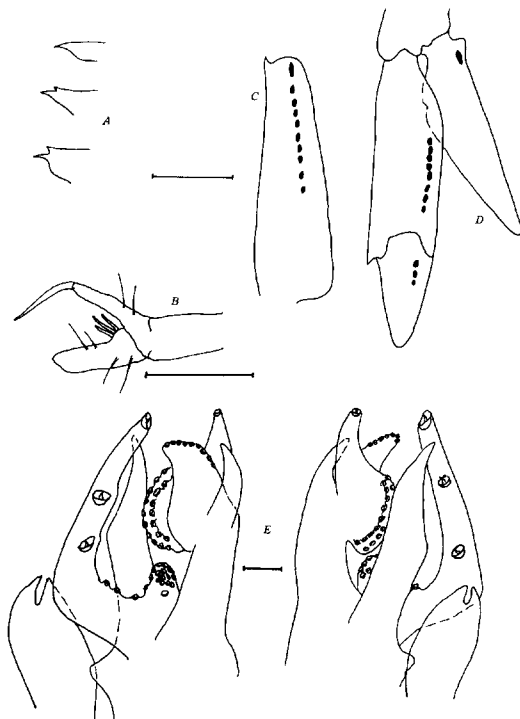

Fig. 16. *Sergia regalis* (Gordon, 1939). A - variation of rostrum shape ("Dana"-II St. 3561, 3914). B-E: male (St. 1183, Cp length 14.0 mm). B - outer antennular flagellum. C - antennal scale. D - uropod. E - right petasma, caudal (left) and oral (right) views. Scales: 3.0 mm (A, C, D), 1 mm (B), 0.2 mm (E).

Sergestes creber Burkenroad, 1940: 44; Yaldwyn 1957: 9; Kensley 1971: 247, fig. 16. Holotype (ZMUC) examined.

Syn. nov.

Sergia regalis: Omori 1974: 236 (by implication).

Material. "Dana"-I Exp.: 1171 (1 ♂); 1174 (1 ♂, 1 ♀); 1177 (4 ♂); 1178 (1 ♂); 1182 (1 ♂, 1 ♀); 1183 (19 ♂, 25 ♀); 1184 (6 ♂, 3 ♀); 1185 (1 ♂); 1188 (2 ♂, 1 ♀); 1196 (2 ♂); 1198 (4 ♂, 4 ♀); 1214 (1 ♀); 1215 (2 ♂); 1216 (1 ♂); 1217 (1 ♀); 1223 (3 ♂, 2 ♀); 1225 (1 ♂); 1245 (2 ♂); 1266 (1 ♂); 1269 (1 ♂); 1270 (1 ♀); 1281 (2 ♀); 1283 (3 ♂, 1 ♀); 1284 (4 ♂, 1 ♀); 1285 (1 ♂, 1 ♀); 1287 (1 ♂); 1288 (1 ♀); 1293 (2 ♂). Cp length: 6½-22½ mm (♂), 9½-20 mm (♀). Total "wire out" range 100-6000 m.

Diagnosis. *Sergia* with firm integument missing hepatic spine or barb (Tab. 1). Cornea wider than eyestalk, the latter without trace of papilla. Lens-less dermal photophores present, forming 1 row (9-13) on antennal scale and 2 rows (6-13) on outer exopod ramus. Petasma with LI, LT, and LC reduced and nearly equal in length; LA long, narrow, strongly curved proximally, usually with small LAc.

Remarks

Burkenroad (1940) described *S. crebra* a year after *S. regalis* had been described by Gordon (1939), and did not compare both species despite their obviously close relationship. Kensley (1971) having examined both species, pointed out their similarity. He found the following distinctions:

- (1) form of rostrum: elongate-lanceolate in *S. crebra* and bidentate in *S. regalis*,
- (2) spination of lower antennular flagellum,
- (3) number of photophores on the outer uropod ramus: higher in *S. crebra*,
- (4) form of LI: more slender in *S. crebra*, and
- (5) number of hooks on LA: less in *S. crebra*.

The form of the rostrum is rather variable in the genus *Sergia* and seems not to be reliable at all. Variations of this character have been noted in original description of *S. regalis* (Gordon 1939), see also Fig. 16. Spination of the antennular flagellum in the holotype of *S. crebra* is more similar to that in *S. regalis* as figured by Gordon (1939) than to that of *S. crebra* figured by Kensley (1971). The number of photophores on the outer exopod ramus ranges from 6 to 13 in "Dana"-I specimens of the "creber" form instead of from 6 to 7 in *S. regalis* (Gordon 1939), thus demonstrating little taxonomic value of this character. The form of LI and number of hooks of LA in "Dana"-I specimens appear not to be closer to *S. crebra* described and figured by Burkenroad (1940) and Kensley (1971), than to *S. regalis* (Gordon 1939). Hence, none of known characters is of value to separate these species, and *S. crebra* is proposed to be a new, younger synonym of *S. regalis*.

Geographical distribution

S. regalis seems to be cosmopolitan species occurring in the tropical zones of all oceans. In the studied area, it has been recorded from numerous stations of the Caribbean and Northwest Atlantic Ocean, being absent in the Central and Eastern parts of the area (Fig. 8). *S. regalis* also lives in the South Atlantic, where the holotype has been found (Gordon 1939), and around South Africa (Kensley 1971). The type specimen of *S. crebra* originates from off northern coast of New Guinea; in addition, this species has been recorded from off Japan (Krygier & Wasmer 1988). My preliminary view on the "Dana"-II collection evidences that *S.*

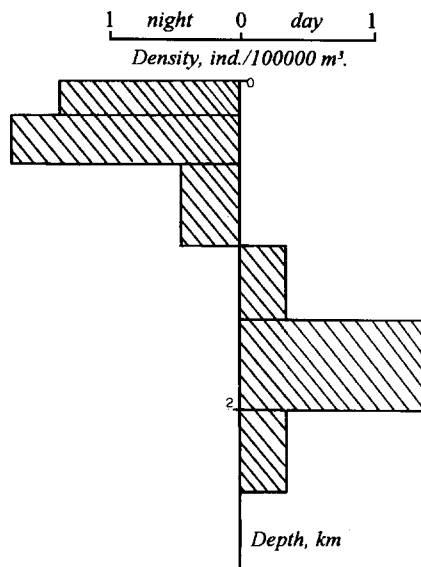

Fig. 17. Vertical distribution of *S. regalis* in the North Atlantic and Caribbean regions.

regalis is rather usual in the Pacific and Indian Oceans.

Vertical distribution

At night, *S. regalis* is abundant at depths of 0-1000 m, with the highest density in the layer 200-500 m where it reaches 1.7 ind./100000 m³ (Fig. 17). In the daytime, the species is evenly distributed throughout the layer 500-2500, and the prominent maximum lies at depths 1500-2000 where the numbers are as high as 1.4 ind./100000 m³.

Sergia extenuata (Burkenroad, 1940)

Figs. 8, 18, 26.

Sergestes extenuatus Burkenroad, 1940: 46; Yaldwyn 1957: 9; Crosnier & Forest 1973: 338, figs. 112-114. Holotype (ZMUC) examined.

Sergestes robustus Illig, 1927: 301, figs. 44-46 (part). Synonymized by Crosnier & Forest (1973).

Sergia extenuata: Omori 1974: 236 (by implication).

Material. "Dana"-I Exp.: St. 1157 (1 ♂, 1 ♀); St. 1159 (2 ♂, 5 ♀); St. 1160 (1 ♂, 2 ♀); St. 1162 (2 ♂, 1 ♀); St. 1165 (2 ♀); St. 1168 (1 ♀); St. 1171 (1 ♂). Cp length: 14½-20½ mm (♂), 11-18 mm (♀). "Wire out" 1000 m.

Diagnosis. *Sergia* with firm integument missing hepatic spine or barb (Tab. 1). Cornea wider than eyestalk, the latter with rudimentary papilla. Lens-less dermal photophores present, single at base of antennal scale, none on outer exopod ramus. Petasma with all lobi undivided, LI reduced, LC

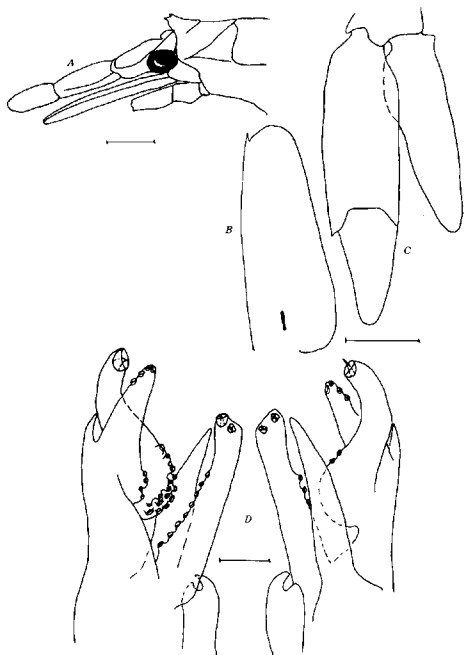

Fig. 18. *Sergia extenuata* (Burkenroad, 1940). ("Dana"-I St. 1160, male, Cp length 11 mm). A - anterior part of Cp, lateral view. B - antennal scale. C - uropods. D - right petasma, oral (left) and caudal (right) views. Scales: 2.0 mm (A, B), 0.5 mm (D).

curved and thickened at base, LA straight, nearly equal to PV in size.

Remarks

S. extenuata is closely related to *S. robusta*. The former species can be easily distinguished on the basis of: (1) form of LA which is almost straight in *S. extenuata* and strongly curved in *S. robusta*, and (2) position of the photophores on the antennal scale (Fig. 18). The armature of LA described by Burkenroad (1940) as a reliable character to separate both species seems to be of no value, varying individually to a great extent. Photophores in *S. extenuata* seem to be fused and compose a short thin line in the proximal part of the antennal scale, throughout 1/8 of its entire length, whilst in *S. robusta* most of the photophores are always well separated forming a curve which is equal to the scale in length. The inner as well as the outer uropod rami of *S. extenuata* seem to be lacking photophores. In *S. robusta* the former bears a single photophore, and the latter has two groups of

several oval photophores on both proximal and distal joints.

Geographical distribution

S. extenuata occurs only in the tropical waters of the Atlantic Ocean. It is known from the vicinity of the Cape Verde Isles, and to the South of about 20° N (Fig. 8). This species is known also from Côte d'Ivoire where the holotype has been found (Burkenroad, 1940), and from the Central Atlantic between 0° and 15° S (Crosnier & Forest 1973).

Vertical distribution

Since *S. extenuata* is a rare species, little may be said about its vertical distribution. All specimens have been caught at night in the layer 200-500 m where the density reaches 2.1 ind/100000 m³. In the daytime, although no specimen has been met in the tows, the highest density is supposed to lie in the layer 500-1000 m because this layer alone has not been sampled at the stations from where *S. extenuata* is recorded.

Sergia wolffi sp. n.

Figs. 7, 19-21, 26.

Material. "Dana"-I Exp.: 1185 (1 ♂); 1196 (1 ♂); 1214 (1 ♂, 1 ♀); 1215 (1 ♀); 1217 (1 ♂, 1 ♀); 1223 (2 ♀); 1225 (1 ♀); 1228 (1 ♂); 1230 (1 ♀); 1239 (3 ♂); 1241 (1 ♂); 1242 (2 ♂); 1243 (2 ♀); 1257 (1 ♂); 1261 (1 ♂); 1267 (1 ♀); 1286 (1 ♂, 1 ♀); 1320 (1 ♂); 1332 (2 ♂, 1 ♀); 1356 (1 ♀); 1358 (1 ♂); 1363 (1 ♂). Cp length: 12-23 mm (♂), 11½-21½ mm (♀). The following two samples contain young individuals and their identification is somewhat dubious: 1156 (1 ♂, 1 ♀); 1157 (1 ♂). Total "wire out" range 300-6000 m.

Holotype: male, "Dana" St. 1217-1, 18° 50' N, 79° 07' W, Cp length 20.0 mm, total length 78 mm, ZMUC. - **Paratype:** female, "Dana" St. 1217-1, Cp length 22.0 mm, total length 83.0 mm, ZMUC.

Diagnosis. *Sergia* with firm integument missing hepatic spine or barb (Tab. 1). Cornea wider than eyestalk, the latter with rudimentary papilla. Lens-less dermal photophores present, none on antennal scale and outer uropod ramus, a single one in proximal part inner uropod ramus. Petasma with LC divided, LI and LT equal in size, PV very slender and as long as LA.

Etymology. It is a great pleasure to name the new species after Dr. Torben Wolff who has curated the "Dana" collection for a long time, and has contributed significantly to the study of deep-sea Crustacea.

Description

Cp (Fig. 19 A) with marked cervical and post-cervical grooves, most distinct on its dorsal side.

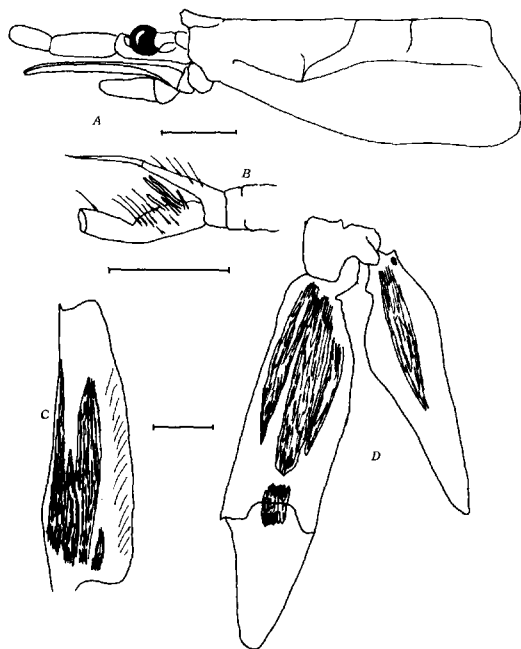

Fig. 19. *Sergia wolffi* sp. n. (holotype, male, "Dana"-I St. 1217-1, Cp length 20.0 mm, total length 78 mm). A - Cp, lateral view. B - outer antennular flagellum. C - antennular scale. D - uropods. Scales: 0.5 mm (A), 0.1 mm (B), 0.2 mm (C, D).

Rostrum short, with tiny apical tooth. Branchiae similar to those of *S. grandis*. Abdominal somite VI with well-defined dorsal spine, almost 1.5 times as long as telson. Telson tapering to point, median groove running along its entire length except 1/10 proximal part.

Cornea as long as distal segment of eyestalk, the latter with rudimentary distal tubercle. Antennular peduncle robust, ratio of its joint lengths 10: 8: 7. Lower antennular flagellum (Fig. 19 B) divided, upper margin of joint IV proximally concave, with 5 blunt stout spines and several setae; upper prolongation of joint III reaching distal end of joint IV. Antennular scale with well-marked tooth, extending as far as middle of antennular peduncle joint III (Fig. 19 C).

Pereopod I reaching end of antennular joint II. Pereopods II and III chelate, reaching well beyond antennular peduncle by length of its two distal joints. Pereopod IV extending as far as end of antennular peduncle joint I, pereopod V much shorter, reaching mouth. Outer uropods ramus

(Fig. 19 D) with distal ciliated part being 1/3 of its entire length. Inner ramus with single proximal photophore near inner margin, reaching suture of outer ramus.

Petasma (Fig. 20) with PV slender, extending as far as end of LT. LA without lobules and hooks at base, distally curved, with a row of 4 large hooks in middle, never reaching end of PV. LC divided into 2 lobules: proximal lobule small and reaching 1/2 of LA length, distal lobule much longer and overlapping PV. LI and LT equal in length, the latter with large basal hook.

Remarks

S. wolffi closely resembles *S. grandis* in the following characters: size of cornea; presence of rudimentary eyestalk papilla; branchial formula; morphology of abdominal somites, telson, pereopods, and uropods; structure of petasma. *S. wolffi* differs from *S. grandis* in missing photophores at least on antennular scale and outer uropod ramus. Probably, evolution of *S. wolffi* has led to the loss of many photophores, although some specimens demonstrate trace of a single photophore in the proximal part of antennular scale, and one specimen (σ 23 1/2 mm from "Dana" St. 1214-4) bears a row of tiny luminescent organs in the proximal part of one of its outer exopod rami. The only reliable distinction between *S. wolffi* and *S. grandis* in the structure of petasma is the form of LA which in *S. wolffi* is more curved and lacks hooks at the base. In addition, joint IV of the outer antennular flagellum in *S. wolffi* has 5 blunt stout spines instead of 2-3 in *S. grandis*. Other characters show variability and seem not to be of taxonomical value.

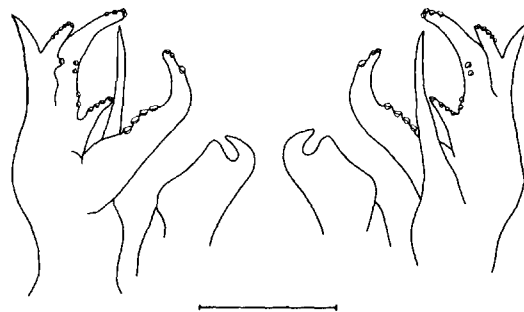

Fig. 20. *Sergia wolffi* sp. n. (holotype). Right petasma, oral (left) and caudal (right) views. Scale: 0.2 mm.

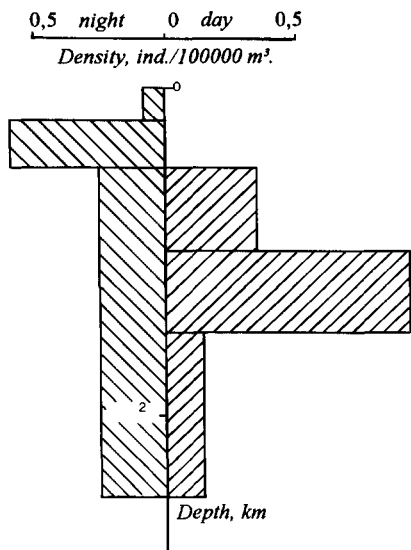

Fig. 21. Vertical distribution of *S. wolffi* in the North Atlantic and Caribbean regions.

Geographical distribution

Since *S. wolffi* is described here as new, it is difficult to decide whether this lives only in the North Atlantic and Caribbean regions or not. My preliminary view on the "Dana"-II collection suggests that the species occurs only in the Atlantic Ocean. So far, *S. wolffi* has been recorded only from the Caribbean and Northeastern Atlantic (Fig. 7).

Vertical distribution

At night, *S. wolffi* dwells in the whole studied water column, with highest density in the layer 200-500 m where it reaches 0.6 ind/100000 m³ (Fig. 21). In the daytime, the species appears below 500 m, and the density maximum lies in the layer 1000-1500 m: 0.9 ind/100000 m³.

The *S. challengeri* species group

Integument firm with prominent hepatic spine/barb. Dermal photophores present, bearing cuticular lens. Cornea wider than eyestalk, the latter without trace of papilla. Recorded from all oceans. In the North Atlantic and Caribbean region 2 species have been found: *S. talismani* and *S. hansjacobi* sp. n.

Sergia talismani (Barnard, 1947)

Figs. 4, 22.

Sergestes talismani Barnard, 1947: 384; Yaldwyn 1957: 9; Crosnier & Forest 1973: 325, figs. 111, 112.

Sergestes splendens Hansen, 1919: 18 (without description, nomen nudum).

Sergestes splendens Hansen, 1920: 480 (preoccupied by *S. splendens* Sund, 1920); 1922: 121, pl. 7, fig. 2; Gordon 1935: fig. 2a; Holthuis 1952: 88. Synonymized by Barnard (1947).

Sergia talismani: Omori 1974: 236.

Material. "Talisman" Exp. 1883: St. 113 (1 ♂, 4 ♀); "Dana"-I Exp.: 1173 (1 ♀); 1184 (1 ♀); 1192 (3 ♂, 1 ♀); 1225 (1 ♂); 1284 (1 ♂); 1285 (1 ♀); 1286 (1 ♂, 1 ♀); 1287 (2 ♂); 1288 (2 ♂). Cp length: 5-12 mm (♂), 5½-12 mm (♀). "Atlantide" Exp. West Africa 1945-46: St. 62 (8 ♂, 3 ♀); St. 82 (3 ♂); St. 120 (1 ♂, 3 ♀). Cp length: 5-13½ mm (♂), 5½-15 mm (♀). Total "wire out" range 50-1731 m.

Diagnosis. *Sergia* with firm integument having hepatic spine (Tab. 1). Cornea wider than eyestalk, the latter without trace of papilla. Lens-bearing dermal photophores present, 4 on antennal scale, 2 on outer uropod ramus. Antennular clasping organ reduced. Petasma with LI curved and wide, bearing heel-like lobule at base, LT divided, LA much larger than LAC, PV slender.

Remarks

S. talismani belongs to the *S. challengeri* species group and differs from *S. lucens* (Hansen, 1922), *S. prehensilis* (Bate, 1881), *S. scintillans* (Burkenroad, 1940), and *S. stellata* (Burkenroad, 1940) in having 4 and 2 photophores on antennal scale and outer uropod ramus, in presence of the hepatic spine instead of barb, and in general form of petasma. On the contrary, the latter characters in *S. talismani* are very similar to those in the other species of the group, *S. fulgens* (Hansen, 1919) and *S. challengeri* (Hansen, 1903), from which *S. talismani* is distinguished by reduced antennular clasping organ and by lacking a process directed downwards on III antennular joint in males.

Geographical distribution

S. talismani occurs in the tropical zones of the Atlantic and Pacific Oceans, being substituted in the Indian Ocean by the closely related species *S. fulgens*. The species apparently prefers insular and coastal waters around islands and continents. In the North Atlantic, *S. talismani* lives in the vicinities of the islands in the Caribbean Sea, and in the coastal waters off South America (Fig. 4). The "Talisman" and "Atlantide" specimens have been found near the Cape Verde Isles, at 16° 52' N, 27°

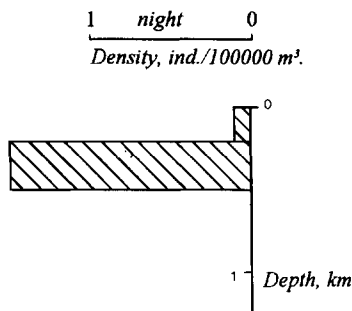

Fig. 22. Vertical distribution of *S. talismani* in the North Atlantic and Caribbean regions.

31' W, and in the Gulf of Guinea. Hansen (1922) reported *S. talismani* from the same area. In addition, this species lives off Guinea Bissau (Holthuis 1952), Gabon, Congo, and Cabinda, Northern Angola (Gordon 1935; Holthuis 1952, Crosnier & Forest 1973). Krygier & Wasmer (1988) reported the species from off Japan and Hawaii.

Vertical distribution

S. talismani has been found only in the night samples in the "Dana"-I material. It occurs at depths 0-500 m, the density is highest in the layer 200-500 m and reaches 1.3 ind./100000 m³ (Fig. 22). In the daytime, this species seems to be absent from the water column over shelves and slopes where it dwells at night. Probably, it occurs only in the thin near-bottom layer which has not been sampled. Holthuis (1952) and Crosnier & Forest (1973) gave a similar range, recording the species from between 180-480 m and 0-500 m respectively, while Hansen (1922) reported on a deeper range, from 550 to 760 m.

Sergia hansjacobi sp. n.

Figs. 2, 23-25.

? *Sergestes challengeri*: Illig, 1927: 297, fig. 34-40.

Material. "Dana"-I Exp.: St. 1174 (4 ♀); St. 1189 (1 ♂, 1 ♀); St. 1196 (4 ♂); St. 1198 (26 ♂, 24 ♀); St. 1223 (1 ♂, 2 ♀); St. 1230 (1 ♂); St. 1250 (7 ♂, 6 ♀); St. 1253 (4 ♂, 11 ♀); St. 1256 (8 ♂, 9 ♀); St. 1257 (1 ♂); St. 1260 (7 ♂, 1 ♀); St. 1261 (9 ♂, 4 ♀); St. 1266 (1 ♂, 4 ♀); St. 1268 (2 ♂); St. 1269 (1 ♂); St. 1270 (4 ♂, 2 ♀); St. 1272 (2 ♂); St. 1273 (1 ♂, 2 ♀); St. 1274 (3 ♂, 5 ♀); St. 1276 (10 ♂, 6 ♀); St. 1278 (29 ♂, 16 ♀); St. 1279 (2 ♂, 1 ♀); St. 1280 (1 ♀); St. 1281 (9 ♂, 7 ♀); St. 1286 (1 ♂); St. 1287 (2 ♂, 1 ♀); St. 1288 (1 ♂ 8.0); St. 1289 (12 ♂, 20 ♀); St. 1291 (2 ♀); St. 1292 (1 ♂, 2 ♀); St. 1293 (11 ♂,

7 ♀); St. 1294 (9 ♂, 5 ♀); St. 1296 (1 ♀); St. 1314 (6 ♂, 4 ♀). Cp length: 2½-11 mm (♂), 4½-10½ mm (♀). Total "wire out" range 100-5000 m.

Holotype: male, "Dana" St. 1198-2, 17° 43' N, 64° 56' W, Cp length 8.5 mm, total length 30.5 mm, ZMUC. - **Paratypes:** female, "Dana" St. 1198-2, Cp length 9.5 mm; male, same station, Cp length 10.5 mm, ZMUC.

Diagnosis. *Sergia* with firm integument having a hepatic barb (Tab. 1). Cornea wider than eyestalk, the latter without trace of papilla. Lens-bearing dermal photophores present, 5 on antennal scale, 3 on outer uropod ramus. Antennular clasp organ developed. Petasma with LI wide and strongly curved in a semicircle, LT divided, LA and LAC reduced and nearly equal in size, PV slender.

Etymology. It is a great pleasure to name the new species after Dr. Hans Jacob Hansen who has initiated progress in study of the family Sergestidae. As *Sergia henseni* would be very similar to *Sergestes henseni* in spelling, the name *S. hansjacobi* was chosen.

Description

Cp (Fig. 23 A) half as long as abdomen, with well-marked cervical and post-cervical grooves. Lateral side of Cp with 5 photophores above branchial region and a separate one near hepatic barb. Rosstrum triangular, tapering to acute tooth directed anteriorly. Abdominal somite VI with dorsal

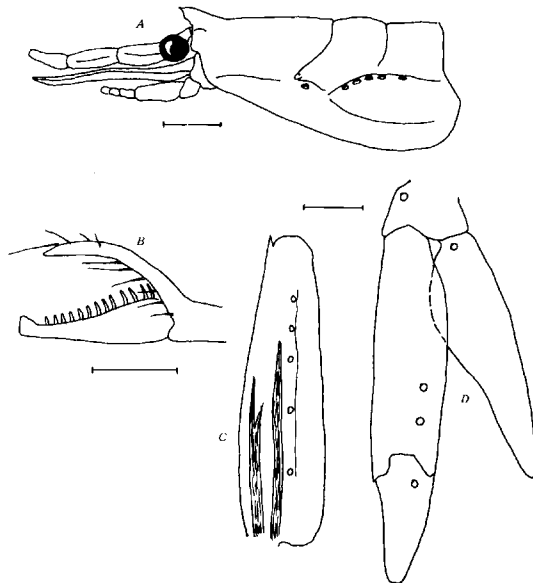

Fig. 23. *Sergia hansjacobi* sp. n. (holotype, male, "Dana"-I St. 1198-2, Cp length 8.5 mm, total length 30.5 mm). A - Cp, lateral view. B - outer antennular flagellum. C - antennal scale. D - uropods. Scales: 2.0 mm (A), 0.5 mm (B), 1.0 mm (C, D).

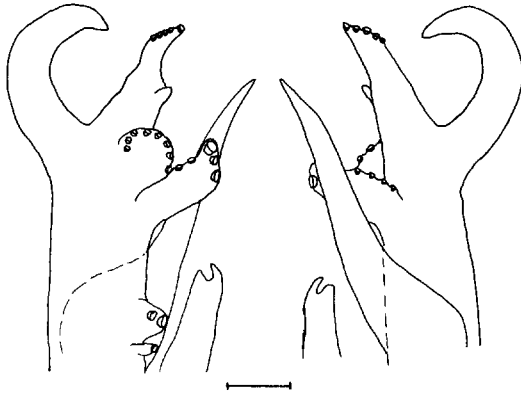

Fig. 24. *Sergia hansjacobi* sp. n. (holotype). Right petasma, oral (left) and caudal (right) views. Scale: 0.2 mm.

spine, 1.4 times as long as telson. Telson with very deep sulcus, especially in proximal part.

Cornea equal to entire eyestalk in length and twice as wide. Eyestalks without distal ocular tubercle but with a photophore at base. Antennular peduncle robust, ratio of its joints 11: 6: 5. Joint IV of outer flagellum with 13 blunt stout spines (Fig. 23 B); joint III with tubercle widening distally and never reaching end of joint IV. Antennal scale nearly extending as far as end of antennular peduncle joint III, with a tooth on the rounded apex, and with 5 photophores (Fig. 23 C).

Pereopod I without proper chela, extending as far as middle of antennular joint II. Pereopods II and III, the latter longer, reaching well beyond antennular peduncle by length of its third joint. Pereopod IV extending as far as end on antennular peduncle joint I, pereopod V much shorter and reaching mouth. Uropods with one photophore at base and one on inner ramus (Fig. 23 D). Outer ramus with two photophores in proximal and one in distal part, the suture being overlapped by inner exopod ramus.

Petasma: PV slender (Fig. 24), never reaching end of LI. LT divided into two unequal lobules, shorter lobule hemispherical. LC with 3 large distal hooks. LI enormous, curved in a hemicircle. LA reduced to a small barb with a single hook. LAc with 2 hooks, equal to LA in length but wider.

Photophores with cuticular lens, not distinct due to preservation of specimens in alcohol for a

long time. In order to avoid errors, only those on antennal scale and uropods have been described.

Remarks

S. hansjacobi belongs to the *S. challengeri* species group and may be easily distinguished from all known species of this group by the number of photophores on the antennal scale. In addition, *S. hansjacobi* differs from *S. lucens* (Hansen, 1922), *S. prehensilis* (Bate, 1881), *S. scintillans* (Burkenroad, 1940), and *S. stellatus* (Burkenroad, 1940) in general form of petasma and comparative size of its lobi. On the contrary, the latter characters in *S. hansjacobi* are very similar to those in the other species: *S. fulgens* (Hansen, 1919), *S. talismani*, and *S. challengeri* from which *S. hansjacobi* is distinguished by:

- (1) number of photophores at least on antennal scale and outer uropod ramus,
- (2) presence of hepatic barb instead of spine,
- (3) reduced LA which is smaller than LAc, and
- (4) enlarged and strongly curved LI.

Specimens described and figured by Illig (1927) as *S. challengeri* are similar to the new species in number of photophores on outer exopod ramus and in form of LI.

Geographical distribution

S. hansjacobi seems to be restricted to insular and coastal waters. In the North Atlantic, it occurs over the isobaths 500-1000 m around islands of the Caribbean Sea, and in the vicinity of South America (Fig. 2). Probably, this species lives in the Indian Ocean as well, for petasma of *S. challengeri* figured by Illig (1927) from the same region, resembles that of *S. hansjacobi*.

Vertical distribution

At night, *S. hansjacobi* dwells at depths 0-1000 m, the density is maximal in the layer 200-500 m where it reaches 4.6 ind/100000 m³ (Fig. 25). In the daytime, only few specimens have been found in the deeper layer 500-1000 m. Since this record appears to be occasional, and the density of the population should be much higher, the real density maximum is supposed to have escaped collecting. Perhaps, *S. hansjacobi* during the daytime mainly occurs in the thin near-bottom layer which has not been sampled.

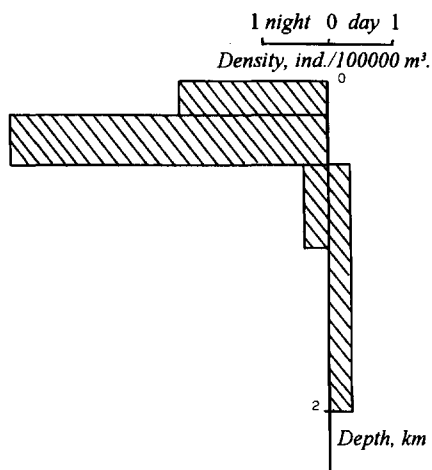

Fig. 25. Vertical distribution of *S. hansjacobi* in the North Atlantic and Caribbean regions.

BIOLOGY

Species of the genus *Sergia* are divided into two principal ecological groups: benthopelagic and pelagic (Vereshchaka 1990a). The *Sergia challengerii* species group has proved to be benthopelagic with only one exception, *S. prehensilis*. On the contrary to the pelagic, benthopelagic animals live in the water column and are closely related to the sea-floor, which they use as a supply source and/or a shelter. I have examined gut contents of *S. talismani* and *S. hansjacobi*, all from the *Sergia challengerii* species group, and found numerous sand grains and bottom-dwelling foraminiferans of the order Miliolida. Most specimens belonging to *S. talismani* and *S. hansjacobi* have been taken in the water column only at night, their highest densities lying in the layer 200-500. Since the range of their vertical migrations is restricted, these species occur only over depths lesser than 1000 m, where the sea-floor is accessible for them. The geographical distribution of these species, found mainly over continental slopes and around islands, confirms the benthopelagic mode of their life.

All other *Sergia* species in the North Atlantic and Caribbean regions appear to be pelagic, they usually occur throughout vast areas. As a criterion

of resemblance in their geographical distribution, for each species pair the quotient (GR) has been used: the numbers of stations where both species have been taken together / the numbers of stations where at least one of the species has been recorded. On the basis of GR-quotient, 3 groups of species which are most geographically related each other, have been revealed (GR exceeds 0.10):

- (1) *S. extenuata*, *S. robusta*, *S. japonica*, *S. laminata*,
- (2) *S. grandis*, *S. splendens*, *S. crebra*, *S. wolffi*, and
- (3) *S. tenuiremis*.

Most of the pelagic *Sergia* species undertake diurnal vertical migrations ascending to 50-500 m at night and descending to 500-2000 m in the daytime. These changes can be traced in the "Dana"-I material, better for those species living in the upper 1000 m where samples are frequent, less clearly for the species occurring below 1000 m. The pelagic species have proved to dwell at different depths, their highest densities being revealed at 0-2500 m at night and at 1000-2500 m in the daytime. Fig. 26 shows in diagrammatic form the diurnal and nocturnal density maxima of the studied pelagic species. It appears that they avoid the depths from 500 to 1000 m at night, when migrating species ascend to the upper layers while non-migrating ones stay deeper. During the daytime no species is found above 500 m.

Pelagic species appear to occupy separate positions in Fig. 26, thus demonstrating sympatric evolution. On the other hand, space divergence inside one pelagic biotope is not always possible, and some species occupy the same positions in Fig. 26. These are the pairs *S. laminata* - *S. tenuiremis*, *S. grandis* - *S. extenuata*, and *S. robusta* - *S. regalis* which were rarely or never sampled together in the studied area: GR-quotient in the pairs ranges from 0 to 0.02. This illustrates allopatric evolution of closely related pelagic species which are very similar both in morphology and ecology.

ACKNOWLEDGMENTS

My stay in Zoological Museum of Copenhagen and study of the "Dana"-I collection was made

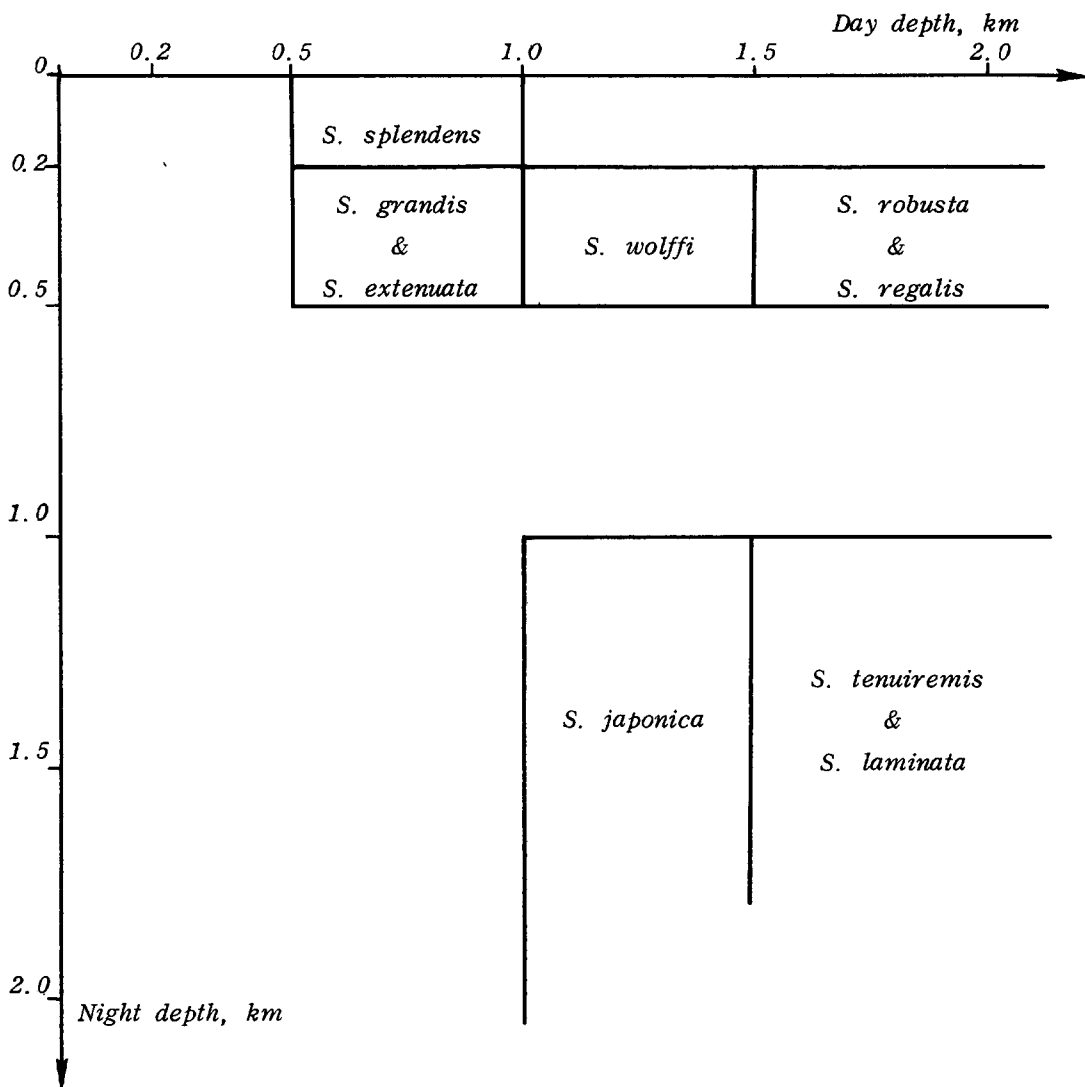

Fig. 26. Diagram of the night and day depth ranges of the North Atlantic and Caribbean regions *Sergia* species.

possible through a grant from the Johannes Schmidt Foundation. I am grateful personally to Drs. Torben Wolff and Jørgen Nielsen (Zoological Museum, Copenhagen) for their advices. I wish to thank all scientists and technicians of the Inverte-

brate Department (ZMUC) for friendly atmosphere around me. My personal thanks to Dr. Henrik Enghoff (ZMUC) for his critical remarks and comments which have improved the manuscript.

REFERENCES

- Barnard K. M. 1947: Description of new species of South African decapod Crustacea, with notes on synonymy and new records. - *Ann. Mag. Nat. Hist.* Ser. 11, 13: 361-392.
- Bate, C. S. 1881: On the Penaeidea. - *Ann. Mag. Nat. Hist.*, Ser. 5, 8: 169-196.
- 1888: Report on the Crustacea *Macrura* collected by H. M. S. "Challenger" during the years 1873-1876. - *Rep. Voy. Challenger 1873-76*, 24: 1-942.
- Burkenroad, M. D. 1937: The Templeton Crocker Expedition. XII. Sergestidae (Crustacea Decapoda) from the Lower Californian region, with descriptions of two new species and some remarks on the organs of *Pesta* in *Sergestes*. - *Zoologica N. Y.* 22: 315-330.
- 1940: Preliminary descriptions of twenty-one new species of pelagic Penaeidea (Crustacea Decapoda) from the Danish Oceanographical Expeditions. - *Ann. Mag. Nat. Hist.* 6: 35-54.
- Crosnier, A. & J. Forest, 1973: Les crevettes profondes de l'Atlantique oriental tropical. - *Faune tropicale* 19: 1-409.
- Dennell, R. 1955: Observations on the luminescence of bathypelagic Crustacea Decapoda of the Bermuda area. - *J. Linn. Soc. London Zool.* 42 (287): 393-406.
- Faxon W. 1893: Preliminary descriptions of new species of Crustacea. - *Bull. Mus. Comp. Zool. Harv. Coll.* 24 (7): 206-220.
- 1895: The Stalk-Eyed Crustacea. - *Mem. Mus. Comp. Zool. Harv. Coll.* 18: 1-292.
- Foxton, P. 1970: The vertical distribution of pelagic Decapods (Crustacea: Natantia) collected on the SOND cruise 1965. II. The Penaeidea and general discussion. - *J. Mar. Biol. Ass. U. K.* 50 (4): 961-1000.
- Gordon, I. 1935: On new or imperfectly known species of Crustacea *Macrura*. - *J. Linn. Soc. London, Zool.* 39: 307-351.
- 1939: A new species of *Sergestes* (Crustacea, Decapoda) from the South Atlantic. - *Ann. Mag. Nat. Hist.* 4: 498-509.
- Hansen H. J. H. 1896: On the development and the species of the Crustaceans of the genus *Sergestes*. - *Proc. zool. Soc. London* 1896: 936-970.
- 1903: On the crustaceans of the genera *Petalidium* and *Sergestes* from the "Challenger", with an account of luminous organs in *Sergestes challengerii* n. sp. - *Proc. Zool. Soc. London* 1903: 52-79.
- 1919: The Sergestidae of the Siboga Expedition. - *Siboga Exped., Monogr.* 38: 1-65.
- 1920: Les Sergestides des Expéditions du Travailleur et du Talisman. - *Bull. Mus. Nat. Hist.* 6: 477-483.
- 1922: Crustaceans decapodes (Sergestides) provenant des campagnes des yachts *Hirondelle* et *Princesse-Alice* (1885-1915). - *Resuls. Camp. scient. Prince Albert I*, 64: 1-232.
- Holthuis, L. B. 1952: Crustacea Decapodes *Macrures*. - *Res. scient. Exp. oceanogr. belge Eaux cotières afric. Atlant. Sud* (1948-1949) 3: 1-88.
- Illig, G. 1927: Die Sergestiden. - *Wiss. Ergeb. Deutsch Tiefsee Exped.* 23: 279-354.
- Kemp, S. 1913: Pelagic Crustacea Decapoda of the Percy Sladen Expedition in H. M. S. "Sealark". - *Trans. Linn. Soc. London* 16: 53-68.
- Kensley B. F. 1971: The family Sergestidae in the waters around Southern Africa (Crustacea, Decapoda, Natantia). - *Ann. S. Afr. Mus.* 57, (10): 215-264.
- Krygier E. E. & R. A. Wasmer 1988: Zoogeography of pelagic shrimps (Natantia: Penaeidea and Caridea) in the North Pacific Ocean (with synopses and keys to the species of the Subarctic and Transitional Zones). - *Bull. Ocean Res. Inst. Univ. Tokyo* 26: 43-98.
- Krøyer H. 1855: Bidrag til kundskab om krebsdyrslægten *Sergestes* Edw. - *Overs. K. danske Vidensk. Selsk. Forh.* 1855: 22-34.
- Lagardere, J. P. 1978: Crustacea pelagiques. - *Fish. Ident. Zooplankton*, 155/156/157: 1-15.
- Omori M. 1974: The biology of pelagic shrimps in the ocean. - *Adv. Mar. Biol.* 12: 233-324.
- Sakai K. & T. Nakano 1983: Studies on the genus *Sergestes* (Crustacea, Decapoda). I. *Sergestes (Sergia) japonicus* Bate, 1881 and *Sergestes (Sergia) mollis* Smith, 1884. - *Res. Crustacea* 12: 97-110.
- Schmidt, J. 1929: Introduction to the oceanographical reports including list of the stations and hydrographical conditions. - *Dan. "Dana" Exped. 1920-22* 1: 1-87.
- Smith S. I. 1882: Report on the Crustacea. Part I. Decapoda. - *Bull. Mus. Comp. Zool. Harv. Coll.* 10 (1): 1-108.
- Stimpson W. 1860: *Prodromus Descriptionis Animalium Evertrebratorum, quae in Expeditione ad Oceanum Pacificum Septentrionalem, a Republica Federata missa, Cadwalarado Ringgoldet Johanne Rodgers Ducibus, observavit et descripsit.* - *Proc. Acad. Nat. Sci. Phila.* 12: 22-47.
- Sund, O. 1920: *Peneides* and *Stenopides* from the "Michael Sars" North Atlantic Deep-sea Expedition. - *Rep. scient. Results Michael Sars N. Atlant. Deep Sea Exped.* 3 (7): 1-32.
- Vereshchaka A. L. 1990a: Macroplankton (Mysids, Euphausiids, and Decapods) in the contact zones of pelagic and benthic communities. - Ph. D. Thesis, Moscow, Oceanology Institute: 1-190. (in Russian).
- 1990b: Pelagic Decapods over seamounts of Nazca and Sala-y-Homez Ridges. - *Trudy Instituta okeanologii* 124: 129-155. (in Russian).
- Yaldwyn, J. C. 1957: Deep-water Crustacea of the genus *Sergestes* (Decapoda, Natantia) from Cook Strait, New Zealand. - *Zoology Publ. Vict. Univ. Coll.* 22: 1-27.

Publisher: Zoological Museum, University of Copenhagen ©

Editors: H. Enghoff (editor-in-chief),

N. M. Andersen (entomology), C. Nielsen (invertebrates), J. G. Nielsen (vertebrates)

Sale and exchange: Steenstrupia, Universitetsparken 15, DK-2100 Copenhagen Ø, Denmark

Printed in Denmark by Zoological Museum, Copenhagen

ISSN 0375-2909