

BECKHOFF New Automation Technology

Manual | EN

CP77xx

Panel PC



2023-10-11 | Version: 3.3

Table of contents

1	Notes on the documentation	5
2	For your safety	6
2.1	Signal words	6
2.2	Intended use	6
2.3	Fundamental safety instructions	7
2.4	Operator's obligation to exercise diligence	7
2.5	Notes on information security	8
3	Product overview	9
3.1	Structure	10
3.2	Interface description	11
3.2.1	RS232	12
3.2.2	Power supply	13
3.2.3	Ethernet RJ45	14
3.3	Name plate	15
3.4	Key functions	16
4	Commissioning	18
4.1	Transport and unpacking	19
4.2	Mounting	19
4.3	Connecting the panel PC	19
4.3.1	Grounding the panel PC	21
4.3.2	Connecting cables and power supply	22
5	Beckhoff Device Manager	23
6	Decommissioning	25
7	Maintenance	26
7.1	Cleaning	26
7.2	Maintenance	28
7.2.1	Replacing the battery	29
7.2.2	Replacing the storage media	31
8	Troubleshooting	32
9	Technical data	33
10	Appendix	34
10.1	Service and support	34
10.2	Approvals	35

1 Notes on the documentation

This description is only intended for the use of trained specialists in control and automation engineering who are familiar with the applicable national standards.

The following instructions and explanations must be followed during installation and commissioning of the components. The responsible staff must ensure that the application or use of the products described satisfy all the requirements for safety, including all the relevant laws, regulations, guidelines and standards.

Disclaimer

The documentation has been prepared with care. The products described are, however, constantly under development. For that reason the documentation is not in every case checked for consistency with performance data, standards or other characteristics. In the event that it contains technical or editorial errors, we retain the right to make alterations at any time and without warning. No claims for the modification of products that have already been supplied may be made on the basis of the data, diagrams, and descriptions in this documentation. All illustrations shown are only examples. The configurations depicted may deviate from the standard.

Trademarks

Beckhoff®, TwinCAT®, TwinCAT/BSD®, TC/BSD®, EtherCAT®, EtherCAT G®, EtherCAT G10®, EtherCAT P®, Safety over EtherCAT®, TwinSAFE®, XFC®, XTS® and XPlanar® are registered and licensed trademarks of Beckhoff Automation GmbH.

Other designations used in this publication may be trademarks whose use by third parties for their own purposes could violate the rights of the owners.

Patents

The EtherCAT Technology is covered, including but not limited to the following patent applications and patents: EP1590927, EP1789857, EP1456722, EP2137893, DE102015105702 and similar applications and registrations in several other countries.

Copyright

© Beckhoff Automation GmbH & Co. KG. Publication of this document on websites other than ours is prohibited. Offenders will be held liable for the payment of damages. All rights reserved in the event of the grant of a patent, utility model or design.

Delivery state

All the components are supplied in particular hardware and software configurations appropriate for the application. Changes to the hardware or software configuration are permitted, provided they are within the specified limits for power consumption and power loss (please refer to the respective data sheet).

Currentness

Please check whether you are using the current and valid version of this document. The current version is always available for download from the Beckhoff website. In case of doubt, contact Technical Support.

Delivery conditions

In addition, the general delivery conditions of the company Beckhoff Automation GmbH & Co. KG apply.

2 For your safety

The signal words and their meanings are explained in the chapter on safety. They contain fundamental safety instructions that are essential for the avoidance of personal injuries and damage to property.

Exclusion of liability

Beckhoff shall not be liable in the event of non-compliance with this documentation and thus the use of the devices outside the documented operating conditions.

2.1 Signal words

The signal words used in the documentation are classified below.

Warning of personal injuries

DANGER

Hazard with high risk of death or serious injury.

WARNING

Hazard with medium risk of death or serious injury.

CAUTION

There is a low-risk hazard that can result in minor injury.

Warning of property and environmental damage

NOTICE

There is a possibility of damage to the environment, equipment or data.

2.2 Intended use

The the Panel PC is intended for use as a control system for automation, visualization and communication in machine and system engineering.

The device has been developed for an IP65 working environment. It offers full protection against contact (dust-tight) and against water jets (nozzle) from any angle.

The specified limits for technical data must be adhered to.

The device can be used within the documented operating conditions.

Improper use

Do not use the device outside the documented operating conditions.

2.3 Fundamental safety instructions

The following safety instructions must be observed when handling the the Panel PC.

Application conditions

- Do not use the device under extreme environmental conditions.
- Only use the device in hazardous areas if it is explicitly designed for this purpose.
- Do not carry out any work on the device while it is live. Always switch off the supply voltage for the device before mounting it, replacing device components or rectifying malfunctions. This does not apply to the replacement of hard disks in a RAID configuration.
- Never plug or unplug connectors during thunderstorms. There is a risk of electric shock.
- Ensure that the device has a protective and functional earth connection.

Damage to property, loss of data and impairment of functions

- If you change the hardware and software configurations, you must keep within the specified limits of power consumption and power loss (please refer to the respective data sheet).
- Ensure that only trained specialists with a control and automation engineering background, operate the device. Use by unauthorized persons can lead to damage to property and loss of data.
- In the case of a 24 V DC power supply unit, fuse the power supply line according to its cross-section to protect the supply line in the event of a short circuit.
- In case of fire, extinguish the device with powder or nitrogen.

2.4 Operator's obligation to exercise diligence

The operator must ensure that

- the products are used only for their intended purpose (see Chapter 2.2 [Intended use](#) [▶ 6]).
- the products are only operated in sound condition and in working order.
- the products are operated only by suitably qualified and authorized personnel.
- the personnel is instructed regularly about relevant occupational safety and environmental protection aspects, and is familiar with the operating instructions and in particular the safety instructions contained herein.
- the operating instructions are in good condition and complete, and always available for reference at the location where the products are used.

2.5 Notes on information security

The products of Beckhoff Automation GmbH & Co. KG (Beckhoff), insofar as they can be accessed online, are equipped with security functions that support the secure operation of plants, systems, machines and networks. Despite the security functions, the creation, implementation and constant updating of a holistic security concept for the operation are necessary to protect the respective plant, system, machine and networks against cyber threats. The products sold by Beckhoff are only part of the overall security concept. The customer is responsible for preventing unauthorized access by third parties to its equipment, systems, machines and networks. The latter should be connected to the corporate network or the Internet only if appropriate protective measures have been set up.

In addition, the recommendations from Beckhoff regarding appropriate protective measures should be observed. Further information regarding information security and industrial security can be found in our <https://www.beckhoff.com/secguide>.

Beckhoff products and solutions undergo continuous further development. This also applies to security functions. In light of this continuous further development, Beckhoff expressly recommends that the products are kept up to date at all times and that updates are installed for the products once they have been made available. Using outdated or unsupported product versions can increase the risk of cyber threats.

To stay informed about information security for Beckhoff products, subscribe to the RSS feed at <https://www.beckhoff.com/secinfo>.

3 Product overview

The CP77xx Panel PC series is designed for installation on the mounting arm and represents a powerful platform for use in machine and system engineering.

Thanks to its processors, you can use the panel PC for the following applications, among others:

- diverse automation and visualization tasks
- wide range of IoT tasks, for example when used as an IoT gateway
- simple HMI applications
- axis control
- short cycle times
- high-volume data handling

The panel PC is available in the following five display sizes, with corresponding resolutions:

- 12-inch (800 x 600)
- 15-inch (1024 x 768)
- 19-inch (1280 x 1024)

The basic configuration of the CP77xx includes the following aspects:

- compact motherboard
- Intel® processor
- DDR4-RAM
- CFast
- 24 V DC power supply unit

3.1 Structure

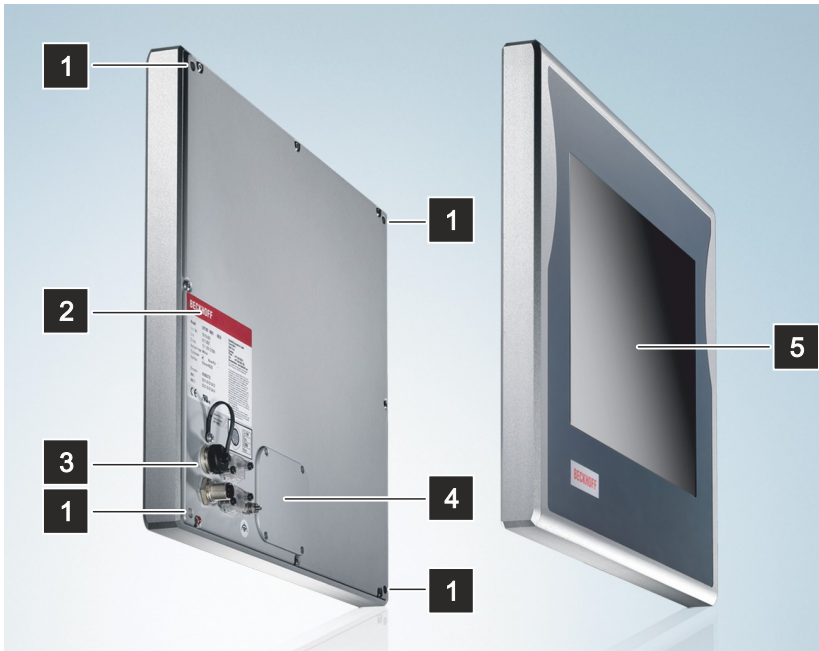

Fig. 1: CP77xx_Structure

Table 1: Legend CP77xx structure

No.	Component	Description
1	4 threaded holes M6 x 18 mm	For installation on the wall
2	Name plate	Information on the equipment of the panel PC
3	Connection section	Access to interfaces
4	Cover	Access to battery and storage media
5	Display and touch screen glass	Operation of the panel PC

3.2 Interface description

In the basic configuration, the panel PC includes the following interfaces:

- RS232 (X100)
- Power supply (X101)
- Ethernet RJ45 (X102, X103)

The interfaces are located at the rear of the panel PC (see fig. 2).

A 19-inch device is shown as an example, with the interfaces located at the bottom right at the rear. In the case of 12-inch and 15-inch displays, the interfaces are located at the bottom left at the rear.

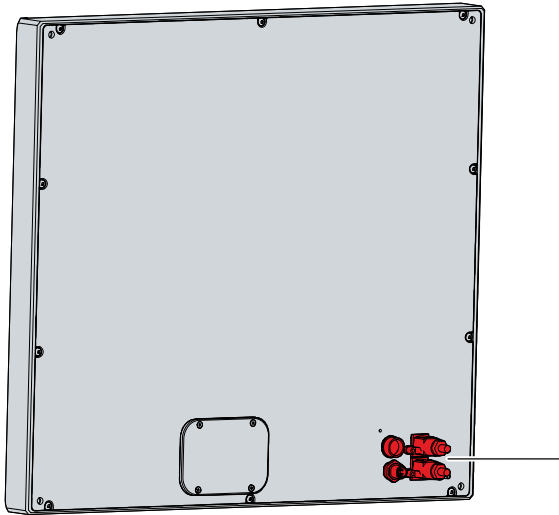

Fig. 2: CP77xx_connection section

3.2.1 RS232

The COM1 serial interface (X100) is fed out via a 12-pin round connector. The signals comply with the RS232 standard. The interface is used to connect serial peripheral devices.

The C9900-K234 adapter cable is supplied with the panel PC. This allows you to connect serial peripheral devices with standard D-sub connector.

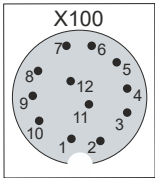

Fig. 3: CP77xx_RS232 pin numbering

Table 2: RS232 pin assignment

Pin	Signal	Description
1	DCD	Data Carrier Detect
2	DSR	Data Set Ready
3	RxD	Receive Data
4	RTS	Request to Send
5	TxD	Transmit Data
6	CTS	Clear to Send
7	DTR	Data Terminal Ready
8	RI	Ring Indicator
9	GND	Ground
10	NC	not used
11	NC	not used
12	NC	not used

3.2.2 Power supply

The panel PC is supplied with a nominal voltage of 24 V. The connection to the power supply is made via the 4-pin M12 voltage socket (X101). The main supply voltage is applied between PIN 1 (24 V) and PIN 3 (0 V) of the socket.

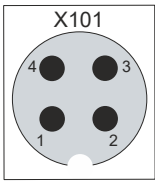

Fig. 4: CP77xx_voltage socket pin numbering

Depending on the device generation, the pin assignment of the voltage socket varies.

Table 3: Voltage socket pin assignment CP77xx-0040

Pin	Signal	Description
1	24 V	Power supply
2	NC	not connected
3	GND	0 V
4	NC	not connected

Table 4: Voltage socket pin assignment CP77xx-0050

Pin	Signal	Description
1	24 V	Power supply
2	P-S	Power status output
3	GND	0 V
4	PC-ON	Input PC-ON

The plug for the power supply is specified for 16 A and can accommodate wire cross-sections of up to 1.5 mm². For long supply lines, use 1.5 mm² cables to achieve a low voltage drop on the supply line. At least 22 V should be present at the voltage connector of the panel PC so that the PC remains switched on in the event of voltage fluctuations.

3.2.3 Ethernet RJ45

The panel PC has two Gigabit LAN ports (X102, X103). The 100Base-T and 1000Base-T Ethernet standards enable the connection of corresponding network components and data rates of 100/1000 Mbit/s. The required speed is selected automatically.

The RJ45 connection technology with twisted-pair cables is used. The maximum length of the cable connection is 100 m.

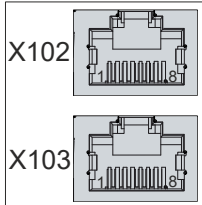

Fig. 5: CP77xx_Ethernet interface pin numbering

Table 5: Ethernet interface pin assignment

Pin	Signal	Description
1	T2 +	Pair 2
2	T2 -	
3	T3 +	Pair 3
4	T1 +	Pair 1
5	T1 -	
6	T3 -	Pair 3
7	T4 -	Pair 4
8	T4 -	

Optionally the following connecting cables are available for the connection to the Ethernet interfaces:

Table 6: Connecting cable CP77xx

Connecting cable	Description
C9900-K605	Connecting cable RJ45, Cat.5, 5 m, one end with IP65 connector cover for Panel PC CP77xx
C9900-K606	Connecting cable RJ45, Cat.5, 10 m, one end with IP65 connector cover for Panel PC CP77xx
C9900-K607	Connecting cable RJ45, Cat.5, 20 m, one end with IP65 connector cover for Panel PC CP77xx
C9900-K608	Connecting cable RJ45, Cat.5, 30 m, one end with IP65 connector cover for Panel PC CP77xx
C9900-K609	Connecting cable RJ45, Cat.5, 40 m, one end with IP65 connector cover for Panel PC CP77xx
C9900-K610	Connecting cable RJ45, Cat.5, 50 m, one end with IP65 connector cover for Panel PC CP77xx

3.3 Name plate

The name plate provides information about the panel PC equipment. The name plate shown here serves only as an example.

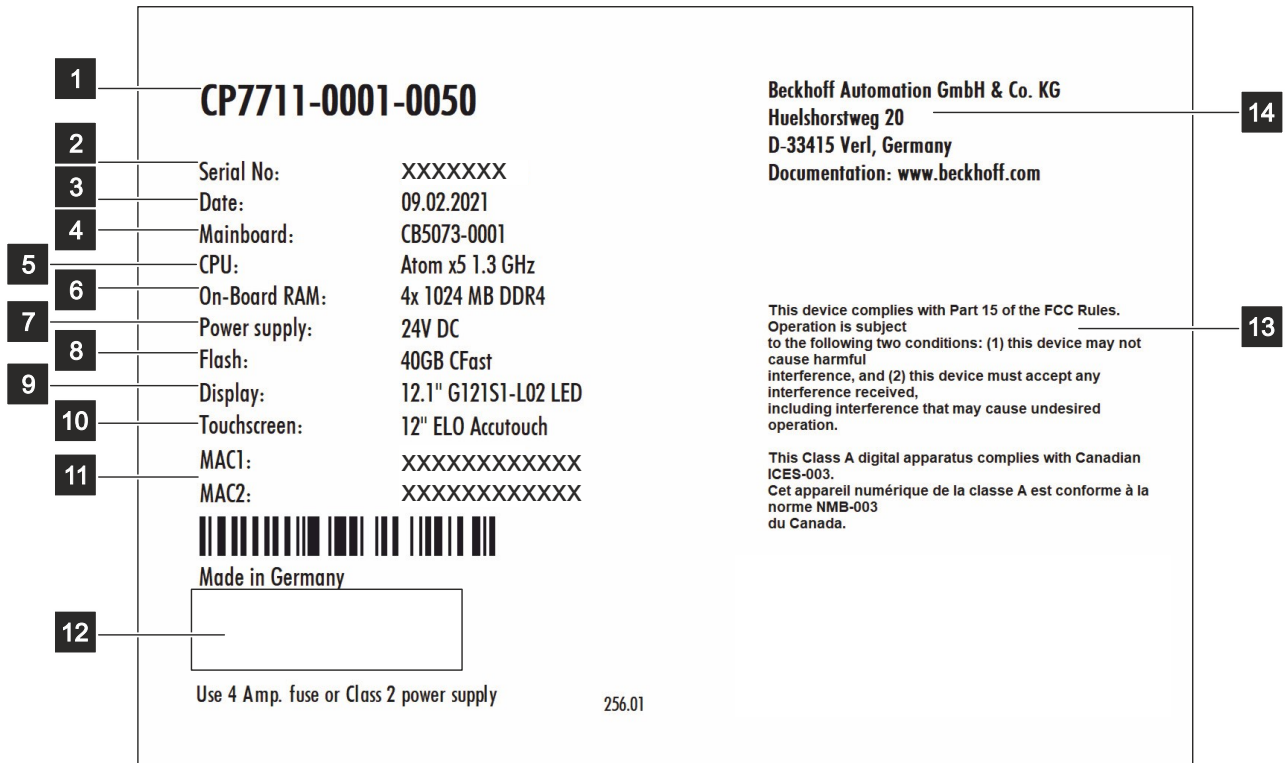



Fig. 6: CP77xx_name plate

Table 7: Legend CP77xx name plate











No.	Description
1	Model: The last four digits indicate the device generation.
2	Serial number (BTN)
3	Date of manufacture
4	Mainboard
5	CPU
6	Main memory
7	Power supply
8	Storage medium
9	Display
10	Touch screen
11	MAC addresses of the Ethernet interfaces
12	Symbols <div style="text-align: right;">  </div> Note: Here are the symbols applicable to the device such as CE, EAC, UKCA,  . The approvals of your device can be found on the name plate and in chapter 10.2 Approvals.
13	FCC approval
14	Address of the vendor





3.4 Key functions

You can order your panel PC with different versions of the front laminate. You can choose between a panel PC without buttons and a panel PC with different button configurations. Please refer to the current price list for specific ordering options.

The following table provides information about the functions of the available keys.

Table 8: Key functions CP77xx

Key	Function
	Move the cursor one step in the corresponding direction
	<i>Home</i> = cursor to beginning of the line <i>End</i> = cursor to end of the line
	<i>Pg Up</i> = scroll forward one page <i>Pg Dn</i> = turn back one page
	<i>Tabulator</i> = cursor to next input field <i>Shift + Tab</i> = cursor to previous input field
	<i>Del</i> = delete character to the right of the cursor
	<i>Enter</i> = confirm input
	<i>Backspace</i> = delete character to the left of the cursor
	<i>Shift</i> pressed with letter = upper case instead of lower case letter <i>Shift</i> pressed with number = displayed character instead of number
	<i>Caps Lock</i> = permanent pressing of the <i>Shift</i> key (pressing the <i>Shift</i> key deactivates the function)
	<i>Ctrl, Alt</i> = change the meaning of a key pressed at the same time
	Open the start menu of the operating system in use

	<p>Opening the properties window of a selected object</p>
	<p><i>Esc</i> = close dialog box, cancel operations</p>
	<p>Set printed character to the cursor position</p>
	<p><i>Function keys</i> = functions of the keys determined by the software</p>
	<p><i>Special keys</i> = special keys with LED that can be controlled by the TwinCAT automation software</p>

4 Commissioning

In order to use the panel PC, you must first commission it. The first step is to transport the device to its operating location and unpack it. This is followed by the installation of the device on the wall or mounting arm, the connection of the cables and the power supply and finally the switching on of the panel PC. Since the panel PC does not have its own power switch, switching the power supply on and off also switches the panel PC on and off.

Operation of the panel PC

NOTICE

Damage to the touch screen

Operating the touch screen with unsuitable objects may damage the touch screen.

- Only operate the touch screen with your bare finger or with your finger using a suitable glove.
- If you use gloves, make sure that no hard particles such as metal shavings, glass splinters or similar adhere to the glove.

If you, as the user, require additional protection for the touch screen against dirt and scratching, for example due to dirty hands, this can be achieved with a Beckhoff protective film. The film provides short-term protection for a few days.

You can either order your device directly with the protective film applied or order a film individually and apply it yourself.

Please refer to the price list for the available protective films according to the display size of your device.

Proceed as follows to attach the protective film to the touch screen:

1. Ensure that the environment is as dust-free as possible.
 2. Thoroughly clean the surface of the device to be fitted with the film and remove all grease residues.
 3. Detach the film from the backing at the short edge and place it on the surface.
 4. Gradually remove the film from the backing. At the same time, use a doctor blade or other object with a soft rubber or felt edge to apply the film.
 5. Brush away air bubbles towards the edge with a doctor blade or other object with a soft rubber or felt edge.
- ⇒ The film is now fitted.

If you want to remove the protective film again, you must proceed with caution so as not to damage the touch foil, which is located between the glass pane of the panel PC and the applied protective film.

To remove the protective film, proceed as follows:

1. Carefully loosen one corner of the protective film.
 2. Carefully pull the protective film off the panel PC at the loosened corner at as flat an angle as possible.
- ⇒ You have removed the protective film.

4.1 Transport and unpacking

The specified storage conditions must be adhered to (see chapter 9 [Technical data \[► 33\]](#)).

Despite the robust design of the unit, the components are sensitive to strong vibrations and impacts. During transport the device must therefore be protected from mechanical stress. Appropriate packaging of the panel PC, in particular the original packaging, can improve the vibration resistance during transport.

NOTICE

Hardware damage due to condensation

Unfavorable weather conditions during transport can cause damage to the device.

- Protect the device against moisture (condensation) during transport in cold weather or in case of extreme temperature fluctuations.
- Do not put the device into operation until it has slowly adjusted to the room temperature.
- Should condensation occur, wait for about 12 hours before switching the device on.

Unpacking

Proceed as follows to unpack the device:

1. Check the packaging for transport damage.
2. Remove packaging.
3. Keep the packaging for possible future transport.
4. Check your delivery for completeness by comparing it with your order.
5. Check the contents for visible shipping damage.
6. In case of discrepancies between the package contents and the order, or in case of transport damage, please inform Beckhoff Service (see Chapter 10.1 Service and Support).

4.2 Mounting

The CP77xx Panel PC is designed for installation on a mounting arm system. Please observe the environmental conditions prescribed for the operation (see Chapter 9 [Technical data \[► 33\]](#)).

NOTICE

Extreme environmental conditions

Extreme environmental conditions can cause damage to the device.

- Avoid extreme environmental conditions.
- Protect the device against dust, moisture and heat.

Dimensions

The dimensions of the control panel can be found on the Beckhoff website: <https://www.beckhoff.com/de-de/support/downloadfinder/technische-zeichnungen/>.

All dimensions are in mm.

4.3 Connecting the panel PC

⚠ CAUTION

Risk of electric shock

Dangerous touch voltages can lead to electric shock. To avoid electric shock, observe the following:

- Never connect or disconnect the device cables during a thunderstorm.
- Provide protective earthing for handling the device.

To make the panel PC ready for operation, you have to connect it. The first step is to ground the device. Then you can connect the cables and the power supply.

An external power supply unit providing 24 V DC (-15 %/+20 %) from an isolated source is required for the power supply. This source must be protected by a UL 248 rated fuse with a maximum rating of 4 A.

The cabling of the panel PC in the control cabinet must be done in accordance with the standard EN 60204-1:2006 PELV = Protective Extra Low Voltage:

- The PE conductor (protective earth) and the "0 V" conductor of the voltage source must be on the same potential (connected in the control cabinet).
- Standard EN 60204-1:2006, section 6.4.1:b stipulates that one side of the circuit, or a point of the energy source for this circuit must be connected to the protective conductor system.

Devices connected to the panel PC with their own power supply must have the same potential for the PE and "0 V" conductors as the panel PC (no potential difference).

4.3.1 Grounding the panel PC

Potential differences are minimized and electrical currents are diverted to the ground through grounding or potential equalization of electronic devices. This is to prevent dangerous touch voltages and electromagnetic interference.

On the rear side of the panel PC there is the protective conductor connection PE (see Fig. 7), which ensures both the protective earthing of the PC and the functional earthing. Use wires with a cross-section of at least 4 mm² or a flat conductor for the ground connection, as the circumference of the conductor should be as large as possible.

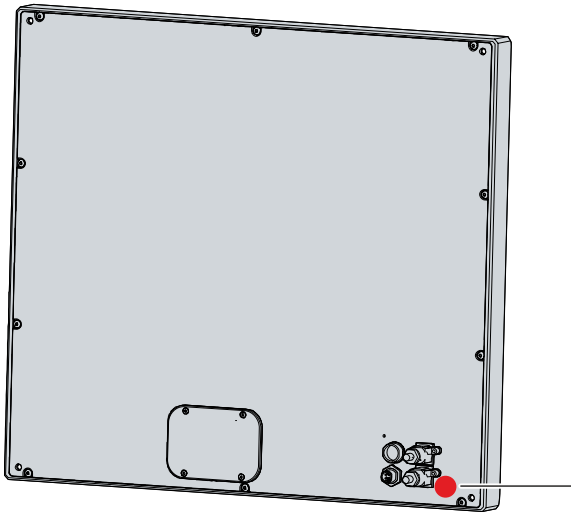

Fig. 7: CP77xx_protective conductor connection

Protective earth

The protective grounding of a device serves to avoid dangerous touch voltages. According to the EN 60204-1 standard (Chapter 8 Potential equalization), protective grounding is required if:

- the device exceeds dimensions of 50 mm x 50 mm,
- the device can be touched or encompassed over a large area,
- contact between the device and active parts is possible,
- an insulation fault may occur.

By connecting the protective earth conductor (PE), you establish a low-resistance protective earth of the panel PC and thus avoid dangerous touch voltages.

EMC

NOTICE

Hardware damage due to electromagnetic interference

The use of the panel PC without a functional earth can lead to material damage due to electromagnetic interference.

- Only use the device with functional earth.

Electromagnetic compatibility (EMC) of the panel PC includes on the one hand not affecting other devices and equipment by electromagnetic interference and on the other hand not being disturbed by electrical or electromagnetic effects itself.

To do this, the panel PC must comply with certain protection requirements. The panel PC has EMC interference immunity according to EN 61000-6-2. The EMC interference emission of the device meets the requirements of EN 61000-6-4.

The functional earth is necessary for the EMC of the device. The functional earth is also established via the connection of the PE protective conductor.

4.3.2 Connecting cables and power supply

NOTICE

Incorrect connection procedure

Incorrect procedure when connecting the cables and the power supply can cause hardware damage.

- Follow the documented procedure for connecting the cables and the power supply.
- Always connect all cables first and only then switch on the power supply.
- Please read the documentation for the external devices prior to connecting them.

The connections are located at the rear in the connection section of the device.

Connecting cables

Make sure that you first ground the panel (see chapter 4.3.1 [Grounding the panel PC](#) [▶ 21]) and then plug in all data transmission cables.

Connect power cable

Cables with a maximum cable cross-section of 1.5 mm² can be used for connecting the power supply. For long supply lines, use 1.5 mm² cables to achieve a low voltage drop on the supply line. There should be at least 22 V at the power supply plug of the panel PC, so that the panel remains switched on during voltage fluctuations.

Proceed as follows to connect the 24 V_{DC} power supply unit:

1. Plug the voltage connector into the voltage socket on the panel.
2. Connect the panel to your external 24 V power supply.
3. Switch on the 24 V power supply.

5 Beckhoff Device Manager

The Beckhoff Device Manager enables detailed system diagnostics with uniform secure access to the existing hardware and software components. System data is recorded, analyzed and evaluated during operation. The data helps to detect deviations at an early stage and prevent PC downtime.

The Beckhoff Device Manager always starts automatically after the industrial PC has been booted. In addition, you have the option of manually starting the previously closed Device Manager at any time.

The industrial PC is delivered with predefined access data as standard:

- User name: Administrator
- Password: 1

You also have the option of using the Beckhoff Device Manager to remotely configure the industrial PC via a web browser. More detailed information is available in the Beckhoff Device Manager [manual](#).

First start Beckhoff Device Manager

When your industrial PC is booted for the first time, the Beckhoff Device Manager also starts automatically for the first time. The Security Wizard opens. This tells you that you should reset the default password set by Beckhoff. Proceed as follows:

1. Click **Next** on the Security Wizard start page.
⇒ This will take you to the **Change Passwords** page:

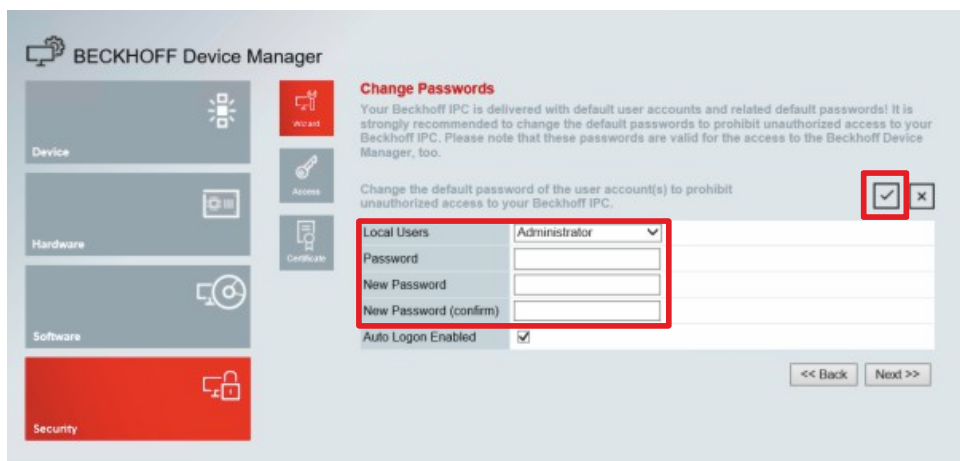

Fig. 8: Beckhoff Device Manager - Change passwords

2. Enter the access data of the Device Manager on delivery.
3. Choose a secure new password. Instructions for choosing a secure password are given below.
4. Confirm the changes by clicking on the tick in the red box on the right.
5. Exit the Security Wizard.
⇒ You have reached the Device Manager start page.

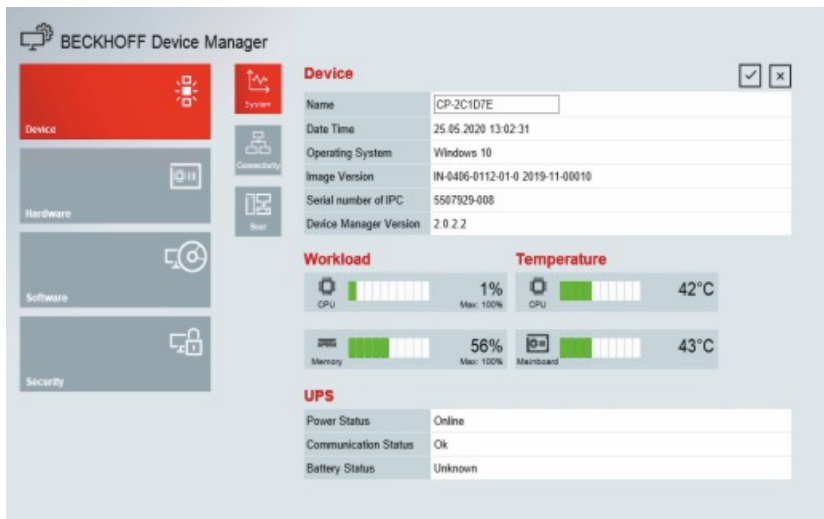

Fig. 9: Beckhoff Device Manager – Start page

Navigate forward in the menu and configure the industrial PC. Note that modifications only become active once they have been confirmed.

Manual start Beckhoff Device Manager

To start the Beckhoff Device Manager manually, proceed as follows:

1. Open a web browser locally on the industrial PC.
2. Enter *localhost/config* in the web browser to start the Beckhoff Device Manager.

The Beckhoff Device Manager starts. The Security Wizard appears.

Secure passwords

Strong passwords are an important prerequisite for a secure system.

Beckhoff supplies the device images with standard user names and standard passwords for the operating system. It is imperative that you change these.

Controllers are shipped without a password in the UEFI/BIOS setup. Beckhoff recommends assigning a password here as well.

Please note the following:

- Passwords should be unique for each user and service.
- Only change passwords after an incident in which passwords have become known without authorization.
- Train the device users in the use of passwords.

A secure password has the following characteristics:

- Password complexity: The password should contain capital and lower-case letters, numbers, punctuation marks and special characters.
- Password length: The password should be at least 10 characters long.

6 Decommissioning

NOTICE

Hardware damage due to power supply

A connected power supply can cause damage to the panel PC during disassembly.

- Disconnect the power supply from the device before starting to disassemble it.

As part of the decommissioning of the panel PC, you must first disconnect the power supply and cables. You can then dismantle the device.

Disconnecting the power supply and cables

⚠ CAUTION

Risk of electric shock

Disconnecting the panel PC during a thunderstorm can lead to electric shock.

- Never disconnect the cables of the panel PC during a thunderstorm.

To disconnect the cables and the power supply, follow the steps below:

1. Shut down the panel PC.
 2. Disconnect the PC from your external 24 V power supply.
 3. Remove the voltage connector from the voltage socket.
 4. Make a note of the wiring of all data transmission cables if you want to restore the cabling with another device.
 5. Disconnect all data transmission cables from the panel PC.
 6. Finally, disconnect the ground connection.
- ⇒ You have disconnected the cables and power supply.

Disposal

If you do not wish to continue using the panel PC, you can remove it from the wall or mounting arm and then dispose of it. When disposing of the devices follow the national electronic scrap regulations.

7 Maintenance

⚠ CAUTION

Risk of electric shock

Working on the panel PC when live can lead to electric shock.

- Turn off the supply voltage before cleaning the device or replacing device components.

Maintenance measures increase the efficiency of the device by ensuring long-term functionality. Cleaning and maintenance of certain device components and the replacement of other device components contribute to this.

7.1 Cleaning

NOTICE

Unsuitable cleaning agents

The use of unsuitable cleaning agents can damage the device.

- Clean the panel PC only as specified.

It is essential to observe the following points when cleaning the PC:

- Keep to the boundary conditions of protection rating IP65.
- Never use compressed air to clean the PC.
- Maintain an ambient temperature range of 0 °C to 45 °C.

Cleaning agents

In order to avoid damage to the front of the panel PC during cleaning, you must use suitable cleaning agents. Examples include:

- benzine
- spirit
- glass cleaner

Avoid the following cleaning agents:

- detergents with scouring or abrasive components
- metal cleaning objects such as razor blades or steel spatulas
- steam jet cleaner or very hot water
- cold water with a heated device
- high water pressure, e.g. high-pressure cleaner

Cleaning the front screen

You can clean the front screen of the panel PC during operation. In order to avoid inadvertent touch entries when doing this, you must first set the device to "Cleaning Mode" with the help of the Beckhoff Control Tool.

The Beckhoff Control Tool does not start automatically when the PC starts up. Proceed as follows to activate the "Cleaning Mode" of the Beckhoff Control Tool:

1. Click the Beckhoff Control Tool to start it.
 - ⇒ When the tool is started, a small sun symbol appears in the taskbar.
2. Right-click the sun symbol. Touch the sun when operating via the touch screen.
3. Select the "Cleaning Mode" (see Fig. 10).
 - ⇒ "Cleaning Mode" is activated. You can now clean the front panel.

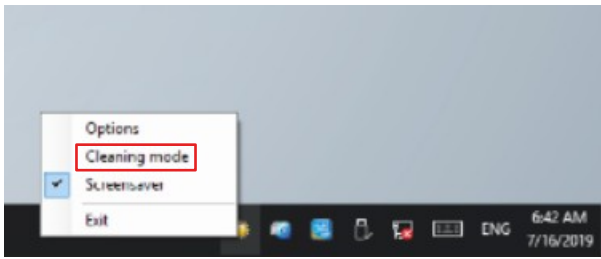

Fig. 10: CP77xx_Select "Cleaning Mode"

You can set the duration for which the PC should remain in Cleaning mode. The period can be set for between 5 and 120 seconds. Right-click the sun symbol again and click "Options". Now select the appropriate period (see fig. 11).

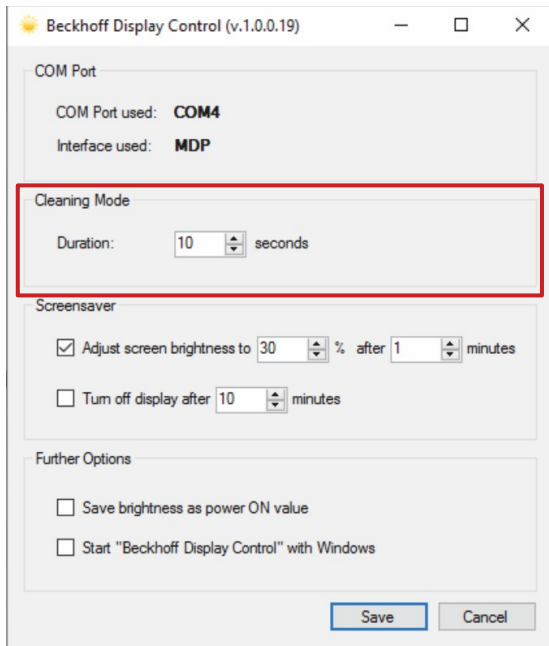

Fig. 11: CP77xx_Configuration "Cleaning Mode"

7.2 Maintenance

NOTICE

Use of incorrect spare parts

The use of spare parts not ordered from Beckhoff Service can lead to unsafe and faulty operation.

- Only use spare parts that you have ordered from Beckhoff Service.

Beckhoff Panel PCs are manufactured from components of the highest quality and robustness. They are selected and tested for best interoperability, long-term availability and reliable function under the specified environmental conditions.

Nevertheless, some components of the panel PC may be subject to a limited service life if they are operated under certain conditions, such as more demanding ambient conditions during operation or during storage, or if they are out of service for long periods of storage.

Beckhoff therefore recommends replacing some of the panel PC components after the time after which predictions of the remaining service life of such components can no longer be reliably calculated.

These are the following components:

- Storage medium
- Battery

The following table provides recommendations for the regular, precautionary replacement of the PC components:

Table 9: Replacement recommendations for PC components

Component	Recommendation for replacement intervals (years)
UPS battery pack	5 years
2.5-inch hard disk	5 years or after 20,000 operating hours at more than 40 °C or after 30,000 operating hours at less than 40 °C
3.5-inch hard disk	5 years, irrespective of the operating hours
Fan	7 years
Compact Flash, CFast or SSD	10 years
Motherboard battery	5 years

Beckhoff is excluded from liability in the event of possible damage occurring during maintenance work. In order to avoid damage caused by electrostatic discharge when replacing device components, protective measures are recommended. Below are some suggestions.

ESD protection

NOTICE

Electrostatic discharge

The replacement of device components without ESD protection can lead to functional impairment and destruction of the device.

- If possible, apply ESD protection measures during maintenance work.

When working on electronic devices, there is a risk of damage due to ESD (electrostatic discharge), which can impair the function or destroy the device.

Protect the panel PC and create an ESD-protected environment in which existing electrostatic charges are safely discharged to ground and charging is prevented.

An ESD-protected environment can best be created by setting up ESD protection zones. The following measures serve this purpose:

- ESD-compliant floors with sufficient conductivity to the reference potential PE;
- ESD-compatible work surfaces such as tables and shelves;
- Wrist grounding strap, especially for sedentary activities;

- grounded and electrostatically dissipating equipment and operating materials (e.g. tools) within the ESD protection zone.

If it is not possible to create an ESD protection zone, you can still protect the device against ESD damage. For example, the following measures can be used:

- Use conductive mats connected to the ground potential as underlays.
- Dissipate possible charges from your own body by touching grounded metal (e.g. control cabinet door).
- Wear a wrist grounding strap.
- Only remove new electronic components from the ESD packaging (tinted plastic bag) after putting on the wrist grounding strap.
- Do not walk around with electronic components in your hand if they are not in ESD packaging.

Access to exchangeable device components

Access is gained to the battery (1) and storage medium (2) from the back of the panel PC. The components are located behind a cover. To gain access to the device components, loosen the four M3x8 screws and remove the cover (see Fig. 12).

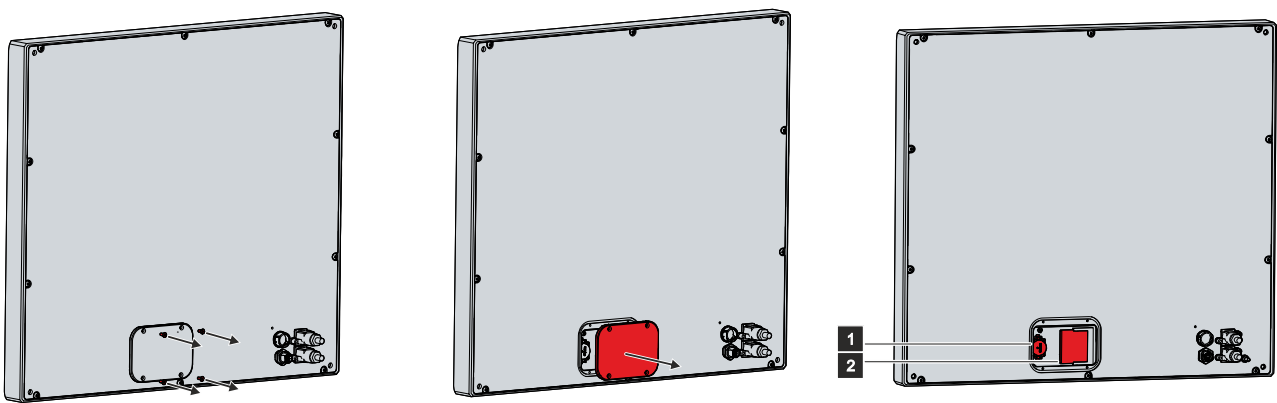

Fig. 12: CP77xx_access device components

7.2.1 Replacing the battery

NOTICE

Incorrect battery type

Inserting the wrong type of battery can damage the device.

- Only replace the battery with a replacement battery from Beckhoff Service.
- When replacing the battery, make sure that the polarity is correct.

NOTICE

Battery damage

Incorrect handling of the motherboard battery can damage it.

- Do not recharge the battery.
- Do not throw the battery on the fire.
- Do not open the battery.
- Protect the battery against direct sunlight and moisture.

NOTICE

Motherboard failure

Scratches on the motherboard may cause the motherboard to fail.

- Be very careful when replacing the battery and be sure to avoid scratches on the motherboard.

The panel PC does not contain a lithium-ion battery. The motherboard battery is a CR2032 lithium-metal cell. It is used to supply power to the clock integrated on the motherboard. If the battery is depleted or missing, the date and time are displayed incorrectly.

Table 10: Technical data of the battery

Battery type	Electrical properties (at 20 °C)		Dimensions		
	Nominal voltage	Nominal capacity	Diameter	Height	Weight
CR2032	3.0 V	225 mAh	20.0 mm	3.20 mm	3.1 g

Chapter 7.2 [Maintenance](#) [► 28] shows where the battery is located.

To replace the battery, follow the steps below:

1. Place a lever made on the negative pole of the battery holder below the battery.
2. Lift the battery side out of the holder.
 - ⇒ The battery is now in an oblique position (see fig. 13).

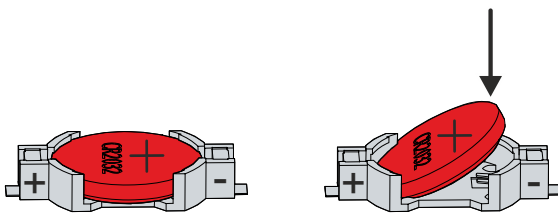

Fig. 13: CP77xx_battery change

3. Remove the battery completely from the battery holder.
4. Insert the new battery with the correct polarity back into the inclined position on the positive pole of the battery holder. The correct polarity is shown in the figure.
5. Push the high side of the battery down into the battery holder (see fig. 13).
 - ⇒ You have successfully replaced the battery.

To dispose of the battery, remove it, stick insulating tape over the poles and take it to the local battery recycling.

7.2.2 Replacing the storage media

For new storage media, please contact your Beckhoff Sales only.

Chapter 7.2 [Maintenance](#) [▶ 28] shows where the storage media are located.

Data transmission before replacement

If you want to exchange a storage medium according to Beckhoff's recommendation, you must copy the data from the old to the new storage medium. You can use the Beckhoff Service Tool (BST) for this purpose. BST is a graphical backup and restore program for PCs with a Windows operating system. You can create an image of your operating system and use it to back up the operating system. Then you can restore the created image to a new data carrier. The BST is available on a bootable BST USB flash drive. This includes Windows and a backup software. Select the size of the BST USB flash drive according to the size of the backup copy of your operating system. You can then keep the flash drive as a backup copy. For this purpose, the BST USB flash drives are designed for particularly long data preservation by means of special flash. For more information on the function of the BST, please refer to the corresponding [manual](#).

If your storage medium is defective and there is no backup, Beckhoff Service can provide you with a fresh Windows image. For this to be possible, the Beckhoff PC must already have been shipped with a valid operating system license. After installing the fresh image, the applications must be reinstalled.

Exchange CFast

To replace the CFast, follow the steps below:

1. Carefully pull the CFast out of the guides (see Fig. 14).

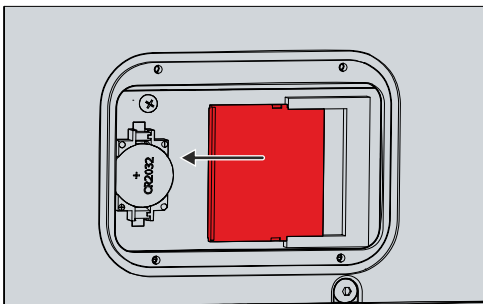

Fig. 14: CP77xx_Exchange CFast

2. Reinsert the new CFast into the guides in the same orientation.
⇒ You have replaced the CFast.

The old storage media must be disposed of in accordance with the national electronic waste regulations.

8 Troubleshooting

Table 11: Troubleshooting

Fault	Cause	Measures
No function of the panel PC	No power supply to the panel PC Cable not connected	Check the power supply cable 1. Correctly connect the cable 2. Call Beckhoff Service
Panel PC boots, software starts, but controller does not work properly	The cause of the error is the software or plant parts outside of the panel PC	Call the machine or software manufacturer
The panel PC only works partially or only temporarily, e.g. dark image or none at all	Defective backlight in the display Components defective in the panel PC	Call Beckhoff Service Call Beckhoff Service

9 Technical data

Table 12: Technical data

Product designation	CP77xx		
Supply voltage	22-30 V _{DC} (24 V _{DC} power supply unit, NEC class 2)		
Power consumption	Data sheet for calculating power consumption and power loss in the download finder: https://www.beckhoff.com/de-de/support/downloadfinder/suchergebnis/?c-1=40717316		
Protection rating	IP65		
Vibration resistance (sinusoidal vibration)	EN 60068-2-6:	10 ... 58 Hz:	0.035 mm
		58 ... 500 Hz:	0.5 G (~ 5 m/ s ²)
Shock resistance (shock)	EN 60068-2-27:	5 G (~ 50 m/ s ²), duration: 30 ms	
EMC interference immunity	conforms to EN 61000-6-2		
EMC interference emission	conforms to EN 61000-6-4		
Permissible ambient temperature	Operation: 0 °C to +45 °C		
	Transport / storage: -25 °C ... +65 °C		
Permissible relative air humidity	Maximum 95%, no condensation		
Transport and storage	The same values for air humidity and shock resistance are to be observed during transport and storage as in operation. The shock resistance during transport can be improved by means of suitably packing the panel PC.		

10 Appendix

In the appendix you will find information for servicing and details of the approvals that your device has.

10.1 Service and support

Beckhoff and its worldwide branch offices offer comprehensive service and support, providing fast and competent assistance with all issues relating to Beckhoff products and system solutions.

Beckhoff Service

The Beckhoff Service Center supports you in all matters of after-sales service:

- on-site service
- repair service
- spare parts service
- hotline service

Hotline: + 49 5246/963-460
email: service@beckhoff.com

If your device requires service, please indicate the serial number, which you can find on the name plate.

Beckhoff Support

Support offers you comprehensive technical assistance, helping you not only with the application of individual Beckhoff products, but also with other, wide-ranging services:

- World-wide support
- Design, programming and commissioning of sophisticated automation systems
- extensive training program for Beckhoff system components

Hotline: + 49 5246/963-157
email: support@beckhoff.com

Headquarters

Beckhoff Automation GmbH & Co. KG
Hülshorstweg 20
33415 Verl
Germany

Phone: + 49 5246/963-0
email: info@beckhoff.de

The addresses of the worldwide Beckhoff branches and agencies can be found on our website at <http://www.beckhoff.com/>.

You will also find further documentation for Beckhoff components there.

10.2 Approvals

Your device has the following approvals:

- CE
- EAC
- UKCA
- FCC

You will find all other applicable approvals on the name plate of your device.

FCC approvals for the United States of America

FCC: Federal Communications Commission Radio Frequency Interference Statement

This device was tested and complies with the limits for a digital device of class A, according part 15 of the FCC regulations. These limits are designed to provide adequate protection against adverse interference, if the device is used in a commercial environment. This device generates, uses and may emit radio frequency energy and may cause adverse interference with radio communications, if it is not installed and used in accordance with the operating instructions. If this device is used in a residential area it is likely to cause adverse interference, in which case the user must take appropriate countermeasures in order to eliminate the interference at his own expense.

FCC approvals for Canada

FCC: Canadian Notice

This device does not exceed the class A limits for radiation, as specified by the Radio Interference Regulations of the Canadian Department of Communications.

List of figures

Fig. 1	CP77xx_Structure	10
Fig. 2	CP77xx_connection section	11
Fig. 3	CP77xx_RS232 pin numbering	12
Fig. 4	CP77xx_voltage socket pin numbering	13
Fig. 5	CP77xx_Ethernet interface pin numbering	14
Fig. 6	CP77xx_name plate	15
Fig. 7	CP77xx_protective conductor connection	21
Fig. 8	Beckhoff Device Manager - Change passwords	23
Fig. 9	Beckhoff Device Manager – Start page	24
Fig. 10	CP77xx_Select "Cleaning Mode"	27
Fig. 11	CP77xx_Configuration "Cleaning Mode"	27
Fig. 12	CP77xx_access device components	29
Fig. 13	CP77xx_battery change	30
Fig. 14	CP77xx_Exchange CFast	31

List of tables

Table 1	Legend CP77xx structure.....	10
Table 2	RS232 pin assignment	12
Table 3	Voltage socket pin assignment CP77xx-0040.....	13
Table 4	Voltage socket pin assignment CP77xx-0050.....	13
Table 5	Ethernet interface pin assignment.....	14
Table 6	Connecting cable CP77xx.....	14
Table 7	Legend CP77xx name plate.....	15
Table 8	Key functions CP77xx	16
Table 9	Replacement recommendations for PC components.....	28
Table 10	Technical data of the battery	30
Table 11	Troubleshooting	32
Table 12	Technical data.....	33

More Information:
www.beckhoff.com/cp77xx

Beckhoff Automation GmbH & Co. KG
Hülshorstweg 20
33415 Verl
Germany
Phone: +49 5246 9630
info@beckhoff.com
www.beckhoff.com

