



**DESIGN MANUAL**  
for  
**DRUID HILLS LOCAL HISTORIC DISTRICT**

The Jaeger Company  
Gainesville, Georgia



# DESIGN MANUAL

## DRUID HILLS LOCAL HISTORIC DISTRICT

The Jaeger Company  
Gainesville, Georgia

**Druid Hills Civic Association**  
**April 1997**

---

# DRUID HILLS LOCAL HISTORIC DISTRICT Design Manual

## Contents

### Preface

### Part One: The District & The Process

<b>1.0 Local District Designation</b>	<b>1</b>
1.1 Druid Hills Local Historic District	1
1.2 Defining the District Boundaries	1
1.3 Goals and Objectives	2
<b>2.0 Design Review in DeKalb County</b>	<b>7</b>
2.1 Obtaining a Certificate of Appropriateness - When Is Design Review Required? Design Review Flow Chart	7 9
2.2 Coordination with Other County Ordinances and Land Development Regulations	9
2.3 Periodic Review of Guidelines by Preservation Commission	10
2.4 State and Federal Review Processes	10
<b>3.0 Historic Development</b>	<b>11</b>
<b>4.0 Historic Resources - Analysis of Existing     Conditions &amp; Historic Character</b>	<b>15</b>
4.1 Landscape Architecture	15
4.1.1 Development Patterns - Form and Layout	
4.1.2 Natural Landscape	
4.1.3 Cultural Landscape	
4.2 Architectural Resources	25

- 4.2.1 Residential Resources
- 4.2.2 Institutional Resources
- 4.2.3 Commercial Resources

### Part Two: General Design Guidelines & Preservation Principles

<b>5.0 Preservation Principles &amp; Approaches For     Architectural Rehabilitation Projects</b>	<b>45</b>
5.1 Use of Historic Properties	45
5.2 Preservation Methods	45
5.3 Secretary of the Interior's "Standards for Rehabilitation"	46
5.4 Eight Steps of a Preservation Project	46
<b>6.0 Architectural Rehabilitation Guidelines</b>	<b>49</b>
6.1 Building Elements and Details	50
6.1.1 Exterior Materials	
6.1.2 Architectural Details	
6.1.3 Entrances and Porches	
6.1.4 Windows	
6.1.5 Roofs, Chimneys, and Dormers	
6.1.6 Foundations	
6.1.7 Gutters	
6.2 Mechanical Services	58
6.3 Accessory Buildings	59
6.4 Adaptive Use	59
6.5 Health and Safety Code Compliance	59
6.6 Demolition by Neglect	60
6.7 Maintenance	60
6.8 Exterior Colors	60
6.9 Interiors	61

---

<b>7.0 Additions &amp; New Construction - Preserving Form &amp; Layout</b>	<b>63</b>	9.7 Residential Landscape Design	91
7.1 Defining the Area of Influence	64	9.8 Signage Within Residential Areas	92
7.2 Recognizing the Prevailing Character of Existing Development	65	9.9 Commercial Streetscape	92
7.2.1 Building Orientation and Setback		9.10 Commercial Signage	92
7.2.2 Directional Emphasis		<b>10.0 Archaeological Resources</b>	<b>93</b>
7.2.3 Shape		<b>11.0 Guidelines for Nonhistoric Properties</b>	<b>93</b>
7.2.4 Massing		<b>Part Three: Character Areas Analyses &amp; Guidelines</b>	
7.2.5 Proportion		<b>12.0 Druid Hills National Register District - Character Areas #1 &amp; #2</b>	<b>101</b>
7.2.6 Rhythm		12.1 Character Area #1	102
7.2.7 Scale/Height		12.2 Character Area #2	109
7.2.8 Individual Architectural Elements		<b>13.0 University Park / Emory Highlands / Emory Estates Character Area</b>	<b>115</b>
7.3 Respecting the Prevailing Character When Designing New Development	74	<b>14.0 Emory Grove Character Area</b>	<b>119</b>
7.3.1 Additions		<b>15.0 Parkwood Character Area</b>	<b>123</b>
7.3.2 New Construction and Subdivision Development		<b>Sources Consulted</b>	<b>127</b>
7.3.3 Demolition and Relocation		<b>Appendices</b>	
<b>8.0 Natural Landscapes - Protecting the Design Context</b>	<b>77</b>	Glossary	i
8.1 Open Space and Parkland Preservation	77	Sources of Information	iii
8.2 Tree Conservation	78	Overview of Local Historic Districts (Handout from January 21, 1996 Workshop)	ix
8.3 Protection of the Historic Watershed Design and Design Concept	79	81 Design Review in DeKalb County (Handout from March 26, 1996 Workshop)	xi
<b>9.0 Cultural Landscapes Guidelines - Maintaining "The Look"</b>	<b>81</b>	82 Zoning Designation Map for the District	xiii
9.1 Original Subdivision Forms	81	90 Kudzu Eradication	xv
9.2 Traditional Streetscape Profile	81	<b>Credits</b>	
9.3 Vegetation	82		
9.4 Enclosures and Walls	90		
9.5 Parking	90		
9.6 Accessory Buildings	91		

---

## List of Illustrations

Illustration A: Local Historic District	3
Illustration B: Area Context	4
Illustration C: National Register Districts	5
Illustration D: Historic Development Plat Map ( <i>includes list of historic plats</i> )	13
Illustration E: O. F. Kauffman Plats	19
Illustration F: Peavine/Lullwater Creek Watershed Map	20
Illustration G: Residential Landscape Plan, Olmsted Brothers, 1903	21
Illustration H: Roadway Section for Main Road of Parkway, Olmsted Brothers, 1902	22
Illustration I: Roadway Sections for 50' Road and Side Road of Parkway, Olmsted Brothers, 1902	23
Illustration J: Character Area Map	99
Zoning Designation Map Appendix	xiii

## **PREFACE**

*Druid Hills is one of Atlanta's most historically significant landscapes. The original section of Druid Hills (the Ponce de Leon corridor) was designed by Frederick Law Olmsted, considered to be the "Father of Landscape Architecture" and also called our nation's "most comprehensive environmental planner and designer." Olmsted assisted Joel Hurt and the Kirkwood Land Company in early designs for Druid Hills. After Olmsted's death in 1903, his company, Olmsted Brothers, continued to be involved in the project.*

*The first plans for Druid Hills were conceived in the 1890s, in the latter years of Olmsted's career. As such the design represents a culmination in suburban design of Olmsted and his successors in which all of the elements of his "ideal" community were fully integrated. With its development and homogeneous architecture intact, Druid Hills is one of the nation's best examples of Olmsted's suburban designs, and, in the metro Atlanta area, it stands apart as the preeminent example of turn-of-the-century suburban planning and development.*

*Druid Hills lies within two local jurisdictions, the City of Atlanta and DeKalb County. In 1979 the entire historic suburb was listed in the National Register of Historic Places at a national level of significance. The Druid Hills Local Historic District encompasses that part of the Druid Hills National Register District that lies within DeKalb County and adjacent historic developments that were clearly influenced by Olmsted. As a designated local historic district, it will be protected under the DeKalb County Historic Preservation Ordinance. The remainder of Druid Hills located in the City of Atlanta is protected under that city's zoning ordinance.*

*Implementation of the design guidelines presented in this manual will contribute to the preservation and protection of one of Georgia's most significant residential developments and landscapes.*

# PART ONE

## THE DISTRICT & THE PROCESS

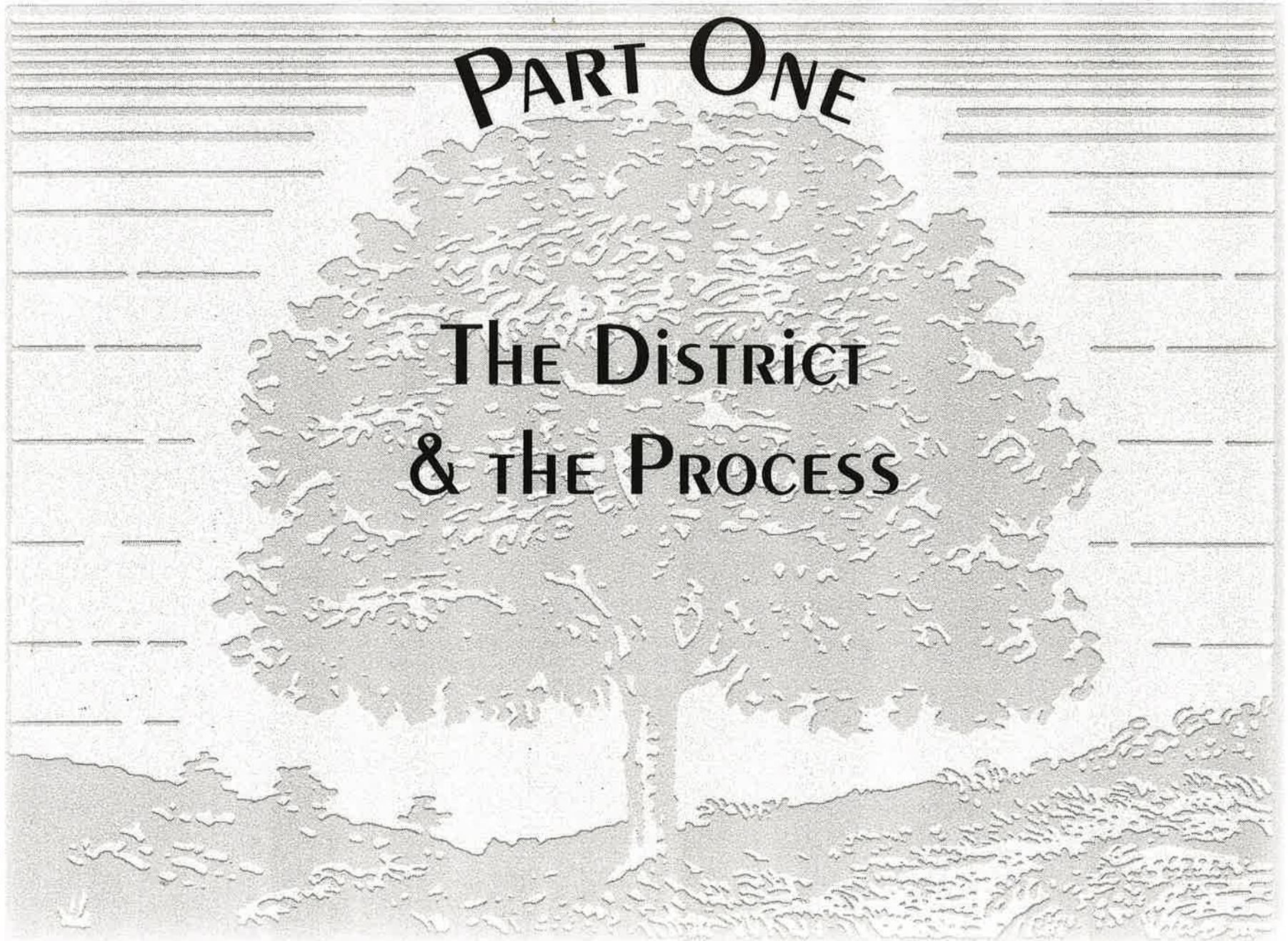

---

## 1.0 LOCAL DISTRICT DESIGNATION

The Druid Hills Local Historic District is designated by local ordinance (DeKalb County Historic Preservation Ordinance), falling under the jurisdiction of the local DeKalb County Historic Preservation Commission. A local historic district is “overlaid” on existing zoning classifications in a community such that the Preservation Commission deals with only the appearance of the district and not the way properties are used.

Design guidelines are a set of criteria uniformly applied to evaluate the appropriateness of proposed changes in historic districts. The ultimate goal of design guidelines is to protect the visual qualities of the district that reflect the history and heritage of that community.

These design guidelines have been established primarily for use by the Preservation Commission in evaluating proposed alterations to historic properties in the Druid Hills Local Historic District. In addition, these guidelines are intended to aid property owners throughout the community who may be considering rehabilitation or new construction projects. The guidelines are not rigid restrictions but rather should be viewed as standards which, if followed, will result in sound preservation practices.

This manual is divided into three sections:

**PART ONE: THE DISTRICT AND THE PROCESS** provides (1) an overview of the district boundaries and the purpose of these guidelines, (2) an introduction to design review in DeKalb County and how the process relates to other local regulations, (3) information on the history of the district, and (4) an analysis of the district’s extensive historic resources.

**PART TWO: GENERAL DESIGN GUIDELINES AND PRESERVATION PRINCIPLES** provides (1) basic preservation principles and design concepts and (2) specific guidelines for architectural rehabilitation, new construction and additions, natural landscapes, cultural landscapes, archeological resources, and nonhistoric properties.

**PART THREE: CHARACTER AREAS ANALYSES & GUIDELINES** presents detailed analyses of the landscape and architectural resources of several distinct sub-areas of the Druid Hills district and offers guidelines specific to those areas. The five areas are (1) Druid Hills Character Area 1, (2) Druid Hills Character Area 2, (3) University Park/Emory Highlands/Emory Estates, (4) Emory Grove, and (5) Parkwood. Analyses and guidelines will be prepared for additional character areas in the future.

### 1.1 DRUID HILLS LOCAL HISTORIC DISTRICT

The Druid Hills Local Historic District has been designated by the Board of Commissioners of DeKalb County under the authority of the 1994 DeKalb County Historic Preservation Ordinance. This ordinance provides for a uniform procedure for designation of historic properties and districts. Such designation, and the subsequent implementation of the design review process, is primarily intended to recognize and preserve the unique character and integrity of these areas and properties while also allowing for their active use. (For boundaries of the district see *Map A: Local Historic District*.)

The DeKalb County Ordinance has established that designated historic districts:

- \* *have special character or special historic or aesthetic value or interest;*
- \* *represent one or more periods, styles, or types of architecture typical of one or more eras in the history of the county, state, or nation;*
- \* *cause such area, by reason of such factors, to constitute a visibly perceptible section of the county;*
- \* *are currently on or have been declared eligible ... for listing in the National (or Georgia) Register of Historic Places.*

The Druid Hills Local Historic District meets these criteria.

### 1.2 DEFINING THE DISTRICT BOUNDARIES

The Druid Hills Local Historic District is an area of historic and architectural significance defined within the boundaries of the Druid Hills Civic Association (DHCA), established in 1938. District boundaries on the west, south, and east sides are in part defined by jurisdictional boundaries—Fulton County to the west, the City of Atlanta to the west and south, and the City of Decatur to the east. (See *Map B: Area Context*.) Within these parameters and the limits of the DHCA, a core area has been defined for the district encompassing two existing National Register districts (Druid Hills and Cameron Court) and one pending National Register district consisting of the University Park, Emory Estates, and Emory Highlands developments. (See *Map C: National Register Districts*.)



Surrounding this core area are other historic developments that have been included in the local district—to the west, Briarwood, Rosedale, Druid Hills Heights, and the west side of Briarcliff Road, not included in the National Register district; and, to the northeast, Emory Grove, a 1940s planned development.

Chelsea Heights and Parkwood, southeast of the core area, have been included because of their historic development patterns. Housing in these subdivisions dates to the 1950s and 1960s, but the road patterns and layout date to the 1920s in Parkwood and the 1930s and 1940s in Chelsea Heights.

An important historic and environmental component of Druid Hills is the Peavine and Lullwater Creek system. One area located on the Emory University campus, Peavine Creek and the open area buffering its west bank, has been included to protect this fragile natural historic resource.

Buffer areas have been included in certain places at the edges of the district. These buffer areas include nonhistoric properties, changes to which have the potential to impact surrounding historic properties as well as the district as a whole. Falling into this category are certain areas along Briarcliff Road and some nonhistoric developments along the southern boundary of the district.

Finally, intrusions (that is, areas with a high concentration of nonhistoric development) within the core area are included because of their potential to impact surrounding historic properties and the district as a whole. Intrusions include development along Ponce de Leon Manor, Ridgecrest Court, Artwood Road, Barton Woods Road, Briardale Lane, and Vilenah Lane/Dan Johnson Road.

### 1.3 GOALS & OBJECTIVES

Designation of the Druid Hills Local Historic District and implementation of these design guidelines will contribute greatly to the realization of the following broad goals.

**1** The primary goal for the community is to preserve the historic and visual integrity so they continue to convey a sense of time and place associated with periods of historic development. The historic relationships of buildings to each other, their sites, lot layouts, and landscapes are important.

**2** The primary goal for individual historic resources is to preserve the integrity of each surviving historic structure, lot layout pattern, and site. Design guidelines for alterations should focus on appropriate rehabilitation procedures that will retain those character-defining features that distinguish the historic resource while allowing for appropriate development. These guidelines should be con-

gruent with the Secretary of the Interior's Standards and Guidelines for Rehabilitation of Historic Buildings.

**3** The primary goal for new development is to accommodate stylistic change while maintaining visual integrity. In this approach designs for new buildings reflect the basic neighborhood characteristics of siting, setback, mass, scale, and materials and contain features that are similar to those of historic structures. Both new designs and new interpretations of historic designs are appropriate provided that they are compatible with their surroundings.

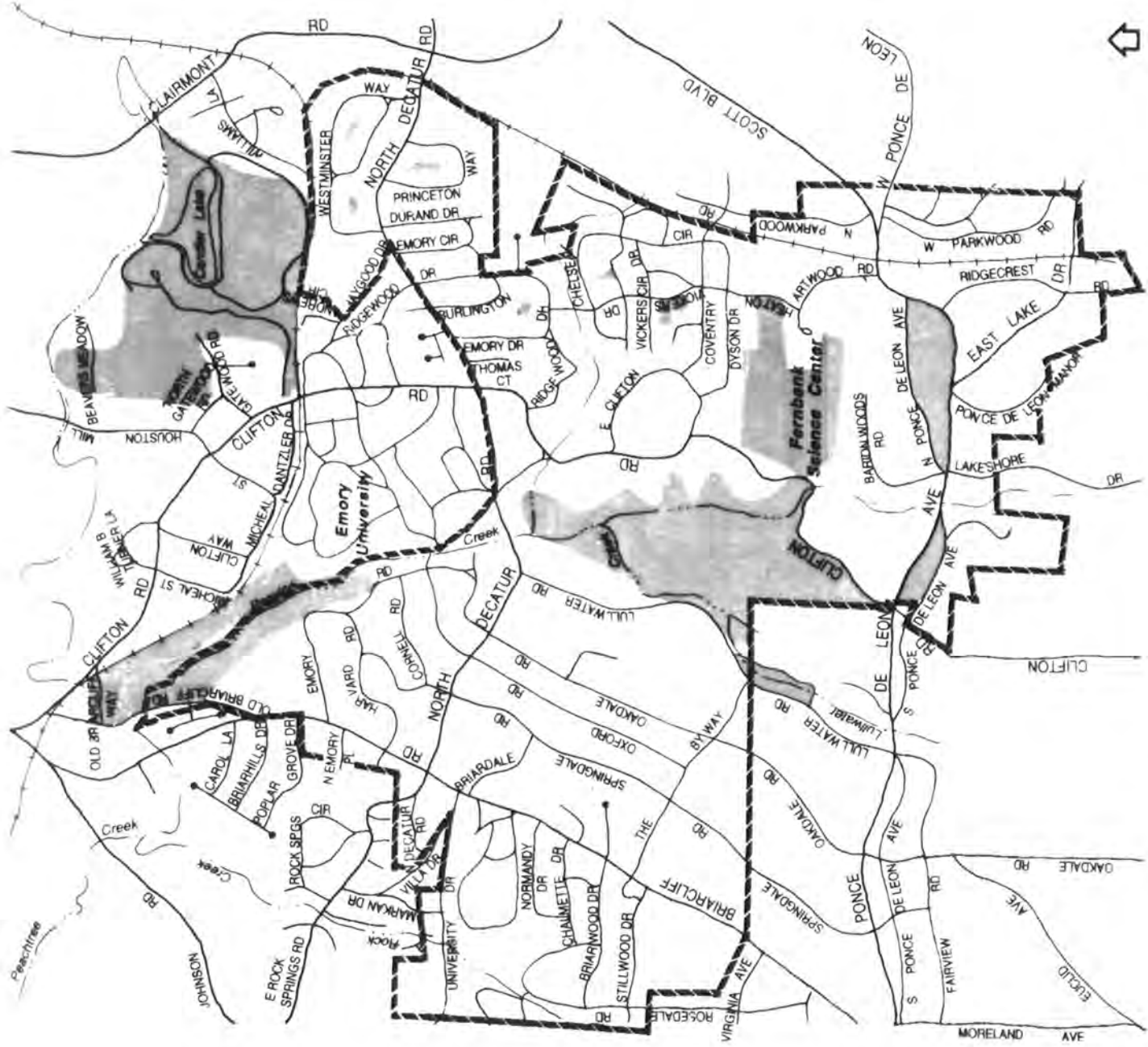

**4** The primary goal for the natural history of the community is to protect the historic landscape design through preservation and rehabilitation of the natural elements—urban forest and Peavine/Lullwater Creek system—on which it was based. Historic integrity of the curvilinear pattern of roads and platting of lots should also be retained in order to protect the visual appearance of the community and water quality in area streams.



**Druid Hills Local Historic District**  
DeKalb County, Georgia

**Illustration A**

**LOCAL HISTORIC DISTRICT**

Legend	
	District Boundary
	Open Space
	Creek System



Not to Scale

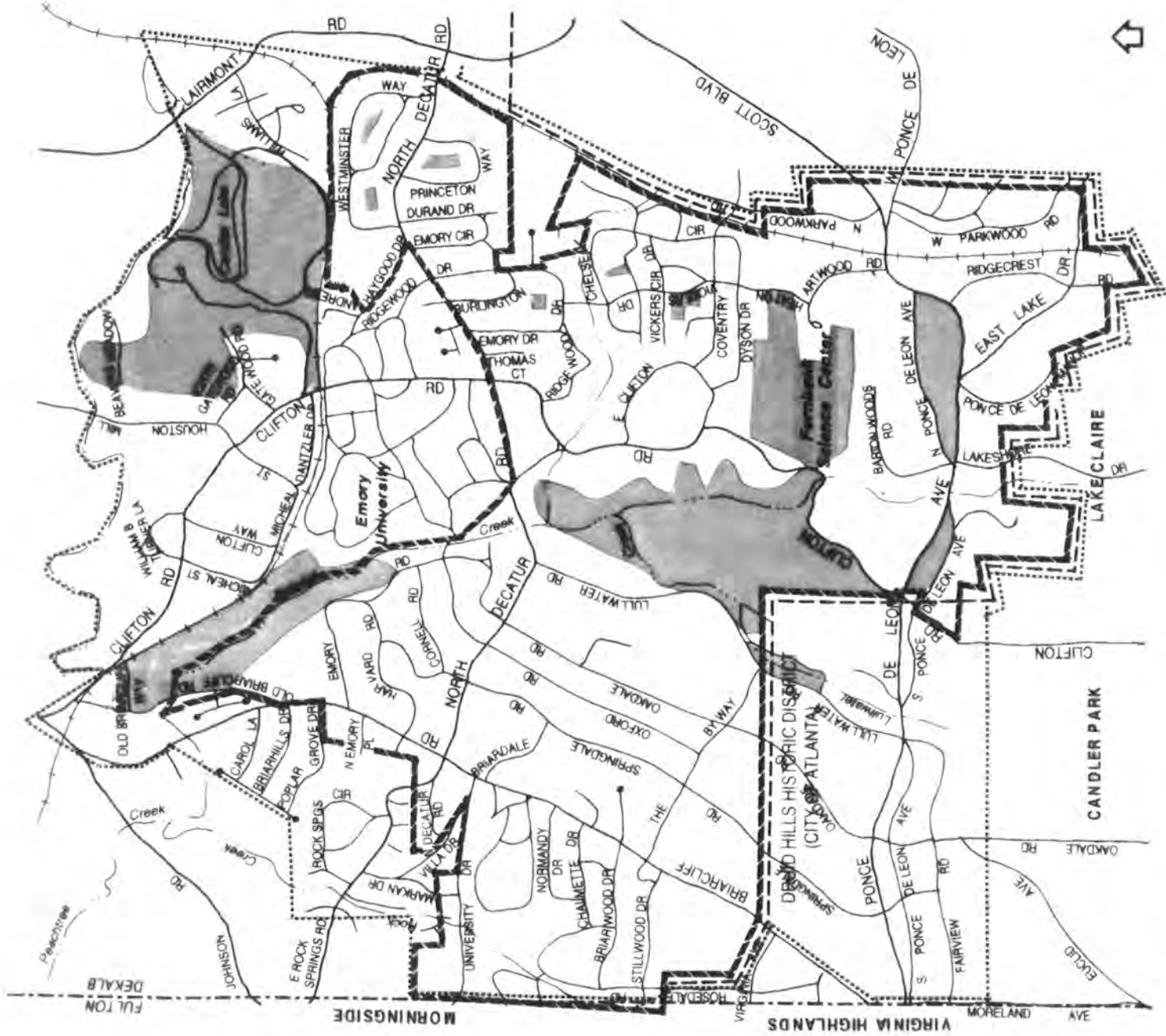

**Illustration B**

**Druid Hills Local Historic District**  
DeKalb County, Georgia

**AREA CONTEXT**

Legend	
	Druid Hills Local District Boundary
	Atlanta City Limits
	Decatur City Limits
	Druid Hills Civic Association
	Open Space
	Fulton/DeKalb County Line



Not to Scale



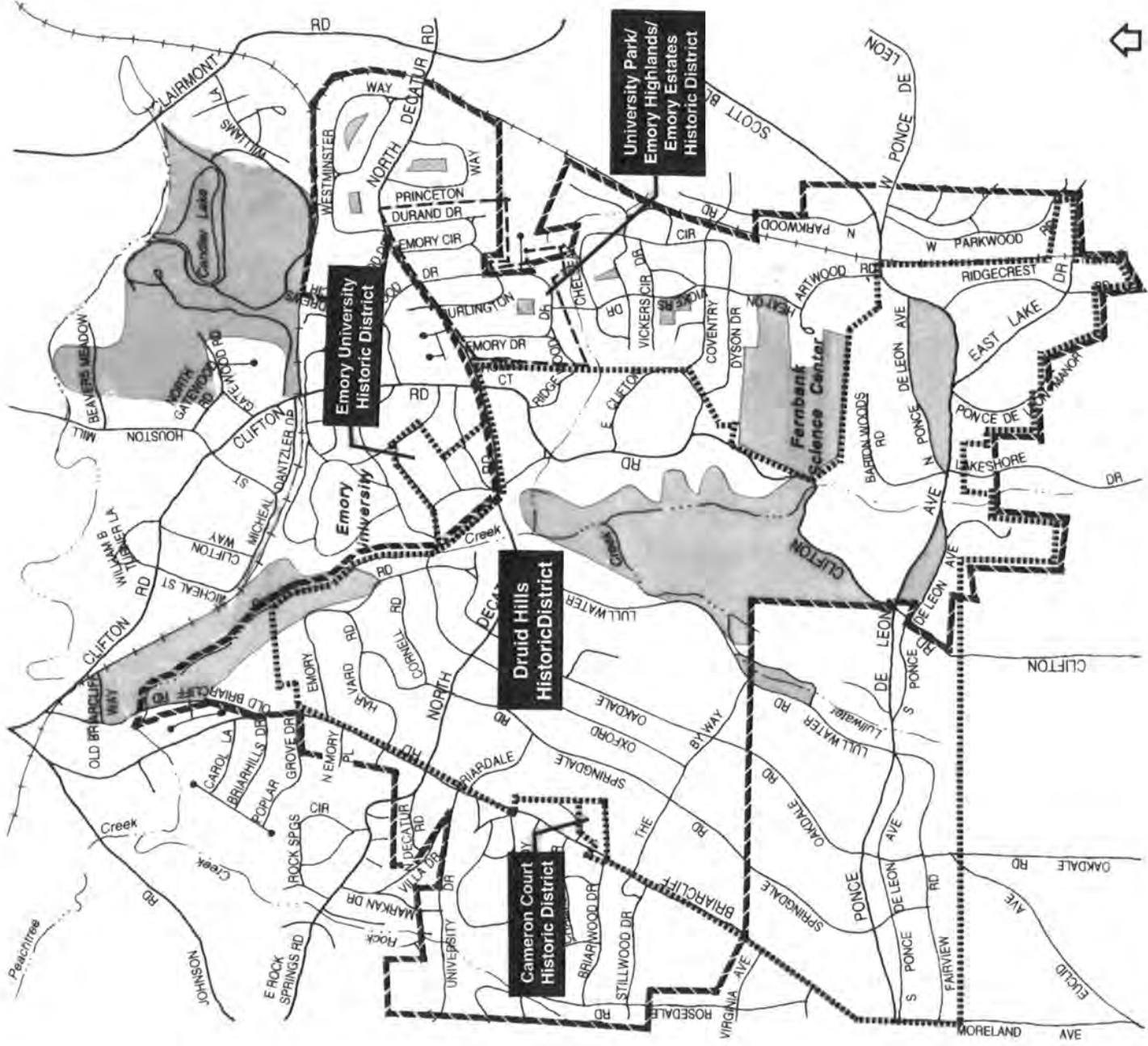



**Druid Hills Local Historic District**  
DeKalb County, Georgia

**Illustration C**

**NATIONAL REGISTER DISTRICTS**

**Legend**

-  Druid Hills Local District Boundary
-  Pending National Register Boundaries
-  Open Space
-  Listed National Register Boundaries

-  Pending National Register Boundaries



Not to Scale

---

## 2.0 DESIGN REVIEW IN DEKALB COUNTY

The DeKalb County Historic Preservation Ordinance was passed in 1994 by the authority of the 1980 Georgia Historic Preservation Act. A copy of the ordinance can be obtained from the DeKalb County Planning Department. This manual does not serve as a substitute for the ordinance, and any property owner interested in the content of the ordinance should obtain a copy as a supplement to this publication.

The primary purpose of the ordinance is stated to be

*to establish a uniform procedure for use in providing for the protection, enhancement, perpetuation and use of places, districts, sites, buildings, structures, objects, landscape features and works of art having a special historical, cultural or aesthetic interest or value*

The DeKalb County Historic Preservation Commission, a seven-member commission consisting of licensed professionals and others with a demonstrated interest in relevant fields, has been established as the administrative authority for the ordinance. The ordinance lists twelve areas of responsibility for the commission. Of particular interest to these guidelines are their responsibilities to

- 1 *prepare and maintain an inventory of all properties which have the potential for designation as a historic property;*
- 2 *recommend to the County Board of Commissioners specific properties and/or districts to be designated by the ordinance; and*
- 3 *review applications for certificates of appropriateness and grant or deny the same in accordance with the provisions of the ordinance.*

Once a district has been designated, all "material changes in appearance" of any property within a district are prohibited prior to the issuance of a Certificate of Appropriateness by the Historic Preservation Commission.

**CERTIFICATE OF APPROPRIATENESS (COA)** is defined in the ordinance as "a document evidencing approval by the Historic Preservation Commission of an application to make material change in the appearance of a designated historic property or of a property located within a designated historic district."

## 2.1 OBTAINING A CERTIFICATE OF APPROPRIATENESS -WHEN IS DESIGN REVIEW REQUIRED?

Design Review is the process by which the DeKalb County Historic Preservation Commission approves major changes that are planned for locally designated properties and districts and issues Certificates of Appropriateness which allow the proposed changes to take place.

There is a four-step process for obtaining a Certificate of Appropriateness:

STEP 1: Determining Whether a Certificate of Appropriateness Is Needed

STEP 2: Submitting an Application for a Certificate of Appropriateness to the DeKalb County Historic Preservation Commission

STEP 3: Commission Review of the Application/Consultation with Property Owner/Public Hearing Upon Request

STEP 4: Application Approved - Certificate of Appropriateness Issued

OR

Application Denied - Owner Makes Design Changes and Resubmits Application

### STEP 1: DETERMINING WHETHER A CERTIFICATE OF APPROPRIATENESS IS NEEDED

Owners planning projects that would constitute a "material change in appearance" to a property located within the district are required to file an application for a COA with the Preservation Commission.

A **MATERIAL CHANGE IN APPEARANCE** is defined by the ordinance as follows:

*a change that will affect either the exterior architectural or environmental features of a historic property or any building, site, object, landscape feature or work of art within a historic district such as:*

**1** A reconstruction or alteration of the size, shape or facade of a historic property, including relocation of any doors or windows or removal or alteration of any architectural features, details or elements.

**2** Demolition or relocation of a historic structure;

**3** Commencement of excavation for construction purposes;

**4** A change in the location of advertising visible from the public right-of-way; or

**5** The erection, alteration, restoration or removal of any building or other structure within a historic property or district, including walls, fences, steps and pavements, or other appurtenant features.

Ordinary maintenance or repair (includes painting) of any exterior architectural feature that does not involve a material change in design, material, or outer appearance is excluded from review. Also, interior changes to properties that do not have an effect on exterior appearance are also excluded from review.

Typically, application for a building permit, land development permit, zoning variance, or re-zoning triggers the design review process.

## STEP 2: SUBMITTING AN APPLICATION FOR A CERTIFICATE OF APPROPRIATENESS TO THE HISTORIC PRESERVATION COMMISSION

Applications are to be submitted to the DeKalb County Planning Department.

Applications are to be accompanied by drawings, photographs, plans and other documentation (as required by the Commission) detailing the proposed project.

The professional staff of the DeKalb County Planning Department can act as a resource when planning a project.

## STEP 3: COMMISSION REVIEW OF THE APPLICATION/CONSULTATION WITH PROPERTY OWNER/PUBLIC HEARING UPON REQUEST

When reviewing applications, the Commission considers the U.S. Secretary of the Interior's "Standards for Rehabilitation" (see *Section 5.3*) and the following factors:

- ✦ historical and architectural value and significance
- ✦ architectural style
- ✦ scale, height, and setback
- ✦ landscaping
- ✦ general design
- ✦ arrangement
- ✦ texture and materials of the architectural features involved and their relationship to the exterior architectural style
- ✦ pertinent features of other properties in the immediate neighborhood

These design guidelines will also serve as a tool in reviewing applications.

The professional architects, landscape architects, and historic preservation planners serving on the Preservation Commission can act as resources when planning a project.

## STEP 4: APPLICATION APPROVED - CERTIFICATE OF APPROPRIATENESS ISSUED

The Commission shall approve or deny an application within 45 days after a complete application has been filed. Failure of the Commission to act within this time period shall constitute approval and no other evidence is needed.

A COA will be issued if the Commission finds that the proposed material change(s) would not have a substantial adverse effect on the aesthetic, historic or architectural significance and value of the property or district.

The Commission may approve the application as proposed or with modifications.

A COA becomes void unless construction is begun within 12 months of the date of issuance.

OR  
Application Denied - Owner Makes Design Changes and Resubmits Application

If an application is denied, the Commission will notify the applicant in writing of its decision and state the reasons for the denial. The Commission may suggest alternative courses of action.

The applicant may make modifications to the plans and may resubmit the application at any time after doing so.

The rejection of an application for a COA shall be binding upon the Development Division of the DeKalb County Public Works Department and no permit shall be issued.

**Four Step Process For Obtaining Certificate of Appropriateness (COA)**

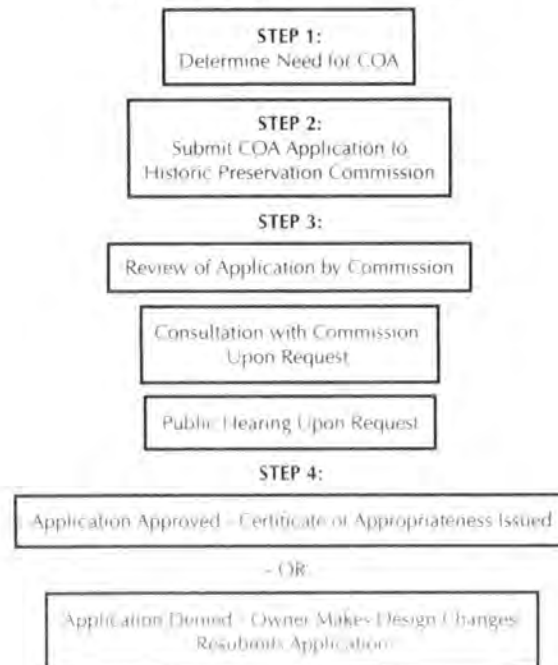

## 2.2 COORDINATION WITH OTHER COUNTY ORDINANCES & LAND DEVELOPMENT REGULATIONS

These design guidelines are concerned with changes to the external appearance of historic district properties and do not affect the use of property which is otherwise regulated through the zoning ordinance and building and development codes. For example, a property owner wishing to renovate a residence for use as an office in an area zoned residential would need to file for rezoning; if proposed changes would alter the exterior appearance of the property, the owner would also have to file a "Request for Certificate of Appropriateness" in order to make those changes. The Historic Preservation Commission would not, however, comment on the proposed use of the property.

Applications for building permits, land development permits, and zoning variances are submitted to the Development Division of the DeKalb County Public Works Department. Any applications received for properties located in the historic district will also be reviewed by the Planning Department staff for the Historic Preservation Commission to determine if the property owner needs to submit an application for a Certificate of Appropriateness to the Preservation Commission. Again, the criteria for determining the need for a COA is the standard of a "material change in appearance."

**1** **BUILDING PERMITS** are required for any type of physical improvements with the exception of routine maintenance. Therefore, the only type of building permit that would likely not trigger the design review process are permits for changes to building interiors. It will still be necessary, however, for the Planning Department to review these applications.

**2** **LAND DEVELOPMENT PERMITS** are required for new construction and the subdivision of property. The Planning Commission reviews applications to assure that the planned development meets the requirements of the zoning ordinance and also protects the flood plain based on state requirements. The Historic Preservation Commission shall comment on any design proposals submitted with the application, such as land subdivision, lot layout and pattern, and site plan. If rezoning is requested, the Commission shall provide comment, and it may be necessary for the owner to apply for a COA.

**3** Requests for **ZONING VARIANCES** are made when a property owner desires to make changes to a property that would violate one or more of the conditions of the existing zoning classification. For example, a property owner may wish to make an addition to the front of a building that would encroach upon the required setback. The Board of Zoning Appeals would have to approve such a request. In cases where requests could relate to an issue addressed in these design guidelines, such as setback or variances that affect lot layout, they shall be passed on to the Preservation Commission staff person for review. The staff person will have the authority to determine if a COA is needed or whether the proposed change is of no consequence under the design guidelines.

**4** Applications for **REZONING** are submitted directly to the Planning Department and reviewed by the Planning Commission. The Historic Preservation Commission shall be allowed to comment on such applications to determine if the proposed zoning classification would potentially impact the historic district.

**5** There are some types of projects that, while constituting a “material change in appearance,” **do NOT REQUIRE A PERMIT OR VARIANCE** of any kind. For example, driveway changes, cutting trees, placing fences, and so on, do not require any of the above-mentioned permits or applications. The DeKalb County Historic Preservation Commission will identify those types of changes that it intends to review and will work with the enforcement division of the Public Works Department to develop a system for assuring compliance with the ordinance. Such monitoring is typically an administrative function reserved for the appointed staff of the Preservation Commission.

In the case of land development permits, zoning variances, and rezoning, applications for building permits would typically be required at some point and would then trigger the design review process. It is important, however, that the Historic Preservation Commission be brought into the permitting process as early as possible so that property owners are aware of the implications of the design guidelines to their project plans.

## 2.3 PERIODIC REVIEW of GUIDELINES by PRESERVATION COMMISSION

**T**he Preservation Commission will review the guidelines periodically to gauge the effectiveness and fairness of the guidelines, to ensure the original intent of historic preservation without undue overregulation, and to eliminate coordination problems with other county codes and administrative procedures.

## 2.4 STATE AND FEDERAL REVIEW PROCESSES

**R**eview of design projects in Druid Hills may also take place at the state and federal levels, under two sets of conditions. The first concerns projects with some level of federal involvement (funding or licensing) that will impact one or more historic properties. According to Section 106 of the **1966 NATIONAL HISTORIC PRESERVATION ACT**, federal agencies must provide the President’s Advisory Council on Historic Preservation an opportunity to comment on the effect of federal, federally assisted, or federally licensed projects involving properties or districts either listed in or eligible for listing in the National Register of Historic Places. Most often it is in fact the State Historic Preservation Office that carries out these reviews. The Secretary of the Interior’s “Standards for Rehabilitation” are always the criteria for evaluation. The comments made are not binding but merely advisory, although this process has in many cases led to modifications of proposals and more sympathetic treatments of historic resources.

Federal involvement will also occur when a property owner wishes to take advantage of **FEDERAL REHABILITATION TAX INCENTIVES** or grants. An income tax credit is available for qualifying rehabilitation projects, and applicants must submit a two-part application to the State Historic Preservation Office. Part One of this application documents the significance of the property while Part Two is a description of the project. After this documentation has been reviewed at the state level, it is sent on to the National Park Service for a final review and a decision concerning the application for tax credits. Again, the Secretary of the Interior’s “Standards for Rehabilitation” are utilized in these evaluations. Persons desiring further information on the tax incentives for historic preservation projects should contact the Historic Preservation Division of the Georgia Department of Natural Resources.

In 1989 the Georgia General Assembly passed a **STATEWIDE PROPERTY TAX DEFERMENT** program for qualified major rehabilitations of properties listed in or determined eligible for listing in the Georgia Register of Historic Places or the National Register of Historic Places—either individually or as a contributing building within a historic district. The law provides for an eight-year freeze on property tax assessments for a historic property that has undergone a “substantial” rehabilitation. As with the federal tax incentives, the application process has two parts. This deferment has been adopted by the DeKalb County Board of Commissioners. For more information on the program, contact the DeKalb County Tax Assessor’s Office and the Historic Preservation Division of the Georgia Department of Natural Resources.



---

## 3.0 HISTORIC DEVELOPMENT

The historic development of the Druid Hills area took place over an approximately forty-year period from the beginning of construction around 1905 into the mid-1940s. Before the suburb of Druid Hills was conceived, the area was rural countryside between the cities of Atlanta and Decatur. Several farms were located here, and a network of roads ran through the area connecting surrounding communities. These roads included those that became Briarcliff, North Decatur, Euclid, Clifton, and Durand Mill Roads. A section of the CSX Railroad corridor to the east was in place as well.

The residential suburb of Druid Hills was envisioned by Atlanta developer Joel Hurt. In the 1890s he organized the Kirkwood Land Company and purchased approximately 1,500 acres of land on which to construct the suburb. Hurt secured the services of nationally renowned landscape architect Frederick Law Olmsted, Sr., to plan and design Druid Hills.

Druid Hills was designed and planned as a whole by Olmsted and his successor firm, the Olmsted Brothers, from 1893 into the early 1900s. Several conceptualizations of the suburb's design were done on area topographic maps by Olmsted as he developed his ideas for the suburb. As Druid Hills developed in the years to follow, the basic concepts of his design were adhered to, although a number of specific elements were eliminated and others were redesigned. For example, some roads were realigned, and other roads were added. Two proposed lakes were never built, but the concept of a large open space in the middle of the suburb to protect the area's natural creek system was realized with the construction of the golf course.

The area that most closely follows Olmsted's design plans is the linear parkway of Ponce de Leon Avenue. The Olmsted Brothers' 1905 General Plan specifically laid out the parallel street pattern, the succession of park spaces, the trolley line, and the siting of street trees and made recommendations for the placement of houses on lots. Very detailed landscaping and planting plans were also prepared for this linear corridor.

The General Plan was laid out by civil engineer O. F. Kauffman, who platted a large portion of the Druid Hills area as well as many of the surrounding developments. Kauffman's exposure to Olmsted's design concepts clearly influenced his work on these later developments.

Construction began on road layout in the Ponce de Leon corridor area in 1905. In 1908, Hurt's Kirkwood Land Company and its Druid Hills holdings were sold to a group of local businessmen who organized the Druid Hills Corporation to continue the planning and development of the suburb. These businessmen included the Coca-Cola Company's Asa Candler and Atlanta real estate developers George and Forrest Adair.

The Druid Hills Corporation continued with the development of Druid Hills. With developments, changes were made to the original plans in order to better suit the economic trends of the early-twentieth-century real-estate market. Some road alignments were altered, and many areas were replatted to provide smaller, more affordable lots in a denser development pattern. Olmsted's original plan for a suburb of large estates had to be adjusted to fit early-twentieth-century economic trends, but his concept of a landscaped suburb was maintained.

The Ponce de Leon corridor continued to be developed in much the way Olmsted had designed it. Fairview (in the City of Atlanta), Springdale, Oakdale, and Lullwater Roads also followed their original designs as parallel, meandering streets that ran northeast from Ponce de Leon Avenue following the area's natural topography. The northern ends of these roads, however, were realigned to intersect with North Decatur Road rather than with each other as originally planned. These roads were in place by 1910, and development began there in the early 1910s. Oxford Road was added between Springdale and Oakdale by 1920 to allow access of the streetcar line into the northern sections of the suburb and to Emory University.

The Emory/Harvard/Cornell Roads area north of North Decatur Road was platted in 1915. A more dense curvilinear street pattern with smaller lots and more modestly sized houses resulted in a development pattern denser than that south of North Decatur Road. Several large parcels were reserved in this area for community purposes such as park space, commercial, and a high school, originally planned for the Springdale-Harvard-Emory Road corner.

Also in 1915 Asa Candler donated approximately seventy-five acres of land for the development of an Atlanta campus for Emory University. Situated on the north side of the suburb, this land was part of Candler's large estate in the area. The first buildings on the new campus were constructed between 1916 and 1919.

The Lullwater Subdivision was also subdivided from Candler property and platted in 1924. This area between Oxford and North Decatur Roads was laid out and developed in much the same way as the adjacent Emory/Harvard/ Cornell Roads area.

While portions of Clifton Road existed before Druid Hills, the existing Clifton/ East Clifton Road area was platted in 1924. The 1924 plat shows the road alignments and lot layouts much as they are today. The adjacent golf course and clubhouse shown on the plat had been previously constructed in the 1910s.

Both East Lake and Ridgecrest Roads were included in the 1905 General Plan. The existing street patterns follow the original design, but both areas were replatted with smaller lots—East Lake in 1919 and Ridgecrest in 1922.

At the same time the Druid Hills suburb was being platted and developed, other similar developments were being planned on adjacent parcels of land. These developments were inspired and influenced by the planning and design concepts of the Druid Hills plan.

One of these developments was Druid Hills Heights, to the west of the Druid Hills suburb and Briarcliff Road. First platted in 1917, the plan was revised in the 1920s and development began soon after. An adjacent area originally platted separately as University Park became part of Druid Hills Heights.

To the east of Druid Hills, another University Park was first platted in 1916, and development began there in the 1920s. University Park was the first of several small-scale, U-shaped developments densely designed to fit onto small parcels of land. Next to University Park, Emory Highlands was platted in 1923 and Emory Estates in 1925 following this same densely designed, U-shaped plan.

Cameron Court off Briarcliff Road also dates from the 1920s. This one-street development was designed by H. W. Nicholes and Harry Kuniansky, who reportedly developed alternating lots. Cameron Court is believed to be the first use of the cul-de-sac street design in the Atlanta area.

The Stillwood Subdivision was platted in 1926 as a single-street development running west off Briarcliff Road. The land was taken from the Hancock property, and the subdivision name came from the Hancock house, Stillwood.

The Chelsea Land Company began platting property to the east of the Clifton Road area of Druid Hills as early as 1912-13. The company owned a fairly large parcel of land that extended east of the railroad. The streets of the Chelsea Heights

Subdivision were laid out during the late 1920s to early 1930s. Revisions were made to the neighborhood plats in 1930 and 1937. While the curvilinear street pattern was influenced by neighboring Druid Hills, the subdivision's much more compact plan was distinctly different. Development took place during the 1950s and 1960s according to the historic plan.

Located east of the railroad corridor, Parkwood was included in the original Druid Hills plan, but with a different proposed street design. The streets were redesigned and at least preliminarily laid out by 1928. The design of Parkwood emulates the Olmsted design concepts of Druid Hills extremely well. Development occurred in Parkwood during the 1950s and 1960s according to the historic plan.

The Emory Grove development was platted and laid out in two separate sections—the first in 1939 south of North Decatur Road and the second in 1941 north of North Decatur Road. These areas were developed by a single developer, Neal Smith, who built one basic house type in several variations, giving the neighborhood a uniform appearance. Houses were built here into the mid-1940s, reflecting a dense 1940s residential development pattern.

The subdivision of Briarwood Hills was platted and laid out to the west of Briarcliff Road in 1940 by the development company Briarwood, Inc. An additional area was platted in 1941. This area was part of the Hancock estate, as the adjacent Stillwood Subdivision had also been. Development in this area occurred in the 1940s and 1950s.

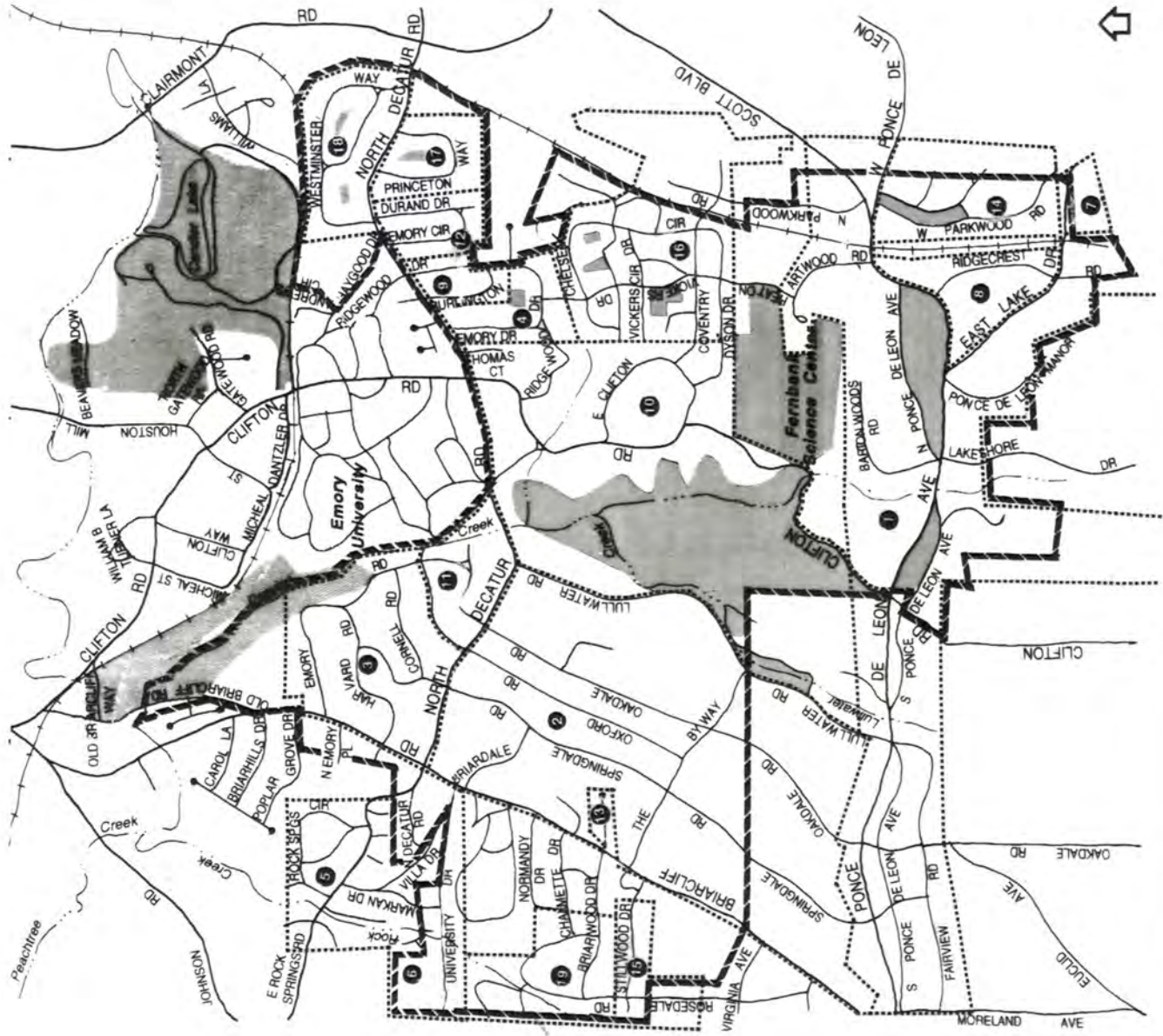

**Druid Hills Local Historic District**  
 DeKalb County, Georgia  
**Historic Development Plat Map**

Map Key	Subdivision Name	Firm Name	Date of Plat
1	Druid Hills 1905 General Plat	Oversted Bros/Kaufman	1905
2	Druid Hills	O. F. Kaufman, C. E.	c. 1910, 1926
3	Druid Hills	O. F. Kaufman, C. E.	1915
4	University Park (Emory Drive)	O. F. Kaufman & Bros.	1916
5	Druid Hills Heights (Rock Springs)	O. F. Kaufman & Bros., C. E.	1917
		C. H. Hughes	1922
		C. H. Hughes	1924
		C. H. Hughes	1924
6	University Drive	O. F. Kaufman	1905, 1919
7	East Lake	O. F. Kaufman	1905, 1922
8	Ridgecrest	O. F. Kaufman	1905, 1922
9	Emory Heights/Barrington	O. F. Kaufman	1923
10	Druid Hills	U. F. Kaufman, C. E.	1924
11	Lullwater Subdivision (Conall)	G. M. Corstals, C. E.	1924
12	Emory Estates (Emory Circle/Durand)	Hugh, C. E.	1925
13	Canaan Court	H. W. Hipsosaphery Kunsasy	1925
14	Parkwood	O. F. Kaufman	1925
15	Shirwood	O. F. Kaufman, C. E.	1925
16	Cheslea Heights (Pemberton)	K. T. Thomas, C. E.	1926
17	Emory Drive, South (Princeton)	O. F. Kaufman & Bros., C. E.	1912
18	Emory Drive, North	Kaufman Bros. & Sons	1915, 1937
19	Barrington Hills	U. R. Roberts & Co., C. E.	1939
		C. R. Roberts & Co.	1941
		Barrwood, Inc.	1940



Not to Scale

---

## 4.0 HISTORIC RESOURCES - ANALYSIS OF EXISTING CONDITIONS & HISTORIC CHARACTER

### 4.1 LANDSCAPE ARCHITECTURE

#### 4.1.1 DEVELOPMENT PATTERNS - FORM AND LAYOUT

The Druid Hills Local Historic District is one of Atlanta's most historically significant landscapes. The original section of Druid Hills was designed by Frederick Law Olmsted, considered to be the "Father of Landscape Architecture" and also called our nation's "most comprehensive environmental planner and designer."<sup>1</sup> Olmsted assisted Joel Hurt and the Kirkwood Land Company in early designs for Druid Hills. After Olmsted's death in 1903, his company, Olmsted Brothers, under the leadership of his son John, continued to be involved in the project. The Olmsted firm created the "1905 General Plan" which guided development along Ponce de Leon Avenue. Earlier concept plans by F. L. Olmsted included the entire Druid Hills Suburb, extending to areas north of Ponce de Leon Avenue along today's Springdale, Oakdale, Lullwater, and Clifton Roads.

Olmsted's influence is evident throughout the Druid Hills Local Historic District, even in neighborhoods outside the boundaries of the original planning area. Many of these subsequent neighborhoods were designed by O. F. Kauffman, a civil engineer, who assisted in the 1905 plan. Kauffman's association with Olmsted resulted in the incorporation of many Olmstedian principles in these later neighborhoods. In most cases, Kauffman's layouts were sensitive to the existing terrain and hydrology. The preservation of open spaces from Olmsted's original concepts was retained in Kauffman's detailed plat designs. Olmsted's original streetscape form with designated spaces for street tree plantings and pedestrian paths was also an element in Kauffman's neighborhoods and others in the district.

*Illustration E: O. F. Kauffman Plats* shows the extent of Kauffman's involvement. Based on rough calculations, Kauffman appears to have been directly associated with the layout of about 70 percent of the Druid Hills Local Historic District.

Other neighborhood designers also refer to many Olmstedian characteristics, though direct ties to Olmsted have not been documented. Emory Estates in 1925 by C. A. Nash; Stillwood in 1926 by K. T. Thomas, C.E.; and Emory Grove by C. R. Roberts in 1939 and 1941 are examples of other subdivision plats and their designers. Emory Estates follows the traditional Druid Hills streetscape section. Emory Grove is particularly Olmstedian in its pedestrian circulation within the by-walks and the presence of several interior park spaces.

<sup>1</sup> Albert Fine, *Frederick Law Olmsted and the American Environmental Tradition*, (New York: George Braziller, 1972), p. 3.

### 4.1.2 NATURAL LANDSCAPE

The Druid Hills Local Historic District is a cultural landscape within a natural setting that contains remnants of a mature hardwood forest within a system of creek corridors. The district is located in the Georgia Piedmont within the Peavine and Lullwater Creek Watershed. The district; portions of Edgewood, Kirkwood, Candler Park, Lake Claire, and Poncey Highlands; and the City of Decatur are included in this watershed. This watershed is located near the sub-continental divide, which separates the Atlantic Ocean and Gulf of Mexico drainage areas. *Illustration F: Peavine/Lullwater Creek Watershed Map* shows the extent of the entire watershed on a USGS base map.

This hydrological system was protected by F. L. Olmsted in his original design for Druid Hills and by the later subdivision designers as well. Roads and subdivision lots followed the natural topography, causing minimal disruption to the landscape. Long rectangular lots with houses sited toward the front of their lots fostered the preservation of drainage ways and stream corridors within rear yard spaces. Significant expanses of the natural landscape surrounding the creek corridors were preserved in the overall plan. Fernbank Forest, Druid Hills Golf and Country Club, the chain of parks along and adjacent to Ponce de Leon Avenue, and the open space surrounding Peavine Creek within the campus of Emory University create a network of green, open space areas that comprise a historic design feature of Olmsted.

Trees throughout the study area were originally part of an Oak-Hickory Climax Forest typical to the rolling terrain of the Georgia Piedmont. Remnants of this forest are still the predominant vegetation throughout the study area. The forest is characterized by white oak, southern and northern red oak, blackjack oak, post oak, sycamore, sweet gum, beech, mockernut hickory, pignut hickory, tulip poplar, black gum, white ash, sourwood, dogwood, redbud, and red maple. Several maturing pine stands are also found throughout the study area.

### 4.1.3 CULTURAL LANDSCAPE

The cultural landscape is composed of private yard spaces, predominately vegetated in naturalistic designs. Yards are typically composed of lawn, ornamental shrub and ground cover plantings, small trees, and large shade trees, many of native varieties. Streets are typically lined with small or large trees, most of which are placed within a publicly owned planting strip.

Residential landscape drawings by Olmsted illustrate the original intent. Individual yards were framed by planting beds filled with ornamental vegetation. Planting beds often lined driveways and walkways. The drives and walks connected the residences with the streets. The planting beds created a separation between individual lots. The balance of the front yard space was grass. In many yards, the lawn became almost a “clearing” surrounded by planting beds. (See *Illustration G: Residential Landscape Plan*.)

Olmsted’s intent for the public right-of-way spaces is contained in a drawing by Olmsted Brothers, dated April 5, 1902, and titled, “Typical cross sections for Parkway and 50’ Road to accompany plan No. 74.” (See *Illustration H: Roadway Section for Main Road of Parkway*.)

The main road of the parkway, Ponce de Leon Avenue, is shown with a 24’ wide drive, bordered by a 3’ wide stone gutter and 6’ wide tree strip. A 6’ wide walk borders the tree strip. Large shade trees are placed in the tree strip. The drawing also shows a vine strip, placed 2’ from the walk. Vines are apparently planted at the base of a fence, which provide an enclosure along the side of the roadway. The existence of this original feature has not been documented. The vine strip is bordered by a 5’ wide turf gutter that formed the edge of the 85’ wide right-of-way. Sloping lawn borders the public right-of-way. This same streetscape section is repeated on the opposite side of the street with a few minor modifications to allow for the “Electric Railroad.”

A drawing for the “50' Road” shows an almost identical streetscape section with two modifications—a 20' wide road and a 5' wide walk. A drawing for a “Side Road of the Parkway” suggests a smaller-scale version of the typical streetscape section with a 16' wide road and a 4' wide walk. (See *Illustration 1: Roadway Sections for 50' Road and Side Road of Parkway.*)

Pedestrian movement within Druid Hills has been enhanced by a system of “by-walks.” These features were not shown on Olmsted’s General Plan. A by-walk is a pedestrian path that bisects a block. On Springdale and Oakdale, the by-walks were used to access Oxford, where the trolley was located. In other areas of the local historic district, the by-walk is a recurring feature, sometimes cutting through the center of blocks and in other cases allowing access to interior park spaces. Though not a feature that can be directly attributed to Olmsted, the feature was used by Kauffman, Olmsted’s protégé, in the plat for the Springdale and Oakdale area. The feature was repeated by other designers in later sections of the Druid Hills subdivision, Emory Grove, and Woodland Park.

The open stone gutter and turf swale were apparently part of a storm water control system. This system is unique because it encouraged infiltration of storm water into the ground, thus recharging the water table and moderating the flow of area streams.

Olmsted’s choice of plant materials for private yard and public spaces was diverse. There was a combination of exotic and native species.

## Bridges

The railroad underpass on Ponce de Leon Avenue is an engineering structure that is an important historic resource in the Druid Hills area. It is clearly identified with the Druid Hills neighborhood with its “Druid Hills” terra cotta logo placed on either side of the concrete structure. The underpass was constructed to allow Ponce de Leon Avenue to continue unbroken to the east of the existing railroad line.

Railroad  
underpass on  
Ponce de Leon  
Avenue.



Several other historic bridges, all of which are concrete structures, exist within the Druid Hills area. These bridges carry rail, vehicular, and pedestrian traffic over the creeks and railroad line.



View of  
architecturally  
significant  
bridge balustrade  
over Peavine  
Creek at Oxford





**Druid Hills Local Historic District**  
DeKalb County, Georgia

**Illustration E**

**O. F. KAUFFMAN PLATS**

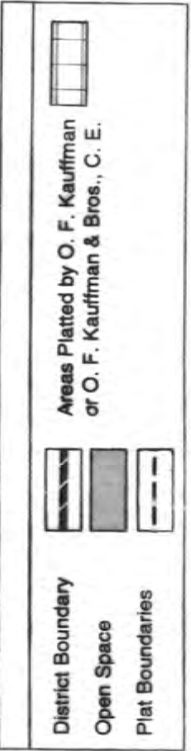

Not to Scale



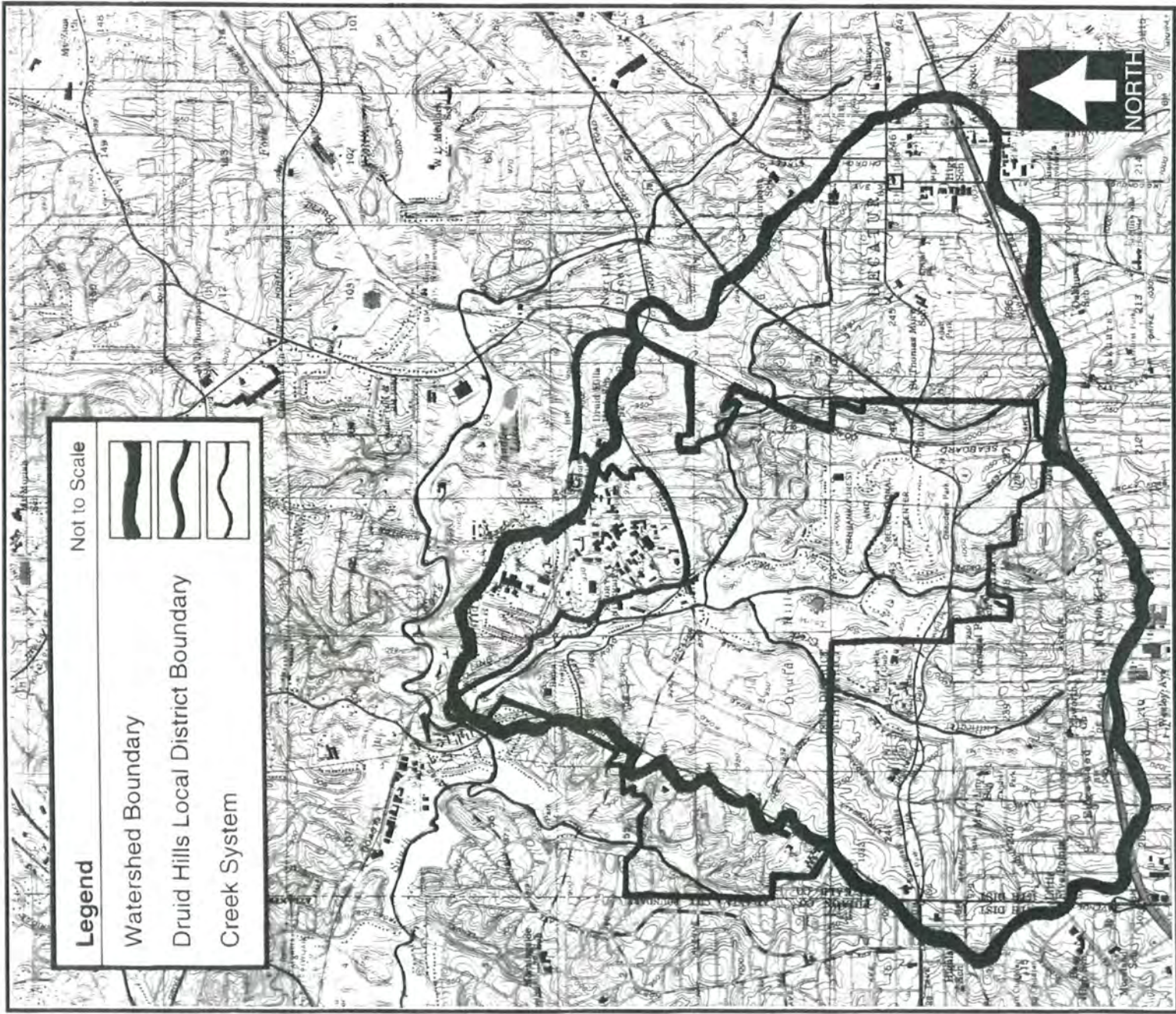

Peavine/Lullwater Creek Watershed Map Illustration F



**Residential Landscape Plan, Olmsted Brothers, 1903**

**Illustration G**

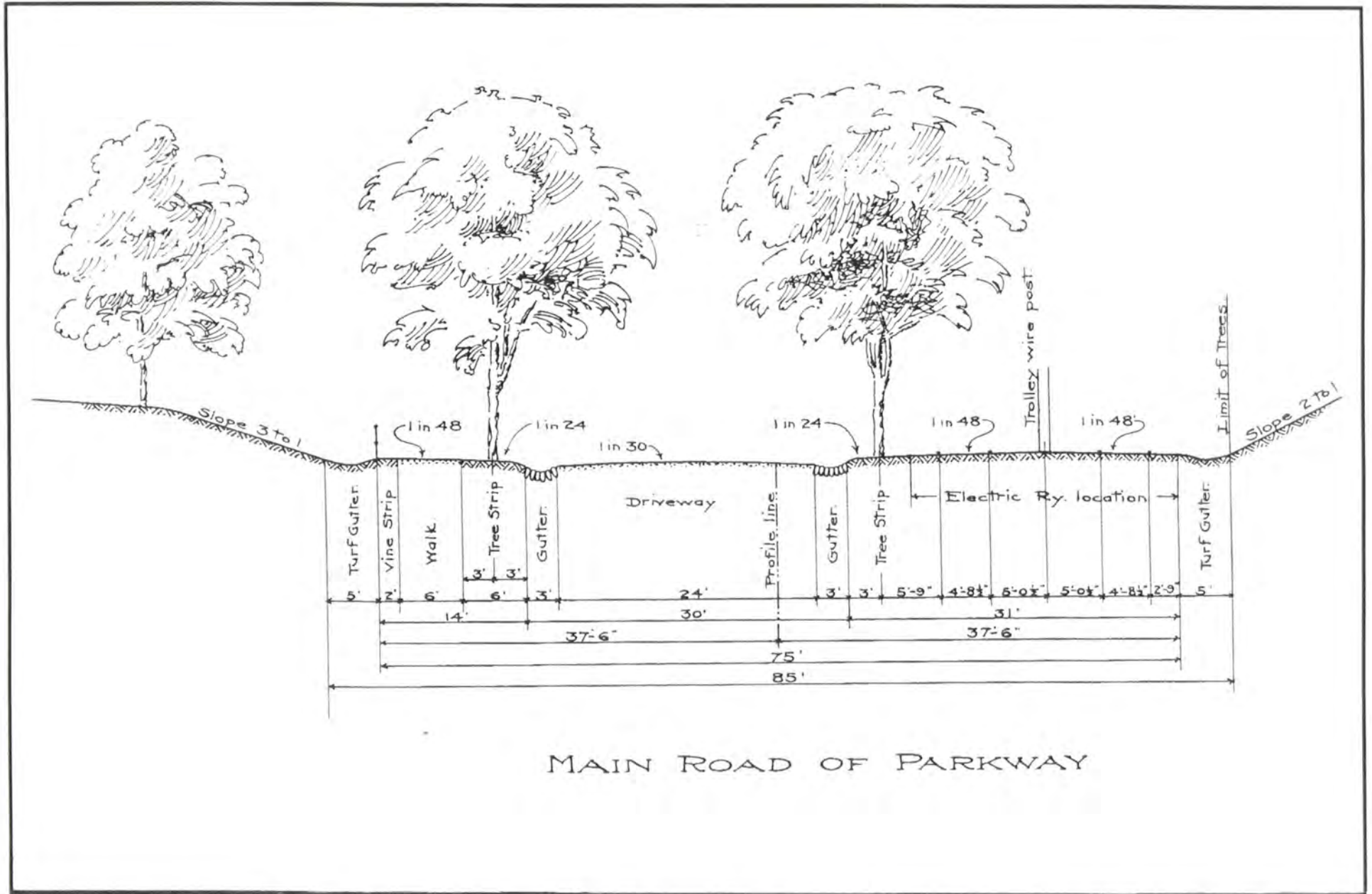

MAIN ROAD OF PARKWAY

Roadway Section For Main Road of Parkway, Olmsted Brothers, 1902 Illustration H

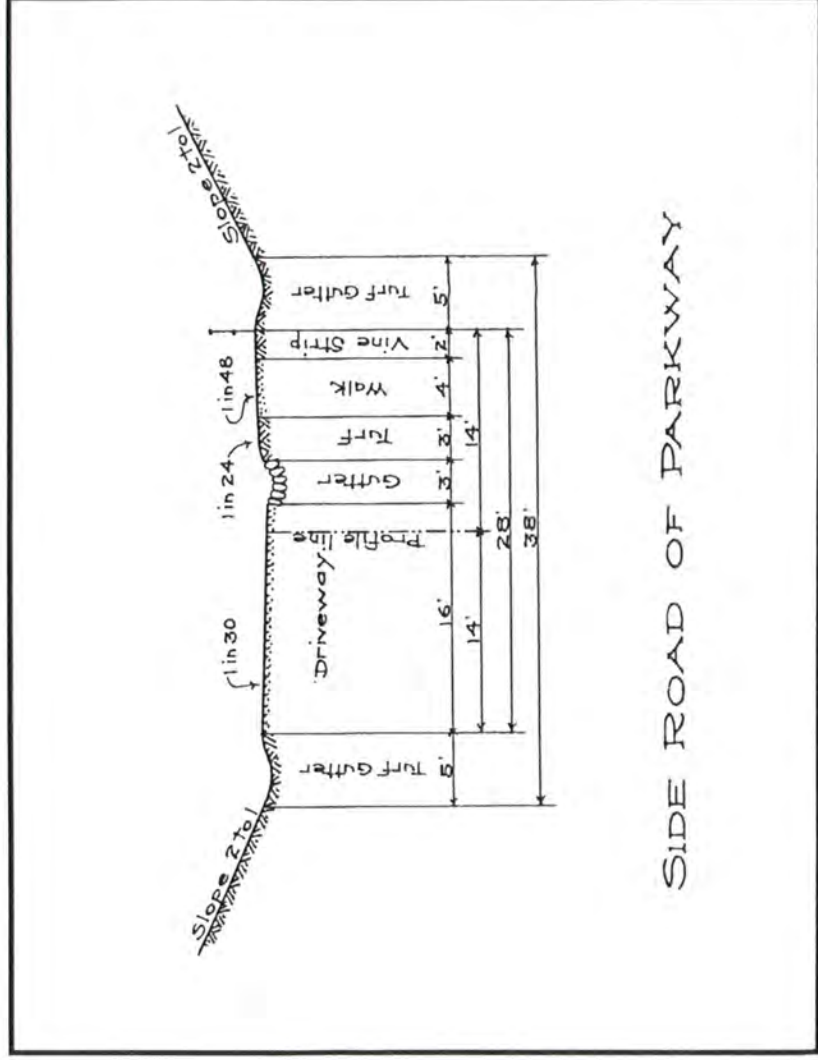
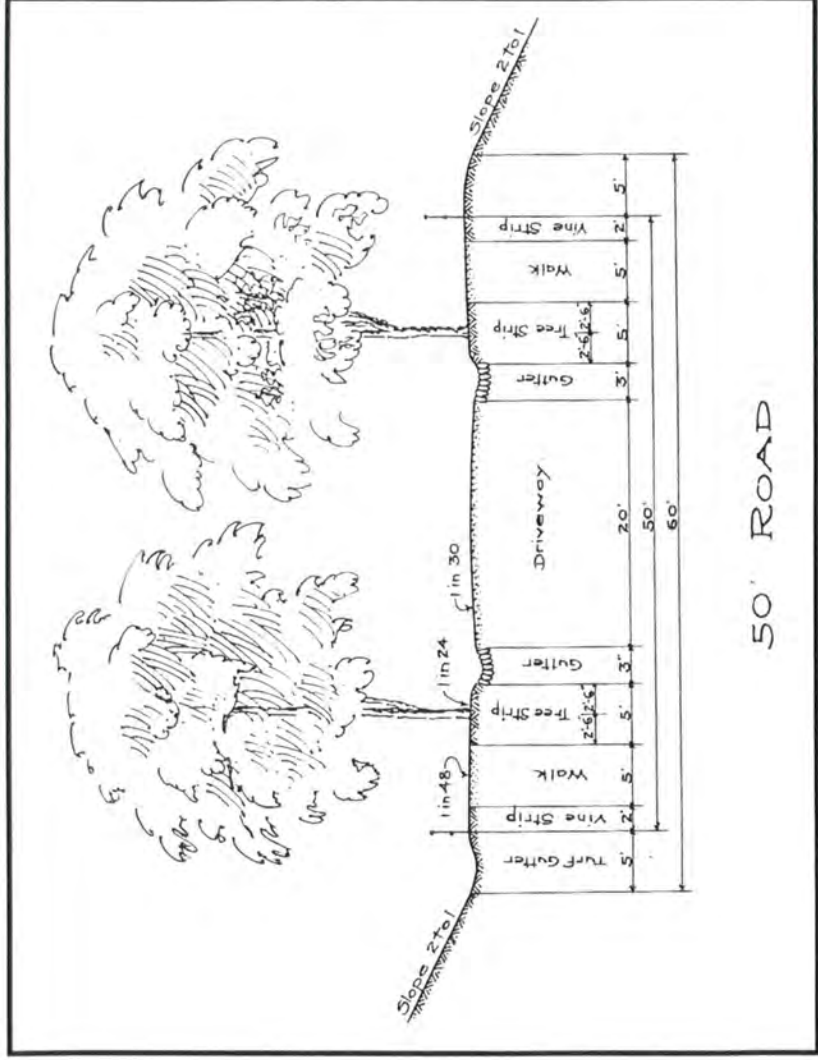

Roadway Sections for 50' Road      Illustration I  
 & Side Road of Parkway,  
 Olmsted Brothers, 1902



---

## 4.2 ARCHITECTURAL RESOURCES

### 4.2.1 RESIDENTIAL RESOURCES

The Druid Hills Local Historic District contains an outstanding collection of early to mid-twentieth-century residential architecture ranging from high-style, architect-designed houses to the modest house forms of the 1940s. The majority of this collection is part of the Eclectic movement that dominated American residential architecture from the turn of the century into the 1930s, promoting the revival of historic styles and the development of modernistic styles. Also included is a significant collection of late 1930s and 1940s housing important for its modest house forms with minimal stylistic influences and the introduction of new elements into the house form such as the garage. These residential resources were constructed in a wide range of scales varying from large to modest, so that many styles are represented in both an elaborately detailed, high-style fashion and a simpler, modest version. A significant number of houses are the work of many of Atlanta's most prominent architects during this period.

The Eclectic movement in American architecture spanned a period from the 1890s to World War II. The movement encompassed both the revival of historic, or period, styles and the advent of modernistic styles. Beginning in the 1890s, the movement was fueled by the 1893 Chicago Columbian Exposition, which stressed correct historic interpretations of European styles. The work of architects most often reflected this early emphasis on the reproduction of period styles. At the same time, the more modern styles such as Craftsman and Prairie were being developed as an alternative to the revival of past styles. The first wave of the use of these innovative styles came before World War I. After the war, the period styles flourished and dominated residential architecture during the 1920s and 1930s. The early 1920s perfection of the technique for applying brick and stone veneers allowed even the most modest houses to mimic the masonry exteriors of Old World architecture, causing the period-style movement to explode across the country. The mid-1930s saw a new wave of modernism beginning as architecture moved toward less stylistic reference and more emphasis on modern form with the International, Art Deco, and Art Moderne styles. Another result of this modernism was the proliferation of many modest houses still with a basically traditional form but only minimal stylistic references.

This residential architecture section is divided into three parts: **ARCHITECTURAL STYLES AND DETAILS**, **PROMINENT ARCHITECTS IN DRUID HILLS**, and **OTHER RESIDENTIAL RESOURCE TYPES**. These include descriptions and examples of the most prominent architectural styles found in the local historic district, some important house types, and a list of architects known to have worked in the Druid Hills area with examples of some of their works. Other types of residential resources found in the district—apartments and garages—are also discussed.

For more information on residential architecture, see *Sources of Information* in the *Appendix*.

## Architectural Styles and Details

**M**ost houses in Druid Hills are easily categorized by their architectural style. In fact, Druid Hills provides a rich study area for early-twentieth-century residential architectural styles and their associated forms and details.

Houses are considered “high-style” examples when all the elements that define a style come together. These high-style houses are often architect designed. It is much more common for houses to have only a few elements of a style. The large percentage of high-style houses in Druid Hills makes it an exceptional residential area in Atlanta and Georgia. Styles are executed in Druid Hills in a wide range of scales from large, high-style houses to smaller, more modest examples.

**ARCHITECTURAL style** may be defined as the decoration or ornamentation that has been put on a building in a systematic pattern or arrangement as well as the design of the overall form such as proportion, scale, massing, symmetry or asymmetry, and relationships among its parts.

The residential architectural styles found in the Druid Hills area may be divided into the two categories of Revival Styles and Modernistic Styles. Following is a list of those styles discussed in detail in this section.

**Revival Styles** - Druid Hills contains a significant collection of period revival styles generally constructed from the 1910s to the 1930s. These houses revived styles based on European as well as American Colonial architecture. These examples are distinguished by fine and carefully executed details and ornament, as well as the use of quality materials for the desired effects of color and texture.

- \* Colonial Revival
- \* Neoclassical Revival
- \* Spanish Colonial Revival
- \* Mediterranean Revival
- \* Italian Renaissance Revival
- \* English Vernacular Revival

**Modernistic Styles** - The popularity of the traditional revival styles was interrupted by the first movement of modernistic styles with the rise of the Craftsman and Prairie styles in the 1910s and 1920s. These styles attempted to provide a more contemporary approach to residential design and are equally well executed and finely detailed with an emphasis on craftsmanship and materials. The second movement of modernistic styles came during the 1930s and 1940s with the introduction of the Art Deco, Art Moderne, and International styles with a focus on modern form.

- \* Craftsman
- \* Prairie
- \* Art Deco
- \* Art Moderne
- \* International Style

## Colonial Revival (1890s-1950s)

This style comes from the late-nineteenth- and early-twentieth-century revival of interest in the architectural heritage of the colonial and early federal periods in America's history. The term "Colonial Revival" is generally used to refer to the revival of both the Georgian and Federal (or Adam) styles built along the eastern seaboard during the eighteenth and early-nineteenth centuries. Most Colonial Revival houses have symmetrical facades, prominent front entrances elaborated with sidelights or fanlights, entry porches with pediments or entablatures supported by delicate columns, multi-paned double-hung windows, and roof dormers. One-story side porches are also a common feature. These examples were based on the classically inspired Georgian and Federal styles brought to America from England and often mixed details from both styles. Some Colonial Revival examples borrowed forms and details from the earlier asymmetrical Postmedieval English buildings of the late-seventeenth to mid-eighteenth centuries, but these examples are less common. The Colonial Revival style was widely popular for a long period from the 1890s until well after World War II. Early examples were more interpretations than reproductions of colonial buildings, but by 1910 it had become fashionable to build carefully researched copies. Later examples, built during the 1940s and 1950s, tended to be much simpler. Druid Hills has an extensive collection of Colonial Revival examples from throughout the style's period of occurrence.



Double-hung, multi-paned windows

Entry portico with entablature supported by columns

Entrance elaborated with fanlight and sidelights

Roof dormers

Symmetrical front facade

One-story side porches often found on revival exteriors

Typical example of the Colonial Revival style with principal features keyed

Colonial Revival House with wood siding.



One-story Colonial Revival House with triple windows reflecting Craftsman-style influence.



Simple one-story Example of the Colonial Revival Style



The **Dutch Colonial Revival** also was part of the movement to revive America's colonial architecture. These houses borrow distinctive features from Dutch colonial traditions. Their major characteristic is the gambrel roof, steeply pitched and side-gabled with two different slopes.

Typical Dutch Colonial Revival House with side-gabled gambrel roof and front shed dormer.



Unusual example of a Dutch Colonial Revival House with front-gabled wing and wood shingle and field stone exterior.





## Neoclassical Revival (1890s-1930s)

This style, which signaled revived interest in classical architecture, developed during the same period as the Colonial Revival and was popular through the 1930s. The Colonial Revival and Neoclassical Revival styles have similar features, but the Neoclassical Revival is typically more elaborate and is distinguished by a dominant full-height portico. It is an eclectic style, meaning it is derived from several earlier styles, and it always exhibits elements of the classical orders. Its full-height porticos most often have prominent pediments supported by classical columns. Neoclassical Revival facades are symmetrical, and the central front entrances are elaborated with classical pilasters, pediments, sidelights, fanlights, or transoms.

Example of portico with square masonry corner columns.



Symmetrical main facade



Dominant full-height portico with classical columns supporting a pediment

Entrance elaborated with pilasters and pediment

Typical example of the Neoclassical Revival style with principal features keyed

Georgian House Floor Plan

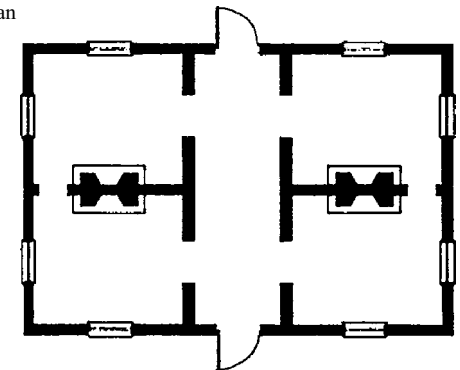

Many of the Colonial Revival and Neoclassical Revival houses whose styles reference classical architecture have symmetrically designed forms that are based on the traditional **GEORGIAN HOUSE TYPE**. House types identify a building's overall form and floor plan independent of its architectural style. The Georgian house type has a symmetrical floor plan consisting of a central hallway with two rooms on either side. This house type is named not for the state but for its association with eighteenth-century English Georgian architecture. It may be the single most popular and long-lived house type in the state, as it has been constructed here in almost all periods of Georgia's history.

### Spanish Colonial Revival (1920s-1930s)

This style was another part of the movement to revive American colonial architecture and drew from the Spanish colonial architectural heritage of the American southwest and Florida, including the mission building traditions of California. The style was not as popular as other colonial styles, but was constructed in neighborhoods during the 1920s and 1930s. Houses in this style have a clay tile roof that is usually gabled with little eave overhang, and walls are of smooth stucco. They are generally asymmetrical, and arched openings and arcaded loggias, or porches, are common. The roof may be elaborated with curvilinear gables or parapets that come from the mission tradition. Several excellent small-scale examples of this style are located in the Cameron Court Sub-division.



Typical example of the Spanish Colonial Revival style with principal features keyed

Example with arcaded front porch.



A more compact example of the Spanish Colonial Revival Style



## Mediterranean Revival (1920s-1930s)

This style was based on both Spanish and Italian vernacular country houses in the Mediterranean Sea area and was constructed during the 1920s and 1930s. Houses in this style are usually asymmetrical and have smooth stuccoed or masonry walls. The roof is covered with clay tile and is generally low-pitched hipped or gabled. Recessed and arcaded loggias and arched window and door openings are common. Houses more Spanish in origin will have little or no roof overhang, while houses more Italian in origin will have wide overhanging eaves. An outstanding group of Mediterranean Revival-style houses can be found on Villa Drive in the Druid Hills area just west of Briarcliff Road.



Typical example of the Mediterranean Revival style with principal features keyed.

Example with wide overhanging eaves and eave brackets of Italian origin.



Group of Mediterranean Revival Style houses on Villa Drive



### Italian Renaissance Revival (1910s-1920s)

This style resulted from the revival of interest in classical architecture during the 1890s and drew directly from Italian Renaissance models. The style was built during the 1910s and 1920s and shares many common characteristics with the Mediterranean Revival style. Houses in this style are generally large symmetrical blocks with low-pitched, hipped roofs covered with clay tile and with wide overhanging eaves and decorative brackets. Renaissance classical details such as columns and pilasters, pediments over openings, and corner quoins are common. Some examples are asymmetrical with doors and windows asymmetrically arranged on the facade. Wall surfaces are smooth stucco or masonry. Window and door openings are often arched and grouped together, and porches may be recessed arched loggias. A significant number of examples of this style are located in the Druid Hills area.



Typical example of the Italian Renaissance Revival style with principal features keyed.

Asymmetrical example with corner quoins.



Simpler example with side-gabled roof.



## English Vernacular Revival (1920s-1940s)

This style appeared in many of Georgia's developing neighborhoods and suburban areas in the early decades of the twentieth century. As its name suggests, the style was derived from the vernacular architectural traditions of medieval England. Characteristic features include steeply pitched roofs, asymmetrical front facades, prominent chimneys, and round-arched entranceways. Brick masonry is the usual exterior material and is often combined with accent materials of stone and decorative half-timbering. Druid Hills has a large number of English Vernacular Revival examples ranging from large elaborate examples to more modest ones. The style is commonly found in the University Park/Emory Highlands/Emory Estates area.



High style example of the English Vernacular Revival style with principal features keyed.

Example with decorative half-timbering.



Example with field stone accenting the gabled entry.



More modest example of the style.

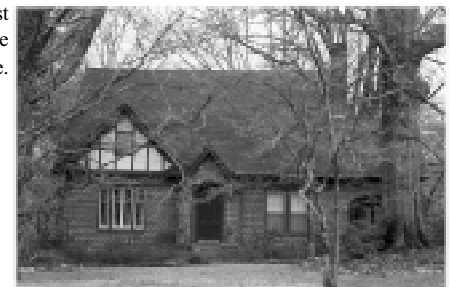

### Craftsman (1910s-1930s)

Perhaps the most popular architectural style in Georgia during the first decades of the twentieth century, the Craftsman style was quite different from the other styles of its era. Instead of reviving a past style, it broke with tradition and moved toward modern house design. The style was American in origin and influenced by both the English Arts and Crafts movement and the wooden architecture of Japan. Craftsman-style houses emphasize structure and materials. They generally have low-pitched gabled, sometimes hipped, roofs with wide overhanging eaves and exposed rafters and decorative brackets. The houses are most often asymmetrical with porches supported by short columns set on heavy masonry piers.



Excellent example of the Craftsman style with principal features keyed.

The Craftsman style is often associated with the **bungalow house type**. The bungalow generally has a long and low form with an irregular floor plan within an overall rectangular shape. Roofs are low-pitched and may be front-gabled, side-gabled, cross-gabled, or hipped, forming subtypes of the bungalow form. Integral porches are common. Bungalows were very popular in all areas of Georgia during the early twentieth century.

Two-story house with Craftsman-style details.



Symmetrical house form with Craftsman-style details.



## Prairie (1910s-1920s)

Like the Craftsman style, the Prairie style was a modern break from the revival styles of the early twentieth century. Developed by American architect Frank Lloyd Wright as a dramatic break with tradition, it was also influenced by the English Arts and Crafts movement as well as Japanese architecture. The Prairie style is characterized by an emphasis on the horizontal. It is usually two stories with one-story porches and wings. The roof is low-pitched and either hipped or gabled and has widely overhanging eaves with exposed rafters. Windows are often grouped together in rows to further emphasize the horizontal. Porches have massive masonry supports. Structure and materials are strongly expressed. The Prairie style was not very popular in Georgia, but when used was often combined with other stylistic influences, particularly the Craftsman style.



Good example of the Prairie style with principal features keyed.

Example with Prairie-style influences combined with Colonial Revival-style details.



Another example with the horizontal emphasis of the Prairie style



# Minimal Traditional Houses

A trend in residential architecture beginning in the late 1930s and extending through much of the 1940s produced houses constructed with basically traditional forms and a minimum of stylistic detail. This category of house is often referred to as Minimal Traditional. These houses are generally more important for their house forms than for their architectural style. Although these house types have been little studied so far, they form a large group of important housing stock from this era.

## Emory Grove House Types

The Emory Grove area consists of a group of these Minimal Traditional houses. These houses were built throughout the Emory Grove development as well as other developments from the same period, such as Druid Hills Heights and Briarwood Hills. While several variations of these house forms exist, they generally consist of a central block with side-gabled roof and little eave overhang, a chimney that may be located within the interior or on the gabled end of the central block, and smaller side- or front-facing gabled wings. The Emory Grove houses generally have masonry exteriors. Minimal Traditional houses have few specific stylistic details but tend generally to reference the traditional Colonial Revival or English Vernacular Revival styles.



Example of the Emory Grove House Type with principal features keyed.

Example from Druid Hills Heights with basement garage.



Another example from Emory Grove with minimal details





## Prominent Architects in the Druid Hills Local Historic District

A number of the Atlanta area's most prominent architects designed houses in the Druid Hills area during this early to mid-twentieth-century period. This work has produced an impressive collection of high-style houses, particularly of the period revival styles. Following is a list of architects and architectural firms known to have worked in Druid Hills. The list is not comprehensive, and certainly will be expanded as other architects and firms are identified.

Daniel Bodine  
A. Ten Eyck Brown  
Eduard Clerk  
Clerk and Lieberman  
Conklin and Mitchell  
Lewis Edmund Crook

John Francis Downing  
Walter T. Downing  
Frazier and Bodine  
Hal Hentz  
Hentz, Adler, and Shutze  
Hentz, Reid, and Adler

Henry Hornbostel  
Ivey and Crook  
Robert Smith Pringle  
Pringle and Smith  
Neel Reid  
Arthur Neal Robinson

Philip Shutze  
DeFord Smith  
Francis Palmer Smith  
Owen James Southwell  
Edward Tilton  
Leila Ross Wilburn

Example of work of Leila Ross Wilburn, who published a number of architectural pattern books that provided well-designed and modern house plans.



Example of work of Neel Reid, well-known for his traditional house designs in the Atlanta area.



# Other Residential Resource Types

## Apartment Buildings

Several examples of historic apartment buildings exist within the district. These are located on the major thoroughfare of Briarcliff Road. All the complexes are designed with a residential appearance to fit into the surrounding neighborhoods.

This apartment complex illustrates the use of the Art Moderne style for post-World-War-II residential buildings. Constructed in 1949, it is an excellent



example of a multi-family complex of residential-scale buildings in a landscaped setting that fits well into the surrounding residential community. This complex could serve as a model for the compatible design of contemporary apartment complexes in the area.

## Accessory Buildings

### Garages

A large number of historic garages exist in the Druid Hills area. They are generally located to the rear of the main house so that they tend to be inconspicuous from the street. These garages are constructed of both wood and brick.

This two-story garage with upstairs apartment is a typical feature of many Druid Hills properties.



## 4.2.2 INSTITUTIONAL RESOURCES

Institutional resources within the Druid Hills Local Historic District include educational, religious, fine arts, and medical-related facilities. Some of these resources were historically constructed as institutional facilities, while others were originally constructed for other purposes and have become institutional facilities. These institutional resources represent some of the most high-style buildings in the Druid Hills area, as they tend to be architect designed. They all represent important institutions within the Druid Hills community.

### DRUID HILLS HIGH SCHOOL

Designed in 1929 by Ivey and Crook, Druid Hills High School is an imposing institutional example of the Colonial Revival style. This educational facility has served many of the community's high school students and has been a meeting place for community activities.

Druid Hills High School



### EMORY PRESBYTERIAN CHURCH

Emory Presbyterian Church was constructed c.1941 in an Academic Gothic style, a popular style for early twentieth-century ecclesiastical architecture which focused on an accurate reproduction of Gothic ornament. The stone building has fine details such as the delicate window tracery and buttresses.

EMORY  
PRESBYTERIAN  
CHURCH



### CALLANWOLDE

Callanwolde currently serves as a fine arts facility but was originally constructed in 1920 as a Candler residence. The large house was designed by Henry Hornbostel in the English Vernacular Revival style with fine stone details and half-timbered upper story.

Callanwolde



## REACH REHABILITATION AND EDUCATION CENTER AND GARDENS

The facility now used by the Reach Rehabilitation and Education Center was originally the Cator Woolford estate. The Neoclassical Revival-style main house remains at the center of the complex. Other nonhistoric buildings have been constructed for use by the center. The estate's landscaped gardens were designed in 1921 by landscape architect Robert Cridland.

GARDENS AT  
REACH  
REHABILITATION  
AND EDUCATION  
CENTER



## FERNBANK

Although not a historic building, the Fernbank Museum of Natural History is an important institutional presence in the Druid Hills community. The museum building was sited on the rear portions of residential lots fronting on Ponce de Leon Avenue, allowing this important historic pattern of residential development to remain intact. The building's design lets it clearly stand out as a new resource in the area.

FERNBANK  
MUSEUM OF  
NATURAL HISTORY



### 4.2.3 COMMERCIAL RESOURCES

#### Emory Village

Only one group of historic commercial resources exists within the Druid Hills Local Historic District. Emory Village at the corner of North Decatur and Oxford Roads is a row of attached masonry commercial buildings. The section of the row nearest the corner of North Decatur and Oxford was constructed in the 1920s, and the row was expanded in the 1930s to the west along North Decatur. The row consists of a series of one-part commercial blocks.

A **ONE-PART COMMERCIAL BLOCK** is a one-story, usually rectangular box with a decorated facade. The facade consists of large plate glass display windows and an entrance topped by a cornice or parapet. A space for signage is usually found between the windows and cornice. These boxes are often attached to form a commercial row, such as in Emory Village.

The one-part commercial block building type was probably developed during the mid-nineteenth century and became common throughout American towns and cities. During the 1920s, efforts were made to make these commercial blocks in suburban areas more ornamental and visually harmonious with their neighborhood surroundings. This can be seen at Emory Village, where the buildings have been elaborated with shaped parapets decorated with delicate classical details in terra cotta such as urns, cartouches, and cornices, reflecting the emphasis on period stylistic detailing. Several of the building facades have been stuccoed over, but their glass storefronts have remained largely intact.



Historic commercial building in Emory Village with principal architectural features keyed.

Commercial buildings with stuccoed exteriors.





**PART TWO**

**GENERAL  
DESIGN GUIDELINES &  
PRESERVATION PRINCIPLES**



---

Part Two of this manual provides (1) basic preservation principles and design concepts and (2) specific guidelines for architectural rehabilitation, new construction and additions, natural landscapes, cultural landscapes, archaeological resources, and nonhistoric properties. These are comprehensive guidelines, applicable to all properties within the district, including those located in the five character areas discussed in Part Three.

Adhering to the information contained in Part Two will assure the preservation and protection of the historic character of the Druid Hills Local Historic District in accordance with the goals established in *Section 1.3*.





---

## 5.0 PRESERVATION PRINCIPLES & APPROACHES FOR ARCHITECTURAL REHABILITATION PROJECTS

Presented in this section are some of the most widely accepted and essential principles of historic preservation. A review of this material will provide the prospective Certificate of Appropriateness applicant with a better understanding of the concerns of the DeKalb County Historic Preservation Commission and why it is important to use a carefully thought-out approach when working with historic resources.

Before any preservation project is begun, a number of fundamental decisions need to be made. What will the property be used for? Will the property be restored to its original condition or rehabilitated for contemporary use? How can the significant architectural and historical features of the building be preserved? What steps need to be taken?

**Design Review Objective - When making a material change to a structure that is in view from a public right-of-way, a higher standard is required to ensure that design changes are compatible with the architectural style of the structure and retain character-defining features. When a proposed material change to a structure is not in view from the public-right-way, the Preservation Commission may review the project with a less strict standard so as to allow the owner more flexibility. Such changes, however, shall not have a substantial adverse effect on the overall architectural character of the structure.**

### 5.1 USE OF HISTORIC PROPERTIES

From a preservation perspective, the most desirable use for a historic property is its original use. Keeping a historic home as a residence or a storefront as retail space usually requires the least physical changes to a property. Due to changes in economic conditions, zoning, and other realities of modern life, however, it sometimes becomes necessary to alter a historic building. For example, a residential building may be converted to office space or a family may need to add to the functional living space of their home. Following is information that will assist property owners in making the right decisions when planning changes to their historic properties.

### 5.2 PRESERVATION METHODS

Preservation is defined as the taking of steps to retain a building, district, object or site as it exists *at the present time*. This often includes an initial stabilization effort necessary to prevent further deterioration as well as more general maintenance work. But “preservation” has become the term most often used when referring to a wide range of conservation practices. Following is a list and definition of the four principle preservation methods. The condition of the property, degree of authenticity desired, and the amount of funding available usually dictate the method used to preserve a historic property. Although “rehabilitation” and “restoration” might sound alike, the end result is quite different.

**STABILIZATION** entails making a building weather resistant and structurally safe, enabling it to be rehabilitated or restored in the future.

Stabilization techniques include covering the roof and windows so that rainwater cannot penetrate, removing overgrown vegetation and dead or dying trees that threaten the structure, exterminating, carrying out basic structural repairs, securing the property from vandalism, and other steps to prevent additional deterioration of the property. This approach is usually taken on a building not currently in use to “mothball” it until a suitable use is found.

**REHABILITATION** involves undertaking repairs, alterations, and changes to make a building suitable for contemporary use, while retaining its significant architectural and historical features.

Rehabilitation often includes undertaking structural repairs, updating the mechanical systems (heating and air conditioning, electrical system, and plumbing), putting on additions for bathrooms, repairing damaged materials such as woodwork and roofing, painting, and addressing contemporary needs such as fire safety and handicap access.

Rehabilitation sometimes necessitates the adaptive use of a building from residential to office or commercial use. This may result in physical changes, such as additions for offices, parking lots, and signage.

If a rehabilitation is sensitive, those changes are made in a way that does not detract from the historic character and architectural significance of the building and its setting.

**RESTORATION** includes returning a building to its appearance during a specific time in its history by removing later additions and changes, replacing original elements that have been removed, carefully repairing parts of the building damaged by time, and replanting vegetation.

Restoration is a more accurate and costly means of preserving a building. It entails detailed research into the history, development, and physical form of the property; skilled craftsmanship; and attention to detail.

Druid Hills' numerous architect-designed buildings are appropriate candidates for restoration.

**RECONSTRUCTION** entails reproducing, by new construction, the exact form and detail of a vanished building, or part of a building, as it appeared at a specific time in its history.

### 5.3 UNITED STATES SECRETARY OF THE INTERIOR'S "STANDARDS FOR REHABILITATION"

The U.S. Secretary's Standards for Historic Preservation Projects were initially developed for use by the Secretary of the Interior in evaluating the appropriateness of work proposed for properties listed in the National Register of Historic Places. Revised in 1990, the "Standards for Rehabilitation" are considered the basis of sound preservation practices. They allow buildings to be changed to meet contemporary needs while ensuring that those features that make buildings historically and architecturally distinctive are preserved. They have meaningful application to virtually every type of project involving historic resources.

The "Standards for Rehabilitation" provide the framework for these design guidelines and will be used by the DeKalb County Historic Preservation Commission in reviewing applications for Certificates of Appropriateness. These standards are listed as follows:

- 1 A property shall be used for its historic purpose or be placed in a new use that requires minimal change to the defining characteristics of the building and its site and environment.
- 2 The historic character of a property shall be retained and preserved. The removal of historic materials or alteration of features and spaces that characterize a property shall be avoided.

- 3 Each property shall be recognized as a physical record of its time, place, and use. Changes that create a false sense of historical development, such as adding conjectural features or architectural elements from other buildings, shall not be undertaken.

- 4 Most properties change over time; those changes that have acquired historic significance in their own right shall be retained and preserved.

- 5 Distinctive features, finishes, and construction techniques or examples of craftsmanship that characterize a historic property shall be preserved.

- 6 Deteriorated historic features shall be repaired rather than replaced. Where the severity of deterioration requires replacement of a distinctive feature, the new feature shall match the old in design, color, texture, and other visual qualities and, where possible, materials. Replacement of missing features shall be substantiated by documentary, physical, or pictorial evidence.

- 7 Chemical or physical treatments, such as sandblasting, that cause damage to historic materials shall not be used. The surface cleaning of structures, if appropriate, shall be undertaken using the gentlest means possible.

- 8 Significant archaeological resources affected by a project shall be protected and preserved. If such resources must be disturbed, mitigation measures shall be undertaken.

- 9 New additions, exterior alterations, or related new construction shall not destroy historic materials that characterize the property. The new work shall be differentiated from the old and shall be compatible with the massing, size, scale, and architectural features to protect the historic integrity of the property and its environment.

- 10 New additions and adjacent or related new construction shall be undertaken in such a manner that if removed in the future, the essential form and integrity of the historic property and its environment would be unimpaired.

### 5.4 EIGHT STEPS OF A PRESERVATION PROJECT

Following is an outline of an accepted approach to **planning** (Steps 1-3) and **implementing** (Steps 4-8) preservation projects. It is highly recommended that property owners review these points carefully and consider their importance. The planning phase must be completed prior to the submission of a Certificate of Appropriateness application. These steps are explained in recommended order.

## STEP 1 — INSPECT THE PROPERTY AND MAKE A WISH LIST

It is essential that a thorough inspection of the structure or site be made, which will allow for an understanding of specific problems that may exist as well as special conditions and features that need to be considered. This inspection should also take into account the character of the surrounding area (area of influence—see *Section 7.1*), with special attention given to how the property in question relates to nearby buildings and sites. Develop a wish list of what needs to be done and what improvements and/or changes are desirable but not necessary to the physical soundness of a property.

It is very important that existing conditions be documented, through photographs, before any work is undertaken. This is especially true when tax credits are being sought. These photographs can be taken at any time during the planning process.

**THE PROPERTY OWNER MAY WISH TO CONSULT WITH THE DEKALB COUNTY HISTORIC PRESERVATION COMMISSION TO OBTAIN PRELIMINARY COMMENTS AND SUGGESTIONS BEFORE DEVELOPING CONCEPT PLANS.**

## STEP 2 — DEFINE THE PROJECT AND DEVELOP A PRELIMINARY CONCEPT

At this stage the property owner must determine the type (stabilization, rehabilitation, renovation, or reconstruction) and extent of the project to be undertaken. Cost will likely be an issue and therefore it is advisable to consult with an architect, landscape architect, interior designer, or preservation planner. These professionals can assist the owner in defining the basic components of the project.

## STEP 3 — REFINE PRELIMINARY CONCEPT AND DEVELOP A MASTER PLAN

This is the final step of the planning process—the end result of which is what might be called a Master Plan. The Master Plan should outline the principal goals of the project and the efforts needed to complete Steps 4 through 8.

**SUBMIT APPLICATION FOR CERTIFICATE OF APPROPRIATENESS.**

## STEP 4 — STABILIZE THE BUILDING

Before any new design work is undertaken, the property must be in a stable condition with all deterioration halted. An example would be the repair of a leaking roof so that further moisture will not enter the structure after new work has been completed.

## STEP 5 — CARRY OUT STRUCTURAL REPAIRS

Once deterioration has been halted, any structural damage that exists must be corrected. Depending upon the location of the damage, work on the project may be continued prior to correcting the damage. It is advisable, however, to address all structural damage in a timely manner. If the approved project involves an addition to the building, it should be made only after all structural repair work has been completed.

## STEP 6 — CARRY OUT INFRASTRUCTURE REPAIRS

Repairs and improvements to mechanical systems (i.e., cooling and heating systems, electrical systems and plumbing) are essential to achieving the highest degree of comfort and economy in any building. It is therefore important to attend to this type of work fairly early in the overall project rather than delaying or even neglecting to complete it. Infrastructure improvements can be costly, which is yet another reason for planning this work early in the project.

## STEP 7 — CARRY OUT ENERGY CONSERVATION IMPROVEMENTS

Most steps to improve energy efficiency are generally quite straightforward and sometimes surprisingly inexpensive. This type of work can therefore usually be put off until more complicated and expensive tasks have been completed. Of course, if the project involves an addition, this work should be done during framing.

## STEP 8 — CARRY OUT COSMETIC WORK

Finishing work, such as exterior painting, minor siding repairs and porch reconstruction, should be the next stage of a preservation or rehabilitation project. This is the work that will generally create the greatest visual impact, and it is

essential that all preliminary work (stabilization, structural repairs, infrastructure improvements) be completed beforehand so that nothing will have to be done twice.

### STEP 9 — LANDSCAPING

If the project involves an addition, landscaping for the addition will likely be the last phase of work. It is helpful, however, to prepare a landscape plan early in the project so as to allow for planting at the earliest appropriate season. See *Section 9.7* for steps to follow in projects involving the redesign of residential landscapes.

---



## 6.0 ARCHITECTURAL REHABILITATION GUIDELINES

These guidelines are intended not only to assist the DeKalb County Historic Preservation Commission in evaluating Applications for Certificates of Appropriateness but also to assist property owners planning preservation projects. These guidelines seek to ensure the preservation of the historic character of individual historic buildings within the district as well as of the district as a whole. An underlying impact of the use of these guidelines, however, will be protection of many of the qualities that give these properties a high market value. Reference to these guidelines will help a property owner make the best decision for preserving the historic and architectural qualities of his property that are so highly valued.

An excellent source of information on architectural rehabilitation and maintenance is the [Preservation Briefs Series](#) available from the National Park Service. (See *Sources of Information* in the *Appendix* for a more complete reference.) At the present time, thirty-eight briefs have been published addressing a wide range of topics, including “Roofing for Historic Buildings” and “The Repair of Historic Wooden Windows.”

## 6.1 BUILDING ELEMENTS AND DETAILS

### 6.1.1 EXTERIOR MATERIALS

The dominant exterior materials used in a neighborhood or historic district contribute to the visual relationships among buildings. If only a few materials are visible, the result is uniformity and continuity. It is also possible for considerable variety of surface materials and treatments to characterize an area, and yet even in such cases the addition of certain materials would greatly disrupt the predominant visual textures.

*Druid Hills - Brick is the predominant exterior wall cladding material. Stucco and wood, such as weatherboard and shingles, are less common. Fieldstone and granite are frequently used as accent materials.*

**Guideline - Original masonry should be retained to the greatest extent possible without the application of any surface treatment, including paint. Repointing of mortar joints should only be undertaken when necessary, and the new mortar should duplicate the original material in composition, color, texture, method of application, and joint profile. Repaired joints should not exceed the width of original joints. The use of electric saws and hammers in the removal of old mortar is strongly discouraged as these methods can seriously damage adjacent bricks.**

The original exterior masonry on this house, including its mortar joints, has been well maintained.



The unusual "knobby" appearance of this masonry is an important character-defining feature of this house's exterior and should be maintained.



The stone masonry provides accent to this house's front entrance and should be properly maintained.



**Guideline - Original stucco should be retained to the greatest extent possible without the application of any surface treatment including paint. Stucco facing requires periodic maintenance and should be repaired with a stucco mixture that matches the original material in both appearance and texture.**

The rough textured stucco exterior of this house is an important character-defining feature. Repairs to the stucco should duplicate the original texture.



The smooth texture of this stucco exterior should be maintained.



**Guideline - The application of artificial or nonhistoric exterior siding materials such as brick veneers; asphalt shingle siding; and cementitious, aluminum, or vinyl siding is discouraged. These materials are not successful in mimicking details of original wood siding (the most common material over which they are applied); subsequently, their use greatly compromises the historic integrity of buildings. Application often results in the loss or distortion of architectural details, and improper installation can result in damage of historic materials.**

Use of compatible and high quality “look-a-like” synthetic building materials may be allowable, especially in order to reduce costs, provided (1) the substitute material can be installed without irreversibly damaging or obscuring the historic material and architectural features and trim of the building and (2) the substitute material can match the historic material in size, profile, and finish so that there is no change in the historic character of the building.

Artificial siding has been applied to this house, altering its exterior appearance and presenting the possibility of damage to original materials underneath.





## 6.1.2 ARCHITECTURAL DETAILS

Stylistic details, such as brackets, cornerboards, moldings, cornice details, decorative window and door trims, and shingles are essential to the historic character of buildings and districts.

*Druid Hills - One of the defining features of Druid Hills is its outstanding collection of high-style buildings representing the entire spectrum of early-twentieth-century architecture.*

**Guideline - Stylistic details should be maintained and treated with sensitivity. The removal of such details or application of details inappropriate to the period or style of a house is strongly discouraged. Damaged elements should be repaired rather than replaced if at all possible. Historic details that have been lost or are beyond repair may be replaced with new materials, provided that their earlier presence can be substantiated by historical documentation and that the new materials match the original in composition, design, color, and texture.**

The half-timbering, stone window and door surrounds, and corner quoins are important stylistic details of this example of the English Vernacular Revival style.



The eave brackets, exposed rafter ends, and decorative half-timbering of this roof gable are typical features expressing the materials and craftsmanship important to the Craftsman style.



### 6.1.3 ENTRANCES AND PORCHES

Entrances and porches are quite often the focus of historic buildings, particularly when they occur on primary elevations. Together with their functional and decorative features, they can be extremely important in defining the overall historic character of a building.

*Druid Hills - The period residences of Druid Hills display a variety of porch forms ranging from a modest Colonial Revival entrance porch to an elaborate two-story Neoclassical portico, from a recessed arcaded corner porch on an English Vernacular Revival cottage to a columned porte cochere typifying the Prairie style. One-story, side porches flanking a two-story central mass are common in the district and associated with many different styles. Many of the early-twentieth-century revival styles highlight the primary entrance with pilasters, pediments, hoods, sidelights and fanlights, and various other details. In contrast, the Minimal Traditional house form of Emory Grove displays a very modest entrance. Regardless of the degree of stylistic expression, these porches and entrances are essential to the character of their buildings.*

**Guideline - Original porches and steps should be retained. Repair of porches should not result in the removal of original materials (such as balusters, columns, hand rails, brackets, and roof detailing) unless they are seriously deteriorated. If replacement materials must be introduced, the new should match the old in design, color, texture, and, where possible, materials. Replacement of missing features should be substantiated, if possible, by documentary and physical evidence.**

**Guideline - The enclosure of front porches and side porches visible from a right-of-way should utilize transparent materials, such as screen or glass, which will help maintain the original open character of the design.**

**Guideline - Porte cocheres are important stylistic features of many homes in Druid Hills. Removal and enclosure are discouraged.**

This side porch has been enclosed with screen, helping to maintain its original open character.



The open pergola design of this entrance porch, side porch, and porte cochere is a significant stylistic feature of this house and should be maintained.



**Guideline - Second-story additions should not be made to one-story porches visible from the public right-of-way.**

**Guideline - Original doors should be retained unless deteriorated beyond repair. Screen and storm doors should not detract from the character of the house and should be designed to be compatible with original doors. In the case of a replacement for a deteriorated door, the new door should be similar to the original in design and materials.**

This simple entrance hood is a primary character-defining feature that focuses attention on this house's main entrance.



This heavy wood door in its original arched entrance is a major stylistic feature of this English Vernacular Revival style house.



This simple screen door does not detract from the Colonial Revival/Craftsman style entrance.



The arched Spanish Colonial Revival style entrance is an important character-defining feature of this house.

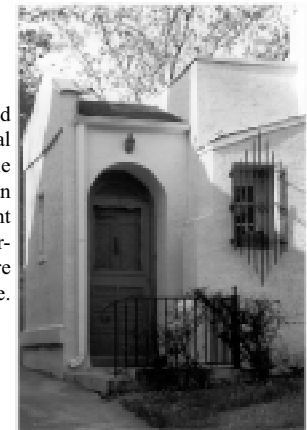

## 6.1.4 Windows

Windows are very important in creating rhythm on a house and also play a role in the directional emphasis and scale of buildings. Highly decorative windows with distinctive shapes or glazing patterns are always character-defining features of buildings and contribute greatly to the architectural variety of the district.

*Druid Hills - The period residences of Druid Hills display a variety of window types and materials. Double-hung sash, casement, pivot, and decorative fixed windows are all common. Wood sashes are most typical, but metal, as in the case of casement, is also present. Single, grouped, tri-partite, and even banded, as seen on the Art Moderne apartments on Briarcliff, are all arrangements found throughout the district. Bay windows are an important massing element. The light patterns, materials, and arrangements of windows play a key role in defining the styles of Druid Hills architecture and contribute to the overall appearance of the district.*

**Guideline - Existing windows, including sashes, lights, lintels, sills, frames, molding, shutters, and all hardware should be retained and repaired through routine maintenance whenever possible. When deteriorated elements must be replaced, new elements should be compatible with the original in terms of material, design and hardware. Should it be necessary to replace an entire window, the replacement should be sized to the original opening and should duplicate all proportions and configurations of the original window.**

**Guideline - The addition of storm windows should be accomplished without seriously compromising original window appearance. Storm windows should not damage original window frames and should be able to be removed at a later date, thus guaranteeing sensitive placement. Interior storm windows are recommended as an alternative to the usual exterior application. Replacement windows, if using insulated glass, should have either true divided lights with muntins no larger than the original or false muntins applied to the exterior and interior (not just snap-on). These windows are now available at reasonable cost.**

These double-hung windows, with six-over-one pane configuration typical of the Craftsman style, have been well-maintained.



This group of round arched windows is a characteristic feature of the Italian Renaissance Revival style.



The row of stepped windows on this house provides the front facade with a distinctive pattern that should be maintained.



## 6.1.5 Roofs, CHIMNEYS, AND DORMERS

Original roof form—with its shape; features such as dormers, cresting, and chimneys; slope; material and color; and patterning—is an essential and character-defining feature of a building. Roof forms frequently create street patterns through repetition of pitch, orientation, and/or shape. In addition, sound roofs are essential to a building's preservation.

*Druid Hills - Hipped, gabled, flat, parapet, cross-gabled, cross-hipped, jerkinhead, and gambrel are all principal roof forms widely represented in Druid Hills' architecture. Massing elements such as projecting bays, porches, and dormers display secondary roofs that may connect with and impact the overall impression of the roof form. An unusually high number of slate and clay tile roofs are present in the district. All of these elements are important character-defining features that contribute to the stylistic expressions of buildings.*

**Guideline - The original roof form should be retained to the greatest extent possible. No addition to a house should greatly alter the original form of a roof or render that form unrecognizable. Original or historic roof dormers should also be retained. Skylights should be installed so as to be as unobtrusive as possible. If additional upper-story space is required, consider using dormers—placed out-of-view of public right-of-way—to create this space.**

The side-gabled gambrel roof with shed dormer is a primary feature of the Dutch Colonial Revival style, and its form should be maintained.



The characteristic gabled and bracketed dormer of the roof of this Craftsman-style house should be retained.



**Guideline - Historic roofing materials, such as clay tile and slate, should be repaired rather than replaced, if at all possible. While repair or replacement with like materials is often considered to be cost prohibitive, it should be remembered that life expectancies of these roofs (slate, 60 to 125 years and longer; clay tile, 100+ years) is considerably greater than most replacement materials. Clay tile and slate roofs are always character-defining features of their buildings; therefore, if replacement is necessary, new materials should match as closely as possible the scale, texture, and coloration of the historic roofing material.**

This clay tile roof is an important character-defining feature of this house and should be maintained and repaired rather than replaced.



This slate roof will last for many years if it continues to be well maintained. The roof dormers are also important stylistic features that should be maintained.



**Guidelines - Original chimneys often add to the character of historic houses and should be properly maintained; they should not be covered with stucco or any other material, unless historically covered. A chimney that is no longer in use still functions as an important element in the overall composition of a house and should not be covered, partially or completely removed, or replaced.**

This front-facade brick chimney adds to the picturesque character of this English Vernacular Revival style house and should be maintained.

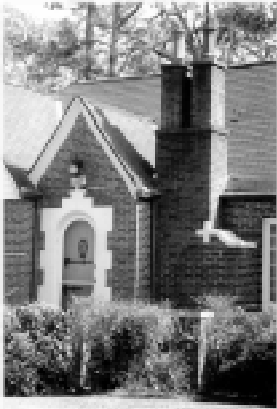

The random-stone masonry of this chimney is unusual in Druid Hills and should be properly maintained.



This interior brick chimney is a small but important element of the roofline of this house.



### 6.1.6 FOUNDATIONS

Foundations primarily play a functional role by protecting the undersides of buildings. Oftentimes they are subtle elements that blend with the rest of the building. They can also contribute to the stylistic expression of a building by utilizing contrasting materials.

*Druid Hills - Foundations in Druid Hills are, for the most part, solid brick or granite. Houses in the area of Emory Grove south of N. Decatur Road display solid granite foundations.*

**Guideline - Work involving foundations should, to the extent possible, preserve original appearances and materials. The primary issues in Druid Hills will be repair and maintenance and the application of inappropriate surface treatments such as stucco (see guidelines under Section 6.1.1 Exterior Materials). Where additions are made to houses with granite foundations, the addition's foundation may use a veneer stone if it matches the existing in color, pattern, and mortar.**

This granite foundation is characteristic of houses found in Emory Grove and should be properly maintained



## 6.1.7 GUTTERS

Adequate roof drainage is necessary to (1) insure that roofing materials provide a weather-tight covering and (2) prevent water from splashing against walls and foundations or draining toward buildings.

*Druid Hills - The high-style buildings in the district often feature colonial "hidden" gutters and copper downspouts with decorative attachments.*

**Guideline - Gutters and downspouts should be maintained in their original appearance and location if functioning properly.**

**Guideline - New downspouts should be placed along the edges and corners of buildings and along porch supports so as to create minimal visual disruption. In locating new downspouts, consideration should be given to water flow with regard to avoiding seepage into basements and impacts to foundation plantings.**

This downspout is appropriately placed along the corner of the house and directs water away from the house's foundation.



## 6.2 MECHANICAL SERVICES

**Guideline - The placement of air conditioners and similar mechanical services should be accomplished without detracting from the historical integrity of a building. The principal elevation (front) of a building should not be disrupted by the addition of mechanical services.**

This window air conditioning unit is inappropriately placed on the house's front facade. It would be better placed on a view-obstructed facade and buffered so as to be as unobtrusive as possible.



### 6.3 ACCESSORY BUILDINGS

**Guideline - Garages, garage apartments, and other accessory buildings that have historic or architectural significance should be preserved as significant site elements. Rehabilitation treatments should follow the design guidelines provided in Section 6.1.1 Building Elements and Details. For construction of new accessory buildings see Section 7.0 Additions and New Construction.**

This wood-framed garage is an important site element of its historic property and should be preserved and maintained.



### 6.4 ADAPTIVE USE

**Guideline - A dwelling converted to a non-residential use must retain its historic architectural integrity and residential character.**

### 6.5 HEALTH AND SAFETY CODE COMPLIANCE

**Guidelines - Compliance with health and safety codes and handicapped access requirements should be carried out with a minimum of impact to the historic character of community institutional buildings. Adding handicapped ramps is a common issue. Placement of new ramps should be done so as to minimize visual impact to the building, particularly the principal elevation (front) of the building.**

**Recommendation - Necessary access ramps on the front facade should be constructed in such a way that they can be removed without damage to the facade.**



## 6.6 DEMOLITION by NEGLECT

Demolition by neglect occurs when a building is allowed to deteriorate due to lack of maintenance and security. Efforts should be made to minimize the occurrence of this condition through the education of property owners concerning proper methods of upkeep and preservation.

*Druid Hills - The DeKalb County Historic Preservation Ordinance authorizes the Historic Preservation Commission to monitor the condition of historic properties located in the historic district. If the Commission determines that failure to provide ordinary maintenance and repair results in "demolition by neglect," it is authorized to take certain steps to correct the situation. See Section 10 of the Preservation Ordinance, "Failure to Maintain Historic Property."*

**Guideline - Property owners shall avoid demolition by neglect.**

Proper maintenance of this property has been neglected, and it is now deteriorating.



## 6.7 MAINTENANCE

See *Sources of Information* in the *Appendix* for list of references on maintenance and rehabilitation.

**Recommendation - The most effective and economical way to preserve a historic building and its site features is to provide regular maintenance, thus minimizing the need to replace historic materials.**

## 6.8 EXTERIOR COLORS

Paint color will not be reviewed by the DeKalb County Preservation Commission.

Appropriate paint colors are usually related to the style and type of the property in question.

**Recommendation - Homeowners considering painting their homes are encouraged to determine the range of paint colors and techniques applicable to the particular architectural period of their property so that a proper choice might be made. The placement of different colors on a house (i.e., the primary color as well as trim colors) is also of critical importance.**

## 6.9 INTERIORS

Although proposed changes to interiors will not be reviewed by the DeKalb County Preservation Commission unless those changes would have an effect on exterior architectural features, it would be wise for property owners to make every effort to preserve the historic characters of their building interiors as they are valuable assets of the property. Following are some helpful recommendations for property owners:

**Recommendation - When planning a rehabilitation, particularly in the case of adaptive use, preserve as much of the significant historic floor plan as possible. If changes are needed, attempt to make changes in such a way that they are reversible and do not damage or result in the loss of historic materials.**

**Recommendation - Care should be taken to preserve character-defining interior features such as wood floors, molding, picture rails, fireplaces, paneling, plaster details, and other details that distinguish historic buildings from new construction.**

**Recommendation - The visible interior features of heating, lighting, air conditioning and plumbing systems may contribute to the overall character of a building. Retaining these elements, when possible, should be considered. This will likely require upgrading and augmenting the system components themselves.**





## 7.0 ADDITIONS & NEW CONSTRUCTION - PRESERVING FORM & LAYOUT

The Druid Hills Local Historic District continues to change and evolve over time. For this area to meet contemporary needs, additions are built, uses change, and new buildings are constructed. The challenge is not to prevent change but to ensure that, when it does inevitably happen, it is compatible with the historic character of the area.

A new building is compatible with its historic setting when it borrows design characteristics and materials from adjacent buildings and integrates them into a modern expression. Before undertaking new development, be it a new building or changes or additions to existing buildings, take time to evaluate what makes the property and the neighborhood distinctive. Evaluate what type of impact the new development will have on the property and neighborhood. Decide how the development can best be designed to complement the property and area.

The underlying guideline for new construction and additions is to consider one's neighbors and nearby structures and reinforce the existing historic character through sensitive, compatible design.

Note that many of these guidelines refer to new development or new construction but are equally applicable to additions to existing buildings.

## 7.1 DEFINING THE AREA OF INFLUENCE

The area of influence may be the back of a property, a streetscape, or several blocks. A consistent streetscape will result when new buildings are designed in consideration with what already exists. To define the area of influence that the new development or addition will have, ask questions such as:

- ☛ *How large an area will the new development impact?*
- ☛ *Is it to be an addition to the rear of a building that will not even be visible to the public? Or is it a new building that will impact the whole streetscape?*
- ☛ *Will the new building be in the middle of a block with only one facade visible to the public or will it be on a corner lot, and therefore will have two facades clearly visible?*
- ☛ *Will the project generate the need for additional parking or impact traffic in the area?*

**Guideline - In considering the appropriateness of a design for a new building or addition in a historic district, it is important to determine the area of influence. This area should be that which will be visually influenced by the building, i.e. the area in which visual relationships will occur between historic and new construction.**

Area of Influence  
Each site within a historic district will have its own unique area of influence. Shown here are two different examples with suggested minimum areas that might be considered. Neighboring buildings should be examined to determine the consistent patterns of design concepts and architectural elements that are present.

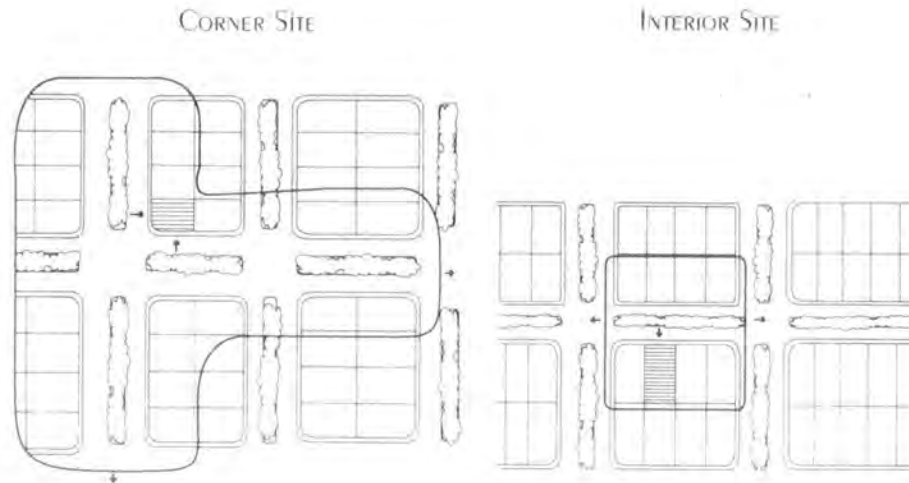

## 7.2 RECOGNIZING THE PREVAILING CHARACTER OF EXISTING DEVELOPMENT

Every building, whether historic or modern, is a product of design, and the design of buildings is accomplished through the utilization of several basic design concepts:

Building Orientation and Setback

Proportions

Directional Emphasis

Rhythm

Shape

Scale/Height

Massing

Materials/Architectural Elements

These concepts form the basis for visual relationships among buildings, which in turn influence the ways in which buildings are perceived by the public. When a new structure is built among historic buildings or an addition is made to an existing building, the level of success with which it relates to existing buildings—and whether it contributes to or detracts from the area—will be determined by the ways in which its design recognizes and is a function of the prevailing design expression in the area of influence.

**Guideline - When looking at a series of historic buildings in the area of influence, patterns of similarities may emerge that help define the predominant physical and developmental characteristics of the area. These patterns must be identified and respected in the design of additions and new construction.**

This section identifies and defines principal design concepts and offers guidelines for using these concepts in evaluating the appropriateness of a proposed new building or addition. Illustrations are intended only to point out the types of relationships between historic and new buildings that are important and are not meant to serve as examples of real-life design solutions.

## 7.2.1 Building Orientation and Setback

Building orientation refers to the directional placement of the building on the site, while setback refers to how far back the building is from the street and side lot lines. Typically, historic areas have strong predominant orientations and setbacks.

**Guideline - The orientation of a new building and its site placement should appear to be consistent with dominant patterns within the area of influence, if such patterns are present.**

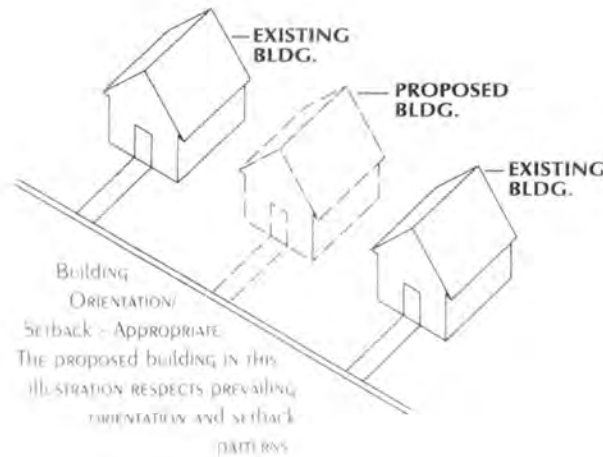

Building Orientation - Inappropriate. This example shows two houses with front-to-back orientations and a neutrally oriented new building that, due to its square plan shape, is inconsistent with the established orientation pattern.

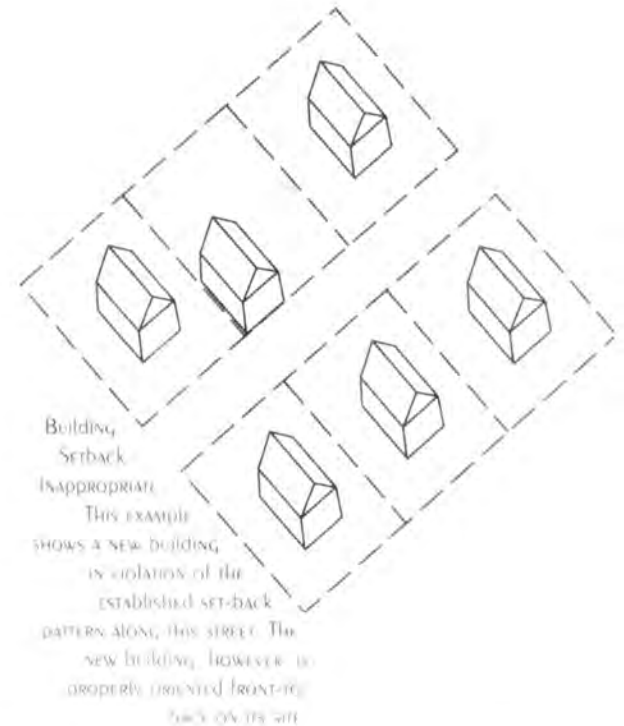
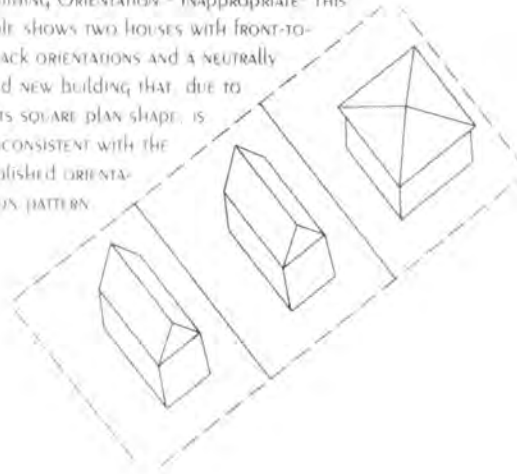

## 7.2.2 DIRECTIONAL Emphasis

Most buildings are either vertical or horizontal in their directional emphasis, which is determined by the size and placement of elements and openings on a building's front facade as well as by the building's overall shape. Directional emphasis may also be influenced by surface materials and architectural detailing.

**Guideline - A new building's directional emphasis should be consistent with dominant patterns of directional emphasis within the area of influence, if such patterns are present.**

Directional Emphasis - Consistent: The two nearly identical houses shown here both exhibit horizontal directional emphasis.

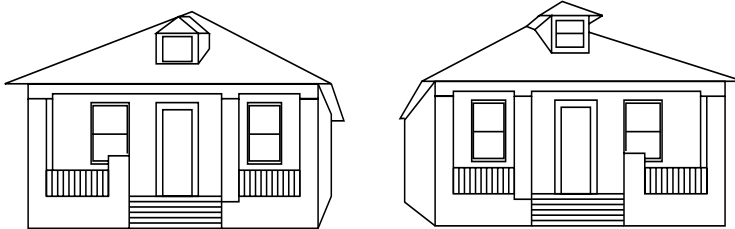

Directional Emphasis - Inappropriate: Shown here are two historic houses, each with a vertical directional emphasis and a new house that is clearly horizontal in emphasis. This new building is neither sympathetic nor consistent with the established pattern of directional emphasis along this street.





### 7.2.3 SHAPE

A building's surfaces and edges define its overall shape. This overall shape, in concert with the shapes of individual elements (such as roof pitch, porch form, and window and door openings), is important in establishing rhythms in a streetscape. Shape can also be an important element of style.

**Guideline - Roof Pitch:** The roof pitch of a new building should be consistent with those of existing buildings within the area of influence, if dominant patterns are present.

SHAPE - Roof Pitch - Inappropriate/Appropriate Examples: These two comparisons depict relationships between roof pitches of historic and new buildings. The example on the left is that of a historic house (shaded) with a steeply-pitched roof standing next to a new building with an inappropriate shallow-pitched roof. The example on the right shows a more compatible roof pitch on the new building.

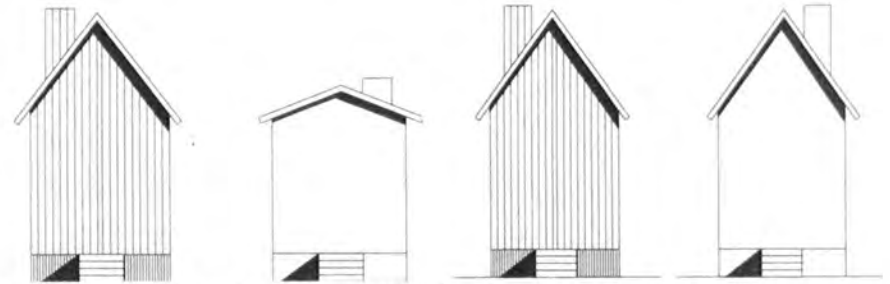

**Guideline - Building Elements:** The principal elements and shapes used on the front facade of a new building should be compatible with those of existing buildings in the area of influence, if dominant patterns are present.

SHAPE - Building Elements - Inappropriate/Appropriate Examples: These two comparisons depict relationships between building elements of historic and new buildings. The example on the left is that of a historic house (shaded) with flat-arched window and door openings standing next to a new building with inappropriate round-arched window and door openings. The example on the right shows more compatible window and door openings on the new building.



Porches throughout the Druid Hills district tend to be small entry porches, side corner porches, porte cocheres, and flanking sun or screened porches.

**Guideline - Porch Form:** The shape and size of a new porch should be consistent with those of existing historic buildings within the area of influence, if dominant patterns are present.

SHAPE - Porch Form - Inappropriate/Appropriate Examples: These two comparisons depict relationships between historic and new buildings in terms of porch form. The example on the left is that of a historic house (shaded) with an extending front gable porch standing next to a new building with an inappropriate integral porch. The example on the right shows a more compatible porch form on the new building.

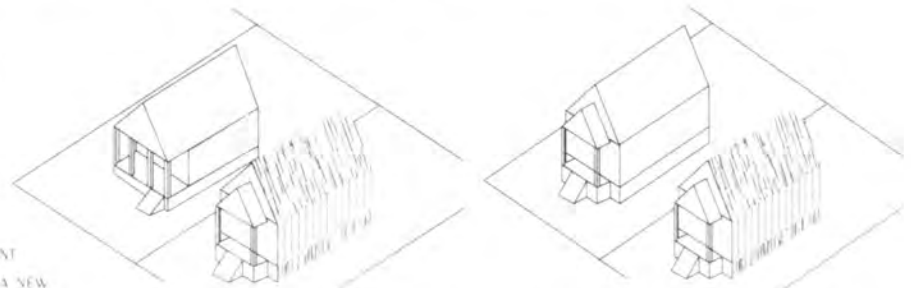

## 7.2.4 MASSING

Mass relates to the height, width, and depth of a building and its elements. A building is often composed of several different massing components—for example, the main mass or body, the roof, projecting bays, and additions. Think of a building as a compilation of various building blocks. If there are similar types of massings in an area, or if irregular massings are the norm, this pattern should be taken into account.

**Guideline - The massing of a new building should be consistent with dominant massing patterns of existing buildings in the area of influence, if such patterns are present.**

MASSING. THESE DRAWINGS SHOW A HOUSE "INTACT" AND "EXPLODED" TO ILLUSTRATE ITS VARIOUS VOLUMETRIC COMPONENTS.

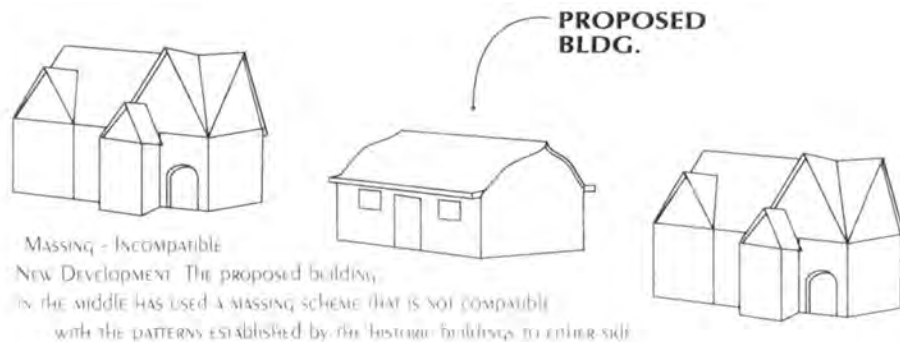
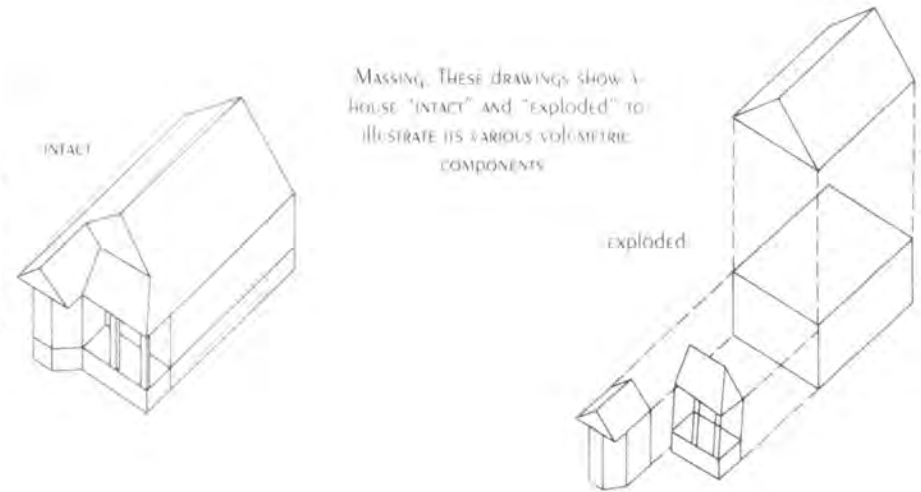

Massing - Incompatible  
New Development. The proposed building in the middle has used a massing scheme that is not compatible with the patterns established by the historic buildings to either side.

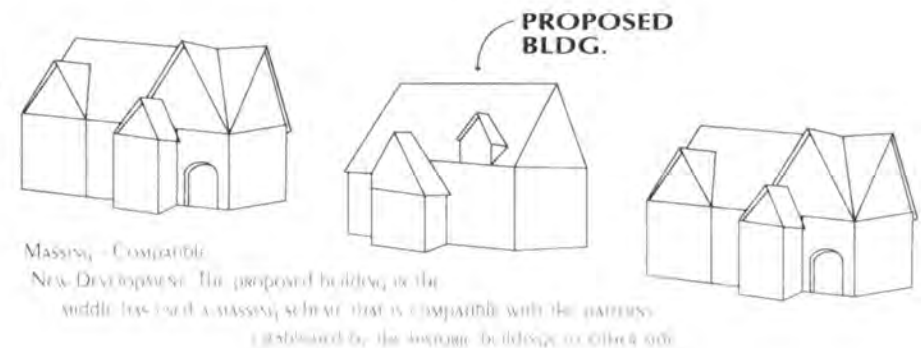

Massing - Compatible  
New Development. The proposed building in the middle has used a massing scheme that is compatible with the patterns established by the historic buildings to either side.

## 7.2.5 PROPORTION

Proportion is the relationship of one dimension to another; for example, the relationship of the height to the width of a building, or the height and width of windows and doors. Individual elements of a building should be proportional to each other and the building.

Residential Proportions: This graphic illustrates the concept of proportion using residential building dimensions.

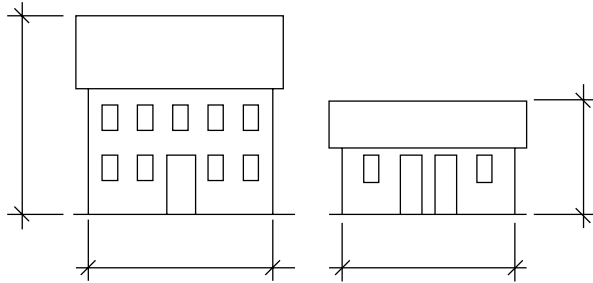

Commercial Proportion: This graphic illustrates the concept of proportion using commercial building dimensions.

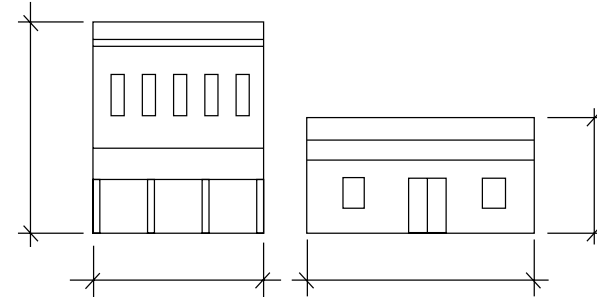

**Guideline - The proportions of a new building should be consistent with dominant patterns of proportion of existing buildings in the area of influence, if such patterns are present.**

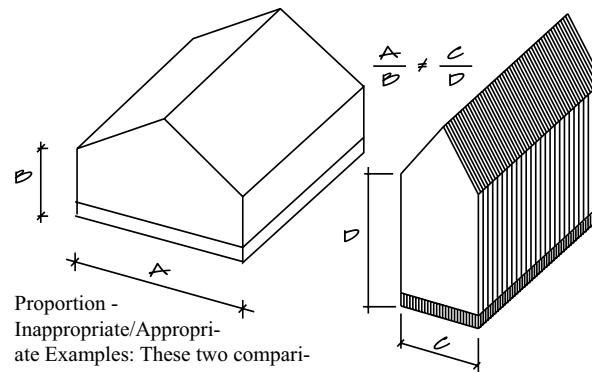

Proportion - Inappropriate/ Appropriate Examples: These two comparisons depict relationships between front-facade

height-to-width ratio of historic and new buildings. The example on the left is that of a historic house (shaded) with a height-to-width ratio resulting in a very vertical expression standing next to a new building with a horizontal height-to-width ratio. The example on the right shows a more compatible height-to-width ratio on the new building.

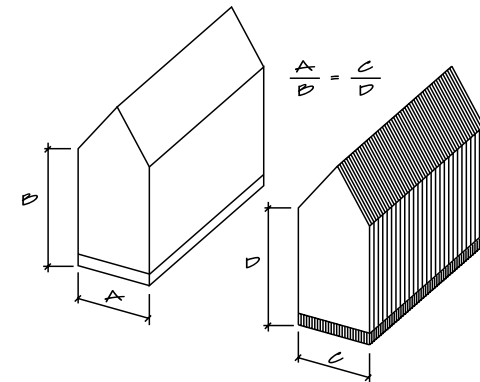

## 7.2.6 Rhythm

Rhythm is the recurring patterns of lines, shapes, forms, or colors (materials) on a building or along a streetscape. For example, the rhythm of openings on a house refers to the number and placement of windows and doors on a facade. Rhythm also occurs on the larger scale of streetscapes as created by development patterns (orientation and setback) and details of individual buildings (directional emphasis, scale, height, massing, etc.).

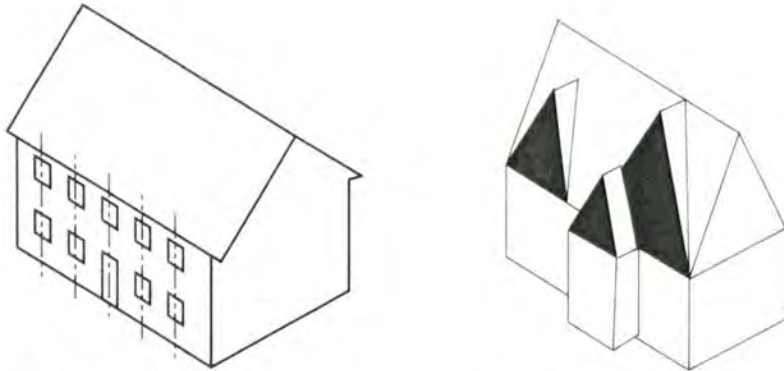

RHYTHM - SYMMETRICAL/ASYMMETRICAL: THESE TWO HOUSES ILLUSTRATE DIFFERENT TYPES OF RHYTHMS CREATED BY INDIVIDUAL BUILDING ELEMENTS. ON THE LEFT IS A BUILDING WITH A REGULAR PLACEMENT OF ELEMENTS CREATING A SYMMETRICAL FACADE. THE BUILDING ON THE RIGHT HAS AN IRREGULAR PLACEMENT OF ELEMENTS CREATING AN ASYMMETRICAL FACADE.

**Guideline - New construction in a historic area should respect and not disrupt existing rhythmic patterns in the area of influence, if such patterns are present.**

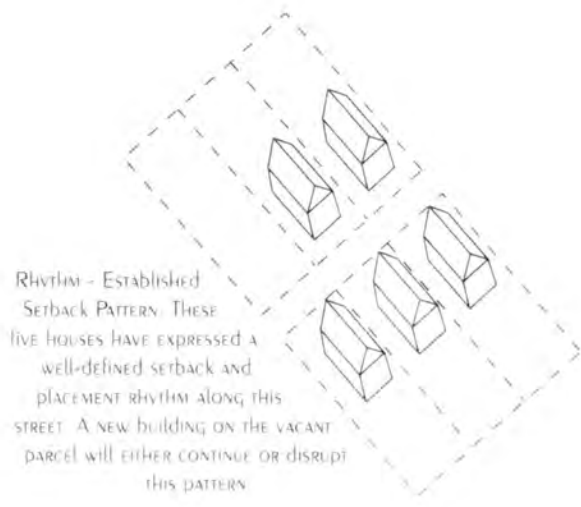

RHYTHM - ESTABLISHED SETBACK PATTERN: THESE FIVE HOUSES HAVE EXPRESSED A WELL-DEFINED SETBACK AND PLACEMENT RHYTHM ALONG THIS STREET. A NEW BUILDING ON THE VACANT PARCEL WILL EITHER CONTINUE OR DISRUPT THIS PATTERN.

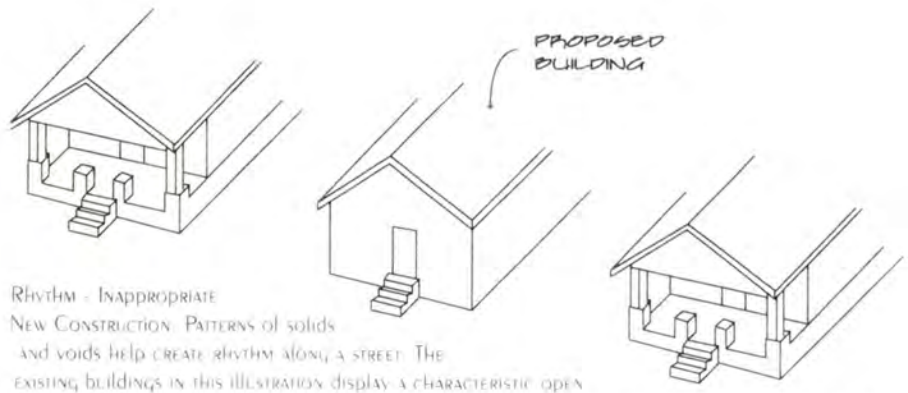

RHYTHM - INAPPROPRIATE NEW CONSTRUCTION: PATTERNS OF SOLIDS AND VOIDS HELP CREATE RHYTHM ALONG A STREET. THE EXISTING BUILDINGS IN THIS ILLUSTRATION DISPLAY A CHARACTERISTIC OPEN PORCH SPACE. THE PROPOSED BUILDING IN THE MIDDLE PRESENTS A SOLID FRONT WALL SURFACE THAT DISRUPTS THE EXISTING RHYTHM.

## 7.2.7 SCALE/HEIGHT

Scale refers to the apparent relationship between two entities, such as the relationship of a building's height to human height, the relationship between different buildings' heights and sizes, or the relationship between the size of an addition and the building to which it is attached. In Druid Hills the two most important issues are (1) the relationship of new construction to historic and (2) the relationship of additions to the historic building to which they are being added.

**Guideline - New construction in historic areas should be consistent with dominant patterns of scale within the area of influence, if such patterns are present. Additions to historic buildings should not appear to overwhelm the existing building.**

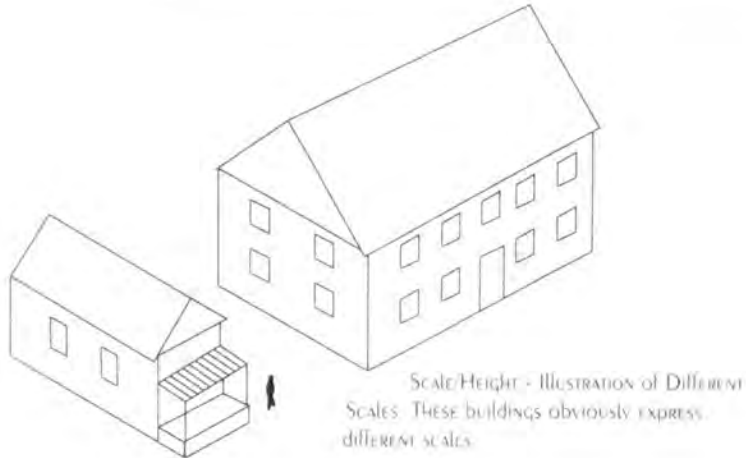

Scale/Height - Inappropriate Addition. This addition (shaded) is too large and overwhelms the original historic structure. It also juts forward, thus accentuating its presence.



**Guideline - A proposed new building should appear to conform to the floor-to-floor heights of existing structures if there is a dominant pattern within the established area of influence. Dominant patterns of cornice lines, string courses, and water tables can be referenced to help create a consistent appearance.**

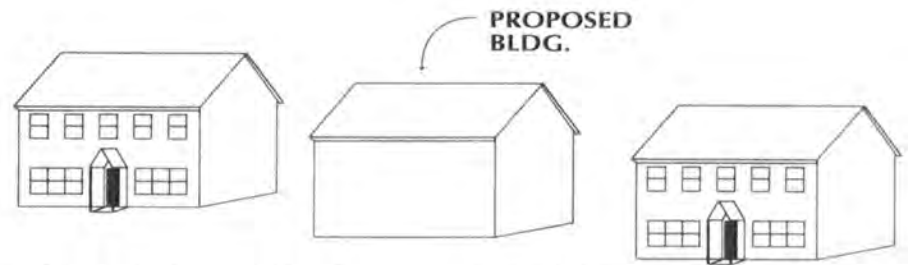

Scale/Height - Appropriate New Construction. The scale of the proposed building in the middle is compatible with that of the historic buildings to either side.

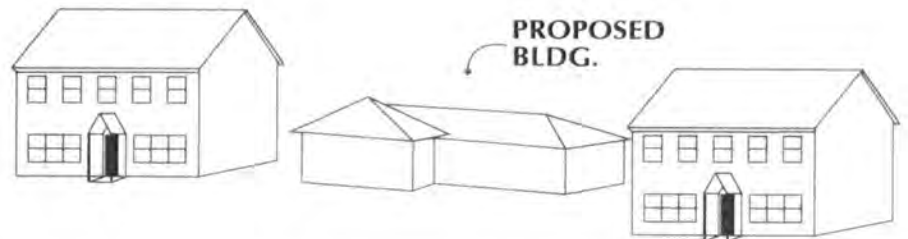

Scale/Height - Inappropriate New Construction. The scale of the proposed building in the middle is incompatible with that of the historic buildings to either side.

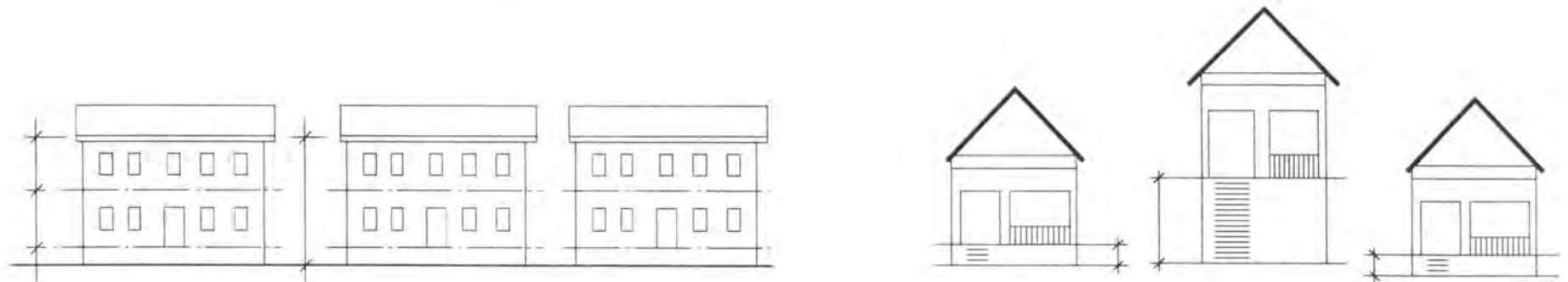

**SCALE/HEIGHT - CONSISTENT FLOOR-TO-FLOOR HEIGHTS.** The sketch on the left shows three buildings with consistent floor-to-floor heights resulting in a uniform sense of proportion and scale. In the sketch on the right, the middle building displays a first-floor height that is inconsistent with the dominant street pattern. As a result, the building appears to be out of scale and proportion even though the main body of the house is identical to that of the other two.

### 7.2.8 Individual Architectural Elements

**P**redominant architectural and site elements in the area of influence should be taken into account. New construction and additions need not attempt to create a “new historical work” but rather acknowledge predominant patterns in a contemporary manner. Following is a list of different types of elements that should be assessed before proceeding with new construction.

- ✦ **Roofs** - A variety of roof shapes, pitches, and types is often found within a historic area. Roof details such as chimney design, gable ornamentation, ridge decoration, and roofing materials may also be a predominant characteristic.
- ✦ **Walls** - The surfaces of the walls may be relatively smooth and uninterrupted, or they may be broken by projecting windows, porches, and other architectural elements.
- ✦ **Windows and Entrances** - There may be patterns of window and entrance placement, size, or ornamentation that are a strong visual component of the area. Shutters and window trim affect this patterning.
- ✦ **Details** - Facia, soffit, eave, and cornice trim; porch columns and supports; and other decorative details can provide a pattern and scale to historic buildings and areas.
- ✦ **Materials** - Buildings may incorporate a variety of materials such as wood, masonry, stucco, stone, and others. These materials may have different textures and shapes, such as coarsely surfaced brick versus a smooth stucco exterior facing. The use and presentation of materials contribute to the overall character of an area.
- ✦ **Landscaping Elements** - Specific types of vegetation such as oak trees, shrubs, or expanses of grassy lawn may predominate in an area. Elements such as walks and drives may also contribute to visual continuity along the street.

**Guideline - New construction and additions should be compatible and not conflict with the predominant site and architectural elements—and their design relationships—of existing properties in the area of influence.**

## 7.3 RESPECTING THE PREVAILING CHARACTER WHEN DESIGNING NEW DEVELOPMENT

After identifying the area of influence and assessing the prevailing character of the development within that area, the next step is to begin the design of the project. Each project is unique and should be taken on a case-by-case basis to meet the needs of the owner while at the same time protecting the historic character of the property and area. There are some general concepts, however, that can assist with the design of the new development. Use these in tandem with the guidelines presented in *Sections 7.1 and 7.2*.

### 7.3.1 Additions

Property owners considering making an addition to a historic building, should ask themselves three questions:

- 1 *Does the proposed addition preserve significant historic materials and features?*
- 2 *Does the proposed addition preserve the historic character?*
- 3 *Does the proposed addition protect the historical significance by making a visual distinction between old and new?*

**Guideline - Additions should not be added to the main facade of the building and should not appear to dominate the original structure. It is preferable to build new additions to the rear of a historic building, where it will have little or no impact on the streetscape facade. Design and materials should be compatible with the existing building. Avoid obscuring character-defining features of the historic building with the addition.**

**Guideline - Additional stories should be set well back from the roof edge to ensure that the historic building's proportions and profile are not radically changed.**

Sometimes historic photographs can give clues to the location of previous additions to the building and thus provide guidance for the location of new additions.

**Recommendation - The Secretary of the Interior's Standards recommend that an addition be designed so that at a later date it can be removed without compromising the historic character of the building.**

**Recommendation - While an addition should be compatible, it is acceptable and appropriate for it to be clearly discernible as an addition rather than appearing to be an original part of the building. Consider providing some differentiation in material, color, and/or detailing and setting additions back from the historic building's wall plane.**

Alterations to buildings that do not contribute to the historic character of the area pose a challenge. If the building is out of scale with its historic neighbors, often little can be done to make it compatible.

**Recommendation - These guidelines do not recommend adding false historical details to a noncontributing building in an effort to make it more compatible with surrounding historic buildings. Every effort should be made, however, to ensure that additions and alterations to the property do not detract further from the character of the historic environment, keeping in mind the design concepts discussed in *Section 7.2*.**

### 7.3.2 NEW CONSTRUCTION AND SUBDIVISION DEVELOPMENT

**Guideline - To be compatible with its environment, new construction should follow established design patterns of its historic neighbors, including building orientation, setback, height, scale, and massing.**

**Guideline - New construction should respect the historic character that makes the area distinctive, but it should not be a mere imitation of historic design.**

### 7.3.3 DEMOLITION AND RELOCATION

**B**uildings and structures that are proposed for demolition or relocation should be thoroughly evaluated for historic and architectural merit and importance to the character of the site and district. If significant, alternative uses that permit continued preservation should be thoroughly investigated. Proposed plans for the redevelopment of the site that effect the appearance should be a part of this evaluation.

**Guideline - Historic buildings and structures should not be demolished unless they are so unsound that rehabilitation is not possible. Historic buildings should not be moved off the property or relocated on the site, nor should other buildings be moved onto the site.**





---

## 8.0 NATURAL LANDSCAPES - PROTECTING THE DESIGN CONTEXT

### 8.1 OPEN SPACE AND PARKLAND PRESERVATION AND CONSERVATION

**OPEN SPACE LINKAGES** - The open spaces, preserved in Olmsted's original concepts for Druid Hills, remain as major open spaces today. These green spaces are connected by the stream corridors that extend through them. It is imperative that the large scale, historic, public and private open spaces be preserved to provide a rich habitat for plants and wildlife and also to protect the stream corridors. The park-like character created by these large open spaces is reinforced by the unbroken landscapes of the residential settings.

View of Druid Hills Golf Course, one of the district's significant open spaces.



**PASSIVE USE OF OPEN SPACES** - The natural character of these open spaces is best protected by passive use activities. Intensive sports activities, such as ballfields and large-scale playgrounds, would damage the character of these spaces and should be avoided.

**ERADICATION OF EXOTIC SPECIES** - The open spaces are comprised primarily of native plant communities. Several open spaces have been damaged by a proliferation of exotic species, particularly privet, ivy, elaeagnus and kudzu. The persuasiveness of these species threatens the bio-diversity. A mono-culture environment is created, resulting in a negative impact to the ecology of the district's open spaces. The predominance of English Ivy within the Fernbank Forest is an example of the invasion by exotic species in a natural environment. These exotic species should be removed by the most environmentally responsive approach possible. (See *Eradication of Kudzu* in the *Appendix*.)

**Guideline** - The original layout of Druid Hills should be preserved through the conservation of major open spaces and the linear system of parks and green spaces that buffer the stream corridors. Retaining these spaces, both public and private, by limiting their uses to passive activities will perpetuate the park-like character in the district today. An exclusive palette of native vegetation is recommended for these spaces to protect and enhance the ecology.

**Recommendation** - The Druid Hills Civic Association or the DeKalb County Historic Preservation Commission should consider discussing with private property owners the concept of conservation easements, in combination with tax credits, to preserve the private "open spaces."

## 8.2 TREE CONSERVATION

The Druid Hills Local District is characterized by remnants of a mature hardwood forest contained within its public open spaces and privately-owned, institutional and residential lots. The management of this vegetative resource within the district will assist in the perpetuation of this significant historic and character-defining feature. A management plan should be developed for the Druid Hills Local Historic District to promote the conservation of the mature hardwood forest. Management of the district's tree resources, both pines and hardwoods, can be accomplished through a variety of techniques - voluntary as well as mandatory.

A tree ordinance is one of the most effective mandatory techniques. Tree replacement and protection of existing trees are fostered through the requirements contained within such an ordinance. Such ordinances are designed to protect and perpetuate the wooded character of mature landscapes, such as Druid Hills. Most ordinances typically control large scale development actions, while individual actions occur unchecked. In Druid Hills, it may be desirable to monitor individual actions related to tree preservation and replacement, since incremental actions over time lead to major changes in the character of a community.

Voluntary actions might include a survey and analysis of existing trees. Survey and analysis activities should include an assessment of the existing resource through a tree inventory and recommendations for rejuvenating the existing urban forest. Pruning of dead wood is suggested to stimulate growth of mature trees. Pruning specifications and guidelines (typically available through county extension offices) should be followed. Trees in deteriorated conditions or of advance age should be removed and replaced.

An underplanting program should be initiated in anticipation of future replacement. In an underplanting effort, young trees of identical or compatible varieties to existing trees are planted adjacent to aged vegetation for the purpose of eventual replacement. In most cases, replanting schemes should follow the diversity of tree types contained within tree groupings. In a few special situations, such as the cluster of beech trees on Oakdale, tree groupings of identical varieties is recommended. Replacement trees should be of adequate size to make a visual impact in the district. For that reason, seedlings are not recommended. Underplanting should be carried out by both the public and private sectors.

**Recommendation - The mature hardwood forest within the Druid Hills Local Historic District should be perpetuated through a district-wide replanting program. Trees should be replaced when mature trees are lost to age or damage or are removed for safety reasons. Replacement trees should be of identical or similar varieties to the original trees. A diversity of tree types is recommended to perpetuate the existing character of most tree groupings. Replacement trees of adequate size (1.5" caliper minimum) are recommended. Existing ordinances that provide for the protection and replacement of the district's tree resources should be applied to development activities within Druid Hills.**

Example of mature hardwood forest that characterizes much of the local historic district.



## 8.3 PROTECTION OF THE HISTORIC WATERSHED

### DESIGN AND DESIGN CONCEPT

Most of the Druid Hills Historic District is contained within the Peavine and Lullwater Creeks Watershed. Peavine and Lullwater Creeks extend through the district's major open spaces including the woods along Peavine Creek at Emory University, Druid Hills Golf and Country Club, Fernbank Forest, and Deepdene Park. The watershed is further comprised of a system of secondary and tertiary streams that feed these major creeks. Olmsted's design placed rear lot lines along these streams and natural drainage ways as a method of protection and flood control.

River protection legislation at the state level requires a 25' setback from the top of a creek bank in the construction of new buildings. This rule should be applied to all drainage ways within the Druid Hills Historic District as a method of limiting development in these environmentally-sensitive zones. Tax maps provide a general location for floodprone zones.

The district's major creek corridors, the floodprone zones taken from tax maps, and other identified drainage ways have been noted on the official "Historic District Map." These primary, secondary, and tertiary system of streams should be considered in all undertakings within the local historic district with the recommended 25' setback maintained.

There are a variety of methods available to address soil erosion along the district's creek corridors. Some methods use rock, such as "rip rap" and "gabions", while others rely on vegetative approaches, such as "live stakes" and "wattling". The City of Atlanta is currently addressing soil erosion city-wide through a comprehensive improvement program in all of the city's drainage basins. Many of the methods used in this effort might be considered for Druid Hills.

Another method for protecting the district's hydrological system includes the reconstruction of the original Olmsted-designed stone and turf gutters and the use of porous paving materials for parking lots, walks, and drives.

View of development along Peavine Creek



**Guideline - All construction within the Druid Hills Local Historic District should follow a 25' setback requirement from the top of bank of creek corridors and drainage ways, as delineated on the official "Historic District Map."**

**Guideline - Methods used to address bankside erosion should complement the natural character of the creek corridor. Natural materials, such as native rock and plants, should be used as the material in erosion control devices.**

Use of granite to control soil erosion along Peavine Creek.

Granite used as "rip rap", in addressing bankside erosion is effective, but more aesthetically-pleasing materials can be used with the same result. Native rock materials instead of granite blend with the natural environment. Also, there are a variety of vegetative approaches, equally as natural in appearance.



View of Lullwater Creek illustrating the use of "gabions". Gabions are large, fenced cages filled with rock, placed along the bankside to arrest erosion.

The use of native stone assists in making gabions a visual complement to the natural environment.





## 9.0 CULTURAL LANDSCAPES GUIDELINES - MAINTAINING “THE LOOK”

The landscape guidelines contained within *Section 8.0: Natural Landscapes - Protecting the Design Context* may also apply to cultural and should be consulted when considering an alteration to a landscape feature within the local historic district.

### 9.1 ORIGINAL SUBDIVISION FORMS

The historic layout of the neighborhoods and subdivisions, located within the Druid Hills Local Historic District, has created the physical framework for the district. This layout, created originally by Frederick Law Olmsted, Sr., has definable characteristics that have been replicated in more recent development plats by later designers. These plans guided the configuration of streets, public open spaces, and private lots. The original layout creates a historical context for the district. The cumulative effect of alterations to this layout would destroy this context. While some zoning classifications within the local district may allow the subdivision of existing lots, such proposed changes to the layout should be designed as a complement to the original design.

Example of the curvilinear alignment of roadways within the local historic district. Many original plats from various areas within Druid Hills are available for reference in



studying the district's original design layouts.

Many of Druid Hills' neighborhoods retain portions of the original streetscape layout. There are several exceptions. Stone gutters are not present and more narrow dimensions are found today for the tree planting strip and sidewalks.

#### Sidewalk Widths -

Throughout Druid Hills today, most sidewalks are predominately 4' wide. Walks along Ponce de Leon are an exception, and as called for in the original plans, are 6' wide.

Example of streetscape profile on Rosedale with sidewalks and tree planting strip lining the street



**Guideline - Elements of the original layout to be retained include lot layouts for public and private spaces and the alignment of streets, drives, walkways, and streetscape profiles.**

**Guideline - In most cases, sidewalks to be repaired or new sidewalks to be added within the local historic district should be 4' wide.**

### 9.2 TRADITIONAL STREETScape PROFILE

Plans by Olmsted Brothers in 1902 document the design intent for the streetscape in Druid Hills. Elements of the traditional streetscape include: (1) street, (2) stone gutter, (3) tree planting strip, (4) sidewalk, (5) vine planting strip, and (6) turf gutter. The scale of the streetscape elements depended on the street's role within the road system. The more intense the anticipated use, the wider the elements. Streets (16'-24' wide) were bordered by a stone gutter, a tree planting strip (5'-6' wide), a sidewalk (4'-6' wide), vine strip, and a turf gutter. There was no curb present in Olmsted's original concept.

**TREE PLANTING STRIP** - The width of tree planting strips within the Druid Hills Local Historic District varies from 4' - 8'. "The more recent the subdivision plat,

the wider the space" is a general rule. Today's tree planting strip contains a mixture of small and large hardwood trees. The placement of large hardwoods adjacent to the road was Olmsted's original intent. The ambiance created by these trees maturing over time is an important character-defining feature of the local historic district.

Example of limited tree planting strip containing mixture of trees types - large maple in foreground and smaller dogwoods behind the maple



Tree planting strips in the 4' wide range may require special features to allow space for large hardwoods. As an example, the 4' strip, located along Springdale and Oakdale Roads, provides a limited area for the large, mature trees now growing there.

**Guideline - Tree planting strips should be retained for that purpose only and should be a part of all new development.**

**Recommendation - The available space within the tree planting strip, which varies from 4' - 8', will determine the most appropriate type of tree to plant. The mature size of trees should be a major consideration. Oaks and maples are the types of trees most suitable for the more spacious locations. Dogwoods, redbuds, and crape myrtles are most suitable for the more narrow spaces.**

**Recommendation - In locations containing large hardwood trees, such as oaks and beeches, where the intent is to retain this type of established tree groupings, special accommodations will be necessary. Techniques to consider in expanding limited planting zones include: (1) using porous pavers in place of non-porous concrete paving for the sidewalk, which allows penetration of water to tree roots; or (2) a re-alignment of the existing sidewalk away from the base of the tree are techniques that will allow the trees maximum growing space.**

**GRANITE CURBS AND STONE**

**GUTTERS** - The streetscape profile has changed over time from Olmsted's original concept. Raised granite curbs have replaced the stone gutter shown on Olmsted's original street sections. The granite curb is one of the most ubiquitous elements in the local district today.

Example of historic granite curb in foreground and nonhistoric concrete curb in background. Note intrusive character of "white-colored concrete" when compared to subtle shades of granite.



**Guideline - Granite curbs are considered a historic element and should be retained and reused in any street improvements. The stone gutter and grassed swales from the original design were important elements in protecting the district's watershed. This design element should be reconstructed at all possible locations along roadways within the district. The "developed" character of the green space bordering roadways in residential neighborhoods will likely not allow for the introduction of a stone gutter. The reconstruction of stone gutters appears to be possible along roadways bordered by parkland and in other locations where curbing is not present.**

**9.3 VEGETATION**

**STREET TREES** - The majority of the street tree plantings are native hardwoods, both large and small. Crape myrtles are an example of an exotic species, sometimes used as small trees in the tree planting strip. Native hardwoods are the most desirable trees for street tree replacements or new plantings. Large hardwoods are recommended to perpetuate Olmsted's original intent. In the more narrow planting strips, special accommodations may be required to allow space for large hardwoods. (Refer to guideline in *Section 9.2: Traditional Streetscape Profile*.) Dogwoods are encouraged as a tree to consider for small tree plantings. Residents fondly remember the character-defining role of these trees in the past when they were more pervasive than today. Other suitable small trees include redbuds, serviceberries, and fringe trees. The presence of overhead wires is another consideration in selecting the appropriate tree species.

**APPROPRIATE PLANT SPECIES** - The character of the landscape is determined by the type of vegetation used. Vegetation through its scale, texture, and form is an important character-defining feature. It is important within a landscape of cultural as well as natural significance to select vegetation appropriate to the area. In historic zones, it is important to select plant materials that would have been used within the period significant to the architecture. In natural areas, it is important to use an exclusive palette of native vegetation.

Example of cluster of maple trees along street within the district



**Recommendation** - The following plant list is intended to assist in the selection of appropriate plant materials. The list has been organized into large trees, small trees, shrubs, annuals/perennials, and vines/ground covers. The list has been developed using the following sources: (1) Olmsted's Planting List from several plans for Druid Hills; (2) Historic Plants compiled as part of the Georgia Landscapes Project by the Historic Preservation Division of the Georgia Department of Natural Resources; and (3) Native Species. Aggressive exotics have also been noted, so that their use can be limited to controlled situations. (Refer to *Section 8.1 Open Space and Parkland Preservation and Conservation: Eradication of Exotic Species.*)

Olmsted's list and the list from the Georgia Landscapes Project provide guidance in selecting materials appropriate for historic landscape projects. The Olmsted list has been updated with current plant names. There are other sources that can be consulted to identify additional plants used by Olmsted in Druid Hills, such as historic planting plans and, particularly the archival record at the Olmsted National Historic Site in Brookline, Massachusetts. The Olmsted list presented in this document should be considered a beginning. Residents of Druid Hills are encouraged to add to this list with historic plants that can be documented as having been used by Olmsted.

Example of planting of Bradford Pears within intrusion areas within the district. Bradford Pear is nonhistoric tree that would not be appropriate in historic areas of the district.



The native list should be used for natural areas within the district, such as creek corridors and drainage ways. Places within the district where the retention of healthy ecological environments is critical are best landscaped with native varieties. Since native plants have been available since the colony of Georgia was established in 1733, native plants are also appropriate for historic landscapes.

## DRUID HILLS- RECOMMENDED PLANT MATERIALS LIST

Botanical Name	Common Name	Olmsted	Ga. Landscp Project	SE Native	Aggressive Exotics
<b>LARGE TREES</b>					
Acer barbatum	Southern Sugar Maple		✓	✓	
Acer negundo californicum (negundo)	Ash-leaf Maple	✓			
Acer rubrum	Red Maple		✓	✓	
Acer saccharinum	Silver Maple	✓		✓	
Betula alba laciniata	Cut-leaf Birch	✓			
Catalpa speciosa	Western Catalpa	✓			
Cedrus deodara	Deodar Cedar		✓		
Chamaecyparous obtusa	Hinoki False Cypress		✓		
Chamaecyparis pisifera plumosa	Plume Sawara False Cypress	✓			
Fagus pendula	Weeping Beech		✓		
Fagus sylvatica 'atropunicea'	Purple Beech		✓		
Firmiana simplex	Chinese Parasol	✓			
Ginkgo biloba	Ginkgo		✓		
Gleditsia triacanthos	Honey Locust	✓		✓	
Halesia diptera	Silverbell	✓		✓	



Botanical Name	Common Name	Olmsted	Ga. Landscp Project	SE Native	Aggressive Exotics
Juniperus virginiana	Red Cedar	✓		✓	
Liquidambar styraciflua	Sweet Gum		✓	✓	
Liriodendron tulipifera	Tulip Tree		✓	✓	
Magnolia acuminata	Cucumber Tree	✓			
Magnolia fraseri	Frazer's Magnolia	✓		✓	
Magnolia grandiflora	Southern Magnolia	✓	✓	✓	
Magnolia macrophylla	Bigleaf Magnolia	✓		✓	
Paulownia imperialis (tomentosa)	Paulownia	✓			✓
Platanus occidentalis	Sycamore	✓		✓	
Platyclusus orientalis	Oriental Arborvitae	✓			
Populus deltoides	Cottonwood	✓		✓	
Quercus alba	White Oak	✓			
Quercus coccinea	Scarlet Oak	✓	✓	✓	
Quercus laurifolia	Darlington Oak	✓		✓	
Quercus nigra	Water Oak		✓	✓	
Quercus phellos	Willow Oak		✓	✓	
Quercus velutina	Black Oak	✓		✓	
Robina pseudoacacia	Yellow Locust	✓		✓	
Salix alba	White Willow	✓		✓	
Salix babylonica	Weeping Willow		✓		
Staphylea colchica	Colchican Bladdernut Tree	✓			
Staphylea trifolia	Tree-leaf Bladdernut Tree	✓		✓	
Stewartia ovata	Mountain Stewartia	✓		✓	
Styrax americanus	American Storax	✓		✓	
Styrax grandifolius	Large-leaf Styrax	✓		✓	
Styrax obassia	Styrax	✓			
Symplocos paniculata	Symplocos	✓			
Thuja occidentalis	American Arborvitae	✓		✓	
Tsuga canadensis	Hemlock	✓	✓	✓	
Ulmus alata	Winged Elm	✓		✓	
Ulmus parviflora	Chinese Elm		✓		
Zelkova serrata	Japanese Zelkova		✓		
<b>SMALL TREES</b>					
Acacia dealbata	Silver Wattle	✓			
Acer palmatum	Japanese Maple		✓		
Acer saccharinum Weirii	Weir's Cutleaf Maple	✓			
Albizia julibrissin	Mimosa				
Cercis canadensis	Redbud	✓	✓	✓	

Botanical Name	Common Name	Olmsted	Ga. Landsc Project	SE Native	Aggressive Exotics
<i>Chionanthus virginicus</i>	Grancy Greybeard	✓		✓	
<i>Cornus florida</i>	Dogwood	✓	✓	✓	
<i>Cornus kousa</i>	Japanes dogwood	✓			
<i>Cornus mas</i>	Cornelian Cherry Dogwood	✓			
<i>Cornus officinalis</i>	Cornel	✓			
<i>Cornus sanguinea</i>	European Red Dogwood	✓			
<i>Cornus stolonifera</i>	Stooling Cornel	✓			
<i>Cotinus americanus (obovatus)</i>	Smoke Tree		✓	✓	
<i>Lagerstroemia indica</i>	Crape Myrtle		✓		
<i>Magnolia virginiana</i>	Sweetbay	✓		✓	
<i>Magnolia x soulangiana</i>	Saucer Magnolia	✓	✓		
<i>Malus floribunda</i>	Japanese Flowering Crabapple		✓		
<i>Malus sargentii</i>	Sargent Crabapple		✓		
<i>Melia azederach umbraculifera</i>	Texas Umbrella Tree	✓			
<i>Oxydendrum arboreum</i>	Sourwood	✓		✓	
<i>Prunus caroliniana</i>	Mock Cherry	✓		✓	
<i>Tamarix chinensis</i>	Tamarisk	✓			
<i>Vitex agnus castus</i>	Chaste Tree	✓			
<b>Shrubs</b>					
<i>Abelia chinensis</i>	Abelia	✓			
<i>Abelia floribunda</i>	Abelia	✓			
<i>Abelia x grandiflora</i>	Glossy Abelia		✓		
<i>Aucuba japonica</i>	Japanese Acuba		✓		
<i>Berberis japonica</i>	Japan Barberry	✓			
<i>Buxus sempervirens</i>	Common Box	✓	✓		
<i>Buxus suffruticosa</i>	Common Box		✓		
<i>Calycanthus floridus</i>	Sweet Shrub	✓		✓	
<i>Camellia japonica</i>	Camellia	✓	✓		
<i>Camellia sasanqua</i>	Fall Blooming Camellia		✓		
<i>Camellia sinensis</i>	Tea Plant		✓		
<i>Cephalanthus occidentalis</i>	Button-bush	✓		✓	
<i>Clerodendrum trichotomum</i>	Clerodendrum	✓			
<i>Clethra alnifolia</i>	White Alder	✓		✓	
<i>Cleyera japonica</i>	Cleyera	✓			
<i>Corylus americana</i>	American Hazelnut	✓		✓	
<i>Cotoneaster microphyllus</i>	Evergreen Cotoneaster	✓			
<i>Cytisus scoparius</i>	Scotch Broom	✓			✓
<i>Deutzia gracilis</i>	Slender Deutzia		✓		

Botanical Name	Common Name	Olmsted	Ga. Landscp Project	SE Native	Aggressive Exotics
Diervilla sessilifolia	Weigelia	✓			
Eleagnus angustifolia	Narrow-leaf Oleaster (Russia)	✓			
Eleagnus argentea	Silver Leaf Oleaster	✓			
Eleagnus macrophylla	Large-leaf Oleaster	✓			
Eleagnus umbellata parvifolia	Oleaster	✓			
Eleagnus pungens	Wild Olive/Thorny Eleagnus	✓	✓		✓
Euonymus bungeana	Spindle Tree				
Euonymus hamiltoniana	Spindle Tree	✓			
Euonymus latifolia	Broad-leaf Euonymous	✓			
Euonymus japonica	Japanese Euonymous				
Forsythia suspensa	Forsythia		✓		
Gardenia jasminoides	Cape Jasmine	✓			
Gordonia franklinia Alatomaha	Alatomaha Gordonia	✓		✓	
Hibiscus syriacus	Shrubby Althaea	✓			
Hibiscus syriacus Meehanii	Meehans Bush Altheae	✓			
Hippophae rhamnoides	Sea Buckthorn	✓			
Hippophae salicifolia	Hippophae	✓			
Hydrangea arborescens	Wild Hydrangea	✓		✓	
Hydrangea arborescens radiata	Downy Hydrangea	✓			
Hydrangea japonica	Japanese Hydrangea	✓			
Hydrangea paniculata	Single Hydrangea	✓			
Hydrangea paniculata Grandiflora	Peegee Hydrangea	✓			
Hydrangea quercifolia	Oak-leaved Hydrangea	✓	✓	✓	
Ilex cassine myrtifolia	(Dahoon) Holly	✓		✓	
Ilex cornuta	Holly	✓			
Ilex crenata	Japanese holly	✓	✓		
Ilex glabra	Inkberry	✓		✓	
Ilex opaca	American Holly	✓		✓	
Illicium anisatum	Anise Tree	✓	✓		
Jasminum nudiflorum	Winter Jasmine	✓	✓		
Kerria japonica	Kerria		✓		
Laurus nobilis	Common English Laurel	✓			
Ligustrum amurense	Privet	✓			
Ligustrum sinense	Privet	✓			
Ligustrum japonicum	Wax Leaf Ligustrum		✓		✓
Ligustrum lucidum	Privet	✓			
Lindera melissaefolia	Spice Bush	✓		✓	
Lonicera periclymenum belgica	Dutch Honeysuckle	✓			
Lonicera fragrantissima	Fragrant/Winter Honeysuckl	✓	✓		

Botanical Name	Common Name	Olmsted	Ga. Landsc Project	SE Native	Aggressive Exotics
Lonicera Korolkowii	Korolkow's Honeysuckle	✓			
Lonicera Ledebourii	Ledebour Honeysuckle	✓			
Lonicera maackii	Honeysuckle	✓			✓
Lonicera Standishii	Standish Honeysuckle	✓			
Lyonia ligustrina	Male Berry	✓			
Lyonia mariana	Staggerbush	✓			
Magnolia hypoleuca	Purple Japan Hydrangea	✓			
Mahonia aquifolium	Mahonia	✓			
Mahonia bealei	Leatherleaf Mahonia		✓		✓
Michelia figo	Banana Shrub		✓		
Myrica cerifera dwf	Dwarf Myrtle	✓		✓	
Nandina domestica	Nandina	✓			
Neviusia alabamensis	Snow Wreath	✓		✓	
Osmanthus fragrans	Tea Olive		✓		
Osmanthus heterophyllus	Holly-leaf Osmanthus	✓			
Phellodendron amurense	Phellodendron	✓			
Philadelphus coronarius	Mock Orange		✓		
Phillyrea angustifolia	Phyllyrea				
Pieris japonica	Japanese Pieris	✓			
Poncirus trifoliata	Hardy Japan Orange	✓			
Prunus laurocerasus	English Laurel	✓			
Prunus lusitanica	Portugal Laurel				
Pterostyrax hispida	Pterostyrax	✓			
Pyracantha coccinea	Firethorn		✓		
Pyracantha coccinea lalandei	Evergreen Thorn	✓			
Rhododendron indica formosa	Indian Azalea	✓			
Rosa bracteata	Macartney Rose	✓			
Shepherdia argentea	Buffalo Berry	✓			
Spiraea x vanhouttei	Vanhoutte Spirea		✓		
Spiraea prunifolia	Bridal Wreath		✓		
Spirea thunbergii	Thunberg Spirea		✓		
Syringa laciniata	Cutleaf Lilac		✓		
Syringa pekinensis	Pekin Lilac	✓			
Syringa villosa	Syringa	✓			
Syringa vulgaris	Common Lilac	✓			
Vaccinium arboreum	Farkleberry	✓		✓	
Viburnum Opulus	High-bush Cranberry	✓			
Viburnum plicatum	Japan Snowball	✓			
Viburnum Wrightii	Arrowwood	✓			

Botanical Name	Common Name	Olmsted	Ga. Landscp Project	SE Native	Aggressive Exotics
Weigela florida	Weigela		√		
<b>ANNUALS/PERENNIALS</b>					
Ageratum houstonianum	Mexican Ageratum		√		
Amorpha canescens	Lead Plant	√			
Artemesia frigida	Artemesia	√			
Artemisia abrotanum	Southern Wood	√			
Calendula officinalis	Pot Marigold		√		
Canna hybrids	Canna		√	√	
Catharanthus roseus	Madagascar Periwinkle		√		
Centaurea gymnocarpa	Dusty Miller		√		
Chrysanthemum hybrids	Chrysanthemum		√		
Chrysanthemum x superbum	Shasta Daisy		√		
Chrysanthemum leucanthemum	Daisy		√		
Coleus hybrids	Coleus		√		
Cytisus decumbens	Prostrata Genista	√			
Dahlia hybrids	Dahlia		√		
Echinacea purpurea	Purple Cone Flower		√	√	
Genista pilosa	Green-weed	√			
Hosta plantaginea	Hosta		√		
Hosta species	Plantain Lily		√		
Iris x germanica	Bearded/German Iris	√	√		
Iris kaempferi	Japanese Iris		√		
Oenothera biennis	Evening Primrose		√	√	
Oenothera fruticosa	Sundrops		√		
Paeonia species	Peony		√		
Peony lactiflora	Peony		√		
Petunia x hybrida	Petunia		√		
Petunia multiflora	Petunia		√		
Phlox subulata	Thrift		√		
Platycodon grandiflorus	Balloon Flower		√		
Ruta graveolens	Common Rue	√			
Salvia splendens	Scarlet Sage		√		
Stokesia laevis	Stokes' Aster		√	√	
Tropaeolum majus	Nasturtium		√		
Verbena canadensis	Verbena		√	√	

Botanical Name	Common Name	Olmsted	Ga. Landscp Project	SE Native	Aggressive Exotics
Viola odorata	Sweet Violet		√		
Viola tricolor hortensis	Pansy		√		
Zinnia elegans	Small Flowered Zinnia		√		
<b>VINES/GROUND COVERS</b>					
Clematis x Jackmanii	Jackman Clematis		√		
Clematis paniculata	Sweet Autumn Clematis		√		
Euonymus fortunei vegetus	Bigleaf Wintercreeper		√		√
Gelsemium sempervirens	Yellow Jessamine	√	√	√	
Hedera helix	English Ivy		√		√
Ipomoea purpurea	Morning Glory		√		
Lonicera japonica	Japanese Honeysuckle	√			√
Lycium barbarum	Matrimony Vine	√			
Parthenocissus quinquefolia	Virginia Creeper		√	√	
Parthenocissus tricuspidata	Boston Ivy		√		
Rosa Banksiae	Banks Rose		√		
Smilax lanceolata	Smilax		√		
Trachelospermum jasminoides	Star Jasmine		√		
Wisteria senensis	Chinese Wisteria		√		√

## 9.4 ENCLOSURES AND WALLS

The sensitive layout of the Druid Hills' neighborhoods by the Olmsted firm and subsequent designers following this original design intent has limited the need for retaining walls. A few retaining walls are used in locations with severe topography. Stone with concrete mortar are the traditional materials used in retaining wall construction. Fences, though noted on Olmsted's streetscape section as a location for vine plantings in front yard spaces, are not a common element within the district today. Without fences, private front yard spaces are visually connected. Together they create a continuous landscape intermittently framed with planting beds.

Fences are used, however, in the rear yard of residential spaces. Rear yard fencing is defined as fencing which starts at the rear of the structure (not the side or front of the building line). Rear yard fencing does not disrupt the visual continuity of the front yard spaces between structures. Rear yard fencing is appropriate within the neighborhoods of the local historic district. Rear yard fencing also assists in buffering obtrusive traffic noise at major intersections within the district.

Example of intrusive front yard fencing; note how fence blocks visibility between front yard spaces



**Guideline - Fences and walls should not be built in front yard spaces and are strongly discouraged from corner lot side yard spaces. Retaining walls should only be used in situations where topography requires their use.**

**Recommendation - Fences are appropriate in rear yard spaces. Rear yard fences should be coordinated with existing county codes. Suggested materials include wood and chain link. Vinyl-covered chain link fencing, typically in bronze, brown, or black, assist in making fences less obtrusive. Vines are suggested to "soften" the appearance of metal chain link fencing. If wood fencing is used, the paint color and design should be compatible with the architecture of the adjacent residence. Fence heights can range from 4' to 6' depending on the reason for the enclosure.**

## 9.5 PARKING

Parking is a necessity within the district. The width of existing streets (20' and less in some cases) limits the space available for on-street parking. In most cases, parking will need to be accommodated within private residential lots.

**Guideline - Parking should be addressed in a manner that does not distract from the overall character of the district. Parking to serve private residential lots should be accommodated on-site, when at all possible, using the pathway of original drives and parking. Front yard parking should not be allowed unless it is a public safety issue. When front yard parking is necessary, it should be added in a manner that does not destroy the unbroken landscaped character of the front yard spaces in Druid Hills. Rear yard spaces should be considered for expansion of parking areas**

**Guideline - Curb cuts should not be added or expanded in order to protect the character of the district's streets.**

**Recommendation - It is preferable to expand an existing driveway for parking, rather than to add a separate parking pad, since the result is usually less paved surface. Plant materials can be added around parking spaces to visually buffer the parking from the street.**

**Recommendation - In surfacing new parking areas, the use of impervious paving materials is discouraged. The intent is to limit the amount of run-off within the district's watershed. Consideration should be given to the use of porous materials that allow water penetration and preserve the open character of the landscape.**

Caution should be used in considering porous asphalt paving. This material has been determined to create soil compaction and to deteriorate the paving material through oil and gas leaks. Other porous materials that have been shown to be effective are open paver blocks, sometimes referred to as “grasscrete” or “grass blocks”. There are also a variety of soil compaction systems now available that offer additional porous surfaces. These systems are designed to accommodate vehicles within open lawn surfaces. Other options offer granular materials and result in a graveled surface effect.

Entire front yard space has been graveled to provide parking; front yard landscape lost



## 9.6 ACCESSORY BUILDINGS

There is a wide variety of accessory buildings within the local historic district, in terms of both types and styles. Many are no more than modest sheds, while others are miniature duplicates of the adjacent residences. Most are situated in rear yard spaces.

**Guideline - New accessory buildings, such as garages and storage houses, are to be located in rear yard spaces and visually buffered from adjacent property owners and the public right-of-way. Accessory buildings that complement the architecture of the adjacent residence do not require the same level of buffering and may remain more visible within the local district. If the new building will be visible from the street, it should respect the established setbacks and orientations of the historic buildings in the area.**

**Recommendation - Recreational structures, such as tree houses and play houses, should be added only to rear yard spaces in a manner that is compatible with the architecture and siting patterns of the adjacent area.**

## 9.7 RESIDENTIAL LANDSCAPE DESIGN

In developing a plan to guide residential landscape improvements, basic decisions will need to be made at the outset of a project. Is it the intent to accurately restore the grounds to the appearance when the building was constructed, or to a later period when the landscape design had matured? Is it the desire to keep the overall character of the property but to integrate modern plantings and features? Or is it the intent to use the site, and integrate parking and other functions necessary for contemporary use of the property?

Residential yards in the Druid Hills Local Historic District feature landscaped front yards with diverse collections of plant materials in naturalistic arrangements. Rear yards are used more informally and are not typically visible from the public right-of-way.

Callanwolde, example of high style residential landscape design



Olmsted’s intent for front yards included planting beds filled with ornamental vegetation with free-flowing bed edges surrounding an open lawn. Sinuous-formed drives and walks extended from the public street to the house. Historic landscape layouts and forms should be retained or recreated or interpreted in improvements to residential yards. Olmsted also used planting beds to separate individual lots by lining drives with planting beds or extending a planting bed along a property boundary.

**Recommendation - For residential yards, created without the assistance of landscape designers, historic landscape plans for other residential lots within the district should be used for guidance. These plans can be interpreted to create a new landscape plan that is based on historic traditions. Care should be taken to select designs for yards of similar size containing houses of similar style and scale.**



**Recommendation - Residential yards, originally created by noted landscape designers, will require special attention. Original plans and specifications can be used, if they can be located, in updating plantings. Suggested steps to follow in the redesign of residential landscapes are noted below:**

- 1** Understand the original landscape design through historic research; for example, try to locate original plans and specifications and historic photographs;
- 2** Compare the existing landscape with the documented historic landscape;
- 3** Identify any features that are part of the historic landscape;
- 4** Be sensitive to the potential of archaeological features (Refer to *Chapter 10.0: Archeology*);
- 5** Identify site needs, develop a program for the site (circulation versus planting zone); and
- 6** Develop an updated plan for the landscape that retains as much historic material, as possible, and accommodates today's functional needs in a manner that is in the spirit of the historic design.

## 9.8 SIGNAGE WITHIN RESIDENTIAL AREAS OF LOCAL HISTORIC DISTRICT

**Guideline - Signage is incompatible with the residential character found in most areas of the local historic district. Permanent signs are prohibited in residentially-zoned areas. Public signage within public right-of-ways in the district should be designed to be compatible with the character of the district.**

**Recommendation - Temporary signs, such as posters and banners announcing upcoming events, should be displayed in a timely manner prior to the events and should be removed promptly after the events. Nonpermanent signs, including small security signs, may be allowed.**

## 9.9 COMMERCIAL STREETSCAPE

**E**morey Village constitutes the major commercial area within the local historic district. Emory Village is currently a mixture of historic and non-historic commercial structures in a predominately paved landscape.

View of Emory Village, illustrating dominance of the automobile



**Recommendation - Improvements to Emory Village in the future should include the following considerations: (1) encourage pedestrian access by establishing new walkways or enhancing existing sidewalks; (2) explore other options to parking in front of stores, if parking must be retained, mix parking spaces with tree plantings; (3) provide for short term parking spaces to allow ease of access to businesses; (4) enhance the character of Emory Village with compatible pedestrian amenities - benches, trash receptacles, bike racks, and lighting; (5) consider restoration/rehabilitation of historic storefronts to enhance architectural character of the building grouping; and (6) promote additional tree plantings in a manner that provides shade while allowing visibility to signs.**

## 9.10 COMMERCIAL SIGNAGE

**Guideline - Signage on commercial historic buildings should be subordinate to the architecture of the building and sized for legibility at a reasonable distance, particularly to pedestrians on sidewalks and motorists driving past Emory Village. Signage on historic or nonhistoric buildings should be set flush on the building face. Appropriate locations for signage within a traditional storefront include the lintel space which separates the storefront from the upper floor and the space above the transom in the storefront. Other potential locations include the window. Signs for nationally-franchised concerns can be designed to complement the scale and character of the district with recognizable logos still readable.**

---

## 10.0 ARCHAEOLOGICAL RESOURCES

**Guideline - When planning new construction, additions, site improvements, or demolition, minimize disturbance of terrain to reduce the possibility of destroying unknown archaeological materials.**

**Recommendation - Check with the county in the planning stages to see if the subject property is an area of low or high archaeological site potential or an area of recorded historic occupation.**

**Recommendation - Hire qualified professionals to survey areas where major terrain alteration is planned to identify potential archaeological resources. Preserve in place known archaeological material whenever possible. If preservation in place is not possible, document resources before proceeding with a project.**

## 11.0 GUIDELINES FOR NONHISTORIC PROPERTIES

Located within the boundaries of the Druid Hills Local Historic District are three “types,” based on location, of nonhistoric properties: (1) those located in the core of the district, adjacent to or in the immediate vicinity of historic properties; (2) those located in buffer areas situated along the edges of the district; and (3) those located in areas defined as “intrusions.”

Specific guidelines for certain nonhistoric character areas, such as Barton Woods, may be developed in the future; these guidelines may address character-defining features of the architecture and landscape architecture of these areas. See *Section 15.0 Parkwood Character Area* as an example.

**Guideline - In reviewing an application for a Certificate of Appropriateness for a material change to a nonhistoric building, the Preservation Commission should evaluate the change for its potential impacts to any historic development (architecture and natural and cultural landscapes) in the area of influence of the nonhistoric property. Guidelines presented in *Section 7.0: Additions and New Construction* are relevant to such evaluations.**

The 2-story house in this photograph located on Westminster Way is non-historic. Any proposed change requiring a Certificate of Appropriateness to this building would be reviewed for its potential to impact the surrounding historic area. Effects to the building itself would not be relevant.







**PART THREE**

**ANALYSES & GUIDELINES  
FOR CHARACTER AREAS**

**PART THREE: CHARACTER AREAS ANALYSES AND GUIDELINES** provides an analysis of the design characteristics of five “character areas” included in the Druid Hills Local Historic District. These include: (1) Druid Hills Character Area #1, (2) Druid Hills Character Area #2, (3) University Park/Emory Highlands/Emory Estates, (4) Emory Grove, and (5) Parkwood. (See *Illustration J: Character Area Map*.) These areas display certain developmental, landscape, and architectural features that distinguish them as sub-areas of the larger district. These distinct neighborhoods have been identified as “character areas.”

Detailed information about the landscape and architectural character is provided for each area. Knowledge of these predominant characteristics, such as setbacks, materials, and scale of development, can assist property owners in the design of compatible new development and landscaping that respects the historic environment of their neighborhood. The information contained in *Sections 12.0-15.0*, in combination with the general guidelines of Part Two of this manual, should be used as guidance for alterations, additions, new construction, and site improvements. In addition, guidelines specific to each character area are included at the end of *Sections 12.0 - 15.0*.

Other potential historic character areas located in the district include:

- (1) Cameron Court
- (2) Briarwood Hills/Stillwood
- (3) Briarcliff Road<sup>1</sup>
- (4) Chelsea Heights (“Fernbank”)
- (5) Emory Village.

Various nonhistoric areas such as Barton Woods Road could also develop guidelines that would preserve amenities of their area such as consistent patterns in the architecture and site development.

Preserving the historic platting pattern of the character areas is critical to the integrity of each area. “Historic platting pattern” refers to a pattern of development that dates to a pre-World War II plat. The majority of the areas within the Druid Hills Historic District retain their original plat pattern.

**Recommendation - Preserve historic plat patterns through respect for existing site development patterns and rhythms.**

NON-HISTORIC  
HOUSE ON NORTH  
PONCE DE LEON  
ADHERES TO  
PREVAILING  
SETBACK AND SCALE  
PREDOMINANT IN  
AREA OF INFLUENCE



<sup>1</sup> Properties along the east side of Briarcliff are included in the National Register district and are considered as part of Druid Hills Character Areas #1 and #2; it is recommended however, that Briarcliff Road be developed as a separate character area, at a later date, because of the type of development pressures it may face in the future. The west side currently has considerable multi-family and office-institutional zoning.

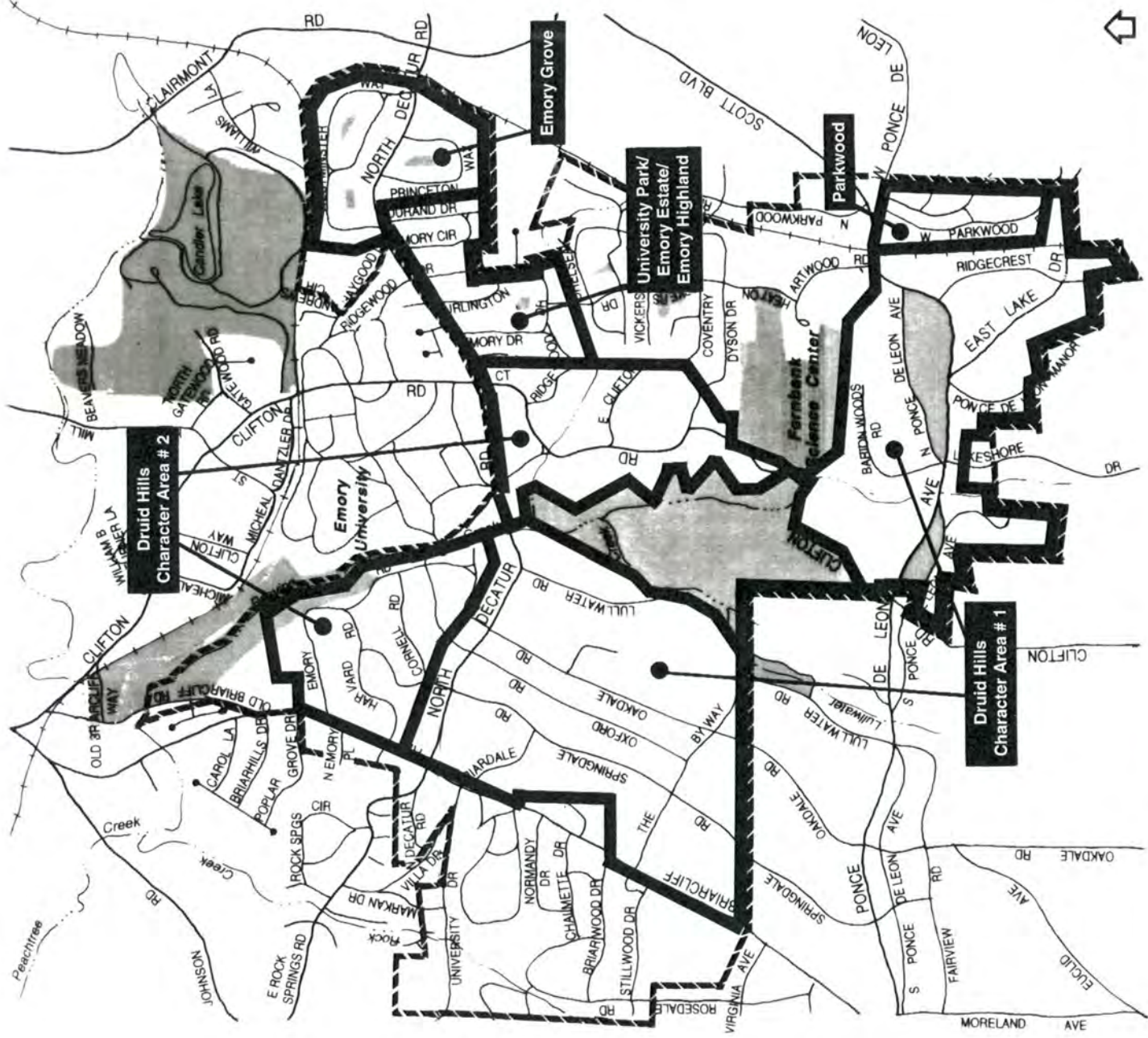

**Druid Hills Local Historic District**  
DeKalb County, Georgia

**Illustration J**

**CHARACTER AREA MAP**

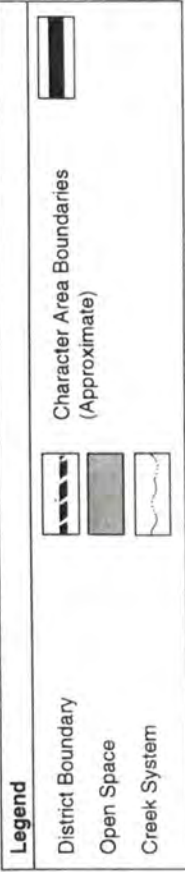

Not to Scale

## 12.0 DRUID HILLS NATIONAL REGISTER DISTRICT - CHARACTER AREAS #1 & #2

Druid Hills Local Historic District Character Areas #1 and #2 together encompass the majority of the Druid Hills National Register District that is located in DeKalb County outside the City of Atlanta. Excluded from these character areas are the golf course and Emory Village. Another portion of the National Register District is located in the City of Atlanta and is a locally designated Landmark District under that city's zoning ordinance.

This residential suburb is set into a heavily landscaped, gently rolling terrain. Its suburban street pattern respects the Piedmont countryside by following the natural contours of the land. Dense development throughout the area is characterized by naturally landscaped lawns and tree-lined streets that, together with the numerous park and open spaces, create Druid Hills' landscaped park appearance.

The architecture of the Druid Hills suburb is almost entirely residential with houses ranging widely in size and stylistic influence, representing the early-twentieth century eclectic and revivalist trends in American residential architecture. The majority of houses were constructed from around 1905 through the 1930s. They range from large mansions to small cottages and include examples of Colonial Revival, English Vernacular Revival, Italian Renaissance Revival, Neoclassical Revival, and Spanish Colonial Revival period styles. The more modernistic styles of Craftsman and Prairie are also represented, but with less frequency. A number of Druid Hills houses are architect-designed and represent the work of many of Atlanta's best-known architects and architectural firms. A landscape architect who designed the landscapes of a number of properties was William Pauley.

The historic suburb of Druid Hills forms the core of the local historic district and is located in an area roughly bounded by Briarcliff Road to the west, Ponce de Leon Avenue and East Lake Road to the south, the Seaboard Railroad and Clifton/East Clifton Road to the east, and North Decatur, Oxford, and Emory Roads to the north. It encompasses a portion of the area developed by the Kirkwood Land Company and its successor, the Druid Hills Corporation according to the plans of Frederick Law Olmsted, Sr., and the Olmsted Brothers.

**Character Area #1 encompasses Ponce de Leon corridors, East Lake, Ridgecrest, Springdale, Oakdale, Lullwater, Oxford, and Clifton from Ponce de Leon north to entrance to Fernbank Forest on east side.**

**Character Area #2 encompasses the somewhat later developments north of North Decatur Road and along Clifton and East Clifton north of Fernbank Forest entrance.**

Patterns of development, in terms of street layout and lot size, and site development, in terms of setbacks, distinguish these areas from each other. Architecturally these two areas are very similar except for the scale of development - Area #1 features larger scale development than that found in Area #2.

## 12.1 DRUID HILLS NATIONAL REGISTER CHARACTER AREA #1

Character Area #1 includes a portion of the National Register District as described below:

- 1 The Ponce de Leon/East Lake corridors platted in 1905 as part of Olmsted's "General Plan." (See *Illustration D: Historic Development Plat Map*, area keyed as 1.)
- 2 The east end of East Lake/Ridgecrest corridors laid out in the 1905 plan but re-platted with smaller lots in 1919 and 1922, respectively, by O. F. Kauffman. (See *Historic Development Plat Map*, areas keyed as 7 and 8.)
- 3 The Springdale/Oakdale/Oxford/Lullwater corridors as bounded by Briarcliff Road to the west, rear property lines on north side of N. Decatur Road to the north, the golf course and Lullwater Road to the east, and the Atlanta city limits to the south. (See *Historic Development Plat Map*, area keyed as 2.) This last area was included in Olmsted's early conceptualizations for the suburb, but it is unclear exactly when the area was platted; based on historic development, Kauffman likely platted it prior to 1910.
- 4 East side of Clifton as it runs parallel to golf course from Ponce de Leon north to Fernbank; part of Olmsted's early conceptualizations, platted in 1924 by Kauffman.

Included in this character area is a portion of the signature linear parkway of Ponce de Leon Avenue that was designed to connect the suburb with the city. The parkway provided the framework upon which the remainder of the suburb was designed. This linear parkway system—consisting of parks, parkway, and a trolley line—most closely followed Olmsted's plan and remains largely intact, though the trolley line no longer exists. This was the first area to be laid out with construction beginning around 1905. Residences in this area and its vicinity represent the largest scale development in the district. Large houses are set well back from the street on generously sized lots. A large estate that remains intact along this Ponce de Leon corridor is the former Cator Woolford estate, now used by the Reach Rehabilitation and Education Center. The estate's landscaped gardens were designed in 1921 by landscape architect Robert Cridland and provide another park space in this area. (Approximately one-half of the Ponce de Leon corridor is within the City of Atlanta and not included in this historic district boundary.)

The west central portion of Druid Hills features the north-south streets of Springdale, Oakdale, and Lullwater which meander parallel to each other following the land's natural topography. This area immediately followed the Ponce de Leon parkway in its development. It is a combination of large as well as more moderately-scaled development. Oxford Road was added between Springdale and Oakdale by around 1920 to allow the trolley line to reach Emory University.



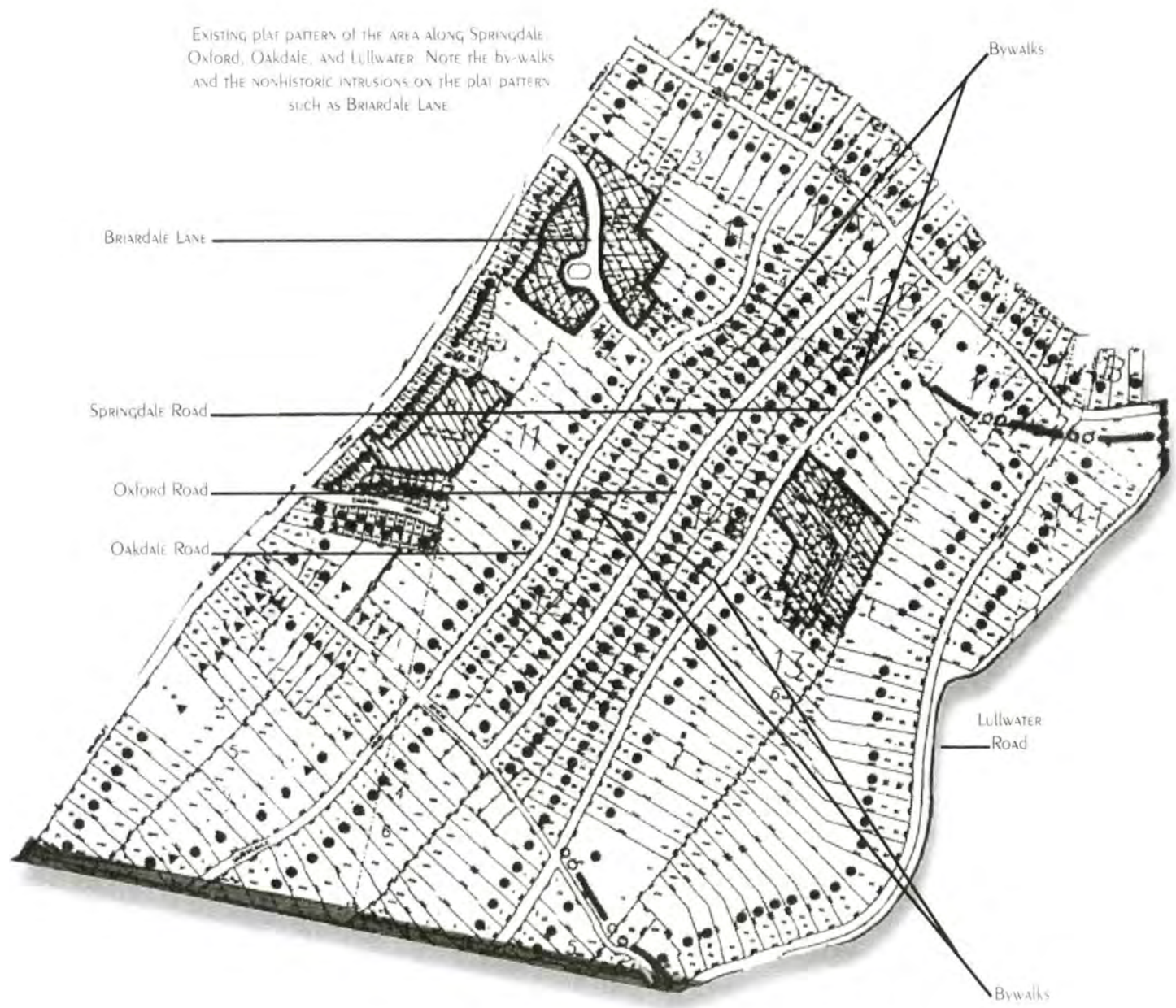

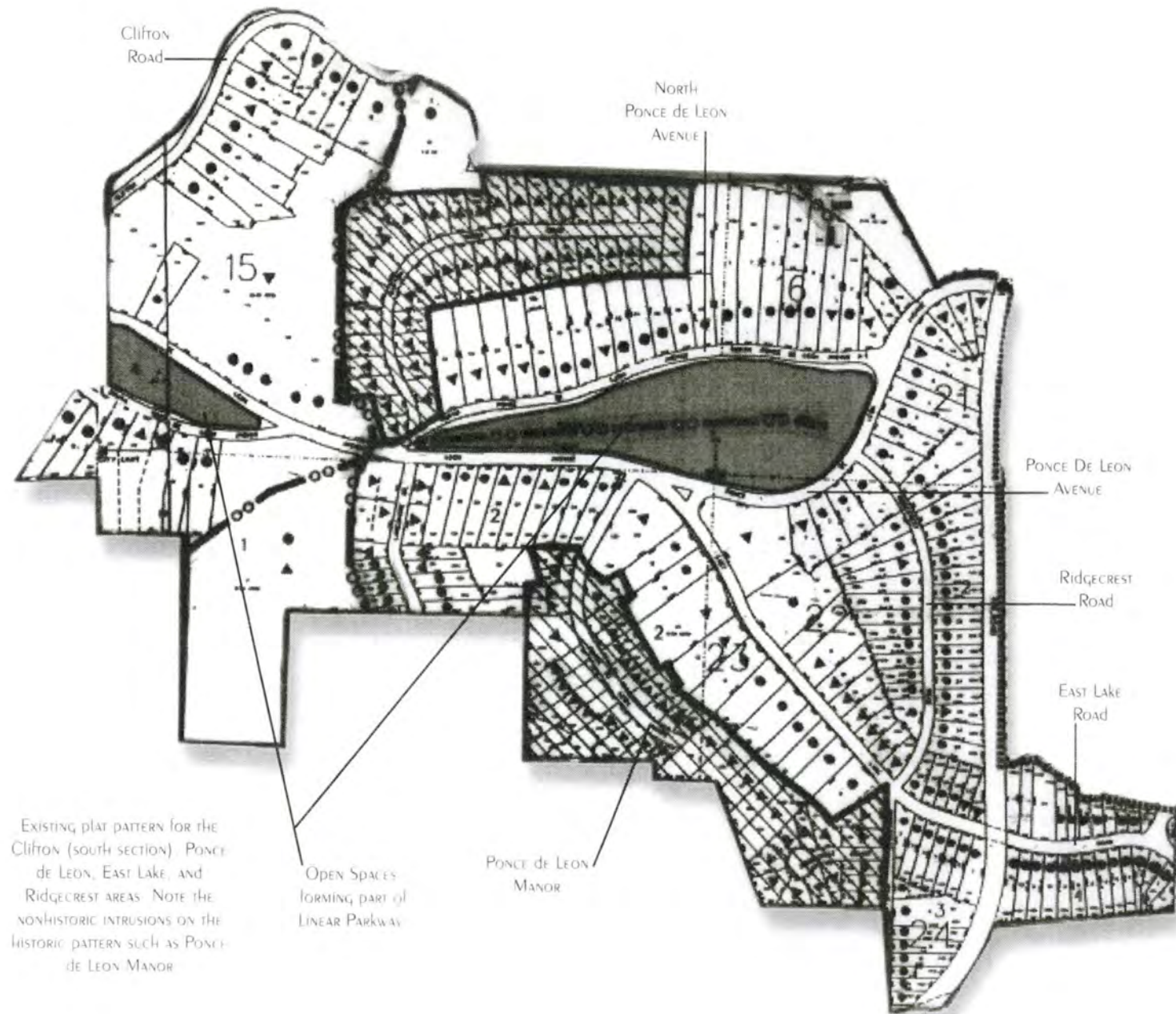

## CHARACTER-DEFINING FEATURES

### LANDSCAPE CHARACTERISTICS:

#### FRONT SETBACK

- ✦ extremely spacious setbacks along Ponce de Leon in 200' range
- ✦ other streets, such as Oakdale, Springdale and Oxford, in 50'-80' range; setbacks consistent along streets creating a line following the curve of the topography

#### SIDE SETBACK

- ✦ 25' on Ponce de Leon
- ✦ 10' on Oakdale, Springdale, and Oxford

#### TYPICAL LOT SIZE

- ✦ wide variety of lot sizes throughout character area
- ✦ lot sizes along Ponce de Leon in the 1.5 to 2 acre range

- ✦ lot sizes in areas north of Ponce de Leon are typically smaller:
- ✦ between Springdale, Oxford, and Oakdale, 100' x 200' (.5 ac);
- ✦ between Oakdale and Lullwater, long narrow lots (1-1.5 ac)

#### TYPICAL BUILDING SIZE

- ✦ wide variety in size of buildings within character area; typically, the smaller houses are located on the narrower lots with less setback

#### STREETSCAPE

- ✦ streetscape cross sections illustrate typical patterns and dimensions which vary, primarily in areas along Ponce de Leon versus sections to the north of Ponce
- ✦ along Ponce de Leon 20' wide roadway is bordered by park space on one side and improved streetscape on other side, featuring granite curb, 4' planting space, 4' wide sidewalk, and spacious front yards planted with grass and clusters of large and small hardwoods

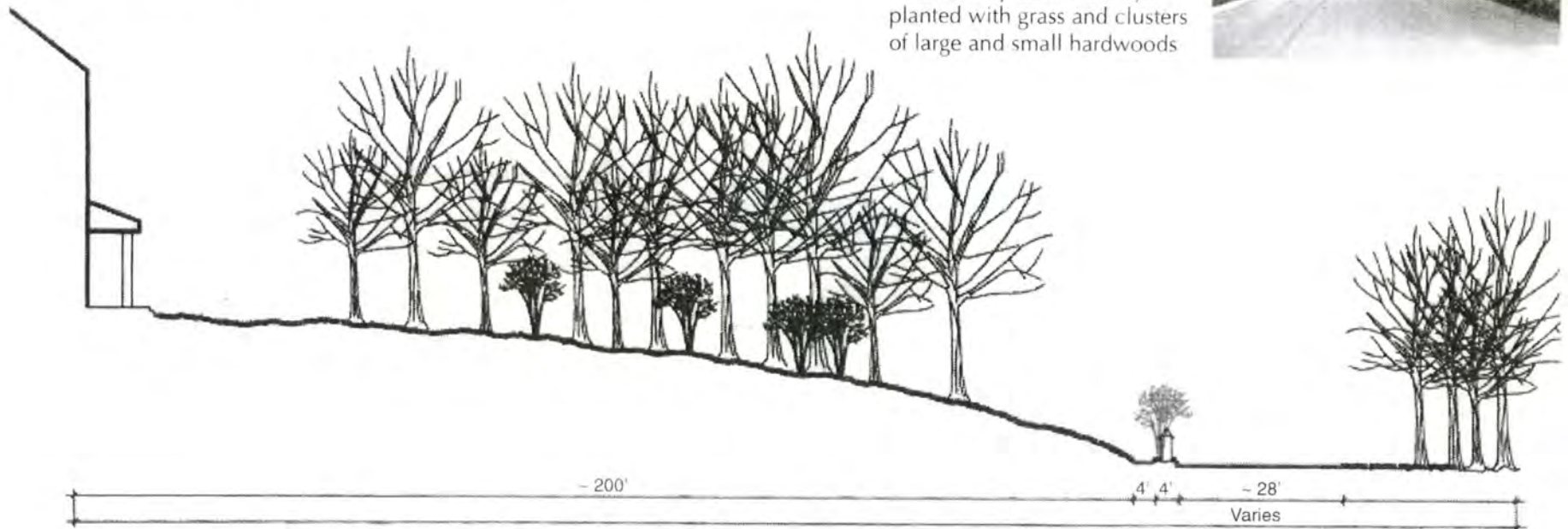

North Ponce de Leon  
Druid Hills

- along Springdale, Oakdale, and Oxford typical pattern includes asphalt road, granite curb, planting space, sidewalk, front yard
- sidewalks on both sides of street throughout area, 4' width
- planting space - 4' width (typically too small for the many large hardwoods that grow there); combination of tree sizes used throughout this section of the character area (numerous dogwoods and variety of large hardwoods); trees frequently placed in clusters of single varieties, such as the picturesque grouping of beech trees on Oakdale

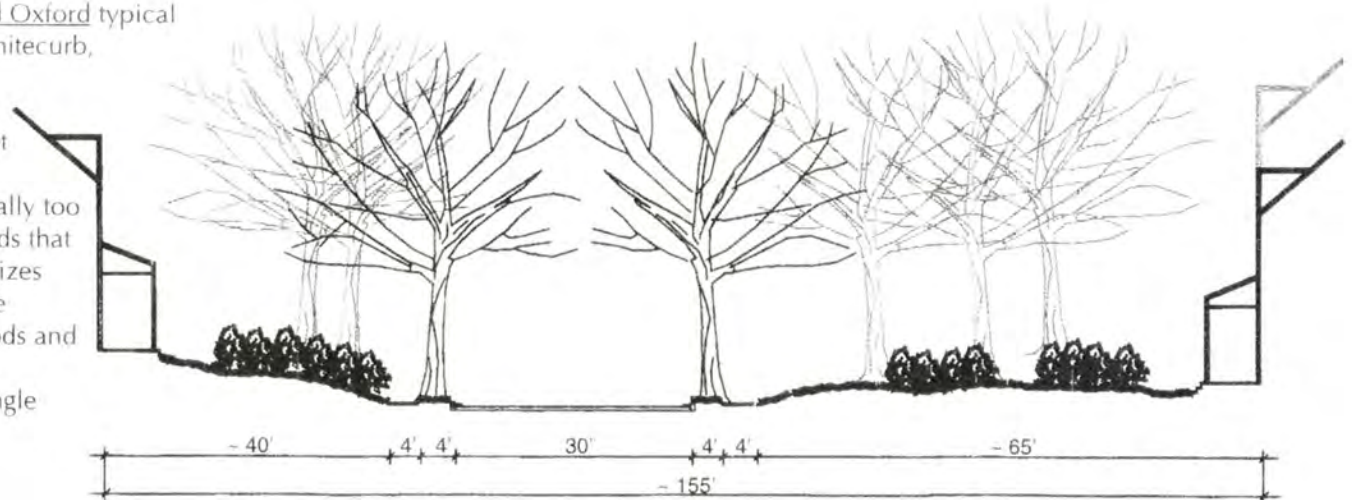

**OTHER**

- driveways - Many front yard spaces within character area are reminiscent of Olmsted's residential design plans, described in *Section 4.1.3*. These yards feature curved drives that seem to sweep across the grassed lawns, which are framed in planting beds. Most original drives are constructed of concrete; brick is also used; and concrete pavers are a more contemporary material. Many original drives feature concrete edges with a distinctive quarter-round profile

THIS DRIVEWAY ON NORTH PONCE DE LEON IS BEING INAPPROPRIATELY STRAIGHTENED



Example of "SWEEPING" DRIVEWAY LAYOUT



**Building CHARACTERISTICS:**

Oakdale Road  
Druid Hills

**Scale**

- predominantly 1 1/2-2 story; highest concentration of 1 story located along East Lake, east of Ridgecrest

**Type**

- single-family detached dwellings

**Style**

- full range of early- to mid-twentieth century revival styles and some examples of the modernistic Craftsman and Prairie styles

**MATERIAL**

- predominantly brick veneer exterior; less common but well-represented are stucco and wood, such as weatherboard and shingles; fieldstone and granite used as accent materials

**Roof Form**

- multiple variations of gable and hip; other types less common

**Roof Pitch**

- predominantly moderately-pitched roofs - low and very steeply pitched less common: flat/parapet roofs found in Spanish Revival style examples

**MASSING**

- ☛ tendency towards basic massing components, consisting primarily of main building block with projecting front and side porches and wings/bays; principal roof; symmetrical and asymmetrical facades both well-represented

**DIRECTIONAL EMPHASIS**

- ☛ tendency toward horizontal or neutral emphasis primarily due to horizontal arrangement of architectural elements such as moderately-pitched roofs, cornice lines, windows, and first story wings and side porches

**OTHER**

- ☛ roof material - slate and clay tile common; important stylistic component
- ☛ accessory buildings - existing historic accessory buildings are not prominent site features and frequently are not visible from the public right-of-way
- ☛ porches - front-facade porches tend to be entrance bay only - 3 bays at most, rather than full-facade; side porches and porte cocheres very common and prominent feature
- ☛ windows/doors/dormers - great variety of types contributing to the stylistic expression of the buildings

Good example of clay tile roof on Oakdale Road.



THE OPEN CHARACTER OF THIS PORTE COCHERE IS AN IMPORTANT FEATURE THAT SHOULD BE RETAINED



**By-Walks**

- ☛ characteristic feature in area north of The By-Way; by-walks provide pedestrian paths within centers of blocks and connect parallel roads; by-walks extend between Springdale, Oxford, and Oakdale

VIEW OF A BY-WALK RUNNING BETWEEN OAKDALE ROAD AND OXFORD ROAD



**HISTORIC PLAT PATTERNS**

- ☛ The original layout protected the watershed by ensuring that waterways would be situated within the large public open spaces and at the rear of private residential lots. This environmentally sound approach resulted in large scale lots (1-2 acres) in long rectangular shapes.

**HIGH STYLE ARCHITECTURE**

- ☛ Buildings are almost exclusively high style; stylistic detail plays an important role in defining buildings and the area as a whole.

**PONCE DE LEON RAILROAD BRIDGE**

- ☛ distinctive feature historically associated with the Druid Hills suburb

**INTRUSIONS:**

**PLAT SUBDIVISIONS**

- ☛ Non-historic development has intruded upon historic plat patterns through subdivision of existing large lots for additional development.

LARGE EMPTY LOT AT INTERSECTION OF THE BY-WAY AND OAKDALE ILLUSTRATES THREAT OF SUBDIVISION



**SPECIAL AREA FEATURES:**

**LINEAR PARKWAY**

- ☛ signature feature in Olmsted's original plan; park spaces situated along Ponce de Leon; two parks Deepdene and Dellwood are within this character area and the Druid Hills Local Historic District

### NEW CONSTRUCTION

- ❖ New properties have been built without regard for prevailing scale, setback, directional emphasis, and materials predominant in the **AREA OF INFLUENCE**.

### DRIVEWAYS & PARKING

- ❖ Limited street widths limit on-street parking. Front yard spaces have been paved for parking and in an attempt to provide a turn-around space.

ONE-STORY  
NON-HISTORIC  
HOUSE ON  
RIDGECREST -  
STRONG  
HORIZONTAL  
EMPHASIS OUT-OF-  
CHARACTER FOR  
AREA



**Guideline - Special features of the area such as the by-walks and the linear parkway should be maintained as public areas and protected from intrusions and alterations.**

**Recommendation - Preserve the historic plat pattern through respect for existing site development patterns and rhythms. Subdivision of large lots should be strongly discouraged.**

## 12.2 DRUID HILLS NATIONAL REGISTER CHARACTER AREA #2

Character Area #2 includes a portion of the National Register District as described below.

**1** Area of Druid Hills suburb north of North Decatur Road platted in 1915 by O. F. Kauffman. (See *Illustration D: Historic Development Plat Map*, area keyed as 3.)

**2** Lullwater Subdivision platted in 1924 by G. M. Crusselle. (See *Historic Development Plat Map*, area keyed as 11.)

**3** Clifton and East Clifton Road area platted in 1924 by O. F. Kauffman south to entrance to Fernbank Forest. (See *Historic Development Plat Map*, area keyed as 10.)

The Emory-Harvard-Cornell Road area north of North Decatur Road is the most densely developed area within the original Druid Hills suburb. Platted largely in 1915, the area was laid out with smaller lots and more modest houses. The subdivision of Lullwater Estates between Oxford and North Decatur Roads was carved out of the Candler estate in 1924.

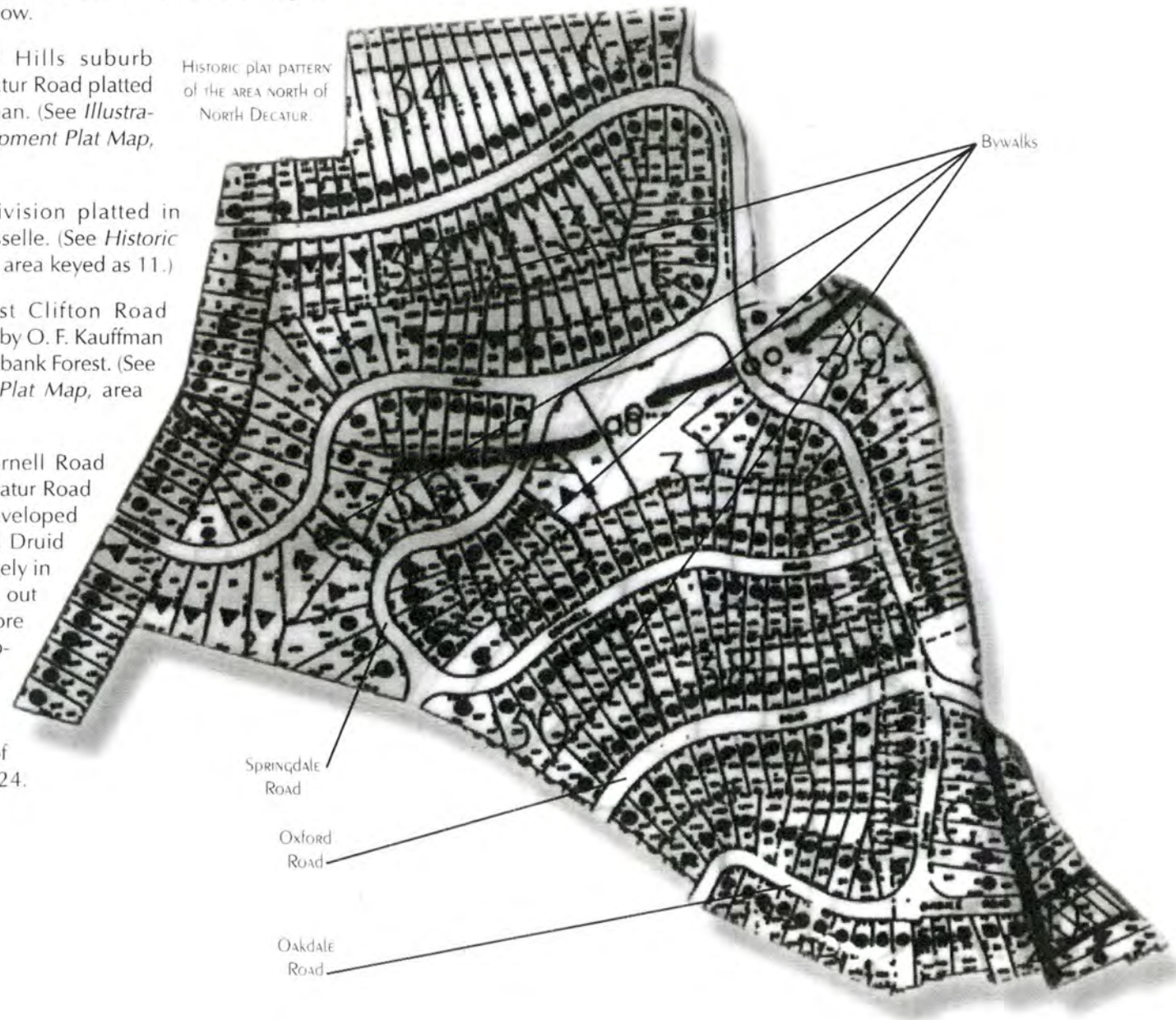



At the center of Druid Hills is the large open space of the Druid Hills Golf Course that provides a park-like environment in the middle of the surrounding residential development. To the east of the golf course is the Clifton Road area, the final section of the original Druid Hills plan to be laid out and developed. Parts of Clifton Road had previously existed as a turnpike through the area. The majority of lots along Clifton and East Clifton Roads were platted in 1924 and appear to have been developed over a period of years. The area is a mixture of large to moderate to small-scale development as well as both historic and non-historic houses.

## CHARACTER-DEFINING FEATURES

### LANDSCAPE CHARACTERISTICS:

#### FRONT SETBACK

- ✦ area north of Decatur Road - 50' range
- ✦ Clifton Road area - 40-50' range

#### SIDE SETBACK

- ✦ 10'

#### TYPICAL LOT SIZE

- ✦ 70' wide x 350-500' deep range (lot width remains fairly consistent with depth of lots varying)

#### TYPICAL BUILDING SIZE

- ✦ variety in size of buildings within character area range

VIEW OF REMNANTS OF STREET TREES ALONG EMORY ROAD



#### STREETSCAPE

- ✦ north of N. Decatur Road streetscape section includes 30-32' wide roadway, granite curb, 4' planting space, 4' sidewalk, front yard
- ✦ Oxford Road is slightly wider than other roads in area
- ✦ East Clifton Road is more narrow, 22' roadway width, granite curb, 8' planting space, 4' sidewalk, front yard



OTHER

retaining walls - This character area contains the most severe topography within the local district. For that reason, the area contains more retaining walls. Most walls are only a few feet high and are situated flush with the sidewalk. Wall materials are typically stone, cast concrete, or concrete block. Walls are of modest design with little detailing. Vegetation behind walls varies (open lawns or banks covered with shrubs and ground covers).

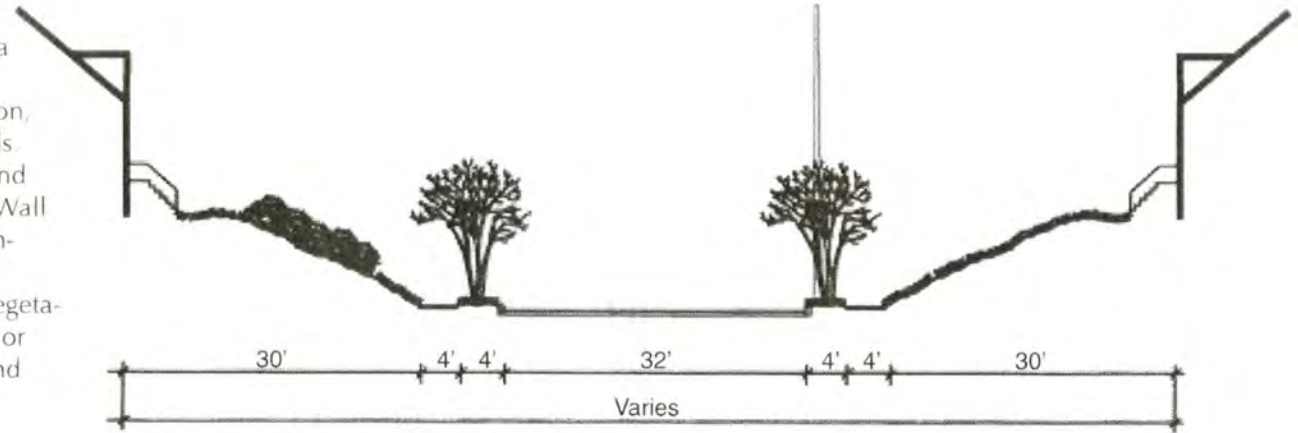

Wall within CHARACTER AREA RETAINS OPEN FRONT YARD.



Oxford Road  
Druid Hills

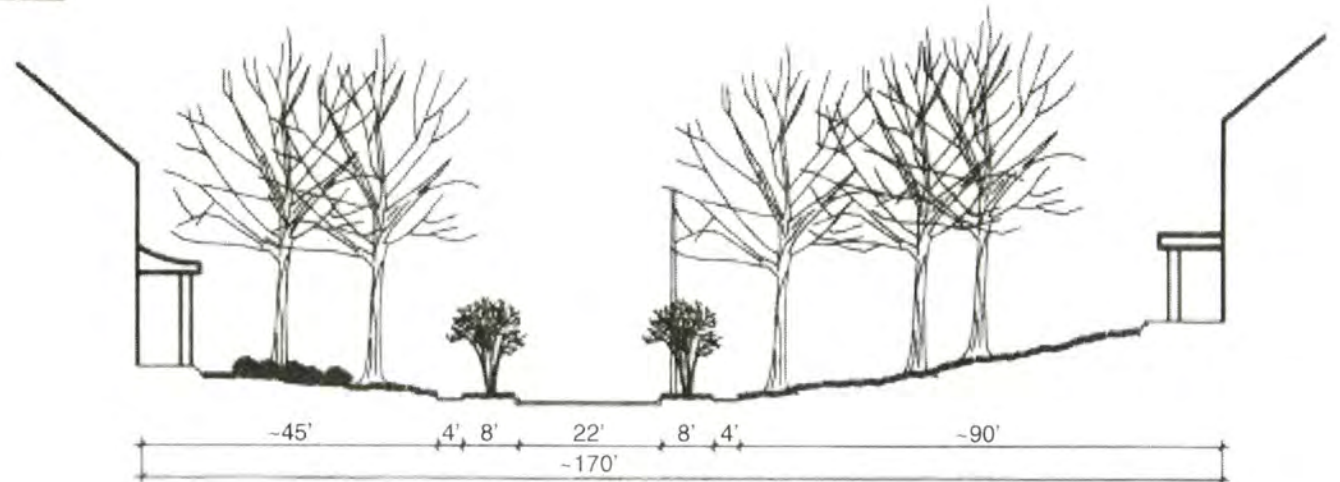

East Clifton Road  
Druid Hills

## BUILDING CHARACTERISTICS:

### SCALE

- ☞ predominantly 1-2 story

View along  
Oakdale showing  
modest scale  
development



### TYPE

- ☞ single-family detached dwellings

### STYLE

- ☞ full range of early- to mid-twentieth century revival styles as well as examples of the modernistic Craftsman style

### MATERIAL

- ☞ predominantly brick veneer exterior; less common but well-represented are stucco and wood, such as weatherboard and shingles; fieldstone and granite used as accent materials

### Roof FORM

- ☞ multiple variations of gable and hip; other types less common

### Roof Pitch

- ☞ predominantly moderately-pitched roofs - low and very steeply pitched less common; flat/parapet roofs found in Spanish Revival style examples

### MASSING

- ☞ tendency towards basic massing components, consisting primarily of main building block with projecting front and side porches and wings/bays; principal roof; symmetrical and asymmetrical facades both well-represented

### DIRECTIONAL Emphasis

- ☞ tendency toward horizontal or neutral emphasis primarily due to horizontal arrangement of architectural elements such as moderately-pitched roofs, cornice lines, windows, and first story wings and side porches

## OTHER

- ☞ roof material - asphalt most common but clay tile and slate well represented
- ☞ porches - front-facade porches tend to be entrance bay only - 3 bays at most, rather than full-facade; integral and/or small side porches very common; porte cocheres less common than in Area #1 due to narrower lots
- ☞ windows/doors/dormers - great variety of types contributing to the stylistic expression of the buildings; non-functional windows used for decorative effect are common
- ☞ accessory buildings - existing historic accessory buildings are not prominent site features and frequently are not visible from the public right-of-way

NON-HISTORIC  
GARAGE ON  
CORNELL, VERY  
VISIBLE AND  
INCOMPATIBLE  
WITH EXISTING  
HISTORIC  
STRUCTURE



## SPECIAL AREA FEATURES:

### By-Walks

- ☞ Characteristic feature in Emory/Cornell/Harvard Road area; by-walks provide pedestrian paths within centers of blocks and allow access between roads; by-walk system is extensive in this area of the district, connecting Emory, Harvard, Cornell and Oxford Roads

View of  
by-walk between  
Harvard and  
Springdale



### HISTORIC PLAT PATTERNS

- ☞ The original layout protected the watershed by ensuring that waterways would be situated at the rear of private residential lots. This environmentally sound approach resulted in rectangular shapes for most residential lots and a curvilinear arrangement of streets.

**Traffic Islands**

✦ The curvilinear arrangement of streets within this character area creates spacious areas at the intersections; there are a number of traffic islands throughout the district; many are landscaped and others offer opportunities for landscape enhancements.

EXAMPLE OF LANDSCAPED TRAFFIC ISLAND



**Guideline - By-walks should be maintained as public areas and protected from intrusions and alterations.**

**High Style Architecture**

✦ Buildings are almost exclusively high style; stylistic details play an important role in defining buildings and the area as a whole.

**Guideline - Traffic islands should be maintained as landscaped features and should not be paved.**

**INTRUSIONS:**

**NEW CONSTRUCTION**

✦ New properties have been built without regard for prevailing scale, setback, and materials.

LARGE REAR ADDITION MADE TO THIS HOUSE OUT OF SCALE WITH ORIGINAL BUILDING



**Recommendation - Preserve the historic plat pattern through respect for existing site development patterns and rhythms. Subdivision of large lots should be strongly discouraged.**

**Adjoining DEVELOPMENT**

✦ The area north of N. Decatur Road adjoins Emory University campus. Potential impact of large scale development within campus.

**ON-SITE PARKING**

✦ Width of roadways, particularly the narrow proportions of East Clifton Road, and heavy traffic limits on-street parking resulting in the addition of on-site parking; parking in front yard spaces can be intrusive to former landscaped character of these spaces.

VIEW OF THE CHARACTER AREA ALONG PEAVINE CREEK. LARGE SCALE BUILDING ON EMORY CAMPUS VISUALLY IMPACTS THE NEIGHBORHOOD





## 13.0 UNIVERSITY PARK / EMORY HIGHLANDS / EMORY ESTATES CHARACTER AREA

The University Park, Emory Highlands, and Emory Estates subdivisions are located on the south side of North Decatur Road and east of Emory University in the northeast quadrant of the local historic district. The area consists of three sections: (1) University Park along Emory and Ridgewood Drives, (2) Emory Highlands along Burlington Road and Ridgewood Drive, and (3) Emory Estates along Emory Circle and Durand Drive. A National Register nomination request for these neighborhoods is currently pending.

These neighborhoods were planned and developed during the late 1910s and 1920s and reflected the growing need for affordable suburban housing easily accessible by the automobile. While adjacent to the large Druid Hills suburb, these subdivisions were placed on small parcels of land. All of these factors resulted in a dense development pattern with streets placed closely together, small lots, and little open space, a much different situation from that in neighboring Druid Hills. The land was sold to the Druid Hills Company in 1916 but was then sold again to another developer, W. D. Thompson. The area was platted and laid out in three phases—University Park in 1916, Emory Highlands in 1923, and Emory Estates in 1925. O. F. Kauffman was responsible for the layout of both University Park and Emory Highlands. C. A. Nash was responsible for the layout of Emory Estates. This is the only neighborhood within the local district known to be associated with this civil engineer. Emory Highlands and Emory Estates were probably developed by the same developer, Augustine Sams.

The area is characterized by U-shaped streets, hilly terrain, uniform building setbacks, sidewalks, and a variety of landscaping. Overall, the development is small-scale with small lots and front yards and modestly-sized houses. The architecture of these neighborhoods reflects, at a modest scale, the early-twentieth-century movement toward period revival styles such as English Vernacular Revival, Colonial Revival, and Dutch Colonial Revival as well as the modernistic movement of the Craftsman style. Many of the houses have driveways and garages for the increasingly popular automobiles of the early-twentieth century. The houses were constructed from the 1920s into the 1940s.

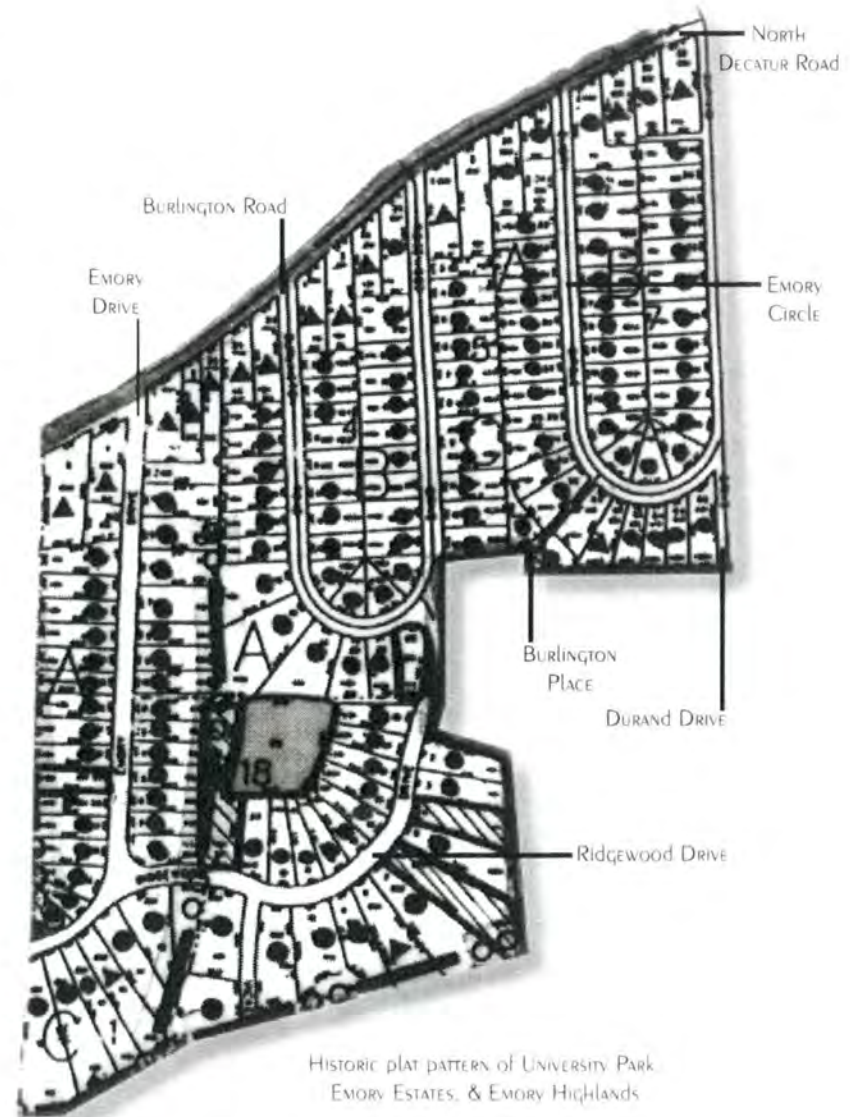

## CHARACTER-DEFINING FEATURES

### LANDSCAPE CHARACTERISTICS:

#### FRONT SETBACK

- ☛ 25'-35' range; setbacks in Emory Estates somewhat higher, in 30'-50' range

#### SIDE SETBACK

- ☛ 10'-20' range

#### TYPICAL LOT SIZE

- ☛ 50'-70' x 150'-200'; with a few oversized exceptions at curves and in areas of severe topography; .2 acres - .3 acres

#### TYPICAL BUILDING SIZE

- ☛ 1,300-2,300 square foot range; majority in the 1,800+ square foot range

#### STREETSCAPE

- ☛ streetscape cross section illustrates the typical patterns and dimensions: asphalt street, granite curb, planting space, sidewalk, front yard
- ☛ sidewalks on both sides of street throughout - 4' in width
- ☛ planting space ranges from 6'-8'; Emory Drive within University Park is 6' wide and contains large hardwoods; combination of large and small trees used in 8' wide space on Ridgewood Drive within Emory Highlands; small trees predominant on Durand Drive within Emory Estates

#### OTHER

- ☛ drives and parking - lots typically contain paved access drive; parking within residential lots as well as on-street; street widths range from 20'-24' providing limited space for on-street parking

UNUSUAL DRIVEWAY  
FEATURE IN  
EMORY ESTATES  
ILLUSTRATES SEVERE  
TOPOGRAPHY.



- ☛ traffic islands - two traffic islands within character area; one at intersection of Durand Drive and Emory Circle

LANDSCAPED  
TRAFFIC ISLAND AT  
DURAND DRIVE  
AND EMORY  
CIRCLE - EXISTING  
LANDSCAPE FEATURE  
WITHIN CHARACTER  
AREA



- ☛ contains small tree; other island at intersection of Ridgewood Drive, Burlington Road, and Durand Mill Drive has concrete surface

- ☛ front yard spaces - Severe terrain, particularly in the Emory Estates and Emory Highlands neighborhoods, results in residential structures elevated above the roadways. Front yard spaces in such situations are too steep for the maintenance of a lawn. For that reason, ground cover vegetation is predominant.

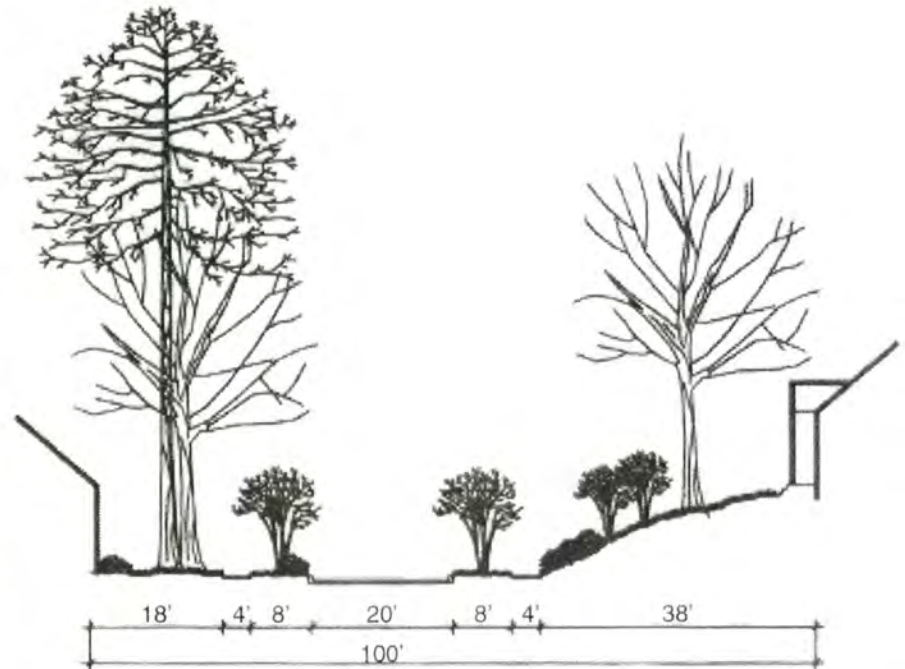

Durand Drive  
Emory Estates

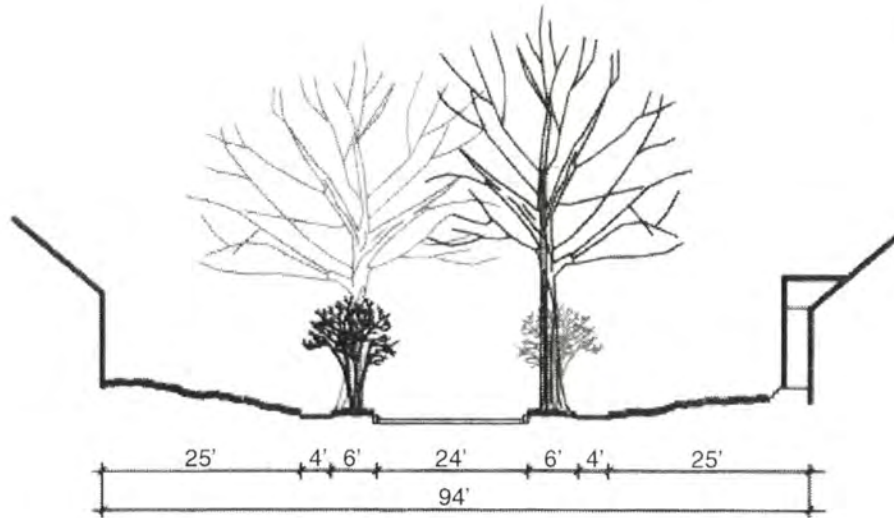

Emory Drive  
University Park

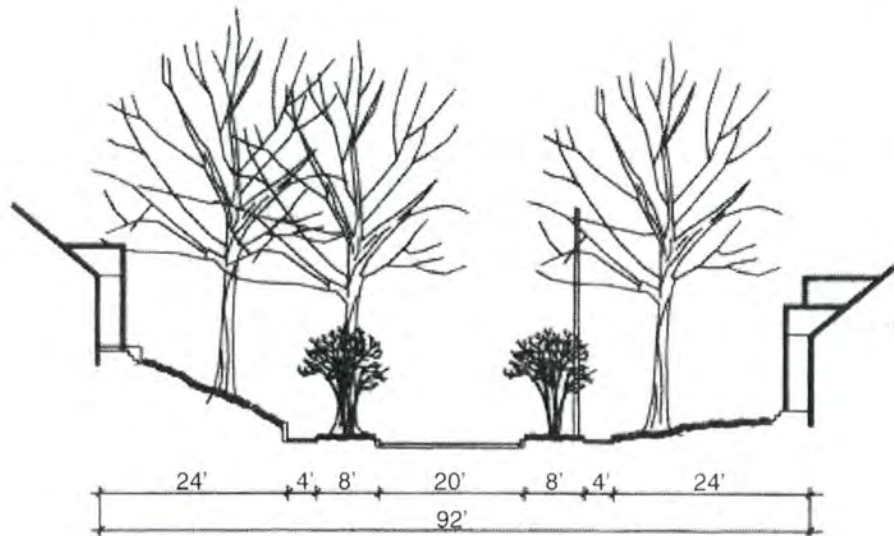

Ridgewood Drive  
Emory Highlands

## Building CHARACTERISTICS:

### Scale

- ☞ 1-1 1/2 story

Good example of  
English  
Vernacular  
Revival style.

### Type

- ☞ single-family detached dwellings

### Style

- ☞ primarily English Vernacular Revival and Colonial Revival; Craftsman also represented, especially in University Park area



### MATERIAL

- ☞ primarily brick veneer exterior; limited weatherboard siding and asbestos; weatherboard most common in University Park; granite used as accent material around entrances and porches and in chimneys

### Roof FORM

- ☞ predominant side gable main roof with cross hips and gables; English Vernacular Revival examples display steeply-pitched front-facing gables

### Roof Pitch

- ☞ moderate pitches main side gable; steeply-pitched projecting bays

### MASSING

- ☞ asymmetrical front facade with multiple building elements such as projecting gables and entrances, dormers, chimneys, and variety of window arrangements; some Colonial Revival examples with symmetrical facades

### DIRECTIONAL Emphasis

- ☞ main block of building - horizontal
- ☞ front-facing gables - in English Vernacular Revival examples, these front-facing gables have a vertical emphasis

STREET VIEW  
ILLUSTRATING  
RHYTHMS CREATED  
BY FRONT-FACING  
GABLES



**DETAILS**

- ✦ foundations - water table with solid brick foundations; isolated granite foundations, primarily in Emory Highlands
- ✦ chimneys - Chimney placement varies; ridgeline, interior roof slope and front exterior all common
- ✦ porches - small front corner porches characteristic of the area
- ✦ entrances - frequently accented w/ decorative surrounds such as granite/fieldstone detailing, sidelights, other wood trim
- ✦ windows - double-hung sash, 6/6 and 6/1, most common but other treatments well-represented such as other sash combinations with decorative glazing patterns/multi-paned; casement also present throughout

**INTRUSIONS:**

**Porch Infill**

- ✦ Inappropriate porch enclosures detract from overall integrity of area.

SCREENING OF THIS PORCH PRESERVES THE OPEN CHARACTER; ALSO NOTE GRANITE ENTRANCE AND PORCH SURROUNDS.



**NEW CONSTRUCTION**

- ✦ New properties have been built without regard for prevailing scale, setback, and materials.

NEW CONSTRUCTION THAT DOES NOT CONFORM TO PREVAILING SETBACK, MASSING, PREDOMINANT AREA STYLISTIC FEATURES



**Traffic Islands**

- ✦ Traffic island at Ridgewood, Burlington and Durand Mill has been surfaced with concrete; this is not the historic treatment.

**Adjoining DEVELOPMENT**

- ✦ Emory University's continued high rise expansion and development has had an adverse effect on the historic resources and the district's visual integrity.

**ON-STREET PARKING**

- ✦ Emory also appears to be having an adverse effect on the area created by extensive on-street parking.

**Guideline - New construction should be compatible with the predominant architectural styles of the area, English Vernacular Revival and Colonial Revival, and should reference important building elements of these styles such as the projecting gables, prominent chimneys, and small-side porches of English Vernacular and the accented entrances of both styles.**

**Guideline - Traffic islands should be maintained as landscaped features and should not be paved.**



CONCRETE TRAFFIC ISLAND AT INTERSECTION OF RIDGEWOOD DRIVE, BURLINGTON ROAD, AND DURAND MILL DRIVE - before and after stone wall added



## 14.0 EMORY GROVE CHARACTER AREA

The neighborhood of Emory Grove is located in the northeast quadrant of the district along both sides of North Decatur Road and bounded to the east by the railroad. The area was platted in two sections: (1) Princeton Way south of North Decatur Road in 1939 and (2) Westminster Way and Edinburgh Terrace north of North Decatur Road in 1941. It was developed by a single builder, Neal Smith, resulting in the uniform appearance of its houses.

The development is small-scale with modest houses sitting fairly close together on small lots, reflecting a dense, early-1940s development pattern. The houses were constructed during the first half of the 1940s and consist of one basic house type with several variations. The basic house type is a one-story, rectangular form with side-gabled roof, interior ridgeline chimney, and smaller side-gabled wings. Variations include front-gabled porches, slightly projecting front-gabled wings, and various chimney placements. The houses are not high-style but are instead a minimal traditional design with Colonial Revival stylistic influences.

C. R. Roberts and Company, Engineers, was responsible for the layout of both sections of Emory Grove, again resulting in continuity of the neighborhood's design. Loop roadways connect with North Decatur Road. The interior roadways are lined with lots of uniform size, although lots situated along curves and at intersections are somewhat larger and houses tend to be oriented diagonally toward the corner. The roadway itself is narrow by Druid Hills' neighborhood standards. There is limited space for on-street parking.

Emory Grove contains three interior park spaces. Designated paths between residential lots provide access to these spaces. These park areas contain a variety of amenities, including tennis courts, open ballfields, and picnic shelters. Rear lot lines bordering these park spaces are typically fenced, providing clear separation between public and private spaces.

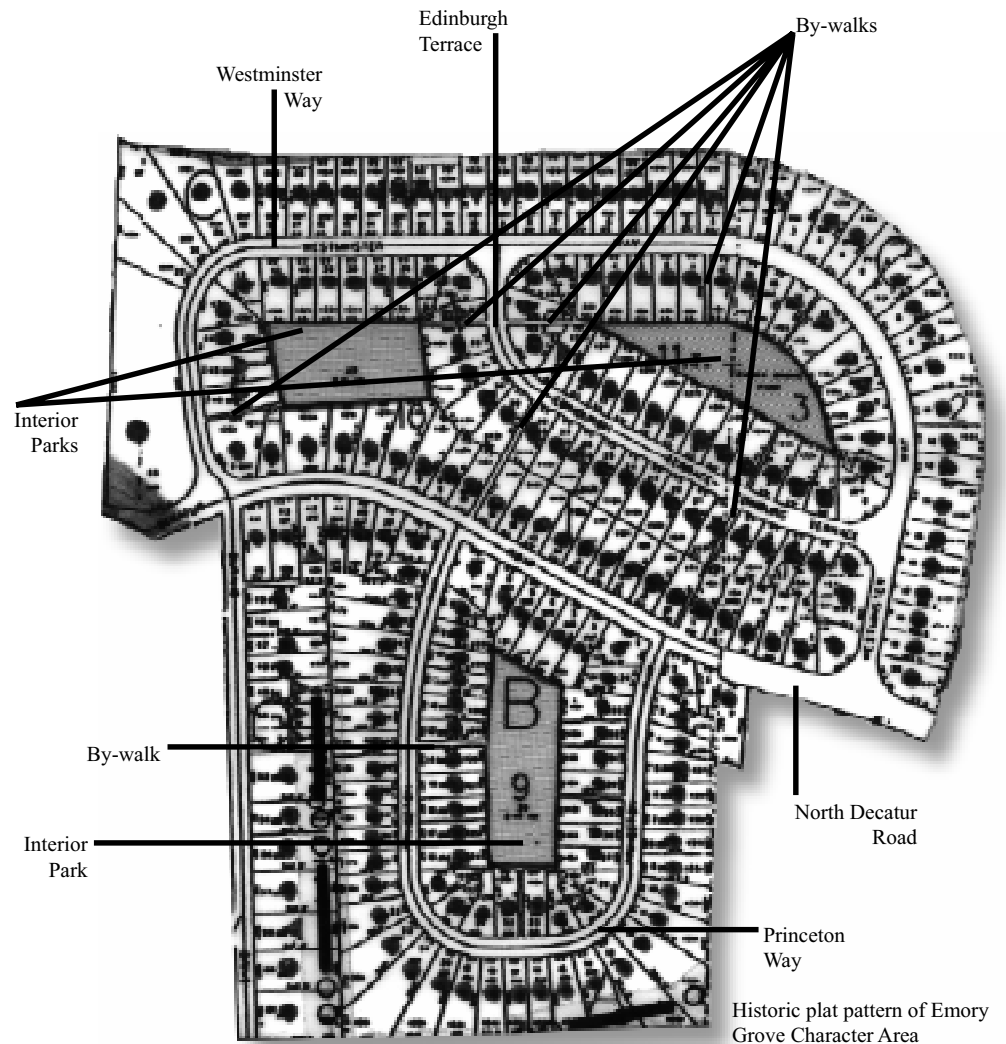

## CHARACTER-DEFINING FEATURES

### LANDSCAPE CHARACTERISTICS:

#### FRONT SETBACK

- \* 45'-50'

#### SIDE SETBACK

- \* 10+'

#### TYPICAL LOT SIZE

- \* 65' x 175' (approximately .3 acre)

#### TYPICAL BUILDING SIZE

- \* 1,100-1,800 square feet

#### STREETSCAPE

- \* streetscape cross section illustrates the typical patterns and dimensions: asphalt street, granite curb, front grassed yard
- \* front yards contain large hardwoods and in a few areas, pine groupings; shrub plantings at most house foundations
- \* no sidewalks

#### OTHER

- \* drives & parking- lots typically contain paved access drives with parking on-site; limited area for on-street parking due to narrow width of street
- \* walls and fences- The section of Emory Grove situated south of North Decatur Road has topography requiring the use of retaining walls; fences in a variety of design and materials are used in rear yards as separation from interior park spaces.
- \* traffic islands- approximately four traffic islands within character area; large island situated at intersection of Westminster Way and Edinburgh Terrace is grassed.

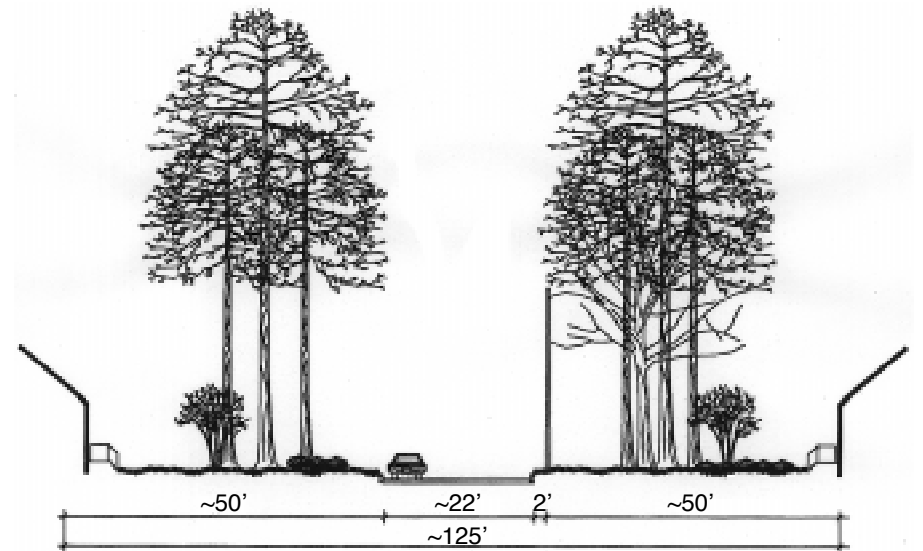

Edinburgh Terrace  
**Emory Grove**

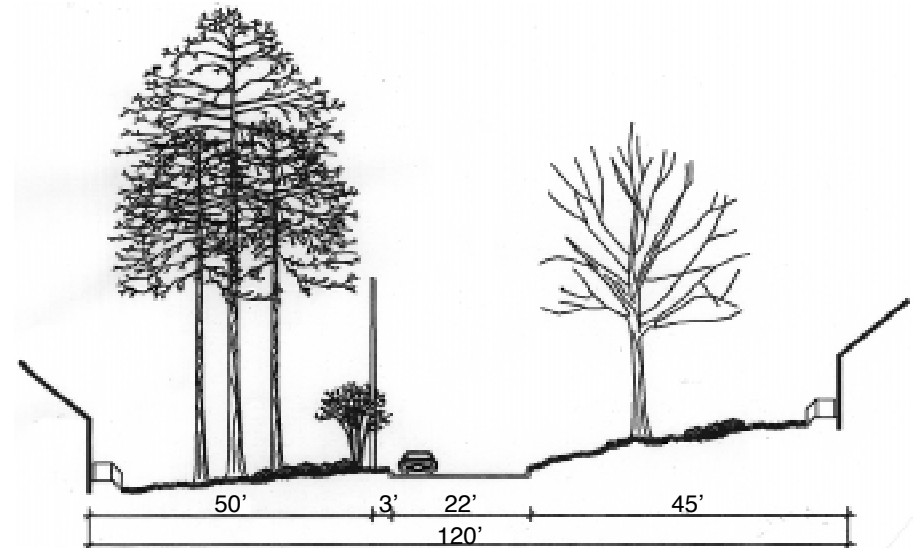

Princeton Way  
**Emory Grove**

## Building CHARACTERISTICS:

### SCALE

- \* predominantly 1 story structures north; limited 1 1/2 story structures south of N. Decatur Rd.

### TYPE

- \* single-family detached dwellings

### STYLE

- \* minimal traditional design with Colonial Revival stylistic influences

### MATERIAL

- \* predominantly brick veneer exteriors

### Roof FORM

- \* principal side gable roof with smaller side and front gable extensions

### Roof Pitch

- \* low to moderate pitches main side gable (south side more steeply pitched) with minimal or no overhang

### MASSING

- \* asymmetrical facade with minimal building elements - 2/3 solid wall surface to 1/3 openings

Characteristic side gable house form shown in these photographs. The streetscape view illustrates the rhythm created by the repetition of form and elements.



### DIRECTIONAL Emphasis

- \* main mass has horizontal emphasis; other building elements reflect or do not diminish this emphasis

### DETAILS

- \* raised foundations - solid granite foundations in section

south of N. Decatur

- \* chimneys - ridgeline and exterior-end brick—placed between porch and main body of house; an important feature of the house type

\* garages - “basement” garages an important feature south of N. Decatur with limited presence on Edinburgh

- \* porches - small side porches significant feature on Edinburgh and south of N. Decatur

\* entrances - door and trim are modest

- \* wood trim - used modestly as door and window trim, cornice line, gable ends

- \* windows - double-hung sash, 6/6 and 8/8; multi-paned casement also present, more common south of N. Decatur

These photographs depict the characteristic raised granite foundations, exterior-end chimney placements, small side porches, and basement garages.



## SPECIAL AREA FEATURES:

### INTERIOR PARKS

- \* three interior parks, approximately two acres in size; one appears to be a passive-use space; one has benches, playground equipment, picnic tables and shelters; one space contains tennis courts & informal ballfield; access to park spaces through designated pedestrian routes, some more defined than others; each park space contains a minimum of two, and in one case three, access paths; parks are maintained by DeKalb County Parks and Recreation Department

Interior park north of N. Decatur Road.



**By-Walks**

- \* two by-walk lanes allow pedestrian access from North Decatur Road to Edinburgh Terrace; one by-walk provides direct connection with access path to interior park space

By-walk north of N. Decatur Road



**Guideline - New construction should be compatible with the predominant minimal traditional/Colonial Revival housing and should reference important building characteristics such as the horizontal directional emphasis, low to moderate roof pitches, brick veneer exteriors, and front-facing gables**

**EMORY PRESBYTERIAN CHURCH**

- \* distinctive architectural landmark in the area—the only institutional building

The integrity of Emory Grove’s characteristic house type has been compromised in many places due to attempts to *dress it up*. Many properties in Emory Grove have been subject to changes such as infilled porches, window replacements, and entrance “stylizing” - these changes detract from the appearance of the property. Windows and entrances are common subjects of such projects.

**INTRUSIONS:**

Illustrates excessive paving in front yard space.



**NEW CONSTRUCTION**

- \* New properties have been built without regard for prevailing scale, setback, and materials.

**Guideline - This house type was meant to have minimal detail and works best when its streamlined appearance is maintained. The minimal traditional character of the Emory Grove house type should be preserved and attempts to “dress up” houses should be discouraged.**

**PAVING**

- \* Several examples exist of excessive paving in front yard spaces for parking.

**WOOD FENCING**

- \* Example of wood picket fence, an anomaly in the neighborhood

Illustrates need to better define public access routes to interior park spaces.



**Guideline - Interior park spaces should be improved with better definition of existing access routes and the eradication of exotic plant species that currently threaten the natural character of these spaces.**

**Guideline - Traffic islands should be maintained as landscaped features and should not be paved.**

## 15.0 PARKWOOD CHARACTER AREA

The development known as Parkwood is located east of the railroad in the southeast corner of the local historic district and includes West and East Parkwood Roads south of West Ponce de Leon. (The easternmost portion of Parkwood within the Decatur city limits is not included in the local historic district.) Much of this area was part of the original land holdings of the Kirkwood Land Company for the Druid Hills suburb and was included in Olmsted's plan. The existing street pattern does not follow Olmsted's original design for the area, but the curvilinear street pattern, lot layout, and open park space reflect Olmstedian principles. The area of East and West Parkwood Roads may have been originally platted by O. F. Kauffman, the civil engineer who platted much of the Druid Hills suburb and other surrounding developments, which would explain the close similarity to the earlier Druid Hills plan.

The current street layout appears on the 1928 USGS map in dashed lines. A 1934 map of the area shows the current layout as well. A revised 1948 plat shows the lot layout basically as it exists today, but development in Parkwood did not occur until the 1950s and 1960s. As in Chelsea Heights (Fernbank), Parkwood was historically platted and laid out even though it was not developed until after the historic period.

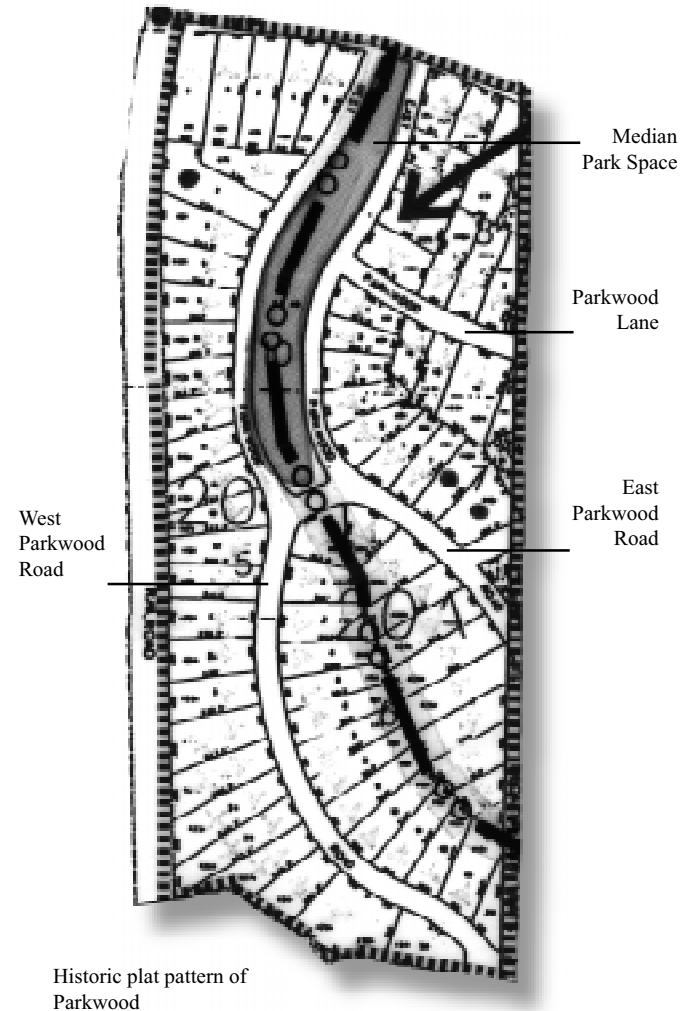

## CHARACTER-DEFINING FEATURES

### LANDSCAPE CHARACTERISTICS:

#### FRONT SETBACK

- \* 75'-100'

#### SIDE SETBACK

- \* 15'

#### TYPICAL LOT SIZE

- \* large, irregular sized lots;  
range of sizes - 70' x 200' (.3 acres) and 90' x 250' (.5 acres)

#### TYPICAL BUILDING SIZE

- \* few historic houses within character area range in size from 1,500 square feet to 3,000 square feet

#### STREETSCAPE

- \* streetscape cross section illustrates the typical patterns and dimensions: median park space located between East and West Parkwood Drives, width varies from 100' to 160'; surrounding streets of asphalt (24' wide with concrete curb), 6' wide planting space, 4' wide sidewalk, front yard space; median park space contains mature vegetation, primarily hardwoods; planting space adjacent to street contains small trees, when trees present, otherwise only grass; large hardwood trees situated in front lawn zones

Illustrates streetscape section in southern section of Parkwood consisting of roadway, curbing, small trees in park space, and sidewalk.



#### OTHER

- \* drives & parking- drives and parking accommodated on-site

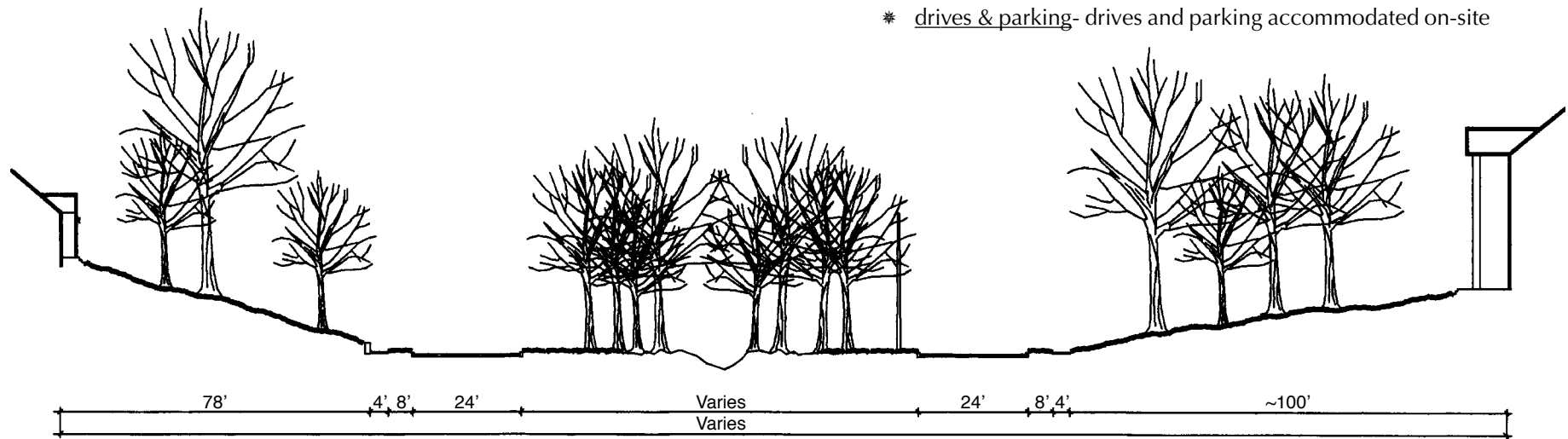

West/East Parkwood  
**Parkwood**

## Building CHARACTERISTICS:

### SCALE

- \* 1 story with occasional 2 story

Transitional house form moving from minimal traditional to ranch.



### TYPE

- \* single-family detached dwellings

### STYLE

- \* mix of 1950s ranch and Colonial Revival; also minimal traditional forms in transition to ranch

### MATERIAL

- \* brick veneer exteriors

### Roof FORM

- \* side gable and hip

### Roof Pitch

- \* low to moderate pitches

Typical Parkwood ranch house.



### MASSING

- \* varies

### DIRECTIONAL Emphasis

- \* horizontal

### LAYOUT

- \* overall layout of Parkwood resembles layout of original sections of Druid Hills with spacious lots, long setbacks, adjacent park land, and environmentally-sensitive design of floodprone zone (described above)

### INTRUSIONS:

#### NEW CONSTRUCTION

- \* New houses constructed at southeast corner of E. Parkwood and West Ponce de Leon do not conform to prevailing scale and form of existing properties.

**Guideline - Floodprone zones situated in median park and rear yard spaces should be protected by adhering to the historic design concept of requiring these areas to remain in a natural state.**

While housing in Parkwood is nonhistoric in a traditional sense, it still displays prevailing characteristics which give the neighborhood a sense of identity. The neighborhood is typified by medium-scale housing on large lots.

**Guideline - New construction, additions, and rehabilitations should respect the prevailing housing characteristics of the neighborhood (in particular, scale and materials).**

## SPECIAL AREA FEATURES:

### FloodPRONE ZONES

- \* median park space totals 3.2 acres; entire park space designated as floodplain zone on county tax maps; additional floodplain area noted in rear yard spaces of lots located south of the median park; original design of Parkwood with floodprone areas within median park and in rear yard spaces of residential lots represents historic watershed design

**Recommendation - Subdivision of large lots should be strongly discouraged.**

---

## SOURCES CONSULTED

- “Cameron Court,” National Register of Historic Places Nomination, Historic Preservation Division, Georgia Department of Natural Resources, Atlanta, Georgia, 1982.
- “Druid Hills,” National Register of Historic Places Nomination, Historic Preservation Division, Georgia Department of Natural Resources, Atlanta, Georgia, 1979.
- DeKalb County Comprehensive Plan, Land Development Regulations, and Zoning Ordinance.
- DeKalb County Historic Preservation Ordinance.
- DeKalb County Plat Records, DeKalb County Courthouse, Decatur, Georgia. (See Illustration D: Historic Development Plat Map for list of plats used in analyzing developmental history of the district.)
- DeKalb County Tax Maps, DeKalb County Planning Department, Decatur, Georgia.
- “Druid Hills Civic Association Papers”, Special Collections Department, Robert W. Woodruff Library, Emory University, Atlanta, Georgia.
- Druid Hills Driving and Walking Tour Guides, 1987, 1989, 1992, and 1993, Druid Hills Civic Association, Atlanta, Georgia.
- “Druid Hills Historic District Design Guidelines,” (City of Atlanta), prepared for the Atlanta Urban Design Commission.
- “Druid Hills Local Historic District Nomination,” prepared by The Jaeger Company for the Druid Hills Civic Association, April 1996.
- Private research collection of Sally Harbaugh, Atlanta, Georgia.
- Roth, Darlene R. “Druid Hills National Landmark: Case Statement,” prepared for the Druid Hills Civic Association and the Atlanta Olmsted Parks Association, 1989.
- “University Park, Emory Highlands, Emory Estates,” National Register of Historic Places Nomination (Pending), Historic Preservation Division, Georgia Department of Natural Resources, Atlanta, Georgia, 1994.





# APPENDICES

---

## Glossary

**ADDITION** — A non-original element placed onto an existing building, site or structure.

**ALTERATION** — Any act or process which changes the exterior architectural appearance of a building.

**APPROPRIATE** — Suitable to or compatible with what exists. Proposed work on historic properties is evaluated for “appropriateness” during the design review process.

**BUFFER AREAS** — These areas are generally located along the district boundaries and adjacent to historic areas in the district. They are nonhistoric but similar in scale and character to the district’s historic development. These areas provide a buffer against intrusive development that might encroach upon the district.

**CERTIFICATE OF APPROPRIATENESS** — A document giving approval to work proposed by the owner of a property located within a locally-designated historic district or designated as a local landmark. Specific conditions, set forth by the Historic Preservation Commission and to be followed during the project, may be specified in the document. Possession of a Certificate of Appropriateness does not remove any responsibility on the part of the property owner to acquire a building permit prior to beginning the project.

**CHARACTER** — Those individual qualities of buildings, sites and districts that differentiate and distinguish them from other buildings, sites and districts.

**COMPATIBLE** — Not detracting from surrounding elements, buildings, sites or structures; appropriate given what already exists.

**COMPONENT** — An individual part of a building, site or district.

**CONTEMPORARY** — Of the current period.

**CONTRIBUTING** — Essential to the full significance of a historic district. (A “contributing building” in a historic district is one that may be of limited individual significance but nevertheless functions as an important component of the district.)

**CONTEXT** — The setting in which a historic element or building exists.

**DEMOLITION** — Any act or process that destroys a structure in part or in whole.

**ELEMENT** — An individual defining feature of a building, structure, site or district.

**High Style** — A completely authentic or academically correct interpretation of one or more architectural styles. A building that combines one or more styles is typically referred to as eclectic.

**HISTORIC DISTRICT** — A geographically definable area designated as possessing a concentration, linkage, or continuity of sites, buildings, structures, or objects of historic, archaeological, architectural or aesthetic value.

**HISTORIC PLAT PATTERN** - A pattern of development that dates to a pre-World War II plat. The majority of the areas within the Druid Hills Local Historic District retain their original plat pattern.

**HISTORIC SITE** — A site worthy of protection or preservation, designated as historic because of its historic, archaeological or aesthetic value.

**HISTORIC STRUCTURE** — A structure worthy of preservation, designated as historic because of its historic, archaeological, architectural or aesthetic value.

**HOUSE TYPE** — A definition based on floor plan, height and sometimes roof shape, having nothing to do with architectural style. Most houses that fall into a particular type are of vernacular design, meaning that their designs are based on regional tradition and utilize regional materials.

**Infill** — New construction within a historic district, generally situated on the site of a demolished structure but possibly on a site never previously developed.

**INTRUSION** — Intrusions are those areas of development that are intrusive to the district’s historic development pattern. These areas are nonhistoric (constructed after 1946) and have a development pattern very different from the district’s historic layout. Some intrusions have subdivided the original lot layout and added streets in sharp contrast to historic street patterns. Intrusions are identified on the *Historic District Map*.

**LANDMARK** — A building, structure, object or site worthy of preservation, designated as historic because of its historic, archaeological, architectural or aesthetic value.

**MAINTENANCE** — Routine care for a building, structure or site that does not involve design alterations.

**NEGLECT** — The failure to care for a property in such a manner as to prevent its deterioration. Neglect is often not intentional, but may lead to very serious deterioration of materials and even structural systems.

**NEW CONSTRUCTION** — The construction of a new element, building, structure or landscape component; new construction involves the introduction of designs not original to the building, structure or site.

**NONHISTORIC** — Nonhistoric properties within the district are those properties constructed after 1946. Nonhistoric properties are identified on the *Historic District Map*.

**PRESERVATION** — The taking of steps to sustain the form, details and integrity of a property essentially as it presently exists. Preservation may involve the elimination of deterioration and structural damage, but does not involve reconstruction to any significant degree.

**RECONSTRUCTION** — The process of reproducing the exact form of a component, building, structure or site that existed at some time in the past.

**REHABILITATION** — The process of returning a building to a state of utility while retaining those elements essential to its architectural, historical and/or aesthetic significance.

**REPAIR** — Any minor change to a property that is not construction, removal, demolition or alteration and that does not change exterior architectural appearance.

**RESTORATION** — The process of returning a building to its appearance at an earlier time (though not necessarily to its original appearance). Restoration involves the removal of later additions and the replacement of missing components and details.

**SETTING** — The immediate physical environment of a building, structure, site or district.

**SIGNIFICANT** — Possessing importance to a particular building, structure, site or district; essential to maintaining the full integrity of a particular building, structure, site or district.

**SITE** — A place or plot of land where an event occurred or where some object was or is located.

**STABILIZATION** — Maintaining a building as it exists today by making it weather-resistant and structurally safe.

**STREETSCAPE** — All physical elements that may be viewed along a street.

**STRUCTURE** — Anything constructed or erected which has, or the use of which requires, permanent or temporary location on or in the ground, or which is attached to something having a permanent location on the ground, including, but not limited to, the following: buildings, gazebos, signs, billboards, tennis courts, radio and television antennae and satellite dishes (including supporting towers), swimming pools, light fixtures, walls, fences and steps.

**STYLE** — Showing the influence of shapes, materials, detailing or other features associated with a particular architectural style.

**VERNACULAR** — Based on regional tradition and utilizing regional materials.

---

# SOURCES OF INFORMATION

## PRESERVATION BRIEFS

- 1 The Cleaning and Waterproof Coating of Masonry Buildings
- 2 Rejointing Mortar Joints in Historic Brick Buildings
- 3 Conserving Energy in Historic Buildings
- 4 Roofing for Historic Buildings
- 6 Dangers of Abrasive Cleaning to Historic Buildings
- 7 The Preservation of Historic Glazed Architectural Terra-Cotta
- 8 Aluminum and Vinyl Siding on Historic Buildings
- 9 The Repair of Historic Wooden Windows
- 10 Exterior Paint Problems on Historic Woodwork
- 11 Rehabilitating Historic Storefronts
- 12 The Preservation of Historic Pigmented Structural Glass
- 13 The Repair and Thermal Upgrading of Historic Steel Windows
- 14 New Exterior Additions to Historic Buildings: Preservation Concerns
- 15 Preservation of Historic Concrete: Problems and General Approaches
- 16 The Use of Substitute Materials on Historic Buildings
- 17 Architectural Character: Identifying the Visual Aspects of Historic Buildings as an Aid to Preserving Their Character
- 18 Rehabilitating Interiors in Historic Buildings
- 19 The Repair and Replacement of Historic Wooden Shingle Roofs
- 20 The Preservation of Historic Barns
- 21 Repairing Historic Flat Plaster - Walls and Ceilings
- 22 The Preservation and Repair of Historic Stucco
- 23 Preserving Historic Ornamental Plaster
- 24 Heating, Ventilating, and Cooling Historic Buildings: Problems and Recommended Approaches
- 25 The Preservation of Historic Signs
- 26 The Preservation and Repair of Historic Log Buildings
- 27 The Maintenance and Repair of Architectural Cast Iron
- 28 Painting Historic Interiors
- 29 The Repair, Replacement, and Maintenance of Historic Slate Roofs
- 30 The Preservation and Repair of Historic Clay Tile Roofs
- 31 Mothballing Historic Buildings
- 32 Making Historic Properties Accessible
- 33 The Preservation and Repair of Historic Stained and Leaded Glass
- 34 Applied Decoration for Historic Interiors: Preserving Composition Ornament
- 35 Understanding Old Buildings: The Process of Architectural Investigation
- 36 Protecting Cultural Landscapes: Planning, Treatment and Management of Historic Landscapes
- 37 Appropriate Methods for Reducing Lead: Paint Hazards in Historic Housing
- 38 Removing Graffiti from Historic Masonry
- 39 Managing Moisture Problems in Historic Buildings
- 40 Preserving Historic Ceramic Tile Floors

## ARCHITECTURAL HISTORY/IDENTIFICATION GUIDES

- Blumenson, John J. Identifying American Architecture: A Pictorial Guide to Styles and Terms, 1600-1945. Nashville, Tennessee: American Association for State and Local History, second edition, 1983.
- Georgia Office of Historic Preservation. Georgia's Living Places: Historic Houses in Their Landscaped Settings. Technical material produced as part of the Georgia's Living Place project, undertaken 1989-1990.
- Gottfried, Herbert and Jan Jennings. American Vernacular Design 1870-1940. Ames, Iowa: Iowa State University Press, 1985.
- Harris, Cyril M. Illustrated Dictionary of Historic Architecture. New York: Dover, 1983.
- Harris, Cyril M., editor. Dictionary of Architecture and Construction. New York: McGraw-Hill Book Co., 1975.
- Longstreth, Richard. The Buildings of Main Street: A Guide to American Commercial Architecture. Washington, D.C.: The Preservation Press, 1987.
- McAlester, Virginia and Lee McAlester. A Field Guide to American Houses. New York: Alfred Knopf, 1985.
- Phillips, Steven J. Old House Dictionary: An Illustrated Guide to American Domestic Architecture, 1600-1940. Lakewood, Colorado: American Source Books, 1989.
- Rifkind, Carole. A Field Guide to American Architecture. New York: New American Library, 1980.
- Roth, Leland M. A Concise History of American Architecture. New York: Harper and Row, 1979.
- Stevenson, Katherine Cole, and H. Ward Jandl. Houses by Mail: A Guide to Houses from Sears, Roebuck and Company. Washington, D.C.: The Preservation Press, 1986.
- Chambers, J. Henry. Cyclical Maintenance for Historic Buildings. Washington, D.C.: Technical Preservation Services, U.S. Department of the Interior, 1976.
- Georgia Office of Historic Preservation. Georgia's Living Places: Historic Houses in Their Landscaped Settings. Technical material produced as part of the Georgia's Living Places project, undertaken 1989-1990.
- Howe, Barbara J., Dolores A. Flemming, Emery L. Kemp and Ruth Ann Overbeck. "Houses and Homes: Exploring Their History," in Volume II of The Nearby History Series. Nashville, Tennessee: American Association for State and Local History, 1987
- Labine, Clem and Carolyn Flaherty, editors. The Original Old House Journal Compendium. Woodstock, New York: Overlook Press, 1980.
- Maddex, Diane, editor. All About Old Buildings: The Whole Preservation Catalog. Washington, D.C.: The Preservation Press, 1985.
- Milner, John and Assoc. The Beaufort Preservation Manual. West Chester, Penn.: John Milner Assoc., 1979.
- Morton, W. Brown, III, Gary L. Hume, Kay D. Weeks, and H. Ward Jandl. The Secretary of the Interior's Standards for Rehabilitation with Illustrated Guidelines for Rehabilitating Historic Buildings. Washington D.C.: National Park Service, U.S. Department of the Interior, 1992.
- Munsell, Kenneth, editor. Small Town - Historic Preservation Resourcebook for Small Communities. Ellensburg, Wash.: Small Towns Institute, 1983.
- Old House Journal. The Old House Journal Catalog. New York: The Old House Journal Corporation, 1985.
- Preservation League of New York State. A Primer: Preservation for the Property Owner. Albany, New York: Preservation League of New York State, 1978.
- Preservation Tech Notes. Washington, D.C.: National Park Service, U.S. Department of the Interior.
- Simonson, Kaye Ellen, compiler. Maintaining Historic Buildings; An Annotated Bibliography. Washington, D.C.: National Park Service, U.S. Department of the Interior, 1990.
- Slaton, Deborah, and Rebecca Shiffer, editors. Preserving the Recent Past. Washington, D.C.: National Park Service/Historic Preservation Education Foundation, 1995.

## GENERAL PRESERVATION/REHABILITATION

- Bowsher, Alice Merriwether. Design Review in Historic Districts - A Handbook for Virginia Review Boards. Washington DC: The Preservation Press, 1978.

State Historical Society of Colorado. Good Neighbors - Building Next to History - Design Guidelines Handbook. State Historical Society of Colorado, 1980.

Stipe, Robert E. and Antoinette J. Lee, editors. The American Mosaic: Preserving a Nation's Heritage. Washington, D.C.: U.S./ICOMOS, 1987.

U.S. Department of the Interior, National Park Service. Preservation Tax Incentives for Historic Buildings. Washington, D.C.: Department of the Interior, 1990.

Waters, John C. Maintaining a Sense of Place: A Citizen's Guide to Community Preservation. Athens, Georgia: Institute of Community and Area Development, 1983.

Weeks, Kay D., and Anne E. Grimmer, editors. The Secretary of the Interior's Standards for the Treatment of Historic Properties with Illustrated Guidelines for Preserving, Rehabilitating, Restoring, and Reconstructing Historic Building. Washington, D.C., National Park Service, U.S. Department of the Interior, 1995.

Weeks, Kay D., and Diane Maddex, editors. Respectful Rehabilitation: Answers to Your Questions On Historic Buildings. Washington, D.C.: The Preservation Press, 1982.

Zuchelli, Hunter and Assoc. Guidelines for Exterior Rehabilitation, Charleston, West Virginia. Charleston, West Virginia: The Charleston Renaissance Corp., 1984.

## TECHNICAL INFORMATION

### GENERAL MATERIALS

Bleekman, George M., III, et al. Twentieth-Century Building Materials: 1900-1950; An Annotated Bibliography. Washington, D.C.: National Park Service, U.S. Department of the Interior, 1993.

Jester, Thomas C., editor. Twentieth-Century Building Materials: History and Conservation. Washington, D.C.: Preservation Assistance Division, National Park Service, U.S. Department of the Interior, 1995.

### ADDITIONS AND NEW CONSTRUCTION

National Trust for Historic Preservation. Old and New Architecture: Design

Relationship. The Preservation Press: National Trust for Historic Preservation, 1980.

Brolin, Brent C. Architecture in Context, Fitting New Buildings with Old. New York: Van Nostrand Reinhold Company, 1980.

### LANDSCAPING AND SITE IMPROVEMENTS

Birnbaum, Charles A., editor. The Secretary of the Interior's Standards for the Treatment of Historic Properties with Illustrated Guidelines for Preserving, Rehabilitating, Restoring, and Reconstructing Cultural Landscapes. Washington, D.C.: National Park Service, U.S. Department of the Interior, 1995.

Favretti, Rudy J. and Joy Putnam. For Every House a Garden. Chester, Connecticut: The Pequot Press, 1977.

Landscapes and Gardens for Historic Buildings. Nashville: American Association for State and Local History, 1978.

Freeman, John Crosby. "Post Victorian Houses: Fences and Gates," Old House Journal, March 1986, pp. 78-81.

Kunst, Scott G. "Post-Victorian Landscapes and Gardens," Old House Journal, April 1986, pp. 128-136.

Sloane, Eric. Our Vanishing Landscape. "Fences and Walls." New York: Ballantine, 1975.

Strombeck, Janet A. and Richard H. Gazebos and other Garden Structure Designs. Delafield, WI: Rexstrom Co. Inc., 1983.

### LIGHTING

Baroni, Daniele. The Electric Light: A Century of Design. New York: Van Nostrand Reinhold, 1983.

Dietz, Ulysses G. Victorian Lighting: The Dietz Catalogue of 1860. New York: American Life Foundation, 1982.

Myers, Denys Peter. Gaslighting in America: A Guide for Historical Preservation. Washington, DC: U.S. Department of the Interior, 1978.

## MASONRY

- Blades, Keith, Gail Sussman and Martin Weaver, editors. Masonry Conservation and Cleaning Handbook. Ottawa, Canada: Association for Preservation Technology, 1984.
- Briggs, Paul. "Mortars and Finishes," Old House Journal, July/August 1991, pp. 35-37.
- Carosino, Catherine, et al., compilers. Historic Masonry Deterioration and Repair Techniques; An Annotated Bibliography. Washington, D.C.: National Park Service, U.S. Department of the Interior, 1993.
- Conway, Brian D. Stucco. Springfield, Ill.: Illinois Department of Conservation, Division of Historic Sites, 1980.
- Grimmer, Anne E. A Glossary of Historic Masonry Deterioration Problems and Preservation Treatments. Washington DC: National Park Service, Preservation Assistance Division, 1984.
- Keeping It Clean: Removing Dirt, Paint, Stains, and Graffiti from Historic Exterior Masonry. Washington, D.C.: National Park Service, U.S. Department of the Interior, 1987.
- Poore, Patricia. "Stripping Exterior Masonry," Old House Journal, January/February 1985, pp. 1, 26-28.
- Smith, Baird M. Moisture Problems in Historic Masonry Walls: Diagnosis and Treatment. Washington, D.C.: National Park Service, U.S. Department of the Interior, 1986.
- Tindall, Susan. "Repointing Masonry - Why Repoint?," Old House Journal, January/February 1987, pp. 24-31.

## METALS

- Gayle, Margot, David W. Look and John G. Waite. Metals in America's Historic Buildings: Uses and Preservation Treatments. Washington, D.C.: Technical Preservation Services Division, U.S. Department of the Interior, 1992.
- Howell, J. Scott. "Architectural Cast Iron," APT Bulletin, No. 3, 1987, pp. 51-55.
- Menten, Theodore. Art Nouveau Decorative Ironwork. New York: Dover Publications, Inc., 1981.

- Murray, John. Cast Iron. London: John Murray Publishers Ltd., 1985.
- Pilling, Ron. "Decorative Cast Iron," The Old House Journal, February 1982, pp. 39-42.
- Southworth, Susan and Michael. Ornamental Iron Work. Boston: David R. Godine, Publisher, 1978.
- "Stamped Metal Ornament," The Old House Journal, October 1975, p. 12.

## PAINTS AND PAINTING

- Bevil, Marianne, et al., compilers. Painting Historic Buildings: Materials and Techniques; An Annotated Bibliography. Washington, D.C.: National Park Service, U.S. Department of the Interior, 1993.
- Bock, Gordon. "Painting Exterior Wood," Old House Journal. May/June 1991, pp. 26-29.
- Dornsife, Samuel J. and Roger Moss, Jr. Victorian House Colors. Nashville, Tennessee: American Association for State and Local History.
- Freeman, John Crosby. "Anything Goes: An Approach to Exterior Paint Color for Early 20th Century Houses," Old House Journal, May/June 1991, pp. 37-40.
- Miller, Kevin H., editor. Paint Color Research and Restoration of Historic Paint. Ottawa, Ontario: Association for Preservation Technology, 1977.
- Moss, Roger A. Century of Color: Exterior Decoration for American Buildings, 1820-1920. Watkins Glen, New York: American Life Foundation, 1981.
- O'Bright, Alan. "Paint Removal from Wood Siding," in Number 2 of Preservation Tech Notes, Exterior Woodwork. Washington, D.C.: National Park Service, Preservation Assistance Division, 1986.
- Old House Journal Technical Staff. "Exterior Painting: Problems and Solutions," Old House Journal, September/October 1987.
- Park, Sharon C., AIA. "Proper Painting and Surface Preparation," in Number 1 of Preservation Tech Notes, Exterior Woodwork. Washington, D.C.: National Park Service, Preservation Assistance Division, 1986.
- "Special Issue: Exterior Painting," in Old House Journal, April 1981, pp. 71-94.

## PORCHES

- Bock, Gordon. "Reviving Railings," in Old House Journal, July/August 1990, pp. 45-46.
- Jowers, Walter. "Rescuing a Porch Roof," in Old House Journal, January/February 1984, pp. 1, 22-26.
- Trescott, Jerry. "Restoring a Period Porch," in Old House Journal, July/August 1990, pp. 41-44.
- Wilkinson, Jeff. "The Story of Porches: An American Tradition." in Old House Journal, July/August 1990, pp. 30-40.

## Roofs and Roofing

- Bock, Gordon. "Gutter Talk," Old House Journal, May/June 1990, pp. 32-33.
- "Composition Shingles of the 1920's and the 1930's," Old House Journal, May/June 1990, pp. 222-227.
- Labine, Clem. "How to Repair an Old Roof," Old House Journal, April 1983, pp. 64-75.
- Poore, Patricia. "What Most Roofers Don't Tell You About Traditional and Historic Roofs." Old House Journal, April 1983, pp. 61-63.

## Windows and Doors

- Association for Preservation Technology. "Architectural Glass: History and Conservation," Bulletin, Vol. 13, 1981.
- Bock, Gordon. "The Sash Window Balancing Act: Sash Weight and Tape-Balance Systems," in Old House Journal, September/October 1989, pp. 31-34.
- Fisher, Charles E., III, editor. The Window Handbook: Successful Strategies for Rehabilitating Windows in Historic Buildings. Washington, D.C.: National Park Service, U.S. Department of the Interior and Atlanta, Georgia: Center for Architectural Conservation, Georgia Institute of Technology, 1986.
- The Window Workbook for Historic Buildings. Washington, D.C.: National Park Service, Historic Preservation Education Foundation, 1986.
- O'Donnell, Bill. "Troubleshooting Old Windows: What to Do with Neglected

*Double-Hung Windows*," Old House Journal, January/February 1986, pp. 16-23.

- Poore, Jonathon. "How to Fix Old Doors," Old House Journal, June 1986, pp. 222-227.
- "Special Window Issue." Old House Journal, April 1982.

## Wood

- Avrami, Erica C., compiler. Preserving Wood Features in Historic Buildings; An Annotated Bibliography. Washington, D.C.: National Park Service, U.S. Department of the Interior, 1993.
- Bock, Gordon. "Clapboards: A Siding Glossary," Old House Journal. May/June 1989, pp. 32-41.
- Curtis, John Obed. "Salvage of Original Clapboards," Old House Journal, August/September 1985, pp. 135, 156-158.
- Johnson, Ed. Old House Woodwork Restoration: How to Restore Doors, Windows, Walls, Stairs, and Decorative Trim to Their Original Beauty. Englewood Cliffs, NJ: Prentice-Hall, 1983.
- Jones, Larry. "Wood Cornice Restoration and Repair," Old House Journal, August/September 1985, pp. 141-147.
- Leeke, John. "How To Use Epoxies To Repair Rotted Exterior Wood," Old House Journal. May/June 1989, pp. 22-26.
- Phillips, Morgan W. and Judith E. Selwyn. Epoxies for Wood Repairs in Historic Buildings. Washington, DC: U.S. Department of the Interior, Technical Preservation Services, 1978.
- Poore, Jonathan. "Woodwork Repairs: How to Remedy all the Minor Messy Problems You're Bound to Find After You Strip, to Prepare Woodwork for a Clear Finish," Old House Journal. May/June 1987, pp. 32-37.





---

# OVERVIEW of LOCAL HISTORIC DISTRICTS

## DEFINITION

A local historic district is a district designated by local ordinance and falls under the jurisdiction of a local preservation review commission. A local historic district is generally “overlaid” on existing zoning classifications in a community; therefore, a local district commission deals only with the appearance of the district, not with the uses to which properties in the district are put.

## WHAT MAKES A PROPERTY HISTORIC?

Several **CRITERIA** are used to determine whether a property is historic. They include:

- \* **AGE** - Properties greater than or equal to 50 years old are considered historic.
- \* **SPECIAL ARCHITECTURAL SIGNIFICANCE** - Some properties less than 50 years old are considered historic because they possess special architectural significance; for example, they might be the first of a type built; be an exceptionally good example of a particular method of construction or style; or represent the work of a noted architect or master builder.
- \* **HISTORIC ASSOCIATION** - Some properties less than 50 years old are considered historic because of their association to significant events or persons; for example, properties associated with the Civil Rights movement are now being considered historic at the national level as well as the state and local levels. Another example would be a President’s home that is not 50 years old but would certainly be considered historic.

## My PROPERTY IS NON HISTORIC. Why Is It Included?

Non historic properties are included in districts because of their **POTENTIAL TO IMPACT** surrounding historic properties as well as the district as a whole.

One of the primary reasons for designating historic districts is to protect the historic character and integrity of the **DISTRICT AS A WHOLE**. Selectively deleting non historic properties from boundaries would create a “Swiss cheese” effect

and would defeat the purpose of trying to preserve the historic character and integrity of the district.

## WHAT DOES DESIGNATION DO?

- \* **PROTECTS** the significant properties and historic character of the district.
- \* **ENSURES** that growth, development, and change take place in ways that respect important architectural, historical, and environmental characteristics.
- \* **ENCOURAGES** sensitive development and **DISCOURAGES** unsympathetic changes from occurring.

## WHAT DOES IT MEAN TO ME?

Property owners in historic districts are subject to a **DESIGN REVIEW PROCESS** whereby the preservation commission approves any material changes in appearance to the district and issues **CERTIFICATES OF APPROPRIATENESS** which allow the proposed changes to take place. Ordinary maintenance and repair are excluded from the review process.

Designation **DOES NOT** (1) restrict the uses of property, (2) require you to make improvements, (3) prevent new construction within the district, or (4) require permission to paint your house.

## BENEFITS

Property owners directly benefit from the protection of the appearance and historic character of the district. It is a proven fact that protection leads to **ENHANCED PROPERTY VALUES** and contributes to the overall economic development of an area through **HERITAGE TOURISM**.

Property owners also have access to **FREE TECHNICAL ASSISTANCE** in designing changes to their homes and businesses. Members of the commission are available to work with you in creating design solutions that meet your stated needs while preserving those architectural features that add to the value of your property.



---

# DRUID HILLS HISTORIC DISTRICT DESIGN GUIDELINES

## DESIGN REVIEW IN DEKALB COUNTY

### THE ORDINANCE

The DeKalb County Historic Preservation Ordinance was passed in 1994 by the authority of the 1980 Georgia Historic Preservation Act. The primary purpose of the ordinance is stated to be “to establish a uniform procedure for use in providing for the protection, enhancement, perpetuation and use of places, districts, sites, buildings, structures, objects, landscape features and works of art having a special historical, cultural or aesthetic interest or value....”

### THE COMMISSION

The DeKalb County Historic Preservation Commission has been established as the administrative authority for the ordinance. The ordinance lists twelve areas of responsibility for the commission, including:

- (1) prepare and maintain an inventory of all properties which have the potential for designation as a historic property;
- (2) recommend to the County Board of Commissioners specific properties to be designated by the ordinance;
- (3) and review applications for certificates of appropriateness and grant or deny the same in accordance with the provisions of the ordinance.

### THE PROCESS

Properties located within a designated historic district are subject to design review. Property owners proposing to make a “**MATERIAL CHANGE IN APPEARANCE**” to a property within the district are required to apply for a **CERTIFICATE OF APPROPRIATENESS** from the Historic Preservation Commission before making any changes. The Commission is required to grant a Certificate unless it can justify not doing so.

**CERTIFICATE OF APPROPRIATENESS (COA)** is defined as “a document evidencing approval by the Historic Preservation Commission of an application to make material change in the appearance of a designated historic property or of a property located within a designated historic district.”

The ordinance defines a **MATERIAL CHANGE IN APPEARANCE** as follows:

“a change that will affect either the exterior architectural or environmental features of a historic property or any building, site, object, landscape feature or work of art within a historic district such as:

- 1 A reconstruction or alteration of the size, shape or facade of a historic property, including relocation of any doors or windows or removal or alteration of any architectural features, details or elements;
- 2 Demolition or relocation of a historic structure;
- 3 Commencement of excavation for construction purposes;
- 4 A change in the location of advertising visible from the public right-of-way; or
- 5 The erection, alteration, restoration or removal of any building or other structure within a historic property or district, including walls, fences, steps and pavements, or other appurtenant features.”

**ORDINARY MAINTENANCE OR REPAIR OF ANY EXTERIOR ARCHITECTURAL FEATURE, THAT DOES NOT INVOLVE A MATERIAL CHANGE IN DESIGN, MATERIAL, OR OUTER APPEARANCE, IS EXCLUDED FROM REVIEW. ALSO, INTERIOR CHANGES TO PROPERTIES THAT DO NOT HAVE AN EFFECT ON EXTERIOR APPEARANCE ARE ALSO EXCLUDED FROM REVIEW.**



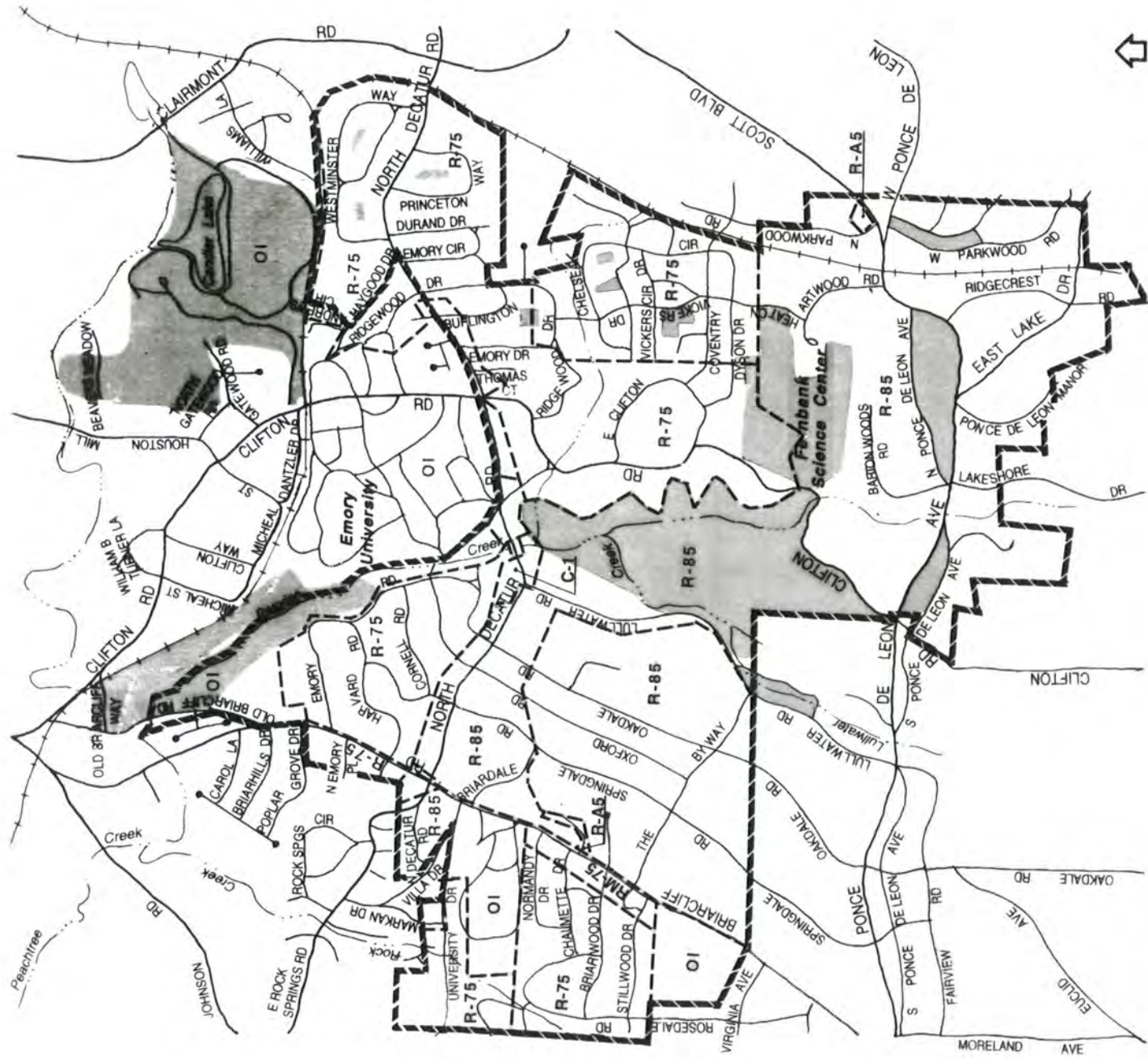

Not all small areas of zoning are depicted, due to scale of map.

**ZONING DESIGNATION MAP**

	District Boundary		Commercial	<b>C-1</b>
	Open Space		Office/Institutional	<b>OI</b>
	Zoning Designation		Single Family Residential	<b>R-75/R-85</b>
	Boundaries		Single Family Attached Residential	<b>R-A5</b>

**Druid Hills Local Historic District**  
DeKalb County, Georgia



Not to Scale



---

## ERADICATION of Kudzu

All kudzu vines which are climbing into trees or other vertical elements shall be cut at a height of 4' - 5' above grade. All kudzu below this height shall be sprayed with Roundup brand (or other similar herbicide) per manufacturer's instructions. The best time for spraying is in late May after all of the new foliage has emerged, however, spraying can be done at any time during the growing season. A second spraying of any remaining live kudzu shall take place 3 - 4 weeks after the initial spraying. No planting should take place in these areas until a minimum of seven days after the second spraying. Any remaining live kudzu can be sprayed a third time, though this will probably not be necessary. Isolated spot spraying may be necessary the following year. In areas of dense growth, most of the old vines will decay within 12 - 24 months. Supplemental methods such as discing or mowing may be used to assist with kudzu removal once the initial spraying has taken place. Stronger herbicides may be somewhat more effective, but due to the higher toxicity and potential hazard we do not endorse their use.

*Specification obtained from Kennesaw National Battlefield Park, National Park Service, U.S. Department of the Interior.*





---

# CREDITS

**DRUID HILLS CIVIC ASSOCIATION**

**DEKALB COUNTY HISTORIC PRESERVATION COMMISSION**

**DEKALB COUNTY BOARD OF COMMISSIONERS**

**DEKALB COUNTY PLANNING DEPARTMENT**

**THE RESIDENTS OF DRUID HILLS, 1995-1996**

## **THE JAEGER COMPANY**

Dale Jaeger, Principal Landscape Architect/Preservation Planner

Amy C. Kissane, Project Manager/Senior Preservation Planner

Debbie Curtis, Architectural Historian

Jon Calabria, Landscape Architect

Kristina M. Spurgin, Graphic Designer

## CHELSEA HEIGHTS CHARACTER AREA

The Chelsea Heights subdivision is located in unincorporated DeKalb County west of the City of Decatur in the east central area of Druid Hills Local Historic District.

The Chelsea Land Company began platting property to the east of the Clifton Road area of Druid Hills as early as 1912-1913. The company owned a fairly large parcel of land that extended to the railroad and east of the railroad. Chelsea Heights subdivision, located west of the railroad, was platted in 1914 by the Realty Engineering Company (recorded in Plat Book 4 Page 32). Street and home construction did not commence until the mid-1920s and 1930s with the overwhelming majority of homes being constructed during the late 1940s through the mid-1950s. Significant changes were made to the 1914 plat when the neighborhood was developed, including the consolidation of most of the original platted 50 foot lots into larger building lots. Further, two of the platted road connections were not fulfilled on the ground: Hertford Circle does not connect to Chelsea Circle and Chelsea Circle does not connect to Hummingbird Lane. With the exception of the eastern section of Dyson Drive that has a revised plat recorded in 1950, none of the revised and enlarged lots were recorded with the county.

The subdivision is unassuming in character and has a compact curvilinear street pattern influenced by neighboring Druid Hills. The neighborhood features rolling terrain and an established pine and oak forest canopy that shades the majority of the homes in the area and creates a lush backdrop for modest historic Minimal Traditional and non-historic Ranch-style homes. The Minimal-traditional homes are found throughout the neighborhood but they are most prevalent along the main thoroughfare of Coventry Road, and its “feeder” streets of Vickers, Heaton Park and Dyson Drives, where they constitute the bulk of the early built and historic homes that follow the original platting pattern of 50 foot lots. These homes likely were built to conform with the ideals as set forth by the Federal Housing Administration (FHA) in their *Principles of Planning Small Houses* and the small house program of the early 40s. The non-historic Ranch-style homes prevalent through out the rest of the Chelsea Heights subdivision constitute a strong divergence from the architectural, platting , and landscaping ideals represented by the small house program. These homes represent the growing affluence of the 50s and 60s and the general fascination with the “West Coast” lifestyle. In the areas of Chelsea Heights where these homes are prevalent, the original 50 foot lots typically were aggregated to form lots with widths at the street from 75 to 150 feet. In addition, the landscape design associated with these homes emphasize an integration of the indoor and outdoor living spaces with terraces and patios becoming integral to “outdoor living”. In Chelsea Heights this new relation to the landscape resulted in more intimate garden spaces near the home with, planting of many large trees away from the home to reinforce the horizontal and vertical planes that are an integral part of the architectural heritage of these homes.

Finally, while the Minimal Traditional and Ranch styles predominate in Chelsea Heights, other styles including those influenced by the Bungalow movement, the Cape Cod and Contemporary exist and were built more than 50 years from today (2008).

## GUIDELINES AND RECOMMENDATIONS

Throughout this document reference is made to both **guidelines** and **recommendations**. The term guideline is used to denote a requirement. A guideline may occasionally be waived but, only rarely and under the most exigent circumstance. The term recommendation is used to denote a “best practice” for meeting specific guidelines, as well as meeting the ideals as set forth in the guidelines and the historic preservation ordinance. Often, recommendations should be viewed as a possible way to meet the requirements of the guidelines or the intent of the ordinance—although not the only way.



Chelsea Heights Neighborhood, based on 2006 tax-parcel information. Notice the bimodal nature of development in the subdivision with the original “50 foot” lots located along the main thoroughfare of Coventry Road and its “feeder” streets and the much larger “combined” lots of later construction elsewhere in the subdivision.

## CHARACTER-DEFINING FEATURES

### Site and Landscape Characteristics:

#### Front Setback

Varies from 20' to 60' with the typical setback in the 25-40' range.

#### Side Setback

Generally greater than 10'.

#### Typical Lot Size:

Lots vary in size, shape and dimension because 1) the curvilinear street pattern in the neighborhood creates irregularly shaped and often larger corner lots and 2) many but not all of the original platted 1914 lots were enlarged and/or combined when the homes in the neighborhood were constructed during the years between the mid-1920s and the 1950s.

Existing lot dimensions range from 37'-150' wide to 100'-203' deep.

Existing lot acreage ranges from .11 acres to .90 acres; typical lot size is approximately .3 acres.

#### Typical Building Size:

900 to 4,000+ square foot range; typical house in the 1,700-1,800 square foot range.

#### Percentage of Lot Coverage (Home to Lot):

Lot Coverage varies substantially throughout the neighborhood from 5 to 54 %. More typical however is the occurrence of lots with 15 to 20% coverage . During the early development period relatively small homes were built on relatively small lots, later this gave way to relatively large homes on relatively large lots, in both cases the proportion of lot coverage remained relatively constant.

#### Streetscape:

Variable width asphalt street, granite curb, planting strip, 3 ½ - 4' sidewalk, retaining walls in front yard space. Limited sidewalks, frequently one side, some newer additions at edge of road with no curb, narrow grass strip in some locations with older sidewalks. Street facing garages and carports occur intermittently throughout Chelsea Heights.

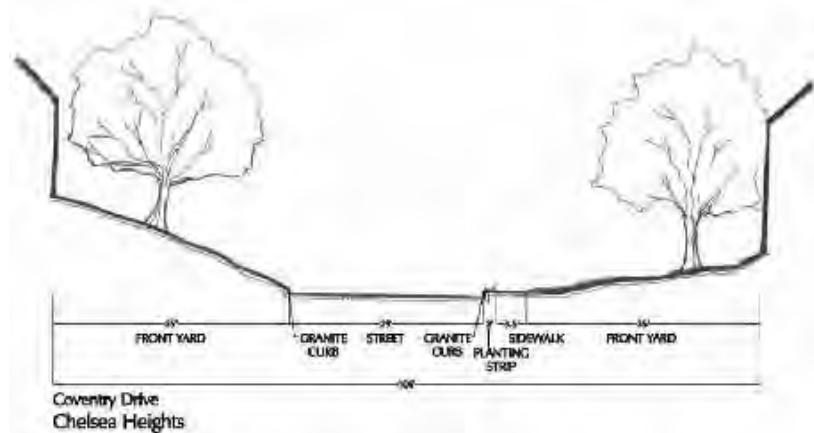

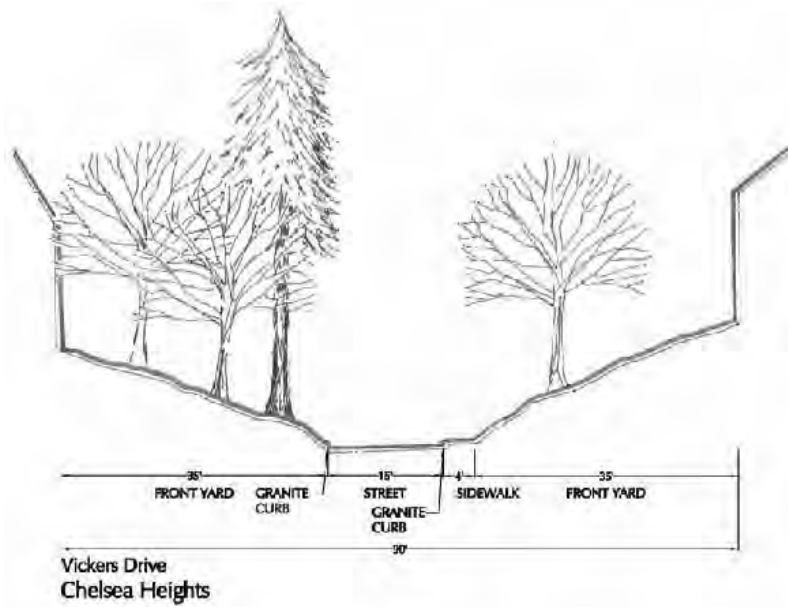

## Other

### Masonry elements:

Granite, cast concrete, cement skimmed concrete block, and rarely, brick or concrete block retaining walls, granite with some cement, curbing; field stone, cement and brick entrance walks, and stairs, brick and rarely granite mailbox piers.

### Drives and parking

Paved access drive, typically concrete with drive terminating in a side yard parking pad or street-facing attached garage on the Minimal Traditional homes or for the Ranch Style home the drive terminating in side or back yard parking pads, or in attached street-facing carports or garages. Original, detached garages do occur but are atypical.

## Front yard spaces

For the Minimal Traditional homes small open lawns with some trees; For the Ranch-style homes there are also small open lawns but most are wooded with abundant pine and oak trees.

## Signage

Wrought iron street name and way-finding signs.

## Parks:

Heaton Park is an original feature in the middle of the neighborhood; there is also a small park in middle of Chelsea Circle & Hertford Circle and another bordered by Hummingbird Lane and Hertford Circle.

## Building Characteristics:

### Scale

Relative to one another houses in Chelsea Heights are either small, in keeping with the FHA small house principles or large in keeping with the low rambling floor plans associated with ranch-style houses (these are nowhere near the scale of National Register Character Area #1 homes). All of the Minimal-traditional houses along Coventry Road appear from the street as 1 to 1 ½ stories with some basements and basement parking. In the areas where ranch houses dominate the houses are typically 1 story with or without a finished basement, however there are a number of 1 ½ to 2 story and split-level houses included in areas where ranches are the dominant style.

### Type

single family detached dwellings



*Example of Minimal-Traditional House type with a moderate pitched side gable roof, Chelsea Circle*

### **Style**

Primarily Minimal Traditional and Ranch (including split level) but with some Arts and Crafts influenced, Cape Cod and Contemporary homes built more than 50 years ago (2008).

### **Material**

Brick veneer exterior, clapboard, masonry accents around entrances and porches. Foundations primarily were built with granite on the Minimal Traditional and some of the earlier Ranch and Cape Cod homes with brick and sometimes cast concrete and concrete block becoming more prevalent in later-built homes.



*Example of Ranch House type with a low pitched hip roof, Chelsea Circle*

### **Roof Form**

Hip and side gable.

### **Roof Pitch**

majority are low to moderate roof pitch , Low = less than 30 degrees (4/12 to 7/12) on most of the Ranch homes. Moderate = between 30 to 45 degrees (12/12) occurs on most of the Minimal-Traditional and other style homes.

### **Massing (three-dimensional form)**

strong horizontal emphasis of main building block with both symmetrical and asymmetrical facades; small projecting wings and subordinate front gables on some houses.



*Example of a 2 story home with a strong horizontal orientation or emphasis.*

### **Directional Emphasis**

The strong Horizontal emphasis of the Minimal traditional, Ranch, and other older homes is one of the most important defining characteristics of the homes within Chelsea Heights. Maintaining the Horizontal Emphasis will assure that Chelsea Heights maintains its original character in both the Minimal Traditional and the Ranch dominated areas of the subdivision.

### **Other**

#### Details

Minimal building elements.

#### Roof material

Composition or asphalt shingle.

### **Garages and parking**

Integral garages for Minimal Traditional homes, with both garages and carports for Ranches. Generally both garages and carports are front loading with parking on side driveway or on rear pads where garages or carports are absent. Small scale detached garages set to the side or slightly behind homes occur; these garages are front loading and are accessed via a straight narrow drive from the road.

### **Porches**

Small entrance stoops, are characteristic of the Minimal-Traditional homes while side porches, and distinct rear patios or terraces that contribute to the indoor/outdoor living style of the Ranch house are dominant .



*Example of integral front loading garage, Coventry Drive.*





*Example of small scale detached garage to right of house, Dyson Drive.*

#### Windows

Varied, including single and paired, double-hung, casement and horizontal sash. Wood and steel being typical of earlier homes with wood and aluminum introduced in the later Ranch homes.

#### Chimneys

Prominent front chimneys on some (mostly Ranch) houses.

#### Accessory buildings

Not a prominent site feature.

#### Retaining Walls

In many areas of Chelsea heights topographic relief is high. Because of this there are a number of retaining walls. The majority of these are only a few feet high follow topography and are flush with the sidewalk. Detailing and accents are minimal. Walls typically are built with granite, cast concrete or concrete block and rarely brick.

#### Foundation Materials

Granite, brick, concrete block, and cast concrete are the only foundation materials that occur in the character area that were not introduced in the last ten years (since 2008).

## Special Area Features

### Historic Plat Patterns vs. Evolution of Established Neighborhood

The neighborhood was originally platted in 1914 with a majority of lots with a 50' street frontage. Building construction began during the mid-1920s into the 1930s. Homes built during this period typically followed the Minimal-Traditional style and in keeping with the FHA small homes movement were relatively small. Currently, (2008) 50' lots occur on Coventry Road and its "feeder" streets. The majority of the neighborhood homes were constructed from the late 1940s through the mid-1950s. During the period of building construction, two to three of the original 50' lots were combined to create the existing lots found in most of the neighborhood today. Lots in this portion of the neighborhood range in frontage from 75 to 150 feet. Homes built during this period varied and include those that were influenced by the Cape Cod and Bungalow styles however, the vast majority of homes built during this time and in these areas were 1 story and rarely split level ranch homes. In addition, the landscape design associated with these homes emphasize an integration of the indoor and outdoor living spaces with terraces and patios becoming integral to "outdoor living". In Chelsea Heights this new relation to the landscape resulted in more intimate garden spaces near the home with, planting of many large trees away from the home to reinforce the horizontal and vertical planes that are an integral part of the architectural heritage of these homes.

## Infill Development

Because of the increasing desirability of in-town housing, a current trend in the Chelsea Heights is to attempt to construct proportionally large homes on relatively small lots, thereby introducing additional structures to the neighborhood that often are at an increased scale and mass from the existing buildings such, that the rhythm of the street is disrupted. At issue is the compatibility of infill development with the existing character of the neighborhood.

Infill construction can be appropriate to the established visual character of the neighborhood by respecting established site, landscape and building characteristics.

In particular three elements must be considered when making decisions regarding construction within the subdivision. These are:

- The strong horizontal orientation or emphasis of most of the homes that were built in the area prior to the 1970s.
- The rhythm or the strong recurring pattern between the landscape and the home that exists. Put another way, the strong relation between the built environment and the landscape or void spaces between such is an integral part of the character of the area. In areas where the 50 foot platting pattern occurs this rhythm is such that the buildings dominate. The opposite is true in the areas where ranch homes occur and where the landscape or voids define the rhythm of the streetscape.
- The sense of place imparted by the canopy of trees that have grown since the inception of construction.

## DESIGN OBJECTIVES:

Ensure compatibility of new construction and building additions by continuing the established patterns of building mass and scale, strong horizontal directional emphasis, roof form and pitch, and setback.

- Nurture the existing sense of place in the neighborhood while also accommodating compatible new construction and alterations.
- Promote development that maintains the scale, or perception of scale, of existing buildings as seen from the street.
- Facilitate additions to existing houses that minimize perceived building mass.
- Maintain the established and differing rhythms or pattern of solid to void (building to open space) in the neighborhood.
- Preserve significant tree canopy on individual lots.
- Encourage creative architectural designs that respect the basic development patterns of the neighborhood but do not dictate architectural models.

## GUIDELINES AND RECOMMENDATIONS:

These Guidelines and Recommendations are to be applied in the place of and intended to supersede the existing Guidelines of the Druid Hills Historic District, except as to Sections 5, 6, 8 & 9 of the General Guidelines, which shall fully apply to Chelsea Heights. Additionally, all of the General Guidelines are to apply to contributing homes in Chelsea Heights built on or before 1946, and these Guidelines are not to apply to such homes. It is the intent of these Guidelines and Recommendations to preserve the as-built historical pattern of development of Chelsea Heights without unduly restricting or regulating the architectural style and features of homes constructed or renovated in the District.

## Setback

There are a variety of setbacks that occur within Chelsea Heights. These are the result of the many styles of homes built over any number of years. Generally though front setbacks are “deep” in relation to the length of the yard. This pattern should be maintained.



*There are a variety of setbacks in the neighborhood; New construction front-yard setbacks should rarely exceed the plane of existing setbacks. Generally front yard setbacks are “deep” in relation to the length of the yard. The aerial photograph depicts the typical setback along Dyson Drive.*

Recommendation — New construction front-yard setbacks should rarely exceed the plane of existing setbacks. In other words the distance from the street should be about the same for new construction as adjacent existing homes

### Horizontal Emphasis

Prior to the 1970s all of the homes in Chelsea Heights were constructed with a strong horizontal orientation or emphasis. In the early periods of construction this was a function of the FHA small house designs that were prevalent at the time, later introduction of the low and rambling Ranch style homes reinforced this emphasis and as such this is one of the definitive visual characters of the neighborhood and thus must be strongly considered when making design decisions.

Guideline — New construction and additions should preserve and reinforce the streetscape character of Chelsea Heights by maintaining the predominant horizontal building emphasis of the neighborhood. Primary building façades should create a horizontal emphasis versus a vertical emphasis.

### Plate Height

Plate height is the height from the finished floor of a structure to the top of the exterior wall. By limiting the plate height the perceived scale and the horizontal orientation of new construction is more readily attained. The use of tray or vaulted ceilings may be used to increase ceiling height while maintaining plate height.

Recommendation — New construction and additions should have perceived plate heights that are compatible with those of adjacent properties and homes along the street. Ensuring compatible plate heights can address, more specifically, the appropriate scale of new construction than addressing the number of stories alone.



*Illustration of plate height— limiting plate height can help decrease the height and massing of new construction and increase the horizontal emphasis of such.*

Recommendation — In keeping with the guidelines of scale, the perceived scale of new infill residences and additions should be minimized. New construction or additions generally should be consistent with the height of nearby structures. Typically there should be no more than two floors as viewed from the primary street frontage to ensure compatibility with the predominant housing character of Chelsea Heights. This means that those lots that slope down and away from the fronting street can accommodate taller structures and still maintain the general character of the street. Lots that slope upward from the street will need special attention given to building height and rooflines to avoid a building that towers over the street and neighboring homes. Special attention will need to be paid to foundation heights and topography represented on drawings to ensure that foundations do not add to the visual perception of height.

*Below left—recent construction (2007) that minimizes plate height has a strong horizontal emphasis, and appears to be 1 ½ stories. Roof pitch is atypically steep but in general house is in keeping with character of neighborhood.*



*Recent construction (2007) that minimizes plate height has a strong horizontal emphasis, and appears to be 1 ½ stories. The well considered use of landscape grading and retaining walls to minimize the perceived scale of this new infill exemplifies the intent of the Chelsea Heights character area guidelines.*



#### Roof pitch and form

Both the Minimal Traditional and the ranch exhibit relatively low roof pitches from 4/12 for ranches to 12/12 on some of the Minimal Traditional forms. While not universal these are typical and as such help to reinforce the horizontal emphasis typified by the bulk of the neighborhood homes. In addition, side-gable roofs typically are the norm on the Minimal-Traditional homes with subordinate front gable. The ranch is more typified by the hip roof form.

Guideline — Primary roof forms on new and renovated buildings should be side gable, or hip roofs. Front gable roofs are appropriate when they are greatly subordinate to the primary side-gabled or hipped roof.



*Minimal-Traditional house with a side-gabled roof with subordinate front gable (right) compared to recently constructed (2007) Craftsman style side-gable roof with dominant front gable. While handsome the large front gable is not congruous with the homes in the area of influence.*

Guideline — Roofs typically should feature a low (4/12) to moderate (12/12) pitch.



*New construction (2008) completed with a low-pitched hipped roof form. Note how the roof form accentuates the horizontal orientation of the home.*

#### Foundations and retaining walls

Because of relatively abrupt changes in topographic relief, the use of retaining walls has been an inherent part of Chelsea Heights neighborhood since its inception. However in attempting to minimize the overall height of new homes while maximizing plate, story and basement heights large earth cuts are being employed for new construction. This in turn causes construction of foundation heights and retaining walls that are out of scale with the neighborhood. In addition, new and incongruous foundation and wall materials (and application of such as a façade) on these monolithic structures add an obvious arrhythmic element to the typical streetscape.

Guideline — The height of foundations and retaining walls should be modest and congruous with the existing topography and homes in the area of influence. Special attention should be given to grading plans during design review to ensure that cuts are necessary and not excessive with contour grading being the norm.



*Large retaining wall on new construction that is out of scale with the built environment of Chelsea Heights.*



*Tall foundation with non-historic materials applied as a façade interjects an arrhythmic element to the typical Chelsea Heights Streetscape.*

Guideline — Foundation and retaining wall materials should be limited to brick, concrete block, cast concrete and granite. Application of other materials as a façade should not be allowed if visible from the right of way.

*Cast concrete retaining wall on new construction (right) Retaining wall is modest in scale and minimal in design, following topographic relief and is an example of good design practice for retaining wall in Chelsea Heights.*



Beside, the previous guidelines and recommendations and as an aid to current and future residents there are additional recommendations and examples that could aid one in the design of homes that are compatible with the current homes in Chelsea Heights. Creative new designs that are compatible with the design traditions of the established neighborhood are encouraged, whether there is a new building or a new addition. While it is not the intent to require that new buildings copy older building styles, the use of established building forms and patterns is likely to ease the process of gaining approval. Accordingly, new second story additions to homes including ranch style houses are acceptable when they comply with these Guidelines.



*Well conceived addition that would substantially increase the size of the home while minimizing the appearance of the mass of the home. Breaking buildings into smaller architectural components avoids the perception of monumental façade.*



*Poorly conceived addition that would mask the homes original proportions and character.*

Recommendation — Place an addition at the rear of a building or set back from the front to minimize the visual impact on the original structure to allow the original proportions and character to remain prominent and to differentiate the old from the new.





*Well conceived addition that would complement the homes original proportions and character.*



*An additional story or split-level addition on an existing ranch home could be in keeping with the horizontal orientation of the homes in Chelsea Heights (below left)*



*Well executed new construction (2008) in Chelsea Heights subdivision. Horizontal emphasis is maintained by judicious use of a hipped roof. Foundation is low (because of well conceived contour grading) and granite. Multiple architectural elements and roof setbacks avoid a monumental façade. Architectural details are important but minimal.*

#### Special note regarding materials

In general materials should be in keeping with those that are endemic to the neighborhood, namely, wood, granite, brick and asphalt. However newer materials may be introduced into the neighborhood if in keeping with the historical context of these older materials. For example the use of cementitious siding that mimics the profile and texture of wood (commonly referred to as Hardiplank) may be consistent with some exterior applications. The introduction of some “green” materials for example solar shingling and panels may be appropriate and should be given special design consideration.



These two pictures illustrate the differences in streetscape rhythm between the areas where 50 foot lots are common and the areas where larger lots occur. On the left 50 foot frontages lead to homes dominating the rhythm of the streetscape while on larger lots the voids are the dominant element of rhythm. In both areas the tree canopy is important but much more so in the areas where ranch homes were built on combined lots. Note that in both areas the horizontal orientation, rhythm and tree canopy are the hallmarks of the Chelsea Heights subdivision. The significance of the extent of the lot and the specific character of the landscape is clear and the character of the property is largely dependent on an extensive and principally green canopied landscape