

# UC San Diego

## SIO Reference

### Title

A Preliminary Report on Expeditions Monsoon and Lusiad 1960 - 1963 University of California, San Diego Scripps Institution of Oceanography Cruises to the Indian Ocean

### Permalink

<https://escholarship.org/uc/item/2q24q7ss>

### Author

Fisher, Robert L

### Publication Date

1964-06-02

**A Preliminary Report on Expeditions *Monsoon* and  
*Lusiad* 1960 - 1963  
University of California, San Diego  
Scripps Institution of Oceanography  
Cruises to the Indian Ocean**

**By  
The Members of the Expedition**

**Edited by  
Robert L. Fisher**

S. I. O. Reference 64-19

---

— i —

## **FOREWORD**

Field participation in the International Indian Ocean Expedition by scientists and research vessels of the University of California's Scripps Institution of Oceanography comprises three multi-program investigations: MONSOON (1960-1), LUSIAD (1962-3) and DODO (1964). All three expeditions, though first broadly outlined in 1959, lie within the cooperative international exploration of the Indian Ocean being sponsored by the Scientific Committee on Oceanic Research and UNESCO. Therefore, though original schedules have to date been met, the programs have in fact been influenced and modified by the plans, interests and findings of other agencies and laboratories, and direct participation by marine scientists, students and trainees from other areas has been welcomed. Although the final SIO IIOE cruise, DODO, is just underway, a preliminary report on some generalized results of the first two expeditions seems appropriate now, with the clear understanding that many conclusions stated here may indeed be premature. Final analyses, syntheses and results will appear in more specialized formal publications and in the proposed SCOR-sponsored atlases which eventually will summarize Indian Ocean Expedition findings.

At Scripps Institution, it is customary to give names, rather than number designations, to the major expeditions. The 1960-1 investigation, 3 ½ months in the Indian Ocean, embraced the first SIO field work in the "monsoon seas". It was funded primarily by the Office of Naval Research of the Navy Department, with auxiliary support for personnel and special equipment from the Bureau of Ships and the National Science Foundation. The primarily two-ship 1962-3 cruise, 11 ½ calendar months in the Indian Ocean, drew its name from "Os Lusíadas", the epic poem (ca. 1572) of Luis Camões celebrating the early explorations of the Indian Ocean by Portuguese

navigators. LUSIAD was a joint operation of the University of California and the University of Rhode Island; the two three-months' equatorial current studies, aboard *Argo*, were planned

---

— ii —

and carried out under the over-all direction of John Knauss, formerly of SIO, now Dean of the Graduate School of Oceanography of URI. In greater part, LUSIAD was funded nearly equally by the Navy Department (through ONR and BuShips contracts) and by the National Science Foundation (NSF G-22255). The current cruise on *Argo*, DODO, receives its support from these same sources. Its name, with a slight bow to Lewis Carroll of course, commemorates the now-extinct flightless bird of Mauritius, an island intimately linked with all three SIO cruises to the Indian Ocean.

Robert L. Fisher  
Director, SIO Indian Ocean Program

*June 2, 1964*

---

— iii —

Scripps Institution of Oceanography research vessels *Argo* and *Horizon*. R/V *Argo* carried out Monsoon Expedition and R/V *Argo* and *Horizon* carried out Lusiad Expedition.

---

— 1 —

## ACKNOWLEDGMENTS

This preliminary report was written by some members of MONSOON and LUSIAD Expeditions, as indicated in the several chapters covering various aspects of the scientific programs, and, in a few instances, by shore-based scientists who worked up samples or data records. Each member of LUSIAD Expedition is indebted to SIO's James Faughn, who visited in advance each *Argo* port between Manila and Cochin to make logistic and personnel arrangements; he also acted as scientific liaison at these ports and at Djakarta.

The bulk of the preparation took place while the editor was based at the Department of Geodesy and Geophysics, Madingley Rise, Cambridge, and would not have occurred without the constant on-the-ground aid at Scripps Institution of Mrs. Marie Jantsch, Thomas W. C. Hilde and David Crouch of the SIO Indian Ocean Program Office. The clerical and logistic services of Mrs. Sue Chappell and Joseph Redfarn at Madingley Rise are gratefully acknowledged. Finally, the editor thanks Sir Edward Bullard and Dr. Maurice Hill for the facilities and support given him during his stay at the Department of Geodesy and Geophysics.

---

— 2 —

# MONSOON EXPEDITION - NARRATIVE

## A. San Diego to Port Darwin (August 26 – October 17, 1960)

The University of California's first oceanographic field study of the Indian Ocean got underway when R/V *Argo*, with Laurence E. Davis as Master, sailed from San Diego on August 26. George G. Shor, Jr., seismologist, was chief scientist, and the scientific party included eighteen others, primarily physical scientists but also two ichthyologists aboard to make air-borne insect, plankton and fish collections. Programs planned, and carried out in varying degree, for this segment enroute to the Indian Ocean included: short seismic refraction lines employing *Argo's* 32-foot utility boat as second vessel; continuous underway topographic, magnetic and gravity observations; hydrographic casts, piston and gravity coring, heat flow measurements, bottom photography and dredging, plankton tows and dip-netting on stations; BT's at two-hour intervals while underway; occasional air samples for CO<sub>2</sub> analysis and surface water samples for radiocesium analysis.

When *Argo* left San Diego, her first major port of call was to be Suva, Fiji. However, in 1960 *Argo* was a recently-reactivated and newly-converted vessel, and there were numerous small and large troubles plaguing her electrical circuits and her machinery, and especially the winches. On September 2, near 13°N, 145°W, her starboard-side steering cable nearly parted, and it was necessary to detour to Honolulu for repairs. En route, even so, a short seismic refraction line was attempted on the shelf and the upper slope in the lee, west of the island of Hawaii.

*Argo* was in Honolulu from September 6 – 17, undergoing repairs to the ship's machinery and modifications to the large dredging winch. Due to this unplanned port stop, Suva was dropped from the itinerary and *Argo* sailed for Cairns, Queensland, on the afternoon of September 17. She reached Cairns on October 6 after brief stops

---

— 3 —

at Howland (September 24) and Nanumea (September 28). Between these stops, fourteen crew and scientists, in a "two-birds ceremony", were initiated as shellbacks when *Argo* crossed the Equator at 180° Longitude, a point "neither east nor west, north nor south". On October 1, while crossing the North New Hebrides Trench in the vicinity of Vanikoro Island (site of the shipwreck and loss of La Perouse's *Astrolabe* and *Boussole*, incidentally), *Argo* logged and confirmed a flat trench bottom at 4695 fms uncorrected (sounding velocity 4800 ft/second), about 1100 fms deeper than previously accepted for that trench. (Subsequent detailed exploration here by R/V *Spencer F. Baird* early in 1962 established that the North New Hebrides Trench reaches a depth of 5010 fms — Matthews-corrected — near *Argo's* crossing). En route across the Pacific Basin, *Argo's* complex scientific program yielded, in part, 5 seismic refraction stations (some reversed), 21 gravity cores, 11 temperature probe lowerings, 7 camera stations, 12 micro-plankton tows, 10 radiocesium samples, 11 GEK jogs in the Coral Sea, 8 hydrographic casts, 247 BT's nearly-continuous underway PDR, gravity and magnetic observations, and shore biological collections and a gravity station at Howland Island.

At Cairns, three scientists (Belshe, Mero and Von Herzen) and the ship's physician (Chassy) left the expedition; another scientist (Helfer) went ashore to carry out a gravity survey overland to Port Darwin. Three men joined: Robert Thyer of the Australian Bureau of Mineral Resources, Frank Carey of Western Gear Company and Alvin Edgerton, gravity program aide from UCLA. Here also inspections and arrangements were made to charter M/V *Malita*, Bert Cummings, Master, to serve as primary shooting ship during the Cairns to Djakarta portion of MONSOON. *Argo* left Cairns on October 8<sup>[\*]</sup>, and proceeded under coastal pilot inside the Barrier Reef to Princess Charlotte Sound; during this run the water was too shallow to permit towing of the magnetometer, and the primary program was measurement of gravity. In the Sound, an *Argo*-tender short seismic line was shot, to check the depth of the Tertiary sediments in the basin. Meanwhile, the biologists were making collections on nearby Wharton Reef. *Argo*

---

— 4 —

transited Torres Strait on October 10 and made gravity and magnetic runs southwest of the Strait before anchoring off Thursday Island October 11 to await *Malita*. *Malita* had sailed from Cairns on October 9 with two of the seismic party aboard. At Thursday Island a third seismologist, supplies, communications equipment and explosives were put aboard *Malita* and both ships headed for Tanimbar. On October 12 a 45-mile seismic line was shot on the shelf northwest of Carpenteria Lightship; this was followed by two similar shelf lines the next two days. During this period a great deal of time and effort went into correcting electrical troubles in the scientific equipment aboard *Malita*. On October 15 *Argo* and *Malita*, passing between Tanimbar and the Aroe Islands, reached the smooth-floored middle of the 3800-fm Weber Deep. Here *Argo's* recently-repaired dredging winch was tested by lowering a gravity corer to the basin floor. During retrieval, the wire walked out of the grooves in the winch's traction drums and snarls developed, necessitating the cutting and long-splicing of the cable before the corer with core was recovered. As a further test of the big winch, however, an otter trawl was towed southeastward along the flat-bottomed Weber Deep. Shortly after midnight a maximum of 12,000 meters of wire was out. No difficulties were experienced during the retrieval, although on surfacing the trawl was found to be wrapped in the cable. The trawl probably did not touch bottom, even at the slow speed (1.5<sup>+</sup> knots) and large wire scope (1.6 – 1.7) tried. However, the winch operation was judged to be successful although several post-expedition modifications and procedural changes were suggested. At the conclusion of these tests *Argo* and *Malita* headed for Port Darwin, which they reached on the afternoon of October 17. Between Cairns and Port Darwin the expedition had logged four more seismic stations, 46 more BT's, several biological collections, plus the usual underway topographic, gravity and - after Torres Strait - magnetic observations; further, *Argo's* winch and *Malita's* shooting circuits had been tested and repaired. To this point, the close of the first phase of MONSOON Expedition, *Argo* steamed more than 9600 miles since leaving San Diego. Here, too Shor, Silverman, Thyer and Carey left the cruise and Fisher, Parker, Raitt, Shipek (U.S. Navy Electronics Laboratory) and Vacquier joined; Helfer came back aboard after his overland gravity trek from Cairns.

---

— 5 —

## B. Port Darwin to Djakarta (October 19 – November 14, 1960)<sup>[\*]</sup>

At Port Darwin, Robert L. Fisher replaced George Shor as scientific leader, and other change-overs brought the scientific party to 16 on *Argo*, 3 on *Malita*. *Malita* was careened in Doctor's Gully and *Argo*'s unmounted spare transducer was installed in *Malita*'s hull. On October 19, after powder transfers to *Malita* and testing of seismic circuits off the harbor, *Argo* headed for sea and spent two days investigating the Timor Trough. Before *Malita*'s arrival on the 22nd, *Argo* carried out a bathymetric and gravity reconnaissance of this shallow eastward extension of the Indonesian Trench here constrained between the Indonesian island-deep complex and the massive Australian block. Her deepwater sampling off Timor preceded but complemented and extended the shelf and slope investigations carried out under van Andel's direction by *Malita* later in 1960 and *Stranger* in 1961. Seismic refraction and bottom-sampling stations were occupied in the deepest ( $1760 \pm$  fms<sup>[\*\*]</sup>) part of the Timor Trough off eastern Timor and eastward along the axis, southeast of Moa. Both otter trawl and midwater trawl attempts were unsuccessful. Both ships ran northwest to cross the island ridge in the vicinity of Moa; en route *Argo* encountered and dredged a ridge or guyot that yielded a relict Miocene (shallow-water?) molluscan fauna now lying at a depth of 890–900 fms. On October 24 a seismic station, with attendant core-probe-hydro cast-camera lowerings, was completed in a deep portion of the large, irregular-floored, "gravitationally positive", Banda Basin "behind" or north of the island arc. A midwater trawl here was successful, although the large wire was extremely "wild" on retrieval and next day, on the first of several such occasions, it was streamed underway to remove the wildness. For the next five days *Argo* and *Malita* worked westward north of the main island arc, examining crustal structure and other geophysical properties of the Banda Basin and the smaller topographically-complex Flores Basin. North of Alor, while running through very placid seas, *Argo* paralleled a spectacular zone of 2 – 3 foot-high whitecaps, possibly

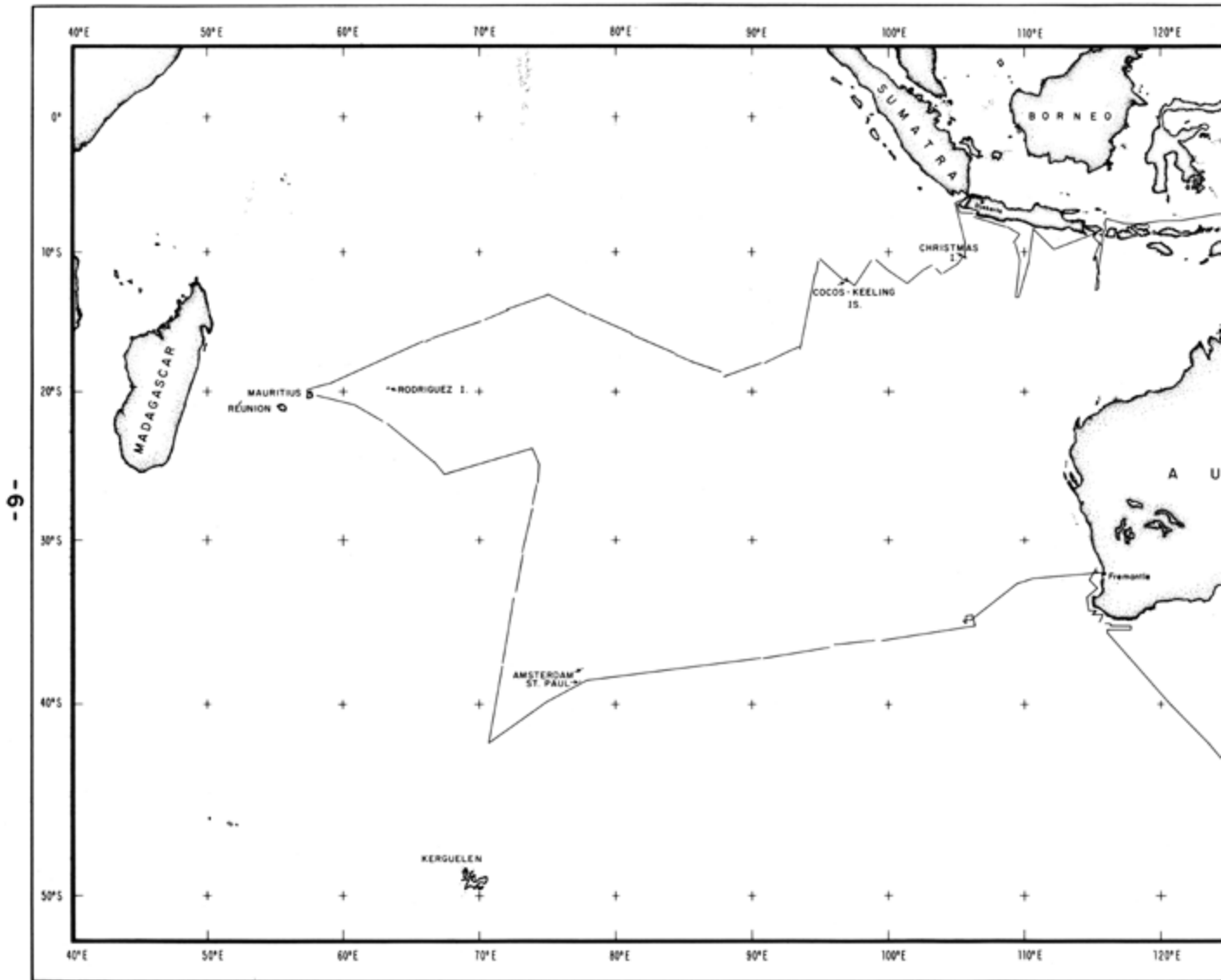


Fig. 1

marking a convergence, about 400–500 yards wide and extending east-west for dozens of miles. After a stop near Tambora, Soembawa, to replenish *Malita's* fuel and explosives supply, both ships diverted eastward to search for possible submarine volcanic activity; large (up to 40 feet) breaking bubbles had been reported by *Malita* when passing Sangeang Island. This South Sea Bubble Hunt too came to naught; hydrophones were streamed but no activity was detected here, although tremors had been recorded during our deepwater seismic station in the Flores Sea. After a reversed seismic station in the shoaler western portion of the Flores Basin, the ships headed south through Lombok Strait into the Indian Ocean proper. En route *Argo* passed close to Bali; though the hour was early and the range somewhat extreme, the entire ship's company turned out for a hopeful look.

Among the chief objectives of MONSOON Expedition was a re-examination, employing recently-developed techniques and equipment, of several areas studied intensively by Vening Meinesz aboard Dutch submarines (gravity) and Kuenen and others on Snellius (geology: sediments and structure). Their work had and still has the greatest effect on geotectonics and theories of island arc-trench-mountain formation. *Argo* (with *Malita*) was prepared to add chiefly seismic refraction measurements of crustal structure, heat flow measurements, precise sounding important for sediment studies, and continuous gravity and magnetic observations. With the short time available for the studies, it was decided to concentrate on just two profiles of measurements south of the island festoon. After a scouting run south through Lombok Strait and well into the northern part of the Wharton Basin, six complex stations (in six days) were occupied on a N–S section south-southeast of Bali in a region where there is well-developed the island-double trench-ocean basin transition. From south to north, seismic refraction observations to mantle were made by E – W runs in Wharton Basin (flattish at about 2850 fms), on the upper edge of the southern trench flank (at 2660 fms), near the Indonesian Trench bottom at 3400–3550 fms, along the ridge (here about 1800 fms deep but reaching 1400 fms nearby) separating the deep trench from the smooth-floored Bali Trough, within that wide sedimented trough (here flat at 2305+5 fms) and south-southwest of Lombok on the rather steep north flank of the trough (in about 1650–1800

---

— 8 —

fms). These six stations together with the earlier station north of Lombok make a good beginning in determining the crustal structure along a 325-mile section from the Flores Basin south through the transition zone to the Indian Ocean proper. They are supplemented by five cores and by a dredge haul (that "cored" a stiff foraminiferal sand dominantly of Miocene age) from the ridge south of the Bali Trough, by heat flow measurements on the two southern stations and in the Bali Trough and by a camera lowering that showed rock outcrops in 2650 fms on the lip of the southern flank of the Indonesian Trench. Lowerings to bottom in the 3350–3550 fm deep trench were curtailed by the loss of the E.G.G. stereo camera (on its 13th lowering, incidentally) and 6620 meters of tapered dredging wire. Just after the gear had been lowered to bottom, the half-inch wire was pulled apart in the winch room through machine or pilot error. Shippek, the bottom photographer, was able to improvise and assemble two other units so his program could continue, and *Argo's* large wire was re-spliced to its original length within a few days. In the meantime, the shortened wire was used for rock dredging and two very successful midwater trawls. The hydrographic cast, radiocesium and net-tow programs proceeded uneventfully. In



both the Bali Trough and the southern trench flank—Wharton Basin areas, the PDR displayed well-developed shallow (<10 fm) sub-bottom echoes characteristic of flattish areas seaward of trenches and volcanic chains in the Pacific. Such sub-bottom returns were present on flattish portions of the majority of lines run on MONSOON and LUSIAD offshore of the trench between Australia and the Andamans.

On the completion of the multi-station section, both ships ran for lee west or across the peninsula from Benoa, Bali. There again *Malita's* magazine and larder were re-stocked from *Argo*, and *Argo's* biologists dipnetted several representatives each from three species of sea-snake, the largest over four feet long and as thick-bodied as a rattlesnake. Leaving Bali, the slower *Malita* struck out for a shooting position several hundred miles to the southwest. *Argo* zig-zagged across the Bali Trough and bordering central ridge, both of which shoal and become more irregular westward, then ran south to scout for another multi-station N–S section off central Java. The island-to-basin profile off central Java differs from

---

— 9 —

the one off Bali described above: here the island shelf is much wider, the Bali Trough considerably narrower, the central ridge is shoal and irregular, the Indonesian Trench is deeper (here 3720± fms but flat-bottomed bordering an axial knoll) and the southern flank shoals to a narrow ridge. Further offshore, beyond a flattish saddle, there is a larger mountainous region with several hundred fms of relief, in contrast to the deep flat seafloor outside the trench off Bali. Again, six seismic-refraction profiles were completed: in the outer mountains, on the intermediate plain, along the trench bottom (at 3450–3650 fms), on the wide central ridge (here only 795–820) fms in depth), in the 1760± 10 fm Bali Trough and on the shelf, in 65–75 fms, south of Java. Unfortunately, strong westerly drift here prevented placing the receiving stations along the uninterrupted topographic-magnetic-gravity line scouted earlier. These seismic stations were supplemented by gravity and piston coring, bottom photographs (including some from the trench floor), heat flow measurements (except on the shallow ridge and Java shelf); other observations included several hydrographic casts, biological grabs and net-tows. One attempt to dredge the shoal central ridge resulted in the loss of a dredge; on a second attempt, only a little foraminiferal sand was obtained. At the close of this work, *Argo* and *Malita* proceeded to a rendezvous in the northeast part of Wynkoops Bay, Java, where, in a setting of tropical grandeur, SIO equipment, personnel and the remaining powder were retrieved from *Malita*. After *Argo* fueled *Malita*, the ships passed through Sunda Strait and parted, *Argo* to reach Djakarta on November 14, Captain Cummings and *Malita* to run north of the Indonesian island chain and back to Port Darwin to pick up another SIO team and carry out sediment sampling between Port Darwin and Timor<sup>[\*]</sup>. During the 26-day, 4050 mile run from Port Darwin to Djakarta, *Argo* (with *Malita*) had completed successfully 17 seismic refraction stations, taken 22 cores, 8 camera stations, 10 probes, 9 hydrographic casts, 3 midwater trawls, 4 rock dredges, 11 radiocesium samplings, 210 BT's and made a considerable number of net-tows and other biological observations. Additionally, *Argo* recorded 4030 miles of PDR soundings and magnetic observations and, thanks to good weather, almost that coverage for gravity measurements.

---

— 10 —

At Djakarta the six-man seismic party left the expedition, as did Harrison who had supervised the gravity program; henceforth, seismic work consisted of reflection shooting at occasional stations. Rakestraw and Waterman, the chemists who would set up and carry out the radiocarbon, trace element and carbon dioxide programs, came aboard there, and Chassy, the ship's physician, rejoined the cruise. *Argo* scientists called at the U.S. Embassy and at Madjelis Ilmu Pengetahuan Indonesia where they were graciously received by its Director, Dr. Soediman Kartohadiprodo. A reception marking *Argo's* visit was hosted by Mr. J.W. Lydman, Consul at the Embassy. Aid tendered by Majoor A.F.H. Rosenow, harbor master, and by Ronald Palmer of the U.S. Embassy staff is gratefully acknowledged. During the four days *Argo* remained at Djakarta, the resident travel aides showed great enterprise in arranging and carrying out excursions to Bandung, Borobudur, and Jogjakarta, to give the sea-weary visitors a view of the Javanese countryside.

### **C. Djakarta to Port Louis (November 18 – December 7, 1960)<sup>[\*]</sup>**

*Argo* sailed from Djakarta at mid-morning on November 18 and by late afternoon had reached Krakatau, the volcano on the western side of Sunda Strait that had erupted calamitously in 1883, leaving a fragmented rim and caldera. Just at dusk *Argo* crossed the submerged south rim of the caldera to approach within two miles of then active Anak Krakatau, the parasitic "daughter" formed in the 1920's. Fire bursts and periodic ejection of large blocks made for a spectacular display; meanwhile, hydrophones were streamed and water-borne sounds of the eruption recorded. *Argo* then ran south directly across the here-less-complex trench system to Christmas Island, to make a land lie by gravity observations there. Convoyed by Golden Bosun Birds, *Argo* reached Flying Fish Cove in the late afternoon of November 19. While the gravity party and a biologist landed to make their observations, a group of phosphate company employees visited *Argo* and resident skin divers gave biologists samples of the local marine macro-fauna. *Argo* sailed west at sunset, and zig-zagged toward Cocos-Keeling on a track designed to investigate a possible ridge

---

— 11 —

connecting the two small islands. One or two isolated peaks 1500 to 2000 fms shallower than the general 2700 – 3000 fm basin floor were found on each of the six long tracks between Christmas and Cocos-Keeling; a discontinuous ridge system linking them and probably extending somewhat east of Christmas Island seems likely.

En route to Cocos-Keeling the large-volume water sampler was tested and modified, and a deep-diving-dredge attempt was unsuccessful in reaching the flat  $2980 \pm 10$  fm bottom (it did, however, serve as a useful midwater trawl and the one bottom-dwelling fish obtained did suggest a near miss, the nearest of the entire diving-dredge series). Cores from this deep flat area were varicolored multi-layered stiff mud, some with overlying red clay. Probes had difficulty in penetrating this material, but five gravity cores and three successful heat flow measurements were made before *Argo* turned south near  $95^\circ\text{E}$ . Here too the first serial radiocarbon cast was obtained; fifty-gallon samples, obtained from six levels between the surface and 5000 meters, were processed by Rakestraw. Throughout this period and later, there were technical difficulties

with the CO<sub>2</sub> analyzer; operation was intermittent. On November 23 *Argo* passed east-to-west between Cocos and Keeling atolls in order to obtain good magnetic and gravity profiles across the saddle joining them. On the 400-mile southern run, no areas shoaler than 2600 fms were found; usual depths were 2800–2950 fms, with one basin reaching 3155 fms. Heading west-southwest, with core-probe pairs on stations, *Argo* ran up on the gradually-shoaling smooth east flank of the East Indian Ocean Ridge (of Bezrukov) or Ninetyeast Ridge (of Heezen). Near 19°S, 88°E, this very long meridional ridge is rather broad and flat-topped, at 950 to 1100 fms. Cores and probes did not penetrate the hard bottom; photographs showed foraminiferal sand, later dredged. The deep-diving-dredge did not reach bottom even here, with the ship held at 2 knots and a 2.3 x wire scope used. After this failure the diving dredge was dismantled and that program abandoned. Henceforth, only the consistently-successful midwater trawls were used, and no underway benthic sampling was attempted. Running west-northwest across a moderately deep and

---

— 12 —

irregular bottom, rough seas and electrical troubles made PDR traces most difficult to obtain; these rough seas put the gravity meter out of action from near 81°E to 69°E, for a period of 4 ½ days. At the northernmost central Indian Ocean MONSOON station, near 13°S, Rakestraw obtained the first station of the meridional (along 75°E) profile of radiocarbon serial stations he would continue southward (after Mauritius) and extend both north and south on LUSIAD. Extreme ship motion led to the loss of the large water-sampler on a 3000-meter lowering after successful 100- and 1000-meter casts. A standby, early model slim sampler was pressed into service to complete the profile the following day, and was used thereafter until Fremantle.

The MONSOON track in the central Indian Ocean was chosen to provide four widely-spaced crossings of the seismically-active median ridge system, in the shape of the inverted Y, that bisects the region. One of these crossings took place between 14°S, 72°E and Mauritius. Heat flow measurements and cores were emphasized on this whole run, with four sampling stations pinpointed in locally-sedimented flat pockets between the peaks of this extremely irregular, broad (450–550 mile) rise. Magnetic topography was rough here as well, and bottom photographs, dredged ejectamenta and volcanic sands in the cores attested to the primarily volcanic nature of the ridge. No single obvious central "rift" or cleft was found. The 175–225 mile-wide generally-irregular "flanks" are here separated by a region, about 100 miles wide, in which four broader peaks (ridges?) are separated by deeps, each feature being ten to fifteen miles wide. On the present crossing, this zone centers at 15°45'S, 67°55'E, about 140 miles eastward from the center of the strip of earthquake epicenters as so far drawn. Unfortunately, no heat flow measurements were obtained in the central zone. The average depth of the very rough west flank is about 300 fms less than that of the equally rough east flank; this generally-shoaler character continues to about 61°E. From there to Mauritius, larger shoal peaks, probably related to Rodriguez-Mauritius-Mascarene Ridge, appear. After biological dredge hauls and an unsuccessful camera station on the upper insular slope northeast of Mauritius, *Argo* reached Port Louis at mid-morning on December 7. During the 20-day,

---

— 13 —

3870-mile run from Djakarta, *Argo* had taken successfully 17 cores, 12 heat flow measurements, 7 hydrographic casts and horizontal net tows, 3 midwater trawls and 2 rock dredges, plus 17 microplankton tows, 8 radiocesium samples and 154 BT's. Six radiocarbon stations had been occupied; two of these extended to 3000 and 5000 meter depths. The CO<sub>2</sub> apparatus still was not functioning properly, the gravity meter had been out for several days (but came back into operation in time for the ridge crossing) and the deep-diving-dredge program had been cancelled.

At Port Louis Robert Parker, the benthic biologist, left the expedition and William C. White, a geologist from the Bureau of Mineral Resources, Canberra, joined. The ship's company spent three days enthusiastically exploring this Tahiti-sized oceanic island of magnificent land- and seascapes. Some pounded rocks and swam in the company of Fisheries Officer Jean deB. Baissac and his family, charming hosts and raconteurs. Four disturbingly-athletic scientists scaled 2690 ft Pieter Both, the island's most striking landmark, which when viewed from a distance seems to have a huge inverted conical rock balanced on its similarly-conical peak. Three senior scientists were received with great hospitality by Sir Colville and Lady Deverell and their sons at luncheon at Le Redit. All found a shore base and a welcome at the Port Louis Merchant Navy Club, with Mrs. Brodie and her staff. The gravity specialists, always thinking, hired a car and made observations at the fuel dock and at La Plaisance Airport, while the biologists collected on the reefs. An early evening open house aboard *Argo*, anchored in the harbor, was attended by almost 100 members of the government, mercantile and scientific communities of the island. There shipboard scientists were able to display *Argo's* equipment and collections and to explain her program under the most relaxed of conditions to a most charming of audiences. The next afternoon, on December 10, *Argo* sailed for Fremantle.

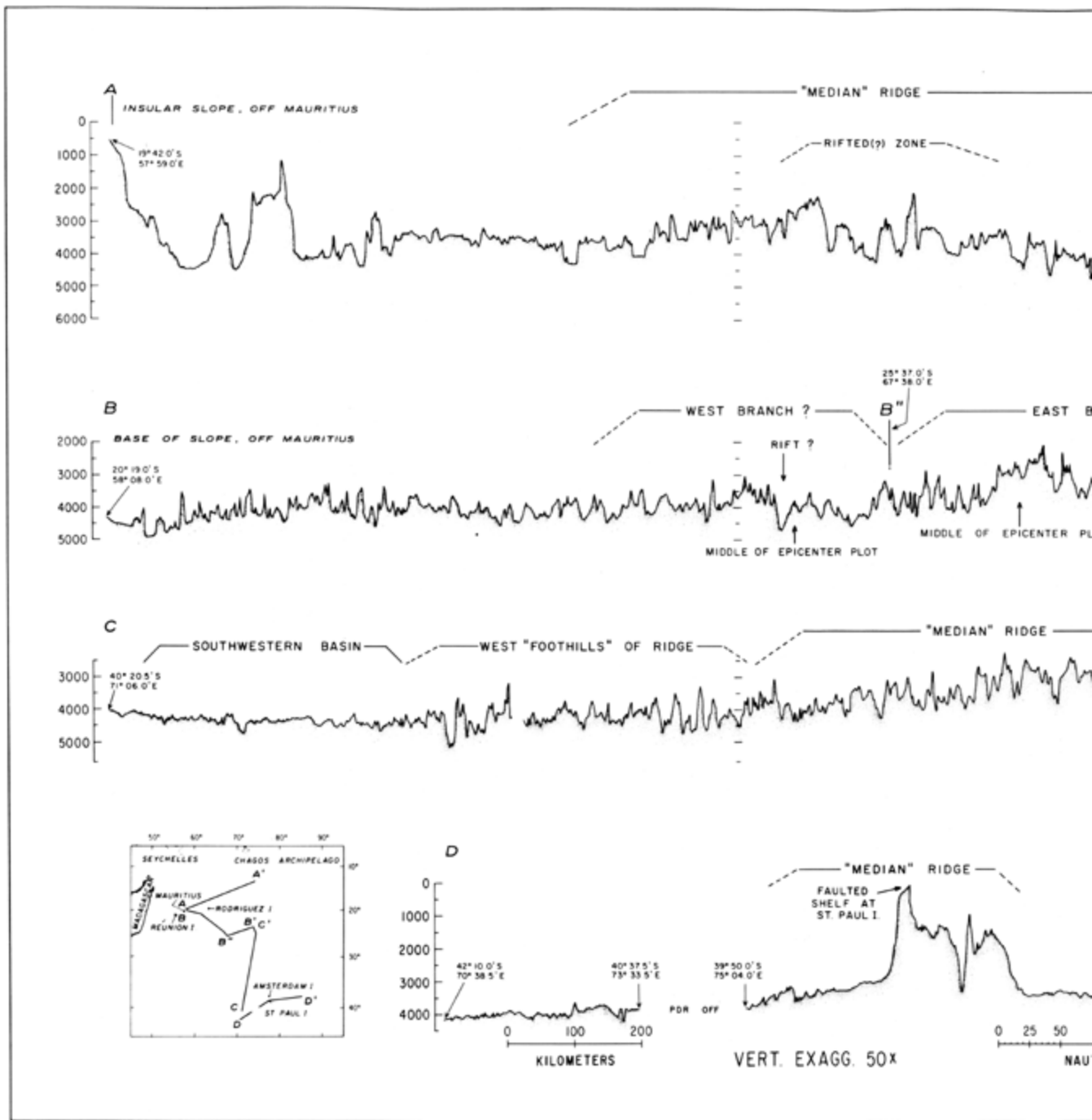


Fig. 2

## D. Port Louis to Fremantle (December 10, 1960 - January 2, 1961)<sup>[\*]</sup>

On leaving Port Louis, *Argo* skirted the west and south coasts of Mauritius and spent the remainder of December 10 and half of the next day running sight-controlled lines east of the island, within twenty miles of the coast. These were chosen to trace, topographically and magnetically, submerged volcanic structures on the eastern slope and to confirm the absence of shoal potential fishing grounds there. After successfully re-occupying the earlier-aborted camera station on the slope northeast of the island and making a detailed hydrographic cast at the base of the island pile, *Argo* crossed the complex elongated ridge-and-trough topography southeast of Mauritius. She headed east-southeast to cross the median ridge system south of the juncture (based on earth-quake epicenter plots) of the circum-South African and major circum-South Australia branches. East of the effects of sedimentation from Mauritius, the bottom was extremely irregular and without even locally-sedimented basins suitable for core-probe attempts; such rugged topography suggests comparative youth or a paucity of biogenous sedimentation. However, a midwater trawl in the region yielded a good if unspectacular catch, and the surface waters as well may not be depauperate. On this east-southeast track, no obvious western ridge and intervening deep were detected; the entire region was rough but a low ridge may be present. On the subsequent east-northeast track the expected east branch appeared as an extremely-rugged rise 250–300 miles across and with a strip, centered near 25°46'S, 70°30'E on this crossing, of rifted(?) topography similar to *Argo's* crossing prior to visiting Mauritius. During this run, a large and soon-to-be chastened shark, striking from behind, left deep scratches and several teeth embedded in the towed 8"-diameter cylindrical fibreglass magnetometer case. A major station was occupied about 100 miles east of this ridge, at latitude 24°S; here the second multi-lowering in Rakestraw's 75°E meridional radiocarbon profile, and probe, hydro cast, piston-gravity core and camera lowerings were made.

Running south, a probe-core pair was made just at the eastern base of the main ridge, and, after a run onto a very rugged shoaling bottom,

---

— 16 —

two coring attempts were made in a 1950-fm hole between 1300-fm peaks. The "cores" obtained consisted of fragments of black and green conchoidally-fracturing volcanic glass. Some shards had feldspar phenocrysts or dull chilled surfaces and ropy structure. No probe lowering was attempted. Subsequently the bottom generally deepened as *Argo* ran off the ridge, but it remained extremely rugged on this south-southwest track that stayed in the western foothills to the vicinity of 36°S. Meanwhile, at 33°20'S, 73°E, another detailed station was occupied: operations included multi-leveled radiocarbon sampling, core-and-probe, bottom photography, hydrographic casts and, finally, a midwater trawl that yielded a very rich catch of fish and invertebrates. However, the most specatacular specimen, a saccopharyngiform fish, came up tangled in the pinger bridle after a core lowering. From 36° to 42°S, the bottom became deeper and smoother but not flat, at 2250 fms ±100, except for a local 2550-fm deep near 38°30'S. On this portion of the south-southwest course, excessive ship motion put the gravity meter out of operation. The southernmost station of the run was occupied at 42°S, 71°40'E where 15 – 20 foot

seas of 52°F water, breaking at the stern, ripped up plates from *Argo's* sternbasket and made lifejackets compulsory attire. An "anchor" radiocarbon station was taken, with attendant hydro casts, two cores, and probe; then *Argo* finally turned ENE to run down-weather, taking a midwater trawl that produced few fish but a great many very odd-looking squid and jellyfish. With *Argo* running this relatively-easy east-northeast course, the trouble-bedevelled echo sounder gave out completely, with the fault at length being traced to intermittent contact of abraded leads in the extendable column shorting out the transducer. The sea-chest was opened, the retractable hull cover-plate did hold, and the faulty transducer was replaced by the unit from *Argo's* utility boat. During the changeover, hydro casts, core and probe were taken, the depth being checked by reflection times of explosions: with the new transducer installed, stray noise appearing on the PDR trace, and heretofore variously attributed to bubbles, scatterers and rough seas, disappeared.

*Argo* continued east-northeast across the slowly-shoaling, rough west flank of the median ridge, which here is narrow and unmistakable.

---

— 17 —

Shortly after noon on December 23 the soundings shoaled dramatically and almost immediately the tiny, uninhabited Saint Paul Island came into view. By 1600 *Argo* had anchored near Rocher Quille (Ninepin Rock) directly off the crater entrance on the northeast side of the islet. A six man party, under White, was put ashore to measure gravity and to make geological and biological collections. They were brought back aboard the following afternoon. Saint Paul Island, a French possession equidistant from Madagascar and Australia and well outside modern shipping lanes, has been visited but rarely since the days of wind-powered whaling ships. Knowledge of its geology rests on the work of Ferdinand von Hochstetter, a noted petrographer who spent 18 days there in 1857 with the Austrian expedition aboard the frigate *Novara*; Velain and later writers mainly draw from his work. The present published nautical chart for the island, limited to work very near shore, is based chiefly on data collected by a group of French surveyors and scientists who went there in 1874 to observe the Transit of Venus that occurred in December of that year. Saint Paul is a geologically-young volcanic island, nearly entirely basaltic, but with the oldest exposed flows, at Penguin Bay, consisting of rhyolite. Hot springs and warm ground are still present, and the central crater is spectacularly developed, although its northeast section, and that part of the islet generally, has been removed through faulting. During *Argo's* brief visit we could hardly hope to improve upon von Hochstetter's work, and the shore party collected rock specimens primarily for radioactive dating and reference collection purposes. However, we could contribute new types of observations: gravity was measured ashore (at the "Tonkinois" monument and at the north and south ends of the northern cobble spit) and *Argo* overnight made a 17 hour sight - and radar-controlled bathymetric, magnetic and — with limited success — gravity survey that extended from a few hundred feet to about 5 miles offshore, with both radial and concentric runs.<sup>[\*]</sup>

---

— 18 —





These tracks reach deep water immediately east of the island because there material has been faulted away; west, north, and south of the island one or two narrow shelves, and submerged flow lobes, are obvious. Camera and dredging stations were made on the eastern slope. The shore geologists measured sections, mapped parasitic cones and collected along geologic traverses; the biologists trapped insects and collected carcasses of, for example, black rabbits, swallow-tailed terns and the yellow-crested rockhopper penguins that populate the small islands in the southern oceans.

A lobstering vessel, *Sapmer*, based at St. Denis, Reunion, happened to be working Saint Paul; her captain, M. Barbenton, offered *Argo* the French chart used that night as the base-map for the bathymetric survey. He explained that the island had been uninhabited since the short-lived lobster cannery, set up inside the northeast slope of the crater, was abandoned in 1928. *Sapmer's* boats piloted *Argo's* utility boat through the breached cobble spit that nearly blocks the crater; Barbenton had said a French motor vessel, *La Parisienne*, had sunk in this channel more than 40 years earlier, and that her boiler was only two feet under water at low tide. After Captain Barbenton lunched aboard *Argo* and holiday tokens were exchanged, *Argo* headed for Fremantle, with the pensive ship's company only partially diverted by Christmas Eve special fare — bisque and a lobster-tail entree.

Forty miles east of Saint Paul *Argo* crossed a single hole or cleft<sup>[\*]</sup>, 800 fms deeper than the general ridge level, before dropping off the ridge onto an only moderately deep seafloor of rather subdued relief (1900 fms  $\pm$ 100) that extends 450 miles east of the ridge. In this gently-rolling bottom that deepens slowly toward the east, probes were successful but gravity corers surprisingly did not penetrate more than a few centimeters into the bottom. Finally, near 36°15'S, 99°E, in 2350 fm depths, a piston corer yielded 20 – 25 cm of light-colored ooze overlying 970 cm of dry brown clay. Between Saint Paul and this point

*Argo* had made camera stations, hydrographic casts, net tows, and a very rich midwater trawl, and had dredged and photographed the surface of a probable guyot (near 36°38'S, 95°27'E) with a 1659–1670 fm summit at least two miles wide: At this point, *Argo's* third officer developed an inflamed appendix and for several hours the ship ran for Fremantle at near flank speed; the next morning the physician recommended that a normal speed and work schedule to port would be acceptable. Hence Rakestraw's last multi-level radiocarbon station, hydro casts, the piston-gravity cores mentioned above, and an otter trawl were carried out at the final pre-Fremantle station: Rough weather and electrical troubles had wiped out 24 hours of gravity readings and five days of magnetic observations respectively, but all underway gear was functioning well when on December 31 *Argo* made a systematic survey of the environs of 34°59.5'S, 105°36'E where H.M.A.S. *Diamantina* had reported a localized 4500 fm deep. For 16 hours, during which celestial positioning was good and PDR records were excellent, *Argo* ran lines from which no soundings shoaler than 2680 fms or deeper than 3088 fms were logged. The area is deep,

generally, but without local pits. Earlier on December 31, near 35°37'S, 103°50'E, *Argo* recorded depths of 3400–3467 fms for several miles. On *Argo's* 80°T course, this deep was separated from *Diamantina's* deep by sharp peaks reaching 1620 fms; this run and later lines show there is a linear ridge and trough system generally developed off southwest Australia.

After surviving a subdued shipboard New Year's Eve celebration and the usual rough seas approaching Fremantle, *Argo* docked late on January 2, having run 4800 miles since Port Louis. Here Rakestraw and White left the expedition, and Stephen Calvert, an SIO sedimentologist, and Ronald Green, a University of Tasmania magnetician, joined. John Hedrick, *Argo's* third officer, turned in hospital at Perth; after undergoing an appendectomy he rejoined *Argo* at Wellington. During the 90 hour stay, the gravity team occupied five stations around Perth and Fremantle, the biologists made collections at Rottnest Island and the geologists-geophysicists discussed techniques and results with scientists from Mundaring Seismological Observatory, University of Western Australia,

---

— 21 —

the museums, the various petroleum exploration groups then active and especially with Mr. Malovich and his staff from Geophysical Services Corporation who were most hospitable to *Argo's* people. The many kindnesses, and the hospitality, of the United States Consul in Perth, Mr. Sverre Backe, and Mrs. Backe, are especially acknowledged.

## **E. Fremantle to Wellington (January 6 – 22) via Hobart, and thereafter**

Leaving Fremantle at mid-morning on January 6, *Argo* ran southerly courses to Geographe Bay, where a striking magnetic anomaly was registered northwest of Cape Naturaliste. Zig-zag easterly and south-westerly courses were run off Cape Leeuwin and then east - west runs to King George Sound; these tracks were chosen to look for seaward indications of the Dunsborough and Darling fault systems. After two days of these magnetic explorations, *Argo* ran southeast to examine the "median ridge" at about 50°S. During the run southeast, Lawrence Davis, *Argo's* captain, became seriously ill. His illness was diagnosed as hepatitis; it was decided to carry out some station work, but to proceed with good speed to Hobart where he could be hospitalized.

The bottom deepened gradually as *Argo* ran south of the Australian block; then, south of a 2710-fm-deep smooth-floored basin, the sea-floor became very rough, with depths ranging from 1915 to 3185 to 2000 fms within a 20 mile southeastly run. This rugged zone may well be connected to the similarly-rough topography, of nearly the same depth, west of "Diamantina Deep". Both regions lie somewhat south of extensive shoal or continental areas that are not markedly active (seismically) at present. Core, probe and camera lowerings and a net tow were made in 2600± fms south of the rough topography, near 39°S, 120°E, and for the next 60 hours *Argo* crossed a region with subdued bottom topography, ranging in depth from 1900–2700 fms, before she ran onto the gently-sloping north flank of the "median ridge". A southeast-north jog was made to determine the magnetic grain of the ridge at this point (49°30'S, 132°E) and a core (just a few grains recovered), probe, hydrocast and camera station was completed. A midwater trawl

was easily successful (the haul was noted as "immense") in the unexpectedly excellent weather. *Argo* then ran a direct northeasterly course for Hobart, reaching there at mid-afternoon on January 15. En route from the rise, *Argo* ran for 36 hours in 1850–2150 fm flank depths, then into a narrow rougher-bottomed zone of 1950–2650 fm depth about 350 miles WSW of Hobart, followed by a 2350–2550 fm basin and a smooth rise up the Australian continental slope to Tasmania.

At Hobart, Captain Davis was placed in hospital; Gilbert Chassy, ship's physician, remained with him, ultimately accompanying the partially-recovered Davis back to San Diego by air. From Hobart to Wellington First Officer Hansen served as Master. Vacquier left the expedition; Charles David Keeling and Robert Warren of SIO and Thomas B. Harris of the U.S. Weather Bureau joined the scientific party. Ashore, the biologists and gravity party discharged their usual shore responsibilities. On the second day of *Argo's* visit, Dr. Samuel Carey of the University of Tasmania and Dr. J. C. Jaeger of Australian National University, Canberra, guided several scientists on a tour of seismological and hydroelectric installations and of the scenic, zoological botanical and paleontological points of interest of south-central Tasmania.

*Argo* sailed for Wellington on the afternoon of 17 January. Extremely rough weather, with seas from just aft of the starboard beam, caused suspension of gravity meter observations for almost all and of the BT program for most of the five day crossing of the Tasman Sea. On the credit side, the PDR and magnetometer functioned well and, just before *Argo* reached the open sea, Keeling did place the CO<sub>2</sub>-sampling apparatus in really proper working order for the first time on this expedition. Commencing at the base of the Australian continental slope, *Argo* ran for about 425 miles over 2325–2660-fm-deep flattish sedimented bottom and abyssal hills. Then, for the next 120–130 miles, *Argo* crossed an abyssal plain shoaling very gently toward the east; the smooth surface was interrupted by a 4-mile wide, shallow (50–55 fm) steep-walled depression (deep-sea channel?) bordered on either side by zones of slightly rougher (relief 5–10 fms) topography. Thereafter, the plain shoaled smoothly eastward again for another 40 miles, except for one small channel(?). Then the 2400 to 2100 fm bottom roughened,

but generally shoaled eastward, commonly in steplike-fashion. Finally, about 22 miles west of the base of the continental slope off South Island, *Argo* crossed an extremely steep, apparently smooth east-facing scarp; the bottom record showed deepening of from 2072 to 2272 fms in less than two minutes. The watchstanders' immediate impression was that the PDR was malfunctioning (band slippage) but the 200-fm drop proved to be real. At the base of the scarp is a two-mile wide trough; eastward the hummocky seafloor shoals to a broad mound, then levels out as a sedimented terrace at the base of the extensive continental slope off New Zealand. From the nature of the January 19–20 sounding record, it seems probable that the 200-fm cliff is a faulted structure and that its present relief post-dates most of the sedimentation in this portion of the Tasman Sea. Unfortunately, *Argo* was unable to carry out a bathy-metric and magnetic exploration of this very spectacular feature.

At midmorning on January 22, having run 3825 miles from Fremantle, *Argo* docked at Wellington, North Island. Wellington was the second major changeover port (Port Darwin had been the first) and many of *Argo's* Indian Ocean team left the expedition. Fisher was replaced as scientific leader by Henry W. Menard. Hohnhaus, Edgerton, Keeling, Fisher, Green, Giobbi, Rowland and Shipek left the scientific party; a group of SIO geologists and geochemists (George Bien, Richard Von Herzen, Kurt Fredriksson, Harmon Craig), physician William McGee, Wladimir Nesteroff of the Sorbonne and scientists from J. W. Brodie's group in Wellington joined.

On January 28 *Argo*, with Barnes Collinson as Master, left Wellington and began an eleven week, 12,400 mile geological-geophysical-geochemical exploration of the southwest Pacific. Her southernmost penetration was a traverse across the "median ridge", here the East Pacific Rise, in the vicinity of 64°30'S, 173°E. A detailed description of *Argo's* program after Wellington is beyond the scope of this primarily-Indian Ocean account; it should be noted that after a second stop at Wellington and visits to Campbell Island, Dunedin, Bounty Island and Papeete, *Argo* reached San Diego on April 18, after a 235 day, 38,600 mile voyage. During MONSOON Expedition, 40 crew and 45 scientific party members served aboard *Argo* at one time or another. Of these totals, 23 crew and 5 scientists made the entire cruise.

(R.L.F.)

# TASMAN SEA

(on run between Hobart, Tasmania and Wellington, New Zealand)

-24-

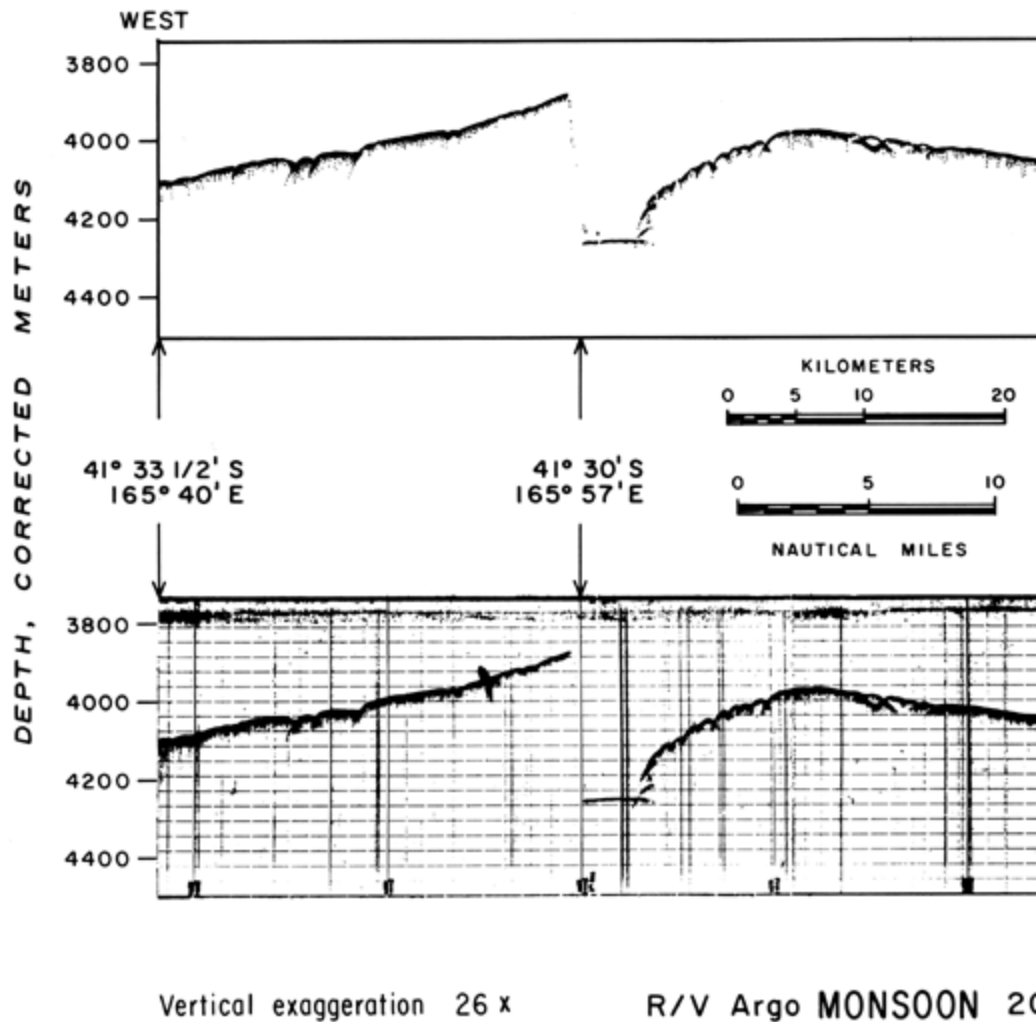


Fig. 4

## **A. San Diego to Singapore (May 15 – June 24, 1962)**

*Argo*, at 213 foot length and 2100 tons displacement the largest vessel in the SIO research fleet, sailed from San Diego on May 15, 1962, with Alan W. Phinney as Master, George Bien as Chief Scientist, and a scientific party of nine. She ran a nearly great-circle course to Manila, with an underway program consisting of standard 900 foot bathythermograph lowerings (Kenneth H. Drummond, Jan B. Lawson) and continuous atmospheric CO<sub>2</sub> sampling (Lee S. Waterman, Vernon L. Chi, Frank Manley), gravimeter (Clarence L. Hager, Marvin D. Helfer and Dan M. Kimble, all of Institute of Geophysics, UCLA), magnetometer and Precision-Depth-Recorder operation. *Argo* did make hydrographic casts and large-volume water sampling stations (for radioisotope analysis) in the western Pacific, but the 27-day run to Manila was in large part a time of equipment testing and training of personnel. *Argo* reached Manila on June 11.

At Manila, James Faughn replaced the departing George Bien as Chief Scientist, and Thomas Hilde joined to assist in the geological program. *Argo* sailed for Singapore on June 14, and visited Jesselton, North Borneo, where she spent one day. During the Manila-Jesselton-Singapore run, the scientific program was designed to supplement and extend, by means of specially-selected tracks and gravity-core samples, the South China Sea studies of the 1959–1961 NAGA Expedition. *Argo* reached Singapore where six of her scientific party departed on June 24. New arrivals then swelled the scientific party to twenty-two men and, after three days of unpacking and re-stowing of gear, *Argo* was ready to begin her Indian Ocean work proper.

(R.L.F.)

## **B. Singapore to Cochin, India (June 28 – September 24, 1962)<sup>[\*]</sup>**

At Singapore *Argo* was turned over to the current studies group under the leadership of John A. Knauss of the Graduate School of Oceanography of the University of Rhode Island. In addition to scientists

-26-

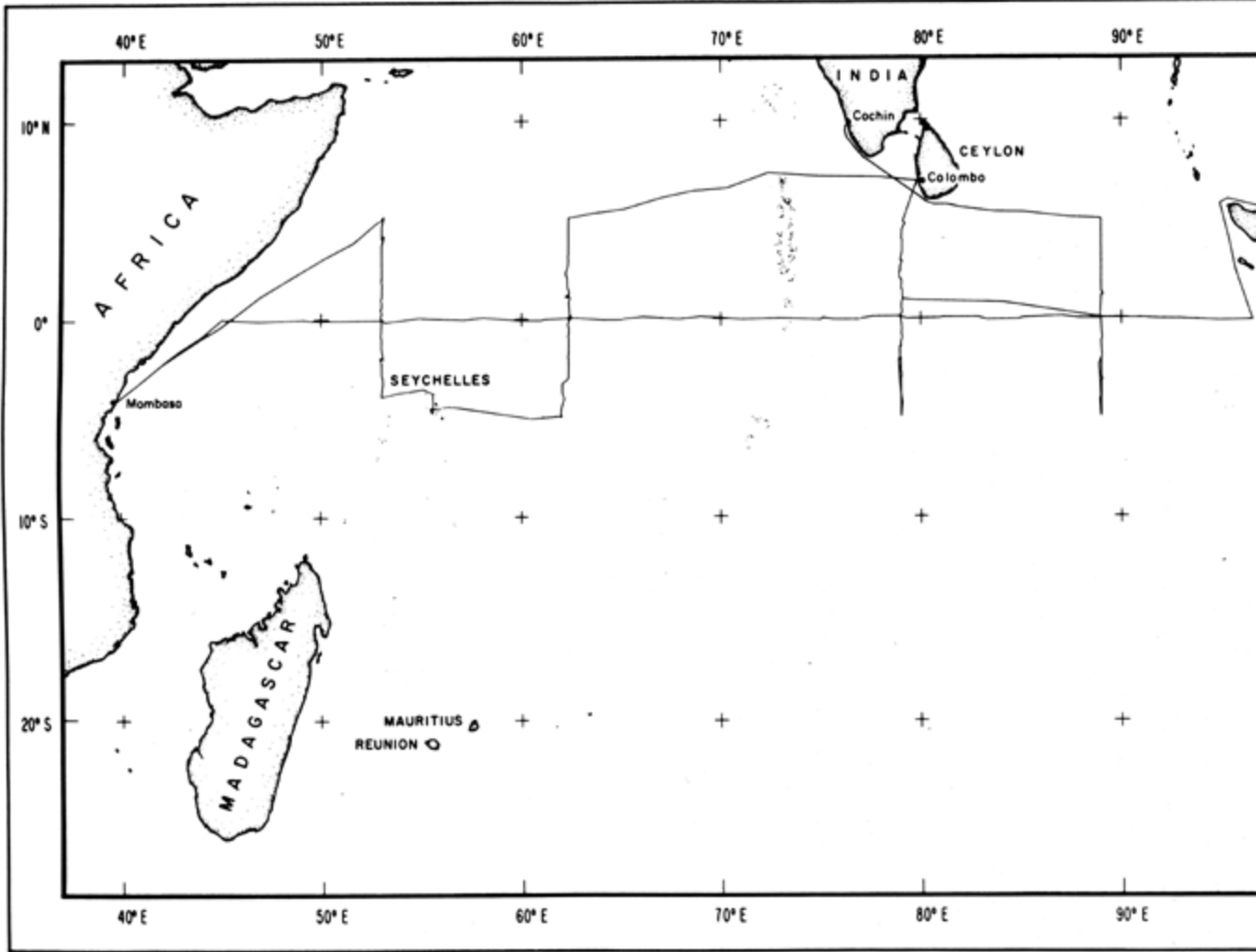


Fig. 5

from institutions in the United States and Japan there were three shipboard UNESCO Fellows in the scientific party: Selim A. Marcos of the United Arab Republic; A.V.S. Murty of India, and Ghulam S. Quaraishee of Pakistan. These fellowships were set up to promote the marine sciences in the nations bordering the Indian Ocean.

The primary objective of the scientific program of *Argo* for the next three months was to assess the subsurface equatorial circulation of the Indian Ocean during the southwest monsoon. This program involved making a number of hydrographic sections and direct current measurements in the region from 5°N to 5°S ([See Fig. 5](#)).

Several underway scientific programs were run concurrently with the current studies. The carbon dioxide and gravity programs were continued under the respective direction of Lee Waterman (SI0) and Dan M. Kimble (UCLA). Due to malfunction of the magnetometer, no magnetic measurements were made from *Argo* during this period. A plankton sampling program was carried out by Charles Jerde (SI0). Oblique plankton hauls to 200 meters and vertical hauls with the standard Indian Ocean net were made at each station. Phytoplankton and dip net samples were collected at a number of stations.

On June 28, *Argo* sailed from Singapore for its first station. The plan for the first month was to occupy a section of stations spanning the ocean along the equator. Hydrographic stations were made at two-degree intervals with alternate stations reaching the bottom. A number of plastic water bottle samples were taken by James A. Gast for determination of the concentration of various metallic ions. Taut wire buoys were to be planted at 89°E, 79°E, 65°E and 55°E for direct current measurements. Measurements from the surface down to 400 meters were made with a telemetering current meter and below 300 meters with neutrally-buoyant (Swallow) floats. We occupied our first station on the equator, 97°E, on July 1 and began to work west along the equator from there. Buoys planted on this line were not retrieved, in hopes that they might be used again when these stations were reoccupied during the last two months. It was necessary to alter the positioning of our buoys on the western side of the ocean because of rough bottom topography. Buoys were placed at 62°20'E and 53°E. Eight Swallow floats were tracked on the first three buoys and typically throughout the cruise three lowerings of the meter were made at each location.

---

— 28 —

The ship put into Mombasa, Kenya on July 24 for a four day stop. James Faughn (SI0) met the ship upon arrival to act as a liaison with the ship's agents. James A. Gast and William Allen, Jr. left the ship to return to the U.S.A. Henry Stommel (Harvard Univ.), Jule Charney (M.I.T.), John Garrett (Harvard Univ.), Robert Blandford (Calif. Inst. Technology) and Tim P. Barnett (SI0) joined the ship at Mombasa to bring the scientific party to twenty-six members.

On the morning of July 29, *Argo* departed Mombasa enroute to 5°N 53°E to begin the first meridional cross section. Hydrographic stations were spaced at one-half degree intervals from 3°N to 3°S and at one-degree intervals outside of this region. Bottom casts were made on stations located at odd degrees. This station spacing was retained on all four meridional sections. Buoys



were placed and retrieved at 2°N, 1°N, 0°, 1°S and 2°S for current measurements. Two Swallow floats were tracked at 2°N. At this time it was decided to drop the Swallow float observations in order to concentrate our efforts on the upper portion of the water column. After completing the southernmost station on this section the ship headed for Port Victoria, Seychelles for a one day stop. *Argo* arrived at Port Victoria on the morning of August 12 and departed the following morning.

After leaving Port Victoria we proceeded to 5°S 62°20'E to begin the second meridional section. On the first buoy station at 2°S 62°20'E we lost the only Hytech current meter aboard. Apparently the single conductor cable, from which the current meter is suspended from the ship, was corroded by electrolysis during use and failed when sufficiently weakened. Subsequent measurements were made with the Roberts current meter with, unfortunately, a loss in quality. The current structure on this section was highly complicated and convinced us of variability of the flows we were trying to measure. The section was completed on August 22 and *Argo* proceeded toward Colombo, Ceylon.

We docked at Colombo on the afternoon of August 25 for a four day stop. James Faughn again met the ship and arranged for a number of contacts between local scientists and students and the scientific personnel aboard *Argo*. Several groups of students from the University of Ceylon toured the ship. A symposium on the scientific program of *Argo* was presented to the Ceylon Association for the Advancement of

---

— 29 —

Science at the University of Ceylon. Participants in the symposium were James Faughn, Bruce A. Taft, Charles W. Jerde, Lee Waterman and Dan M. Kimble. Preceding the symposium a tea was given for the *Argo* scientists by the science faculty of the University. Several members of the scientific party and Capt. Phinney were entertained at the home of Miss Frances Willis, the United States Ambassador to Ceylon.

A number of personnel left the ship at Colombo: John A. Knauss, Henry Stommel, Jule Charney, Tim Barnett, William Holland, Kern Kenyon, Iqbal Ahmed and Ghulam Quaraishee. Bruce A. Taft replaced John A. Knauss as chief scientist aboard *Argo*.

*Argo* departed Colombo on the afternoon of August 28 to complete the last two meridional sections at 79°E and 89°E. Because of the strong time dependence of the measured currents during the first two months of work, the cruise plan for the remaining month was modified. The number of velocity soundings per station was reduced to allow for more than one occupancy of some of the buoy stations. The section at 79°E was worked from 5°N to 5°S and then we returned to make another set of current observations at 1°S, 0° and 1°N. We recovered the original buoy set at 0° 79°E in July which means that it maintained its position for a period of two months. It was the only buoy we recovered of the original four set along the equator. From 1°N 79°E we ran to 0° 89°E to begin the last section. Stations were run first from the equator to 5°S on 89°E and then a second set of current observations were made at 1°S on 0° on the return northward. Due to rough bottom topography the spacing of the buoy stations had to be changed. Buoys were planted at 2 ½°S and 2 ½°N instead of at 2°S and 2°N. We were able to make an

additional set of measurements at  $4\frac{1}{2}^{\circ}\text{N}$  due to surplus time accumulated on the section. We completed the section on the morning of August 21 and *Argo* headed for Cochin, India. Due to the reduction in the size of the scientific party we were unable to complete the shipboard processing of the data. For this reason we did not realize that our current measurements had revealed the presence of a counterpart in the Indian Ocean to the Equatorial Undercurrent of the other oceans.

Cochin marked the end of the first current studies cruise and a major exchange of scientists took place here. All of the members of

---

— 30 —

the current studies group left *Argo* with some of the personnel connected with the other programs remaining.

Before departing from Cochin for the United States a number of scientists participated in a series of events arranged by the United States Information Agency and the Indian National Committee for the International Indian Ocean Expedition to promote the exchange of information between scientists aboard *Argo* and Indian marine scientists. James Faughn was instrumental in arranging these events. Bruce A. Taft, Charles W. Jerde and Lee Waterman participated with members of the scientific party coming aboard *Argo* in Cochin and those who arrived on *Horizon* in a seminar given at Maharaja College (Kerala State). During *Argo's* stay in Cochin many Indian scientists were able to tour the ship and several informal gatherings were arranged by the welcoming committee. A set of plankton samples collected during the previous three months was transferred to the Indian Ocean Biological Data Center at the Oceanographic Laboratory, Maharaja College. E. Gene Gilley and Peter Benson flew to Karachi, Pakistan, at the request of the Pakistan Navy, to consult with them on the use of various kinds of oceanographic equipment.

(B.A.T., J.A.K.)

## **C. Cochin to Port Louis, Mauritius (October 4 – 26, 1962)**<sup>[\*]</sup>

On Saturday, September 29, *Argo* was joined at Cochin by R/V *Horizon*, Marvin Hopkins, Master. *Horizon*, another vessel of the SIO research fleet, had been making geological and geochemical observations (Expedition ZEPHYRUS) across the Atlantic and through the Mediterranean and Red Sea en route to this rendezvous. Her final port before Cochin had been Aden; there Richard Von Herzen and David Keith had joined a hold-over four-man scientific party (Norman Anderson, Fred Dixon, John Donovan and Richard McGehee) to make heat flow, coring, and hydrographic cast observations on the ten-day run eastward across the Arabian Sea.

Cochin was a scheduled change-over point for *Argo's* crew; almost half the crew were replaced here (most of those remaining were similarly relieved in Colombo the following February). Of the 20 – 26 scientists

---

— 31 —

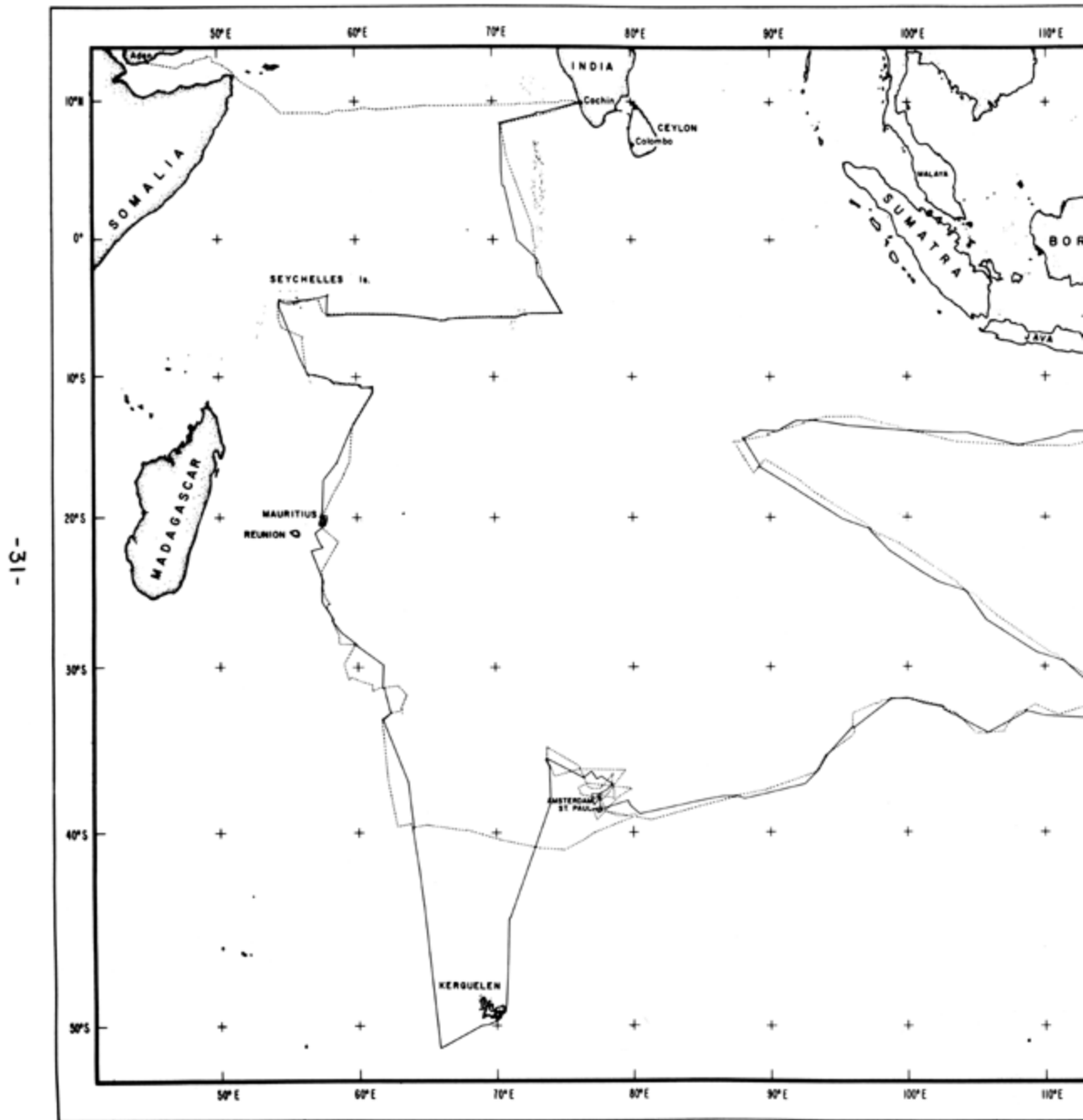


Fig. 6

who had been aboard for the Undercurrent work, all but Kimble (gravity) and Chi (CO<sub>2</sub>) returned to their home laboratories. They were replaced on *Argo* by geophysical-geochemical-geological investigators: Norris Rakestraw and Lee Waterman (C<sup>14</sup>, CO<sub>2</sub>), Haley Hodnett and Samuel Scripps (photography, hydrography), Alan Jones and Dwight Pollard (seismic studies), Richard Von Herzen and David Keith (heat flow), George Hohnhaus and William Ross (bottom-sampling) and Surendra Mathur of UCLA (gravity). One UNESCO Fellow, Mohammad Rafiguel Islam (Pakistan) joined *Argo's* scientific party. From *Horizon's* scientific complement, only Anderson and Dixon left the expedition. *Horizon* acquired George G. Shor, Jr. (seismology), Keith Rhea (heat flow), John Wageman (magnetics) and Gidon Almagor, a UNESCO Fellow from Israel. These persons spent several days adapting *Argo* and *Horizon* to the ensuing two-ship geophysical program; on September 30 twenty-four tons of explosives were transferred from *Argo* to *Horizon*, since the program required that both ships be able to shoot and receive seismic refraction lines.

Early on October 4 *Horizon* sailed from Cochin with George Shor as Expedition Leader and Chief Scientist; *Argo*, with Norris Rakestraw as Chief Scientist, sailed that evening, after a fruitless delay awaiting air-shipments of scientific gear. The next day a refraction line, with *Horizon* as the receiving ship, was shot just east of the Laccadive-Maldive Ridge in the vicinity of 9°N. The following day, in deep water west of the ridge, both ships collected large-volume samples for C<sup>14</sup> and trace element analysis, shot-and-received refraction profiles and headed south to parallel the Maldive trend. Hoped-for permission to shoot very long refraction profiles along the Maldive Ridge had not been forthcoming; *Horizon* made two short (11 and 20 mile) reflection profiles among the sediment-surrounded abyssal hills to the west of the structure and both ships held Shellback initiations as the Line was crossed. Shortly after midnight *Horizon* experienced extremely strong easterly sets and repeatedly had to adjust course to clear Addu Atoll. Later that day, October 9, a quasi-reversed line was shot along the ridge well south of Addu Atoll and the ships headed south-southeast to a rendezvous over the deep plain east of the Chagos Archipelago. There, at about 5°20'S, 75°E, another

C<sup>14</sup> station was occupied jointly; this radiocarbon station became the northernmost in the meridional profile of C<sup>14</sup> stations near 75°E begun by Rakestraw on MONSOON two years earlier. Since Cochin the ships had made six core-probe lowerings and three hydrographic casts as they lay-to on seismic receiving stations.

From the deep-plain station *Horizon* steamed westward shooting, to begin the 14-station set of reversed or end-to-end refraction profile that, though with gaps in the eastern portion, were to extend essentially from east of Chagos westward to the Seychelles and that would link with the lines shot later between East Africa and the Seychelles by Cambridge University scientists. "Reversed" lines, on generally east to west runs in latitudes 5 ½° – 6°S, were made leap-frog fashion east of Chagos Ridge, on that ridge in 400–1000 fm water south of Salomon Island, in the basin beside the western foot of the ridge, in the area of irregular deep bottom, and in the deeper basin near 6°S, 64°E. At the latter position both ships again took samples for C<sup>14</sup> analysis; each stop had been accompanied by core-probe lowerings and, in the case of *Argo's* stations, a hydrographic cast. On October 15 a four-station series of leap-frog reversed lines was begun; this

patter extended from 2180 fm water up the east flank of the ridge supporting the Seychelles, with the westernmost station, *Argo* receiving, lying in 1370 fms. The proposed following run, with the shooting ship (suggested as *Argo*) to approach Mahé on a 90-mile shallow water run from the east-southeast, was cancelled [\*] because water depths were considered unsafe for *Argo*, and *Argo* instead ran off the northeast flank of Seychelles Bank to make a core-probe-hydro cast-particulate matter station. Meanwhile *Horizon* dredged, in 30 fms on the bank, and awaited a modified firing run by *Argo*. Delays caused by hydrographic winch trouble on *Argo* made this seismic work

---

— 34 —

inadvisable so *Horizon* landed a dredge-load of coral, shells, fish and invertebrates and headed for Port Victoria. *Horizon* tied up to Long Jetty about noon; *Argo*, with a greater draft, anchored in the outer harbor in late afternoon.

October 17 and 18 passed eventfully ashore on Mahé. After hardly-unexpected departure delays, *Argo* preceded *Horizon* out of Port Victoria at mid-morning on the 19th. *Horizon* carried, in a corral on the boat-deck, a huge female Aldabra tortoise that had been purchased by Captain Hopkins as a gift to the San Diego Zoo [\*]. Following discussions ashore any plans for shooting southeasterly from Mahé were abandoned; rather *Argo* and *Horizon* shot, and received from anchor, a short (50<sup>+</sup> km) reversed line on Seychelles Bank westward from Silhouette Island. Radar ranges were required beyond the shortest distances, as shallow water and a sharp thermocline caused the early disappearance of water-wave arrivals (In 1963 the better-equipped *Owen-Discovery* overcame this problem by resurrecting the well-known survey-ship taut wire technique for traversing). On the short LUSIAD line, no apparent seismic velocities greater than 6.2 – 6.5 km/sec were recorded. At the conclusion of this run, both ships headed south and off Seychelles Bank, to rendezvous near Agalega Island, where another joint C<sup>14</sup> station was occupied. The ships then shot, in heavy weather, a two-part, six-station leap-frog profile eastward across the sedimented flat and part way up the west flank of the Mascarene (or Seychelles-Mauritius) Ridge. Since the Seychelles are granitic while Mauritius and the other Mascarene islands (Rodriguez, Réunion) are basaltic, an attempt was made at Saya de Malha, midway along the ridge joining Seychelles to Mauritius, to determine seismic velocities in the crustal structure underlying the superficial coralline material. To this end a long (110 km), eastward, reversed line was shot in water 45–65 fms deep, with *Argo* and then *Horizon* receiving at anchor, to be followed by a south-trending shorter reversed line. No mantle arrivals were logged on the long line, and no obvious "granitic" velocities were recorded. *Horizon* anchored by dredge (in 64 fms) retrieved

---

— 35 —

a large haul of shell and coralline material. At the close of the seismic work both ships headed for Port Louis, arriving there early on October 26. En route, *Horizon* crossed Cargados Carajos Shoal near Albatross Island making magnetometer observations, which showed an extremely rugged volcanic topography beneath the flat coral. *Argo*, meanwhile, in deeper water to the west, had taken a core-probe station, her eighteenth since leaving Cochin. *Argo's* probes were additional to thirteen by *Horizon*, and the ships had collaborated on thirty seismic refraction

stations, six  $C^{14}$  stations and more than 25 cores. Underway operations had included  $CO_2$  and gravity observations on *Argo* and magnetic, BT and PDR recordings on both ships.

At Port Louis, SIO scientists and crew renewed acquaintances begun during *Argo's* MONSOON visit. Shor left the expedition, to be replaced as leader by Robert L. Fisher. Von Herzen left *Argo* for San Diego. Russell Raitt, SIO seismologist, and T.J.G. Francis, a seismologist from Cambridge University's Department of Geodesy and Geophysics, joined *Argo*. The scientific equipment missed at Cochin caught *Argo* at Port Louis; at last the ships were fully equipped. On October 28, the final night of the planned stay, a reception for many friends on Mauritius was held aboard *Argo*.

## D. Port Louis to Fremantle (October 30 – November 28, 1962) <sup>[\*]</sup>

Shortly after 1515 on October 29 *Horizon* sailed from the fuel dock at Port Louis, bound for Fremantle; even more shortly thereafter she had, at dead slow speed, gone aground on the southeast edge of the harbor channel. Her hull stayed sound, but it required twelve hours of effort by all hands, principally to lighten her by offloading onto barges all fuel, water, removable gear and explosives, and most especially the help of Commander Booker, Harbormaster, and his pilot staff and tugs to free her. All the following day was spent in inspections by divers, repairs to deck equipment and reloading of supplies and equipment. *Argo*, standing by to render assistance, did not sail until the afternoon of October 30. Then *Argo* ran north, before cutting between Mauritius and the small

---

— 36 —

islands just offshore, to extend and to detail close inshore the topographic, magnetic and gravity investigations carried out east of Mauritius on MONSOON. After 125 miles of such surveying *Argo* headed southward, in a series of zig-zags crossing  $57^\circ E$ , to a rendezvous with *Horizon*. En route *Argo* made a core-probe station near  $22^\circ S$  in the northern part of the Réunion Basin; in this vicinity the elongated, northeast-trending "Mauritius Trench" and its associated lineations are well-developed. Meanwhile, back on *Horizon*, preparations and repairs were completed; she sailed at 0800 on October 31. En route to the first seismic refraction station *Horizon* ran a zig-zag pattern chosen to complement and reinforce the topographic, magnetic and gravity studies of *Argo* and Columbia University's *Vema* in the zone where the smoothly sedimented basin northwest of Réunion-Mauritius and the well-developed Mascarene Ridge abut on the deep, topographically-complex, disrupted volcanic seafloor.

On November 1, in the northern part of the Réunion Basin, the ships collaborated on the first of a slightly-different type of seismic refraction station; like nearly all of those between Mauritius and Port Darwin, it was shot as a "split" or "T" <sup>[\*]</sup>. Here too *Argo* tried for the first time on LUSIAD, and successfully, the deep-sea stereo camera. The next day a similar station was shot in the deep (2700–3050 fm) portion of the Réunion Basin; the seismic work was accompanied by core-probe, large-volume water sampling and a hydrographic cast. For the next 36–40 hours the

ships explored the extremely rough (2200± 1000 fms here) seismically-active ridge that connects south of Africa to the Mid-Atlantic Ridge and east of Mauritius to the Mid-Indian Ocean Ridge.

---

— 37 —

Local deeps and closely-bordering peaks or ridges were found, but these were impossible to correlate from line to line at the time: because of the extreme roughness a planned seismic run along the ridge was abandoned, but a core-and-probe was taken by *Argo* in a local, 2450 fm deep. An east-northeast seismic run paralleling the ridge was made just off the southeast flank — in an area antipodal to San Diego County, incidentally — and C<sup>14</sup>, hydrographic cast and core-and-probe lowerings completed. Continuing the general movement south-southeasterly, on November 5 a split-then reversed profile (with each ship shooting and receiving) and attendant cores, probes and bottom photography was carried out in the deeper part of the Southwest Indian Ocean (or Crozet) Basin. As the ship continued further southeast, the weather and the magnetometer records roughened, the seafloor became deeper with hills smoothed by sedimentation, and the abundance of long-finned "fish-tail" traces in shallow layers on the echo sounder attested to the increased productivity in these southern waters. On November 7, after a C<sup>14</sup> station and a down-weather seismic run near 39° 45S, 64° 00E that several times was halted because of rough seas on *Horizon's* fantail, the ships separated. *Horizon* ran east-southeast to make a profile of core-probe stations from the deep basin east to the Mid-Indian Ocean Ridge and to carry out topographic and magnetic explorations around Saint Paul and Amsterdam. *Argo* struck off almost directly south to obtain a high-latitude CO<sub>2</sub> run and to collect deep-water C<sup>14</sup> and Nansen bottle samples near 52°S, 66°E, in the basin southwest of Kerguelen Island.

Running slightly east of south from 40°S, 64°E, *Argo* recorded a deep, sediment-subdued bottom that reached a maximum depth of 2880 fms near 43°20S, immediately north of a 2000-fm-deep ridge or seamount. South of that shoal the bottom was deep (2400–2600 fms) and irregular before, at 45°S, *Argo* started running over the smoothly-shoaling seafloor that reached a minimum depth of 1160 fms near 47°S. From there south to about 50°S, 65°45'E, where a minimum depth of 190 fms was recorded, the bottom depths ranged generally from 750 to 1200 fms in a succession of swells and swales. South of the 190 fm sounding, which lies about 120 miles west-southwest of Kerguelen, the bottom drops

---

— 38 —

steeply but irregularly to 1740 fm depths. At about 51°S, 66°E, in the basin, *Argo* made a deep C<sup>14</sup> and hydrographic cast station, as a southernmost "anchor" point on the MONSOON-LUSIAD C<sup>14</sup> profiles. Running east-northeast to K<sub>erguelen</sub>, *Argo* reached the anchorage in the sunny midmorning of November 11. Her landing party arrived unexpected and unannounced as a feast was being held by the 65–70 members of the French scientific base there, and was immediately and most hospitably pressed to remain to dine. [\*] *Argo* was the first ship in eleven months (the present shore personnel were due for relief late in November) but the all-male shorebase appeared well-stocked with almost all of the amenities. Afterward the resident scientists conducted a tour of the establishment, where they make magnetic field observations, radiosoundings of the ionosphere and studies of whistlers, and balloon probes of the upper atmosphere for both meteorological and cosmic-ray measurements. A long-continuing program

of geological mapping (and perhaps paleomagnetic studies as well) was being carried out. The geologist ashore presented *Argo* with a much-desired suite of sediment and volcanic samples from this rarely-visited island for the SIO reference collections. After a short sub-Antarctic night *Argo* sailed early on November 12 to rejoin *Horizon* west of the median ridge, near 36°S, 73°40'E. En route north *Argo* stayed in shallow water (< 100 fm) for the first 110 miles after leaving harbor; the bottom then deepened rapidly but smoothly to 1700 fms in the next fifteen miles and, except for one narrow 2500-fm-deep region near 39°S, 73°30'E, remained at depths of 1900 to 2250 fms for nearly all of *Argo's* 750 mile run northward.

Meanwhile, back on *Horizon*, a four-station core-and-probe profile extending from the Crozet Basin on to the west flank (in 1620 fms) of the Mid-Indian Ocean Ridge was completed. *Horizon* crossed the ridge on an east-northeast course about 60 miles south of Saint Paul; there, except for one eight-minute period of depths of more than 1410 fms, the bottom stayed at depths of 900–1250 fms for nearly seventy-five miles of

---

— 39 —

the traverse. After a steeper descent (450 fms in nine miles) the bottom remained at 1640–1750 fms, with gently-rolling topography, for another 60 miles. One impression gained from this ridge crossing is that the run after the fairly-abrupt deepening was on a down-faulted (or not-uplifted) block but that there was no well-developed "rift". The magnetic record, too, suggests such a boundary; there were several 100–150 gamma peaks of short period west of the decline, and broader variations, with a wavelength of about 11 – 12 miles, to the east. The following day, while *Argo* was visiting Kerguelen, *Horizon* reached the still-unspoiled Saint Paul and put ashore a group to collect rock and biological specimens. After a four-hour collecting period, *Horizon* made a sight and radar-controlled bathymetric and magnetic exploration with 2 ½ circuits around the island; these lines extended and helped detail the survey begun on MONSOON. A shoal region was discovered 7 to 10 miles northeast of Saint Paul, with deep water intervening. It could not be determined whether this was the missing, faulted-off portion of the island base. The next three days the topographic-magnetic surveys were extended and refined both south and north of Amsterdam-Saint Paul. A terraced shoal, with summit at 38 fms, was found 20 miles SSE of Saint Paul and separated from it by deep water. It was found that in these latitudes the median ridge generally trends north or somewhat east of north and that the capping volcanic ridges or structures, if elongated, may have a more westerly, en echelon pattern. Extensive sedimented areas probably result from deposition of airborne volcanic ash west and northwest of Amsterdam. Attempts were made, by radar ranging and star-sights, to determine the distance between the islands and the probable position of Amsterdam. <sup>[\*]</sup>

After some discussion as to positions (*Argo* had been on dead reckoning since leaving Kerguelen three days earlier) the ships made radar contact and a seismic, core-probe and camera station was made in deep water just west of the "median" ridge. The following day a

---

— 40 —

seismic line (with concomitant core-probes, C<sup>14</sup> and hydrographic cast) was shot in intermediate depths (1600–1900 fms, generally) 85 miles northwest of Amsterdam, on the western flank.



However, during most of this run, *Argo's* listening position turned out to lie in and just south of a flat-bottomed (at  $2283 \pm 5$  fm) cleft or re-entrant about six miles wide. The trend of this depression was not established, but the northwestern wall appears to be step-faulted, possibly along lines transverse to the ridge. The next day, November 17, in worsening weather, a split seismic run was made along the shallow, rather irregular ( $1000 \pm 450$  fm) crest of the ridge (as established by *Horizon's* scouting) 60 miles northeast of Amsterdam. While on this listening station, in 1030 fms, *Argo* lost a temperature probe and pinger when the hydrographic wire parted. No excessive tension had been noted; presumably the fairly new wire was locally but not obviously bad. A few hours later, at the close of a camera sequence in this rough volcanic terrain, bottom contact was lost for 12 minutes during tests while the camera was near bottom. During the interval the sea-floor shoaled from 1015 to 980 fms and the camera fouled. Although no markedly excess tension was noted, on recovery the frame was found to be twisted beyond repair, the strobe and pinger units were missing, the pinger transducer was ruptured, but the two cameras and exposed film were intact. This incident terminated the LUSIAD bottom-photography program.

During this day, November 17, David O'Connor, a crewman on *Horizon*, was found to be extremely ill, and in need of blood transfusions. Both ships ran to shelter in the very slight lee east of Amsterdam, where early on November 18 a small-boat transfer of three donors, oxygen, and specialized medical equipment was made from *Argo* to *Horizon*, and Fisher went over to *Argo* for consultations. Weather continued to worsen; about an hour later the attempted reverse transfer of personnel could not be effected. Therefore the ships moved out, in fog and high seas, to attempt a rendezvous and personnel-equipment transfer at the possibly-more-sheltered South Cove at Saint Paul, fifty miles to the south. The larger *Argo* made it and reported no shelter; *Horizon* could not get close. The patient's condition worsened and at mid-afternoon (1600)

---

— 41 —

it was decided that both ships should run at *Horizon's* best speed for Fremantle, 1900 nautical miles eastward, while help was sought from shore facilities. Extremely rough seas precluded a direct run (course about  $075^\circ\text{T}$ ) toward Fremantle; for the next twelve hours *Horizon* ran courses, at best safe speed, in generally east to southeasterly directions until she could prudently head for Fremantle. Meanwhile, contact had been established with naval authorities in Australia and HMS *Cavalier* <sup>[\*]</sup> was dispatched to rendezvous with *Horizon* and pick up O'Connor for passage to hospital in Perth. On the eastern run, *Argo*, two knots faster than *Horizon*, drew ahead and took up a listening station directly along *Horizon's* track to rendezvous. As *Horizon* approached and then drew away without slowing, she dropped a number of small charges that were recorded by *Argo*. Except for the routine underway gravity, magnetic and PDR programs this was the only scientific work done by the ships from November 18 to the morning of November 22. Shortly after noon on November 21, at a point 1140 miles from Fremantle, *Cavalier* drew along-side *Horizon*. In a display of rough-water seamanship by *Cavalier's* boat crew, O'Connor and Robert Garrett, physician, were taken aboard for the high-speed run to Fremantle. *Cavalier* reached Fremantle on November 23, and David O'Connor was placed in hospital.

On November 22 *Horizon-Argo* shot a split profile in 2300–2400 fm depths near 34°S, 94°E, in the extensive basin south of a major, broad, flattened east-west-trending ridge. C<sup>14</sup> and hydrographic casts and core-probe lowerings were made; three engineers and Fisher were transferred back to *Argo* and *Horizon*, respectively. Both ships then ran northeast across very irregular bottom ranging in depth from 1500 to 2975 fms before crossing a 2800–fm bordering deep and the very steep south flank of the flattish ridge. On the ridge, in 730 and 1100 fms, *Horizon* and *Argo* took up shooting and receiving positions, respectively, for a west to east profile. While waiting *Horizon* dredged up one clinker and some living invertebrates; *Argo* made a hydrographic cast

---

— 42 —

and attempted several cores and one unsuccessful probe. After the usual split profile, *Horizon* stopped, still on the ridge in 1300 fms, and received *Argo's* shots. *Horizon* managed to obtain one short calcareous core and a questionable (small-penetration) heat-flow record. The following day, November 24, *Horizon*, lying in 2700 fms just east of the very steep (fault scarp?) east end of the ridge, received *Argo's* run and made a core-probe lowering; then she reversed the profile, running southeast to *Argo* in 2700–2800 fms as *Argo* cored. The next three days *Argo* and *Horizon* made two basin seismic split profiles (in 3000± fms fifty miles north of "Diamantina Deep" and in 2800–2900 fms 80 miles northwest of the abrupt western termination of Naturaliste Bank), four core-probe lowerings, two hydrographic casts, and final C<sup>14</sup> large-volume and particulate matter (El Wardani) casts. Off the continental shelf near Fremantle *Argo* shot a group of large shots for long-range sound transmission studies. Early on November 28 both ships raised Rottneest Island. *Horizon*, under pilot, entered Cockburn Sound to take two piston cores requested by scientists of the University of Western Australia, then followed *Argo* to an anchorage off Fremantle.

Here Captain Hopkins turned *Horizon* over to Terry Hansen, her new Master, and Fisher turned the expedition over to Raitt. Norris Rakestraw, Samuel Scripps, Tim Francis, Hopkins and Fisher left the expedition; Nozumu Den of Hokkaido University and Sien-Tien Chang and Hseuh-Pei Liu of the Republic of China joined.

## **E. Fremantle to Port Darwin (December 2 – 23, 1962)<sup>[\*]</sup>**

*Argo* sailed from Fremantle shortly after noon on December 2, headed northwest and made a core-two probe-hydrographic cast station on the lower part of the continental slope. *Horizon* left the dock early the next morning, retrieved her 15 ½ tons of explosives from the explosives-stowage barge, and departed. Offshore, four 188 pound shots were fired for recording ashore by the Mundaring Seismological Observatory and farther at sea by *Argo*. The ships then began an eight day northwesterly run that extended to 15°S, 87°30'E. En route they completed

---

— 43 —

successfully four split seismic stations, five gravity core and eight probe lowerings and four hydrographic casts. For the first two days the ships moved over generally flattish, 2600–2965 fm bottom that became slightly shoaler and less regular as a ridge south of the main Wharton Basin

was crossed. After a day's run of 2750± 100 fm bottom the ships passed over an irregular seafloor shoaling to 2250 fms, then—near 23°40'S, 101°10'E—an abrupt (faulted?) slope down to 3320 fms. After 325 miles of flattish, rolling bottom and 2970–3150 fm soundings the general depth decreased to 2700–2850 fms; northwest of 19°S, 93°20'E the bottom shoaled locally in a series of 2300–2350 fm ridges, then deepened (locally to 3230 fms) and shoaled (locally to 2150 fms) in a basin more generally 2700–2900 fms deep. On December 11 the northwest end of the traverse was "anchored" with a west-to-east split seismic profile on the broad, shoal (here 1050–1500 fm deep) "East Indian Ocean Ridge" or "Ninetyeast Ridge". *Argo* received, in about 1300–1500 fms of water, near 14°30'S, 88°E.

At the close of the ridge seismic station, with its associated probes and cores, *Argo* and *Horizon* ran easterly courses toward Port Darwin. Just east of the ridge they crossed a marginal deep or moat reaching 2910 fms, passed over rough (2500 ±350 fms) bottom which deepened eastward, with flats and deeps of local extent reaching 3250<sup>+</sup> fms. Southwest and south-southwest of Cocos-Keeling, on easterly tracks passing about 80 miles south of those islands, the ships logged shoal depths of 1700, 1165 and 1400 fms in a generally 2300–2600 fm area 175 miles wide. East of an isolated 2040–fm shoal near 98°20'E the bottom stayed deep and fairly irregular, at 2600 to 3335 fms, for 250<sup>+</sup> miles. East of a narrow rise centered near 103°E, the seafloor deepened and flattened, with depths of 2950–3260 fms (except for three isolated peaks within 240 miles of Christmas Island) for 550 miles. During this latter traverse, a station was shot well south of Java, on the extension southward of a MONSOON Expedition cross-section. After crossing a shoaling apron and its parent broad, low (2285 fm) ridge, the ships passed over an abyssal plain in which depths increased smoothly from 2965 to 3025 and decreased back to 2940 fms over a distance eastward of 250 miles. On part of this

---

— 44 —

plain the apparent slopes were as gentle as 18 fms in 55 miles, or 0.0003; here, as in sedimented areas to the west (and north to the Indonesian Trench, from MONSOON echograms), multiple shallow (6–25 meter) sub-bottom reflecting layers were very extensively developed. Again, an outer seismic line extending the MONSOON Lombok Strait cross-section to 300 miles south of Bali was completed. Near 13°20'S, 119°E, the ships began ascending, at a gentle angle, the broadly-irregular but generally-shoaling continental slope off northwest Australia, reaching 100 fm depths at 124°E, nearly 300 miles east. Since leaving the "East Indian Ocean Ridge", *Argo* and *Horizon* had completed six split seismic profiles and fourteen probe, eleven core and four hydrographic casts on the deepwater eastern run. *Horizon* in addition took two piston cores on the Sahul Shelf. PDR and BT profiling had been continuous on both ships since Fremantle; gravity and magnetic records were slightly less complete.

Both ships tied up at Port Darwin by 0800 on December 23, marking the close of two-ship work on LUSIAD Expedition. There all but four — Almagor, Chi, Islam and Mathur — of *Argo's* scientific party left the expedition. After a Christmas break and several days of gear transfer and shipboard housekeeping, *Horizon* sailed from Port Darwin on December 28 and transited Torres Strait. En route to San Diego, with a six-man scientific party directed by William Riedel, *Horizon* carried out sediment sampling (by coring) and heat flow operations across the southwest and central Pacific in furtherance of a long-range paleontologic field study by Riedel. *Horizon's*

stops included Port Moresby, Honiara (Guadalcanal), Kwajalein, and Honolulu, before reaching San Diego on February 19. Since leaving San Diego on June 14, she had gone around the world in 3.2 times 80 days, and 41670 miles. Thus, *Horizon* became the first SIO research vessel to circle the globe.

## **F. Port Darwin to Colombo, via Djakarta (January 1 - February 12, 1963)<sup>[\*]</sup>**

After a Spartan sailing from Port Darwin at the unlikely time of 0710 on New Year's Day, *Argo* crossed the pinnacled and plateau-ed

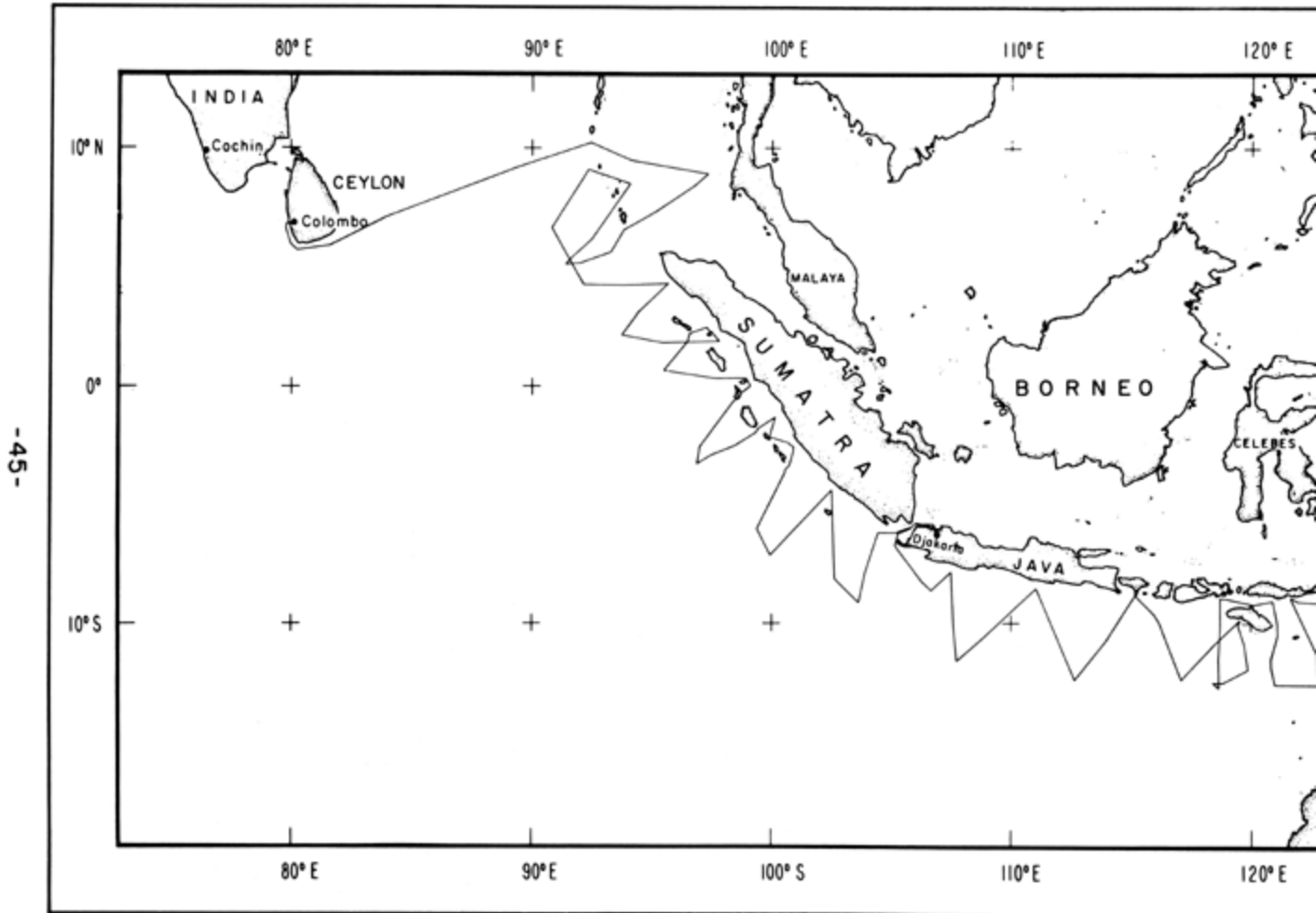


Fig. 7

Sahul Shelf on a northwest course to sampling stations on the upper slope southeast of the Timor Trough. Robert L. Fisher was again scientific leader; the four-man holdover party was augmented by Fred Dixon and John B. Sherman III of SIO, Marvin Helfer of UCLA, Kolla Venkataratnam, a UNESCO Fellow from Andhra University, and three Indonesian scientists: Chaidir, Rustamadji and Sujatno. Thus, in *Argo's* twelve man scientific party five nationalities were represented. On January 2 *Argo* took gravity core-piston core pairs at two stations on the south wall of the Timor Trough, in the trough's flat sedimented bottom (at 1765 fms) and at one station, in 700 fms, on the northwest wall. These cores were collected (as were those of *Horizon* just before she reached Port Darwin) for the use of Tj. H. van Andel of SIO who, with SIO and Australian co-workers, was carrying out sedimentary studies in the region including the Timor Trough and the Sahul Shelf. Then, passing between Timor and Leti and then between Wetar and Roma, *Argo* entered the Banda Sea and embarked on her primary mission: underway topographic, gravity and magnetic investigations of deep-water areas — within the Indonesian arc, the deep outer Indonesian trench and the shorter, inner, shoaler Bali Trough — from the Moluccas around the island chains to the Nicobar Islands. A second program, underway measurements of CO<sub>2</sub> in atmosphere and surface waters, was carried out by Chi assisted by Almagor and, in rotation, one of the Indonesian scientists.

The accuracy of topographic, gravity and magnetic measurements depends largely on having steady or known speeds and excellent navigation; hence, except for two port visits only stops due to engine or steering difficulties were made. From January 2 when *Argo* concluded the coring program until January 18 when she reached Bali for a one-day visit, *Argo* was underway essentially continuously. Uninterrupted PDR records were obtained in all depths encountered on this segment. The towed magnetometer program, under Sherman, gave continuous records after 1200 on January 5, from a point near Misool. The LaCoste-Romberg gravity meter functioned practically without interruption from Port Darwin until *Argo* was near Roti, southwest of Timor, on January 13; then moderately bad weather until January 18 cut usable observations by more than half. The lack of observations here was particularly

---

— 47 —

unfortunate in that these continuous profiles were especially desired to determine the continuity, trends or relations of the negative gravity patterns near Soemba, close to the east end of the inner, sedimented Bali Trough.

However, all three types of observations were obtained continuously on long runs over the sedimented and disrupted floor of the deep Banda Sea, around Ceram and the nearby strongly "negative" and "positive" zones, across the Banda Basin — Banda Ridge - Weber Deep (flattish floored at  $3805 \pm$  fms and deeper than 3000 fms for forty miles in an E-W direction) — Kai Tanimbar Ridge to the Aroe Islands, across the "intermediate" zone in shallow water between the islands off the southwestern peninsula of Celebes, and in the extremely flat ( $1763 \pm 3$  fms) channel between the "inner" and "outer" arcs as *Argo* skirted the shores of Timor and then Flores. South of Roti, at about the time the gravity record became fragmentary, *Argo* crossed the saddle (here 1035 fms) between the Timor Trough and the Indonesian Trench proper, and ran over sharply-faulted shoal areas, in 150 to 350 fms, near Ashmore Reef. The next trench crossing, near 121°E, gave a depth of 2113 fms but the following southward run, near 118°40E,

revealed a single flat-bottomed (3590–3612 fms for  $1\frac{1}{3}$  miles) very deep trench. A triangular pattern was run over the shoal charted at  $12^{\circ}26'S$ ,  $118^{\circ}40'E$ ; as expected nothing shoaler than 2800 fms was recorded. The northern run, toward the middle of Soemba, revealed a somewhat smoothed trench bottom at 2985 fms. The inner, flat Bali Trough — smoothish ridge — main deep trench sequence first made its appearance on *Argo's* run southwest from Soemba; on this crossing the depths are  $2087 \pm 2$  (for  $2\frac{1}{2}$  miles), 1710, and  $3687 \pm 8$  (flattish) fms, respectively. (The momentary 3695 fm - uncorrected - sounding is the greatest depth found on *Argo's* 1963 explorations of this trench; on MONSOON a greater depth,  $3715 \pm 2$  fms, uncorrected, was recorded on a crossing south of Central Java.) On the following northwest track the trench and ridge had shoaled slightly but the Bali Trough was deeper ( $2330 \pm 10$  fms) and had an apparent width on this course of 38–40 miles.

---

— 48 —

Early on January 18 *Argo* anchored off Benoa, on the south coast; nearly all hands visited Den Pasar and inspected the famed sites of Bali. *Argo* sailed at sunset. During this stop the weather had improved, and, except for several short periods, the gravity meter gave usable data to Djakarta. Four long runs crossing the trough-ridge-trench sequence were made, in addition to abridged crossings of the trough-and-ridge on two tracks south of western Java. The four trench-bottom crossings gave depths of  $3507 \pm 1$ ,  $3513 \pm 2$ ,  $3560 \pm 5$  and  $3545 \pm 15$  fms, from east to west.<sup>[\*]</sup> However, on the first three of these crossings both the Bali Trough and its bordering ridge shoal westward, and each becomes more irregular. West of  $108^{\circ}$ , where they deepen to  $1845 \pm 5$  and 1085 fms respectively, and widen, they again shoal and become rougher; west of Sunda Strait these topographic features are not obvious.

A bout 2300 on January 22 *Argo* rounded the southwest tip of Java and entered Sunda Strait. On this visit, unlike that of 1960, Krakatau was inactive. At midmorning January 23 *Argo* welcomed aboard old friend Majoor Rosenov, Harbormaster; shortly afterward she was moored. Among the scientific visitors welcomed aboard were Dr. Arifin Bey, Col. Wadiman of the Hydrographic Department and Captain A. L. Lumanau of his staff, Dr. Teuku Mohammad Radhie of the General Affairs Division of Madgelis Ilmu Pengetahuan Indonesia (the Council for Sciences of Indonesia) and Dr. Raoul Serene, taxonomist, of UNESCO. On January 25 *Argo's* scientists visited the MIPI offices where, under the chairmanship of Professor Sarwono Prawirohardis, several of them presented informal descriptions of their programs and discussed with local scientists the Indonesian participation in the IIOE. The hospitality and many kindnesses during *Argo's* visit tendered by Robert F. Grealy of the United States Embassy and by James Markey of USIS are gratefully acknowledged.

*Argo* sailed from Djakarta bound for Colombo on the afternoon of January 26; she ran west to the vicinity of the southern point of Sumatra where a departure was taken for a series of long zig-zags across the

---

— 49 —

island chain - trench - offshore ridge(?) fronting on Sumatra. At the first open-water south-southwest course change the gravity meter went out of operation; recording was resumed 27 hours later on the next northerly course. The gravity meter then gave continuous records (except for one short period off the Nicobars) to Colombo. On the Djakarta-Colombo run the PDR and towed magnetometer functioned continuously. Since Chaidir, Rustamadji and Sujatno had left the expedition at Djakarta, the nine-man scientific party aboard was shorthanded to man watches. Therefore, from Djakarta to Colombo Chi and Almagor shared the CO<sub>2</sub> watches, and the analyzer was shut down for part of each day.

In the interval January 27 to February 5 *Argo* made eleven crossings of the inner basin - "negative" island arc - continental slope - trench - outer ridge (where present) - deep seafloor between Sunda Strait and the northwest extremity of Sumatra. In order to measure the entire gravity sequence, attempts were made to reach the reef flats adjacent to Sumatra; hence *Argo* passed inshore of the shelf islands of Pini and Banjak. *Argo's* PDR lines indicate, in part (1) the disappearance of the Bali Trough (most probably into the swale behind Enggano); (2) the extreme width of the very rough, pinnacled upper continental slope (shoaler than 1900–2300 fms) southwest of all the islands and beyond, to the northwest; (3) the presence of a faulted offshore flank and low swell outside the trench off Enggano and Selanton that is probably joined to a more-irregular ridge off Siberut; (4) the usual occurrence, on crossing the gentle slopes outside the trench, of one or more shallow subbottom reflections; (5) the extensive occurrence of dead reef, and multiple reef levels, fringing Sumatra and extending along the island chain; and (6) the extreme flatness and steep walls of the sedimented inner basins. On the eleven crossings, the trench floor consistently decreased in depth and topographic expression from southeast to northwest, from 3440 ± 4 fms off Sunda Strait to 2401 ± 1 fms west of Tjalang, Sumatra. However, on every crossing a flattened trench floor two to sixteen miles in (apparent) width was found. On a northwesterly run northwest of Sumatra and well outside the trench, *Argo* crossed a gently

---

— 50 —

shoaling 2100-to-1950 fm bottom that became rougher and, near 6°15'N, 91°E, reached a depth of 1290 fms; this shoal area almost certainly is part of the East Indian Ocean Ridge that extends several thousand miles to the south.

From mid-day on February 5 until midmorning on February 8 *Argo* explored off the structurally-similar but topographically-more complex Nicobar Archipelago. Following a long northeastern run in shallow water to the vicinity of Similan Island off the Malay Peninsula, the ship turned west to make a long "anchor" line of gravity-magnetic-topographic observations to Colombo. On this traverse *Argo* twice crossed 10°N and passed within sight of Little Andaman Island; the line was designed to overlap and supplement the detailed observations that were to be carried out by the U.S. Coast and Geodetic Survey vessel *Pioneer* in March and April, 1964. After traversing the moderately-irregular west flank of the Andaman Ridge, *Argo* crossed a smoothly-sedimented plain and a westward-shoaling apron reaching a least depth of 1620 fathoms at a low divide near 9°30' N, 90°15' E. This rise, only 300 fathoms shoaler than the basin to the east, may be the very minor expression of the East Indian Ocean Ridge at this latitude. From this point on the track until she reached the base of the insular slope off Ceylon, *Argo* was crossing the Bay of Bengal



abyssal plain and the sea-floor deepened generally and extremely gently to the west. Several groups of shallow, steep-walled gullies or troughs in the sedimented plain were crossed on February 10 and 11. Such features, reported from further north in this region by the Swedish Albatross Expedition, are usually attributed to slumping or to erosion and sediment transport by turbidity currents. The best-developed set ([Fig. 8](#)) show very clearly the several sub-bottom reflections, the low levees, and the accordant terraces (or second channels) that might be expected with such an origin, all superimposed on the generally-westward sloping surface. Fig. 8 bears comparison with Fig. 4, which shows a larger but somewhat similar topographic feature in the Tasman Sea; in the latter occurrence, however, a fault origin is favored.

*Argo*, 11,600 miles out of Port Darwin, reached Colombo on February 12. This stop marked the close of intensive geological-geophysical

SOUTHERN PORTION, BAY OF BENGAL  
( on run between Little Andaman and Colombo, o/c 250° T )

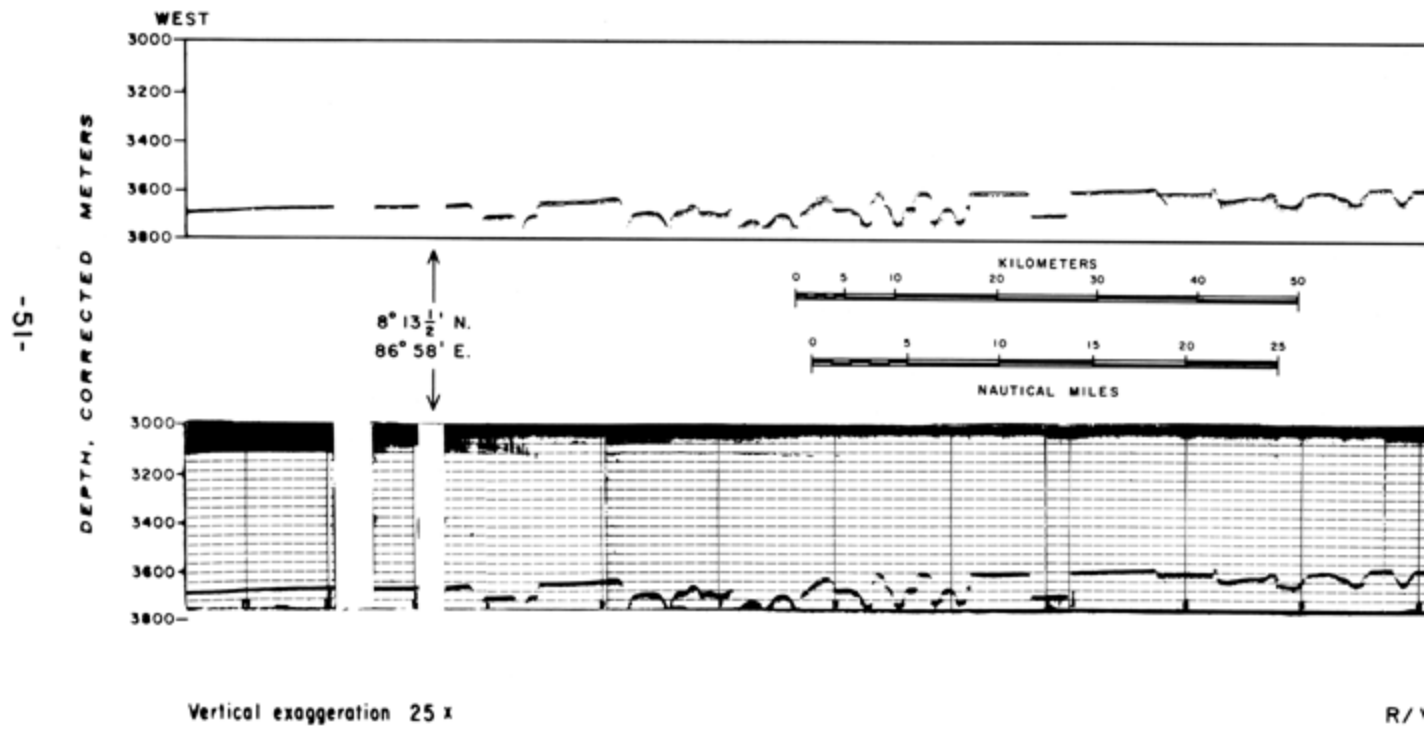


Fig. 8

work in the Indian Ocean on LUSIAD Expedition. Hereafter, until Cape Town, such programs would be of secondary importance. *Argo* was met by Dr. V. Basnayake and colleagues of the Ceylon Association for the Advancement of Science, by staff of the United States Embassy, and by members of the oncoming equatorial current studies team unable to hide their eagerness to begin. There were informal meetings with Ceylonese colleagues and hospitality at the residence of Miss Frances Willis, the United States Ambassador to Ceylon. At Colombo, Fisher, Dixon, Islam, Mathur and Venkataratnam left the expedition. Colombo was the second principal crew change-over point. Here Alan Phinney turned *Argo* over to Noel Ferris, her new Master, and a number of other crew members were relieved.

(R.L.F.)

## **G. Colombo to Mombasa (February 16 – May 15, 1963)<sup>[\*]</sup>**

The second phase of the current studies program of LUSIAD commenced at Colombo, Ceylon on February 16. John A. Knauss took over the scientific leadership of *Argo* from Robert L. Fisher. Since one of the principal objectives of the current studies program was to compare the equatorial circulation between the two phases of the Indian Ocean monsoon, the station plan and types of measurements made were essentially the same as on the earlier cruise (See Fig. 5).

The carbon dioxide and gravity programs continued with Vernon Chi and Marvin Helfer in charge respectively. John Sherman remained on board to run the magnetometer. No biological sampling was done during the first month of this portion of the current studies program.

*Argo* departed Colombo at noon on February 16 for the northernmost station on the first cross section at 85°E. The distribution of stations on the cross sections throughout the second cruise was the same as on the first cruise. No hydrographic casts were made to the bottom during the spring cruise. In order to get better resolution of the vertical distribution of properties within the thermocline, double casts were made from 2°N to 2°S on the cross sections with 36 bottles spaced in

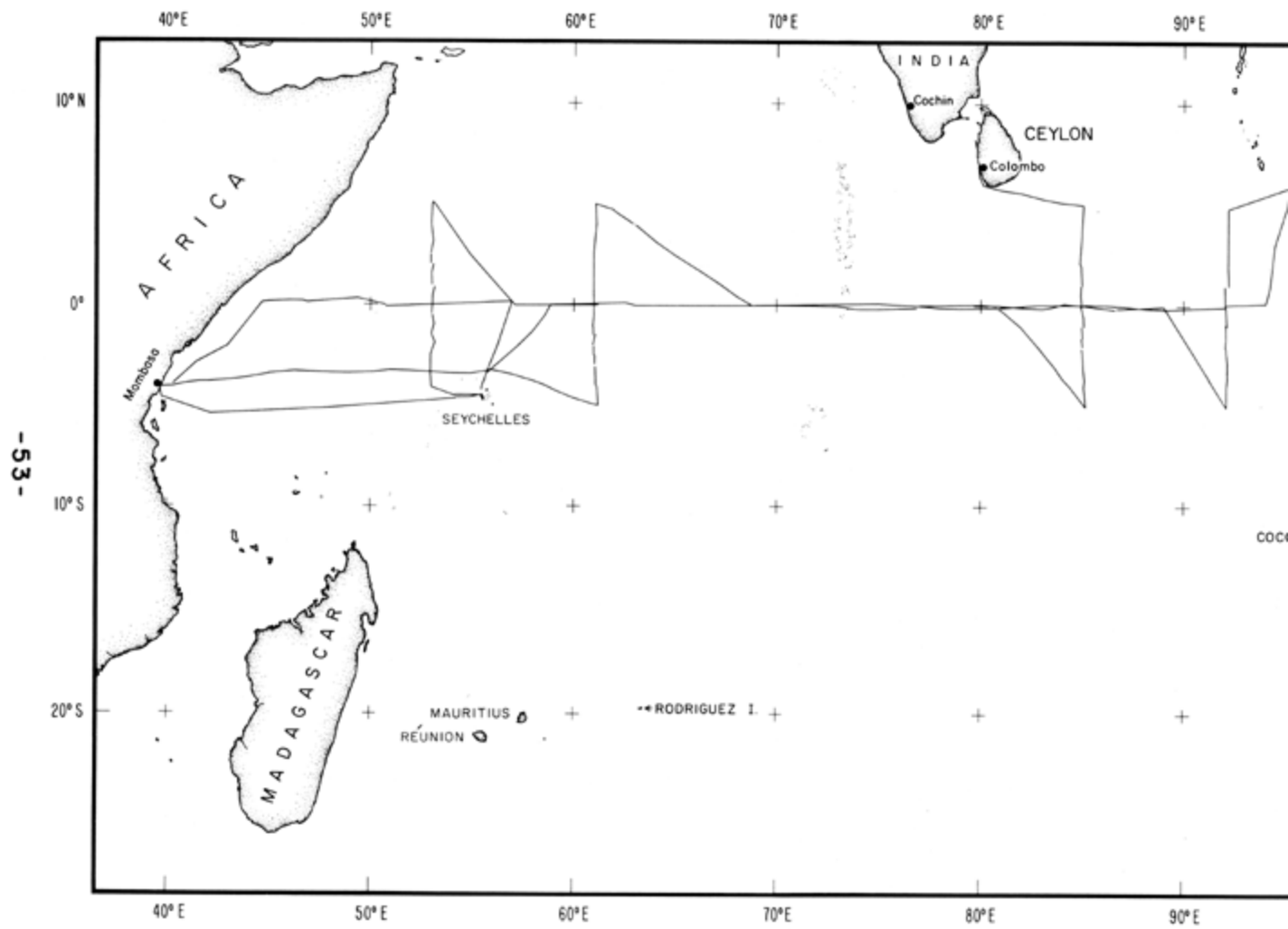


Fig. 9

the top 1200 m. The first cast extended from the surface to 200 m and the second sampled to 1200 m. The doubling up of the casts brought the bottle spacing in the thermocline down to 10 meters. Two special casts were made by Olof Arrhenius, during the first month, for Gustav Arrhenius (SIO) for trace element analysis ashore. After completing the cross section at 85°E we returned to the equator to make hydrographic stations at four-degree intervals along the equator and to measure currents at 77°E and 69°E. The 61°E section was completed on March 13 and *Argo* proceeded to Mombasa. The section at 61°E showed a half-knot eastward flow in the thermocline suggestive of the Equatorial Undercurrent.

The ship was anchored in the stream at Mombasa late in the afternoon of March 17. John A. Knauss, Allan R. Robinson, Marvin Helfer and Olof Arrhenius left the scientific party here. Bruce A. Taft assumed leadership of the scientific party from John A. Knauss. Lee Waterman and James Coatsworth joined the carbon dioxide program and John W. Schlue took over responsibility for the gravity program from Helfer. Due to extensive engine repairs required at Mombasa *Argo* could not depart until the early morning of March 23. For this reason one buoy station had to be cut from the program for the next month.

During the second month *Argo* occupied a section of stations along the equator with current measurements at 53°E, 61°E, 85°E and 92°E. James Coatsworth took net tows in addition to his responsibilities with the carbon dioxide program. A single oblique net tow was made at most of the stations during the last two months of the current studies work. Several days outside of Mombasa a considerable fraction of the men aboard *Argo* began to suffer from intestinal disorders and all drinking water was boiled and precautions were taken with the preparation of the food. John W. Schlue was under the care of Otto Vogel, ship's physician, for suspected peritonitis. Due to Schlue's worsened condition, *Argo* left the equator for Port Victoria, Seychelles, to place him in the hospital there. On April 3 Schlue was transferred to the Port Victoria hospital. Schlue's condition was found to be due to a ruptured appendix and he was operated on the same day. Bacteriological tests were performed on the

---

— 55 —

ship's water and the galley crew in hopes of isolating the source of the trouble. The tests were indeterminate. Several days after leaving the Seychelles the problems subsided.

*Argo* resumed working stations on April 4 at 59°E. On this section the sea surface was shown to slope up toward the east and an Undercurrent was measured at all four buoy stations. The maximum amplitude of the Undercurrent was found at 92°E. The surface currents were all westward at these stations as is to be expected during the northeast monsoon. The gravity watch was maintained by personnel from the current studies group during Schlue's absence. Although the records were at times erratic, most of the data seemed to be of good quality. The section was completed on April 10 and *Argo* headed for Penang, Malaysia.

On Vogel's recommendation, E. G. Gilley left the ship and was returned to San Diego for medical observation. John Sherman also left the scientific party at Penang. The departure date of *Argo* from Penang had to be postponed two days to April 17 because of the late arrival of two

crew replacements from San Diego. Penang is a free port and *Argo* departed Penang laden with new cameras, radios and tape recorders.

Since we were sailing without personnel to maintain the magnetometer and gravity programs, the current studies group took over their maintenance. The gravity meter was operated until April 24 (?) when the records were judged to be of highly questionable value. Due to the complexity of the instrument no attempt was made to analyze the performance of the meter. The magnetometer was streamed but continuous operation was impossible because of periodic leaking of the case.

Upon leaving Penang we ran the cross section at 92°E. The current measurements revealed a subsurface current quite similar to the Equatorial Undercurrent of the Atlantic and Pacific oceans. These measurements were probably of the best quality of the cruise. The ship then steamed west along the equator to the last cross section at 53°E. The phase of the monsoon had definitely shifted by this time and both the winds and surface currents were typical of the southwest monsoon. The section was completed on May 10. By this time J. W. Schlue had recuperated sufficiently well from his appendectomy to rejoin the ship for the run into

---

— 56 —

Mombasa. We arrived in Port Victoria at mid-day on May 11 and brought Schlue aboard in the early afternoon. Three young tortoises were taken aboard *Argo* for transport to the San Diego Zoo.

The ship's crew and scientific party went ashore for the afternoon and evening. The warmth and hospitality of the Seychelles people is truly memorable. Many aboard *Argo* realized with sadness that this was the last time they would visit this island group. The morning of the 12th *Argo* left Port Victoria for the three day run to Mombasa. We were anchored in the stream at Mombasa in the late morning of the 15th.

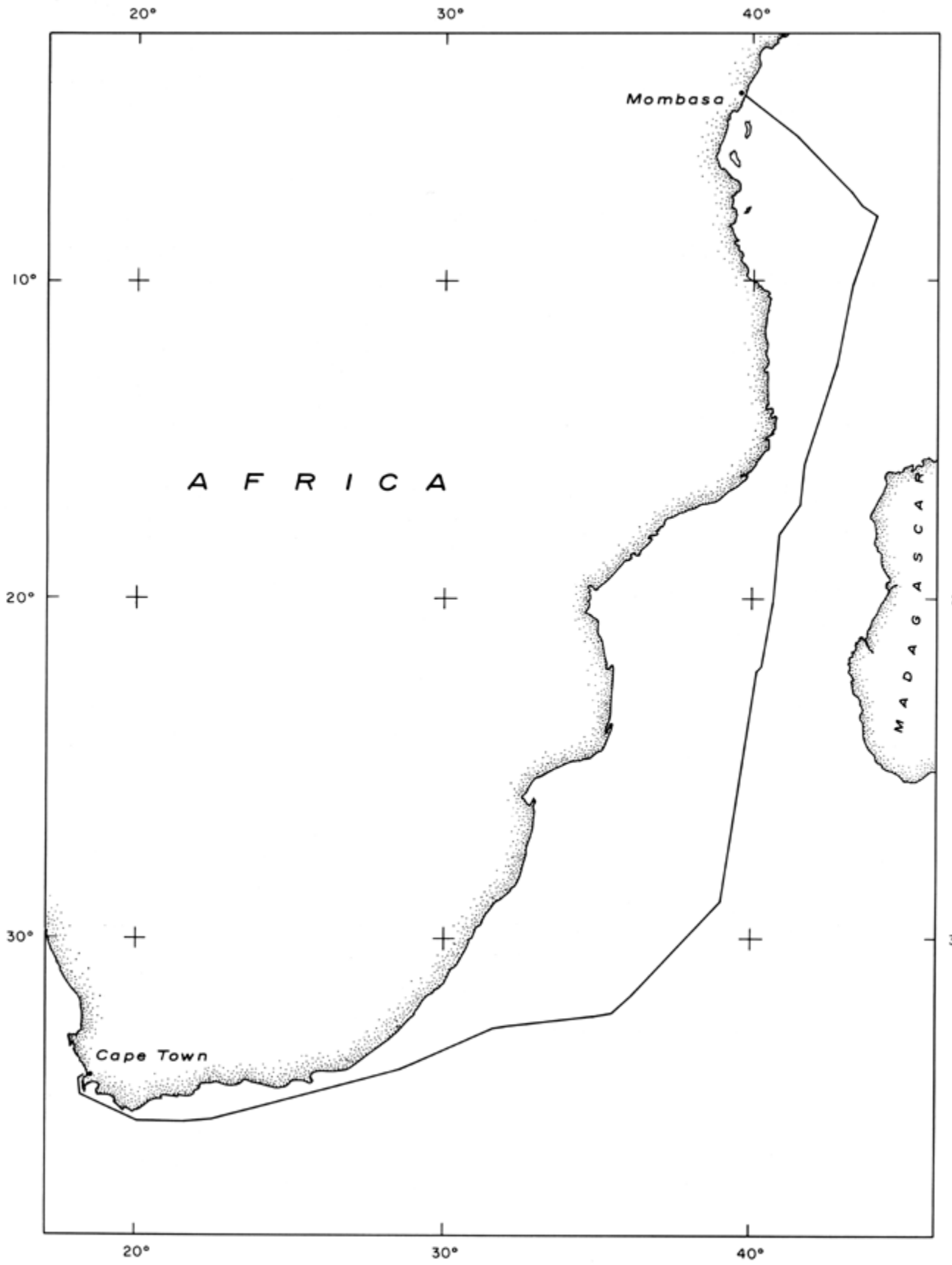
(B.A.T., J.A.K.)

## **H. Mombasa to Cape Town, South Africa (May 18 – 29, 1963)<sup>[\*]</sup>**

*Argo* remained at Mombasa for three days while the twelve departing physical oceanographers and chemists stowed gear and abstracted observations. Only Chi, Coatsworth and Waterman of the previous team stayed aboard; the scientific party was brought to ten by the arrival of Charles David Keeling (who would direct the run to Cape Town), Fred Dixon, Marvin Helfer, Steven Hansen, Jan Lawson, Surendra Mathur, and Keith Rhea. Helfer and Mathur soon restored the gravity meter to operation and Hansen repaired the magnetometer. Rhea was aboard to make heat flow measurements in passage and, especially, on a profile across the submarine ridge south of some East African rift lakes being sampled by Von Herzen and Vacquier.

*Argo* sailed at 0800 on May 18 and the next day occupied, near 8°S, 44°E, a hydrographic station close to the recommended SCOR-IOC IIOE Reference Station 13. On May 20 the ship passed

within ten miles of Grand Comoro Island. Weather worsened as *Argo* headed south into Mozambique Channel. On May 22 another IIOE Reference Station (No. 14) was occupied near 18°S, 41°E. A young baleen whale convoyed *Argo* for a while on May 25, and sea birds became abundantly in evidence after the ship passed 30°S. Through an unfortunate lapse in communications ashore, the final hydrographic cast, intended for sampling at IIOE Reference Station 15, was made in relatively shallow water 52 miles southeast of





the agreed-upon position. On the southern run the gravity meter was hampered by high seas and was shut down much of the time; the magnetometer record was somewhat better, and the PDR and CO<sub>2</sub> programs ran continuously.

*Argo* arrived at Cape Town at 1400 on May 29, ending 11 ½ months of operation in the Indian Ocean. She was met by Commander Copenhagen, representing the city, and officials. That evening scientists and ship's officers were guests at a civic reception by the Lord Mayor of Cape Town. South African scientists were welcomed aboard *Argo* informally during her stay. Here Alan Phinney returned to replace Noel Ferris as Master. Keeling left the expedition; Victor Vacquier, Richard Von Herzen, and Philip Sloan joined.

## **I. Cape Town to San Diego, via Freetown and Panama (June 3 – August 15, 1963)**

With Victor Vacquier as Chief Scientist, *Argo* left Cape Town on June 3 and commenced a magnetic survey-heat flow examination of the Mid-Atlantic Ridge between Latitudes 30°S and 10°N. Secondary programs included midwater trawling and CO<sub>2</sub>-hydrographic studies (in the region of the Atlantic Equatorial Undercurrent). These non-Indian Ocean observations are discussed elsewhere than in this report. It might be remarked, however, that between Cape Town and Freetown, Sierra Leone, *Argo* made the longest run, both in distance and in time at sea, of the entire LUSIAD Expedition: 8010 miles and 34 days, respectively. The geophysical, geochemical and biological projects were continued across the tropical North Atlantic to Colon, Panama, which *Argo* reached on July 29. Leaving Balboa on July 31, *Argo* carried out under the direction of J. C. Harrison a long, L-shaped gravity traverse west to the longitude of San Diego and then directly north.

On August 15, exactly fifteen months after her departure from San Diego, *Argo* reached home amid not-inconsiderable celebration. During LUSIAD Expedition she had, like *Horizon*, circled the globe, but at greater length; she had steamed 83,000 miles, 57,000 of this total in the Indian Ocean. On a more personal level, six crew members

had made the entire voyage: Rudolph Alviar, engineer, Basil Brady, messman, William Calder, electronics technician, George Jeffries, electrician, Raymond Souza, boatswain, and William Trivelpiece, radio operator (two, Jeffries and Trivelpiece, had made all of MONSOON Expedition also). Only one member of the scientific party, Vernon Chi, had made the whole cruise but he, like the other six, was presented on the spot with a hand-lettered certificate and condolences.

(R.L.F.)

# FOOTNOTES

1. (See Fig. 1)

2. (See Fig. 1)

3. In this narrative, sea depths will be given as uncorrected (4800 ft/sec) PDR soundings unless otherwise noted.

4. *Malita's* subsequent work on the Sahul Shelf will be reported elsewhere.

5. (See Fig. 1)

6. ([See Figs. 1 & 2](#))

7. On LUSIAD, this detailed survey was extended further from Saint Paul and in part to Amsterdam Island, 49 miles to the north, to determine the relation of these two small islands to the fault(?) structure of the median ridge.

8. Further exploration on LUSIAD shows that this deep has little extent along the structure. It is, however, symptomatic of an irregular "rifted" zone.

9. ([See Fig. 4](#))

10. ([See Fig. 5](#))

11. ([See Fig. 6](#))

12. Fortunately R.R.S. *Discovery* and HMS Owen were able to make a very long run along almost exactly this line, but a year later; these data are being worked up for publication at Cambridge University's Department of Geodesy and Geophysics.

13. She made it, though - at 385 pounds - a bit down from her best weight.

14. (See Fig. 6)

15. Ideally on such operations daylight would find *Argo* on station, hydrophones streamed and quiet, 50 or so miles ahead of *Horizon* along the planned line of advance. *Horizon* would run toward *Argo*, commencing her firing run when 40–55 miles distant and firing smaller charges and more frequently as the range decreased. On passing *Argo*, *Horizon* continued shooting out a similar distance in some chosen direction of advance. This technique permits a concentration of seismic and other data processing on the receiving ship, which also has a period of eight to twelve hours on station to carry out not only core-probes but also large-volume water sampling, hydrographic casts, bottom photography, dredging or other station measurements without the risks and inconveniences of a shooting program tooling-up on the fantail. *Horizon*, then, was

largely concerned with core-probes either before or just after the firing run, occasionally streaming her hydrophones for sea-quake detection, or, most often, with sounding and magnetic explorations, and BTs.

16. The shore activities here summarized were reported by T.J.G. Francis, *Argo's* Kerguelen correspondent.

17. From *Horizon* data (radar ranges with the ship between the islands) and star-sights on three occasions while the ship lay within range of Amsterdam, it appears that Amsterdam and Saint Paul are 49 nautical miles apart and that Amsterdam is 0.6 miles north and 2.0 miles east of its charted (B.A. 1921) position.

18. *Cavalier*, a U.K. destroyer ordinarily on Far East station at Singapore, was then in Fremantle in conjunction with the 1962 Empire Games, Perth.

19. (See Fig. 6)

20. ([See Fig. 7](#))

21. The differing values for "precision" are, rather, indications of the degree of flatness of the recognizable trench bottom.

22. ([See Fig. 9](#))

23. ([See Fig. 10](#))

## **DIRECT CURRENT MEASUREMENTS AND RELATED HYDROGRAPHIC WORK LUSIAD EXPEDITION**

This program of observations was designed to determine the nature of the subsurface circulation near the equator in the Indian Ocean. Since the monsoon winds and the surface circulation of the Indian Ocean go through an annual cycle the observations were made during the two phases of the monsoon. The first cruise (late June to late September) took place during the southwest phase while the second cruise (mid-February to mid-May) commenced at the end of the northeast phase and concluded during the southwest phase.

The strategy of the two cruises was based on the results of previous descriptive work done on the Equatorial Undercurrent (Cromwell Current) in the Pacific. Four meridional sections across the equator with stations at one degree intervals from 2°N to 2°S were made to give a representation

of the zonal component of current. An ocean-wide section along the equator was occupied to give an estimate of the slope of the sea surface and the associated pressure distribution (Figs. A-1, A-2). Reoccupation of a number of current measurement stations along the equator provided a measure of the time variability of the subsurface currents.

The direct current measurements were made by a telemetering current meter suspended from a drifting ship. On all current measurement stations a tautwire reference buoy was planted. The ship's velocity through the water was estimated by monitoring its position relative to the reference buoy at five minute intervals. The true current was computed by vectorially subtracting the ship's velocity from the measured current. The majority of measurements were made with a meter manufactured by the Hytech Corporation of San Diego. At other times a modified Roberts current meter was used.

Most of the data collected on these two cruises has not yet been analyzed but it is possible to make some tentative descriptive generalizations based on shipboard analyses of the data. It is doubtful that these qualitative interpretations will be substantially changed after the data has been reworked. This report will be focused on the question of the existence of the Equatorial Undercurrent in the Indian Ocean.

The distribution of the zonal component of velocity with depth on the meridional sections at 79°E, 89°E and 92°E was similar to that of the

---

— 61 —

Equatorial Undercurrent. The core of these eastward flows was located in the middle of the thermocline, the maximum eastward speeds were centered at the equator, the associated meridional components were small in comparison to the zonal component and the current structure in the thermocline was stable over periods of at least one week. The surface current on these sections was eastward at 79°E, 89°E and westward at 92°E. The zonal velocity structure most closely resembled that of the Undercurrent on the 92°E section in April where the maximum eastward speeds in the thermocline were measured (Fig. A-3). The speed at the core of the eastward flow was 80 cm/sec which compares with 125 cm/sec for the speed at the core of the Undercurrent in the Pacific. The measurements at 79°E and 89°E during the southwest monsoon revealed westward velocity maxima in the thermocline of somewhat lower amplitude than at 92°E. The section at 79°E in September showed a complicated zonal velocity structure with a peak of westward flow in the lower portion of the surface layer underlain by eastward flow in the thermocline from 2°N to 2°S with a maximum eastward speed of 60 cm/sec at the equator. The portion of this section from 1°N to 1°S was repeated approximately one week after the first run and the core of 60 cm/sec eastward flow in the thermocline was again found to be present. The section at 89°E also showed eastward flow in the thermocline from 2.5°N to 1°S with a maximum eastward current at the equator of 50 cm/sec.

A lower amplitude eastward flow was measured in the thermocline from 2°N to 1°S on the 61°E cross-section in early March. The maximum eastward speed (38 cm/sec) was not located at the equator and thus the velocity structure departed from that usually associated with the Undercurrent. When considered with the hydrographic evidence and the current measurements at

0°61°E three weeks after the section was occupied, which are discussed below, our interpretation is that the Undercurrent was probably present at this section but weakly developed.

On four sections, *i.e.* 53°E in both May and August, 62°E in August and 85°E in February, the Undercurrent was not measured. The measurements on the 85°E section did indicate eastward velocities in the lower thermocline of magnitude 15 cm/sec. Since 15 cm/sec is the order of the uncertainty in the current measurements the reality of this eastward flow cannot be established. On the two sections at 53°E and 62°E the zonal component of velocity in the thermocline was either westward or its magnitude was below the noise level of the measurements. In addition, at 53°E and 62°E the meridional flow was

---

— 62 —

considerably stronger than the zonal flow.

Further evidence for the presence of the Undercurrent exists from current measurements at stations on the equator at 61°E, 69°E and 77°E in March and at 85°E and 92°E in April. These observations seem to indicate the Undercurrent was continuous from 61°E to 92°E during late March and early April. The magnitude of the eastward velocity maximum increased from 57 cm/sec at 61°E to 81 cm/sec at 92°E. Table 1 summarizes the measurements of the Undercurrent along the equator during the two cruises.

The repetition of current measurements on the equator at the longitudes of the meridional sections provided a measure of the steadiness of the flows observed on the sections. Measurements were made on the equator at 61°E, 79°E, 89°E and 92°E with time differences between the single occupancy and that on the section of one to three weeks. In all cases the maximum eastward flow in the Undercurrent was found to be reproducible at approximately the same depth with differences in magnitude ranging from 6 to 30 cm/sec. The zonal flows measured on the sections were clearly not short period transients but were stable over periods of weeks. The meridional components associated with the maximum eastward speed were not steady and even their sign appeared to be unpredictable. However, the Undercurrent does appear to undergo fluctuations of longer periods. An Undercurrent was not measured on the section at 85°E in February even though an eastward flow of 60 cm/sec was measured at 0°85°E in April. Current measurements at 0°89°E in July did not show an Undercurrent structure although the section at 89°E in September did show an eastward Undercurrent. These comparisons indicate that the Undercurrent is at least considerably weakened at times or possibly is not present at all. The steadiness associated with the Equatorial Undercurrent of the Pacific does not characterize the Undercurrent of the Indian Ocean. At the present time no relationship can be established between these fluctuations and the monsoonal variation of the wind field.

The distributions of properties on the meridional sections do show many of the features associated with the undercurrents of the other oceans. The spreading of the thermocline at the equator is characteristic of the thermal structure of the Undercurrent. On two of the sections where the Undercurrent was clearly developed (79°E and 92°E) the thickness of the thermocline, as measured by the separation of the 15°C and 25°C isotherms

was a maximum at the equator (Fig.A-4). Associated with the spreading of the thermocline at 92°E, where the Undercurrent was best developed, were low values of dissolved oxygen and high values of inorganic phosphate in the surface layer. On the other section where the Undercurrent was clearly present (89°E) the thermocline was sharper than on the other meridional sections and showed no tendency to weaken at the equator. The meridional distributions of temperature, dissolved oxygen and inorganic phosphate on the 61°E section, where the presence of the Undercurrent was suggested but not clearly established, all showed spreading of the isopleths at the equator. Thus even in the Indian Ocean where the Undercurrent is not as well developed nor as steady as in the other oceans, these indications of upwelling of water from the region of the thermocline may be found. It should also be noted that the weakening of the thermocline at the equator was not observed on the other sections where the Undercurrent was not present.

A salinity maximum is found in the thermocline along the equator during both phases of the monsoon whose value at the maximum decreases from west to east. On the meridional sections at 85°E, 89°E and 92°E this maximum was found to be meridionally isolated from water of a comparable salinity (Fig.A-4). In order to persist throughout the year this salinity maximum would require eastward transport of high salinity water for its maintenance. The eastward Undercurrent measured at 79°E, 89°E, 89°E and 92°E provides the required eastward transport. An analogous relationship exists between the Atlantic Undercurrent and a salinity maximum at the equator in the Atlantic.

The equatorial sections occupied during July of the first current studies cruise and March and April of the second indicated a slope of the sea surface up to the east (positive slope). The sea surface slope during the first cruise occurred from 45°E to approximately 83°E, with no apparent slope east of 83°E. The magnitude of this slope was  $5 \times 10^{-8}$  and thus was comparable to that in the other oceans but of opposite sign (Fig.A-5). The March-April section also indicated a positive slope at the sea surface but of half the magnitude and restricted to the eastern side of the ocean. These measurements indicate that even though magnitude of the sea surface slope may vary there is no evidence that it is negative as in the other oceans. On the eastern side of the ocean the slope of the deeper isobars changed sign on both equatorial sections. The slope of the 100-decibar surface in July and the

125-decibar surface in April was negative. The magnitude of this slope as well as its sign is comparable to that found at the core of the Undercurrent in the Pacific. The eastward Undercurrent is therefore associated with an eastward pressure-gradient even though the pressure-gradient at the sea surface is westward.

Our preliminary interpretation of the data collected on the two cruises is that an Equatorial Undercurrent does exist in the Indian Ocean with many of the properties associated with the undercurrents of the Pacific and Atlantic. There is no evidence that it is restricted to only one phase of the monsoon although its maximum development occurred during the end of the

northeast monsoon. The tendency for the Undercurrent to develop in the Indian Ocean is more marked on the eastern side of the ocean than on the western side. The Undercurrent did not appear on either of our westernmost sections at 53°E. However, the observed current structure is different from that typically observed at the equator in the other oceans. The amplitude of the eastward flow in the Undercurrent is only half that of the Pacific. Although the eastward velocity component does appear to be steady over periods of weeks when the Undercurrent is developed and can be traced over half the width of the ocean, there were times at which the Undercurrent was either weakly developed or not present.

(B.A.T., J.A.K.)

## REFERENCES

Knauss, J. A. and Taft, B. A. (1963) , Measurements of Currents along the Equator in the Indian Ocean: *Nature*, v. 198, no. 4878, pp. 376–377. Knauss, J. A. and Taft, B. A. (1964) , Equatorial Undercurrent of the Indian Ocean: *Science*, v. 143, no. 3604, pp. 354–356.

— 65 —

Table 1 Maximum measured eastward velocity component in thermocline and associated meridional velocity component and depth for equatorial stations where the Undercurrent was present. Positive meridional components are northward and negative components are southward.				
Longitude	Date	Zonal Comp. (cm/sec)	Meridional Comp. (cm/sec)	Depth (m)
61°E	9-III	27	+ 13	81
	31-III	57	- 5	80
69°E	4-III	49	- 16	90
77°E	1-III	31	+ 2	120
79°E	9-VIII	19	- 7	125
	2-IX	67	+ 20	110
	8-IX	61	- 32	100
85°E	7-IV	60	+ 23	105
89°E	11-IX	51	+ 12	120
	17-IX	34	+ 14	140
92°E	9-IV	81	- 7	100
	22-IV	76	+ 19	120

— 66 —

## Captions

Fig. A-1 Track chart of LUSIAD current studies cruise - June 28 to September 24, 1962. The heavy lines denote sections of hydrographic stations. Current meter stations are indicated by an open circle if occupied once, by a filled circle if occupied twice and by a ringed filled circle if occupied three times. At the southern end of each section is given the period during which the section was made. The dates given for single current meter stations on the equator are the time of occupancy in addition to that while working the section.

Fig. A-2 Track chart of LUSIAD current studies cruise - February 16 to May 15, 1963. The heavy lines denote sections of hydrographic stations. Current meter stations are indicated by open circles if occupied once and by filled circles if occupied twice. At the southern end of each section is given the period during which the section was made. The dates given for single current meter stations on the equator are the time of occupancy in addition to that while working the section.

Fig. A-3 Vertical section of zonal component of measured current velocity (cm/sec) at 92°E (April 1963). Eastward current is positive and westward current is negative.

Fig. A-4 Vertical section of temperature (solid line, °C) and salinity (dotted line, per mille) at 92°E (April 19–25, 1963).

Fig. A-5 Dynamic topography of the sea surface at the equator (relative to 1000 decibars). Solid line is the Indian Ocean based on measurements of *Argo* during July, 1962; dash-dot line is the Atlantic based on *Crawford* cruise, November, 1958; dotted line is a composite of all Pacific data.

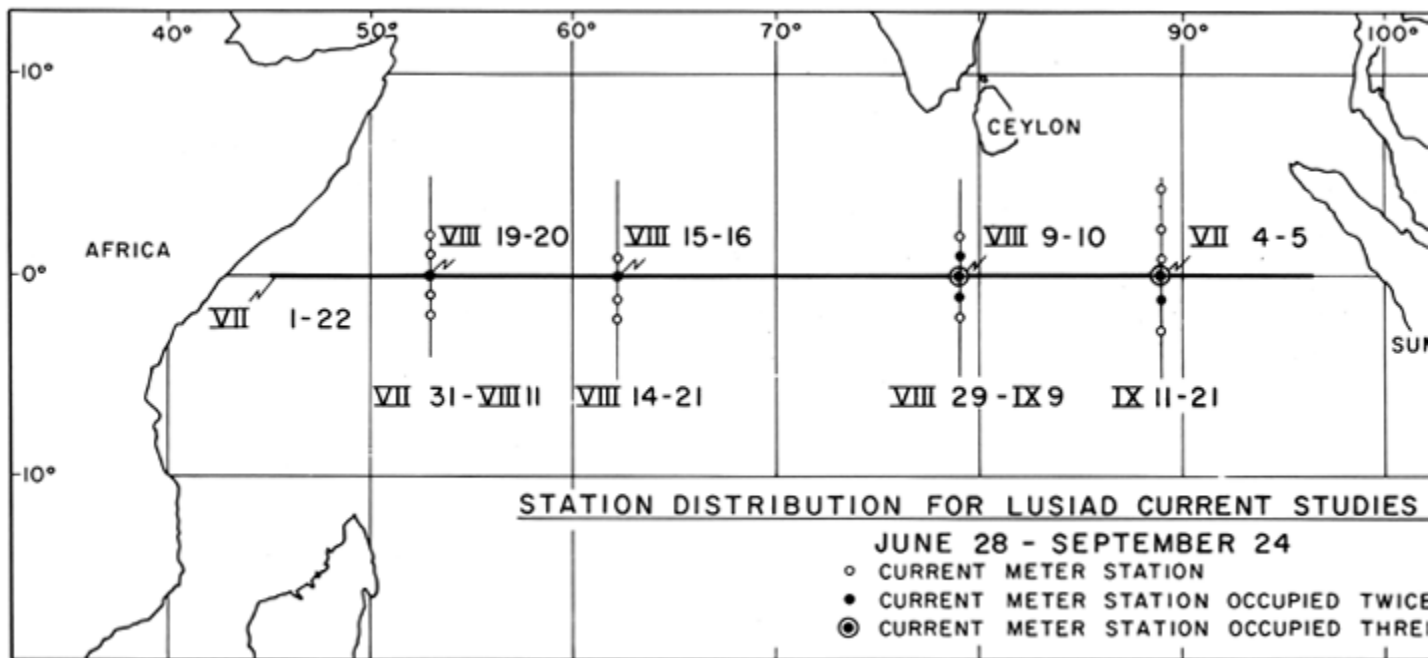


Fig. A-1



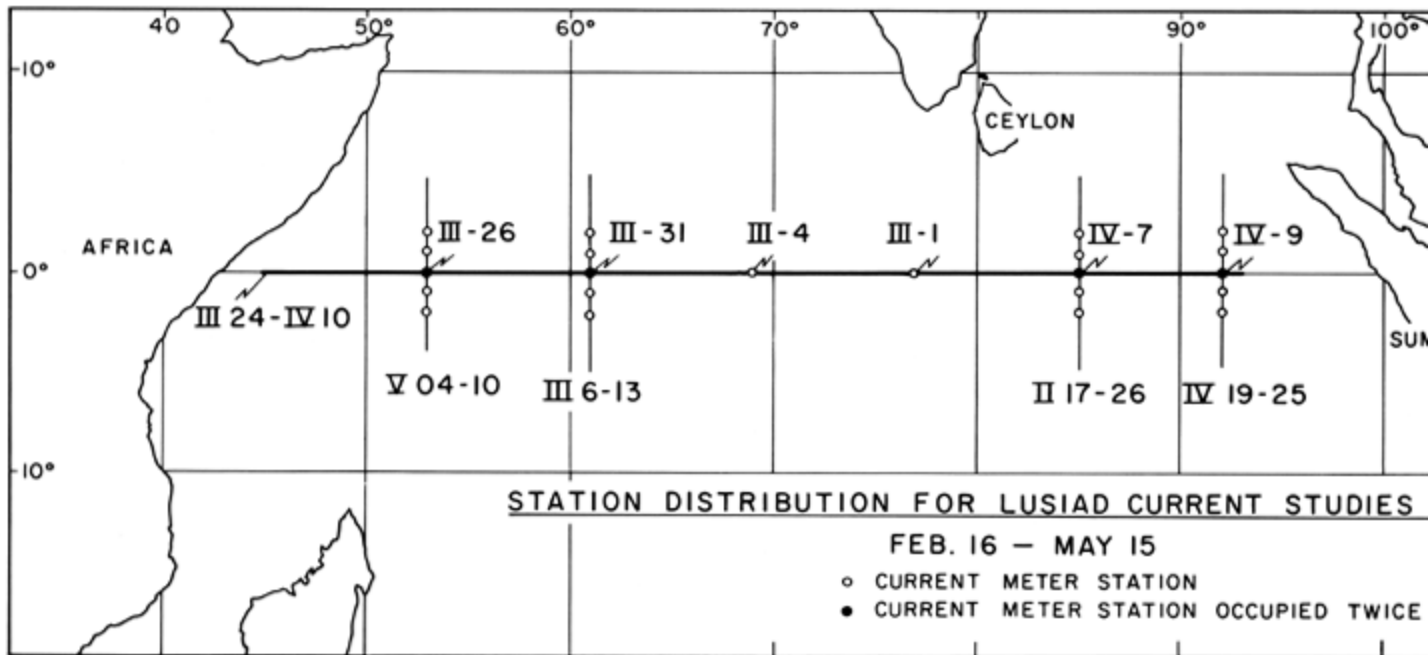


Fig. A-2

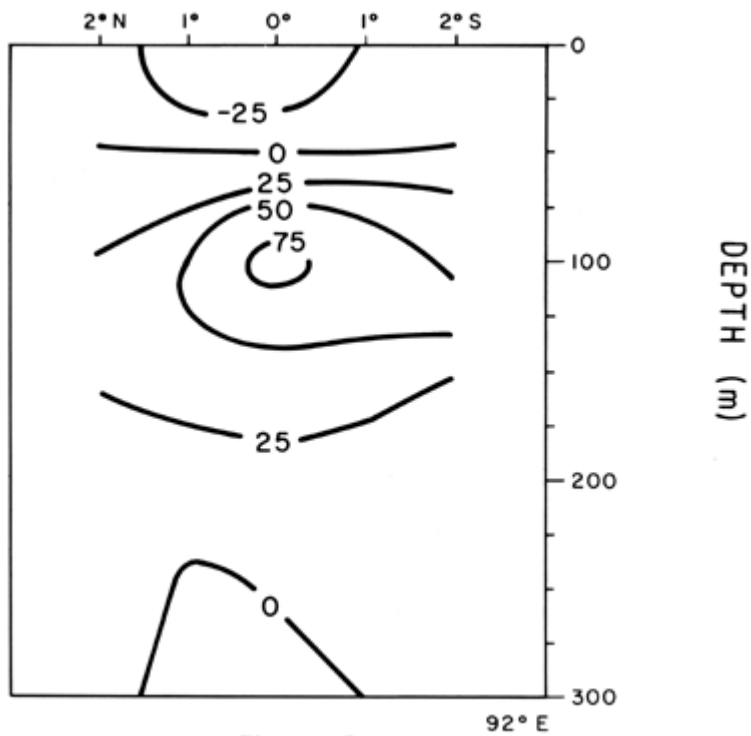


Fig. A-3

Fig. A-3

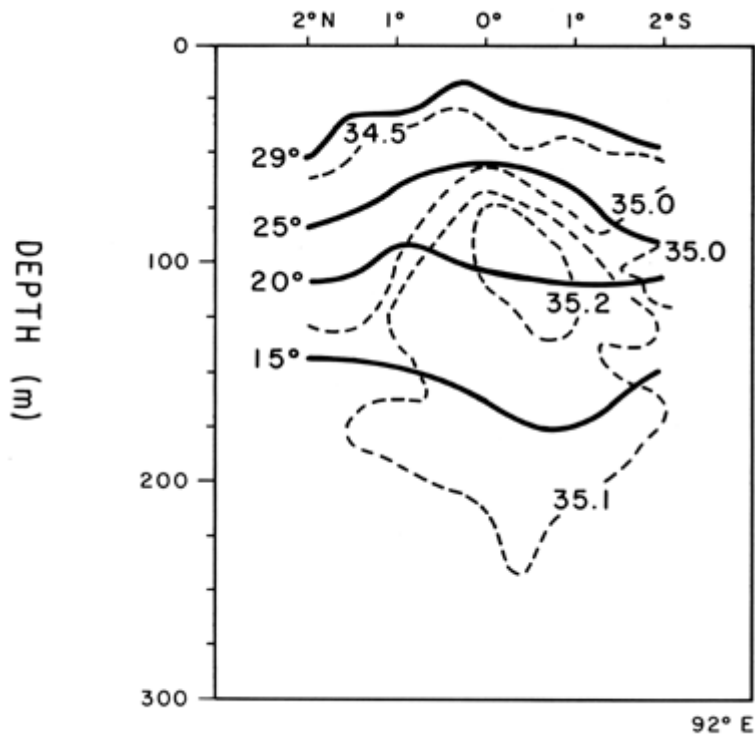


Fig. A-4

Fig. A-4

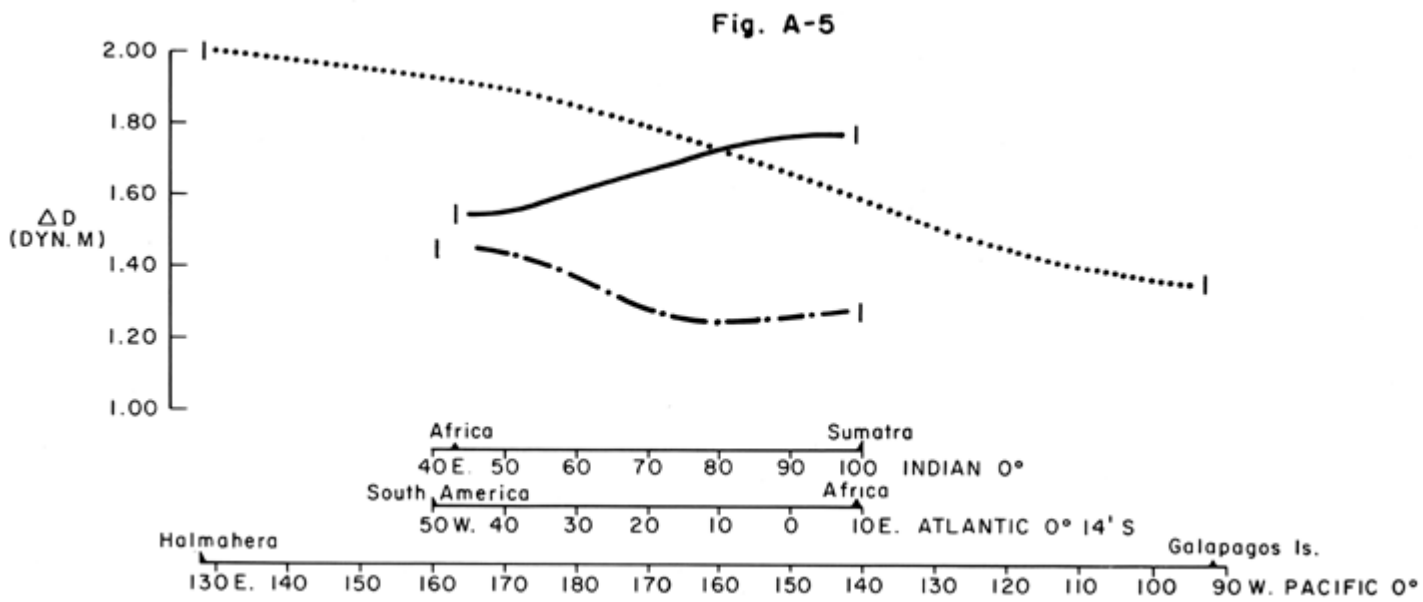


Fig. A-5

Fig. A-5

# HYDROGRAPHIC SAMPLING BY MEANS OF NANSEN BOTTLES DURING MONSOON-LUSIAD INDIAN OCEAN INVESTIGATIONS, 1960–63

Hydrographic sampling was carried out on both MONSOON and LUSIAD expeditions. On some casts sea water samples were taken close to the bottom; on others, detailed sampling was done to a depth of several hundred meters, or deep water samples were occasionally collected for special studies (for example, two-liter deep-water samples for chemical analysis by Roland Cox of National Institution of Oceanography, England). Positions for all the casts taken on MONSOON and LUSIAD are compiled in Appendix C, Tables II and III.

The closely-spaced hydrographic sampling carried out on LUSIAD during the two three-month equatorial investigations was designed to supplement the direct current measurements being emphasized then; the less intensive hydrographic program during MONSOON and on the remainder of LUSIAD was an adjunct to the primarily geological-geophysical investigations. Therefore, the chemical results from the two equatorial current programs are discussed and illustrated separately (Section II) from those of MONSOON and the rest of LUSIAD.

Techniques used in the latter investigations were similar for each cruise and to those for ZEPHYRUS stations in the northwestern Indian Ocean; hence MONSOON cruise methods will be discussed in most detail (Section I) with occasional additions for LUSIAD and ZEPHYRUS observations. The corresponding horizontal illustrations of chemical and physical data will incorporate results from all three cruises.

In choosing the LUSIAD cast positions, effort was made to occupy as many as possible of the recommended "IIOE Reference Stations" (p.4, IIOE Inf. Paper No. 1, UNESCO/NS/IOC/INF-22, August, 1962). It was possible to sample at or near eight out of the 15 recommended positions. Reference Station #4 was visited four times (although as much as 64 miles east or west of the suggested

---

— 68 —

0°, 90 E position, the LUSIAD casts were taken practically on the equator in an east-west trending current system), #5 was visited three times (with the same reservation as for #4), #10 was sampled twice, and numbers 12, 13, 14 and 15<sup>[1]</sup> once each. Data resulting from these especially-critical casts are tabulated in Appendix C-1.

I. Hydrographic work on MONSOON (R/V *Argo* - Port Darwin to Wellington), LUSIAD (R/V *Argo* - Cochin to Port Darwin, Mombasa to Cape Town) and ZEPHYRUS (R/V *Horizon* - Aden to Cochin).

Nineteen standard hydrographic casts were made during *Argo's* 1960–61 cruise to the central and southern Indian Ocean. Thirteen additional casts of one or two Nansen bottles each were made as "piggyback" operations<sup>[2]</sup>, on lowerings for other purposes, mainly on temperature probe stations. Two stations were made between Aden and Cochin by *Horizon* en route to join *Argo* for the two-ship portion of LUSIAD proper. After Cochin, 31 hydrographic stations were made aboard the *Argo* in the central and southern Indian Ocean<sup>[3]</sup>, and three stations for inter-calibration purposes, were occupied between Mombasa and Cape Town. Fig. B-1 is an index chart of these MONSOON, LUSIAD and ZEPHYRUS stations.

---

— 69 —

A MONSOON Expedition hydrographic station usually consisted of one or more BT observations and two casts. One cast was made to near bottom with an Edgerton pinger placed five meters below the lowest Nansen bottle. This cast could be lowered to close proximity of the seafloor; however, after once the cast was set and the messenger sent, the cast would almost invariably begin to rise off the bottom so that the lowest bottle's distance from the seafloor could not be predicted before the bottle was tripped. A close estimate of the bottle's distance off the bottom could be made after it was tripped from the PDR record. A second cast of eighteen Nansen bottles was made to overlap the deep cast and to sample levels to the sea surface. The upper portion of this cast was spaced on the hydro wire after considering gradients indicated by the BT.

One or more Nansen bottles were placed on the wire of other lowerings in connection with temperature probe, camera, or gravity core. These were intended to supplement the deep water information between the scheduled hydrographic stations. These "piggyback" lowerings can yield data at little risk and with only the use of a few minutes of valuable station time.

The data collected were temperature, salinity and oxygen<sup>[4]</sup>. Two protected reversing thermometers were used with each Nansen bottle for determination of temperature, and ten unprotected thermometers per cast were used for depth determination. Temperature readings were corrected as soon as possible after the cast. Depth of the samples was determined by the L-Z system of Reid<sup>[5]</sup> and

---

— 70 —

Pollak<sup>[6]</sup> with further corrections for variation in  $p_m$  with depth taken from tables prepared by Klein<sup>[7]</sup>.

Salinities were determined by means of a Wheatstone conductance bridge designed by scientists of the University of Washington and the Pacific Naval Laboratories. The salinities were measured alternately with single and duplicating runs. When duplicate runs were made the resulting values were average to thousandths if they were within  $\pm 0.010\%$  salinity. Single runs were recorded in hundredths<sup>[8]</sup>. Standard sea water (Copenhagen) was used to determine the cell constants. Batches of Copenhagen water have a determined conductance relative to Batch P33, since the stated chlorinity does not give the computed conductance. The assumed conductance of

Batch 33 results in a salinity of 35.000%. The oxygen was determined by the Winkler method as modified by Wooster<sup>[9]</sup>.

Processing of the data was carried out at the Data Collection and Processing Group, Scripps Institution of Oceanography, using the method described by Klein<sup>[10]</sup>. Bathythermograph traces from the hydrographic stations were used in temperature

---

— 71 —

interpolation.

Preliminary findings are summarized on five charts:

Fig. B-2 and B-3 show sections of the surface temperature distribution found on MONSOON and LUSIAD, respectively. The horizontal distribution of temperature is based on the station data only. Fluctuations recorded on the thermograph are not included;

Fig. B-4 the temperature distribution at the temperature minimum;

Fig. B-5 the distribution of dissolved oxygen, in ml/L at the temperature minimum;

Fig. B-6 the distribution of salinity at the deep salinity minimum.

Examination of the data indicates high values of the deep temperature minimum run generally along the Mid-Indian Ocean ridge. The observed depth of this feature varies from about 3200 m at MONSOON IV-16 to 4500 m at MONSOON III-10. Stations with single or double bottle lowerings have been plotted. Since these samples are not necessarily at the minimum, they are contoured with their values as the upper limits. The corresponding oxygen values are low generally along the same area of high temperature minimum values. Another feature noted in the Indian Ocean is the deep salinity maximum occurring generally at about 2500 meters. The samples were determined by salinity conductance bridge with an accuracy of about  $\pm .005$ , so that this appears to be a real feature. The feature is least evident over the Mid-Indian Ocean ridge, and has lower maximum values than the surrounding waters ([See Fig. B-6](#)).

Oceanographic features common to the two ZEPHYRUS stations between Aden and Cochin are (1), a salinity maximum at 400 to 800 meters ( $d_t$ , 70 to 110); and (2), a change in gradient of temperature around 450 meters, from near isothermal water shallower than 450 meters to a fast decrease in temperature with depth below

---

— 72 —

450 meters. Density, however, does not reflect this effect, but show a smooth curve vs. depth.

In addition to the Nansen bottle casts, the hydrographic program on Expedition MONSOON included special sampling for comparative chemical analysis (to be carried out by Cox at N. I. O.) and surface samples for radiocesium analysis. In all, thirty-two radiocesium samples were

collected, at about three-day intervals, while underway between Port Darwin and Wellington. As discussed elsewhere in this report, on both MONSOON and LUSIAD large volume water samples, for isotopic analysis and water-dating, were collected in the central and southern Indian Ocean.

On MONSOON, bathythermograph observations were taken, weather permitting, every two hours while *Argo* was underway, as well as on stations; 524 BT's were taken between Port Darwin and Wellington. On LUSIAD, BT's were taken routinely every four hours, weather permitting, while *Argo* and *Horizon* were underway, and at appropriate intervals on stations. Between Cochin and Port Darwin, *Argo* made 201 BT observations, and *Horizon* made 298.

A continuous thermograph record of surface water temperature was maintained throughout the periods described above.

*Note on Tripping Technique used on deep Nansen bottle lowerings*

On MONSOON cruise, in order to reduce on deep "piggyback" lowerings the time normally required for the messenger to run the hydro wire, a formula was derived to enable computation of the meter reading at which a messenger could be sent so that its arrival at the top bottle would be five minutes after the arrival of the lowered gear at the bottom. The formula is:

$$X = \frac{LM_{vm} + 5M_{vs} W_v + N_T W_v}{W_v + M_{vm}}$$

where X = meter wheel reading when messenger is sent;

---

— 73 —

L = total anticipated amount of wire out when lowering completed;  $M_{vm}$  = messenger velocity (relative to the wire) on moving hydro wire in meters per minute;  $M_{vs}$  = messenger velocity on stationary hydro wire in meters per minute;  $M_v$  = lowering speed of the winch in meters per minute;  $N_T$  = meter wheel reading to top Nansen bottle.

Since  $W_v + M_{vm}$  will approach a constant equal to the free fall of a messenger in the water (our messengers free fall 220 meters per minute at most), and within the normal lowering speed of the winch (80 to 125 meters per minute) we can use this value as a *safe* constant, so the formula simplifies to:

$$X = \frac{W_v (5M_{vs} + N_T - L)}{220} + L$$

Furthermore  $M_{vs}$  should be a high estimate, to prevent tripping the bottles before equilibrium is reached.

$W_v$  can easily be determined by the rate-meter on the winch or by stop watch and L can be estimated during the lowering if an Edgerton pinger is used by comparing winch readings with fathoms traversed (toward bottom) as shown by the pinger pattern on the precision depth

recorder (PDR). There usually is sufficient time to do this, as the lowering is about  $\frac{2}{3}$  out before the messenger need be sent.

If multiple bottles are used, the time that all bottles have tripped should be determined. Using the distance between the top Nansen bottle and the bottom bottle, add 1000 meters and divide by  $M_{vs}$ , estimated now on the low side. The time so determined added to the time when the lowering reached bottom will be the minimum time for all bottles to have tripped.

On LUSIAD the usual method of tripping casts on temperature probe lowerings was to rapidly lower the probe into the sea floor to measure heat flow, and the

---

— 74 —

wire then wound in until the pinger indicated that the probe had cleared the bottom. Then the Nansen bottles were tripped (allowing a messenger speed of 175 meters per minute, plus the safety factor of 10 to 15 minutes, depending on wire angle). On several occasions, bottles were added to gravity core cast but this proved an unsatisfactory procedure as some bottles were pre-tripped when the corer struck bottom. During the Fremantle to Port Darwin segment of LUSIAD, there was sufficient station time to perform hydrographic casts independently of other lowerings.

(N.E.A., H.L.H., J.B.L.)

II. Hydrographic work, with emphasis on the chemical oceanography, on the Equatorial Current study portions of LUSIAD (R/V *Argo* - Singapore to Cochin, 1962, and Colombo to Mombasa, 1963).

The chemical oceanography program of two three-month segments of LUSIAD Expedition was designed to supplement the investigation of Indian Ocean equatorial circulation. The positions of 204 hydrographic stations occupied during these segments are tabulated in Appendix C, Tables A, C ; the locations are plotted on Fig. B-7 and B-8.

Sea water samples from these 204 oceanographic stations were analyzed for salinity, dissolved oxygen, phosphate-phosphorous, silicate-silicon<sup>[11]</sup> and nitritenitrogen<sup>[12]</sup>. Salinity determinations were made with a conductivity salinometer. Cell constants were calibrated with Copenhagen water. Dissolved oxygen was determined by the Winkler method using potassium bi-iodate as the standard.

---

— 75 —

Phosphate was determined by the Molybdate-blue method. Silicate was determined by the silico-molybdate method using sodium fluosilicate as the standard. Nitrite was determined by the diazotization method. A Beckman DU spectrophotometer with 100 mm absorption cells was used for these determinations.

The equatorial profiles of the Indian Ocean for the July, 1962 crossing are illustrated in Figs. B-9 to B-12. The thermocline extended to a depth of 100 meters. Surface salinity increased from east

to west, and highly saline water originating in the Arabian Sea region can be traced from the African coast to 65°E. Dissolved oxygen reached its minimum value of 1.0 ml/L at the 800-meter depth and then increased to a 4 ml/L toward the bottom. A tongue of low oxygen water also was detected beneath the thermocline the the eastern equatorial Indian Ocean.

The phosphate content of the water above the thermocline was uniform, with 0.2 ug - at/L in the eastern portion and 0.4 ug - at/L in the western region. Phosphate reached a maximum of 2.8 ug - at/L at 1000 meters and decreased to 2.3 ug - at/L at 4000 meters. Small quantities (0.4 ug - at/L) of nitrite were found between 80 and 150 meters depth; along the African coast, nitrite was also detected near the surface. No nitrite occurred below 300 meters. The relatively high content of dissolved oxygen in the water favors the nitrification rprocesses. During the 1960 R/V *Vityaz* cruise, nitrite in several ug - at/L quantities was detected in the Arabian Sea region. The silicate concentration increased with increasing depth and reached 120 ug - at/L near the bottom.

Sea water samples were taken, preserved and brought back for further minor elements analysis which is now in progress. The chemical data and samples obtained will be incorporated into other projects for publication. For example:

- 1. The determination of rubidium in sea water is now in progress.

---

— 76 —

- 2. The phosphate, silicate and nitrite data from the Indian Ocean will be combined with those of the Pacific into a single paper which is now in preparation.
- 3. The geochemistry of lead isotopes in the sediments and manganese nodules from MONSOON and LUSIAD Expedition is being studied and will be published as a paper.

(M.J., A.M., T.J.C.)

## REFERENCES

Pollak, M. J. (1950) , Notes on Determining the Depths of Sampling in Serial Oceanographic Observations: *Jour. Marine Res.*, v. 9, #1  
Wooster, W. S. (1950) , Methods in Chemical Oceanography Employed in the California Sardine Research Program: *S.I.O. Tech. Report*.



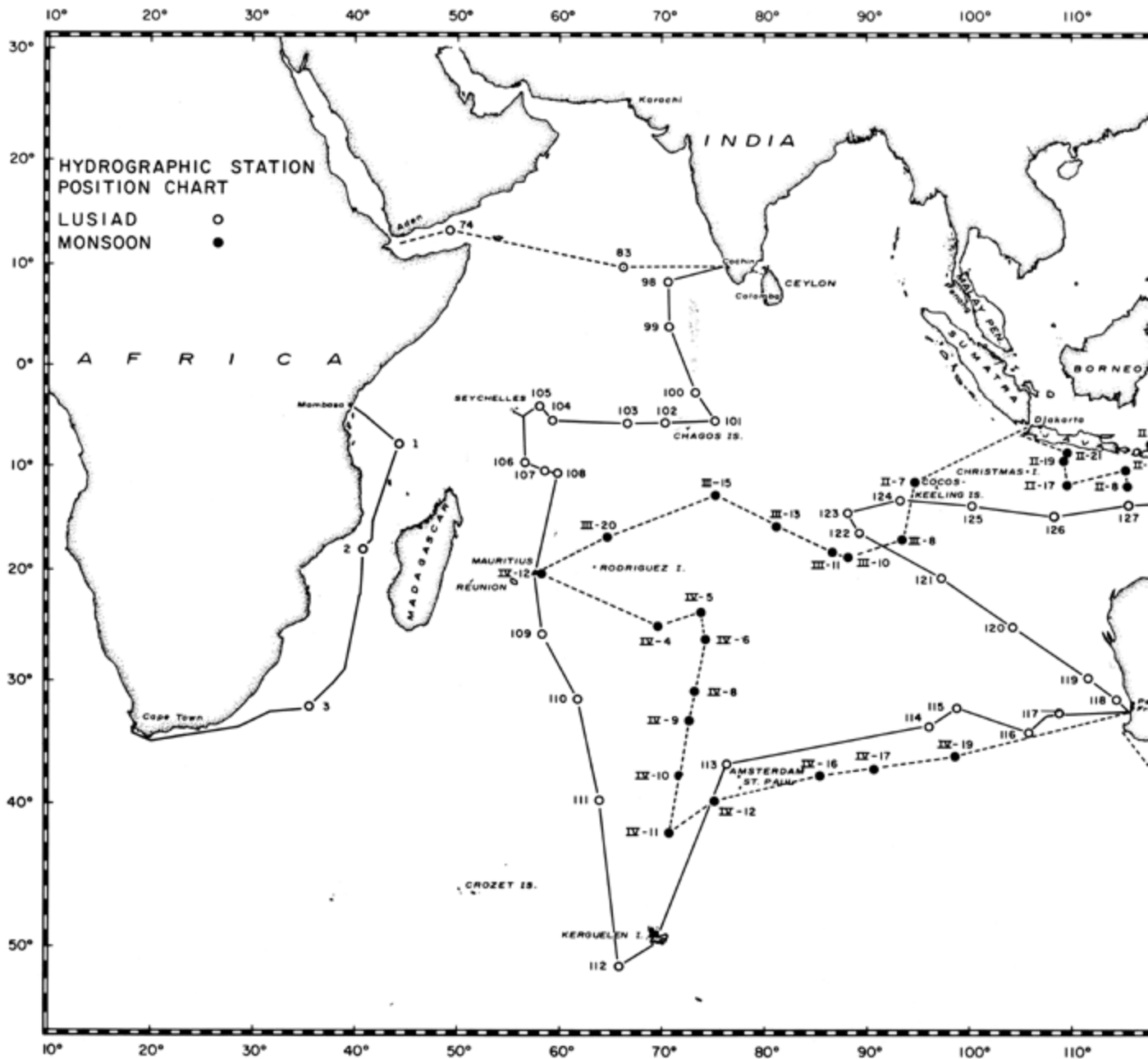


Fig. B-1

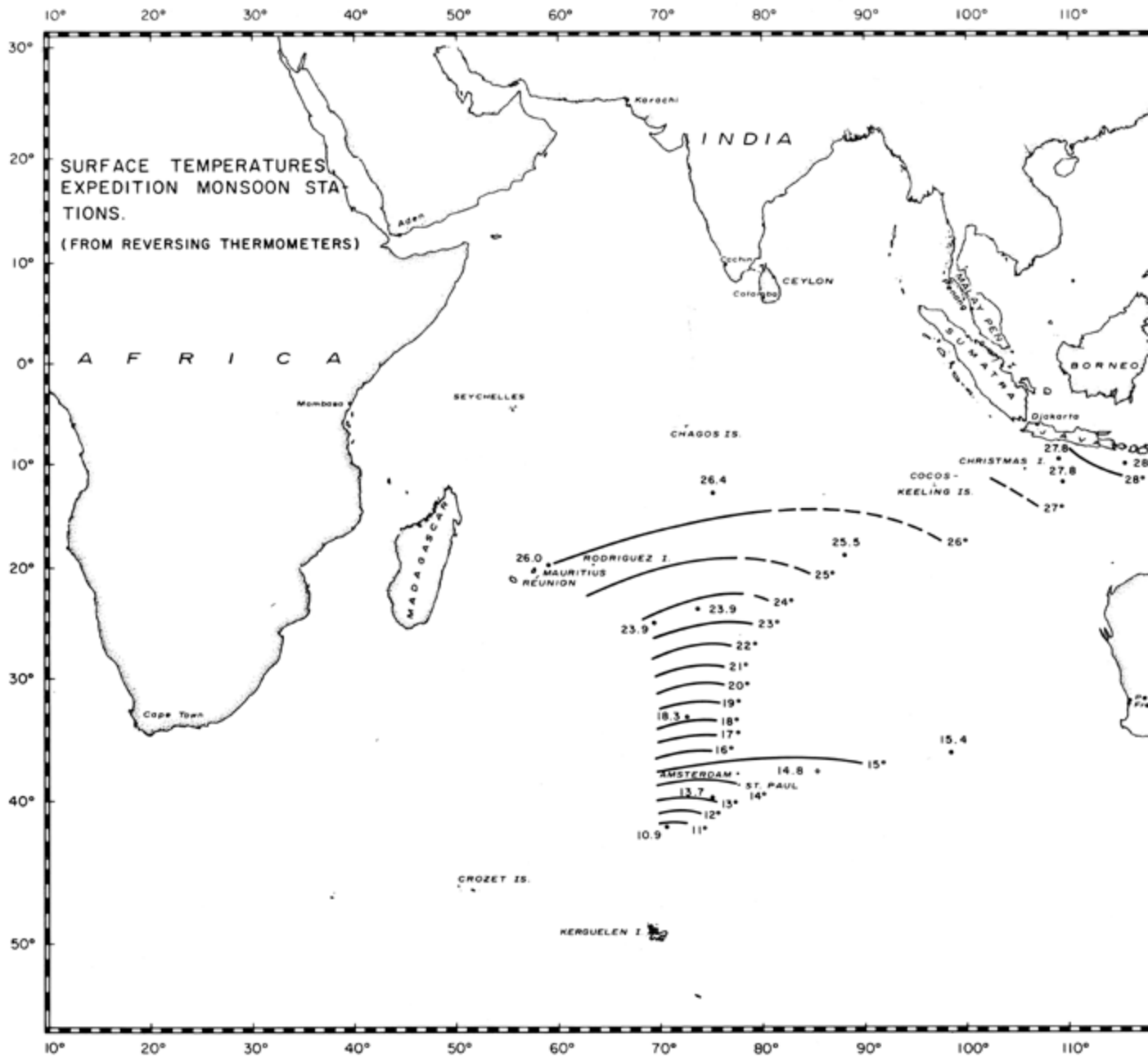


Fig. B-2

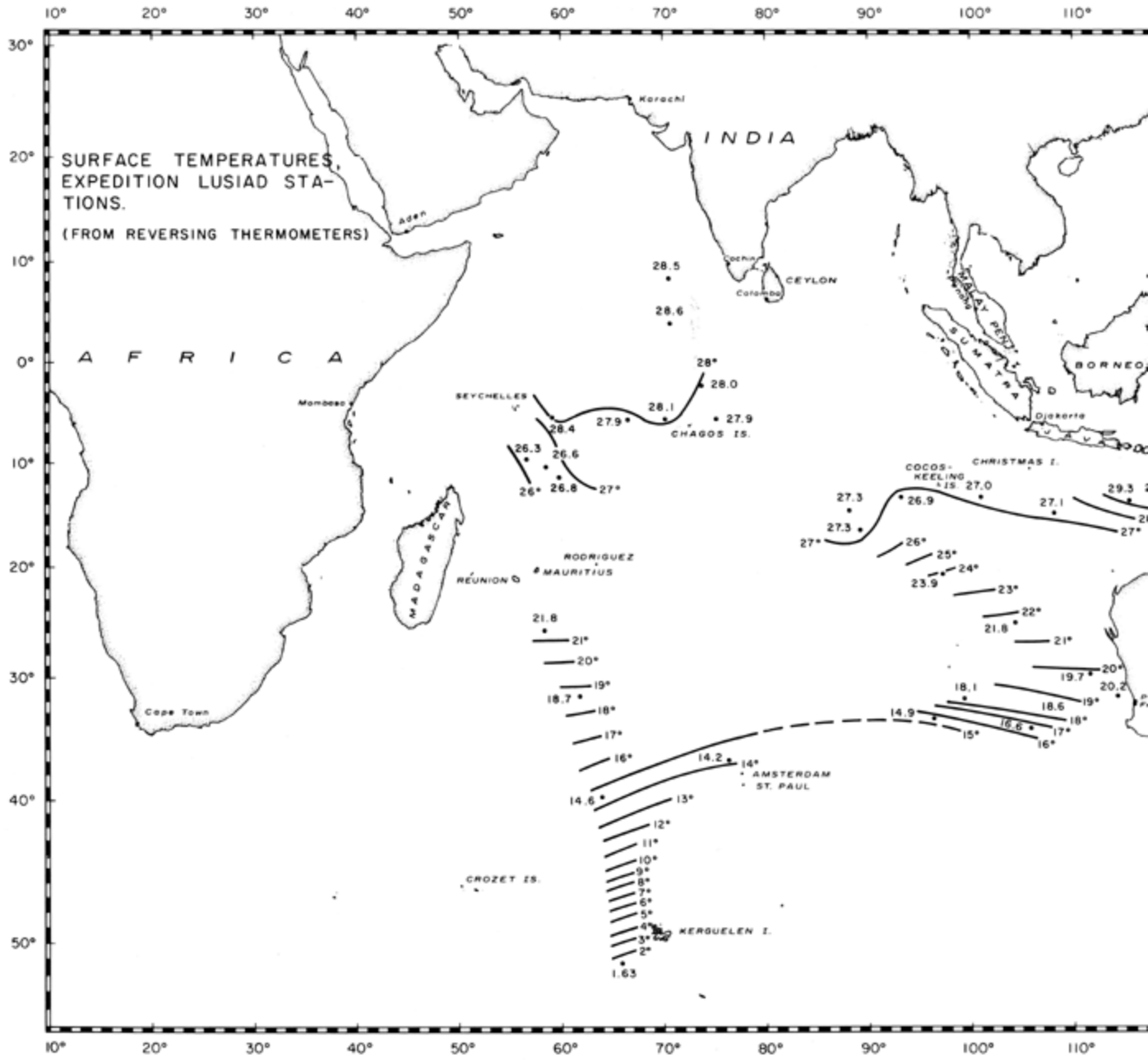


Fig. B-3



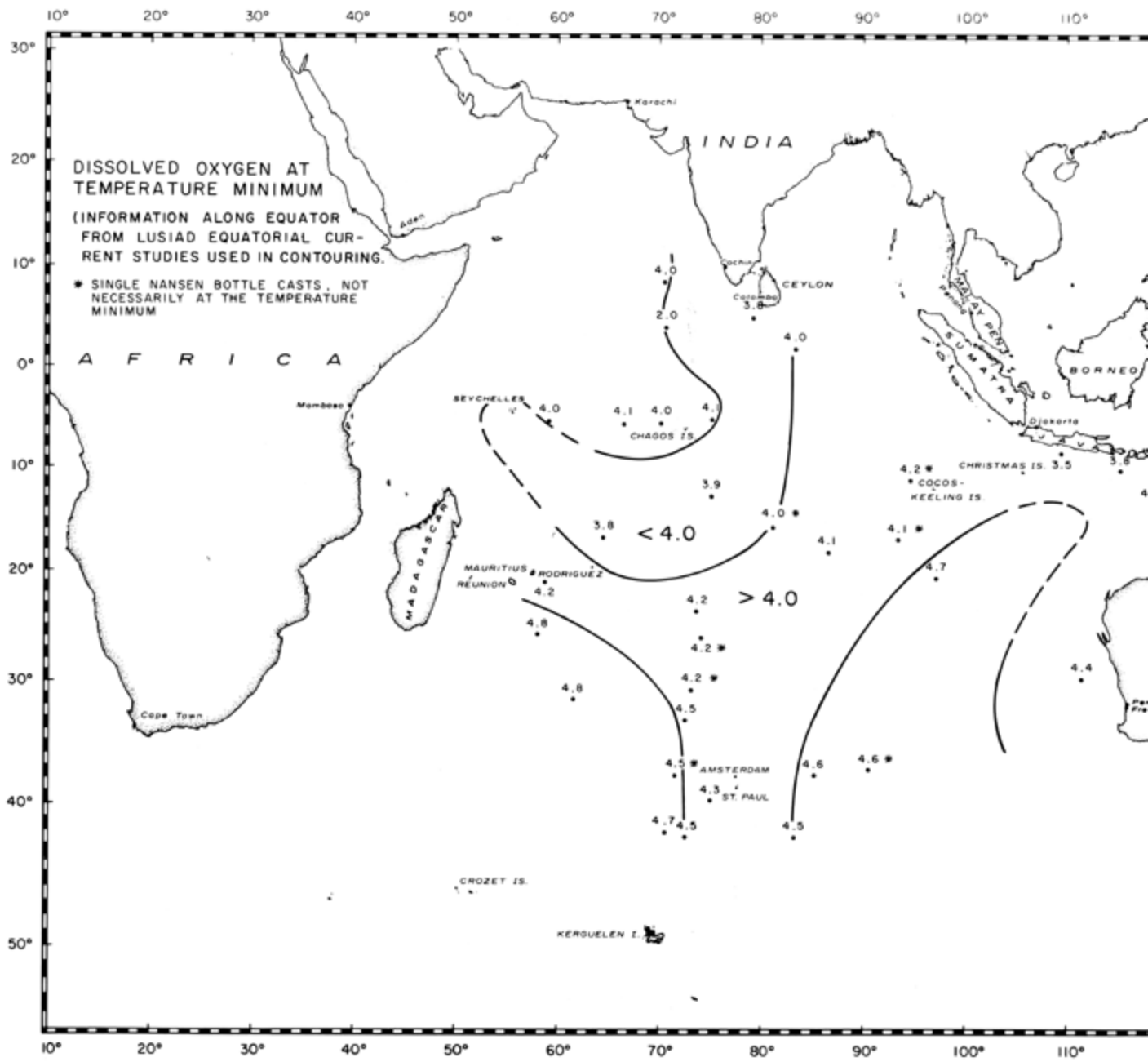


Fig. B-5



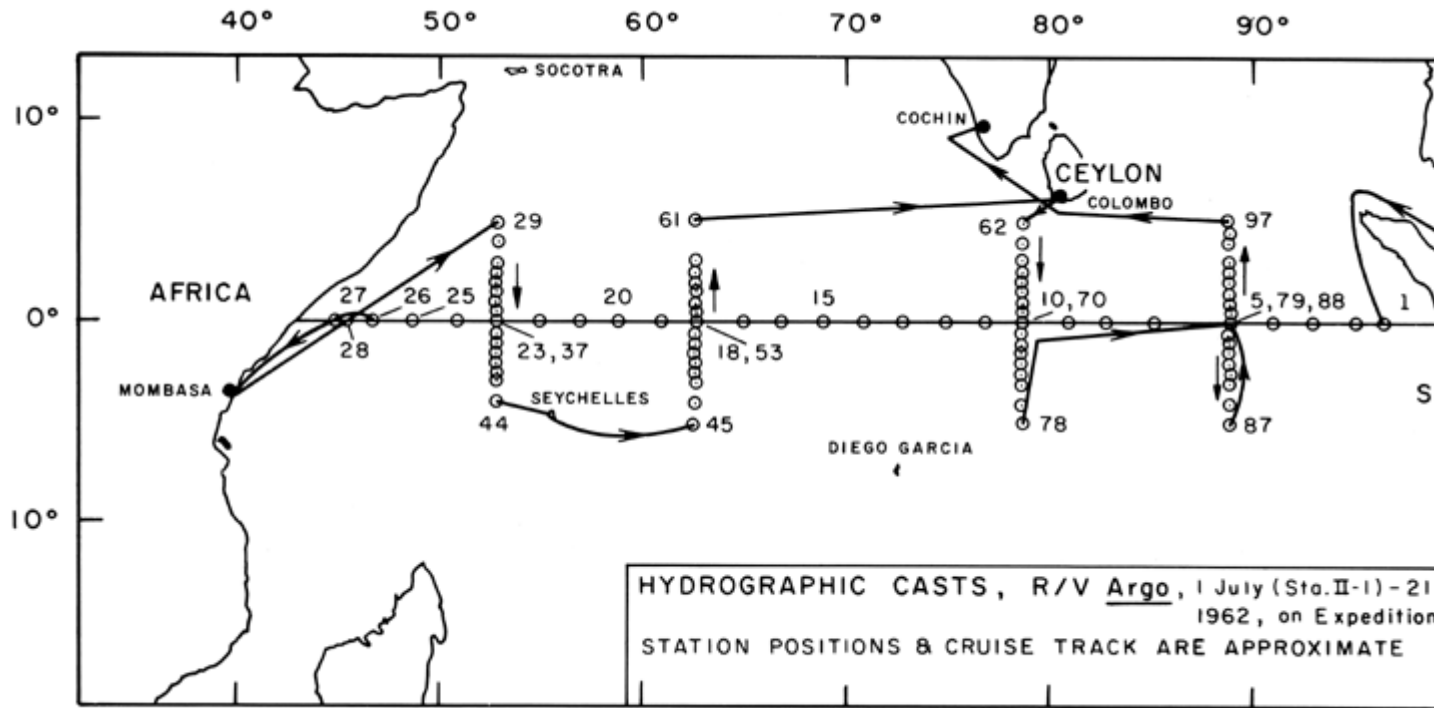


Fig. B-7

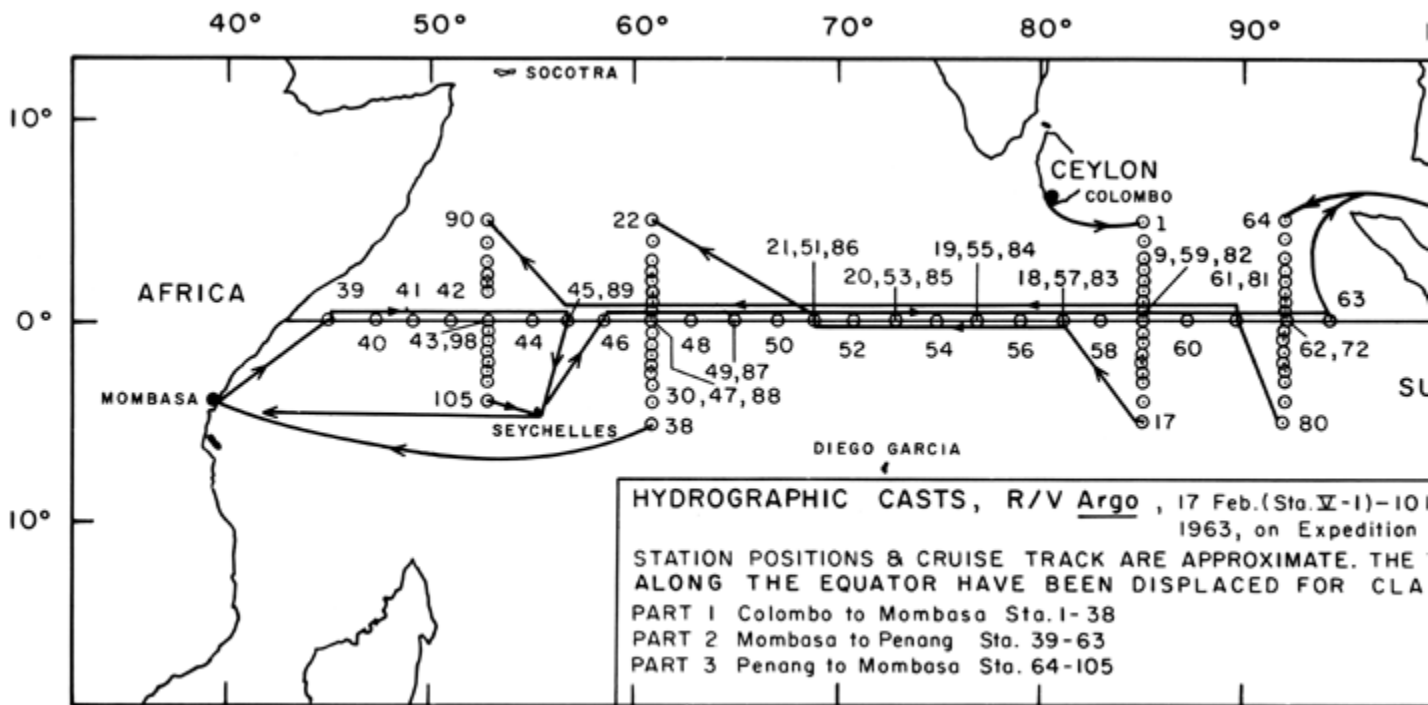
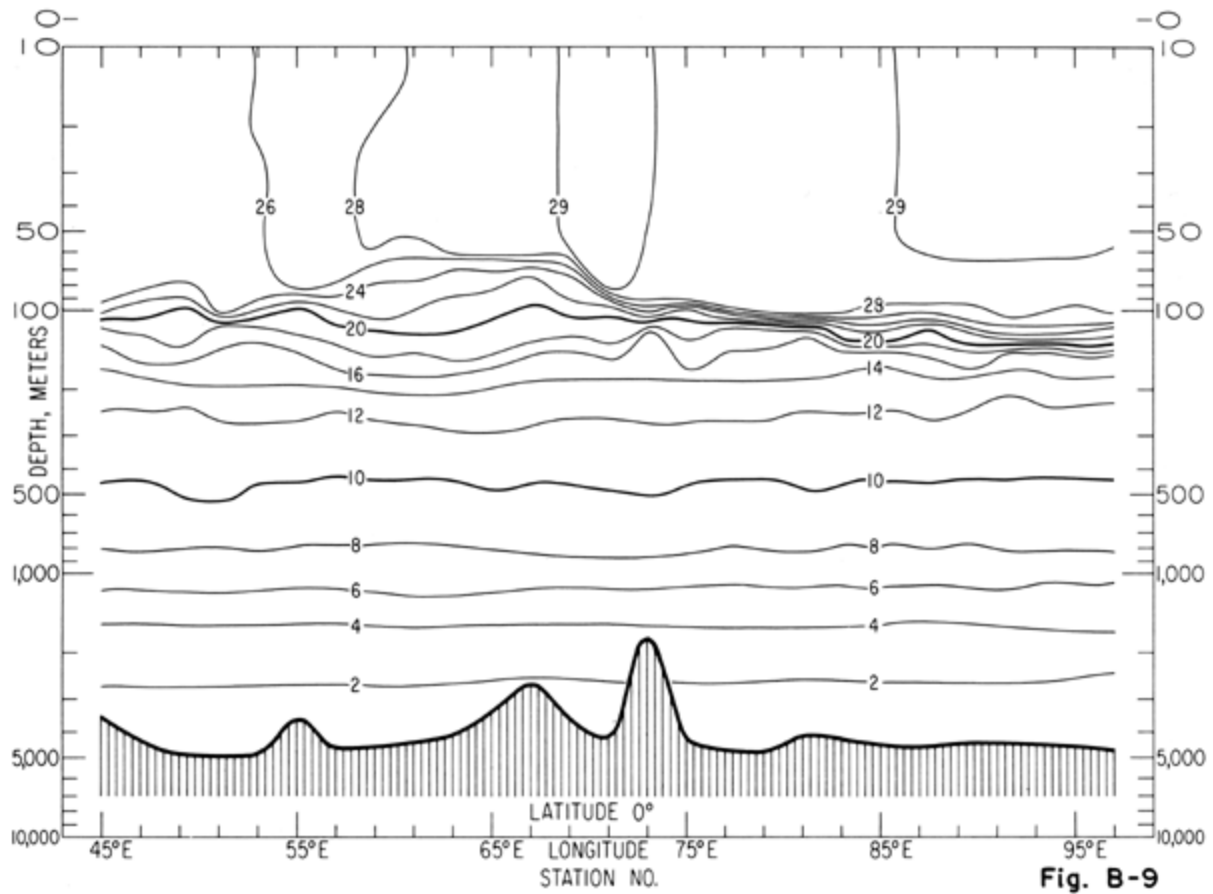


Fig. B-8

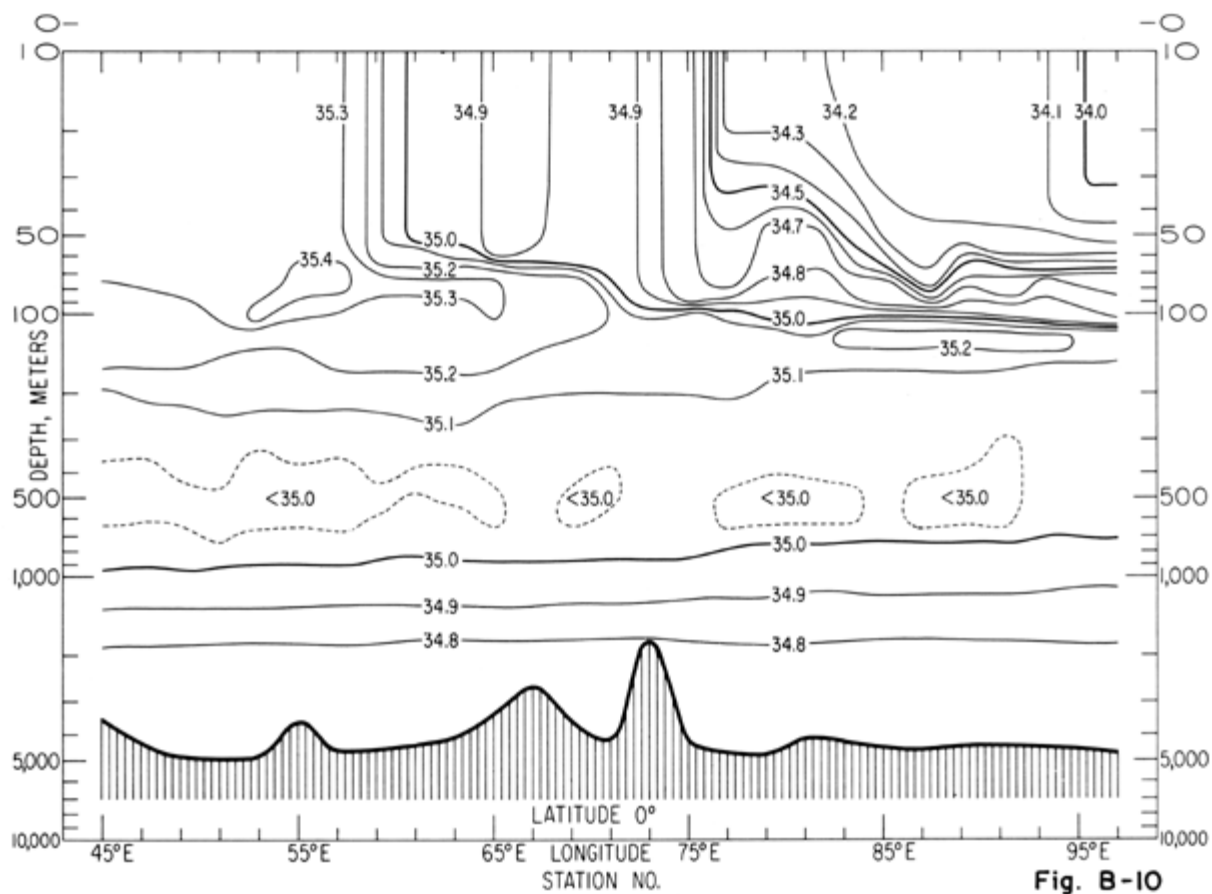


VERTICAL DISTRIBUTION OF TEMPERATURE ALONG THE EQUATOR.  
 CONTOUR INTERVAL: 2°C. DATE: JULY 1-22, 1962.

**Fig. B-9**

Fig. B-9

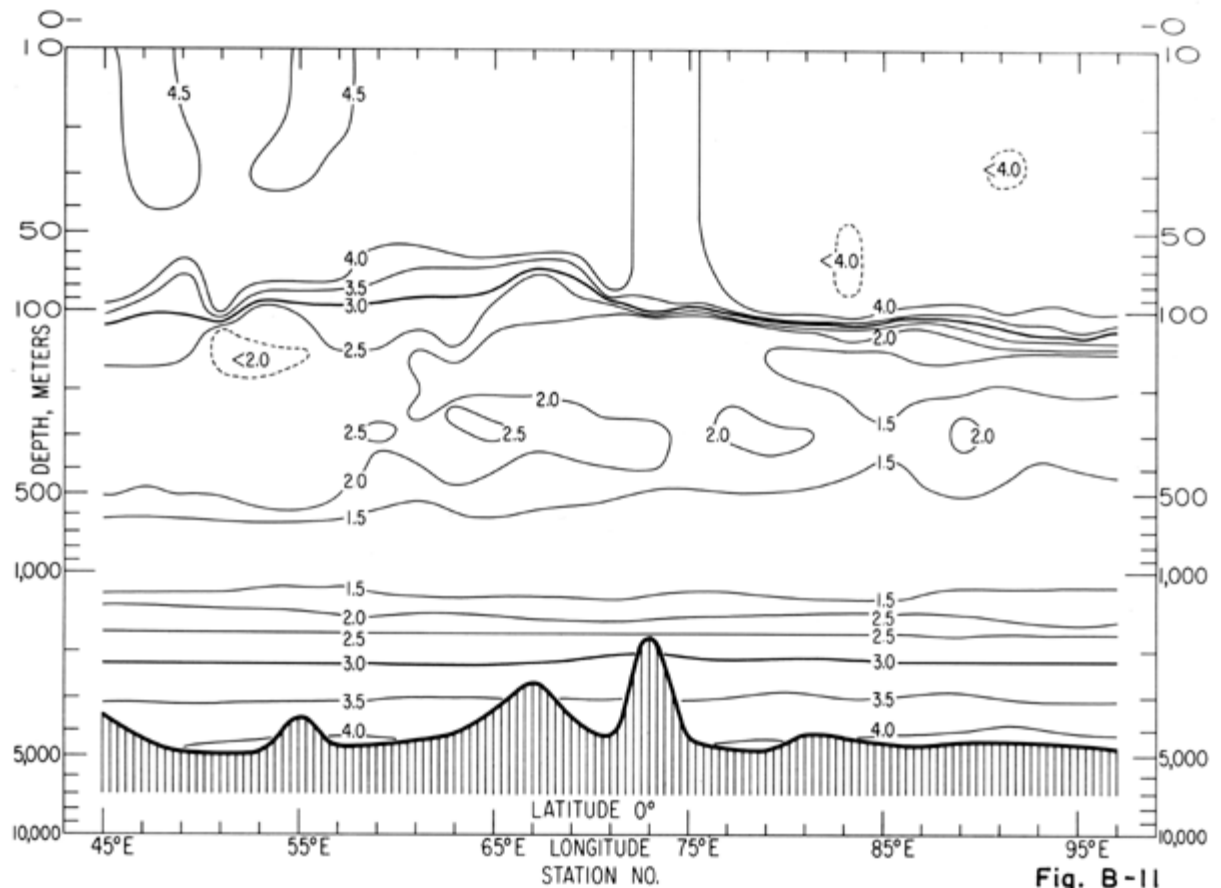




**Fig. B-10**

VERTICAL DISTRIBUTION OF SALINITY ALONG THE EQUATOR.  
 CONTOUR INTERVAL: 0.1 ‰. DATE: JULY 1 - 22, 1962.

Fig. B-10



VERTICAL DISTRIBUTION OF DISSOLVED OXYGEN ALONG THE EQUATOR.  
 CONTOUR INTERVAL: 0.5 ml/L. DATE: JULY 1-22, 1962.

Fig. B-11

Fig. B-11

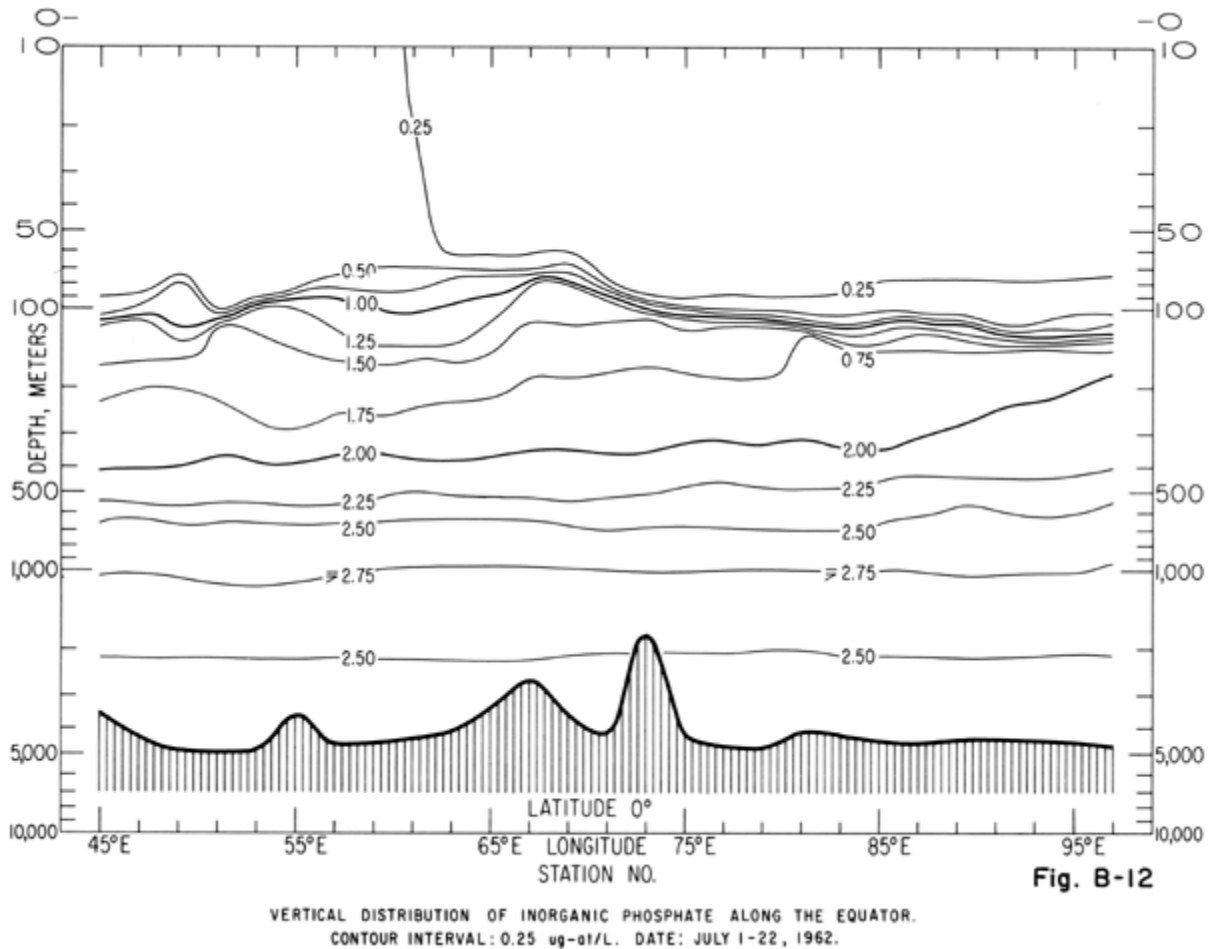


Fig. B-12

1 Regrettably, the suggestion that IIOE Reference Station #15 be moved from 32°00'S, 35°20'E, to another previously sampled locality at 31°30'S, 34°30'E, (Inf. Paper No. 2, UNESCO/NS/IOC/INF-42, March, 1963) did not reach *Argo* before her passage from Mombasa to Cape Town. Therefore, LUSIAD Station IV-H-3 was taken at 32°00'S, 35°12'E, one mile from the earlier and 52 miles from the later-accepted position for Reference Station #15. (See tabulation on page 181).

2 See note concerning technique used in tripping the casts at the end of section A.

3 These stations (similar to the two ZEPHYRUS stations) commonly consisted of the usual shallow detailed cast in association with a cast consisting of 6 to 10 Nansen bottles placed at 500-meter intervals on the hydrographic wire, with a temperature probe at the end of the wire and an Edgerton pinger 100 fms (about 180 meters) above the probe.

4 At the two ZEPHYRUS stations, only salinity and temperatures were measured. For the three stations between Mombasa and Cape Town, T, S, O<sub>2</sub>, and inorganic phosphate were determined.

5 Reid, Robert O., 1950 "A Rational Method for Interpolating Depths for Hydrographic Casts".

6 Pollak, M. J., 1950, "Notes on Determining the Depths of Sampling in Serial Oceanographic Observations."

7 Klein, Hans T., 1957, "Tables for Adjustment of Accepted Depth Below 1100 Meters."

8 For the three LUSIAD casts between Mombasa and Cape Town, salinities were determined by means of an inductive salinometer designed and constructed by Auto Lab Industries, Sydney, Australia. Duplicate runs were made, and the values were averaged to hundredths because of the difficulties with controlling instrument drift aboard ship. On ZEPHYRUS, duplicate runs were made on a U of W and PNL conductance bridge.

9 Wooster, W. S., 1950, "Methods in Chemical Oceanography Employed in the California Sardine Research Program". For the three Mombasa-Cape Town casts the oxygen was determined by the Winkler method, as modified by T. J. Chow (1961) "Chemical Analysis of Sea Water". The inorganic phosphate was determined by the Doniges method, as adapted by T. J. Chow (1961), as above, using the Beckman DU Spectrophotometer.

10 Klein, Hans T., 1956, "A new technique for processing physical oceanographic data".

11 Not done on all stations.

12 Upper 1000 meters only.

---

— 77 —

## **INDIAN OCEAN BATHY THERMOGRAPH TEMPERATURE SECTIONS**

### **MONSOON Expedition 1960–61 and LUSIAD Expedition (Cochin to Port Darwin) 1962**

One of the several purposes of the Indian Ocean expeditions of the Scripps Institution was, and is, the taking of Bathythermograph (BT) temperature observations along the ships' tracks.

Fig. C-1 is an index chart of *Argo's* Indian Ocean tracks on MONSOON Expedition and *Horizon* and *Argo* tracks on the Cochin - Port Darwin (4 October – 23 December, 1962) portion of LUSIAD Expedition. The temperature data have been assembled into roughly latitudinal and longitudinal sections. The section numbers are indicated in Fig. C-1. Sections have been numbered chronologically, beginning with Section 1 from MONSOON observations starting on October 12, 1960, and ending with Section 33 based on LUSIAD observations of December 22, 1962.

However, in Figs. C-2 through C-7 the sections are not presented in chronological order. Rather, portions of the cruises that fall on approximately the same latitude or longitude are presented together, with breaks between the sections indicating gaps in the time continuity. The primary latitude or longitude scale is drawn (as a bar-scale) at the bottom of each section; an additional scale, below the sections shows the secondary geographical coordinate. Ticks along the zero depth line of the sections indicate BT observations. Inverted T's on the face of the sections show the depth to which the individual BT traces extended. These depths are variable. Dashed lines are used when isotherms are drawn below the depths of intermediate BT observations.

In Figs. C-2 and C-3 are presented the temperature sections based on *Argo's* MONSOON Expedition data; Figs. C-4 through C-7 show the data taken on tracks between Cochin and Port Darwin on LUSIAD Expedition. On this portion of LUSIAD *Horizon* and *Argo* followed roughly parallel tracks (except for *Argo's* diversion to Kerguelen while *Horizon* visited Saint Paul Island). Hence, on Figs. C-4 to C-7 the temperature sections

---

— 78 —

prepared from each ship's BT data are arranged with *Horizon's* sections drawn above *Argo's* data but employing the same latitude or longitude scales; this is done to draw attention to the differences in temperature structure that appear from observations taken at nearly the same time from ships displaced only a relatively small distance apart.

The most noticeable differences between the *Horizon* and *Argo* sections are those related to oscillations in the depth of the thermocline which are not in phase with each other.

The tracks of MONSOON and LUSIAD crossed at five localities, making it possible to make comparisons of the temperature structure at these points from observations taken approximately two years apart.

At the 12°S, 94°E crossing of MONSOON section 15 and LUSIAD section 33, BT's taken on November 24, 1960 were compared with BT's taken on December 13, 1962. The temperatures in the surface isothermal layer were 27.3°C and 27.6°C for MONSOON and LUSIAD observations, respectively. A secondary thermocline occurred at 38 m on both sections; the main thermocline was located at 88 m (MONSOON), at 110 m (LUSIAD).

At the 17°S, 92°E crossing of MONSOON section 16 and LUSIAD section 32, BT's taken on November 26, 1960 and December 9, 1962 showed that temperatures in the isothermal layer were 26.0°C and 26.1°C and the depth of the thermocline 50 m and 57 m, respectively, for the two lowerings.

At the latitude of these two crossings, about 12°S and 17°S, respectively, seasonal changes in the surface layer are small. These data also indicate that the net differences in temperature structure at these two locations between November, 1960 and December, 1962 were insignificant.

---

— 79 —

It is not possible to distinguish the seasonal differences from the year-to-year differences for the MONSOON-LUSIAD crossing at 33°S, 118°E, at 40°S, 71° and at 40°S, 73°E. At these crossings the seasonal time intervals are respectively 36 and 43 days, and month-to-month differences from November to January are large at these latitudes. In these comparisons the temperature differences above the thermocline exceed 2°C, and the differences in thermocline depths exceed 70 m.

The BT temperature sections based on data taken during the Equatorial Undercurrent Survey will be presented and discussed in a forthcoming publication of the detailed results of this survey.

(M.K.R.)

## CAPTIONS

Fig. C-1 Index chart of BT temperature sections for portions of SIO Expeditions MONSOON and LUSIAD, 1960–1962.

Fig. C-2 MONSOON Expedition, *Argo* BT temperature sections: Longitudinal sections 1, 3, 4, 5, 6, 9, 12; Latitudinal sections 2, 7, 8, 10, 11, 13, 15, 18.

Fig. C-3 MONSOON Expedition, *Argo* BT temperature sections: Longitudinal sections 14, 16, 17, 19, 20.

Fig. C-4 LUSIAD Expedition, *Horizon* and *Argo* BT temperature sections: Latitudinal sections 22 and 24.

Fig. C-5 LUSIAD Expedition, *Horizon* and *Argo* BT temperature sections: Longitudinal sections 25, 26, 27, 28, 29, 30; Latitudinal section 32.

Fig. C-6 LUSIAD Expedition, *Horizon* and *Argo* BT temperature sections: Longitudinal sections 21, 23, 31.

Fig. C-7 LUSIAD Expedition, *Horizon* and *Argo* BT temperature sections: Longitudinal section 33.

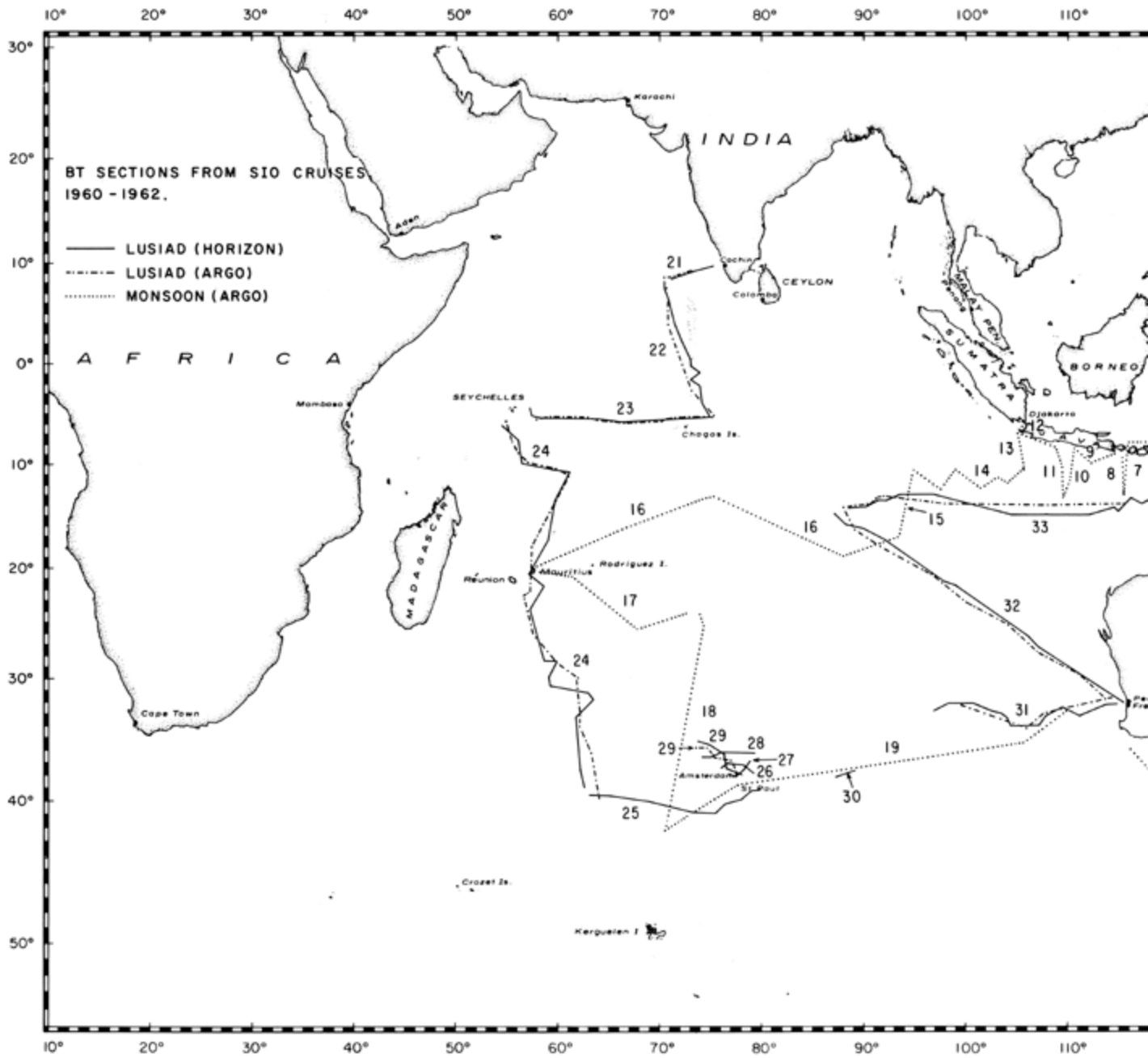


Fig. C-1





# LONGITUDE SECTIONS

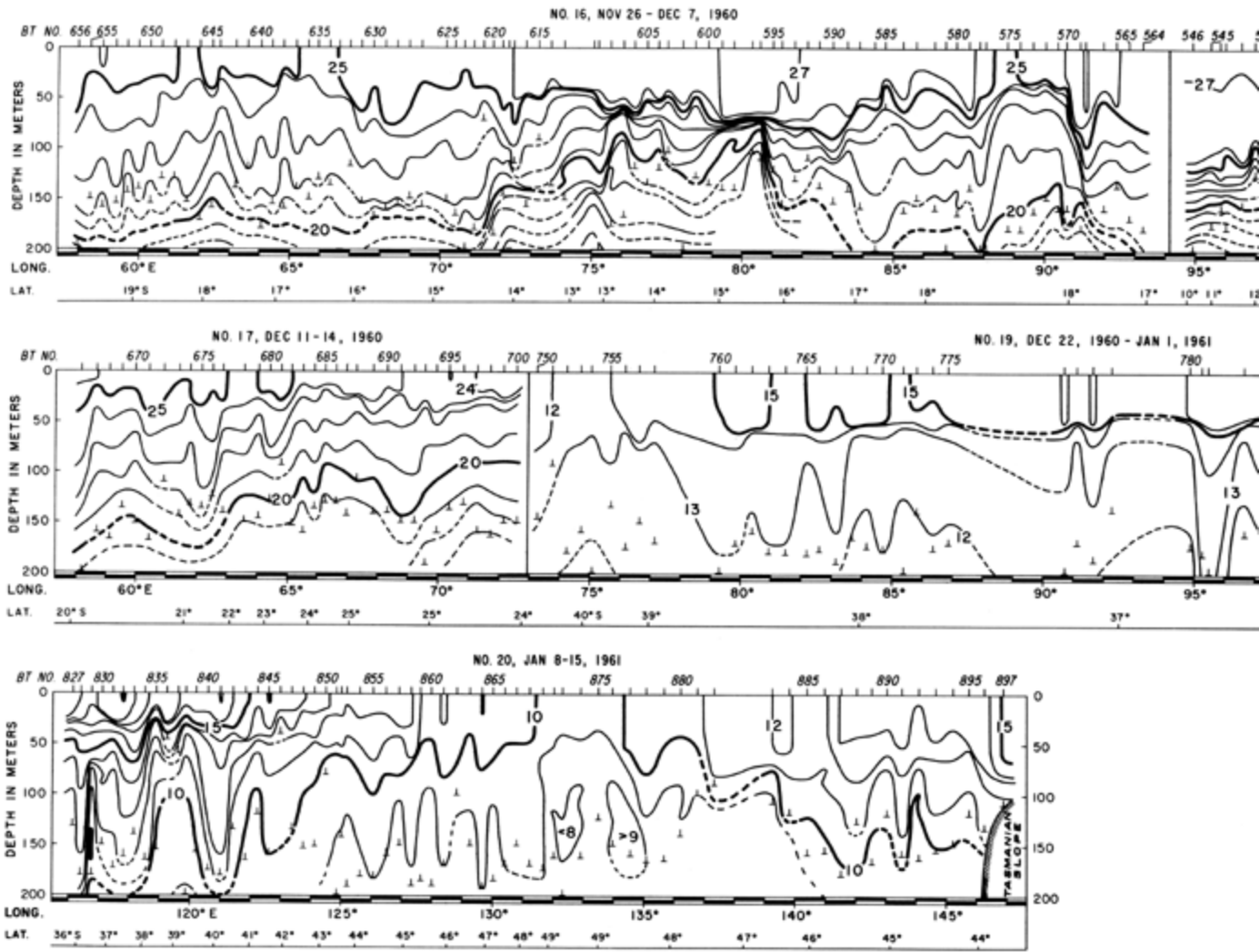


Fig. C-3

# LATITUDE SECTIONS

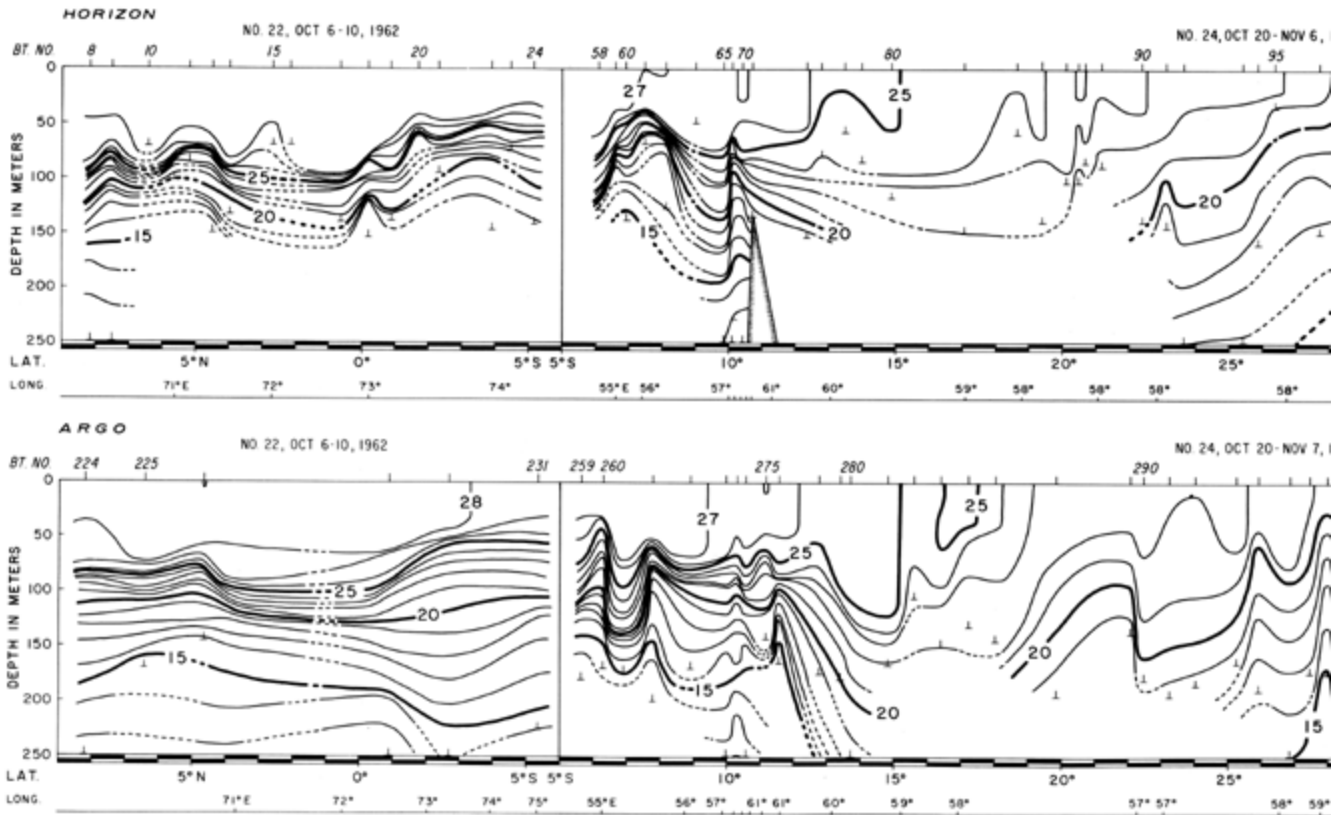


Fig. C-4

# LONGITUDE SECTIONS

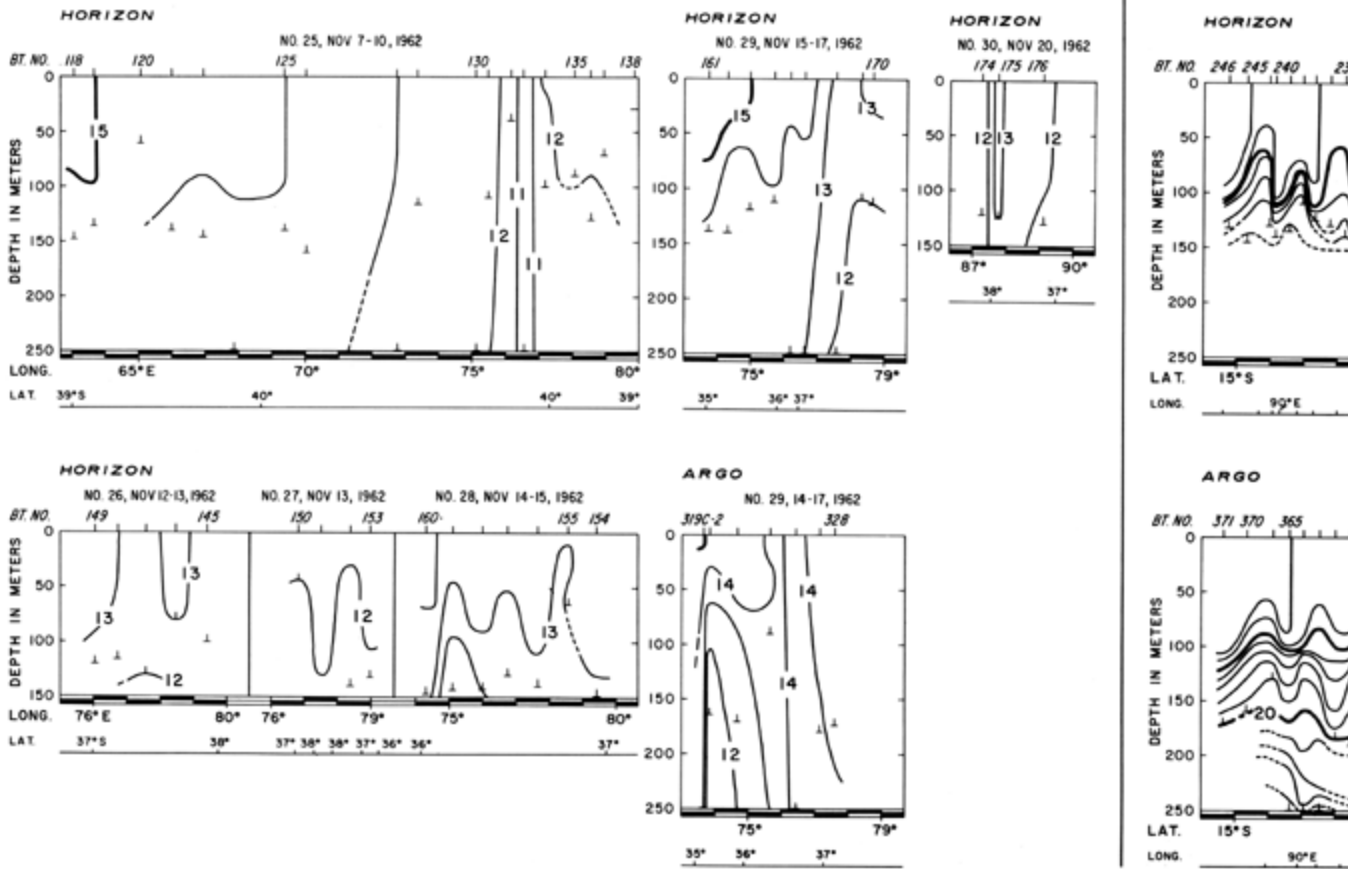


Fig. C-5

LONGITUDE SECTIONS

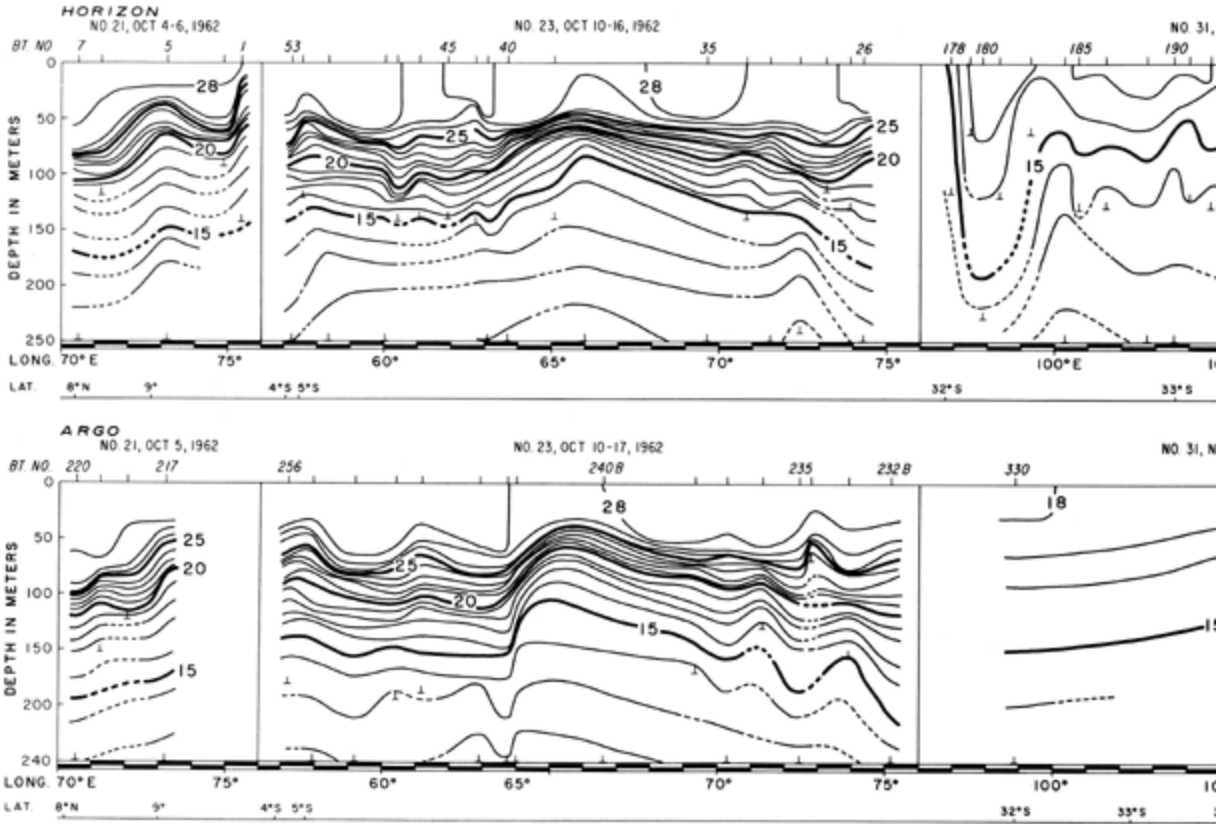


Fig. C-6

# LONGITUDE SECTIONS

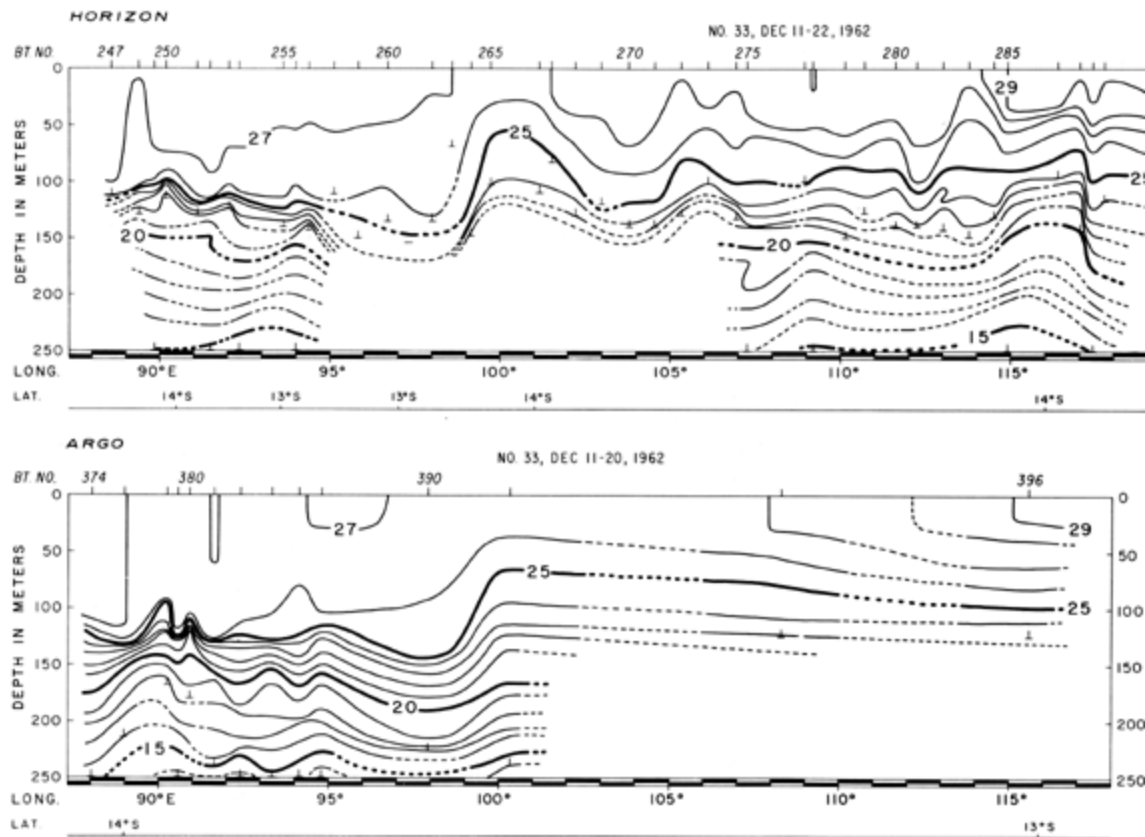


Fig. C-7

# INDIAN OCEAN EXPEDITION INVESTIGATIONS BY MEMBERS OF THE SIO CARBON DIOXIDE PROJECT, 1960–63

## I. MONSOON Expedition

Prior to January, 1961, when *Argo* left Wellington for San Diego, CO<sub>2</sub> investigations were limited to the collection of 51 air samples in flasks. Thirty-four of these samples were taken in the Indian Ocean in an area bounded by 10°30'S to 49°30'S and 61°40'E to 153°46'E between October 4, 1960 and January 12, 1961. The planned program of seasurface partial pressure measurements in the Indian Ocean was abandoned when the analyzer was found damaged by sea salt. After Wellington, with this equipment finally in operation, 1580 hours of continuous analyzer air sampling were logged, in latitudes 65°S to 30°N in the Pacific. Some discussion of these results is contained in Bolin and Keeling, 1963.

## II. LUSIAD Expedition

### Introduction

The SIO Carbon Dioxide Project participated in LUSIAD Expedition on R/V *Argo* as part of a continuing program to elucidate the role of air-sea interaction in the geochemical cycle of carbon. Using an infrared gas analyzer as described by Smith (1953), measurements of partial pressure of carbon dioxide in the atmosphere and surface sea water were carried out during the entire 15 months of the expedition. A detailed description of the apparatus and experimental procedure, as well as a tabulation and discussion of data obtained on DOWNWIND and MONSOON Expeditions is reported by Keeling et al. (1964). The sea water equilibrators used to mix a closed

---

— 81 —

circuit of air with a continually renewed supply of surface water was an improved version of the design employed on MONSOON Expedition.

The first three days at sea were utilized to complete the installation and for testing and initial calibration of the equipment. Continuous analysis of atmospheric air for CO<sub>2</sub> content was started on May 18 and sea water partial pressure measurement on May 22.

From May 15 to November 28 the program was operated by a staff of three during 24 hours per day. Continuous measurements of atmospheric CO<sub>2</sub>, interrupted only by periodic equipment calibrations, were carried out during the entire time the ship was at sea. Surface water partial

pressure measurements were made at all times when the ship was underway and during some of the periods when the ship was occupying stations. From July 2 to September 21, 1962, the sea water equilibrator was shut down on buoy stations in order to utilize the time for preliminary reduction of data.

From December 3, 1962, to March 17, 1963, continuous operation of the program was curtailed to allow observations by a single technician assisted occasionally by UNESCO Fellows and other members of the scientific party. Continuous atmospheric measurements were made automatically on a 30 minute cycle, using an electric timer during periods when no operator was in attendance. Sea surface partial pressure measurements were mostly limited to intervals when the ship was underway. Commencing March 23 and continuing to the end of the expedition the program was again operated by a staff of three on a round-the-clock basis.

In the course of the whole expedition 14,000 individual measurements were made of partial pressure of carbon dioxide in the surface ocean waters and

---

— 82 —

30,000 assays of atmospheric CO<sub>2</sub> were obtained. In addition 71 pairs of discrete air samples were collected in evacuated glass flasks for analysis in the laboratory at Scripps. An additional 20 pairs of samples were taken aboard the other ship participating in LUSIAD Expedition, R/V *Horizon*, during January and February, 1963, on its return trip to San Diego from Port Darwin, Australia.

Data from several sections of the track have been processed to give partial pressure values expressed in units of parts per million carbon dioxide by volume (p.p.m.) for both atmospheric measurements and for air equilibrated with surface sea water. This comprises 95% of the 1962 data plus an Atlantic equatorial crossing about 6 months later. Initial evaluation of the sections are discussed below, with emphasis on the results obtained for the sea water.

## **Pacific Ocean**

The first leg of the expedition, from San Diego to Manila, yielded partial pressure measurements along a longitudinal track in the North Pacific Ocean ([Fig. D-1](#)). From 1500 May 18 to 1400 June 9 a total of 1477 atmospheric and 983 sea surface measurements were made. The run at 35°N Lat. is the farthest north and the longest east-west profile so far obtained by Scripps. The results are assembled in Fig. D-2 which shows the surface partial pressure of carbon dioxide, the atmospheric concentration, and sea water surface temperature, all versus longitude. The plotted points represent means obtained by averaging data for two-and-one-half-degree longitudinal intervals.

The atmospheric values appear as an almost regular horizontal line. Likewise the sea surface temperature remains nearly constant along the 35°N parallel and then rises gradually as the track turns south. On the other hand

---

the sea water partial pressure decreases steadily from 309 p.p.m. to a minimum of 252 p.p.m., then rises steadily until 320 p.p.m. (equilibrium with air) is reached in the 135°–132.5°E long. interval at 25°N Lat. The feature is approximately symmetrical about 175°E longitude and the minimum is significantly lower than any similarly averaged value previously recorded in the Pacific Ocean (Keeling et al., 1964) or the minimum for the Indian Ocean recorded in October, 1962, on this expedition.

## Indian Ocean

During the first phase of the subsurface current study, July-September, 1962, 1,780 air and 732 sea water partial pressure measurements were made on a 20 day equatorial run from Singapore to Mombasa. When averaged in 2 ½° longitudinal intervals the average air concentration varies only slightly ( $\pm 1$  p.p.m.) while the average sea surface values range from 324 p.p.m. (8 p.p.m. above the average air values) to 343 p.p.m. with an average value of 330 p.p.m. (14 p.p.m. above air). Two features are apparent: (1) a "hump" between 66°E and 79°E straddling the Mid-Indian Ocean and Carlsberg ridges, and (2) a second "hump" between 46°E and 56°E, over the Somalia Basin.

An additional 3,521 air and 1,069 sea surface partial pressure measurements were made along the four 5°N to 5°S cross-sections occupied during the second and third months of the study. These data have been averaged in one degree latitudinal intervals. Again air values show only small variations. Sea water partial pressure values average about 10 p.p.m. higher than air for each of the four cross-sections with an overall range from 320 p.p.m. to 348 p.p.m. The individual plots show no distinctive features. All four cross-sections show a trend toward lower values going from north to south.

A more complete study of the equatorial region of the Indian Ocean depends primarily on completing the reduction of data taken from February 16 to May 15, 1963 during the second current study. It will then be possible to compare two seasons.

The track followed by R/V *Argo* from October 5 to December 23, 1962, is shown in Fig. D-3. During this period 4,535 air and 2,090 water measurements were recorded. The results of averaging these data in two and one half degree latitudinal intervals is shown in Fig. D-4. As in the case of Fig. D-2 the average sea surface temperature is also plotted. Both the atmospheric concentration and the sea surface temperature are shown by a single line representing an average of all values obtained for each interval. Differences observed when the ship passed through the same latitudinal interval steaming south to north on the return run were small in both cases and it is impractical to show clearly the separate tracks on this scale. Sea surface partial pressure data obtained in the areas around the Seychelles and Saint Paul and Amsterdam Islands have likewise been averaged to give a single value per interval in cases when the ship's track zig-zags.



Sea water partial pressures equal to or above air partial pressure are recorded for only about 23% of the track covered in the October-December, 1962, period. With the exception of the two intervals between 47.5° and 52.5°S latitude, near Kerguelen Island, all the higher-than-air values were observed while running between 10°N and 12.5°S latitude from October 6 to 24. As can be seen in Fig. D-3 nearly one half of this portion of the track comprises a longitudinal run from 75°E and is, therefore, represented by a single point in Fig. D-4. Likewise this type of presentation of LUSIAD data

---

— 85 —

masks details of longitudinal variations in the predominantly west to east run in the 30°-40°S latitude region and again at 15°S latitude.

The sudden increase in sea surface partial pressure observed near Kerguelen Island may not be representative of general conditions in the higher latitudes of the Indian Ocean, but may be an "island effect" where the surface waters have been modified by a variety of runoff products. The track does not extend sufficiently far south to determine if the increase in pressure is sustained.

The effect of temperature on sea surface CO<sub>2</sub> partial pressure can be deduced from the investigation of the carbon dioxide system by Buch et al. (1932), Buch (1951) or from the experimental values between 3° to 30°C obtained by Takahashi (1961). The change in pressure with temperature varies from 8 p.p.m. to 13 p.p.m. CO<sub>2</sub>/C° for pressures near 300 p.p.m. It is observed in Fig. D-4 that the sea surface temperature decreases from about 28° in the first plotted interval to 5°C in the 47.5°-50°S interval while the partial pressure changed from 334 p.p.m. to 272 p.p.m. Thus the low surface water values cannot be explained purely on the basis of temperature decrease since the observed temperature change would produce a much larger partial pressure differential.

On the return run north from Kerguelen there are no marked departures from the mean values obtained on the initial run south; neither is there close retracing such as was observed at the same latitudes in the Pacific Ocean during DOWNWIND Expedition (Keeling, et al., 1964).

## **Atlantic Ocean**

Measurements from a portion (15°S to 7°N) of the track between Cape Town,

---

— 86 —

South Africa and Freetown, Sierra Leone, representing 827 atmospheric and 408 sea surface partial pressure measurements have been evaluated ([Fig. D-5](#)). Air values show small variations. Sea surface values appear to be nearly in equilibrium with the air (310 p.p.m.) from 15°S to 5°S, then rise sharply in the 5°-4°S Lat. interval, reach a maximum of 334 p.p.m. in the 3°-2°S interval, then fall 20 p.p.m. below air to 290 p.p.m. just north of the equator and remain low until the equilibrator was shut down approaching Freetown ([Fig. D-6](#)).

This equatorial increase is not as large as the similar feature observed on the two earlier expeditions in the Pacific Ocean, and is located wholly in the southern hemisphere. The low sea surface partial pressure values observed north of the equator may result from continental runoff which markedly reduced by dilution the surface water salinity.

## Summary

1. In the Pacific Ocean surface water partial pressure measurements made during May and June, 1962, along an E-W cross-section at 35°N Lat. between 152.5°W and 122.5°E Long. show a marked under-pressure in carbon dioxide with respect to the atmosphere. A maximum under-pressure of 68 p.p.m. was observed at 175°E Long.
2. A total of 3,891 sea water partial pressure measurements made in the Indian Ocean, July-December, 1962, indicate a CO<sub>2</sub> over-pressure in the surface waters with respect to the atmosphere north of 15°S and an under-pressure between 15°S and 52°S Lat., except for over-pressure observed near Kerguelen Island.
3. In the Indian Ocean no high partial pressure, as has been observed in the tropical Pacific, was found on any of four equatorial cross-sectional tracks during the first subsurface current study (July-September, 1962).

---

— 87 —

4. In the Atlantic Ocean a high partial pressure near 2°-3°S Lat., at 10°E Long. was observed in a single equatorial crossing in July, 1963. Surface water values near equilibrium were found between 15°S-5°S Lat. and an under-pressure north of the equator.
5. Atmospheric CO<sub>2</sub> partial pressure from May 18 to December 21, 1962 (Indian Ocean), were found to range from 313 p.p.m. to 322 p.p.m.; from June 28 to July 7, 1963 (Atlantic), these ranged from 310 p.p.m. to 311 p.p.m.

(L. S. W.)

## REFERENCES

- Bolin, B., and Keeling, C. D., (1963) Large-scale atmospheric mixing as deduced from the seasonal and meridional variations of carbon dioxide, *J. Geophys. Res.*, v. 68, pp. 3899 – 3920.
- Buch, K. (1951) , Das Kohlensäure gleichgewichtssystem im Meerwasser. Havsforskn Inst. Skr., Helsingf., no. 151.
- Buch, K., Harvey, H. W., Wattenberg, H. and Gripenberg, S. (1932) , Ueber das Kohlensäuresystem im Meerwasser. *Rapp. Cons. Explor. Mer*, 79. 1–70.
- Keeling, C. D., Rakestraw, N. W., Waterman, L. S., (1964) , Carbon dioxide in surface waters of the Pacific Ocean, to be submitted to *J. Geophys. Res.*
- Smith, V. N., (1953) , A recording infrared analyzer, *Instruments*, 26, pp. 421–427.
- Takahashi, T. (1961) , Carbon dioxide in the Atmosphere and in Atlantic Ocean water, *J. Geophys. Res.*, 66, pp. 477–494.
-

## CAPTIONS

Fig. D-1 LUSIAD Expedition: Track of R/V *Argo*, May 18 to June 9, 1962.

Fig. D-2 The average partial pressure of CO<sub>2</sub> in sea water and in the atmosphere, near the sea surface, versus longitude along the track shown in Fig. D-1.

Fig. D-3 LUSIAD Expedition: Track of R/V *Argo*, October 6 to December 21, 1962.

Fig. D-4 The average partial pressure of CO<sub>2</sub> in sea water and in the atmosphere, near the sea surface, versus latitude along the track shown in Fig. D-3.

Fig. D-5 LUSIAD Expedition: Track of R/V *Argo*, June 28 to July 7, 1963.

Fig. D-6 The average partial pressure of CO<sub>2</sub> in sea water and in the atmosphere, near the sea surface, versus latitude along the track shown in Fig. D-5.

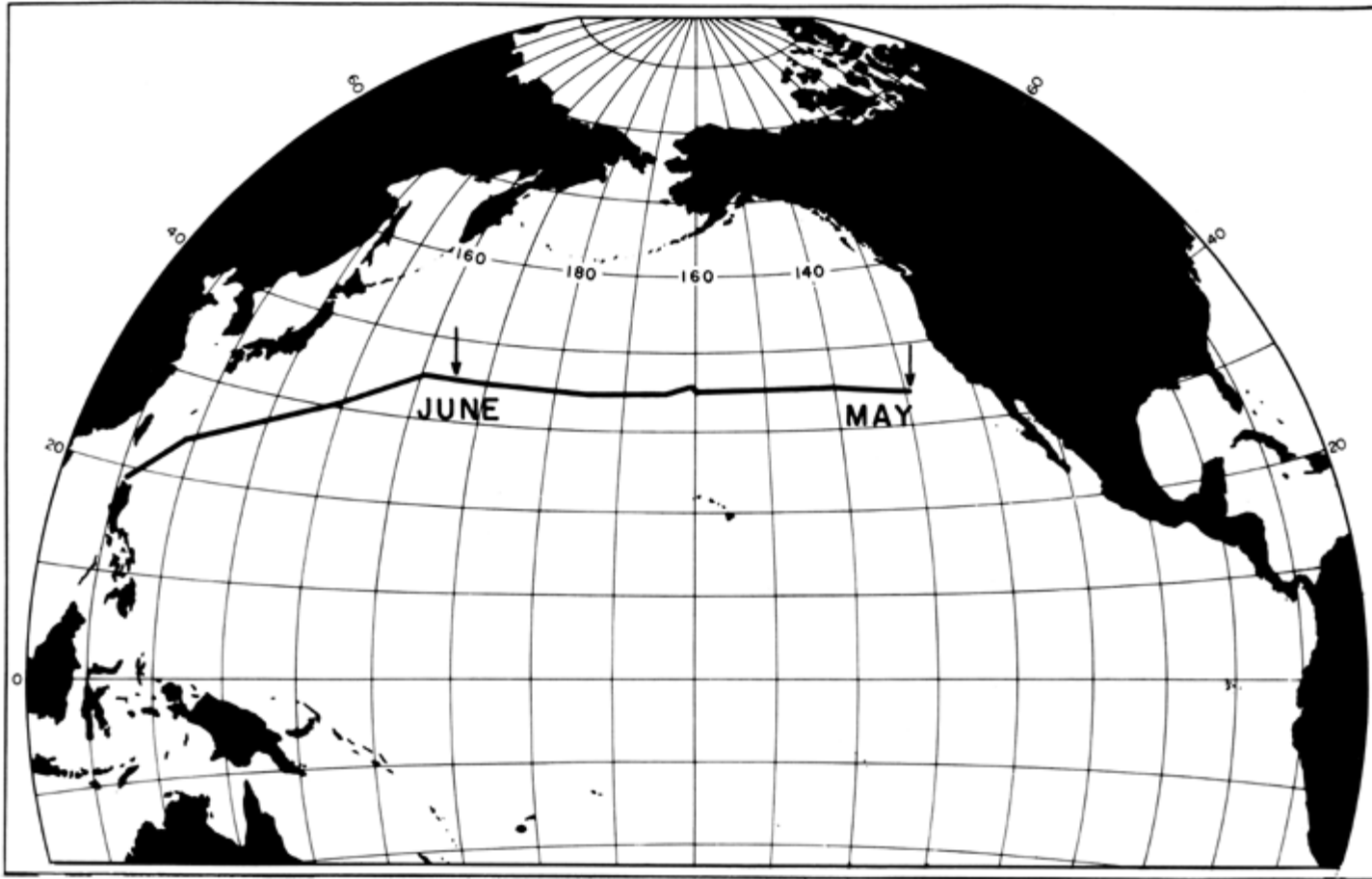


Fig. D-

Fig. D-1

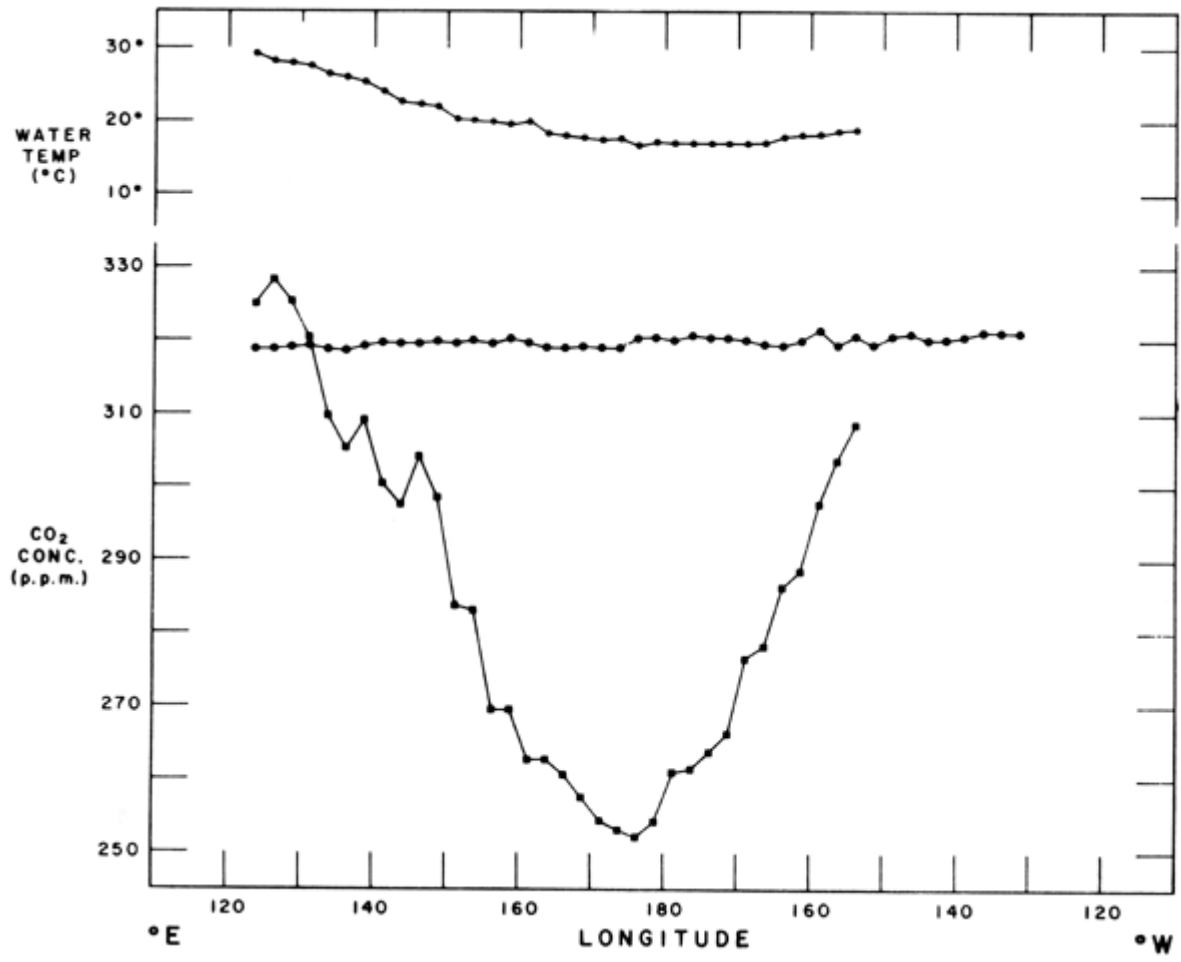


Fig. D-2

Fig. D-2

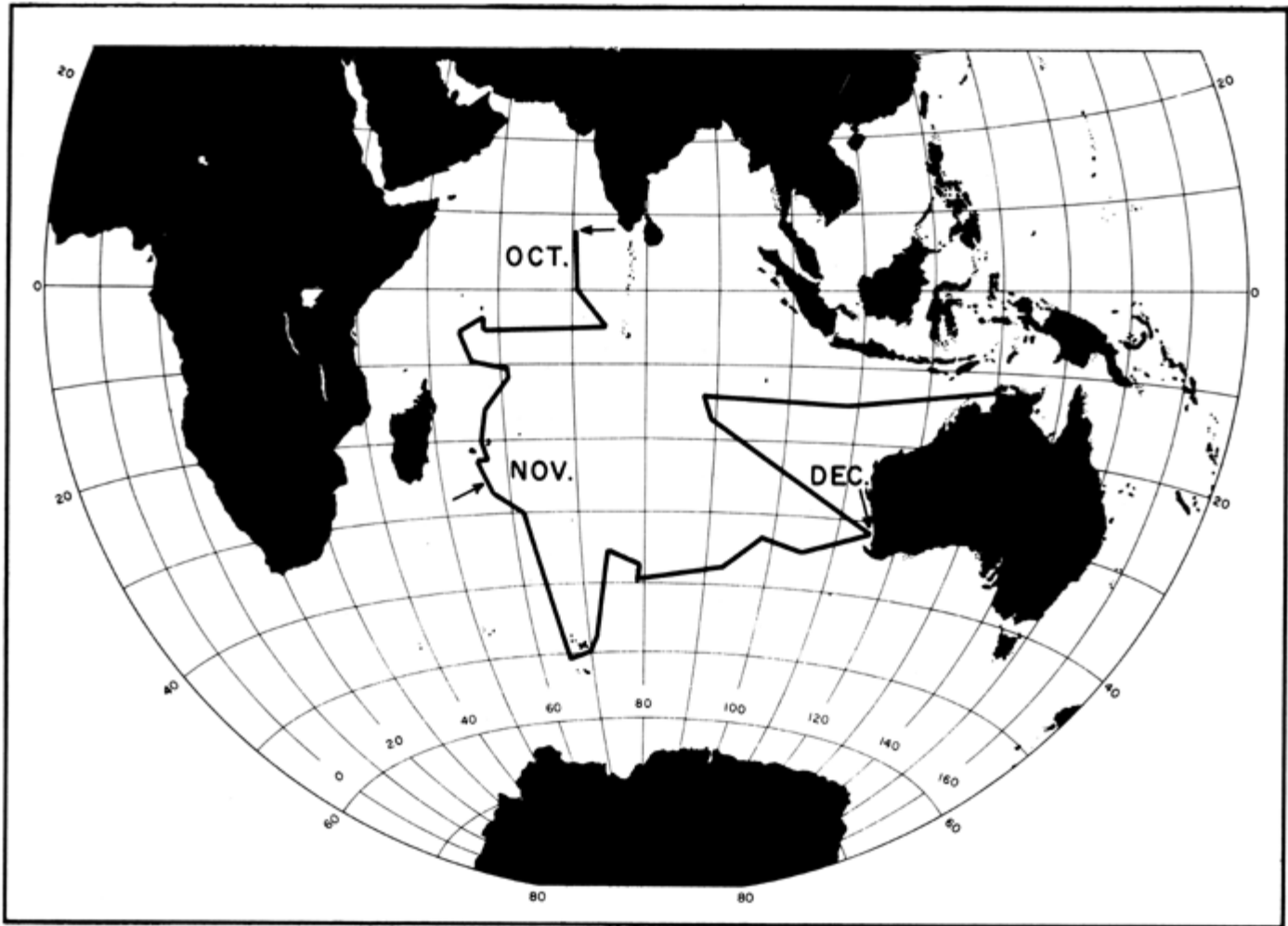


Fig. D-3

Fig. D-3

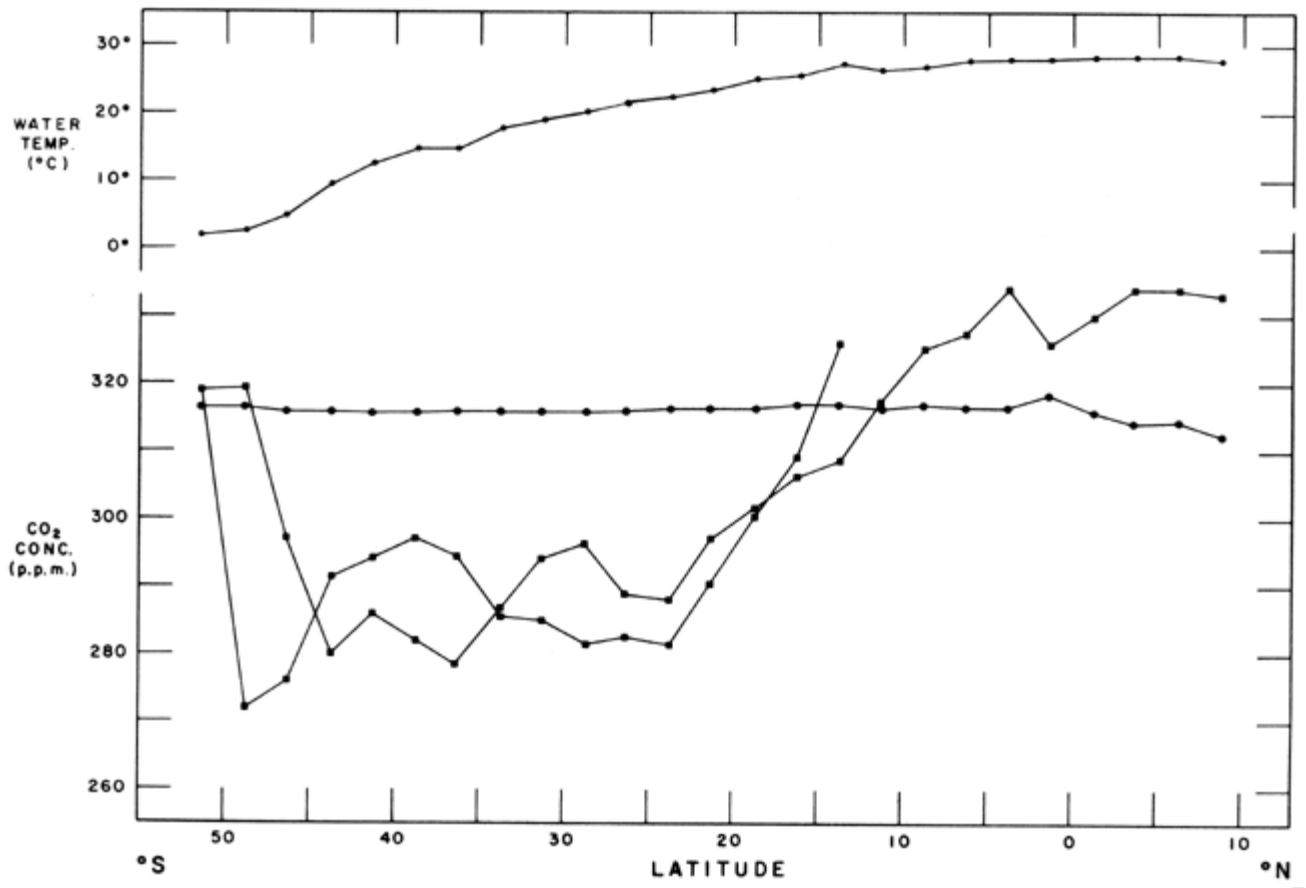


Fig. D-4

Fig. D-4

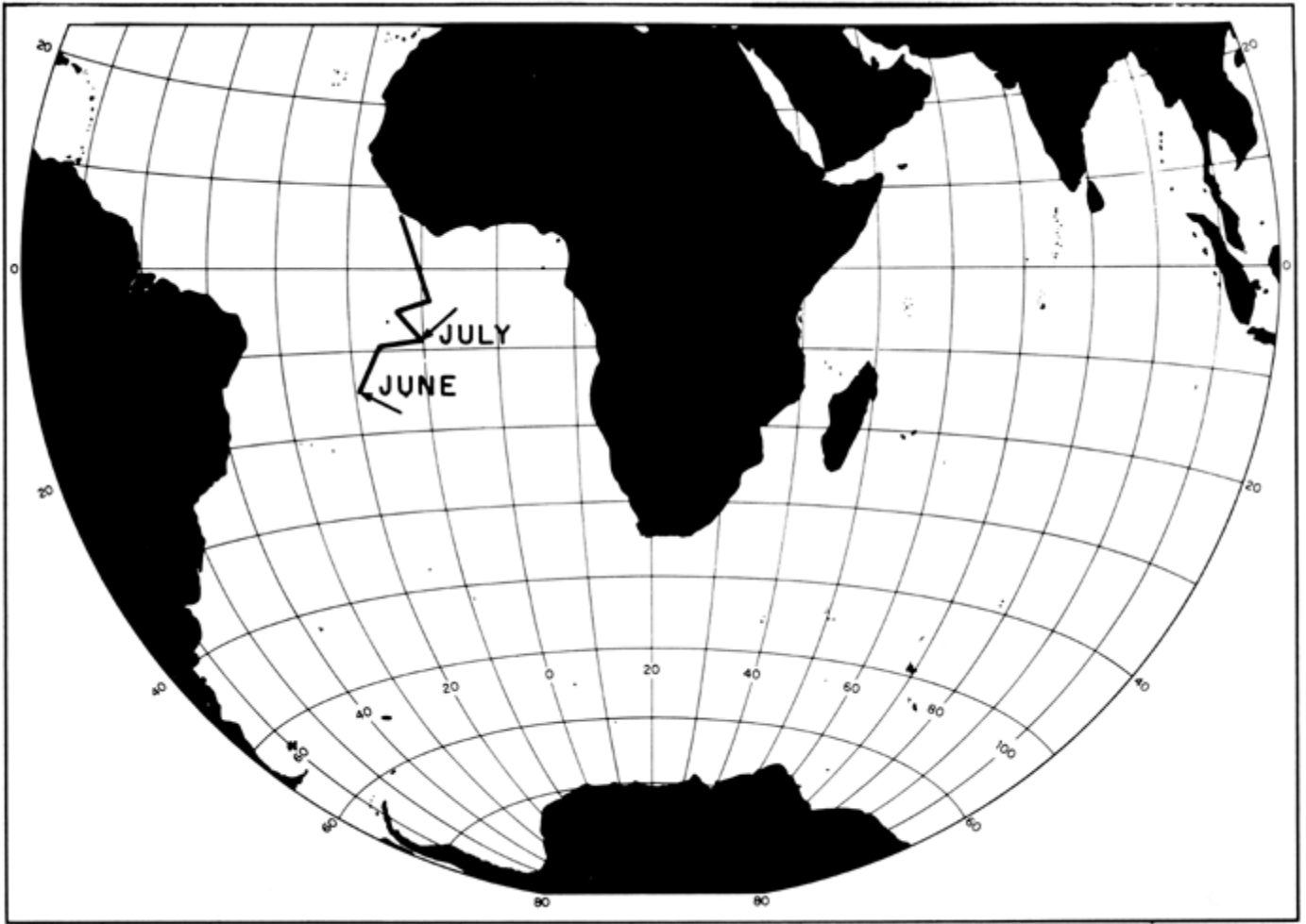


Fig. D-5

Fig. D-5



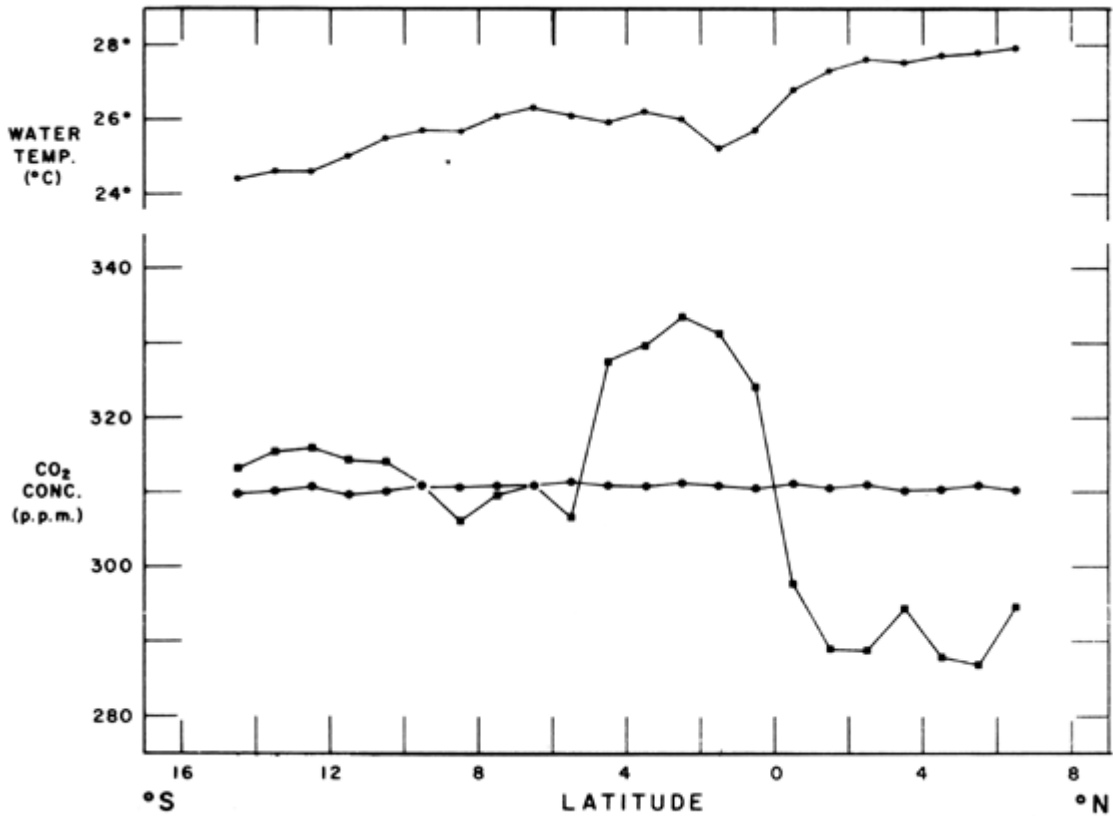


Fig. D-6

FIG. 6

Fig. D-6

## REPORT ON SAMPLING OPERATIONS - C<sup>14</sup> AND TRACE ELEMENTS, 1960-63<sup>[\*]</sup>

*MONSOON: Djakarta-Mauritius (III Series) and Mauritius-Fremantle (IV Series), November 1960-January 1961.*

A. Water samples for C-14 determination were taken from the following stations and depths.

<i>Stations (C<sup>14</sup> Designations)</i>	<i>Latitude, Longitude</i>	<i>Depths of Samples</i>
III-2	11°20'S, 103°35'E	0 m
III-4	10°27.5'S, 98°58.5'E	0, 100, 350, 1000, 3000, 5000 m
III-6	10°36.4'S, 94°54.6'E	350 m
III-6A	18°49'S, 88°33'E	0 m

III-12	17°18.5'S, 84°23.8'E	350 m
III-15	12°58'S, 75°02'E	<u>0,100,1000</u> m
III-16	14°05.5'S, 72°14.6'E	350, 3000 m
III-19A	16°45'S, 65°15'E	0 m
III-20	16°55.5'S, 64°46.7'E	350 m
IV-3+	23°S, 64°10'E	0 m
IV-5	23°56'S, 73°15'E	<u>0,100,1000,2000,3000</u> m
IV-9	33°21'S, 72°42'E	<u>0,100,1000,3000,4000</u> m
IV-11	42°03'S, 70°45'E	<u>0,100,1000,3000,4000</u> m
IV-16	37°50'S, 85°22'E	0 m
IV-19	36°18.5'S, 98°40.5'E	<u>0,100,1000,3000</u> m
IV-19A	33°14'S, 108°45'E	0 m

Those underlined were also used for Ra determination after removal of CO<sub>2</sub>.

---

— 90 —

B. Two-liter surface samples for tritium analysis at Stations:

III-2	11°20'S, 103°35'E
III-4	10°27.5'S, 98°58.5'E
III-15	12°58'S, 75°02'E
III-20	16°55.5'S, 64°46.7'E
IV-3	22°10'S, 63°15'E
IV-5	23°56'S, 73°51'E
IV-9	33°21'S, 72°42'E
IV-11	42°03'S, 70°45'E
IV-16	37°50'S, 85°22'E
IV-19	36°18.5'S, 98°40.5'E

C. 1000 cc samples for Rb determination were taken from Stations:

III-2	11°20'S, 103°25'E	0 m
III-4	10°27.5'E, 98°58.5'E	0,100,350,1000, 3000,5000 m

---

*LUSIAD: Cochin—Fremantle, October–November, 1962*

A.

Stations (Hydro-cast Designation)	Latitude, Longitude	$C^{14}$ samples (50-gal) from depths	Notes
III-98	8°16'N, 70°37'E	0, 100, 200, 400, 600, 800, 1000, 2000, 3000, 3800 m	Several of these were also used for Ra determination
III-101	5°21'S, 75°06'E	0, <u>1000</u> , 3000, <u>5000</u> m	Those underlined were also used for Ra determination. Samples from 0 and 3000 were subsequently given to the Tata Institute (after removal of CO <sub>2</sub> ). Samples (about 25) from a hydro cast were sealed in glass ampoules for later determination of deuterium and O <sup>18</sup> .
III-103A	5°35'S, 63°47'E	0, 2000, 3000, 4000 m	All of these were also used for Ra precipitation after removal of CO <sub>2</sub> .
III-106A	9°54'S, 56°20'E	0, 3500 m	
III-106B	13°41'S, 59°42'E	0 m	
III-106C	17°19'S, 57°42'E	0 m	
III-108A	22°S, 57°30'E	0 m	
III-109	26°51'S, 58°15'E	0, 5500 m	Deep sample was also used for Ra determination after removal of CO <sub>2</sub> .
III-110	31°27'S, 61°50'E	0, 3500, 4400 m	Samples (50 gals.) from surface and 3400 m were also collected for Tata Institute. Two samples, from 3300 and 4385 m, in a hydro cast were collected and sealed in steel for He determination by Suess.
III-111	39°45'S, 63°58'E	0, 4800 m	Both these were used for Ra determination after removal of CO <sub>2</sub> .
III-112	51°08'S, 65°52'E	0, 3185 m	The deep sample was also used for Ra determination. Two samples, from 1880 and 3220 m, in a hydro cast were sealed in steel for He determination by Suess.

III-112A	35°47'S, 73°35'E	0 m	
III-113	36°51'S, 76°23'E		Large water samples (50 gals.) were taken from 0, 500, 1000, 2000 m for Tata Institute.
III-113A	37°56'S, 87°38'E	0 m	
III-114	33°48'S, 96°01'E	0, 4300 m	Both were used for Ra determination after CO <sub>2</sub> removal.
III-115	32°02'S, 98°52'E		Three water samples-from 21, 581 and 1355 m- in a hydro cast were taken and sealed in steel for He determination by Suess.
III-116	34°11'S, 105°54'E	3430 m	
III-117	32°50'S, 108°45'E	0, 5525 m	

B. The following 4-liter water samples were taken and filtered for later determination of organic matter in water and particulate matter by Sayed El Wardani at San Jose State College.

III-105	4°00'S, 58°00'E	0, 3700 m
III-106A	9°54'S, 56°20'E	0, 100, 500, 1000, 2000 m.
III-117	32°50'S, 108°45'E	0, 50, 100, 500, 1500 m.

(N. W. R.)

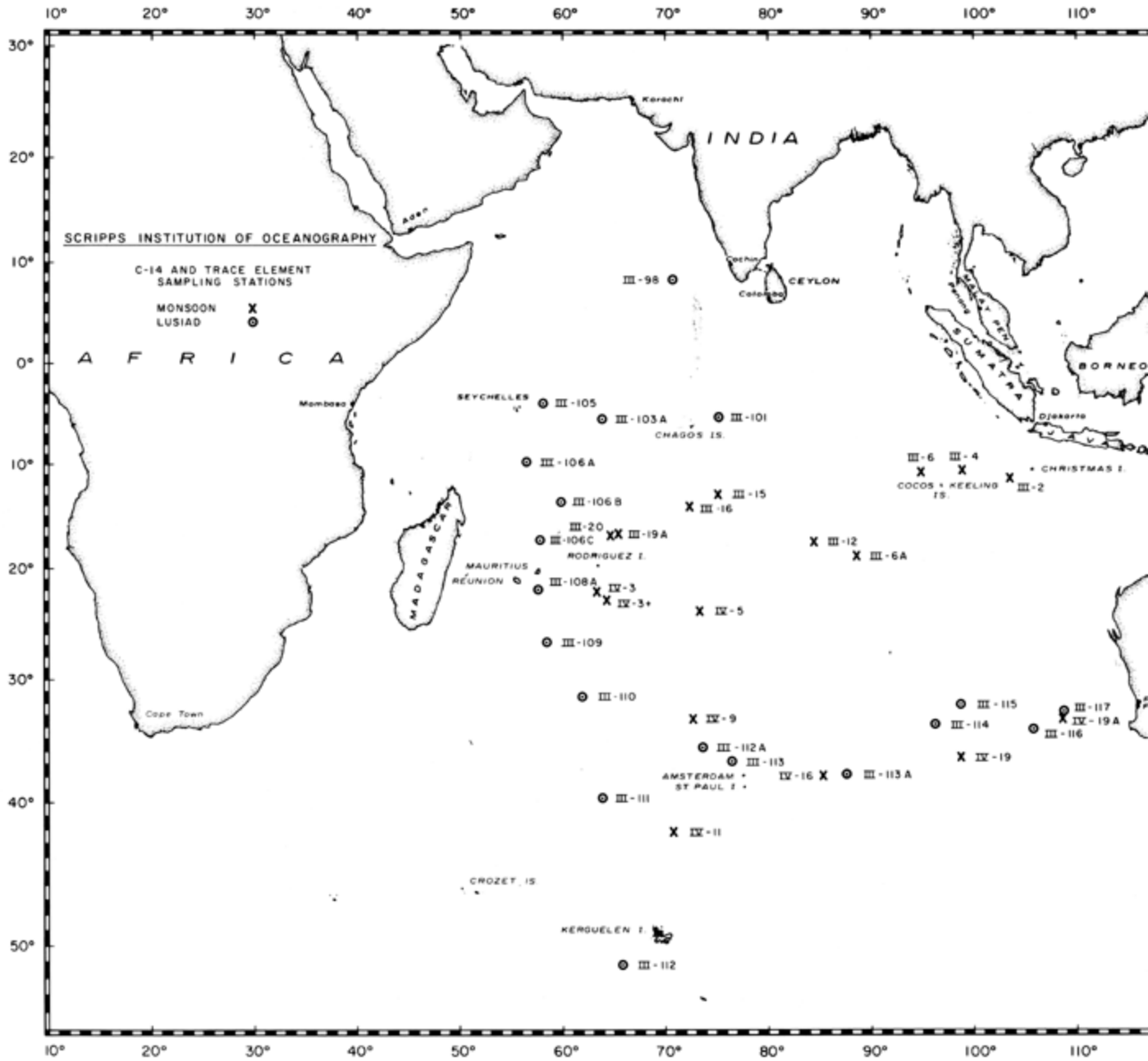


Fig. E-1

\* (See Fig. E-1)

## BENTHIC BIOLOGICAL STUDIES - MONSOON EXPEDITION<sup>[1]</sup>

As originally designed, the benthic biological studies for MONSOON Expedition were expected to provide additional information on the faunas of the lower continental slope and the abyssal-to-hadal sea floor close to continents and to further examine questions of the relative age of deep sea faunas with regard to relative ages of deep sea features and topography (as discussed in Parker, 1961 and in press). Considerable sampling of this environment on the comparatively old Pacific Ocean floor has been carried out during Scripps Institution investigations along the coast of Middle America. It was then decided to explore regions of similar depths in the Indian Ocean, of perhaps lesser age, but adjacent to old (Pre-Cambrian) continental masses.

Robert Rowland of Scripps Institution and San Diego State College, who participated in the expedition from San Diego to Wellington, New Zealand, was responsible for benthic biological sampling from Hawaii to Port Darwin, Australia, and from Mauritius to New Zealand. The author joined the expedition at Port Darwin and left at Mauritius. Considerable assistance was given by the other members of the expedition, and most especially by biologists James Coatsworth and Curtis Russell. After *Argo* left the Indian Ocean, several very productive dredge hauls were obtained on the Chatham Rise, southeast of New Zealand; these were taken for the geological program under H. W. Menard's direction.

Equipment used for the benthic sampling program consisted of the Isaacs-Kidd high-speed, deep-diving dredge, a 30-foot otter trawl with "hydroflow" trawl boards, a  $\frac{1}{2}$  meter<sup>2</sup> Peterson grab, a small half-meter-wide shell dredge, and the standard chain-bag rock dredge. The larger of these samplers did not operate correctly, especially at great depths. It is assumed that malfunction of the then-new and relatively-untried dredging winch on *Argo* contributed much to the failure of the diving dredge and the otter trawl. In operations aboard *Spencer F. Baird* both of these devices were used successfully in abyssal depths before and after MONSOON Expedition. On several occasions it was observed that the cable was twisting at a rapid rate as it was paid out, and that a definite torque was being applied to the deep-diving dredge as the dredge was being retrieved; that is, the dredge itself was twisted way off center in the direction of the torque. Several very deep lowerings were made, both with the deep-diving dredge and otter trawl. As many as 12,000 meters of cable were paid out in the Weber Deep, where the water depth is about 7250 meters, with no indication that the otter trawl ever hit bottom. Again, south of Lombok in the Java Trench, over 10,000 meters of cable were paid out in an attempt to get the deep-diving dredge to the bottom, but with no success. After six attempts to get towed gear very near the bottom, in water depths of over 1,000 meters, it was evident that the performance of the winch and cable would not allow any deep trawling on the expedition. For this reason, the author left

*Argo* at Mauritius, rather than continuing on to Fremantle. It was not difficult to obtain samples by methods which did not involve towing on the bottom: Peterson grabs, rock dredges and shell dredges were taken in fairly shallow water. Thirty successful benthic biological collections were taken between Hawaii and Wellington; several more, not recorded under the benthic biological program, were taken on the leg of

---

— 95 —

MONSOON from Wellington to Tahiti (see [Fig. F-1](#) station locations for benthic biological samples between Cairns and Wellington).

The majority of the sublittoral samples were obtained during the Port Darwin-Djakarta-Mauritius legs of the expedition. Successful samples included 4 rock dredges, from depths ranging from 200 to 2,000 meters; 2 Peterson grab samples, one in shelf depths off Soembawa, Indonesia, and the other in the Java Trench south of Java; and five shell dredges, mostly in shelf depths. A number of shore and subtidal collections were made at Cairns, near Thursday Island, Port Darwin, Christmas Island, Mauritius, St. Paul Island, and near Fremantle. All the trawls and deep-diving dredge hauls attempted produced bathypelagic material which was included in the results of the mid-water trawl studies; mid-water trawl station numbers rather than benthic biological station numbers were given to these stations.

All samples resulting from the benthic biological program were sorted aboard ship into invertebrate classes. Specimens were fixed in formalin for two days and then transferred into ethyl alcohol for later identification. Some of the smaller and lesser-known organisms were fixed in Bouin's Fixative, for sectioning and study of the internal morphology. At the present time, all alcohol-preserved material resides in the Invertebrate Collection at the Scripps Institution, awaiting eventual analysis and identification there or by specialists in other laboratories. Echinoid material is to be studied by J. Wyatt Durham of the Museum of Paleontology, University of California, Berkeley, while some of the crustacean material is to be examined at the Allan Hancock Foundation. It is expected that the bulk of the MONSOON benthic material eventually will be sent to the United States Sorting Center at the U.S. National Museum, Washington, D.C., to be incorporated in the Indian Ocean Expedition general collections for the use of specialists engaged in the study of various Indian Ocean faunas.

---

— 96 —

No further studies on the MONSOON benthic material by this author are anticipated, as the specimens now reside at Scripps Institution, and the author is engaged in entirely different research at the Marine Biological Laboratory at Woods Hole, Massachusetts.

(R. H. P.)

<sup>1</sup>Supported by a grant from the National Science Foundation, G-13163.

# PRELIMINARY RESULTS

Only a portion of one sample was studied in some detail; this revealed a very puzzling result. A rock dredge lowering on the flat top of a shallow (1800-meter) seamount (guyot?) or ridge—on the northern flank of the eastern portion of the Timor Trough, just south of the island of Werwaru—yielded a large haul of stiff, greenish, gritty clay and shell debris and contained a curious collection of animal remains. The biological material consisted mainly of very large (80 to 120 mm.) shells of a pelecypod which was identified as a form of *Thyasira bisecta* Conrad, 1849. Other dead shells consisted of a new species of *Vesicomya*, a large *Xenophora*, a few *Nassarius* and other small pelecypods and gastropods. Living species consisted of a new large *Solemya*, various abyssal taxodont pelecypods and a few deep sea Trochids. The living assemblage was typical of the lower bathyal and upper abyssal zones in most tropical areas.

The puzzling member of the dead shell assemblage was the *Thyasira* (Fig. F-2). Oldroyd (1924) gave the range of the typical form of this species as "Off Alaska Peninsula to Puget Sound. In the Pliocene of California and Washington and Miocene of same range." Grant and Gale (1931) stated that this species has been found in the Oligocene of Washington and Miocene of Oregon and Alaska, Pliocene of Northern California and Pleistocene (coldest) of Southern California, while the recent range is

---

— 97 —

from the Alaskan Peninsula to the Oregon coast. The *Thyasira* specimens taken in the dredge haul were identical to a form named *T. bisecta* var. *nipponica* Yabe and Nomura, 1925 in a review of the *Thyasiridae* by Yabe and Nomura (1925). These authors' elongated form (corresponding to the dredged specimens) was found only in the middle Miocene (considered warmer) of Japan and the Kamchatka Peninsula. Typical *Thyasira bisecta* also occurs in lower and upper Miocene to Pleistocene deposits in Japan and on the Pacific coast of Siberia. Yabe and Nomura state that the *nipponica* variety seems to be endemic to the warm middle Miocene, while (to the writer's knowledge) the typical *T. bisecta* occurred only to the north during that time. In the upper Miocene, when the climate of Japan cooled, var. *nipponica* disappeared and was replaced by *T. bisecta*. In collections of Recent and of Tertiary material, *T. bisecta* occurs in typical shallow to deep shelf assemblages and has never been associated with sediments or species from depths greater than 100 meters. Furthermore, the shell is so large and distinctive that this form cannot be confused with any other species.

The presence of this species as abundant dead shell possibly in situ (the hinge ligament was well-preserved in a few shells) at a depth of 1850 meters on top of an Indonesian seamount poses several questions. Is it possible that this is a Recent representative of the Japanese Miocene form that has migrated into deeper, but colder waters where it still survives? This seems somewhat unlikely, since waters at depths of 200 to 1800 meters in the region between Japan and Timor have been relatively well explored by the Japanese, yet this species has never appeared in their collections. It has not been found in shallower waters between Japan and Timor, a distance of more than 3,200 miles. Secondly, this species has not been found in Tertiary deposits south of Japan. A review of the



literature on Tertiary mollusks of the East Indies produced no records of this or closely related species in fossil deposits of the region. Was there a continuous population in extant from Japan to Java in the Tertiary? If so (which is highly unlikely), in the southern portion of its range it would have certainly migrated into deeper waters, if it was to meet its probable normal temperature requirements of 4 to 12°C. Finally, is it possible that these shells were deposited during the Middle Miocene, when this topographic feature may have been much shallower? The surface of the ridge or seamount certainly has the flattened top so typical of many guyots in the western Pacific, suggesting erosion at or near sea level. If these animals lived here in shelf depths during the Miocene, it would suggest that there has been subsidence relative to sea level of approximately 1650 to 1750 meters in about 10 to 15 million years. This would not be an inordinately great tectonic change, especially if one considers that this seamount lies on the flank of an active island arc and at the edge of a major trench complex. A shallow-water origin for this assemblage seems likely, inasmuch as there were other shallow-water species mixed in with the *Thyasira* specimens, and notably the *Xenophora* (carrier shell) which had various shallow-water pelecypods cemented to its shell, as is typical of the genus. It is unlikely that these shells drifted or slumped on to the seamount from nearby shallower areas, since they would have had to cross a deep chasm to get there. Even if the shells were deposited in the Miocene, it is still a rather great problem to get this species to Indonesia from its occurrences in Japan, a 3000 to 4000-mile distance. Observations on similar species indicate that most of the deeper (outer shelf and upper slope) forms have a lecithitrophic development. This means that dispersal would be slow, a pelagic larval

stage being very short or absent. The fact that throughout time the few species of this complex have been exclusively Arctic to Boreal creates an even greater problem, considering that the presently-described occurrence lies just 8° south of the equator. This material is undergoing further study, and in the near future an attempt will be made to obtain an absolute date on the shells of this occurrence. It would also be desirable to obtain an  $O^{16}/O^{18}$  paleotemperature determination from these shells, since the temperature at which the shells formed would suggest whether the species lived in its present depth of collection or in shallow waters.

(R. H. P.)

## REFERENCES

Grant, U.S. and Gale, H.R. (1931), Catalogue of the Pliocene and Pleistocene Mollusca of California: *Mem. San Diego Soc. Nat. Hist.*, v. 1, 1036 pp., 32 pls. Oldroyd, Ida Shepard (1924), the marine shells of the west coast of North America: *Stanford Univ. Publ., Geol. Sci.*, v. 1, no. 1, 248 pp., 57 pls. Parker, Robert H. (1961), Speculations on the origin of the invertebrate fauna of the lower continental slope: *Deep Sea Res.*, v.8, pp. 286–293. Parker, Robert H. (1964), Zoogeography and ecology of some macroinvertebrates, particularly mollusks, in the Gulf of California and the continental slope off Mexico: *Vid. Medd. fra Dansk Naturhist. For.*, v.126, 208 pp. Yabe, H. and Nomura, S. (1925), Notes on the Recent and Tertiary species of *Thyasira*

## CAPTIONS

Fig. F-2a *Thyasira bisecta* Conrad. This specimen is rather quadrate in outline, thus approaching variety *nipponica*. Locality - a little north of the mouth of the Mächi River, on the west coast of Russian Säkhalin. Mid-Miocene. Exterior view. Copied by Ruth von Arx from Fig. 9, Pl. XXIII, Yabe and Nomura (1925). Specimen size: 60 × 54 mm.

Fig. F-2b *Thyasira bisecta* Conrad var. *nipponica* Yabe and Nomura. Locality - Morai, province of Ishirari, Hokkaido, Mid-Miocene. Exterior surface, side view. Copied by Ruth von Arx from Fig. 32, Pl. XXIII, Yabe and Nomura (1925). Specimen size: 65 × 63 mm.

Fig. F-2c External view of small specimen to *Thyasira bisecta* of var. *nipponica* from MONSOON dredge haul on a seamount east of Timor (Station at 8°29'S, 128°23'E). Specimen size: 56 × 51 mm. Photo by Charles Spooner, WHOI.

Fig. F-2d Internal view of same small specimen of *Thyasira*.

Fig. F-2e External view of large (but not largest) specimen of *Thyasira bisecta* of var. *nipponica* from MONSOON dredge haul at 8°29'S, 128°23'E. Depth: 1850 meters. Specimen size: 112 × 86 mm. Sizes of *Thyasira bisecta* s. str. as reported by Yabe and Nomura (1925) are 42 × 55 mm ranging up to 66 × 83 mm. Sizes of *T. bisecta* var. *nipponica* are reported by Yabe and Nomura to be 57 × 65 mm up to 125 × 170 mm. Therefore, in size range the Timor specimens fall well into the *T. bisecta* var. *nipponica* range.

Fig. F-2f Internal view of same specimen.

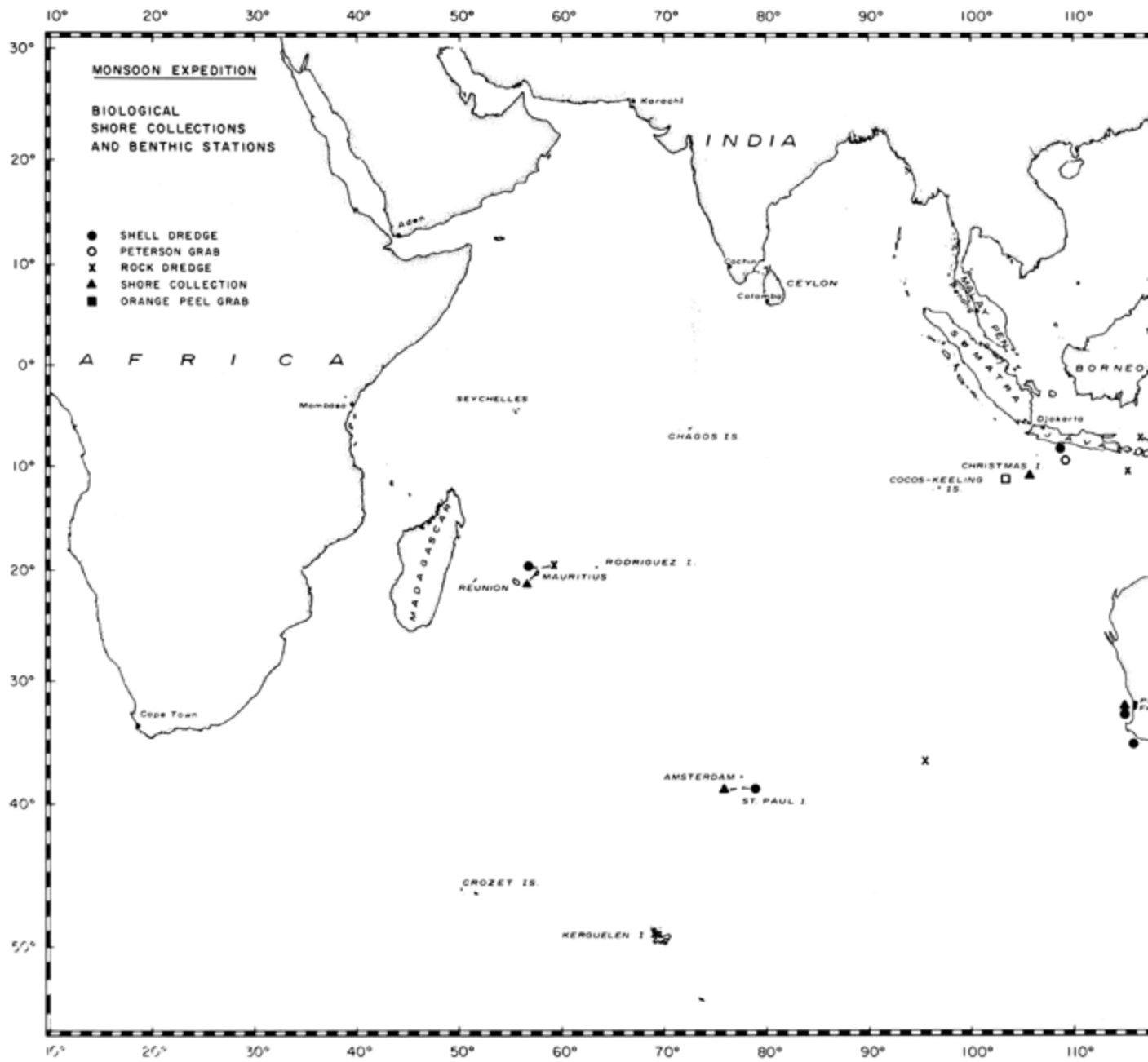
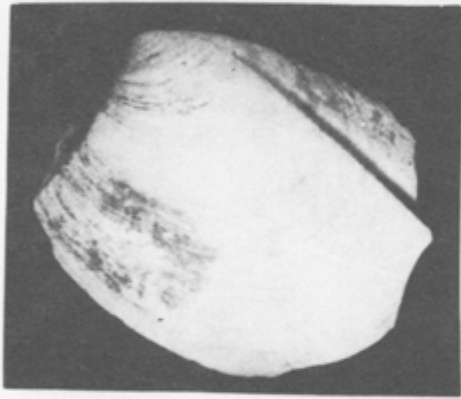
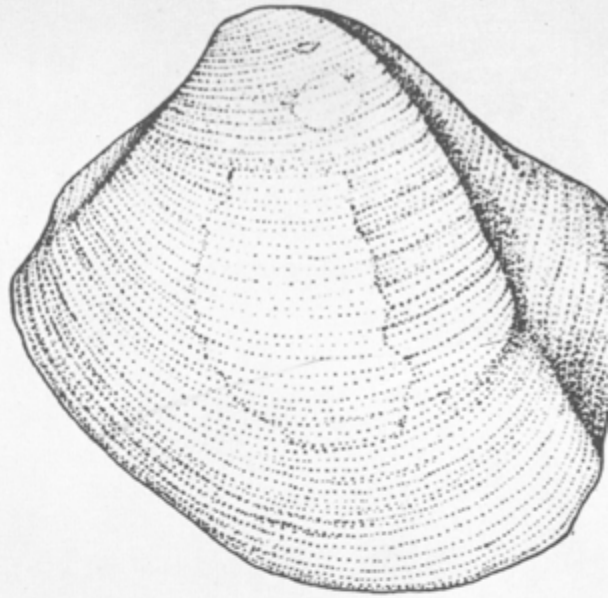


Fig. F-1



1



3



4



5



## PELAGIC BIOLOGICAL INVESTIGATIONS

The biological collections made on expeditions MONSOON and LUSIAD were designed to meet a number of research objectives.

- 1. As part of the International Indian Ocean Biological program during LUSIAD vertical net tows were made with the I.I.O.E. standard net (Table 1-B).<sup>[\*]</sup> These samples were deposited with the Indian Ocean Biological Center, Cochin, India.
- 2. A series of one-meter oblique net tows and Isaacs-Kidd midwater trawl (10-foot mouth opening) hauls were taken in the South Pacific and Indian Oceans (MONSOON) and South Atlantic Ocean (LUSIAD), ([Fig. F-3](#) in part and Tables I & V). On MONSOON pelagic collections in the Indian Ocean extended from about 8°S to 42°S, chiefly in the Central Indian Ocean water mass; the sampling included 1-meter oblique tows and midwater trawls. The former sampled the 0–200 meter or 0–360 meter zones; the latter rang from 1400 to 2700 meters depth. The primary purpose of these collections was to provide data, from critical and little-studied areas of the world's oceans, that will contribute to long-range and continuing zoo-geographic and faunal studies of plankton and bathypelagic nekton. Such studies are aimed at determining the distributions of oceanic organisms and the composition of open ocean and deep-sea communities and, more fundamentally, at explaining how these patterns and faunal groupings came about and how they are maintained. This also involves studies of current systems and water masses.

- 3. A special series of samples (oblique one-meter net tows) was made in conjunction with the LUSIAD equatorial undercurrent studies ([Fig. F-4](#) and Table I A). The purpose of this series was to examine the effects of the changing monsoonal circulation on the distribution and abundance of equatorial zooplankton.
- 4. Phytoplankton collections were made in the Pacific and Indian Oceans: horizontal 17 cm net tows on MONSOON (Table IV), 0–100 meter vertical 20 cm net tows on LUSIAD (Table I C).
- 5. Night-light dip-net collections to sample the macroplankton and nekton of the surface waters were made whenever sea conditions permitted (Table I D, II in part).
- 6. Whenever possible on MONSOON shallow-water collections of fishes-by poisoning-were carried out to augment the research collections at SIO, particularly with reference to Indo-Pacific shore fishes (Table VI b).

- 7. Efforts were made to sample the terrestrial biota of oceanic islands visited, particularly at remote locations such as Saint Paul (Indian Ocean) and Campbell Island (Southwest Pacific), (Fig. F-5 in part and Table VI b).
- 8. Continuous sampling of serial plankton (Insecta) by use of fine-mesh fixed nets was attempted during both expeditions. This was undertaken as part of a study of the dispersal of terrestrial organisms by wind currents over the open ocean that is being carried out by Linsley Gressitt and co-workers of the Bernice P. Bishop Museum, Honolulu.

---

— 103 —

- 9. During MONSOON attempts were made by several methods to sample the deep-sea benthic populations. This topic is reported separately by R. H. Parker. Most of the sampling positions are shown on Fig. F-5 and are listed in Table VI a.
- 10. During LUSIAD, special efforts were made with 1-meter and ½-meter nets to collect shallow-water coastal zooplankton to provide much needed material for zoogeographic and systematic studies of Copepoda. Data are particularly needed from both East and West coasts of Africa; LUSIAD's program contributed tows at Mombasa, Cape Town and Freetown (Sierra Leone).
- 11. Finally, in the course of making open ocean stations for other purposes, pelagic fishes and invertebrates were collected informally and sporadically by a variety of scientific and sporting gear.

*Chaetognatha, Siphonophorae and Medusae (Tables VII, VIII, IX respectively in Appendix D).*

Chaetognaths were either sorted and counted directly (in samples of relatively small size) or their population calculated from an aliquot (in the case of larger samples). Neither siphonophores nor medusae were studied quantitatively.

Two well-defined zoogeographic demarcations in the Indian Ocean were indicated by study of these three groups: 1) the equatorial boundary, extending south of the equator (trending ESE from about 5°S in the west to 15°S in the east); 2) the Subtropical Convergence, at about 40°S. These limits are coincident with hydrographic boundaries, and marks latitudinally, three main regions in the Indian Ocean: Equatorial, Central and Subantarctic.

---

— 104 —

The typical equatorial species of the Pacific which also occur in the Indian Ocean appear restricted to the equatorial waters. Warm-temperature water species which are cosmopolitan in distribution are found in both Equatorial and Central Indian waters, while cold water species do not extend into the Central water mass, but appear to be limited in northern extent by the Subtropical Convergence. Comparison of distributional patterns during different seasons of the year indicate marked changes in the distribution of species and relative concentrations of individuals. These shifts in both boundaries and densities of populations in the Indian Ocean may be largely due to the monsoon seasons. On MONSOON, however, sampling was carried out only

during the NE monsoon season (November to January). The distribution of each species is correlated with the distribution of temperature, salinity and dissolved oxygen in the prevailing system of oceanic circulation, with temperature being the most evident parameter.

Twenty-three species of chaetognaths were recorded (Table VII). In distribution, ten are cosmopolitan and seventeen are Indo-Pacific. There are seventeen epipelagic species, of which 15, in the Indian Ocean, connect through Indonesian waters with their respective regions of distribution in the Pacific. The mesoplanktonic species *S. decipiens* and *S. zetesios* also appear to connect with Pacific populations along this route, while *S. planktonis*, *S. gazellae*, and *S. tasmanica* extend into the Pacific through South Australian waters. *S. hexaptera* populations appear continuous into the Pacific both north and south of Australia. In general, populations of warm water species are connected between Indian and Pacific

---

— 105 —

Oceans via Indonesia, whereas cold water species populations are continuous between the two oceans through the waters of South Australia and Tasmania. *S. planktonis*, *S. gazellae*, and *S. tasmanica* are bounded on the north by the Subtropical Convergence, while this serves as the southern boundary for *S. hexaptera*. The southern boundary for *S. regularis* coincided with the boundary between the Equatorial and central waters. The chaetognaths collected on MONSOON Expedition are treated in detail by Alvarino (1964).

In the case of the siphonophores, MONSOON catches in some instances represent new occurrences in the Indian Ocean for species known to be widely distributed in the Atlantic and Pacific. It may be noted that species occurring abundantly in the Indian Ocean samples are also found abundantly throughout wide distributional ranges in all three oceans, whereas species sparsely represented in the Indian Ocean samples are also scarce through the rest of their ranges. Also, the abundant species are found in the upper layers of water, the scarce species in deeper waters. These two facts may be evidence for species regression in these scarce species.

Forty-four species of siphonophores were observed in the Indian Ocean: 29 species were collected in the upper 400 meters, the remainder in strata below this level (Table VIII). Of these species not previously known from the Indian Ocean are *Abyla carina*, *L. challengerii*, and *Nectodroma reticulata*. *S. angusta*, *M. orthocannoides*, and *Amphicaryon ernesti* were reported by Totten, 1954, the former two from South and East African waters, the latter from the Red Sea.

---

— 106 —

Siphonophores recorded by Alvarino in collections from the Western Pacific, Philippine, or Indonesian waters, and also recorded from the Indian Ocean by previous workers, but not occurring in MONSOON samples include:

- 1. *Abyla brownia*, *S. tottoni*
- 2. *Bargmannia elongata*
- 3. *Ceratocymba intermedia*

- 4. *Diphyes chamissoni*
- 5. *Enneagonun hyalinum*
- 6. *Erenna richardi*
- 7. *Lensia campanella*, *L. subtiloides*, *L. reticulata*
- 8. *Melophysa melo*
- 9. *Nectopyramis diomedae*
- 10. *Praya* sp.
- 11. *Porpita* sp.
- 12. *Sulculeolaria monoica*
- 13. *Stephanomia bijuga*
- 14. *Vogtia glabra*

Metric siphonophores (*Muggiaea atlantica* or *M. kochi*) were not observed due to the oceanic nature of the samples; this also probably accounts for the absence of *D. chamissoni*.

The siphonophores inhabiting Equatorial waters include:

- 1. *Diohyes bojani*
- 2. *Diphyopsis mitra*
- 3. *Chelophyes contorta*
- 4. *Abylopsis tetragona*; *A. eschscholtzi*

---

— 107 —

- 5. *Lensia Lcnoidea*; *L. meteori*
- 6. *Sulculeolavia augusta*; *S. biloba*; *S. quadridentata*
- 7. *Vogtia pentacantha*; *V. Spinosa*
- 8. *Agalma oveni*
- 9. *Stephanomia rubra*
- 10. *Marrus orthocannoides*
- 11. *Amphicaryon acaule*; *A. ernesti*

*Abyla bicarinata*, *A. carina*, *A. haeckeli*, *A. schmidtii*; *Ceratocymba dentata*, *C. leuckarti*, and *C. sagittata* (the last also observed in the upper layers near the Subtropical Convergence), were found occupying the deep layers of the Indian Equatorial waters, close to Indonesia, in the northeastern part of the region sampled on MONSOON.

Some of the above species (*Diphyes bojani*; *Abylopsis tetragona* and *A. eschscholtzi*; *Lensia conoidea* and *L. meteori*; *Sulculeolana quadridentata*; *Amphicaryon acaule*, and *A. ernesti*) inhabit the tropical-equatorial region of the Pacific and extend also into the Central Pacific.

*Chelophyes appendiculata*; *Eudoxoides spiralis*; *Lensia challengerii* and *L. subtilis*; *Vogtia serrata*; *Nectopyramis thetis*, *N. natans*; and *Vella* sp. appeared to be the characteristic siphonophores in Central Indian waters, and they also occur in similar habitat regions in the Pacific. Figs. present examples of patterns of distribution of some siphonophore species in the Indian Ocean.



Medusae were not found extensively in the MONSOON Indian Ocean collections. A few species were taken at only three or four stations each, and only *Atolla wyvillei* was observed in 5 mid-water trawls in the Indian Ocean. Several species, whose presence might have been

---

— 108 —

expected, were absent despite their known occurrence in the Indonesian passages, and in warm Atlantic and Pacific waters. The occurrence of medusae may be regarded as seasonal for both the monsoons regime and the life history of these organisms. Species of medusae and locations taken are as in Table

*Aequorea pensilis*, *Aegina citrea*, *Atolla wyvillei*, *Colobonema sericeum*, *Crossota brunnea*, *Calycopsis borchgrevinki*, *Halicreas minimum*, *Meator rubatra*, and *Periphylla hyacinthina* appear to live consistently at depths greater than 400 meters, although *A. citrea* is reported to range from 0 to 1000 meters.

*Aeginura grimaldii*, *Bougainvillea fulva*, *Liriope tetraphylla*, and *Aequorea macrodactyla* were found in Equatorial Indian waters.

*Rhopalonema velatum* inhabits Central Indian Ocean waters, extending into the Equatorial region along deep layers.

*Crossota brunnea* and *Meator rubatra* are typical species from sub-Antarctic waters.

In conclusion it appears from the distributional data obtained on the Chaetognatha, Siphonophorae, and Medusae, that the Indian and Pacific Oceans cannot be zoogeographically separated. The entire tropical-equatorial belt, from the eastern Pacific to the western Indian Ocean, appears to be an uninterrupted faunal band.

## **Euphausiids**

The zooplankton collections made during MONSOON have been studied with respect to the distribution and abundance of the euphausiid crustaceans, and similar studies are planned for the LUSIAD collections.

---

— 109 —

MONSOON provided the first substantial oceanic collections from some parts of the western South Pacific. These data were of value in establishing zoogeographical boundaries in this region (Brinton, 1962). Indian Ocean samples from MONSOON have helped to establish some of the general features of euphausiid distribution in the southern half of that ocean. In conjunction with material from the Gulf of Thailand and South China Sea collected by NAGA Expedition, samples collected by R/V *Argo* in Indo-Australian waters have aided in indicating the very limited extent to which Indian Ocean and Pacific euphausiid populations are in communication with each other, (Brinton, 1963). MONSOON samples from south of Australia aided in

demonstrating that subtropical oceanic provinces do not communicate between the two oceans at those latitudes.

## Copepoda

Plankton collections from MONSOON have proven most useful in the study of this group of organisms. There was no previous material at SIO from the areas concerned. The collections have provided a very valuable adjunct to extensive Pacific collections. This is of particular importance with reference to problems of a biogeographic and systematic nature. A number of problems involving comparisons of Indo-Pacific populations with Atlantic populations have been worked out, notably for *Centropages violaceus* and *C. furcatus* (the former an epiplanktonic oceanic species complex, the latter a neritic group).

The shallow-water coastal collections from LUSIAD provided much significant material (including further specimens of *C. furcatus*) for comparison of Indian Ocean and Atlantic populations, a new species in the

---

— 110 —

genus *Pontella* from collections made off West Africa, and specimens of a relatively scarce species of *Labidocera* from the same area. This allowed comparison with Caribbean and Gulf of Mexico populations, and the resolution of some species problems in this group. As with MONSOON collections, these coastal neritic samples have proven extremely valuable in providing material previously unavailable in the United States.

## *Fishes*

The collections of fishes taken on Expeditions MONSOON and LUSIAD have greatly enhanced the studies of oceanic species by Scripps investigators. The ready availability of fishes from infrequently-visited and scarcely-collected areas of the oceans is of immeasurable benefit.

MONSOON has provided an extremely valuable collection of myctophid fishes from far southern latitudes. Although many of these have not yet been studied in detail, there are several intriguing systematic and ecological problems outlined for study. A new genus and species, from near New Zealand, has been described by Wisner (1963).

With reference to the collections of pelagic animals of large size made on MONSOON, particularly the organisms taken in the Indian Ocean midwater trawl hauls, it should be noted that these collections appear to be the first such collections made by any oceanographic vessel from countries other than the U.S.S.R., in the area framed by 10°S to 42°S, 60°E to 100°E, comprising most of the Central Indian Ocean. The other principal biological collections in the Indian Ocean were made by the DANA and GALATHEA expeditions of Denmark; those efforts were concentrated

---

around the continental perimeter of the Indian Ocean and the waters west and south of Sumatra and Java in the East Indies. Specimens from these MONSOON trawl hauls have contributed to the study of the spiny-rayed deep-sea fishes of the family Melamphaidae. Results of these studies have been published, in part, as "Dana Reports".

As part of *Argo's* post-Cape Town program on LUSIAD, eight midwater trawls and twenty-two dipnet stations were made in the South and Equatorial Atlantic, in addition to an abbreviated series of paired meter net tows, totalling five stations, made to coincide with an intensive hydrographic program in the Gulf of Guinea. The primary effort of the trawling program was to sample on either side of the Walvis Ridge, off South-West Africa; dipnet stations were occupied whenever possible during the heat flow and coring operations which were the principal concern during this portion of the expedition.

Although the number of biological stations occupied was certainly insufficient to constitute an adequate faunal survey of the regions covered, the results appear, on preliminary analysis, to have been very successful. By the nature of faunal and systematic studies, detailed conclusions from the study of the collected material must await completion of the time-consuming processes of sorting, identification and publishing of necessary new descriptions and systematic revisions. It should be emphasized that the Atlantic LUSIAD material, together with the excellent MONSOON deep-sea biological collections from the Indian Ocean, will undoubtedly enable completion of many unfinished systematic, distributional and faunal studies of Pacific Ocean organisms, studies which have

so often in the past been hampered by the absence from our collections of comparative specimens from the other oceans.

Although for most of the biological material only very preliminary analysis have been made, a few noteworthy findings may be mentioned here. Most spectacular, in the vertebrate collections, is a new genus and species of saury (Synentognathi: Scomberesocidae), which is to be described in the near future by C. L. Hubbs and R. L. Wisner. In addition, the ranges of three species of deep-sea fishes are extended into the Atlantic for the first time: *Pellisolus* sp. (Isospondyli: Searsiidae), known formerly only from the Gulf of Panama, is now recorded from the Gulf of Guinea; the deep-sea angler fishes *Lophodolus dinema* (Pediculati: Oneirodidae), known previously only from the South China Sea, and *Centrophryne spinulosa* (Pediculati: Centrophrynidae), recorded from the Gulf of Panama and New Guinea, are now known to occur in the South Atlantic. Finally, there appear to be several new species of myctophid fishes represented.

Table II presents pertinent data for the midwater trawls, 1-meter net tows and dipnet stations made in the Atlantic. Table X includes a preliminary analysis of the vertebrates collected at Station 79, the only trawl collection analyzed at this time. Identifications were made by R. H. Rosenblatt, R. L. Wisner, and P. R. Sloan. No analyses are yet available for the invertebrates.

The results of the aerial plankton sampling program on MONSOON were published by Gressitt, et al (1962).

---

— 113 —

This report has been compiled from contributions by Mme. Angeles Alvarino (Chaetognaths, Siphonophores and Medusae), Edward Brinton (Euphausiids), Abraham Fleminger (Copepods), and Robert Wisner and Philip Sloan (Fishes). John McGowan contributed advice on objectives and programs. Richard Rosenblatt provided identification of bathypelagic fishes and other valuable information. Oversights and omissions in the compilation are the writer's responsibility.

(J. C.)

## **REFERENCES**

Alvarino, A. (1964) The Chaetognatha of the MONSOON Expedition in the Indian Ocean: *Pacific Science*, v. XVIII, no. 3, pp. 336–348. Brinton, E. (1962) , The distribution of Pacific Euphausiids: *Bull. Scripps Inst. Oceanog., U. of Calif.*, 8 (2), pp. 51–270. Brinton, E. (1963) , Barriers between tropical Pacific and Indian Ocean Euphausiid species (Zooplankton, Crustacea): *Proc. XVI Int. Zool. Congr. Wash. D.C.*, v. 1, p. 204. Ebeling, A.W., Weed, W.H. (1963) , Melamphaidae III. Systematics and distribution of the species in the bathypelagic fish genus *Scopelogadus* Vaillant: *Dana Report*, no. 60, pp. 1–58. Gressitt, J.L., Coatsworth, J. and Yoshimoto, C.M. (1962) , Air-borne insects trapped on MONSOON Expedition: *Pacific Insects* 4(2), pp. 319–323. Moss, S. A. (1962) , Melamphaidae II. A new melamphaid genus, *Sio*, with a redescription of *Sio nordenskjöldii* (Lönnerberg): *Dana Report*, no. 56. Wisner, R.L. (1963) , A new genus and species of myctophid fish from the south-central Pacific Ocean, with notes on related genera and the designation of a new tribe, Electronini: *Copeia*, no. 1, pp. 24–28.

---

— 114 —

## **CAPTIONS**

Fig. F-3 Station plan for the plankton collections of the MONSOON Expedition in the Indian Ocean.

Fig. F-4 Positions of 1-meter net tows for LUSIAD Expedition 1962–63

Fig. F-5 Benthic stations and shore collections in the Indian Ocean regions MONSOON Expedition

Fig. F-6 Distribution of *Chelophyes contorta* and *Ch. appendiculata* in the Indian Ocean (MONSOON Expedition).

Fig. F-7 Distribution of *Abylopsis tetragona* and *Eudoxoides spiralis* in the Indian Ocean (MONSOON Expedition).

Fig. F-8 Distribution of *Diphyes bojani* and *Dipyopsis mitra* in the Indian Ocean (MONSOON Expedition).

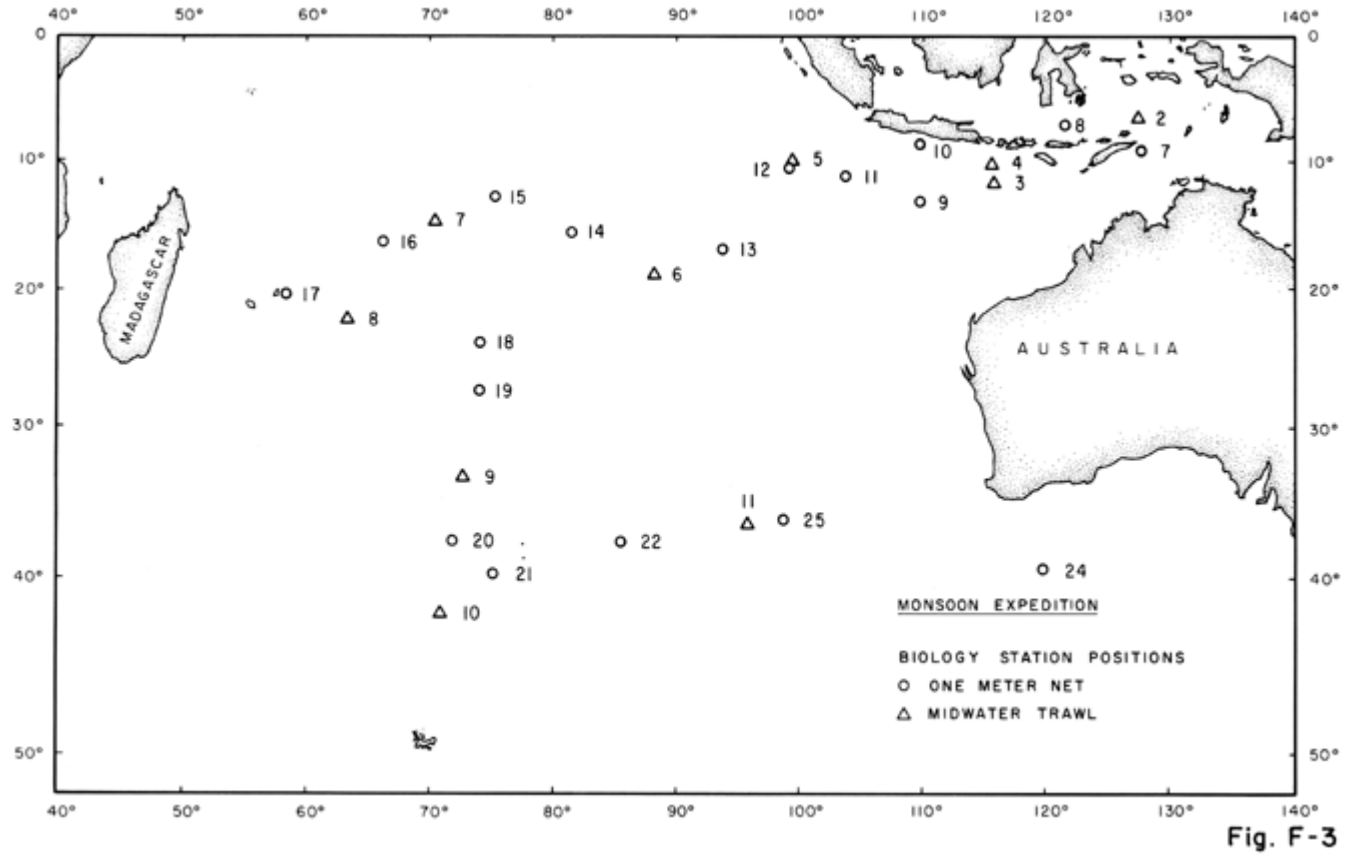


Fig. F-3

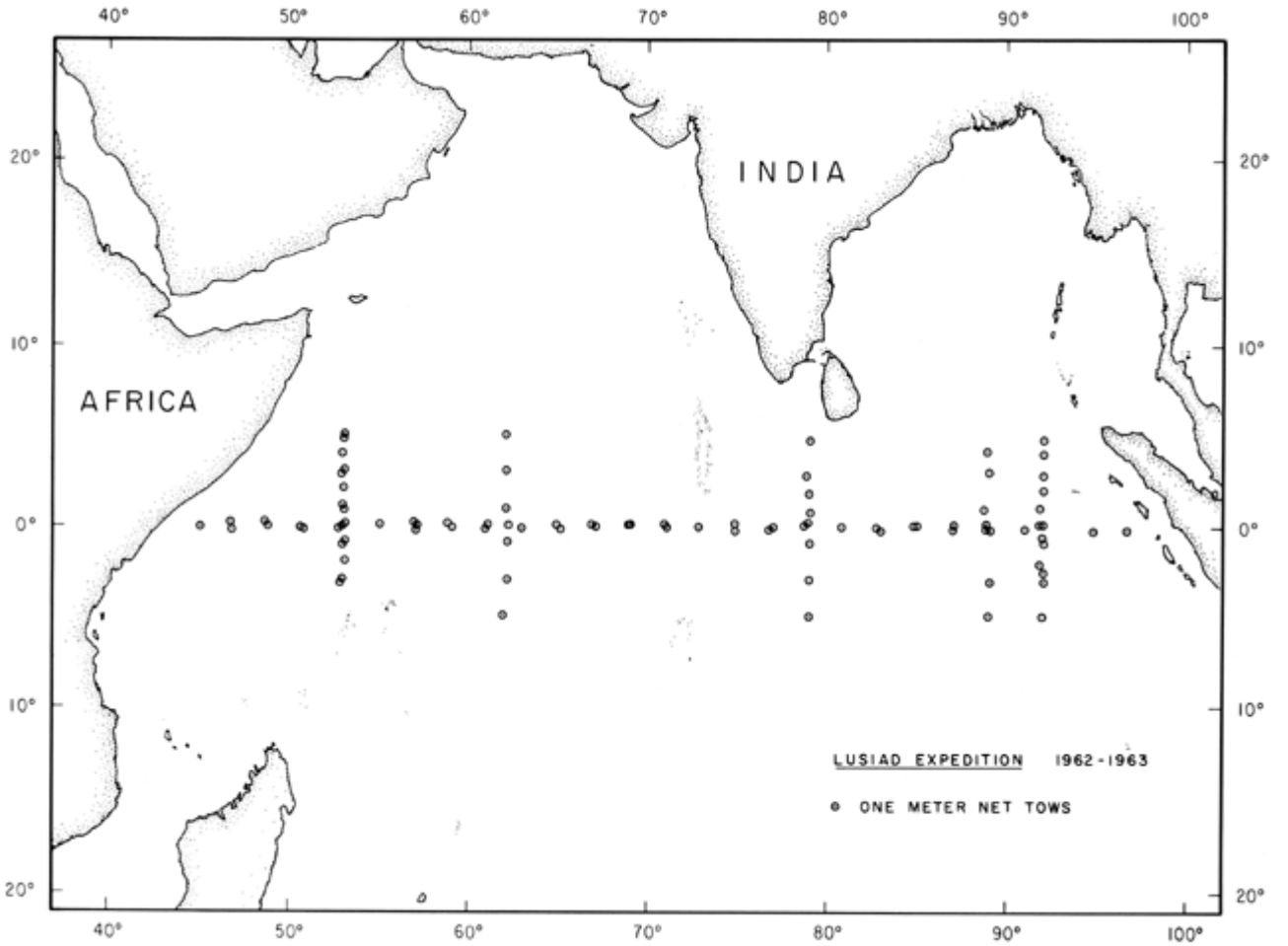


Fig. F-4

Fig. F-4

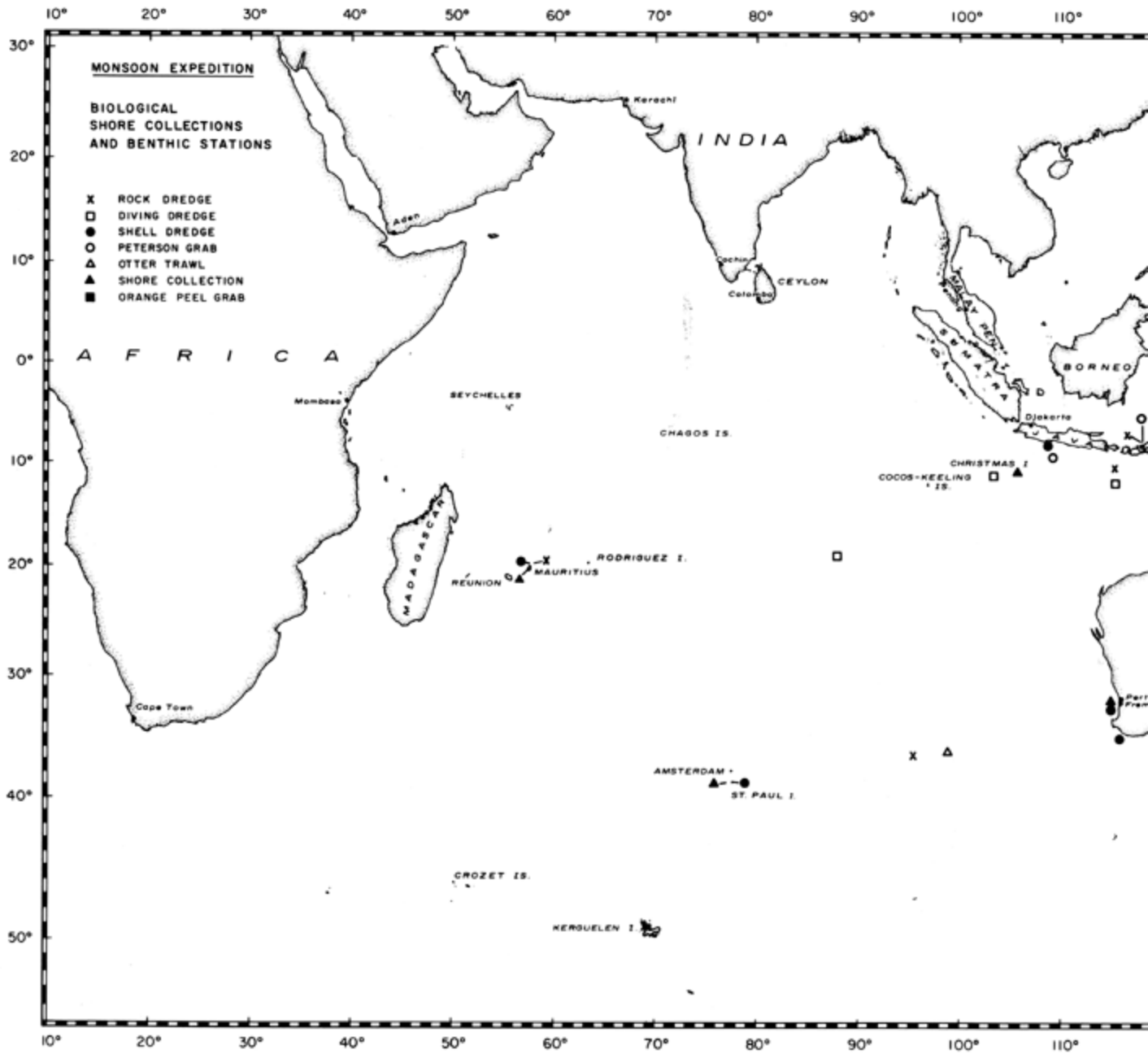


Fig. F-5

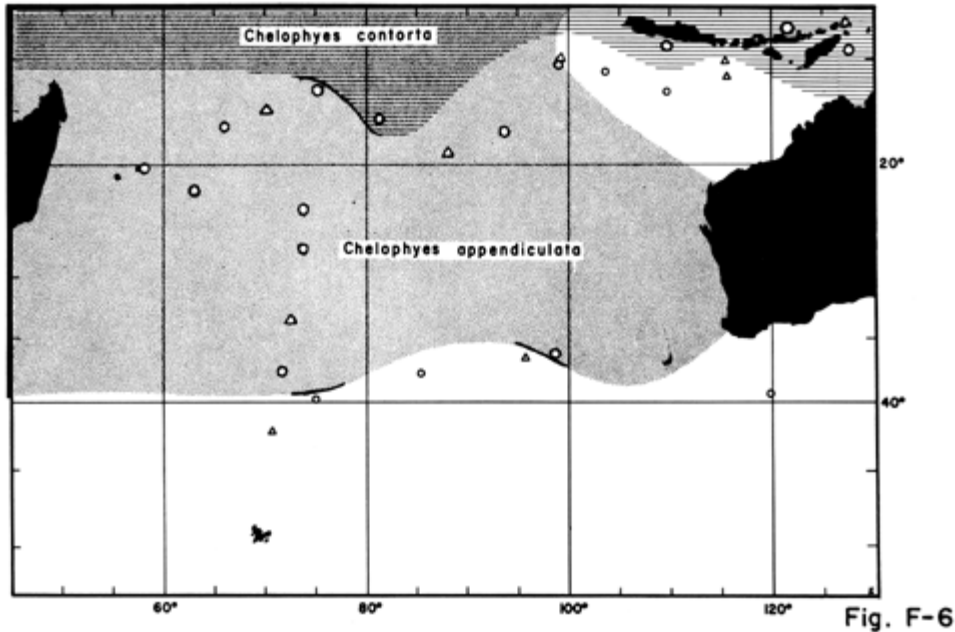


Fig. F-8

\* Tables I - X are found in Appendix D.

## DEEP-SEA CAMERA STUDIES IN THE INDIAN OCEAN - R/V Argo, 1960-3

### I. MONSOON Expedition

The track of MONSOON Expedition extended into relatively unexplored regions of the Indian Ocean, making it possible to photographically explore the microrelief in previously little-known recent sea floor sedimentary areas and other bottom environments. Stations chosen for depth and geographic accessibility were selected along a pre-arranged track to permit the study and sampling of the greatest number of different underwater relief features. Camera stations usually consisted of lowerings to the sediment-water interface, with bottom photography and sediment sampling, and the use of related precise soundings, including sonar control, to determine the nature of the micro-roughness in recently-accumulated sediments. Other objectives for the photographic program included delineation of sediment boundary contacts, examination of the shoal flanks of isolated volcanic islands for the detection of fish and other organisms, and the investigation of physical, biological, and chemical processes in action on and around a variety of underwater features of intermediate relief.



The sediment-sampling programs of previous scientific expeditions to the Indian Ocean had established that calcareous sediments predominate in the western area and that red clay is the major bottom material in the generally-deeper eastern region. Bottom photographs have in general confirmed this distribution. The "rifted" mountain system (the "median ridge" and associated highs) which trends in a NW-SE direction through the Indian

---

— 116 —

Ocean appears to form the general boundary between the two major deep-sea sediment types. Two small patches of radiolarian ooze, however, are known to exist in the Indian Ocean. One lies just east of Madagascar, the other just north of Cocos-Keeling Island. Terrigenous sediments occur in narrow bands along the coasts of Australia, Indonesia, India and Africa. On MONSOON Expedition, terrigenous sediments were photographed only in some of the nearshore basins of the Indonesian area.

Fig. G-1 shows the locations of SIO-NEL bottom photography in the Indian Ocean area. Early and later legs of MONSOON passed through and sampled the southwest Pacific Ocean but the camera stations were not included in this index chart. Three deep-sea camera rigs employed on MONSOON Expedition are pictured in Fig. G-2.

### **Indonesian Area**

The sea floor environments in and bordering the Indonesian archipelago showed the greatest variety in microrelief and also a greater magnitude of major relief than in other areas. Closed basins to the northeast of Java revealed an abundance of benthic organisms, such as brittle stars and sea cucumbers, on the surface of a well-churned silty clay. In these steep-walled basins, bordered by islands, organic food materials are relatively abundant. Here some brittle stars attain great size: one specimen, seen in Fig. G-3 measured 18" from arm tip to arm tip. South of the island festoon, rocky outcrops and gravels were photographed on the upper flanks of the Indonesian Trench (at =5020 meters) and on a ridge separating the trench from Java. Where sands occur, they were rippled by bottom currents, a proof of the latter's existence at depths of over 3350 meters. On the still shoaler upper slopes around the trench, benthic crawling and

---

— 117 —

burrowing organisms, not directly observed, have churned the volcanic silts, leaving grooves, scratches, mounds and pits. An unforeseen winch difficulty on *Argo* resulted in loss of a complete stereo underwater camera system in 6700 meters of water. Therefore, no photographs were obtained from the deeper parts of the Indonesian Trench.

### **Western Area**

The "rifted" mountains and moderately rough bottom topography to the west typify the western part of the Indian Ocean, offshore of the sedimentary influence of Africa and India. Topographic highs and rises of intermediate relief, together with occasional isolated volcanic islands such as Saint Paul, Mauritius, Rodriguez, and Reunion, appear to have the greatest influence on bottom

environments. Foraminiferal sands and oozes are common on the rises, with cross-ripping of the sediments attesting to the presence of bottom currents of variable magnitude. Scour can be the result of normal flow around bottom obstructions. Manganous crusts on bedrock was revealed on one topographic high to the northeast of Mauritius Island, only a shore distance from an area of cross-rippled coarse sediments. Red clay was not found on any of the topographic highs. Bottom-living organisms were not observed in this current-washed environment. Samples of sand contained pieces of manganous-coated pumice mixed with fragments of volcanic bombs. Wave length and amplitude measurements of ripple marks such as those in Fig. G-4 indicate bottom currents having velocities ranging from less than 30 cm/sec to as much as 61 cm/sec.

Between highs and rises the calcareous oozes have been churned by unseen burrowing organisms. A system of delicate trails and mounds, considered together with the apparent lack of visible organisms, suggest that here

---

— 118 —

concentration of bottom life is less than 1 specimen per square meter. Since food is probably scarce at the sediment-water interface, most of the organisms burrow below the surface for survival. Fine white ooze billowed up like smoke when touched by the camera frame ([Fig. G-5](#)). Depressions on the western side of the median ridge contained calcareous ooze, and there manganese nodules were quite commonly found lying on the sediment surface. Lack of visible organisms in the bottom photographs again suggests an environment poor in organic materials.

In contrast, red clay is the normal sediment in the somewhat deeper depressions on the eastern flank of the median ridge. Within the rough mountainous region, camera lowerings were restricted by the numerous steep slopes and the small extent of the basin floors to be photographed.

Steep upper submarine slopes on Mauritius Island revealed through photography an environment rich in benthic organisms—including worms, branching corals, hydroids and shell growth—but no bottom fish were detected ([Fig. G-6](#)). Disturbance and rippling of coarse terrigenous sediments and sands indicated that sediment grain sizes varied locally. Bottom water at a depth of 479 meters was moderately clear with very little suspended matter detectable. A similar slope off Saint Paul Island, in 448 meters of water, showed fragments of brown and black volcanic rocks, grey sands, and a variety of attached corals and other benthic organisms such as large holothurians and sea urchins. The latter animals were concentrated on rippled sands, whereas hydroid and crinoid-like organisms were concentrated on a bed of volcanic rock fragments. Algal growth appears to cover the greater portion of the upper surfaces of the volcanic fragments. Mounds and pits superimposed on the rippled sands indicate a fair degree of recent activity by burrowing organisms; such mounds are about 3–4 cm in height.

---

— 119 —

### *Eastern Area*

The small number of deep camera stations in the eastern area of the Indian Ocean helped establish only the general nature of the red clay sediments. No stations were occupied within the narrow zone of terrigenous sediments and calcareous ooze bordering the western coast of Australia. A camera station off the southwest coast of Australia revealed a sea floor environment of red clay with medium to large size manganese nodules scattered irregularly on the sediment surface at the interface (Fig. G-7). The nodules photographed were moderately clean and fresh-looking on their upper surfaces. Branching corals are growing up from some of the nodules; large specimens of brittle stars were found between the nodules. Low mounds, up a meter in diameter, have indented or impressed crests that suggest the presence there previously of brittle stars, possibly. Surface irregularities in the red clay between the isolated nodules indicates a moderate amount of activity by burrowing organisms.

On a ridge station to the southwest of Tasmania calcareous ooze is the predominant bottom sediment. Numerous interesting trails and tracks indicate a moderate amount of surface feeding. The fine-grained white calcareous ooze is easily disturbed into fluffy clouds by bottom disturbances such as the camera dragging in the soft sediment.

A single sponge, observed attached to the bottom, probably reflects the paucity of organic debris for food. Except for this stalked sponge, no identifiable benthic organisms are present. Unlike in the deeper red clay areas to the northwest, this environment appears devoid of any signs of manganese nodule formation.

---

— 120 —

The Indian Ocean, then, has extremes in environment, depth and bottom sediment types. Interpretation of bottom photographs taken at widely-separated but selected stations shows in general that large areas of this ocean are rather barren as far as the production of larger benthic organisms is concerned. The rifted mountain system controls the movement of deep water masses and acts as an obstruction to the flow of subaerial materials into the deeps of the Indian Ocean. The presence of unburied manganese nodules on the floors of basins and deeps is evidence of slow rates of sediment accumulation. Photography is helping to unlock the problems of the deep oceans. —(Carl J. Shipek, Code 3190, USNEL).

## II. LUSIAD Expedition

Four camera stations were occupied in the southern Indian Ocean during Expedition LUSIAD;<sup>[\*]</sup> at these stations water depths ranged from 2050 to 4900 meters. An Edgerton, Germeshausen and Grier camera system, consisting of strobe light, pinger (for positioning just above the bottom) and two cameras mounted in stereo was used. The array was lowered to within three meters of the ocean floor, kept at approximately that distance by use of the pinger, and held there for 100 minutes while each camera operated automatically, taking pictures at the rate of one exposure every twelve seconds. One camera was loaded with Kodak Plus X film, the other with Ektachrome film. On each, the lens setting was f/11, with the shutter fixed open.

The cameras, with each electrically-driven 35mm still camera mechanism encased in a watertight steel housing, take five hundred separate exposures on a standard 100 foot roll of 35 mm film. With each exposure, the camera

---

— 121 —

also photographs an internal data chamber mounted on the rear end-cap. This data chamber exposure shows a depth gauge, an accurate clock and a data card.

Approximately 100 frames per camera per station were exposed while the cameras were within proper focal range (3 ½ to 20 ft.) of the bottom. Thus on LUSIAD a total of 400 black-and-white and 400 color usable exposures were obtained. On the fourth station, in very rough, intermediate depth ridge topography east of Amsterdam Island, the rig caught on bottom. The cameras, exposed film, and transducer were saved. The remainder of the rig was lost, thus terminating LUSIAD camera lowerings.

(H. L. H.)

---

— 122 —

## ***CAPTIONS***

- Fig. G-1 MONSOON and LUSIAD Deep Sea Camera Stations
- Fig. G-2 Wire-lowered deep-sea cameras used by Carl J. Shipek C Code 3190, NEL in the Indian Ocean on Expedition MONSOON:
  - a) Edgerton, Germeshausen and Grier stereo camera<sup>[\*]</sup> usable to any known sea depth. Here rigged to take photographs vertically. Electronic flash; equipped with sonar pinger for determining array's position above sea floor. 35 mm film. f 11 Hopkins lens.
  - b) NEL Type VI Deep-sea Camera. Good to 18,000 ft. sea depths. Electronic flash; positioned near bottom with portable E.G. and G. sonar pinger (not shown) for high oblique photographs. 35 mm film. f 2.8 3 cm lens.
  - c) NEL Type VII Deep-Sea Camera. Good to 24,000 ft. sea depths. Electronic flash; equipped with E.G. and G. sonar pinger for positioning for oblique photographs. 35 mm film. f 11 Hopkins lens on a modified E.G. and G. camera.
- Fig. G-3 Sunda Sea Basin, north of Soembawa, Indonesia. The churned silty clay shows a large brittle star and numerous small spiny sea-cucumbers. The sediment-water interface is a sharp surface of contact showing scratches, tracks and grooves made by crawling, tumbling and semi-burrowing organisms. Water depth: 2090 meters. Area pictured: approximately 1 square meter.
- Fig. G-4 Western Indian Ocean. The upper portion of a topographic high photographed at a depth of 2810 meters. Large ripple marks formed in coarse sand are cross-rippled by weaker oscillatory currents. Note the accumulation of coarsest particles in the troughs of the larger ripple marks. Area photographed: approximately 3 square meters.

- Fig. G-5 West central part of the Indian Ocean, between topographic highs. The light-colored calcareous ooze has billowed up like smoke when touched by the camera frame. Fine delicate trails, sediment churning and mounds in this area lacking visible organisms suggests a low concentration of animal life here and a paucity of food in a barren environment. Depth of water: 4085 meters. Area photographed: approximately 3 square meters.

---

— 123 —

- Fig. G-6 Upper slope of Mauritius Island in the western part of the Indian Ocean. This photograph displays a bottom environment rich in benthic organisms, including branching corals, hydroids and shell growth attached to rocky outcrops. Depth: 479 meters. Area of photograph: approximately 3 square meters.
- Fig. G-7 Eastern part of Indian Ocean. Manganese nodules are resting on red clay. Large brittle stars are visible in background, and branching corals on the nodules. Smooth surface of red clay suggests only a small amount of animal disturbances, due to the scarcity of food supplies.

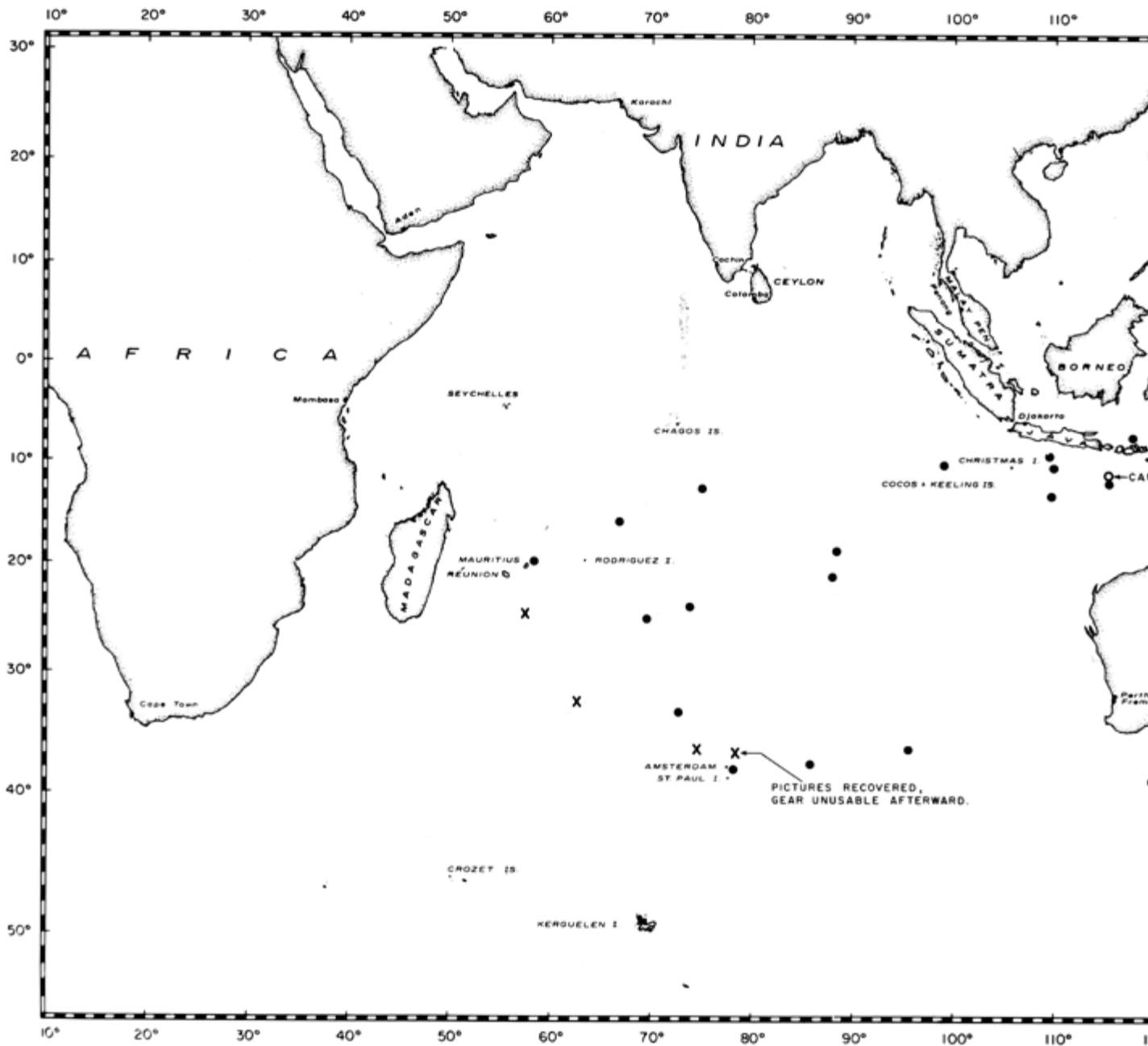
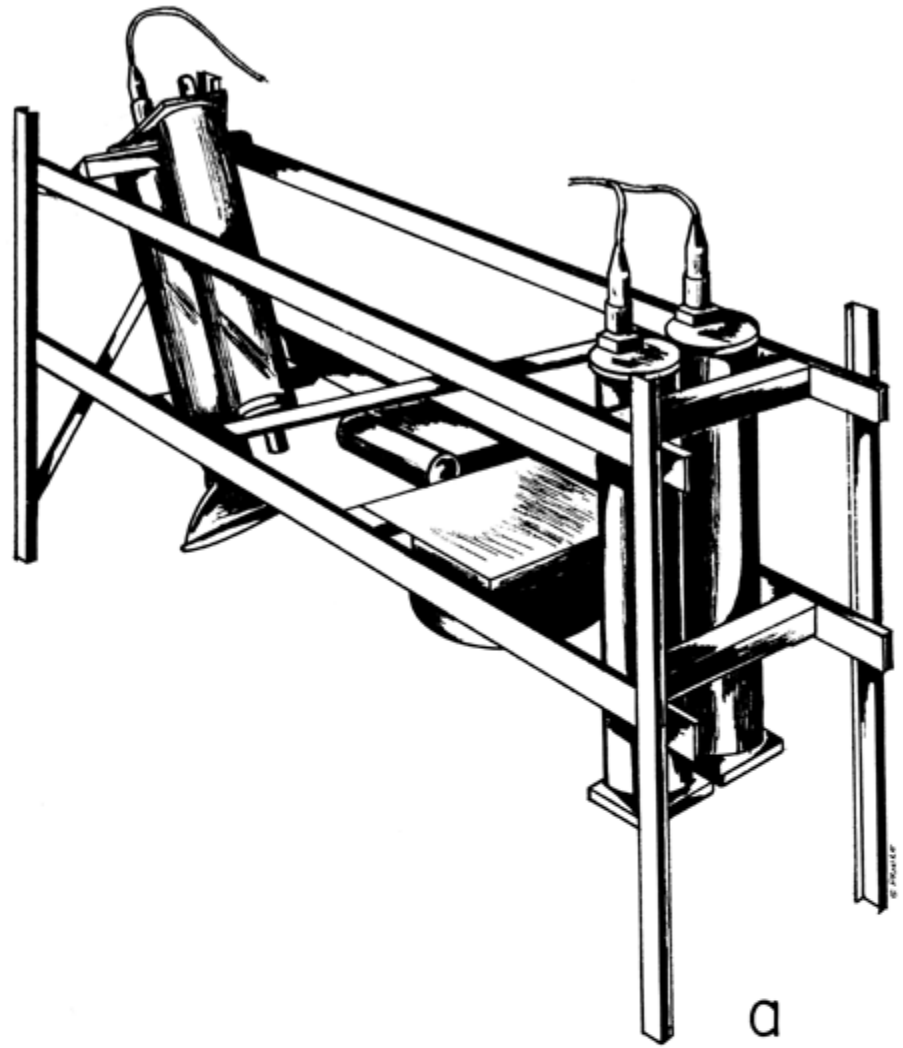
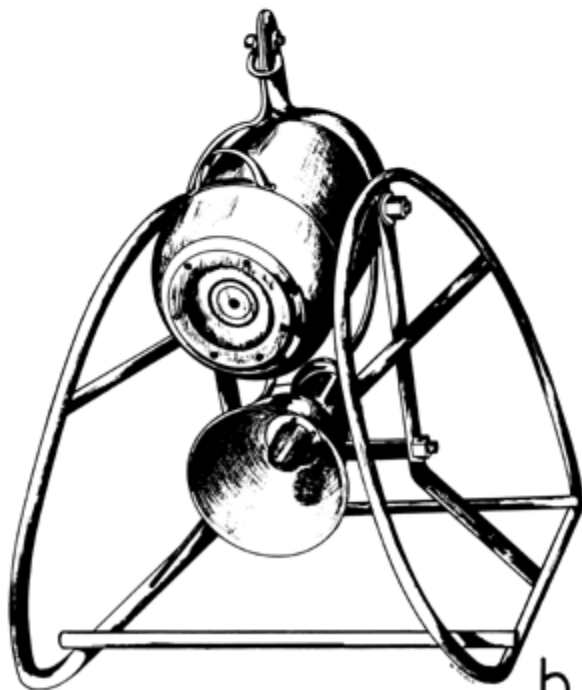


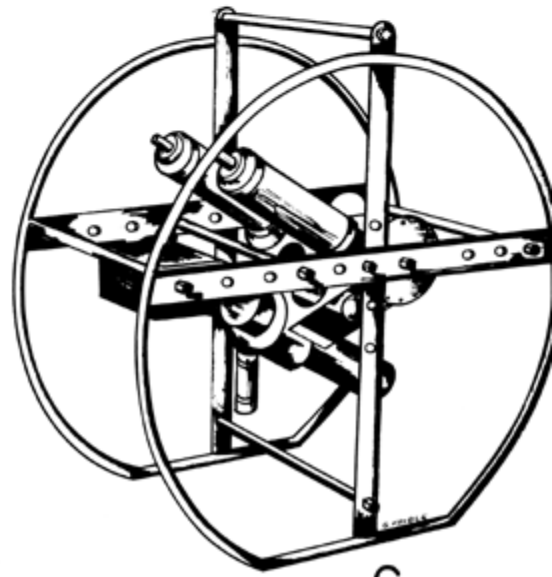
Fig. G-1



a



b



c

Fig. G-2



Fig. G-3

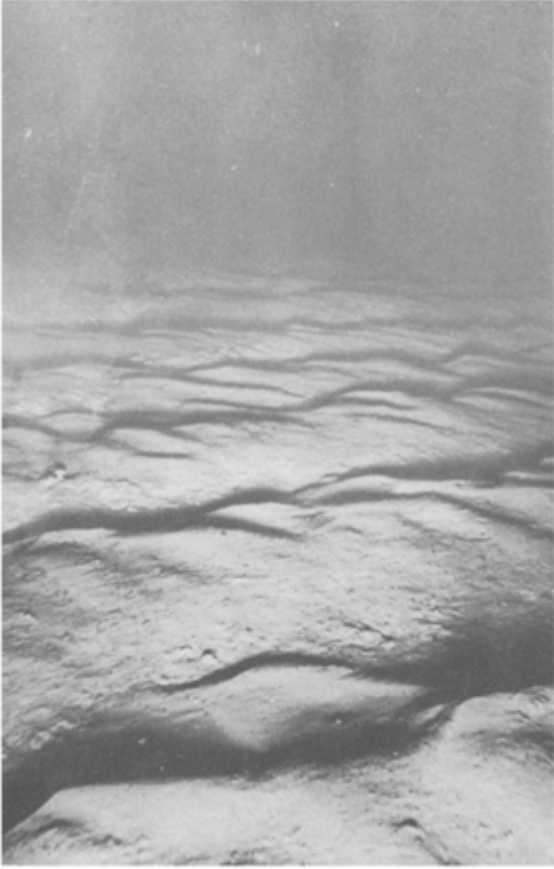
Fig. G-3





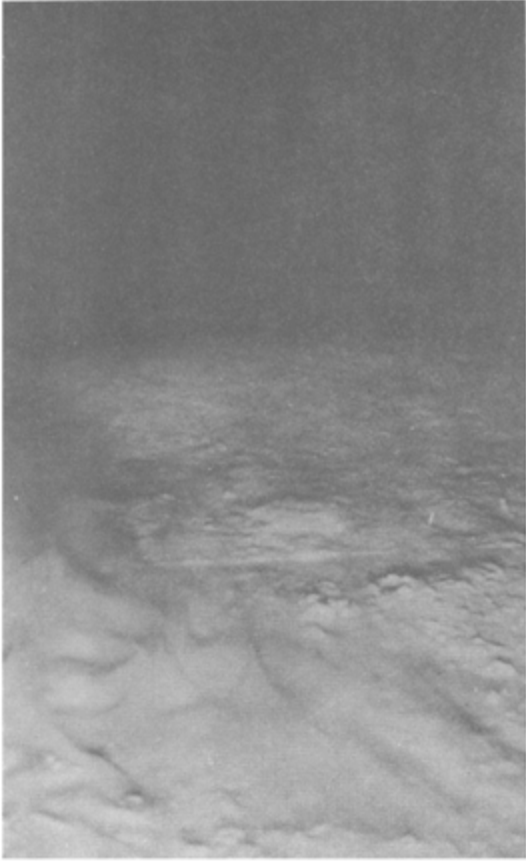
Fig. G-7

FIG. G-4



**Fig. G-4**

Fig. G-5



**Fig. G-5**

Fig. G-6

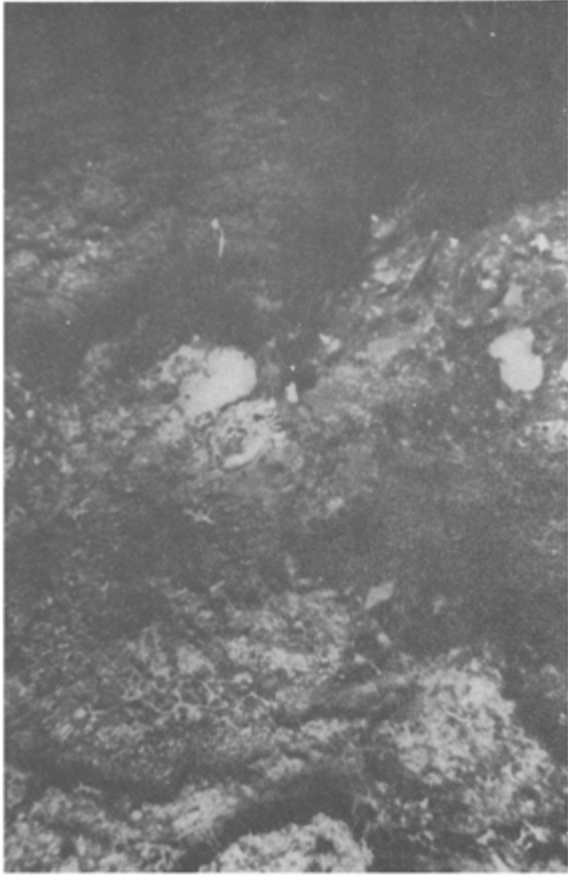


Fig. G-6

Fig. G-7

\* [\(See Fig. G-1\)](#)

\* A later very similar version of this assembly was used by Hodnett and Scripps on Expedition LUSIAD in November, 1962.

***SEISMIC REFRACTION STUDIES IN THE  
INDIAN OCEAN AND INDONESIAN  
REGION  
ON MONSOON AND LUSIAD  
EXPEDITIONS***

Seismic refraction observations, employing two ships, were carried out between Port Darwin and Djakarta for one month of MONSOON Expedition and throughout the southern tropical and temperate Indian Ocean — between Cochin, Saint Paul Island, Fremantle and Port Darwin — for three months of LUSIAD Expedition. Except for data from two localities already published (Shor and Pollard, 1963), this will be a progress report only. Analysis of all the results has not been completed; some conclusions made from preliminary inspection of the data are changing. Even later impressions may be modified by observational results of expeditions of the USSR, United Kingdom, Australia, Lamont Geological Observatory and Woods Hole Oceanographic Institution recently or soon to be in the area. As presently known, however, none of these agencies plans intensive long-profile refraction programs in the area generally covered by the present report, except possibly in the vicinity of the Seychelles and Mascarene Ridge.

Previous work consists of some fairly short-range radio-buoy stations recorded by Gaskell and Swallow on the world cruise of HMS *Challenger* (Gaskell, Hill and Swallow, 1958) and one station by Neprochnov (1962) in the Central Indian Ocean. The Gaskell and Swallow profiles recorded only the upper layers, but Neprochnov achieved penetration to the Moho and reported normal oceanic structure.

---

— 125 —

The locations of the seismic refraction observations from both cruises are shown by Fig. H-1. The 17 stations designated (M-11 to M-26) were occupied in October – November, 1960, on MONSOON Expedition. Here *Argo* served as receiving ship and M/V *Malita*, a chartered Australian coastal trader, fired the charges. On MONSOON, stations were placed to examine (1) the structure of the Timor Trough between Timor and Australia and the Banda and Flores basins north of the island chain and (2), by means of two multi-station profiles south of Lombok Strait and Central Java, the crustal structure transition from the Indonesian Islands south to the inner sedimented Bali Trough, then across the intervening submarine ridge down into the deep Indonesian Trench, finally up the southern flank of the trench to the northern reaches of the deep Wharton Basin. The geologically-complicated Indonesian islands lie in a complex region of great irregularity of crustal structure. Seismic refraction observations are not only difficult to obtain but their analysis is also difficult and in some cases obscure. The general structure shown by the Lombok Strait and Java investigations is roughly summarized in Fig. H-2 South of the trench the sediment and crustal thickness are essentially oceanic, possibly somewhat thicker than average. At the trench axis the sediment thickness remains small but the crustal thickness increases to a value nearly twice the oceanic value. North of the trench the sediment thickens markedly to more than 2 km. The maximum sediment thickness of nearly 3 km is found beneath the ridge separating the trench from the Bali Trough. Moho depth north

---

— 126 —

of the trench is variable. Its average value, about 20 km, is intermediate between a normal oceanic value at about 11 km and the normal continental thickness of 35 km.

The stations numbered 1 through 59 on Fig. H-1 were occupied during October – December 1962, when *Argo* and *Horizon* were carrying out part of the between-monsoons program of LUSIAD. Both vessels were equipped to shoot or receive profiles and would interchange functions when recording a reversed profile. The distribution of stations gives a far-from-complete coverage; it was not possible to make extensive detailed surveys. Furthermore, as this was an exploratory cruise, emphasis was placed on broad reconnaissance. Nevertheless, it was possible to place a significant number of stations on ridges and banks, such as Chagos Ridge, Seychelles and Saya de Malha Banks, the Mid-Indian Ocean Ridge and on two recently-recognized very large shoal features in the east central Indian Ocean. These highs, (1) the apparently aseismic, roughly east-west-trending ridge lying well off-shore between southwest Australia and Saint Paul Island and (2) the more active, rather linear meridional "East Indian Ocean Ridge" (Bezrukov, 1962) or "Ninetyeast Ridge" (Heezen and Ewing, 1963) both had rather flat tops at the unusual depth of about 1800–2000 meters where investigated by *Argo* and *Horizon*. The seismically-very active northeast-trending ridge southeast of South Africa was proposed for study, but its mountainous topography made seismic refraction studies impossible. A set of closely-spaced stations westward from Chagos Archipelago to the Seychelles was shot to

---

— 127 —

complement the line of seismic refraction stations between Kenya and the Seychelles subsequently recorded late in 1963 by Cambridge University scientists.

The field observations were reduced by techniques and statistical methods standard to marine seismic refraction work. Plots of travel-times of sound waves (waves produced in this instance by explosion of bombs of one to 200 pound weight thrown overboard by the underway ship) were subjected to corrections and analysis to determine average compressional wave velocities and crustal layer thicknesses. The result, in this case, was a simplified abstraction of the true structure. At some stations, the data justified greater detail and "dipping layer" solutions were used to show horizontal trends in structure.

LUSIAD profiles recorded on two banks in the western Indian Ocean were reported by Shor and Pollard (1963); the inferred structures are shown in Fig. H-3. Both of these banks, Seychelles and Saya de Malha, lie on the Mascarene Ridge, but in a north-south direction they are separated by several hundred kilometers of passes and shoals. The Seychelles Islands are notable for the presence there of granite, a common feature of continents but unique here to small oceanic islands. Samples of this granite have been dated by Miller and Mudie (1961) and found to be at least 600 million years old, in contrast to probable basement rocks of other oceanic islands which are seldom, if ever, older than Cretaceous. In the center in Fig. H-3 is the structure deduced by Shor and Pollard for Seychelles Bank together with the results Gaskell and Swallow recorded on *Challenger*. Here, the velocity of 6.22 km/sec is determined by a 50-km reversed profile in shoal water

---

— 128 —

west of Mahe Island and it confirms the hypothesis that much of Seychelles Bank is formed of material with typical continental velocity (6.0 – 6.3 km/sec). In addition, the LUSIAD profile shows wedge-shaped layers thickening westward. The velocity of the upper layer (2.37 km/sec) is consistent with its being coral debris, and the second one, 3.97 km/sec, is very close to the velocity (4 km/sec) of lava as observed on the flanks of well-known oceanic islands. At the bottom of Fig. H-3 is the deduced structure of Saya de Malha Bank, which is seen to be quite different. The sequence of velocities, from 1.7 to 6.8 km/sec, is very similar to that observed in the Pacific beneath volcanic islands, atolls and ridges. The typical continental velocity, 6 km/sec, observed on Seychelles Bank is missing under Saya de Malha Bank, which appears to be a normal oceanic feature.

LUSIAD investigations revealed very complex changes in structure in an east-west direction across the several ridges and basins of the southern Indian Ocean. A final section, Fig. H-4, lying along an irregular track, highly schematic and with large gaps between stations, extends nearly completely across this region, between 30° and 40°S. The section runs from Crozet Basin eastward across the Mid-Indian Ocean Ridge, through the region of moderate depth just east of that ridge, on to the super-guyot or ridge mentioned above that trends nearly east-west off southwest Australia and, finally, down into a 4800–5000 meter deep basin lying west of Fremantle. The latter basin is probably separated from the great Wharton Basin, largest and deepest of the Indian Ocean basins, by a rather low ridge.

---

— 129 —

Along the east-west section, there is great variability in thickness of all the layers, more than we are accustomed to observe in the Pacific. This variability is not randomly distributed but is related to topography and geographical position. There is an east-west asymmetry, the crustal thickness and Moho depth being greater on the east side of the Mid-Indian Ocean Ridge. The transition occurs at the ridge, and the change between stations 38 and 39 is so abrupt as to suggest a major fault. Such a fault system or major discontinuity here is suggested also by the topographic and magnetic data. A striking result is the very shallow Moho depth of station 39 on the west side of the ridge. This is the shallowest Moho we have yet observed. The structure on the large east-west(?) ridge of intermediate depth also is complex. The estimated depth to Moho is somewhat dubious as it depends on second arrivals. The structure is neither clearly oceanic or clearly continental and is probably intermediate. The topographic relations of this ridge to the seismically-active median ridge to the west and to the north-trending East Indian Ocean Ridge are not yet established; its east edge, however, seems to be a steeply-faulted contact with the deep basin off Fremantle. Naturaliste Bank, the shoal protruding west from the southwest corner of Australia, does not join this intermediate-depth ridge.

All stations and sections will be reported in detail later, but even now one can summarize several features of the Indian Ocean that are unlike Pacific oceanic structure:

- 1) There is continental structure beneath the Seychelles Bank
-

and quasi-continental structure beneath the elevated feature off southwest Australia;

2) There is great variability and complexity of structure; and

3) The crustal thickness is correlated with geographic position but not with sea depth.

However, from the LUSIAD observations, average crustal thickness in the Indian Ocean is not significantly different from average thickness in the Pacific.

(R.W.R., G.G.S., Jr.)

## REFERENCES

- Bezrukov, P.L. (1962) , On the irregular distribution of deep-water oceanic sediments: *Inst. Oceanology, Acad. Sci. USSR*, v. 2, no. 1, pp. 9–25, (in Russian). Gaskell, T. F., Hill, M. N. and Swallow, J. C. (1958) , Seismic Measurements made by HMS Challenger in the Atlantic, Pacific and Indian Oceans and in the Mediterranean Sea: *Roy. Soc. London*, ser. A 251, 23. Heezen, B. C. and Ewing, M. (1963) , The mid-Oceanic Ridge: v. 3, *The Sea*, pp. 388–396–410. Miller, J. A. and Mudie, J. D. (1961) , Potassium Argon age determinations on gravite from the island of Mahé in the Seychelles archipelago: *Nature*, v. 192, no. 4808, pp. 1174–1175. Neprochnov, Iu. P. (1962) , New data on structure of earth's crust beneath the Indian Ocean: *Dokl., Acad. Sci. USSR*, v. 144, no. 2, pp. 438–440, (in Russian). Shor, G. G., Jr. and Pollard, D. D. (1963) , Seismic Investigations of Seychelles and Saya de Malha Banks, Northwest Indian Ocean: *Science*, v. 142, no. 3588, pp. 48–49.

## CAPTIONS

Fig. H-1 Seismic refraction stations occupied in the Indian Ocean during MONSOON and LUSIAD Expeditions.

Fig. H-2 Generalized crustal structure of the Indonesian Trench south from Lombok Strait.

Fig. H-3 Mascarene Ridge seismic sections.

Fig. H-4 Composite east-west crustal section across the southern Indian Ocean.



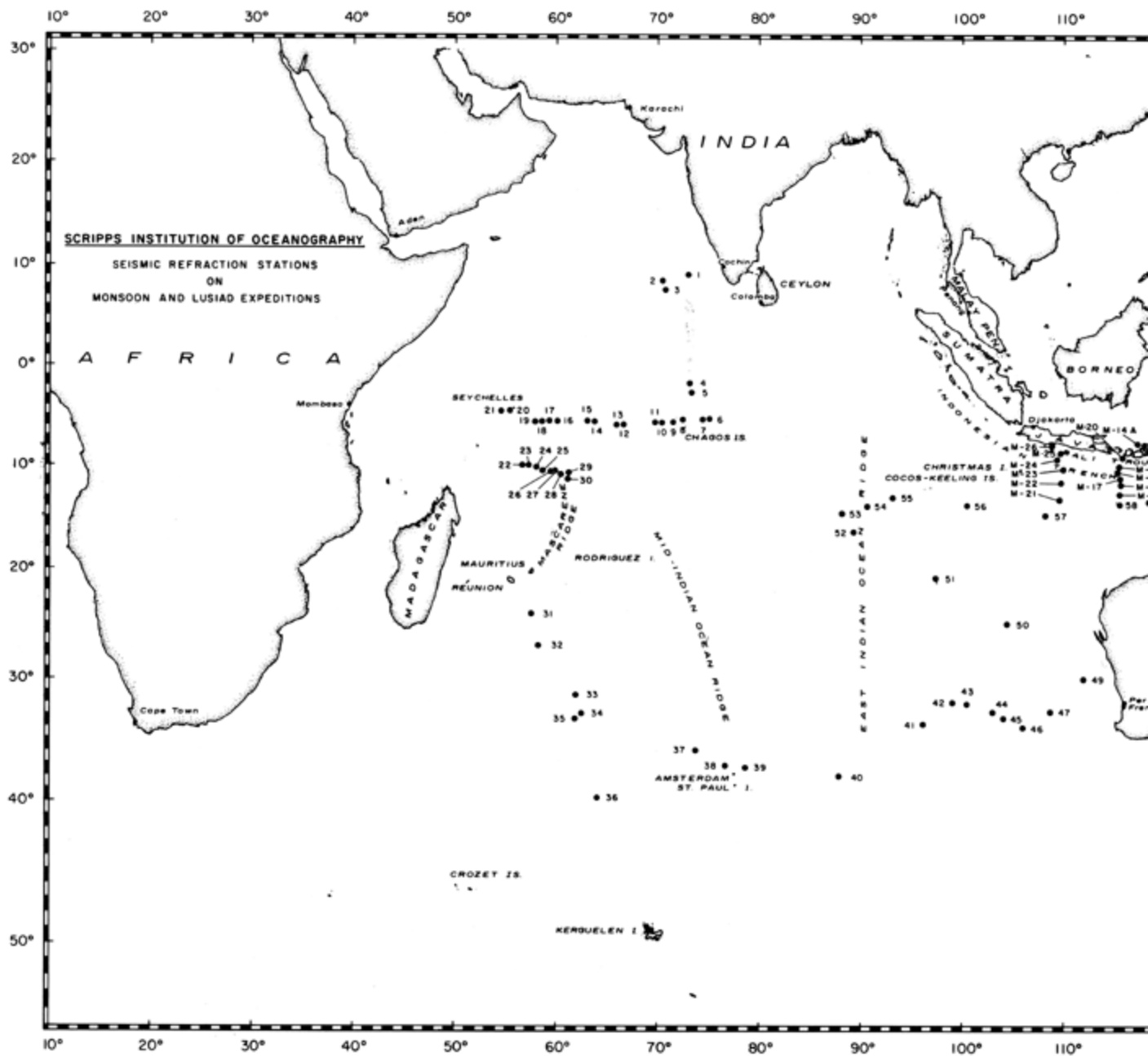


Fig. H-1

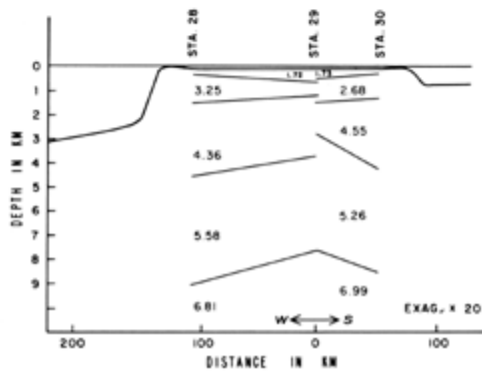
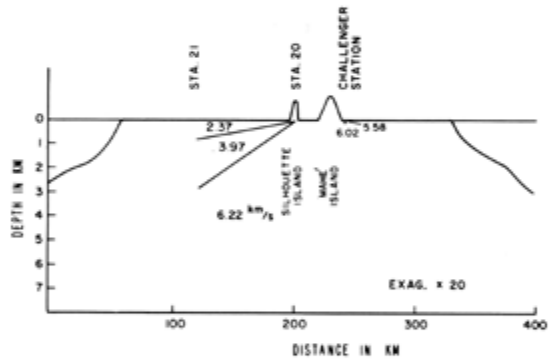
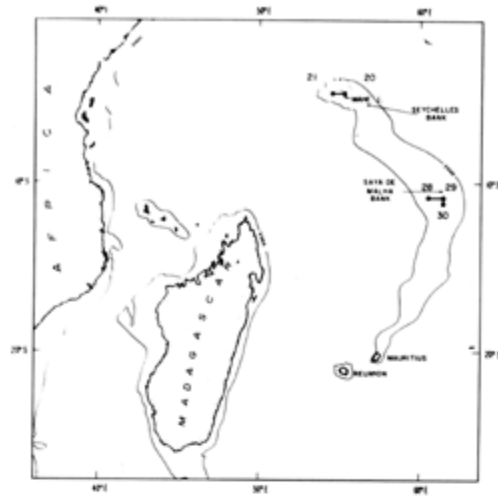


Fig. H-3

Fig. H-3

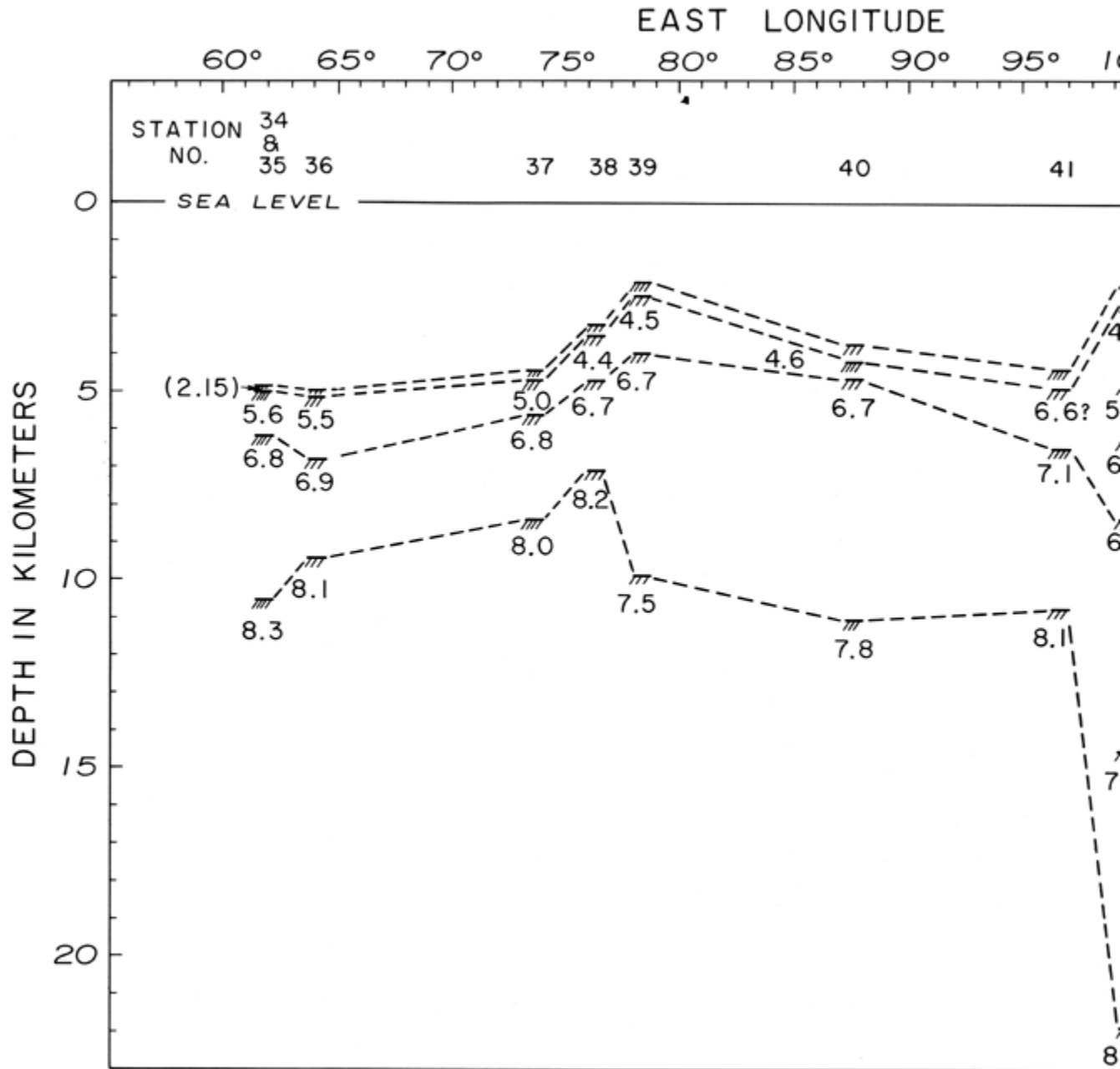


Fig. H-4

# MAGNETIC DATA OBTAINED BY SCRIPPS RESEARCH VESSELS IN THE INDIAN OCEAN, 1960–63

## PART I. MAGNETOMETER OPERATIONS

### A. *MONSOON Expedition*

A proton precession magnetometer was towed behind *Argo* nearly continuously during the August-April work in the Pacific and Indian Oceans. Single line surveys can only convey some idea of the roughness of the magnetic field along the ship's track. The MONSOON results confirm the findings of Russian workers (for example, M. M. Ivanov, 1961) that the field is smooth near the continents and away from the mid-ocean ridges, and rough along a band, sometimes as wide as 2000 kms., paralleling the ridges. The approaches to the central Indonesian island from the Indian Ocean side are characterized by a very smooth field, whereas the magnetic record from Saint Paul Island to Fremantle is rough nearly all the way. No large magnetic anomalies were found over the Indonesian Trench. Two box-like sets of tracks on the flanks of the oceanic "median rise" south of Australia and New Zealand were traversed to determine whether in such ridge areas the magnetic contours are parallel to the general strike of the topography. Fig. I-1 suggests that this is the case. More detailed interpretations will become possible as the number of tracks increases. This would be particularly true if bathymetric and magnetic data were taken along pairs of tracks between 10 and 30 nautical miles apart.

(V. V.)

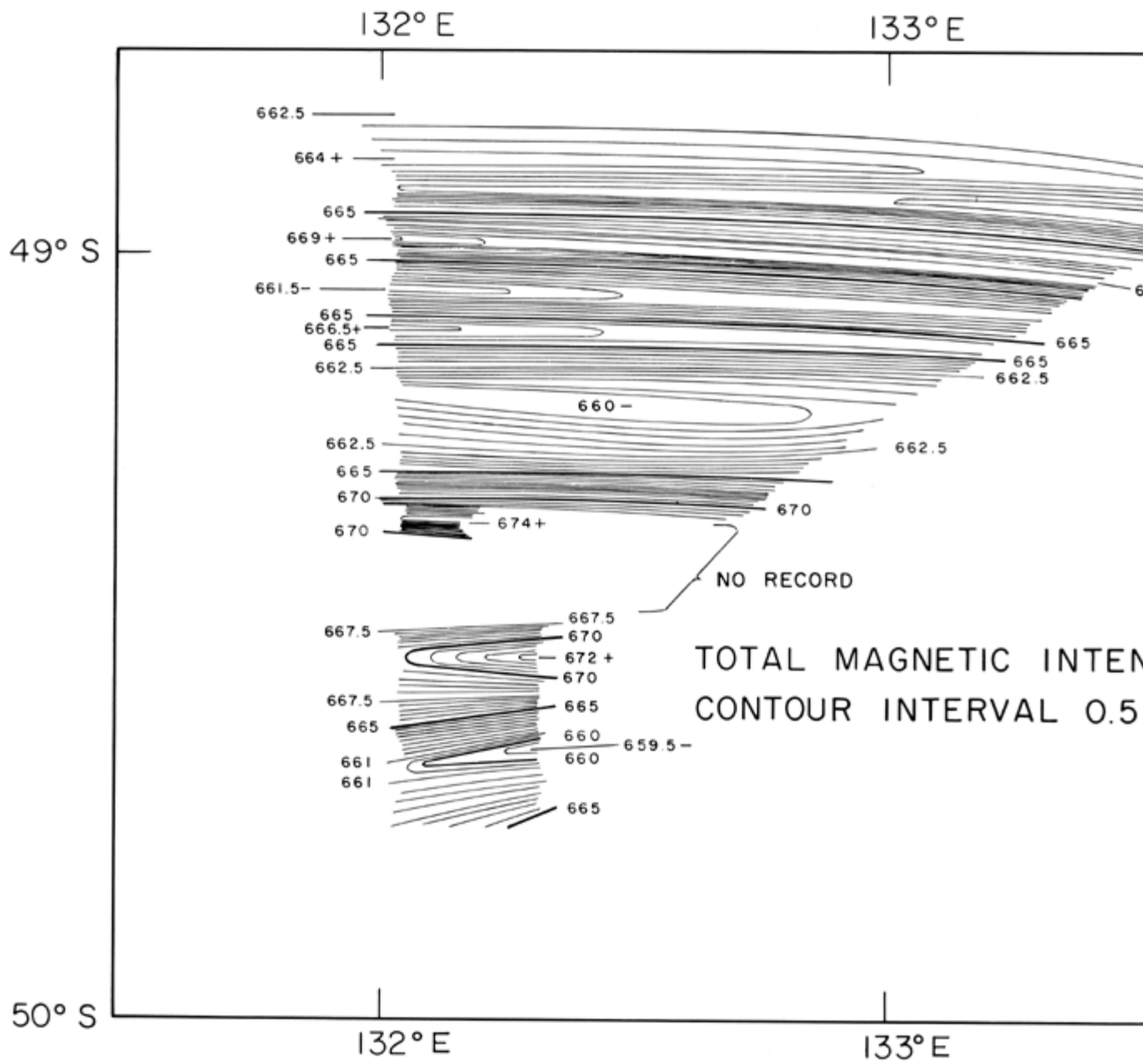


Fig. I-1

## **B. LUSIAD Expedition**

On LUSIAD Expedition the magnetic data were obtained with proton precession type magnetometers towed five hundred feet astern of *Argo* and *Horizon*.

### **Magnetic Anomaly**

The general magnetic relief (magnetic anomalies) of the Indian Ocean region is similar to that of the Pacific Ocean and the Atlantic Ocean Areas. The chart ([Fig. I-2](#)) that includes not only SIO but also Lamont Geological Observatory and United Kingdom (*Owen*) lines serves as a magnetic physiographic map of this ocean. Crosses indicate traverses of high anomaly intensity and unfilled circles lie along those of low anomaly intensity. It is quite probable that such a detailed physiographic chart would delineate geomorphic provinces and boundaries, not otherwise revealed, of as much interest to oceanographers as are the topographically expressed rises and trenches.

### **Oceanic Ridges**

Where the magnetometer was operating as the ship crossed a "median" ridge, the magnetic trace was often characterized by a ridge anomaly such as is often found across ridges in the other oceans (Vacquier and Von Herzen, 1964). The anomaly was absent or present in about the same proportion as for the other oceans. It is not caused by the topographic relief, but rather by something deeper and probably associated with temperature. It is a matter of speculation whether the degree of occurrence of the characteristic ridge anomaly is proportional to the degree of localized activity of the ridge.

---

— 134 —

From the magnetic anomaly profiles estimates of the maximum depths to the anomaly-causing bodies were made. The depths range from eight to twenty-five kilometers. (Fig. I-3)

### **Indonesian Trench**

The most complete magnetic record was taken over the Indonesian Trench. Parts of this record, with the corresponding depth profiles, are shown in Fig. I-4, and locations appear in the inset. In all sections the right hand side of the profiles is the nearshore side. In this figure the earth's smooth magnetic field gradient is removed from the magnetic profiles leaving the anomaly only.

From inspection of both the sounding the magnetic profiles, it is apparent that the trench changes in character along its length: Changes in characteristics as they pertain to, or may be indicated by, the magnetic profiles are discussed below.

- a. In order to determine if the trench as a whole causes an anomaly in the earth's smooth field, a long profile was drawn from a world magnetic intensity chart and then compared with the short profile, D-D', with which it coincides. The gross topographic feature of the

trench does not appear to cause a significant magnetic anomaly. This indicates that the near-surface material of the trench is not igneous.

- b. The magnetic profiles taken in sequence, show sufficient similarity to indicate that magnetic rock-discontinuities generally strike parallel to the trench.

---

— 135 —

- c. Along parts of the trench the magnetic profiles are relatively smooth over the inshore half of the trench, in spite of the fact that the water is shallower here. This indicates that the materials just beneath the sea floor on the nearshore flank are less magnetic and probably less igneous in bulk composition than those on the offshore side; as examples, profiles B-B', D-D', F-F', G-G' and I-I'. Exceptions are profiles E-D', H-H', and J-J', in which the shallow occurring material is certainly somewhat magnetic.
- d. One of several instances in which the shallow water material is markedly non-magnetic is the flat-topped section of (depth) profile C-C'. The portions of profiles A-A', B-B' and intermediate crossings off Northern Sumatra where the water is less than a thousand fathoms deep also have rough bottom topography that does not cause magnetic irregularities.
- e. The islands, or at least the shorelines of the islands, appear to cause a magnetic anomaly. This is seen as a change in slope of the magnetic profiles as they approach the coast. The knee of the slope change is usually fifteen to thirty miles from the shoreline. This effect can be noted in profiles C-C', E-D', G-G', H-H', and J-J'. Profile H-H' runs north between the islands of Bali and Lombok and shows more completely the shape of this island-caused anomaly.

### ***Mauritius Island***

Unfortunately the magnetometer was not in operation on about half the occasions when the ships were near Mauritius. There are, however, some

---

— 136 —

useful tracks on the eastern side. The magnetic traces, when compared with the bathymetric chart, show that the magnetic relief here reflects closely the topographic relief. This is reasonable; at Mauritius, a "basaltic" island, the topographic surface is that of a volcanic pile of the molten rock (flow) type, not of one composed primarily of ash and pumice.

(A. D. R.)

## ***REFERENCES***

Vacquier, Victor and Von Herzen, R. P. (1964) , "Evidence for Connection between Heat Flow and the Mid-Atlantic Ridge Magnetic Anomaly," *J. Geophys. Res.*, v. 69, no. 6, pp. 1093–1101.

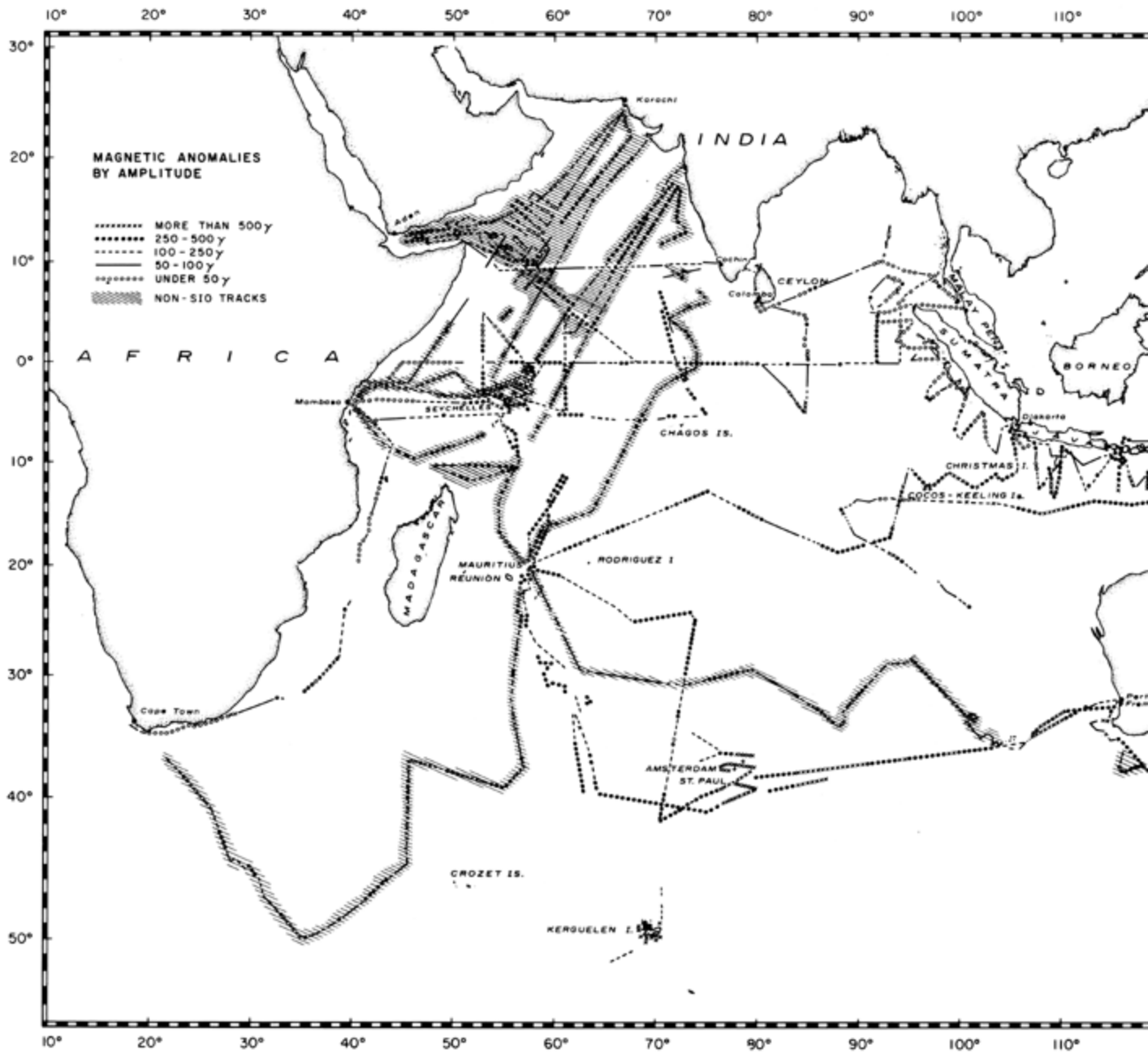
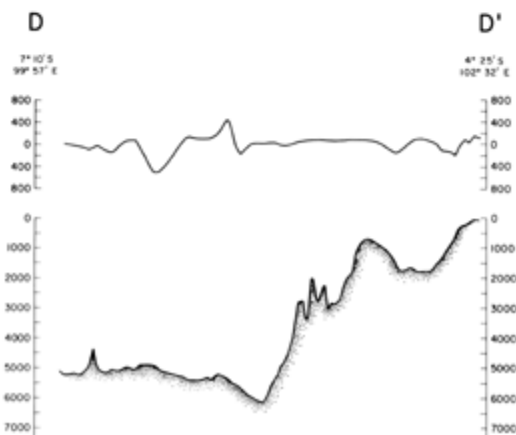
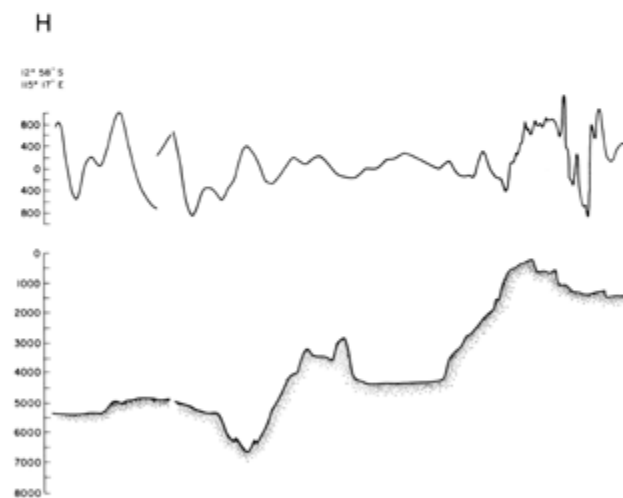
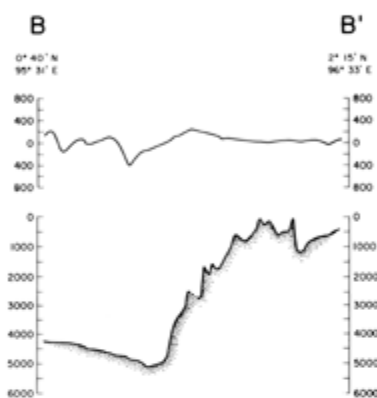
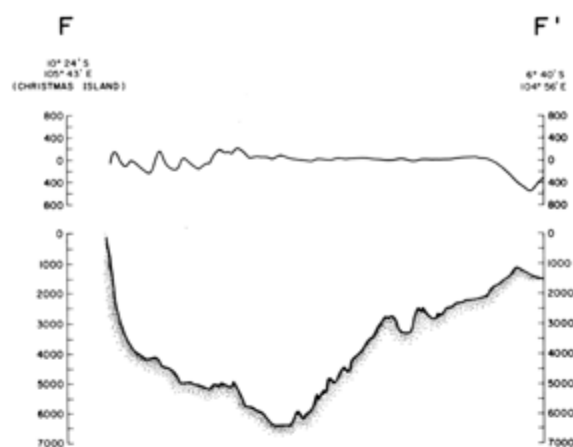
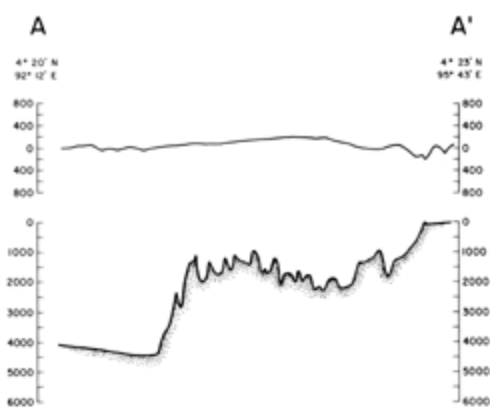


Fig I-2





## II. MAGNETIC STUDIES OF INDIAN OCEAN SEDIMENTS

### *Introduction*

Twenty-one cores collected in the Indian Ocean on Expedition MONSOON have been sampled for magnetic measurements; the results from eight of the cores are discussed briefly in this report. The positions from which all these cores were obtained are plotted on Fig. I-5. The purpose of the study was to determine something about the past history of the Earth's magnetic field, and to examine the possible uses of magnetic properties in the study of deep ocean sediments.

All samples were measured, on an astatic magnetometer, for declination and inclination of remanence; the susceptibility of all samples was measured on an AC bridge. From these data the Q factor, that is, the ratio of remanence/susceptibility was determined (See Table 1 below for mean values of the intensity of remanence and susceptibility). As the cores were unoriented, the declination has no significance except in comparing the values between samples from a single core. The directions of remanence were plotted on equal area diagram, the numbers next to each direction referring to the distance in cm. from the top of the core from which that sample was taken.

The accuracy of the direction of remanence is to within  $2.5^\circ$ . The probable cause of this large value is disturbance of the sediment when the core is collected, as well as disturbance when sampling. The magnetic sampling procedure consists of pressing small hollow glass cylinders into the flat side of the core divided in half lengthwise; a thin layer of sediment adjacent to the inner surface of the glass cylinder thus becomes disturbed.

For each core, a mean value of the direction of remanence was calculated using Fisher's statistics for distribution over a sphere. The  $\alpha_{95}$  represents the semi-angle of the cone of confidence at the 95% level around the mean direction. The value of  $k$ , the precision parameter, shows the degree of dispersion of the population of directions. Large values of  $k$  show tightly grouped directions. If a series of spot readings of the geomagnetic field is made over a period of time large enough to average out the secular variation (c. 10,000 years), then the value of  $k$  expected for the population of directions will be of the order of 20.

Since a comparison will be made of the dip of the mean direction from each core with the dip of the geomagnetic field, it is necessary to discuss whether the corer penetrates the sediment vertically or not. M. J. Keen, of Cambridge University, came to the conclusion that piston cores taken on *Discovery II* by himself and M. N. Hill were not tilted by more than a few degrees from the vertical. Sir Edward Bullard showed, from experiments done in a wind tunnel, that the stable position for a falling heat probe was in the vertical position. Richard P. Von Herzen has found an inclination of as much as  $20^\circ$  in only one out of the great many heat probe measurements made on S.I.O. vessels. From this evidence it may be assumed that the corer falls vertically, and probably enters the sediment within  $10^\circ$  of the vertical. Nevertheless, information as regards the precise attitude of the corer in the sediment would be of great value, especially as the mean direction of magnetization from a core may have a confidence interval around it of less than  $10^\circ$ .

In addition, in order to gain the most information from the magnetic properties of any core, it would be useful to know the absolute declination

---

— 139 —

of remanence, and not just the relative declination within one core. For these reasons, an inclinometer and compass orienting device, working on a photographic principle, is being developed for use on future cruises collecting cores for use in magnetic studies.

### ***Results of magnetic sampling of eight MONSOON cores***

The general results are illustrated in Figs. I-6 to I-12. First, it should be noted that samples from piston cores MSN 56 P and MSN 67 P ([Figs. I-8](#) and [I-12](#)) produce a far greater scatter of directions of magnetization than do samples from gravity cores. This has been confirmed in studies of piston cores from the Pacific Ocean. The cause of this greater scatter is probably the extrusion process by which piston-core material is removed from the core barrel.

Second, with the exception of MSN 33G ([Fig. I-6](#)) and MSN 33 ([Fig. I-6](#)) all the gravity cores seem to show stable magnetization, as there is no sign of any streaking of directions of remanence or of a large scatter. These are the usual signs of instability. In addition, the mean directions are approximately consistent with the dip of the axial field, or that field produced by a hypothetical dipole at the Earth's center oriented along the rotational axis. Any differences between the dip of the mean direction in a core and the axial dip may be due to non-vertical entry of the corer. However, work done on nine additional cores from the Indian Ocean ([Fig. I-5](#)) suggests that there is a systematic steepening of dip in the remanence compared to the axial field. The cause of this possibly-systematic effect is not known. It is suggested that it may be due to the Earth's magnetic field (averaged to remove secular variation) differing from an axial field for long periods of time. Further coring in the Indian Ocean is necessary to elucidate this problem.

Third, it is found that several of the cores have a pronounced magnetic susceptibility anisotropy ([Fig. I-8](#) and [I-11](#)). It is not known whether all the cores have this type of anisotropy, but it is likely that any anisotropy showing a consistent maximum direction of susceptibility

---

in a horizontal plane such as in core MSN 62 Ga is caused by the action of some stress (deep-water current, or turbidity flow, for example) during the time the sediment was being deposited. Core MSN 62 Ga contains several graded beds. This suggests that deposition was from repeated turbidity currents, providing a possible explanation of the grouping of maximum susceptibility directions.

Fourth, the presence of a highly magnetic band has been discovered in cores MSN 56P and 56 GP. The measurement of bulk susceptibility together with the intensity of remanence and the Q factor in these two cores is illustrated in Figs. I-7 and I-9. Fig. I-10 illustrates the saturation magnetization vs. temperature curve for the magnetic mineral from this locality. It shows a Curie point of 640°C. Both this and X-ray diffraction data suggest that the mineral is maghemite. Fig. I-8 shows the maximum susceptibility directions for five specimens from the highly magnetic portions of MSN 56P and MSN 56GP. These directions group round the vertical, the first time that such a phenomenon has been observed. Furthermore, the intermediate susceptibility is nearer to the minimum than to the maximum value, the susceptibility tensor have the shape of a prolate ellipsoid (see Table 2 below). In studies of sedimentary rocks, the normal shape for the tensor is that of an oblate ellipsoid. All this evidence suggests that the magnetic material has been formed in situ (Harrison and Peterson, in preparation).

Fifth, it is noted that cores MSN 34G, MSN 59G, MSN 60G, MSN 62G and MSN 68G (Fig. I-6) have extremely tight groupings of directions of remanence. The values of (between) 129 and 37 for  $k$  are considerably larger than those normally obtained with suites of continental rocks. The reason for the large values for  $k$  is that the magnetization of each sample (of diameter 1.7 cm) represents an average direction of the Earth's magnetic field over at least 1,700 years. Thus a large part of the variation in direction due to the secular variation will be averaged out in these samples. In further studies on core material it is hoped that the variations in the directions of remanence will help to describe in more detail than has hitherto been possible the long period variations of the Earth's

magnetic field, such as dipole wobble.

Sixth, it is obvious that most of the scatter in core MSN 34GP (Fig. I-6) is caused by a rotation of the corer as it penetrated the sediment. It is difficult to say what the true value of  $k$  should be.

## *Conclusions*

The measurements so far made on Indian Ocean sediments suggest that the remanence from this material is stable. Except in the piston cores, which always have a great scatter due to the extrusion process, only two cores, MSN 33G and 33Ga, show any signs of magnetic instability. These cores come from almost the same area and there is probably some common magnetic mineral which is the cause for this instability. For most of the cores there is a good agreement with the mean direction of remanence and the dip of the axial geomagnetic field. The pattern of magnetization expected from material with an unstable remanence would be far more scattered

than has been found, and would probably show a streaking of directions. Repeat measurements on MSN 62Ga show that this material is stable over a period of three months.

As with all the Pacific material so far studied, piston cores requiring extrusion have been shown to be completely unsuitable for magnetic studies. Samples from "lined" piston cores, such as those studied by Keen at Cambridge University, have given good magnetic results. Lined corers should be used as much as possible in the future. To enable a further check to be made on the magnetic stability and to allow the maximum possible information to be drawn from the cores, it is essential that an inclinometer and compass orienting device be employed when taking cores for magnetic measurements.

Three geographical areas of interest which have come to light from this brief survey of the magnetic properties of Indian Ocean sediments are as follows:

1) More cores should be taken south of Java to enable a further investigation to be made as to why the magnetization of cores 33G and 33Ga is unstable, and to discover why core 34G has such a large  $k$  value.

---

— 142 —

2) A further investigation in the vicinity of MSN 56P is indicated in order to discover something more about the occurrence of the magnetic mineral found in the upper 58 cm of this core. As this material is likely to have been caused by volcanic activity associated with the Indian Ocean "median" ridge, a series of cores should be taken along latitude  $24^{\circ}$  South from longitude  $70^{\circ}$  to  $75^{\circ}$  East.

3) The area where MSN 62Ga was collected should be sampled further to investigate the conditions of deposition causing layered structure in this core. Information regarding possible turbidity current deposition may be obtained from a study of the magnetic susceptibility anisotropy. If an orienting compass is used in taking cores, an idea of the direction from which the turbidity current came could also be obtained.

Speaking more generally the whole area off the "median" ridge, and especially to the east, appears promising for a study of the paleomagnetism displayed by deep-sea sediments. Further concentrated coring at selected areas will probably verify current notions about recent changes in the Earth's magnetic field.

(C. G. A. H.)

---

— 143 —

**Table 1 The mean values and standard deviations of intensity of remanent magnetization, Q factor (remanent**

**magnetization/susceptibility), and intensity of magnetic susceptibility for the nine cores described in the text.**

<i>CORE NO.</i>	<i>INTENSITY</i>	<i>Q FACTOR</i>	<i>SUSCEPTIBILIT</i>			
	micro e.m.u./c.c.			<i>Y</i>		
	mean	st.dev.	mean	st.dev.	mean.	st.dev.
MSN 33 G	5.9	2.3	.57	.18	10.8	3.8
MSN 33 GA	10.9	4.9	.56	.33	21.8	9.9
MSN 34 G	19.8	5.9	.88	.20	22.8	5.0
MSN 34 GP	16.7	5.0	.77	.21	22.2	6.0
MSN 56 GP	20.8	21.0	.23	.16	358.	485.
MSN 59 G	10.1	2.2	.37	.10	28.0	1.6
MSN 60 G	16.3	6.3	.50	.13	31.9	12.4
MSN 62 G	112.	50.	.84	.12	128.	28.
MSN 68 G	16.9	6.4	.28	.05	54.8	11.4

Table 2 The relative values of the three principal susceptibilities for the five highly-magnetic samples from MSN 56 P and MSN 56 GP.

*MAGNETIC ANISOTROPY OF MSN 56 P AND GP*

<i>Specimen number</i>	<i>Maximum</i>	<i>Intermediate</i>	<i>Minimum</i>
2	1.0	.987	.976
30	1.0	.978	.967
41	1.0	.973	.969
16 (GP)	1.0	.991	.982
23 (GP)	1.0	.979	.976

***CAPTIONS***

Fig. I-5 Cores which were sampled for paleomagnetic measurements.

Fig. I-6 The directions of remanent magnetization of the samples from gravity cores. Also given are the core locations and the depth of water, and 95 and k using Fisher's statistics. Marked on

each equal-area net are the mean diameter of magnetization, the axial field dip, and the dip of the present-day field. In this and the similar figures open circles represent positive dips and closed circles represent negative dips.

Fig. I-7 The Q factor, intensity of remanent magnetization and intensity of magnetic susceptibility for MSN 56GP plotted against distance from the top of the core.

Fig. I-8 The directions of remanent magnetization of the samples from MSN 56P, MSN 59G and MSN 60G, and the maximum and minimum susceptibility directions of five samples from MSN 56P and MSN 56GP plotted on equal-area nets.

Fig. I-9 The Q factor, intensity of remanent magnetization and intensity of magnetic susceptibility plotted against distance from the top of the core, for MSN 56P.

Fig. I-10 The value of the ratio of the saturation magnetization at  $T^{\circ}\text{C}$  to that at  $0^{\circ}\text{C}$  plotted against temperature of the magnetic mineral from the top of MSN 56P, showing Curie temperature at  $640^{\circ}\text{C}$ . The dots show values during the heating cycle, and the open circle shows the value after cooling to  $100^{\circ}\text{C}$  had taken place.

Fig. I-11 The directions of remanent magnetization and of maximum and minimum susceptibility of the samples from MSN 62Ga.

Fig. I-12 The directions of remanent magnetization of the samples from MSN 67P and MSN 68G.

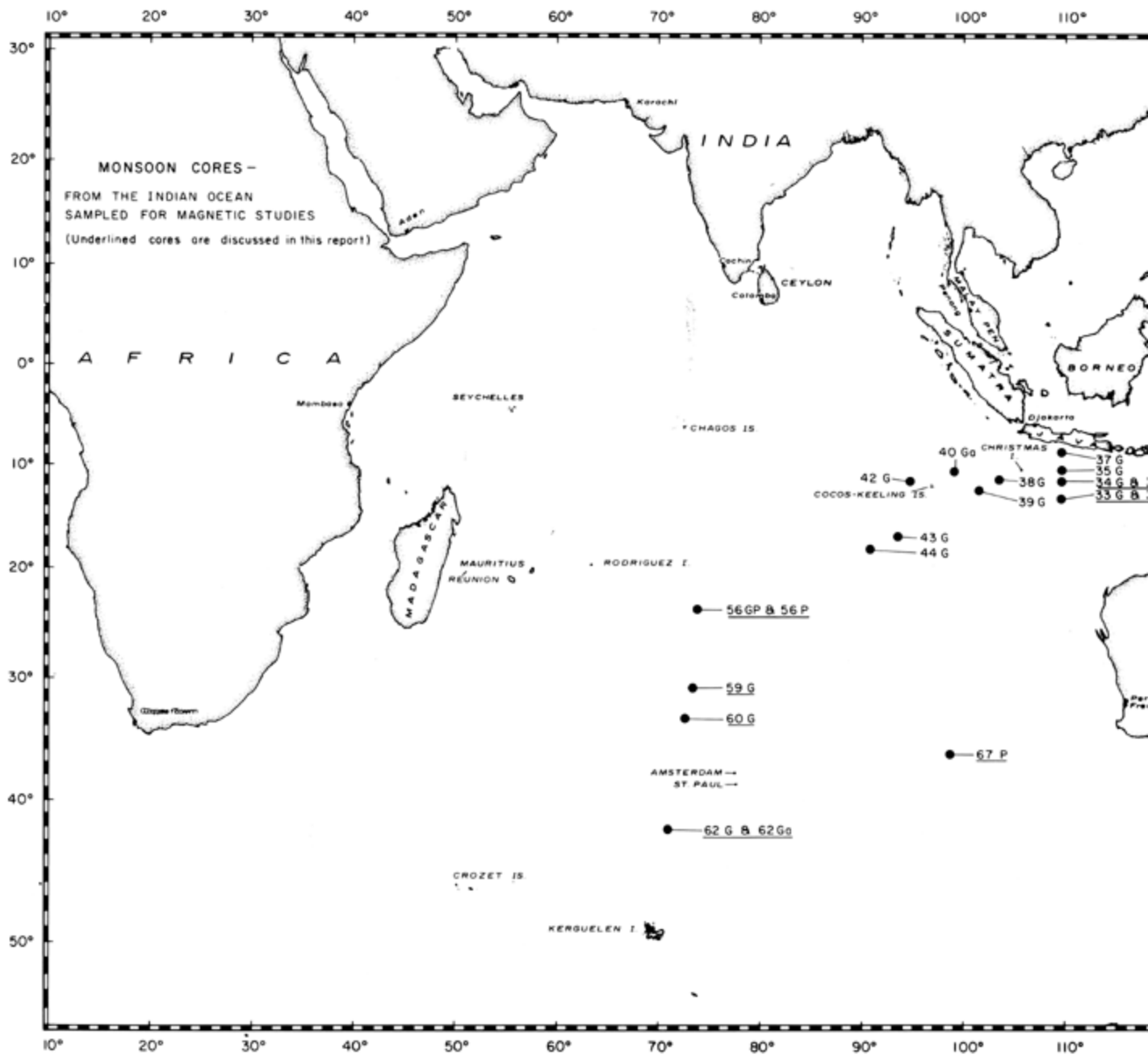


Fig. I-5



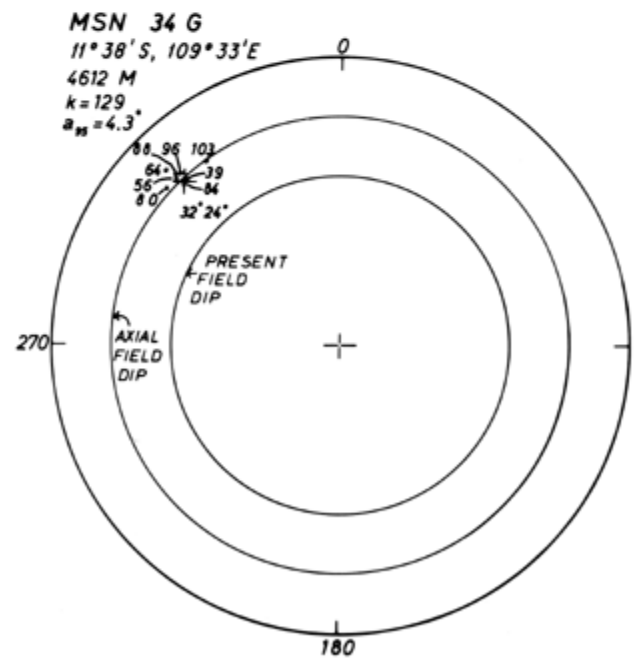
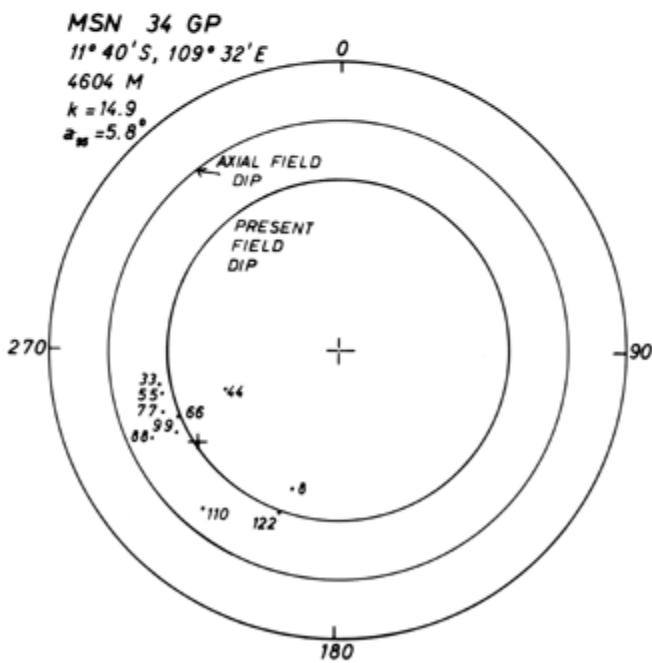
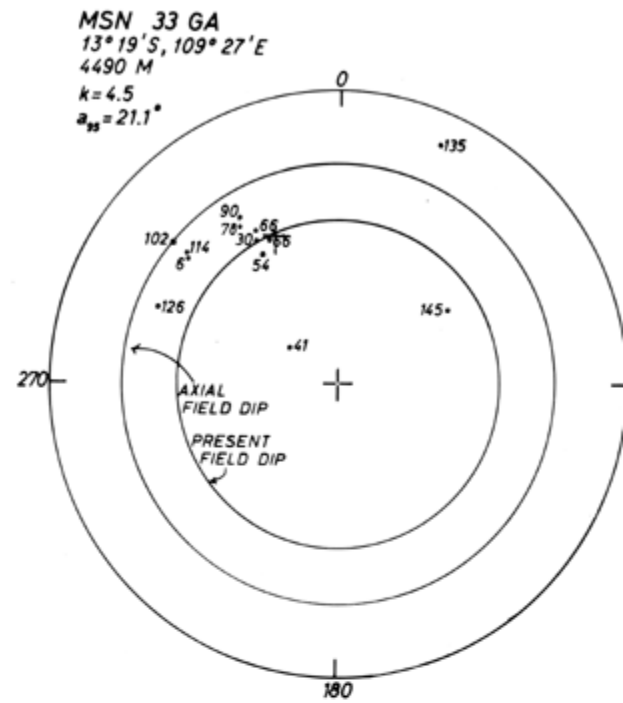
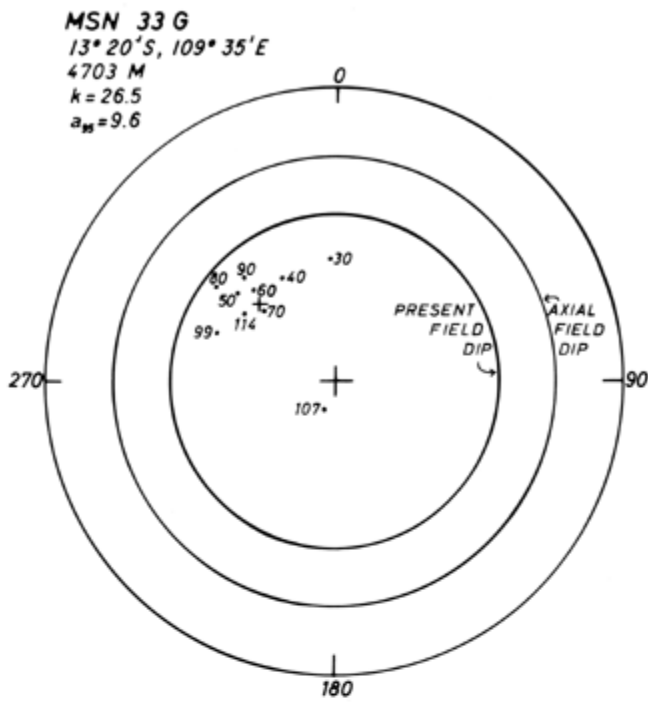


Fig. I-

Fig. I-6

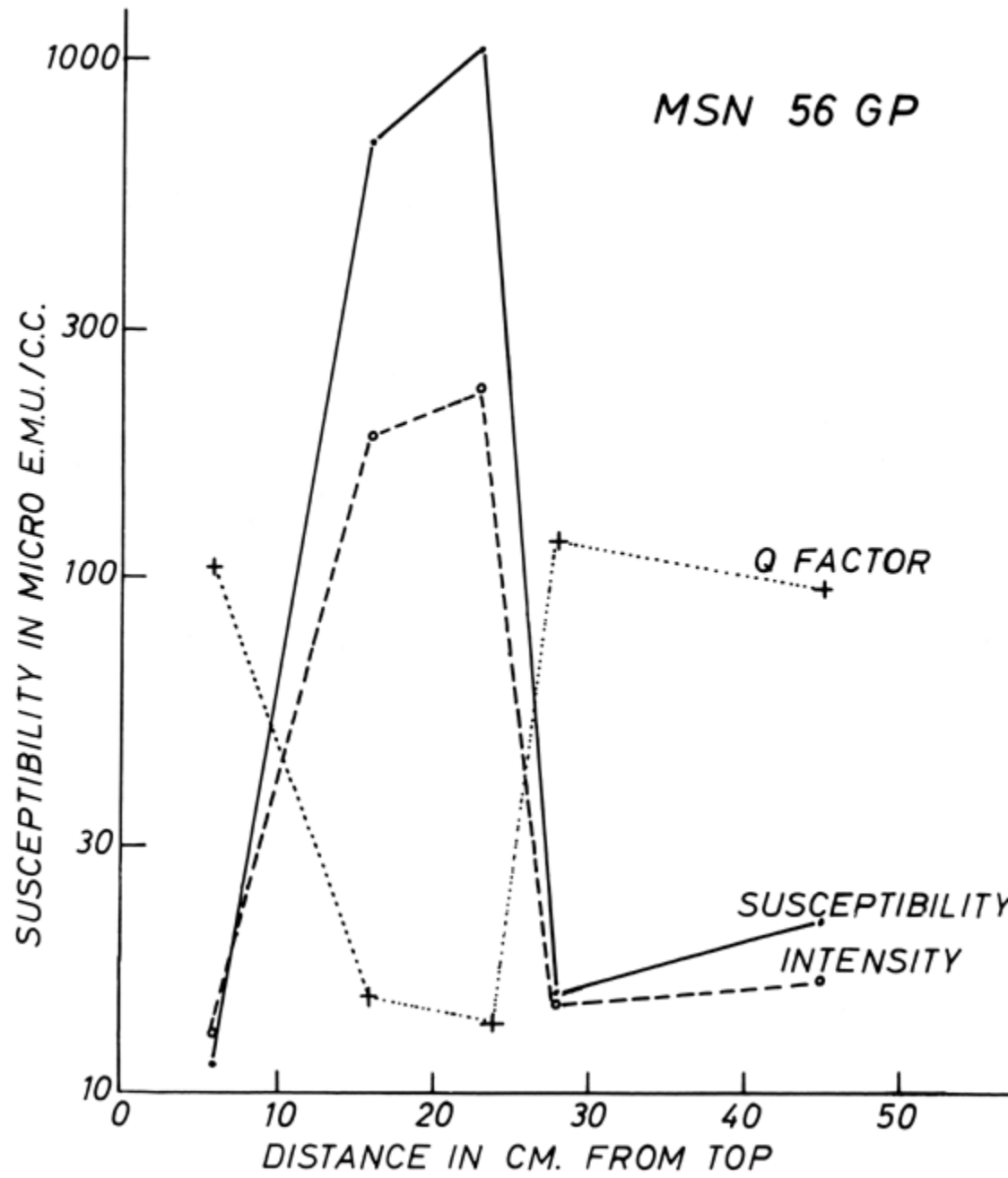
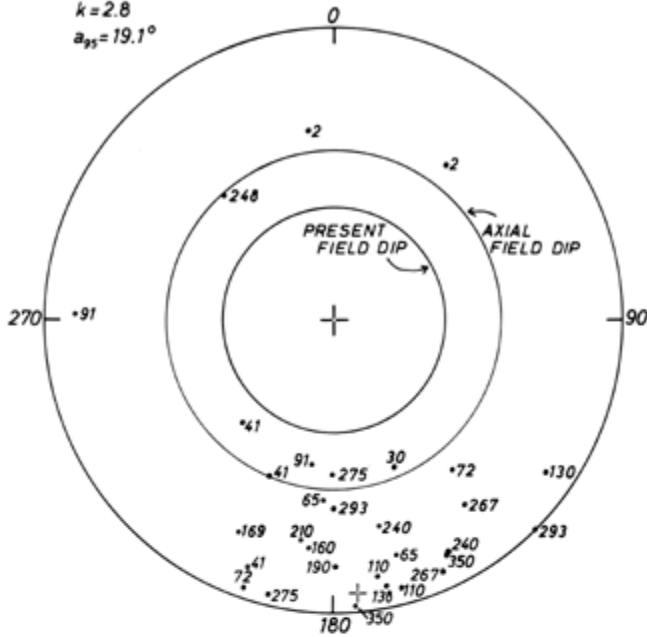
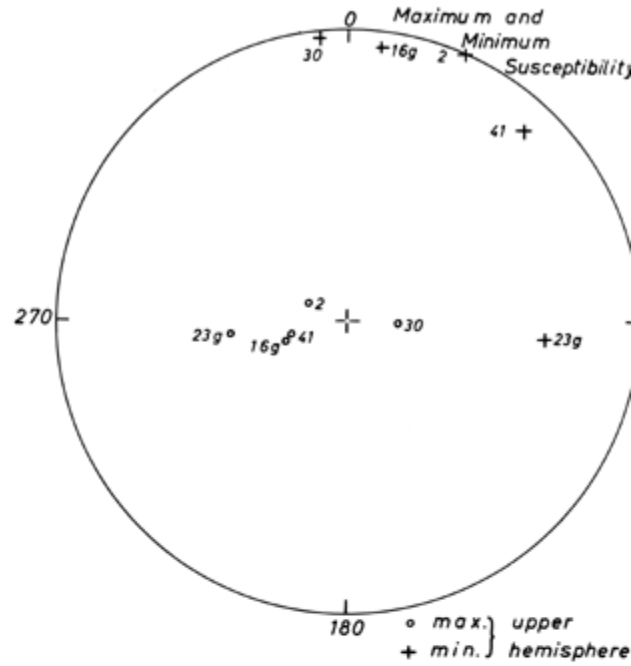


Fig. I-7

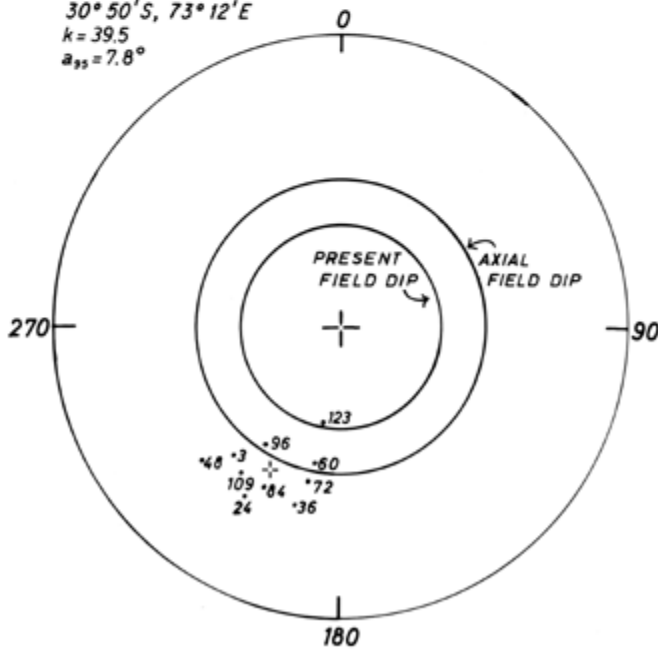
MSN 56 P  
 23° 56' S, 73° 53' E  
 3700 M  
 k = 2.8  
 a<sub>95</sub> = 19.1°



MSN 56 P and PG



MSN 59 G  
 30° 50' S, 73° 12' E  
 k = 39.5  
 a<sub>95</sub> = 7.8°



MSN 60 G  
 33° 20' S, 72° 38' E  
 k = 36.6  
 a<sub>95</sub> = 8.6°

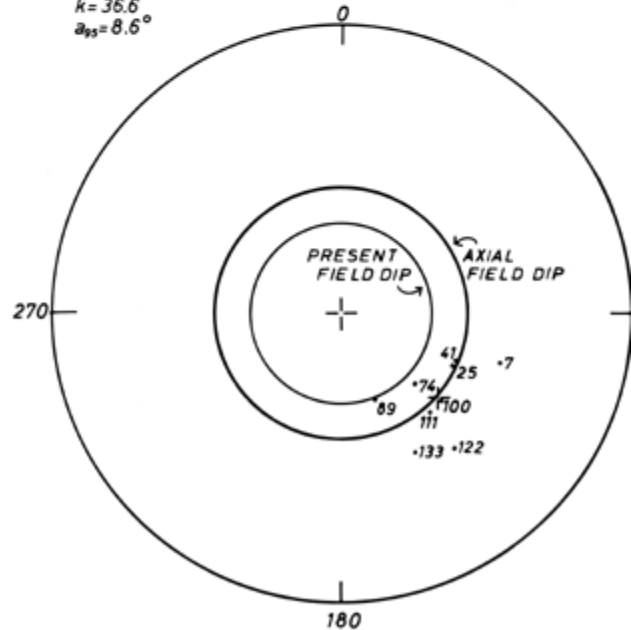


Fig. I-8

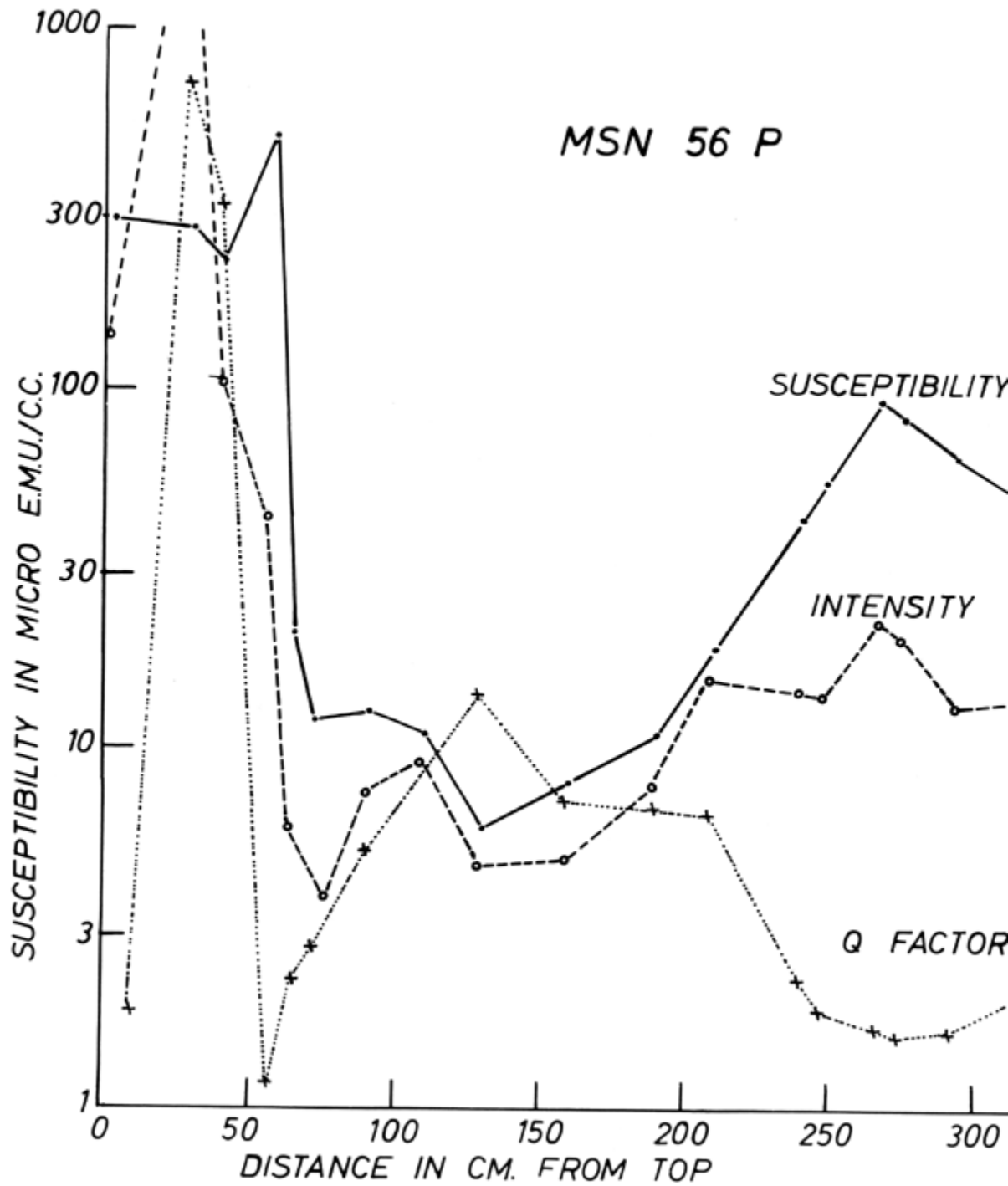


Fig. I-9

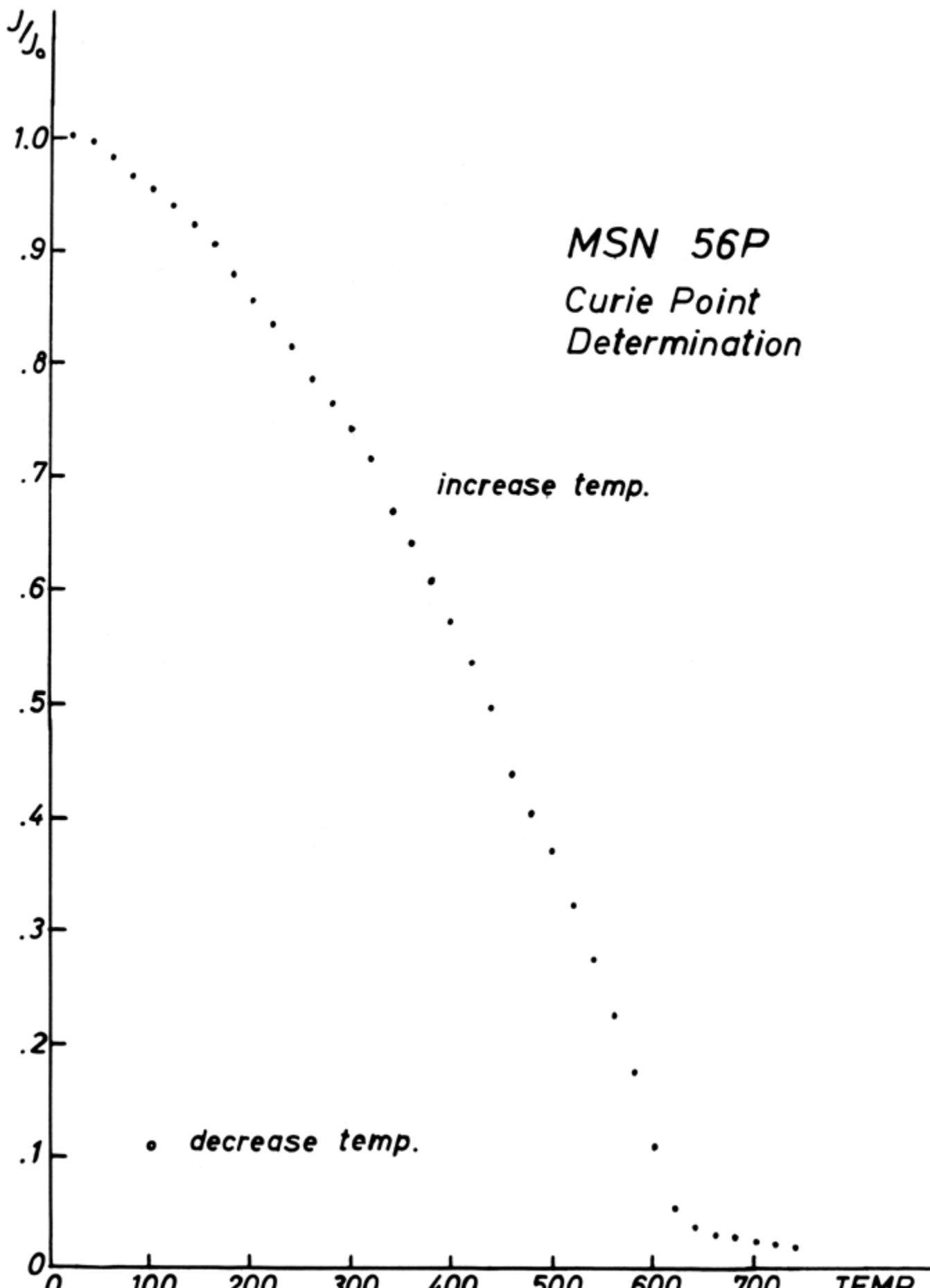


Fig. I-10

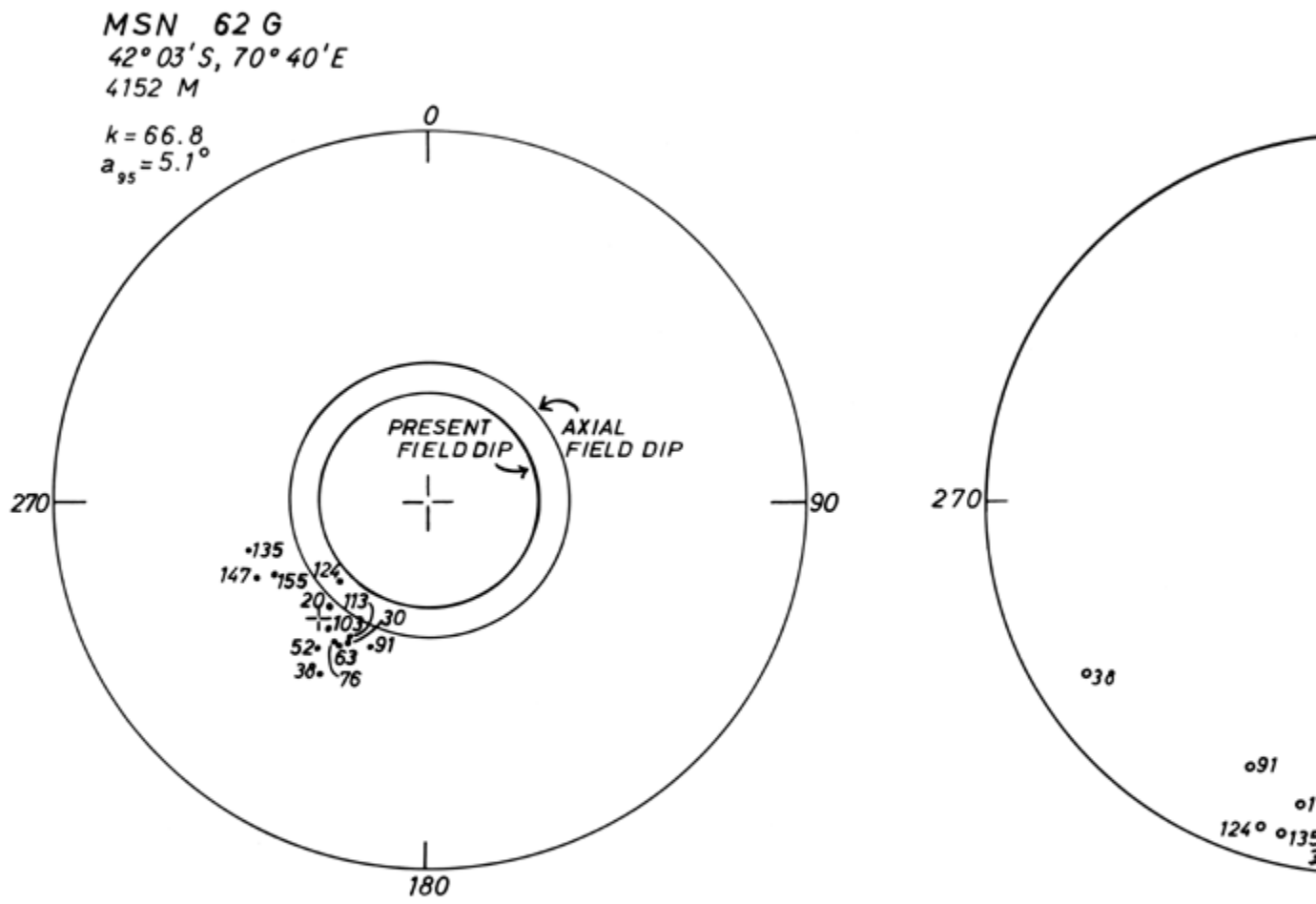


Fig. I-11

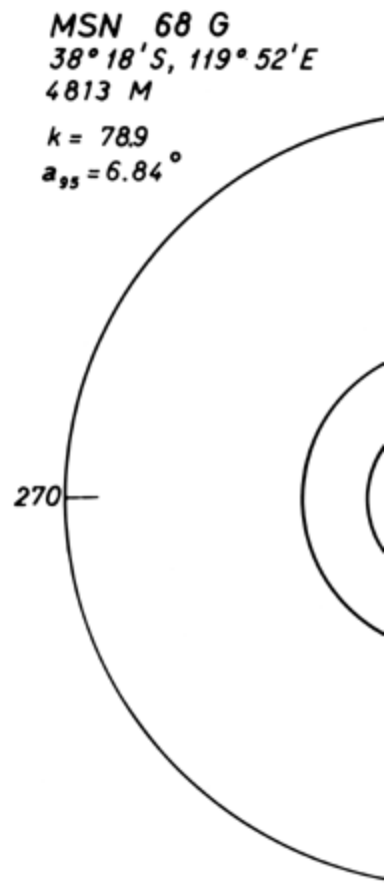
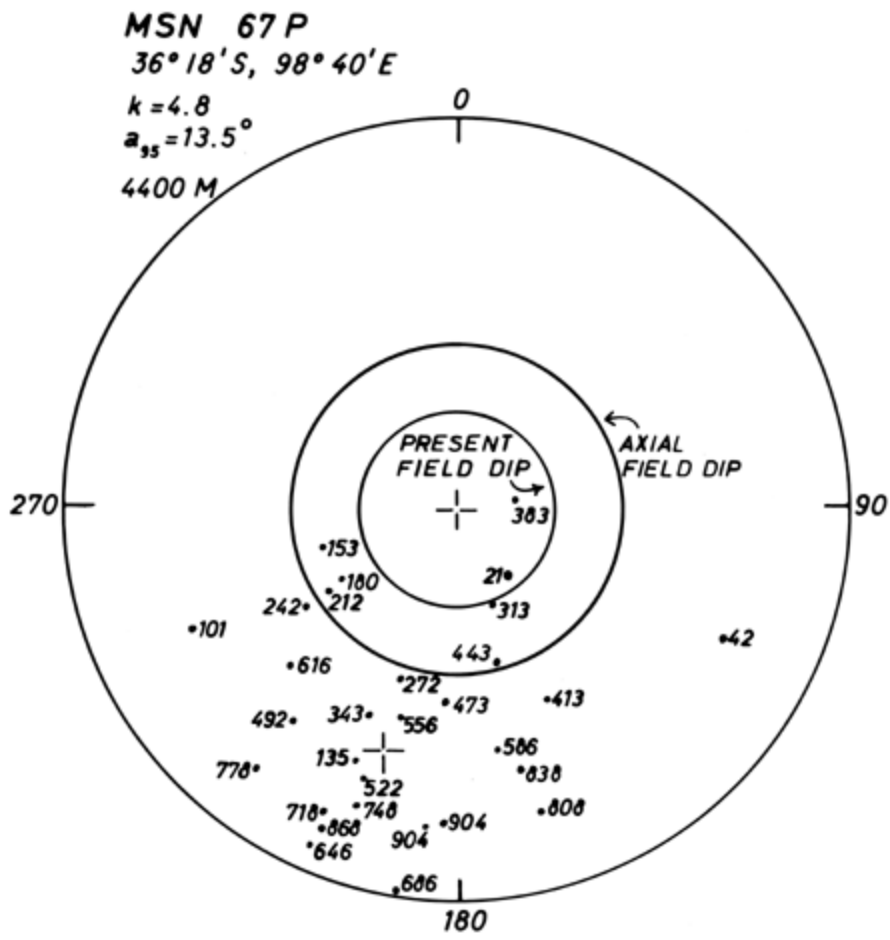


Fig. I-12

# GRAVITY OBSERVATIONS ON MONSOON AND LUSIAD EXPEDITIONS

Scientists from the Institute of Geophysics and Planetary Physics, University of California at Los Angeles, carried out gravity observations at sea and on several rarely-visited islands, and in ports during all of expeditions MONSOON and LUSIAD. On *Argo*, these men (John C. Harrison, Marvin D. Helfer and A. T. Edgerton, MONSOON: Marvin D. Helfer, Surendra Mathur, Clarence Hager, Dan Kimble and John Schlue, LUSIAD) were assisted in the 24-hour-a-day operation of the meter by Scripps scientific personnel and by visiting investigators from other agencies. The meter used at sea on both expeditions was LaCoste-Romberg Air-Sea Gravity Meter S-3. Dock and land observations were made with a LaCoste-Romberg DL1; where possible the dock was tied to a known gravity station as base.

Tracks along which observations were obtained with the LaCoste-Romberg gravity meter are shown in Figs. J-1 and J-2. The small-scale map of the Indian Ocean ([Fig. J-1](#)) shows both MONSOON and LUSIAD gravity tracks exclusive of those in the Indonesian Trench area. The Indonesian area ([Fig. J-2](#)) previously studied so intensively with submarine pendulum stations by F. A. Vening Meinesz, was chosen for special topographic, gravity and magnetic investigation on LUSIAD. Runs were chosen to complement *Argo's* MONSOON lines between Timor and the Sunda Strait, and to carry continuous gravity profiles both eastward into the Molucca region studied by Vening Meinesz and westward off Sumatra and the Nicobar Islands. *Argo's* work was extended even further into the Andaman-Bay of Bengal region by the U.S. Coast and Geodetic Survey's *Pioneer* during her current expedition.

No portion of *Argo's* 1960–61 or 1962–63 data yet have been interpreted by the participating scientists. Short discussion of programs, accuracy, and agreement with Vening Meinesz data — as well as tabulations of observation positions and free-air anomalies — for LUSIAD and MONSOON cruises are found in the documents:

Helfer, M.D., Caputo, M., and Harrison, J.C., Gravity measurements in the Pacific and Indian Oceans, MONSOON Expedition 1960–61: Interim Report, November, 1962, Institute of Geophysics and Planetary Physics, University of California, Los Angeles.

---

— 146 —

Helfer, M.D., Caputo, M., and Fisher, R.L., Gravity measurements in the Indonesian Archipelago, January–February, 1963, (R/V *Argo*): Interim Report, December, 1963, Institute of Geophysics and Planetary Physics, University of California, Los Angeles.

Caputo, M., Helfer, M.D. and Hager, C.L., Gravity measurements in the Atlantic, Indian and Pacific Oceans: Interim Report, July, 1964, Institute of Geophysics and Planetary Physics, University of California, Los Angeles.



A brief analysis of the data on the equator for discussing the Earth's equator oblateness appears in Caputo (1964).

The impossibility of taking frequent enough star fixes during such work at sea means that the position of the ship, its velocity and course are not known in sufficiently accurate detail. This causes an error in the Eötvös correction which could easily be of the order of 3 mgals. The accuracy of the data taken is discussed in each report and in Caputo *et al.* Generally the free-air anomalies have errors of less than 7 mgal. However, due to bad adjustments of the horizontal accelerometers, accelerations caused by long period motion were not properly estimated during some parts of LUSIAD Expedition. The associated anomalies are marked accordingly

(Michele Caputo, Institute of Geophysics and Planetary Physics, UCLA; R.L.F.)

## REFERENCES

Caputo, M. (1964) , Some space gravity formulas and the dimensions and mass of the Earth: *Pure and Applied Geophysics*, v. 57, pp. 66–82. Caputo, M., Harrison, J.C., Von Huene, R., and Helfer, M.D. (1963) , Accuracy of gravity measurements off the coast of Southern California: *J. Geophys. Res.*, v. 68, pp. 3273–3282.

---

— 147 —

## CAPTIONS

Fig. J-1 Tracks showing gravity observations obtained with the LaCoste-Romberg gravity meter, exclusive of the Indonesian Trench.

Fig. J-2 Gravity observations in the Indonesian Trench area.

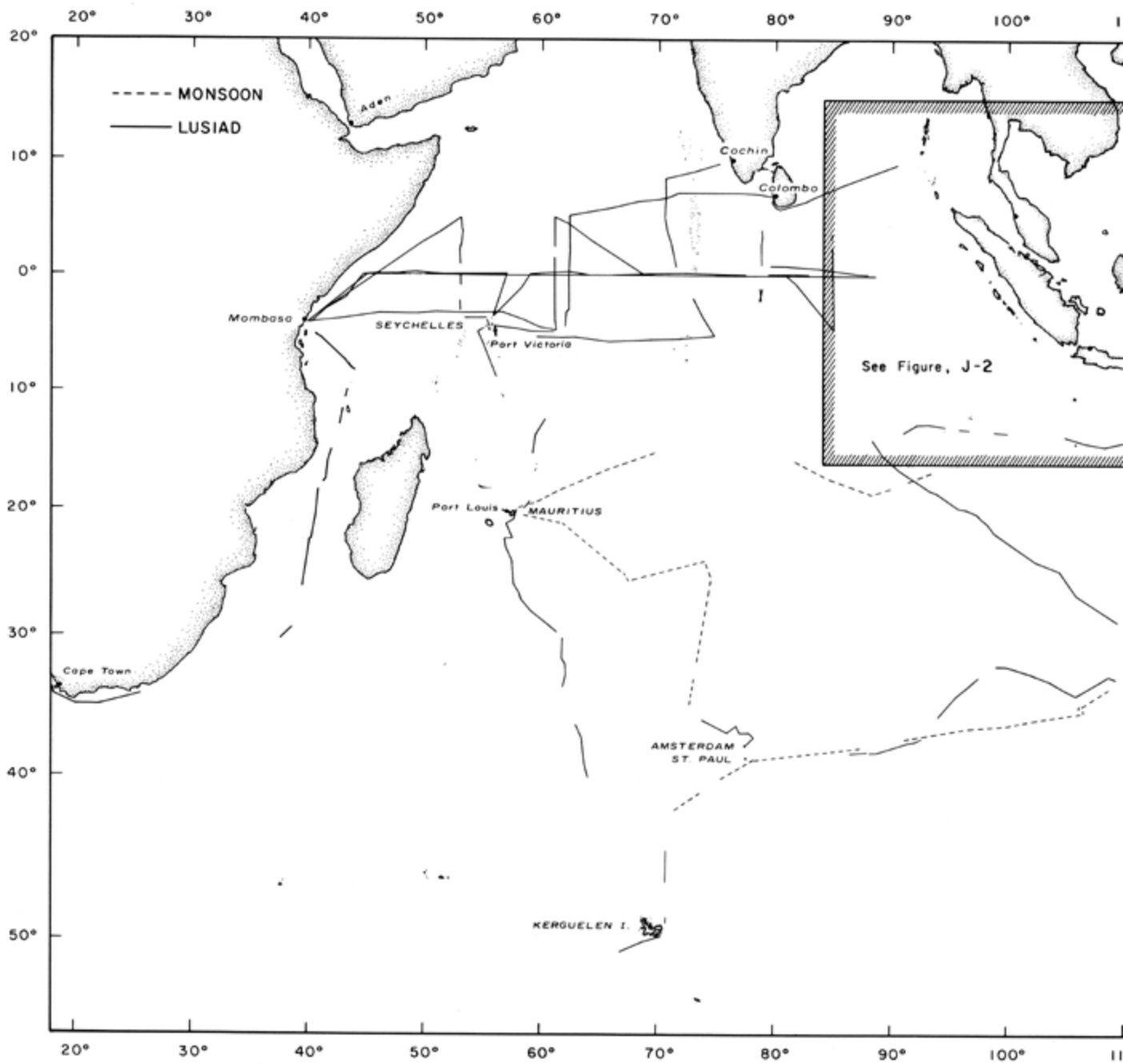


Fig. J-1

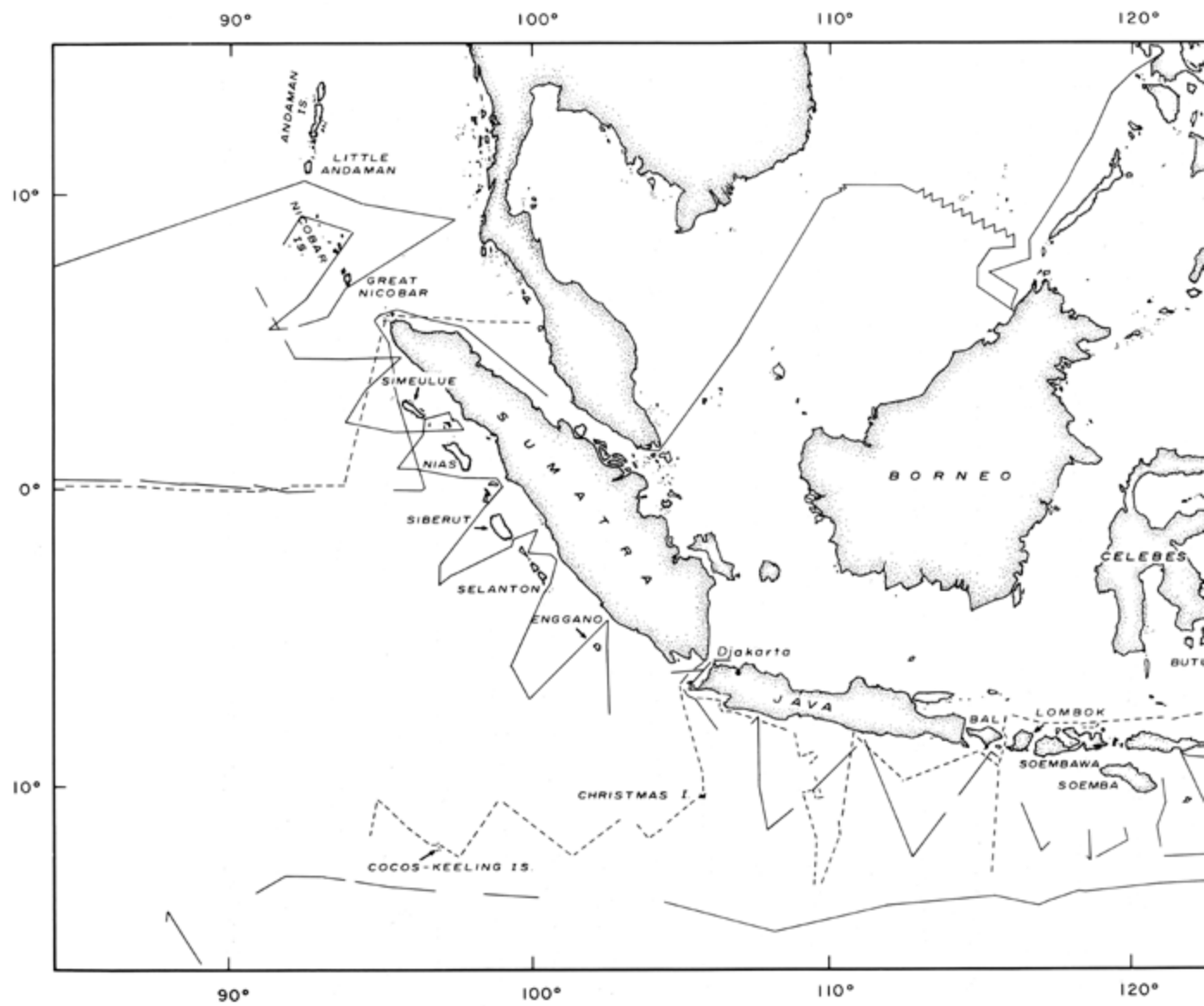


Fig. J-2

# INDIAN OCEAN HEAT FLOW

Ocean floor heat-flow measurements by Scripps Institution of Oceanography in the Indian Ocean total 26 on Expedition MONSOON and 98 on Expedition LUSIAD. The measurements extend all the distance across the Indian Ocean and to 44°S latitude ([Fig. K-1](#)). Many of the measurements can be considered as profiles across the large topographic features of the Indian Ocean, *i.e.*, mid-ocean rises and deep trenches (East Indies).

All the measurements were made by utilizing a cylindrical probe about 2 m long and 1.9 cm in diameter to measure the temperature gradient near the surface of the ocean floor and a transient needle-probe method to measure the thermal conductivity of a cored sample of the ocean floor sediments nearby to the temperature gradient measurements (Von Herzen *et al.*, 1963; Von Herzen and Maxwell, 1959). The product of these two measured quantities gives the heat flow at any locality. The measurements have not yet been worked up in detail, but some general results are obvious from the preliminary values.

The heat-flow values cover a large range; from nearly zero to  $5 \times 10^{-6}$  cal/cm<sup>2</sup> sec, which is comparable to the range observed in the Pacific and Atlantic Ocean areas (Von Herzen and Uyeda, 1963; Bullard and Day, 1961). The average of the Indian Ocean measurements does not appear to differ significantly from the average of  $1.2 - 1.4 \times 10^{-6}$  cal/cm<sup>2</sup> sec observed in other ocean areas. Many, but not all, of the high values occur on or near the mid-ocean rises of the Indian Ocean.

The relationships between the many intersecting ridges and rises in the Indian Ocean are not well understood; in this respect, the Indian

---

— 149 —

Ocean floor structure is perhaps more complicated than that of other oceans. The heat flow on these ridges likewise shows a similar complexity. In the northwest Indian Ocean, measurements on the Carlsberg Ridge gave normal or only slightly greater values; likewise for the Chagos-Maldiva Ridge south of India. On the other hand, the Gulf of Aden, supposedly the extension of the Carlsberg Ridge and world-wide rift system between Africa and Arabia, shows values up to 3 or 4 times normal (Von Herzen, 1963). The high values on the central mid-Indian Ocean Ridge occur east and southeast of Mauritius Island, the highest being nearly  $5 \times 10^{-6}$  cal/cm<sup>2</sup> sec about 700 miles north of Amsterdam in an area of rough topography. In the vicinity of Amsterdam-Saint Paul Islands, the maximum values observed on and near the ridge give only slightly more than  $2 \times 10^{-6}$  cal/cm<sup>2</sup> sec. In this vicinity also are observed regions of low heat flow to each side of the ridge, resulting in a pattern similar to that recently observed across the mid-Atlantic Ridge (Nason and Lee, 1962). On the continuation of this ridge into the Pacific, mostly normal values are observed on the crest south of Australia and New Zealand. Hence the pattern and magnitude of heat flow varies on different parts of the Indian Ocean ridges.

Significant regions of low heat flow appear in several of the large basins of the Indian Ocean, in addition to those mentioned above on each side of the ridge near Amsterdam-Saint Paul Islands.

Such regions indicated by the measurements are the central basin of the Arabian Sea between Socotra Island and India; part of the basin between the Chagos Archipelago and the Seychelles; the deep basin west of Australia; and the very flat basin north of western Australia and south of the Indonesian

---

— 150 —

Trench. The latter two basins are characterized by values only slightly, but consistently, lower than normal (about  $1 \times 10^{-6}$  cal/cm<sup>2</sup> sec). Following west from Port Darwin, Australia, the heat flow appears to increase systematically from slightly less than  $1 \times 10^{-6}$  cal/cm<sup>2</sup> sec to about  $2 \times 10^{-6}$  cal/cm<sup>2</sup> sec near Cocos-Keeling Islands.

Isolated high and very low values are occasionally observed which are apparently related only to the local environments. These high values are frequently recorded only as a partial penetration of the probe, indicating a hard bottom (rock?) which may suggest a region of relatively recent volcanic activity. The isolated low values may be explained by the local sediments being in thermal disequilibrium, or as an effect of sediment-covered topography on the sea floor (Von Herzen and Uyeda, 1963). One moderately low value ( $0.7 \times 10^{-6}$  cal/cm<sup>2</sup> sec) was observed in the trench south of Java on MONSOON Expedition.

(R. P. V. H.)

## REFERENCES

Nason, R. D. and W. H. K. Lee, (1962) Preliminary heat-flow profile across the Atlantic, *Nature*, v. 196, p. 975. Von Herzen, R. and A. E. Maxwell, (1959) The measurement of thermal conductivity of deep-sea sediments by a needle-probe method, *J. Geophys. Res.* v. 64, pp. 1557–1563. Von Herzen, R. P., A. E. Maxwell, and J. M. Snodgrass, (1962) Measurement of heat flow through the ocean floor, *Fourth Symposium on Temperature*, Reinhold Publishing Corp., New York, pp. 769–777. Von Herzen, R. P., (1963) Geothermal heat flow in the Gulfs of California and Aden, *Science*, v. 140, pp. 1207–1208. Von Herzen, R. P. and S. Uyeda, (1963) Heat flow through the eastern Pacific Ocean floor, *J. Geophys. Res.*, v. 68, pp. 4219–4250.



# MICROFOSSILS IN INDIAN OCEAN SEDIMENTS

## Preliminary Examination of MONSOON-LUSIAD Material

**A. In the preliminary investigation of cores collected by MONSOON and LUSIAD Expeditions, attention has been concentrated on four specific questions regarding Indian Ocean sedimentation:**

- (1) What has been the general pattern of areas of high and low rates of biological production during the Quaternary, as indicated by the sediments?
- (2) Which of the cores collected contain Tertiary deposits?
- (3) Is there any relationship between the localities of the Tertiary samples and inferred rates of accumulation of Quaternary sediments?
- (4) Do the Tertiary sediments indicate that conditions in the Indian Ocean at the time of their deposition were similar to, or different from, Quaternary conditions?

### **1. Pattern of Quaternary biological production.**

In the Pacific it is found that areas of high rates of biological production at the present day are characterized by Quaternary sequences rich in siliceous microfossils. In areas of relatively low biological productivity the top few centimeters of the sediments may contain rather numerous siliceous microfossils, but these do not persist downward through the Quaternary section of the cores. It seems reasonable to assume that this same relationship

---

— 152 —

obtains in the Indian Ocean, and the areas of high rates of biological production plotted on Fig. L-1 are based on the occurrence of abundant siliceous microfossils. Quaternary sediments in these areas are siliceous or calcareous-siliceous oozes, depending on the water depth at the locality (greater or less than the calcium carbonate compensation depth).

In areas of lower rates of biological production, sediments deposited above the calcium carbonate compensation depth are calcareous oozes or calcareous clays lacking siliceous microfossils, and those deposited at deeper localities are clays with very few or no microfossils.

### **2. Cores containing Tertiary sediments (or reworked microfossils).**

*LSDA 101G*: 2°41'S, 73°12'E; depth 2960 m.; core length 50 cm.

0–29 cm. Buff Quaternary calcareous-siliceous ooze. Sharp contact, with few burrow-mottled extensions, with

29–50 cm. White Pliocene calcareous-siliceous ooze.

*LSDA 106G*: 5°34'S, 63°43'E; depth 4090 m.; core length 57 cm.

Mottled light/dark buff Quaternary calcareous-siliceous ooze, with few Eocene (and perhaps Oligocene) radiolarians admixed in the lower part of the core.

*LSDA 107Ga*: 5°26'S, 59°15'E; depth 4010 m.; core length 140 cm.

0–9 cm. Light buff calcareous-siliceous ooze. Mottled junction with

9–60 cm. Graded bed (fine above, coarse below) of white calcareous ooze. Sharp contact with

60–140 cm. Mottled light buff/light gray/greenish calcareous-siliceous ooze.

---

— 153 —

The core is Quaternary throughout, with few Eocene to Miocene radiolarians admixed.

*LSDA 107Gb*: 5°26'S, 59°15'E; depth 3930 m.; core length 148 cm.

Mottled light/dark buff Quaternary calcareous-siliceous ooze, with rare admixed Eocene to Miocene radiolarians.

*LSDA 122G*: 29°54'S, 61°53'E; depth 4400 m.; core length 119 cm.

0 – 68 cm. Buff Quaternary calcareous-siliceous ooze, becoming darker downward, grading to

69 – 119 cm. Light brown throughout. Quaternary calcareous-siliceous ooze overlying Late Tertiary calcareous ooze.

A 4 cm. Mn nodule at the top, and 1 cm. nodule at the bottom of the core.

*LSDA 144G*: 13°09'S, 93°13'E; depth 5226 m.; core length 50 cm.

Brown, clayey siliceous ooze with a 2 cm. Mn nodule at 29–31 cm.

The core is Quaternary in its upper part, and apparently enters Pliocene somewhere below 35 cm.

*LSDH 3G*: 7°27'N, 70°39'E; depth 4110 m.; core length 132 cm.



Mottled light/dark/greyish buff calcareous ooze, with abundant siliceous microfossils only in the top few cm. (Quaternary). At 59.5 – 62.5 cm. is a somewhat coarser, highly foraminiferal layer with a moderate number of radiolarians, apparently a mixture of Eocene and Miocene. Somewhere below 94 cm. the core apparently enters Miocene sediment containing a few admixed Eocene radiolarians.

---

— 154 —

*MSN 53G*: 16°25'S, 66°02'E; depth approx. 3660 m.; core length 84 cm.

Buff Quaternary calcareous-siliceous ooze. Many Late Tertiary discoasters admixed, especially at the bottom of the core.

*MSN 54V*: 16°58'S, 64°42'E; depth 4044 m.

A small amount of buff calcareous-siliceous ooze, probably Quaternary with many late Tertiary discoaster admixed.

*MSN 56PG*: 23°56'S, 73°53'E; depth 3700m.; core length 54 cm.

Dark buff calcareous ooze, probably Quaternary throughout, with siliceous microfossils only in the top few cm.

*MSN 56P*: Same location as 56PG: core length 694 cm.

Light/dark buff, apparently Late Tertiary, calcareous ooze with no siliceous microfossils. Below about 300 cm, vertically streaked — probably flowed into core barrel and no sequence retained.

*MSN 59G*: 30°50'S, 73°12'E; depth 4160 m.; core length 125 cm.

0 – 11 cm. Buff Quaternary calcareous ooze with few siliceous microfossils. Mottled gradation to

11–125 cm. Light buff, Late Tertiary calcareous ooze.

In addition, Eocene microfossils have been reported at the following localities by Wiseman and Riedel (1960).

*Egeria* Sounding no. 10: 20°40'S, 85°29'E; depth 4722 m. Eocene calcareous ooze.

---

— 155 —

*Planet Station 127*: 8°45'S, 64°52'E; depth 4220 m. Calcareous-siliceous ooze containing Eocene radiolarians.

The localities of the cores containing Tertiary microfossils are indicated in Fig. L-1

### **3. Relationship between Tertiary localities and Quaternary accumulation rates.**

Quaternary calcareous-siliceous oozes accumulate at approximately 10 meters/million years, and unfossiliferous clays at about 0.5–1 m./m.y. Intermediate values of about 2–4 m./m.y. and 8 m./m.y. can be assumed for siliceous oozes and calcareous oozes lacking siliceous microfossils, respectively. Most of Scripps cores from the Indian Ocean have been collected with gravity corers about two meters long, which (on the basis of the above rates) would not be expected to encounter Tertiary deposits in areas of uninterrupted accumulation except where the Quaternary sediments are unfossiliferous clays.

Five of the Tertiary samples are from areas in which Quaternary sediments indicate relatively low biological productivity (LSDA 122, LSDH 3, MSN 56, MSN 59, and the *Egeria* sample). Even in these areas, where the Quaternary covers is relatively thin, hiatuses in the sediment column or locally abnormally slow accumulation seem to be responsible for the Tertiary being within reach of the corers used.

In the areas of high biological productivity, Quaternary sediments contain admixed Tertiary microfossils (presumably derived from nearby topographic elevations) in cores LSDA 106G, LSD 107G (a and b), MSN 53G, MSN 54V and the Planet sample. Two cores entering Pliocene

---

— 156 —

deposits (LSDA 101 and LSDA 144) are from localities near the edges of areas in which Quaternary sediments indicate high biological productivity.

Thus the localities of Tertiary samples so far obtained in the Indian Ocean are, as would be expected, concentrated in areas where Quaternary sediments have accumulated relatively slowly.

### **4. Oceanic conditions indicated by the Tertiary sediments.**

Late Tertiary sediments are similar to the Quaternary deposits in cores LSDA 101G, LSDA 144G, MSN 56PG & P and MSN 59G. However, in LSDA 122G the Late Tertiary lacks siliceous microfossils, indicating that biological productivity at that locality was less than it is now. A decrease in productivity since the Late Tertiary may be indicated by the Miocene radiolarians in LSDH 3G.

The absence of siliceous microfossils in the Eocene *Egeria* sample indicates that biological productivity was low at that locality, as it is now. Most of the cores containing admixed Eocene radiolarians (LSDA 106G, LSDA 107G a and b and the Planet sample) are from localities at which the Quaternary sediments also contain many siliceous microfossils. The Eocene radiolarians in LSDH 3G, however, may indicate higher biological productivity.

These few Tertiary samples obviously do not provide a sufficient basis for determining even the broad outlines of the Tertiary paleocenaography of the Indian Ocean, but they serve to indicate general areas in which more samples suitable for such an investiigation

---

— 157 —

could be collected by future expeditions.

### **B. Positions of cores collected in the Indian Ocean by Argo on**

Expedition MONSOON and LUSIAD and by *Horizon* on Expedition LUSIAD are plotted on Fig. L-2. Brief ship-board descriptions of these cores are compiled in Appendix F.

(W. R. R.)

## **REFERENCES**

Wiseman, J. D. H., and W. R. Riedel (1960) , Tertiary Sediments from the floor of the Indian Ocean. *Deep-Sea Research*, v. 7, 215–217.

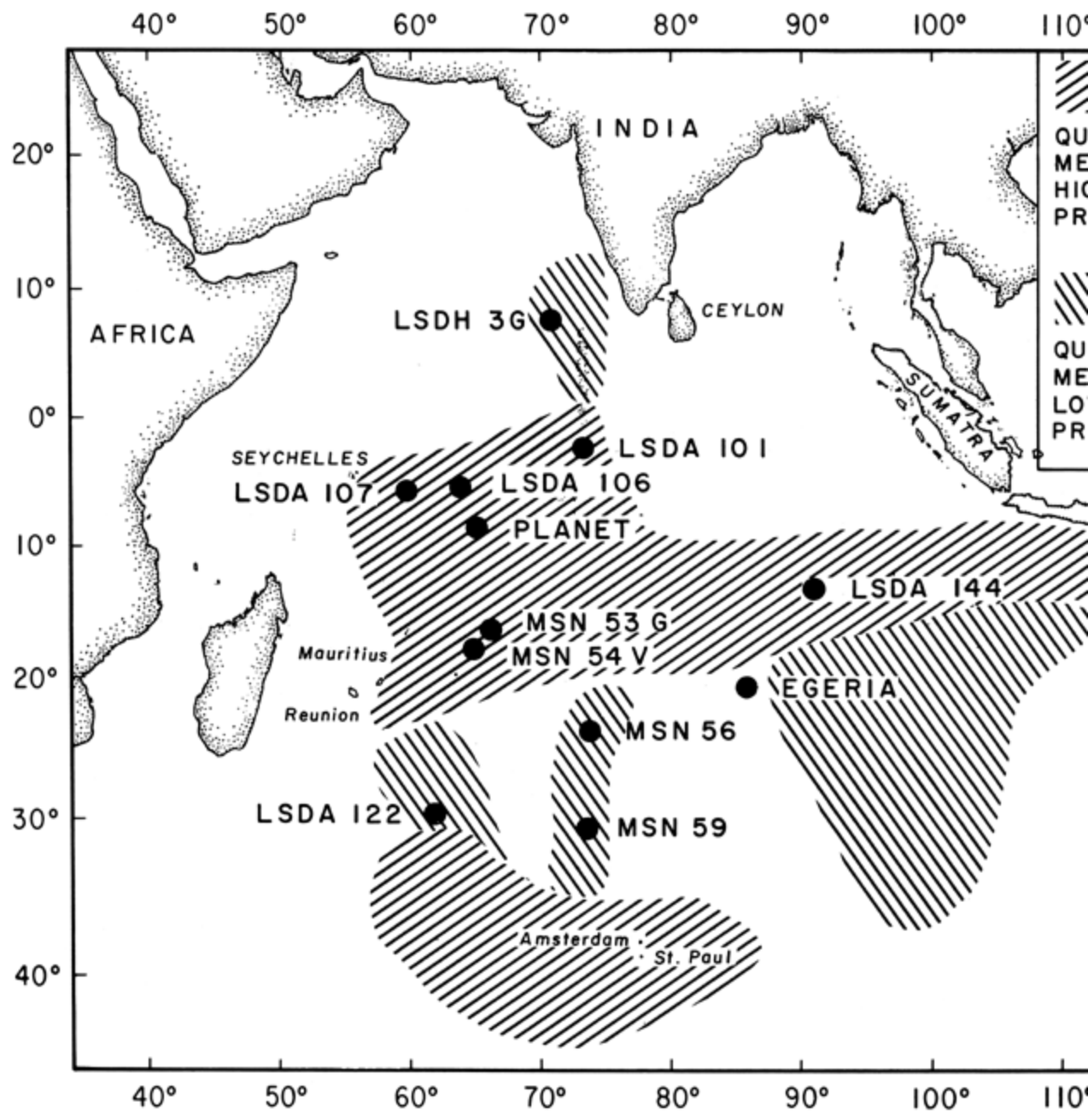


Fig. L-1

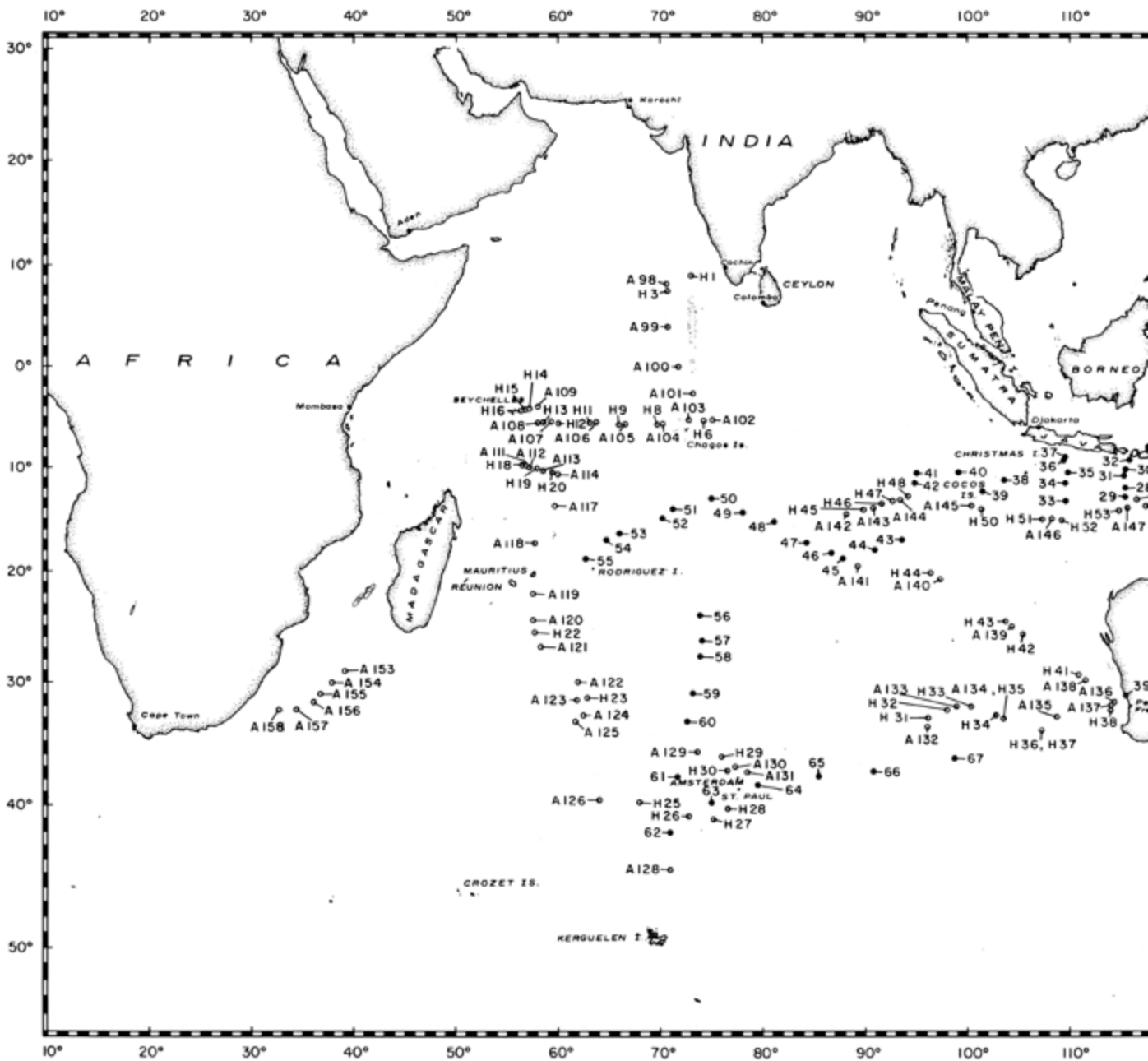


Fig. L-2

# **PUBLICATIONS RESULTING WHOLLY OR IN PART FROM MONSOON OR LUSIAD OBSERVATIONS WITHIN THE INDIAN OCEAN**

Alvarino, A., 1964, The Chaetognatha of the MONSOON Expedition in the Indian Ocean: *Pacific Science*, v. XVIII, no. 3, pp. 336–348.

Brinton, E., 1963, Barriers between tropical Pacific and Indian Ocean Euphausiid species (Zooplankton, Crustacea): Proc. XVI Int. Congr. Zool., Wash., D. C., v. 1, p. 204.

Caputo, M., Helfer, M.D. and Hager, C.L., Gravity measurements in the Atlantic, Indian and Pacific Oceans: Interim Report, July, 1964, Institute of Geophysics and Planetary Physics, University of California, Los Angeles.

Goldberg, E.D. and Koide, M., 1963, Rates of sediment accumulation in the Indian Ocean: in "Earth Science and Meteoritics," compiled by J. Geiss and E.D. Goldberg, North Holland Publishing Co., Amsterdam, pp. 90–102.

Gressitt, J.L., Coatsworth, J. and Yoshimoto, C.M., 1962, Air-borne insects trapped on MONSOON Expedition: *Pacific Insects* 4(2), pp. 319–323.

Helfer, M.D., Caputo, M. and Harrison, J.C., Gravity measurements in the Pacific and Indian Oceans, MONSOON Expedition 1960–61: Interim Report, November, 1962, Institute of Geophysics and Planetary Physics, University of California, Los Angeles.

Helfer, M.D., Caputo, M. and Fisher, R.L., Gravity measurements in the Indonesian Archipelago, January–February, 1963, (R/V *Argo*): Interim Report, December, 1963, Institute of Geophysics and Planetary Physics, University of California, Los Angeles.

Knauss, J.A. and Taft, B.A., 1963, Measurements of Currents along the Equator in the Indian Ocean: *Nature*, v. 198, no. 4878, pp. 376–377.

Knauss, J.A. and Taft, B.A., 1964, Equatorial Undercurrent of the Indian Ocean: *Science*, v. 143, no. 3604, pp. 354–356.

Northrup, J. and Raitt, R.W., 1963, Seaquakes in the Flores Sea: *Bull. Seismol. Soc. America*, v. 53, no. 3, pp. 577–583.

Shipek, C.J., 1961, Microrelief on the sea floor: *The Science Teacher*, v. 28, no. 6.

Shor, G.G., Jr. and Pollard, D.D., 1963, Seismic Investigations of Seychelles and Saya de Malha Banks, Northwest Indian Ocean: *Science* v. 142, no. 3588, pp. 48–49.

van Andel, Tj. H., Curray, J.R. and Veevers, J.J., 1961, Recent carbonate sediments of the Sahul Shelf, Northwestern Australia: Proc. Coastal and Shallow Water Res. Conf., pp. 564–567.

van Andel, Tj. H., Curray, J.R. and Veevers, J.J. (in press), Sediments and Morphology of the Timor Sea: *Bull. Bur. Min. Resources, Geol. and Geophys.*, Commonwealth of Australia.

Von Herzen, R.P., 1963, Geothermal heat flow in the Gulfs of California and Aden: *Science*, v. 140, no. 3572, pp. 1207–1208.

Von Herzen, R.P. and Langseth, M. (in press), Present status of oceanic heat-flow measurements in "Physics and Chemistry of the Earth," edited by Runcorn, Pergamon Press, N.Y.

## APPENDIX A

### PERSONNEL

<i>MONSOON - R/V Argo</i>		
Scientific Personnel:		
ACKERMANN, R.E.		San Diego to Djakarta
ANDERSON, N.E.		San Diego to San Diego
BELSHE, J.C., Dr.		San Diego to Cairns
BIEN, G., Dr.		Wellington to Papeete
BONATTI, E.		Papeete to San Diego
BRODIE, J.W., Dr.	Oceanographic Lab. New Zealand	Wellington to Wellington
CALVERT, S.		Fremantle to San Diego
CAREY, Frank	Western Gear Co.	Cairns to Port Darwin
COATSWORTH, James L.		San Diego to San Diego
CRAIG, Harmon, Dr.		Papeete to San Diego
DIBBLE, R.	Oceanographic Lab. New Zealand	Wellington to Wellington
DIXON, F.S.		San Diego to San Diego
EDGERTON, A.T.	U.C.L.A.	Cairns to Wellington

FISHER, R.L., Dr.		Port Darwin to Wellington
FREDRIKSSON, K., Dr.		Dunedin, New Zealand to Papeete
HARRIS, T.B.	U.S. Weather Bureau	Hobart to San Diego
HARRISON, J.C., Dr.		San Diego to Djakarta
HELPER, M.D.	U.C.L.A.	San Diego to Cairns Port Darwin to San Diego
HOHNHAUS, G.W.		San Diego to Wellington
GIOBBI, A.H.		San Diego to Wellington
GREEN, R., Dr.	Univ. of Tasmania	Fremantle to Wellington
JONES, Alan C.		Port Darwin to Djakarta
KEELING, C.D., Dr.		Hobart to Wellington
MERO, J.L., Dr.	Univ. of Calif., Berkeley	San Diego to Cairns
MENARD, H.W., Dr.		Wellington to Papeete
NEWHOUSE, D.A.		San Diego to Djakarta
NESTEROFF, W., Dr.	Univ. of Paris	Wellington to San Diego
PARKER, R.H.		Port Darwin to Port Louis
RAKESTRAW, N., Dr.		Djakarta to Fremantle
REILLY, W.I.	Oceanographic Lab. New Zealand	Wellington to Wellington
ROWLAND, R.W.		San Diego to Wellington
RUSSELL, J.C.	U.C.L.A.	San Diego to San Diego
SHIPEK, C.J.	USNEL, San Diego	Port Darwin to Wellington
SHOR, G.G., Jr., Dr.		San Diego to Port Darwin
SILVERMAN, Max		San Diego to Port Darwin
STEWART, J.R.		San Diego to San Diego
STONE, F.W.		San Diego to Djakarta
THYER, R.F., Dr.	Bur. Min. Resources, Canberra	Cairns to Port Darwin
VACQUIER, Victor		Port Darwin to Hobart
VAN HOY, L.N.		Port Darwin to Djakarta
VON HERZEN, R.P., Dr.		San Diego to Cairns Dunedin to Papeete
WARREN, R.E.		Hobart to San Diego
WATERMAN, Lee		Djakarta to San Diego
WHITE, William	Bur. Min. Resources,	Port Louis to Fremantle



	Canberra	
M/V <i>Malita</i> - Sahul Shelf sediment studies		
CURRAY, J. R., Dr.		
VAN ANDEL, Tj. H., Dr.		
VEEVERS, J. J., Dr.		

— 161 —

<i>MONSOON - R/V Argo</i>	
Crew:	
ARMSTRONG, Timothy C.	
ART, Harold L.	
BARKER, Robert L.	
BAUGHN, Robert G.	
BUSSMAN, Floyd C.	San Diego to Fremantle
BROWNING, William C.	
BINGMAN, Steven A.	
CARLSON, John L.	
COBB, William R.	Dunedin to San Diego
CLARK, Geoffrey C.	San Diego to Fremantle - Hobart to San Diego
CLAY, Amos	
CHASSY, Gilbert, M.D.	San Diego to Cairns - Djakarta to Hobart
COLLINSON, Barnes, Capt.	Wellington to San Diego
COPELAND, Thomas W.	
DAHLBERG, Ivar L	
DAVIS, L.E., Capt.	San Diego to Darwin
DECKERT, James A.	San Diego to Honolulu
DOWNES, George A	
ESHOM, George	Papeete to San Diego
GUMPAD, Fausto P.	San Diego to Port Darwin - Fremantle to San Diego
HAINES, Robert B.	San Diego to Honolulu
HANSEN, Terry	Honolulu to San Diego
HEDRICK, John D.	San Diego to Fremantle - Wellington to San Diego
HODGES, Carl	Honolulu to San Diego
HORN, Morris E.	

HOWARD, George D., Jr.	
JEFFRIES, George E.	
KELLY, H.J.	Dunedin to San Diego
KIDD, William L.	
LAND, Wesley M.	
LEWIS, Raymond J.	
MARBLE, George W.	Wellington to San Diego
MATTOS, Manuel	San Diego to Hobart
MC GEE, W.B., M. D.	Wellington to Papeete
O'GORMAN, Thomas V.	
PAINE, Charlws S.	
PULVER, William	
SHEEAN, Joseph J.	
SMITH, Edward W.	
STEVENS, K. E.	Wellington to San Diego
TRIVELPIECE, William	

Note: Crew member made entire voyage unless otherwise indicated.

<i>LUSIAD — R/V Horizon</i>		
Scientific Personnel:		
ALMAGOR, Gidon	UNESCO Fellow, Israel	Cochin to Fremantle
ANDERSON, N. E.		Aden to Cochin
BRADNER, Hugh, Dr.		Honolulu to San Diego
CHANG, Sien Tien	Republic of China	Port Darwin to Honolulu
DIXON, F.S.		Aden to Mauritius
DONOVAN, J. T.		Aden to Port Darwin
FISHER, R. L., Dr.		Mauritius to Fremantle
FORBES, G. F.		Honolulu to San Diego
HOHNHAUS, G. W.		Fremantle to Port Darwin
ISLAM, Mohammad R.	UNESCO Fellow, Pakistan	Fremantle to Port Darwin
KEITH, David	Pennsylvania State Univ.	Aden to Cochin Port Darwin to San Diego

MC GEHEE, R. P.		Aden to Port Darwin
NORTHRUP, John		Honolulu to San Diego
POLLARD, D. D.		Mauritius to Fremantle
RAFF, A. D.		Honolulu to San Diego
RHEA, K. P.		Port Darwin to San Diego
RIEDEL, W. R.		Port Darwin to Honolulu
ROSS, W. B.	Reed College, Oregon	Port Darwin to Honolulu
SHOR, G. G. Jr. Dr.		Cochin to Mauritius
VON HERZEN, R. P. Dr.		Aden to Cochin
WALSH, T. J.		Port Darwin to Honolulu
WAGEMAN, J. M.		Cochin to Port Darwin

— 164 —

<i>LUSIAD — R/V Horizon</i>	
Crew:	
AMES, Oscar	MC CULLOUGH, Joe
ANDRECO, Paul	PATSTONE, Henry
BROWNING, William	PRICE, Thomas
BUSSMAN, Floyd	ROMERO, Jess
CORREIRA, Anthony	SCHNEIDER, Theodore
DANIELS, Earl	SNIDER, Peter
DORAN, Anthony	TRAUTNER, Vincent
EGAN, James	WEIDINGER, William
FUGETT, Earl	WHITING, Billy
GARRETT, Robert, M.D.	YOUNG, Robert
GIVENS, John	
HAINES, Robert	
HANNAY, Stephen	
HANSEN, Terry, Capt., Fremantle to San Diego	
HARRIS, Clyde	
HAY, Malcom, M.D.	
HOPKINS, Marvin, Capt., San Diego to Fremantle	
JACINTO, Hipolito	
JERVIS, William, M. D.	

LACY, Jimmy	
LAPINSKI, Leon	

— 165 —

<i>LUSIAD - R/V Argo</i>		
Scientific Personnel:		
AHMED, Iqbal	Oakland City College, S. F. (citizen of Pakistan)	Singapore to Colombo
ALLEN, William	Minneapolis Honeywell	Singapore to Mombasa
ALMAGOR, Gidon	UNESCO Fellow, Israel	Fremantle to Penang
ARRHENIUS, Olof		Colombo to Mombasa
BAKER, James	Univ. of Rhode Island	Singapore to Cochin Colombo to Mombasa
BEDARD, P. P.	Univ. of Rhode Island	Singapore to Cochin Colombo to Mombasa
BIEN, G.S., Dr.		San Diego to Manila
BENSON, P.W.		Singapore to Cochin Colombo to Mombasa
BLANDFORD, Robert	Harvard University	Mombasa to Cochin
BRENNEN, R.E.		Singapore to Cochin
BROWN, L.B.	Emertron Inc., Maryland	Colombo to Mombasa
BRYAN, W.R.		Colombo to Mombasa
CHAJDIR	Indonesian Trainee	Port Darwin to Djakarta
CHANG, Sien Tien	Republic of China	Fremantle to Port Darwin
CHARNEY, J.G.	M.I.T.	Mombasa to Colombo
*CHI, V.L.	Antioch College, Ohio	
COATSWORTH, James		Colombo to San Diego
DEN, Nozomu, Dr.	Hokkaido Univ., Japan	Fremantle to Port Darwin
DIXON, F.S.		Darwin to Colombo Mombasa to Panama
DRUMMOND, K.H.		San Diego to Singapore
FARRELL, D.E.		Singapore to Cochin
FAUGHN, J.L.		Manila to Singapore
FISHER, R.L., Dr.		Port Darwin to Colombo
FRANCIS, T.J.G.	Dept. Geodesy-Geophysics Cambridge	Mauritius to Fremantle

GARRETT, John	Harvard University	Mombasa to Cochin
GAST, J.A.	Humbolt State College Arcata, California	Singapore to Mombasa
GILLEY, G.E.		Singapore to Cochin Colombo to Penang
HAGER, C.L.	U.C.L.A.	San Diego to Singapore Freetown to Panama
HANSEN, Steven		Mombasa to Panama
HARRISON, J.C.	Hughes Research Co. Maliku	Panama to San Diego
HELPER, M.D.	U.C.L.A.	San Diego to Singapore Port Darwin to Colombo Mombasa to Freetown
HESTER, A.W.		Colombo to Mombasa
HILDE, T.W.C.		Manila to Singapore
HODNETT, Haley L.		Cochin to Port Darwin
HOHNHAUS, G.W.		Cochin to Fremantle
HOLLAND, W.R.		Singapore to Colombo
ISLAM, M.R.	UNESCO Fellow (Pakistan)	Cochin to Fremantle Port Darwin to Colombo
JERDE, C.E.		Singapore to Cochin
JONES, A.C.		Cochin to Port Darwin
KEELING, C.D., Dr.		Mombasa to Cape Town
KEITH, David	Pennsylvania State University	Cochin to Port Darwin
KENYON, K.E.		Singapore to Colombo
KIMBLE, D.M.	U.C.L.A.	San Diego to Port Darwin
KNAUSS, J.A., Dr.	University of Rhode Island	Singapore to Colombo Colombo to Mombasa (March, 1963)
LAWSON, J.P.		San Diego to Singapore Mombasa to Freetown
LIU, Hsueh-Pei	Republic of China	Fremantle to Port Darwin
MANLEY, F.P.		San Diego to Cochin
MANTYLA, A.W.		Singapore to Cochin Colombo to Mombasa

MARCOS, S.A., Dr.	UNESCO Fellow, Univ of Alexandria, Egypt	Singapore to Cochin
MATHUR, S.P.	U. C. L. A. (citizen of India)	Cochin to Colombo Mombasa to San Diego
MURTY, A.V.S.	UNESCO Fellow, Andhra Univ., India	Singapore to Cochin
MC VEY, R.L.		Colombo to Mombasa
POLLARD, D.D.		Cochin to Mauritius
QUARISHEE, G.S.	UNESCO Fellow, Pakistan Navy	Singapore to Cochin
RAITT, R.W., Dr.		Mauritius to Port Darwin
RAKESTRAW, N.W., Dr.		Cochin to Fremantle
RHEA, K.P.		Cochin to Fremantle Mombasa to Panama
ROBINSON, Allan	Harvard University	Colombo to Penang
ROSS, W.B.	Reed College, Oregon	Cochin to Port Darwin
LT. RUSTAMADJT	Indonesian Trainee	Port Darwin to Djakarta
SCHLUE, J.W.	U. C. L. A.	Colombo to Mombasa
SCRIPPS, Samuel		Cochin to Fremantle
SHERMAN, J.B. III		Port Darwin to Penang
SHULMAN, E.	Harvard University	Colombo to Mombasa
SLOAN, P.R.		Cape Town to San Diego
STOMMEL, H.M.	Harvard University	Mombasa to Cochin
SUJATNO	Indonesian Trainee	Port Darwin to Djakarta
TAFT, B.A.		Singapore to Cochin Colombo to Mombasa
TSUCHIYA, Mizuki, Dr.	Meteorological College Japanese Met. Agency, Japan	Singapore to Cochin Colombo to Mombasa
VACQUIER, Victor		Capetown to Panama
VENKATARATNAM, Kolla	UNESCO Fellow, Andhra Univ. India	Port Darwin to Colombo Cochin to Mauritius
VON HERZEN, R.P., Dr.		Capetown to Freetown
WATERMAN. L.S.		San Diego to Fremantle Mombasa to San Diego
YOUNG, Anthony		Colombo to Mombasa

Crew:	
-------	--

ALI, James	CURRAGNO, Ross
[*]ALVIAR, Rudolph	CARDOSO, Americo
ARMSTRONG, Kenneth Jr.	CASTELLANOS, Mack
BEYER, Fred	CLAMPITT, Clanton
[*]BRADY, Basil	CLAY, Amos
BRATZ, Arthur	COBB, William R.
BUSSMAN, Floyd	CONGER, Clyde
[*]CALDER, William	DALY, Timothy
DE JESUS, Joseph	MC BRIDE, Robert
ESHOM, George	MC CART, Clyde
FERNANDES, Mario	MC CULLOUGH, Joe
FERRELL, William	MILLER, F.M. Jr.
FERRIS, Noel, Capt. (Colombo to Cape Town)	O'GORMAN, Thomas
FISH, Frank	PAINE, Charles
GARRETT, Robert, M. D.	PELZ, Alfred
HALLSTROM, Jack	PHINNEY, Alan, Capt. (San Diego to Colombo) Cape Town to San Diego
HANNAY, Stephen	POLLOCK, James
HARDY, Benson	PULVER, William
HOLDER, John	QUARESMA, Fernando
HORN, Morris	QUIAOIT, Peter
HUGHES, Earl	RICE, Maurice
JACOBS, William	SAWDAY, William
[*]JEFFRIES, George	SILVA, Richard
KANE, Andrew	[*]SOUZA, Raymond
KIDD, William	SYLVADA, Fred
KING, William	TOBEY, Wilson
LAMBRECHT, Patrick	[*]TRIVELPIECE, William
LANG, Wesley	VAUGHN, Gerald
LAPINSKI, Leon	VOGEL, Otto, M. D.
LYALL, Charles	WATERSON, Maurice
MACNEAR, Robert	WEIDINGER, William
MARCHAND, Richard	WHITELAW, Andrew
MARICICH, John	WIRT, Sheldon, M. D.

\* Aboard during entire expedition

\* From data provided by the Marine Facilities Office, Scripps Institution of Oceanography.

---

— 170 —

## **APPENDIX B**

### ***MILES ACTUALLY STEAMED ON MONSOON AND LUSIAD EXPEDITIONS<sup>[\*]</sup>***

#### **I. MONSOON - *Argo***

San Diego to Honolulu	2850 miles
Honolulu to Cairns	4345 "
Cairns to Port Darwin	2425 "
Port Darwin to Djakarta	4020 "
Djakarta to Port Louis	3865 "
Port Louis to Fremantle	4720 "
Fremantle to Hobart	2375 "
Hobart to Wellington	1445 "
Wellington to Wellington	1205 "
Wellington to Dunedin	3745 "
Dunedin to Papeete	3280 "
Papeete to San Diego	4175 "
	Total miles 38,450

---

— 171 —

#### **II<sub>A</sub>. LUSIAD - *Argo***

San Diego to Manila	6845 miles
Manila to Singapore (via Jesselton)	2265 "
Singapore to Mombasa	5495 "



Mombasa to Port Victoria	1745 "
Port Victoria to Colombo	2070 "
Colombo to Cochin	3590 "
Cochin to Port Victoria	2575 "
Port Victoria to Port Louis	1360 "
Port Louis to Kerguelen	2375 "
Kerguelen to Fremantle	4295 "
Fremantle to Port Darwin	4550 "
Port Darwin to Bali	5115 "
Bali to Djakarta	1375 "
Djakarta to Colombo	5130 "
Colombo to Mombasa	4610 "
Mombasa to Penang	4570 "
Penang to Mombasa (via Port Victoria)	5320 "
Mombasa to Cape Town	2805 "
CapeTown to Freetown	8005 "
Freetown to Panama	4780 "
Panama to San Diego	4050 "
	Total miles 82,925 =83,000
	Miles in Indian Ocean 56,980 =57,000

---

— 172 —

## II<sub>B</sub>. LUSIAD - *Horizon*

a. San Diego to Aden, via Mediterranean (ZEPHYRUS) — 14,280 miles	
b. Indian Ocean (Aden to Port Darwin)	
Aden to Cochin	2020 miles
Cochin to Seychelles	2495 "
Seychelles to Mauritius	1395 "
Mauritius to Fremantle	6745 "
Fremantle to Port Darwin	4945 "
c. Pacific Ocean (Port Darwin to San Diego)	
Port Darwin to Port Moresby	1210 "

Port Moresby to Honiara, Guadalcanal	1400 "
Honiara, Guadalcanal to Kwajalein	1540 "
Kwajalein to Honolulu	2970 "
Honolulu to San Diego	2670 "
	Total miles 41,670
	Total in Indian Ocean 17,600

## APPENDIX C

---

## APPENDIX C

TABLE I

## SCOR-IOC IIOE HYDROGRAPHIC REFERENCE STATIONS

OBSERVED							COMPUTED	INTERPOLATED				COMPUTED		
Z	T	S	O <sub>2</sub>	PO <sub>4</sub> -P	SiO <sub>3</sub> -Si	NO <sub>2</sub> -N	δ <sub>T</sub>	Z	T	S	O <sub>2</sub>	σ <sub>t</sub>	δ <sub>T</sub>	ΔD
m	°C	‰	ml/L	μg at/L	μg at/L	μg at/L	cl/ton	m	°C	‰	ml/L	g/L	cl/ton	dyn m
ARGO; July 3, 1962; 0614, 0830 GCT; 0°02'S, 91°02'E <sup>1</sup> sounding, 2416 fm; wind, 250°, force 4; weather, cloudy; sea, rough; wire angle, 16°, 20°.														
0	29.28	34.222	4.19	0.21	0.7	0.00	640	0	29.28	34.22	4.19	21.41	640	0.00
9	29.20	34.218	4.06	0.17	1.3	0.00	638	10	29.18	34.22	4.10	21.44	637	0.06
28	29.11	34.211	3.71	0.18	4.6	0.00	635	20	29.11	34.21	4.00	21.46	635	0.13
58	29.04	34.242	4.28	0.19	3.7	0.00	631	30	29.10	34.21	3.73	21.46	635	0.19
77	28.77	34.721	4.25	0.23	4.2	0.00	588	50	29.07	34.23	4.15	21.48	632	0.32
96	28.46	34.871	4.13	0.26	4.6	0.11	567	75	28.80	34.62	4.27	21.87	596	0.47
115	26.94	34.883	4.04	0.44	5.1	0.36	519	100	28.10	34.87	4.09	22.29	556	0.62
134	18.80	35.202	1.88	1.48	13	0.01	273	125	23.23	35.27	2.91	24.09	383	0.74
153	15.01	35.090	1.16	1.98	20	0.00	196	150	15.90	35.12	1.26	25.88	213	0.81
172	12.95	35.079	1.28	1.90	20	0.00	156	200	11.98	35.06	1.57	26.66	139	0.90
201	11.94	35.060	1.57	1.87	19	0.00	138	250	11.23	35.05	1.62	26.79	126	0.97
247	11.26	35.049	1.60	2.08	24	0.00	127	300	10.89	34.99	1.81	26.81	125	1.04
293	10.94	34.999	1.80	2.06	22	0.00	125	400	10.14	34.96	1.75	26.92	115	1.16
359	10.53	34.976	1.84	2.13	22	0.00	120	500	9.30	34.97	1.23	27.07	100	1.28
442	9.68	34.948	1.55	2.32	28	0.00	108	600	8.87	34.99	1.07	27.15	92	1.39
544	9.08	34.983	1.09	2.44	38	0.00	96	700	8.53	35.01	0.95	27.22	86	1.49
663	8.68	35.000	1.06	2.65	43	0.00	89	800	8.10	34.99	0.90	27.27	81	1.59
794	8.13	34.997	0.91	-	49	0.00	81	1000	6.83	34.94	1.13	27.42	67	1.77
954	7.16	34.951	1.09	2.74	55	0.00	71	1200	5.39	34.88	1.55	27.56	54	1.92
1128	5.70	34.896	1.46	2.78	77	0.00	56	1500	4.28	34.83	1.96	27.64	46	2.11
								2000	2.73	34.77	2.60	27.75	36	2.38
729a)	8.44	35.009	0.90	2.60	44	-	85	2500	2.03	34.73	3.06	27.77	33	2.62
909	7.30	34.955	0.94	2.68	53	-	72	3000	1.66	34.72	3.44	27.80	31	2.83
1096	5.94	34.921	1.27	2.52	67	0.00	57	4000	1.19	34.71	4.10	27.82	29	3.24
1280	5.10	34.873	1.61	2.58	71	-	51							
1468	4.38	34.836	1.96	2.52	75	-	46							
1653	3.75	34.810	1.94	2.54	81	-	42							
1841	3.20	34.798	2.57	2.48	86	-	38							
2026	2.66	34.770	2.62	2.51	89	0.00	35							
2214	2.34	34.755	2.90	2.46	89	-	34							
2400	2.20	34.743	3.01	2.38	89	-	34							
2587	1.90	34.729	3.09	2.51	94	-	32							
2776	1.77	34.724	3.26	2.40	91	-	32							
2966	1.67	34.717	3.41	2.43	91	-	32							
3155	1.62	34.722	3.47	2.41	91	-	31							
3346	1.52	34.720	3.36	2.37	96	-	30							
3535	1.43	34.707	3.60	2.33	93	-	31							
3728	1.25	34.712	3.78	2.31	89	-	29							
3921	1.20	34.708	4.07	2.36	89	-	29							
4114	1.16	34.703	4.10	2.28	86	0.00	29							

<sup>1</sup>This station lies 62 miles east of SCOR-IOC, IIOE Reference Station #4 (0°, 90°E)

a) Overlapping casts; reconciliation of property curves when necessary.

Table I  
SCOR-IOC IIOE HYDROGRAPHIC REFERENCE STATIONS

---

Appendix C (cont.)

TABLE I (Cont.)

SCOR-IOC IIOE HYDROGRAPHIC REFERENCE STATIONS

OBSERVED							COMPUTED	INTERPOLATED				COMPUTED		
Z	T	S	O <sub>2</sub>	PO <sub>4</sub> -P	SiO <sub>3</sub> -Si	NO <sub>2</sub> -N	δ <sub>T</sub>	Z	T	S	O <sub>2</sub>	σ <sub>t</sub>	δ <sub>T</sub>	ΔD
m	°C	‰	ml/L	μg at/L	μg at/L	μg at/L	cl/ton	m	°C	‰	ml/L	g/L	cl/ton	dyn m
ARGO; July 3, 1962; 2317 GCT; 0°00', 88°56'E; <sup>1</sup> sounding, 2394 fm; wind, 240°, force 3; weather, missing; sea, slight; wire angle, 00°.														
0	29.14	34.082	4.56	0.27	3.5	0.00	645	0	29.14	34.08	4.56	21.35	645	0.00
10	29.16	34.084	4.45	0.24	2.7	0.00	646	10	29.16	34.08	4.45	21.34	646	0.06
30	29.15	34.085	4.48	0.23	1.3	0.00	645	20	29.16	34.08	4.47	21.34	646	0.13
60	29.03	34.462	4.34	0.25	1.3	0.00	615	30	29.15	34.08	4.48	21.34	646	0.19
80	28.70	34.779	4.34	0.30	3.0	0.00	581	50	29.11	34.25	4.48	21.49	632	0.32
100	27.04	34.943	3.74	0.44	4.2	0.23	518	75	28.72	34.67	4.34	21.93	590	0.48
120	21.53	35.272	2.34	1.20	9.3	0.03	337	100	27.04	34.94	3.74	22.68	518	0.61
140	17.49	35.159	1.66	1.67	15	0.00	246	125	20.58	35.25	2.16	24.82	314	0.72
160	15.71	35.113	1.72	1.80	17	0.00	209	150	17.02	35.14	1.69	25.64	236	0.79
180	13.11	35.073	1.37	2.09	19	0.00	159	200	12.78	35.07	1.46	26.51	153	0.89
210	12.50	35.064	1.56	1.99	20	0.00	148	250	11.94	35.06	1.97	26.67	138	0.97
258	11.86	35.056	2.03	1.95	18	0.00	137	300	11.60	35.04	2.14	26.71	134	1.04
308	11.53	35.038	2.18	1.98	19	0.00	133	400	10.40	35.00	1.92	26.90	116	1.17
377	10.72	35.004	1.96	2.16	24	0.00	121	500	9.27	34.97	1.75	27.07	100	1.29
467	9.57	34.977	1.87	2.25	33	0.00	104	600	8.69	34.97	1.24	27.16	91	1.39
576	8.79	34.963	1.29	2.60	42	0.00	93	700	8.38	35.00	1.19	27.24	84	1.49
706	8.37	34.997	1.19	2.75	51	0.00	84	800	7.96	34.98	1.19	27.28	80	1.59
845	7.71	34.961	1.19	2.80	57	0.00	78	1000	6.90	34.93	1.26	27.40	69	1.77
1015	6.84	34.938	1.27	2.83	65	0.00	68	1200	(5.55)	(34.87)	(1.55)	(27.53)	(57)	(1.92)
1194	5.59	34.878	1.53	2.88	77	0.00	57							
ARGO; April 8, 1963; 0251 GCT; 0°06.5'S, 89°31.5'E; <sup>2</sup> sounding, 1652 fm; wind, 130°, force 3; weather, cloudy; sea, rough; wire angle, 04°.														
0	29.36	34.285	4.53	0.18		0.00	638	0	29.36	34.28	4.53	21.42	638	0.00
10	29.34	34.280	4.49	0.18		0.00	638	10	29.34	34.28	4.49	21.43	638	0.06
30	29.30	34.282	4.47	0.18		0.00	636	20	29.32	34.28	4.48	21.44	637	0.13
49	28.86	34.466	4.58	0.19		0.00	609	30	29.30	34.28	4.47	21.44	636	0.19
78	23.58	34.973	2.84	1.00		0.39	414	50	28.82	34.47	4.58	21.75	607	0.32
98	21.80	35.022	2.42	1.21		0.34	362	75	23.70	34.97	2.88	23.73	418	0.44
117	18.42	35.197	1.70	1.53		0.05	265	100	20.50	35.10	2.10	24.72	323	0.54
137	17.20	35.170	1.68	1.75		0.02	238	125	18.06	35.19	1.67	25.42	257	0.61
157	15.73	35.124	1.54	1.78		0.01	209	150	16.32	35.14	1.56	25.80	221	0.67
176	13.85	35.096	1.40	2.01		0.01	172	200	13.00	35.09	1.63	26.48	156	0.77
205	12.96	35.092	1.65	1.94		0.01	155	250	12.72	35.09	1.71	26.54	151	0.85
254	12.70	35.084	1.72	1.71		0.01	151	300	11.60	35.05	1.83	26.72	133	0.92
303	11.52	35.052	1.83	2.04		-	131	400	10.19	35.00	1.74	26.94	113	1.05
371	10.36	34.998	1.80	2.12		-	115	500	9.82	34.99	1.51	26.99	107	1.17
457	9.96	34.996	1.56	2.36		-	109	600	9.38	34.99	1.41	27.07	100	1.29
565	9.58	34.990	1.45	2.41		-	103	700	8.81	34.98	1.29	27.15	92	1.40
690	8.87	34.982	1.30	2.51		-	93	800	8.29	34.99	1.10	27.24	84	1.50
827	8.10	34.993	1.05	2.72		-	81	1000	6.50	34.93	1.26	27.45	64	1.68
992	6.53	34.933	1.24	2.81		-	64							
1169	5.99	34.908	1.44	2.86		-	59							

<sup>1</sup>This station lies 64 miles west of SCOR-IOC, IIOE Reference station #4 (0°, 90°E)

<sup>2</sup>This station lies 30 miles west-southwest of SCOR-IOC, IIOE Reference Station #4

Table I (Cont.)

---

Appendix C (cont.)

TABLE I (Cont.)

SCOR-IOC IIOE HYDROGRAPHIC REFERENCE STATIONS

OBSERVED							COMPUTED	INTERPOLATED				COMPUTED		
Z	T	S	O <sub>2</sub>	PO <sub>4</sub> -P	SiO <sub>3</sub> -Si	NO <sub>2</sub> -N	δ <sub>T</sub>	Z	T	S	O <sub>2</sub>	σ <sub>t</sub>	δ <sub>T</sub>	ΔD
m	°C	‰	ml/L	μg at/L	μg at/L	μg at/L	cl/ton	m	°C	‰	ml/L	g/L	cl/ton	dyn m

ARGO; April 26, 1963; 1930 GCT; 0°00', 89°00'E<sup>1</sup>; sounding, 2417 fm; wind, 230°, force 4; weather, drizzle; sea, missing; wire angle, 15°.

0	29.80	34.000	4.54	0.16		0.00	673	0	29.80	34.00	4.54	21.07	673	0.00
10	29.80	34.015	4.64	0.18		0.00	672	10	29.80	34.02	4.64	21.08	671	0.07
29	28.90	34.523	4.74	0.21		0.00	606	20	29.02	34.48	4.74	21.69	613	0.13
47	27.04	34.988	4.20	0.43		0.04	514	30	28.88	34.54	4.74	21.78	604	0.19
76	22.30	35.223	2.90	1.05		0.30	361	50	25.75	35.13	3.83	23.23	465	0.30
95	19.84	35.236	2.37	1.29		0.05	296	75	22.31	35.22	2.91	24.32	362	0.40
113	18.44	35.215	1.90	-		-	264	100	19.44	35.23	2.25	25.10	287	0.49
133	16.64	35.179	1.83	1.62		0.00	225	125	17.30	35.19	1.85	25.61	239	0.55
151	15.46	35.137	1.55	1.74		0.00	202	150	15.54	35.14	1.56	25.98	204	0.61
169	14.30	35.115	1.66	1.89		0.00	180	200	13.10	35.10	1.82	26.47	157	0.70
197	13.16	35.098	1.83	1.99		0.00	158	250	12.30	35.08	1.81	26.61	143	0.78
243	12.36	-	-	-		-	-	300	11.87	35.07	1.76	26.69	136	0.85
291	12.00	35.068	1.75	2.00		-	139	400	10.55	35.01	1.85	26.88	118	0.99
356	10.94	35.026	1.86	2.03		-	123	500	9.99	35.00	1.56	26.97	109	1.11
438	10.29	34.998	1.77	2.21		-	114	600	9.30	35.00	1.28	27.09	98	1.23
541	9.77	34.999	1.42	2.40		-	106	700	8.71	34.99	1.22	27.18	90	1.33
662	8.86	34.992	1.23	2.56		-	92	800	8.23	34.99	1.20	27.25	83	1.43
794	8.29	34.990	1.20	2.69		-	84	1000	6.43	34.92	1.36	27.45	64	1.61
959	6.64	34.931	1.31	2.82		-	65							
1135	5.90	34.912	1.50	2.79		-	58							

ARGO; July 8, 1962; 1354, 1425, 1724 GCT; 0°01'N, 78°59'E<sup>2</sup>; sounding, 2585 fm; wind, 170°, force 4; weather, missing; sea moderate; wire angle, 25°, 34°, 37°.

1	28.80	34.235	4.12	0.18	5.6	0.00	623	0	(28.80)	(34.24)	(4.12)	(21.58)	(623)	(0.00)
10	28.78	34.235	4.39	0.18	4.0	0.00	623	10	28.78	34.24	4.39	21.59	622	0.06
47	28.82	34.718	4.44	0.20	6.1	0.00	589	20	28.69	34.34	4.41	21.69	612	0.12
78	28.88	34.817	4.36	0.20	5.5	0.02	584	30	28.76	34.49	4.43	21.78	604	0.19
94	28.52	34.932	4.28	0.25	4.4	0.15	565	50	28.74	34.75	4.41	21.98	585	0.30
115	16.76	35.140	1.60	1.68	18	0.01	230	75	28.89	34.81	4.37	21.98	585	0.45
141	15.87	35.123	1.48	1.75	20	0.00	212	100	28.25	34.94	4.24	22.29	555	0.59
174	14.02	35.118	1.88	1.67	20	0.00	174	125	16.32	35.13	1.52	25.79	221	0.69
199	12.78	35.088	2.00	1.76	20	0.00	152	150	15.62	35.12	1.49	25.94	207	0.75
215	12.49	35.079	1.86	1.78	19	0.00	147	200	12.76	35.09	2.00	26.53	151	0.84
230	12.08	35.062	1.98	1.80	22	0.00	141	250	12.01	35.07	1.92	26.66	139	0.91
								300	11.38	35.03	2.36	26.75	131	0.99
244	12.04	35.068	1.91	1.83	21	0.00	140	400	10.39	35.00	1.77	26.90	116	1.12
277	11.80	35.063	2.14	1.82	20	0.00	136	500	9.51	34.98	1.45	27.04	103	1.24
322	10.92	34.990	2.46	1.86	21	0.00	126	600	9.11	35.00	1.24	27.12	95	1.35
382	10.62	35.011	1.89	2.00	25	0.00	119	700	8.67	35.00	1.14	27.19	89	1.45
458	9.67	34.973	1.57	2.19	28	0.00	106	800	8.11	35.00	1.14	27.28	80	1.55
558	9.30	34.984	1.31	2.37	36	0.00	99	1000	6.51	34.92	1.26	27.44	65	1.72
669	8.80	35.004	1.14	2.40	41	0.00	90	1200	5.76	34.90	1.49	27.53	57	1.88
811	8.04	35.000	1.14	2.54	64	0.00	79	1500	4.21	34.83	2.21	27.65	45	2.07
978	6.64	34.928	1.21	2.60	68	0.00	66	2000	2.61	34.76	2.97	27.75	36	2.34
								2500	2.04	34.74	3.34	27.78	33	2.57
1005	6.50	34.922	1.27	2.52	71	-	64	3000	1.73	34.72	3.58	27.79	32	2.79
1183	5.83	34.903	1.47	2.57	80	-	58	4000	1.41	34.71	3.97	27.81	30	3.21

<sup>1</sup>This station lies 60 miles west of SCOR-IOC, IIOE Reference Station #4 (0°, 90°E)

<sup>2</sup>This station lies 61 miles west of SCOR-IOC, IIOE Reference Station #5 (0°, 80°E)

Table I (Cont.)

---



Appendix C (cont.)

TABLE I (Cont.) SCOR-IOC IIOE HYDROGRAPHIC REFERENCE STATIONS

OBSERVED							COMPUTED	INTERPOLATED				COMPUTED		
Z	T	S	O <sub>2</sub>	PO <sub>4</sub> -P	SiO <sub>3</sub> -Si	NO <sub>2</sub> -N	δ <sub>T</sub>	Z	T	S	O <sub>2</sub>	σ <sub>t</sub>	δ <sub>T</sub>	ΔD
m	°C	‰	ml/L	μg at/L	μg at/L	μg at/L	cl/ton	m	°C	‰	ml/L	g/L	cl/ton	dyn m
ARGO; August 31, 1962; 2121 GCT; 0°02'N, 79°04'E <sup>1</sup> ; sounding, 2522 fm; wind, 250°, force 5; weather, partly cloudy; sea, rough; wire angle, 13°.														
1	28.48	34.415	4.41	0.23		0.01	600	0	(28.48)	(34.42)	(4.41)	(21.82)	(600)	(0.00)
11	28.48	34.410	4.37	0.21		0.00	601	10	28.48	34.41	4.37	21.82	601	0.06
30	28.47	34.414	4.33	0.20		0.00	600	20	28.48	34.41	4.35	21.82	601	0.12
59	28.40	34.441	4.30	0.23		0.02	596	30	28.47	34.41	4.33	21.82	600	0.18
79	25.36	34.953	3.18	0.75		0.49	467	50	28.42	34.43	4.31	21.85	597	0.30
99	21.16	35.216	2.17	1.25		0.19	332	75	27.00	34.74	3.89	22.54	531	0.44
118	19.06	35.226	1.84	1.47		0.05	278	100	21.12	35.22	2.16	24.65	330	0.55
136	17.60	35.152	1.53	1.65		0.02	249	125	18.32	35.19	1.70	25.36	263	0.63
156	16.38	35.133	1.42	1.79		0.02	222	150	16.72	35.14	1.45	25.71	230	0.69
175	13.74	35.114	1.82	1.85		0.01	169	200	13.20	35.10	1.90	26.45	159	0.79
205	13.08	35.099	1.90	1.79		0.01	157	250	12.19	35.08	1.90	26.63	141	0.87
254	12.10	35.074	1.90	1.91		0.00	140	300	11.23	35.04	2.30	26.78	127	0.94
301	11.20	35.035	2.30	1.96		-	127	400	10.38	35.00	1.84	26.91	116	1.07
369	10.60	35.009	2.04	2.15		-	119	500	9.79	34.99	1.42	27.00	107	1.19
455	10.06	34.985	1.57	2.30		-	111	600	9.23	35.00	1.27	27.10	97	1.30
561	9.44	34.994	1.30	2.42		-	101	700	8.76	35.01	1.17	27.18	89	1.41
684	8.82	35.007	1.19	2.56		-	90	800	8.33	35.01	1.07	27.25	83	1.51
819	8.27	35.014	1.04	2.70		-	82	1000	6.91	34.95	1.06	27.41	68	1.69
982	7.02	34.957	1.02	2.80		-	69							
1158	5.80	34.894	1.41	2.85		-	58							
ARGO; April 5, 1963; 0247 GCT; 0°04.5'N, 78°59'E <sup>2</sup> ; sounding, 2522 fm; wind, 130°, force 3; weather, cloudy; sea, missing; wire angle, 20°.														
0	28.94	34.630	4.44	0.23		0.00	600	0	28.94	34.63	4.44	21.83	600	0.00
9	28.96	34.636	4.62	0.21		0.00	600	10	28.97	34.63	4.62	21.82	601	0.06
28	29.06	34.738	4.55	0.22		0.00	596	20	29.02	34.68	4.59	21.84	599	0.12
46	28.60	34.752	4.58	0.22		0.00	580	30	29.03	34.74	4.55	21.88	595	0.18
74	26.38	35.029	3.99	0.52		0.09	491	50	28.42	34.78	4.57	22.11	572	0.30
93	22.81	35.189	2.71	1.04		0.29	377	75	26.32	35.03	3.98	22.98	490	0.43
111	20.84	35.236	2.59	1.17		0.08	322	100	21.13	35.23	2.61	24.65	330	0.53
130	19.93	35.238	2.34	1.38		0.05	299	125	20.22	35.24	2.42	24.91	306	0.61
148	18.57	35.223	1.99	1.48		0.02	266	150	18.50	35.22	1.98	25.33	265	0.69
166	15.18	35.167	1.93	1.70		0.02	194	200	13.77	35.12	1.96	26.35	169	0.80
195	13.84	35.127	1.97	1.78		0.01	170	250	12.29	35.06	1.73	26.60	145	0.88
241	12.47	35.053	1.70	1.98		0.00	149	300	11.85	35.07	1.87	26.69	136	0.95
288	11.91	35.070	1.85	1.98		-	137	400	10.67	35.01	2.02	26.86	120	1.09
350	11.62	35.059	2.03	1.98		-	133	500	9.77	35.00	1.62	27.01	106	1.21
429	10.16	34.992	2.01	2.15		-	113	600	9.23	35.00	1.41	27.10	97	1.32
528	9.62	35.003	1.49	2.37		-	103	700	8.59	34.99	1.25	27.20	88	1.43
645	8.98	34.995	1.36	2.47		-	94	800	7.92	34.98	1.09	27.29	79	1.53
779	8.03	34.989	1.08	2.69		-	80	1000	6.88	34.94	1.30	27.41	68	1.70
945	7.14	34.950	1.22	2.77		-	71							
1121	6.32	34.937	1.49	2.85		-	61							

<sup>1</sup>This station lies 56 miles west of SCOR-IOC, IIOE Reference Station #5 (0°, 80°E)

<sup>2</sup>This station lies 61+ miles west of SCOR-IOC, IIOE Reference Station #5

Table I (Cont.)

---

Appendix C (cont.)

TABLE I (Cont.) SCOR-IOC IIOE HYDROGRAPHIC REFERENCE STATIONS

OBSERVED							COMPUTED	INTERPOLATED				COMPUTED		
Z	T	S	O <sub>2</sub>	PO <sub>4</sub> -P	SiO <sub>3</sub> -Si	NO <sub>2</sub> -N	δ <sub>T</sub>	Z	T	S	O <sub>2</sub>	σ <sub>t</sub>	δ <sub>T</sub>	ΔD
m	°C	‰	ml/L	μg at/L	μg at/L	μg at/L	cl/ton	m	°C	‰	ml/L	g/L	cl/ton	dyn m

ARGO; July 18, 1962; 1539 GCT; 0°03'N, 55°03'E<sup>1</sup>; sounding, 1934 fm; wind, 200°, force 4; weather, partly cloudy; sea, moderate; wire angle, 12°.

0	27.52	35.410	4.42	0.44	3.0	0.01	499	0	27.52	35.41	4.42	22.88	499	0.00
10	27.50	35.412	4.51	0.30	2.8	0.00	498	10	27.50	35.41	4.51	22.89	498	0.05
29	27.35	35.409	4.51	0.28	4.0	0.00	494	20	27.40	35.41	4.51	22.92	495	0.10
58	27.02	35.378	4.45	0.33	4.8	0.02	486	30	27.35	35.41	4.51	22.94	494	0.15
78	26.14	35.445	4.33	0.45	2.8	0.27	454	50	27.25	35.40	4.49	22.96	491	0.25
97	19.61	35.317	2.70	1.20	12	0.18	285	75	26.14	35.44	4.35	23.34	455	0.37
116	17.72	35.250	2.44	1.33	12	0.04	244	100	19.33	35.31	2.63	25.19	278	0.46
135	17.23	35.234	2.45	1.34	13	0.04	234	125	17.50	35.24	2.44	25.60	240	0.53
155	15.38	35.173	1.92	1.68	17	0.02	198	150	15.81	35.18	1.97	25.95	207	0.58
174	14.20	35.159	2.24	1.59	16	0.02	174	200	13.87	35.16	2.38	26.36	168	0.68
204	13.82	35.152	2.41	1.53	13	0.02	167	250	12.23	35.09	2.63	26.63	141	0.76
251	12.20	35.088	2.63	1.65	18	0.00	141	300	11.42	35.05	2.49	26.76	130	0.83
299	11.42	35.056	2.49	1.72	17	0.00	129	400	10.34	34.99	2.34	26.90	116	0.96
366	10.60	34.999	2.52	1.91	19	0.00	119	500	9.83	34.97	2.04	26.98	109	1.08
454	10.04	34.978	2.00	2.04	24	0.00	112	600	9.33	34.98	2.00	27.07	100	1.20
561	9.55	34.966	2.12	2.08	28	0.00	105	700	8.54	35.03	1.31	27.23	84	1.30
687	8.65	35.031	1.35	2.52	39	0.00	86	800	7.80	35.00	1.16	27.32	76	1.40
824	7.62	35.003	1.14	2.63	51	0.00	73	1000	6.81	35.00	1.19	27.47	63	1.57
991	6.85	35.005	1.19	2.63	56	0.00	63							
1169	5.67	34.928	1.49	2.62	72	0.00	54							

ARGO; March 27, 1963; 1236, 1325 GCT; 0°05.5'N, 55°02.5'E<sup>2</sup>; sounding, 2160 fm; wind, 160°, force 2; weather, partly cloudy; sea, rough; wire angle, 14°, 09°.

0	28.52	35.390	4.54	0.25		0.00	532	0	28.52	35.39	4.54	22.54	532	0.00
10	27.92	35.381	4.47	0.25		0.00	513	10	27.92	35.38	4.47	22.73	513	0.05
29	27.58	35.378	4.47	0.25		0.01	503	20	27.69	35.38	4.47	22.80	506	0.10
47	27.48	35.376	4.32	0.27		0.01	500	30	27.57	35.38	4.47	22.84	503	0.15
77	25.96	35.466	4.26	0.36		0.39	447	50	27.32	35.38	4.29	22.92	495	0.25
96	23.73	35.524	3.55	0.67		0.06	379	75	26.01	35.46	4.27	23.40	449	0.37
114	21.47	35.382	3.07	0.96		0.05	328	100	23.21	35.50	3.43	24.27	366	0.48
133	18.98	35.253	2.82	1.23		0.04	274	125	20.49	35.33	2.94	24.90	306	0.56
152	16.48	35.245	2.74	1.32		0.01	217	150	16.63	35.24	2.76	25.80	220	0.63
170	15.27	35.210	2.42	1.47		0.01	193	200	14.28	35.18		26.28	175	0.73
197	14.34	35.181	2.16	1.47		0.01	176	250	13.02	35.14		26.52	153	0.81
244	13.14	35.151	-	1.51		0.00	154	300	11.68	35.05		26.71	134	0.89
290	11.82	35.066	-	1.60		-	136	400	10.55	34.99		26.87	119	1.02
356	11.12	35.014	-	1.58		-	127	500	9.76	35.01		27.02	105	1.15
438	10.07	34.983	-	2.07		-	112	600	9.11	35.02		27.14	94	1.26
540	9.56	35.024	-	2.30		-	101	700	8.40	35.02	1.26	27.25	83	1.36
								800	8.01	35.04	1.15	27.32	76	1.45
								1000	6.99	35.02	1.19	27.46	63	1.62
678	8.50	35.018	1.26	2.50		-	85							
811	7.97	35.038	1.13	2.58		-	76							
974	7.11	35.023	1.15	2.56		-	65							
1147	6.26	34.985	1.46	2.65		-	57							

<sup>1</sup>This station lies 4½ miles northeast of SCOR-IOC, IIOE Reference Station #10 (0°, 55°E)

<sup>2</sup>This station lies 6½ miles north-northeast of SCOR-IOC, IIOE Reference Station

Table I (Cont.)

---

Appendix C (cont.)

TABLE I (Cont.) SCOR-IOC IIOE HYDROGRAPHIC REFERENCE STATIONS

OBSERVED							COMPUTED	INTERPOLATED				COMPUTED		
Z	T	S	O <sub>2</sub>	PO <sub>4</sub> -P	SiO <sub>3</sub> -Si	NO <sub>2</sub> -N	δ <sub>T</sub>	Z	T	S	O <sub>2</sub>	σ <sub>t</sub>	δ <sub>T</sub>	ΔD
m	°C	‰	ml/L	μg at/L	μg at/L	μg at/L	cl/ton	m	°C	‰	ml/L	g/L	cl/ton	dyn m
0	30.4	36.057					545	0	30.4	36.06		22.40	544	0.00
10	27.98	36.060					466	10	27.98	36.06		23.22	466	0.05
19	20.56	35.646					285	20	20.38	35.64		25.17	281	0.09
29	19.72	35.615					266	30	19.58	35.61		25.36	263	0.12
38	18.67	35.597					242	50	17.82	35.62		25.81	220	0.16
62	17.16	35.632					204	75	16.53	35.61		26.11	191	0.22
86	16.00	35.598					180	100	15.47	35.60		26.35	169	0.26
113	15.12	35.611					160	125	14.91	35.61		26.48	156	0.30
141	14.62	35.606					150	150	14.49	35.61		26.57	147	0.34
187	13.96	35.626					135	200	13.86	35.66		26.74	131	0.41
256	13.74	35.783					120	250	13.73	35.76		26.85	121	0.48
350	13.89	35.989					107	300	13.81	35.89		26.93	113	0.54
446	13.76	36.103					97	400	13.91	36.07		27.05	102	0.66
543	12.50	35.910					86	500	13.08	36.01		27.18	90	0.77
665	12.10	35.943					76	600	12.38	35.94		27.26	82	0.87
814	11.06	35.814					67	700	11.88	35.92		27.34	74	0.96
1015	10.28	-						800	11.14	35.82		27.41	68	1.05
1217	7.84	35.420					45	1000	10.34	35.80		27.54	56	1.22
1472	5.59	35.136					37	1200	8.01	35.44		27.64	46	1.37
								1500	5.41	35.11		27.73	37	1.55
1762	4.06	34.952					34	2000	3.18	34.86		27.78	33	1.81
1862	3.64	34.918					33							
1961	3.29	-												
2060	3.06	34.855					32							
2159	2.96	34.845					32							

HORIZON; September 21, 1962; 1727, 1545 GCT; 13°16.5'N, 49°15'E;<sup>1</sup>sounding, 1326 fm; wind, 250°, force 4; weather, overcast; sea, moderate; wire angle, 16°, 05°.

<sup>1</sup>This station lies 21+ miles northeast of SCOR-IOC, IIOE Reference Station #12 (13°N, 50°E)

Table I (Cont.)

---

Appendix C (cont.)

TABLE I (Cont.) SCOR-IOC IIOE HYDROGRAPHIC REFERENCE STATIONS

OBSERVED							COMPUTED	INTERPOLATED				COMPUTED		
Z	T	S	O <sub>2</sub>	PO <sub>4</sub> -P	SiO <sub>3</sub> -Si	NO <sub>2</sub> -N	δ <sub>T</sub>	Z	T	S	O <sub>2</sub>	σ <sub>t</sub>	δ <sub>T</sub>	ΔD
m	°C	‰	ml/L	μg at/L	μg at/L	μg at/L	cl/ton	m	°C	‰	ml/L	g/L	cl/ton	dyn m
ARGO; May 19, 1963; 1506, 1206 GCT; 7°56'S, 44°02'E <sup>1</sup> ; sounding, 2209 fm; wind, 180°, force 5; weather, overcast; sea, very rough; wire angle, 12°, 11°.														
0	27.19	-	4.72					0	27.19	(34.93)	4.72	(22.63)	(523)	(0.00)
10	27.21	34.93	4.75				524	10	27.21	34.93	4.75	22.62	524	0.05
29	27.20	34.92	4.74				524	20	27.20	34.93	4.74	22.62	523	0.10
39	27.20	34.94	4.75				523	30	27.20	34.93	4.75	22.62	523	0.16
53	25.10	34.99	4.87				456	50	26.50	34.95	4.80	22.86	501	0.26
68	21.70	35.14	4.15				351	75	21.00	35.19	4.09	24.66	329	0.36
92	19.04	35.37	3.96				267	100	17.95	35.32	3.56	25.55	245	0.44
111	16.52	35.22	3.01				219	125	15.38	35.22	3.21	26.08	194	0.49
129	15.06	35.22	3.27				188	150	14.23	35.21	3.40	26.32	171	0.54
148	14.28	35.22	3.39				172	200	12.88	35.13	3.72	26.54	151	0.62
177	13.56	35.17	3.59				161	250	11.83	35.06	3.70	26.69	136	0.70
210	12.60	35.12	3.76				146	300	11.01	34.98	3.99	26.78	128	0.77
239	12.02	35.07	3.63				139	400	9.78	34.87	3.76	26.91	115	0.90
287	11.20	35.00	3.97				130	500	8.77	34.81	3.29	27.03	104	1.01
341	10.45	34.92	4.02				123	600	8.02	34.81	2.69	27.14	93	1.12
424	9.52	-	-					700	7.49	34.84	2.47	27.24	84	1.22
507	8.70	34.80	3.25				104	800	7.06	34.85	2.13	27.31	77	1.32
591	8.08	34.82	2.71				93	1000	5.99	34.83	2.08	27.44	65	1.48
691	7.50	34.83	2.48				84	1200	5.03	34.79	2.40	27.53	57	1.63
793	7.12	34.86	2.18				77	1500	3.77	34.76	2.91	27.64	46	1.83
								2000	2.58	34.76	3.36	27.75	35	2.09
687a)	7.56	34.84	2.53				85	2500	2.18	34.76	3.64	27.79	32	2.32
784	7.12	34.84	2.11				79	3000	1.86	34.75	3.73	27.80	31	2.54
877	6.58	34.85	1.94				71							
975	6.12	34.84	2.02				66							
1169	5.18	34.79	2.37				58							
1268	4.74	34.78	2.49				54							
1364	4.35	34.78	2.60				50							
1559	3.51	34.76	3.01				43							
1753	3.04	34.76	3.25				39							
1949	2.64	34.76	3.33				36							
2145	2.44	34.76	3.50				34							
2341	2.29	34.77	3.35				32							
2537	2.16	34.76	3.64				32							
2734	2.02	34.76	3.67				31							
2932	1.91	34.75	3.71				31							
3129	1.76	34.75	3.80				30							
3329	1.64	34.75	4.32				29							
3527	1.56	34.73	4.13				30							
3728	1.42	34.74	-				28							
3829	1.38	34.76	4.10				26							

<sup>1</sup>This station lies 4½ miles north-northeast of SCOR-IOC, IIOE Reference Station #13 (8°S, 44°E)

a) Overlapping casts; reconciliation of property curves when necessary.

Table I (Cont.)

---



Appendix C (cont.)

TABLE I (Cont.) SCOR-IOC IIOE HYDROGRAPHIC REFERENCE STATIONS

OBSERVED							COMPUTED	INTERPOLATED				COMPUTED		
Z	T	S	O <sub>2</sub>	PO <sub>4</sub> -P	SiO <sub>3</sub> -Si	NO <sub>2</sub> -N	δ <sub>T</sub>	Z	T	S	O <sub>2</sub>	σ <sub>t</sub>	δ <sub>T</sub>	ΔD
m	°C	‰	ml/L	μg at/L	μg at/L	μg at/L	cl/ton	m	°C	‰	ml/L	g/L	cl/ton	dyn m
ARGO; May 22, 1963; 0329, 0103 GCT; 18°01'S, 40°51'E; <sup>1</sup> sounding, 1340 fm; wind, 180°, force 4; weather, partly cloudy; sea, very rough; wire angle, 17°, 32°.														
0	26.73	34.90	4.58				511	0	26.73	34.90	4.58	22.75	511	0.00
10	26.72	34.90	4.59				511	10	26.72	34.90	4.59	22.75	511	0.05
28	26.72	34.89	4.57				512	20	26.72	34.90	4.58	22.75	511	0.10
57	26.74	34.90	4.58				512	30	26.72	34.90	4.58	22.75	511	0.15
67	26.70	34.91	4.63				510	50	26.74	34.90	4.58	22.75	512	0.26
81	24.89	35.03	4.79				447	75	25.50	34.99	4.79	23.20	468	0.38
96	23.68	35.09	4.42				409	100	23.36	35.10	4.33	23.93	399	0.49
110	22.72	35.12	4.13				380	125	21.92	35.17	3.89	24.39	355	0.58
134	21.48	35.19	3.75				342	150	20.72	35.23	3.58	24.76	319	0.67
153	20.63	35.23	3.57				317	200	17.93	35.31	3.39	25.54	245	0.81
182	18.71	35.31	3.42				263	250	15.36	35.28	3.32	26.13	190	0.93
211	17.42	35.30	3.34				234	300	13.92	35.23	3.73	26.40	164	1.02
240	15.76	35.29	3.26				197	400	12.06	35.10	4.23	26.67	138	1.18
288	14.20	35.24	3.64				169	500	10.58	34.94	4.20	26.82	123	1.32
340	13.07	35.19	3.98				150	600	9.48	34.82	4.13	26.92	114	1.45
422	11.72	35.06	4.24				134	700	8.43	34.75	3.60	27.03	104	1.57
505	10.51	34.93	4.19				123	800	7.58	34.73	3.19	27.14	93	1.68
589	9.56	34.84	4.11				114	1000	6.00	34.72	2.71	27.35	73	1.88
596a)	9.54	34.81	4.15				116	1200	5.08	34.78	2.56	27.51	58	2.03
682	8.61	34.76	3.66				106	1500	3.40	34.73	3.38	27.65	45	2.23
768	7.83	34.73	3.32				96	2000	2.63	34.77	3.86	27.76	35	2.49
853	7.23	34.74	2.93				87							
938	6.63	34.74	2.72				80							
1023	5.84	34.72	2.71				71							
1109	5.58	34.77	2.45				65							
1199	5.09	34.78	2.55				58							
1288	4.38	34.73	2.88				54							
1380	3.84	34.73	3.09				49							
1472	3.48	34.72	3.39				46							
1565	3.24	34.75	3.37				42							
1658	3.06	34.72	3.73				42							
1751	2.97	34.75	3.64				39							
1846	2.89	34.75	3.78				39							
1942	2.70	34.77	3.82				36							
2042	2.58	34.76	3.92				35							
2138	2.48	34.78	4.20				33							
2233	2.41	34.78	4.25				32							
2330	2.32	34.80	4.34				30							

<sup>1</sup>This station lies 8½ miles westerly of SCOR-IOC, IIOE Reference Station #14 (18°S, 41°E)

a) Multiple casts; reconciliation of property curves when necessary.

Table I (Cont.)

---

Appendix C (cont.)

TABLE I (Cont.) SCOR-IOC IIOE HYDROGRAPHIC REFERENCE STATIONS

OBSERVED							COMPUTED	INTERPOLATED				COMPUTED		
Z	T	S	O <sub>2</sub>	PO <sub>4</sub> -P	SiO <sub>3</sub> -Si	NO <sub>2</sub> -N	δ <sub>T</sub>	Z	T	S	O <sub>2</sub>	σ <sub>t</sub>	δ <sub>T</sub>	ΔD
m	°C	‰	ml/L	μg at/L	μg at/L	μg at/L	cl/ton	m	°C	‰	ml/L	g/L	cl/ton	dyn m
ARGO; May 25, 1963; 2352 GCT; 32°00'S, 35°21'E <sup>1</sup> ; sounding, 920 fm; wind, 250°, force 6; weather, missing; sea, missing; wire angle, 05°.														
0	20.87	35.54	4.93				301	0	20.87	35.54	4.93	24.96	301	0.00
10	20.88	35.54	4.72				301	10	20.88	35.54	4.72	24.96	301	0.03
30	20.85	35.54	4.75				300	20	20.87	35.54	4.74	24.96	301	0.06
50	20.30	35.53	4.50a)				287	30	20.85	35.54	4.75	24.96	300	0.09
70	19.66	35.54	4.62				270	50	20.30	35.53	4.50	25.10	287	0.15
99	18.76	35.56	4.77				246	75	19.50	35.55	4.66	25.33	265	0.22
149	17.10	35.54	4.72				209	100	18.74	35.56	4.78	25.53	246	0.28
198	16.18	35.50	4.46				191	125	17.86	35.56	4.77	25.75	225	0.34
272	15.24	35.44	4.56				175	150	17.08	35.55	4.71	25.93	208	0.40
345	14.13	35.35	4.67				159	200	16.16	35.50	4.46	26.11	191	0.50
419	13.20	35.25	4.81				148	250	15.52	35.46	4.52	26.23	180	0.60
494	12.26	35.14	4.76				138	300	14.79	35.40	4.60	26.34	169	0.69
592	11.26	35.00	4.80				131	400	13.46	35.28	4.77	26.53	151	0.86
691	9.96	34.82	4.80				122	500	12.20	35.13	4.76	26.67	138	1.01
790	8.79	34.70	4.61				113	600	11.14	34.98	4.80	26.75	130	1.16
889	7.27	34.59	4.37				99	700	9.85	34.82	4.80	26.86	120	1.30
988	6.34	34.50	4.19				94	800	8.63	34.68	4.58	26.95	112	1.43
1087	5.26	34.49	4.04				82	1000	6.23	34.50	4.18	27.15	93	1.67
1190	4.47	34.46	4.15				76	1200	4.42	34.46	4.14	27.33	75	1.86
1388	3.49	34.56	3.90				58							

a) Mean value of 4.46 and 4.55 ml/L.

<sup>1</sup>This station lies 52+ miles southeasterly of the finally accepted position for SCOR-IOC, IIOE Reference Station #15 (31°30'S, 34°30'E)

Table I (Cont.)

— 182 —

**Table II *HYDROGRAPHIC CASTS - MONSOON EXPEDITION INDIAN OCEAN***

Station No.	Date	Local time	Time Zone	Lat.	Long.	Bottom depth (m)	Deepest obs. (m)
II-1 <sup>[*]</sup>	Oct 22, 1960			09°45'S	127°33'E	3292	3203
II-2	Oct 23, 1960	S. 1959	-9	09°01'S	128°40'E	3096	2761
		D. 1402		09°00'S	128°35.5'E		
II-4	Oct 24, 1960	S. 2250	-9	07°08.5'S	127°12'E	4718	4506
		D. 1607		07°09.5'S	127°17'E		
II-6 <sup>[*]</sup>	Oct 28, 1960			07°58.5'S	117°47'E	2107	2029
II-8	Oct 30, 1960	1228	-8	11°55'S	115°26'E	5009	3006
II-11	Nov 2, 1960	S. 1424	-8	10°10'S	115°16.5'E	4319	4249
		D. 1246		10°10'S	115°17'E		
II-17	Nov 8, 1960	S. 1604	-8	11°42'S	109°34'E	4598	860
		D 1115		11°39.5'S	109°36'E		
II-19	Nov 10, 1960	0907	-8	09°22.5'S	109°17'E	1580	1292
II-21	Nov 11, 1960	1441	-8	08°48'S	109°36'E	3281	3115
III-7 <sup>[*]</sup>	Nov 24, 1960	1810	-6	11°26'S	094°41'E	5559	5468
III-8 <sup>[*]</sup>	Nov 26, 1960			17°01'S	093°28.4'E	5238	4958
III-10	Nov 27, 1960	1529	-6	18°53'S	088°02'E	2377	977

III-11	Nov 28,1960	1236	-6	18°13.5'S	086°38'E	4444	4444
III-13 <sup>[*]</sup>	Nov 29,1960			15°52'S	081°07'E	4989	4895
III-15	Dec 1, 1960	S. 2045	-5	12°58'S	075°05'E	5139	5107
		D. 1334		12°58'S	075°10'E		
III-20 <sup>[*]</sup>	Dec 5, 1960			16°57.5'S	064°41.6'E	4041	3942
IV-2	Dec 11,1960	S. 1848	-4	20°19'S	058°08'E	4316	4213
		D 1632		20°19'S	058°09.5'E		
IV-4	Dec 14,1960	1303	-5	25°01.5'S	069°34.5'E	2719	2184
IV-5	Dec 15,1960	S. 2106	-5	23°58'S	073°56'E	3660	3623
		D. 1218		23°55'S	073°51'E		
IV-6 <sup>[*]</sup>	Dec 16,1960			26°22'S	074°08 4'E	4246	4055
IV-8 <sup>[*]</sup>	Dec 17,1960	2000	-5	30°49.7'S	073°12.5'E	3900 ±	3801
IV-9	Dec 18,1960	S. 2057	-5	33°20.5'S	072°40.5'	4151	4009
		D. 1641		33°20.5'S	072°41'E		
IV-10 <sup>[*]</sup>	Dec 20,1960			37°44'S	071°41.6'E	4261	4213
IV-11	Dec 21,1960	S. 2255	-5	42°03'S	070°41'E	4072	4055
		D. 1417		42°03'S	070°40'E		
IV-12	Dec 22,1960	S. 0124	-5	39°49.5'S	075°03.5'E	3840	3679
		D. 2235		39°49.5'S	075°02.5'E		
IV-16	Dec 26,1960	S. 0740	-6	37°51.5'S	085°22.5'E	3647	3188
		D. 0352		37°49.5'S	085°22'E		
IV-17 <sup>[*]</sup>	Dec 27,1960			37°19.3'S	090°43.4'E	3900 ±	3730
IV-19	Dec 29,1960	S. 2243	-6	36°19'S	098°40'E	3561	3446

		D. 1143		36°18'S	098°41'E		
V-2 <sup>[*]</sup>	Jan 9, 1961	1125	-8	39°18'S	119°53'E	4900 +	4915
V-4	Jan 12,1961	1757	-9	49°28'S	132°17'E	3561	3446

— 183 —

**Table III**

A. Equatorial Current Studies: June 28 – September 24, 1962 (Singapore to Cochin)							
Station No.	Date	Local time	Time Zone	Lat.	Long.	Bottom depth (m)	Deepest obs. (m)
Q-1	July 1,1962	2237	-7	00°06'S	96°31'E	4718	760
Q-2	July 1,1962	2348	-7	00°06'S	96°31'E	4718	757
1	July 2,1962	0119	-7	00°07'S	96°31'E	4685	1182
2 D	July 2,1962	1143	-7	00°11.2'S	94°56.7'E	4535	1169
2 S	July 2,1962	1527	-7	00°12.2'S	94°55'E	4544	4354
3	July 3,1962	0116	-6	00°05'S	93°01'E	4398	1184
4 S	July 3,1962	1214	-6	00°02'S	91°02'E	4418	1128
4 D	July 3,1962	1430	-6	00°02'S	91°02'E	4416	4114
5	July 4,1962	0517	-6	00°00'S	88°56'E	4378	1194
6 S	July 6,1962	1240	-6	00°01'N	87°01'E	4550	1162
6 D	July 6,1962	1551	-6	00°01'N	87°01'E	4550	4299
7	July 7,1962	0405	-6	00°02'S	84°56'E	4416	1152

8 S	July 7,1962	1514	-6	00°01'N	82°54'E	4206	1169
8 D	July 7,1962	1730	-6	00°01'N	82°52'E	4206	4139
9	July 8,1962	0429	-6	00°00'	80°56.5'E	4118	1137
10 S	July 8,1962	1954	-6	00°01'N	78°59'E	4727	978
10 D	July 8,1962	2324	-6	00°01'N	78°59'E	4735	4515
11	July 10,1962	2325	-5	00°03'S	76°56'E	4627	1055
12 S	July 11,1962	1010	-5	00°01'S	74°59'E	4261	1017
12 D	July 11,1962	1243	-5	00°02.5'S	74°58.5'E	4272	4285
13	July 12,1962	0034	-5	00°01'N	72°56.0'E	1866	863
14 S	July 12,1962	1114	-5	00°02.5'S	71°04'E	4246	1120
14 D	July 12,1962	1354	-5	00°03'S	71°02'E	--	2372
15	July 13,1962	0448	-5	00°09'N	68°59'E	3585	1128
16	July 13,1962	1642	-5	00°02'N	66°56'E	2609	1172
17 S	July 14,1962	0340	-5	00°01'S	65°04.5'E	3385	1170
17 D	July 14,1962	0645	-5	00°02'S	65°03.5'E	--	3307
18	July 14,1962	1940	-5	00°03'N	62°41'E	4118	1147
19 S	July 17,1962	0031	-4	00°03'S	61°00'E	4389+	1187
19 D	July 17,1962	0315	-4	00°04'S	61°00'E	4389+	4153
20	July 17,1962	1456	-4	00°00'	59°01'E	4546	1147
21 S	July 18,1962	0345	-4	00°01 5'S	57°05.5'E	4704	1196

21 D	July 18,1962	0639	-4	00°01.5'S	57°05.5'E	4704	4558
22	July 18,1962	1939	-4	00°03'N	55°03'E	3537	1169
23 S	July 19,1962	1141	-4	00°04'S	52°55'E	4916	1192
23 D	July 20,1962	0520	-4	00°04'S	52°55'E	4912	4866
24	July 21,1962	0510	-4	00°05'S	50°56'E	4938	1191
25 S	July 21,1962	1623	-4	00°00'	48°55'E	4806	1073
25 D	July 21,1962	1951	-4	00°00'	48°55'E	--	4479
26	July 22,1962	0631	-3	00°08'S	46°52'E	4250	964
27 S	July 22,1962	1642	-3	00°01'N	45°02.5'E	--	1185
27 D	July 22,1962	1927	-3	00°01'N	45°03'E	--	3458
28	July 29,1962	1658	-3	00°01'N	45°25'E	3713	1139
29 S	July 31,1962	1524	-4	05°02'N	53°01'E	4947	986
29 D	July 31,1962	1820	-4	05°08'N	53°05'E	5104	4571
30	Aug 1,1962	0550	-4	04°09' N	53°10' E	4969	965
31 S	Aug 1,1962	1514	-4	02°59' N	53°02' E	4971	1199
31 D	Aug 1,1962	1659	-4	02°59' N	53°02' E	5127	5018
32	Aug 1,1962	2355	-4	02°30' N	53°00' E	4965	1193
33	Aug 2,1962	1215	-4	02°00' N	52°58' E	4964	1136
34	Aug 4,1962	1423	-4	01°30' N	52°59' E	4960	1100
35 S	Aug 4,1962	2153	-4	01°00' N	53°00' E	4953	1163



35 D	Aug 5,1962	0045	-4	01°00' N	53°00' E	5112	4725
36	Aug 6,1962	0548	-4	00°29' N	52°58' E	4953	1164
37	Aug 6,1962	1438	-4	00°00'	53°00' E	4912	1081
38	Aug 7,1962	1711	-4	00°31.5'S	52°58.5'E	4896	1030
39 S	Aug 8,1962	0211	-4	01°00' S	53°00' E	4872	1070
39 D	Aug 8,1962	0448	-4	01°00' S	53°00' E	4872	4923
40	Aug 9,1962	0744	-4	01°29' S	53°01' E	4625	1190
41	Aug 9,1962	1543	-4	02°02' S	53°03' E	4931	1002
42	Aug 10,1962	2326	-4	02°30.2'S	53°00' E	4444	1151
43 S	Aug 11,1962	0337	-4	03°00' S	53°00' E	4188	1085
43 D	Aug 11,1962	0654	-4	02°54' S	53°02' E	3575	3203
44	Aug 11,1962	1447	-4	03°56.5'S	52°59' E	3994	1073
45 S	Aug 14,1962	2012	-4	05°00' S	62°00' E	3906	948
45 D	Aug 14,1962	2255	-4	04°57.5'S	61°58' E	4054	3944
46	Aug 15,1962	0540	-4	04°07' S	62°10' E	3902	1180
47 S	Aug 15,1962	1335	-4	03°00' S	62°20' E	4543	1077
47 D	Aug 15,1962	1608	-4	02°57.5'S	62°20' E	4543	4137
48	Aug 15,1962	2051	-4	02°29' S	62°20' E	4416	1122
49	Aug 16,1962	0304	-4	02°00' S	62°00' E	4480	1138
50	Aug 16,1962	2331	-4	01°28.5'S	62°20' E	4453	1043

51 S	Aug 17,1962	0553	-4	00°57' S	62°19' E	4319	956
51 D	Aug 17,1962	0835	-4	00°55' S	62°19' E	4389+	4176
52	Aug 18,1962	0437	-4	00°28.5'S	62°19.5'E	4085	1121
53	Aug 18,1962	1153	-4	00°05.5'N	62°20' E	4228	1191
54	Aug 19,1962	0314	-4	00°29' N	62°19' E	3182	975
55 S	Aug 19,1962	0908	-4	01°02.5'N	62°20' E	4277	1036
55 D	Aug 19,1962	1115	-4	01°02.5'N	62°20' E	--	3892
56	Aug 20,1962	1143	-4	01°32.5'N	62°20.5'E	4122	1186
57	Aug 20,1962	1741	-4	02°05.5'N	62°15.5'E	3810	1121
58	Aug 21,1962	1050	-4	02°31' N	62°20' E	4133	1129
59 S	Aug 21,1962	1423	-4	03°06' N	62°19' E	3676	1185
59 D	Aug 21,1962	1626	-4	03°06' N	62°19' E	3383–3493	3381
60	Aug 21,1962	2144	-4	04°00' N	62°19' E	2670	1159
61 S	Aug 22,1962	0337	-4	05°02' N	62°20.5'E	2505	1091
61 D	Aug 22,1962	0605	-4	05°09.5'N	62°24' E	2798	2745
62 S	Aug 29,1962	0546	-5½	04°51' N	79°04.5'E	4212	1192
62 D	Aug 29,1962	0835	-5½	04°49' N	79°08' E	4220	4137
63	Aug 29,1962	1600	-5½	04°00' N	79°02' E	4164	1138
64 S	Aug 29,1962	2229	-5½	02°55.5'N	78°58.5'E	4136	1158
64 D	Aug 30,1962	0226	-5½	02°55' N	79°01.5'E	4142	3941

65	Aug 30,1962	0635	-5½	02°26.5'N	78°56' E	3255	1181
66	Aug 30,1962	1412	-5½	01°54' N	79°01' E	4254	1101
67	Aug 31,1962	1428	-5½	01°28' N	79°01.5'E	4447	1141
68 S	Aug 31,1962	2118	-5½	00°55' N	79°04' E	4565	1166
68 D	Sept 1,1962	0036	-5½	00°55' N	79°04' E	--	4423
69	Sept 1,1962	1650	-5½	00°30' N	79°01.5'E	4599	1128
70	Sept 2,1962	0251	-5½	00°02' N	79°04' E	4612	1158
71	Sept 2,1962	2011	-5½	00°30' S	79°02' E	4620	1189
72 S	Sept 3,1962	0318	-5½	00°56' S	79°03' E	4630	1185
72 D	Sept 3,1962	0617	-5½	00°56' S	79°03' E	4766	4674
73	Sept 3,1962	2243	-5½	01°27' S	78°57.5'E	4799	1000
74	Sept 4,1962	0516	-5½	01°55' S	78°54.5'E	4790	950
75	Sept 4,1962	2221	-5½	02°30' S	78°59' E	4786	1188
76 S	Sept 5,1962	0239	-5½	03°00' S	79°01' E	4678	1186
76 D	Sept 5,1962	0545	-5½	03°00' S	78°59.5'E	--	4493
77	Sept 5,1962	1333	-5½	04°00' S	79°00' E	4854	948
78 S	Sept 5,1962	2026	-5½	05°00' S	79°00' E	5062	1188
78 D	Sept 5,1962	2352	-5½	05°00' S	79°00' E	--	5010
79	Sept 11,1962	1331	-6	00°01' N	88°56' E	4352	874
80	Sept 12,1962	0658	-6	00°38.5'S	89°03' E	3261	897

81 S	Sept 12,1962	1227	-6	01°08' S	89°05.5'E	2468	1167
81 D	Sept 12,1962	1430	-6	01°08' S	89°05.5'E	--	2228
82	Sept 13,1962	0645	-6	01°30.5'S	89°00' E	2316	1168
83	Sept 13,1962	1304	-6	02°30.5'S	89°00.5'E	3512	1188
84 S	Sept 14,1962	1140	-6	03°03' S	89°03' E	3288	1180
84 D	Sept 14,1962	1339	-6	03°03' S	89°03' E	--	3242
85	Sept 14,1962	2024	-6	04°01' S	89°00' E	2571	1145
86 S	Sept 15,1962	0248	-6	05°00' S	89°00' E	3438	1069
86 D	Sept 15,1962	0508	-6	05°00' S	89°00' E	--	2867
87	Sept 15,1962	2131	-6	01°59.5'S	88°59.5'E	3127	1074
88	Sept 16,1962	2012	-6	00°06' N	88°58.5'E	4294	1128
89	Sept 17,1962	1012	-6	00°31' N	89°01' E	4114	1094
90 S	Sept 17,1962	1621	-6	01°00' N	88°52.5'E	3975	1076
90 D	Sept 17,1962	1848	-6	01°00' N	88°52.5'E	--	3466
91	Sept 18,1962	2201	-6	01°30.5'N	89°00' E	3607	1100
92	Sept 19,1962	0209	-6	02°01' N	88°58.5'E	3146	1093
93	Sept 19,1962	0754	-6	02°35' N	88°58' E	3383	1084
94 S	Sept 20,1962	0017	-6	03°02' N	89°01' E	3574	1146
94 D	Sept 20,1962	0234	-6	03°02' N	89°01' E	--	3189
95	Sept 20,1962	0912	-6	04°02' N	89°00' E	3310	1100

96	Sept 20,1962	1334	-6	04°16.5'N	88°59' E	3632	206
97 S	Sept 21,1962	0714	-6	04°59.5'N	89°01' E	3446	1032
97 D	Sept 21,1962	1015	-6	04°58.5'N	89°03' E	--	3283

— 186 —

B. South and Central Indian Ocean - October 4 - December 23, 1962 (Cochin to Port Darwin)							
Station No.	Date	Local Time	Time Zone	Lat.	Long.	Bottom depth (m)	Deepest obs. (m)
98 S	Oct. 6, 1962	1305	-5	08°18'N	070°35'E	3856	1172
98 D	Oct. 6, 1962	1928	-5	08°16'N	070°37'E	3856	3860
99 D	Oct. 7, 1962	2015	-5	03°58'N	070°48'E	4198	3891
99 S	Oct. 8, 1962	0006	-5	03°58'N	070°48'E	4198	109
100 D	Oct. 9, 1962	1441	-5	02°41'S	073°12'E	2893	2779
100 S	Oct. 9, 1962	1735	-5	02°40'S	073°15'E	2893	159
101 D	Oct. 10,1962	2035	-5	05°21'S	075°06'E	5066	4397
101 S	Oct. 11,1962	0111	-5	05°21.5'S	075°10'E	5066	2066
102 D	Oct. 12,1962	1002	-5	05°40'S	070°17'E	3913	3623
102 S	Oct. 12,1962	1342	-5	05°40'S	070°17'E	3913	1306
103 D	Oct. 13,1962	1000	-5	05°50'S	066°36'E	4246	3920
103 S	Oct. 13,1962	1417	-5	05°50'S	066°36'E	4246	1327
104 D	Oct. 15,1962	1400	-4	05°26'S	059°13'E	3928	3536
104 S	Oct.	1733	-4	05°26'S	059°13'E	3928	1149

	15,1962						
105	Oct. 16,1962	1740	-4	04°00'S	058°00'E	3931	3126
106 D	Oct. 21,1962	0500	-4	09°53'S	056°32'E	3658	2015
106 S	Oct. 21,1962	0709	-4	09°53'S	056°32'E	3658	1288
107 D	Oct. 22,1962	1035	-4	10°22'S	058°31'E	3383	2955
107 S	Oct. 22,1962	1344	-4	10°22'S	058°31'E	3383	169
108	Oct. 23,1962	0201	-4	10°34'S	059°52'E	2268	323
109 D	Nov. 2, 1962	0911	-4	26°51'S	058°15'E	5449	4867
109 S	Nov. 2, 1962	1202	-4	26°54'S	058°11'E	5449	2155
110 D	Nov. 4, 1962	0645	-4	31°27'S	061°50'E	4294	4492
110 S	Nov. 4, 1962	0929	-4	31°27'S	061°50'E	4294	1120
111 D	Nov. 7, 1962	1125	-4	39°45'S	063°58'E	4817	4526
111 S	Nov. 7, 1962	1507	-4	39°45'S	063°58'E	4817	3040
112 D	Nov. 10,1962	0647	-4	51°08.5'S	065°52'E	3193	3195
112 S	Nov. 10,1962	1240	-4	51°06'S	065°51'E	3193	872
113	Nov. 16,1962	1305	-5	36°51'S	076°23'E	3804	1160
114	Nov. 22,1962	1018	-6	33°48'S	096°01'E	4184	1069
115	Nov. 23,1962	1030	-7	32°02'S	098°52'E	1939	1855
116 S	Nov. 25,1962	0650	-7	34°12'S	105°52'E	5413	1534
116 D	Nov. 25,1962	1439	-7	34°10'S	105°57'E	5413	3358
117	Nov.	1602	-7	32°50'S	108°45'E	5200	1975

	26,1962						
118 D	Dec. 3, 1962	0120	-8	31°27'S	114°24.5'E	3713	3517
118 S	Dec. 3, 1962	0335	-8	31°27.5'S	114°23'E	3713	1175
119 D	Dec. 4, 1962	1247	-8	29°42'S	111°32'E	5186	3534
119 S	Dec. 4, 1962	1527	-8	29°42'S	111°34'E	5186	2105
120	Dec. 6, 1962	1437	-7	25°02'S	104°11'E	4821	1957
121 D	Dec. 8, 1962	1208	-7	20°42.5'S	097°12.5'E	5541	5153
121 D	Dec. 8, 1962	1454	-7	20°42.5'S	097°12.5'E	5541	2138
121 S	Dec. 8, 1962	1628	-7	20°42.5'S	097°12.5'E	5541	519
122	Dec. 10,1962	1652	-6	16°25'S	089°19'E	5546	2115
123	Dec. 11,1962	1207	-6	14°32'S	088°02'E	2505	1920
124	Dec. 13,1962	1110	-6	13°09'S	093°12'E	5121	2085
125	Dec. 15,1962	1220	-7	13°50'S	100°15'E	5768	603
126	Dec. 17,1962	1516	-7	14°55'S	108°10'E	5405	1182
127	Dec. 19,1962	1110	-8	13°46'S	115°32'E	5505	600
128 D	Dec. 20,1962	1331	-8	13°31'S	118°28'E	5501	5067
128 S	Dec. 20,1962	1607	-8	13°31'S	118°28'E	5501	1606

— 187 —

C. Equatorial Current studies: February 16 – May 15, 1963  
(Colombo to Mombasa)

Station	Date	Local	Time	Lat.	Long.	Bottom depth	Deepest obs.
---------	------	-------	------	------	-------	--------------	--------------

No.		time	Zone			(m)	(m)
Q-1	Feb. 17,1963	1734	-5	05°01.5'N	085°05.5'E	3946	675
Q-2	Feb. 17,1963	1846	-5	05°01.5'N	085°05.5'E	3946	650
1	Feb. 17,1963	2024	-5	05°00.5'N	085°03.5'E	3946	941
2	Feb. 18,1963	0429	-5	04°03'N	084°58.5'E	4034	826
3	Feb. 18,1963	1052	-5	03°06.5'N	084°55'E	4133	1118
4	Feb. 18,1963	1455	-5	02°37'N	084°53'E	4184	1176
5 D	Feb. 18,1963	2155	-5	02°08'N	084°51'E	4252	1033
5 S	Feb. 19,1963	0021	-5	02°08'N	084°51'E	4252	191
6 S	Feb. 20,1963	0341	-5	01°35.5'N	084°58'E	4297	198
6 D	Feb. 20,1963	0513	-5	01°33'N	084°57.5'E	—	1104
7 S	Feb. 20,1963	1213	-5	01°00.5'N	084°59'E	4352	198
7 D	Feb. 20,1963	1413	-5	01°00.5'N	084°59'E	—	1112
8 S	Feb. 21,1963	0917	-5	00°31'N	084°54.5'E	4389	191
8 D	Feb. 21,1963	1055	-5	00°30'N	084°54'E	—	1025
9 S	Feb. 21,1963	1633	-5	00°01.5'N	084°50.5'E	4415	190
9 D	Feb. 21,1963	1855	-5	00°01.5'N	084°50.5'E	—	921
10 S	Feb. 23,1963	1607	-5	00°31'S	085°01'E	4466	206
10 D	Feb. 23,1963	1805	-5	00°32'S	085°01'E	—	1136
11 S	Feb. 24,1963	0016	-5	01°04'S	085°02'E	4517	208
11 D	Feb.	0207	-5	01°04'S	085°02'E	—	1180



	24,1963						
12 S	Feb. 25,1963	0017	-5	01°33'S	084°59.5'E	4544	209
12 D	Feb. 25,1963	0143	-5	01°34'S	084°59'E	—	1056
13 S	Feb. 25,1963	0751	-5	02°03.5'S	084°57.5'E	4572	209
13 D	Feb. 25,1963	0924	-5	02°03.5'S	084°57.5'E	—	1143
14	Feb. 26,1963	0505	-5	02°32'S	084°59'E	4603	1186
15	Feb. 26,1963	0841	-5	03°01'S	085°02'E	4654	1178
16	Feb 26,1963	1438	-5	04°01'S	085°01.5'E	4770	1144
17	Feb. 26,1963	2049	-5	05°00'S	085°07'E	4856	1137
18 S	Feb. 28,1963	0533	-5	00°05'S	080°48.5'E	4497	191
18 D	Feb. 28,1963	0657	-5	00°05'S	080°48'E	4497	1019
19 S	Mar. 1, 1963	0247	-5	00°06'S	076°54'E	4462	206
19 D	Mar. 1, 1963	0435	-5	00°06'S	076°54'E	—	1151
20 S	Mar. 2, 1963	1813	-5	00°01.5'S	072°58'E	1641	199
20 D	Mar. 2, 1963	1950	-5	00°01.5'S	072°54.5'E	—	1162
21 S	Mar. 3, 1963	1343	-4	00°10'N	069°01.5'E	3840	205
21 D	Mar. 3, 1963	1520	-4	00°10'N	069°01.5'E	—	1187
22	Mar. 6, 1963	0058	-4	04°58.5'N	061°03'E	3404	1176
23	Mar. 6, 1963	0742	-4	03°59'N	061°05'E	4078	1029
24	Mar. 6, 1963	1305	-4	03°02.5'N	061°00'E	4140	1145
25	Mar. 6,	1630	-4	02°35'N	060°58'E	3888	1154

	1963						
26 D	Mar. 6, 1963	2130	-4	02°10'N	060°57'E	5198	1141
26 S	Mar. 6, 1963	2305	-4	02°10'N	060°57'E	5198	203
27 D	Mar 7, 1963	2033	-4	01°31'N	060°59'E	4188	1188
27 S	Mar. 7, 1963	2212	-4	01°30'N	060°58.5'E	4188	208
28 D	Mar. 8, 1963	0321	-4	01°05'N	061°00'E	4678	1190
28 S	Mar. 8, 1963	0413	-4	01°05'N	061°00'E	4678	207
29 D	Mar. 8, 1963	2348	-4	00°32'N	060°59'E	4638	1186
29 S	Mar. 9, 1963	0115	-4	00°32'N	060°58.5'E	4638	208
30 D	Mar. 9, 1963	0605	-4	00°04'N	060°56'E	4429	1183
30 S	Mar. 9, 1963	0729	-4	00°04'N	060°56'E	4429	208
31 D	Mar. 10,1963	0503	-4	00°27.5'S	060°59.5'E	4568	1173
31 S	Mar. 10,1963	0636	-4	00°28'S	060°58.5'E	—	193
32 D	Mar. 10,1963	1142	-4	01°02'S	060°57'E	4347	1190
32 S	Mar. 10,1963	1310	-4	01°02'S	060°57'E	4347	201
33 D	Mar. 11,1963	0735	-4	01°29'S	061°00.5'E	4488	1177
33 S	Mar. 11,1963	0858	-4	01°29.5'S	061°00'E	4488	205
34 D	Mar. 11,1963	1321	-4	01°59.5'S	060°58'E	4468	1167
34 S	Mar. 11,1963	1504	-4	01°59.5'S	060°58'E	4468	208
35	Mar. 12,1963	1142	-4	02°32'S	060°59.5'E	4233	1136
36	Mar.	1546	-4	03°00'S	061°01.5'E	4193	1184

	12,1963						
37	Mar. 12,1963	2121	-4	04°00'S	061°08.5'E	3704	1103
38	Mar. 13,1963	0250	-4	04°57'S	061°14'E	4446	695
39	Mar. 24,1963	1056	-4	00°03.5'N	044°34.5'E	3179	1232
40	Mar. 24,1963	2252	-4	00°06.5'N	046°53.5'E	4125	1171
41	Mar. 25,1963	0959	-4	00°14'N	048°40'E	4601	1180
42	Mar. 25,1963	2103	-4	00°08'S	051°04.5'E	4931	1185
43 D	Mar. 26,1963	1045	-4	00°02'N	053°03'E	4892	1063
43 S	Mar. 26,1963	1236	-4	00°02'N	053°03'E	4892	205
44	Mar. 27,1963	1636	-4	00°05.5'N	055°02.5'E	3950	1147
45	Mar. 28,1963	0300	-4	00°11'N	056°59'E	4576	1162
46	Mar. 30,1963	1620	-4	00°02'N	058°52'E	3867	1161
47 D	Mar. 31,1963	0946	-4	00°07'N	061°09'E	4572	1184
47 S	Mar. 31,1963	1121	-4	00°07'N	061°09'E	4572	206
48	Apr. 1, 1963	1535	-4	00°01'S	063°00'E	4261	1182
49	Apr. 2, 1963	0306	-4	00°01'S	065°03.5'E	3444	1184
50	Apr. 2, 1963	1349	-4	00°00.5'S	067°02.5'E	3380	1182
51	Apr. 3, 1963	0053	-4	00°00'S	069°00.5'E	3840	1181
52	Apr. 3, 1963	1220	-5	00°00.5'N	071°00.5'E	3823	1181
53	Apr. 3, 1963	2347	-5	00°03'N	073°05'E	1474	1173
54	Apr. 4,	1009	-5	00°08'N	074°58.5'E	4160	1175

	1963						
55	Apr. 4, 1963	2124	-5	00°01'N	077°01.5'E	4616	1155
56	Apr. 5, 1963	0747	-5	00°04.5'N	078°59'E	4612	1121
57	Apr. 5, 1963	1913	-5	00°00'N	081°05'E	4480	1103
58	Apr. 6, 1963	0702	-6	00°07'S	083°01'E	4222	1083
59 D	Apr. 6, 1963	1958	-6	00°03'N	085°00'E	4407	1177
59 S	Apr. 6, 1963	2129	-6	00°03'N	085°00'E	4407	183
60	Apr. 7, 1963	2009	-6	00°00.5'S	087°04.5'E	4411	1173
61	Apr. 8, 1963	0851	-6	00°06.5'S	089°31.5'E	3021	1169
62 S	Apr. 8, 1963	20	-6	00°08'N	092°04.5'E	4402	202
62 D	Apr. 9, 1963	112	-6	00°08'N	092°04.5'E	—	1171
63	Apr. 10,1963	0620	-6	00°07.5'N	094°05'E	4321	1183
64	Apr. 19,1963	0716	-6	04°54.5'N	092°04'E	3913	1198
65	Apr. 19,1963	1317	-6	04°00'N	092°03'E	3981	1074
66	Apr. 19,1963	1929	-6	02°56'N	092°02.5'E	4041	1185
67	Apr. 19,1963	2302	-6	02°30'N	092°02.5'E	4105	1184
68 S	Apr 20,1963	0358	-6	02°00.5'N	092°03'E	4151	207
68 D	Apr 20,1963	0534	-6	02°00.5'N	092°03'E	—	1182
69 S	Apr. 21,1963	0206	-6	01°29.5'N	092°05'E	—	206
69 D	Apr. 21,1963	0344	-6	01°29.5'N	092°05'E	4136	1185
70 S	Apr.	0826	-6	01°01'N	091°58.5'E	4297	198

	21,1963						
70 D	Apr. 21,1963	1000	-6	01°01'N	091°58.5'E	4297	1163
71 D	Apr. 21,1963	2351	-6	00°30'N	091°59'E	4356	1185
71 S	Apr. 22,1963	0102	-6	00°30'N	091°59'E	'	197
72 S	Apr. 22,1963	0540	-6	00°00.5'N	091°59'E	4398	205
72 D	Apr. 22,1963	0707	-6	00°00.5'N	091°59'E	4398	1183
73 D	Apr. 22,1963	2130	-6	00°29.5'S	092°00'E	3695	1181
73 S	Apr. 22,1963	2238	-6	00°29.5'S	092°00'E	3695	204
74 S	Apr. 23,1963	0330	-6	00°56.5'S	092°03'E	4493	207
74 D	Apr. 23,1963	0516	-6	00°56.5'S	092°03'E	—	1163
75 D	Apr. 24,1963	0501	-6	01°30'S	092°00'E	4539	1176
75 S	Apr 24,1963	0611	-6	01°30'S	092°00'E	4539	207
76 S	Apr. 24,1963	1101	-6	02°01'S	091°57'E	4590	207
76 D	Apr. 24,1963	1228	-6	02°01'S	091°57'E	4590	1166
77	Apr. 25,1963	0412	-6	02°28'S	092°01'E	4645	1158
78	Apr. 25,1963	0812	-6	03°01'S	092°03.5'E	4691	1108
79	Apr. 25,1963	1437	-6	04°00'S	092°00'E	4746	1183
80	Apr. 25,1963	2030	-6	05°00'S	092°00'E	4856	1145
81	Apr. 27,1963	0130	-6	00°00'S	089°00'E	4420	1135
82	Apr. 27,1963	2003	-6	00°03'N	084°58.5'E	4407	1183
83	Apr.	1343	-5	00°01'S	081°00'E	4482	1182

	28,1963						
84	Apr. 29,1963	0732	-5	00°00'	077°00'E	4625	1179
85	Apr. 30,1963	0203	-5	00°06.5'N	073°11.5'E	1710	1091
86	Apr. 30,1963	2257	-5	00°05'N	069°00'E	3840	1160
87	May 1, 1963	1807	-4	00°03.5'S	064°57'E	3512	1178
88	May 2, 1963	1323	-4	00°01'N	060°59.5'E	4297	1170
89	May 3, 1963	0824	-4	00°00.5'N	057°02.5'E	4572	1183
90 S	May 4, 1963	1505	-4	05°00.5'N	053°03'E	4947	206
90 D	May 4, 1963	1630	-4	05°00.5'N	053°03'E	—	1183
91 D	May 4, 1963	2224	-4	04°00'N	053°00'E	4962	1180
91 S	May 4, 1963	2327	-4	04°00'N	053°00'E	4962	206
92 S	May 5, 1963	0452	-4	03°03.5'N	053°09.5'E	4971	189
92 D	May 5, 1963	0617	-4	03°03.5'N	053°09.5'E	—	1181
93	May 5, 1963	1008	-4	02°29.5'N	052°59.5'E	4962	1179
94 S	May 5, 1963	1445	-4	02°01'N	053°02.5'E	4965	199
94 D	May 5, 1963	1608	-4	02°01'N	053°02.5'E	4965	1159
95 D	May 6, 1963	0828	-4	01°27'N	053°00.5'E	4956	1180
95 S	May 6, 1963	0935	-4	01°27'N	053°00.5'E	4956	206
96 S	May 6, 1963	1428	-4	00°56'N	053°05'E	4947	187
96 D	May 6, 1963	1546	-4	00°56'N	053°05'E	—	1172
97 D	May 7,	0512	-4	00°30'N	053°03'E	4927	1026

	1963						
97 S	May 7, 1963	0614	-4	00°30'N	053°03'E	4927	207
98 S	May 7, 1963	1055	-4	00°02.5'N	053°02'E	4910	191
98 D	May 7, 1963	1228	-4	00°02.5'N	053°02'E	—	1164
99 D	May 8, 1963	0420	-4	00°29.5'S	053°03'E	—	1155
99 S	May 8, 1963	0532	-4	00°29.5'S	053°03'E	4896	207
100 S	May 8, 1963	0948	-4	00°56.5'S	053°06'E	4865	196
100 D	May 8, 1963	1119	-4	00°56.5'S	053°06'E	—	1182
101 D	May 9, 1963	0411	-4	01°30'S	053°00.5'E	—	1175
101 S	May 9, 1963	0531	-4	01°30'S	053°00.5'E	4623	206
102 S	May 9, 1963	1128	-4	01°56'S	053°05.5'E	4938	179
102 D	May 9, 1963	1325	-4	01°56'S	053°05.5'E	—	1176
103	May 10,1963	1229	-4	02°23.5'S	052°59'E	4667	1155
104	May 10,1963	1630	-4	03°00.5'S	052°58.5'E	4773	1166
105	May 10,1963	2310	-4	04°00'S	053°00'E	4085	1176

D. Southwest Indian Ocean - May 18–29, 1963  
(Mombasa to Cape Town)

1 D	May 19,1963	1506	-3	07°56'S	044°02'E	4040	3829
1 S	May 19,1963	1806	-3	07°56'S	044°02'E	4040	793
2 D	May 22,1963	0403	-3	18°01'S	040°51'E	2450	2330
2 S	May 22,1963	0629	-3	18°01'S	040°51'E	2450	589
3	May 26,1963	0152	-2	32°00'S	035°21'E	1682	1388

Arabian Sea - September 19–29, 1962

(Aden to Cochin)							
74	Sept. 21, 1962	S.2027	-3	13°16.5'N	049°15'E	2425	2159
		D.1845					
83	Sept. 26, 1962	S.2119	-4	09°40'N	066°19'E	4459	4193
		D.1802					

\*Stations with single or two bottles only on a cast.

— 191 —

## APPENDIX D

### TABLE I

#### *LUSIAD Expedition - Pelagic Samples*

(A) 1-meter Net Tows <sup>[1]</sup>				
28 June - 29 September, 1962 (Singapore to Cochin)				
<i>Station</i>	<i>Date</i>	<i>Start Time</i>	<i>Latitude</i>	<i>Longitude</i>
1	July 1	2308	0°02'S	96°31'E
2	July 2	1337	0°11'S	94°56'E
4	July 3	1305	0°02'S	91°02'E
5	July 4	0812	0°00	88°57'E
6	July 6	1335	0°01'N	87°01'E
8	July 7	1612	0°01'N	82°52'E
9	July 8	0520	0°00	80°53'E
10	July 8	2119	0°03'N	78°54'E
11	July 11	0037	0°03'S	76°56'E
12	July 11	1111	0°02'S	74°59'E
13	July 12	0142	0°01'N	72°57'E
14	July 12	1221	0°03'S	71°04'E
15	July 13	0618	0°09'N	68°59'E
16	July 13	1739	0°02'N	66°56'E
17	July 14	0450	0°03'S	65°03'E
Buoy No. 3	July 15	0041	0°03'N	62°20'E



19	July 17	0138	0°04'S	61°00'E
20	July 17	1556	0°00	59°02'E
21	July 18	0451	0°03'S	57°04'E
22	July 18	2043	0°04'N	55°03'E
23	July 19	1243	0°04'S	52°55'E
24	July 21	0610	0°05'S	50°55'E
25	July 21	1717	0°00	48°55'E
26	July 22	0725	0°08'S	46°52'E
27	July 22	1751	0°01'N	45°02'E
29	July 31	1618	5°02'N	53°01'E
31	Aug. 1	1612	2°59'N	53°02'E
35	Aug. 4	2255	01°06'N	53°00'E
39	Aug. 8	0308	01°00'S	53°00'E
40–41	Aug. 9	1215	01°58'S	53°06'E
43	Aug. 11	0447	03°00'S	53°00'E
45	Aug. 14	2109	05°00'S	62°00'E
47	Aug. 15	1429	3°00'S	62°20'E
51	Aug. 17	0652	3°57'S	62°19'E
55	Aug. 19	1001	01°02'N	62°20'E
59	Aug. 21	1520	3°06'N	62°19'E
61	Aug. 22	0432	5°02'N	62°20'E
62	Aug. 29	0647	04°51'N	79°04'E
64	Aug. 30	0030	2°55'N	78°58'E
65	Aug. 30	1803	1°54'N	79°01'E
*]66	Aug. 30	1845	1°54'N	79°01'E
68	Aug. 31	2223	0°55'N	79°04'E
72	Sept 3	0430	0°56'N	79°03'E
76	Sept 5	0339	3°00'S	79°01'E
78	Sept 5	2127	5°00'S	79°00'E
Buoy No.21	Sept 7	0113	0°54'S	79°08'E
81	Sept 12	1314	0°08'S	89°05'E
84	Sept 14	1225	3°03'S	89°03'E
86	Sept 15	0343	5°00'S	89°00'E
88	Sept 16	1903	0°06'E	88°58'E
90	Sept 17	1709	1°00'N	88°52'E

94	Sept 20	0110	3°02'N	89°01'E
Buoy No.31	Sept 20	1253	4°16'N	88°59'E
96	Sept 21	0826	4°16'N	88°59'E

16 February-15 May, 1963 (Colombo to Mombasa)				
<i>Station</i>	<i>Date</i>	<i>Start Time</i>	<i>Latitude</i>	<i>Longitude</i>
40	Mar. 24	2319	0°7'N	46°53'E
41	Mar. 25	0928	0°15'N	48°38'E
42	Mar. 25	2132	0°5'S	50°49'E
( <sup>[*]</sup> ( <sup>[**]</sup> 42	Mar. 27	0415)	(0°1'N	53°2'E)
( <sup>[*]</sup> ( <sup>[**]</sup> 43	Mar. 27	0444)	(0°1'N	53°2'E)
45	Mar. 28	0341	0°11'N	57°0'E
46	Mar. 30	1652	0°2'N	58°52'E
(47	Mar. 31	1011)	(0°7'N	61°8'E)
(47	Mar. 31	1035)	(0°7'N	61°8'E)
48	April 1	1604	0°1'S	63°0'E
50	April 2	1416	0°0	67°2'E
52	April 3	1247	0°1'N	71°0'E
54	April 4	1036	0°8'N	74°59'E
56	April 5	0813	0°5'N	78°59'E
58	April 6	0555	0°7'S	83°2'E
(59	April 6	2023)	(0°4'N	85°2'E)
(59	April 6	2047)	(0°4'N	85°2'E)
60	April 7	2043	0°1'S	87°4'E
(62	April 8	2333)	(0°3'N	92°2'E)
(62	April 8	2355)	(0°3'N	92°2'E)
64	April 19	0802	4°54'N	92°4'E
65	April 19	1348	4°1'N	92°3'E
66	April 19	2001	2°56'N	92°2'E
(68	April 20	0416)	(2°2'N	92°2'E)
(68	April 20	0422)	(2°2'N	92°2'E)
(70	April 21	0842)	(1°3'N	91°59'E)
(70	April 21	0909)	(1°3'N	91°59'E)
(72	April 22	0555)	(0°2'N	91°58'E)
(72	April 22	0621)	(0°2'N	91°58'E)

73	April 22	2156	0°30'S	92°1'E
(74	April 23	0358)	(0°58'S	92°4'E)
(74	April 23	042)	(0°58'S	92°4'E)
76	April 24	1109	2°1'S	91°58'E
77	April 25	0438	2°28'S	92°1'E
78	April 25	0840	3°1'S	92°4'E
80	April 25	2057	5°0'S	92°0'E
82	April 27	2033	0°3'N	84°59'E
84	April 29	0801	0°0	77°0'E
86	April 30	2326	0°5'N	69°E
87	May 1	1831	0°4'S	64°57'E
89	May 3	0850	0°1'N	57°3'E
90	May 4	1543	5°1'N	53°3'E
91	May 4	2247	4°0'N	53'E
(92	May 5	0502)	(3°4'N	53°10'E)
(92	May 5	0527)	(3°4'N	53°10'E)
94	May 5	1632	2°1'N	53°2'E
96	May 6	1617	0°56'N	53°5'E
98	May 7	1106	0°2	53°2'E
(100	May 8	1000)	(0°56'S	53°6'E
(100	May 8	1027)	(0°56'S	53°6'E)
104	May 10	1659	3°1'S	52°58'E

18 - 29 May 1963 (Mombasa to Capetown)

<i>Station</i>	<i>Date</i>	<i>Start Time</i>	<i>Latitude</i>	<i>Longitude</i>
1	May 19	1658	7°56'S	44°2'E
[*](4	May 25	0654)	(30°07'S	37°48'E)
[*](4	May 25	0715)	(30°07'S	37°48'E)
(8	May 26	0610)	(32°15'S	34°41'E)
(8	May 26	0633)	(32°15'S	34°41'E)

(B) I.I.O.E. Net: Vertical Tows

<i>Station No.</i>	Positions & dates as in Section (A)
29	"

30 - 39	"
40 - 49	"
50 - 59	"
60 - 87	"
89 - 96	"

(C) Phytoplankton Net Tows

<i>Station No.</i>	Positions & dates as in Section (A)
10 - 20	"
21 - 29	"
31, 35	"
43, 45, 47	"
51, 55, 59	"
61, 62, 64, 68	"
72, 76, 78	"
81, 84, 86, 90, 94, Buoy 31 and 96	"

(D) Dipnet Stations

<i>Station No.</i>	Positions & dates as in Section (A)
1, 2, 5, 6, 9, 10	"
11, 14, Buoy 3	"
22, 23, 25, 27, 29	"
31, 35, 39	"
51	"
78	"

Dipnet Stations occupied at localities other than at 1-meter Net stations

<i>Station No.</i>	<i>Date</i>	<i>Start Time</i>	<i>Latitude</i>	<i>Longitude</i>
7	July 7	0400	0°02'S	84°56'E
18	July 14	1905	0°03'N	62°41'E
32	Aug. 1	2345	2°30'N	53°E
70	Sept. 2	0320	0°02'N	79°04'E
73	Sept. 3	2300	1°27'S	78°57'E
79	Sept. 11	2100	0°01'N	88°56'E
83	Sept. 13	1430	2°30'S	89°E

87	Sept. 15	2210	1°59'S	88°59'E
93	Sept. 19	2000	2°35'N	88°58'E

— 198 —

**TABLE II**  
**LUSIAD EXPEDITION**

Atlantic Ocean Mid-water Trawls					
<i>Station No.</i> <sup>[*]</sup>	<i>Date</i>	<i>Time</i>	<i>Lat.</i>	<i>Long.</i>	<i>Depth in Meters</i>
11	June 4, 5 1963	2025-0044	33°47'S to 33°46'S	15°47'E to 15°31'E	0-2300
14	June 6, 1963	1530-2300	32°30'S to 32°24'S	9°04'E to 8°25'E	0-3400
19	June 9, 1963	0423-0846	31°11'S to 31°07'S	00°55'E to 00°35'E	0-2200
21	June 10, 1963	0205-0450	30°23'S to 30°21'S	2°47'E to 3°03'W	0-600
24	June 10,11,1963	1900-0151	30°09'S to 30°07'S	4°42'E to 5°15'W	0-3500
52	June 24,25,1963	2100-0145	19°13'S to 18°58'S	13°44'W to 13°37'W	0-2000
55	June 25,26,1963	2130-0230	18°58'S to 18°30'S	10°15'W	0-2500
79	July 6, 1963	0250-0745	00°56'N to 1°25'N	11°29'W to 11°43'N	0-2300

Atlantic Ocean 1-meter net tows				
<i>Station No.</i> <sup>[*]</sup>	<i>Date</i>	<i>Time</i>	<i>Lat.</i>	<i>Long.</i>
69 <sup>[**]</sup>	Aug. 2, 1963	0817-0839	7°25'S	12°34'W
73	Aug. 3, 1963	2124-2146	4°57'S	9°28'W
75	Aug. 4, 1963	2159-2226	0°28'S	10°51'W
80	Aug. 6, 1963	1918-1940	2°38'N	12°12'W
81 <sup>[**]</sup>	Aug. 7, 1963	1244-	5°1'N	12°45'W

— 199 —

Atlantic Ocean Dipnet Stations				
S.I.O. Collection No.	Date	Time	Latitude	Longitude
S1063-545	June 12, 1963	Between 2100 and 0400	29°51.5'S	11°07'W
-546	June 19, 1963	"	24°02.5'S	15°32'W
-548	June 20, 1963	"	23°42'S	12°12.5'W
-549	June 22, 1963	"	21°21'S	11°34'W
-550	June 24, 1963	"	20°10'S	11°30.5'W
-553	June 26, 1963	"	17°39'S	12°20'W
-555	June 28, 1963	"	15°48'S	16°50'W
-556	July 3,4,1963	"	4°56.5'S	9°28'W
-557	July 4,5,1963	"	0°56'S	10°25'W
-558	July 5, 1963	"	0°26'N	11°14'W
-559	July 5,6,1963	"	0°52'N	11°27'W
-563 <sup>[*]</sup>	July 10, 1963	"	8°30'N	13°14'W
-564	July 13, 1963	"	6°47'N	19°18'W
-565	July 15, 1963	"	3°21'N	30°51'W
-566	July 16,17,1963	"	3°57'N	34°04'W
-567	July 17, 1963	"	5°59'N	32°25'W
-568	July 17, 1963	"	6°10'N	32°13'W
-569	July 20, 1963	"	9°39'N	37°40'W
-570	July 21, 1963	"	9°41'N	40°49'W
-571	July 22, 1963	"	11°35'N	44°01'W
-574	July 25, 1963	"	15°04'N	59°58'W
-575	July 26,27,1963	"	15°00'N	63°50'W

— 200 —

### TABLE III MONSOON EXPEDITION

400 Meter Plankton Tows							
No.	Station	Latitude	Longitude	Date	LST to	LST to	H <sub>2</sub> O Filtered M <sup>2</sup>
1	L	3°12.5'N	173°53.5'W	23-IX-60	1958	2034	821

2	N	0°06.5'N	179°56.5'W	26-IX-60	1828	1901	859
3	O	2°08.8'S	178°12.3'E	27-IX-60	1838	1903	669
4	Q	7°38.7'S	173°18.0'E	29-IX-60	1844	1912	878
5	T	11°02'S	167°47.0'E	1-X-60	1821	1854	816
6	V	14°55.5'S	152°53.0'E	4-X-60	1922	1952	952
Port Darwin							
7	II-1	9°11.5'S	127°33.5'E	22-X-60	1745	1811	658
8	II-5	7°47.0'S	121°16.5'E	26-X-60	2109	2135	1014
9	II-16	13°19.5'S	109°35.5'E	7-XI-60	2012	2037	977
10	II-20	8°53"S	109°38"E	11-XI-60	0437	0501	546
Djakarta							
11	III-2	11°15"S	103°32"E	20-XI-60	2203	2227	569
12	III-4	10°30.0"S	98°59.0"E	22-XI-60	1929	1950	574
13	III-8	17°01"S	93°28.6"E	25-XI-60	2300	2327	1233
14	III-13	15°51.0"S	81°10.3"E	29-XI-60	2213	2249	931
15	III-15	12°57.9"S	75°13.6"E	1-XII-60	2108	2134	783
16	III-19	16°24.5"S	66°02.4"E	5-XII-60	0319	0346	1238
Port Louis							
17	IV-2	20°18.9"S	58°09.6"E	11-XII-60	1753	1819	733
18	IV-5	23°59.4"S	73°57.5"E	15-XII-60	0044	0109	691
19	IV-7	27°48.6"S	73°51.5"E	17-XII-60	0313	0342	906
20	IV-10	37°40.1"S	71°41"E	20-XII-60	0435	0507	1003
21	IV-12	39°50"S	75°03.7"E	22-XII-60	1151	0018	No reading
22	IV-16	37°49.6"S	85°21.7"E	26-XII-60	0509	0540	797
23	IV-19	36°18.7"S	98°41.1"E	30-XII-60	0013	0041	855
Fremantle							
24	V-2	39°18"S	119°51"E	9-I-61	1733	1806	858
Wellington							
25	VI-11	57°43"S	169°12"E	6-II-61	1059	1130	940 Drifting
26	VI-17	64°11"S	165°56"W	13-II-61	1239	1308	937
27	VI-23	57°34"S	174°15"W	16-II-61	1615	1644	491
28	VI-25	54°31"S	177°12"W	18-II-61	0551	0621	987
Dunedin							
29	VII-10	40°37"S	164°08"W	4-III-61	0035	0100	485
30	VII-14	36°29"S	163°09"W	5-III-61	2159	2232	1166

31	VII-17	32°35.4"S	160°55.8"W	8-III-61	1708	1733	1005
32	VII-20	28°35.3"S	158°57.5"W	9-III-61	2221	2252	1061
33	VII-23	26°28.1"S	156°28.0"W	11-III-61	0922	0957	961
Papeete							
34	VIII-2	12°21.5"S	150°54.5"W	25-III-61	0214	0250	896
35	VIII-5	5°58"S	149°31"W	27-III-61	1508	1538	1111
36	VIII-6	4°26"S	149°24.2"W	28-III-61	1611	1635	722
37	VIII-8	1°32"S	148°39"W	30-III-61	0408	0440	948
38	VIII-11	2°00"N	147°06"W	1-IV-61	2131	2202	940
39	VIII-16	7°02"N	145°38"W	3-IV-61	1944	2015	945
40	VIII-23	11°03"N	142°28"W	6-IV-61	0112	0137	735

— 202 —

**TABLE IV**  
**MONSOON EXPEDITION**  
**17 cm Net Tows**

Station Number	Date 1960	Time Start	Time Finish	Latitude	Longitude
1	8/29	1510		23°15.0"N	130°46.0"W
2	8/30	2016		20°12"N	134°53"W
3	8/31	2250		17°30.2"N	138°22.2"W
4	9/18	1104		18°08.5"N	159°21.0"W
5	9/19	1050		14°10.5"N	161°08.0"W
6	9/21	1036		8°30.0"N	167°10.5"W
7	9/22	1021		6°03.3"N	169°59.5"W
8	9/23	1328	1338	3°03.0"N	173°55.0"W
9	9/26	1227	1237	00°6.5"N	179°56.0"W
10	9/27	1107		2°08.8"S	178°12.3"E
11	10/2	1020	1030	12°35.0"S	164°20.0"E
12	10/5	0321	0331	14°47.3"S	151°14.0"E
13	10/12	1846		10°11.0"S	139°31.0"E
14	10/13	1117	1137	9°10.7"S	136°49.0"E



15	10/14	1150	1201	7°53.5"S	134°04.0"E
16	10/15	1620	1630	5°45.0"S	130°59.2"E
17	10/22	1203		9°11.5"S	127°33.5"E
18	10/28	1427		7°56.8"S	117°52.0"E
19	10/30	1712		12°00.0"S	115°25.0"E
20	10/31	1654		12°57.0"S	115°17.0"E
21	11/1	0520	0530	11°17.5"S	115°27.5"E
22	11/3	1830		10°43.0"S	115°14.9"E
23	11/4	1900	1910	9°21.5"S	115°42.0"E
24	11/7	0816		13°19.5"S	109°35.5"E
25	11/8	1411		11°29.0"S	109°32.1"E
26	11/9	0912		10°28.5"S	109°46.0"E
27	11/10	0735		9°23.0"S	109°18.0"E
28	11/20	0830		11°15.3"S	103°31.5"E
29	11/21	0857		12°20.9"S	101°30.0"E
30	11/22	0930		10°30.0"S	98°59.0"E
31	11/22	2027	2037	10°30.0"S	98°59.0"E
32	11/24	0641	0651	10°31.3"S	94°57.5"E
33	11/26	0027	0037	16°58"S	93°28.4"E
34	11/27	1517	1527	18°53"S	88°02.1"E
35	11/28	0207	0213	18°41"S	87°51"E
36	11/29	0100	0110	17°20"S	84°23.2"E
37	11/29	1940	1950	15°51.4"S	81°03.8"E
38	12/1	0950	1000	12°58.3"S	75°00"E
39	12/2	1609	1619	14°04"S	72°16"E
40	12/2	2022	2032	14°05.5"S	72°14.6E
41	12/3	1220	1230	14°56"S	70°11.4"E
42	12/4	1845		16°12.2"S	66°35"E
43	12/4	2015		16°12.2"S	66°35"E
44	12/6	0135	0145	17°48"S	62°40"E
45	12/11	1204		19°44.4"S	57°56.6"E
46	12/11	1622		20°18.9"S	58°09.6"E
47	12/11	1917		20°19.2"S	58°07.85"E
48	12/14	1056		25°08.7"S	69°31.1"E
49	12/15	1230	1240	23°54.5"S	73°50"E

50	12/15	2214	2224	23°54.5"S	73°50"E
51	12/16	1715		26°22"S	74°08.4"E
52	12/17	0109	0119	27°48"S	73°49.7"E
53	12/17	2015		30°50"S	73°12.5"E
54	12/18	1250		33°20.6"S	74°42"E
55	12/18	2017	2027	33°20.6"S	74°42"E
56	12/20	0750		37°42"S	71°41.2"E
57	12/21	1800	1810	42°03.8"S	70°39.9"E
58	12/21	2100	2110	42°03.8"S	70°39.9"E
59	12/22	2320		39°49.3"S	75°02.4"E
60	12/26	0743		37°52.2"S	85°23.1"E
61	12/27	1003	1017	37°19.3"S	90°43.4"E
62	12/28	1518	1522	36°36.4"S	95°28.5"E
63	12/29	1630	1640	36°18"S	98°41.2"E
	<i>1961</i>				
64	1/9	1005		39°18.1"S	119°53.4"E
65	1/10	2043		43°26.2"S	124°50.4"E
66	1/12	1645	1655	49°26.6"S	132°18.2"E
67	1/12	2300		49°26.5"S	132°18.4"E
68	1/29	0353	0403	43°09"S	175°15"E
69	1/29	0535	0545	43°10"S	175°15"E
70	1/30	1110	1120	43°21"S	179°30"E
71	1/31	0945		43°16"S	178°20"W
72	1/31	1753	1803	43°38"S	177°26"W
73	2/4	1248	1258	49°31"S	170°32"E
74	2/6	2025	2035	53°02"S	169°17"E
75	2/6	1925	1935	57°43"S	169°12"E
76	2/6	2330	2340	58°17.2"S	168°58.4"E
77	2/8	1832	1842	58°26"S	169°02"E
78	2/8	0107	0117	59°21"S	169°29"E
79	2/9	1510		60°58"S	170°16"E
80	2/10	0110		62°11"S	170°58"E
81	2/11	1618		63°04"S	178°29"E
82	2/13	0835		64°11"S	165°56"W
83	2/14	0415		63°37"S	167°02"W

84	2/15	0830	0840	60°12"S	171°32"W
85	2/17	0825	0835	55°39"S	177°52"W
86	2/26	2322	2332	46°12"S	173°09"E
87	2/27	1645		46°26"S	176°20"E
88	2/28	1110		47°41"S	179°03"E
89	2/28	1855	1905	46°30"S	176°46"W
90	¾	0855	1905	39°21"S	163°51"E
91	¾	1800	1810	38°25"S	163°40"W
92	¾	2047	2057	38°25"S	163°40"W
93	¾	1040		37°02"S	163°14"W
94	¾	2113		36°29"S	163°09"W
95	3/6	0910		38°50"S	163°01"W
96	3/7	0835	0845	38°50"S	163°01"W
97	¾	1115		32°40.4"S	160°57.2"W
98	3/9	1218		30°27"S	159°27.3"W
99	3/9	2045		28°35.3"S	158°57.5"W
100	3/10	1615		27°20.3"S	157°31.8"W
101	3/11	1054	1104	26°28.1"S	156°28.0"W
102	3/24	1015		13°53"S	150°35"W
103	3/25	0153		12°21.5"S	150°54.5"W
104	3/25	1400		10°34"S	151°05"W
105	3/26	0745		8°17"S	151°34"W
106	3/27	1615		5°58"S	149°31"W
107	3/27	2356		5°51"S	149°44.3"W
108	3/28	1715		4°26"S	149°24.2"W
109	3/28	2012		4°26"S	149°24.2"W
110	3/29	2045		1°54"S	148°45"W
111	3/31	0320		0°05.1"S	147°28.9"W
112	3/31	1545		00°15"S	147°34"W
113	4/1	1702	1712	2°00"N	147°06"W
114	4/1	2102	2112	2°00"N	147°06"W
115	4/2	0707	0717	3°32"N	146°47"W
116	4/2	2122	2132	5°20"N	146°13"W
117	4/3	0308		5°32"N	146°09"W
118	4/3	1627		7°02"N	145°38"W

119	4/4	0820		8°07"N	145°25"W
120	4/8	0830		13°04"N	138°59"W
121	4/11	1850		18°07.5"N	133°11.9"W
122	4/13	1930		23°44.1"N	128°07.0"W
123	4/14	1315		24°19.0"N	126°26.9"W
124	4/14	2215		24°57.5"N	125°42.7"W
125	4/15	2245		27°51.7"N	122°26.8"W
126	4/16	0910	0920	29°06.0"N	121°04.2"W
127	4/17	0356	0406		
128	4/17	1615			

— 205 —

**TABLE V**  
***MONSOON EXPEDITION***

Midwater Trawl					
Isaacs-Kidd mid-water trawl (10-foot mouth opening)	Latitude <i>Start/Finish</i>	Longitude <i>Start/Finish</i>	Date <i>Start/Finish</i>	Estimated Greatest depth of trawl ( <i>Meters</i> )	Time <i>Start/Finish</i>
Monsoon 2	7°10"00"S	127°22"00"E	24-X-1960	2121	2339
(SIO 61-30)	7°09"00"S	126°58"54"E	25-X-1960		0259
Monsoon 3	11°56"42"S	115°22"12"E	29-X-1960	2179	2157
(SIO 61-31)	12°15"30"S	115°30"06"E	30-X-1960		0359
Monsoon 4	10°10"00"S	115°17"12"E	2-XI-1960	1721	0121
(SIO 61-12)	10°43"00"S	115°14"54"E			0451
Monsoon 5	10°39"00"S	98°50"36"E	22-XI-1960	1408	2239
(SIO 61-33)	10°50"00"S	98°43"42"E	23-XI-1960		0253
Monsoon 6	18°49"24"S	88°05"42"E	27-XI-1960	1643	1817
(SIO 61-34)	18°41"06"S	87°51"30"E			2300
Monsoon 7	14°54"00"S	70°12"00"E	3-XII-1960	2000	1649
(SIO 61-35)	15°01"24"S	69°52"00"E			2128

Monsoon 8	22°04"18"S	63°02"00"E	12-III-1960	2000	1910
(SIO 61-36)	22°15"30"S	63°19"00"E			2342
Monsoon 9	33°19"18"S	72°34"24"E	19-XII-1960	1878	0324
(SIO 61-37)	33°38"06"S	72°31"00"E			0829
Monsoon 10	42°03"48"S	70°39"54"E	21-XII-1960	2060	2326
(SIO 61-38)	42°01"06"S	71°00"18"E	22-XII-1960		0415
Monsoon 11	36°35"00"S	95°28"00"E	28-XII-1960	2000	1738
(SIO 61-39)	36°32"18"S	95°52"30"E			2312
Monsoon 12					
(SIO 61-40)	Not an IKMT				
Monsoon 13	49°26"30"S	132°18"24"E	13-I-1961	1878	0004
(SIO 61-41)	49°21"00"S	132°39"24"E			0457
Monsoon 14	57°55"48"S	168°53"12"E	6-II-1961	2424	1751
(SIO 61-42)	58°17"12"S	168°58"24"E			2333
Monsoon 15	63°05"36"S	178°31"24"E	11-II-1961	2000	1856
(SIO 61-43)	63°05"24"S	179°00"00"E			2400
Monsoon 16	54°21"48"S	177°16"42"W	18-II-1961	2500	1412
(SIO 61-44)	54°09"30"S	177°28"42"W			2145
Monsoon 17	46°53"00"S	179°48"00"W	28-II-1961	1878	2206
(SIO 61-45)	46°42"00"S	179°32"00"W	1-III-1961		0250
Monsoon 18	34°01"00"S	161°49"00"W	7-III-1961	2723	2046
(SIO 61-46)	33°45"00"S	161°39"00"W			0303
Monsoon 19	25°52"0"S	155°44"00"W	11-III-1961	2250	0420
(SIO 61-47)	25°40"00"S	155°34"00"W			0917
Monsoon 20	8°14"30"S	151°36"30"W	26-III-1961	2500	1121
(SIO 61-48)	7°55"30"S	151°52"18"W			1726

**TABLE VI a**  
**MONSOON EXPEDITION - BENTHIC BIOLOGY**  
**STATIONS - INDIAN OCEAN**

**(Cairns, Australia, Oct. 6, 1960 - Cape Leeuwin, Australia, Jan. 7, 1961)**

<i>Type</i>	<i>Location</i>	<i>Date</i>	<i>Time</i>	<i>Depth</i>	<i>Material Taken</i>	<i>Remarks</i>
Peterson grab	Thursday Is.	Oct. 11, 1960	?	?	Shells, polyheates Forams, algae, coral	Sample = $\frac{1}{8}$ m <sup>2</sup>
Rock Dredge	10°11"S 139°31"E	Oct. 12, 1960	1700-2013			Chain bag dredge haul on seismic sta.
Otter trawl	Weber Deep, Indonesia	Oct. 15, 1960		12,000 m.w.o.		Failed to reach bottom
Rock Dredge	8°29" 128°23"E to 8°32"S 128°24"E	Oct. 23, 24, 1960	2348	890 fms		On seamount (guyot ?)
Orange Peel grab	8°06"S 117°58"E	Oct. 27, 1960	1600			
Peterson grab	7°58"S 117°51"E	Oct. 28, 1960		1,016 fms	Large sample formas	
Diving Dredge	11°52"S 115°23"E to 12°02"S 115°20"E	Oct. 30, 1960	1900-0100			Isaccs-kidd deep-diving dredge failed to reach bottom
Rock Dredge	10°30"S 115°15"E to 12°02"S 115°11"E	Nov. 2, 1960	2145-0100			On ridge between trenches
Peterson grab	9°23"S 109°14"E	Nov. 10, 1960	1500-1600			
Shell Dredge	8°08"S 108°44"E	Nov. 12, 1960		70 fms		
Diving Dredge	11°14"S 103°32"E to	Nov. 20, 1960				Failed to reach bottom

	10°55"S 103°20"E					
Diving Dredge	19°00"S 87°56"E to 18°53"S 88°02"E	Nov. 27,1960		1,110 fms		Failed to reach bottom
Shell Dredge	19°50"S 57°39"E to 19°51"S 57°39"E	Dec. 7, 1960	0700– 0730			
Shell Dredge	Saint Paul Island	Dec. 23,1960		400 fms		East of island
Rock Dredge	36°38"S 95°30"E to 36°36"S 95°28"E	Dec. 28,1960			Forams	On guyot (?)
Otter Trawl	36°19"S 98°41"S to 36°15"S 99°11"E	Dec. 30,1960				Failed to reach bottom
Shell Dredge	35°15"S 115°52"E	Jan. 7, 1961	1843– 1949			

— 208 —

## TABLE VI b MONSOON EXPEDITION

Shore Collections			
No. 1	Sept 10, 1960	Hawaii (Oahu)	
2	Sept 28, 1960	Nanumea Atoll (Ellice Is.)	5°39.9"S, 176°7.8"E
3	Oct. 7, 1960	Cairns, Australia	
4	Oct. 9, 1960	Wharton Reef, Australia	14°08"S, 144°00"E
5	Nov. 19, 1960	Christmas Island, Indian Ocean	10°24"S, 105°43.5"E
6	Dec 23,24,1960	Saint Paul Island	38°42.8"S, 77°29.9"E
7	Jan. 5, 1961	Rottnest Island off Fremantle, Australia	
8	Feb. 5, 1961	Campbell Island	52°33"S, 169°10"E
9	Feb. 28, 1961	Bounty Islands	47°41"S, 179°03"E

## TABLE VII CHAETOGNATHA - MONSOON EXPEDITION

- *Eukrohnia bathypelagica* Alvarino
- *E. fowleri* Ritter-Zahony
- *E. hamata* (Möbius)
- *Krohnitta pacifica* (Aida)
- *K. subtilis* (Grassi)
- *Pterosagitta draco* (Krohn)
- *Sagitta bedoti* Beraneck
- *S. bipunctata* d'Orbigny
- *S. decipiens* Fowler
- *S. enflata* Grassi
- *S. ferox* Doncaster
- *S. gazellae* Ritter-Zahony
- *S. hexaptera* Quoy and Gaimard
- *S. lyra* Krohn
- *S. Minima* Grassi
- *S. neglecta* Aida
- *S. pacifica* Tokioka
- *S. planctonis* Steinhaus
- *S. pulchra* Doncaster
- *S. regularis* Aida
- *S. robusta* Doncaster
- *S. tasmanica* Thomson
- *S. zetesios* Fowler

## TABLE VIII SIPHONOPHORES - MONSOON EXPEDITION

(a) (Indian and Pacific Oceans, occupying mainly the upper 400 m)

(a) (Indian and Pacific Oceans, occupying mainly the upper 400 m)

- *Chelophyes appendiculata* Eschscholtz
- *Ch. contorta* (Lens and Riemsdijk)
- *Diphyes bojani* (Chun)
- *D. dispar* Chamisso and Eysenhardt (Also in deep waters)
- *Diphyopsis mitra* (Huxley)



- *Dimophyes arctica* (Chun) (also in deep waters)
- *Eudoxoides spiralis* Bigelow
- *Abyla carina* Haeckel
- *A. ingeborgae* Sears
- *Abylopsis tetragona* (Otto)
- *A. eschscholtzi* (Huxley)
- *Ceratocymba sagittata* Quoy and Gaimard
- *Bassia bassensis* (Quoy and Gaimard)
- *Lenzia challengerii* Totton
- *L. conoidea* Keferstein and Ehlers
- *L. hotspur* Totton
- *L. meteori* (Leloup)
- *L. multicristata* (Moser)
- *L. subtilis* (Chun)
- *Sulculeolaria angusta* Totton
- *S. biloba* Sars
- *S. quadridentata* (Quoy and Gaimard)
- *Agalma okeni* Eschscholtz
- *Stephanomia rubra* (Vogt)

---

— 211 —

- *Physophora hydrostatica* Forskal
- *Hippopodius hippopus* (Forskal)
- *Vogtia pentacantha* Kolliker
- *V. serrata* Moser
- *Amphicaryon acaule* Chun
- *Verella* sp. Lamarck

**(b) Occurring below 400 meters**

(b) Occurring below 400 meters

- *Chuniphyes multidentata* Lens and Riemsdijk
- *Ch. moserae* Totton
- *Abyla bicarinata* Moser
- *A. haeckeli* Lens and Riemsdijk
- *A. trigona* Quoy and Gaimard
- *A. schmidti* Sears
- *Ceratocymba dentata* Bigelow
- *C. leuckarti* Huxley
- *C. sagittata* Quoy and Gaimard
- *Rosacea plicata* Quoy and Gaimard
- *Nectopyramis natans* (Bigelow)
- *N. thetis* Bigelow

- *Nectodroma reticulata* Bigelow
- *Marrus orthocannoides* Totton
- *Vogtia spinosa* Keferstein and Ehlers
- *Amphicaryon ernesti* Totton

**(c) Pacific Ocean only upper 400 m**

(c) Pacific Ocean only upper 400 m

- *Diphyes antarctica* Moser
- *Nectopyramis diomedae* Bigelow
- *Erenna richardi* Bedot
- *Bargmannia elongata* Totton

---

— 212 —

## TABLE IX MEDUSAE - MONSOON EXPEDITION

**(a) Indian Ocean**

(a) Indian Ocean

- *Bougainvillea fulva* Agassiz and Mayer : St. 8
- *Meator rubatra* Bigelow : midwater trawl 10
- *Aequorea macrodactyla* Brandt : St. 16
- *A. pensilis* (Modeer) : midwater trawl 6
- *Colobonema sericeum* Vanhoffen : midwater trawl 9, 10, 11
- *Crossota brunnea* Vanhoffen : midwater trawl 10
- *Halicreas minimum* Fewkes : midwater trawls 4, 6, 9, 10, 11
- *Liriope tetraphylla* (Chamisso & Eysenhardt) : midwater trawl 2
- *Rhopalonema velatum* Gegenbaur : Sts. 20, 22, 23 midwater trawl 3
- *Aeginura grimaldii* Maas : St. 7
- *Atolla wyvillei* Haechel : midwater trawl 3, 4, 6, 9, 10
- *Periphylla hyacinthina* Steenstrup : midwater trawls 9, 10
- *Pelagia panopyra* Peron & Leseur : midwater trawl 10

**(b) Pacific collections only**

(b) Pacific collections only

- *Calycopsis borchgrevinki* (Browne)
- *Zanclaea costata* Gegenbaur
- *Aegina citrea* Eschscholtz

- *Solmaris corona* (Keferstein & Ehlers)

**TABLE X**  
**PRELIMINARY LIST OF VERTEBRATES TAKEN IN**  
**ISAACS-KIDD MIDWATER TRAWL,**  
**(10 FT. MOUTH OPENING) STATION 79, ATLANTIC**  
**OCEAN, LUSIAD EXPEDITION**

	No. of <i>Specimens</i>
Order Isospondyli	
Stomiatoidea	
Astronesthidae	
<i>Astronesthes cyaneus</i> (Brauer)	(1)
Gonostomatidae	
<i>Bonapartia pedaliota</i> Goode & Bean	(14)
<i>Vinciguerria nimbaria</i> (Jordan & Williams)	(10)
<i>Valencienellus tripunctulatus</i> (Esmark)	(1)
<i>Cyclothone</i> sp.	(236)
Sternoptychidae	
<i>Argyropelacus hemigygnus</i>	(2)
<i>A. affinis</i> Garman	(3)
<i>A. lychnus lychnus</i> Garman	(1)
<i>Sternoptyx diaphana</i> Hermann	(12)
Melanostomiidae	
<i>Eustomias</i> sp.	(1)
Malacosteidae	
<i>Malacosteus</i> sp.	(2)
Clupeoidea	
Searsiidae	
<i>Pellisolus</i> sp.	(1)
Order Iniomi	

Myctophoidea	
Myctophidae	
Electrona rissoi (Cocco	(2)
Benthosema suborbitale (Gilbert)	(1)
Diogenichthys atlanticus (Taning)	(3)
Myctophum nitidulum Garman	(1)
M. asperum Richardson	(1)
Notolychnus valdiviae (Brauer)	(17)
Lampanyctus alatus Goode & Bean	(3)
L. nobilis	(2)
L. sp. nov.	(4)
Lepidophanes guentheri Goode & Bean	(2)
Lobianchia (=Diaphus) dotleini (Zugmayer)	(1)
Alepisauroida	
Omosudidae	
Omosudis lowii Günther	(1)
Paralepididae	
Stemonosudis sp.	(1)
Paralepis sp.	(1)
Scopelarchidae	
Scopelarchus sp.	(1)
Order Cetunculi	
Rondeletiidae	
Rondeletia bicolor Goode & Bean	(1)
Order Giganturiformes	
Giganturidae	
Bathyleptus gracilis (Regan)	(1)
Order Lyomeri	
Eurypharynx pelecanoides Vaillant	(1)
Order Apodes	
Serrivomeridae	
Serrivomer beanii	(1)
Serrivomer sp.	(1)
Order Berycomorphi	
Anoplogasteridae	

Anoplogaster cornuta (Cuvier & Valenciennes)	(3)
Melamphaidae	
Scopeloberyx spp.	(12)
Scopelogadus mizolepis mizolepis (Gunther)	(3)
Melamphaes polylepis Ebeling	(1)
Order Percomorphi	
Chiasmodontidae	
Chiasmodon microcephalus	(2)
Order Pediculati	
Gigantactidae	
Gigantactis "van hoeffeni"	(1)
Oneirodidae	
Oneirodes sp.	(1)

1 All stations oblique tows 0–200 meters, net with 1-meter diameter mouth opening. 280 meters of wire out with elapsed time for each tow approximately 20 minutes, except where indicated.

\* Station 66, August 30, 1 oblique tow, 400 m.w.o.

\*(" Indicates 2 consecutive hauls on same station

\*\*Station 43, March 27, 1 oblique tow, 1,400 m.w.o.

\*(" Indicates 2 consecutive hauls on same station.

\* Station numbers correspond to geologic and geophysical stations.

\*\* All stations 0-200 meters, 280 meters of wire out, except where indicated. Two tows in succession at each station, except for single tow at stations 81. Elapsed time each tow 19 minutes.

\*\*\* Wire angle very large; depth << 200 meters, time 22 minutes.

\*Freetown, Sierra Leone

# APPENDIX E

## INDIAN OCEAN HEAT FLOW MEASUREMENTS

Station	Position	Water	Thermal <sup>2</sup> Conductivity	Heat Flow	
No.	Lat.	Long.	Depth (m)	(10 <sup>-3</sup> cal °C <sup>-1</sup> cm <sup>-1</sup> sec <sup>-1</sup> )	(10 <sup>-6</sup> cal cm <sup>-2</sup> sec <sup>-1</sup> )
<i>MONSOON Expedition</i>					
12	9° 14"S	127° 30"E	3210	2.11	1.69
15	7° 46"S	121° 14"E	4820	2.07	1.3 – 1.8
16	11° 58"S	115° 26"E	5005	1.78	1.10
17	12° 48"S	115° 24"E	5350	1.67	1.00
20	13° 19"S	109° 34"E	4690	1.87	1.45
21	11° 39"S	109° 35"E	4660	1.81	1.63
23	8° 49"S	109° 36"E	3300	1.92	0.71
24	12° 21"S	101° 25"E	4760	2.00	1.54
28	16° 59"S	93° 29"E	5320	1.63	1.0
29	18° 14"S	86° 42"E	4500	1.84	1.64
30	15° 51"S	81° 10"E	5000	1.72	1.74
32	14° 05"S	72° 15"E	5190	1.57	1.21
33	14° 56"S	70° 13"E	4450	2.10	0.13
34	16°	66°	3660	1.99	2.79

	25"S	01"E			
35	16° 58"S	64° 46"E	4040	<a href="#">[(1.99)]</a>	2.19
38	26° 22"S	74° 08"E	4250	1.98	4.91
40	33° 20"S	72° 37"E	4270	2.19	0.92
41	37° 44"S	71° 47"E	4280	2.08	1.35
42	42° 09"S	70° 37"E	4220	2.06	1.67
44	38° 26"S	79° 34"E	3410	<a href="#">[(2.0)]</a>	0.5
45	37° 50"S	85° 22"E	3590	<a href="#">[(2.0)]</a>	0.7
46	37° 18"S	90° 42"E	3840	<a href="#">[(2.0)]</a>	1.3
47A	36° 19"S	98° 41"E	4350	1.93	0.77
48	39° 18"S	119° 52"E	4940	1.78	1.05
49	49° 31"S	132° 14"E	3520	<a href="#">[(1.8)]</a>	1.3
<i>ZEPHYRUS Expedition</i>					
1	12° 27"N	47° 07"E	1820	2.03	5.98
2	12° 57"N	48° 16"E	2205	<a href="#">[(1.92)]</a>	3.62
3 <sup>[*]</sup>	13° 17"N	49° 15"E	2425	1.81	3.22
4	12° 54"N	49° 38"E	2200	<a href="#">[(1.92)]</a>	2.47
5 <sup>[*]</sup>	12° 25"N	50° 33"E	2420	2.02	3.09
6	9° 08"N	54° 42"E	3705	2.11	1.66
7	9° 09"N	57° 30"E	3265	<a href="#">[(2.01)]</a>	1.37
8	9° 16"N	59° 00"E	3200	1.91	1.74

9	9° 34"N	59° 52"E	3895	<a href="#">[(2.01)]</a>	1.68
10 <sup>[**]</sup>	9° 32"N	61° 24"E	4580	2.10	0.95
11 <sup>[**]</sup>	9° 34"N	63° 06"E	4505	2.25	0.23 <a href="#">[PP]</a>
12 <sup>[**]</sup>	9° 40"N	66° 19"E	4450	2.30	0.8 <a href="#">[PP]</a>
13 <sup>[**]</sup>	9° 48"N	69° 15"E	4550	2.17	1.49
14	9° 50"N	71° 50"E	2370	2.21	1.29
15	9° 56"N	73° 08"E	1925	2.09	1.70
16	9° 59"N	74° 50"E	2285	1.92	1.57
<i>LUSIAD Expedition: R/V Argo</i>					
1	8° 13"N	70° 39"E	4145	2.03	1.44
2 <sup>[**]</sup>	3° 57"N	70° 49"E	4130	1.91	1.6 <a href="#">[PP]</a>
3 <sup>[**]</sup>	0° 05"S	71° 50"E	4200	2.15	1.1 <a href="#">[PP]</a>
4	2° 40"S	73° 16"E	2980	2.28	1.8 <a href="#">[PP]</a>
5 <sup>[**]</sup>	5° 21"S	75° 08"E	5220	1.64	1.51
6 <sup>[*]</sup>	5° 23"S	72° 47"E	2530	2.28	1.92
7	5° 40"S	70° 17"E	3935	1.88	0.57
8 <sup>[*]</sup>	5° 52"S	66° 36"E	4370	<a href="#">[(1.90)]</a>	0.30
9	5° 34"S	63° 42"E	4210	1.91	1.67
10A	5° 26"S	59° 14"E	3980	1.97	3.78 <a href="#">[PP]</a>
10B <sup>[**]</sup>	5° 25"S	59° 13"E	3980	1.97	1.62



11	5° 30"S	57° 56"E	2525	2.02	1.23
12A <sup>[*]</sup>	9° 57"S	57° 07"E	4040	<a href="#">[(2.03)]</a>	1.54
12B <sup>[*]</sup>	9° 56"S	57° 07"E	4050	<a href="#">[(2.03)]</a>	1.56
13	10° 21"S	58° 31"E	3575	2.02	0.92
14	10° 34"S	59° 51"E	2315	2.04	1.44
15 <sup>[**]</sup>	13° 42"S	59° 42"E	3900	2.00	1.00
16 <sup>[**]</sup>	17° 20"S	57° 42"E	4145	2.21	1.32
17	22° 01"S	57° 34"E	4750	1.77	0.90
18	24° 34"S	57° 26"E	5000	1.57	1.21
19	26° 53"S	58° 12"E	5550	1.58	0.91
20	29° 53"S	61° 52"E	4620	1.70	0.7
21B	31° 25"S	61° 56"E	4420	1.73	0.42
22	32° 55"S	62° 25"E	4745	1.59	0.68
23B	39° 44"S	63° 56"E	4810	<a href="#">[(2.18)]</a>	3.7 <a href="#">[PP]</a>
24	44° 36"S	70° 57"E	3580	1.89	1.49
25	35° 47"S	73° 37"E	4380	1.93	0.38
26	36° 52"S	76° 22"E	3925	2.17	2.03
30A	31° 29"S	114° 25"E	3730	2.04	0.88
30B	31° 27"S	114° 24"E	3750	2.04	1.22
32 <sup>[**]</sup>	29° 42"S	111° 30"E	5340	<a href="#">[(2.18)]</a>	1.79

33	25° 03"S	104° 12"E	5100	1.63	1.15
34	16° 25"S	89° 19"E	5625	1.64	1.39
35	13° 48"S	90° 50"E	5200	1.59	1.30
36	13° 09"S	93° 13"E	5230	1.64	3.0 <a href="#">[PP]</a>
37	14° 56"S	108° 09"E	5580	1.70	1.15
38 <sup>[**]</sup>	13° 46"S	115° 32"E	5680	1.65	1.14
39 <sup>[**]</sup>	13° 31"S	118° 29"E	5680	1.64	0.93
50 <sup>[**]</sup>	30° 08"S	37° 47"E	4990	1.97	1.00
51 <sup>[*]</sup>	31° 04"S	36° 40"E	4535	<a href="#">[(2.26)]</a>	2.22
52 <sup>[*]</sup>	31° 39"S	35° 57"E	2545	2.40	0.82
53	32° 14"S	34° 16"E	2660	<a href="#">[(2.30)]</a>	1.45
54 <sup>[**]</sup>	32° 22"S	32° 47"E	3560	2.12	0.04
<i>LUSIAD Expedition: R/V Horizon</i>					
1	9° 07"N	72° 59"E	2135	2.08	1.61
2	9° 03"N	73° 10"E	2110	2.08	1.18
3 <sup>[*]</sup>	7° 24"N	70° 40"E	4110	2.19	1.44 <a href="#">[PP]</a>
4	5° 22"S	74° 17"E	4780	1.64	1.88
5 <sup>[*]</sup>	5° 40"S	69° 40"E	3815	2.00	0.00
6 <sup>[*]</sup>	5° 53"S	65° 57"E	4260	1.90	1.16
7 <sup>[*]</sup>	5° 31"S	63° 04"E	4255	(1.94)	2.26

8 <sup>[**]</sup>	5° 28"S	60° 02"E	4100	<a href="#">[(1.97)]</a>	1.54
9A	5° 26"S	59° 29"E	3945	2.02	4.6 <a href="#">[PP]</a>
9B	5° 26"S	59° 29"E	3960	2.02	3.3 <a href="#">[PP]</a>
11	4° 10"S	57° 15"E	3765	2.03	1.9 <a href="#">[PP]</a>
13 <sup>[*]</sup>	9° 49"S	56° 28"E	3885	2.03	0.27
14	10° 05"S	57° 53"E	3935	<a href="#">[(2.02)]</a>	1.29
15A	10° 30"S	59° 23"E	2870	1.94	1.22
15B	10° 30"S	59° 23"E	2845	1.94	1.34
18A	31° 14"S	62° 57"E	5065	1.60	0.24
18B	31° 14"S	62° 58"E	5060	1.60	0.19
20	33° 16"S	61° 43"E	4695	1.56	1.77
21	39° 54"S	67° 53"E	4065	2.18	0.00
22	40° 47"S	72° 46"E	4000	2.30	0.40
23 <sup>[*]</sup>	40° 58"S	75° 08"E	4030	2.16	0.54
24 <sup>[*]</sup>	40° 19"S	76° 32"E	3020	2.25	2.12
25	36° 05"S	75° 59"E	3290	<a href="#">[(2.17)]</a>	1.74
26	37° 21"S	76° 35"E	3380	2.10	0.92
27	32° 58"S	96° 02"E	4030	<a href="#">[(2.1)]</a>	0.01
28	32° 06"S	100° 20"E	2450	2.37	2.9 <a href="#">[PP]</a>
29	32° 45"S	102° 45"E	4760	1.71	0.93

30 <sup>[*]</sup>	32° 59"S	103° 33"E	5130	1.70	1.27
32	33° 01"S	111° 11"E	4390	[(2.26)]	5.3 [PP]
33	32° 17"S	113° 58"E	4190	2.26	0.99
34 <sup>[**]</sup>	29° 16"S	110° 42"E	5550	2.18	2.0 [PP]
35	25° 40"S	105° 22"E	4830	[(1.63)]	1.13
36 <sup>[*]</sup>	24° 33"S	103° 39"E	5400	[(1.63)]	1.04
37	20° 11"S	96° 22"E	4910	1.59	1.05
38 <sup>[*]</sup>	14° 12"S	89° 50"E	5315	1.63	1.07
39	13° 39"S	91° 31"E	5150	[(1.59)]	1.48
40	13° 23"S	92° 32"E	1.73	3.20	
43 <sup>[*]</sup>	14° 06"S	101° 22"E	5110	1.63	1.81
44	14° 56"S	107° 16"E	5805	1.74	1.37
45	14° 58"S	109° 12"E	5630	[(1.74)]	1.13
46 <sup>[**]</sup>	14° 13"S	114° 54"E	5670	1.62	1.02
47 <sup>[**]</sup>	13° 09"S	116° 29"E	5670	1.60	1.11
48 <sup>[**]</sup>	13° 41"S	117° 23"E	5715	[(1.62)]	0.94

PP Partial penetration of temp. gradient probe.

( ) Parentheses indicate therm. cond. estimated at station.

\* Local bottom relief < 20 m.

\*\* Bottom relief < 20 m extends for > 10 km to each side of station along ship's track.

# APPENDIX F

## SHIPBOARD LOG OF INDIAN OCEAN CORES

<i>MONSOON Expedition - (R/V Argo)</i>	
MSN 22G:	15 Oct. 1960, 1330–2145 hrs.; 5°43"S, 131°00"E; depth 7267 m.; core length 63 cm.; dark blue-green clay. Flat bottom.
MSN 23G:	22 Oct. 1960, 1124 hrs.; 9°12"S, 127°35"E; depth 3213 m.; length 133 cm.; a little brown clay overlying greenish-blue clay. Bottom of basin.
MSN 23V:	22 Oct. 1960, 1324 hrs.; 9°13"S, 127°33"E; depth 3213 m.; length 12 cm.; greenish-blue clay.
MSN 24G:	23 Oct. 1960, 1736 hrs.; 9°00"S, 128°37"E; depth 3008 m.; length 104 cm; bluish-green clay. Flat Basin.
MSN 24P:	23 Oct. 1960, 1736 hrs.; simultaneous with core 24G; length 331 cm. Bottom section (1), 56 cm.; next (2) 71 cm.; next (3) 74 cm.; next (4) 77 cm.; top section (5) 53 cm.; bluish-green clay with some shells.
MSN 25G:	24 Oct. 1960, 1051 hrs.; 7°08"S, 127°13"E; depth 4683 m.; length 123 cm.; a foot of red clay overlying bluish-green clay with brownish streaks. Flat bottom.
MSN 25V:	24 Oct. 1960, 1256 hrs.; 7°09"S, 127°15"E; depth 4714 m.; length 12 cm.; dark brown clay. Flat bottom.
MSN 26G:	26 Oct. 1960, 0856 hrs.; 7°48"S, 121°13"E; depth 4824 m.; length 158 cm.; bluish-green clay, brown near top. Flat bottom in Flores Basin.
MSN 27G:	28 Oct. 1960, 0842 hrs.; 7°58"S, 117°48"E; depth (uncorrected) 1654 m.; small amount of green mud with some sand and cinders.
MSN 28G:	30 Oct. 1960, 0645 hrs.; 11°58"S, 115°23"E; depth 5005 m.; length 148 cm.; brownish mud with darker spots and streaks. Flat bottom.
MSN 29G:	31 Oct. 1960, 1120 hrs.; 12°50"S, 115°20"E, depth 5386 m.; length 105 cm.; brown mud with greenish streaks near bottom. Flat bottom.
MSN 29P:	Simultaneously with 29G: length 29.42 feet—section 1, 80 cm.; section 2, 81 cm.; section 3, 81 cm.; section 4, 80 cm.; section 5, 79 cm.; section 6, 79 cm.; section 7, 79 cm.; section 8, 77 cm.; section 9, 77 cm.; section 10, 78 cm.; section 11, 76 cm.; section 12, 34 cm. Bluish-green mud with traces of grey to black material.
MSN 29V:	31 Oct. 1960, 1413 hrs.; 12°50"S, 115°20"E; depth 5386 m.; length 12 cm.; brown mud. Flat bottom.

MSN 30G:	2 Nov. 1960, 0739 hrs.; 10°12"S, 115°19"E; depth 4322 m.; length 65 cm.; greenish-blue mud with brown streaks mostly near top—small calcareous concretion at top. Flat bottom.
MSN 31G:	3 Nov. 1960, 0746 hrs.; 10°43"S, 115°15"E; depth 3376 m.; length 77 cm.; greenish-blue mud, brown at top. Flat bottom.
MSN 32G:	4 Nov. 1960, 0754 hrs.; 9°18"S, 115°47"E; depth 2640 m.; length 7 cm.; green mud with brown streaks. Some of the sample washed out before reaching surface. Slope on north flank of Java Trench.
MSN 33G:	7 Nov. 1960, 0635 hrs.; 13°20"S, 109°35"E; depth 4703m.; length 116 cm.; brown mud; greenish-grey in the lower part, and with small blackish patches. Flat bottom.
MSN 33Ga:	7 Nov. 1960, 1045 hrs.; 13°18"S, 109°27"E; depth 4490 m.; length 159 cm.; light buff ooze, fairly compact.
MSN 33P:	Simultaneously with core 33Ga. Very small catcher sample of light buff ooze.
MSN 33V:	7 Nov. 1960, 0822 hrs.; 13°19"S, 109°32"E; depth 4692 m.; small amount of brown mud.
MSN 34G:	8 Nov. 1960, 0612 hrs.; 11°38"S, 109°33"E; depth 4612 m.; length 117 cm.; greenish-blue mud, brown in the upper third. Flat bottom.
MSN 34V:	8 Nov. 1960, 0806 hrs.; 11°40"S, 109°32"E; depth 4612 m.; length 12 cm.; brownish-grey mud. Flat bottom.
MSN 34GP:	8 Nov. 1960, 1315 hrs.; 11°40"S, 109°32"E; depth 4604 m.; length 124 cm.; greenish-blue mud, brown in upper fifth. Flat bottom.
MSN 34P:	Simultaneously with core 34Gp. Section 1 (at bottom), 77 cm.; section 2, 77 cm.; section 3, 78 cm.; section 4, 77 cm.; section 5, 79 cm.; section 6, 79 cm.; section 7, 79 cm.; section 8, 81 cm.; section 9, 79 cm.; section 10, 79 cm.; section 11, 78 cm.; section 12 (top of core), 53 cm. Greenish-blue mud, fairly compact.
MSN 35G:	9 Nov. 1960, 0715 hrs.; 10°28"S, 109°46"E; depth 6550 m.; length 100 cm.; greenish-blue mud, brownish in upper fifth.
MSN 35V:	9 Nov. 1960, 1052 hrs.; 10°28"S, 109°44"E; depth 6550 m.; length 10 cm.; greenish mud.
MSN 36Ga:	10 Nov. 1960, 0745 hrs.; 9°22"S, 109°17"E; depth 1582 m.; length 30 cm.; gritty, compact, foraminiferal green clay.
MSN 36G:	10 Nov. 1960, 0702 hrs.; same location as 36 Ga; very small amount of green foraminiferal clay.
MSN 37G:	11 Nov. 1960, 0750 hrs.; 8°53"S, 109°36"E; depth 3300 m.; length 166 cm.; greenish-grey foraminiferal clay, brownish at top. Flat bottom.
MSN 37V:	11 Nov. 1960, 0931 hrs.; 8°52"S, 109°37"E; depth 3300 m.; small amount of greenish foraminiferal clay.
MSN 37GP:	11 Nov. 1960, 1630 hrs.; 8°48"S, 109°38"E; depth 3210 m.; length 99 cm.; dark greenish-grey foraminiferal clay. Flat bottom.

MSN 37P:	Simultaneously with 37Gp. Section 1 (bottom of core), 84 cm.; section 2, 84 cm.; section 3, 84 cm.; section 4, 84 cm.; section 5, 85 cm.; section 6, 85 cm.; section 7, 84 cm.; section 8, 85 cm.; section 9, 86 cm.; section 10, 83 cm.; section 11 (top of core), 75 cm. Rather compact, uniform dark greyish-green clay and silt.
MSN 38G:	20 Nov. 1960, 0854 hrs.; 11°15"S, 103°28"E; depth 5527 m.; length 124 cm.; upper two thirds brownish mud, bottom third greenish, with dark brown bands throughout. Flat bottom.
MSN 39G:	21 Nov. 1960, 0842 hrs.; 12°22"S, 101°25"E; depth 4771 m.; length 95 cm.; fairly compact, greenishgrey to brown foraminiferal mud, with some layering. Flat bottom.
MSN 39V:	21 Nov. 1960; 12°21"S, 101°25"E; depth 4771 m.; greyish foraminiferal ooze. Flat bottom.
MSN 40G:	22 Nov. 1960, 0315 hrs.; 10°30"S, 99°00"E; depth 5325 m.; no sample.
MSN 40Ga:	22 Nov. 1960, 0806 hrs.; 10°30"S, 99°00"E; depth 5461 m.; length 80 cm.; mottles brownish, buff and greenish silty mud.
MSN 41G:	24 Nov. 1960, 0245 hrs.; 10°32"S, 94°54"E; depth 5266 m.; length 58 cm.; mottled brownish to greenish silty mud. Hilly.
MSN 42G:	24 Nov. 1960, 1338 hrs.; 11°30"S, 94°41"E; depth 5554 m.; length 102 cm.; mottled, banded, brownish to greenish silty mud. Flat bottom.
MSN 43G:	26 Nov. 1960, 2343 hrs.; 17°00"S, 93°28"E; depth 5194 m.; length 80 cm.; compact red clay. Flat bottom.
MSN 44G:	26 Nov. 1960, 1814 hrs.; 18°02"S, 90°50"E; depth 5060 m.; length 131 cm.; chocolate clay.
MSN 45G:	27 Nov. 1960, 2309 hrs.; 18°41"S, 87°51"E; depth 1735 m.; no sample.
MSN 45Ga:	27 Nov. 1960, 2357 hrs.; same position as 45G; catcher sample only; light grey, clean foraminiferal sand. Flat bottom.
MSN 46G:	28 Nov. 1960, 0753 hrs.; 18°13"S, 86°43"E; depth 4500 m.; length 121 cm.; dark brown clay.
MSN 46V:	28 Nov. 1960, 0943 hrs.; 18°13"S, 86°42"E; depth 4502 m.; length 6 cm.; brown foraminiferal mud.
MSN 47G:	29 Nov. 1960, 0040 hrs.; 17°20"S, 84°24"E; depth 5010 m.; very small amount of manganese crust.
MSN 48G:	29 Nov. 1960, 1908 hrs.; 15°15"S, 81°08"E; depth 4996 m.; length 177 cm.; brown clay.
MSN 49G:	30 Nov. 1960, 1345 hrs.; 14°27"S, 78°03"E; depth 5214 m.; length 170 cm.; brown clay.
MSN 50G:	1 Dec. 1960, 0712 hrs.; 12°58"S, 75°01"E; depth 5226 m.; length 148 cm.; brown clay with lighter streaks.
MSN	2 Dec. 1960, 1744 hrs.; 14°05"S, 72°15"E; depth 5197 m.; length 133 cm.; brown clay

51G:	with lighter material throughout.
MSN 52G:	3 Dec. 1960, 1512 hrs.; 14°54"S, 70°12"E; depth 3980 m.; length 127 cm.; buff foraminiferal ooze.
MSN 52V:	3 Dec. 1960, 1204 hrs.; 14°56"S, 70°11"E; depth 4458 m.; small amount of clayey foraminiferal ooze. Flat bottom.
MSN 53V:	5 Dec. 1960, 0028 hrs.; 16°25"S, 66°00"E; depth 3660 m.; short core of fluid, buff foraminiferal ooze. Flat bottom.
MSN 53G:	5 Dec. 1960, 0201 hrs.; 16°25"S, 66°02"E; depth approx. 2000 fm.; length 89 cm.; buff foraminiferal ooze. Flat bottom.
MSN 54V:	5 Dec. 1960, 1156 hrs.; 16°58"S, 64°42"E; depth 4044m.; small amount offluid, buff foraminiferal ooze. Flat bottom.
MSN 55V:	6 Dec. 1960, 0048 hrs.; 17°48"S, 62°40"E; depth 3733 m.; short core of fluid, buff foraminiferal ooze. Rough topography.
MSN 55G:	6 Dec. 1960, 0126 hrs.; 17°48"S, 62°40"E; depth 3738 m.; length 127 cm.; buff foraminiferal ooze. Rough topography.
MSN 56GP:	15 Dec. 1960, 1330 hrs.; 23°56"S, 73°53"E; depth 3700 m.; length 58 cm.; buff, silty foraminiferal clay. Undulating topography.
MSN 56P:	Simultaneously with 56Gp. Section 1, 80 cm.; section 2, 82 cm.; section 3, 82 cm.; section 4, 82 cm.; section 5, 80 cm.; section 6, 82 cm.; section 7, 82 cm.; section 8, 79 cm.; section 9, 35 cm. Top 114 cm. buff foraminiferal ooze, remainder (568 cm.) khaki volcanic silts and clays.
MSN 57G:	16 Dec. 1960, 1556 hrs.; 26°22"S, 74°08"E; depth 4110 m.; length 144 cm.; predominantly brown clay, grading into foraminiferal ooze at top of core. Flat bottom (double echo).
MSN 58G:	17 Dec. 1960, 0107 hrs.; 27°48"S, 73°50"E; depth 3830 m.; few small chips of glassy volcanic rock. Intermontane flat.
MSN 58Ga:	17 Dec. 1960, 0353 hrs.; 27°48"S, 73°51"E; depth 3630 m.; ? no core?
MSN 59G:	17 Dec. 1960, 1947 hrs.; 30°50"S, 73°12"E; depth 4160 m.; length 131 cm.; buff volcanic silts and clays. Flat bottom.
MSN 60G:	18 Dec. 1960, 1217 hrs.; 33°20"S, 72°38"E; depth 4224 m.; length 138 cm.; khaki volcanic silts and clays. Flat bottom.
MSN 61G:	20 Dec. 1960, 0515 hrs.; 37°44"S, 71°42"E; depth 4286 m.; length 38 cm.; light buff volcanic mud. Moderately rough topography.
MSN 61V:	Approx. same position as 61G; small amount of buff volcanic mud.
MSN 62G:	21 Dec. 1960, 1146 hrs.; 42°03"S, 70°40"E; depth 4080 m.; a few pieces of manganese nodules. Gentle hills.
MSN 62Ga:	21 Dec. 1960, 2059 hrs.; 42°01"S, 71°00"E; depth 4152 m.; length 166 cm.; light buff volcanic silt and clay. Gentle hills.



MSN 62V:	Same position as 62Ga: length 10 cm.
MSN 63G:	23 Dec. 1960, 0209 hrs.; 39°50"S, 75°03"E; depth 3768 m.; ? only catcher sample ?; whitish silty clay.
MSN 63V:	Same position as 63G; small amount of whitish silty clay.
MSN 64G:	25 Dec. 1960, 0147 hrs.; 38°26"S, 79°34"E; depth (uncorrected) 1822 fm.; no core. Gently rolling topography.

— 227 —

<i>LUSIAD Expedition (R/V Argo)</i>	
LSDA 98G:	6 October 1962, 1850–1950 hrs.; 8°14"N, 70°38"E; depth 4060 m.; core length 179 cm. Light brown to medium brown mud, becoming darker downward. Relatively flat bottom.
LSDA 99G:	7 October 1962, 2014 hrs.; 3°58"N, 70°48"E; depth 4130 m.; core length 59 cm. Light brown mud. Flat bottom.
LSDA 100G:	8 October 1962, 1945–2100 hrs.; 0°04"S, 71°47"E; depth 4200 m.; core length 84 cm. Buff to light brown homogeneous mud. Flat bottom.
LSDA 101G:	9 October 1962, 1412–1531 hrs.; 2°41"S, 73°12"E; depth 2960 m.; core length 53 cm. Heavy white clay. Abyssal hills; valley 1–2 miles north.
LSDA 102G:	10 October 1962, 2001–2210 hrs.; 5°21"S, 75°07"E; depth 5240 m.; core length 171 cm. Medium brown to cream colored, mottled mud. Very flat basin.
LSDA 103V:	11 October 1962, 1247–1421 hrs.; 5°23"S, 72°47"E; depth 2530 m.; core of only a few cm. Cream colored calcareous ooze. Locally flat bottom.
LSDA 104G:	12 October 1962, 0925–1113 hrs.; 5°40"S, 70°17"E; depth 3960 m.; core length 62 cm. Generally light tan, darker in mid-section. Flat bottom.
LSDA 105G:	13 October 1962, 0920–1120 hrs.; 5°40"S, 66°36"E; depth 4365 m.; core length 22 cm. Very watery white clay. Flat bottom.
LSDA 106G:	14 October 1962, 0410–0515 hrs.; 5°34"S, 63°43"E; depth 4090 m.; core length 61 cm. Light buff calcareous ooze. Abyssal hills.
LSDA 107Ga:	15 October 1962, 1315–1515 hrs.; 5°26"S, 59°15"E; depth 4010 m. White calcareous clay. Small abyssal hills.
LSDA 107 Gb:	15 October 1962, 2020 hrs.; 5°26"S, 59°15"E; depth 3930 m.; core length 155 cm. White calcareous ooze. Small abyssal hills.
LSDA 108G:	16 October 1962, 0523–0610 hrs.; 5°30"S, 57°56"E; depth 2550 m.; core length 117 cm. White calcareous ooze.
LSDA 109G:	16–17 October 1962, 1657–0330 hrs.; 3°59"S, 58°00"E; depth 4035 m. No core. Winch broke down, core washed out. Flat bottom.

LSDA 111Ga:	21 October 1962, 0425–0610 hrs.; 9°53"S, 56°32"E; depth 3760 m. No core; core evidently ran out. Very small amount of gritty material.
LSDA 111Gb:	21 October 1962, 1012–1118 hrs.; 9°53"S, 56°32"E; depth 3843 m. (double bottom: upper-3750 m.); core length 29 cm. Watery, buff colored, granular sediment.
LSDA 112G:	21 October 1962, 2005–2130 hrs.; 9°58"S, 57°08"E; depth 4040 m.; core length 13 cm. White mud.
LSDA 113G:	22 October 1962, 0750–0850 hrs.; 10°21"S, 58°31"E; depth 3495 m.; core length 94 cm. White calcareous ooze. Flat bottom.
LSDA 114Ga:	22 October 1962, 2223 hrs.; 10°36"S, 59°52"E; depth 2350 m. No core; washed out.
LSDA 114Gb:	23 October 1962, 0030–0110 hrs.; 10°36"S, 59°52"E; depth 2270 m.; core length 155 cm. White calcareous ooze.
LSDA 117G:	24 October 1962, 1715–1820 hrs.; 13°41"S, 59°41"E; depth 3900 m.; core length 146 cm. White and buff calcareous ooze.
LSDA 118G:	28 October 1962, 1700 hrs.; 17°20"S, 57°42"E; depth 4150 m. No core in two attempts; washed out.
LSDA 118V:	25 October 1962; 17°21"S, 57°42"E; depth 4150 m.; core length 12 cm. Flat bottom.
LSDA 119G:	31 October 1962, 1036–1200 hrs.; 22°02"S, 57°33"E; depth 4770 m.; core length 172 cm. Light to medium brown mud.
LSDA 120Ga:	1 November 1962, 0650 hrs.; 24°30"S, 57°29"E; depth 4958m. No. core.
LSDA 120Gb:	1 November 1962, 0851–1113 hrs.; 24°30"S, 57°29"E; depth 4990 m.; Core length 148 cm. Brown mud. Flat bottom surrounding abyssal hills.
LSDA 121G:	2 November 1962, 0524 hrs.; 26°51"S, 58°14"E; depth 5335 m.; core length 63 cm. Medium brown mud.
LSDA 122G:	3 November 1962, 1738 hrs.; 29°54"S, 61°53"E; depth 4400 m.; core length 124 cm. Medium brown mud; Mn nodule at top.
LSDA 123G:	4 November 1962, 1008–1123 hrs. 31°27"S, 61°49"E; depth 4200 m.; core length 167 cm. Brown mud, darker on top, buff below, with 2 Mn nodules. Flat bottom.
LSDA 124G:	5 November 1962, 0515–0700 hrs.; 32°44"S, 62°24"E; depth 4780 m.; core length 170 cm. Brown to light brown clay. Flat to moderately hilly bottom.
LSDA 125G:	5 November 1962, 1815–1950 hrs.; 33°14"S, 61°43"E; depth 4800 m.; core length 172 cm. Brown mud.
LSDA 126G:	7 November 1962, 0807 hrs.; 39°46"S, 64°00"E, depth 4980 m.; core length 10 cm. Buff to light brown mud with Mn nodule.
LSD 128G:	13 November 1962, 0610–0800 hrs.; 44°38"S, 70°58"E; depth 3616 m.; core length 78 cm. Calcareous ooze.
LSDA 129G:	15 November 1962, 0525–0700 hrs.; 35°47"S, 73°36"E; depth 4240 m.; core length 85 cm. Buff and light brown calcareous (?) ooze.

LSDA 129 PG&P:	15 November 1962, 1507–1745 hrs.; 35°47"S, 73°36"E; depth 4230 m; core length 2–3 cc. in gravity catcher, 1 cc. in piston corer. Piston barrel bent.
LSDA 130G:	16 November 1962, 0540–0714 hrs.; 36°52"S, 76°22"E; depth 3550 m.; core length 27 cm. Homogenous buff mud.
LSDA 130V:	16 November 1962, 0719 hrs.; 36°52"S, 76°22"E; depth 3940 m.; core length 13 cm. Light tan mud, pushed by hand back into corer when it came out.
LSDA 131G:	17 November 1962, 0406–0500 hrs.; 37°19"S, 78°26"E; depth 1920 m.; core length 39 cm. Buff calcareous ooze. Abyssal hills.
LSDA 132PG:	22 November 1962, 1115 hrs.; 33°47"S, 96°00"E; depth 4328 m.; core length 86 cm. Buff at top to chocolate brown at bottom. Abyssal hills.
LSDA 132P:	Simultaneously with LSDA 132PG. Core length Section 1, 152 cm.; Section 2, 71 cm.; Section 3, 45 cm.; Section 4, 25 cm.; Section 5, 23 cm.; Section 6, 109 cm. Cocoa-colored granular sediment. 0–109 cm. chocolate mud; 109–132 cm., buff mud; 132–157 cm., light brown with fine particles; 157–425 cm., light brown granular sediment. NOTE: Numerical sequence of sections of core as to top and bottom of core is unknown.
LSDA 133Ga:	23 November 1962, 0650–0740 hrs.; 32°00"S, 98°52"E; depth 2180 m.; Catcher only. White calcareous sediment. Flat bottom.
LSDA 133Gb:	23 November 1962, 1235–1315 hrs.; 32°00"S, 98°52"E; depth 1925 m. Catcher only; small amount of white sand. Flat bottom.
LSDA 134PG:	24 November 1962, 1535 hrs.; 33°02"S, 103°29"E; depth 5165 m.; core length 131 cm. Chocolate mud. Abyssal hills.
LSDA 134P:	Simultaneously with LSDA 134PG. Core length: Section 1 (bottom of core), 152 cm.; Section 2, 133 cm. Chocolate mud.
LSDA 135G:	26 November 1962, 0425 hrs.; 32°51"S, 108°44"E; depth 5330 m. No core; did not hit bottom. Flat bottom.
LSDA 136G:	2 December 1962, 2020–2140 hrs.; 31°30"S, 114°23"E; depth 3860 m.; core length 21 cm. Cream to white calcareous ooze. Bottom of continental slope, abyssal hills.
LSDA 136V:	3 December 1962, 31°30"S, 114°23"E; depth 3741 m. Very light tan mud.
LSDA 137G:	3 December 1962, 1218–1354 hrs.; 31°45"S, 113°56"E; depth 4545 m.; core length 26 cm. Calcareous ooze. Bottom of continental slope.
LSDA 138G:	4 December 1962, 0628–0833 hrs.; 29°42"S, 111°28"E; depth 5355 m. Catcher only. Orange-yellow clay with black particles. Flat bottom.
LSDA 138V:	4 December 1962; 29°42"S, 111°28"E; depth 5355 m.; core length 8 cm. Orange yellow clay. Flat bottom.
LSDA 139Ga:	6 December 1962, 0627 hrs.; 25°05"S, 104°14"E; Depth 5240 m. No core. No bottom echo observable. Flat bottom.
LSDA 139Gb:	6 December 1962, 0855–1100 hrs.; 25°05"S, 104°14"E; depth 5215 m.; core length 148 cm. Chocolate brown clay. Catcher contaminated with red pencil markings used

	in extrusion. Flat bottom.
LSDA 140G:	8 December 1962, 0718–1105 hrs.; 20°43"S, 97°12"E; depth 5690 m.; core length 142 cm. Chocolate brown clay. Three breaks in core at 8-½, 12-½ and 17 cm. from the top. Flat bottom.
LSDA 141G:	10 December 1962, 1000–1200 hrs.; 19°27"S, 89°19"E; depth 5620 m.; core length 78 cm. Chocolate brown clay. Flat bottom.
LSDA 142Ga:	11 December 1962, 0810 hrs.; 14°35"S, 88°02"E; depth 2320 m. No core; few grains of sand. Flat, plateau.
LSDA 142Gb:	11 December 1962, 0927–1010 hrs.; 14°35"S, 88°02"E; depth 2422 m. Catcher only, 1 cc. white granules. Plateau.
LSDA 142D:	11 December 1962, 1600–1800 hrs.; 14°35"S, 88°02"E; depth 2630 m. 4 plastic boxes from 2 pipes. Calcareous ooze.
LSDA 143PG:	12 December 1962, 1020–1220 hrs.; 13°53"S, 90°48"E; depth 5320 m.; core length 145 cm. Chocolate brown at top, grading to cream color at bottom, with abrupt change of color and texture at approx. 115 cm. Flat, valley.
LSDA 143P:	Simultaneously with LSDA 142PG. No core.
LSDA 144G:	13 December 1962, 1205–1335 hrs.; 13°09"S, 93°13"E; depth 5226 m.; core length 51 cm. Chocolate brown clay with small white particles.
LSDA 145PGa:	15 December 1962, 0755–1115 hrs.; 13°40"S, 100°20"E; depth 5984 m.; core length 145 cm. Partially calcareous (?) chocolate mud.
LSDA 145Pa:	Simultaneously with LSDA 145 PGa. No core.
LSDA 145 PGb:	15 December 1962, 1315–1618 hrs.; 13°40"S, 100°20"E; depth 5987 m.; core length 107 cm. Chocolate layer at top to white below.
LSDA 145 Pb:	Simultaneously with LSDA 145 PGb. Core length: Section 1 (bottom of core), 152 cm.; Section 2, 152 cm.; Section 3, 91 cm.; Section 4, 158 cm.; 0–158 cm., brown with black bands; 158–249 cm., brown with some white; 249–401 cm., homogeneous, light brown mud; 401–553 cm., light brown mud. Top 5–8 cm. washed out of liner or removal of piston and placed in box, allowed to settle and water was drained off. Top looks good, but bottom 60 cm. may be disturbed. Flat bottom.
LSDA 146G:	17 December 1962, 0705–0910 hrs.; 14°59"S, 108°08"E; depth 5564 cm.; core length 39 cm. Tan with yellow parts and dark specks. Sample very broken up. Flat bottom.
LSDA 147PG:	19 December 1962, 0700–1000 hrs.; 13°48"S, 115°37"E; depth 5679 m.; core length 117 cm. Catcher sample.
LSDA 147P:	Simultaneously with LSDA 147 PG. Core length: Section 1 (bottom of core), 153 cm.; Section 2, 153 cm.; Section 3, 153 cm.; Section 4, 113 cm.; 0–113 cm., striated and variegated mud; 113–572 cm., buff and gray-brown mud. Also top and bottom piston catcher samples, therefore, part of top of core in plastic box.

LSDA 148G:	20 December 1962, 1023–1205 hrs.; 13°30"S, 118°22"E; depth 5679 m.; core length 115 cm. Chocolate brown top merging to gray at bottom.
LSDA 149PG:	2 January 1963, 0320–0350 hrs.; 9°54"S, 127°39"E; depth 432m.; core length 76 cm. Gray-green clay mixed with sand and small shell fragments.
LSDA 149P:	Simultaneously with LSDA 149PG. Core length 138 cm. Gray-green clay with sand and small shell fragments mixed. Partial penetration in sandy-shell bottom.
LSDA 150PG:	2 January 1963, 0620–0721 hrs.; 9°29"S, 127°22"E; depth 1570 m.; core length approx. 15 cm. in catcher box. Partial penetration, hard bottom. Gray-green clay, quite sandy.
LSDA 150P:	Simultaneously with LSDA 150PG. Core length 48 cm., plus approx. 20 cm., in two catcher boxes. Gray-green clay, quite sandy.
LSDA 151PGa:	2 January 1963, 0917–1108 hrs.; 9°13"S, 127°27"E; depth 3305 m.; core length 128 cm. Gray-green clay.
LSDA 151Pa:	Simultaneously with LSDA 151 PG. No core, core barrel lost on pull-out.
LSDA 151PGb:	2 January 1963, 1245–1445 hrs.; 9°13"S, 127°27"E; depth 3305 m.; core length 128 cm. Gray-green clay; top 15 cm. brown with sand shell fragments.
LSDA 151Pb:	Simultaneously with LSDA 151PGb. Core length: Section 1 (top of core), 141 cm.; Section 2, 152 cm.; Section 3, 41 cm. Gray-green clay. NOTE: Sequence may actually be reversed.
LSDA 152PG:	2 January 1963, 1733–1834 hrs.; 8°44"S, 127°29"E; depth 1312 m.; core length 119 cm. Gray-green clay with some brown mud near top.
LSDA 152P:	Simultaneously with LSDA 152PG. Core length: Section 1 (top of core), 152 cm.; Section 2, 88 cm. Gray-green, slightly sandy clay. NOTE: Sequence may actually be reversed.
LSDA 153G:	24 May 1963, 1639–1840 hrs.; 28°58"S, 39°01"E; depth 4895 m. Very small amount of sand and gravel.
LSDA 154G:	25 May 1963, 0257–0428 hrs.; 30°06"S, 37°47"E; depth 5000 m.; core length 103 cm. Light brown mud.
LSDA 154V:	25 May 1963, 0436–0643 hrs.; 30°06"S, 37°47"E; depth 4990 m.; core length 10 cm. Medium to light brown, slightly mottled mud.
LSDA 155V:	25 May 1963, 1407–1601 hrs.; 31°04"S, 36°43"E; depth 4535 m.; core length approx. 4 cm. Light buff to buff calcareous ooze with small Mn nodule.
LSDA 156G:	25 May 1963, 2038–2126 hrs.; 31°39"S, 35°57"E; depth 2560 m.; core length 41 cm.
LSDA 156V:	25 May 1963, 2136–2250 hrs.; 31°39"S, 35°57"E; depth 2545 m. Light buff calcareous ooze.
LSDA 157V:	26 May 1963, 0933–1055 hrs.; 32°16"S, 34°18"E; depth 2660 m.; core length 10 cm. Light buff calcareous ooze, many small black particles.
LSDA	26 May 1963, 1830–1930 hrs.; 32°23"S, 32°33"E; depth 3560 m.; core length 112

158G:	cm. Light brown mud at top, green-gray clay at bottom.
LSDA 158V:	26 May 1963, 1951–213 hrs.; 32°23"S, 32°33"E; depth 3560 m.; core length 10 cm. Gray fossiliferous mud.

— 233 —

<i>LUSIAD Expedition (R/V Horizon)</i>	
LSDH 1G:	5 October 1962, 0815-0850 hrs.; 9°07"N, 72°59"E; depth 2200 m.; core length 120 cm. Tan, gritty mud at top. light gray-green in bottom three-fourths. Small hills.
LSDH 1Va:	5 October 1962, 0913-1020 hrs.; 9°07"N, 72°58"E; depth 2134 m.; core length approx. 10 cm. Highly fossiliferous, gritty, medium gray mud. Small, 10 to 20 fm. hills.
LSDH 1Vb:	5 October 1962, 1651-1803 hrs.; 9°03"N, 73°07"E; depth 2110 m.; core length 7 cm. Light brownish-gray foraminiferal ooze; very gritty, as LSDH 1Va. Small, 10 to 20 fm. hills.
LSDH 3G:	6–7 October 1962, 2344-0109 hrs.; 7°27"N, 70°39"E; depth 4110 m.; core length 136 cm. Light brown and buff colored fossiliferous mud. Irregular bottom, generally 20 to 40 fm. relief, but occasionally up to 160 fm. relief.
LSDH 6V:	11 October 1962, 0053-0248 hrs.; 5°22"S, 74°17"E; depth 4780 m.; Catcher sample only. Mottled gray-brown fossiliferous mud; some elongate dark brown areas. Abyssal hills, relief up to 120 fm.
LSDH 6G:	11 October 1962, 0255-0415 hrs.; 5°22"S, 74°17"E; depth 4900 m.; core length 24 cm. Medium brown, slightly mottled mud. Abyssal hills.
LSDH 8G:	12 October 1962, 1500-1550 hrs.; 5°40"S, 69°40"E; depth 3450 m.; core length 31 cm. Foraminiferal ooze. Very hilly bottom, relief up to 200 fm.
LSDH 8V:	12 October 1962, 1611-1738 hrs.; 5°40"S, 69°40"E; depth 3815 m.; core length approx. 7 cm. Light buff calcareous sand. Bathymetry as for LSDH 8G.
LSDH 9G:	13 October 1962, 1540-1646 hrs.; 5°43"S, 65°58"E; depth 4250 m.; core length 155 cm. Calcareous ooze, light brown at top. Flat bottom approx. 4 miles west of extensive area of high relief.
LSDH 9V:	13 October 1962 1703-1844 hrs.; 5°43"S, 65°58"E; depth 4260 m.; core length approx. 7 cm. Light brown foraminiferal ooze with buff mottling. Bathymetry as for LSDH 9G.
LSDH 11G:	14 October 1962, 1433-1556 hrs.; 5°31"S, 63°04"E; depth 4070 m.; core length approx. 40 cm. in box. Light buff calcareous ooze. Mostly gently rolling bottom with occasional flats up to four miles wide; some hills of 180 fm. relief.
LSDH 11V:	14 October 1962, 1616-1808 hrs.; 5°31"S, 63°04"E; depth 4260 m.; core length approx. 6 cm. Light buff calcareous ooze. Bathymetry as for LSDH 11G.
LSDH 12V:	15 October 1962, 1036-1216 hrs.; 5°28"S, 60°02"E; depth 4100 m.; core length approx. 7 cm. Light buff calcareous ooze. Flat Abyssal plain.
LSDH	15 October 1962, 1218 hrs.; 5°28"S, 60°02"E; depth 4100 m.; small amount of

12G:	material in freezer box. Light buff calcareous ooze. Flat abyssal plain.
LSDH 13G:	16 October 1962, 0101-0210 hrs.; 5°26"S, 58°29"E; depth 3950 m.; core length 46 cm. Light buff calcareous ooze. Abyssal plain.
LSDH 14G:	16 October 1962, 1707 hrs.; 4°10"S, 57°15"E; depth 3775 m.; core length 41 cm. Light buff calcareous ooze. Gently rolling abyssal hills.
LSDH 15G:	16 October 1962, 2230-2315 hrs.; 4°20"S, 56°45"E; depth 2620 m.; core length 125 cm. Light buff calcareous ooze. Flank of Seychelles platform; very irregular bottom of up to 40 fm. relief.
LSDH 16G:	17 October 1962, 0330-0639 hrs.; 4°26"S, 56°20"E; depth < 1000 m.; One burlap bag of sponges; 2 boxes of coral; 1 box of shells; 1 jar of fish and invertebrates. Anchored with dredge.
LSDH 18V:	21 October 1962, 1321-1458 hrs.; 9°49"S, 56°27"E; depth 3890 m.; core length approx. 7 cm. Light buff calcareous ooze. Hilly topography of approx. 300 fm. relief.
LSDH 18G:	21 October 1962, 1505-1605 hrs.; 9°49"S, 56°29"E; depth 3890 m.; core length 155 cm. Light buff calcareous ooze. Bathymetry as for LSDH 18V.
LSDH 19G:	22 October 1962, 0042-0140 hrs.; 10°06"S, 57°52"E; depth 3933 m.; core length 10 cm. in catcher box. Calcareous ooze. Abyssal plain.
LSDH 19V:	22 October 1962, 0150-0322 hrs.; 10°06"S, 57°52"E; depth 3938 m.; core length approx. 10 cm. Light buff calcareous ooze. Abyssal plain.
LSDH 20G:	22 October 1962, 1541-1630 hrs.; 10°29"S, 59°23"E; depth 2870 m.; core length 105 cm. Light gray-buff calcareous ooze. Hummocky to gently rolling topography.
LSDH 20V:	22 October 1962, 1818-1934 hrs.; 10°27"S, 59°24"E; depth 2845 m.; core length approx. 6 cm. Light buff to gray-buff calcareous ooze. Hummocky to gently rolling topography.
LSDH 22G:	1 November 1962, 1743-2010 hrs.; 25°26"S, 57°38"E; depth 5105 m.; core length 135 cm. Uniform dark chocolate brown mud.
LSDH 22V:	1–2 November 1962, 2352-0147 hrs.; 25°30"S, 57°39"E; depth 5100 m.; core length approx. 10 cm. Uniform dark chocolate brown mud.
LSDH 23G:	4 November 1962, 1626-1749 hrs.; 31°14"S, 62°58"E; depth 4910 m.; core length 137 cm. Uniform dark chocolate brown mud.
LSDH 25G:	8 November 1962, 0531–0652 hrs.; 39°43"S, 67°58"E; depth 4115 m.; core length 146 cm. Uniform light buff diatomaceous-foraminiferal ooze (?).
LSDH 25V:	8 November 1962, 0721–0915 hrs.; 39°44"S, 67°53"E; depth 4065 m.; core length approx. 6 cm. Light buff diatomaceous-foraminiferal (?) ooze.
LSDH 26G:	9 November 1962, 0614–0728 hrs.; 40°46"S, 72°47"E; depth 4045 m.; core length 99 cm. Uniform light buff mud.
LSDH 26V:	9 November 1962, 0744–0928 hrs.; 40°46"S, 72°46"E; depth 4000 m.; core length approx. 6 cm. Uniform light buff mud.
LSDH 27G:	9 November 1962, 1857–2012 hrs.; 41°00"S, 75°10"E; depth 4190 m.; core length 75 cm. Uniform light buff mud. Core tubing had to be forced out, and core probably

	disturbed.
LSDH 28G:	10 November 1962, 0624–0718 hrs.; 40°21"S, 76°31"E; depth 3025 m.; core length 20 cm. Light buff mud.
LSDH 28V:	10 November 1962, 0744–0900 hrs.; 40°21"S, 76°31"E; depth 3020 m.; core length approx. 8 cm. Light buff mud with darker particles and one shark's tooth.
LSDH 29V:	16 November 1962, 0500–0616 hrs.; 36°07"S, 75°59"E; depth 3290 m.; core length approx. 7 cm. Light buff Globigerina (?) ooze.
LSDH 30G:	16 November 1962, 1535–1632 hrs.; 37°21"S, 76°34"E; depth 3375 m.; core length 19 cm. Light buff Globigerina (?) ooze.
LSDH 30V:	16 November 1962, 1644–1800 hrs.; 37°21"S, 76°34"E; depth, multiple bottom: approx. 3350 m.; core length approx. 7 cm. Light buff Globigerina (?) ooze.
LSDH 31V:	22 November 1962, 1512–1643 hrs.; 32°58"S, 96°02"E; depth 4034 m.; core length approx. 8 cm. Light buff ooze (Globigerina?)
LSDH 32D:	23 November 1962, 0247–0509 hrs.; 32°22"S, 97°51"E; depth 1349–2489 m.; Apparently lost overboard.
LSDH 33G:	23 November 1962, 1900–1943 hrs.; 32°06"S, 100°20"E; depth 2455 m.; core length 13 cm. Light buff Globigerina (?) ooze.
LSDH 34V:	24 November 1962, 1106–1248 hrs.; 32°45"S, 102°45"E; depth 4800 m.; core length 10 cm. Dark chocolate brown foraminiferal mud with darker brown mottles.
LSDH 34G:	24 November 1962, 1301–1423 hrs. (Second of two attempts); 32°45"S, 102°45"E; depth 4755 m.; core length 144 cm. Dark chocolate brown (almost deep red) foraminiferal mud. In basin about 20–25 miles east of slope from large east-west trending ridge.
LSDH 35V:	24 November 1962, 1913–2107 hrs.; 32°59"S, 103°33"E; depth 5130 m.; core length approx. 10 cm. Dark chocolate brown mud.
LSDH 36V:	25 November 1962, 1640–2116 hrs.; 33°58"S, 107°12"E; depth 5300 m.; core length approx. 12 cm. Dark chocolate brown mud.
LSDH 37G:	25 November 1962, 2233–2348 hrs.; 33°54"S, 107°13"E; depth 4512 m.; few grains in catcher. Light buff, gritty (foraminiferal ?) ooze with small deep yellow particles.
LSDH 38G:	27 November 1962, 1358 hrs.; 32°16"S, 113°56"E; depth 4275 m.; core length 35 cm. Light buff foraminiferal ooze.
LSDH 39P:	28 November 1962, 0709 hrs. 31°57"S, 115°37"E; depth 18 m. Small amount from catcher of poorly to moderately sorted dark gray sand containing one live mollusc and a small gastropod fragment; approx. 20% black grains (up to 0.5mm) and fine silt size; mostly medium to coarse sand size. No penetration; corer fell over.
LSDH 39G:	28 November 1962, 0814–0900 hrs.; 31°57"S, 115°37"E, depth 18 m.; core length approx. 10 cm. Description as for LSDH 39P, but also containing live worms. Core washed out on deck.
LSDH 40G:	28 November 1962, 0733–0738 hrs.; 31°57"S, 115°37"E; depth 18 m. Description taken from catcher sample: Gray-green silt with a few small shell fragments.



LSDH 41G:	4 December 1962, 1645–1818 hrs.; 29°15"S, 110°44"E; depth 5550 m.; core length 11 cm. Light buff and light brown mottled foraminiferal (?) mud.
LSDH 42V:	6 December 1962, 0448–0531 hrs.; 25°42"S, 105°22"E; depth 4840 m.; core length approx. 9 cm. Dark brown fossiliferous mud and one 2 cm. Mn nodule.
LSDH 43V:	6 December 1962, 1727–1928 hrs.; 24°36"S, 103°37"E; depth 5400 m.; core length 3 cm. after approx. 5 cm. washed out. Uniform dark brown mud.
LSDH 44V:	8 December 1962, 1715–1907 hrs.; 20°11"S, 96°22"E; depth 4910 m.; core length 10 cm. Dark brown compacted mud with medium to light brown mottling.
LSDH 45V:	12 December 1962, 0042–0240 hrs.; 14°13"S, 89°41"E; depth 5315 m.; core length 10 cm. Uniform dark brown, slightly gritty mud.
LSDH 45G:	12 December 1962, 0533–0705 hrs.; 14°07"S, 89°35"E; depth 5255 m.; core length 92 cm. Dark brown mud with apparently large Mn nodules near the top. Catcher sample graded rapidly to chalky mud.
LSDH 46V:	12 December 1962, 1848–2040 hrs.; 13°39"S, 91°32"E; depth 5150 m.; core length 8 cm. Uniform dark brown mud.
LSDH 47G:	13 December 1962, 0515-0646 hrs.; 13°23"S, 92°31"E, depth 5165 m.; core length 45 cm. Uniform dark brown mud.
LSDH 48G:(?)	13 December 1962, 1848-1854 hrs.; 12°50"S, 94°05"E. No core.
LSDH 49G:(?)	15 December 1962, 0500-0709 hrs.; 13°39"S, 99°32"E. No core.
LSDH 50V:	15 December 1962, 1718-1909 hrs.; 14°06"S, 101°22"E; depth 5110 m.; core length 7 cm. Medium brown foraminiferal mud with light brown mottling.
LSDH 51G:	17 December 1962, 0353-0535 hrs.; 14°57"S, 107°16"E; depth 5637 m.; core length 143 cm. Top 10 cm. dark brown foraminiferal clay and white calcareous ooze.
LSDH 52V:	17 December 1962, 1722-1924 hrs.; 14°58"S, 109°13"E; depth 5640 m.; core length 8 cm. Dark brown foraminiferal mud with black particles.
LSDH 53G:	19 December 1962, 0405-0533 hrs.; 14°13"S, 114°43"E; depth 5660 m.; core length 141 cm. Dark brown to gray sandy mud.
LSDH 54G:	19 December 1962, 1645-1818 hrs.; 13°08"S, 116°30"E; depth 5660 m.; core length 159 cm. Dark brown to dark gray mud.
LSDH 55V:	20 December 1962, 0218-0423 hrs.; 13°42"S, 117°23"E; depth 5715 m.; core length 7 cm. Dark brown mud.
LSDH 56P:	22 December 1962, 0908-0916 hrs.; 12°08"S, 127°14"E; depth 95 m.; Two attempts: (1) faulty core catcher; medium gray mud with abundant shell fragments; (2) catcher sample, very little penetration: medium gray to white very hard clay with shell fragments and coral.
LSDH 57P:	22 December 1962, 1339-1345 hrs.; 11°44"S, 127°57"E; depth 132 m.; core length: Section 1(?) 152 cm.; Section 2(?) 145 cm. Medium gray-green mud with shell fragments and sandy lenses and/or layering.

