

BenQ

FP73E S/FP93E S
LCD Color Monitor
User Manual

Welcome

Copyright

Copyright © 2007 by BenQ Corporation. All rights reserved. No part of this publication may be reproduced, transmitted, transcribed, stored in a retrieval system or translated into any language or computer language, in any form or by any means, electronic, mechanical, magnetic, optical, chemical, manual or otherwise, without the prior written permission of BenQ Corporation.

Disclaimer

BenQ Corporation makes no representations or warranties, either expressed or implied, with respect to the contents hereof and specifically disclaims any warranties, merchantability or fitness for any particular purpose. Further, BenQ Corporation reserves the right to revise this publication and to make changes from time to time in the contents hereof without obligation of BenQ Corporation to notify any person of such revision or changes.

Please follow these safety instructions for best performance, and long life for your monitor

Power Safety

- The AC plug isolates this equipment from the AC supply.
- The power supply cord serves as a power disconnect device for pluggable equipment. The socket outlet should be installed near the equipment and be easily accessible.
- This product should be operated from the type of power indicated on the marked label. If you are not sure of the type of power available, consult your dealer or local power company.

Care And Cleaning

- Cleaning. Always unplug your monitor from the wall outlet before cleaning. Clean the LCD monitor surface with a lint-free, non-abrasive cloth. Avoid using any liquid, aerosol or glass cleaners.
- Slots and openings on the back or top of the cabinet are for ventilation. They must not be blocked or covered. Your monitor should never be placed near or over a radiator or heat source, or in a built-in installation unless proper ventilation is provided.
- Never push objects or spill liquid of any kind into this product.

Servicing



- Do not attempt to service this product yourself, as opening or removing covers may expose you to dangerous voltages or other risks. If any of the above mentioned misuse or other accident such as dropping or mishandling occurs, contact qualified service personnel for servicing.

Table of Contents

Getting started	4
Getting to know your monitor	6
Front view	6
Back view	6
How to assemble your monitor hardware	7
Viewing angle adjustment	10
Storing the monitor	10
Getting the most from your BenQ monitor	11
How to install the monitor on a new computer	12
How to upgrade the monitor on an existing computer	13
How to install on Windows Vista systems	14
How to install on Windows XP system	15
How to adjust the screen resolution	16
How to adjust the screen refresh rate	17
Picture optimization	18
How to adjust your monitor	19
The control panel	19
On Screen Display (OSD) menu structure	20
Hot key mode	21
Main menu mode	22
Troubleshooting	32
Frequently asked questions (FAQ)	32
Need more help?	33
Supported PC Timings	34
Specifications	35

1. Getting started

When unpacking please check you have the following items. If any are missing or damaged, please contact the place of purchase for a replacement.

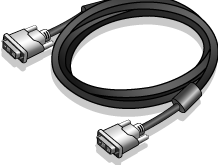
BenQ LCD Monitor	 A black BenQ LCD monitor with a silver bezel and a black stand.
Quick Start Guide	 A white quick start guide booklet with a small image of the monitor on the cover.
CD-ROM	 A standard CD-ROM disc.
Power Cord	 A black power cord with a standard AC power plug and a DC power connector.
Signal Cable: D-Sub	 A black D-Sub signal cable with D-Sub connectors on both ends.
Signal Cable: DVI-D (optional)	 A black DVI-D signal cable with DVI-D connectors on both ends.



💡 Consider keeping the box and packaging in storage for use in the future when you may need to transport the monitor. The fitted foam packing is ideal for protecting the monitor during transport.

2. Getting to know your monitor

Front view

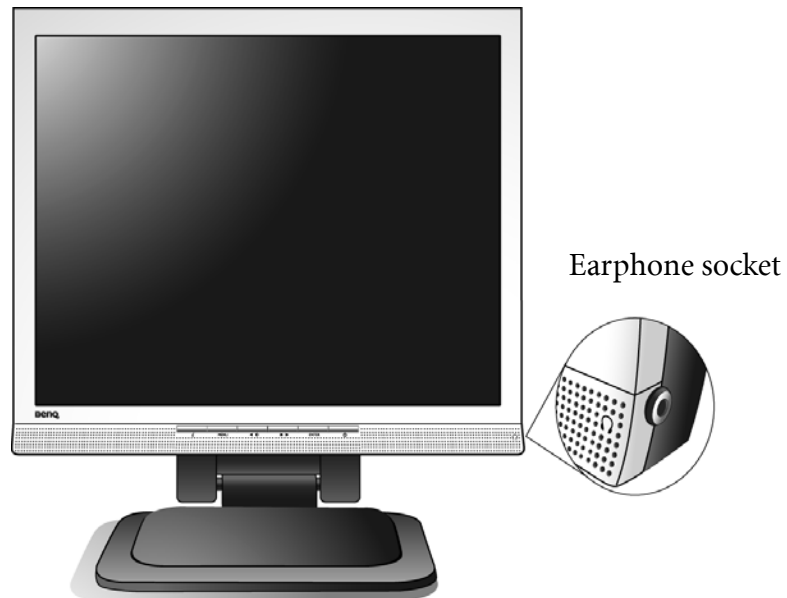

Back view



1. Audio cable socket
2. Power AC input jack
3. DVI-D input socket
4. D-Sub input socket

3. How to assemble your monitor hardware

☞ If the computer is turned on you must turn it off before continuing.
Do not plug-in or turn-on the power to the monitor until instructed to do so.

1. Unpack the monitor and place the monitor on the desk as illustrated before you cut the retaining strap.

☞ Please be careful to prevent damage to the monitor. Placing the screen surface on an object like a stapler or a mouse will crack the glass or damage the LCD substrate voiding your warranty. Sliding or scraping the monitor around on your desk will scratch or damage the monitor surround and controls.

Protect the monitor and screen by clearing a flat open area on your desk and placing a soft item like the monitor packaging bag on the desk for padding.

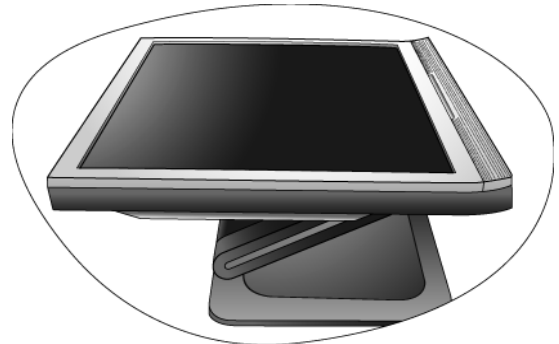

2. Adjust the viewing angle.

Lift the screen upward and then pull the screen forward until a clicking sound is heard.

For more information about the adjustment of the viewing angle, refer to "[Viewing angle adjustment on page 10](#)".

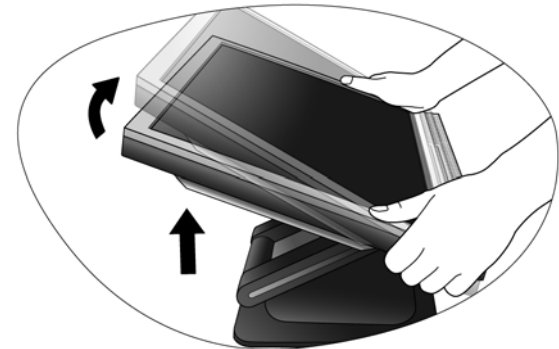

💡 You should position the monitor and angle the screen to minimize unwanted reflections from other light sources.

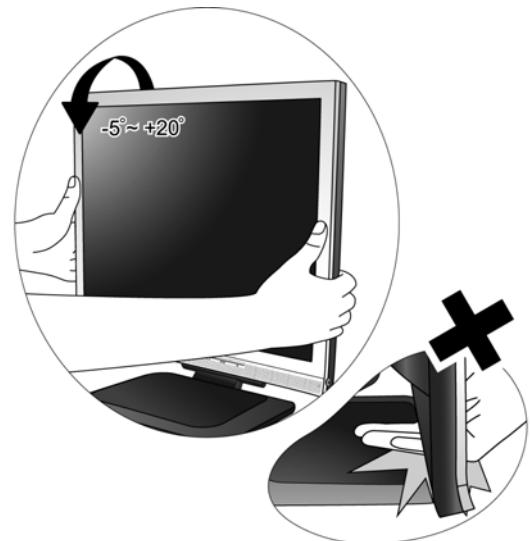

3. Connect the PC video cable.

Do not use both DVI-D cable and D-Sub cable on the same PC. The only case in which both cables can be used is if they are connected to two different PCs with appropriate video systems.

Connect one end of the DVI-D cable to the monitor DVI-D socket and the other end to the DVI-D port on your computer. (optional)

The DVI-D format is used for direct digital connection between source video and digital LCD monitors or projectors. The digital video signals produce a superior quality picture than analog video signals.

Connect the plug of the D-Sub cable (at the end without the ferrite filter) to the monitor D-Sub socket. Connect the other plug of the D-Sub cable (at the end with the ferrite filter) to the computer video D-Sub socket.

Tighten all finger screws to prevent the plugs from accidentally falling out during use.

Either

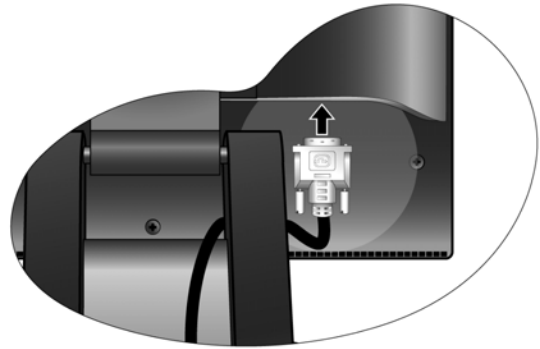

Or

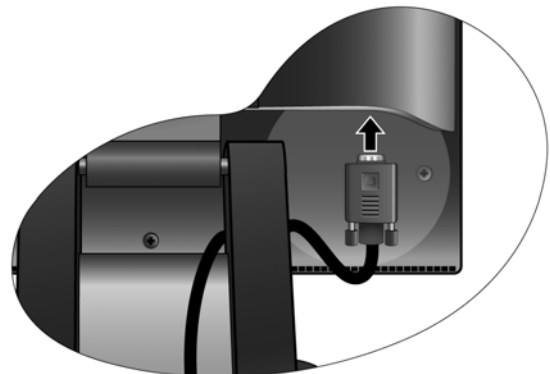

4. Connect the audio cable.

Connect the audio cable between the socket on the rear of the monitor and your computer audio outlet.

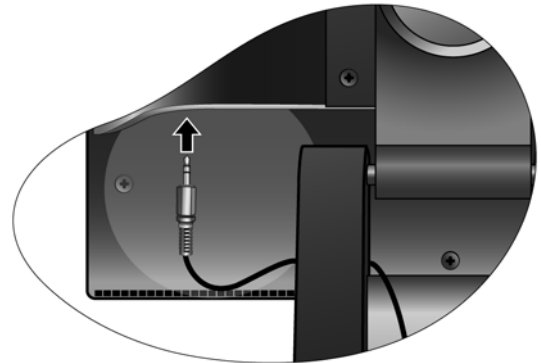

If you wish, you may connect an earphone into the earphone socket located on the side panel of the monitor.

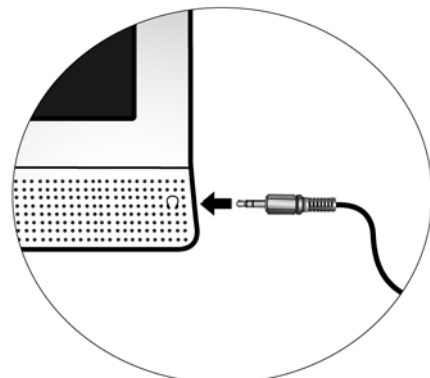

5. Connect the power cable to the monitor.

Plug one end of the power cord into the socket labelled 'POWER IN' on the rear of the monitor. Do not connect the other end to a power point just yet.

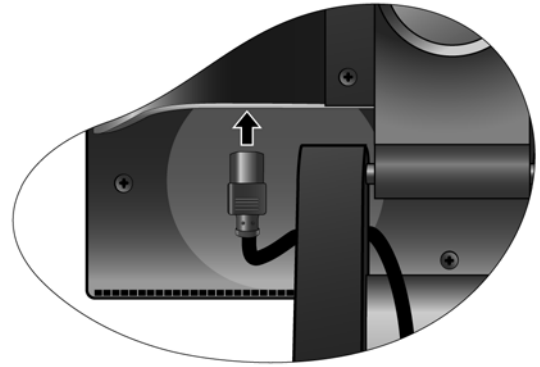

6. Turn on the power.

Plug the other end of the power cord into a electric outlet and turn it on.

Turn on the monitor by pressing the power button on the front of the monitor.

Turn on the computer too, and follow the instructions in Section 4: [Getting the most from your BenQ monitor](#) on page 11 to install the monitor software.

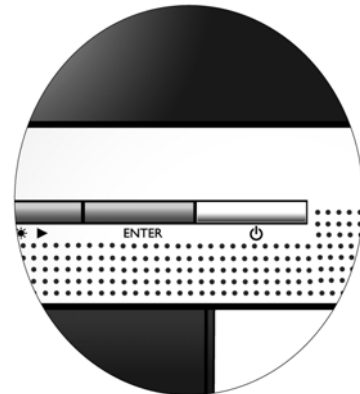
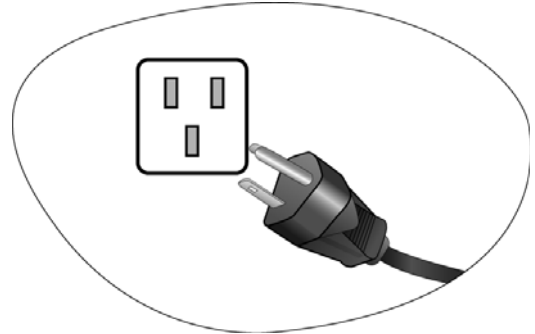

Viewing angle adjustment

You may position the screen to the desired angle with -5° to $+20^{\circ}$ monitor tilt, 360° monitor swivel, and 72 mm (FP73E S)/60 mm (FP93E S) monitor height.

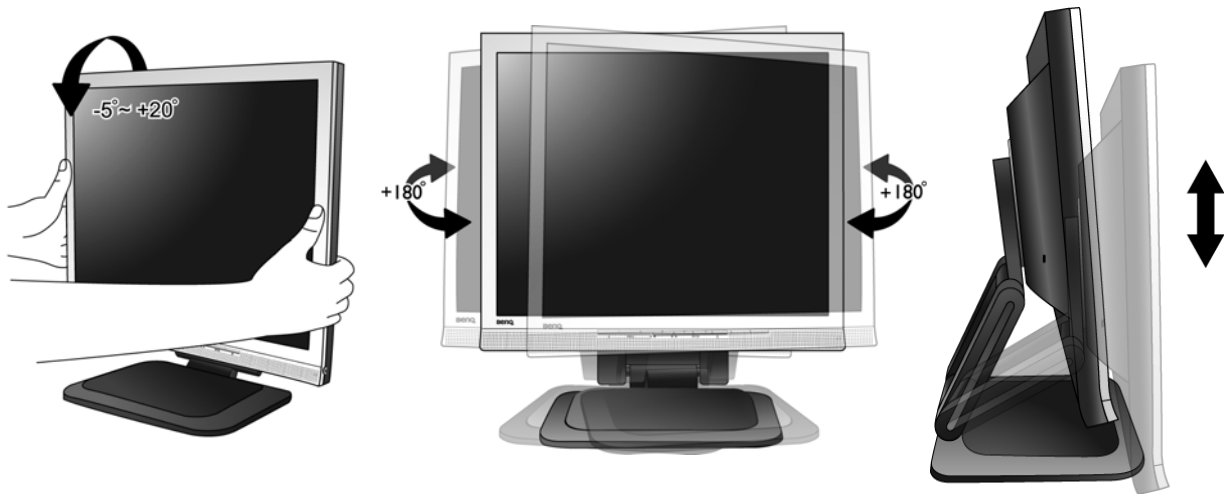

Storing the monitor

If you need to store your monitor for an extended period of time, please unplug your monitor from the electric outlet and all connected cables before any action is taken. It is recommended to pack the monitor in its original equipment.

To pack the display itself

Hold the monitor base with your left hand and gently tilt the display backward with your right hand till the display reaches the second lock. Then push the display back to its place as illustrated.

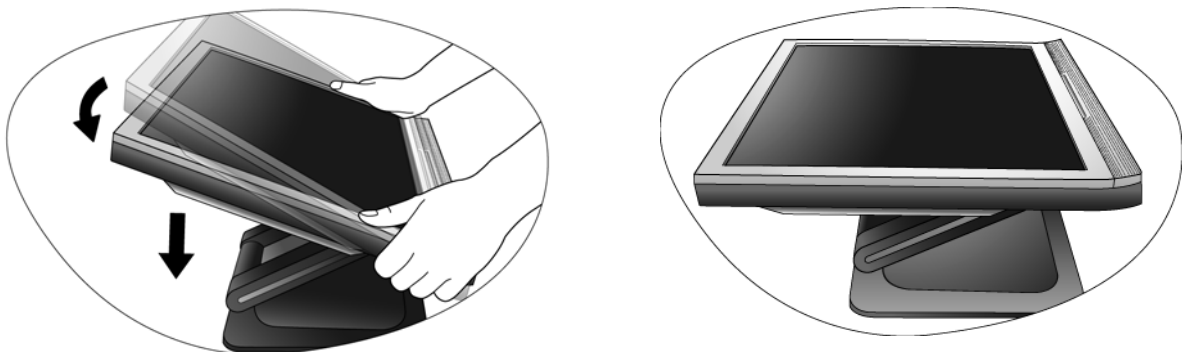

4. Getting the most from your BenQ monitor

To gain the most benefit from your new BenQ color LCD flat screen monitor, you should install the custom BenQ LCD Monitor driver software as provided on the BenQ LCD Monitor CD-ROM.

The circumstances under which you connect and install your BenQ LCD Monitor will determine which process you need to follow to successfully install the BenQ LCD Monitor driver software. These circumstances relate to which version of Microsoft Windows you are using, and whether you are connecting the monitor and installing the software onto a new computer (without existing monitor driver software), or whether you are upgrading an existing installation (which already has existing monitor driver software) with a newer monitor.

In either case however, the very next time you turn on your computer (after connecting the monitor to your computer), Windows will automatically recognise the new (or different) hardware, and will launch its **Found New Hardware** wizard.

Follow the wizard instructions until it asks you to select a monitor model. At that point, click the **Have Disk** button, insert the BenQ LCD Monitor CD-ROM and select the appropriate monitor model. Further details and step-by-step instructions for both an automatic (new) or upgrade (existing) installation follow. See:

- [How to install the monitor on a new computer on page 12.](#)
- [How to upgrade the monitor on an existing computer on page 13](#)

 If you require a User Name and Password to login to your Windows computer, you must be logged on as an Administrator or as a member of the Administrators group in order to install the monitor driver software. Furthermore, if your computer is connected to a network which has security access requirements, network policy settings may prevent you from installing software on your computer.

How to install the monitor on a new computer

This instruction details the procedure for selecting and installing the BenQ LCD Monitor driver software on a new computer which has never had a monitor driver installed before. This instruction is only suitable for a computer which has never been used before, and for which the BenQ LCD Monitor is the first ever monitor to be connected to it.

 If you are adding the BenQ LCD Monitor to an existing computer that has already had another monitor connected to it (and has monitor driver software installed), you should not be following these instructions. You should instead be following the instructions for How to upgrade the monitor on an existing computer.

1. Follow the instructions in [How to assemble your monitor hardware on page 7](#).
When Windows starts, it will automatically detect the new monitor and launch the **Found New Hardware Wizard**. Follow the prompts until it displays the option to **Install Hardware Device drivers**.
2. Insert the BenQ LCD Monitor CD-ROM into a CD drive on the computer.
3. Check **Search for a suitable driver for my device** option, and click **Next**.
4. Check the option for **CD-ROM drives** (uncheck all others) and click **Next**.
5. Look to confirm that the wizard has selected the correct name of your monitor as “BenQ FP73ES/FP93ES” and click **Next**.
6. Click **Finish**.
7. Restart the computer.

How to upgrade the monitor on an existing computer

This instruction details the procedure for manually updating the existing monitor driver software on your Microsoft Windows computer. It is currently tested as compatible (and recommended only) for Windows XP and Windows Vista Operating System (OS).

 The BenQ LCD Monitor driver for your model may well function perfectly with other versions of Windows, however, as at the time of writing, BenQ has done no testing of this driver on other versions of Windows and cannot guarantee its operation on those systems.

Installing monitor driver software involves selecting an appropriate information file (.inf) on the BenQ LCD Monitor CD-ROM for the particular model monitor you have connected, and letting Windows install the corresponding driver files from the CD. You need only steer it in the right direction.

See:

- [How to install on Windows Vista systems on page 14.](#)
- [How to install on Windows XP system on page 15.](#)

How to install on Windows Vista systems

1. Open **Display Settings**.

Right-click the desktop and select **Personalize** from the popup menu.

Select **Display Settings** from the **Personalize appearance and sounds** window.

The **Display Settings** window will display.

2. Click the **Advanced Settings** button.

The **Generic PnP Monitor Properties** window will display.

3. Click the **Monitor** tab and the **Properties** button.

4. Click **Continue** in the prompted **User Account Control** window.

5. Click the **Driver** tab and the **Update Driver** button.

6. Insert the BenQ LCD Monitor CD-ROM into a CD drive on the computer.

7. In the **Update Driver Software** window, select the option '**Browse my computer for driver software**'.

8. Click '**Browse**' and select **Driver>Windows Vista>FP73ES/FP93ES** from the CD, and click the **Next** button.

This will copy and install the appropriate monitor driver files to your computer.

9. Click **Close**.

You do not need to restart Windows Vista, as the BenQ LCD monitor drivers will operate immediately with no further action required by you.

How to install on Windows XP system

1. Open **Display Properties**.

The quickest shortcut to **Display Properties** is through the Windows desktop. Right-click the desktop and select **Properties** from the popup menu.

Alternatively, the Windows menu to **Display Properties** is located in **Control Panel**.

In Windows XP version, **Control Panel** is located directly under the main **Start** menu item. The menu options displayed will depend upon which type of view is selected for your system.

- Under the Classic view, click **Start | Control Panel | Display**.
- Under the Category view, click **Start | Control Panel | Appearance and Themes | Change the screen resolution**.

The **Display Properties** window will display.

2. Click the **Settings** tab and the **Advanced** button.

The **Advanced Display Properties** window will display.

3. Click the **Monitor** tab and select the 'Plug and Play Monitor' from the list.

If there is only one monitor in the list, it will already be selected for you.

4. Click the **Properties** button.

The **Monitor Properties** window will display.

If the driver provider is listed as BenQ, and the model matches that of your new monitor, the proper drivers are already installed, and you need do nothing further. Cancel out of these property windows. However, if BenQ is not listed as the manufacturer, or the correct model is not currently shown, you will need to continue with these instructions.

5. Click the **Driver** tab and the **Update Driver** button.

The **Hardware Update Wizard** will display. Follow the wizard instructions noting the steps below:

6. Insert the BenQ LCD Monitor CD-ROM into a CD drive on the computer you attached the monitor to.

7. Check the option '**Install from a list or specific location**' and click **Next**.

8. Check the option '**Search for the best driver in these locations**' and also check '**Search removable media**', then click **Next**.

Please wait while the wizard searches for drives and the BenQ LCD Monitor CD inserted in step 6. When complete, the wizard should have found and selected the BenQ driver on the CD appropriate to your monitor model, in this case 'BenQ FP73ES/BenQ FP93ES' in the location 'd:\Driver\Windows XP\FP73ES\FP93ES\FP73ES.inf\FP93ES.inf' or similar.

 The drive letter for your CD drive may differ from the example above depending upon your system – it may be 'D:' or 'E:' or 'F:' etc.

9. Select (single-click) the file named '**FP73ES/FP93ES**' on the CD, and click the **Next** button.

This will copy and install the appropriate monitor driver files to your computer.

10. Click **Finish**.

This will close the wizard and return you to the **Monitor Properties** window, now renamed **BenQ FP73ES/FP93ES Properties**.

11. Click **Close, OK, and OK**.

This will close the **Display Properties** windows. You do not need to restart Windows XP, as the BenQ LCD monitor drivers will operate immediately with no further action required by you.

5. How to adjust the screen resolution

Due to the nature of liquid crystal display (LCD) technology, the screen resolution is always fixed. The best possible picture for your FP73E S/FP93E S is achieved with a resolution of 1280 x 1024. This is called “Native Resolution” or maximal resolution – that is, the clearest picture. Lower resolutions are displayed on a full screen through an interpolation circuit. Image blurring across pixel boundaries can occur with the interpolated resolution depending upon the image type and its initial resolution.

 To take full advantage of LCD technology you should select the native resolution setting of 1280 x 1024.

1. Open **Display Properties** and select the **Settings** tab.

You can open **Display Properties** by right-clicking on the Windows desktop and selecting **Properties** from the pop-up menu.

2. Use the slider in the ‘Screen area’ section to adjust the screen resolution.

Select the recommended resolution of 1280 x 1024 then click **Apply**.



If you select some other resolution, be aware that this other resolution is interpolated and may not accurately display the screen image as well as it could do at the native resolution setting.

3. Click **OK** then **Yes**.
4. Close the **Display Properties** window.

6. How to adjust the screen refresh rate

You don't have to choose the highest possible refresh rate on an LCD display, because it is not technically possible for an LCD display to flicker. The best results are obtained by using the factory modes already set in your computer. There is a table with the factory modes in the specification section of this User Manual: [Supported PC Timings on page 34](#)





You can choose 60, 70 and 75 Hertz, (but not 72Hz) for the native resolution of 1280 x 1024.

1. Double click the **Display** icon in **Control Panel**.
2. From the **Display Properties** window, select the **Settings** tab and click the **Advanced** button.
3. Select the **Adapter** tab, and select an appropriate refresh rate to match one of the applicable factory modes as listed in the specification table.
4. Click **Change**, **OK**, then **Yes**.
5. Close the **Display Properties** window.

7. Picture optimization

The easiest way to obtain an optimal display from an analog (D-Sub) input is to use the *i* key function. Press the *i* key to optimize the currently displayed image to the screen.

 When you connect a digital video output using a digital (DVI) cable to your monitor, the *i* key and the Auto Adjustment function will be disabled, because the monitor will automatically display the best image.

 Please ensure that the connected graphic card on your computer is set to the native resolution of the monitor (1280 x 1024) when you use the *i* key function.

If you wish, you can always adjust the screen geometric settings manually using geometry menu items. To assist you in this endeavour, BenQ has provided a screen test image utility which you can use to check for screen color, grayscale and line gradient display.

1. Run the test program auto.exe from CD-ROM. You could also use any other image, such as the desktop of your operating system. However, we recommend that you use auto.exe. As you run auto.exe, a test pattern displays.
2. Press the *i* key on the monitor.
3. Press the **MENU** key to access the monitor On-Screen Display (OSD) menu.
4. Use the ◀ or ▶ keys to select **DISPLAY** and press the **ENTER** key to enter the menu.
5. If you notice a vertical noise (like a curtain effect-shimmering of vertical lines), press the ◀ or ▶ keys to select **Pixel Clock** and press the **ENTER** key. Then press the ◀ or ▶ keys to adjust the monitor until the noise disappears.
6. If you notice a horizontal noise, press the ◀ or ▶ keys to select **Phase** and press the **ENTER** key. Then press the ◀ or ▶ keys adjust the monitor until the noise disappears.

8. How to adjust your monitor

The control panel

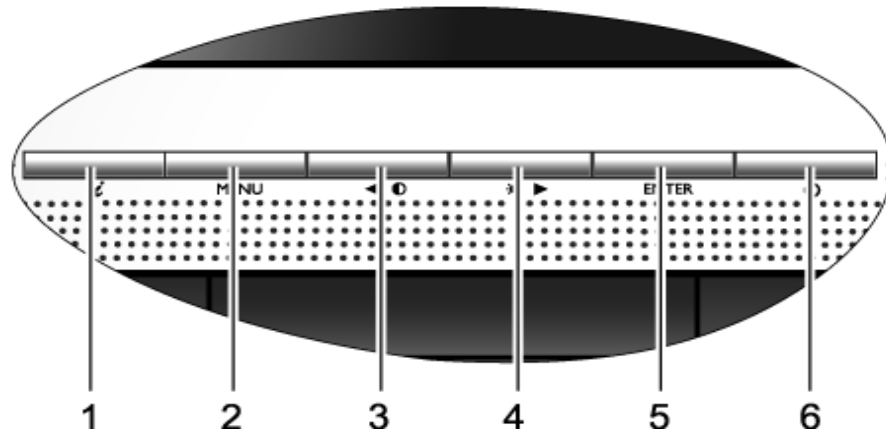

1. “ikey”: Adjust vertical position, phase, horizontal position and pixel clock automatically.
2. “MENU” key: Activate OSD main menu and return to the previous menu or exit OSD.
3. ◀ (Left) key: For Left/Decrease adjustment. Left key is the hot key for Contrast.
4. ▶ (Right) key: For Right/Increase adjustment. Right key is the hot key for Brightness.
5. “ENTER” key: Enter sub menus and select items.
6. “Power”: Turn the power on or off.



OSD = On Screen Display.

The hot-keys will display a graduated scale for adjusting the value of that setting, and will only operate whilst the OSD menu is not currently displaying. Hot-key displays will disappear after a few seconds of no key activity. See [Hot key mode on page 21](#).

On Screen Display (OSD) menu structure

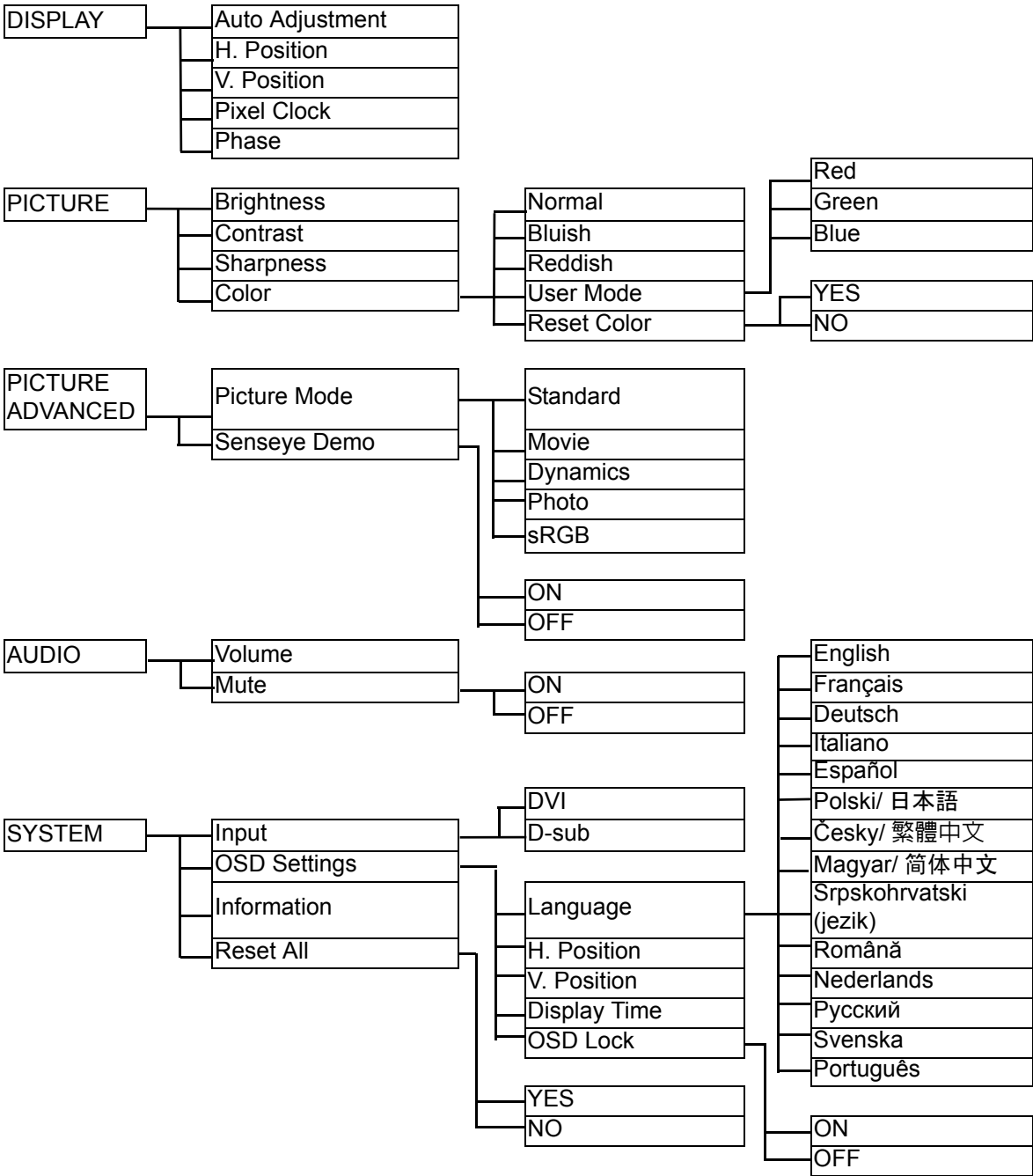

Hot key mode

The monitor keys perform as hotkeys to provide direct access to particular functions whenever the menu isn't currently displaying on-screen.

Brightness hot key



Press the **▶** key to display the **Brightness** indicator. Further press the **▶** key to increase or the **◀** key to decrease the screen brightness, and press the **MENU** key to exit.

Contrast hot key



Press the **◀** key to display the **Contrast** indicator. Further press the **▶** key to increase or the **◀** key to decrease the screen contrast, and press the **MENU** key to exit.

Volume hot key



Press the **ENTER** key to enter the **Volume** indicator. Further press the **▶** key to increase or the **◀** key to decrease the volume, and press the **MENU** key to exit.

Main menu mode

You can use the OSD (On Screen Display) menu to adjust all the settings on your monitor. Press the **MENU** key to display the following main OSD menu.

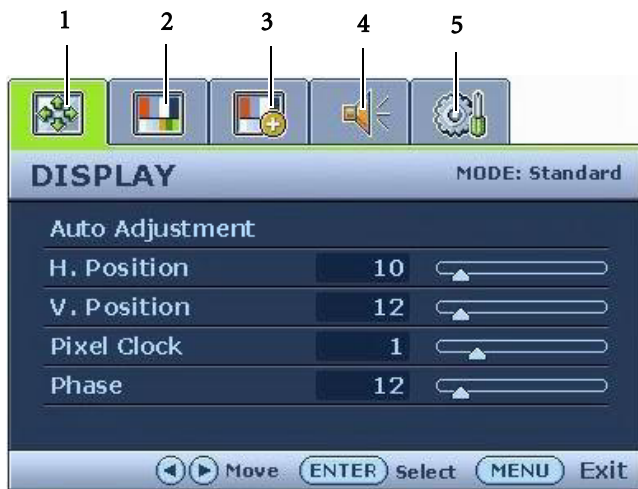

There are five main OSD menus:

1. Display
2. Picture
3. Picture Advanced
4. Audio
5. System

Use the ◀ (left) or ▶ (right) keys to highlight a menu item, and press the **ENTER** key to enter the Menu item settings.



There are 14 different menu languages, see “[Language on page 30](#)” under “OSD Settings” for more details.

For more information on each menu, please refer to the following pages:

- [Display menu on page 23](#)
- [Picture menu on page 25](#)
- [Picture Advanced menu on page 27](#)
- [Audio menu on page 29](#)
- [System menu on page 30](#)

Display menu

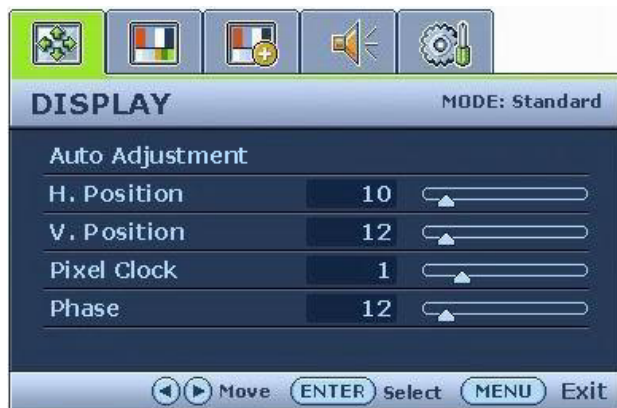

1. Press the **MENU** key to display the main menu.
2. Press the ◀ or ▶ keys to select **DISPLAY** and then press the **ENTER** key to enter the menu.
3. Press the ◀ or ▶ keys to move the highlight to a menu item and then press the **ENTER** key to select that item.
4. Press the ◀ or ▶ keys to make adjustments or selections.
5. To return to the previous menu, press the **MENU** button.

Item	Function	Operation	Range
Auto Adjustment	<p>Optimizes and adjusts the screen settings automatically for you. The <i>i</i> key is a 'hot-key' for this function.</p> <p>☞ When you connect a digital video output using a digital (DVI) cable to your monitor, the <i>i</i> key and the Auto Adjustment function will be disabled.</p>	Press the ENTER key to select this option and make adjustment.	

H. Position	Adjusts the horizontal position of the screen image.	Press the ◀ or ▶ keys to adjust the value.	0 to 100
V. Position	Adjusts the vertical position of the screen image.		0 to 100
Pixel Clock	Adjusts the pixel clock frequency timing to synchronize with the analog input video signal. Not applicable to a digital input signal. See also: Picture optimization on page 18		0 to 100
Phase	Adjusts the pixel clock phase timing to synchronize with the analog input video signal. Not applicable to a digital input signal. See also: Picture optimization on page 18		0 to 63

Picture menu



1. Press the **MENU** key to display the main menu.
2. Press the ◀ or ▶ keys to select **PICTURE** and then press the **ENTER** key to enter the menu.
3. Press the ◀ or ▶ keys to move the highlight to a menu item and then press the **ENTER** key to select that item.
4. Press the ◀ or ▶ keys to make adjustments or selections.
5. To return to the previous menu, press the **MENU** button.

Item	Function	Operation	Range
Brightness	Adjusts the balance between light and dark shades.	Press the ▶ key to increase the brightness and press the ◀ key to decrease the brightness.	0 to 100
Contrast	Adjusts the degree of difference between darkness and lightness.	Press the ▶ key to increase the contrast and press the ◀ key to decrease the contrast.	0 to 100
Sharpness	Adjusts the clarity and visibility of the edges of the subjects in the image.	Press the ▶ key to improve the crispness of the display and press the ◀ key to have softness effect on the display.	1 to 5
Color - Press ENTER to enter the Color menu.			

Normal	Allows video and still photographs to be viewed with natural coloring. This is the factory default color.	Press the ◀ or ▶ keys to select this option.	
Bluish	Applies a cool tint to the image and is factory pre-set to the PC industry standard white color.		
Reddish	Applies a warm tint to the image and is factory pre-set to the news print standard white color.		
User Mode	Tailors the image color tint. The blend of the Red, Green and Blue primary colors can be altered to change the color tint of the image. The default start setting is 50. Decreasing one or more of the colors will reduce their respective influence on the color tint of the image. e.g. if you reduce the Blue level the image will gradually take on a yellowish tint. If you reduce Green, the image will become a magenta tint.	Press the ◀ or ▶ keys and the ENTER key to select Red, Green, or Blue . Then use the ◀ or ▶ keys to make the color adjustments.	<ul style="list-style-type: none"> • Red (0 to 100) • Green (0 to 100) • Blue (0 to 100)
Reset Color	Resets the User Mode custom color settings to the factory defaults.	Press the ◀ or ▶ keys to change the settings.	<ul style="list-style-type: none"> • YES • NO

Picture Advanced menu



1. Press the **MENU** key to display the main menu.
2. Press the ◀ or ▶ keys to select **PICTURE ADVANCED** and then press the **ENTER** key to enter the menu.
3. Press the ◀ or ▶ keys to move the highlight to a menu item and then press the **ENTER** key to select that item.
4. Press the ◀ or ▶ keys to make adjustments or selections.
5. To return to the previous menu, press the **MENU** button.

Item	Function	Operation	Range
Picture Mode	<p>Selects a picture mode that best suits the type of images shown on the screen.</p> <ul style="list-style-type: none"> • Standard - for basic PC application. • Movie - for viewing videos. • Dynamics - for viewing landscape-specific videos and playing games. • Photo - for viewing still images. • sRGB - for better color matching representation with the peripheral devices, such as printers, DSCs, etc. 	Press the ◀ or ▶ keys to change the settings.	<ul style="list-style-type: none"> • Standard • Movie • Dynamics • Photo • sRGB

Senseye Demo	Displays the preview of screen images under the selected mode from Picture Mode . The screen will be divided into two windows; the left window demonstrates images of Standard mode, while the right window presents the images under the specified mode.	Press the ◀ or ▶ keys to change the settings.	<ul style="list-style-type: none">• ON• OFF
--------------	--	---	--

Audio menu

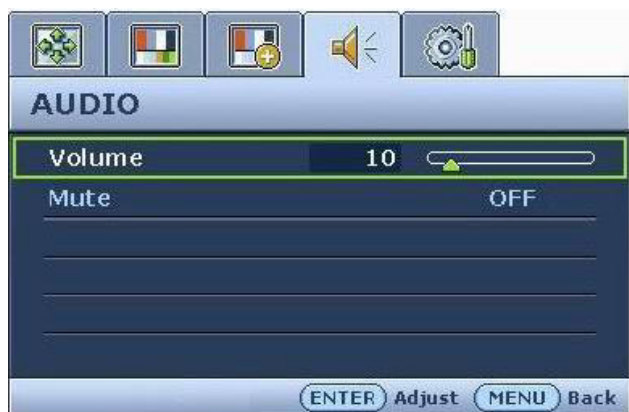

1. Press the **MENU** key to display the main menu.
2. Press the ◀ or ▶ keys to select **AUDIO** and then press the **ENTER** key to enter the menu.
3. Press the ◀ or ▶ keys to move the highlight to a menu item and then press the **ENTER** key to select that item.
4. Press the ◀ or ▶ keys to make adjustments or selections.
5. To return to the previous menu, press the **MENU** button.

Item	Function	Operation	Range
Volume	Adjusts the level of volume.	Press the ▶ key to increase the volume and press the ◀ key to decrease the volume.	0 to 100
Mute	Mutes the audio input.	Press the ◀ or ▶ keys to adjust the value.	<ul style="list-style-type: none"> • ON • OFF

System menu



1. Press the **MENU** key to display the main menu.
2. Press the ◀ or ▶ keys to select **SYSTEM** and then press the **ENTER** key to enter the menu.
3. Press the ◀ or ▶ keys to move the highlight to a menu item and then press the **ENTER** key to select that item.
4. Press the ◀ or ▶ keys to make adjustments or selections.
5. To return to the previous menu, press the **MENU** button.

Item	Function	Operation	Range
Input	Selects the D-sub (analog) or DVI (digital) input. Use this to change the input to that appropriate to your video cable connection type.	Press the ◀ or ▶ keys to adjust the value.	<ul style="list-style-type: none"> • DVI • D-sub
OSD Settings - Press ENTER to enter the OSD Settings menu.			
Language	Sets the OSD menu language.	Press the ◀ or ▶ keys to adjust the value. ☞ The language options displayed on your OSD may differ from those shown on the right, depending on the product supplied in your region.	<ul style="list-style-type: none"> • English • Français • Deutsch • Italiano • Español • Polski/ 日本語 • Česky/ 繁體中文 • Magyar/ 简体中文 • SICG/BiH/ CRO • Română • Nederlands • Русский • Svenska • Português

H. Position	Adjusts the horizontal position of the OSD menu.	Press the ◀ or ▶ keys to adjust the value.	0 to 100
V. Position	Adjusts the vertical position of the OSD menu.		0 to 100
Display Time	Adjusts the display time of the OSD menu.		<ul style="list-style-type: none"> • 5 sec. • 10 sec. • 15 sec. • 20 sec. • 25 sec. • 30 sec.
OSD Lock	Prevents all the monitor settings from being accidentally changed. When this function is activated, the OSD controls and hotkey operations will be disabled.	<p>Press the ◀ or ▶ keys to adjust the value.</p> <p> To unlock the OSD controls when the OSD is preset to be locked, press and hold the 'MENU' button for 15 seconds to enter the 'OSD Lock' option and make changes. Alternatively, you may use the ◀ or ▶ keys to select 'OFF' in the 'OSD Lock' submenu from the 'OSD Settings' menu, and all OSD controls will be accessible.</p>	<ul style="list-style-type: none"> • ON • OFF
Press MENU to leave the OSD Settings menu.			
Information	Displays the current monitor property settings.	Press the ENTER key to select this option.	
Reset All	Resets all mode, color and geometry settings to the factory default values.	Press the ◀ or ▶ keys to adjust the value.	<ul style="list-style-type: none"> • YES • NO

9. Troubleshooting

Frequently asked questions (FAQ)

② The image is blurred:

☞ Read the [How to adjust the screen resolution on page 16](#) section, and then select the correct resolution, refresh rate and make adjustments based on these instructions.

☞ How do you use a VGA extension cable?

Remove the extension cable for the test. Is the image now in focus? If not, optimize the image by working through the instructions in the [How to adjust the screen refresh rate on page 17](#) section. It is normal for blurring to occur due to conduction losses in extension cables. You can minimize these losses by using an extension cable with better conduction quality or with a built-in booster.

☞ Does the blurring only occur at resolutions lower than the native (maximum) resolution?

Read the [How to adjust the screen resolution on page 16](#) section. Select the native resolution.

② Pixel errors can be seen:

☞ One of several pixels is permanently black, one or more pixels are permanently white, one or more pixels are permanently red, green, blue or another color.

- Clean the LCD screen.
- Cycle power on-off.
- These are pixels that are permanently on or off and is a natural defect that occurs in LCD technology.

② The image has a faulty coloration:

☞ It has a yellow, blue or pink appearance.

Select MENU > PICTURE > Color > Reset Color, and then choose “YES” in the “Caution” message box to reset the color settings to the factory defaults.

If the image is still not correct and the OSD also has faulty coloration, this means one of the three primary colors is missing in the signal input. Now check the signal cable connectors. If any pin is bent or broken off, please contact your dealer to get necessary support.

② No image can be seen:

☞ Is the prompt on the display illuminated in green?

If the LED is illuminated in green and there is a message “Out of Range” on the screen, this means you are using a display mode that this monitor does not support, please change the setting to one of the supported mode. Please read “[Supported PC Timings on page 34](#)” section.

② Faint shadow from the static image displayed is visible on the screen:

- Activate the power management function to let your computer and monitor go into a low power "sleep" mode when not actively in use.
- Use a screensaver to prevent the occurrence of image retention.

② Is the prompt on the display illuminated in orange?

If the LED is illuminated in orange, the power management mode is active. Press any button on the computer keyboard or move the mouse. If that does not help, check the signal cable connectors. If any pin is bent or broken off, please contact your dealer to get necessary support.

☞ Is the prompt on the display not illuminated at all?

Check the power supply mains socket, the external power supply and the mains switch.

② The image is distorted, flashes or flickers:

☞ Read the [How to adjust the screen resolution on page 16](#) section and then select the correct resolution, refresh rate and make adjustments based on these instructions.

② The image is displaced in one direction:

☞ Read the [How to adjust the screen resolution on page 16](#) section and then select the correct resolution, refresh rate and make adjustments based on these instructions.

② The OSD controls are inaccessible:

- To unlock the OSD controls when the OSD is preset to be locked, press and hold the “MENU” key for 15 seconds to enter the “OSD Lock” option and make changes.
- Alternatively, you may use the ◀ or ▶ keys to select “OFF” in the “OSD Lock” submenu from the “OSD Settings” menu (under SYSTEM), and all OSD controls will be accessible.

Need more help?

If your problems remain after checking this manual, please contact your place of purchase or e-mail us at: Support@BenQ.com

10. Supported PC Timings

Incoming display mode (Input timing)				
Resolution	Horizontal Frequency (KHz)	Vertical Frequency (Hz)	Pixel Frequency (MHz)	Comment
640 x 350	31.47(P)	70.08(N)	25.17	DOS
720 x 400	31.47(N)	70.08(P)	28.32	DOS
640 x 480	31.47(N)	60.00(N)	25.18	DOS
640 x 480	35.00(N)	67.00(N)	30.24	Macintosh
640 x 480	37.86(N)	72.80(N)	31.50	VESA
640 x 480	37.50(N)	75.00(N)	31.50	VESA
800 x 600	35.16(P)	56.25(P)	36.00	VESA
800 x 600	37.88(P)	60.32(P)	40.00	VESA
800 x 600	48.08(P)	72.19(P)	50.00	VESA
800 x 600	46.87(P)	75.00(P)	49.50	VESA
832 x 624	49.72(N)	74.55(N)	57.29	Macintosh
1024 x 768	48.36(N)	60.00(N)	65.00	VESA
1024 x 768	56.48(N)	70.10(N)	75.00	VESA
1024 x 768	60.02(P)	75.00(P)	78.75	VESA
1152 x 864	67.50(P)	75.00(P)	108.00	VESA
1152 x 870	68.68(N)	75.06(N)	100.00	Macintosh
1152 x 900	61.80(N)	66.00(N)	94.50	SUN 66
1152 x 900	71.81(N)	76.14(N)	108.00	SUN
1280 x 1024	64.00(P)	60.00(P)	108.00	VESA
1280 x 1024	75.83(N)	71.53(N)	128.00	IBMI
1280 x 1024	80.00(P)	75.00(P)	135.00	VESA
1280 x 1024	81.18(N)	76.16(N)	135.09	SPARC2

- Modes not listed in the table may not be supported. For an optimal picture, we recommended you choose a mode listed in the table above.
- There are 22 available modes that are compatible with Windows.
- Image disruption may occur as a result of signal frequency differences from graphic cards which do not correspond with the usual standard. This is not, however, an error. You may improve this situation by altering an automatic setting or by manually changing the phase setting and the pixel frequency from the “DISPLAY” menu.
- If you switch off the monitor, interference lines can occur on your screen. But do not be concerned about this, as it is normal.
- To extend the service life of the product, we recommend that you use your computer's power management function.

11. Specifications

BenQ FP73E S

Model	FP73E S
Display type	17.0", active, TFT
Viewable diagonal	432 mm
Native (maximum) resolution	1,280 x 1,024
Colors	16.7 million
Contrast / Brightness	800:1 / 300 cd/m ²
Response time	5 ms
Viewing angle (left/right, up/down)	160, 160 (CR _≥ 10) 170, 170 (CR _≥ 5)
Line frequency	31 - 83 kHz Multi- frequency monitor
Image frequency	56 - 76 Hz modes within these parameters
Image diagnostics	Digital, OSD Technology, <i>i</i> key (automatic image setting)
Controls	5 buttons and <i>i</i> key.
Functions	Contrast, brightness, vert. & hor. image position, phase, pixel clock, color balance, color palette, multiple-language OSD, OSD position, input selection, picture mode, Senseye demo
Power management	VESA DPMS, EPA
Max. power consumption	45 Watt
Standby power consumption	< 1 Watt
	 This product comply with ENERGY STAR® Program Requirements Computer Monitors. Version 4.0
Input signal	
PC	RGB analog 0.7 Vpp/75 Ohm positive Digital: DVI-D (optional)
Speaker	1 W x 2
Synchronization	TTL separate signal connection 15-pin mini D-sub cable
Temperature (operating)	0 °C - 40 °C
Air humidity (operating)	10% - 90%
Certifications	TCO 03, TÜV/Ergonomics, TÜV/ GS, FCC Class B, ISO 13406-2, VCCI, CB Report, CE, C-Tick, BSMI, Fimko, GOST, CSA, CCC, eK

Operating voltage	Automatic switched mode power supply, 100-240 V, 50-60 Hz
Tilt (down/up)	-5° ~ +20 °
Swivel (left/right)	180°/180°
Height adjustment	72 mm
Dimensions (H x W x D)	416.1 x 371.6 x 222 mm
Weight	6.2 kg

BenQ FP93E S

Model	FP93E S
Display type	19.0", active, TFT
Viewable diagonal	480 mm
Native (maximum) resolution	1,280 x 1,024
Colors	16.7 million
Contrast / Brightness	800:1 / 300 cd/m ²
Response time	5 ms
Viewing angle (left/right, up/down)	160, 160 (CR _≥ 10)
Line frequency	31 - 83 kHz Multi- frequency monitor
Image frequency	56 - 76 Hz modes within these parameters
Image diagnostics	Digital, OSD Technology, <i>i</i> key (automatic image setting)
Controls	5 buttons and <i>i</i> key.
Functions	Contrast, brightness, vert. & hor. image position, phase, pixel clock, color balance, color palette, multiple-language OSD, OSD position, input selection, picture mode, Senseye demo
Power management	VESA DPMS, EPA
Max. power consumption	50 Watt
Standby power consumption	< 1 Watt
	 This product comply with ENERGY STAR® Program Requirements Computer Monitors. Version 4.0
Input signal	
PC	RGB analog 0.7 Vpp/75 Ohm positive Digital: DVI-D (optional)
Speaker	1 W x 2
Synchronization	TTL separate signal connection 15-pin mini D-sub cable
Temperature (operating)	0 °C - 40 °C
Air humidity (operating)	10% - 90%
Certifications	TCO 03, TÜV/Ergonomics, TÜV/ GS, FCC Class B, ISO 13406-2, VCCI, CB Report, CE, C-Tick, BSMI, Fimko, GOST, CSA, CCC, eK

Operating voltage	Automatic switched mode power supply, 100-240 V, 50-60 Hz
Tilt (down/up)	-5° ~ +20 °
Swivel (left/right)	180°/180°
Height adjustment	60 mm
Dimensions (H x W x D)	429 x 409.2 x 222 mm
Weight	6.76 kg