

Control Real-Time Flowchart for Symmetrical Components of the Power Systems

S. Costinas, C. Zoller and R. Dobra

Abstract--The symmetry of voltages, among other parameters, into real power networks, is essential for ensuring optimum performances of the electrical systems and a standard quality of energy. To control this, there are specific electric and electronic relays, which are hardware programmed to survey symmetrical components of currents and voltages, [1], [2]. The paper describes a fast flowchart to control the positive sequence, negative sequence and zero sequence components of voltages and currents that are generated into the real power systems, using the facilities of the *VEE Pro* software – for simulation and a data acquisition board – for real time control with the *PC*, as a complex protective relaying.

Index Term-- Data acquisition, Flowcharts, Industrial power systems, Protective relaying, Power quality, Sampling methods, Voltage control.

I. INTRODUCTION

REAL power systems must be symmetrical and balanced, so for practical purposes they must be analyzed consequently [3]. Frequently the degree of unbalance cannot be neglected [4]. Such cases may occur during emergency conditions like unsymmetrical faults (one or two-phase short-circuiting), unbalanced loads, open conductors, unsymmetrical operation of rotating machines, etc [5], [6]. Electrical power systems require specific standards regarding energy quality [7]. For this reason, we have developed a digital technologies based on a peculiar fast flowchart which provides information in real time on symmetrical components generated by the asymmetry of the systems in their abnormal operating conditions. Reference [8] shows an example of fast method for identification of symmetrical components for power system protection.

Electrotechnical general theory offers mathematical models based on Fortescue theorem, [9]. Such cases may be calculated analytically or graphically with specific difficulties when superposition theory can be applied (on linear presumed systems).

The key idea of symmetrical component analysis is to discompose any unbalanced (unsymmetrical) three-phase system of phasors into three balanced systems of phasors, know as the: positive sequence system, negative sequence system and zero sequence system.

Any arbitrary set of three phasors, say $\underline{V}_a, \underline{V}_b, \underline{V}_c$, can be represented as a sum of three sequence sets:

$$\begin{aligned}\underline{V}_a &= \underline{V}_a^0 + \underline{V}_a^+ + \underline{V}_a^-; \\ \underline{V}_b &= \underline{V}_b^0 + \underline{V}_b^+ + \underline{V}_b^-; \\ \underline{V}_c &= \underline{V}_c^0 + \underline{V}_c^+ + \underline{V}_c^-.\end{aligned}\quad (1)$$

where $\underline{V}_a^0, \underline{V}_b^0, \underline{V}_c^0$ is the zero sequence set, $\underline{V}_a^+, \underline{V}_b^+, \underline{V}_c^+$ is the positive sequence set and $\underline{V}_a^-, \underline{V}_b^-, \underline{V}_c^-$ is the negative sequence set. The positive sequence set is represented by a balanced system of phasors having the same phase sequence as the original unbalanced system. This set consists of three-phase line-to-neutral voltages supplied by the power system generator and therefore of positive or counterclockwise phase rotation. Thus, the phasors of the positive sequence system are equal in magnitude and displaced from each other by $2\pi/3$.

The negative sequence set is represented by a balanced system of phasors having the opposite phase sequence from the original system and, therefore, a negative phase rotation. The phasors of the negative sequence system are also equal in magnitude and displaced from each other by $2\pi/3$.

The zero sequence system is represented by three single phasors that are equal in magnitude and phase. Note that the zero sequence system is a set of rotating phasors also.

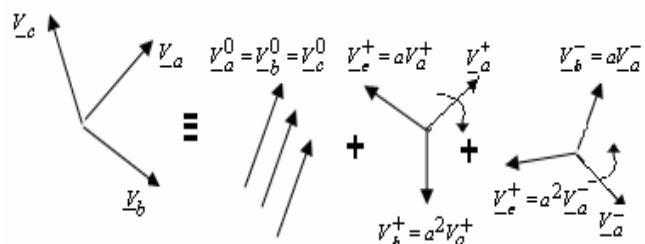

Fig. 1 The symmetrical components of three unbalanced voltages.

Only three of the sequence values are unique, $\underline{V}_a^0, \underline{V}_a^+, \underline{V}_a^-$; the others are determined as follow:

$$a = -\frac{1}{2} + j\frac{\sqrt{3}}{2} \quad \text{and} \quad a^2 = -\frac{1}{2} - j\frac{\sqrt{3}}{2}.\quad (2)$$

in which a and a^2 are phasors operators.

$$\begin{aligned}\underline{V}_a^0 &= \underline{V}_b^0 = \underline{V}_c^0; \\ \underline{V}_b^+ &= a^2 \underline{V}_a^+; \quad \underline{V}_c^+ = a \underline{V}_a^+; \\ \underline{V}_b^- &= a \underline{V}_a^-; \quad \underline{V}_c^- = a^2 \underline{V}_a^-.\end{aligned}\quad (3)$$

S. Costinas is with University of Bucharest, Power Engineering Faculty (e-mail: sorina_costinas@yahoo.com).

C.Zoller is with the University of Petrosani, Electrical and Energetical Department (e-mail:zoller_carol@yahoo.com).

R.Dobra is with the University of Petrosani, Electrical and Energetical Department (e-mail: dobra@upet.ro).

$$\begin{bmatrix} V_a \\ V_b \\ V_c \end{bmatrix} = V_a^0 \begin{bmatrix} 1 \\ 1 \\ 1 \end{bmatrix} + V_a^+ \begin{bmatrix} 1 \\ a^2 \\ a \end{bmatrix} + V_a^- \begin{bmatrix} 1 \\ a \\ a^2 \end{bmatrix} = \begin{bmatrix} 1 & 1 & 1 \\ 1 & a^2 & a \\ 1 & a & a^2 \end{bmatrix} \cdot \begin{bmatrix} V_a^+ \\ V_a^- \\ V_a^0 \end{bmatrix} \quad (4)$$

This being possible because "A", the symmetrical transformation matrix, is different from zero "(5)".

$$A = \begin{bmatrix} 1 & 1 & 1 \\ 1 & a^2 & a \\ 1 & a & a^2 \end{bmatrix} \neq 0. \quad (5)$$

II. THE SIMULATION OF SYMMETRICAL COMPONENTS

For simulation of symmetrical voltage components has synthesized a graphical program using *HPVEE Pro software* [10] whose graphical interface is presented in figure 2, [11]. *HP VEE* is a powerful visual programming language that handles day-to-day programming tasks in instrument control, measurement processing and test reporting. It simplifies test development with enhancements for system integration, debugging, structured program design, and documentation. It automates instrument configuration, accelerates the creation of operator interfaces, streamlines test sequencing, and simplifies application development and management across the *World Wide Web*. It supports *ActiveX® Controls* that add application-specific functionality, and provides *ActiveX Automation* links for seamless integration between *HP VEE* and other applications such as databases, spreadsheets, and word processors.

A *MATLAB/GUI* based fault simulation tool for power system education is presented in [12], [13].

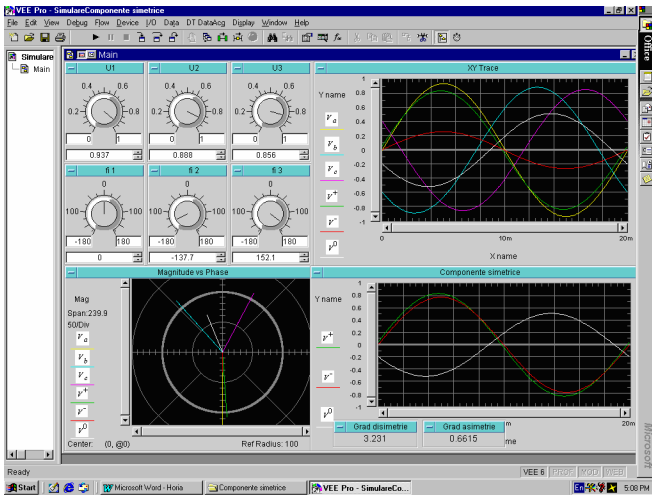

Fig. 2. The simulator interface for direct components.

III. CONTROL REAL-TIME FLOWCHART

A simple algorithm for symmetrical components relaying and monitoring is described in [14].

For real time control of the voltage symmetrical components was developed a peculiar fast flowchart as

presented in figure 3, supported by the temporary voltages. In order to obtain the symmetrical components values the following calculation will be made.

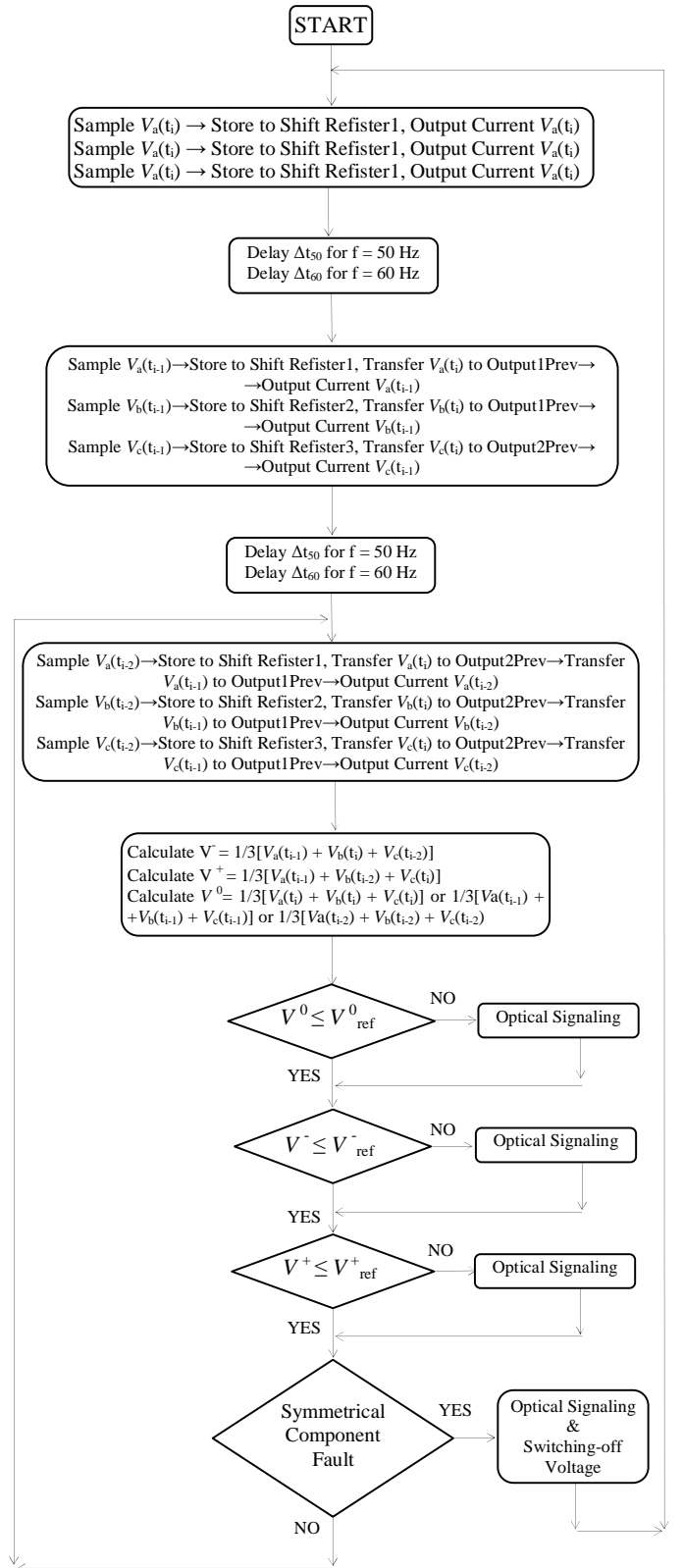

Fig. 3. The flowchart to obtain symmetrical components.

Using these method measurements will be done at different sequence time positions, t_i, t_{i-1}, t_{i-2} respectively, with a specific sampling time of 6.66 [ms] for a 50Hz frequency voltage.

For obtaining zero sequence components must summed three sampling voltages at specific time t_i or at t_{i-1} or at t_{i-2} as graphically presented in figure 4 (i.e $\Sigma''o''$).

For obtaining positive sequence components must summed three sampling voltages $v_b(t_i) + v_a(t_{i-1}) + v_c(t_{i-2})$ as graphically presented in figure 4 (i.e $\Sigma''\diamond''$).

For obtaining negative sequence components must summed three sampling voltages $v_c(t_i) + v_a(t_{i-1}) + v_b(t_{i-2})$ as graphically presented in figure 4 (i.e $\Sigma''\ast''$).

Every shift registers has an output as current, 1 previous and 2 previous which refresh information at every sampling moment t_i . At one moment on the current output can be read voltage amplitude at sampling time t_i , on the 1 previous output can be read voltage amplitude at sampling time t_{i-1} and on the 2 previous output can be read voltage amplitude at sampling time t_{i-2} , respectively. The presented flowchart sequentially treats what was above presented for each voltage component, taking into account that sampling voltages are stored in to shift registers. Temporary voltages $v_a(t), v_b(t), v_c(t)$ are presented in figure 4.

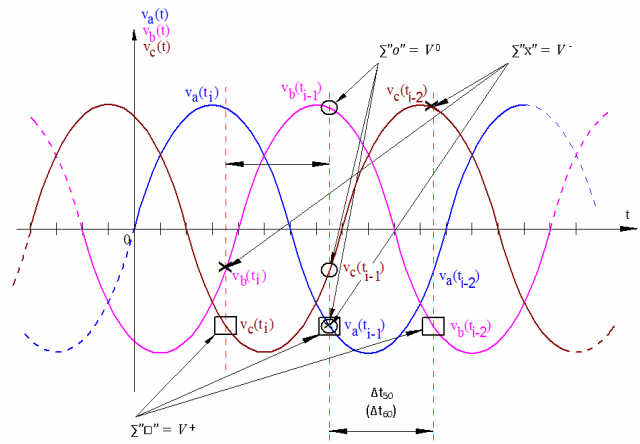

Fig. 4. The voltage samplings and the strategy to obtain symmetrical components.

For every measured voltage $v_a(t), v_b(t), v_c(t)$ there is a specific shift register (i.e shift register 1, shift register 2 and shift register 3 respectively). For every calculated sampling symmetrical voltages an comparator determine if respective voltage is in between permissible standard limits

III. PROGRAMS SYNTHESIS OF THE FLOWCHART SIMULATOR

Using the facilities of the HPVEE Pro software the graphical program presented in figure 5 was obtained. Sampling voltages are obtained through the A/D Config. and "Get Single Value" instrument.

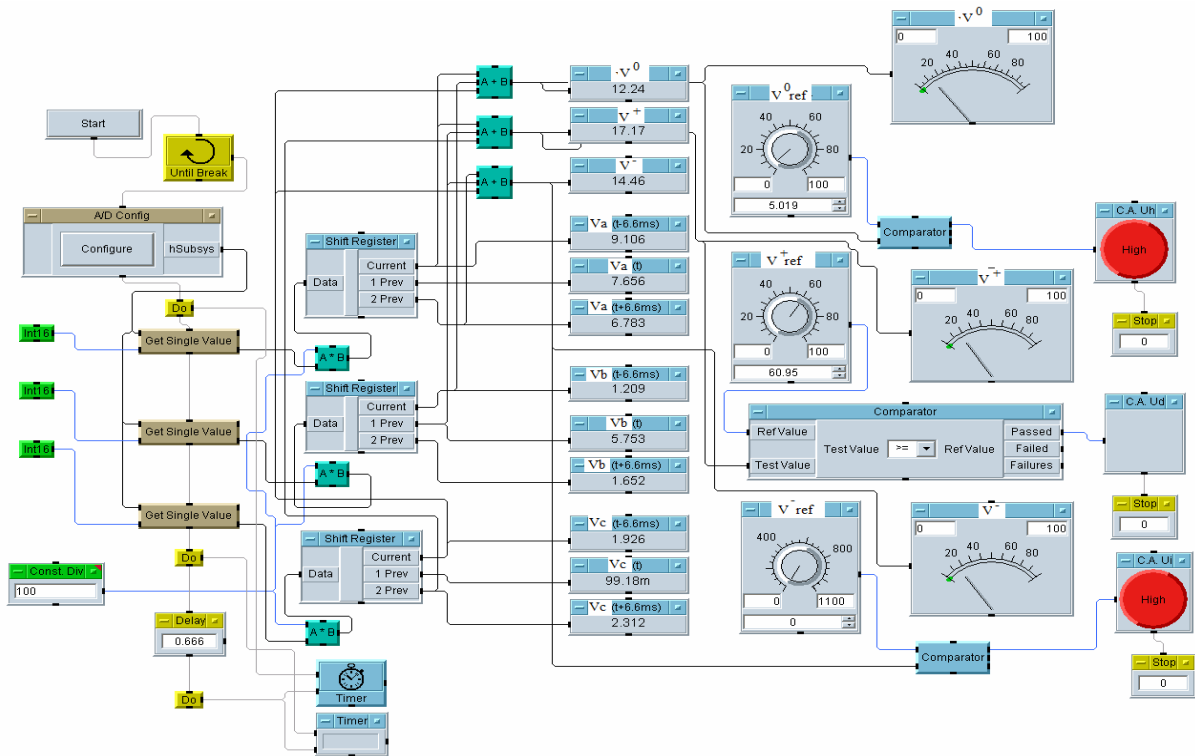

Fig. 5. The graphical program for symmetrical components relay.

The sampling voltages are refreshing shift register graphical instrument outputs (current, 1 previous and 2 previous). The direct compilation of the current, 1 previous or 2 previous digitized information, by summing them, gives the zero sequence voltages component.

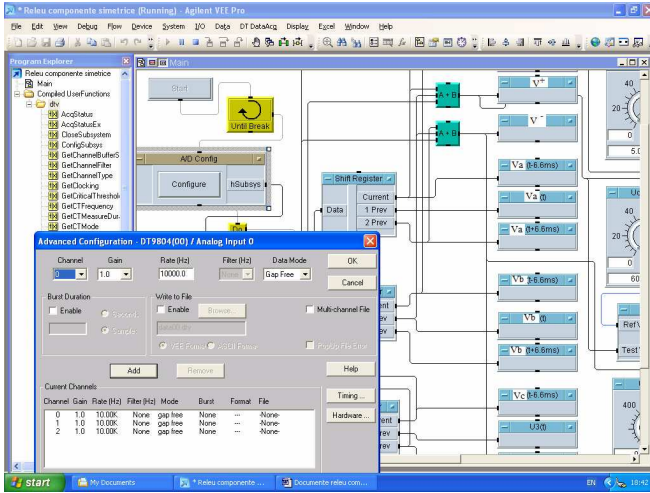

Fig.6. The graphical program for symmetrical components relay and advanced configuration of the hardware.

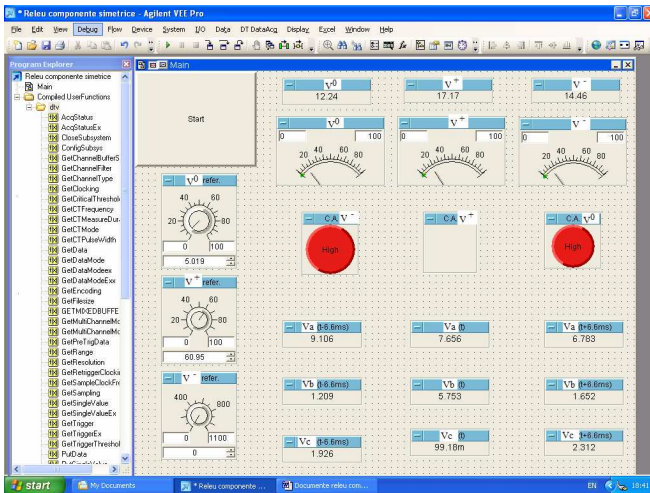

Fig. 7. The graphical relay interface for voltages symmetrical components.

The cross compilation of the same information:

$$\begin{cases} v_b(t_i) + v_a(t_{i-1}) + v_c(t_{i-2}) \\ v_c(t_i) + v_a(t_{i-1}) + v_b(t_{i-2}) \end{cases} \quad (6)$$

gives the zero sequence, respectively the negative sequence voltages components of the system.

The graphical synthesized program cyclic refreshes voltage information with a constant time delay of 0.66(6) [ms].

In the graphical program appear also instruments as comparators, data continuous inputs as “real knobs” for prescribing references admissible values, display color alarm indicators and meter indicators [15].

For laboratory testing’s of the above described graphical software we used a data acquisition board DT 9805 series from Data Translation, [10].

The obtained virtual instrument is used for real-time control of the voltage symmetrical components has the graphical interface presented in figure 7 and contain the same graphical instruments as already described.

V. THE EXPERIMENTAL SYSTEM

The synthesized virtual system gives information in connection with voltages lines of the controlled power system. Voltages are measured using three voltage measurement transducers T_1 , T_2 , T_3 , like in figure 8.

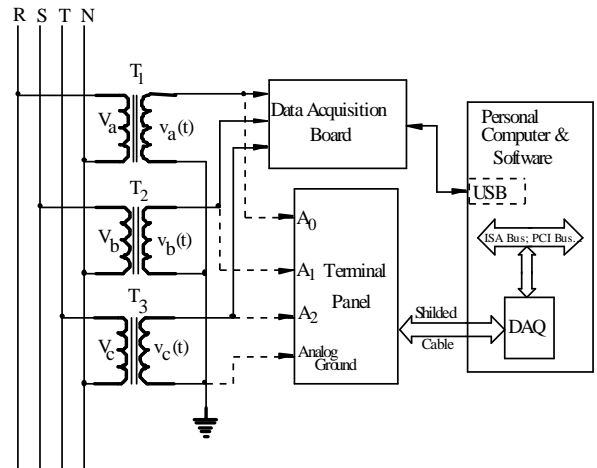

Fig. 8. Basis scheme the virtual instrument.

The information of voltages from the three network phases, are brought in computer via a data acquisition board. In order to become an operational system, it is necessary to install the driver's operating system of the data acquisition board and the adapted application software to a dedicated PC.

If the unbalance degree exceeds the reference value set in the graphical program, then using the I/O port of the data acquisition board a switching-off command will be given.

VI. CONCLUSIONS

The problem to control voltage symmetrical components in power systems, especially in Romania, is a matter of novelty, with a high opportunity and seeks adjustment to the specific *Communitarian European Standards*.

In order to determine the voltage symmetrical components has developed a new technology that allows a fast identification in the abnormal conditions for monitoring and maintaining them in the default indicators in terms of their asymmetrical point of view.

The algorithm for processing the synthesized voltage information for monitoring power systems requires data processing of only nine voltage samples taken in three consecutive stages. This method gives the advantage of getting a quick response on the state system in terms of its symmetry.

Was develop a virtual simulator for symmetrical components using a dedicated software and in order to measure in real time the symmetrical components a virtual instrument was developed using data acquisition board and a graphical program named *HPVEE Pro*.

The virtual instrument was adapted to the symmetrical components flowchart for power networks.

The symmetrical components flowchart was synthesized and based on it, using a virtual instrument we can measure voltage symmetrical components with. The virtual instrument will work as a protection relay for every symmetrical components, positive-sequence, negative-sequence and zero-sequence respectively.

VII. REFERENCES

- [1] Westinghouse Electric Corporation, Applied Protective Relaying, Chapter 2: Technical Tools of the Relay Engineer - Phasors, Polarity, and Symmetrical Components., Coral Springs, FL, 1982.
- [2] Gajić, Z., "Differential Protection for Arbitrary Three-Phase Power Transformers", Doctoral Dissertation Department of Industrial Electrical Engineering and Automation, 2008.
- [3] Niculescu, T., Costinaș, S. *Electrotehnică*, Editura Printech, București, 1988, p.268-280.
- [4] Saadat, H., *Power System Analysis. Chapter 10: Symmetrical Components and Unbalanced Faults*. The McGraw-Hill Companies, New York, NY, 1999.
- [5] Mantilla F., *An analytical and graphical study of the symmetrical components in an induction motor supply in relation to the voltage unbalance parameters*, Electrical Engineering Journal (Archiv fur Elektrotechnik), Volume 89, Number 7 / July, 2007.
- [6] Blackburn L., *Symmetrical Components for Power Systems Engineering*, New York, 1993, pp. 21-37.
- [7] Iordache, M., Chiuță, I., Costinaș, S., *Controlul calității energiei electrice*, Editura AGIR, București, 2000, p.112-120.
- [8] EL-NAGGAR K.M., *A fast method for identification of symmetrical components for power system protection*, IEE Proceedings Generation, Transmission & Distribution, vol. 23, n.8, pp.813-817, 2001.
- [9] Horak J., *A derivation of symmetrical component theory and symmetrical component networks*, Atlanta, Georgia, April 27-29, 2005, pp.25-30.
- [10] ****Agilent Technologies, *VEE PRO User's Guide*, Agilent Technologies Inc, E2110-90062, USA, 2000.
- [11] Zoller C, Fotau I, Risteiu M., Pana, L., *Using VEE Pro6 software to control the quality of energy in to the electrical power networks*. Acta Universitatis Apulensis. Mathematics-Informatics. Proceedings of the International Conference on Theory and Applications of Mathematics and Informatics, ICTAMI 2004, Thessaloniki, Nr 8/2004. Pag. 471...480.
- [12] Savas, K., Zafer A., *A MATLAB/GUI based fault simulation tool for power system education*, Mathematical and Computational Applications, Vol. 14, No. 3, pp. 207-217, 2009.
- [13] Zoller, C., Fotău I., *Virtual instruments to analyze the quality of the electrical power networks*. Annals of the University of Petrosani, Electrical Engineering, vol 6(XXXIII), Petrosani, 2004.
- [14] Durić M., Radojević Z., Škokljević I., Terzija V., *A simple algorithm for the symmetrical components relaying and monitoring*, Electrical Engineering Journal (Archiv fur Elektrotechnik), Volume 79, Number 3 / June, 1996 .
- [15] ***Data Translation, *DT 9800 User's Manual*, Data Translation, Inc., 100 Locke Drive, Marlboro, MA 01752-1192 USA.

VIII. BIOGRAPHIES



Sorina Costinas. She had graduated in Romania, attending University "Politehnica" Bucharest, Department of Power Engineering, in 1987. Ph.D in 1997, with doctoral dissertation related power supply distribution network, with applicability in hazardous areas. Present position: Associate Professor in Division of Energy Generation and Use (www.energ.pub.ro). Didactic activities on Electrical Part of Power Plants, Substations, Electrical Equipment Maintenance and Power Supply Quality. Her fields of interest are including Design, Operation, Maintenance and Economical Optimization of Electricity Distribution Networks.



Carol L. Zoller born in Petrosani in Romania, on Mai 29, 1951. Graduated Mining Institute of Petrosani, Romania, the Electromechanical Faculty, specialization Automatics and Telemecanique into the mining areas. Present position: Professor. His employment experience included the Electromechanic Department in to the Jiu Valley Mining Company, the University of Petrosani, Romania and a stage to the Technological University of Eindhoven, Netherlands as visiting scientist. Special fields of interest include electronic measurements, power switching and protection equipments.



Remus Dobra born in Alba-Iulia, Romania, on March 23, 1981. He graduated from the University of Petrosani. Currently, He is Assistant PhD Student at the Power Engineering Department of the University of Petrosani. His special fields of interest included electronic measurements and electrical apparatus. Training's: „Erasmus – Socrates”, Institut Für Elektrische Energietechnik T.U.Clausthal, Germany – 2003 and *Leonardo da Vinci*, Practice and Improving Competences on European Modern Technologies, Firenze, Italy, 2006.