

GRAND RAPIDS CHAIR COMPANY

DELIVERED

PRICE LIST

2017



LAST UPDATED: OCT 23, 2017

TABLE OF CONTENTS

About the Company	3
How to Order	4
Delivery & Freight	5
Upholstery Information	6
Wood Finishes	7
Metal Finishes	8
Seating: Personalization Options	9-10

SEATING

Wood

Andy	12-13
Bentwood Classics	14-18
Brooke	19-21
Cara	22-24
Chloe	25-27
Dylan	28-30
Harbor	31-32
Hugh	33-34
Lena	35-36
Merano	37-38
Molly	39-42
Tilly	43-44
Wood Mama Melissa	45-49
Wood Melissa	50-57

Steel

Artisan II	60-62
Atoll	63-64
Ava	65-66
Brady	67-68
Brent	69-70
Cheyenne	71-72
Emma	73-74
Felix	75-77
Felix Jr.	78-80
Harper	81-86
Hurdle	87-88
Jill	89-91
Ladder Back	92-93
Leo	94-95
Liz	96-97
Mama Melissa	98-105
Mama Samantha	106-107
Melissa Anne	108-117
Mia	118-119
Nadia	120-121
Opla	122-123
Reece	124-127
Rosie	128-129
Sadie	130-131
Sadie II	132-133
Samantha	134-135
Trucks & Carts	136-137

Aluminum

Atlantis	140-142
Atoll Aluminum	143-144
Siren	145-146

TABLE OF CONTENTS

TABLES

Tables Information	148-149
Tables: Personalization Options	150
Table Edges	151-152

Pedestal Tables – Cast Iron Base

Kalypso	154-155
Orbit	156-157
Spartan	158-159
Zeus	160-161

Pedestal Tables – Steel Base

Brady Pedestal	164-165
Cassandra	166-167
Ellipse	168-169
Jerome	170-171
Rambo	172-173
Trap	174-175

Post Leg Tables

Andy	178-180
Core-Drilled/Bolt-Down	181-182
Opla	183-184
Sadie	185-186
Somerset	187-188

Cantilever Table

Cantilever	190-191
------------	---------

Communal Tables

Brady	194-197
Dylan	198-201

Occasional Tables

Nadia	204-205
Roy	206-207
Torch	208-210
Walloon	211-212

ADDITIONAL INFORMATION

Care & Maintenance	213
Seating Planner	214
Terms & Conditions	215-218
Warranty	219
Seating Index	220-226
Tables Index	227-237

YOUR COMMERCIAL FOODSERVICE PARTNER

Grand Rapids Chair is an American furniture manufacturer dedicated to creating high-quality chairs and tables for commercial foodservice spaces. Our goal with every product is to help elevate the overall dining experience for brands and their customers.

In our inception, our first major customer was a fast-food chain. Nearly twenty years later, GRC is still serving large multi-unit restaurants and cafes across the country.

We're a second-generation family business that started in Grand Rapids, Michigan, and still call West Michigan "home" today. Currently, more than 110 employees work in over 150,000 square-feet of manufacturing and administrative space. We're growing—and we love partnering with companies that are growing, too.

OPERATIONALLY EXCELLENT

Our approach to creating quality and durable commercial furniture is unique; we are operationally excellent. Meaning, we balance cost, service requirements, and quality to meet the needs of each customer. In other words, it's not a one-size-fit all approach.

We also balance hand-crafted quality and aesthetics with fully automated machinery and processes. From working with designers on a custom product to producing large volumes with short lead times—our unique approach allows us to do both, and to do both well.

DURABLE & QUALITY

We specialize in durable and quality products designed for high-traffic spaces. While many commercial furniture companies are racing overseas for products, we choose to build our products in Michigan, using high quality, local materials along with American engineering and manufacturing techniques. All products are tested to meet or exceed BIFMA standards and offer a 10 year warranty.

SIT HAPPY

Sit happy is a reflection of our products, people, and culture. From first interaction, to sales order, to the customer sitting in our restaurant chair, our goal is to create furniture that not only makes our customers happy, but their customers, too.

SALES & CUSTOMER SERVICE

Grand Rapids Chair Company
1250 84th Street SW
Byron Center, MI 49315
Phone: 616.774.0561
Fax: 616.774.0563
Website: www.grandrapidschair.com
sales@grandrapidschair.com | literature@grandrapidschair.com

HOW TO ORDER

All orders must be submitted in writing and are subject to acceptance by Grand Rapids Chair Company. Orders cannot be processed until they contain all information required for production. Once all information is received and the order is approved, it will be scheduled into production.

It is the customer's responsibility to check the accuracy of each and every order acknowledgment sent by the factory. We will, of course, make every effort to find inadvertent errors, but will execute the order as approved and cannot accept responsibility for errors made on the customer's part.

Please note that all orders will be acknowledged with estimated lead times. Lead time begins once the order, along with custom stain matches and custom engineering prints have been approved, and C.O.M. fabric is received.

PLEASE MAIL OR SEND ORDERS TO:

Grand Rapids Chair Company
1250 84th Street SW
Byron Center, MI 49315
Phone: 616.774.0561
Fax: 616.774.0563
E-mail: orderentry@grandrapidschair.com

If orders have previously been faxed, please mark hard copies sent to the office as "CONFIRMING." Orders not marked accordingly run the risk of being duplicated at the customer's expense.

NEW ACCOUNTS

To expedite the credit approval process, please fill out a credit application that can be furnished to you by calling the sales office at 616.774.0561. Allow thirty (30) days to process a credit application.

CREDIT CARDS

We accept Visa, Master Card, Discover, and American Express. Additional charges may apply.

MINIMUM ORDERS

For orders less than \$250.00 net, a setup/handling fee of \$50.00 will be charged.

CANCELLATIONS/CHANGES

All orders are considered firm. Any cancellation or change is subject to our approval, and will result in an order cancellation fee including all applicable costs plus a reasonable profit of 10%.

RETURNS

Merchandise cannot be returned for credit without an approved return material authorization. The nature of our customized products inhibits most return requests, but for those items that can be returned, a restocking fee of 15% will be assessed for all items.

MATCHING GOODS

In the event a customer would like to match a previous order to a new order, the customer must send a physical sample to their Account Manager. Due to continual engineering improvements and modifications, we cannot guarantee each good will be an exact match to their previous order. In the event that we cannot offer a matching good, a suitable alternative (comparable in design, style, and durability) will be offered to the customer.

DELIVERY

Orders will be shipped with normal shipping times. Special requests will be honored if possible. Once production has begun, orders cannot be held for extended delivery. It is the customer's responsibility to accept and store the furniture if there is an installation delay. Grand Rapids Chair Company will not be responsible or liable to purchaser for damages whether incidental, consequential, or otherwise for failure to fill orders, delays in delivery, or any error in filling the order.

FREIGHT

Risk of loss shall pass to the seller upon delivery of goods to a carrier. Grand Rapids Chair Company is not responsible for damage or delays in transit. It is the customer's responsibility to inspect product upon delivery for possible freight damage. It is also the responsibility of the customer to file freight claims for any damaged goods. Claims should be filed with the common carrier immediately upon discovery of such damage. Visible freight damage should be noted on the freight bill prior to taking receipt of the orders. Concealed damage claims must be filed within 10 days of receipt of shipment. C.O.D. shipments are subject to the freight carrier's fees for C.O.D. shipments.

FREIGHT CLASSIFICATIONS

Our products are shipped using the NMFC #80580 and classified by density per the general guidelines noted below:

Category	Freight Classifications
Assembled Wood Chairs	Class #250
Aluminum Chairs	Class #300
Steel Chairs	Class #250
Counter Seats	Class #250
Tables and Bases	Class #70

Freight quotes are valid for 30 days and are subject to change prior to shipment.

HOLDING ORDERS

Grand Rapids Chair will hold an order at no charge for up to 15 days after the original scheduled ship date. Any order beyond that time will be subject to charges of \$40 per pallet per month. For orders with 10 pallets or more, a minimum \$500 charge will apply per month. Note: A partial month is considered one month.

UPHOLSTERY INFORMATION

UPHOLSTERY

Prices are based on a solid color 54" wide upholstery. Any upholstery with 3" or greater repeat, length or width, which requires pattern matching, add 10% to overall list price. Thread color will be chosen by factory to match the upholstery as closely as possible, unless otherwise specified.

GRADED-IN PRICING

To determine graded-in pricing for grades beyond what is shown for a particular product, add \$16 list per yard, per grade. Be sure to visit our website to see our fabric partners and to gain a better understanding of our grading. Click on the textiles tab on the bottom of each product page.

CUSTOMER'S OWN MATERIAL (C.O.M.) AND CUSTOMER'S OWN LEATHER (C.O.L.)

Please consult the factory prior to placing your C.O.M. or C.O.L. order. We may be able to supply materials at a lower cost due to our volume discounts with the textile mills. All C.O.M. materials should be sent in rolls only, folding can cause adverse and irreversible deformations to some materials, especially leather.

A sample swatch must be supplied with the order along with the name of the supplying textile company and a description of the material (pattern name, color and any accompanying numerical description). We cannot accept responsibility for costs incurred for replacement material if the mill sends the incorrect fabric.

All C.O.M. yardage requirements in this price lists are based on 54" wide roll. Yardage is approximate. Add 10% to the yardage requirements if striped or patterned materials are specified, if pattern requires matching, or if width of material is less than 54" wide. For striped, patterned or unique designs, directions on upholstery application must be provided. If no directions are stated on the order or in a subsequent "confirmed and acknowledged" document, we will upholster the product in what we deem to be the most appropriate manner. We assume no responsibility thereafter.

Grand Rapids Chair Company assumes no liability as to the flame retardant qualities of a C.O.M.

For orders with C.O.L., add 10% to the list price of C.O.M. in our price list. We also advise adding 25% to the yardage requirements if specifying leather. Irregularities in grain, natural marks or variations in color are to be expected and are normal characteristics of natural luxurious leather, making each piece unique.

Acknowledged ship dates are dependent upon the timely receipt of C.O.M. or C.O.L. Delays in receiving the material will result in the rescheduling of production. We maintain the right to refuse the use of any customer-supplied material or leather that is not suitable due to pattern, stretch, weight or workability.

All C.O.M. must be shipped prepaid and clearly marked with your company name and purchase order number.

CALIFORNIA TECHNICAL BULLETIN 133

Chairs can be constructed to meet California Technical Bulletin 133, add \$65 list per yard of fabric. Testing, sampling and freight charges will apply as required.

WOODS

Wood is an organic material that undeniably adds warmth to any space. Unlike man made materials, wood is a naturally renewable resource that poses no threat to human health during processing. Each species of wood has a unique and naturally occurring pattern that can vary greatly. Due to the complex structure of wood, small knots, piths, pores, rings, etc. may appear and add decorative appeal.



Woodgrain - Maple

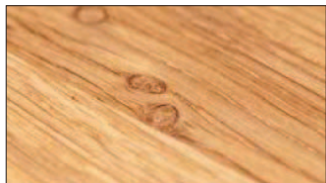

Knots

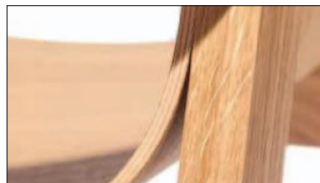

Mirrors

WOOD COLOR & SPECIES

Each species of wood has an innate base color, ranging from white to pinkish, yellow to brown and this impacts the way that stains and paints appear when applied. We primarily work with Beech and Maple wood species for our chairs and table tops. Each of our standard wood stains have been color matched so that any standard color will appear the same in both species. We have the capabilities to source Ash, American Walnut, Oak, etc. and request that for any custom color match or special finish a reference sample is provided and approved of prior to production.

STANDARD WOOD STAINS ("*" implies that finish is also available on Bentwood Collection)



Natural*

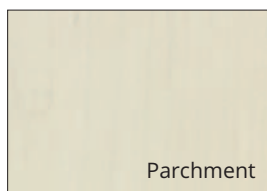

Parchment

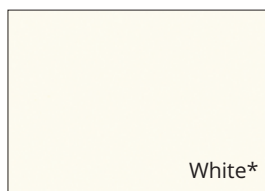

White*

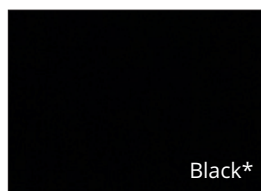

Black*

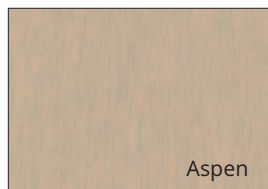

Aspen

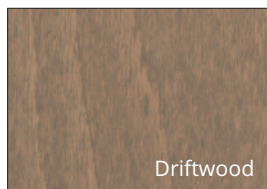

Driftwood

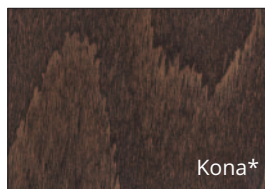

Kona*

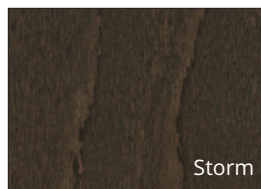

Storm

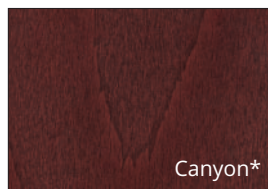

Canyon*

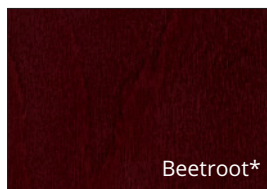

Beetroot*



Dune*

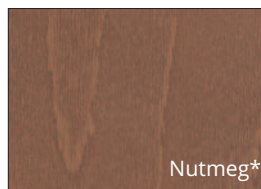

Nutmeg*

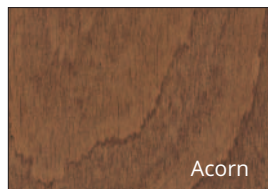

Acorn

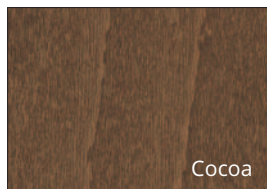

Cocoa

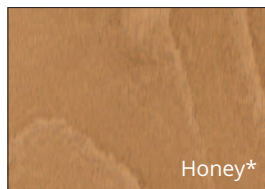

Honey*

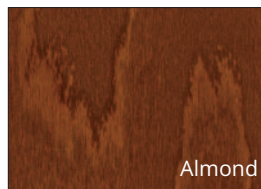

Almond

WOOD STAIN COLOR MATCHING

There is a \$200 net charge to match any wood stain. A physical sample chip must be sent to the Grand Rapids Chair factory for matching. Digital or paper copies will not be accepted. There is no minimum order. If there are any additional glazing operations, please contact Grand Rapids Chair company to be quoted by customer service.

METAL FINISHES

STEEL & ALUMINUM

We hand-tailor, cope and braze all joints to add even more stability, exceeding strength and durability standards and customer expectations. Powder coating is a type of coating that is applied as a free-flowing, dry powder. The coating is applied electrostatically and is then cured under heat to allow it to flow and form a "skin." It is used to create a hard finish that is tougher than conventional paint.

STANDARD METAL FINISHES

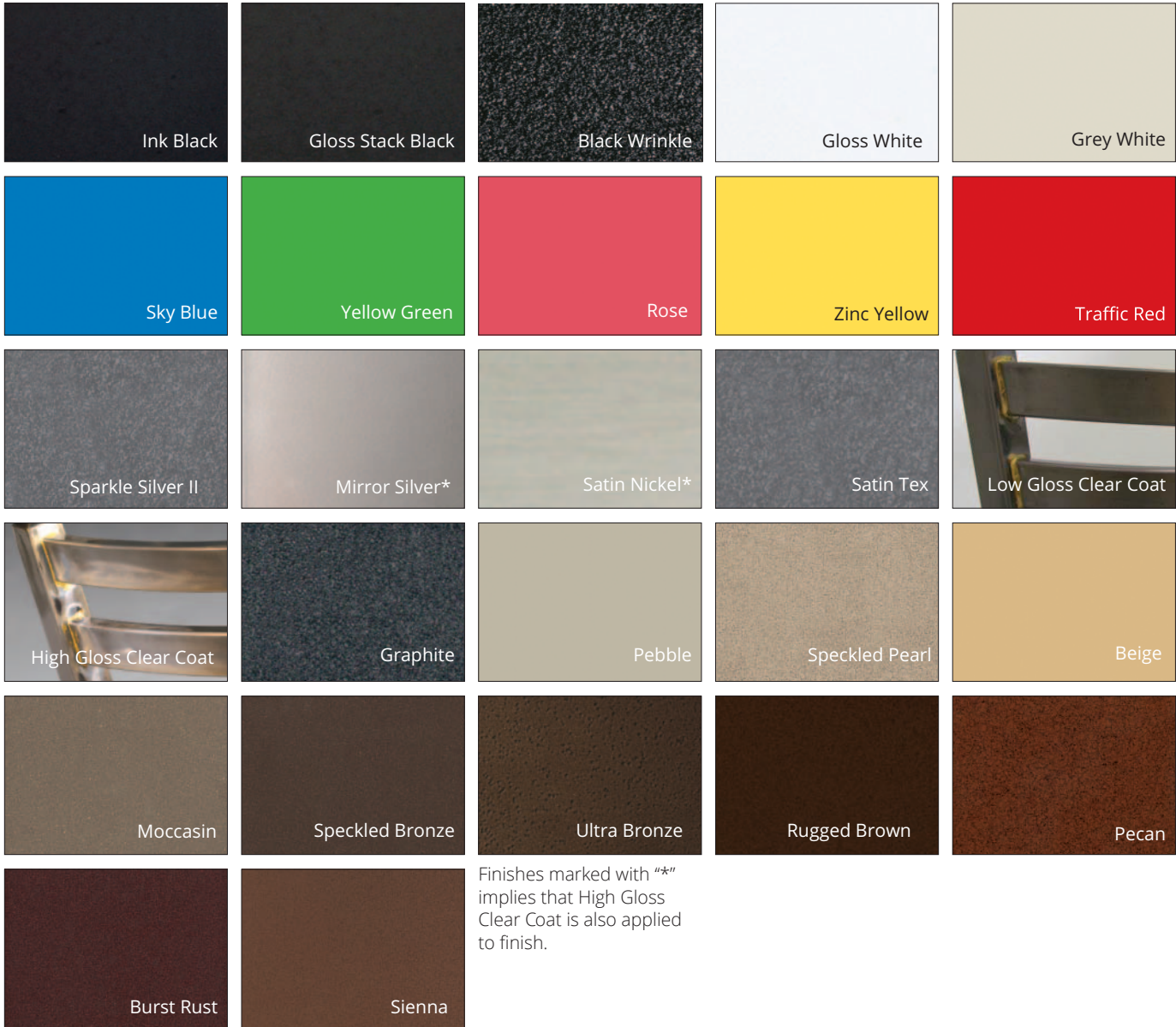

CUSTOM POWDER COAT COLORS

All custom powder coat colors must be quoted by customer service. This is due to a minimum powder quantity applied by suppliers as the powder often varies based on color and complexity.

An RAL number is required for custom powder coat colors. If a non-RAL color is requested (like Pantone or Benjamin Moore), a physical sample chip must be sent to the Grand Rapids Chair factory for matching. Digital or paper copies will not be accepted. Grand Rapids Chair is not responsible for obtaining physical samples. Grand Rapids Chair will not be able to quote until we have a physical chip sample for non-RAL colors.

For physical samples of non-RAL colors, please contact the color manufacturer for the sample. Often times sample chips can be ordered online. Please note, non-RAL colors will result in extended lead times.

DISTRESSING

Giving chairs that lived-in look requires a little extra attention. We hand-distress each one, just to your liking in either light or heavy, using a mixture of both traditional and unconventional wood working techniques.

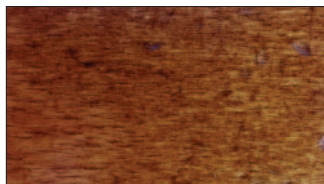

Light Distressing



Heavy Distressing

UPHOLSTERY DETAILS

Select models, can be complemented with decorative nails. Refer to individual product pages for upcharge.



Nailhead Colors:



Brass #12



Antique Bronze #37



Matte Silver #10



Antique Pewter #41

NAILHEAD COBBLER SEAT

Nailhead trim is applied to a wood seat leaving an irregular wood perimeter around the upholstery material.

NAILHEAD WATERFALL COBBLER SEAT

Nailhead trim is applied to a wood seat leaving a wood perimeter on the back and two sides of the seat. The upholstery material wraps over the front of the seat completing the waterfall appearance.

NAILHEAD SURROUND BACK

Nailhead trim is applied to the outside edges of the upholstery material located on the back side of the chair.

NAILHEAD TRIM SURROUNDING FRONT LEGS ON PULLMAN SEAT

Nailhead trim is applied around the front and side edges of the front legs on Pullman style applications.

WELTING

Welting, often referred to as piping, is a fabric-covered cord positioned on the corners and edges of upholstered pieces that restricts contact with the sewn seams, acting as a buffer to abrasions as the furniture is used.

BOXED SEAT

A sewn upholstery cover is pulled over thicker foam to produce a built up seat. Typically 2" tall. Boxed seats are not available on nesting chairs.

WEBBED SEAT

Commercial grade webbing is installed over custom plywood panels. This option adds additional comfort and longevity to any seat.

CAL 133

An added physical layer of knit fire barrier material underneath the material that you see.

SEATING: PERSONALIZATION OPTIONS

REDUCE TO COUNTER SEAT HEIGHT

Many of our barstools can be reduced to counter seat height, which is 24". See individual product pages for available models.

HANDHOLD CUT-OUT

Many of our chairs and barstools can be customized with a handhold cut-out. Available on solid wood and upholstered options.

ENGRAVING & LASER CUT-OUTS



Laser Cut-Out - Wood



Laser Engraving - Wood



Laser Cut-Out - Metal

Custom laser cut-outs and engraving adds a personal touch to your space. From logos to unique designs, we can do it all. Pricing for custom work must be discussed with the factory and vary depending on graphics/designs and the size of the project. Add a graphic setup fee of \$100 net per image, per order on projects with proper artwork. For projects without proper artwork, add \$150 net per image, per order. Acceptable vectorized formats for artwork include: .ai, .dxf, .cdr, and .eps files. Artwork and a copy of the image for reference should be e-mailed to sales@grandrapidschair.com

Add \$30 list per side for each 6" x 6" or smaller engraving. Call factory to confirm pricing or to obtain pricing on larger images. The engraved image is back filled with customer's choice of black, silver, or gold. Other colors are available with small up-charge.

*The edges of the cut-out are colored in dark brown which remains visible especially when chairs are finished in some light colors.

Standard Back Fill Colors:



Black



Silver



Gold

REQUIRED TO ORDER:

Please be sure to provide all necessary information prior to submitting your order.

WOOD SEATING



ABOUT THIS COLLECTION

The Andy Collection includes two upholstered lounges, one with arms and one without them.

STANDARD FEATURES

- Solid European Beech frame
- Upholstered seat features 2" of high resilience foam
- Metal carpet glides
- Technical Bulletin CAL 117 fire retardant upholstery

PERSONALIZATION OPTIONS

- The table to the right explains all of the available options for the Andy Collection.

OPTIONS	PAGE	ADD TO LIST PRICE
CAL 133	9	\$65/Yard
Substitute Premium Metal or Plastic Glides	-	\$3
Light Distressing on Chairs	9	\$30
Heavy Distressing on Chairs	9	\$37.50



W2625

ANDY LOUNGE

MODEL	WOOD	COM	GRADE 10	GRADE 20	GRADE 30	GRADE 40	GRADE 50
W2625	N/A	1219	1348	1395	1453	1514	1572

Overall Height: 29" Seat Height: 15" Overall Depth: 30" Overall Width: 26"
 C.O.M.: 3 yd Shipping Weight/Chair: 35# No. Per Carton: 1



W2625A

ANDY LOUNGE WITH ARMS

MODEL	WOOD	COM	GRADE 10	GRADE 20	GRADE 30	GRADE 40	GRADE 50
W2625A	N/A	1463	1580	1639	1697	1755	1816

Overall Height: 29" Seat Height: 15" Overall Depth: 30" Overall Width: 28"
 C.O.M.: 3 yd Shipping Weight/Chair: 35# No. Per Carton: 1

BENTWOOD CLASSICS COLLECTION



ABOUT THIS COLLECTION

The Bentwood Classics Collection includes chairs, armchairs, counter height barstools, backless barstools, and barstools.

STANDARD FEATURES

- Solid European Beech frame
- Steam bent Beech wood
- Choose from our standard Bentwood approved finishes
- Beech veneer seat or upholstered seats available
- Stainless steel footrest protector on barstools
- Metal carpet glides

PERSONALIZATION OPTIONS

- The table to the right explains all of the available options for the Bentwood Classics Collection.

OPTIONS

OPTIONS	PAGE	ADD TO LIST PRICE
Nailhead Seat Treatment on Upholstered Seat	9	\$60

PAGE

9

ADD TO LIST PRICE

\$60



B014-VEN

NO. 14 CHAIR

MODEL	WOOD
B014-VEN	314

Overall Height: 33.25" Seat Height: 18.25" Overall Depth: 20.25" Overall Width: 16"
 Shipping Weight/Chair: 20# No. Per Carton: 2



B014-UPH

NO. 14 CHAIR

MODEL	SELECT VINYL	COM	GRADE 10	GRADE 20	GRADE 30	GRADE 40	GRADE 50
B014-UPH	455	378	398	408	417	426	435

Overall Height: 33.25" Seat Height: 18.25" Overall Depth: 20.25" Overall Width: 16"
 C.O.M.: .5 yd Shipping Weight/Chair: 20# No. Per Carton: 2



B014P-VEN

NO. 14 PETITE CHAIR

MODEL	WOOD
B014P-VEN	280

Overall Height: 23.75" Seat Height: 12.5" Overall Depth: 16" Overall Width: 12.25"
 Shipping Weight/Chair: 20# No. Per Carton: 2



B018-VEN

NO. 18 CHAIR

MODEL	WOOD
B018-VEN	323

Overall Height: 33.25" Seat Height: 18.25" Overall Depth: 20.25" Overall Width: 16"
 Shipping Weight/Chair: 20# No. Per Carton: 2



B018-UPH

NO. 18 CHAIR

MODEL	SELECT VINYL	COM	GRADE 10	GRADE 20	GRADE 30	GRADE 40	GRADE 50
B018-UPH	407	386	407	416	425	434	444

Overall Height: 33.25" Seat Height: 18.25" Overall Depth: 20.25" Overall Width: 16"
 C.O.M.: .5 yd Shipping Weight/Chair: 20# No. Per Carton: 2



B018BS-VEN

NO. 18 BARSTOOL

MODEL	WOOD
B018BS-VEN	423

Overall Height: 43.5" Seat Height: 30" Overall Depth: 19.75" Overall Width: 16"
 Shipping Weight/Chair: 25# No. Per Carton: 1



B018BS-UPH

NO. 18 BARSTOOL

MODEL	SELECT VINYL	COM	GRADE 10	GRADE 20	GRADE 30	GRADE 40	GRADE 50
B018BS-UPH	506	486	506	516	525	535	544

Overall Height: 43.5" Seat Height: 31" Overall Depth: 19.75" Overall Width: 16"
 C.O.M.: .5 yd Shipping Weight/Chair: 25# No. Per Carton: 1



B020-UPH-BK

NO. 20 CHAIR

MODEL	SELECT VINYL	COM	GRADE 10	GRADE 20	GRADE 30	GRADE 40	GRADE 50
B020-UPH-BK	536	506	536	550	564	579	593

Overall Height: 33.25" Seat Height: 18.25" Overall Depth: 21.25" Overall Width: 16"
 C.O.M.: .75 yd Shipping Weight/Chair: 20# No. Per Carton: 2



B020A-UPH-BK

NO. 20 ARMCHAIR

MODEL	SELECT VINYL	COM	GRADE 10	GRADE 20	GRADE 30	GRADE 40	GRADE 50
B020A-UPH-BK	669	640	669	684	699	713	727

Overall Height: 33.25" Seat Height: 18.25" Overall Depth: 23.25" Overall Width: 16.75" Arm Height: 26.5"
 Arm Width: 21.25" C.O.M.: .75 yd Shipping Weight/Chair: 20# No. Per Carton: 1



B025A-VEN

NO. 25 ARMCHAIR

MODEL	WOOD
B025A-VEN	421

Overall Height: 31.75" Seat Height: 18.25" Overall Depth: 21.75" Overall Width: 16.75" Arm Height: 28.25"
 Arm Width: 22.5" Shipping Weight/Chair: 20# No. Per Carton: 1



B025A-UPH

NO. 25 ARMCHAIR

MODEL	SELECT VINYL	COM	GRADE 10	GRADE 20	GRADE 30	GRADE 40	GRADE 50
B025A-UPH	514	484	514	528	541	555	570

Overall Height: 31.75" Seat Height: 18.25" Overall Depth: 22.5" Overall Width: 16.75" Arm Height: 28.25"
 Arm Width: 22.5" C.O.M.: .75 yd Shipping Weight/Chair: 20# No. Per Carton: 1



B025BS-VEN

NO. 25 BARSTOOL

MODEL	WOOD
B025BS-VEN	485

Overall Height: 42.25" Seat Height: 30" Overall Depth: 19.25" Overall Width: 15.5" Arm Height: 40.5"
 Arm Width: 21.25" Shipping Weight/Chair: 25# No. Per Carton: 1



B025BS-UPH

NO. 25 BARSTOOL

MODEL	SELECT VINYL	COM	GRADE 10	GRADE 20	GRADE 30	GRADE 40	GRADE 50
B025BS-UPH	575	545	575	590	603	617	632

Overall Height: 41.5" Seat Height: 30" Overall Depth: 19.25" Overall Width: 15.5" Arm Height: 39.5"
 Arm Width: 21.25" C.O.M.: .75 yd Shipping Weight/Chair: 25# No. Per Carton: 1



B030A-VEN

NO. 30 ARMCHAIR

MODEL	WOOD
B030A-VEN	391

Overall Height: 31" Seat Height: 18.25" Overall Depth: 22.5" Overall Width: 19" Arm Height: 27.5"
 Arm Width: 21.5" Shipping Weight/Chair: 20# No. Per Carton: 1



B030A-UPH

NO. 30 ARMCHAIR

MODEL	SELECT VINYL	COM	GRADE 10	GRADE 20	GRADE 30	GRADE 40	GRADE 50
B030A-UPH	484	454	484	498	511	526	540

Overall Height: 30" Seat Height: 18.25" Overall Depth: 22.5" Overall Width: 19" Arm Height: 26.75"
 Arm Width: 21.5" C.O.M.: .75 yd Shipping Weight/Chair: 20# No. Per Carton: 1



B030A-UPH-BK

NO. 30 ARMCHAIR

MODEL	SELECT VINYL	COM	GRADE 10	GRADE 20	GRADE 30	GRADE 40	GRADE 50
B030A-UPH-BK	743	694	743	767	791	814	839

Overall Height: 31" Seat Height: 18.25" Overall Depth: 22.5" Overall Width: 19" Arm Height: 27.25"
 Arm Width: 21.5" C.O.M.: 1.25 yd Shipping Weight/Chair: 20# No. Per Carton: 1



B073BS-VEN

NO. 73 BARSTOOL

MODEL	WOOD
B073BS-VEN	375

Overall Height: 31" Seat Height: 31" Overall Depth: 18.5" Overall Width: 18.5"
 Shipping Weight/Chair: 25# No. Per Carton: 1



B073BS-UPH

NO. 73 BARSTOOL

MODEL	SELECT VINYL	COM	GRADE 10	GRADE 20	GRADE 30	GRADE 40	GRADE 50
B073BS-UPH	458	430	458	473	487	501	517

Overall Height: 31" Seat Height: 31" Overall Depth: 18.5" Overall Width: 18.5"
 C.O.M.: .75 yd Shipping Weight/Chair: 25# No. Per Carton: 1



B150-VEN

NO. 150 CHAIR

MODEL	WOOD
B150-VEN	366

Overall Height: 34.25" Seat Height: 18.25" Overall Depth: 15.94" Overall Width: 17.75"
 Shipping Weight/Chair: 20# No. Per Carton: 2



B150-UPH

NO. 150 CHAIR

MODEL	SELECT VINYL	COM	GRADE 10	GRADE 20	GRADE 30	GRADE 40	GRADE 50
B150-UPH	458	430	458	473	487	501	517

Overall Height: 33.5" Seat Height: 18.25" Overall Depth: 15.94" Overall Width: 17.75"
 C.O.M.: .75 yd Shipping Weight/Chair: 20# No. Per Carton: 2



B150BS-VEN

NO. 150 BARSTOOL

MODEL	WOOD
B150BS-VEN	490

Overall Height: 43.25" Seat Height: 30" Overall Depth: 18.75" Overall Width: 17.75"
 Shipping Weight/Chair: 25# No. Per Carton: 1



B150BS-UPH

NO. 150 BARSTOOL

MODEL	SELECT VINYL	COM	GRADE 10	GRADE 20	GRADE 30	GRADE 40	GRADE 50
B150BS-UPH	580	551	580	594	608	623	638

Overall Height: 42.5" Seat Height: 30" Overall Depth: 18.75" Overall Width: 17.75"
 C.O.M.: .75 yd Shipping Weight/Chair: 25# No. Per Carton: 1



B763-VEN

NO. 763 CHAIR

MODEL	WOOD
B763-VEN	280

Overall Height: 31" Seat Height: 18.25" Overall Depth: 18.75" Overall Width: 18"
 Shipping Weight/Chair: 20# No. Per Carton: 2



B763-UPH

NO. 763 CHAIR

MODEL	SELECT VINYL	COM	GRADE 10	GRADE 20	GRADE 30	GRADE 40	GRADE 50
B763-UPH	365	335	365	379	393	408	422

Overall Height: 31" Seat Height: 18.25" Overall Depth: 18.75" Overall Width: 18"
 C.O.M.: .75 yd Shipping Weight/Chair: 20# No. Per Carton: 2



ABOUT THIS COLLECTION

The Brooke Collection includes a chair, counter height stool, and a barstool. This wood seating collection features a simple slatted back and multiple upholstery options.

STANDARD FEATURES

- Beech frame
- Available as all wood chair or with multiple upholstery variations
- UPH1 features 1/2" thick foam on seat
- UPH3 features 3/4" thick foam on seat
- UPH4 features 3/4" on seat and 1/2" thick foam on back
- CAL 117 fire resistant upholstery materials
- Stainless steel footrest protector on counter and barstools
- Metal carpet glides

PERSONALIZATION OPTIONS

- The table to the right explains all of the available options for the Brooke Collection.

OPTIONS

	PAGE	ADD TO LIST PRICE
Substitute Premium Metal or Plastic Glides	-	\$3
CAL 133	9	\$65/Yard
Light Distressing on Chairs	9	\$30
Heavy Distressing on Chairs	9	\$37.50
Light Distressing on Barstools	9	\$37.50
Heavy Distressing on Barstools	9	\$50

UPHOLSTERY OPTIONS



UPH1



UPH3



UPH4



W520-W

BROOKE CHAIR

WOOD

MODEL	YARDAGE	WOOD	GRADE 10	GRADE 20	GRADE 30	GRADE 40	GRADE 50
W520-W	N/A	477	N/A	N/A	N/A	N/A	N/A

WOOD - PARTIALLY UPHOLSTERED SEAT

MODEL	YARDAGE	COM	GRADE 10	GRADE 20	GRADE 30	GRADE 40	GRADE 50
W520-W-UPH1	0.4	534	551	559	567	575	583

WOOD - FULLY UPHOLSTERED SEAT

MODEL	YARDAGE	COM	GRADE 10	GRADE 20	GRADE 30	GRADE 40	GRADE 50
W520-W-UPH3	0.5	604	624	633	642	651	659

WOOD - FULL UPHOLSTERED SEAT & BACK

MODEL	YARDAGE	COM	GRADE 10	GRADE 20	GRADE 30	GRADE 40	GRADE 50
W520-W-UPH4	1.0	618	657	676	685	694	703

Overall Height: 30.5" Overall Depth: 20.71" Overall Width: 19.1" No. Per Carton: 2

Seat Height: W520-W 19", W520-W-UPH1 19.5", W520-W-UPH3 19.5", W520-W-UPH4 19.5"

Shipping Weight/Chair: 20#



W520CH-W

BROOKE COUNTER HEIGHT STOOL

WOOD

MODEL	YARDAGE	WOOD	GRADE 10	GRADE 20	GRADE 30	GRADE 40	GRADE 50
W520CH-W	N/A	602	N/A	N/A	N/A	N/A	N/A

WOOD - PARTIALLY UPHOLSTERED SEAT

MODEL	YARDAGE	COM	GRADE 10	GRADE 20	GRADE 30	GRADE 40	GRADE 50
W520CH-W-UPH1	0.4	660	676	684	692	700	708

WOOD - FULLY UPHOLSTERED SEAT

MODEL	YARDAGE	COM	GRADE 10	GRADE 20	GRADE 30	GRADE 40	GRADE 50
W520CH-W-UPH3	0.5	683	703	711	719	727	735

WOOD - FULL UPHOLSTERED SEAT & BACK

MODEL	YARDAGE	COM	GRADE 10	GRADE 20	GRADE 30	GRADE 40	GRADE 50
W520CH-W-UPH4	1.0	743	782	790	798	806	814

Overall Height: W520CH-W 34", W520CH-W-UPH1 34", W520CH-W-UPH3 34", W520CH-W-UPH4 36"

Overall Depth: 19.6" Overall Width: 18.4" No. Per Carton: 1

Seat Height: W520CH-W 25.5", W520CH-W-UPH1 26", W520CH-W-UPH3 26", W520CH-W-UPH4 26"

Shipping Weight/Chair: 12#



W520BS-W

BROOKE BARSTOOL

WOOD

MODEL	YARDAGE	WOOD	GRADE 10	GRADE 20	GRADE 30	GRADE 40	GRADE 50
W520BS-W	N/A	592	N/A	N/A	N/A	N/A	N/A

WOOD - PARTIALLY UPHOLSTERED SEAT

MODEL	YARDAGE	COM	GRADE 10	GRADE 20	GRADE 30	GRADE 40	GRADE 50
W520BS-W-UPH1	0.4	650	666	674	682	690	698

WOOD - FULLY UPHOLSTERED SEAT

MODEL	YARDAGE	COM	GRADE 10	GRADE 20	GRADE 30	GRADE 40	GRADE 50
W520BS-W-UPH3	0.5	673	693	701	709	717	725

WOOD - FULLY UPHOLSTERED SEAT & BACK

MODEL	YARDAGE	COM	GRADE 10	GRADE 20	GRADE 30	GRADE 40	GRADE 50
W520BS-W-UPH4	1.0	733	772	780	788	796	804

Overall Height: W520BS-W 40", W520BS-W-UPH1 40", W520BS-W-UPH3 40", W520BS-W-UPH4 42"

Overall Depth: 20.6" Overall Width: 19.7" No. Per Carton: 1

Seat Height: W520BS-W 31.5", W520BS-W-UPH1 32", W520BS-W-UPH3 32", W520BS-W-UPH4 32"

Shipping Weight/Chair: 13#



ABOUT THIS COLLECTION

The Cara Collection includes chairs, armchairs, and barstools.

STANDARD FEATURES

- Solid European Beech frame
- Available in multiple upholstery variations
- Upholstered variations feature 1" of high resilience foam (seat treatments increases seat height by 1" but relaxes over a short period of time)
- Webbed seat construction is standard for all upholstery Variation seat treatments
- Technical Bulletin CAL 117 fire retardant upholstery
- Stainless steel footrest protector on barstools
- Metal carpet glides

PERSONALIZATION OPTIONS

- The table to the right explains all of the available options for the Cara Collection.

OPTIONS	PAGE	ADD TO LIST PRICE
Nailhead Trim Surrounding Front Legs on Pullman Seats	9	\$30
Boxed Seat	9	\$25
Reduce Barstool Seat Height to 24"	10	\$25
CAL 133	9	\$65/Yard
Substitute Premium Metal or Plastic Glides	-	\$3
Light Distressing on Chairs	9	\$30
Heavy Distressing on Chairs	9	\$37.50
Light Distressing on Barstools	9	\$37.50
Heavy Distressing on Barstools	9	\$50



W630

CARA CHAIR

MODEL	WOOD	COM	GRADE 10	GRADE 20	GRADE 30	GRADE 40	GRADE 50
W630	N/A	685	740	767	795	823	849

Overall Height: 40" Seat Height: 18" Overall Depth: 23.5" Overall Width: 21.5"
 C.O.M.: 1.5 yd Shipping Weight/Chair: 25# No. Per Carton: 2

CARA CHAIR — UPHOLSTERY OPTIONS

MODEL	COM	GRADE 10	GRADE 20	GRADE 30	GRADE 40	GRADE 50	TOTAL YARDAGE
W630-V23	818	894	930	967	1003	1039	2
W630-V16	818	889	923	957	991	1025	1.875
W630-V26	875	950	986	1022	1058	1095	2

Overall Height: 40" Seat Height: 18" Overall Depth: 23.5" Overall Width: 21.5"
 Shipping Weight/Chair: 25# No. Per Carton: 2



W630-V23
Seat Treatment



W630-V16
Back Treatment



W630-V26
Combo Treatment



W630A

CARA ARMCHAIR

MODEL	WOOD	COM	GRADE 10	GRADE 20	GRADE 30	GRADE 40	GRADE 50
W630A	N/A	767	824	850	878	905	932

Overall Height: 40" Seat Height: 18" Overall Depth: 23.5" Overall Width: 21.5" Arm Height: 26.75"
 Arm Width: 22.25" C.O.M.: 1.5 yd Shipping Weight/Chair: 30# No. Per Carton: 1

CARA ARMCHAIR — UPHOLSTERY OPTIONS

MODEL	COM	GRADE 10	GRADE 20	GRADE 30	GRADE 40	GRADE 50	TOTAL YARDAGE
W630A-V23	902	976	1013	1049	1085	1121	2
W630A-V16	902	972	1006	1040	1074	1108	1.875
W630A-V26	957	1032	1068	1105	1142	1178	2

Overall Height: 40" Seat Height: 18" Overall Depth: 23.5" Overall Width: 21.5" Arm Height: 26.75"
 Arm Width: 22.25" Shipping Weight/Chair: 30# No. Per Carton: 1



W630A-V23
Seat Treatment



W630A-V16
Back Treatment



W630A-V26
Combo Treatment



W630BS

CARA BARSTOOL

MODEL	WOOD	COM	GRADE 10	GRADE 20	GRADE 30	GRADE 40	GRADE 50
W630BS	N/A	737	793	819	847	875	902

Overall Height: 40.25" Seat Height: 31.25" Overall Depth: 20" Overall Width: 17.5"
 C.O.M.: 1.5 yd Shipping Weight/Chair: 35# No. Per Carton: 1

CARA BARSTOOL — UPHOLSTERY OPTIONS

MODEL	COM	GRADE 10	GRADE 20	GRADE 30	GRADE 40	GRADE 50	TOTAL YARDAGE
W630BS-V23	871	946	983	1019	1055	1091	2
W630BS-V16	871	941	975	1009	1043	1078	1.875
W630BS-V26	926	1002	1038	1074	1111	1147	2

Overall Height: 40.25" Seat Height: 31.25" Overall Depth: 20" Overall Width: 17.5"
 Shipping Weight/Chair: 35# No. Per Carton: 1



W630BS-V23
Seat Treatment



W630BS-V16
Back Treatment



W630BS-V26
Combo Treatment



ABOUT THIS COLLECTION

The Chloe Collection includes chairs, armchairs, and barstools.

STANDARD FEATURES

- Solid European Beech frame
- Available in multiple upholstery variations
- Upholstered variations feature 1" of high resilience foam (seat treatment increases seat height by 1" but relaxes over a short period of time)
- Webbed seat construction is standard for all upholstery Variation seat treatments
- Technical Bulletin CAL 117 fire retardant upholstery
- Stainless steel footrest protector on barstools
- Metal carpet glides

PERSONALIZATION OPTIONS

- The table to the right explains all of the available options for the Chloe Collection.

OPTIONS	PAGE	ADD TO LIST PRICE
Nailhead Surround Back	9	\$60
Nailhead Trim Surrounding Front Legs on Pullman Seats	9	\$30
Welting*	9	\$15/Seat
Boxed Seat	9	\$25
Reduce Barstool Seat Height to 24"	10	\$25
CAL 133	9	\$65/Yard
Substitute Premium Metal or Plastic Glides	-	\$3
Light Distressing on Chairs	9	\$30
Heavy Distressing on Chairs	9	\$37.50
Light Distressing on Barstools	9	\$37.50
Heavy Distressing on Barstools	9	\$50

*Standard on upholstered back



W610

CHLOE CHAIR

MODEL	WOOD	COM	GRADE 10	GRADE 20	GRADE 30	GRADE 40	GRADE 50
W610	N/A	523	546	558	569	580	591

Overall Height: 34" Seat Height: 18.5" Overall Depth: 22" Overall Width: 18.25"
 C.O.M.: .625 yd Shipping Weight/Chair: 25# No. Per Carton: 2

CHLOE CHAIR — UPHOLSTERY OPTIONS

MODEL	COM	GRADE 10	GRADE 20	GRADE 30	GRADE 40	GRADE 50	TOTAL YARDAGE
W610-V21	668	706	724	743	761	779	1
W610-V12	676	716	734	752	770	788	1
W610-V22	766	814	836	860	882	905	1.25

Overall Height: 34" Seat Height: 18.5" Overall Depth: 22" Overall Width: 18.25"
 Shipping Weight/Chair: 25# No. Per Carton: 2



W610-V21
Seat Treatment



W610-V12
Back Treatment



W610-V22
Combo Treatment



W610A

CHLOE ARMCHAIR

MODEL	WOOD	COM	GRADE 10	GRADE 20	GRADE 30	GRADE 40	GRADE 50
W610A	N/A	663	686	697	708	720	731

Overall Height: 34" Seat Height: 18.5" Overall Depth: 22" Overall Width: 18.25" Arm Height: 27"
 Arm Width: 22.25" C.O.M.: .625 yd Shipping Weight/Chair: 30# No. Per Carton: 1

CHLOE ARMCHAIR — UPHOLSTERY OPTIONS

MODEL	COM	GRADE 10	GRADE 20	GRADE 30	GRADE 40	GRADE 50	TOTAL YARDAGE
W610A-V21	808	846	864	882	900	919	1
W610A-V12	816	855	873	891	909	928	1
W610A-V22	906	954	976	1000	1022	1045	1.25

Overall Height: 34" Seat Height: 18.5" Overall Depth: 22" Overall Width: 18.25" Arm Height: 27"
 Arm Width: 22.25" Shipping Weight/Chair: 30# No. Per Carton: 1



W610A-V21
Seat Treatment



W610A-V12
Back Treatment



W610A-V22
Combo Treatment



W610BS

CHLOE BARSTOOL

MODEL	WOOD	COM	GRADE 10	GRADE 20	GRADE 30	GRADE 40	GRADE 50
W610BS	N/A	675	700	711	722	734	745

Overall Height: 40.5" Seat Height: 30.5" Overall Depth: 20.5" Overall Width: 17.5"
 C.O.M.: .625 yd Shipping Weight/Chair: 35# No. Per Carton: 1

CHLOE BARSTOOL — UPHOLSTERY OPTIONS

MODEL	COM	GRADE 10	GRADE 20	GRADE 30	GRADE 40	GRADE 50	TOTAL YARDAGE
W610BS-V21	820	860	878	896	914	932	1
W610BS-V12	830	868	887	905	923	941	1
W610BS-V22	920	968	990	1013	1036	1058	1.25

Overall Height: 40.5" Seat Height: 30.5" Overall Depth: 20.5" Overall Width: 17.5"
 C.O.M.: .625 yd Shipping Weight/Chair: 35# No. Per Carton: 1



W610BS-V21
Seat Treatment



W610BS-V12
Back Treatment



W610BS-V22
Combo Treatment

DYLAN COLLECTION



ABOUT THIS COLLECTION

The Dylan Collection includes multiple benches available in solid wood or laminate.

STANDARD FEATURES

- 1.5" Solid Maple or laminate
- Metal mitered-corner bracket available in any standard powder coat color
- CAL 117 fire retardant upholstery materials
- Black height-adjustable, non-skid glide
- 1/2" Thick free state foam; grade 2580

PERSONALIZATION OPTIONS

- The table to the right explains all of the available options for the Dylan Collection.

OPTIONS

	PAGE	ADD TO LIST PRICE
Light Distressing	9	Call For Quote
Heavy Distressing	9	Call For Quote



DYL-B

DYLAN 22" BENCH

MODEL	WOOD	COM	GRADE 10	GRADE 20	GRADE 30	GRADE 40	GRADE 50
DYL-B-SW-172217	1958	2084	2104	2114	2123	2133	2141

MODEL	LAMINATE	COM	GRADE 10	GRADE 20	GRADE 30	GRADE 40	GRADE 50
DYL-B-LAM-172217	1795	1918	1938	1947	1957	1966	1976

Overall Height: 17" Seat Height: 17" Overall Depth: 17" Overall Width: 22"

C.O.M.: .75 yd Shipping Weight/Chair: 40# No. Per Carton: 1



DYL-B

DYLAN 48" BENCH

MODEL	WOOD	COM	GRADE 10	GRADE 20	GRADE 30	GRADE 40	GRADE 50
DYL-B-SW-174817	2087	2210	2239	2255	2268	2283	2297

MODEL	LAMINATE	COM	GRADE 10	GRADE 20	GRADE 30	GRADE 40	GRADE 50
DYL-B-LAM-174817	2009	2132	2160	2175	2189	2204	2218

Overall Height: 17" Seat Height: 17" Overall Depth: 17" Overall Width: 48"

C.O.M.: 1 yd Shipping Weight/Chair: 55# No. Per Carton: 1



DYL-B

DYLAN 54" BENCH

MODEL	WOOD	COM	GRADE 10	GRADE 20	GRADE 30	GRADE 40	GRADE 50
DYL-B-SW-175417	2194	2619	2673	2700	2727	2753	2780

MODEL	LAMINATE	COM	GRADE 10	GRADE 20	GRADE 30	GRADE 40	GRADE 50
DYL-B-LAM-175417	2083	2206	2260	2286	2314	2340	2367

Overall Height: 17" Seat Height: 17" Overall Depth: 17" Overall Width: 54"

C.O.M.: 1.5 yd Shipping Weight/Chair: 60# No. Per Carton: 1



DYL-B

DYLAN 66" BENCH

MODEL	WOOD	COM	GRADE 10	GRADE 20	GRADE 30	GRADE 40	GRADE 50
DYL-B-SW-176617	2257	2384	2442	2471	2499	2527	2556

MODEL	LAMINATE	COM	GRADE 10	GRADE 20	GRADE 30	GRADE 40	GRADE 50
DYL-B-LAM-176617	2211	2333	2391	2420	2448	2477	2506

Overall Height: 17" Seat Height: 17" Overall Depth: 17" Overall Width: 66"
 C.O.M.: 1.75 yd Shipping Weight/Chair: 70# No. Per Carton: 1



DYL-B

DYLAN 78" BENCH

MODEL	WOOD	COM	GRADE 10	GRADE 20	GRADE 30	GRADE 40	GRADE 50
DYL-B-SW-177817	2342	2465	2531	2565	2599	2632	2665

MODEL	LAMINATE	COM	GRADE 10	GRADE 20	GRADE 30	GRADE 40	GRADE 50
DYL-B-LAM-177817	2298	2421	2489	2522	2555	2589	2621

Overall Height: 17" Seat Height: 17" Overall Depth: 17" Overall Width: 78"
 C.O.M.: 2 yd Shipping Weight/Chair: 80# No. Per Carton: 1



DYL-B

DYLAN 90" BENCH

MODEL	WOOD	COM	GRADE 10	GRADE 20	GRADE 30	GRADE 40	GRADE 50
DYL-B-SW-179017	2501	2624	2701	2739	2777	2815	2854

MODEL	LAMINATE	COM	GRADE 10	GRADE 20	GRADE 30	GRADE 40	GRADE 50
DYL-B-LAM-179017	2436	2558	2634	2672	2710	2749	2787

Overall Height: 17" Seat Height: 17" Overall Depth: 17" Overall Width: 90"
 C.O.M.: 2.25 yd Shipping Weight/Chair: 90# No. Per Carton: 1



ABOUT THIS COLLECTION

The Harbor Collection includes barstools.

STANDARD FEATURES

- Solid Maple frame
- Steam bent curved wood legs
- Tongue and groove, glued and screwed seat rails
- 2" of high resilient foam
- Brushed stainless steel foot ring
- Metal carpet glides

PERSONALIZATION OPTIONS

- The table to the right explains all of the available options for the Harbor Collection.
- Thread color will be chosen by factory to match the upholstery as closely as possible, unless otherwise specified. Choose between white, black, beige, dark grey, or beaver.

OPTIONS

	PAGE	ADD TO LIST PRICE
Nailhead Cobbler Seat	9	\$60
Brass Foot Ring Available	-	\$35
CAL 133	9	\$65/Yard
Substitute Premium Metal or Plastic Glides	-	\$3
Optional Wood Seat Made of 1" Saddled Ply	-	\$38 to COM
Light Distressing on Barstools	9	\$37.50
Heavy Distressing on Barstools	9	\$50



W465BS

HARBOR BARSTOOL

MODEL	WOOD	COM	GRADE 10	GRADE 20	GRADE 30	GRADE 40	GRADE 50
W465BS	739	696	734	752	770	788	807

Overall Height: 30" Seat Height: 30" Overall Depth: 18" Overall Width: 18"

C.O.M.: 1 yd Shipping Weight/Chair: 28# No. Per Carton: 1



ABOUT THIS COLLECTION

The Hugh Collection includes just one wooden chair with a simple, Shaker style design.

STANDARD FEATURES

- Solid European Beech frame
- Metal carpet glides

PERSONALIZATION OPTIONS

• The table to the right explains all of the available options for the Hugh Collection.

OPTIONS	PAGE	ADD TO LIST PRICE
Light Distressing on Chairs	9	\$30
Heavy Distressing on Chairs	9	\$37.50



W515

HUGH CHAIR

MODEL	WOOD
-------	------

W515	452
------	-----

Overall Height: 33" Seat Height: 18" Overall Depth: 23" Overall Width: 18"

Shipping Weight/Chair: 13# No. Per Carton: 2



ABOUT THIS COLLECTION

The Lena Collection includes a backless barstool.

STANDARD FEATURES

- Formed plywood shell seat made from 11 layers of face-grade hardwood European Beech veneer
- Mortise-and-tenon construction
- Choose from our standard Bentwood approved finishes
- Comes standard with two stainless steel footrest protectors
- Metal carpet glides

PERSONALIZATION OPTIONS

- The table to the right explains all of the available options for the Lena Collection.

OPTIONS	PAGE	ADD TO LIST PRICE
Two Separate Finishes	-	\$50
Reduce Barstool Seat Height to 24"	10	\$25 List
Brass Footrest Protector	-	\$30
Substitute Premium Metal or Plastic Glides	-	\$3
Light Distressing on Barstools	9	Call For Quote
Heavy Distressing on Barstools	9	Call For Quote



W640BS

LENA BARSTOOL

MODEL WOOD

W640BS 670

Overall Height: 31" Seat Height: 31" Overall Depth: 15.75" Overall Width: 16.5"

Shipping Weight/Chair: 22# No. Per Carton: 1



ABOUT THIS COLLECTION

The Merano By Ton Collection includes chairs, armchairs, counter height barstools, and barstools.

STANDARD FEATURES

- Solid European Beech frame, available in any standard Bentwood finishes
- Available in European Oak or American Walnut in natural finish only
- CAL 117 fire retardant upholstery materials
- Available in all wood or with upholstered seat and back
- Metal carpet glides
- Standard fabric program available for quicker lead times. Please see website for fabric detail.
- Merano Chairs stack four high
- Stools come with stainless steel footrest

PERSONALIZATION OPTIONS

- The table to the right explains all of the available options for the Merano Collection.
 - COM is available with extended lead time - call for quote.
-



W400SC

MERANO CHAIR

MODEL	BEECH	EUROPEAN OAK	AMERICAN WALNUT
W400SC – Wood Seat & Back	643	1001	1611
W400SC – Upholstered Seat & Back, Standard Vinyl	898	1013	1818
W400SC – Upholstered Seat & Back, Standard Fabric	938	1053	1858

Overall Height: 31" Seat Height: 18" Overall Depth: 17" Overall Width: 17"

C.O.M.: 1 yd Shipping Weight/Chair: 26# No. Per Carton: 2



W400AC

MERANO ARMCHAIR

MODEL	BEECH	EUROPEAN OAK	AMERICAN WALNUT
W400AC – Wood Seat & Back	784	987	2094
W400AC – Upholstered Seat & Back, Standard Vinyl	1057	1258	2367
W400AC – Upholstered Seat & Back, Standard Fabric	1102	1304	2412

Overall Height: 31" Seat Height: 18" Overall Depth: 15" Overall Width: 19"

C.O.M.: 1 yd Shipping Weight/Chair: 30# No. Per Carton: 1



W400CH

MERANO BARSTOOL — 24" COUNTER HEIGHT

MODEL	BEECH	EUROPEAN OAK	AMERICAN WALNUT
W400CH – Wood Seat & Back	772	1001	2129
W400CH – Upholstered Seat & Back, Standard Vinyl	1021	1204	2330
W400CH – Upholstered Seat & Back, Standard Fabric	1061	1244	2370

Overall Height: 32" Seat Height: 24" Overall Depth: 14" Overall Width: 17"

C.O.M.: 1 yd Shipping Weight/Chair: 26# No. Per Carton: 1



W400BS

MERANO BARSTOOL — 30" BARSTOOL

MODEL	BEECH	EUROPEAN OAK	AMERICAN WALNUT
W400BS – Wood Seat & Back	772	1001	2129
W400BS – Upholstered Seat & Back, Standard Vinyl	1021	1204	2330
W400BS – Upholstered Seat & Back, Standard Fabric	1061	1244	2370

Overall Height: 39" Seat Height: 30" Overall Depth: 14" Overall Width: 17"

C.O.M.: 1 yd Shipping Weight/Chair: 26# No. Per Carton: 1



ABOUT THIS COLLECTION

The Molly Collection includes chairs, nesting chairs, armchairs, and barstools.

STANDARD FEATURES

- Solid European Beach Frame
- Available in all wood or upholstered options
- Upholstered models feature 2" high resilience foam
- Nesting model available
- Barstools come with stainless steel footrest
- Metal carpet glides standard on all models unless otherwise specified
- Nests five high

PERSONALIZATION OPTIONS

- The table to the right explains all of the available options for the Molly Collection.
- Cut-out back graphics and laser engraved graphics should not exceed 6" x 6".
- Boxed seats and wood seats are not available on nesting chairs.

OPTIONS	PAGE	ADD TO LIST PRICE
Cut-Out	10	\$30
Engraved Back	10	\$30/Side
Nailhead Cobbler Seat	9	\$60
Nailhead Waterfall Cobbler Seat	9	\$60
Nailhead Surround Back	9	\$60
Nailhead Trim Surrounding Front Legs on Pullman Seats	9	\$30
Welting	9	\$15/Seat, \$15/Back
Boxed Seat	9	\$25
Reduce Barstool Seat Height to 24"	10	\$25
CAL 133	9	\$65/Yard
Substitute Premium Metal or Plastic Glides	-	\$3
Light Distressing on Chair	9	\$30
Heavy Distressing on Chair	9	\$37.50
Light Distressing on Barstool	9	\$37.50
Heavy Distressing on Barstool	9	\$50



W507

MOLLY CHAIR

MODEL	WOOD	COM	GRADE 10	GRADE 20	GRADE 30	GRADE 40	GRADE 50
W507	527	483	500	509	516	526	533

Overall Height: 34.75" Seat Height: 19" Overall Depth: 20.5" Overall Width: 18"
 C.O.M.: .45 yd Shipping Weight/Chair: 26# No. Per Carton: 2

MOLLY CHAIR — UPHOLSTERY OPTIONS

MODEL	COM	GRADE 10	GRADE 20	GRADE 30	GRADE 40	GRADE 50	TOTAL YARDAGE
W507-V21	618	647	659	673	688	701	.75
W507-V31	743	780	798	816	835	854	1
W507-V12	618	655	673	691	711	729	1
W507-V22	688	735	757	780	803	827	1.25
W507-V32	731	787	814	842	870	897	1.5

Overall Height: 34.75" Seat Height: 19" Overall Depth: 20.5" Overall Width: 18"
 Shipping Weight/Chair: 26# No. Per Carton: 2



W507-V21
Seat Treatment



W507-V31
Seat Treatment



W507-V12
Back Treatment



W507-V22
Combo Treatment



W507-V32
Combo Treatment



WN507

MOLLY NESTING CHAIR

MODEL	COM	GRADE 10	GRADE 20	GRADE 30	GRADE 40	GRADE 50
WN507	524	532	540	548	556	564

Overall Height: 34.75" Seat Height: 19" Overall Depth: 20.5" Overall Width: 18"
 C.O.M.: .45 yd Shipping Weight/Chair: 26# No. Per Carton: 2



W507A

MOLLY ARMCHAIR

MODEL	WOOD	COM	GRADE 10	GRADE 20	GRADE 30	GRADE 40	GRADE 50
W507A	587	544	561	569	577	586	594

Overall Height: 34.75" Seat Height: 19" Overall Depth: 20.5" Overall Width: 18" Arm Height: 26.375"
 C.O.M.: .45 yd Shipping Weight/Chair: 26# No. Per Carton: 1

MOLLY ARMCHAIR — UPHOLSTERY OPTIONS

MODEL	COM	GRADE 10	GRADE 20	GRADE 30	GRADE 40	GRADE 50	TOTAL YARDAGE
W507A-V21	678	706	720	734	748	761	.75
W507A-V31	802	841	859	877	896	914	1
W507A-V12	678	716	734	752	771	789	1
W507A-V22	748	795	817	841	864	887	1.25
W507A-V32	792	847	875	902	930	957	1.5

Overall Height: 34.75" Seat Height: 19" Overall Depth: 20.5" Overall Width: 18" Arm Height: 26.375"
 Shipping Weight/Chair: 26# No. Per Carton: 1



W507A-V21
Seat Treatment



W507A-V31
Seat Treatment



W507A-V12
Back Treatment



W507A-V22
Combo Treatment



W507A-V32
Combo Treatment



W507BS

MOLLY BARSTOOL

MODEL	WOOD	COM	GRADE 10	GRADE 20	GRADE 30	GRADE 40	GRADE 50
W507BS	671	628	644	653	660	670	678

Overall Height: 43.75" Seat Height: 30" Overall Depth: 18.5" Overall Width: 17.75"
 C.O.M.: .45 yd Shipping Weight/Chair: 32# No. Per Carton: 1

MOLLY BARSTOOL — UPHOLSTERY OPTIONS

MODEL	COM	GRADE 10	GRADE 20	GRADE 30	GRADE 40	GRADE 50	TOTAL YARDAGE
W507BS-V21	762	791	803	817	832	845	.75
W507BS-V31	887	924	942	961	979	999	1
W507BS-V12	762	799	817	835	855	873	1
W507BS-V22	832	879	902	924	948	971	1.25
W507BS-V32	876	931	958	986	1014	1041	1.5

Overall Height: 43.75" Seat Height: 30" Overall Depth: 18.5" Overall Width: 17.75"
 Shipping Weight/Chair: 32# No. Per Carton: 1



W507BS-V21
Seat Treatment



W507BS-V31
Seat Treatment



W507BS-V12
Combo Treatment



W507BS-V22
Combo Treatment



W507BS-V32
Combo Treatment



ABOUT THIS COLLECTION

The Tilly Collection includes a chair, counter height stool, and a barstool. The Tilly Collection is a wood seating collection that is considered a modern take on a classic café chair with its open back and steam bent curves.

STANDARD FEATURES

- Solid European Beech frame
- Steam bent, offset backrest
- Wood seat or upholstered seat available
- Metal carpet glides

PERSONALIZATION OPTIONS

- The table to the right explains all of the available options for the Tilly Collection.

OPTIONS	PAGE	ADD TO LIST PRICE
CAL 133	9	\$65/Yard
Substitute Premium Plastic Glides	-	\$3



W107

TILLY CHAIR

WOOD							
MODEL	YARDAGE	WOOD	GRADE 10	GRADE 20	GRADE 30	GRADE 40	GRADE 50
W107	N/A	698	N/A	N/A	N/A	N/A	N/A

WOOD - UPHOLSTERED SEAT							
MODEL	YARDAGE	COM	GRADE 10	GRADE 20	GRADE 30	GRADE 40	GRADE 50
W107-UPH	0.35	767	781	788	794	800	807

Overall Height: 33.52" Seat Height: 18.61" Overall Depth: 20.125" Overall Width: 18.5"
 Shipping Weight/Chair: 13# No. Per Carton: 2



W107CH

TILLY COUNTER HEIGHT STOOL

WOOD							
MODEL	YARDAGE	WOOD	GRADE 10	GRADE 20	GRADE 30	GRADE 40	GRADE 50
W107CH	N/A	1025	N/A	N/A	N/A	N/A	N/A

WOOD - UPHOLSTERED SEAT							
MODEL	YARDAGE	COM	GRADE 10	GRADE 20	GRADE 30	GRADE 40	GRADE 50
W107CH-UPH	0.35	1099	1113	1120	1126	1133	1140

Overall Height: 38.5" Seat Height: 24.75" Overall Depth: 19" Overall Width: 18"
 Shipping Weight/Chair: 19# No. Per Carton: 1



W107BS

TILLY BARSTOOL

WOOD							
MODEL	YARDAGE	WOOD	GRADE 10	GRADE 20	GRADE 30	GRADE 40	GRADE 50
W107BS	N/A	996	N/A	N/A	N/A	N/A	N/A

WOOD - UPHOLSTERED SEAT							
MODEL	YARDAGE	COM	GRADE 10	GRADE 20	GRADE 30	GRADE 40	GRADE 50
W107BS-UPH	0.35	1071	1084	1091	1097	1104	1111

Overall Height: 43.61" Seat Height: 30.36" Overall Depth: 19.25" Overall Width: 19.25"
 Shipping Weight/Chair: 21# No. Per Carton: 1



ABOUT THIS COLLECTION

The Wood Mama Melissa Collection includes chairs, armchairs, and barstools.

STANDARD FEATURES

- Solid European Beech frame
- Available in multiple upholstery variations
- Upholstered variations feature 1" of high resilience foam (seat treatment increases seat height by 1" but relaxes over a short period of time)
- Wood seats made of 1" saddle ply
- Webbed seat construction is standard for all upholstery variation seat treatments
- Technical Bulletin CAL 117 fire retardant upholstery materials
- Stainless steel footrest protector on barstools
- Metal carpet glides

PERSONALIZATION OPTIONS

- The table to the right explains all of the available options for the Wood Mama Melissa Collection.
- Cut-out back graphics and laser engraved graphics should not exceed 6" x 6".
- Nailhead Cobbler Seat only available on standard models or V12, V15, and V16 models.
- Nailhead Waterfall Cobbler Seat only available on standard models or V12, V15, and V16 models.

OPTIONS	PAGE	ADD TO LIST PRICE
Cut-Out Design	10	\$30
Engraved Back	10	\$30/Side
Nailhead Cobbler Seat	9	\$60
Nailhead Waterfall Cobbler Seat	9	\$60
Nailhead Surround Back	9	\$60
Nailhead Trim Surrounding Front Legs on Pullman Seats	9	\$30
Handhold	10	\$20
Welting	9	\$15/Seat, \$15/Back
Boxed Seat	9	\$25
Reduce Barstool Seat Height to 24"	10	\$25
CAL 133	9	\$65/Yard
Substitute Premium Metal or Plastic Glides	-	\$3
Light Distressing on Chairs	9	\$30
Heavy Distressing on Chairs	9	\$37.50
Light Distressing on Barstools	9	\$37.50
Heavy Distressing on Barstools	9	\$50

WOOD MAMA MELISSA



W574

WOOD MAMA MELISSA CHAIR

MODEL	WOOD	COM	GRADE 10	GRADE 20	GRADE 30	GRADE 40	GRADE 50
W574	551	508	527	536	545	554	563

Overall Height: 34.75" Seat Height: 18.5" Overall Depth: 21.5" Overall Width: 19"
 C.O.M.: .5 yd Shipping Weight/Chair: 26# No. Per Carton: 2

WOOD MAMA MELISSA CHAIR — UPHOLSTERY OPTIONS

MODEL	COM	GRADE 10	GRADE 20	GRADE 30	GRADE 40	GRADE 50	TOTAL YARDAGE
W574-V21	641	672	687	702	717	730	.75
W574-V31	710	749	769	788	808	827	1
W574-V12	641	682	701	720	739	759	1
W574-V15	650	707	736	764	793	820	1.5
W574-V16	660	719	747	776	803	832	1.5
W574-V22	712	761	784	809	832	856	1.25
W574-V32	755	813	842	870	898	926	1.5
W574-V25	763	826	856	887	918	948	1.625
W574-V35	792	867	905	942	979	1018	2
W574-V26	763	836	873	908	944	982	1.875
W574-V36	792	867	905	942	979	1018	2

Overall Height: 34.75" Seat Height: 18.5" Overall Depth: 21.5" Overall Width: 19"
 Shipping Weight/Chair: 26# No. Per Carton: 2



W574-V21
Seat Treatment



W574-V31
Seat Treatment



W574-V12
Back Treatment



W574-V15
Back Treatment



W574-V16
Back Treatment



W574-V22
Combo Treatment



W574-V32
Combo Treatment



W574-V25
Combo Treatment



W574-V35
Combo Treatment



W574-V26
Combo Treatment



W574-V36
Combo Treatment



WN574

WOOD MAMA MELISSA NESTING CHAIR

MODEL	COM	GRADE 10	GRADE 20	GRADE 30	GRADE 40	GRADE 50
WN574	537	559	568	577	586	595

Overall Height: 34.75" Seat Height: 18.5" Overall Depth: 21.5" Overall Width: 19"

C.O.M.: .5 yd Shipping Weight/Chair: 26# No. Per Carton: 2

WOOD MAMA MELISSA



W574A

WOOD MAMA MELISSA ARMCHAIR

MODEL	WOOD	COM	GRADE 10	GRADE 20	GRADE 30	GRADE 40	GRADE 50
W574A	634	590	610	619	628	637	647

Overall Height: 34" Seat Height: 18.5" Overall Depth: 21.5" Overall Width: 19" Arm Height: 27"
 C.O.M.: .5 yd Shipping Weight/Chair: 26# No. Per Carton: 1

WOOD MAMA MELISSA ARMCHAIR — UPHOLSTERY OPTIONS

MODEL	COM	GRADE 10	GRADE 20	GRADE 30	GRADE 40	GRADE 50	TOTAL YARDAGE
W574A-V21	724	755	770	784	799	813	.75
W574A-V31	793	832	851	871	890	909	1
W574A-V12	724	764	783	802	823	842	1
W574A-V15	732	791	818	847	876	904	1.5
W574A-V16	744	801	830	859	887	915	1.5
W574A-V22	795	844	867	891	915	939	1.25
W574A-V32	838	896	924	953	982	1009	1.5
W574A-V25	846	908	939	970	1001	1031	1.625
W574A-V35	875	951	988	1025	1063	1100	2
W574A-V26	846	920	956	991	1027	1064	1.875
W574A-V36	875	951	988	1025	1063	1100	2

Overall Height: 34" Seat Height: 18.5" Overall Depth: 21.5" Overall Width: 19" Arm Height: 27"
 Shipping Weight/Chair: 26# No. Per Carton: 2



W574A-V21
Seat Treatment



W574A-V31
Seat Treatment



W574A-V12
Back Treatment



W574A-V15
Back Treatment



W574A-V16
Back Treatment



W574A-V22
Combo Treatment



W574A-V32
Combo Treatment



W574A-V25
Combo Treatment



W574A-V35
Combo Treatment



W574A-V26
Combo Treatment



W574A-V36
Combo Treatment



W574BS

WOOD MAMA MELISSA BARSTOOL

MODEL	WOOD	COM	GRADE 10	GRADE 20	GRADE 30	GRADE 40	GRADE 50
W574BS	672	629	649	657	667	675	685

Overall Height: 45.5" Seat Height: 30" Overall Depth: 21.75" Overall Width: 19.5"
 C.O.M.: .5 yd Shipping Weight/Chair: 32# No. Per Carton: 1

WOOD MAMA MELISSA BARSTOOL — UPHOLSTERY OPTIONS

MODEL	COM	GRADE 10	GRADE 20	GRADE 30	GRADE 40	GRADE 50	TOTAL YARDAGE
W574BS-V21	763	794	809	824	838	851	.75
W574BS-V31	831	871	890	909	929	948	1
W574BS-V12	763	802	823	842	861	880	1
W574BS-V15	771	829	858	886	914	942	1.5
W574BS-V16	782	841	868	897	925	954	1.5
W574BS-V22	833	882	906	930	954	977	1.25
W574BS-V32	877	935	962	991	1020	1048	1.5
W574BS-V25	884	947	977	1008	1039	1070	1.625
W574BS-V35	913	989	1026	1064	1101	1138	2
W574BS-V26	884	958	994	1030	1066	1102	1.875
W574BS-V36	913	989	1026	1064	1101	1138	2

Overall Height: 45.5" Seat Height: 30" Overall Depth: 21.75" Overall Width: 19.5"
 Shipping Weight/Chair: 32# No. Per Carton: 1



W574BS-V21
Seat Treatment



W574BS-V31
Seat Treatment



W574BS-V12
Back Treatment



W574BS-V15
Back Treatment



W574BS-V16
Back Treatment



W574BS-V22
Combo Treatment



W574BS-V32
Combo Treatment



W574BS-V25
Combo Treatment



W574BS-V35
Combo Treatment



W574BS-V26
Combo Treatment



W574BS-V36
Combo Treatment

WOOD MELISSA 504 COLLECTION



ABOUT THIS COLLECTION

The Wood Melissa 504 Collection includes chairs, nesting chairs, armchairs, and barstools.

STANDARD FEATURES

- Solid European Beech frame
- Available in multiple upholstery variations
- Upholstered variations feature 2" of high resilience foam (seat treatment increases seat height by 1" but relaxes over a short period of time)
- Wood seats made of 1" saddle ply
- Webbed seat construction is standard for all upholstery variation seat treatments
- Technical Bulletin CAL 117 fire retardant upholstery
- Stainless steel footrest protector on barstools
- Metal carpet glides
- Nests five high

PERSONALIZATION OPTIONS

- The table to the right explains all of the available options for the Wood Melissa 504 Collection.
- Cut-out back graphics and laser engraved graphics should not exceed 6" x 6".
- Nailhead Cobbler Seat only available on standard models or V12, V15, and V16 models.
- Nailhead Waterfall Cobbler Seat only available on standard models or V12, V15, and V16 models.
- Boxed seats are not available on nesting chairs.

OPTIONS	PAGE	ADD TO LIST PRICE
Cut-Out Design	10	\$30
Engraved Back	10	\$30/Side
Nailhead Cobbler Seat	9	\$60
Nailhead Waterfall Cobbler Seat	9	\$60
Nailhead Surround Back	9	\$60
Nailhead Trim Surrounding Front Legs on Pullman Seats	9	\$30
Handhold	10	\$20
Welting	9	\$15/Seat, \$15/Back
Boxed Seat	9	\$25
Reduce Barstool Seat Height to 24"	10	\$25
CAL 133	9	\$65/Yard
Substitute Premium Metal or Plastic Glides	-	\$3
Light Distressing on Chairs	9	\$30
Heavy Distressing on Chairs	9	\$37.50
Light Distressing on Barstools	9	\$37.50
Heavy Distressing on Barstools	9	\$50



W504

WOOD MELISSA CHAIR

MODEL	WOOD	COM	GRADE 10	GRADE 20	GRADE 30	GRADE 40	GRADE 50
W504	483	441	458	465	474	482	491

Overall Height: 35" Seat Height: 18" Overall Depth: 19.5" Overall Width: 17.5"
 C.O.M.: .45 yd Shipping Weight/Chair: 26# No. Per Carton: 2

WOOD MELISSA CHAIR — UPHOLSTERY OPTIONS

MODEL	COM	GRADE 10	GRADE 20	GRADE 30	GRADE 40	GRADE 50	TOTAL YARDAGE
W504-V21	575	603	617	631	644	657	.75
W504-V31	642	681	699	717	736	754	1
W504-V12	575	612	631	649	668	686	1
W504-V15	583	629	652	674	699	721	1.25
W504-V16	594	650	676	704	732	760	1.5
W504-V22	644	691	714	737	761	783	1.25
W504-V32	688	744	771	798	827	854	1.5
W504-V25	696	752	779	807	834	862	1.5
W504-V35	724	792	825	856	890	923	1.75
W504-V26	696	752	779	807	834	862	1.5
W504-V36	724	794	828	862	897	931	1.875

Overall Height: 35" Seat Height: 18" Overall Depth: 19.5" Overall Width: 17.5"
 Shipping Weight/Chair: 26# No. Per Carton: 2



W504-V21
Seat Treatment



W504-V31
Seat Treatment



W504-V12
Back Treatment



W504-V15
Back Treatment



W504-V16
Back Treatment



W504-V22
Combo Treatment



W504-V32
Combo Treatment



W504-V25
Combo Treatment



W504-V35
Combo Treatment



W504-V26
Combo Treatment



W504-V36
Combo Treatment



WN504

WOOD MELISSA NESTING CHAIR

MODEL	COM	GRADE 10	GRADE 20	GRADE 30	GRADE 40	GRADE 50
WN504	466	483	490	499	507	516

Overall Height: 35" Seat Height: 18" Overall Depth: 19.5" Overall Width: 17.5"
 C.O.M.: .45 yd Shipping Weight/Chair: 26# No. Per Carton: 2



W504A

WOOD MELISSA ARMCHAIR

MODEL	WOOD	COM	GRADE 10	GRADE 20	GRADE 30	GRADE 40	GRADE 50
W504A	559	515	532	541	548	558	565

Overall Height: 35" Seat Height: 18" Overall Depth: 19.5" Overall Width: 17.5" Arm Height: 26.5"
 C.O.M.: .45 yd Shipping Weight/Chair: 26# No. Per Carton: 1

WOOD MELISSA ARMCHAIR — UPHOLSTERY OPTIONS

MODEL	COM	GRADE 10	GRADE 20	GRADE 30	GRADE 40	GRADE 50	TOTAL YARDAGE
W504A-V21	650	678	691	705	720	732	.75
W504A-V31	718	755	773	792	811	829	1
W504A-V12	650	687	705	723	743	761	1
W504A-V15	657	704	727	749	773	796	1.25
W504A-V16	669	724	752	779	808	834	1.5
W504A-V22	720	766	789	812	835	859	1.25
W504A-V32	763	818	846	873	902	929	1.5
W504A-V25	771	827	854	881	909	937	1.5
W504A-V35	799	866	899	931	966	999	1.75
W504A-V26	771	827	854	881	909	937	1.5
W504A-V36	799	868	903	937	972	1006	1.875

Overall Height: 35" Seat Height: 18" Overall Depth: 19.5" Overall Width: 17.5" Arm Height: 26.5"
 Shipping Weight/Chair: 26# No. Per Carton: 1



W504A-V21
Seat Treatment



W504A-V31
Seat Treatment



W504A-V12
Back Treatment



W504A-V15
Back Treatment



W504A-V16
Back Treatment



W504A-V22
Combo Treatment



W504A-V32
Combo Treatment



W504A-V25
Combo Treatment



W504A-V35
Combo Treatment



W504A-V26
Combo Treatment



W504A-V36
Combo Treatment



W504BS

WOOD MELISSA BARSTOOL

MODEL	WOOD	COM	GRADE 10	GRADE 20	GRADE 30	GRADE 40	GRADE 50
W504BS	604	561	578	586	594	603	611

Overall Height: 44.25" Seat Height: 29.75" Overall Depth: 18.5" Overall Width: 17.5"
 C.O.M.: .45 yd Shipping Weight/Chair: 32# No. Per Carton: 1

WOOD MELISSA BARSTOOL — UPHOLSTERY OPTIONS

MODEL	COM	GRADE 10	GRADE 20	GRADE 30	GRADE 40	GRADE 50	TOTAL YARDAGE
W504BS-V21	695	723	737	750	765	778	.75
W504BS-V31	763	800	818	836	856	875	1
W504BS-V12	695	732	750	769	788	807	1
W504BS-V15	703	749	772	795	812	842	1.25
W504BS-V16	669	724	752	779	852	880	1.5
W504BS-V22	765	812	834	858	881	904	1.25
W504BS-V32	809	864	891	919	902	929	1.5
W504BS-V25	771	827	854	881	909	937	1.5
W504BS-V35	845	912	944	976	1010	1043	1.75
W504BS-V26	816	872	899	926	955	983	1.5
W504BS-V36	845	914	948	983	1018	1052	1.875

Overall Height: 44.25" Seat Height: 29.75" Overall Depth: 18.5" Overall Width: 17.5"
 Shipping Weight/Chair: 32# No. Per Carton: 1



W504BS-V21
Seat Treatment



W504BS-V31
Seat Treatment



W504BS-V12
Back Treatment



W504BS-V15
Back Treatment



W504BS-V16
Back Treatment



W504BS-V22
Combo Treatment



W504BS-V32
Combo Treatment



W504BS-V25
Combo Treatment



W504BS-V35
Combo Treatment



W504BS-V26
Combo Treatment



W504BS-V36
Combo Treatment

WOOD MELISSA 509 COLLECTION



ABOUT THIS COLLECTION

The Wood Melissa 509 Collection includes chairs, nesting chairs, armchairs, and barstools.

STANDARD FEATURES

- Solid European Beech frame
- Available in multiple upholstery variations
- Upholstered variations feature 2" of high resilience foam (seat treatment increases seat height by 1" but relaxes over a short period of time)
- Wood seats made of 1" saddle ply
- Webbed seat construction is standard for all upholstery variation seat treatments
- Technical Bulletin CAL 117 fire retardant upholstery
- Stainless steel footrest protector on barstools
- Metal carpet glides
- Nests five high

PERSONALIZATION OPTIONS

- The table to the right explains all of the available options for the Wood Melissa 509 Collection.
- Nailhead Cobbler Seat only available on standard models or V12 models.
- Nailhead Waterfall Cobbler Seat only available on standard models or V12 models.
- Boxed seats are not available on nesting chairs.

OPTIONS	PAGE	ADD TO LIST PRICE
Nailhead Cobbler Seat	9	\$60
Nailhead Waterfall Cobbler Seat	9	\$60
Nailhead Surround Back	9	\$60
Nailhead Trim Surrounding Front Legs on Pullman Seats	9	\$30
Welting	9	\$15/Seat, \$15/Back
Boxed Seat	9	\$25
Reduce Barstool Seat Height to 24"	10	\$25
CAL 133	9	\$65/Yard
Substitute Premium Metal or Plastic Glides	-	\$3
Light Distressing on Chairs	9	\$30
Heavy Distressing on Chairs	9	\$37.50
Light Distressing on Barstools	9	\$37.50
Heavy Distressing on Barstools	9	\$50



WOOD MELISSA CHAIR

MODEL	WOOD	COM	GRADE 10	GRADE 20	GRADE 30	GRADE 40	GRADE 50
W509	513	470	488	495	504	512	520

Overall Height: 34.75" Seat Height: 18" Overall Depth: 21.25" Overall Width: 17.25"
 C.O.M.: .45 yd Shipping Weight/Chair: 26# No. Per Carton: 2

WOOD MELISSA CHAIR — UPHOLSTERY OPTIONS

MODEL	COM	GRADE 10	GRADE 20	GRADE 30	GRADE 40	GRADE 50	TOTAL YARDAGE
W509-V21	604	633	647	157	674	687	.75
W509-V31	672	710	728	746	765	783	1
W509-V12	604	641	659	678	697	716	1
W509-V22	674	721	744	766	791	813	1.25
W509-V32	718	773	800	828	856	883	1.5

Overall Height: 34.75" Seat Height: 18" Overall Depth: 21.25" Overall Width: 17.25"
 Shipping Weight/Chair: 26# No. Per Carton: 2



W509-V21
Seat Treatment



W509-V31
Seat Treatment



W509-V12
Back Treatment



W509-V22
Combo Treatment



W509-V32
Combo Treatment



WOOD MELISSA NESTING CHAIR

MODEL	COM	GRADE 10	GRADE 20	GRADE 30	GRADE 40	GRADE 50
WN509	499	516	524	532	540	548

Overall Height: 34.75" Seat Height: 18" Overall Depth: 21.25" Overall Width: 17.25"
 C.O.M.: .45 yd Shipping Weight/Chair: 26# No. Per Carton: 2



W509A

WOOD MELISSA ARMCHAIR

MODEL	WOOD	COM	GRADE 10	GRADE 20	GRADE 30	GRADE 40	GRADE 50
W509A	570	527	544	552	560	569	577

Overall Height: 35" Seat Height: 18.75" Overall Depth: 21" Overall Width: 17.25" Arm Height: 26.5"
 C.O.M.: .45 yd Shipping Weight/Chair: 26# No. Per Carton: 1

WOOD MELISSA ARMCHAIR — UPHOLSTERY OPTIONS

MODEL	COM	GRADE 10	GRADE 20	GRADE 30	GRADE 40	GRADE 50	TOTAL YARDAGE
W509A-V21	660	689	703	717	731	744	.75
W509A-V31	729	766	784	802	823	841	1
W509A-V12	660	699	717	735	754	772	1
W509A-V22	731	778	800	824	847	870	1.25
W509A-V32	775	830	858	884	913	940	1.5

Overall Height: 35" Seat Height: 18.75" Overall Depth: 21" Overall Width: 17.25" Arm Height: 26.5"
 Shipping Weight/Chair: 26# No. Per Carton: 1



W509A-V21
Seat Treatment



W509A-V31
Seat Treatment



W509A-V12
Back Treatment



W509A-V22
Combo Treatment



W509A-V32
Combo Treatment



W509BS

WOOD MELISSA BARSTOOL

MODEL	WOOD	COM	GRADE 10	GRADE 20	GRADE 30	GRADE 40	GRADE 50
W509BS	643	601	618	625	634	642	651

Overall Height: 44" Seat Height: 29.75" Overall Depth: 19" Overall Width: 16"
 C.O.M.: .45 yd Shipping Weight/Chair: 32# No. Per Carton: 1

WOOD MELISSA BARSTOOL — UPHOLSTERY OPTIONS

MODEL	COM	GRADE 10	GRADE 20	GRADE 30	GRADE 40	GRADE 50	TOTAL YARDAGE
W509BS-V21	735	763	777	791	805	817	.75
W509BS-V31	802	841	859	877	896	914	1
W509BS-V12	735	772	791	809	828	846	1
W509BS-V22	805	851	875	897	921	943	1.25
W509BS-V32	848	904	931	958	987	1014	1.5

Overall Height: 44" Seat Height: 29.75" Overall Depth: 19" Overall Width: 16"
 Shipping Weight/Chair: 32# No. Per Carton: 1



W509BS-V21
Seat Treatment



W509BS-V31
Seat Treatment



W509BS-V12
Back Treatment



W509BS-V22
Combo Treatment



W509BS-V32
Combo Treatment

STEEL SEATING

ARTISAN II COLLECTION



ABOUT THIS COLLECTION

The Artisan II Collection includes chairs, barstools, swivel barstool models, and fixed seating.

STANDARD FEATURES

- 1.25" metal tube frame
- Wood seats made of 1" saddled ply
- Upholstered variations feature 2" of high resilience foam
- Five standard back designs available
- Technical Bulletin CAL 117 fire retardant upholstery materials
- Premium nylon glides

PERSONALIZATION OPTIONS

- The table to the right explains all of the available options for the Artisan II Collection.
- Cut-out back graphics and laser engraved graphics should not exceed 6" x 6".
- Custom laser cut-outs and engravings must be discussed with the factory.
- Please note for counter seat, model numbers with 3000 denote core-drilled mounts and model numbers with 4000 denote bolt-down mounts.

OPTIONS

	PAGE	ADD TO LIST PRICE
Webbed Seat Construction	9	\$8
Reduce Barstool Seat Height to 24"	10	\$25
CAL 133	9	\$65/Yard
Premium Metal Glides	-	\$3
Cut-Out Design	10	\$30
Engraved Back	10	\$30/Side
Swivel Barstool Seat Height Available Up to 36"	-	\$25
Light Distressing on Wood Backs	9	\$12.50
Heavy Distressing on Wood Backs	9	\$17.50
Light Distressing on Wood Seats	9	\$12.50
Heavy Distressing on Wood Seats	9	\$17.50
Fixed Seating 19" Diameter Foot Ring on Counter Height Seat	-	\$65
Fixed Seating 19" Diameter Foot Ring on Bar Height Seat	-	\$65



528
(Shown as 528-CE)

ARTISAN II CHAIR

MODEL	WOOD	COM	GRADE 10	GRADE 20	GRADE 30	GRADE 40	GRADE 50
528	372	323	342	352	361	371	379

Overall Height: 32.5" Seat Height: 18" Overall Depth: 17.5" Overall Width: 16.5"
C.O.M.: .45 yd Shipping Weight/Chair: 26# No. Per Carton: 2



528BS
(Shown as 528BS-CE)

ARTISAN II BARSTOOL

MODEL	WOOD	COM	GRADE 10	GRADE 20	GRADE 30	GRADE 40	GRADE 50
528BS	465	416	435	444	452	464	472

Overall Height: 42.5" Seat Height: 29.5" Overall Depth: 16.5" Overall Width: 16"
C.O.M.: .45 yd Shipping Weight/Chair: 30# No. Per Carton: 1



6528BS
(Shown as 6528BS-CE)

ARTISAN II SWIVEL BARSTOOL

MODEL	WOOD	COM	GRADE 10	GRADE 20	GRADE 30	GRADE 40	GRADE 50
6528BS	610	562	582	590	599	609	618

Overall Height: 45" Seat Height: 31" Overall Depth: 21.5" Overall Width: 20"
C.O.M.: .45 yd Shipping Weight/Chair: 46# No. Per Carton: 1



6528-3000 Core-drilled/
6528-4000 Bolt-down

ARTISAN II CHAIR CHAIR HEIGHT FIXED SEATING

MODEL	WOOD	COM	GRADE 10	GRADE 20	GRADE 30	GRADE 40	GRADE 50
6528-3000	671	622	641	649	658	666	677
6528-4000	671	622	641	649	658	666	677

Overall Height: 32.5" Seat Height: 18" Overall Depth: 17.5" Overall Width: 16.5"
C.O.M.: .45 yd Shipping Weight/Chair: 18.5# No. Per Carton: 2



6529CH-3001 Core-drilled/
6528CH-4001 Bolt-down

ARTISAN II CHAIR COUNTER HEIGHT FIXED SEATING

MODEL	WOOD	COM	GRADE 10	GRADE 20	GRADE 30	GRADE 40	GRADE 50
6528CH-3001	688	640	672	680	689	697	708
6528CH-4001	688	640	672	680	689	697	708

Overall Height: 37" Seat Height: 25" Overall Depth: 17.5" Overall Width: 16.5"
C.O.M.: .45 yd Shipping Weight/Chair: 21# No. Per Carton: 2



6528BS-3002 Core-drilled/
6528BS-4002 Bolt-down

ARTISAN II CHAIR BAR HEIGHT FIXED SEATING

MODEL	WOOD	COM	GRADE 10	GRADE 20	GRADE 30	GRADE 40	GRADE 50
6528BS-3002	706	657	689	697	708	716	725
6528BS-4002	706	657	689	697	708	716	725

Overall Height: 42.5" Seat Height: 30" Overall Depth: 17.5" Overall Width: 16.5"
C.O.M.: .45 yd Shipping Weight/Chair: 22.5# No. Per Carton: 2



527
(Shown as 527-CE)

ARTISAN II CHAIR

MODEL	WOOD	COM	GRADE 10	GRADE 20	GRADE 30	GRADE 40	GRADE 50
527	357	309	329	338	346	356	366

Overall Height: 32.5" Seat Height: 18" Overall Depth: 17.5" Overall Width: 16.5"
C.O.M.: .45 yd Shipping Weight/Chair: 26# No. Per Carton: 2



527BS
(Shown as 527BS-CE)

ARTISAN II BARSTOOL

MODEL	WOOD	COM	GRADE 10	GRADE 20	GRADE 30	GRADE 40	GRADE 50
527BS	449	401	420	428	439	448	457

Overall Height: 42.5" Seat Height: 29.5" Overall Depth: 16.5" Overall Width: 16"
C.O.M.: .45 yd Shipping Weight/Chair: 30# No. Per Carton: 1



6527BS
(Shown as 6527BS-CE)

ARTISAN II SWIVEL BARSTOOL

MODEL	WOOD	COM	GRADE 10	GRADE 20	GRADE 30	GRADE 40	GRADE 50
6527BS	598	550	569	577	586	595	606

Overall Height: 45" Seat Height: 31" Overall Depth: 21.5" Overall Width: 20"
C.O.M.: .45 yd Shipping Weight/Chair: 46# No. Per Carton: 1



ABOUT THIS COLLECTION

The Atoll Collection includes five different barstools with a similar silhouette.

STANDARD FEATURES

- 1.25" metal tube frame
- Wood seats made of 1" saddled ply
- Upholstered variations feature 2" of high resilience foam
- Technical Bulletin CAL 117 fire retardant upholstery materials
- Premium nylon glides

PERSONALIZATION OPTIONS

- The table to the right explains all of the available options for the Atoll Collection.

OPTIONS	PAGE	ADD TO LIST PRICE
Webbed Seat Construction	9	\$8
Reduce Barstool Seat Height to 24"	10	\$25
CAL 133	9	\$65/Yard
Premium Metal Glides	-	\$3



400BS
(Round Tube Legs)

ATOLL BARSTOOL

MODEL	WOOD	COM	GRADE 10	GRADE 20	GRADE 30	GRADE 40	GRADE 50
400BS	305	263	282	293	303	312	322

Overall Height: 30" Seat Height: 30" Overall Depth: 16.75" Overall Width: 16.75"
C.O.M.: .55 yd Shipping Weight/Chair: 26# No. Per Carton: 1



410BS
(Round Tube legs)

ATOLL BARSTOOL

MODEL	WOOD	COM	GRADE 10	GRADE 20	GRADE 30	GRADE 40	GRADE 50
410BS	305	263	279	287	295	304	311

Overall Height: 30" Seat Height: 30" Overall Depth: 16.75" Overall Width: 16.75"
C.O.M.: .45 yd Shipping Weight/Chair: 26# No. Per Carton: 1



415BS
(Square Tube legs)

ATOLL BARSTOOL

MODEL	WOOD	COM	GRADE 10	GRADE 20	GRADE 30	GRADE 40	GRADE 50
415BS	305	263	282	293	303	312	322

Overall Height: 30" Seat Height: 30" Overall Depth: 16.75" Overall Width: 16.75"
C.O.M.: .55 yd Shipping Weight/Chair: 31# No. Per Carton: 1



420BS
(Square Tube legs)

ATOLL BARSTOOL

MODEL	WOOD	COM	GRADE 10	GRADE 20	GRADE 30	GRADE 40	GRADE 50
420BS	305	263	279	287	295	304	311

Overall Height: 30" Seat Height: 30" Overall Depth: 16.75" Overall Width: 16.75"
C.O.M.: .45 yd Shipping Weight/Chair: 31# No. Per Carton: 1



506BS
(Square Tube legs)

ATOLL SWIVEL BARSTOOL

MODEL	WOOD	COM	GRADE 10	GRADE 20	GRADE 30	GRADE 40	GRADE 50
506BS	346	305	321	329	337	345	353

Overall Height: 30" Seat Height: 30" Overall Depth: 17" Overall Width: 17"
C.O.M.: .45 yd Shipping Weight/Chair: 31# No. Per Carton: 1



ABOUT THIS COLLECTION

The Ava Collection includes chair height, counter height, and bar height upholstered stools available in freestanding, core-drilled, or bolt-down variations.

STANDARD FEATURES

- Webbed seat construction is standard
- 2" of high resilience foam on all models
- 3" round metal column with 1/4" steel base
- Felt glides
- Technical Bulletin CAL 117 fire retardant upholstery materials

PERSONALIZATION OPTIONS

- The table to the right explains all of the available options for the Ava Collection.
- A fabric width less than 54" will require either an additional vertical seam or a "railroaded" application of the material. Thread color will be chosen by the factory to match the upholstery as closely as possible, unless otherwise specified. Choose between white, black, beige, dark grey, or beaver.
- Foot ring standard on counter and bar height models. Subtract \$65 list for products without foot rings.
- Consult with your architect or general contractor for proper installation of bolt-down and core-drilled models, attachment varies by floor construction.

OPTIONS

	PAGE	ADD TO LIST PRICE
CAL 133	9	\$65/Yard
Add Premium Adjustable Glides	-	\$30



1400 Free Standing/
1401 Bolt-down/
1402 Core-drilled

AVA CHAIR HEIGHT BARSTOOL

MODEL	WOOD	COM	GRADE 10	GRADE 20	GRADE 30	GRADE 40	GRADE 50
1400	N/A	575	626	653	678	702	728
1401	N/A	575	626	653	678	702	728
1402	N/A	575	626	653	678	702	728

Overall Height: 20" Seat Height: 20" Overall Depth: 18" Overall Width: 18"
C.O.M.: 1.25 yd Shipping Weight/Chair: 26# No. Per Carton: 1



1400CH-FR Free Standing/
1401CH Bolt-down/
1402CH-FR Core-drilled

AVA COUNTER HEIGHT BARSTOOL

MODEL	WOOD	COM	GRADE 10	GRADE 20	GRADE 30	GRADE 40	GRADE 50
1400CH-FR	N/A	749	800	826	852	877	902
1401CH	N/A	749	800	826	852	877	902
1402CH-FR	N/A	749	800	826	852	877	902

Overall Height: 25" Seat Height: 25" Overall Depth: 19" Overall Width: 19"
C.O.M.: 1.25 yd Shipping Weight/Chair: 26# No. Per Carton: 1



1400BS-FR Free Standing/
1401BS-FR Bolt-down/
1402BS-FR Core-drilled

AVA BAR HEIGHT BARSTOOL

MODEL	WOOD	COM	GRADE 10	GRADE 20	GRADE 30	GRADE 40	GRADE 50
1400BS-FR	N/A	777	828	854	879	905	930
1401BS-FR	N/A	777	828	854	879	905	930
1402BS-FR	N/A	777	828	854	879	905	930

Overall Height: 30" Seat Height: 30" Overall Depth: 19" Overall Width: 19"
C.O.M.: 1.25 yd Shipping Weight/Chair: 26# No. Per Carton: 1



ABOUT THIS COLLECTION

The Brady Collection includes chairs, barstools, and backless barstools in both bar and counter height varieties.

STANDARD FEATURES

- Brazed, coped and sanded welds
- 1.25" Solid wood seat and back
- Super tough nylon glide
- Steel seat tabs
- CAL 117 fire retardant upholstery materials
- C.O.M. yardage is for upholstered seat option, upholstered back is not available

PERSONALIZATION OPTIONS

• The table to the right explains all of the available options for the Brady Collection.

OPTIONS	PAGE	ADD TO LIST PRICE
Premium Metal Glides	-	\$8
Light Distressed Wood	9	\$30
Heavy Distressed Wood	9	\$37.50
Handhold Cut-Out	10	\$30



250

BRADY CHAIR

MODEL	WOOD	COM	GRADE 10	GRADE 20	GRADE 30	GRADE 40	GRADE 50
250	488	479	499	508	518	527	537

Overall Height: 34" Seat Height: 18" Overall Depth: 20" Overall Width: 17"
 C.O.M.: .5 yd Shipping Weight/Chair: 21# No. Per Carton: 2



250BS-24

BRADY 24" COUNTER HEIGHT BARSTOOL

MODEL	WOOD	COM	GRADE 10	GRADE 20	GRADE 30	GRADE 40	GRADE 50
250BS-24	562	548	569	578	587	597	607

Overall Height: 37" Seat Height: 24" Overall Depth: 19" Overall Width: 17"
 C.O.M.: .5 yd Shipping Weight/Chair: 26# No. Per Carton: 1



250BS

BRADY 30" BAR HEIGHT BARSTOOL

MODEL	WOOD	COM	GRADE 10	GRADE 20	GRADE 30	GRADE 40	GRADE 50
250BS	575	560	581	590	599	609	619

Overall Height: 44" Seat Height: 30" Overall Depth: 20" Overall Width: 17"
 C.O.M.: .5 yd Shipping Weight/Chair: 27# No. Per Carton: 1



6250BS-24

BRADY 24" COUNTER HEIGHT BACKLESS BARSTOOL

MODEL	WOOD	COM	GRADE 10	GRADE 20	GRADE 30	GRADE 40	GRADE 50
6250BS-24	432	416	430	436	443	450	457

Overall Height: 24" Seat Height: 24" Overall Depth: 16.2" Overall Width: 14"
 C.O.M.: .35 yd Shipping Weight/Chair: 18# No. Per Carton: 1



6250BS

BRADY 30" BAR HEIGHT BACKLESS BARSTOOL

MODEL	WOOD	COM	GRADE 10	GRADE 20	GRADE 30	GRADE 40	GRADE 50
6250BS	443	428	443	449	456	464	472

Overall Height: 30" Seat Height: 30" Overall Depth: 17" Overall Width: 14"
 C.O.M.: .35 yd Shipping Weight/Chair: 21# No. Per Carton: 1



ABOUT THIS COLLECTION

The Brent Collection includes a chair height stool and barstool.

STANDARD FEATURES

- 19-gauge, high-quality plating grade steel on legs
- Seat is made of 5/8" particleboard with corner bracing and webbed seat
- 3" of 2550FR foam for added cushion
- Premium metal glide
- Technical Bulletin CAL 117 fire retardant upholstery materials

PERSONALIZATION OPTIONS

- The table to the right explains all of the available options for the Brent Collection.

OPTIONS	PAGE	ADD TO LIST PRICE
CAL 133	9	\$65/Yard



200

BRENT CUBE

MODEL	WOOD	COM	GRADE 10	GRADE 20	GRADE 30	GRADE 40	GRADE 50
200	N/A	355	404	427	451	475	499

Overall Height: 16.25" Seat Height: 18" Overall Depth: 16.25" Overall Width: 16.25"

C.O.M.: 1.25 yd Shipping Weight/Chair: 16# No. Per Carton: 2



200BS

BRENT BARSTOOL

MODEL	WOOD	COM	GRADE 10	GRADE 20	GRADE 30	GRADE 40	GRADE 50
200BS	N/A	486	537	562	587	613	639

Overall Height: 37" Seat Height: 30" Overall Depth: 16.25" Overall Width: 16.25"

C.O.M.: 1.25 yd Shipping Weight/Chair: 15.5# No. Per Carton: 1



ABOUT THIS COLLECTION

The Cheyenne Collection includes chairs, barstools, and swivel barstools.

STANDARD FEATURES

- 1.25" metal tube frame
- Upholstered seat is standard
- 2" of high resilient foam on all upholstered models
- Technical Bulletin CAL 117 fire retardant
- Premium nylon glides
- Maple wood back

PERSONALIZATION OPTIONS

- The table to the right explains all of the available options for the Cheyenne Collection.
- Cut-out back graphics and laser engraved graphics should not exceed 6" x 6".
- Call factory for custom cut-outs and custom engraving.

OPTIONS	PAGE	ADD TO LIST PRICE
Webbed Seat Construction	9	\$8
Reduce Barstool Seat Height to 24"	10	\$25
CAL 133	9	\$65/Yard
Premium Metal Glides	-	\$3
Cut-Out Design	10	\$30
Engraved Back	10	\$30/Side
Swivel Barstool Seat Height Available Up to 36"	-	\$25
Wood Back Made of 1" Curved Veneer	-	\$30
Light Distressing on Wood Backs	9	\$12.50
Heavy Distressing on Wood Backs	9	\$17.50
Light Distressing on Wood Seats	9	\$12.50
Heavy Distressing on Wood Seats	9	\$17.50



507-WB

CHEYENNE CHAIR

MODEL	WOOD	COM	GRADE 10	GRADE 20	GRADE 30	GRADE 40	GRADE 50
507-WB	325	260	291	307	322	338	353

Overall Height: 32.5" Seat Height: 18" Overall Depth: 19" Overall Width: 17"
 C.O.M.: .875 yd Shipping Weight/Chair: 32# No. Per Carton: 1



507BS-WB

CHEYENNE BARSTOOL

MODEL	WOOD	COM	GRADE 10	GRADE 20	GRADE 30	GRADE 40	GRADE 50
507BS-WB	398	336	368	383	399	414	430

Overall Height: 42.5" Seat Height: 30" Overall Depth: 19" Overall Width: 17"
 C.O.M.: .875 yd Shipping Weight/Chair: 32# No. Per Carton: 1



6507BS-WB

CHEYENNE SWIVEL BARSTOOL

MODEL	WOOD	COM	GRADE 10	GRADE 20	GRADE 30	GRADE 40	GRADE 50
6507BS-WB	536	477	509	524	540	555	571

Overall Height: 45" Seat Height: 29.5" Overall Depth: 19" Overall Width: 17"
 C.O.M.: .875 yd Shipping Weight/Chair: 45# No. Per Carton: 1



ABOUT THIS COLLECTION

The Emma Collection includes four nesting chairs with different back styles.

STANDARD FEATURES

- 1.25" metal square tube frame
- Wood seats made of 1" saddled ply
- Wood back variation made from Beech wood
- Upholstered variations feature 2" of high resilience foam
- Nests four high
- Premium nylon glides
- Wall saver chair
- Technical Bulletin CAL 117 fire retardant upholstery materials

PERSONALIZATION OPTIONS

- The table to the right explains all of the available options for the Emma Collection.
- Cut-out back graphics and laser engraved graphics should not exceed 6" x 6".
- Wrinkle finishes not available on nesting chairs.

OPTIONS

	PAGE	ADD TO LIST PRICE
Webbed Seat Construction	9	\$8
CAL 133	9	\$65/Yard
Premium Metal Glides	-	\$3
Cut-Out Design	10	\$30
Engraved Back	10	\$30/Side
Light Distressing on Wood Backs	9	\$12.50
Heavy Distressing on Wood Backs	9	\$17.50
Light Distressing on Wood Seats	9	\$12.50
Heavy Distressing on Wood Seats	9	\$17.50



N901

EMMA NESTING CHAIR

MODEL	WOOD	COM	GRADE 10	GRADE 20	GRADE 30	GRADE 40	GRADE 50
N901	347	306	322	330	338	346	354

Overall Height: 32.5" Seat Height: 18" Overall Depth: 19" Overall Width: 17"
 C.O.M.: .45 yd Shipping Weight/Chair: 26# No. Per Carton: 2



N903

EMMA NESTING CHAIR

MODEL	WOOD	COM	GRADE 10	GRADE 20	GRADE 30	GRADE 40	GRADE 50
N903	347	306	322	330	338	346	354

Overall Height: 32.5" Seat Height: 18" Overall Depth: 19" Overall Width: 17"
 C.O.M.: .45 yd Shipping Weight/Chair: 26# No. Per Carton: 2



N904

EMMA WOOD BACK NESTING CHAIR

MODEL	WOOD	COM	GRADE 10	GRADE 20	GRADE 30	GRADE 40	GRADE 50
N904	385	343	359	368	375	384	391

Overall Height: 32.5" Seat Height: 18" Overall Depth: 19" Overall Width: 17"
 C.O.M.: .45 yd Shipping Weight/Chair: 26# No. Per Carton: 2



N933

EMMA CRISS-CROSS NESTING CHAIR

MODEL	WOOD	COM	GRADE 10	GRADE 20	GRADE 30	GRADE 40	GRADE 50
N933	354	312	329	337	344	353	361

Overall Height: 32.5" Seat Height: 18" Overall Depth: 19" Overall Width: 17"
 C.O.M.: .45 yd Shipping Weight/Chair: 26# No. Per Carton: 2



ABOUT THIS COLLECTION

The Felix Collection includes chairs, armchairs, and barstools, available in either a wood or laminate shell. Designed by John Kaloustian.

STANDARD FEATURES

- Two-piece formed plywood shell
- 14-gauge steel tube frame
- Upholstered options have 1.5" high resilience foam
- Available with wood or laminate shells
- Felix shell grommets are painted to match frame finish
- Premium nylon glides
- Technical Bulletin CAL 117 fire retardant upholstery materials are standard
- Chairs stack five high

PERSONALIZATION OPTIONS

- The table to the right explains all of the available options for the Felix Collection.
- Special laminate orders under 50 pc. are subject to a one time, \$350 NET set-up fee. For orders over 50 pc., call for quote.
- Cut-out back graphics and laser engraved graphics should not exceed 5" x 5".

OPTIONS

	PAGE	ADD TO LIST PRICE
Reduce Barstool Seat Height to 24"	10	\$10
Premium Metal Glides	-	\$3
Cut-Out Design	10	\$30
Engraved Back	10	\$30/Side

LAMINATE OPTIONS

Laminate shell pricing includes select standard laminates from Formica and Wilsonart, listed on chart directly below. These select standard laminates are readily available and in stock by our supplier.

Formica	Style Number	Wilsonart	Style Number
White	949-58	Beige	1530-60
Antique White	932-58	Black	1595-60
Natural Birch	7481-58	Designer White	D354-60
Fog	961-58	Dove Grey	D92-60
Storm	912-58	Fashion Grey	D381-60
White	949-58	Natural Almond	D30-60
Acajou Mahogany	7008-43	Frosty White	1573-60
Amber Maple	7012-58	Grey	1500-60
Natural Maple	756-58	Haze	D97-60
Natural Oak	346-58	Khaki Brown	D50-60
Select Cherry	7759-43	Northsea	D90-60
Wild Cherry	5904-58	Pepperdust	D327-60
		Slate Grey	D91-60
		Wallaby	D439-60
		Amber Cherry	7919K-78
		Bannister Oak	7806-60
		Kensington Maple	10776-60
		Manitoba Maple	7911-60
		Natural Pear	7061-60
		Wild Cherry	7054-60

Please note, orders for fewer than 10-like shells will have an \$85.00 set-up charge. We do accept special laminates. If laminates are chosen that are outside our selected standards, please keep these guidelines in mind:

- Pricing and lead times will vary depending on laminate chosen – call for quote
- Laminate needs to be vertical grade
- Sheets available in 5' x 12' size will have the best yield
- Cannot use High Gloss Laminates
- If you choose a patterned laminate, please note that the pattern consistency will vary from shell to shell



990

FELIX 18" WOOD CHAIR

MODEL	WOOD	COM	GRADE 10	GRADE 20	GRADE 30	GRADE 40	GRADE 50
990-FU	545	690	728	747	765	783	801
990-PU	545	606	624	633	642	651	660

Overall Height: 33" Seat Height: 18" Overall Depth: 20" Overall Width: 20"
 Part. Uph. C.O.M.: .5 yd Full Uph. C.O.M.: 1.25 yd Shipping Weight/Chair: 22# No. Per Carton: 2



990BS

FELIX 30" WOOD BARSTOOL

MODEL	WOOD	COM	GRADE 10	GRADE 20	GRADE 30	GRADE 40	GRADE 50
990BS-FU	606	751	788	806	825	843	861
990BS-PU	606	666	685	693	702	712	720

Overall Height: 45" Seat Height: 30" Overall Depth: 20" Overall Width: 20"
 Part. Uph. C.O.M.: .5 yd Full Uph. C.O.M.: 1.25 yd Shipping Weight/Chair: 30# No. Per Carton: 1



991

FELIX 18" LAMINATE CHAIR

MODEL	LAMINATE	COM	GRADE 10	GRADE 20	GRADE 30	GRADE 40	GRADE 50
991-FU	618	751	788	806	825	843	861
991-PU	618	678	697	706	715	723	731

Overall Height: 33" Seat Height: 18" Overall Depth: 20" Overall Width: 20"
 Part. Uph. C.O.M.: .5 yd Full Uph. C.O.M.: 1.25 yd Shipping Weight/Chair: 22# No. Per Carton: 2



991BS

FELIX 30" LAMINATE BARSTOOL

MODEL	LAMINATE	COM	GRADE 10	GRADE 20	GRADE 30	GRADE 40	GRADE 50
991BS-FU	678	824	861	880	898	916	934
991BS-PU	678	653	672	680	689	697	706

Overall Height: 45" Seat Height: 30" Overall Depth: 22" Overall Width: 20"
 Part. Uph. C.O.M.: .5 yd Full Uph. C.O.M.: 1.25 yd Shipping Weight/Chair: 30# No. Per Carton: 1

FELIX JR. COLLECTION



ABOUT THIS COLLECTION

The Felix Jr. Collection is a slightly smaller, one-piece shell version of the original Felix Collection. Felix Jr. has a steel frame and legs and is available in both wood and laminate shells. The chairs stack five high.

STANDARD FEATURES

- One-piece formed plywood shell
- 14-gauge steel tube frame
- Upholstered options have 1.5" high resilience foam
- Available with wood or laminate shells
- Premium nylon glides
- Technical Bulletin CAL 117 fire retardant upholstery materials are standard
- Chairs stack five high

PERSONALIZATION OPTIONS

- The table to the right explains all of the available options for the Felix Jr. Collection.
- Special laminate orders under 50 pc. are subject to a one time, \$350 NET set-up fee. For orders over 50 pc., call for quote.
- Call factory for custom cut-outs and custom engraving.

OPTIONS

	PAGE	ADD TO LIST PRICE
Reduce Barstool Seat Height to 24"	10	\$10
Premium Metal Glides	-	\$3
Signature Felix "Smile"	-	\$30
Engraved Back	10	\$30/Side

UPHOLSTERY OPTIONS



UPH1: Upholstered Seat

LAMINATE OPTIONS

Laminate shell pricing includes select standard laminates from Formica and Wilsonart, listed on chart directly below. These select standard laminates are readily available and in stock by our supplier.

Formica	Style Number	Wilsonart	Style Number
White	949-58	Beige	1530-60
Antique White	932-58	Black	1595-60
Natural Birch	7481-58	Designer White	D354-60
Fog	961-58	Dove Grey	D92-60
Storm	912-58	Fashion Grey	D381-60
White	949-58	Natural Almond	D30-60
Acajou Mahogany	7008-43	Frosty White	1573-60
Amber Maple	7012-58	Grey	1500-60
Natural Maple	756-58	Haze	D97-60
Natural Oak	346-58	Khaki Brown	D50-60
Select Cherry	7759-43	Northsea	D90-60
Wild Cherry	5904-58	Pepperdust	D327-60
		Slate Grey	D91-60
		Wallaby	D439-60
		Amber Cherry	7919K-78
		Bannister Oak	7806-60
		Kensington Maple	10776-60
		Manitoba Maple	7911-60
		Natural Pear	7061-60
		Wild Cherry	7054-60

Please note, orders for fewer than 10-like shells will have an \$85.00 set-up charge. We do accept special laminates. If laminates are chosen that are outside our selected standards, please keep these guidelines in mind:

- Pricing and lead times will vary depending on laminate chosen – call for quote
- Laminate needs to be vertical grade
- Sheets available in 5' x 12' size will have the best yield
- Cannot use High Gloss Laminates
- If you choose a patterned laminate, please note that the pattern consistency will vary from shell to shell



992

FELIX JR. CHAIR

WOOD

MODEL	YARDAGE	WOOD	GRADE 10	GRADE 20	GRADE 30	GRADE 40	GRADE 50
992-W	N/A	404	N/A	N/A	N/A	N/A	N/A

WOOD - UPHOLSTERED SEAT

MODEL	YARDAGE	COM	GRADE 10	GRADE 20	GRADE 30	GRADE 40	GRADE 50
992-W-UPH1	0.45	501	517	525	534	542	550

Overall Height: 32" Seat Height: 19" Overall Depth: 21" Overall Width: 20"
 Shipping Weight/Chair: 14.5# No. Per Carton: 2



992BS

FELIX JR. BARSTOOL

WOOD

MODEL	YARDAGE	WOOD	GRADE 10	GRADE 20	GRADE 30	GRADE 40	GRADE 50
992BS-W	N/A	421	N/A	N/A	N/A	N/A	N/A

WOOD - UPHOLSTERED SEAT

MODEL	YARDAGE	COM	GRADE 10	GRADE 20	GRADE 30	GRADE 40	GRADE 50
992BS-W-UPH1	0.45	519	536	544	552	560	569

Overall Height: 44" Seat Height: 30" Overall Depth: 21" Overall Width: 18"
 Shipping Weight/Chair: 18.5# No. Per Carton: 1



993

FELIX JR. CHAIR

LAMINATE

MODEL	YARDAGE	LAMINATE	GRADE 10	GRADE 20	GRADE 30	GRADE 40	GRADE 50
993-L	N/A	478	N/A	N/A	N/A	N/A	N/A

LAMINATE - UPHOLSTERED SEAT

MODEL	YARDAGE	COM	GRADE 10	GRADE 20	GRADE 30	GRADE 40	GRADE 50
993-L-UPH1	0.45	575	591	599	608	616	624

Overall Height: 32" Seat Height: 19" Overall Depth: 21" Overall Width: 20"
 Shipping Weight/Chair: 14.5# No. Per Carton: 2



993BS
 (Shown as
 993BS-L-UPH1)

FELIX JR. BARSTOOL

LAMINATE

MODEL	YARDAGE	LAMINATE	GRADE 10	GRADE 20	GRADE 30	GRADE 40	GRADE 50
993BS-L	N/A	499	N/A	N/A	N/A	N/A	N/A

LAMINATE - UPHOLSTERED SEAT

MODEL	YARDAGE	COM	GRADE 10	GRADE 20	GRADE 30	GRADE 40	GRADE 50
993BS-L-UPH1	0.45	595	612	620	628	637	645

Overall Height: 44" Seat Height: 30" Overall Depth: 21" Overall Width: 18"
 Shipping Weight/Chair: 18.5# No. Per Carton: 1



ABOUT THIS COLLECTION

The Harper Collection includes a chair, counter height stool, barstool, and a lounge. Harper features multiple types of bases including an X-base, four-leg base and an A-frame stacker. This collection also features partially upholstered or fully wrapped upholstery, on either wood or laminate shells.

STANDARD FEATURES

- Steel tube frame
- Available in wood or laminate shells
- Technical Bulletin CAL 117 fire retardant upholstery materials
- Upholstered models feature 1/2" thick foam
- 272 models stack four high
- Premium plastic glides used on models 271, 272, 271CH, and 271BS
- Standard Nylon sled glides used on models 270, 273, 270CH, and 270BS

PERSONALIZATION OPTIONS

- The table to the right explains all of the available options for the Harper Collection.
- Textured finishes are not suggested for stacking chairs.
- Custom laser cut-outs and engravings must be discussed with the factory.
- Call for extended lead time on fully upholstered Harper models if order quantity is over 20 pcs.

OPTIONS

OPTIONS	PAGE	ADD TO LIST PRICE
CAL 133	9	\$65/Yard
Cut-Out Design	10	\$30
Engraved Back	10	\$30/Side

UPHOLSTERY OPTIONS



UPH1



UPH3

BACK OPTIONS

Without Upholstery – Available on Wood Shell, Chairs Only



C1



C2



C3



C4



C5

With Partial Upholstery – Available on Wood Shell, Chairs Only



C1



C2



C3

LAMINATE OPTIONS

Laminate shell pricing includes select standard laminates from Formica and Wilsonart, listed on chart directly below. These select standard laminates are readily available and in stock by our supplier.

Formica	Style Number	Wilsonart	Style Number
White	949-58	Beige	1530-60
Antique White	932-58	Black	1595-60
Natural Birch	7481-58	Designer White	D354-60
Fog	961-58	Dove Grey	D92-60
Storm	912-58	Fashion Grey	D381-60
White	949-58	Natural Almond	D30-60
Acajou Mahogany	7008-43	Frosty White	1573-60
Amber Maple	7012-58	Grey	1500-60
Natural Maple	756-58	Haze	D97-60
Natural Oak	346-58	Khaki Brown	D50-60
Select Cherry	7759-43	Northsea	D90-60
Wild Cherry	5904-58	Pepperdust	D327-60
		Slate Grey	D91-60
		Wallaby	D439-60
		Amber Cherry	7919K-78
		Bannister Oak	7806-60
		Kensington Maple	10776-60
		Manitoba Maple	7911-60
		Natural Pear	7061-60
		Wild Cherry	7054-60

Please note, orders for fewer than 10-like shells will have an \$85.00 set-up charge. We do accept special laminates. If laminates are chosen that are outside our selected standards, please keep these guidelines in mind:

- Pricing and lead times will vary depending on laminate chosen – call for quote
- Laminate needs to be vertical grade
- Sheets available in 5' x 12' size will have the best yield
- Cannot use High Gloss Laminates
- If you choose a patterned laminate, please note that the pattern consistency will vary from shell to shell



270

HARPER CHAIR — X-BASE

WOOD							
MODEL	YARDAGE	WOOD	GRADE 10	GRADE 20	GRADE 30	GRADE 40	GRADE 50
270-W	N/A	593	N/A	N/A	N/A	N/A	N/A

WOOD - PARTIALLY UPHOLSTERED							
MODEL	YARDAGE	COM	GRADE 10	GRADE 20	GRADE 30	GRADE 40	GRADE 50
270-W-UPH1	0.5	645	658	665	672	679	685

FULLY UPHOLSTERED							
MODEL	YARDAGE	COM	GRADE 10	GRADE 20	GRADE 30	GRADE 40	GRADE 50
270-UPH3	1.0	799	833	850	866	883	899

LAMINATE							
MODEL	YARDAGE	LAMINATE	GRADE 10	GRADE 20	GRADE 30	GRADE 40	GRADE 50
270-LAM	N/A	655	N/A	N/A	N/A	N/A	N/A

LAMINATE - PARTIALLY UPHOLSTERED							
MODEL	YARDAGE	COM	GRADE 10	GRADE 20	GRADE 30	GRADE 40	GRADE 50
270-LAM-UPH1	0.4	707	720	727	733	741	747

Overall Height: 31.52" Overall Depth: 20.38" Overall Width: 17.33" No. Per Carton: 2
 Seat Height: 270-W 18.8", 270-W-UPH1 19.5", 270-UPH3 19.5", 270-LAM 18.8", 270-LAM-UPH1 19.5"
 Shipping Weight/Chair: 270-W 32.64#, 270-W-UPH1 35.4#, 270-UPH3 37#, 270-LAM 32.64#, 270-LAM-UPH1 35.4#



270CH

HARPER COUNTER HEIGHT STOOL — X-BASE

WOOD							
MODEL	YARDAGE	WOOD	GRADE 10	GRADE 20	GRADE 30	GRADE 40	GRADE 50
270CH-W	N/A	588	N/A	N/A	N/A	N/A	N/A

WOOD - PARTIALLY UPHOLSTERED							
MODEL	YARDAGE	COM	GRADE 10	GRADE 20	GRADE 30	GRADE 40	GRADE 50
270CH-W-UPH1	0.4	640	652	657	663	670	675

FULLY UPHOLSTERED							
MODEL	YARDAGE	COM	GRADE 10	GRADE 20	GRADE 30	GRADE 40	GRADE 50
270CH-UPH3	0.8	794	820	832	845	857	869

LAMINATE							
MODEL	YARDAGE	LAMINATE	GRADE 10	GRADE 20	GRADE 30	GRADE 40	GRADE 50
270CH-LAM	N/A	650	N/A	N/A	N/A	N/A	N/A

LAMINATE - PARTIALLY UPHOLSTERED							
MODEL	YARDAGE	COM	GRADE 10	GRADE 20	GRADE 30	GRADE 40	GRADE 50
270CH-LAM-UPH1	0.4	712	724	729	735	742	747

Overall Height: 33.21" Overall Depth: 17.88" Overall Width: 16.07" No. Per Carton: 1
 Seat Height: 270CH-W 25.98", 270CH-W-UPH1 26.62", 270CH-UPH3 26.62", 270CH-LAM 25.89", 270CH-LAM-UPH1 26.62"
 Shipping Weight/Chair: 270CH-W 18.4#, 270CH-W-UPH1 19.35#, 270CH-UPH3 20#, 270CH-LAM 18.4#, 270CH-LAM-UPH1 19.35#



270BS

HARPER BAR HEIGHT STOOL — X-BASE

WOOD

MODEL	YARDAGE	WOOD	GRADE 10	GRADE 20	GRADE 30	GRADE 40	GRADE 50
270BS-W	N/A	598	N/A	N/A	N/A	N/A	N/A

WOOD - PARTIALLY UPHOLSTERED

MODEL	YARDAGE	COM	GRADE 10	GRADE 20	GRADE 30	GRADE 40	GRADE 50
270BS-W-UPH1	0.4	650	662	667	674	680	685

FULLY UPHOLSTERED

MODEL	YARDAGE	COM	GRADE 10	GRADE 20	GRADE 30	GRADE 40	GRADE 50
270BS-UPH3	0.8	804	830	843	855	867	880

LAMINATE

MODEL	YARDAGE	LAMINATE	GRADE 10	GRADE 20	GRADE 30	GRADE 40	GRADE 50
270BS-LAM	N/A	660	N/A	N/A	N/A	N/A	N/A

LAMINATE - PARTIALLY UPHOLSTERED

MODEL	YARDAGE	COM	GRADE 10	GRADE 20	GRADE 30	GRADE 40	GRADE 50
270BS-LAM-UPH1	0.4	712	724	729	735	742	747

Overall Height: 33.95" Overall Depth: 16.8" Overall Width: 16.02" No. Per Carton: 1

Seat Height: 270BS-W 30.47", 270BS-W-UPH1 31.13", 270BS-UPH3 31.13", 270BS-LAM 30.47", 270BS-LAM-UPH1 31.13"

Shipping Weight/Chair: 270BS-W 18.22#, 270BS-W-UPH1 20.58#, 270BS-UPH3 21.5#, 270BS-LAM 18.22#, 270BS-LAM-UPH1 20.58#



271

HARPER CHAIR — 4-LEG

WOOD

MODEL	YARDAGE	WOOD	GRADE 10	GRADE 20	GRADE 30	GRADE 40	GRADE 50
271-W	N/A	542	N/A	N/A	N/A	N/A	N/A

WOOD - PARTIALLY UPHOLSTERED

MODEL	YARDAGE	COM	GRADE 10	GRADE 20	GRADE 30	GRADE 40	GRADE 50
271-W-UPH1	0.5	593	607	614	620	627	633

FULLY UPHOLSTERED

MODEL	YARDAGE	COM	GRADE 10	GRADE 20	GRADE 30	GRADE 40	GRADE 50
271-UPH3	1.0	748	782	798	815	831	848

LAMINATE

MODEL	YARDAGE	LAMINATE	GRADE 10	GRADE 20	GRADE 30	GRADE 40	GRADE 50
271-LAM	N/A	604	N/A	N/A	N/A	N/A	N/A

LAMINATE - PARTIALLY UPHOLSTERED

MODEL	YARDAGE	COM	GRADE 10	GRADE 20	GRADE 30	GRADE 40	GRADE 50
271-LAM-UPH1	0.4	655	668	676	682	689	695

Overall Height: 31.82" Overall Depth: 20.38" Overall Width: 17.29" No. Per Carton: 2

Seat Height: 271-W 19.09", 271-W-UPH1 19.66", 271-UPH3 19.66", 271-LAM 19.09", 271-LAM-UPH1 19.66"

Shipping Weight/Chair: 271-W 31.58#, 271-W-UPH1 34.14#, 271-UPH3 36#, 271-LAM 31.58#, 271-LAM-UPH1 34.14#



271CH

HARPER COUNTER HEIGHT STOOL — 4-LEG

WOOD							
MODEL	YARDAGE	WOOD	GRADE 10	GRADE 20	GRADE 30	GRADE 40	GRADE 50
271CH-W	N/A	537	N/A	N/A	N/A	N/A	N/A
WOOD - PARTIALLY UPHOLSTERED							
MODEL	YARDAGE	COM	GRADE 10	GRADE 20	GRADE 30	GRADE 40	GRADE 50
271CH-W-UPH1	0.4	588	600	606	612	618	623
FULLY UPHOLSTERED							
MODEL	YARDAGE	COM	GRADE 10	GRADE 20	GRADE 30	GRADE 40	GRADE 50
271CH-UPH3	0.8	743	768	781	793	805	818
LAMINATE							
MODEL	YARDAGE	LAMINATE	GRADE 10	GRADE 20	GRADE 30	GRADE 40	GRADE 50
271CH-LAM	N/A	598	N/A	N/A	N/A	N/A	N/A
LAMINATE - PARTIALLY UPHOLSTERED							
MODEL	YARDAGE	COM	GRADE 10	GRADE 20	GRADE 30	GRADE 40	GRADE 50
271CH-LAM-UPH1	0.4	650	662	667	674	680	685

Overall Height: 33.45" Overall Depth: 17.27" Overall Width: 16.2" No. Per Carton: 1
 Seat Height: 271CH-W 26.12", 271CH-W-UPH1 26.81", 271CH-UPH3 26.81", 271CH-LAM 26.12",
 271CH-LAM-UPH1 26.81"
 Shipping Weight/Chair: 271CH-W 19.46#, 271CH-W-UPH1 20.3#, 271CH-UPH3 21#,
 271CH-LAM 19.46#, 271CH-LAM-UPH1 20.3#



271BS

HARPER BAR HEIGHT STOOL — 4-LEG

WOOD							
MODEL	YARDAGE	WOOD	GRADE 10	GRADE 20	GRADE 30	GRADE 40	GRADE 50
271BS-W	N/A	547	N/A	N/A	N/A	N/A	N/A
WOOD - PARTIALLY UPHOLSTERED							
MODEL	YARDAGE	COM	GRADE 10	GRADE 20	GRADE 30	GRADE 40	GRADE 50
271BS-W-UPH1	0.4	598	611	616	622	628	633
FULLY UPHOLSTERED							
MODEL	YARDAGE	COM	GRADE 10	GRADE 20	GRADE 30	GRADE 40	GRADE 50
271BS-UPH3	0.8	753	779	791	803	816	828
LAMINATE							
MODEL	YARDAGE	LAMINATE	GRADE 10	GRADE 20	GRADE 30	GRADE 40	GRADE 50
271BS-LAM	N/A	609	N/A	N/A	N/A	N/A	N/A
LAMINATE - PARTIALLY UPHOLSTERED							
MODEL	YARDAGE	COM	GRADE 10	GRADE 20	GRADE 30	GRADE 40	GRADE 50
271BS-LAM-UPH1	0.4	660	673	678	684	690	695

Overall Height: 34.12" Overall Depth: 16.24" Overall Width: 16.52" No. Per Carton: 1
 Seat Height: 271BS-W 30.63", 271BS-W-UPH1 31.11", 271BS-UPH3 31.11", 271BS-LAM 30.63",
 271BS-LAM-UPH1 31.11"
 Shipping Weight/Chair: 271BS-W 18.77#, 271BS-W-UPH1 20.96#, 271BS-UPH3 21.5#,
 271BS-LAM 18.77#, 271BS-LAM-UPH1 20.96#



272

HARPER CHAIR — STACKER

WOOD

MODEL	YARDAGE	WOOD	GRADE 10	GRADE 20	GRADE 30	GRADE 40	GRADE 50
272-W	N/A	533	N/A	N/A	N/A	N/A	N/A

WOOD - PARTIALLY UPHOLSTERED

MODEL	YARDAGE	COM	GRADE 10	GRADE 20	GRADE 30	GRADE 40	GRADE 50
272-W-UPH1	0.5	584	597	605	611	618	624

FULLY UPHOLSTERED

MODEL	YARDAGE	COM	GRADE 10	GRADE 20	GRADE 30	GRADE 40	GRADE 50
272-W-UPH3	1.0	739	773	789	805	822	838

LAMINATE

MODEL	YARDAGE	LAMINATE	GRADE 10	GRADE 20	GRADE 30	GRADE 40	GRADE 50
272-LAM	N/A	594	N/A	N/A	N/A	N/A	N/A

LAMINATE - PARTIALLY UPHOLSTERED

MODEL	YARDAGE	COM	GRADE 10	GRADE 20	GRADE 30	GRADE 40	GRADE 50
272-LAM-UPH1	0.4	646	659	666	673	680	686

Overall Height: 31.69" Overall Depth: 20.36" Overall Width: 22.38" No. Per Carton: 2
 Seat Height: 272-W 18.84", 272-W-UPH1 19.6", 272-W-UPH3 19.6", 272-LAM 18.84", 272-LAM-UPH1 19.6"
 Shipping Weight/Chair: 272-W 36#, 272-W-UPH1 38.48#, 272-W-UPH3 40#, 272-LAM 36#, 272-LAM-UPH1 38.48#



273

HARPER LOUNGE CHAIR

WOOD

MODEL	YARDAGE	WOOD	GRADE 10	GRADE 20	GRADE 30	GRADE 40	GRADE 50
273-W	N/A	696	N/A	N/A	N/A	N/A	N/A

WOOD - PARTIALLY UPHOLSTERED

MODEL	YARDAGE	COM	GRADE 10	GRADE 20	GRADE 30	GRADE 40	GRADE 50
273-UPH1	1.0	825	884	913	941	970	999

FULLY UPHOLSTERED

MODEL	YARDAGE	COM	GRADE 10	GRADE 20	GRADE 30	GRADE 40	GRADE 50
273-UPH3	2.3	954	971	980	988	996	1004

LAMINATE

MODEL	YARDAGE	LAMINATE	GRADE 10	GRADE 20	GRADE 30	GRADE 40	GRADE 50
273-LAM	N/A	758	N/A	N/A	N/A	N/A	N/A

LAMINATE - PARTIALLY UPHOLSTERED

MODEL	YARDAGE	COM	GRADE 10	GRADE 20	GRADE 30	GRADE 40	GRADE 50
273-LAM-UPH1	1.0	810	827	835	844	852	860

Overall Height: 31.32" Overall Depth: 27.35" Overall Width: 25.58" No. Per Carton: 1
 Seat Height: 273-W 15.62", 273-UPH1 17", 273-UPH3 17", 273-LAM 15.62", 273-LAM-UPH1 17"
 Shipping Weight/Chair: 273-W 23.22#, 273-UPH1 25.77#, 273-UPH3 26.5#, 273-LAM 23.22#, 273-LAM-UPH1 25.77#



ABOUT THIS COLLECTION

The Hurdle Collection includes a chair, a dining-height stool, a counter height stool and barstool. Designed by Dowel Jones.

STANDARD FEATURES

- 7/8" round tube, 14-gauge steel frame
- Flat seat made of 1" solid wood
- Species: White Oak in natural finish (other finishes not available)
- Plastic glides

PERSONALIZATION OPTIONS

- The table to the right explains all of the available options for the Hurdle Collection.



331

HALF HURDLE CHAIR

MODEL	WOOD
331	389

Overall Height: 22.25" Seat Height: 18" Overall Depth: 20.5" Overall Width: 20.5"
Shipping Weight/Chair: 23.5# No. Per Carton: 1



330

HURDLE STOOL

MODEL	WOOD
330	359

Overall Height: 18.5" Seat Height: 18.5" Overall Depth: 15" Overall Width: 17"
Shipping Weight/Chair: 13# No. Per Carton: 2



330CH

HURDLE COUNTER STOOL

MODEL	WOOD
330CH	433

Overall Height: 24" Seat Height: 24" Overall Depth: 15" Overall Width: 17"
Shipping Weight/Chair: 17# No. Per Carton: 1



330BS

HURDLE BARSTOOL

MODEL	WOOD
330BS	444

Overall Height: 30" Seat Height: 30" Overall Depth: 17.5" Overall Width: 17"
Shipping Weight/Chair: 18# No. Per Carton: 1



ABOUT THIS COLLECTION

The Jill Collection includes chairs, nesting chairs, and barstools with wood, metal, or upholstered back options.

STANDARD FEATURES

- Rectangular steel tube frame
- Wood or upholstered seat models
- Upholstered variations feature 2" of high resilience foam
- Wood slat, metal, or upholstered back designs
- Premium nylon glides
- CAL 117 fire retardant upholstery materials standard
- Wood seats made of 1" saddled ply
- Wood back variation made from Beech wood
- Nests five high

PERSONALIZATION OPTIONS

- The table to the right explains all of the available options for the Jill Collection.
- Textured finishes are not recommended for use on nesting chairs.
- Custom laser engraving or cut-out designs available, call factory for quote.

OPTIONS

	PAGE	ADD TO LIST PRICE
Webbed Seat Construction	9	\$8
Reduce Barstool Seat Height to 24"	10	\$10
CAL 133	9	\$65/Yard
Light Distressing on Wood Backs	9	\$12.50
Heavy Distressing on Wood Backs	9	\$17.50
Light Distressing on Wood Seats	9	\$12.50
Heavy Distressing on Wood Seats	9	\$17.50



310

JILL CHAIR

MODEL	WOOD	COM	GRADE 10	GRADE 20	GRADE 30	GRADE 40	GRADE 50
310	465	422	439	447	454	464	471

Overall Height: 32.25" Seat Height: 19.5" Overall Depth: 19" Overall Width: 18.5"
 C.O.M.: .45 yd Shipping Weight/Chair: 26# No. Per Carton: 2



N310

JILL NESTING CHAIR

MODEL	WOOD	COM	GRADE 10	GRADE 20	GRADE 30	GRADE 40	GRADE 50
N310	465	422	439	447	454	464	471

Overall Height: 32.25" Seat Height: 19.5" Overall Depth: 19" Overall Width: 18.5"
 C.O.M.: .45 yd Shipping Weight/Chair: 26# No. Per Carton: 2



310BS

JILL BARSTOOL

MODEL	WOOD	COM	GRADE 10	GRADE 20	GRADE 30	GRADE 40	GRADE 50
310BS	592	551	568	575	583	591	599

Overall Height: 43.875" Seat Height: 31.25" Overall Depth: 20" Overall Width: 18.5"
 C.O.M.: .45 yd Shipping Weight/Chair: 32# No. Per Carton: 1



311

JILL CHAIR

MODEL	WOOD	COM	GRADE 10	GRADE 20	GRADE 30	GRADE 40	GRADE 50
311	N/A	438	479	499	518	539	558

Overall Height: 32.25" Seat Height: 19.5" Overall Depth: 19" Overall Width: 18.5"
 C.O.M.: 1.125 yd Shipping Weight/Chair: 26# No. Per Carton: 2



N311

JILL NESTING CHAIR

MODEL	WOOD	COM	GRADE 10	GRADE 20	GRADE 30	GRADE 40	GRADE 50
N311	N/A	438	479	499	518	539	558

Overall Height: 32.25" Seat Height: 19.5" Overall Depth: 19" Overall Width: 18.5"
 C.O.M.: 1.125 yd Shipping Weight/Chair: 26# No. Per Carton: 2



311BS

JILL BARSTOOL

MODEL	WOOD	COM	GRADE 10	GRADE 20	GRADE 30	GRADE 40	GRADE 50
311BS	N/A	569	609	629	649	668	688

Overall Height: 43.875" Seat Height: 31.25" Overall Depth: 20" Overall Width: 18.5"
 C.O.M.: 1.125 yd Shipping Weight/Chair: 32# No. Per Carton: 1



312

JILL CHAIR

MODEL	WOOD	COM	GRADE 10	GRADE 20	GRADE 30	GRADE 40	GRADE 50
312	388	346	363	371	378	387	394

Overall Height: 32.25" Seat Height: 19.5" Overall Depth: 19" Overall Width: 18.5"
 C.O.M.: .45 yd Shipping Weight/Chair: 26# No. Per Carton: 2



N312

JILL NESTING CHAIR

MODEL	WOOD	COM	GRADE 10	GRADE 20	GRADE 30	GRADE 40	GRADE 50
N312	388	346	363	371	378	387	394

Overall Height: 32.25" Seat Height: 19.5" Overall Depth: 19" Overall Width: 18.5"
 C.O.M.: .45 yd Shipping Weight/Chair: 26# No. Per Carton: 2



312BS

JILL BARSTOOL

MODEL	WOOD	COM	GRADE 10	GRADE 20	GRADE 30	GRADE 40	GRADE 50
312BS	494	452	469	477	484	493	501

Overall Height: 43.875" Seat Height: 31.25" Overall Depth: 20" Overall Width: 18.5"
 C.O.M.: .45 yd Shipping Weight/Chair: 32# No. Per Carton: 1

LADDER BACK COLLECTION



ABOUT THIS COLLECTION

The Ladder Back Collection includes chairs, barstools, and swivel barstools.

STANDARD FEATURES

- 1.25" round metal tube
- Upholstered or wood seats available
- Wood seats made of 1" saddled ply
- Upholstered models features 2" of high resilience foam
- Technical Bulletin CAL 117 fire retardant upholstery materials

PERSONALIZATION OPTIONS

- The table to the right explains all of the available options for the Ladder Back Collection.

OPTIONS	PAGE	ADD TO LIST PRICE
Webbed Seat Construction	9	\$8
Reduce Barstool Seat Height to 24"	10	\$10
CAL 133	9	\$65/Yard
Swivel Barstool Seat Height Available Up to 36" High	-	\$25
Premium Metal Glides	-	\$3
Light Distressing on Wood Seats	9	\$12.50
Heavy Distressing on Wood Seats	9	\$17.50



105

LADDER BACK CHAIR

MODEL	WOOD	COM	GRADE 10	GRADE 20	GRADE 30	GRADE 40	GRADE 50
105	318	276	293	300	308	316	324

Overall Height: 31.75" Seat Height: 17.75" Overall Depth: 19.25" Overall Width: 16.25"
 C.O.M.: .45 yd Shipping Weight/Chair: 24# No. Per Carton: 2



105BS

LADDER BACK BARSTOOL

MODEL	WOOD	COM	GRADE 10	GRADE 20	GRADE 30	GRADE 40	GRADE 50
105BS	408	367	383	390	399	407	415

Overall Height: 44" Seat Height: 29.75" Overall Depth: 18.75" Overall Width: 16.25"
 C.O.M.: .45 yd Shipping Weight/Chair: 30# No. Per Carton: 1



6105BS

LADDER BACK SWIVEL BARSTOOL

MODEL	WOOD	COM	GRADE 10	GRADE 20	GRADE 30	GRADE 40	GRADE 50
6105BS	571	528	545	553	560	570	577

Overall Height: 45" Seat Height: 28.5" Overall Depth: 20" Overall Width: 16.25"
 C.O.M.: .45 yd Shipping Weight/Chair: 46# No. Per Carton: 1

LEO COLLECTION



ABOUT THIS COLLECTION

The Leo Chair is made with steel tubing, featuring a slightly arched steel back, legs, and frame.

STANDARD FEATURES

- Steel dowel legs
- Armless
- Wood or upholstered seat available
- Metal glide

PERSONALIZATION OPTIONS

- The table to the right explains all of the available options for the Leo Collection.

OPTIONS

CAL 133

PAGE

9

ADD TO LIST PRICE

\$65/Yard



725

LEO CHAIR

MODEL	WOOD	COM	GRADE 10	GRADE 20	GRADE 30	GRADE 40	GRADE 50
725	439	474	513	531	551	570	589

Overall Height: 32" Seat Height: 18" Overall Depth: 20" Overall Width: 21"
 C.O.M.: .5 yd Shipping Weight/Chair: 15# No. Per Carton: 2



ABOUT THIS COLLECTION

The Liz Collection includes four nesting chairs with different back styles.

STANDARD FEATURES

- 1.25" metal square tube frame
- Wood seats made of 1" saddled ply
- Wood back variation made from Beech wood
- Upholstered variations feature 2" of high resilience foam
- Nests four high
- Premium nylon glides
- Wall saver chair
- Technical Bulletin CAL 117 fire retardant upholstery materials

PERSONALIZATION OPTIONS

- The table to the right explains all of the available options for the Liz Collection.
- Cut-out back graphics and laser engraved graphics should not exceed 6" x 6".
- Call factory for custom cut-outs and custom engraving.
- Wrinkle finish is not available on nesting chairs.

OPTIONS

OPTIONS	PAGE	ADD TO LIST PRICE
Webbed Seat Construction	9	\$8
CAL 133	9	\$65/Yard
Premium Metal Glides	-	\$3
Cut-Out Design	10	\$30
Engraved Back	10	\$30/Side



N921

LIZ NESTING CHAIR

MODEL	WOOD	COM	GRADE 10	GRADE 20	GRADE 30	GRADE 40	GRADE 50
N921	385	343	359	368	375	384	391

Overall Height: 36" Seat Height: 18" Overall Depth: 19" Overall Width: 17"
 C.O.M.: .45 yd Shipping Weight/Chair: 26# No. Per Carton: 2



N923

LIZ NESTING CHAIR

MODEL	WOOD	COM	GRADE 10	GRADE 20	GRADE 30	GRADE 40	GRADE 50
N923	385	343	359	368	375	384	391

Overall Height: 36" Seat Height: 18" Overall Depth: 19" Overall Width: 17"
 C.O.M.: .45 yd Shipping Weight/Chair: 26# No. Per Carton: 2



N924

LIZ WOOD BACK NESTING CHAIR

MODEL	WOOD	COM	GRADE 10	GRADE 20	GRADE 30	GRADE 40	GRADE 50
N924	422	381	398	405	413	421	430

Overall Height: 36" Seat Height: 18" Overall Depth: 19" Overall Width: 17"
 C.O.M.: .45 yd Shipping Weight/Chair: 26# No. Per Carton: 2



N934

LIZ CRISS-CROSS NESTING CHAIR

MODEL	WOOD	COM	GRADE 10	GRADE 20	GRADE 30	GRADE 40	GRADE 50
N934	393	352	369	376	384	392	401

Overall Height: 36" Seat Height: 18" Overall Depth: 19" Overall Width: 17"
 C.O.M.: .45 yd Shipping Weight/Chair: 26# No. Per Carton: 2

MAMA MELISSA 571 COLLECTION



ABOUT THIS COLLECTION

The Mama Melissa 571 Collection includes chairs, barstools, swivel barstools, and fixed seating that are slightly larger than our original Melissa Anne Collection.

STANDARD FEATURES

- Ladder back design
- 1.25" metal square tube frame
- Available with wood or upholstered seat
- Wood seats made of 1" saddled ply
- Upholstered models feature 2" high resilience foam
- Premium nylon glides
- Technical Bulletin CAL 117 fire retardant upholstery materials are standard

PERSONALIZATION OPTIONS

- The table to the right explains all of the available options for the Mama Melissa 571 Collection.
- Please note for counter seat, model numbers with 3000 denote core-drilled mounts and model numbers with 4000 denote bolt-down mounts.

OPTIONS	PAGE	ADD TO LIST PRICE
Webbed Seat Construction	9	\$8
CAL 133	9	\$65/Yard
Premium Metal Glides	-	\$3
Reduce Barstool Seat Height to 24"	10	\$10
Light Distressing on Wood Seats	9	\$12.50
Heavy Distressing on Wood Seats	9	\$17.50
Swivel Barstool Seat Height Available Up to 36"	-	\$25
Fixed Seating 19" Diameter Foot Ring on Counter Height Seat	-	\$65
Fixed Seating 19" Diameter Foot Ring on Bar Height Seat	-	\$65



571

MAMA MELISSA CHAIR

MODEL	WOOD	COM	GRADE 10	GRADE 20	GRADE 30	GRADE 40	GRADE 50
571	361	319	344	356	369	382	393

Overall Height: 36" Seat Height: 19" Overall Depth: 22" Overall Width: 19"
 C.O.M.: .7 yd Shipping Weight/Chair: 30# No. Per Carton: 2



571BS

MAMA MELISSA BARSTOOL

MODEL	WOOD	COM	GRADE 10	GRADE 20	GRADE 30	GRADE 40	GRADE 50
571BS	454	413	438	450	462	476	487

Overall Height: 46.5" Seat Height: 30" Overall Depth: 20.25" Overall Width: 19.25"
 C.O.M.: .7 yd Shipping Weight/Chair: 35# No. Per Carton: 1



6571BS

MAMA MELISSA SWIVEL BARSTOOL

MODEL	WOOD	COM	GRADE 10	GRADE 20	GRADE 30	GRADE 40	GRADE 50
6571BS	606	563	589	602	614	626	639

Overall Height: 46.5" Seat Height: 30.5" Overall Depth: 23" Overall Width: 19.25"
 C.O.M.: .7 yd Shipping Weight/Chair: 46# No. Per Carton: 1



6571-3000 Core-drilled/
6571-4000 Bolt-down

MAMA MELISSA CHAIR CHAIR HEIGHT FIXED SEATING

MODEL	WOOD	COM	GRADE 10	GRADE 20	GRADE 30	GRADE 40	GRADE 50
6571-3000	672	623	652	666	680	694	750
6571-4000	672	623	652	666	680	694	750

Overall Height: 36" Seat Height: 18" Overall Depth: 22" Overall Width: 19"
 C.O.M.: .7 yd Shipping Weight/Chair: 25# No. Per Carton: 2



6571CH-3001 Core-drilled/
6571CH-4001 Bolt-down

MAMA MELISSA CHAIR COUNTER HEIGHT FIXED SEATING

MODEL	WOOD	COM	GRADE 10	GRADE 20	GRADE 30	GRADE 40	GRADE 50
6571CH-3001	689	641	670	684	698	712	793
6571CH-4001	689	641	670	684	698	712	793

Overall Height: 40" Seat Height: 25" Overall Depth: 22" Overall Width: 19"
 C.O.M.: .7 yd Shipping Weight/Chair: 32# No. Per Carton: 2



6571BS-3002 Core-drilled/
6571BS-4002 Bolt-down

MAMA MELISSA CHAIR BAR HEIGHT FIXED SEATING

MODEL	WOOD	COM	GRADE 10	GRADE 20	GRADE 30	GRADE 40	GRADE 50
6571BS-3002	707	658	688	696	706	715	750
6571BS-4002	707	658	688	696	706	715	750

Overall Height: 46.5" Seat Height: 30" Overall Depth: 22" Overall Width: 19"
 C.O.M.: .7 yd Shipping Weight/Chair: 33# No. Per Carton: 2

MAMA MELISSA 573 COLLECTION



ABOUT THIS COLLECTION

The Mama Melissa 573 Collection includes chairs, barstools, and swivel barstools that are slightly larger than our original Melissa Anne Collection.

STANDARD FEATURES

- Linear back design
- 1.25" metal square tube frame
- Available with wood or upholstered seat
- Wood seats made of 1" saddled ply
- Upholstered models feature 2" high resilience foam
- Premium nylon glides
- Technical Bulletin CAL 117 fire retardant upholstery materials are standard

PERSONALIZATION OPTIONS

- The table to the right explains all of the available options for the Mama Melissa 573 Collection.

OPTIONS	PAGE	ADD TO LIST PRICE
Webbed Seat Construction	9	\$8
CAL 133	9	\$65/Yard
Premium Metal Glides	-	\$3
Reduce Barstool Seat Height to 24"	10	\$10
Light Distressing on Wood Seats	9	\$12.50
Heavy Distressing on Wood Seats	9	\$17.50
Swivel Barstool Seat Height Available Up to 36"	-	\$25



573

MAMA MELISSA CHAIR

MODEL	WOOD	COM	GRADE 10	GRADE 20	GRADE 30	GRADE 40	GRADE 50
573	361	319	344	356	369	382	393

Overall Height: 36" Seat Height: 19" Overall Depth: 22" Overall Width: 19"
 C.O.M.: .7 yd Shipping Weight/Chair: 30# No. Per Carton: 2



573BS

MAMA MELISSA BARSTOOL

MODEL	WOOD	COM	GRADE 10	GRADE 20	GRADE 30	GRADE 40	GRADE 50
573BS	454	413	438	450	462	476	487

Overall Height: 46.5" Seat Height: 30" Overall Depth: 20.25" Overall Width: 19.25"
 C.O.M.: .7 yd Shipping Weight/Chair: 35# No. Per Carton: 1



6573BS

MAMA MELISSA SWIVEL BARSTOOL

MODEL	WOOD	COM	GRADE 10	GRADE 20	GRADE 30	GRADE 40	GRADE 50
6573BS	606	563	589	602	614	626	639

Overall Height: 46.5" Seat Height: 30.5" Overall Depth: 23" Overall Width: 19.25"
 C.O.M.: .7 yd Shipping Weight/Chair: 46# No. Per Carton: 1

MAMA MELISSA 574 COLLECTION



ABOUT THIS COLLECTION

The Mama Melissa 574 Collection includes chairs, barstools, and swivel barstools that are slightly larger than our original Melissa Anne Collection.

STANDARD FEATURES

- Wood back design with space for custom engraving or cut-out available
- Upholstered back design also available
- 1.25" metal square tube frame
- Available with wood or upholstered seat
- Wood seats made of 1" saddled ply
- Upholstered models feature 2" high resilience foam
- Premium nylon glides
- Technical Bulletin CAL 117 fire retardant upholstery materials are standard

PERSONALIZATION OPTIONS

- The table to the right explains all of the available options for the Mama Melissa 574 Collection.
- Custom laser engraving or cut-out designs available, call factory for quote.

OPTIONS

OPTIONS	PAGE	ADD TO LIST PRICE
Webbed Seat Construction	9	\$8
CAL 133	9	\$65/Yard
Premium Metal Glides	-	\$3
Cut-Out Design	10	\$30
Engraved Back	10	\$30/Side
Reduce Barstool Seat Height to 24"	10	\$10
Swivel Barstool Seat Height Available Up to 36"	-	\$25
Light Distressing on Wood Seats	9	\$12.50
Heavy Distressing on Wood Seats	9	\$17.50
Light Distressing on Wood Backs	9	\$12.50
Heavy Distressing on Wood Backs	9	\$17.50

BACK OPTIONS



-BD Bell Dot



-CC Custom Cut-Out



-CE Custom Engraved



-DT Dot



-MX Matrix



-PF Picture Frame



-SOLID



-SL Slot



-ST Star



-TS Three Slot



574

MAMA MELISSA CHAIR

MODEL	WOOD	COM	GRADE 10	GRADE 20	GRADE 30	GRADE 40	GRADE 50
574	418	376	402	414	425	439	451

Overall Height: 36" Seat Height: 19" Overall Depth: 22" Overall Width: 19"
 C.O.M.: .7 yd Shipping Weight/Chair: 30# No. Per Carton: 2



574-UB

MAMA MELISSA CHAIR — UPHOLSTERED BACK

MODEL	WOOD	COM	GRADE 10	GRADE 20	GRADE 30	GRADE 40	GRADE 50
574-UB	335	293	342	368	391	417	441

Overall Height: 36" Seat Height: 19" Overall Depth: 22" Overall Width: 19"
 C.O.M.: 1.4 yd Shipping Weight/Chair: 30# No. Per Carton: 2



574BS

MAMA MELISSA BARSTOOL

MODEL	WOOD	COM	GRADE 10	GRADE 20	GRADE 30	GRADE 40	GRADE 50
574BS	530	489	514	526	539	552	563

Overall Height: 46.5" Seat Height: 30" Overall Depth: 20.25" Overall Width: 19.25"
 C.O.M.: .7 yd Shipping Weight/Chair: 35# No. Per Carton: 1



574BS-UB

MAMA MELISSA BARSTOOL — UPHOLSTERED BACK

MODEL	WOOD	COM	GRADE 10	GRADE 20	GRADE 30	GRADE 40	GRADE 50
574BS-UB	420	378	428	453	478	503	527

Overall Height: 46.5" Seat Height: 30" Overall Depth: 20.25" Overall Width: 19.25"
 C.O.M.: 1.4 yd Shipping Weight/Chair: 35# No. Per Carton: 1



6574BS

MAMA MELISSA SWIVEL BARSTOOL

MODEL	WOOD	COM	GRADE 10	GRADE 20	GRADE 30	GRADE 40	GRADE 50
6574BS	681	639	664	677	688	701	714

Overall Height: 46.5" Seat Height: 30.5" Overall Depth: 23" Overall Width: 19.25"
 C.O.M.: .7 yd Shipping Weight/Chair: 46# No. Per Carton: 1



6574BS-UB

MAMA MELISSA SWIVEL BARSTOOL — UPHOLSTERED BACK

MODEL	WOOD	COM	GRADE 10	GRADE 20	GRADE 30	GRADE 40	GRADE 50
6574BS-UB	538	495	545	571	594	620	645

Overall Height: 46.5" Seat Height: 30.5" Overall Depth: 23" Overall Width: 19.25"
 C.O.M.: 1.4 yd Shipping Weight/Chair: 46# No. Per Carton: 1

MAMA MELISSA 577 COLLECTION



ABOUT THIS COLLECTION

The Mama Melissa 577 Collection includes chairs, barstools, and swivel barstools that are slightly larger than our original Melissa Anne Collection.

STANDARD FEATURES

- Criss-cross back design
- Upholstered back design also available
- 1.25" metal square tube frame
- Available with wood or upholstered seat
- Wood seats made of 1" saddled ply
- Upholstered models feature 2" high resilience foam
- Premium nylon glides
- Technical Bulletin CAL 117 fire retardant upholstery materials are standard

PERSONALIZATION OPTIONS

- The table to the right explains all of the available options for the Mama Melissa 577 Collection.

OPTIONS	PAGE	ADD TO LIST PRICE
Webbed Seat Construction	9	\$8
CAL 133	9	\$65/Yard
Premium Metal Glides	-	\$3
Reduce Barstool Seat Height to 24"	10	\$10
Swivel Barstool Seat Height Available Up To 36"	-	\$25
Light Distressing on Wood Seats	9	\$12.50
Heavy Distressing on Wood Seats	9	\$17.50



577

MAMA MELISSA CHAIR

MODEL	WOOD	COM	GRADE 10	GRADE 20	GRADE 30	GRADE 40	GRADE 50
577	368	318	348	362	376	391	405

Overall Height: 36" Seat Height: 19" Overall Depth: 22" Overall Width: 19"
 C.O.M.: .7 yd Shipping Weight/Chair: 30# No. Per Carton: 2



577BS

MAMA MELISSA BARSTOOL

MODEL	WOOD	COM	GRADE 10	GRADE 20	GRADE 30	GRADE 40	GRADE 50
577BS	468	420	449	464	477	492	506

Overall Height: 46.5" Seat Height: 30" Overall Depth: 20.25" Overall Width: 19.25"
 C.O.M.: .7 yd Shipping Weight/Chair: 35# No. Per Carton: 1



6577BS

MAMA MELISSA SWIVEL BARSTOOL

MODEL	WOOD	COM	GRADE 10	GRADE 20	GRADE 30	GRADE 40	GRADE 50
6577BS	623	575	605	618	631	647	661

Overall Height: 46.5" Seat Height: 30.5" Overall Depth: 23" Overall Width: 19.25"
 C.O.M.: .7 yd Shipping Weight/Chair: 46# No. Per Carton: 1

MAMA SAMANTHA COLLECTION



ABOUT THIS COLLECTION

The Mama Samantha Collection includes chairs, barstools, and swivel barstools that are slightly larger than our original Samantha Collection.

STANDARD FEATURES

- 1.25" metal square tube frame
- Available with wood or upholstered seat
- Wood seats made of 1" saddled ply
- Mixed material back design
- Upholstered models feature 2" high resilience foam
- Premium nylon glides
- Technical Bulletin CAL 117 fire retardant upholstery material

PERSONALIZATION OPTIONS

- The table to the right explains all of the available options for the Mama Samantha Collection.

OPTIONS	PAGE	ADD TO LIST PRICE
Webbed Seat Construction	9	\$8
CAL 133	9	\$65/Yard
Premium Metal Glides	-	\$3
Reduce Barstool Seat Height to 24"	10	\$10



575

MAMA SAMANTHA CHAIR

MODEL	WOOD	COM	GRADE 10	GRADE 20	GRADE 30	GRADE 40	GRADE 50
575	427	385	410	422	435	448	460

Overall Height: 36" Seat Height: 19" Overall Depth: 22" Overall Width: 19"
 C.O.M.: .7 yd Shipping Weight/Chair: 26# No. Per Carton: 2



575BS

MAMA SAMANTHA BARSTOOL

MODEL	WOOD	COM	GRADE 10	GRADE 20	GRADE 30	GRADE 40	GRADE 50
575BS	538	495	521	533	545	558	571

Overall Height: 46.5" Seat Height: 30" Overall Depth: 20.25" Overall Width: 19.25"
 C.O.M.: .7 yd Shipping Weight/Chair: 35# No. Per Carton: 1



6575BS

MAMA SAMANTHA SWIVEL BARSTOOL

MODEL	WOOD	COM	GRADE 10	GRADE 20	GRADE 30	GRADE 40	GRADE 50
6575BS	684	642	667	680	692	705	717

Overall Height: 46.5" Seat Height: 30.5" Overall Depth: 23" Overall Width: 19.25"
 C.O.M.: .7 yd Shipping Weight/Chair: 26# No. Per Carton: 2

MELISSA ANNE 501 COLLECTION



ABOUT THIS COLLECTION

The Melissa Anne 501 Collection includes chairs, barstools, swivel barstools, and fixed seating.

STANDARD FEATURES

- Ladder back design
- 1.25" metal square tube frame
- Available with wood or upholstered seat
- Wood seats made of 1" saddled ply
- Upholstered models feature 2" high resilience foam
- Premium nylon glides
- Technical Bulletin CAL 117 fire retardant upholstery material

PERSONALIZATION OPTIONS

- The table to the right explains all of the available options for the Melissa Anne 501 Collection.
- Please note for counter seat, model numbers with 3000 denote core-drilled mounts and model numbers with 4000 denote bolt-down mounts.

OPTIONS	PAGE	ADD TO LIST PRICE
Webbed Upholstery Seat	9	\$8
CAL 133	9	\$65/Yard
Premium Metal Glides	-	\$3
Reduce Barstool Seat Height to 24"	10	\$10
Swivel Barstool Seat Height Available Up to 36"	-	\$25
Light Distressing on Wood Seats	9	\$12.50
Heavy Distressing on Wood Seats	9	\$17.50
Nailhead Cobbler Seat	9	\$40
Fixed Seating 19" Diameter Foot Ring on Counter Height Seat	-	\$65
Fixed Seating 19" Diameter Foot Ring on Bar Height Seat	-	\$65



501

MELISSA ANNE CHAIR

MODEL	WOOD	COM	GRADE 10	GRADE 20	GRADE 30	GRADE 40	GRADE 50
501	296	253	270	278	285	295	303

Overall Height: 32.5" Seat Height: 18" Overall Depth: 19" Overall Width: 17"
 C.O.M.: .45 yd Shipping Weight/Chair: 26# No. Per Carton: 2



501BS

MELISSA ANNE BARSTOOL

MODEL	WOOD	COM	GRADE 10	GRADE 20	GRADE 30	GRADE 40	GRADE 50
501BS	385	343	359	368	375	384	391

Overall Height: 42.5" Seat Height: 30" Overall Depth: 19" Overall Width: 17"
 C.O.M.: .45 yd Shipping Weight/Chair: 35# No. Per Carton: 1



6501BS

MELISSA ANNE SWIVEL BARSTOOL

MODEL	WOOD	COM	GRADE 10	GRADE 20	GRADE 30	GRADE 40	GRADE 50
6501BS	533	491	508	515	523	531	540

Overall Height: 45" Seat Height: 29.5" Overall Depth: 19" Overall Width: 17"
 C.O.M.: .45 yd Shipping Weight/Chair: 46# No. Per Carton: 1



6501-3000 Core-drilled/
6501-4000 Bolt-down

MELISSA ANNE CHAIR CHAIR HEIGHT FIXED SEATING

MODEL	WOOD	COM	GRADE 10	GRADE 20	GRADE 30	GRADE 40	GRADE 50
6501-3000	600	552	571	580	589	597	633
6501-4000	600	552	571	580	589	597	633

Overall Height: 36" Seat Height: 18" Overall Depth: 19" Overall Width: 17"
 C.O.M.: .45 yd Shipping Weight/Chair: 25# No. Per Carton: 2



6501CH-3001 Core-drilled/
6501CH-4001 Bolt-down

MELISSA ANNE CHAIR COUNTER HEIGHT FIXED SEATING

MODEL	WOOD	COM	GRADE 10	GRADE 20	GRADE 30	GRADE 40	GRADE 50
6501CH-3001	618	570	589	597	607	615	651
6501CH-4001	618	570	589	597	607	615	651

Overall Height: 40" Seat Height: 25" Overall Depth: 19" Overall Width: 17"
 C.O.M.: .45 yd Shipping Weight/Chair: 28# No. Per Carton: 2



6501BS-3002 Core-drilled/
6501BS-4002 Bolt-down

MELISSA ANNE CHAIR BAR HEIGHT FIXED SEATING

MODEL	WOOD	COM	GRADE 10	GRADE 20	GRADE 30	GRADE 40	GRADE 50
6501BS-3002	623	587	607	615	624	633	668
6501BS-4002	623	587	607	615	624	633	668

Overall Height: 46.5" Seat Height: 30" Overall Depth: 19" Overall Width: 17"
 C.O.M.: .7 yd Shipping Weight/Chair: 29# No. Per Carton: 2

MELISSA ANNE 503 COLLECTION



ABOUT THIS COLLECTION

The Melissa Anne 503 Collection includes chairs, barstools, and swivel barstools.

STANDARD FEATURES

- Ladder back design
- 1.25" metal square tube frame
- Available with wood or upholstered seat
- Wood seats made of 1" saddled ply
- Upholstered models feature 2" high resilience foam
- Premium nylon glides
- Technical Bulletin CAL 117 fire retardant upholstery material

PERSONALIZATION OPTIONS

- The table to the right explains all of the available options for the Melissa Anne 503 Collection.

OPTIONS	PAGE	ADD TO LIST PRICE
Webbed Seat Construction	9	\$8
CAL 133	9	\$65/Yard
Premium Metal Glides	-	\$3
Reduce Barstool Seat Height to 24"	10	\$10
Swivel Barstool Seat Height Available Up to 36"	-	\$25
Light Distressing on Wood Seats	9	\$12.50
Heavy Distressing on Wood Seats	9	\$17.50
Nailhead Cobbler Seat	9	\$40



503

MELISSA ANNE CHAIR

MODEL	WOOD	COM	GRADE 10	GRADE 20	GRADE 30	GRADE 40	GRADE 50
503	296	253	270	278	285	295	303

Overall Height: 32.5" Seat Height: 18" Overall Depth: 19" Overall Width: 17"
 C.O.M.: .45 yd Shipping Weight/Chair: 26# No. Per Carton: 2



503BS

MELISSA ANNE BARSTOOL

MODEL	WOOD	COM	GRADE 10	GRADE 20	GRADE 30	GRADE 40	GRADE 50
503BS	385	343	359	368	375	384	391

Overall Height: 42.5" Seat Height: 30" Overall Depth: 19" Overall Width: 17"
 C.O.M.: .45 yd Shipping Weight/Chair: 35# No. Per Carton: 1



6503BS

MELISSA ANNE SWIVEL BARSTOOL

MODEL	WOOD	COM	GRADE 10	GRADE 20	GRADE 30	GRADE 40	GRADE 50
6503BS	533	491	508	515	523	531	540

Overall Height: 45" Seat Height: 29.5" Overall Depth: 19" Overall Width: 17"
 C.O.M.: .45 yd Shipping Weight/Chair: 46# No. Per Carton: 1

MELISSA ANNE 504 COLLECTION



ABOUT THIS COLLECTION

The Melissa Anne 504 Collection includes chairs, barstools, and swivel barstools.

STANDARD FEATURES

- Wood back design with space for custom engraving or cut-out available
- 1.25" metal square tube frame
- Available with wood or upholstered seat
- Wood seats made of 1" saddled ply
- Upholstered models feature 2" high resilience foam
- Premium nylon glides
- Technical Bulletin CAL 117 fire retardant upholstery material

PERSONALIZATION OPTIONS

- The table to the right explains all of the available options for the Melissa Anne 504 Collection.
- Cut-out back graphics and laser engraved graphics should not exceed 6" x 6".
- Custom laser engraving or cut-out designs available, call factory for quote.

OPTIONS

	PAGE	ADD TO LIST PRICE
Webbed Seat Construction	9	\$8
CAL 133	9	\$65/Yard
Premium Metal Glides	-	\$3
Cut-Out Design	10	\$30
Engraved Back	10	\$30/Side
Reduce Barstool Seat Height to 24"	10	\$10
Swivel Barstool Seat Height Available Up to 36"	-	\$25
Light Distressing on Wood Seats	9	\$12.50
Heavy Distressing on Wood Seats	9	\$17.50
Nailhead Cobbler Seat	9	\$40

BACK OPTIONS



-BD Bell Dot



-CC Custom Cut-Out



-CE Custom Engraved



-DT Dot



-MX Matrix



-PF Picture Frame



-SOLID



-SL Slot



-ST Star



-TS Three Slot



504
(Shown as 504-PF)

MELISSA ANNE CHAIR

MODEL	WOOD	COM	GRADE 10	GRADE 20	GRADE 30	GRADE 40	GRADE 50
504	341	299	315	323	331	340	347

Overall Height: 32.5" Seat Height: 18" Overall Depth: 19" Overall Width: 17"
C.O.M.: .45 yd Shipping Weight/Chair: 26# No. Per Carton: 2



504BS
(Shown as 504BS-PF)

MELISSA ANNE BARSTOOL

MODEL	WOOD	COM	GRADE 10	GRADE 20	GRADE 30	GRADE 40	GRADE 50
504BS	421	379	397	404	412	420	428

Overall Height: 42.5" Seat Height: 30" Overall Depth: 19" Overall Width: 17"
C.O.M.: .45 yd Shipping Weight/Chair: 35# No. Per Carton: 1



6504BS
(Shown as 6504BS-PF)

MELISSA ANNE SWIVEL BARSTOOL

MODEL	WOOD	COM	GRADE 10	GRADE 20	GRADE 30	GRADE 40	GRADE 50
6504BS	564	523	540	547	555	563	572

Overall Height: 45" Seat Height: 29.5" Overall Depth: 19" Overall Width: 17"
C.O.M.: .45 yd Shipping Weight/Chair: 46# No. Per Carton: 1

MELISSA ANNE 504-UB COLLECTION



ABOUT THIS COLLECTION

The Melissa Anne 504-UB Collection includes chairs, barstools, and swivel barstools.

STANDARD FEATURES

- Upholstered back design
- 1.25" metal square tube frame
- Available with wood or upholstered seat
- Wood seats made of 1" saddled ply
- Upholstered models feature 2" high resilience foam
- Premium nylon glides
- Technical Bulletin CAL 117 fire retardant upholstery material

PERSONALIZATION OPTIONS

- The table to the right explains all of the available options for the Melissa Anne 504-UB Collection.

OPTIONS	PAGE	ADD TO LIST PRICE
Webbed Seat Construction	9	\$8
CAL 133	9	\$65/Yard
Premium Metal Glides	-	\$3
Reduce Barstool Seat Height to 24"	10	\$10
Swivel Barstool Seat Height Available Up to 36"	-	\$25
Light Distressing on Wood Seats	9	\$12.50
Heavy Distressing on Wood Seats	9	\$17.50
Nailhead Cobbler Seat	9	\$40



504-UB

MELISSA ANNE UPHOLSTERED BACK CHAIR

MODEL	WOOD	COM	GRADE 10	GRADE 20	GRADE 30	GRADE 40	GRADE 50
504-UB	399	356	388	405	420	437	452

Overall Height: 32.5" Seat Height: 18" Overall Depth: 19" Overall Width: 17"
 C.O.M.: .9 yd Shipping Weight/Chair: 26# No. Per Carton: 2



504BS-UB

MELISSA ANNE UPHOLSTERED BACK BARSTOOL

MODEL	WOOD	COM	GRADE 10	GRADE 20	GRADE 30	GRADE 40	GRADE 50
504BS-UB	508	466	497	514	529	546	561

Overall Height: 42.5" Seat Height: 30" Overall Depth: 19" Overall Width: 17"
 C.O.M.: .9 yd Shipping Weight/Chair: 35# No. Per Carton: 1



6504BS-UB

MELISSA ANNE UPHOLSTERED BACK SWIVEL BARSTOOL

MODEL	WOOD	COM	GRADE 10	GRADE 20	GRADE 30	GRADE 40	GRADE 50
6504BS-UB	654	613	645	661	677	693	709

Overall Height: 45" Seat Height: 29.5" Overall Depth: 19" Overall Width: 17"
 C.O.M.: .9 yd Shipping Weight/Chair: 46# No. Per Carton: 1



ABOUT THIS COLLECTION

The Melissa Anne 533 Collection includes chairs, barstools, and swivel barstools.

STANDARD FEATURES

- Criss-cross back design
- 1.25" metal square tube frame
- Available with wood or upholstered seat
- Wood seats made of 1" saddled ply
- Upholstered models feature 2" high resilience foam
- Premium nylon glides
- Technical Bulletin CAL 117 fire retardant upholstery material

PERSONALIZATION OPTIONS

- The table to the right explains all of the available options for the Melissa Anne 533 Collection.

OPTIONS	PAGE	ADD TO LIST PRICE
Webbed Seat Construction	9	\$8
CAL 133	9	\$65/Yard
Premium Metal Glides	-	\$3
Reduce Barstool Seat Height to 24"	10	\$10
Swivel Barstool Seat Height Available Up to 36"	-	\$25
Light Distressing on Wood Seats	9	\$12.50
Heavy Distressing on Wood Seats	9	\$17.50
Nailhead Cobbler Seat	9	\$40



533

MELISSA ANNE CHAIR

MODEL	WOOD	COM	GRADE 10	GRADE 20	GRADE 30	GRADE 40	GRADE 50
533	316	275	291	299	307	315	323

Overall Height: 32.5" Seat Height: 18" Overall Depth: 19" Overall Width: 17"
 C.O.M.: .45 yd Shipping Weight/Chair: 26# No. Per Carton: 2



533BS

MELISSA ANNE BARSTOOL

MODEL	WOOD	COM	GRADE 10	GRADE 20	GRADE 30	GRADE 40	GRADE 50
533BS	401	358	375	383	390	400	407

Overall Height: 42.5" Seat Height: 30" Overall Depth: 19" Overall Width: 17"
 C.O.M.: .45 yd Shipping Weight/Chair: 35# No. Per Carton: 1



6533BS

MELISSA ANNE SWIVEL BARSTOOL

MODEL	WOOD	COM	GRADE 10	GRADE 20	GRADE 30	GRADE 40	GRADE 50
6533BS	546	505	521	528	537	545	553

Overall Height: 45" Seat Height: 29.5" Overall Depth: 19" Overall Width: 17"
 C.O.M.: .45 yd Shipping Weight/Chair: 46# No. Per Carton: 1



ABOUT THIS COLLECTION

The Mia Collection includes chair height, counter height and bar height upholstered stools available in freestanding, bolt-down, or core-drilled variations.

STANDARD FEATURES

- Webbed seat construction
- 2" of high resilience foam on all models
- 3" round metal column with 1/4" steel base
- Felt glides
- Technical Bulletin CAL 117 fire retardant upholstery materials
- Foot ring standard on counter and bar height models

PERSONALIZATION OPTIONS

- The table to the right explains all of the available options for the Mia Collection.
- A fabric width less than 54" will require either an additional vertical seam or a "railroaded" application of the material. Thread color will be chosen by the factory to match the upholstery as closely as possible, unless otherwise specified. Choose between white, black, beige, dark grey, or beaver.
- Foot ring standard on counter and bar height models. Subtract \$65 list for products without foot rings.
- Consult with your architect or general contractor for proper installation of bolt-down and core-drilled models, attachment varies by floor construction.

OPTIONS

	PAGE	ADD TO LIST PRICE
CAL 133	9	\$65/Yard
Add Premium Adjustable Glides	-	\$30



1500 Free Standing/
1501 Bolt-down/
1502 Core-drilled

MIA CHAIR HEIGHT BARSTOOL

MODEL	WOOD	COM	GRADE 10	GRADE 20	GRADE 30	GRADE 40	GRADE 50
1500	N/A	609	661	687	712	736	763
1501	N/A	609	661	687	712	736	763
1502	N/A	609	661	687	712	736	763

Overall Height: 20" Seat Height: 20" Overall Depth: 18" Overall Width: 18"
C.O.M.: 1.25 yd Shipping Weight/Chair: 26# No. Per Carton: 1



1500CH-FR Free Standing/
1501CH Bolt-down/
1502CH-FR Core-drilled

MIA COUNTER HEIGHT BARSTOOL

MODEL	WOOD	COM	GRADE 10	GRADE 20	GRADE 30	GRADE 40	GRADE 50
1500CH-FR	N/A	783	835	860	886	911	937
1501CH	N/A	783	835	860	886	911	937
1502CH-FR	N/A	783	835	860	886	911	937

Overall Height: 25" Seat Height: 25" Overall Depth: 19" Overall Width: 19"
C.O.M.: 1.25 yd Shipping Weight/Chair: 26# No. Per Carton: 1



1500BS-FR Free Standing/
1501BS-FR Bolt-down/
1502BS-FR Core-drilled

MIA BAR HEIGHT BARSTOOL

MODEL	WOOD	COM	GRADE 10	GRADE 20	GRADE 30	GRADE 40	GRADE 50
1500BS-FR	N/A	811	862	889	914	939	964
1501BS-FR	N/A	811	862	889	914	939	964
1502BS-FR	N/A	811	862	889	914	939	964

Overall Height: 30" Seat Height: 30" Overall Depth: 19" Overall Width: 19"
C.O.M.: 1.25 yd Shipping Weight/Chair: 26# No. Per Carton: 1

NADIA COLLECTION



ABOUT THIS COLLECTION

The Nadia Collection features upholstered benches in either 44" or 66" long.

STANDARD FEATURES

- 16-gauge steel legs
- Available in 44" or 66" length
- High density foam
- Technical Bulletin CAL 117 fire retardant upholstery materials

PERSONALIZATION OPTIONS

- The table to the right explains all of the available options for the Nadia Collection.
- Requires one or two center seams or for upholstery to be railroaded. Yardage noted will accommodate all three alternatives.

OPTIONS

CAL 133

PAGE

9

ADD TO LIST PRICE

\$65/Yard



2130-44

NADIA 44" BENCH

MODEL	WOOD	COM	GRADE 10	GRADE 20	GRADE 30	GRADE 40	GRADE 50
2130-44	N/A	1267	1337	1371	1405	1441	1475

Overall Height: 20" Seat Height: 20" Overall Depth: 21.75" Overall Length: 43.25"
 C.O.M.: 2 yd Shipping Weight/Chair: 65# No. Per Carton: 1



2130-66

NADIA 66" BENCH

MODEL	WOOD	COM	GRADE 10	GRADE 20	GRADE 30	GRADE 40	GRADE 50
2130-66	N/A	1778	1882	1933	1986	2037	2089

Overall Height: 20" Seat Height: 20" Overall Depth: 21.75" Overall Length: 65.25"
 C.O.M.: 3* yd Shipping Weight/Chair: 90# No. Per Carton: 1

*Requires 1 or 2 center seams or for upholstery to be railroaded.
 Yardage noted will accommodate all three alternatives.

OPLA COLLECTION



ABOUT THIS COLLECTION

The Opla Collection features an outdoor chair and an outdoor armchair.

STANDARD FEATURES

- 5/8" round, 12-gauge steel tube frame
- Powder coated steel wire mesh seat and back
- Plastic glides
- Quick Ship option available in Alloy Silver

PERSONALIZATION OPTIONS

- High gloss and low gloss clear coat not available on Opla Seating Collection.



840-ALLOY-SILVER
Available only in Alloy Silver

OPLA CHAIR – QUICK SHIP

MODEL	\$LIST PRICE
840-ALLOY-SILVER	384

Overall Height: 28.5" Seat Height: 18.63" Overall Depth: 23" Overall Width: 18.5"
Shipping Weight/Chair: 22# No. Per Carton: 4



840A-ALLOY-SILVER
Available only in Alloy Silver

OPLA ARMCHAIR – QUICK SHIP

MODEL	\$LIST PRICE
840A-ALLOY-SILVER	426

Overall Height: 28.5" Seat Height: 18.63" Overall Depth: 23" Overall Width: 23.5"
Shipping Weight/Chair: 22# No. Per Carton: 2



840

OPLA CHAIR

MODEL	\$LIST PRICE
840	384

Overall Height: 28.5" Seat Height: 18.63" Overall Depth: 23" Overall Width: 18.5"
Shipping Weight/Chair: 22# No. Per Carton: 4



840A

OPLA ARMCHAIR

MODEL	\$LIST PRICE
840A	426

Overall Height: 28.5" Seat Height: 18.63" Overall Depth: 23" Overall Width: 23.5"
Shipping Weight/Chair: 22# No. Per Carton: 2

REECE COLLECTION



ABOUT THIS COLLECTION

The Reece Collection includes a chair, counter height stool, and a barstool. All models are available with upholstery options. The base frame and legs can be powder coated a separate color from upper frame assembly (this includes handle and back bars).

STANDARD FEATURES

- Steel tube frame
- Available in wood or laminate shells
- Upholstered models feature 1" foam
- Premium plastic glides
- Technical Bulletin CAL 117 fire retardant upholstery materials
- 280 models stack four high
- Legs and back bracket can be powder coated separate colors

PERSONALIZATION OPTIONS

- The table to the right explains all of the available options for the Reece Collection.

OPTIONS

CAL 133

PAGE

9

ADD TO LIST PRICE

\$65/Yard

UPHOLSTERY OPTIONS



UPH1



UPH2

LAMINATE OPTIONS

Laminate shell pricing includes select standard laminates from Formica and Wilsonart, listed on chart directly below. These select standard laminates are readily available and in stock by our supplier.

Formica	Style Number	Wilsonart	Style Number
White	949-58	Beige	1530-60
Antique White	932-58	Black	1595-60
Natural Birch	7481-58	Designer White	D354-60
Fog	961-58	Dove Grey	D92-60
Storm	912-58	Fashion Grey	D381-60
White	949-58	Natural Almond	D30-60
Acajou Mahogany	7008-43	Frosty White	1573-60
Amber Maple	7012-58	Grey	1500-60
Natural Maple	756-58	Haze	D97-60
Natural Oak	346-58	Khaki Brown	D50-60
Select Cherry	7759-43	Northsea	D90-60
Wild Cherry	5904-58	Pepperdust	D327-60
		Slate Grey	D91-60
		Wallaby	D439-60
		Amber Cherry	7919K-78
		Bannister Oak	7806-60
		Kensington Maple	10776-60
		Manitoba Maple	7911-60
		Natural Pear	7061-60
		Wild Cherry	7054-60

Please note, orders for fewer than 10-like shells will have an \$85.00 set-up charge. We do accept special laminates. If laminates are chosen that are outside our selected standards, please keep these guidelines in mind:

- Pricing and lead times will vary depending on laminate chosen – call for quote
- Laminate needs to be vertical grade
- Sheets available in 5' x 12' size will have the best yield
- Cannot use High Gloss Laminates
- If you choose a patterned laminate, please note that the pattern consistency will vary from shell to shell



REECE CHAIR

WOOD							
MODEL	YARDAGE	WOOD	GRADE 10	GRADE 20	GRADE 30	GRADE 40	GRADE 50
280-W	N/A	538	N/A	N/A	N/A	N/A	N/A
WOOD - UPHOLSTERED SEAT							
MODEL	YARDAGE	COM	GRADE 10	GRADE 20	GRADE 30	GRADE 40	GRADE 50
280-W-UPH1	0.35	589	602	607	613	619	624
WOOD - UPHOLSTERED SEAT & BACK							
MODEL	YARDAGE	COM	GRADE 10	GRADE 20	GRADE 30	GRADE 40	GRADE 50
280-W-UPH2	0.50	615	632	641	649	657	665
LAMINATE							
MODEL	YARDAGE	LAMINATE	GRADE 10	GRADE 20	GRADE 30	GRADE 40	GRADE 50
280-LAM	N/A	599	N/A	N/A	N/A	N/A	N/A
LAMINATE - UPHOLSTERED SEAT							
MODEL	YARDAGE	COM	GRADE 10	GRADE 20	GRADE 30	GRADE 40	GRADE 50
280-LAM-UPH1	0.35	651	663	668	675	681	686
LAMINATE - UPHOLSTERED SEAT & BACK							
MODEL	YARDAGE	COM	GRADE 10	GRADE 20	GRADE 30	GRADE 40	GRADE 50
280-LAM-UPH2	0.50	677	694	702	711	719	727

Overall Height: 31.7" Overall Depth: 18.21" Overall Width: 18.75" No. Per Carton: 2
 Seat Height: 280-W 17.6", 280-W-UPH1 19.01", 280-W-UPH2 19.01", 280-LAM 17.6", 280-LAM-UPH1 19.01"
 280-LAM-UPH2 19.01"
 Shipping Weight/Chair: 280-W 28.42#, 280-W-UPH1 31.74#, 280-W-UPH2 30#, 280-LAM 28.42#,
 280-LAM-UPH1 30#, 280-LAM-UPH2 31.74#



REECE COUNTER HEIGHT STOOL

WOOD							
MODEL	YARDAGE	WOOD	GRADE 10	GRADE 20	GRADE 30	GRADE 40	GRADE 50
280CH-W	N/A	563	N/A	N/A	N/A	N/A	N/A
WOOD - UPHOLSTERED SEAT							
MODEL	YARDAGE	COM	GRADE 10	GRADE 20	GRADE 30	GRADE 40	GRADE 50
280CH-W-UPH1	0.35	615	627	632	639	645	650
WOOD - UPHOLSTERED SEAT & BACK							
MODEL	YARDAGE	COM	GRADE 10	GRADE 20	GRADE 30	GRADE 40	GRADE 50
280CH-W-UPH2	0.50	641	658	666	675	683	691
LAMINATE							
MODEL	YARDAGE	LAMINATE	GRADE 10	GRADE 20	GRADE 30	GRADE 40	GRADE 50
280CH-LAM	N/A	625	N/A	N/A	N/A	N/A	N/A
LAMINATE - UPHOLSTERED SEAT							
MODEL	YARDAGE	COM	GRADE 10	GRADE 20	GRADE 30	GRADE 40	GRADE 50
280CH-LAM-UPH1	0.35	677	689	694	700	707	712
LAMINATE - UPHOLSTERED SEAT & BACK							
MODEL	YARDAGE	COM	GRADE 10	GRADE 20	GRADE 30	GRADE 40	GRADE 50
280CH-LAM-UPH2	0.50	702	720	728	736	745	753

Overall Height: 38.34" Overall Depth: 18.67" Overall Width: 18.75" No. Per Carton: 1
 Seat Height: 280CH-W 24.35", 280CH-W-UPH1 25.74", 280CH-W-UPH2 25.74", 280CH-LAM 24.35",
 280CH-LAM-UPH1 25.74", 280CH-LAM-UPH2 25.74"
 Shipping Weight/Chair: 280CH-W 19.76#, 280CH-W-UPH1 20.95#, 280CH-W-UPH2 21.48#, 280CH-LAM 19.76#,
 280CH-LAM-UPH1 20.95#, 280CH-LAM-UPH2 21.48#



280BS

REECE BAR HEIGHT STOOL

WOOD

MODEL	YARDAGE	WOOD	GRADE 10	GRADE 20	GRADE 30	GRADE 40	GRADE 50
280BS-W	N/A	584	N/A	N/A	N/A	N/A	N/A

WOOD - UPHOLSTERED SEAT

MODEL	YARDAGE	COM	GRADE 10	GRADE 20	GRADE 30	GRADE 40	GRADE 50
280BS-W-UPH1	0.35	636	648	653	659	665	671

WOOD - UPHOLSTERED SEAT & BACK

MODEL	YARDAGE	COM	GRADE 10	GRADE 20	GRADE 30	GRADE 40	GRADE 50
280BS-W-UPH2	0.50	661	679	687	695	703	712

LAMINATE

MODEL	YARDAGE	LAMINATE	GRADE 10	GRADE 20	GRADE 30	GRADE 40	GRADE 50
280BS-LAM	N/A	646	N/A	N/A	N/A	N/A	N/A

LAMINATE - UPHOLSTERED SEAT

MODEL	YARDAGE	COM	GRADE 10	GRADE 20	GRADE 30	GRADE 40	GRADE 50
280BS-LAM-UPH1	0.35	697	710	715	721	727	732

LAMINATE - UPHOLSTERED SEAT & BACK

MODEL	YARDAGE	COM	GRADE 10	GRADE 20	GRADE 30	GRADE 40	GRADE 50
280BS-LAM-UPH2	0.50	723	741	749	757	765	774

Overall Height: 44.34" Overall Depth: 18.68" Overall Width: 18.75" No. Per Carton: 1

Seat Height: 280BS-W 30.35", 280BS-W-UPH1 31.71", 280BS-W-UPH2 31.71", 280BS-LAM 30.35",

280BS-LAM-UPH1 31.71", 280BS-LAM-UPH2 31.71"

Shipping Weight/Chair: 280BS-W 21.65#, 280BS-W-UPH1 22.85#, 280BS-W-UPH2 23.37#, 280BS-LAM 21.65#,

280BS-LAM-UPH1 22.85#, 280BS-LAM-UPH2 23.37#



ABOUT THIS COLLECTION

The Rosie Collection includes chair height, counter height, and bar height upholstered stools available in core-drilled or bolt-down variations with or without foot ring.

STANDARD FEATURES

- 3" round metal tube frame
- 2" of high resilience upholstery foam
- 360 degree flat swivel seat
- Technical Bulletin CAL 117 fire retardant upholstery materials
- Available with wood or upholstered seat

PERSONALIZATION OPTIONS

- The table to the right explains all of the available options for the Rosie Collection.
- Call for custom heights.
- Consult with your architect or general contractor for proper installation of bolt-down and core-drilled models, attachment varies by floor construction.

OPTIONS

	PAGE	ADD TO LIST PRICE
CAL 133	9	\$65/Yard
Light Distressing on Wood Seats	9	\$12.50
Heavy Distressing on Wood Seats	9	\$17.50
Foot Ring on Counter and Barstool Height	-	\$65



220 Bolt-down/
230 Core-drilled

ROSIE CHAIR HEIGHT BARSTOOL

MODEL	WOOD	COM	GRADE 10	GRADE 20	GRADE 30	GRADE 40	GRADE 50
220	342	300	316	324	332	341	348
230	342	300	316	324	332	341	348

Overall Height: 18" Seat Height: 18" Overall Depth: 16" Overall Width: 16"

C.O.M.: .45 yd Shipping Weight/Chair: 25# No. Per Carton: 1



220CH Bolt-down/
230CH Core-drilled

ROSIE COUNTER HEIGHT BARSTOOL

MODEL	WOOD	COM	GRADE 10	GRADE 20	GRADE 30	GRADE 40	GRADE 50
220CH	452	410	427	435	443	451	459
230CH	452	410	427	435	443	451	459

Overall Height: 25" Seat Height: 25" Overall Depth: 16" Overall Width: 16"

C.O.M.: .45 yd Shipping Weight/Chair: 25# No. Per Carton: 1



220BS Bolt-down/
230BS Core-drilled

ROSIE BAR HEIGHT BARSTOOL

MODEL	WOOD	COM	GRADE 10	GRADE 20	GRADE 30	GRADE 40	GRADE 50
220BS	501	459	476	483	491	500	508
230BS	501	459	476	483	491	500	508

Overall Height: 30" Seat Height: 30" Overall Depth: 16" Overall Width: 16"

C.O.M.: .45 yd Shipping Weight/Chair: 25# No. Per Carton: 1

SADIE COLLECTION



ABOUT THIS COLLECTION

The Sadie Collection includes outdoor chairs and barstools. Designed by Joey Ruiter.

STANDARD FEATURES

- 18-gauge steel frame
- Stainless steel frame, back, and seat
- Plastic glides

PERSONALIZATION OPTIONS

- The table to the right explains all of the available options for the Sadie Collection.

OPTIONS

Reduce Barstool Seat Height to 24"

PAGE

10

ADD TO LIST PRICE

\$25



838

SADIE OUTDOOR CHAIR

	ALL
MODEL	METAL
838	663

Overall Height: 33" Seat Height: 19.5" Overall Depth: 23.5" Overall Width: 22.5"

Shipping Weight/Chair: 26# No. Per Carton: 2



838BS

SADIE OUTDOOR BARSTOOL

	ALL
MODEL	METAL
838BS	836

Overall Height: 42" Seat Height: 29.5" Overall Depth: 23.5" Overall Width: 24.39"

Shipping Weight/Chair: 35# No. Per Carton: 1

SADIE II COLLECTION



ABOUT THIS COLLECTION

The Sadie II Collection includes indoor chairs and barstools. Designed by Joey Ruiter.

STANDARD FEATURES

- 18-gauge steel frame
- Wood or upholstered seats available
- Upholstered models feature 1" of high resilience foam
- Plastic glides
- Technical Bulletin CAL 117 fire retardant upholstery materials

PERSONALIZATION OPTIONS

- The table to the right explains all of the available options for the Sadie II Collection.

OPTIONS

CAL 133

PAGE

9

ADD TO LIST PRICE

\$65/Yard



827

SADIE II INDOOR CHAIR

MODEL	COM	GRADE 10	GRADE 20	GRADE 30	GRADE 40	GRADE 50	WOOD SEAT & BACK
827	444	464	474	483	492	502	384

Overall Height: 31.3" Seat Height: 17.79" Overall Depth: 22.06" Overall Width: 19.57"
 Seat C.O.M.: .5 yd Shipping Weight/Chair: 24# No. Per Carton: 2



827CH

SADIE II INDOOR COUNTER STOOL

MODEL	COM	GRADE 10	GRADE 20	GRADE 30	GRADE 40	GRADE 50	WOOD SEAT & BACK
827CH	617	627	636	655	674	692	563

Overall Height: 36.76" Seat Height: 23.24" Overall Depth: 22.79" Overall Width: 20.56"
 Seat C.O.M.: .5 yd Shipping Weight/Chair: 28# No. Per Carton: 1



827BS

SADIE II INDOOR BARSTOOL

MODEL	COM	GRADE 10	GRADE 20	GRADE 30	GRADE 40	GRADE 50	WOOD SEAT & BACK
827BS	592	612	621	630	639	647	538

Overall Height: 42.83" Seat Height: 30" Overall Depth: 22.57" Overall Width: 21.6"
 Seat C.O.M.: .5 yd Shipping Weight/Chair: 30# No. Per Carton: 1



ABOUT THIS COLLECTION

The Samantha Collection includes chairs, nesting chairs, barstools, and swivel barstools.

STANDARD FEATURES

- 1.25" metal square tube frame
- Available with wood or upholstered seat
- Wood seats made of 1" saddled ply
- Wood back variation made from Beech wood
- Upholstered models feature 2" high resilience foam
- Premium nylon glides
- Technical Bulletin CAL 117 fire retardant upholstery materials
- Nests five high

PERSONALIZATION OPTIONS

- The table to the right explains all of the available options for the Samantha Collection.

OPTIONS	PAGE	ADD TO LIST PRICE
Webbed Seat Construction	9	\$8
CAL 133	9	\$65/Yard
Reduce Barstool Seat Height to 24"	10	\$10
Light Distressing on Wood Seats	9	\$12.50
Heavy Distressing on Wood Seats	9	\$17.50
Light Distressing on Wood Backs	9	\$12.50
Heavy Distressing on Wood Backs	9	\$17.50
Nailhead Cobbler Seat	9	\$60
Premium Metal Glides	-	\$3



505

SAMANTHA CHAIR

MODEL	WOOD	COM	GRADE 10	GRADE 20	GRADE 30	GRADE 40	GRADE 50
505	362	320	337	344	352	361	369

Overall Height: 32.5" Seat Height: 18" Overall Depth: 19" Overall Width: 17"
 C.O.M.: .45 yd Shipping Weight/Chair: 26# No. Per Carton: 2



N905

SAMANTHA NESTING CHAIR

MODEL	WOOD	COM	GRADE 10	GRADE 20	GRADE 30	GRADE 40	GRADE 50
N905	399	356	373	381	388	398	405

Overall Height: 32.5" Seat Height: 18" Overall Depth: 19" Overall Width: 17"
 C.O.M.: .45 yd Shipping Weight/Chair: 26# No. Per Carton: 2



N925

SAMANTHA NESTING CHAIR

MODEL	WOOD	COM	GRADE 10	GRADE 20	GRADE 30	GRADE 40	GRADE 50
N925	435	392	409	417	424	434	441

Overall Height: 36" Seat Height: 18" Overall Depth: 19" Overall Width: 17"
 C.O.M.: .45 yd Shipping Weight/Chair: 26# No. Per Carton: 2



505BS

SAMANTHA BARSTOOL

MODEL	WOOD	COM	GRADE 10	GRADE 20	GRADE 30	GRADE 40	GRADE 50
505BS	454	413	430	437	445	453	461

Overall Height: 42" Seat Height: 30" Overall Depth: 20" Overall Width: 17"
 C.O.M.: .45 yd Shipping Weight/Chair: 35# No. Per Carton: 1



6505BS

SAMANTHA SWIVEL BARSTOOL

MODEL	WOOD	COM	GRADE 10	GRADE 20	GRADE 30	GRADE 40	GRADE 50
6505BS	600	558	575	583	590	599	607

Overall Height: 42" Seat Height: 30" Overall Depth: 20" Overall Width: 17"
 C.O.M.: .45 yd Shipping Weight/Chair: 35# No. Per Carton: 1

TRUCKS & CARTS COLLECTION



ABOUT THIS COLLECTION

Trucks and carts are available to help you move products more quickly and efficiently.

STANDARD FEATURES

TRUCKS

- Made of 1" heavy-wall 14-gauge steel tube
- Fully welded
- No assembly required
- Stack black standard finish

CART

- Made of 1" heavy-wall 14-gauge steel tube
- 3/4" thick wood platform nested in steel frame
- 1/2" high lip to prevent chairs from sliding off
- Removable handle
- Stack black standard finish

800-2W TRUCK

5 Felix

800-2W-N TRUCK

5 Nesting Wood Melissa
5 Nesting Jill
4 Nesting Liz
4 Nesting Emma
4 Nesting Samantha

800 CART

2 stacks of 5 Jill
2 stacks of Nesting Wood Melissa
2 stacks of Molly



800-2W TRUCK

TRUCK

MODEL	\$LIST PRICE
800-2W TRUCK	514

Shipping Weight: 40#

Holds any of the following:

5 Felix



800-2W-N TRUCK

TRUCK

MODEL	\$LIST PRICE
800-2W-N TRUCK	492

Shipping Weight: 40#

Holds any of the following:

5 Nesting Wood Melissa

5 Nesting Jill

4 Nesting Liz

4 Nesting Emma

4 Nesting Samantha



800 CART

CART

MODEL	\$LIST PRICE
800 CART	298

Shipping Weight: 75#

Holds any of the following:

2 stacks of 5 Jill

2 stacks of Nesting Wood Melissa

2 stacks of Molly

ALUMINUM SEATING



ABOUT THIS COLLECTION

The Atlantis Collection includes chairs, barstools, and fixed seating.

STANDARD FEATURES

- Brushed aluminum frame
- Available with wood seat, upholstered seat, or aluminum seat
- Wood seats made of 1" saddled ply
- Upholstered models feature 2" of high resilience foam
- 1 1/8" quarter round tube legs
- Premium metal glides
- Technical Bulletin CAL 117 fire retardant upholstery materials

PERSONALIZATION OPTIONS

- The table to the right explains all of the available options for the Atlantis Collection.
- Please note for fixed seat options model numbers with 3000 denote core-drilled mounts and model numbers with 4000 denote bolt-down mounts.

OPTIONS	PAGE	ADD TO LIST PRICE
Webbed Seat Construction	9	\$8
CAL 133	9	\$65/Yard
Reduce Barstool Seat Height to 24"	10	\$10
Light Distressing on Wood Seats	9	\$12.50
Heavy Distressing on Wood Seats	9	\$17.50
Fixed Seating 19" Diameter Foot Ring on Counter Height Seat	-	\$65
Fixed Seating 19" Diameter Foot Ring on Bar Height Seat	-	\$65



750

ATLANTIS CHAIR

MODEL	WOOD	BRUSHED ALUMINUM	COM	GRADE 10	GRADE 20	GRADE 30	GRADE 40	GRADE 50
750	564	564	521	538	546	553	563	570

Overall Height: 32.5" Seat Height: 19" Overall Depth: 18.5" Overall Width: 15.5"
 C.O.M.: .45 yd Shipping Weight/Chair: 18# No. Per Carton: 2



750BS

ATLANTIS BARSTOOL

MODEL	WOOD	BRUSHED ALUMINUM	COM	GRADE 10	GRADE 20	GRADE 30	GRADE 40	GRADE 50
750BS	825	825	783	800	807	816	824	833

Overall Height: 44" Seat Height: 30.5" Overall Depth: 18.25" Overall Width: 16"
 C.O.M.: .45 yd Shipping Weight/Chair: 18# No. Per Carton: 1



753

ATLANTIS CHAIR

MODEL	WOOD	BRUSHED ALUMINUM	COM	GRADE 10	GRADE 20	GRADE 30	GRADE 40	GRADE 50
753	699	748	648	668	677	687	698	708

Overall Height: 32.5" Seat Height: 19" Overall Depth: 18.5" Overall Width: 15.5"
 C.O.M.: .45 yd Shipping Weight/Chair: 18# No. Per Carton: 2



753BS

ATLANTIS BARSTOOL

MODEL	WOOD	BRUSHED ALUMINUM	COM	GRADE 10	GRADE 20	GRADE 30	GRADE 40	GRADE 50
753BS	978	1026	926	947	957	966	977	986

Overall Height: 44" Seat Height: 30.5" Overall Depth: 18.25" Overall Width: 16"
 C.O.M.: .45 yd Shipping Weight/Chair: 18# No. Per Carton: 1



750-3000 Core-drilled/
750-4000 Bolt-down

ATLANTIS CHAIR FIXED SEATING — CHAIR HEIGHT

MODEL	WOOD	BRUSHED			GRADE	GRADE	GRADE	GRADE	GRADE
		ALUMINUM	COM	10	20	30	40	50	
750-3000	869	919	824	843	853	861	869	878	
750-4000	869	919	824	843	853	861	869	878	

Overall Height: 32.5" Seat Height: 18" Overall Depth: 18.5" Overall Width: 15.5"
C.O.M.: .45 yd Shipping Weight/Chair: 18.5# No. Per Carton: 2



750CH-3001 Core-drilled/
750CH-4001 Bolt-down

ATLANTIS CHAIR FIXED SEATING — COUNTER HEIGHT

MODEL	WOOD	BRUSHED			GRADE	GRADE	GRADE	GRADE	GRADE
		ALUMINUM	COM	10	20	30	40	50	
750CH-3001	887	937	842	861	870	879	887	896	
750CH-4001	887	937	842	861	870	879	887	896	

Overall Height: 37" Seat Height: 25" Overall Depth: 18.5" Overall Width: 15.5"
C.O.M.: .45 yd Shipping Weight/Chair: 21# No. Per Carton: 2



750BS-3002 Core-drilled/
750BS-4002 Bolt-down

ATLANTIS CHAIR FIXED SEATING — BAR HEIGHT

MODEL	WOOD	BRUSHED			GRADE	GRADE	GRADE	GRADE	GRADE
		ALUMINUM	COM	10	20	30	40	50	
750BS-3002	906	954	860	880	888	897	906	915	
750BS-4002	906	954	860	880	888	897	906	915	

Overall Height: 44" Seat Height: 30" Overall Depth: 18.5" Overall Width: 15.5"
C.O.M.: .45 yd Shipping Weight/Chair: 22.5# No. Per Carton: 2



ABOUT THIS COLLECTION

The Atoll Aluminum Collection includes two styles of barstools, one with a square frame design and another with an "A" frame design.

STANDARD FEATURES

- Brushed aluminum frame
- Available with wood or upholstered seat
- Upholstered models feature 2" of high resilience foam
- 1 1/8" quarter round tube legs
- Premium metal glides
- Technical Bulletin CAL 117 fire retardant upholstery materials are standard

PERSONALIZATION OPTIONS

- The table to the right explains all of the available options for the Atoll Aluminum Collection.
- Ask about our e-coating process to make this chair suitable for outdoor applications.

OPTIONS	PAGE	ADD TO LIST PRICE
Webbed Seat Construction	9	\$8
CAL 133	9	\$65/Yard
Reduce Barstool Seat Height to 24"	10	\$10
Light Distressing on Wood Seats	9	\$12.50
Heavy Distressing on Wood Seats	9	\$17.50



700BS

ATOLL ALUMINUM BARSTOOL

MODEL	WOOD	BRUSHED		COM	GRADE 10	GRADE 20	GRADE 30	GRADE 40	GRADE 50
		ALUMINUM							
700BS	538	N/A		495	516	525	536	546	555

Overall Height: 31" Seat Height: 31" Overall Depth: 16" Overall Width: 16"

C.O.M.: .55 yd Shipping Weight/Chair: 21# No. Per Carton: 1



710BS

ATOLL ALUMINUM BARSTOOL

MODEL	WOOD	BRUSHED		COM	GRADE 10	GRADE 20	GRADE 30	GRADE 40	GRADE 50
		ALUMINUM							
710BS	538	N/A		495	511	520	527	537	544

Overall Height: 30" Seat Height: 30" Overall Depth: 15" Overall Width: 15"

C.O.M.: .55 yd Shipping Weight/Chair: 21# No. Per Carton: 1



ABOUT THIS COLLECTION

The Siren Collection includes chairs, barstools, and fixed seating.

STANDARD FEATURES

- Brushed aluminum frame
- Available with wood seat, upholstered seat, or aluminum seat
- Wood seats made of 1" saddled ply
- Upholstered models feature 2" of high resilience foam
- 1 1/8" quarter round tube legs
- Premium metal glides

PERSONALIZATION OPTIONS

- The table to the right explains all of the available options for the Siren Collection.
- Please note for fixed seat options model numbers with 3000 denote core-drilled mounts and model numbers with 4000 denote bolt-down mounts.

OPTIONS	PAGE	ADD TO LIST PRICE
Webbed Seat Construction	9	\$8
CAL 133	9	\$65/Yard
Reduce Barstool Seat Height to 24"	10	\$10
Light Distressing on Wood Seats	9	\$12.50
Heavy Distressing on Wood Seats	9	\$17.50
Fixed Seating 19" Diameter Foot Ring on Counter Height Seat	-	\$65
Fixed Seating 19" Diameter Foot Ring on Bar Height Seat	-	\$65



850

SIREN CHAIR

MODEL	WOOD	BRUSHED ALUMINUM	COM	GRADE 10	GRADE 20	GRADE 30	GRADE 40	GRADE 50
850	580	580	537	553	562	569	579	586

Overall Height: 34.25" Seat Height: 18.25" Overall Depth: 19.5" Overall Width: 16"
 C.O.M.: .45 yd Shipping Weight/Chair: 18# No. Per Carton: 2



850BS

SIREN BARSTOOL

MODEL	WOOD	BRUSHED ALUMINUM	COM	GRADE 10	GRADE 20	GRADE 30	GRADE 40	GRADE 50
850BS	810	810	768	784	792	800	809	817

Overall Height: 43.5" Seat Height: 30" Overall Depth: 19" Overall Width: 16"
 C.O.M.: .45 yd Shipping Weight/Chair: 18# No. Per Carton: 1



850-3000 Core-drilled/
850-4000 Bolt-down

SIREN CHAIR FIXED SEATING — CHAIR HEIGHT

MODEL	WOOD	BRUSHED ALUMINUM	COM	GRADE 10	GRADE 20	GRADE 30	GRADE 40	GRADE 50
850-3000	864	936	841	860	869	878	887	897
850-4000	864	936	841	860	869	878	887	897

Overall Height: 34" Seat Height: 18" Overall Depth: 19" Overall Width: 16"
 C.O.M.: .45 yd Shipping Weight/Chair: 18# No. Per Carton: 2



850CH-3001 Core-drilled/
850CH-4001 Bolt-down

SIREN CHAIR FIXED SEATING — COUNTER HEIGHT

MODEL	WOOD	BRUSHED ALUMINUM	COM	GRADE 10	GRADE 20	GRADE 30	GRADE 40	GRADE 50
850CH-3001	895	953	859	878	887	897	905	915
850CH-4001	895	953	859	878	887	897	905	915

Overall Height: 37" Seat Height: 25" Overall Depth: 19" Overall Width: 16"
 C.O.M.: .45 yd Shipping Weight/Chair: 21# No. Per Carton: 2



850BS-3002 Core-drilled/
850BS-4002 Bolt-down

SIREN CHAIR FIXED SEATING — BAR HEIGHT

MODEL	WOOD	BRUSHED ALUMINUM	COM	GRADE 10	GRADE 20	GRADE 30	GRADE 40	GRADE 50
850BS-3002	914	971	877	897	905	915	924	932
850BS-4002	914	971	877	897	905	915	924	932

Overall Height: 44" Seat Height: 30" Overall Depth: 19" Overall Width: 16"
 C.O.M.: .45 yd Shipping Weight/Chair: 22# No. Per Carton: 2

TABLES

TABLES INFORMATION

ABOUT OUR TABLES

Our table line includes a tremendous variety of standard materials, shapes, sizes, and edge treatments. We offer a number of innovative options to increase functionality and comfort. We're uniquely adept at creating custom table solutions. Using our CNC laser-cutting machinery, we can make nearly any shape and size table you need. Tables are built for commercial indoor use. For outdoor solutions, please contact the factory.

Bases and tops can be purchased separately, however, to ensure the best quality product and fit, we suggest specifying complete tables. Tops are shipped separate from bases, but are pre-drilled for easy installation into their accompanying bases.

BASES

All of our table bases are made of either high-strength, structural steel—30% stronger than the average steel—or heavy-duty cast iron. Columns on both are heavy-wall tubes made of 14-gauge steel. All connections are hard welded using state-of-the-art machinery and a deep-penetration welding process that maximizes strength.

Bases are cleaned and primed before paint is applied via an automotive-grade powder coat system that assures even and thorough coverage. The environmentally friendly epoxy/polyester finish is baked in to create a beautiful, durable, color-rich surface.

Please note, smooth metal finishes will show the natural imperfections on cast iron bases.

WOOD TOPS

Strong, affordable, sustainably harvested Maple is our standard for solid wood table tops, but we can source and work with other species as requested.

We sand and stain every square inch of wood ourselves—by hand. We then enhance the grain with expertly applied finishes that ensure long-lasting beauty. Wood edge tables get a water-based acrylic topcoat for superior durability. All wood products are available in any of our standard wood stains, or we can custom color match. Because wood is a natural material, color may vary slightly from one piece to another, but every effort is made in the factory to match pieces consistently. Standard thickness for wood tables is 1.5".

Please note scratches, dings, and dents are common issues that occur to tops in our busy world. Grand Rapids Chair guarantees the stability of our topcoat finish for one year when properly taken care of and used. This use does not extend to unfinished plating or ceramics, issues with other dining ware or set pieces, or to customer abuse. We will accommodate warranted work on finish failures. Please see our Warranty for further information.

Disclaimer: Plank direction always goes in the direction of the longest dimension unless instructed otherwise.

LAMINATE TOPS

We use BIFMA-strength approved, industrial-grade, low-formaldehyde particle board for the cores of our laminate table tops. Standard face for laminate top is .05" (counter top commercial grade) with a phenolic resin backer for balanced construction. Tops can also be specified with custom-designed laminates or certain high-performance grades for chemical resistant surfaces, fire-rated surfaces, and exceptional high-wear surfaces. Contact the factory for details and pricing.

Pricing for laminate tops is based on the Wilsonart "Standards" Collection, but other laminates are available, we work with most major laminate providers: Wilsonart, Pionite, Formica, Nevamar, Arborite, etc. Call factory for information on laminate inlays.

STONE & SOLID SURFACE TABLE TOPS

All prices are for a minimum of 5 tables. For quantities less than this, please contact Grand Rapids Chair Company. All tops have an eased edge. For a custom edge, please contact Grand Rapids Chair Company for quotation.

TOLERANCES

Standard tables are 30" high. Counter height tables are 36" high. Pub height or bar height tables are 42" high. All dimensions listed for tops and bases are nominal and may vary slightly according to base configuration, edge profile selected, and any added accessories.

For example, if a table is listed in the price list as a 24" length, then the actual dimensions will vary just slightly depending on your selected edge profile. Please see table below for nominal dimensions and actual dimension comparisons.

Nominal Dimensions	Vinyl, Aluminum Urethane	Solid Wood	0.75" Solid Wood	1.25" Solid Wood	2" Solid Wood
24.000	23.500	23.500	23.500	23.500	23.500
30.000	29.500	29.500	29.500	29.500	29.500
36.000	35.500	35.500	35.500	35.500	35.500
42.000	41.500	41.500	41.500	41.500	41.500
48.000	47.500	47.500	47.500	47.500	47.500
54.000	53.500	53.500	53.500	53.500	53.500
60.000	59.500	59.500	59.500	59.500	59.500
72.000	71.500	71.500	71.500	71.500	71.500
84.000	83.500	83.500	83.500	83.500	83.500
96.000	95.500	95.500	95.500	95.500	95.500

*If tolerances are critical to the job application, acceptable tolerances must be noted on the purchase order.

BASE ONLY PURCHASES

Customers purchasing table base(s) without a top should note that we cannot and do not guarantee the strength, stability, and performance of the completed table with a top from a different source. Grand Rapids Chair tables are not meant to be sold as separate parts, but as whole products. Furthermore, if the customer purchases bases and table tops as separate parts, we will not provide construction and installation instructions for purchased parts to the customer, contractor, or installation crew.

TABLES: PERSONALIZATION OPTIONS

DISTRESSING

Giving tables that lived-in look requires a little extra attention. We hand-distress each one, just to your liking in either light or heavy, using a mixture of both traditional and unconventional wood working techniques.

LASER ENGRAVING

Call factory for pricing and options.



FIXED PUB HEIGHT

Most table bases are available in pub height, with a surface height of 42" high. Configurations denoted with a "P" require a larger base for pub height applications. Custom heights available, call factory for pricing.



FOOT RINGS

A 19" diameter foot ring is hard-welded to the vertical column on pub height tables. Available with most base designs. All standard finishes available.



PURSE SHELF

An "under-top" option to accommodate purses, coats, cameras, etc. on pub height tables. Each shelf has four storage hooks affixed to the bottom of the shelf. Standard size is 15" in diameter, finished to match the table top. Call factory for pricing.



SELF-LEVELING GLIDES

A patented product that self-levels table bases on uneven floors. Table Shox are also available, call factory.



TABLE-FLIP MECHANISM

Usually specified to accommodate table storage, this high-strength steel assembly allows the table top to easily flip into a vertical position. Available on square and round tops up to 48".



TABLE-FOLD MECHANISM

Mechanism allowing T-base tables to fold. Typically used to accommodate table storage.

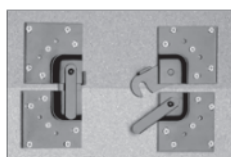
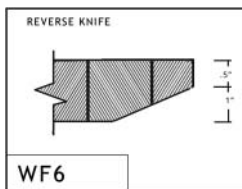
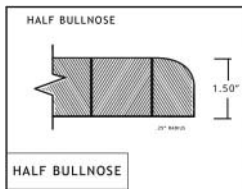
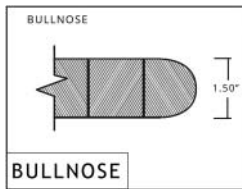
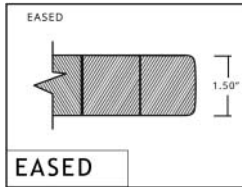

TABLE CONNECTORS

Used to join square and rectangular tables together for reconfiguring spaces, featuring our patented "Sure Lock" mechanism.

Grand Rapids Chair offers a wide variety of standard table edges. For solid wood tops, we offer solid wood table edges. For laminate table tops, we offer the remaining edges listed on the pages. Those include vinyl, edgeband, aluminum, laminate overlay, wood edges, and two types of urethane. Three inch radius corners are standard, but other radii available upon request. Call the factory for more information or to see samples.

Solid Wood



Vinyl Edges

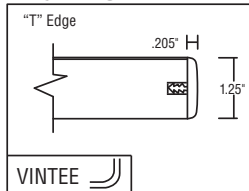

Edgeband

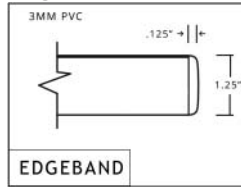

EDGE GRAIN VS. RANDOM PLANK

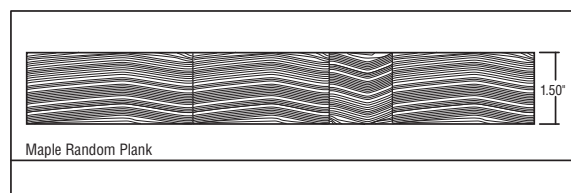
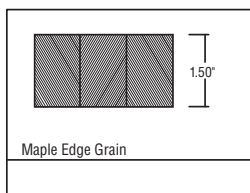

Customers can choose between edge grain block and random plank when purchasing a solid wood table. Our edge grain block table tops features wood planks with equal width. Our random plank table tops features planks with varying widths. Each technique provides dimension and texture to our smooth wood tables.

TABLE EDGES

Laminate Overlay Edges (Butt Joint)

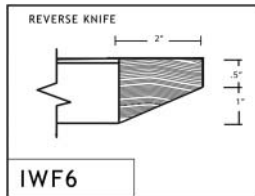
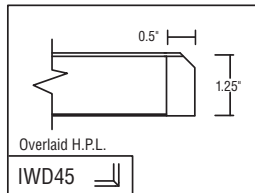
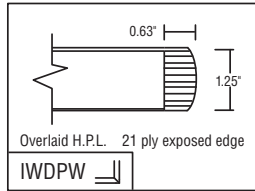
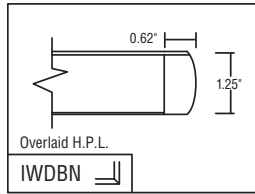

Wood Edges

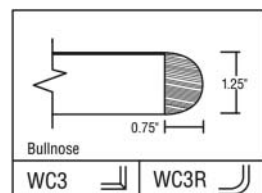
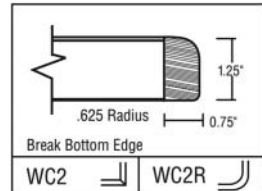
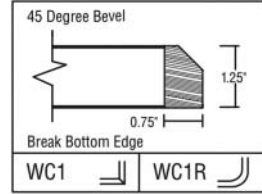

Wood Edges

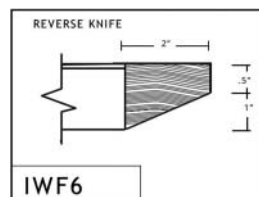
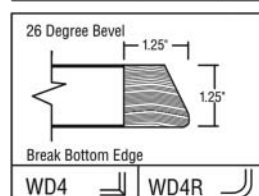
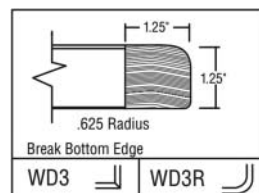
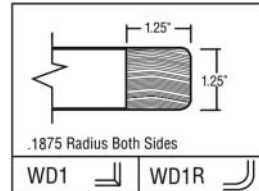
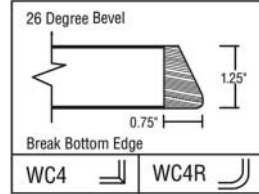

Urethane Edges

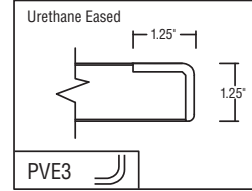
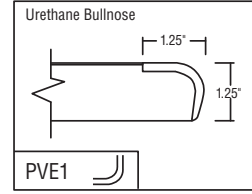

Woodgrain Urethane Edges

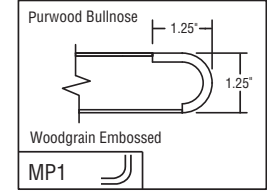
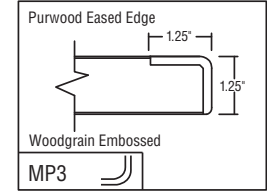

PEDESTAL TABLES - CAST IRON BASE

KALYPSO TABLE COLLECTION



ABOUT THIS COLLECTION

The Kalypso Collection consists of a decorative cast iron disc base and structural-grade steel column.

STANDARD FEATURES

- Cast iron base with structural-grade steel tube column
- Adjustable glides
- Ink Black and Black Wrinkle are standard base finishes
- Shipped ready to assemble

PERSONALIZATION OPTIONS

- The table to the right explains all of the available options for the Kalypso Collection.
- Special base finishes include: Stack Black, Gloss White, Grey White, Sky Blue, Yellow Green, Rose, Yellow, Traffic Red, Sparkle Silver, Satin Tex, Graphite, Pebble Grey, Speckled Pearl, Beige, Moccasin, Speckled Bronze, Ultra Bronze, Rugged Brown, Pecan Burst Rust, Sienna, Mirror Silver.

OPTIONS

	PAGE	ADD TO LIST PRICE
Fixed Pub Height	150	\$65 List/Column, \$90/X-Base Marked with a P
Foot Rings (Pub Tables - Not Available on Multi-Column Bases)	150	\$65/Column
Purse Shelf: Vintee Surfaces	150	\$250 list
Self-Leveling Glides	150	\$25/Round Bases, \$40/Oval Bases
Special Base Finish	-	\$13.50/Base
Table-Flip Mechanism	150	\$140/Base
Table Connectors	150	\$75/Connection

BASE SIZE VARIATIONS



Round Base
17R
22R
30R

























Oval Base
20x29OV



Oval Base
30x36OV



SOLID WOOD TABLE TOPS	LAMINATE TABLE TOPS						
Solid Wood  Eased  Bullnose  Half Bullnose  WF6	Vinyl  Vintee	Edgeband  3MM	Laminate Overlay  IWDBN  IWDPW  IWD45  IWF6  IPWFlat	Wood Edges  WC1  WC2  WC3  WC4	Wood Edges  WD1  WD3  WD4  WF6	Urethane  PVE1  PVE3	Woodgrain Urethane  MP1  MP3

SIZE	MODEL	QTY-SIZE/BASE	\$LIST PRICE									UNPKG.D. WGT. #*
Round												
24 dia. ^P	KA24R	1-17R	568	336	442	469	713	773	709	709	44	
30 dia.	KA30R	1-22R	760	385	495	632	883	958	830	830	66	
36 dia.	KA36R	1-22R	1012	480	594	845	1105	1197	959	959	75	
42 dia.	KA42R	1-30R	1331	549	667	1148	1413	1532	1012	1012	100	
48 dia.	KA48R	1-30R	1781	736	872	1434	1718	1863	1148	1148	130	
54 dia.	KA54R	1-30R	2159	880	1024	1855	2248	2437	1182	1182	158	
60 dia.	KA60R	1-30R	2664	1132	1163	2018	2399	2601	1245	1245	185	
Square												
24x24 ^P	KA24S	1-17R	554	336	442	395	478	492	652	652	44	
30x30	KA30S	1-22R	650	426	535	535	683	691	797	797	75	
36x36	KA36S	1-22R	1012	480	594	664	853	879	892	892	90	
42x42	KA42S	1-30R	1292	549	667	853	1178	1214	939	939	110	
48x48	KA48S	1-30R	1728	736	872	1115	1467	1511	1101	1101	151	
Rectangle												
24x30	KA2430RT	1-22R	667	388	493	477	581	596	695	695	66	
24x36	KA2436RT	1-22R	770	422	519	531	653	670	734	734	72	
24x42	KA2442RT	1-22R	840	419	554	595	709	730	813	813	78	
24x48	KA2448RT	1-20x29OV	975	480	605	660	820	845	909	909	90	
24x60	KA2460RT	2-17R	1306	668	819	903	1106	1138	1146	1146	87	
24x72	KA2472RT	2-17R	1477	727	882	908	1250	1287	1182	1194	99	
30x36	KA3036RT	1-22R	949	642	554	782	951	980	1026	1026	82	
30x42	KA3042RT	1-20x29OV	1028	499	625	712	898	926	914	914	94	
30x48	KA3048RT	1-20x29OV	1131	526	656	754	966	994	982	982	102	
30x60	KA3060RT	2-17R	1519	720	874	1020	1287	1326	1212	1212	86	
30x72	KA3072RT	2-17R	1735	782	940	1398	1700	1746	1272	1272	111	
36x42	KA3642RT	1-20x29OV	1208	512	680	768	985	1015	915	915	116	
36x48	KA3648RT	1-30R	1269	630	763	904	1158	1193	1047	1047	123	
36x60	KA3660RT	1-30x36OV	1800	836	998	1211	1531	1577	1321	1321	176	
36x72	KA3672RT	1-30x36OV	2057	913	1078	1367	1748	1801	1437	1437	194	
42x48	KA4248RT	1-30R	1556	859	872	1180	1560	1607	-	-	139	
42x60	KA4260RT	1-30x36OV	2015	967	1112	1367	1841	1895	-	-	191	
Square-to-Round												
30x30x42	KA303042R	1-22R	1968	931	931	-	2206	2219	-	-	93	
36x36x51	KA363651R	1-30R	2745	1485	1485	-	2485	2498	-	-	98	

NOTES:

^PPub height version of this table size requires a larger base.

*Unpackaged weights based on solid wood pricing. Call factory for specific weight information.

\$250.00 Charge for orders fewer than 5.

Required to Order: Model Number, Edge Profile, Finishes, Any Additional Options

Nominal top sizes listed. Actual top sizes vary based on selected edge profile. See page 149 for actual dimensions.

TOP SHAPES



Round



Square



Rectangular



Rectangular



Square-to-Round

ORBIT TABLE COLLECTION



ABOUT THIS COLLECTION

The Orbit Collection consists of round cast iron bases and structural-grade steel columns.

STANDARD FEATURES

- Cast iron base with structural-grade steel tube column
- Hard-welded table top mounting plate
- Adjustable glides
- Optional steel cap gives smoother surface aesthetic to disc base
- Ink Black and Black Wrinkle are standard base finishes
- Shipped ready to assemble

PERSONALIZATION OPTIONS

- The table to the right explains all of the available options for the Orbit Collection.
- Special base finishes include: Stack Black, Gloss White, Grey White, Sky Blue, Yellow Green, Rose, Yellow, Traffic Red, Sparkle Silver, Satin Tex, Graphite, Pebble Grey, Speckled Pearl, Beige, Moccasin, Speckled Bronze, Ultra Bronze, Rugged Brown, Pecan Burst Rust, Sienna, Mirror Silver.

OPTIONS

OPTIONS	PAGE	ADD TO LIST PRICE
Steel Cap Base Cover	-	\$72/17" Cap, \$82/22" Cap, \$98/30" List
Fixed Pub Height	150	\$65 List/Column, \$90/Base Marked with a ^P
Foot Rings (Pub Tables)	150	\$65/Column
Purse Shelf: Vintee Surfaces	150	\$250 List
Self-Leveling Glides	150	\$25/Base
Special Base Finish	-	\$13.50/Base
Table-Flip Mechanism	150	\$140/Base
Table Connectors	150	\$75/Connection

BASE SIZE VARIATIONS

























Standard without steel cap
17R
22R
30R



Shown with steel cap



SOLID WOOD TABLE TOPS	LAMINATE TABLE TOPS						
 Eased  Bullnose  Half Bullnose  WF6	 Vinyl Vintee	 Edgeband 3MM	 Laminate Overlay IWDBN  IWDPW  IWD45  IWF6  IPWFlat	 Wood Edges WC1  WC2  WC3  WC4	 Wood Edges WD1  WD3  WD4  WF6	 Urethane PVE1  PVE3	 Woodgrain Urethane MP1  MP3

SIZE	MODEL	QTY-SIZE/BASE	\$LIST PRICE								UNPKG.D. WGT. #*
Round											
24 dia. ^P	OR24R	1-17R	558	306	368	440	685	741	681	681	46
30 dia.	OR30R	1-22R	750	356	446	604	854	927	803	803	59
36 dia.	OR36R	1-22R	1009	458	568	824	1084	1174	939	939	74
42 dia.	OR42R	1-30R	1327	605	676	1202	1467	1590	1066	1066	104
48 dia.	OR48R	1-30R	1755	706	849	1407	1689	1831	1120	1120	127
Square											
24x24 ^P	OR24S	1-17R	544	306	368	367	447	461	623	623	46
30x30	OR30S	1-22R	730	356	446	478	610	629	739	739	69
36x36	OR36S	1-22R	1009	458	568	645	833	857	872	872	85
42x42	OR42S	1-30R	1287	605	676	908	1235	1272	994	994	126
48x48	OR48S	1-30R	1718	706	849	1086	1439	1481	1072	1072	148
Rectangle											
24x30	OR2430RT	1-22R	627	328	454	421	520	536	638	638	61
24x36	OR2436RT	1-22R	729	374	491	496	614	633	699	699	67
24x42	OR2442RT	1-22R	838	398	529	574	687	707	794	794	73
24x48	OR2448RT	1-22R	923	421	552	604	760	782	853	853	79
24x60	OR2460RT	2-17R	1286	610	773	847	1046	1077	1087	1087	86
24x72	OR2472RT	2-17R	1457	670	836	852	1191	1227	1136	1136	98
30x36	OR3036RT	1-22R	881	421	469	566	723	747	809	809	68
30x42	OR3042RT	1-30R	959	440	549	656	838	863	857	857	83
30x48	OR3048RT	1-30R	1062	470	603	697	904	932	925	925	83
30x60	OR3060RT	2-17R	1499	706	828	1005	1273	1311	1199	1199	101
30x72	OR3072RT	2-17R	1715	768	917	1136	1453	1497	1256	1256	116
36x60	OR3660RT	2-22R	1715	761	912	1136	1453	1497	1248	1248	153
36x72	OR3672RT	2-22R	1972	837	992	1296	1671	1721	1363	1363	171
Square-to-Round											
30x30-42d	OR303042R	1-22R	1969	932	932	-	2208	2220	-	-	97
36x36-51d	OR363651R	1-30R	2365	1324	1324	-	2389	2401	-	-	139

NOTES:

^PPub height version of this table size requires a larger base.

*Unpackaged weights based on solid wood pricing. Call factory for specific weight information.

\$250.00 Charge for orders fewer than 5.

Required to Order: Model Number, Edge Profile, Finishes, Any Additional Options

TOP SHAPES



Round



Square



Rectangular



Rectangular



Square-to-Round

SPARTAN TABLE COLLECTION



ABOUT THIS COLLECTION

Spartan Collection consists of cast iron bases and structural-grade thick-wall steel tube columns.

STANDARD FEATURES

- Cast iron base with structural-grade steel tube column
- Adjustable glides
- Ink Black and Black Wrinkle are standard base finishes
- Shipped ready to assemble

PERSONALIZATION OPTIONS

- The table to the right explains all of the available options for the Spartan Collection.
- Special base finishes include: Stack Black, Gloss White, Grey White, Sky Blue, Yellow Green, Rose, Yellow, Traffic Red, Sparkle Silver, Satin Tex, Graphite, Pebble Grey, Speckled Pearl, Beige, Moccasin, Speckled Bronze, Ultra Bronze, Rugged Brown, Pecan Burst Rust, Sienna, Mirror Silver.

OPTIONS

	PAGE	ADD TO LIST PRICE
Fixed Pub Height	150	\$65 List/Column, \$90/X-Base Marked with a P
Foot Rings (Pub Tables - Not Available on Multi-Column Bases)	150	\$65/Column
Purse Shelf: Vintee Surfaces	150	\$250
Self-Leveling Glides	150	\$12/T-Base, \$24/X-Base
Special Base Finish	-	\$13.50/Base
Table-Flip Mechanism	150	\$140/Base
Table Connectors	150	\$75/Connection

BASE SIZE VARIATIONS



X-Base
20X
22X
30X
33X



T-Base
22T



40X-Base
40X



SOLID WOOD TABLE TOPS	LAMINATE TABLE TOPS						
Solid Wood Eased Bullnose Half Bullnose WF6	Vinyl Vintee	Edgeband 3MM	Laminate Overlay IWDBN IWDPW IWD45 IWF6 IPWFlat	Wood Edges WC1 WC2 WC3 WC4	Wood Edges WD1 WD3 WD4 WF6	Urethane PVE1 PVE3	Woodgrain Urethane MP1 MP3

SIZE	MODEL	QTY-SIZE/BASE	\$LIST PRICE									UNPKG.D. WGT. #*
Round												
24 dia.	SP24R	1-22X	444	303	331	437	680	737	678	678	36	
30 dia.	SP30R	1-22X	638	354	384	601	852	923	799	799	48	
36 dia.	SP36R	1-30X	881	445	484	810	1071	1162	926	926	64	
42 dia.	SP42R	1-33X	1301	501	558	1099	1364	1479	963	963	85	
48 dia.	SP48R	1-33X	1636	601	754	1304	1587	1720	1018	1018	101	
54 dia.	SP54R	1-40X	2066	813	935	1790	2183	2367	1116	1116	132	
60 dia.	SP60R	1-40X	2573	1000	1075	1953	2334	2531	1180	1180	155	
Square												
24x24	SP24S	1-22X	433	303	331	362	444	639	621	621	42	
30x30	SP30S	1-22X	618	364	384	486	606	827	748	748	55	
36x36	SP36S	1-30X	881	429	484	616	802	1028	843	843	75	
42x42	SP42S	1-33X	1261	501	649	805	1128	1378	892	892	100	
48x48	SP48S	1-33X	1582	601	754	983	1329	1596	969	969	122	
Rectangle												
24x30	SP2430RT	1-22X	515	325	354	417	518	717	634	634	50	
24x36	SP2436RT	1-22X30	616	360	389	481	602	807	683	683	56	
24x42	SP2442RT	1-22X30	706	384	438	559	673	885	780	780	65	
24x48	SP2448RT	1-22X30	877	525	531	706	866	1095	955	955	70	
24x60	SP2460RT	2-22T	1049	577	584	813	1011	1253	1056	1056	85	
24x72	SP2472RT	2-22T	1220	636	647	819	1157	1409	1104	1104	99	
30x36	SP3036RT	1-22X30	744	407	438	551	710	926	796	796	65	
30x42	SP3042RT	1-22X30	826	427	458	642	823	1049	843	843	75	
30x48	SP3048RT	2-22T	1016	432	489	659	865	1094	886	886	80	
30x60	SP3060RT	2-22T	1262	487	640	792	1048	1292	983	983	87	
30x72	SP3072RT	2-22T	1477	549	705	922	1229	1486	1043	1043	110	
36x42	SP3642RT	1-33X	1112	464	610	719	933	1169	868	868	90	
36x48	SP3648RT	1-33X	1240	498	645	774	1022	1262	915	915	100	
36x60	SP3660RT	2-22X	1491	711	711	1087	1402	1675	1197	1197	121	
36x72	SP3672RT	2-22X30	1755	809	810	1262	1641	1991	1334	1334	147	
42x48	SP4248RT	1-33X	1412	574	754	900	1267	1529	-	-	110	
42x60	SP4260RT	2-22X30	1710	696	844	1103	1561	1848	-	-	144	
Square-to-Round												
30x30-42d	SP303042R	1-30X	1848	817	817	-	2087	2099	-	-	80	
36x36-51d	SP363651R	1-33X	2370	1329	1329	-	2394	2406	-	-	80	
42x42-60d	SP424260RT	1-40X	2653	1398	1398	-	3012	3052	-	-	122	

NOTES:

40X-base column is 4" in diameter vs 3" on smaller X-bases.

*Unpackaged weights based on solid wood pricing. Call factory for specific weight information.

\$250.00 Charge for orders fewer than 5.

Required to Order: Model Number, Edge Profile, Finishes, Any Additional Options

Nominal top sizes listed. Actual top sizes vary based on selected edge profile. See page 149 for actual dimensions.

TOP SHAPES



Round



Square



Rectangular



Rectangular



Rectangular



Square-to-Round

ZEUS TABLE COLLECTION



ABOUT THIS COLLECTION

The Zeus Collection consists of stylized cast iron bases and structural-grade steel columns.

STANDARD FEATURES

- Cast iron base with structural-grade steel tube column
- Hard-welded table top mounting plates
- Adjustable glides
- Ink Black and Black Wrinkle are standard base finishes
- Shipped ready to assemble

PERSONALIZATION OPTIONS

- The table to the right explains all of the available options for the Zeus Collection.
- Special base finishes include: Stack Black, Gloss White, Grey White, Sky Blue, Yellow Green, Rose, Yellow, Traffic Red, Sparkle Silver, Satin Tex, Graphite, Pebble Grey, Speckled Pearl, Beige, Moccasin, Speckled Bronze, Ultra Bronze, Rugged Brown, Pecan Burst Rust, Sienna, Mirror Silver.

OPTIONS

	PAGE	ADD TO LIST PRICE
Fixed Pub Height	150	\$65 List/Column, \$90/X-Base Marked with a P
Foot Rings (Pub Tables - Not Available on Multi-Column Bases)	150	\$65/Column
Purse Shelf: Vintee Surfaces	150	\$250
Self-Leveling Glides	150	\$14/T-Base, \$24/X-Base
Special Base Finish	-	\$13.50/Base
Table-Flip Mechanism	150	\$140/Base
Table Connectors	150	\$75/Connection

BASE SIZE VARIATIONS



X-Base
22X
30X



T-Base
22T



SOLID WOOD TABLE TOPS	LAMINATE TABLE TOPS						
	Solid Wood	Vinyl	Edgeband	Laminate Overlay	Wood Edges	Wood Edges	Urethane
Eased	Vintee	3MM	IWDBN	WC1	WD1	PVE1	MP1
Bullnose			IWDPW	WC2	WD3	PVE3	MP3
Half Bullnose			IWD45	WC3	WD4		
WF6			IWF6	WC4	WF6		
			IPWFlat				

SIZE	MODEL	QTY-SIZE/BASE	\$LIST PRICE								UNPKG.D. WGT. #*
Round											
24 dia.	ZE24R	1-22X	561	310	431	443	722	722	684	684	44
30 dia. ^P	ZE30R	1-22X	754	359	484	606	902	902	804	804	50
36 dia.	ZE36R	1-30X	1049	468	599	833	1150	1150	947	947	70
42 dia.	ZE42R	1-30X	1338	537	673	1136	1474	1474	1000	1000	85
48 dia.	ZE48R	1-30X	1619	638	779	1341	1708	1708	1053	1053	100
Square											
24x24	ZE24S	1-22X	548	310	431	368	473	486	626	626	44
30x30 ^P	ZE30S	1-22X	732	359	484	481	645	664	742	742	57
36x36	ZE36S	1-30X	1019	468	599	652	882	908	879	879	75
42x42	ZE42S	1-30X	1298	537	673	842	1223	1260	927	927	100
48x48	ZE48S	1-30X	1567	638	779	1020	1368	1479	1005	1005	122
Rectangle											
24x30	ZE2430RT	1-22X	629	330	454	640	549	538	640	640	50
24x36	ZE2436RT	1-30X	761	481	511	599	760	747	801	801	56
24x42	ZE2442RT	1-30X	847	505	560	677	837	820	898	898	70
24x48	ZE2448RT	2-22T	933	528	560	708	914	896	957	957	76
24x60	ZE2460RT	2-22T	1254	578	759	816	1065	1045	1059	1059	87
24x72	ZE2472RT	2-22T	1425	638	822	821	1217	1195	1105	1105	99
30x36	ZE3036RT	1-30X	890	562	560	703	914	896	947	947	65
30x42	ZE3042RT	1-30X	968	573	580	760	994	975	1002	1002	80
30x48	ZE3048RT	2-22T	1220	577	611	800	1065	1045	1029	1029	80
30x60	ZE3060RT	2-22T	1467	632	814	933	1255	1231	1126	1126	98
30x72	ZE3072RT	2-22T	1682	691	880	1065	1377	1419	1185	1185	113
36x42	ZE3642RT	1-30X	1148	501	781	756	972	1029	927	927	86
36x48	ZE3648RT	1-30X	1425	534	669	811	1057	1089	1074	1074	92
36x72	ZE3672RT	2-22T	1939	799	952	1256	1631	1678	1378	1378	131
Square-to-Round											
30x30-42d	ZE303042R	1-30X	1949	913	913	-	2185	2201	-	-	78
36x36-51d	ZE363651R	1-30X	2346	1306	1306	-	2370	2381	-	-	105

NOTES:

^PPub height version of this table size requires a larger base.

*Unpackaged weights based on solid wood pricing. Call factory for specific weight information.

\$250.00 Charge for orders fewer than 5.

Required to Order: Model Number, Edge Profile, Finishes, Any Additional Options

Nominal top sizes listed. Actual top sizes vary based on selected edge profile. See page 149 for actual dimensions.

TOP SHAPES



Round



Square



Rectangular



Rectangular



Rectangular



Square-to-Round

PEDESTAL TABLES - STEEL BASE

BRADY TABLE COLLECTION



ABOUT THIS COLLECTION

The Brady Pedestal Collection consists of bases with a square metal column and base plate with wood or laminate tops.

STANDARD FEATURES

- 1.5" solid wood or laminate table top
- 14-gauge steel base
- Brazed, coped, and sanded welds
- Felt glides

PERSONALIZATION OPTIONS























- The table to the right explains all of the available options for the Brady Pedestal Collection.
- High gloss and low gloss clear coat not available on Brady Pedestal models.

OPTIONS

	PAGE	ADD TO LIST PRICE
Fixed Pub Height - Available on all Bases	150	\$90
Light Distressing	150	Call for Quote
Heavy Distressing	150	Call for Quote

BRADY PEDESTAL TABLES



SOLID WOOD TABLE TOPS	LAMINATE TABLE TOPS						
Solid Wood  Eased  Bullnose  Half Bullnose  WF6	Vinyl  Vintee	Edgeband  3MM	Laminate Overlay  IWDBN  IWDPW  IWD45  IWF6  IPWFlat	Wood Edges  WC1  WC2  WC3  WC4	Wood Edges  WD1  WD3  WD4  WF6	Urethane  PVE1  PVE3	Woodgrain Urethane  MP1  MP3

SIZE	MODEL	\$LIST PRICE								UNPKG.D. WGT. #*
Round										
24 dia.	BR24R	647	578	549	738	1034	1120	1030	1030	58**
30 dia.	BR30R	854	761	628	1053	1358	1472	1295	1295	84**
36 dia.	BR36R	1076	858	711	1296	1611	1746	1436	1436	94**
42 dia.	BR42R	1520	1033	933	1752	2074	2248	1588	1588	139**
48 dia.	BR48R	1841	1455	1536	2294	2636	2857	1945	1945	154**
54 dia.	BR54R	2423	1631	1686	2805	3279	3555	1987	1987	172**
60 dia.	BR60R	2924	1859	1875	3003	3465	3757	2063	2063	192**
Square										
24x24	BR24S	622	578	537	648	756	779	961	961	69
30x30	BR30S	822	761	615	902	1077	1110	1218	1218	98
36x36	BR36S	1064	858	698	1077	1321	1360	1353	1353	113
42x42	BR42S	1482	1033	933	1394	1806	1861	1500	1500	165
48x48	BR48S	1785	1156	1038	1612	2054	2115	1593	1593	187

NOTES:

*Unpackaged weights based on solid wood pricing. Call factory for specific weight information.

**Weights are based on dining height table base. Please use this as an estimate. Weights will vary upon table base and height.

\$250.00 Charge for orders fewer than 5.

Required to Order: Model Number, Edge Profile, Finishes, Any Additional Options

TOP SHAPES



Round Square

CASSANDRA TABLE COLLECTION



ABOUT THIS COLLECTION

The Cassandra Collection consists of solid steel bases and structural-grade thick-wall steel tube columns.

STANDARD FEATURES

- 1/2" x 2" solid steel bases
- Vertical columns are structural-grade thick-wall steel tube
2" for T and 4X bases
3" for X and 2T bases
- Adjustable glides
- Shipped ready to assemble

PERSONALIZATION OPTIONS

- The table to the right explains all of the available options for the Cassandra Collection.

OPTIONS	PAGE	ADD TO LIST PRICE
Fixed Pub Height	150	\$65 List/Column, \$90/X-Base Marked with a P
Foot Rings (Pub Tables - Not Available on Multi-Column Bases)	150	\$65/Column
Purse Shelf: Vintee Surfaces	150	\$250
Self-Leveling Glides	150	\$14/T-Base, \$24/X-Base
Table-Flip Mechanism	150	\$140/Base
Table-Fold Mechanism	150	\$250/Table
Table Connectors	150	\$75/Connection

BASE SIZE VARIATIONS



X-Base
18X
22X
24X
26X
30X
33X



T-Base
22T
26T



2 T-Base
32TT
39TT



4 X-Base
22x30
32x32-4
39x39-4



SOLID WOOD TABLE TOPS	LAMINATE TABLE TOPS						
Solid Wood Eased Bullnose Half Bullnose WF6 	Vinyl Vintee	Edgeband 3MM	Laminate Overlay IWDBN IWDPW IWD45 IWF6 IPWFat	Wood Edges WC1 WC2 WC3 WC4	Wood Edges WD1 WD3 WD4 WF6	Urethane PVE1 PVE3	Woodgrain Urethane MP1 MP3

SIZE	MODEL	QTY-SIZE/BASE	\$LIST PRICE								UNPKGD. WGT. #*	
Round												
24 dia.	CA24R	1-22X	659	422	520	579	866	940	878	878	44	
30 dia.	CA30R	1-22X	853	482	572	773	1069	1159	1007	1007	57	
36 dia.	CA36R	1-24X	1114	577	682	1008	1315	1427	1145	1145	75	
42 dia.	CA42R	1-33X	1460	697	781	1402	1716	1861	1242	1242	100	
48 dia.	CA48R	1-32x32-4	2018	1005	1103	1829	2163	2345	1489	1489	122	
54 dia.	CA54R	1-39x39-4	2436	1199	1292	2349	2811	3048	1553	1553	158	
60 dia.	CA60R	1-39x39-4	2942	1421	1431	2541	2990	3243	1627	1627	185	
72 dia.	CA72R	1-39x39-4	4194	1506	-	2967	3170	3429	1914	1914	228	
Square												
24x24	CA24S	1-18X	621	422	494	493	590	609	797	797	44	
30x30	CA30S	1-26X	858	400	598	544	699	719	853	853	57	
36x36	CA36S	1-33X	1140	612	707	830	1056	1088	1099	1099	92	
42x42	CA42S	1-32x32-4	1644	885	998	1239	1636	1684	1341	1341	126	
48x48	CA48S	1-39x39-4	2004	1028	1140	1474	1898	1954	1456	1456	155	
Rectangle												
24x30	CA2430RT	1-22X	729	449	543	556	677	697	812	812	50	
24x36	CA2436RT	1-22x30	844	477	581	620	762	785	859	859	56	
24x42	CA2442RT	1-22x30	929	506	630	712	847	873	974	974	70	
24x48	CA2448RT	1-22x30	1016	453	630	671	853	879	964	964	76	
24x60	CA2460RT	2-22T	1439	684	925	964	1201	1236	1251	1251	87	
24x72	CA2472RT	2-22T	1609	769	988	1097	1385	1427	1322	1322	99	
30x48	CA3048RT	2-26T	1457	696	973	961	1214	1250	1230	1230	88	
30x60	CA3060RT	2-26T	1704	760	1031	1115	1427	1470	1345	1345	103	
30x72	CA3072RT	2-26T	1919	853	1096	1290	1662	1712	1432	1432	118	
36x42	CA3642RT	1-33X	1269	653	743	952	1212	1248	1128	1128	116	
36x48	CA3648RT	1-32x32-4	1623	882	994	1202	1509	1554	1371	1371	123	
36x60	CA3660RT	2-32TT	1972	987	809	1428	1807	1862	1559	1559	130	
36x72	CA3672RT	2-32TT	2229	1077	889	1615	2063	2126	1696	1696	147	
36x96	CA3696RT	2-32TT	2901	1407	-	1753	2750	2892	-	-	182	
42x48	CA4248RT	1-32x32-4	1793	971	1103	1352	1800	1854	-	-	149	
42x60	CA4260RT	2-39TT	2291	1139	1355	1615	2171	2238	-	-	154	
Square-to-Round												
30x30-42	CA303042R	1-30X	2158	1027	1027	-	2397	2410	-	-	109	
36x36-51	CA363651R	1-32x32-4	2851	1700	1700	-	2873	2886	-	CALL	134	
42x42x60	CA424260R	1-32x32-4	3134	1769	1769	-	3492	3532	-	-	185	

NOTES:

*Pub height version of this table size requires a larger base.

*Unpackaged weights based on solid wood pricing. Call factory for specific weight information.

\$250.00 Charge for orders fewer than 5.

Required to Order: Model Number, Edge Profile, Finishes, Any Additional Options

Nominal top sizes listed. Actual top sizes vary based on selected edge profile. See page 149 for actual dimensions.

TOP SHAPES



Round



Square



Rectangular



Rectangular



Rectangular



Square-to-Round

ELLIPSE TABLE COLLECTION



ABOUT THIS COLLECTION

The Ellipse Collection consists of bases and columns that are made of structural-grade round tubing with an arched design.

STANDARD FEATURES

- Structural-grade steel base and tube column with arched X and T base detail
- Hard-welded table top mounting plate
- Adjustable glides
- Shipped ready to assemble

PERSONALIZATION OPTIONS

- The table to the right explains all of the available options for the Ellipse Collection.

OPTIONS

	PAGE	ADD TO LIST PRICE
Fixed Pub Height	150	\$65 List/Column, \$90/X-base Marked with a P
Foot Rings (Pub Tables - Not Available on Multi-Column Bases)	150	\$65/Column
Purse Shelf: Vintee Surfaces	150	\$250
Self-Leveling Glides	150	\$14/T-Base, \$24/X-Base
Table-Flip Mechanism	150	\$140/Base
Table-Fold Mechanism	150	\$250/Table
Table Connectors	150	\$75/Connection

BASE SIZE VARIATIONS



X-Base
22X
26X



T-Base
22T
26T



SOLID WOOD TABLE TOPS	LAMINATE TABLE TOPS						
	Vinyl	Edgeband	Laminate Overlay	Wood Edges	Wood Edges	Urethane	Woodgrain Urethane
Eased Bullnose Half Bullnose WF6	Vintee	3MM	IWDBN IWDPW IWD45 IWF6 IPWFlat	WC1 WC2 WC3 WC4	WD1 WD3 WD4 WF6	PVE1 PVE3	MP1 MP3

SIZE	MODEL	QTY-SIZE/BASE	\$LIST PRICE								UNPKG.D. WGT. #*	
Round												
24 dia. ^P	EL24R	1-22X	738	451	595	581	825	896	823	791	44	
30 dia. ^P	EL30R	1-22X	932	501	648	745	948	1080	944	908	57	
36 dia.	EL36R	1-26X	1223	581	757	945	1147	1305	1060	1019	75	
42 dia.	EL42R	1-26X	1512	668	832	1041	1382	1435	1174	1128	-	
Square												
24x24 ^P	EL24S	1-22X	726	451	585	507	596	614	764	735	44	
30x30	EL30S	1-26X	937	501	664	621	760	782	880	847	57	
36x36	EL36S	1-26X	1193	581	748	764	959	987	993	955	75	
Rectangle												
24x30	EL2430RT	1-22X	807	473	610	561	668	689	780	750	50	
24x36	EL2436RT	1-22X	910	554	635	671	799	823	873	840	56	
24x42	EL2442RT	1-26X	1023	578	709	749	872	898	970	933	70	
24x48	EL2448RT	2-22T	1206	599	862	779	945	972	1028	988	76	
24x60	EL2460RT	2-22T	1439	651	914	886	1089	1121	1129	1086	87	
24x72	EL2472RT	2-22T	1873	711	978	892	1235	1272	1177	1132	99	
30x36	EL3036RT	1-26X	1096	847	709	983	1162	1197	1226	1179	65	
30x42	EL3042RT	1-26X	1143	866	729	1073	1276	1315	1275	1226	80	
30x48	EL3048RT	2-26T	1431	897	760	1114	1344	1384	1342	1291	80	
30x60	EL3060RT	2-26T	1678	952	996	1246	1525	1570	1439	1384	102	
30x72	EL3072RT	2-26T	1839	1013	1061	1378	1707	1758	1498	1440	117	
Square-to-Round												
30x30-42d	EL303042R	1-26X	2136	1090	1090	-	2374	2387	-	-	93	
36x36-51d	EL363651R	1-26X	2532	1552	1552	-	2556	2567	-	-	134	

NOTES:

^PPub height version of this table size requires a larger base.

*Unpackaged weights based on solid wood pricing. Call factory for specific weight information.

\$250.00 Charge for orders fewer than 5.

Required to Order: Model Number, Edge Profile, Finishes, Any Additional Options

Nominal top sizes listed. Actual top sizes vary based on selected edge profile. See page 149 for actual dimensions.

TOP SHAPES



Round



Square



Rectangular



Square-to-Round

JEROME TABLE COLLECTION



ABOUT THIS COLLECTION

The Jerome Collection consists of bases and columns that are made of structural-grade round tube.

STANDARD FEATURES

- Structural-grade steel base
 - 3" steel tube column on X bases
 - 2" steel tube columns for T, 2T, and 4X base styles
- Adjustable glides
- Hard-welded table top mounting plate
- Shipped ready to assemble

PERSONALIZATION OPTIONS

- The table to the right explains all of the available options for the Jerome Collection.

OPTIONS	PAGE	ADD TO LIST PRICE
Fixed Pub Height	150	\$65 List/Column, \$90/X-Base Marked with a P
Foot Rings (Pub Tables - Not Available on Multi-Column Bases)	150	\$65/Column
Purse Shelf: Vintee Surfaces	150	\$250
Self-Leveling Glides	150	\$14/T-Base, \$24/X-Base
Table-Flip Mechanism	150	\$140/Base
Table-Fold Mechanism	150	\$250/Table
Table Connectors	150	\$75/Connection
Casters	-	\$25/T-Base, \$45/X-Base

BASE SIZE VARIATIONS



X-Base
18X
22X
24X
30X
33X



T-Base
22T
26T



C-Base
(must specify)



2 T-Base
32TT



4 X-Base
22x30
32x32-4
39x39-4
48x48-4



SOLID WOOD TABLE TOPS	LAMINATE TABLE TOPS						
	Vinyl	Edgeband	Laminate Overlay	Wood Edges	Wood Edges	Urethane	Woodgrain Urethane
Solid Wood Eased Bullnose Half Bullnose WF6	Vintee	3MM	IWDBN IWDPW IWD45 IWF6 IPWFlat	WC1 WC2 WC3 WC4	WD1 WD3 WD4 WF6	PVE1 PVE3	MP1 MP3

SIZE	MODEL	QTY-SIZE/BASE	\$LIST PRICE									UNPKGD. WGT. #*
Round												
24 dia. ^P	JE24R	1-18X	627	480	488	627	900	929	897	863	44	
30 dia. ^P	JE30R	1-22X	826	545	547	821	1101	1137	1043	1003	57	
36 dia.	JE36R	1-24X	1082	636	650	1044	1334	1378	1174	1128	75	
42 dia.	JE42R	1-33X	1433	776	796	1443	1741	1798	1291	1241	100	
48 dia.	JE48R	1-32x32-4	2018	1121	1137	1901	2216	2287	1579	1518	122	
54 dia.	JE54R	1-39x39-4	2436	1329	1361	2414	2853	2945	1660	1597	158	
60 dia.	JE60R	1-39x39-4	2942	1538	1615	2597	3023	3122	1731	1664	185	
72 dia.	JE72R	1-48x48-4	3392	1506	-	2967	3316	3417	1914	1840	-	
Square												
24x24 ^P	JE24S	1-22X	621	489	494	554	653	672	843	811	44	
30x30 ^P	JE30S	1-24X	825	545	565	679	836	860	973	935	57	
36x36	JE36S	1-24X	1082	664	684	870	1088	1120	1124	1081	75	
42x42	JE42S	1-32x32-4	1644	1008	1067	1341	1723	1776	1438	1383	100	
48x48	JE48S	1-39x39-4	2004	1166	1209	1585	1997	2056	1567	1507	122	
Rectangle												
24x30	JE2430RT	1-22X	702	516	518	614	734	755	859	826	50	
24x36	JE2436RT	1-22x30	818	542	556	676	815	839	902	867	56	
24x42	JE2442RT	1-22x30	903	569	604	762	897	923	1010	971	70	
24x48	JE2448RT	1-22x30	990	578	604	780	960	988	1059	1018	76	
24x60	JE2460RT	2-22T	1439	943	959	1203	1441	1484	1475	1418	87	
24x72	JE2472RT	2-22T	1609	1011	1022	1208	1602	1651	1529	1470	99	
30x60	JE3060RT	2-26T	1652	1035	1095	1366	1678	1728	1583	1522	87	
30x72	JE3072RT	2-26T	1867	1105	1160	1513	1881	1937	1648	1585	102	
36x42	JE3642RT	1-30X	1481	992	1004	1269	1532	1579	1560	1500	116	
36x48	JE3648RT	1-30X	1623	1005	1063	1306	1604	1652	1464	1408	123	
36x60	JE3660RT	2-32TT	2024	1263	1316	1677	2053	2114	1800	1731	130	
36x72	JE3672RT	2-32TT	2283	1349	1396	1853	2295	2364	1930	1855	147	
36x96	JE3696RT	2-32TT	2955	1388	-	-	2663	2744	-	-	182	
42x48	JE4248RT	2-32TT	1939	1333	1369	1701	2132	2195	-	-	110	
42x60	JE4260RT	2-32TT	2239	1408	1431	1853	2398	2470	-	-	144	
Square-to-Round												
30x30-42d	JE303042R	1-30X	2035	1214	1214	-	2343	2355	-	-	93	
36x36-51d	JE363656R	1-32x32-4	2605	1700	1700	-	2702	2714	-	-	134	
42x42-60d	JE424251R	1-32x32-4	2936	1769	1769	-	3320	3360	-	-	185	

NOTES:

^PPub height version of this table size requires a larger base.

*Unpackaged weights based on solid wood pricing. Call factory for specific weight information.

\$250.00 Charge for orders fewer than 5.

Required to Order: Model Number, Edge Profile, Finishes, Any Additional Options

Nominal top sizes listed. Actual top sizes vary based on selected edge profile. See page 149 for actual dimensions.

TOP SHAPES



Round



Square



Rectangular



Rectangular



Rectangular



Square-to-Round

RAMBO TABLE COLLECTION



ABOUT THIS COLLECTION

The Rambo Collection consists of 1/4" thick steel plate bases and 14-gauge structural-grade steel columns.

STANDARD FEATURES

- Structural-grade steel plate base and column
- 1/4" solid steel plate base in a variety of shape configurations
- Dining height tables use 3" single column, pub height tables use 4" column
- Felt glides
- Shipped ready to assemble

PERSONALIZATION OPTIONS

- The table to the right explains all of the available options for the Rambo Collection.

OPTIONS

	PAGE	ADD TO LIST PRICE
Fixed Pub Height - Available on all Bases	150	\$65 List/Column, \$90/X-Base Marked with a P
Foot Rigs (Pub Tables) - Not Available on Multi-Column Bases	150	\$65/Column
Purse Shelf: Vintee Surfaces	150	\$250 List
Self-Leveling Glides	150	Call for Pricing
Table-Flip Mechanism	150	\$140/Base
Table Connectors	150	\$75/Connection

BASE SIZE VARIATIONS



Round
20R
24R
32R



Round w/Foot Ring



3-Column Round
36R
39R



Square
20S
24S
32S



Rectangular
18x24RT
18x30RT
20x20S
20x24RT
20x30RT
20x36RT
22x22S
24x30RT
24x24S
24x36RT
30x48RT



Oval
18x24RT
18x30RT
20x20S
20x24RT
20x30RT
20x36RT
22x22S
24x30RT
24x24S
24x36RT
30x48RT



SOLID WOOD TABLE TOPS	LAMINATE TABLE TOPS						

SIZE	MODEL	QTY-SIZE/BASE	\$LIST PRICE								UNPKG.D. WGT. #*
Round											
24 dia.	RAM24R	1-20R	653	584	554	745	1044	1132	1040	1040	46
30 dia.	RAM30R	1-24R	862	768	634	1063	1370	1486	1308	1308	80
36 dia.	RAM36R	1-24R	1087	866	718	1309	1626	1764	1450	1450	93
42 dia.	RAM42R	1-32R	1535	1043	942	1769	2094	2270	1603	1603	119
48 dia.	RAM48R	1-36R	1859	1469	1551	2316	2662	2885	1964	1964	161
54 dia.	RAM54R	1-36R	2447	1647	1702	2833	3311	3590	2006	2006	181
60 dia.	RAM60R	1-39R	2953	1877	1893	3032	3499	3794	2083	2083	208
Square											
24x24	RAM24S	1-20S	628	584	542	654	763	786	970	970	51
30x30	RAM30S	1-24S	831	768	621	910	1088	1120	1230	1230	84
36x36	RAM36S	1-24S	1074	866	705	1087	1334	1373	1366	1366	100
42x42	RAM42S	1-32S	1496	1043	942	1408	1824	1880	1514	1514	152
48x48	RAM48S	1-32S	1803	1168	1048	1628	2074	2136	1609	1609	174
Rectangle											
24x30	RAM2430RT	1-18x24RT	744	612	604	720	853	879	987	987	65
24x36	RAM2436RT	1-18x24RT	841	642	629	786	942	970	1035	1035	71
24x42	RAM2442RT	1-18x30RT	923	762	679	971	1125	1157	1242	1242	90
24x48	RAM2448RT	1-18x30RT	1357	790	679	1008	1214	1250	1312	1312	96
24x60	RAM2460RT	2-20x20S	1445	1528	1019	1803	2086	2149	2101	2101	114
24x72	RAM2472RT	2-20x20S	1608	1602	1082	1809	2265	2332	2159	2159	126
30x36	RAM3036RT	1-20x24RT	965	699	679	872	1075	1107	1171	1171	84
30x42	RAM3042RT	1-20x30RT	1051	782	712	1041	1278	1317	1288	1288	121
30x48	RAM3048RT	1-20x36RT	1187	880	781	1152	1422	1465	1432	1432	115
30x60	RAM3060RT	2-20x20S	1650	1230	1074	1590	1935	1995	1828	1828	129
30x72	RAM3072RT	2-22x22S	1877	1427	1238	1870	2284	2351	2017	2017	148
36x42	RAM3642RT	1-24x30RT	1260	938	805	1244	1526	1572	1426	1426	121
36x48	RAM3648RT	1-24x30RT	1382	979	840	1310	1632	1681	1485	1485	130
36x60	RAM3660RT	2-24x24S	1903	1077	1186	1534	1929	1987	1668	1668	182
36x72	RAM3672RT	2-24x24S	2148	1634	1265	2182	2673	2753	2266	2266	200
36x96	RAM3696RT	2-24x24S	2789	1798	-	2336	3199	3296	-	-	236
42x48	RAM4248RT	1-24x36RT	2073	1688	1107	2068	2566	2644	-	-	190
42x60	RAM4260RT	1-30x48RT	2359	1819	1365	2300	2910	2997	-	-	225
Square-to-Round											
30x30-42	RAM303042R	1-24R	1982	944	944	-	2221	2233	-	-	109
36x36-51	RAM363651R	1-36R	2662	1607	1607	-	2686	2699	-	-	171
42x42-60	RAM424260R	1-39R	2974	1702	1702	-	3272	3312	-	-	208

NOTES:

^PPub height version of this table size requires a larger base.

*Unpackaged weights based on solid wood pricing. Call factory for specific weight information.

\$250.00 Charge for orders fewer than 5.

Required to Order: Model Number, Edge Profile, Finishes, Any Additional Options

Nominal top sizes listed. Actual top sizes vary based on selected edge profile. See page 149 for actual dimensions.

TOP SHAPES



Round



Square



Rectangular



Rectangular



Square-to-Round

TRAP TABLE COLLECTION



ABOUT THIS COLLECTION

The Trap Collection consists of a 1/4" steel plate base with inverted pyramid column and molded top plate.

STANDARD FEATURES

- 1/4" solid steel plate base in a variety of shape configurations
- Molded top plate for easy installation
- Felt glides
- Shipped ready to assemble

PERSONALIZATION OPTIONS

- The table to the right explains all of the available options for the Trap Table Collection.

OPTIONS

	PAGE	ADD TO LIST PRICE
Fixed Pub Height - Available on all Bases	150	\$120/Column, \$145/Base Marked with a ^P
Self-Leveling Glides - Quantity Varies According to Size of Base	150	Call for Quote
Table Connectors	150	\$75/Connection

BASE SIZE VARIATIONS



Round
20R
24R
30R
36R



Square
20S
22S
24S
30S



Rectangle
18x24RT
18x30RT
20x24RT
20x30RT
24x30RT



2-Column Rectangle



Oval



SOLID WOOD TABLE TOPS	LAMINATE TABLE TOPS						
	Solid Wood	Vinyl	Edgeband	Laminate Overlay	Wood Edges	Wood Edges	Urethane

SIZE	MODEL	QTY-SIZE/BASE	\$LIST PRICE								UNPKG.D. WGT. #*
Round											
24 dia. ^P	TRAP24R	1-20R	1063	970	926	1147	1492	1589	1471	1471	57
30 dia.	TRAP30R	1-24R	1292	1172	998	1497	1850	1977	1765	1765	92
36 dia.	TRAP36R	1-24R	1538	1280	1090	1766	2132	2283	1921	1921	105
42 dia.	TRAP42R	1-30R	2031	1473	1277	2272	2645	2838	2089	2089	123
48 dia.	TRAP48R	1-36R	2387	1942	1433	2873	3269	3514	2486	2486	171
54 dia.	TRAP54R	1-36R	2784	2138	1600	3440	3983	4288	2532	2532	192
60 dia.	TRAP60R	1-36R	3339	2390	1753	3660	4187	4512	2616	2616	214
Square											
24x24	TRAP24S	1-20S	1035	970	926	1047	1184	1209	1394	1394	36
30x30	TRAP30S	1-24S	1257	1172	984	1329	1540	1576	1679	1679	96
36x36	TRAP36S	1-24S	1525	1280	1077	1523	1810	1853	1829	1829	112
42x42	TRAP42S	1-30S	1989	1474	1277	1875	2349	2409	1992	1992	154
48x48	TRAP48S	1-30S	2325	1611	1394	2117	2623	2691	2096	2096	176
Rectangle											
24x30 ^P	TRAP2430RT	1-18x24RT	1163	1001	951	1120	1282	1310	1413	1413	77
24x36	TRAP2436RT	1-18x24RT	1269	1034	979	1192	1380	1410	1465	1465	83
24x42	TRAP2442RT	1-18x30RT	1359	1166	1034	1396	1580	1616	1693	1693	101
24x48	TRAP2448RT	1-18x30RT	1835	1208	1034	1436	1678	1718	1770	1770	107
24x60	TRAP2460RT	2-22S	2276	2335	1756	2637	2982	3051	3371	3371	162
24x72	TRAP2472RT	2-22S	2112	2088	1826	2316	2833	2907	2701	2701	173
30x36	TRAP3036RT	1-20x24RT	1405	1096	1034	1287	1526	1560	1615	1615	95
30x42	TRAP3042RT	1-20x30RT	1499	1188	1904	1472	1748	1791	1744	1744	169
30x48	TRAP3048RT	1-20x30RT	1994	1624	1938	1923	2252	2298	2230	2230	118
30x60	TRAP3060RT	2-22S	2502	2008	1817	2404	2816	2881	2665	2665	176
30x72	TRAP3072RT	2-22S	2753	2225	1914	2711	3198	3273	2873	2873	159
36x42	TRAP3642RT	1-24x30RT	1729	1359	1222	1695	2021	2072	1895	1895	132
36x48	TRAP3648RT	1-24x30RT	1863	1404	1844	1768	2138	2191	1959	1959	170
36x60	TRAP3660RT	2-24S	2780	1840	1906	2342	2810	2873	2489	2489	188
36x72	TRAP3672RT	2-24S	3049	2452	1994	3054	3627	3715	3146	3146	206
36x96	TRAP3696RT	2-24S	3753	2632	-	-	4204	4310	-	-	242
42x48	TRAP4248RT	2-30S	2966	2511	2204	2929	3509	3594	-	-	244
42x60	TRAP4260RT	2-30S	3281	2656	2272	3184	3886	3983	-	-	265
Square-to-Round											
30x30-42d	TRAP303042R	1-24R	2371	1222	1222	-	2633	2647	-	-	96
36x36-51d	TRAP363651R	1-30R	3089	1922	1922	-	3115	3129	-	-	151
42x42-60d	TRAP424260D	1-36R	3414	2010	2010	-	3808	3851	-	-	214

NOTES:

^PPub height version of this table size requires a larger base.

*Unpackaged weights based on solid wood pricing. Call factory for specific weight information.

\$250.00 Charge for orders fewer than 5.

Required to Order: Model Number, Edge Profile, Finishes, Any Additional Options

Nominal top sizes listed. Actual top sizes vary based on selected edge profile. See page 149 for actual dimensions.

TOP SHAPES



Round



Square



Rectangular



Rectangular



Square-to-Round

POST LEG TABLES

ANDY TABLE COLLECTION



ABOUT THIS COLLECTION

The Andy Table Collection consists of solid wood tables in dining and pub heights.

STANDARD FEATURES

- Solid Maple wood frame
- Top mounting plate is laser-cut, high-strength steel, custom-sized to maximize strength and stability
- Solid maple, random plank wood tops
- Plastic glides





PERSONALIZATION OPTIONS

- The table to the right explains all of the available options for the Andy Collection.

OPTIONS

	PAGE	ADD TO LIST PRICE
Light Distressing	150	Call for Quote
Heavy Distressing	150	Call for Quote
Optional Power (Standard Grommet Includes Power Ports and Two USB Ports)	-	\$250



SOLID WOOD TABLE TOPS			
 Eased	 Bullnose	 Half Bullnose	 WF6

SIZE	MODEL	\$LIST PRICE				UNPKG.D. WGT. #**
Round						
36 dia.	AND36R	1914	1914	1914	1914	39
42 dia.	AND42R	2206	2206	2206	2206	39
48 dia.	AND48R	2540	2540	2540	2540	39
54 dia.	AND54R	2920	2920	2920	2920	44
Square						
36x36x30	AND36S	1924	1924	1924	1924	39
42x42x30	AND42S	2206	2206	2206	2206	39
48x48x30	AND48S	2540	2540	2540	2540	39
54x54x30	AND54S	2920	2920	2920	2920	44
Rectangle						
36x60x30	AND3660RT	2451	2451	2451	2451	39
36x72x30	AND3672RT	2540	2540	2540	2540	39
36x84x30	AND3684RT	2718	2718	2718	2718	39
36x96x30	AND3696RT	2920	2920	2920	2920	44
42x60x30	AND4260RT	2674	2674	2674	2674	N/A**
42x72x30	AND4272RT	2987	2987	2987	2987	N/A**
42x84x30	AND4284RT	3299	3299	3299	3299	N/A**
42x96x30	AND4296RT	3612	3612	3612	3612	N/A**

NOTES:

*Unpackaged weights based on solid wood pricing. Call factory for specific weight information.

**Call for shipping quote.

Required to Order: Model Number, Edge Profile, Finishes, Any Additional Options

TOP SHAPES



Round







Square



Rectangular

ANDY BAR HEIGHT TABLES



SOLID WOOD TABLE TOPS			
Solid Wood	Solid Wood	Solid Wood	Solid Wood
			
Eased	Bullnose	Half Bullnose	WF6

SIZE	MODEL	\$LIST PRICE				UNPKG.D. WGT. #*
Rectangle						
30x60x42	AND3060RT	3056	3056	3056	3056	N/A**
30x72x42	AND3072RT	3305	3305	3305	3305	N/A**
30x84x42	AND3084RT	3560	3560	3560	3560	N/A**
30x96x42	AND3096RT	3813	3813	3813	3813	N/A**
36x60x42	AND3660RT	3294	3294	3294	3294	N/A**
36x72x42	AND3672RT	3589	3589	3589	3589	N/A**
36x84x42	AND3684RT	3884	3884	3884	3884	N/A**
36x96x42	AND3696RT	4182	4182	4182	4182	N/A**
42x60x42	AND4260RT	3529	3529	3529	3529	N/A**
42x72x42	AND4272RT	3872	3872	3872	3872	N/A**
42x84x42	AND4284RT	4213	4213	4213	4213	N/A**
42x96x42	AND4296RT	4555	4555	4555	4555	N/A**

NOTES:

*Unpackaged weights based on solid wood pricing. Call factory for specific weight information.

**Call for shipping quote.

Required to Order: Model Number, Edge Profile, Finishes, Any Additional Options

TOP SHAPE



Rectangular



ABOUT THIS COLLECTION

The Core-Drilled/Bolt-Down Table Collection consists of fixed table mounts with a 3" round metal tube column and labor-saving plate.

STANDARD FEATURES

- 3" structural-grade steel column
- Labor saving attachment
- Available in dining, counter, and bar height models

PERSONALIZATION OPTIONS

- The table to the right explains all of the available options for the Core-drilled/Bolt-down Collection.
- Consult your architect or general contractor for proper installation. Installation techniques vary based on floor material. Call for custom sizing.

OPTIONS

Custom Height and Diameters Available

PAGE

-

ADD TO LIST PRICE

Call Factory for Pricing/Dimensions

CORE-DRILLED/BOLT-DOWN



3100 Core-drilled/
4100 Bolt-down

CORE-DRILLED/BOLT-DOWN TABLE BASE

MODEL	\$LIST PRICE	UNPKG.D. WGT. #
3100	185	N/A**
4100	185	N/A**

Overall Height: 28.75"



3101 Core-drilled/
4101 Bolt-down

CORE-DRILLED/BOLT-DOWN COUNTER HEIGHT TABLE BASE

MODEL	\$LIST PRICE	UNPKG.D. WGT. #
3101	211	N/A**
4101	211	N/A**

Overall Height: 34.75"



3102 Core-drilled/
4102 Bolt-down

CORE-DRILLED/BOLT-DOWN PUB HEIGHT TABLE BASE

MODEL	\$LIST PRICE	UNPKG.D. WGT. #
3102	237	N/A**
4102	237	N/A**

Overall Height: 40.75"



3103 Core-drilled/
4103 Bolt-down

CORE-DRILLED/BOLT-DOWN COUNTER HEIGHT TABLE BASE WITH FOOT RING

MODEL	\$LIST PRICE	UNPKG.D. WGT. #
3103	279	N/A**
4103	279	N/A**

Overall Height: 34.75"



3104 Core-drilled/
4104 Bolt-down

CORE-DRILLED/BOLT-DOWN PUB HEIGHT TABLE BASE WITH FOOT RING

MODEL	\$LIST PRICE	UNPKG.D. WGT. #
3104	305	N/A**
4104	305	N/A**

Overall Height: 40.75"

NOTES:

**Call for shipping quote.



ABOUT THIS COLLECTION

The Opla Table Collection consists of steel bases with perforated steel tops. Opla is suitable for outdoors.

STANDARD FEATURES

- 5/8" round steel frame
- Perforated round or square steel top
- Powder coated finish
- Plastic glides
- Quick Ship option available in Alloy Silver

PERSONALIZATION OPTIONS

- High gloss and low gloss clear coat not available on Opla Table Collection.

OPLA OUTDOOR TABLES



ROUND OPLA OUTDOOR TABLE - QUICK SHIP

MODEL	\$LIST PRICE	UNPKGD. WGT. #
Round		
OP30R-Alloy-Silver	575	17

Overall Height: 30"



SQUARE OPLA OUTDOOR TABLE - QUICK SHIP

MODEL	\$LIST PRICE	UNPKGD. WGT. #
Square		
OP30S-Alloy-Silver	639	25

Overall Height: 30"



ROUND OPLA OUTDOOR TABLE

MODEL	\$LIST PRICE	UNPKGD. WGT. #
Round		
OP30R	630	17

Overall Height: 30"



SQUARE OPLA OUTDOOR TABLE

MODEL	\$LIST PRICE	UNPKGD. WGT. #
Square		
OP30S	694	25

Overall Height: 30"

NOTES:

Required to Order: Model Number, Finishes

TOP SHAPES



Round



Square



ABOUT THIS COLLECTION

The Sadie Collection consists of indoor and outdoor tables constructed using steel or stainless steel bases.

STANDARD FEATURES



















- Indoor tables use steel bases
- Outdoor tables use stainless steel bases
- Outdoor tables use WERZALIT tops
- Plastic glides

PERSONALIZATION OPTIONS

- Standard WERZALIT Outdoor Tops
 - 001 White
 - 179 Ponderosa Grey
 - 103 Wenge
 - 120 Black Granite

SADIE TABLES



SOLID WOOD TABLE TOPS	LAMINATE TABLE TOPS					WERZALIT
Solid Wood  Eased  Bullnose  Half Bullnose  WF6	Vinyl  Vintee	Edgeband  3MM	Laminate Overlay  IWDBN  IWDPW  IWD45  IWF6  IPWFlat	Wood Edges  WC1  WC2  WC3  WC4	Wood Edges  WD1  WD3  WD4  WF6	Outdoor Top

SIZE	MODEL	\$LIST PRICE							UNPKG.D. WGT. #*
Round									
30 dia.	SAD30R	768	423	589	731	811	833	-	N/A**
36 dia.	SAD36R	1003	460	667	778	945	1013	923	N/A**
42 dia.	SAD42R	1281	532	735	871	1040	1124	1018	N/A**
48 dia.	SAD48R	1601	578	832	998	1160	1246	1057	N/A**
54 dia.	SAD54R	1633	613	972	1117	1502	1588	-	N/A**
Square									
30x30x30	SAD30S	768	423	589	731	802	806	-	N/A**
32x32x30	SAD32S	841	532	-	860	859	861	793	N/A**
36x36x30	SAD36S	1003	578	667	976	970	977	-	N/A**
42x42x30	SAD42S	1281	613	735	1158	1084	1091	-	N/A**
48x48x30	SAD48S	1602	822	832	1345	1197	1205	-	N/A**
Rectangle									
36x60x30	SAD3660RT	1516	758	784	1136	1325	1334	-	N/A**
36x72x30	SAD3672RT	1773	789	858	1229	1421	1430	-	N/A**
42x60x30	SAD4260RT	1730	779	889	1238	1402	1411	-	N/A**
42x72x30	SAD4272RT	2031	810	-	1332	1496	1506	-	N/A**

NOTES:

*Unpackaged weights based on solid wood pricing. Call factory for specific weight information.

**Call for shipping quote.

\$250.00 Charge for orders fewer than 5.

Required to Order: Model Number, Edge Profile, Finishes, Any Additional Options

TOP SHAPES



Round



Square



Rectangular



ABOUT THIS COLLECTION

The Somerset Collection consists of a structural thick wall steel tube.

STANDARD FEATURES

- Hard-welded table top mounting plates
- Adjustable glides

PERSONALIZATION OPTIONS

- The table to the right explains all of the available options for the Somerset Collection.

OPTIONS	PAGE	ADD TO LIST PRICE
Fixed Pub Height	150	Call for Quote
Self-Leveling Glides	150	\$5/Leg
Table Connectors	150	\$75/Connection

SOMERSET TABLES



SOLID WOOD TABLE TOPS	LAMINATE TABLE TOPS						
	Vinyl	Edgeband	Laminate Overlay	Wood Edges	Wood Edges	Urethane	Woodgrain Urethane

SIZE	MODEL	QTY-SIZE/BASE	\$LIST PRICE								UNPKG.D. WGT. #*
Round											
24 dia.	SOM24R	4-2R	870	287	511	462	780	846	776	776	44
30 dia.	SOM30R	4-2R	1064	353	563	676	1003	1087	933	933	57
36 dia.	SOM36R	4-3R	1351	456	679	934	1273	1381	1084	1084	71
42 dia.	SOM42R	4-3R	1671	548	754	1329	1675	1815	1153	1153	86
48 dia.	SOM48R	4-3R	2004	681	859	1596	1962	2127	1223	1223	105
54 dia.	SOM54R	4-3R	2528	868	1011	2141	2652	2876	1266	1266	125
60 dia.	SOM60R	4-3R	3033	1113	1151	2354	2849	3089	1348	1348	146
72 dia.	SOM72R	4-3R	4220	1488	-	3062	3316	3630	1914	1914	194
Square											
24x24	SOM24S	4-2R	858	287	511	367	467	481	701	701	48
30x30	SOM30S	4-3R	1095	353	595	512	679	699	852	852	62
36x36	SOM36S	4-3R	1351	456	679	701	939	966	996	996	75
42x42	SOM42S	4-3R	1631	548	754	947	1362	1402	1059	1059	100
48x48	SOM48S	4-3R	1952	681	859	1180	1624	1672	1159	1159	122
Rectangle											
24x30	SOM2430RT	4-2R	940	315	534	437	561	578	720	720	50
24x36	SOM2436RT	4-2R	1043	347	559	507	655	676	770	770	56
24x42	SOM2442RT	4-2R	1128	378	608	609	749	771	896	896	70
24x48	SOM2448RT	4-2R	1214	408	608	648	844	869	971	971	76
24x60	SOM2460RT	4-2R	1385	474	661	788	1032	1064	1103	1103	87
24x72	SOM2472RT	4-2R	1556	553	724	794	1221	1257	1165	1165	99
30x36	SOM3036RT	4-2R	1171	408	608	598	796	820	914	914	65
30x42	SOM3042RT	4-2R	1248	433	628	714	946	973	977	977	80
30x48	SOM3048RT	4-2R	1351	471	659	769	1032	1064	1065	1065	87
30x60	SOM3060RT	4-2R	1599	543	717	939	1268	1306	1190	1190	102
30x72	SOM3072RT	4-2R	1813	624	782	1110	1504	1549	1266	1266	116
36x42	SOM3642RT	4-2R	1428	501	683	834	1109	1143	1028	1028	92
36x48	SOM3648RT	4-2R	1556	543	718	906	1221	1257	1090	1090	101
36x60	SOM3660RT	4-2R	1813	615	775	1110	1504	1549	1254	1254	119
36x72	SOM3672RT	4-3R	2124	714	854	1315	1787	1841	1404	1404	132
42x48	SOM4248RT	4-3R	-	644	859	1069	1541	1588	-	-	113
42x60	SOM4260RT	4-3R	-	782	1046	1315	1905	1962	-	-	134

NOTES:

*Unpackaged weights based on solid wood pricing. Call factory for specific weight information.

\$250.00 Charge for orders fewer than 5.

Required to Order: Model Number, Edge Profile, Finishes, Any Additional Options

Nominal top sizes listed. Actual top sizes vary based on selected edge profile. See page 149 for actual dimensions.

TOP SHAPES



Round



Square



Rectangular

CANTILEVER TABLE

CANTILEVER COLLECTION



ABOUT THIS COLLECTION

The Cantilever Table Collection consists of 2" square tube table mount frames in three sizes.

STANDARD FEATURES

- 2" square tube steel frame
- 10", 19", and 33" variations
- Custom sizes available

PERSONALIZATION OPTIONS

- Consult your architect or general contractor for proper installation. Installation techniques vary based on wall material. Call for custom sizing.

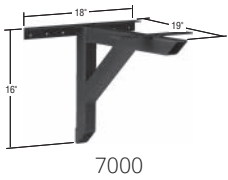

CANTILEVER TABLE MOUNTS

MODEL	SIZE	\$LIST PRICE	UNPKGD. WGT. #
7000	24"-36"	270	-

Overall Height: 16" Overall Width: 18" Overall Depth: 19"



CANTILEVER TABLE MOUNTS

MODEL	SIZE	\$LIST PRICE	UNPKGD. WGT. #
7005	36"-54"	284	-

Overall Height: 16" Overall Width: 18" Overall Depth: 33"

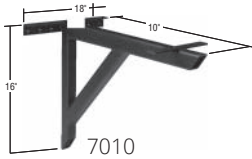

CANTILEVER TABLE MOUNTS

MODEL	SIZE	\$LIST PRICE	UNPKGD. WGT. #
7010	14"-20"	257	-

Overall Height: 16" Overall Width: 18" Overall Depth: 10"

COMMUNAL TABLES

BRADY COMMUNAL TABLE COLLECTION



ABOUT THIS COLLECTION

The Brady Communal Collection consists of steel bases with wood or laminate tops.

STANDARD FEATURES

- 1.5" solid wood or laminate table top
- 14-gauge steel base
- Brazed, coped, and sanded welds
- Super Tough Nylon glide

PERSONALIZATION OPTIONS

- The table to the right explains all of the available options for the Brady Communal Table Collection.

OPTIONS

- Light Distressing
- Heavy Distressing

PAGE

- 150
- 150

ADD TO LIST PRICE

- Call for Quote
 - Call for Quote
-

BRADY DINING HEIGHT COMMUNAL TABLES



Solid Wood Top



Eased

BRADY DINING HEIGHT COMMUNAL TABLE – SOLID WOOD TABLE TOPS

SIZE	MODEL	\$LIST PRICE	UNPKG.D. WGT. #*
Rectangle			
24x48x30	BR-SW-244830	1215	82
24x60x30	BR-SW-246030	1358	93
24x72x30	BR-SW-247230	1598	110
24x84x30	BR-SW-242430	1714	123
24x94x30	BR-SW-249430	1821	133
30x48x30	BR-SW-304830	1359	96
30x60x30	BR-SW-306030	1450	111
30x72x30	BR-SW-307230	1780	131
30x84x30	BR-SW-308430	1875	148
30x94x30	BR-SW-309430	2038	160
36x48x30	BR-SW-364830	1538	111
36x60x30	BR-SW-366030	1662	129
36x72x30	BR-SW-367230	1902	152
36x84x30	BR-SW-368430	2073	172
36x94x30	BR-SW-369430	2330	187



Laminate Top**



IWDPW

BRADY DINING HEIGHT COMMUNAL TABLE – LAMINATE TABLE TOPS

SIZE	MODEL	\$LIST PRICE	UNPKG.D. WGT. #*
Rectangle			
24x48x30	BR-LAM-244830	993	82
24x60x30	BR-LAM-246030	1157	93
24x72x30	BR-LAM-247230	1427	110
24x84x30	BR-LAM-248430	1521	123
24x94x30	BR-LAM-249430	1554	133
30x48x30	BR-LAM-304830	1007	96
30x60x30	BR-LAM-306030	1121	111
30x72x30	BR-LAM-307230	1354	131
30x84x30	BR-LAM-308430	1448	148
30x94x30	BR-LAM-309430	1653	160
36x48x30	BR-LAM-364830	1102	111
36x60x30	BR-LAM-366030	1217	129
36x72x30	BR-LAM-367230	1404	152
36x84x30	BR-LAM-368430	1498	172
36x94x30	BR-LAM-369430	1655	187

NOTES:

*Unpackaged weights based on solid wood pricing. Call factory for specific weight information.

**The laminate tops include a Baltic Birch core with exposed or finished edges.

Required to Order: Model Number, Edge Profile, Finishes, Any Additional Options

TOP SHAPE



Rectangular

BRADY COUNTER HEIGHT COMMUNAL TABLES



Solid Wood Top



Eased

BRADY COUNTER HEIGHT COMMUNAL TABLE – SOLID WOOD TABLE TOPS

SIZE	MODEL	\$LIST PRICE	UNPKG.D. WGT. #*
Rectangle			
30x48x36	BR-SW-304836	2053	115
30x60x36	BR-SW-306036	2214	132
30x72x36	BR-SW-307236	2622	154
30x84x36	BR-SW-308436	2792	172
30x94x36	BR-SW-309436	2938	186
36x48x36	BR-SW-364836	2193	131
36x60x36	BR-SW-366036	2354	151
36x72x36	BR-SW-367236	2763	176
36x84x36	BR-SW-368436	2933	198
36x94x36	BR-SW-369436	3079	214



Laminate Top**



IWDPW

BRADY COUNTER HEIGHT COMMUNAL TABLE – LAMINATE TABLE TOPS

SIZE	MODEL	\$LIST PRICE	UNPKG.D. WGT. #*
Rectangle			
30x48x36	BR-LAM-304836	1742	115
30x60x36	BR-LAM-306036	1863	132
30x72x36	BR-LAM-307236	1981	154
30x84x36	BR-LAM-308436	2030	172
30x94x36	BR-LAM-309436	2060	186
36x48x36	BR-LAM-364836	1826	131
36x60x36	BR-LAM-366036	1945	151
36x72x36	BR-LAM-367236	2064	176
36x84x36	BR-LAM-368436	2148	198
36x94x36	BR-LAM-369436	2196	214

NOTES:

*Unpackaged weights based on solid wood pricing. Call factory for specific weight information.

**The laminate tops include a Baltic Birch core with exposed or finished edges.

Required to Order: Model Number, Edge Profile, Finishes, Any Additional Options

TOP SHAPE



Rectangular

BRADY BAR HEIGHT COMMUNAL TABLES



Solid Wood Top



Eased

BRADY BAR HEIGHT COMMUNAL TABLE - SOLID WOOD TABLE TOPS

SIZE	MODEL	\$LIST PRICE	UNPKG.D. WGT. #*
Rectangle			
30x48x42	BR-SW-304842	2276	118
30x60x42	BR-SW-306042	2453	135
30x72x42	BR-SW-307242	2901	157
30x84x42	BR-SW-308442	3088	-
30x94x42	BR-SW-309442	3248	190
36x48x42	BR-SW-364842	2430	134
36x60x42	BR-SW-366042	2607	154
36x72x42	BR-SW-367242	3056	179
36x84x42	BR-SW-368442	3242	201
36x94x42	BR-SW-369442	3403	217



Laminate Top**



IWDPW

BRADY BAR HEIGHT COMMUNAL TABLE - LAMINATE TABLE TOPS

SIZE	MODEL	\$LIST PRICE	UNPKG.D. WGT. #*
Rectangle			
30x48x42	BR-LAM-304842	1934	118
30x60x42	BR-LAM-306042	2066	135
30x72x42	BR-LAM-307242	2174	157
30x84x42	BR-LAM-308442	2227	-
30x94x42	BR-LAM-309442	2290	190
36x48x42	BR-LAM-364842	2024	134
36x60x42	BR-LAM-366042	2168	154
36x72x42	BR-LAM-367242	2399	179
36x84x42	BR-LAM-368442	2453	201
36x94x42	BR-LAM-369442	2492	217

NOTES:

*Unpackaged weights based on solid wood pricing. Call factory for specific weight information.

**The laminate tops include a Baltic Birch core with exposed or finished edges.

Required to Order: Model Number, Edge Profile, Finishes, Any Additional Options

TOP SHAPE



Rectangular

DYLAN COMMUNAL TABLE COLLECTION



ABOUT THIS COLLECTION

The Dylan Collection consists of communal tables with a metal corner bracket that adds strength and optional color.

STANDARD FEATURES

- Available in solid wood or laminate
- Brazed, coped, and sanded welds
- Black height adjustable, non-skid glide
- Power integration available

PERSONALIZATION OPTIONS

• The table to the right explains all of the available options for the Dylan Communal Table Collection.

*Electrical and power integration includes two electrical outlets and two USB ports.

OPTIONS

OPTIONS	PAGE	ADD TO LIST PRICE
Electrical and Power Integration*	-	\$700/Module
Light Distressing on Wood Tops	150	Call for Quote
Heavy Distressing on Wood Tops	150	Call for Quote

POWER & ELECTRICAL PLANNING

Power and electrical can be specified on either wood or laminate Dylan Tables. One or two power modules may be used per table. Each module consists of two power and two USB ports finished in a Silver Anodized Aluminum with a white trim. Each module also includes a wire management system for a three-prong cord for 120 Volts at 120" long. Wire management is designed to neatly encase cords and is securely placed on the inside of one leg. For two power units, there will be two separate cords and encasings, each placed securely on the inside of each leg.

There are two standard options for module placement. For one module, the module will be placed in the center of table top. For two modules, modules will be placed at both ends of the table top, equal distance from the edge of the table for a symmetrical effect. Please note, requests for alternate placement of modules will extend lead times and may not be honored due to design limitations. For all power and integration, please call for quote.

OPTION 1

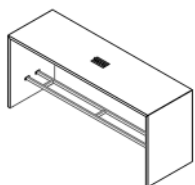

In Table

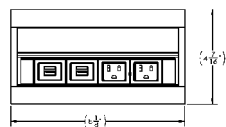

Power Module
Standard Configuration

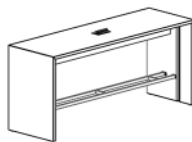

Wire Management

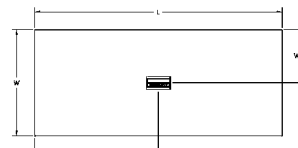

Overhead View

OPTION 2

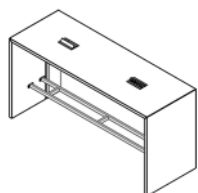

In Table

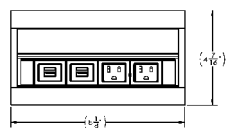

Power Module
Standard Configuration

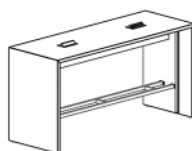

Wire Management

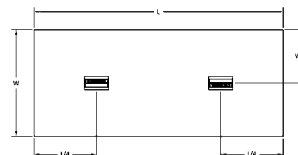

Overhead View

Please note, power modules on Option 2 are placed in opposite directions.

DYLAN DINING HEIGHT COMMUNAL TABLES



Solid Wood Top



Eased

DYLAN DINING HEIGHT COMMUNAL TABLE – SOLID WOOD TABLE TOPS

SIZE	MODEL	\$LIST PRICE	UNPKGD. WGT. #*
Rectangle			
24x60x30	DYL-T-SW-246030	4399	115
24x72x30	DYL-T-SW-247230	4570	124
24x84x30	DYL-T-SW-248430	4736	135
24x94x30	DYL-T-SW-249430	5040	166
30x60x30	DYL-T-SW-306030	4612	136
30x72x30	DYL-T-SW-307230	4786	148
30x84x30	DYL-T-SW-308430	4950	160
30x94x30	DYL-T-SW-309430	5257	172
36x60x30	DYL-T-SW-366030	4853	157
36x72x30	DYL-T-SW-367230	5027	171
36x84x30	DYL-T-SW-368430	5192	185
36x94x30	DYL-T-SW-369430	5444	199



Solid Wood Top with Laminate Overlay



IWDPW

DYLAN DINING HEIGHT COMMUNAL TABLE – LAMINATE TABLE TOPS

SIZE	MODEL	\$LIST PRICE	UNPKGD. WGT. #*
Rectangle			
24x60x30	DYL-T-LAM-246030	3298	115
24x72x30	DYL-T-LAM-247230	3551	124
24x84x30	DYL-T-LAM-248430	3736	135
24x94x30	DYL-T-LAM-249430	3832	166
30x60x30	DYL-T-LAM-306030	3665	136
30x72x30	DYL-T-LAM-307230	3715	148
30x84x30	DYL-T-LAM-308430	3788	160
30x94x30	DYL-T-LAM-309430	3899	172
36x60x30	DYL-T-LAM-366030	3767	157
36x72x30	DYL-T-LAM-367230	3910	171
36x84x30	DYL-T-LAM-368430	4056	185
36x94x30	DYL-T-LAM-369430	4182	199

NOTES:

*Unpackaged weights based on solid wood pricing. Call factory for specific weight information.

Required to Order: Model Number, Edge Profile, Finishes, Any Additional Options

TOP SHAPE



Rectangular

DYLAN COUNTER HEIGHT COMMUNAL TABLES

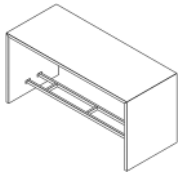

Solid Wood Top



Eased

DYLAN COUNTER HEIGHT COMMUNAL TABLE – SOLID WOOD TABLE TOPS

SIZE	MODEL	\$LIST PRICE	UNPKGD. WGT. #*
Rectangle			
24x60x36	DYL-T-SW-246036	5143	134
24x72x36	DYL-T-SW-247236	5314	146
24x84x36	DYL-T-SW-248436	5480	159
24x94x36	DYL-T-SW-249436	5784	192
30x60x36	DYL-T-SW-306036	4971	156
30x72x36	DYL-T-SW-307236	5150	171
30x84x36	DYL-T-SW-308436	5357	185
30x94x36	DYL-T-SW-309436	5610	199
36x60x36	DYL-T-SW-366036	5843	179
36x72x36	DYL-T-SW-367236	6017	196
36x84x36	DYL-T-SW-368436	6223	212
36x94x36	DYL-T-SW-369436	6476	228

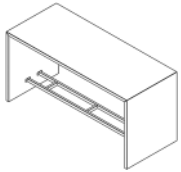

Solid Wood Top with Laminate Overlay



IWDPW

DYLAN COUNTER HEIGHT COMMUNAL TABLE – LAMINATE TABLE TOPS

SIZE	MODEL	\$LIST PRICE	UNPKGD. WGT. #*
Rectangle			
24x60x36	DYL-T-LAM-246036	3702	134
24x72x36	DYL-T-LAM-247236	3914	146
24x84x36	DYL-T-LAM-248436	4113	159
24x94x36	DYL-T-LAM-249436	4224	192
30x60x36	DYL-T-LAM-306036	4166	156
30x72x36	DYL-T-LAM-307236	4311	171
30x84x36	DYL-T-LAM-308436	4453	185
30x94x36	DYL-T-LAM-309436	4581	199
36x60x36	DYL-T-LAM-366036	4425	179
36x72x36	DYL-T-LAM-367236	4587	196
36x84x36	DYL-T-LAM-368436	4747	212
36x94x36	DYL-T-LAM-369436	4887	228

NOTES:

*Unpackaged weights based on solid wood pricing. Call factory for specific weight information.

Required to Order: Model Number, Edge Profile, Finishes, Any Additional Options

TOP SHAPE



Rectangular

DYLAN BAR HEIGHT COMMUNAL TABLES

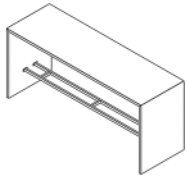

Solid Wood Top



Eased

DYLAN BAR HEIGHT COMMUNAL TABLE - SOLID WOOD TABLE TOPS

SIZE	MODEL	\$LIST PRICE	UNPKG.D. WGT. #*
Rectangle			
24x60x42	DYL-T-SW-246042	5317	126
24x72x42	DYL-T-SW-247242	5488	139
24x84x42	DYL-T-SW-248442	5654	151
24x94x42	DYL-T-SW-249442	5958	184
30x60x42	DYL-T-SW-306042	5275	151
30x72x42	DYL-T-SW-307242	5542	166
30x84x42	DYL-T-SW-308442	5776	180
30x94x42	DYL-T-SW-309442	6327	194
36x60x42	DYL-T-SW-366042	6021	176
36x72x42	DYL-T-SW-367242	6229	192
36x84x42	DYL-T-SW-368442	6407	208
36x94x42	DYL-T-SW-369442	6632	224

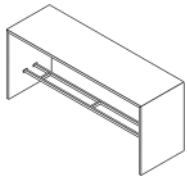

Solid Wood Top with Laminate Overlay



IWDPW

DYLAN BAR HEIGHT COMMUNAL TABLE - LAMINATE TABLE TOPS

SIZE	MODEL	\$LIST PRICE	UNPKG.D. WGT. #*
Rectangle			
24x60x42	DYL-T-LAM-246042	3857	126
24x72x42	DYL-T-LAM-247242	4186	139
24x84x42	DYL-T-LAM-248442	4468	151
24x94x42	DYL-T-LAM-249442	4573	184
30x60x42	DYL-T-LAM-306042	4176	151
30x72x42	DYL-T-LAM-307242	4295	166
30x84x42	DYL-T-LAM-308442	4569	180
30x94x42	DYL-T-LAM-309442	4819	194
36x60x42	DYL-T-LAM-366042	4566	176
36x72x42	DYL-T-LAM-367242	4789	192
36x84x42	DYL-T-LAM-368442	5020	208
36x94x42	DYL-T-LAM-369442	5176	224

NOTES:

*Unpackaged weights based on solid wood pricing. Call factory for specific weight information.

Required to Order: Model Number, Edge Profile, Finishes, Any Additional Options

TOP SHAPE



Rectangular

OCCASIONAL TABLES

NADIA OCCASIONAL TABLE COLLECTION



ABOUT THIS COLLECTION

The Nadia Table Collection consists of metal base occasional tables with wood or laminate tops. Available with round, square, or rectangular table tops.

STANDARD FEATURES

- Tapered steel legs
 - Steel skirt
 - Solid wood or laminate options
 - Adjustable glides
-



NADIA OCCASIONAL TABLE

SIZE	MODEL	EDGE PROFILE	\$LIST PRICE	UNPKG.D. WGT. #*
Round				
16 dia. x 18	NAD16R	SOLID WOOD	923	40
16 dia. x 18	NAD16R	VINYL	729	40
16 dia. x 18	NAD16R	EDGE BAND	779	40
16 dia. x 18	NAD16R	LAMINATE OVERLAY	801	40



NADIA OCCASIONAL TABLE

SIZE	MODEL	EDGE PROFILE	\$LIST PRICE	UNPKG.D. WGT. #*
Round				
22 dia. x 18	NAD22R	SOLID WOOD	964	40
22 dia. x 18	NAD22R	VINYL	779	40
22 dia. x 18	NAD22R	EDGE BAND	809	40
22 dia. x 18	NAD22R	LAMINATE OVERLAY	857	40



NADIA OCCASIONAL TABLE

SIZE	MODEL	EDGE PROFILE	\$LIST PRICE	UNPKG.D. WGT. #*
Round				
22x22x18	NAD22S	SOLID WOOD	964	45
22x22x18	NAD22S	VINYL	779	45
22x22x18	NAD22S	EDGE BAND	809	45
22x22x18	NAD22S	LAMINATE OVERLAY	857	45



NADIA OCCASIONAL TABLE

SIZE	MODEL	EDGE PROFILE	\$LIST PRICE	UNPKG.D. WGT. #*
Rectangle				
22x42x18	NAD2242BOW	SOLID WOOD	1214	55
22x42x18	NAD2242BOW	VINYL	1039	55
22x42x18	NAD2242BOW	EDGE BAND	1069	55
22x42x18	NAD2242BOW	LAMINATE OVERLAY	1116	55









NOTES:

*Unpackaged weights based on solid wood pricing. Call factory for specific weight information.

\$250.00 Charge for orders fewer than 5.

Required to Order: Model Number, Edge Profile, Finishes, Any Additional Options

EDGE PROFILES

Solid Wood	Vinyl	Edgeband	Laminate Overlay	Laminate Overlay	Laminate Overlay	Laminate Overlay	Laminate Overlay
							
Eased	Vintee	3MM	IWDBN	IWDPW	IWD45	IWF6	IPWFLAT

ROY OCCASIONAL TABLE COLLECTION



ABOUT THIS COLLECTION

The Roy Table Collection consists of occasional tables with a square steel tube base and a modern silhouette.

STANDARD FEATURES

- Designed by Chris Carter
 - Solid wood or laminate table top options
 - Steel legs
 - Laminate top with exposed baltic birch edge, available in any of our standard wood stains
 - Nylon glides
-



18" ROY OCCASIONAL TABLE

SIZE	MODEL	SURFACE MATERIAL	\$LIST PRICE	UNPKG.D. WGT. #*
Square				
22x22x18	ROY222218S	LAMINATE OVERLAY	1111	40
22x22x18	ROY222218S	SOLID SURFACE	1565	40
22x22x18	ROY222218S	GRANITE	1790	40
22x22x18	ROY222218S	QUARTZ	2266	40
22x22x18	ROY222218S	SOLID WOOD	1003	40



ROY OCCASIONAL TABLE

SIZE	MODEL	SURFACE MATERIAL	\$LIST PRICE	UNPKG.D. WGT. #*
Rectangle				
24x48x15	ROY244815RT	LAMINATE OVERLAY	1269	50
24x48x15	ROY244815RT	SOLID SURFACE	2472	50
24x48x15	ROY244815RT	GRANITE	2568	50
24x48x15	ROY244815RT	QUARTZ	3726	50
24x48x15	ROY244815RT	SOLID WOOD	1129	50



15" ROY OCCASIONAL TABLE

SIZE	MODEL	SURFACE MATERIAL	\$LIST PRICE	UNPKG.D. WGT. #*
Square				
36x36x15	ROY363615S	LAMINATE OVERLAY	1427	35
36x36x15	ROY363615S	SOLID SURFACE	2609	35
36x36x15	ROY363615S	GRANITE	2653	35
36x36x15	ROY363615S	QUARTZ	3712	35
36x36x15	ROY363615S	SOLID WOOD	1256	35

NOTES:

*Unpackaged weights based on solid wood pricing. Call factory for specific weight information.

\$250.00 Charge for orders fewer than 5.

Required to Order: Model Number, Edge Profile, Finishes, Any Additional Options

Laminate Overlay has two edges: Eased with stain and IPWFlat. Please see pages 151-152 for edge profiles.

TORCH OCCASIONAL TABLE COLLECTION



ABOUT THIS COLLECTION

The Torch Table Collection consists of metal base occasional tables with wood or laminate tops.

STANDARD FEATURES

- Metal platform glides
 - Solid wood or laminate table top options
-



TORCH OCCASIONAL TABLE – SOLID WOOD TABLE TOPS

SIZE	MODEL	\$LIST PRICE	UNPKG.D. WGT. #*
Square			
20x20x15	TOR202015S	572	39
20x20x18	TOR202018S	582	39
20x20x22	TOR202022S	594	39
24x24x15	TOR242415S	626	44
24x24x18	TOR242418S	636	44
24x24x22	TOR242422S	647	44
30x30x15	TOR303015S	803	57
30x30x18	TOR303018S	813	57
30x30x22	TOR303022S	822	57
Rectangle			
20x24x15	TOR202415RT	667	48
20x24x18	TOR202418RT	677	50
20x24x22	TOR202422RT	687	52
24x30x15	TOR243015RT	749	50
24x30x18	TOR243018RT	760	50
24x30x22	TOR243022RT	768	50
30x48x15	TOR304815RT	1193	80
30x48x18	TOR304818RT	1202	80
30x48x22	TOR304822RT	1212	80



EDGE PROFILES

Solid Wood



NOTES:

*Unpackaged weights based on solid wood pricing. Call factory for specific weight information.

\$250.00 Charge for orders fewer than 5.

All wood tops with profiles shown below are flush with base.

Required to Order: Model Number, Edge Profile, Finishes, Any Additional Options

TOP SHAPES



TORCH OCCASIONAL TABLES



TORCH OCCASIONAL TABLE – LAMINATE TABLE TOPS

SIZE	MODEL	\$LIST PRICE			UNPKGD. WGT. #*
		Vinyl	Wood Edge WC	Wood Edge WD	
Square					
20x20x15	TOR202015S	422	641	703	39
20x20x18	TOR202018S	432	653	716	39
20x20x22	TOR202022S	442	664	726	39
24x24x15	TOR242415S	461	705	774	44
24x24x18	TOR242418S	470	714	783	44
24x24x22	TOR242422S	481	726	793	44
30x30x15	TOR303015S	528	922	1038	57
30x30x18	TOR303018S	538	933	1050	57
30x30x22	TOR303022S	550	944	1061	57
Rectangle					
20x24x15	TOR202415RT	515	802	879	48
20x24x18	TOR202418RT	524	813	888	50
20x24x22	TOR202422RT	534	823	900	52
24x30x15	TOR243015RT	580	898	985	50
24x30x18	TOR243018RT	591	909	997	50
24x30x22	TOR243022RT	600	920	1006	50
30x48x15	TOR304815RT	755	1410	1597	80
30x48x18	TOR304818RT	766	1420	1607	80
30x48x22	TOR304822RT	777	1431	1619	80

EDGE PROFILES

Vinyl Wood Edges



NOTES:

*Unpackaged weights based on solid wood pricing. Call factory for specific weight information.

\$250.00 Charge for orders fewer than 5.

Vinyl edge and custom radius edge profile tops are 2" wider than base size to accommodate radius top corners.

Required to Order: Model Number, Edge Profile, Finishes, Any Additional Options

TOP SHAPES

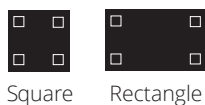



ABOUT THIS COLLECTION

The Walloon Table Collection consists of steel base occasional tables with wood or laminate tops.

STANDARD FEATURES

- Metal platform glides

PERSONALIZATION OPTIONS

- All wood tops with profiles shown above are flush with base.

WALLOON OCCASIONAL TABLES



WALLOON OCCASIONAL TABLE – SOLID WOOD TABLE TOP

SIZE	MODEL	\$LIST PRICE	UNPKGD. WGT. #*
Round		Solid Wood	
20 dia. x 15	WAL2015	735	39
20 dia. x 18	WAL2018	746	39
20 dia. x 22	WAL2022	756	39
24 dia. x 15	WAL2415	825	44
24 dia. x 18.	WAL2418	837	44
24 dia. x 22	WAL2422	846	44
30 dia. x 15	WAL3015	1032	57
30 dia. x 18	WAL3018	1043	57
30 dia. x 22	WAL3022	1053	57

EDGE PROFILES



Eased



Bullnose



Half Bullnose



WALLOON OCCASIONAL TABLE – LAMINATE TABLE TOP

SIZE	MODEL	\$LIST PRICE			UNPKGD. WGT. #*
Round		Vinyl	Wood Edge WC	Wood Edge WD	
20 dia. x 15	WAL2015	517	672	687	39
20 dia. x 18	WAL2018	527	683	698	39
20 dia. x 22	WAL2022	538	693	709	39
24 dia. x 15	WAL2415	581	755	772	44
24 dia. x 18.	WAL2418	592	765	784	44
24 dia. x 22	WAL2422	602	776	793	44
30 dia. x 15	WAL3015	679	970	1022	57
30 dia. x 18	WAL3018	688	981	1033	57
30 dia. x 22	WAL3022	699	991	1044	57

EDGE PROFILES

Vinyl Wood Edges



Vintee



WC1R



WC2R



WC3R



WC4R



WD1R



WD3R



WD4R

NOTES:

*Unpackaged weights based on solid wood pricing. Call factory for specific weight information.

\$250.00 Charge for orders fewer than 5.

Required to Order: Model Number, Edge Profile, Finishes, Any Additional Options

TOP SHAPE



Round

To maintain the beauty of decorative laminates, clean with a solution of liquid dishwashing detergent and warm water and dry with a clean, non-abrasive cloth. This should remove most surface stains. On high-gloss laminates, this solution may leave streak marks. These can be removed using glass cleaner with ammonia and a dry, clean, non-abrasive cloth.

For stubborn stains, use a household cleaner such as Formula 409[®], Fantastik[®], Windex[®] or diluted Simple Green[®]. It may be necessary to use a soft bristle brush with light scrubbing to assist in removing the stain.

If stain persists, try a mixture of baking soda and water. Apply with a soft bristle brush and lightly scrub with 10-20 strokes. Baking soda is a mild abrasive cleaner so use as instructed. Other types of abrasive cleaners will cause scratching and discoloration of laminate. As a last resort, try undiluted bleach, IMMEDIATELY rinsing with warm water. DO NOT allow bleach to sit on stain for more than one minute, as prolonged exposure of laminate to bleach will cause discoloration.

For pre-finished veneer, clean with a solution of liquid dishwashing detergent, warm water and a damp rag. Dry with a clean, non-abrasive cloth.

Self, PVC and T-mold edges should be cleaned with a solution of liquid dishwashing detergent and warm water. Dry with a clean, non-abrasive cloth. For stubborn stains, try rubbing alcohol with a clean, non-abrasive cloth.

Clean wood edges with a solution of liquid dishwashing detergent and warm water. Dry with a clean, non-abrasive cloth. This should remove most stains from the surface.

For urethane edges, please request specific care recommendations from the factory.

Natural wood products are naturally susceptible to damage from radical changes in heat and humidity; care must be taken to ensure that they are in a temperate environment.

SEATING PLANNER

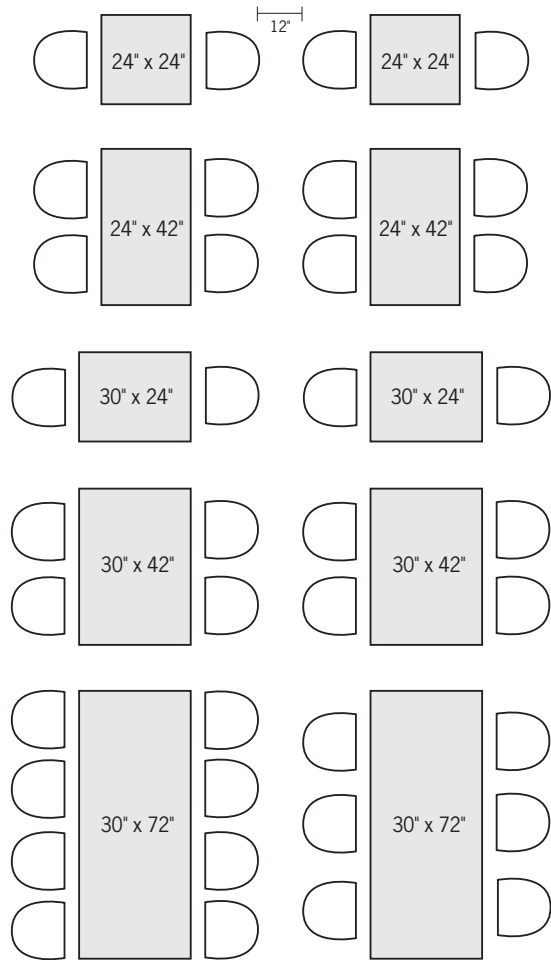

Minimum Back-to-Back Spacing - 12"

Consult local fire codes for legal requirements. Spacing requirements will vary depending on selected chair width.

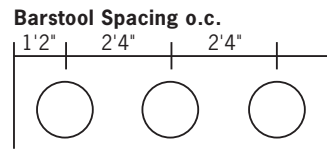
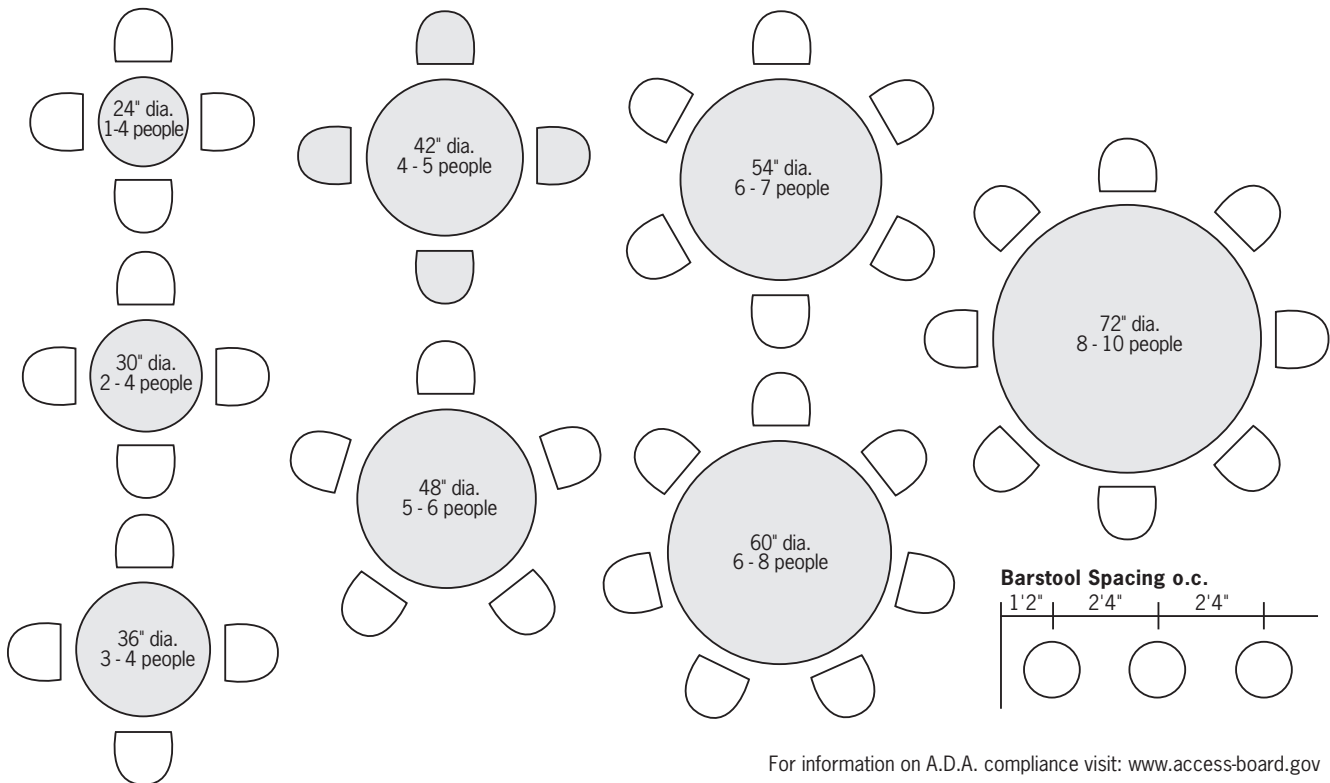
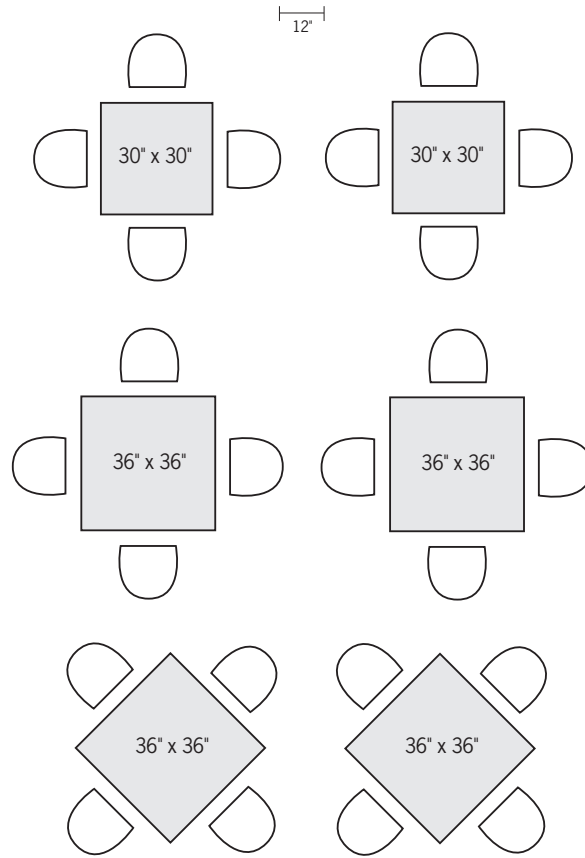

For information on A.D.A. compliance visit: www.access-board.gov

1. THE AGREEMENT

All sales by GRAND RAPIDS CHAIR COMPANY or its affiliates (the "Seller") shall be governed by the following terms and conditions of sale. The agreement between Seller and Buyer with respect to the sale of goods described in the Seller's quote (the "goods") shall consist only of the terms appearing herein and in the Seller's quote or proposal and any attachments, exhibits and supplements (the "contract") together with any terms mutually agreed to in writing hereafter by Seller and Buyer. Buyer's issuance of a purchase order constitutes its acknowledgment that Seller's quote is the first document exchanged, containing the essential elements of, and therefore constitutes an offer. Seller objects to and shall not otherwise be bound by any additional or different terms, whether printed or otherwise, in Buyer's purchase order or in any other communication from Buyer to Seller. The contract shall be for the benefit of Seller and Buyer and not for the benefit of any other person. Prior courses of dealing, trade usage and verbal agreements not reduced to a writing signed by Seller, to the extent they differ from, modify, add to or detract from the contract, shall not be binding on Seller. There are no agreements, promises or understandings, either verbal or written, that are not fully expressed herein. No statements, recommendations, or assistance by either party has been relied upon by either party or shall constitute a waiver by either party of the provisions hereof.

2. NO IMPLIED ACCEPTANCE

Notwithstanding any contrary provision in Buyer's purchase order, no action by Seller such as delivery of goods, the rendering of services or the commencement of work on goods to be specially manufactured for Buyer, will be deemed an acceptance by Seller of any purchase order from Buyer with terms different than those contained in this contract.

3. TERMINATION OR MODIFICATION

The contract may be modified or terminated only upon Seller's written consent. If all or part of the contract is terminated, Buyer, in the absence of contrary written agreement with Seller, Buyer shall pay a termination charge equal to expenses and costs incurred by Seller in the production of the goods to the date such termination is accepted by Seller, including work in process, raw materials not usable by Seller for other purposes, and reimbursement for any commitments to third parties made in order to satisfy Buyer's requirements, plus a reasonable profit. In addition, any

goods completed on or prior to Seller's acceptance of such termination shall be accepted and paid for in full by Buyer.

4. TERMS OF PAYMENT

Payment terms are determined on an individual company basis. Payments shall be made to Seller at the address specified in the invoice. Pro rata payments shall become due as shipments are made. If any shipment is delayed by Seller at the request of Buyer, payment shall become due on the date when Seller is prepared to make shipment. Prices are FOB shippers selling point unless otherwise stated in contract. Orders for non-standard or special order product, replacement parts, and orders that exceed normal credit limits, require down payments up to full value of the order prior to order entry. Delay in payment of deposits may delay production. When any payment is not paid on or before its due date, Buyer agrees to pay a late charge on the sum outstanding, from the due date for receipt of payment to the actual date of receipt of payment, at a rate of one and one half percent (1.5%) per month on the unpaid balance. If a payment is not paid on or before its due date, Buyer agrees that Seller may also cease performance under any and all of Buyer's purchase orders whether or not related to the late payment. Whenever, in the judgment of Seller, the financial condition of the Buyer does not justify the continuation of production or shipment on the specified terms of payment, the Seller may require full or partial payment in advance. Seller shall have a security interest in all tools, molds, and dies and other property of Buyer, which come into the possession of Seller, as security for all sums owing from Buyer to Seller from time to time.

5. DELIVERY

Delivery dates are not guaranteed but are estimated on the basis of immediate receipt by Seller of all information to be furnished by Buyer, and all shipments are subject to Seller's production schedule. Seller shall in good faith endeavor to meet estimated delivery dates. Seller shall not be responsible for claims for error in quantity, weight or number not made within ten (10) days after Buyer's receipt of goods. Seller will not be liable for any delay in performance of this contract or delivery of goods when the delay is caused directly or indirectly by fire, flood, explosion, accident, riot, acts of God, war, governmental interference, embargo, strikes or other labor difficulties, shortage of labor, fuel, power, materials or supplies, transportation delays, failure of tooling or the repair, maintenance or rehabilitation of the tooling, or any other

TERMS & CONDITIONS

cause or causes whatsoever beyond its control. In the event Seller is delayed in performance by Buyer or at Buyer's request, Buyer will be responsible for any resulting increase in cost, including handling, insurance and storage charges, and Seller may invoice goods ready for shipment with payment to be made in accordance with the payment schedule as if the goods had been shipped. In the event delay is caused by Buyer's failure to furnish information necessary for Seller's performance, Seller may extend the shipment date for a reasonable time in proportion to the period of Buyer's delay.

6. INSTALLMENT DELIVERIES AS SEPARATE SALES

Each installment of goods to be delivered pursuant to this contract is to be considered as a separate sale and Buyer shall be liable to pay the agreed price for each such installment without regard to any failure to deliver other installments, and Seller's breach or default in the delivery of any installment shall not give Buyer the right to refuse to receive any other installments.

7. RISK OF LOSS

Buyer assumes all risk of loss of goods upon delivery by Seller to carrier. Seller agrees to package the goods, put them in the possession of a carrier, make appropriate arrangements for their transportation, and obtain and deliver documents necessary to enable Buyer to obtain possession of the goods. Seller shall not be obligated to obtain insurance or to prepay transportation costs unless the contract provides otherwise. Buyer agrees to pay all loading, unloading and other charges incidental to transportation. Seller will attempt to follow Buyer's shipping instructions, but may make reasonable changes thereto. Whether or not Seller pays shipping charges, risk of loss shall pass to Buyer upon delivery of the goods to a carrier. Breach of this contract shall have no effect upon this provision controlling the risk of loss.

8. LIMITED WARRANTIES

Wood Chairs: One year free from defects and workmanship; 10 years structural integrity

Metal Chairs: One year free from defects and workmanship; 10 years structural integrity

Outdoor Chairs and Tables: One year free from defects and workmanship; 3 years structural integrity

Tables: One year free from defects and workmanship; 10 years structural integrity

Fabric: Subject to warranty of the textile company

Laminate Tables: Subject to the warranty of the laminate company

SELLER MAKES NO OTHER WARRANTIES OR REPRESENTATIONS, EXPRESS OR IMPLIED, BY OPERATION OF LAW OR OTHERWISE, INCLUDING WITHOUT LIMITATION ANY IMPLIED WARRANTY OF MERCHANTABILITY OR FITNESS FOR A PARTICULAR PURPOSE, ALL OF WHICH ARE HEREBY SPECIFICALLY DISCLAIMED. IN PARTICULAR, BUT WITHOUT LIMITING THE GENERALITY OF THE FOREGOING EXCLUSION, (i) IF THE GOODS ARE MADE ACCORDING TO BUYER'S SPECIFICATIONS, SELLER DOES NOT WARRANT ADEQUACY OF SUCH SPECIFICATIONS OR THAT THE GOODS WILL PERFORM IN ACCORDANCE WITH SUCH SPECIFICATIONS, (ii) IF ANY GOODS FURNISHED HEREUNDER ARE MADE BY ANY SUPPLIER OTHER THAN SELLER, SELLER DOES NOT PROVIDE ANY WARRANTY WITH RESPECT TO SUCH GOODS, (iii) SELLER DOES NOT WARRANT THAT THE GOODS ARE IN COMPLIANCE WITH LAWS OF ANY COUNTRY, AND (iv) IF THE GOODS ARE MODULES OR ASSEMBLIES, SELLER DOES NOT WARRANT DESIGN, DESIGN PERFORMANCE, DURABILITY OR SYSTEM INTEGRATION OF THE MODULES, ASSEMBLIES OR ANY COMPONENTS THEREOF. LIMITED WARRANTY BASED ON 8HR, 200 DAY USE. Seller's sole obligation under the foregoing warranties will be limited to either, at Seller's option, replacing or repairing defective goods or refunding the purchase price paid for such goods previously paid by Buyer, and Buyer's exclusive remedy for breach of any of such warranties will be enforcement of such obligation of Seller. These warranties will not extend to goods subjected to misuse, abuse, neglect, damage, accident or improper installation or maintenance or which have been altered or repaired by anyone other than Seller or its authorized representative. Seller shall not be liable on any claim for defective goods, which is not made within thirty (30) days after discovery of defect.

9. REMEDIES AND LIMITATION OF LIABILITY

In the event Buyer claims Seller has breached any of its obligations under the contract, whether of warranty or otherwise, Seller may request the return of the goods and tender to Buyer the purchase price previously paid by Buyer, and in such event, Seller shall have no further obligation under the contract except to refund such purchase price upon redelivery of the goods. No goods may be returned without Seller's written request. If Seller requests the return of the goods, the goods will be unless otherwise authorized in writing by Seller. Seller reserves the right to inspect any claimed defect, repair defective goods or install replacement parts, and perform any adjustment incident to satisfactory

operation of the goods. In the event Buyer claims Seller has breached any of its obligations under the contract, whether of warranty or otherwise, and Seller has not delivered any goods to Buyer, Seller may tender to Buyer the purchase price previously paid by Buyer, and, in such event, Seller shall have no further obligation under the contract except to refund such purchase price previously paid by Buyer. The remedies contained in this and the preceding paragraph shall constitute the sole recourse of Buyer against Seller for breach of any of Seller's obligations under the contract, whether of warranty or otherwise. In no event shall Seller be liable for incidental, consequential or special damages, including without limitation, lost revenues, profits or recall expenses, nor shall Seller's liability on any claim for damages arising out of or connected with the contract or the manufacture, sale, delivery or use of the goods exceed the purchase price of the goods previously paid by Buyer to Seller. Any warranty rights which Seller may have relating to any goods provided by other suppliers will be assigned to Buyer upon request. Seller shall not be liable for failure to perform its obligations under the contract resulting directly or indirectly from circumstances beyond Seller's reasonable control.

10. INDEMNIFICATION

Buyer shall indemnify Seller against, and hold Seller harmless from, any and all claims and liabilities, including reasonable attorney's fees, arising out of, connected with, or resulting from the goods, including but not limited to, the design, manufacturing, selection, delivery, possession, storage, use, operation or disposition of the goods. Seller's entire liability for goods is limited as set forth in paragraph 9 above.

11. PATENTS

Buyer shall indemnify Seller against liability, loss, damage or expense in any instance involving alleged violation of patent rights relating to Buyer's specifications and/or the goods resulting from those specifications. Buyer shall bear the full burden for all liability, loss, damage or expense in any such instance. Such indemnification of Seller against all liability, loss, damage or expense pursuant to this provision shall include, but is not limited to, litigation expenses, reasonable attorney's fees, and damages awarded under an adverse judgment or established by way of compromise settlement where both Buyer and Seller have notice of and consent to such compromise settlement.

12. CHANGES

Changes in the work to be performed under the contract may be made only if Buyer submits written instructions for such changes and if Seller accepts those changes in writing. If any such approved changes in drawings, materials, quantities, dates of performance or design of the part, units, tools, or fixtures, in Seller's sole judgment, increase Seller's costs, Seller may condition approval of any such change on agreement by Buyer to a price increase to recoup such cost increase, plus a reasonable return.

13. CANCELLATION/RESCHEDULE OF PURCHASE ORDERS

- A. In the event of any cancellation of all or part of any purchase order by Buyer, Buyer agrees to pay Seller for all reasonable and allocable materials, material management, labor, overhead and general and administrative costs and expenses incurred as a result of any such cancellation, plus a reasonable profit hereby stipulated to be ten percent (10%) of such costs and expenses within thirty (30) days from the date of Seller's invoice setting forth such costs and expenses. By way of illustration and not limitation, Seller's costs incurred by reason of Buyer's cancellation may include the storage costs for the items to be purchased, and costs associated with relocating the production to an alternate source, as well as the costs of unreimbursed and/or unamortized research and development costs, capital equipment, and other property and supplies of Seller needed to produce and which are unique to the goods.
- B. In the event of such cancellation and upon receipt of payment as described above, all completed goods, assemblies in process, components and any tooling, and equipment owned by Buyer and furnished to Seller under this contract shall be returned to Buyer in accordance with instructions specified by Buyer.
- C. In the event of any cancellation, inventory carrying charges will be assessed at a rate of two percent (2%) per month on the value of such inventory until the relevant inventory is disposed of and paid for by Buyer.
- D. In the event of any reschedule of delivery of goods by Buyer for a period of more than two weeks, inventory carrying charges will be assessed at a rate of two percent (2%) per month until such goods are shipped.

14. DISCLOSURE AND USE OF INFORMATION

Any technical or confidential information disclosed by Seller during the term of this agreement is proprietary and may not be used by Buyer or disclosed by Buyer to any other entity without the written consent of the Seller of such information. Any information owned or developed by Seller, including but not limited to, patents, trademarks, copyrights, know-how and proprietary information, and used for the supply of goods under this contract shall remain the sole and exclusive property of Seller. Except as authorized in writing by and on terms acceptable to Seller, Buyer shall have no right to disclose any technical information to any third party or to have any third party make any goods that use the technical information owned by Seller.

15. MATERIAL PRICE INCREASES

Seller's price quotation shall be subject to pricing of raw materials or other commodities used in the manufacture of goods as described to Buyer. If any such price shall increase by more than five percent (5%) during the term of the Contract, then the quoted price shall be adjusted on the last day of each month thereafter to reflect the full amount of any such price increase.

16. GOVERNING LAW AND FORUM

The formation and performance of the contract shall be governed by the Uniform Commercial Code, as adopted in the state of Michigan. Any action for breach of the contract, including any breach of warranty, must be commenced within one (1) year after the cause of action has accrued. This contract shall not be subject to or governed by the United Nations Convention on Contracts for the International Sale of Goods. Any legal or equitable actions arising out of or relating to this contract or any other contract between the parties, shall be brought only in the United States District Court for the Western District of Michigan, or in the district or circuit courts of Kent County, Michigan. Seller and Buyer agree that such court shall have in personam jurisdiction over the parties.

17. TAXES

Unless the contract provides otherwise, sales, use, occupation, excise and other taxes upon the production, sale or use of the goods are not included in the price and such taxes or any costs in connection therewith, wherever levied and whether imposed before or after payment of invoice, shall be paid by Buyer.

18. MINIMUM PURCHASE REQUIREMENTS.

Buyer hereby acknowledges and agrees that the prices set forth in this contract are contingent upon Buyer's agreement to purchase the total quantities set forth in the Buyer's request for quote/proposal. If Buyer fails to purchase at least ninety percent (90%) of the quantities of goods contained in its request for quote/proposal, Buyer agrees that the pricing on the goods delivered to Buyer shall be adjusted retroactively to reflect the impact of lower volume on material pricing, labor efficiencies and other cost and expenses of Seller. Buyer hereby agrees to pay Seller such additional sums within thirty (30) days of the date of Seller's invoice for payment. Orders for amounts less than \$250 net price will be charged a minimum order charge of \$50. Table orders with quantities less than 5 tops will be charged a set up charge of \$250 net.

19. ASSIGNMENT AND DELEGATION.

No right or interest in this contract shall be delegated or assigned by Buyer without the written permission of Seller. Any attempt at assignment or delegation shall be void unless made in conformity with this paragraph. Buyer represents and warrants to Seller that any assignee of Buyer's rights under this contract shall be in a financial condition and otherwise able to perform all of Buyer's obligations hereunder. No assignment of this contract shall relieve Buyer of its liability under this contract.

Wood Chairs: One year free from defects and workmanship; 10 years structural integrity

Metal Chairs: One year free from defects and workmanship; 10 years structural integrity

Outdoor Chairs and Tables: One year free from defects and workmanship; 3 years structural integrity

Tables: One year free from defects and workmanship; 10 years structural integrity

Fabric: Subject to warranty of the textile company

Laminate Tables: Subject to the warranty of the laminate company

Seller makes no other warranties or representations, express or implied, by operation of law or otherwise, including without limitation any implied warranty of merchantability or fitness for a particular purpose, all of which are hereby specifically disclaimed. In particular, but without limiting the generality of the foregoing exclusion, (i) if the goods are made according to buyer's specifications, seller does not warrant adequacy of such specifications or that the goods will perform in accordance with such specifications, (ii) if any goods furnished hereunder are made by any supplier other than seller, seller does not provide any warranty with respect to such goods, (iii) seller does not warrant that the goods are in compliance with laws of any country, and (iv) if the goods are modules or assemblies, seller does not warrant design, design performance, durability or system integration of the modules, assemblies or any components thereof. Limited warranty based on 8hr, 200 day use. Seller's sole obligation under the foregoing warranties will be limited to either, at Seller's option, replacing or repairing defective goods or refunding the purchase price paid for such goods previously paid by Buyer, and Buyer's exclusive remedy for breach of any of such warranties will be enforcement of such obligation of Seller. These warranties will not extend to goods subjected to misuse, abuse, neglect, damage, accident or improper installation or maintenance or which have been altered or repaired by anyone other than Seller or its authorized representative. Seller shall not be liable on any claim for defective goods, which is not made within thirty (30) days after discovery of defect.

REMEDIES AND LIMITATION OF LIABILITY

In the event Buyer claims Seller has breached any of its obligations under the contract, whether of warranty or otherwise, Seller may request the return of the goods and tender to Buyer the purchase price previously paid by Buyer, and in such event, Seller shall have no further obligation under the contract except to refund such purchase price upon redelivery of the goods. No goods may be returned without Seller's written request. If Seller requests the return of the goods, the goods will be unless otherwise authorized in writing by Seller. Seller reserves the right to inspect any claimed defect, repair defective goods or install replacement parts, and perform any adjustment incident to satisfactory operation of the goods. In the event Buyer claims Seller has breached any of its obligations under the contract, whether of warranty or otherwise, and Seller has not delivered any goods to Buyer, Seller may tender to Buyer the purchase price previously paid by Buyer, and, in such event, Seller shall have no further obligation under the contract except to refund such purchase price previously paid by Buyer. The remedies contained in this and the preceding paragraph shall constitute the sole recourse of Buyer against Seller for breach of any of Seller's obligations under the contract, whether of warranty or otherwise. In no event shall Seller be liable for incidental, consequential or special damages, including without limitation, lost revenues, profits or recall expenses, nor shall Seller's liability on any claim for damages arising out of or connected with the contract or the manufacture, sale, delivery or use of the goods exceed the purchase price of the goods previously paid by Buyer to Seller. Any warranty rights which Seller may have relating to any goods provided by other suppliers will be assigned to Buyer upon request. Seller shall not be liable for failure to perform its obligations under the contract resulting directly or indirectly from circumstances beyond Seller's reasonable control.

SEATING INDEX

<u>Model</u>	<u>Description</u>	<u>Page</u>
105	Ladder Back Chair	93
105BS	Ladder Back Barstool	93
1400	Ava Chair Height Barstool	66
1400BS-FR	Ava Bar Height Barstool	66
1400CH-FR	Ava Counter Height Barstool	66
1401	Ava Chair Height Barstool	66
1401BS-FR	Ava Bar Height Barstool	66
1401CH	Ava Counter Height Barstool	66
1402	Ava Chair Height Barstool	66
1402BS-FR	Ava Bar Height Barstool	66
1402CH-FR	Ava Counter Height Barstool	66
1500	Mia Chair Height Barstool	119
1500BS-FR	Mia Bar Height Barstool	119
1500CH-FR	Mia Counter Height Barstool	119
1501	Mia Chair Height Barstool	119
1501BS-FR	Mia Bar Height Barstool	119
1501CH	Mia Counter Height Barstool	119
1502	Mia Chair Height Barstool	119
1502BS-FR	Mia Bar Height Barstool	119
1502CH-FR	Mia Counter Height Barstool	119
200	Brent Cube	70
200BS	Brent Barstool	70
2130-44	Nadia 44" Bench	121
2130-66	Nadia 66" Bench	121
220	Rosie Chair Height Barstool	129
220BS	Rosie Bar Height Barstool	129
220CH	Rosie Counter Height Barstool	129
230	Rosie Chair Height Barstool	129
230BS	Rosie Bar Height Barstool	129
230CH	Rosie Counter Height Barstool	129
250	Brady Chair	68
250BS	Brady 30" Bar Height Barstool	68
250BS-24	Brady 24" Counter Height Barstool	68
270	Harper Chair — X-Base	83
270BS	Harper Bar Height Stool — X-Base	84
270CH	Harper Counter Height Stool — X-Base	83
271	Harper Chair — 4-Leg	84
271BS	Harper Bar Height Stool — 4-Leg	85
271CH	Harper Counter Height Stool — 4-Leg	85
272	Harper Chair — Stacker	86
273	Harper Lounge Chair	86
280	Reece Chair	126
280BS	Reece Bar Height Stool	127
280CH	Reece Counter Height Stool	126
310	Jill Chair	90
310BS	Jill Barstool	90
311	Jill Chair	90
311BS	Jill Barstool	90
312	Jill Chair	91
312BS	Jill Barstool	91
330	Hurdle Stool	88
330BS	Hurdle Barstool	88
330CH	Hurdle Counter Stool	88
331	Half Hurdle Chair	88
400BS	Atoll Barstool	64

<u>Model</u>	<u>Description</u>	<u>Page</u>
410BS	Atoll Barstool	64
415BS	Atoll Barstool	64
420BS	Atoll Barstool	64
501	Melissa Anne Chair	109
501BS	Melissa Anne Barstool	109
503	Melissa Anne Chair	111
503BS	Melissa Anne Barstool	111
504	Melissa Anne Chair	113
504BS	Melissa Anne Barstool	113
504BS-UB	Melissa Anne Upholstered Back Barstool	115
504-UB	Melissa Anne Upholstered Back Chair	115
505	Samantha Chair	135
505BS	Samantha Barstool	135
506BS	Atoll Swivel Barstool	64
507BS-WB	Cheyenne Barstool	72
507-WB	Cheyenne Chair	72
527	Artisan II Chair	62
527BS	Artisan II Barstool	62
528	Artisan II Chair	61
528BS	Artisan II Barstool	61
533	Melissa Anne Chair	117
533BS	Melissa Anne Barstool	117
571	Mama Melissa Chair	99
571BS	Mama Melissa Barstool	99
573	Mama Melissa Chair	101
573BS	Mama Melissa Barstool	101
574	Mama Melissa Chair	103
574BS	Mama Melissa Barstool	103
574BS-UB	Mama Melissa Barstool — Upholstered Back	103
574-UB	Mama Melissa Chair — Upholstered Back	103
575	Mama Samantha Chair	107
575BS	Mama Samantha Barstool	107
577	Mama Melissa Chair	105
577BS	Mama Melissa Barstool	105
6105BS	Ladder Back Swivel Barstool	93
6250BS	Brady 30" Bar Height Backless Barstool	68
6250BS-24	Brady 24" Counter Height Backless Barstool	68
6501-3000	Melissa Anne Chair Chair Height Fixed Seating	109
6501-4000	Melissa Anne Chair Chair Height Fixed Seating	109
6501BS	Melissa Anne Swivel Barstool	109
6501BS-3002	Melissa Anne Chair Bar Height Fixed Seating	109
6501BS-4002	Melissa Anne Chair Bar Height Fixed Seating	109
6501CH-3001	Melissa Anne Chair Counter Height Fixed Seating	109
6501CH-4001	Melissa Anne Chair Counter Height Fixed Seating	109
6503BS	Melissa Anne Swivel Barstool	111
6504BS	Melissa Anne Swivel Barstool	113
6504BS-UB	Melissa Anne Upholstered Back Swivel Barstool	115
6505BS	Samantha Swivel Barstool	135
6507BS-WB	Cheyenne Swivel Barstool	72
6527BS	Artisan II Swivel Barstool	62
6528-3000	Artisan II Chair Chair Height Fixed Seating	61
6528-4000	Artisan II Chair Chair Height Fixed Seating	61
6528BS	Artisan II Swivel Barstool	61
6528BS-3002	Artisan II Chair Counter Height Fixed Seating	61
6528BS-4002	Artisan II Chair Bar Height Fixed Seating	61

SEATING INDEX

<u>Model</u>	<u>Description</u>	<u>Page</u>
6528CH-4001	Artisan II Chair Counter Height Fixed Seating	.61
6529CH-3001	Artisan II Chair Counter Height Fixed Seating	.61
6533BS	Melissa Anne Swivel Barstool	.117
6571-3000	Mama Melissa Chair Chair Height Fixed Seating	.99
6571-4000	Mama Melissa Chair Chair Height Fixed Seating	.99
6571BS	Mama Melissa Swivel Barstool	.99
6571BS-3002	Mama Melissa Chair Fixed Seating Bar Height Counter Seat Mounts	.99
6571BS-4002	Mama Melissa Chair Bar Height Fixed Seating	.99
6571CH-3001	Mama Melissa Chair Counter Height Fixed Seating	.99
6571CH-4001	Mama Melissa Chair Counter Height Fixed Seating	.99
6573BS	Mama Melissa Swivel Barstool	.101
6574BS	Mama Melissa Swivel Barstool	.103
6574BS-UB	Mama Melissa Swivel Barstool — Upholstered Back	.103
6575BS	Mama Samantha Swivel Barstool	.107
6577BS	Mama Melissa Swivel Barstool	.105
700BS	Atoll Aluminum Barstool	.144
710BS	Atoll Aluminum Barstool	.144
725	Leo Chair	.95
750	Atlantis Chair	.141
750-3000	Atlantis Chair Fixed Seating — Chair Height	.142
750-4000	Atlantis Chair Fixed Seating — Chair Height	.142
750BS	Atlantis Barstool	.141
750BS-3002	Atlantis Chair Fixed Seating — Bar Height	.142
750BS-4002	Atlantis Chair Fixed Seating — Bar Height	.142
750CH-3001	Atlantis Chair Fixed Seating — Counter Height	.142
750CH-4001	Atlantis Chair Fixed Seating — Counter Height	.142
753	Atlantis Chair	.141
753BS	Atlantis Barstool	.141
800	Cart	.137
800-2W	Truck	.137
800-2W-N	Truck	.137
827	Sadie II Indoor Chair	.133
827BS	Sadie II Indoor Barstool	.133
827CH	Sadie II Indoor Counter Stool	.133
838	Sadie Outdoor Chair	.131
838BS	Sadie Outdoor Barstool	.131
840	Opla Chair	.123
840A	Opla Armchair	.123
840A-ALLOY-SILVER	Opla Armchair – Quick Ship	.123
840-ALLOY-SILVER	Opla Chair – Quick Ship	.123
850	Siren Chair	.146
850-3000	Siren Chair Fixed Seating — Chair Height	.146
850-4000	Siren Chair Fixed Seating — Chair Height	.146
850BS	Siren Barstool	.146
850BS-3002	Siren Chair Fixed Seating — Bar Height	.146
850BS-4002	Siren Chair Fixed Seating — Bar Height	.146
850CH-3001	Siren Chair Fixed Seating — Counter Height	.146
850CH-4001	Siren Chair Fixed Seating — Counter Height	.146
990	Felix 18" Wood Chair	.77
990BS	Felix 30" Wood Barstool	.77
991	Felix 18" Laminate Chair	.77
991BS	Felix 30" Laminate Barstool	.77
992	Felix Jr. Chair	.80
992BS	Felix Jr. Barstool	.80
993	Felix Jr. Chair	.80

Model	Description	Page
993BS	Felix Jr. Barstool	80
B014P-VEN	No. 14 Petite Chair	15
B014-UPH	No. 14 Chair	15
B014-VEN	No. 14 Chair	15
B018BS-UPH	No. 18 Barstool	16
B018BS-VEN	No. 18 Barstool	15
B018-UPH	No. 18 Chair	15
B018-VEN	No. 18 Chair	15
B020A-UPH-BK	No. 20 Armchair	16
B020-UPH-BK	No. 20 Chair	16
B025A-UPH	No. 25 Armchair	16
B025A-VEN	No. 25 Armchair	16
B025BS-UPH	No. 25 Barstool	17
B025BS-VEN	No. 25 Barstool	16
B030A-UPH-BK	No. 30 Armchair	17
B030A-UPH	No. 30 Armchair	17
B030A-VEN	No. 30 Armchair	17
B073BS-UPH	No. 73 Barstool	17
B073BS-VEN	No. 73 Barstool	17
B150BS-UPH	No. 150 Barstool	18
B150BS-VEN	No. 150 Barstool	18
B150-UPH	No. 150 Chair	18
B150-VEN	No. 150 Chair	18
B763-UPH	No. 763 Chair	18
B763-VEN	No. 763 Chair	18
DYL-B	Dylan 22" Bench	29
DYL-B	Dylan 48" Bench	29
DYL-B	Dylan 54" Bench	29
DYL-B	Dylan 66" Bench	30
DYL-B	Dylan 78" Bench	30
DYL-B	Dylan 90" Bench	30
N310	Jill Nesting Chair	90
N311	Jill Nesting Chair	90
N312	Jill Nesting Chair	91
N901	Emma Nesting Chair	74
N903	Emma Nesting Chair	74
N904	Emma Wood Back Nesting Chair	74
N905	Samantha Nesting Chair	135
N921	Liz Nesting Chair	97
N923	Liz Nesting Chair	97
N924	Liz Wood Back Nesting Chair	97
N925	Samantha Nesting Chair	135
N933	Emma Criss-Cross Nesting Chair	74
N934	Liz Criss-Cross Nesting Chair	97
W107	Tilly Chair	44
W107BS	Tilly Barstool	44
W107CH	Tilly Counter Height Stool	44
W2625	Andy Lounge	13
W2625A	Andy Lounge With Arms	13
W400AC	Merano Armchair	38
W400BS	Merano Barstool — 30" Barstool	38
W400CH	Merano Barstool — 24" Counter Height	38
W400SC	Merano Chair	38
W465BS	Harbor Barstool	32
W504	Wood Melissa Chair	51

SEATING INDEX

<u>Model</u>	<u>Description</u>	<u>Page</u>
W504A	Wood Melissa Armchair	52
W504A-V12	Wood Melissa Armchair	52
W504A-V15	Wood Melissa Armchair	52
W504A-V16	Wood Melissa Armchair	52
W504A-V21	Wood Melissa Armchair	52
W504A-V22	Wood Melissa Armchair	52
W504A-V25	Wood Melissa Armchair	52
W504A-V26	Wood Melissa Armchair	52
W504A-V31	Wood Melissa Armchair	52
W504A-V32	Wood Melissa Armchair	52
W504A-V35	Wood Melissa Armchair	52
W504A-V36	Wood Melissa Armchair	52
W504BS	Wood Melissa Barstool	53
W504BS-V12	Wood Melissa Barstool	53
W504BS-V15	Wood Melissa Barstool	53
W504BS-V16	Wood Melissa Barstool	53
W504BS-V21	Wood Melissa Barstool	53
W504BS-V22	Wood Melissa Barstool	53
W504BS-V25	Wood Melissa Barstool	53
W504BS-V26	Wood Melissa Barstool	53
W504BS-V31	Wood Melissa Barstool	53
W504BS-V32	Wood Melissa Barstool	53
W504BS-V35	Wood Melissa Barstool	53
W504BS-V36	Wood Melissa Barstool	53
W504-V12	Wood Melissa Chair	51
W504-V15	Wood Melissa Chair	51
W504-V16	Wood Melissa Chair	51
W504-V21	Wood Melissa Chair	51
W504-V22	Wood Melissa Chair	51
W504-V25	Wood Melissa Chair	51
W504-V26	Wood Melissa Chair	51
W504-V31	Wood Melissa Chair	51
W504-V32	Wood Melissa Chair	51
W504-V35	Wood Melissa Chair	51
W504-V36	Wood Melissa Chair	51
W507	Molly Chair	40
W507A	Molly Armchair	41
W507A-V12	Molly Armchair	41
W507A-V21	Molly Armchair	41
W507A-V22	Molly Armchair	41
W507A-V31	Molly Armchair	41
W507A-V32	Molly Armchair	41
W507BS	Molly Barstool	42
W507BS-V12	Molly Barstool	42
W507BS-V21	Molly Barstool	42
W507BS-V22	Molly Barstool	42
W507BS-V31	Molly Barstool	42
W507BS-V32	Molly Barstool	42
W507-V12	Molly Chair	40
W507-V21	Molly Chair	40
W507-V22	Molly Chair	40
W507-V31	Molly Chair	40
W507-V32	Molly Chair	40
W509	Wood Melissa Chair	55
W509A	Wood Melissa Armchair	56

<u>Model</u>	<u>Description</u>	<u>Page</u>
W509A-V12	Wood Melissa Armchair	56
W509A-V21	Wood Melissa Armchair	56
W509A-V22	Wood Melissa Armchair	56
W509A-V31	Wood Melissa Armchair	56
W509A-V32	Wood Melissa Armchair	56
W509BS	Wood Melissa Barstool	57
W509BS-V12	Wood Melissa Barstool	57
W509BS-V21	Wood Melissa Barstool	57
W509BS-V22	Wood Melissa Barstool	57
W509BS-V31	Wood Melissa Barstool	57
W509BS-V32	Wood Melissa Barstool	57
W509-V12	Wood Melissa Chair	55
W509-V21	Wood Melissa Chair	55
W509-V22	Wood Melissa Chair	55
W509-V31	Wood Melissa Chair	55
W509-V32	Wood Melissa Chair	55
W515	Hugh Chair	34
W520-W	Brooke Chair	20
W520BS-W	Brooke Barstool	21
W520CH-W	Brooke Counter Height Stool	20
W574	Wood Mama Melissa Chair	46
W574A	Wood Mama Melissa Armchair	48
W574A-V12	Wood Mama Melissa Armchair	48
W574A-V15	Wood Mama Melissa Armchair	48
W574A-V16	Wood Mama Melissa Armchair	48
W574A-V21	Wood Mama Melissa Armchair	48
W574A-V22	Wood Mama Melissa Armchair	48
W574A-V25	Wood Mama Melissa Armchair	48
W574A-V26	Wood Mama Melissa Armchair	48
W574A-V31	Wood Mama Melissa Armchair	48
W574A-V32	Wood Mama Melissa Armchair	48
W574A-V35	Wood Mama Melissa Armchair	48
W574A-V36	Wood Mama Melissa Armchair	48
W574BS	Wood Mama Melissa Barstool	49
W574BS-V12	Wood Mama Melissa Barstool	49
W574BS-V15	Wood Mama Melissa Barstool	49
W574BS-V16	Wood Mama Melissa Barstool	49
W574BS-V21	Wood Mama Melissa Barstool	49
W574BS-V22	Wood Mama Melissa Barstool	49
W574BS-V25	Wood Mama Melissa Barstool	49
W574BS-V26	Wood Mama Melissa Barstool	49
W574BS-V31	Wood Mama Melissa Barstool	49
W574BS-V32	Wood Mama Melissa Barstool	49
W574BS-V35	Wood Mama Melissa Barstool	49
W574BS-V36	Wood Mama Melissa Barstool	49
W574-V12	Wood Mama Melissa Chair	46
W574-V15	Wood Mama Melissa Chair	46
W574-V16	Wood Mama Melissa Chair	46
W574-V21	Wood Mama Melissa Chair	46
W574-V22	Wood Mama Melissa Chair	46
W574-V25	Wood Mama Melissa Chair	46
W574-V26	Wood Mama Melissa Chair	46
W574-V31	Wood Mama Melissa Chair	46
W574-V32	Wood Mama Melissa Chair	46
W574-V35	Wood Mama Melissa Chair	46

SEATING INDEX

<u>Model</u>	<u>Description</u>	<u>Page</u>
W574-V36	Wood Mama Melissa Chair46
W610	Chloe Chair26
W610A	Chloe Armchair26
W610A-V12	Chloe Armchair26
W610A-V21	Chloe Armchair26
W610A-V22	Chloe Armchair26
W610BS	Chloe Barstool27
W610BS-V12	Chloe Barstool27
W610BS-V21	Chloe Barstool27
W610BS-V22	Chloe Barstool27
W610-V12	Chloe Chair26
W610-V21	Chloe Chair26
W610-V22	Chloe Chair26
W630	Cara Chair23
W630A	Cara Armchair23
W630A-V16	Cara Armchair23
W630A-V23	Cara Armchair23
W630A-V26	Cara Armchair23
W630BS	Cara Barstool24
W630BS-V16	Cara Barstool24
W630BS-V23	Cara Barstool24
W630BS-V26	Cara Barstool24
W630-V16	Cara Chair23
W630-V23	Cara Chair23
W630-V26	Cara Chair23
W640BS	Lena Barstool36
WN504	Wood Melissa Nesting Chair51
WN507	Molly Nesting Chair40
WN509	Wood Melissa Nesting Chair55
WN574	Wood Mama Melissa Nesting Chair47

<u>Model</u>	<u>Description</u>	<u>Page</u>
3100	Core Drilled/Bolt Down Table Base	182
3101	Core Drilled/Bolt Down Counter Height Table Base	182
3102	Core Drilled/Bolt Down Pub Height Table Base	182
3103	Core Drilled/Bolt Down Counter Height Table Base with Foot Ring	182
3104	Core Drilled/Bolt Down Pub Height Table Base with Foot Ring	182
4100	Core Drilled/Bolt Down Table Base	182
4101	Core Drilled/Bolt Down Counter Height Table Base	182
4102	Core Drilled/Bolt Down Pub Height Table Base	182
4103	Core Drilled/Bolt Down Counter Height Table Base with Foot Ring	182
4104	Core Drilled/Bolt Down Pub Height Table Base with Foot Ring	182
7000	Cantilever Table Mounts	191
7005	Cantilever Table Mounts	191
7010	Cantilever Table Mounts	191
AND3060RT	Andy Bar Height Tables	180
AND3072RT	Andy Bar Height Tables	180
AND3084RT	Andy Bar Height Tables	180
AND3096RT	Andy Bar Height Tables	180
AND3660RT	Andy Bar Height Tables	180
AND3660RT	Andy Tables	179
AND3672RT	Andy Bar Height Tables	180
AND3672RT	Andy Tables	179
AND3684RT	Andy Bar Height Tables	180
AND3684RT	Andy Tables	179
AND3696RT	Andy Bar Height Tables	180
AND3696RT	Andy Tables	179
AND36R	Andy Tables	179
AND36S	Andy Tables	179
AND4260RT	Andy Bar Height Tables	180
AND4260RT	Andy Tables	179
AND4272RT	Andy Bar Height Tables	180
AND4272RT	Andy Tables	179
AND4284RT	Andy Bar Height Tables	180
AND4284RT	Andy Tables	179
AND4296RT	Andy Bar Height Tables	180
AND4296RT	Andy Tables	179
AND42R	Andy Tables	179
AND42S	Andy Tables	179
AND48R	Andy Tables	179
AND48S	Andy Tables	179
AND54R	Andy Tables	179
AND54S	Andy Tables	179
BR24R	Brady Pedestal Tables	165
BR24S	Brady Pedestal Tables	165
BR30R	Brady Pedestal Tables	165
BR30S	Brady Pedestal Tables	165
BR36R	Brady Pedestal Tables	165
BR36S	Brady Pedestal Tables	165
BR42R	Brady Pedestal Tables	165
BR42S	Brady Pedestal Tables	165
BR48R	Brady Pedestal Tables	165
BR48S	Brady Pedestal Tables	165
BR54R	Brady Pedestal Tables	165
BR60R	Brady Pedestal Tables	165
BR-LAM-244830	Brady Dining Height Communal Table – Laminate Table Tops	195
BR-LAM-246030	Brady Dining Height Communal Table – Laminate Table Tops	195

Model	Description	Page
BR-SW-364842	Brady Bar Height Communal Table – Solid Wood Table Tops	197
BR-SW-366030	Brady Dining Height Communal Table – Solid Wood Table Tops	195
BR-SW-366036	Brady Counter Height Communal Table – Solid Wood Table Tops	196
BR-SW-366042	Brady Bar Height Communal Table – Solid Wood Table Tops	197
BR-SW-367230	Brady Dining Height Communal Table – Solid Wood Table Tops	195
BR-SW-367236	Brady Counter Height Communal Table – Solid Wood Table Tops	196
BR-SW-367242	Brady Bar Height Communal Table – Solid Wood Table Tops	197
BR-SW-368430	Brady Dining Height Communal Table – Solid Wood Table Tops	195
BR-SW-368436	Brady Counter Height Communal Table – Solid Wood Table Tops	196
BR-SW-368442	Brady Bar Height Communal Table – Solid Wood Table Tops	197
BR-SW-369430	Brady Dining Height Communal Table – Solid Wood Table Tops	195
BR-SW-369436	Brady Counter Height Communal Table – Solid Wood Table Tops	196
BR-SW-369442	Brady Bar Height Communal Table – Solid Wood Table Tops	197
CA2430RT	Cassandra Tables	167
CA2436RT	Cassandra Tables	167
CA2442RT	Cassandra Tables	167
CA2448RT	Cassandra Tables	167
CA2460RT	Cassandra Tables	167
CA2472RT	Cassandra Tables	167
CA24R	Cassandra Tables	167
CA24S	Cassandra Tables	167
CA303042R	Cassandra Tables	167
CA3048RT	Cassandra Tables	167
CA3060RT	Cassandra Tables	167
CA3072RT	Cassandra Tables	167
CA30R	Cassandra Tables	167
CA30S	Cassandra Tables	167
CA363651R	Cassandra Tables	167
CA3642RT	Cassandra Tables	167
CA3648RT	Cassandra Tables	167
CA3660RT	Cassandra Tables	167
CA3672RT	Cassandra Tables	167
CA3696RT	Cassandra Tables	167
CA36R	Cassandra Tables	167
CA36S	Cassandra Tables	167
CA424260R	Cassandra Tables	167
CA4248RT	Cassandra Tables	167
CA4260RT	Cassandra Tables	167
CA42R	Cassandra Tables	167
CA42S	Cassandra Tables	167
CA48R	Cassandra Tables	167
CA48S	Cassandra Tables	167
CA54R	Cassandra Tables	167
CA60R	Cassandra Tables	167
CA72R	Cassandra Tables	167
DYL-T-LAM-246030	Dylan Dining Height Communal Table – Laminate Table Tops	199
DYL-T-LAM-246036	Dylan Counter Height Communal Table – Laminate Table Tops	200
DYL-T-LAM-246042	Dylan Bar Height Communal Table – Laminate Table Tops	201
DYL-T-LAM-247230	Dylan Dining Height Communal Table – Laminate Table Tops	199
DYL-T-LAM-247236	Dylan Counter Height Communal Table – Laminate Table Tops	200
DYL-T-LAM-247242	Dylan Bar Height Communal Table – Laminate Table Tops	201
DYL-T-LAM-248430	Dylan Dining Height Communal Table – Laminate Table Tops	199
DYL-T-LAM-248436	Dylan Counter Height Communal Table – Laminate Table Tops	200
DYL-T-LAM-248442	Dylan Bar Height Communal Table – Laminate Table Tops	201
DYL-T-LAM-249430	Dylan Dining Height Communal Table – Laminate Table Tops	199

<u>Model</u>	<u>Description</u>	<u>Page</u>
DYL-T-SW-367242	Dylan Bar Height Communal Table – Solid Wood Table Tops201
DYL-T-SW-368430	Dylan Dining Height Communal Table – Solid Wood Table Tops199
DYL-T-SW-368436	Dylan Counter Height Communal Table – Solid Wood Table Tops200
DYL-T-SW-368442	Dylan Bar Height Communal Table – Solid Wood Table Tops201
DYL-T-SW-369430	Dylan Dining Height Communal Table – Solid Wood Table Tops199
DYL-T-SW-369436	Dylan Counter Height Communal Table – Solid Wood Table Tops200
DYL-T-SW-369442	Dylan Bar Height Communal Table – Solid Wood Table Tops201
EL2430RT	Ellipse Tables169
EL2436RT	Ellipse Tables169
EL2442RT	Ellipse Tables169
EL2448RT	Ellipse Tables169
EL2460RT	Ellipse Tables169
EL2472RT	Ellipse Tables169
EL24R	Ellipse Tables169
EL24S	Ellipse Tables169
EL303042R	Ellipse Tables169
EL3036RT	Ellipse Tables169
EL3042RT	Ellipse Tables169
EL3048RT	Ellipse Tables169
EL3060RT	Ellipse Tables169
EL3072RT	Ellipse Tables169
EL30R	Ellipse Tables169
EL30S	Ellipse Tables169
EL363651R	Ellipse Tables169
EL36R	Ellipse Tables169
EL36S	Ellipse Tables169
EL42R	Ellipse Tables169
JE2430RT	Jerome Tables171
JE2436RT	Jerome Tables171
JE2442RT	Jerome Tables171
JE2448RT	Jerome Tables171
JE2460RT	Jerome Tables171
JE2472RT	Jerome Tables171
JE24R	Jerome Tables171
JE24S	Jerome Tables171
JE303042R	Jerome Tables171
JE3060RT	Jerome Tables171
JE3072RT	Jerome Tables171
JE30R	Jerome Tables171
JE30S	Jerome Tables171
JE363656R	Jerome Tables171
JE3642RT	Jerome Tables171
JE3648RT	Jerome Tables171
JE3660RT	Jerome Tables171
JE3672RT	Jerome Tables171
JE3696RT	Jerome Tables171
JE36R	Jerome Tables171
JE36S	Jerome Tables171
JE424251R	Jerome Tables171
JE4248RT	Jerome Tables171
JE4260RT	Jerome Tables171
JE42R	Jerome Tables171
JE42S	Jerome Tables171
JE48R	Jerome Tables171
JE48S	Jerome Tables171

TABLES INDEX

Model	Description	Page
JE54R	Jerome Tables	171
JE60R	Jerome Tables	171
JE72R	Jerome Tables	171
KA2430RT	Kalypso Tables	155
KA2436RT	Kalypso Tables	155
KA2442RT	Kalypso Tables	155
KA2448RT	Kalypso Tables	155
KA2460RT	Kalypso Tables	155
KA2472RT	Kalypso Tables	155
KA24R	Kalypso Tables	155
KA24S	Kalypso Tables	155
KA303042R	Kalypso Tables	155
KA3036RT	Kalypso Tables	155
KA3042RT	Kalypso Tables	155
KA3048RT	Kalypso Tables	155
KA3060RT	Kalypso Tables	155
KA3072RT	Kalypso Tables	155
KA30R	Kalypso Tables	155
KA30S	Kalypso Tables	155
KA363651R	Kalypso Tables	155
KA3642RT	Kalypso Tables	155
KA3648RT	Kalypso Tables	155
KA3660RT	Kalypso Tables	155
KA3672RT	Kalypso Tables	155
KA36R	Kalypso Tables	155
KA36S	Kalypso Tables	155
KA4248RT	Kalypso Tables	155
KA4260RT	Kalypso Tables	155
KA42R	Kalypso Tables	155
KA42S	Kalypso Tables	155
KA48R	Kalypso Tables	155
KA48S	Kalypso Tables	155
KA54R	Kalypso Tables	155
KA60R	Kalypso Tables	155
NAD16R	Nadia Occasional Table	205
NAD2242BOW	Nadia Occasional Table	205
NAD22R	Nadia Occasional Table	205
NAD22S	Nadia Occasional Table	205
OP30R	Square Opla Outdoor Table	184
OP30R-Alloy-Silver	Square Opla Outdoor Table – Quick Ship	184
OP30S	Square Opla Outdoor Table	184
OP30S-Alloy-Silver	Round Opla Outdoor Table – Quick Ship	184
OR2430RT	Orbit Tables	157
OR2436RT	Orbit Tables	157
OR2442RT	Orbit Tables	157
OR2448RT	Orbit Tables	157
OR2460RT	Orbit Tables	157
OR2472RT	Orbit Tables	157
OR24R	Orbit Tables	157
OR24S	Orbit Tables	157
OR303042R	Orbit Tables	157
OR3036RT	Orbit Tables	157
OR3042RT	Orbit Tables	157
OR3048RT	Orbit Tables	157
OR3060RT	Orbit Tables	157

<u>Model</u>	<u>Description</u>	<u>Page</u>
OR3072RT	Orbit Tables	157
OR30R	Orbit Tables	157
OR30S	Orbit Tables	157
OR363651R	Orbit Tables	157
OR3660RT	Orbit Tables	157
OR3672RT	Orbit Tables	157
OR36R	Orbit Tables	157
OR36S	Orbit Tables	157
OR42R	Orbit Tables	157
OR42S	Orbit Tables	157
OR48R	Orbit Tables	157
OR48S	Orbit Tables	157
RAM2430RT	Rambo Tables	173
RAM2436RT	Rambo Tables	173
RAM2442RT	Rambo Tables	173
RAM2448RT	Rambo Tables	173
RAM2460RT	Rambo Tables	173
RAM2472RT	Rambo Tables	173
RAM24R	Rambo Tables	173
RAM24S	Rambo Tables	173
RAM303042R	Rambo Tables	173
RAM3036RT	Rambo Tables	173
RAM3042RT	Rambo Tables	173
RAM3048RT	Rambo Tables	173
RAM3060RT	Rambo Tables	173
RAM3072RT	Rambo Tables	173
RAM30R	Rambo Tables	173
RAM30S	Rambo Tables	173
RAM363651R	Rambo Tables	173
RAM3642RT	Rambo Tables	173
RAM3648RT	Rambo Tables	173
RAM3660RT	Rambo Tables	173
RAM3672RT	Rambo Tables	173
RAM3696RT	Rambo Tables	173
RAM36R	Rambo Tables	173
RAM36S	Rambo Tables	173
RAM424260R	Rambo Tables	173
RAM4248RT	Rambo Tables	173
RAM4260RT	Rambo Tables	173
RAM42R	Rambo Tables	173
RAM42S	Rambo Tables	173
RAM48R	Rambo Tables	173
RAM48S	Rambo Tables	173
RAM54R	Rambo Tables	173
RAM60R	Rambo Tables	173
ROY222218S	Roy Occasional Table	207
ROY244815RT	Roy Occasional Table	207
ROY363615S	Roy Occasional Table	207
SAD30R	Sadie Tables	186
SAD30S	Sadie Tables	186
SAD32S	Sadie Tables	186
SAD3660RT	Sadie Tables	186
SAD3672RT	Sadie Tables	186
SAD36R	Sadie Tables	186
SAD36S	Sadie Tables	186

TABLES INDEX

<u>Model</u>	<u>Description</u>	<u>Page</u>
SAD4260RT	Sadie Tables	186
SAD4272RT	Sadie Tables	186
SAD42R	Sadie Tables	186
SAD42S	Sadie Tables	186
SAD48R	Sadie Tables	186
SAD48S	Sadie Tables	186
SAD54R	Sadie Tables	186
SOM2430RT	Somerset Tables	188
SOM2436RT	Somerset Tables	188
SOM2442RT	Somerset Tables	188
SOM2448RT	Somerset Tables	188
SOM2460RT	Somerset Tables	188
SOM2472RT	Somerset Tables	188
SOM24R	Somerset Tables	188
SOM24S	Somerset Tables	188
SOM3036RT	Somerset Tables	188
SOM3042RT	Somerset Tables	188
SOM3048RT	Somerset Tables	188
SOM3060RT	Somerset Tables	188
SOM3072RT	Somerset Tables	188
SOM30R	Somerset Tables	188
SOM30S	Somerset Tables	188
SOM3642RT	Somerset Tables	188
SOM3648RT	Somerset Tables	188
SOM3660RT	Somerset Tables	188
SOM3672RT	Somerset Tables	188
SOM36R	Somerset Tables	188
SOM36S	Somerset Tables	188
SOM4248RT	Somerset Tables	188
SOM4260RT	Somerset Tables	188
SOM42R	Somerset Tables	188
SOM42S	Somerset Tables	188
SOM48R	Somerset Tables	188
SOM48S	Somerset Tables	188
SOM54R	Somerset Tables	188
SOM60R	Somerset Tables	188
SOM72R	Somerset Tables	188
SP2430RT	Spartan Tables	159
SP2436RT	Spartan Tables	159
SP2442RT	Spartan Tables	159
SP2448RT	Spartan Tables	159
SP2460RT	Spartan Tables	159
SP2472RT	Spartan Tables	159
SP24R	Spartan Tables	159
SP24S	Spartan Tables	159
SP303042R	Spartan Tables	159
SP3036RT	Spartan Tables	159
SP3042RT	Spartan Tables	159
SP3048RT	Spartan Tables	159
SP3060RT	Spartan Tables	159
SP3072RT	Spartan Tables	159
SP30R	Spartan Tables	159
SP30S	Spartan Tables	159
SP363651R	Spartan Tables	159
SP3642RT	Spartan Tables	159

<u>Model</u>	<u>Description</u>	<u>Page</u>
SP3648RT	Spartan Tables	159
SP3660RT	Spartan Tables	159
SP3672RT	Spartan Tables	159
SP36R	Spartan Tables	159
SP36S	Spartan Tables	159
SP424260RT	Spartan Tables	159
SP4248RT	Spartan Tables	159
SP4260RT	Spartan Tables	159
SP42R	Spartan Tables	159
SP42S	Spartan Tables	159
SP48R	Spartan Tables	159
SP48S	Spartan Tables	159
SP54R	Spartan Tables	159
SP60R	Spartan Tables	159
TOR202015S	Torch Occasional Table – Laminate Table Tops	210
TOR202015S	Torch Occasional Table – Solid Wood Table Tops	209
TOR202018S	Torch Occasional Table – Laminate Table Tops	210
TOR202018S	Torch Occasional Table – Solid Wood Table Tops	209
TOR202022S	Torch Occasional Table – Laminate Table Tops	210
TOR202022S	Torch Occasional Table – Solid Wood Table Tops	209
TOR202415RT	Torch Occasional Table – Laminate Table Tops	210
TOR202415RT	Torch Occasional Table – Solid Wood Table Tops	209
TOR202418RT	Torch Occasional Table – Laminate Table Tops	210
TOR202418RT	Torch Occasional Table – Solid Wood Table Tops	209
TOR202422RT	Torch Occasional Table – Laminate Table Tops	210
TOR202422RT	Torch Occasional Table – Solid Wood Table Tops	209
TOR242415S	Torch Occasional Table – Laminate Table Tops	210
TOR242415S	Torch Occasional Table – Solid Wood Table Tops	209
TOR242418S	Torch Occasional Table – Laminate Table Tops	210
TOR242418S	Torch Occasional Table – Solid Wood Table Tops	209
TOR242422S	Torch Occasional Table – Laminate Table Tops	210
TOR242422S	Torch Occasional Table – Solid Wood Table Tops	209
TOR243015RT	Torch Occasional Table – Laminate Table Tops	210
TOR243015RT	Torch Occasional Table – Solid Wood Table Tops	209
TOR243018RT	Torch Occasional Table – Laminate Table Tops	210
TOR243018RT	Torch Occasional Table – Solid Wood Table Tops	209
TOR243022RT	Torch Occasional Table – Laminate Table Tops	210
TOR243022RT	Torch Occasional Table – Solid Wood Table Tops	209
TOR303015S	Torch Occasional Table – Laminate Table Tops	210
TOR303015S	Torch Occasional Table – Solid Wood Table Tops	209
TOR303018S	Torch Occasional Table – Laminate Table Tops	210
TOR303018S	Torch Occasional Table – Solid Wood Table Tops	209
TOR303022S	Torch Occasional Table – Laminate Table Tops	210
TOR303022S	Torch Occasional Table – Solid Wood Table Tops	209
TOR304815RT	Torch Occasional Table – Laminate Table Tops	210
TOR304815RT	Torch Occasional Table – Solid Wood Table Tops	209
TOR304818RT	Torch Occasional Table – Laminate Table Tops	210
TOR304818RT	Torch Occasional Table – Solid Wood Table Tops	209
TOR304822RT	Torch Occasional Table – Laminate Table Tops	210
TOR304822RT	Torch Occasional Table – Solid Wood Table Tops	209
TRAP2430RT	Trap Tables	175
TRAP2436RT	Trap Tables	175
TRAP2442RT	Trap Tables	175
TRAP2448RT	Trap Tables	175
TRAP2460RT	Trap Tables	175

TABLES INDEX

<u>Model</u>	<u>Description</u>	<u>Page</u>
TRAP2472RT	Trap Tables	175
TRAP24R	Trap Tables	175
TRAP24S	Trap Tables	175
TRAP303042R	Trap Tables	175
TRAP3036RT	Trap Tables	175
TRAP3042RT	Trap Tables	175
TRAP3048RT	Trap Tables	175
TRAP3060RT	Trap Tables	175
TRAP3072RT	Trap Tables	175
TRAP30R	Trap Tables	175
TRAP30S	Trap Tables	175
TRAP363651R	Trap Tables	175
TRAP3642RT	Trap Tables	175
TRAP3648RT	Trap Tables	175
TRAP3660RT	Trap Tables	175
TRAP3672RT	Trap Tables	175
TRAP3696RT	Trap Tables	175
TRAP36R	Trap Tables	175
TRAP36S	Trap Tables	175
TRAP424260D	Trap Tables	175
TRAP4248RT	Trap Tables	175
TRAP4260RT	Trap Tables	175
TRAP42R	Trap Tables	175
TRAP42S	Trap Tables	175
TRAP48R	Trap Tables	175
TRAP48S	Trap Tables	175
TRAP54R	Trap Tables	175
TRAP60R	Trap Tables	175
WAL2015	Walloon Occasional Table – Laminate Table Top	212
WAL2015	Walloon Occasional Table – Solid Wood Table Top	212
WAL2018	Walloon Occasional Table – Laminate Table Top	212
WAL2018	Walloon Occasional Table – Solid Wood Table Top	212
WAL2022	Walloon Occasional Table – Laminate Table Top	212
WAL2022	Walloon Occasional Table – Solid Wood Table Top	212
WAL2415	Walloon Occasional Table – Laminate Table Top	212
WAL2415	Walloon Occasional Table – Solid Wood Table Top	212
WAL2418	Walloon Occasional Table – Laminate Table Top	212
WAL2418	Walloon Occasional Table – Solid Wood Table Top	212
WAL2422	Walloon Occasional Table – Laminate Table Top	212
WAL2422	Walloon Occasional Table – Solid Wood Table Top	212
WAL3015	Walloon Occasional Table – Laminate Table Top	212
WAL3015	Walloon Occasional Table – Solid Wood Table Top	212
WAL3018	Walloon Occasional Table – Laminate Table Top	212
WAL3018	Walloon Occasional Table – Solid Wood Table Top	212
WAL3022	Walloon Occasional Table – Laminate Table Top	212
WAL3022	Walloon Occasional Table – Solid Wood Table Top	212
ZE2430RT	Zeus Tables	161
ZE2436RT	Zeus Tables	161
ZE2442RT	Zeus Tables	161
ZE2448RT	Zeus Tables	161
ZE2460RT	Zeus Tables	161
ZE2472RT	Zeus Tables	161
ZE24R	Zeus Tables	161
ZE24S	Zeus Tables	161
ZE303042R	Zeus Tables	161

<u>Model</u>	<u>Description</u>	<u>Page</u>
ZE3036RT	Zeus Tables	161
ZE3042RT	Zeus Tables	161
ZE3048RT	Zeus Tables	161
ZE3060RT	Zeus Tables	161
ZE3072RT	Zeus Tables	161
ZE30R	Zeus Tables	161
ZE30S	Zeus Tables	161
ZE363651R	Zeus Tables	161
ZE3642RT	Zeus Tables	161
ZE3648RT	Zeus Tables	161
ZE3672RT	Zeus Tables	161
ZE36R	Zeus Tables	161
ZE36S	Zeus Tables	161
ZE42R	Zeus Tables	161
ZE42S	Zeus Tables	161
ZE48R	Zeus Tables	161
ZE48S	Zeus Tables	161



MAIN LOCATION
1250 84th Street SW
Grand Rapids, Michigan 49315

CONTACT US:
SALES@GRANDRAPIDSCHAIR.COM

T 616 774 0561
F 616 774 0563
GRANDRAPIDSCHAIR.COM