

Operations Guide - SAP CRM 7.0 EHP4

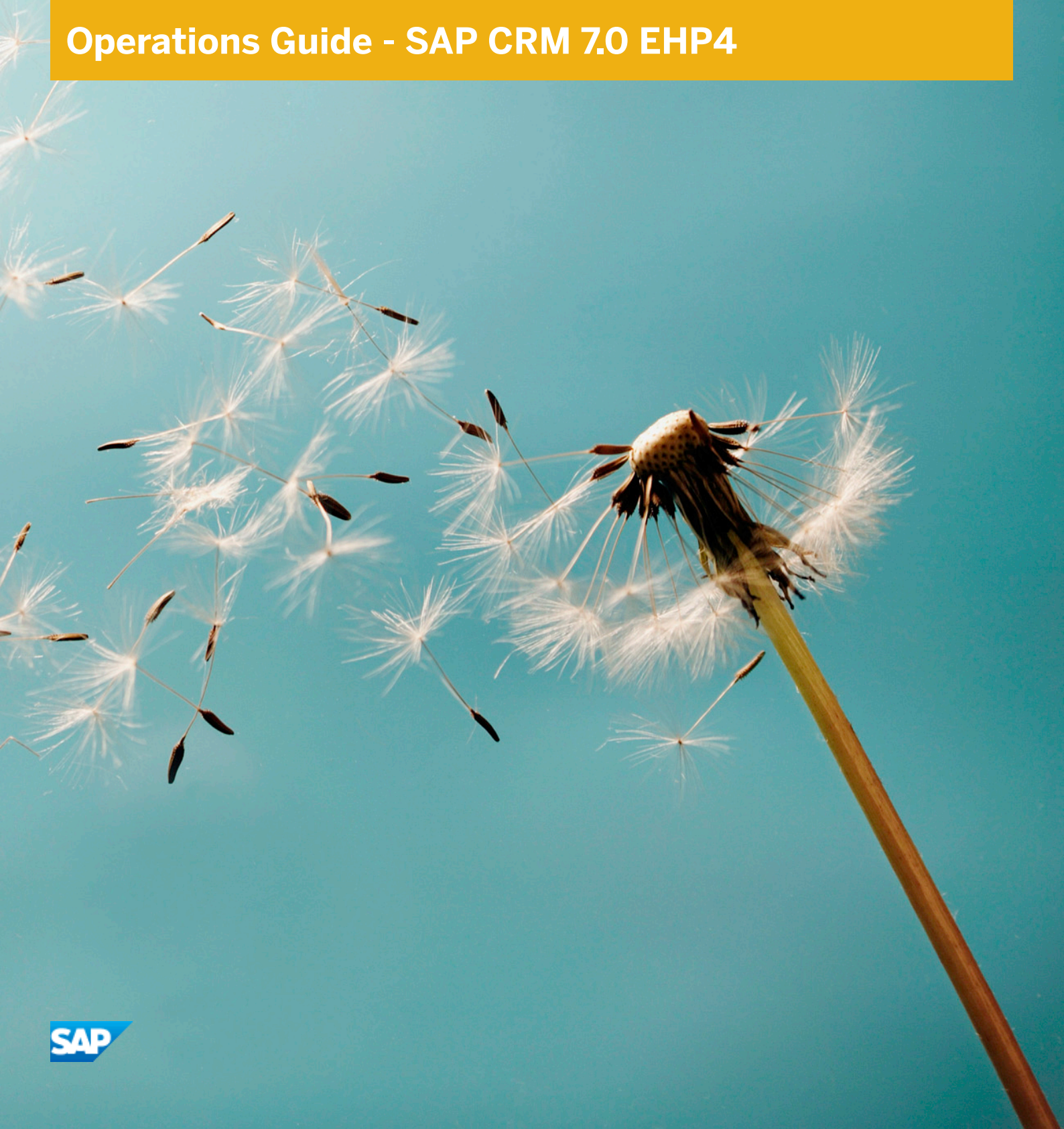

Content

1	Document History	5
2	Getting Started	6
2.1	About this Guide	6
2.2	Global Definitions	7
3	Technical System Landscape	8
3.1	Related Documentation	8
4	Monitoring of SAP CRM	10
4.1	Alert Monitoring with CCMS	10
	CCMS Monitoring Installation and Setup	11
	Alert Monitoring of Components	11
	Scenario Alert Monitoring	16
4.2	Detailed Monitoring and Tools for Problem and Performance Analysis	17
	CRM Server Analysis Tools	17
5	Management of SAP CRM	64
5.1	Administration Tools of Software Components	64
	BW Adapter	64
	Web Channel and Partner Channel Management Components	65
	Interaction Center	66
5.2	Starting and Stopping	68
5.3	Backup/Restore and Recovery	69
	Backup and Recovery in an SAP CRM System Landscape	70
	Step-By-Step Procedure	78
5.4	System Copy	83
	SAP NetWeaver Application Server	83
	Interaction Center	83
5.5	Periodic Tasks	84
	Scheduled Periodic Tasks	84
	Required Manual Periodic Tasks	92
5.6	Logon and Load Balancing	94
5.7	User Management	95
6	High Availability	99
6.1	Web Channel and Partner Channel Management	99
6.2	Interaction Center	101

7	Software Change Management.	102
7.1	Transport and Change Management.	102
	Web Channel and Partner Channel Management.	102
7.2	Development Requests and Development Release Management.	103
	Web Channel and Partner Channel Management.	103
7.3	Template Management.	103
7.4	Support Packages and SAP Notes Implementation.	103
7.5	Release and Upgrade Management.	104
8	Troubleshooting.	105
8.1	CRM Middleware.	105
8.2	Mobile Laptop Solution - Export Import Manager.	106
	Overview.	106
	Common Problems & Solutions.	106
8.3	Groupware Connector.	107
8.4	Interaction Center.	107
	E-Mail.	107
	Simplified ABAP Messaging (SAM).	108
	SAPphone.	108
	Mandatory SICF Services.	108
8.5	Loyalty Management.	108
8.6	Supportability Tools.	109
	ARS DB Consistency Checker.	109
	BOL Tester.	110
	Diagnostics Mode.	111
	Environment Analyzer Report Analyzer Tool.	111
	Environment Check Modeler Tool.	112
	Metadata Consistency Checker.	114
	Runtime Analyzer - BO Browser.	116
	Runtime Analyzer - Trace Viewer.	116
9	Support Desk.	118
10	Industry-Specific Scenarios.	119
10.1	Utilities.	119
	Scenario Alert Monitoring.	119
	Scenario-Specific Problem Analysis Tools.	122
	Troubleshooting.	126
10.2	Financial Services.	127
	Business Partner Data Management.	127
	Account Origination.	129
10.3	Public Sector.	134

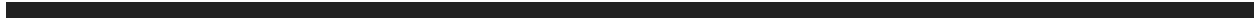

- Scenario Social Case Management. 134
- Service Processes for Grantor Management. 138
- 10.4 Provider Order and Contract Management. 140
 - Scenario Sales and Order Management. 140
- A Appendix. 147**
- A.1 Related Information. 147

1 Document History

Table 1: Document History

Version	Date	Description
1.0	2016-01-20	First Version

2 Getting Started

Caution

This guide does not replace the daily operations handbook, which we recommend to customers for creating their specific productive operations.

SAP Fiori Apps

For information about SAP Fiori apps for SAP CRM, see SAP Help Portal at <http://help.sap.com/crm>. Choose a release and then *Application Help*.

2.1 About this Guide

Designing, implementing, and running your SAP applications at peak performance 24 hours a day has never been more vital for your business success than now.

This guide provides a starting point for managing your SAP applications and maintaining and running them optimally. It contains specific information for various tasks and lists the tools that you can use to implement them. This guide also provides references to the documentation required for these tasks, so you will sometimes also need other Guides such as the Master Guide, Technical Infrastructure Guide, and SAP Library.

Target Groups

- Technical Consultants
- System Administrators
- Solution Consultants
- Business Process Owners
- Support Specialists

2.2 Global Definitions

SAP Application

A SAP application is an SAP software solution that serves a specific business area like ERP, CRM, PLM, SRM, and SCM.

Business Scenario

From a microeconomic perspective, the business scenario is a cycle that consists of several different chronological and logical processes affiliated with each other. Typically, a business scenario covers several company departments and could involve other business partners. From a technical point of view, a business scenario needs at least one or more SAP application components (such as SAP ERP, SAP APO) for the cycle, and possibly other third-party systems. A business scenario is a unit that can be implemented and that has releases. A business scenario represents a course of business from the customer's perspective.

Component

A component is the smallest individual unit considered within the Solution Development Lifecycle; components are separately produced, delivered, installed and maintained.

Usage Type and Product Instance

As of software provisioning manager 1.0 SP07 (SL Toolset 1.0 SP12), the term "product instance" replaces the term "usage type" for SAP systems based on SAP NetWeaver 7.3 including enhancement package 1 and higher. Note that there is no terminology change for older releases and the mentioned terms can be used as synonyms.

3 Technical System Landscape

The Master Guide for SAP CRM contains information about the technical system landscape and the technical components needed for a specific scenario. The guide is published on SAP Service Marketplace at <http://service.sap.com/crm-inst>.

3.1 Related Documentation

The following table lists sources of more information about the technical system landscape:

Table 2:





Content	Location on SAP Service Marketplace
Technical Configuration	Master Guide (http://service.sap.com/crm-inst) <choose release> > Plan >
Sizing	http://service.sap.com/sizing http://service.sap.com/quicksizer
Security Map Application Security Guide	http://service.sap.com/security http://service.sap.com/securityguide
High Availability	Master Guide (http://service.sap.com/crm-inst) <choose release> > Plan >
Performance	http://service.sap.com/performance
SAP Solution Manager	http://support.sap.com/solutionmanager

Further Useful Links

The following table lists further useful links on SAP Service Marketplace:

Table 3:

Content	Location on SAP Service Marketplace
SAP Support Portal	http://support.sap.com

Content	Location on SAP Service Marketplace
SAP Notes search	http://support.sap.com/notes 
SAP Software Distribution Center (software download and ordering of software)	http://support.sap.com/swdc 
SAP Online Knowledge Products (OKPs): Role-specific learning maps	http://service.sap.com/rkt 
Guide Finder for Technical Documentation in SAP NetWeaver	http://service.sap.com/guidefinder 

4 Monitoring of SAP CRM

Monitoring is an essential task within the management of SAP Technology. For more information about the underlying technology, see SAP Help Portal at http://help.sap.com/nw_platform >> <choose release> > *System Administration and Maintenance Information* > *Technical Operations for SAP NetWeaver* > *Administration of SAP NetWeaver Systems* >.

For information about industry-specific monitoring tasks and tools, see the section *Industry-Specific Scenarios*.

4.1 Alert Monitoring with CCMS

Proactive automatic monitoring is the basis for ensuring reliable operations for your SAP system environment. SAP provides you with the infrastructure and recommendations needed to set up your alert monitoring to recognize critical situations for SAP CRM as quickly as possible.

SAP CRM is technically based on SAP NetWeaver Application Server, and reuses SAP NetWeaver monitoring tools such as the Computing Center Management System (CCMS).

The following predefined component and scenario monitors are available for SAP CRM:

Component Monitors

Component monitor: CRM Appl Server ABAP

Component monitor: CAT Server

Component monitor: CRM Middleware

Component monitor: CRM Middleware

Component monitor: E-Selling

Component monitor: E-Service

Component monitor: IC Web Client

Component monitor: IC Workforce Management

Component monitor: Intelligence Connector

Component monitor: Software Agent Framework

Component monitor: TREX

J2EE Applications by Server

Scenario Monitoring Templates

The following scenario monitoring templates are available:

- CRM E-Service Monitor template
- CRM Field Applications Monitor template
- CRM Interaction Center Monitor template
- CRM Marketing Monitor template
- CRM Partner Channel Monitor template
- CRM Sales Monitor template
- CRM Service Monitor template

4.1.1 CCMS Monitoring Installation and Setup

CCMS provides a flexible infrastructure, which permits the monitoring of an entire landscape centrally and reports problems quickly and reliably. The architecture can be easily extended to include additional SAP and non-SAP components.

We recommend that you set up the monitoring infrastructure as described in the following documents:

Application Server for ABAP

http://help.sap.com/nw_platform >> <choose release> > System Administration and Maintenance Information > Technical Operations for SAP NetWeaver > Administration of SAP NetWeaver Systems > Administration of Application Server ABAP > Monitoring and Administration Tools for Application Server ABAP >

Application Server for Java

http://help.sap.com/nw_platform >> <choose release> > System Administration and Maintenance Information > Technical Operations for SAP NetWeaver > Administration of SAP NetWeaver Systems > Administration of Application Server Java (AS JAVA) > Monitoring >

In order to enable the auto-alert mechanism of CCMS, see SAP Note [617547](#).

4.1.2 Alert Monitoring of Components

You can use CCMS monitoring to monitor the following components:

- CRM Middleware (CRM Server)

- CRM Appl Server ABAP
- CRM Appl Server Java
- IC Web Client
- IC Workforce Management
- VM Container
- TREX

To enable the auto-alert mechanism of CCMS, see SAP Note [617547](#).

For more information about predefined monitors for the alert monitor, see SAP Help Portal at http://help.sap.com/nw_platform >> <choose release> > *System Administration and Maintenance Information* > *Technical Operations for SAP NetWeaver*. Search for the following topics:

- “Central Monitoring”
- “Alert Monitor”
- “Alert Configuration”
- “Configuring the CCMS Alert Monitor”
- “CCMS Alert Monitor”

4.1.2.1 CRM Application Server ABAP

Use

This component is based on SAP NetWeaver Application Server.

i Note

CCMS integration is not available for the ABAP MapBox. However, there is an application logging mechanism, which logs all errors and traces during processing in ABAP MapBox.

To activate application logging, perform the following: In table `ISPCFG`, for parameter `CRM_MAPBOX`, maintain the parameter value 2 and enter **x**.

The monitor template for this component can be used for local monitoring. To monitor the component centrally, create a monitor-set using the following monitor tree elements that are available for local monitoring:

- H7L\p246204_H7L_00\...\OperatingSystem\...
- H7L\p246204_H7L_00\...\DatabaseClient\...
- H7L\p246204_H7L_00\...\R3Service\...
- H7L\p246204_H7L_00\...\R3BasisSystem\...
- H7L\p246204_H7L_00\...\R3Abap
- H7L\p246204_H7L_00\...\R3Syslog
- H7L\p246204_H7L_00\...\VM Container\...
- H7L\p246204_H7L_00\...\Security
- H7L\p246204_H7L_00\...\InstanceAsTask
- H7L\p246204_H7L_00\...\Server Configuration

- H7L\p246204_H7L_00\...\Web Service ABAP\...
- H7L\p246204_H7L_00\...\Web Dynpro ABAP

i Note

Use the central monitoring system that is recommended for the SAP NetWeaver release on which your SAP CRM installation runs.

More Information

SAP Help Portal at http://help.sap.com/nw_platform > > <choose release> > *System Administration and Maintenance Information* > *Technical Operations for SAP NetWeaver* >.

4.1.2.2 CRM Middleware

This component is based on SAP NetWeaver Application Server. For more information, see SAP Help Portal at http://help.sap.com/nw_platform > > <choose release> > *System Administration and Maintenance Information* > *Technical Operations for SAP NetWeaver* >.

The CRM Middleware (CRM MW) Alert Monitor monitors the most important CRM Middleware processes and generates alerts when critical situations arise. It is based on the SAP CCMS Alert Monitoring Infrastructure, which allows sending of information about alerts through the mail interface of SAP systems.

The monitor can be called via transaction `RZ20` and is available under the monitor collection "SAP CRM Monitor Templates" with the name *CRM Middleware*.

The CRM MW Alert Monitor monitors the following:

- CRM MW -specific qRFC queues in the SAP CRM system
- CRM MW -specific qRFC queues in the SAP ERP backend system
- The qRFC QIN scheduler of the SAP CRM system
- The qRFC QOUT scheduler of the SAP CRM system
- The processing status of messages in the BDoc message flow
The following monitors are relevant for the scenario Field Applications only:
- The replication & realignment queues and the R&R queue demon
- Status of the Communication Station

CRM-Specific qRFC Monitors

SAP delivers the following qRFC groups for CRM MW:

Table 4:

CRM Queue Groups Outbound Queues	Description Outbound Queues
CDB*	Start queues for loads CRM -> CDB
CRM_SITE*	Load queues for Mobile Clients
CSA*	Send queues of CRM Server Applications
EXT*	Start queues for loads CRM -> Ext.
R3AI/R*	Start queues for loads from ERP backend system
R3AU*	Load queues CRM -> ERP backend system

Table 5:

CRM Queue Groups Inbound Queues	Description Inbound Queues
CRI*	Initial load queues CRM -> CDB
CRM_SITE*	Load queues from Mobile Clients
R3A*	Load queues ERP backend -> CRM
CSA*	Send inbound queues of CRM Server Applications

The queue groups are active for all clients in the system except '000' and '066'. Alerts are triggered in the case of **blocked queues** or a **high number of queue entries**, except for the CRM_SITE* (Mobile Client) outbound queues (in this case, the age of the queue is monitored). Thresholds are listed in the next section.

Customizing the CCMS qRFC Monitors

It is possible to add new queues or change the thresholds for the existing queues.

- To monitor specific qRFC queues, use both the SAP Basis Infrastructure and customizing of queue groups.
- To customize qRFC queues for monitoring use transaction RZ21 → [Technical Infrastructure](#) → [Configure qRFC monitoring](#) (Transaction SM34 → View Cluster QRFC_MONITORING_E).
- Create client-specific monitoring nodes for the queue, that is, for every client there is a node for the corresponding queue group. The analysis methods that are assigned are logical names of methods. You can display the definition using transaction RZ21 → [Method definitions](#).

For every node, there are two exit function modules with respect to faulty queues:

- Exit function module SALK_CRM_QRFC_QUEUE_ENTRIES creates an additional node, which monitors the number of entries in a queue, or the queues of a queue group.

Table 6:

Alert	Threshold values for inbound queues	Threshold values for outbound queues
For a yellow alert	5,000	500,000
For a red alert	10,000	1,000,000

- Exit function module `SALK_CRM_QUEUE_AGE` creates an additional node, which monitors the age of the queues. An alert is triggered, as soon as the oldest entry of a queue is older than 7 days. This standard value can be changed for a queue group, by specifying the parameter `Maximum_Queue_Age` and a corresponding value in the fields *Exit Parameter* and *Parameter Value*.

Monitoring the Communication Station

This is used in only in field application. It helps enable data transfer between the SAP CRM Server and the CRM mobile client. Alerts are triggered when the communication station is not running (programs are corrupt), when the machine on which it is installed is down, or if network connection cannot be established.

4.1.2.3 CRM Application Server Java

This component is based on SAP NetWeaver AS Java.

For more information about SAP NetWeaver Java Monitoring, see section [Java Monitoring and Management \[page 40\]](#).

You can set up scenario-specific monitors for the Web applications. For information, see section [Scenario Alert Monitoring \[page 119\]](#).

4.1.2.4 Interaction Center

TREX

For more information about TREC-based functions such as search and classification, and knowledge articles, see SAP Help Portal at http://help.sap.com/nw_platform >> <choose release> >. In the application help, search for "Monitoring TREC with CCMS".

SAPconnect

For more information, see SAP Help Portal at http://help.sap.com/nw_platform >> <choose release> >. In the application help, search for “Alert Monitor for SAPconnect”.

SAPphone

For more information, see SAP Help Portal at http://help.sap.com/nw_platform >> <choose release> >. In the application help, search for “Alert Monitor for SAPphone”.

4.1.3 Scenario Alert Monitoring

In addition to the required monitoring of each component, some other monitoring objects are designed to monitor cross-component communications, and other scenario-specific critical situations.

Caution

A description is provided, only if specific alert monitoring for scenarios is available in addition to the standard scenario monitors.

The following standard scenario monitors are available:

Table 7:

Scenario	Component Monitor
CRM Marketing	TREX CRM Application Server ABAP
CRM Sales	CRM Middleware J2EE Engine CRM Application Server ABAP
CRM Service	TREX CRM Middleware CRM Application Server ABAP
CRM Interaction Center	CRM Middleware CRM Application Server ABAP

Scenario	Component Monitor
CRM Field Applications	CRM Appl Server ABAP CRM Middleware IC WebClient VM Container
CRM Partner Channel Management	E-Selling TREX CRM Middleware J2EE Engine CRM Application Server ABAP

4.1.3.1 Lead Management in Partner Channel Management

For external Lead Dispatching, a workflow is started if an error-free lead is dispatched to a channel partner. The sales partner is set to a channel partner and the status is set to *Dispatch to Sales Partner*.

For more details, see *Workflow Monitoring* (transaction: CRMD_BUS2000108 or SWI14).

4.2 Detailed Monitoring and Tools for Problem and Performance Analysis

4.2.1 CRM Server Analysis Tools

The CRM Server is technically based on SAP NetWeaver Application Server. For more information about database, operating system, workload analysis, and so on, see SAP Help Portal at http://help.sap.com/nw_platform

► <choose release> ► *System Administration and Maintenance Information* ► *Technical Operations for SAP NetWeaver* ►.

This guide covers only differences and additional information specific to this solution.

Table 8: CRM Server Central Monitoring Activities / Functions

CRM Server Central Monitoring Activities / Functions	Monitoring Tool (Transaction)	Monitoring Frequency Periods and Events
<p>Monitoring Cockpit</p> <p>This is the CRM Middleware (MW) centralized monitoring tool that must be used by the administrator. It is based on CCMS qRFC monitoring.</p> <p>For more information, see CRM Log Objects and Subobjects for SAP NetWeaver AS ABAP [page 20]</p> <p>You can use transaction SLG1 to analyze object and subobject logs for SAP CRM ABAP-based components. This also includes CRM UI specific logs. To see a complete list of the logs available for SAP CRM, enter CRM* in the <i>Object</i> field.</p> <p>See also Monitoring Cockpit (Generic) [page 25].</p>	<p>SMWP</p>	<ul style="list-style-type: none"> • Several times a day depending on the business process • After implementing the support package • After new transports related to changes of BDoc types, replication objects, or publications
<p>qRFC Outbound Queue Monitor:</p> <p>Monitors data transfer between the ERP backend and the CRM Server, between the CRM Server and mobile clients, and other connected systems.</p>	<p>SMQ1 / SMWP / RZ20</p>	<ul style="list-style-type: none"> • Use of alert monitoring • Several times a day, depending on the business process
<p>QOUT Scheduler</p> <p>Ensures that all destinations are registered. Only destination NONE must be excluded. See also SAP Notes 400330 and 480543.</p>	<p>SMQS / SMWP / RZ20</p>	<ul style="list-style-type: none"> • Use of alert monitoring • In case of performance problems or error messages
<p>qRFC Inbound Queue monitor:</p> <p>Monitors data transfer between the ERP Backend system and the CRM Server, between mobile clients and the CRM Server, and all other queues that must be stored in the CRM Online DB.</p> <p>Monitors data transfer between CRM Online and the CDB (field application only) or other data receivers (ERP adapter or Groupware adapter).</p>	<p>SMQ2 / SMWP/ RZ20</p>	<ul style="list-style-type: none"> • Use of alert monitoring • Several times a day, depending on the business process

CRM Server Central Monitoring Activities / Functions	Monitoring Tool (Transaction)	Monitoring Frequency Periods and Events
<p>QIN Scheduler Status</p> <p>This transaction runs the scheduler to check the inbound queues on the CRM Server,</p>	SMQR / SMWP / RZ20	<ul style="list-style-type: none"> • Use of alert monitoring • In case of performance problems
<p>Message Flow Statistics</p> <p>This is a performance monitor. It collects statistical data about the workload on the CRM Server caused by BDoc messages.</p> <p>Use this as a starting point for analyzing performance problems.</p> <p>It ensures that the CRM Middleware message flow statistics are switched on</p>	SMWMFLOW	<ul style="list-style-type: none"> • In case of performance problems during message processing
<p>BDoc Messages/Summary</p> <p>Monitors the status of the BDoc messages and detects the application or customizing errors during data exchange.</p> <p>SMW01: Displays BDoc message content and possible validation or receiver errors</p> <p>SMW02: Displays BDoc message summary in dependency on the sender site ID</p> <p>SMW02a: Groups BDoc messages according to validation or receiver errors</p> <p>SMW03: Displays cross-client BDoc message summary</p>	SMW01 / SMW02 / SMW02A / SMW03	<ul style="list-style-type: none"> • Use of automatic notification mechanism by error handler SMW00 • Several times a day, depending on the business process • In case of an error message • Before applying support packages
<p>Check Flow Definitions</p> <p>Only after changes in the customizing</p> <p>Consistency check for Flow Definitions</p>	SMO8FD	After BDoc type changes or changes in services or in the message flow

Table 9: CRM Server ERP Adapter / Load Monitoring Activities / Functions

CRM Server ERP Adapter / Load Monitoring Activities / Functions	Monitoring Tool (Transaction)	Monitoring Frequency Periods and Events
Monitor Load Status Checks whether the initial load was successfully completed	R3AM1 or SMWP Runtime Information -> Adapter Status Information -> Initial Load Status	During/after initial load
Monitor Request Used in certain cases to ensure the consistency for specific instances of business objects between a source and target database (ERP backend, CRM, CDB, and others)	R3AR3 or SMWP Runtime Information -> Adapter Status Information -> Request Status	In case of an error message, if the databases are not consistent and a request from the ERP Backend, CRM, or the CDB is necessary
Check Object Types from Administration Console Checks subscriptions, replication objects, publications, interlinkages, sites, and subscription agents	SMOECK	After new replication objects or publications are created or transported

4.2.1.1 Log Objects and Subobjects for CRM Application Server ABAP

You can use transaction `SIG1` to analyze object and subobject logs for SAP CRM ABAP based components, this also includes CRM UI specific logs. To see a complete list of the logs available for SAP CRM, enter **CRM*** in the *Object* field.

Log Objects and Subobjects

Table 10:

Object	Object Text	Grouping	Subgrouping
CRM_ES	None	Analytics	None
CRM_OR	CRM Interactive Reporting	Analytics	None
CRM_OR_RT	CRM OLTP Report	Analytics	None

Object	Object Text	Grouping	Subgrouping
BEA	Billing Engine Application	Basic Functions	None
BEF	Billing Engine Framework	Basic Functions	None
CMW_MBX	Mapbox	Basic Functions	None
CMW_MBX_MIGR	Mapbox Migration	Basic Functions	None
CRM_ACE	None	Basic Functions	None
CRM_BSP	CRM Blueprint Applications	Basic Functions	None
CRM_DAM	CRM Digital Asset Management	Basic Functions	None
CRM_DAM_INT	None	Basic Functions	None
CRM_DATAARCHIVING	CRM: Data Archiving	Basic Functions	None
CRM_DOCUMENT	CRM One Order Document	Basic Functions	None
CRM_EEWA	None	Basic Functions	None
CRM_LOG	None	Basic Functions	None
CRM_MPK	Measuring Point Kernel	Basic Functions	None
CRM_PRT_TEL	CRM Portal Telephony Integration	Basic Functions	None
CRM_UI_PFCG_ROLE	CRM UI PFCG Role	Basic Functions	None
CRMWST	None	Basic Functions	None
CRMXIF	CRM External Interfaces	Basic Functions	None
CRM_IFS	None	Industries	Financial Services
CRM_PROD_FS	Financial Service Product	Industries	Financial Services
CRM_FIMAN_INT_RECALC	CRM FIMA Correction Report for Interest	Industries	Leasing
CRM_LAM	Leasing and Asset Management	Industries	Leasing
CRM_LEAS_MASS	Leasing Mass Change Processes	Industries	Leasing
CRM_PROD_FIN	Financing Product	Industries	Leasing

Object	Object Text	Grouping	Subgrouping
CRM_IPM	Media: Intellectual Property Management	Industries	Media
CRM_NM	Pharma: Notification Manager	Industries	Pharma
CRM_EVT	SSE (Social Services Eventing)	Industries	Social Services
CRM_PS_4S_3	Social Services Migration object	Industries	Social Services
CRM_PS_4S_BRFP	None	Industries	Social Services
CRM_ISX	None	Industries	Telecommunications
CRM_IJUDIT_ERRORLOG	Bal Log object for CRM Utilities DIT	Industries	Utilities
CRM_CLM	Call List Management in CRM	Interaction Center	None
CRM_IC_EVENT	None	Interaction Center	None
CRM_SMF	Service Management Framework	Interaction Center	None
CRM_ALLOC	None	Marketing	None
CRM_DEDUP	None	Marketing	None
CRM_ELM	External List Management	Marketing	None
CRM_LEADIF	None	Marketing	None
CRM_MAIL	Object for Marketing Mail Forms	Marketing	None
CRM_PRODASSOCRULE	Marketing Product Association Rule	Marketing	None
CRM_SEG	CRM Segmentation	Marketing	None
CRM_SEGMOD	None	Marketing	None
CRM_TGGRP	Marketing Target Group	Marketing	None
CRM_TOPN	Top N Messages	Marketing	None
CRMLOY	Loyalty Programs	Marketing	None
CRM_MKT	None	Marketing	None

Object	Object Text	Grouping	Subgrouping
CRM_MKTB	Marketing Bounce Management	Marketing	None
CRM_MKTBP	Marketing Features	Marketing	None
CRM_MKTPL	Marketing Planning	Marketing	None
CRM_MKTSAPR	None	Marketing	None
CRM_MKTSC	None	Marketing	None
COM_PRODUCT_CATALOG	Product Catalog	Master Data	None
CRM_BP_ASS	CRM Rule-Based Assignment of Employees Responsible	Master Data	None
CRM_BUPA	CRM Business Partner	Master Data	None
CRM_BUPA_HIERARCHY	CRM Business Partner Hierarchy	Master Data	None
CRM_CONDITION	None	Master Data	None
CRM_MDM_LOG	None	Master Data	None
CRM_PRODUCT_MAINTAIN	Maintain Product Master Data	Master Data	None
CRM_PRODUCTS_UPLOAD	None	Master Data	None
CRM_PRP	Partner/Product Selections	Master Data	None
CRM_TERR	None	Master Data	None
CRM_ICM	CRM: Incentive and Commission Management	Other	Incentive & Commission Management
CRM_PPM	Pipeline Performance Management	Other	Pipeline Performance Management
CRM_WEB	Gift Card Certificates	Other	Web Channel
CMS	None	Partner Channel Management	None
CMS_CB	Chargeback	Partner Channel Management	None
CMS_CI	Price Buckets Maintenance	Partner Channel Management	None
CMS_CIR	Channel Inventory Reconciliation	Partner Channel Management	None
CMS_CM	Master Data Cascade	Partner Channel Management	None

Object	Object Text	Grouping	Subgrouping
CMS_DRGN	None	Partner Channel Management	None
CMS_IR	Inventory Report Processing	Partner Channel Management	None
CMS_PP	Price Protection	Partner Channel Management	None
CMS_PRODUCT	None	Partner Channel Management	None
CMS_REV_REG	None	Partner Channel Management	None
CMS_RTCM	Resale and Claim Message Processing	Partner Channel Management	None
CMS_SI	Sales/Billing to Channel Partners	Partner Channel Management	None
CMS_TO	Transmission Report	Partner Channel Management	None
CRM_CHM_TG	None	Partner Channel Management	None
CRM_DD	None	Partner Channel Management	None
CRM_R4XP	Request for Corporate Family Member and Third Party Resource	Partner Channel Management	None
CRM_APO	CRM / APO Integration	Quotation & Order Management	None
CRM_CFG_SC	None	Quotation & Order Management	None
CRM_CREDIT_WB	None	Quotation & Order Management	None
CRM_DNL_PLANT	Download from plants from ERP to CRM	Quotation & Order Management	None
CRM_CASE	CRM Case Management	Service	None
CRM_CAT	CRM Multilevel Categorization	Service	None
CRM_DWP	CRM: Dispatchers Workplace	Service	None
CRM_MASS_CP	None	Service	None
CRM_UBB	UBB Usage-Based Billing	Service	None
CRM_WTY	Warranty processing	Service	None

Object	Object Text	Grouping	Subgrouping
CRM_CLA_BILL_UPD	None	Trade Promotion Management	None
CRM_CLA_CPP	None	Trade Promotion Management	None
CRM_CLA_CSD	None	Trade Promotion Management	None
CRM_CLA_CSR	None	Trade Promotion Management	None
CRM_FM_ACL	None	Trade Promotion Management	None
CRM_FM_BPO_RULE	None	Trade Promotion Management	None
CRM_FM_FND	None	Trade Promotion Management	None
CRM_FM_FPO	Fund Management Posting	Trade Promotion Management	None
CRM_FM_FPO_AGR	None	Trade Promotion Management	None
CRM_FM_LRTP	None	Trade Promotion Management	None
CRM_TPM_AGR	None	Trade Promotion Management	None
CRM_TPM_PPG	None	Trade Promotion Management	None
CRM_TPM_STATUS	None	Trade Promotion Management	None
CRM_CC_PT	None	None	None
CRM_SOCM	Change Request Management	None	None

4.2.1.2 Monitoring Cockpit (Generic)

This is the central CRM Middleware monitoring tool and is based on CCMS qRFC monitoring (transaction `SMWP`). This is the administrator's main tool and replaces all Middleware-specific tools described in this document.

In addition, it displays the status of background jobs and important system settings associated with the data exchange between CRM, CDB, ERP, and mobile clients.

The monitoring cockpit displays the status of the different CRM Middleware processes associated with the components involved (CRM, ERP, mobile clients). To ensure that the business processes and the technical data exchange are working correctly, you must ensure that the traffic light is green for the different parts of the monitoring cockpit. If the traffic light is yellow, it indicates a warning or information.

Generation Information

The generation of the different services, structures, replication, publication, and other objects is cross-client.

The generation can be started in the following cases:

- Initial setup of the system/client
- After applying a support package
- After modifying a BDoc type
- After creating a publication or replication object in the Administration Console
- After a change to a BDoc/replication or publication is transported from a source system (from development system to test system or production system)
- By executing a program

Table 11:

Node	Description
Status of generation processes	<p>Transaction <code>GENSTATUS</code> displays the list of generation processes that are still waiting to be started, or are already in error status. This tool also monitors the generation process in the other CRM server. You can then monitor your development, test, and production CRM servers in the same monitoring cockpit.</p> <p>For troubleshooting of the reported generation errors: double-click the line item and you get the list of detailed generation logs in the right-hand frame.</p>
BDoc types: generation of structures	<p>If there are structures that are not generated successfully, double-click the corresponding node and you get the list of the BDoc types. The structures are the segment structures of a BDoc type. Start the BDoc Modeler, and check the BDoc type and the corresponding generation log.</p>
BDoc types: generation of other runtime objects	<p>Other runtime objects are the different flow services, and other related generated function modules. By double-clicking the node <i>Not generated / generated with errors</i> the list of the BDoc types with erroneous services is displayed.</p>

Node	Description
Replication objects per industry: runtime objects	<p>This displays the status of the generation of the extract, replication wrapper, and realignment services.</p> <p>It is possible to use different industry templates on one CRM server. Therefore, on each client, you can use only one unique industry template. For each of these templates and for a specific replication object (listed in transaction <code>SMOEAC</code>), there are some runtime objects that are generated. This is performed after a new replication object is created, modified, or transported from another CRM server.</p>
Publications per industry: runtime objects	<p>When a publication is created, modified, or transported, the generation of function groups and function modules starts. Double-click <i>Not generated / generated with errors</i> if some entries are reported. It is possible that the error occurred due to a problem during the transport of data, or with the replication objects.</p>
Missing indexes	<p>Based on the implementation of the different flow services and with respect to the kind of the replication model, some indexes for the CDB tables are proposed.</p>

Runtime Information

Message Processing Active

This information is cross-client. The traffic light is red if message processing is set to *No*, and green if message processing is set to *Yes*. The message processing is set to *No*, if the generation or last upgrade was not completed successfully.

If the message processing is *No*, no BDoc messages are created, all the CRM online transactions are cancelled, and all delta changes coming from the ERP backend system remain in the R3A* inbound queues, with the status *SYSFAIL*.

Data Exchange using qRFC Queues

The qRFC queues are important to ensure that the data is transferred correctly within the CRM system landscape. These queues are used between the ERP backend system and the CRM server, CRM and mobile clients, and CRM and MapBox (Groupware). All these queues must either be monitored actively, or the alert monitoring of CCMS must be used to ensure that the administrator is informed about stopped or failed queues.

If the red traffic light appears for one of these queues, you have to double-click the corresponding node to determine the cause of the error. All queues that enable data exchange between CRM, ERP, and mobile clients, are included in the monitoring cockpit. The status information is related to the queue groups listed in the section *CRM-Specific qRFC Monitors* under [CRM Middleware \[page 13\]](#), and is provided by the CCMS Monitoring methods.

Adapter Status Information

Initial Load Status

This status reflects the information provided by transaction R3AM1. This information is client-specific. Start the Monitoring Cockpit on each productive client on your CRM Server.

Table 12:

Node	What the Node Displays
Waiting objects	<p>The number of objects in waiting status during the initial load.</p> <p>In the field <i>Additional Information</i>, you can find more information about the reason for the waiting status.</p> <p>You can choose to cancel this load by clicking the icon <i>Cancel</i> and then restart the initial load for this business object (if this is allowed by your CRM business team).</p>
Running objects	<p>The list of the objects for which the initial load has not been completed successfully.</p> <p>Check whether there are still queues related to that initial load (example: the inbound queue CRI* could be in status <i>SYSPFAIL</i>, and the status of the initial load of that object from CRM to CDB is then <i>running</i>. In this case, the reason for the sysfail must be found and resolved).</p> <p>If no queues are displayed, check whether there are any open BDoc messages in <i>SMW01</i> related to that load that are in error state (example: E04 for initial load from ERP to CRM).</p>
Processed objects	<p>The list of successful initial loads.</p>
Aborted objects	<p>This node displays the list of the objects for which the initial load or request has been cancelled manually by an end user. The load had status <i>Running</i> or <i>Wait</i>. The corresponding BDoc messages can be found in transaction <i>SMW01</i>: use queue name or context MO3 or MI0, the and receiver/sender site.</p>
Waiting inactive objects	<p>These are objects that are not marked as not active on the CRM server, and for such objects it is no longer possible to start an initial load.</p>
Running inactive objects	<p>These are objects that are not marked as not active on the CRM server, and for such objects it is no longer possible to start an initial load.</p>

Request Status

Table 13:

Node	What the Node Displays
Waiting objects	Same as initial load.
Running objects	Same as initial load. Requests are defined in R3AR2, can be started with transaction R3AR4, and are monitored with transaction R3AR3. You can start the request several times and for each run you can find one entry in the request monitor. Requests can remain in running state, because the corresponding R3AR* queue is still running (outbound queue direction ERP to extract the data from ERP, or inbound queue from ERP to CRM, or from CRM to CDB). It is possible that the queue has been deleted manually. In this case, you can 'cancel' this request (after agreement from the CRM business team).
Processed objects	Displays the list of requests that were successful (from a technical point of view). It is still possible that no data has been transmitted (you can see the block size).
Aborted objects	Same as for initial load. It is necessary to delete the related queues and BDoc messages.

Inactive Objects

The table SMOFBJPAR contains dependencies between objects. The child object can be loaded only if the parent object is active.

The different object types are displayed in R3AC1, R3AC3, and R3AC5. Setting the flag *Inactive* in the corresponding maintenance transaction can deactivate these objects.

This SMWF node informs you about inactive objects, which are also defined as parent objects.

Table 14:

Node	What the Node Displays
With active child objects	Traffic light is green: there are no inactive parent objects with active child objects. Traffic light is red: Check whether it makes sense to activate the parent object — you may also have to deactivate the corresponding child objects, or else any type of load will not be successful.
Without active child objects	Since this is not an error situation, information is displayed only to show if there are any objects that do not have any active child objects.

Parameters in ERP Backend(s)

The sites for the ERP backend systems are defined in the Administration Console (SMOEAAC). This is also client-specific information. For each site, the following information is displayed and evaluated (data is gathered from the ERP backend system through an RFC connection).

The meaning of the different entries in CRMRFPCPAR can be found in SAP Note [0510192](#).

Table 15:

Node	What the Node Displays
Entries with RFC destination for the local CRM system	Check if an entry related to the current CRM Server (RFC connection) exists. If the traffic light is red, read the documentation of the IMG step to enter the right RFC connection.
CRM default entry for object load from ERP backend	Green: CRM is entered as consumer in table CRMRFPCPAR and this is valid for all the object types in ERP and for all the download types. This indicates that each change in ERP must be sent to CRM. Exception: if filters have been defined, or other more specific entries are made in CRMRFPCPAR.
XML active for object load from ERP backend	This parameter determines the format in which the data must be transferred from ERP to CRM. SAP Notes 442277 and 487229 explain in which cases, and as of which release, this transfer mode can be used. Yellow – not all objects use XML Green – all objects use XML
Use CRM inbound queues for object load from ERP backend	If this flag is set, the inbound queue in the target system must be used. This is the recommended standard response if a CRM server is linked. Yellow – not all objects use inbound queues Green – all objects use inbound queues
Entries in table CRMPAROLTTP	The number of entries in table CRMPAROLTTP, where CRM is consumer (or user as it is displayed in the maintenance view). This table contains settings that provide measures for performance improvements or additional options in Support Packages. See SAP Note 350176 for more information.

ERP Backend System Parameter Settings

The parameters for data exchange with an ERP backend are defined in tables CRMCONSUM (IMG) and CRMRFPCPAR in the ERP backend. These tables are customized during system installation and are normally not changed during system operations. The CRMRFPCPAR table controls the RFC between the ERP Backend system and the CRM Server (see SAP Note [0510192](#) for a detailed description of this table). The CRMPAROLTTP table contains different parameters related to the data exchange between ERP backend and CRM Server (example: see SAP Note [628949](#)).

CRM Middleware BDoc Messages in the Flow

There are two nodes for each client. The first node displays the BDoc messages in error status (status: E01, E02, E04, E5, E06, E07) for each client on the CRM server. Double-click one node associated to one client, to start the transaction `SMW02` on the local client and display a summary of the BDoc messages with an error status. Such BDoc messages must be analyzed, and the cause of the error message must be resolved. If these BDoc messages are not taken into account, data inconsistencies in the system landscape can occur. The second node displays the summary of the BDoc messages that are in waiting status (status: 001). The *Waiting* status indicates that a response from the ERP backend system and other data receivers is pending.

It is important to check the status of the BDoc messages. Waiting (for a long time and not ending) and erroneous BDoc messages can cause severe system inconsistencies. Hints on how to analyze and solve such unsuccessful processing can be found in the best practice for BDoc message analysis that is attached to SAP Note [768503](#).

Status of R&R Queue Demon

This status must be monitored only for Field Application scenarios.

The R&R queue demon is a cross-client queue scheduler and if it is running, the status is green. However, if the traffic light is red, then the queue demon is not running. By double-clicking the node, the transaction `SMOHQQUEUE` is started (in the local client). Click *Start Queue Demon* to start the queue demon again. CCMS also triggers an alert if the queue demon is not running anymore, and must then be completed as soon as the problem is solved.

Status of R&R Queues

This status must be monitored only for field application scenarios.

Displays information about the status and contents of the replication and realignment queues in the mobile sites defined on your CRM Server. All queues must be running or waiting. The *Number of entries* displays the number of entries that are currently in the queue. This number must continuously decrease, unless new entries are entered into the queue at the same time. Double-click the field number to view the entries in the respective queue. If you interrupt queue processing, the processing of the current entry is completed and then the queue is set to status *Hold*.

By setting the status icon in the status column, you can:

- Release queues for processing by setting their status to *Released* (yellow light)
- Reset released queues to *Hold* (red light)
- Interrupt queue processing (status *Running* – green light) by setting the status to *Hold*

System Settings

The node *System Settings* displays the different sites of the Administration Console that are configured on your local client on the CRM Server. This information can provide an overview on the types of receivers that are active in the local client (number of mobile clients, ERP backend systems, implementation of Groupware integration, use of XIF adapter to connect external systems).

Monitoring Tools/Statistics

Table 16:

Monitoring Tool	SAP Recommendation	Description
BDoc Type / BDoc Service Workload Statistics	Not required in production environment. Only if performance analysis is required.	<p>Green – active</p> <p>Yellow – not active</p> <p>To activate these statistics, start transaction <code>SMWMFLOW</code>: Choose ► Goto ► Activate Statistics ► Kernel application statistics ► Check if <i>Middleware Message Hub Statistic</i> is active.</p> <p>To view the statistics data, start transaction <code>SMWMFLOW</code>, click <i>Message Service Kernel Application Statistics</i> and then choose the option required (the whole workload or the most current statistics).</p>
BDoc Message Flow Processing Statistics	<p>Not required in production environment. Only for performance analysis.</p> <p>These statistic files can be reorganized using the <i>Delete Statistic File</i> option in transaction <code>SMWMFLOW</code> ► Goto ► Middleware flow statistics ►.</p>	<p>Green – Active</p> <p>Yellow – Not active</p> <p>To activate these statistics, call transaction <code>SMWMFLOW</code>: Choose ► Goto ► Activate Statistics ► Middleware flow statistics ► Check if <i>Monitoring Message Flow</i> is set to Off . Switch on/off to activate the statistics.</p> <p>To view this statistics information, call transaction <code>SMWMFLOW</code>: choose <i>Message / Site / Queue Statistics</i> and then <i>Message Flow Statistics</i></p>
Mobile Client Communication Statistics	This information is only relevant for Field Applications scenarios. In the case of performance problems, this data can be analyzed. These alerts can be displayed in CCMS view for the CRM Middleware monitor set.	<p>Green – Mobile Client Communication Statistics is active and data collector background job is running</p> <p>Yellow – not active or no current data available</p> <p>To activate these statistics, start transaction <code>SMWMMCOMM</code> then choose ► Environment ► Run Collector ►.</p> <p>The results can be viewed in transaction <code>SMWMMCOMM</code>, select tab page <i>Statistics</i>.</p>

Monitoring Tool	SAP Recommendation	Description
Status of CRM Middleware Alert Monitor	Complete alerts related to problems that have been solved already.	Green – active, without alerts Yellow – not active Red – active, with red alert This node displays the alerts (if any) in the CRM Middleware CCMS monitor set.
Trace Status	Double-click (transaction <code>SMWTAD</code>) and then set <i>All Environments</i> to <i>Warning</i> . For <i>Generation, Detail Level 2</i> is allowed	Green – active and same as default SAP trace level Yellow – active, with higher trace level than default values delivered by SAP

Background Jobs

Table 17:

Monitoring Tool	Description
Middleware Reorganization	<p>This job manages the reorganization of CRM Middleware trace information, BDoc messages in final status, BDoc links and other temporary traces. Such entries must be deleted at regular intervals to prevent these tables from increasing in size. To do this, keep the trace information (particularly errors) in the log for 1 day or 1 week and delete the data afterwards.</p> <p>Green – running (scheduled or currently running) Yellow – not running</p> <p>This job is client-specific. Check that it is running properly in all the clients on the CRM server.</p> <p>You can monitor the report <code>SMO6_REORG2</code> by double-clicking and checking the background job overview (transaction <code>SM37</code>).</p> <p>You can schedule this job to run on all the 7 days (use recommended SAP variant) or choose to decrease this value in a production environment or increase it in test systems.</p> <p>See also SAP note 713173.</p>

Monitoring Tool	Description
Collector for Monitoring Cockpit	<p>To be able to use the centralized status monitoring for the generation and runtime steps, you must call up the Monitoring Cockpit (transaction <code>SMWP</code>) and activate the background job for status processing by clicking on Schedule Background Job.</p> <p>Note that the status monitoring is available only the following day.</p> <p>Green – running (scheduled or currently running)</p> <p>Yellow – not running</p> <p>This job is client-specific. Ensure that it is running properly in all the clients on the CRM server.</p> <p>Report <code>SMWP_BATCH</code></p> <p>If this job is not running, the monitoring cockpit does not display the correct status information.</p>
Collector for BDoc Messages/Site Statistics	<p>This job collects different data from BDoc message store and from the Mobile Client communication monitor to provide the statistics that could be viewed in transaction <code>SMWMMCOMM</code>, tab page Statistics, and transaction <code>SMWMMFLOW</code>.</p> <p>Green – running (scheduled or currently running)</p> <p>Yellow – not running</p> <p>This job is client-specific. Ensure that it is running properly in all the clients on the CRM server.</p> <p>Report <code>RSMWM_BSTAT_COLLECTOR</code></p>
Check Generation Status of Objects	<p>This job checks the status of the generation on the CRM Server. If any changes are made to the template, this job detects this situation and requests a new generation.</p> <p>Green – running (scheduled or currently running)</p> <p>Yellow – not running: last run of BGD Job is cancelled</p> <p>Cross-client. Ensure that this job is at least running once and properly.</p> <p>Report <code>GN_GENERATE_CHECK</code></p>

Monitoring Tool	Description
Periodical Background Generation	<p>The generation processes are waiting in transaction <code>GENSTATUS</code> and are started by this job.</p> <p>Green – running (scheduled or currently running)</p> <p>Yellow – not running</p> <p>Red – cancelled</p> <p>This job is cross-client.</p> <p>Report <code>GN_WORKLIST_GENERATE</code></p>
Administration Console Subscription Agent	<p>This information is only relevant for Field Applications scenarios.</p> <p>If you are using the subscription agent (feature in the Administration console, transaction <code>SMOEAC</code>) to automatically generate subscriptions for the mobile clients, you must ensure that this job is running.</p> <p>Green – running</p> <p>Yellow – not running</p> <p>This job is client-specific. Check that it is running properly in all the clients on the CRM Server.</p> <p>Report <code>SOME_SUBSCR_AGENT_EXECUTE_JOB</code></p>
Administration Console Site Scheduling	<p>This information is only relevant for Field Applications scenarios.</p> <p>If you are using mobile client replacement rules (can be activated in the Administration Console, transaction <code>SMOEAC</code>), this job ensures that the site is deactivated for the defined period of time.</p> <p>Green – running</p> <p>Yellow – not running</p> <p>This job is client-specific. Ensure that it is running properly in all the clients on the CRM server.</p> <p>Report <code>SMOE_SCHEDULING_EXECUTE_JOB</code></p>

4.2.1.3 SAP Virtual Machine Container

SAP CRM includes the software layer SAP Application Platform (SAP_AP), which contains the pricing, product configuration, and transaction tax engine components, known prior to SAP CRM 5.0 as “Internet Pricing and Configurator” (IPC). These components use the SAP Virtual Machine Container (VMC) as runtime environment.

For more information, see SAP Help Portal at http://help.sap.com/nw_platform > <choose release> > *System Administration and Maintenance Information* > *Technical Operations for SAP NetWeaver* : Search for *SAP Virtual Machine Container*.

- Logging and Tracing in the VM Container**
 The VMC logging and tracing system is called up by Java programs to output messages that enable errors to be found later and to reproduce the program flow. These Java programs can be components of the VMC environment itself, or even applications that use the VMC to execute Java code.
- The Single Activity Trace (SAT)**
 SAT is used to trace individual activities in the system. The traces can then be examined in detail. In case of performance problems the Single Activity Trace is used to analyze a component in detail.
- JARM in the VM Container**
 Java Application Response time Measurement (JARM) is used to measure Java application requests.
- Profiling in the VM Container**
 Profiling provides information about the running and resource consumption of a Java application.
- Displaying VMC**
 Statistics in the Workload Monitor Statistic records are very useful for searching for performance bottle necks. In the workload monitor, you can display the workload in different Analysis Views, which highlight the workload from a particular perspective. One of these views shows how the available resources are made use of at specific times when the VMC is operating.

4.2.1.4 ERP Backend System Analysis Tools

The transactions used to monitor these interface points are listed along with a brief label describing their function. The table below lists transactions for monitoring the ERP backend system:

Table 18:

ERP backend system monitoring queue monitoring activities / functions	Monitoring tool (Transaction)	Monitoring frequency periods and events
qRFC Outbound Queue Monitor: <ul style="list-style-type: none"> Monitors the data exchange from the ERP backend system to the CRM Server Queues must be relatively short and quickly processed Check if the latest qRFC version is implemented (see SAP note 438015 ) To prevent data inconsistencies, you need to monitor the interfaces regularly for aborted or stopped data transfer 	SMQ1 or SMWP (CRM Server): Runtime Information -> Data Exchange using qRFC Queues -> qRFC Queues in ERP Backend(s) -><ERP SID> ->Loads for CRM Server or CCMS Alert monitoring (Transaction RZ20: SAP CRM Monitor Templates -> CRM Middleware -> CRM Middleware-> Queue info->ERP OLTP qRFC Queues)	<ul style="list-style-type: none"> No active monitoring – setup CCMS alert monitoring Active monitoring – number of times a day depending on the business process. In case of an error message or during particular loads (initial load or loads causing mass updates)

ERP backend system monitoring queue monitoring activities / functions	Monitoring tool (Transaction)	Monitoring frequency periods and events
Status of Queue Scheduler <ul style="list-style-type: none"> Monitor status of the QOUT Scheduler 	SMQS or SMWP or CCMS (Transaction RZ20)	<ul style="list-style-type: none"> Use Alert Monitoring In case of an error situation or outbound queues are not processed

4.2.1.5 Communication Station Analysis Tools

This information is only relevant for Field Applications scenarios.

i Note

For the SAP Communication Station to register automatically in the System Landscape Directory (SLD) and transfer changes, you need to schedule a daily Windows batch job that performs the executable file described in SAP note [1150170](#).

Data transfer between the mobile clients and the CRM server is traced on the communication station in the `TransferService.Log` log file. The location of this log file is displayed in tool `QmtCnfg.exe` under field *Trace File* (**Start > Middleware > QmtCnfg.exe >**).

The traces have to be set manually and should be activated only when a problem arises. To activate the transfer trace on the communication station, in the registry editor on the communication station, go to `HKEY_LOCAL_MACHINE\SOFTWARE\SAP\TransferService\Parameters\`

Create a key with name `#TraceFile#` and specify the directory where you want to store `TransferService.log`. The `TransferService.log` file is created in the location specified in the `TraceFile` for example `(c:\temp)`.

By default, trace level is `#2#`. If you want to increase the level to 3 or 4, create a key `#TraceLevel#` in the same path and mention trace level in it.

To generate RFC traces on the Communication Station, create the following two environmental variables on the Communication Station:

- `RFC_TRACE` with value 1
- `RFC_TRACE_DIR` with trace directory path

The directory path described in `RFC_TRACE_DIR` provides the location where the RFC traces will be generated.

i Note

Remember to either delete the above environmental variables or set the value of `RFC_TRACE` to 0, once the problem is solved. Otherwise, it will affect the performance of the Communication Station. The RFC trace files have to be sent to SAP for analysis.

Table 19:

Communication Station monitoring activities / functions	Monitoring tool	Monitoring frequency periods and events
<p>Tracing the Transfer Service</p> <p>The SAP CRM Queued Transfer Service component logs the communication sessions between the mobile clients and the CRM server in the <code>TransferService.log</code> file.</p>	<p><code>TransferService.log</code></p> <p>Start -> Middleware -> <code>QmtCnfg.exe</code> is a tool, which can be used to view the current trace level and log file location</p>	<p>For troubleshooting:</p> <p>Data synchronization is not possible</p> <p>or</p> <p>Outbound queues are not fetched</p>

4.2.1.6 Mobile Client Analysis Tools

This information is only relevant for Field Applications scenarios.

To check the version information for the Mobile Client, see file `MTConfig.cfg` under `<Mobile Root Dir>\Bin.net`.

Table 20:

Mobile client monitoring activities / functions	Monitoring type	Monitoring frequency periods and events
<p>Queued Transfer Service</p> <p>The <code>QmtCnfg</code> program displays the connection status between the mobile client and the Communication Station.</p>	<p><code>QmtCnfg.exe</code> -> Click Test Connection</p> <p><code>TransferService.log</code></p>	<p>In case of an error message in the data transfer phase</p>
<p>Client Console</p> <p>Checks the metadata, starts the generation, and compares BDoc structures between local database and CRM Server.</p> <p>The inbound and outbound queues of the mobile client can be displayed using the Client Console.</p>	<p>Start Client Console -> Troubleshooting -> Check Environment</p> <p>Start Client Console -> Data Transfer -> Queue manager</p>	<p>After a support package or patch is applied on each mobile client</p> <p>In case of an error message in the import phase</p>
<p>Client Upgrade Target</p> <p>Deployment of the Mobile Upgrade Packages/fixes to the client laptops.</p>	<p><code>ClientUpgrade.log</code> is created in temporary folder. Information is appended to old log file. It is a text file and can be viewed by opening the same in notepad. Now severity level is displayed in the log.</p>	<p>In case of error during upgrade, or to check the general status of upgrade.</p>

Mobile client monitoring activities / functions	Monitoring type	Monitoring frequency periods and events
<p>Installation Assistant, SwitchDB, Windows Installer Package</p> <p>Used to install the SAP CRM Mobile Client Framework and Application on the target machines.</p>	<p>All logs and traces are produced in the %Programfiles%\sap\mobile_installation_logfiles folder and can be viewed in notepad.</p>	<p>In case of error during installation/upgrade or to check the general status of installation/upgrade.</p>
<p>Environment Analyzer</p> <p>To check the sanctity of the Mobile system landscape after an upgrade or to check for the availability of pre-requisites.</p>	<p>Start > All Programs > SAP CRM Mobile > Supportability > Environment Analyzer.</p> <p>Environment check results are stored as EnvAnalyzer_*.xml where * represents the date and time. It can be viewed using the Environment Analyzer itself.</p> <p>Trace information can be found in Temp folder as EnvCheck-*.log. It is a text file and can be viewed through notepad.</p>	<p>To check the sanctity of the Mobile Landscape.</p>
<p>Customer Modification Analyzer</p> <p>Used to check for customer made modifications in the Mobile Application Repository Database.</p>	<p>The file is saved as CustomerModification_*.html where * represents the date-time format. To view the log double click on the log file in ".../SAP/Mobile/Support/Logs" to view the same in InternetExplorer.</p>	<p>Whenever any SAP standard objects are modified by customers, this tool could be used to find the modifications made.</p>
<p>Log Viewer</p> <p>To check for any exceptions that might have occurred during the operation of Mobile Client runtime.</p>	<p>Displays function entry and exits along with any exceptions throws while performing an action in Mobile Client. This log shows calls for UI, BOL and App. The log is saved as RuntimeLog_*.log where * represents the datetime format. To view the log you can use the logviewer menu from Runtime analyzer to load the log file.</p>	<p>In case of any exceptions occurring during the operation of the MobileClient.exe</p>
<p>SQL Logviewer</p> <p>Logs all the queries fired from within the application on the user database.</p>	<p>The file is saved as RuntimeSQL_*.sqllog where * represents the datetime format. To view the log you can use the SQLLogviewer menu to load an existing log file.</p>	<p>Can be used to view the queries run on the user database from within the runtime framework.</p>
<p>BOL Framework Log</p>	<p>Log saved as MTBLLFW.log inside the <MobileDir>\appName\Bol\apps\sfa-bol. Can be viewed in notepad.</p>	<p>To trace exceptions when BO load failed, DB Connection string details.</p>

Mobile client monitoring activities / functions	Monitoring type	Monitoring frequency periods and events
<p>Runtime Analyzer /Trace Viewer</p> <p>Used to view the trace messages in a tree structure that includes entry, exit calls and the exceptions occurred from runtime framework and application, for which trace enabled.</p>	<p>Tracing itself can be enabled or disabled from Mobile support center. The Trace messages can be saved in the form of *.trace file with the timestamp in an automatically generated location from the trace viewer.</p> <p>The saved trace files can also be opened from the Trace viewer which is displayed on the trace view.</p>	None

4.2.1.7 Rollout Manager Analysis Tools

This information is relevant for field application scenarios only.

During the rollout process or as soon as it is complete, you can display the centralized log file for the stationary site. The default location is on the [File Logging Options](#) screen under file name C:\Temp\MCDDataManager.txt.

Additional log files associated to each of the rolled out mobile clients are created and are named MCDDataManager_<Sitename>.txt.

4.2.1.8 Web Channel Components

Monitoring is available for the following software components:

- CRM JAVA APPLICATIONS
- SAP SHARED JAVA APPLICATIONS

Additionally, the following components exist. They do not contain any business applications but provide a technical framework for customer extensions. Hence, monitoring is not required for them.

- CRM Java Components
- CRM Web Application Components
- Shared Java Components
- Shared Web Application Components

4.2.1.8.1 Java Monitoring and Management

The task of Java monitoring and management is to provide developers, supporters and customers with information about

- Configuration information, such as release, version, host, port
- Critical conditions monitoring for IT operations
- Detailed performance and status data for detecting and diagnosing problems
- Detailed statistics on activity and resource consumption for accounting and auditing, SLA reporting and problem analysis

For more information about CRM Java components monitoring and management, see SAP Help Portal at http://help.sap.com/nw_platform >> <choose release> > *System Administration and Maintenance Information* > *Technical Operations for SAP NetWeaver* > *Administration of Application Server Java (AS JAVA)* > *Monitoring* >.

Java Monitoring and Management comprises the following topics:

JMX (Java Management Extensions)

The SAP J2EE Engine has a flexible management infrastructure based on the JMX (Java Management Extensions) standard. JMX is used to manage and monitor all server components (services, interfaces, libraries).

The JMX infrastructure is provided by the JMX Adapter service which in turn uses the SAP-JMX library. The SAP-JMX library provides a nearly complete implementation of the JMX 1.2 core APIs. The JMX Adapter service adds features like clustering support and integration with the SAP J2EE Engine class loading, thread management, and security concepts.

Java Monitoring

- Java Application Monitoring
- The Java Application Monitoring API gives programmers a high-level interface to attach to the central monitoring infrastructure. Every resource, which should be monitored, must be represented by a JMX MBean (Resource-MBean). The management interface of the Resource-MBean is used by a component-agent, to read the values of the attributes and send it to the monitoring infrastructure.
- Java Monitoring Service
- SAP NetWeaver AS Java provides monitoring of the most important server parameters, hence offers a monitoring architecture for accumulation, history and alert generation.

The most important resources of the J2EE Engine being monitored by the monitor service are:

- Network Connections
- Memory Consumption
- Threads
- Class loaders
- Database Connections
- Database Transactions
- HTTP Cache
- JMS Queues and Topics
- Sessions

Logging and Tracing

Logs are addressed to an administrator of a customer system.

Traces show the details of the control flow – they are watched by developers and the support organization. On the other hand the administrator has to check the system regularly. Logs are written during normal operation.

By default logging is activated at the info level and the tracing has to be activated at the error level. The tools are Log Viewer Standalone and Visual Administrator (preferred).

CRM Web Channel Components use standard logging and tracing functions of the SAP NetWeaver AS Java. The logging and tracing messages are written into the central log files of the SAP NetWeaver AS Java. The Log Viewer, which is automatically installed with the SAP NetWeaver AS Java, is used to view log and trace files.

If you want to change trace settings you have to change them for specific locations or categories.

The following table lists some of the most important locations:

Table 21:

Location	Description
com.sap.isa	Root location for Internet Sales applications. Default severity level is set to ERROR.
com.sap.eservice	Root location for E-Service applications. Default severity level is set to ERROR.

The administrator can filter the logs and traces using the application names. The following default CRM Web Channel application names can be used as reference; for example:

- sap.com/crm~b2b
- sap.com/crm~b2c
- sap.com/crm~icss_b2b
- sap.com/crm~icss_b2c
- sap.com/crm~isauseradm

The following table lists categories used in CRM Web Channel Components:

Table 22:

Category	Description
/Applications/Common/Security	Parts of Web Channel dealing with security. Default severity level "Info".
/Applications/UserInterface	User Interface Layer (Struts Actions). Default severity level "Info".
/Applications/BusinessLogic	Most of the Java based Web Channel coding. Default severity level "Info".

i Note

Some of the categories might not have been preconfigured in the LogConfigurator. In that case you can add them manually.

➔ Recommendation

For more information about Web Channel-specific logging and tracing, see SAP Note [2207842](#) **🔗** *Session logging functionality in Web Channel*.

4.2.1.8.2 Java Problem Detection and Analysis

Use

Achieving higher availability and performance optimization is important to ensure a robust and scalable environment. SAP NetWeaver AS provides efficient monitoring and administration tools for displaying the entire J2EE Engine system landscape centrally. If an error occurs, instead of logging on to each host component to check its status, the person responsible is notified automatically. Special tools providing cross-system detailed information help performing an efficient problem analysis to find the source of error.

More Information

For more information about technical operations in SAP NetWeaver, see SAP Help Portal at http://help.sap.com/nw_platform **🔗** *<choose release>* **➤** *System Administration and Maintenance Information* **➤** *Technical Operations for SAP NetWeaver* **➤**.

For more information about Web Channel-specific logging and tracing, see SAP Note [2207842](#) **🔗** *Session logging functionality in Web Channel*.

For more information about how to do a memory analysis, see the following:

- SAP Knowledge Base Article 1883568 - *How to self analyze a Heap Dump using MAT*
- SAP Note [1259465](#) **🔗** - *How to get a heapdump which can be analyzed with MAT*
- SAP Note [1267126](#) **🔗** - *IBM i: How to get a heapdump which can be analyzed with MAT*
- SAP Note [1053604](#) **🔗** - *JDK heap dump and heap profiling on HP-UX*

For more information about how to do a thread dump analysis, see the following:

SAP Note [1020246](#) **🔗** - *Thread Dump Viewer for SAP Java Engine*

SAP Note [1783031](#) **🔗** - *Analyzing AS Java performance with SAP JVM Profiler*

4.2.1.8.3 Error Handling for SAP NetWeaver Application Server Java

Monitoring the SAP system helps the administrator to identify resource bottlenecks or problems early and to take action if required. We recommend using the CCMS to monitor a production application server. The prerequisite for this is that the J2EE Engine is connected to a central monitoring system (CEN) by means of the agent SAPCCMSR with option –J2EE. The central monitoring system must be an SAP Web Application Server ABAP 6.40. In addition to extensive monitoring functions, the CCMS allows you to monitor entire system landscapes. Independent of the CCMS, you can check the logs of production systems in the Log Viewer of the Visual Administrator.

The SAP Technology Troubleshooting Guide contains the following problem analysis scenarios for the various components of SAP NetWeaver Application Server Java:

- Change Management Server Problem Analysis Scenarios
- J2EE Engine Problem Analysis Scenarios
- Web Dynpro Java (ESS Scenario) Problem Analysis Scenarios
- Design Time Repository Problem Analysis Scenarios
- SAP Java Connector Problem Analysis Scenarios

For more information, see the SAP Technology Troubleshooting Guide at <http://wiki.sdn.sap.com/wiki/x/wIN3Cw>

4.2.1.9 Interaction Center Analysis Tools

4.2.1.9.1 Interactive Script Editor (ISE) Trace Analysis Tool

Default is INFO.

1. Set up user parameter `CRM_ISE_LOGLEVEL`, value 0 (ALL), 100 (DEBUG), 200 (INFO), 300 (WARNING), 400 (ERROR).
2. On the client machine, view the trace in the Java console.

4.2.1.9.2 Broadcast Supervisor

A log of sent messages is provided and accessible within the supervisor UI. To access this, in the SAP Enterprise Portal in the *IC Manager* role, go to *Managing Operations* → *Broadcast Messaging* workset.

4.2.1.9.3 Software Agent Framework Diagnosis Tool

Transaction `CRMC_SAF_TOOL` gives details of the search engine status, index compilation status, index content, and application status.

4.2.1.9.4 E-Mail Response Management System

For SAPconnect alert monitor and trace, use transaction SCOT.

For workflow log and monitor, use transaction SWI1.

For trace information regarding individual e-mails, use the E-Mail Response Management System workbench. In SAP Enterprise Portal, access the workbench in the *IC Manager* role via either of the following work sets:

- Managing Operations → E-Mails → Overview
- Managing Operations → E-Mails → E-Mail Workbench

To view the e-mail response trace, use transaction CRM_ERMS_LOGGING.

4.2.1.9.5 Business Communication Broker and Integrated Communication Interface (BCB/ICI)

Trace View

To view the BCB trace, use transaction CRM_ICI_TRACE.

Trace Level Adjustment

The default is OFF. You can increase the trace level on an individual user basis. To increase the trace level:

1. Choose *System* → *User Profile* → *Own Data*.
2. On the *Parameters* tab page, enter CRM_ICI_TRACELEVEL as the parameter ID and xxx as the parameter value.
3. Save.

4.2.1.9.6 Call List Log

Application log SLG1

Object CRM_CLM

4.2.1.9.7 Business Workplace

The e-mail inbox uses business workplace functions. For more information, see the following document on SAP Help Portal under *SAP ERP* and *ERP Enterprise*:

[Business Workplace \(BC-SRV-GBT\)](#)

4.2.1.9.8 Pricing, Product Configuration, and Transaction Tax Engine (Formerly Internet Pricing and Configurator)

SAP CRM includes the software layer SAP Application Platform (SAP_AP), which contains the pricing, product configuration, and transaction tax engine components, known prior to SAP CRM 5.0 as “Internet Pricing and Configurator ” (IPC). These components use the SAP Virtual Machine Container (VMC) as runtime environment.

For more information, see SAP Help Portal at http://help.sap.com/nw_platform >> <choose release> > *System Administration and Maintenance Information* > *Technical Operations for SAP NetWeaver* > Search for *SAP Virtual Machine Container*.

4.2.1.9.9 SAP Business Warehouse

SAP Business Warehouse (SAP BW) is optional. User navigation data from interactive scripting is exported to SAP BW for analysis. In addition, Computer Telephony Integration (CTI) statistics are stored here. For more information, see SAP Help Portal at :

- Interaction Center Analytics: <http://help.sap.com/nwbw> >> *BI Content* > <choose release> > *Application Help* > *BI Content* > *Customer Relationship Management* > *CRM Analytics* > *Interaction Channel Analyses* > *Interaction Center Analytics* >.
- Interaction Center Manager: <http://help.sap.com/nwbw> >> *BI Content* > <choose release> > *Application Help* > *BI Content* > *Customer Relationship Management* > *CRM Analytics* > *Interaction Channel Analyses* > *Interaction Center Analytics* > *Roles* > *Interaction Center Manager* >.

4.2.1.9.10 SAPphone

For more information about SAPphone, see SAP Help Portal at http://help.sap.com/nw_platform >> <choose release> >. In the application help, search for “SAPphone (BC-SRV-COM-TEL)”.

4.2.1.9.11 SAP Business Workflow

To view the SAP Business Workflow log, use transaction SWDP.

4.2.1.9.12 Data Archiving Monitor

The archiving objects for call list management and Solution Database are CRM_CLM and CRM_SDBPBL respectively. For more information about the data archiving monitor, see SAP Help Portal at http://help.sap.com//nw_platform >> <choose release> >. In the application help, search for *Data Archiving Monitor*.

4.2.1.10 CRM Middleware Monitoring for Groupware Integration

Several analysis tools are available on the CRM server to monitor the data exchange between the Groupware solution and the CRM server.

The following table contains the monitoring functions to be performed on the CRM server to monitor the data flow between the CRM server and the groupware server.

Table 23:

Monitoring activities / functions	Monitoring tool (transaction)	Monitoring frequency periods and events
qRFC Outbound Queue Monitor <ul style="list-style-type: none"> Displays outbound queues ISP_O* and checks that the messages from the following outbound queue are pulled by the GW Connector on a regular basis 	SMQ1	Daily on a regular basis
qRFC Inbound Queue Monitor <ul style="list-style-type: none"> Checks that the following inbound queues are registered (TA SMQR) and running (TA SMQ2): ISP_D*, ISP_I*, and ISP_S* 	SMQ2	Daily on a regular basis
BDoc messages related to the Groupware Integration	SMW01 / SMW02 / SMW03	Use of alert monitoring or start transaction daily on regular basis

4.2.1.10.1 Groupware Connector

Use

Table 24:

Monitoring Activities / Functions	Monitoring Tool	Monitoring Frequency Periods and Events
Monitor connector processing and errors	Groupware Connector Administrative Tool	In case of error

The logs can be found in the following location: <Groupware installation directory>\logs

Logs and traces are created in the form of text files (log.txt, error.txt, trace.txt). To view the logs and traces, open the corresponding txt-files.

The severity level can be set only for the trace files and not for the `error.txt` and `log.txt`. The following severity levels are available for the trace files:

- *Fatal*
- *Error*
- *Warning*
- *Info*
- *Path*
- *Debug*

The default severity level *Warning*. It is possible to change the severity level dynamically.

More Information

Administration Guide for SAP Groupware Connector on SAP Service Marketplace at <http://service.sap.com/crm-inst> >> <choose release> > <choose "Operate" or other subfolder> . In the Administration Guide, see sections *Logging* and *Connector Logging Information*.

4.2.1.11 BW Adapter Analysis Tools

BW Adapter is technically based on SAP NetWeaver Application Server. Therefore, standard logging and tracing functions for ABAP applications apply. Only additional monitoring functions are mentioned here.

For information about monitoring and technical problem analysis (for database, operating system, workload analysis, and so on) see SAP Help Portal at http://help.sap.com/nw_platform >> <choose release> > *System Administration and Maintenance Information* > *Technical Operations for SAP NetWeaver* .

Table 25:

Monitor	Detailed Description
Transaction <code>RSMON</code> in BW	The monitoring of data extraction to BW can be performed using the standard functionality of BW (transaction <code>RSMON</code>). The user can check the success and points of failure of the extraction process, such as, whether the error occurred in the source system or in BW.

4.2.1.12 Segment Builder Analysis Tools

The Segment Builder is technically based on SAP NetWeaver Application Server. That means the standard logging and tracing functions for ABAP applications apply here. Only additional monitoring functions are mentioned here.

For information about monitoring and technical problem analysis (for database, operating system, workload analysis, and so on) see SAP Help Portal at http://help.sap.com/nw_platform >> <choose release> > *System Administration and Maintenance Information* > *Technical Operations for SAP NetWeaver* .

- Target groups can be created in the background using batch jobs. These batch jobs use the ABAP program `CRM_MKTTG_GENERATE_SEG_MODEL` and run under job name `TARGET_GROUP_SELECTION`.

System administrators can track those jobs using transaction `SM37`.

- Business Partner Segmentation deals with large volumes of data. When selecting a target group, all matching business partners are stored in database tables. These tables begin with `CRMD_MKTTG_TG_I*`. Since they constantly increase in size, the system administrator must track them and ensure that obsolete entries are removed as soon as possible. Target groups can be deleted using the mass deletion program `CRM_MKTTG_TG_DELETE`.

4.2.1.12.1 Execution Flowchart

The execution flowchart is a tool, that enables those with a detailed technical knowledge of SAP Business Warehouse Accelerator (BWA) functions, to analyze errors and performance problems. The execution flowchart enables you to do the following:

- Visualize the steps that the system performs to calculate the number of business partners in a segment.
- Observe what happens during the execution of individual filters and actions.
- Precisely read the individual actions and operations.
- Determine the calculation time the individual actions and operations require.

While processing the individual steps, the system saves the BWA calls for each segment in a temporary materialized result index(MRI). The MRIs are only kept for the active session; once the session is closed, the system deletes them. The MRI IDs are visible in the execution flowchart.

You can call up the execution flowchart in graphical modeling, by choosing **▶ Execution Analysis ▶ Execution Flowchart** from the segment context menu.

To make this menu entry visible;

1. Choose **▶ System ▶ User Profile ▶ Own Data**.
2. On the *Parameters* tab page, enter `CRM_MKTTG_SEG_BWA_EF` as the parameter ID and `X` as the parameter value.
3. Save.

4.2.1.13 Scenario-Specific Problem Analysis Tools

4.2.1.13.1 Web Application Components

The Web Application Components are technically based on the SAP NetWeaver Application Server (AS) Java. For information about technical problem analysis (for example for database, operating system, workload analysis) refer to the corresponding section of the SAP NetWeaver Problem Analysis Guide (PAG).

Trace and Log Files

CRM Web Channel Components use standard logging and tracing functions of the SAP NetWeaver AS Java. The logging and tracing messages are written into the central log files of the SAP NetWeaver AS Java. The Log Viewer, which is automatically installed with the SAP NetWeaver AS Java, is used to view log and trace files.

If you want to change trace settings you have to change them for specific locations or categories.

The following table lists some of the most important locations:

Table 26:

Location	Description
com.sap.isa	Root location for Internet Sales applications. Default severity level is set to ERROR.
com.sap.eservice	Root location for E-Service applications. Default severity level is set to ERROR.

The administrator can filter the logs and traces using the application names. The following default CRM Web Channel application names can be used as reference; for example:

- sap.com/crm~b2b
- sap.com/crm~b2c
- sap.com/crm~icss_b2b
- sap.com/crm~icss_b2c
- sap.com/crm~isuseradm

The following table lists categories used in CRM Web Channel Components:

Table 27:

Category	Description
/Applications/Common/Security	Parts of Web Channel dealing with security. Default severity level "Info".
/Applications/UserInterface	User Interface Layer (Struts Actions). Default severity level "Info".
/Applications/BusinessLogic	Most of the Java based Web Channel coding. Default severity level "Info".

i Note

Some of the categories might not have been preconfigured in the LogConfigurator. In that case you can add them manually.

➔ Recommendation

For more information about Web Channel-specific logging and tracing, see SAP Note [2207842](#)  *Session logging functionality in Web Channel*.

Interfaces

Interface monitors are essential for analyzing problems with interfaces such as RFC, IDoc, and HTTP. Web Application Components use the SAP Java Connector (JCo) for RFC based connectivity to the CRM system. The SAP Java Connector provides tracing mechanisms to monitor the RFC communication, which can be activated within SAP NetWeaver Administrator by choosing [NWA](#) > [Availability and Performance](#) > [Resource Monitoring](#) > [JCo Monitoring](#).

i Note

The trace produces a large amount of data and significantly slows down the engine. Turn the trace on only while developing or testing.

Data Archiving Monitors

For periodic tasks required to contain data growth (for example, reorganization of temporary data) refer to the periodical tasks section in this guide.

The Java Web Applications in Web Channel and Partner Channel Management store data in the database of the SAP NetWeaver Web Application Server. For information about how to set up data archiving monitoring, see SAP Help Portal at http://help.sap.com/nw_platform > [<choose release>](#) > [System Administration and Maintenance Information](#) > [Technical Operations for SAP NetWeaver](#) > [Administration of Application Server Java \(AS Java\)](#).

XCM Configuration Monitoring

XCM is used for managing the XML based configuration files of the various web applications. The XCM Administrator provides a monitoring area enabling you to view the content of the configuration files managed by XCM at runtime:

1. Start XCM Administrator: `http://host:port/<applicationname>/admin/xcm/init.do`.
2. Log on using a user of the SAP NetWeaver AS Java, which is either assigned to the role `isaadmin` or `administrators`.
3. Press the [monitoring](#) button.
4. Select the application configuration from the dropdown list box for which you would like to examine the configuration files.
5. The list box shows only loaded XCM configuration (means, which have been called at least one time). The [bootstrap-scenario](#) configuration is build in and needed for the initialization of the web application.
6. The upper table shows a list of the files managed by XCM. Clicking on a file name opens a separate window shown the content of the file.
7. The lower table shows the XCM parameter settings of the selected application configuration.

4.2.1.13.2 Service

Case Management

SAP CRM case management is based on SAP NetWeaver Case Management, which is an enhancement of the [SAP Records Management](#) component.

4.2.1.13.3 Field Applications

The Field Applications scenarios that contain a CRM server and a mobile client, use the CRM Middleware monitoring objects.

CRM Middleware Monitoring for Field Applications

Settings

For all BDoc types that you are planning to use in field application scenarios, you must enable the Mobile Bridge: You must set field ACTIVE to 'X' in table SMW3FDCUST according to SAP note [629861](#).

Table 28:

Monitoring Activities / Functions	Monitoring Type	Monitoring Frequency Periods and Events
Replication and Realignment Queues Monitor Displays information about the status and contents of the replication and realignment queues defined in the CRM Server	SMOHQUEUE or SMWP: Runtime Information -> CRM Middleware R&R Queues	<ul style="list-style-type: none">• Several times a day depending on the business process
Mobile Client Communication Monitor Monitors individual sessions and statistics of the data exchange for each mobile client site	SMWMMCOMM	<ul style="list-style-type: none">• Every day• In case of performance problems
Mobile Client Message Recovery Reports messages informing the CRM Server about errors during the import on the mobile clients	CMWQ Architecture and Technology -> Middleware -> Monitoring -> Mobile Client -> Message Recovery	<ul style="list-style-type: none">• Use of automatic notification mechanism• Everyday

Monitoring Activities / Functions	Monitoring Type	Monitoring Frequency Periods and Events
<p>Operating System / Gateway</p> <p>This is a operating system performance monitor.</p> <p>The SAP system statistic collector daemons, SAPOSCOL and RFCOSCOL, run on the Communication Station and gather hardware resource consumption data. Complementary programs run on the CRM server and collect and display statistical data.</p> <p>While the Communication Station is running, data is continually being collected via existing connections and system data is also collected for subsequent evaluation. This data is called up periodically by the CRM Server and can be displayed and analyzed there by using monitoring tools. The gateway, which is installed on the Communication Station, is used to call up the collected data.</p>	<p>OS07</p> <p>or</p> <p>SMWMMCOMM, Menu Goto -> CommSta</p> <p>OS Monitor</p>	<ul style="list-style-type: none"> In case of performance problems during data transfer
<p>Monitor Data Extractor Status</p> <p>Displays information about all data collectors. Among other properties the status, the collected data and the extraction properties can be monitored. The data extraction process is triggered by the standard Queue Demon, which can also be started and stopped from this transaction</p>	<p>SMOJDC</p>	<p>Daily (Check first if this feature is used)</p>

CRM Mobile Client Problem Analysis Tool for Field Applications

Settings

File `UIConfig.uifcfg` is available in the Root directory of the application. In this configuration file, set the entry [Development](#) to 1. When the application is started again in the menu option [Tools](#) there is an entry to start `UFAnalyser`.

4.2.1.13.4 Sales

Account Management

Table 29:

Monitor	Detailed Description	Prerequisites
Monitoring Business Partner Data Exchange	below	System landscape set up for the ERP customer master to CRM business partner data exchange
Object Links	below	None

Monitoring Business Partner Data Exchange (Transaction CRMM_BUPA_MAP)

This application shows the mapping of a business partner in CRM to its business partner number, the business partner GUID and the corresponding ERP customer number.

It can be used to display the current BDoc entries corresponding to the displayed business partner.

It can be used to initiate a direct send of the business partner to ERP and to initiate a request of a customer from ERP to CRM.

- **Choose the business partner to be displayed**

Enter an identifying number in either of the three fields, business partner number, business partner GUID or ERP customer number. After confirming with enter the missing data are retrieved from the system and be shown in the other fields.

- **Send Business Partner Data**

Initiates a direct send of the displayed business partner to ERP. The data to be sent (with or without relations, the target system) can be chosen in the following screen. This is the same as using the transaction "Send Business Partner Data" (CRMM_BUPA_SEND).

- **Gather Information about Customer**

This button sends a request for the customer data to ERP.

- **Button Queues and BDocs**

Shows an overview on the Technical Middleware Queues, the general number of queues and the number of unprocessed transactions, and the number of non final BDocs. It also provides links to the respective applications to view the Queue-State and the BDocs in more detail.

Object Links

To follow the message flow for a certain business partner, it is faster to use the corresponding object links directly. In Maintain Business Partners (Transaction BP) there is a button *Services for Object* to the left of the transaction title. Choose *Relationships* to navigate to an overview of objects related to the selected business partner. For example, the BP's corresponding BDocs. The BDoc can then be opened in a detailed view by double-clicking on the entry in the table.

Other Scenario-Specific Problem Analysis Tools

Table 30:

Monitor	Detailed Description	Prerequisites
Business Partner Diagnosis	Transaction CRMM_BPD Compare Customizing / Sales Areas with ERP, to find data exchange errors due to differing customizing	None

Available DIMa Objects:

Table 31:

DIMa Object	External System	Header Compare	Detail Compare	Filters Possible	Remark
CUSTOMER	ERP Customer Master	X	X	X	None
CONTACTS	ERP Customer Master	X	X	X	None
PARTNERFUNCTION	ERP Customer Master	X	X	X	None
PARTNER	ERP Business Partner	X	X	X	None
RELATIONS	ERP Business Partner	X	X	X	None
CDB_CAPGEN	CDB	X	X	X	Includes Relationship Compare
CDB_CONGEN	CDB	X	X	X	Includes Relationship Compare

4.2.1.13.5 Product Master

Table 32:

Monitor	Detailed Description	Prerequisites
Data Integrity Manager	Transaction SDIMA Compare Master Data between CRM and an external system. Either Header Compare (Object exists in both systems) or Detail Compare (comparison on field level)	None

Available DIMa Objects:

Table 33:

DIMa Object	External System	Header Compare	Detail Compare	Filters Possible?
MATERIAL	ERP	X	X	X
SERVICE_MASTER	ERP	X	X	X
PRODUCT_MAT	CDB	X	X	X
PRODUCT_SRV	CDB	X	X	X
BOM	ERP	X	X	X
CUST_MAT_INFO1	ERP	X	X	None
PRODUCT_IL_MAT	CDB	X	X	None

4.2.1.13.6 Partner/Product Ranges

Table 34:

Monitor	Detailed Description
Data Integrity Manager	Transaction SDIMA Compare Master Data between CRM and an external system. Either Header Compare (Object exists in both systems) or Detail Compare (comparison on field level)

Available DIMa Objects:

Table 35:

DIMa Object	External System	Header Compare	Detail Compare	Filters Possible?
PPR	CDB	X	X	X

4.2.1.13.7 Marketing

Lead Management

This scenario is based on SAP NetWeaver Application Server. This guide only covers differences and additional information specific to this scenario.

Leads are used in Campaign Management and Partner Channel Management. For more information about Leads and Opportunity Management with Channel Partners, see the latest version of the SAP CRM Master Guide available on SAP Service Marketplace at <http://service.sap.com/crm-inst> > <choose release> > Plan >.

Rule Based Document Distribution

The document distribution function requires monitoring of batch job CRM_DD_BATCH. If you want to use rule based distribution, plan the job periodically. The result a processed job are stored in the application log (transaction SLG1) under the object CRM_DD, subobject 01.

For more information, see SAP Library on SAP Help Portal at <http://help.sap.com/crm> > <choose release> > Application Help > Marketing > Campaign Management > Lead Management > Lead Distribution > Rule-Based Document Distribution >.

Database Tables

The attributes for leads in Lead Management are stored in table CRMD_LEAD_H. All other lead data is available in the objects, based on the business transaction data model mentioned above.

Trace and Log Files

Trace and log files are necessary for analyzing problems. Lead Management uses workflow trace.

Data Archiving Monitors

The Lead Management uses the standard functionality of the business transaction with the archiving object CRM_LEAD for data archiving. For more information, see SAP Library on SAP Help Portal at <http://help.sap.com/crm> > <choose release> > Application Help > Basic Functions > Data Archiving > Archiving of Business Transactions >.

In addition to Lead Management support, you can use the workflow basis tools with the standard workflow template WS10001011 and WS13100008. To analyze the work items created for the mentioned workflow, you can use the Monitor for work items (transaction SWI1). For more information, see SAP Library on SAP Help Portal at <http://help.sap.com/crm> > <choose release> > Application Help > Basic Functions > SAP Business Workflow > SAP Business Workflow in Business Transactions > SAP Business Workflow in Lead Management >.

Product Proposal

Interfaces

Interface monitors are necessary for analyzing problems with interfaces such as RFC, IDoc, and HTTP.

Table 36:

Monitor	Detailed Description
Report CRM_MKTPR_PRODUCT_PROPOSAL	Report for simulating product proposals. This report can be helpful to locate problems related to product proposal generation. It can be used to determine if it is a problem of the scenario itself or the use of the scenario. (For more information, see in transaction CRMD_MKT_TOOLS)

Table 37:

Monitor	Detailed Description
Transaction SE16	See Solution Operation Guide for SAP NetWeaver AS

External List Management

External List Management offers functions in CRM and SAP Business Warehouse (). However, because SAP uses a different architecture than CRM, the functionality and the used monitors differ.

External List Management in CRM

Files on Application Server

External List Management stores files uploaded from workstation (PC of the user) on the application server. The directory used can be customized in IMG activity [Customer Relationship Management > Marketing > External List Management > Maintain File Path](#). The customized directory must be located on a file system with sufficient free space. The necessary size of that file system depends on the following key figures:

- Number of lists uploaded into CRM
- Size of files uploaded as lists into CRM

The naming convention of these files is `ELM<GUID of the list>`. The GUID of the list can be found in the table `CRMD_MKTLIST_H`.

In addition, External List Management allows uploading files stored on the application server. The user can browse through the directories of the application server and choose a file. The location of these files depends on the organizational settings within the IT department of the customer.

Workflow Monitoring

The scenario External List Management requires the workflow template `WS14000029` to execute the selected process steps. For more details, see the IMG activity [Customer Relationship Management > Marketing > External List Management > Implement Workflow Customizing](#). A description of the workflow template `WS14000029` is available in the SAP Help Portal.

In addition, the workflow templates, WS140000129 and WS140000111 can be used. For more details, see the IMG activity [Customer Relationship Management > Marketing > External List Management > Implement Workflow Customizing](#) and SAP Library.

The monitor for work items (transaction SWI1) can be used to analyze the work items created for the workflow templates specified.

Database Tables

External list management can handle a large volume of data.

Table 38:

Tables	Purpose/ Description
CRMD_MKTLIST_C	This table is used to store the content of uploaded files.
CRMD_MKTLIST_ADR, CRMD_MKTLIST_ORG, CRMD_MKTLIST_PER, CRMD_MKTLIST_CEN, CRMD_MKTLIST_ATR, CRMD_MKTLIST_ACT, CRMD_MKTLIST_LEA, CRMD_MKTIST_BCI, CRMD_MKTLIST_SUV, CRMD_MKTLIST_CLR	After data mapping, the content of the files are stored in these additional tables
CRMD_MKTLIST_E	This table stores error messages per data record
CRMD_MKTLIST_I	This table stores the link between data record of a list and the business partner and the activity or lead object.
BUT000, BUT020, BUT021, BUT051, ADRC, ADRP, ADR2, ADR3, ADR6	These database tables increase in size if business partners are created within external list management
CRMD_ORDERADM_H, CRMD_ACTIVITY_H, CRMD_LEAD_H, CRMD_PARTNER	These database tables increase in size if business transactions (activity or lead) are created within external list management.

Use the corresponding database monitor in CCMS to check the size of the tables and the remaining free space. The size and growth of the mentioned tables depends on the following key figures:

- Number of lists uploaded into CRM
- Size of fields uploaded as lists into CRM
- Retention time of a list
- Usage of functionality to delete temporary data of a list (used or not used; frequency of the usage)
- Deletion of list (used or not used; frequency of the usage)

Table 39:

Tables	Purpose/ Description
CRMD_MKTLIST_C, CRMD_MKTLIST_ADR, CRMD_MKTLIST_ORG, CRMD_MKTLIST_PER, CRMD_MKTLIST_CEN, CRMD_MKTLIST_ATR, CRMD_MKTLIST_ACT, CRMD_MKTLIST_LEA, CRMD_MKTIST_BCI, CRMD_MKTLIST_SUV, CRMD_MKTLIST_CLR	These tables reduce in size only if the temporary data of a list is deleted or the complete list is deleted. Both functions are offered within the maintenance UI of the list.

Tables	Purpose/ Description
CRMD_MKTLIST_E, CRMD_MKTLIST_I	These tables reduce in size only if the list is deleted.
BUT000, BUT020, BUT021, BUT051, ADRC, ADRP, ADR2, ADR3, ADR6	<p>These tables reduce in size only if the business partners are deleted.</p> <p>If a list is deleted, the business partners are deleted only if they are still marked as rented. To delete not-rented business partners a deletion program can be used. The details are available in SAP Note 415007</p>

Distribution of Business Partners

The rented business partners are distributed to ERP systems and CRM Mobile. If External List Management is used to create a huge amount of not-rented business partners, problems within the distribution can occur.

Use the corresponding middleware monitors to check the distribution during the creation of business partners.

i Note

Use the transaction `SMW01` to check the BDocs of type `BUFA_MAIN`.

If rented business partners are created, they are marked as rented with a flag. This flag can be deleted automatically via an action if the business partner is used in a sales order in CRM. The action runs as soon as the sales order is saved. The flag is removed and the business partner is distributed to the ERP system. The sales order is also distributed to ERP.

Depending on middleware queue settings, there might be cases where the sales order reaches the ERP system before the business partner is created in the ERP system. In such a case, the sales order is rejected by the ERP system and gets an error status in CRM.

Use the corresponding middleware monitors to check the distribution of the sales order and business partner.

i Note

Use the transaction `SMW01` to check the BDocs of type `BUFA_MAIN` and `BUS_TRANS_MSG`.

Troubleshooting

Details for tips and tricks within External List Management and for trouble shooting can be found in SAP Note [708557](#).

External List Management in SAP

Database Tables

The content of the uploaded file is stored in the InfoObject `0ELM_GUID_I`.

Use the tools (such as transaction `RSD1`) to find the generated database tables of the mentioned InfoObject.

Use the corresponding database monitor to check the size and free space of the assigned database tables.

Programs









External List Management in uses the following programs in batch processing:

ELM_CHECK_POSTAL This program executes the postal check of the uploaded data.

ELM_CHECK_DUPLICATE This program executes the duplicate check of the uploaded data.



ELM_DELETE This program deletes the uploaded data.

The programs are started within the user interface of External List Management (transaction ELM) if the corresponding step is executed.

For more information, see SAP Help Portal at <http://help.sap.com/nwbw>  [BI Content](#)  [<choose release>](#)  [Application Help](#)  [BI Content](#)  [Customer Relationship Management](#)  [Marketing Analyses](#)  [External List Analysis](#) .



Other Scenario-Specific Problem Analysis Tools

Table 40:

Monitor	Detailed Description
Workflow	See SAP Help Portal at http://help.sap.com/nw_platform   <choose release>  : In the application help, search for "Workflow Trace".

Marketing Attributes with Mobile Sales

Troubleshooting

Details for tips and tricks for data exchange of marketing attributes with Mobile Sales can be found in SAP Notes [545391](#)  and [551918](#) . It is also possible to use transaction SDIMA to compare the data on the CRM server and in CDB.

Segment Builder with Mobile Sales

Troubleshooting

Use transaction SMW01 to control BDocs for the data exchange between CRM server and Mobile Sales. Here you can find unprocessed and incorrect BDocs. You can also find BDocs that were processed with an error (type F01 or E01). Using transaction SDIMA, you can compare data between CRM server and CDB and you can create BDocs to correct the inconsistencies.

4.2.1.13.8 Marketing Planning

Interfaces

Interface monitors are essential for analyzing problems with interfaces such as RFC, IDoc, and HTTP.

Logs are written with information on data flow to SAP NetWeaver BW, SAP ERP, and SAP APO. This information is application-specific, and is recorded for each marketing element. The logs can be accessed in the Marketing Planner application.

Table 41:

Monitor	Detailed Description	Prerequisites
Transfer to SAP NetWeaver BW	Application-specific messages concerning the online update of marketing elements to SAP NetWeaver BW.	none
Transfer to SAP ERP Project Systems	Application-specific messages concerning the update of marketing elements to SAP ERP Project Systems.	none
Transfer to SAP APO (Trade Promotion Management only)	Application-specific messages concerning the update of trade promotions and trade promotion tasks to SAP APO Promotion Management.	none

Data Archiving Monitors

SAP CRM uses standard tools available in SAP NetWeaver, for archiving and monitoring data archiving. For more information about the data archiving monitor, see SAP Help Portal at http://help.sap.com/nw_platform

▶ *<choose release>* ▶. In the application help, search for “Data Archiving Monitor”.

The fastest growing tables are:

CGPL_PROJECT, CGPL_TASK, CRM_MKTPL_ATTR, CRM_MKTPL_TPATTR, CRMD_MKTPL_AL00, CRMD_MKTPL_AL01, CRMD_MKTPL_AL02, CRMD_MKTPL_AL03, CRMD_MKTPL_COSTA, CRMD_MKTPL_CSTKP, CRMD_MKTPL_DATE, CRMD_MKTPL_PROD, CRMD_MKTPL_TMPL, CRMD_MKTPL_TGGRP

For periodical tasks required to constrain data growth (reorganization of temporary data) refer to the [Periodic Tasks \[page 84\]](#) section in this guide.

Distributed Statistical Records

Not applicable

Monitoring of Document Flow

See [CRM Middleware \[page 105\]](#).

Other Scenario-Specific Problem Analysis Tools

Table 42:





Monitor	Detailed Description	Prerequisites
Hierarchy consistency report	Report CRM_MKTPL_HIERARCHY could be used to monitor inconsistencies in the marketing element hierarchies.	none

4.2.1.13.9 Trade Promotion Management

See [Marketing Planning](#) [page 61].





5 Management of SAP CRM

SAP provides you with an infrastructure to help your technical support consultants and system administrators effectively manage all SAP components and complete all tasks related to technical administration and operation.

For more information about the underlying technology, see SAP Help Portal at http://help.sap.com/nw_platform  *<choose release>*  *System Administration and Maintenance Information*  *Technical Operations for SAP NetWeaver*  *Administration of SAP NetWeaver Systems* .

For information about industry-specific technical administration tasks and tools, see the section *Industry-Specific Scenarios*.

5.1 Administration Tools of Software Components

You can find more information about the underlying technology on the SAP Help Portal at http://help.sap.com/nw_platform  *<choose release>*  *System Administration and Maintenance Information*  *Technical Operations for SAP NetWeaver* .

For CRM Server, the central administration tool is SAP Solution Manager.

5.1.1 BW Adapter

Table 43:

Transaction/Tool	Detailed Description
SMQ1	Use this transaction to monitor whether the delta data is being filled into the outbound queue.
SMQR	Use this transaction to check the status of the scheduler, and stop or start it.
BWA7	Use this transaction to monitor for active DataSources, and re-generate an extraction report. You can also monitor the BW Adapter delta queues.
BWA5	Use this transaction to carry out activation of BW Adapter metadata in customer systems.
RSA3	Use this transaction to check and simulate the data extraction.

SAP NetWeaver BW Workbook Integration for CRM Mobile Sales:

Table 44:

Transaction/Tool	Detailed Description	Prerequisites
SMOBILEBW	This transaction is used to schedule requests in SAP NetWeaver BW to execute queries and to provide Solution Workbooks to CRM Mobile Clients. Can be called from the CRM Middleware administration console (SMOEC).	SAP NetWeaver Business Warehouse, CRM Mobile

Replication of Analytical Results from SAP NetWeaver BW to SAP CRM:

Table 45:

Transaction/Tool	Detailed Description	Prerequisites
CRMBWTARGETS	Use this transaction to release data targets in CRM to be available for update from SAP NetWeaver BW. You can also define new data targets.	SAP NetWeaver Business Warehouse

5.1.2 Web Channel and Partner Channel Management Components

Table 46:

Transaction/Tool	Detailed Description	Prerequisites
Log viewer	<p>The log viewer is a tool that you can use to access all log files of the SAP NetWeaver Application Server Java.</p> <p>Since the Java components are using the logging and tracing functionality of the SAP NetWeaver AS, the log viewer is used to access their log files too.</p>	The log viewer is automatically installed with the SAP NetWeaver Application Server Java.

Transaction/Tool	Detailed Description	Prerequisites
XCM administrator	<p>Configuration of the web applications in Web Channel and partner channel management is done with the extended configuration management administrator (XCM Admin).</p> <p>The configuration for the Web applications is described in the Java components of the installation guide for e-selling and partner channel management.</p> <p>You can find the guide on the SAP Service Marketplace (http://service.sap.com/crm-inst).</p>	The XCM administrator is automatically deployed with each Web application.
Internet Sales user administrator	The Internet Sales user administrator is a Web application.	The ISA user admin is automatically deployed to the SAP NetWeaver AS Java during the installation of the Java components.

5.1.3 Interaction Center

Table 47:

Transaction/Tool	Description	Requirements
<p>Indexes</p> <p>(BSP application CRM_EI_CMP_ADMN, also accessible from the Software Agent Framework (SAF) diagnosis tool)</p>	Compile knowledge bases defined in the SAF. Compilation is a prerequisite for searching the knowledge bases in the knowledge search.	<p>The database contains master data such as Solution Database (SDB) records, business partners, and cases.</p> <p>You have defined the knowledge bases in Customizing for the SAF.</p>
<p>(CRM UI for business role IC_MANAGER: ▶ Process Modeling ▶ Interactive Script Editor ▶)</p>	Define interactive scripts.	Interaction center manager role is assigned to your SAP Enterprise Portal (EP) user.
<p>Solution Database</p> <p>(transaction IS01 or via SAP EP CRM portal administrator role, Knowledge Bases workset)</p>	Maintain problems and solutions	None

Transaction/Tool	Description	Requirements
E-Mail Response Management System (ERMS) administration	<p>Maintain mail forms: CRM UI for business role IC_MANAGER: Knowledge Management > Mail Forms</p> <p>Maintain rule policies: CRM UI for business role IC_MANAGER: Process Modeling > Rule Policies</p> <p>Maintain categorization schemas: CRM UI for business role IC_MANAGER: Knowledge Management > Categorization Schemas</p>	RFC loopback node is set up via SAPconnect, and inbound distribution is specified under SAP Business Workflow
SAPconnect (transaction SCOT)	SAPconnect administration required for ERMS	None
SAP Business Workflow (transaction SO28)	Inbound distribution specified for ERMS	None
<p>Only valid up to Customer Relationship Management 7.0 Including SAP Enhancement Package 3 SP02:</p> <p>Accelerated agent inbox search: initial load for business transaction table</p>	<p>For more information, see SAP Help Portal at http://help.sap.com/crm ></p> <p>> <choose release> Application Help > Interaction Center > Interaction Center WebClient > Agent Inbox in the Interaction Center WebClient > Accelerated Inbox Search > Business Transaction Table for Accelerated Search</p>	See <i>Application Help</i> on SAP Help Portal
<p>Only valid from Customer Relationship Management 7.0 Including SAP Enhancement Package 3 SP03:</p> <p>Agent inbox: data upload to predefined inbox search tables</p>	<p>For more information, see SAP Help Portal at http://help.sap.com/crm ></p> <p>> <choose release> Application Help > Interaction Center > Interaction Center WebClient > Agent Inbox in the Interaction Center WebClient > Inbox Search > Predefined Inbox Search Tables</p>	See <i>Application Help</i> on SAP Help Portal

5.2 Starting and Stopping

Start and Stop Sequence and Tools

For information about starting and stopping, see SAP Help Portal at http://help.sap.com/nw_platform

▶ <choose release> ▾. In the application help, search for “Starting and Stopping SAP Systems”.

This guide covers only differences and additional information specific to this solution.

If there are errors during starting and stopping, shut down all components and restart them in the following order:

Table 48:

Software Component	Sequence	Tool	Detailed Description
All Scenarios			
CRM Server	1	None	SAP Note 624921
Field Applications			
Communication Station	1	None	No need to stop or start this component
Web Channel and Partner Channel Management			
Web Channel	1	SAP J2EE Engine Administrator	How to start and stop web applications is described in the administration manual of SAP NetWeaver AS Java. <ol style="list-style-type: none"> 1. Start SAP NetWeaver Administrator and log on. 2. Navigate to ▶ Operations ▶ Start & Stop ▾. 3. Select tab Java Applications. 4. Filter for your application name and click button Stop, Start or Restart.
Scheduler	2	SAP J2EE Engine Administrator	Scheduler is started and stopped implicitly when the Web Channel applications are started or stopped by SAP NetWeaver AS Java.

5.3 Backup/Restore and Recovery

You must back up your system landscape regularly to ensure that you can restore and recover it in the event of failure.

The backup and restore concept for SAP CRM consists of two parts:

- Backup and restore for each component
- Cross-system data dependencies and handling

The backup and restore concept for your system landscape should not only consider SAP systems. It should be embedded in the overall business requirements and take into account the whole process flow in your company.

In addition, the backup and restore strategy must cover disaster recovery processes, such as the loss of a data center through fire. It is most important in this context that you ensure that backup devices are not lost together with normal data storage (separation of storage locations).

The data and application integration is one of the main features of SAP CRM. The CRM server exchanges data with one or more ERP backends. This complex landscape of distributed and redundantly stored data has an important impact on the recovery procedure. You should involve the team in your company that is responsible for interfaces or for the interface to the ERP systems and to non-SAP systems.

The following table lists further documentation on the topic of backup and recovery:

Table 49:

Topic	Details / Link
SAP NetWeaver technical operations information	SAP Help Portal at http://help.sap.com/nw_platform ▶ <choose release> ▶ System Administration and Maintenance Information ▶ Technical Operations for SAP NetWeaver <ul style="list-style-type: none"> • Solution Life Cycle Management Backup and Recovery • Administration of Databases
Best Practice documentation: "Backup and Restore for SAP System Landscapes" "Emergency Handling for Recovery of SAP System Landscapes" "Backup and Recovery for SAP APO (3.x) / mySAP SCM (4.x)"	SAP Service Marketplace at http://service.sap.com/solution-managerbp Choose <i>Topic Area</i> "Technical Operations" and <i>Project Phase</i> "Operations Implementation"

Backup Frequency

SAP recommends that you back up your database on a daily basis.

Online Backup

The data contained in the database can be backed up online: however, it is not possible to do the same for the runtime infrastructure. An online backup refers to the system landscape and not the databases that contain the business-critical application, or the infrastructure components.

i Note

If you perform a backup while the server is running, open files may not be backed up.

5.3.1 Backup and Recovery in an SAP CRM System Landscape

The data and application integration is one of the main features of SAP CRM. The CRM server usually exchanges data with one or more ERP back ends. This complex landscape of distributed and redundantly stored data has an important impact on the recovery procedure.

You should involve the team that is responsible for interfaces or for the interface to the ERP systems and to non-SAP systems.

The following sections detail the backup and recovery procedure for the main components in the CRM landscape.

i Note

It is possible that some components that are used in your company system landscape are not covered in the following sections. Possible reasons are that this component delivers its own backup and recovery concept, or it is not relevant in the data integration/exchange in the landscape (and its backup and recovery is self-descriptive). If necessary, send your feedback to SAP, or contact your SAP consultant, to add this component in the next document release.

5.3.1.1 CRM Server

For the three tier client server architecture part of SAP CRM, the backup and recovery strategy is the same as for SAP ERP systems. Further, additional backup and recovery requirements must be taken into account for additional architecture components such, communication station, mobile client, and IPC.

Below you can find a summary of additional backup and recovery considerations relevant for SAP CRM. For more information about SAP CRM IT architecture, see the SAP CRM Master Guide on the SAP Service Marketplace.

The standard high availability solutions, cluster for failover, database hot standby, data mirroring, RAID, and so on, can be applied to the CRM Server in similar ways as for the standard SAP NetWeaver AS. The configuration is based on the NetWeaver configuration.

Cluster solutions are also supported for SAP server database, as long as the corresponding SAP technology partner takes over the responsibility for the implementation of their high availability solutions.

One of the key capabilities of SAP CRM is the application integration between the CRM Server database and the ERP backend databases. This leads to a special challenge by defining the backup and recovery and the high availability solutions within the CRM landscape. The data in the CRM landscape is distributed among the SAP CRM server database and ERP back-end database. Some data is available redundantly in the CRM Server and ERP back end. Other data is only available in the CRM Server, or only in the ERP back end. Database modifications are committed separately, on SAP server database and ERP back end. Therefore, consistency between CRM Server and ERP back end is ensured in several ways, one of them being the data-consistent qRFC technology used for integration between ERP back end and CRM Server. For information about data consistency checks for SAP CRM, see the following section.

Consistency Between CRM Server and ERP Back End

In contrast to the traditional ERP systems, SAP CRM uses several SAP component systems to implement cross-system processes. Data is no longer held centrally in a single ERP system but is, instead, distributed between several SAP systems. Data is often held redundantly, whereas each system might also hold originals of some pieces of data. Data transfer between the systems is automated and must ensure that data is always consistent between the participating systems. There may be different input sources for the same type of data in the same system. For example, sales orders in the SAP ERP system can originate from the Internet, via the SAP CRM Server, or can be entered directly in the SAP ERP system.

From a technical point of view, data may be held in databases provided by different database vendors, or data may even be held directly in files without using a database at all. There is no common “checkpoint” between the component systems and, thus, no common point of consistency, because data is constantly and automatically exchanged between systems.

A full technical recovery, up to the last committed state before crash, guarantees both external (SAP ERP – SAP CRM Server) data consistency. After restoring the last available backup and the last logs, the data consistency may need to be corrected eventually. Data consistency is a relevant topic, not only in case of disaster recovery. So even if the main backup and recovery approach for the CRM Server is the same as described for SAP NetWeaver AS, this approach must be enhanced in the case of incomplete recoveries using data consistency tools.

Eventual inconsistencies within the CRM Server, and with external back ends, can be checked and restored using the Data Integrity Manager, DIMa. The following section summarizes recommendations, information, and documentation available for consistency checks for SAP CRM.

General Recommendations About Consistency Checks

- Consistency checks may be applied during normal operation and, depending on the case, after disaster recovery
- If you plan to run consistency checks, we recommend you do so during phases with lowest system activity. This recommendation is important for system performance reasons, and in order to avoid irrelevant inconsistencies occurring. If you run consistency checks during high system activity, “ghost” inconsistencies may show up, which may be completely irrelevant.
- Depending on the case, consistency checks can be included as part of a disaster recovery scenario. For example, if, for some reason, you suspect data inconsistencies after recovery, you can run the available consistency checks. In other cases, there may be no reason to assume data inconsistencies due to the recovery scenario itself. For example, if you recover your database up to the last committed state immediately before a crash, and if there are no data transfer or application related reasons to suspect inconsistencies after recovery, then you do not need to run consistency checks directly after recovery.
- The corresponding project team at the customer site must decide when, or how, to run consistency checks, depending on the business scenario. After running consistency checks, the application team must also decide which of the eventual resulting inconsistencies are relevant and need to be restored, and which of them can be ignored.
- Old results from previous consistency checks can decelerate the process of restoring the data consistency in the system landscape. Make sure you remove such general or old inconsistencies on a regular basis, to avoid any additional problems or time-consuming activities after a system restore.

Data Integrity Manager DIMa

The data integrity manager tool, DIMa, is the official data consistency check tool for the CRM Server. The transaction `SDIMA` runs on the CRM Server, checks data between SAP CRM and CDB (for Mobile scenarios), and SAP CRM and the ERP back end, and also enables the restoration of data consistency between these databases.

Note

For information about DIMa see SAP Help Portal at <http://help.sap.com/crm> **Application Help** > **Data Exchange and Mobile Technologies** > **CRM Integration Services** > **System Monitoring** > **Data Integrity Manager**.

See also the DIMa collective SAP Note [531217](#). This SAP Note collects relevant SAP Notes regarding DIMa and offers different references to find the most relevant information to the application-specific notes.

The usage of DIMa will be explained in detail, according to the CRM key capability, and to the corresponding business objects (used for the data exchange). The process integration between SAP CRM and the ERP back end is taken into account. This is because there is no reason to get an additional data inconsistency between SAP CRM and CDB after a data restore, as the backup of both databases is done at the same time, by the same mechanism (both are stored on the same physical database).

Detecting Data Inconsistency

DIMa detects the data inconsistency between two databases, based on the business object and its filtering possibilities. You may want to start a complete and full data consistency check for both databases (in this case for SAP CRM and ERP) after an incomplete recovery.

When to Carry Out Data Consistency Checks

This is a very time-consuming activity and will not always be feasible, especially if the crash occurs in the productive environment, and if the business data must have the latest status immediately. This decision should be made by the CRM application team, with the support of the system administrators, and in accordance with the urgency and availability of the data.

Using Filters to Restrict What Is Checked

It is quite possible that in your scenario it is satisfactory for specific business data to remain inconsistent for the duration of the whole data check. For example, general data of business partners. But there might be other data that is relevant to the accuracy of the business processes, and would therefore have an extremely negative impact on the whole business if it remained inconsistent. For example, the usage of old sales conditions in new orders).

This situation leads to the idea of restricting the amount of data to be checked by using appropriate filters. The simplest filtering possibility is the date and time of the creation or modification of the business object. DIMa enables the usage of the filtering feature, therefore, it depends on the business object if the filtering according to the date and time is available.

The following sections cover this topic according to the main SAP CRM key capabilities:

DIMa for Business Partners

DIMa compares master data between SAP CRM and an external system, either using header compare (object exists in both systems) or detail compare (comparison on field level). The following table lists the different DIMa objects related to the business partners, and used for the data comparison:

Table 50:

DIMa Object	External System	Header Compare	Detail Compare	Filters Possible
CUSTOMER	ERP Customer Master	X	X	X
CONTACTS	ERP Customer Master	X	X	X

DIMa Object	External System	Header Compare	Detail Compare	Filters Possible
PARTNERFUNCTION	ERP Customer Master	X	X	X
PARTNER	ERP Business Partner	X	X	X
RELATIONS	ERP Business Partner	X	X	X

Generally for the CRM business partner there are two different exchange scenarios with the ERP back end:

- With the ERP customer master
- With the ERP business partner (special industry solutions).

The DIMa objects and the filters differ in the two scenarios as follows:

ERP Customer Master

- DIMa object **CUSTOMER** (ERP customers)
Filter KNA1-ERDAT is available and is related to the date of creation. The change date is not available.
- DIMa object **CONTACTS** (ERP contact persons)
Filter KNA1-ERDAT available (date of creation). This is the date when the customer to whom the contact person belongs was created, and not the date the contact person themselves was created. The change date is not available.
- DIMa Object **PARTNERFUNCTION** (ERP partner function assignments)
Same as for CONTACTS; KNA1-ERDAT is available for the corresponding customer, not for the partner function itself. This information is not available on the ERP database. No change filters available.

ERP Business Partner

- DIMa object **PARTNER**
No change or creation filters
- DIMa object **RELATIONS**
Change and creation filters available, BUT050-CHDAT and BUT050-CRDAT

In this case, the object RELATIONS is the only object that provides a check based on the creation or last change date. Therefore this information is stored in database fields that are not exchanged via middleware; they are filled whenever the object is created in the target system. This means the date and time of creation or change in one system can differ according to the duration of the processing of the data exchange itself (during the processing of the qRFC queues, which is also dependent on the degree of parallelization of the queues, and the system hardware and configuration). For example, you change a business partner in SAP CRM at 23:59 and the data arrives in SAP ERP at 00:01. This leads to the two systems having a different change date for the data. Therefore, a filter using the change date criteria may not be helpful, especially if the filtering is based on a short period of time, and not only on the date. Thus, we do not recommend you using the fields listed above for filtering data to write your own reports. Therefore, you need to make a full data comparison, without any filtering, in most cases of business processes involving business partners.

DIMa for Sales Documents

You can filter the DIMa objects SALESDOCUMENT and SALESCONTRACT according to the date, by including VBAK-ERDAT in the selection criteria for ERP orders. You cannot filter by time (field VBAK-ERZET). So it is possible to check for consistency of all orders and contracts (created in ERP), incoming from ERP, for a specific date. You cannot consider the orders created in SAP CRM or on mobile clients. In this case, it is currently not possible to use DIMa for any consistency checks.

DIMa for Product Master

Compares master data between SAP CRM and an external system, either using header compare (object exists in both systems) or detail compare (comparison on field level).

DIMa for Product / Product Ranges

Compares master data between CRM and an external system, either using header compare (object exists in both systems) or detail compare (comparison on field level).

Table 51:

DIMa Object	External System	Header Compare	Detail Compare	Filters Possible?
MATERIAL	ERP	X	X	X
SERVICE_MASTER	ERP	X	X	X
PRODUCT_MAT	CDB	X	X	X
PRODUCT_SRV	CDB	X	X	X
BOM	ERP	X	X	X
CUST_MAT_INFO1	ERP	X	X	None
PRODUCT_IL_MAT	CDB	X	X	None

Table 52:

DIMa Object	External System	Header Compare	Detail Compare	Filters Possible?
PPR	CDB	X	X	X

5.3.1.2 Groupware Integration

Groupware integration uses CRM Middleware for data synchronization and replication. It is possible to re-synchronize or extract CRM data for a particular user if there has been a data loss on the Groupware side. This is possible from the middleware replication and re-alignment service and extract service.

The Groupware integration adapter uses a subset of CRM application data. If there is a data loss, it can be restored with once the CRM data is restored.

5.3.1.3 SAP ERP Back-End System

For SAP ERP core-based SAP components, the SAP standard system management recommendations and high availability solutions are valid.

For more information, see SAP Service Marketplace at <http://www.sdn.sap.com/irj/sdn//ha>.

As the SAP ERP back end is involved in data exchange processes within the CRM landscape, see the section related to information on data consistency checks after an incomplete recovery.

5.3.1.4 SAP APO and SAP liveCache

For the three tier client server architecture part of SAP APO, the backup and recovery strategy is the same as for the SAP NetWeaver Application Server. In addition, additional backup and recovery requirements must be taken into account due to the fact that SAP APO has additional architecture components, for example, SAP liveCache.

For more information, see <http://service.sap.com//solutionmanagerbp>  *Checklist for Recovery of SAP APO liveCache >= 7.4* .

5.3.1.5 Web Channel Components

The application data of Web Channel and Partner Channel Management is stored in the database of the SAP NetWeaver AS Java. This is true for application data from Extended Configuration Management, Shop Management, rules-based personalization, and from the lean basket back end. Backup, restore, and recovery is to be as for the SAP NetWeaver Application Server Java database standards.

5.3.1.6 Software Agent Framework (ABAP)

This component contains application data original to the CRM system.

Backup:

Software data is in the file system; configuration and application data are in the database. File system backup and database backup are required. Backup frequency follows the SAP standard.

Restore:

There is no cross-system data. Therefore, the normal restore of SAP CRM online with database is enough.

5.3.1.7 Communication Station

The communication station is an optional SAP CRM architecture component. It is only required for specific SAP CRM business scenarios. It is not relevant from the backup and recovery perspective, as it is not a database system. The communication station runs C++ executables built on top of optimization C++ libraries. It is supported to use several communication stations in a CRM landscape (high availability) to enable a server failover. You do not need preventative solutions from the data storage point of view, because the communication station can be restarted after a server crash, and there is no relevant data loss within the communication station.

Backup

It is not necessary to backup the client software. The software can be installed using the installation CDs any time. To reduce exchange times for laptops, you may consider keeping some pre-installed laptops on stock.

Restore

Initialization of Communication Station

The communication station merely consists of the software itself, which is installed on the host, and some configuration information, which is kept in the registry. There is no application data, but it might be of interest to back up the log files of the communication station for further analysis, in case of security issues or incomplete recovery of the CRM Server. The log files enable you to determine the clients that logged on to the server in a specific time interval.

Software backup: We recommend a full system backup after installation and configuration changes, to ensure that all registry entries and libraries are included. If you are aware of all configuration entries and changes that have been made on the communication station since installation, re-installing the software is also an option.

Type: File system backup, either full or incremental, registry backup on Microsoft Windows platforms.

Interval: After installation and software or configuration changes.

Data Backup: There is no application data that needs to be backed up. Nevertheless, the log files of the communication station (TransferService.log) should be backed up, because they may be valuable for analysis reasons.

Type: File system backup of log file directory.

Interval: Regularly.

Restore: Restore host from file system backup. **Alternative:** New installation.

5.3.1.8 CRM Mobile Client

An exception to the above is represented by the data of the mobile client databases in SAP CRM. Although at some time they hold original data (the data that was entered during the day), there is no need for a special backup if the data is uploaded to the CRM Server on a very regular basis. If the mobile client database is destroyed, it can be rebuilt by downloading all relevant data from SAP CRM. However, all data that has been entered on the mobile client and not yet been uploaded to the CRM Server will be lost.

Backup

The mobile client holds original application data that is kept in a local database. Data is exchanged with the CRM Server on a regular basis, using the program ConnTrans. Since it is expected that the mobile client software be installed on a laptop, there are no measures foreseen to do a backup of the client database. Sending new data to the CRM Server regularly helps you to avoid the need for backup. The CRM Server database is being backed up itself. The more often a client connects to the CRM Server, the lower the risk of losing data if the laptop crashes. We recommend connection to the CRM Server at least once a day.

Business data from the mobile clients is uploaded to the CRM Server. There is no need to backup this data on the mobile clients if it is uploaded regularly to SAP CRM. We recommend uploading data to the CRM Server on a daily basis. This not only reduces data loss in the case of problems with the laptop, but also in the case of the CRM Server facing an incomplete recovery (which could lead to the need to send a full extract to the client to resolve data inconsistencies). A full extract will cause original data on the clients to be lost. If the clients are used to store additional data, which is not uploaded to SAP CRM, you might want to consider using an external laptop backup tool. Such tools can be used to back up delta information, even across low speed connections.

Restore

Installation of mobile client software on the laptop (preferably by restoring a laptop image).

Start the extract of data on the administration console of the CRM Server. When the extract is finished, and the outbound queue on the CRM Server is filled, the initial download to the client can be started. To reduce the time needed for the extract and initial download, the mobile client recovery manager can be used. For more information, see the corresponding documentation.

Restore: Restore host from file system backup. **Alternative:** New installation.

5.3.1.9 Mobile Application Studio

Introduction

The Mobile Application Studio is used for adapting the Mobile Sales application. All development is stored in the Mobile Application Repository. The Mobile Application Studio itself does not store any data.

Backup

Type: File system backup, either full or incremental, registry backup on Windows platforms.

Interval: On a regular basis, at least after installation and software upgrades or configuration changes.

Data Backup: There is no application data that needs to be backed up.

Restore

Restore host from file system backup. **Alternative:** New installation. **Dependencies:** None.

5.3.1.10 Mobile Application Repository

Backup

The Mobile Application Repository is used to store development objects of the mobile application development. This data is stored in an SQL Server database. Released development objects (change lists) are transported from the development landscape to the test and production landscapes using the SAP change and transport system. Change lists are attached to transports. They should always be transported separately and not be mixed in the same transport together with other SAP objects.

Type: Database and log backup of the Mobile Application Repository database, both in the development and production landscape.

Interval: Regular database backup, continuous log backup.

Restore

- Restore host from file system backup. **Alternative:** New installation.
- Restore repository database from backup and apply logs. Change lists for the production environment can instead be re-imported into the database from their corresponding transports. However, this procedure requires in-depth knowledge of the transfer mechanisms for change lists.

Dependencies:

Mobile Application Software on mobile clients

Change and transport system of CRM Server

Dependencies: CRM Server

Backup

Type: File system backup, either full or incremental, registry backup on Microsoft Windows platforms.

Interval: On a regular basis, at least after installation and software upgrades or configuration changes.

5.3.1.11 Interaction Center - Communication Channels

Recovery of IC WebClient communications channels is necessary when application finished unexpectedly due to hardware failure, software failure or power outage. Also the recovery has to take place when IC WebClient agent closes the application having in his workspace unfinished or just created items like active phone call, chats or e-mails in different states.

Recovery allows the agent to proceed with a customer interaction after the system has experienced an unexpected outage (e.g. hardware failure, software failure, power outage). There will be the case that the connection active while the outage occurred is still active as well as the case that the interaction center went on with operations without using the WebClient and therefore a completely unknown connection is active when WebClient is started again.

Recovery path:

1. Identify active connections via ICI
2. Determine connection Ids & status & type, Tel#/e-mail address
3. Find associated business partner (manual identification)

Telephony always wins. Only telephony connection is recovered on startup.

If Agent has unfinished mails in Inbox folder during startup, alert is going to be raised. This alert is to be used for navigation into mail recovery screen.

The same screen can be reached via index entry or navigation bar entry.

5.3.2 Step-By-Step Procedure

5.3.2.1 Preparation Steps

Backup and recovery protects against loss of data in the case of system crashes. Therefore, it is important to define a stable strategy for backup and recovery of your system landscape. It is also important to verify the whole backup and recovery procedure, before going live during an intensive test phase. Before performing this, ensure that you perform the following preliminary tasks or checks in the system.

Create a backup concept that meets your general security requirements:

Backup Media

When you create a backup of your system, you need to specify backup media. You can specify backup media. The backup can be written to a file, to a tape, or in a pipe. Backups on parallel media are supported. Data backups can be transferred directly to external backup tools. For more information, see SAP Note [119863](#).

Data Backup

It is advisable to back up your data once a day. This may also be an incremental data backup that writes all changes made since the last complete save to the backup media.

Log Backup

Log backups copy the content of the log area into version files. These version files are located in a file system and are archived using file system backup.

Backup History

Data backup and the associated log backups should last for at least four generations. Keep the backups available for at least four weeks. If you run a restore and the data backup has errors, you can go back to a previous data backup, as long as it, and all the log backups that were created since then, are still available.

Schedule Data Backup

You use transaction DB13C for the data backups.

Check and Test Recovery

We strongly advise that you test the recovery a number of times in both the test and production systems. You can do this in a number of ways, for example:

- Simulate a crash in a system that is not being used (no open transactions, no users in the system, qRFC queues stopped). Before the crash, use consistency check tool DIMa to check the data consistency between SAP CRM and ERP. After the recovery, this transaction must show the same consistencies or the same inconsistencies as before the crash.
- Simulate a crash with a full system load. Start a background job to generate middleware activities (data exchange between CRM Server and ERP back end). During this, carry out a system stop. After the recovery, verify the data consistency of your landscape. Be sure to test a complete restore run, including data and log.

Verify

Periodically verify your backups.

5.3.2.2 During System Operation

Check the Backups

Make daily checks to see whether the required backups have been created successfully. To perform this check, in the DBMGUI choose ► [Information](#) ► [Backup History](#) ►. In the *Result* column for the relevant backup, you should see *OK*.

Check the Verify

Check when the last verify ran, and if it was successful.

5.3.2.3 Activities After a System Crash

If a component crashes, you need to determine whether the failure has been caused by disk errors, or by other hardware or software problems. Usually the CRM Server and ERP back ends can be restarted if no disk errors have occurred, and the servers are then available.

Activities After a Crash Without Disk Errors

After a crash, start the CRM Server or ERP back end. Then activate the cancelled qRFC queues that could not be processed during the downtime. All transaction data that had been committed at the time of the crash is available after the restart. Changes caused by transactions that had not been completed at the time of the crash are rolled back. Depending on the queue type, use transaction SMQ2 for inbound queues and SMQ1 for outbound queues. Check the status of the queues in all relevant systems.

A crash may have caused queue entries with status SYSFAIL if the processing of these entries was interrupted by the crash. When the CRM Server is available again, these transfers can be easily re-executed. If you manually restart the queues, you should also execute the SYSFAIL entries in SMQ1 and SMQ2, or use the programs RSQOWKEX (outbound) and RSQIWKEX (inbound) to start several queues in parallel. Of course, errors not caused by the crash will result in status SYSFAIL again.

For information about all steps to be carried out after such a system restart, see SAP Note [624921](#).

Activities After a Crash Caused By Disk Errors

Disk or disk system errors can have a variety of effects. They can prevent the server from restarting. If the structure of individual blocks on the disks is destroyed, it may still be possible to start the server. However, data from individual class containers or SQL tables is then no longer accessible. If the disks of the CRM Server have errors, data is not lost if a data backup and all associated log backups are available.

Prepare for a Recovery

Recovery usually takes quite a while. Therefore, we advise you make a few preparations in the CRM Server:

- Ask all users in the system to log off as soon as possible. You can inform the users about the recovery using a system message (transaction SM02).
- Prevent other users from logging on to the system
- Deschedule all programs scheduled to run in the background, particularly jobs triggering data exchange processes

Data and Log Recovery

Change the defective disk and start last backup.

Follow-Up Work for a Recovery

After a recovery, activate the queues as described above. In addition, perform the following tasks:

- Remove system messages relating to recovery (SM02)
- Create an SAP support notification if you are unable to determine the reason for the disk failure
- Start or schedule background jobs and planning runs that were descheduled, or that did not start due to the downtime
- Unlock the system for users

Table 53:

Categories of System Components	Category Properties	Suggested Backup and Recovery Methods	Example
I	Only software. No configuration or application data.	<ul style="list-style-type: none"> - No backup, new installation in case of a restore or - Initial software backup after installation and upgrade - Backup of log files 	None
II	Only software and configuration information. No application data.	<ul style="list-style-type: none"> - Backup after changes have been applied or - No backup, New installation and configuration in case of a restore - Backup of log files 	SAP Gateway Communication Station SAP Business Connector
III	Only replicated application data. Replication time is sufficiently small for a restore.	<p>Data:</p> <ul style="list-style-type: none"> - No data backup needed - Backup of software, configuration, log files 	None
IV	Only replicated application data. Backup recommended, because replication time is too long data not managed by a DBMS	<p>Data:</p> <ul style="list-style-type: none"> - Application-specific file system backup or - Multiple instances - Backup of software, configuration, log files 	None
V	Only replicated application data. Backup recommended, because replication time is too long data managed by a DBMS	<p>Data:</p> <ul style="list-style-type: none"> - Database and log backup or - Multiple instances - Backup of software, configuration, log files 	None

Categories of System Components	Category Properties	Suggested Backup and Recovery Methods	Example
VI	Original application data, standalone system, data not managed by a DBMS	Data: - Application-specific file system backup - Backup of software, configuration, log files	None
VII	Original application data, standalone system, data managed by a DBMS, not based on SAP NetWeaver AS	Data: - Database and log backup - Backup of software, configuration, log files	None
VIII	Original application data, standalone system, based on SAP NetWeaver AS	Data: - Database and log backup, application log backup (for example, job logs in file system) - Backup of software, configuration, log files	CRM Server ERP back end
IX	Original application data, data exchange with other systems, data not managed by a DBMS	Data: - Application-specific file system backup, data consistency with other systems must be regarded - Backup of software, configuration, log files	None
X	Original application data, data exchange with other systems, data managed by a DBMS, not based on SAP NetWeaver AS	Data: - Database and log backup, data consistency with other systems must be regarded - Backup of software, configuration, log files	SAP liveCache SAP Mobile Workbench
XI	Original application data, data exchange with other systems, based on SAP NetWeaver AS	Data: - Database and log backup, application log backup (for example, job logs in file system), data consistency with other systems must be regarded - Backup of software, configuration, log files	SAP ERP back end CRM Server SAP APO

5.4 System Copy

5.4.1 SAP NetWeaver Application Server

For information about how to copy the SAP NetWeaver AS Java including all applications and all database tables, see SAP Help Portal at http://help.sap.com/nw_platform > > <choose release> >. In the application help, search for "System Copy".

This system copy contains all data stored in persistence of the SAP NetWeaver AS including the application data in XCM, Shop Management, lean basket back end, and rules-based personalization.

5.4.1.1 Post System Copy Steps

After you have successfully performed the system copy, you have to match the configurations to the new SAP NetWeaver AS.

5.4.2 Interaction Center

The following configuration needs to be revisited after the system copy:

- Search and Classification (TREX) and Software Agent Framework (SAF)
 - After setting up the connection to TREX in transaction SM59, change the RFC destination to point to the new TREX connection. You do this in Customizing for *Customer Relationship Management*, under > > *Enterprise Intelligence* > *Software Agent Framework* > *Configure RFC Destinations* >.
 - In Customizing for the Software Agent Framework, follow the steps to set up indexes and compile them.
- Computer Telephony Integration (CTI)

Adjust the RFC configuration for CTI (ICI or SAPphone) according to the new system landscape:

 - ICI

After setting up the connection to the communication software in transaction SM59, assign the newly configured RFC destination to your communication management software system ID in transaction CRMM_BCB_ADM.
 - SAPphone

After setting up the connection to the communication software in transaction SM59, create a telephony server with the newly created RFC destination in transaction SPHB.
For more information about configuring communication management software, see SAP Solution Manager.
- Transaction Launcher and Action Box

Adjust the logical systems and URLs for transaction launcher in the new system and configure transaction launcher in Customizing for Customer Relationship Management, under > > *Interaction Center WebClient* > *Basic Functions* > *Transaction Launcher* > *Configure Transaction Launcher (Wizard)* >.

Reconfigure the action box configuration in transaction EWFC0.

5.5 Periodic Tasks

CRM-specific jobs need to be scheduled in your SAP CRM system and, where specified, in all the connected SAP ERP systems.

You should run all jobs, unless otherwise specified, at times of minimal system activity, so as not to affect performance or otherwise disrupt your daily operations. All jobs, unless otherwise specified, can be restarted.

5.5.1 Scheduled Periodic Tasks

5.5.1.1 Middleware

Table 54:

Program / Task	Recommended Frequency	Description
Detect aborted BDoc messages: RSMWFLOWWATCHDOG	Daily	Transaction SMW3WD
Process aborted BDoc messages: RSMWAPP01	Daily	Transaction SMW20

5.5.1.2 Billing

Table 55:

Program / Task	Recommended Frequency	Description
/BEA/CRMB04 (Analyze Incomplete Billing Due List)	Depending on the frequency of the billing process, schedule this transaction before the billing run is started.	This transaction resolves inconsistencies in the billing due list which might be caused by enqueue conflicts or inconsistent data.
/BEA/CRMB07 (Reject Incomplete Billing Due List)	Depending on the frequency of the billing process, schedule this transaction before the billing run is started.	This transaction cleans up the derivation due list for incomplete due list items.

5.5.1.3 Social Media

Table 56:

Program	Recommended Frequency	Description
CRM_SOC_SMC_HARVEST_DU	As appropriate	Retrieves posts, private messages, and comments from social media platforms
CRM_SOCIAL_IMG_DES	Daily	Deletes retrieved social media posts for which there are no follow-up actions
CRM_BUPA_SMI_UPDATE	As appropriate	Updates the social media user data in your database

5.5.1.4 Web Channel

Table 57:

Program / Task	Recommended Frequency	Description
XCM Configuration	After changing configuration	The XCM configuration is stored in the persistence of the SAP NetWeaver AS. Instructions for the backup of the table are in the documentation of the SAP NetWeaver AS Java in the subsection of the corresponding database.
Shop	After modifying shops	The shop configuration is stored in the persistence of the SAP NetWeaver AS. Instructions for the backup of the table are in the documentation of the SAP NetWeaver AS Java in the subsection of the corresponding database.
SAP NetWeaver AS Java DB	None	Since the application data is stored in the database form the SAP NetWeaver AS Java, strategies for the corresponding database have to be used.

5.5.1.5 Software Agent Framework (SAF)

Table 58:

Program / Task	Recommended Frequency	Description
Compilation of knowledge base	Not less than 5 minutes	<p>The frequency of the background job for delta compilation can be set in Customizing and can be specified individually for different knowledge bases. See Customizing for <i>Customer Relationship Management</i>, under Enterprise Intelligence > <i>Software Agent Framework</i> > <i>Configure Compilation</i> ></p> <p>the job is an administrative background job. It updates data to the Search and Classification (TREX) server for further data search. It does not influence system availability, but data availability.</p> <p>If the job was not executed for some reason, a full compilation should be done.</p>

5.5.1.6 Interaction Center

Table 59:

Program / Task	Recommended Frequency	Description
Upload interaction statistics (transaction CRM_CIC_CTI_LOAD)	Daily	<p>Report used to upload statistics data from the communication system (for example, CTI server) to SAP CRM. For more information, choose Help > <i>Application Help</i> > in the transaction.</p>

Program / Task	Recommended Frequency	Description
Compile knowledge bases (BSP application CRM_EI_CMP_ADMN, also accessible from the Software Agent Framework (SAF) diagnosis tool)	Not less than 5 min	<p>You set the frequency in the <i>Indexes</i> application. You can set the frequency individually for different knowledge bases.</p> <p>This is an administrative background job, with the purpose of populating the data to Search and Classification (TREX) for further data searching. It does not influence system availability, but does influence data availability.</p> <p>If, for some reason, the job was not executed, you can remedy the situation with a full compilation.</p>
Background job data load for SAP SAP Business Information Warehouse	None	For IC analytics statistics data
CRM_WEC_PSP_ORDER_UPDATE <i>CCMS – Jobs – Maintenance</i> (transaction SM37)	Daily	<p>Note: This program is only available if you have activated the business function <i>SAP Multichannel Foundation for SAP CRM</i> (CRM_MCF_R1).</p> <p>Use this program to identify and process incomplete sales and service orders that customers create using payment service providers. For more information, see the online documentation for program CRM_WEC_PSP_ORDER_UPDATE.</p>

5.5.1.7 Marketing Product Proposal: Top n Product Lists

Table 60:

Program / Task	Recommended Frequency	Description
CRM_MKT_TOPN_PROD_SELECTION_BW	As appropriate	None

5.5.1.8 External List Management

Table 61:

Program / Task	Recommended Frequency	Description
Program CRM_MKTLIST_BW_WONCUST_BATCH in CRM	Depends on required schedule of update of BW data	This program calculates the key figure <i>Customers Won</i> in CRM and fills the delta queue to update this key figure in SAP NetWeaver Business Warehouse. For more information, see Customizing for <i>Customer Relationship Management</i> , under Marketing > External List Management > Business Add-Ins > Define Determination of Key Figure 'Customers Won' .

5.5.1.9 Marketing Planning

Table 62:

Program / Task	Recommended Frequency	Description
CRM_MKTPL_CHECK_AC	Not specified	Sets the status of the selected marketing elements to <i>To be Archived</i> .
CRM_MKTPL_WRITE_AC	Not specified	Updates the selected marketing elements to the archive.
CRM_MKTPL_DELETE_AC	Not specified	Deletes all data related to the selected marketing elements from the operative database.

5.5.1.10 Segment Builder

Table 63:

Program / Task	Recommended Frequency	Description
CRM_MKTG_TREX_UPDATE	Daily	To update fast find enabled attributes (transaction CRM_MKTDS) within the TREX cache

5.5.1.11 Loyalty Management

Table 64:

Program / Task	Recommended Frequency	Description
RLOY_PT_ACCT_EXPR_RUN	Based on business need	Expires loyalty points in point accounts which have transactions with expiry date that has already passed.
RLOY_PT_ACCT_INA_EXPR_RUN	Based on business need	Expires loyalty points in point accounts based on inactivity of membership.
RLOY_ENGINE_CACHE_REFRESH	Based on changes in the loyalty reward rules and loyalty campaigns	Loads and refreshes loyalty engine cache
LOY_ENGINE_BATCH_PROCESS	Based on business need	Processes loyalty member activities
RLOY_TIER_EXPIRY_REPORT	Based on business need	Creates member activities for tier evaluation
RLOY_PPA_TXN_EXTRACT	Based on business need and usage of partnership	Exports partner point transactions in a .CSV format for a given partnership and attaches it to a partnership
CRM_LOY_PSH_EXPIRE	Based on business need and usage of partnership	Expires <i>Active</i> partnerships where the end date has already passed.
Report: RCRM_LOY_OUTBND_PROCESS_QUEUE	Based on business need	Processes and sends queued messages.
RLOY_CARD_EXP_REPLACE	Based on business need	Expires cards where the <i>Valid To</i> date lies in the past; it also creates replacements for the same
RLOY_CARD_ORDERING_EXTERNAL	Based on business need	Orders cards for printing from an external service provider
RLOY_CARD_ORDER_STATUS_UPDATES	Based on business need	Receives status updates from the external service provider
RLOY_CPG_VOUCHER_GENERATION	Based on business need	Generates vouchers through member activity; Rule-based voucher generation
RLOY_CRD_ATC_GENERATE	Based on business need	Generates anonymous temporary cards
Transaction LSMW	Based on business need	Set up the project with transaction LSMW using the standard report CRM_LOY_MEMBER_ACTIVITY_LOAD.

Mass Upload of Member Activities

Input data should be provided in a spreadsheet with the following columns:

Table 65:

ActivityType	ActivityCategory	ActivityDate	Timezone	MembershipID	MemberID	CardID	ProgramPartnerID
FLIGHT	ACCRUAL	2008020612 3000	INDIA	1072	None	None	None
FLIGHT	ACCRUAL	2008020612 3000	INDIA	1071	None	None	None

Table 66:

ProgramPartnerID	UserStatus	PointType	PointsEarned	PointQualificationType	ProductID	ProductCategoryID
<Enter ID>	E004	Miles	3000	LEVEL3	None	None
<Enter ID>	E004	Miles	3000	LEVEL3	None	None

Table 67:

Product-Quantity	Product-QuantityUnit	Amount	Currency	TierGroup	TieLevels	CampaignID	RewardRuleID
None	None	None	None	None	None	None	None
None	None	None	None	None	None	None	None

Table 68:

TicketingDate	AirlineID	BookingClass	Origin Airport	DestinationAirport	FlightCategory	FlightNumber
20080602	#REF!	None	DEN	LHR	WRLD	None
20080602	#REF!	None	DEN	LHR	WRLD	None

Table 69:

BaseMiles	TicketNumber	PNR	FareBasis
4683	None	None	None
4683	None	None	None

Data cleansing is not supported. Data is provided in the spreadsheet. If too many member activities go into the "Contains Error" status, then data correction becomes extensive.

The order of fields in the spreadsheet is very important. The field names should not be given in the spreadsheet during upload. The row containing field names should be used only as a reference to fill data in the spreadsheet. This row of field names should be deleted before upload.

Output

In case there are any validation errors, the member activity would still get created but it would be in “Contains Error” status.

Provided the incoming data is clean and all validations are cleared, the member activity gets created in the “Created” status or in the status value that has been given in the spreadsheet. You can set the user status code as “Created” or “Ready for Batch”

5.5.1.12 Partner Channel Management

Partner Management

Table 70:

Program / Task	Recommended Frequency	Description
Unusable business partners	Weekly	Report CRM_CHM_DEL_CP_ACT deletes unusable business partners from the request for registration process. It runs in the background. Use transaction SM36 to plan batch jobs, and transaction SM37 to get an overview of planned batch jobs.

Partner Segmentation

Table 71:

Program / Task	Recommended Frequency	Description
Updating master group	Daily	You should update the master group for each channel partner. This batch job is done by report CRMD_MKTSEG_MGR. A master group based on program <i>Partner Channel Management Accounts</i> must exist. Use transaction SM36 to plan batch jobs, and transaction SM37 to get an overview of planned batch jobs.

5.5.2 Required Manual Periodic Tasks

5.5.2.1 Interaction Center

Table 72:

Task or Transaction	Description	Recommended Frequency
Delete Reporting Data (CRMD_ERMS_DEL_RDATA)	Removes e-mails from the system. To ensure that non processed items remain in the system, be sure to select <i>Extracted Data Only</i> .	Daily
Compilation	None	If regular delta compilation is scheduled in the <i>Indexes</i> application, no manual task is required. This task does not influence system availability, but does influence data availability.
SAP BW data load	For IC analytics statistics data	None
Transport scripts	Scripts created in the interactive script editor require manual transport with transaction SE09	As required.
Delete obsolete saved transcripts (Report CRM_IC_SCR_DELETE_TRANSCRIPTS)	Saved transcripts are not archived with their corresponding Interaction Record. This report will delete all transcripts, whose associated Interaction Records have been archived	As required

5.5.2.2 Loyalty Management

Table 73:

Task or Transaction	Description	Recommended Frequency
Statement of points in a loyalty program	Report: RLOY_PT_ACCT_STATEMENT gives the sum of all earned, redeemed, expired and balance points for each point type across the loyalty program. This report is not scheduled and can be executed directly.	Based on business need

Task or Transaction	Description	Recommended Frequency
Generation of partnership account statements	Report: RLOY_PSH_ACCOUNT_STATEMENT Generates partnership account statements for all, or selected partnerships – as PDF attachments in partnership UI	Based on business need
Loyalty partnership point account settlement report	Report: CRM_LOY_PSH_POINT_SETTLEMENT Creates sales orders for the corresponding transaction type to settle point balances of the specified partnerships	Based on business need

5.5.2.3 Software Agent Framework

Table 74:

Task or Transaction	Description	Recommended Frequency
Compilation	None	If delta compilation is set for the system, the manual task is not required. This task does not influence system availability, but does influence data availability.

5.5.2.4 Marketing Product Proposal: Top n Product Lists

Manually scheduled tasks can be used to select products for top n product lists.

Table 75:

Task or Transaction	Description	Recommended Frequency
CRM_MKT_TOPN_PROD_SELECTION_BW	None	Arbitrary

5.5.2.5 Service Contract and Entitlement Management

Table 76:

Task or Transaction	Description	Recommended Frequency
Check batch job for periodic action processing (PPF report <code>RSPPFFPROCESS</code>)	PPF report is used to monitor SLA parameters in service transactions	Depends on SLA configuration (daily)
Check Message Status for e-mails sent (T-Code SCOT)	SLA monitoring is using e-mail channel by default	Depends on SLA configuration (daily)



5.5.2.6 Planned Services

Table 77:

Task or Transaction	Description	Recommended Frequency
Check batch job for periodic action processing (PPF report <code>RSPPFFPROCESS</code>)	PPF report is used to generate service transactions periodically out of service plans	Depends on service plan configuration (weekly)

5.6 Logon and Load Balancing

SAP CRM uses the standard functionality of SAP NetWeaver for logon and load balancing.

For more information, see SAP Help Portal at http://help.sap.com/nw_platform  *System Administration and Maintenance Information*  *Technical Operations for SAP NetWeaver* : Search for “Load Balancing”.

CRM specifics are indicated below where applicable.



Additional Logon and Load Balancing Tools

Table 78:

Tool	Detailed Description	Prerequisites
SAP Web Dispatcher	<p>A web dispatcher can distribute the load to several Application Server Java Engines.</p> <p>For further information, see the following SAP NetWeaver Library documentation at SAP Web Dispatcher.</p>	At least two Application Server Java Engines where the Web applications are deployed and configured equally.

Tool	Detailed Description	Prerequisites
XCM Admin	As of Web Channel 7.54, JCo connection properties are no longer maintained within XCM. These properties are now specified for a so-called destination that can be created within SAP NetWeaver Administrator (NWA). There you can decide if you use a direct connection to one CRM Server, or if you connect to a SAP Gateway that can distribute the load to several CRM Server or ERP installations.	SAP Gateway

5.7 User Management

SAP CRM uses the standard functionality of SAP NetWeaver for user management. For more information, see SAP Help Portal at http://help.sap.com/nw_platform  *System Administration and Maintenance Information*  *<choose release>* . In the application help, search for “User Management”.

Further User Management Tools

Table 79:

Tool	Detailed Description	Prerequisites
CRM or ECC / ERP Server transactions SU01	You must maintain the users required by your customers to log on to the Web shops. In B2C, customers create their own users (maintainable in transaction). For B2B, you first have to create SU01 users that your customers can log on. For more details about user administration, see SAP Solution Manager.	Not applicable
Internet Sales User Admin	The Internet Sales User Admin is a Web application that allows you to maintain users in your CRM Server. For more details about user administration, see SAP Solution Manager.	Deployed and configured web application on a Application Server Java Engine.
SAP NetWeaver AS Java 6.40 Administrator	You must maintain the users required to access the persuserinterface component in the Application Server Java Engine. For more details about user administration, see SAP Solution Manager.	Not applicable

Tool	Detailed Description	Prerequisites
Transaction PPOCW	Create organization and staffing	Not applicable
Transaction PPOMW	Change organization and staffing	Not applicable
User maintenance (transaction SU01)	SAP NetWeaver AS user management	Not applicable
Profile generator (transaction PFCG)	Create roles and assign authorizations to users in ABAP-based systems	Not applicable
Application Server Java Engine user management	Mainly for defining users in running CRM applications in SAP Enterprise Portal	Not applicable
AMT	Authorization Management Tool	You are working with any of the SAP CRM Field Applications
SMO_AUTH_TRANSPORT_40	Transport of Authorizations to Mobile Clients Relevant setting across the system landscape (DEV -> QTEST -> PROD)	Not applicable
Mobile laptop applications	The users for mobile laptop applications are created in the admin console (SMOEC). The users are then mapped to an employee (defined in CRM downloaded to CDB)	Not applicable

User

Table 80:

User	Detailed Description	Single Sign-On
SU01 user	You require a user with the privileges to administrate users. Use this user to log on to the Internet Sales user admin and to the CRM system.	No

User	Detailed Description	Single Sign-On
Anonymous back-end user in SAP CRM	<p>Web Channel requires a user in the back end to get some data from the back end, which should be displayed before the customer logs on (for example in the B2C scenario).</p> <p>This user has to be of the type 'Service' the roles 'SAP_CRM_ISA_ITSLOGIN' and 'SAP_CRM_ISA_WEBSHOP_MANAGER' have to be assigned to this user.</p> <p>The user has to be configured in the respective destination within NWA for authentication type <i>Technical User</i>.</p>	No
Anonymous back-end user in ECC / ERP using B2C	<p>This user needs the appropriate permissions for following authorization objects in the ERP system:</p> <p>C_TCLS_BER, C_TCLA_BKA, C_TCLS_MNT, F_KNA1_APP, F_KNA1_BUK, F_KNA1_GEN, S_RFC, V_KNA1_VKO, V_VBAK_AAT, V_VBAK_VKO, V_VBRK_FKA, V_VBRK_VKO.</p> <p>The first three ones are only relevant if you want to use IPC configuration. Note that since all sales documents are technically created for this user, authorization objects V_VBAK_VKO and V_VBAK_AAT must allow the creation of data.</p> <p>The values for objects F_KNA1_APP, F_KNA1_BUK and V_KNA1_VKO that are relevant for B2C registration must also allow the creation of data.</p>	No

Table 81:

User	Detailed Description	Single Sign-On
Customer SU01 user	<p>Every SU01 user that enters the ISA B2B application must be allowed to create sales documents (the user needs to have the 'create' permission for V_VBAK_VKO and V_VBAK_AAT).</p>	No

User	Detailed Description	Single Sign-On
Customer users	If you want to copy your CRM system, ensure that the users of your customers are copied too.	No
"isaadmin" user	You need a user in the Web application that is assigned to the user role "isaadmin". This user is required to access the admin areas of the different Web applications.	No

6 High Availability

SAP CRM follows the general high availability concept that applies to all SAP NetWeaver-based systems. For more information on high availability, SAP Help Portal at https://help.sap.com/nw_platform > <choose release> > *System Administration and Maintenance Information* > *Technical Operations for SAP NetWeaver* > *SAP NetWeaver Library: Function-Oriented View* > *Solution Life Cycle Management* > *SAP High Availability* >

6.1 Web Channel and Partner Channel Management

One single point of failure is SAP NetWeaver Application Server Java, which can crash or stop.

You can distribute the load to several servers by using a web dispatcher. See section [Logon and Load Balancing \[page 94\]](#).

Table 82:

If...	Then...
A customer is using your web shop and SAP NetWeaver Application Server Java crashes	<p>An error message is displayed after having sent a new request to SAP NetWeaver Application Server Java.</p> <p>The Lean Basket Backend allows you to make recovery backups of a shopping basket your customer created. Every time your customers send a new request (for example, when adding a product to the basket), the actual basket is stored. When the shop is available again, customers can access their old shopping baskets and they do not have to add all products from scratch again.</p>
The backend (CRM server or SAP ERP) is not available	Your customers cannot log on to the web shop
A customer is logged on when the connection to the CRM server or SAP ERP is cut off	<p>An error message is displayed when a new request is sent to CRM or ERP.</p> <p>It is possible to configure Internet Sales Web Applications where an SAP Gateway is used to connect to the backend.</p>

If...	Then...
The pricing component AP-PRC-PR (optional for ISA ERP Edition) is not available	<p>your customers cannot configure products.</p> <p>No prices are displayed either. This depends on your settings. If you have configured to take list prices, the prices are displayed in the catalog, but they are not displayed in the basket.</p> <p>If you are running ISA (ERP edition) without IPC, the prices are displayed regularly.</p> <p>If you have configured to take prices from the IPC, no prices are displayed in the catalog.</p>
TREX crashes	The Shop is not accessible, because there is no product information available. It is possible to connect to several TREX Servers by using an SAP Gateway
A connection to the CRM back-end system cannot be established	An error message is displayed to the user. You can check out the <i>JCo 3.0 in WebChannel 7.54 - Configuration & Migration Help</i> guide (http://service.sap.com/crm-inst) <i>SAP CRM 7.0 Enhancement Package 4 > Operate</i> that describes typical error messages related to JCo destinations. If it turns out to be a configuration issue, first check your destinations maintained in NWA, then check the correct destination assignment in XCM.

There are some tests to check availability of all configured components. You can use the link `http://<host>:<port>/<application>/admin/highav/init.do?scenario.xml=<APP-CONFIG>` to check the availability of all required components.

- <host> name of the machine on which the J2EE Engine is installed
- <port> http port of the J2EE Engine
- <application> the application you want to check (for example, b2b or b2c)
- <APP-CONFIG> name of the application configuration, which should be tested.

For all available components, a green field in the returned table is displayed. Components that are not available are shown in a red field.

- If a component does not respond within 10 seconds, the field becomes yellow and it contains a timeout message.
- If all components are available, the http result is `SC_OK (200)`.
- If one component is not available, the http result is `SC_NOT_FOUND (404)`.
- If you want to check the catalog search server, you need to add the request parameter `shop_id` to the URL.

6.2 Interaction Center

The connection to third-party CTI vendors is via XML/SOAP. High availability and failover concepts for this component have to be discussed with the corresponding CTI vendor. Depending on the capabilities of the third-party product, the CTI component might be a single point of failure (SPOF).

If the TREX Server crashes, the Search and Classification (including Knowledge Article Search) is not available. It is possible to connect to several TREX Servers by using an SAP Gateway.

When a heartbeat profile is used, the system checks for continued communication between the application server session, the communication management software (CMS), and the Web browser. In case this communication is disrupted beyond a given timeframe, the system will log the user off the CMS.

The heartbeat profile can be configured in Customizing under [Customer Relationship Management](#) > [Interaction Center WebClient](#) > [Basic Functions](#) > [Communication Channels](#) > [Define Heartbeat Profile](#).

7 Software Change Management

Software Change Management standardizes and automates software distribution, maintenance, and testing procedures for complex software landscapes and multiple software development platforms. These functions support your project teams, development teams, and application support teams.

The goal of software change management is to establish consistent, solution-wide change management that allows for specific maintenance procedures, global rollouts (including localizations), and open integration with third-party products.



This section provides additional information about the most important software components.

The following topics are covered:

- Transport and Change Management – Enables and secures the distribution of software changes from the development environment to the quality assurance and productive environment.
- Development Request and Development Release Management – Enables customer-specific maintenance procedures and open integration with third-party products.
- Template Management – Enables and secures the rollout of global templates, including localizations
- Quality and Test Management – Reduces the time, costs, and risks associated with software changes.
- Support Packages and SAP Notes Implementation – Provides standardized software distribution and maintenance procedures.
- Release and Upgrade Management – Reduces the time, costs, and risks associated with upgrades.

7.1 Transport and Change Management

For transport and change management issues, the procedures of SAP NetWeaver apply. SAP NetWeaver includes the Change and Transport System (CTS) which is a tool that helps you organize development projects in the ABAP Workbench and in Customizing, and then transport the changes between the SAP systems in your system landscape.

For more information, see SAP Help Portal at http://help.sap.com/nw_platform  *<choose release>* . In the application help, search for “Change and Transport System”.

7.1.1 Web Channel and Partner Channel Management

From SAP CRM 5.0 onwards, it is possible to transport the XCM application configuration to another server or application on the same server.





7.2 Development Requests and Development Release Management

The transport workflow provides a framework for transporting enhancements or new developments of existing business functions in a system landscape. It provides a direct connection between development and transport administration. The transport workflow manages the transport process, determines the user for each individual step automatically, and then displays an interface that they can use to perform the task directly.







It is an efficient method of transporting a selected number of requests into a group of transport targets, and uses clearly defined approval steps to ensure the quality of your target systems.

7.2.1 Web Channel and Partner Channel Management

The SAP NetWeaver Java Development Infrastructure (NWDI) is used for customer modifications. The SAP NetWeaver Developer Studio (NWDS) is used as integrated development environment (IDE), which connects to the Design Time Repository (DTR) that serves as change management system. When you upgrade a modified Java component, conflicts are shown in the Developer Studio.

For more information see SAP Service Marketplace at <http://service.sap.com/crm-inst>  [SAP CRM 7.0 Enhancement Package 4](#)  [Operate](#)  [Development & Extension Guide – SAP E-Commerce 7.54](#) .

7.3 Template Management

You can deploy Customizing settings by using Business Configuration Sets (BC sets). For more information, see SAP Help Portal at http://help.sap.com/nw_platform  [<choose release>](#)  [System Administration and Maintenance Information](#)  [Technical Operations for SAP NetWeaver](#)  [SAP NetWeaver Library: Function-Oriented View](#)  [Solution Life Cycle Management](#)  [Customizing](#) .

7.4 Support Packages and SAP Notes Implementation

For an overview of which Support Packages are available and which releases and support packages of the used components should be installed, see SAP Service Marketplace at <http://service.sap.com/sp-stacks> . The SP stacks give you an overview of the versions of the different components that are required for each Support Package.

7.5 Release and Upgrade Management

For an overview of the required components and their releases, see SAP Service Marketplace at <http://service.sap.com/sp-stacks>.

8 Troubleshooting

8.1 CRM Middleware

The main task of a SAP CRM system administrator is to ensure the data consistency and the stable data synchronization in the whole SAP CRM landscape. In case of an incorrect usage of the monitoring tools (BDoc messages in error state remain unprocessed for a long time or queue entries are deleted manually) it is important to rebuild the system consistency. The following table lists the main tools that support the administrator (with the close cooperation of the SAP CRM project team):

Table 83:

Troubleshooting Activities	Tool	Monitoring Frequency Periods and Events
<p>Data Integrity Manager</p> <p>SAP Note 531217 contains the different features of the tool (DIMA) according to the different CRM applications</p>	SDIMA	In case of general data inconsistencies
<p>BDoc Message Recovery</p> <p>SAP Note 856439 contains the different features of the tool according to the functionalities provided by the SAP CRM applications. This tool integrated the analysis of BDoc messages and the use of the different synchronization tools (DIMA, Request mechanism, post current state).</p>	SMWRC	In case of many 'old' BDoc messages in error state in the system
<p>Mobile Client Recovery / Extract</p> <p>For field applications only.</p> <p>If the outbound queue of a Mobile Client is deleted (which should never happen in a production environment), it is possible to run a full extract (from the Administration Console) and to synchronize the data again.</p> <p>In case of severe hardware or software problems and the laptop has to be replaced, it is recommended to use the Mobile Client recovery tool.</p>	SMOEC -> Extract Mobile Client Recovery tool	In case of problems with the Mobile Client

8.2 Mobile Laptop Solution - Export Import Manager

8.2.1 Overview

This function enables you to export customized metadata from a source system to a file, and then import the metadata from this file to a target system. You can use *Export-Import* in the following scenarios:

- A SAP consultant designs reports or document layouts on a PC and needs to upload this data to the customer's system.
- A customer makes developmental changes and needs to update these changes across the test and production environments.
- SAP needs to deliver customized metadata to the customer or to create, modify, and ship this metadata.

SAP delivers customized metadata and demo data, as a database, to the customer with the mobile client applications. This database is known as prefill and advanced prefill. *Export-Import* simplifies the collection and shipment process of these databases.

The prefill database consists of choice fields, application parameters, password parameters, inbox UI mappings, relationship categories, and demo data. The advanced prefill database consists of reports, charts, business content providers, advanced selections, advanced selection criteria, document layouts and their elements, contact person types, business hours, sales transaction customization entries, and field property maintenance entries.

8.2.2 Common Problems & Solutions

Error message: Not able to Import from CAR file

Symptom: On Selecting a CAR file for Import the either the fetching of entries fails or data is not inserted into the database.

Cause: The CAR file might have been prepared using an earlier release of Mobile Sales Application.

Solution: You must have the same version of the mobile client application on both the source system and the target system.

Error message: Not able to Import from CAR file

Symptom: On Selecting a CAR file for Import the either the fetching of entries fails or data is not inserted into the database.

Cause: The CAR file might have been renamed.

Solution: You have to rename the CAR file with the name with which it was created originally.

8.3 Groupware Connector

The groupware connector component is not automatically registered in the System Landscape Directory (SLD). To register the groupware connector component, you need to do the following:

1. Open the SAP Groupware Connector Administrative Tool.
You access the tool by logging on to the groupware connector system using the administrative account and starting the `AdminTool.exe` file, which can be found in the installation folder under *Connector*.
2. Navigate to the window *SLD Server Configuration/General*.
3. Enable power user mode, select the *SLD Registration* checkbox, and enter the required details for the SLD registration.
4. Save the settings and restart the connector services.

To check the component version information at the central SLD, do the following:

1. Navigate to URL of the central SLD (example: `http://<centralsystemhost>:5<instancenumber>00/sld`)
2. Log on to the groupware connector system using the administrative account.
3. Navigate to Software Catalog- Software Components and filter by component name (example : SAP-GRPWCN).
4. Select the component with the correct version from the displayed list.
5. Open the *Installed Systems* tab and click on the system name.
6. View the description box for version and patch information.

8.4 Interaction Center

8.4.1 E-Mail

Technically, e-mail can be handled in the IC WebClient in the following ways:

- Agent inbox
To use the agent inbox do the following:
 - In Customizing for *Customer Relationship Management*, choose ► *Interaction Center WebClient* ► *Basic Functions* ► *Communication Channels* ► *Define E-Mail Profiles* ►.
Enter the profile ID and choose *INBOX* as the e-mail provider.
 - Configure the agent inbox in Customizing for *Customer Relationship Management* under ► *Interaction Center WebClient* ► *Agent Inbox* ►.
 - Make sure that SAPconnect and SAPoffice are set up correctly.
- Integrated Communication Interface (ICI) / Business Communication Broker (BCB)

To use ICI/BCB, go to Customizing for *Customer Relationship Management* and choose ► *Interaction Center WebClient* ► *Basic Functions* ► *Communication Channels* ► *Define E-Mail Profiles* ►.

Enter the profile ID and choose *ICI* as the e-mail provider. To troubleshoot the ICI, see the section *Monitoring of SAP CRM* above.

For more information, see SAP Help Portal at <http://help.sap.com/crm> >> <choose a release> > *Application Help* > *Interaction Center* > *Integrated Communication Interface* >.

8.4.2 Simplified ABAP Messaging (SAM)

SAP Note [828884](#) may be helpful for troubleshooting.

8.4.3 SAPphone

See SAP Help Portal at http://help.sap.com/nw_platform >> <choose a release> > *Application Help* > *SAP Library* >: Search for "SAPphone (BC-SRV-COM-TEL)".

8.4.4 Mandatory SICF Services

For information about the SICF services that are required for IC WebClient, see SAP Note [1295006](#).

8.5 Loyalty Management

Loyalty Processing Engine

SAP note [1222887](#) contains information for troubleshooting.

Simulation of Member Activity

Simulation should be allowed **only in a test system and not in the productive system**. However, you can import loyalty reward rule versions from the simulation system into the productive system.

In order to activate simulation in the test system, you need to make the following settings in the test system, in Customizing for *Customer Relationship Management*, under >> *Marketing* > *Loyalty Management* > *Basic Settings* > *Define Basic Settings* >:

Maintain the following values for the parameters:

SIMU_SYSTEM = <no entry>

SIMU_ACTIVE = 1

In order to be able to import loyalty reward rule version from the test system into the production system, you need to do the following settings in the productive system, in Customizing for *Customer Relationship Management*, under **Marketing > Loyalty Management > Basic Settings > Define Basic Settings**:

Maintain the following values for the parameters:

`SIMU_SYSTEM = <RFC Destination to the test system>`

`SIMU_ACTIVE = 0`

i Note

The following IDs must be the same in the test system and the productive system, otherwise the import will not work:

- Loyalty program ID
- Loyalty reward rule group ID
- Loyalty reward rule ID

8.6 Supportability Tools

8.6.1 ARS DB Consistency Checker

Purpose

You use this tool to perform various checks to verify the consistency of ARS DB and check ARS database constraints. The tool provides a read-only view of the consistency checks performed on the underlying ARS database. If there are any inconsistencies in the underlying database, we recommend that you do not correct these inconsistencies.

Prerequisites

You must ensure that either the Mobile Application Studio or Mobile Application Repository must be installed.

Process

You can launch *ARS DB Consistency Checker* in any of the following ways:

From the Mobile Support Center user interface

From the folder `<MobileRootDir>\Support\ARSDBConsistencyChecker`.

Using the following command line options:

1. `"/m<Dsn><Username><Password>"`

For example, `ARSDBConsistencyChecker.exe /m ars_test arsadmin arspwd`

This will launch the tool in the UI mode and start performing the consistency checks provided ARS login credentials are proper.

2. `"/b <Dsn> <Username> <Password>"`

For example, `<EXE path> /b ars_test arsadmin`

This will launch the tool in a silent batch mode without displaying user interface.

Procedures:

Performing an ARS Integrity Check

1. Click on the Start option that appears in Options menu.
This will open a new ARS Login window.
2. Select the DSN from the drop down available, give the input values for user name and password
The tool starts performing consistency checks in a numerical order.

Results:

- A total of 38 predefined consistency checks are performed on the underlying database. The tool displays description of the consistency check being performed and its status
- The tool should display status as passed for all consistency checks that are performed, which indicates that ARS database is stable
- If the tool displays the status as failed, it indicates the database is inconsistent with respect to the particular consistency check. In such cases, the issue has to be reported to the support.
- If the tool displays the status as passed, it indicates database is in stable state with respect to that particular consistency check.

i Note

Failure of consistency checks 10 and 37 can be treated as warnings.

Opening Log Files

Click on *Last Status Log* in the View menu.

The tool opens the contents of the previous run that was performed. This avoids running the tool every time.

Deleting Log Files

Click on *Delete Logs* option in the View menu.

The tool deletes all the log files present under *SAP\Mobile\Support\Log* folder.

8.6.2 BOL Tester

Purpose

You use this tool to test BQs, BOs and BDOCs from MAS.

To verify if a modeled BO or BQ works fine, you need not depend on the corresponding UI components for testing. The BDOC/BQ query and BO details can be tested using this tool after modeling and generating the BOL component, without having to model the corresponding UI components.

Prerequisites

You must ensure that MDW (Development Workstation) has been installed properly.

Process

BOL Tester can be accessed from the
MAS (Tools menu->BOL tester)

Support Center.

Directly from *boltester.exe* present in *Bin.Net* folder.

Features

BOL Tester contains two tabs *Business Document* tab and *Business Query* tab.

- The BDoc tab lists the BDocs. Selection of BDocs displays the BDoc parameter and segments. You can select a segment and enter values for the parameters; the corresponding BDoc query is created. On executing the query the result set is displayed in a grid.
- The BQ tab lists the BQs. Selecting the BQ displays its attributes. You can set some attributes and fire the query that is generated. On executing the query, the BQ result set is displayed in a grid below. You can double click on a particular row in the BQ result set to load the corresponding BO.

8.6.3 Diagnostics Mode

Purpose

Diagnostic mode is a command prompt to Mobile Client application which launches runtime analyzer along with the Mobile Application with all the diagnostic tools enabled irrespective of what is set in the Support Center.

Prerequisite

You must ensure the Mobile Client is installed on a running Mobile Application.

Process

You can invoke the *Runtime Analyzer* tool in the diagnostic mode using:

the command prompt `C:\Program Files\SAP\Mobile\Bin.NET\MobileClient.exe /DIAGNOSTIC` or by specifying the application path along with the diagnostic command prompt `C:\Program Files\SAP\Mobile\Bin.NET\MobileClient.exe /Application "C:\Program Files\SAP\Mobile\APP.Net\MSA" /DIAGNOSTIC`

8.6.4 Environment Analyzer Report Analyzer Tool

Purpose

You use the Environment Analyzer report analyzer tool (RAT), to view reports that are send back by the Environment Analyzer tool from the client machines. This again, is using the checks that were modeled using the Environment Check Modeler tool.

Prerequisites

This tool is to be installed on the master development workstation. An e-mail client must also be configured properly on this machine.

Process

You can access the tool in the following ways:

- From the Mobile Support Center user interface
- By double clicking on the tool *ReportAnalyzerTool* in the *Support/Tools* folder

When the tool is invoked, you can enter the e-mail details and read-in the data in your e-mail inbox. The tool will then extract all the logs and display them in the window on the right pane.

Features

This tool provides the following features:

- **Fetch\ Delete e-mails**
You have to specify the From and the To addresses and the Subject to fetch the e-mails. You have to specify the display name and not the actual e-mail IDs.
For example, you have to specify Gordon, Flash and not *Flash.Gordon@example.com*. Using these parameters, the e-mails are read from your default inbox. Also, the reports are extracted and displayed on the screen.
You can also delete all these e-mails using the setup as described above.
- **Sort machines by success rate**
The list of machines on the left pane can be sorted to show all failed machines on top or all successful machines on top. Color coding is provided to easily identify the state of the machines.
- **Filter machines success rate**
The list of machines can be filtered to show all failed machines, or all successful machines, or all machines. Color coding is provided to easily identify the state of the machines.

8.6.5 Environment Check Modeler Tool

Purpose

You use the *Environment Check Modeler* to do the following:

- Model check files which can be run on any client machine
- Verify if the setup is fine
- Fetch a report about the status of the machine

The checks are run on the client machines using the tool *Environment Analyzer* tool and the reports created by that tool is read using the *Environment Analyzer' Report Analyzer* tool.

Prerequisites

You must install the *Environment Check Modeler* tool on the master development workstation.

Ensure the following for the subsequent tools to work properly:

- VBScript should be allowed to run on the client machine
- An E-Mail client should also be configured properly on the client machine
- The client machine should also have the *Environment Analyzer* tool installed properly, if it is a mobile client.

Process

To access the tool, go to *Mobile Support Center* user interface

OR

Double click on the tool *EnvironmentCheckModelerTool* in the *Support/Tools* folder.

Once the tool is available, you can model for any phase of check using the Menu bar. The various types of checks applicable for the phase chosen by the user are available in the left pane. You can drag and drop the checks into the tree on the right.

Double clicking on any of the checks will open up a detailed view of the checks where the values can be edited. By clicking on the *Create Package* button, the modeling will be converted either into a *VBS* file for pre-upgrade phase or into an *ENV* file for all other phases. These files can then be transferred to the clients and executed.

You may also model the reporting mode (E-mail reporting and/or CRM Server reporting).

Features

Following are the *Phases* of checks that can be modeled:

- **Pre-Upgrade Checks**

These checks will be run well in advance before the actual upgrade process. This will enable the administrator to identify those clients that are not upgradeable and take corrective actions. These checks are performed while the client is still in the lower service pack stage. These checks will be deployed by SMS action and the report sent back to the client.

From a reporting point of view, all the checks modeled here, will add an entry into a log file and no specific operation based on the checks will be performed by the checker tool. This phase is based on VB scripts and will only have E-Mail reporting.

- **Upgrade Checks**

These checks will be deployed along with the actual upgrade package through any of the existing means, For example, *ConnTrans*. The *ClientUpgradeTarget* tool, which is responsible for deploying upgrades, will first invoke this set of checks. If the check succeeds, then it will continue the upgrade. If the checks fail, then the *ClientUpgradeTarget* will send the report back to the administrator and stop the upgrade process.

The checks modeled here would be very critical, since based on these checks; the upgrade will continue or stop. Of the n checks modeled here, even if one fails, then the whole upgrade process will be stopped. Only if all succeed, the upgrade will continue.

This phase is based on *ENV* files and will only have E-Mail/CRM Server reporting.

- **Post-Upgrade Checks**

These checks will also be deployed along with the actual upgrade package. After the upgrade is complete, these checks will be performed and irrespective of success or failure case, the report will be sent back to the administrator.

From the reporting point of view, all the checks modeled here, will add an entry into a log file and no specific operation based on the checks will be performed by the checker tool.

This phase is based on *ENV* files and will only have E-Mail/CRM Server reporting.

Note: For upgrade and post-upgrade checks to be modeled into a single upgrade package, they should have the same identifier.

- **Application-Run Checks**

These checks can be modeled and either deployed along with the upgrade or subsequently as a separate entity. During each run of the mobile applications, these checks will be performed (if modeled) and if the checks fail, the application will not be launched and a report will be send back. If the checks succeed, then the application will be launched and no report will be sent.

The checks modeled here would be very critical, as based on these checks; the application launch will continue or stop. Failure of any checks that are modeled will not launch the application and a report is sent. The application will continue loading only if all the checks succeed.

This phase is based on *ENV* files and will only have E-Mail/CRM Server reporting.

- **General Checks**

These checks will be general checks which the customer can run anytime he wants.

This will be purely from a reporting point of view. All the checks modeled here, will add an entry into a log file and no specific operation based on the checks will be performed by the checker tool.

This phase is based on ENV files and will only have E-Mail/CRM Server reporting.

- **File Checks**

These checks will deal with specified files existing at specified locations. It will also check whether the given file is within a specified version range, or it will return the current version of the file.

For example: `UFCore.dll` should be present in the *bin folder* and be within version 1.0.0.1 and version 1.0.0.5

Following are the *Types* of checks that can be modeled:

- **File Permission Checks**

These checks will find out whether the specified user group has proper access permissions on a file or not. Or it will return the current permissions on that file.

For example: `UFCore.dll` should have read and write permissions.

- **Registry Checks**

These checks will deal with specified registry entries existing at specified locations or it will return the current value for the entry

For example, `CRMVersion` registry key should be present under the key `HKLM\Software\SAP\MSA`

- **GAC Checks**

These checks will find out whether a specified .NET component has been added to the GAC or not, and with the appropriate version.

For example: `UFCoreExt.dll` should be present in the GAC with version 1.0.0.1

- **Process Checks**

These checks will check the running state of specified processes.

For example, *SQL Server 2005 Enterprise Edition* should be installed and running.

- **Hard Disk Space Checks**

These checks will deal with hard disk-specific checks.

For example: At least 20 GB free space should be present.

- **Hard Disk Consistency Checks**

These checks will deal with hard disk specific checks.

For example: No more than 3 bad sectors should be present.

- **SQL Query Checks**

The user will be allowed to fire a SELECT query on the DB and the check will be whether a record set is returned or not. For reporting, the entire record set may be returned.

For example: User can fire a query to find out if `smusers` table has any users or not.

- **Installed Software**

Here the user will be allowed to fetch a list of all installed software.

- **Installed Upgrades**

Here the user will be allowed to fetch a list of all upgrades already applied on the client.

- **Group Checks**

Here the use can model any number of any of the above checks and a 'AND' or 'OR' operation will be performed on their output to return one return value.

8.6.6 Metadata Consistency Checker

Purpose

You use the *Metadata Consistency Checker* tool to perform basic metadata and interdependent source file checks that could ease debugging and identifying the source of the problem much faster in the application.

Prerequisites

For the metadata consistency checker to run you must ensure the base installation landscape is made available. For each application, for example, MSA or MSV, their corresponding repository files, source files (not mandatory) and configuration files should be present for the tool to function properly.

Process

The tool is a binary module which is available to the user as an executable file (`MetadataConsistencyChecker.exe`). The tool is installed by default in the Mobile Directories `Bin.Net` folder. The relative is `<MobileDir>/Bin.Net/MetadataConsistencyChecker.exe`

You can also invoke the `MetadataConsistencyChecker.exe` tool using the `SupportCenter.exe` tool, which is located in `<MobileDir>/support/SupportCenter.exe`.

For further information, see [Mobile Runtime Analyzer](#) documentation.

Features

- **UI Metadata Consistency Checker**
 - UI Configuration and pre-configuration structure check
XML structure of the configuration file is verified. Incorrect xml structure is captured.
 - Application repository file check
The repository file is loaded and read to make sure it is not corrupt.
 - `MSA.dll` file check
A list of all tiles available in application repository file is compared against a list of all tile classes in `MSA.dll`.
For each tile, the order of the controls, hyperlinks, and anchors is checked in the assignment area of `MSA.dll`.
 - Application and framework caption file checks
A basic caption search is done internally for framework caption, and a keyword search is provided at the UI level to indicate that the required captions have been generated.
- **BOL Metadata Consistency Checker**
 - BOL configuration file check
The XML structure of the file is checked. Incorrect XML structures are captured and reported.
 - Source files against repository check:
Checks for the list of business objects and query objects whose metadata information is missing in `arsrep.dat` file but the same is present in the corresponding class files of `sfabol.dll` is done. This check includes both standard and customized business objects.
 - `MsgInfo` file check
Size of the file `MsgInfo_XX.dat` (message info repository file) is checked, the minimum size of the file should be at least 1MB, Incorrect file size means missing data
`MsgInfo` file is read using the BOL FW APIs and those lookup ID's with no source information and error IDs with no description are captured and reported.
 - BOL metadata check
Checks for the business objects, combo engines, and query objects with corrupt metadata is done by reading the metadata information from `arsrep.dat` using BOL FW APIs. The list is captured and displayed.

8.6.7 Runtime Analyzer - BO Browser

Purpose

You use the *Runtime Browser* tool to view runtime Business Object Layer (BOL) objects. The runtime details can be viewed, but not edited through the BO Browser.

Prerequisites

You must ensure the Mobile Client is installed with a working application.

Process

BO Browser is a part of Mobile Runtime Analyzer. You can invoke the tool in the following ways:

From the menu in the Mobile Application

OR

By pressing **CTRL** + **Shift** + **F11** from the application.

Features

The tool provides a structured tree view of the current loaded Business Objects, Business Queries and Business Collections along with their individual details.

- **Business Objects node**
 1. Expand the Business Objects node to display the list of all the current loaded Business Objects.
 2. Select a particular Business Object to view its attributes.
 3. Expand the Business Object to view its properties and relationships.
 4. Select a specific property or relationship to view its details in the window pane on the right.
 5. Expand the Relationships node to view the related Business Object.
 6. Expand the Property node to view the underlying Combo Engine, if there are any.
- **Business Queries node**
 1. Expand the Business Queries node to display a list of all the current loaded Business Queries.
 2. Select an individual Business Query to view its details.
 3. Expand an individual Business Query to view its properties, on the right window pane.
- **Business Collection node**
 1. Expand the Business Collection node to display a list of all the current loaded Business Collections.
 2. Select a specific Business Collection to view its details, on the right window pane.

8.6.8 Runtime Analyzer - Trace Viewer

Purpose

You use the *Trace Viewer*, to view the trace messages generated from the runtime framework and application. The trace messages are displayed in a tree structure. The messages indicate entry and exit into methods and any exception generated in code.

Prerequisites

-
- You must ensure the Trace Viewer is enabled using Support Center. Tracing causes a performance overhead and can significantly slow down the Mobile Client application. It should be enabled only when really required.
 - To obtain trace calls in the Runtime Framework, the trace enabled runtime framework binaries are required. You can trace the application code using the Instrumentation Tool.
 - You can invoke the Trace Viewer in either of the following ways:
 - Directly from the Mobile Support Center user interface
 - Using the Trace View tab in the Mobile Runtime Analyzer user interface
 - You can disable tracing by deselecting the *Enable Runtime Tracing* checkbox under *Settings* in the SAP Mobile Support Center user interface.

Features

When enabled, tracing begins as soon as the Mobile Runtime Analyzer tool is invoked. You can do the following:

- Start and stop tracing
Use the *Start/Stop* Trace button. Trace messages will be displayed only after the trace has been started. The *Save File* button will be enabled only after tracing is stopped.
- Save the trace messages as a *.trace file in the automatically generated trace location
Use the *Save* button. All the trace messages in that particular session are saved to that file and a new file name is generated with a different timestamp. Every session is saved with a new file name differentiated by the timestamp.
- Clear the trace messages currently displayed on the screen
Select *Clear Trace*.
- Open a trace file that has been saved using Mobile Runtime Analyzer
Click *Open File*. The trace messages from the log file are displayed in the trace view.

9 Support Desk

Support Desk Management enables you to set up an efficient internal support desk for your support organization that seamlessly integrates your end users, internal support employees, partners, and SAP Active Global Support specialists with an efficient problem resolution procedure.

For support desk management, you need the methodology, management procedures, and tools infrastructure to run your internal support organization efficiently. SAP CRM uses the standard SAP NetWeaver read-only access support roles.

For the problem message handover, choose from the SAP CRM components available under the main SAP CRM node.

For more information about remote support setup, see SAP Service Marketplace at <http://service.sap.com/instguides> » [SAP NetWeaver](#) » [<choose release>](#) » [Installation](#) » [Master Guide](#) ».

For more information about the standard SAP NetWeaver read-only access support roles, see SAP Help Portal at http://help.sap.com/nw_platform » [<choose release>](#) ». In the application help, search for “Setting Up Service Connections for SAP Remote Support”.

10 Industry-Specific Scenarios

This section describes scenario-specific details for industry scenarios.

10.1 Utilities

This section describes the monitoring tools of the Service Industry Extension business scenarios.

10.1.1 Scenario Alert Monitoring

In addition to the required monitoring of each component, some additional monitoring objects are designed to monitor cross-component communications and other scenario-specific critical situations.

10.1.1.1 Service Processes for Utilities

CRM Middleware Queues

For the following objects, CRM Middleware queues are relevant for this scenario:

- Business partner
- Business agreement
- Contact

Details are described below, in the section *Sales Management for Residential Customers*.

10.1.1.2 Sales Management for Commercial and Industrial Customers

CRM Middleware Queues

For the following objects CRM Middleware queues are relevant for this scenario:

- Business partner
- Business agreement
- Contact
- Connection object
- Point of delivery

- Contract

Details are described below in the section *Sales Management for Residential Customers*.

10.1.1.3 Sales Management for Residential Customers

CRM Middleware Queues

The following CRM Middleware queues are relevant for this scenario.

The naming convention of the queue is as follows:

<System-ID><Mode>_<object-id><extension>

System-ID: R3 represents backend system (ERP); CS represents CRM.

Mode: AD represents delta download, AI represents initial load, AR represents request.

Extension:

- In case of delta download the extension represents the object key.
- in case of initial load the extension is optionally a two digit number.
- in case of request the extension is a sequence of request name and optionally a two digit number (format <name><xx>).

The two-digit number is generated in case of parallel queue processing.

Table 84:

Object	Queue ID	Naming Convention for Key	Purpose	Comment
Business partner (BUPA_MAIN)	R3AD_BUPA<key> (for delta download) R3AI_BUPA<xx> (for initial download) R3AR_<name><xx> (for request)	<key> represents the business partner key.	Transport business partner objects from backend (ERP) to CRM	None
Business agreement (BUAG_MAIN)	R3AD_BUPA<key> (for delta download) R3AI_BUPA<xx> (for initial download) R3AR_<name><xx> (for request)	<key> represents the business partner key.	Transport contract account objects from backend (ERP) to CRM	The queue is the same as for business partner replication.

Object	Queue ID	Naming Convention for Key	Purpose	Comment
Contact (SI_BCONTACT)	R3AD_BUPA<key> (for delta download) R3AI_SI_BCONTACT<xx> (for initial download) R3AR_<name><xx> (for request)	<key> represents the business partner key.	Transport contact objects from backend (ERP) to CRM	The delta-queue is the same as for business partner replication. However, contacts are replicated only from ERP to CRM, not vice versa.
Connection Object (SI_CONNOBJ)	R3AD_CONNOBJ<key> (for delta download) R3AI_SI_CONNOBJ<xxx> (for initial download) R3AR_<name><xx> (for request)	<key> represents the IS-U key (TPLNR) of the connection object	Transport connection objects from IS-U (ERP) to CRM	None
Point of delivery (SI_POD)	R3AD_CONNOBJ<key> (for delta download) R3AI_SI_CONNOBJ<xxx> (for initial download) R3AR_<name><xx> (for Request)	<key> represents the IS-U key (TPLNR) of the connection object	Transport PoDs from IS-U (ERP) to CRM	The key of the PoD (INT_UI) is just a GUID. To know which object is meant it is better to use the ID of the leading connection object.
Contract (SI_CONTRACT)	R3AD_BUPA<key> (for delta download) R3AI_SI_CONTRACT<xx> (for initial download) R3AR_<name><xx> (for Request)	<key> represents the business partner key.	Transport ISU-Contract objects from backend (ERP) to CRM	The delta-queue is the same as for business partner replication, but may switch to the R3AD_CONNOBJ<key> queue. If there exists a queue for the needed connection object.

10.1.1.4 Demand Side Management

The CRM Middleware queues *Business Partner* and *Business Agreement*, as described in above section *Sales Management for Residential Customers*, are relevant for this scenario.

You can monitor the outbound queue using transaction SMQ1.

Table 85:

Object	Queue ID	Naming Convention for Key	Purpose
DSM Application <key> DSM Agreement <key>	CSA_ORDER_<key>	<key> is the object ID, for example 5000000879 for an application and 6000000310 for an agreement	Inbound queue before outbound adapter

10.1.2 Scenario-Specific Problem Analysis Tools

10.1.2.1 Service Processes for Utilities

Table 86:

Monitor	Detailed Description
Data Integrity Manager (DIMa)	<p>Transaction <code>SDIMA</code>.</p> <p>Compare master data between IS-U and CRM.</p> <p>You can find details on DIMa objects and their features below.</p> <p>The Data Integrity Manager checks the consistency of data in ERP and CRM for the objects named below. A header comparison checks whether the objects exist in both systems. A detail comparison compares the objects at field level. In general, the header compare is not included in the detail compare.</p> <p>If the DIMa does not support a filter, or the filter is not used, then all records are compared. This must be considered during resource planning for the DIMa run.</p> <div style="background-color: #fff9c4; padding: 10px; margin: 10px 0;"> <p>i Note</p> <p>You should not execute a second comparison within a DIMa instance without saving in the meantime. It is particularly important not to execute a header comparison and then a detail comparison without saving between the two comparisons.</p> </div> <p>For more information, see the documentation for the DIMa wizard.</p>

Table 87:

DIMa Object Name	Technical Object Name	Supported Comparisons	DIMa Filter Possible?
Business Partner	PARTNER	Header comparison	Yes
Business Agreement	BUAG_MAIN	Header comparison Detail comparison	No
IS-U Contact	SI_CONTACTS	Header comparison Detail comparison	No

Table 88:

DIMa Object Name	Features
IS-U Contact	<p>The header comparison for the IS-U contact only takes place in one direction. This is because the CRM Middleware does not support an upload. The comparison checks which objects exist in both systems, and which objects only exist in the IS-U system.</p> <p>The header compare is included in the detail compare.</p>

10.1.2.2 Sales Management for Commercial and Industrial Customers

Table 89:

Monitor	Detailed Description
Data Integrity Manager (DIMa)	<p>Transaction <code>SDIMA</code>.</p> <p>Compares master data between IS-U and CRM.</p> <p>See the above section <i>Service Processes for Utilities</i> for descriptions of the DIMa analysis tool.</p> <p>You can find details of further DIMa objects and their features below.</p>
Report <code>ECRM_CHECK_EVERH</code>	<p>Like the DIMa, this report checks the consistency of data in IS-U and CRM for the utility contract object. As well as a header comparison, you can also check the move-in date and move-out date fields.</p>
Error Processing: IS-U/CRM Replication	<p>The IS-U Error Monitor (transaction <code>ECRMREPL</code>) is used to manage incorrect replications of CRM utility contracts in an IS-U system.</p>

Monitor	Detailed Description
Enhanced Message Management in IS-U	Extraction of billing data from IS-U to BW: Billing document data can be extracted from IS-U to BW in parallel using transaction <code>EBW_DQ_SS</code> . Unbilled revenue data can be extracted from IS-U to BW in parallel using transaction <code>EAMS01</code> . These jobs are monitored using transaction EMMA in IS-U.

Table 90:

DIMa Object Name	Technical Object Name	Supported Comparison	DIMa Filter Possible?
IS-U Contract	SI_CONTRACT	Header comparison	No
IS-U Connection Object	SI_CONNOBJ	Header comparison	Yes
IS-U Point of Delivery	SI_POD	Header comparison	Yes

Table 91:

DIMa Object Name	Features
IS-U Contract	Contract items in CRM are compared with utility contracts in IS-U. Upload from CRM to IS-U after comparison is not possible.
IS-U Connection Object and IS-U Point of Delivery	For objects that exist in IS-U but not in CRM, the field <code>HAUS</code> is displayed in the result list instead of the field <code>CRM_GUID</code> . This is because a subsequent load can, in this case, only be started using the <code>HAUS</code> field.

10.1.2.3 Sales Management for Residential Customers

Table 92:

Monitor	Detailed Description	Prerequisites
Data Integrity Manager (DIMa)	See <i>Scenario Sales Management for Commercial and Industrial Customers (Utilities)</i>	Not specified
Report ECRM_CHECK_EVERH	See <i>Scenario Sales Management for Commercial and Industrial Customers (Utilities)</i>	Not specified

Monitor	Detailed Description	Prerequisites
Error Processing: IS-U/CRM Replication	See <i>Scenario Sales Management for Commercial and Industrial Customers (Utilities)</i>	Not specified

10.1.2.4 Demand Side Management

SAP CRM Server Analysis Tools

Table 93:

SAP CRM Server Central Monitoring Activities / Functions	Monitoring Tool (Transaction)	Used in FS AO for Monitoring Of
<p>BDoc Messages/Summary</p> <ul style="list-style-type: none"> Monitors the status of the BDoc messages and detects the application or Customizing errors during data exchange. SMW01: Displays BDoc message content and possible validation or receiver errors. SMW02: Displays BDoc message summary in dependency on the sender site ID. SMW02a Groups BDoc messages according to validation or receiver errors. SMW03 Displays client-independent BDoc message summary. 	SMW01 / SMW02 / SMW02A / SMW03	Document replication to CML, CMS through BDocs

SAP ERP Server Analysis Tools

Table 94:

SAP ERP Server Central Monitoring Activities / Functions	Monitoring Tool (Transaction)	Used in FS AO for Monitoring Of
Analysis of billable items.	FKKBIXBITB_MON	SAP CRM billing request items replication into billable items in the ERP systems.

10.1.3 Troubleshooting

10.1.3.1 Scenario: Service Processes for Utilities

In IS-U, you can search for business partners by a combination of name and premise address if one of the following Customizing parameters is switched on:

- Parameter *Adjust standard address of move-in customer* (IMG: [▶ SAP Utilities ▶ Customer Service ▶ Process Execution ▶ Move-In/Out ▶ Move-In ▶ Define Move-In Control Parameters at Document Level ▶](#)).
If this parameter is switched on the search is possible using the business partner address fields.
- Parameter *Search index: Search for business partner by premise address* (IMG: [▶ SAP Utilities ▶ Basic Settings/Enterprise Structure ▶ Define System Parameters for IS-U ▶](#)).
If this parameter is switched on the search is possible using the premise/connection object address fields.

If only the first parameter is switched on and the search performance is not satisfactory, the second parameter should be switched on, too.

10.2 Financial Services

10.2.1 Business Partner Data Management

10.2.1.1 Important Notes

Table 95:

SAP Note Number	Title	Comment
1354442	Integration Account Origination – Business Partner	Describes a sample configuration for the replication of business partners for an integration scenario "Account Origination and Loans Management"

10.2.1.2 Monitoring for Financial Services Business Partner

The following are the most important monitoring tools for Financial Services (FS) Business Partner Web services:





Table 96:





Description	Monitoring Tool (Transaction)	Comments
Message Monitoring	SXMB_MONI	For XI 3.0 messages
Message Monitoring	SRT_MONI	For Web services
Web Service Utilities	SRT_UTIL	None
Web Service Utilities: Sequence Monitor	SRT_MONIS	None
Error and Conflict Handler: Process Postprocessing Orders	ECH_MONI_SEL	None

10.2.1.3 Scheduled Periodic Tasks: FS Business Partner

Table 97: Scheduled Periodic Tasks

Program Name/Task	Recommended Frequency	Detailed Description
Program OAFR_PP_RUN_AGENTS (<i>Execute Agent</i>)	As required, presumably hourly or daily (scheduled execution)	Collects open change pointers for the specified agent IDs and sends the corresponding information messages. For more information about this program, its parameters, and scheduling its execution, see the program documentation in the system.
Transaction OAFT_PP_RUN_AGT_LOG (<i>Execute Agent Application Log</i>)	As required	Can be used to monitor the agent runs.

For information about SAP CRM enterprise services, see SAP Help Portal at <http://help.sap.com/crm> 
 [Integration & Analytics Information](#)  [Enterprise Services Documentation](#) .

For more information about Banking Services from SAP, see SAP Help Portal at <http://help.sap.com/bankingservices> 
 [Integration & Analytics Information](#)  [Enterprise Services Documentation](#) .

If you schedule program OAFR_PP_RUN_AGENTS, make sure you send the information messages in the following recommended order:

1. Business Partner
2. Business Partner Relationship
3. Business Partner Blocking
4. Business Partner Unblocking

If you are using information messages to synchronize the operational and analytical business partner and relationship data, it is important that you select and process open change pointers for an appropriate time period (for example, process sequence 1, 2, 3, and 4 as mentioned above **day for day**).

This is because if business partner relationship changes are processed, new business partner versions are created as successors of the current business partner version at the same time. Therefore, if business partner changes are processed for a long time period (such as one month), analytical business partner relationship changes become visible after the most recent business partner change. This might be at the end of the long time period, even if the relationship change happened at the beginning of the long time period. This can lead to a loss of analytical relationship data from a user perspective and a potential risk for subsequent analytical processes.

Use the parameters *creation date* and *creation time* of program OAFR_PP_RUN_AGENTS to define appropriate time periods respective selection subsets.

10.2.1.4 Required Manual Periodic Tasks: FS Business Partner

The tasks below are manual tasks that are only required if data is inconsistent between the sender and target system, and requires reconciliation.

Table 98:

Program Name/Task	Recommended Frequency	Detailed Description
Program <code>FSBP_CREATE_RC_CP</code> (<i>Select Business Partner and Info About BP Relationship for Sending</i>)	As required	Creates change pointers for the specified business partners and business partner relationships for reconciliation purposes.
Program <code>FSBP_CREATE_RC_CP_DP</code> (<i>Select Business Partner Lock Information for Sending</i>)	As required	Creates change pointers for blocking/ unblocking information for the specified business partners for reconciliation purposes.
Transaction <code>OAFI_PP_RUN_AGENTS</code> (<i>Execute Agent</i>)	As required (online execution)	Collects open change pointers for the specified service operations and sends the corresponding reconciliation messages using report <code>OAFI_PP_RUN_AGENTS</code> .
Transaction <code>OAFI_PP_RUN_AGT_LOG</code> (<i>Execute Agent Application Log</i>)	As required	Can be used to monitor the agent runs.

For more information about the above reconciliation programs/transaction, their input parameters, and their execution, see the program/transaction documentation in the system. The reconciliation programs mentioned above create change pointers for the specified service operation.

If you use multiple reconciliation programs, send the reconciliation messages in the following recommended order:

1. Reconciliation Business Partner
2. Reconciliation Business Partner Relationship
3. Reconciliation Business Partner Blocking
4. Reconciliation Business Partner Unblocking

10.2.2 Account Origination

The financial services business scenario account origination is an application for an integrated customer-oriented software solution, linking the front office (SAP CRM) to the back office (bank or insurance core processing applications).









Out of the variety of processing flows in the financial services industry, the most prominent and most requested scenario, Loan Origination, was chosen to be realized first.

Loan Origination is the phase that starts with a customer applying for a loan that is provided by a financial institute, and ends when the contract is signed by both parties. The scenario includes analysis of customer data and requirements, calculation and creation of customer-specific offers, underwriting, risk assessment and validation, as well as parts of the closing and funding process.

10.2.2.1 Related Documentation

The following table lists where you can find more information about the technical system landscape of the scenario Account Origination:

Table 99:

Topic	Guide/Resource	Quick Link to SAP Service Marketplace
Technology components	Master Guide	http://service.sap.com/instguides  <i>Industry Solutions</i> > <i>Industry Solution Guides</i> > <i>SAP for Banking</i> > <i>Solution Guides</i> 
Security	Security Guide	http://service.sap.com/securityguide   <i>Security</i> > <i>Security in Detail</i> > <i>SAP Security Guides</i> > <i>SAP Business Suite Applications</i> > <i>SAP CRM</i> 
SAP Exchange Infrastructure	SAP Exchange Infrastructure Security Guides	http://service.sap.com/securityguide 
SAP Solution Manager	SAP Solution Manager	http://service.sap.com/solutionmanager 
Related SAP Notes	SAP Notes	http://service.sap.com/notes 

10.2.2.2 CRM-Specific qRFC Monitors

Table 100:

CRM Queue Groups	Description
Outbound Queues	
CSA*	Send queues of CRM Server Applications: Document replication to CML, CMS via BDocs
XBQS*, XBTS	Document replication to CML, CMS via XIF Adapter Business Partner distribution via Proxy
Inbound Queues	
XBQR*, XBTR*	Document replication to CML, CMS via XIF Adapter Business Partner distribution via Proxy

10.2.2.3 CRM Server Analysis Tools

Table 101: qRFC Outbound Queue Monitor

CRM Server Central Monitoring Activities / Functions	Monitoring Tool (Transaction)	Used in FS AO for Monitoring Of
qRFC Outbound Queue Monitor: Monitors data transfer between the ERP backend and the CRM Server	SMQ1	Document replication to CML, CMS via BDocs Business partner distribution via proxy
qRFC Inbound Queue Monitor: Monitors data transfer between the ERP Backend system and the CRM Server	SMQ2	Document replication to CML, CMS via BDocs Business partner distribution via proxy
Integration Engine – Monitoring	SXMB_MONI	Document replication to CML, CMS via XIF Adapter Business partner distribution via proxy
BDoc Messages/Summary Monitors the status of the BDoc messages and detects the application or customizing errors during data exchange. SMW01: Displays BDoc message content and possible validation or receiver errors. SMW02: Displays BDoc message summary in dependency on the sender site ID. SMW02a: Groups BDoc messages according to validation or receiver errors. SMW03: Displays client-independent BDoc message summary.	SMW01 / SMW02 / SMW02A / SMW03	Document replication to CML, CMS via BDocs

10.2.2.4 ERP Backend System Analysis Tools

Table 102:

CRM Server Central Monitoring Activities / Functions	Monitoring Tool (Transaction)	Used in FS AO for monitoring of
qRFC Inbound Queue monitor: • Monitors data transfer between the ERP Backend system and the CRM Server	SMQ2	Incoming Request to Collateral Management System
System Application log	SLG1	Application Monitoring for Objects type FVVD_LOS in SAP-CML.
Integration Engine – Monitoring	SXMB_MONI	Document replication and Business Partner distribution in the XI System, to the ERP-Systems

10.2.2.5 Archiving

Table 103:

Archiving Object	Description	Archiving Object
Business Partner	You can store business partner data that is no longer required and subsequently delete it physically from the database. For more information, see SAP Help Portal at http://help.sap.com/crm ▶ <choose release> ▶ <i>Application Help</i> ▶ <i>Master Data</i> ▶ <i>Business Partners</i> ▶ <i>Functions</i> ▶ <i>Archiving Business Partners</i> ▶	CA_BUPA
Opportunity	You can store opportunity data that is no longer required and subsequently delete it physically from the database	CRM_OPPT
Loyalty Management Point Account	Using archiving you can store point accounts data that is no longer required and subsequently delete it physically from the database.	LOY_PTACCT

Archiving Object	Description	Archiving Object
Loyalty Management Member Activity	Using archiving you can store member activities data that is no longer required and subsequently delete it physically from the database	LOY_MA
Loyalty Management Membership	Using archiving you can store memberships and associated tiers that are no longer required and subsequently delete them physically from the database	LOY_MSH
Loyalty Management Anonymous Temporary Card	Using archiving you can store anonymous temporary cards that are no longer required and subsequently delete them physically from the database.	LOY_ATC
Loyalty Management Card	Using archiving you can store loyalty management cards that are no longer required and subsequently delete them physically from the database.	LOY_CARD
Loyalty Management Partnership	Using archiving you can store partnerships that are no longer required and subsequently delete them physically from the database.	LOY_PSH
Loyalty Management Partner Point Transaction	Using archiving you can store partner point transactions that are no longer required and subsequently delete them physically from the database.	LOY_PPT
Gift Cards	<p>Note: This object is only available if you have activated the business function SAP Multichannel Foundation for SAP CRM (CRM_MCF_R1).</p> <p>You can archive gift cards that have been fully redeemed or that have exceeded their validity period.</p>	CRM_GC

Archiving Object	Description	Archiving Object
FS Product	<p>You can store product master data that is no longer required and subsequently delete physically from the database. The SAP Product Archiving Environment is completely controlled by status and is connected to the SAP Archive Information System.</p> <p>A product can be selected for archiving directly from product maintenance (transaction <code>COMMPR01</code>) by setting the status <i>To Be Archived</i>. You can find the archiving administration in transaction SARA.</p> <p>For more information, see Archiving the SAP Product</p>	PRODUCT_MD
CRM FS Contract/Quotation	<p>You can use the <i>CRM FS Contract/Quotation</i> archiving object to destroy all data for the following objects:</p> <ul style="list-style-type: none"> • Banking customer quotes • FS quotations • Banking sales contracts 	CRM_LEAS
Personal Financial Statement of a Business Partner	<p>You can use the <i>Personal Financial Statement of a Business Partner</i> archiving object to destroy all personal financial statement data.</p>	CRM_FS_PFS

10.3 Public Sector

10.3.1 Scenario Social Case Management

CRM Middleware

The following diagram illustrates the Social Services Framework component connection between SAP CRM and SAP ERP via CRM Middleware.

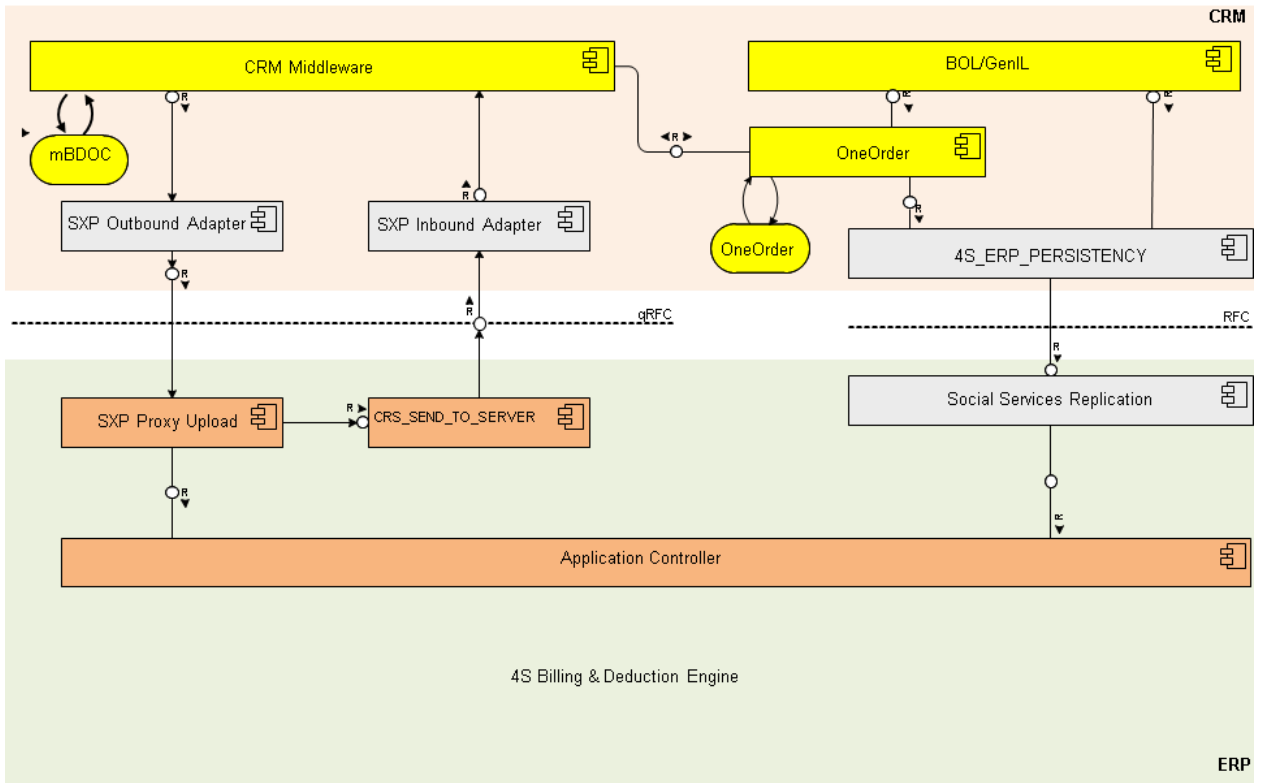

Figure 1: Social Services Framework components between SAP CRM and SAP ERP

The following activity diagram illustrates the sequence of actions that are triggered by the creation of a business transaction in SAP CRM.

Active and confirmed SXPs are never updated in SAP ERP, even if they are saved again in SAP CRM (after the change process has been executed). The system terminates (save) processing in RFC function modules `PSSC00_REPL_SXP_SAVE` and `PSSC00_REPL_SXP_STATUS_ADJUST` in the SAP ERP system and reports any success back to SAP CRM.

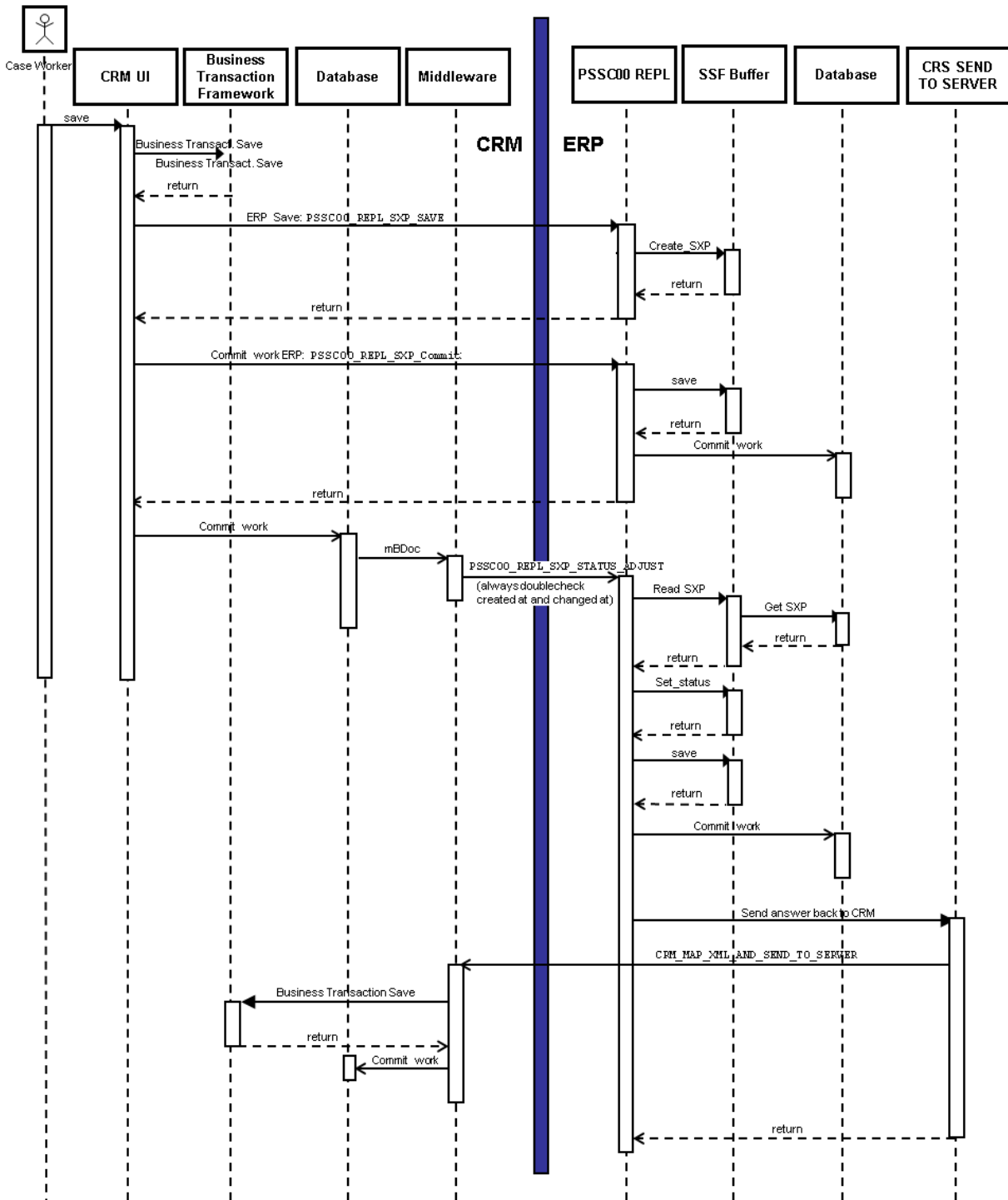

Figure 2: Activity Diagram: Sequence of Actions Triggered by Creating a Business Transaction in SAP CRM

Usage of Application Log

The application log is used in the following application events in the SAP ERP system:

Table 104:

Application Event	Object	Subobject
<p>At the end of the following RFCs from CRM to ERP:</p> <ul style="list-style-type: none"> • PSSC00_REPL_SSP_GE_CALCULATE (Trigger gross entitlement calculation) • PSSC00_REPL_SSP_GP_CALCULATE (Trigger gross payment calculation) • PSSC00_REPL_SSP_RR_EXECUTE (Execute reimbursement for SSP chain) • PSSC00_REPL_SSP_RR_READ (Read reimbursement) • PSSC00_REPL_SXP_BA_CHECK (Before the assessment check for an SXP) • PSSC00_REPL_SXP_GET_ALL (Read all data for an SXP) • PSSC00_REPL_SXP_PROXY_UPLOAD_MW (Proxy upload) • PSSC00_REPL_SXP_SAVE (Save) • PSSC00_REPL_SXP_SIMULATE_NET (Execute net calculation and read the simulation results) • PSSC00_REPL_SXP_STATUS_ADJUST (Proxy communication confirm) 	PSSC	SXP_RFC
<p>The accounting adapter is always triggered using the function module PSSC00_ACC_MD_CREATE.</p> <p>For example, once an SSP or an SDP is activated in SAP CRM, a contract account is to be created in SAP ERP (this is necessary if a contract account does not already exist)</p>	PSSC	ERROR
<p>Once an SSP or SDP has been activated in SAP CRM, the system triggers the net calculation automatically in SAP ERP.</p>	PSSC_NET_RFC	ERROR (if an error occurs) ADD_INFO (in other cases)

Application Event	Object	Subobject
The program RPSSC00_SXPINDEX, which is started after ERP 600 EhP6 is switched on, updates the data for active SSPs, which have been created in a former release/enhancement.	PSSC_INDEX	MSG

Background RFC Monitor

Once a social service plan (SSP) or a social deduction plan (SDP) has been activated in SAP CRM, the system triggers the net calculation and the accounting adapter automatically in SAP ERP. Both functions are linked using bgRFCs (background remote function calls).

To view the processing of these bgRFC units, you can use the bgRFC monitor (transaction `SBGRFCMON`). On the screen *Monitor for bgRFC Units*, under *Inbound* you can check the queue name you have specified in SAP ERP Customizing under [Public Sector Management](#) [Social Services](#):

- [Net Calculation](#) [Define Control Parameters for Net Calculation](#)
- [Billing and Accounting](#) [Define Control Parameters for Accounting Adapter](#)

For more information about each of the configuration options for the bgRFC monitor, see SAP Help Portal at http://help.sap.com/nw_platform [<choose release>](#). In the application help, search for “bgRFC Monitor”.

Customizing Consistency Check Report

The check report provides you with an overview of the consistency of RCF connections and Customizing settings for Social Services entries in SAP CRM and SAP ERP. You can also navigate from the report directly to the respective Customizing tables by choosing the corresponding Customizing entries.

The check report is available in SAP CRM Customizing under [Customer Relationship Management](#) [Industry-Specific Solutions](#) [Public Sector](#) [Social Services](#) [Integration](#) [Check Social Services Customizing Consistency](#).

Social Services Eventing

The event browser simplifies the analysis of events that have occurred that are raised by Social Services Eventing (SSE) in SAP CRM. All SSE events that were raised for a system are stored in the database. The event browser provides a convenient search and analysis tool for these events. Administrators can restrict the search by specifying various general criteria (such as the event type, business partner, organizational unit, date and time of the event), as well as BOR criteria.

You can monitor all data that matches the specified criteria read from the persistence layer of the SSE and is displayed in tabular format on the screen. You can customize the output table by creating specific layout variants that can have a different number and sequence of columns to those shown here. You start the event browser using the program `CRM_EVT_EVENT_BROWSER` in transaction `SE38`.

10.3.2 Service Processes for Grantor Management

CRM Middleware Queues

For the following objects, CRM Middleware queues are relevant for this scenario:

- Business partner
- Business agreement
- Contact

Inbound queues can be monitored with transaction `SMQR` and outbound queue can be monitored with transaction `SMQ1`.

Table 105:

Object	Queue ID	Naming Convention for Key	Purpose	Comment
Grantor Program (CRM_GPM_NODE)	CSAGPMGPM	No key convention. Fixed name	CRM Middleware in-bound queue (before outbound)	Messaging BDoc CRM_GPM_NODE filled by the Grantor Program Management
Grantor Program (CRM_GPM_NODE)	R3AUGPMGPM	No key convention. Fixed name	CRM Middleware out-bound queue	Function module CRM_GPM_PSM_OUTBOUND reads CSAGPMGPM queue and fills R3AUGPMGPM
Grantor Program (CRM_GPM_NODE)	R3AD_CRM_GPM_NODE	No key convention. Fixed name	CRM Middleware in-bound queue (ERP answer)	Answers back from ERP proxy function module GTR_CRM_GPM_NODE_PSM_PROXY
Grantor Application <key> Grantor Agreement <key>	CSA_ORDER_<key>	<key> is the object ID, for example 4000000879 for an application and 0006000310 for an agreement	Inbound queue before outbound adapter	None
Grantor Application <key> Grantor Agreement <key>	R3AUORDER_<key>	<key> is the object ID, for example 4000000879 for an application and 0006000310 for an agreement	Outbound queue after outbound adapter	None

Object	Queue ID	Naming Convention for Key	Purpose	Comment
Grantor Application (updated)	R3AD_GRM_DOCUMENT	None	Inbound queue before inbound adapter	None
Grantor Agreement (updated)				

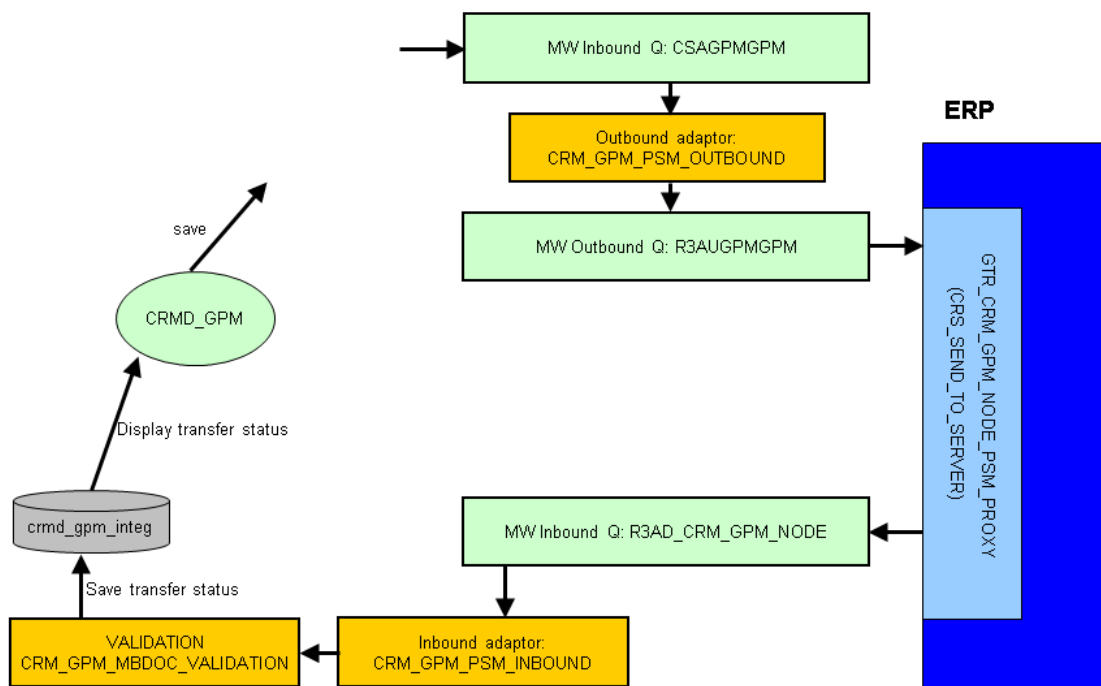

Figure 3: Grantor Program Middleware queues and ERP integration overview

10.4 Provider Order and Contract Management

10.4.1 Scenario Sales and Order Management

You can use the Sales and Order Management scenario to sell postpaid and prepaid services, B2B processes, and your industry's standard product bundle of services and goods through your call center. The business scenario is integrated with SAP Convergent Invoicing (SAP CI) and SAP Convergent Charging (SAP CC) to provide an end-to-end order-to-cash scenario. The integrated scenario replicates and synchronizes different types of data across

systems. To control the integration and to keep the data consistent, you may need access to the applications that store this data to restrict access to persons who are authorized to view this information only.

10.4.1.1 Product Replication

The commercial products are defined in SAP CRM. In addition to SAP CRM product data being mapped to SAP CC charge plan data, product data is also replicated to SAP ERP. The replication can either use the standard product master data in SAP ERP or it can store the product-relevant data in SAP CI-specific tables.

CRM Middleware Queues

CRM Middleware queues are relevant for this scenario for the following objects:

- CRM Material
- CRM Service Product

Table 106:

Object	Queue ID	Naming Convention for Key	Purpose
CRM Material (PRODUCT_MAT)	R3AUPR_MAT<KEY>	<KEY> represents the product ID	Transport CRM material from CRM to backend (ERP)
CRM Service Product (PRODUCT_SRV)	R3AUPR_SRV<KEY>	<KEY> represents the product ID	Transport CRM service product from CRM to backend (ERP)

CRM Server Analysis Tools

qRFC Outbound Queue Monitor:

Table 107:

CRM Server Central Monitoring Activities / Functions	Monitoring Tool (Transaction)
qRFC Outbound Queue Monitor: Monitors data transfer between the CRM Server and ERP backend	SMQ1

CRM Server Central Monitoring Activities / Functions	Monitoring Tool (Transaction)
BDoc Messages/Summary Monitors the status of the BDoc messages and detects any application or Customizing errors during data exchange. SMW01: Displays BDoc message content and possible validation or receiver errors SMW02: Displays BDoc message summary according to the sender site ID SMW02a: Groups BDoc messages according to validation or receiver errors SMW03: Displays client-independent BDoc message summary	SMW01 / SMW02 /SMW02A /SMW03

ERP Backend System Analysis Tools

Table 108:

CRM Server Central Monitoring Activities / Functions	Monitoring Tool (Transaction)
gRFC Inbound Queue monitor: Monitors data transfer between the CRM Server and the ERP backend system	SMQ2

10.4.1.2 Recurring Charges

In the Consume-to-Cash scenario, condition records for recurring charges need to be replicated from SAP CRM to SAP CC. Price conditions are maintained in the SAP CRM product master. Some of these price conditions represent recurring charges.

SAP CRM pricing determines the (gross or net) prices, discounts and surcharges based on the condition technique. The condition technique allows prices to be defined according to marketing requirements. These marketing requirements are SAP CRM-driven and do not need to be remodelled in SAP CC. Marketing-driven pricing criteria are campaigns or customer groups that can determine the price conditions for a product. In SAP CRM pricing all master data can be used for price determination. Since not all master data is available in SAP CC, pricing is performed in SAP CRM. Therefore the pricing conditions need to be replicated from SAP CRM to SAP CC since the charging of the recurring charges takes place in SAP CC.

All fields in a condition table that influence a price condition are grouped by an ID known as the *price key ID*. This ID is used to replicate the condition records from SAP CRM to SAP CC.

CRM Server Analysis Tools

qRFC Outbound Queue Monitor:

Table 109:

CRM Server Central Monitoring Activities / Functions	Monitoring Tool (Transaction)
<p>qRFC Outbound Queue Monitor:</p> <p>Monitors data transfer between the CRM server and ERP backend</p>	SMQ1
<p>BDoc Messages/Summary</p> <p>Monitors the status of the Bdoc messages and detects any application or customizing errors during data exchange.</p> <p>SMW01: Displays BDoc message content and possible validation or receiver errors</p> <p>SMW02: Displays BDoc message summary according to the sender site ID</p> <p>SMW02a: Groups BDoc messages according to validation or receiver errors</p> <p>SMW03: Displays client-independent BDoc message summary</p>	SMW01 / SMW02 / SMW02A / SMW03

10.4.1.3 Business Partner and Business Agreement (BUAG) Distribution

The business partner and business agreement data is captured in SAP CRM. The business agreement is captured during an order creation or change process.

In the business agreement, you can store controlling data for long-term business relationships with a business partner. This data controls processes in invoicing, contract accounts receivable and payable, taxation, and correspondence processing. You can define several business agreements for each business partner.

CRM Middleware Queues

CRM Middleware queues are relevant for this scenario for the following objects:

- CRM Material
- CRM Service Product

Table 110:

Object	Queue ID	Naming Convention for Key	Purpose
CRM Material (PRODUCT_MAT)	R3AUPR_MAT<KEY>	R3AUPR_MAT<KEY> represents the product ID	Transport CRM material from CRM to backend (ERP)

Object	Queue ID	Naming Convention for Key	Purpose
CRM Service Product (PRODUCT_SRV)	R3AUPR_SRV<KEY>	R3AUPR_SRV<KEY>represents the product ID	Transport CRM service product from CRM to backend (ERP)

CRM Server Analysis Tools

qRFC Outbound Queue Monitor:

Table 111:

CRM Server Central Monitoring Activities / Functions	Monitoring Tool (Transaction)
<p>qRFC Outbound Queue Monitor:</p> <p>Monitors data transfer between the CRM server and ERP backend</p>	SMQ1
<p>BDoc Messages/Summary</p> <p>Monitors the status of the BDoc messages and detects any application or customizing errors during data exchange.</p> <p>SMW01: Displays BDoc message content and possible validation or receiver errors</p> <p>SMW02: Displays BDoc message summary according to the sender site ID</p> <p>SMW02a: Groups BDoc messages according to validation or receiver errors</p> <p>SMW03: Displays client-independent BDoc message summary</p>	SMW01 / SMW02 / SMW02A / SMW03

10.4.1.4 Master Agreement

The master agreement in the Sales and Order Management scenario is used for data distribution between SAP Customer Relationship Management (SAP CRM), SAP Enterprise Resource Planning (SAP ERP), and SAP Convergent Charging (SAP CC). The master agreement is a contract between a provider and another company, which you use to manage B2B scenarios and in which you can define the following individual sales agreements for a specific validity period:

- Authorized persons
- Individual products (define specific product attributes)
- Individual prices and discounts

Sales agreements in the master agreement are used as a template for sales contracts (provider contracts), which are created with reference to these sales agreements. If an authorized company (business partner) references an

existing master agreement in their order, individual products and agreements can be released from the master agreement (release order). The agreed prices and products are automatically transferred to the subsequent document (provider contract).

10.4.1.5 Order Distribution Infrastructure and Common Object Layer Framework

A provider order is captured in the Sales and Order Management scenario. When the order is submitted, the system creates a provider contract. This contract is distributed to the SAP ERP using the Order Distribution Infrastructure (ODI),

In the SAP ERP system, the Common Object Layer Framework (COL Framework) is responsible for creating a provider contract by calling the relevant API.

Monitoring: Use transaction `CRM_ISX_DMON` to select contracts by contract number, status, user, and so on, to see the status of the distribution steps. The status of the messages can be changed. If a step has failed, it can be processed once again.

Contract Activation: Use the batch report `CRM_ISX_MSG_START_PLANNED` for contract activation and cancellation. The report selects all contracts that should be activated.

10.4.1.6 One-Offs

One-off fees can be captured with a provider order. Examples of one-off-charge-types are activation charges, installation charges or early cancellation charges.

One-off fees can be transferred to SAP ERP (CI) by the Order Distribution Infrastructure (ODI).

You can reverse one-off charges that were defined previously in the SAP CRM product and posted to SAP Convergent Invoicing.

The system status of a one-off item is set to *Rejected* in SAP CRM before this reversal is transferred to SAP ERP Convergent Invoicing.

As soon as the system status of a released one-off item is set to *Rejected*, this reversal is also automatically transferred to SAP ERP CI.

CRM Middleware Queues

CRM Middleware queues are relevant for this scenario for the following objects:

- CRM Material
- CRM Service Product

Table 112:

Object	Queue ID	Naming Convention for Key	Purpose
CRM Sales Orders (BUS_TRANS_MSG)	R3AUORDER_<KEY>	<KEY> represents the sales order ID	Transport one-off charges from CRM to backend (ERP)

10.4.1.7 Data Integrity Manager (DIMa)

The Data Integrity Manager (DIMa) checks whether provider contracts, created in SAP CRM, have been replicated to SAP ERP and SAP CC.

DIMa uses the object `ISX_PRV_CONTR` to check whether a provider contract exists in another system by comparing the header. DIMa does not check the details of a provider contract. Use the business partner or the contract ID to select the provider contracts that you want to compare in detail.

You can start a new DIMa request using the transaction `SDIMA`. You can either start a comparison for an existing DIMa instance or create a new DIMa instance using the wizard. If you create a new DIMa instance, you have to enter following parameters:

- Name of the DIMa instance
- DIMa object `ISX_PRV_CONTR`
- Filter settings
 - You can use the business partner (field name `GPART`) or the contract ID (field name `VTKEY`) to search for your provider contracts.

Once the comparison is finished, you can see how many contracts exist in both systems (SAP CRM, SAP ERP, and SAP CC) and how many contracts exist only in SAP CRM. To analyze why some contracts do only exist in SAP CRM, you can display the contract just by double clicking on the contract ID.

A Appendix

A.1 Related Information

For more information about SAP CRM functions, see SAP Library for SAP Customer Relationship Management on SAP Help Portal at <http://help.sap.com/crm> >> <choose release> > <Application Help >.

For more information about system administration and maintenance of SAP NetWeaver see http://help.sap.com/nw_platform >> *System Administration and Maintenance Information* > *Technical Operations for SAP NetWeaver* >.

Important Disclaimers and Legal Information

Coding Samples

Any software coding and/or code lines / strings ("Code") included in this documentation are only examples and are not intended to be used in a productive system environment. The Code is only intended to better explain and visualize the syntax and phrasing rules of certain coding. SAP does not warrant the correctness and completeness of the Code given herein, and SAP shall not be liable for errors or damages caused by the usage of the Code, unless damages were caused by SAP intentionally or by SAP's gross negligence.

Gender-Neutral Language

As far as possible, SAP documentation is gender neutral. Depending on the context, the reader is addressed directly with "you", or a gender-neutral noun (such as "sales person" or "working days") is used. If when referring to members of both sexes, however, the third-person singular cannot be avoided or a gender-neutral noun does not exist, SAP reserves the right to use the masculine form of the noun and pronoun. This is to ensure that the documentation remains comprehensible.

Internet Hyperlinks

The SAP documentation may contain hyperlinks to the Internet. These hyperlinks are intended to serve as a hint about where to find related information. SAP does not warrant the availability and correctness of this related information or the ability of this information to serve a particular purpose. SAP shall not be liable for any damages caused by the use of related information unless damages have been caused by SAP's gross negligence or willful misconduct. All links are categorized for transparency (see: <https://help.sap.com/viewer/disclaimer>).

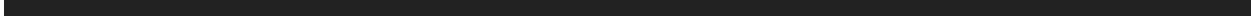



**go.sap.com/registration/
contact.html**

© 2017 SAP SE or an SAP affiliate company. All rights reserved.
No part of this publication may be reproduced or transmitted in any form or for any purpose without the express permission of SAP SE or an SAP affiliate company. The information contained herein may be changed without prior notice.
Some software products marketed by SAP SE and its distributors contain proprietary software components of other software vendors. National product specifications may vary.
These materials are provided by SAP SE or an SAP affiliate company for informational purposes only, without representation or warranty of any kind, and SAP or its affiliated companies shall not be liable for errors or omissions with respect to the materials. The only warranties for SAP or SAP affiliate company products and services are those that are set forth in the express warranty statements accompanying such products and services, if any. Nothing herein should be construed as constituting an additional warranty.
SAP and other SAP products and services mentioned herein as well as their respective logos are trademarks or registered trademarks of SAP SE (or an SAP affiliate company) in Germany and other countries. All other product and service names mentioned are the trademarks of their respective companies.
Please see <https://www.sap.com/corporate/en/legal/copyright.html> for additional trademark information and notices.