

1. ELECTROLYSIS

My Battery Story

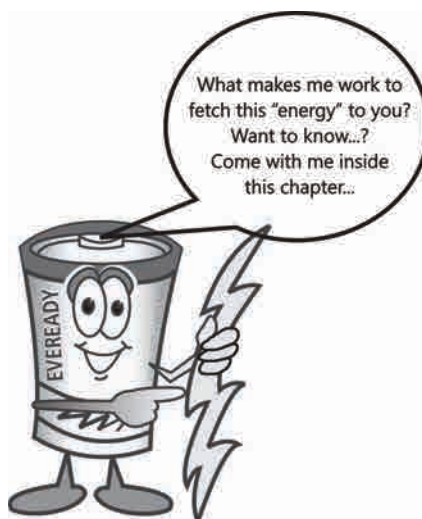

1. Introduction to Electrolysis

Electrolysis is a process by which electrical energy is used to produce a chemical change. Perhaps the most familiar example of electrolysis is the decomposition (breakdown) of water into hydrogen and oxygen by means of an electric current. The same process can be used to decompose compounds other than water. Sodium, chlorine, magnesium, and aluminum are four elements produced commercially by electrolysis.

1.1 Electric Current and Substances

Substances behave differently towards electric current; some allow the current to pass through them while some do not.

Substances which allow the passage of current are called conductors; those which do not allow the passage of current are non-conductors or insulators. Conductors are classified as

- (i) Metallic conductors
- (ii) Electrolytic conductors

- (i) **Metallic conductors:** They do not undergo any change when current passes through them except that they get warmed up during the flow of current. The flow of current in metallic conductors is through electrons. Most metals are good conductors of electricity. E.g. lighting of electric bulb
- (ii) **Electrolytic conductors or Electrolytes:** They are aqueous solutions or substances in the fused state which allow the passage of current. They undergo chemical change and get decomposed. These substances are called **electrolytes**. E.g. electrolysis of water produces hydrogen and oxygen.

Illustration 1: Explain why

- (a) Cu, though a good conductor of electricity is a non-electrolyte.
- (b) Solid sodium chloride does not allow electricity to pass through.

Sol:

- (a) Because copper is an electronic conductor as it is a metal.
- (b) Sodium chloride (an ionic solid) does not conduct electricity in its solid state. It is because the anions (chloride Cl^-) and cations (sodium- Na^+), remain in fact occupying fixed position in the crystal lattice due to strong electrostatic attractive forces among them. The ions, therefore are unable to move to any large extent when electric field is affected. Hence, no current.

1.2 Electrolysis

The process of decomposition of an electrolyte into its component ions by the passage of current through the electrolyte is called **electrolysis**. The vessel in which electrolysis takes place is called the electrolytic cell. The points at which the current enters and leaves the solution are called the electrodes; anode is the positive electrode and cathode is the negative electrode. During electrolysis, the electrolyte decomposes into its ions.

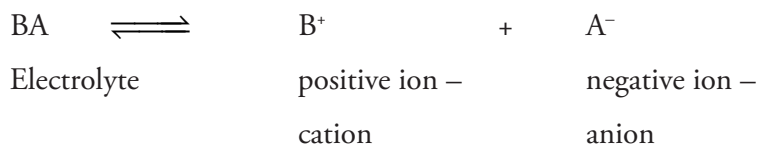

The positive ion (cation) moves towards the cathode where it gets its positive charge neutralized by the negative charge on the cathode and appears as neutral atom. Similarly, the negative ion (anion) moves towards the anode and gets discharged at the electrode as the neutral atom or radical.

E.g. the products of electrolysis of a solution of sodium chloride are sodium at the cathode and chlorine at the anode.

In some cases the products of electrolysis may react further with water or with the electrode and give rise to secondary reactions.

Illustration 2: Electrolysis is a redox process, Explain.

Sol: Electrolysis is the dissociation of electrolyte i.e. Oxidation and reduction takes place at the same time. The reaction at the cathode involves reduction of cations as they gain electrons to become neutral atoms and oxidation takes place at anode as they lose electrons to become neutral.

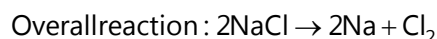
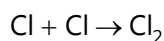
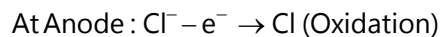
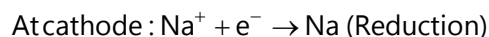

1.3 Theory of Ionisation

Postulates of Arrhenius theory of Electrolytic Dissociation-

1. Acids, bases and salts in aqueous solution yield two types of charged particles called ions – cation (positive) and anion (negative).
2. When an electrolyte is put into water, it dissociates to greater or smaller extent into its component ions. At any given temperature, the undissociated molecules of the electrolyte are in equilibrium with the ions.
3. Dilution increases ionization and at infinite dilution almost all electrolytes are completely ionized.
4. The movement of ions through the solution constitutes the electric current through the electrolyte.
5. The properties of the electrolytes in solution are the properties of the ions.

E.g. acid properties are due to H^+ ions; basic properties due to OH^- ions and blue colour of copper sulphate solution is due to Cu^{2+} ions, etc.

for example hydrogen chloride.

PLANCESS CONCEPTS

The electrodes ... Which is which?

How to remember:

Anode \longrightarrow ADD = + i.e. positive

The anode (positive) hence cathode (negative)

Anion (negative) goes to Anode

Cation (positive) goes to Cathode

A to A and C to C

Vipul Singh

AIR 1, NSO

1. In the gaseous state or in the pure liquid state, HCl is unionized and does not conduct an electric current.
2. It is, however, polar covalent in nature, i.e. shows charge distribution in its molecule such that the hydrogen atom has a slight positive charge and the chlorine atom has a slight negative charge.

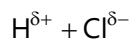

3. When hydrogen chloride is added to water [a polar solvent], the slightly negatively charged oxygen atom of the water exerts an electrostatic pull on the slightly positively charged hydrogen ions present in the molecule of HCl.

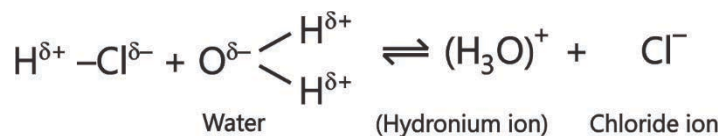

Thus, H^+ ions combine with water to form hydronium ions $[\text{H}_3\text{O}]^+$.

Illustration 3: Name two substances in each case: (a) Contain only molecules, (b) Contain only ions (c) Contain ions as well as molecules

Sol: (a) Glucose, Distilled water, Kerosene

(b) Sodium Chloride (aq) HCl, NaOH

(c) $\text{Ca}(\text{OH})_2$, NH_4OH , acetic acid

PLANCESS CONCEPTS

The charge on an ion, positive or negative is equal to the valency of the atom or the ion.

Neeraj Toshniwal

AIR 23, NSO

1.4 Strong and Weak Electrolytes

All electrolytes do not conduct electricity to the same extent.

E.g. 0.1 M HCl has a very high conductance whereas,

0.1 M acetic acid has a relatively low conductance.

It may therefore be inferred that there are more ions in 0.1 M HCl than in 0.1 M acetic acid. HCl is said to be a strong electrolyte, while acetic acid is a weak electrolyte. When HCl is dissolved in water, the following reaction takes place:

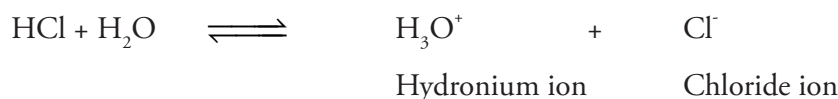

The reaction is reversible but almost all the HCl molecules are converted into hydronium and chloride ions. Hence, HCl is a strong electrolyte.

When acetic acid is dissolved in water, hydronium and acetate ions are produced:

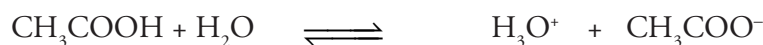

H_3O^+ and CH_3COO^- recombine to give back acetic and water. The forward reaction i.e. formation of hydronium ion and acetate ion proceeds to a very small extent producing only a very few ions. Hence, a solution of acetic acid is a weak electrolyte.

Table 1.1: Difference between strong and weak electrolyte

		Strong Electrolytes	Weak electrolytes
1.	Ionisation	Ionise to a large extent (i.e.) almost completely ionized)	Ionise only to a small extent in aqueous solution
2.	Conductance	Have high conductance	Have low conductance
3.	Examples	Mineral (strong) acids HCl, H_2SO_4 and HNO_3 . Strong bases NaOH, KOH and all salts	Organic (weak) acids oxalic, acetic, etc. weak bases NH_4OH , Na_2CO_3 and water

1. 5 Degree of Ionisation or Degree of Dissociation (α)

It is the fraction of 1 mole of an electrolyte that has dissociated under the given conditions. Strong electrolytes have a high degree of ionisation e.g. 0.1 M HCl may have $\alpha = 0.99$ (i.e. it is 99% dissociated). Weak electrolytes have a low degree of ionization E.g. 0.1M acetic acid solution may have $\alpha = 0.02$ (i.e. it is only about 2% dissociated).

X-ray studies of crystals have revealed that salts contain ions even in the solid state. When a salt is placed in water, the inter-ionic attractive forces are weakened and the ions get separated. They are now free to move and they conduct electricity. (It is to be noted that in the solid state, the ions are not mobile and so they do not conduct electricity.)

$$\alpha = \frac{A_c}{A_\infty} \text{ where } A_c \text{ is the conductance of the solution at a particular concentration 'c'}$$

and A_∞ is the conductance

At infinite dilution i.e. when all the molecules are dissociated.

$$= \frac{\text{Number of ions in solution}}{\text{Total number of ions produced by complete dissociation}}$$

This is true only for weak electrolytes. For strong electrolytes α approximately = 1

Factors which affect the value of α : The value of degree of ionization α depends upon:

1. The nature of solute
2. The nature of solvent
3. Temperature and
4. Dilution.

PLANCESS CONCEPTS

Revise it: The process by which polar covalent compounds are converted into ions, in water solution, is called ionisation.

Shivam Agarwal

AIR 3 , NSO

1.5.1 Characteristics of Electrolysis

1. The passage of electricity through an electrolyte causes the positive ions i.e., cations to migrate towards the cathode and negative ions i.e., anions to migrate towards the anode.
2. The number of electrons gained by the anode is equal to the number of electrons given by the cathode.
3. The products of electrolysis are formed at the anode and cathode itself since the exchange of electrons takes place only at the surface of the electrodes.
4. Only hydrogen gas and metals are formed at the cathode and hence are called electro-positive elements.
5. Only non-metals are formed at the anode and are called electronegative elements.
6. The mass of a substance produced at an electrode during electrolysis is proportional to the quantity of electricity passing through the electrolyte (Faraday's Law of electrolysis).
7. The process of electrolysis is a redox reaction.

The reaction at the cathode involves reduction of cations as they gain electrons to become neutral atoms while that at anode involves oxidation of anions as they lose electrons to become neutral.

Example: Dissociation of sodium chloride during electrolysis.

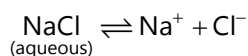

At cathode: $\text{Na}^+ + \text{e}^- \rightarrow \text{Na}$ (reduction)

At anode: $\text{Cl}^- - \text{e}^- \rightarrow \text{Cl}$ (oxidation)

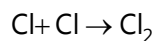

Overall reaction: $2\text{NaCl} \rightarrow 2\text{Na} + \text{Cl}_2$

8. The alternating current (A.C.) does not cause any chemical change when passed through an electrolyte and therefore does not help electrolysis to occur. Electrolysis is caused by direct current.

PLANCESS CONCEPTS

The difference between Arrhenius and Modern concept.

Arrhenius considered that water ionizes electrolytes but Modern concept consider that electrolytes are ionic even in solid state and their ions are held by strong electrostatic forces which make them immobile.

Water renders these ions mobility by breaking the electrostatic forces.

Anand K

AIR 1, NSO 2011

1.6 Electrochemical Series of Metals

Sodium gets converted to Na^+ much more easily than copper to Cu^{2+} , Zn becomes Zn^{2+} more easily than Ag to Ag^+ .

Based on the ease with which atoms of metals lose electrons to form positively charged ions, the metals are arranged in a series known as the electrochemical series.

Table 1.2: Electrochemical series of metals

Metals		Cations	
K	Cations are discharged at cathode by gain of electron (s)	K^+	 Increasing ease of discharge at cathode
Ca		Ca^{2+}	
Na		Na^+	
Mg		Mg^{2+}	
Al		Al^{3+}	
Zn		Zn^{2+}	
Fe		Fe^{3+}	
Ni		Ni^{2+}	
Sn		Sn^{4+}	
Pb		Pb^{2+}	
H		H^+	
Cu		Cu^{2+}	
Hg		Hg^{2+}	
Ag		Ag^+	
Au		Au^{3+}	
Pt		Pt^{4+}	

Illustration 4. Among Zn and Cu, which would occur more readily in nature as metal and which as ion?

Sol: Since the electron releasing tendency of zinc is more than that of copper, therefore, copper would occur more readily in nature as metal and zinc as ion.

About Electrochemical Series of Metals

1. A metal with a higher position in the series displaces the one with a lower position.
2. Metals below hydrogen cannot displace hydrogen from acids while those above it can.
3. Elements lower in the series get discharged more easily at the cathode during electrolysis because their cations can easily gain electrons.
4. Metal atoms which form their ions most easily, will accept the electrons back to form the atoms with greatest difficulty.
5. Hydrogen has some properties of a metal, e.g. formation of a positive ion. Thus, its position amongst metals confirms its identify with metals. Therefore, it has been placed along with metals in the series.

Electrochemical series of the anions

Anions are negatively charged ions. On electrolysis, they move towards the anode. They lose their extra electrons or the negative charge at the anode and are discharged there. But all anions do not have identical tendency to lose electrons.

Based on their tendency to lose electrons and get discharged at the anode, the anions have been arranged in the increasing order.

Illustration 5: A solution contains magnesium ions (Mg^{2+}), iron (II) ions (Fe^{2+}) and copper ions (Cu^{2+}). On passing an electric current through this solution which ions will be the first to be discharged at the cathode? Write the equation for the cathode reaction?

Sol: Cu^{2+} (Copper ions will get discharged at cathode)

Note: An ion present lower in the electrochemical series gets discharged at the relevant electrode in preference to ions above it.

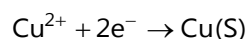

(Copper is deficient in e^{-} , it will accept two electrons and get deposited at cathode.)

Table 1.3: Electrochemical series of anions

Electrochemical Series of Anions		About Electrochemical Series of Anions
Increasing ease of discharge	SO_4^{2-} NO_3^- Cl^- Br^- I^- OH^-	Increasing ease of oxidation
		1. Lower the position of an anion in the series, more easily it gets discharge at anode. 2. Higher the position of an anion in the series, more difficult for it to lose electrons or get oxidised.

Illustration 6: Can we store CuSO_4 solution in iron vessel?

Sol: Iron is above copper in the electrochemical series and is thus more electropositive than copper. So, iron displaces copper from copper sulphate solution. This liberated copper appears in the form of a red precipitate. Hence CuSO_4 solution cannot be stored in an iron vessel.

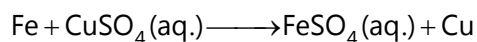

PLANCESS CONCEPTS

Electrolyte	Dissociation of electrolytes	Ions migrating to cathode	Ion discharged at cathode	Ions migrating at anode	Ion discharged at anode
1. Dilute CuSO_4 solution	$\text{CuSO}_4 \longrightarrow \text{Cu}^{2+} + \text{SO}_4^{2-}$ $\text{H}_2\text{O} \rightleftharpoons \text{H}^+ + \text{OH}^-$	$\text{Cu}^{2+}, \text{H}^+$	Cu^{2+}	$\text{SO}_4^{2-}, \text{OH}^-$	OH^-
2. Dilute H_2SO_4 solution	$\text{H}_2\text{SO}_4 \rightleftharpoons 2\text{H}^+ + \text{SO}_4^{2-}$ $\text{H}_2\text{O} \rightleftharpoons \text{H}^+ + \text{OH}^-$	Only H^+	H^+	$\text{SO}_4^{2-}, \text{OH}^-$	OH^-
3. Dilute NaCl solution	$\text{NaCl} \longrightarrow \text{Na}^+ + \text{Cl}^-$ $\text{H}_2\text{O} \rightleftharpoons \text{H}^+ + \text{OH}^-$	Na^+, H^+	H^+	Cl^-, OH^-	OH^-

Vaibhav Gupta

AIR 2, NSO 2011

Illustration 7: On electrolysis of dilute copper (II) sulphate solution, in presence of platinum anode copper is deposited at the cathode but no hydrogen gas evolves there. Explain why?

Sol: Copper is below hydrogen in the electrochemical series. So, Cu^{2+} gets easily reduced to metallic copper than does H^+ to hydrogen gas.

Answer to the Battery Story

A battery is a single electric cell (or two or more such cells linked together for additional power) used as a source of electrical energy.

A **battery** is a device that converts chemical energy to electrical energy.

The Italian physicist **Alessandro Volta** discovered the principle of the electric cell (see voltaic cell) in 1800. Within a few weeks **William Nicholson** and **Sir Anthony Carlisle**, English scientists, performed the first electrolysis, breaking water down into oxygen and hydrogen.

The chemical reactions in the battery causes a build up of electrons at the anode. This results in an electrical difference between the anode and the cathode. You can think of this difference as an unstable build-up of the electrons. The electrons want to rearrange themselves to get rid of this difference. But they do this in a certain way. Electrons repel each other and try to go to a place with fewer electrons.

In a battery, the only place to go is to the cathode. But, the electrolyte keeps the electrons from going straight from the anode to the cathode within the battery. When the circuit is closed, (a wire connects the cathode and the anode) the electrons will be able to get to the cathode. In the picture above, the electrons go through the wire, lighting the light bulb along the way. This is one way of describing how electrical potential causes electrons to flow through the circuit.

However, these electrochemical processes change the chemicals in anode and cathode to make them stop supplying electrons. So there is a limited amount of power available in a battery.

When you recharge a battery, you change the direction of the flow of electrons using another power source, such as solar panels. The electrochemical processes happen in reverse, and the anode and cathode are restored to their original state and can again provide full power.

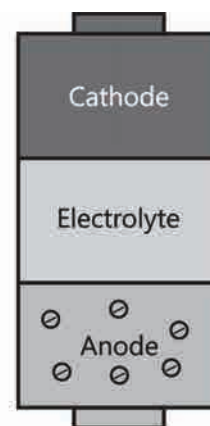

Due to a chemical reaction within the battery the anode builds up an excess of electrons.

Figure 1.1: Battery

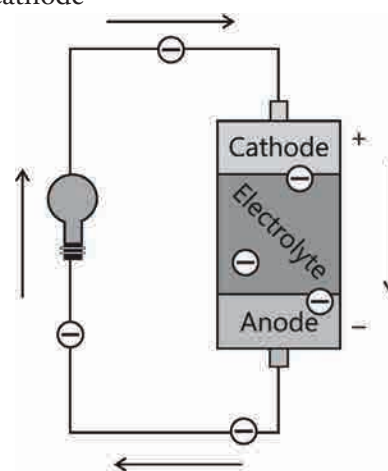

This causes an electrical difference between the anode and the cathode.

Figure 1.2: Working of battery

1.7 Preferential or Selective Discharge of Ions at Electrodes

When two or more ions of the same charge are present in a solution of an electrolyte, under identical conditions, and are competing for discharge at the same electrode, one of them gets preferentially discharged. This is known as selective discharge of ions.

Selective discharge of ions depends on three factors:

- (a) The relative position of ions in the electrochemical (activity) series.
- (b) The relative concentration of ions.
- (c) The nature of the electrodes.
 - a) The lower the position of the ion in the E.C.S. it will be more preferentially discharged as compared to the other ions above it in the E.C.S (Electrochemical Series), at the electrode they are attracted to.
 - b) The higher the concentration of that particular type of ions (eg. Ca^{2+} is less concentrated as compared to Mg^{2+}) it will help to promote its discharge.
 - c) The nature of electrodes used may influence the choice of ions discharged

Example:

- (a) Electrolysis of concentrated (aq) NaCl

At the cathode:

Platinum Cathode – hydrogen gas evolved

Mercury Cathode – Sodium is preferentially discharged and sodium amalgam is deposited

1.8 Examples of Electrolysis

I. Electrolysis of molten lead bromide

- (i) **Electrolyte:** Molten lead bromide (PbBr_2).
- (ii) **Temperature:** Above 380°C , the melting point of PbBr_2 is maintained by continuous heating by a burner
- (iii) **Electrolytic cell:** Crucible is made of silica because silica is non-reactive, withstands high temperature and is almost a non-conductor of electricity.
- (iv) **Electrodes:** The cathode and anode are both made of graphite plates which are inert. They are connected by copper wires to the two ends of a battery.
- (v) **Current:** 3 amperes.
- (vi) **Ions present:** Pb^{2+} and Br^- , i.e., lead ions and bromide ions.
- (vii) **Electrode reaction:**

At the cathode: $\text{Pb}^{2+} + 2\text{e}^{-} \longrightarrow \text{Pb}$

At the anode: $\text{Br}^{-} - \text{e}^{-} \longrightarrow \text{Br}$

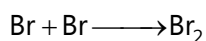

The overall reaction is: $\text{PbBr}_2(\text{l}) \longrightarrow \text{Pb}(\text{s}) + \text{Br}_2(\text{g})$

The process is shown in the Fig.

(viii) Observations:

- Dark reddish brown fumes of bromine evolve at the anode.
- Greyish white metal lead is formed on the cathode.

Explanation: When the current is turned on, the positive lead ions (Pb^{2+}) migrate towards the cathode. They take 2 electrons each and become neutral lead atoms. The negative bromide ions (Br^{-}) come in contact with the anode, give an electron each and become bromine atoms. These two atoms combine to form bromine molecule.

Note:

- Since silica is non-reactive, hence an electrolytic cell is made of silica. It can withstand high temperature and is almost a non-conductor of electricity. The silica crucible is heated slowly from outside.
 - Solid lead bromide is a non-conductor of electric current since its ions are not free but held together by an electrostatic force of attraction.
 - The ions become free when lead bromide is in the fused or molten state. Hence the crucible is heated from outside to keep lead bromide in the molten state.
- Graphite anode is preferred to other inert electrodes such as platinum since graphite is unaffected by the reactive bromine vapours.

II. Electrolysis of acidified water using platinum electrodes:

Electrolytic Cell: Hoffman's Voltmeter

Electrolyte: Acidified water (Water + dilute H_2SO_4)

Note : Dilute sulphuric acid is preferred because it is non-volatile while dilute nitric acid or hydrochloric acid are volatile acids.

Electrodes: Platinum foils, which are inert, connected by copper wires to the two terminals of a battery.

Current: 3 amperes.

Dissociation of water: Water is a nonconductor of electricity. It consists almost entirely of molecules. It

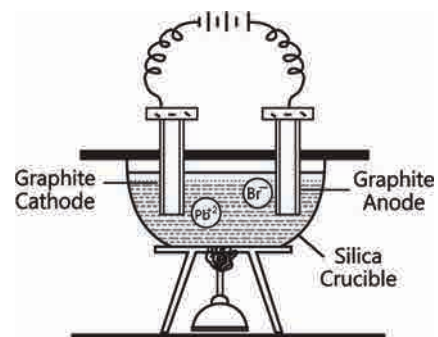

Electrolysis of molten lead bromide

Figure 1.3: Electrolysis of lead bromide

is a polar covalent compound and can form ions, when traces of dilute Sulphuric acid is added. As dilute sulphuric acid catalyse this dissociation, hence electrolysis of acidified water is considered as an example of catalysis.

Ionisation of acidified water:

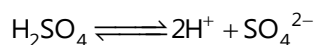
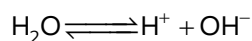

Ions present Sol: $\text{H}^+, \text{OH}^-, \text{SO}_4^{2-}$

Particles present in Sol: $\text{H}^+, \text{OH}^-, \text{SO}_4^{2-}, \text{H}_2\text{O}$.

Reaction at Cathode: Hydrogen ions, H^+ , being the only positively charged ions, migrate to the cathode. Since the cathode is a reservoir of electrons, H^+ gains an electron and becomes a neutral hydrogen atom.

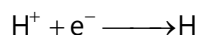

Hydrogen atoms combine to form a molecule and this comes out as hydrogen gas.

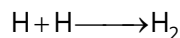

Reaction at Anode: The SO_4^{2-} and OH^- both migrate to the anode. OH^- being lower in the electrochemical series is discharged preferentially.

OH^- loses one electron to the anode and becomes neutral OH.

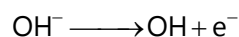

The combination of OH forms water with the liberation of oxygen, which is given off at the anode.

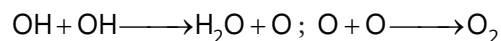

Note: Since SO_4^{2-} ions migrate to the anode, and H^+ ions have been discharged, the concentration of sulphuric acid will decrease at cathode.

At anode: The discharge of OH^- disturbs the ionic equilibrium of water and to maintain it, more water ionises.

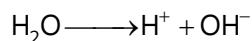

The excess of H^+ ions, thus produced and the SO_4^{2-} ions present increase the concentration of sulphuric acid at anode.

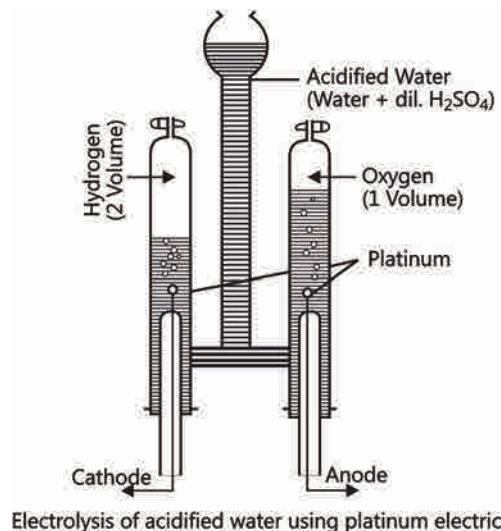

Figure 1.4: Electrolysis of acidified water

Thus there is decrease in acidity at cathode and increase in acidity at anode.

Ratio of Hydrogen to Oxygen is 2:1 by volume.

In the electrolysis of acidified water:

At anode, OH^- loses one electron and becomes neutral OH.

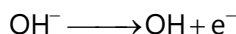

The combination of OH forms water with the liberation of oxygen.

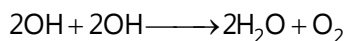

Since 4 OH neutral particles are involved in the equation so 4 electrons are lost in order to get 4OH neutral particles.

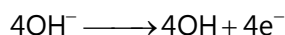

Thus, the formation of 1 molecule of oxygen at the anode releases 4 electrons and there is no buildup of electrons in any part of the circuit, the reaction of the cathode must take up 4 electrons, i.e.

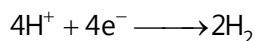

This shows that the number of molecules of hydrogen is twice that of oxygen molecules. According to Avogadro's Law, molecules can be substituted by volumes.

Hence, electrolysis of water gives 2 volumes of H_2 and 1 volume of O_2 .

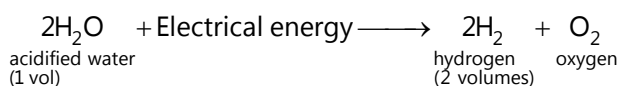

III. Electrolysis of copper sulphate solution using platinum anode and copper or platinum cathode

Electrolyte: Saturated solution of copper (II) sulphate, prepared in distilled water with a small amount of conc. sulphuric acid (to increase the electrical conductivity of electrolyte).

Electrolytic cell: Glass or a porcelain jar (Fig.).

Dissociation of aqueous copper sulphate:

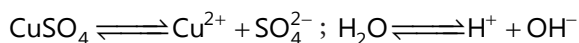

Particles present: Cu^{2+} , H^+ , SO_4^{2-} , OH^- and H_2O molecules

Ions present: Cu^{2+} , H^+ , SO_4^{2-} , OH^-

Reaction at cathode: The copper ions are below hydrogen ions in the activity series, thus copper ions discharge in preference to (H^+) ions, to form neutral copper atoms.

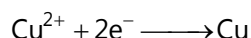

The copper atoms deposits themselves on the cathode.

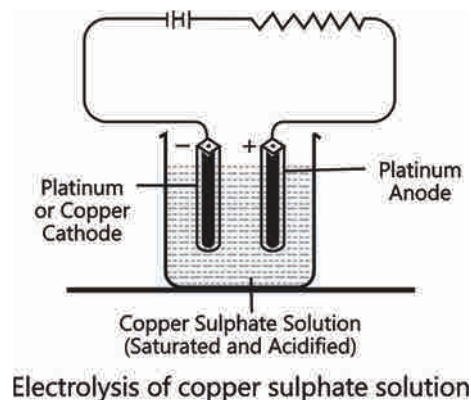
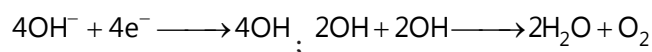

Figure 1.5: Electrolysis of copper sulphate using Pt electrode

Reaction at anode: The SO_4^{2-} and OH^- ions both migrate to the anode. The OH^- ions, being lower in electrochemical series as compared to SO_4^{2-} ions, discharge to form neutral (OH) radical. The neutral (OH) radicals reunite to form water and oxygen.



Product at anode: Oxygen.

Product at cathode: Reddish brown copper is deposited.

When the deposition of Cu ions is completed, then electrolysis of water takes place. Hydrogen gas is liberated at the cathode and oxygen gas is liberated at the anode.

Note: The blue colour of Cu^{2+} ions in the electrolyte solution fades due to decrease in Cu^{2+} ions and finally the solution becomes colourless as soon as Cu^{2+} ions are finished.

IV. Electrolysis of aqueous copper sulphate using copper electrodes

1. **Electrolytic cell** Iron crucible or glass voltameter
2. **Electrolyte** Aqueous copper sulphate
3. **Electrode** Cathode: Copper ; Anode: Copper
4. **Temperature** Ordinary temperature
5. **Current** Current: 3 ampere
6. **Dissociation of:** $\text{CuSO}_4 \rightleftharpoons \text{Cu}^{2+} + \text{SO}_4^{2-}$

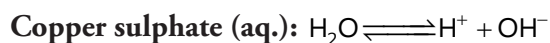

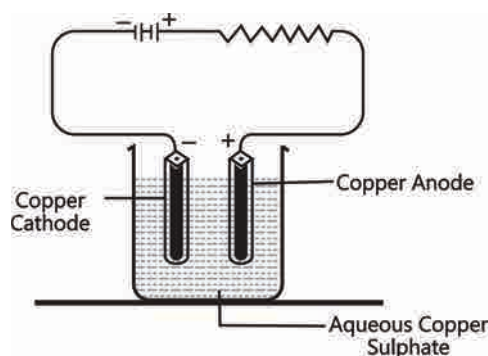

Figure 1.6: Electrolysis of copper sulphate using Cu electrode

Reaction at cathode: $\text{Cu}^{2+} + 2\text{e}^{-} \longrightarrow \text{Cu}$

Both Cu^{2+} and H^{+} ions migrate to the cathode, Cu^{2+} ions discharged as neutral copper atoms, by accepting electrons (as it is lower in the series).

Reaction at anode: $\text{Cu} - 2\text{e}^{-} \longrightarrow \text{Cu}^{2+}$

SO_4^{2-} and OH^{-} ions migrate to anode but neither of them are discharged due to the nature of the anode, (copper loses electrons more easily than SO_4^{2-} and OH^{-}) because copper anode itself ionises to give Cu^{2+} ions.

Product at anode: Nil because copper anode keep dissolving during the reaction, as Cu^{2+} ions are formed.

Product at cathode: Reddish brown Cu is deposited.

- Note:**
1. The electrolyte aqueous copper [II] sulphate may be acidified with traces of dilute sulphuric acid. This enhances the conductivity of the electrolyte and may prevent its hydrolysis.
 2. The blue colour of aq. copper [II] sulphate solution remains unchanged during its electrolysis due to the copper electrodes.

Reason: For every copper ion [Cu^{2+}] discharged at the cathode as neutral copper atom, a copper ion [Cu^{2+}] is released or added to the solution by the anode and hence total number of Cu^{2+} ions remains the same. Therefore, the blue colour does not fade. H^{+} ions and OH^{-} ions do not take part in the electrolytic reaction and are known as spectator ions.

Illustration 8: A compound which liberates reddish brown gas around the anode during electrolysis in its molten state is:

- | | |
|--------------------------|-----------------------|
| (a) Sodium chloride | (b) Copper(II) oxide |
| (c) Copper (II) sulphate | (d) Lead (II) bromide |

Sol: (d) Lead (II) bromide

2. Applications of Electrolysis

1. In the extraction of metals such as sodium, potassium, calcium and magnesium by the electrolysis of their fused chlorides; and of aluminium by the electrolysis of pure Al_2O_3 dissolved in molten cryolite.
2. In the refining of metals such as copper and silver; the impure metal is made the anode and a thin strip of the pure metal forms the cathode. Generally, the electrolyte is an acidic solution of a salt of the metal; e.g. in the electrolytic refining of copper, the electrolyte is CuSO_4 + dilute H_2SO_4 . On passing a current, the impure metal at the anode dissolves and very pure metal is deposited on the cathode.
3. In electroplating; the deposition of metals by electrolysis is of great technical importance. Electro-deposition may be done for decorative purposes such as silver-plating of tableware; for engineering purposes as in chromium plating on the surface of special tools.
4. Printing surfaces for books and textiles are prepared by copper plating.
5. In the manufacture of certain compounds like NaOH , KOH , KClO_3 , etc.

2.1 Electroplating

Electroplating is a process in which a thin film of a metal like gold, silver, nickel, chromium, etc. gets deposited on another metallic article with the help of electricity.

Reasons for electroplating:

- (i) Decoration purpose: For example, brass objects are frequently plated with silver to give them the shining appearance and beauty of silver article.
- (ii) To protect from rusting and corrosion: Iron tools and instruments are often electroplated with nickel or chromium or zinc to protect against rusting.

PLANCESS CONCEPTS

When plating is not desired on certain areas of the substrate, stop-offs are applied to prevent the bath from coming in contact with the substrate. Typical stop-offs include tape, foil, lacquers, and waxes.

Makarand Manda

KVPY Fellow

Conditions for electroplating

Condition	Reason
1. The article to be electroplated is always placed at the cathode.	During electrolytic reaction, the metal is always deposited at the cathode by gain of electrons.
2. The metal to be placed on the article is always made the anode and has to be periodically replaced.	The metal anode continuously dissolves as ions in solution and is replaced periodically.
3. The electrolyte must contain ions of the metal which is to be plated on the article [i.e. be a suitable salt of the plating metal].	The electrolyte dissociates into ions of the metal which migrate towards the cathode and are deposited as neutral metallic atoms on the cathode.
4. A low current for a longer time should be used.	Higher current causes uneven deposition of the metal. Longer time and low current initiates a thicker uniform deposition.
5. A direct current and not A.C. current should be used.	A.C. current causes discharge and ionisation to alternate at the cathode thus giving no effective coating.

2.1.1 Electroplating an Article with Silver

In order to get perfect deposit of silver on an article, say brass spoon. The spoon is first cleaned and then it is washed in a hot solution of caustic soda followed by dilute hydrochloric acid and water. It is now thoroughly washed with detergent and several times with distilled water. The spoon is then dried and made the cathode.

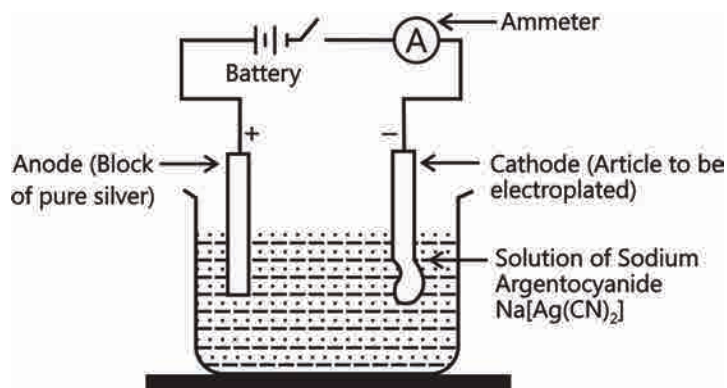
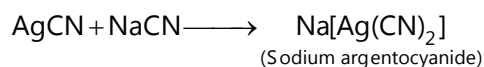
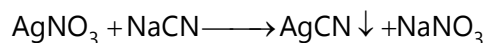

Figure 1.7: Electroplating of brass spoon and silver

Electrolyte: Sodium argentocyanide $\text{Na}[\text{Ag}(\text{CN})_2]$ or potassium argentocyanide $\text{K}[\text{Ag}(\text{CN})_2]$

Sodium silver cyanide is prepared by adding sodium cyanide to a solution of silver nitrate until the precipitate formed just dissolves.



Dissociation:

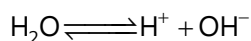
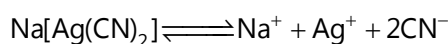

Cathode: Article to be electroplated is duly cleaned.

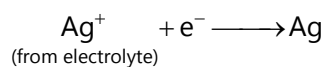

Anode: Plate of pure clean silver.

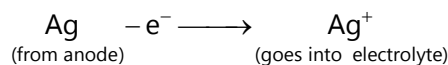

The negative ions (anions) CN^- and OH^- ions migrate to the anode but none of them are discharged. Instead, the atoms of anode (silver) lose electrons and pass into solution as silver ions (Ag^+) due to the nature of the anode. Silver ions are attracted to the brass spoon (cathode). Here, they gain electrons and become atoms of silver which deposit on the spoon as a firm coating.

The thickness of coating will depend on the duration of the current passed.

The spoon is taken out of the bath repeatedly, washed several times with water, dried and polished.

Note: If silver nitrate solution is used directly instead of double cyanide of sodium and silver, the deposition of silver will be very fast and hence not very smooth and uniform.

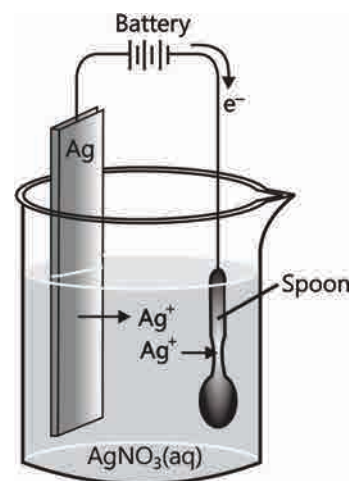

Figure 1.8: Electroplating with silver

PLANCESS CONCEPTS

The plating is most commonly a single metallic element, not an alloy. However, some alloys can be electrodeposited, notably brass and solder.

Makarand Manda

KVPY Fellow

Illustration 9: Copy and complete the following table, which refers to two practical applications of electrolysis

	Anode	Electrolyte	Cathode
Silver plating of a spoon		Solution of potassium argentocyanide	
Purification of copper			

Sol:

	Anode	Electrolyte	Cathode
Silver plating of a spoon	Rod of pure silver	Solution of potassium argentocyanide	Spoon
Purification of copper	Rod of impure copper	CuSO_4 solution and dil. H_2SO_4	A thin rod of pure copper

PLANCESS CONCEPTS

Direct current is the unidirectional flow of electric charge. Direct current is produced by such sources as batteries, thermocouples, solar cells

Uday Kiran G

KVPY Fellow

2.1.2 Electroplating with Nickel

Iron gets easily rusted when exposed to air. If iron articles are coated with a metal like nickel, tin or zinc, rusting can be prevented.

If nickel plating is to be done, the iron article to be coated is made the cathode, nickel plate is made the anode, and a solution of nickel sulphate containing a small amount of dilute sulphuric acid is used as an electrolyte.

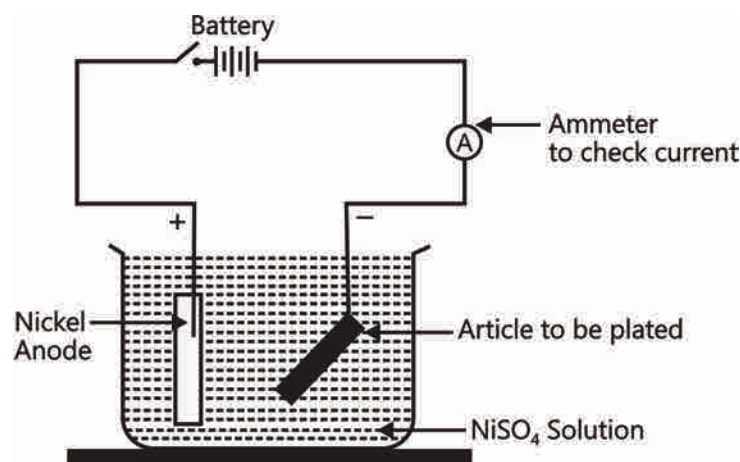
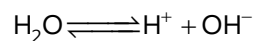

Figure 1.9: Electroplating with nickel

Electrolyte: Aqueous solution of nickel sulphate [NiSO_4].



Cathode: Article to be electroplated is duly cleaned.

Anode: Block of pure nickel metal.

Reaction at cathode: $\text{Ni}^{2+} + 2\text{e}^- \longrightarrow \text{Ni}$ [deposited]

Nickel ions are deposited at the cathode as neutral nickel atoms by gain of electrons [in preference of H^+ ions].

Reaction at anode: $\text{Ni} - 2\text{e}^- \longrightarrow \text{Ni}^{2+}$

SO_4^{2-} and OH^- ions both migrate to the anode but neither are discharged due to the nature of electrode. Instead, the nickel anode loses electrons to give Ni^{2+} ions in solution.

Note: Article to be plated is always kept at the cathode.

PLANCESS CONCEPTS

Electrolyte solution are reduced at the interface between the solution and the cathode, such that they “plate out” onto the cathode. The rate at which the anode is dissolved is equal to the rate at which the cathode is plated, vis-a-vis the current flowing through the circuit. In this manner, the ions in the electrolyte bath are continuously replenished by the anode.

Vijay Senapathi

KVPY Fellow

2.2 Electrolytic Refining of Metals

Electrolytic refining is process by which metals containing impurities are purified electrolytically to give pure metal.

Refining of Copper:

The most important use of copper is in the form of wire for electric transmission. For this, copper must be absolutely pure because very small amounts of impurities reduce its conductivity to a great extent.

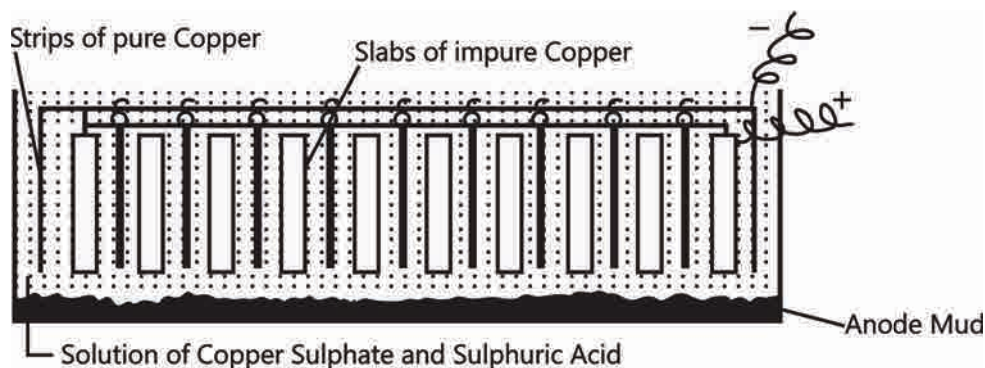

Figure 1.10: Refining of copper

Electrolyte: A solution of copper sulphate and dilute sulphuric acid.

Cathode: Thin strip of pure copper.

Anode: Impure copper.

When the current is passed through the electrolyte, the copper ions of the copper sulphate solution are attracted to the cathode where they gain electrons and get deposited on the pure copper strips. The impure copper loses electrons and passes into solution as soluble copper ions.

Reaction:

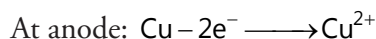
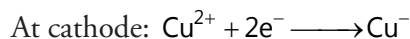

These copper ions migrate to the cathode in the form of a procession and after gaining electrons from it, get deposited on the cathode. The net result is that, gradually the impure slabs of copper get finished and thin strips of pure copper become thicker and thicker. The copper deposited on the cathode is 99.9% pure. After the electrolysis is over, these strips are melted and transformed into desired shapes.

Some impurities get dissolved in the acid while others, namely silver and gold which are insoluble get collected near the anode (anode mud) and are recovered.

Metals like zinc, lead, mercury, silver and copper are refined (purified) by electrolysis.

2.3 Electrometallurgy

Electrometallurgy is the process of extraction of metals by electrolysis.

PLANCESS CONCEPTS

Electrometallurgy, the science of producing metals from metallic ores through the use of electricity. It deals with both the use of electricity for various heating processes and the use of electricity to produce chemical changes (a process called electrolysis).

T P Varun

KVPY Fellow

Metals which are higher in the activity series are generally extracted by electrolysis.

Reactive metals are extracted from their halides (chlorides, bromides, etc.) by electrolysis using inert electrodes. Cathode is usually made of iron and anode of graphite.

Reactive metals: They are not extracted from their aqueous salt solutions by electrolysis as they can react with water.

For example:

Potassium

Electrolyte: Fused potassium bromide

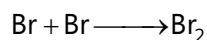

Sodium

Electrolyte: Fused sodium chloride

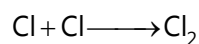

SUMMARY

Terminologies

1. Particles present in non-electrolyte are molecules only e.g. , carbon tetrachloride.
2. Sodium chlorides contains ions only.
3. Acetic acid contains both ions and molecules.
4. Electrolysis: “The process of decomposition of a chemical compound in aqueous solutions or in molten state accompanied by a chemical change by using direct electric current.”
5. To conduct electricity the substance should be in ionic form.

SOLVED EXAMPLES

Example.1. Zinc can produce hydrogen on reacting with acids but copper cannot. Explain.

Sol: Since zinc is above hydrogen in the electrochemical series, it is more electropositive and can displace hydrogen from acids like HCl, H_2SO_4 , HNO_3 .

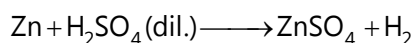

Whereas Cu is below hydrogen and is less electropositive than hydrogen. Therefore, it cannot displace hydrogen from acids.

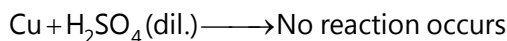

Example.2. Name:

- A salt which is a weak electrolyte.
- A base which is a weak electrolyte
- An inert electrode and an active electrode.
- A positively charged non-metallic ion.
- The electrode at which reduction occurs.
- A non-metallic element which is a conductor of electricity.

Sol:

- sodium carbonate
- A base which is a weak electrolyte is Ammonium Hydroxide $[\text{NH}_4\text{OH}]$
- An inert electrode-graphite, platinum.
An active electrode-silver, nickel.
- H^+
- Electrode is Cathode.
- Carbon (graphite).

Example.3. Explain the following

- A solution of cane sugar does not conduct electricity, but a solution of sodium chloride is a good conductor.
- During the electrolysis of an aqueous solution of NaCl hydrogen ion is reduced at the cathode and not the sodium ion though both Na^+ and H^+ ions are present in the solution.

Sol:

- Sugarcane solution being a covalent compound does not dissociate into ions in solution and does not conduct electricity. Whereas sodium chloride (NaCl) being ionic compound dissociates completely in solution and conducts electricity.
- H^+ ion is much lower in the electrochemical series than Na^+ and concentration of H^+ is much higher than Na^+ . Therefore H^+ ions accept electrons and get liberated as hydrogen gas rather than sodium metal although both Na^+ and H^+ ions are present in the solution.

Example.4.

- How would you change a metal like Cu into its ions?
- How would you change Cu^{2+} ion to Cu?

Sol:

- By reacting its salt with more reactive metal.
- By supplying 2 electrons to Cu^{2+}

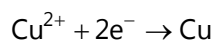

Example.5. During electrolysis of an aqueous solution of sulphuric acid between platinum electrodes, two types of anions migrate towards anode but only one of them is discharged.

- Name the two anions.
- Name the main product of the discharge of anion at the anode and write the anode reaction.
- Name the product at the cathode and write the reaction,
- Do you notice any change in colour. State why?
- Why this electrolysis, is considered as an example of catalysis?

Sol:

- SO_4^{2-} and OH^-
- Main product is oxygen gas
 $OH^- - e^- \rightarrow OH$
 $4OH \rightarrow 2H_2O + O_2(g)$
- Main product is H_2 Gas.
- No colour change in observed.
- Water is a poor conductor of electricity. It does not form ions. When dilute sulphuric acid is added. Water being polar ionizes and becomes electrolyte. Thus, it is regarded as an example of catalysis.

Example.6 An electrolytic cell is set up using two platinum electrodes and an aqueous solution of copper (II) sulphate.

- Name the ions present in the cell.
- Name the ions migrating towards the anode
- Name the ions migrating towards the cathode
- Name the ions which will not be discharged at electrodes during electrolysis
- Write the reaction at the cathode.
- Write the reaction at the anode
- Name the spectator ion in the solution.

Sol:

- $\text{Cu}^{2+}, \text{SO}_4^{2-}, \text{H}^+$ and OH^-
- $[\text{SO}_4^{2-}]$ and $[\text{OH}^-]$
- Cu^{2+} and H^+
- $[\text{SO}_4^{2-}]$ and $[\text{H}^+]$
- $\text{Cu}^{2+} + 2\text{e}^- \rightarrow \text{Cu}$
- $\text{OH}^- - \text{e}^- \rightarrow \text{OH}$; $4\text{OH} \rightarrow 2\text{H}_2\text{O} + \text{O}_2(\text{g})$
- $[\text{SO}_4^{2-}]$ ions and $[\text{OH}^-]$ ions are spectator ions.

Example.7. Give reasons for the following:

- The blue colour of aqueous copper sulphate fades when it is electrolyzed using platinum electrodes.
- Ammonia is unionized in the gaseous state but in the aqueous solution is a weak electrolyte.
- For electroplating with silver. Silver nitrate is not used as electrolyte.
- Carbon tetrachloride is a liquid but does not conduct electricity.

Sol:

- It is because the Cu^{2+} ions formed get deposited on cathode and do not remain in solution.
- Ammonia in gaseous state in molecular form and in aqueous solution feebly forms ions and behaves as a weak electrolyte.
- If we use silver nitrate as electrolyte “the deposition of silver will be very fast and hence not very smooth and uniform.”
- Carbon tetrachloride $[\text{CCl}_4]$ is organic compound is non-electrolyte as it has no ions even in solution, but contain only molecules.

Example.8.

- What kind of particles will be found in a liquid compound which is a non-electrolyte?
- If HX is a weak acid, what particles will be present in its dilute solution apart from those of water?
- Cations are formed by(loss/gain) of electrons and anions are formed by(loss/gain) of electrons.
(Choose the correct words to fill in the blanks.)
- What ions must be present in a solution used for electroplating a particular metal?
- Explain how electrolysis is an example of redox reactions.

Sol:

- only molecules
- molecules and Ions, (Ionised HX) H^+ , X^- and (Unionised HX) HX.
- loss, gain
- Cations of that particular metal to be deposited.
- ELECTROLYSIS is an example of REDOX reaction.

REDOX Reaction "A chemical reaction in which loss of electrons and the gain of electrons takes place simultaneously is called REDOX reaction."

Example 9: Explain the electrolysis of potassium chloride.

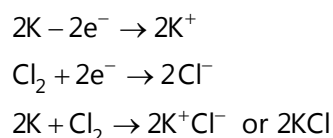
Sol:

The potassium atoms lose one electron each from their valence shells to form potassium ions. As loss of electrons takes place therefore, potassium metal is oxidized to Potassium ions [K^+].

Chlorine atoms gain one electron each in their valence shells to form chloride ions. As gain of electrons take place, therefore, chlorine atoms are reduced to chloride ions [Cl^-]. Since reduction and oxidation takes place simultaneously, therefore, electrolysis is a Redox reaction.



Example.10. (a) Here is an electrode reaction:

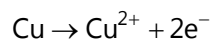

At which electrode (anode or cathode) would such a reaction take place? Is this an example of oxidation or reduction?

- (b) Why is carbon tetrachloride, which is a liquid, a non-electrolyte?

Sol:

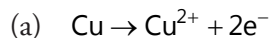

This reaction takes place at anode.

This is an example of oxidation.

- (b) Carbon tetrachloride is a non-electrolyte because it is a covalent compound, it does not ionize and hence do not conduct electricity.

Example.11. Mr. Ramu wants to electroplate his key chain with nickel to prevent rusting.

For this electroplating:

- Name the electrolyte
- Name the cathode
- Name the anode
- Give the reaction at the cathode
- Give the reaction at the anode.

Sol:

- Nickel sulphate
- Key chain
- Nickel electrode
- At cathode: $\text{Ni}^{2+} + 2\text{e}^{-} \rightarrow \text{Ni}(s)$
- At Anode: $\text{Ni}(s) - 2\text{e}^{-} \rightarrow \text{Ni}^{2+}$

Example.12. Three different electrolytic cells A, B and C are connected in separate circuits. Electrolytic cell A contains sodium chloride solution. When the circuit is completed, a bulb in the circuit glows brightly. Electrolytic cell B contains acetic acid solution and in this case the bulb in the circuit glows dimly. The electrolytic cell C contains sugar solution and the bulb does not glow. Give a reason for each of these observations.

Sol:

Cell A: Strong electrolyte (NaCl) \rightarrow Bulb glows brightly.

Cell B: Weak electrolyte (Acetic acid) \rightarrow Bulb glows dimly.

Cell C: Non electrolyte (Sugar solution) \rightarrow Bulb doesn't glow.

Example.13. What is the difference between:

- Electrolytic dissociation and ionization.
- Electrolytic dissociation and thermal dissociation.

Sol: (a)

Dissociation	Ionisation
(1) Separation of ions which are already present in an ionic compound.	(1) Formation of positively or negatively charged ions from molecules which are not initially in the ionic state.
(2) Electrovalent compounds show dissociation e.g., potassium chloride, lead bromide $KCl \rightarrow K^+ + Cl^-$	(2) Polar covalent compounds show ionization e.g. HCl, H_2CO_3, NH_4OH $HCl \xrightarrow{H_2O} H^+ + Cl^-$

Sol: (b)

Electrolytic Dissociation	Thermal Dissociation
<ol style="list-style-type: none"> The process due to which an ionic compound dissociates into ions in the fused state or in aqueous solution is called electrolytic dissociation. It is reversible process. Dissociates into charged particles i.e. ions. Electrodes help to attract oppositely charged ions. 	<ol style="list-style-type: none"> The decomposition of a compound into its elements by heat is called thermal dissociation. It is not reversible process. Ions are not formed. Electrodes are not present.

EXERCISE 1 – For School Examinations

- Q. 1.** During the electrolysis of molten lead bromide, which of the following takes place:
- A : Bromine is released at the cathode.
B: Lead is deposited at the anode.
C : Bromine ions gain electrons.
D: Lead is deposited at the cathode.
- Q. 2.** Here is an electrode reaction : $\text{Cu} \rightarrow \text{Cu}^{2+} + 2\text{e}^-$. [i.e. $\text{Cu} - 2\text{e}^- \rightarrow \text{Cu}^{2+}$]. At which electrode(anode or cathode) would such a reaction take place. Is this an example of oxidation or reduction?
- Q. 3.** A solution contains magnesium ions(Mg^{2+}), iron (II) ions (Fe^{2+}) and copper ions (Cu^{2+}). On passing an electric current through this solution which ions will be the first to be discharged at the cathode. Write the equation for the cathode reaction.
- Q.4.** An electrode 'A' is connected to the positive terminal of a battery and electrode 'B' to the negative terminal.
- (i) Give the names of the electrodes A and B.
(ii) Which electrode is the oxidizing electrode?
- Q. 5.** State the appropriate term used for: – A liquid or solution, which conducts electricity with accompanying chemical change.
- Q.6.** Electrons are getting added to an element Y.
- (i) Is Y getting oxidized or reduced?
(ii) What charge will Y have after the addition of electrons?
(iii) Which electrode will Y migrate to during electrolysis?
- Q. 7.** Explain how electrolysis is an example of redox reaction.
- Q. 8.** What kind of particles will be found in a liquid compound which is a non-electrolyte?
- Q.9.** Complete the sentence by choosing the correct words – Electrolysis is the passage of [electricity / electrons] through a liquid or a solution accompanied by a [physical / chemical] change.
- Q.10.** Name a liquid which is a non-electrolyte.
- Q.11.** Name one substance which contains : (i) ions only (ii) molecules only (iii) both ions and molecules.
- Q. 12.** (i) What is meant by the term 'electrolyte'?
(ii) What are the particles present in a compound which is non-electrolyte?

- (iii) If an electrolyte is described as a 'strong electrolyte', what does this mean?
- Q. 13.** Explain why (i) solid sodium chloride does not allow electricity to pass through. (ii) copper, though a good conductor of electricity, is a non-electrolyte.
- Q. 14.** Classify the following substances under three headings: (i) Strong Electrolytes (ii) Weak Electrolytes (iii) Non Electrolytes – Acetic acid, ammonium chloride, ammonium hydroxide, carbon tetrachloride, dilute hydrochloric acid, sodium acetate, dilute sulphuric acid.
- Q. 15.** Fill in the blanks : -
- (i) As we descend the electrochemical series containing cations, the tendency of the cations to get _____ [oxidized / reduced] at the cathode increases.
- (ii) The [higher / lower] _____ the concentration of an ion in a solution, the greater is the probability of its being discharged at its appropriate electrode.
- Q.16.** (i) Name a solid which undergoes electrolysis when molten.
- (ii) What should be the physical state of lead bromide if it is to conduct electricity?
- (iii) What particles are present in pure lead bromide? Write the equations for the reactions which take place at the electrodes during the electrolysis of lead bromide.
- (iv) Supply the word [or words] that will make the sentence into a correct statement which is to be written down again completely: -
- The electrolysis of lead bromide liberates lead and bromine.
- Q. 17.** If the compound formed between X [a metal with valency 2] and Y [a non-metal with valency 3] is melted and an electric current passed through the molten compound, the element X will be obtained at the _____ and Y at the _____ of the electrolytic cell. [Provide the missing words.]
- Q.18.** (i) Write the equations of the reactions which take place at the cathode and anode when acidified water is electrolyzed.
- (ii) Name the gas released at the cathode when acidulated water is electrolyzed.
- (iii) Copy and complete the following sentence:
- With platinum electrodes hydrogen is liberated at the _____ and oxygen at the _____ during the electrolysis of acidified water.
- (iv) When the electrolysis of acidified water is carried out:
- [1] What is the ratio of the volume of hydrogen produced to the volume of oxygen.
- [2] Give the equation for the discharge of ions at the cathode.
- Q.19.** (i) If HX is a weak acid, what particles will be present in its dilute solution apart from those of water.
- (ii) Write down the words or phrase from the brackets that will correctly fill in the blanks in the following:

- (1) Pure water consists almost entirely of _____ (ions / molecules).
- (2) We can expect that pure water _____ (will / will not) normally conduct electricity.
- (iii) To carry out the so-called “electrolysis of water”, sulphuric acid is added to water.
- How does the addition of sulphuric acid produce a conducting solution.

Q. 20.

- (i) State what is observed when copper sulphate solution is electrolyzed using a platinum anode.
- (ii) What ions must be present in a solution used for electroplating a particular metal.
- (iii) A solution of silver nitrate is a good electrolyte but it is not used for electroplating an article with silver.
- (iv) Choosing only words from the following list write down the appropriate word to fill in the blanks below : -

‘ anions, anode, cathode, cations, electrode, electrolyte, nickel, voltameter’.

To electroplate an article with nickel requires an (a) _____ which must be a solution containing (b) _____ ions. The article to be plated is placed as the (c) _____ of the cell in which the plating is carried out. The (d) _____ of the cell is made from pure nickel. The ions which are attracted to the negative electrode and discharged are called (e) _____ .

Q. 21.

- (a) Select the correct compound from the list – Ammonia, Copper oxide, Copper sulphate, Hydrogen chloride, Hydrogen sulphide, Lead bromide – which matches with the description given below: (i) A solution of this compound is used as the electrolyte when copper is purified. (ii) When the compound is electrolyzed in the molten state, lead is obtained at the cathode.
- (b) Write two applications of electrolysis in which the anode diminishes in mass.
- (c) Complete the following table which refers to two practical applications of electrolysis:

	Anode	Electrolyte	Cathode
Silver plating of spoon		Solution of potassium argentocyanide	
Purification of copper			

Q. 22. The following questions refer to the electrolysis of copper sulphate solution with copper electrodes:

- (i) Compare the change in mass of the anode.
- (ii) What is seen to happen to the colour of the copper sulphate solution if platinum electrodes are used? Explain this observation.
- (iii) What is the practical application of the electrolysis of copper sulphate solution? Briefly describe one such application.

Q. 23. Choose A, B, C or D to match the descriptions (i) to (v) below. Some alphabets may be repeated.

A. non-electrolyte.

B. strong electrolyte.

C. weak electrolyte.

D. metallic conductor.

(i) Molten ionic compound.

(ii) Carbon tetrachloride.

(iii) An aluminium wire.

(iv) A solution containing solvent molecules, solute molecules and ions formed by the dissociation of solute molecules.

(v) A sugar solution with sugar molecules and water molecules.

SOLUTIONS

EXERCISE 1 – For School Examinations

- 1 D.
- 2 At anode. Oxidation.
- 3 Mg^{2+} ($\text{Mg}^{2+} + 2\text{e}^- \rightarrow \text{Mg}$)
- 4 (i) A – Anode, B – Cathode. (ii) A.
- 5 Electrolytes.
- 6 (i) Reduced (ii) Negative (iii) Anode
- 7 A redox reaction is one in which reduction and oxidation occurs simultaneously.
(i) Cathode (Reducing electrode) : – At cathode, the cations gain electrons to form neutral atoms. As electrons are gained, the ion is said to be reduced.
(ii) Anode (Oxidizing electrode) : – At anode, the anions lose electrons to form neutral atoms. As electrons are lost, the ion is said to be oxidized.
- 8 Molecules.
- 9 Electricity, Chemical.
- 10 Alcohol.
- 11 (i) NaOH (ii) Alcohol (iii) Na_2CO_3 .
- 12 (i) Chemical compounds which conduct electricity either in a fused or in aq. solution state and undergo chemical decomposition due to the flow of current through it are called electrolytes.
(ii) Molecules only.
(iii) (a) They are electrolytes which allow a large amount of electricity to flow through them and hence are good conductors of electricity.
(b) Are almost completely dissociated in fused or aqueous solution state.
(c) The solution contains almost only free mobile ions.
- 13 (i) In sodium chloride, Na^+ and Cl^- ions are not free to carry the electric current in solid state.
(ii) Copper metal is solid and has no mobile ions whereas an electrolyte should dissociate into oppositely charged ions to conduct the electric current but it has free electrons which are responsible for the conduction of current in metals.
- 14 (i) Strong Electrolytes – Ammonium chloride, dilute hydrochloric acid, dilute sulphuric acid.
(ii) Weak Electrolytes – Ammonium hydroxide, acetic acid.

- (iii) Non Electrolytes – Carbon tetrachloride.
- 15 (i) Reduced (ii) higher.
- 16 (i) Lead bromide.
(ii) Molten state.
(iii) Lead ions and Bromide ions.
At cathode $\text{Pb}^{2+} + 2\text{e}^- \rightarrow \text{Pb}$
At anode $2\text{Br}^- - 2\text{e}^- \rightarrow 2[\text{Br}]$
 $2[\text{Br}] \rightarrow \text{Br}_2 \uparrow$
(iv) The electrolysis of molten lead bromide liberates lead and bromine.
- 17 Cathode, Anode.
- 18 (i) At cathode $2\text{H}^+ + 2\text{e}^- \rightarrow 2\text{H} \rightarrow \text{H}_2$
At anode $2\text{OH}^- - 2\text{e}^- \rightarrow 2\text{OH} \rightarrow \text{H}_2\text{O} + \text{O}$
 $\text{O} + \text{O} \rightarrow \text{O}_2$.
(ii) Hydrogen.
(iii) Cathode, Anode.
(iv) [1] 2 : 1.
[2] $\text{H}^+ + \text{e}^- \rightarrow [\text{H}]$
 $2[\text{H}] \rightarrow \text{H}_2$.
- 19 (i) Non-ionized molecules: H^+ and X^- .
(ii) Molecules, will not.
(iii) Sulphuric acid ionizes H_2O to form ions which conduct electricity.
- 20 (i) Blue colour of the solution disappears.
(ii) Metal ions of the metal with which electroplating is done.
(iii) Because electroplating is not uniform due to very fast reaction.
(iv) (a) Electrolyte (b) Nickel (c) Cathode (d) Anode (e) Cations.
- 21 (a) (i) Copper sulphate (ii) Lead bromide.
(b) (i) Electroplating of an article (ii) Electro-refining of metals.

(c)

	Anode	Electrolyte	Cathode
Silver plating of spoon	Pure silver	Solution of potassium argentocyanide	Spoon
Purification of copper	Impure block of copper	Copper sulphate solution	Pure strip of copper

- 22 (i) Anode diminishes in mass.
(ii) The colour of the solution fades since the blue Cu^{2+} ions which are discharged at the cathode are not replaced or added at the anode.
(iii) Electro-refining of impure copper: The pure copper metal dissolves out from the copper anode [impure copper block] and the Cu^{2+} ions formed in solution at the anode are deposited at the cathode [the thin pure sheet of copper]. The impurity present in impure copper anode settle down as anode mud or slime which contains insoluble gold and silver. Impurities such as iron, zinc etc ionize and dissolve in the electrolytic copper sulphate solution.
- 23 (i) B (ii) A (iii) D (iv) C (v) A.