



TOOLS & EQUIPMENT

Cordless Power Tools & Accessories 1224-1231

Corded Tools & Accessories 1232-1253

Saw Blades..... 1254-1258

Anti-Vibration 1259

Drill Chucks 1260-1261

Machinery..... 1262-1270

Air Tools & Accessories 1272-1331

Hand Tools 1332-1434

Tool Storage 1435-1452



aurora tools



CLE-FORCE



TOPRING



CORDLESS POWER TOOLS & ACCESSORIES



CORDLESS COMPACT DRILLS/DRIVERS

	12 V LI-ION DRIVER DRILLS	12 V SUB-COMPACT DRIVER KITS, LITHIUM-ION	12 V COMPACT METAL CHUCK DRILL/DRIVER KITS, LITHIUM-ION
Features:	Two speed gearing Built-in LED light Ergonomic soft grip design for vibration absorption	Light compact design Built-in LED light Battery Fuel gauge	The only tool in its class with an all metal locking chuck Delivers 250 in.-lbs. of torque in a compact lightweight design Integrated LED and fuel gauge
Includes:	(2x) 12 V Lithium-Ion Batteries, Charger, Holster and Tool bag	(2x) 1.4 Ah Lithium-Ion Batteries, Charger and Tool bag	1.4 Ah Lithium-Ion Batteries, Charger and Case
Voltage:	12 V	12 V	12 V
Chuck Size:	3/8"	1/4"	3/8"
Max torque:	200 in.-lbs.	150 in.-lbs.	250 in.-lbs.
# of Speed settings:	2	1	2
No Load RPM Setting #1:	0-350	0-500 RPM	0-400
No Load RPM Setting #2:	0-1300		0-1500
Clutch settings:	18	14+1	
Chuck Type:	Ratcheting Keyless	Hex Quick Connect	Metal Single Sleeve Ratcheting
Tool Weight:	2.2 lbs.	2.1 lbs.	2.5 lbs.
Mfg. No.:	DF330D	2401-22	2410-21
Replacement Battery			
Model No.:	TLV226	TLZ368	TLZ368
Model No.:	TLV183	TLZ166	TLV036
Price/Each:	\$221.05	\$144.57	\$211.05



CORDLESS DRILLS/DRIVERS

	12 V (1.3 AH), 3/8" DRIVER DRILLS	14.4 V (1.3 AH) 3/8" DRIVER DRILLS	14.4 V 1/2" DRIVER DRILLS
Features:	All metal gears for more efficient power transmission Compact design with a reduced body length of only 7 9/16" Ergonomic soft grip design for vibration absorption	All metal gears for more efficient power transmission Compact design with a reduced body length of only 7 9/16" Ergonomic soft grip design for vibration absorption	Shift lock drive converts from Drill to Driver mode All metal gears for more efficient power transmission Ergonomic soft grip design for vibration absorption
Includes:	(2x) 12 V (1.3 Ah) NiCd Batteries, Charger and Case	(2x) 12 V (1.3 Ah) NiCd Batteries, Charger and Case	(2x) 14.4 V (3.0 Ah) Ni-MH Batteries, Charger, Side Handle and Case
Voltage:	12 V	12 V	14.4 V
Chuck Size:	3/8"	3/8"	1/2"
Max torque:	250 in.-lbs.	320 in.-lbs.	450 in.-lbs.
# of Speed settings:	2	2	3
No Load RPM Setting #1:	0-400	0-400	0-300
No Load RPM Setting #2:	0-1300	0-1300	0-600
No Load RPM Setting #3:			0-1700
Clutch settings:	16	16	16
Chuck Type:	Ratcheting Keyless	Ratcheting Keyless	Ratcheting Keyless
Tool Weight:	3.3 lbs.	3.5 lbs.	5.1 lbs.
Mfg. No.:	6271DWPE	6281DWPE	6339DWFE
Replacement Battery			
Model No.:	VI457	VI457	TLZ850
Model No.:	TLZ848	TLZ849	TGV716
Price/Each:	\$136.68	\$153.77	\$339.69



	14.4 V CORDLESS COMPACT DRILLS/DRIVERS	18 V COMPACT DRILLS	18 V, 1/2" CORDLESS DRIVER DRILLS
Features:	Compact size: allows users to fit into tight spaces High performance frameless motor Built-in LED light	Compact Length (7 3/4") fits in tight areas Built-in LED light Battery Fuel gauge	Variable 2-speed, reversible, 16 torque settings deliver up to 340 in.-lbs. of torque Single sleeve keyless drill chuck for easy bit installation and removal All metal gears and ergonomic soft rubber grip design
Includes:	(2x) 14.4 V Batteries, Charger and Case	(2x) 18 V Compact Lithium-Ion Batteries, Charger and Tool bag	(2x) 18 V (Compact) Li-ion Batteries, Charger, Double Ended Bit 2-65, Battery Cover and Plastic Carrying Case
Voltage:	14.4 V	18 V	18 V
Chuck Size:	1/2"	1/2"	1/2"
Max torque:	300 UW0	400 in.-lbs.	372 in.-lbs.
# of Speed settings:	2	2	2
No Load RPM Setting #1:	0-500	0-350	0-400
No Load RPM Setting #2:	0-1700	0-1400	0-1300
Clutch settings:	17	21	16
Chuck Type:	Ratcheting Keyless	Ratcheting Keyless	Ratcheting Keyless
Tool Weight:	4.3 lbs.	4 lbs.	2.6 lbs.
Mfg. No.:	DC730KA	2601-22	BDF453H
Replacement Battery			
Model No.:	TT907	TLZ453	TLZ854
Model No.:	TLZ873	TLZ447	TLV230
Price/Each:	\$223.00	\$280.72	\$278.65



CORDLESS POWER TOOLS & ACCESSORIES

CORDLESS DRILLS/DRIVERS

	2-TOOL COMBO KITS	18 V, 1/2" DRIVER DRILLS	12 V HAMMER DRILL DRIVERS
Features:	M18™ 1/2" hammer drill driver with Milwaukee M18™ 1/4" hex compact impact driver Compatibility: Works with M18™ XC high capacity RedLithium™ batteries and M18™ compact RedLithium™ batteries	New battery protection system provides over-discharge, temperature and current protection for enhanced performance, battery cycle life and overall battery life LED job light with afterglow feature Ergonomic soft rubber grip and comfortable operation	2-Speed metal gear box: 0-22 500 BPM, 0-400 / 0-1500 RPM 3/8" Metal single sleeve ratcheting chuck: Maximum durability, grip, and bit retention On-board fuel gauge
Includes:	M18™ 2602-20 1/2" Hammer Drill Driver, M18™ 2650-20 1/4" Hex Compact Impact Driver, (2x) M18™ XC High Capacity RedLithium™ Batteries, Charger, Contractor Bag	(2x) 18V (3.0 Ah) Li-Ion Batteries BL1830, Charger, Hook, Plastic Carrying Case, Double Ended Bit 2-45,	2411 M12™ Cordless Lithium-Ion 3/8" Hammer Drill Driver (2x) M12™ RedLithium™ Batteries 30-Minute Charger and Carrying Case
Voltage:	18 V	18 V	12 V
Chuck Size:	1/2" for the hammer drill driver and 1/4" for the hex compact impact driver	1/2"	3/8"
Max torque:	550 in-lbs. for the M18™ 1/2" hammer drill driver 1400 in-lbs. for the M18™ 1/4" hex compact impact driver	480 in-lbs.	275 in-lbs.
# of Speed settings:	2	2	2
No Load RPM Setting #1:	0-450	0-400	0-400
No Load RPM Setting #2:	0-1700	0-1500	0-1500
Clutch settings:	24	16	24
Chuck Type:	Keyless Drill Chuck	Keyless Drill Chuck	3/8" Single Sleeve
Tool Weight:	13.67 lbs.	4.0 lbs.	2.8 lbs.
Mfg. No.:	2697-22	LXFD01	2411-22
Replacement Battery			
Model No.:	TLZ452	TLZ847	TLZ368
Model No.:	TLV047	TLV227	TLV188
Price/Each:	\$454.26	\$413.68	\$259.35



	18 V XRP DRILLS/DRIVERS	18 V HAMMER DRILL DRIVER KITS	18 V, 1/2" COMPACT DRILL/DRIVER KITS
Features:	3-speed all-metal transmission High power, high efficiency motor Built-in LED light	Compact & ergonomic design: 8 1/2" length Digital power management overload protection prevents damage to the tool and battery in abusive situations All metal gear case	Compact size allows users to fit into tight spaces High performance frameless motor Built-in LED light
Includes:	(2x) 18 V Batteries, Charger, Side Handle and Case	Two XC High Capacity RedLithium™ Batteries, Charger, Kit box	(2x) 18 V Batteries, Charger and Case
Voltage:	18 V	18 V	18 V
Chuck Size:	1/2"	1/2"	1/2"
Max torque:	450 UWO	550 in-lbs.	410 UWO
# of Speed settings:	3	2	2
No Load RPM Setting #1:	0-500	0-450	0-500
No Load RPM Setting #2:	0-1250	0-1700	0-1700
No Load RPM Setting #3:	0-2000		
Clutch settings:	22	24	17
Chuck Type:	Ratcheting Keyless	Single Sleeve	Ratcheting Keyless
Tool Weight	6.25 lbs.	4.9 lbs.	4.8 lbs.
Mfg. No.:	DCD940KX	2602-22	DC720KA
Replacement Battery			
Model No.:	TT906	TLZ452	TT906
Model No.:	TLZ874	TLV189	TLZ205
Price/Each:	\$342.00	\$407.12	\$238.00



CORDLESS HAMMER DRILLS/DRILL DRIVERS

	18 V HAMMER DRIVER DRILLS	18 V, 1/2" HAMMER DRIVER DRILLS	18 V HAMMER DRILLS
Features:	New battery protection system provides over-discharge, temperature and current protection Ultra-compact design (only 8 1/8" long) LED job light with afterglow feature	Compact and lightweight design (only 9 11/16" length) Soft rubber grip design for vibration absorption	Milwaukee® 4-Pole Frameless Motor Built-in LED light Battery Fuel gauge
Includes:	(2x) 18 V (Compact) Li-Ion Batteries BL1815, Charger, Hook, Plastic Carrying Case, Double Ended Bit 2-45	(2x) 18 V (Compact) Li-Ion Batteries BL1815, Charger, Battery Cover, Double Ended Bit, Hook, Plastic Carrying Case	(2x) 18 V High Capacity Lithium-Ion batteries, Side Handle, Charger and Tool bag
Voltage	18 V	18 V	18 V
Chuck Size	1/2"	1/2"	1/2"
Max torque	480 in-lbs.	372 lbs	650 in-lbs.
# of Speed settings	2	2	2
No Load RPM Setting #1	0-400	0-400	0-450
No Load RPM Setting #2	0-1500	0-1300	0-1800
Max BPM Setting #1			0-28000
Clutch settings	16	16	24
Chuck Type	Keyless Drill Chuck	Keyless Drill Chuck	Metal Ratcheting Keyless
Tool Weight	3.5 lbs.	2.9 lbs.	5.3 lbs.
Mfg. No	LXPH01C1	BHP453H	2611-24
Replacement Battery			
Model No.	TLZ854	TLZ854	TLZ452
Model No.	TLV228	TLV229	TLZ446
Price/Each	\$327.82	\$286.85	\$498.48



R33691E



CORDLESS HAMMER DRILLS/DRIVERS

18 V XRP HAMMER DRILLS/DRILLS/DRIVERS

Features:	3-speed all-metal transmission High power, high efficiency motor Built-in LED light
Includes:	(2x) 18 V Batteries, Charger, Side Handle and Case
Voltage:	18 V
Chuck Size:	1/2"
Max torque:	450 UWO
# of Speed settings:	3
No Load RPM Setting #1:	0-500
No Load RPM Setting #2:	0-1250
No Load RPM Setting #3:	0-2000
Max BPM Setting #1:	0-8500
Max BPM Setting #2:	0-21250
Max BPM Setting #3:	0-34000
Clutch settings:	22
Chuck Type:	Ratcheting Keyless
Tool Weight:	6.25 lbs.
Mfg. No.:	DCD950KX
Replacement Battery	
Model No.:	TT906
Model No.:	TLZ875
Price/Each	\$349.95



28 V HAMMER DRILLS

Features:	Revolutionary 28 V lithium-ion technology 750 in.-lbs. of maximum torque 1-2" all-metal, single-sleeve ratcheting chuck with carbide jaws Up to 2X run-time of 18 V tools
Includes:	M28™ Cordless 28 Volts 1/2 in. Hammer-Drill, (2x) 28 V Lithium-Ion Batteries, Charger, Side Handle, No. 2 Phillips Bit
Voltage:	28 V
Chuck Size:	1/2"
Max torque:	750 in.-lbs.
# of Speed settings:	2
No Load RPM Setting #1:	0-450
No Load RPM Setting #2:	0-1800
Clutch settings:	24
Chuck Type:	Ratcheting Chuck With Carbide Jaws
Tool Weight:	6.7 lbs.
Mfg. No.:	0726-22
Replacement Battery	
Model No.:	TGX012
Model No.:	TLV092
Price/Each	\$594.96



QUIK-LOK™ FLAT BORING SETS

- 1/4" Quick-change hex shank provides quick and easy accessory changes
- Double wing spurs for easy hole formation and reduced vibration, preventing "break out"
- Patented cutting edge for easier and faster wood boring and fast chip removal which dissipates heat from the bit
- Includes: 6" universal Quik-Lok™ bit extension, 3/8", 1/2", 5/8", 3/4", 7/8", and 1 1/8" spade bits

Model No. TBO612
Price/Each \$37.94



CORDLESS IMPACT DRIVERS

12 V, 1/4" M12 CORDLESS HEX IMPACT DRIVER KITS

Features:	12 V lithium-ion battery offers longer run-time and lighter weight 0-2000 RPM variable speed trigger Battery fuel gauge displays remaining run-time Built-in LED light illuminates work surface
Includes:	2450-20, (2x) 12 V Lithium-Ion Batteries 48-11-2401, Carrying Case
Voltage:	12 V
Chuck Size:	1/4" Hex
Max torque:	850 in.-lbs.
No Load RPM Setting:	0-2000
Max BPM Setting #1:	0-3000
Tool Weight:	1.9 lbs.
Mfg. No.:	2450-22
Replacement Battery	
Model No.:	TLZ368
Model No.:	TLZ365
Price/Each	\$257.28



CORDLESS IMPACT DRIVERS - WRENCHES

HEX IMPACT DRIVERS

18 V, 1/4" W/2.8 AH BATTERY

Features:	Milwaukee® 4-Pole Frameless Motor Built-in LED light Battery Fuel gauge
Includes:	(2x) 18 V High Capacity Lithium-Ion Batteries, Charger and Tool bag
Voltage:	18 V
Socket Size:	1/4" HEX
Max Torque:	116.66 ft.-lbs.
No Load RPM Setting:	0-2200
Max BPM Setting:	0-3200
Tool Weight:	3.5 lbs.
Mfg. No.:	2650-22
Replacement Battery	
Model No.:	TLZ452
Model No.:	TLZ823
Price/Each	\$533.66



HEX IMPACT DRIVERS

18 V, 1/4" W/1.4 AH BATTERY

Features:	Milwaukee® 4-Pole Frameless Motor Built-in LED light Battery Fuel gauge
Includes:	(2x) 18 V Compact Lithium-Ion Batteries, Charger and Tool bag
Voltage:	18 V
Socket Size:	1/4" HEX
Max Torque:	116.66 ft.-lbs.
No Load RPM Setting:	0-2200
Max BPM Setting:	0-3200
Tool Weight:	3.2 lbs.
Mfg. No.:	2650-21
Replacement Battery	
Model No.:	TLZ453
Model No.:	TLZ448
Price/Each	\$397.98



CORDLESS IMPACT DRIVERS - WRENCHES

18 V 1/2" HIGH TORQUE IMPACT WRENCHES W/PIN DETENT

Features:	Milwaukee® 4-pole motor and a powerful impact mechanism A variable speed trigger provides speed control between 0-1900 RPM & 0-2200 IPM Has a 1/2" anvil with detent pin to achieve superior socket retention
Includes:	(2x) 18V XC Lithium-Ion Batteries, Case and Charg
Voltage:	18 V
Socket Size:	1/2" Square
Max torque:	450 ft.-lbs.
No Load RPM Setting:	0-1900
Max BPM Setting:	0-2200
Tool Weight:	6.7 lbs.
Mfg. No.:	2662-22
Replacement Battery Model No.:	TLZ452
Model No.:	TLZ826
Price/Each:	\$536.67



Milwaukee

18 V 1/2" HEAVY-DUTY COMPACT IMPACT WRENCHES

Features:	Durable all-metal gear case and transmission Variable speed trigger and electric brake Heavy-duty impact mechanism delivers torque without kickback
Includes:	(2x) 18 V Batteries, Charger and Case
Voltage:	18 V
Socket Size:	1/2"
Max torque:	160 ft.-lbs.
No Load RPM Setting:	2100
Max BPM Setting:	3200
Tool Weight:	5.3 lbs.
Mfg. No.:	DC821KA
Replacement Battery Model No.:	TT906
Model No.:	TLZ876
Price/Each:	\$412.62



DEWALT

18 V LXT 1/2" IMPACT WRENCHES

Features:	Compact and lightweight Built-in LED Light Ergonomically designed handle with soft grip
Includes:	
Voltage:	18 V
Socket Size:	1/2"
Max torque:	169.6 ft.-lbs.
No Load RPM Setting:	0-2100
Max BPM Setting:	0-3200
Tool Weight:	3.7 lbs.
Mfg. No.:	BTW251
Replacement Battery Model No.:	TLZ847
Model No.:	TLZ858
Price/Each:	\$641.19



Makita

18 V LXT 1/2" IMPACT WRENCHES

Features:	Compact and lightweight Built-in LED Light Ergonomically designed handle with soft grip
Includes:	
Voltage:	18 V
Socket Size:	1/2"
Max torque:	325 ft.-lbs.
No Load RPM Setting:	1600
Max BPM Setting:	2200
Tool Weight:	7.5 lbs.
Mfg. No.:	BTW450
Replacement Battery Model No.:	TLZ847
Model No.:	TLZ859
Price/Each:	\$756.77



Makita

28 V IMPACT WRENCH KITS

Features:	Revolutionary 28 V lithium-ion technology 750 in.-lbs. of maximum torque 1/2" all-metal, single-sleeve ratcheting chuck with carbide jaw Up to 2X run-time of 18 V tools
Includes:	M28™ Cordless 28 Volts 1/2" Hammer-Drill, (2x) 28 V Lithium-Ion Batteries, Charger, Side Handle, No. 2
Voltage:	28 V
Socket Size:	1/2"
Max torque:	325 ft.-lbs.
No Load RPM Setting:	0-1450
Max BPM Setting:	0-2450
Tool Weight:	8.9 lbs.
Mfg. No.:	0779-22
Replacement Battery Model No.:	TGX012
Model No.:	TEX928
Price/Each:	\$781.89



Milwaukee

CORDLESS BANDSAWS

18 V BANDSAW KITS

Features:	Heavy-duty, compact, lightweight design Work light, blade ejection system and a tool-free adjustable material guide Drop resistant pulley guard
Includes:	18V XC Lithium-Ion Batteries, Saw Blade, Case and Charger
Voltage:	18 V
No Load FPM:	0-480
Cut Capacity:	3 1/4" X 3 1/4"
Tool Weight:	10.25 lbs.
Mfg. No.:	2629-22
Replacement Battery Model No.:	TLZ452
Model No.:	TLV037
Price/Each:	\$587.93



Milwaukee

GRINDERS

ANGLE GRINDERS

Features:	18 V LXT, 4 1/2" Overload protection to prevent over-heating Soft grip design for vibration absorption Removable side handle can be mounted on either side	18 V GRINDER L-shape vents keep debris from entering the tool and damaging internal components Overload protection to prevent overheating Tool free guard adjustment, paddle switch design
Includes:	(2x) 18 V Li-Ion Batteries (3.0Ah), (1x) Cutting Wheel, (1x) Grinding Wheel, Side handle, Wrench and Charger	2 18 V XC Lithium-Ion Batteries, Cutting Wheel, Tool Bag, Wrench, Side Handle and Charger
Voltage:	18 V	18 V
Wheel Diameter:	4 1/2"	4 1/2"
No Load RPM:	10000	9000
Spindle Size:	5/8"	5/8"
Spindle Lock:	Yes	Yes
Tool Weight:	4 lbs.	5.9 lbs.
Mfg. No.:	BGA452	2680-22
Replacement Battery Model No.:	TLZ855	TLZ452
Model No.:	TLZ856	TLV035
Price/Each:	\$459.29	\$471.35



Makita



Milwaukee

CORDLESS POWER TOOLS & ACCESSORIES



CORDLESS RECIPROCATING SAWS

	18 V LXT RECIPROCATING SAWS	18 V SAWZALL® RECIPROCATING SAW KITS W/ 2 BATTERIES	28 V M28™ SAWZALL® RECIPROCATING SAW KITS
Features:	One-handed, fast tool-less blade changes and shoe adjustments Externally accessible brushes for serviceability Two built-in L.E.D. lights for more illumination	Low vibration high speed functioning Lever Action Quik-Lok™ Blade Clamp Patented Gear-Protecting Clutch	Revolutionary 28 Volt lithium-ion technology 0-2000/0-3000 SPM for metal or wood cutting QUIK-LOK™ blade clamp for quick tool-free blade changes Gear protecting clutch for extreme durability Keyless shoe adjustment quickly adjusts blade depth
Includes:	(2x) 18 V Li-Ion Batteries (3.0 Ah), (2x) Saw Blade and Charger	(2x) 18 V High Capacity Lithium-Ion batteries, Saw Blade, Charger and Tool Bag	M28™ Sawzall® Reciprocating Saw, Two Super Sawzall® Blades, (2x) 28V LITHIUM-ION Batteries, Charger
Voltage:	18 V	18 V	28 V
Max strokes per minute (SPM):	0-2900	0-3200	0-3000
Stroke Length:	1 1/8"	1"	1 1/8"
Tool Weight:	7.7 lbs.	7.9 lbs.	9.4 lbs.
Mfg. No.:	BJR181X	2620-22	0719-22
Replacement Battery Model No.:	TLZ847	TLZ452	TGX012
Model No.:	TLZ860	TLZ449	TEX920
Price/Each:	\$449.24	\$533.66	\$594.96

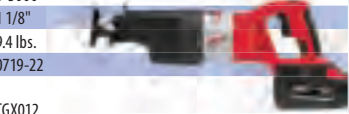

CORDLESS CIRCULAR SAWS

	18 V CIRCULAR SAWS	18 V LXT 6 1/2" CIRCULAR SAWS	METAL SAW KITS
Features:	Easy-to-read aircraft aluminium shoe 18 V XC High Capacity Lithium-Ion battery provides up to 20% more torque Battery Fuel gauge	Two built-in L.E.D. lights for more illumination Electric blade brake & dust blower Externally accessible brushes for serviceability	Exclusive 4-Pole Frameless Motor delivers up to 35% more cutting power Compact, low-profile design for easy handling and increased control Extra-Large cut guide, impact resistant window and LED light for more accurate cut Lightweight 5.8 lbs design for easier overhead cuts and less user fatigue Superior Cut Quality - 30T METAL TECH™ Carbide-Tipped blade produces cool, burr-free cuts through EMT, strut, threaded rod, sheet metal, angle iron and other ferrous materials. Tool-Free Depth Adjustment quickly and easily adjusts cutting depth from 1/8"-2"
Includes:	(2x) 18 V High Capacity Lithium-Ion Batteries, Charger and Tool bag	(2x) 18 V Li-Ion (3.0 Ah) Battery, (1x) Saw Blade, Guide Rule and Charger	M18™ Cordless Lithium-Ion 5-3/8" Metal Saw, (2x) M18 XC™ High Capacity RedLithium™ Battery Packs, Charger, 30T METAL TECH™ Carbide-Tipped Blade, Blade Wrench, Contractor Bag
Voltage:	18 V	18 V	18 V
Blade Diameter:	6 1/2"	6 1/2"	6 1/2"
No Load RPM	3500 RPM	3700	3600
Capacity @ 90°:	2 1/8"	2 1/4"	2"
Capacity @ 45°:	1 5/8"	1 9/16"	-
Spindle Lock:	Yes	Yes	-
Electric Brake:	Yes	Yes	-
Arbour:	5/8"	5/8"	6/8"
Blade Guard Material:	Magnesium	Aluminum	Polycarbonate
Shoe Material:	Aircraft Aluminium	Aluminum	Stainless Steel
Tool Weight:	8.5 lbs.	7.1 lbs.	5.8 lbs.
Mfg. No.:	2630-22	BSS610X2	2682-22
Replacement Battery Model No.:	TLZ452	TLZ847	TLZ452
Model No.:	TLZ450	TLZ862	TLV190
Price/Each:	\$620.09	\$421.10	\$478.16



SAW BLADES

GENERAL PURPOSE

- For cutting oak, pine, plywood, pressure treated lumber and beams

freud



Model No.	Mfg. No.	Blade Dia.	Arbor"	No. of Teeth	Hook Grind	Price /Each
TDX901	D1040X	10	5/8	40	ATB	51.45
TDX926	D1244X	12	1	44	ATB	52.20

MARATHON® SAW BLADES

- Ultra thin kerf
- Face ground carbide teeth

IRWIN
Industrial Tools



FRAMING & RIPPING

Model No.	Mfg. No.	Blade Dia."	Arbor	No. of Teeth	Hook Grind	Price /Each
TBQ329	14015	5 3/8	10 mm	18	ATB	21.87
TBQ330	14017	5 3/8	10 mm	24	ATB	23.29
TBQ407	14027	5 1/2	10 mm	18	ATB	21.87
TBQ331	14011	5 1/2	10 mm	24	ATB	23.29
TBQ332	14020	6 1/2	5/8"	18	ATB	22.45
TBQ334	14029	6 1/2	5/8"	24	ATB	23.73

CORDLESS POWER TOOLS & ACCESSORIES

KITS

2-TOOL COMBO KITS M12™ CORDLESS LITHIUM-ION

Features: M12™ 3/8" hammer drill driver delivers best-in-class 275 in-lbs. of peak torque, 0-400 / 0-1500 RPM, & 0-22 500 BPM at just 2.8 lbs. M12™ 1/4" hex impact driver delivers best-in-class 850 in-lbs. of torque at only 2.3 lbs. and 0-2000 RPM for fast driving

Includes: 2411-20 M12™ 3/8" Hammer Drill Driver, 2450-20 M12™ 1/4" Hex Impact Driver, (2x) M12™ Redlithium™ Batteries, Charge, Contractor Bag

Voltage: 12 V

Mfg. No.: 2497-22

Replacement Battery

Model No.: TLZ368

Model No.: TLV191

Price/Each: \$292.58



18 V DRILL/IMPACT COMBO KITS - NANO

Features: XRP™ 18 V cordless hammerdrill with 3-speed all-metal transmission and 1/2" self-tightening chuck, delivers 450 units watts out 18 V Impact driver delivers 1330 in-lbs. of torque and 0-2400 RPMs offering power and speed *Dewalt® XRP™* exclusive nano-phosphate lithium ion cells offer long battery life and durability: 2000 recharges

Includes: (2x) 18 V XRP™ Lithium-Ion Batteries, Charger, 360° Side Handle and Contractor Bag

Voltage: 18 V

Mfg. No.: DCK275L

Model No.: TLZ883

Model No.: TLZ884

Price/Each: \$549.85



18 V COMBO KIT COMPACT DRILL/IMPACT DRILL KITS

Features: M18™ 1/2" compact drill/driver delivers 400 in-lbs. of torque and is only 4 lbs. and 7 3/4" Long M18™ 1/4" hex compact impact with the Milwaukee® 4-Pole Frameless Motor delivers 1400 in-lbs. of torque Lithium-Ion M18™ cordless system delivers more torque, more power, and longer run-time

Includes: (2x) 18 V Lithium-Ion Compact Batteries, Charger, Carrying Case

Voltage: 18 V

Mfg. No.: 2691-22

Model No.: TLZ453

Model No.: TLZ887

Price/Each: \$369.84



18 V COMBO HAMMER DRILL/SAWZALL®/IMPACT DRILL/WORKLIGHT KITS

Features: M18™ Sawzall®, 1/2" hammer drill/driver, 6 1/2" circular saw

Includes: (2x) 18 V XC high capacity lithium-ion batteries, M18™ work light, charger and contractor bag

Voltage: 18 V

Mfg. No.: 2690-24

Replacement Battery

Model No.: TLZ452

Model No.: TLZ443

Price/Each: \$795.96



18 V LXT 2 PIECE COMBO KITS

Features: 1/4" Cordless impact driver

Includes: (2x) 18 V (3.0 Ah) Li-Ion Batteries, Charger, Case

Voltage: 18 V

Mfg. No.: LXT211

Model No.: TLZ855

Model No.: TLZ888

Price/Each: \$492.45



M12 CORDLESS LITHIUM-ION GREASE GUN

Features: Powerful 12 V motor: Delivers over 8000 PSI max operating pressure Best in class run-time: Dispenses up to 7 cartridges per charge Superior handle balance and ergonomics: Only 14" long and 7.2 lbs. Integrated hose storage and LED fuel gauge: Added user convenience and less down time Air bleeder valve: Priming mechanism for quick flow M12™ Lithium-Ion System: Compatible with over 20 M12™ lithium-ion tools for greater versatility in the workplace Maximum durability: Backed by a 5-year warranty

Includes: 2446-20 Grease Gun, M12™ XC Lithium-Ion Battery Pack 48-11-2402, 30-Minute Charger, 36" Flex Hose with Spring Guard, Grease Coupler, Carrying Case

Voltage: 12 V

Output Pressure: Over 8000 PSI

Grease Capacity: 14-oz. cartridge 16-oz. bulk

Hose Type: 36" high pressure flex hose w/ spring guard

Tool Weight: 7.2 lbs.

Mfg. No.: 2446-21XC

Model No.: TLV192

Price/Each: \$246.33



M12™ CORDLESS LITHIUM-ION ROTARY TOOLS

Features: Powerful motor: Unmatched performance under load 1/8" collet: Compatible with all current rotary tool accessories Variable speed (5000-32 000): Up to 10% faster than the competition Compact and lightweight: Only 9.5" long and 1.3 lbs. Milwaukee durability: Grinder style exhaust ports and protected front bearing deliver up to 10X the tool life

Includes: 2460-20 M12™ Cordless Lithium-Ion Rotary Tool, M12™ Redlithium™ Battery, (5x) Cutting Wheels, Mandrel, Wrench, 30-Minute Charger

Voltage: 12 V

Number of speed settings: 2

No Load RPM setting #1: 0-5000

No Load RPM setting #2: 0-32 000

Tool Weight: 1.3 lbs.

Mfg. No.: 2460-21

Model No.: TLV193

Price/Each: \$137.93



CORDLESS POWER TOOLS & ACCESSORIES

HEAVY-DUTY FLASHLIGHTS

- Flexible neck for hands free operation
- Head locks in place for lantern style use
- Runs on standard XR battery (not included)
- Spare xenon bulb included



DEWALT

Model No	Mfg. No.	Volts	Price/Each
VE421	DW919	18	72.76

HEAVY-DUTY 2.4 V CORDLESS SCREWDRIVER KITS

- 6-position adjustable clutch
- Forward/reverse button with switch lock feature
- Includes: 1 hour 120 V AC charger, (2) 2.4 V battery packs, 1/4" chuck attachment with key, 1/4" socket driver with 1/4" hex, 1/8" twist bit, 3/16" twist bit, 1/4" twist bit and impact-resistant carrying case

Model No.	TF595
Mfg. No.	6547-22
Max. torque:	26 in.-lbs.
No load speed:	400 RPM, 200 RPM
Tool weight:	0.88 lbs.
Price/Each	\$182.31



M18™ WORK LIGHTS

- Ergonomic, compact, and lightweight design for operator comfort
- Fold-away utility hook
- 135° rotating head
- Tool weight: 0.71 lbs.
- Battery not included

Model No. TLZ451
Price/Each \$90.85



HEAVY-DUTY 1/4" 7.2 V CORDLESS 2-POSITION SCREWDRIVER KITS

- Adjustable 2-position handle allows for use as both in-line and pistol grip
- Industrial quick release hex-shank chuck
- Includes: 1 hour charger, (2) 7.2 V compact batteries, 2 screwdriver bits and heavy-duty kit box

Model No.	UQ999
Mfg. No.	DW920K-2
Max. torque:	80 in.-lbs.
No load speed:	0-500 RPM
Tool weight:	3.5 lbs.
Price/Each	\$121.03



M12™ WORK LIGHTS

- 12 V lithium-ion battery
- 90° pivoting head
- Xenon incandescent bulb
- Integrated magnet provides hands-free use
- Battery not included

Model No. TLZ369
Price/Each \$75.48



M12™ CORDLESS 3/8" RIGHT ANGLE DRILL DRIVERS

- 3/8" Single sleeve ratcheting chuck
- 3 3/4" Head length, great for working in tight spaces
- Extended paddle switch
- Battery fuel gauge
- Built-in LED light

- Includes:**
- 12 V Li-Ion battery pack
 - 12 V Charger
 - Carrying case

Model No.	TLV038
Voltage :	12 V
Chuck size:	3/8"
Max torque:	100 in.-lbs.
Number of speed settings:	1
No load RPM setting #1:	0-800
Clutch settings:	11
Chuck type:	Single Sleeve Ratcheting
Tool weight:	2.43 lbs
Mfg. No.:	2415-21
Replacement Battery	
Model No.:	TLZ368
Price/Each	\$179.64



HEAVY-DUTY FLASHLIGHTS

- High quality construction
- 4-position pivoting head
- Uses standard pod style Makita battery (not included)
- Lightweight design

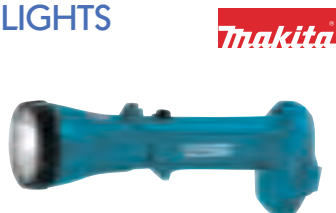

Makita

Model No.	Mfg. No.	Volts	Price/Each
TJ128	ML180	18	90.82
TJ129	ML140	14.4	78.73
TJ134	ML120	12	70.65
VW015	ML903	9.6	66.59

M12 COPPER TUBING CUTTERS

- Close quarter rotating cutting head cuts pipe in confined spaces
- Automatic adjustment from 3/8" - 1" tubing
- Auto locking mechanism delivers up to 200 cuts per charge
- Water resistant sealed metal cutter head
- Battery fuel gauge
- Built-in LED light

- Includes:**
- 12 V Li-Ion battery pack
 - 12 V charger
 - Compact driver storage bag

Model No.	TLZ366
Mfg. No.	2471-22
Voltage	12 V
Speed	500 RPM
Capacity	1/2" to 1 1/8" O.D.
Tool Weight	3.2 lbs.
Price/Each	\$251.25



CORDLESS POWER TOOLS & ACCESSORIES

BATTERIES

Model No.	Mfg. No.	Voltage	Manufacturer	Price /Each
TF352	48-11-0100	2.4 V Battery Pack		41.91
TLZ368	48-11-2401	M12™ Lithium-Ion Battery		70.70
TLV039	48-11-2402	M12™ XC Battery Pack		124.12
TEA842	48-11-1024	Battery 14.4 V 2.4 Ah		132.86
TLZ881	48-11-1830	Battery 18 V (Single Pack)		198.04
UG948	48-11-2230	Battery 18 V 2.4 Ah NiCd		158.95
TFX221	48-11-2232	Battery 18 V 2.4 Ah		240.20
TLZ452	48-11-1828	Battery 18 V Lithium High Capacity XC		214.00
TLZ453	48-11-1815	Battery 18 V Lithium 1.4 Ah XC		130.05
TGX012	48-11-2830	28 V Battery Li-ion		263.31
TLV226	195332-9	12 V Li-Ion 1.3 Ah BL1014 - Single	57.85	
VI457	192681-5	12 V Battery 1220 w/clip (1.3 Ah)	97.80	
TLZ880	193062-6	14.4V NiCd 1.3 Ah	103.46	
TLZ850	193139-7	14.4V Ni-MH Battery 1435 (3.0 Ah)	187.33	
TDX430	193159-1	18 V 2.6 Ah Ni-MH Battery Pod Style 1834		184.09
TLZ847	194205-3	18 V Li-Ion Battery BL1830 (3.0 Ah)		230.57
TLZ851	193140-2	18 V Ni-MH Battery 1835 (3.0 Ah)		209.50
TLZ854	194309-1	18 V Li-Ion Battery BL1815 (1.5 Ah)		120.82
TLZ879	194230-4	18 V Li-Ion 3.0 Ah BL1830 - Twin		483.30
TT909	DW9061	Battery Pack 9.6 V		82.23
TT908	DC9071	Battery Pack 12.0 V XRP		113.00
TT907	DC9091	Battery Pack 14.4 V XRP		134.18
TT906	DC9096	Battery Pack 18.0 V XRP		158.77
TLZ883	DC9180	Heavy Duty 18 V Battery Pack - NANO		216.45
TKZ094	625473000	12 V 1.4 Ah Air-Cooled NiCd Battery		108.13
TKZ095	625474000	12 V 2.0 Ah Air-Cooled NiCd Battery		139.01
TKZ097	625475000	14.4 V 1.4 Ah Air-Cooled NiCd Battery	115.85	
TKZ098	625486000	14.4 V 2.0 Ah Air-Cooled NiCd Battery	163.72	
TKZ099	625482000	14.4 V 2.2 Ah Air-Cooled Lithium Battery	183.82	
TKZ090	631749000	15.6 V 2.4 Ah NiCd Battery	193.08	
TKZ092	631857000	18 V 2.0 Ah NiCd Battery	185.36	
TKZ091	631740000	18 V 2.4 Ah NiCd Battery	220.87	
TKZ100	625477000	18 V 1.4 Ah Air-Cooled NiCd Battery	139.01	
TKZ101	625478000	18 V 2.0 Ah Air-Cooled NiCd Battery	185.36	
TKZ102	625484000	18 V 2.2 Ah Air-Cooled Lithium Battery	231.69	

TDX430



TLZ368

TKZ099



TLV039





TT906



TKZ453

metabo®

CHARGERS

Model No.	Mfg. No.	Description	Manufacturer	Price /Each
TT869	48-59-0192	Charger Supercharger Li-Ion 120 V		99.14
TLY293	48-59-0200	7.2 V Charger 120 V		111.15
TEA462	48-59-0255	Charger Universal		97.59
TLY294	48-59-0280	Charger Multi Bay Li-Ion/NiCd		288.44
TEA461	48-59-0300	Charger 2.4 V 120 V		84.17
TLY295	48-59-0490	Charger 4 V		88.04
TLY296	48-59-1812	Charger 18 V		98.09
TLY297	48-59-2401	Charger 12 V		86.18
TKZ860	48-59-2818	Charger 18 - 28 V Li-Ion/NiCd		101.05
TDX433	DC1804	7.2 V-18 V Charger for NiCd & Ni-MH		
TD654	DC1414	7.2 V-14.4 V Charger for NiCd, 1.3AH-3.0AH	96.11	
TLZ901	DC18RA	LXT Lithium-Ion 18 V Charger	120.65	
VE139	DC012	Charger/Radio (Charges Most 7.2 V - 18 V DeWalt Batteries)	225.67	
THZ762	DC9000	36 V 1 Hour Charger		163.10
TLZ204	DC9310	Heavy Duty 7.2 V - 18 V 1 Hour Charger - NANO/NiCd		121.95
TLZ878	DC9319	Heavy Duty 7.2 V - 18 V 1 Hour Vehicle Charger - NANO/NiCd		163.10
TLZ855	DC9320	Heavy Duty 7.2 V - 18 V Dual Port 1 Hour Charger - NANO/NiCd		166.30
TSW568	DW0246	24 V 1 Hour Charger w/Tune-up Mode, Air Cooled Technology		175.41
TSW574	DW0249	24 V 1 Hour Auto Charger, Air Cooled Technology		206.80
TT903	DW9109	1 Hour Vehicle Charger 9.6V-18V		145.57
TKZ104	627277000	Universal Air-Cooled Lithium Charger AC30 Plus - Takes All Batteries		128.21

TLZ901



TKZ104



VE139



VE937



TKZ860



R33696E

OFFICE PRODUCTS

INSTRUMENTS, SCALES & ELECTRICAL

SHIPPING & PACKAGING

TOOLS & EQUIPMENT

WELDING & METALWORKING

SAFETY EQUIPMENT & SUPPLIES

JANITORIAL & MAINTENANCE

MATERIAL HANDLING & STORAGE

1231

CORDED GRINDERS & SANDERS



4 1/2" GRINDERS



SMALL ANGLE GRINDERS PADDLE W/LOCK-ON OR SLIDE SWITCH

Features: Debris baffles- protect internal components by deflecting damaging debris out of the airflow at the intake vents multi-port exhaust-reduces motor burn-up by efficiently venting hot air out of the grinder. 25% longer lasting epoxy motor protection extends tool life by protecting the copper wires from abrasion. Extra-large paddle switch with lock-on provides ease-of-use when operating in various positions.

Includes: Side handle and spanner wrench

Wheel Diameter	4 1/2
Voltage	120
Amperage	7.5
No Load RPM	10 000
Spindle Size"	5/8
Tool Weight lbs.	6.5
Mfg. No	6140-30
Model No.	TLY385
Price/Each	\$112.76



Slide switch Model No.: TLZ803



ANGLE GRINDERS W/CASE

Labyrinth construction seals motor and bearings from contamination. Thumb switch conveniently located for operator comfort. Ergonomic soft grip for vibration absorption and comfortable operation. Slim housing design for easy handling and maneuverability.

Grinding wheel, lock nut, lock nut wrench, inner flange, wheel cover assembly, plastic carrying case

Wheel Diameter	4 1/2
Voltage	120
Amperage	6
No Load RPM	11 000
Spindle Size"	5/8
Tool Weight lbs.	3.1
Mfg. No	GA4530K
Model No.	TLV165
Price/Each	\$88.75



MINI-GRINDER™

Safety Clutch eliminates backlash Spindle speeds are fully adjustable Exclusive QUICK feature for tool-free wheel change.

(1x) Grinding wheel, side handle

Wheel Diameter	4 1/2
Voltage	120
Amperage	8
No Load RPM	10 000
Spindle Size"	5/8
Tool Weight lbs.	4.0
Mfg. No	30-A-161
Model No.	TD920
Price/Each	\$265.00



SMALL ANGLE GRINDERS

Features: Powerful 7.5 Amp, 10 000 RPM motor: Provides maximum performance and durability. Overload protection: Maximizes motor life. Electronic clutch: Extends tool life and prevents bind-up. Tool-free accessory change: Easily change "All Accessories" without a wrench. Tool-free adjustable guard: Provides quick guard installations and adjustments.

Includes: 4 1/2" grinding wheel, wheel guard, lock nut, lock nut wrench, side handle & inner flange

Wheel Diameter	4 1/2
Voltage	120
Amperage	7.5
No Load RPM	10 000
Spindle Size"	5/8
Tool Weight lbs.	4.5
Mfg. No	9557NB
Model No.	TGZ314
Price/Each	\$99.50



SMALL ANGLE GRINDERS W/TRIGGER GRIP

Features: Powerful 11 Amp, 11 000 RPM motor: Provides maximum performance and durability. Overload protection: Maximizes motor life. Electronic clutch: Extends tool life and prevents bind-up. Tool-free accessory change: Easily change "All Accessories" without a wrench. Tool-free adjustable guard: Provides quick guard installations and adjustments. Trigger grip handle: Provides better control, reach and leverage.

Includes: Lock-on, type 27 guard, side handle, spanner wrench, flanges

Wheel Diameter	4 1/2
Voltage	120
Amperage	11
No Load RPM	11 000
Spindle Size"	5/8
Tool Weight lbs.	5.4
Mfg. No	6121-30
Model No.	TLV196
Price/Each	\$153.26



HEAVY-DUTY SMALL ANGLE GRINDERS

Features: Dust Ejection System™ provides durability by ejecting dust particles that enter the tool through the air intake vents. Jam-pot, low profile gear case provides precise gear alignment for a smoother, quieter transmission. Auto-off brushes shut the tool down when the brushes need replacing.

Includes: 2-position side handle, keyless adjustable guard and wrench

Wheel Diameter	4 1/2
Voltage	120
Amperage	10
No Load RPM	11 000
Spindle Size"	5/8
Tool Weight lbs.	4.6
Mfg. No	D28402
Model No.	TGZ306
Price/Each	\$116.00



DISC GRINDERS

Features: Electronic current limiter protects the motor from accidental overload. SJS spring clutch protects the operator from accidental wheel lock. Labyrinth construction seals motor and bearings from contamination

Includes: 1 4 1/2" grinding wheel, side handle

Wheel Diameter"	4 1/2
Voltage	120
Amperage	12
No Load RPM	10 500
Spindle Size"	5/8
Tool Weight lbs.	4
Mfg. No	9564CV
Model No.	TDU693
Price/Each	\$187.94



NORTON METAL DEPRESSED CENTRE WHEELS TYPE 27

- Metal, quality aluminum oxide abrasive, ideal for grinding alloys, metals, steels and ferrous metals
- Ideal for on site and small unit job



Model No.	Mfg. No.	Size			Max RPM	Price /Each
		D"	x	H"		
NS130	DC4514M	4 1/2	x 1/4	x 7/8	13 580	2.12
NS132	DC514M	5	x 1/4	x 7/8	12 225	2.84
NS134	DC714M	7	x 1/4	x 7/8	8600	4.22

CORDED GRINDERS & SANDERS

5" GRINDERS



SMALL ANGLE GRINDERS W/LOCK-ON

Features:	Powerful 13 Amp, 11 000 RPM motor: Provides maximum performance and durability. Overload protection: Maximizes motor life. Electronic clutch: Extends tool life and prevents bind-up. Tool-free accessory change: Easily change "All Accessories" without a wrench. Tool-free adjustable guard: Provides quick guard installations and adjustments. Anti-vibration side handle: Reduces vibration, increasing user comfort during extended use. Soft start: Allows maximum control at start-up.
Includes:	Lock-on, type 27 guard, side handle, spanner wrench, flanges
Wheel Diameter"	5
Voltage	120
Amperage	13
No Load RPM	11 000
Spindle Size"	5/8
Tool Weight lbs.	5.7
Mfg. No	6117-30
Model No.	TLV197
Price/Each	\$176.94



HEAVY-DUTY HIGH PERFORMANCE GRINDERS

Features:	<i>Dust Ejection System™</i> provides increased durability by ejecting damaging dust and debris particles that enter the tool through the air intake vents. <i>E-Clutch™</i> shuts the grinder off when a wheel pinch or wheel stall occurs, <i>Power-Off™</i> overload protection shuts the tool off before it reaches overload or burn-up. <i>Power Loss Reset™</i> prevents accidental re-starts following a power disruption when the tool is left in the "on" position
Includes:	2-position side handle, depressed centre wheel and wrench
Wheel Diameter"	4 1/2 - 5
Voltage	120
Amperage	13
No Load RPM	11 000
Spindle Size"	5/8
Tool Weight lbs.	4.6
Mfg. No	D28131
Model No.	TKZ855
Price/Each	\$217.42



ANGLE GRINDERS

Features:	Labyrinth construction seals motor and bearings from contamination. Side handle can be mounted on left or right side of tool. Conveniently located thumb switch for operator comfort.
Includes:	5" depressed centre wheel, side handle
Wheel Diameter"	5
Voltage	120
Amperage	7.5
No Load RPM	11 000
Spindle Size"	5/8
Tool Weight lbs.	3.5
Mfg. No	9558NB
Model No.	TT957
Price/Each	\$120.60



SUPER-5 GRINDER™

Features:	Safety Clutch eliminates backlash. Spindle speeds are fully adjustable. <i>DUSTGUARD™</i> protects motor from abrasive particles
Includes:	(1x) Grinding wheel, side handle
Wheel Diameter"	5
Voltage	120
Amperage	8.5
No Load RPM	10 000
Spindle Size"	5/8
Tool Weight lbs.	4.2
Mfg. No	30-A-150
Model No.	TD921
Price/Each	\$320.00



ANGLE GRINDERS

Features:	Rear handle design for greater control. Trigger lock. Light weight for high production work with less fatigue.
Includes:	5" grinding wheel 24 grit, side handle
Wheel Diameter"	5
Voltage	120
Amperage	10
No Load RPM	10 000
Spindle Size"	5/8
Tool Weight lbs.	6.6
Mfg. No	9005B
Model No.	TF719
Price/Each	\$166.83



ANGLE GRINDERS

Features:	Labyrinth construction seals motor and bearings from contamination. New motor with added resistance to heat and overload. Motor winding protection to protect the wires from abrasion
Includes:	Side handle, 15" grinding wheel
Wheel Diameter"	5
Voltage	120
Amperage	10.5
No Load RPM	11 000
Spindle Size"	5/8
Tool Weight lbs.	7.9
Mfg. No	GA5010
Model No.	TLZ330
Price/Each	\$148.74



HEAVY-DUTY MEDIUM ANGLE GRINDERS

Features:	High power-to-weight ratio for greater efficiency and reduced user fatigue. External brush doors for easy servicing. Sealed ball and roller bearings for extended motor life
Includes:	Grinding wheel, wrench, keyless adjustable guard and 2 position side handle
Wheel Diameter"	5
Voltage	120
Amperage	12
No Load RPM	10 000
Spindle Size"	5/8
Tool Weight lbs.	7.4
Mfg. No	DW831
Model No.	VE980
Price/Each	\$123.00



ANGLE GRINDERS

Features:	Labyrinth construction seals motor and bearings from contamination. Side handle can be mounted on left or right side of tool. AC/DC paddle switch
Includes:	5" depressed centre wheel, side handle
Wheel Diameter"	5
Voltage	120
Amperage	12.5
No Load RPM	10 000
Spindle Size"	5/8
Tool Weight lbs.	7.7
Mfg. No	9015DB
Model No.	VK529
Price/Each	\$209.04



R29539E

OFFICE PRODUCTS

INSTRUMENTS, SCALES & ELECTRICAL

SHIPPING & PACKAGING

TOOLS & EQUIPMENT

WELDING & METALWORKING

SAFETY EQUIPMENT & SUPPLIES

JANITORIAL & MAINTENANCE

MATERIAL HANDLING & STORAGE

CORDED GRINDERS & SANDERS



6" GRINDERS



SMALL ANGLE GRINDERS W/TRIGGER GRIP

Features: Powerful 13 Amp, 9000 RPM motor: Provides maximum performance and durability. Overload protection: Maximizes motor life. Electronic clutch: Extends tool life and prevents bind-up. Tool-free accessory change: Easily change "All Accessories" without a wrench. Tool-free adjustable guard: Provides quick guard installations and adjustments. Anti-vibration side handle: Reduces vibration, increasing user comfort during extended use. Trigger grip handle: Provides better control, reach and leverage.

Includes:	Lock-on, type 27 guard, side handle, spanner wrench, flanges
Wheel Dia."	6
Voltage	120
Amperage	13
No Load RPM	9000
Spindle Size"	5/8
Tool Weight lbs.	5.7
Mfg. No	6124-30
Model No.	TLV198
Price/Each	\$196.50



SMALL ANGLE GRINDERS W/LOCK-ON

Features: Powerful 13 Amp, 9000 RPM motor: Provides maximum performance and durability. Overload protection: Maximizes motor life. Electronic clutch: Extends tool life and prevents bind-up. *Constant Power Technology™*: Maintains constant speed under load. Tool-free accessory change: Easily change "All Accessories" without a wrench. Tool-free adjustable guard: Provides quick guard installations and adjustments. Anti-vibration side handle: Reduces vibration, increasing user comfort during extended use. Soft start: Allows maximum control at start-up.

Includes:	Lock-on, type 1 guard, side handle, spanner
Wheel Dia."	6
Voltage	120
Amperage	12
No Load RPM	9000
Spindle Size"	5/8
Tool Weight lbs.	6.3
Mfg. No	6161-30
Model No.	TLV199
Price/Each	\$193.66



HEAVY-DUTY HIGH PERFORMANCE CUT-OFF/GRINDERS

Dual Clutch Protection™ prevents the gears from stripping and motor from burning up in a wheel pinch/stall. Provides increased durability by ejecting damaging dust and debris particles that enter the tool through the air intake vents. *E-Clutch®* shuts the grinder off when a wheel pinch or wheel stall occurs. *Power-Off™* overload protection shuts the tool off before it reaches overload or burn-up. *Power-Loss Reset®* prevents accidental re-starts following a power disruption when the tool is left in the "on" position

Includes:	2-position side handle, depressed centre wheel, cutting wheel
Wheel Dia."	6
Voltage	120
Amperage	13
No Load RPM	9000
Spindle Size"	5/8
Tool Weight lbs.	4.6
Mfg. No	D28140
Model No.	TKZ854
Price/Each	\$243.09



5 - 6" GRINDERS



HIGH PERFORMANCE GRINDERS W/ TRIGGER GRIP

Features: *Dust Ejection System™* provides increased durability by ejecting damaging dust and debris particles that enter the tool through the air intake vents. Jam-pot, low profile gear case provides precise gear alignment for a smoother, quieter transmission while allowing access to tight spaces. Auto-off brushes shut the tool down when the brushes need replacing to avoid tool damage

Includes:	2-position side handle, 5" keyless adjustable guard and 6" keyless adjustable guard
Wheel Diameter"	5 or 6
Voltage	120
Amperage	13
No Load RPM	9000
Spindle Size"	5/8
Tool Weight lbs.	4.75
Mfg. No	D28065
Model No.	TLZ232
Price/Each	\$174.80



7" - 9" GRINDERS



LARGE ANGLE GRINDERS TRIGGER GRIP W/LOCK-ON OR NON LOCK-ON

Features: Debris baffles protect internal components by deflecting damaging debris out of the airflow at the intake vents. External brush doors reduce service time by providing easy access to brushes. Soft-grip main handle provides better control and comfort

Includes:	Side handle, 7" & 9" type 27 guard and spanner wrench
Wheel Diameter"	7 to 9
Voltage	120
Amperage	15
No Load RPM	6000
Spindle Size"	5/8
Tool Weight lbs.	13.7
Mfg. No	6088-30
Model No.	TLZ819
Price/Each	\$230.15



Trigger, non lock-on Model No.: TLZ820



ROTO™ LARGE ANGLE GRINDERS TRIGGER GRIP W/LOCK-ON OR NON LOCK-ON

9-position rotating handle allows the user to adjust the main handle for better control. Debris baffles protect internal components by deflecting damaging debris out of the airflow at the intake vents. External brush doors - reduces service time by providing easy access to brushes

Includes:	Side handle, 7" & 9" type 27 guard and spanner wrench
Wheel Diameter"	7 to 9
Voltage	120
Amperage	15
No Load RPM	6000
Spindle Size"	5/8
Tool Weight lbs.	13.7
Mfg. No	6089-30
Model No.	TLZ821
Price/Each	\$230.15



Trigger, non lock-on Model No.: TLZ82

7" GRINDERS



HEAVY-DUTY MEDIUM ANGLE GRINDERS

Features: High power-to-weight ratio for greater efficiency and reduced user fatigue. External brush doors for easy servicing. Sealed ball and roller bearing for extended motor life.

Includes:	Grinding wheel, 2-position side handle
Wheel Diameter"	7
Voltage	120
Amperage	13
No Load RPM	8000
Spindle Size"	5/8
Tool Weight lbs.	8
Mfg. No	DW840
Model No.	VE383
Price/Each	\$170.20



ANGLE GRINDERS

Ergonomic soft rubber grip for vibration absorption and comfortable operation. Removable side handle can be mounted on left or right side of tool. Rotatable gear housing can be positioned at every 90°. Rear handle swivels 180°.

Includes:	Vibration proof grip, dust cover attachment set, lock nut wrench, toolless wheel cover assembly, inner flange, lock nut
Wheel Diameter"	7
Voltage	120
Amperage	15
No Load RPM	8500
Spindle Size"	5/8
Tool Weight lbs.	13.5
Mfg. No	GA7031
Model No.	TLV144
Price/Each	\$239.19



ANGLE GRINDERS

Labyrinth construction seals motor and bearings from contamination. Removable side handle can be mounted in 3 positions. Low vibration rear handle with soft grip for operator comfort and control

Includes:	7" depressed centre wheel, side handle
Wheel Diameter"	7
Voltage	120
Amperage	15
No Load RPM	8500
Spindle Size"	5/8
Tool Weight lbs.	11.2
Mfg. No	GA7020
Model No.	TLV386
Price/Each	\$213.06



CORDED GRINDERS & SANDERS

DIE/STRAIGHT GRINDERS



HEAVY-DUTY 1 1/2" DIE GRINDERS

Features:	AC/DC capacity works off welding machines and generators for increased productivity and versatility. Convenient paddle switch with lock-on button for easy gripping. Precision 1/4" cullet with 1/8" reducing sleeve securely holds all proper accessories
Includes:	2 wrenches, 1/4" cullet, 1/8" reducing sleeve
Cullet Size"	1/4
Voltage	120
Amperage	3.0 AC/DC
No Load RPM	25000
Tool Weight lbs.	3.25
Mfg. No	DW887
Model No.	TT977
Price/Each	\$218.61



DIE GRINDERS

Features:	All ball and roller bearing construction. Paddle switch operated with body grip control. 1/4" cullet standard equipment, 1/8" cullet available
Includes:	11/16" open end wrench and 1/2" open end wrench
Cullet Size"	1/4
Voltage	120
Amperage	4.5
No Load RPM	21000
Tool Weight lbs.	4.5
Mfg. No	5194
Model No.	TF420
Price/Each	\$340.70



DIE GRINDERS

Features:	Low speed with very high torque, ideal for grinding and finishing work using brushes, flap discs and points. Labyrinth dust proof construction prolongs tool life. Electronic constant speed controller with soft start and variable speed dial
Includes:	Cullet 1/4", 2 wrench and side handle set
Cullet Size"	1/4
Voltage	120
Amperage	6.6
No Load RPM	1800-7000
Tool Weight lbs.	5.2
Mfg. No	GD0810C
Model No.	TDU735
Price/Each	\$425.12



SHEARS



16 GAUGE SHEARS

Features:	Built-in thickness gauge for convenience. Lever switch for comfort and easy use
Includes:	Replaceable blades with a total of 8 cutting edges
Voltage	120
Amperage	2.8
Strokes per minute	4000
Capacity in Steel ga.	16
Capacity in Stainless Steel ga.	18
Tool Weight lbs.	3.7
Mfg. No	JS1600
Model No.	TF868
Price/Each	\$466.32



14 GAUGE SHEARS

Features:	Rugged aluminium alloy gear case for maximum durability. Paddle switch for convenient one-handed operation. Cuts radius as small as 1"
Includes:	Blade kit (upper and lower blades, screws, nuts and wrenches)
Voltage	120
Amperage	3
Strokes per minute	2700
Capacity in Steel ga.	14
Capacity in Stainless Steel ga.	16
Tool Weight lbs.	5.5
Mfg. No	DW892
Model No.	TT960
Price/Each	\$581.45



18 GAUGE SHEARS

Features:	360° swivel head. Trigger speed control. Ergonomic tactile grip for optimal user comfort
Includes:	Hex wrench
Voltage	120
Amperage	6.8
Strokes per minute	2500
Capacity in Steel ga.	18
Capacity in Stainless Steel ga.	20
Tool Weight lbs.	4.1
Mfg. No	6852-20
Model No.	THZ879
Price/Each	\$288.44



NIBBLERS



NIBBLERS 16 GAL

Features:	Cuts up to 7 ft. per minute. Cutter can be set in 8 positions. Paddle switch.
Includes:	Allen wrench and plate wrench
Voltage	120
Amperage	4
Strokes per minute	1900
Capacity in Steel gal.	16
Capacity in Stainless Steel gal.	18
Tool Weight lbs.	4.8
Mfg. No	6890
Model No.	TF638
Price/Each	\$982.89



NIBBLERS 16 GAL

Features:	Die rotates 360°, easy punch and die replacement for less down time. Built-in thickness gauge for convenience. Lock-on sliding switch for continuous use.
Includes:	Wrench, hex wrench, punch & die
Voltage	120
Amperage	5
Strokes per minute	2200
Capacity in Steel gal.	16
Capacity in Stainless Steel gal.	18
Tool Weight lbs.	3.5
Mfg. No	JN1601
Model No.	TW024
Price/Each	\$557.78



1/4" SHEET SANDERS



SHEET PALM SANDERS

Features:	Dust bag for clean and efficient sanding with extended sandpaper life by reducing clogging. All ball bearing construction for smooth operation, engineered to operate at low noise level with reduced vibration. Comes with easy to use clamp lever and hook and loop pad
Includes:	Dust bag, nozzle, dust nozzle, punch plate, three sanding paper and plastic case
Sandpaper Size"	1/4
Voltage	120
Amperage	2
Orbits per minute	14000
Orbit Diameter"	-
Tool Weight lbs.	2.4
Mfg. No	B04555K
Model No.	TLY382
Price/Each	\$76.38



SHEET PALM SANDERS

Features:	100% ball bearing construction. Dust sealed switch. Dual plane counter-balanced, low vibration design reduces fatigue
Includes:	Dust bag with vacuum adapter and sandpaper punch
Sandpaper Size"	1/4
Voltage	120
Amperage	2.4
Orbits per minute	13500
Orbit Diameter"	1/16
Tool Weight lbs.	3
Mfg. No	D26441
Model No.	TGZ307
Price/Each	\$75.18



SHEET PALM SANDERS

Features:	Removable top allows for easy service and brush replacement. Integrated vacuum ports fits 1/4" or 2 1/4" hoses. In-line dust port with flexible dust collection bag captures maximum amount of dust without compromising site line
Includes:	Dust bag, 1/4" sheet punch pad, three 1/4" sheet sandpapers 180 gr, 200 gr, 220 gr and carrying case
Sandpaper Size"	1/4
Voltage	120
Amperage	3
Orbits per minute	14000
Orbit Diameter"	1/16
Tool Weight lbs.	3.2
Mfg. No	6020-21
Model No.	TLY384
Price/Each	\$93.11



R29541E

OFFICE PRODUCTS

INSTRUMENTS, SCALES & ELECTRICAL

SHIPPING & PACKAGING

TOOLS & EQUIPMENT

WELDING & METALWORKING

SAFETY EQUIPMENT & SUPPLIES

JANITORIAL & MAINTENANCE

MATERIAL HANDLING & STORAGE

CORDED GRINDERS & SANDERS



5" SANDERS



RANDOM ORBIT PALM SANDERS

Features:	Variable speed dial: 7000-12000 orbits per minute. Electronic soft start quickly and steadily ramps the motor up in stages. Integrated vacuum ports fits 1 1/4" or 2 1/4" hoses.
Includes:	Dust bag and carrying case
Sandpaper Size"	5
Voltage	120
Amperage	3
Orbits per minute	7000-12000
Orbit Diameter"	3/32
Tool Weight lbs.	3.3
Mfg. No	6021-21
Model No.	TLZ441
Price/Each	\$111.00



RANDOM ORBIT PALM SANDERS

Features:	Fast random-orbit action for aggressive sanding. Efficient through the pad dust collection system. High power motor for heavy duty application.
Includes:	(1x) 5" Abrasive disc, dust bag and pad
Sandpaper Size"	5
Voltage	120
Amperage	3
Orbits per minute	12000
Orbit Diameter"	1/8
Tool Weight lbs.	2.9
Mfg. No	B05030
Model No.	TLY383
Price/Each	\$102.51



BELT SANDERS



VARIABLE-SPEED SANDERS

Features:	Motor is located over platen for maximum performance and perfect balance. Variable-speed dial is conveniently placed on the handle, allowing belt speed adjustment from 1000 to 1500 SFPM. Fingertip belt tracking knob for quick, accurate belt adjustments, quick release belt change lever
Includes:	100 g ceramic aluminium oxide belt and dust bag assembly
Belt Size"	4x24
Voltage	120
Amperage	12
Surface feet per minute	1000-1500
Tool Weight lbs.	14.5
Mfg. No	362V
Model No.	TD645
Price/Each	\$431.70



VARIABLE SPEED SANDERS

Features:	Motor is located over platen for maximum performance and perfect balance. Variable-speed dial is conveniently placed on the handle, allowing belt speed adjustment from 850 to 1300 SFPM. Fingertip belt-tracking knob for quick, accurate belt adjustments, quick release belt change lever
Includes:	100 g ceramic aluminium oxide belt and dust bag assembly
Belt Size"	3 x 21
Voltage	120
Amperage	8
Surface feet per minute	850-1300
Tool Weight lbs.	10.75
Mfg. No	352VS
Model No.	TF258
Price/Each	\$266.98



PORTABLE BELTS

Typical Applications

- Grinding and finishing of all metals
- Blending of welds
- Sanding and finishing of wood
- Glass seaming and polishing

METALITE R228 BELTS – FOR METAL AND WOOD

- Aluminum oxide abrasive
- Aggressive cutting; resistant to heat
- Strong X-wt cotton backing

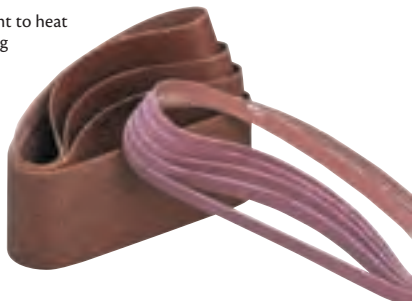
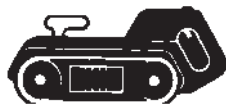

Model No.	Mfg. No.	Size			Grit	Price /Each
		W"	x	L"		
NZ283	78072721691	3	x	21	40	2.49
NZ284	78072721690	3	x	21	50	2.56
NZ285	78072721685	3	x	21	60	2.33
NZ286	78072721680	3	x	21	80	2.22
NZ287	78072721676	3	x	21	100	2.17
NZ288	78072721675	3	x	21	120	2.17
NZ289	78072721770	3	x	24	36	2.87
NZ290	78072721765	3	x	24	40	2.71
NZ291	78072721760	3	x	24	50	2.59
NZ292	78072721755	3	x	24	60	2.49
NZ293	78072721750	3	x	24	80	2.40
NZ294	78072721745	3	x	24	100	2.31
NZ295	78072721740	3	x	24	120	2.31
NZ302	78072722058	4	x	24	36	4.94
NZ303	78072722057	4	x	24	40	4.36
NZ304	78072722056	4	x	24	50	4.20
NZ305	78072722055	4	x	24	60	4.04
NZ306	78072722050	4	x	24	80	3.80
NZ307	78072722045	4	x	24	100	3.71
NZ308	78072722044	4	x	24	120	3.71

CORDED RECIPROCATING SAWS



SAWZALL® RECIPROCATING SAW KITS

RECIPROCATING SAWS, 9.0 AMPS VARIABLE SPEED

HEAVY-DUTY 10 AMPS RECIPROCATING SAWS

Features: Powerful 12 Amp motor: Delivers 0-3000 SPM for high performance cutting in a variety of materials
3/4" Stroke length
Counter weighted mechanism: Provides reduced vibration for smoother operation
Quik-Lok™ blade clamp: Provides fast, tool-free blade changes

Tool-less blade change system
Blade can be inverted for near flush cutting
Accepts standard 1/2" shank blades

4-position blade clamp
Lever-action keyless blade clamp
Variable speed trigger

Includes: Sawzall® Recip saw, carrying case

One saw blade

Carrying case

Stroke Length" 3/4

1 1/8

1 1/8

Amperage 12

9.0

10.0

Strokes per minute 0-3000

0-2800

0-2800

Tool Weight lbs. 7.1

7.1

7

Mfg. No. 6509-31

JR3050TY

DW304PK

Model No. TLV200

TFX099

TGZ303

Price/Each \$174.16

\$124.62

\$149.00

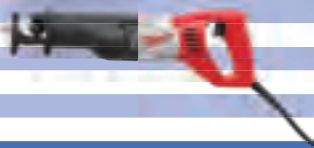

CORDED RECIPROCATING SAWS



SAWZALL® RECIPROCATING SAW KITS

HEAVY-DUTY 13 AMPS RECIPROCATING SAWS

360° ROTATING HANDLE ORBITAL SUPER SAWZALL®

Features: Powerful 12 Amp motor: Delivers 0-3000 SPM for high performance cutting in a variety of materials
1-1/8" Stroke length
Counter weighted mechanism: Provides reduced vibration for smoother operation
Quik-Lok™ blade clamp for fast, tool-less blade changes

Orbital action
Keyless blade clamp and keyless adjustable shoe
Variable speed trigger and dial

Rotating handle locks at 45° increments
Variable speed trigger and dial speed control
Quik-Lok™ blade clamp, tool-less blade change and impact protection

Includes: Sawzall® Recip saw, carrying case

Carrying case

Carrying case and one blade

Stroke Length" 1 1/8

1 1/8

1 1/4

Amperage 12.0

13.0

13.0

Strokes per minute 0-3000

0-2700

0-3000

Tool Weight lbs. 7.1

9

10

Mfg. No. 6519-31

DW311K

6523-21

Model No. TLV201

TGZ301

TFX209

Price/Each \$174.16

\$241.10

\$261.30

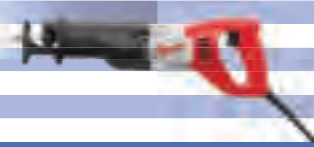

CORDED RECIPROCATING SAWS



15 AMPS SUPER SAWZALL®

15 AMPS ANTI-VIBRATION RECIPROCATING SAWS

Features: Maintains constant speed under load
Variable speed trigger and dial speed control
Quik-Lok™ blade clamp, tool-less blade change and impact protection

Features anti-vibration technology (AVT)
Orbital change lever offers three stages and one straight cutting action
Accepts standard 1/2" shank blades

Includes: Carrying case and one blade

One saw blade and carrying case

Stroke Length" 1 1/4

1 1/4

Amperage 15.0

15.0

Strokes per minute 0-2800

0-2800

Tool Weight lbs. 9.8

9.5

Mfg. No. 6538-21

JR3070CT

Model No. TLY299

TGX675

Price/Each \$282.41

\$291.45



CORDED SAWS



CORDED BAND SAWS



COMPACT CORDED BAND SAWS

Features: 45% lighter than deep cut, 9.5 lbs. compact lightweight design for cutting overhead and in tight places
200-360 SFPM variable speed dial
Drop resistant pulley guard, cast aluminum gear case, LED work light

Includes: Blade and case

Amperage 7.0

Saw Surface Feet per Minute (SFPM) 200-360

Max Capacity" (Rectangular) 3 1/4 x 3 1/4

Max Capacity" (Round) 3 1/4

Tool Weight lbs. 9.5

Mfg. No. 6242-6

Model No. TLV040

Price/Each \$295.47



DEEP CUT PORTA-BAND® SAWS

Dual bearing blade guide rollers increase durability in the blade support system
Speed control knob allows to tailor the blade speed
Blade tracking adjustment increases blade life

Includes: Hex wrench and standard blade

Amperage 6.0

100-245

4 1/2 x 4 3/4

4 3/4

14

DW328

TKZ842

\$397.21



DEEP CUT BAND SAWS

Variable speeds dial and trigger and 2-finger variable speed trigger
Adjustable material guide
Rear blade guard - 30% thicker steel protects the guard from bending or pinching during material break-through

Includes: Carrying case

Amperage 10.5

0-420

4 7/8 x 4 7/8

4 7/8

17.5

6232-21

TLV447

\$407.00



CORDED JIG SAWS



JIG SAWS

Features: Uses tang style blades only

Variable speed, vacuum port, three orbital settings plus straight cutting
Adjustable base bevels from 0°-45° left and right

Includes: One jig saw blade and carrying case

Amperage 3.9

Stroke Length" 11/16

Strokes per minute (SPM) 500-3100

Tool Weight lbs. 4.2

Mfg. No. 4329K

Model No. TLY335

Price/Each \$115.58



COMPACT JIG SAWS

Features: Keyless blade lever

Variable speed with 4-position orbital action
Shoe bevels 0° to 45° for bevelled cuts

Includes: Heavy-duty case and one blade

Amperage 5.5

1

0-3100

6.2

DW317K

TDX440

\$147.77



CORDED ORBITAL JIG SAWS

Keyless shoe adjustment with 45° in both directions and orbital action with four adjustment levels
Quik-Lok™ blade change system and built-in dust collection port
Tachometer feedback for constant cutting speed
Dust shield and two blades

Amperage 6.5

1

0-3000

6.4

6268-21

TKZ868

\$256.28



CORDED JIG SAWS



ORBITAL/STRAIGHT JIG SAWS

Features: Built-in LED job light
Orbital change lever offers three stages and one straight cutting action, accepts tang shank blades
Adjustable cast aluminium base; 0-45° bevel right and left

Includes: Jig saw blade set and carrying case

Amperage 6.3

Stroke Length" 1

Strokes per minute (SPM) 800-2800

Tool Weight lbs. 5.3

Mfg. No. 4350FCT

Model No. TLY334

Price/Each \$289.44



HEAVY-DUTY JIG SAWS

Features: Keyless blade lever
Variable speed with 4-position orbital action
Integrated dust blower maintains visibility of cut line

Includes: Heavy-duty case and blade

Amperage 6.5

1

500-3100

6.4

DW331K

TGZ304

\$213.88



CORDED CIRCULAR SAWS



7 1/4" CIRCULAR SAWS

Features: High power, maximum cutting depth of 2 1/2"
Electric brake, twin LED lights, heavy gauge aluminium base with ruler markings
Bevel adjustment with positive stops at 22.5° and 45°

Includes: Guide rule, Hex. wrench, 1 7/4" 24 CT black M-Force saw blade

Amperage 15.0

No Load RPM 5800

Depth of Cut" at 45° 1 3/4 (1 3/8 at 50°)

Depth of Cut" at 90° 2 1/2

Tool Weight lbs. 13.8

Mfg. No. 5007NFA

Model No. TDU707

Price/Each \$178.89



7 1/4" LIGHTWEIGHT CIRCULAR SAWS

Clear line of sight aids in blade visibility from any angle
56° bevelling capacity with stops at 45° and 22.5°
Lower guard design

Includes: Carbide tipped blade, blade wrench and heavy-duty kit box

Amperage 15.0

No Load RPM 5800

Depth of Cut" at 45° 1 3/4

Depth of Cut" at 90° 2 3/8

Tool Weight lbs. 9.5

Mfg. No. DW368K

Model No. WJ025

Price/Each \$172.40



7 1/4" CIRCULAR SAWS WITH HIGH STRENGTH BASE

High strength base will withstand a one story drop
56° bevelling capacity with stops at 45° and 22.5°
Electric brake stops blade after use

Includes: Carbide tipped blade, blade wrench and heavy-duty kit box

Amperage 15.0

No Load RPM 5800

Depth of Cut" at 45° 1 3/4

Depth of Cut" at 90° 2 3/8

Tool Weight lbs. 9.8

Mfg. No. DW369CSK

Model No. TSW598

Price/Each \$214.00



CORDED CIRCULAR SAWS



7 1/4" LEFT BLADE CIRCULAR SAWS

Features: Handle position can be moved to eight different positions
Full 50° bevel capacity
Cut visibility for right hand users with the blade on the left side

Includes: Case, circular saw blade and hex blade wrench

Amperage 15.0

No Load RPM 5800

Depth of Cut" at 45° 1 13/16

Depth of Cut" at 90° 2 7/16

Tool Weight lbs. 10.4

Mfg. No. 6391-21

Model No. TEA172

Price/Each \$248.24



TILT-LOK™ 7 1/4" CIRCULAR SAWS

Handle position can be moved to eight different positions
Full 50° bevel capacity
Blade visibility from either side

Includes: Case, circular saw blade and hex blade wrench

Amperage 15.0

No Load RPM 5800

Depth of Cut" at 45° 1 13/16

Depth of Cut" at 90° 2 7/16

Tool Weight lbs. 10.4

Mfg. No. 6390-21

Model No. TJ275

Price/Each \$240.20



8" METAL CUTTING SAWS

Durable blade shield with integral chiptank deflects hot chips and sparks
Quick-release shield latch for fast waste disposal and blade changes
Lever's location ensures user has both hands firmly on the saw

Includes: Case, circular saw blade and hex blade wrench

Amperage 13.0

No Load RPM 3700

Depth of Cut" at 45° -

Depth of Cut" at 90° 2 9/16

Tool Weight lbs. 13.3

Mfg. No. 6370-21

Model No. TEX280

Price/Each \$272.62



CORDED CIRCULAR SAWS



8 1/4" CIRCULAR SAWS

Features: Rear pivot depth of cut adjustment
50° bevel capacity
Electric brake stops blade after use

Includes: carbide tipped blade and blade wrench

Amperage 15.0

No Load RPM 5800

Depth of Cut" at 45° 2 1/4

Depth of Cut" at 90° 2 15/16

Tool Weight lbs. 12.75

Mfg. No. DW384

Model No. TW314

Price/Each \$286.47



8 1/4" CIRCULAR SAWS

High performance magnesium blade casing and base.
Bevel adjustment with positive stops at 22.5°, 45°, and 50°.
Electric brake, two built in LED lights, rubberized grips

Includes: 1 81/4" CT. saw blade 24T, guide rule, hex wrench

Amperage 15.0

No Load RPM 5200

Depth of Cut" at 45° 2 1/4 (2 at 50°)

Depth of Cut" at 90° 3

Tool Weight lbs. 13

Mfg. No. 5008MGA

Model No. TLY363

Price/Each \$236.18



CORDED SAWS

MITRE SAWS



10" DUAL SLIDING COMPOUND MITRE SAWS WITH LASER

Features: Sliding rail mechanism incorporating three linear ball bearings provides increased rigidity to produce precise cuts right out of the box. Sliding fence (left side) can be adjusted outwards when bevel cutting or inwards for increased support of small or delicate materials. Battery operated, factory calibrated Class 2 laser. Bevel capacity of 45° left or right. Mitre capacity of 47° left or 60° right with positive stops at 0°, 15°, 22.5°, 31.6° and 45°. 2-stage safety switch for increased operator safety.

Includes: 10" Mitre saw blade 40CT, box wrench, dust bag, vertical vise, triangle rule, 2 ea. holder

Amperage	13.0
No Load RPM	4300
Arbor"	5/8
Mitre Range	47° left to 60° right
Bevel Range	45° left to 45° right
Soft Start	Yes
Tool Weight lbs.	43.7
Mfg. No.	LS1018L
Model No.	TLV225
Price/Each	\$569.79



12" DUAL SLIDING COMPOUND MITRE SAWS

Features: Dual sliding rail mechanism incorporating six linear ball bearings provides increased rigidity to produce precise, adjustment free cuts right out of the box. 3-stage gear reduction system greatly increases capacity. Electronic speed control maintains constant speed under heavy load. Bevel capacity of 45° left or right with positive stops at 0°, 22.5°, 33.9° and 45°. Mitre capacity of 52° left or 60° right with positive stops at 0°, 15°, 22.5°, 31.6° and 45°. Re-located mitre scale enables easier viewing during operation.

Includes: 12" Mitre saw blade 70CT, box wrench, dust bag, 2 ea. switch safety buttons, vertical vise, triangle rule, 2 ea. holder

Amperage	15.0
No Load RPM	3200
Arbor"	1
Mitre Range	52° Left to 60° Right
Bevel Range	45° Left to 45° Right
Soft Start	Yes
Tool Weight lbs.	58.6
Mfg. No.	LS1216
Model No.	TLV171
Price/Each	\$771.74



10" SLIDING COMPOUND MITRE SAWS WITH LASER

Features: Twin laser guide system indicates the cut line on both sides of the blade kerf for reliable cuts every time. Dual rail sliding system for sturdy, accurate and smooth sliding action. Rotating table has nine positive stops at 0°, 15°, 22.5°, 30° and 45° right and left.

Includes: 2-position vertical hold down vise, retractable extension wings, dust bag and blade socket wrench

Amperage	15.0
No Load RPM	5200
Arbor"	5/8
Mitre Range	45° Left to 45° Right
Bevel Range	45° Left to 0° Right
Soft Start	-
Tool Weight lbs.	40
Mfg. No.	8380
Model No.	TBS757
Price/Each	\$249.36



12" SLIDING DUAL COMPOUND MITRE SAWS WITH LASER

Features: Twin laser guide system indicates the cut line on both sides of the blade kerf for reliable cuts every time. Dual rail sliding system for sturdy, accurate and smooth sliding action. Rotating table has nine positive stops at 0°, 15°, 22.5°, 30° and 45° right and left.

Includes: 2-position vertical hold down vise, retractable extension wings, dust bag and blade socket wrench

Amperage	15.0
No Load RPM	3600
Arbor"	1
Mitre Range	45° Left to 45° Right
Bevel Range	45° Left to 45° Right
Soft Start	-
Tool Weight lbs.	-
Mfg. No.	8390
Model No.	TLY298
Price/Each	\$396.05



12" DUAL-BEVEL COMPOUND MITRE SAWS

Features: Digital angle readout provides accuracy of +/- 0.1°. Fine adjust to dial-in precise mitre angles. Integral dust channel captures up to 75% of the dust and debris cut. Dual integral jobsite lights illuminate the work piece and cut line from either side of the blade. Carbide tipped blade, dust bag and blade wrench.

Includes: 12" Dual-bevel compound mitre saw

Amperage	15.0
No Load RPM	3200
Arbor"	5/8 or 1
Mitre Range	52° Left to 52° Right
Bevel Range	48° Left to 48° Right
Soft Start	Yes
Tool Weight lbs.	55
Mfg. No.	6950-20
Model No.	TLZ333
Price/Each	\$767.82



12" DUAL-BEVEL SLIDING COMPOUND MITRE SAWS

Features: Digital angle readout provides accuracy of +/- 0.1°. Fine adjust to dial-in precise miter angles. Integral dust channel captures up to 75% of the dust and debris cut. Oversized single lever bevel adjustment allows the saw to easily bevel left and right. Carbide tipped blade, dust bag and blade wrench.

Includes: 12" Dual-bevel sliding compound mitre saw

Amperage	15.0
No Load RPM	3200
Arbor"	5/8 or 1
Mitre Range	55° Left to 60° Right
Bevel Range	48° Left to 48° Right
Soft Start	Yes
Tool Weight lbs.	65
Mfg. No.	6955-20
Model No.	TLZ332
Price/Each	\$833.15



12" SINGLE-BEVEL COMPOUND MITRE SAWS

Features: Adjustable stainless steel mitre detent plate with 11 positive stops. Tall sliding fence supports crown molding up to 5 1/4" nested and base molding up to 6 1/2" vertically against the fence. Designed for use with the THZ670 adjustable mitre saw laser system.

Includes: Carbide blade, extension kit, dust bag and blade wrench

Amperage	15.0
No Load RPM	4000
Arbor"	5/8 or 1
Mitre Range	50° Left to 50° Right
Bevel Range	48° Left to 3° Right
Soft Start	-
Tool Weight lbs.	42
Mfg. No.	DW715
Model No.	TGZ308
Price/Each	\$492.57



12" COMPOUND MITRE SAWS

Features: Positive stops at nine settings; 15°, 22.5°, 31.6°, 45°, left and right and 0° mitre cuts. Horizontal D-handle design.

Includes: Carbide blade, socket wrench, dust bag, triangular rule, two holders and vertical vise

Amperage	15.0
No Load RPM	4000
Arbor"	1
Mitre Range	48° Left to 48° Right
Bevel Range	45° Left to 0° Right
Soft Start	-
Tool Weight lbs.	36.4
Mfg. No.	LS1221
Model No.	TDU772
Price/Each	\$447.23



CHOP SAWS



14" CHOP SAWS

Features: Guide plate adjusts 45° right and left and moves to three locations for various sizes of materials
Spark guard, adjustable depth stop and quick release vice
Cuts a wide variety of materials including ferrous and non-ferrous metals

Includes: One abrasive wheel, socket wrench and quick vise
Amps: 15.0
Motor Horsepower: 3.2
No load speed RPM: 3800
Blade Diameter": 14
Tool Weight lbs.: 43
Mfg. No.: 2414DB
Model No.: VI526
Price/Each: \$260.30



14" ABRASIVE CHOP SAWS

Features: Powerful 15 Amp, 4.0 max. HP motor: Delivers maximum cutting performance in a wide variety of materials
Large cutting capacity: Provides versatility for a wide range of cutting applications, up to 5" pipe
45° miter capacity with adjustable fence
Quick adjust vise clamp: Allows clamp to be adjusted quickly when cutting different material sizes
All ball bearing construction: Delivers maximum durability

Includes: Chop saw, vise, abrasive wheel, hex wrench
Amps: 15.0
Motor Horsepower: 4
No load speed RPM: 3900
Blade Diameter": 14
Tool Weight lbs.: 40
Mfg. No.: 6177-20
Model No.: TLV202
Price/Each: \$229.43



PERFORMANCE PLUS 14" CHOP SAWS

Ball bearing induction motor
Spark deflector for safe operation
Quick release vise for holding workpiece, which allows cuts up to a 45° angle

Includes: Max. depth of cut 4". Max. width of cut 7 1/4"
Amps: 15.0
Motor Horsepower: 4
No load speed RPM: 3750
Blade Diameter": 14
Tool Weight lbs.: 45
Mfg. No.: 8342
Model No.: WK772
Price/Each: \$185.28



CHOP SAWS



HEAVY-DUTY 14" CHOP SAWS

Features: 45° pivoting fence allows accurate angle cuts
Spindle lock allows users to make wheel changes quickly
Cutting capacity: 4 1/2" round / 4 3/4" x 5 1/3" rectangle

Includes: 14" abrasive wheel and wrench
Amps: 15.0
Motor Horsepower: 4
No load speed RPM: 3800
Blade Diameter": 14
Tool Weight lbs.: 35
Mfg. No.: D28700
Model No.: TGZ305
Price/Each: \$248.19



HEAVY-DUTY 14" MULTI-CUTTER SAWS

Cuts a wide variety of materials including ferrous and non-ferrous metals
Depth of cut remains constant for carbide tipped blade
Cutting capacity: 5 3/16" round / 6 1/2" x 4 1/2" rectangle

Includes: 14" carbide tipped blade, wrench and vertical clamp
Amps: 15.0
Motor Horsepower: 4
No load speed RPM: 1300
Blade Diameter": 14
Tool Weight lbs.: 47
Mfg. No.: DW872
Model No.: UG967
Price/Each: \$713.97



14" CHOP SAWS KEYLESS BLADE CHANGE

45° adjustable fence allows angle cuts without using a wrench
Soft start extends gear and motor life
Cutting capacity: 5" round / 4 1/2" x 6 1/2" rectangle

Includes: 14" abrasive wheel, fence wrench and tool free flange system
Amps: 15.0
Motor Horsepower: 5.5
No load speed RPM: 4000
Blade Diameter": 14
Tool Weight lbs.: 39
Mfg. No.: D28715
Model No.: TJZ872
Price/Each: \$295.77



CHOP SAWS



DRY CUT MACHINES

Features: Powerful 4.8 max HP motor, 15 Amp motor, 1500 RPM
Tool-free fence and vise system
Heavy-duty cast base
Horizontal D-handle for optimum comfort
Largest cutting capacity in class
Cuts fast with virtually no sparks or burrs

Includes: Hex key
Amps: 15.0
Motor Horsepower: 4.8
No load speed RPM: 1500
Blade Diameter": 14
Tool Weight lbs.: 49.5
Mfg. No.: 6190-20
Model No.: TEA158
Price/Each: \$832.14



GEMINI CHOP SAW REINFORCED CUT-OFF WHEELS

- Free Cut:** side reinforced; engineered for larger cross-sections and/or hard-to-cut materials, resist breakage and provide straight cuts
- Long Life:** side reinforced; ideal for small cross-section work pieces, resist breakage and provide straight cuts
- Rapid Cut:** centrally reinforced; free cutting, non-binding; burr- and burn-free cuts rough sides
- Type 01



Model No.	Mfg. No.	Size D" x T" x A"	Max RPM	Price /Each
GEMINI LONG LIFE				
NS255	C010764G	10 x 3/32 x 1	6110	8.40
NS256	C012764G	12 x 3/32 x 1	5095	6.23
NS259	C014764GLL	14 x 3/32 x 1	4365	8.52
NS261	C016764G	16 x 3/32 x 1	3820	14.78
GEMINI RAPID CUT				
NS257	C012764GRC	12 x 3/32 x 1	5095	6.91
NS260	C014764GRC	14 x 3/32 x 1	4365	8.98

CORDED DRILLS



PISTOL GRIP DRILLS



1/4" MAGNUM® DRILLS

Features: All metal gear case and diaphragm
Heavy-duty keyed chuck
360° locking side handle, 8 feet cord

Includes: Side handle and chuck key holder

Chuck Size 1/4"

Amperage 7

No Load RPM 0-2500

Chuck Type Keyed

Tool Weight 4.7 lbs.

Mfg. No 0100-20

Model No. WJ092

Price/Each \$230.15



3/8" VSR DRILLS

Helical-cut steel, heat-treated gears for increased durability
Single-sleeve keyless chuck with spindle lock
Two-finger trigger

Includes: Chuck key and holder

Chuck Size 3/8"

Amperage 6.7

No Load RPM 0-1200

Chuck Type Keyless

Tool Weight 3.3 lbs.

Mfg. No DW222

Model No. TD933

Price/Each \$166.80



3/8" CLOSE QUARTER ANGLE DRILLS

Angled chuck for reaching close quarters
Large paddle trigger
Angled cord exit and metal framed gear train

Includes: Chuck key and holder

Chuck Size 3/8"

Amperage 3.5

No Load RPM 0-1300

Chuck Type Keyed

Tool Weight 3.9 lbs.

Mfg. No 0370-20

Model No. TLZ155

Price/Each \$203.01



3/8" MAGNUM® DRILLS

Features: All metal Grip-Lok™ 2-sleeve keyless chuck
All metal gear case and diaphragm
360° locking side handle, 10 feet cord

Includes: Side handle

Chuck Size 3/8"

Amperage 7

No Load RPM 0-2500

Chuck Type Keyless

Tool Weight 4.1 lbs.

Mfg. No 0201-20

Model No. WJ090

Price/Each \$191.50



3/8" VSR DRILLS

Durable all ball-bearing construction
Textured handle provides better gripping surface
Glass-filled nylon housing is durable and impact resistant

Includes: Chuck key and holder

Chuck Size 3/8"

Amperage 6

No Load RPM 0-2500

Chuck Type Keyed

Tool Weight 3.2 lbs.

Mfg. No D21002

Model No. WK990

Price/Each \$78.68



3/8" DRILLS WITH CASE

Low decibel rating (79dB) for quieter operation
Variable speed
Keyless chuck for fast and easy bit installation and removal

Includes: Plastic case

Chuck Size 3/8"

Amperage 4.9

No Load RPM 0-2500

Chuck Type Keyless

Tool Weight 3.1 lbs.

Mfg. No 6408K

Model No. TDU647

Price/Each \$99.50



3/8" MAGNUM® DRILLS

Features: Heavy-Duty industrial keyless chuck
8 ft. 2-wire rubber cord, Exclusive brush cartridge system changes brushes in less than one minute

Includes: Side handle

Chuck Size 3/8"

Amperage 5.5

No Load RPM 0-2800

Chuck Type Keyless

Tool Weight 4.0 lbs.

Mfg. No 0233-20

Model No. TT997

Price/Each \$149.64



1/2" VSR DRILLS

Single-sleeve keyless chuck with spindle lock
Triple gear reduction provides increased torque
Helical-cut steel, heat-treated gears for increased durability

Includes: 360° locking side handle

Chuck Size 1/2"

Amperage 7.8

No Load RPM 0-600

Chuck Type Keyless

Tool Weight 4.4 lbs.

Mfg. No DW246

Model No. TD936

Price/Each \$242.65



1/2" VSR DRILLS

Triple gear reduction provides increased torque
Metal gear housing for jobsite durability
Helical-cut steel, heat-treated gears for increased durability

Includes: 360° side handle and chuck key with holder

Chuck Size 1/2"

Amperage 7.8

No Load RPM 0-600

Chuck Type Keyed

Tool Weight 4.4 lbs.

Mfg. No DW245

Model No. TD935

Price/Each \$220.37



PISTOL GRIP DRILLS



1/2" MAGNUM® DRILLS

Features: Powerful 8.0 Amp motor with variable speed control
All metal gear case and diaphragm
8 ft. 3-wire rubber cord and 360° locking side handle

Includes: Side handle and chuck key with holder

Chuck Size 1/2"

Amperage 8

No Load RPM 0-850

Chuck Type Keyed

Tool Weight 5.4 lbs.

Mfg. No 0299-20

Model No. TEA090

Price/Each \$151.45



1/2" MAGNUM® DRILLS

Features: Trigger speed control with reversing
Heavy-Duty industrial chuck and 8 feet 3-wire cord
Exclusive brush cartridge system changes brushes in less than one minute

Includes: Side handle and chuck key with holder

Chuck Size 1/2"

Amperage 5.5

No Load RPM 0-850

Chuck Type Keyed

Tool Weight 4.8 lbs.

Mfg. No 0234-6

Model No. TF016

Price/Each \$221.10



1/2" DRILLS

Features: Industrial aluminum gear housing for durability
Large reversing switch and lock-on button
Convenient belt clip

Includes: Side handle and chuck key

Chuck Size 1/2"

Amperage 6.5

No Load RPM 0-850

Chuck Type Keyed

Tool Weight 4.8 lbs.

Mfg. No 6303H

Model No. TW242

Price/Each \$184.95



1/2" MAGNUM® DRILLS

Features: Powerful 8.0 Amp motor with variable speed control
All metal ratcheting chuck with carbide jaws has the highest grip torque on bits
Ergonomic tactile grip and two finger trigger

Includes: Side handle

Chuck Size 1/2"

Amperage 8

No Load RPM 0-850

Chuck Type Keyless

Tool Weight 5.6 lbs.

Mfg. No 0302-20

Model No. TEA092

Price/Each \$232.16



HAMMER DRILLS



PISTOL GRIP DUAL TORQUE 1/2" HAMMER DRILLS

Features: 1/2" capacity; 7.5 Amp motor
Trigger-lock, trigger speed control in two ranges: 0-1350 RPM, 0-22 000 BPM; 0-2500 RPM, 0-40 000 BPM; reversing
Hammer with rotation or rotation only
Self-stop brush system

Includes: Depth gauge, side handle and chuck key

Chuck Size 1/2"

Amperage 7.5

No Load RPM 0-1350/0-2500

No Load BPM 0-20 000/0-40 000

Chuck Type Keyed

Tool Weight 6.0 lbs.

Mfg. No 5378-21

Model No. TEA141

Price/Each \$224.12



D-HANDLE DRILLS



1/2" D-HANDLE DRILLS

Features: Heat treated metal gears for quiet performance
Trigger speed control: 0-500 rpm, reversing,
Can be used with our right angle drive attachment to increase versatility

Includes: Side handle and chuck key with holder

Chuck Size 1/2"

Amperage 7

No Load RPM 0-500

Chuck Type Keyed

Tool Weight 6.8 lbs.

Mfg. No 1107-6

Model No. TF058

Price/Each \$331.65



1/2" SPADE HANDLE DRILLS

Features: Variable speed reversing switch avoids air bubbles when mixing mud and offers greater control, 0-550 RPM provides increased torque for drilling and mud mixing, soft grip handle provides comfort and ergonomics

Includes: 3-position side handle, chuck key with holder and 2-position rear spade handle

Chuck Size 1/2"

Amperage 9

No Load RPM 0-550

Chuck Type Keyed

Tool Weight 7.5 lbs.

Mfg. No DW130V

Model No. TKZ843

Price/Each \$205.56



1/2" DRILLS WITH HANDLE

Features: Rocker switch for easy one handed reversing
Double gear reduction for added torque
Rear handle rotates 360°

Includes: Side handle and chuck key

Chuck Size 1/2"

Amperage 6.3

No Load RPM 550

Chuck Type Keyed

Tool Weight 6.2 lbs.

Mfg. No 6013BR

Model No. TF481

Price/Each \$214.07



CORDED DRILLS



D-HANDLE DRILLS



1/2" COMPACT DRILLS

Features: Made for two handed operation, Rear mounted assist spade handle Heat treated gears are helical-cut for quiet performance

Includes: Pipe handle

Chuck Size 1/2"

Amperage 7

No Load RPM 500

Chuck Type Keyed

Tool Weight 11.4 lbs.

Mfg. No 1660-6

Model No. TF092

Price/Each \$336.68



3/4" LARGE DRILLS

Heavy duty aluminum alloy housing
Powerful reversing motor
Drive shafts run smoothly on pre-lubricated ball-bearings

Pipe handle

3/4"

10

350

Keyed

19 lbs.

1854-1

TF103

\$893.45



1/2" D-HANDLE RIGHT ANGLE DRILLS

Heat treated metal gears for quiet performance
All ball and roller bearings
Head and handle swivel 360°

Carrying case, RAD assembly, side handle, 9/16" open end wrench, 3/16" socket wrench and chuck remover bar

1/2"

7

335/500/750

Keyed

10.3 lbs.

3102-6

TF198

\$439.19



RIGHT ANGLE DRILLS



1/2" RIGHT ANGLE DRILLS

Features: Three speed ranges. 400/900 rpm for right angle drilling and 600 rpm for straight, Die-cast metal gear housing for jobsite durability, 5-position side handle

Includes: Chuck key with holder, 5-position handle, Allen wrench and heavy-duty kit box

Chuck Size 1/2"

Amperage 7

No Load RPM 400/600/900

Chuck Type Keyed

Tool Weight 9.75 lbs.

Mfg. No DW120K

Model No. TW249

Price/Each \$413.32



1/2" SUPER HAWG™

Two operating speeds of 1750 and 450 rpm with a clutch in the low gear range
Grip Roto-Lok® handle features 3 positions with 90° left-right rotation

Side handle

1/2"

13

450/1750

Keyed

14.7 lbs.

1680-21

TEA124

\$610.04



3/8" ANGLE DRILLS

Built-in LED job light and reduced head height (2.5/8")
Compact (10 5/8" length) design for close quarters
Paddle switch with speed limiting dial

Grip, chuck key with holder

3/8"

4

0-2400

Keyed

3.1 lbs.

DA3010F

TF811

\$312.56



HAMMER DRILLS



1/2" VSR SINGLE SPEED HAMMER DRILLS

Features: Lightweight design for less user fatigue, Dual mode hammer drill/drill for wood, steel or masonry applications
Variable speed allows for precise hole placement on work surface

Includes: 360° side handle, depth rod and chuck key with holder

Chuck Size 1/2"

Amperage 6.7

No Load RPM 0-2700

No Load BPM 0-46 000

Chuck Type Keyed

Tool Weight 4.3 lbs.

Mfg. No DW511

Model No. TSW576

Price/Each \$144.02



1/2" DUAL TORQUE HAMMER DRILLS

Trigger speed control in two ranges: 0-1350 rpm, 0-22 000 BPM, 0-2500 rpm, 0-40 000 BPM, reversing, A removable side handle assists in setting the depth rod for pre-set hole drilling
Hammer with rotation or rotation only

Depth gauge, side handle and chuck key

1/2"

7.5

0-1350/0-2500

0-20 000/0-40 000

Keyed

6.0 lbs.

5378-20

TT928

\$221.10



1/2" HAMMER DRILLS WITH CARRYING CASE

Anti-vibration system (AVS): Delivers maximum comfort by minimizing vibration, 2-mode operation: Hammer drill/drill for maximum versatility in wood, metal, and concrete, 2-speed gear box: Allows the user to select the correct drilling speed for the material and accessory, 360° side handle with depth gauge

Depth gauge, removable side handle and carrying case

1/2"

9

0-1500/0-3500

0-24 000/0-56 000

Keyed

7.3 lbs.

5380-21

TLZ439

\$234.17



HAMMER DRILLS



1/2" VSR DUAL RANGE HAMMER DRILLS

Features: High/low speed for high speed drilling or high torque applications
Lightweight design for less user fatigue
360° side handle with depth rod offers greater control

Includes: Side handle, chuck key and plastic carrying case

Chuck Size 1/2"

Amperage 7.8

No Load RPM 0-1100/0-2700

No Load BPM 0-19 000/0-46 000

Chuck Type Keyed

Tool Weight 4.8 lbs.

Mfg. No DW5050

Model No. TD944

Price/Each \$189.04



1/2" VSR DUAL RANGE HAMMER DRILLS

Features: High/low speed for high speed drilling or high torque applications
8.2 Amp motor provides high performance and overload protection
360° side handle with depth rod offers greater control

Includes: Heavy-duty kit box, 360° side handle, depth rod and chuck key with holder

Chuck Size 1/2"

Amperage 8.2

No Load RPM 0-1100/0-2700

No Load BPM 0-19 000/0-46 000

Chuck Type Keyed

Tool Weight 5.3 lbs.

Mfg. No DW520K

Model No. TKZ841

Price/Each \$229.45



1/2" TWO-SPEED IMPACT DRILLS

Features: Thumbwheel for preselecting of speed.
Die cast aluminum gear housing. Two-speed gear unit.
Clockwise and anticlockwise rotation.
Auto-stop carbon brushes

Includes: Chuck key, long side handle, depth guide and carrying case

Chuck Size 1/2"

Amperage 6.2

No Load RPM 0-1000/0-3000

No Load BPM 0-57 000

Chuck Type Keyed

Tool Weight 5.2 lbs.

Mfg. No SBE750

Model No. TKZ001

Price/Each \$395.90



ROTARY HAMMERS



1" THREE MODE SDS ROTARY HAMMERS

Features: Three modes of operation: hammer-drill, drill only, and chipping
Variable speed allows for precise hole placement on work surface
Factory set clutch reduces sudden, high torque reactions if bit jams

Includes: 360° side handle

Solid Bit Capacity 1"

Amps 8

No Load RPM 0-850

No Load BPM 0-4300

Impact Energy 2.5 ft.-lbs

Tool Weight 5.7 lbs.

Mfg. No D25113K

Model No. TKZ858

Price/Each \$311.72



1" COMPACT SDS ROTARY HAMMERS WITH ANTI-VIBRATION



Features: Three modes of operation: hammer-drill, drill only, and chipping
The all metal, magnesium gear case and block construction provide precise bearing and gear seating for durability
Anti-Vibration System, soft grip handle and two-finger trigger

Includes: Depth gauge, side handle and carrying case

Solid Bit Capacity 1"

Amps 7

No Load RPM 0-1400

No Load BPM 0-5980

Impact Energy 2.0 ft.-lbs.

Tool Weight 7.9 lbs.

Mfg. No 5363-21

Model No. TLZ832

Price/Each \$485.42



POWER DRILL LONG SHIP AUGER BITS



Model No.	Diameter"	Shank Size"	Twist Length"	Overall Length"	Price /Each
TH663	3/8	5/16 hex	12	17	35.48
TH664	7/16	5/16 hex	12	17	38.58
TH665	1/2	5/16 hex	12	17	37.41
TH666	9/16	7/16 hex	12	17	41.04
TH667	5/8	7/16 hex	12	17	41.81
TH668	11/16	7/16 hex	12	17	44.35
TH669	3/4	7/16 hex	12	17	44.78
TH670	13/16	7/16 hex	12	17	49.06
TH671	7/8	7/16 hex	12	17	49.87
TQ661	15/16	7/16 hex	12	17	50.17
TH673	1	7/16 hex	12	17	53.43
TH674	1 1/8	7/16 hex	12	17	68.48
TH675	1 1/4	7/16 hex	12	17	75.44
TH676	1 3/8	7/16 hex	12	17	90.76
TH677	1/2	7/16 hex	12	17	95.88

POWER DRILL I-100 AUGER BITS



Model No.	Diameter"	Shank Size"	Twist Length"	Overall Length"	Price /Each
TH785	1/4	7/32 hex	4 1/2	7 1/2	16.46
TH786	5/16	7/32 hex	4 1/2	7 1/2	16.46
TH787	3/8	7/32 hex	4 1/2	7 1/2	16.60
TH788	7/16	7/32 hex	4 1/2	7 1/2	16.60
TH789	1/2	7/32 hex	4 1/2	7 1/2	16.71
TH790	9/16	5/16 hex	4 1/2	7 1/2	16.71
TH791	5/8	5/16 hex	4 1/2	7 1/2	16.78
TH792	11/16	5/16 hex	4 1/2	7 1/2	17.35
TH793	3/4	5/16 hex	4 1/2	7 1/2	18.03
TH794	13/16	5/16 hex	4 1/2	7 1/2	19.92
TH795	7/8	5/16 hex	4 1/2	7 1/2	20.67
TH796	15/16	5/16 hex	4 1/2	7 1/2	21.64
TH797	1	5/16 hex	4 1/2	7 1/2	22.30

CORDED DRILLS

ROTARY HAMMERS



1 1/8" SDS DRIVE L-SHAPE
ROTARY HAMMERS

Features: Three modes of operation: hammering, hammer-only and rotation-only. Speed control switch allows operator controlled starts for less bit walk. A 3-jaw chuck adapter kit VG088 is available.

Includes: Side handle and depth gauge

Solid Bit Capacity 1 1/8"

Amps 7.4

No Load RPM 0-980

No Load BPM 0-4200

Impact Energy 2.5 ft.-lbs.

Tool Weight 8.3 lbs.

Mfg. No 5359-21

Model No. TEA135

Price/Each \$587.93



1 3/4" SDS-MAX
ROTARY HAMMERS

Clutch reduce the tools reaction to embedded steel when bits "lock-up" in operation. Electronic Variable Speed allows the user to control the speed of drilling and chipping.

Includes: 360° side handle, depth rod and heavy-duty kit box

Solid Bit Capacity 1 3/4"

Amps 11.5

No Load RPM 140-280

No Load BPM 1330-2660

Impact Energy 8 ft.-lbs.

Tool Weight 13.4 lbs.

Mfg. No D25602K

Model No. TSW682

Price/Each \$930.79



1 9/16" SPLINE
ROTARY HAMMERS

Electronic Variable Speed allows the user to control the speed of drilling and chipping. Spline tool holder is compatible with all spline drive bits

Includes: 360° side handle, depth rod and heavy-duty kit box

Solid Bit Capacity 1 9/16"

Amps 11

No Load RPM 14-280

No Load BPM 1330-2660

Impact Energy 7.3 ft.-lbs.

Tool Weight 14.5 lbs.

Mfg. No D25553K

Model No. TSW672

Price/Each \$796.30



1 3/4" SDS-MAX
ROTARY HAMMERS

Features: AVS: anti vibration system that actively reduces user vibration, 2-speed impact mode: low reduces speed (350 RPM) and beats per minute (2200 BPM) for light materials. Constant power technology maintains drilling speed and power when the tool is under load mechanical clutch and protects the gears and provides added control

Includes: Side handle, depth rod and carrying case

Solid Bit Capacity 1 3/4"

Amperage 14

No Load RPM 0-350

No Load RPM 0-2200

Impact Energy 8.8 ft.-lbs.

Mfg. No 5426-21

Model No. TLZ834

Price/Each \$944.70



COMPACT SDS 1" ROTARY HAMMERS WITH
ANTI-VIBRATION SYSTEM

Three modes of operation: Hammer drill, drill only, chipping for maximum versatility, 2-speed mode: 0-1400 and 0-5980 RPM, Anti-vibration system, soft grip handle and two-finger trigger for optimal operator comfort, Rotating brush plate for equal power in forward and reverse for easy removal of jammed bits and extended brush life

Includes: Depth gauge, side handle and carrying case

Solid Bit Capacity 1"

Amperage 7

No Load RPM 0-1400

No Load RPM 0-5980

Impact Energy 2.0 ft.-lbs.

Mfg. No 5363-21

Model No. TLZ832

Price/Each \$485.42



5/8" SDS+ ROTARY HAMMERS

Lightweight, 4.6 lbs, compact, 10 1/4" length: Allows for work in tight spaces, Mechanical clutch: Protects tool when bit binds up, AVS - Anti vibration system: Delivers maximum comfort by minimizing vibration, 2-mode operation: Rotary hammer and rotation only for maximum versatility

Includes: 5263-20 5/8" rotary hammer, side handle, depth rod and carrying case

Solid Bit Capacity 5/8"

Amperage 5.5

No Load RPM 0-3700

No Load RPM 0-4400

Impact Energy 1.5 ft.-lbs.

Mfg. No 5263-21

Model No. TLV203

Price/Each \$271.68



2" SPLINE DRIVE ROTARY HAMMERS

Features: Large electric hammer used for drilling large holes or breaking concrete and asphalt. System of vibration absorption/reduction reduces operator fatigue. The side handle can be attached to the rear switch handle which minimizes bending over

Includes: Side handle and carrying case

Solid Bit Capacity 2"

Amps 15

No Load RPM 125-250

No Load BPM 975-1950

Impact Energy 19.9 ft.-lbs.

Tool Weight 26.2 lbs.

Mfg. No 5340-21

Model No. TFX201

Price/Each \$1619.06



POWER SCRAPERS



POWER SCRAPERS

Features: Quick change bit retainer for easy changes. Motor has auto shut-off feature when brushes must be replaced. Factory grease packed for approximately 200 hours of maintenance free operation

Includes: 1 3/16" and 2" scaling chisels, bull point, dust cover and plastic carrying case

Amps 5

No Load RPM 0-3200

Impact Energy 2.9 ft.-lbs.

Tool Weight 7 lbs.

Mfg. No HK1810

Model No. TF850

Price/Each \$627.12



CORDED DRILLS



DEMOLITION HAMMERS



DEMOLITION HAMMERS WITH ANTI-VIBRATION

Features: Anti-Vibration Technology enabled to reduce fatigue and injury due to exposure to vibration. Extra long auto cut off carbon brushes provides reduced maintenance. Electronic speed and variable control gives efficient hammering at the desired speed.

Includes: Side handle, bull point and carrying case

Solid Bit Capacity N/A

Amps 14

No Load RPM N/A

BPM 950-1900

Impact Energy 18.95 ft.-lbs.

Tool Weight 27.1 lbs.

Mfg. No HM1214C

Model No. TLY750

Price/Each \$1340.67



PAVEMENT BREAKERS

Active Vibration Control reduces user fatigue and increases comfort and productivity. Electronic soft start increases productivity by reducing bit walking. Rubber coated handles provide greater comfort and control.

N/A

15

N/A

900

61 ft.-lbs.

68.3 lbs.

D25980

TLY751

\$2385.92



SCREWGUNS



DRYWALL SCREW GUNS

Features: Variable speed control. Ramp-off depth locator for easy depth adjustments. Ergonomic tactile grip and two finger trigger for user comfort and balance

Includes: Includes belt clip

Amperage 6.5

No Load RPM 0-4000

Tool Weight 3.5 lbs.

Mfg. No 6742-20

Model No. WJ087

Price/Each \$153.77



LIGHTWEIGHT VSR DRYWALL SCREW GUNS

Depth-sensitive nosepiece for consistent fastener depth. Two-finger trigger. Helical-cut, heat-treated gears for durability.

6

0-4000

2.8 lbs

DW252

VE236

\$138.37



HIGH SPEED VSR DRYWALL SCREW GUNS

Depth-sensitive nosepiece for consistent fastener depth. Two-finger trigger. Helical-cut, heat-treated gears for durability.

6

0-5300

2.9 lbs.

DW255

TSW573

\$121.25



IMPACT WRENCHES



1/2" IMPACT WRENCHES

Features: Pin-detent system to retain sockets or adapters and a rocker switch for quick selection of forward or reverse. Ergonomic handle with a soft cushioned grip provides a well-balanced and controllable feel to the tool. Rocker switch for quick selection of forward and reverse

Includes:

Socket Size 1/2"

Amperage 7

Torque 300 ft.-lbs.

No Load RPM 1800

No load IPM 2600

Tool Weight 6 lbs.

Mfg. No 9070-20

Model No. WJ082

Price/Each \$306.53



1/2" VSR IMPACT WRENCH KITS

Pin-detent system to retain sockets or adapters and a rocker switch for quick selection of forward or reverse. Ergonomic handle with a soft cushioned grip provides a well-balanced and controllable feel to the tool. 10 ft. Quik-Lok® 2-wire cord

Includes: Includes case and 6 sockets

1/2"

7

100-300 ft.-lbs.

600-1800

1000-2600

6 lbs.

9072-22

WJ083

\$401.00



1/2" (13MM) IMPACT WRENCHES

Forward/Reverse rocking switch. Soft grip handle. Ball bearing construction for durability.

1/2"

7.5

345 ft.-lbs.

2100

2700

7 lbs.

DW293

TDX438

\$268.87



IMPACT WRENCHES



1/2" IMPACT WRENCHES

Features: Heavy-duty aluminum gear housing. Rubber inlay grip reduces vibration. Rocker switch for forward and reverse.

Includes: Plastic carrying case

Socket Size 1/2"

Amperage 3.5

Torque 258.2 ft.-lbs.

No Load RPM 2000

No load IPM 2000

Tool Weight 6.4 lbs.

Mfg. No TW0350

Model No. TDX437

Price/Each \$299.49



3/4" IMPACT WRENCHES

3/4" detent pin anvil. Forward/Reverse rocking switch. Soft grip handle.

Ball bearing construction

3/4"

7.5

345 ft.-lbs.

2100

2700

7 lbs.

DW294

TDX439

\$373.39



3/4" IMPACT WRENCHES

Rocker reversing switch for one handed forward/reverse operation. Side handle adjusts 360°. Heavy duty rubber bumper in front.

Steel carrying case and grip assembly

3/4"

9

433 ft.-lbs.

1500

1600

11 lbs.

6906

TF646

\$677.37



IMPACT WRENCHES



3/4" IMPACT WRENCHES

Features: Rocker switch for quick selection of forward and reverse. Friction ring socket retention. Light weight with balanced feel and cushioned grip

Includes:

Socket Size 3/4"

Amperage 7

Torque 380 ft.-lbs.

No Load RPM 1750

No load IPM 2500

Tool Weight 6.2 lbs.

Mfg. No 9075-20

Model No. TEA202

Price/Each \$481.40



4-PIECE AUGER SETS

- Double wing spurs for clean hole cutting
- Non-stick coated flutes for faster chip ejection
- Impact rated shank
- Canvas roll-up pouch for easy storage and job site organization
- Includes: 1/2" auger bit, 3/4" auger bit, 7/8" auger bit, 1" auger bit

Model No. TBO615

Price/Each \$65.82



MAGNETIC DRILLING MACHINES



COMPACT ELECTROMAGNETIC DRILL PRESSES

Features: Two-coil magnet provides 2 300 lbs. of dead lift force on 1 in. thick steel. Light weight with carrying handle. Feed handle can be relocated to the opposite side without tools

Includes: Lubricant bottle, nylon safety strap and two hex wrenches

Amps 9

Drill Capacity 1/2"

No Load RPM 450

Drill Point Pressure 750 lbs.

Drill Travel 6.6"

Tool Weight 26.5 lbs.

Mfg. No 4270-20

Model No. WK773

Price/Each \$1555.74



1/2" ADJUSTABLE POSITION ELECTROMAGNETIC DRILL PRESSES

Solid state electronic switching. Feedback speed control. Line Lock-Out prevents tool from operating should voltage be restored to an interrupted line

7.2

1/2"

600

1610/1650 lbs.

9"

57 lbs.

4204-1

TF318

\$2107.49



3/4" FIXED POSITION ELECTROMAGNETIC DRILL PRESSES

Solid state electronic switching. Feedback speed control. Line Lock-Out prevents tool from operating should voltage be restored to an interrupted line

12.5

3/4"

350

1630/1670 lbs.

9"

62 lbs.

4210-1

TF322

\$2288.39



CORDED DRILLS



MAGNETIC DRILLING MACHINES



3/4" ADJUSTABLE POSITION ELECTROMAGNETIC DRILL PRESSES

Features: Solid state electronic switching. Feedback speed control. Line Lock-Out prevents tool from operating should voltage be restored to an interrupted line.

Amps	12.5
Drill Capacity	3/4"
No Load RPM	350
Drill Point Pressure	1630/1670 lbs.
Drill Travel	11"
Tool Weight	70 lbs.
Mfg. No	4206-1
Model No.	TF319
Price/Each	\$2460.24



1 1/4" ADJUSTABLE POSITION ELECTROMAGNETIC DRILL PRESSES

Features: Solid state electronic switching. Feedback speed control. Line Lock-Out prevents tool from operating should voltage be restored to an interrupted line.

Amps	12.5
Drill Capacity	1 1/4"
No Load RPM	500/250
Drill Point Pressure	1530/1600 lbs.
Drill Travel	11"
Tool Weight	72 lbs.
Mfg. No	4208-1
Model No.	TF320
Price/Each	\$2687.37



1 1/4" ADJUSTABLE POSITION ELECTROMAGNETIC DRILL PRESSES

Features: Solid state electronic switching. Feedback speed control. Line Lock-Out prevents tool from operating should voltage be restored to an interrupted line.

Amps	12.5
Drill Capacity	1 1/4"
No Load RPM	750/375
Drill Point Pressure	1530/1600 lbs.
Drill Travel	11"
Tool Weight	72 lbs.
Mfg. No	4209-1
Model No.	TEA125
Price/Each	\$2687.37



MAGNETIC DRILLING MACHINES



3/4" MOTOR FOR ELECTROMAGNETIC DRILL PRESSES

Features: Dual mount gear case. Reverse mount for tight quarter drilling. Taps up to 1 inch-14 threaded hole. Develops up to 1670 pounds of drill point pressure with a 1 inch steel plate.

Amps	11.5
Drill Capacity	3/4"
No Load RPM	350
Drill Point Pressure	1630/1670 lbs.
Drill Travel	N/A
Tool Weight	21
Mfg. No	4262-1
Model No.	TF328
Price/Each	\$928.62



Look for this symbol



for environmentally friendly products!

CORING RIGS



DIAMOND CORING RIGS WITH SMALL BASE, VAC-U-RIG® KIT, METER BOX AND MOTOR

Features: Cast aluminum base with four levelling screws for adjustment. Durable precision-ground 2 1/2" steel column, 43 1/2" high. Rear mounted rack and pinion feed.

Includes:	4096 Diamond Coring Motor
Height	43 1/2"
Wheels	Yes
Vac Base	Yes
Vac Pump	Yes
Motor	Yes
Meter Box	Yes
Tool Weight	111.5 lbs.
Mfg. No	4115-22
Model No.	VH886
Price/Each	\$3210.98



DIAMOND CORING RIGS WITH LARGE BASE, VAC-U-RIG® KIT, METER BOX AND MOTOR

Features: Cast aluminum base with four levelling screws for adjustment. Durable precision-ground 2 1/2" steel column, 43 1/2" high. Rear mounted rack and pinion feed.

Includes:	4096 Diamond Coring Motor
Height	43 1/2"
Wheels	Yes
Vac Base	Yes
Vac Pump	Yes
Motor	Yes
Meter Box	Yes
Tool Weight	115.3 lbs.
Mfg. No	4120-22
Model No.	VH889
Price/Each	\$3311.48



DIAMOND CORING LARGE BASE STANDS

Features: Cast aluminum base with four levelling screws for adjustment. Durable precision-ground 2 1/2" steel column, 43 1/2" high. Rear mounted rack and pinion feed.

Includes:	Jackscrew for ceiling and back wall bracing
Height	43 1/2"
Wheels	Yes
Vac Base	Yes
Vac Pump	No
Motor	No
Meter Box	No
Tool Weight	67 lbs.
Mfg. No	4120
Model No.	TEA017
Price/Each	\$1029.12



HEAVY-DUTY VARIABLE TEMPERATURE HEAT GUNS

- LED digital readout display
- Removable air filter
- Ceramic encapsulated heating element
- Thermo protection prevents tool from overheating

Model No. TEA200
Mfg. No. 8988-20
Air volume: Cool air only: 7.06 cu.ft./min.
 Low air with heat: 8.83 cu.ft./min.
 High air with heat: 15.89 cu.ft./min.
Air temperatures: 90°F-1050°F
Motor: 120 V AC, 12.5 A
Weight: 2.0 lbs.
Price/Each \$230.15



VARIABLE TEMPERATURE HEAT GUNS

- Electronic control for progressive temperature variation
- 3-speed settings
- 13 A, 1400 W
- Air temperatures: 50/350/550°C
- 3 CFM settings: 8.8, 12.4, 17.7

Model No. TKZ033
Mfg. No. H1600
Price/Each \$152.80



HEAVY-DUTY DUAL TEMPERATURE HEAT GUNS

- Increases surface temperature to required working temperature faster than conventional hot air heat guns
- 3-position rocker switch: off, high and low
- Impact resistant heating element
- Support stand enables gun to be stationary for workbench or assembly work

Model No. TF714
Mfg. No. 8975-6
Air volume: 14.8 cu.ft./min.
Air temperatures: 570° F/1000°F
Motor: 120 V AC, 11.6 A
Weight: 1.6 lbs.
Price/Each \$109.65



HEAVY-DUTY VARIABLE TEMPERATURE HEAT GUN KITS

- Increases surface temperature to required working temperature faster than conventional hot air heat guns
- Impact resistant heating element
- Support stand enables gun to be stationary for workbench or assembly work
- Includes: accessory assortment and impact resistant carrying case

Model No. TF718
Mfg. No. 8985
Air volume: 14.8 cu.ft./min.
Air temperatures: 140°F-1040°F
Motor: 120 V AC, 11.6 A
Weight: 1.6 lbs.
Price/Each \$203.01



HEAVY-DUTY VARIABLE TEMPERATURE HEAT GUN KITS

- Impact resistant heating element
- Removable air filter
- Ceramic encapsulated heating element
- Thermo protection prevents tool from overheating
- Includes: air reduction nozzle and hook nozzle

Model No. WJ097
Mfg. No. 8978-20
Air volume: 14.8 cu.ft./min.
Air temperatures: 200°F-1050°F
Motor: 120 V AC, 12.5 A
Weight: 1.8 lbs.
Price/Each \$213.06



ACCESSORIES

AIR REDUCTION NOZZLE

- Intensified heat in a specific area – soldering

Model No. TF373 **Mfg. No.** 49-80-0297
Price/Each \$19.24

HOOK NOZZLE

- For surround-bending, soldering pipe or shrinking tubing

Model No. TF370 **Mfg. No.** 49-80-0292
Price/Each \$19.24

DEFLECTOR

- Deflects air away from glass when stripping paint or softening putty

Model No. TF371 **Mfg. No.** 49-80-0293
Price/Each \$19.48

AIR SPREADER

- Intensified heat for removing floor coverings, paint burning and vinyl top removal

Model No. TF372 **Mfg. No.** 49-80-0294
Price/Each \$19.48

ACCESSORY ASSORTMENT

- Includes TF373, TF370, TF371 and TF372

Model No. TF374 **Mfg. No.** 49-80-0300
Price/Each \$59.65

THERMOCOUPLE HEAT GUNS

- Precise temperature maintained by thermocouple control
- Variable temp. control 250°F - 1100°F
- 2-speed blower setting for 8 CFM or 14 CFM
- 12.5 A
- 10" overall length
- Weight: 1.3 lbs.
- Heating element protected by ceramic core for longer tool life

Model No. TF849 **Mfg. No.** HG1100
Price/Each \$139.70



ACCESSORIES



Model No.	Description	Price/Each
TD196	Wide-Angle Slit Nozzle	54.28
TD197	Large Reflector Nozzle	25.66
TD198	Reflector Nozzle	15.90
TD199	PVC Plastic Welding Rods 16/pkg	14.41
TD200	ABS Plastic Welding Rods 16/pkg	21.20
TD201	Plastic Welding Nozzle (attaches to D)	10.39
TD202	3" Surface Nozzle	14.83
TD203	3/8" Reduction Nozzle	12.30
TD204	9/16" Reduction Nozzle	12.30
TD205	25/32" Reduction Nozzle	12.30
TD206	3/8" Reflector Nozzle	20.56
TD207	3" Window Nozzle	14.83

HEAT GUNS



1500 W ELECTRONIC HOT AIR GUNS

- Electronically controlled hot air gun with continuously variable temperature
- Ceramic-encapsulated heating element
- Heating element has the *Steinel*® thermocouple technology

Model No. ZD551
Mfg. No. HG2000E
Price/Each \$240.20



ACCESSORIES



WJ583



WJ584



WJ585



WJ586



WJ587



WJ588



WJ589



WJ590



WJ591



WJ592



WJ593

Model No.	Mfg. No.	Description	Price /Each
WJ583	07081-1	Reduction Nozzle 20 mm	15.83
WJ584	07071-2	Reduction Nozzle 14 mm	15.83
WJ585	07061-3	Reduction Nozzle 9 mm	31.66
WJ586	07461-1	Soldering Reflector Nozzle	18.34
WJ587	07051-4	Reflector Nozzle	15.83
WJ588	07031-6	Window Nozzle 50 mm	15.83
WJ589	07011-8	Surface Nozzle 50 mm	15.83
WJ590	07471-0	Wide-Slit Nozzle	32.41
WJ591	07301-0	Large Reflector Nozzle	22.36
WJ592	07041-5	Window Nozzle 75 mm	15.83
WJ593	07021-7	Surface Nozzle 75 mm	15.83

HB 1750 HEAT BLOWERS

- Powerful turbine blower with air delivery rate up to 23 CFM
- Colour coded keys for the right temperature every time
- Maintenance free factory sealed motor
- Lightweight, well balanced design
- Soft grip handle with convenient slide switch
- Ultra quiet operation
- Plug-in heating element takes only seconds to change
- Quick-lock stand is fully adjustable and stores keys
- Applications: Packaging, paint drying, window tinting, stripping paint, cable assembly
- Includes: Quick lock stand, 5 temperature keys, large reflector, spare element, silver case

Model No TLV254
Mfg. No. 34759
Price/Each \$249.95



TLV255



TLV256



TLV257



TLV258

ACCESSORIES

Model No.	Mfg. No.	Description	Price/Each
TLV255	07695	7 mm Reducer Nozzle	45.95
TLV256	07725	200 mm Spreader Nozzle	54.95
TLV257	07705	50 mm Large Reflector Nozzle	22.95
TLV258	07715	20 mm Small Reflector Nozzle	16.95

Can't find what you're looking for?
Call us today!



ENGRAVERS

The model **TF191** engraver is the perfect tool for personalizing and protecting your valuables.



DREMEL®

Model No.	Mfg. No.	Description	Price/Each
TF191	290-01	Engraver	38.94
TF794	9924	Carbide replacement point	11.51
TF796	9929	Diamond engraving point	35.52

DREMEL® TWO-SPEED ROTARY TOOL KITS

- Ideal for multiple applications on a variety of materials
- Two-speed control allows you to set your speed at 15 000 or 35 000 RPM
- **Includes:** 1 attachment and 15 accessories

Model No. WJ132
Mfg. No. 200-1/15
Price/Each \$129.00



DREMEL®

DREMEL® VARIABLE SPEED ROTARY TOOL KITS

- 3000 Series variable speed rotary tool
- Multipurpose grinding guide attachment
- Includes storage case and 28 genuine *Dremel*® accessories

Model No. TLV170
Mfg. No. 3000-2/28
Price/Each \$177.48



DREMEL® MULTI-MAX OSCILLATING TOOLS

- Multi-tasking tool with fast side-to-side motion
- Optimal control, safe operation, high precision, minimal dust
- For cutting, grinding, sanding, scraping and grout removal

Model No. TLY789
Mfg. No. 6300-02
Price/Each \$205.67



DREMEL®

DREMEL®

DREMEL® MINIMITE CORDLESS ROTARY TOOLS

- Features two speeds and can be used with any *Dremel*® accessory bit with up to a 1/8" shank
- Ideal performance for small craft projects
- Lightweight and compact for precision and control
- 4.8 V battery and charger

Model No. TLV261
Mfg. No. 7300-N/8
Price/Each \$69.95



DREMEL® CORDLESS LITHIUM-ION ROTARY TOOLS

- Fastest, strongest performing cordless rotary tool available
- Can be used with all *Dremel*® accessories and attachments
- Lithium-ion battery maintains charge up to two years while in storage

Model No. TLY791
Mfg. No. 8200-2/28
Price/Each \$169.76



DREMEL®

DREMEL® ATTACHMENTS

(ALL ROTARY TOOLS & BITS ARE SOLD SEPARATELY)

FLEX-SHAFT ATTACHMENTS

Flexible 36" shaft allows fingertip control for polishing, carving, sanding, engraving and more.

Model No. TW002
Mfg. No. 225
Price/Each \$52.60



WORK STATIONS

Functions as an articulating drill press that rotates 90°, rotary tool holder, and flex-shaft tool stand

- Detents click the tool in place in 15° increments from vertical to horizontal
- "Crow's Nest" provides on-board storage for *Dremel*® accessories
- Durable, die-cast aluminum base

Model No. TGZ380
Mfg. No. 220-01
Price/Each \$84.81



FLEX-SHAFT TOOL HOLDERS

Conveniently suspends *Flex-Shaft* tools above workbench.

Model No. TW001
Mfg. No. 2222
Price/Each \$42.04



RIGHT-ANGLE ATTACHMENTS

Allows to get to hard-to reach areas.

Model No. WJ125
Mfg. No. 575
Price/Each \$43.37



DREMEL® 160 PIECE ACCESSORY SETS

- This kit contains 160 genuine *Dremel*® accessories including 8 EZ Lock accessories to accomplish almost any job

Model No. TLV147
Mfg. No. 710-02
Price/Each \$90.20



DREMEL®

SAW BLADES

ICE HARDENED™ HOLE SAW KITS

Ice Hardened™ products utilize a proprietary cryogenic hardening process (harden to the core by minimizing soft metal and creating more hard metal) that improves upon traditional heat treat processes.

Features & benefits:

- Ice Hardened™ for up to 50% longer life
- Optimized tooth form for up to 2x faster cutting
- Functional slots for faster plug removal

15-PC GENERAL PURPOSE ICE HARDENED™ HOLE SAW KIT

Comes with:

- Eleven (11) hole saws: 3/4", 7/8", 1", 1 1/8", 1 3/8", 1 1/2", 1 3/4", 2", 2 1/8", 2 1/4", 2 1/2"
- Two (2) arbors: **VH701, TBO276**
- Two (2) drill bits: **TW232**
- One (1) adapter: **VH066**
- One (1) spacer: **VH435**
- Space for additional hole saws

Model No. **TBO157**
Price/Each **\$211.03**



19-PC MASTER ELECTRICIANS ICE HARDENED™ HOLE SAW KIT

Comes with:

- Fourteen (14) hole saws: 3/4", 7/8", 1 1/8", 1 3/8", 1 1/2", 1 3/4", 2", 2 1/4", 2 1/2", 2 5/8", 3", 3 5/8", 4 1/8", 4 3/4"
- Two (2) arbors: **VH701, TBO276**
- Three (3) drill bits: **TW232**
- One (1) adapter: **VH066**
- One (1) spacer: **VH435**
- Space for additional hole saws

Model No. **TBO159**
Price/Each **\$324.58**



28-PC ALL PURPOSE PROFESSIONAL ICE HARDENED™ HOLE SAW KIT

Comes with:

- Twenty-two (22) hole saws: 3/4", 7/8", 1", 1 1/8", 1 1/4", 1 3/8", 1 1/2", 1 3/4", 2", 2 1/8", 2 1/4", 2 1/2", 2 5/8", 3", 3 1/4", 3 3/8", 3 5/8", 3 3/4", 4 1/8", 4 1/4", 4 1/2", 4 3/4"
- Three (3) arbors: **VH070, VH701, TBO276**
- Three (3) drill bits: **TW232**
- Space for additional hole saws

Model No. **TBO165**
Price/Each **\$482.36**



10-PC PLUMBERS ICE HARDENED™ HOLE SAW KIT

Comes with:

- Six (6) hole saws: 3/4", 7/8", 1 1/8", 1 1/2", 1 3/4", 2 1/4"
- Two (2) arbors: **VH701, TBO276**
- Two (2) drill bits: **TW232**
- One (1) adapter: **VH066**
- One (1) spacer: **VH435**
- Space for additional hole saws

Model No. **TBO163**
Price/Each **\$129.38**



10-PC ELECTRICIANS ICE HARDENED™ HOLE SAW KIT

Comes with:

- Six (6) hole saws: 7/8", 1 1/8", 1 1/4", 1 1/2", 2", 2 1/2"
- Two (2) arbors: **VH701, TBO276**
- Two (2) drill bits: **TW232**
- One (1) adapter: **VH066**
- One (1) spacer: **VH435**
- Space for additional hole saws

Model No. **TBO160**
Price/Each **\$131.95**



18-PC MASTER PLUMBERS ICE HARDENED™ HOLE SAW KIT

Comes with:

- Thirteen (13) hole saws: 3/4", 7/8", 1 1/8", 1 3/8", 1 1/2", 1 3/4", 2 1/4", 2 5/8", 3", 3 1/2", 4", 4 1/4", 4 1/2"
- Two (2) arbors: **VH701, TBO276**
- Three (3) drill bits: **TW232**
- One (1) adapter: **VH066**
- One (1) spacer: **VH435**
- Space for additional hole saws

Model No. **TBO164**
Price/Each **\$322.57**



BIG HAWG® KITS

Big Hawk® hole cutters are specifically designed for drilling large holes in rough wood applications.

Features & benefits:

- Aggressive tooth geometry for up to ten times faster cutting than hole saws
- Deep gullets for easy plug removal
- Three hardened steel teeth provide maximum durability against unintended nail impacts.
- Cuts up to 600 holes in wood without needing to be re-sharpened
- Storage space for additional hole cutters

7-PC BIG HAWG® KIT

Comes with:

- Three (3) hole cutters: 2 1/8", 2 9/16", 3 5/8"
- One (1) arbour with pilot bit
- Two (2) pilot bits
- One (1) diamond file
- One (1) hex wrench and impact resistant case

Model No. **TBO277**
Price/Each **\$160.89**



10-PC BIG HAWG® KIT

Comes with:

- Six (6) hole cutters: 2 1/8", 2 1/4", 2 9/16", 3", 3 5/8", 4 1/4"
- One (1) arbour with pilot bit
- Two (2) pilot bits
- One (1) diamond file
- One (1) hex wrench and impact resistant case

Model No. **TBO278**
Price/Each **\$282.38**



ICE HARDENED™ & CARBIDE TIPPED HOLE SAWS

ICE HARDENED™ HOLE SAWS

Utilize a proprietary cryogenic hardening process that improves upon traditional heat treat processes. Unlike surface coatings that wear away, cryogenics harden to the core by minimizing soft metal (austenite) and creating more hard metal (martensite).

Feature & benefits:

- Ice Hardened™ for up to 50% longer life than the competition
- Optimized tooth form for up to 2x faster cutting
- Functional slots for faster plug removal
- Matrix II bi-metal teeth for greater durability



CARBIDE TIPPED 3 TEETH PER INCH HOLE SAWS

Provide longer life and faster cutting when holes are needed in ceramic tile, flake board, fibreboard, fibreglass and wood. Carbide tipped hole saws are **NOT** recommended for use on metal.

Feature & benefits:

- Carbide-tipped 3 teeth per inch design
- Sturdy 3/16" thick steel back



ICE HARDENED™

CARBIDE TIPPED

Saw diameter		Model No.	Price /Each	Model No.	Price /Each
Inches	mm				
5/8	16	TB0108	10.51	TW198	18.36
11/16	17	TB0109	10.51	-	-
3/4	19	TB0110	10.51	TW199	18.39
13/16	21	TB0111	10.51	-	-
7/8	22	TB0112	10.51	TW200	18.77
15/16	24	TB0113	10.51	-	-
1	25	TB0114	10.60	TW201	18.77
1 1/16	27	TB0115	10.60	-	-
1 1/8	29	TB0116	10.60	TW202	18.77
1 3/16	30	TB0117	10.60	-	-
1 1/4	32	TB0118	10.60	TW203	20.60
1 5/16	33	TB0119	10.60	-	-
1 3/8	35	TB0120	11.16	TW204	22.26
1 7/16	37	TB0121	11.16	-	-
1 1/2	38	TB0122	11.16	TW205	23.92
1 9/16	40	TB0123	11.16	-	-
1 5/8	41	TB0124	11.16	TW206	23.92
1 11/16	43	TB0125	11.16	-	-
1 3/4	44	TB0126	14.03	TW207	27.44
1 13/16	46	TB0127	14.03	-	-
1 7/8	48	TB0128	14.03	TW208	27.44
2	51	TB0129	14.03	TW209	30.85
2 1/16	52	TB0130	16.72	-	-
2 1/8	54	TB0131	16.72	TW210	30.85
2 1/4	57	TB0132	16.72	TW211	32.31
2 5/16	59	TB0133	16.72	-	-
2 3/8	60	TB0134	16.72	TW212	32.31
2 1/2	64	TB0135	18.45	TW213	35.88
2 9/16	65	TB0136	18.45	-	-
2 5/8	67	TB0137	18.45	TW214	37.69
2 3/4	70	TB0138	18.45	TW215	37.69
2 7/8	73	TB0139	18.78	TW216	37.69
3	76	TB0140	19.59	TW217	37.69
3 1/8	79	TB0141	19.59	-	-
3 1/4	83	TB0142	19.59	TW218	41.05
3 3/8	86	TB0143	19.59	-	-
3 1/2	89	TB0144	20.95	TW219	41.05
3 5/8	92	TB0145	23.12	-	-
3 3/4	95	TB0146	26.28	TW220	44.62
3 7/8	98	TB0147	27.39	-	-
4	102	TB0148	28.99	TW221	51.31
4 1/8	105	TB0149	31.00	-	-
4 1/4	108	TB0150	41.05	TW222	65.11
4 3/8	111	TB0151	48.34	-	-
4 1/2	114	TB0152	56.93	TW223	82.00
4 3/4	121	TB0153	63.15	-	-
5	127	TB0154	70.14	TW224	102.55
5 1/2	140	TB0155	84.16	-	-
6	152	TB0156	98.28	TW225	123.20

HOLE SAW ARBOR & PILOT DRILLS

Features & benefits:

- Quick Change VH072: Backing plate equipped with push pins which lock into holes on the backing plate of the hole saw for positive efficient transmission of torque



VH067



VH070



VH072



Model No.	For Hole Saw Diameter"	Shank"	Thread"	Will Fit Chuck Size"	Standard Pilot Included (General Purpose Wood & Metal)	Can Also be Used with 1/4" Carbide Pilot	Price /Each
VH067	9/16 to 1 3/16	1/4 round	1/2 - 20	1/4 and larger	TW229	TW233	9.59
VH070	9/16 to 1 3/16	7/16 hex	1/2 - 20	1/2 and larger	TW229	TW233	13.45
VH071	9/16 to 1 3/16	3/8 hex	1/2 - 20	3/8 and larger	TW232	-	12.32
VH072	1 1/4 and +	7/16 hex	5/8 - 18	1/2 and larger	TW229	TW233	26.93

FG4847E

SAW BLADES

UNIVERSAL-SHANK JIG-SAW BLADES

Bi-Metal - Super-tough bonded alloy steel for long life and faster cuts.

High-Carbon Steel - Tough durable carbon alloy blade for multi-purpose uses.

High-Speed Steel - General-purpose blade.

Sold in packs of 5



Length"	Width"	Teeth"	Tooth Type	Blade Material	Recommended Use	Model No.	Price /Each
GENERAL PURPOSE							
4	9/32	6	Milled and set	Bi-metal	Fast cutting, nail-embedded wood	TT427	16.14
4	9/32	10	Milled and set	Bi-metal	Fast cutting, nail-embedded wood	TT428	16.14
2 3/4	3/16	12	Milled, wavy set	Bi-metal	Scroll in wood and metal	TT429	20.60
4	9/32	6	Milled and set	High-carbon steel	Very fast rough-cutting wood	TT430	9.54
4	9/32	8	Milled and set	High-carbon steel	Fast straight-cutting wood	TT431	9.54
WOOD CUTTING							
4	9/32	6	Taper ground	Bi-metal	Very fast clean cutting	TT435	20.70
4	9/32	10	Taper ground	Bi-metal	Fast clean cutting	TT436	20.70
2 3/4	3/16	20	Taper ground	Bi-metal	Scroll cutting in wood and laminates	TT437	20.70
4	9/32	6	Ground and set	High-carbon steel	Very fast rough cutting	TT438	18.82
4	9/32	6	Taper ground	High-carbon steel	Very fast clean cutting	TT439	13.74
3 1/8	7/32	8	Taper ground	High-carbon steel	Clean cutting	TT441	11.15
4	9/32	10	Taper ground	High-carbon steel	Straight clean cutting	TT442	13.74
4	9/32	10	Taper ground	High-carbon steel	Reverse, no top splinters	TT443	16.38
2 3/4	5/32	12	Milled, wavy set	High-carbon steel	Clean scroll cutting	TT444	8.90
METAL CUTTING							
4	9/32	8	Milled and set	Bi-metal	Aluminum, non-ferrous metals	TT455	18.04
3 5/8	9/32	14	Milled, wavy set	Bi-metal	Thick over 1/4" thick	TT456	15.12
5	9/32	14	Milled, raker set	Bi-metal	Thick metal, tubing, etc.	TT457	22.51
2 3/4	9/32	18	Milled, wavy set	Bi-metal	Metal over 1/8" thick	TT458	14.47
2 3/4	9/32	24	Milled, wavy set	Bi-metal	Metal under 1/8" thick	TT459	14.47
3 5/8	9/32	24	Milled, wavy set	Bi-metal	Thin metal under 1/8" thick	TT460	21.36
2 3/4	9/32	14	Milled, raker set	High-speed steel	Metal over 1/4" thick	TT461	10.61
2 3/4	9/32	18	Milled, wavy set	High-speed steel	Metal over 1/8" thick	TT462	10.61
2 3/4	9/32	24	Milled, wavy set	High-speed steel	Metal under 1/8" thick	TT463	10.61
SPECIAL APPLICATION							
2 3/4	5/16	-	-	Carbide-tipped grit	Ceramics, tile	TT470	31.21

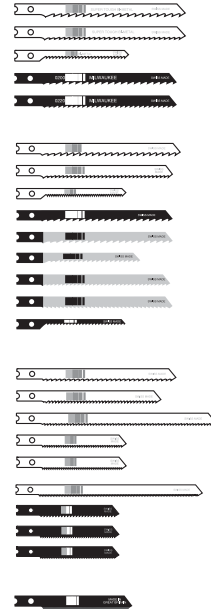

CORDED RECIPROCATING SAWS



SAWZALL® RECIPROCATING SAW KITS

Features: Powerful 12 Amp motor: Delivers 0-3000 SPM for high performance cutting in a variety of materials
3/4" Stroke length
Counter weighted mechanism: Provides reduced vibration for smoother operation
Quik-Lok™ blade clamp: Provides fast, tool-free blade changes

Includes: Sawzall® Recip saw, carrying case

Stroke Length" 3/4

Amperage 12

Strokes per minute 0-3000

Tool Weight lbs. 7.1

Mfg. No. 6509-31

Model No. TLV200

Price/Each \$174.16

RECIPROCATING SAWS, 9.0 AMPS VARIABLE SPEED

Tool-less blade change system
Blade can be inverted for near flush cutting
Accepts standard 1/2" shank blades

One saw blade

1 1/8

9.0

0-2800

7.1

JR3050TY

TFX099

\$124.62

HEAVY-DUTY 10 AMPS RECIPROCATING SAWS

4-position blade clamp
Lever-action keyless blade clamp
Variable speed trigger

Carrying case

1 1/8

10.0

0-2800

7

DW304PK

TGZ303

\$149.00



HIGH PERFORMANCE SUPER SAWZALL® BLADES

Matrix II high speed steel teeth with 8% cobalt. Tough bi-metal design for the fastest cutting, longest blade life available. 1/2" universal tang.



ICE HARDENED™ SAWZALL® BLADE FOR METAL

- Cryogenically treated to minimize soft metal (austenite) and create more hard metal (martensite) for up to 50% longer life than standard blades
- Combination of relief angles forms a radius on the back of the tooth that reduces stress build-up and extends blade life
- Precision forming process creates sharper teeth for fast cutting
- Matrix II bi-metal teeth for greater durability

ICE HARDENED™ THE TORCH® SAWZALL® BLADE FOR METAL

- All the features of Ice Hardened™ Sawzall® blade for metal, plus:
- Precision forming process creates sharper teeth for fast cutting
- A thicker, more rigid blade body resists fracturing and bending for maximum durability
- The 1" tall blade body reduces blade twisting for straighter, more accurate cuts

Dimensions L" x W" x Thick"	TPI	Recommended for Cutting	Pack of 5 Model No.	Price /Each	Pack of 50 Model No.	Price /Each
--------------------------------	-----	-------------------------	------------------------	----------------	-------------------------	----------------

WOOD CUTTING BLADES

6 x 3/4 x 0.050	6	Very fast cutting nail embedded wood and general roughing in	TW181	22.41	TE519	184.81
9 x 3/4 x 0.050	6		TW182	29.35	TE520	245.20
12 x 3/4 x 0.050	6		TW183	33.27	TE521	274.34

WOOD, NAIL EMBEDDED WOOD & DEMOLITION

6 x 1.0 x 0.062	5	Plunge cutting	TW185	25.13	-	-
9 x 1.0 x 0.062	5	Demolition work	TW186	33.37	-	-
12 x 1.0 x 0.062	5	Long demolition blade	TW187	38.34	-	-

PLASTER CUTTING BLADE

5 x 3/4 x 0.050	6	Cuts forward and backward stroke	TW188	16.53	-	-
-----------------	---	----------------------------------	-------	-------	---	---

METAL CUTTING BLADES

6 x 3/4 x 0.035	14	Metal 3/16" thru 1/4"	TW189	18.77	TE527	156.97
6 x 3/4 x 0.035	18	Metal 1/8" thru 3/16"	TW190	18.77	TE529	156.97
9 x 3/4 x 0.035	18	Metal 1/8" thru 3/16"	TW191	22.96	TE530	194.40
6 x 3/4 x 0.035	24	Metal thinner than 1/8"	TW192	18.77	TE532	156.97
4 x 3/4 x 0.035	14	Metal 3/16" thru 1/4"	TE533	13.69	-	-
9 x 3/4 x 0.035	14	Metal 3/16" thru 1/4"	TE534	22.96	TE528	194.40
12 x 3/4 x 0.035	18	Metal 1/8" thru 3/16"	TE535	28.72	TE531	240.17

ALL PURPOSE BLADES

6 x 3/4 x 0.050	8 1/2	All Woods, Nail Embedded	TW193	18.77	TE523	156.97
8 x 3/4 x 0.050	8 1/2	Composition Material, Plastic	TW194	24.12	TE524	202.99
12 x 3/4 x 0.050	8 1/2	Non-Ferrous Metals, Cast Iron	TW195	36.63	TE525	306.50

ICE HARDENED™ THE TORCH® SAWZALL® BLADE FOR METAL

6 x 1 x 0.042	10		TB0316	31.91	TB0317	572.82
6 x 1 x 0.042	14		TB0320	31.91	TB0321	572.82
6 x 1 x 0.042	18		TB0324	31.91	TB0325	572.82
9 x 1 x 0.042	14		TB0336	42.51	TB0337	753.69
9 x 1 x 0.042	18		TB0340	42.51	TB0341	753.69

ICE HARDENED™ SAWZALL® BLADE FOR METAL

6 x 1 x 0.042	14		TB0318	24.07	TB0319	403.99
6 x 1 x 0.042	18		TB0322	24.07	TB0323	403.99
6 x 1 x 0.042	24		TB0326	24.07	TB0327	403.99
6 x 1 x 0.042	8-12		TB0328	24.07	TB0329	403.99
6 x 1 x 0.042	8-12		TB0330	30.80	TB0331	518.54
9 x 1 x 0.042	14		TB0334	29.45	TB0335	494.40
9 x 1 x 0.042	18		TB0338	29.45	TB0339	494.40

Dimensions L" x W" x Thick"	Type Grit	Recommended for Cutting	Pack of 3 Model No.	Price /Each
--------------------------------	--------------	-------------------------	------------------------	----------------

TUNGSTEN CARBIDE BLADES

6 x 3/4 x 0.030	Coarse	fibreglass, ceramic tile, stone brick, plaster and marble	TW197	25.38
9 x 3/4 x 0.039	Coarse		TE536	32.61

DIAMOND GRIT THE TORCH™ SAWZALL® BLADE

Features & benefits:

- D6A steel body, durable 1" tall profile for straighter and cleaner cuts
- Featuring industrial diamond grit embedded in high strength nickel
- Blades last up to 30x longer and cut 2x faster than traditional carbide grit blades

Dimensions L" x W" x Thick"	Type Grit	Recommended for Cutting	Model No.	Price /Each
6 x 1 x 0.042	Diamond coarse	Cast iron, hard tile (grade 5), ceramic tile, plaster, masonry, brick, fibreglass and other abrasive materials	TB0299	19.65
9 x 1 x 0.042	Diamond coarse		TB0300	23.92



Wood Cutting Blade



Wood, Nail Embedded Wood and Demolition

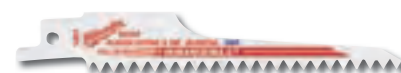

Plaster Cutting Blade



Metal Cutting Blade



All Purpose Blade



Ice Hardened™ The Torch® Sawzall® Blade for metal



Ice Hardened™ Sawzall® Blade for metal



Tungsten Carbide Blade



SAW BLADES

CONTRACTOR SAW BLADES

DIABLO® SAW BLADES

- Thin kerf, ideal for portable and low powered saws
- *Perma-Shield®* coating, keeps the blades resistant to gumming and corrosion
- Laser-cut stabilizer vents reduces vibration and heat built up

GENERAL PURPOSE

- For cutting oak, pine, plywood, pressure treated lumber and beams

Model No.	Mfg. No.	Blade Dia.™	Arbor™	No. of Teeth	Hook Grind	Price /Each
TDX901	D1040X	10	5/8	40	ATB	51.45
TDX926	D1244X	12	1	44	ATB	52.20

freud



CROSSCUT & PLYWOOD

- Smooth crosscut and plywood

Model No.	Mfg. No.	Blade Dia.™	Arbor™	No. of Teeth	Hook Grind	Price /Each
TV663	TK303	7 1/4	5/8	40	FTG	30.29
TV664	TK304	8 1/4	5/8	40	FTG	32.89
TV665	TK306	10	5/8	40	FTG	49.30

freud

INDUSTRIAL BLADES

METAL CUTTING SAW BLADE

- For cutting ferrous metals up to 25 HRC, aluminum, wood and composite material

Model No.	Mfg. No.	Blade Dia.™	Arbor™	No. of Teeth	Kerf	Price /Each
TB0728	8-40 MET	8	5/8	40	0.086	105.02
TB0729	10-48 MET	10	1	48	0.094	105.01
TRW240	12-80 MET	12	1	80	0.094	184.87
TB0730	14-90 MET	14	1	90	0.1	227.94

DIMAR



CLASSIC SERIES SAW BLADES

- Precision ground teeth
- Corrosion resistant

FRAMING & RIPPING

Model No.	Mfg. No.	Blade Dia.™	Arbor™	No. of Teeth	Hook Grind	Price /Each
TB0166	15120	6 1/2	5/8	24	ATB	11.76
WI929	15130	7 1/4	5/8	24	ATB	9.73

IRWIN
Industrial Tools



MARATHON® SAW BLADES

- Ultra thin kerf
- Face ground carbide teeth

FRAMING & RIPPING

Model No.	Mfg. No.	Blade Dia.™	Arbor™	No. of Teeth	Hook Grind	Price /Each
TBQ407	14027	5 1/2	10 mm	18	ATB	21.87
TBQ331	14011	5 1/2	10 mm	24	ATB	23.29
TBQ332	14020	6 1/2	5/8"	18	ATB	22.45
TBQ334	14029	6 1/2	5/8"	24	ATB	23.73

IRWIN
Industrial Tools



SAWS FOR NON-FERROUS METAL

- Material must be clamped firmly to the table on both sides during cutting operation and the use of coolant is very important

Model No.	Mfg. No.	Blade Dia.™	Arbor™	No. of Teeth	Kerf™	Degrees	Hook Grind	Price /Each
TRW244	7 1/4-58 N/F	7 1/4	5/8	58	0.113	-6	TCG	115.70
TRW117	10-80 N/F	10	5/8	80	0.126	-6	TCG	183.09
TRW153	10-100 N/F	10	5/8	100	0.126	-6	TCG	219.92
TRW119	12-96 N/F	12	1	96	0.126	-6	TCG	224.92

DIMAR



TCS

Feature *Freud's* newest and most resilient *PermaShield®* coating. This blade now combines *Freud's* highest quality blade with its highest quality coating. The TCS coating helps reduce blade distorting heat and makes cutting a breeze.

GENERAL PURPOSE

- Crosscut and cutoff of hard and soft woods

Model No.	Mfg. No.	Blade Dia.™	Arbor™	No. of Teeth	Kerf™	Degrees	Hook Grind	Price /Each
TT817	LU84R010	10	5/8	50	0.126	10	MCT	77.50
TT818	LU84R012	12	1	60	0.126	10	MCT	141.96

freud



CROSSCUT & FINISHING

- Ultra smooth crosscut and mitres

Model No.	Mfg. No.	Blade Dia.™	Arbor™	No. of Teeth	Kerf™	Degrees	Hook Grind	Price /Each
TT823	LU85R010	10	5/8	80	0.116	10	ATB	109.85
TT824	LU85R012	12	1	96	0.116	10	ATB	189.47



LAMINATE & CHIPBOARD

- Cuts dense abrasive man-made materials

Model No.	Mfg. No.	Blade Dia.™	Arbor™	No. of Teeth	Kerf™	Degrees	Hook Grind	Price /Each
TT838	LU98R010	10	5/8	80	0.126	-10	TCG	117.50
TT839	LU98R012	12	1	96	0.126	-10	TCG	166.30



MITRE CROSSCUT

- Crosscut and mitre of hard and soft woods

Model No.	Mfg. No.	Blade Dia.™	Arbor™	No. of Teeth	Kerf™	Degrees	Hook Grind	Price /Each
TT684	LU73M010	10	5/8	60	0.126	10	ATB	87.38
TT685	LU73M012	12	1	72	0.126	10	ATB	129.07

freud



GENERAL PURPOSE SAW BLADES

- For crosscutting thick hardwoods and softwoods (3/4" to 3 1/2") and thinner stock material (1/4" to 1")
- Anti-vibration design, *Silver Ice™* coating

Model No.	Mfg. No.	Blade Dia.™	Arbor™	No. of Teeth	Kerf™	Degrees	Hook Grind	Price /Each
TT637	LU72M010	10	5/8	40	0.126	13	ATB	75.66
TT638	LU72M012	12	1	48	0.126	13	ATB	105.06
TT639	LU72M014	14	1	54	0.138	13	ATB	140.63

freud



DOUBLE SIDED LAMINATE/MELAMINE

- Rips wood, crosscuts wood, chip board, plywood, melamine, laminate

Model No.	Mfg. No.	Blade Dia.™	Arbor™	No. of Teeth	Kerf™	Hook Grind	Price /Each
TB0361	LM97R010	10	5/8	80	0.126	TCG	111.87
TB0362	LM97R012	12	1	96	0.126	TCG	142.56

freud



LEVELING MOUNTS

Self aligning leveling mounts compensate for uneven floors or mounting deflection. Made from oil resistant non-skid, ribbed neoprene rubber. VS series are used where maximum dampening of shock is required or to prevent creeping and walking of workshop machines.

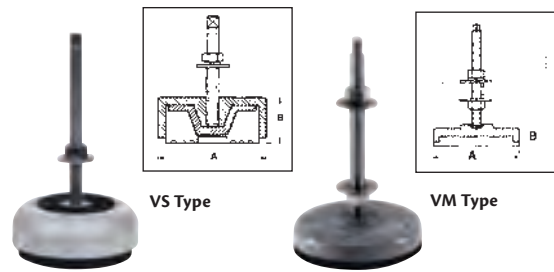

Model No.	Type	Maximum Load in lbs.		Leveling Adjustment"	Leveling Bolt Sizes"	Mount Dimensions		Price /Each
		Non-Impact Machinery	Impact			A"	B"	
UD172	VM	500	350	1.0	1/2NC x6	4.0	1	55.92
TP197	VM	1000	700	1.0	1/2NC x6	4.0	1	61.00
UA279	VM	2000	1400	1.0	5/8NC x8	4.0	1	71.17
UA278	VM	2000	1400	1.0	3/4NF x6	7.0	1 1/4	142.35
UA277	VM	4000	2800	1.0	3/4NF x6	7.0	1 1/4	149.12
UA276	VM	8000	5600	1.0	3/4NF x6	7.0	1 1/4	152.52
UA297	VM	12,000	8500	1.0	1NS x8	7.0	1 1/4	184.71
UD170	NVS	1500	1000	1/2	1/2NC x6	3.5	1 1/2	93.20
UD171	NVS	4500	3000	1/2	5/8NC x8	5.5	2	186.41
UA290	NVS	15,000	7000	1/2	1NS x8	9	2 1/4	381.29
UA289	NVS	15,000	17,000	1/2	1NS x8	9	2 1/4	389.76

ANTI-VIBRATION CUPMOUNTS

Industrial cupmounts provide excellent protection against severe impact shock, vibration and noise

- High vibration dampening characteristics
- Fail-safe, rugged interlocking metal and neoprene construction provides exceptional performance against shear and compression forces and flexible vertically and stable horizontally
- Metal cupmount component is cold-rolled steel coupled with an elastomer-in-compression design
- High-grade neoprene elastomer provides resistance to oil and ozone
- Each side flange has through holes allowing for effective attachment to supporting equipment structure

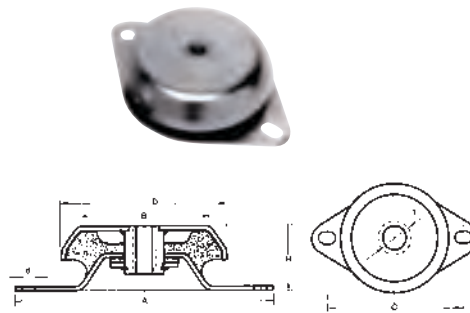

Model No.	Maximum load in lbs.		Mount Dimensions			Price /Each
	Non-impact Machinery	Impact	A"	B"	C"	
UD185	400	250	6	2 3/4	5	94.90
UD186	700	450	6	2 3/4	5	99.98
UD187	1400	900	7 11/16	4	6 3/8	140.65
UD188	2600	1700	7 11/16	4	6 3/8	145.74

CYLINDRICAL VIBRATION ISOLATORS

- Natural rubber isolators can be used on all industrial motors, compressors, fans and machinery
- Not suitable for wall or ceiling mounting applications or with use in oil or solvent soaked environments

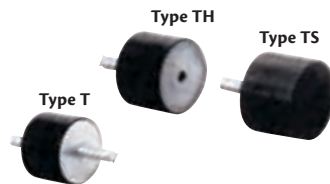

Model No.	Type	Dimensions mm				Load Cap. lbs.	Price /Each
		A	B	C	D		
UA280	T	20	15	M-6	13	55	11.37
UD167	T	20	25	M-6	13	50	12.03
UA281	T	25	25	M-8	20	85	12.59
UA282	T	25	30	M-8	20	75	13.04
UA283	T	30	30	M-8	20	175	15.01
UA284	T	35	35	M-8	20	195	18.27
UA285	T	40	30	M-10	25	330	18.92
UA286	T	40	40	M-10	25	260	20.50
UA287	TH	20	15	M-6	13	55	12.67
UA293	TH	25	25	M-8	20	85	13.98
UA294	TH	30	30	M-8	20	175	16.32
UA298	TS	20	15	M-6	13	55	10.72
UA299	TS	25	25	M-8	20	85	11.19
UA288	TS	30	30	M-8	20	175	13.53
UA300	TS	40	30	M-10	25	330	16.03

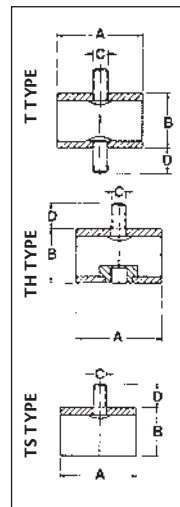

VIBRA-WEDGE ISOLATORS

- Designed for the installation and precision leveling of heavy industrial machinery
 - 3 machined wedges are mounted and held together by a horizontal adjusting bolt
 - A lock screw secures the mount in the levelled position
 - A special opening allows for bolting of the machine to the floor
- Note:** Max. levelling is 1/4" (6 mm). If more height is required use a shim plate.

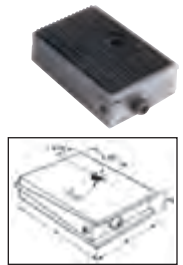

Model No.	A mm	B mm	H mm	Max. Load lbs.	Price /Each
UP587	150	100	40+/-5	15000	376.20
UP588*	150	100	50+/-5	9000	398.23

*Neoprene top and bottom included.

NEOPRENE MOUNTING PADS

- 18" x 18" x 1/4" thick pads
- Provide a way to reduce vibration and shock for lighter applications
- Sheets can be cut and can also be stacked for added isolation



Model No.	Load Range	Size"	Price /Each
UA272	40-60 PSI	18 x 18 x 1/4	57.62

NEOPRENE VIBRATION PADS

Install machinery and equipment on double sided moulded neoprene pads to isolate vibration, shock and reduce noise level. Waffle design allows material expansion without losing stability. Pads should be cut to the size of machines feet allowing 1/2" margin on all sides. Pads resist oil and solvents.

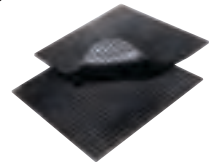

Model No.	Load Range	Size"	Price /Each
UA295	1-25 PSI	18 x 18 x 5/16	91.51
UA291	10-50 PSI	18 x 18 x 5/16	93.20
UA270	40-100 PSI	18 x 18 x 5/16	94.90
UD168	75-200 PSI	18 x 18 x 1/2	127.09
UA292	150-300 PSI	18 x 18 x 1/2	132.18
UA273	1-25 PSI	6 x 6 x 5/16	13.56
UA271	10-50 PSI	6 x 6 x 5/16	13.56
UA275	40-100 PSI	6 x 6 x 5/16	15.26
UA274	75-200 PSI	6 x 6 x 1/2	20.33
UA296	150-300 PSI	6 x 6 x 1/2	22.03



DRILL CHUCKS

PLAIN BEARING CHUCKS

- For medium or heavy-duty portable, bench or floor-mounted power tools
- Exceptionally high accuracy, gripping power and durability
- Wide range of capacities for use on threaded and taper-mounted spindles
- Jaws treated to ensure thread life and high gripping surface hardness
- 1-piece sleeve

TAPER-MOUNTED – HEAVY-DUTY MODELS

- Fluted sleeve standard except model **TB844**, which is smooth and ground
- Chucks with minimum capacity of 0" will hold a No. 60 (0.040") drill
- Models **TB839** and **TB846** are equipped with a positive drive slot
- Models **TB840** and **TB847** are equipped with a pin-type positive drive
- Model **TB844** is equipped with locking collar - 1 1/16-20 thread

Model No.	Mfg. No.	Cap. Min."	Cap. Max."	Mfg. Mount	Key No.	Price /Each
TB838	3A	0.125	0.625	3JT	K3	204.64
TB839	3KD	0.125	0.625	3JT	K3	279.04
TB840	3PD	0.125	0.625	3JT	K3	321.18
TB841	34-02	0.040	0.500	2JT	K3	127.91
TB842	34-06	0.040	0.500	6JT	K3	170.68
TB002	34-33	0.040	0.500	33JT	K3	147.72
TB844	34-33C	0.040	0.500	33JT	K3C	133.61
TB845	36	0.180	0.800	3JT	K4	260.44
TB846	36KD	0.180	0.800	3JT	K4	251.69
TB847	36PD	0.180	0.800	3JT	K4	247.53

TAPER-MOUNTED – MEDIUM-DUTY MODELS

- Fluted sleeve standard except models **TB848** and **TB849**, which are smooth and ground
- All series 33 Plain Bearing Chucks are hammer capable
- Chucks with a minimum capacity of 0" will hold a No. 60 (0.040") drill except model **TB848** which will hold a No. 80 (0.0135") drill
- Model **TB855** is equipped with a positive drive slot

Model No.	Mfg. No.	Capacity Min."	Capacity Max."	Mfg. Mount	Key No.	Price /Each
TB848	0	0.135	0.156	0JT	K0	113.29
TB849	1A	0.040	0.250	1JT	K1	92.73
TB850	2A	0.040	0.375	2JT	K2	128.04
TB853	33	0.08	0.500	33JT	K32	143.37
TB854	3326A	0.08	0.500	.6250	K32	182.75
TB855	33KD	0.08	0.500	33JT	K32	157.38

THREAD-MOUNTED – HEAVY-DUTY MODELS

- Fluted sleeve standard on all models
- Chuck with a minimum capacity of 0" will hold a No. 60 (0.040") drill

Model No.	Mfg. No.	Cap. Min."	Cap. Max."	Mfg. Mount	Key No.	Price /Each
TB856	3B 5/8	0.125	0.625	5/8-16	K3	206.26
TB857	7BA 3/8	0	0.250	3/8-24	K7	105.54
TB859	3B	0.125	0.625	1/2-20	K3	155.29
TB860	36B3/4	0.188	0.800	3/4-16	K4	296.55
TB861	36B 5/8	0.188	0.800	5/8-16	K4	310.29

THREAD-MOUNTED – MEDIUM-DUTY MODELS

- Fluted sleeve standard except models **TB862**, **TB863** and **TB866**, which are smooth and ground
- Chucks with a minimum capacity of 0" will hold a No. 60 (0.040") drill except model **TB862** which will hold a No. 80 (0.0135") drill

Model No.	Mfg. No.	Capacity Min."	Capacity Max."	Mfg. Mount	Key No.	Price /Each
TB862	0B 5/16	0	0.156	5/16-24	K0	141.16
TB863	1B3/8	0.040	0.250	3/8-24	K1	94.16
TB864	2BA 3/8	0.040	0.375	3/8-24	K2	125.85
TB865	41BA 3/8	0.040	0.375	3/8-24	K30	48.95
TB866	41BA 3/8-S	0.040	0.375	3/8-24	K30	111.62
TB867	41BA 1/2	0.040	0.375	1/2-20	K30	147.72
TB868	33BA1/2	0.08	0.500	1/2-20	K32	128.14
TB869	33BA 3/8	0.08	0.500	3/8-24	K32	135.70
TB870	33BA 5/8	0.08	0.500	5/8-16	K32	133.56



Taper-Mounted



Thread-Mounted

BALL BEARING CHUCKS

- For heavy-duty, close tolerance production drilling
- Fits jig borers, milling machines, lathes and radials
- Ball thrust bearings reduce friction
- Jaws are centre-ground for absolute straightness and alignment
- Jaws treated to ensure extended life and high gripping surface hardness
- 1-piece sleeve
- Fluted sleeve standard



Model No.	Mfg. No.	Capacity Min."	Capacity Max."	Mfg. Mount	Key No.	Price /Each
TB832	8 1/2N	0.040	0.250	2JT	K30	171.79
TB833	11N	0.040	0.375	2JT	K32	191.50
TB834	14N	0.040	0.500	3JT	K3	263.23
TB835	16N	0.125	0.625	3JT	K4	302.13
TB836	18N	0.125	0.750	4JT	K4	457.28
TB837	20N	0.375	1.000	5JT	K5	612.05

Chucks with minimum capacity of 0" will hold a No. 60 (0.040") drill

PORTABLE TOOL CHUCKS

HAND-TITE® KEYLESS DRILL CHUCKS

- Keyless operation
- Made from high performance materials
- Durable, long lasting performance
- Fits all variable speed corded and cordless portable drill



HAND-TITE® KEYLESS HAMMER DRILL CHUCKS

Patented *Hammerlock*® mechanism expands *Hand-Tite*® Keyless chucks performance and convenience to include 13 mm AC or cordless hammer drills.

Model No.	Mfg. No.	Capacity	Cap. Min."	Cap. Max. "	Mount Thread	Wt. lbs.	Price /Each
HAND-TITE® KEYLESS DRILL CHUCKS							
TT566	30354	3/8" (10 mm)	0.040	0.375	3/8 - 24	1/2	32.29
TT567	31038	1/2" (13 mm)	0.062	0.50	1/2 - 20	3/4	51.62
TT568	31037	1/2" (13 mm)	0.062	0.50	3/8 - 24	3/4	49.92

STAINLESS KEYED CHUCKS

- For special applications on either portable drills or stationary machine tools
- Mainly used in medical and chemical industries
- Resists chemical corrosion
- Reduces potential for hazardous sparking
- Minimises risk of ferrous contamination in sterile environment
- Stainless steel chucks available in both thread mounting and taper mounting



Model No.	Mfg. No.	Capacity (in)	Capacity (mm)	Chuck Mount	Price /Each
TDR876	0M	0-5/32	0-4	#0 JT	229.24
TDR878	0BM 5/16	0-5/32	0-4	5/16-24	228.71
TDR881	1M	0-1/4	0-6	#1 JT	209.07
TDR877	1BM 5/16	0-1/4	0-6	5/16-24	228.56
TDR879	1BM 3/8	0-1/4	0-6	3/8-24	223.04

Jacobs®

TAPER CHUCK ARBORS

- Precision machined and ground to master gauges
- For use with custom tool and work holder designs
- For specialized machining applications



Jacobs®

MORSE TAPER TO JACOBS® TAPER

Model No.	Mfg. No.	Morse to Mfg.	Overall Length"	Price /Each
TB885	A0101	1 Morse x 1JT	3.38	27.84
TB886	A0102	1 Morse x 2JT	3.59	31.06
TB887	A0106	1 Morse x 6JT	3.72	33.89
TB888	A0133	1 Morse x 33JT	3.72	32.86
TB889	A0201	2 Morse x 1JT	3.94	29.60
TB890	A0202	2 Morse x 2JT	4.16	24.22
TB891	A0203	2 Morse x 3JT	4.50	23.35
TB892	A0204	2 Morse x 4JT	4.94	30.32
TB893	A0206	2 Morse x 6JT	4.28	32.58
TB894	A0233	2 Morse x 33JT	4.28	24.22
TB895	A0301	3 Morse x 1JT	4.69	33.83
TB896	A0302	3 Morse x 2JT	4.94	33.29
TB897	A0303	3 Morse x 3JT	5.27	32.64
TB898	A0304	3 Morse x 4JT	5.70	37.28
TB899	A0305	3 Morse x 5JT	5.94	39.58
TB900	A0306	3 Morse x 6JT	5.06	33.83
TB901	A0333	3 Morse x 33JT	5.06	33.29
TB902	A0402	4 Morse x 2JT	5.91	58.79
TB903	A0403	4 Morse x 3JT	6.25	50.82
TB904	A0404	4 Morse x 4JT	6.69	51.64
TB905	A0405	4 Morse x 5JT	6.91	71.10
TB906	A0406	4 Morse x 6JT	6.03	51.76
TB907	A0433	4 Morse x 33JT	6.06	54.46
TB908	A0503	5 Morse x 3JT	7.50	107.32
TB909	A0504	5 Morse x 4JT	7.94	105.67
TB910	A0505	5 Morse x 5JT	8.16	104.31

KEY LEASHES

Key leashes for chuck keys.



Model No.	Mfg. No.	Fits Key No.	Price /Each
TB973	3685	TB963, TB964, TB970	4.94
TB974	3686	TB971, TB972, TB966	4.85

CHUCK KEYS

These standard chuck keys are used for plain, ball-bearing and other chucks.

Jacobs®

Model No.	Mfg. No.	Pilot Size"	Used on Mfg.	Price /Each
T-HANDLE				
TB963	K0	1/8	0 Series	7.24
TB964	K1	5/32	1 Series	5.00
TB965	K5	7/16	20N	31.16
THUMB HANDLE				
TB966	K2	1/4	2 Series	7.09
TB967	K3	5/16	3, 34 Series & 14N	8.42
TB968	K3C	5/16	34-33C	10.10
TB969	K4	3/8	36, 16, 18N	13.94
TB970	K7	7/32	7 Series	5.81
TB971	K30	15/64	31 Series & 8 1/2N	6.85
TB972	K32	1/4	32, 33 Series & 11N	7.26



KEY-BAK® CHUCK KEY RETRACTORS

- 24" stainless steel chain
- Chrome texture finish
- Fastens directly to the side of the drill press
- Never misplace your chuck key again

Model No. TL2012
Mfg. No. #7LSC
Price/Each \$17.07



DRILL SLEEVES & EXTENSION SOCKETS



DRILL SLEEVES - MORSE TAPER ARCHER® SERIES 600 & 700

- Drill sleeves adapt Morse taper shank tools to larger machine spindles
- Series 600 is oil toughened and externally precision ground with hardened tang
- Series 700 drill sleeves are through-hardened and precision ground internally and externally

Jacobs®

Morse Taper No.	Series 600	Price	Series 700	Price
Out. Ins. Lgth."	Model No.	Mfg. No. /Each	Model No.	Mfg. No. /Each
1 0 2.56	TB911	610 15.54	TB924	710 15.83
2 1 3.62	TB912	621 15.54	N/A	
3 2 4.38	TB913	632 19.88	TB926	732 21.97
3 1 3.88	TB914	631 20.20	N/A	
4 3 5.50	TB915	643 61.50	TB928	743 31.99
4 2 4.88	TB916	642 29.79	TB929	742 30.92
4 1 4.88	TB917	641 29.79	N/A	
5 1 6.12	TB918	651 57.50	TB931	751 85.88
5 4 6.69	TB919	654 55.02	TB932	754 85.88
5 3 6.12	TB920	653 55.02	TB933	753 85.88
5 2 6.12	TB921	652 57.50	TB934	752 85.88
6 4 8.56	TB922	664 144.45	TB935	764 244.02
6 5 8.56	TB923	665 144.45	N/A	

EXTENDED SOCKETS - MORSE TAPER ARCHER® SERIES 800

Extended sockets extend tool lengths and application distances while adapting for increases or decreases in applied tool Morse taper sizes. These extension sockets are externally precision ground with hardened tang.



Jacobs®

Series 800	Mfg. No.	Morse Taper No.	Price
Model No.		Outside Inside Length"	/Each
TB937	811	1 1	5.71 38.84
TB938	812	1 2	6.30 44.91
TB939	821	2 1	6.30 38.84
TB940	822	2 2	6.89 56.99
TB941	823	2 3	7.72 69.46
TB942	831	3 1	6.89 44.91
TB943	832	3 2	7.64 56.99
TB944	833	3 3	8.46 72.64
TB945	834	3 4	9.45 112.71
TB946	842	4 2	8.46 71.65
TB947	843	4 3	9.45 71.65
TB948	844	4 4	10.43 116.00
TB949	845	4 5	11.81 212.29
TB950	853	5 3	10.35 108.96
TB951	854	5 4	11.81 115.99
TB952	855	5 5	13.19 212.30

EJECTING DRIFTS

These drifts eject Morse taper sizes 0 through 6 from sleeves, sockets and machine spindles.

Jacobs®



Model No.	Mfg. No.	For Ejection of	Price /Each
TB953	900	Nos. 0 Morse Tapers	9.20
TB954	902	Nos. 1 & 2 Morse Tapers	13.62
TB955	903	Nos. 3 & 4 Morse Tapers	15.86
TB956	904	Nos. 4 & 5 Morse Tapers	23.68
TB957	906	No. 6 Morse Taper	47.74
TB958	914	Combined Drifts Nos. 1, 2, 3 and 4	59.43

WEDGE SETS

For removing taper mount chucks from arbors or chucks.

Model No.	Set No.	Used on Mfg. Taper No.	Price /Each
TB959	#1 Wedge Set	1JT	11.69
TB960	#2 Wedge Set	2JT	11.69
TB961	#3 Wedge Set	3JT	11.51
TB962	#6 Wedge Set	6JT & 33JT	11.51

Note: Removal of Jacobs® tapers no. 4 and no. 5 requires stacking of no. 3 and no. 6 wedge sets.





8" DRILL PRESSES W/LASER

- Dual intersecting adjustable laser guides
- Spindle is supported by high quality ball bearings
- Switch located at the front of the machine for easy access
- Positive depth stop for quick and easy adjustment
- 45° tilting table for angular drilling
- Includes: 1/2" drill chuck and key



Model No. TBW134
Mfg. No. KC-1088L
Chuck size: 1/2"
Speeds: 5 (620-3100 RPM)
Table size: 6 1/2" x 6 1/4"
Spindle Taper: #33 Jacobs
Motor: 2 A, 1 phase, 60 Hz
Voltage: 110 V
Dimensions: 9" L x 16 3/4" W x 23" H
Weight: 46 lbs.
Price/Each \$150.38

10" DRILL PRESSES W/LASER

- Dual intersecting adjustable laser guides
- Spindle is supported by high quality ball bearings
- Switch located at the front of the machine for easy access
- Positive depth stop for quick and easy adjustment
- 45° tilting table for angular drilling
- Includes: 1/2" drill chuck and key



Model No. TBW135
Mfg. No. KC-110C
Chuck size: 1/2"
Speeds: 5 (570-3050 RPM)
Table size: 7 3/4" x 7 3/4"
Spindle Taper: #33 Jacobs
Motor: 3.2 A, 1 phase, 60 Hz
Voltage: 110 V
Dimensions: 11" L x 18 1/2" W x 29" H
Weight: 70 lbs.
Price/Each \$190.68

13" DRILL PRESSES W/LASER

- Spindle is supported by high quality ball bearings
- Cast-iron pulleys reduces vibrations
- Comes with non-slip rubber feed handles
- 45° tilting table for angular drilling
- Locking depth stop for accurate repetitive blind hole drilling
- Includes: 5/8" drill chuck, key and 4" vise
- Light socket incorporated into drill press head (standard light bulb not included)



Model No. BV666
Mfg. No. KC-116C
Chuck size: 5/8"
Max. distance chuck to table: 13 3/4"
Max. distance chuck to base: 26"
Table size: 12 13/16"
Speeds: 16 (210-3670 RPM)
Spindle Taper: #2 Morse
Motor: 7.5 A, 1 phase, 60 Hz
Voltage: 110 V
Dimensions: 12 13/16" L x 25" W x 42" H
Weight: 125 lbs.
Price/Each \$278.70

JOBBER LENGTH HSS, 135° SPLIT POINT

- 135° split point is self-centering, for reduced thrust and easier penetration
- Black oxide finish for increased wear resistance and improved lubricity
- Designed for tool and alloy steel application



TGJ538

GENERAL PURPOSE MRO

Model No.	Mfg. No.	No. of Pieces	Size Range	Case	Price /Each
TGJ524	C21157	13	1/16" - 1/4" x 1/64"	Metal	27.93
TGJ530	C21110	15	1/16" - 1/2" x 1/32"	Metal	73.74
TGJ535	C21115	21	1/16" - 3/8" x 1/64"	Metal	68.68
TGJ538	C21119	29	1/16" - 1/2" x 1/64"	Metal	133.31
TGJ544	C21124	60	#1 - #60	Metal	122.87
TGJ549	C21128	115	1/16" - 1/2" x 1/64"; #1 - #60; A-Z	Metal	427.91

JOBBER LENGTH COBALT, 135° SPLIT POINT

- M35, 8% cobalt HSS construction
- Straw finish adds lubricity and easily identifies cobalt drills
- Designed to drill tough, high-tensile materials and work-hardening materials like high-strength alloy steels, stainless steel, titanium, manganese steel, armor plate and inconel

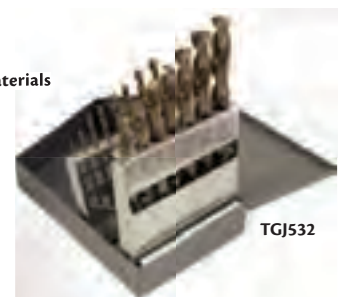

TGJ532

GENERAL PURPOSE MRO

Model No.	Mfg. No.	No. of Pieces	Size Range	Case	Price /Each
TGJ526	C21107	13	1/16" - 1/4" x 1/64"	Metal	48.60
TGJ532	C21112	15	1/16" - 1/2" x 1/32"	Metal	134.08
TGJ540	C21121	29	1/16" - 1/2" x 1/64"	Metal	248.93
TGJ550	C21129	115	1/16" - 1/2" x 1/64"; #1 - #60; A-Z	Metal	694.92



13" FLOOR DRILL PRESSES W/LASER

- Spindle is supported by high quality ball bearings
- Cast-iron pulleys reduce vibrations
- Comes with non-slip rubber feed handles
- 45° tilting table for angular drilling
- Locking depth stop for accurate repetitive blind hole drilling
- Includes: 5/8" drill chuck, key and 4" vise
- Light socket incorporated into drill press head (standard light bulb not included)



Model No.	TM209
Mfg. No.	KC-116FC
Chuck size:	5/8"
Max. distance chuck to table:	24"
Max. distance chuck to base:	45 1/2"
Table size:	12 13/16"
Speeds:	16 (210-3670 RPM)
Spindle Taper:	#2 Morse
Motor:	7.5 A, 1 phase, 60 Hz
Voltage:	110 V
Dimensions:	12 13/16" L x 25" W x 63 1/2" H
Weight:	147 lbs.
Price/Each	\$370.57

15" DRILL PRESSES W/LASER

- Spindle is supported by high quality ball bearings
- Cast-iron pulleys reduces vibrations
- Comes with non-slip rubber feed handles
- 45° tilting table for angular drilling
- Locking depth stop for accurate repetitive blind hole drilling
- Includes: 5/8" drill chuck, key and 4" vise
- Light socket incorporated into drill press head (standard light bulb not included)



Model No.	TS206
Mfg. No.	KC-117C
Chuck size:	5/8"
Max. distance chuck to table:	13"
Max. distance chuck to base:	25 1/4"
Table size:	13 5/8"
Speeds:	16 (210-3670 RPM)
Spindle Taper:	#2 Morse
Motor:	10.5 A, 1 phase, 60 Hz
Voltage:	110 V
Dimensions:	13 5/8" L x 25" W x 42" H
Weight:	143 lbs.
Price/Each	\$381.38

15" FLOOR DRILL PRESSES W/LASER

- Spindle is supported by high quality ball bearings
- Cast-iron pulleys reduces vibrations
- Comes with non-slip rubber feed handles
- 45° tilting table for angular drilling
- Locking depth stop for accurate repetitive blind hole drilling
- Includes: 5/8" drill chuck, key and 4" vise
- Light socket incorporated into drill press head (standard light bulb not included)



Model No.	TM211
Mfg. No.	KC-117FC
Chuck size:	5/8"
Max. distance chuck to table:	23"
Max. distance chuck to base:	44 1/2"
Table size:	13 5/8"
Speeds:	16 (210-3670 RPM)
Spindle Taper:	#2 Morse
Motor:	10.5 A, 1 phase, 60 Hz
Voltage:	110 V
Dimensions:	13 5/8" L x 25" W x 63 1/2" H
Weight:	157 lbs.
Price/Each	\$484.07

17" FLOOR DRILL PRESSES

- Spindle is supported by high quality ball bearings
- Cast-iron pulleys reduces vibrations
- Comes with non-slip rubber feed handles
- Tilting table for angular drilling
- Light fixture incorporated into the head casting illuminates the work table (light bulb not included)
- Includes: 5/8" drill chuck and key



Model No.	TM213
Mfg. No.	KC-118FC
Chuck size:	5/8"
Speeds:	16 (240-3400 RPM)
Table size:	13 3/4"
Spindle Taper:	#2 Morse
Motor:	12 A @ 110 V, 6 A @ 220 V 1 HP, 1 phase, 60 Hz
Voltage:	110 V/220 V
Dimensions:	13 3/4" L x 25" W x 64" H
Weight:	185 lbs.
Price/Each	\$586.75



22" FLOOR DRILL PRESSES

- Spindle is supported by high quality ball bearings
- Cast-iron pulleys reduce vibrations
- Tilting table for angular drilling
- Light fixture incorporated into the head casting illuminates the work table (light bulb not included)
- Comes with non-slip rubber feed handles



Model No.	TM214
Mfg. No.	KC-122FC
Chuck size:	3/4"
Speeds:	12 (150-4200 RPM)
Table size:	18 3/4" x 16 1/4"
Spindle Taper:	#4 Morse
Motor:	1 HP, 1 phase, 60 Hz
	12.5 A @ 110 V, 6.25 A @ 220 V
Voltage:	110/220 V
Dimensions:	18 3/4" L x 33" W x 69" H
Weight:	360 lbs.
Price/Each	\$1173.51

21" GEARHEAD DRILLING MACHINES

- 1.5 HP
- Spindle is equipped with four heavy-duty tapered roller bearings
- Forward and reverse switch
- Head tilts 90° to the left and 30° to the right
- Includes: 1/2" chuck with key, 3 1/2" angle vise and safety guard



Model No.	TS208
Mfg. No.	KC-40HS
Chuck size:	1/2"
Speeds:	6 (60-1500 RPM)
Table size:	21 3/4" x 19 1/2"
Spindle Taper:	#3 Morse
Motor:	1.5 HP, 11 A
Voltage:	220 V, 1 phase, 60 Hz
Dimensions:	21 1/4" L x 30" W x 78" H
Weight:	575 lbs.
Price/Each	\$4156.24

28" VARIABLE SPEED GEARHEAD DRILL PRESSES

- Quill has an internal MT#4 to accept tapered drill press accessories
- Feed selector dial and automatic power down-feed lever
- Production sized table with coolant collector
- 1/8 HP coolant pump built-in
- Positive depth stop for quick, easy adjustment



Model No.	TDX416
Mfg. No.	KC-50
Chuck size:	5/8"
Speeds:	2-range, variable
	(60-870 and 120-1740)
Table size:	22" x 22"
Spindle taper:	#4 Morse
Motor:	2 HP
Voltage:	550 V, 3 phases, 60 Hz
Dimensions:	22" L x 37" W x 91" H
Weight:	1012 lbs.
Price/Each	\$4848.94

MILLING DRILLING MACHINES

- Spindle is equipped with four heavy-duty tapered roller bearings
- Table control hand wheels have large micrometer dials graduated in 0.001"
- Head swivels 360° and is easily raised and lowered
- Includes: 3" face cutter, 1/2" chuck with key, 3 1/2" angle vise and safety guard



Model No.	TS218
Mfg. No.	PDM-30
Drilling capacity:	1 1/4"
Diameter of column:	4 3/4"
Speeds:	12 (150-2500 RPM)
Working area of table:	8 1/4" x 28 3/4"
Size of T-slot on table:	5/8"
Motor:	22 A @ 110 V, 11 A @ 220 V,
	1 phase, 60 Hz
Voltage:	110/220 V
Pre-wired at:	110 V
Dimensions:	43" L x 39" W x 42" H
Approx. shipping weight:	600 lbs.
Price/Each	\$2200.35

14" X 40" GEARHEAD METAL LATHES

- Safety guard automatically shuts lathe off when lifted
- Full length spindle foot brake incorporated in the cabinet stand for easy operation and reliable safety
- Includes: 6" 3-jaw chuck, 8" 4-jaw chuck, replacement gears, quick change tool post, steady rest, follow rest, 12" DI-4 camlock face plate, coolant system, full length splash guard, thread chasing dial indicator, 2 MT#3 dead centers, JT#5-MT#3 sleeve, chip tray, tool box, halogen lamp, chuck keys, hex keys and cabinet stand



Model No.	TEB022
Mfg. No.	KC-1440ML
Distance between centers:	40"
Swing over bed:	14"
Swing over gap:	20 1/4"
Spindle bore:	1 7/16"
Swing over cross slide:	8 5/8"
Taper in headstock:	MT#5
Taper in tailstock:	MT#3
Width of bedways:	7 5/16"
Total travel of cross slide:	6 3/16"
Total travel of top slide:	3 1/2"
Spindle speeds:	8 (70-2000 RPM)
Thread cutting range:	4-56 TPI
Motor:	2 HP, 10 A, 1 phase, 60 Hz
Voltage:	220 V
Dimensions:	75" L x 32" W x 53" H
Weight:	2025 lbs.
Price/Each	\$6234.36

HAND BRAKES

- Constructed with welded steel plate
- Heavy truss rods and braces designed for stability and strength
- Both bed and apron are bored in line to assure the utmost in accuracy
- Includes: Extension handles, cast iron counter (only **TBM406**) weight and apron stop



Model No.	TBM405	TBM406
Mfg. No.	BB-H4822	BB-H4816
Capacity (mild steel):	22 gauge	16 gauge
Bending length:	48 1/4"	48 1/2"
Max. lift of beam:	7/8"	1 1/4"
Beam adjustment:	1/4"	5/8"
Min. reverse bend:	1/4"	5/16"
Min. flange in capacity material:	3/8"	1"
Dimensions (less counterweight):	56" L x 16" W x 24" H	56" L x 16" W x 24" H
Weight:	290 lbs.	470 lbs.
Price/Each	\$1320.21	\$2007.34

BOX & PAN BRAKES

- Constructed with welded steel plate
- Spring-loaded handle allows for fast and easy action
- Heavy truss rods and braces designed for stability and strength
- Includes: extension handles, cast iron counter weight (only **TCW450**), apron stop and replaceable bushings



Model No.	TCW451	TCW450
Mfg. No.	BB-BP4822	BB-BP4816
Capacity (mild steel):	22 gauge	16 gauge
Bending length:	48 1/4"	48 1/2"
Max. lift of beam:	7/8"	1 1/4"
Beam adjustment:	1/4"	5/8"
Min. reverse bend:	1/4"	5/16"
Min. flange in capacity material:	3/8"	1"
Max. depth of box:	3"	4"
Finger widths:	5 x 2", 6 x 3", 5 x 4"	5 x 2", 6 x 3", 5 x 4"
Dimensions (less counterweight):	56" L x 16" W x 24" H	56" L x 16" W x 24" H
Weight:	320 lbs.	505 lbs.
Price/Each	\$1389.69	\$2200.35

LIVE CENTRES

- Very accurate
- Fitted with taper roller bearings



Model No.	TZ825	TZ826
Mfg. No.	KLC-2M	KLC-3M
Use:	Metal lathe	Metal lathe
Taper shank:	MT#2	MT#3
Price/Each	\$72.11	\$87.46



Canada's Leading Material Handling Manufacturer

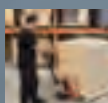

R29353E

OFFICE PRODUCTS

INSTRUMENTS, SCALES & ELECTRICAL

SHIPPING & PACKAGING

TOOLS & EQUIPMENT

WELDING & METALWORKING

SAFETY EQUIPMENT & SUPPLIES

JANITORIAL & MAINTENANCE

MATERIAL HANDLING & STORAGE

5" X 6" METAL CUTTING BANDSAWS

- Can be used horizontally or vertically; table for vertical cutting included
- Adjustable ball bearing guides
- Portable design for easy movement
- Automatic shut-off switch



Model No. TJJZ785
Mfg. No. KC-129C
Cutting capacity at 90°: Rect. 4 1/2" x 6"
 Round 5"
Cutting capacity at 45°: Rect. 3" x 4 1/2"
 Round 3"
Speeds: 3 (80, 120, 200 RPM)
Blade: 6 1/2" x 1/2" x 0.025"
Motor: 6 A, 1 phase, 60 Hz
Voltage: 110 V
Dimensions: 42" L x 18" W x 38" H
Weight: 110 lbs.
Price/Each \$469.40

5" X 6" DUAL SWIVEL METAL CUTTING BANDSAWS

- Portable design for easy movement
- Adjustable hydraulic down feed control
- Adjustable hydraulic cylinder
- Adjustable ball bearing guides
- Automatic shut-off switch
- Head swivels 0° - 45° to the right and 0° - 60° to the left



Model No. TJJZ749
Mfg. No. KC-129DS
Cutting capacity at 90°: Rect. 5" x 6", Round 5"
Cutting capacity at 45°: Rect. 4" x 2 15/16";
 Round 5"
Speeds: 3 (80, 120, 200 RPM)
Blades: 64 1/2" x 1/2" x 0.25"
Motor: 6 Amps
Voltage: 110 V, 1 phase, 60 Hz
Dimensions: 39" L x 23" W x 43" H
Weight: 180 lbs.
Price/Each \$880.13

7" X 12" METAL CUTTING BANDSAWS

- Can be used horizontally or vertically
- Adjustable ball bearing guides
- Portable design for easy movement
- Coolant system
- Automatic shut-off switch
- Adjustable hydraulic downfeed control
- Tru-Lock™ quick locking vise system



Model No. TS211
Mfg. No. KC-712-BC
Cutting capacity at 90°: Rect. 7" x 12", Round 7"
Cutting capacity at 45°: Rect. 4 1/2" x 5", Round 5"
Speeds: 4 (85, 130, 180, 235 RPM)
Blade: 0.75" x 0.032" x 93"
Motor: 1 HP, 12 A @ 110 V, 1 phase, 60 Hz
Voltage: 110 V
Pre-wired at: 110 V
Dimensions: 50" L x 20" W x 39" H
Weight: 275 lbs.
Price/Each \$1320.21

7" X 12" METAL CUTTING BANDSAWS W/GEARDRIVE

- Can be used horizontally or vertically
- Adjustable ball bearing guides
- Portable design for easy movement
- Coolant system
- Automatic shut-off switch
- Adjustable hydraulic downfeed control
- Tru-Lock™ quick locking vise system



Model No. BV709
Mfg. No. KC-712GH-5
Cutting capacity at 90°: Rect. 7" x 12", Round 7"
Cutting capacity at 45°: Rect. 4 1/2" x 5", Round 5"
Speeds: 3 (110, 230, 340 RPM)
Blade: 0.75" x 0.032" x 93"
Motor: 1 HP, 12 A, 1 phase, 60 Hz
Voltage: 110 V
Dimensions: 47" L x 21" W x 40" H
Weight: 280 lbs.
Price/Each \$1852.93

BELT DISC SANDERS

- Motors are all sealed ball bearing construction
- Comes with adjustable tilting tables
- Easy belt tracking system for quick changing of belts
- Handles finishing operations including sanding, surfacing, grinding, cleaning and deburring on wood, metal and plastic



Model No.	BV495
Mfg. No.	KC-705L
Belt size:	4" x 36"
Belt lift:	0° - 90°
Belt speed:	2000 SFPM
Disc diameter:	6"
Disc speed:	3450 SFPM
Motor:	5.2 A
Voltage:	110 V, 1 phase, 60 Hz
Dimensions:	17" L x 14" W x 11" H
Weight:	42 lbs.
Price/Each	\$153.45

BELT DISC SANDERS

- Motors are all sealed ball bearing construction
- Comes with adjustable tilting tables
- Easy belt tracking system for quick changing of belts
- Handles finishing operations including sanding, surfacing, grinding, cleaning and deburring on wood, metal and plastic



Model No.	TBW148
Mfg. No.	KC-702C
Belt size:	1" x 30"
Belt lift:	0° - 45°
Belt speed:	2000 SFPM
Disc diameter:	5"
Disc speed:	2800 SFPM
Motor:	2.5 A
Voltage:	110 V, 1 phase, 60 Hz
Dimensions:	14 1/2" L x 12 1/2" W x 14" H
Weight:	26 lbs.
Price/Each	\$129.21

12" DISC SANDERS W/INTEGRAL DUST COLLECTION

- Tilting cast iron table with 90° and 45° positive stops locks in position with spring-loaded, table-locking handles
- Cast iron base with pre-drilled base holes for easy bench mounting
- Features a 3/8" x 3/4" mitre gauge slot machined into the table for projects that require sanding an angle or straight edge
- Includes: Integral dust collection, dust hose with 2 1/4" I.D. connectors, 80-grit abrasive disc and manual brake



Model No.	BV843
Mfg. No.	31-120C
Disc diameter:	12"
Disc speed:	2500 RPM
Table tilt:	45° down - 45° up
Table size:	17 1/4" X 6 1/4"
Motor:	1/2 HP, 1 phase, 60 Hz
Voltage:	120 V
Dimensions:	17 1/4" L x 17 3/4" W x 15" H
Weight:	72 lbs.
Price/Each	\$404.18

6" X 48" BELT & 12" DISC SANDERS

- Heavy-duty cast iron tables and body
- Steel plate covered with graphite to reduce friction for longer belt life
- Adjustable belt unit operates vertically, horizontally, or at any set angle in between
- Includes: 2 - 4" dust chutes, sturdy cabinet stand, quick belt release mechanism and mitre gauge



Model No.	WK947
Mfg. No.	KC-788FX
Belt size:	6" x 48"
Belt lift:	45° down - 45° up
Belt speed:	1570 SFPM
Disc diameter:	12"
Disc speed:	2000 RPM
Disc adjustment:	45° down - 45° up
Motor:	1.5 HP belt-drive
	13.4 A @ 110 V/6.7 A @ 220 V
Voltage:	110/220 V, 1 phase, 60 Hz
Pre-wired at:	110 V
Dimensions:	30" L x 23" W x 55" H
Weight:	215 lbs.
Price/Each	\$1114.84

MACHINERY

6" BENCH GRINDERS

- 3.5 A, 110 V, single phase
- Wheel diameter: 6"
- 3500 RPM
- Weight: 18 lbs.
- Includes: Adjustable tool rests, removable wheel covers, plastic eye shields and medium and coarse grinding wheels



Model No. BT354
Mfg. No. KC-690
Price/Each \$69.04

6" BENCH GRINDERS WITH LAMP

- 3.5 A, 110 V, single phase
- Wheel diameter: 6"
- 3500 RPM
- Weight: 19 lbs.
- Includes: Adjustable tool rests, removable wheel covers, plastic eye shields and medium, coarse grinding wheels and work light



Model No. TG113
Mfg. No. KC-690L
Price/Each \$84.39

8" BENCH GRINDERS

- 7 A, 110 V, single phase
- Wheel diameter: 8"
- 3450 RPM
- Weight: 36 lbs.
- Includes: Adjustable tool rests, removable wheel covers, plastic eye shields and medium and coarse grinding wheels



Model No. TM223
Mfg. No. KC-890
Price/Each \$107.41



BENCH GRINDER STANDS

- Made of cast iron with coolant reservoir
- 32 3/4" high

Model No. WK731
Mfg. No. SS-150
Price/Each \$85.92



6" BENCH GRINDERS

- Powerful 5/8 HP induction motor for heavy-duty grinding operations
- Motor runs at 3450 RPM for high speed material removal
- Industrial cast iron base and motor housing provide durability and prolong life
- Precision-machined aluminum tool rests allow the user to accurately position work
- Rear exhaust ports in wheel guards for smoother operation
- 12 1/2" distance between wheels for longer and larger grinding applications
- Includes: 36-grit wheel, 60-grit wheel, eye shields, spark deflectors, tool rests, adjusting wrench



Model No. VE369
Amps: 4.0 AC
Horsepower: 5/8 HP
No load speed: 3450 RPM
Wheel dia.: 6"
Price/Each \$146.43

Spindle dia: 1/2"
Adjustable tool resets: Yes
Tool length: 15"
Tool weight: 28.5 lbs.

10" BENCH GRINDERS

- 14 A, 110 V, single phase
- Wheel diameter: 10"
- 1720 RPM
- Weight: 80 lbs.
- Includes: Removable wheel covers, plastic eye shields and medium and coarse grinding wheels



Model No. TZ815
Mfg. No. KC-1090
Price/Each \$322.71



10" X 4 1/2" WET/DRY GRINDERS

- 4.2 A, 110 V, single phase
- Medium grinding wheel diameter: 10"
- Coarse grinding wheel diameter: 4 1/2"
- 1725/3450 RPM
- Weight: 33 lbs.
- Includes: Removable wheel covers, plastic eye shields and medium and coarse grinding wheels



Model No. TG114
Mfg. No. KC-10SG
Price/Each \$293.37



INDUSTRIAL BENCH GRINDERS

- Warranted for three full years these grinders are made for constant industrial use
- They are supplied with 8 ft. 3-wire cord, eyeshields and pressed tool rests and supports



Model No.	Mfg. No.	Wheel Dia."	HP	Arbor"	RPM	Motor	Wt. lbs.	Price /Each
TM148	612R	6 x 3/4	1/3	1/2	3600	115 V/1 PH	29	414.79
TM154	712R	7 x 1	1/2	5/8	3600	115 V/1 PH	45	658.40

ACCESSORIES FOR INDUSTRIAL GRINDERS

Model No.	Mfg. No.	Description	Wt. lbs.	Price /Each
TS193	GA14R	Pedestal for 6" and 7" Grinders	54	302.80
TM190	GA16R	Cast Iron Pedestal for 6" and 7" Grinders	61	401.31
TS194	GA9S	Lighted Eyeshield w/On-Off Switch	2	187.69

BENCH GRINDING WHEELS

D x T x H: Diameter x Thickness x Hub Size

GEMINI

- Quality, grey aluminum oxide for metal general purpose applications and sharp, green silicon carbide for nonferrous applications
- Each wheel contains nested bushings, accommodates a wide variety of standard arbor sizes
- Economical prices; ideal for small job shops and numerous applications



NORTON

Model No.	Mfg. No.	Size			Grade	Max RPM	Price /Each		
		D"	x	T"	x	H"			
ALUMINUM OXIDE WHEELS FOR STEEL APPLICATION									
NS320	36132	6	x	1/2	x	1	Coarse	4140	20.86
NS321	36131	6	x	1/2	x	1	Medium	4140	20.86
NS322	36133	6	x	1/2	x	1	Fine	4140	20.86
NS323	37103	6	x	3/4	x	1	Coarse	4140	24.38
NS324	37102	6	x	3/4	x	1	Medium	4140	24.38
NS325	37101	6	x	3/4	x	1	Fine	4140	24.38
NS326	37958	6	x	1	x	1	Coarse	3600	28.16
NS327	37957	6	x	1	x	1	Medium	3600	28.16
NS328	37100	6	x	1	x	1	Fine	3600	28.16
NS329	42292	7	x	1	x	1	Coarse	3600	34.42
NS330	42294	7	x	1	x	1	Medium	3600	34.42
NS331	42295	7	x	1	x	1	Fine	3600	34.42
NS332	42315	8	x	3/4	x	1	Coarse	3600	35.77
NS333	42316	8	x	3/4	x	1	Medium	3600	35.77
NS334	42317	8	x	3/4	x	1	Fine	3600	35.77
NS335	44454	8	x	1	x	1	Very coarse	3600	42.21
NS336	44449	8	x	1	x	1	Coarse	3600	42.21
NS337	44448	8	x	1	x	1	Medium	3600	42.21
NS338	44447	8	x	1	x	1	Fine	3600	42.21
NS339	60788	10	x	1	x	1	Very coarse	2485	64.93
NS340	60787	10	x	1	x	1	Coarse	2485	64.93
NS341	60789	10	x	1	x	1	Medium	2485	64.93
NS342	60350	10	x	1	x	1	Fine	2485	64.93
NS343	61250	10	x	1 1/4	x	1 1/4	Coarse	2485	77.16
NS344	61251	10	x	1 1/4	x	1 1/4	Medium	2485	77.16
NS345	61393	10	x	1 1/2	x	1 1/4	Coarse	2485	89.34
NS346	61395	10	x	1 1/2	x	1 1/4	Medium	2485	89.34
NS347	63052	12	x	1 1/2	x	1 1/2	Coarse	2070	122.76
NS348	63053	12	x	1 1/2	x	1 1/2	Medium	2070	122.76
NS349	63054	12	x	2	x	1 1/2	Very coarse	2070	157.29
NS350	63055	12	x	2	x	1 1/2	Coarse	2070	157.29
NS351	63056	12	x	2	x	1 1/2	Medium	2070	157.29

SCOTCH-BRITE™ MULTI-FINISHING WHEELS

Produces uniform grain finishes on stainless steel and other metals.

- Highly conformable
- Tough enough to finish edges and welds

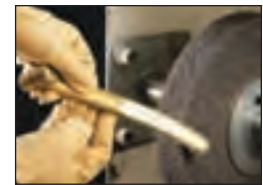

Model No.	Grit	Finish	Size"			Max. RPM	Price /Each		
BP715	25	Coarse	6	x	1	x	1	6000	53.69
BP717	25	Medium	6	x	1	x	1	6000	53.69
BP718	25	Coarse	6	x	2	x	1	6000	83.62
BP720	25	Medium	6	x	2	x	1	6000	83.62
BP721	25	Coarse	8	x	1	x	3	4500	76.23
BP723	25	Medium	8	x	1	x	3	4500	76.23

SCOTCH-BRITE™ EXL DEBURRING WHEELS

Use to clean, finish, blend, deburr or polish all types of metals, composites and glass.



Model No.	Grit	Finish	Size"			Max. RPM	Price /Each		
BP694	8A	Medium	6	x	1/2	x	1	6000	57.97
BP695	8S	Fine	6	x	1/2	x	1	6000	57.97
BP696	9S	Fine	6	x	1/2	x	1	6000	57.97
BP690	8A	Medium	6	x	1	x	1	6000	76.85
BP692	8S	Fine	6	x	1	x	1	6000	76.85
BP693	9S	Fine	6	x	1	x	1	6000	76.85
BP701	8A	Medium	8	x	1/2	x	3	4500	73.48
BP703	9S	Fine	8	x	1/2	x	3	4500	73.48
BP697	8A	Medium	8	x	1	x	3	4500	98.25
BP698	8S	Fine	8	x	1	x	3	4500	98.25
BP700	9S	Fine	8	x	1	x	3	4500	98.25

CRIMPED WIRE WHEEL BRUSHES

- Can be mounted horizontally or vertically
- Highly flexible, ideal for light to medium duty surface preparation on irregular surface
- Offered a variety of style from aggressive material removal to surface conditioning and polishing

NARROW FACE

- More flexible than the wide and medium style
- Can be mounted in multiples
- To be used with a straight grinder, a bench/pedestal grinder or a right angle grinder
- Application:** Deburring and cleaning narrow areas, producing antique finishes, rust and paint removal



Brush Dia."	Arbor Hole"	Wire Gauge"	Trim Length"	Face Width"	Max RPM	Model No.	Price /Each
STEEL							
6	1 1/4	0.0104	1 1/8	5/8	6000	BW882	16.50
8	1 1/4	0.014	1 1/2	5/8	4500	BW886	26.94
10	1 1/4	0.014	2 1/2	5/8	3600	BW888	35.42
STAINLESS							
6	1 1/4	0.0104	1 1/8	5/8	6000	BW899	40.70
8	1 1/4	0.0104	3/4	1/2	4500	BW900	48.66



MEDIUM FACE

- Greater fill density and more aggressive brushing action
- Can be adaptable to multiple mounting for brushing wider areas
- To be used with a bench/pedestal grinder
- Application:** Edge blending, deburring, rust removal, surface finishing and cleaning



Brush Dia."	Arbor Hole"	Wire Gauge"	Trim Length"	Face Width"	Max RPM	Model No.	Price /Each
STEEL							
6	2	0.0118	1	7/8	6000	BW996	32.14
8	2	0.0118	1 1/2	5/8	4500	BX006	45.40
10	2	0.0118	2	1 1/4	3600	BX022	74.80
STAINLESS							
6	2	0.0118	1	7/8	6000	BX040	55.02
8	2	0.0118	1 1/2	5/8	4500	BX038	72.76

MACHINERY

1 HP PORTABLE DUST COLLECTORS

- Heavy-duty motor and solid construction to effectively handle the collection of wood chips and sawdust
- Complete with 4 casters for portability
- Comes with dust bag, 4" x 10' flexible hose, and wide dust head which mounts on the arm support



Model No.	TEX134
Mfg. No.	KC-1105C
Air suction capacity:	600 CFM
Noise level reading at 36":	55-65 dB
Static pressure (Inch of water):	8
Bag quantity:	1
Bags size:	13" x 24"
Motor:	1 HP, 1 phase, 60 Hz
Voltage:	110 V
Dimensions:	40" L x 17" W x 40" H
Weight:	57 lbs.
Price/Each	\$262.48

1 HP DUST COLLECTORS

- Heavy-duty motor and solid construction to effectively handle the collection of wood chips and sawdust
- Improved metal impeller is precision balanced and designed for maximum air flow performance
- Complete with 4 casters for portability
- Lower collection bag comes with plastic; 1 micron felt upper bag, offers optimum air flow efficiency



Model No.	TEX143
Mfg. No.	KC-2105C
Air suction capacity:	600 CFM
Noise level reading at 36":	55-65 dB
Static pressure (Inch of water):	8.5
Bag quantity:	2
Bags size:	14" x 25"
Motor:	1 HP, 1 phase, 60 Hz
Voltage:	110 V
Dimensions:	28" L x 15" W x 61" H
Weight:	65 lbs.
Price/Each	\$322.71

1 HP SINGLE STAGE DUST COLLECTORS

- Curved steel impeller produces maximum air velocity for efficient dust collection
- Finned aluminum motor housing keeps motor running cool during long periods of use
- Sturdy steel base with four easy-gliding wheels provides maximum mobility
- Two 30 microns collection bags
- Includes: Advanced blower design, 4" x 5" collection hose, base with four swivel caster assemblies, cord and plug

Model No.	TBM417
Mfg. No.	AP400
Air suction capacity:	650 CFM
Static pressure (inch of water):	8.5
Bag size:	20 sq.ft.
Bag quantity:	1
Motor:	1 HP, TEFC, 12 A @ 120 V, 6 A @ 240 V, 1 phase, 60 Hz
Voltage:	120 V/240 V
Dimensions:	27" L x 14" W x 57" H
Weight:	90 lbs.
Price/Each	\$542.45



1.5 HP DUST COLLECTORS

- Heavy-duty motor and solid construction to effectively handle the collection of wood chips and sawdust
- Improved metal impeller is precision balanced and designed for maximum air flow performance
- Complete with 4 casters for portability
- Lower collection bag comes with plastic; 1 micron felt upper bag, offers optimum air flow efficiency



Model No.	BV573
Mfg. No.	KC-3105C
Air suction capacity:	1200 CFM
Noise level reading at 36":	66-77 dB
Static pressure (Inch of water):	9.5
Bag quantity:	2
Bags size:	20" x 34 1/2"
Motor:	12 A @ 110 V, 6 A @ 220 V, 1 phase, 60 Hz
Voltage:	110 V/220 V
Dimensions:	38" L x 27" W x 80" H
Weight:	145 lbs.
Price/Each	\$513.40

PRICING

The prices shown in this catalogue are for "REFERENCE AND BUDGET PURPOSES ONLY" as of July 2012, and should be used exclusively as a guideline.

Freight charges and applicable taxes (GST, PST & HST) are extra.

In the event of a pricing or typographical error, we reserve the right to charge the correct price without prior notice.

We also reserve the right to modify prices based on changing manufacturer and economic conditions.

SPECIAL ORDERS

This catalogue represents only a portion of the products that are available to you. If you can't find what you need, please call us!

Canada's Best Value in Industrial Tools... Period.



aurora tools®

aurora tools®

Aurora pneumatic tools are constructed to withstand the most demanding applications. These professional pneumatic tools are ideal for use in automotive, construction and industrial applications.

5" PNEUMATIC ANGLE GRINDERS

- Polyurethane grip reduces operator fatigue and vibration
- 5/8" x 11 unc spindle
- Powerful twin – chamber motor-delivers much higher torque
- Side handle and wrenches included

Model No. THZ674



aurora tools®

Model No.	Grinding Wheel		Spindle Thread		Free Speed RPM	Average Air Consumption		Air Inlet	Hose Size	Vibration Less Than	Sound Pressure Level	Net Weight		Price /Each
	in	mm	in	mm		CFM	in					mm	lbs.	
THZ674	5	127	5.8	15.9	10,000	5	1/4" - 18 NPT	3/8	9.5	3.1	83	3.1	1.41	177.00

1/4" PNEUMATIC MINI DIE GRINDERS

- Polyurethane grip reduces operator fatigue and vibration
- Power/speed regulator allows for easy rpm adjustment
- Twin-bearing design for smooth operation
- Wrenches included

Model No. THZ678



aurora tools®

1/4" PNEUMATIC ANGLE DIE GRINDERS

- Polyurethane grip reduces operator fatigue and vibration
- Power/speed regulator allows for easy rpm adjustment
- Twin-bearing design for smooth operation
- Wrenches included

Model No. THZ679



aurora tools®

Model No.	Collet Size		Free Speed RPM	Average Air Consumption		Hose Size	Horsepower	Vibration Less Than	Sound Pressure Level	Net Weight		Price /Each	
	in	mm		CFM	Air Inlet					in	mm		HP
THZ678	1/4	6.4	25,000	3	1/4" - 18 NPT	3/8	9.5	0.35	0.1	83	0.9	0.43	70.70
THZ679	1/4	6.4	18,000	3	1/4" - 18 NPT	3/8	9.5	0.45	0.1	80	1.7	0.77	83.20

3" AIR CUT-OFF TOOLS

- Polyurethane handle reduces operator fatigue and vibration
- Power/speed regulator allows for easy rpm adjustment
- Twin-bearing design for smooth operation and cut off powerfully
- Wrenches included

Model No. THZ677



aurora tools®

Model No.	Cutting Wheel		Free Speed RPM	Average Air Consumption		Hose Size	Horsepower	Vibration Less Than	Sound Pressure Level	Net Weight		Price /Each	
	in	mm		CFM	Air Inlet					in	mm		HP
THZ677	3	76.2	21,000	3	1/4"-18 NPT	3/8	9.5	0.45	0.2	81	1.8	0.82	62.20

3/8" AIR REVERSIBLE DRILLS

- Lightweight composite design minimizes operator fatigue
- Ergonomic grip reduces vibration
- Two-gear structure runs smoothly

Model No. THZ675



aurora tools

1/2" AIR REVERSIBLE DRILLS

- Lightweight composite design minimizes operator fatigue
- Ergonomic grip reduces vibration
- Two-gear structure runs smoothly
- Side handle included

Model No. THZ676



aurora tools

Model No.	Chuck Size in mm	Spindle Thread	Free Speed RPM	Average Air Consumption CFM	Air Inlet	Hose Size in mm	Vibration Less Than m/s ²	Sound Pressure Level dB(A)	Net Weight lbs. kg	Price /Each
THZ675	3/8 9.5	3/8" - 24 threads	1800	4	1/4" - 18 NPT	3/8 9.5	0.10	88	2.0 0.91	110.00
THZ676	1/2 12.7	3/8" - 24 threads	450	4	1/4" - 18 NPT	3/8 9.5	0.15	88	3.0 1.36	139.00

3/4" HEAVY-DUTY AIR IMPACT WRENCHES

- Lightweight composite design minimizes operator fatigue
- Ergonomic grip reduces vibration
- Twin hammer impact mechanism
- Three step forward/reverse regulator allows the operator to adjust the power to the job
- Rear exhaust directs air away from work piece and operator
- Special heat-treatment of major parts & anvil for long life

Model No. THZ672



aurora tools

1/2" HEAVY-DUTY AIR IMPACT WRENCHES

- Pin-clutch hammer mechanism
- Built-in regulator to prevent over-torquing
- Low noise, low vibration
- Forward-reverse switch, and high-low speed regulator
- Durability and longer life

Model No. THZ673



aurora tools

Model No.	Square Drive in mm	Bolt Capacity in mm	Free Speed RPM	Torque Range ft.-lbs.	Average Air Consumption CFM	Air Inlet	Hose Size in mm	Vibration Less Than m/s ²	Sound Pressure Level dB(A)	Net Weight lbs. kg	Price /Each
THZ672	3/4 19	1 25.4	4600	1100	9	1/4" - 18 NPT	3/8 9.5	6.1	90	11.21 5.09	349.00
THZ673	1/2 12.7	5/8 15.9	7000	320	12	1/4" - 18 NPT	3/8 9.5	3.1	94	5 2.27	119.00

3/8" HEAVY-DUTY COMPOSITE AIR IMPACT WRENCHES

- Lightweight composite design minimizes operator fatigue
- Ergonomic grip reduces vibration
- Exhaust air outlet directs air away from operator
- Forward-reverse switch, and high-low speed regulator
- Low noise, low vibration
- Overall length: 7"
- Weight: 2.8 lbs.

Model No. TLZ137



aurora tools

1/2" HEAVY-DUTY COMPOSITE AIR IMPACT WRENCHES

- Lightweight composite design minimizes operator fatigue
- Ergonomic grip reduces vibration
- Exhaust air outlet directs air away from operator
- Forward-reverse switch, and high-low speed regulator
- Low noise, low vibration
- Overall length: 7 3/4"
- Weight: 4.6 lbs.

Model No. TLZ138



aurora tools

Model No.	Square Drive in mm	Bolt Capacity in mm	Free Speed RPM	Torque Range ft.-lbs.	Average Air Consumption CFM	Air Inlet	Hose Size in mm	Vibrations Less Than m/s ²	Sound Pressure Level dB(A)	Price /Each
TLZ137	3/8 9.53	1/2 13	10,000	280	10.6	1/4" - 18 NPT	3/8 9.5	3.7	91.5	239.00
TLZ138	1/2 12.7	5/8 16	10,000	1000	13.7	1/4" - 18 NPT	3/8 9.5	6.0	94	309.00

R26467E

AIR TOOLS

COMPOSITE 3/4" HEAVY-DUTY AIR IMPACT WRENCHES

- Lightweight composite design minimizes operator fatigue
- Ergonomic grip reduces vibration
- Exhaust air outlet directs air away from operator
- Forward-reverse switch, and high-low speed regulator
- Overall length: 8"
- Weight: 5 lbs.

Model No. TLZ139



aurora tools

Model No.	Square Drive in mm	Bolt Capacity in mm	Free Speed RPM	Torque Range ft-lbs	Average Air Consumption CFM	Air Inlet	Hose Size in mm	Vibrations Less Than m/s ²	Sound Pressure Level dB(A)	Price /Each
TLZ139	3/4 19.1	1 26	9000	1000	13.7	1/4" - 18 NPT	3/8 9.5	9.2	95.9	445.00

3/8" HEAVY-DUTY AIR RATCHET WRENCHES

- Lightweight aluminum design minimizes operator fatigue
- Polyurethane grip reduces vibration
- Variable speed, reversible
- Paddle style trigger provides better speed control
- Ideal for automotive and industrial fastener removal and installation work

Model No. THZ671



aurora tools

1/2" HEAVY-DUTY AIR RATCHET WRENCHES

- Lightweight aluminum design minimizes operator fatigue
- Polyurethane grip reduces vibration
- Variable speed, reversible
- Paddle style trigger provides better speed control
- Ideal for automotive and industrial fastener removal and installation work

Model No. THZ680



aurora tools

Model No.	Square Drive Size in mm	Free Speed RPM	Torque Range ft-lbs.	Average Air Consumption CFM	Air Inlet	Hose Size in mm	Horse Power HP	Vibration Less Than m/s ²	Sound Pressure Level dB(A)	Net Weight lbs. kg	Price /Each
THZ671	3/8 9.5	175	5-75	3	1/4" - 18 NPT	3/8 9.5	0.45	1.0	78	2.6 1.18	86.95
THZ680	1/2 12.7	175	5-75	3	1/4" - 18 NPT	3/8 9.5	0.45	1.0	83	2.6 1.18	105.00

1/4" STUBBY TYPE AIR RATCHET WRENCHES

- Lightweight aluminum design minimizes operator fatigue
- Polyurethane grip reduces vibration
- Variable speed, reversible
- Paddle style trigger provides better speed control
- Powerful tool in a compact design
- (Polyurethane handle helps insulate vibration)
- Overall length: 7 1/4"
- Weight: 1.4 lbs.

Model No. TLZ140



aurora tools

Model No.	Square Drive in mm	Free Speed RPM	Torque Range ft-lbs	Average Air Consumption CFM	Air Inlet	Hose Size in mm	Vibrations Less Than m/s ²	Sound Pressure Level dB(A)	Price /Each
TLZ140	1/4 6.35	230	30	3	1/4" - 18 NPT	5/16 8	4.4	87	120.00

aurora tools

The best value in industrial tools . . . period

5" DUAL-ACTION ORBIT SANDERS

- Dual-action, compact and lightweight design
- Lever throttle offers one hand control
- Low vibration for swirl-free finishes
- Non-vacuum model
- Pad size (5"-6")
- Overall length: 6 1/2"
- Weight: 1.8 lbs.
- Stick-on pad comes standard (TLZ472)
- Optional Hook & Loop pad (TLZ473)

Model No. TLZ142



aurora tools®

6" DUAL-ACTION ORBIT SANDERS

- Dual-action, compact and lightweight (ergonomic) design
- Lever throttle offers one hand control
- Low vibration for swirl-free finishes
- Non-vacuum model
- Pad size (5"-6")
- Overall length: 7"
- Weight: 1.9 lbs.
- Stick-on pad comes standard (TLZ474)
- Optional Hook & Loop pad (TLZ475)

Model No. TLZ143



aurora tools®

Model No.	Free Speed RPM	Average Air Consumption CFM	Air Inlet	Hose Size in mm	Horse Power HP	Vibrations Less Than m/s ²	Sound Pressure Level dB(A)	Price /Each
TLZ142	10,000	9	1/4" - 18 NPT	3/8 9.5	0.35	0.80	78	199.00
TLZ143	10,000	9	1/4" - 18 NPT	3/8 9.5	0.35	0.80	78	199.00

AIR FLUX CHIPPERS & NEEDLE SCALERS

- Lightweight compact design permits increased operator efficiency
- Paddle style trigger offers better speed control and precision
- Low noise, low vibration
- Durability and longer life

TLZ133

- Overall length: 10 1/4"
- Weight: 4.1 lbs.
- Comes with 35mm flat chisel

- Available accessories: TLZ134 - 20mm flat chisel
TLZ135 - 35mm flat chisel
TLZ136 - moil point

TLZ131

- Weight: 6.1 lbs.
- Comes with 19 needles
- Replacement needles TLZ132



TLZ131



TLZ133

aurora tools®

Model No.	Stroke in mm	Blows per minute BPM	Average Air Consumption CFM	Air Inlet	Hose Size in mm	Vibrations Less Than m/s ²	Sound Pressure Level dB(A)	Price /Each
TLZ133	1-1/2 38	4400	9	1/4" - 18 NPT	3/8 9.5	10.2	92	178.00
TLZ131	1-1/2 38	4000	9	1/4" - 18 NPT	3/8 9.5	10.2	104.3	199.00

AIR HOSES NYLON COIL C/W FITTING

- Light and easy to handle
- Maximum working pressure, 300 PSI
- 3/8" NPT Male threads
- High impact and abrasion resistance
- Excellent elastic memory, can be stretched repeatedly yet return to original shape for convenient storage
- Colour: High-viz yellow



aurora tools®

Model No.	NPT (M)	Length	Price/Each
TLZ150	1/4"	25'	10.45
TLZ151	1/4"	50'	16.65
TLZ152	3/8"	25'	18.70
TLZ153	3/8"	50'	27.85

PLUG QUICK COUPLER KITS, 5 PIECES

Set includes:

- One 1/4" Quick coupler
- One 1/4" Female plug
- Three 1/4" Male plugs

Model No. TLZ148

Price/Each \$14.25



aurora tools®

Look for this symbol for environmentally friendly products!



AIR TOOLS

3/8" IMPACT WRENCHES

General duty for maintenance/repair.

- Energy-efficient motor
- Pistol-type grip with ergonomic handle
- Rocking dog clutch
- 1/4" (NPTF) air inlet thread
- 3/8" min. hose size

Model No. THZ943



3/8" IMPACT WRENCHES

General duty for maintenance/repair.

- Streamlined housing for easier access to tight areas
- Butterfly throttle
- Rocking dog clutch with oil lubrication
- 360° swivel air inlet
- 1/4" (NPTF) air inlet thread
- 3/8" min. hose size

Model No. TG048



3/8" IMPACT WRENCHES

General duty for maintenance/repair.

- High torque
- Dyna Pact™ clutch
- Ergonomic handle for excellent balance and feel
- 1/4" (NPTF) air inlet thread
- 3/8" min. hose size

Model No. THZ944



1/2" IMPACT WRENCHES

Standard duty for use in a variety of fastening operations.

- Dyna Pact™ clutch
- Built-in power regulator
- Push-through reverse mechanism

Model No. TLZ156



1/2" IMPACT WRENCHES

For general duty repair/maintenance and light-to-medium assembly applications.

- Twin clutch increases ultimate torque for smooth operation under heavy loading
- Oil bath clutch
- Teasing throttle

Model No. THZ948



3/4" IMPACT WRENCHES

High ultimate torque for tough applications.

- Ideal for hard pull up conditions
- Push-through reverse mechanism
- Teasing throttle
- Oil bath clutch chamber
- Pin clutch
- 3/8" (NPTF) air inlet thread
- 3/8" min. hose size

Model No. TG058



1" IMPACT WRENCHES

Standard duty for use in steel erection, heavy assembly/disassembly, maintenance/repair, and construction.

- Teasing throttle
- Rocking dog clutch
- Closed-grip inside trigger
- 6" extended shank
- 1/2" (NPTF) air inlet thread
- 1/2" min. hose size

Model No. TJZ370



Model No.	Mfg. No.	Shank			Working Torque		Maximum Torque		CFM	Overall Length		Net Weight		Price /Each
		Size		Retainer Type	ft.-lbs.	Nm	ft.-lbs.	Nm		in.	mm	lbs.	kg	
		in.	mm											
THZ943	CP721	3/8	10	Friction Ring	5-50	6.8-70	90	122	10	5 3/4	146	2 5/8	1.2	281.37
TG048	CP9522-B	3/8	10	Friction Ring	5-50	6.8-70	90	122	10	5 3/4	146	2	0.9	199.33
THZ944	CP724H	3/8	10	Friction Ring	20-160	27-217	200	272	12	6	152	3 1/10	1.4	244.00
TLZ156	CP9540-B	1/2	13	Friction Ring	25-310	34-420	425	576	15	7 1/2	191	5	2.3	237.90
THZ948	CP749	1/2	13	Friction Ring	25-330	34-450	450	610	16	7 1/2	194	5 1/2	2.5	281.37
TG058	CP9560	3/4	19	Friction Ring	150-700	200-950	1000	1360	24	9 5/8	244	10 1/2	4.8	591.47
TJZ370	CP797	1	25.4	Hole for Socket Pin	150-900	200-1225	1400	1900	40	15 1/2	394	27	12.3	1242.80

Noise levels are @ 1.0 m per Pneurop Standard 8N-1. Vibration levels are per ISO 8662-1.

Standard equipment: removable dead handle. TG063: Socket pin and retaining ring. TG065: adjustable and removable dead handle, socket pin and retaining ring.

DRILLS

NON-REVERSIBLE DRILLS 1/8" TO 3/8" CAPACITY

For maintenance and general use

- 1/2 HP motor
- Light weight
- Triple idler planetary gears
- Double ball bearing supported spindle
- Teasing throttle
- 1/4" (NPTF) air inlet thread
- 3/8" min. hose size

Model No. **TG070**



REVERSIBLE DRILLS 1/8" TO 1/2" CAPACITY

For precision drilling, hole sawing, honing, countersinking, and reaming

- 1/2 HP reversible motor
- Variable speed
- Teasing throttle
- Jacobs chuck
- 1/4" (NPTF) air inlet thread
- 3/8" min. hose size

Model No. **TG072**



REVERSIBLES ANGLE DRILLS/ NON-REVERSIBLE IN-LINE DRILLS 1/8" TO 3/8" CAPACITY

For drilling in hard-to-reach areas

- Compact for confined spaces
- Rear exhaust
- Teasing throttle
- 1/4" (NPTF) air inlet thread
- 3/8" min. hose size

Model No. **TG074**

Model No. **THZ740**

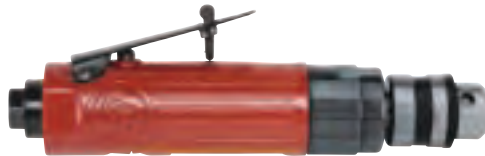

THZ740



Model No.	Mfg. No.	Chuck Size		Spindle Thread	Free Speed RPM	Air Consumption CFM	Overall Length		Net Weight		Price /Each
		in	mm				in	mm	lbs.	kg	
TG070	CP9285	3/8	10	3/8"-24	2900	21	6.5	165	2.4	1.1	147.67
TG072	CP9789	1/2	13	3/8"-24	800	24	7	177	4	1.8	263.37
THZ740	CP887	3/8	10	3/8"-24	2500	26	8.5	215	2	0.9	141.10

Noise levels are @ 1.0 m per Pneurop Standard 8N-1. Vibration levels are per ISO 8662-1. Standard equipment: Removable support handle on **TG072**.

INDUSTRIAL SCREWDRIVERS

REVERSIBLE, PISTOL GRIP SCREWDRIVERS

- One hand operation reverse valve
- Compact pistol grip
- Roller clutch
- Shut-off clutch

Model No. **TG090**

Model No. **TG091**



REVERSIBLE IN-LINE SCREWDRIVERS

- Progressive lever start
- Ideal for centering screws during the fastening cycle
- Roller clutch
- Reversible
- Use for disassembly

Model No. **TG092**



REVERSIBLE IN-LINE SCREWDRIVERS

- Push-to-start operation
- Quick change reverse operation
- Shut-off clutch
- Ideal for continuous operation
- Positive shut-off at preset torque

Model No. **TG093**



Model No.	Mfg. No.	Free Speed RPM	Torque Range in.-lbs. (Nm) Soft-pull-up Work		CFM	dBA	Vibration m/s ²	Overall Length in. (mm)	Net Weight lbs. (kg)	Price /Each
			Min.	Max.						
TG090	CP2612	1470	3.5 (0.4)	39 (4.4)	14	75	2.3-3.9	72 (182)	1.8 (0.8)	436.73
TG091	CP2611	1000	3.5 (0.4)	38 (4.3)	20	76	<2.5	72 (182)	1.8 (0.8)	945.35
TG092	CP2621	1000	3.5 (0.4)	39 (4.4)	14	77	9-35	9.6 (224)	2.58 (1.2)	674.45
TG093	CP2622	1700	3.5 (0.4)	38 (4.3)	14	81	<2.5	8.8 (223)	1.39 (0.7)	674.45

1/4" (NPTF) air inlet thread; 3/8" min. hose size.

Noise levels are @ 1.0 m per Pneurop Standard 8N-1. Vibration levels are per ISO 8662-1.



RATCHETS

1/4" RATCHETS

For light duty repair or assembly work

- Also for confined space or hard to reach areas
- 1/4" square drive spindle with pin retainer
- Reverse button
- Ball-type socket retainer
- Teasing throttle
- 1/4" (NPTF) air inlet

Model No. THZ865



3/8" RATCHETS

For assembly, including electronics, appliances, and light manufacturing

- Fast change, 3/8" square drive spindle
- Improved ratchet head
- Reverse button
- Use as hand ratchet for final torque up or to break fastener loose
- 1/4" (NPTF) air inlet

Model No. THZ869



1/2" RATCHETS

For assembly, including electronics, appliances, and light manufacturing

- Fast change, 1/2" square drive spindle
- Improved ratchet head
- Reverse button
- Use as hand ratchet for final torque up or to break fastener loose
- 1/4" (NPTF) air inlet

Model No. TG069



Model No.	Mfg No.	Square Drive in.	Free Speed RPM	Torque Range		CFM	dBA	Vibration m/s ²	Head Dimensions		Overall Length in. (mm)	Net Weight lbs. (kg)	Price /Each
				Ft.-lbs. (Nm) Min.	Max				Ht. To Rear of Socket in. (mm)	Side to Centre in. (mm)			
THZ865	CP825	1/4	200	5 (7)	15 (20)	10	87	10	1 5/16 (24)	1 19/32 (15)	6 1/2 (165)	1 7/8 (.85)	182.93
THZ869	CP828	3/8	150	10 (14)	50 (68)	16	92	10	1 3/16 (30.2)	25/32 (19.8)	10 (254)	2 5/8 (1.2)	164.07
TG069	CP828H	1/2	150	10 (14)	50 (68)	16	92	10	1 3/16 (30.2)	25/32 (19.8)	10 (254)	2 5/8 (1.2)	175.30

Noise levels are @ 1.0 m per Pneurop Standard 8N-1. Vibration levels are per ISO 8662-1. For initial loosening and final tightening, apply torque by hand, not to exceed 30 ft.-lbs. (41 Nm)

MINI RATCHET WRENCHES 1/4" & 3/8"

- Under 6" in length
- Small, lightweight and compact
- Soft handle grip
- TLZ709 has a quick release button
- Up to 27 ft.-lbs. in torque
- Speed: 275 RPM



TLZ708

LIGHTWEIGHT, HEAVY-DUTY, MAGNESIUM IMPACT WRENCHES

- Lightweight, high power, low noise
- Composite body and magnesium clutch housing
- Great durability and power
- 3 forward power settings



TLZ323



Model No.	TLZ708	TLZ709
Mfg. No.	CP9426	CP9427
Square drive:	1/4"	3/8"
Free Speed:	275 RPM	275 RPM
Torque range:	5-27 ft.-lbs.	5-27 ft.-lbs.
Length:	5.1"	5.1"
Air Flow:	12.5 CFM	12.5 CFM
Air Inlet:	1/4"	1/4"
Air Hose Bore:	-	-
Sound Level:	82 dB (A)	82 dB (A)
Sound Power:	93 dB (A)	93 dB (A)
Vibration Level:	5.5 m/s ²	4.5 m/s ²
Weight:	1.08 lbs.	1.11 lbs.
Price/Each	\$166.53	\$167.35



Model No.	TLZ320	TLZ321	TLZ322	TLZ323
Mfg. No.	CP8222	CP8242	CP8252	CP8272
Square drive:	3/8"	1/2"	1/2"	3/4"
Socket retainer:	Friction ring	Friction ring	Friction ring	Friction ring
Clutch Type:	Twin hammer	Twin hammer	Twin hammer	Twin hammer
Torque working:	184-295 ft.-lbs.	184-295 ft.-lbs.	220-590 ft.-lbs.	100-960 ft.-lbs.
Torque max.:	331 ft.-lbs.	479 ft.-lbs.	775 ft.-lbs.	1217 ft.-lbs.
Length:	6.96"	6.96"	7.87"	9.05"
Air Flow:	32 CFM	32 CFM	28.8 CFM	48 CFM
Air Inlet:	1/4" NPTF	1/4" NPTF	1/4" NPTF	3/8" NPTF
Air Hose Bore:	3/8"	3/8"	3/8"	1/2"
Sound Level:	89 dBA	89 dBA	94 dBA	96 dBA
Sound Power:	100 dBA	100 dBA	105 dBA	107 dBA
Vibration Level:	3.9 m/s ²	3.9 m/s ²	7.9 m/s ²	9 m/s ²
Weight:	2.53 lbs.	2.64 lbs.	4.4 lbs.	7.16 lbs.
Price/Each	\$307.40	\$307.40	\$308.28	\$666.63

DIRECT DRIVE REVERSIBLE SCREWDRIVERS

- Suitable for variable torque
- High speed fast screw rundown
- Ergonomic pistol grip improves operator comfort and productivity

Model No.	TLZ339
Mfg. No.	CP2755
Clutch Type	Direct drive reversible
Handle style	Pistol grip
Operation	Trigger start
Free Speed	2200 RPM
Output	Hex. 1/4"
Torque range	124 in.-lbs.
Length	6.3"
Weight	2.27 lbs.
Air Flow	29 CFM
Air Inlet	1/4"NPTF
Air Hose Bore	3/8"
Sound Level	90 dBA
Vibration Level	<2.5 m/s ²
Price/Each	\$259.91



POSITIVE CLUTCH REVERSIBLE SCREWDRIVERS

- Quick change chuck
- Operator can force clutch engagement for higher torque
- Reverse control at the trigger
- Good for prevailing torque applications
- High speed and high torque

Model No.	TLZ340
Mfg. No.	CP2780
Clutch Type	Positive clutch
Handle style	Pistol grip
Operation	Trigger start
Free Speed	2100 RPM
Output	Hex. 1/4"
Torque range	133 in.-lbs.
Length	6.46"
Weight	2.35 lbs.
Air Flow	29 CFM
Air Inlet	1/4"NPTF
Air Hose Bore	3/8"
Sound Level	89 dBA
Vibration Level	26.8 m/s ²
Price/Each	\$305.68



SANDERS

RANDOM ORBITAL SANDERS

Use the orbital motion for fine finishing; rotary motion for rapid material removal.

- Balanced counterweight design
- Heavy-duty bearing construction
- Cross-bolt-style hub mounting
- 1/4" (NPTF) air inlet thread
- 3/8" min. hose size

Model No. THZ829



THZ829



TG086

SANDERS

For use in a variety of sanding, blending and smoothing operations in the appliance, construction, shipyard and electronics industries or wherever metal or fiberglass is being prepared or finished.



TG084



TG085



Model No.	Mfg. No.	Paper Size		Spindle Thread	Free Speed RPM	CFM	dBA	Vibration m/s ²	Net Weight		Price /Each
		in.	mm						lbs.	kg	
THZ829	CP870	6	150	5/16"-24	10000	18	94	<2.5	4	1.9	83.67
TG084	CP7265S	7	178	5/8"-11	4500	24	89	<2.5	4.5	2.0	340.43
TG085	CP7269S	7	178	5/8"-11	4500	24	89	<2.5	6.5	3.0	345.40
TG086	CP7202	3	75	3/8"-24	14,000	19	77	<2.5	1.5	0.7	147.67

Noise levels are @ 1.0 m per Pneuop Standard 8N-1. Vibration levels are per ISO 8662-1.

ANGLE GRINDERS

4" & 5" ANGLE GRINDERS

For cleaning, deburring, blending and smoothing

- 0.8 HP motor
- Aluminum alloy housing
- Spiral bevel gearing in angle head
- 1/4" (NPTF) air inlet
- 3/8" minimum hose size

Model No. TG080

Model No. TG081



7" ANGLE GRINDERS

For cleaning, deburring, blending, and smoothing

- Use with 7", Type 27 grinding wheels
- 1.12 HP motor
- Aluminum alloy housing
- Spiral bevel gearing in angle head
- 3/8" (NPTF) air inlet
- 3/8" minimum hose size

Model No. TKZ804



Model No.	Mfg No.	Wheel Size in. (mm)	Spindle Thread"	Free Speed RPM	CFM	dBA	Vibration m/s ²	Overall Length Less Guard in. (mm)	Net Weight Less Guard lbs. (kg)	Price /Each
TG080	CP9120CR	4 (102)	3/8-24	14,000	21	84	7.5	9 (229)	4.0 (1.8)	296.18
TG081	CP9121CR	5 (127)	3/8-24	12,000	21	84	8.1	9 (229)	4.2 (1.9)	296.18
TLV383	CP9122BR	4.5 (114)	5/8-11	12,000	30	84	8.6	9	4.2	610.00
TKZ804	CP9123	7 (178)	5/8-11	7500	33	93	4.2	13 1/8 (333)	6 1/4 (2.84)	542.28

Noise levels are @ 1.0 m per Pneuop Standard 8N-1. Vibration levels are per ISO 8662-1.

R30778E

OFFICE PRODUCTS

INSTRUMENTS, SCALES & ELECTRICAL

SHIPPING & PACKAGING

TOOLS & EQUIPMENT

WELDING & METALWORKING

SAFETY EQUIPMENT & SUPPLIES

JANITORIAL & MAINTENANCE

MATERIAL HANDLING & STORAGE

AIR TOOLS



AIR SCRIBE® PENS

- Vibration level: 4.2 m/s²
- INCLUDED ACCESSORIES:**
- Air hose - 3/16" (5 mm) I.D.
- Air filter assembly
- Stylus - carbide tipped for writing and engraving
- Anvil for use with chisels and blank
- Flat chisel for scaling and deburring
- Chisel blank, customized to suit
- Round nose chisel for cleaning weld beads
- Carrying case



Model No.	Mfg. No.	Max Blows Per Minute	Weight lbs. kg	Length in. mm	Air Flow L/s CFM	Min Hose Bore in. mm	Sound Level dBA	Price /Each
AIR SCRIBE® KIT								
TCW246	CP9361-1 KIT	13 500	0.31 0.14	5 127	0.5 1.1	3/16 5	79	527.40
TKZ813	P054177			Replacement Stylus				35.09

NON-VACUUM ORBITAL SANDERS

- Random orbital sanders for general sanding, orbit dia. 3/16" (5 mm)**
- Low noise and vibration
 - 3/16" orbit



TDU633



Model No.	Mfg. No.	Pad		Weight lbs. kg	Height with Pad in. mm		Air Consumption (CFM) Average At load		Air Inlet Thread"	Hose I.D."	Price /Each
		Size in.	Dia. mm		in.	mm					
TCW303	CP3511	5	127	1.63 0.74	3 1/4	83	8.0	16.6	1/4	1/4	215.75
TDU633	CP7255	6	150	1.74 0.79	3 1/4	83	8.0	16.6	1/4	1/4	235.50

COMPACT ENGRAVING PENS

- Finger tip start valve
- Fine point stylus
- Enhanced control
- Compact and lightweight
- Engraves at 32,400 BPM
- Quiet operation @ 59 dB(A)



Model No. THZ727
Mfg. No. CP9160
Price/Each \$174.70

INDUSTRIAL DIE GRINDERS

- Excellent ergonomics
- Very low maintenance
- Low vibration
- Built for continuous use



TCW168

TCW258

TCW174

TCW144

TCW044



Model No.	Mfg. No.	Free Speed RPM	Collet Max Capacity"	HP	Power W	Weight		At Free Speed		Air Consumption		Air Inlet Thread"	Hose I.D."	Price /Each
						lbs.	kg	CFM	L/s	At Max Output CFM	L/s			
TCW168	CP3451-18SEC	18 000	1/4	1.0	750	3.1	1.4	14	6.7	17	8	1/4	5/16	613.65
TCW258	CP3000-424R	24 000	1/4	0.5	400	1.8	0.84	27	13	25	12	1/4	5/16	361.55
TCW144	CP3030-420R	13 000	1/4	0.8	600	2.6	1.3	21	10	40	19	3/8	3/8	417.95
TCW044	CP3109-13AC	13 000	1/4	0.8	600	2.4	1.1	21	10	32	15	3/8	3/8	918.00
TCW088	CP3109-24ES	24 000	1/4	0.8	600	2.9	1.3	21	10	32	15	3/8	3/8	1348.00
TCW174	CP3109-24	24 000	1/4	0.8	600	2.0	0.9	21	10	32	15	3/8	3/8	724.00

BELT SANDERS

- Ergonomic design
- Low maintenance motor
- Easy belt changes
- Unequaled power to weight ratio



TCW005



TCW006



Model No.	Mfg. No.	Free Speed RPM	Belt Size L x I		Power		Weight		Air Consumption At Free Speed		Air Inlet Thread"	Hose I.D."	Price /Each
			in.	mm	HP	W	lbs.	kg	CFM	L/s			
TCW005	CP9779	22 000	13 x 3/8	330 x 10	0.4	300	2.09	0.95	14	6	1/4	3/8	529.00
TCW006	CP9780	20 000	20.4 x 3/4	520 x 20	0.4	300	2.09	0.95	15	7	1/4	3/8	302.70

UTILITY HAMMERS

For light to medium duty chipping, trimming, riveting, cutting, piercing & peening jobs

- Aluminum body
- 2 5/8" stroke (TG087), 3 1/2" stroke (TG088)
- Piston air-cushioned on return stroke
- 1/4" (NPTF) air inlet
- 3/8" minimum air hose size



TG087



TG088



Model No.	Mfg. No.	Capacity Cold Rivets in. (mm)		Bore and Stroke in. (mm)	Blows per Minute	Rivet Set and Chisel Shank	CFM	dBA	Vibration m/s ²	Overall Length in. (mm)	Net Weight lbs. (kg)	Price /Each
		Dural	Steel									
TG087	CP7111	1/4 (6.4)	3/16 (4.8)	3/4 x 2 5/8 (19 x 67)	3000	0.401 (10.19 mm)	25	100	8.9	6 3/4 (171)	3 1/2 (1.6)	70.55
TG088	CP7150	5/16 (7.9)	1/4 (6.4)	3/4 x 3 1/2 (19 x 89)	2300	0.401 (10.19 mm)	25	100	9.4	8 7/8 (225)	4.2 (1.9)	94.12

Noise levels are @ 1.0 m per Pneuop Standard 8N-1. Vibration levels are per ISO 8662-1.

INDUSTRIAL CHIPPERS/SCALERS

- For industrial use
- Powerful
- Durable



TCW253



TCW235

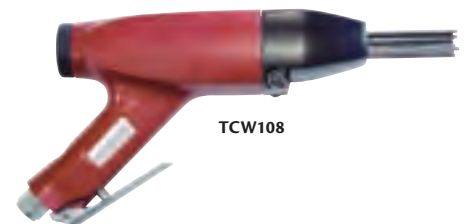

TCW108



Model No.	Mfg. No.	Bore		Stroke		Shank"	Blows Per Minute	Weight		Air Consumption At Free Speed		Air Inlet Thread"	Hose I.D."	Price /Each
		in.	mm	in.	mm			lbs.	kg	CFM	L/s			
TCW253	CP9356NS	0.71	18.0	1.18	30.0	ISO 1/2 square	3800	3.3	1.5	3.0	1.4	1/4	5/16	667.32
TCW235	CP9356WF	0.93	23.5	1.40	35.6	ISO 1/2 square	3000	4.4	2.0	5.5	2.6	1/4	3/8	750.74
TCW108	CP0952	1.30	33.0	1.94	49.2	ISO 1/2 square	2200	8.8	4.0	8.5	4.0	1/4	3/8	1640.00



WELD FLUX CHIPPERS & NEEDLE SCALERS

- For removing rust, scale, paint & medium duty weld flux removal
- Simple plate valve design allows for smooth throttling
- Heat-treated piston, cylinder sleeve and chisel bushing for long life
- Removal of needle attachment converts tool to a weld flux chipper

Model No.	TLZ158
Mfg. No.	CP7120
Bore	1 1/8"
Blows per minute	4800 BPM
Shank Length	1/2 sq.in. 18"
Weight	6.2 lb
Air Flow	15.5 CFM
Min. Hose Size	3/8"
Air Inlet	1/4" NPT
Sound Level	99 dBA
Sound Power	110 dBA
Vibration Level	9.7 m/s ²
Price/Each	\$260.77

Kit Includes:
 1 x Tool Body
 1 x 19 needles
 1 x 35mm chisel



SPECIALTY TOOLS

AIR SHEARS FOR CUTTING SQUARES & ANGLES IN ALUMINUM, TIN & STEEL

- Cuts up to 18 gauge steel
- Powerful 1/2 HP motor
- Triple idler planetary gears
- Ergonomic handle design
- 1/4" (NPTF) air inlet



HEAVY-DUTY RECIPROCATING SAWS FOR CUTTING PLASTIC, FIBREGLASS, & METAL UP TO 16 GAUGE

- Ergonomic rubber grip
- Heavy-duty construction
- Lock-off throttle
- Universal saw blade holder
- 1/4" (NPTF) air inlet
- 3/8" minimum hose size



Model No.	Mfg. No.	Strokes per Minute	Capacity Steel	CFM	dBa	Vibration m/s ²	Overall Length in. (mm)	Net Weight lbs. (kg)	Price /Each
TG096	CP7855	2400	18 gauge	50	92	3.2	8 2/3 (220)	2 1/2 (1.1)	329.00
TG097*	CP9881	5000	16 gauge	27	81	<2.5	10 1/2 (268)	2.2 (1)	328.00

Noise levels are @ 1.0 m per *Pneurop* Standard 8N-1. Vibration levels are per ISO 8662-1.

*Standard equipment: saw blade, 24 teeth per in.

REPLACEMENT BLADES FOR TG097

Model No.	Mfg No.	Description	Price/Each
TKZ808	205 048 893 3	14T Saw Blade, pack of 5	7.07
TKZ809	205 048 894 3	18T Saw Blade, pack of 5	7.07
TKZ810	205 048 895 3	24T Saw Blade, pack of 5	7.07

INDUSTRIAL IMPACT WRENCHES

- Heavy-duty
- More durable
- More serviceable



Model No.	Mfg. No.	Drive"	Socket Retainer	Clutch Type	Handle Style	Torque Working pi-lbs.	Torque max ft-lbs.	Air Consumption CFM*	Overall Length"	Side to Center"	Weight lbs.	Price /Each
3/4" DRIVE- 75-650 FT-LB												
TBW429	CP6060 SASAB	3/4	Hole	2-jaw	Pistol	650	1000	42	7.63	1.78	11.6	2200.28
TG059	CP9561	3/4	Hole	Pin	Pistol	500	750	30	8.5	1.535	11.1	883.43
1"-1 1/2" DRIVE- 280-2400 FT-B												
TBW274	CP0611 PASED	1	Hole	2-jaw	D inside trigger	900-1800	2800	85	12.5	2.25	22.4	4090.97
TG065	CP0611P RS	1	Hole	2-jaw	Pistol	900	2800	48	10.7	1.811	23.1	3427.57

*Free speed. Torque ranges should be used as a guide only. Final torque will depend on the joint, operating pressure and drive accessories. Air inlet 1/4" NPT.

INDUSTRIAL ANGLE GRINDERS

- Powerful production tool
- Easy maintenance
- Lubricate only every 1000 hours
- Unequaled power to weight ratio



Model No.	Mfg. No.	Free Speed RPM	Wheel		Threaded Spindle	Power HP W	Weight		Air Consumption				Air Inlet Thread"	Hose I.D."	Price /Each
			in.	Max. Capacity mm			lbs.	kg	At Free Speed CFM L/s	At Max Output CFM L/s					
TCW014	CP3450-12AC4	12 000	4	100	3/8"-24	1.1 810	3.7	1.7	18	10	36	18	3/8	1/2	729.73
TBW661	CP3450-12AB5	12 000	5	127	5/8"-11	1.1 810	6.3	2.9	18	14	36	18	1/2	1/2	729.73

GRINDERS

MINI ANGLE DIE GRINDERS

For high-speed blending, smoothing, porting and deburring in confined areas.

- Compact, lightweight design
- Lock-off throttle
- 90° angle head
- Front exhaust
- 1/4" (NPTF) air inlet thread
- 3/8" min. hose size

Model No. TG077



DIE GRINDERS & EXTENDED SPINDLE DIE GRINDERS

For die contouring and repair, weld cleaning, casting and forging cleanup, deburring, blending, and smoothing.

- 1/2 HP motor
- Square handle design
- Lock-off throttle
- Rear exhaust
- TG079 - 6" extended spindle
- 1/4" (NPTF) air inlet thread
- 3/8" min. hose size

Model No. TG078, TG079



MINI DIE GRINDERS

For high-speed blending, smoothing, porting and deburring in confined areas.

- Compact, lightweight design
- Lock-off throttle
- Front exhaust
- 1/4" (NPTF) air inlet thread
- 3/8" min. hose size

Model No. TG076



Model No.	Mfg. No.	Collet Size		Spindle Thread"	Free Speed RPM	CFM	dBA	Vibration m/s ²	Overall Length		Net Weight		Price /Each
		in.	mm						in.	mm	lbs.	kg	
TG076	CP876	1/4	6	3/8"-24	28 000	16	101	2.5	4 3/4	119	3/4	0.3	87.78
TG077	CP875	1/4	6	3/8"-24	21 000	16	101	2.5	4 7/8	123	1	0.5	79.57
TG078	CP860	1/4	6	M10 x 1.25"	24 000	20	90	3.0	5 3/4	146	1 1/4	0.6	178.02
TG079	CP860ES	1/4	6	M10 x 1.25"	24 000	20	90	3.0	11 3/4	298	2 1/10	.95	351.10

Noise levels are @ 1.0 m per Pneuop Standard 8N-1. Vibration levels are per ISO 8662-1.

MANDREL MOUNTED FLAP WHEELS

- Mandrel mounted high performance
- Designed with the 1/4" mandrel as a integral part of the wheel
- More aggressive and works great in heavy stock removal operations
- A very durable, long lasting mini flap wheel

MERIT



Model No.	Size			Grit	Max RPM	Price /Each
	D"	T"	S"			
BQ567	1	x	1 x 1/4	40	30000	3.96
NP722	1	x	1 x 1/4	50	30000	3.96
BQ730	1	x	1 x 1/4	60	30000	3.96
BQ731	1	x	1 x 1/4	80	30000	3.96
BQ732	1	x	1 x 1/4	120	30000	3.96
BQ733	1	x	1 x 1/4	180	30000	3.96
BQ701	1	x	1 x 1/4	240	30000	3.96
BQ734	1	x	1 x 1/4	320	30000	3.96
BQ677	1 1/2	x	1 x 1/4	40	25000	5.02
BQ741	1 1/2	x	1 x 1/4	60	25000	5.02
BQ707	1 1/2	x	1 x 1/4	80	25000	5.02
BQ708	1 1/2	x	1 x 1/4	120	25000	5.02
BQ742	1 1/2	x	1 x 1/4	180	25000	5.02
BQ613	1 1/2	x	1 x 1/4	240	25000	5.02
BQ709	1 1/2	x	1 x 1/4	320	25000	5.02

Model No.	Size			Grit	Max RPM	Price /Each
	D"	T"	S"			
BQ710	2	x	3/4 x 1/4	40	25000	5.67
BQ711	2	x	3/4 x 1/4	60	25000	5.67
BQ712	2	x	3/4 x 1/4	80	25000	5.67
BQ713	2	x	3/4 x 1/4	120	25000	5.67
BQ714	2	x	3/4 x 1/4	180	25000	5.67
BQ754	2	x	1 x 1/4	40	25000	6.39
NP723	2	x	1 x 1/4	50	25000	6.39
BQ748	2	x	1 x 1/4	60	25000	6.39
BQ749	2	x	1 x 1/4	80	25000	6.39
BQ750	2	x	1 x 1/4	120	25000	6.39
BQ751	2	x	1 x 1/4	180	25000	6.39
BQ752	2	x	1 x 1/4	240	25000	6.39
BQ753	2	x	1 x 1/4	320	25000	6.39

R27370E

AIR TOOLS

DYNAFILE® ABRASIVE BELT MACHINES

- Replaces tedious hand filing and sanding
- Superior belt tracking and fast abrasive belt changes
- New composite quick-change housing cover reduces vibration and is thermal-insulated
- New belt housing has larger opening for belt tracking and operation
- Includes: Contact arm THZ336

DYNAFILE® VERSATILITY KITS

TGY725 Dynafile® with 5 contact arms, **THZ353**, **THZ354**, **THZ336**, **THZ337** & **THZ355** and abrasive belts in a durable case

Model No. TGY726 Mfg. No: 14010
Price/Each \$839.48

Model No.
Mfg. No.
Abrasive Belt Size:

Air Flow Rate @ 90 psig:
Sound Level:
Horsepower:
Free Speed:
Air Pressure:
Air Inlet Thread:
Hose Size (I.D.):
Max. SFPM:
Length:
Height:
Weight:
Price/Each:

TGY725
14000
1/8-1/2" W x 24" L
(3-13 mm x 610 mm)
31 SCFM
77 dB (A)
0.50 HP
20 000 RPM
90 PSI
1/4 NPT
3/8" (10 mm)
5800 SFPM
14 3/5" (371 mm)
4" (102 mm)
3.1 lbs. (1.41 kg)
\$663.05



TGY726 Versatility Kit

DYNAFILE® II ABRASIVE BELT MACHINES

- New lightweight composite housing reduces vibration and is thermal-insulated to prevent cold air transmission to the operator's hand. Grinding head pivots 360°
- Air motor easily converts to 1/4" die grinder or 1/4" drill
- Order collet and chuck separately

DYNAFILE® II ABRASIVE BELT MACHINE VERSATILITY KITS

Kit Includes: Dynafile® II model **TGY737**, 3-contact arms (**THZ343**, **THZ341** & **THZ342**), 8-abrasive belts, 1/4" Collet for die grinder use and carrying case

Model No. TGY738 Mfg. No. 40321
Price/Each \$802.40

Model No.
Mfg. No.
Abrasive Belt Size:

Air Flow Rate @ 90 psig:
Sound Level:
Horsepower:
Free Speed:
Air Pressure:
Air Inlet Thread:
Hose Size (I.D.):
Max. SFPM:
Length:
Height:
Weight:
Price/Each:

TGY737
40320
1/4" - 3/4" W x 18"- 24" L
(6-19 mm) x (457-610 mm)
28 SCFM
80 dB (A)
0.50 HP
20 000 RPM
90 PSI
1/4 NPT
3/8" (10 mm)
4550 SFPM
14 1/4" (362 mm)
4 7/8" (124 mm)
2.5 lbs. (1.14 kg)
\$650.68



TGY738 Versatility Kit

ELECTRIC DYNAFILE® II ABRASIVE BELT MACHINES

- Runs coated-abrasive and non-woven nylon belts
- Ideal for grinding, deburring, blending, finishing and surface conditioning
- Tool includes model **THZ341** contact arm, for abrasive belts 1/2" wide by 18" long
- Tool accepts over 20 interchangeable contact arms
- Sanding head pivots 360°, for working in previously inaccessible areas
- Side handle included for operator comfort
- Handle is reversible for left or right hand use
- Tool is double-insulated for safety, includes electric cord 8 feet in length

ELECTRIC DYNAFILE® II ABRASIVE BELT MACHINE VERSATILITY KITS

- Includes model **TGY744** electric Dynafile® II with model **THZ341** contact arm, and two additional arms models **THZ340** and **THZ342**, eight abrasive belts of various grits, and an assortment of platen pads
- All items contained in handy and durable carrying case

Model No. TGY745 Mfg. No. 40611 **Price/Each \$510.21**

Model No.
Mfg. No.
Abrasive Belt size:

Max. RPM:
Max. SFPM:
Length:
Height:
Weight:
Price/Each:

TGY744
40610
1/4" - 3/4" W x 18"- 24" L
(6-19 mm) x (457-610 mm)
11 000 RPM
2520 SFPM
19" (445 mm)
5 1/2" (121 mm)
5 lbs. (2.1 kg)
\$373.10



TGY745 Versatility Kit

MINI-DYNAFILE® II ABRASIVE BELT MACHINES

- Pop-off guard for easy abrasive belt changes
- Multi-positioning grinding head pivots 360°
- Easy abrasive belt tracking with adjustment knob
- Strap polish, grind, deburr, enter narrow openings
- Materials: woodworking, metal, ceramics, composites, stainless steel, plastics, fibreglass, rubber, glass & stone

MINI-DYNAFILE® II ABRASIVE BELT MACHINE VERSATILITY KITS

- Kit includes: Mini-Dynafile® model **TGY731**, 2 additional contact arms (models **THZ346** and **THZ356**), assorted belts, threaded collet insert and durable carrying case
- Multi-positioning grinding head pivots 180°
- Easy abrasive belt tracking with adjustment knob

Model No. TGY732 Mfg. No. 15006
Price/Each \$746.21

Model No.
Mfg. No.
Abrasive Belt Size:

Air Flow Rate @ 90 psig:
Sound Level:
Horsepower:
Free Speed:
Air Pressure:
Air Inlet Thread:
Hose Size (I.D.):
Max. SFPM:
Length:
Height:
Weight:
Price/Each:

TGY731
15003
1/8-1/2" W x 12" L
(3-13 mm) x (305 mm)
20 SCFM
78 dB (A)
0.35 HP
25 000 RPM
90 PSI
1/4 NPT
1/4" (6 mm)
4890 SFPM
10 3/4" (273 mm)
3 1/2" (89 mm)
1.8 lbs. (0.82 kg)
\$638.32



TGY732 Versatility Kit



DYNAFILE® III ABRASIVE BELT MACHINES

- Lightweight, ergonomic design for operator control & comfort
- Composite housing reduces vibration and is thermal-insulated to prevent cold air transmission to operator
- Grinding head pivots 360°

DYNAFILE® III ABRASIVE BELT MACHINE VERSATILITY KITS

- Composite housing reduces vibration and is thermal-insulated to prevent cold air transmission to operator.
- Grinding head pivots 360°
- Kit includes: *Dynaflex III* model **TGY733**, 3-Contact A rms models **THZ348**, **THZ357** and **THZ351**, spare drive wheel, wrenches, hex keys, 6 abrasive belts and carrying case

Model No. **TGY734** Mfg. No. 15302
Price/Each \$1042.89

Model No. **TGY733**
Mfg. No. 15300
Abrasive Belt Size:

1/4" - 1" W x 18" L
(6-25 mm) x (457 mm)
32 SCFM
87 dB (A)
0.70 HP
20 000 RPM
90 PSI
1/4 NPT
3/8" (10 mm)
4550 SFPM
14 1/4" (362 mm)
47/8" (124 mm)
2.5 lbs. (1.14 kg)
\$873.20

Air Flow Rate @ 90 psig:
Sound Level:
Horsepower:
Free Speed:
Air Pressure:
Air Inlet Thread:
Hose Size (I.D.):
Max. SFPM:
Length:
Height:
Weight:
Price/Each:



TGY734 Versatility Kit

DYNAFILE® CONTACT ARMS

4" to 14" Workable Reach (Includes bearing and shaft)



THZ336 THZ337 THZ338 THZ339

Model No.	Mfg. No.	Description	Belt Size	Contact Wheel Ass.	Platen Pad	Price /Each
THZ336	11218	Standard Arm on TGY725	1/2" x 24"	11078 5/8" Dia. x 3/8" W, rubber	11025 1/2" w	66.21
THZ337	11219	No platen due to offset design, Grind radiuses, slack polish, Offset for slack polishing	1/4", 5/16" or 2" x 24"	11080 1" Dia. x 3/8" wide, radius rubber	None	66.21
THZ338	11232	For 1/8" wide belts, No platen due to offset design Grind corners, strap polish	1/8" or 1/4" x 24"	11086 1" Dia. x 3/8" W, tapered urethane	None	90.00
THZ339	11215	Enter 1/2" x 1/2" openings	1/4" x 24"	11072 7/16" Dia. x 1/4" wide 1/8" wide, brass	11034	75.00

DYNAFILE® III CONTACT ARMS

4" to 6 3/4" Workable Reach



THZ348 THZ349 THZ350 THZ351 THZ352

Model No.	Mfg. No.	Description	Belt Size	Contact Wheel Ass.	Platen Pad	Price /Each
THZ348	15350	Reversible Arm - arm can be flipped to allow for platen sanding or strap polishing Standard with tool	1" x 18"	15349 90 durometer 2" Dia. x 1" W	15323 1" W	180.00
THZ349	15351	Reversible Arm - arm can be flipped to allow for platen sanding or strap polishing	1" x 18"	15348 70 durometer 2" Dia. x 1" W	15323 1" W	180.00
THZ350	15356	Reversible Arm - arm can be flipped to allow for platen sanding or strap polishing	1" x 18"	15346 40 durometer 2" Dia. x 5/8" W	15323 1" W	187.50
THZ351	15357	Reversible Arm - arm can be flipped to allow for platen sanding or strap polishing "V" shape wheel	1" x 18"	15347 2" Dia. x 1" W	15323 1" W	187.50
THZ352	15375	Great for strap polishing	1" x 24"	15348 70 durometer 2" Dia. x 1" W	None	259.66

DYNAFILE® II CONTACT ARMS

For Air and electric Models - 4" to 17" Workable Reach



THZ340 THZ341 THZ342 THZ343 THZ344

Model No.	Mfg. No.	Description	Belt Size	Contact Wheel Ass.	Platen Pad	Price /Each
THZ340	11202	Enter 5/16" x 3/4" openings	1/4" x 18"	11074 5/8" Dia. x 1/8" W, rubber	11032 1/4" W	66.21
THZ341	11203	Standard on Models TGY742 and TGY744, Grind over contact wheel or platen	1/2" x 1/8"	11078 5/8" Dia. x 3/8" W, rubber	11025 1/2" W	66.21
THZ342	11204	Unique offset design Strap polishing is easy with this arm	1/8", 1/4", 5/16" or 1/2" x 18"	11080 1" Dia. x 3/8" W, radiused rubber	None	66.21
THZ343	11206	Standard on models TGY737 and TGY741	5/8" or 3/4" x 18"	11282 3/4" Dia. x 5/8" W, rubber	11109 3/4" W	76.55
THZ344	11280	Grind corners, enter grooves, strap polish "V" shape wheel	1/8" or 1/4" x 18"	11086 1" Dia. x 3/8" W, urethane, tapered	None	98.79

MINI-DYNAFILE® II CONTACT ARMS

3" workable Reach



THZ345 THZ346 THZ347

Model No.	Mfg. No.	Description	Belt Size	Contact Wheel Ass.	Platen Pad	Price /Each
THZ345	15026	Standard on model TGY731 Grind corners, enter grooves, strap polish	1/2" x 12" 5/8" Dia. x 3/8" W	11078 1/2" W rubber	11026	66.21
THZ346	15028	No Platen due to offset design Grind radiuses, slack polish or Offset for slack polishing	1/4" x 5/16" 1/2" x 12"	11080 1" Dia. x 3/8" wide rubber	None	66.21
THZ347	15029	Grind corners, enter grooves and strap polish	1/8" x 12"	11086 1" Dia. x 3/8" W urethane	None	87.16



5" NON-VACUUM DYNORBITAL-SPIRIT™ RANDOM ORBITAL SANDERS



- Anti-clog vacuum design; replaceable drop-in motor
- Palm-style grip
- Colour-coded composite lever (identifies orbit size)
- Low sound levels
- One-piece speed control dial
- Custom engineered composite cylinder
- Double row balancer bearing keeps out contaminants
- Includes low profile, premium urethane, weight-mated, non-vac pad
- Can be converted easily to self-generated or central vac model for hook-up to dust collection system



TGY861



TGY852



TGY870

5" NON-VACUUM DYNORBITAL-SPIRIT™ RANDOM ORBITAL SANDERS

Model No	TGY861	TGY852	TGY870
Mfg. No.	59020	59005	59035
Abrasive Information:	5" dia. discs (127 mm)	5" dia. discs (127 mm)	5" dia. discs (127 mm)
Pad Information:	5" dia. pad (127 mm)	5" dia. pad (127 mm)	5" dia. pad (127 mm)
Air Flow Rate @ 90 psig:	14 SCFM	14 SCFM	14 SCFM
Sound Level:	80 dB (A)	82 Db (A)	79 dB (A)
Horsepower:	0.25 HP	0.25 HP	0.25 HP
Free Speed:	12,000 RPM	12,000 RPM	12,000 RPM
Air Pressure:	90 PSI	90 PSI	90 PSI
Air Inlet Thread:	1/4 NPT	1/4 NPT	1/4 NPT
Hose Size (I.D.):	1/4" (6 mm)	1/4" (6 mm)	1/4" (6 mm)
Orbit Diameter:	3/16" (4.8 mm)	3/8" (9.5 mm)	3/32" (2.4 mm)
Tool Spindle Thread:	5/16"- 24 female	5/16"- 24 female	5/16"- 24 female
Length:	6 1/2" (165 mm)	6 1/2" (165 mm)	6 1/2" (165 mm)
Height:	3 1/2" (89 mm)	3 1/2" (89 mm)	3 1/2" (89 mm)
Weight:	1.4 lbs. (0.64 kg)	1.5 lbs. (0.68 kg)	1.4 lbs. (0.64 kg)
Price/Each	\$273.09	\$273.09	\$273.09

6" NON-VACUUM DYNORBITAL-SPIRIT™ RANDOM ORBITAL SANDERS



- Anti-clog vacuum design; replaceable drop-in motor
- Palm-style grip
- Colour-coded composite lever (identifies orbit size)
- Low sound levels
- One-piece speed control dial
- Custom engineered composite cylinder
- Double row balancer bearing keeps out contaminants
- Includes low profile, premium urethane, weight-mated, non-vac pad
- Can be converted easily to self-generated or central vac model for hook-up to dust collection system



TGY873



TGY855

Model No	TGY855	TGY873
Mfg. No.	59010	59040
Abrasive Information:	6" dia. discs (152 mm)	6" dia. discs (152 mm)
Pad Information:	6" dia. pad (152 mm)	6" dia. pad (152 mm)
Air Flow Rate @ 90 PSIG:	14 SCFM	14 SCFM
Sound Level:	80 dB (A)	80 dB (A)
Horsepower:	0.25 HP	0.25 HP
Free Speed:	12,000 RPM	12,000 RPM
Air Pressure:	90 PSI	90 PSI
Air Inlet Thread:	1/4 NPT	1/4 NPT
Hose Size (I.D.):	1/4" (6 mm)	1/4" (6 mm)
Orbit Diameter:	3/8" (9.5 mm)	3/32" (2.4 mm)
Tool Spindle Thread:	5/16"- 24 female	5/16"- 24 female
Length:	7" (178 mm)	7" (178 mm)
Height:	3 1/2" (89 mm)	3 1/2" (89 mm)
Weight:	1.6 lbs. (0.73 kg)	1.5 lbs. (0.68 kg)
Price/Each	\$273.09	\$273.09

3 1/2" NON-VACUUM DYNORBITAL-SPIRIT™ RANDOM ORBITAL SANDERS

- Anti-clog vacuum design
- Replaceable drop-in motor
- Palm-style grip; colour coded composite lever (identifies orbit size)
- Low sound levels
- One-piece speed control dial
- Custom engineered composite cylinder; double row balancer bearing keeps out contaminants
- Includes low profile, premium urethane, weight-mated, non-vac pad
- Can be converted easily to self-generated or central vac model for hook-up to dust collection system



Model No.	TGY858
Mfg. No.	59015
Abrasive Information:	3 1/2" (89 mm) dia. discs
Pad Information:	3 1/2" (89 mm) dia. pad
Air Flow Rate @ 90 PSIG:	16 SCFM
Sound Level:	73 dB (A)
Horsepower:	0.25 HP
Free Speed:	12,000 RPM
Air Pressure:	90 PSI
Air Inlet Thread:	1/4 NPT
Hose Size (I.D.):	1/4" (6 mm)
Orbit Diameter:	3/16" (4.8 mm)
Tool Spindle Thread:	5/16"-24 female
Length:	6" (152 mm)
Height:	3 1/2" (89 mm)
Weight:	1.4 lbs. (0.64 kg)
Price/Each:	\$273.09



3 1/2" NON-VACUUM DYNORBITAL® SUPREME RANDOM ORBITAL SANDERS

- Includes low profile, premium urethane, weight-mated, non-vac pad
- Can be converted easily to self-generated vac model for hook-up to dust collection system
- Random circular & elliptical motion produces superior finishes



Model No	TGY810
Mfg. No.	56800
Abrasive Information:	3 1/2" (89 mm) dia. discs
Pad Information:	3 1/2" (89 mm) dia.
Length:	6" 152 mm
Height:	3 3/4" (95 mm)
Weight:	2.1 lbs. (0.95 kg)
Air Flow Rate @ 90 PSIG:	18 SCFM
Sound Level:	76 dB(A)
Horsepower:	0.24 HP
Free Speed:	12,000 RPM
Air Pressure:	90 PSI
Air Inlet Thread:	1/4 NPT
Hose Size (I.D.):	1/4" (6 mm)
Orbit Diameter:	3/16" (4.8 mm)
Tool Spindle Thread:	5/16"-24 female
Price/ Each:	\$303.43



5" & 6" NON-VACUUM DYNORBITAL® SUPREME RANDOM ORBITAL SANDERS

- Can be converted easily to self-generated vac model for hook-up to dust collection system
- Random circular & elliptical motion produces superior finishes
- Includes low profile, premium urethane, weight-mated, non-vac pad



Model No.	TGY813	TGY816
Mfg. No.	56815	56826
Abrasive Information:	5" (127 mm) dia. discs	6" (152 mm) dia. discs
Pad Information:	5" (127 mm) dia.	6" (152 mm) dia.
Air Flow Rate @ 90 PSIG:	18 SCFM	18 SCFM
Sound Level:	79 dB (A)	79 dB (A)
Horsepower:	0.28 HP	0.24 HP
Free Speed:	12,000 RPM	12,000 RPM
Air Pressure:	90 PSI	90 PSI
Air Inlet Thread:	1/4 NPT	1/4 NPT
Hose Size (I.D.):	1/4" (6 mm)	1/4" (6 mm)
Orbit Diameter:	3/16" (4.8 mm)	3/16" (4.8 mm)
Tool Spindle Thread:	5/16"-24 female	5/16"-24 female
Length:	6 1/2" (165 mm)	7" (178 mm)
Height:	3 5/8" (92 mm)	3 1/2" (89 mm)
Weight:	2.1 lbs. (0.95 kg)	2.2 lbs. (1 kg)
Price/Each	\$303.43	\$303.43

AIR LINE CONNECTORS

- Swivels 360° at two pivot points allowing the air hose to drop directly to the floor while providing superb tool handling

THZ359



THZ360



THZ361



COMPOSITE DYNASWIVEL® AIR LINE CONNECTORS

Model No.	THZ359
Mfg. No.	94300
Thread Size:	1/4" NPT
Weight:	2.15 oz. (0.06 kg)
Air Flow Range:	up to 33 SCFM
Maximum Air Pressure:	150 PSIG
Price/Each:	\$20.49

1/4" NPT HEAVY-DUTY DYNASWIVEL® AIR LINE CONNECTORS

Model No.	THZ361
Mfg. No.	95460
Air Inlet Thread Size:	1/4" NPT
Air Flow Range:	up to 25 SCFM
Maximum Air Pressure:	150 PSIG
Weight:	0.20 lbs. (0.09 kg)
Price/ Each:	\$33.85

COMPOSITE FLOW CONTROL DYNASWIVEL® AIR LINE CONNECTORS

Model No	THZ360
Mfg. No.	94407
Thread Size:	1/4" NPT
Air Flow Range:	up to 46 SCFM
Maximum Air Pressure:	150 PSIG
Weight:	2.4 oz. (0.08 kg)
Price/Each:	\$28.95

R26552E

AIR TOOLS

DYNASTRAIGHT® AIR POWERED ABRASIVE FINISHING TOOLS

- Ideal set-up for *Dynacushion*® wheel (not included)
- Threaded arbour (5/8" -11) for exclusive use with *Dynacushion*® pneumatic wheel
- Shown with optional pneumatic wheel

Model No. TGY774
Mfg. No. 13505
Abrasive Information: 15-1/2" long x 3-1/2" wide *Dynacushion*® belts (394 mm) x (89 mm)
Air Flow Rate @ 90 psig: 44 SCFM
Sound Level: 88 dB (A)
Horsepower: 1.00 HP
Free Speed: 3400 RPM
Air Pressure: 90 PSI
Air Inlet Thread: 3/8 NPT
Hose Size (I.D.): 3/8" (10 mm)
Threaded Arbour: 5/8" - 11 male
Tool Spindle Thread: 1/2" - 20 male
Length: 14 7/8" (378 mm)
Height: 1 7/8" (48 mm)
Weight: 4 lbs. (1.82 kg)
Price/Each: \$870.95



DYNISHER® FINISHING TOOLS

- Excellent for blending and finishing stainless steel and most other metals, leaving an in-line pattern
- Includes: 3/4" dia. arbour for mounting a variety of abrasives & accessories
- Shown with optional *Dynacushion*® pneumatic wheel not included

Model No TGY767
Mfg. No. 13450
Abrasive Information: 3-1/2"(84 mm) x 15-1/2"(394 mm) abrasive belts 4" dia. (102 mm) Abrasive flap wheels 4" (102 mm) dia. conditioning discs 42 SCFM
Air Flow Rate @ 90 psig: 80 dB (A)
Sound Level: 1.00 HP
Horsepower: 2800 RPM
Free Speed: 90 PSI
Air Pressure: 3/8 NPT
Air Inlet Thread: 3/8" (10 mm)
Hose Size (I.D.): 3665 SFPM
Max. SFPM: 3/4" x 2 5/16" (19 mm) x (59.5 mm)
Arbour Information: 15" (381 mm)
Length: 7" (178 mm)
Height: 5.7 lbs. (2.59 kg)
Weight: \$1353.06
Price/Each:



DIE GRINDERS STRAIGHT & 90°

- Gearless motor reduces downtime and lessens repair expense compared to geared tools
- Governor-controlled to maintain RPM under heavy load
- Lightweight thermal-insulated housing reduces cold air transmission and vibration to the operator



TGZ172



4" LIGHTWEIGHT DYNINGER® FINISHING TOOLS (1/4" COLLET)

- Mount 4" dia. spindle-mount dry-cut sanding stars with 1/4" shank. Order stars separately
- Tool includes air-flow control *Dynaswivel*® fitting for maximum tool manoeuvrability and control
- Eliminates raised grain and removes loose fibres when whitewood sanding as well as scuffing sealer coats

Model No TGY792
Mfg. No. 52050
Abrasive Information: -
Order Separately: 3/4", 1", 1 1/2", 2", 3", & 4" dia. sanding stars (19, 25, 38, 51, 76, & 102 mm)
Air Flow Rate @ 90 PSIG: 21 SCFM
Sound Level: 81 dB (A)
Horsepower: 0.40 HP
Free Speed: 0 to 3 200 RPM
Air Pressure: 90 PSI
Air Inlet Thread: 1/4 NPT
Hose Size (I.D.): 1/4" (6 mm)
Max. SFPM: 3350 SFPM
Tool Spindle Thread: 3/8"-24 male
Length: 8 3/4" (222 mm)
Height Diameter: 2 3/8" (60 mm)
Weight: 2.2 lbs. (1 kg)
Price/Each: \$601.24



Model No.	TGZ172	TGZ174	TGZ175	TGZ073
Mfg. No.	52666	52668	52669	52205
Head type	Straight	Straight	Straight	90 Deg
Collet Insert Size:	1/4"	1/4"	1/4"	1/4"
Free Speed (RPM):	12 000	18 000	20 000	25 000
HP (W):	1.0 (746)	1.0 (746)	1.0 (746)	0.3 (224)
Motor Characteristic:	Gearless	Gearless	Gearless	Gearless
Exhaust Type:	Rear	Rear	Rear	Rear
Wt. lbs.:	2.3	2.4	2.4	1.5
Price/Each:	\$513.58	\$513.58	\$513.58	\$409.07

PENCIL GRINDERS 60 000 RPM

- High-speed air motor, controlled with patented governor, provides constant speed under load
- Precision, high-tolerance, low run-out collet. Run-out is a true 0.0002 @ 1" (25 mm) from face
- Super flexible hose for maximum agility

Model No. TGZ034
Mfg. No. 51700
Collet Insert Size: 1/8"
Motor Characteristic: Oil-Less Turbine
Free Speed: 60 000 RPM
Bearing Type: Metal
Exhaust Type: Rear
8 (1) (227): 8 (1) (227)
Weight: 0.6 lbs.
Packaged Weight: 1.6 lbs.
Price/Each: \$452.89



ELECTRIC DYNISHER® FINISHING TOOLS

- 3/4" (19 mm) dia. arbour; pneumatic tire and abrasive sold separately
- Variable speed On/Off switch
- 5/8" - 11 spindle and 3/4" arbor

Model No THZ358
Mfg. No. 51585
Max. RPM: 0-3000 RPM
Voltage: 120 V (AC) Phase: 1
Current: 11 A, 60 Hz Frequency
Length: 17" (468 mm)
Height: 8" (468 mm)
Weight: 9.5 lbs. (3.8 kg)
Price/Each: \$753.00



DYNISHER® FINISHING TOOL VERSATILITY KITS

- Excellent for blending and finishing stainless steel and most other metals, leaving an in-line pattern
- Includes: 3/4" dia. Arbour for mounting a variety of abrasives & accessories
- Shown with optional *Dynacushion*® pneumatic wheel, not included

Model No	TGY768
Mfg. No.	13460
Abrasive Information:	3 1/2"(84 mm) x 15-1/2"(394 mm) Abrasive belts. 4"(102 mm) dia. Abrasive flap wheels. 4"(102 mm) dia. conditioning discs
Air Flow Rate @ 90 psig:	41 SCFM
Sound Level:	84 dB (A)
Horsepower:	1.00 HP
Free Speed:	2800 RPM
Air Pressure:	90 PSI
Air Inlet Thread:	3/8 NPT
Hose Size (I.D.):	3/8" (10 mm)
Max. SFPM:	3665 SFPM
Arbour Information:	3/4" x 2 5/16" (19 mm x 59.5 mm)
Length:	15" (381 mm)
Height:	7" (178 mm)
Weight:	5.7 lbs. (2.59 kg)
Price/Each:	\$1430.61



ELECTRIC RIGHT ANGLE POLISERS

- Double-Insulated tool housing for protection against electric shock; variable speed control and with feather-touch trigger
- Lock in desired speed with *Lock-Set* button; Easy removal of backing pad with *Locking-Head*
- Two-hand control for addition comfort when working in vertical positions; Simple brush replacement



Shown with optional backing pad

Model No	TGY974
Mfg. No.	51580
Abrasive Information:	5-8" dia. buffs (127-203 mm) 6"-8" dia. (127-203 mm)
Pad Information:	6"-8" dia. (127-203 mm)
Sound Level:	88 dB (A)
Voltage:	120 V (AC) Phase: 1
Current:	11 Amps Frequency: 60 Hz
Horsepower:	1.12 HP
Free Speed:	0 - 3000 RPM
Tool Spindle Thread:	5/8" - 11 Male
Length:	17" (423 mm)
Height:	5 1/4" (127 mm)
Weight:	7.8 lbs. (3.2 kg)
Price/Each:	\$327.03



Call us for
all your Tools
& Equipment
requirements!



AIR TOOLS

1 3/4" COIL ROOFING NAILERS

- Operates in bump fire mode
- 6 depth nailing settings with adjustment knob
- Convenient adjustable belt hook
- Rubberized grip for increased comfort
- Easy to remove contact top to clear nail/debris jams
- Includes: Safety goggles, oil supply, hex wrench

Model No. TLV231
Mfg. No. AN453
Operating Air Pressure: 65 -120 PSIG
Nail Size: 3/4" - 1 3/4"
Magazine Capacity: 120 nails
Dimensions: 10 3/8" L x 4 5/8" W x 10 5/8" H
Tool Weight: 5.5 lbs.
Price/Each: \$409.78



3 1/2" FRAMING NAILERS

- 3 modes: Sequential, bump, lock-off
- 9 depth nailing setting in 1/16" increments with adjustment knob
- Convenient collapsible rafter hook
- Nose piece with sure-grip spikes
- Dry fire prevention system prolongs life of tool
- Includes: Hook assy, oil supply 30 cc, safety goggles

Model No. TLV232
Mfg. No. AN923
Operating Air Pressure: 65-120 PSIG
Nail Size: 2" - 3 1/2"
Nail Type: 0.113" - 0.162" 22° round head
Magazine Capacity: 64-74 nails
Dimensions: 22" L x 4 1/4" W x 13 11/16" H
Tool Weight: 8.7 lbs.
Price/Each: \$412.90



2" BRAD NAILERS

- 360° exhaust system directs exhaust away from operator
- Rubber grip for comfortable handling
- Quick release nose enables fast and easy removal of jammed nails
- Quick release, side loading magazine
- Convenient adjustable belt hook
- Includes: Oil supply, safety goggles, nose adapter, plastic carrying case

Model No. TLV233
Mfg. No. AF505
Operating Air Pressure: 60 - 115 PSIG
Nail Size: 5/8" - 2"
Nail Type: 18-gauge brad nails
Magazine Capacity: 100 nails
Dimensions: 10 1/4" L x 2 1/2" W x 9 3/8" H
Tool Weight: 3.1 lbs.
Price/Each: \$393.39



1/4" CROWN STAPLERS

- 18-gauge crown stapler
- 360° exhaust system directs exhaust away from operator
- Quick release magazine: staples load from the top
- Convenient adjustable belt hook
- Clear window allows operator to see number of remaining staples
- Includes: Oil dispenser, plastic carrying case, safety glasses, wrench 3, wrench 4

Model No. VK854
Mfg. No. AT638
Operating Air Pressure: 60 - 115 PSIG
Staple Size: 5/8" - 1 1/2"
Magazine Capacity: 100 nails
Dimensions: 9 3/4" L x 2 7/16" W x 9 3/4" H
Tool Weight: 3.2 lbs.
Price/Each: \$254.27



3 1/2" FRAMING NAILERS

- 31° clipped head framing strip nailer
- 3 modes: Sequential, bump, lock-off
- 9 depth nailing setting in 1/16" increments with adjustment knob
- Convenient collapsible rafter hook
- Nose piece with sure-grip spikes prevents slipping
- Dry fire prevention system prolongs life of tool
- Includes: Hook assembly, oil supply 30 cc, safety goggles

Model No. TLV234
Mfg. No. AN943
Operating Air Pressure: 65 - 120 PSIG
Nail Type: 0.113" - 0.131" 31° clipped head
Nail Size: 2" - 3 1/2"
Magazine Capacity: 60 - 84 Nails
Dimensions: 17 7/8" L x 4 1/4" W x 14 3/8" H
Tool Weight: 8.4 lbs.
Price/Each: \$417.58



3 1/2" CORDLESS FRAMING NAILERS

- Cordless 34° clipped head framing nailer
- Utilizes industry standard fuel cells
- LED warning system indicates low battery capacity or tool malfunction
- Anti-slip sure grip spikes provide optimal hold against material
- Dual position rafter hook for operator convenience
- Rubber housing bumper protects tool and materials from damage and prevents slipping
- Ergonomic soft rubber grip design for vibration absorption
- Includes: 2 - 7.2 V Li-Ion batteries BL7010, charger, plastic carrying case, safety goggles, hex wrench

Model No. TLV235
Mfg. No. GN9005E
Battery Type: 7.2 V Li-ion
Charging Time: 30 minutes
Battery Life: Approx. 4000 nails
Fuel Cell Life: Approx. 1200 nails
Nail Type: 34° clipped head
Driving Speed: Nails/sec/ 2-3
Dimensions: 12 5/8" L x 4 1/4" W x 14 1/2" H
Tool Weight: 7.5 lbs.
Price/Each: \$725.90



2 1/2" COIL SIDING NAILERS

- 15° round head coil siding nailer
- 360° exhaust system directs exhaust away from the operator
- 3 modes: Sequential, bump, lock-off
- 9 depth nailing settings in 1/16" increments with adjustment knob
- Convenient adjustable belt hook
- Rubberized grip for increased comfort
- Built-in air filter prevents dust or foreign matter from entering the tool
- Includes: Hex wrench 4, plastic carrying case, safety goggles, oil supply

Model No. TDU796
Mfg. No. AN611
Operating Air Pressure: 65 - 120 PSIG
Nail Type: 0.80" - 0.99" 15° round head
Nail Size: Wire Collated: 1 1/4" - 2 1/2"
Nail Size: Plastic Collated: 1 1/4" - 2"
Magazine Capacity: 200 - 400 Nails
Dimensions: 13 1/16" L x 5" W x 12 1/2" H
Tool Weight: 4.9 lbs.
Price/Each: \$546.72



Model No.	Mfg. No.	Description	Length"	Width"	Gauge /Size"	Coating	Galv.	Qty /Box	Price /Each
PLAIN NAILS									
TBS618	GD21APBSK	FRH/Plastic	2	-	0.113	Yes	No	3500	58.46
TBS625	GD25ASBSK	FRH/Plastic	2 1/2	-	0.113	Yes	Yes	2500	134.02
TBS620	HD27APBSK	FRH/Plastic	3	-	0.12	Yes	No	2500	56.25
TBS622	HD29APBSK	FRH/Plastic	3 1/2	-	0.12	Yes	No	2500	66.17

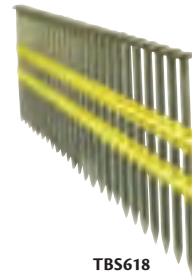

TBS618

Model No.	Mfg. No.	Description	Length"	Width"	Gauge /Size"	Coating	Galv.	Qty /Box	Price /Each
PLAIN NAILS									
TBS633	GD21APBPK	Coil/Metal/Angle	2	-	0.113	Yes	No	7200	102.15
TBS634	GD25APBPK	Coil/Metal/Angle	2 1/2	-	0.113	Yes	Yes	7200	125.57

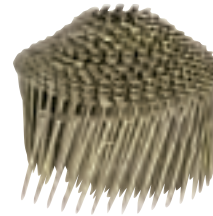

TBS633

Model No.	Mfg. No.	Description	Length"	Width"	Gauge /Size"	Coating	Galv.	Qty /Box	Price /Each
PLAIN NAILS									
TBS638	HG13ATAPK	Coil/Metal	1	-	0.12	No	Yes	7200	87.27
TBS639	HG15ATAPK	Coil/Metal	1 1/4	-	0.12	No	Yes	7200	90.96
TBS640	HG17ATAPK	Coil/Metal	1 1/2	-	0.12	No	Yes	7200	105.42
TBS641	HG19ATAPK	Coil/Metal	1 3/4	-	0.12	No	Yes	7200	113.97

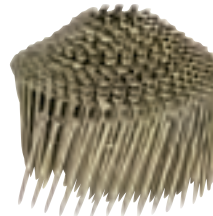

TBS638

Model No.	Mfg. No.	Description	Length"	Width"	Gauge /Size"	Coating	Galv.	Qty /Box	Price /Each
SPIRAL NAILS									
TBS627	BK21APBK	Coil/Metal	2	-	0.099	Yes	No	7200	74.82
TBS628	BK23APBK	Coil/Metal	2 1/4	-	0.099	Yes	No	7200	91.71
TBS629	BK25APBK	Coil/Metal	2 1/2	-	0.099	Yes	No	7200	88.67
TBS630	HK27APBK	Coil/Metal	3	-	0.12	Yes	No	3600	98.00
TBS631	HK28APBK	Coil/Metal	3 1/4	-	0.12	Yes	No	3600	63.32
TBS632	BK25AABK	Coil/Metal/Angle	2 1/2	-	0.099	Yes	No	7200	113.97



TBS627

Model No.	Mfg. No.	Description	Length"	Width"	Gauge /Size"	Coating	Galv.	Qty /Box	Price /Each
CROWN STAPLES									
TBS677	N15BRB	Staple/Chisel	1 1/4	7/16	16	Yes	No	5000	59.04
TBS685	N15FAB	Staple/Divergent	1 1/4	7/16	16	Yes	Yes	10 000	107.27
TBS686	N17BAB	Staple/Chisel	1 1/2	7/16	16	Yes	Yes	10 000	68.04
TBS678	N17BRB	Staple/Chisel	1 1/2	7/16	16	Yes	No	10 000	60.06
TBS689	N17BGB	Staple/Steel	1 1/2	7/16	16	Yes	No	10 000	150.44
TBS679	N18BRB	Staple/Chisel	1 5/8	7/16	16	Yes	No	10 000	61.09
TBS687	N19BAB	Staple/Chisel	1 3/4	7/16	16	Yes	Yes	10 000	79.32
TBS680	N19BRB	Staple/Chisel	1 3/4	7/16	16	Yes	No	10 000	70.64
TBS688	N21BAB	Staple/Chisel	2	7/16	16	Yes	Yes	10 000	88.52
TBS681	N21BRB	Staple/Chisel	2	7/16	16	Yes	No	10 000	81.76

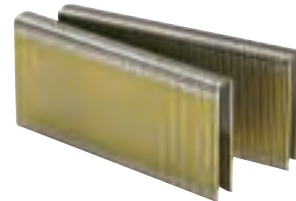

TBS677

Model No.	Mfg. No.	Description	Length"	Width"	Gauge /Size"	Coating	Galv.	Qty /Box	Price /Each
CROWN STAPLES									
TBS694	L06BAB	Stapler/Chisel	3/8	1/4	18	Yes	Yes	10 000	28.29
TBS695	L08BAB	Stapler/Chisel	1/2	1/4	18	Yes	Yes	10 000	28.29
TBS696	L10BAB	Stapler/Chisel	5/8	1/4	18	Yes	Yes	5000	15.62
TBS697	L11BAB	Stapler/Chisel	3/4	1/4	18	Yes	Yes	5000	20.05
TBS690	L11BRB	Stapler/Chisel	3/4	1/4	18	Yes	No	5000	18.22
TBS698	L11HAB	Stapler/X-cut, Chisel	3/4	1/4	18	Yes	Yes	5000	25.96
TBS699	L12BAB	Stapler/Chisel	7/8	1/4	18	Yes	Yes	5000	19.27
TBS700	L13BAB	Stapler/Chisel	1	1/4	18	Yes	Yes	5000	21.70
TBS691	L13BRB	Stapler/Chisel	1	1/4	18	Yes	No	5000	21.08
TBS701	L14BAB	Stapler/Chisel	1 1/8	1/4	18	Yes	Yes	5000	23.70
TBS692	L14BRB	Stapler/Chisel	1 1/8	1/4	18	Yes	No	5000	22.30
TBS702	L15BAB	Stapler/Chisel	1 1/4	1/4	18	Yes	Yes	5000	27.60
TBS693	L15BRB	Stapler/Chisel	1 1/4	1/4	18	Yes	No	5000	25.26
TBS703	L17BAB	Stapler/Chisel	1 1/4	1/4	18	Yes	Yes	5000	28.90
TBS682	N13BAB	Stapler/Chisel	1	7/16	16	Yes	Yes	5000	29.60
TBS683	N13FAB	Stapler/Divergent	1	7/16	16	Yes	Yes	5000	39.75
TBS684	N15BAB	Stapler/Chisel	1 1/4	7/16	16	Yes	Yes	10 000	71.86



TBS694

AIR TOOLS & ACCESSORIES

IN-LINE AIR FLOW REGULATORS

- Especially designed to control air pressure to air tools
- High volume air adjusting regulator

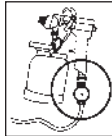

Model No.	Inlet NPT(M)"	Outlet NPT(F)"	Price /Each
TA838	1/4	1/4	21.88

TOPRING



AIR ADJUSTING VALVES

- Permits accurate flow control in either direction
- Set knurled knob to desired flow rate
- Spring-loaded ratchet permit positive flow adjustment without drift
- Oil resistant seals prevent leakage

Warning: Do not use as a shut-off-valve

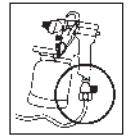
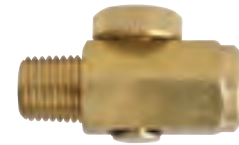

Model No.	Inlet (F) NPT"	Outlet (M) NPT"	Price /Each
TA837	1/4	1/4	16.71

IN-LINE PRE-SET PRESSURE REGULATORS

- Ensure optimal air tool efficiency by supplying a constant pre-set pressure
- Limit over-consumption of compressed air, thereby reducing energy costs
- Blow guns in order to respect OSHA and other Safety Agencies' requirements (maximum pressure of 30 PSI)

Model No.	Mfg. No.	Pre-Set Pressure	Price/Each
TLZ016	62.202C	27	18.91
TLZ014	62.210C	90	47.66

TOPRING



MINI REGULATORS

- Specially designed for use with air tools for accurate pressure regulation
- Full diaphragm regulation for precise air pressure
- 3-position knob pushed to lock and can be removed for taper - resistance
- Push-pull lock setting to avoid unplanned readjustment
- Lightweight and compact
- Temp. Range: 40°F to 120°F
- Flow Cap.: up to 25 SCFM



TOPRING

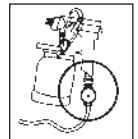

Model No.	Port Size (M) NPT"	Pressure PSI	Price /Each
TA849	1/4	0-165	56.70
TA796		Replacement Gauge	11.40

ANTI HOSE WHIP SAFETY VALVES

- Anti hose whip safety valve is an inline emergency shutoff valve
- Under failure conditions, the valve closes - the air is shut off
- Small amount of air continues to bleed after shut off at a rate of 9 SCFM.
- Automatically return to the normal position when pressure is re-established

OSHA standard no. 1926.302(b)(7): "All hoses exceeding 1/2" inside diameter shall have a safety device at the source of supply or branch line to reduce pressure in case of hose failure." *Topring* anti hose whip safety valves satisfy this standard.

Model No.	Mfg. No.	Port Size NPT	Port Size (F) NPT	Shutoff Range* (SCFM)	Length"	Flats"	Price /Each
BB396	58.952	1/4 (M)	1/4	18	1 7/8	7/8	49.63
BB398	58.957	3/8 (M)	3/8	58	1 7/8	1 1/16	64.76
UQ888	58.962	1/2 (M)	1/2	97	3 1/8	1 1/2	74.14
UQ889	58.967	3/4 (F)	3/4	100	3	1 1/2	135.81

* Based on an inlet pressure of 100 PSIG

TOPRING



PRESSURE GAUGES

- Corrosion resistant stainless steel case and ring, plastic lens
 - Balanced adjustable black pointer
 - Soft soldered phosphor bronze tube with brass socket.
- Suitable for steam, water, air, oil, gas or any medium not corrosive to copper alloys

- Phosphor bronze movement is recommended for average general use
- Easy to read dial, white background with bold black numerals and graduations, 270° arc
- 1/4" NPT bottom connection only
- 1% accuracy

Model No.	Mfg. No.	Dial Ranges	Figure Intervals	Minor Div.	Price /Each
PRESSURE RANGES					
IA326	421AVND-30	0-30 PSI	5 PSI	0.5 PSI	19.00
IA327	421AVND-60	0-60 PSI	10 PSI	1 PSI	19.00
IA328	421AVND-100	0-100 PSI	10 PSI	1 PSI	19.00
IA329	421AVND-160	0-160 PSI	20 PSI	2 PSI	19.00
IA330	421AVND-200	0-200 PSI	20 PSI	2 PSI	19.00
IA331	421AVND-300	0-300 PSI	50 PSI	5 PSI	19.00
IA332	421AVND-500	0-500 PSI	50 PSI	5 PSI	19.00
VACUUM RANGES					
IA333	421AVND-30VAC	30"-0 Hg Vac	5"	0.5"	19.00

REED



TWO-PIECE STAINLESS STEEL BALL VALVES - SERIES BV2M

FULL PORT, 1000 PSIG (69 BAR)

End Connections: Female NPT
Pressure Limits: 1000 PSI (69 bar) WOG, 150 PSI (10.3 bar) SWP
Wetted Materials: Body, ball, end cap: CF8M SS; stem: 316 SS; seat, thrust washer: RTFE; end gasket, stem packing: PTFE
Temperature Limits: -20 to 450°F (-29 to 232°C)

Model No.	Mfg. No.	Size"	Price/Each
THZ590	BV2M100	1/4	36.00
THZ591	BV2M101	3/8	33.00
THZ592	BV2M102	1/2	40.00
THZ593	BV2M103	3/4	51.00
THZ594	BV2M104	1	86.00
THZ595	BV2M105	1 1/4	98.00
THZ596	BV2M106	1 1/2	134.00
THZ597	BV2M107	2	193.00
THZ598	BV2M108	2 1/2	391.00
THZ599	BV2M109	3	506.00



THREE-PIECE BALL VALVES - SERIES 2BVS

INVESTMENT CAST STAINLESS STEEL CONSTRUCTION, INTEGRAL ACTUATOR MOUNTING PAD

End Connections: Female NPT
Pressure Limits: 1000 PSI (68.9 bar) WOG; 150 PSI (10.3 bar) SWP
Wetted Materials: Body, ball, end cap: CF8M SS; stem: 316 SS; seat, thrust washer: RTFE; stem packing: PTFE
Temperature Limits: -20 to 450°F (-29 to 232°C)

Model No.	Mfg. No.	Size"	Price/Each
THZ600	2BVS3 AT1000	1/4	110.00
THZ601	2BVS3BT1000	3/8	110.00
THZ602	2BVS3CT1000	1/2	110.00
THZ603	2BVS3ET1000	3/4	127.00
THZ605	2BVS3GT1000	1 1/4	249.00
THZ606	2BVS3HT1000	1 1/2	350.00
THZ607	2BVS3JT1000	2	520.00
THZ608	2BVS3KT1000	2 1/2	386.00
THZ609	2BVS3MT1000	3	565.00



TWO-PIECE HAND LEVER BRASS BALL VALVES - SERIES BV2MB

FULL PORT, ECONOMICAL, BLOWOUT-PROOF STEM

Body: Two-Piece
End Connections: 1/4" to 3" female NPT
Pressure Limits: 1/4" to 1": 600 PSI (41.4 bar), 1 1/4" to 2": 400 PSI (27.6 bar), 2 1/2 to 3": 200 PSI (13.8 bar) WOG
Wetted Materials: Body and body cap: forged brass (ASTM B283-C37700); ball and stem: brass; seat and packing Teflon®
Temperature Limits: 10 to 200°F (-12 to 93°C)
Other Materials: Body seal: rubber; handle: plated steel; nut and gasket: brass



Model No.	Mfg. No.	Size"	Cv	Price/Each
THZ610	BV2MB00	1/4	7.5	6.00
THZ611	BV2MB01	3/8	7.5	6.00
THZ612	BV2MB02	1/2	16	10.00
THZ613	BV2MB03	3/4	43	16.00
THZ614	BV2MB04	1	58	25.00
THZ615	BV2MB05	1 1/4	105	38.00
THZ616	BV2MB06	1 1/2	160	54.00
THZ617	BV2MB07	2	325	84.00
THZ618	BV2MB08	2 1/2	475	174.00
THZ619	BV2MB09	3	780	253.00

BUTTERFLY VALVES - SERIES BFV

LOW COST, LEVER OPERATED, LUG OR WAFER PATTERN, 225 PSIG

Service: Compatible liquids, gases, and steam
Line Size: 2" to 12"
Body Style: 2-way, wafer or lug butterfly
End Connections: Flange, to be used with flanges that are ANSI Class 125 (B16.1) and ANSI Class 150 (B16.5) dimensions
Pressure Limits: 225 PSI (151.5 bar) WOG
Wetted Materials: Body: Ductile iron
 Disc: 316 SS
 Seat and O-ring: EPDM or PTFE
 Stem: 410 SS
Temperature Limits: EPDM: -50 to 250°F (-46 to 121°C). PTFE: 0 to 300°F (-18 to 149°C)
 Nylatron
Bearings: See Cv chart
Flow Rate: See Cv chart
Operator: 2 to 6": 10-position locking hand lever. 8 to 12": manual gear



Wafer



Lug



CV VALUES

Size	Degree Opening									Full Open	
	10°	20°	30°	40°	50°	60°	70°	80°	90°	100°	110°
2	0.1	5	12	24	45	64	90	125	135		
2 1/2	0.2	8	20	37	65	98	144	204	220		
3	0.3	12	22	39	70	116	183	275	302		
4	0.5	17	36	78	139	230	364	546	600		
5	0.8	29	61	133	237	392	620	930	1022		
6	2	45	95	205	366	605	958	1437	1579		
8	3	89	188	408	727	1202	1903	2854	3136		
10	4	151	320	694	1237	2047	3240	4859	5340		
12	5	234	495	1072	1911	3162	5005	7505	8250		

Model No.	Mfg. No.	Size"	Type	Liner	Price /Each
THZ620	BFV202WFB311HLO	2	Wafer	EPDM	79.00
THZ621	BFV202WFB341HLO	2	Wafer	PTFE	109.00
THZ622	BFV202LTB311HLO	2	Lug	EPDM	95.00
THZ623	BFV202LTB341HLO	2	Lug	PTFE	117.00
THZ624	BFV225WFB311HLO	2 1/2	Wafer	EPDM	91.00
THZ625	BFV225WFB341HLO	2 1/2	Wafer	PTFE	138.00
THZ626	BFV225LTB311HLO	2 1/2	Lug	EPDM	117.00
THZ627	BFV225LTB341HLO	2 1/2	Lug	PTFE	149.00
THZ628	BFV203WFB311HLO	3	Wafer	EPDM	109.00
THZ629	BFV203WFB341HLO	3	Wafer	PTFE	164.00
THZ630	BFV203LTB311HLO	3	Lug	EPDM	113.00
THZ631	BFV203LTB341HLO	3	Lug	PTFE	174.00
THZ632	BFV204WFB311HLO	4	Wafer	EPDM	153.00
THZ633	BFV204WFB341HLO	4	Wafer	PTFE	221.00
THZ634	BFV204LTB311HLO	4	Lug	EPDM	164.00
THZ635	BFV204LTB341HLO	4	Lug	PTFE	244.00
THZ636	BFV205WFB311HLO	5	Wafer	EPDM	204.00
THZ637	BFV205WFB341HLO	5	Wafer	PTFE	283.00

MINI BRASS BALL VALVES - SERIES MV

ECONOMICAL, BLOWOUT-PROOF STEM

Service: Gases and liquids compatible with wetted materials. Not rated for steam use.
Wetted Materials: Valve body: nickel plated brass (CW617N)
 Valve ball: chrome-plated brass
 O-ring stem seal: Viton®
 Ball seats: PTFE
Pressure Limits: MV4: -4 to 200°F (-20 to 93.3°C)
 MV5: -4 to 250°F (-20 to 121°C)
Connections: NPT, see model chart



Pipe Size"	Cv Value	Model No.	Mfg. No.	Price /Each	Model No.	Mfg. No.	Price /Each
------------	----------	-----------	----------	-------------	-----------	----------	-------------

LEVER HANDLE - 200 PSI (CWP) MAXIMUM PRESSURE

1/8	5.3	THZ638	MV4-LF1	12.00	THZ654	MV4-LM1	12.00
1/4	6.6	THZ639	MV4-LF2	11.00	THZ655	MV4-LM2	11.00
3/8	6.6	THZ640	MV4-LF3	11.00	THZ656	MV4-LM3	11.00
1/2	11	THZ641	MV4-LF4	14.00	THZ657	MV4-LM4	14.00

TEE HANDLE - 200 PSI (CWP) MAXIMUM PRESSURE

1/8	5.3	THZ642	MV4-TF1	12.00	THZ658	MV4-TM1	12.00
1/4	6.6	THZ643	MV4-TF2	11.00	THZ659	MV4-TM2	11.00
3/8	6.6	THZ644	MV4-TF3	11.00	THZ660	MV4-TM3	11.00
1/2	11	THZ645	MV4-TF4	14.00	THZ661	MV4-TM4	14.00

WEDGE HANDLE - 450 PSI (CWP) MAXIMUM PRESSURE

1/8	5.3	THZ646	MV5-WF1	9.00	THZ662	MV5-WM1	9.00
1/4	6.6	THZ647	MV5-WF2	8.00	THZ663	MV5-WM2	8.00
3/8	6.6	THZ648	MV5-WF3	8.00	THZ664	MV5-WM3	8.00
1/2	11	THZ649	MV5-WF4	11.00	THZ665	MV5-WM4	9.00

SCREWDRIVER SLOT - 450 PSI (CWP) MAXIMUM PRESSURE

1/8	5.3	THZ650	MV5-SF1	11.00	THZ666	MV5-SM1	11.00
1/4	6.6	THZ651	MV5-SF2	10.00	THZ667	MV5-SM2	10.00
3/8	6.6	THZ652	MV5-SF3	10.00	THZ668	MV5-SM3	10.00
1/2	11	THZ653	MV5-SF4	13.00	THZ669	MV5-SM4	13.00



MAXJET INTERCHANGEABLE TIP BLOW GUN KITS

- Each tip fits both blow gun bodies with a convenient, quick coupler style connection
- Ergonomic blow gun body provides a narrow, high velocity jet of air

INCLUDED IN THE KIT:

- Plastic-body ergonomic blow gun with quick coupler style connection for tips
- Compact metal blow gun with quick coupler style connection for tips
- 1/4 industrial plug, 1/4 (M) NPT
- Plastic safety tip
- Safety booster tip
- Rubber tip
- Inflator needle
- Aerosol spray nozzle
- Siphon tip
- 3 inch needle extension tip
- 4 inch extension tip
- 6 inch safety extension

Model No. TKZ833
Mfg. No. 60.550
Price/Each \$50.05



TOPRING

NON-RESTRICTED BLOW GUNS

This model does not have a safety by-pass and must be used on airlines which have a pressure regulator set at 30 PSI maximum to conform to OSHA requirements.

Characteristics

- A very compact gun with exclusive features
- The gun works by simply bending the body made from pure *Buna-N* rubber and automatically stops by simply releasing the body back to a straight position
- The contoured body lies perfectly in the palm of the hand and with only one finger you can operate the progressive valve which adjusts the flow with a sensitive and gradual manner
- The body is made to protect the palm of the hand against the connection fittings
- Especially indicated for specialized fields such as: car repair, aviation etc... where compact size, progressive flow and anti-scratch materials are required

Specifications

- Working Temperature: -4° F to 176° F (-20°C to 80°C)
- Maximum Working Pressure: 150 PSI

Applications

- Air, water, oil, grease, glue
- Fluids compatible with *Buna-N* rubber

BY-PASS TIP BLOW GUNS

- Eliminates risk if hole is obstructed

Model No. TA835
Price/Each \$28.04



12" BASIC BLOW GUNS

- Straight tip 12" long

Model No. TA832
Price/Each \$29.82



RUBBER TIP BLOW GUNS

- Anti-scratch tip
- Will not scratch or mark surfaces

Applications

- Used in automotive and industrial shops for blowing out blocked passages such as automatic transmissions, carburetors, moulds and dies

Model No. TA833
Price/Each \$20.78



5" BASIC BLOW GUNS

- Curved tip 5" long

Model No. TA831
Price/Each \$17.13

TOPRING

AIR BLOW GUNS

- Contoured body fits comfortably in the operators hand and made to protect the palm of the hand against the connection fittings
- Curved tip 5" long
- 1/4" (F) - 18 NPT Air Inlet

Model No. TLZ146
Price/Each \$9.95



aurora tools®

Topring's Airpro safety blow guns are engineered to meet OSHA and other safety agencies' requirements of 30 PSI maximum pressure when dead-ended up to 150 PSI inlet pressure. Ergonomic design reduces hand fatigue. Adjustable trigger controls the amount of air supplied.

SAFETY BLOW GUNS WITH VENTURI TIP

Features

- Specially designed to project a large volume of air at low velocity
- Venturi function increases the amount of inlet air by 100%

Applications

- Automotive and industrial applications
- Ideally suited for moving a large volume of chips or drying or cooling

Model No. UW573 Price/Each \$30.12

SILENT SAFETY BLOW GUNS

Features

- Specially designed to keep noise level under 79 dB

Applications

- Ideal for automotive and industrial cleaning applications
- Ideal for the electronics industry, repair shops or other industries requiring a low noise level and precise control of air flow

Model No. UW574 Price/Each \$32.16

SILENT SAFETY BLOW GUNS WITH THROTTLE SCREW

Features

- Specially designed to keep noise level under 75 dB

Applications

- Ideal for automotive and industrial cleaning applications
- Ideal for the electronics industry, repair shops or other industries requiring a low noise level and precise control of air flow

Model No. UW575 Price/Each \$44.64

SAFETY BLOW GUNS WITH LIMITED PRESSURE OF 30 PSI

Features

- Meets the safety requirements of OSHA and other health and safety agencies' strictest norms
- Reduction valve in the handle of the blow gun limits the pressure to 30 PSI
- Pressure is controlled so that it does not exceed 30 PSI as recommended by OSHA and other safety agencies' requirements

Applications

- For cleaning equipment where maximum safety is required
- For very delicate operations requiring small quantity of air

Model No. UW576 Price/Each \$44.64

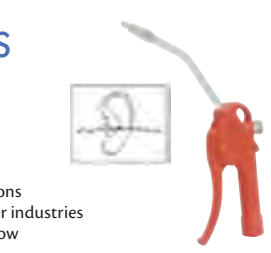
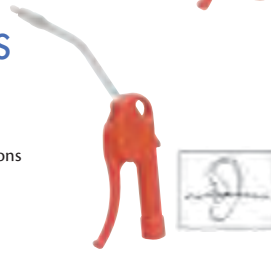
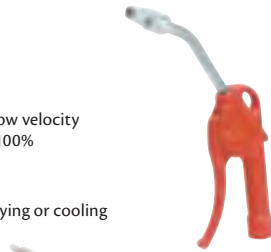

BLOW GUNS

Features

- Powerful air stream

Applications

- Ideal for cleaning equipment in industries, as well as automobile repair shops

WITH ANGLED TUBE

Model No. UW577

Price/Each \$15.88

WITH STRAIGHT TUBE

Model No. UW578

Price/Each \$19.74

BLOW GUNS WITH THROTTLE SCREW

Features

- Adjustable knob controls the amount of air supplied
- Ergonomic design reduces hand fatigue

Applications

- Ideal for cleaning equipment in industries, as well as automobile repair shops
- Perfect for uses where reduced air flow is required

Model No. UW579 Price/Each \$36.34

LONG TIP BLOW GUNS

Features

- 12" or 20" long tip
- Ideal for cleaning places which are not easily accessible

Applications

- Ideal for cleaning motors, equipment and machinery in industrial and agricultural sectors

12" LONG

Model No. UW580

Price/Each \$31.14

20" LONG

Model No. UW581

Price/Each \$34.26

TOPRING

TOPRING

SAFETY AIR GUNS

- Safe and trouble free
- Heavy-duty, powerful air guns
- Lightweight, rugged, cast aluminum construction

- Ergonomically designed to reduce hand fatigue
- Hangs by large hook or trigger
- 1/4" NPT inlet

Model No.	Description	Air Consumption*		Price /Each
		CFM	Max. PSI**	
TG341	Jet Guard safety air gun	29	120	43.03
TG342	Jet Guard safety air gun, with adjustable trigger	29	120	49.69
TG343	Booster safety air gun	25	150	48.50
TG344	Whisper Jet safety air gun	16	150	53.92
TG345	Long extension safety air gun, 12"	24	150	69.58
TG346	Long extension safety air gun, 24"	24	150	75.17
TG347	Long extension safety air gun, 36"	24	150	81.02
TG348	Long extension safety air gun, 48"	24	150	86.95
TG349	Long extension safety air gun, 60"	24	150	92.85
TG350	Extra thrust safety air gun	32	150	64.27
TG351	Extra thrust safety air gun, with 12" extension	32	150	80.54
TG352	Extra thrust safety air gun, with 24" extension	32	150	86.37
TG353	Blind hole safety air gun	25	120	59.16

* At 100 PSI air line pressure

** Maximum working input pressure allowable to limit output pressure to 30 PSI, as per OSHA



AIR TOOLS & ACCESSORIES

BLIND HOLE AIR GUNS

The most effective blind hole air gun available, it is ideal for both deep crevices and blind holes. This air gun is 100% effective in delivering a high velocity jet of air to flush out chips and dirt. It has a small diameter air tube to access into holes down to 1/8" diameter, a 1/4" NPT air inlet, and a maximum operating pressure of 120 PSI. Safety air shield provides effective chip-guarding as required by OSHA. Pistol grip casting and angled extension make this light weight air gun easy to handle. It has a 4" straight extension and a 2" extension after the 45 degree bend.

Model No. TB136
Mfg. No. 74BH006Z
Price/Each \$37.89

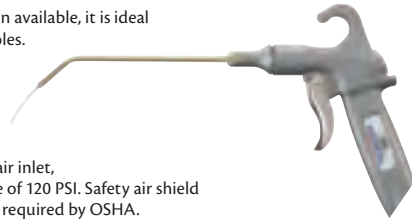

JET GUARD SAFETY AIR GUNS

Ideally suited for machine shop and production line operation, it provides for years of dependable, non-fatiguing, effective operation. It incorporates a protective air cone which is recognized by OSHA as an effective safeguard for reducing injury from flying chips. An operator controlled knurled adjusting nut to control air volume. Air thrust can be set for whisper or blast.

Model No. TB137
Mfg. No. 74SK
Price/Each \$34.47



WHISPER JET SAFETY AIR GUNS

The quietest safety air gun available has a unique nozzle with a serrated periphery that reduces noise levels 6-20 dB less than conventional air guns. Solid conical tip design prevents blockage of nozzle, has a 1/4" NPT inlet with a maximum operating pressure of 150 PSI meets NPT standard.

Model No. TB151
Mfg. No. 80WJ
Price/Each \$31.73



SYPHON SPRAY GUNS

The most economical spray gun available. Ideal for spraying thin and medium solutions such as oils, solvents, insulating compounds, metal preservatives and coatings. Operates on compressed air with no moving electrical parts. The high vacuum syphon delivers up to 16 gallons per hour, has a 1/4" NPT inlet and maximum operating pressure of 150 PSI meets OSHA standards. It includes a 12" extension for reaching difficult, hard to reach locations, 6 feet of feed tube and sinker, and an adjustable trigger and nozzle tip to control volume and spray pattern.

Model No. TB152
Mfg. No. 79-SG12
Price/Each \$91.41



BLO-HARD BOOSTER AIR GUNS

The most compact safety air gun available that fits in the palm of your hands. It is constructed of an economical, rugged die cast aluminum. The Venturi tip, consisting of a 1/4" NPT inlet with a maximum operating pressure of 120 PSI, boosts the thrust and limits static pressure to less than 30 PSI. Also includes an air shield to prevent hazardous chip fly-back.

STANDARD MODEL **WITH AIR SHIELD**
Model No. TB153 **Model No. TB154**
Mfg. No. 900 **Mfg. No. 900S**
Price/Each \$16.84 **Price/Each \$21.51**



XTRA-THRUST SAFETY AIR GUNS

The most powerful safety air gun available, it is designed to quickly move large volumes of debris. The Venturi tip increases thrust, with a 1/4" inlet and a maximum operating pressure of 150 PSI, resulting in a very high volume of air that equals 1/2" open pipe in effectiveness, yet meets OSHA standard with a limit of 30 PSI dead end static pressure. Constructed with rugged, cast aluminum body and full length trigger. For maximum performance of XTRA Thrust Air Gun high flow couplers and connectors of 5/16" interior diameter are recommended, as opposed to 3/16" I.D. for standard couplers and connectors.



Model No.	Mfg. No.	Overall Length"	Price /Each
TB138*	75XXT	6	36.66
TB139	75XT012AA	12	45.58
TB140	75XT024AA	24	49.25
TB141	75XT036AA	36	52.89
TB142	75XT048AA	48	56.56
TB143	75XT060AA	60	60.21
TB144	75XT072AA	72	63.88

* Includes air gun and nozzle only

HIGH FLOW CONNECTORS FOR XTRA-THRUST

Model No.	Description	Price /Each
TB156	Connector, male 1/4" NPT 5/16" I.D.	4.60
TB158	1/4" hose barb for 1/4" hose	26.44
TB159	3/8" hose barb for 3/8" hose	23.21

LONG JOHN SAFETY AIR GUNS

The longest safety air gun available, it is ideal for cleaning areas that are hard to reach. Long John air guns are used for blowing floor debris into piles, cleaning masonry forms, tanks, ovens, large molds, pipelines, rafters as well as heavy machinery and storage areas. These air guns meet OSHA standards, has a 1/4" NPT inlet with a maximum operating pressure of 150 PSI. The pistol grip casting and aluminum extension make Long John lightweight and easy to handle. Special Venturi tip increases thrust by 200%.



Model No.	Mfg. No.	Extension Length"	Price /Each
TB130	75LJ012AA	12	39.51
TB131	75LJ024AA	24	43.18
TB132	75LJ036AA	36	46.83
TB133	75LJ048AA	48	50.50
TB134	75LJ060AA	60	54.15
TB135	75LJ072AA	72	57.82

BLO-HARD SAFETY AIR GUNS

The lightest, thumb lever operated, extended reach, safety air gun available. It is ideal for cleaning and drying machines, ovens, floors and rafters and production equipment. It fits comfortably in the palm of your hand and is constructed of an economical, rugged, die cast aluminum. The Venturi tip has a 1/4" NPT inlet, and a maximum operating pressure 120 PSI, boosts the thrust and limits static pressure to less than 30 PSI when tip is blocked. Meets OSHA standards.



Model No.	Mfg. No.	Overall Length"	Price /Each
TB145	900LJ012AA	12	34.36
TB146	900LJ024AA	24	37.28
TB147	900LJ036AA	36	40.21
TB148	900LJ048AA	48	43.14
TB149	900LJ060AA	60	46.06
TB150	900LJ072AA	72	48.99

WHISPER JET® EXTENDED REACH AIR GUNS

- Durable cast aluminum body
- Unique *Coandaire*® nozzle reduces noise 6 to 20 dB compared to conventional air guns
- Solid conical tip design prevents blockage of nozzle
- Standard stock lengths from 6" - 72"
- 1/4" FNPT inlet
- Meets OSHA standards



Model No.	Mfg. No.	Description	Price/Each
TLZ747	80LJ006AA	Whisper Jet® w/ Aluminum Extension & Aluminum Nozzle, 6"	33.78
TLZ748	80LJ012AA	Whisper Jet® w/ Aluminum Extension & Aluminum Nozzle, 12"	35.31
TLZ749	80LJ018AA	Whisper Jet® w/ Aluminum Extension & Aluminum Nozzle, 18"	36.84
TLZ750	80LJ036AA	Whisper Jet® w/ Aluminum Extension & Aluminum Nozzle, 36"	41.41
TLZ751	80LJ048AA	Whisper Jet® w/ Aluminum Extension & Aluminum Nozzle, 48"	44.45

LAZER SERIES PALM ACTUATED AIR GUNS

- All-metal construction with rubber over-molded trigger
- Unique shape and soft over-molded trigger conforms to any hand
- Ergonomic grip reduces hand fatigue
- Ready for use with any 1/4" NPT inlet connector
- Features 1/8" NPSM outlet for optional safety nozzles
- Meets OSHA 1910.242(b) regarding output pressure



Model No.	Mfg. No.	Description	Price/Each
TLZ759	LZR600	Palm Switch Style Lazer Air Gun	16.45
TLZ760	LZR600006AA	Palm Switch Style Lazer Air Gun w/6" extension	31.48
TLZ761	LZR600012AA	Palm Switch Style Lazer Air Gun w/12" extension	34.85
TLZ762	LZR600018AA	Palm Switch Style Lazer Air Gun w/18" extension	33.06
TLZ763	LZR600024AA	Palm Switch Style Lazer Air Gun w/24" extension	33.78
TLZ764	LZR600036AA	Palm Switch Style Lazer Air Gun w/36" extension	35.37
TLZ765	LZR600048AA	Palm Switch Style Lazer Air Gun w/48" extension	36.95
TLZ766	LZR600060AA	Palm Switch Style Lazer Air Gun w/60" extension	38.54
TLZ767	LZR600072AA	Palm Switch Style Lazer Air Gun w/72" extension	40.13

FORCE 5 SERIES AIR GUNS

- Advanced *Venturi* nozzle delivers 100% of the power
- Air speed increases as it passes through the nozzle, drawing surrounding ambient air through the side ports
- The increased volume of air greatly intensifies power at the tip
- Meets OSHA Standards



SPECIFICATIONS

Inlet Pressure (PSI)	Thrust (lbf)	Flow (SCFM)	Dead End PSI
80	13	170	15
100	16	208	17
120	18	244	21
150	24	302	29



Model No.	Mfg. No.	Description	Price/Each
TLZ769	F5024AA	Force 5 Series with 24" Aluminum Extension And Standard Nozzle	231.71
TLZ770	F5036AA	Force 5 Series with 36" Aluminum Extension And Standard Nozzle	236.59
TLZ771	F5048AA	Force 5 Series with 48" Aluminum Extension And Standard Nozzle	241.47
TLZ772	F5060AA	Force 5 Series with 60" Aluminum Extension And Standard Nozzle	246.35

SYPHON SPRAY GUN KITS

- High vacuum siphon delivers up to 12 gallons per hour, knurled adjusting nut controls air volume
- Both 6" and 12" extensions allow for a longer reach
- One quart metal screw-on canister eliminates feed tubes and buckets
- 1/4" FNPT inlet
- Includes: Gun, canister, 6" rigid and 12" flexible plastic spray nozzles
- Conforms to MIL-G-952 type 1
- Meets OSHA standards



Model No.	Mfg. No.	Description	Price/Each
TLZ783	795GM	Siphon Spray Gun Kit	121.63

LAZER SERIES PISTOL GRIP AIR GUNS

- All-metal construction
- Unique design offers comfort for any size hand
- Ergonomic grip reduces hand fatigue
- Ready for use with any 1/4" NPT inlet connector
- Features 1/8" NPSM outlet for optional safety nozzles
- Meets OSHA 1910.242(b) regarding output pressure



Model No.	Mfg. No.	Description	Price/Each
TLZ752	LZR650	Pistol Grip Style Lazer Air Gun	16.45
TLZ753	LZR650006AA	Pistol Grip Style Lazer Air Gun w/ 6" extension	31.48
TLZ754	LZR650012AA	Pistol Grip Style Lazer Air Gun w/12" extension	34.85
TLZ755	LZR650018AA	Pistol Grip Style Lazer Air Gun w/18" extension	33.06
TLZ756	LZR650024AA	Pistol Grip Style Lazer Air Gun w/24" extension	33.78
TLZ757	LZR650036AA	Pistol Grip Style Lazer Air Gun w/36" extension	35.37
TLZ758	LZR650048AA	Pistol Grip Style Lazer Air Gun w/48" extension	36.95

EASY ACCESS SAFETY AIR GUNS

- Durable cast aluminum body
- Patented air-shield protective air cone protects operator from dangerous chip fly-back
- Delivers high thrust in hard to reach areas
- 6" screw-on brass extension
- 1/4" FNPT inlet
- Meets OSHA standards



Model No.	Mfg. No.	Description	Price/Each
TLZ768	765006	Booster Safety Air Gun	26.46

QUIET FORCE™ NOZZLES

- Made from rugged, lightweight components
- Nozzle is ideal for noise sensitive applications
- Up to 20 dBA quieter than conventional nozzles
- Develops 7 lbs. of thrust using 130 SCFM @100 PSI
- Meets OSHA Standards



Model No.	Mfg. No.	Description	Price/Each
TLZ773	F5024AQF	24" Force 5 (Quiet Force™ nozzle)	353.67
TLZ774	F5036AQF	36" Force 5 (Quiet Force™ nozzle)	358.55
TLZ775	F5048AQF	48" Force 5 (Quiet Force™ nozzle)	363.42
TLZ776	F5060AQF	60" Force 5 (Quiet Force™ nozzle)	368.30
TLZ777	F5072AQF	72" Force 5 (Quiet Force™ nozzle)	373.18

INFORCER AIR GUNS

- Super *Venturi* nozzle accelerates air flow
- 3/4" FNPT inlet, adjustable handle
- Thermally insulated ergonomic grip
- Palm or finger actuated dead man safety trigger



SPECIFICATIONS

Incoming Air Line Pressure (PSIG)	Flow (SCFM)	Thrust (lbs.)
80	160	9
100	185	12
120	230	14



Model No.	Mfg. No.	Description	Price/Each
TLZ778	INF5024AA	Inforcer 24" Air Gun with Aluminum Ext and Std Nozzle	250.01
TLZ779	INF5036AA	Inforcer 36" Air Gun with Aluminum Ext and Std Nozzle	254.88
TLZ780	INF5048AA	Inforcer 48" Air Gun with Aluminum Ext and Std. Nozzle	259.76
TLZ781	INF5060AA	Inforcer 60" Air Gun with Aluminum Ext and Std Nozzle	264.64

THE ORIGINAL SAFETY AIR GUNS

- Patented protective air cone protects operator from dangerous chip fly-back
- *Venturi* nozzle draws in ambient air to intensify both power and thrust
- Knurled adjusting nut controls air volume
- 1/4" FNPT inlet, convenient hanging hook
- Meets OSHA standards



Model No.	Mfg. No.	Description	Price/Each
TLZ782	57S30XB	The Original Safety Air Gun with Volume Control	24.31

AIR TOOLS & ACCESSORIES



Topring's Airpro safety blow guns are engineered to meet OSHA and other safety agencies' requirements of 30 PSI maximum pressure when dead-ended up to 150 PSI inlet pressure. Ergonomic design reduces hand fatigue. Adjustable trigger controls the amount of air supplied.

SAFETY BLOW GUNS

CHARACTERISTICS

- Flow stabilizer valve for precise air control
- Contoured design to fit comfortably into the user's hand
- Chrome plated, lightweight zinc body
- Cushioned thumb lever
- The hook design enables the gun to be stored conveniently by hanging on almost anything up to 1" diameter
- Meets OSHA requirements of 30 PSI maximum outlet pressure when dead-ended up to 150 PSI inlet pressure
- Industrial and automotive applications
- 1/4" (F) NPT inlet

TAPERED TIP BLOW GUNS

- Convenient thumb lever control
- Tapered tip
- Compact design for ease of operation

Applications

- Use in industrial and automotive shops for general cleaning, where high velocity air is not required

Model No. TA820
Price/Each \$16.70



BLOW GUNS WITH EXTENSION



Model No.	Description	Price/Each
TA821	3" Straight extension	30.10
TA822	6" Straight extension	33.24
TA823	12" Straight extension	39.19

SIPHON TIP BLOW GUNS

- Complete with 8' of plastic suction tubing and 6" extension
- Convenient thumb lever control
- Chrome plated brass siphon tip

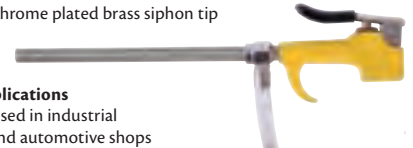

Applications

- Used in industrial and automotive shops for spraying air and liquid mixtures, (i.e. cleaners, solvents and sealants)

Model No. TA825
Price/Each \$45.15

AIR SCREEN TIP BLOW GUNS

- Brass air screen tip producing 30° conical safety air screen designed to deflect particles away from operator
- Minimizes blow-back of chips or particles



Applications

- Used in machine, tool and die and where drilled or tapped blind holes must be blown out causing chip and particle blow-back

Model No. TA817
Price/Each \$28.68

RUBBER TIP BLOW GUNS

- Will not scratch or mark surfaces
- Provides a leak proof seal between gun and fluid lines



Applications

- Used in automotive and industrial shops for blowing out blocked passages such as automatic transmissions, carburetors, moulds and dies

Model No. TA819
Price/Each \$17.02

INTERCHANGEABLE TIP BLOW GUN KITS

- Designed for light duty applications
- Contoured design fits comfortably in operator's hand
- Cushioned thumb lever
- Large hanging hook
- Lightweight zinc body
- Brass valve with only one moving part
- 1/4" Female NPT
- Chrome plated
- Comes with four tips: safety tip, rubber tip, needle tip, and long needle tip

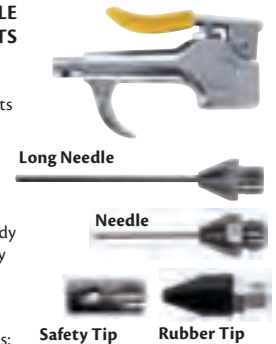

Model No. BV804
Price/Each \$17.22

TOPRING

COMPACT PERMATIP SAFETY BLOW GUNS

- Tamper-proof vent holes increase total air flow
- In the event of tip blockage, air escapes through radial holes, keeping tip pressure safely below 30 PSI
- Case-hardened steel restrictor inside the gun provides a concentrated air stream

Model No.	Mfg. No.	Noise Level* dB	Air Consumption* SCFM	Price/Each
TA816	60.100C	89	2.5	16.35

*At 75 PSI air line pressure



TOPRING

AIR BLOW GUNS WITH BRASS SAFETY NOZZLE

- Contoured design fits comfortably in operators hand
- Brass tip increases air flow
- Cushioned thumb lever
- Hook design allows for easy and convenient storage
- 1/4" (F) - 18 NPT inlet

Model No. TLV118
Price/Each \$10.70



aurora tools®

5-PC. BLOW GUN KITS

- Contoured design fits comfortably in operators hand
- Chrome plated
- Large hanging hook
- 1/4" (F) - 18 NPT
- Comes with four tips: Safety tip, rubber tip, needle tip, and long needle tip

Model No. TLZ147
Price/Each \$10.15



aurora tools®

TIRE PRESSURE GAUGES

TOPRING

All pencil gauges have a precision engineered brass chuck to assure gauge fits squarely on the valve. This prevents air leakage and guarantees accurate pressure readings. All gauges have a permanent deflating pin to release excessive air.

LOW PRESSURE TIRE GAUGES

- PSI/kPa calibration
- 4 sided nylon indicator
- Calibrated 2 sides from 10 to 50 PSI in 1 PSI increment
- Calibrated 2 sided from 75 to 340 kPa
- Chrome plated

Applications

- Auto and light truck

Model No. TA888

Price/Each \$5.50



HIGH PRESSURE TIRE GAUGES

- 4 sided nylon indicator
- Calibrated from 20 to 120 PSI in 2 PSI increments
- Chrome plated

Applications

- Bicycle, motorcycle or any equipment requiring high pressure readings

Model No. TA889

Price/Each \$6.39



TIRE PRESSURE GAUGES – DUAL WHEEL TYPE

TOPRING

All dual-wheel truck tire gauges have precision-engineered brass chuck guides to assure gauge fits squarely on the valve. This prevents air leakage and guarantees accurate pressure reading.

PISTOL GRIP DIAL INFLATOR GAUGES

- Excellent all purpose inflation gauge
- Air pressure may be set without touching the tire or valve core
- 3-in-1 function: Inflates, releases pressure and measures pressure
- 2" dial gauge 0-200 PSI (0-15 Bar)
- 12" flexible hose

Model No. BC317 Mfg. No. 63.665

Price/Each \$44.83



DUAL FOOT SERVICE GAUGES

- 4 sided unbreakable aluminum indicator
- Calibrated from 10 to 150 PSI in 2 PSI increments, number at 10 PSI with 5 PSI marker between
- Brass construction
- Chrome plated
- Approx. 12" long

Model No. TA891 Price/Each \$22.88



DUAL STRAIGHT CHUCK SERVICE GAUGES

- Straight chuck for outside dual wheels and 30° reverse angle for inside wheel
- Calibrated for 10 to 150 PSI in 2 PSI increments
- 2 sided heavy-duty aluminum bar
- Brass chrome finish
- Approx. 12" long

Model No. TA892 Price/Each \$25.03

MAXPRO DIGITAL TIRE GAUGES

- Reads from 2-100 PSI
- Displays in increments of 0.5 PSI
- Accuracy of +/- 1%
- Lightweight and compact
- Ergonomic shape



Model No. TGA777 Mfg. No. 63.630C

Price/Each \$15.66

DUAL FOOT INFLATOR GAUGES

- 12" hose
- For uses on motor homes and other vehicles with smaller dual wheels
- Nitrogen compatible

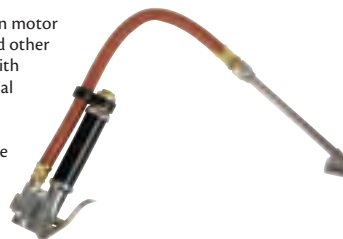

Model No. TGA457

Price/Each \$66.93

TOPRING

LEVER TYPE DIAL INFLATION GAUGES

- All purpose inflation gauge
- 3-in-1 function: inflates, releases air and measures tire pressure
- 2" dial gauge calibrated 10-220 PSI
- Gauge is encased in rubber cushion for longer service life
- 12" flexible hose with brass ball foot air chuck
- Nitrogen compatible



Model No. TLZ033

Mfg. No. 63.659

Price/Each \$37.38

STANDARD AIR CHUCKS

For regular live air lines. These chucks have a built-in shutoff valve and will not work on inflator gauges.

LOCK-ON AIR CHUCKS

- Firmly locks onto valve when pushed forward
- Releases when pulled back
- 1/4" (F) NPT

Model No. TA877

Price/Each \$17.85



HEX BALL FOOT AIR CHUCKS

- 3/4" hex
- 1/4" (F) NPT

Model No. TA879

Price/Each \$4.03



BALL FOOT AIR CHUCKS

- 1/4" (M) NPT

Model No. TA880

Price/Each \$7.58



DUAL FOOT AIR CHUCKS

- For truck and tractor
- 1/4" (F) NPT
- 6" long
- Plated finish

Model No. TA881

Price/Each \$7.47



DUAL FOOT AIR CHUCKS

- For hard-to-reach valves
- For truck, bus, tractor
- 1/4" (F) NPT
- 13" long
- Plated finish

Model No. TA882

Price/Each \$14.52



DUAL FOOT CHUCKS

- Straight-on chuck with 30° reverse angle
- 6" long
- 1/4" (F) NPT

Model No. TA883

Price/Each \$12.65



DUAL FOOT CHUCKS

- Straight-on chuck with 30° reverse angle
- 14" long
- 1/4" (F) NPT

Model No. TA884

Price/Each \$17.13



LOCK ON AIR CHUCKS

- Firmly locks onto valve
- 1/4" hose bark

Model No. TA886

Price/Each \$10.46



TOPRING

R26870E

AIR TOOLS & ACCESSORIES

LIQUID TRANSFER & CLEAN-UP SYSTEMS

Fills a 55-gal. (205 L) drum in less than 2 minutes without electricity - eliminates shop vac liquid handling.

- Transforms an ordinary 55-gal. drum into a liquid vacuum cleaner; a simple two-way valve and 80-100 PSI air allows pumping to a sealed drum
- Easily picks up high-viscosity liquids, chip, granulated products
- Ideal for paint, coolant, oils - any non-flammable liquids
- Safe in wet areas, no electricity; requires only compressed air
- Lightweight, portable, easily transferred to another drum in minutes
- Stainless steel construction
- No moving parts, no motor or hand crank, maintenance-free
- Instant On/Off control from air valve
- Easy to clean
- No spills; overflow protected with automatic valve
- Complete system includes vacuum unit, 12' hose with tapered PVC couplings, PVC tapered hose bung, extension tubes, crevice tool, skimmer tool, round brush

Model No TG142 Complete kit
Price/Each \$924.79

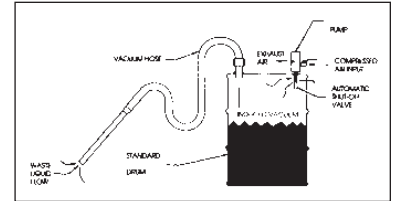
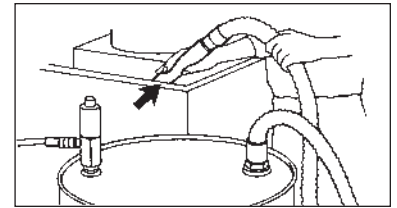

SPARE PARTS

Model No.	Description	Price/Each
TG143	Vacuum/pump unit	735.19
TG144	10' suction hose	104.95
TG145	Squeegee	81.92
TG146	19" extension tube	27.26

TOPRING

Model No.	Description	Price/Each
TG147	Male drum adaptor 2"	43.47
TG148	Crevice tool	21.40
TG149	Round brush	31.42
TG150	Skimmer	19.81

GUN-VAC VACUUM UNITS

The most powerful pneumatic *Gun-Vac* available and it handles like a blow gun. Vacuums metal chips, debris, sawdust, pellets, trimmings, and crumbs instead of blowing them. Sumps can be drained by removing the bag and connecting vac to a drum with a hose. It has no electrical fields or wires. Kit comes complete with 9" crevice tool. Constructed of rugged aluminum, it has a 1/4" NPT inlet and operates at 80-160 PSI.

Model No. TB155
Mfg. No. 1500
Price/Each \$126.14



GUARDAIR
CORPORATION

MAXPRO GRAVITY FED SAND BLASTERS

- High pressure blasting force for powerful cleaning
- Material control valve meters sand flow precisely
- Spot blast system included
- Ceramic nozzle
- 1/4 (F) NPT inlet

Model No. TKZ834
Mfg. No. 61.040
Price/Each \$105.22



TOPRING



CONTRACTOR SERIES

- Direct drive units have splash lubricated pump with cast iron sleeve for longer life
- Belt drive units have durable cast iron pumps
- Splash type lubrication
- All cast iron pumps have steel valves for longer life
- Flywheels designed for excellent pump cooling
- Manual reset for overload protection
- Dual control-start/stop with pressure switch or constant speed operation for electric belt drive unit
- All gas units equipped with *Honda*® gas engines
- Idle-down throttle control for gas belt drive units
- All units are factory tested prior to shipment
- 2-year warranty



TFA011



TFA012



TFA017

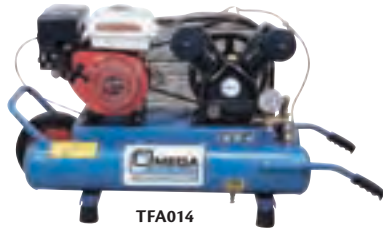

TFA014



TFA016



TFA013

Model No.	Mfg. No.	Peak HP	Running HP @ 90 PSI	Actual FAD-CFM 90 PSI	Actual FAD-CFM 125 PSI	Max. PSI	Voltage Phase	Tank Size	Noise Level dBA	Amp Draw @ 125 PSI	Pump RPM	Wt. lbs.	Remarks	Price /Each
TFA011	DP-2004V	2	1.5	6.0	4.6	125	115 V/1 PH	3.2	83	12	3450	55	Pan-Cake	432.59
TFA012	DP-2022H	2	1.5	6.0	4.6	125	115 V/1 PH	4	83	12	3450	65	Twin-Stack	430.54
TFA013	PUK-2008MDC	2	2.0	9.5	8.0	125	115 V/1 PH	8	70	22	900	200	Twin-Tank	1106.08
TFA014	PUK-5508G	5.5	5.5	12.5	10.5	125	5.5 HP Gas	8	90 Run/82 Idle	N/A	1100	190	Twin-Tank	1405.41
TFA015	PUK-5520G	5.5	5.5	12.5	10.5	125	5.5 HP Gas	20	90 Run/82 Idle	N/A	1100	190	20 gal. portable	1686.29
TFA016	PUK-9008G	9	9	20.6	17.6	125	9 HP Gas	8	90 Run/82 Idle	N/A	1100	250	Twin-Tank	2623.35
TFA017	TUE-8008GE	8	8	15.6	12.5	175	8 HP Gas	8	90 Run/82 Idle	N/A	1100	250	Electric Start	2970.53

PROFESSIONAL SERIES

- Quiet operation
- All units are belt driven
- Durable cast iron pumps
- Splash type lubrication
- All cast iron pumps have steel valves for longer life
- Flywheels designed for excellent pump cooling
- Manual reset for overload protection
- Portable units equipped with built-in regulator, pressure gauges and on/off switch
- Fully assembled - require handle and wheel attachment
- All units are factory tested prior to shipment
- For professional and automotive applications
- 2-year warranty



TFA019



TFA023



TFA022



TFA021



TFA024

SEE PAGES 1272-1290 FOR A GREAT SELECTION OF AIR TOOLS

Model No.	Mfg. No.	HP	Actual FAD-CFM 40 PSI	Actual FAD-CFM 90 PSI	Max. PSI	Voltage/Phase	Tank Size	Noise Level dBA	Wt. lbs.	Remarks	Price /Each
TFA018	PK-1008	1	2.2	1.7	125	115 V/1 PH	8	80	80	Horizontal-Portable	433.71
TFA019	PK-2008	2	4.0	3.2	125	115 V/1 PH	8	80	90	Horizontal-Portable	504.01
TFA020	PK-3011	3	6.0	5.3	125	115 V/1 PH	11	80	110	Horizontal-Portable	620.19
TFA021	PK-5020	5	7.8	6.4	125	115 V/1 PH	20	70	150	Horizontal-Portable	755.50
TFA022	PK-5020VP	5	7.8	6.4	125	115 V/1 PH	20	70	150	Vertical-Portable	793.88
TFA023	PP-6060V	6	12.5	11.0	125	230 V/1 PH	60	75	300	Vertical-15 A Motor	1044.37
TFA024	PK-6560V	6.5	20.0	18.0	125	230 V/1 PH	60	75	330	Electric Start	1474.09

RT0400E

COMPRESSORS, HOSES & FITTINGS

INDUSTRIAL SERIES

- Quiet operation
- Heavy-duty two-stage high efficient air compressors
- Durable cast iron pumps for performance and durability
- Splash type lubrication
- All cast iron pumps have steel valves for longer life
- Flywheels designed for excellent pump cooling
- All units are factory tested prior to shipment
- For commercial, automotive and industrial applications
- 2-year warranty



5 HP VERTICAL COMPRESSORS – TWO STAGE

Mfg. No.:	TK-5080V	No. of cylinders:	3
CFM @ 100 PSI:	19.4	Pump RPM:	960
Max. PSI:	175	Noise Level:	79 dBA
Tank Size:	80 gallons	Wt. Lbs.:	600

Model No.	Mfg. No.	Voltage	Price/Each
TFA031	TK-5080V-01M	208-230 V - 1 phase	2538.15
TFA032	TK-5080V-02M	200-208 V - 3 phase	2612.80
TFA033	TK-5080V-03M	230-240 V - 3 phase	2612.80
TFA034	TK-5080V-04M	460-480 V - 3 phase	2612.80
TFA035	TK-5080V-05M	575-600 V - 3 phase	2500.82

5 HP HORIZONTAL COMPRESSORS – TWO STAGE

Mfg. No.:	TK-5080	No. of cylinders:	3
CFM @ 100 PSI:	19.4	Pump RPM:	960
Max. PSI:	175	Noise Level:	79 dBA
Tank Size:	80 gallons	Wt. Lbs.:	600

Model No.	Mfg. No.	Voltage	Price/Each
TFA041	TK-5080-01M	208-230 V - 1 phase	2612.80
TFA042	TK-5080-02M	200-208 V - 3 phase	2612.80
TFA043	TK-5080-03M	230-240 V - 3 phase	2612.80
TFA044	TK-5080-04M	460-480 V - 3 phase	2612.80
TFA045	TK-5080-05M	575-600 V - 3 phase	2612.80

7.5 HP VERTICAL COMPRESSORS – TWO STAGE

Mfg. No.:	TK-7580V	No. of cylinders:	2
CFM @ 100 PSI:	26.1	Pump RPM:	995
Max. PSI:	175	Noise Level:	78 dBA
Tank Size:	80 gallons	Wt. Lbs.:	650

Model No.	Mfg. No.	Voltage	Price/Each
TFA051	TK-7580V-01M	208-230 V - 1 phase	3529.81
TFA052	TK-7580V-02M	200-208 V - 3 phase	3256.50
TFA053	TK-7580V-03M	230-240 V - 3 phase	3163.46
TFA054	TK-7580V-04M	460-480 V - 3 phase	3256.50
TFA055	TK-7580V-05M	575-600 V - 3 phase	3256.50

7.5 HP HORIZONTAL COMPRESSORS – TWO STAGE

Mfg. No.:	TK-7580	No. of cylinders:	2
CFM @ 100 PSI:	26.1	Pump RPM:	995
Max. PSI:	175	Noise Level:	78 dBA
Tank Size:	80 gallons	Wt. Lbs.:	650

Model No.	Mfg. No.	Voltage	Price/Each
TFA061	TK-7580-01M	208-230 V - 1 phase	3529.81
TFA062	TK-7580-02M	200-208 V - 3 phase	3256.50
TFA063	TK-7580-03M	230-240 V - 3 phase	3256.50
TFA064	TK-7580-04M	460-480 V - 3 phase	3256.50
TFA065	TK-7580-05M	575-600 V - 3 phase	3256.50

10 HP HORIZONTAL COMPRESSORS – TWO STAGE

Mfg. No.:	TK-100120	No. of cylinders:	3
CFM @ 100 PSI:	36.1	Pump RPM:	843
Max. PSI:	175	Noise Level:	80 dBA
Tank Size:	120 gallons	Wt. Lbs.:	950

Model No.	Mfg. No.	Voltage	Price/Each
TFA070	TK-100120-02M	200-208 V - 3 phase	3880.15
TFA071	TK-100120-03M	230-240 V - 3 phase	3880.15
TFA072	TK-100120-04M	460-480 V - 3 phase	3880.15
TFA073	TK-100120-05M	575-600 V - 3 phase	3880.15

15 HP HORIZONTAL COMPRESSORS – TWO STAGE

Mfg. No.:	TK-150120	No. of cylinders:	3
CFM @ 100 PSI:	52.3	Pump RPM:	668
Max. PSI:	175	Noise Level:	80 dBA
Tank Size:	120 gallons	Wt. Lbs.:	1100

Model No.	Mfg. No.	Voltage	Price/Each
TFA078	TK-150120-02M	200-208 V - 3 phase	5656.14
TFA079	TK-150120-03M	230-240 V - 3 phase	5656.14
TFA080	TK-150120-04M	460-480 V - 3 phase	5656.14
TFA081	TK-150120-05M	575-600 V - 3 phase	5413.73

20 HP HORIZONTAL COMPRESSORS – TWO STAGE

Mfg. No.:	TK-200120	No. of cylinders:	3
CFM @ 100 PSI:	70	Pump RPM:	890
Max. PSI:	175	Noise Level:	82 dBA
Tank Size:	120 gallons	Wt. Lbs.:	1160

Model No.	Mfg. No.	Voltage	Price/Each
TFA086	TK-200120-02M	200-208 V - 3 phase	6087.74
TFA087	TK-200120-03M	230-240 V - 3 phase	6087.74
TFA088	TK-200120-04M	460-480 V - 3 phase	5876.69
TFA089	TK-200120-05M	575-600 V - 3 phase	5876.69

25 HP HORIZONTAL COMPRESSORS – TWO STAGE

Mfg. No.:	TK-250240	No. of cylinders:	4
CFM @ 100 PSI:	87.7	Pump RPM:	542
Max. PSI:	175	Noise Level:	78 dBA
Tank Size:	240 gallons	Wt. Lbs.:	1500

Model No.	Mfg. No.	Voltage	Price/Each
TFA094	TK-250240-02M	200-208 V - 3 phase	10278.14
TFA095	TK-250240-03M	230-240 V - 3 phase	10278.14
TFA096	TK-250240-04M	460-480 V - 3 phase	9835.99
TFA097	TK-250240-05M	575-600 V - 3 phase	9835.99

30 HP HORIZONTAL COMPRESSORS – TWO STAGE

Mfg. No.:	TK-300240	No. of cylinders:	4
CFM @ 100 PSI:	100.8	Pump RPM:	650
Max. PSI:	175	Noise Level:	80 dBA
Tank Size:	240 gallons	Wt. Lbs.:	1500

Model No.	Mfg. No.	Voltage	Price/Each
TFA102	TK-300240-02M	200-208 V - 3 phase	10512.40
TFA103	TK-300240-03M	230-240 V - 3 phase	10512.40
TFA104	TK-300240-04M	460-480 V - 3 phase	10074.47
TFA105	TK-300240-05M	575-600 V - 3 phase	10074.47

11 HP GAS ENGINE COMPRESSORS

Mfg. No.:	TK-11030G	No. of cylinders:	3
CFM @ 100 PSI:	19.4	Pump RPM:	960
Max. PSI:	175	Noise Level:	90 dBA (run) 82 dBA (idle)
Tank Size:	30 gallons	Wt. Lbs.:	450

Model No.	Price/Each
TFA106	3445.39

3 HP ELECTRIC AIR COMPRESSORS

- Oil lubricated for cooler operation and reduced noise
- High output cast iron pump, delivers maximum performance
- Designed especially for framing nailers
- Air pressure regulator enables adjustments of line pressure to tool
- Stores 50' of 3/8" air hose with handle folded or upright

Model No. TLZ557 Mfg. No. MAC5200
Price/Each \$463.31

Horsepower: 3.0 HP
Tank Size: 5.2 gal.
Power Supply: 120 V, 13.8 A,
CFM @90 PSI: 6.5 CFM
Max PSI: 140
Dimensions: 29" L x 19" W x 19 1/2" H
Weight: 88 lbs.
Includes: 1/4" quick coupler, air filter, compressor oil



0.3 CONTINUOUS HP 1-GALLON SINGLE TANK HAND CARRY COMPRESSORS

- 0.75 SCFM delivered @ 90 PSI pump, 1.0 gallon tank and 135 max PSI enables more nails to be fired and provides quicker recovery
- Durable oil-free pump provides extended maintenance-free operation
- Low 71 dBA* allows for quieter operation (*Tested per ISO3744)
- Roll cage and control panel provide protection to key compressor components
- Low 2.6 amp draw motor provides easy start-up and reduces breaker tripping
- Ball valve drain allows for quick and thorough tank draining
- One quick coupler to easily support one nailer
- High-flow regulator for increased performance

Model No. TJZ977 Mfg. No. D55140
Price/Each \$204.67

Drive: Belt drive
Horsepower: 0.3 continuous HP
Tank Size: 1.0 gal.
Power Supply: 120 V, 10 A, 60 Hz, universal motor
CFM @90 PSI: 0.75 CFM
Pump Speed: 2200 RPM
Dimensions: 19" L x 14.5" W x 9" H
Weight: 29 lbs.



PORTABLE CONTRACTOR SERIES COMPRESSORS – OIL LUBE, DIRECT DRIVE

- For professional, farm, home and hobbyists
- Quiet running and low 1720 RPM pump
- Die cast aluminum pump with cast iron sleeves and stainless steel valves for longer life
- All electrical units draw 15 amps or under
- Manual reset for overload protection
- Includes: Regulator, pressure gauge, pressure switch with on/off, universal coupler, filter silencer with replacement element and pump oil
- Factory tested prior to shipment
- Not intended for commercial use
- CSA approved
- 1-year limited manufacturer's warranty



Model No.	Mfg. No.	Peak HP	Running HP @ 90 PSI	Actual FAD-CFM		Voltage Phase	Amp Draw @ 125 PSI	Tank Size	Pump RPM	Dimensions			Wt. lbs.	Price /Each		
				90 PSI	125 PSI					L"	W"	H"				
TFA008	DD-1004	1	1	4.5	4	115V/1PH	15	4	1720	16	x	16	x	23	65	370.85
TFA009	DD-1503	1.5	1.5	6	4.6	115V/1PH	14	3.2	1720	22	x	9	x	23	55	340.70
TFA010	DD-2022B	2	1.5	6	4.6	115V/1PH	15	4	1720	21	x	20	x	20	80	393.96

COMPRESSORS, HOSES & FITTINGS

COMPRESSED AIR FILTERS

- Internal float drain with all models
- Push on filter element for reduced maintenance and down time
- Filters are manufactured using die-cast aluminum housings
- EPC coated on inside of housing to eliminate corrosion
- All housings are powder coated
- Pop up indicators are supplied with A20 (grade) and A30 (grade) to monitor filter performance



- Differential pressure indicators are supplied with A55 (grade) to A153 (grade) to monitor filter performance
- Thread filters and filter elements are silicone free
- Neat and easily serviceable layout of components
- Powder paint coated finish
- Automatic electronic drains
- Electronic controls complete with LED readout is standard on all models
- Suitable for high inlet air temperature or high ambient air temperature
- All dryers are factory tested prior to shipment



TFA296

X1 SERIES PREFILTERS

Are designed to remove dirt particles 1 micron in size and larger. They are ideally suited to act as prefilters for coalescing filters and may be used ahead of refrigerated air dryers.

XA SERIES COALESCING FILTERS

Are designed to remove dirt particles and oil 0.01 micron in size and larger. They are ideally suited to be used after a prefilter and in applications where oil free air is of importance.

Model No.	Mfg. No.	SCFM	Pipe Size"	Max PSI	Height"	Dimensions Width"	Depth"	Wt. lbs.	Price /Each	Replacement Element	Price /Each
X1 SERIES - PREFILTER - 1 MICRON											
TFA296	A20X1	20	1/4	232	8	3	3	1.43	205.02	TFA317	84.42
TFA297	A30X1	30	3/8	232	8	3	3	1.43	251.15	TFA318	113.97
TFA298	A55X1	63	1/2	232	13	3.5	4	2.87	370.06	TFA319	161.97
TFA299	A76X1	127	3/4	232	15	5	4	5.95	457.98	TFA320	188.89
TFA300	A106X1	176	1	232	21	5	6	7.72	608.88	TFA321	228.99
TFA301	A126X1	318	1 1/4	232	21	5	6	7.72	724.96	TFA322	241.65
TFA302	A153X1	427	1 1/2	232	22	5	6	9.7	1015.15	TFA323	279.64
XA SERIES - COALESCING - 0.01 MICRON											
TFA303	A20XA	20	1/4	232	8	3	3	1.43	205.02	TFA324	84.63
TFA304	A30XA	30	3/8	232	8	3	3	1.43	251.15	TFA325	113.97
TFA305	A55XA	63	1/2	232	13	3.5	4	2.87	380.95	TFA326	166.73
TFA306	A76XA	127	3/4	232	15	5	4	5.95	457.98	TFA327	188.89
TFA307	A106XA	176	1	232	21	5	6	7.72	608.88	TFA328	228.99
TFA308	A126XA	318	1 1/4	232	21	5	6	7.72	724.96	TFA329	241.65
TFA309	A153XA	427	1 1/2	232	22	5	6	9.7	1015.15	TFA330	279.64

Larger sizes available upon request. Different micron sizes available upon request.

COMPRESSED AIR FILTERS

- Aluminum housing
- Chromed protective layer between paint and aluminum for better paint adhesion and better protection against corrosion and aggressive substances
- Epoxy powder coated (exterior and interior) for added durability and corrosion resistance
- Tie-rod insert allows for securing element in housing and easy installation
- Three quality degree of filtration available
- Element included
- Drain included with filter element
- Differential pressure gauge included



TLV317

TOPRING

Model No.	Mfg. No.	SCFM	Max. PSI	Pipe Size" (F) NPTF	Dimensions Diameter"	Height"	Price /Each
GENERAL PURPOSE – 1 MICRON							
TLV317	53.641	88	232	3/4	3.58	11.58	470.79
TLV320	53.661	132	232	1	5.47	11.18	546.42
TLV323	53.671	375	232	1 1/2	5.47	19.25	867.84
TLV326	53.681	494	232	1 1/2	5.47	26.93	1005.86
TLV329	53.701	727	232	2	7.48	24.41	1599.55
TLV332	53.711	1089	232	2 1/2	7.48	31.50	1764.04
OIL – 0.01 MICRON							
TLV318	53.642	88	232	3/4	3.58	11.58	470.79
TLV321	53.662	132	232	1	5.47	11.18	546.42
TLV324	53.672	375	232	1 1/2	5.47	19.25	867.84
TLV327	53.682	494	232	1 1/2	5.47	26.93	1005.86
TLV330	53.702	727	232	2	7.48	24.41	1599.55
TLV333	53.712	1089	232	2 1/2	7.48	31.50	1764.04
DUST – 0.01 MICRON							
TLV319	53.643	88	232	3/4	3.58	11.58	470.79
TLV322	53.663	132	232	1	5.47	11.18	546.42
TLV325	53.673	375	232	1 1/2	5.47	19.25	867.84
TLV328	53.683	494	232	1 1/2	5.47	26.93	1005.86
TLV331	53.703	727	232	2	7.48	24.41	1599.55
TLV334	53.713	1089	232	2 1/2	7.48	31.50	1764.04

AIR REQUIREMENT ESTIMATING GUIDE

The size of pipes and hoses also contributes to pressure loss in a system. Almost without exception, the single largest pressure loss in a system serving portable tools, is found in two areas - uses of hoses that are either too small or too long, the correct size of hose plays a critical role in avoiding pressure drop. Use of smaller than recommended hose size will result in serious reduction of tool performance. It is recommended to use the shortest hose possible and to make sure it is the correct size for the application. With most air tools the proper air hose size is at least one size larger than that of the air inlet pipe thread.



Description	Continuous Air Consumption at 90 PSI
22-18 Gauge Staplers	0.1 SCFM
18 Gauge Brad Nail Guns	0.1 SCFM
Finishing Nail Gun	0.2 SCFM
Coil Roofing Nail Gun	0.2 SCFM
Framing Nail Gun	0.4 SCFM
Caulking Gun	0.1 SCFM*
Grease Gun	0.8 SCFM
Riveter	1.1 SCFM
Engine Cleaner	6.1 SCFM
Conventional Spray Gun	7.0 SCFM**
HVLP Spray Gun	9.5 SCFM**
Screwdriver	9.6 SCFM

Description	Continuous Air Consumption at 90 PSI
Straight Line Sander	9.6 SCFM
1/4" Mini Ratchet	12.5 SCFM
1/4" Impact Driver	14.0 SCFM
Mini Die Grinder	16.5 SCFM
Random Orbital Sander	16.6 SCFM
3/8" Angle Drill	17.3 SCFM
Pull Type Air Nibbler	17.3 SCFM
4" Angle Disc Grinder	18.4 SCFM
Mini Belt Sander (10 mm)	18.9 SCFM
3/8" Ratchet	19.2 SCFM
D.A. Sander	19.2 SCFM
Jitterbug Sander	19.2 SCFM

Description	Continuous Air Consumption at 90 PSI
Pistol Grip Shears	19.2 SCFM
Chisel/Hammer	21.9 SCFM
High Speed Sander	22.7 SCFM
3/8" Reversible Drill	23.8 SCFM
Abrasion Cut Off Tool	25.4 SCFM
Full Size Die Grinder	25.4 SCFM
1/2" Reversible Drill	26.4 SCFM
1/2" Impact Wrench	28.6 SCFM
7" Angle Sander	29.6 SCFM
7" Vertical Polisher	31.0 SCFM
3/4" Impact Wrench	34.7 SCFM
1" Impact Wrench	87.5 SCFM

*at 20 PSI **at 40 PSI

PRESSURE CONVERSION

From	To	mm Hg.	in. Hg.	ft. H ₂ O	atm	lb/in ² PSI	kgf/cm ²	kPa
mm Hg		1.0000	0.0394	0.0446	0.0013	0.0193	0.0013	0.133
in. Hg.		25.4000	1.0000	1.134	0.3342	0.4912	0.0345	3.386
atm (Bar)		760.0000	29.9200	33.9000	1.0000	14.7000	1.0330	101.300
lb/in ² (PSI)		51.7100	2.0360	2.3070	0.0680	1.0000	0.0704	6.895
kg/cm ²		735.6000	28.9600	32.840	0.9678	14.2200	1.0000	98.050
kPa		7.5000	0.2953	0.3349	0.0098	0.1450	0.0102	1.000

FLOW RATE CONVERSION

From	To	litre/sec	litre/min	gallon/min.	ft ³ /sec	ft ³ /min (SCFM)
Litre/sec		1.0000	60.0000	15.852	0.0357	2.1192
Litre/min		0.0167	1.0000	0.2642	0.00059	0.0357
Gallon/min		0.063	3.7850	1.0000	0.00222	0.1337
Cu.ft/sec		28.3170	1699.0200	448.8	1.0000	60.0000
Cu.ft/min (SCFM)		0.4719	28.3170	7.480	0.0166	1.0000

AIR PREPARATION

The lay-out of air-supply piping, the selection of adequate hose sizes and appropriate fittings and couplers and the preparation of air before it enters a tool are very important.

Why efficient treatment of compressed air at the work station is vital?

The harmful agents in a compressed air system are:

LIQUIDS & CONDENSATES:

- Cause line corrosion
- Cause reduced performance of tools and cylinders
- Cause lubricants to wash away

COMPRESSOR OIL:

- Forms corrosive acids from lubricant aerosols
- Forms sticky emulsions, reducing tools' speed and performance
- Forms clogging residues

SOLID CONTAMINANTS:

- Cause premature wear and damage to controls, tools and cylinders
- Cause seizing and scoring of cylinders and air powered motors

Proper air preparation will result in improved performance and increased tool life.

**SEE PAGES 1272-1290
FOR AIR TOOLS**

FILTERING, REGULATING & LUBRICATING AT THE WORK STATION

Compressed-air treatment program units and modular components are indispensable to insure maximum efficiency of controls, pneumatic tools, air cylinders and other pneumatic equipment.

THEY ALLOW:

- To prolong pneumatic equipment life as well as of air cylinders
- Proper filtering and lubricating of air prolong their life and top performance by a ratio of 1 to 20
- Increase tools and equipment performance up to standard of efficiency, by preventing damages due to overheat and seizure
- They insure a dependable source of smooth vibrationless power to operate tools at an efficient and steady speed
- To reduce downtime, therefore improve the overall performance and efficiency of any compressed air system, tools, air cylinders or other pneumatic equipment

Proper usage of compressed air calls for:

FILTERS/MICRO COALESCING:

- To remove moisture and particles

REGULATORS:

- To control pressure for the particular use

GAUGES:

- To show pressure

LUBRICATORS:

- To protect power tools by injecting a metered quantity of lubricant

Components may be purchased separately or in pre-assembled combinations

SUGGESTIONS FOR INSTALLING FRL & DRAINS

The filter, regulator, and lubricator should be installed in the order shown in the illustration. Individual take-off lines to the FRL unit and air tool(s) should be from the top of the compressed air line.

To trap and expel water, sludge, and other contaminants which may collect on the bottom of the air line, a mechanical drain should be used. Mechanical drains should be installed at low points in the piping system and at the far end of the distribution system.

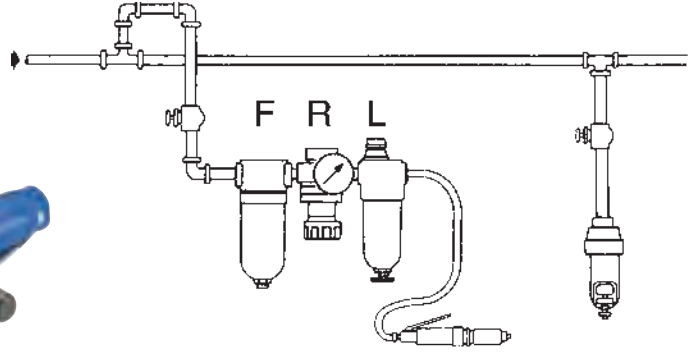

APPROXIMATE AIR CONSUMPTION FOR SELECTED AIR TOOLS

4-7	C.F.M.	Wire and terminal wrapping tools	21-23	C.F.M.	Medium screwdrivers (to 23 ft/lbs.)
8-13	C.F.M.	Small air drills (1/4" cap.)	22-34	C.F.M.	Large impact tools (3/4" sq. drive)
8-13	C.F.M.	Small nut runners and impact wrenches (1/4" sq. drive)	23-25	C.F.M.	Foundry casting cleaners
8-13	C.F.M.	Small air screwdrivers to 1" dia. screws (16 ft/lbs.)	25-27	C.F.M.	Standard back fill tampers
8-13	C.F.M.	Small orbital sanders (automotive type)	24-30	C.F.M.	Small (2" wheel) air grinders (horizontal)
9-14	C.F.M.	Medium impact tools (3/8" sq. drive)	27-32	C.F.M.	Foundry casting chippers
10-13	C.F.M.	Small air die grinders (high speed)	34-60	C.F.M.	Large impact tools (1" sq. drive)
13-15	C.F.M.	Foundry casting scalers	36-39	C.F.M.	Medium cup wheel grinders (7" wheel), 1 HP (vertical)
14-17	C.F.M.	Large impact wrenches (1/2" sq. drive)	35-40	C.F.M.	Disc sanders (7" size), 1 HP
14-29	C.F.M.	Foundry sandtampers	39-42	C.F.M.	Medium duty (4" wheel) horizontal grinders
15-20	C.F.M.	Reciprocating saws - files	48-65	C.F.M.	Heavy duty (6" wheel) horizontal grinders
19-20	C.F.M.	Large impact tools (5/8" sq. drive)	60-65	C.F.M.	Large cup wheel vertical grinder (7" wheel), 2 HP

TYPICAL COMPRESSED AIR NETWORK

1. Compressor and tank
2. Electronic automatic drain
3. Flexible vibration absorbing hose
4. Pre-filter
5. Refrigerated air dryer
6. Bypass circuit with isolation ball valve
7. After filter
8. Air line pipe
9. Y strainer to capture large contaminants
10. Mechanical automatic drain
11. Pre-formed drop pipe
12. Filter/regulator + lubricator air treatment unit
13. Water trap T drop fitting
14. Filter/regulator air treatment unit
15. Isolation ball valve

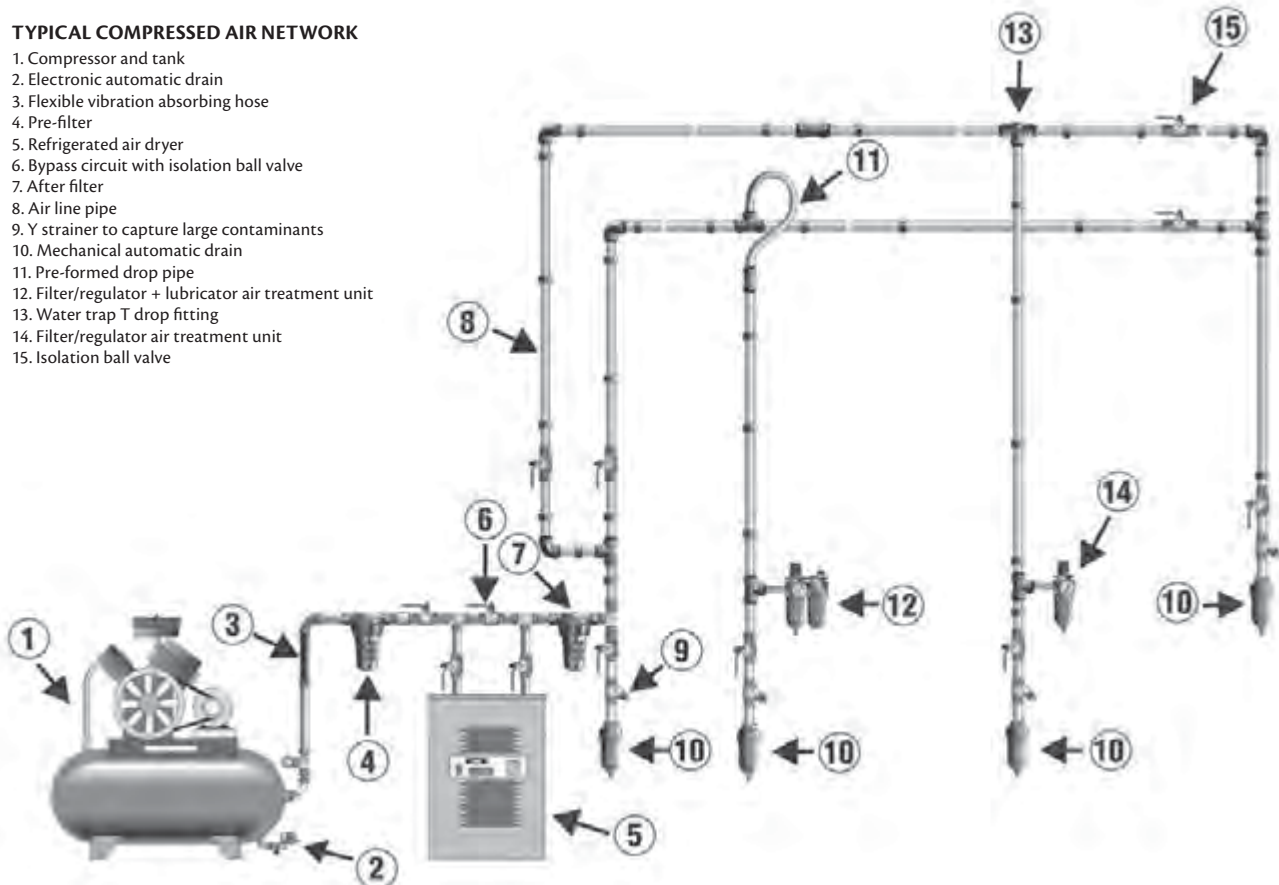

AIR LINE FILTERS

A filter is a necessity in every compressed air system. Filters remove the danger of corrosive damage to air tools and equipment by removing condensed moisture, pipe scale, dirt and rust from the air stream.



Micro Coalescing Filter



Pressure Regulator



Air Line Lubricator



Filter/Regulator



Filter/Regulator/Lubricator



Filter/Regulator and Lubricator



Filter/Regulator and Micro Coalescing Filter

AIR LINE FILTERS

Selection:

- Filter element rating is the prime selection criteria
- For most industrial applications, filter elements rated at 40 microns are adequate
- When necessary, filtration down to 20 or 5 microns or finer can be provided
- However, finer filtration increases pressure drop through the element
- Next, the flow capacity and pressure rating of the filter should be considered
- Finally, port size should match piping to avoid unnecessary pressure drops through restricting adapters
- Filter should be located as far from the compressor as possible to trap as much condensation as possible

MICRO COALESCING FILTERS

- Used in compressed air systems that require compressed air virtually free of oil vapours
- Remove liquid aerosols and very small particles
- The efficiency of removing such liquid aerosols is as high as 99.9%
- A pre-filter should always be used to increase life and efficiency of micro mist filters
- Typical application: Paint spraying

PRESSURE REGULATORS

Operation:

- Pressure regulators are used in compressed-air systems to reduce system pressure to a level suitable to operate air tools and equipment
- Regulators maintain the reduced pressure despite changes in the inlet pressure and changes in downstream flow requirements
- Pressure regulators reduce line pressure to a usable range, at a lower pressure than the compressor is set to deliver
- Regulators maintain a steady flow of air regardless of the fluctuations that may take place in line pressure
- Pneumatic equipment or tools operating at higher than recommended pressure, waste the energy to generate that pressure
- It creates a potential safety hazard and the tool will wear out prematurely. Operating below specified pressure can cause the tool to fail to meet performance specifications, therefore, precise air pressure control is essential for efficient operation of compressed air equipment

Selection:

- Inlet pressure rating and downstream controlled range, as well as flow capacity must be determined before selecting a regulator
- Port size should match piping size
- Required response time relieving capability and type of adjustment are other considerations

AIR LINE LUBRICATORS

Operation:

- Most pneumatic tools require oil lubrication for proper operation and long service life
- Too little oil can cause excessive wear and premature failure
- Too much oil is wasteful and can become a contaminant
- Intermitent lubrication may be the worst situation because the oil film can dry out to form sludges and varnishes on internal surfaces
- Lubricators protect expensive power tools
- Lubricators are ideal for lubrication of air tools or equipment, they inject a finely divided "fog" of oil into the air stream
- External adjustment and visible sight dome make precise adjustment easy
- This unit should be located as close as possible to the tool or the point where lubrication is required, a lubricator should never be located between compressor and filter or regulator, or on an air line supply to a paint gun
- Whenever possible, lubricators should be located at an elevation higher than the tools being lubricated

COMBINATION FILTER/REGULATORS

Operation:

- Filter/regulators are used in compressed air systems to filter air and to regulate pressure
- Filter/regulators combine the functions in one compact, space saving unit

COMBINATION FILTER/REGULATOR/LUBRICATOR

Selection:

- When selecting the individual filter/regulator/lubricator unit, the air consumption of the tool(s) to be serviced should be appropriate with the flow capacity of the unit
- Filter/regulator/lubricator should be as close as practical to the tool or work station
- Filter/regulator/lubricator should be in an area of easy accessibility because these units require regular maintenance
- A shut-off valve (ball valve) should be installed ahead of the unit to facilitate maintenance
- An air line may be equipped with the best filters and lubricators available, but if they are not positioned in the system where they do the most good, or if filters are not drained, or if lubricator reservoirs are not re-filled, the money spent for their use may have been wasted

POPULAR COMBINATIONS

FILTER/REGULATOR + LUBRICATOR OR FILTER + REGULATOR + LUBRICATOR

Typical application: Air tools

- These units are ready for immediate installation into the air line

FILTER/REGULATOR + MICRO COALESCING FILTER

Typical application: Paint spraying

- This unit is ideal for body shop operations where filtered, dried and regulated air supply is necessary for painting
- This unit provides the painter with a clean, moisture free air supply and saves money



MODULAR FRL SYSTEMS

TOPRING

MODULAR COMBINATION UNITS FILTER + REGULATOR + LUBRICATOR

- Accurate pressure control
- Lubricator fillable under pressure
- Lubrication automatically proportioned to air flow
- Pressure gauge, piping adaptors and mounting bracket included

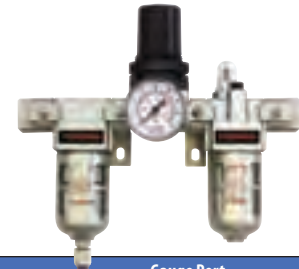

TOPRING

Model No.	Mfg. No.	Port Size"	Max Air Flow @ 100 PSI	Max PSI	Reduced Pressure Range	Bowl Type	Bowl Capacity	Drain	Gauge Port Size"	Series	Price /Each
TLZ602	51.210	1/4 (F) NPT	18 SCFM	150	5-125	Polycarbonate w/Steel Guard	0.5 fl.oz.	Semi-auto	1/8 (F) NPT	200	118.55
TLZ611	51.310	1/4 (F) NPT	70 SCFM	150	5-125	Polycarbonate w/Steel Guard	0.7 fl.oz.	Semi-auto	1/8 (F) NPT	300	159.95
TLZ613	51.315	3/8 (F) NPT	70 SCFM	150	5-125	Polycarbonate w/Steel Guard	0.7 fl.oz.	Semi-auto	1/8 (F) NPT	300	163.74
TLZ637	51.410	3/8 (F) NPT	140 SCFM	150	5-125	Polycarbonate w/Steel Guard	1.6 fl.oz.	Semi-auto	1/4 (F) NPT	400	210.70
TLZ639	51.415	1/2 (F) NPT	140 SCFM	150	5-125	Polycarbonate w/Steel Guard	1.6 fl.oz.	Semi-auto	1/4 (F) NPT	400	210.70
TLZ663	51.510	3/4 (F) NPT	175 SCFM	150	5-125	Die Cast Alum w/Sight Glass	4.4 fl.oz.	Semi-auto	1/4 (F) NPT	500	339.63
TLZ665	51.515	1 (F) NPT	175 SCFM	150	5-125	Die Cast Alum w/Sight Glass	4.4 fl.oz.	Semi-auto	1/4 (F) NPT	500	350.78

MODULAR COMBINATION UNITS FILTER + REGULATOR + LUBRICATOR

- Accurate pressure control
- Lubricator fillable under pressure
- Lubrication automatically proportioned to air flow
- Pressure gauge, piping adaptors and mounting bracket included

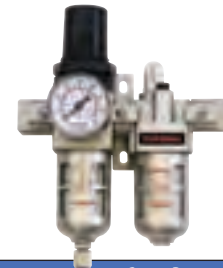

TOPRING

Model No.	Mfg. No.	Port Size"	Max Air Flow @ 100 PSI	Max PSI	Reduced Pressure Range	Bowl Type	Bowl Capacity	Drain	Gauge Port Size"	Series	Price /Each
TLZ603	51.220	1/4 (F) NPT	18 SCFM	150	5-125	Polycarbonate w/Steel Guard	0.5 fl.oz.	Semi-auto	1/8 (F) NPT	200	112.57
TLZ615	51.320	1/4 (F) NPT	60 SCFM	150	5-125	Polycarbonate w/Steel Guard	0.7 fl.oz.	Semi-auto	1/8 (F) NPT	300	135.53
TLZ617	51.325	3/8 (F) NPT	60 SCFM	150	5-125	Polycarbonate w/Steel Guard	0.7 fl.oz.	Semi-auto	1/8 (F) NPT	300	135.53
TLZ641	51.420	3/8 (F) NPT	105 SCFM	150	5-125	Polycarbonate w/Steel Guard	1.6 fl.oz.	Semi-auto	1/4 (F) NPT	400	182.53
TLZ643	51.425	1/2 (F) NPT	105 SCFM	150	5-125	Polycarbonate w/Steel Guard	1.6 fl.oz.	Semi-auto	1/4 (F) NPT	400	193.59

AIR LINE FILTERS & LUBRICATION

MODULAR FILTER/REGULATORS

- Removes water through centrifugal force
- Filters contaminants down to 25 microns
- Accurate pressure control
- Pressure gauge and mounting bracket included

TOPRING

Model No.	Mfg. No.	Port Size"	Max Air Flow @ 100 PSI	Max PSI	Reduced Pressure Range	Bowl Type	Bowl Capacity	Drain	Gauge Port Size"	Series	Price /Each
TLZ608	51.250	1/4 (F) NPT	19 SCFM	150	5-125 PSI	Polycarbonate w/Steel Guard	0.5 fl.oz.	Semi-auto	1/8 (F) NPT	200	59.84
TLZ627	51.350	1/4 (F) NPT	70 SCFM	150	5-125 PSI	Polycarbonate w/Steel Guard	0.7 fl.oz.	Semi-auto	1/8 (F) NPT	300	82.93
TLZ629	51.355	3/8 (F) NPT	70 SCFM	150	5-125 PSI	Polycarbonate w/Steel Guard	0.7 fl.oz.	Semi-auto	1/8 (F) NPT	300	82.93
TLZ653	51.450	3/8 (F) NPT	141 SCFM	150	5-125 PSI	Polycarbonate w/Steel Guard	1.6 fl.oz.	Semi-auto	1/4 (F) NPT	400	118.93
TLZ655	51.455	1/2 (F) NPT	141 SCFM	150	5-125 PSI	Polycarbonate w/Steel Guard	1.6 fl.oz.	Semi-auto	1/4 (F) NPT	400	118.93



MODULAR FILTERS

- Removes water through centrifugal force
- Filters contaminants down to 25 microns
- Mounting bracket included

TOPRING

Model No.	Mfg. No.	Port Size"	Max Air Flow @ 100 PSI	Max PSI	Bowl Type	Bowl Capacity	Drain	Series	Price /Each
TLZ609	51.260	1/4 (F) NPT	27 SCFM	150	Polycarbonate w/Steel Guard	0.5 fl.oz.	Semi-auto	200	30.31
TLZ631	51.360	1/4 (F) NPT	53 SCFM	150	Polycarbonate w/Steel Guard	0.7 fl.oz.	Semi-auto	300	48.42
TLZ633	51.365	3/8 (F) NPT	53 SCFM	150	Polycarbonate w/Steel Guard	0.7 fl.oz.	Semi-auto	300	48.42
TLZ657	51.460	3/8 (F) NPT	141 SCFM	150	Polycarbonate w/Steel Guard	1.6 fl.oz.	Semi-auto	400	62.13
TLZ659	51.465	1/2 (F) NPT	141 SCFM	150	Polycarbonate w/Steel Guard	1.6 fl.oz.	Semi-auto	400	64.00
TLZ675	51.560	3/4 (F) NPT	247 SCFM	150	Die cast alum w/Sight Glass	4.4 fl.oz.	Semi-auto	500	118.47
TLZ677	51.565	1 (F) NPT	247 SCFM	150	Die cast alum w/Sight Glass	4.4 fl.oz.	Semi-auto	500	118.47



MODULAR REGULATORS

- Removable locking Push/Pull adjusting knob
- Accurate pressure control
- Pressure gauge and mounting bracket included

TOPRING

Model No.	Mfg. No.	Port Size"	Max Air Flow @ 100 PSI	Max PSI	Gauge Port Size"	Series	Price /Each
TLZ605	51.240	1/4 (F) NPT	19 SCFM	150	1/8 (F) NPT	200	30.23
TLZ621	51.340	1/4 (F) NPT	88 SCFM	150	1/8 (F) NPT	300	44.22
TLZ624	51.345	3/8 (F) NPT	88 SCFM	150	1/8 (F) NPT	300	44.22
TLZ647	51.440	3/8 (F) NPT	212 SCFM	150	1/4 (F) NPT	300	52.09
TLZ650	51.445	1/2 (F) NPT	212 SCFM	150	1/4 (F) NPT	400	55.81
TLZ669	51.540	3/4 (F) NPT	282 SCFM	150	1/4 (F) NPT	500	97.94
TLZ672	51.545	1 (F) NPT	282 SCFM	150	1/4 (F) NPT	500	97.94



MODULAR LUBRICATORS

- Lubricator fillable under pressure
- Lubrication automatically proportioned to air flow
- Mounting bracket included

TOPRING

Model No.	Mfg. No.	Port Size"	Max Air Flow @ 100 PSI	Max PSI	Bowl Type	Bowl Capacity	Series	Price /Each
TLZ604	51.230	1/4 (F) NPT	28 SCFM	150	Polycarbonate w/Steel Guard	0.85 fl.oz.	200	41.75
TLZ619	51.330	1/4 (F) NPT	60 SCFM	150	Polycarbonate w/Steel Guard	1.7 fl.oz.	300	55.98
TLZ620	51.335	3/8 (F) NPT	60 SCFM	150	Polycarbonate w/Steel Guard	1.7 fl.oz.	300	55.98
TLZ645	51.430	3/8 (F) NPT	176 SCFM	150	Polycarbonate w/Steel Guard	1.6 fl.oz.	400	67.86
TLZ646	51.435	1/2 (F) NPT	176 SCFM	150	Polycarbonate w/Steel Guard	1.6 fl.oz.	400	65.36
TLZ667	51.530	3/4 (F) NPT	247 SCFM	150	Die cast alum. w/Sight Glass	4.4 fl.oz.	500	112.84
TLZ668	51.535	1 (F) NPT	247 SCFM	150	Die cast alum. w/Sight Glass	4.4 fl.oz.	500	115.14



MODULAR PIPING ADAPTORS

- Each item listed below includes two adaptors

TOPRING

Model No.	Mfg. No.	Port Size"	Series	Price /Each
TLZ690	51.950	1/4 (F) NPT	200	22.65
TLZ691	51.951	1/4 (F) NPT	300	33.39
TLZ692	51.952	3/8 (F) NPT	300	33.39
TLZ693	51.953	3/8 (F) NPT	400	56.38
TLZ694	51.954	1/2 (F) NPT	400	45.43
TLZ695	51.955	3/4 (F) NPT	500	56.65
TLZ696	51.956	1 (F) NPT	500	56.65



AIR LINE FILTERS & LUBRICATION

MAXDRAIN ELECTRONIC AUTOMATIC DRAINS AIR SAFETY VALVES

- Cost effective solution for regular, reliable condensation removal
- Fully automatic
- No maintenance
- Adjustable interval and discharge time
- Valve opens 0.5 to 10 seconds in 0.5 to 45 minute cycle times
- Test switch - for routine inspection and depressurization
- Solid-state timer for long life and reliability
- Rugged fire-resistant ABS housing



Model No.	Mfg. No.	Inlet	Price/Each
WITH STRAINER AND VALVE			
TGA424	59.345	1/2 (M) NPT" and 1/4 (F) NPT"	142.92
DRAIN UNIT ONLY			
TGA425	59.346	1/4 (F) NPT"	128.49

Constructed of brass and steel, safety valve is designed in accordance with the ASME code. These high quality, corrosion resistant safety valves provide optimum high-flow discharge rates and are colour coded to prevent replacement errors.

Operating Temperature:
-40°F to 350°F (-40°C to 177°C)



Model No.	Pressure ±3% PSI	Flow Cap. SCFM	Price /Each
TA803	50	47	16.92
TA804	75	66	16.92
TA805	115	96	16.92
TA806	125	103	16.92
TA807	140	115	16.92

Model No.	Pressure ±3% PSI	Flow Cap. SCFM	Price /Each
TA808	155	126	16.92
TA809	163	132	16.92
TA810	190	152	16.92
TA811	200	160	16.92

HEAVY-DUTY DESICCANT SYSTEMS

TOPRING

Nevada 3 stage desiccant system is engineered to provide high-quality air. Effective for removing liquid condensate (dirt, oil, water) but ideal for removing residual water vapour and aerosols. Delivers extremely dry compressed air without the use of electricity or refrigerants. Silica gel provides maximum moisture absorption. System consists of the following: filter (5 microns) with auto drain, coalescing filter (0.7 micron) with auto drain, desiccant dryer (30 CFM capacity) with sight glass indicating need for service, pressure regulator with gauge and mounting bracket.

SPECIFICATIONS:

Max. Working Pressure: 175 PSI
Port Size: 1/2" NPT
Air Flow Capacity: 30 SCFM

Model No.	Description	Price /Each
TZ906	3-Stage Heavy-Duty Desiccant System	1259.52
TZ907	Desiccant Silica Gel (5 lbs)	123.16

3 STAGE FILTRATION:

1. Centrifugal unit removes water, oil and dirt particles down to 5 microns
2. Coalescent filters out oil and water aerosols and smaller dirt down to 0.7 micron
3. Desiccant dryer removes all remaining water vapour



STANDARD DUTY DESICCANT SYSTEMS

TOPRING

The standard duty desiccant system offers the same benefits as the heavy-duty system, but is designed for less frequent use. It is also a 3-stage system engineered to provide high quality air. It removes dirt, water, oil, and uncondensed moisture from compressed air lines. Very efficient at protecting expensive and sensitive air tools. Does not require electricity or refrigerants to provide extremely dry compressed air. Silica gel provides maximum absorption, which can be monitored through a small sight glass. When the blue gel turns pink, the gel is then saturated with water and should be replaced with fresh gel to allow the system to remain effective. System consists of a filter (5 microns) with auto drain, coalescing filter (0.1 microns) with auto drain, desiccant dryer, filter/regulator with gauge, and a safety slide valve.

SPECIFICATIONS

Max. Working Pressure: 250 PSI
Port Size: 1/2" NPT
Air Flow Capacity: 20 SCFM

Model No.	Description	Price /Each
TG132	3-Stage Standard Duty Desiccant System	796.58
TZ907	Desiccant Silica Gel (5 lbs.)	123.16

3 STAGE FILTRATION:

1. Integral filter/regulator removes particulates down to 5 microns in size, to protect the regulator, which then reduces the pressure to the desired pressure setting
2. Coalescing filter removes 99.99% of oil aerosols and microscopic particles down to 0.1 microns in size
3. Desiccant dryer removes all remaining water vapour and a 40 micron filter element removes traces of any desiccant dust before it leaves the system



WATER SEPARATORS

- Cost effective way of ensuring that bulk water is removed from compressed air
- Ideal as a first treatment step between the compressor and receiver tank
- Requires no electricity and almost no maintenance
- Uses centrifugal force to remove up to 99% of bulk water
- Very low maintenance costs
- Simple and easy to install
- Efficient automatic drain
- Robust Aluminum body
- Maximum working pressure 232 PSI

TOPRING



Model No.	Mfg. No.	Pipe Connection" (F) NPT"	Flow Capacity SCFM	Weight lb.	Dimensions (in)		Price /Each
					Diameter	Height	
TLV335	56.010	1/2	88	2.4	3.42	8.23	302.53
TLV336	56.020	3/4	144	3.1	3.42	10.98	319.00
TLV337	56.030	1	232	8.4	5.12	12.4	454.55
TLV338	56.040	1 1/2	373	9.3	5.12	16.34	487.33
TLV339	56.050	1 1/2	488	10.6	5.12	20.28	545.89
TLV340	56.060	1 1/2	600	13.7	5.12	28.15	918.06

AIR LINE FILTERS & LUBRICATION

FILTERS/REGULATORS/LUBRICATORS (GAUGE INCLUDED)

- High-flow capacity reduces costly pressure drop
- Compact size allows greater design flexibility
- **Heavy-Duty:** High-capacity performance featuring rugged design for the most demanding applications

TOPRING

Model No.	NPT Size"	Max SCFM @ 100 PSI	Max PSI	Reduced Pressure Range PSI	Max Temp.°F	Drain Type	Bowl Type	Bowl Cap. oz.	H"	W"	Wt. lbs.	Price /Each
COMPACT MODULAR DESIGN, 20-MICRON FILTRATION												
TA689	1/4	39	150	0-125	120	Manual	Isoplast	1.5	7 15/64	4 51/64	2.25	206.77
TA690	1/4	39	150	0-125	120	Auto	Isoplast	1.5	7 15/64	4 51/64	2.25	214.77
COMPACT MODULAR DESIGN, 40-MICRON FILTRATION												
TA693	1/4	23	150	0-125	120	Manual	Isoplast	3.8	8 1/16	6 35/64	3.85	281.57
TA694	1/4	23	150	0-125	120	Auto	Isoplast	3.8	8 1/16	6 35/64	3.85	321.40
TA697	3/8	68	150	0-125	120	Manual	Isoplast	3.8	8 1/16	6 35/64	3.85	281.57
TA698	3/8	68	150	0-125	120	Auto	Isoplast	3.8	8 1/16	6 35/64	3.85	321.40
TA701	1/2	68	150	0-125	120	Manual	Isoplast	3.8	8 1/16	6 35/64	3.85	281.57
TA702	1/2	68	150	0-125	120	Auto	Isoplast	3.8	8 1/16	6 35/64	3.85	321.40
TA703	1/2	68	250	0-125	150	Manual	Zinc	3.8	8 1/16	6 35/64	4.55	309.98
STANDARD DUTY MODULAR DESIGN, 40-MICRON FILTRATION												
TA705	1/2	127	150	0-125*	120	Manual	ISO w/Guard	8.5	10 5/16	8 1/16	3.85	348.72
TA706	1/2	127	150	0-125*	120	Auto	ISO w/Guard	8.5	10 5/16	8 1/16	3.85	388.49
TA709	3/4	127	150	0-125*	120	Manual	ISO w/Guard	8.5	10 5/16	8 1/16	3.85	357.01
TA710	3/4	127	150	0-125*	120	Auto	ISO w/Guard	8.5	10 5/16	8 1/16	3.85	396.80
HEAVY-DUTY, 40-MICRON FILTRATION												
TA713	1	320	250	0-125**	150	Manual	Zinc	16	10 3/8	15 13/64	16.8	773.97
TA714	1	320	175	0-125**	150	Auto	Zinc	16	10 3/8	15 13/64	16.8	793.74
TA715	1 1/4	360	250	0-125**	150	Manual	Zinc	16	14 1/6	16 1/2	20.70	958.99
TA716	1 1/4	360	175	0-125**	150	Auto	Zinc	16	14 1/6	16 1/2	20.70	979.30
TA717	1 1/2	360	250	0-125**	150	Manual	Zinc	16	14 1/6	16 1/2	20.70	931.42
TA718	1 1/2	360	175	0-125**	150	Auto	Zinc	16	14 1/6	16 1/2	20.70	952.83

*Also available 0-25 PSI, 0-60 PSI, 0-250 PSI **Also available 0-250 PSI



Compact Design w/Isoplast Bowl



Compact Design w/Zinc Bowl



Heavy-Duty Design w/Zinc Bowl

FILTERS/REGULATORS & COALESCING FILTERS (GAUGE INCLUDED)

- High-flow capacity reduces costly pressure drop
- Compact size allows greater design flexibility
- Lightweight construction for ease of installation

TOPRING

Model No.	NPT Size"	Max SCFM @ 100 PSI	Max PSI	Reduced Pressure Range PSI	Max Temp.°F	Drain Type	Bowl Type	Bowl Cap. oz.	H"	W"	Wt. lbs.	Price /Each
COMPACT MODULAR DESIGN, 20-MICRON FILTRATION												
TA743	1/4	14	150	0-125	120	Manual	Isoplast	1.5	7 7/32	3 13/64	1.48	213.31
TZ031	1/4	14	150	0-125	120	Auto	Isoplast	1.5	7 7/32	3 13/64	1.50	229.25
COMPACT MODULAR DESIGN, 40-MICRON FILTRATION												
TA745	1/4	30	150	0-125	120	Manual	ISO w/Guard	3.8	8 1/16	3.64	2.75	312.08
TA746	1/4	30	150	0-125	120	Auto	ISO w/Guard	3.8	8 1/16	3.64	2.75	392.21
TA747	1/4	30	250	0-125	150	Manual	Zinc	3.8	8 1/16	3.64	3.45	337.21
TA748	1/4	30	250	0-125	150	Auto	Zinc	3.8	8 1/16	3.64	3.45	437.66
TA749	3/8	30	150	0-125	120	Manual	ISO w/Guard	3.8	8 1/16	3.64	2.75	312.06
TA750	3/8	30	150	0-125	120	Auto	ISO w/Guard	3.8	8 1/16	3.64	2.75	392.13
TA751	3/8	30	250	0-125	150	Manual	Zinc	3.8	8 1/16	3.64	3.45	337.06
TA752	3/8	30	250	0-125	150	Auto	Zinc	3.8	8 1/16	3.64	3.45	438.57
TA761	1/2	30	150	0-125	120	Manual	ISO w/Guard	3.8	8 1/16	3.64	2.75	312.08
TA762	1/2	30	150	0-125	120	Auto	ISO w/Guard	3.8	8 1/16	3.64	2.75	392.21
TA763	1/2	30	250	0-125	150	Manual	Zinc	3.8	8 1/16	3.64	3.45	337.34
TA764	1/2	30	250	0-125	150	Auto	Zinc	3.8	8 1/16	3.64	3.45	437.83
STANDARD DUTY MODULAR DESIGN, 40-MICRON FILTRATION												
TA753	1/2	80	150	0-125*	120	Manual	ISO w/Guard	8.5	10 21/64	5 25/64	3.30	369.65
TA754	1/2	80	150	0-125*	120	Auto	ISO w/Guard	8.5	10 21/64	5 25/64	3.30	449.22
TA755	1/2	80	250	0-125*	150	Manual	Zinc	8.5	10 21/64	5 25/64	4.60	406.54
TA756	1/2	80	175	0-125*	150	Auto	Zinc	8.5	10 21/64	5 25/64	4.60	486.52
TA757	3/4	80	150	0-125*	120	Manual	ISO w/Guard	8.5	10 21/64	5 25/64	3.30	369.67
TA758	3/4	80	150	0-125*	120	Auto	ISO w/Guard	8.5	10 21/64	5 25/64	3.30	449.22
TA759	3/4	80	250	0-125*	150	Manual	Zinc	8.5	10 21/64	5 25/64	4.60	406.73
TA760	3/4	80	175	0-125*	150	Auto	Zinc	8.5	10 21/64	5 25/64	4.60	486.65

*Also available 0-25 PSI, 0-60 PSI, 0-250 PSI



Compact Design w/Isoplast Bowl



Compact Design w/Isoplast Bowl and Guard

R26858E

OFFICE PRODUCTS

INSTRUMENTS, SCALES & ELECTRICAL

SHIPPING & PACKAGING

TOOLS & EQUIPMENT

WELDING & METALWORKING

SAFETY EQUIPMENT & SUPPLIES

JANITORIAL & MAINTENANCE

MATERIAL HANDLING & STORAGE

1311

AIR LINE FILTERS & LUBRICATION

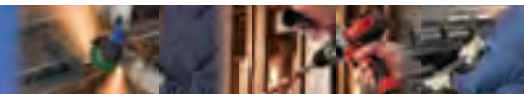

FILTERS/REGULATORS (GAUGE INCLUDED)

- High-flow capacity reduces costly pressure drop
- Compact size allows greater design flexibility
- Lightweight construction for ease of installation

TOPRING

Model No.	NPT Size"	Max SCFM @ 100 PSI	Max PSI	Reduced Pressure Range PSI	Max Temp.°F	Drain Type	Bowl Type	Bowl Cap. oz.	H"	W"	Wt. lbs.	Price /Each
COMPACT MODULAR DESIGN, 20-MICRON FILTRATION												
TA620	1/4	39	150	0-125	120	Manual	Isoplast	1.5	7 1/16	1 19/32	0.80	108.81
TA621	1/4	39	150	0-125	120	Auto	Isoplast	1.5	7 1/16	1 19/32	0.80	116.83
TA622	1/4	39	250	0-125	150	Manual	Zinc	1.5	7 1/16	1 19/32	1.05	117.62
TA623	1/4	39	175	0-125	150	Auto	Zinc	1.5	7 1/16	1 19/32	1.05	125.62
COMPACT MODULAR DESIGN, 40-MICRON FILTRATION												
TA624	1/4	50	150	0-125	120	Manual	ISO w/Guard	3.8	8 1/16	2	1.50	153.77
TA625	1/4	50	150	0-125	120	Auto	ISO w/Guard	3.8	8 1/16	2	1.50	188.45
TA626	1/4	50	250	0-125	150	Manual	Zinc	3.8	8 1/16	2	1.85	170.01
TA627	1/4	50	175	0-125	150	Auto	Zinc	3.8	8 1/16	2	1.85	211.82
TA628	3/8	68	150	0-125	120	Manual	ISO w/Guard	3.8	8 1/16	2	1.50	153.77
TA629	3/8	68	150	0-125	120	Auto	ISO w/Guard	3.8	8 1/16	2	1.50	188.45
TA630	3/8	68	250	0-125	150	Manual	Zinc	3.8	8 1/16	2	1.85	169.96
TA631	3/8	68	175	0-125	150	Auto	Zinc	3.8	8 1/16	2	1.85	211.74
TA632	1/2	68	150	0-125	120	Manual	ISO w/Guard	3.8	8 1/16	2	1.50	153.77
TA633	1/2	68	150	0-125	120	Auto	ISO w/Guard	3.8	8 1/16	2	1.50	188.45
TA634	1/2	68	250	0-125	150	Manual	Zinc	3.8	8 1/16	2	1.85	169.96
TA635	1/2	68	175	0-125	150	Auto	Zinc	3.8	8 1/16	2	1.85	211.74
STANDARD DUTY MODULAR DESIGN, 40-MICRON FILTRATION												
TA636	1/2	127	150	0-125*	120	Manual	ISO w/Guard	8.5	10 21/64	2 11/16	2.25	200.34
TA637	1/2	127	150	0-125*	120	Auto	ISO w/Guard	8.5	10 21/64	2 11/16	2.25	230.54
TA638	1/2	127	250	0-125*	150	Manual	Zinc	8.5	10 21/64	2 11/16	2.85	223.37
TA639	1/2	127	175	0-125*	150	Auto	Zinc	8.5	10 21/64	2 11/16	2.85	277.31
TA640	3/4	127	150	0-125*	120	Manual	ISO w/Guard	8.5	10 21/64	2 11/16	2.25	200.34
TA641	3/4	127	150	0-125*	120	Auto	ISO w/Guard	8.5	10 21/64	2 11/16	2.25	230.54
TA642	3/4	127	250	0-125*	150	Manual	Zinc	8.5	10 21/64	2 11/16	2.85	223.37
TA643	3/4	127	175	0-125*	150	Auto	Zinc	8.5	10 21/64	2 11/16	2.85	277.31

*Also available 0-25 PSI, 2-60 PSI, 2-250 PSI



Compact Design w/Isoplast Bowl and Guard



Compact Design w/Isoplast Bowl

FILTERS/REGULATORS & LUBRICATORS (GAUGE INCLUDED)

- High-flow capacity reduces costly pressure drop
- Compact size allows greater design flexibility
- Lightweight construction for ease of installation

TOPRING

Model No.	NPT Size"	Max SCFM @ 100 PSI	Max PSI	Reduced Pressure Range PSI	Max Temp.°F	Drain Type	Bowl Type	Bowl Cap. oz.	H"	W"	Wt. lbs.	Price /Each
COMPACT MODULAR DESIGN, 20-MICRON FILTRATION												
TA719	1/4	39	150	0-125	120	Manual	ISO Plast	1.5	7 15/64	3 13/64	1.50	190.81
TA720	1/4	39	150	0-125	120	Auto	ISO Plast	1.5	7 15/64	3 13/64	1.50	198.75
COMPACT MODULAR DESIGN, 40-MICRON FILTRATION												
TA723	1/4	23	150	0-125	120	Manual	ISO w/Guard	3.8	8 1/16	4 23/64	2.75	246.17
TA724	1/4	23	150	0-125	120	Auto	ISO w/Guard	3.8	8 1/16	4 23/64	2.75	287.75
TA727	3/8	68	150	0-125	120	Manual	ISO w/Guard	3.8	8 1/16	4 23/64	2.75	246.17
TA728	3/8	68	150	0-125	120	Auto	ISO w/Guard	3.8	8 1/16	4 23/64	2.75	287.75
TA731	1/2	68	150	0-125	120	Manual	ISO w/Guard	3.8	8 1/16	4 23/64	2.75	246.17
TA732	1/2	68	150	0-125	120	Auto	ISO w/Guard	3.8	8 1/16	4 23/64	2.75	288.01
TA733	1/2	68	250	0-125	150	Manual	Zinc	3.8	8 1/16	4 23/64	3.50	277.77
STANDARD DUTY MODULAR DESIGN, 40-MICRON FILTRATION												
TA735	1/2	127	150	0-125*	120	Manual	ISO w/Guard	8.5	10 21/64	5 25/64	3.30	310.21
TA736	1/2	127	150	0-125*	120	Auto	ISO w/Guard	8.5	10 21/64	5 25/64	3.30	349.99
TA739	3/4	127	150	0-125*	120	Manual	ISO w/Guard	8.5	10 21/64	5 25/64	3.30	315.07
TA740	3/4	127	150	0-125*	120	Auto	ISO w/Guard	8.5	10 21/64	5 25/64	3.30	354.89

*Also available 0-25 PSI, 0-60 PSI, 0-250 PSI



Compact Design w/Isoplast Bowl and Guard



Compact Design w/Isoplast Bowl

AIR LINE FILTERS & LUBRICATION

REGULATORS (GAUGE INCLUDED)

- High performance
- Compact design allows for greater design flexibility
- **Heavy-Duty:** High-capacity performance featuring rugged design for the most demanding applications

TOPRING

Model No.	NPT Size"	Max SCFM @ 100 PSI	Max PSI	Reduced Pressure Range PSI	Max Temp. °F	Bowl Type	H"	W"	Wt. lbs.	Price /Each
MINI MODULAR DESIGN										
TA644	1/4	39	300	0-125	120	Zinc	4 3/32	1 19/32	0.80	68.56
TA645	1/4	39	300	0-125(Non-Rel)	120	Zinc	4 3/32	1 19/32	0.80	72.34
TA646	1/4	39	300	0-25	120	Zinc	4 3/32	1 19/32	0.80	69.81
TA647	1/4	39	300	0-60	120	Zinc	4 3/32	1 19/32	0.80	72.51
COMPACT MODULAR DESIGN										
TA648	1/4	78	300	0-125	120	Zinc	4 9/64	2	1.40	88.58
TA649	1/4	78	300	0-125(Non-Rel)	120	Zinc	4 9/64	2	1.40	94.61
TA650	1/4	78	300	0-25	120	Zinc	4 9/64	2	1.40	93.36
TA651	1/4	78	300	0-60	120	Zinc	4 9/64	2	1.40	97.05
TA652	3/8	78	300	0-125	120	Zinc	4 9/64	2	1.40	88.58
TA655	3/8	78	300	0-60	120	Zinc	4 9/64	2	1.40	97.05
TA656	1/2	78	300	0-125	120	Zinc	4 9/64	2	1.40	88.58
STANDARD DUTY MODULAR DESIGN										
TA660	1/2	190	300	0-125*	120	Aluminum	5 9/16	2 11/16	1.65	113.90
TA661	1/2	190	300	0-125(Non-Rel)*	120	Aluminum	5 9/16	2 11/16	1.65	121.67
TA664	1/2	190	300	0-250*	120	Aluminum	5 9/16	2 11/16	1.65	118.45
TA665	3/4	190	300	0-125*	120	Aluminum	5 9/16	2 11/16	1.65	113.90
TA666	3/4	190	300	0-125(Non-Rel)*	120	Aluminum	5 9/16	2 11/16	1.65	121.67
TA669	3/4	190	300	0-250*	120	Aluminum	5 9/16	2 11/16	1.65	118.45
HEAVY-DUTY										
TA670	1	360	300	0-125**	120	Zinc	10 7/16	4 15/16	7.2	207.62
TZ028	1 1/4	360	300	0-125**	120	Zinc	10 13/16	4 15/16	7.2	285.95
TA672	1 1/2	360	300	0-125**	120	Zinc	10 13/16	4 15/16	7.2	285.95

*Also available 0-25 PSI, 0-60 PSI, 0-250 PSI **Also available 0-250 PSI



Mini



Standard Duty



Heavy-Duty

LUBRICATORS

- High performance over a wide flow range
- Fillable under pressure through fill port
- No need to depressurize or remove bowl

TOPRING

Model No.	NPT Size"	Max SCFM @ 100 PSI	Max PSI	Max Temp. °F	Bowl Type	Bowl Cap. oz.	H"	W"	Wt. lbs.	Price /Each
MINI MODULAR DESIGN										
TA675	1/4	47	150	120	Isoplast	1.5	5 3/4	1 19/32	0.70	83.76
COMPACT MODULAR DESIGN										
TA677	1/4	23	150	120	ISO w/Guard	3.8	6 15/16	2 3/16	1.25	106.22
TA679	3/8	90	150	120	ISO w/Guard	3.8	6 15/16	2 3/16	1.25	106.22
TA681	1/2	90	150	120	ISO w/Guard	3.8	6 15/16	2 3/16	1.25	106.22
STANDARD DUTY MODULAR DESIGN										
TA683	1/2	160	150	120	ISO w/Guard	8.5	8 9/16	2 11/16	1.10	126.75
TA684	1/2	160	250	150	Zinc	8.5	8 9/16	2 11/16	1.60	151.11
TA685	3/4	160	150	120	ISO w/Guard	8.5	8 9/16	2 11/16	1.10	130.08
TA686	3/4	160	250	150	Zinc	8.5	8 9/16	2 11/16	1.60	149.56



Compact Design w/Isoplast Bowl



Compact Design w/Zinc Bowl

AIR TOOL OIL

Air Tool Oil is specially formulated to preserve and maintain the internal seals and mechanisms present in most hand held air tools. Air Tool Oil lubricates under high pressure to fine tolerances and resists moisture induced corrosion, maximizing the service life and performance of your air tools. Air Tool Oil contains no silicone.



Model No.	Container	Price /Each
AA091	8-oz. Poly Bottle	5.24
AA090	4-litre Jug	46.43

Call us for all your Tools & Equipment requirements!



R26861E

OFFICE PRODUCTS

INSTRUMENTS, SCALES & ELECTRICAL

SHIPPING & PACKAGING

TOOLS & EQUIPMENT

WELDING & METALWORKING

SAFETY EQUIPMENT & SUPPLIES

JANITORIAL & MAINTENANCE

MATERIAL HANDLING & STORAGE

1313

AIR LINE FILTERS & LUBRICATION

FILTERS

- High flow capacity reduces costly pressure drop
- Compact size allows greater design flexibility
- Lightweight for ease of installation

TOPRING

Model No.	NPT Size"	Max SCFM @ 100 PSI	Max PSI	Max Temp.°F	Drain Type	Bowl Type	Bowl Cap. oz.	H"	W"	Wt. lbs.	Price /Each
MINI MODULAR DESIGN, 20-MICRON FILTRATION											
TA590	1/4	39	150	120	Manual	Isoplast	1.5	5 3/64	1 19/32	0.70	61.86
TA591	1/4	39	150	120	Auto	Isoplast	1.5	5 3/64	1 19/32	0.70	69.86
TA592	1/4	39	250	150	Manual	Zinc	1.5	5 3/64	1 19/32	1.00	70.56
TA593	1/4	39	175	150	Auto	Zinc	1.5	5 3/64	1 19/32	1.00	78.56
COMPACT MODULAR DESIGN, 40-MICRON FILTRATION											
TA594	1/4	50	150	120	Manual	ISO w/Guard	3.8	6 3/16	2 3/16	1.25	92.06
TA595	1/4	50	150	120	Auto	ISO w/Guard	3.8	6 3/16	2 3/16	1.25	131.86
TA598	3/8	68	150	120	Manual	ISO w/Guard	3.8	6 3/16	2 3/16	1.25	92.06
TA599	3/8	68	150	120	Auto	ISO w/Guard	3.8	6 3/16	2 3/16	1.25	131.86
TA602	1/2	68	150	120	Manual	ISO w/Guard	3.8	6 3/16	2 3/16	1.25	92.06
TA603	1/2	68	150	120	Auto	ISO w/Guard	3.8	6 3/16	2 3/16	1.25	131.86
STANDARD DUTY MODULAR DESIGN, 40-MICRON FILTRATION											
TA606	1/2	127	150	120	Manual	ISO w/Guard	8.5	7 63/64	2 11/16	1.10	120.21
TA607	1/2	127	150	120	Auto	ISO w/Guard	8.5	7 63/64	2 11/16	1.10	155.40
TA610	3/4	127	150	120	Manual	ISO w/Guard	8.5	7 63/64	2 11/16	1.10	119.59
TA611	3/4	127	150	120	Auto	ISO w/Guard	8.5	7 63/64	2 11/16	1.10	159.80
HEAVY-DUTY, 40-MICRON FILTRATION											
TA614	1	360	250	150	Manual	Zinc	16	8 5/8	4 61/64	6.30	290.60
TA615	1	360	175	150	Auto	Zinc	16	8 5/8	4 61/64	6.30	330.42
TA616	1 1/2	380	250	150	Manual	Zinc	16	9 29/64	5 3/16	7.00	326.98
TA617	1 1/2	380	175	150	Auto	Zinc	16	9 29/64	5 3/16	7.00	366.87
TA618	2	1125	250	150	Manual	Zinc	26	13 1/32	6 3/16	9.80	933.60
TA619	2	1125	175	150	Auto	Zinc	26	13 1/32	6 3/16	9.80	973.40



Mini Design w/Isoplast Bowl



Compact Design w/Isoplast Bowl and Guard



Heavy-Duty Design w/Zinc Bowl

COALESCING FILTERS

Highly efficient filters designed for applications requiring the removal of all solid particles greater than 0.3 micron, together with 99.97% of the oil and water aerosols.

TOPRING

Model No.	NPT Size"	Max SCFM @ 100 PSI	Max PSI	Max Temp.°F	Drain Type	Bowl Type	Bowl Cap. oz.	H"	W"	Wt. lbs.	Price /Each
COMPACT MODULAR DESIGN, 0.3-MICRON FILTRATION											
TA765	1/4	14	150	120	Manual	Isoplast	1.5	5 3/64	1 19/32	0.70	107.11
TA766	1/4	14	150	120	Auto	Isoplast	1.5	5 3/64	1 19/32	0.70	115.09
TA767	1/4	14	250	150	Manual	Zinc	1.5	5 3/64	1 19/32	1.00	116.32
COMPACT MODULAR DESIGN, 0.3-MICRON FILTRATION											
TA769	1/4	30	150	120	Manual	ISO w/Guard	3.8	6 3/16	2 3/16	1.25	165.93
TA770	1/4	30	150	120	Auto	ISO w/Guard	3.8	6 3/16	2 3/16	1.25	216.09
TA771	1/4	30	250	150	Manual	Zinc	3.8	6 3/16	2 3/16	1.60	178.41
TA772	1/4	30	175	150	Auto	Zinc	3.8	6 3/16	2 3/16	1.60	228.02
TA777	3/8	30	150	120	Manual	ISO w/Guard	3.8	6 3/16	2 3/16	1.25	165.93
TA778	3/8	30	150	120	Auto	ISO w/Guard	3.8	6 3/16	2 3/16	1.25	216.09
TA779	3/8	30	250	150	Manual	Zinc	3.8	6 3/16	2 3/16	1.60	178.41
TA780	3/8	30	175	150	Auto	Zinc	3.8	6 3/16	2 3/16	1.60	228.02
TA773	1/2	30	150	120	Manual	ISO w/Guard	3.8	6 3/16	2 3/16	1.25	165.93
TA774	1/2	30	150	120	Auto	ISO w/Guard	3.8	6 3/16	2 3/16	1.25	216.09
TA775	1/2	30	250	150	Manual	Zinc	3.8	6 3/16	2 3/16	1.60	178.63
TA776	1/2	30	175	150	Auto	Zinc	3.8	6 3/16	2 3/16	1.60	228.23
STANDARD DUTY MODULAR DESIGN, 0.3-MICRON FILTRATION											
TA781	1/2	80	150	120	Manual	ISO w/Guard	8.5	8 63/64	2 11/16	1.10	190.02
TA782	1/2	80	150	120	Auto	ISO w/Guard	8.5	8 63/64	2 11/16	1.10	231.84
TA783	1/2	80	250	150	Manual	Zinc	8.5	8 63/64	2 11/16	1.75	213.03
TA784	1/2	80	250	150	Auto	Zinc	8.5	8 63/64	2 11/16	1.75	260.94
TA785	3/4	80	150	120	Manual	ISO w/Guard	8.5	8 63/64	2 11/16	1.10	190.02
TA786	3/4	80	150	120	Auto	ISO w/Guard	8.5	8 63/64	2 11/16	1.10	231.84
TA787	3/4	80	250	150	Manual	Zinc	8.5	8 63/64	2 11/16	1.75	219.23
TA788	3/4	80	250	150	Auto	Zinc	8.5	8 63/64	2 11/16	1.75	261.07



Compact Design w/Isoplast Bowl



Compact Design w/Isoplast Bowl and Guard

ELBOWS 90°

Class 150 Malleable Iron Pipe Fittings



TBY636

Size"	Model No.	Mfg. No.	Price/Each
1/8	TBY636	DBM100-A	0.62
1/4	TBY637	DBM100-B	0.62
1/4 x 1/8	TBU887	DBM100-BA	0.77
3/8	TBY986	DBM100-C	0.62
3/8 x 1/4	TBV219	DBM100-CB	0.77
1/2	TBY987	DBM100-D	0.51
1/2 x 1/4	TBV220	DBM100-DB	0.70
1/2 x 3/8	TBV221	DBM100-DC	0.70
3/4	TBY988	DBM100-E	0.73
3/4 x 3/8	TBV222	DBM100-EC	0.90
3/4 x 1/2	TBV223	DBM100-ED	0.90
1	TBZ410	DBM100-F	1.18
1 x 1/2	TBV478	DBM100-FD	1.40
1 x 3/4	TBV479	DBM100-FE	1.40
1 1/4	TBY328	DBM100-G	1.77
1 1/4 x 1/2	TBU946	DBM100-GD	2.21

FLOOR FLANGES

Class 150 Malleable Iron Pipe Fittings



TBX917

Size"	Model No.	Mfg. No.	Price/Each
1/8	TBX917	DBMFF-A	1.89
1/4	TBX918	DBMFF-B	1.89
3/8	TBX919	DBMFF-C	1.89
1/2	TBX920	DBMFF-D	1.57
3/4	TBX921	DBMFF-E	2.18
1	TBY369	DBMFF-F	2.53
1 1/4	TBX304	DBMFF-G	3.86
1 1/2	TBX305	DBMFF-H	4.52
2	TBY370	DBMFF-I	5.48

STREET ELBOWS 90°

Class 150 Malleable Iron Pipe Fittings



TBX040

Size"	Model No.	Mfg. No.	Price/Each
1/8	TBX040	DBM116-A	0.71
1/4	TBX041	DBM116-B	0.71
3/8	TBX042	DBM116-C	0.71
1/2	TBX043	DBM116-D	0.59
3/4	TBX044	DBM116-E	0.87
1	TBX586	DBM116-F	1.26
1 1/4	TBV737	DBM116-G	2.43
1 1/2	MLM511	DBM116-H	2.61
2	MLM480	DBM116-I	4.14

CLOSE NIPPLES

Black Iron



TDV902

Size"	Model No.	Mfg. No.	Price/Each
1/8 x CLOSE	TDV902	DBM112-A	0.78
1/4 x CLOSE	TDV903	DBM112-B	0.71
3/8 x CLOSE	TBX899	DBM112-C	0.74
1/2 x CLOSE	TBX900	DBM112-D	0.44
3/4 x CLOSE	TBX901	DBM112-E	0.49
1 x CLOSE	TBY339	DBM112-F	0.83
1 1/4 x CLOSE	TBX290	DBM112-G	1.06
1 1/2 x CLOSE	TBX291	DBM112-H	1.25
2 x CLOSE	TBY340	DBM112-I	1.76
2 1/2 x CLOSE	MLM520	DBM112-J	4.68
3 x CLOSE	TBY341	DBM112-K	5.82
4 x CLOSE	TBY342	DBM112-L	9.08

HEX BUSHINGS

Class 150 Malleable Iron Pipe Fittings



TBX021

Size"	Model No.	Mfg. No.	Price/Each
1/4 x 1/8	TBX021	DBM110-BA	0.77
3/8 x 1/8	TBX022	DBM110-CA	0.57
3/8 x 1/4	TBX023	DBM110-CB	0.57
1/2 x 1/8	TBX024	DBM110-DA	0.46
1/2 x 1/4	TBX025	DBM110-DB	0.46
1/2 x 3/8	TBX026	DBM110-DC	0.46
3/4 x 1/8	TBX027	DBM110-EA	0.52
3/4 x 1/4	TBX028	DBM110-EB	0.52
3/4 x 3/8	MLM709	DBM110-EC	0.52
3/4 x 1/2	TBX030	DBM110-ED	0.52
1 x 1/4	TBX580	DBM110-FB	0.77
1 x 3/8	MLM666	DBM110-FC	0.77
1 x 1/2	TBX582	DBM110-FD	0.77
1 x 3/4	MLM667	DBM110-FE	0.77
1 1/4 x 1/4	TBV729	DBM110-GB	1.24
1 1/4 x 3/8	TBV730	DBM110-GC	1.24

REDUCING COUPLINGS

Class 150 Malleable Iron Pipe Fittings



TBV231

Size"	Model No.	Mfg. No.	Price/Each
1/4 x 1/8	TBV231	DBM119-BA	0.56
3/8 x 1/8	TBV232	DBM119-CA	0.56
3/8 x 1/4	TBV233	DBM119-CB	0.56
1/2 x 1/8	TBV234	DBM119-DA	0.52
1/2 x 1/4	TBV235	DBM119-DB	0.52
1/2 x 3/8	TBV236	DBM119-DC	0.52
3/4 x 1/4	TBV237	DBM119-EB	0.73
3/4 x 3/8	TBV238	DBM119-EC	0.73
3/4 x 1/2	TBV239	DBM119-ED	0.73
1 x 1/4	TBV485	DBM119-FB	0.97
1 x 3/8	TBV486	DBM119-FC	0.97
1 x 1/2	TBV487	DBM119-FD	0.97
1 x 3/4	TBV488	DBM119-FE	0.97
1 1/4 x 1/2	TBU953	DBM119-GD	1.42
1 1/4 x 3/4	TBU954	DBM119-GE	1.42
1 1/4 x 1	TBV240	DBM119-GF	1.42
1 1/2 x 1/2	TBU955	DBM119-HD	1.83
1 1/2 x 3/4	TBU956	DBM119-HE	1.83
1 1/2 x 1	TBV241	DBM119-HF	1.83

FITTINGS

TEES

Class 150 Malleable
Iron Pipe Fittings



TDV166

Size"	Model No.	Mfg. No.	Price/Each
1/8	TDV166	DBM101-A	0.81
1/4	MLB513	DBM101-B	0.81
3/8	MLB514	DBM101-C	0.81
1/2	MLB546	DBM101-D	0.68
3/4	MLB472	DBM101-E	1.00
1	MLB371	DBM101-F	1.60
1 1/4	TBZ720	DBM101-G	2.38

UNIONS

Class 150 Malleable
Iron Pipe Fittings



TBZ727

Size"	Model No.	Mfg. No.	Price/Each
1/8	TBZ727	DBM104-A	5.92
1/4	TBZ728	DBM104-B	2.88
3/8	TBZ729	DBM104-C	2.88
1/2	TBZ730	DBM104-D	2.48
3/4	TBZ731	DBM104-E	3.01
1	TDV173	DBM104-F	4.08
1 x 1/2	TBY088	DBM104-FD	4.08
1 x 1/2	TBY089	DBM104-FE	4.08
1 1/4	TBZ183	DBM104-G	5.27
1 1/2	TBZ184	DBM104-H	6.93

REDUCING ELBOWS 90°

Galvanized



TLY067

Size"	Model No.	Mfg. No.	Price/Each
1/2 x 3/8	TLY067	DBMG100-DC	0.90
3/4 x 1/2	TLY069	DBMG100-ED	1.21
1 x 1/2	TLY072	DBMG100-FD	1.90
1 x 3/4	TLY073	DBMG100-FE	1.90

COUPLINGS

Class 150 Malleable
Iron Pipe Fittings



TBY989

Size"	Model No.	Mfg. No.	Price/Each
1/8	TBY989	DBM103-A	0.49
1/4	TBY990	DBM103-B	0.49
3/8	TBY991	DBM103-C	0.49
1/2	TBY992	DBM103-D	0.41
3/4	TBY993	DBM103-E	0.57
1	TBZ414	DBM103-F	0.89

LONG NIPPLE

TLZ943



Black Iron				Galvanized		
Size"	Model No.	Mfg. No.	Price/Each	Model No.	Mfg. No.	Price/Each
1/8 x 1 1/2	TLZ943	DBM113-A1 1/2	0.80	-	-	-
1/8 x 2	TLZ947	DBM113-A2	0.83	-	-	-
1/8 x 2 1/2	TLZ948	DBM113-A2 1/2	0.89	-	-	-
1/8 x 3	TLZ949	DBM113-A3	0.93	-	-	-
1/8 x 3 1/2	TLZ950	DBM113-A3 1/2	1.09	-	-	-
1/8 x 4	TDX191	DBM113-A4	1.11	-	-	-
1/8 x 4 1/2	TLZ951	DBM113-A4 1/2	1.31	-	-	-
1/8 x 5	TDX192	DBM113-A5	1.44	-	-	-
1/8 x 5 1/2	TLZ952	DBM113-A5 1/2	1.64	-	-	-
1/8 x 6	TDX193	DBM113-A6	1.82	-	-	-
1/8 x 7	TLZ953	DBM113-A7	3.11	-	-	-
1/8 x 8	TLZ954	DBM113-A8	3.27	-	-	-
1/8 x 9	TLZ955	DBM113-A9	3.38	-	-	-
1/8 x 10	TLZ944	DBM113-A10	3.51	-	-	-
1/8 x 11	TLZ945	DBM113-A11	3.66	-	-	-
1/8 x 12	TLZ946	DBM113-A12	3.97	-	-	-
1/4 x 1 1/2	TLZ956	DBM113-B1 1/2	0.73	-	-	-
1/4 x 2	TDX194	DBM113-B2	0.80	-	-	-
1/4 x 2 1/2	TLZ960	DBM113-B2 1/2	0.84	-	-	-
1/4 x 3	TDX195	DBM113-B3	0.94	-	-	-
1/4 x 3 1/2	TLZ961	DBM113-B3 1/2	1.09	-	-	-
1/4 x 4	TDX196	DBM113-B4	1.19	-	-	-
1/4 x 4 1/2	TLZ962	DBM113-B4 1/2	1.44	-	-	-
1/4 x 5	TDX197	DBM113-B5	1.74	-	-	-
1/4 x 5 1/2	TLZ963	DBM113-B5 1/2	1.89	-	-	-
1/4 x 6	TDX198	DBM113-B6	2.06	-	-	-
1/4 x 7	TLZ964	DBM113-B7	3.15	-	-	-
1/4 x 8	TLZ965	DBM113-B8	3.30	-	-	-
1/4 x 9	TLZ966	DBM113-B9	3.49	-	-	-
1/4 x 10	TLZ957	DBM113-B10	3.69	-	-	-
1/4 x 11	TLZ958	DBM113-B11	3.88	-	-	-
1/4 x 12	TLZ959	DBM113-B12	4.05	-	-	-
3/8 x 1 1/2	TLZ967	DBM113-C1 1/2	0.77	-	-	-
3/8 x 2	TBZ002	DBM113-C2	0.81	-	-	-
3/8 x 2 1/2	TLZ971	DBM113-C2 1/2	0.92	-	-	-
3/8 x 3	TBZ003	DBM113-C3	1.02	-	-	-
3/8 x 3 1/2	TLZ972	DBM113-C3 1/2	1.14	-	-	-
3/8 x 4	TBZ004	DBM113-C4	1.25	-	-	-
3/8 x 4 1/2	TLZ973	DBM113-C4 1/2	1.57	-	-	-
3/8 x 5	TBZ005	DBM113-C5	1.66	-	-	-
3/8 x 5 1/2	TLZ974	DBM113-C5 1/2	1.82	-	-	-
3/8 x 6	TBZ006	DBM113-C6	2.06	-	-	-
3/8 x 8	TLZ975	DBM113-C8	3.17	-	-	-
3/8 x 10	TLZ968	DBM113-C10	3.95	-	-	-
3/8 x 11	TLZ969	DBM113-C11	4.39	-	-	-
3/8 x 12	TLZ970	DBM113-C12	4.46	-	-	-
1/2 x 1 1/2	TLZ976	DBM113-D1 1/2	0.47	TLY105	DBMG113-D11/2	0.60
1/2 x 2	TBZ007	DBM113-D2	0.56	TLY106	DBMG113-D2	0.70
1/2 x 2 1/2	TLZ980	DBM113-D2 1/2	0.60	TLY107	DBMG113-D21/2	0.78
1/2 x 3	TBZ008	DBM113-D3	0.62	TLY108	DBMG113-D3	0.81

CROSSES

Class 150 Malleable
Iron Pipe Fittings



TBZ725

Size"	Model No.	Mfg. No.	Price/Each
1/4	TBZ723	DBM102-B	3.68
3/8	TBZ724	DBM102-C	2.12
1/2	TBZ725	DBM102-D	3.20
3/4	MLY003	DBM102-E	4.36

COMPRESSION ELBOWS 90°

TUBE TO TUBE

TBY758



Model No.	Mfg. No.	Size"	Price/Each
TBY758	D65-2	1/8	3.08
TBY466	D65-3	3/16	3.04
TBY759	D65-4	1/4	2.41
TBY467	D65-5	5/16	2.46
TBY760	D65-6	3/8	2.19
TBY468	D65-6-4	3/8 x 1/4	5.58
TBY469	D65-7	7/16	5.60
TBY761	D65-8	1/2	3.56
TBY470	D65-8-6	1/2 x 3/8	7.99

COMPRESSION ELBOWS 90°

TUBE TO MALE PIPE

TBX736



Model No.	Mfg. No.	Size"	Price/Each
TBX736	D69-2A	1/8 x 1/8	2.11
TBX404	D69-3A	3/16 x 1/8	1.39
TBX405	D69-3B	3/16 x 1/4	2.26
TBX737	D69-4A	1/4 x 1/8	1.06
TBX738	D69-4B	1/4 x 1/4	1.21
TBX739	D69-4C	1/4 x 3/8	1.91
TBX740	D69-4D	1/4 x 1/2	3.46
TBX406	D69-5A	5/16 x 1/8	1.73
TBX407	D69-5B	5/16 x 1/4	1.77
TBX408	D69-5C	5/16 x 3/8	6.89
TBX741	D69-6A	3/8 x 1/8	1.83
TBX742	D69-6B	3/8 x 1/4	1.46
TBX743	D69-6C	3/8 x 3/8	1.70
TBX744	D69-6D	3/8 x 1/2	2.77
TBX745	D69-6E	3/8 x 3/4	5.13
TBX409	D69-7B	7/16 x 1/4	3.69

COMPRESSION UNIONS

TDV239



Model No.	Mfg. No.	Size"	Price/Each
TDV234	D62-2	1/8	1.03
TDV235	D62-3	3/16	0.70
TDV398	D62-4	1/4	0.72
TDV236	D62-5	5/16	0.89
TDV399	D62-6	3/8	1.11
TDV037	D62-7	7/16	5.37
TDV237	D62-8	1/2	2.04
TDV238	D62-10	5/8	2.60
TDV239	D62-12	3/4	5.04
TDV240	D62-14	7/8	6.99

COMPRESSION CONNECTORS

TUBE TO MALE PIPE

TBX716



Model No.	Mfg. No.	Size"	Price/Each
TBX716	D68-2A	1/8 x 1/8	0.65
TBX388	D68-3A	3/16 x 1/8	0.56
TBX389	D68-3B	3/16 x 1/4	1.17
TBX717	D68-4A	1/4 x 1/8	0.58
TBX718	D68-4B	1/4 x 1/4	0.72
TBX719	D68-4C	1/4 x 3/8	1.19
TBX720	D68-4D	1/4 x 1/2	1.93
TBX390	D68-5A	5/16 x 1/8	1.09
TBX391	D68-5B	5/16 x 1/4	0.80
TBX392	D68-5C	5/16 x 3/8	1.10
TBX393	D68-5D	5/16 x 1/2	9.87
TBX721	D68-6A	3/8 x 1/8	0.90
TBX722	D68-6B	3/8 x 1/4	0.80
TBX723	D68-6C	3/8 x 3/8	1.09
TBX724	D68-6D	3/8 x 1/2	1.41
TBX725	D68-6E	3/8 x 3/4	5.01
TBX170	D68-7A	7/16 x 1/8	4.12

COMPRESSION REDUCING UNIONS

TBY002



Model No.	Mfg. No.	Size"	Price/Each
TBY002	D62-8-6	1/2 x 3/8	1.91
TBY001	D62-4-2	1/4 x 1/8	1.94
TBX694	D62-4-3	1/4 x 3/16	3.31
TBX695	D62-5-4	5/16 x 1/4	3.28
TBZ096	D62-6-4	3/8 x 1/4	1.27
TBX696	D62-6-5	3/8 x 5/16	1.71
TBY003	D62-10-6	5/8 x 3/8	2.32
TBY004	D62-10-8	5/8 x 1/2	3.01

COMPRESSION SEALING PLUGS

Model No.	Mfg. No.	Size"	Price/Each
TDV405	D67-4	1/4	2.38

COMPRESSION TEES

TUBE ALL ENDS

TDV528



Model No.	Mfg. No.	Size"	Price/Each
TDV528	D64-2	1/8	3.18
TDV402	D64-3	3/16	2.62
TDV529	D64-4	1/4	2.12
TBX377	D64-4-2	1/4 x 1/4 x 1/8	5.64
TBX169	D64-4-3	1/4 x 1/4 x 3/16	5.42
TBX378	D64-4-6	1/4 x 1/4 x 3/8	6.53
TDV403	D64-5	5/16	3.11
TDV530	D64-6	3/8	3.01
TBX379	D64-6-4	3/8 x 3/8 x 1/4	6.30
TBV652	D64-6-4-4	3/8 x 1/4 x 1/4	6.72
TDV531	D64-8	1/2	4.77
TBX380	D64-8-4	1/2 x 1/2 x 1/4	10.91
TBX381	D64-8-6	1/2 x 1/2 x 3/8	9.86
TDV532	D64-10	5/8	6.46
TBX382	D64-10-8	5/8 x 5/8 x 1/2	11.67
TDV533	D64-12	3/4	19.90
TDV534	D64-14	7/8	20.10

COMPRESSION CONNECTORS

TUBE TO FEMALE PIPE

TBX697



Model No.	Mfg. No.	Size"	Price/Each
TBX697	D66-2A	1/8 x 1/8	0.94
TBX383	D66-3A	3/16 x 1/8	0.86
TBX384	D66-3B	3/16 x 1/4	1.11
TBX698	D66-4A	1/4 x 1/8	0.68
TBY240	D66-4B	1/4 x 1/4	1.06
TBX699	D66-4C	1/4 x 3/8	2.71
TBX700	D66-4D	1/4 x 1/2	2.98
TBX385	D66-5A	5/16 x 1/8	1.74
TBX386	D66-5B	5/16 x 1/4	1.61
TBX387	D66-5C	5/16 x 3/8	2.66
TBX701	D66-6A	3/8 x 1/8	1.38
TBX702	D66-6B	3/8 x 1/4	1.03
TBX703	D66-6C	3/8 x 3/8	1.21
TBX704	D66-6D	3/8 x 1/2	1.62
TBX705	D66-6E	3/8 x 3/4	6.88
TBX706	D66-8B	1/2 x 1/4	8.86
TBX707	D66-8C	1/2 x 3/8	1.79
TBX708	D66-8D	1/2 x 1/2	2.15
TBX709	D66-8E	1/2 x 3/4	6.81
TBX710	D66-10C	5/8 x 3/8	5.11

FITTINGS

FLARE ELBOWS 45° FORGED

TUBE TO MALE PIPE

TLY151



SAE 45° FLARE FITTINGS

Model No.	Mfg. No.	Size"	Price/Each
TBV328	DF54-4A	1/4 x 1/8	1.60
TBV329	DF54-4B	1/4 x 1/4	2.45
TBV330	DF54-4C	1/4 x 3/8	3.52
TBV187	DF54-5A	5/16 x 1/8	4.67
TBV188	DF54-5B	5/16 x 1/4	5.12
TBV331	DF54-6B	3/8 x 1/4	2.01
TBV332	DF54-6C	3/8 x 3/8	2.52
TBV333	DF54-6D	3/8 x 1/2	4.23

FLARE NUT FORGED SHORT STANDARD

TBY443



SAE 45° FLARE FITTINGS

Model No.	Mfg. No.	Size"	Price/Each
TBY443	D40-3	3/16	2.26
TBY733	D40-4	1/4	0.51
TBX373	D40-4-3	1/4 x 3/16	2.74
TBY444	D40-5	5/16	1.22
TBX374	D40-5-4	5/16 x 1/4	6.57
TBY734	D40-6	3/8	0.70
TBX674	D40-6-4	3/8 x 1/4	1.43
TBX375	D40-6-5	3/8 x 5/16	2.77

FLARE COPPER GASKETS

TBZ627



SAE 45° FLARE FITTINGS

Model No.	Mfg. No.	Size"	Price/Each
TBZ627	D59-3	3/16	1.18
TBZ797	D59-4	1/4	0.15
TBZ628	D59-5	5/16	0.79
TBZ798	D59-6	3/8	0.89

FLARE ELBOWS 90° FORGED

TUBE TO MALE PIPE

TBV290



SAE 45° FLARE FITTINGS

Model No.	Mfg. No.	Size"	Price/Each
TBV290	DF49-2A	1/8 x 1/8	2.95
TBV179	DF49-3A	3/16 x 1/8	2.56
TBV180	DF49-3B	3/16 x 1/4	4.53
TBV291	DF49-4A	1/4 x 1/8	0.94
TBV292	DF49-4B	1/4 x 1/4	1.19
TBV293	DF49-4C	1/4 x 3/8	3.31
TBV294	DF49-4D	1/4 x 1/2	4.55
TBV181	DF49-5A	5/16 x 1/8	1.73
TBV182	DF49-5B	5/16 x 3/8	1.96
TBV183	DF49-5C	5/16 x 1/4	6.09
TBV295	DF49-6A	3/8 x 1/8	1.86
TBV296	DF49-6B	3/8 x 1/4	1.66
TBV297	DF49-6C	3/8 x 3/8	1.51
TBV298	DF49-6D	3/8 x 1/2	2.31
TBV299	DF49-6E	3/8 x 3/4	4.89

FLARE ELBOWS 90° FORGED

TUBE TO TUBE

TBU852



SAE 45° FLARE FITTINGS

Model No.	Mfg. No.	Size"	Price/Each
TBU852	DF55-3	3/16	3.24
TBU921	DF55-4	1/4	1.56
TBU853	DF55-5	5/16	2.10
TBU922	DF55-6	3/8	2.04
TBU594	DF55-6-4	3/8 x 1/4	4.49

Call us for all
your Tools
& Equipment
requirements!



TUBING, FITTINGS & VALVES

FITTINGS

HOSE BARB SPLICERS



Model No.	Hose I.D."	Price/Each
TA492	1/4	1.19
TA493	5/16	1.49
TA494	3/8	1.47
TA495	1/2	2.48
TA496	5/8	3.61
TA497	3/4	5.05

HOSE BARB TO FEMALE PIPE CONNECTORS



Model No.	Hose I.D."	Thread (F) NPT"	Price /Each
TZ072	1/4	1/8	1.80
TA502	1/4	1/4	1.89
TZ073	5/16	1/4	2.08
TA503	3/8	1/4	2.08
TA504	3/8	3/8	2.89
TA505	1/2	1/2	4.54

HOSE BARB TO MALE PIPES



Model No.	Hose I.D."	Thread (M) NPT"	Price /Each
TZ075	1/8	1/8	1.32
TZ076	3/16	1/8	1.32
TA498	1/4	1/8	1.32
TA499	1/4	1/4	1.42
TZ077*	1/4	1/4	5.54
TZ078	1/4	3/8	2.02
TZ079	5/8	3/8	2.72
TZ080	5/8	1/2	3.55
TZ081	5/8	3/4	5.28
TZ083	5/16	1/4	1.51
TZ084	3/8	1/8	1.38
TA500	3/8	1/4	1.46
TZ085*	3/8	1/4	6.13
TA501	3/8	3/8	1.91
TZ086*	3/8	3/8	7.22
TZ087	3/8	1/2	3.21
TZ088	1/2	1/4	2.08
TZ089	1/2	3/8	2.55
TZ090	1/2	1/2	2.91
TZ091*	1/2	1/2	9.81
TZ092	1/2	3/4	5.46
TZ093	3/4	1/2	3.89
TZ094	3/4	3/4	4.59
TZ095	1	3/4	6.62
TZ096	1	1	10.49

*Swivel

HOSE BARB COUPLERS TO FEMALE BALL END



Model No.	Hose I.D."	Thread (F) NPT"	Price /Each
TZ098	1/4	1/4	3.42
TZ100	5/16	1/4	3.59
TZ101	3/8	1/4	3.59
TZ102	3/8	3/8	3.93

HOSE BARB COUPLERS FLAT SEAT WITH GASKET



Model No.	Hose I.D."	Thread (F) NPT"	Price /Each
TZ105	1/4	1/4	4.24
TZ106	5/16	1/4	4.99
TZ107	3/8	1/4	4.99
TZ108	3/8	3/8	6.03
TZ109	1/2	1/2	8.56

REUSABLE HOSE FITTINGS



Model No.	Hose O.D."	Hose I.D."	Thread (M) NPT"	Price /Each
TZ110	1/2	1/4	1/4	13.14
TZ111	9/16	1/4	1/4	13.80
TZ112	5/8	1/4	1/4	14.03
TZ115	9/16	5/16	1/4	15.09
TZ119	5/8	3/8	1/4	15.09
TZ120	5/8	3/8	3/8	15.54
TZ121	11/16	3/8	1/4	15.54
TZ123	3/4	3/8	1/4	16.01
TZ128	7/8	1/2	1/2	29.80

CONVERSION FACTORS

PRESSURE

1 PSI (pounds/square inch) = 0.0689 Bar
 1 Bar = 14.504 PSI
 1 atm (atmosphere) = 14.696 PSI

1 atm = 1.01325 Bar
 1 atm = 1.0332 Kgf/cm²

FLOW

1 CFM (cubic feet/minute) = 28.32 l/min
 1 l/s (litre/ second) = 60 l/min
 1 l/s = 2.119 CFM
 1 m³/h (cubic meter/hour) = 16.667 l/min

1 CFM = 0.472 l/s
 1 l/min (litre/minute) = 0.0167 l/s
 1 l/min = 0.0353 CFM

UNIMAX UNIVERSAL COUPLERS

UNIVERSAL INTERCHANGE ACCEPTS:

- Ultraflo
- ARO 210
- Lincoln
- 1/4 Industrial
- 1/4 Truflate

- Automatic push-to-connect operation
- Sleeve guard protects against accidental disconnection when the coupler is dragged on the floor or over obstructions
- Deep knurled socket sleeve for positive gripping



Model No.	Mfg. No.	NPT"	Price/Each
FEMALE THREAD			
TKZ830	20.441	1/4	18.62
MALE THREAD			
TKZ831	20.641	1/4	19.04



UNISAFE UNIVERSAL INTERCHANGE SAFETY COUPLERS

UNIVERSAL INTERCHANGE ACCEPTS:

- Ultraflo
- ARO 210
- Lincoln
- 1/4 Industrial
- 1/4 Truflate

- Valve sleeve is operated independently of locking sleeve
- When the valve sleeve is moved to shut off air flow downstream pressure is automatically vented
- Disconnection and connection are performed easily at zero pressure
- Automatic push-to-connect operation

1/4"

Model No.	Mfg. No.	NPT"	Price/Each
FEMALE THREAD			
TGA093	20.448	1/4	23.41
MALE THREAD			
TGA098	20.648	1/4	24.83

TOPRING

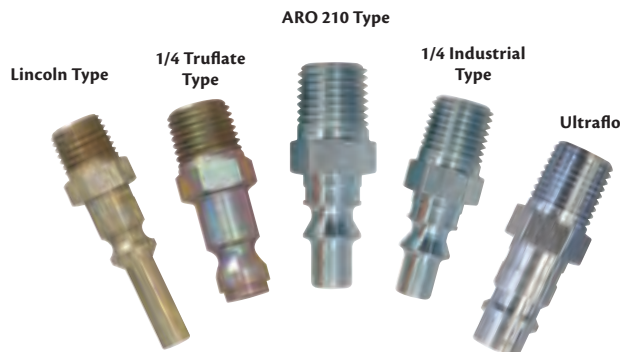

SAFETY COMES FROM 2-STEP DISCONNECTION:



Male/female connected set



Slide the black sleeve to release downstream pressure



Slide the gold sleeve to release plug



Disconnection



R21996E

OFFICE PRODUCTS

INSTRUMENTS, SCALES & ELECTRICAL

SHIPPING & PACKAGING

TOOLS & EQUIPMENT

WELDING & METALWORKING

SAFETY EQUIPMENT & SUPPLIES

JANITORIAL & MAINTENANCE

MATERIAL HANDLING & STORAGE

TUBING, FITTINGS & VALVES

QUICK COUPLERS

High performance, corrosion resistant quick couplers built to interchange with industrial type couplings. Offer a higher flow for maximum on-line performance of hand-held air tools. Heavy-duty, high quality design.



1/4" INDUSTRIAL, ONE WAY SHUT-OFF

Max. Working Pressure: 250 PSI
 Air Flow: 37 SCFM
 Working Temp.: -40°F to 250°F (Manual)
 -40°F to 160°F (Auto)

Plugs			Price /Each	Automatic Couplers			Price /Each	Manual Couplers			Price /Each
Model No.	Mfg. No.			Model No.	Mfg. No.			Model No.	Mfg. No.		
FEMALE THREAD											
1/8"(F) NPT	TA243	20.122	2.50	-	-		-	-	-	-	-
1/4"(F) NPT	TA244	20.142	1.80	TZ184	20.444		9.74	TA268	20.842		8.09
1/4"(F) NPT (stainless)	TLV344	20.146	11.06	-	-	-	-	TLV347	20.846	-	57.55
3/8"(F) NPT with drag guard	TA245	20.162	3.61	-	-	-	-	TA269	20.862	-	11.12
MALE THREAD											
1/8"(M) NPT	TA247	20.222	2.19	-	-	-	-	-	-	-	-
1/4"(M) NPT	TA248	20.242	1.80	TZ185	20.644		9.74	TA271	20.942		8.09
1/4"(F) NPT (w/thread sealant)	TLV345	20.248	1.93	-	-	-	-	-	-	-	-
1/4"(F) NPT (stainless)	TLV346	20.246	11.06	-	-	-	-	TLV348	20.966		51.33
3/8"(M) NPT	TA249	20.262	2.48	TZ227	20.664		11.74	TA272	20.962		10.49
HOSE BARB											
1/4" I.D.	TA252	20.342	3.16	TZ228	20.744		12.25	TA258	20.542		11.55
5/16" I.D.	TA253	20.352	4.48	-	-	-	-	-	-	-	-
3/8" I.D.	TA254	20.362	3.10	TZ230	20.756		12.65	TA260	20.562		11.95

3/8" INDUSTRIAL, ONE WAY SHUT-OFF

Max. Working Pressure: 250 PSI
 Air Flow: 67 SCFM
 Working Temp.: -40°F to 225°F

Plugs			Price /Each	Automatic Couplers			Price /Each	Manual Couplers			Price /Each
Model No.	Mfg. No.			Model No.	Mfg. No.			Model No.	Mfg. No.		
FEMALE THREAD											
1/4" (F) NPT	TA273	21.142	3.57	TA281	21.442		26.68	TZ144	21.842		19.95
3/8" (F) NPT	TA274	21.162	3.86	TA282	21.462		26.68	TZ145	21.862		19.93
1/2" (F) NPT	TZ132	21.182	6.49	TZ137	21.482		27.96	TZ146	21.882		22.16
MALE THREAD											
1/4" (M) NPT	TA278	21.242	3.46	TZ138	21.642		26.96	TZ147	21.942		19.95
3/8" (M) NPT	TA279	21.262	3.67	TA283	21.662		27.43	TZ148	21.962		19.95
1/2" (M) NPT	TZ133	21.282	6.75	TZ139	21.682		28.23	TZ149	21.982		22.16
HOSE BARB											
1/4" I.D.	TZ134	21.342	5.71	-	-	-	-	-	-	-	-
3/8" I.D.	TA280	21.362	5.54	TZ142	21.762		29.84	TZ152	21.562		23.52
1/2" I.D.	TZ136	21.382	6.75	TZ143	21.782		30.25	TZ153	21.582		23.52

1/2" INDUSTRIAL, ONE WAY SHUT-OFF

Max. Working Pressure: 250 PSI
 Air Flow: 99 SCFM
 Working Temp.: -40°F to 225°F

Plugs			Price /Each	Automatic Couplers			Price /Each	Manual Couplers			Price /Each
Model No.	Mfg. No.			Model No.	Mfg. No.			Model No.	Mfg. No.		
FEMALE THREAD											
3/8" (F) NPT	TZ154	22.162	5.99	-	-	-	-	-	-	-	-
1/2" (F) NPT	TZ155	22.182	6.30	TZ165	22.482		33.86	TZ175	22.882		25.98
3/4" (F) NPT	TZ156	22.192	10.47	TZ166	22.492		37.47	TZ176	22.892		26.66
MALE THREAD											
3/8" (M) NPT	TZ158	22.162	5.24	-	-	-	-	-	-	-	-
1/2" (M) NPT	TZ159	22.282	5.88	TZ169	22.682		33.88	TZ179	22.982		25.35
3/4" (M) NPT	TZ160	22.292	10.66	TZ170	22.692		36.89	TZ180	22.992		25.34
HOSE BARB											
3/8" I.D.	TZ161	22.362	6.18	-	-	-	-	-	-	-	-
1/2" I.D.	TZ162	22.382	8.55	TZ172	22.782		44.34	TZ182	22.582		27.06
3/4" I.D.	-	-	-	TZ173	22.792		46.02	-	-	-	-

TOPQUIK INDUSTRIAL SAFETY COUPLERS

- Accepts 1/4 Industrial type plugs (Military specification MIL-C-4109)
- Automatic push-to-connect operation
- When the sleeve is moved to shut off air flow, downstream pressure is automatically vented and disconnection is performed easily at zero pressure
- Meets ISO 4414 safety standards



SAFETY COMES FROM 2-STEP DISCONNECTION:



- Slide the sleeve back to release downstream pressure
- The plug is released, but held within the coupler

1/4" COUPLER

Model No.	Mfg. No.	NPT"	Price/Each
FEMALE THREAD			
TLZ040	20.449	1/4	27.02
TLZ041	20.469	3/8	30.38
MALE THREAD			
TLZ042	20.649	1/4	33.77
TLZ043	20.669	3/8	33.77

3/8" COUPLER

Model No.	Mfg. No.	NPT"	Price/Each
FEMALE THREAD			
TLZ044	21.449	1/4	41.05
TLZ045	21.469	3/8	41.05
TLZ046	21.489	1/2	41.05
MALE THREAD			
TLZ047	21.649	1/4	41.05
TLZ048	21.669	3/8	44.60
TLZ049	21.689	1/2	44.60



- Slide the sleeve forward
- The plug is released completely



QUICKSILVER INDUSTRIAL HI-PRESSURE COUPLERS

- Accepts 1/4 Industrial type plugs (Military specification MIL-C-4109)
- Automatic push-to-connect operation
- Easy to connect, even under pressure
- Deep knurled socket sleeve for positive gripping

Metal Guard Model No.	Mfg. No.	Nylon Guard Model No.	Mfg. No.	NPT"	Price /Each
FEMALE THREAD					
BC080	20.446	BC078	20.445	1/4	19.81
BC082	20.466	-	-	3/8	24.03
MALE THREAD					
BC090	20.646	BC088	20.645	1/4	24.24
BC093	20.666	-	-	1/8	23.92



BC080



BC078

1/4" INDUSTRIAL INTERCHANGE PLUGS

- Hardened steel construction
- Corrosion resistant
- Made to precise standards to ensure fit

Model No.	Mfg. No.	NPT"	Price/Each
FEMALE THREAD			
TA243	20.122	1/8	2.50
TA244	20.142	1/4	1.80
TLV344	20.146	1/4 (stainless)	11.06
TA245	20.162	3/8	3.61
MALE THREAD			
TA247	20.222	1/8	2.19
TA248	20.242	1/4	1.80
TLV345	20.248	1/4 (stainless)	1.93
TA249	20.262	3/8	2.48



TA243



TA247

Model No.	Mfg. No.	I.D."	Price/Each
HOSE BARB			
TA252	20.342	1/4	3.16
TA253	20.352	5/16	4.48
TA254	20.362	3/8	3.10

ARO 210 COUPLERS

- Accepts ARO 210 Plugs
- Automatic push to connect design
- Deep knurled socket sleeve

Model No.	Mfg. No.	NPT"	Price/Each
FEMALE THREAD			
TZ998	23.444	1/4	9.09
MALE THREAD			
TS399	23.644	1/4	9.59



TS404

Model No.	Mfg. No.	I.D."	Price/Each
HOSE BARB			
TS404	23.744	1/4	12.95
TS406	23.764	3/8	13.37

TUBING, FITTINGS & VALVES

1/4" ARO 210 INTERCHANGE PLUGS

- Hardened steel construction
- Corrosion resistant
- Made to precise standards to ensure fit

Model No.	Mfg. No.	NPT"	Price/Each
FEMALE THREAD			
TA284	23.142	1/4	1.76
MALE THREAD			
TS388	23.222	1/8	1.97
TA285	23.242	1/4	1.76
TLV349	23.248	1/4 (w/thread sealant)	1.89



TA284



TS388

Model No.	Mfg. No.	I.D."	Price/Each
HOSE BARB			
TG020	23.342	1/4	3.27
TS391	23.352	5/16	4.37
TS392	23.362	3/8	3.27

TRUFLATE PLUGS

- Accepts 1/4 Truflate couplers
- Compact design
- Automatic push to connect design

Model No.	Mfg. No.	NPT"	Price/Each
MALE THREAD			
TS412	24.242	1/4	2.12



QUICKSILVER ULTRAFLO HI-PRESSURE AUTOMATIC COUPLERS

- Ultraflo high-flow design provides superior tool performance
- High flow valve eliminates pressure drops
- HVLV system offers more air than most comparable couplers
- Provides energy savings and superior tool efficiency

NPT	Metal Guard Model No.	Mfg. No.	Price/Each	Nylon Guard Model No.	Mfg. No.	Price/Each
FEMALE THREAD						
1/4	TS510	31.744	21.59	TS511	31.745	18.40
3/8	TS513	31.764	22.65	-	-	-
MALE THREAD						
1/4	TS514	31.844	22.16	TS515	31.845	20.14
3/8	TS516	31.864	23.22	-	-	-



TS386



TS388

Metal Guard Model No.	Mfg. No.	I.D."	Price/Each
HOSE BARB			
TS518	31.944	1/4	22.50
TS520	31.964	3/8	22.50

ULTRAFLO INTERCHANGE PLUGS

- High flow for better tool performance
- Compatible with European (CEJN 320) type couplers
- Hardened steel construction

Model No.	Mfg. No.	NPT"	Price/Each
FEMALE THREAD			
TZ213	31.542	1/4	2.59
TS506	31.562	3/8	3.31
MALE THREAD			
TZ214	31.642	1/4	2.50
TS508	31.662	3/8	3.31



TZ213



TZ214

Model No.	Mfg. No.	I.D."	Price/Each	
HOSE BARB				
TS517	31.942	1/4	3.37	
TS519	31.962	3/8	3.65	
Model No.	Mfg. No.	(M) NPT"	Type	Price/Each
FREE ANGLE FITTING				
TGA774	62.370C	1/4	30° Free Angle	9.91

TUBING, FITTINGS & VALVES

MAXPRO FREE ANGLE FITTINGS

- Prevents kinking and tangling of hoses
- Reduces operator fatigue by allowing better tool maneuverability
- Reduces tension put on wrist by the hose
- Free angle fittings rotate 360° and up to 30° of deflection of air tool supply line
- Max working pressure 140 PSI

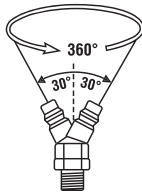

TGA772

Model No	Mfg. No.	Description	Price/Each
TGA770	62.350C	1/4 (M) NPT x 1/4 (M) NPT	9.91
TGA771	62.355C	1/4 (F) NPT x 1/4 (M) NPT	9.91
TGA772	62.360C	1/4 Industrial Type x 1/4 (M) NPT	9.91
TGA773	62.365C	ARO 210 Type x 1/4 (M) NPT	9.91
TGA774	62.370C	Ultra-Flo x 1/4 (M) NPT	9.91

AIR TOOL SWIVEL CONNECTORS

- Improve tool manoeuvrability, minimize operator's fatigue and extend hose life
- Universal-joint that connects portable air tools to an air line
- 360° Swivel at two locations which allows an air hose to drop straight to the floor, no matter how the tool is held



WARNING: Not to be used on percussion tools or in areas of high mechanical abuse

Applications

- For use with most air tools such as: Grinders - Sanders - Staple guns - Drills buffers - Spray guns - Glue guns
- Maximum working pressure: 150 PSI

TOPRING

Model No.	Port Size NPT"	Maximum Air Flow SCFM	Wt. lbs.	Price /Each
TA874	1/4	Up to 30	0.2	35.87
TA876	1/2	46 to 65	0.8	165.83

HOSE WHIPS

- Prolong hose life by eliminating stress
- Easy tool manipulation

Application

- Used between the air tool and quick coupler to act as a "shock absorber" and to prolong the life of the coupler



TLV350

Model No.	Hose I.D."	O.A. Length"	Rigid Fitting (F) NPT"	Price /Each
TLV350	1/4	18	1/4	7.24
TLV351	3/8	18	1/4	7.92

SWIVEL CONNECTORS WITH FLOW CONTROL

- Swivels 360° which allows air hose to drop straight to the floor, no matter how the tool is held
- Integrated air-flow control dial
- Maximum working pressure: 150 PSI



WARNING: Not to be used on percussion tools or in areas of high mechanical abuse

Model No.	Port Size NPT"	Price/Each
THZ360	1/4	28.95



AIR MANIFOLDS

Eliminates the need to connect and disconnect each time the tool is changed.

AIR MANIFOLD (3 IN 1)

- Supplies 3 air tools from a single inlet
- Each manifold accepts 3 outlet hoses or couplers
- Compact design
- Economical
- Lightweight aluminum construction



Model No.	Inlet"	Outlet"	Price/Each
TZ246	1/4 (F) NPT	1/4 (F) NPT	11.68
TZ247	3/8 (F) NPT	1/4 (F) NPT	11.68

TOPRING

AIR MANIFOLD (2 IN 1)

- Supplies 2 air tools from a single inlet
- Each manifold accepts 2 outlet hoses or couplers
- Compact design
- Economical
- Brass, nickel plated construction



Model No.	Inlet"	Outlet"	Price/Each
TZ248	1/4 (F) NPT	1/4 (F) NPT	7.49
TZ249	1/4 (M) NPT	1/4 (F) NPT	7.49

MAXPRO AIR TOOL SWIVEL CONNECTORS

- Universal connector that connects portable air tools to an air line
- Improve tool maneuverability, minimize operator fatigue and extend hose life
- Swivel 360° at two pivot points, allowing the air hose to drop directly to the floor



TLZ018



TLZ017

Model No.	Mfg. No.	Thread NPT"	Description	Price/Each
TLZ016	62.712C	1/4	Flow Regulator Only	18.91
TLZ017	62.714C	1/4	Universal Coupler Only	25.24
TLZ018	62.705C	1/4	Swivel Only	14.88

PNEUMATIC LOCKOUTS

- Prevents fitting from being connected to a pressurized air source
- Stainless steel construction
- Fits virtually all pneumatic fittings in manufacturing facilities

Model No. TLZ098
Mfg. No. S3900
Price/Each \$20.50

Master Lock

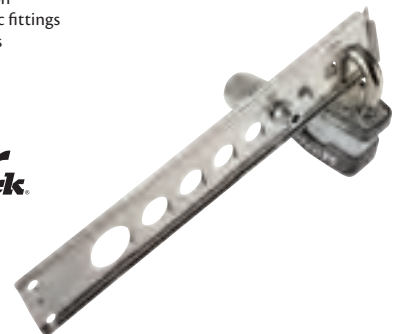

IN-LINE FILTERS

Compressed air contains impurities which in time will cause improper operation of equipment and in some cases, equipment failure. The in-line filters eliminate the impurities.

- Portable
- Lightweight
- In-line installation
- Large element to remove foreign particles from contaminated air supplies

Applications

- Air tools
- Air valves and cylinders
- Precision regulators
- Air controls

TOPRING

STANDARD DUTY CONSTRUCTION

- Clear reservoir shows accumulated water taken out of air line
- Button relief valve for draining tapped liquid from reservoir
- Filter can be removed and cleaned

HIGH PERFORMANCE CONSTRUCTION

- Anodized aluminum zinc plated steel
- 40 micron porous bronze element

Model No.	Inlet (F) NPT"	Outlet (M) NPT"	Price /Each
STANDARD DUTY			
TZ233	1/4	1/4	17.87
HIGH PERFORMANCE			
TA845	1/4	1/4	13.73



TZ233



TA845

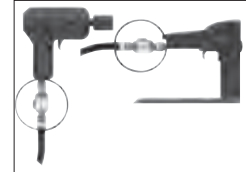

DISPOSABLE IN-LINE DESICCANT FILTERS/DRYERS

Removes all traces of water, oil and dirt by using a porous bronze element for the dirt, an oil removing media for oil vapour and a special filter for removing residual desiccant dust.

Four stage filtration:

- 1st stage: removes dirt
- 2nd stage: removes oil vapours
- 3rd stage: removes water vapours
- 4th stage: removes residual desiccant dust

Features:

- Disposable filter/dryer compact, lightweight
- Can be installed in either direction right at the point of use
- See-through housing shows colour change when dryer needs replacement
- Material highly resistant to chemicals

Specifications

- Compact size: 3 3/4" x 1 11/16"
- Lightweight: 2 oz.
- Maximum Flow Capacity: 15 SCFM
- Maximum Pressure: 125 PSI
- Maximum Temperature: 130°F

Model No. TA851

Price/Each \$19.93

TOPRING



IN-LINE LUBRICATORS

SAVES MONEY - INCREASES EFFICIENCY

In-line lubricators save money by reducing down time on air operated equipment. They also avoid the cost of wall mounted lubricating systems. They increase efficiency by preventing sticking of the working mechanism, power loss caused by inadequate lubrication and by keeping the internal mechanism properly oiled.

- Directly attached to the air tool
- Slotted adjustment screw for oil adjustment
- Pressure range: Up to 300 PSI
- Less than 5% of line pressure drop at 90 PSI
- Automatic lubrication of air upon passage of rated air flow
- Operates in any position
- Will not leak lubricant into air line upon pressure drop or when disconnected from air line

Applications

- Ideal for air tools
- Especially recommended for staplers and nailers

Construction

- Extruded aluminum alloy, steel and nylon

STANDARD DUTY

Pneumatic tools and appliances cannot maintain their full efficiency if the mechanism is impaired by corrosion, condensation or lack of lubrication.

- Automatically lubricates a tool by feeding a measured amount of oil mist each time the tool is cycled
- Max. working pressure: 120 PSI

Model No.	Port Size (M) & (F) NPT"	Price/Each
TZ234	1/4	15.30

HIGH PERFORMANCE

Keeps air-operated hand tools working better, longer.

Model No.	Port Size (M) & (F) NPT"	Flow Rate SCFM	Oil Cap. C.C.'s	Price /Each
TA839	1/4	15	5	65.23
TA840	1/4	20	9	75.57
TA842	3/8	40	22	81.38
TA843	1/2	65	22	79.18

TOPRING



TZ234



TA839

INADEQUATE PIPING & HOSES INFORMATION

The largest pressure loss in a system serving air tools is found in two areas: hoses that are too long and hoses that are too small. The longer the hose, the more friction is created, regardless of size; this can be addressed by increasing hose size. For this reason, small diameter hoses inevitably limit flow. Choosing the proper diameter hose for the distance and flow required will go a long way to limiting pressure loss at the tool.

RECOMMENDED FLEXIBLE HOSE SIZES (I.D.) FOR VARIOUS DISTANCES & FLOWS

Flow (SCFM)	Pressure PSI	Distance							
		25'	35'	50'	75'	100'	150'	200'	
1	100	1/4	1/4	1/4	1/4	1/4	1/4	1/4	1/4
2	100	1/4	1/4	1/4	1/4	1/4	1/4	1/4	1/4
5	100	1/4	1/4	1/4	5/16	5/16	5/16	3/8	3/8
10	100	5/16	5/16	3/8	3/8	3/8	1/2	1/2	1/2
15	100	3/8	3/8	1/2	1/2	1/2	1/2	1/2	1/2
20	100	3/8	1/2	1/2	1/2	1/2	3/4	3/4	3/4
25	100	1/2	1/2	1/2	1/2	3/4	3/4	3/4	3/4
30	100	1/2	1/2	1/2	3/4	3/4	3/4	3/4	3/4
40	100	1/2	3/4	3/4	3/4	3/4	3/4	3/4	3/4
50	100	3/4	3/4	3/4	3/4	3/4	3/4	1	1
60	100	3/4	3/4	3/4	3/4	3/4	1	1	1
70	100	3/4	3/4	3/4	3/4	1	1	1	1
80	100	3/4	3/4	3/4	1	1	1	1	1
90	100	3/4	3/4	1	1	1	1	1	1
100	100	3/4	3/4	1	1	1	1	1	1

Calculations based on a pressure loss (ΔP) of maximum 5 PSIG

AIR HOSE NYLON COIL W/FITTINGS

- Light and easy to handle
- Maximum working pressure, 300 PSI
- 3/8" NPT Male threads
- High impact and abrasion resistance
- Excellent elastic memory, can be stretched repeatedly yet return to original shape for convenient storage
- Colour: high-viz yellow

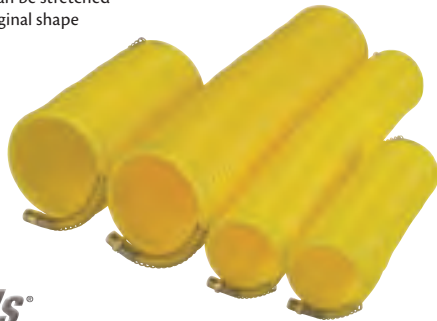

aurora tools

Model No.	NPT (M)"	Length'	Price/Each
TLZ150	1/4	25	10.45
TLZ151	1/4	50	16.65
TLZ152	3/8	25	18.70
TLZ153	3/8	50	27.85

AIR HOSE REPAIR KITS

- For a 3/8" hose, 1/4" NPT threads

Set includes:

- 1 Hose Splicer
- 1 Hose End Fitting
- 3 Hose Clamps

Model No. TLZ149

Price/Each \$6.30



PLUG QUICK COUPLER KITS, 5 PIECES

Set includes:

- One 1/4" Quick coupler
- One 1/4" Female plug
- Three 1/4" Male plugs

Model No. TLZ148

Price/Each \$14.25

aurora tools



VOLUME/CAPACITY

1 in ³ (cubic inch) = 16.387 cm ³	1 m ³ = 35.3 ft ³
1 ft ³ (cubic feet) = 0.0283 m ³	1 litre = 0.001 m ³
1 ft ³ = 28.32 litres	1 litre = 0.0353 ft ³
1 gallon (US) = 3.785 litres	1 litre = 0.264 gallon (US)
1 gallon (imperial) = 4.546 litres	1 litre = 0.220 gallon (imperial)
1 cm ³ (cubic centimeter) = 0.0610 in ³	1 fl. ounce (imperial) = 28.413 ml
1 m ³ (cubic meter) = 1000 litres	1 litre = 35.2 ounces

LENGTH

1 inch = 25.4 mm	1 mm = 0.039 in
1 ft (feet) = 0.305 m	1 m = 3.28 ft

WEIGHT

1 ounce = 28.349 g	1 g = 0.035 ounce
1 pound = 453.592 g	1 kg = 2.205 lbs



HOSES & HOSE CLAMPS

AIRFLEX GENERAL-PURPOSE AIR HOSES

Features:

- Flexible
- Moderate resistance to oil
- Excellent abrasion resistance
- -40°F to 200°F (-40°C to 93°C) working temperature

Applications:

- General air applications where an oil-resistant cover is required
- Ideal in-plant air tool hose
- Ideal for air and water use in servicing applications

Composition:

- Red EPDM cover
- Spiral polyester reinforcement cords
- Black EPDM tube



600' REELS

Model No.	Hose I.D."	Hose O.D."	Max. PSI	Weight lbs/100'	Price/Each ft.
BC384	3/8	0.66	250	14	1.08
BC385	1/2	0.88	200	24	1.61

TOPRING

HOSE ASSEMBLIES WITH FITTINGS

Model No.	Length'	Hose I.D."	Fittings (M) NPT"	Max. PSI	Price/Each
BU259	15	1/4	1/4	200	21.16
BU260	25	1/4	1/4	200	30.21
BU261	35	1/4	1/4	200	38.42
UP477	50	1/4	1/4	200	51.47
BU267	100	1/4	1/4	200	93.87
BU279	15	3/8	3/8	200	27.02
BU281	25	3/8	3/8	200	37.61
BU283	35	3/8	3/8	200	48.76
BU285	50	3/8	3/8	200	65.29
BU295	100	3/8	3/8	200	121.37
BU280	15	3/8	1/4	200	27.09
BU282	25	3/8	1/4	200	36.85
BU284	35	3/8	1/4	200	48.16
BU286	50	3/8	1/4	200	64.89
BU296	100	3/8	1/4	200	120.84
BU299	15	1/2	1/2	200	37.02
BU301	25	1/2	1/2	200	52.68
BU303	35	1/2	1/2	200	68.16
BU305	50	1/2	1/2	200	91.40
BU315	100	1/2	1/2	200	168.39
BU300	15	1/2	3/8	200	35.05
BU302	25	1/2	3/8	200	50.71
BU304	35	1/2	3/8	200	66.16
BU306	50	1/2	3/8	200	89.39
BU316	100	1/2	3/8	200	166.38

CUT TO LENGTH TUBING



GENERAL PURPOSE FOR COMPRESSED AIR

Characteristics:

- Ideal for compressed air and water service
- Moderate resistance to oil
- Resists heat, sunlight, ozone and weather

Applications:

- Air tools

Specifications:

- Working temperature: 40°F to 200°F (40°C to 93°C)

Construction:

Tube: Black EPDM
 Cover: Red EPDM
 Reinforcement: Synthetic rubber - multiple textile plies

Model No.	Hose I.D."	Max. PSI	Price /Each Ft.
TA070	1/4	250	1.10
TA071	5/16	300	1.26
TA072	3/8	250	1.37
TA073	1/2	250	1.79
TZ899	3/4	250	2.69

HEAVY-DUTY FOR COMPRESSED AIR

Characteristics:

- Mainly recommended for heavy-duty outdoor use
- Double-reinforced makes it extra strong and tough
- Durable for rugged environmental conditions
- Economical and versatile general purpose hose (air and water)
- Lightweight, flexible
- Performs well in both hot and cold temperatures
- Good torsion strength
- Excellent abrasion resistance
- Moderate resistance to oil
- Long service-life

Applications:

- Ideal for air tool and compressed air applications
- Used with all kinds of compressed air equipment such as: foundries, shipyards, engineering workshops, construction sites, quarries and mines

Specifications:

- Working temperature: -60°F to 250°F (-51°C to 121°C)
- Working pressure: 250 PSI two braids

Construction:

Tube: Black EPDM
 Cover: Red EPDM
 Reinforcement: Synthetic fibre braids

Model No.	Hose I.D."	Hose O.D."	Wt. lbs. per 100'	Price /Each Ft.
TA074	1/4	0.59	16	1.41
TA075	3/8	0.72	21	1.72
TA076	1/2	0.88	28	2.03

MULTI-PURPOSE FOR COMPRESSED AIR & FLUIDS

Characteristics:

- High quality multi-purpose hose
- Durable for longer life
- High flexibility
- Abrasion resistance
- Good resistance to oils and greases, gasoline and solvents
- May be used to transmit water, oil and many chemicals up to 300 PSI

Applications:

- Ideal for air tool applications

Specifications:

- Working temperature: -20°F to 250°F (-29°C to 121°C)
- Working pressure: 300 PSI two braids

Construction:

Tube: Black Buna-N
 Cover: Red neoprene
 Reinforcement: Synthetic fibre braids

Model No.	Hose I.D."	Hose O.D."	Wt. lbs. per 100'	Price /Each Ft.
TA081	1/4	0.63	18	1.83
TA082	3/8	0.72	20	2.00
TA083	1/2	0.88	27	2.61
TZ901	3/4	1.14	43	3.66
TA084	1	1.50	65	5.44

POLYURETHANE HOSES

FEATURES:

- Excellent recoil memory
- Maximum flexibility
- Softer than nylon self-storing hose with superior elasticity. Maintains flexibility down to -40°C (-40°F)
- Ergonomic
- Superior resistance to abrasion
- Chemical compatibility
- Resistance to fuels, oils, water
- Avoid lacquers, thinners and ketones
- Temperature consideration
- Polyurethane general temperature range of -40°F to 180°F

MINI COIL™ OR FLEXCOIL™ NEVER FORGETS

Can be stretched out to full length without getting damaged. Excellent recoil memory.

Small coil diameter for compact storage.

Full-Flow Fittings

- Reusable male swivel brass fitting

Applications:

- Air ratchets
- Blow gun users
- Impact wrenches
- Tire shops



TOPRING

POLYURETHANE TUBING BURST PRESSURE TECHNICAL INFORMATION

Size I.D." PSI	Approx. Burst Pressure (PSI)@			
	70°F	100°F	125°F	150°F
1/4 125	33	240	200	150
1/4 140	410	320	270	190
3/8 125	345	280	190	160
3/8 140	370	300	240	200
1/2 125	345	280	240	200
1/2 140	370	300	260	220

ASSEMBLIES WITH SWIVEL FITTINGS

Model No.	Hose I.D."	Total Length'	NPT (M)"	Price /Each
TA216	1/4	15	1/4	31.06
TA217	1/4	20	1/4	38.68
TA218	1/4	25	1/4	42.82
TA219	1/4	30	1/4	60.99
TA220	1/4	50	1/4	71.83
TA221	5/16	15	1/4	57.40
TA223	5/16	25	1/4	82.13
TA224	5/16	30	1/4	94.57
TA225	5/16	50	1/4	142.13
TA226	3/8	15	3/8	68.01
TA227	3/8	15	1/4	68.01
TA228	3/8	20	3/8	83.04
TA230	3/8	25	3/8	89.77
TA231	3/8	25	1/4	89.77
TA232	3/8	30	3/8	120.74
TA233	3/8	30	1/4	120.74
TA234	3/8	50	3/8	158.05
TA235	3/8	50	1/4	158.05

Working Pressure: 140 PSI.

Other lengths and colours available on request.

CONTRACTOR GRADE GENERAL PURPOSE PVC AIR HOSES

- Excellent flexibility and performance even in cold temperatures
- Working temperature range: -40 °F to 150 °F (-40 °C to 65 °C)
- Easily re-coiled after use
- 35% lighter than rubber air hose
- Good resistance to oils and abrasion

Composition:

Cover: Yellow PVC compound

Reinforcement: Spiral Polyester cords



Model No.	Length'	Hose I.D."	NPT (M)"	Max PSI	Price /Each
TLZ735	25	1/4	1/4	300	32.10
TLZ736	50	1/4	1/4	300	54.68
TLZ737	100	1/4	1/4	300	95.42
TLZ738	25	3/8	1/4	300	36.47
TLZ739	50	3/8	1/4	300	64.59
TLZ740	100	3/8	1/4	300	117.04

SERIES 11 SELF STORING NYLON AIR HOSES

High Impact Resistance

Excellent Abrasion Resistance

Elastic Memory: Long-lasting elastic memory.

Can be stretched repeatedly yet return to original shape after stress is removed.

Broad Temperature Range: Stable at low

temperature -60°C. Can be used continuously at 65°C and can withstand short term temperature peaks 100°C to 130°C (212°F to 266°F).

Compatibility: Topping self-storing air hose is

compatible with alkalis, coolants, salt solutions, soaps, dilute acids, aromatics, solvents and petroleum products.

Standard Colour: Red

1/4" I.D. and 3/8" I.D. hose polybagged.

ASSEMBLIES WITH SWIVEL FITTINGS

Model No.	Hose I.D."	NPT (M)"	Total Length'	Price /Each
TA181	1/4	1/4	12.5	23.60
TA182	1/4	1/4	25	31.16
TA183	1/4	1/4	50	44.73
TA184	3/8	3/8	12.5	42.77
TA185	3/8	3/8	25	55.61
TA186	3/8	1/4	25	55.61
TA187	3/8	3/8	50	82.15
TA188	3/8	1/4	50	82.15
TA189	1/2	1/2	12.5	89.98
TA190	1/2	1/2	25	115.62
TA191	1/2	1/2	50	174.82

Working Pressure: 250 PSI. Other diameters, lengths and colours available on request.

TOPRING



APPLICATIONS

- Automobile assembly lines
- Robotized and automated operations
- Mechanical construction
- Automotive service stations
- Furniture making
- Maintenance shops
- Packaging industry

AUTOMATIC REWIND HOSE REELS W/PVC AIR HOSE

- Durable construction, made from high impact resistant polypropylene
- Compact design
- Double adjustment action to lock hose at desired length
- Sealed connection points at swivel and hose inlet to prevent leaks
- Integrated wall/overhead swivel bracket
- Non-sag hose rollers reduce hose wear
- Adjustable hose stopper
- 60" lead-in hose included



TLV341

TOPRING

MANUAL REWIND AIR/WATER REELS

- This light weight hand crank is designed for general use and lighter-duty applications that require longer lengths of low pressure air/water hoses
- Economical choice for storing and retrieving hoses
- Brass swivel and brass inlet
- Maximum temperature 150°F (65°C)
- Hose not included and assembly is required



REELCRAFT

Model No.	Mfg. No.	Hose Width"	Hose Length'	Inlet (M) NPT"	Outlet (M) NPT"	Price /Each
TLV341	79.370	1/4	33	1/4	1/4	140.86
TLV342	79.375	3/8	30	1/4	1/4	159.77
TLV343	79.380	3/8	50	1/4	1/4	169.22

Model No	Hose I.D."	Outlet (M)NPT"	Inlet (F)NPT"	Hose Length'	Max PSI	Dimensions W" x D" x H"	Wt lbs.	Price /Each
F1054	3/8	3/8	3/8	50	250	11 1/4 x 11 1/2 x 11	10	113.73
F1055	3/8	3/8	3/8	100	250	15 5/8 x 11 1/2 x 11	13	143.78

R33631E

OFFICE PRODUCTS

INSTRUMENTS, SCALES & ELECTRICAL

SHIPPING & PACKAGING

TOOLS & EQUIPMENT

WELDING & METALWORKING

SAFETY EQUIPMENT & SUPPLIES

JANITORIAL & MAINTENANCE

MATERIAL HANDLING & STORAGE

HOSE REELS

WELDING HOSE REELS

- Heavy-duty, reinforced steel stampings for increased strength
- 1/4" oxygen and acetylene twin hose
- Leakproof double O-ring seals
- Compact design allows reels to fit in tight locations
- Multi-position guide arms for multiple mounting options
- Kinkless, oil resistant high quality hose
- Spring rewind features long life spring with declutching arbour
- Grade R hose
- Durable, corrosion-resistant powder coat paint

aurora tools®

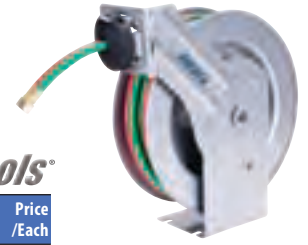

TLZ487

Model No.	Drive Type	Hose I.D."	Hose Length'	Max PSI	Oxygen Inlet & Outlet	Acetylene Inlet & Outlet	Dimensions				Wt. lbs.	Price /Each	
TLZ487	Spring	1/4	25	300	9/16" x 18 UNF (female)	9/16" x 18 UNF (female)	8	x	14 3/4	x	13 5/8	25.9	145.00
TLZ488	Spring	1/4	50	300	9/16" x 18 UNF (female)	9/16" x 18 UNF (female)	8 5/8	x	20 1/2	x	20 1/2	42.2	192.00

AIR/WATER DELIVERY REELS

- Lightweight and easy to handle
- Made of corrosion proof polypropylene
- Working temperature to 65°C
- Designed to protect the hose and allow for easy cleaning of both hose and reel
- Wall or floor mount (floor stand not included)
- Hose included

REELCRAFT



FH821

Model No.	Mfg. No.	Hose I.D."	Hose Length'	Max PSI	Hose Outlet (M) NPT"	Reel Inlet (F) NPT"	Dimensions				Wt. lbs.	Price /Each	
FH821	SGA3650 OLP	3/8	50	232	3/8	3/8	9 1/2	x	22 3/4	x	19	23	355.49
FH822	SGA3665 OLP	3/8	66	232	3/8	3/8	9 1/2	x	22 3/4	x	19	27	386.34
FH823	SGA3850 OLP	1/2	50	232	1/2	1/2	9 1/2	x	22 3/4	x	19	27	368.91

2-Year Limited Warranty

LIGHTWEIGHT & ECONOMICAL INDUSTRIAL REELS

- Lighter spring driven hose reel designed for applications that are less demanding, yet require a product that can withstand industrial use
- Steel components are individually powder coated and teamed with composite materials, which virtually eliminates corrosion

REELCRAFT



FH522

Model No.	Mfg. No.	Drive Type	Hose I.D."	Hose Length'	Max PSI	Hose Outlet (M) NPT"	Reel Inlet (F) NPT"	Reel Outlet (F) NPT"	Dimensions				Wt. lbs.	Price /Each	
LIGHTWEIGHT FOR AIR OR WATER - designed for less demanding applications yet can withstand industrial use - sold with hose															
FH522	RT435-OLP	Spring	1/4	35	300	1/4	3/8	-	5 3/4	x	16 1/2	x	17 7/8	22	227.43
FH523	RT450-OLP	Spring	1/4	50	300	1/4	3/8	-	5 3/4	x	16 1/2	x	17 7/8	25	275.79
FH524	RT635-OLP	Spring	3/8	35	300	1/4	3/8	-	5 3/4	x	16 1/2	x	17 7/8	23	257.48
FH525	RT650-OLP	Spring	3/8	50	300	1/4	1/2	-	6 1/4	x	16 1/2	x	17 7/8	29	333.30
FH56	RT835-OLP	Spring	1/2	35	300	1/2	1/2	-	6 1/4	x	16 1/2	x	17 7/8	30	350.28
FH57	RT850-OLP	Spring	1/2	50	300	1/2	1/2	-	6 1/4	x	16 1/2	x	17 7/8	35	445.70

2-Year Limited Warranty Standard colour as shown - black composite / powder coat paint red base & guide arm

HEAVY-DUTY LARGE CAPACITY INDUSTRIAL REELS

- Constructed for long life and to withstand extreme operating temperatures and road conditions
- Hose reel frames are welded for added strength and durability
- Rolled heads also provide additional strength as well as smooth edges to prevent hose damage
- These welded heavy-duty reels are used in a wide variety of applications worldwide

REELCRAFT

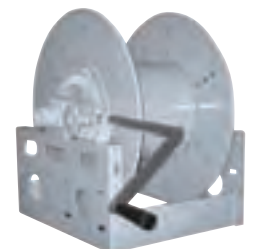

FH530

Model No.	Mfg. No.	Drive Type	Hose I.D."	Hose Length'	Max PSI	Hose Outlet (M) NPT"	Reel Inlet (F) NPT"	Reel Outlet (F) NPT"	Dimensions				Wt. lbs.	Price /Each	
HEAVY-DUTY STEEL REELS															
SERIES 1200 - working temperatures range from -30°C to 105°C - sold without hose															
FH061	HC1200-19-12-10FFL	Manual	1	50	1000	-	1	1	28	x	19	x	21	90	807.28
FH062	HC1200-19-22-10FFL	Manual	1	100	1000	-	1	1	38	x	19	x	21	95	807.28
SERIES 2400 - working temperatures range from -30°C to 105°C - sold without hose															
FH528	BC2400-25-18-10FF	Manual	1	150	1000	-	1	1	28	x	25	x	26 1/2	131	1114.83
FH529	BC2400-25-24-10FF	Manual	1	200	1000	-	1	1	34	x	25	x	26 1/2	139	1130.19
SERIES 3900 - working temperatures range from -60°C to 230°C - sold without hose															
FH530	BC3900-25-12-15FF	Manual	1 1/2	50	300	-	1 1/2	1 1/2	22	x	25	x	26 1/2	125	1413.13
FH531	BC3900-25-22-15FF	Manual	1 1/2	100	300	-	1 1/2	1 1/2	35	x	25	x	26 1/2	138	2014.72
FH532	BC3900-31-12-15FF	Manual	1 1/2	105	300	-	1 1/2	1 1/2	22	x	31	x	32 1/2	140	1566.90

1-Year Limited Warranty Standard colour as shown - powder coat paint grey

HOSE REELS

REELS CONTRIBUTE TO AN IMPROVED WORK ENVIRONMENT WHICH SAVES TIME, EQUIPMENT & MONEY

Standard features Include:

- Durable, corrosion-resistant powder coat paint
- Heavy-duty, reinforced steel stampings for increased strength
- Permanently lubricated for long, trouble-free service
- Multi-position guide arms for versatile mounting options
- Kinkless, high quality hoses
- Spring rewind features long life spring with declutching arbour

FH494



FH502



FH504



REELCRAFT

HEAVY-DUTY INDUSTRIAL STEEL REELS

Model No.	Mfg. No.	Drive Type	Hose I.D."	Hose Length'	Max PSI	Hose Outlet (M)NPT"	Reel Inlet (F)NPT"	Reel Outlet (F)NPT"	Dimensions				Wt. lbs.	Price /Each	
AIR or WATER reels for manufacturing plants, body shops, workshops, service stations, fabricators, spray booths - sold with hose															
TN315	4435-OLP	Spring	1/4	35	300	1/4	3/8	-	5 3/8	x	12 5/8	x	12 7/8	20	312.56
TN317	4625-OLP	Spring	3/8	25	300	1/4	3/8	-	5 3/8	x	12 5/8	x	12 7/8	22	324.64
TN316	5635-OLP	Spring	3/8	35	300	1/4	3/8	-	6	x	13 1/2	x	14 1/2	25	389.03
TN318	7650-OLP	Spring	3/8	50	300	1/4	1/2	-	7	x	19	x	20 1/4	47	587.57
TN319	7850-OLP	Spring	1/2	50	300	3/8	1/2	-	7	x	19	x	20 1/4	51	609.03
FI058	5450-OLP	Spring	1/4	50	300	1/4	3/8	-	6	x	13 1/2	x	14 1/2	26	396.05
FH533	5650-OLP	Spring	3/8	50	300	1/4	3/8	-	6	x	16 1/2	x	17 1/2	36	470.86
FH534	81100-OLP	Spring	3/8	100	300	3/8	1/2	-	10 1/2	x	24	x	25 3/8	112	941.72
FH490	82100-OLP	Spring	1/2	100	300	1/2	1/2	-	10 1/2	x	24	x	25 3/8	121	971.23
FH491	83050-OLP	Spring	3/4	50	250	3/4	3/4	-	10 1/2	x	24	x	25 3/8	108	932.33
FH492	D83075-OLP	Spring	3/4	75	250	3/4	3/4	-	14 1/4	x	24	x	25 3/8	132	1167.08
FH493	D84050-OLP	Spring	1	50	250	3/4	1	-	15 1/4	x	24	x	25 3/8	130	1176.47
FH494	E9350-OLP	Spring	3/4	50	250	3/4	3/4	-	16 3/4	x	26 1/4	x	26 3/8	160	1370.99
FH495	E9450-OLP	Spring	1	50	250	3/4	1	-	16 3/4	x	26 1/4	x	26 3/8	177	1438.06
OIL - medium pressure - furnished standard with S.A.E. 100 RTT one wire braid hose - sold with hose															
TN323	7850-OMP	Spring	1/2	50	2000	1/2	1/2	-	7	x	19	x	20 1/4	57	775.08
GREASE or HYDRAULIC OIL - high pressure reel - furnished standard with S.A.E. 100 R2T two wire braid hose - sold with hose															
TN325	7650-OHP	Spring	3/8	50	4000	1/4	1/2	-	7	x	19	x	20 1/4	60	856.10
WASHDOWN - high pressure reel with maximum product delivery - equipment cleaning, pressure washing - sold without hose															
FI059	PW7600-OHP	Spring	3/8	50	4500	-	1/2	3/8	7	x	19	x	20 1/4	46	593.39
FH496	PW81000-OHP	Spring	3/8	100	4500	-	1/2	1/2	10 1/2	x	24	x	25 3/8	81	887.48
DUAL HYDRAULIC - medium pressure reel ideal for operating hydraulic cylinders, tools and equipment - sold with hose															
FH497	TH88050-OMP	Spring	1/2	50	2000	1/2	1/2	-	13	x	24	x	25 3/8	135	1794.55
FUEL DELIVERY - low pressure equipped with Viton® seals & fuel grade hose for mobile & permanent mount applications - sold with hose															
FH498	F7925-OLP	Spring	3/4	25	250	3/4	3/4	-	7	x	19	x	20 1/4	53	718.88
FH499	F83050-OLP	Spring	3/4	50	250	3/4	3/4	-	10 1/2	x	24	x	25 3/8	109	1223.39
FH500	FD84050-OLP	Spring	1	50	250	1	1	-	15 1/4	x	24	x	25 3/8	140	1344.93
WELDING REELS - used for a wide variety of gases such as acetylene, Mapp gas, propane gas, natural gas and fuel gases - sold with hose															
FH501	TW7450-OLPT	Spring	1/4	50	200	note 1	1/4	-	7	x	19	x	20 1/4	54	690.11
FH502	TW84100-OLPT	Spring	1/4	100	200	note 1	note 2	-	13	x	24	x	25 3/8	125	1382.84
STAINLESS STEEL for AIR, WATER or OIL - corrosion-resistant reels - swivels include Viton® O-rings - sold without hose															
FH503	5600-OLS	Spring	3/8	35	500	-	3/8	3/8	6	x	13 1/2	x	14 1/2	23	894.01
FH504	7800-OLS	Spring	1/2	50	500	-	1/2	1/2	7	x	19	x	20 1/4	44	1313.56
FH505	7800-OMS	Spring	1/2	50	3000	-	1/2	1/2	7	x	19	x	20 1/4	47	1446.88
HAND CRANK for AIR or WATER - designed for medium-duty applications requiring longer lengths of hose - sold without hose															
FH506	CA32106L	Manual	1/2	100	1000	-	1/2	1/2	19	x	17 3/4	x	20 1/4	38	334.03
FH507	CA32112L	Manual	1/2	200	1000	-	1/2	1/2	25	x	17 3/4	x	20 1/4	46	334.03
FH508	CA33112L	Manual	3/4	100	1000	-	3/4	3/4	19	x	17 3/4	x	20 1/4	46	441.35
FI060	CA37118L	Manual	1	100	300	-	1	note 3	34	x	17 3/4	x	20 1/4	58	520.49
HOSE REEL CART FOR 12" HAND CRANK REELS - 8" semi-pneumatic rubber tires, adjustable handle, rugged 1" square tubular steel frame															
FH509*	600741-2	-	-	--	-	-	-	-	27	x	23 3/4	x	Adjustable	-	176.20

2-Year Limited Warranty - Note 1: 9/16" - 18 UNF Female Note 2: 9/16" - 18 UNF Male Note 3: 1" NPTM
Standard colour as shown - powder coat paint red * Handle height adjustable to 35 5/8", 38 5/8", 41 1/2", 44 1/2"



TN315



TN318



FH509 Cart only
FH507 Reel only

TLZ483

HOSE REELS

- Heavy-duty, reinforced steel stampings for increased strength
- For use with air and water
- Compact design allows reels to fit in tight locations
- Multi-position guide arms for multiple mounting options

- Kinkless, oil resistant high quality hose
- Spring rewind features long life spring with declutching arbour
- Durable, corrosion-resistant powder coat paint

aurora tools®



Model No.	Drive Type	Hose I.D."	Hose Length'	Max PSI	Hose Outlet (M) NPT"	Reel Inlet (F) NPT"	Dimensions				Wt. lbs.	Price /Each	
TLZ482	Spring	1/4	35	300	1/4	3/8	6	x	15 1/2	x	14	26.6	198.00
TLZ483	Spring	3/8	25	300	1/4	3/8	6	x	15 1/8	x	13 7/8	26.2	225.00
TLZ484	Spring	3/8	35	300	1/4	3/8	6 5/8	x	17 1/2	x	16 1/2	34.7	275.00
TLZ485	Spring	3/8	50	300	1/4	3/8	6 1/2	x	20	x	18 3/8	40.3	369.00
TLZ486	Spring	1/2	50	300	1/2	1/2	6 5/8	x	20 1/4	x	17 7/8	44.3	387.00

RS3632E

HOSES & HOSE CLAMPS

HOSE CLAMPS

STAINLESS STEEL BAND & SCREW



5/16" HEX HEAD SCREW 1/2" BAND

Model No.	Mfg. No.	Diameter Min."	Diameter Max."	Price/Each
TLY173	DHCS-6	0.375	0.875	0.69
TLY177	DHCS-8	0.438	1	0.70
TLY152	DHCS-10	0.5	1.125	0.73
TLY154	DHCS-12	0.5	1.25	0.73
TLY157	DHCS-16	0.75	1.5	0.77
TLY160	DHCS-20	0.75	1.75	0.82
TLY164	DHCS-24	1	2	0.83
TLY165	DHCS-28	1.313	2.25	0.86
TLY166	DHCS-32	1.563	2.5	0.87
TLY167	DHCS-36	0.875	2.75	0.90
TLY168	DHCS-40	1.125	3	0.93
TLY169	DHCS-44	1.313	3.25	0.94
TLY170	DHCS-48	1.625	3.5	0.97
TLY171	DHCS-52	1.875	3.75	1.01
TLY172	DHCS-56	2.125	4	1.03
TLY175	DHCS-64	2.625	4.5	1.10
TLY176	DHCS-72	3.125	5	1.16
TLY178	DHCS-80	3.625	5.5	1.43
TLY180	DHCS-88	4.25	6	1.21
TLY181	DHCS-96	4.75	6.5	1.29
TLY153	DHCS-104	4	7	1.36
TLY155	DHCS-128	6.5	8.5	1.51
TLY156	DHCS-152	8	10	2.39
TLY158	DHCS-164	8.75	10.75	2.71
TLY159	DHCS-188	10.25	12.25	3.07
TLY161	DHCS-212	11.75	13.75	3.45

HOSE CLAMPS

STAINLESS STEEL BAND & ZINC PLATED SCREW



5/16" HEX HEAD SCREW 1/2" BAND

Model No.	Mfg. No.	Diameter Min."	Diameter Max."	Price/Each
TLY205	DHC6-6	0.375	0.875	0.46
TLY208	DHC6-8	0.438	1	0.48
TLY182	DHC6-10	0.5	1.125	0.48
TLY185	DHC6-12	0.5	1.25	0.53
TLY188	DHC6-16	0.75	1.5	0.53
TLY191	DHC6-20	0.75	1.75	0.53
TLY195	DHC6-24	1	2	0.53
TLY196	DHC6-28	1.313	2.25	0.56
TLY198	DHC6-32	1.563	2.5	0.58
TLY199	DHC6-36	0.875	2.75	0.58
TLY200	DHC6-40	1.125	3	0.62
TLY201	DHC6-44	1.313	3.25	0.68
TLY202	DHC6-48	1.625	3.5	0.70
TLY203	DHC6-52	1.875	3.75	0.70
TLY204	DHC6-56	2.125	4	0.73
TLY206	DHC6-64	2.625	4.5	0.82
TLY207	DHC6-72	3.125	5	0.83
TLY209	DHC6-80	3.625	5.5	0.90
TLY210	DHC6-88	4.25	6	0.91
TLY211	DHC6-96	4.75	6.5	0.96
TLY183	DHC6-104	4	7	1.25
TLY184	DHC6-116	5.75	7.75	1.38
TLY186	DHC6-128	6.5	8.5	1.49
TLY187	DHC6-152	8	10	1.86
TLY189	DHC6-164	8.75	10.75	1.88
TLY190	DHC6-188	10.25	12.25	2.70
TLY760	DHC6-200	11	13	2.66
TLY192	DHC6-212	11.75	13.75	2.91

HOSE CLAMPS

STAINLESS STEEL BAND & SCREW



MINI-GEAR 1/4" HEX HEAD SCREW 5/16" BANDS

Model No.	Mfg. No.	Diameter Min."	Diameter Max."	Price/Each
TLY283	DMHCS-4	0.219	0.625	0.86
TLY284	DMHCS-6	0.316	0.875	0.84
TLY285	DMHCS-8	0.438	1	0.90
TLY281	DMHCS-12	0.563	1.25	1.25
TLY282	DMHCS-28	1.563	2.5	1.06

HOSE CLAMPS

STAINLESS STEEL BAND & ZINC PLATED SCREW



MINI-GEAR 1/4" HEX HEAD ZINC PLATED SCREW 5/16" BANDS

Model No.	Mfg. No.	Diameter Min."	Diameter Max."	Price/Each
TLY289	DMHC6-4	0.219	0.625	0.60
TLY290	DMHC6-5	0.438	0.6875	0.62
TLY291	DMHC6-6	0.438	0.875	0.60
TLY292	DMHC6-8	0.438	1	0.60
TLY286	DMHC6-10	0.5	1.063	0.63
TLY287	DMHC6-12	0.563	1.25	0.63
TLY288	DMHC6-16	0.813	1.75	0.66

KEY TURN HOSE CLAMPS

- Zinc Plated Screw Stainless Steel Band
- TLY752 and TLY753 will accept 22 to 24 inch/lbs. of torque on the key
- Item TLY754 to TLY758 will accept 40 to 50 inch/lbs. of torque on the key



TWO EAR CLAMP

Model No.	Mfg. No.	Size	Price/Each
TLY752	DKTC12-04	6-16 mm	0.21
TLY753	DKTC12-06	8-22 mm	0.21
TLY754	DKTC12-12	12.7-31.7 mm	0.39
TLY755	DKTC12-20	19-44.4 mm	0.42
TLY756	DKTC12-28	31.7-57 mm	0.46
TLY757	DKTC12-36	44.4-69.8 mm	0.45
TLY758	DKTC12-100	100-125 mm	0.80

Call us for quantity pricing!



HOSE CLAMPS



TWO EAR CLAMP

Model No.	Mfg. No.	Size"	Price/Each
TLY272	DHC9-2 1/2	5/32	0.30
TDX141	DHC9-3	3/16	0.30
TDX206	DHC9-4	1/4	0.30
TDX142	DHC9-5	5/16	0.30
TDX207	DHC9-6	3/8	0.32
TDX208	DHC9-8	1/2	0.33
TDX144	DHC9-9	9/16	0.36
TLY276	DHC9-9 1/2	19/32	0.38
TDX209	DHC9-10	5/8	0.37
TDX210	DHC9-12	3/4	0.41
TDX058	DHC9-13	13/16	0.50
TDX211	DHC9-14	7/8	0.41
TDX059	DHC9-15	15/16	0.60
TDX308	DHC9-16	1	0.53
TDV947	DHC9-17	1 1/16	0.58
TDX060	DHC9-18	1 1/8	0.56
TLY270	DHC9-19	1 3/16	0.79
TDV948	DHC9-21	1 5/16	0.68
TDV949	DHC9-23	1 7/16	0.79
TDX061	DHC9-24	1 1/2	0.83
TDX062	DHC9-26	1 5/8	1.00
TDX063	DHC9-28	1 3/4	0.93

HOSE CLAMPS



ONE EAR CLAMP

Model No.	Mfg. No.	Size"	Price/Each
TLY259	DHC8-6	3/8	0.19
TLY260	DHC8-7	7/16	0.19
TLY261	DHC8-7 1/2	15/32	0.24
TLY262	DHC8-8	1/2	0.19
TLY264	DHC8-9	9/16	0.19
TLY212	DHC8-10	5/8	0.21
TLY213	DHC8-11	11/16	0.21
TLY215	DHC8-12	3/4	0.21
TLY216	DHC8-13	13/16	0.21
TLY217	DHC8-14	7/8	0.22
TLY218	DHC8-15	15/16	0.22
TLY219	DHC8-16	1	0.22
TLY220	DHC8-17	1 1/16	0.22
TLY221	DHC8-18	1 1/8	0.22
TLY222	DHC8-19	1 3/16	0.22
TLY223	DHC8-20	1 1/4	0.22
TLY224	DHC8-21	1 5/16	0.24
TLY225	DHC8-22	1 3/8	0.24
TLY226	DHC8-23	1 7/16	0.24
TLY227	DHC8-23 1/2	1 15/32	0.30
TLY228	DHC8-24	1 1/2	0.24
TLY229	DHC8-25	1 9/16	0.24
TLY230	DHC8-26	1 5/8	0.25
TLY231	DHC8-27	1 11/16	0.25
TLY232	DHC8-27 1/2	1 23/32	0.33
TLY233	DHC8-28	1 3/4	0.27
TLY234	DHC8-29	1 13/16	0.27
TLY235	DHC8-30	1 7/8	0.27
TLY236	DHC8-31	1 15/16	0.28
TLY237	DHC8-32	2	0.28
TLY238	DHC8-33	2 1/16	0.30
TLY239	DHC8-34	2 1/8	0.30
TLY240	DHC8-35	2 3/16	0.30
TLY241	DHC8-36	2 1/4	0.30
TLY242	DHC8-37	2 5/16	0.30
TLY243	DHC8-38	2 3/8	0.30
TLY244	DHC8-39	2 7/16	0.30
TLY245	DHC8-40	2 1/2	0.30
TLY246	DHC8-41	2 9/16	0.39
TLY247	DHC8-42	2 5/8	0.32
TLY248	DHC8-43	2 11/16	0.40
TLY249	DHC8-43 1/2	2 23/32	0.42
TLY250	DHC8-44	2 3/4	0.33
TLY251	DHC8-45	2 13/16	0.44
TLY252	DHC8-46	2 7/8	0.35
TLY253	DHC8-47	2 15/16	0.44
TLY254	DHC8-48	3	0.35
TLY255	DHC8-49	3 1/16	0.44
TLY256	DHC8-50	3 1/8	0.46
TLY257	DHC8-51	3 3/16	0.46
TLY258	DHC8-52	3 1/4	0.46

Call us for all your



Tools & Equipment requirements!

Look for this symbol for environmentally friendly products!



VICES, MAGNETS & CLAMPS

COMBINATION PIPE & BENCH VISES

- Perfect to handle any work holding jobs
- Tool steel serrated top jaws and pipe jaws
- Suitable for plant maintenance, oil field service, heavy construction



WILSON

Model No.	Mfg. No.	Jaw Width"	Jaw Opening"	Throat Depth"	Pipe Jaw Capacity"	Price /Each
TM838	C-0	3 1/2	5	4 1/2	1/8 - 2 1/2	1052.54
TM839	C-1	4 1/2	6	4 3/4	1/8 - 3 1/2	1510.16
TM840	C-2	5	7	5 5/16	1/8 - 4 1/2	1967.79
TM841	C-3	6	9	6 5/8	1/4 - 6	2883.04

MULTI-PURPOSE MECHANIC'S VISES

- Jaw opening expands to 9 3/4" when reversed
- Grey iron main castings
- Replaceable, hardened tool steel jaw faces
- Two working anvil surfaces
- Two lock down bolts are furnished
- Swivel base with four mounting lugs allows for 360° swivel



WILSON

Model No.	Mfg. No.	Jaw Width"	Jaw Opening"	Throat Depth"	Pipe Jaw Capacity"	Price /Each
TD672	4500	5 1/2	9 3/4	3 3/4	1/8 - 3	263.13

TRADESMAN VISES

- Meets all Government specifications
- Replaceable top and pipe jaws
- Provides greater clamping surface
- Large anvil
- Fully enclosed spindle
- Straight line design
- Mounting template and parts list included with every vise
- Precision thrust bearing creates greater clamping pressure and increased longevity
- 60 000 PSI ductile iron
- Top jaws are reversible - either standard serrated jaws for extra grip on sturdier materials or smooth jaws for more delicate pieces
- 360° swivel base



WILSON

Model No.	Mfg. No.	Jaw Width"	Jaw Opening"	Throat Depth"	Pipe Jaw Capacity"	Price /Each
TD664	1745	4 1/2	4	3 1/4	1/4 - 2 1/2	686.44
TD665	1755	5 1/2	5	3 3/4	1/4 - 3	823.72
TD666	1765	6 1/2	6 1/2	4	1/4 - 3 1/2	877.11
TD667	1780A	8	7	4 3/4	1/8 - 3 1/2	1315.67

SHOP VISES

- General duty use
- Instant-Action™ vise design ensures immediate engagement of the nut and spindle screw
- Vise rotates 360°
- Rubber pinch point safety guards
- 25 000 PSI castings for long life



WILSON

Model No.	Mfg. No.	Jaw Width"	Jaw Opening"	Throat Depth"	Price /Each
VE839	WS4	4	4	2 3/4	164.46
VE840	WS5	5	5	3	197.35

SWIVEL BASE VISES

- High quality grey iron castings
- Fully enclosed spindle with smooth operation
- Anvil back
- Chrome finished handle
- 360° swivel base

aurora tools®



Model No.	Jaw Width"	Jaw Opening"	Throat Depth"	Wt. lbs.	Price /Each
TEX250	3	4	2	16.5	75.70
TEX251	4	5	2 5/32	26.4	106.00
TEX252	6	7	3	58.1	199.00
TEX253	8	8	4	96.8	305.00

MECHANIC'S VISES

- Meets all Government specifications
- Replaceable hardened steel serrated jaw inserts and replaceable pipe jaws provide sure grip
- Enclosed, unbreakable box frame, steel channel
- Large anvil
- Swivel base rotated 360° and has double lockdowns ensuring maximum stability
- Straight line design - positions spindle and nut horizontally, reducing thread wear and increasing clamping power
- 30 000 PSI castings for long life and added strength
- Ideal for professional mechanics



WILSON

Model No.	Mfg. No.	Jaw Width"	Jaw Opening"	Throat Depth"	Pipe Jaw Capacity"	Price /Each
TD669	744	4	4 1/2	3 7/16	1/4 - 2	252.17
TD670	745	5	5 1/4	3 3/4	1/4 - 2 1/2	350.85
TD671	746	6	5 3/4	4 1/8	1/4 - 3 1/2	460.49

UTILITY WORKSHOP VISES

- Durable, versatile, all-around vises
- Handles a variety of applications
- Perfect for use in utility and light duty applications

WILSON



Model No.	Mfg. No.	Jaw Width"	Jaw Opening"	Throat Depth"	Pipe Jaw Capacity"	Price /Each
TD677	674	4 1/4	4	2 5/8	1/8 - 2	142.53
TD678	675	5 1/2	5	3 7/16	1/8 - 2 1/2	175.42
TD679	676	6 1/2	5 1/2	3 11/16	1/8 - 2 1/2	251.69
TD680	656HD	6	6	4 3/16	1/8 - 3	328.92
TD681	648HD	8	7 1/2	4 1/2	1/8 - 3	491.95

MACHINIST'S VISES

- Strong, ductile iron main castings
- Steel jaw faces made from hardened tool steel - have deep knurled pattern to ensure positive gripping
- Plain jaw faces are available on request
- Stationary models have a flat base, making it unnecessary to modify bench top for mounting
- Swivel base models rotate 360°, and gear lock bolt ensures positive locking against slippage



COLUMBIAN®

Model No.	Mfg. No.	Jaw Width"	Jaw Opening"	Throat Depth"	Price /Each
SWIVEL BASE					
TD686	603M3	3	4	3	686.44
TD687	603/2M3	3 1/2	5	3 1/4	755.08
TD688	604M3	4	6	3 5/8	846.61
TD689	6041/2M3	4 1/2	7	4 1/8	961.01
TD690	605M3	5	8	4 1/4	1395.76
TD691	606M3	6	10	4 3/8	1967.79
STATIONARY BASE					
TD700	503M3	3	4	3	640.67
TD701	5031/2M3	3 1/2	5	3 1/4	686.44
TD702	504M3	4	6	3 5/8	777.96
TD703	5041/2M3	4 1/2	7	4 1/8	846.61
TD704	505M3	5	8	4 1/4	1258.47
TD705	506M3	6	10	4 3/8	1830.50

VICES, MAGNETS & CLAMPS

VERSATILE DRILL PRESS VISES

Rugged design and large workload capacity make these vises perfect for the most difficult drilling, tapping or reaming operations.

MODELS VE855, TE622 & E586

- Made of graded cast iron and offers a ground vise bed for a smooth, consistent jaw movement and hardened top U-groove jaws

MODELS VE857, VE858 & VE859

- Made of graded cast iron and features precision 90° machining of the vise's sidebodies, which allows them to be used as bases
- Rapid action nut allows for fast loading and unloading of production material and extra tightening capabilities
- Main castings provide extra strength and increased durability

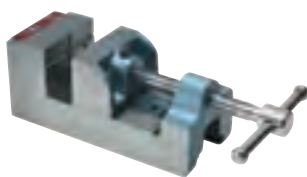

WILCON

Model No.	Mfg. No.	Jaw Width"	Jaw Opening"	Jaw Depth"	Price /Each
CONTINUOUS NUT					
VE855	1335	3 1/2	2 1/2	1 7/8	137.29
TE622	1345	4 1/2	3 3/4	2 1/8	197.35
VE856	1360	6	4 7/8	2 1/8	263.13
RAPID ACTING NUT					
VE857	1435	3 1/2	4 1/4	1 3/4	228.81
VE858	1445	4 1/2	4 3/4	1 7/8	320.34
VE859	1460	6	6 3/4	2 1/8	446.18

VERTI-LOCK® MACHINE VISES

- Jaw widths from 5" up to 8"
- Needle thrust bearing
- Flat bed parallel to 0.0001 per inch
- Ductile steel alloy body parts

SWIVEL BASE

- 360° rotation via two 360° scales
- Calibrated in 1° increments for easy use



WILCON

WORKSTOP

- Quick, accurate positioning
- Ideal for highly repetitive operations

Model No.	Mfg. No.	Jaw Width"	Jaw Opening"	Type of Base	Price /Each
MACHINE VISES					
TE166	1250N	5	4 1/2	Stationary	892.37
TE167	1275N	6	7 1/2	Stationary	1052.54
TE168	1280N	8	7 1/2	Stationary	1967.79
SWIVEL BASES					
TE170	5S	5	-	Swivel	217.37
TE171	6S	6	-	Swivel	251.69
TE172	8S	8	-	Swivel	503.39

MILLING MACHINE VISES

- General purpose vise for both milling and grinding applications
- Durable construction with fine grain cast iron casting and hardened steel vise jaws
- Ground vise bed for smooth, consistent and precise jaw movement
- Hardened V-grooved jaws hold round-shaped objects both vertically and horizontally
- Zinc-plated ACME-threaded screw provides consistent clamping pressure and durability



TLV251



TLV252

WILCON

Model No.	Mfg. No.	Description	Jaw Width"	Maximum Opening"	Jaw Depth"	Weight lbs.	Price /Each
TLV251	11602	Without Base	4	4	1 3/4	18	320.34
TLV252	11603	With Base	4	4	2	23	411.86
TLV253	11604	Without Base	6	6	1 3/4	35	549.15
TLV259	11605	With Base	6	6	2	50	686.44

BRINK & COTTON VACUUM BASE VISES

- Lightweight and portable
- Mounts on any clean, flat surface
- Cast aluminum body
- 360° swivel base and 180° head tilt

WILCON



Model No.	Mfg. No.	Jaw Width"	Jaw Opening"	Type of Base	Price /Each
TJW113	3VB	2 3/4	2 1/2	Vacuum	66.36

DRILL PRESS VISES

STANDARD MODELS

- Precision grinding of Model TM798 sides and front side face, permits additional mounting positions for drilling, tapping or reaming
- The body and sides are also ground perfectly parallel and square to further ensure complete jaw alignment
- Combining a smooth moveable jaw plate with a cross-patterned 90° V-groove stationary jaw, the vise is recommended for general use
- Model TM802 utilizes fine pitched ACME-threaded screws with hexagonal heads for tight clamping

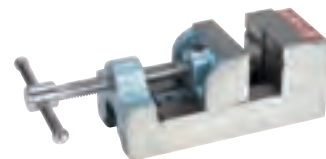

ANGLE MODELS

- Models TM800 and TM804 are mounted on a 90° angle base, sturdily constructed to give workpieces an accurate mount
- The hinge pin hole of the vise body is precision drilled and reamed to avoid lateral play

WILCON

Model No.	Mfg. No.	Jaw Width"	Jaw Opening"	Jaw Depth"	Overall Height"	Price /Each
STANDARD MODELS						
TM798	25	2 1/2	2 1/2	1 1/2	3 2/3	100.87
TM802	30	3	3 1/8	1 3/4	3 2/3	109.64
ANGLE MODELS						
TM800	25A	2 1/2	2 1/2	1 1/2	4 1/3	114.41
TM804	30A	3	3 1/8	1 1/4	4 1/3	171.61

CAM ACTION DRILL PRESS VISES

- Holding pressure is adjustable from 400 to 1100 lbs.
- Recessed parallel steel jaw inserts level work, and can be removed to accommodate your jig and fixture components
- The base is designed for clear through drilling applications
- For added durability, bars and locking mechanisms are hardened and ground
- The unique top locking lever can be raised or lowered to tighten or loosen against the workpiece

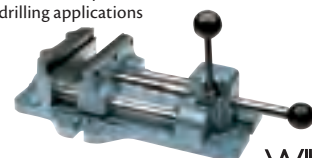

WILCON

Model No.	Mfg. No.	Jaw Width"	Jaw Opening"	Jaw Depth"	Overall Height"	Price /Each
TE161	1203	3	3	1 1/4	2 3/4	228.81
TE162	1204	4	4 11/16	1 5/16	3 1/4	241.21
TE163	1206	6	6 3/16	1 13/16	3 3/4	416.63
TE164	1208	8	8 3/16	2	4 7/16	526.27

SUPER PRECISION 3 WAY TILTING MACHINE VISES

- Perfect vise for 3 axis jobs in milling, drilling, grinding, shaping and jig boring
- Jaw plates hardened and ground
- Accurately indexed for 3 way angular work
- 90° vertical indexing
- 360° swivel base and 45° tilting range on either side



WILCON

Model No.	Mfg. No.	Jaw Width"	Jaw Opening"	Jaw Depth"	Price /Each
TJW130	TLT/SP-50	2	2	5/16	549.15
TJW131	TLT/SP-75	3	3	1 5/16	1006.77
TJW132	TLT/SP-100	4	4	1 9/16	1281.35

R32564E

OFFICE PRODUCTS

INSTRUMENTS, SCALES & ELECTRICAL

SHIPPING & PACKAGING

TOOLS & EQUIPMENT

WELDING & METALWORKING

SAFETY EQUIPMENT & SUPPLIES

JANITORIAL & MAINTENANCE

MATERIAL HANDLING & STORAGE

1335

VICES, MAGNETS & CLAMPS

WISE ACCESSORIES

IMPROVE CLAMPING VERSATILITY & SAFETY

TM830

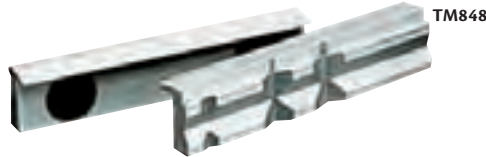

TM854



WILTON MAGNEFIX VISE JAW CAPS TEMPORARY WORK-HOLDING SYSTEMS

- Designed to protect both the vise jaws and the workpiece from marring and distortion during any clamping application
- Caps are constructed from a hardened aluminum alloy with two built-in circular permanent magnets on the backside which hold the product securely to the vise
- The caps are magnetic towards the vise side to prevent steel filings from attaching themselves to the jaws and keep the clamped part from becoming magnetized

TM855



MODEL A - ALUMINUM MAGNEFIX JAW CAPS

- Aluminum alloy design includes six grooves to compensate for the unevenness of the workpiece
- Deeper Vee-Groove ensures more secure clamping of circular work pieces
- Use together with *Rubber Magnefix Jaw Caps* when clamping taper pins and spherical parts

MODEL F - FIBER FACE MAGNEFIX JAW CAPS

- Aluminum alloy with laminated fiber cover to prevent the absorption of outside materials
- Heat parts rapidly by concentrating heat into part
- Use on workpieces to avoid distortion and clamping marks

MODEL R - RUBBER FACE MAGNEFIX JAW CAPS

- Aluminum alloy with synthetic rubber cover
- Jaw cap conforms to workpiece and grips firmly without slipping while protecting work surface
- Use in combination with aluminum and prism jaw caps to clamp taper pins or tapered workpieces

MODEL P - PRISM MAGNEFIX JAW CAPS

- Jaw construction includes a 120° horizontal Vee-Groove, three vertical Vee-Grooves and a 90° groove for marking out and centre punching
- Ideal for light tapping and thread cutting applications

Model No.	Mfg. No.	Jaw Width"	Price /Each	Model No.	Mfg. No.	Jaw Width"	Price /Each
STANDARD ALUMINUM MAGNEFIX JAW CAPS							
TM830	A-3	3	52.63	TJW079	A-5.5	5 1/2	61.78
TM832	A-4	4	52.63	TM835	A-6	6	61.40
TM833	A-4.5	4 1/2	57.20	TJW081	A-6.5	6 1/2	63.59
TM834	A-5	5	57.01				
FIBER FACE MAGNEFIX JAW CAPS							
TM855	F-3.5	3 1/2	52.63	TM846	F-5	5	59.21
TM844	F-4	4	52.63	TM847	F-6	6	61.40
TM845	F-4.5	4 1/2	59.49				
RUBBER FACE MAGNEFIX JAW CAPS							
TM856	R-4	4	52.63	TJW092	R-5.5	5 1/2	61.78
TM857	R-4.5	4 1/2	57.20	TM859	R-6	6	64.07
TM858	R-5	5	57.01	TJW094	R-6.5	6 1/2	66.36
PRISM MAGNEFIX JAW CAPS							
TM851	P-4	4	59.49	TJW100	P-5.5	5 1/2	66.36
TM850	P-4.5	4 1/2	61.78	TM853	P-6	6	65.78
TM852	P-5	5	64.07	TJW102	P-6.5	6 1/2	70.93

Can't find what you're looking for?
Call us today!



Look for this symbol for environmentally friendly products!



PRICING

The prices shown in this catalogue are for "REFERENCE AND BUDGET PURPOSES ONLY" as of July 2012, and should be used exclusively as a guideline.

Freight charges and applicable taxes (GST, PST & HST) are extra.

In the event of a pricing or typographical error, we reserve the right to charge the correct price without prior notice.

We also reserve the right to modify prices based on changing manufacturer and economic conditions.

SPECIAL ORDERS

This catalogue represents only a portion of the products that are available to you. If you can't find what you need, please call us!



CANADA'S LEADER IN WELDING SUPPLIES

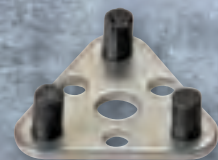
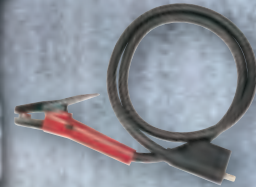

MAGNETIC PARTS RETRIEVERS

Remove steel parts from bins, boxes, kegs, tables or floors.

- Durable aluminum housing with comfortable non-slip handle
- Powerful, lightweight permanent magnet
- Easy release of collected parts or scrap



SHORT HANDLED VERSION

Model No.	Holding Capacity lbs.	L"	W"	H"	Price /Each
RGY633	7	4 1/2	2 3/8	7 1/2	122.36
RGY635	11	4 1/2	2 3/8	7 1/2	156.08

MAGNETIC TRIGGER LIFTS

Hand held lift provides a strong grip on parts with an easy to use trigger release.

- Lightweight aluminum housing
- One hand operation
- Move sheets and parts fast, safely and easily
- Retrieve hot parts from burn tables



BURN TABLE/PARTS HANDLING

Model No.	Holding Capacity lbs.	L"	W"	H"	Price /Each
RGY637	55	3 3/8	2 3/8	4 13/16	150.49

MAG-MAID MAGNETIC CLEAN-UP TOOLS

- Picks up steel chips, fasteners and scrap from swarf
- To clean, simply pull the plunger handle to the top of the tube and the collected metal falls off
- Powerful rare earth magnet



Model No.	Length"	Diameter"	Wt. lbs.	Price /Each
RGY638	15	1	1.25	85.62
RGY639	36	1	2.75	135.56

POWER GRIPS

- Holds against shear force
- Securely grips heavy parts
- Aluminum insulated
- Epoxy encapsulated magnet



Model No.	Length"	Height"	Width"	Holding Value lbs.	Price /Each
LS717	2 1/8	2	3/4	25	40.98
LS718	4	2 1/4	3/4	51.5	50.58
LS719	5 1/4	2 3/4	1 7/8	92.5	56.20

ON/OFF MAGNETIC HANGING HOOKS

- Switchable On/Off rare earth magnets
- Hanging hooks are perfect for temporary holding of lines, hoses, lights, tools and more
- Attaches to flat or round surface with ease



Model No.	Pull lbs.	H"	W"	Wt. lbs.	Price/Each
TLY337	25	3 1/2"	1 1/2"	3	74.75
TLY338	40	4	2 3/4	11	163.07

ON/OFF MAGSQUARES

- Switchable On/Off rare earth magsquares
- Simple, fast work holding on multiple side
- Eliminate the need for tedious clamping
- Can be used on flat or round steel or iron surfaces
- Pre-tapped holes on all sides for mounting



Model No.	Pull lbs.	L"	W"	H"	Tap mm	Wt. lbs.	Price /Each
TLY339	150	1 1/2	1 1/2	2 1/2	M5	0.9	81.55
TLY340	550	3 1/4	2	4	M6	3.5	281.99
TLY341	1000	4 3/4	2 3/4	4 3/4	M10	10.5	676.10

LONG REACH MAGNETIC RETRIEVERS

- Powerful pickup tools
- Durable handle with grip
- Model RGY621 has a 45° angled head

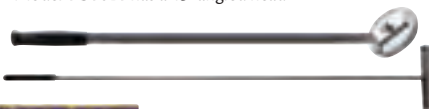

Model No.	Handle Length"	Head Dimensions	Holding Capacity lbs.	Price /Each
RGY621	38	3 1/4" Dia.	47.5	30.58
RGY622	39.72	6" x 1 3/8"	28	63.02

KEY CHAIN-STYLE MAGNETIC RETRIEVERS

- Powerful rare earth magnet
- 3/8" diameter aluminum case is 2" long
- Retrieves parts weighing up to 8 lbs.

Model No. RGY710
Price/Each \$13.08



MAGNETIC STRIPS

- Conforms to any contour
- Holds many times its weight
- Can be cut, drilled or shaped
- Available with or without adhesive backing



Thick"	Width"	Length'	Max. Pull per Lin. Ft. (lbs.)	Model No. w/o Adhesive	Price /Roll	Model No. w/Adhesive	Price /Roll
1/32	1/2	200	2	RGY640	47.30	RGY648	77.89
1/32	3/4	200	3	RGY641	66.76	RGY649	104.33
1/32	1	100	4	RGY642	41.74	RGY650	66.76
1/32	1	200	4	RGY643	81.38	RGY651	121.98
1/16	1/2	100	5	RGY644	38.96	RGY652	61.22
1/16	3/4	100	8	RGY645	50.06	RGY653	75.10
1/16	1	50	11	RGY646	36.86	RGY654	54.94
1/16	1	100	11	RGY647	66.76	RGY655	100.15

MAGNETIC WELDING GROUNDS

- Powerful magnet attaches securely to your steel work surface
- Spring loaded 1/2" diameter stud assures constant electrical ground contact

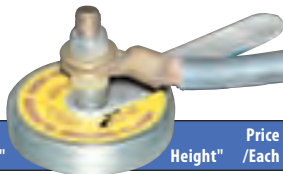

Model No.	Holding Capacity lbs.	Stud Type Amperage	Diameter"	Height"	Price /Each
RGY631	35	250 A/Brass	3 1/2	2 1/4	38.96
RGY632	35	800 A/Copper	3 1/2	2 1/4	51.99

MAGNETIC WELDING SQUARES

- Provides fast set-up and accurate holding of steel sheet stock, plate and tubing for welding
- Holds work pieces at 45°, 90°, 135° and 180° angles
- RGY629 and RGY630 models feature "Breakaway Handle"

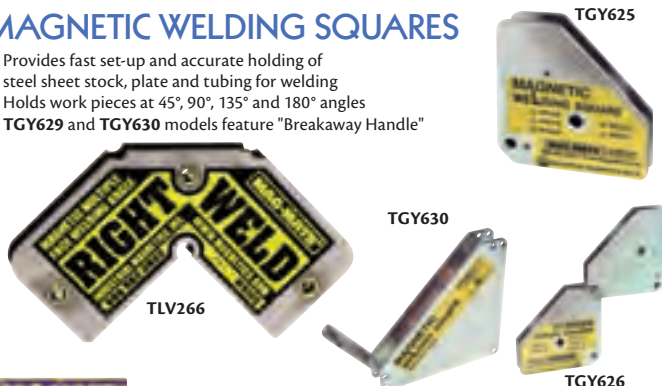

Model No.	Description	Pull lbs.	L"	H"	W"	Price /Each
RGY624	10 Angle	23	3 1/8	2 9/16	1/2	12.58
RGY625	Standard	55	3 3/8	3 3/8	5/8	10.46
TLV266	Inside 90°	40	4 3/3	2 3/4	9/16	23.19
	Outside 45/90°					
RGY627	Standard HD	75	3 3/4	4 3/8	3/4	20.26
RGY628	Covered HD*	75	3 3/4	4 3/8	3/4	26.47
RGY629	Extra HD	150	3 3/4	4 3/8	1 1/2	56.29
RGY630	Super HD*	325	8	8	1 5/8	130.47

* Weld spatter resistant covers on certain models

R27463E

BAR CLAMPS FOR WELDING & FABRICATING

SHOP FLOOR CLAMPS

- Swivel pressure pad
- Rail and fixed top jaw are heat treated and tempered
- High quality construction insures long life

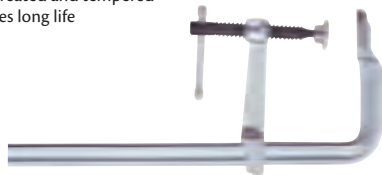

Model No.	Mfg. No.	Pad	Clamping Capacity"	Throat Depth"	Clamping Force (lbs.)	Price /Each
TKZ890	6605-8	Standard-duty	8	4	660	51.71
TKZ891	6605-12	Standard-duty	12	4	660	53.93
TKZ892	6605-18	Standard-duty	18	4	660	56.15
TN210	SQ-4	Standard-duty	6	4 3/4	1330	45.95
TN211	SQ-8	Heavy-duty	8	5 1/2	2660	89.61
TD320	SQ-12	Heavy-duty	12	5 1/2	2660	112.01
TKZ893	SQ-16	Heavy-duty	16	5 1/2	2660	128.96
TD321	SQ-20	Heavy-duty	20	5 1/2	2660	143.64
TKZ894	SQ-24	Heavy-duty	24	5 1/2	2660	176.41

PROFESSIONAL CLAMPS

- Bessey® Morpad™ allows for greater angle of pivot
- Rail and fixed top jaw are heat treated and tempered
- High quality construction insures long life



Model No.	Mfg. No.	Clamping Capacity"	Throat Depth"	Clamping Force (lbs.)	Price /Each
HEAVY-DUTY					
TN047	4800S-12	12	7	4880	289.09
THZ886	4800S-18	18	7	4880	323.18
TKZ901	4800S-24	24	7	4880	354.33
THZ887	4800S-36	36	7	4880	391.40
TKZ902	4800S-48	48	7	4880	425.50
TKZ903	4800S-60	60	7	4880	481.82
EXTRA HEAVY-DUTY					
TN177	7200S-12	12	8	7770	692.03
THZ888	7200S-18	18	8	7770	737.86
THZ889	7200S-36	36	8	7770	848.42

REGULAR-DUTY ALL-STEEL BAR CLAMPS WITH ERGONOMIC BESSEY® GRIP

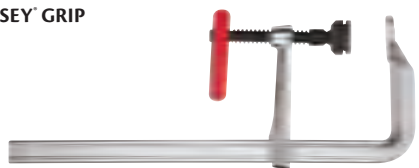

Model No.	Mfg. No.	Clamping Capacity"	Throat Depth"	Clamping Force (lbs.)	Price /Each
TLY342	2400S-8 BGLG	8	5 1/2	2800	155.50
TLY343	2400S-12 BGLG	12	5 1/2	2800	166.03
TLY344	2400S-16 BGLG	16	5 1/2	2800	187.11
TLY345	2400S-20 BGLG	20	5 1/2	2800	209.52
TLY346	2400S-24 BGLG	24	5 1/2	2800	232.42
TLY347	2400S-36 BGLG	36	5 1/2	2800	293.05
TLY348	2400S-48 BGLG	48	5 1/2	2800	337.52
TLY349	2400S-60 BGLG	60	5 1/2	2800	381.99

STEP-OVER STEEL CLAMPS

- Rail, fixed jaws and pressure plate heat-formed in one piece from cold drawn profiled and precision steel
- Heat treated, high carbon Acme threaded screw, spatter resistant
- Unique Bessey® Morpad™ tilts to 35° comes standard with TLY352 and TLY353
- Ergonomic Bessey® grip handle on model TLY352



Model No.	Mfg. No.	Clamping Capacity"	Throat Depth"	Clamping Force (lbs.)	Step-Over"	MorPad	Bessey® /Grip	Price /Each
TLY351	J18-8	10	4 3/4	880	2 1/4	-	Yes	127.50
TLY352	2400J-12	12	5 1/2	2660	4	Yes	Yes	171.97
TLY353	4800J-20	20	7	4880	6	Yes	-	348.40

LEVER CLAMPS (LC SERIES)

- Large tilting pressure plate
- Secure ratchet mechanism for rapid vibration-resistant clamping
- Torsion-resistant, fixed bracket and pressure plate produced and tempered in one piece for maximum tensile strength and sturdiness



Model No.	Mfg. No.	Clamping Capacity"	Throat Depth"	Clamping Force (lbs.)	Price /Each
TLV282	LC4	4	2 3/8	400	79.89
TN207	LC8	8	4	660	84.49
TN205	LC12	12	5 1/2	1200	115.63
TN206	LC20	20	4 3/4	1200	127.50
TLV283	1800L12	10	5 1/2	1800	259.41

MULTI-PURPOSE CLAMPS

- KombiKlamp™ robust Variable Angle Device (VAD) allows for a solid grip on odd shapes - also reverses for spreading
- Ergonomic Bessey® grip offers greater comfort and slides with the T-handle
- Removable screw acts as a slide stop
- Easily converts to a spreading device

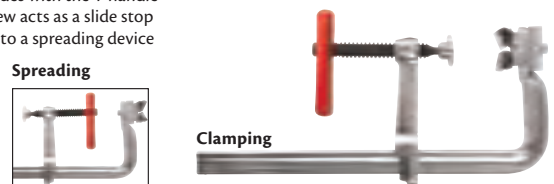

Model No.	Mfg. No.	Clamping Capacity"	Throat Depth"	Clamping Force (lbs.)	Load Limit (lbs.)	Price /Each
TLY350	SG30VAD	11	4.75	2600	3000	112.65

REGULAR-DUTY I BAR CLAMPS NO. 640

- A rapid acting powerful clamp designed and constructed for hard, everyday production work
- Patented, quick action, no slip clutches are 3/4" apart and formed in the web for greater bar strength
- High strength ductile slide cannot slip or bind, easily released
- Steel handle, with comfortable wood crank handle for fast clamping
- Bar dimensions: 7/16" x 1 1/2" x 5/32"
- Screw diameter: 5/8"
- Throat depth is 1 13/16" and clamp face is 1 7/8"



Model No.	Mfg. No.	Opening Capacity'	Load Capacity lbs.	Price /Each
TD798	21801	2	6000	59.49
TD799	21802	2 1/2	6000	64.07
TD800	21803	3	6000	73.22
TD801	21804	4	6000	74.55
TD802	21805	5	6000	91.52
TD803	21806	6	6000	100.87



VICES, MAGNETS & CLAMPS

WELDERS ANGLE CLAMPS

- Automatic adjustment to work pieces of different thicknesses
- Sturdy jaws and base made from high grade cast iron
- Copper plated spindles resist spatter
- Accurate 90° angle



Model No.	Mfg. No.	Jaw Height"	Maximum Material Size for Mitre Joints"	Price /Each
TLY361	WSM9	1 3/8	3 1/2	196.40
TLY362	WSM12	2 2/8	4 3/4	266.55

U STYLE BAR CLAMPS

- Light-duty U style bar clamp offers a unique step-over design
- Small, lightweight and very handy
- Rail is made of quality steel drawn in a single piece for durability and strength
- Sliding arm is made of die cast zinc: light, stable and break resistant
- Comes with non-marking plastic caps on both jaws

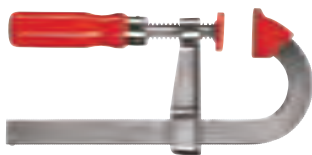

Model No.	Mfg. No.	Clamping Capacity"	Throat Depth"	Clamping Force (lbs.)	Price /Each
TLY358	LMU2.004	4	2	330	8.22
TLY359	LMU2.006	6	2	330	8.55
TLY360	LMU2.008	8	2	330	8.90

PIPE CLAMPS, H STYLE

- H shape foot assembly stabilizes clamp in two dimensions giving dual-axis stability
- Extra high base provides industry leading clearance from the work surface
- Cast jaws for durability
- Smooth action spindle
- Pipe not included



Model No.	Mfg. No.	Pipe Diameter"	Throat Depth"	Price /Each
TLV267	BPC-H34	3/4"	1 3/4	22.09
TLV268	BPC-H12	1/2"	1 1/2	19.01

CLUTCH STYLE BAR CLAMPS

- Powder coated, malleable cast iron jaws
- 2-piece slip clutch plates for quick adjustment
- Nickel-plated, drawn serrated rail
- Non-marring pads on the top and bottom jaws to protect work surface
- Ergonomically shaped wood handle



Model No.	Mfg. No.	Clamping Capacity"	Throat Depth"	Clamping Force (lbs.)	Price /Each
TLV269	GSCC2.506	2 1/2	6	600	12.62
TLV270	GSCC2.512	2 1/2	12	600	14.33
TLV271	GSCC2.518	2 1/2	18	600	16.88
TLV272	GSCC2.524	2 1/2	24	600	18.59
TLV273	GSCC2.530	2 1/2	30	600	20.48
TLV274	GSCC2.536	2 1/2	36	600	21.54
TLV275	GSCC3.512	3 1/2	12	1000	25.06
TLV276	GSCC3.518	3 1/2	18	1000	29.42
TLV277	GSCC3.524	3 1/2	24	1000	33.45
TLV278	GSCC5.012	5	12	1200	42.47
TLV279	GSCC5.018	5	18	1200	51.83
TLV280	GSCC5.024	5	24	1200	58.94

KANT-TWIST® CLAMPS



Model No.	Mfg. No.	Throat Deep Open"	Throat Deep Closed"	Clamping Capacity"	Clamping Force (lbs.)	Price /Each
ORIGINAL KANT-TWIST®						
TKZ949	1KT	1/2	1/2	1 1/16	300	21.97
TKZ950	2KT	1 1/8	1 1/4	2	700	26.60
TKZ952	3KT	1 1/4	1 3/4	3	1500	38.59
TKZ953	4 1/2KT	2 1/4	2 1/2	4 1/2	1500	40.40
TKZ954	6KT	2 1/8	3 3/8	6	1800	61.94
TKZ955	6DKT	4 5/8	5 1/2	6	1800	69.98

QUICK-GRIP® PIPE CLAMPS

- Innovative clutch system eliminates the need for threaded pipe
- Larger feet offer more stability and clearance between handle and worktop
- Larger, more ergonomic handle offers easier clamping with reduced hand fatigue
- Larger clutch plates allow for easier release and increased durability and dependability

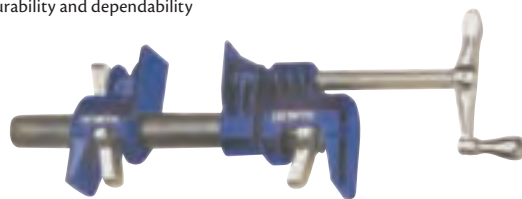

Model No.	Mfg. No.	Pipe Size	Throat Depth	Price /Each
TBR730	224134	3/4" (19 mm)	1 7/8" (47 mm)	26.50
TBR731	224212	1/2" (12 mm)	1 1/2" (37 mm)	21.45

QUICK-GRIP® CLUTCH LOCK BAR CLAMPS

- Soft-Grip handle is larger and more ergonomic, allowing high clamping pressure with less effort
- I-beam bar reduces flexing and bowing
- Larger clutch plates allow for easier release, and increase durability and dependability
- 3" throat depth accommodates a variety of projects



Model No.	Mfg. No.	Clamping Capacity	Throat Depth	Price /Each
TBR488	223106	6" (15 cm)	3 1/8" (76 mm)	20.86
TBR424	223112	12" (30 cm)	3 1/8" (76 mm)	21.94
TBR425	223118	18" (45 cm)	3 1/8" (76 mm)	27.18
TBR426	223124	24" (60 cm)	3 1/8" (76 mm)	28.31
TBR427	223136	36" (91 cm)	3 1/8" (76 mm)	35.70

QUICK-GRIP® PASSIVE LOCK BAR CLAMPS

- Soft-Grip handle is larger and more ergonomic, allowing high clamping pressure with less effort
- I-beam bar reduces flexing and bowing
- 5" throat depth offers greater versatility



Model No.	Mfg. No.	Clamping Capacity	Throat Depth	Price /Each
TBR357	223212	12" (30 cm)	4 7/8" (12 cm)	41.69
TBR358	223218	18" (45 cm)	4 7/8" (12 cm)	50.90
TBR359	223224	24" (60 cm)	4 7/8" (12 cm)	52.97
TBR360	223230	30" (75 cm)	4 7/8" (12 cm)	57.37

VICES, MAGNETS & CLAMPS

BAR CLAMPS FOR CONSTRUCTION & WOODWORKING

PARALLEL BAR CLAMPS K BODY® REVO™

- Large parallel jaw surfaces are made from non-marring polyamide
- Internal steel frames insure 90° angles
- Large composite handle for better comfort while working
- Bessey® anti-slip system for improved grip and safety
- Swivel fitting ensures clamp sits parallel to the bench top
- 3 3/4" throat depth



Model No.	Mfg. No.	Clamping Capacity"	Spreading Capacity"	Price /Each
TKZ904	KR3.512	12	9 1/4 - 15	61.07
TKZ905	KR3.524	24	9 1/4 - 28 1/2	66.48
TKZ906	KR3.531	31	9 1/4 - 36 1/2	71.86
TKZ907	KR3.540	40	9 1/4 - 44	78.45
TKZ908	KR3.550	50	9 1/4 - 53	83.25
TKZ909	KR3.560	60	9 1/4 - 63	88.63
TKZ910	KR3.582	82	9 1/4 - 85	106.49
TKZ911	KR3.598	98	9 1/4 - 100	112.60

TG PROFESSIONAL SERIES MALLEABLE CAST CLAMPS

- High quality construction
- Perfect for high pressure applications and wide openings
- Two part composite handle



Model No.	Mfg. No.	Clamping Capacity"	Throat Depth"	Clamping Force (lbs.)	Price /Each
LIGHT-DUTY					
TKZ912	TGJ2.5062K	6	2 1/2	600	21.03
TKZ913	TGJ2.5122K	12	2 1/2	600	22.62
TKZ914	TGJ2.5182K	18	2 1/2	600	24.71
TKZ915	TGJ2.5242K	24	2 1/2	600	27.34
TKZ916	TGJ2.5302K	30	2 1/2	600	29.97
TKZ917	TGJ2.5362K	36	2 1/2	600	32.61
TKZ918	TG4.0082K	8	4	880	31.56
TKZ919	TG4.0122K	12	4	880	38.23
TKZ920	TG4.0162K	16	4	880	39.92
TKZ921	TG4.0242K	24	4	880	51.81

ACCESSORIES FOR PARALLEL CLAMPS

KP FRAMING SYSTEMS

- Blocks align clamps for door and panel construction
- Clamps sit in grooves to make 90° angles
- Four blocks to a set

Model No. TKZ957
Mfg. No. KP Blocks
Price/Set \$31.07



K BODY® EXTENDERS

- Connects two Bessey® clamps together for extended reach
- Durable aluminum construction
- Includes: Extender, nuts, bolts and washers

Model No. TKZ959
Mfg. No. K Body Extender
Price/Each \$20.51



MEDIUM-DUTY

TKZ922	TG4.5122K	12	4 1/2	1000	43.12
TKZ923	TG4.5182K	18	4 1/2	1000	49.45
TKZ924	TG4.5242K	24	4 1/2	1000	52.61
TKZ925	TG4.5302K	30	4 1/2	1000	58.92
TKZ926	TG4.5402K	40	4 1/2	1000	66.29
TKZ927	TG5.5122K	12	5 1/2	1320	49.96
TKZ928	TG5.5182K	18	5 1/2	1320	60.48
TKZ929	TG5.5242K	24	5 1/2	1320	65.23
TKZ932	TG7.0162K	16	7	1320	60.20
TKZ933	TG7.0242K	24	7	1320	70.60
TKZ936	TG7.0482K	48	7	1320	96.78

HEAVY-DUTY

TKZ937	TGK4.5162K	16	4 1/2	1540	56.68
TKZ938	TGK4.5242K	24	4 1/2	1540	65.76
TKZ939	TGK4.5402K	40	4 1/2	1540	79.68
TKZ940	TGK4.5502K	50	4 1/2	1540	89.43
TKZ941	TGK4.5792K	79	4 1/2	1540	120.01

DEEP REACH

TKZ942	CDS24-10WP	24	10	1550	132.94
TKZ943	CDS24-12WP	24	12	1550	153.04
TKZ944	CDS24-20WP	24	20	990	229.55

QUICK-GRIP® ONE-HANDED CLAMPS

BAR CLAMPS/SPREADERS

- Quick-Change® jaw quickly converts from clamp to spreader and requires no tools
- Constructed of high-tech reinforced resin for strength and durability
- Exerts up to 250 lbs. of clamping pressure
- Patented pistol grip design enhances comfort and ease of use
- Non-marring pads grip firmly and protect workpiece
- Ideal for clamping/gluing, holding work for sawing/drilling and positioning work for fastening



Model No.	Mfg. No.	Clamping Capacity	Spreading Capacity	Throat Depth	Price /Each
TAW063	506QC	6" (15 cm)	7 1/2" - 14 5/8" (195 mm - 360 mm)	3 1/4" (80 mm)	32.77
TAW062	512QC	12" (30 cm)	7 1/2" - 20 5/8" (195 mm - 515 mm)	3 1/4" (80 mm)	36.40
TBR688	518QC	18" (45 cm)	7 1/2" - 26 5/8" (195 mm - 665 mm)	3 1/4" (80 mm)	41.89
TBR689	524QC	24" (60 cm)	7 1/2" - 32 5/8" (195 mm - 820 mm)	3 1/4" (80 mm)	45.53
TBR690	536QC	36" (91 cm)	7 1/2" - 44 5/8" (195 mm - 1120 mm)	3 1/4" (80 mm)	54.66

QUICK-GRIP® ONE-HANDED MICRO BAR CLAMP/SPREADER

- One-handed Quick-Release™ trigger allows for fast and easy positioning
- Perfect size for hobby and craft applications
- Converts to a spreader by reversing the clamp pads

Model No.	Mfg. No.	Clamping Capacity	Spreading Capacity	Throat Depth	Price /Each
TBR692	53006	4 1/4" (10 cm)	8" (20 cm)	1 3/16" (30 mm)	8.05



IRWIN
QUICK-GRIP

XP™ ONE-HANDED BAR CLAMP & SPREADER

- I-beam bar resists twisting and bowing
- Power Locks™ hold better, allowing for up to 900 lbs. of force
- Quick-Change™ jaw, converts clamp to spreader quickly
- Non-marring pads grip securely
- Quick-Release™ trigger

Model No.	Mfg. No.	Clamping Capacity	Spreading Capacity	Throat Depth	Price /Each
TKZ880	2021406	6" (15 cm)	7 1/2"-14 5/8" (190 mm-371 mm)	3 1/4" (83 mm)	40.13
TKZ881	2021412	12" (30 cm)	7 1/2"-20 5/8" (190 mm-523 mm)	3 1/4" (83 mm)	44.76
TKZ882	2021418	18" (45 cm)	7 1/2"-26 5/8" (190 mm-676 mm)	3 1/4" (83 mm)	49.72
TKZ883	2021424	24" (60 cm)	7 1/2"-32 5/8" (190 mm-828 mm)	3 1/4" (83 mm)	55.56
TKZ884	2021436	36" (91 cm)	7 1/2"-44 5/8" (190 mm-1133 mm)	3 1/4" (83 mm)	66.37
TKZ885	2021450	50" (127 cm)	7 1/2"-58 5/8" (190 mm-1489 mm)	3 1/4" (83 mm)	75.66



IRWIN
QUICK-GRIP

PARALLEL JAW CLAMPS

- Deep 3 3/4" jaw depth for optimized pressure distribution
- Secure locking system prevents jaws from slipping
- ProTouch handle for an ergonomic grip
- Resin body and jaws prevents marring and glue adhesion
- Up to 1150 lbs. of pressure



IRWIN
QUICK-GRIP

Model No.	Mfg. No.	Clamping Capacity	Throat Depth"	Price /Each
TLV300	2026500	24" (60 cm)	3 3/4	65.85
TLV301	2026501	48" (115 cm)	3 3/4	79.03

QUICK-GRIP® HANDI-CLAMP®

- Quick-Release™ trigger allows for fast and easy positioning and release
- Patented ratcheting mechanism provides adjustable clamping pressure and significantly reduces hand force required to generate clamping pressure
- High-tech resin construction provides strength and durability
- Specially designed jaws hold odd-shaped workpieces

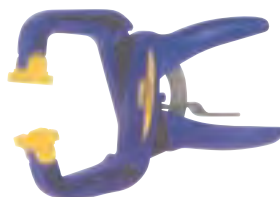

IRWIN
QUICK-GRIP

Model No.	Mfg. No.	Clamping Capacity	Spreading Capacity	Throat Depth	Price /Each
TBQ662	59100CD	1 1/2" (37 mm)	1 1/2" (37 mm)	1 1/2" (37 mm)	5.49
TBR083	59200CD	2" (50 mm)	2" (50 mm)	2" (50 mm)	10.54
TBR085	59400CD	4" (10 cm)	4" (10 cm)	3" (75 mm)	13.35

STEEL QUICK CLAMPS

- One hand mechanism for ease of clamping
- Adjustable and reversible: changes from a clamp to a spreader
- Vinyl-covered grips and tips



KGZ582

FULLER

Model No.	Mfg. No.	Clamping Capacity"	Price /Each
TGZ581	450-0101	1	1.30
TGZ582	450-0102	2	2.51
TGZ583	450-0103	3	5.00

VICES, MAGNETS & CLAMPS

QUICK-GRIP® C-CLAMPS

- Double-rolled thread for faster clamping and increased durability
- Larger handle for greater clamping pressure with less effort and reduced hand fatigue
- Larger swivel pad reduces marring on work surface and increases stability



IRWIN
QUICK-GRIP®

Model No.	Mfg. No.	Clamping Capacity	Throat Depth	Price /Each
TBR751	225101	1" (25 mm)	1 3/16" (30 mm)	2.63
TBR752	225102	2" (50 mm)	1 5/16" (33 mm)	3.77
TBR753	225103	3" (75 mm)	2 1/4" (51 mm)	7.75
TBR754	225104	4" (10 cm)	3" (75 mm)	13.91
TBR755	225106	6" (15 cm)	3 1/2" (87 mm)	21.11
TBR756	225108	8" (20 cm)	4" (10 cm)	30.33
TBQ959	225123	2" (50 mm)	3 1/2" (87 mm)	12.03
TBQ960	225134	3" (75 mm)	4 1/2" (12 cm)	17.89

ECONOMY C-CLAMPS

- Reinforced at all stress points designed to last through the toughest application
- Constructed of high quality ductile iron with a heavy-duty steel screw for maximum strength
- Fully enameled for long life



FULLER

Model No.	Mfg. No.	Max. Opening"	Throat Depth"	Price /Each
VE830*	450-0761	1	1	2.80
VE831*	450-0762	2	1 1/2	3.57
VE832	450-0772	2 1/2	2 3/8	6.21
VE833	450-0763	3	1 3/4	6.21
VE834	450-0764	4	2 3/8	12.74
VE835	450-0765	5	2 1/2	14.45
VE836	450-0766	6	2 3/4	16.36
VE837	450-0768	8	3 3/8	26.11
VE838	450-0769	2 1/2	4 3/8	10.53

* Constructed of malleable iron

C-CLAMPS

GENERAL SERVICE PATTERN

- Designed for uses which do not require the throat depth of the square or deep throat pattern

ARMSTRONG TOOLS

Model No.	Mfg. No.	Capacity"	Depth of Throat from Center of Screw"	Thread Size"	Length of Screw"	Min. Proof Test lbs.	Wt. lbs.	Price /Each
U0707	78-102	2 0	1 3/8	1/2-13	4 7/8	7500	1.26	94.36
U0708	78-103	3 0	1 3/4	5/8-11	6 3/8	8750	2.60	107.03
U0709	78-104	4 0	2	3/4-10	7 7/8	10000	4.13	122.87
U0710	78-106	6 2	2 1/4	3/4-10	7 7/8	11250	5.90	148.64
U0712	78-108	8 4	2 1/4	3/4-10	7 7/8	12500	6.90	176.41
U0714	78-110	10 6	2 3/8	3/4-10	7 7/8	13750	8.00	198.01
U0716	78-112	12 8	2 5/8	7/8-9	10 1/4	15000	11.61	225.00
U0718	78-115	15 10	2 3/4	7/8-9	10 1/4	16250	14.95	328.83
U0720	78-118	18 13	2 7/8	7/8-9	10 1/4	17500	18.21	420.16



C-CLAMPS

SQUARE THROAT PATTERN, BLACK FINISH

- Designed for those jobs where a super deep throat is required
- Square throat clamps offer up to 89% more throat depth than other patterns, but embody all the strength and durability inherent in a drop forged C-clamp

ARMSTRONG TOOLS

Model No.	Mfg. No.	Capacity"	Depth of Throat from Center of Screw"	Thread Size"	Length of Screw"	Min. Proof Test lbs.	Wt. lbs.	Price /Each
U0722	78-303	3 0	3 1/2	1/2-8	4 7/8	3500	2.52	66.01
U0723	78-304	4 0	4 1/2	3/4-6	7 5/8	4100	4.49	66.01
U0724	78-306	6 0	6 1/2	3/4-6	9 7/8	5400	8.05	100.73
U0725	78-308	8 0	8 1/2	3/4-6	12 3/8	5900	13.11	127.41



DEEP THROAT PATTERN, ZINC-PLATED

- Design and materials are exactly the same as deep throat pattern
- Forcing screw is zinc-plated to resist the adhesion of welding spatter

Model No.	Mfg. No.	Capacity"	Depth of Throat from Center of Screw"	Thread Size"	Length of Screw"	Min. Proof Test lbs.	Wt. lbs.	Price /Each
U0740	78-431	1 1/2 0	1 3/8	3/8-16	3 1/4	1400	0.37	36.04
U0741	78-432	2 0	2	1/2-8	4 3/4	3300	1.23	39.41
U0742	78-433	3 0	2 3/8	1/2-8	5 3/4	3500	2.11	47.96
U0743	78-434	4 0	2 3/4	3/4-6	7 5/8	4100	2.89	59.96
U0744	78-436	6 0	3 5/8	3/4-6	9 7/8	5400	4.83	79.23
U0745	78-438	8 0	4 1/2	3/4-6	12 3/8	5900	6.98	104.46
U0746	78-440	10 3	5 3/8	3/4-6	12 3/8	6200	9.66	133.51
U0748	78-442	12 4	5 3/4	7/8-6	13 1/2	9300	12.85	169.54



AUTO-ADJUST TOGGLE CLAMPS

- Automatically adjust to variations in work piece dimensions
- The integrated clamping force adjustment screw can be used to create an actually applied clamping force from 25 to 550 lbs. (max holding capacity of 700 lbs.)
- The large (2 1/4" x 2 1/2") flanged base is designed for use with 1/4" or M6 fasteners
- The removable non-marring plastic cap is included on the 7/8" diameter swivel pads



Model No.	Mfg. No.	Opening"	Clamping Force Range (lbs.)	Holding Capacity (lbs.)	Price /Each
HORIZONTAL TOGGLE CLAMPS					
TLV284	STC-HH50	0 - 2	25 - 550	700	25.67
TLV285	STC-HH70	0 - 2 3/4	25 - 550	700	26.79
INLINE TOGGLE CLAMPS					
TLV286	STC-IHH25	0 - 1	25 - 550	700	27.91



VERTICAL HOLD-DOWN CLAMPS

The most popular type of hold-down clamp, manufactured in capacities of up to 6000 lbs.

The hold-down bar exhibits a minimum 90° opening angle and can be solid or U-shaped.

Stainless steel units are available for the food industry or corrosive environments.

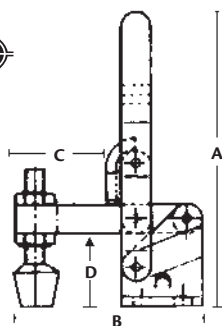

201 SERIES

The smallest vertical clamp available. U-shaped hold-down bar furnished with bonded neoprene-tipped 10-32 spindle assembly (TN140) and flanged washers (TN121).



207 SERIES

Available in solid bar model, including bolt retainer (TN141) 500-lb.-capacity. U-bar model includes two flanged washers (TN125) and accommodates 5/16" spindle (not supplied).



202 SERIES

200-lb. capacity version of 201 series. Furnished with bonded neoprene-tipped 1/4-20 spindle (TN134) lock nuts and flange washers (TN123).



210 SERIES

Heavy-duty clamp holds up to 750 lbs. U-bar model includes two flanged washers (TN124). Bolt retainer supplied with solid bar models (TN142) accommodates any 3/8" spindle (not supplied).



Model No.	Mfg. No.	Holding Cap. lbs.	Dimensions"				Base		Wt. lbs.	Price /Each
			A	B	C	D	L"	W"		
TN059	201-U	100	3 1/16	2 1/64	11/16	5/8	1	x 1 5/16	0.15	18.42
TN061	202-U	200	3 3/4	2 3/8	1	15/16	1	x 1 9/16	0.35	19.34
TN065	207-S	500	5 1/2	3 25/32	-	1 9/16	1 3/8	x 1 3/4	0.69	25.24
TN064	207-U	375	5 1/2	3 25/32	1 3/8	1 9/16	1 3/8	x 1 3/4	0.67	25.24
TN066	210-U	600	7 1/2	5 7/8	2 5/8	1 11/16	1 29/32	x 2 17/32	1.29	36.84
TN067	210-S	750	7 1/2	5 7/8	-	1 11/16	1 29/32	x 2 17/32	1.29	41.15

TOGGLE-LOCK PLUS™ LATCH CLAMPS

Feature a release lever catch accessory which allows clamps to lock in the closed position only. Supplied with latch plate and equipped with an ergonomic handle grip. Model TV727 same as model TV726 only with greater holding capacity.

Model No.	Mfg. No.	Holding Cap. lbs.	Dimensions"		Thread Adjustment"	Base			Drawing Cap."	Wt. lbs.	Price /Each
			A	B		L"	x	W"			
TV726	331-R	700	1 15/32	6 1/4	11/64	1 9/16	x	1 3/4	2	0.6	49.24
TV727	341-R	2000	2 3/4	6 1/2	9/16	2 3/8	x	2 3/8	2 1/2	0.6	64.42



Equipped with a release lever catch accessory which allow clamps to stay locked in the closed position. Large handle pad improves operation of clamp.

Model No.	Mfg. No.	Holding Cap. lbs.	Dimensions"		Thread Adjustment"	Base			Drawing Cap."	Wt. lbs.	Price /Each
			A	B		L"	x	W"			
TV728	351-R	375	1 7/16	9 11/16	5/16	1 1/2	x	1 15/16	4	0.8	40.48
TV729	371-R	750	2 1/4	13	11/16	1 15/16	x	1 15/16	5 3/8	0.6	76.05



R29491E

VICES, MAGNETS & CLAMPS

HORIZONTAL HOLD-DOWN CLAMPS

Low height design makes clamps outstanding when headroom is a concern. Unlike the handle on the vertical clamp, the horizontal clamp moves in the opposite direction. Hold down bar available in solid or U-shaped format. Some models available in stainless steel on request. Holding capacities to 500 lbs. Larger capacities available.

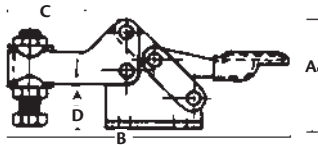

205 SERIES

The smallest clamps in the horizontal series clamps supplied with nylon spindle assembly (TN126). Flanged washers supplied with U-bar models (TN122).



305 SERIES

Feature a handle that can be operated from either side or from behind. U-bar model includes bonded neoprene-tipped spindle (TN140) and flanged washers (TN121).



215 & 225 SERIES

U-bar horizontal clamps provide greater rigidity and overall performance. The 215 Series includes a 1/4-20 bonded neoprene-tipped spindle assembly (TN134) and washers (TN123). The 225 Series includes a 5/16-18 bonded neoprene spindle assembly (TN135) and flanged washers (TN125).



Model No.	Mfg. No.	Holding Cap. lbs.	Dimensions"				Base			Wt. lbs.	Price /Each
			A	B	C	D	L"	x	W"		
TN062	205-U	60	3/4	2 21/32	3/8	5/16	15/16	x	15/16	0.06	14.26
TN063	205-S	60	3/4	2 3/4	-	3/8	15/16	x	15/16	0.06	14.26
TN068	215-U	200	1 1/2	5 7/16	1 1/4	1	1 7/16	x	1 3/8	0.32	19.20
TN069	225-U	500	1 7/8	6 19/32	1 11/32	1 3/8	1 1/2	x	1 3/8	0.55	21.93
TN070	305-U	150	1 3/8	2 1/4	1/2	1/2	1 1/32	x	1	0.13	18.15

LATCH CLAMPS

Commonly used to hold lids, molds, dies and jigs together. Completely adjustable hook grabs latch installed on material or jig to be pulled together, and holds both sides together. Clamps can be bolted or welded into place. Ideal for high vibration applications. Pull bar is threaded for easy adjustment.

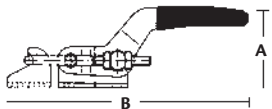

300 SERIES

The over-center toggle locking action of these clamps suits them ideally for holding against heavy forces such as those generated in plastic molding operations, clamping of doors, lids and access covers. Each clamp includes latch plate.



PLIER HOLD-DOWN CLAMPS

Quick action pliers offer excellent workholding capacity, they are portable to many applications and highly versatile. Only normal hand pressure is required to close and lock clamps in place. Clamp thickness may be adjusted by turning the threaded spindle. Once set, the clamp can be used repeatedly at that opening. Standard style clamps open by pulling handles apart. Trigger release style pull the two-way release (up and down) for easy one-handed release.

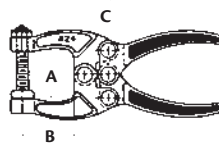

424 SERIES

Has a single 1/4-20 adjustable neoprene-tipped spindle assembly. Clamp opens by manually pulling handles apart.



462 SERIES

Two trigger release clamp includes 3/8-16 steel swivel foot adjustment spindle assembly.



STRAIGHT LINE CLAMPS

Popular in assembly operations or used in conjunction with welding jigs. Straight line clamps provide quick, strong holding force. Most clamps lock in two positions allowing them to be used as a push or pull clamp.

601, 603 & 609 SERIES

These models can be bolted or welded to a flat surface. Plungers extend out to clamp material against a fence or square surface. Model TN103 includes a 8-32 nylon spindle assembly (TN126). Model TN105 plunger is tapped for 5/16-18 adjustment spindle (not provided). Model TN107 plunger is tapped for 5/16-18 neoprene tip or other custom fixture.

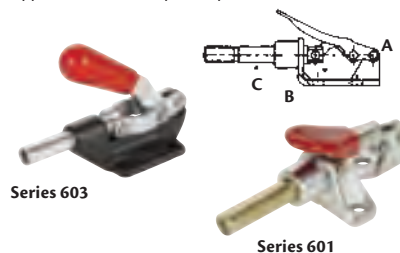

602 & 604 SERIES

Fully retractable locators mount directly through a member by a jam nut on the work side or flush by drilling and tapping the member, a flat surface is not required. Locks in extended or retracted position. When flush-mounted, plunger completely retracts from work area.

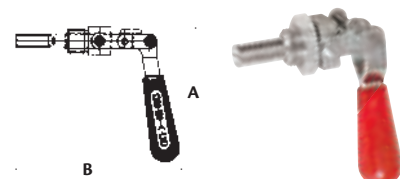

LATCH CLAMPS

Model No.	Mfg. No.	Holding Caps. lbs.	Dimensions"		Thread Adjustment"	L"	Base	Drawing	Wt. lbs.	Price /Each	
			A	B			x	W"			
TN073	323	360	15/32	3 27/32	25/32	5/8	x	1 7/64	1 3/16	0.15	20.43
TN074	324	500	15/32	3 27/32	25/32	5/8	x	1 7/64	1 1/2	0.25	30.69
TN076	331	700	1 5/8	5 5/8	1	3/4	x	1 39/64	1 1/4	0.56	27.20
TN077	341	2000	2 3/4	8 1/4	1 1/2	2 3/8	x	2 33/64	2 1/2	1.43	42.36
TN081	375	4000	4	10 3/8	1/2	3 3/8	x	3 1/8	3 1/2	2.75	95.34

PLIER CLAMPS

Model No.	Mfg. No.	Holding Cap. lbs.	Clamping Thickness" (A)	Throat Depth" (B)	Overall Length" (C)	Spindle Thread"	Wt. lbs.	Price /Each
TN097	424	200	1	1 1/8	4 1/2	1/4 x 20	0.31	28.28
TN102	462	700	1 3/4	2 3/4	8 1/2	3/8 x 16	1.13	55.26

STRAIGHT LINE CLAMPS

Model No.	Mfg. No.	Holding Cap. lbs.	Dimensions"			L"	Base	Plunger Travel"	Wt. lbs.	Price /Each	
			A	B	C		x	W"			
TN103	601	100	1 1/4	2 27/32	1/2	1 5/16	x	1 1/6	5/8	0.09	18.87
TN104	602	200	3 3/32	2 7/16	-	-	-	-	3 3/4	0.25	26.67
TN105	603	600	3 1/2	4 1/2	3 1/32	2	x	1 7/8	1 1/4	0.83	35.59
TN106	604	300	4 1/16	4 15/16	-	-	-	-	1 1/2	0.44	29.84
TN107	609	300	3 3/8	4 7/16	3 1/32	3 9/16	x	2 3/16	1 1/4	0.88	32.28



REPLACEMENT SPINDLES & ACCESSORIES

FLAT-TIP BONDED NEOPRENE CAPS

Adjustable spindles provide a cushion between clamps and clamped item. Neoprene tip resists oils and chemicals and has a durometer of 60-70 and an operating temperature of -40°F to 220°F. Each spindle includes two adjusting nuts.

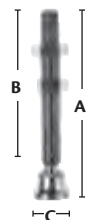

SWIVEL FOOT ADJUSTING SPINDLES

Used primarily for model TN102 plier clamp, but may be used with any clamp with the proper thread size. Steel swivel shoe provides a firm clamp and is suitable for more heavy-duty applications. Includes two adjusting nuts.

HEX HEAD ADJUSTING SPINDLES

Carbon steel fully threaded adjusting spindles are used in applications where a neoprene or swivel type spindle is not necessary. A neoprene cap foot is available for all sizes. Two adjusting nuts included.

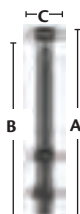

FLANGED WASHERS

Carbon steel replacements for U-bar clamps only.

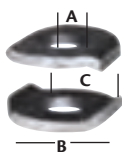

BOLT RETAINERS

Carbon steel replacements for S solid hold-down bars.



NEOPRENE CAPS

Slip-on heads of hex nut spindles, durometer 60-70 and operates between -40°F and 220°F.



Model No.	Mfg. No.	Dimensions			Thread"	Price /Each
		A"	B"	C"		
FLAT-TIP BONDED NEOPRENE CAPS						
TN140	201208	1 3/8	1	9/16	10-32	2.26
TN134	202208	1 5/8	1 1/8	5/8	1/4-20	2.70
TN135	225208	2 3/16	1 9/16	3/4	5/16-18	3.17
TN136	235208	5 1/2	4 3/4	7/8	3/8-16	5.68
TN137	424208	1 1/2	1 1/8	5/8	1/4-20	2.50
TN138	507208	3	2 1/4	3/4	5/16-18	3.22
TN139	527208	3 1/2	2 1/2	7/8	3/8-16	4.67
STEEL SWIVEL FOOT SPINDLE						
TN133	468206	3	2	5/8	3/8-16	6.37
HEX-HEAD FULL THREAD						
TN126	105203	27/32	3/4	1/4	8-32 Nylon	1.36
TN130	461203	1	13/16	1/2	5/16-18	1.81
TN129	441203	1 15/16	1 3/4	1/2	5/16-18	2.24
TN127	207203	2 3/4	2 1/2	1/2	5/16-18	1.65
TN131	491203	1 1/2	1 1/4	9/16	3/8-16	1.81
TN128	210203	3	2 3/4	9/16	3/8-16	1.81
TN132	527203	5 1/4	5	9/16	3/8-16	P.O.A.
FLANGED WASHERS (PER PAIR)						
TN122	105106	11/64	7/16	5/16	Fits Spindle #8	0.36
TN121	102111	13/64	9/16	23/64	10	0.40
TN123	215105	17/64	11/16	29/64	1/4	0.45
TN125	507107	21/64	7/8	5/8	5/16	0.49
TN124	235106	13/32	1	23/32	3/8	0.60
BOLT RETAINERS						
TN141	207105	1 1/4	5/8	21/64	Fits Spindle 5/16"	2.32
TN142	210114	1 1/2	3/4	17/32	3/8	3.42
NEOPRENE CAPS						
TN118	215119	7/16	-	5/8	Fits Spindle 1/4"	0.76
TN119	225119	1/2	-	5/8	5/16	0.83
TN120	235119	17/32	-	3/4	3/8	0.98



Call us for all your Tools & Equipment requirements!



R29493E

OFFICE PRODUCTS

INSTRUMENTS, SCALES & ELECTRICAL

SHIPPING & PACKAGING

TOOLS & EQUIPMENT

WELDING & METALWORKING

SAFETY EQUIPMENT & SUPPLIES

JANITORIAL & MAINTENANCE

MATERIAL HANDLING & STORAGE

HAND FILING TOOLS



ALUMINUM FILES - TYPE "A" FLAT

- Special tooth construction eliminates clogging when filing aluminum
- Flat shape
- Double-cut
- All sizes have same number of teeth per inch
- Smooth finish obtained by using shearing cut toward left

Nicholson®

Model No.	Mfg. No.	Length"	Price /Each
VS433	00001	6	12.02
VS434	00024	8	15.11
VS435	00047	10	17.56
VS436	00070	12	24.56



FARMER'S OWN FILES

- General purpose file suited for agricultural use
- Rectangular shape
- Single-cut
- Safe edges
- Length measured exclusive of handle
- Convenient hang up hole

Nicholson®

Model No.	Mfg. No.	Length"	Price /Each
VS465	6637	6	7.59
VS466	6649	8	10.02
TBG816	08922	8	10.06
VS467	06668	10	14.13



CHAIN SAW FILES - SPIRAL CUT (SUPERIOR)

- Round shape
- Spiral cut
- 6" file has straight tang
- Spiral cut enables more material to be removed with each stroke, reducing amount of strokes to produce raw edges
- Carded - 3 files per card

CHAIN SAW FILES - ROUND SMOOTH

- Round shape
- Smooth cut
- 6" files have a straight tang



Nicholson®

Nicholson®

Model No.	Mfg. No.	Length"	Dia."	Price /Each
TBG761	02228	8	5/32	4.19

Model No.	Mfg. No.	Length"	Dia."	Price /Each
TBG744	01590	6	1/8	3.70
TBG745	01630	6	5/32	3.70
TBG750	01891	8	5/32	3.70
TBG749	01888	8	7/32	3.70

CHAIN SAW FILES - FLAT

- Used for cutter-raker type (2 round edges) chain saw
- Rectangular shape

Nicholson®

Model No.	Mfg. No.	Code No.	Length"	Price /Each
TBG760	02215	18	8	10.29



Call us for all your
Tools & Equipment
requirements!



LONG ANGLE LATHE FILES - FINE

- Specially designed for finishing rapid stock removal on lathe work
- Rectangular shape
- Safe edges
- Cut faster than regular mill files and leave smoother finish



Nicholson®

Model No.	Mfg. No.	Length"	Price/Each
VS510	07835	8	13.90
VS511	07842	10	17.23
VS512	07851	12	23.37
VS513	07863	14	31.46

HANDY FILES

- One side is single-cut for use in tool sharpening and smoothing metal surfaces, reverse side is double-cut for general filing and rapid stock removal
- Rectangular shape
- 1 cut edge, 1 safe edge
- Length measured exclusive of handle



Nicholson®

Model No.	Mfg. No.	Length"	Price/Each
TBG796*	06601	8	11.29
TBG797	06602	8	11.27
TBG799	06686	12	15.78

*Carded

FLAT FILES

- Used by machinists, machinery builders, ship and engine builders, repairman and others who require rapid removal of metal
- Rectangular in cross section and taper slightly towards point in width
- Double-cut on sides, single-cut on edges
- American pattern, available in bastard, second and smooth-cut



Nicholson®

Length"	Bastard Cut			Second Cut			Smooth Cut		
	Model No.	Mfg. No.	Price /Each	Model No.	Mfg. No.	Price /Each	Model No.	Mfg. No.	Price /Each
4	VS468	03367	8.29	VS475	03401	8.70	VS481	03434	10.29
6	VS469	03467	8.70	VS476	03500	9.23	VS482	03533	10.96
8	VS470	03566	10.82	VS477	03599	11.90	VS483	03632	12.70
10	VS471	03665	13.37	VS478	03698	15.37	VS484	03731	16.96
12	VS472	03764	18.31	VS479	03797	20.72	VS485	03830	22.99
14	VS473	03863	25.27	VS480	03896	29.01	VS486	03929	31.83
16	VS474	03980	33.30	-	-	-	-	-	-

HALF ROUND FILES

- Used on concave, convex and flat surfaces
- Rounded on 1 side, flat on opposite
- Backs of all half-round bastard files are double-cut
- Backs of all half-round second-cut files longer than 6" are double-cut
- Backs of all 4 and 6" files are single-cut
- Backs of all half-round smooth files are single-cut
- Flat sides of all half-round files are double-cut
- Pipeliner file model QN384 is single-cut on back and flat sides



Nicholson®

Length"	Bastard Cut			Second Cut			Smooth Cut		
	Model No.	Mfg. No.	Price /Each	Model No.	Mfg. No.	Price /Each	Model No.	Mfg. No.	Price /Each
4	VS487	04695N	12.41	VS494	04729N	13.96	VS500	04762N	14.68
6	VS488	04795N	13.02	VS495	04828NN	14.02	VS501	04861NN	14.54
8	VS489	04896N	15.78	VS496	04927N	16.52	VS502	04960NN	17.70
10	VS490	04995N	19.66	VS497	05026N	21.37	VS503	05059N	22.39
12	VS491	05094N	25.27	VS498	05125N	27.46	VS504	05158N	28.93

HAND FILES

- Rectangular shape
- Double-cut
- 1 safe edge
- Same coarseness as flat files of corresponding lengths



Nicholson®

Length"	Bastard Cut			Second Cut			Smooth Cut		
	Model No.	Mfg. No.	Price /Each	Model No.	Mfg. No.	Price /Each	Model No.	Mfg. No.	Price /Each
4	TBG782	05652	6.39	TBG783	05675	9.37	-	-	-
6	TBG785	05738	9.64	TBG786	05771	10.39	TBG787	05804	10.96
8	TBG788	05853	10.70	QF890	05886	12.84	TBG789	05919	13.11
10	TBG790	05968	14.90	-	-	-	TBG791	06034	18.70
12	TBG792	06084	21.11	TBG793	06117	22.72	TBG794	06150	24.05

KNIFE FILES

- Used primarily by tool and die makers with work having acute angles
- Triangular shape
- Double-cut on sides, single-cut on sharp edge
- Knife files are supplied with safe backs



Nicholson®

Length"	Bastard Cut			Second Cut			Smooth Cut		
	Model No.	Mfg. No.	Price /Each	Model No.	Mfg. No.	Price /Each	Model No.	Mfg. No.	Price /Each
4	TBG801	06711	15.66	TBG802	06742	16.54	TBG803	06773	17.13
6	TBG804	06804	17.88	TBG805	06836	19.80	TBG806	06867	22.05
8	TBG807	06898	21.31	TBG808	06930	23.09	TBG809	06961	23.99
10	TBG810	06992	25.17	TBG811	07023	28.91	TBG812	07054	30.68
12	TBG813	07085	31.15	-	-	-	-	-	-

R15274E

HAND FILING TOOLS

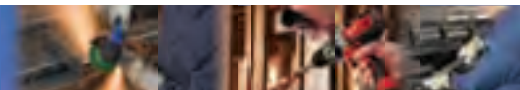

MILL FILES - 1 & 2 ROUND EDGES

- Round edges are used where rounding gullets are preferred, as compared to sharp corners or squared gullets
- Rectangular shape
- Single-cut on sides and edges
- Bastard-cut
- Same as regular mill files except they have 1 or 2 round edges

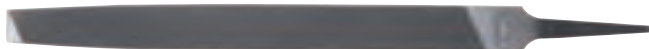

Nicholson®

Length"	One Round Edge			Two Round Edge		
	Model No.	Mfg. No.	Price /Each	Model No.	Mfg. No.	Price /Each
8	V5535	09099	10.17	TBG817	09389	11.37
10	V5536	09179	13.11	TBG818	09469	14.02
12	V5537	09227	16.05	-	-	-

MILL FILES

- Used for sharpening mill or circular saws
- Also for draw-filing and finishing metals
- Rectangular shape
- Single-cut on sides and edges
- 2 square edges
- All sizes taper slightly in width



Nicholson®

Length"	Bastard Cut			Second Cut			Smooth Cut		
	Model No.	Mfg. No.	Price /Each	Model No.	Mfg. No.	Price /Each	Model No.	Mfg. No.	Price /Each
4	V5518	8243	5.88	-	-	-	V5529	08306	8.96
6	V5519	8354	5.88	V5525	08385	8.55	V5530	08416	9.08
8	V5520	8497	7.08	V5526	08529	9.62	V5531	08560	10.70
10	V5521	8642	9.08	V5527	08673	12.29	V5532	08704	13.11
12	V5522	8737	14.82	V5528	08768	16.17	V5533	08799	17.76
12	TBH214	21842H*	16.19	-	-	-	-	-	-
14	V5523	8832	20.05	-	-	-	V5534	08894	24.58
16	V5524	8925	28.64	-	-	-	-	-	-

*Indicates ergonomic handle

MAGICUT® FILES - FLAT

- Used by machinists as all-purpose file to remove stock rapidly and to leave a smooth finish
- Tapered point in width
- File features a pattern of narrow chip breakers created by steep and angled serrations for rapid removal and smoother finish



Nicholson®

Model No.	Mfg. No.	Length"	Price/Each
V5514	07894	8	11.90
V5515	07917	10	15.37
V5516	07941	12	20.58
V5517	07965	14	27.66

SQUARE FILES

- Used on slots, keyways and general surface filing
- Square shape
- Double-cut
- Tapered slightly towards point
- Larger sizes frequently preferred to corresponding flat files because of heavier section and 4 filing surfaces



Nicholson®

Length"	Dia."	Bastard Cut			Second Cut			Smooth Cut		
		Model No.	Mfg. No.	Price /Each	Model No.	Mfg. No.	Price /Each	Model No.	Mfg. No.	Price /Each
4	5/32	V5557	12790	9.06	-	-	-	V5568	12857	10.80
6	1/4	V5558	12967	9.39	-	-	-	V5569	13033	11.37
8	5/16	V5559	13081	11.37	V5565	13114	12.90	V5570	13147	14.31
10	3/8	V5560	13196	14.84	V5566	13229	17.29	V5571	13262	18.50
12	1/2	V5561	13310	21.23	V5567	13343	23.82	V5572	13376	26.31
14	5/8	V5562	13425	28.15	-	-	-	-	-	-

ROUND FILES

- Primarily used to file circular openings or concave surfaces
- Round shape
- All 4, 5, 6, 8, 10, 12" files are single-cut
- 14" bastard file is double-cut
- Tapered slightly towards point



Nicholson®

Length"	Dia."	Bastard Cut			Second Cut			Smooth Cut		
		Model No.	Mfg. No.	Price /Each	Model No.	Mfg. No.	Price /Each	Model No.	Mfg. No.	Price /Each
4	1/8	V5538	11526N	6.57	V5545	11559NN	7.17	V5552	11592NN	7.88
5	3/16	V5539	11637N	6.57	-	-	-	-	-	-
6	1/4	V5540	11716N	6.57	V5547	11748N	7.49	V5553	11781N	8.21
8	5/16	V5541	11904	7.96	V5548	11936	9.23	V5554	11969	10.29
10	3/8	V5542	12019	10.29	V5549	12051	12.11	V5555	12084	13.37
12	1/2	TBG829	12131	14.94	-	-	-	-	-	-
12	1/2	V5543	12134	14.25	V5550	12166	16.25	V5556	12199	17.72
14	5/8	V5544	12248	20.33	-	-	-	-	-	-

TAPER FILES - REGULAR

- Triangular shape
- Edges set and cut for filing gullets between saw teeth
- Tapers slightly towards the point



Model No.	Mfg. No.	Length"	Price /Each
V5576	13807M	6	6.63
V5578	13875M	8	10.33
V5579	13930N	10	14.35

Nicholson®

TAPER FILES - SLIM

- Triangular shape
- Edges set and cut for filing gullets between saw teeth



Model No.	Mfg. No.	Length"	Price /Each
V5582	14162M	5	4.90
V5583	14224M	6	5.41
V5584	14255M	7	6.78
V5585	14290M	8	8.02
V5586	14341N	10	10.88

TAPER FILES - EXTRA SLIM

- Triangular shape
- Edges set and cut for filing gullets between saw teeth



Model No.	Mfg. No.	Length"	Price /Each
V5587	14547M	4	5.47
V5589	14599M	5	5.37
V5590	14665M	6	5.74
V5591	14698N	7	6.78
V5592	14729N	8	8.02

THREE SQUARE FILES

- For general use by machinists for filing internal angles more acute than right angles, clearing out square corners and filing taps and gutters
- Triangular shape
- Double-cut
- Sharp corners are slightly set and cut
- Cut to the point



Nicholson®

Length"	Bastard Cut			Second Cut			Smooth Cut		
	Model No.	Mfg. No.	Price /Each	Model No.	Mfg. No.	Price /Each	Model No.	Mfg. No.	Price /Each
6	TBG845	15925N	11.51	WK741	15958N	12.92	QH788	15991	13.11
8	TBG846	16036N	13.74	TBG847	16069N	15.62	QF613	16102N	16.45
10	TBG848	16147N	17.17	TBG849	16180N	18.60	TBG850	16213N	19.70

WARDING FILES

- Used primarily by locksmiths in repairing and filing ward notches in keys
- Thin rectangular shape
- Double-cut on sides, single-cut on edges
- Also suited for use in narrow spaces where other files will not fit



Nicholson®

Length"	Bastard Cut			Second Cut			Smooth Cut		
	Model No.	Mfg. No.	Price /Each	Model No.	Mfg. No.	Price /Each	Model No.	Mfg. No.	Price /Each
4	VS827	16507	10.60	VS831	16540	11.45	VS835	16573	12.51
6	VS828	16663	11.47	VS832	16696	12.96	VS836	16729	14.45
8	VS829	16761	14.45	VS833	16794	16.39	VS837	16827	18.17

CABINET RASPS

- Used by cabinetmakers and woodworkers
- Half-round
- Single-cut on edges
- Curved side of rasps similar to half-round rasps but has larger radius



Nicholson®

Regular (Second cut)			
Model No.	Mfg. No.	Length"	Price /Each
VS599	17615N	8	24.44
VS600	17683N	10	26.76
VS601	17751N	12	34.30

FARRIER RASPS - DOUBLE EXTRA THIN

- Primarily for race track and other horses with light shoes
- Both sides are safe
- Rasp teeth on one side, file teeth on opposite
- Rasp cut is 6 teeth per row (other horse rasps have 5 teeth per row)
- Rectangular shape
- 18" rasp is specially designed for draft horses
- Sharper than regular horse rasps
- Double extra thin



Nicholson®

Model No.	Mfg. No.	Length"	Price/Each
TBH198	HR14N	14	28.27
TBG863	18157N	14	31.90

PATTERN MAKER'S CABINET RASPS

- Used primarily by cabinetmakers
- Half-round shape
- Narrow pattern, cut edges
- Used when smooth wood finish is required



Nicholson®

Model No.	Mfg. No.	Length"	Code No.	Type	Price /Each
VS602	18846N	10	49	Second cut	51.20
VS603	18861N	10	50	Smooth cut	61.22

WOOD RASPS - ROUND BASTARD

- Used for same purpose as regular wood rasps in places for which their shapes make them particularly effective
- Round shape
- Bastard-cut
- Made from same size steel as round files



Nicholson®

Model No.	Mfg. No.	Length"	Dia."	Price/Each
TBG875	19846	8	5/16	17.76
TBG876	19875	10	3/8	26.48

WOOD RASPS - HALF ROUND

- Used by woodworkers, hobbyists and plumbers
- Half-round shape
- Single-cut file teeth on edge
- For use on wood and soft metals



Nicholson®

Bastard cut			
Model No.	Mfg. No.	Length"	Price /Each
TBG870	19394N	8	16.54
UQ089	19427N	10	21.21
TBG871	19460N	12	32.77
TBG872	19493N	14	42.48

7-PIECE MACHINIST FILE SET

- General purpose file kit for machine shop
- 10"/250 mm flat bastard file
- 10"/250 mm flat smooth file
- 10"/250 mm half-round bastard file
- 10"/250 mm mill bastard file
- 10"/250 mm round bastard file
- 10"/250 mm square bastard file
- 7"/175 mm slim taper file

Model No. TBG943
Mfg. No. 22024N
Price/Each \$93.56



Nicholson®

8-PIECE MACHINIST FILE SET

- 10"/250 mm mill bastard file
- 10"/250 mm half-round bastard file
- 10"/250 mm flat bastard file
- 10"/250 mm flat smooth file
- 10"/250 mm square bastard file
- 10"/250 mm round bastard file
- 7"/175 mm slim taper file
- 10"/250 mm file cleaner (card)
- Complete set of 7 files and file cleaner (card) fits easily and securely into a rugged, compact pouch

Model No. QH790
Mfg. No. 22025N
Price/Each \$116.83



Nicholson®

6-PIECE AMERICAN PATTERN FILE SET

- 4"/100 mm Warding file
- 4"/100 mm Half-Round file
- 4"/100 mm Round file,
- 4"/100 mm Hand file,
- 4"/100 mm Square file
- 4"/100 mm Slim taper file,
- All files come with handles and packed in a plastic pouch

Model No. TBG947
Mfg. No. 22062N
Price/Each \$56.43



Nicholson®

5-PIECE GENERAL PURPOSE SET

- General purpose file kit for home and professional use
- 10"/250 mm half-round bastard file
- 10"/250 mm mill bastard file
- 8"/200 mm mill bastard file
- 8"/200 mm mill smooth file
- Set of 5 files fits easily and securely into rugged, compact pouch

Model No. TBG946
Mfg. No. 22040N
Price/Each \$56.14



Nicholson®

3-PIECE ERGONOMIC FILE SET

- Rubber-coated ergonomic handles for better comfort and control
- Basic selection for home and professional use
- 6"/150 mm mill bastard file
- 6"/150 mm half-round bastard file
- 6"/150 mm round bastard file

Model No. TBH216
Mfg. No. 22015HN
Price/Each \$30.64

Nicholson®



5-PIECE ERGONOMIC FILE SET

- Rubber-coated ergonomic handles for better comfort and control
- General purpose selection for home and professional use
- 6"/150 mm slim taper file
- 8"/200 mm flat bastard file
- 8"/200 mm mill bastard file
- 10"/250 mm mill bastard file
- 10"/250 mm half-round bastard file

Model No. TBH218
Mfg. No. 22040HN
Price/Each \$61.82

Nicholson®



9-PIECE ERGONOMIC FILE SET

- Rubber-coated ergonomic handles for better comfort and control
- Broad selection for home and professional use
- 6"/150 mm XXslim taper file
- 6"/150 mm slim taper file
- 8"/200 mm half-round bastard file
- 8"/200 mm flat bastard file
- 10"/250 mm round bastard file
- 10"/250 mm half-round bastard file
- 10"/250 mm mill bastard file
- 10"/250 mm flat bastard file
- 12"/300 mm mill bastard file

Model No. TBH217
Mfg. No. 22030HN
Price/Each \$143.27

Nicholson®



3-FILE PACK

- For home and professional use
- Pack contains files for every purpose
- 6"/150 mm slim taper file
- 6"/150 mm round file
- 6"/150 mm mill bastard file
- Plastic pouch lists suggested uses for each file

Model No. TBG941
Mfg. No. 22015N
Price/Each \$21.11



Nicholson®

9-PIECE MAINTENANCE FILE SET

- For home and professional use
- 10"/250 mm flat bastard file
- 10"/250 mm flat smooth file
- 10"/250 mm mill bastard file
- 10"/250 mm half-round bastard file
- 10"/250 mm round bastard file
- 8"/200 mm flat smooth file
- 8"/200 mm half-round bastard file
- 8"/200 mm four-in-hand file
- 6"/150 mm slim taper file
- Complete set of 9 files fits easily and securely into rugged, compact pouch

Model No. TBG944
Mfg. No. 22030N
Price/Each \$130.96



Nicholson®

R32540E

FILES WITH ERGONOMIC HANDLES

- Rubber coating and rounded shape eliminates pressure points
- Flared neck, raised ribs, and wide middle section keep your hand from slipping and provides maximum comfort and control
- Rear taper allows your hand to lock securely around the handle, increasing push force
- Hang hole for easy storage

Model No.	Mfg. No.	Length"	Dia."	Price /Each
HALF ROUND				
TBH187	04798HNN	6	-	14.35
TBH210	21745HN	8	-	20.01
TBH211	21746HN	10	-	20.97

Nicholson®



Model No.	Mfg. No.	Length"	Dia."	Price /Each
SLIM TAPER				
TBH207	21729HN	6	-	7.72
HALF ROUND WOOD RASP				
TBG938	21749HN	8	-	16.33

SCREW-ON HANDLES - PLASTIC

- Screw-on design fits most popular files for professional or home handymen
- Handle made of strong high-impact material, contoured to fit hand for straight, lathe and draw filing
- Non-slip textured finish for easier grip



Nicholson®

SELECTION CHART

Item	Size	4"	5"	6"	8"	10"	12"	14"	16"
Mill	PH3	-	PH4	PH5	PH6	PH6	PH7	PH8	
Flat	PH3	-	PH4	PH5	PH6	PH6	PH7	PH8	
Hand	PH3	-	PH4	PH5	PH6	PH7	PH8	-	
Half Round	PH3	-	PH4	PH5	PH6	PH7	PH8	PH8	
Warding	PH3	-	PH4	PH4	PH5	-	-	-	
Knife	PH3	-	PH4	PH5	PH6	PH6	-	-	
Round	PH1	PH2	PH2	PH4	PH4	PH5	PH7	PH7	
Square	PH1	PH2	PH3	PH4	PH5	PH5	PH6	-	
Triangular	PH2	PH2	PH3	PH4	PH5	PH6	PH7	-	
Cantsaw	-	-	PH4	PH5	PH6	-	-	-	
Crosscut	-	-	-	PH5	PH6	-	-	-	
Tanged Horse Rasp	-	-	-	-	-	-	-	PH8	PH8
Platers Special	-	-	-	-	-	-	-	PH8	-

Model No.	Mfg. No.	Handle No.	Price /Each	Model No.	Mfg. No.	Handle No.	Price /Each
VS792	21484	PH1	4.55	VS796	21513	PH5	4.72
VS793	21493	PH2	4.55	VS797	21514	PH6	4.82
VS794	21502	PH3	4.55	VS798	21515	PH7	4.92
VS795	21512	PH4	4.67	VS799	21516	PH8	5.02

METAL FERRULED WOODEN HANDLES

- Made from close grain hardwood with nickel-plated metal ferrules
- Wax finish



Nicholson®

SELECTION CHART

Item	Size	4"	5"	6"	7"	8"	9"	10"
Taper		4	3	3	3	2	1	1
Slim		4	4	4	4	3	-	2
X Slim		4	4	4	4	4	-	-
XX Slim		-	4	4	4	4	-	-

Item	Size	8 x 3/16"	8 x 7/32"	8 x 1/4"	8 x 5/16"	8 x 3/8"
Chainsaw		4	4	4	4	3

Item	Size	4"	6"	8"	10"	12"	14"
Mill		3	2	2	0	0	00
Flat		3	2	2	0	0	00
Hand		3	2	1	1	0	-
Half Round		4	3	2	1	00	000
Warding		3	3	2	1	-	-
Knife		3	2	2	1	0	-
Round		4	4	3	3	1	0
Square		4	4	3	2	1	0
Cantsaw		-	3	2	1	-	-
Crosscut		-	-	1	0	-	-
Tanged Horse Rasp		-	-	-	-	-	000
Platers Special		-	-	-	-	-	000

Model No.	Mfg. No.	Handle No.	Size"	Price/Each
TBG897	21470	000	5 3/4 x 1 5/8	4.47
VS786	21471	00	5 3/4 x 1 5/8	4.47
VS788	21485	1	4 7/8 x 1 5/16	2.82
TBG902*	21526	1	4 7/8 x 1 5/16	2.82
VS789	21494	2	4 1/2 x 1 3/16	2.51
TBG901*	21524	2	4 1/2 x 1 3/16	2.47
VS790	21503	3	4 1/8 x 1 1/16	2.39
TBG900*	21522	3	4 1/8 x 1 1/16	2.43
VS791	21511	4	3 3/4 x 1 5/16	2.12
TBG899*	21520	4	3 3/4 x 1 5/16	2.12

*Carded

THREAD RESTORING FILES

- Used to restore damaged or worn external threads on bolts, pipes, etc.
- Each thread restoring file will work with 8 different thread sizes
- Available in 3 sizes and in a convenient 4-piece set
- Caps are colour coded
- Files are made in U.S.A.



Nicholson®

Model No.	Mfg. No.	Description	Price /Each
TBG955	33001	Regular Bolt; 11-12, 13-14, 16-18, 20-24 TPI	16.68
TBG956	33007	Ex. Fine/Ex. Coarse Bolt; 9-10, 12-16, 20-27, 28-32 TPI	16.68
TBG958	33016	Metric Bolt; 7.5-1.0, 1.25-1.5, 1.75-2.0, 2.5-3.0 mm	16.38
QG251	33024	Set of 4: 1 each of above and a #7 file, in pouch	70.90

FILE CLEANERS

- Available in two styles - file card for general cleaning of file teeth and file card/brush especially for use on finer cut files



Nicholson®

Model No.	Mfg. No.	Length"	Description	Price /Each
QG064	21458	10	File Card	14.23
YA162	21467	10	File Card and Brush	20.03

COLOUR-CODED PLASTIC SHIM STOCKS

- Precision Brand colour-coded shim is made from high quality plastic material
- Resist oil, easy to cut, minimal compression during use
- Thickness to industry standards
- Non conductive to electricity



PLASTIC SHIM STOCK COLOUR-CODED

				5" X 20"		10" x 20"	
Thickness		Qty.		Model	Price	Model	Price
Inch	cm	Pkg.	Colour	No.	/Each	No.	/Each
0.0005	0.013	5	Silver	GR434	35.13	GR451	49.98
0.0010	0.0250	5	Amber	GR435	35.13	GR452	49.98
0.0015	0.0380	5	Purple	GR436	35.13	GR453	49.98
0.0020	0.0510	5	Red	GR437	35.13	GR454	49.98
0.0030	0.0760	5	Green	GR438	35.13	GR455	49.98
0.0040	0.1020	10	Tan	GR439	75.66	GR456	124.31
0.0050	0.1270	10	Blue	GR440	75.66	GR457	124.31
0.0075	0.1910	10	Matte	GR441	75.66	GR458	124.31
0.0100	0.2540	10	Brown	GR442	81.07	GR459	148.59
0.0125	0.3180	10	Black	GR443	81.07	GR460	148.59
0.0150	0.3810	10	Pink	GR444	81.07	GR461	148.59
0.0200	0.5080	10	Yellow	GR445	86.47	GR462	172.91
0.0250	0.6350	10	White	GR446	99.96	GR463	194.52
0.0300	0.7620	10	Coral	GR447	99.96	GR464	194.52
0.0400	1.0160	3	Clear	GR448	44.58	GR465	83.47
0.0500	1.2700	3	Clear	GR449	44.58	GR466	88.35
0.0600	1.524	3	Clear	GR450	59.98	GR467	102.13

PLASTIC SHIM STOCK COLOUR-CODED ASSORTMENTS

Each assortment contains 1 each of the following: 0.0005", 0.001", 0.0015", 0.002", 0.003", 0.004", 0.005", 0.0075", 0.010", 0.015", 0.020", 0.025", 0.030"

Model No.	Description	Price/Each
GR468	5" x 20" 14 sheets	83.76
GR469	10" x 20" 14 sheets	167.51

FEELER GAGE STOCKS

- Precision Brand feeler gage is made from 1/2" wide spring steel stock, close grain C1095 high-carbon steel
- Hardened and tempered to RC 48-62
- Thickness clearly etched
- Material is ground and polished to precision tolerances
- 12 pieces per box



FEELER GAGE STOCK FLAT LENGTHS 1/2" X 12"

Model No.	Thickness	Price /Each	Model No.	Thickness	Price /Each
Inch	cm		Inch	cm	
GR470	0.0010	103.84	GR487	0.0160	39.77
GR471	0.0015	55.34	GR488	0.0170	39.77
GR472	0.0020	55.34	GR489	0.0180	39.77
GR473	0.0025	55.34	GR490	0.0190	39.77
GR474	0.0030	55.34	GR491	0.0200	39.77
GR475	0.0040	45.03	GR492	0.0210	39.77
GR476	0.0050	45.03	GR493	0.0220	39.77
GR477	0.0060	45.03	GR494	0.0230	39.77
GR478	0.0070	39.77	GR495	0.0240	39.77
GR479	0.0080	39.77	GR496	0.0250	39.77
GR480	0.0090	39.77	GR497	0.0280	39.77
GR481	0.0100	39.77	GR498	0.0300	39.77
GR482	0.0110	39.77	GR499	0.0310	41.44
GR483	0.0120	39.77	GR500	0.0320	41.44
GR484	0.0130	39.77	GR501	0.0340	41.44
GR485	0.0140	39.77	GR502	0.4000	41.53
GR486	0.0150	39.77			

STEEL FEELER GAGE ASSORTMENT

The "Big Poc-Kit" Assortment
Contains 20 Blades - 1/2" X 12" including case

Model No. GR503
Price/Each \$121.29

KEY STOCKS



ZINC PLATED

Model No.	Size"	Length"	Price /Each
GR183	3/32	12	6.90
GR184	1/8	12	2.03
GR185	5/32	12	2.57
GR186	3/16	12	2.12
GR187	7/32	12	3.21
GR188	1/4	12	2.63
GR189	9/32	12	4.10
GR190	5/16	12	3.54
GR191	3/8	12	4.32
GR192	7/16	12	5.58
GR193	1/2	12	7.11
GR194	9/16	12	13.37
GR195	5/8	12	11.29
GR196	11/16	12	19.14
GR197	3/4	12	14.73
GR198	13/16	12	27.84
GR199	7/8	12	19.64
GR200	1	12	23.93
GR201	1-1/8	12	43.58
GR202	1-3/16	12	68.27
GR203	1-1/4	12	56.34
GR204	1-3/8	12	63.32
GR205	1-1/2	12	75.64
GR206	1-3/4	12	104.18
GR207	2	12	148.80

- Steel keystock is used to provide driving torque between shafts and pulleys, gears, sprockets, etc.
- Material is high-quality, cold-drawn, low carbon C1018 steel
- Most tolerances on material are oversized to assure tight fit in keyways for positive, zero backlash power transmission
- Meets ASTM standard A-108

ZINC-PLATED KEYSTOCK TOLERANCES

Size"	Square"
3/32 - 5/8	+0.003/-0
11/16	+0.001/-0.004
3/4	+0.003/-0
13/16 - 1-1/2	+0.004/-0
1-3/4 - 2	+0.005/-0

STAINLESS STEEL

Model No.	Fraction Size"	Metric Size mm	Length"	Price /Each
GR251	1/8	3.18	12	6.05
GR252	3/16	4.76	12	6.07
GR253	1/4	6.35	12	8.71
GR254	5/16	7.94	12	17.76
GR255	3/8	9.53	12	19.73
GR256	7/16	11.11	12	27.56
GR257	1/2	12.70	12	36.22
GR258	5/8	15.88	12	58.12
GR259	3/4	19.05	12	72.07
GR260	7/8	22.23	12	103.27
GR261	1	25.40	12	131.74

STAINLESS STEEL KEYSTOCK ASSORTMENT

Model No.	Sizes"	Length"	Qty /Each	Price /Each
GR262	3/16	12	4	443.98
	1/4	12	4	
	5/16	12	4	
	3/8	12	4	
	7/16	12	4	
	1/2	12	4	

ZINC-PLATED KEYSTOCK ASSORTMENT

Model No.	Sizes"	Length"	Qty/Each	Price/Each
GR208	3/16	12	6	126.17
	5/16	12	6	
	7/16	12	4	
	1/2	12	4	

R30559E

MEASURES, RULES, SQUARES & LEVELS

SERIES 2000 MEASURING TAPES

- Ergonomic, lightweight chrome-finished case
- Bright yellow easy-to-read blade
- Quad-riveted end hook to insure long life
- Removable belt clip



Lufkin®

Model No.	Mfg. No.	Blade Width"	Length	Graduations	Stud Markings"	Price /Each	Replacement Blade
TY276	2212	1/2	12'	in/ft.	16	13.11	TJ799
TY277	2312	3/4	12'	in/ft.	16	16.69	-
TY278	2316	3/4	16'	in/ft.	16	20.71	TJ801
TY279	2325	3/4	25'	in/ft.	16	22.88	TJ802
TY280	2125	1	25'	in/ft.	16/19.2	24.26	TJ803
TY281	2130	1	30'	in/ft.	16/19.2	25.20	TJ804
TY284	2024CME	1/2	13 3/4 m	in/cm	16	13.07	-
TY285	2034CME	3/4	13 3/4 m	in/cm	16	16.62	-
TY286	2033CME	3/4	10 2/3 m	in/cm	16	14.45	-
TY287	2035CME	3/4	16 1/5 m	in/cm	16	20.62	TJ808
TY289	2048CME	1	25 7/8 m	in/cm	16/19.2	24.16	-
TY291	2410CME	1	33 1/10 m	in/cm	16/19.2	26.35	-
TY293	2335ME	3/4	16 1/5 m	in/mm	16	20.62	-
TY296	2035CM	3/4	5 m	cm	-	20.62	-

700 SERIES MAGNETIC END HOOK MEASURING TAPES

- Magnetic end hook is a time-saver for framers, HVAC installers and more
- Use for one-man measurements of steel framing and drop ceiling grids
- Powerful dual magnets can also serve as a pick-up tool
- Non-slip co-molded rubber grip
- Durable clear coat blade protection for longer blade life
- Steel reinforced end hook for longer service life
- Tough ABS case to stand up to the toughest work site



Lufkin®

Model No.	Mfg. No.	Blade Width"	Length	Graduations	Stud Markings"	Price /Each
TLZ169	L725MAG	1	25'	in/ft.	16/19.2	15.75
TLZ076	L748MAG	1	26' (8 m)	in/cm	16/19.2	15.75

FIXED TWO POINT SCRIBES

- Hardened steel needle points are fixed to knurled body
- One straight point and one 90° bent point
- 8 7/16" long



Model No. TV189
Mfg. No. 80
Price/Each \$6.23

TUNGSTEN CARBIDE SCRIBERS & MAGNETS

- Durable tungsten carbide point makes precise marks to 1/100"
- End cap magnet picks up stray metal shavings
- The point to be reversed for safe storage in pocket or toolbox
- 5 7/16" long



Model No. TV176
Mfg. No. 88CM
Price/Each \$12.28

REPLACEMENT POINT
Model No. TV177
Price/Each \$4.90

HI-VIZ® ORANGE MEASURING TAPES

- Ergonomic, high-impact case
- Easy-to-read blade
- Quad-riveted end hook to insure long life
- Cushion blade return
- Removable belt clip



Model No.	Mfg. No.	Blade Width"	Length	Graduations	Stud Markings"	Price /Each	Replacement Blade
TY303	HV1012	1/2	12'	in/ft.	16	9.32	TJ799
TY304	HV1312	3/4	12'	in/ft.	16	12.92	WJ038
TY305	HV1316	3/4	16'	in/ft.	16	15.30	TJ801
TY306	HV1325	3/4	25'	in/ft.	16	18.35	TJ802
TY307	HV1425	1	25'	in/ft.	16/19.2	19.84	TJ803
TY309	HV1433	1	33'	in/ft.	16/19.2	21.96	-
WJ199	HV1024CME	1/2	13 3/4 m	in/cm	-	9.32	-
TY313	HV1034CME	3/4	13 3/4 m	in/cm	16	12.92	-
TY314	HV1035CME	3/4	16 1/5 m	in/cm	16	15.30	TJ808
TY316	HV1048CME	1	25 7/8 m	in/cm	16	19.84	-
TY318	HV1410CME	1	33 1/10 m	in/cm	16	21.96	-

AUTOLOCK MEASURING TAPES

- 1 1/25 mm wide tape
- High visibility with rubber comfort grip
- Automatic blade lock
- Recessed lock release
- TLZ075 comes with magnetic end hook



Lufkin®

Model No.	Mfg. No.	Blade Width"	Length	Graduations	Stud Markings"	Price /Each
TJZ389	AL725	1	25'	in/ft.	16/19.2	13.45
TJZ388	AL748CME	1	26 7/8 m	in/cm	16/19.2	13.45
TLZ075	AL725MAG	1	25'	in/ft.	16/19.2	15.26

800 SERIES EXTRA-WIDE POWER RETURN MEASURING TAPES

- New blade design achieves 10' stand-out, make longer measurements
- Soft touch lock button for better feel and control
- Rubber cushion absorbs impact and improved grip
- Clear coat blade protection - more durable markings
- 4-rivet end hook - increased strength for long blade life
- Non-slip slide lock for positive blade locking
- Easy on/off belt clip for fast attachment to belt
- Orange case designed to fit your hand



Lufkin®

Model No.	Mfg. No.	Blade Width"	Length'	Graduations	Price /Each
IA627	XL8525	1 3/16	25	in/ft.	18.54

MEASURING TAPES

- Heavy-duty tape line
- Sure locking break
- Easy-to-read blade
- Four rivets holding the tip for extra security
- Composite covering for extra comfort



aurora tools®

Model No.	Blade Width"	Length'	Graduations	Price /Each
TJZ115	5/8	12	in/ft.	3.30
TJZ116	1/2	12	in/cm	3.30
TJZ117	3/4	16	in/ft.	4.40
TJZ118	3/4	16	in/cm	4.40
TJZ801	1	25	in/ft.	8.95
TJZ802	1	25	in/cm	8.95
TJZ803	1	30	in/ft.	11.60
TJZ804	1 1/4	25	in/ft.	14.10

MEASURES, RULES, SQUARES & LEVELS

LONG MEASURING TAPES

- High-visibility, high-impact case
- Easy-to-read blade
- English marking on one side, metric on the other
- Easy-wind blade return



Lufkin®

Model No.	Mfg. No.	Blade Width"	Length	Graduations	Stud Markings"	Price /Each
TY324	HV15CME	3/8	50/15 m	in/ft. - m/cm	16	23.11
TY325	HV30CME	3/8	100/30 m	in/ft. - m/cm	16	34.05

LONG STEEL MEASURING TAPES

- High-visibility, high-impact orange case
- Easy-to-read blade
- Steel tape (nominal thickness 0.022") is nylon clad for long life
- Fast-rewind blade return



Lufkin®

Model No.	Mfg. No.	Blade Width"	Length'	Graduations	Stud Markings"	Price /Each
TJ789	1806	1/2	100	in/ft.	1/8	77.34
TJ790	1806D	1/2	100	in/ft.	1/10-1/100	77.34
TJ791	1808	1/2	200	in/ft.	1/8	122.83
TJ792	1808D	1/2	200	in/ft.	1/10-1/100	122.83

SMALL MEASURING WHEELS

- Small wheel ideal for flat surfaces
- Dial indicator measures up to 999' 11" without resetting
- Telescoping handle reduces to 17" for easy storage
- Measure as fast as you can walk
- Fits in most briefcases



Lufkin®

Model No.	Mfg. No.	Measures	Graduations	Price /Each
TJ797	MW18TP	Imperial	in/ft.	59.60
TJ798	MW18M	Metric	cm/m	59.60

LARGE MEASURING WHEELS

- Large wheel ideal for rough terrain or flat surfaces
- Dial indicator measures up to 9999' 11" without resetting
- Retractable handle adjusts for user comfort
- Measure as fast as you can walk
- Rubber wheel with tough plastic hub



Lufkin®

Model No.	Mfg. No.	Measures	Graduations	Price /Each
TJ795	MW38TP	Imperial	in/ft.	122.42
TJ796	MW38M	Metric	cm/m	122.44

FIBREGLASS MEASURING TAPES

- High-visibility, high-impact case
- Easy-to-read blade
- English marking on one side, metric on the other
- Fast-rewind blade return



Lufkin®

Model No.	Mfg. No.	Blade Width"	Length	Graduations	Price /Each
TY326	HY1715CME	1/2	50/15 m	in/ft. - m/cm	20.09
TY327	HY1730CME	1/2	100/30 m	in/ft. - m/cm	26.43
TY328	HY1750CME	1/2	164/50 m	in/ft. - m/cm	35.39
TY329	HY17100CME	1/2	330/100 m	in/ft. - m/cm	72.09

EXTRA-WIDE FIBREGLASS LONG MEASURING TAPES

- Ring end hook snaps onto stake for 1-person measurements
- Standard folding end hook for general measuring needs
- 3-to-1 rewind for fast blade retraction
- 3/4" 2-sided blade is more durable; large numbers are easy to read
- Fibreglass strands and double-PVC coating for durability and strength
- Cushion grips on handle and frame arms for comfort
- Includes three interchangeable end attachments



Lufkin®

Model No.	Mfg. No.	Blade Width"	Length	Graduations	Price /Each
TLV311	PSFE100	3/4	100'	in/ft. & decimal ft.	68.72
TLV312	PSFE200	3/4	200'	in/ft. & decimal ft.	122.83
TLV313	PSFE300	3/4	300'	in/ft. & decimal ft.	146.22
TLV314	PSFM030CME	3/4	30 m/100'	in/ft. & mm/cm/m	68.72
TLV315	PSFM060CME	3/4	60 m/200'	in/ft. & mm/cm/m	122.83
TLV316	PSFM100CME	3/4	100 m/328'	in/ft. & mm/cm/m	146.22

STEEL PLUMB BOBS

- Steel plumb bobs feature a hexagonal body of cold-drawn steel with nickel plating
- Includes a 10' braided cord and a removable cap for adjusting and replacing the cord



GENERAL®

Model No.	Mfg. No.	Weight Oz.	Grams	Price /Each
TLV299	42612	5	141	9.25
TLV300	42615	8	230	9.95
TLV301	42618	12	340	12.95

STRAIT-LINE MACH 6 CHALK REELS

- 6 times faster than traditional chalk reels
- 6:1 gear ratio
- Aluminum housing with metal components
- Metal handle
- Wide pronged hook
- 100' nylon/polyester braided line
- Chalk not included

IRWIN STRAIT-LINE®

Model No.	Mfg. No.	Description	Price /Each
IA629	2031314D5	100' chalk reel	21.39
TLZ337	2031333	Replacement line only	3.72



MEASURES, RULES, SQUARES & LEVELS

ALUMINUM CARPENTER SQUARES

- Permanent 1/8" stamped graduations
- Clear (silver) anodized finish

Model No.	Size"	Material	Grad."	Price /Each
TDP689	16 x 24	Aluminum	1/8	15.56

ALUMINUM RAFTER SQUARES

- Permanent 1/8" stamped graduations include rafter square layout with tables and Essex board measure
- Clear (silver) anodized finish
- Model TDP649 is black anodized finish with yellow filled graduations

Model No.	Size"	Material	Grad."	Price /Each
TDP688	16 x 24	Aluminum	1/8	15.66
TDP649	16 x 24	Aluminum	1/8	27.11

STEEL CARPENTER SQUARES

- Permanent 1/8" stamped graduations
- Rust protective coating
- Model TDP720 version available in mm

Model No.	Size	Material	Grad.	Price /Each
TDP727	16" x 24"	Steel	1/8"	10.13
TDP720	16" x 24"	Steel	mm	10.93
	(40.64 cm x 60.96 cm)			
TDP750	8" x 12"	Steel	1/8"	6.21

DRYWALL SCORING SQUARES

- Foam-molded high impact plastic head
- Insert-molded, perforated aluminum blade to accept utility knife point for scoring drywall
- Screened increments in 1/16"
- Black thermal bonded graduations

Model No.	Size"	Grad."	Price /Each
TDP608	24	1/16	44.20

BRASS STAIR GAUGES

- Machined solid brass with knurled screws
- Furnished in pairs



Model No.	Description	Price /Each Pair
TDQ462	2/card	4.90

ALUMINUM RAFTER ANGLE SQUARES

- Solid aluminum cast body with exclusive CNC computer machined edges
- Permanent molded graduations
- Low-glare, protective powder coat finish

Model No.	Size"	Price /Each
TDP719	7	10.93

ALUMINUM RAFTER ANGLE SQUARES

- Solid aluminum cast body with exclusive CNC computer machined edges
- Permanent molded graduations
- Low-glare, protective powder coat finish

Model No.	Size"	Price /Each
TDP659	12	23.09

STRUCTO-CAST® TRY & MITRE SQUARES

- High impact plastic handle with hand grip and insert-molded blade
- Stainless steel blade with permanent stamped graduations
- Metric version - 1/8" and mm graduations

Model No.	Size"	Grad.	Price /Each
VS810	8	1/8", mm	5.72

HARDWOOD SLIDING T-BEVELS

- No. 1 select hardwood handle with routed hand grip and brass edging
- Stainless steel blade with wing-nut fastener

Model No.	Size"	Price /Each
TDP693	8	14.85

STRUCTO-CAST® SLIDING T-BEVELS

- Durable high-impact plastic handle with hand grip
- Stainless steel blade with wing-nut fastener

Model No.	Size"	Price /Each
TDP764	8	5.11

ALUMINUM ADJUST-A-SQUARE®

- Heavy-duty extruded aluminum blade with clear (silver) anodized finish
- Screened thermal bonded graduations in black
- Precision machined head and blade lock together for perfect 90°
- Head adjusts to any angle
- Folds flat for easy transport

Model No.	Size"	Grad."	Price /Each
TDP603	48	1/8, 1/16	46.21

ALUMINUM DRYWALL T-SQUARES

- Extruded aluminum blade and head with clear (silver) anodized finish
- Screened thermal bonded 1/8" graduations in black
- Exclusive designed solid four rivet construction permanently "bonds" head to blade

Model No.	Size"	Grad."	Price /Each
TDP658	47 7/8	1/8	22.09

HEAVY-DUTY ALUMINUM DRYWALL T-SQUARES

- Heavy-duty extruded aluminum blade and head with clear (silver) anodized finish
- Screened thermal bonded 1/8" graduations in black
- Exclusive designed solid four rivet construction permanently "bonds" head to blade

Model No.	Size"	Grad."	Price /Each
TDP626	53 7/8	1/8	34.15

JOHNSON

DIGITAL SLIDING T-BEVELS

- 8" stainless steel blade
- Holds and transfers angles between work pieces
- Auto shut-off feature with full LCD display
- 0.3° accuracy
- Range 0° - 360° (Resolution 0.05°)
- 3 V lithium battery (CR2032) included



Model No.	Size"	Price /Each
TLV295	8	49.50

MEASURES, RULES, SQUARES & LEVELS

ALUMINUM TORPEDO LEVELS WITH MAGNETIC BASE

- Oversized solid aluminum base
- Oversized 1/2" diameter vials are easy to read
- V-grooved base for surface leveling and tubular work
- Strong magnetic base
- Model TLV298 allows you to read slope in 1/8" increments



TLV297



TLV298

JOHNSON

Model No.	Mfg. No.	Description	Price /Each
TLV297	40-2210	10", 3 Vials Read Plumb, Level, and 45°	32.75
TLV298	40-2212	12", 4 Vials Read Plumb, Level, Multi-Pitch, and 45°	34.50

DIGITAL PRECISION PROTRACTORS

- 6" stainless steel protractor arm with knuckled locking nut
- Absolute and relative measurements
- Large, easy-to-read display
- Accuracy 0.1°
- Range 0° to 180° (Resolution 0.05°)
- 3 V lithium battery (CR2032) included



GENERAL

Model No.	Mfg. No.	Description	Price Each
TLV296	026008	Digital Protractor 1702	49.50

ALUMINUM BOX BEAMS LEVELS

- Anti-slip shock absorbing end caps
- Reinforced aluminum alloy frame
- Solid vials with permanent vial markings

JOHNSON



Model No.	Mfg. No.	Size"	Price /Each
TLZ508	40-2026	24	28.99
TLZ509	40-2028	48	49.09

ALUMINUM TOP READ LEVELS

- Durable aluminum frame
- Top reading vial window
- Easy to read cat's-eye green vials

JOHNSON



Model No.	Mfg. No.	Description	Price /Each
TLZ510	40-2050	24" level	20.60
TLZ511	40-2054	48" level	29.88
TLZ512	40-2060	24" level w/magnetic edge	23.45
VS807	40-2064	48" level w/magnetic edge	36.58

EXPANDABLE LEVELS

- Expandable 36" to 48"
- Durable aluminum frame
- Top reading vial window
- Solid, machined acrylic vials with permanent vial markings

JOHNSON



Model No.	Mfg. No.	Description	Price /Each
TLZ516	40-2048	Expandable 36" to 48"	77.97

BIG J® PROFESSIONAL ALUMINUM LEVELS

- Oversized solid aluminum frame is job site tough
- Machined working edges assure maximum accuracy
- Oversized 1/2" diameter vials are easy to read
- Quik-Change® replaceable cover plates and vials for in the field service
- Oversized top-read windows for easy viewing
- SurroundView® vial system for enhanced readability
- Oversized anti-slip/anti-shock end caps protect frame
- Rubberised cushioned hand grips

JOHNSON



Model No.	Mfg. No.	Description	Price /Each
TLZ513	40-2224	Aluminum Level 24"	39.47
TLZ514	40-2248	Aluminum Level 48"	57.19
TLZ515	40-2272	Aluminum Level 72"	98.24

Call us for all your Tools & Equipment requirements!



R34562E

OFFICE PRODUCTS

INSTRUMENTS, SCALES & ELECTRICAL

SHIPPING & PACKAGING

TOOLS & EQUIPMENT

WELDING & METALWORKING

SAFETY EQUIPMENT & SUPPLIES

JANITORIAL & MAINTENANCE

MATERIAL HANDLING & STORAGE

1359

MEASURES, RULES, SQUARES & LEVELS

HEAVY-DUTY ELEVATING TRIPODS

- Lightweight durable aluminum construction with elevating platform
- 5/8"-11 mounting screw
- Sharp pointed feet for uneven terrain
- Retractable rubber covers for slick surfaces
- Folds for easy portability
- Adjustable height ranges from 49.825" to 118.25" (126.5 cm to 300 cm)

Model No. TGZ564
Mfg. No. 40-6330
Price/Each \$310.55



ALUMINUM TRIPODS

- Lightweight durable aluminum construction
- 5/8"-11 mounting screw
- Sharp pointed feet for uneven terrain
- Retractable rubber covers for slick surfaces
- Folds for easy portability
- Adjustable height ranges from 41.75" to 67" (106 cm to 170 cm)

Model No. TGZ570
Mfg. No. 40-6340
Price/Each \$78.37



MAGNETIC TORPEDO LASER LEVELS, FLAT BOTTOM

- Built-in, rotating head changes from point to horizontal or vertical lines
- Cross-check vial for more accurate levelling
- Machined gauging edge
- Includes: Laser level, two AAA batteries and carrying case



TECHNICAL SPECIFICATIONS

Model No. TGZ561
Mfg. No. 40-6164
Laser wave length: 650 nm ± 10 nm
Laser classification: Class 111a
Accuracy: ± 1/8" @ 50' (± 1 mm @ 5 m)
Working range: Max. 100' (30 m) depending on light conditions
Working temperature: 14°F to 113°F (-10°C to 40°C)
Price/Each \$67.31

MAGNETIC TORPEDO LASER LEVELS, V-GROOVED BOTTOM

- Built-in, rotating head changes from point to horizontal or vertical lines
- Cross-check vial for more accurate levelling
- V-grooved bottom for use on pipes or conduit
- Includes: Laser level, two AAA batteries, levelling bracket, two mounting straps and carrying case



TECHNICAL SPECIFICATIONS

Model No. TGZ562
Mfg. No. 40-6174
Laser wave length: 650 nm ± 10 nm
Laser classification: Class 111A
Accuracy: ± 1/8" @ 50' (± 1 mm @ 5 m)
Working range: Max. 100' (30 m) depending on light conditions
Working temperature: 14°F to 113°F (-10°C to 40°C)
Price/Each \$94.45

LASER PLUMB BOBS

- Self-levelling plumb bob is accurate to ±1/8" @ 50'
- One button operation is fast and easy to use
- Overmolded housing helps maintain calibration under job site conditions
- Focused laser beam keeps dot small even over long distances for improved accuracy and visibility
- Locating magnets hold laser plumb bob to metal track for easy positioning
- Cross-hair beam pattern helps user find centre of beam
- Includes: Kit box



TECHNICAL SPECIFICATIONS

Model No. TSW589
Mfg. No. DW082K
Power supply: 4 AA Alkaline
Indoor visibility range: +/- 100'
Laser classification: Class II (<1 mW) @ 635 nm
Price/Each \$ 198.00



SELF LEVELLING LEVELS, PLUMBS, & SQUARE, 4-BEAM LASERS

- Self-levelling 4 beam laser is accurate to ±1/4" @ 100'
- One button operation is fast and easy to use
- Overmolded housing helps maintain calibration under job site conditions
- Focused laser beam keeps dots small even over long distances for improved accuracy and visibility
- Locating magnets hold laser to metal track for easy positioning
- Includes: Kit box



TECHNICAL SPECIFICATIONS:

Model No. TLZ507
Mfg. No. DW084K
Power Supply: 4 AA Alkaline
Indoor visibility range: +/- 100'
Laser classification: Class II (<1 mW) @ 635 nm
Price/Each \$ 529.00



SELF-LEVELLING LINE LASERS (HORIZONTAL & VERTICAL)

- Accurate to +/- 1/8" @ 30' for level applications
- Built-in magnetic pivot bracket mounts easily on metal surfaces
- Overmolded housing for job site durability
- One button operation and control panel for ease of use
- Includes: 3 AA batteries for 20+ hours run-time and kit box

TECHNICAL SPECIFICATIONS

Model No. TLZ506
Mfg. No. DW087K
Power supply: 3 AA batteries
Self-Levelling Range: 5°
Indoor visibility range: 50'
Laser classification: Class II
Price/Each \$229.00



238-PC. MASTER TOOL SETS WITH STEEL CHEST & CART

Model No. TLV423
Price/Each \$1895.00

KIT INCLUDES:

Model No.	Description	Model No.	Description
TBP314	ATB300 Tool Chest, 6 Drawer, 26" x 18" x 19"	TJZ097	Locking plier, C-Clamps w/ Swivel Pads, 11" L
TBP315	ATB300 Tool cart, 7 Drawer, 27" x 18" x 35 1/2"	TJZ100	Wrench, Adjustable, 6", w/ Composite grip
TJZ057	Screwdriver, Slot cabinet, 1/8" Tip, 3" Shank	TJZ101	Wrench, Adjustable, 8", w/ Composite grip
TJZ058	Screwdriver, Slot cabinet, 3/16" Tip, 4" Shank	TJZ102	Wrench, Adjustable, 10", w/ Composite grip
TJZ059	Screwdriver, Slot cabinet, 3/16" Tip, 6" Shank	TJZ103	Wrench, Adjustable, 12", w/ Composite grip
TJZ060	Screwdriver, Slot mechanics, 1/4" Tip, 1-1/2" Stubby shank	TJZ104	Wrench, Adjustable, 15"
TJZ061	Screwdriver, Slot mechanics, 1/4" Tip, 4" Shank	TJZ105	Wrench, Adjustable, 18"
TJZ062	Screwdriver, Slot mechanics, 1/4" Tip, 5" Shank	TJZ108	Wrench, Straight pipe, 12", 2" Pipe capacity
TJZ063	Screwdriver, Slot mechanics, 1/4" Tip, 6" Shank	TLV055	Aurora 14-pc. SAE Wrench set with pouch
TJZ064	Screwdriver, Slot mechanics, 5/16" Tip, 6" Shank	TLV056	Aurora 14-pc. Metric Wrench set with pouch
TJZ065	Screwdriver, Slot mechanics, 3/8" Tip, 8" Shank	TLV356	Socket set, 22-pc., 1/4" Drive SAE
TJZ066	Screwdriver, Phillips, #0 Tip, 2-1/2" Shank	TLV357	Socket set, 20-pc., 3/8" Drive SAE
TJZ067	Screwdriver, Phillips, #1 Tip, 3-1/4" Shank	TLV358	Socket set, 24-pc., 3/8" Drive Metric
TJZ068	Screwdriver, Phillips, #2 Tip, 4" Shank	TLV359	Socket Set, 29-pc., 1/2" Drive SAE/Metric
TJZ069	Screwdriver, Phillips, #2 Tip, 1-1/2" Stubby shank	TLZ420	Cold chisel set, 6-pc.
TJZ070	Screwdriver, Phillips, #3 Tip, 6" Shank	TLZ421	Pin punch set, 7-pc.
TJZ071	Screwdriver, Square, #0 Tip, 4" Shank	TLZ422	Draft Punch set, 7-pc.
TJZ072	Screwdriver, Square, #1 Tip, 4" Shank	TLZ423	Centre punch set, 5-pc.
TJZ073	Screwdriver, Square, #2 Tip, 6" Shank	TJZ030	Hacksaw frame, Standard, Adjustable 10" to 12"
TJZ074	Screwdriver, Square, #3 Tip, 6" Shank	TJZ047	Action bar, 1-3/8" x 1/4" x 13-1/2"
TJZ075	Screwdriver, Square, #1 Tip, 1-1/2" Stubby shank	PE812	Utility knife, H-D, w/ Auto Reload, Snap-off blades
TJZ076	Screwdriver, Square, #2 Tip, 1-1/2" Stubby shank	TJZ033	Hammer, Hickory handle, 16-oz., Claw
TJZ077	Screwdriver, Square, #3 Tip, 1-1/2" Stubby shank	TJZ034	Hammer, Hickory handle, 22-oz., Framing
TJZ078	Plier, Slip joint, 6" L	TJZ035	Hammer, Dead blow, 8-oz.
TJZ079	Plier, Groove joint, 8" L	TJZ036	Hammer, Dead blow, 16-oz.
TJZ080	Plier, Groove joint, 10" L	TJZ037	Hammer, Dead blow, 24-oz.
TJZ082	Plier, Diagonal cutting, 5" L	TJZ038	Hammer, Dead blow, 32-oz.
TJZ083	Plier, Diagonal cutting, 6" L	TJZ039	Hammer, Ball Peen, 8-oz.
TJZ084	Plier, Diagonal cutting, 7" L	TJZ040	Hammer, Ball Peen, 16-oz.
TJZ085	Plier, Long nose cutting, 5" L	TJZ041	Hammer, Ball Peen, 24-oz.
TJZ086	Plier, Long nose cutting, 6" L	TJZ042	Hammer, Ball Peen, 32-oz.
TJZ087	Plier, Long nose cutting, 8" L	TJZ043	Mallet, 16-oz., Black
TJZ088	Plier, Linesman cutting, 7" L	TJZ044	Mallet, 32-oz., Black
TJZ089	Plier, Linesman cutting, 8" L	TJZ052	Hex keys, SAE Short arm, 13 Keys, 0.050" - 3/8"
TJZ090	Locking plier, Curved jaw w/ wire cutter, 4" L	TJZ053	Hex keys, Metric Short arm, 9 Keys
TJZ091	Locking plier, Curved jaw w/ wire cutter, 5" L	TJZ801	Measuring tape, HD, 1" W x 25' L, in/ft, Composite grip
TJZ092	Locking plier, Curved jaw w/ wire cutter, 7" L	TJZ802	Measuring tape, HD, 1" W x 25' L, in/cm, Composite grip
TJZ093	Locking plier, Curved jaw w/ wire cutter, 10" L	TJZ861	Digital Caliper, Stainless steel, 8"
TJZ094	Locking plier, Long nose w/ wire cutter, 4" L	AD084	Mini grease gun, Push type, 80CC
TJZ095	Locking plier, Long nose w/ wire cutter, 6" L		
TJZ096	Locking plier, C-Clamps w/ Swivel Pads, 6" L		



17-PC. BASIC TOOL KITS

Model No. TLV075
Price/Each \$115.00

KIT INCLUDES:

Model No.	Description
TJZ062	1/4" Slot screwdriver
TJZ068	#2 Phillips screwdriver
TJZ073	#2 Robertson screwdriver
TJZ033	Hammer, 16-oz. claw
TJZ079	Groove joint pliers
TJZ083	Diagonal cutting pliers
TJZ086	Long nose pliers
TJZ092	Locking pliers
TJZ095	Long nose Locking pliers
TJZ117	Measuring tape
TJZ115	Tool box
PE549	Utility knife
TJZ102	Adjustable combo Wrench
TJZ060	1/4" Stubby Slot screwdriver
TJZ069	#2 Stubby Phillips screwdriver
TJZ076	#2 Stubby Robertson screwdriver
TJZ075	#1 Stubby Robertson screwdriver



R33901E

TOOL KITS

70-PC. STARTER TOOL SETS WITH STEEL CHEST

Model No. TLV421
Price/Each \$520.00

KIT INCLUDES:

Model No.	Description
TEP312	ATB300 Tool Chest, 4 Drawer, 26" x 12" x 14 1/2"
TJZ040	Hammer, Ball Peen, 16-oz.
TJZ036	Hammer, Dead blow, 16-oz.
TJZ033	Hammer, Hickory handle, 16-oz., Claw
TJZ078	Plier, Slip joint, Blacknickel finish, 6" L
TJZ079	Plier, Groove joint, 8" L
TJZ084	Plier, Diagonal cutting, 7" L
TJZ086	Plier, Long nose, Cutting, 6" L
TJZ088	Plier, Linesman cutting, 7" L
TJZ092	Locking plier, Curved jaw w/ wire cutter, 7" L
TLZ417	Centre punch, 5/32" x 5" L
TLZ418	Centre punch, 1/4" x 6" L
TLZ403	Pin punch 1/8" x 4-3/4" L
TLZ405	Pin punch 3/16" x 5-1/4" L
TLZ397	Cold chisel, 3/8" x 5 1/2" L
TLZ398	Cold chisel, 1/2" x 6" L
TLZ400	Cold chisel, 3/4" x 7" L
TLZ412	Drift punch 1/4" x 12" L
TJZ072	Screwdriver, Square, #1 Tip, 4" Shank
TJZ073	Screwdriver, Square, #2 Tip, 6" Shank
TJZ067	Screwdriver, Phillips, #1 Tip, 3-1/4" Shank
TJZ068	Screwdriver, Phillips, #2 Tip, 4" Shank
TJZ057	Screwdriver, Slot cabinet, 1/8" Tip, 3" Shank
TJZ061	Screwdriver, Slot mechanics, 1/4" Tip, 4" Shank
TJZ064	Screwdriver, Slot mechanics, 5/16" Tip, 6" Shank
TJZ101	Wrench, Adjustable, 8", Composite grip
TJZ103	Wrench, Adjustable, 12", Composite grip
TJZ054	Hex keys, SAE, Composite grip fold-up, 9 Keys
TLV055	Aurora 14-pc. SAE Wrench Set with pouch
TLV357	Socket set, 20-pc., 3/8" Drive SAE

aurora tools



118-PC. PROFESSIONAL TOOL KITS

Model No. TLZ460
Price/Each \$510.00



aurora tools

KIT INCLUDES:

Model No.	Description
PE812	Utility knife
TJZ030	Hacksaw
TJZ033	Hammer
TJZ041	Pein Hammer
TJZ047	Action bar
TJZ078	Split joint pliers
TJZ080	Groove joint pliers
TJZ084	Diagonal cutting pliers
TJZ087	Long nose pliers
TJZ089	Linesman pliers
TJZ093	Locking pliers
TJZ095	Long nose Locking pliers
TJZ102	Adjustable Wrench
TLZ119	Tool box
TJZ801	Measuring tape
TLV053	SAE combo Wrench set
TLV054	Metric Wrench set
TLV357	20-pc. SAE socket set
TLV358	24-pc. metric socket set
TJZ861	Caliper
TJZ052	SAE hex key set
TJZ053	Metric hex key set
TJZ057	1/8" Slot screwdriver
TJZ058	3/16" Slot screwdriver
TJZ060	1/4" Stubby Slot screwdriver
TJZ061	1/4" Slot screwdriver
TJZ064	5/16" Slot screwdriver
TJZ065	3/8" Slot screwdriver
TJZ066	#0 Phillips screwdriver
TJZ067	#1 Phillips screwdriver
TJZ068	#2 Phillips screwdriver
TJZ069	#2 Stubby Phillips screwdriver
TJZ070	#3 Phillips screwdriver
TJZ071	#0 Robertson screwdriver
TJZ072	#1 Robertson screwdriver
TJZ073	#2 Robertson screwdriver
TJZ074	#3 Robertson screwdriver
TJZ076	#2 Stubby Robertson screwdriver
SA0051	Work gloves
SAP877	Glasses

86-PC. TRADESMAN TOOL KITS

Model No. TLV076
Price/Each \$355.00

aurora tools

KIT INCLUDES:

Model No.	Description
PE812	Utility knife
TJZ030	Hacksaw
TJZ033	Hammer, 16-oz. claw
TJZ036	Dead blow Hammer
TJZ052	Hex keys, SAE
TJZ053	Hex keys, metric
TJZ078	Split joint pliers
TJZ080	Groove joint pliers
TJZ084	Diagonal cutting pliers
TJZ087	Long nose pliers
TJZ089	Linesman pliers
TJZ093	Locking pliers
TJZ095	Long nose Locking pliers
TJZ102	Adjustable combo Wrench
TJZ801	Measuring tape
TJZ057	1/8" Slot screwdriver
TJZ058	3/16" Slot screwdriver
TJZ060	1/4" Stubby Slot screwdriver
TJZ061	1/4" Slot screwdriver
TJZ064	5/16" Slot screwdriver
TJZ065	3/8" Slot screwdriver
TJZ066	#0 Phillips screwdriver
TJZ067	#1 Phillips screwdriver
TJZ068	#2 Phillips screwdriver
TJZ069	#2 Stubby Phillips screwdriver
TJZ070	#3 Phillips screwdriver
TJZ071	#0 Robertson screwdriver
TJZ072	#1 Robertson screwdriver
TJZ073	#2 Robertson screwdriver
TJZ074	#3 Robertson screwdriver
TJZ076	#2 Stubby Robertson screwdriver
TLV053	11-pc. SAE Wrench set
TLV357	20-pc. 3/8" SAE socket set
SA0051	Gloves
SAP877	Glasses
TJZ047	Action bar
TLZ119	Tool box



40-PC. MAINTENANCE TOOL KITS

Model No. TLZ459
Price/Each \$185.00

aurora tools

KIT INCLUDES:

Model No.	Description
PE549	Utility knife
TJZ030	Hacksaw
TJZ033	Hammer
TJZ043	Rubber mallet
TJZ054	Hex key set
TJZ080	Groove joint pliers
TJZ083	Diagonal cutting pliers
TJZ086	Long nose cutting pliers
TJZ092	Curved jaw Locking pliers
TJZ095	Long nose Locking pliers
TJZ102	Adjustable Wrench
TJZ117	Measuring tape
TJZ115	Tool box
TJZ057	1/8" Slot screwdriver
TJZ061	1/4" Slot screwdriver
TJZ064	5/16" Slot screwdriver
TJZ067	#1 Phillips screwdriver
TJZ068	#2 Phillips screwdriver
TJZ072	#1 Robertson screwdriver
TJZ073	#2 Robertson screwdriver
TLV053	SAE combo Wrench set
SAN638	Work gloves



RG3903E

TOOL KITS

112-PC. INTERMEDIATE TOOL SETS WITH STEEL CHEST

Model No. TLV422
Price/Each \$875.00

KIT INCLUDES:

Model No.	Description
TEP315	ATB300 Tool cart, 7 Drawer, 27" x 18" x 35 1/2"
TJZ057	Screwdriver, Slot cabinet, 1/8" Tip, 3" Shank
TJZ058	Screwdriver, Slot cabinet, 3/16" Tip, 4" Shank
TJZ060	Screwdriver, Slot mechanics, 1/4" Tip, 1-1/2" Stubby shank
TJZ061	Screwdriver, Slot mechanics, 1/4" Tip, 4" Shank
TJZ064	Screwdriver, Slot mechanics, 5/16" Tip, 6" Shank
TJZ065	Screwdriver, Slot mechanics, 3/8" Tip, 8" Shank
TJZ066	Screwdriver, Phillips, #0 Tip, 2-1/2" Shank
TJZ067	Screwdriver, Phillips, #1 Tip, 3-1/4" Shank
TJZ068	Screwdriver, Phillips, #2 Tip, 4" Shank
TJZ069	Screwdriver, Phillips, #2 Tip, 1-1/2" Stubby shank
TJZ070	Screwdriver, Phillips, #3 Tip, 6" Shank
TJZ071	Screwdriver, Square, #0 Tip, 4" Shank
TJZ072	Screwdriver, Square, #1 Tip, 4" Shank
TJZ073	Screwdriver, Square, #2 Tip, 6" Shank
TJZ074	Screwdriver, Square, #3 Tip, 6" Shank
TJZ076	Screwdriver, Square, #2 Tip, 1-1/2" Stubby shank
TJZ078	Plier, Slip joint, 6" L
TJZ079	Plier, Groove joint, 8" L
TJZ082	Plier, Diagonal cutting, 5" L
TJZ084	Plier, Diagonal cutting, 7" L
TJZ085	Plier, Long nose cutting, 5" L
TJZ087	Plier, Long nose cutting, 8" L
TJZ089	Plier, Linesman Cutting, 8" L
TJZ091	Locking plier, Curved jaw w/ wire cutter, 5" L
TJZ093	Locking plier, Curved jaw w/ wire cutter, 10" L
TJZ095	Locking plier, Long nose w/ wire cutter, 6" L
TJZ097	Locking plier, C-Clamps w/ Swivel Pads, 11" L
TJZ100	Wrench, Adjustable, 6", w/ Composite grip
TJZ103	Wrench, Adjustable, 12", w/ Composite grip
TLV053	Aurora 11-pc. SAE Wrench Set with pouch
TLV054	Aurora 11-pc. Metric Wrench Set with pouch
TLV360	Socket Set, 41-pc., 1/4" & 3/8" Drive SAE/Metric
TLZ396	Cold chisel, 5/16" x 5" L
TLZ398	Cold chisel, 1/2" x 6" L
TLZ400	Cold chisel, 3/4" x 7" L
TLZ417	Centre punch, 5/32" x 5" L
TLZ415	Centre punch, 5/64" x 3 1/2" L
TLZ419	Centre punch, 3/8" x 6 1/4" L
TLZ402	Pin punch 3/32" x 4-1/2" L
TLZ405	Pin punch 3/16" x 5-1/4" L
TLZ403	Pin punch 1/8" x 4-3/4" L
TJZ030	Hacksaw frame, Standard, Adjustable 10" to 12"
TJZ047	Action bar, 1-3/8" x 1/4" x 13-1/2"
PE812	Utility knife, H-D, w/ auto reload, Snap-off blades
TJZ033	Hammer, Hickory handle, 16-oz., Claw
TJZ036	Hammer, Dead blow, 16-oz.
TJZ038	Hammer, Dead blow, 32-oz.
TJZ040	Hammer, Ball Peen, 16-oz.
TJZ042	Hammer, Ball Peen, 32-oz.
TJZ052	Hex keys, SAE Short arm, 13 Keys, 0.050" - 3/8"
TJZ801	Measuring tape, HD, 1" W x 25' L, in/ft, Composite grip



aurora tools[®]

aurora tools[®]

The best value in industrial tools . . . period

41-PC. 1/4" & 3/8" DRIVE SAE/METRIC SOCKET SETS

- Chrome vanadium steel for extra strength and durability
- Ratchet with contoured handle for comfort and added torque
- Chrome-plated sockets to resist rust
- 6-point sockets for a snug fit
- Laser-marked socket size on each socket for easy identification

aurora tools®



SET INCLUDES:

- 19 1/4" standard sockets:** 3/16", 7/32", 1/4", 9/32", 5/16", 11/32", 3/8", 7/16", 1/2", 4, 4.5, 5, 6, 7, 8, 9, 10, 11, 12 mm
- 16 3/8" standard sockets:** 3/8", 7/16", 1/2", 9/16", 5/8", 11/16", 3/4", 13/16", 10, 11, 12, 13, 14, 15, 17, 19 mm
- 6 accessories:** Quick release ratchet 3/8" drive
Extensions 3/8" drive: 3" and 6"
Universal joint 3/8" drive
3/8" drive adapter (3/8" F x 1/4" M)
Plastic handle driver 1/4"

Model No. TLV360
Price/Each \$102.00

120-PC. 1/4", 3/8", & 1/2" DRIVE SAE/METRIC SOCKET & WRENCH SETS

aurora tools®



SET INCLUDES:

- 20 1/4" standard sockets:** 5/32", 3/16", 7/32", 1/4", 9/32", 5/16", 11/32", 3/8", 7/16", 1/2", 4, 5, 6, 7, 8, 9, 10, 11, 12, 13 mm
- 20 3/8" standard sockets:** 3/8", 7/16", 1/2", 9/16", 5/8", 11/16", 3/4", 13/16", 7/8", 9, 10, 11, 12, 13, 14, 15, 16, 17, 18, 19 mm
- 11 1/2" standard sockets:** 15/16", 1", 1 1/16", 1 1/4", 20, 21, 22, 24, 27, 30, 32 mm
- 4 1/4" deep sockets:** 8, 9, 10, 11 mm
- 4 3/8" deep sockets:** 13, 14, 15, 17 mm
- 8 3/8" Torx sockets:** E8, E10, E11, E12, E14, E16, E18, E20
- 4 1/2" impact sockets:** 17, 19, 21, 24 mm
- 7 1/4" Torx bits:** T10, T15, T20, T25, T27, T30, T40
- 17 3/8" bit sockets:** Torx: T20, T30, T40, T45, T50, T55, T60
Hex: 3, 4, 5, 6mm
Phillips: #1, #2
Slotted: 5.5, 6.5mm
Square: #1, #2
- 23 accessories:** Quick release ratchet 1/4", 3/8" and 1/2"
Spark plug socket 3/8" drive: 16, 21 mm
Universal joint 1/4", 3/8", 1/2"
Extension 1/4" drive: 2"
Extension 3/8" drive: 3" and 6"
Extension 1/2" drive: 5" and 10"
Plastic handle driver 1/4" drive
Bit adapter 1/4" drive
Combination wrench: 8, 9, 10, 11, 12, 13, 14, 17, 18, 19 mm

Model No. TLV361
Price/Each \$265.00

210-PC. 1/4", 3/8", & 1/2" DRIVE SAE/METRIC SOCKET & WRENCH SETS

- Chrome vanadium steel for extra strength and durability
- Ratchet with contoured handle for comfort and added torque
- Chrome-plated sockets to resist rust
- 6-point sockets for a snug fit
- Laser-marked socket size on each socket for easy identification

aurora tools®



SET INCLUDES:

- 24 1/4" standard sockets:** 5/32", 3/16", 7/32", 1/4", 9/32", 5/16", 11/32", 3/8", 7/16", 1/2", 9/16", 4, 4.5, 5, 6, 6.5", 7, 8, 9, 10, 11, 12, 13, 14 mm
- 25 3/8" standard sockets:** 1/4", 9/32", 5/16", 11/32", 3/8", 7/16", 1/2", 9/16", 5/8", 11/16", 3/4", 6, 7, 8, 9, 10, 11, 12, 13, 14, 15, 16, 17, 18, 19 mm
- 27 1/2" standard sockets:** 5/16", 3/8", 7/16", 1/2", 9/16", 5/8", 11/16", 3/4", 7/8", 1", 8, 9, 10, 11, 12, 13, 14, 15, 16, 17, 18, 19, 20, 21, 22, 23, 24 mm
- 15 1/4" deep sockets:** 1/4", 5/16", 3/8", 7/16", 1/2", 9/16", 6, 7, 8, 9, 10, 11, 12, 13, 14 mm
- 20 3/8" deep sockets:** 5/16", 3/8", 7/16", 1/2", 9/16", 5/8", 11/16", 3/4", 8, 9, 10, 11, 12, 13, 14, 15, 16, 17, 18, 19 mm
- 21 1/2" deep sockets:** 5/16", 3/8", 7/16", 1/2", 5/8", 9/16", 11/16", 3/4", 13/16", 7/8", 10, 11, 12, 13, 14, 16, 17, 19, 20, 21, 22 mm
- 30 1/4" shank bits:** Phillips: #0, 1, 2, 3
Slotted: 3, 4, 5, 6, 7, 8 mm
Pozidriv: #0, 1, 2, 3
Hex: 2, 3, 4, 5, 6, 8 mm
Torx: T8, T10, T15, T20, T25, T27, T30
Square: #1, 2, 3
- 12 8 mm shank bits:** Phillips: #3, 4
Pozidriv: #3, 4
Hex: 8, 10, 12, 14 mm
Torx: T40, T45, T50, T55
- 34 accessories:** Quick release ratchet 1/4", 3/8" and 1/2"
Spark plug socket 1/2" drive: 16, 21 mm
Universal joint 1/4", 3/8", 1/2"
Extension 1/4" drive: 2", 4"
Extension 3/8" drive: 3" and 6"
Extension 1/2" drive: 5" and 10"
Plastic handle driver 1/4" drive
Sliding T-bar: 1/4" and 3/8"
3-Way adapter (3/8" F x 1/2" M)
Bit adapter 1/4" drive
Bit adapter 1/2" drive
Combination wrench: 8, 10, 11, 13, 14, 16, 18, 19 mm
5/16", 3/8", 7/16", 1/2", 9/16", 5/8", 11/16", 3/4"

Model No. TLV362
Price/Each \$435.00

R83912E

SOCKET SETS



SOCKET SETS

- Chrome vanadium steel for extra strength and durability
- Ratchet with contoured handle for comfort and added torque
- Chrome-plated sockets to resist rust
- 6-point sockets for a snug fit
- Laser-marked socket size on each socket for easy identification

aurora tools

22-PC. 1/4" DRIVE SAE SOCKET SETS

SET INCLUDES:

9 standard sockets: 3/16", 7/32", 1/4", 9/32", 5/16", 11/32", 3/8", 7/16", 1/2"

7 deep sockets: 1/4", 9/32", 5/16", 11/32", 3/8", 7/16", 1/2"

6 accessories: Quick release ratchet
Extensions: 2" and 6"
Universal joint
Drive palm ratchet
Plastic handle driver

Model No. TLV356
Price/Each \$61.10



20-PC. 3/8" DRIVE SAE SOCKET SETS

SET INCLUDES:

9 standard sockets: 3/8", 7/16", 1/2", 9/16", 5/8", 11/16", 3/4", 13/16", 7/8"

8 deep sockets: 3/8", 7/16", 1/2", 9/16", 5/8", 11/16", 3/4", 13/16"

3 accessories: Quick release ratchet
Extensions: 2" and 3"

Model No. TLV357
Price/Each \$68.30



24-PC. 3/8" DRIVE METRIC SOCKET SETS

SET INCLUDES:

13 standard sockets: 7, 8, 9, 10, 11, 12, 13, 14, 15, 16, 17, 18, 19 mm

8 deep sockets: 10, 11, 12, 13, 14, 15, 17, 19 mm

3 accessories: Spark plug socket 16 mm
Ratchet
3" extension

Model No. TLV358
Price/Each \$65.25



29-PC. 1/2" DRIVE SAE/METRIC SOCKET SETS

SET INCLUDES:

24 standard sockets: 3/8", 7/16", 1/2", 9/16", 5/8", 11/16", 3/4", 13/16", 7/8", 15/16", 1" 9, 10, 11, 12, 13, 14, 15, 16, 17, 18, 19, 20, 21 mm

5 accessories: Quick release ratchet
Extensions: 5" and 10"
Universal joint
3/8" drive adapter
(3/8" F x 1/2" M)

Model No. TLV359
Price/Each \$118.00



3/8" DRIVE METRIC SOCKET SETS

- Includes steel case

Model No. TI997
Price/Each \$341.70



ARMSTRONG TOOLS

SET INCLUDES:

Model No.	Mfg. No.	Size mm
12-POINT STANDARD LENGTH		
T1937	38-108	8
T1938	38-109	9
T1939	38-110	10
T1940	38-111	11
T1941	38-112	12
T1942	38-113	13
T1943	38-114	14
T1944	38-115	15
T1945	38-116	16
T1946	38-117	17
T1947	38-118	18
T1948	38-119	19

Model No.	Mfg. No.	Size mm
12-POINT DEEP LENGTH		
T1949	38-308	8
T1950	38-309	9
T1951	38-310	10
T1952	38-311	11
T1953	38-312	12
T1954	38-313	13
T1955	38-314	14
T1956	38-315	15
T1957	38-316	16
T1958	38-317	17
T1959	38-318	18
T1960	38-319	19

DRIVE TOOLS

Model No.	Mfg. No.	Description
T1961	11-918	Hinge Handle
T1962	11-922	Extension 3"
T1963	11-923	Extension 6"
T1965	11-947	Universal Joint
T1966	11-972	Ratchet 7 1/2"

3/8" DRIVE S.A.E. SOCKET SETS

- Includes steel case

Model No. WJ151
Price/Each \$552.75



ARMSTRONG TOOLS

SET INCLUDES:

Model No.	Mfg. No.	Size "
12-POINT STANDARD LENGTH		
T1969	11-112	3/8
T1970	11-114	7/16
T1971	11-116	1/2
T1972	11-118	9/16
T1973	11-120	5/8
T1974	11-122	11/16
T1975	11-124	3/4
T1976	11-126	13/16
T1977	11-128	7/8
8-POINT SOCKETS		
UM143	11-408	1/4
UM145	11-410	5/16
UM146	11-412	3/8

Model No.	Mfg. No.	Size "
12-POINT DEEP LENGTH		
T1978	11-312	3/8
T1979	11-314	7/16
T1980	11-316	1/2
T1981	11-318	9/16
T1982	11-320	5/8
T1983	11-322	11/16
T1984	11-324	3/4
T1985	11-326	13/16
T1986	11-328	7/8
12-POINT FLEX SOCKETS		
T1988	11-514	7/16
T1989	11-516	1/2
T1990	11-518	9/16
T1991	11-520	5/8
T1993	11-524	3/4

DRIVE TOOLS

Model No.	Mfg. No.	Description
T1961	11-918	Hinge Handle
T1962	11-922	Extension 3"
T1963	11-923	Extension 6"
T1964	11-927	Extension 12"

Model No.	Mfg. No.	Description
T1965	11-947	Universal Joint
T1996	11-935	Speed Handle
T1966	11-972	Ratchet 7 1/2"

3/8" DRIVE S.A.E. HEX BIT SETS

- Standard length
- Includes socket bar and clips

Model No. VE003
Price/Each \$101.08

Model No.	Mfg. No.	Size"
VE012	11-708	1/8
VE013	11-710	5/32
VE014	11-711	3/16
VE015	11-712	7/32
VE016	11-713	1/4
VE017	11-714	5/16
VE018	11-715	3/8



1/2" DRIVE METRIC HEX BIT SETS

- Standard length
- Includes socket bar and clips

Model No. VE004
Price/Each \$135.09

Model No.	Mfg. No.	Size mm
VE019	39-711	6
VE020	39-713	8
VE021	39-715	10
VE022	39-717	12
VE023	39-719	14
VE024	39-722	17



1/2" DRIVE S.A.E. HEX BIT SETS

- Standard length
- Includes socket bar and clips

Model No. VE005
Price/Each \$158.16

Model No.	Mfg. No.	Size"
VE025	12-713	1/4
VE026	12-714	5/16
VE027	12-715	3/8
VE028	12-716	7/16
VE029	12-717	1/2
VE030	12-718	9/16
VE031	12-719	5/8



1/2" DRIVE METRIC SOCKET SETS

- Includes steel case

Model No. TDR171
Price/Each \$593.96



ARMSTRONG TOOLS

SET INCLUDES:

12-POINT STANDARD LENGTH

Model No.	Mfg. No.	Size mm
TI448	39-110	10
TI449	39-111	11
TI450	39-112	12
TI451	39-113	13
TI452	39-114	14
TI453	39-115	15
TI454	39-116	16
TI455	39-117	17
TI456	39-118	18
TI457	39-119	19
TI458	39-120	20

Model No.	Mfg. No.	Size mm
TI459	39-121	21
TI460	39-122	22
TI461	39-123	23
TI462	39-124	24
TI463	30-125	25
TI464	39-126	26
TI465	39-127	27
TI466	39-128	28
TI467	39-129	29
TI468	39-120	30
TI469	39-132	32
TI470	39-136	36

DRIVE TOOLS

Model No.	Mfg. No.	Description
TI935	12-918	Hinge Handle
TI543	12-921	Extension 2"
TI544	12-923	Extension 5"
TI545	12-924	Extension 10"
TI549	12-947	Universal Joint
TI550	12-972	Ratchet 10 1/2"

1/2" DRIVE S.A.E. SOCKET SETS

- Includes steel case

Model No. WJ154
Price/Each \$646.22



ARMSTRONG TOOLS

SET INCLUDES:

Model No.	Mfg. No.	Size"
12-POINT STANDARD LENGTH		
TI403	12-112	3/8
TI404	12-114	7/16
TI405	12-116	1/2
TI406	12-118	9/16
TI408	12-120	5/8
TI410	12-122	11/16
TI411	12-124	3/4
TI413	12-126	13/16
TI414	12-128	7/8
TI415	12-130	15/16
TI416	12-132	1
TI417	12-134	1 1/16
TI418	12-136	1 1/8
TI420	12-140	1 1/4

Model No.	Mfg. No.	Size"
12-POINT DEEP LENGTH		
TI492	12-316	1/2
TI493	12-318	9/16
TI494	12-320	5/8
TI495	12-322	11/16
TI496	12-324	3/4
TI497	12-326	13/16
TI498	12-328	7/8
TI499	12-330	15/16
TI500	12-332	1
TI501	12-334	1 1/16
TI502	12-336	1 1/8
TI504	12-340	1 1/4

DRIVE TOOLS

Model No.	Mfg. No.	Description
TI935	12-918	Hinge Handle
TI544	12-923	Extension 5"
TI545	12-924	Extension 10"
TI550	12-972	Ratchet 10 1/2"

Call us for all your



Tools & Equipment requirements!

R33911E

OFFICE PRODUCTS

INSTRUMENTS, SCALES & ELECTRICAL

SHIPPING & PACKAGING

TOOLS & EQUIPMENT

WELDING & METALWORKING

SAFETY EQUIPMENT & SUPPLIES

JANITORIAL & MAINTENANCE

MATERIAL HANDLING & STORAGE

TORQUE WRENCHES

DIAL TORQUE WRENCHES

Dial torque wrenches are accurate within $\pm 4\%$ of indicated value between 20% and 100% of the range. These units provide readings in both clockwise and counterclockwise directions. Oversized dial allows for easy quick reading and memory needle permits the user to check the highest torque level achieved. Several units listed below are equipped with an indicator light that can be set to illuminate along with a buzzer that will sound when desired torque level is achieved.



MICROMETER TORQUE WRENCHES



Micrometer adjustable "Clicker" torque wrenches emit an audible click and an impulse when torque setting has been reached. Once the pressure is relieved, the wrench resets itself. Tools are calibrated in the right hand direction only, left hand calibration is available upon special request. Accuracy is $\pm 3\%$ between 20% and 100% of the range. A factory calibration tape is supplied with each wrench. Re-calibration is done externally so there is no need to disassemble the wrench. All wrenches come with a carrying case.



MICROMETER TORQUE WRENCHES

- Pliable, elastomer handle grip for superior comfort and oil resistance
- Accurate in clockwise direction +/- 3% in upper 80% of the range
- Micrometer twist lock ring provides secure locking mechanism
- Sealed tear-drop head provides access and strength and keeps out contaminants



Model No.	Mfg. No.	Drive"	Torque Range	Price/Each
TLV411	85050	1/4	30-200 inch-lbs	190.71
TLV412	85051	3/8	25-250 inch-lbs	184.00
TLV413	85052	3/8	10-100 foot-lbs	186.53
TLV414	85054	1/2	20-250 foot-lbs	209.00

DEFLECTING BEAM TORQUE WRENCHES

- Measures torque in both left and right hand directions
- Accuracy +/- 7% of indicated reading
- ASME B107.14M ISO 6789

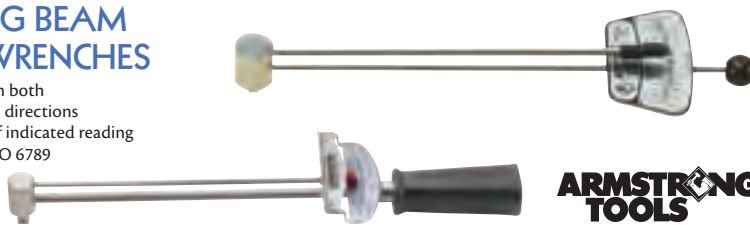

Model No.	Mfg. No.	Torque Range	Graduations	Drive Size"	Length"	Wt. lbs.	Price/Each		
U0068*	64-720	0-60 in.-lbs.	0-70 cm/kg	2.5 in.-lbs.	0.25 cm/kg	1/4	11	0.5	107.52
U0069	64-730	0-600 in.-lbs.	0-70 Nm	25 in.-lbs.	5 Nm	3/8	15	0.8	121.52
U0070	64-740	0-150 ft.-lbs.	0-200 Nm	5 ft.-lbs.	10 Nm	1/2	18.3	1.5	121.89

* Round ended handle

REACTION BAR TORQUE MULTIPLIERS

- Can easily be applied by one person using 1/2" drive tools
- Planetary gear system provides output accuracy of $\pm 5\%$
- Square output drive shears at 3-10% overload to protect expensive internal components from damage
- Anti-backlash input torque holding ratchet device



Model No.	Output Drive"	Max. Input	Max. Output	Torque Ratio	Overall Length"	Price/Each
UG970	3/4	227 ft.-lbs.	750 ft.-lbs.	3.3:1	8.53	759.78
UG971	3/4	200 ft.-lbs.	1200 ft.-lbs.	6.0:1	14.13	1163.79
UG972	1	162 ft.-lbs.	2200 ft.-lbs.	13.6:1	20.0	2141.66
UG973	1	173 ft.-lbs.	3200 ft.-lbs.	18.5:1	20.0	2833.10

Model No.	By Range	By Graduations	Drive Size"	Length"	Wt. lbs.	Price/Each		
U0044	0-75 in.-lbs.	0-8 Nm	1 in.-lbs.	0.2 Nm	1/4	10.25	1.2	313.29
U0045	0-250 in.-lbs.	0-27 Nm	5 in.-lbs.	0.5 Nm	3/8	10.25	1.3	333.38
U0046	0-600 in.-lbs.	0-66 Nm	20 in.-lbs.	2.0 Nm	3/8	12.50	1.3	344.84
U0047	0-50 ft.-lbs.	0-66 Nm	1 ft.-lbs.	2.0 Nm	3/8	12.50	1.3	341.58
U0048	0-175 ft.-lbs.	0-225 Nm	5 ft.-lbs.	5.0 Nm	1/2	21	2.9	376.61
U0049	0-250 ft.-lbs.	0-330 Nm	5 ft.-lbs.	10.0 Nm	1/2	21	2.9	403.02
U0050	0-250 ft.-lbs.	0-330 Nm	5 ft.-lbs.	10.0 Nm	1/2*	23.30	3.5	414.86
U0051	0-350 ft.-lbs.	0-450 Nm	10 ft.-lbs.	10.0 Nm	3/4	47	8.3	730.64
U0052	0-600 ft.-lbs.	0-800 Nm	10 ft.-lbs.	20.0 Nm	3/4	47**	8.3	819.08

DIAL TORQUE WRENCHES WITH ADJUSTABLE TORQUE INDICATOR LIGHT

U0053	0-600 ft.-lbs.	0-800 Nm	10 ft.-lbs.	20.0 Nm	3/4	47**	8.3	772.85
U0054	0-1000 ft.-lbs.	0-1325 Nm	20 ft.-lbs.	25.0 Nm	1	72**	17.8	1250.22
U0055	0-2000 ft.-lbs.	0-2650 Nm	50 ft.-lbs.	50.0 Nm	1	111***	42	2573.81

* Indicates ratchet head, ** Indicates extension handle included, *** Indicates 4 extension handles included

Model No.	By Range	By Graduations	Drive Size"	Length"	Wt. lbs.	Price/Each		
U0024	5-50 in.-lbs.	0.58-6.21 Nm	1 in.-lbs.	0.11 Nm	1/4	8.0	0.71	273.57
U0025	30-200 in.-lbs.	4-23 Nm	1 in.-lbs.	0.11 Nm	1/4	9.5	0.76	265.83
U0026	-	4-25 Nm	0.1 Nm	-	1/4	9.5	0.76	291.25
U0027	50-250 in.-lbs.	6-29 Nm	1 in.-lbs.	0.11 Nm	3/8	9.5	0.76	275.15
U0028	100-1000 in.-lbs.	14-116 Nm	5 in.-lbs.	0.6 Nm	3/8	17.1	2.05	290.42
U0029	10-100 ft.-lbs.	17-139 Nm	0.5 ft.-lbs.	0.7 Nm	3/8	17.1	2.05	289.87
U0030	-	10-100 Nm	-	1.0 Nm	3/8	17.1	2.05	304.39
U0031	240-1800 in.-lbs.	34-210 Nm	12 in.-lbs.	1.4 Nm	1/2	20.5	2.45	334.22
U0032	300-3000 in.-lbs.	43-348 Nm	18 in.-lbs.	2.03 Nm	1/2	20.5	2.45	344.84
U0033	10-100 ft.-lbs.	17-139 Nm	0.5 ft.-lbs.	0.7 Nm	1/2	17.1	2.05	303.53
U0034	10-150 ft.-lbs.	20-210 Nm	1 ft.-lbs.	1.4 Nm	1/2	20.5	2.45	319.13
U0035	25-250 ft.-lbs.	43-348 Nm	1 ft.-lbs.	1.4 Nm	1/2	24	2.45	356.23
U0036	-	40-340 Nm	-	2.0 Nm	1/2	24	2.45	376.69
U0037	50-400 ft.-lbs.	85-559 Nm	2.5 ft.-lbs.	3.4 Nm	3/4	33.0	9.62	834.15
U0038	100-600 ft.-lbs.	153-830 Nm	2.5 ft.-lbs.	3.4 Nm	3/4	40.5	10.72	1007.01
U0039	-	150-800 Nm	-	2.5 Nm	3/4	40.5	10.72	1034.15

ADJUSTABLE TORQUE SCREWDRIVERS

Adjustable torque limiting screwdriver with calibrated micrometer scale. Simply turn the back to the desired setting then proceed. Unit can be used either clock-wise or counter-clockwise and offers a range of setting of 2 - 36 in.-lbs. (0.2 - 4.0 Nm). High quality, lightweight design made of aluminum with non-slip grip makes this unit one of the preferred on the market. 1/4" hex female drive with easy release feature. Kit comes complete with screwdriver, 8-piece bit set and protective carrying case. A complete list of included bit sizes is listed below, quantity of 1 each.

Model No. TJ884
Price/Each \$396.08



INCLUDES:

Type	Size	Type	Size
Phillips tip	no.1	Slot	1/4" x .038"
Phillips tip	no.2	Slot	5/16" x .046"
Slot	3/16" x .034"	Slot	3/8" x .050"
Slot	7/32" x .036"	1/4" Socket Adaptor	



SOCKETS & ACCESSORIES



1/4" DRIVE RATCHETS

Model No. TJZ163 5 1/4" L
Price/Each \$11.15



1/4" DRIVE QUICK-RELEASE RATCHETS

Model No. TLV363 5 3/4" L
Price/Each \$21.90



1/4" DRIVE HINGE HANDLES

Model No. TJZ165 5 3/4" L
Price/Each \$8.05



1/4" PLASTIC HANDLE DRIVERS

Model No. TJZ166
Price/Each \$5.60



1/4" DRIVE QUICK-RELEASE RUBBER GRIP RATCHETS

Model No. TLV380 6" L
Price/Each \$16.05



EXTENSIONS



Model No.	Overall Length"	Price/Each
TJZ167	2	2.00
TJZ168	4	2.70
TJZ169	6	2.95

ADAPTORS



Model No.	Size"	Price/Each
TJZ170	1/4 F x 3/8 M	2.35

1/4" DRIVE ACCESSORIES

6-POINT S.A.E
STANDARD LENGTH
SOCKETS



6-POINT S.A.E
DEEP LENGTH
SOCKETS



Model No.	Hex Size"	Length"	Price/Each
TJZ171	5/32	0.82	1.80
TJZ172	3/16	0.82	1.80
TJZ173	7/32	0.82	1.80
TJZ174	1/4	0.82	1.80
TJZ175	9/32	0.82	1.80
TJZ176	5/16	0.82	1.80
TJZ177	11/32	0.82	1.80
TJZ178	3/8	0.82	1.80
TJZ179	7/16	0.82	1.80
TJZ180	1/2	0.82	1.80
TJZ181	9/16	0.82	1.80

Model No.	Hex Size"	Length"	Price/Each
TJZ195	5/32	1.94	2.00
TJZ196	3/16	1.94	2.00
TJZ197	7/32	1.94	2.00
TJZ198	1/4	1.94	2.00
TJZ199	9/32	1.94	2.00
TJZ200	5/16	1.94	2.00
TJZ201	11/32	1.94	2.00
TJZ202	3/8	1.94	2.00
TJZ203	7/16	1.94	2.05
TJZ204	1/2	1.94	2.15
TJZ205	9/16	1.94	2.40

6-POINT METRIC
STANDARD LENGTH
SOCKETS



6-POINT METRIC
DEEP LENGTH
SOCKETS



Model No.	Hex Size mm	Length mm	Price/Each
TJZ182	4	21.3	1.80
TJZ183	4.5	21.3	1.80
TJZ184	5	21.3	1.80
TJZ185	5.5	21.3	1.80
TJZ186	6	21.3	1.80
TJZ187	7	21.3	1.80
TJZ188	8	21.3	1.80
TJZ189	9	21.3	1.80
TJZ190	10	21.3	1.80
TJZ191	11	21.3	1.80
TJZ192	12	21.3	1.80
TJZ193	13	21.3	1.80
TJZ194	14	21.3	1.80

Model No.	Hex Size mm	Length mm	Price/Each
TJZ206	4	49.3	1.90
TJZ207	4.5	49.3	1.90
TJZ208	5	49.3	1.90
TJZ209	5.5	49.3	1.90
TJZ210	6	49.3	1.90
TJZ211	7	49.3	1.90
TJZ212	8	49.3	1.90
TJZ213	9	49.3	1.90
TJZ214	10	49.3	1.90
TJZ215	11	49.3	1.90
TJZ216	12	49.3	1.95
TJZ217	13	49.3	2.05
TJZ218	14	49.3	2.40

Call us for
quantity pricing!



Look for this symbol



for environmentally
friendly products!

3/8" DRIVE RATCHETS

Model No. TJZ219 7 7/8" L
Price/Each \$14.70



TJZ219

3/8" DRIVE QUICK-RELEASE RATCHETS

Model No. TLV364 8" L Price/Each \$22.75
Model No. TJZ221 10" L Price/Each \$23.50



TJZ221

3/8" DRIVE HINGE HANDLES

Model No. TJZ222 9 1/2" L Price/Each \$10.75
Model No. TJZ223 8 1/2" L Price/Each \$9.85



TJZ222

3/8" DRIVE QUICK-RELEASE RUBBER GRIP RATCHET

Model No. TLV381 8" L Price/Each \$20.65



TLV381

3/8" DRIVE ACCESSORIES

6-POINT S.A.E STANDARD LENGTH SOCKETS



Model No.	Hex Size"	Length"	Price/Each
TLV367	1/4	0.87	1.70
TLV368	5/16	0.87	1.70
TJZ235	3/8	0.87	1.70
TJZ236	7/16	0.87	1.70
TJZ237	1/2	0.9	1.70
TLV369	9/16	0.9	1.85
TJZ239	5/8	0.97	2.00
TJZ240	11/16	0.97	2.00
TJZ241	3/4	1.1	2.05
TJZ242	13/16	1.1	2.30
TJZ243	7/8	1.2	2.50

6-POINT S.A.E DEEP LENGTH SOCKETS



Model No.	Hex Size"	Length"	Price/Each
TJZ262	1/4	1.95	2.40
TJZ263	5/16	1.95	2.50
TJZ265	3/8	2.43	2.50
TLV370	7/16	2.43	2.50
TLV371	1/2	2.43	2.65
TLV372	9/16	2.43	3.00
TJZ269	5/8	2.43	3.30
TJZ270	11/16	2.43	3.40
TLV373	3/4	2.43	3.90
TLV374	13/16	2.46	4.55
TJZ273	7/8	2.46	4.75

6-POINT METRIC STANDARD LENGTH SOCKETS



Model No.	Hex Size mm	Length mm	Price/Each
TJZ244	6	22.1	1.70
TJZ245	7	22.1	1.70
TJZ246	8	22.1	1.70
TJZ247	9	22.1	1.70
TJZ248	10	22.1	1.70
TJZ249	11	22.1	1.70
TJZ250	12	22.9	1.70
TJZ251	13	22.9	1.85
TJZ252	14	22.9	2.00
TJZ253	15	22.9	2.00
TJZ254	16	24.7	2.05
TJZ255	17	24.7	2.10
TJZ256	18	27.9	2.10
TJZ257	19	27.9	2.35
TJZ258	20	27.9	2.40
TJZ259	21	30.5	2.50
TJZ260	22	30.5	2.65

6-POINT METRIC DEEP LENGTH SOCKETS



Model No.	Hex Size mm	Length mm	Price/Each
TJZ274	6	50.8	2.35
TJZ275	7	50.8	2.35
TJZ276	8	50.8	2.35
TJZ277	9	61.7	2.35
TJZ278	10	61.7	2.45
TJZ279	11	61.7	2.45
TJZ280	12	61.7	2.50
TJZ281	13	61.7	2.65
TJZ282	14	61.7	2.85
TJZ283	15	61.7	3.20
TJZ284	16	61.7	3.20
TJZ285	17	61.7	3.30
TJZ286	18	61.7	3.30
TJZ287	19	61.7	3.50
TJZ288	20	71.5	3.60
TJZ289	21	71.5	3.60
TJZ290	22	73	3.70
TJZ291	23	73	4.20

aurora tools®

EXTENSIONS



Model No.	Overall Length"	Price/Each
TLV365	3	2.25
TLV366	6	3.20
TJZ226	8	4.10
TJZ227	12	5.70

ADAPTORS



Model No.	Size"	Price/Each
TJZ228	3/8 F x 1/4 M	1.75
TJZ229	3/8 F x 1/2 M	2.05

SPARK PLUG SOCKETS



Model No.	Hex Size"	Price/Each
TJZ230	5/8	3.50
TJZ231	13/16	4.15

UNIVERSAL JOINTS



Model No.	Price/Each
TJZ232	5.70

Can't find what you're looking for?



Call us today!

1/2" DRIVE RATCHETS

Model No. TLV375 10" L
Price/Each \$22.75



TLV375

1/2" DRIVE QUICK-RELEASE RATCHETS

Model No. TLV376 10" L
Price/Each \$32.05



TLV376

1/2" DRIVE HINGE HANDLES

Model No. TJZ294 14 1/4" L
Price/Each \$30.75



TJZ294

1/2" DRIVE QUICK-RELEASE RUBBER GRIP RATCHET

Model No. TLV382 10" L
Price/Each \$26.50



TLV382

aurora tools®

EXTENSIONS



Model No.	Overall Length"	Price/Each
TJZ297	3	2.45
TLV377	5	3.80
TJZ299	10	5.60

SPEEDERS



Model No.	Overall Length"	Price/Each
TJZ833	16 1/2	10.75

1/2" DRIVE ACCESSORIES

6-POINT S.A.E STANDARD LENGTH SOCKETS



6-POINT S.A.E DEEP LENGTH SOCKETS



Model No.	Hex Size"	Length"	Price/Each
TJZ303	3/8	1.46	2.15
TJZ304	7/16	1.46	2.30
TJZ305	1/2	1.46	2.30
TJZ306	9/16	1.46	2.30
TJZ307	5/8	1.46	2.30
TJZ308	11/16	1.46	2.50
TJZ309	3/4	1.46	2.85
TJZ310	13/16	1.46	3.05
TJZ311	7/8	1.46	3.35
TJZ312	15/16	1.46	3.60
TJZ313	1	1.58	3.95
TJZ314	1 1/16	1.58	4.45
TJZ315	1 1/8	1.64	4.75
TJZ316	1 3/16	1.72	4.90
TJZ317	1 1/4	1.72	5.05

Model No.	Hex Size"	Length"	Price/Each
TJZ336	7/16	3.19	3.95
TJZ337	1/2	3.19	3.95
TJZ338	9/16	3.19	3.95
TJZ339	5/8	3.21	3.95
TJZ340	11/16	3.21	3.95
TJZ341	3/4	3.21	3.95
TJZ342	13/16	3.21	5.10
TJZ343	7/8	3.21	5.15
TLV379	15/16	3.21	5.70
TJZ345	1	3.21	6.65
TJZ346	1 1/16	3.21	7.55
TJZ347	1 1/8	3.21	9.25
TJZ348	1 1/4	3.21	10.65

ADAPTORS



Model No.	Size"	Price/Each
TJZ295	1/2 F x 3/8 M	2.95
TJZ296	1/2 F x 3/4 M	8.25

SPARK PLUG SOCKETS



Model No.	Hex Size"	Price/Each
TJZ301	5/8	3.80
TJZ302	13/16	4.15

6-POINT METRIC STANDARD LENGTH SOCKETS



6-POINT METRIC DEEP LENGTH SOCKETS



Model No.	Hex Size mm	Length mm	Price/Each
TJZ318	10	37	2.30
TJZ319	11	37	2.30
TJZ320	12	37	2.30
TJZ321	13	37	2.30
TJZ322	14	37	2.40
TJZ323	15	37	2.40
TJZ324	16	37	2.40
TJZ325	17	37	2.40
TJZ326	18	37	2.70
TJZ327	19	37	3.05
TJZ328	20	41	3.05
TJZ329	21	41	3.10
TJZ330	22	43	3.40
TJZ331	23	43	3.45
TJZ332	24	43	3.60
TJZ333	27	44	4.10
TJZ334	30	49	5.95
TJZ335	32	49	6.10

Model No.	Hex Size mm	Length mm	Price/Each
TJZ349	10	37	4.10
TJZ350	11	37	4.10
TJZ351	12	37	4.10
TJZ352	13	37	4.20
TJZ353	14	37	4.35
TJZ354	15	37	4.45
TJZ355	16	37	4.45
TJZ356	17	37	4.50
TJZ357	18	37	4.55
TJZ358	19	37	4.60
TJZ359	20	37	4.75
TJZ360	21	37	5.10
TJZ361	22	37	5.40
TJZ362	23	37	5.65
TJZ363	24	37	5.85
TJZ364	27	40	7.20
TJZ365	30	42	8.30
TJZ366	32	44	8.85

UNIVERSAL JOINTS



Model No.	Price/Each
TLV378	6.25

R33915E

3/4" DRIVE RATCHETS

Model No. WJ148 19" L
Mfg. No. 13-972
Price/Each \$177.09



3/4" DRIVE HINGE HANDLES

Model No. UM332 22" L
Mfg. No. 13-918 Price/Each \$105.84



3/4" DRIVE T-HANDLES

Model No. VE959 20" L
Mfg. No. 13-938 Price/Each \$75.46



EXTENSIONS



Model No.	Mfg. No.	Overall Length"	Price/Each
UM333	13-922	5	39.91
VE960	13-923	8	46.35
VE961	13-925	16	66.76

UNIVERSAL JOINTS



Model No.	Mfg. No.	Price/Each
VE962	13-947	110.88

ADAPTORS



Model No.	Mfg. No.	Size"	Price/Each
VE956	13-951	3/4 F x 1/2 M	26.27
UM334	13-952	3/4 F x 1 M	36.87

3/4" DRIVE ACCESSORIES

12-POINT S.A.E. STANDARD LENGTH SOCKETS



Model No.	Mfg. No.	Hex Size"	Overall Length"	Price/Each
UM274	13-124	3/4	1.9	25.27
UM275	13-126	13/16	1.94	25.44
UM276	13-128	7/8	1.97	24.71
VE939	13-130	15/16	1.97	22.58
VE940	13-132	1	2.00	25.10
VE941	13-134	1 1/16	2.09	25.28
VE942	13-136	1 1/8	2.13	25.28
UM277	13-138	1 3/16	2.19	25.48
VE943	13-140	1 1/4	2.19	27.12
VE944	13-142	1 5/16	2.23	30.10
VE945	13-144	1 3/8	2.23	33.55
VE946	13-146	1 7/16	2.3	36.72
VE947	13-148	1 1/2	2.3	39.02
UM278	13-150	1 9/16	2.4	44.87
VE948	13-152	1 5/8	2.49	46.93
VE949	13-154	1 11/16	2.49	48.51
VE950	13-156	1 3/4	2.64	48.95
VE951	13-158	1 13/16	2.8	53.20
VE952	13-160	1 7/8	2.86	60.94
VE953	13-164	2	2.99	68.86
UM280	13-166	2 1/16	3.02	76.44
VE954	13-168	2 1/8	3.05	82.13
UM281	13-170	2 3/16	3.05	87.84
VE955	13-172	2 1/4	3.17	105.65
UM282	13-174	2 5/16	3.24	110.50
UM283	13-176	2 3/8	3.24	120.48

12-POINT METRIC STANDARD LENGTH SOCKETS



Model No.	Mfg. No.	Hex Size mm	Overall Length mm	Price/Each
UM666	40-119	19	49.2	26.38
UN667	40-120	20	49.2	26.58
UN668	40-121	21	50	26.74
UN669	40-122	22	50	26.86
UN670	40-123	23	50	26.92
UN671	40-124	24	50	27.02
UN672	40-125	25	50.8	27.12
UN673	40-126	26	52.4	27.26
UN674	40-127	27	53.2	27.26
UN675	40-128	28	53.8	27.33
UN676	40-129	29	53.8	27.52
UN677	40-130	30	55.6	29.27
UN678	40-132	32	55.1	32.51
UN679	40-135	35	56.8	36.11
UN680	40-136	36	58.3	38.55
UN681	40-138	38	59.9	42.11
UN682	40-141	41	63.9	50.70
UN683	40-142	42	64.6	52.43
UN684	40-146	46	71	62.23
UN685	40-150	50	75.8	72.30
UN686	40-154	54	77.2	86.32
UN687	40-155	55	79.8	111.03
UN688	40-158	58	82.2	117.16
UN689	40-160	60	82.2	130.29

12-POINT S.A.E. DEEP LENGTH SOCKETS



Model No.	Mfg. No.	Hex Size"	Overall Length"	Price/Each
UM292	13-328	7/8	3.38	38.53
UM293	13-330	15/16	3.38	39.77
UM294	13-332	1	3.38	40.20
UM295	13-334	1 1/16	3.50	40.46
UM296	13-336	1 1/8	3.50	39.75
UM297	13-340	1 1/4	3.50	39.94
UM298	13-342	1 5/16	3.50	42.81
UM299	13-344	1 3/8	3.50	48.30
UM300	13-346	1 7/16	3.50	52.61
UM301	13-348	1 1/2	3.50	54.31
UM302	13-352	1 5/8	3.50	66.06

12-POINT METRIC DEEP LENGTH SOCKETS



Model No.	Mfg. No.	Hex Size mm	Overall Length mm	Price/Each
UN690	40-319	19	85.7	41.67
UN691	40-322	22	85.7	41.67
UN692	40-323	23	85.7	41.67
UN693	40-324	24	85.7	41.72
UN694	40-327	27	88.9	42.49
UN695	40-330	30	88.9	42.96
UN696	40-332	32	88.9	43.16
UN697	40-335	35	88.9	52.17
UN698	40-336	36	88.9	55.25
UN699	40-338	38	88.9	58.73
UN700	40-341	41	88.9	65.78
UN701	40-346	46	88.9	78.83
UN702	40-350	50	101.6	94.73
UN703	40-355	55	108	113.64
UN704	40-360	60	114.3	136.38

Look for this symbol



for environmentally friendly products!

Can't find what you're looking for?

Call us today!

IMPACT SOCKET SETS

9-PC. 6-POINT 3/8" DRIVE IMPACT SOCKET SETS

- Includes socket bar **UM500** and (10) socket clips **UM505**
- Approximate weight, 1.00 lb.
- Includes the following sizes: 1/4", 5/16", 3/8", 7/16", 1/2", 9/16", 5/8", 11/16", 3/4"

Model No. TDR353
Mfg. No. 19-890
Price/Each \$68.62



9-PC. 6-POINT 3/8" DRIVE DEEP IMPACT SOCKET SETS

- Includes socket bar **UM500** and (9) socket clips **UM505**
- Approximate weight, 1.25 lbs.
- Includes the following sizes: 1/4", 5/16", 3/8", 7/16", 1/2", 9/16", 5/8", 11/16", 3/4"

Model No. TDR344
Mfg. No. 19-895
Price/Each \$84.58



7-PC. 6-POINT 3/8" DRIVE UNIVERSAL IMPACT SOCKET SETS

- Includes socket bar **UM500** and (7) socket clips **UM505**
- Approximate weight, 1.00 lb.
- Includes the following sizes: 3/8", 7/16", 1/2", 9/16", 5/8", 11/16", 3/4"

Model No. TDR252
Mfg. No. 19-894
Price/Each \$249.19



11-PC. 6-POINT 3/8" DRIVE IMPACT SOCKET SETS - METRIC

- Includes socket bar **UM500** and (20) socket clips **UM505**
- Approximate weight, 1.25 lbs.
- Set contains sockets from 7 mm to 17 mm

Model No. TDR337
Mfg. No. 19-890
Price/Each \$93.74



11-PC. 6-POINT 3/8" DRIVE DEEP IMPACT SOCKET SETS - METRIC

- Includes socket bar **UM500** and (20) socket clips **UM505**
- Approximate weight, 1.80 lbs.
- Set contains sockets from 7 mm to 17 mm

Model No. TDR332
Mfg. No. 46-898
Price/Each \$112.21



14-PC. 6-POINT 3/4" DRIVE IMPACT SOCKET SETS

- Includes (2) socket bars **UM503** and (20) socket clips **UM507**
- Approximate weight, 16.25 lbs.
- Includes the following sizes: 3/4", 13/16", 7/8", 15/16", 1", 1-1/16", 1-1/8", 1 3/16", 1 1/4", 1 5/16", 1 3/8", 1 7/16", 1 1/2", 1 5/8"

Model No. UM730
Mfg. No. 21-893
Price/Each \$383.91



11-PC. 6-POINT 1/2" DRIVE IMPACT SOCKET SETS

- Includes socket bar **UM503**, and (20) socket clips **UM506**
- Approximate weight, 4.32 lbs.
- Includes the following sizes: 1/2", 9/16", 5/8", 11/16", 3/4", 13/16", 7/8", 15/16", 1", 1 1/16", 1 1/8"

Model No. T1812
Mfg. No. 20-893
Price/Each \$145.82



8-PC. 6-POINT 1/2" DRIVE DEEP IMPACT SOCKET SETS

- Includes socket bar **UM500**, and (8) socket clips **UM506**
- Approximate weight, 5.09 lbs.
- Includes the following sizes: 1/2", 9/16", 5/8", 11/16", 3/4", 13/16", 7/8", 15/16"

Model No. UM709
Mfg. No. 20-897
Price/Each \$135.43



9-PC. 6-POINT 1/2" DRIVE UNIVERSAL IMPACT SOCKET SETS

- Includes socket bar **UM502** and (9) socket clips **UM506**
- Approximate weight, 4.00 lbs.
- Includes the following sizes: 1/2", 9/16", 5/8", 11/16", 3/4", 13/16", 7/8", 15/16", 1"

Model No. TDR241
Mfg. No. 20-899
Price/Each \$397.14



14-PC. 6-POINT 1/2" DRIVE IMPACT SOCKET SETS - METRIC

- Includes socket bar **UM502** and (20) socket clips **UM506**
- Approximate weight, 3.77 lbs.
- Set contains sockets from 10 mm to 24 mm

Model No. T1813
Mfg. No. 20-899
Price/Each \$156.82



14-PC. 6-POINT 1/2" DRIVE DEEP IMPACT SOCKET SETS - METRIC

- Includes socket bar **UM503** and (20) socket clips **UM506**
- Approximate weight, 7.89 lbs.
- Set contains sockets from 10 mm to 24 mm

Model No. UN777
Mfg. No. 47-897
Price/Each \$256.71



12-PC. 6-POINT 3/4" DRIVE IMPACT SOCKET SETS - METRIC

- Includes 2 socket bars **UM502** and (20) socket clips **UM507**
- Approximate weight, 13.6 lbs.
- Includes the following sizes: 19 mm, 20 mm, 21mm, 22 mm, 23 mm, 24 mm, 27mm, 30 mm, 32 mm, 36 mm, 41mm, 46 mm

Model No. UN783
Mfg. No. 48-893
Price/Each \$374.03



44-PC. IMPACT SAE/METRIC STANDARD & DEEP SOCKET SETS, 3/8" DRIVE

- Chrome molybdenum alloy steel (CR-MO) for exceptional strength and long lasting durability
- High visibility laser-etched markings
- Reinforced molded case with sizes marked for quick identification and storage

INCLUDES:

- 6-point 5/16" to 3/4" standard and deep sockets
- 6-point 8 mm to 19 mm standard and deep sockets, and a 21 mm deep socket
- 3 extensions (3", 6" and 10")



Model No. TLV390
Mfg. No. 84916
Price/Each \$216.18



IMPACT STANDARD SOCKET SETS 1/2" DRIVE

- Chrome molybdenum alloy steel (CR-MO) for exceptional strength and long lasting durability
- High visibility laser-etched markings
- Reinforced molded case with sizes marked for quick identification and storage
- 6-point sockets



Model No.	Mfg. No.	Number of Pieces	Description	Price /Each
TLV393	84932	19	SAE 3/8" to 1-1/2"	162.13
TLV394	84933	25	Metric 8 mm to 36 mm	180.13

IMPACT DEEP SOCKET SETS, 1/2" DRIVE

- Chrome molybdenum alloy steel (CR-MO) for exceptional strength and long lasting durability
- High visibility laser-etched markings
- Reinforced molded case with sizes marked for quick identification and storage
- 6-point sockets



Model No.	Mfg. No.	Number of Pieces	Description	Price /Each
TLV397	84934	19	SAE 3/8" to 1 1/2"	306.24
TLV398	84935	29	Metric 8 mm to 36 mm	396.33

12-PC. IMPACT DEEP SOCKET SETS, 1/2" DRIVE

- Chrome molybdenum alloy steel (CR-MO) for exceptional strength and long lasting durability
- High visibility laser-etched markings
- Reinforced molded case with sizes marked for quick identification and storage
- 6-point sockets



Model No.	Mfg. No.	Description	Price /Each
TLV395	84942	SAE 3/8" to 1 1/16"	135.09
TLV396	84944	Metric 8 mm to 19 mm	126.09

12-PC. IMPACT STANDARD SOCKET SETS, 1/2" DRIVE

- Chrome molybdenum alloy steel (CR-MO) for exceptional strength and long lasting durability
- High visibility laser-etched markings
- Reinforced molded case with sizes marked for quick identification and storage
- 6-point sockets



Model No.	Mfg. No.	Description	Price /Each
TLV391	84931	3/8" to 1 1/16"	81.07
TLV392	84930	8 mm to 19 mm	72.04

13-PC. IMPACT UNIVERSAL SOCKET SETS, 1/2" DRIVE

- Chrome molybdenum alloy steel (CR-MO) for exceptional strength and long lasting durability
- High visibility laser-etched markings
- Reinforced molded case with sizes marked for quick identification and storage
- 6-point sockets



Model No.	Mfg. No.	Description	Price /Each
TLV399	84938	SAE 1/2" to 1 1/4"	324.27
TLV400	84939	Metric 10 mm to 24 mm	336.89

IMPACT & POWER SOCKETS

1 1/2" DRIVE SOCKETS 6-POINT



Model No.	Mfg. No.	Size"	Overall Length"	Price /Each
UM830	23-044	1 3/8	3.125	156.92
UM831	23-046	1 7/16	3.125	156.25
UM832	23-048	1 1/2	3.125	156.25
UM833	23-052	1 5/8	3.125	155.06
UM834	23-054	1 11/16	3.13	159.62
UM835	23-058	1 13/16	3.31	159.62
UM836	23-060	1 7/8	3.50	155.06
UM837	23-064	2	3.63	155.06
UM838	23-066	2 1/16	3.63	159.62
UM839	23-068	2 1/8	3.63	171.79
UM840	23-070	2 3/16	3.63	172.90
UM841	23-072	2 1/4	3.94	188.45
UM842	23-076	2 3/8	4.125	223.87
UM843	23-078	2 7/16	4.125	230.46
UM844	23-080	2 1/2	4.13	225.23
UM845	23-082	2 9/16	4.13	242.47
UM846	23-084	2 5/8	4.250	243.92
UM847	23-088	2 3/4	4.375	290.16
UM849	23-094	2 15/16	4.500	327.72
UM850	23-096	3	4.625	358.24
UM851	23-100	3 1/8	4.625	385.78
UM852	23-108	3 3/8	4.625	429.56
UM853	23-112	3 1/2	5.00	447.78
UM854	23-116	3 5/8	5.13	510.54
UM855	23-120	3 3/4	5.25	578.88
UM857	23-128	4	5.48	695.46
UM858	23-132	4 1/8	5.53	730.64
UM859	23-136	4 1/4	5.60	745.71
UM862	23-160	5	7.00	1079.37

2 1/2" DRIVE SOCKETS 6-POINT



Model No.	Mfg. No.	Size"	Overall Length"	Price /Each
UM871	24-064	2	5.12	804.00
UM872	24-068	2 1/8	5.12	809.03
UM873	24-072	2 1/4	5.12	813.05
UM874	24-076	2 3/8	5.12	817.07
UM875	24-084	2 5/8	5.12	822.09
UM876	24-088	2 3/4	5.12	830.13
UM877	24-094	2 15/16	5.12	834.15
UM878	24-096	3	5.12	754.76
UM879	24-100	3 1/8	5.12	758.78
UM881	24-108	3 3/8	5.51	846.21
UM882	24-112	3 1/2	5.51	866.31
UM883	24-116	3 5/8	5.51	885.41
UM884	24-120	3 3/4	5.51	943.70
UM885	24-124	3 7/8	5.51	972.84
UM886	24-128	4	5.51	902.49
UM887	24-132	4 1/8	5.91	928.62
UM888	24-136	4 1/4	5.91	1134.65
UM889	24-140	4 3/8	5.91	1297.46
UM890	24-144	4 1/2	5.91	1321.58
UM891	24-148	4 5/8	5.91	1345.70
UM892	24-152	4 3/4	5.91	1296.45
UM893	24-156	4 7/8	5.91	1427.10
UM894	24-160	5	6.69	1459.26
UM896	24-168	5 1/4	6.69	1588.91
UM898	24-176	5 1/2	6.69	1718.55
UM899	24-184	5 3/4	6.69	1929.60
UM900	24-196	6 1/8	7.09	1698.45
UM901	24-208	6 1/2	7.09	1746.69
UM902	24-220	6 7/8	7.09	1824.08
UM903	24-244	7 5/8	8.86	2741.64

1 1/2" DRIVE O-RINGS & RETAINER PINS



Model No.	Mfg. No.	Description	Price /Each
UM868	23-962	2 7/8" Dia. O-Ring	5.38
UM869	23-963	2 7/8" Lg. Retainer Pin	2.62

1 1/2" DRIVE EXTENSIONS



Model No.	Mfg. No.	Overall Length"	Price /Each
UM864	23-924	8.000	439.50
UM865	23-928	15.000	487.53

2 1/2" DRIVE O-RINGS & RETAINER PINS

Use with UM876 to UM904



Model No.	Mfg. No.	Description	Price /Each
UM905	24-961	4 1/2" I.D. O-Ring	8.80
UM906	24-962	5 1/2" I.D. O-Ring	9.62
UM907	24-963	4 1/2" Lg. Retainer Pin	18.02



1/4" DRIVE POWER SOCKETS 6-POINT

For Self-Tapping Screws



Model No.	Mfg. No.	Size"	Overall Length"	Price /Each
UM543	18-036	3/16	0.880	7.77
UM544	18-038	1/4	0.880	7.88
UM545	18-039	9/32	1.000	8.16
UM546	18-040	5/16	1.000	8.23
UM548	18-042	3/8	1.000	8.39
UM549	18-044	7/16	1.000	8.43
UM550	18-046	1/2	1.000	8.59

MAGNETIC

UM551	18-076	3/16	0.88	16.22
UM552	18-078	1/4	0.88	15.75
UM553	18-079	9/32	1	16.22
UM554	18-080	5/16	1	16.22
UM555	18-081	11/32	1	16.22
UM556	18-082	3/8	1	16.22
UM557	18-084	7/16	1	16.22
UM558	18-086	1/2	1	16.22

1/4" DRIVE POWER EXTENSIONS



Model No.	Mfg. No.	Overall Length"	Price /Each
UM567	18-921	2	8.89
UM568	18-923	6	12.40

1/4" DRIVE POWER SOCKETS THIN WALL 6-POINT

Suitable for hand use, or limited-clearance power applications only



Model No.	Mfg. No.	Size"	Overall Length"	Price /Each
UM534	18-006	3/16	0.820	6.82
UM535	18-007	7/32	0.820	7.02
UM536	18-008	1/4	0.820	7.02
UM537	18-009	9/32	0.820	7.06
UM538	18-010	5/16	0.820	6.85
UM539	18-011	11/32	0.820	7.06
UM540	18-012	3/8	0.820	7.06
UM541	18-014	7/16	0.820	7.10
UM542	18-016	1/2	0.820	7.14

1/4" DRIVE POWER SOCKETS DEEP THIN WALL 6-POINT

Suitable for hand use, or limited-clearance power applications only



Model No.	Mfg. No.	Size"	Overall Length"	Price /Each
UM559	18-206	3/16	1.94	9.16
UM560	18-208	1/4	1.94	9.18
UM561	18-209	9/32	1.94	8.97
UM562	18-210	5/16	1.94	9.00
UM563	18-211	11/32	1.94	9.27
UM564	18-212	3/8	1.94	9.00
UM565	18-214	7/16	1.94	9.27
UM566	18-216	1/2	1.94	9.32

3/8" DRIVE MAGNETIC POWER SOCKETS 6-POINT

For self tapping screws



Model No.	Mfg. No.	Size"	Overall Length"	Price /Each
UM579	19-080	5/16	1.25	16.57
UM580	19-082	3/8	1.25	17.72
UM581	19-084	7/16	1.5	19.95
UM582	19-086	1/2	1.5	19.95
UM583	19-088	9/16	1.5	19.37

NOTE: POWER SOCKETS ARE NOT FOR USE WITH IMPACT TOOLS



DOUBLE BOX SETS

GEARWRENCH

Model No.	TDS937	TDS890	TDS902
Mfg. No.	9240	9260	9224
	4 pcs. Double Box SAE 5/16" – 3/4"	6 pcs. Double Box Metrics 8 mm – 19 mm	4 pcs. Double Box E-Torx E6 – E24
Price/Each	\$77.33	\$110.55	\$92.41



COMBINATION RATCHETING WRENCH SETS

- Surface Drive® nearly eliminates fastener rounding
- Exceed ANSI box-end strength requirement
- Forged metal
- Mirror chrome finish
- 5° ratcheting box end



GEARWRENCH

Model No.	TDS803	TDS792	TDS903	TDS904	TDS888	TDS842
Mfg. No.	9312	9416	9317	9417	9308	9412
	13 pcs. SAE 1/4" – 1"	16 PCS. metrics 8 mm – 24 mm	7 pcs. SAE 5/16" – 3/4"	7 pcs. metrics 8 mm – 18 mm	8 pcs. SAE 5/16" – 3/4"	12 pcs. metrics 8 mm – 19 mm
Price/Each	\$215.07	\$251.25	\$75.32	\$75.32	\$98.44	\$144.72

REVERSIBLE RATCHETING WRENCH SETS

- One-finger operated compact reversible lever – No side push pin
- 15° offset provides additional knuckle clearance



GEARWRENCH

Model No.	TDS860	TDS816	TGZ812	TGZ813
Mfg. No.	9533	9620	9509	9602
	8 pcs. SAE 5/16" – 3/4"	12 pcs. metrics 8 mm – 19 mm	13 pcs. SAE 5/16" – 1"	16 pcs. metrics 8 mm – 25 mm
Price/Each	\$163.98	\$255.20	\$337.20	\$420.95

FLEXIBLE RATCHETING WRENCH SETS

- Flex Head: Tilts up to 180° at any interval
- Spring washer design: providing continuous head tension
- One touch direction assistant



GEARWRENCH

Model No.	TGZ814	TGZ815	TDS843	TDS844	TDS829	TDS793
Mfg. No.	9702	9902	9700	9900	9701	9901
	13 pcs. SAE 5/16" – 1"	16 pcs. metrics 8 mm – 24 mm	7 pcs. SAE 3/8" – 3/4"	7 pcs. metrics 10 mm – 19 mm	8 pcs. SAE 5/16" – 3/4"	12 pcs. metrics 8 mm – 19 mm
Price/Each	295.47	354.77	130.65	130.65	171.86	234.17

XL X-BEAM™ REVERSIBLE COMBINATION RATCHETING WRENCH SETS

- Up to 25% longer to access those hard-to-reach fasteners
- Surface Drive Plus™ reduces fastener rounding and delivers up to 25% more torque
- Improved box end strength
- Up to 500% increase in surface contact area (vs. standard handle wrench)



GEARWRENCH

Model No.	TLZ797	TLZ798
Mfg. No.	85398	85388
	9 pcs. SAE 5/16" – 3/4"	12 pcs. metric 8 mm – 19 mm
Price/Each	\$160.80	\$212.06

XL: EXTRA LONG HIGH PERFORMANCE COMBINATION WRENCH SETS

- Up to 25% longer for more leverage
- Surface Drive Plus™ - patented anti-spread open end
- Ability to apply more torque
- Minimize fastener rounding
- Oval shaped handle



GEARWRENCH

Model No.	TGZ820	TGZ821	TGZ822	TGZ823
Mfg. No.	85198	85098	85199	85099
	8 pcs. SAE 5/16" – 3/4"	12 pcs. metrics 8 mm – 19 mm	13 pcs. SAE 1/4" – 1"	16 pcs. metrics 8 mm – 24 mm
Price/Each	\$123.62	\$182.91	\$260.30	\$296.48

Call us for all your Tools & Equipment requirements!



WRENCHES

STUBBY COMBINATION RATCHETING WRENCH SETS

- Ratcheting box end needs as little as 5° to move fasteners
- Up to 25% more torque with less fastener rounding



GEARWRENCH

Model No.	Mfg. No.	Description	Price /Each
TLV401	9520	Metric 10-piece set 10 mm to 19 mm	167.13
TLV402	9507	SAE 7-piece set 3/8" to 3/4"	114.82

STUBBY FLEX COMBINATION RATCHETING WRENCH SETS

- Flex Head tilts up to 180°
- Ratcheting box end needs as little as 5° to move fasteners
- Up to 25% more torque with less fastener rounding



GEARWRENCH

Model No.	Mfg. No.	Description	Price /Each
TLV403	9550	Metric 10-piece set 10 mm to 19 mm	249.80
TLV404	9570	SAE 7-piece set 3/8" to 3/4"	185.31

INDEXING COMBINATION RATCHETING WRENCH SETS

- 13 locking positions allow access to hard-to-get places
- Wrench pumped by piston motion
- Ratcheting box end needs as little as 5° to move fasteners
- Up to 25% more torque with less fastener rounding



GEARWRENCH

Model No.	Mfg. No.	Description	Price /Each
TLV405	85488	Metric 12-Piece Set 8 mm to 19 mm	314.76
TLV406	85498	SAE 8-Piece Set 5/16" to 3/4"	209.84

QUADBOX™ RATCHETING WRENCH SETS

- Each wrench has 4 different head sizes
- 4 dedicated recessed reversing levers
- 5° ratcheting mechanism for greater productivity
- Thin profile head for tight hard-to-reach places

GEARWRENCH

Model No.	TLZ799	TLZ800
Mfg. No.	85204	85215
	3 pcs. SAE	4 pcs. metric
	12 head sizes	16 head sizes
	5/16" to 1"	8 mm to 24 mm
Price/Each	\$136.68	\$169.85



GEAR RATCHET™ VORTEX™ SOCKET SYSTEM

- 5° ratcheting box end
- Up to 50% thinner
- 40% stronger by eliminating the driver tang
- Eliminates need for deep sockets

GEARWRENCH

Model No.	TGZ835	TGZ836
Mfg. No.	8925	8921
	25 pcs. 1/4" Dr.	21 pcs. 3/8" Dr.
Price/Each	47.97	60.94



Can't find what you're looking for?

Call us today!

WRENCHES

CRESCENT ADJUSTABLE WRENCHES



Crescent®

Model No.	Mfg. No.	Length"	Max. Jaw Width"	Price /Each
CHROME FINISH				
VE032	AC14V	4	1/2	24.95
VE033	AC16V	6	15/16	25.22
VE034	AC18V	8	1 1/8	26.20
VE035	AC110V	10	1 5/16	33.49
VE036	AC112V	12	1 1/2	48.06
VE037*	AC115	15	1 11/16	79.30
VE038*	AC118	18	2 1/16	137.42
VE039*	AC124	24	2 7/16	235.01
CUSHION GRIP, CHROME FINISH				
VE040	AC14CV	4	1/2	27.26
VE041	AC16CV	6	15/16	27.57
VE042	AC18CV	8	1 1/8	29.16
VE043	AC110CV	10	1 5/16	35.57
VE044	AC112CV	12	1 1/2	51.43
VE045*	AC115C	15	1 11/16	80.30

Model No.	Mfg. No.	Length"	Max. Jaw Width"	Price /Each
BLACK PHOSPHATE FINISH				
VE046	AT14V	4	1/2	21.51
VE047	AT16V	6	15/16	21.42
VE048	AT18V	8	1 1/8	22.24
VE049	AT110V	10	1 5/16	28.01
VE050	AT112V	12	1 1/2	43.28
VE051*	AT115	15	1 11/16	71.44
VE052*	AT118	18	2 1/16	124.29
CUSHION GRIP, BLACK PHOSPHATE FINISH				
VE055	AT18CV	8	1 1/8	24.74
VE056	AT110CV	10	1 5/16	30.43
VE057	AT112CV	12	1 1/2	46.43

*Tapered handle

COMBINATION WRENCHES

- Chrome vanadium steel for strength and durability
- Heat treated for consistent hardness
- Precision broached jaws for sure gripping
- 12-point box end for snug fit
- Thin walled construction for access in cramped quarters
- Meets ANSI standards

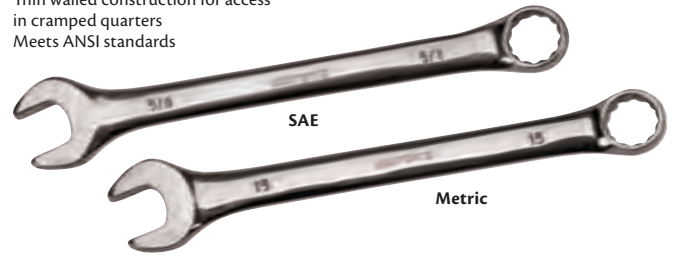

aurora tools®

Model No.	Size"	Length"	Price /Each
SAE			
TJZ119	1/4	3 7/8	2.25
TJZ120	5/16	4 3/4	2.35
TJZ121	11/32	5 1/8	2.45
TJZ122	3/8	5 1/2	2.50
TJZ123	7/16	5 7/8	2.75
TJZ124	1/2	6 5/8	3.10
TJZ125	9/16	6 7/8	3.35
TJZ126	5/8	7 2/3	3.90
TJZ127	11/16	8 1/16	4.20
TJZ128	3/4	8 7/8	5.25
TJZ129	13/16	9 2/3	5.85
TJZ130	7/8	9 7/8	7.50
TJZ131	15/16	10 7/8	8.75
TJZ132	1	11 5/8	10.15
TJZ133	1 1/16	13 3/8	11.65
TJZ134	1 1/8	15	13.20
TJZ136	1 1/4	17 1/8	15.65

Model No.	Size mm	Length mm	Price /Each
METRIC			
TJZ137	6	100	1.90
TJZ138	7	110	2.10
TJZ139	8	120	2.35
TJZ140	9	130	2.50
TJZ141	10	140	2.65
TJZ142	11	150	2.75
TJZ143	12	160	3.00
TJZ144	13	170	3.15
TJZ145	14	175	3.35
TJZ146	15	185	3.75
TJZ147	16	195	4.45
TJZ148	17	205	4.65
TJZ149	18	215	5.30
TJZ150	19	225	5.65
TJZ151	20	235	6.05
TJZ152	21	245	6.55
TJZ153	22	250	7.35
TJZ154	23	265	7.75
TJZ155	24	275	8.75
TJZ156	25	285	10.00
TJZ157	26	295	10.40
TJZ158	27	340	12.10
TJZ159	28	355	12.75
TJZ160	29	380	13.20
TJZ161	30	395	14.20
TJZ162	32	435	15.65

ADJUSTABLE WRENCHES

- Superior grade chrome vanadium steel
- Precision machined jaws
- Slim profile head slips into cramped quarters
- Tight tolerances ensure close fitting, wobble-free action
- Smooth, non-sticking mechanism
- Black nickel finish resists rust
- Meets ANSI standards

aurora tools®



Model No.	Length"	Description	Price/Each
TJZ100	6	Standard jaw, composite body	8.15
TJZ101	8	Reversible jaw, composite body	11.75
TJZ102	10	Reversible jaw, composite body	15.50
TJZ103	12	Reversible jaw, composite body	21.15
TJZ104	15	Standard jaw, steel body	36.95
TJZ105	18	Standard jaw, steel body	68.85

6-PIECE ADJUSTABLE WRENCH SETS

- Kit includes: TJZ100, TJZ101, TJZ102, TJZ103, TJZ104 and TJZ105

Model No. TLZ796
Price/Each \$155.00

COMBINATION WRENCH SETS

- Chrome vanadium steel for strength and durability
- Heat treated for consistent hardness
- Precision broached jaws for sure gripping
- 12-point box end for snug fit
- Thin walled construction for access in cramped quarters
- Meets ANSI standards



aurora tools®



Model No.	Description	Price/Each
TLV053	11 SAE Combination Wrenches: 1/4", 5/16", 3/8", 7/16", 1/2", 9/16", 5/8", 11/16", 3/4", 13/16", 7/8"	37.17
TLV054	11 Metric Combination Wrenches: 7 mm, 8 mm, 9 mm, 10 mm, 11 mm, 12 mm, 13 mm, 14 mm, 15 mm, 17 mm, 19 mm	37.17
TLV055	14 SAE Combination Wrenches: 3/8", 7/16", 1/2", 9/16", 5/8", 11/16", 3/4", 13/16", 7/8", 15/16", 1", 1 1/16", 1 1/8", 1 1/4"	83.90
TLV056	14 Metric Combination Wrenches: 10 mm, 12 mm, 13 mm, 14 mm, 15 mm, 16 mm, 17 mm, 18 mm, 19 mm, 22 mm, 24 mm, 27 mm, 30 mm, 32 mm	83.90

WRENCHES

ADJUSTABLE HOOK SPANNER WRENCHES



Model No.	Mfg. No.	Capacity Range for Dia."	Thickness"	Hook Specifications Depth"	Length"	Price /Each
UN498	34-301	3/4 - 2	0.34375	0.125	6 3/8	48.25
UN499	34-305	1 1/4 - 3	13/32	0.15625	8 1/8	54.90
UN500	34-307	2 - 4 3/4	15/32	0.1875	11 3/8	75.83
UN501	34-310	4 1/2 - 6 1/4	15/32	0.25	12 1/8	80.98
UN502	34-313	6 1/8 - 8 3/4	15/32	0.3125	13 3/4	98.82

ADJUSTABLE PIN SPANNER WRENCHES



Model No.	Mfg. No.	Capacity Range for Dia."	Hook Thickness"	Pin Specifications Dia."	Height"	Length"	Price /Each
UN503	34-351	3/4 - 2	0.34375	0.125	0.125	6.375	51.53
UN504	34-354	3/4 - 2	0.34375	0.1875	0.15625	6.375	51.53
UN505	34-358	1 1/4 - 3	0.40625	0.1875	0.1875	8.125	59.10
UN506	34-361	1 1/4 - 3	0.40625	0.25	0.21875	8.125	59.10
UN507	34-363	2 - 4 3/4	0.46875	0.25	0.25	11.375	81.05
UN508	34-366	4 1/2 - 6 1/4	0.46875	0.375	0.25	12.375	86.81

PIN SPANNER WRENCHES



Model No.	Mfg. No.	For Circle Dia."	Dia."	Pin Specifications Height"	Length"	Price /Each
UN483	34-201	1	3/16	5/32	4	15.61
UN484	34-204	1 1/4	13/64	5/32	4 1/2	17.40
UN485	34-207	1 1/2	7/32	3/16	5	17.48
UN486	34-210	1 3/4	15/64	3/16	5 1/2	17.33
UN487	34-213	2	1/4	7/32	6	19.66
UN488	34-216	2 1/4	17/64	1/4	6 1/2	20.97
UN489	34-219	2 1/2	9/32	9/32	7	19.76
UN490	34-222	2 3/4	19/64	9/32	7 1/2	22.49
UN491	34-225	3	5/16	9/32	8	24.48
UN492	34-228	3 1/4	21/64	9/32	8 1/2	26.95
UN493	34-231	3 1/2	11/32	5/16	9	28.41
UN494	34-234	3 3/4	23/64	11/32	9 1/2	30.52
UN495	34-237	4	3/8	11/32	10	31.12
UN496	34-240	5	7/16	13/32	12	40.99
UN497	34-243	6	1/2	9/16	14	57.60

FACE SPANNER WRENCHES



Model No.	Mfg. No.	Span Distance"	Dia."	Pin Specifications Height"	Length"	Price /Each
UN467	34-101	1	3/16	3/16	4 1/2	17.48
UN468	34-104	1 1/4	7/32	7/32	5	19.66
UN469	34-107	1 1/2	7/32	7/32	5 1/2	20.45
UN470	34-110	1 3/4	7/32	7/32	6	24.48
UN471	34-113	2	1/4	1/4	6 1/2	27.31
UN472	34-116	2 1/4	1/4	1/4	7	30.35
UN473	34-119	2 1/2	9/32	9/32	7 1/2	36.76
UN475	34-124	3	5/16	5/16	8 1/2	47.98
UN476	34-127	3 1/4	5/16	5/16	9 1/8	55.10
UN477	34-130	3 1/2	5/16	5/16	9 3/4	65.44
UN478	34-133	3 3/4	3/8	3/8	10 3/8	26.51
UN479	34-136	4	3/8	3/8	11	85.92

ADJUSTABLE CONSTRUCTION WRENCHES



Head is offset 15° from centerline, black finish.



Model No.	Mfg. No.	Overall Length"	Capacity"	Price /Each
UN361	32-495	15	1.5	126.52

ADJUSTABLE FACE SPANNER WRENCHES



Model No.	Mfg. No.	Capacity"	Extreme Dia."	Pin Specifications Height"	Length"	Price /Each
UN480	34-151	2	3/16	1/8	6 3/8	41.66
UN481	34-154	3	1/4	3/16	8 1/4	61.07
UN482	34-157	4	5/16	1/4	10-3/8	88.26

STRUCTURAL WRENCHES BLACK FINISH, 12-POINT LOBULAR OPENING



Model No.	Mfg. No.	Opening"	Length"	Price /Each
UN387	32-728	7/8	12	74.05
UN388	32-730	15/16	13.5	76.08
UN389	32-732	1	13.5	76.08
UN390	32-734	1 1/16	14.75	82.56
UN391	32-736	1 1/8	14.75	83.19
UN392	32-740	1 1/4	17	88.95
UN393	32-742	1 5/16	17	92.30

Model No.	Mfg. No.	Opening"	Length"	Price /Each
UN394	32-746	1 7/16	21	121.27
UN395	32-748	1 1/2	21	121.95
UN396	32-752	1 5/8	21.5	147.02
UN397	32-758	1 13/16	23	155.97
UN398	32-760	1 7/8	23	155.97
UN399	32-764	2	24.5	166.53

STRUCTURAL WRENCHES, BLACK FINISH



Model No.	Mfg. No.	Opening"	Length"	Price /Each
UN362	32-520	5/8	12.125	31.46
UN363	32-524	3/4	12.125	34.19
UN364	32-528	7/8	14.5	46.07
UN365	32-530	15/16	14.5	43.85
UN366	32-532	1	14.5	50.03
UN367	32-534	1 1/16	17	56.65
UN368	32-536	1 1/8	17	59.91
UN369	32-540	1 1/4	19	71.74

Model No.	Mfg. No.	Opening"	Length"	Price /Each
UN370	32-542	1 5/16	19	76.28
UN371	32-546	1 7/16	21	91.39
UN372	32-548	1 1/2	21	98.76
UN373	32-552	1 5/8	23	124.76
UN374	32-558	1 13/16	25	186.08
UN375	32-560	1 7/8	25	192.26
UN376	32-564	2	25	204.98

R25501E

OFFICE PRODUCTS

INSTRUMENTS, SCALES & ELECTRICAL

SHIPPING & PACKAGING

TOOLS & EQUIPMENT

WELDING & METALWORKING

SAFETY EQUIPMENT & SUPPLIES

JANITORIAL & MAINTENANCE

MATERIAL HANDLING & STORAGE

WRENCHES

COMBINATION WRENCH SETS

ARMSTRONG TOOLS

15-PC. 12-POINT FULL POLISH LONG

- Approximate weight 10.39 lbs. (4.7 kg)
- Kit contains wrenches in the following sizes: 5/16", 3/8", 7/16", 1/2", 9/16", 5/8", 11/16", 3/4", 13/16", 7/8", 15/16", 1", 1 1/16", 1 1/8", 1 1/4"
- Includes vinyl roll

Model No. TDQ894
Price/Each \$528.63



10-PC. 12-POINT FULL POLISH LONG - METRIC

- Approximate weight 2.96 lbs. (1.3 kg)
- Kit contains wrenches from 10 mm to 19 mm
- Includes vinyl roll

Model No. T1078
Price/Each \$268.93



10-PC. 12-POINT FULL POLISH LONG

- Approximate weight 5.4 lbs. (2.5 kg)
- Kit contains wrenches in the following sizes: 7/16", 1/2", 9/16", 5/8", 11/16", 3/4", 13/16", 7/8", 15/16", 1"
- Includes vinyl roll

Model No. UQ068
Price/Each \$341.72



9-PC. 12-POINT FULL POLISH LONG - METRIC

- Approximate weight 2.72 lbs. (1.2 kg)
- Kit contains wrenches from 7 mm to 15 mm
- Includes vinyl roll

Model No. TDQ969
Price/Each \$200.60



7-PC. 12-POINT FULL POLISH LONG

- Approximate weight 1.87 lbs. (0.9 kg)
- Kit contains wrenches in the following sizes: 3/8", 7/16", 1/2", 9/16", 5/8", 11/16", 3/4"
- Includes vinyl roll

Model No. UM991
Price/Each \$174.89



GEARED COMBINATION WRENCH SETS

10-PC. METRIC GEARED

- Approximate weight 4 lbs. (1.7 kg)
- Kit contains wrenches from 10 mm to 19 mm
- Includes vinyl roll

Model No. TDQ933
Price/Each \$385.96



13-PC. 12-POINT FULL POLISH SHORT

- Approximate weight 3.96 lbs. (1.8 kg)
- Kit contains wrenches in the following sizes: 1/4", 5/16", 3/8", 7/16", 1/2", 9/16", 5/8", 11/16", 3/4, 13/16", 7/8", 15/16", 1"
- Includes vinyl roll

Model No. T1075
Price/Each \$380.36



10-PC. SAE GEARED

- Approximate weight 2.8 lbs. (1.3 kg)
- Kit contains wrenches in the following sizes: 1/4", 5/16", 11/32", 3/8", 7/16", 1/2", 9/16", 5/8", 11/16", 3/4"
- Includes vinyl roll

Model No. TDQ944
Price/Each \$325.41



7-PC. 12-POINT FULL POLISH EXTRA SHORT

- Approximate weight 1.1 lbs. (0.5 kg)
- Kit contains wrenches in the following sizes: 3/8", 7/16", 1/2", 9/16", 5/8", 11/16", 3/4"
- Includes vinyl roll

Model No. UM983
Price/Each \$153.26



7-PC. SAE GEARED

- Approximate weight 2.6 lbs. (1.2 kg)
- Kit contains wrenches in the following sizes: 3/8", 7/16", 1/2", 9/16", 5/8", 11/16", 3/4"
- Includes vinyl roll

Model No. TDQ959
Price/Each \$257.55



18-PC. 12-POINT FULL POLISH LONG METRIC

- Approximate weight 7.26 lbs. (3.3 kg)
- Kit contains wrenches from 7 mm to 24 mm
- Includes vinyl roll

Model No. TDQ898
Price/Each \$510.54



SCREWDRIVERS, INSERT BITS & HEX KEYS

INDIVIDUAL SCREWDRIVERS



- Industrial quality and strength
- Chrome vanadium steel blade
- Treated blade tip for a lifetime of performance
- Extra large ergonomic handle for maximum torque and comfort
- Screwdriver type indication on the base of the grip
- Colour-coded handle for Robertson type
- Genuine Robertson blades
- Meets ANSI standards



aurora tools

Screwdriver type indication on the base of the grip. (Colour-coded handle for Robertson type.)



Model No.	Tip Width"	Blade Length"	Price /Each
SLOT ELECTRICIANS			
 TJZ057	1/8	3	2.45
TJZ058	3/16	4	3.00
TJZ059	3/16	6	3.40
SLOT MECHANICS			
TJZ060	1/4	1 1/2 Stubby	2.95
TJZ061	1/4	4	3.65
TJZ062	1/4	5	3.75
TJZ063	1/4	6	4.20
TJZ064	5/16	6	5.70
TJZ065	3/8	8	6.50
PHILLIPS TIP		TIP NUMBER	
 TJZ066	#0	2 1/2	2.45
TJZ067	#1	3 1/4	3.15
TJZ068	#2	4	3.65
TJZ070	#3	6	5.25
TJZ069	#2	1 1/2 Stubby	2.95
ROBERTSON TIP			
 TJZ071	#0	4	3.60
TJZ072	#1	4	4.10
TJZ073	#2	6	4.80
TJZ074	#3	6	5.65
TJZ075	#1	1 1/2 Stubby	2.75
TJZ076	#2	1 1/2 Stubby	3.05
TJZ077	#3	1 1/2 Stubby	3.05



TJZ057



TJZ061



TJZ066



TJZ073

SCREWDRIVER SETS



TJZ827

TJZ828

TJZ826

Model No.	Description	Contents	Price/Each
TJZ826	3-Pc Set	Robertson: #1, #2, #3	14.05
TJZ827	7-Pc Set	Robertson: #1, #2 Phillips: #1, #2 Flat: 1/8", 1/4", 5/16"	26.45
TJZ828	16-Pc Set	Robertson: #0, #1, #2, #3, #2 Stubby Phillips: #0, #1, #2, #3, #2 Stubby Flat: 1/8", 3/16", 1/4", 5/16", 3/8", 1/4" Stubby	59.65



aurora tools

R24347E

OFFICE PRODUCTS

INSTRUMENTS, SCALES & ELECTRICAL

SHIPPING & PACKAGING

TOOLS & EQUIPMENT

WELDING & METALWORKING

SAFETY EQUIPMENT & SUPPLIES

JANITORIAL & MAINTENANCE

MATERIAL HANDLING & STORAGE

1389

SCREWDRIVERS, INSERT BITS & HEX KEYS

KLEIN® CUSHION-GRIP SCREWDRIVERS

Klein® screwdrivers are made of the highest quality materials. Designed for the serious industrial user, these screwdrivers are the standard. Featuring cushion grip for user comfort and durability. Chrome plated shank and heat treated tip insure long life. Grip is resistant to gas, oil and water.



KLEIN TOOLS
For Professionals... Since 1857®



A. HEAVY-DUTY SQUARE SHANK, SLOT KEYSTONE TIP

Model No.	Mfg. No.	Tip Width"	Shank Length"	Price /Each
TV500*	600-1	1/4	1 1/2	11.19
TV501	600-4	1/4	4	15.14
TV502	600-6	5/16	6	18.33
TV503	600-8	3/8	8	24.75
TV504	600-12	1/2	12	30.24

* Stubby

B. HEAVY-DUTY ROUND SHANK, SLOT KEYSTONE TIP

Model No.	Mfg. No.	Tip Width"	Shank Length"	Price /Each
TV505	602-3	7/32	3	13.53
TV506	602-4	1/4	4	14.33
TV507	602-6	5/16	6	17.53
TV508	602-8	3/8	8	23.11
TV509	602-10	3/8	10	27.23
TV510	600-12	3/8	12	30.60

C. HEAVY-DUTY ROUND SHANK, SLOT CABINET TIP

Model No.	Mfg. No.	Tip Width"	Shank Length"	Price /Each
TV511	605-4	1/4	4	13.22
TV512	605-6	1/4	6	14.49
TV513	605-8	1/4	8	16.93
TV514	605-10	1/4	10	18.94

D. ROUND SHANK, SLOT CABINET TIP

Model No.	Mfg. No.	Tip Width"	Shank Length"	Price /Each
TV515	601-3	3/16	3	11.46
TV516	601-4	3/16	4	11.97
TV517	601-6	3/16	6	12.91
TV518	601-8	3/16	8	14.00
TV519	601-10	3/16	10	16.03

G. ROUND SHANK, TORX® TIP

Model No.	Mfg. No.	Tip No.	Shank Length"	Price /Each
TV533	19542	T15	4	11.92
TV534	19543	T20	4	11.92
TV535	19544	T25	4	11.92
TV536	19545	T27	4	11.92
TV537	19546	T30	4	11.92

J. CONDUIT FITTING & REAMING SCREWDRIVER

- Hood over tip keeps the tip from slipping out of the head especially when working overhead
- Conduit reamer will accommodate 1/2", 3/4", 1" thin wall conduit
- Reamer part is replaceable

Model No.	Mfg. No.	Tip Width"	Shank Length"	Price /Each
TJ880	85191	5/16	2 1/2	49.06

E. ROUND SHANK, SPECIAL PROFILATED® PHILLIPS TIP

Model No.	Mfg. No.	Tip Width"	Shank Length"	Price /Each
TV520*	603-1	2	1 1/2	11.37
TV521	603-3	1	3	11.46
TV522	603-4	2	4	13.22
TV523	603-6	3	6	17.53
TV524	603-7	2	7	14.80
TV525	603-10	2	10	16.73

* Stubby

H. ROUND SHANK, CABINET TIP PLASTIC COATED

- Plastic coating is intended for circuit protection only
- Dipped coating is thin enough to be used in confined areas
- A preferred tool among telecommunications companies
- Screwdriver is not insulated for electricity
- Tip is exposed 1/8" beyond coating

Model No.	Mfg. No.	Tip Width"	Shank Length"	Price /Each
TJ868	621-6	3/16	5 3/4	18.51
TJ870	621-8	3/16	7 3/4	19.89
TJ871	621-10	3/16	9 3/4	21.85
TJ872*	620-3	3/16	2 3/4	17.06
TJ873*	620-4	1/4	3 3/4	19.45
TJ874*	620-6	5/16	5 3/4	23.32
TJ875*	620-8	3/8	7 3/4	29.01

* Heavy-duty shank

F. ROUND SHANK, SQUARE RECESS TIP

Model No.	Mfg. No.	Tip No.	Shank Length"	Price /Each
TV526	660	0	4	13.22
TV527	661	1	4	13.22
TV528	662	2	4	13.22
TV529	663	3	4	13.22
TV530	665	1	8	14.94
TV531	666	2	8	14.94
TV532	667	3	8	14.94

I. RAPI-DRIV® SLOT & PHILLIPS TIPS

Crank-action handle spins screws in and out at high speeds saving both time and effort on long screws.

Model No.	Mfg. No.	Tip Width	Shank Length"	Price /Each
SLOT				
TJ876	670-6	3/16"	6	16.15
TJ877	671-6	1/4"	6	17.71
PHILLIPS TIP				
TJ878	681-6	1	6	15.61
TJ879	682-6	2	6	16.39

7-PIECE CANADIAN BASIC SETS

Set includes 1 each of the following:

- Square Tip: #1, #2, #3
- Phillips Tip: #1, #2
- Slot: 3/16", 1/4"

Model No. TJ881
Price/Each \$85.93



8-PIECE LONG & SHORT SETS

Set includes 1 each of the following:

- Square Tip: #2 (shank length 8")
- Phillips Tip: #2 (shank length 1 1/2"), #2 (shank length 10")
- Slot: 1/2", 3/8", 3/16", 1/4" (shank length 1 1/2"), 1/4" (shank length 10")

Model No. TJ882
Price/Each \$138.69



R24350E

OFFICE PRODUCTS

INSTRUMENTS, SCALES & ELECTRICAL

SHIPPING & PACKAGING

TOOLS & EQUIPMENT

WELDING & METALWORKING

SAFETY EQUIPMENT & SUPPLIES

JANITORIAL & MAINTENANCE

MATERIAL HANDLING & STORAGE

1391

SCREWDRIVERS, INSERT BITS & HEX KEYS

HOLLOW SHAFT NUT DRIVERS, 6-POINT OPENING



IMPERIAL

Model No.	Mfg. No.	Opening"	Wt. lbs.	Drive End"	Shaft Length"	Handle Size" Dia. x Length	Overall Length"	Bolt Clearance"	Handle Colour	Price /Each
U0163	66-806	3/16	0.12	0.328	3	1.00 x 3.6	6.62	0.140	Black	10.95
U0164	66-807	7/32	0.12	0.373	3	1.00 x 3.6	6.62	0.140	Brown	11.28
U0165	66-808	1/4	0.13	0.421	3	1.00 x 3.6	6.62	0.196	Red	10.95
U0166	66-809	9/32	0.13	0.451	3	1.00 x 3.6	6.62	0.203	Orange	10.95
U0167	66-810	5/16	0.14	0.490	3	1.00 x 3.6	6.62	0.196	Amber	13.02
U0168	66-811	11/32	0.14	0.531	3	1.00 x 3.6	6.62	0.203	Green	13.02
U0169	66-812	3/8	0.16	0.570	3	1.00 x 3.6	6.62	0.272	Blue	13.42
U0170	66-814	7/16	0.19	0.648	3	1.06 x 4.0	7.00	0.272	Brown	17.93
U0171	66-816	1/2	0.21	0.718	3	1.06 x 4.0	7.00	0.333	Red	17.93
U0172	66-818	9/16	0.24	0.806	4	1.19 x 4.5	8.50	0.397	Red	20.94
U0173	66-820	5/8	0.27	0.890	4	1.19 x 4.5	8.50	0.453	Red	21.57

METRIC

Model No.	Mfg. No.	Opening mm	Wt. lbs.	Drive End mm	Shaft Length mm	Handle Size mm Dia. x Length	Overall Length mm	Bolt Clearance mm	Price /Each
U0174	66-829	4	.10	8.0	76.0	25 x 91	167.0	4.0	10.95
U0175	66-831	5	.12	10.0	76.0	25 x 91	167.0	4.0	11.56
U0176	66-832	5.5	.12	10.0	76.0	25 x 91	167.0	4.0	11.48
U0177	66-833	6	.13	11.0	76.0	25 x 91	167.0	5.0	11.53
U0178	66-834	7	.13	12.0	76.0	25 x 91	167.0	5.0	11.78
U0179	66-835	8	.14	13.0	76.0	25 x 91	167.0	5.0	12.08
U0180	66-836	9	.14	14.0	76.0	25 x 91	167.0	5.0	12.28
U0181	66-837	10	.15	15.0	76.0	26 x 101	177.0	7.0	12.62
U0182	66-838	11	.18	17.0	76.0	26 x 101	177.0	7.0	13.15
U0183	66-839	12	.20	17.0	76.0	26 x 101	177.0	7.0	21.95
U0184	66-840	13	.27	18.0	76.0	26 x 101	177.0	8.0	21.48

7-PC. NUT DRIVER SETS

- Includes: 7 nut drivers from 1/4" to 1/2"
- Approximate weight: 1.45 lbs.

Model No. UO185
Price/Each \$130.65

VINYL ROLL

Model No. TDQ611
Price/Each \$21.36



11-PC. NUT DRIVER SETS

METRIC

- Includes 11 nut drivers from 4 mm to 13 mm
- Approximate weight: 1.98 lbs.

Model No. UO189
Price/Each \$168.33

IMPERIAL

- Includes 11 nut drivers from 3/16" to 5/8"
- Approximate weight: 2.31 lbs.

Model No. UO187
Price/Each \$177.81



CUSHION GRIP NUT DRIVERS

- Solid plastic amber handle with cushion grip for user comfort
- Handle caps are colour-coded for easy size identification
- Full hollow shaft permits turning nuts on long screws
- Chrome-plated shaft to help insure long life
- Available with or without magnetic tip



Size"	Shaft Length"	Handle Colour	Model No.	Mfg. No.	Price /Each	Magnetic		
						Model No.	Mfg. No.	Price /Each
3/16	3	Black	TV600	630-3/16	11.30	TLZ559	630-3/16M	14.05
1/4	3	Red	TV601	630-1/4	11.46	TBT557	630-1/4M	14.55
5/16	3	Yellow	TV602	630-5/16	11.61	TBT558	630-5/16M	15.61
11/32	3	Green	TV603	630-11/32	11.78	TLZ560	630-11/32M	16.39
3/8	3	Blue	TV604	630-3/8	11.95	TLZ561	630-3/8M	17.29
7/16	3	Brown	TV605	630-7/16	13.51	TLZ562	630-7/16M	19.36
1/2	3	Red	TV606	630-1/2	14.42	TLZ563	630-1/2M	20.49
9/16	3	Orange	TV607	630-9/16	18.53	-	-	-
5/8	3	Yellow	TV608	630-5/8	19.74	-	-	-
3/16	6	Black	TBT572	646-3/16	12.50	TLZ564	646-3/16M	15.01
1/4	6	Red	TBT569	646-1/4	12.39	TBT570	646-1/4M	16.72
5/16	6	Yellow	TBT574	646-5/16	12.54	TBT575	646-5/16M	18.18
11/32	6	Green	TBT571	646-11/32	13.01	TLZ565	646-11/32M	17.33
3/8	6	Blue	TBT573	646-3/8	12.86	TLZ566	646-3/8M	18.22
7/16	6	Brown	TBT577	646-7/16	14.74	TLZ567	646-7/16M	20.59
1/2	6	Red	TBT568	646-1/2	15.70	TLZ568	646-1/2M	21.83
9/16	6	Orange	TBT578	646-9/16	20.54	-	-	-
5/8	6	Yellow	TBT576	646-5/8	21.76	-	-	-

7-PC CUSHION GRIP NUT DRIVER SETS

- Includes: 7 nut drivers from 3/16" to 1/2"
- Available with or without magnetic tip



3" SHAFTS

Model No. TV617
Mfg. No. 631
Price/Each \$81.59

Model No. TLZ570 Magnetic Tips
Mfg. No. 631M
Price/Each \$113.38

6" SHAFTS

Model No. TBS773
Mfg. No. 647
Price/Each \$88.87

Model No. TLZ569 Magnetic Tips
Mfg. No. 647M
Price/Each \$122.81



Call us for all your Tools & Equipment requirements!



SCREWDRIVERS, INSERT BITS & HEX KEYS

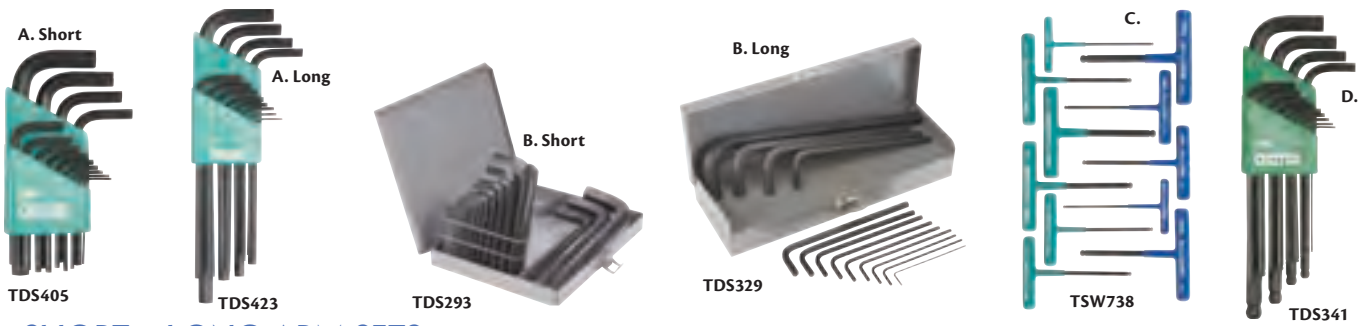
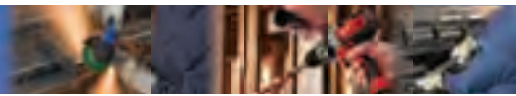

A. SHORT & LONG ARM SETS

With plastic holder.



Model No.	Mfg. No.	No. of Keys	Key Sizes"	Price /Each
SAE - SHORT ARM				
TDS405	56080	13	0.050, 1/16, 5/64, 3/32, 7/64, 1/8, 9/64, 5/32, 3/16, 7/32, 1/4, 5/16, 3/8	18.73
TDS481	56108	12	0.050, 1/16, 5/64, 3/32, 7/64, 1/8, 9/64, 5/32, 3/16, 7/32, 1/4, 5/16	10.06
SAE - LONG ARM				
TDS578	56148	7	5/64, 3/32, 7/64, 1/8, 9/64, 5/32, 3/16	6.61
TDS423	56152	12	0.050, 1/16, 5/64, 3/32, 7/64, 1/8, 9/64, 5/32, 3/16, 7/32, 1/4, 5/16	15.82
QN289	56081	13	0.050, 1/16, 5/64, 3/32, 7/64, 1/8, 9/64, 5/32, 3/16, 7/32, 1/4, 5/16, 3/8	26.12
METRIC - SHORT ARM				
KEY SIZES (MM)				
TDS460	56008	9	1.5, 2, 2.5, 3, 4, 5, 6, 8, 10	11.71
METRIC - LONG ARM				
TDS401	56149	9	1.5, 2, 2.5, 3, 4, 5, 6, 8, 10	19.26

C. BALL PLUS™ CUSHION GRIP T-HANDLE SETS



Model No.	Mfg. No.	No. of Keys	Key Sizes"	Key Sizes (mm)	Price /Each
TSW737	56131	6	5/32, 3/16, 7/32, 1/4, 5/16, 3/8	4, 5, 6, 8, 10	56.20
QN276	56130	10	3/32*, 7/64*, 1/8, 9/64, 5/32, 3/16, 7/32, 1/4, 5/16, 3/8		75.79
TSW738	56134	11	5/32, 3/16, 7/32, 1/4, 5/16, 3/8		104.43
METRIC					
Model No.	Mfg. No.	No. of Keys	Key Sizes (mm)	Price /Each	
TSW739	56133	5	4, 5, 6, 8, 10	48.25	
QN275	56132	7	2.5*, 3, 4, 5, 6, 8, 10	58.06	

*Hex end only

B. SHORT & LONG ARM SETS

With metal box.



Model No.	Mfg. No.	No. of Keys	Key Sizes"	Price /Each
SAE - SHORT ARM				
TDS320	56028	15	0.028, 0.035, 0.050, 1/16, 5/64, 3/32, 7/64, 1/8, 9/64, 5/32, 3/16, 7/32, 1/4, 5/16, 3/8	33.79
TDS293	56026	18	0.028, 0.035, 0.050, 1/16, 5/64, 3/32, 7/64, 1/8, 9/64, 5/32, 3/16, 7/32, 1/4, 5/16, 3/8, 1/2, 9/16, 5/8	60.06
SAE - LONG ARM				
TDS329	56128	13	1/16, 5/64, 3/32, 7/64, 1/8, 9/64, 5/32, 3/16, 7/32, 1/4, 5/16, 3/8, 1/2	30.85
METRIC - LONG ARM				
KEY SIZES (MM)				
TDS328	56085	10	1.5, 2, 2.5, 3, 4, 5, 6, 8, 10, 12	30.85
METRIC - SHORT ARM				
TDS317	56038	12	0.7, 0.9, 1.3, 1.5, 2, 2.5, 3, 4, 5, 6, 8, 10	37.96
TDS287	56036	15	0.7, 0.9, 1.3, 1.5, 2, 2.5, 3, 4, 5, 6, 8, 10, 12, 14, 17	64.65

D. BALL PLUS™ SETS



Model No.	Mfg. No.	No. of Keys	Key Sizes"	Price /Each	
FRACTIONAL					
QN274	56190	13	0.050, 1/16, 5/64, 3/32, 7/64, 1/8, 9/64, 5/32, 3/16, 7/32, 1/4, 5/16, 3/8	25.98	
TDS362	59901	13	0.050, 1/16, 5/64, 3/32, 7/64, 1/8, 9/64, 5/32, 3/16, 7/32, 1/4, 5/16, 3/8	25.93	
TDS391	56196	12	0.050, 1/16, 5/64, 3/32, 7/64, 1/8, 9/64, 5/32, 3/16, 7/32, 1/4, 5/16	20.59	
TDS441	56198	7	5/64, 3/32, 7/64, 1/8, 9/64, 5/32, 3/16	13.48	
METRIC					
KEY SIZES (MM)					
TDS383	59915	9	1.5, 2, 2.5, 3, 4, 5, 6, 8, 10	21.55	
QN217*	56194	9	1.5, 2, 2.5, 3, 4, 5, 6, 8, 10	20.21	
FRACTIONAL/METRIC COMBO SET					
Model No.	Mfg. No.	No. of Keys	Key Sizes"	Key Sizes (mm)	Price /Each
TDS307	59801	22	0.050, 1/16, 5/64, 3/32, 7/64, 1/8, 9/64, 5/32, 3/16, 7/32, 1/4, 5/16, 3/8	2, 2.5, 3, 4, 5, 6, 8, 10	47.51

*Long arm version

HEX KEY POUCH SETS

- Chrome vanadium steel for strength and durability
- Tips are chamfered for ease of entry and proper fit

aurora tools



Model No.	No. of Keys	Key Sizes	Price /Each
SAE - SHORT ARM			
TJZ052	13	1/20", 1/16", 5/64", 3/32", 7/64", 1/8", 9/64", 5/32", 3/16", 7/32", 1/4", 5/16", 3/8"	10.50
METRIC - SHORT ARM			
TJZ053	9	1.5 mm, 2.0 mm, 2.5 mm, 3.0 mm, 4.0 mm, 5.0 mm, 6.0 mm, 8.0 mm, 10.0 mm	8.45

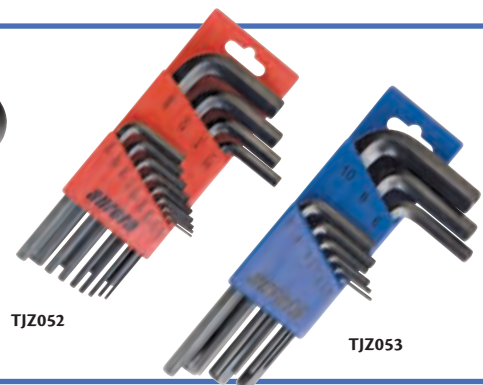

SCREWDRIVERS, INSERT BITS & HEX KEYS

BALL DRIVER LONG LENGTH SCREWDRIVERS



TLV460



SAE

Model No.	Mfg. No.	Key Sizes"	Price /Each
TLV452	10704	5/64	4.27
TLV453	10705	3/32	4.39
TLV454	10706	7/64	5.26
TLV455	10707	1/8	5.26
TLV456	10708	9/64	5.69
TLV457	10709	5/32	6.80
TLV458	10710	3/16	7.55
TLV459	10711	7/32	8.46
TLV460	10712	1/4	9.83
TLV461	10713	5/16	11.72
TLV462	10714	3/8	13.90

METRIC

Model No.	Mfg. No.	Key Sizes (mm)	Price /Each
TLV463	10752	2.0	4.39
TLV464	10754	2.5	4.68
TLV465	10756	3.0	5.54
TLV466	10760	4.0	5.97
TLV467	10764	5.0	8.15
TLV468	10768	6.0	8.75
TLV469	10772	8.0	12.11
TLV470	10776	10.0	14.88

BALL DRIVER SCREWDRIVER SETS

TX401



Model No.	Mfg. No.	No. of Keys	Key Sizes"	Price /Each
SAE				
TX399	10632	8	0.050, 1/16, 5/64, 3/32, 7/64, 1/8, 9/64, 5/32	31.23
TX400	10633	8	7/64, 1/8, 9/64, 5/32, 3/16, 7/32, 1/4, 5/16	50.69
TX401	10637	13	0.050, 1/16, 5/64, 3/32, 7/64, 1/8, 9/64, 5/32, 3/16, 7/32, 1/4, 5/16, 3/8	75.18
TX402	10645	7	5/64, 3/32, 7/64, 1/8, 9/64, 5/32, 3/16	30.90
METRIC				
TX403	10686	6	1.5, 2, 2.5, 3, 4, 5	27.47
TX404	10687	7	1.27, 1.5, 2, 2.5, 3, 4, 5	30.65
TX405	10699	9	1.5, 2, 2.5, 3, 4, 5, 6, 8, 10	60.38

INDIVIDUAL T-HANDLE HEX KEYS



TX408



TX421

SAE

Model No.	Mfg. No.	Size"	Price /Each
TX406	13205	3/32	5.34
TX407	13206	7/64	5.73
TX408	13207	1/8	6.06
TX409	13208	9/64	6.41
TX410*	13109	5/32	6.80
TX411*	13110	3/16	7.14
TX412*	13111	7/32	8.46
TX413*	13112	1/4	8.64
TX414*	13113	5/16	13.24

METRIC

Model No.	Mfg. No.	Size (mm)	Price /Each
TX416	13254	2.5	6.06
TX417	13256	3	6.41
TX418*	13160	4	7.14
TX419*	13164	5	8.19
TX420*	13168	6	8.93
TX421*	13172	8	13.43
TX422*	13176	10	14.74
-	-	-	-
-	-	-	-

* Ballpoint

DURACAST® BALL END FOLD-UP



Model No.	Mfg. No.	No. of Keys	Key Sizes"	Handle Length"	Price /Each
TSW740	56382	9	5/64, 3/32, 7/64, 1/8, 9/64, 5/32, 3/16, 7/32, 1/4	4 1/4	32.35

STANDARD FOLD-UPS



TDT616

Model No.	Mfg. No.	No. of Keys	Key Sizes"	Handle Length"	Price /Each
SAE					
TDT616	56066	9	0.050, 1/16, 5/64, 3/32, 7/64, 1/8, 9/64, 5/32, 3/16	3 3/8	6.82
TDT615	56321	9	0.050, 1/16, 5/64, 3/32, 7/64, 1/8, 9/64, 5/32, 3/16	3 3/8	6.91
QN277	56114	8	0.050, 1/16, 5/64, 3/32, 7/64, 1/8, 9/64, 5/32	3	5.59
TDT623	56314	8	0.050, 1/16, 5/64, 3/32, 7/64, 1/8, 9/64, 5/32	3	5.70
QN283	56067	9	5/64, 3/32, 7/64, 1/8, 9/64, 5/32, 3/16, 7/32, 1/4	3 3/4	8.75
TDT566	56316	9	5/64, 3/32, 7/64, 1/8, 9/64, 5/32, 3/16, 7/32, 1/4	3 3/4	8.82
METRIC					
KEY SIZES (MM)					
QN269	56070	7	1.5, 2, 2.5, 3, 4, 5, 6	3 3/4 (95 mm)	7.08
TDT612	56360	7	1.5, 2, 2.5, 3, 4, 5, 6	3 3/4 (95 mm)	7.14

DURACAST® FOLD-UPS



UQ073

Model No.	Mfg. No.	No. of Keys	Key Sizes"	Handle Length"	Price /Each
SAE					
TDT380	56346	9	0.050, 1/16, 5/64, 3/32, 7/64, 1/8, 9/64, 5/32, 3/16	3 1/2	16.92
UQ073	56347	9	5/64, 3/32, 7/64, 1/8, 9/64, 5/32, 3/16, 7/32, 1/4	4 1/4	18.88
METRIC					
KEY SIZES (MM)					
TDT371	56349	7	1.5, 2, 2.5, 3, 4, 5, 6	3 1/2	17.35
TORX®					
TDT224	56348	7	T-10, T-15, T-20, T-25, T-27, T-30, T-40	4 1/4	30.65

FOLDING HEX KEY SETS



- Chrome vanadium steel for strength and durability
- Tips are chamfered for ease of entry and proper fit
- Set folds securely into convenient storage compartment

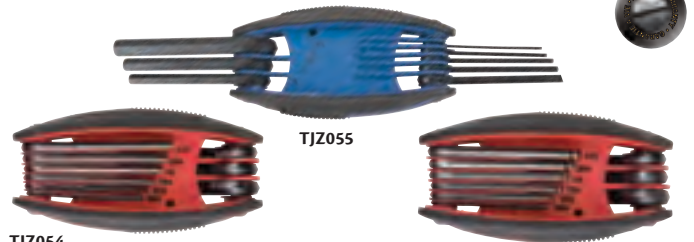

TJZ054

TJZ055

TJZ056

Model No.	No. of Keys	Key Sizes	Price /Each
SAE FOLD UP			
TJZ054	9	5/64", 3/32", 7/64", 1/8", 9/64", 5/32", 3/16", 7/32", 1/4"	8.25
METRIC FOLD UP			
TJZ055	8	1.5 mm, 2.0 mm, 2.5 mm, 3.0 mm, 4.0 mm, 5.0 mm, 6.0 mm, 8.0 mm	8.60
SAE - BALL END FOLD UP			
TJZ056	9	5/64", 3/32", 7/64", 1/8", 9/64", 5/32", 3/16", 7/32", 1/4"	10.15

PLIERS

SLIP JOINT PLIERS

- Sure gripping precision milled jaws
- Light and rugged drop-forged alloy steel
- Flush pivot design for use in tight spaces
- Length: 6 1/2"
- Meets ANSI standards

Model No. TJZ078
Price/Each \$7.75



aurora tools

SLIP JOINT PLIERS

Model No.	Mfg. No.	Overall Length"	Price /Each
U0230	67-667	6.500	16.58
U0231	67-669	8.000	22.15
U0232	67-671	10.000	27.95



ARMSTRONG TOOLS

DIAGONAL CUTTING PLIERS

- Precision tested jaws provide uniform cut
- Slim profile reaches into cramped quarters
- Black nickel finish resists rust
- Induction heat-treated cutting edge
- Smooth non-sticking lever mechanism
- Meets ANSI standards

Model No.	Length"	Price/Each
TJZ082	5	7.75
TJZ083	6	8.20
TJZ084	7	9.90



aurora tools

DIAGONAL CUTTING PLIERS

- Precision machined cutting edges meet at the tip, providing improved cutting performance
- Induction hardened cutting edge ensures maximum durability and long life

Model No.	Mfg. No.	Overall Length"	Price /Each
U0199	67-155	4.250	29.83
U0200	67-159	5.125	29.31
U0201	67-161	6.375	28.85
U0202	67-163	7.438	32.90



ARMSTRONG TOOLS

LONG NOSE CUTTING PLIERS

- Strong sure gripping jaws manipulate wire and other awkward objects
- Slim tapered head extends reach and maintains visibility in small areas
- Black nickel finish resists rust
- Meets ANSI standards

Model No.	Length"	Price/Each
TJZ085	5	7.40
TJZ086	6	8.15
TJZ087	8	9.30

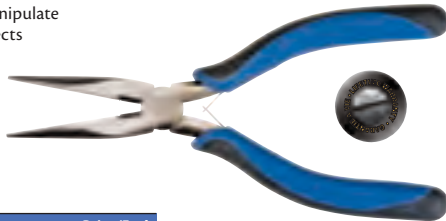

aurora tools

LONG NOSE CUTTING PLIERS

Model No.	Mfg. No.	Overall Length"	Price /Each
U0208	67-253	4.750	23.95
U0209	67-255	5.313	28.15
U0210	67-257	6.313	27.85
U0211	67-259	7.875	31.16

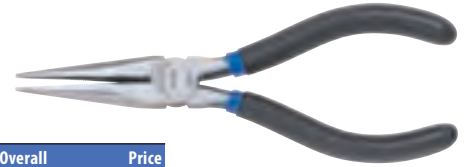

ARMSTRONG TOOLS

GROOVE JOINT PLIERS

- Sure gripping precision milled jaws
- Grooves undercut and milled to prevent slipping when tightening
- Light and rugged drop-forged alloy steel
- Flush pivot design for use in tight spaces
- Meets ANSI standards

Model No.	Length"	Price/Each
TJZ079	8	10.10
TJZ080	10	11.60



aurora tools

GROOVE JOINT PLIERS

- Precision milled undercut rib joint provides positive interlock between the two halves, eliminating separation
- Angled teeth provide superior gripping power over standard teeth
- Specially designed fastener ensures permanent assembly and smooth operation

Model No.	Mfg. No.	Overall Length"	Price /Each
U0237	67-717	5.000	22.64
U0241	67-777	7.000	19.19
U0242	67-779	10.000	23.45
U0243	67-781	12.000	26.20
U0244	67-783	16.000	44.61



ARMSTRONG TOOLS

LINESMAN CUTTING PLIERS

- Precision milled jaw grip and hold wire without slipping
- Black nickel finish resists rust
- Meets ANSI standards

Model No.	Length"	Price/Each
TJZ088	7	10.75
TJZ089	8	11.30



aurora tools

LINESMAN CUTTING PLIERS

- Precision machined cutting edges meet at the hinge, providing improved cutting performance
- Induction hardened cutting edge ensures maximum durability and long life
- Diamond serrated jaws provides a firm grip

Model No.	Mfg. No.	Overall Length"	Price /Each
U0191	67-063	6.438	40.94
U0192	67-065	7.375	43.65
U0193	67-067	8.375	46.26
U0194	67-069	9.500	46.73



ARMSTRONG TOOLS

PIPE WRENCH PLIERS

- Tongue and groove design
- Adjusts to fit within its maximum capacity
- Anti-slip jaws with angled head for increased leverage
- Plastic-dipped handles



Model No.	Mfg. No.	Overall Length"	Maximum Capacity"	Price /Each
TJ922	D503-10	10 1/4	2 1/8	47.03
TJ923	D503-12	13 1/4	2 5/8	70.14



GROOVE JOINT PLIERS

- Tongue and groove design
- Adjusts to fit within its maximum capacity
- Anti-slip jaws
- Plastic-dipped handles



Model No.	Mfg. No.	Overall Length"	Maximum Capacity"	Price /Each
TJ915	D502-6	6 1/2	1	27.78
TJ916	D502-10	10	1 3/4	34.45
TJ917	D502-12	12 1/4	2 1/8	42.70
TJ918	D502-16	16 3/4	4 1/4	81.98



SLIP-JOINT PLIERS

- Nickel-chrome plated finish
- Shear-type wire cutters
- Adjustable two-position jaws
- Plastic-dipped handles



Model No.	Mfg. No.	Overall Length"	Price /Each
TJ912	D511-6	6 9/16	19.68
TJ913	D511-8	8 1/16	26.24
TJ914	D511-10	9 7/8	34.42



END CUTTING NIPPERS

For cutting wire and small nails close to the surface. The head is designed to provide maximum strength and leverage.



Model No.	Mfg. No.	Overall Length"	Price /Each
TDQ424	406-1956	6	6.21



LONG REACH CHAIN NOSE PLIERS

Extra long handle allows greater access to confined, restricted areas and provides more holding power at the tip with less effort.



Model No.	Mfg. No.	Overall Length"	Price /Each
TDR572	67-240	11.562	59.02



HIGH LEVERAGE SIDE CUTTERS

- Smooth, streamlined nose with knurled jaws
- High-leverage design for maximum power
- Plastic-dipped handles (TJ887 has thicker heavy-duty grips)



Model No.	Mfg. No.	Overall Length"	Price /Each
TJ885	D213-8NE	8 11/16	50.17
TJ886	D213-9NE	9 3/8	49.40
TJ887	HD213-9NE	9 1/2	54.89
TJ888*	D2000-9NE	9 3/8	65.02



* Has extra heavy-duty side cutters.

RATCHETING CABLE CUTTERS

- Cuts cable straight with minimum effort
- Cuts up to: 600 mcm aluminum (not ACSR), 400 mcm copper
- Quick release mechanism and hold open spring
- Plastic finger formed grips



Model No.	Mfg. No.	Overall Length"	Price /Each
TJ953	63060	10	378.54



HIGH LEVERAGE SIDE CUTTERS WITH CRIMPING DIE

- Smooth, streamlined nose with knurled jaws
- High-leverage design for maximum power
- Crimping die at hinge
- Plastic-dipped handles



Model No.	Mfg. No.	Overall Length"	Price /Each
TJ889	D213-9NE-CR	9 3/8	65.13
TJ890*	D2000-9NE-CR	9 3/8	76.84



* Has extra heavy-duty side cutters.

HIGH LEVERAGE CABLE CUTTERS

- Cuts cables with remarkable ease
- Cuts up to: 4/0 aluminum (not ACSR), 2/0 soft copper
- Compact design fits easily in most tool pouches
- Plastic-dipped handles



Model No.	Mfg. No.	Overall Length"	Price /Each
VU139	63050	9 9/16	46.24



HIGH LEVERAGE SIDE CUTTERS WITH BOLT HOLDER

- Smooth, streamlined nose with knurled jaws
- High-leverage design for maximum power
- Designed to hold 5/8"-11 bolts without damaging them
- Plastic-dipped handles



Model No.	Mfg. No.	Overall Length"	Price /Each
TJ891	D213-9NETH	9 3/8	57.23
TJ892*	HD213-9NETH	9 1/2	61.95



* Has extra heavy-duty side cutters.

R29556E

PLIERS

SIDE CUTTERS FOR REBAR WORK

- Specially designed knurled jaws
- Cutter designed to cut rebar tie wire
- Hook bend in one handle for no-slip grip
- Coil spring holds jaws open
- Plastic-dipped handles

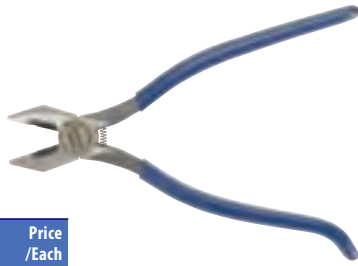

Model No.	Mfg. No.	Overall Length"	Price /Each
TJ893	D201-7CST	9 1/4	55.66
TJ894*	D2000-7CST	9 1/4	69.00

* Has extra heavy-duty side cutters.



HIGH LEVERAGE SIDE CUTTERS FOR REBAR WORK

- High-leverage design for maximum power
- Cutter designed to cut rebar tie wire
- Hook bend in one handle for no-slip grip
- Coil spring holds jaws open
- Plastic-dipped handles



Model No.	Mfg. No.	Overall Length"	Price /Each
TJ895	D213-9ST	9 3/8	55.66
TJ896*	D2000-9ST	9 3/8	73.10

* Has extra heavy-duty side cutters.



HIGH-LEVERAGE DIAGONAL CUTTERS

- High-leverage design for maximum power
- Standard bevel cut design
- Plastic-dipped, hand-form style handles



Model No.	Mfg. No.	Overall Length"	Price /Each
TJ897	D228-8	8 1/16	38.79
TJ898*	D2000-28	8 1/16	47.58

* Has extra heavy-duty cutters.



ANGLED HEAD DIAGONAL CUTTERS

- High-leverage design for maximum power
- Standard bevel cut design
- Angled head for easier work in confined areas
- Plastic-dipped, hand-form style handles



Model No.	Mfg. No.	Overall Length"	Price /Each
TJ899	D248-8	8 1/16	40.35
TJ900*	D2000-48	8 1/16	50.24

* Has extra heavy-duty cutters.



TAPERED NOSE DIAGONAL CUTTERS

- Tapered nose for working in confined areas
- Standard bevel cut design
- Plastic-dipped, hand-form style handles



Model No.	Mfg. No.	Overall Length"	Price /Each
TJ901	D202-5	5 9/16	37.51
TJ903	D202-6	6 1/8	39.37
TJ904*	D202-6C	6 1/8	41.98

* Has coil spring to hold jaws open.



MIDGET TAPERED NOSE DIAGONAL CUTTERS

- Sharp nose for reaching into confined areas
- Semi-flush cut design
- Plastic-dipped handles

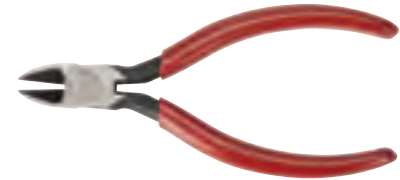

Model No.	Mfg. No.	Overall Length"	Price /Each
TJ905	D245-5	5 1/16	39.75

MIDGET STANDARD NOSE DIAGONAL CUTTERS

- General purpose cutter
- Semi-flush cut design
- Plastic-dipped handles



Model No.	Mfg. No.	Overall Length"	Price /Each
TJ909	D257-4	4 1/4	40.62
TJ910*	D257-4C	4 1/4	42.91

* Has coil spring to hold jaws open.



MIDGET POINTED NOSE DIAGONAL CUTTERS

- Sharp nose for reaching into confined areas
- Semi-flush cut design
- Coil spring holds jaws open
- Plastic-dipped handles



Model No.	Mfg. No.	Overall Length"	Price /Each
TJ907	D209-4C	4 1/4	43.14
TJ908	D209-5C	5 1/16	43.40



MIDGET TAPERED NOSE DIAGONAL CUTTERS

- Small head for precise cuts in hard-to-reach areas
- Flush cut design for a squared off finish
- Has coil spring to hold jaw open
- Plastic-dipped handles



Model No.	Mfg. No.	Overall Length"	Price /Each
TJ911	D295-4C	4 1/4	50.12

Call us for all your Tools & Equipment requirements!



STANDARD LONG NOSE PLIERS

- Knurled jaws for solid grip
- Durable design for long life
- Plastic-dipped handles



Model No.	Mfg. No.	Overall Length"	Price /Each
TJ925	D301-6	6 5/8	30.05
TJ928*	D301-6C	6 5/8	32.67

* Has coil spring to hold jaws open.



LONG NOSE WITH SIDE CUTTER

- Knurled jaws for solid grip
- Side cutter
- Plastic-dipped handles

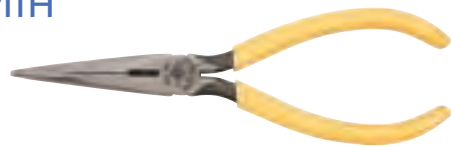

Model No.	Mfg. No.	Overall Length"	Price /Each
TJ930	D203-5	5 5/8	21.25
TJ931	D203-6	6 5/8	34.01
TJ932	D203-7	7 3/16	35.48
TJ933	D203-8	8 7/16	44.25
TJ934*	D203-5C	5 5/8	35.90
TJ935*	D203-6C	6 5/8	36.60
TJ936*	D203-7C	7 3/16	38.77

* Has coil spring to hold jaws open.



LONG NEEDLE NOSE PLIERS

- Knurled jaws for solid grip
- Ideal for assembly work in tight areas
- Coil spring to hold jaws open
- Plastic-dipped handles



Model No.	Mfg. No.	Overall Length"	Price /Each
TJ938	D318-51/2C	5 5/8	36.11



SLIM LONG NOSE PLIERS

- Knurled jaws for solid grip
- Needle tip only 1/32" for precise work
- Coil spring to hold jaws open
- Plastic-dipped handles



Model No.	Mfg. No.	Overall Length"	Price /Each
TBT712	D307-51/2C	5 5/8	33.85



MIDGET SLIM NOSE PLIERS

- Knurled jaws for solid grip
- Designed for extremely precise work
- Coil spring to hold jaws open
- Plastic-dipped handles



Model No.	Mfg. No.	Overall Length"	Price /Each
TJ940	D321-41/2C	4 3/16	31.84



MIDGET CURVED NEEDLE NOSE PLIERS

- Polished jaws to prevent wire nicking
- Angled tip for intricate work
- Coil spring to hold jaws open
- Plastic-dipped handles



Model No.	Mfg. No.	Overall Length"	Price /Each
TJ941	D320-41/2C	4 3/4	40.42



WIRE STRIPPERS/CUTTERS

- Hardened steel construction for long life
- Narrow nose design fits into hard to reach areas
- Black oxide finish
- Plastic-dipped handle



Model No.	Mfg. No.	Strips AWG Gauges	Overall Length"	Price /Each
TJ946	11045	10, 12, 14, 16, 18 solid wire	6 1/4	20.67
TJ947	11046	16, 18, 20, 22, 24, 26 stranded	6 1/4	21.75
TJ948	11047	22, 24, 26, 28 30 solid wire	6 1/4	22.79



WIRE STRIPPERS/CUTTERS

- Scissor style with 1/2" cutter
- Nose designed to bend, shape or pull wire
- Holes for looping wire ends
- Coil spring to hold jaws open
- Plastic-dipped handles

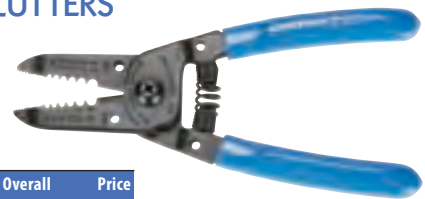

Model No.	Mfg. No.	Strips AWG Gauges	Overall Length"	Price /Each
TJ949	1011	10, 12, 14, 16, 18, 20	6 1/8	19.82



COMPACT WIRE STRIPPERS/CUTTERS

- Lightweight, compact design
- Nut along side locks in required stripping size
- Hole for looping wire ends
- Plastic-dipped handles



Model No.	Mfg. No.	Strips AWG Gauges	Overall Length"	Price /Each
TJ950	1004	12 - 26	5	12.57
TJ951*	1003	12 - 26	5	14.00

* With spring to hold jaws open.



ALL-PURPOSE LONG NOSE TOOLS

- Cuts bolts and wire, strips and crimps
- Nose designed to bend, shape or pull wire
- Long nose for reaching into tight areas
- Plastic-dipped handles



Model No.	Mfg. No.	Strips AWG Gauges	Overall Length"	Price /Each
TJ952	1010	10 - 22	8 1/4	33.16



R29558E

PLIERS

LOCKING PLIERS

- Tempered chrome vanadium steel jaws
- Hardened tension bar with toggle mechanism provides secure locking action
- Smooth screw adjustment for easy and rapid setting
- Meets ANSI standards

aurora tools®



CURVED JAWS WITH WIRE CUTTER

Model No.	Grip	Length"	Price/Each
TJZ090	Steel	4	6.30
TJZ091	Composite	5	9.00
TJZ092	Composite	7	9.95
TJZ093	Composite	10	12.25



LONG NOSE WITH WIRE CUTTER

Model No.	Grip	Length"	Price/Each
TJZ094	Steel	4	4.80
TJZ095	Composite	6	9.25



C-CLAMPS WITH SWIVEL PADS

Model No.	Grip	Length"	Price/Each
TJZ096	Steel	6	11.80
TJZ097	Steel	11	19.00



LOCKING WELDING CLAMPS

Model No.	Grip	Length"	Price/Each
TJZ098	Steel	9	16.40



LOCKING SHEET METAL TOOLS

Model No.	Grip	Length"	Price/Each
TJZ099	Steel	8	14.40



LOCKJAW™ SELF-ADJUSTING LOCKING PLIERS & C-CLAMPS

- Heavy-duty steel construction
- Self-adjusts to the work piece
- Pressure screw allows the user to set their own jaw pressure
- Re-engineered release lever gives pinch free controlled release
- Meets or exceeds all ANSI and ASME standards



TLV139



TLV142



Model No.	Mfg. No.	Description	Price/Each
TLV302	09300	7" Needle Nose	18.64
TLV140	06100	6" Curved Jaw	17.88
TLV139	10100	10" Curved Jaw	19.99
TLV304	06200	7" C-Clamp	18.38
TLV141	06201	7" C-Clamp with Swivel Pads	19.99
TLV305	10200	11" C-Clamp	26.78
TLV142	10201	11" C-Clamp with Swivel Pads	29.49
TLV306	18200	19" C-Clamp	36.23
TLV143	18201	19" C-Clamp with Swivel Pads	40.05

WISE-GRIP®

IRWIN VISE-GRIP®

CURVED JAWS WITH WIRE CUTTER

Model No.	Overall Length"	Price/Each
TM909	4	16.18
TM910	5	18.12
TM917	7	17.42
TM873	10	18.92



STRAIGHT JAWS

Model No.	Overall Length"	Price/Each
TM916	7	17.42
TM872	10	18.92



LONG NOSE WITH WIRE CUTTER

Model No.	Overall Length"	Price/Each
TM908	4	17.22
TM912	6	19.50
TM952	9	21.90



LOCKING CHAIN CLAMPS

Model No.	Overall Length"	Price/Each
TM985	9	41.62
TM984*	18	21.01



* Extension chain.

C-CLAMPS WITH REGULAR TIPS

Model No.	Overall Length"	Price/Each
TM913	6	16.30
TM971	11	27.51
TM980	18	42.95
TM996	24	52.93



C-CLAMPS WITH SWIVEL PADS

Model No.	Overall Length"	Price/Each
TN052	4	17.14
TM914	6	18.36
TM972	11	31.57
TM981	18	44.15
TM997	24	55.13



LOCKING WELDING CLAMPS

Model No.	Overall Length"	Price/Each
TN198	9	32.77



LOCKING SHEET METAL TOOLS

Model No.	Overall Length"	Price/Each
TN197	8	25.78



LARGE JAW LOCKING PLIERS

Model No.	Overall Length"	Price/Each
TM875	12	28.61



LOCKING WRENCHES WITH WIRE CUTTER

Model No.	Overall Length"	Price/Each
TD351	10	24.77
TD352	7	19.50
TD353	4	16.03



6-PC. INTERNAL/EXTERNAL CONVERTIBLE PLIER SETS

- 3 pliers and 3 replacement tip sets in blow-moulded plastic case
- Approximate weight: 3.48 lbs.

Set Includes:

Pliers and tips for shaft and bore dia.:
1/8" to 1", 1/4" to 2", 1 1/2" to 4"

Model No. UO284
Mfg. No. 68-079
Price/Each \$173.62



3-PIECE BASIC PLIERS SETS

- Precision-milled jaws
- Black nickel finish resists rust
- Meets ANSI standard

Set Includes:

TJZ078 – 6" L Slip joint
TJZ083 – 6" L Diagonal cutting
TJZ086 – 6" L Long nose cutting

Model No. TLZ795
Price/Each \$22.65



3-PIECE DIAGONAL CUTTING PLIERS SETS

- Precision-tested jaws provide uniform cut
- Slim profile reaches into cramped quarters
- Induction heat-treated cutting edge
- Smooth non-sticking lever mechanism
- Black nickel finish resists rust
- Meets ANSI standards

Set includes:

TJZ082 – 5" L
TJZ083 – 6" L
TJZ084 – 7" L

Model No. TLZ789
Price/Each \$24.45



3-PIECE LONG NOSE CUTTING PLIERS SETS

- Strong sure gripping jaws manipulate wire and other awkward objects
- Slim tapered head extends reach and maintains visibility in small areas
- Black nickel finish resists rust
- Meets ANSI standards

Set includes:

TJZ085 – 5" L
TJZ086 – 6" L
TJZ087 – 8" L

Model No. TLZ790
Price/Each \$23.75



12-PC QTR-TURN™ CONVERTIBLE RETAINING RING PLIERS SETS

- For 1/4" to 3 1/2" rings
- Use with either external or internal retaining rings
- For fast and easy conversion, make a 1/4 turn to release halves, then position into alternate slot - another 1/4 turn and it is back together
- Furnished in blow-moulded plastic case

Model No. TLZ109
Mfg No. 68-016
Price/Each \$379.89



SET INCLUDES:

Model No.	Mfg. No.	Description	Price /Each
TLY794	68-001	0.038" Tip, 1/4 Convertible, Straight	31.91
TLY795	68-002	0.038" Tip, 1/4 Convertible, 45°	32.54
TLY796	68-003	0.038" Tip, 1/4 Convertible, 90°	32.54
TLY797	68-004	0.047" Tip, 1/4 Convertible, Straight	33.63
TLY798	68-005	0.047" Tip, 1/4 Convertible, 45°	35.42
TLY799	68-006	0.047" Tip, 1/4 Convertible, 90°	35.42
TLY800	68-007	0.070" Tip, 1/4 Convertible, Straight	35.86
TLY801	68-008	0.070" Tip, 1/4 Convertible, 45°	38.34
TLY802	68-009	0.070" Tip, 1/4 Convertible, 90°	38.34
TLY803	68-010	0.090" Tip, 1/4 Convertible, Straight	47.04
TLY804	68-011	0.090" Tip, 1/4 Convertible, 45°	54.36
TLY805	68-012	0.090" Tip, 1/4 Convertible, 90°	54.36

11-PIECE ALL-PURPOSE PLIERS SETS

- Precision-milled jaws
- Black nickel finish resists rust
- Meets ANSI standard

Set includes:

TJZ078 – 6" L Slip joint
TJZ079 – 8" L Groove joint
TJZ080 – 10" L Groove joint
TJZ082 – 5" L Diagonal cutting
TJZ083 – 6" L Diagonal cutting
TJZ084 – 7" L Diagonal cutting
TJZ085 – 5" L Long nose cutting
TJZ086 – 6" L Long nose cutting
TJZ087 – 8" L Long nose cutting
TJZ088 – 7" L Linesman cutting
TJZ089 – 8" L Linesman cutting

Model No. TLZ793
Price/Each \$93.75

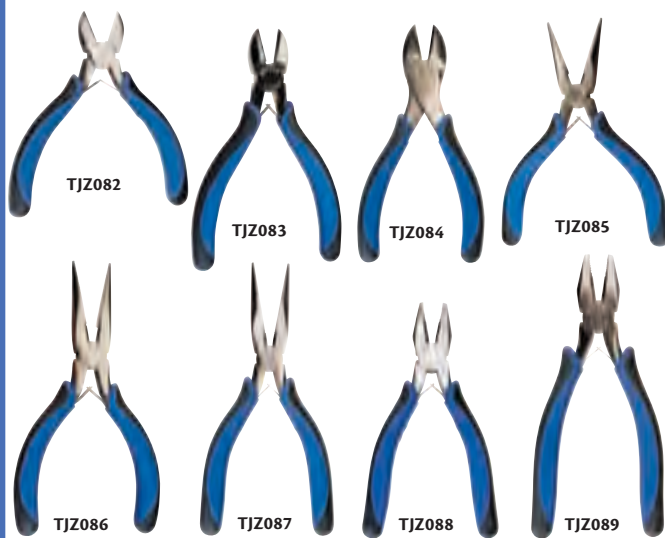

PLIERS

4-PIECE CURVED JAW LOCKING PLIERS W/WIRE CUTTER SETS

- Tempered chrome vanadium steel jaws
- Hardened tension bar with toggle mechanism provides secure locking action
- Smooth screw adjustment for easy and rapid setting
- Meets ANSI standards

Set includes:

- TJZ090 – 4" L
- TJZ091 – 5" L
- TJZ092 – 7" L
- TJZ093 – 10" L

Model No. TLZ791
Price/Each \$34.95

aurora tools



TJZ090 TJZ091 TJZ092 TJZ093

8-PIECE LOCKING PLIERS SETS

- Tempered chrome vanadium steel jaws
- Hardened tension bar with toggle mechanism provides secure locking action
- Smooth screw adjustment for easy and rapid setting
- Meets ANSI standards

Set includes:

- TJZ090 – 4" L Curved jaw w/wire cutter
- TJZ091 – 5" L Curved jaw w/wire cutter
- TJZ092 – 7" L Curved jaw w/wire cutter
- TJZ093 – 10" L Curved jaw w/wire cutter
- TJZ094 – 4" L Long nose w/wire cutter
- TJZ095 – 6" L Long nose w/wire cutter
- TJZ096 – 6" L C-clamps w/swivel pads
- TJZ097 – 11" L C-clamps w/swivel pads

Model No. TLZ792
Price/Each \$77.20

aurora tools

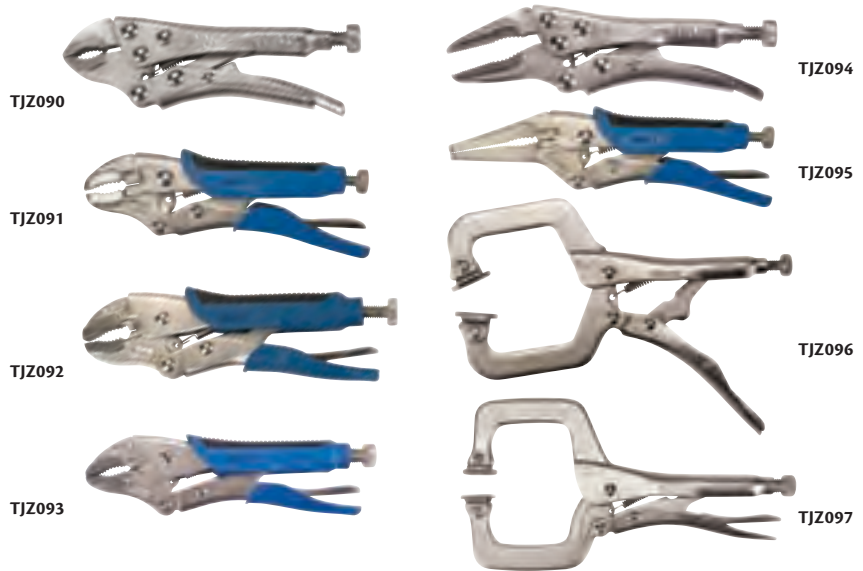

19-PIECE ALL-PURPOSE PLIERS SETS

PLIERS:

- Precision-milled jaws
- Black nickel finish resists rust
- Meets ANSI standard

LOCKING PLIERS:

- Tempered chrome vanadium steel jaws
- Hardened tension bar with toggle mechanism provides secure locking action
- Smooth screw adjustment for easy and rapid setting
- Meets ANSI standards

Set includes:

- TJZ078 – 6" L Slip joint
- TJZ079 – 8" L Groove joint
- TJZ080 – 10" L Groove joint
- TJZ082 – 5" L Diagonal cutting
- TJZ083 – 6" L Diagonal cutting
- TJZ084 – 7" L Diagonal cutting
- TJZ085 – 5" L Long nose cutting
- TJZ086 – 6" L Long nose cutting
- TJZ087 – 8" L Long nose cutting
- TJZ088 – 7" L Linesman cutting
- TJZ089 – 8" L Linesman cutting
- TJZ090 – 4" L Curved jaw w/wire cutter
- TJZ091 – 5" L Curved jaw w/wire cutter
- TJZ092 – 7" L Curved jaw w/wire cutter
- TJZ093 – 10" L Curved jaw w/wire cutter
- TJZ094 – 4" L Long nose w/wire cutter
- TJZ095 – 6" L Long nose w/wire cutter
- TJZ096 – 6" L C-clamps w/swivel pads
- TJZ097 – 11" L C-clamps w/swivel pads

Model No. TLZ794
Price/Each \$162.00

aurora tools

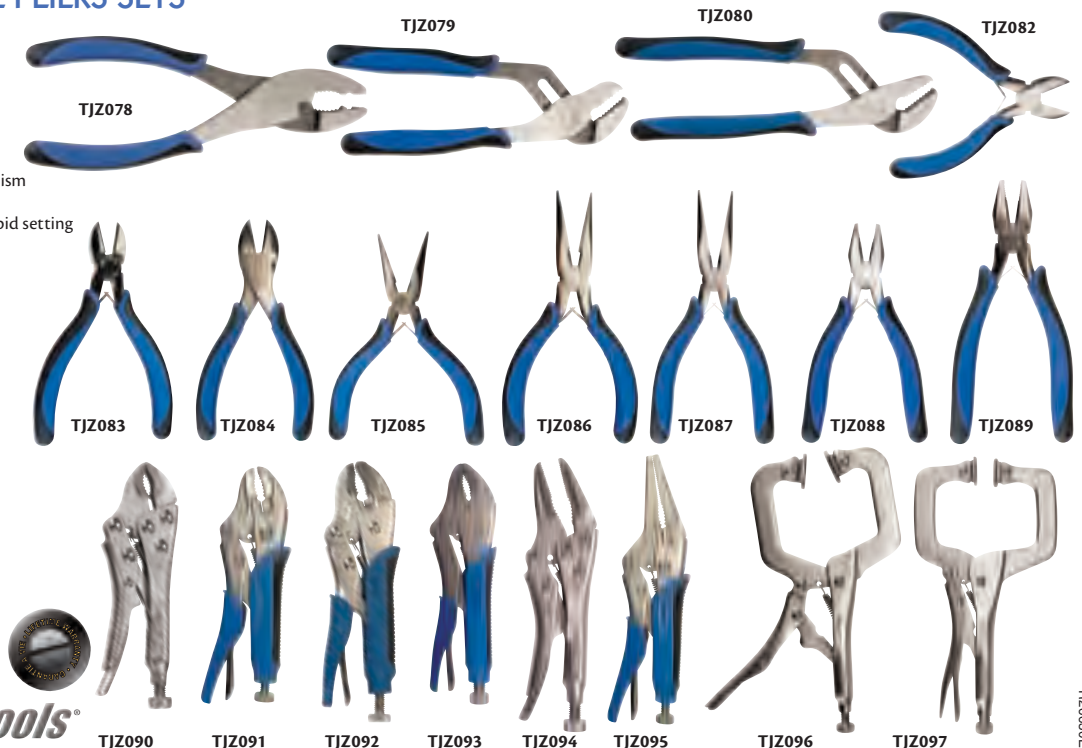

KNIVES, SCISSORS & BOLT CUTTERS

MULTI-PLIER® 600

- Stainless steel handle
- One-handed opening tool
- Patented *Saf.T.Plus™* locking system assures tool components stay in place while in use

Components: Needlenose pliers, wire cutter, wire crimper, fine edge knife, serrated knife, cross point screwdriver, small, medium and large flat blade screwdrivers, lanyard ring, can opener, bottle opener, file, ruler and nylon sheath

Specifications:
Overall Length: 6.61"
Closed Length: 5.04"
Weight: 9 oz.



Model No. TE179 Stainless finish
Price/Each \$84.37



COMPACT SPORT™ MULTI-PLIER® 400

- Smaller version of our *Multi-Plier® 600* series
- Stainless steel handle
- One-handed opening tool
- Patented *Saf.T.Plus™* locking system assures tool components stay in place while in use

Components: Needlenose pliers, wire cutter, wire crimper, serrated knife blade, scissors, cross point screwdriver, small, medium and large flat blade screwdrivers, can opener, bottle opener and nylon sheath

Specifications:
Overall length: 5.63"
Closed length: 4.37"
Weight: 6.8 oz.



Model No. UG697
Price/Each \$66.42



DIESEL™ MULTI-PLIER®

- Big, industrial-strength multi-tool featuring the ease and convenience of wrist-flick deployment
- Bigger than average individual stainless steel tools and more rugged than normal
- Patented *Saf.T.Plus™* locking system assures tool components stay in place while in use

Components: Needlenose pliers, wire cutter, partially serrated knife blade, cross point screwdriver, small, medium and large flat blade screwdrivers, can opener, bottle opener, file, saw and scissors, ballistic nylon sheath

Specifications:
Overall Length: 6.61"
Closed Length: 4.92"
Weight: 9.0 oz.



Model No. TLZ909
Price/Each \$103.94



GRAPPLER™ MULTI-TOOLS

- Locking plier feature locks down for a tight bite
- Snaps into ready position with just one-hand
- Stainless steel-stain finish
- With 12 total components including a sturdy-sized knife blade

Components: Pliers, locking plier adjustment screw, V-cut wire cutters, nail puller, pry bar, cross driver, ruler (in./cm), one finger open/close button, wire stripper, liner lock on all components, file and large flat driver, 1/2 fine edge and serrated blade, nylon sheath

Specifications:
Overall Length: 6.0"
Closed Length: 5.0"
Weight: 10.5 oz.



Model No. TLV290
Price/Each \$99.75



INDUSTRIAL MULTI-TOOLS

- Stainless steel components
- Anodized aluminum body with ABS inlays provides premium comfort
- Heavy duty nylon pouch
- Self locking components for safe use
- Gun metal finish

Components: Flat-nose pliers, wire cutter, fine edge knife, Phillips screwdriver, bottle opener, small and medium flat screwdriver, metal/wood file, double tooth saw, serrated knife, can opener

Specifications:
Overall length: 6.25"
Closed length: 4"
Weight: 9.3 oz.



Model No. TLZ463
Price/Each \$19.95



E-Z-OUT® SERIES

- Smooth one-handed opening and convenient pocket clip make it easy to use and carry for everyday tasks and chores
- *E-Z-Out™* knives utilize a lightweight fiberglass filled nylon handle with non-slip *Kraton®* inserts to ensure a comfortable and secure grip
- The high-carbon stainless steel blade is manufactured in either a fine edge or a one half serrated edge



Model No.	Description	Blade Length"	Price /Each
TE188	E-Z-Out® Junior	2.375	42.16
TE189	E-Z-Out® Junior Serrated	2.375	42.16



LIGHTWEIGHT KNIVES SERIES

- Combining light weight, smooth action and tough construction
- *L.S.T.®* Knives signify Gerber® *Legendary Blades* commitment to quality and innovation
- Each knife has a lightweight fiberglass-filled nylon handle for durability and strength and each blade is manufactured with premium quality high carbon stainless steel
- When selecting any pocket knife, make sure it is light enough to be carried everywhere, smooth opening for everyday activities and tough enough to do anything



Model No.	Description	Blade Length"	Price /Each
TE190	<i>L.S.T.® Black</i>	2.625	31.89
TE193	<i>Ultralight L.S.T.®</i>	1.96	21.88
TE192	<i>Magnum L.S.T.®</i>	3.50	35.57



POWERFRAME FOLDING KNIVES

- Powerframe is a one-hand operated folding knife
- Strong stainless steel handle is cut out to save weight
- Titanium-coated blade and handles make it more corrosion resistant

Specifications:
Overall Length: 7"
Length Closed: 4"
Width: 0.55"
Weight: 3.20 oz.



Model No.	Mfg. No.	Description	Blade Length"	Price/Each
TLZ904	22-01965	Fine Edge	3.00	35.44
TLZ905	22-01964	Serrated Edge	3.00	35.44



REMIX FOLDING KNIVES

- *Remix* is a one-hand operated folding knife
- 440A stainless steel blade
- Titanium nitride coated aluminum handles add support and corrosion resistance
- Features a large finger hole for extra stability and grip

Specifications:
Overall length: 7.35"
Closed length: 4.45"
Width closed: 0.55"
Weight: 4.20 oz.



Model No.	Mfg. No.	Description	Blade Length"	Price/Each
TLZ906	22-41968	Fine Edge	2.90	42.16
TLZ907	22-41969	Serrated Edge	2.90	42.16



R32955E

OFFICE PRODUCTS

INSTRUMENTS, SCALES & ELECTRICAL

SHIPPING & PACKAGING

TOOLS & EQUIPMENT

WELDING & METALWORKING

SAFETY EQUIPMENT & SUPPLIES

JANITORIAL & MAINTENANCE

MATERIAL HANDLING & STORAGE

1405

KNIVES, SCISSORS & BOLT CUTTERS

INDUSTRIAL

HEAVY-DUTY INDUSTRIAL SHEARS

- Finest quality cutlery steel
- Black handle standard, cushion grip on some
- Hot drop-forged polished blades
- Patented *Set-Easy*® pivot



Wiss®

Model No.	Mfg. No.	Description	Overall Length"	Cut Length"	Wt. lbs.	Price /Each
UG758	W22N	Black handle	12 1/4	6 1/8	1.13	53.43
UG759	W20PN	Red cushion grip	10 1/4	4 3/4	0.76	49.08
UG760	W22PN	Red cushion grip	12 1/4	6 1/8	1.17	52.10
UG761	W20SPN	Black Handle*	10 1/4	4 3/4	0.76	50.99

* Safety point blades

INDUSTRIAL SHEARS

- Often used in the poultry industry
- Made from high quality carbon steel
- Comfortable handle with enlarged lower ring
- Hot drop-forged nickel-plated blades
- Patented *Set-Easy*® pivot



Wiss®

Model No.	Mfg. No.	Description	Overall Length"	Cut Length"	Wt. lbs.	Price /Each
UG766	1DSN	Nickel-plated handle	8 1/2	3	0.42	33.88

INDUSTRIAL SHEARS

- Professional dressmaker and industrial use
- Finest quality cutlery steel
- Comfortable, shaped handle
- Hot drop-forged nickel-plated blades
- Patented *Set-Easy*® pivot



Wiss®

Model No.	Mfg. No.	Description	Overall Length"	Cut Length"	Wt. lbs.	Price /Each
WJ189	426N	Black handle	6 1/4	2 5/8	0.21	31.12
UG763	27N	Black handle	7 1/2	3 1/8	0.19	34.99
UG764	28N	Black handle	8 1/8	3 3/4	0.36	35.32
UG765	29N	Black handle	9 1/4	4	0.48	39.51

8" TAKE APART UTILITY SCISSORS

- Blades come apart for easy cleaning and sharpening
- Serrated blade
- Semi-circular notch on lower blade, keeps circular items in place when cutting
- Corrosion resistant stainless blades, polypropylene ergonomic grips

Model No. TKZ887

Mfg. No. W8TA

Price/Each \$16.72

Wiss®



10" SHOP SHEARS

- High leverage grip
- 420 stainless blades
- Serrated lower blade
- Heavy-duty blades cut cardboard, heavy fabric, rope, rubber, screen and more

Model No. TKZ886

Mfg. No. W912

Price/Each \$17.01

Wiss®



9" EASY SNIP UTILITY SHEARS

- Spring loaded blades, reduce fatigue
- Soft grip handles
- 420 stainless blade
- Wire cutting notch, for light gauge wire
- Safety latch to keep closed when not in use

Model No. TKZ888

Mfg. No. WEZSNIP

Price/Each \$14.22

Wiss®



INDUSTRIAL STRAIGHT TRIMMERS

- Designed for industrial use
- Finest quality cutlery steel
- Hot drop-forged nickel-plated blades
- Patented *Set-Easy*® pivot



Wiss®

Model No.	Mfg. No.	Description	Overall Length"	Cut Length"	Wt. lbs.	Price /Each
UG774	37N	Black handle	7 1/8	3 1/8	0.25	32.64
UG775	38N	Black handle	8 1/8	3 3/4	0.36	36.23
UG777	30N	Black handle	10 1/4	4 7/8	0.75	67.86

HIGH-LEVERAGE INDUSTRIAL SHEARS

- Finest quality cutlery steel
- One blade ground to knife-edge for faster, cleaner, easier cutting of tough synthetic fibers
- Red cushion grip handles provide maximum leverage
- Hot drop-forged polished blades, safely-rounded for extra protection



Wiss®

Model No.	Mfg. No.	Description	Overall Length"	Cut Length"	Wt. lbs.	Price /Each
WJ178	1225HLSN	Red cushion handle	10 1/4	4 3/4	0.7	50.60

GENERAL PURPOSE

SOLID-STEEL STRAIGHT TRIMMERS

- High quality nickel plated blades
- Made of high quality carbon steel
- High quality construction for long life



Wiss®

Model No.	Mfg. No.	Description	Overall Length"	Cut Length"	Wt. lbs.	Price /Each
UG793	438N	Black handle	8 1/8	3 3/4	0.40	33.25

HIGH-LEVERAGE SHEARS

- Designed for heavy duty cutting
- Used extensively by florists for stem and wire cutting
- Hot drop-forged, commercial quality
- Serrated nickel-plated blades for easy cuts



Wiss®

Model No.	Mfg. No.	Description	Overall Length"	Cut Length"	Wt. lbs.	Price /Each
UQ067	2DAN	Black handle	8 1/4	2 1/4	0.56	36.08

HEAVY-DUTY LEATHER CUTTING SCISSORS

- Finest quality cutlery steel
- Hot drop-forged nickel-plated blades
- One serrated blade, the other is edged
- Patented *Set-Easy*® pivot



Wiss®

Model No.	Mfg. No.	Description	Overall Length"	Cut Length"	Wt. lbs.	Price /Each
UG798	8BLTN	Ring handle	4 1/2	2 5/8	0.67	55.54

8 1/2" GENERAL PURPOSE SCISSORS

- Stainless blades
- Adjustable pivot
- Blades can be resharpened
- Comfortable grip, high leverage bottom ring

Model No. TKZ889

Mfg. No. W812

Price/Each \$10.13



Wiss®

TEXTILE & FABRIC

Wiss®

UPHOLSTERY, CARPET & FABRIC SHEARS

- Finest quality cutlery steel
- Hot drop-forged polished blades
- Thicker, heavy duty blades to cut tough material
- Patented Set-Easy® pivot



Model No.	Mfg. No.	Description	Overall Length"	Cut Length"	Wt. lbs.	Price /Each
UG799	20WN	Black handle	10 1/4	4 3/4	0.88	58.94
UG802	22WN	Black handle	12 1/4	6 1/8	1.29	70.93

POCKET SCISSORS

- Hot drop-forged solid steel
- Flat pattern blades with blunt points
- Scissors are fully nickel plated



Model No.	Mfg. No.	Description	Overall Length"	Cut Length"	Wt. lbs.	Price /Each
UG796	166	Ring handle	6 1/4	3 3/4	0.21	23.90

PROFESSIONAL PINKING SHEARS

- Will cut light or heavy materials
- Hot drop-forged cutlery steel
- Nickel plated blades
- Bearing pivot reduces friction and finger fatigue



Model No.	Mfg. No.	Description	Overall Length"	Cut Length"	Wt. lbs.	Price /Each
UG812	AA	Black handle	10 5/8	3 7/8	0.83	62.11

INDUSTRIAL THREAD NIPPERS

- Ice tempered, stainless steel blades
- Blades are micro-honed for smooth precise cutting
- 50% lighter than forged clippers
- Easy to re-sharpen



Model No.	Mfg. No.	Description	Overall Length"	Cut Length"	Wt. lbs.	Price /Each
UG813	TC1	Sharp points	4 3/4	1 1/8	0.21	17.44

DUCKBILL COMBINATION PATTERN SNIPS

- Cuts moderately tight curves left or right in light stock as well as straight
- Popular with home craftsman and professionals
- Blades of finest quality steel, hot drop-forged for sharp edge and long life
- Rust resistant blades
- Cushion handle for comfort and better grip



Model No.	Mfg. No.	Length"	Cut Length"	Recommended max. capacity low carbon cold rolled steel	Price /Each
VQ291	V10N	10 1/4	2 1/4	23-gauge	21.94
VQ292	V19N	13	3	21-gauge	28.34

SPECIALTY

Wiss®

ELECTRICIAN'S SCISSORS

- Double stripping notch for 19 and 23 gauge wire
- Scraper and file on back edge of blade
- Full nickel plate for corrosion resistance
- Used for wire splicing, stripping and cutting



Model No.	Mfg. No.	Description	Overall Length"	Cut Length"	Wt. lbs.	Price /Each
UG817	175E5	Ring handle	5 1/4	1 7/8	0.17	17.70

ELECTRONICS & FILAMENT SCISSORS

- Hot drop-forged solid steel
- Coil spring opens blades after each cut
- Straight, precise cutting jaws
- High quality polished blades



Model No.	Mfg. No.	Description	Overall Length"	Cut Length"	Wt. lbs.	Price /Each
UG819	605N	Black handle	5	3/4	0.21	26.62

LIGHT METAL-CUTTING SNIPS

- Used in electronic and appliance light metal cutting
- Straight, precise cutting jaws
- High quality polished blades



Model No.	Mfg. No.	Description	Overall Length"	Cut Length"	Wt. lbs.	Price /Each
UG820	J75N	Black handle	7	1 1/4	0.33	27.01

INDUSTRIAL TRIMMING, GRAPE & ORCHID SNIPS

- Hot drop-forged solid steel
- Coil spring opens blades after each cut
- High quality polished blades with adjustment nut
- Closing latch holds jaws shut when not in use



Model No.	Mfg. No.	Description	Overall Length"	Cut Length"	Wt. lbs.	Price /Each
UG821	C4ASN	Black handle	8	2 1/4	0.36	34.86

KITCHEN SHEARS

- Hot drop-forged stainless steel
- Handles have nut cracking/jar opening jaws
- One blade is serrated
- Ideal for food preparation



Model No.	Mfg. No.	Description	Overall Length"	Cut Length"	Wt. lbs.	Price /Each
UG822	KSRN	Red handle	8	2 5/8	0.42	41.09

KNIVES, SCISSORS & BOLT CUTTERS

METALMASTER® COMPOUND SNIPS

- **VQ280** Cuts left from tight curves to straight
- **VQ281** Cuts right from tight curves to straight
- **VQ282** Cuts straight, left or right in light stock
- Non-slip serrated jaws



Wiss®

Model No.	Mfg. No.	Grip Colour	Length"	Cut Length"	Recommended Max. Capacity Low Carbon Cold Rolled Steel	Price /Each
VQ280	M1R	Red	9 3/4	1 3/8	18-gauge steel	26.29
VQ281	M2R	Green	9 3/4	1 3/8	18-gauge steel	26.29
VQ282	M3R	Yellow	9 3/4	1 1/2	18-gauge steel	26.29

METALMASTER® SPECIAL SERIES SNIPS

- **TBH824** cuts left
- **TBH825** cuts right
- Specially hardened to cut exotic metals
- Non-slip serrated jaw
- Spring-action for fast, effortless feed
- Non-slip, textured grips and safety latch for superior control



Wiss®

Model No.	Mfg. No.	Grip Colour	Length"	Cut Length"	Recommended Max. Capacity Low Carbon Cold Rolled Steel	Price /Each
TBH824	M1R51	Blue	9 3/4	1 3/8	18-gauge stainless steel	39.60
TBH825	M2R51	Blue	9 3/4	1 3/8	18-gauge stainless steel	39.60

METALMASTER® COMPOUND ACTION OFFSET VERTICAL SNIPS

- Vertical offset blades keep hands clear of material
- Ideal for increased reach in overhead projects or ground-level cutting
- Cuts low carbon cold rolled steel and other heavy gauge materials
- Non-slip serrated jaw blades help grip material to minimize slip
- Spring-action for fast, effortless feed
- High tensile alloy steel handles and comfort grips for secure control
- Safety latch aids in tool storage and secures tool when not in use
- Red grips (**TLZ902**), cut to the left
- Green grips (**TLZ903**), cut to the right

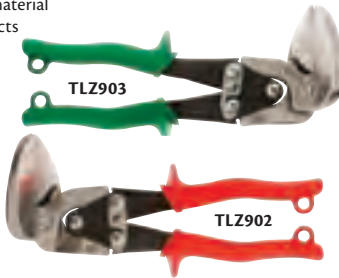

Wiss®

Model No.	Mfg. No.	Description	Price/Each
TLZ902	M8R	Offset Vertical Snips cuts to the left	40.32
TLZ903	M9R	Offset Vertical Snips cuts to the right	40.32

METALMASTER® PIPE & DUCT SNIPS

- Cuts curves, straight or any combination
- Cuts any shape ducts, seams, sheet metal stock, vinyl tiles and plastic laminates
- Non-slip serrated jaw
- Patented ball-bearing jaw action automatically adjusts blade clearance for squarer, cleaner cuts
- Spring-action for fast, effortless feed



Wiss®

Model No.	Mfg. No.	Grip Colour	Length"	Cut Length"	Recommended Max. Capacity Low Carbon Cold Rolled Steel	Price /Each
TBH826	M41R	Yellow	9 1/4	9/16	20-gauge steel	43.87

METALMASTER® OFFSET SNIPS

- **VQ283** cuts left and straight
- **VQ284** cuts right and straight
- Offset blades keep hands clear of metal
- Non-slip serrated jaw
- Spring-action for fast, effortless feed



Wiss®

Model No.	Mfg. No.	Grip Colour	Length"	Cut Length"	Recommended Max. Capacity Low Carbon Cold Rolled Steel	Price /Each
VQ283	M6R	Red	9 1/4	1 1/4	18-gauge steel	30.49
VQ284	M7R	Green	9 1/4	1 1/4	18-gauge steel	30.49

METALMASTER® BULLDOG SNIPS

- For notching or trimming extra heavy stock
- Non-slip, serrated
- Spring-action for fast, effortless feed



Wiss®

Model No.	Mfg. No.	Grip Colour	Length"	Cut Length"	Recommended Max. Capacity Low Carbon Cold Rolled Steel	Price /Each
TBH827	M5R	Red	9 1/4	7/8	16-gauge steel	32.40

METAL-WIZZ® SNIPS

- Cuts curves, straight or any combination
- *Metal-Wizz*® snips designed for home craftsman
- Used for cutting screening, hardware cloth, synthetic shingles, tile gutters, downspouts, and carpeting
- Non-slip serrated jaw
- Spring-action for fast, effortless feed

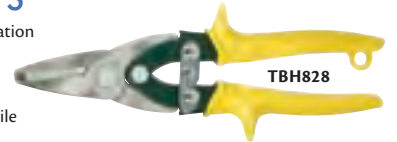

Wiss®

Model No.	Mfg. No.	Length"	Cut Length"	Recommended Max. Capacity Low Carbon Cold Rolled Steel	Price /Each
TBH828	MPC3	9	1 3/8	20-gauge steel	19.72

COMPACT AVIATION SNIPS

- All the power of a full size aviation snip, but is 25% smaller
- Extremely compact cutting head allows for great maneuverability, cutting the narrowest radii
- Designed for long continuous, straight and curved cuts, sliding the surface being cut beneath your fingers and reducing the chance of injury
- Practical locking mechanism allows one-handed open and close operation, and limits the maximum opening of the snip
- Compound leverage considerably reduces effort required, improving productivity while reducing hand fatigue
- Ergonomic handles keep hand from slipping



Model No.	Mfg. No.	Length"	Cut Length"	Cutting Capacity (Regular Metal)	Cutting Direction	Price /Each	
TLV291	D15A-BE	7 3/16	13/16	18-gauge	Right	17.39	
TLV292	D15AL-BE	7 3/16	13/16	18-gauge	Left	17.39	
TLV293	D15S-BE	7 3/16	13/16	18-gauge	Straight	17.39	
TLV294	D15-SET	All three styles in a nylon pouch					52.18

KNIVES, SCISSORS & BOLT CUTTERS

3-BLADE HAND CRIMPERS

- Crimps up to 22- and 24-gauge sheet metal
- Compound action jaw made of finest quality steel for better edges and long life
- Rust resistant blades
- Cushion handle for all-weather comfort
- Matte black finish and red plastisol grip



Wiss®

Model No.	Mfg. No.	Overall Length"	Throat Depth"	Price/Each
TBH818	HC3V	9 1/4	1 1/4	45.38

5-BLADE HAND CRIMPERS

- Joins sheet metal pipes of same size that are corrugated, round or square
- Compound action jaw made of finest quality steel for better edges and long life
- Rust resistant blades
- Cushion handle for all-weather comfort
- Matte black finish and red plastisol grip

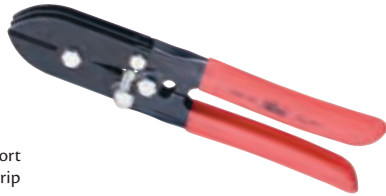

Wiss®

Model No.	Mfg. No.	Overall Length"	Throat Depth"	Price/Each
VQ293	HCSV	9 1/4	1 1/4	31.79

METALMASTER® SNIPS

- Combines the long cut of tinners snips with the strength of compound action
- Compound action multiplies the force of the hand by five times
- Cuts up to 20-gauge steel



Wiss®

Model No.	Mfg. No.	Cut Length"	Recommended Max. Capacity Low Carbon Cold Rolled Steel	Price /Each
QF327	M300	10 1/2	20-gauge steel	25.53

INDUSTRIAL USE STRAIGHT PATTERN

- Used for straight cuts and wide curves (on light gauge stock)
- Blades individually hand edged for maximum cutting efficiency
- Flat face guides tool along straight line
- Rust resistant blades
- Cushion handle for comfort and better grip



Wiss®

Model No.	Mfg. No.	Length"	Cut Length"	Recommended Max. Capacity Low Carbon Cold Rolled Steel	Price /Each
TBH849	W7N	14 1/2	4	18-gauge	61.50

HVAC COMPOUND ACTION PIPE & DUCT SNIPS

- Ideal for cutting straight or curves or any combination in rigid, non-metallic sheet materials such as fiberglass panels, decorative plastic kitchen laminates and synthetic shingles
- Jaw made of finest carbon steel with patented ball-bearing jaw action, automatically adjusts blade clearance for squarer, cleaner cuts
- Rust resistant blades
- Handle of high tensile strength steel
- Matte black finish and red plastisol grip



Wiss®

Model No.	Mfg. No.	Overall Length"	Depth of Cut"	Recommended Max. Capacity Low Carbon Cold Rolled Steel	Price /Each
TBH820	HM41V	9 1/4	9/16	20-Gauge Steel (0.035"/0.89 mm)	42.91

OFFSET HAND SEAMERS

- 1/4" incremental depth marks on jaw
- Compound action jaw for easy metal bending and flattening made of finest quality steel for better edges and long life
- Rust resistant blades
- Cushion handle for all-weather comfort
- Matte black finish and red plastisol grip



Wiss®

Model No.	Mfg. No.	Overall Length"	Jaw Depth"	Jaw Width"	Price/Each
VQ296	HS2	8 3/4	1/4 - 1 1/4	3 1/4	74.87

STRAIGHT PATTERN

- Cuts straight and wide curves (when trimming light gauge stock)
- For plumbing, heating, air conditioning and roofing trades, also used as handyman's tool
- Flat face guides tool along straight line
- Blades of finest quality steel, hot drop-forged for sharp edge and long life
- Rust resistant blades
- Cushion handle for comfort and better grip



Wiss®

Model No.	Mfg. No.	Length"	Cut Length"	Recommended Max. Capacity Low Carbon Cold Rolled Steel	Price /Each
VQ285	A13N	7	1 3/4	23-gauge	18.22
VQ286	A12N	8 1/4	2	23-gauge	20.03
VQ287	A11N	9 3/4	2 1/4	23-gauge	21.94
VQ288	A10N	11	2 1/2	21-gauge	25.49
VQ289	A9N	12 1/2	3	20-gauge	28.38

Call us for all your Tools & Equipment requirements!



R32958E

OFFICE PRODUCTS

INSTRUMENTS, SCALES & ELECTRICAL

SHIPPING & PACKAGING

TOOLS & EQUIPMENT

WELDING & METALWORKING

SAFETY EQUIPMENT & SUPPLIES

JANITORIAL & MAINTENANCE

MATERIAL HANDLING & STORAGE

1409

KNIVES, SCISSORS & BOLT CUTTERS



BOLT CUTTERS

- Chrome molybdenum steel jaws
- Centre cutting blades
- Adjusting screws allow for easy and perfect alignment of jaws
- Strong tubular handle with slip-proof rubber grips

aurora tools

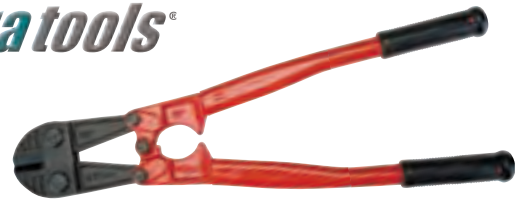

Model No.	Length"	Max. Jaw Opening"	Price/Each
TJZ111	14	1/4	26.80
TJZ112	18	5/16	34.85
TJZ113	24	3/8	46.25
TJZ114	36	9/16	78.80

INDUSTRIAL GRADE CENTRE CUT CUTTERS

- General plant maintenance tool
- Drop-forged, precision ground, alloy tool steel jaws with centre-cut blades
- Cuts soft, medium, or hard materials
- Maximum hardness of material to be cut: *Brinell 455/Rockwell C48*
- Lockplate keeps jaws from loosening
- Toggle joints turn 50 lbs. hand pressure to 4000 lbs. cutting pressure
- Screw-type adjustment realigns edges
- Steel handles with rubber grips



H.K. Porter

Model No.	Mfg. No.	Wt. lbs.	Overall Length		Cutting Capacity				Price /Each	Replacement Cutterhead		
			in.	mm	Soft and Medium Hard Materials (Up to Brinell 300, Rockwell C31)		Hard Materials (Up to Brinell 455, Rockwell C48)			Model No.	Mfg. No.	Price /Each
TBG120	1490MC	2.75	14	356	5/16	8	3/16	5	124.66	TBG109	1413C	91.78
YC552	0090MC	3.5	18	457	3/8	10	1/4	6	132.27	TBF924	0013C	91.53
YC554	0190MC	5.25	24	610	7/16	11	5/16	8	153.17	YC548	0113C	112.54
TBG005	0290MC	8.5	30	762	1/2	13	3/8	10	187.69	TBF983	0213C	151.69
TBG041	0390MC	12.9	36	914	9/16	14	7/16	11	226.13	TBG019	0313C	156.95
TBG082	0590MC	17.2	42	1067	11/16	18	1/2	13	301.78	TBG060	0513C	186.04

GENERAL PURPOSE CENTRE CUT BOLT CUTTERS

- Series 2000 bolt cutter
- Drop-forged jaws with centre-cut blades
- Heat treated for wear resistance and long cutting life
- Cuts soft, and medium/hard materials
- Maximum hardness of material to be cut: *Brinell 300/Rockwell C31*
- Toggle joints turn 50 lbs. hand pressure to 4000 lbs. of cutting pressure
- Precision cast, 1-piece, aluminum alloy handles with rubber grips

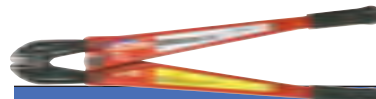

H.K. Porter

Model No.	Mfg. No.	Wt. lbs.	Overall Length		Cutting Capacity				Price /Each	Replacement Cutterhead		
			in.	mm	Soft and Medium Hard Materials (Up to Brinell 200, Rockwell C15)		Hard Materials (Up to Brinell 300, Rockwell C31)			Model No.	Mfg. No.	Price /Each
QG954	1490AC	1.7	14	356	5/16	8	1/4	6	68.19	TBG107	1413AC	42.26
QH783	0090AC	2.4	18	457	3/8	10	5/16	8	83.80	TBF923	0013AC	46.35
QG952	0190AC	4	24	610	7/16	11	3/8	10	109.20	TBF945	0113AC	49.31

INDUSTRIAL GRADE CLIPPER CUT CUTTERS

- All-purpose jaws with clipper-cut blades for close or flush cutting
- Not for cutting hard materials
- Maximum hardness of material to be cut: *Brinell 300/Rockwell C31*
- Lockplate keeps jaws from loosening
- Toggle joints turn 50 lbs. hand pressure to 4000 lbs. cutting pressure
- Screw-type adjustment realigns edges



H.K. Porter

Model No.	Mfg. No.	Wt. lbs.	Overall Length		Cutting Capacity				Price /Each	Replacement Cutterhead		
			in.	mm	Soft and Medium Hard Materials (Up to Brinell 200, Rockwell C15)		Hard Materials (Up to Brinell 300, Rockwell C31)			Model No.	Mfg. No.	Price /Each
TBG121	1490MNE	2.75	14	356	5/16	8	1/4	6	166.05	TBG110	1413NE	102.24
TBF934	0090MNE	3.5	18	457	3/8	10	5/16	8	167.45	TBF925	0013NE	97.84
TBF971	0190MNE	5.25	24	610	7/16	11	3/8	10	183.37	TBF950	0113NE	117.37
TBG008	0290MNE	8.5	30	762	1/2	13	7/16	11	249.73	TBF987	0213NE	160.72
TBG046	0390MNE	12.9	36	914	9/16	14	1/2	13	284.05	TBG025	0313NE	176.12

GENERAL PURPOSE CENTRE CUT CUTTERS

- All-purpose jaws with centre-cut blades
- Cuts soft, medium, and hard metals
- Maximum hardness of material to be cut: *Brinell 455/Rockwell C48*
- Lockplate keeps jaws from loosening
- Toggle joints turn 50 lbs. hand pressure to 4000 lbs. cutting pressure
- Screw-type adjustment realigns edges
- Strong, lightweight fiberglass handles
- Popular cutter

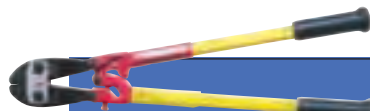

H.K. Porter

Model No.	Mfg. No.	Wt. lbs.	Overall Length		Cutting Capacity				Price /Each	Replacement Cutterhead		
			in.	mm	Soft and Medium Hard Materials (Up to Brinell 200, Rockwell C15)		Hard Materials (Up to Brinell 455, Rockwell C48)			Model No.	Mfg. No.	Price /Each
TBF933	0090FC	3.5	18	464	3/8	10	1/4	6	193.75	TBF924	0013C	91.53
TBF963	0190FC	4.5	24	622	7/16	11	5/16	8	222.68	YC548	0113C	112.54
TBG001	0290FC	7.5	30	775	1/2	13	3/8	10	270.52	TBF983	0213C	151.69
TBG037	0390FC	11.5	36	927	9/16	14	7/16	11	323.08	TBG019	0313C	156.95

KNIVES, SCISSORS & BOLT CUTTERS

HEAVY-DUTY CUTTERS

- Recommended for the most demanding hand cutting applications
- Heavy-duty straps support the jaws
- Maximum hardness of material to be cut: *Brinell 455/Rockwell C48*
- Lockplate keeps jaws from loosening
- Toggle joints turn 50 lbs. hand pressure to 4000 lbs. cutting pressure
- Screw-type adjustment realigns edges
- Available with tubular steel or lightweight, fiberglass handles

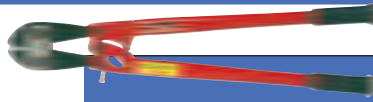

H.K. Porter®

Model No.	Mfg. No.	Wt. lbs.	Overall Length		Cutting Capacity (Up to Brinell 455, Rockwell C48)				Price /Each	Replacement Cutterhead		
			in.	mm	in.	mm	in.	mm		Model No.	Mfg. No.	Price /Each
TBF968	0190MCX	5.5	24	610	5/16	8			243.35	TBF946	0113CX	153.13
TBG006	0290MCX	9.25	30	762	3/8	10 (#3 Bar)			265.79	TBF985	0213CX	190.27
TBG043	0390MCX	14.2	36	914	7/16	11			333.21	TBG020	0313CX	229.28
TBG084	0590MCX	18.25	42	1067	1/2	13 (#4 Bar)			395.71	TBG061	0513CX	279.94
LIGHTWEIGHT, FIBERGLASS HANDLES												
TBF964	0190FCX	5.5	24	610	5/16	8			300.20	TBF946	0113CX	153.13
TBG039	0390FCX	11.5	36	914	7/16	11			402.46	TBG020	0313CX	229.28

BOLT CUTTER/CABLE CUTTERS

- Cuts soft, medium hard, and hard materials
- Cuts metal rod to 7/16" diameter
- Strap cuts wire rope to 1/4" diameter
- Maximum hardness of material to be cut: *Brinell 455/Rockwell C48*
- Lockplate keeps jaws from loosening
- Toggle joints turn 50 lbs. hand pressure to 4000 lbs. cutting pressure
- Screw-type adjustment realigns edges



H.K. Porter®

Model No.	Mfg. No.	Wt. lbs.	Overall Length		Cutting Capacity				Price /Each	Replacement Cutterhead		
			in.	mm	Rockwell C31 in.	Rockwell C48 mm	in.	mm		Model No.	Mfg. No.	Price /Each
TBF967	0190MCS	5.5	24	610	7/16	11	5/16	8	252.02	TBF949	0113MCS	141.77

SHEAR TYPE CABLE CUTTERS

- Notched, shear-cut blades hold and lock cable in cutting position
- Cuts steel cable, coarse- or fine-stranded cable, or wire rope with minimal distortion
- Toggle joints turn 50 lbs. hand pressure to 4000 lbs. cutting pressure
- Screw-type adjustment realigns edges



H.K. Porter®

Model No.	Mfg. No.	Wt. lbs.	Overall Length		Cutting Capacity						Price /Each	Replacement Cutterhead		
			in.	mm	Rope in.	mm	Steel Cable in.	mm	Cable in.	mm		Model No.	Mfg. No.	Price /Each
TBG122	1490MTN	2.75	14	356	1/4	6	1/4	6	1/4	6	243.43	TBG111	1413TN	122.37
TBF972	0190MTN	5	24	610	3/8	10	3/8	10	3/8	10	261.08	YC555	0113TN	176.43
TBG047	0390MTN	12	36	914	5/8	16	5/8	16	5/8	16	383.39	TBG026	0313TN	249.08
TBG088	0590MTN	17	42	1067	3/4	19	3/4	19	3/4	19	467.61	TBG067	0513TN	287.01

REBAR CUTTERS & BENDERS

- Rugged contractor's tool
- Shear-cut blades
- Mounts easily on most flat surfaces to enhance leverage and increase safety



H.K. Porter®

Model No.	Mfg. No.	Wt. lbs.	Length		Maximum Capacity		Price /Each	Replacement Cutterhead		
			in.	mm	in.	mm		Model No.	Mfg. No.	Price /Each
WK859	0590RBJ	31	52	1320	5/8	16	508.60	TBG065	0513RBJ	294.24

SLOTTED ANGLE IRON SHEARS

- Used to make braces, shelves, and tables
- Lightweight, portable shear
- Shear-cut blades
- Cuts pre-drilled and slotted angles up to 45° on either leg

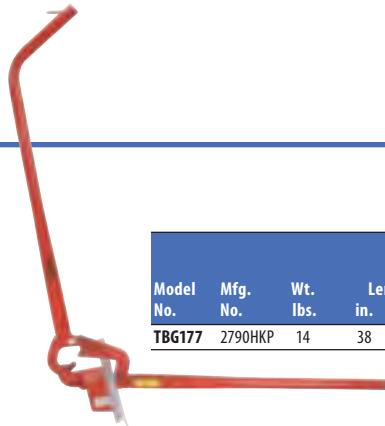

H.K. Porter®

Model No.	Mfg. No.	Wt. lbs.	Length		Capacity"	Price /Each	Replacement Blades					
			in.	mm			Model No.	Lower Mfg. No.	Price /Each	Upper Model No.	Mfg. No.	Price /Each
TBG177	2790HKP	14	38	965	3 x 1/12 x 1/8	531.90	TBG175	2710HK	96.96	TBG176	2711HK	151.76

R26452E

OFFICE PRODUCTS

INSTRUMENTS, SCALES & ELECTRICAL

SHIPPING & PACKAGING

TOOLS & EQUIPMENT

WELDING & METALWORKING

SAFETY EQUIPMENT & SUPPLIES

JANITORIAL & MAINTENANCE

MATERIAL HANDLING & STORAGE

1411

SAWS, HAMMERS, PRY BARS & PUNCHES

CUSHION GRIP HACKSAW FRAMES

- Unique cushioned rubber grip reduces slippage for better control and comfort
- Rugged, sturdy frame built for professional tool users
- High tension technology for tightening the blade to 30,000 PSI
- Blade can be positioned for 45° or 90° cutting
- Patented quick change blade design

Model No. TJ246
Mfg. No. 80965
Price/Each \$36.75



Nicholson®

HIGH TENSION HACKSAW FRAMES

- Quick changing blades
- Adjustable crank handle for tension up to 30,000 PSI torque and micro-adjustment
- Spare blades can be stored inside frame
- Blade can be positioned for 45° or 90° cutting
- End of frame can be used as a jab saw

Model No. TJ557
Mfg. No. 80956
Price/Each \$28.68



Nicholson®

HEAVY-DUTY HACKSAW FRAMES

- High impact, contoured handle
- Adjust to 10" or 12"
- 45° blade adjustment

Model No. TBH296
Mfg. No. 80952
Price/Each \$25.61

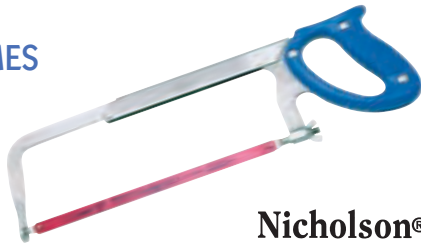

Nicholson®

ECONOMY HACKSAW FRAMES

- Adjustable from 10"/250 mm to 12"/300 mm
- Cuts to 2.75"/70 mm in depth
- For DIY and home use

Model No. TJ251
Mfg. No. 80950
Price/Each \$10.05



Nicholson®

GENERAL PURPOSE HACKSAW FRAMES

- Instantly adjustable for 10"/250 mm to 12"/300 mm blades
- Adjusts 90° for vertical or horizontal cuts

Model No. VU145
Mfg. No. 80951
Price/Each \$13.67



Nicholson®

HACKSAWS

- Heavy 16-gauge round steel tubing
- Comfort grip handle
- Adjustable for 10" and 12" blades
- Spring loaded release for quick blade changes
- Cuts at 45° and 90°

Model No. TJZ030
Price/Each \$15.65



aurora tools®

LITTLE-NIC® UTILITY HACKSAWS

- Ergonomic cushioned handle
- Gets into small places
- Overall length 10"/250 mm,
- Uses any standard size hacksaw blade

Model No. TBH298
Mfg. No. 80968
Price/Each \$13.14



Nicholson®

JAB SAWS

- Special saw always needed for the difficult jobs: those narrow, hard-to-reach areas
- Jab saw will work with any standard size hacksaw blade
- Can replace worn blade easily

Model No. TJ252
Mfg. No. 80969
Price/Each \$8.78



Nicholson®



TJZ032



TJZ033



TJZ034



TJZ035



TJZ036



TJZ037



TJZ038



TJZ039



TJZ040



TJZ041



TJZ042



TJZ043



TJZ044



TJZ045



TJZ046

2-PC. HICKORY HANDLE HAMMER SETS

- Large natural colour, American hickory handle
- Extra tough, heat-treated, fully polished head
- Extra large striking face
- Natural shock absorbing qualities of natural wood
- Meets ANSI standards

Set includes:

TJZ033 – 16 oz. Claw

TJZ034 – 22 oz. Framing

Model No. TLV114

Price/Each \$24.50

4-PC. DEAD BLOW HAMMER SETS

- 1-piece urethane construction
- Completely enclosed steel shank
- Shot-filled head
- High visibility orange

Set includes:

TJZ035 – 8 oz.

TJZ036 – 16 oz.

TJZ037 – 24 oz.

TJZ038 – 32 oz.

Model No. TLV113

Price/Each \$61.10

4-PC. BALL PEIN HAMMER SETS

- High quality construction
- Kiln-dried hickory handle
- Natural shock-absorbing qualities of natural wood
- Meets ANSI standards

Set includes:

TJZ039 – 8 oz.

TJZ040 – 16 oz.

TJZ041 – 24 oz.

TJZ042 – 32 oz.

Model No. TLV112

Price/Each \$40.95

4-PC. RUBBER MALLET SET

- Hardwood handle
- Non-marking white rubber head (TJZ045 and TJZ046)

Set includes:

TJZ043 – 16 oz. Black

TJZ044 – 32 oz. Black

TJZ045 – 16 oz. White

TJZ046 – 32 oz. White

Model No. TLV115

Price/Each \$23.95

8-PC. UNIVERSAL HAMMER SETS

- The most popular striking tools for a wide variety of applications

Set includes:

TJZ032 – 16 oz. Tubular steel, claw

TJZ034 – 22 oz. Hickory, framing

TJZ036 – 16 oz. Dead blow

TJZ038 – 32 oz. Dead blow

TJZ040 – 16 oz. Ball peen

TJZ042 – 32 oz. Ball peen

TJZ044 – 32 oz. Mallet, black

TJZ045 – 16 oz. Mallet, white

Model No. TLV116

Price/Each \$83.30

15-PC. ULTIMATE HAMMER SETS

- The most comprehensive hammer sets on the market
- Includes a hammer for virtually every application

Set includes:

TJZ032 – 16 oz. Tubular steel, claw

TJZ033 – 16 oz. Hickory, claw

TJZ034 – 22 oz. Hickory, framing

TJZ035 – 8 oz. Dead blow

TJZ036 – 16 oz. Dead blow

TJZ037 – 24 oz. Dead blow

TJZ038 – 32 oz. Dead blow

TJZ039 – 8 oz. Ball peen

TJZ040 – 16 oz. Ball peen

TJZ041 – 24 oz. Ball peen

TJZ042 – 32 oz. Ball peen

TJZ043 – 16 oz. Mallet, black

TJZ044 – 32 oz. Mallet, black

TJZ045 – 16 oz. Mallet, white

TJZ046 – 32 oz. Mallet, white

Model No. TLV117

Price/Each \$149.00

aurora tools[®]

STEEL HANDLE HAMMERS

SOLID STEEL HAMMERS

- Fully polished head
- Cushion grip handle



FULLER

Model No.	Mfg. No.	Type	Head oz.	Price /Each
UQ079	600-5016	Claw	16	23.09
WJ145	600-5020	Claw	20	23.09

TUBULAR HANDLE HAMMERS

- 1.4 mm hardened tubular steel shaft
- Fully polished heat-treated face with octagonal neck
- Shock-absorbing cushion grip handle
- Steel overstrike ring
- Meets ANSI standards



aurora tools®

Model No.	Type	Head oz.	Price /Each
TJZ032	Claw	16	10.45

SOLID STEEL ANTI-SHOCK PREMIUM CURVED CLAW HAMMERS

- Anti-vibration feature helps absorb shock
- 1-piece forged solid steel construction
- Co-molded contoured handle for increased comfort and control
- High-luster, full polished finish



Plumb®

Model No.	Mfg. No.	Head oz.	Length"	Face	Price /Each
UQ988	SS16CN	16	12.875	Polished	29.52
WJ190	SS20CN	20	13.75	Polished	33.05

SOLID STEEL ANTI-SHOCK PREMIUM RIPPING CLAW HAMMERS

- Anti-vibration feature helps absorb shock
- 1-piece forged solid steel construction
- Co-molded contoured handle for increased comfort and control
- High-luster, full polished finish

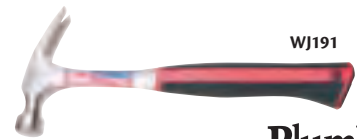

Plumb®

Model No.	Mfg. No.	Head oz.	Length"	Face	Price /Each
WJ191	SS16RN	16	12.875	Polished	29.52
TJ561	SS20RN	20	13.75	Polished	33.05
UQ989	SS22RN	22	15.875	Polished	37.48
TBH515	SS28RN	28	16	Polished	41.01

SOLID STEEL BRICK HAMMERS

- Solid steel for extra strength
- Forged handle and head
- Sharp cutting bit
- Cushion grip for extra comfort



Plumb®

Model No.	Mfg. No.	Head oz.	Overall length"	Price /Each
WJ194	SS20BHN	20	11	32.46
TBH514	SS24BHN	24	11	34.85

SCALING HAMMERS

- Forged head
- Durable, black epoxy powder paint finish on head
- Red hickory handle
- PermaBond® construction between head and handle



Plumb®

Model No.	Mfg. No.	Head wt. oz.	Overall length"	Price /Each
TJ587	11530	16	13	25.03

WOOD HANDLE HAMMERS

HICKORY HANDLE HAMMERS

- Large natural colour, American hickory handle
- Extra tough, heat-treated fully polished head
- Extra large striking face
- Natural shock absorbing qualities of natural wood
- Meets ANSI standards



TJ575

aurora tools®

Model No.	Type	Head oz.	Price /Each
TJZ033	Claw	16	12.30
TJZ034	Framing	22	16.35

PREMIUM RED HICKORY HANDLE HAMMERS

- High-luster, full-polished
- PermaBond® construction between head and handle
- Factory balanced



TJ575

Plumb®

Model No.	Mfg. No.	Head oz.	Type	Price /Each
TJ575	11438	13	Curved Claw	23.11
TJ576	11436	16	Curved Claw	23.74
TJ577	11435	20	Curved Claw	25.03
TBH418*	11439	22	Ripping Claw	27.60

* Ripping claw (Straight claw)

FIBERGLASS HANDLE HAMMERS

PREMIUM RIPPING CLAW HAMMERS

- Octagon-shaped neck
- Virtually unbreakable fiberglass handle
- Contoured handle for increased comfort
- PermaBond® construction between head and handle



TBH413

Plumb®

Model No.	Mfg. No.	Head oz.	Length"	Face	Price /Each
TBH413	11414N	22	13 1/2	Polished	29.54
TJ571	11415N	16	13	Polished	25.99
TJ573	11416N	22	15	Polished	31.79
TJ574	11417N	22	15	Checkered	32.75
TJ572	11420N	20	13	Polished	27.93

FIBERGLASS HANDLE HAMMERS

- Shock-absorbing fiberglass shaft
- Cushion-grip handle



WJ146

FULLER

Model No.	Mfg. No.	Type	Head oz.	Price /Each
WJ146	600-3316	Claw	16	10.13

PREMIUM CURVED CLAW HAMMERS

- Octagon-shaped neck
- Virtually unbreakable fiberglass handle
- Contoured handle for increased comfort
- PermaBond® construction between head and handle



TJ569

Plumb®

Model No.	Mfg. No.	Head oz.	Length"	Face	Price /Each
TJ569	11402	16	13	Polished	25.99
TJ568	11403	13	12 1/2	Polished	24.70
TJ570	11400	20	13	Polished	27.93

ANTI-VIBRATION NAIL HAMMERS

- Patented Wavex waves significantly reduce harmful shock
- Polished alloy steel head
- Tough jacketed shaft protects hammer in case of overstrike
- Extra soft ergonomic grip
- Model TDU804 features a precision milled face



TDU801

FULLER

Model No.	Mfg. No.	Head oz.	Type	Face	Price /Each
TDU801	600-8016	16	claw	Smooth	16.36
TDU802	600-8020	20	Claw	Smooth	18.04
TDU803	600-8120	20	Rip	Smooth	17.06
TDU804	600-8322	22	Rip	Milled	19.88

SAWS, HAMMERS, PRY BARS & PUNCHES

BALL PEIN HAMMERS

- Kiln-dried hickory handle
- High quality construction
- Natural shock-absorbing qualities of natural wood
- Meets ANSI standards



Model No.	Weight oz.	Price/Each
TJZ039	8	8.10
TJZ040	16	9.10
TJZ041	24	12.10
TJZ042	32	13.85

BALL PEIN HAMMERS

- Ground, black head
- Polished poles and peins
- Quality, hickory handle
- PermaBond® construction between head and handle



Model No.	Mfg. No.	Head Wt. oz.	Overall length"	Price /Each
TBH422	11494	4	10 1/2	16.03
TBH424	11496	8	11 1/4	17.99
TBH425	11497	12	11 1/4	18.62
TBH426	11498	16	12 3/4	19.27
TBH427	11499	20	12 3/4	19.92
TBH430	11520	24	15	20.86
TBH431	11521	32	15	21.50
TBH432	11522	40	15	22.48

BALL PEIN DEAD BLOW HAMMERS

- Safety red
- Shot-filled canister absorbs shock
- Hot cast urethane with steel reinforced handle
- Reduces noise when striking metal objects



Model No.	Mfg. No.	Weight Class oz.	Overall Length"	Face Dia."	Head Length"	Price /Each
TLZ699	68-516	16	12.75	1.000	4.2	65.93
TLZ700	68-524	24	13.00	1.250	4.5	83.26
TLZ701	68-532	32	13.62	1.375	4.8	98.99
TLZ702	68-540	40	16.50	1.375	4.8	112.56

COPPER HAMMERS

- Soft non-marring head
- Ideal for driving bushings and gears
- Hickory handle



Model No.	Mfg. No.	Weight Class lbs.	Length"	Wt. lbs.	Price /Each
U0348	69-480	1 1/2	13 7/16	1.98	63.14
U0349	69-485	2	13 1/2	2.34	67.03

ANTI-VIBRATION BALL PEIN HAMMERS

- Patented Wavex waves significantly reduce harmful shock
- Polished alloy steel head
- Extra-large striking surface
- Tough jacket shaft protects hammer in case of overstrike
- Extra soft ergonomic grip



Model No.	Mfg. No.	Head oz.	Price /Each
TDU805	611-8016	16	14.15
TDU806	611-8024	24	18.17
TDU807	611-8032	32	19.58

BALL PEIN HAMMERS

- Heads are drop forged
- Hollow core fiberglass handle for balance
- Absorbs shock better than solid fiberglass



Model No.	Mfg. No.	Weight Class	Length"	Wt. lbs.	Price /Each
U0335	69-404	8 oz.	12 1/2	1.00	45.69
U0336	69-406	12 oz.	13	1.26	49.10
U0337	69-408	1 lbs.	13	1.47	52.01
U0338	69-410	1 1/2 lbs.	14 1/2	2.07	56.61
U0339	69-412	2 lbs.	14 3/4	2.63	61.71

BALL PEIN HAMMERS - FIBERGLASS

- Rust-resistant, forged black head with polished poles and peins
- Professional quality fiberglass handle
- PermaBond® construction between head and handle
- Comfortable black cushion grip



Model No.	Mfg. No.	Head oz.	Weight grams	Overall Inch	Length mm	Price /Each
TJ594	11426	16	454	12 3/4	324	24.07
TJ596	11428	24	681	15	377	26.31
TJ597	11429	32	908	15	377	27.60

BRASS HAMMERS

- Fiberglass handle
- Soft brass head
- Surface protective, non-sparking, non-marring
- Absorbs blows and reduces rebound



Model No.	Mfg. No.	Weight Class lbs.	Face Dia."	Length"	Wt. lbs.	Price /Each
U0355	69-513	1.5	1 1/16	12	1.95	64.98
U0356	69-515	2.5	1 1/2	12	2.68	119.21
U0357	69-517	4	1 7/8	12	3.94	207.30

For non-sparking and non-magnetic striking tools and accessories, please see pages 1428-1434.



SAWS, HAMMERS, PRY BARS & PUNCHES

DOUBLE-FACED SLEDGE HAMMERS

- High-quality hickory handle
- Forged, new treated head
- Head secured with wood and steel wedges



Model No.	Mfg. No.	Head lbs.	Face	Length"	Price /Each
TV691	D40104	4	Polished	16	29.03
TV692	D40304	6	Polished	32	38.35
TV693	D40404	8	Polished	32	45.63
TV694	D40504	10	Polished	36	53.14
TV695	D40604	12	Polished	36	60.21

CLUB HAMMERS

- High-quality hickory handle
- Forged, new treated head
- Head secured with wood and steel wedges



Model No.	Mfg. No.	Head lbs.	Face	Length"	Price /Each
TV688	D10004	2.5	Polished	10	23.00
TV689	D10204	4	Polished	16	28.77

DOUBLE-FACED, FIBERGLASS SLEDGE HAMMERS

- High-quality fiberglass handle
- Forged, new treated head
- Head secured with epoxy



Model No.	Mfg. No.	Head lbs.	Face	Length"	Price /Each
TV698	DF1034FG	10	Polished	34	50.40

NAIL PULLERS WITH HANDLE

- Small nail puller
- Forged and tempered steel
- Comfortable hexagonal handle
- Ideal for hard-to-reach places



Model No.	Mfg. No.	Overall Length"	Price /Each
TLZ697	NP10	10	6.57

BLACKSMITH HAND HAMMERS

- Quality, steel forged head, hardened and tempered
- Durable, flat black finish on head
- Hickory handle



Model No.	Mfg. No.	Head wt. oz.	Overall Length"	Price /Each
TBH433	11524	40	14	26.95

HAND DRILLING HAMMERS

- Black forged head
- Hickory handle



Model No.	Mfg. No.	Head wt. oz.	Overall Length"	Price /Each
TBH448	11649	48	10 3/4	31.46

ACTION BARS

- High quality heat-treated carbon steel
- Edges are specially bevelled for pulling, lifting and scraping
- Baked paint finish



Model No.	Size"	Colour	Price /Each
TJZ047	13 1/2 x 1 3/8	Black	6.60

SCRAPER & PRY BARS

- Heat-treated carbon steel
- Bevelled edges
- Slotted at one end for nail removal, scraper at other end to remove paint, coatings and accumulation
- Baked paint finish



Model No.	Mfg. No.	Overall Length"	Price /Each
TDP844	615-5514	9 1/2	7.22

GOOSENECK WRECKING BARS

- High quality steel
- Hexagon shank
- Bevelled edges for pulling and lifting



Model No.	Diameter"	Length"	Weight lbs.	Price /Each
TJZ048	5/8	18	1.9	6.10
TJZ049	3/4	24	3.0	8.35
TJZ050	3/4	30	4.0	10.55
TJZ051	3/4	36	5.0	11.95

EXTENDABLE PRY BARS

- Extends for greater access and leverage and collapses so you can store it securely in your tool box
- Knurled handle provides a better overall grip
- Indexible head turns 180° for greater leverage
- Features 14 locking positions
- Grooved foot gives added traction
- Exceeds ANSI requirements for proven strength



TLV416



TLV417



Model No.	Mfg. No.	Description	Price /Each
TLV416	82220	18" to 29" Extendable Pry Bar	116.96
TLV417	82248	29" to 48" Extendable Pry Bar	251.91

SAWS, HAMMERS, PRY BARS & PUNCHES

PRY BARS



Model No.	Mfg. No.	Tip Width"	Stock Size"	Blade Length"	OAL"	Wt. lbs.	Price /Each
U0454	70-531	5/8	3/8	7	12	0.47	27.58
U0455	70-533	5/8	3/8	12	17	0.75	37.53
U0456	70-535	11/16	1/2	18	25	1.72	48.41
U0457	70-537	11/16	1/2	24	31	2.28	58.38
U0458	70-539	1	7/8	28	36	3.69	117.23

4-PC. PRY BAR SETS

- Blade lengths included: 3/8" x 7", 3/8" x 12", 1/2" x 18", 1/2" x 24
- Approximate weight: 5.51 lbs.

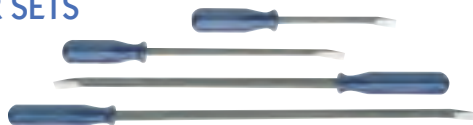

Model No. UO466
Price/Each \$171.90

ROLLING HEAD BARS



Model No.	Mfg. No.	Stock Size"	Length"	Wt. lbs.	Price /Each
U0451	70-517	3/8	9	0.29	26.91
U0452	70-519	1/2	15	0.87	34.15
U0453	70-521	5/8	18	1.59	40.09

ALIGNING PRY BARS

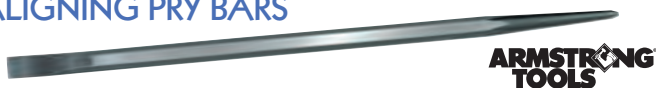

Model No.	Mfg. No.	Stock Size"	Length"	Wt. lbs.	Price /Each
U0445	70-501	1/2	14	0.78	24.54
U0446	70-503	5/8	16	1.45	34.17
U0447	70-505	3/4	24	3.08	45.48
U0448	70-507	7/8	30	4.78	77.20
U0449	70-509	7/8	46	7.33	78.51
U0450	70-511	1 1/16	54	10.45	101.23

4-PC. ALIGNING/ROLLING HEAD SETS

- Kit contains aligning pry bars in stock sizes 5/8" and 3/4" and rolling head bars in stock sizes 1/2" and 5/8"
- Approximate weight: 7.04 lbs.



Model No. TDQ979
Price/Each \$153.90

IRWIN MARPLES® BLUE CHIP® WOODWORKING CHISELS

- Long blade and handle for increased leverage
- For either hand or mallet work
- High carbon steel
- Polypropylene handle



Model No.	Mfg. No.	Blade Width(s)"	Price /Each
TBQ831	M444/-1/8N	1/8	17.50
TBQ830	M444/-1/4N	1/4	15.03
TBQ833	M444/-3/8N	3/8	14.54
TBQ829	M444/-1/2N	1/2	14.91
TBQ834	M444/-5/8N	5/8	15.75
TBQ832	M444/-3/4N	3/4	16.54
TBR087	M444/-1N	1	17.40
TBQ665	M444/1-1/4N	1 1/4	19.17
TBQ664	M444/1-1/2N	1 1/2	26.41
TBR088	M444/2N	2	32.11

SETS

Model No.	Mfg. No.	Description	Sizes"	Price /Each
TGZ494	M444/S4	4-Pc Set	1/4, 1/2, 3/4, 1	61.54
TGZ496	M444/SB6	6-Pc Boxed Set	1/4, 3/8, 1/2, 5/8, 3/4, 1	114.77

PUNCH & CHISEL HOLDERS

- Holds punches and chisels up to 1 1/16" hex stock
- Protects against hand injury
- Tri-oval shaped handle conforms to the hand, increasing comfort
- Warning is prominently visible
- "V" shaped head traps punch/chisel reducing risk of injury



ARMSTRONG TOOLS

Model No.	Mfg. No.	Contracted Length"	Expanded Length"	Wt. lbs.	Price /Each
TDQ546	70-000	7.5	8.75	0.72	28.47

COLD CHISELS

- Individually forged from high quality alloy steel
- Manufactured to the highest safety standards
- Precisely ground cutting edge is induction hardened to 52-58 HRC
- Striking head is hardened to 42 HRC to prevent splintering during use



6-PC. COLD CHISEL SET

Set includes sizes: 1/4", 5/16", 3/8", 1/2", 5/8", and 3/4"

Model No. TLZ420
Price/Each \$38.50

aurora tools®

Model No.	Width of Cut"	Stock Size"	Overall Length"	Price /Each
TLZ395	1/4	1/4	5	4.65
TLZ396	5/16	1/4	5	5.60
TLZ397	3/8	5/16	5 1/2	7.60
TLZ398	1/2	7/16	6	7.60
TLZ399	5/8	1/2	6 1/2	8.15
TLZ400	3/4	5/8	7	13.60
TLZ556	7/8	3/4	7 1/2	16.75

TOOL STEEL COLD CHISELS



ARMSTRONG TOOLS

Model No.	Mfg. No.	Width of Cut"	Stock Size"	Length"	Wt. lbs.	Price /Each
TDQ550	70-325	3/8	5/16	5 1/2	0.13	11.38
TDQ549	70-329	1/2	7/16	6	0.26	13.74
TDQ548	70-331	5/8	1/2	6 1/2	0.37	15.23
TDQ547	70-333	3/4	5/8	7	0.60	19.59
TDQ545	70-335	7/8	3/4	7 1/2	0.90	29.09
TDQ544	70-337	1	7/8	8	1.25	30.50

COLD CHISEL SETS

5-PC. COLD CHISEL SET

- Includes sizes: 5/16", 3/8", 7/16", 1/2", 5/8" and a vinyl roll, Mfg. No. 29-407
- Approximate weight: 1.19 lbs.

Model No. TDQ543
Price/Each \$55.14



7-PC. COLD CHISEL SET

- Includes sizes: 5/16", 3/8", 7/16", 1/2", 5/8", 3/4", 7/8" and a vinyl roll, Mfg. No. 29-406
- Approximate weight: 2.80 lbs.

Model No. TDQ542
Price/Each \$93.70



ARMSTRONG TOOLS

SAWS, HAMMERS, PRY BARS & PUNCHES

COLD CHISELS



ARMSTRONG TOOLS

Model No.	Mfg. No.	Width of Cut"	Stock Size"	Length"	Wt. lbs.	Price /Each
U0410	70-301	1/4	1/4	4 3/4	0.08	8.45
U0411	70-303	5/16	5/16	5	0.12	8.50
U0412	70-305	3/8	5/16	5 1/4	0.13	8.92
U0413	70-307	7/16	3/8	5 1/2	0.16	9.46
U0414	70-309	1/2	3/8	6	0.19	10.82
U0415	70-311	5/8	1/2	6 1/2	0.33	11.93
U0416	70-313	3/4	5/8	7	0.60	15.32
U0417	70-315	7/8	3/4	7 1/2	0.91	23.35
U0418	70-317	1	7/8	8	1.33	23.91
U0419	70-319	1 1/8	7/8	8	1.39	28.05

EXTRA LONG COLD CHISELS



ARMSTRONG TOOLS

Model No.	Mfg. No.	Width of Cut"	Stock Size"	Length"	Wt. lbs.	Price /Each
U0420	70-347	5/8	1/2	12	0.68	18.57
U0421	70-353	3/4	5/8	12	1.05	30.70
U0423	70-357	3/4	5/8	18	1.42	37.85
U0424	70-361	7/8	3/4	12	1.54	30.73
U0425	70-367	1	7/8	12	2.08	38.55
U0426	70-369	1	7/8	18	3.01	49.95

CAPE CHISELS



ARMSTRONG TOOLS

Model No.	Mfg. No.	Width of Cut"	Stock Size"	Length"	Wt. lbs.	Price /Each
U0427	70-391	3/16	1/4	5	0.10	12.53
U0428	70-393	7/32	5/16	5	0.10	13.26
U0429	70-395	1/4	3/8	5	0.13	13.25
U0430	70-397	5/16	3/8	5 3/4	0.19	14.57
U0431	70-399	3/8	1/2	6	0.27	17.89

CENTRE PUNCHES



ARMSTRONG TOOLS

Model No.	Mfg. No.	Stock Size"	Length"	Wt. lbs.	Price /Each
U0401	70-231	1/4	4 1/4	0.06	7.16
U0402	70-233	5/16	4 1/2	0.08	7.23
U0403	70-235	3/8	5	0.13	9.60
WJ369	70-237	7/16	5 1/2	0.21	10.17
U0404	70-239	1/2	6	0.28	10.32
U0405	70-241	5/8	7	0.42	14.15

CENTRE PUNCHES

- Single piece construction with hexagonal shank increases durability
- Manufactured from high quality carbon steel
- Accurately hardened for increased service life
- Bevelled striking end to prevent breakage
- The working tips are centred and ground to 90° for increased marking efficiency



5-PC. CENTRE PUNCH SET

Set includes sizes: 5/64", 1/8", 5/32", 1/4", and 3/8"

Model No. TLZ423

Price/Each \$25.95

aurora tools®

Model No.	Point Diameter"	Stock Size"	Length"	Price /Each
TLZ415	5/64	1/4	3 1/2	4.65
TLZ416	1/8	5/16	4 1/4	5.20
TLZ417	5/32	3/8	5	5.20
TLZ418	1/4	1/2	6	6.55
TLZ419	3/8	5/8	6 1/4	8.65

PIN PUNCHES

- Ideal for driving out and removing already loosened pins and keys after initial movement by a starting punch
- Manufactured from high quality carbon steel
- Single piece construction with hexagonal shank increases durability
- Accurately hardened for increased service life



7-PC. PIN PUNCH SET

Set includes sizes:

1/16", 3/32", 1/8", 5/32", 3/16", 7/32", and 1/4"

Model No. TLZ421

Price/Each \$31.95

aurora tools®

Model No.	Point Diameter"	Stock Size"	Length"	Price /Each
TLZ401	1/16	1/4	4	4.15
TLZ402	3/32	5/16	4 1/2	4.75
TLZ403	1/8	5/16	4 3/4	5.20
TLZ404	5/32	5/16	5	5.20
TLZ405	3/16	5/16	5 1/4	5.20
TLZ555	7/32	3/8	5 1/2	5.50
TLZ406	1/4	3/8	5 3/4	5.70
TLZ407	5/16	7/16	6	7.80

PUNCH & CHISEL SETS

- Punch and chisel sets are an excellent way to keep your tools organized
- These sets are packed in heavy-duty vinyl rolls for easy access, organization and storage

8-PC. PUNCH & CHISEL SET:

Model No. TLZ433

Price/Each \$51.50

aurora tools®

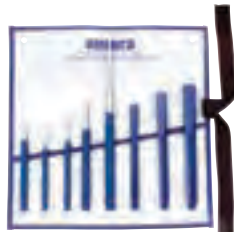

Set includes:

Model No.	Style	Size"	Price /Each
TLZ398	Cold Chisel	1/2	7.60
TLZ399	Cold Chisel	5/8	8.15
TLZ400	Cold Chisel	3/4	13.60
TLZ417	Centre Punch	5/32	5.20
TLZ403	Pin Punch	1/8	5.20
TLZ405	Pin Punch	3/16	5.20
TLZ406	Pin Punch	1/4	5.70
TLZ410	Drift Punch	3/16	9.95

aurora tools®

14-PC. PUNCH & CHISEL SET:

Model No. TLZ434

Price/Each \$84.25

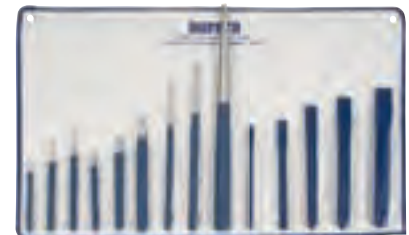

Set includes:

Model No.	Style	Size"	Price /Each	Model No.	Style	Size"	Price /Each
TLZ397	Cold Chisel	3/8	7.60	TLZ418	Centre Punch	1/4	6.55
TLZ398	Cold Chisel	1/2	7.60	TLZ401	Pin Punch	1/16	4.15
TLZ399	Cold Chisel	5/8	8.15	TLZ403	Pin Punch	1/8	5.20
TLZ400	Cold Chisel	3/4	13.60	TLZ405	Pin Punch	3/16	5.20
TLZ556	Cold Chisel	7/8	16.75	TLZ408	Drift Punch	1/8	7.10
TLZ416	Centre Punch	1/8	5.20	TLZ409	Drift Punch	5/32	7.80
TLZ417	Centre Punch	5/32	5.20	TLZ413	Drift Punch	5/16	14.95

SAWS, HAMMERS, PRY BARS & PUNCHES

PIN PUNCHES



ARMSTRONG TOOLS

Model No.	Mfg. No.	Point Dia."	Stock Size"	Length"	Wt. lbs.	Price /Each
U0369	70-101	1/16	5/16	4-1/4	0.07	7.40
U0370	70-103	3/32	5/16	4-3/4	0.08	7.88
U0371	70-105	1/8	5/16	5	0.08	8.25
U0372	70-107	5/32	5/16	5-1/4	0.08	9.18
U0373	70-109	3/16	5/16	5-1/2	0.08	9.53
U0374	70-129	7/32	3/8	7	0.16	11.33
U0375	70-131	1/4	3/8	7	0.18	11.80
U0376	70-133	5/16	1/2	7	0.30	13.85

ROLL PIN PUNCHES



ARMSTRONG TOOLS

Model No.	Mfg. No.	Point Dia."	Stock Size"	Length"	Wt. lbs.	Price /Each
WJ370	70-260	1/16	3/16	2 3/4	0.02	8.12
WJ371	70-262	3/32	3/16	3 1/2	0.02	8.82
WJ372	70-264	1/8	1/4	4	0.04	9.49
WJ373	70-266	5/32	1/4	4 1/2	0.04	10.42
WJ374	70-268	3/16	3/8	4 1/2	0.08	11.26
WJ375	70-270	7/32	3/8	5	0.08	12.00
WJ376	70-272	1/4	7/16	5 1/2	0.13	13.43
WJ377	70-274	5/16	7/16	6	0.17	14.01
WJ378	70-276	3/8	1/2	6	0.21	14.55
WJ379	70-280	1/2	5/8	6	0.38	15.06

TOOL STEEL LONG PIN PUNCHES



ARMSTRONG TOOLS

Model No.	Mfg. No.	Point Dia."	Stock Size"	Length"	Wt. lbs.	Price /Each
TDQ699	70-041	1/8	5/16	8	0.12	11.47
TDQ698	70-042	5/32	5/16	8	0.13	12.07
TDQ697	70-043	3/16	3/8	8	0.16	13.11
TDQ696	70-044	7/32	3/8	8	0.18	14.86
TDQ695	70-045	1/4	3/8	8	0.19	15.53
TDQ694	70-047	5/16	7/16	8	0.28	16.97
TDQ688	70-049	3/8	1/2	8	0.38	17.70

LONG ALIGNING PUNCHES



ARMSTRONG TOOLS

Model No.	Mfg. No.	Point Dia."	Stock Size"	Length"	Wt. lbs.	Price /Each
U0400	70-221	5/16	3/4	18	0.82	27.58

DRIFT PUNCHES

- Ideal for lining up holes in two or more pieces of metal and for drawing pins through various assemblies
- Manufactured from high quality carbon steel
- Single piece construction with hexagonal shank increases durability
- Accurately hardened for increased service life

7-PC. DRIFT PUNCH SET

Set includes sizes:

1/8", 5/32", 3/16", 7/32", 1/4", 5/16", and 3/8"

Model No. TLZ422

Price/Each \$72.95

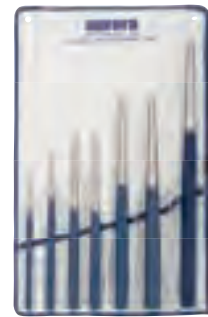

DRIFT PUNCHES



ARMSTRONG TOOLS

Model No.	Mfg. No.	Point Dia."	Stock Size"	Length"	Wt. lbs.	Price /Each
U0392	70-187	3/32	3/8	7 1/2	0.26	16.44
U0393	70-189	1/8	3/8	8	0.29	16.78
U0394	70-191	5/32	1/2	8 1/2	0.34	16.87
U0395	70-193	3/16	1/2	9	0.38	17.28
U0396	70-195	7/32	1/2	9 1/2	0.45	18.37
U0397	70-197	1/4	5/8	11	0.68	18.58
U0398	70-199	5/16	5/8	11	0.72	20.78
U0399	70-201	3/8	3/4	11	0.76	26.43

STARTING PUNCHES



ARMSTRONG TOOLS

Model No.	Mfg. No.	Point Dia."	Stock Size"	Length"	Wt. lbs.	Price /Each
U0384	70-153	1/16	5/16	4 1/2	0.08	7.88
U0385	70-155	3/32	5/16	4 1/2	0.09	8.38
U0386	70-157	1/8	5/16	4 1/2	0.09	9.73
U0387	70-159	5/32	3/8	5	0.13	10.05
U0388	70-161	3/16	3/8	5	0.13	10.17
U0389	70-163	7/32	1/2	5 1/2	0.27	10.68
U0390	70-165	1/4	1/2	6	0.29	10.62
U0391	70-167	5/16	5/8	7	0.32	10.98

LIGHTWEIGHT AUTOMATIC CENTRE PUNCHES

- One-hand spring impact operation, no hammer needed
- Lightweight aluminum body with long wearing alloy steel parts
- Spring tension adjusts for light or heavy markings
- Hardened steel point
- Pencil slim design with pocket clip



GENERAL

Model No.	Mfg. No.	Price /Each
TV173	87	26.11

ALLPAX®

GASKET CUTTER SYSTEMS

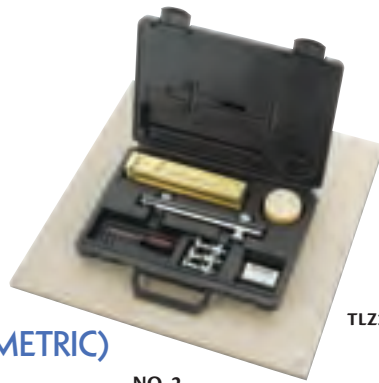

TLZ374

EXTENSION GASKET CUTTERS

- Hefty brass cutting head slides easily over a variety of gasket materials
- Modular extension design allows you to quickly adjust your cutting size from 1/4" up to 61" in diameter (TLZ374)
- Special cutting blades are held securely, ensuring consistent and repetitive cuts in material up to 3/4" thick
- Choose from 10 convenient kits to accommodate your cutting requirements

GASKET CUTTER KITS (METRIC)

NO. 1

- Cuts 6 mm to 330 mm in diameter

PARTS INCLUDED:

Cutter block & head assembly	19 mm long centre pin
Cutter head screws (2)	457 mm cutting board
Gasket cutter blades (6)	Cutting knob for small diameters
Pivot post	Post with offset pin
Knurled nuts (2)	Piercing tool
Fibre washers (2)	Hex key
13 mm short centre pin	
Weight: 10.4 lbs.	

Model No. TLZ377 Mfg. No. 100KM330

Price/Each \$303.84

NO. 2

- Cuts 6 mm to 635 mm in diameter

PARTS INCLUDED:

Cutter block & head assembly	19 mm long centre pin
Cutter head screws (2)	Extension bar 330 mm to 635 mm
Gasket cutter blades (6)	457 mm cutting board
Pivot post	Cutting knob for small diameters
Pivot post for extension bars	Post with offset pin
Knurled nuts (3)	Piercing tool
Fibre washers (3)	Hex key
13 mm short centre pin	
Weight: 10.5 lbs.	

Model No. TLZ378 Mfg. No. 100KM635

Price/Each \$329.50

NO. 3

- Cuts 6 mm to 940 mm in diameter

PARTS INCLUDED:

Cutter block & head assembly	19 mm long centre pin
Cutter head screws (2)	Extension bar 330 mm to 635 mm
Gasket cutter blades (6)	Extension bar over 635 mm
Pivot post	457 mm cutting board
Pivot post for extension bars	Cutting knob for small diameters
Knurled nuts (3)	Post with offset pin
Knurled nuts for extension bar	Piercing tool
Fibre washers (3)	Hex key
13 mm short centre pin	
Weight: 10.8 lbs.	

Model No. TLZ379 Mfg. No. 100KM940

Price/Each \$344.54

NO. 4

- Cuts 6 mm to 1245 mm in diameter

PARTS INCLUDED:

Cutter block & head assembly	19 mm long centre pin
Cutter head screws (2)	Extension bar 330 mm to 635 mm
Gasket cutter blades (6)	Extension bar over 635 mm (2)
Pivot post	457 mm cutting board
Pivot post for extension bars	Cutting knob for small diameters
Knurled nuts (3)	Post with offset pin
Knurled nuts for extension bars (2)	Piercing tool
Fibre washers (3)	Hex key
13 mm short centre pin	
Weight: 11.8 lbs.	

Model No. TLZ375 Mfg. No. 100KM1245

Price/Each \$364.90

NO. 5

- Cuts 6 mm to 1550 mm in diameter

PARTS INCLUDED:

Cutter block & head assembly	19 mm long centre pin
Cutter head screws (2)	Extension bar 330 mm to 635 mm
Gasket cutter blades (6)	Extension bar over 635 mm (3)
Pivot post	457 mm cutting board
Pivot post for extension bars	Cutting knob for small diameters
Knurled nuts (3)	Post with offset pin
Knurled nuts for extension bars (3)	Piercing tool
Fibre washers (3)	Hex key
13 mm short centre pin	
Weight: 11.8 lbs.	

Model No. TLZ376 Mfg. No. 100KM1550

Price/Each \$385.26

GASKET CUTTER KITS (IMPERIAL)

NO. 1

- Cuts 1/4" I.D. to 13" in diameter

PARTS INCLUDED:

Cutter block & head assembly	3/4" long centre pin
Cutter head screws (2)	18" cutting board
Gasket cutter blades (6)	Cutting knob for small diameters
Pivot post	Post with offset pin
Knurled nuts (2)	Piercing tool
Fibre washers (2)	Hex key
1/2" short centre pin	
Weight: 10.4 lbs.	

Model No. TLZ370 Mfg. No. 100K13

Price/Each \$303.84

NO. 2

- Cuts 1/4" to 25" in diameter

PARTS INCLUDED:

Cutter block & head assembly	3/4" long centre pin
Cutter head screws (2)	Extension bar 13" to 25"
Gasket cutter blades (6)	18" cutting board
Pivot post	Cutting knob for small diameters
Pivot post for extension bars	Post with offset pin
Knurled nuts (3)	Piercing tool
Fibre washers (3)	Hex key
1/2" short centre pin	
Weight: 10.5 lbs.	

Model No. TLZ371 Mfg. No. 100K25

Price/Each \$329.50

NO. 3

- Cuts 1/4" to 37" in diameter

PARTS INCLUDED:

Cutter block & head assembly	3/4" long centre pin
Cutter head screws (2)	Extension bar 13" to 25"
Gasket cutter blades (6)	Extension bar over 25"
Pivot post	18" cutting board
Pivot post for extension bars	Cutting knob for small diameters
Knurled nuts (3)	Post with offset pin
Knurled nuts for extension bar	Piercing tool
Fibre washers (3)	Hex key
1/2" short centre pin	
Weight: 10.8 lbs.	

Model No. TLZ372 Mfg. No. 100K37

Price/Each \$344.54

NO. 4

- Cuts 1/4" to 49" in diameter

PARTS INCLUDED:

Cutter block & head assembly	3/4" long centre pin
Cutter head screws (2)	Extension bar 13" to 25"
Gasket cutter blades (6)	Extension bar over 25" (2)
Pivot post	18" cutting board
Pivot post for extension bars	Cutting knob for small diameters
Knurled nuts (3)	Post with offset pin
Knurled nuts for extension bars (2)	Piercing tool
Fibre washers (3)	Hex key
1/2" short centre pin	
Weight: 11.8 lbs.	

Model No. TLZ373 Mfg. No. 100K49

Price/Each \$364.90

NO. 5

- Cuts 1/4" to 61" in diameter

PARTS INCLUDED:

Cutter block & head assembly	3/4" long centre pin
Cutter head screws (2)	Extension bar 13" to 25"
Gasket cutter blades (6)	Extension bar over 25" (3)
Pivot post	18" cutting board
Pivot post for extension bars	Cutting knob for small diameters
Knurled nuts (3)	Post with offset pin
Knurled nuts for extension bars (3)	Piercing tool
Fibre washers (3)	Hex key
1/2" short centre pin	
Weight: 11.8 lbs.	

Model No. TLZ374 Mfg. No. 100K61

Price/Each \$385.26

PLUMBING TOOLS

STRAIGHT PIPE WRENCHES

- Sturdy, cast iron housing and I-beam handle with full-floating forged hook jaw
- Nonstick adjustment nut, replaceable hook and heel jaws



TV792
RIDGID

Model No.	Cat. No.	Mfg. No.	Nom. Size in. mm	Pipe Capacity in. mm	Weight lbs. kg	Price /Each
TV792	31000	6	6 150	3/4 20	1/2 0.2	20.01
TV793	31005	8	8 200	1 25	3/4 0.3	23.37
TV794	31010	10	10 250	1 1/2 40	1 3/4 0.8	30.87
TV795	31015	12	12 300	2 50	2 3/4 1.2	35.63
TV796	31020	14	14 350	2 50	3 1/2 1.6	39.93
TV797	31025	18	18 450	2 1/2 65	5 3/4 2.6	57.66
TV798	31030	24	24 600	3 80	9 3/4 4.4	91.29
TV799	31035	36	36 900	5 125	19 8.7	185.57
TR181	31040	48	48 1200	6 150	34 1/4 15.6	285.34
TR182	31045	60	60 1500	8 200	51 1/4 23.3	415.74

RAPIDGRIP™

- Quick one-handed operation
- Spring-loaded jaw design provides rapid ratcheting action



TCX021
RIDGID

Model No.	Cat. No.	Mfg. No.	Nom. Size in. mm	Pipe Capacity in. mm	Fittings Cap. in. mm	Weight lbs. kg	Price /Each
TCX021	10348	10	10 250	1 1/2 37.5	1 25	1.6 0.7	36.23
TCX023	10358	14	14 350	2 50	1 1/2 37.5	3.1 1.4	42.54

WRENCH PARTS: ALWAYS INSIST ON GENUINE RIDGID® PARTS

Wrench Size Str.	End	Pipe Cap.¹	Handle Assembly			Nut Model No.	Pin Model No.	Heel Jaw & Pin Assembly Model No.	Coil & Flat Spring Assembly Model No.	Hook Jaw Model No.
			Straight Iron Model No.	End Iron Model No.	Straight Aluminum Model No.					
6	E-6	3/4	THX688	THX699	-	THX719	THX721	THX717	THX718	THX716
8	E-8	1	THX689	THX700	-	THX725	THX727	THX723	THX724	THX722
10	E-10	1 1/2	THX690	THX701	THX710	THX733	THX736	THX731	THX735	THX729
12	E-12	2	THX691	THX702	THX159	THX740	THX741	THX738	THX739	THX737
14	E-14	2	THX692	THX704	THX711	THX744	THX741	THX738	THX743	THX742
18	E-18	2 1/2	THX694	THX706	THX712	THX748	THX749	THX746	THX747	THX745
24	E-24	3	THX695	THX707	THX713	THX753	THX754	THX751	THX752	THX750
36	E-36	5	THX696	THX709	THX714	THX758	THX759	THX756	THX757	THX755
48	-	6	THX697	-	THX715	THX763	THX764	THX761	THX762	THX760
60	-	8	THX698	-	-	THX768	THX770	THX766	THX767	THX765

Call our order desk for pricing

HEAVY-DUTY OFFSET PIPE WRENCHES

- Jaw opening parallel to the handle
- Narrow hook jaw head provides easy entry into tight spots



TR159
RIDGID

Model No.	Cat. No.	Mfg. No.	Nom. Size in. mm	Pipe Capacity in. mm	Weight lbs. kg	Price /Each
TR159	89435	14	14 350	2 50	2 1/4 1.0	69.46
TR160	89440	18	18 450	2 1/2 65	5 3/4 2.6	102.60
TR161	89445	24	24 600	3 80	9 3/4 4.4	162.37

ALUMINUM HANDLE STRAIGHT PIPE WRENCHES

- Nearly 40% lighter than comparable cast iron models of the same size
- Jaws and all other parts identical to RIDGID® heavy-duty wrenches
- Also available with special hook and heel jaws for plastic-coated pipe

Model No.	Cat. No.	Mfg. No.	Nom. Size		Pipe Capacity		Weight		Price /Each
			in.	mm	in.	mm	lbs.	kg	
TR009	31090	810	10	250	1 1/2	40	1	0.4	49.18
TR010	47057	812	12	300	2	50	2 1/2	1.1	58.87
TR011	31095	814	14	350	2	50	2 1/2	1.1	66.78
TR012	31100	818	18	450	2 1/2	65	3 3/4	1.7	83.25
TR013	31105	824	24	600	3	80	6	2.7	132.96
TR014	31110	836	36	900	5	125	11	5.0	217.84
TR015	31115	848	48	1200	6	150	18 1/2	8.4	429.19

RIDGID



TR009

END PIPE WRENCHES

- Fast and easy grip for pipe working in restricted spaces or close to a wall



TR001
RIDGID

Model No.	Cat. No.	Mfg. No.	Nom. Size in. mm	Pipe Capacity in. mm	Weight lbs. kg	Price /Each
TR001	31050	E-6	6 150	3/4 20	1/2 0.2	23.85
TR002	31055	E-8	8 200	1 25	3/4 0.3	27.66
TR003	31060	E-10	10 250	1 1/2 40	1 3/4 0.8	36.85
TR004	31065	E-12	12 300	2 50	2 3/4 1.3	42.87
TR005	31070	E-14	14 350	2 50	3 1/2 1.6	48.96
TR006	31075	E-18	18 450	2 1/2 65	5 3/4 2.6	70.00
TR007	31080	E-24	24 600	3 80	9 3/4 4.4	110.18
TR008	31085	E-36	36 900	5 125	19 8.7	226.15

PIPE WRENCHES

- Drop-forged alloy steel jaw
- Durable ductile steel body provides the ultimate in performance
- Precision milled sure gripping teeth
- Spring action ensures sure grip and quick release



aurora tools™ TJZ106

Model No.	Length"	Pipe Capacity"	Price/Each
TJZ106	8	1	10.35
TJZ107	10	1 1/2	13.75
TJZ108	12	2	17.45
TJZ109	14	2	20.80
TJZ110	18	2 1/2	24.30

COMPOUND LEVERAGE WRENCHES

- Unique design multiplies the turning force applied to a pipe
- Ideal for freeing locked couplings and joints frozen by age or damage

Model No.	Cat. No.	Mfg. No.	Nom. Size in. mm	Pipe Capacity in. mm	Weight lbs. kg	Price /Each
THX681	31375	S-2	- -	2 50	7 1/4 3.3	457.00
THX682	31380	S-4A	- -	5 125	33 1/2 15.2	667.00
THX683	31385	S-6A	- -	6 150	45 1/2 20.6	851.00
THX684	31390	S-8A	- -	8 200	68 1/2 31.1	1268.00

STRAP WRENCHES

- Best for any polished pipe
- Strong, woven nylon strap gives tight grip
- Polyurethane-coated strap
- Replaceable straps available



RIDGID

Model No.	Cat. No.	Mfg. No.	Handle Length		Strap Length		Strap Width		Pipe Capacity		Tube Capacity (O.D.)		Weight		Price /Each
			in.	mm	in.	mm	in.	mm	in.	mm	in.	mm	lbs.	kg	
TR023	31335	1	11 3/4	300	17	425	1/2	12	2	50	3 1/2	90	1 1/4	0.5	38.41
TR163	31340	2	11 3/4	300	17	425	1 1/8	30	2	50	3 1/2	90	1 3/4	0.8	44.25
TR026	31355	2P*	11 3/4	300	17	425	1 1/16	27	2	50	3 1/2	90	1 3/4	0.8	47.46
TR025	31350	2	11 3/4	300	24	600	1 1/8	30	2	50	5 1/2	135	1 3/4	0.8	52.24
TR027	31360	5	18	450	29 1/4	750	1 3/4	45	5	125	7	175	2	0.9	84.90
TR029	31370	5P*	18	450	29 1/4	750	1 3/4	45	5	125	5 1/2	135	2 1/8	1.0	88.99
TR024	31345	2	11 3/4	300	30	760	1 1/8	30	2	50	5 1/2	135	1 3/4	0.8	48.54
TR028	31365	5	18	450	48	1200	1 3/4	45	5	125	12	300	2	0.9	102.00

* Strap designed for use with plastic pipe.

HEX WRENCHES

- Provides multi-sided, secure grip on all hex nuts, square nuts, unions, and valve packing nuts
- Extra-wide opening offset model is ideal for securing drain nuts on sinks and tubs



TDX443

RIDGID

Model No.	Cat. No.	Mfg. No.	Length		Capacity		Weight		Price /Each
			in.	mm	in.	mm	lbs.	kg	
THX679	31305*	E-110	9 1/2	240	1 1/8-2 5/8	29-67	1 1/2	0.6	46.54
TDX443	31275	17	14 1/2	362	5/8-1 1/4	16-30	4 1/2	2.0	75.88
TDX444	31280	25	20	500	1-2	25-50	8 3/4	4.0	116.54

* Offset Hex

SPUD WRENCHES

- Narrow jaws to fit into tight places
- Smooth, toothless jaws ideal for square or rectangular stock



TR030

RIDGID

Model No.	Cat. No.	Mfg. No.	Length		Capacity		Weight		Price /Each
			in.	mm	in.	mm	lbs.	kg	
TR030	31400	-	12	300	3/8-2 5/8	10-67	2 1/2	1.1	56.20

CHAIN TONGS

- Provide extra leverage for the toughest jobs
- Double-end jaw styles which can be reversed, (except model TTX127 which is a single-end tong)
- All chains are tested to 2/3 of their breaking strength



TTX129

RIDGID

Model No.	Cat. No.	Mfg. No.	Total Length		Pipe Capacity		Chain Length		Breaking Strain*		Weight		Price /Each
			in.	mm	in.	mm	in.	mm	lbs.	kg	lbs.	kg	
TTX129	92665	3229	27	686	1/4-2 1/2	13-73	17 1/2	445	13 800	6260	11	5	347.00
TTX131	92670	3231	37	939	3/4-4	26-114	22 1/2	572	17 600	7983	21	10	466.00
TTX133	92675	3233	44	1117	1-6	33-168	32	813	20 100	9117	29	13	598.00
TTX135	92680	3235	50	1270	1 1/2-8	48-219	40 1/2	1029	22 000	9979	39	18	731.00
TTX137	92685	3237	64	1625	2-12	60-323	55 1/2	1410	31 000	14 061	67	30	1130.00
TTX127	92660	3215	87	2209	4-18	114-457	74 1/2	1892	56 000	25 401	156	71	2679.00

Note: Chain breaking strain: All chains are tested to 2/3 of their breaking strength.

CHAIN WRENCHES

- Double jaw gives fast, ratchet-like action in either direction
- Replaceable alloy steel jaws
- One-piece forged alloy steel handle and jaw
- Ideal for use in close quarters



TR019

RIDGID

Model No.	Cat. No.	Mfg. No.	Rated Pipe Cap. in.	Actual O.D. Cap mm	Chain Length		Weight		Price /Each		
					in.	mm	lbs.	kg			
TR019	31310	C-12	2	50	4	100	15 3/4	390	1 3/4	0.8	63.41
TR162	31315	C-14	2	50	5	125	18 1/2	460	2 3/4	1.2	84.77
TR020	31320	C-18	2 1/2	60	5	125	20 1/4	500	6	2.7	121.13
TR021	31325	C-24	3	75	5	125	20 1/4	500	8 1/4	3.7	140.59
TR022	31330	C-36	4 1/2	110	7 1/2	185	29	725	15 3/4	7.1	288.59

Call us for all your

Tools & Equipment requirements!

PLUMBING TOOLS



MIDGET TUBING CUTTERS

NOS. 101, 103, 104, 117 & 118

- For use in restricted spaces on small diameter, hard and soft copper, aluminum, brass, and plastic tubing
- Strong, lightweight slide and wheel housing, and large knurled feed screw knob give easy control of cutting pressure for clean cuts
- Self-feeding cutter wheel automatically cuts after tightening the knob only once
- Model **TTX925** features a special knob for easier tightening of the feed screw



TR043

RIDGID

Model No.	Cat. No.	Mfg. No.	Description	Std. Wheel	Capacity		Weight		Price /Each
					in.	mm	lbs.	kg	
TR043	40617	101	Midget Cutter with Spare Wheel	E-3469	1/4-1 1/8	6-28	1/2	0.23	30.75
TR166	32975	103	Midget Cutter	E-3469	1/8-5/8	3-16	1/3	0.15	18.58
TR167	32985	104	Midget Cutter	E-3469	3/16-1 5/16	5-24	1/3	0.15	21.66
TTX925	97787	117	Self-Feeding Midget Cutter	E-3469	3/16-1 5/16	5-24	1/3	0.15	27.95
TSX282	86127	118	Self-Feeding Midget Cutter	E-3469	1/4-1 1/8	6-28	5/8	0.28	38.40

ENCLOSED SCREW TUBING CUTTERS

- Enclosed feed screw to eliminate clogging and jamming
- Grooved rolls for close-to-flare cuts, and a fold-away reamer
- Made from high-strength zinc alloy with a spare cutter wheel in the handle
- Cuts copper, brass, and aluminum tubing, and thin-wall conduit
- Model **TR169** and **TR045** have all the features of model **TR168** and **TR044**, plus a quick-acting mechanism



TR068

RIDGID

Model No.	Cat. No.	Mfg. No.	Description	Std. Wheel	Capacity		Weight		Price /Each
					in.	mm	lbs.	kg	
TR168	31622	150	Enclosed Feed Cutter	E-3469	1/8-1 1/8	3-28	1	0.45	39.88
TR044	31627	150	Above w/H-D Wheel(s)	E-4546	1/8-1 1/8	3-28	1	0.45	41.55
TR169	33055	205	Ratcheting Encl. Feed Cutter	E-3469	1/4-2 3/8	6-60	2	0.91	102.05
TR045	33070	205	Above w/H-D Wheel(s)	E-4546	1/4-2 3/8	6-60	2	0.91	103.85
TQX037	66737	150-L	Enclosed Feed Cutter	E-3469	1/4-1 3/8	3-35	1	0.45	41.00
TQX038	66742	150-LS	Above w/H-D Wheel(s)	E-4546	1/4-1 3/8	3-35	1 1/8	0.51	41.00

STANDARD TUBING CUTTERS

NOS. 10, 15, 20, 30, & 15-SI

- Clean, square cuts are easily made on copper, brass, aluminum, and thin-wall conduit
- Models **TR046** – **TR051** feature a convenient fold-away reamer
- **TR052** and **TR053** are rated for larger diameter steel and stainless steel tubing
- **TTX876** is especially designed for stainless steel tubing



TR048

RIDGID

Model No.	Cat. No.	Mfg. No.	Description	Std. Wheel	Capacity		Weight		Price /Each
					in.	mm	lbs.	kg	
TR046	32910	10	Screw Feed Cutter*	F-158	1/8-1	3-25	7/8	0.40	39.17
TR047	32915	10	Above w/H-D Wheel*	E-1240	1/8-1	3-25	7/8	0.40	40.72
TR048	32920	15	Screw Feed Cutter*	F-158	3/16-1 1/8	5-28	1 1/2	0.68	45.62
TR049	32925	15	Above w/H-D Wheel*	E-1240	3/16-1 1/8	5-28	1 1/2	0.68	47.45
TR050	32930	20	Screw Feed Cutter*	F-158	5/8-2 1/8	16-54	13/4	0.80	83.63
TR051	32935	20	Above w/H-D Wheel*	E-1240	5/8-2 1/8	16-54	13/4	0.80	85.83
TR052	32940	30	Screw Feed Cutter	E-2558	1-3 1/8	25-79	3 1/2	1.60	127.44
TR053	32950	30	Above w/H-D Wheel	E-2191	1-3 1/8	25-79	3 1/2	1.60	129.68
TTX876	97212	15-SI	Stainless Steel Cutter	E-1525	3/16-1 1/8	5-28	1 1/2	0.68	63.94

* Now available with spare cutter wheel and extra large knob for easier tightening of feed screw.

QUICK-ACTING TUBING CUTTERS

- Quick-acting design, I-beam construction, hardened wear surfaces, and thrust bearing slide assemblies for smooth operation
- Models **TR054** and **TR056** feature fold-away reamers



TR054

RIDGID

Model No.	Cat. No.	Mfg. No.	Description	Std. Wheel	Capacity		Weight		Price /Each
					in.	mm	lbs.	kg	
TR054	31632	151	Quick-Acting Cutter	E-3469	1/4-1 5/8	6-42	1 1/4	0.57	70.52
TR055	31637	151-P	Above w/Wheel for Plastic	E-2155	1/8-1 1/4*	10-40*	1 1/4	0.57	81.23
TR056	31642	152	Quick-Acting Cutter	E-3469	1/4-2 5/8	6-66	2	0.91	108.43
TR057	31647	152-P	Above w/Wheel for Plastic	E-2155	1/4-2*	10-63*	2	0.91	119.61
TR058	34572	152-P	Above w/Wheel for PVC	E-5272	1/4-2*	10-63*	2	0.91	119.18
TR059	36597	153	Quick-Acting Cutter	E-3469	1 1/4-3 1/2	32-90	2	0.91	140.59
TR060	36592	153-P	Above w/Wheel for Plastic	E-2155	1-3*	25-75*	2	0.91	147.00
TR061	31652	154	Quick-Acting Cutter	E-2558	1 7/8-4 1/2	48-116	3 7/8	1.76	163.00
TR062	31657	154-P	Above w/Wheel for Plastic	E-2156	1 1/2-4*	50-110*	3 7/8	1.76	173.00
TR063	31662	156	Quick-Acting Cutter	E-2558	4-6 5/8	100-170	5	2.27	205.00
TR064	31667	156-P	Above w/Wheel for Plastic	E-2157	4-6*	110-160*	5	2.27	218.00

* Nominal plastic pipe size.

K-25 HAND SPINNERS

The professional's choice for many years, the K-25 hand spinner offers premium quality. It's the ideal tool for the user who demands the best.

Includes:

- Premium quality precision machined 3-jaw chuck firmly secures cable; loosens/tightens with the flick-of-the-wrist
- Cast aluminum ribbed hand grip that won't slip in your hand
- Rotary molded plastic drum that won't dent or rust – cleans easily
- Well balanced for comfortable operation
- 5/16" x 25' vinyl-wrapped inner core kink-resistant cables
- Capacity for 35' x 5/16"
- Available in bulb head and drop head models



RIDGID

TNX353

Model No.	Cat. No.	Mfg. No.	Description	Width and Length				Weight		Price /Each		
				in.	x	ft.	mm	x	m		lbs.	kg
TNX353	58890	K-25-BP	Hand Spinner with C-11C Bulb Auger Cable	5/16	x	25	8	x	7.6	8	3.6	170.00
TNX354	58895	K-25-DH	Hand Spinner with C-21C Drop Head Cable	5/16	x	25	8	x	7.6	8	3.6	188.00

POWER SPIN™ & KWIK-SPIN® HAND SPINNERS

- Light-duty product for drains to 11.2" (38 mm)
- Comfortable hand grip eases effort
- 1.4" x 25' hollow core cable held securely by a steel collar and thumb screw
- Power Spin™ automatically advances and retrieves cable
- Power Spin™ operates by hand or by adding any variable speed drill



RIDGID

TSX514

Model No.	Cat. No.	Description	Width and Length				Weight		Price /Each		
			in.	x	ft.	mm	x	m		lbs.	kg
TSX514	88387	Power-Spin™ Drill/Hand Driven Spinner	1/4	x	25	6.3	x	7.6	4.5	2.0	46.86
TCX526	15733	Kwik-Spin® Hand Spinner	1/4	x	25	6.3	x	7.6	5	2.3	30.31
TCX349	14013	Kwik-Spin®/Power Spin™ Replacement Cable	1/4	x	25	6.3	x	7.6	1	0.5	16.20

K-5 GRAPPLER HOOKS

- Retrieves rocks, tools, objects
- Extends your reach 6' to deepest traps



RIDGID

TNX413

Model No.	Cat. No.	Mfg. No.	Description	Weight		Price /Each
				lbs.	kg	
TNX413	59190	K-5	Grappler Hook	5	2.3	275.00

ONE-PIECE FLAT SEWER TAPE

- Sizes and lengths for use on sewer and drain lines through 8" (200 mm) in diameter and up to 100' (30 m) in length
- Carrier included with all except 25' model
- All models have spear point at one end and roller ball at the other, and hand grip



RIDGID

TPX195

Model No.	Cat. No.	Mfg. No.	Width		Thickness		Length		Weight		Price /Each
			in.	mm	in.	mm	ft.	m	lbs.	kg	
TPX195	62530	E-2724	1/2	12	1/16	2	25	7.6	3	1.4	70.74
TPX196	62535	E-2725	1/2	12	1/16	2	50	15.2	6	2.7	89.15
TPX198	62540	E-2726	1/2	12	1/16	2	75	22.8	9	4.1	116.72
TPX200	62545	E-2727	1/2	12	1/16	2	100	30.4	12	5.4	146.77
TPX203	62555	E-2729	3/4	20	1/16	2	50	15.2	8	3.6	116.72
TPX206	62565	E-2731	3/4	20	1/16	2	100	30.4	18	8.2	192.00
TPX213	62595	E-2737	3/4	20	1/8	3	50	15.2	16	7.3	192.00
TPX215	62605	E-2739	3/4	20	1/8	3	100	30.4	34	15.4	345.00
TPX216	62615	E-2741	1	25	1/8	3	50	15.2	22	10.0	255.00
TPX217	62625	E-2743	1	25	1/8	3	100	30.4	45	20.4	463.00

K-45 ELECTRIC DRAIN CLEANERS

- Excellent for small line cleaning. Opens clogged lavatory, sink lines, urinals, and tub/shower drains
 - 5/16" cables best for 3/4" to 1 1/2" lines
 - 3/8" cables best for 1 1/4" to 2 1/2" lines
- Lightweight, easy-to-use, no set-up required
- Variable speed 1/2" ball bearing power unit rotates cable 0-600 RPM
- Two-piece twist lock canister with interchangeable inner drum
 - Makes cable changeout simple; easy to match the right cable to the job
 - New inner drum prevents water leaks and greatly reduces cable flip-over
 - Drums won't rust or dent – ever
- Drum capacity: 50' of 5/16" (15 m/8 mm) or 35' of 3/8" (11 m/10 mm)
- Slide action chuck
- CSA approved, 115 V
- Approved to UL standards (NRTLCL)



TQX212

RIDGID

Model No.	Cat. No.	Mfg. No.	Description	Weight		Price /Each
				lbs.	kg	
TQX212	36013	K-45-1	K-45 Drain Cleaner with C-11C Cable w/Bulb Auger (5/16" x 25') and C-6429 Carrying Case	26	11.8	504.00
TQX213	36023	K-45-5	Same as TQX212 plus: C-6 Cable w/5/8" Coupling (3/8" x 35'), A-13 Pin Key, T-203 Bulb Auger, T-205 "C" Cutter, T-210 Grease Cutter, T-217 Drop Head Auger	33	15.0	656.00

RE9517E



KLEIN TOOLS

For Professionals... Since 1857®

Klein insulated tools are NFPA-70 compliant, which is harmonized with CSA-Z462. Klein insulated tools meet and/or exceed the IEC60900 and ASTM F1505 standards. Serious electricians and technicians choose Klein products first due to their high quality and precision. All Klein insulated hand tools are rated for up to **1000 V** and clearly marked with the official **1000 V** rating symbol. High quality coating protects while providing user comfort.

INSULATED ANGLED HEAD DIAGONAL CUTTERS

- High-leverage design for maximum power
- Angled head for easier access in confined areas
- Standard bevel cut design



Model No.	Mfg. No.	O.A. Length"	Price/Each
TJ826	D248-8-INS	8	92.73
TJ827*	D2000-48-INS	8	105.40

* Indicates extra tough cutters

INSULATED LONG NOSE WITH SIDE CUTTERS

- High-quality construction
- Powerful side cutters
- Ideal for looping and wrapping wire



Model No.	Mfg. No.	O.A. Length"	Price/Each
TJ830	D203-6-INS	6 5/8	70.61
TJ859*	D203-7-INS	7 1/8	79.00

* Indicates extra tough cutters

INSULATED HIGH-LEVERAGE SIDE CUTTERS

- Smooth, streamlined nose with knurled jaws
- High-leverage design for maximum power
- Powerful side cutters



Model No.	Mfg. No.	O.A. Length"	Price/Each
TJ817	D213-9NE-INS	9 1/4	106.67
TJ818*	D2000-9NE-INS	9 1/4	120.75

* Indicates extra tough side cutters

INSULATED COMPACT CABLE CUTTERS

- One-handed cutting of copper and multi-strand wire
- Provides a clean non-fraying cut
- Not designed for cutting steel or ACSR



Model No.	Mfg. No.	O.A. Length"	Price/Each
TJ862	63050-INS	8	106.76

INSULATED SIDE CUTTERS WITH CRIMPING DIE

- Powerful knurled jaws with toothed pipe grip
- Built-in wire cutters on both sides
- Powerful side cutters



Model No.	Mfg. No.	O.A. Length"	Price/Each
TJ819	12098-INS	8 1/2	112.94

INSULATED CRIMPING TOOLS

- Thin nose design allows access into confined areas
- Works for both insulated and non-insulated crimps
- Accepts wire from 10 to 22AWG
- Wire cutter in nose



Model No.	Mfg. No.	O.A. Length"	Price/Each
TJ864	1005-INS	9 3/4	101.50

INSULATED WIRE STRIPPER-CUTTERS

- Compact high quality construction
- Cuts, strips and loops wire, spring loaded jaws
- Accepts solid wire gauges 10, 12, 14, 16 and 18
- Wire cutter portion near jaw pivot for improved power



Model No.	Mfg. No.	O.A. Length"	Price/Each
TJ865	11045-INS	7	68.76

INSULATED PUMP PLIERS

- Adjustable tongue and groove system
- Pliers adjust to the size of the required work
- Powerful jaws have amazing gripping power



Model No.	Mfg. No.	O.A. Length"	Price/Each
TJ860	D502-10-INS	10	87.33



Cimco **1000 V** insulated safety-tools are checked tested according to IEC60900:2004. The double dip coated insulation (inside: orange, outside: red) guarantees optimal safety. As soon as the outer red coating is damaged, the now visible colour orange with its signal effect call attention to the no longer 100% safety, according to the safety instructions.

SIDE CUTTERS W/WIRE STRIPPER 1.5 + 2.5 MM, 1000 V



Model No.	Mfg. No.	OAL mm	Price/Each
THZ370	108792	160	73.15

COMBINATION PLIERS, 1000 V



Model No.	Mfg. No.	OAL mm	Price/Each
THZ380	108781	165	50.57
THZ381	108782	185	53.33
THZ382	108783	200	56.52

SNIP NOSE PLIERS W/STRAIGHT JAWS, 1000 V



Model No.	Mfg. No.	OAL mm	Price/Each
THZ376	108779	165	60.68
THZ377	108778	200	65.80

HEAVY-DUTY SIDE CUTTERS, 1000 V



Model No.	Mfg. No.	OAL mm	Price/Each
THZ371	108789	170	72.60
THZ372	108784	200	82.29

WIRE STRIPPING PLIERS, 1000 V



Model No.	Mfg. No.	OAL mm	Price/Each
THZ384	108790	160	61.64

NON-SPARKING, NON-MAGNETIC TOOLS



Ampco non-sparking, non-magnetic, corrosion-resistant safety tools are FM approved. Made in the U.S.A. Backed by a limited lifetime warranty. Effectively limit sparking, and meet OSHA requirements for use in locations where flammable vapours and/or combustible residues are present. Non-sparking or intrinsically safe tools are required and/or recommended also by NFPA, MSHA, and NIOSH. Ideal for petroleum, metalworking, paint finishing, and transportation applications. Also used in woodworking, fertilizer production, and grain handling where high levels of dust are prominent. Non-sparking, copper-based alloy tools conduct electricity and therefore are not anti-static.

Non-sparking metal - High-strength for impact and torque applications. Brinell hardness is 200 to 350. Tensile strength is 95,000 to 150,000 PSI.

Beryllium Copper* Superior strength for impact and torque applications. Most effective material for tools with cutting edges or gripping teeth. Brinell hardness is 332 to 382. Tensile strength is up to 200,000 PSI.

* All models made from non-sparking metal, some contain beryllium copper where indicated.

WRECKING & PRYING BARS

Cast from a high-strength nickel-aluminum bronze. Ideal for handling potentially flammable or hazardous items.

Model No.	Description	Bar Size"	Overall Length"	Wt. lbs.	Price /Each
TP415	Hammer/Claw Crate Opener Stock: 3/4"W x 0.339" Thick	2 3/4	9	0.94	64.87
TP416	Nail Puller Shank Dia.: 0.705"; Jaw Width: 0.325"		18	4.0	359.60
TP417	Crow Bar	5/8 Hex.	18	1.9	143.27
TP418	Crow Bar	3/4 Hex.	24	3.8	181.05
TP419	Crow Bar	7/8 Hex.	30	6.0	239.22
TP420	Crow Bar	7/8 Hex.	36	7.2	252.82
TP421	Pinch Bar w/Bent Chisel Tip	3/4 Hex.	18	2.3	67.25
TP422	Pinch Bar w/Bent Chisel Tip	7/8 Hex.	30	5.1	182.96
TP423	Pinch Bar w/Bent Chisel Tip	1 Hex.	36	8.7	302.47
TP424	Pry Bar w/Straight Chisel Tip	1 1/4	60	18.8	617.69
TP425	Pry Bar w/Straight Chisel Tip	1 3/8	68	24.5	853.36

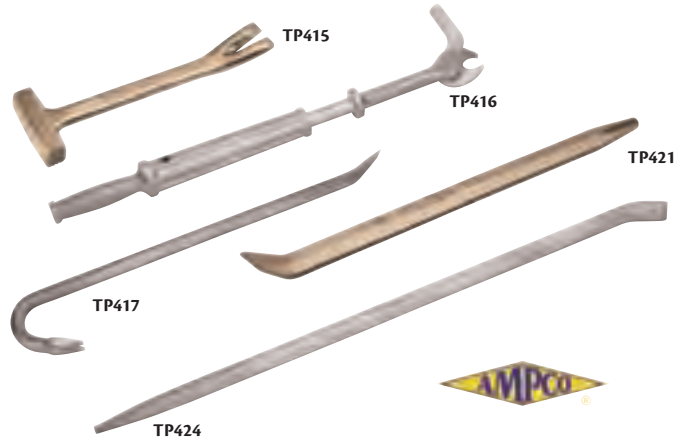

HAMMERS & MALLETS

Non-sparking metal construction, cast from a high strength nickel-aluminum bronze. Fibreglass handle for durability and vibration control.

Model No.	Description	Head Wt. lbs.	Face Dia."	Overall Length"	Price /Each
BB512	Curved-Claw Nail Hammer Smooth Striking Face	0.75	5/8	14	80.98
BB514	Curved-Claw Nail Hammer Smooth Striking Face	1.00	1	14	86.16
BB517	Curved-Claw Nail Hammer Smooth Striking Face	1.25	1	14	129.71
BB486	Ball Pein Hammer	0.25	3/8	9 3/4	49.49
BB487	Ball Pein Hammer	0.75	1	14	64.87
BB488	Ball Pein Hammer	1.00	1 1/4	14	71.96
BB489	Ball Pein Hammer	1.50	1 3/8	14	81.22
BB490	Ball Pein Hammer	2.00	1 1/4	14	94.82
BB491	Ball Pein Hammer	2.25	1 5/8	14	108.13
BB492	Ball Pein Hammer	2.75	1 3/4	14	109.98
BB498	Double-Face Engineer's Hammer	1.75	1 3/8	14	97.18
BB503	Double-Face Engineer's Hammer	2.25	1 3/8	14	107.29
BB504	Double-Face Engineer's Hammer	2.75	1 1/2	15	130.82
BB509	Double-Face Engineer's Hammer	3.00	1 1/2	15	135.44
WI940	Sledge Hammer	3.00	1 3/4	15	151.29
WI941	Sledge Hammer	5.00	2	33	217.49
WI942	Sledge Hammer	7.50	2 1/4	33	300.11
WI943	Sledge Hammer	10.00	2 3/8	33	369.09
WI944	Sledge Hammer	15.00	2 3/4	33	535.20
WI945	Sledge Hammer	18.00	3	33	759.00
WI953	Mallet	2.00	1 1/2	14	99.20
WI954	Mallet	4.00	2	15	145.58
WI955	Mallet	6.00	2 1/4	15	238.11
BB497	Bricklayer's Hammer	1.50	3/4	14	131.56
BB541	Scaling Hammer	1.00	1 x 1/8	14	89.96



NON-SPARKING, NON-MAGNETIC TOOLS

CLAY PICKS

Cast from a high strength nickel-aluminum bronze.
Eye opening size is 1 5/8" W x 2 1/2" L. **Fibreglass handle sold separately.**



Fibreglass handle sold separately

Model No.	Head Wt. lbs.	Head Length"	Price/Each
TP464	4 1/2	21	234.38
TP465	6 3/4	25	257.42
TP466	10 2/5	27 1/2	602.13
TP467*	Fibreglass Handle	36"	44.42

* Fibreglass handle sold separately

SAFETY FLANGE WEDGES

Cast from high strength Nickel-Aluminium Bronze



TLV219

Model No.	Mfg. No.	Dimensions			Price /Each
		L"	W"	H"	
TLV212	W-1	3	1/2	1/4	13.58
TLV213	W-2	4	3/4	1/2	13.58
TLV214	W-3	6	1	1/2	18.71
TLV215	W-4	6	1 1/2	3/4	30.60
TLV216	W-5	7	1 1/4	1/2	25.62
TLV217	W-6	7	2	3/4	45.98
TLV218	W-7	8	1 1/2	1 5/8	63.25
TLV219	W-8	8	1 1/2	1	49.56
TLV220	W-9	8	2	3/4	50.76
TLV221	W-10	8 1/2	2	1 1/4	67.24
TLV222	W-11	7	2	3/8	35.22
TLV223	W-12	3 1/2	2	3/8	24.27
TLV224	W-13	8	2	2	162.96

SHOVELS & SCOOPS

Non-sparking metal construction. One-piece blade, hollow-socket shovels and scoops.
High strength and manageable weight allow for continuous and effective use. Long-handled models have fibreglass handles and D-handled models have fibreglass handles with a plastic grip bar.



TP512



TP511

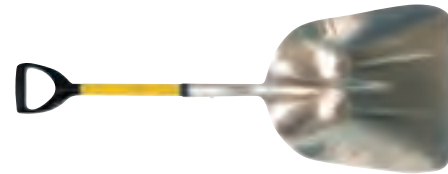

TP513



TP510



TP509

Model No.	Blade Size			Handle Style	Overall Length"	Price /Each
	W"	x	H"			
ROUND-POINT SHOVELS						
TP509	9	x	11 1/4	D	37	291.65
TP510	9	x	11 1/4	Long	56 1/2	301.33
SQUARE-POINT SHOVELS						
TP511	9	x	11	D	37	334.84
TP512	9	x	11	Long	58	338.60
SCOOP SHOVELS						
TP513	14	x	17	D	44	146.25
TP514	14	x	17	Long	67	151.15

CHISELS

- Cast from a high strength nickel-aluminum bronze
- Hexagonal shank



HAND CHISELS

Model No.	a"	b"	c"	Price/Each
TP493	1/4	1/4	5 1/4	23.09
TP494	7/16	3/8	5 3/4	30.82
TP495	9/16	1/2	6 1/2	23.73
TP496	3/4	5/8	6	30.53
TP497	13/16	3/4	8	39.22
TP498	11/16	5/8	9 1/8	42.35
TP499	3/4	3/4	9	46.36
TP500	7/8	7/8	9	51.89
TP501	1 1/16	1	9 1/4	62.20
TP502	9/16	1/2	12	40.05
TP503	7/8	3/4	12	55.60
TP504	1	7/8	30	247.00

R30482E

OFFICE PRODUCTS

INSTRUMENTS, SCALES & ELECTRICAL

SHIPPING & PACKAGING

TOOLS & EQUIPMENT

WELDING & METALWORKING

SAFETY EQUIPMENT & SUPPLIES

JANITORIAL & MAINTENANCE

MATERIAL HANDLING & STORAGE

NON-SPARKING, NON-MAGNETIC TOOLS



PUTTY KNIVES & SPATULAS

- Made from nickel copper
- Use with volatile resins, paints, inks and other compounds
- Blade is riveted to wood handle



Model No.	a"	b"	c"	Price /Each
PUTTY KNIVES - STIFF BLADE				
TX710	1 1/4	3 9/16	7 3/4	22.75
TX711	2	4	8	30.16
TX712	3 1/2	4 1/2	8 1/2	43.82
PUTTY KNIFE - FLEXIBLE BLADE				
TX713	3 1/2	4 1/2	8 1/2	47.53
SPATULAS				
TX714	1	6	10 1/4	35.11
TX715	1 1/2	9	14	66.71
TX716	2	14	19 1/4	88.09

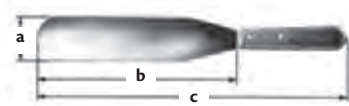
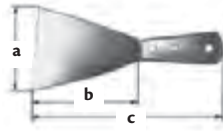

HAND SCRAPERS

- Cast from a high strength nickel-aluminum bronze
- Choose from a variety of models



Model No.	Description	Blade Size			O.A. Length"	Price /Each
		L"	x	W"		
TP474	Spray Booth Scraper	4	x	3	9 1/4	46.36
TP475	Pick and Scaler Scraper	2 1/4	x	3	17 3/4	88.91
TP476	Hand Styler Scraper w/Plastic Handle	3 3/4	x	3 3/4	18 3/4	153.42
TP477	Deck Scraper w/Single Blade and Handle	-		1 1/2	15	107.02
TP478	Deck Scraper w/Blade on Each End	-		7/8	7 7/8	35.56
TP479	Deck Scraper w/Blade on Each End	-		2	12	51.78

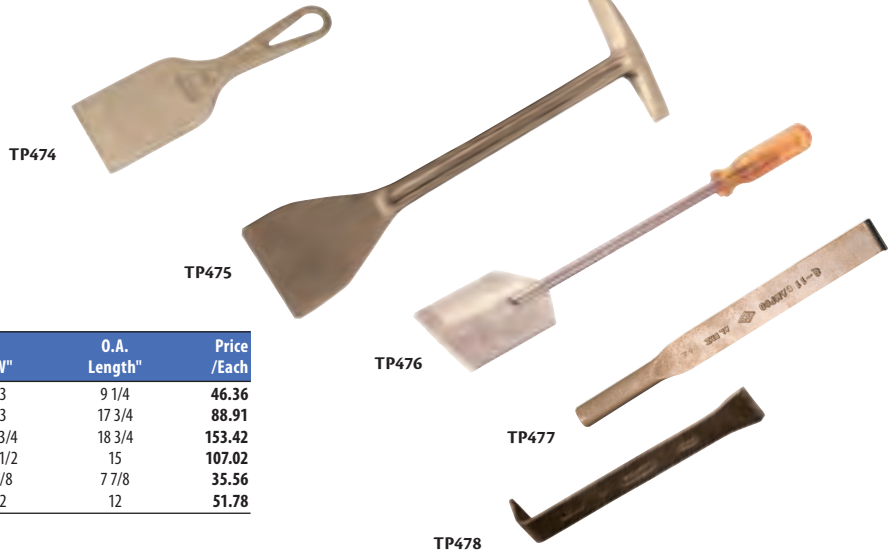

SCRAPERS

- Cast from a high strength nickel-aluminum bronze
- Fibreglass handle sold separately



Model No.	Description	Blade Size			O.A. Length"	Price /Each
		L"	x	W"		
TP480	Scraper, Short Blade	1 1/2	x	3	7	66.91
TP481	Scraper, Short Blade	1 1/2	x	4	7	92.16
TP482	Scraper, Short Blade	1 1/4	x	5	7	101.78
TP483	Scraper, Short Blade	1 1/2	x	6	6 3/4	97.07
TP485	Scraper, Long Blade	2 1/2	x	4	9	87.95
TP486	Scraper, Long Blade	2 1/2	x	5	9	96.73
TP487	Scraper, Long Blade	2 1/4	x	6	8 1/2	97.53
TP489	Plain Floor Scraper	6 3/4	x	6	6 3/4	96.89
TP469	Fibreglass Handle for Floor Scraper				65	45.53

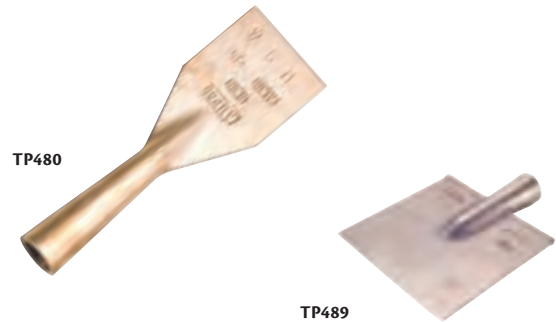

KNIVES



Model No.	Description	Blade Length"	Total Length"	Wt. lbs.	Price /Each
TD486	Knife with Straight Blade	3 1/8	6 3/4	0.06	20.36
TD622	Utility Knife	4	8 3/4	0.18	28.22
TD485	Knife with Curved Blade	5 3/4	10 1/4	0.17	32.69
TD621	Linoleum Knife	4 9/16	7 1/2	0.18	54.15

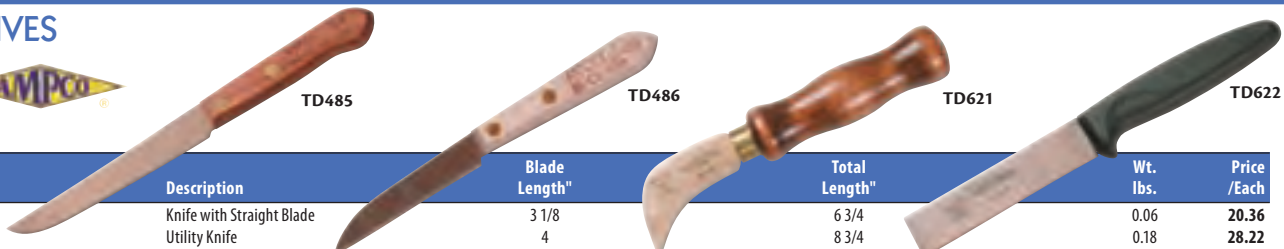

NON-SPARKING, NON-MAGNETIC TOOLS

SCREWDRIVERS

Model No.	Type	a"	b"	c"	Wt. lbs.	Price /Each
STANDARD						
TD625	-	1/8	6	9 1/2	0.12	22.11
TD613	-	9/32	3	6 1/2	0.14	23.65
TD614	-	5/16	6	10 1/8	0.3	36.75
TD615	-	3/8	8	13	0.5	52.25
TD616	-	3/8	12	17	0.64	61.65
PHILLIPS						
TD617	#1	-	3	6 1/2	0.12	18.31
TD618	#2	-	4	7 1/2	0.16	23.18
TD619	#3	-	6	10 1/8	0.3	35.87
TD620	#4	-	8	13	0.5	50.36

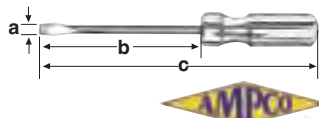

Model No.	a"	b"	c"	Wt. lbs.	Price /Each
CABINET-TIP					
TD623	1/4	2	5 5/8	0.14	24.67
TD624	3/16	4	7 5/8	0.14	22.98
TD626	3/16	8	11 5/8	0.16	29.95
TD627	3/8	15	20 3/16	0.75	92.04



6-PC. SCREWDRIVER SETS

Non-sparking, non-magnetic, corrosion-resistant screwdriver set.

Model No. TLZ291
Mfg. No. M-39
Price/Each \$190.25



MAINTENANCE BRUSHES

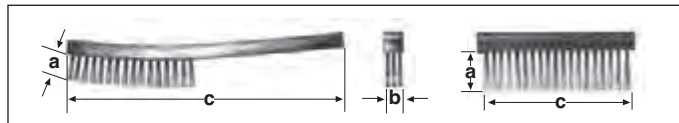

INCLUDES:

Model No.	Mfg. No.	Description
TD613	S-48	Std Screwdriver 5/16" tip, 3" Blade
TD614	S-49	Std Screwdriver 5/16" tip, 6" Blade
TD615	S-50	Std Screwdriver 25/64" tip, 8" Blade
TD617	S1099A	#1 Phillips Screwdriver
TD618	S1099	#2 Phillips Screwdriver
TD619	S1100	#3 Phillips Screwdriver

Model No.	Description	a"	b"	c"	Wt. lbs.	Price/Each
TD465	Round-Wire Push Broom	2 1/2	2 3/4	12	2.2	164.84
TD466	Shoe-Handle Scratch Brush	1 1/8	1 1/8	9 3/4	0.42	37.07
TD467	Curved-Handle Scratch Brush	1 1/8	1 1/8	13 3/4	0.55	33.55
TD468	Flat-Back Scratch Brush	1 5/8	2 1/4	7	0.88	66.71
UQ914	Toothbrush Style	1 7/8	1 5/8	7 7/8	0.1	5.58

HEX KEYS



Model No.	Hex Key Size"	Wt. lbs.	Price/Each
TD628	1/16	0.01	7.62
TD629	5/64	0.02	8.02
TD630	3/32	0.02	8.25
TD631	1/8	0.02	8.67
TD632	5/32	0.02	9.44
TD633	3/16	0.04	11.18
TD634	7/32	0.06	14.91
TD635	1/4	0.08	18.73
TD636	5/16	0.14	22.47
TD637	3/8	0.24	30.87
TD644	Hex Key Set	0.7	140.18



PLIERS

Cast from a high-strength nickel-aluminum bronze. Cushion-grip handle provides powerful leverage, comfort and added safety.



Model No.	Description	Jaw Width"	Overall Length"	Price /Each
TP452	Combination Slip-Joint Pliers	5/16	6 1/2	80.00
TP453	Combination Slip-Joint Pliers	1/2	8	89.78
TP454	Lineman's Pliers w/Side Cutter	5/8	8 1/2	155.24
TP455	Tongue and Groove Pliers, 6 Positions	1 1/2	10	154.89
TP456	Tongue and Groove Pliers, 6 Positions	2 1/8	12	187.56
TLV205	Diagonal Cutting Pliers	5/8	7	166.24
TP457	Long-Nose Pliers w/Side Cutter, 1/8" Jaw Tip	1/3	7	133.11

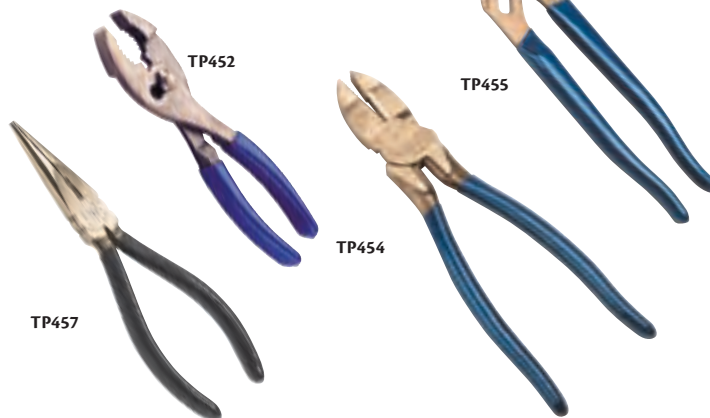

R30494E

OFFICE PRODUCTS

INSTRUMENTS, SCALES & ELECTRICAL

SHIPPING & PACKAGING

TOOLS & EQUIPMENT

WELDING & METALWORKING

SAFETY EQUIPMENT & SUPPLIES

JANITORIAL & MAINTENANCE

MATERIAL HANDLING & STORAGE

NON-SPARKING, NON-MAGNETIC TOOLS

COMBINATION WRENCHES

- 15° angle and 12-point box

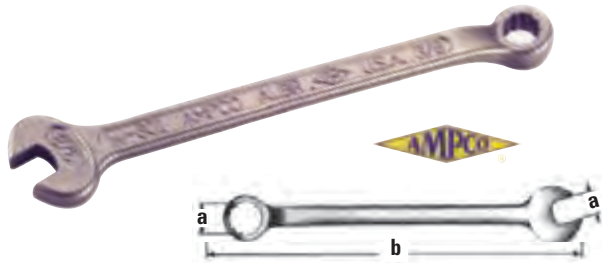

Model No.	a"	b"	Price/Each
TX692	3/8	6 5/16	62.84
TX693	7/16	7 1/4	62.84
TX694	1/2	7 1/4	64.49
TX695	9/16	8 1/4	68.60
TX696	5/8	8 7/8	75.45
TX697	11/16	10 1/8	82.31
TX698	3/4	10 1/8	88.75
TX699	7/8	13 1/4	105.65
TX700	15/16	13 1/4	120.05
TX701	1	13 1/4	137.20
TX702	1 1/16	17	137.20
TX703	1 1/8	17	156.07
TX704	1 1/4	19 1/2	176.65
TX705	1 5/16	16 15/16	176.65
TX706	1 3/8	21 1/4	199.56
TX707	1 7/16	21 1/4	199.56
TX708	1 1/2	22	199.56
TX709	1 5/8	22	224.69

ADJUSTABLE WRENCHES



Model No.	a" max.	b"	Price/Each
TX679	15/16	6	87.76
TX680	1 1/8	8	99.96
TX681	1 5/16	10	136.89
TX682	1 1/2	12	174.44
TX683	1 11/16	15	314.80

ADJUSTABLE PIPE WRENCHES

- Cast from nickel-aluminum bronze
- Available with aluminum handles



Model No.	Jaw Material	Handle Material	a" max.	b"	Price/Each
TX684	Nickel-Aluminum Bronze	Nickel-Aluminum Bronze	1 15/16	8	220.35
TX685	Nickel-Aluminum Bronze	Nickel-Aluminum Bronze	2 1/2	10	234.67
TX686	Nickel-Aluminum Bronze	Nickel-Aluminum Bronze	2 13/16	14	295.71
TX687	Nickel-Aluminum Bronze	Nickel-Aluminum Bronze	3 3/16	18	330.05
TX688	Nickel-Aluminum Bronze	Nickel-Aluminum Bronze	4 1/4	24	459.25
TX689	Nickel-Aluminum Bronze	Nickel-Aluminum Bronze	5 11/16	36	779.25
TX690	Nickel-Aluminum Bronze	Nickel-Aluminum Bronze	7 9/16	48	1346.16
TLV206	Nickel-Aluminum Bronze	Aluminum	2 1/2	10	242.98
TLV207	Nickel-Aluminum Bronze	Aluminum	2 13/16	14	296.69
TLV208	Nickel-Aluminum Bronze	Aluminum	3 3/16	18	340.20
TLV209	Nickel-Aluminum Bronze	Aluminum	4 1/4	24	414.42
TLV210	Nickel-Aluminum Bronze	Aluminum	5 11/16	36	658.93
TLV211	Nickel-Aluminum Bronze	Aluminum	7 9/16	48	1274.31

BUNG WRENCHES

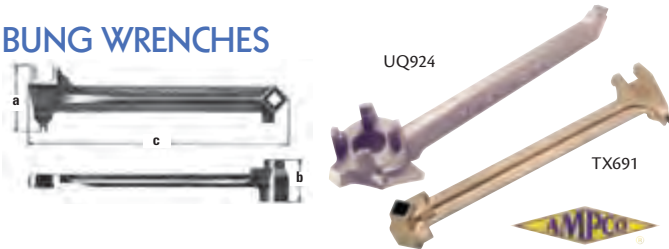

Model No.	Description	a"	b"	c"	Price/Each
UQ924	For 3/4 and 2" Bungs	2	2	12	52.93
TX691	For 22 Different Bung Sizes	2 1/2	2 1/4	15	103.65

7-PC. COMBINATION WRENCH SETS

Non-sparking, Non-Magnetic, Corrosion-Resistant Combination Wrench Set.

Model No. TLZ292

Mfg. No. M-41

Price/Each \$523.84



INCLUDES:

Model No.	Mfg. No.	Description
TX692	W-601	3/8" Combination Wrench
TX693	W-611	7/16" Combination Wrench
TX694	W-621	1/2" Combination Wrench
TX695	W-631	9/16" Combination Wrench
TX696	W-641	5/8" Combination Wrench
TX698	W-661	3/4" Combination Wrench
TX699	W-671	7/8" Combination Wrench

Note: Metric sizes available



NON-SPARKING, NON-MAGNETIC TOOLS

SOCKETS



Model No.	Size mm	Length mm	Price /Each
1/4" DRIVE INDIVIDUAL SOCKET, 6 POINT			
TD494	4	14	50.53
TD495	4.5	14	50.53
TD496	5	14	50.53
TD497	5.5	14	50.53
TD498	6	14	50.53
TD499	7	14	50.53
TD500	8	16	50.73
TD501	9	16	51.24
TD502	10	17	52.25
TD503	11	17	53.96
TD504	12	21	54.76
TD505	13	21	54.76
TD506	14	22	57.67

Model No.	Size"	Length"	Price /Each
1/2" DRIVE INDIVIDUAL SOCKET, 6 POINT			
TD507	8	30	47.04
TD508	9	30	47.49
TD509	10	30	47.49
TD510	11	30	47.98
TD511	12	30	48.73
TD512	13	30	48.73
TD513	14	30	49.38
TD514	15	30	50.02
TD515	16	37	53.16
TD516	17	37	55.02
TD517	18	37	57.89
TD518	19	37	57.89
TD519	20	37	64.56
TD520	21	38	65.49
TD521	22	38	76.98
TD522	23	38	77.45
TD523	23	38	77.45
TD524	25	38	88.42
TD525	26	38	93.62
TD526	27	38	93.62
TD527	28	41	96.65
TD528	29	41	112.07
TD529	30	41	112.07
TD530	32	41	112.07

Model No.	Size"	Length"	Price /Each
3/4" DRIVE INDIVIDUAL SOCKET, 6 POINT			
TD531	30	48	150.89
TD532	33	50	175.67
TD533	34	50	175.67
TD534	35	50	175.67
TD535	36	50	180.04
TD536	37	52	180.04
TD537	38	52	181.69
TD538	41	52	195.98
TD539	42	57	205.31
TD540	46	57	207.13
TD541	47	62	207.13
TD542	50	62	207.13
TD543	52	67	324.93
TD544	55	67	354.71
TD545	60	73	438.07

Model No.	Size"	Length"	Price /Each
1/4" DRIVE INDIVIDUAL SOCKET, 6 POINT			
TD546	3/16	9/16	50.53
TD547	7/32	9/16	50.53
TD548	1/4	5/8	50.73
TD549	9/32	5/8	50.73
TD550	5/16	5/8	50.73
TD551	11/32	5/8	51.24
TD552	3/8	11/16	52.25
TD553	7/16	11/16	53.96
TD554	1/2	13/16	54.76
TD555	9/16	7/8	57.67

Model No.	Size"	Length"	Price /Each
1/2" DRIVE INDIVIDUAL SOCKET, 6 POINT			
TJZ875	5/16	1 3/16	47.04
TJZ876	3/8	1 3/16	47.49
TJZ877	7/16	1 3/16	47.98
TJZ878	1/2	1 3/16	48.73
TJZ879	9/16	1 3/16	49.38
TJZ880	19/32	1 3/16	50.02
TJZ881	5/8	1 7/16	53.16
TJZ882	11/16	1 7/16	55.02
TJZ883	3/4	1 7/16	57.89
TJZ884	25/32	1 7/16	65.76
TJZ885	13/16	1 7/16	65.76
TJZ886	7/8	1 1/2	76.98
TJZ887	15/16	1 1/2	77.45
TJZ888	1	1 1/2	88.42
TJZ889	1-1/16	1 1/2	93.62
TJZ890	1-1/8	1 5/8	96.65
TJZ891	1-1/4	1 5/8	112.07

Model No.	Size"	Length"	Price /Each
3/4" DRIVE INDIVIDUAL SOCKET, 6 POINT			
TJZ892	1-5/16	2	175.67
TJZ893	1-3/8	2	175.67
TJZ894	1-7/16	2	180.04
TJZ895	1-1/2	2 1/16	181.69
TJZ896	1-9/16	2 1/4	205.31
TJZ897	1-5/8	2 1/4	205.31
TJZ898	1-11/16	2 1/4	205.31
TJZ899	1-3/4	2 9/16	205.31
TJZ900	1-13/16	2 9/16	207.13
TJZ901	1-7/8	2 9/16	207.13
TJZ902	2	2 9/16	216.71

RATCHET WRENCHES

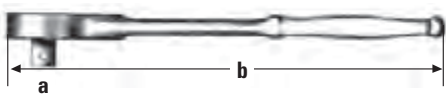

Model No.	a"	b"	Wt. lbs.	Price/Each
TD491	1/4	5 1/8	0.19	519.22
TD492	1/2	10	1.24	254.95
TD493	3/4	18	3.96	532.71

Look for this symbol for environmentally friendly products!



RS0496E

OFFICE PRODUCTS

INSTRUMENTS, SCALES & ELECTRICAL

SHIPPING & PACKAGING

TOOLS & EQUIPMENT

WELDING & METALWORKING

SAFETY EQUIPMENT & SUPPLIES

JANITORIAL & MAINTENANCE

MATERIAL HANDLING & STORAGE

NON-SPARKING, NON-MAGNETIC TOOLS

11-PC. TOOL KITS

Non-Sparking, Non-Magnetic, Corrosion-Resistant Tool Kit.

Model No. TP519

Mfg. No. M-48

Price/Each \$927.96



INCLUDES:

Model No.	Mfg. No.	Description
TP453	P-31	8" Combination Slip-Joint Pliers
TD466	B-399	Shoe-Handle Scratch Brush
TX710	K-21	Putty Knife – Stiff Blade
TD486	K-1	Knife with Straight Blade
TP455	P-39	Tongue and Groove Pliers, 6 Positions
TD618	S-1099	Phillips Screwdriver No. 2
BB514	H-20FG	Curved-Claw Nail Hammer, Smooth Striking Face
TX679	W-70	6" Adjustable Wrench
TX681	W-72	10" Adjustable Wrench
TX685	W-211	10" Adjustable Pipe Wrench
TD614	S-49	Standard Screwdriver 5/16" Tip, 6" Blade

6-PC. TOOL KITS

Non-Sparking, Non-Magnetic, Corrosion-Resistant Tool Kit.

Model No. TP518

Mfg. No. M-47

Price/Each \$446.76



INCLUDES:

Model No.	Mfg. No.	Description
TD613	S-48	Standard Screwdriver - 5/16" Tip, 3" Blade
TP452	P-30	6 1/2" Adjustable End Wrench
TX680	W-71	Adjustable Wrench 8"
TD618	S-1099	Phillips Screwdriver No. 2
TP455	P-39	Tongue and Groove Pliers, 6 Positions
TP415	CJ-1-ST	9" Hammer/Crate Opener

16-PC. TOOL KITS

Non-Sparking, Non-Magnetic, Corrosion-Resistant Tool Kit.

Model No. TP520

Mfg. No. M-49

Price/Each \$1263.96



INCLUDES:

Model No.	Mfg. No.	Description
TLZ293	W-3109	Double End Box Wrench – 5/16" x 3/8"
TLZ294	W-3120	Double End Box Wrench – 7/16" x 1/2"
TLZ295	W-3150	Double End Box Wrench – 9/16" x 5/8"
TLZ296	W-3180	Double End Box Wrench – 3/4" x 7/8"
TD618	S-1099	# 2 Phillips Screwdriver
TD614	S-49	Standard Screwdriver 5/16" tip, 6" blade
TX681	W-72	10" Adjustable Wrench
TP452	P-30	6 1/2" Combination Pliers
TP453	P-31	8" Combination Pliers
TP455	P-39	10" Groove Joint Pliers
TD486	K-1	Common Knife 3 1/8" Blade, 6 3/4" OAL
TX710	K-21	Putty Knife (Stiff) 1 1/4" x 3 9/16"
BB514	H-20FG	Claw Hammer with Fibreglass Handle
TX686	W-212	14" Adjustable Pipe Wrench
TD466	B-399	Shoe Handle Brush
TP479	S-10G	Deck Scraper

17-PC. HAZMAT TOOL KITS

Non-Sparking, Non-Magnetic, Corrosion-Resistant Hazmat Tool Kit.

Model No. TP521

Mfg. No. M-51

Price/Each \$1655.69



INCLUDES:

Model No.	Mfg. No.	Description
TD466	B-399	Shoe Handle Brush
TP415	CJ-1-ST	9" Crate Opener
BB514	H-20FG	16 oz Claw Hammer w/Fibreglass Handle
TD485	K-5	Common Knife 5 3/4" Blade, 10 3/4" OAL
TX710	K-21	Putty Knife (stiff) 1 1/4" x 3 9/16" Blade
TP456	P-312	12" Groove Joint Pliers
TP457	P-326	7" Long Nose Pliers with Cutters
TP453	P-31	8" Combination Pliers
TP477	S-11G	Deck Scraper, 1 1/2" Blade x 15" Long
TP474	S-40	Spray Booth Scraper, 3" Blade x 9 1/4" lo
TD614	S-49	Standard Screwdriver – 5/16" Tip, 6" Blade
TD619	S-1100	# 3 Phillips Screwdriver
TP459	S-1144	12" Tin Snaps
TX680	W-71	8" Adjustable Wrench
TX682	W-73	12" Adjustable Wrench
UQ916	W-212AL	14" Pipe Wrench (Aluminum)
UQ924	W-56	12" Bung Wrench (Fits 3/4" x 2")

HORIZONTAL CELL HOLDERS

- Designed for cell phone, BlackBerry®-style mobile device, or larger iPod®, or iPhone®
- Includes ear-bud pocket and sleeve for business or credit cards
- Belt clip swivels to accommodate wearing on left or right side
- Dimensions: 5" L x 5" H

Model No. TEP219
Price/Each \$8.92



RADIO POUCHES

- Made of durable top grain leather
- Designed to fit a wide range of portable work radios
- Fits belts up to 2 1/2" wide
- Dimensions: 3 1/2" L x 6 1/2" H

Model No. TBN164
Price/Each \$31.97



UTILITY POUCHES

- Made of full grain leather
- Holds a knife, pencil, felt marker and other miscellaneous tools
- Excellent for warehousing and utility use
- Dimensions: 4 3/4" L x 11.75" H

Model No. TP214
Price/Each \$9.67



SMALL CELL HOLDERS

- Neoprene inserts and pocket flap with magnetic closure
- Webbing loops for pens and markers, plus carabiner for keys
- Belt clip swivels to accommodate wearing on left or right side
- Dimensions: 3 1/2" L x 6" H

Model No. TEP220
Price/Each \$9.64



MULTI-PURPOSE TOOL HOLDERS

- Four pockets made of ballistic nylon
- Versatile 3-way attachment for pants, web suspenders, work aprons, etc.
- Securely holds small tools or accessories like pliers, mini flashlights, screwdrivers, etc.
- Dimensions: 5 1/4" L x 8 1/2" H

Model No. WI957
Price/Each \$10.18



TOOL POUCHES

- Made of full grain leather
- Designed to fit assorted utility items: pens, markers, tape, utility knife, etc.
- 2" wide belt slots
- Rivet reinforced
- Dimensions: 3 3/4" L x 11" H

Model No. TSW497
Price/Each \$9.99



BLACKBERRY® HOLDERS

- Designed for PDA, BlackBerry®-style mobile device, or iPhone®
- Includes ear-bud pocket and sleeves for business cards, credit cards, pens or touch-screen stylus
- Belt clip swivels to accommodate wearing on left or right side
- Magnetic shut off feature
- Dimensions: 3 1/2" L x 6" H

Model No. TEP218
Price/Each \$11.62



LARGE TAPE HOLDERS

- Made of top grain leather
- Designed to fit up to 30" tapes
- All rivet construction
- Dimensions: 6 3/4" L x 4 1/2" H

Model No. TBN166
Price/Each \$6.84



UTILITY KNIFE, PEN/PENCIL HOLDERS

- Made of full grain leather
- Designed to fit pen/pencil and utility knife
- Comes with quick release snap belt loop
- Dimensions: 7 3/4" L x 2 3/4" H

Model No. TBN197
Price/Each \$8.01



MULTI-POCKET TOOL & PHONE HOLDERS

- Attached to belt with snap closure or wide padded flap
- Four pockets and one padded pocket with elastic binding sized to fit most compact cell phones
- Detachable electrical tape sling
- Dimensions: 6" L x 11" H

Model No. TJZ972
Price/Each \$12.96



UTILITY POUCHES

- Made of top grain leather
- Holds knife, tape and pencil
- Fits most belts
- Dimensions: 7 3/4" L x 4 1/4" H

Model No. TN236
Price/Each \$11.07



UTILITY KNIFE & PLIERS HOLDERS

- Made of heavy top grain leather
- Fits most standard utility style trim knives and most pliers
- All rivet construction
- Dimensions: 8 1/2" L x 2 1/2" H

Model No. TN244
Price/Each \$4.54



R29335E

TOOL STORAGE

FLASHLIGHT HOLDERS

- Made of durable top grain leather
- Fold over belt loop with snaps easily attaches to belt
- Fits a large variety of flashlights
- Dimensions: 8" L x 3 1/2" H

Model No. TBN210
Price/Each \$7.20



DRILL HOLDERS

- Ballistic polyester fabrication -1680D
- Holds cordless and regular drills
- Security strap with snap closure
- Pocket for drill bits, accessories
- Heavy gauge 6-ply nylon stitching
- Dimensions: 6 1/2" L x 3" H

Model No. TEP009
Price/Each \$22.31



3100 TOOL LANYARDS

Tethers tools to help worker prevent injury, damage and lost productivity from dropped tools.

- Stretch cord surrounded by tubular nylon webbing
- Lock stitching at both ends for extra security
- Maximum safe working capacity: 10 lbs.
- Aluminum carabiner
- Adjustable barrel lock for tool attachment
- Colour: Black

Model No. TEP213
Price/Each \$11.53



STEEL LOOP HAMMER HOLDERS

- Made of top grain leather
- Cradle design eliminates hammer pivoting
- Fits belts up to 2 3/4" wide
- Dimensions: 3 3/4" L x 7 1/2" H

Model No. TN237
Price/Each \$3.58



HAMMER & KNIFE HOLDERS

- Made of top grain leather
- Cradle design steel hammer holder, roll over type back
- Lock stitched rivet reinforced
- Dimensions: 8" L x 3 1/4" H

Model No. TBN171
Price/Each \$7.58



PLIERS POUCHES

- Made of heavy top grain leather
- Fits almost all pliers
- Dimensions: 8 1/4" L x 2 3/4" H

Model No. TN243
Price/Each \$6.43



PLIERS POUCHES

- Made of heavy top grain leather
- Holds a variety of pliers and miscellaneous tools
- Fits belts up to 2 1/4" wide
- Dimensions: 9" L x 3 1/4" H

Model No. TBN201
Price/Each \$6.90



SCISSORS & CABLE-SPLICER'S KNIFE HOLDERS

- Leather construction
- Specially designed for WL294, TBT410 and TJ971
- Riveted and stitched for extra durability
- Slotted belt connection
- Fits belts up to 2 1/4" wide
- Dimensions: 2" L x 7 1/4" H

Model No. TBS844
Price/Each \$13.00



KNIFE HOLDERS

- Leather construction
- Designed for utility knives and Klein's TBS981 and TBS985
- Corners riveted and stitched for extra durability
- Slotted belt connection
- Fits belts up to 2 1/2" wide
- Dimensions: 2 5/8" x 8 1/4"

Model No. TBS842
Price/Each \$15.15



PLIERS HOLDERS – OPEN BOTTOM

- Leather construction
- Long-nose pliers may protrude through opening at bottom
- Riveted to assure long life
- Slotted belt connection
- Fits belts up to 2" wide



Model No. TBT465

- Holds 6" or 7" long-nose or diagonal-cutting pliers
- Dimensions: 3 1/2" x 8 1/2"

Price/Each \$26.48

Model No. TBT466

- Holds 8" or 9" long-nose or diagonal-cutting pliers
- Dimensions: 3 3/4" L x 11" H

Price/Each \$34.16



LINEMAN'S KNIFE HOLDERS

- Leather construction
- Designed for knives and Klein's TJ970, TBT404 and TBT403
- Riveted to assure long life
- Slotted belt connection
- Fits belts up to 2" wide
- Dimensions: 3 1/2" x 9 3/8"

Model No. TBS831
Price/Each \$13.12



PADDED TOOL RIG SUSPENDERS



- Ballistic polyester fabrication – 1680D
- Quick adjust suspender style
- Thick, vented foam padding for comfort
- Gel at key ride points for optimal comfort
- Heavy gauge 6-ply nylon stitching
- Spring-loaded, pivoting clips (nickel-plated)
- Clips to any belt or rig
- Cell phone holder



Model No. TEP012
Price/Each \$46.26

HEAVY-DUTY WORK SUSPENDERS

- Adjustable to fit all sizes
- Heavy-duty clips on front and rear
- 2" wide heavy-duty elastic straps
- Nylon stitched for durability

No modèle TP208 Black
Prix/Chacun \$13.55

No modèle TBN236 Red
Prix/Chacun \$13.80



PADDED CONSTRUCTION SUSPENDERS

- Designed to transfer weight from waist to shoulders
- Fully adjustable length, front and back to fit all sizes
- Heavy-duty padding for user comfort
- Heavy-duty nylon web for extra strength
- Convenient quick fastening system

Model No. TBN243
Price/Each \$31.00



TOOL BELTS

A. 1 1/2" INDUSTRIAL BELTS

- Made of top grain leather
- 1 1/2" width with heavy roller buckle
- One size fits all

Model No. TN233 Price/Each \$13.82



C. 2" DOUBLE TONGUE BELTS

- Made of top grain leather
- 2" width with heavy-duty double tongue roller buckle
- One size fits all

Model No. TP207 Price/Each \$15.94



E. 2" WEB WORK BELTS

- Heavy-duty poly web
- Quick-release buckle
- Fits waist sizes 29" to 46"

Model No. TAW990 Price/Each \$8.79



B. 2" INDUSTRIAL BELTS

- Made of top grain leather
- 2" width, with heavy-duty roller buckle
- One size fits all

Model No. TN234 Price/Each \$16.42



D. TAPERED LEATHER WORK BELTS

- Heavy-duty top grain leather
- Padded back panel for support and comfort
- Steel double tongue roller buckle
- Fits waist sizes 29" to 46"

Model No. TBN018 Price/Each \$49.75



TOOL BELTS

A. LIGHTWEIGHT TOOL BELTS

- Leather fabrication
- Designed to carry lightweight tool pouches

B. HEAVY-DUTY EMBOSSED TOOL BELTS

- Strong, heavy-duty leather
- Equipped with a double-tongue buckle

C. LIGHTWEIGHT UTILITY BELTS

- Strong, lightweight, synthetic-web
- Quickly adjusts for waist sizes through 52"
- Accepts tunnel-loop and slotted pouches and holders
- Tough, molded, non-metallic, slide-action buckle provides single-handed, quick release and adjustment

D. GENERAL-PURPOSE BELTS

- Strong, heavy-duty leather
- Removable single-tongue buckle held by two heavy-duty snaps



KLEIN TOOLS
For Professionals... Since 1857®

Model No.	Colour	Size	Belt Width"	Wt. lbs.	Price /Each
A. TBS851	Tan	33"-45"	1	0.30	16.66
B. TBT511	Tan	32"-40"	2	0.63	38.53
TBS856	Tan	36"-44"	2	0.64	39.80
TBT510	Tan	40"-48"	2	0.64	41.00
TBT512	Tan	44"-52"	2	0.65	42.26
C. TBS852	Blue	One Size Fits All	2	0.20	12.66
D. TBT501	Tan	32"-40"	1 1/2	0.40	36.88
TBT500	Tan	38"-46"	1 1/2	0.45	38.39
TBT502	Tan	46"-54"	1 1/2	0.50	39.98

TOOL STORAGE

JOURNEYMAN ELECTRICAL POUCHES

- Made of top grain heavy leather
- Large accessible tool pouch within side corrugated strip for screwdrivers and wrenches
- Large front dividers for extra tools, tape chain and quick release snap
- Roll over type back to fit most industrial belts up to 4"
- Rivet reinforced at all stress points
- Dimensions: 11" L x 8 1/2" H

Model No. TBN136
Price/Each \$60.10



4-POCKET TOOL POUCHES

- Leather fabrication
- Riveted and stitched for extra durability
- Speciality add-ons: Knife snap
- Slotted belt connection
- Fits belts up to 2" wide
- Dimensions: 8 1/2" L x 10 3/4" H

Model No. WK777
Price/Each \$29.69



MAINTENANCE TOOL POUCHES

- Double zipper that keeps the tools in place and accommodate longer tools
- Push-button that keeps the cover away from the tools access
- Several compartments can store a wide variety of tools
- Carabiner and tape holder
- Belt clip that fits belts up to 2 3/4" wide
- Dimensions: 6" L x 9 3/4" H

Model No. TEP259
Price/Each \$16.89



10-POCKET TOOL POUCHES

- Leather fabrication
- Riveted and stitched
- Speciality add-ons: Snife snap
- Slotted belt connection
- Fits belts up to 2" wide
- Dimensions: 10" L x 10" H

Model No. TBS833
Price/Each \$81.77



11-POCKET PROFESSIONAL ELECTRICIAN'S POUCHES

- Double layer of rugged, lightweight nylon
- Two large main pockets, three smaller pockets
- Six large screwdriver holders, electrical tape chain and tool snap
- Metal clip holds all measuring tape sizes
- Dimensions: 8 1/2" L x 14 1/2" H

Model No. WI969
Price/Each \$42.20



8-POCKET EXTRA-CAPACITY TOOL POUCHES

- Leather fabrication
- Extra-capacity multi-purpose pouch
- Stitched and riveted
- Speciality add-ons: Knife snap & Leather Tape Thong
- Tunnel loop belt connection
- Fits belts up to 3" wide
- Dimensions: 8 1/2" L x 10 3/4" H

Model No. TGZ768
Price/Each \$158.66



21-POCKET ZIPPERED PROFESSIONAL ELECTRICIAN'S TOOL POUCHES

- Double layer of rugged, lightweight 600D polyester fabric
- Zippered top flap to prevent spillage of tools when not in use
- Ergonomic rubber handle and padded shoulder strap design for easy storage and the ideal way to carry loaded tool pouch
- Zippered back pocket for 8" x 5" writing pad
- Outside pocket to hold cell phone holder and three outside large screwdriver holders
- Dimensions: 11 1/2" L x 16" H

Model No. TBN126
Price/Each \$51.31



8-POCKET ELECTRICIAN'S TOOL POUCHES

- Top grain leather
- One main deep pocket, six additional front and side pockets for screwdrivers, wrenches, etc.
- Fits belts up to 2 3/4" wide
- Leather hammer loop
- Leather holder fits up to 30" measuring tape
- Tape chain and metal tool clip
- Dimensions: 10 1/2" L x 11" H

Model No. TBN138
Price/Each \$36.01



ELECTRICIAN'S TOOL POUCHES

- Ballistic polyester fabrication – 1680D
- Two large main pockets, five small pockets
- Nylon/PP reinforced pouch bindings
- Heavy gauge 6-ply nylon stitching
- Electrical tape chain and tool spring clip
- Screened nickel-plated steel storm drains
- Metal clip holds all measuring tape sizes
- Nickel-plated steel rivets
- Dimensions: 12 1/2" L x 11" H

Model No. TEP008
Price/Each \$44.18



6-POCKET TOOL POUCHES

- Leather fabrication
- Riveted to assure long life
- Speciality add-ons: Knife snap
- Dimensions: 7" L x 10" H

Model No. TBS816

- Slotted belt connection
- Fits belts up to 2" wide

Price/Each \$57.36

Model No. TBT486

- Tunnel loop belt connection
- Fits belts up to 2 1/2" wide

Price/Each \$60.48



3-WAY LINEMAN TOOL POUCHES

- Made of top grain leather
- Bottom is vented to prevent collection of dirt
- Slotted to fit belt up to 2" wide
- Double backed and riveted
- Dimensions: 9 1/4" L x 6 1/4" H

Model No. TN246
Price/Each \$24.08



Call us for all your



Tools & Equipment requirements!

6-POCKET NAIL/SCREW & TOOL POUCHES

- Leather fabrication
- Heavy hammer-loops on both sides
- Riveted and stitched for extra durability
- Speciality add-ons:
 - Two hammer loops
- Tunnel loop belt connection
- Fits belts up to 3" wide
- Dimensions: 11" L x 11 3/4" H

Model No. TBS964
Price/Each \$54.62



3-POCKET UTILITY POUCHES

- Leather fabrication
- Features 1" reinforced gusset
- Has 2" outside pockets
- Riveted and stitched for extra durability
- Tunnel loop belt connection
- Fits belts up to 1" wide
- Dimensions: 5 1/4" L x 7" H

Model No. TBS825
Price/Each \$39.92



11-POCKET TOOL POUCHES

- Leather fabrication
- Soft, pliable, and moisture-resistant to retain flexibility even after being wet and dried
- Riveted and stitched
- Stainless steel power-return tape holder clip (accommodates from 8' to 30' tapes)
- Heavy-duty chain tape thong securely fastened with a rivet
- Speciality add-ons: Knife snap, Chain tape thong, Metal tape measure holder
- Slotted belt connection
- Fits belts up to 2 3/4" wide
- Dimensions: 10" L x 10 1/2" H

Model No. TBS835
Price/Each \$134.00



10-POCKET TOOL POUCHES

- Leather fabrication
- Riveted throughout to assure long life
- Ten separate compartments
- Slotted-leather tape thong (allows easy removal of 1" I.D. tape rolls)
- Speciality add-ons:
 - Leather tape thong
- Slotted belt connection
- Fits belts up to 1 3/4" wide
- Dimensions: 6" L x 8 3/4" H

Model No. TBS846
Price/Each \$59.40



16-POCKET APRONS

- Five pockets for larger tools and cell phone
- Eight small pockets
- 3-compartment chest pocket
- Adjustable neck strap and belt with quick-release buckle
- Dual hammer loops
- Dimensions: 15" L x 10 3/4" H

Model No. TEP028
Price/Each \$31.92



12-POCKET CANVAS BIB APRONS

- Canvas fabrication
- Five large pockets
- Two nylon hammer loops
- Dimensions: 15" L x 10 3/4" H

Model No. TN215
Price/Each \$60.10



2-POCKET CANVAS WORK APRONS

- 6-8 oz. canvas fabrication
- Two large nail pockets
- Dimensions: 15 3/4" L x 10 3/4" H

Model No. TN216
Price/Each \$3.13



13-POCKET WAIST APRONS

- Five pockets for larger tools and cell phone
- Eight pockets for pens, pencils, and small tools
- Dual hammer loops
- Dimensions: 20" L x 12" H

Model No. TEP029
Price/Each \$26.18



JOURNEYMAN CARPENTER APRONS

- Made of heavy split leather
- Steel hammer holder
- Centre pocket for tape or other tool
- Heavy leather belt with roller buckle
- Reinforced at all stress points
- Dimensions: 23 1/2" L x 12 1/2" H

Model No. TN221
Price/Each \$56.40



Look for this symbol for environmentally friendly products!



TOOL STORAGE

75-POCKET TOOL BACKPACKS

- Made of DuPont Cordura Plus fabric
- Enough interior panels to hold a multitude of tools including: 14-pc. wrench sets, electric drills, extension cords, pliers, screwdrivers and much more
- 7" x 5" multi-compartment plastic tray included
- Dimensions: 13" L x 17 1/2" W x 9" H

Model No. TBN248
Price/Each \$120.83



48-POCKET BUCKET BUDDY

- 14 double row pockets inside and 34 triple row pockets outside organize a wide range of tools and accessories
- Security pocket with hook and loop closure
- Drill pocket with hook and loop handle strap
- Designed to fit most 3 1/2 - 5 gallon buckets
- Measuring tape strap and key clip included

Model No. VQ267
Price/Each \$21.19



25-POCKET TOOL ROLL-UPS

- Ballistic poly fabrication - 1680D
- Rolls up for easy stowing
- Carry handle for easy transport
- Heavy gauge 6-ply nylon stitching
- Socket pockets hold 3/8" or 1/4" sockets
- Product open dimensions: 27" L x 14 3/4" W

Model No. TEP032
Price/Each \$28.13



STANDARD NUT & BOLT BAGS

- Heavy-duty canvas duck
- Large main pocket and two tapered drift pin holders
- Canvas loop accepts belts up to 4" wide
- Dimensions: 12" L x 9" H

Model No. TBN273
Price/Each \$20.28



17-POCKET ELECTRICAL & MAINTENANCE TOOL POUCHES

- Heavy-duty top grain leather
- Box-shaped design prevents tipping
- Large divided main pocket for extra tool capacity
- Leather reinforced carrying handle and electrical tape chain
- Dimensions: 8 1/2" L x 16" H

Model No. VE823
Price/Each \$160.81



6-POCKET CINCH UP

- Ballistic poly fabrication - 1680D
- Six compartments for fasteners, etc.
- 13 exterior pockets
- Can be stacked in a 5-gallon bucket

Model No. TEP034
Price/Each \$30.44



HEAVY-DUTY CANVAS BUCKETS

- Made with top grade heavy-duty canvas material and high strength top ring
- Polypropylene (back-braided) rope handle, reinforced with leather and grommet eyelets where it is spliced around top ring
- Dimensions: 12" L x 27" H

Model No. TP204
Plastic bottom
Price/Each \$64.19

Model No. WL001
Leather bottom
Price/Each \$74.35



22-POCKET BIGMOUTH® BAGS

- 12-multi-use pockets inside and outside organize tools and accessories
- Opens wide for easy access to bag's contents
- Padded reinforced web carrying handles and adjustable shoulder strap
- Dimensions: 16" L x 8 1/2" W x 10" H

Model No. BB391
Price/Each \$32.81



28-POCKET ELECTRICAL & MAINTENANCE TOOL POUCHES

- 7" x 5 1/2" multi-compartment plastic tray included, slides securely into bottom of pouch
- Box-shaped design prevents tipping
- Pockets for drill bits and tips, electrical tape strap, etc.
- Dimensions: 8 1/2" L x 17" H

Model No. BB390
Price/Each \$47.45



ALL-PURPOSE GEAR BAGS

- All-purpose gear bag perfect for carrying air hoses, kneepads, power tools, extension cords, etc.
- Outside pockets to organize small tools or accessories
- Abrasion resistant rubber feet
- Reinforced padded carrying handles
- Dimensions: 24" L x 12" W x 12" H

Model No. TEP215
Price/Each \$29.45



OPEN TOP 14" SOFT SIDE TOOL BOXES

- Removable and adjustable metal frame partition slides securely into place to customize tool box to your storage needs
- Plastic reinforced internal pocket for utility knife or other tools
- Sturdy metal handle bar with molded foam grip for easy carrying
- Wide open space below handle for easy access to tool carrier's main compartment
- 21 multi-use pockets and 10 webbing loops to organize a wide range of tools and accessories
- Adjustable, padded shoulder strap
- Dimensions: 14" L x 11" W x 11" H

Model No. TJZ969
Price/Each \$50.96



43-POCKET ELECTRICAL & MAINTENANCE BAGS

- 7" x 5 1/2" multi-compartment plastic tray included
- Two Window Pockets™ for easy view of pocket contents, one removable and one stationary
- Box-shaped design prevents tipping
- Pockets for drill bits and tips, cell phone, electrical tester, electrical tape strap, etc.
- Dimensions: 23" L x 12" W x 15" H

Model No. WI963
Price/Each \$50.91



OPEN TOP 20" SOFT SIDE TOOL BOXES

- Removable and adjustable metal frame partition slides securely into place to customize tool box to your storage needs
- Plastic reinforced internal pocket for utility knife or other tools
- Sturdy metal handle bar with molded foam grip for easy carrying
- Wide-open space below handles for easy access to tool carrier's main compartment
- 27 multi-use pockets and six webbing loops to organize a wide range of tools and accessories
- Adjustable, padded shoulder strap
- Dimensions: 20" L x 11" W x 11" H

Model No. TEP217
Price/Each \$59.59



OPEN TOP TOOL ORGANIZERS

- Ballistic polyester fabrication - 1680D
- 30 pockets: 21 exterior, 9 interior, adjustable internal divider
- Detachable cell phone holder, parts organizer and junk pouch
- Molded rubber base
- Bio-curved padded shoulder strap and carry handle for heavy loads
- Wide, reinforced opening
- Heavy gauge 6-ply nylon stitching
- Plastic parts organizer
- Nickel-plated tape measure holder
- Outside tape loop
- Dimensions: 13 1/2" L x 7 1/2" W x 11" H

Model No. TEP022
Price/Each \$109.13



WIDEMOUTH SMALL TOOL ORGANIZERS

- Ballistic polyester fabrication - 1680D
- 27 pockets: 10 exterior, 17 interior, adjustable internal divider
- Molded rubber base
- Bio-curved padded shoulder strap and carry handle for heavy loads
- Wide, reinforced opening
- Outside tape loop and end pockets for gloves or rags
- Exterior cell phone pocket
- Heavy gauge 6-ply nylon stitching
- Dimensions: 13" L x 10" W x 9 1/2" H

Model No. TEP021
Price/Each \$94.18



TOTE BAGS WITH TOP PLASTIC TRAY

- 13 pockets inside and 24 pockets outside to organize tools and accessories
- 13 1/2" x 3" multi-compartment plastic tray to organize small parts on top for easy access
- Reinforced web carrying handles and adjustable shoulder strap
- Large zippered outside pocket and heavy-duty tape clip
- Dimensions: 18" L x 11" W x 11" H

Model No. TEP216
Price/Each \$41.43



TOOL STORAGE

PLASTIC TOOL BOXES

- ABS plastic latches
- Heavy-duty polypropylene fabrication
- Removable inner trays
- Deep storage compartments
- Padlock eye for safe storage



TLV082



TLV083



TLV084

aurora tools

Model No.	Dimensions				Features	Price /Each
	W"	x	D"	x H"		
TLV082	15	x	7	x 5 1/2	1 removable inner tray	16.45
TLV083	17 1/2	x	9 1/2	x 8	2 removable inner trays	22.60
TLV084	17 1/2	x	9 1/2	x 8	2 removable inner trays, 2 parts boxes, 1 organizer	27.55
TLV085	22	x	11	x 10 1/2	1 removable inner tray, 3 organizers	33.45
TLV086	22	x	11	x 14 1/2	1 removable inner tray, 3 organizers, 2 drawers	52.95



TLV085



TLV086

WATERLOO PORTABLE TOOL STORAGE SERIES

- Available in a choice of plastic and metal options
- Polyurethane portables with new design features provide additional strength



PLASTIC TOOL BOXES

Model No.	Mfg No.	Description	Dimensions				Price /Each
			W"	x	D"	x H"	
TEP471	PP-2314BK	3-drawer plastic portable chest	23	x	10 1/2	x 13 1/2	73.09
TEP473	PP-2610BK	26" plastic tool box w/tote	26	x	10 1/2	x 10	33.20
TEP474	PP-2310BK	23" plastic tool box w/tote	23	x	10 1/2	x 10	29.51
TEP475	PP-2009BK	20" plastic tool box w/tote	20	x	9 1/4	x 9	22.78
TEP476	PP-1709BK	17" plastic tool box w/tote	17	x	9 1/4	x 9	18.31
TEP477	PP-1406BK	14" plastic tool box w/tote	14	x	7 1/2	x 6 1/4	11.18

TEP471



METAL TOOL BOXES

Model No.	Mfg No.	Description	Dimensions				Price /Each
			W"	x	D"	x H"	
TEP478	MP-2012BK	20" 3-drawer portable chest	20	x	9	x 12	77.98
TEP479	MP-2009BK	20" Tool box w/metal tote	20	x	8	x 9	47.05
TEP480	MP-1608BK	16" Tool box w/plastic tote	16	x	7	x 7 1/2	32.53

TEP478



ATB100 PORTABLE TOOL BOXES

- Durable steel construction
- Heavy-plated latches
- Inner trays in regular hand boxes
- High gloss powder coat paint finish



TEP337



TEP338



TEP336

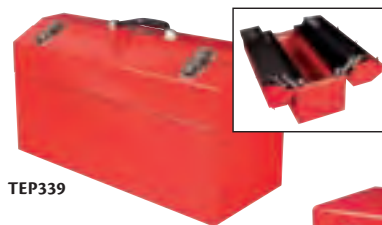

TEP339

aurora tools

Model No.	Description	Overall Dimensions			Wt. lbs.	Price /Each
		L"	x W"	x H"		
TEP336	21" Tool Box w/ Metal Tool Tray	21	x 8 3/4	x 9	12	42.95
TEP337	26" Tool Box w/ Metal Tool Tray	26	x 8 3/4	x 9	15	56.90
TEP338	20" Hip Roof Box w/ Metal Tool Tray	20	x 7	x 8	8	39.50
TEP339	21" Cantilever Tool Box	21	x 8 3/4	x 12	16	76.95
TEP340	21" 3-Drawer Chest	21	x 8 3/4	x 12	20	69.50



TEP340

ATB200 TOOL BOXES

- Double wall construction for added strength
- Full extension drawers with smooth action compound drawer slides
- Sturdy 5" x 2" casters
- Heavy-duty 14-gauge caster rails to support heavy loads
- 75-lb. load rated drawers
- Non-slip drawer liners
- High gloss powder coat scratch resistant red paint



aurora tools® Made in Canada

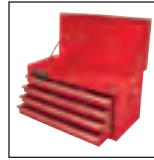

TEP328

Model No.	No. of drawers	Dimensions L" x W" x H"	Capacity lbs.	Wt. lbs.	Price /Each
CHESTS (RED)					
TEP328	6	26 x 12 x 14 1/2	525	54	315.00
TEP329	12	26 x 17 7/8 x 20 1/2	925	59	620.00
TEP330	10	26 x 17 7/8 x 20 1/2	825	85	659.00
TOOL CARTS (RED)					
TEP331	5	27 x 18 3/4 x 35 5/8	600	93	463.00
TEP332	11	27 x 18 3/4 x 42 3/8	1600	135	655.00

ACCESSORIES FOR ATB200 TOOL BOXES

Model No.	Description	Dimensions L" x W" x H"	Wt. lbs.	Price /Each
TEP333	1-shelf side cabinet	15 x 18 3/4 x 30 1/2	57	250.00
TEP334	7-drawer side cabinet	15 x 18 3/4 x 30 1/2	73	425.00
TEP335	8-drawer side cabinet	15 x 18 3/4 x 37	89	480.00



TEP331



TEP335

ATB300 TOOL BOXES

- Double wall steel construction for added strength
- Full extension ball bearings slides on all drawers
- Extruded aluminum drawer handle trim
- Heavy-duty casters 5" x 2" (56" & 42") 5" x 1 1/4" (27")
- Gas struts are in the lid of 56" & 42" wide chest for ease of opening and closing
- Non-slip drawer liners
- High gloss powder coat scratch resistant black paint



aurora tools® Made in Canada

Model No.	No. of Drawers	Dimensions L" x W" x H"	Drawer Capacity lbs.	Unit Capacity lbs.	Wt. lbs.	Price /Each
CHESTS (BLACK)						
TEP312	4	26 x 12 x 14 1/2	75	375	41	205.00
TEP314	6	26 x 17 7/8 x 19	75	675	75	295.00
TEP316	10	41 x 17 7/8 x 19	120	1200	119	615.00
TEP318	6	56 x 24 x 19	120	720	163	1058.00
TOOL CARTS (BLACK)						
TEP313	5	27 x 18 x 31	100	500	85	310.00
TEP315	7	27 x 18 x 35 1/2	100	700	102	428.00
TEP317	11	42 x 18 x 40	120	1320	175	955.00
TEP319	10	56 x 24 x 39 1/2	120	1200	320	1688.00



TEP312



TEP314



TEP315

TOOL STORAGE

ATB400 TOOL BOXES

- Heavy-duty double wall steel construction for added strength
- Quadra level ball bearing slides on all drawers
- Heavy-duty reinforced bottom support rails for heavier loads
- Heavy-duty casters 5" x 2" with double layer ball bearings
- Full extension slides for easy reach inside
- Integrated latch security drawer system prevents drawers from accidentally opening
- Heavy-duty gas struts on top lid
- High-gloss powder coat scratch-resistant blue paint
- Includes non-slip drawer liners

TEP322



Made in Canada

aurora tools®

Model No.	No of Drawers	Dimensions W" x D" x H"			Drawer Capacity Lbs.	Unit Capacity Lbs.	Wt. lbs.	Price /Each		
CHESTS (BLUE)										
TEP320	4	26 7/8	x	18 1/4	x	18 1/4	100	500	74	655.00
TEP322	5	26 7/8	x	18 1/4	x	17	100	600	84	745.00
TEP324	6	41 1/2	x	18 1/4	x	20	100	700	118	940.00
TEP326	9	53 1/2	x	18 1/4	x	22 1/4	100	1000	173	1198.00
TOOL CARTS (BLUE)										
TEP321	5	28 7/8	x	18 7/8	x	31 3/8	100	600	111	710.00
TEP323	7	28 7/8	x	18 7/8	x	36 5/8	100	800	135	880.00
TEP325	14	43 3/8	x	18 7/8	x	37 3/4	120	1600	221	1260.00
TEP327	13	55 7/16	x	18 7/8	x	37 1/2	120	2400	264	1910.00



TEP323

UTILITY CARTS

- Heavy-duty steel construction
- Full extension ball bearing slides on all drawers
- High quality 4" swivel casters
- Drawer capacity: 100 lbs.
- Unit capacity: 550 lbs.
- High-gloss powder coat scratch-resistant black paint

Model No. TEP483
Price/Each \$442.00



aurora tools®

WATERLOO SPECIALTY TOOL STORAGE SERIES

- Utility cart offers ball-bearing slides, Posi-Latch drawer latching system, and tubular keyed lock
- Project centres available in two models: 5-drawer with power or non-powered 3-drawer with bulk storage



UTILITY CARTS

Model No.	Mfg No.	No. of Drawers	Dimensions W" x D" x H"			Price /Each		
TEP463	SP-UC3BK	3	34	x	20.7	x	36.75	480.40

PROJECT CENTRES

Model No.	Mfg No.	No. of Drawers	Dimensions W" x D" x H"			Price /Each		
TEP464	SP-PC5BK-P	5	34.3	x	19.2	x	32.3	324.67
TEP465	SP-PC3BK	3	33.7	x	19.7	x	34.3	270.53

TOOL CENTRES WITH PART BIN

Model No.	Mfg No.	No. of Drawers	Dimensions W" x D" x H"			Price /Each		
TEP462	STC-266RD-F	6	26	x	14	x	44	250.98

TEP464



TEP463



WATERLOO SHOP SERIES WITH FRICTION SLIDES

- Full-width drawer pulls
- Friction slides provide 25-lb. drawer load rating
- Sturdy 4" casters for easy mobility provide 500-lb. unit load rating (Tool Centre has 3" casters)
- External lock bar with keyed lock
- Top chests include inset handles
- Colour: Red



Model No.	Mfg No.	No. of Drawers	Dimensions				Price /Each	
CHESTS								
TEP457	SCH-264RD-F	4	26	x	12	x	15 1/2	172.31
TEP458	SCH-267RD-F	7	26	x	12	x	17 1/2	204.40
INTERMEDIATE CHESTS								
TEP460	SIN-263RD-F	3	26	x	12	x	11 1/2	147.71
CABINETS								
TEP459	SCA-26514RD-F	5	26	x	14	x	32	218.42
TEP461	SCA-265RD-F	5	26	x	18	x	32	272.56



TEP457

WATERLOO HEAVY-DUTY TOOL STORAGE SERIES

- Ball-bearing slides provide 50-lb. drawer load rating
- Standard 4 1/2" x 1 1/2" casters provide 700-lb. unit load rating
- Keyed locks with internal lock bars
- 41" cabinet includes MDF work surface and full-width top drawer for long-tool storage
- Colour: Red



Model No.	Mfg No.	No. of Drawers	Dimensions				Price /Each	
CHESTS								
TEP411	WCH-266RD	6	26	x	12	x	15 1/2	262.16
TEP415	WCH-265RD	5	26	x	16	x	20	342.16
TEP439	WCH-418RD	8	41	x	16	x	20	719.13
INTERMEDIATE CHESTS								
TEP435	WIN-262RD	2	26	x	16	x	10 1/4	225.20
CABINETS								
TEP419	WCA-265RD	5	26	x	18	x	32	399.20
TEP427	WCA-266RD	6	26	x	18	x	41	541.76
TEP443	WCA-4111RD	11	41	x	18	x	37 1/2	1137.73



TEP411

TEP419

WATERLOO PROFESSIONAL TOOL STORAGE SERIES

- Posi-Latch drawer latching system included on all units
- Full-width top drawers on cabinets offer opportunity for long tool storage
- Heavy-duty ball-bearing slides with 75-lb. drawer load rating
- Standard 5" x 2" heavy-duty swivel and locking casters provide 1120-lb. unit load rating
- Internal keyed locking system for secure tool storage
- Chests come complete with gas-struts
- Chests include full-width lid stiffener for added strength
- Colour: Red



TEP381

TEP385



TEP407



TEP405

Model No.	Mfg No.	No. of Drawers	Dimensions				Price /Each	
CHESTS								
TEP381	PCH-418RD	8	41	x	18	x	19	1157.44
TEP393	PCH-528RD	8	52	x	18	x	20	1611.38
CABINETS								
TEP385	PCA-4111RD	11	41	x	18	x	41	1654.69
TEP397	PCA-5211RD	11	52	x	20	x	41	2898.40

STAINLESS STEEL UNITS

Model No.	Mfg No.	No. of Drawers	Dimensions				Price /Each	
TEP405	PCH-4111SS	11	41	x	18	x	20	1282.09
TEP407	PCA-4112SS	12	41	x	18	x	20	1874.76

RG34500E



JOBOX® OFFERS:

EZ-LOADER® SKID BOLSTERS

- Fork lift from any side
- Easily load or unload heavy, fully loaded boxes from any sides
- One piece 7-gauge steel skid bolster reinforces the bottom of the box
- With holes for optional caster

TEXTURED POWDER PAINT FINISH

- Improved durability over liquid paint
- 10 times more corrosion resistance
- 5 times more abrasion resistance
- 2 times more chip resistance
- 2 times more scratch resistance

SITE-VAULT™ SECURITY SYSTEM

- Three locking point system
- Cover plates protect the 3-lock hooks from being bent, broken, cut or pulled out
- Full length, high strength 12-gauge lock console protects the system and reinforces the front of the lid or door
- Requires only one *Masterlock*® #5 Padlock (SR890-keyed differently; SR867-keyed alike)
- Padlock is securely installed inside the fully welded 14-gauge steel housing
- Exclusive: fluorescent reflective orange tape indicates when the *Jobox*® is unlocked



HIGH CAPACITY DROP-FRONT CHESTS

- *Site-Vault*™ security system with 12-gauge steel lock console with two locking points, full length console and fully welded padlock housing make the lid virtually impossible to bend or pry
- *Ez-Loader*® skid bolster made of 7-gauge one piece steel allows fork lift access from all sides to allow easier loading and unloading
- *Grip-rite*™ lifting channel
- Power cord access on the top side of the chest
- 37% more capacity for storing taller, bulkier equipment
- Extra wide (44" W), low-incline ramp supports up to 1000 lbs. for safe and easy loading and unloading and is pad-lockable
- 7-gauge, one-piece steel bolsters resist damage when dropped



Model No.	W"	x	D" x H"	Usable Cu. Ft.	Wt. lbs.	Price /Each
TEP341	60	x	31 x 45	41.5	340	1597.12

HIGH CAPACITY DROP-FRONT CHEST ACCESSORY OPTIONS

ACCESSORY SUPPORT BARS

- 1 1/2" square steel tube is the core component needed to support accessories

Model No. TEP342
Price/Each \$40.18

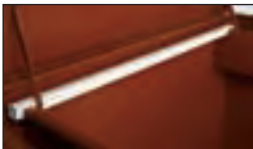

BACK WALL SHELVES

- Ability to tightly secure shelf to chest yet removable when needed
- Includes hardware

Model No. TEP343
Price/Each \$94.17

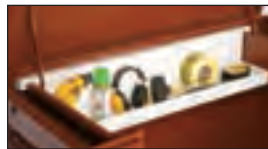

PEG BOARDS

- Can be mixed and matched side by side with the parts bin board (TEP345)

Model No. TEP344
Price/Each \$71.57

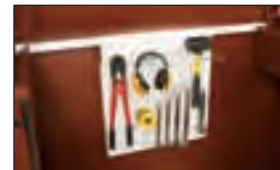

PARTS BIN BOARDS

- Can be mixed and matched side by side with peg board (TEP344)
- Supports most small parts bins

Model No. TEP345
Price/Each \$71.57



TOOL & EQUIPMENT HOOKS

- Industrial grade hooks are perfect for hanging harnesses, rope or chains
- Easy to position and quick to remove
- Package of 6

Model No. TEP346
Price/Each \$31.40



PIANO BOXES

- Site-Vault™ security system
- Ez-Loader™ skid bolsters
- Grip-Rite™ recessed lifting channel
- Lift-N-Stow™ bottom shelf
- 3/8" continuous hinges with 1/4" steel pin and extra-large 1" knuckles
- Recessed handles, door opens full 90°
- Two storage bins on both sides of walls
- Formed lid sides welded to lid bolsters resists pry bar entry
- Formed side wall design allows the door to overlap the side walls when closed to resist pry bars and moisture
- Gas springs assist with opening and closing the door. They are embedded in the side walls and protected from damage and jamming. Guards reinforce the side walls.
- TEP347 has one fixed rear shelf and one storage bin on side wall



TEP162



TEP165

- TEP164: Punch holes for hanging safety harnesses, three shelves with 500-lb. capacity and three storage bins
- TEP165 and TEP166: Tapered drop down ramp that closes with a padlock (not included)

JOBBOX

Model No.	Dimensions					Usable Cu. Ft.	Wt. lbs.	Price /Each
	W"	x	D"	x	H"			
TEP161	48	x	31	x	50	38	286	1423.22
TEP347	60	x	31	x	38	34.5	283	1289.51
TEP162	60	x	31	x	50	47.5	326	1423.22
TEP163	74	x	31	x	50	56.5	423	1762.53

Model No.	Dimensions					Usable Cu. Ft.	Wt. lbs.	Price /Each
	W"	x	D"	x	H"			
HIGH CAPACITY MODEL								
TEP164	74	x	34 5/8	x	63	85.7	500	2112.41
DROP-FRONT MODEL								
TEP165	60	x	30	x	50	47.5	405	1852.33
TEP166	74	x	30	x	50	56.5	468	2145.63

JOBBOX® CHESTS

- Site-Vault™ security system
- Ez-Loader™ skid bolsters
- Grip-Rite™ recessed lifting channel
- Staked and welded hinge: 14-gauge steel, 3/8 continuous hinges with 1/4" steel pin and extra-large 1" knuckles
- Heavily reinforced lid and body: Full length A-frame lid bolster, resists bending from weight placed on top and from break-in attempts, welded corner gussets reinforce body



TEP158



TEP137

SLOPE LID CHESTS

All the characteristics of a regular Jobox® chest plus:

- Propped lid allows for a flat working surface
- Full length reinforced channel
- Lift-N-Stow™ hinged shelf to store bulky items in the bottom



JOBBOX

Model No.	Dimensions					Usable Cu. Ft.	Wt. lbs.	Price /Each
	W"	x	D"	x	H"			
TEP159	60	x	30	x	39 1/2	32.7	243	1195.94

JOBBOX

Model No.	Dimensions					Usable Cu. Ft.	Wt. lbs.	Price /Each
	W"	x	D"	x	H"			
TEP092	36	x	20	x	23 3/4	8.3	98	532.06
TEP136	42	x	20	x	23 3/4	9.3	118	606.01
TEP137	48	x	24	x	27 3/4	15.4	148	715.59
TEP156	60	x	24	x	27 3/4	19.3	182	866.09
TEP157	48	x	30	x	33 3/8	24.3	190	828.28
TEP158	72	x	24	x	27 3/4	23.2	220	983.60

CASTERS

- Heavy-duty casters for added mobility
- Set includes: 2 fixed and 2 swivels
- Hardware included



4"
Model No. TEP230
Price/Each \$91.33

6"
Model No. TEP231
Price/Each \$103.83

TOOL STORAGE

WELDER'S BOXES & SMALL CHESTS

- Compact and portable for flexible, secure storage
- A heavily-reinforced 16-gauge steel construction
- **TEP175** offers a heavily-reinforced lid able to resist pry bar entry, a recessed grip channel for opening lid, a bolt cutter proof locking system with a padlock (not included, **SR890**) protecting the lock from bolt cutters and pry bars and tall, strong bottom bolsters
- Staked and welded steel hinges
- **TEP348** is a welder's box that offers a notched upper side for storing tools connected to supply hoses



TEP175

TEP348

TEP349



Model No.	Description	Dimensions W" x D" x H"	Usable Cu. Ft.	Wt. lbs.	Price /Each
TEP175	Small chest w/embedded lock	31 x 18 x 15 1/2	4	5.7	456.80
TEP349	Small chest w/hasp lock	30 x 16 x 12	3.3	4.6	213.45
TEP348	Welder's box	30 x 16 x 12	3.3	4.6	210.95

JOBSITE CHESTS

- Steel body and lid provide superior security for tools and equipment
- Bolt cutter proof locking system protects padlock inside 12-gauge steel housing
- Heavy-duty hinge is staked and welded to prevent the pin from being driven out to break in
- Lifting handles are protected inside tall, deep recessed to prevent pinched knuckles and damage
- Heavy-duty locking arm secures the lid in the open position
- Tall bottom bolsters for easily moving a loaded chest with a forklift
- 1-year limited warranty



TEP226



Model No.	Dimensions W" x D" x H"	Usable Cu. Ft.	Wt. lbs.	Price /Each
TEP226	36 x 19 1/2 x 22	6.8	85	443.61
TEP227	42 x 20 x 23 1/2	9.3	101	516.23
TEP211	48 x 24 x 27 1/2	15.4	133	508.41
TEP212	60 x 24 x 27 1/2	19.2	155	760.47

DRAWER CABINETS

- Site-Vault™ security system
- Ez-Loader™ anti-tip skid bolsters: Front of bolster is extended to prevent tipping when drawers are open
- Heavy-duty doors with Grip-Rite™ channel
- Hand or foot operated latch released system
- 4 1/2" deep top shelf and 3" x 3" deep shelves on each door
- 3/8" continuous hinges with hardened 1/4" steel pin and extra-large 1" knuckles
- Three 5/8" steel locking pins per door
- High load capacity drawer: Three 2 1/2" deep drawers have 75-lb. capacity, five 5 1/2" deep drawers have 125-lb. load rating



Anti-Tip Skid Bolster



Model No.	Dimensions W" x D" x H"	Usable Cu. Ft.	Wt. lbs.	Price /Each
TEP173	60 1/8 x 30 1/4 x 53 1/4	58.7	610	3651.83

CABINETS

- Site-Vault™ security system
- Heavy-duty doors with Grip-Rite™ channel
- Hand or foot operated latch released system
- 3/8" continuous hinges with hardened 1/4" steel pin and extra-large 1" knuckles
- Heavy-duty high strength shelves
- Three 5/8" steel locking pins per door
- Five models to choose from:
 - TEP168:** 2 doors, 24" deep
 - TEP169:** 4 doors features front and back access
 - TEP170:** 2 doors, tall closet on right side
 - TEP171:** 2 doors, 30" deep
 - TEP172:** 2 doors, bin and clam shell, has heavy-duty galvanized movable dividers



TEP168



TEP170



TEP169



TEP172



Model No.	Dimensions W" x D" x H"	Usable Cu. Ft.	Wt. lbs.	Price /Each
TEP168	60 1/8 x 24 1/4 x 60 3/4	47.5	379	1926.27
TEP169	60 1/8 x 32 1/4 x 60 3/4	63.7	523	2743.48
TEP170	60 1/8 x 24 1/4 x 60 3/4	47.5	366	2300.76
TEP171	60 1/8 x 30 1/4 x 60 3/4	58.7	436	2307.81
TEP172	72 x 24 x 60 5/8	49	522	2301.20

ROLLING WORK BENCHES

- High capacity, fully adjustable interior; drawers and shelves are easy to move to match your requirements, additional drawers and shelves can be added in
- 18-gauge steel drawers with heavy-duty ball bearing glides

Includes: Two fixed and two lockable swivelling casters



TEP176



ADDITIONAL DRAWERS & SHELVES:

Model No.	Description	Dimensions			Usable Cu. Ft.	Wt. lbs.	Price /Each
		W"	x D"	x H"			
TEP180	Basic Unit with 6" Casters	49 7/8	x 26 7/8	x 40 5/8	24.6	264	1546.03
TEP176	2 Drawers, 2 Shelves, 4" Casters	43 7/8	x 26 7/8	x 38 1/2	21.7	266.5	1577.71
TEP177	2 Drawers, 2 Shelves, 6" Casters	43 7/8	x 26 7/8	x 40 1/2	21.7	279.5	1692.58
TEP178	4 Drawers, 1 Shelf, 4" Casters	43 7/8	x 26 7/8	x 38 1/2	21.7	294	1852.33
TEP179	4 Drawers, 1 Shelf, 6" Casters	43 7/8	x 26 7/8	x 40 1/2	21.7	307	1934.17
TEP181	6 Drawers, 1 Shelf, 6" Casters	49 7/8	x 26 7/8	x 40 5/8	24.6	342	2596.93

For TEP176, TEP177, TEP178 and TEP179	For TEP180 and TEP181	Description
TEP182	TEP183	Shelf
TEP184	TEP185	2 1/2" Drawer
TEP186	TEP187	4 1/2" Drawer
TEP188	TEP189	5 1/2" Drawer
TEP190	TEP191	10 1/2" Drawer

ROLLING CLAM SHELL CABINETS

- Rugged 16-gauge steel construction
- Flexible interior storage: Movable top and bottom shelves, open storage closet and lockable storage locker
- Latching hasp: 10-gauge construction reaches a full 4" to align and draw sides together, only key area of padlock is exposed
- Eight 4" heavy-duty casters
- Hinge stop prevents cabinet from fully opening and reduces tipping
- High center handle



Latching Hasp



Model No.	Dimensions			Usable Cu. Ft.	Wt. lbs.	Price /Each
	W"	x D"	x H"			
TEP174	62 1/2	x 30	x 63 1/2	72	472	2633.90

FIELD OFFICES

- Site-Vault™ security system
- Ez-Loader™ skid bolsters
- Grip-Rite™ recessed lifting channel
- One handle lock operation, slides down to release bottom doors, slides up for top door
- 30 cu. ft. storage locker, stores items up to 60" length and is opened by a lanyard inside the lower cabinet
- Full length heavy-duty stainless steel hinges resists corrosion and rust
- Built-in bottom door storage shelves
- Overhead tube storage, steel pegboard, storage area for plans and binders, lockable large desktop area and door safety pin latch



Model No.	Dimensions			Usable Cu. Ft.	Wt. lbs.	Price /Each
	W"	x D"	x H"			
TEP167	63	x 42	x 80	100	660	3456.43

R32178E

OFFICE PRODUCTS

INSTRUMENTS, SCALES & ELECTRICAL

SHIPPING & PACKAGING

TOOLS & EQUIPMENT

WELDING & METALWORKING

SAFETY EQUIPMENT & SUPPLIES

JANITORIAL & MAINTENANCE

MATERIAL HANDLING & STORAGE

TOOL STORAGE

ALUMINUM TRUCK CHESTS

- Gear-Lock II™ locking system offers a self-adjusting dual rotary lock system, a ratcheting action that pulls lid tight to resist over 2000 lbs. of prying and pulling force, and the highest level of security and moisture resistance available
- Self-aligning latch hoops, pivots from side to side to align with Gear-Lock II™ dual rotary lock system
- Heavy-duty gas spring guards protects the gas springs from damage and jamming
- High-strength deep bevelled edge lid provides increased strength and superior weather protection
- Recessed hinge on all chests, allows lid to be raised fully even when chest is placed flush against truck bed
- 5-year limited warranty



Model No.	Colour	Dimensions					Usable Cu. Ft.	Wt. lbs.	Price /Each
		W"	x	D"	x	H"			
TEP214	Clearcoat	59 3/8	x	20 1/4	x	19	10.2	49	872.68
TEP247	Black	59 3/8	x	20 1/4	x	19	10.2	49	872.68
TEP248	White	59 1/8	x	20 1/4	x	19	10.2	120	854.20

CROSSOVERS TRUCK BOXES

- Gear-Lock II™ locking system offers a self-adjusting dual rotary lock system, a ratcheting action pulls lid tight to resist over 2000 lbs. of prying and pulling force and provides the highest level of security and moisture resistance available
- Self-latching latch hoops cannot be bent or pried out of the lock, automatically aligns in locking system and guarantees a tight seal first time every time
- Deep beveled edge lid design allows body to fit deeper inside the lid keeping out wind driven rain and prying tool and creates a superior moisture protection and security for your cargo
- Channel reinforced front panel, one-piece box body construction, full length bolster reinforcement
- Full-length lock console, drill resistant push button locks
- Bulb-shaped automotive weather stripping, 90° lid opening, small part bin storage and lift out storage tray
- Available in durable Armorbrite™ white powder paint finish steel or aluminum clear coat, in gull wing or single lid
- **Aluminum crossover truck box** has RSL™ rigid structural lid 3-layer lid has an inner core of rigid foam and reverse bevelled liner for superior strength and rigidity
- **Steel crossover truck box** has an Armorbrite™ white powder paint finish for superior rust resistance
- 5-year limited warranty



TEP194
Gull Wing



TEP192
Single Lid



SINGLE LID CROSSOVERS TRUCK BOXES

Model No.	Colour	Dimensions							Usable Cu. Ft.	Wt. lbs.	Price /Each
		A"	B"	C"	D"	E"	F"	G"			
ALUMINUM											
TEP192	Clearcoat	70 1/8	60 1/8	18 7/8	12	20 1/4	21	72	10.7	75	1056.21
TEP232	Black	70 1/8	60 1/8	18 7/8	12	20 1/4	21	72	10.7	75	1056.21
TEP234	Clearcoat	70 1/8	60 1/8	18 7/8	12	29 1/4	30	72	17.5	97.5	1126.20
TEP235	Black	70 1/8	60 1/8	18 7/8	12	29 1/4	30	72	17.5	97.5	1126.20
STEEL											
TEP196	White	70 1/8	60 1/8	18 7/8	12	20 1/4	21	72	10.7	156	987.56
TEP241	White	70 1/8	60 1/8	18 7/8	12	29 1/4	30	72	17.5	191	1086.57

GULL WING CROSSOVERS TRUCK BOXES

Model No.	Colour	Dimensions							Usable Cu. Ft.	Wt. lbs.	Price /Each
		A"	B"	C"	D"	E"	F"	G"			
ALUMINUM											
TEP194	Clearcoat	70 1/8	60 1/8	20 1/2	12	20 1/4	21	72	11.7	64	1169.74
TEP239	Black	70 1/8	60 1/8	20 1/2	12	20 1/4	21	72	11.7	64	1169.74
STEEL											
TEP198	White	70 1/8	60 1/8	20 1/2	12	20 1/4	21	72	11.7	142	987.56

INNERSIDES TRUCK BOXES

- Gear-Lock II™ locking system offers a self-adjusting dual rotary lock system, ratcheting action pulls lid tight to resist over 2000 lbs. of prying and pulling force and provides the highest level of security and moisture resistance available
- Self-latching latch hoops cannot be bent or pried out of the lock, automatically aligns in locking system and guarantees a tight seal first time every time
- Deep bevelled edge lid design allows body to fit deeper inside the lid keeping out wind driven rain and prying tool and creates a superior moisture protection and security for your cargo
- Full-length storage bin, provides quick and easy access to small parts and tools
- Includes: support legs and mounting kit
- 5-year limited warranty



TEP242



TEP245

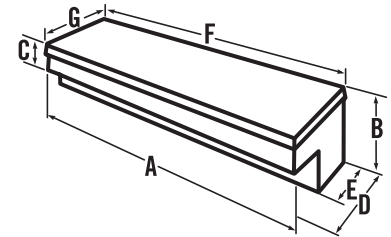

Model No.	Colour	A"	B"	C"	Dimensions				Usable Cu. Ft.	Wt. lbs.	Price /Each
					D"	E"	F"	G"			
ALUMINUM											
TEP242	Clearcoat	57	13 3/4	6 7/8	14 3/4	8 1/2	57 3/4	14 3/8	3.6	41.5	778.96
TEP243	Black	57	13 3/4	6 7/8	14 3/4	8 1/2	57 3/4	14 3/8	3.6	41.5	778.96
TEP371	Clearcoat	57	13 3/4	6 7/8	17	11 1/8	57 3/4	17 1/4	4.5	44.5	831.22
TEP372	Black	57	13 3/4	6 7/8	17	11 1/8	57 3/4	17 1/4	4.5	44.5	831.22
STEEL											
TEP245	White	57	13 5/8	6 7/8	14 5/8	8 1/2	57 1/2	14 1/8	4.5	86.5	735.38
TEP376	White	57	13 5/8	6 7/8	17 1/4	11 1/8	57 1/2	16 3/4	4.9	96.5	765.93

TOPSIDES TRUCK BOXES

- 3-point locking system: Doors are locked at the top and both sides to resist break-ins, covers protect the locking system and reinforce the high-strength doors
- Full-length hinge on each door provides extra security against break-ins and gives extra durability and reliable service
- Handles have reinforced cam locks and are sealed to prevent moisture from getting inside
- High-strength coated galvanized steel aircraft cable door supports handle 300-lb. load
- 12" tall door openings for easier access, door frames are recessed for superior strength and security
- Automatic-style bulb weather stripping surrounds the door opening to seal out moisture and dust
- **Aluminum topside** features 0.100-gauge aluminum reinforced doors, center posts and ends
- **Steel topside** feature 14-gauge steel reinforced doors, center posts and ends
- 5-year limited warranty



TEP377



TEP380



Model No.	Colour	W"	x	Dimensions		x	H"	Usable Cu. Ft.	Wt. lbs.	Price /Each
				D"						
ALUMINUM										
TEP377	Clearcoat	72	x	13 3/16	x	16 11/16		8.4	59	1009.49
TEP378	Black	72	x	13 3/16	x	16 11/16		8.4	59	1009.49
STEEL										
TEP380	Black	72	x	13 3/16	x	16 9/16		8.4	124.5	1015.78

R29348E

OFFICE PRODUCTS

INSTRUMENTS, SCALES & ELECTRICAL

SHIPPING & PACKAGING

TOOLS & EQUIPMENT

WELDING & METALWORKING

SAFETY EQUIPMENT & SUPPLIES

JANITORIAL & MAINTENANCE

MATERIAL HANDLING & STORAGE

TOOL STORAGE



UNDERBED TRUCK BOXES

- 3-point locking system locks the door at the top and on both sides for strength and durability and draws the high-strength door tight against the bulb-shaped weather stripping to seal out moisture and dust
- Rotating T-Handle draws the door tight against the weather stripping, and drill resistant lock cylinder prevents break-ins
- Heavy-duty housing covers the locking system and locking rods to prevent damage and jamming. Housing adds extra strength to the door
- 3/4" wide rain gutter surrounds the door opening to channel moisture around the opening to protect the contents
- Quick-release keyway connectors allow the door end of the support cable to be easily and quickly disconnected to allow the door to drop down
- **Steel underbed truck box** has industrial grade hinges for the have rugged 3" long, 7/8" outside diameter hinges with 1/2" diameter stainless steel pin
- **Aluminum underbed truck box** has continuous 3/8" diameter hinges with 1" knuckles for superior strength and durability
- Available in steel *Armor-Brite™* powder paint or 0.100 gauge aluminum



STEEL

White Model No.	Black Model No.	Dimensions W" x D" x H"	Wt. lbs.	Price /Each
TEP199	TEP249	18 x 18 x 18	55	484.52
TEP200	TEP250	24 x 18 x 18	68	487.17
TEP201	TEP251	30 x 18 x 18	80	551.86
TEP202	TEP252	36 x 18 x 18	92	599.40
TEP203	TEP253	48 x 18 x 18	117	673.34
TEP204	TEP254	60 x 18 x 18	142	798.76

ALUMINUM

Model No.	Dimensions W" x D" x H"	Wt. lbs.	Price /Each
TEP205	18 x 18 x 18	35	600.72
TEP206	24 x 18 x 18	40	631.07
TEP207	30 x 18 x 18	44	707.67
TEP208	36 x 18 x 18	48	749.91
TEP209	48 x 18 x 18	61	884.58
TEP210	60 x 18 x 18	74	1016.61

MOUNTING BRACKETS

- Heavy-duty 2" C-channel brackets for mounting underbed boxes
- Brackets have multiple mounting holes for easy installation
- Sold in pairs

Model No.	Description	Wt. lbs.	Price /Each
TEP360	Mounting brackets, 18" x 18"	15	144.39
TEP361	Mounting brackets, 24" x 24"	15	172.02

QUICK PAC™ REMOVABLE SIDE RACKS

- Pair of easy-to-install removable racks for carrying a ladder, canoe, light load of conduit, lumber or other long material
- Heavy-duty front and rear mounting base bolt to the truck bed and side wall for stability and strength
- Can be mounted on either side
- 14-gauge, 1 1/2" square steel uprights support up to 250-lbs. load
- Support arms adjust from 18" to 32" in width
- Superior corrosion resistant finish with yellow zinc dichromate undercoat with marine grade polyester epoxy powder coat finish
- Lifetime frame warranty

Model No. TEP255
Price/Each \$333.41



Can't find what you're looking for?
Call us today!

