

Particle Detectors

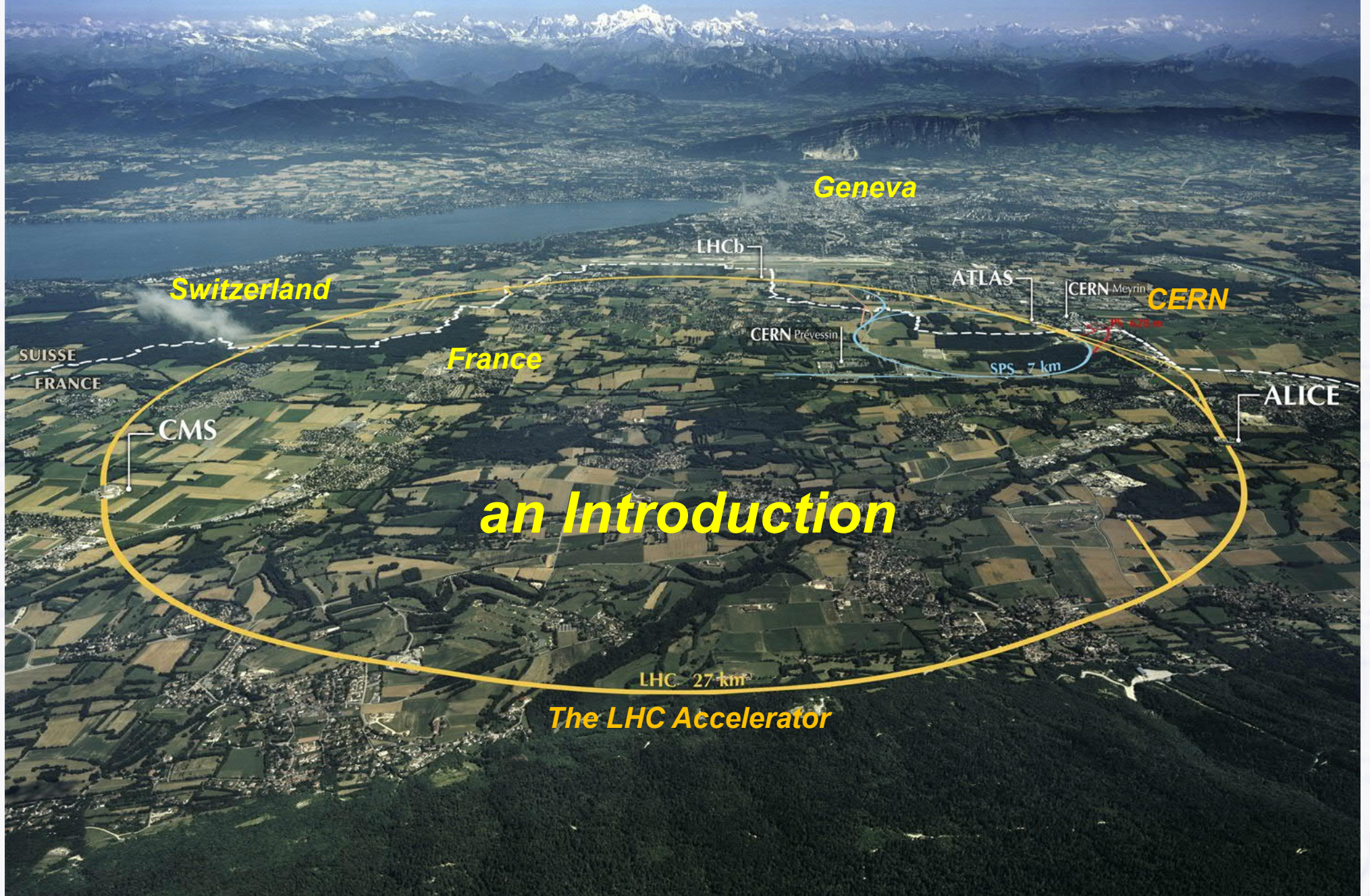

Historic Detector: Bubble Chamber

- Invented 1952 by Donald Glaser (Noble Prize 1960)

- chamber with liquid (e.g. H_2) at boiling point (“superheated”)

- charged particles leave trails of ions

- formation of small gas bubbles around ions

- take photos of interactions and look for interesting events...

- nice pictures, but **SLOW!!!**

- only 1 photo/event every few seconds, need something faster → electronic detectors

BEBC bubble chamber



tracks in CERN 2m bubble chamber

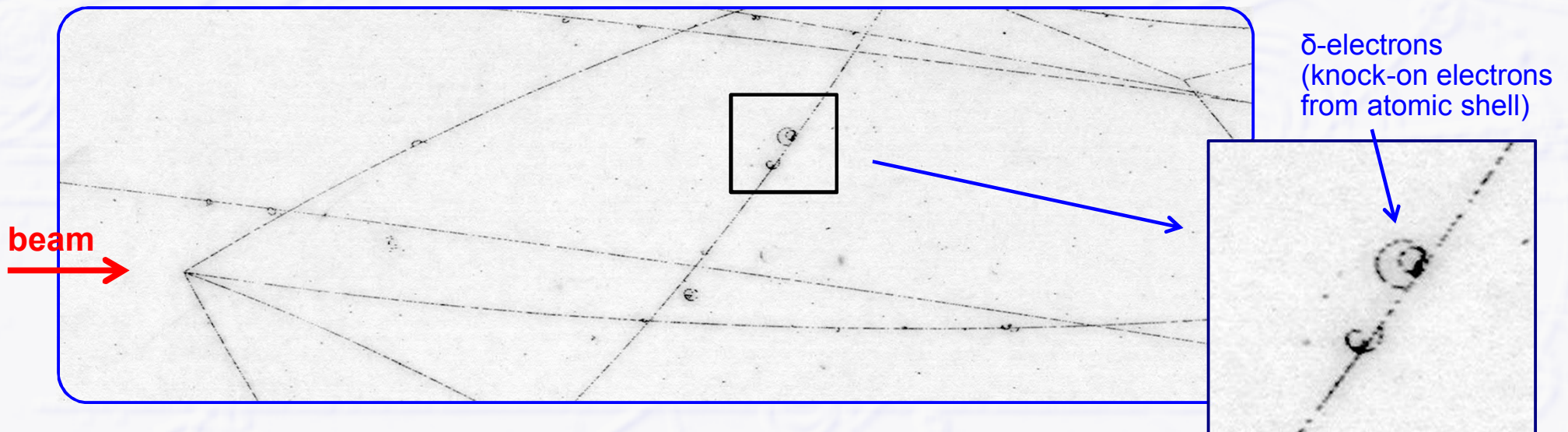

LHC Detectors

General purpose detectors
(good for everything...)

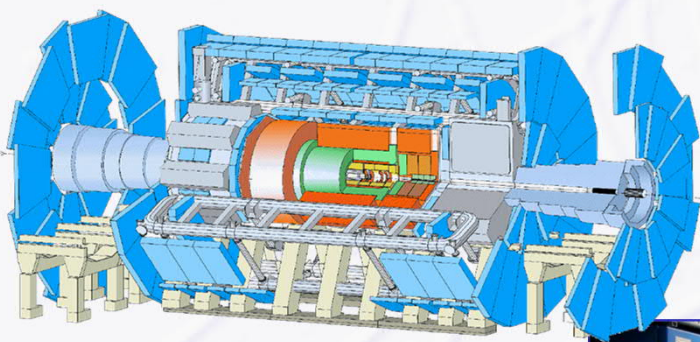

ATLAS



CMS



ALICE

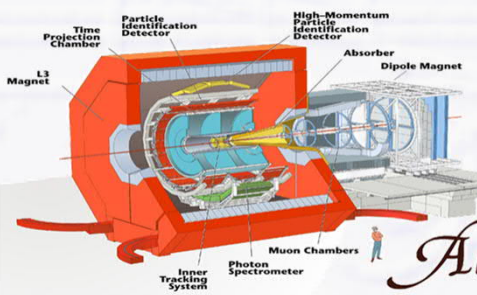

Alice

dedicated for
Heavy Ion collisions

dedicated for
b-physics

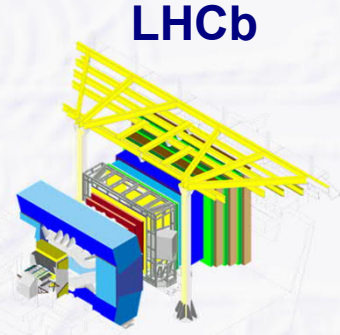

LHCb

Particle Physics Methods

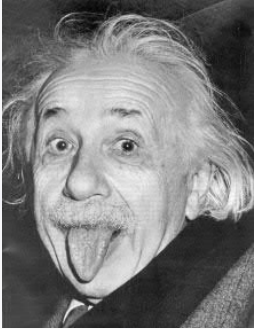

**Einstein
(1905):**

**Matter is
concentrated energy!**

**Matter can be transformed
into energy and back!**

$$E = m c^2$$

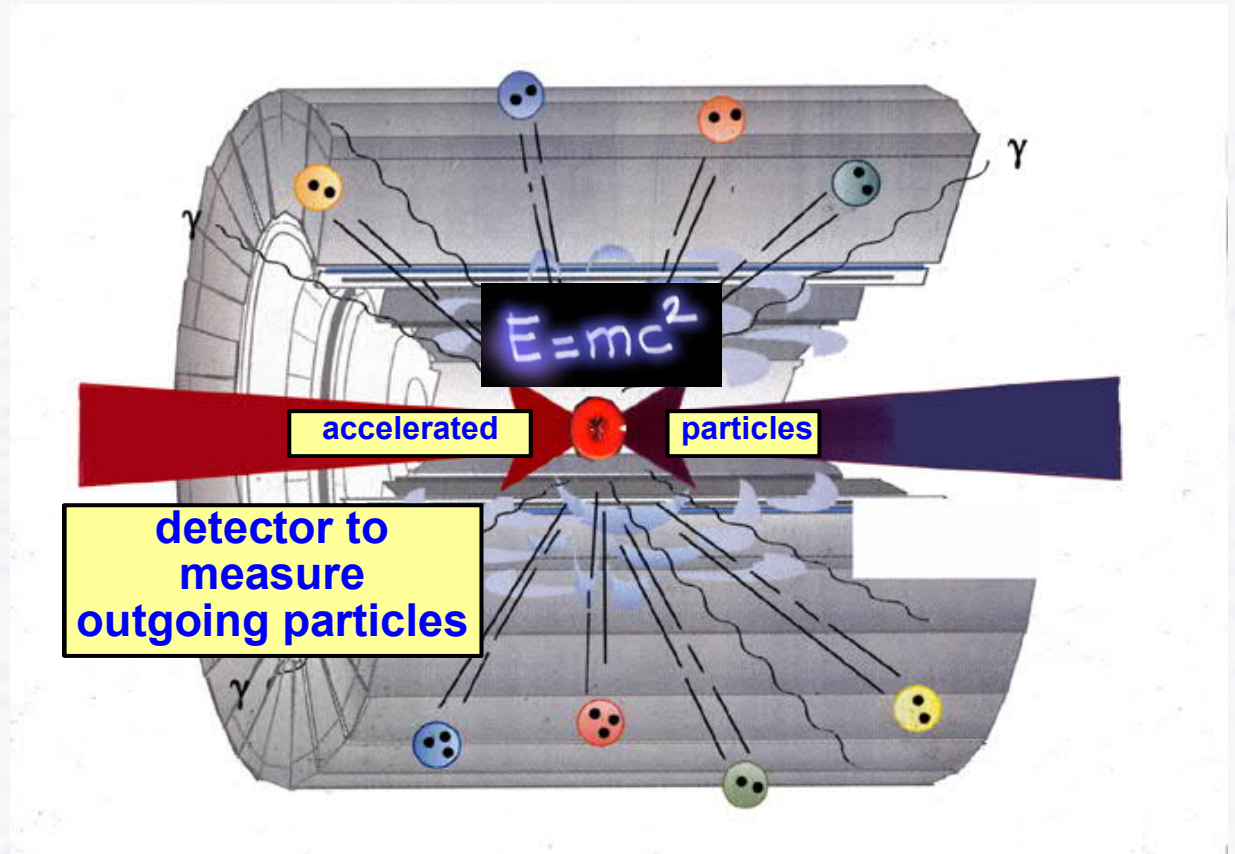

● We use this at a particle accelerator

- protons are accelerated ⇒ **energy**
- kinetic energy is **transformed** into matter at the collision
- **new particles** are being produced (new matter)

The Perfect Detector...

- ...should reconstruct any interaction of any type with 100% efficiency and unlimited resolution

→ get “4-momenta” of basic physics interaction

→ = **energy / momentum / mass + charge of ALL involved particles**

- in practice: limitations by detector inefficiency (not all particles detected) + detector resolution (measurements have statistical + systematic uncertainties)

Fixed target geometry

“Magnetic spectrometer”

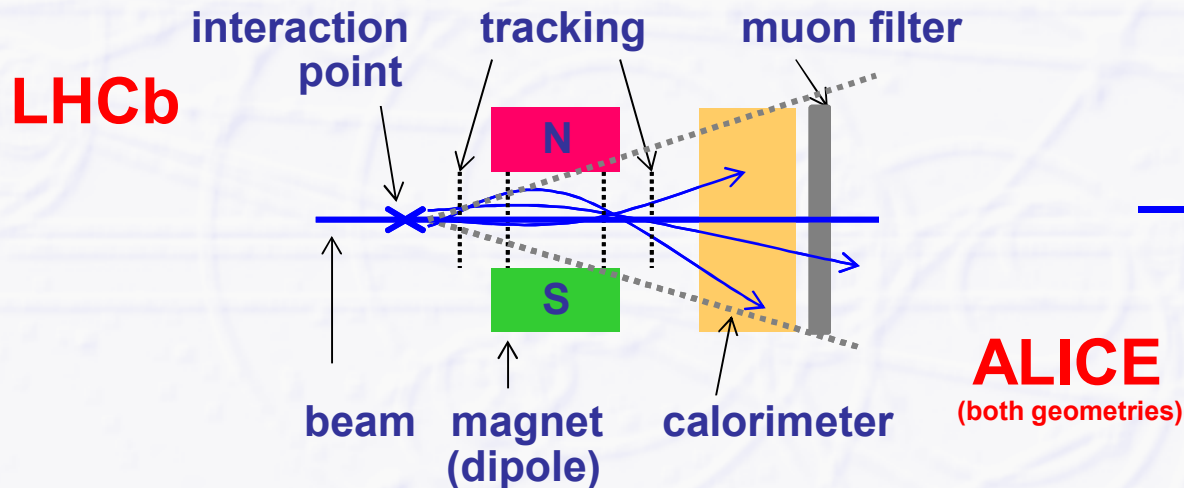

- Limited solid angle $d\Omega$ coverage
- rel. easy access (cables, maintenance)

Collider geometry

“4 π multi purpose detector”

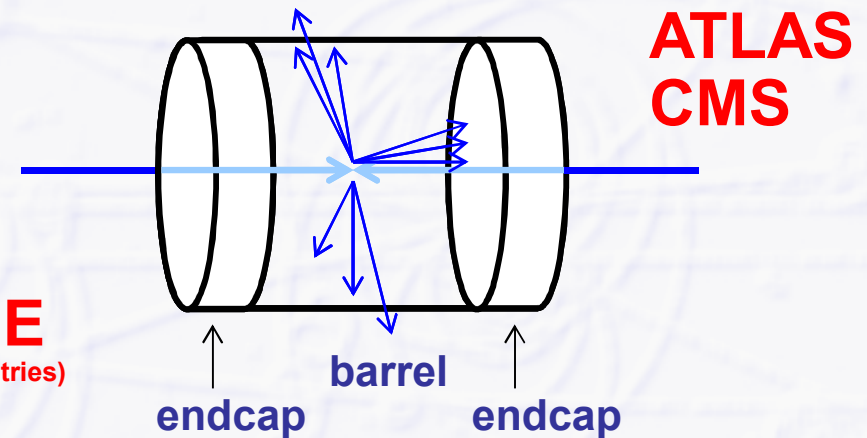

- “full” $d\Omega$ coverage
- very restricted access

High Energy Collider Detectors

- **Tracking Detector (or Tracker) = momentum measurement**
 - closest to interaction point: **vertex detector** (often silicon pixels)
 - measures primary interaction vertex and secondary vertices from decay particles
 - main or **central tracking detector**
 - measures momentum by curvature in **magnetic field** + charge of particle
- **Calorimeters = energy measurement**
 - **electro-magnetic calorimeters** (light particles: e^- , e^+ , γ)
 - measures energy of **light EM particles** (electrons, positrons, photons) based on electro-magnetic showers by bremsstrahlung and pair production
 - two concepts: homogeneous (e.g. CMS) or sampling (e.g. ATLAS)
 - **hadron calorimeters** (heavy hadronic particles: π , K, p, n)
 - measures **energy of heavy (hadronic) particles** (pions, kaons, protons, neutrons) based on nuclear showers created by nuclear interactions
- **Muon Detectors = momentum measurement for muons (more precise)**
 - outermost detector layer, **basically a tracking detector**

A typical Particle Detector

- Cut-away view of ATLAS: several layers of detectors

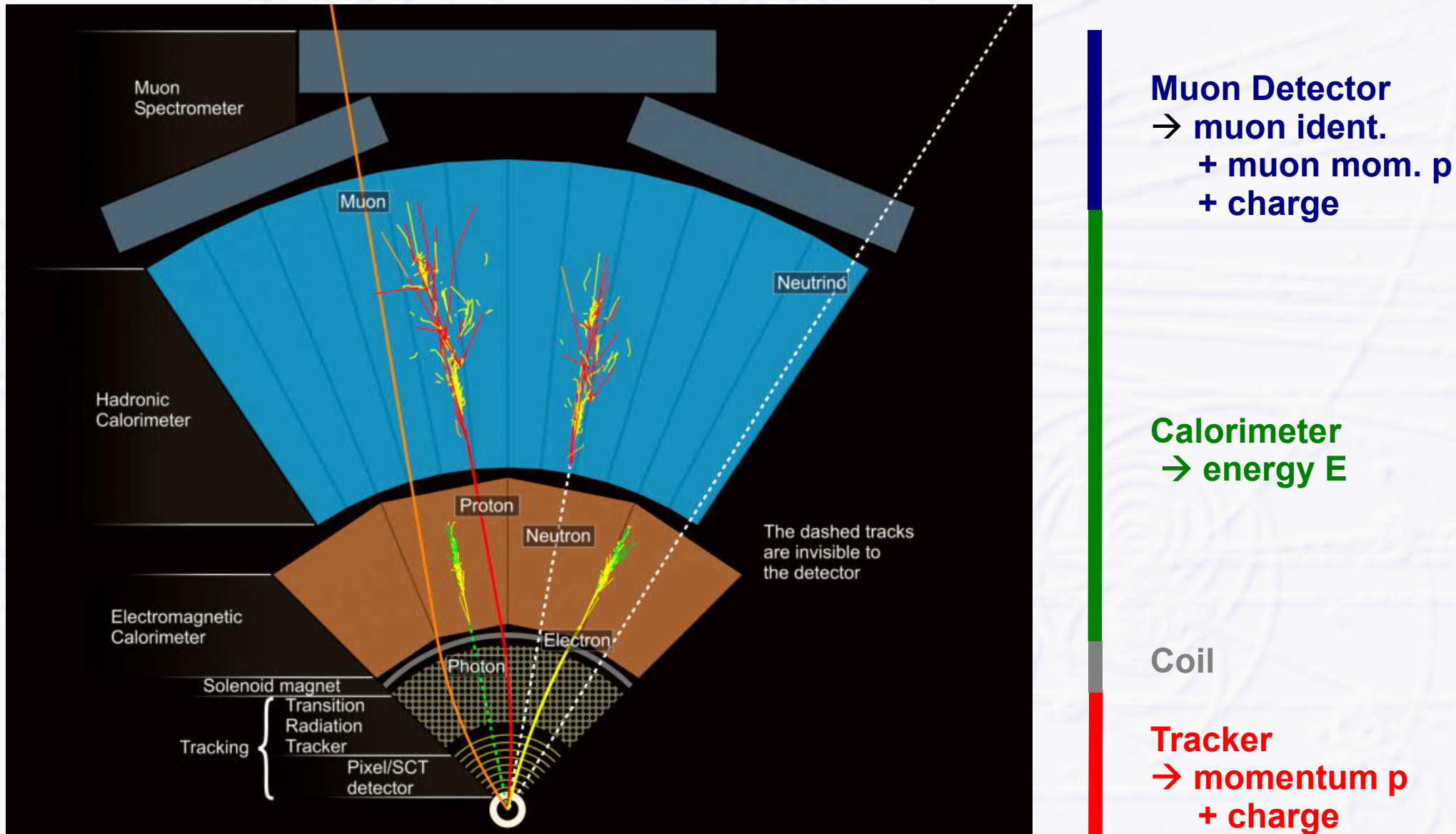

Detector Challenges at LHC

- **High energy collisions**

- sufficiently **high momentum resolution** up to TeV scale

- **High luminosity (high interaction rate)**

- **high rate** capabilities, **fast** detectors (25 ns bunch crossing rate)

- **High particle density**

- **high granularity**, sufficiently **small detector elements** to resolve particles

- **High radiation (lots of strongly interacting particles)**

- radiation mainly due to particles emerging from collisions, not machine background

- **radiation-hard detectors** and electronics (have to survive ~10 years)

- **LARGE collaborations!!!**

- ~O(3000) physicists for ATLAS and CMS each

- **communication, sociological aspects**

- exponential raise of meetings, phone + video conferences...



July 2010

LARGE Detectors

- Everything is LARGE at the LHC...

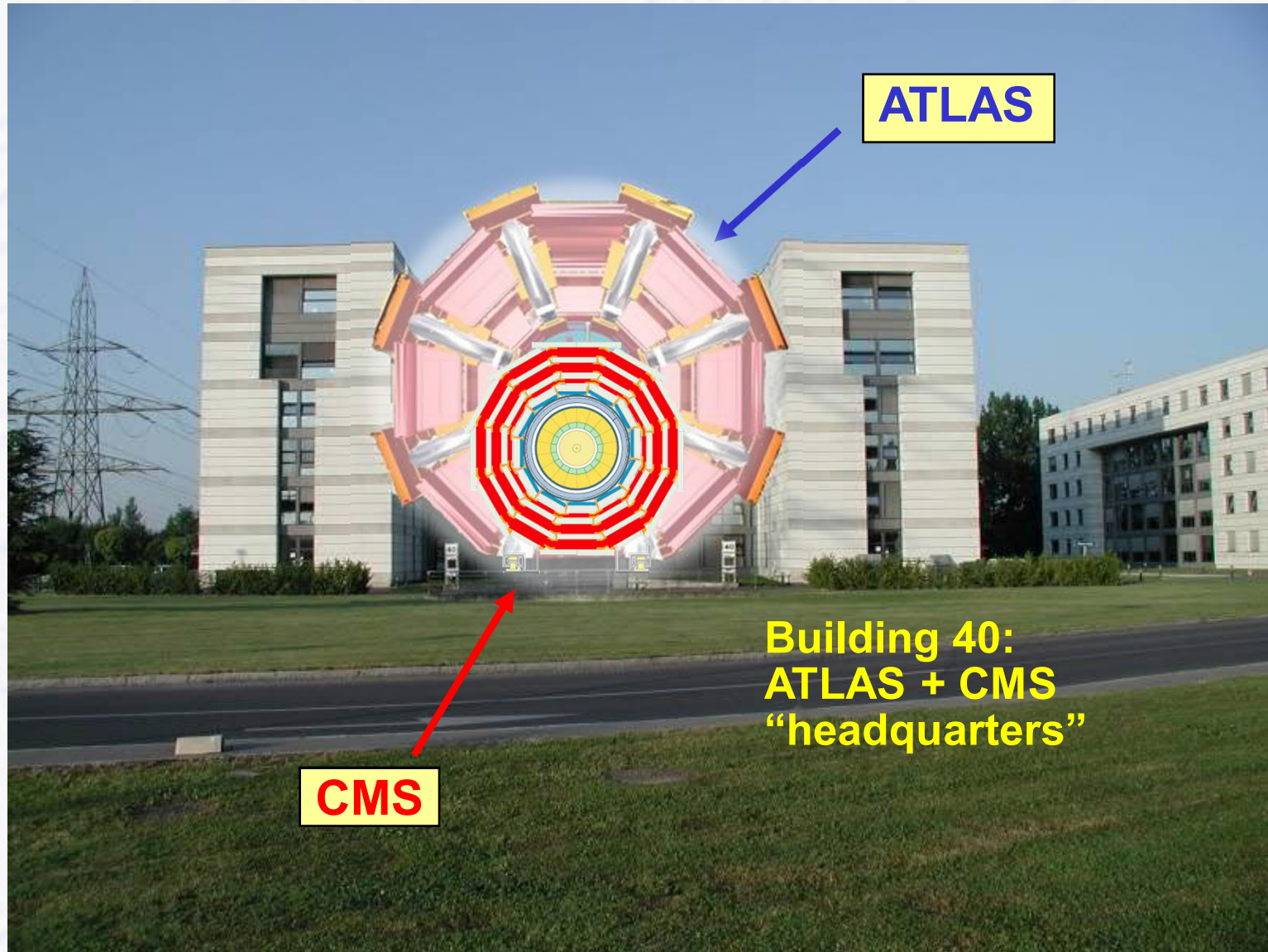

200 MRad

Radiation Doses at LHC

- $\sim 2 \times 10^6$ Gray / r_T^2 / year at LHC design luminosity

where r_T [cm] = transverse distance to the beam

- Lots of R&D over >10 years to develop rad.-hard silicon detectors, gaseous detectors and electronics

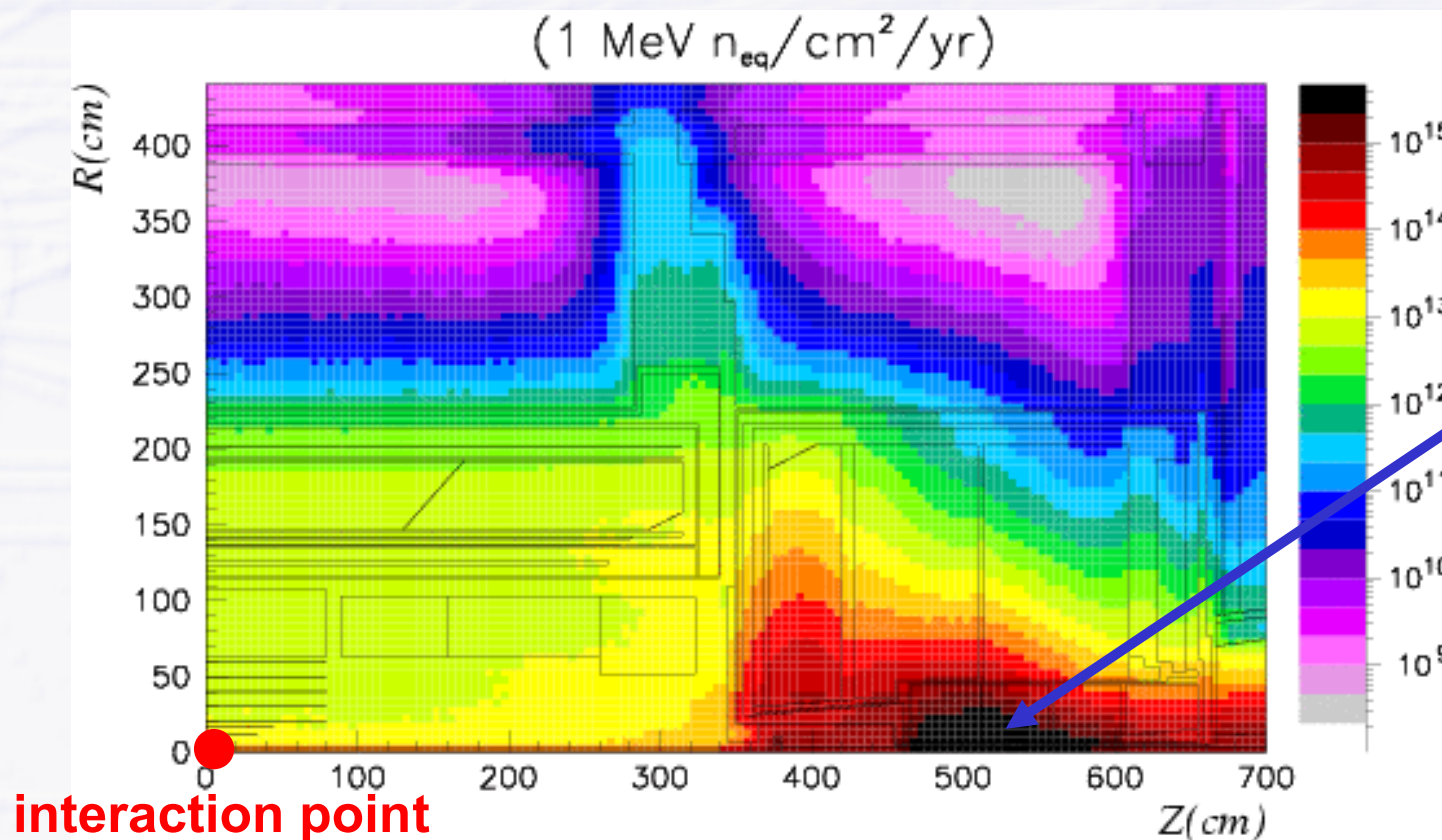

**ATLAS
neutron fluences:**

**> 10^{15} n/cm²/yr
close to beam line**

Challenging Conditions: Pile-up

2012 event with pile-up: 25 reconstructed primary vertices

~7 cm

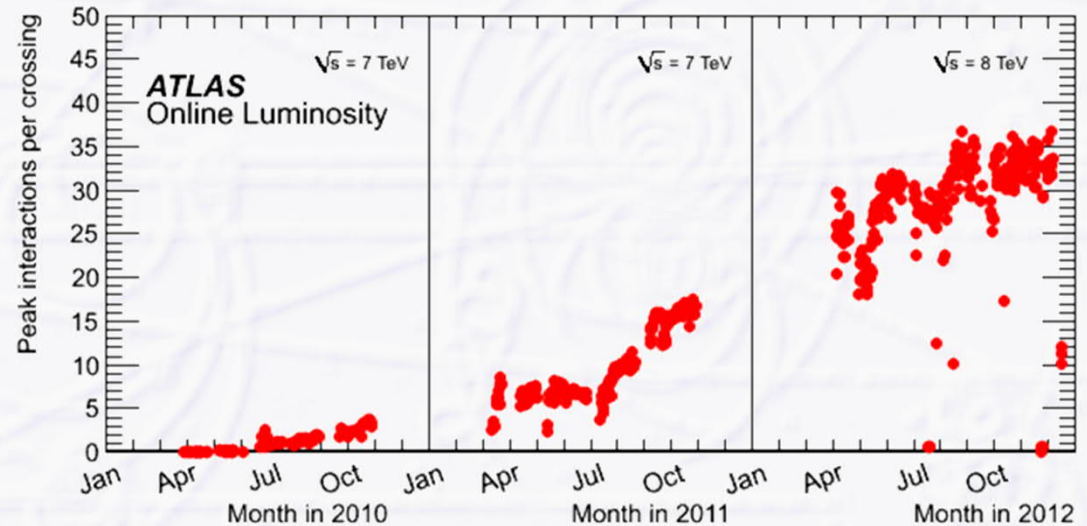
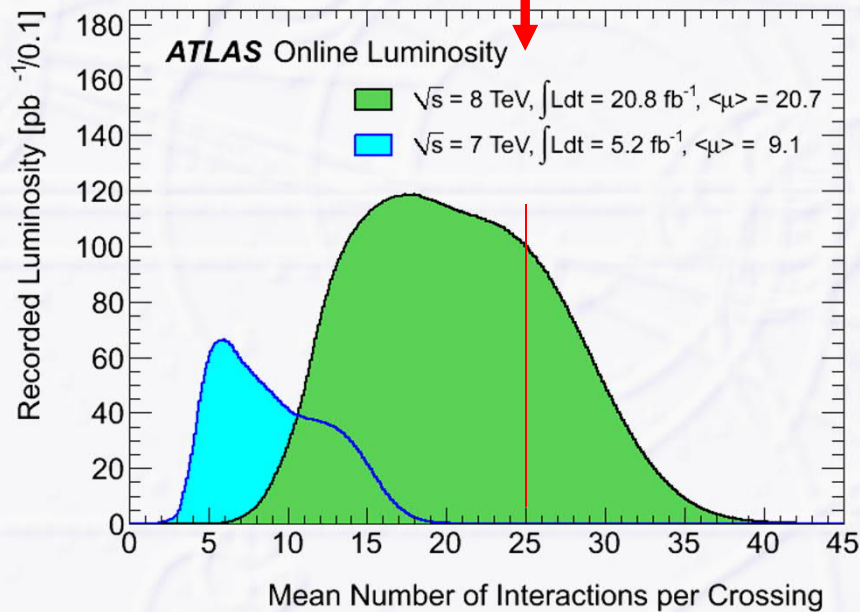
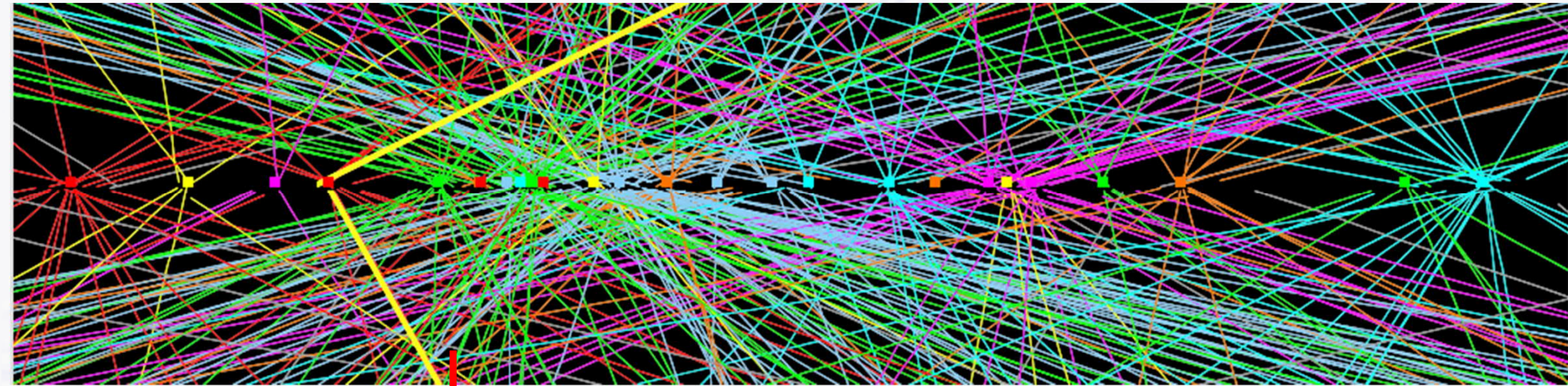

Tracking Detectors

How to measure momentum and charge?

Tracker Technologies

→ 3 major technologies of tracking detectors

● Gaseous detectors

→ **ionization in gas**

- typically ~ 100 e⁻/cm → not sufficient to create significant signal height above noise for standard amplifiers

→ typical amplifier noise = some 100...1000 ENC (equivalent noise charge, in electrons)

→ requires gas amplification $\sim 10^4$ to get enough signal over noise (S/N)

● Silicon detectors (solid state detectors)

→ **creation of electron – hole pairs in solid state material**

- typically ~ 100 e⁻ - hole pairs/ μm = 10^4 more than in gaseous detectors

→ 300 μm thick detector creates high enough signal w/o gas amplification

- $\sim 30'000$ charge carriers per detector layer, noise ~ 1000 ENC, S/N $\sim 30:1$

● rarely used: fiber trackers

→ **scintillating fibers**

- scintillation light detected with photon detectors (sensitive to single electrons)

Tracking Detector Principles

- **Typical: several layers of sensitive detector elements**
 - each layer gives a 2D hit coordinate (+ detector position → 3D)
- **Magnetic field bends (charged) particle trajectories**

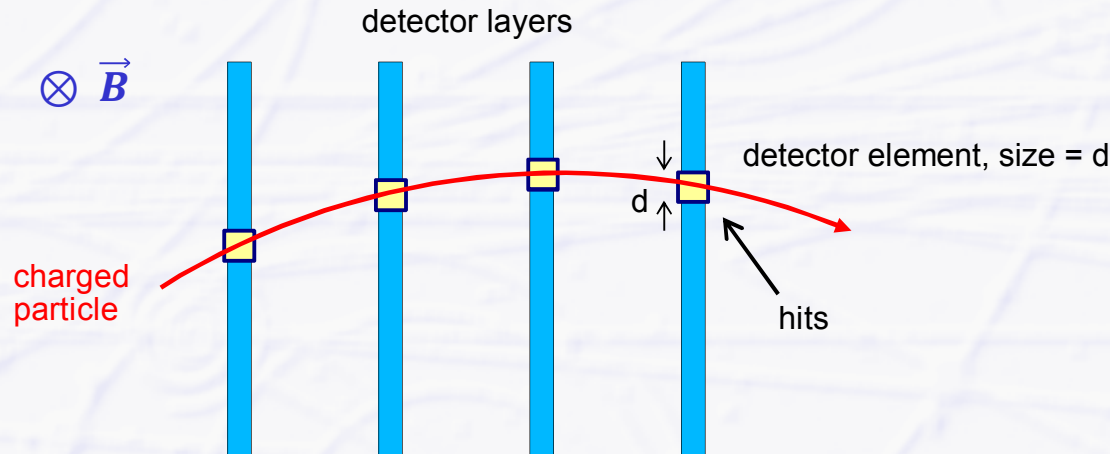

can reconstruct + fit track (radius) with at least 3 hits

→ **resolution of each hit depends on size d of detector elements**

→ some uncertainty where the particle passed the detector element d
→ probability distribution is "flat"

→ take the width of an equivalent Gaussian distribution as resolution

e.g. for $d = 30 \mu\text{m}$ → $\sim 10 \mu\text{m}$ resolution

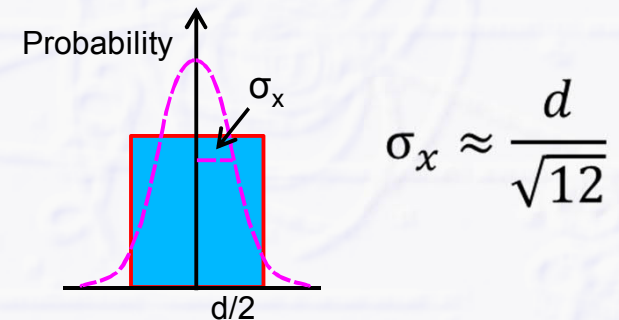

Magnet Concepts at LHC experiments

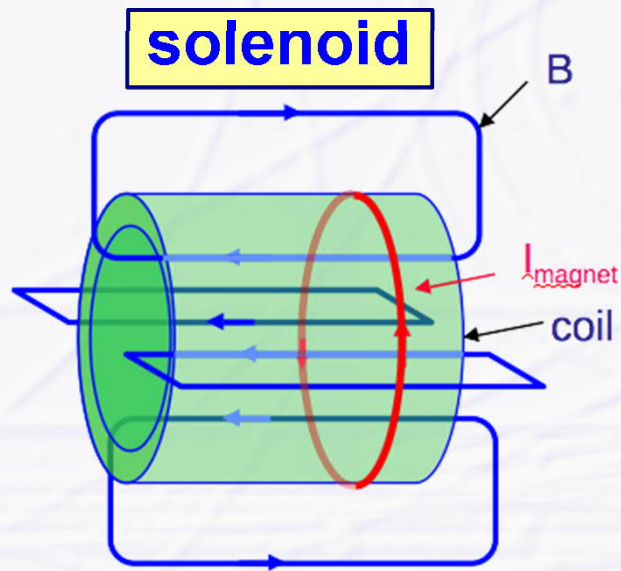

- + large homogenous field inside coil
- needs iron return yoke (magnetic shortcut)
- limited size (cost)
- coil thickness (radiation lengths)

(air-core) toroid

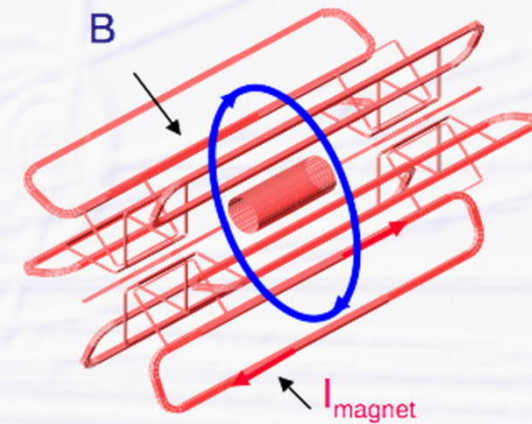

- + can cover large volume
- + air core, no iron, less material
- needs extra small solenoid for general tracking
- non-uniform field
- complex structure

CMS, ALICE

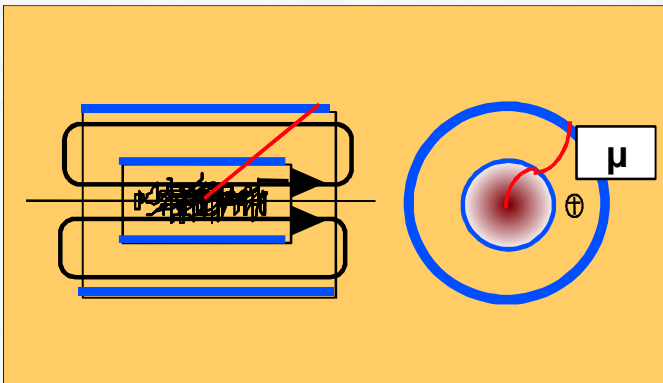

ATLAS

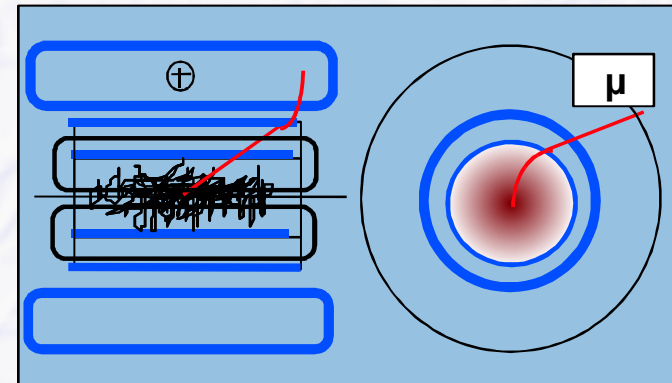

ATLAS and CMS Coils

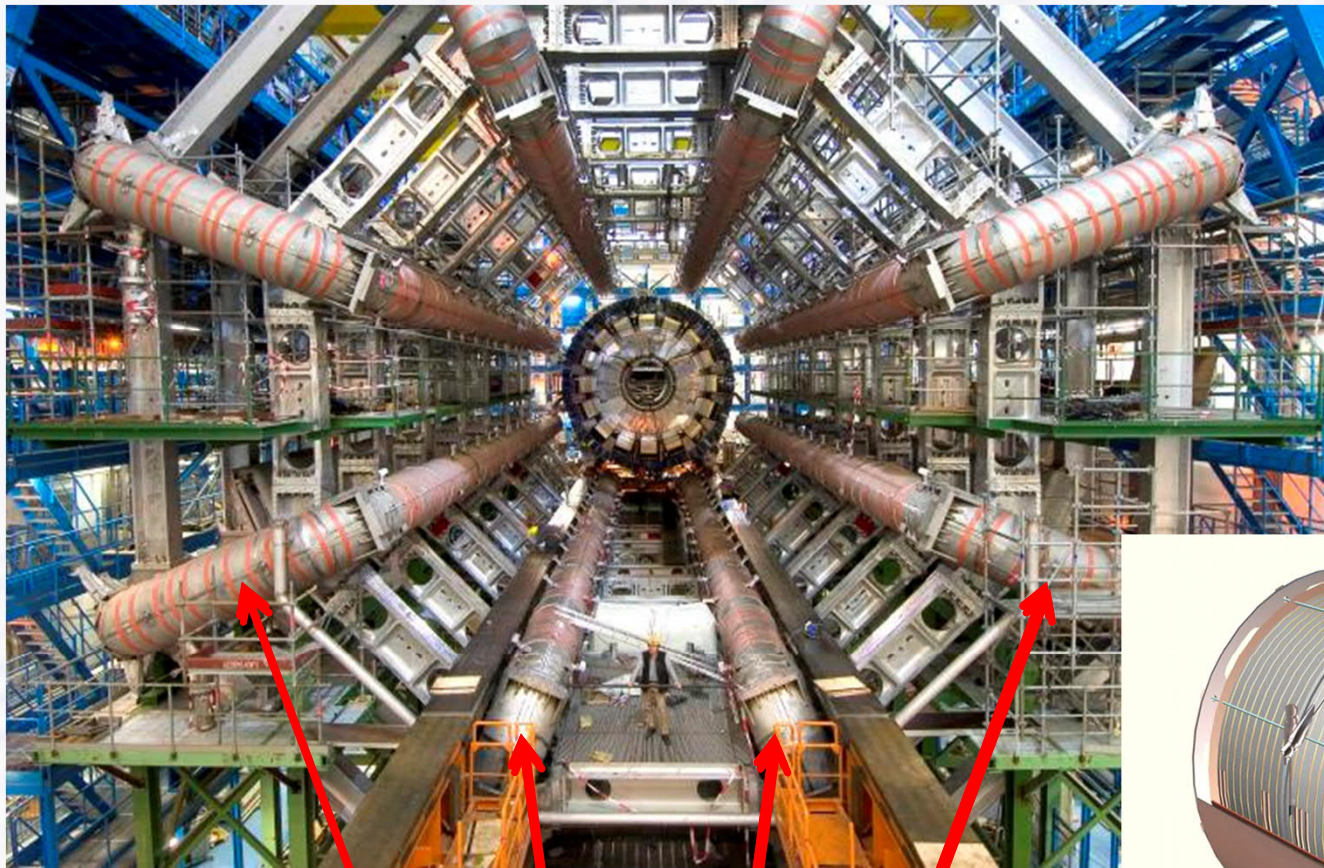

ATLAS barrel toroid coils

autumn 2005

**CMS solenoid
(5 segments)**

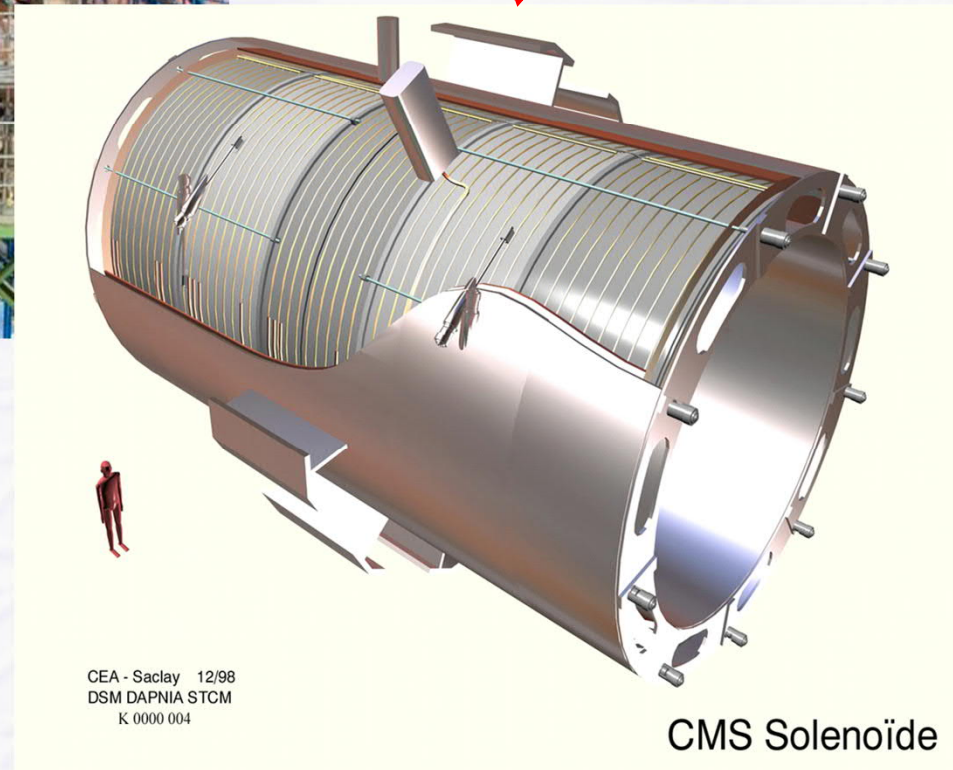

CMS Solenoïde

CEA - Saclay 12/98
DSM DAPNIA STCM
K 0000 004

Momentum Measurement

- (Only) charged particles are deflected by magnetic fields

- homogeneous B-field → particle follows a circle with radius r

$$p_t [GeV/c] = 0.3 \cdot B [T] \cdot r [m]$$

measurement of p_t by measuring the radius

- this is just the momentum component perpendicular to the B-field

= **transverse momentum** p_t

- no particle deflection parallel to magnetic field

- if particle has **longitudinal momentum** component

→ particle follows a **helix**

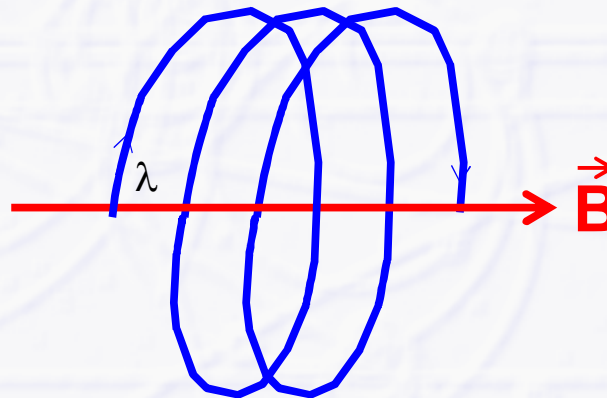
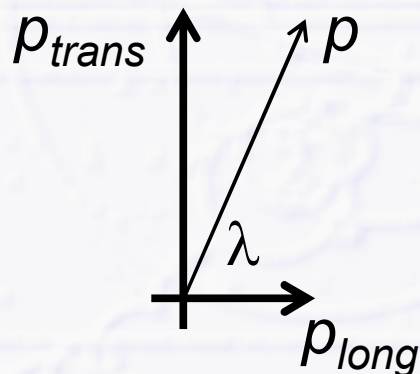

total momentum p to be measured by dip angle λ

$$p = \frac{p_t}{\sin \lambda}$$

Basic Gaseous Detector – Geiger-Müller Tube

● Geiger-Müller tube by Hans Geiger and Walther Müller 1928

- tube filled with inert gas (He, Ne, Ar) + organic vapour (e.g. CH₄) or CO₂
- central thin wire (20 – 50 μm Ø), high voltage (several 100...1000 Volts) between wire and tube

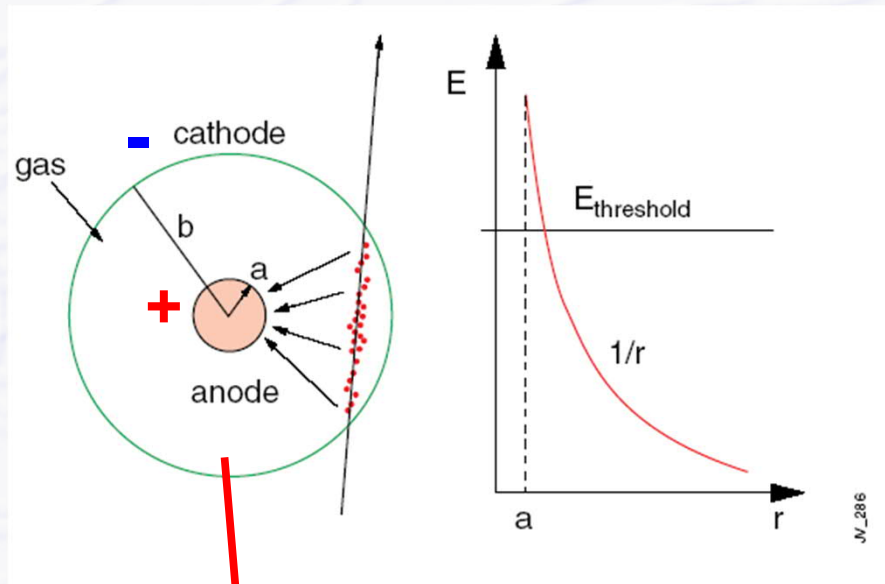

- strong increase of E-field close to the wire
 - electron gains more and more energy
- above some threshold (>10 kV/cm)
 - electron energy high enough to ionize other gas molecules
 - newly created electrons also start ionizing
- **avalanche effect**: exponential increase of electrons (and ions)
 - measurable signal on wire
 - organic substances or CO₂ responsible for “quenching” (stopping) the discharge
- absorption of UV photons

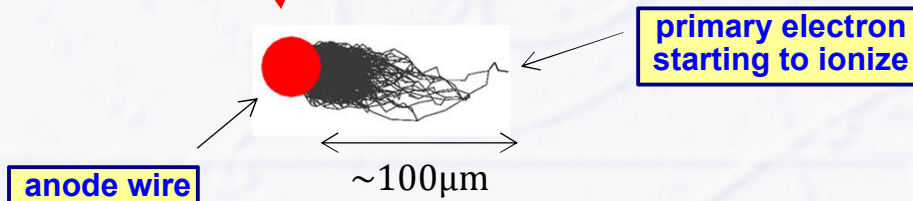

Solid State Detectors

- **Basic element of a solid state (silicon) detector is... a diode**

→ p-type and n-type doped silicon material is put together



Current flow through diode if connected like this

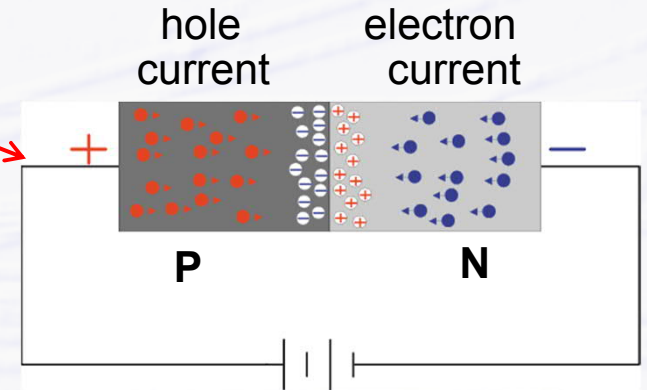

→ for use as particle detector diode needs to be connected in opposite way

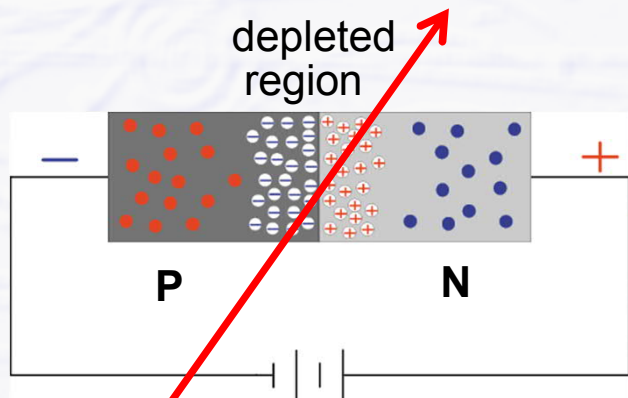

- **around junction of p- and n-type material depletion region is created**

→ **zone free of charge carriers**

- no holes, no electrons
- thickness of depletion region depends on voltage, doping concentration

charged particle can create new electron/hole pairs in depletion area sufficient to create a signal

typically 20'000 – 30'000 electron/hole pairs in 300 μm thick material

Silicon Strip Detectors

- Now take a large Si crystal, e.g. 10 x 10 cm², 300 μm thick

make bottom layer p-type

and subdivide the top n-type layer into
many strips with small spacing

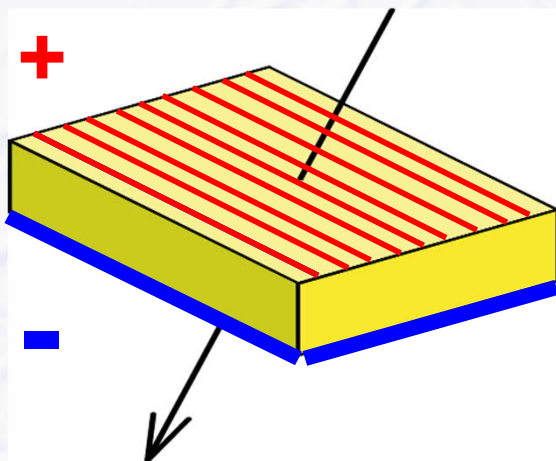

many diodes next to each other
with **position information**
(strip number)

- Advantage compared to wire/gas detectors**

→ strip density (pitch) can be rather high (e.g. ~20 μm)

- high single point accuracy: $\sigma_x = 20 \mu\text{m} / \sqrt{12} = 5.8 \mu\text{m}$
- but also many electronics channels

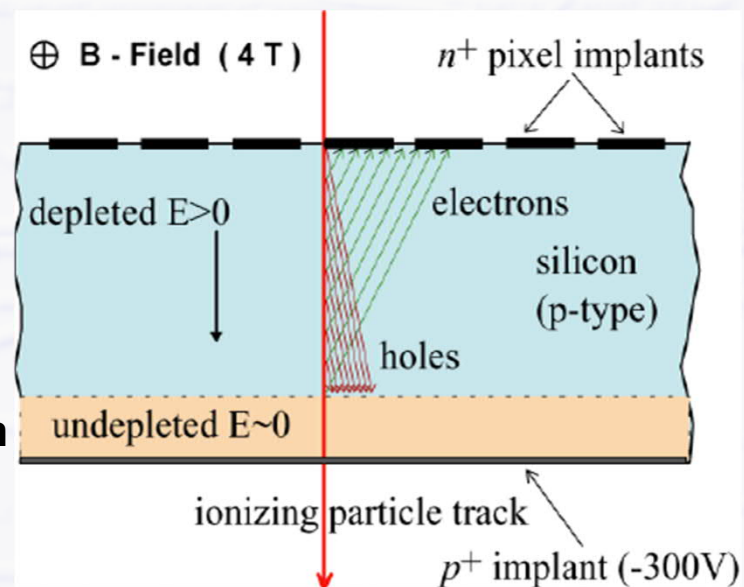

Si-Detector Electronics and Si-Pixels

- Silicon strip detectors have a laaaarge number of electronics channels, $\sim 10^7$ each for ATLAS and CMS Si trackers
 - requires highly integrated chips for amplification, shaping, zero suppression (only information of strips with signals is read-out) and multiplexing (put all strip signals on a few cables only)
- electronics is directly connected to the sensor (the “multi-diode”) via wire bonds

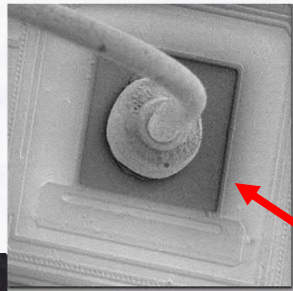

wire bonds

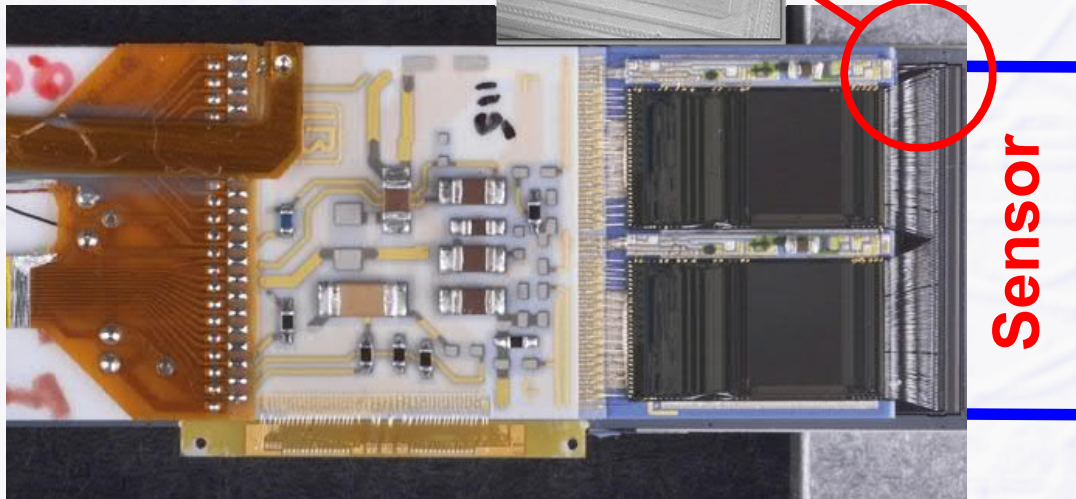

Sensor

Si-strip detectors provide only 1 coordinate, Pixel detectors are 2D detectors

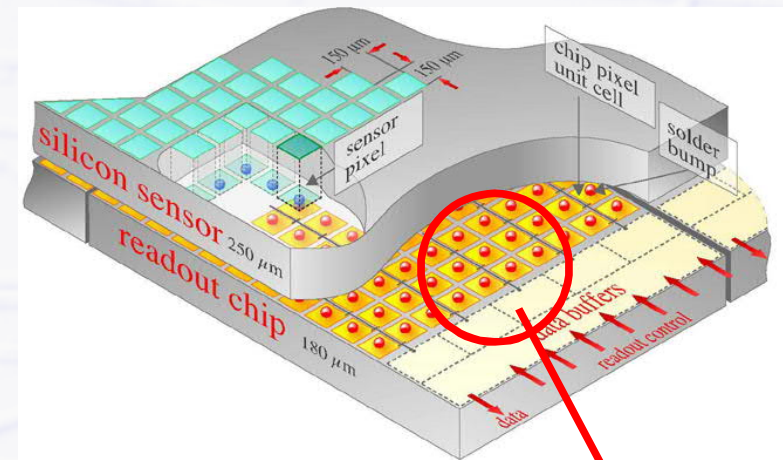

Pixel detector need “bump” bonding and have even more channels, $\sim 10^8 - 10^9$

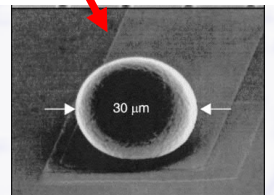

ATLAS Inner Tracker

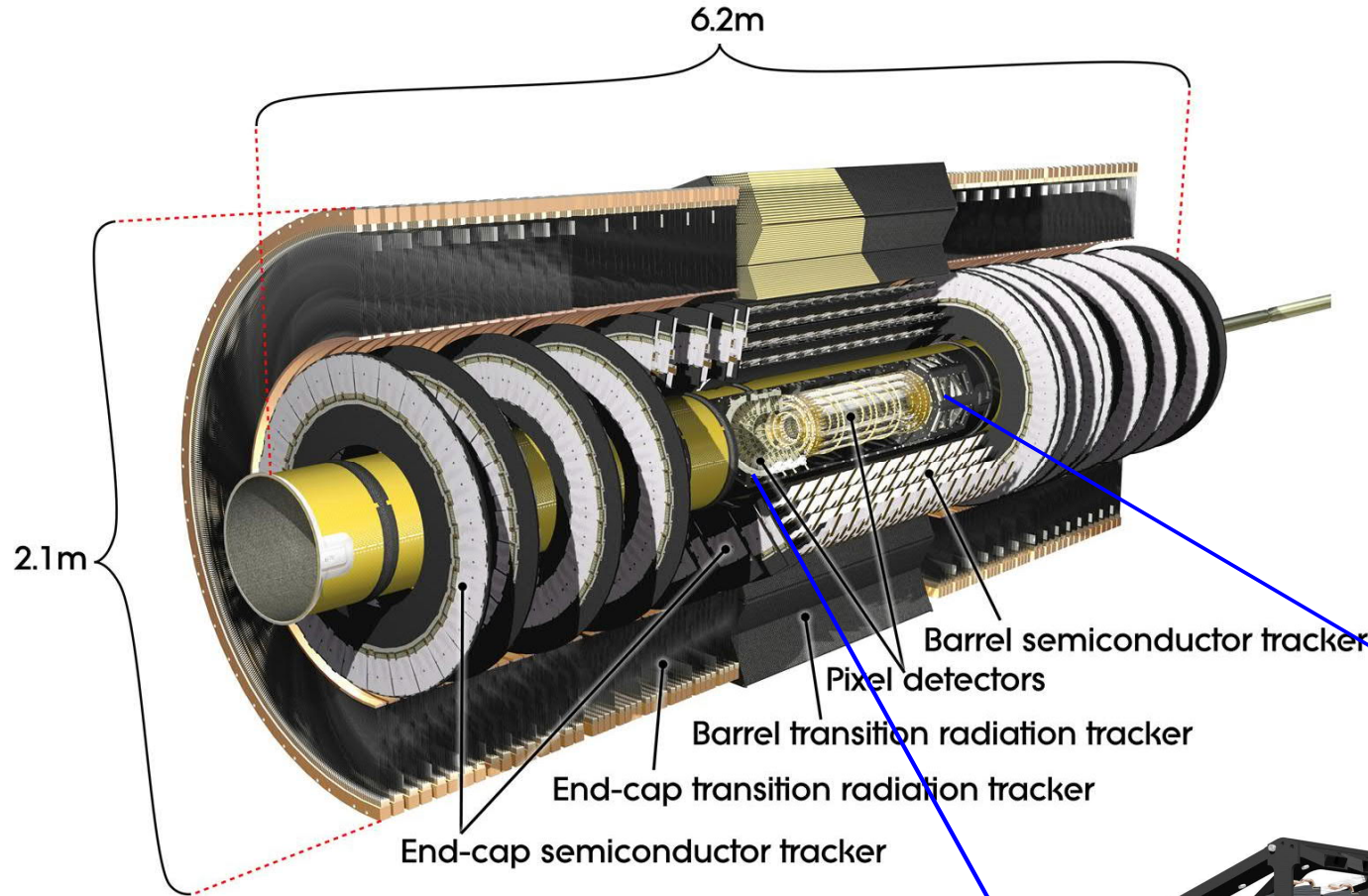

- 4-layer Si Pixel
 - 3 → 4 layers in 2014
- 4-layer Silicon Strips
- Transition Radiation Tracker (gaseous)

Pixel alignment with cosmic rays 2008

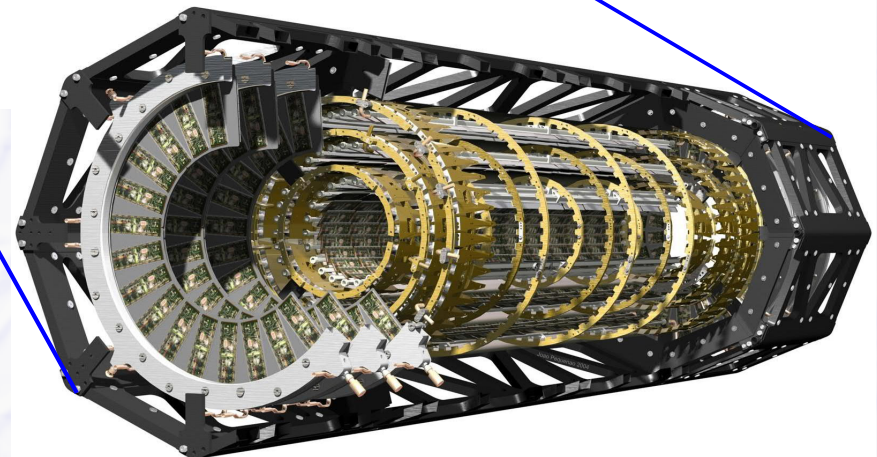
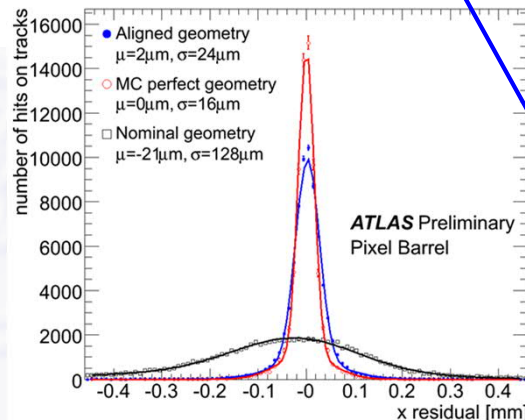

The ATLAS Pixel Detector

- Re-insertion in December 2013 during Long Shutdown 1

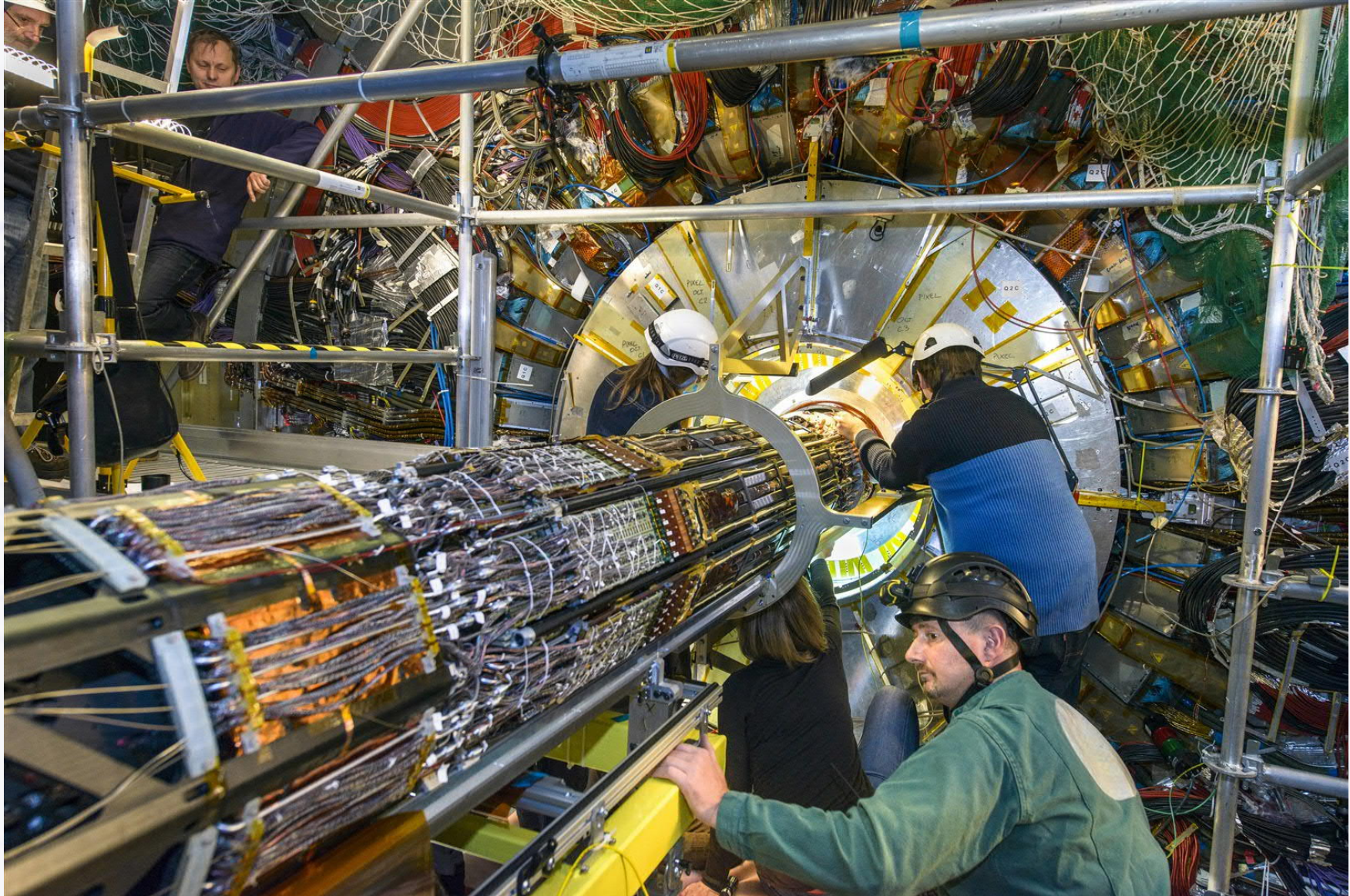

CMS Full Silicon Tracker

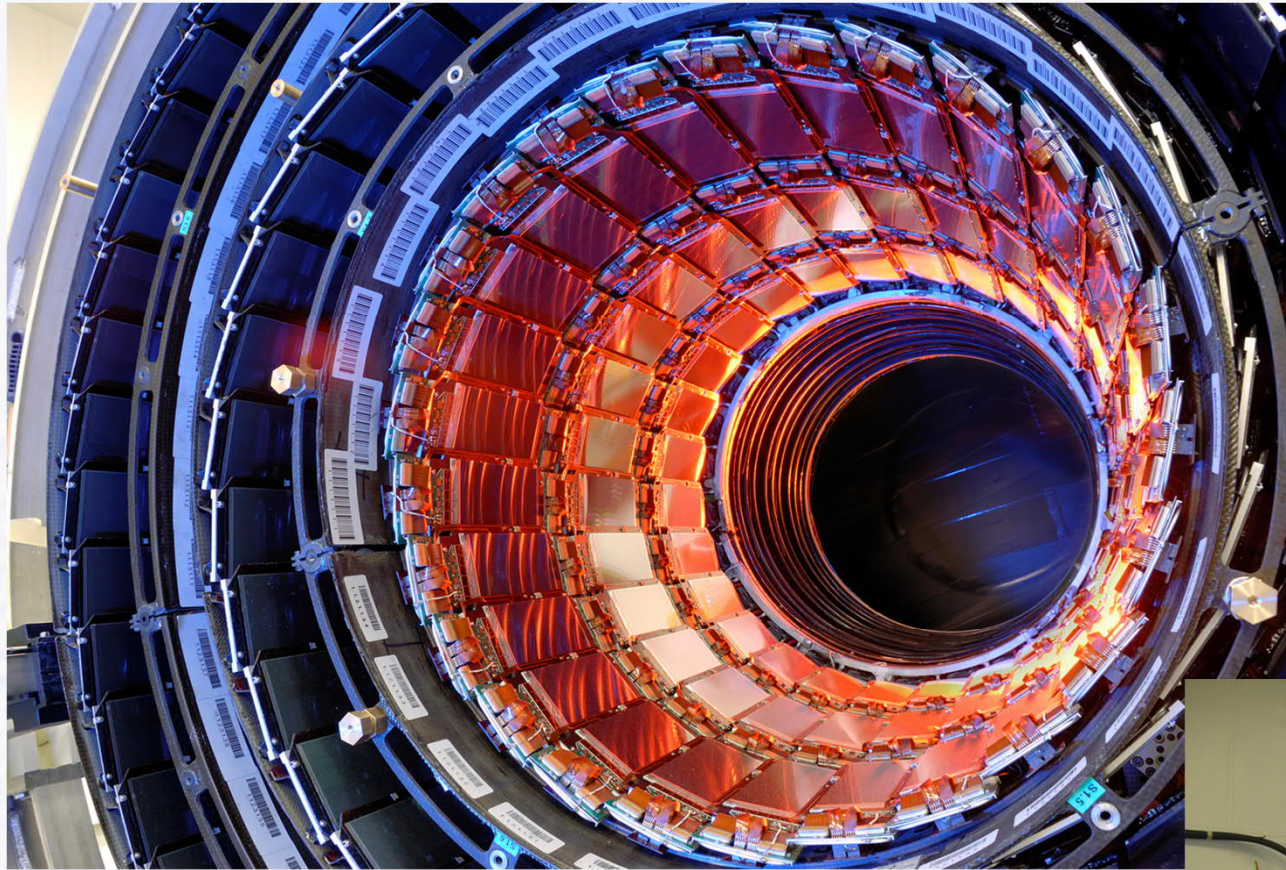

Tracker Inner Barrel TIB

- **4-layers Si Pixel**
 - 3 → 4 layers in 2017
- **10-layers Silicon Strips**
 - 210 m², largest silicon detector ever built

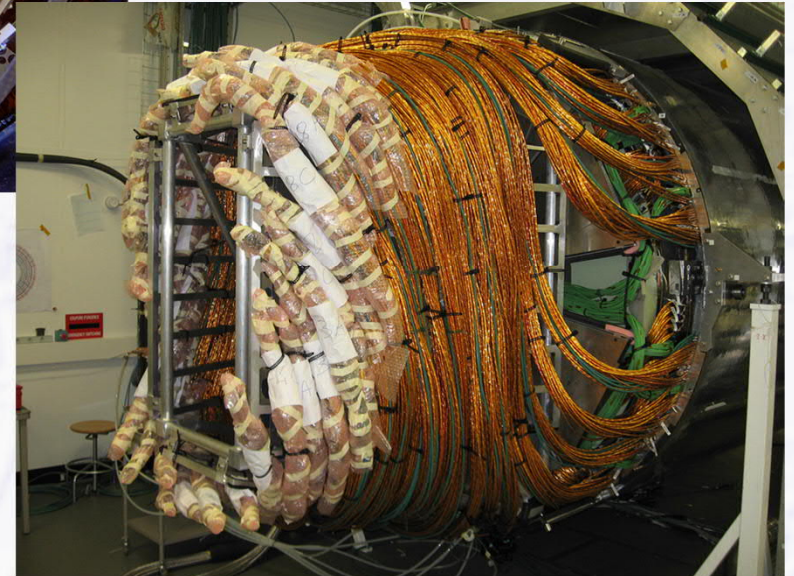

Material Budget

- **Tracking Detectors should be light-weighted and thin**
 - multiple scattering by material degrades resolution at low momenta
 - unwanted photon conversions in front of calorimeters
 - material often very inhomogeneous (in particular Si detectors)
- **Power & cooling adds most of the material**

not the Si sensor material

ATLAS

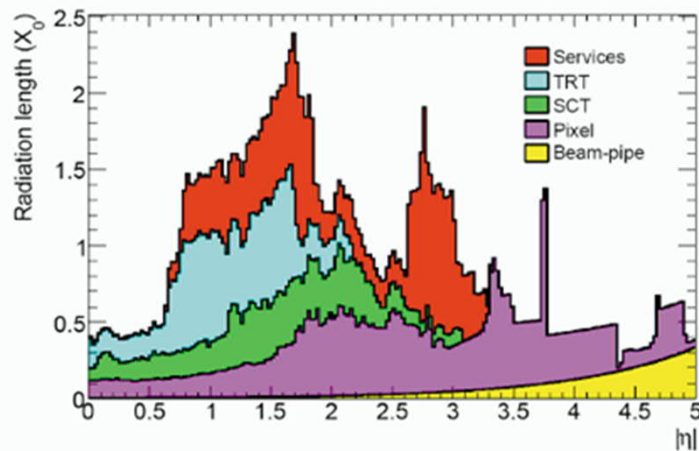

$ \eta $	radiation length	interaction length
< 1	$\sim 0.2 X_0$	$\sim 0.05 \lambda$
< 3.3	$\lesssim 0.5 X_0$	$\lesssim 0.2 \lambda$

CMS

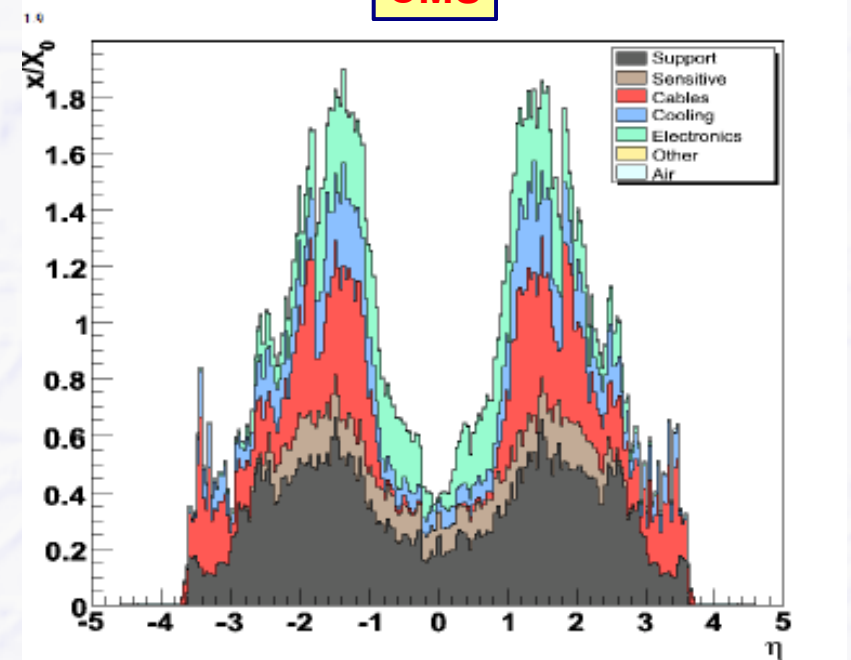

Calorimeters

How to measure energy?

Particle Showers in Calorimeters

- Initial particle creates electro-magnetic shower of secondary particles (electrons, positrons, photons) in dense material

→ by **bremsstrahlung** and **pair production**

→ shower depth depends on **radiation length X_0** (characteristic material constant)

→ for e^\pm = length after all but 1/e of energy lost by Bremsstrahlung

→ for γ = 7/9 of mean free path length for pair production

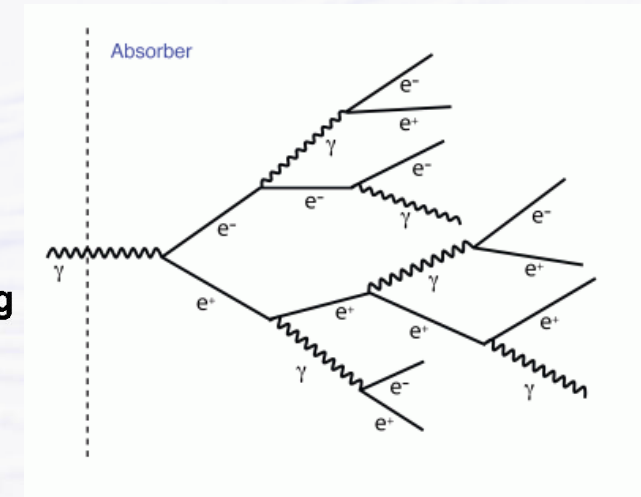

shower maximum

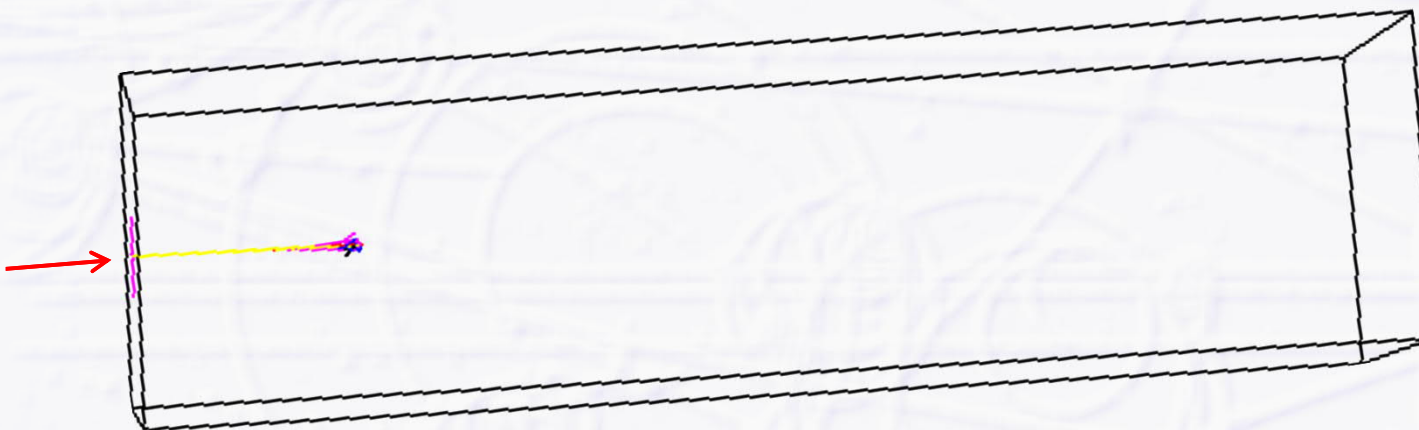

80 GeV electron in lead glass block

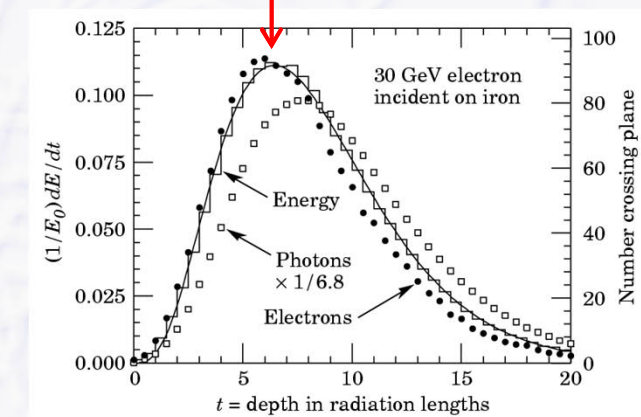

energy profile

Energy Resolution of Calorimeters

- Number of particles in shower is proportional to energy of initial particle

$$N_{shower} \propto \frac{E}{E_c}$$

← Critical Energy (typically ~10 MeV)

- error of energy measurement determined by (statistical) fluctuations in the number of shower particles

$$\sigma_{N_{shower}} \propto \sqrt{N_{shower}}$$

- resulting relative energy measurement error is

$$\frac{\sigma_E}{E} \propto \frac{1}{\sqrt{E}}$$

- More contributions from detector inhomogeneities and electronic noise

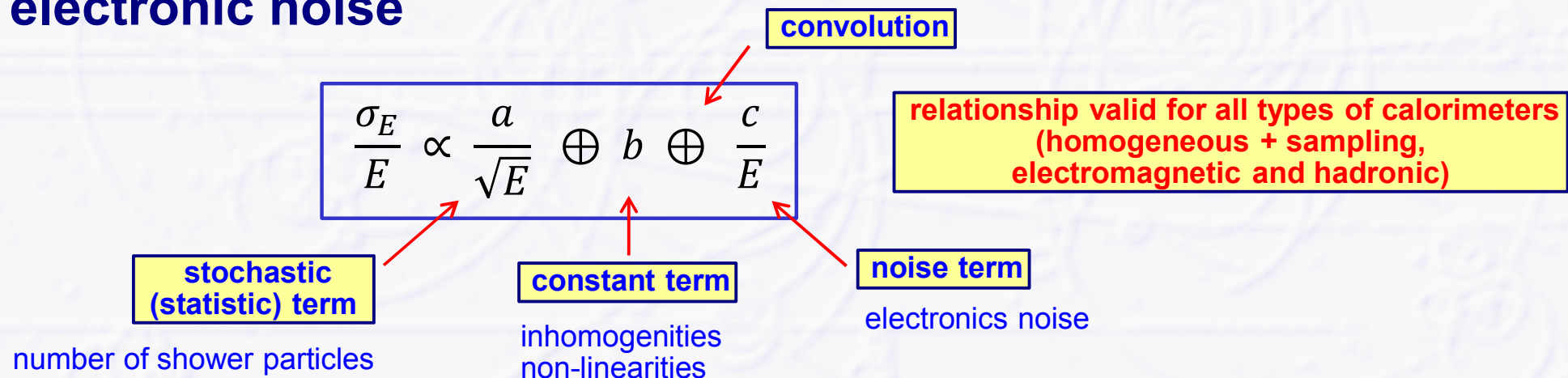

Calorimeter Concepts

● Homogeneous calorimeters (e.g. CMS)

→ absorber material (generation of the shower) = detector material

- typically an electromagnetic shower is created in an optical transparent absorber, photons created in the shower are collected and detected with some photo detector



● Sampling calorimeters (e.g. ATLAS)

→ passive (heavy) absorber material (iron, copper, lead, tungsten, uranium) interleaved with active detector material

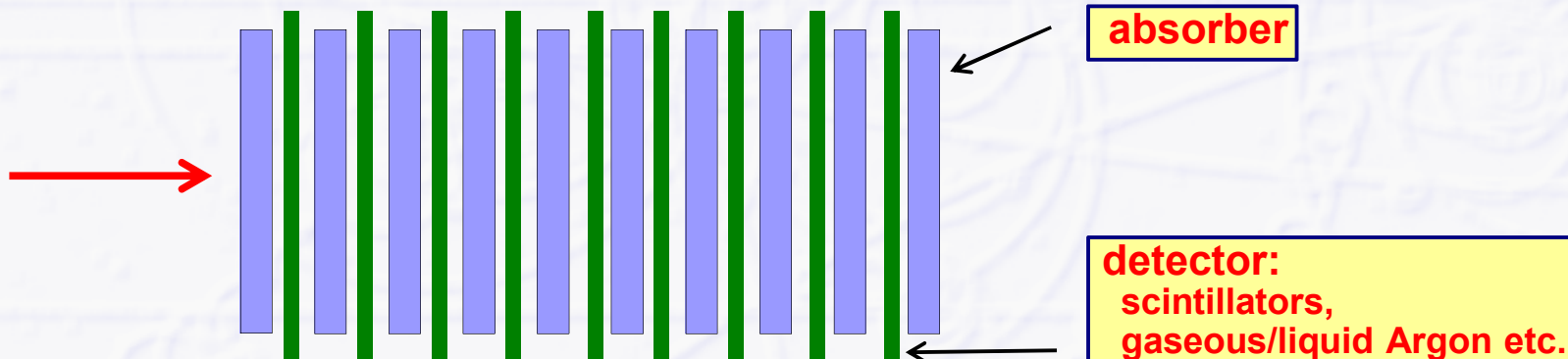

CMS: Homogeneous EM Calorimeter

- **Clear advantage: good energy resolution**

- the entire shower is kept in active detector material

- no shower particle is lost in passive absorber

- **Disadvantages**

- limited granularity, no information on shower shape in longitudinal direction (along particle flight direction)

- position information is useful to resolve near-by energy clusters, e.g. single photons versus two photons from π^0 decay

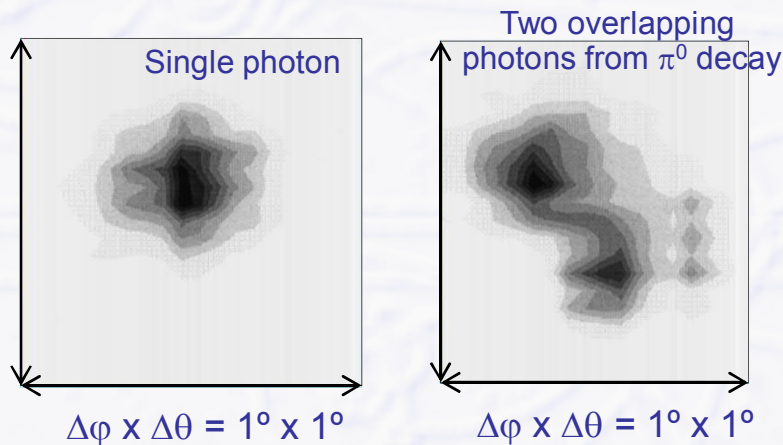

CMS PbWO₄ crystal

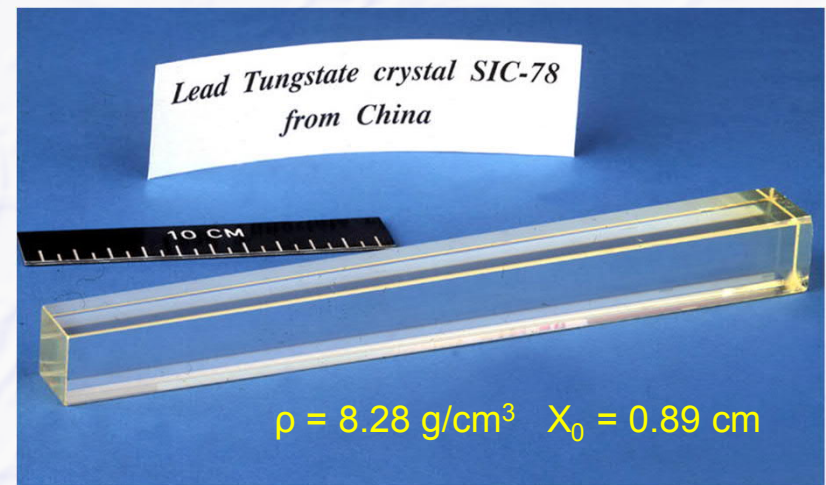

dense, transparent materials needed with short radiation length and high light yield

ATLAS: Sampling EM Calorimeter

- Typical sampling calorimeters use iron or lead absorber material, variety of detectors in between possible
 - gas detectors (MWPCs), plastic scintillators, **liquid noble gases** (LAr, LKr)
- LAr with “acordeon” shaped Fe-Pb-Fe absorbers at ATLAS

- LAr is ionized by charged shower particles
- Charge collected on pads
 - ionization chamber, no “gas” amplification
 - pads can be formed as needed → high granularity

- acordeon structure helps to avoid dead zones (cables etc.)

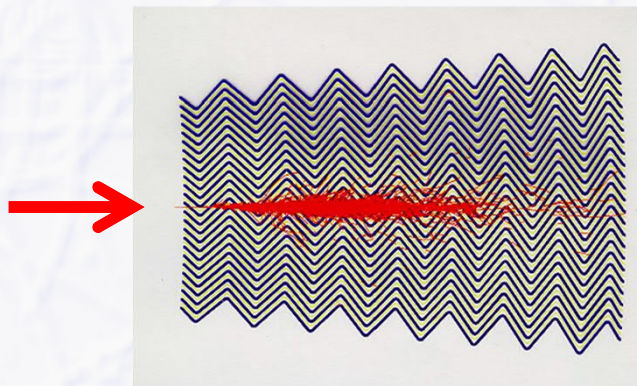

simulated shower



ATLAS LAr calorimeter

ATLAS/CMS Hadron Calorimeters

- Measure energy of heavy hadronic particles: π , K , p , n , ...
- Energy resolution much worse than for el.-magn. calorimeters
 - shower created by nuclear interactions (hadronic shower, fewer particles in shower)
 - usually only a few nuclear interaction lengths deep ($5 - 6 \lambda_I$)
- Both ATLAS and CMS use scintillators as detector material
 - need many optical fibers to transport light from scintillators to photo detectors

ATLAS

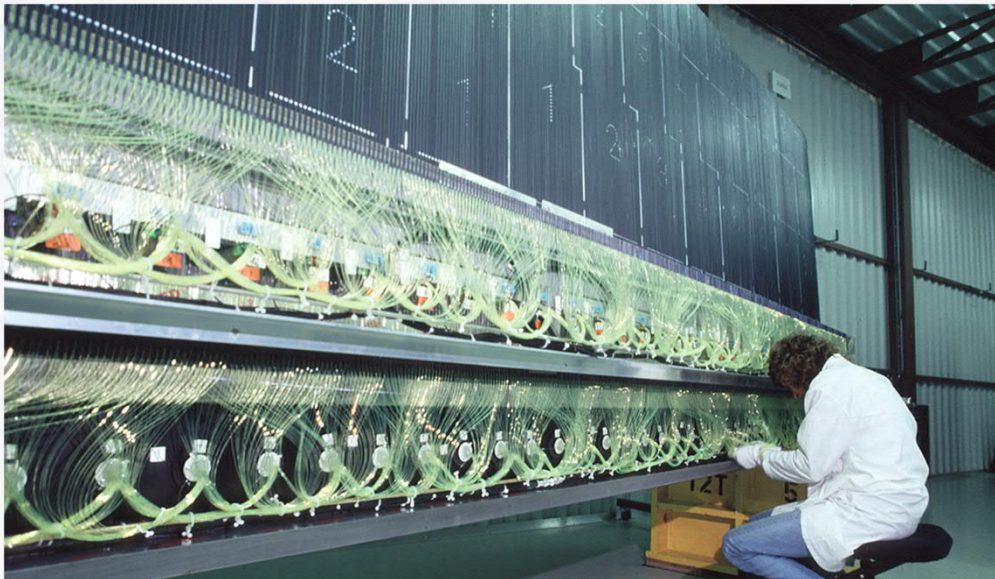

CMS



ATLAS Muon Detector

- Muon detectors are **tracking detectors** (e.g. wire chambers)
 - they form the outer shell of the (LHC) detectors
 - they are **not only sensitive to muons** (but to all charged particles)!
 - just by “definition”: if a particle has reached the muon detector
 - it's considered to be a muon
 - all other particles should have been absorbed in the calorimeters

- **Challenge for muon detectors**

- large surface to cover (outer shell)
- keep mechanical positioning stable over time

Aluminum tubes with central wire filled with 3 bar gas

- **ATLAS Muon System**

- 1200 chambers with 5500 m²
- needs also good knowledge of (inhomogeneous) magnetic field

ATLAS Muon Detector Elements

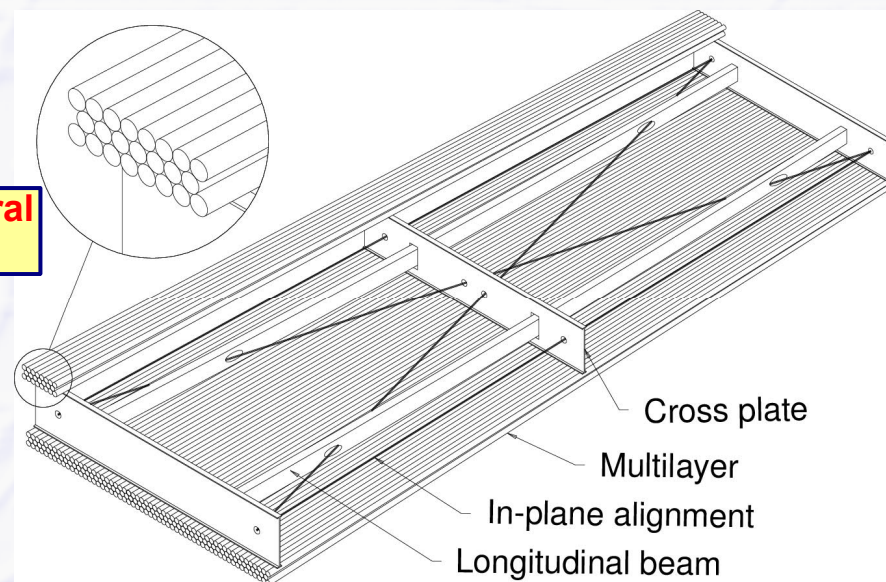

ATLAS Detector Status

(a 100 megapixel camera with 40 MHz framerate = 1 PB/second)

Subdetector	Number of Channels	Approximate Operational Fraction
Pixels	92 M	98.2%
SCT Silicon Strips	6.3 M	98.6%
TRT Transition Radiation Tracker	350 k	97.3%
LAr EM Calorimeter	170 k	100%
Tile calorimeter	4900	99.2%
Hadronic endcap LAr calorimeter	5600	99.6%
Forward LAr calorimeter	3500	99.8%
LVL1 Calo trigger	7160	100%
LVL1 Muon RPC trigger	370 k	99.75%
LVL1 Muon TGC trigger	320 k	100%
MDT Muon Drift Tubes	357 k	99.7%
CSC Cathode Strip Chambers	31 k	98.4%
RPC Barrel Muon Chambers	370 k	96.6%
TGC Endcap Muon Chambers	320 k	99.6%

How to Select Interesting Events?

- **Bunch crossing rate: 40 MHz, ~20 interactions per BX (10^9 evts/s)**
 - can only record ~1000 event/s (1 MB each), still ~1 GB/s data rate
- **Need highly efficient and highly selective TRIGGER**
 - raw event data (**1 PB/s**) are stored in pipeline until trigger decision

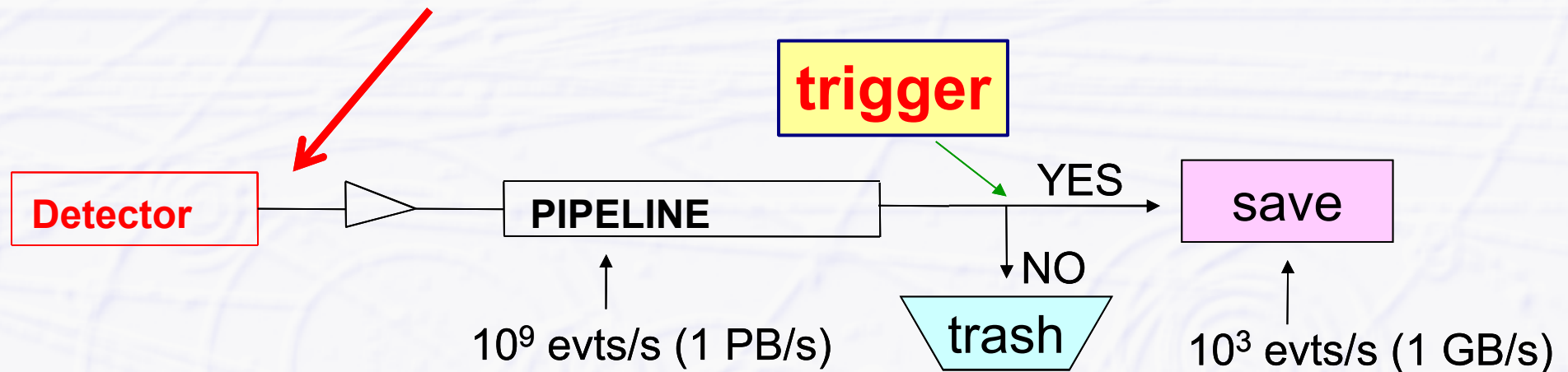

- **ATLAS + CMS triggers have 2 levels**
 - Level-1: hardware (FPGAs), ~3 μ s decision time, 40 MHz \rightarrow 100 kHz
 - Level-2: software (computer farm), ~4 s decision time, 100 kHz \rightarrow 1 kHz

From Physics to Raw Data

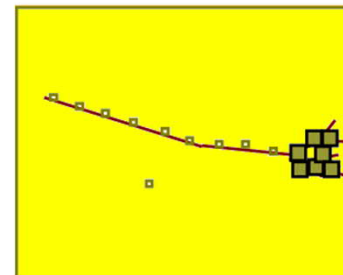
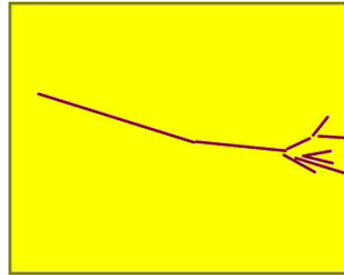
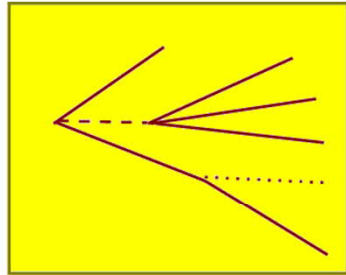
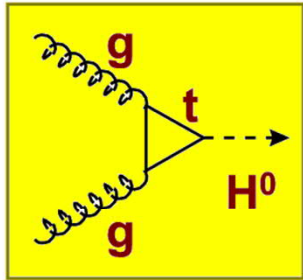

2037	2446	1733	1699
4003	3611	952	1328
2132	1870	2093	3271
4732	1102	2491	3216
2421	1211	2319	2133
3451	1942	1121	3429
3742	1288	2343	7142

Basic physics

Fragmentation,
Decay

Interaction with
detector material
Multiple scattering,
interactions

Detector
response
Noise, pile-up,
cross-talk,
inefficiency,
ambiguity,
resolution,
response
function,
alignment

Raw data

Read-out
addresses,
ADC, TDC
values,
Bit patterns

Collision Point

● Actually recorded are **raw data with ~1 GB/s for ATLAS/CMS**

→ mainly electronics numbers

e.g. number of a detector element where the ADC (Analog-to-Digital converter) saw a signal with x counts...

From Raw Data To Physics

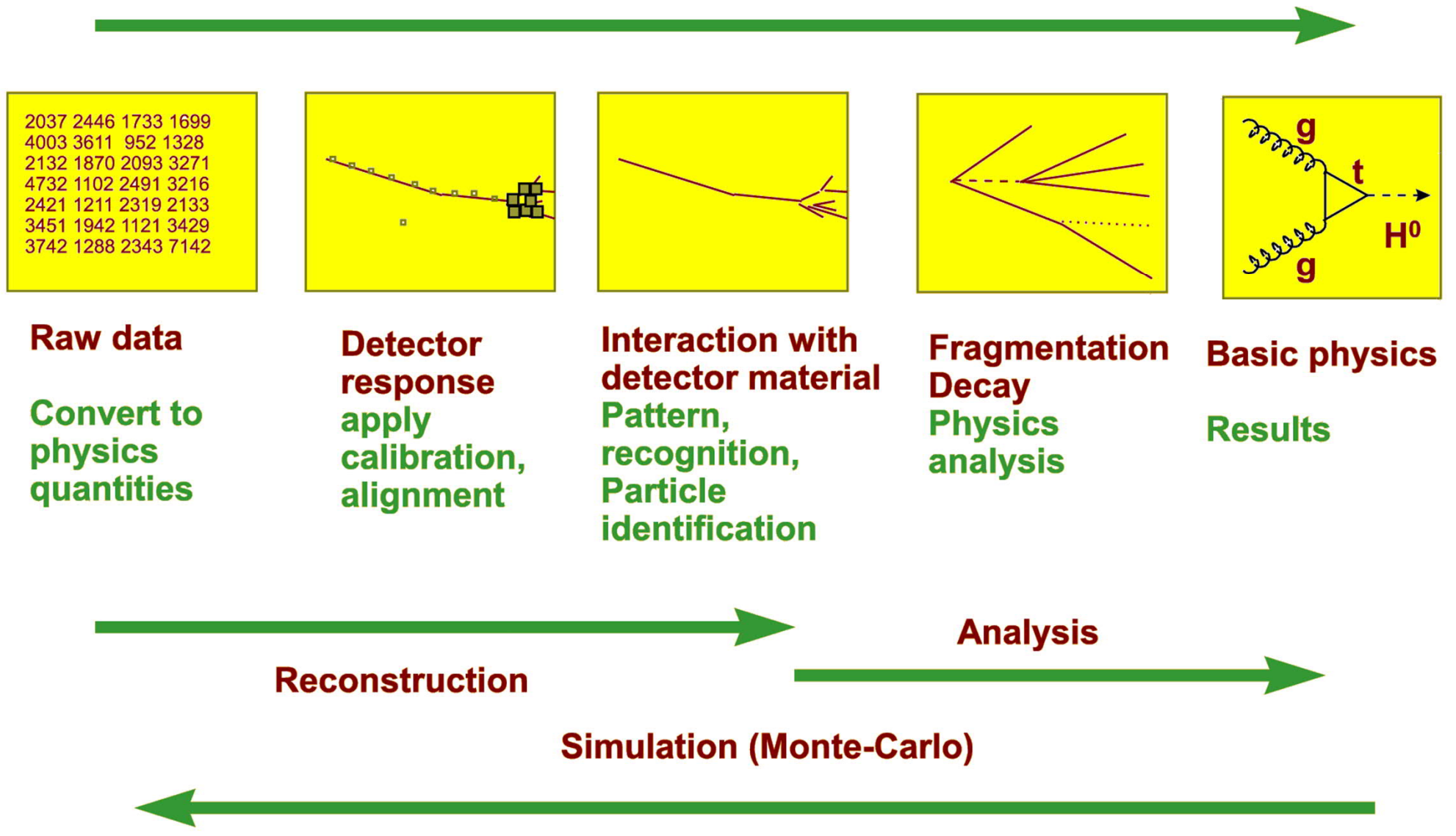

● **We need to go from raw data back to physics**

→ reconstruction + analysis of the event(s)

Simulation (Monte Carlo)

- **Even with best calibration + alignment**

- some detector influence, e.g. efficiency for track reconstruction etc. will not be known well enough from data

- Use detector simulation (Monte Carlo) to “unfold” detector influence

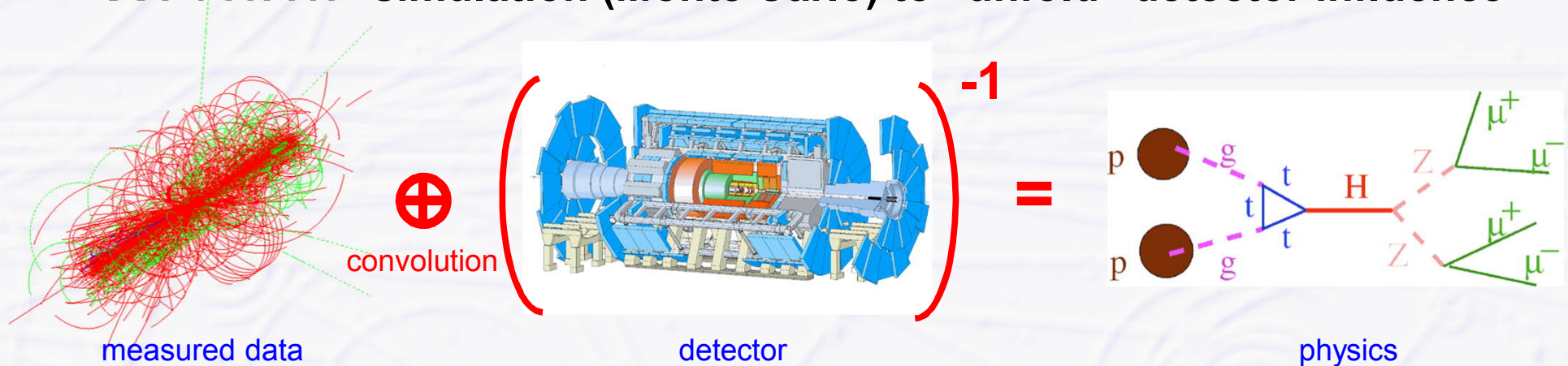

- **Event “generator” simulates physics processes**

- **Full detector description**

- geometry, detector volumes, detector response (noise etc.)
- physics interactions with matter and tracking particles through detector volumes

- also needed for detector design studies before detector actually built

ATLAS (A Toroidal LHC ApparatuS)

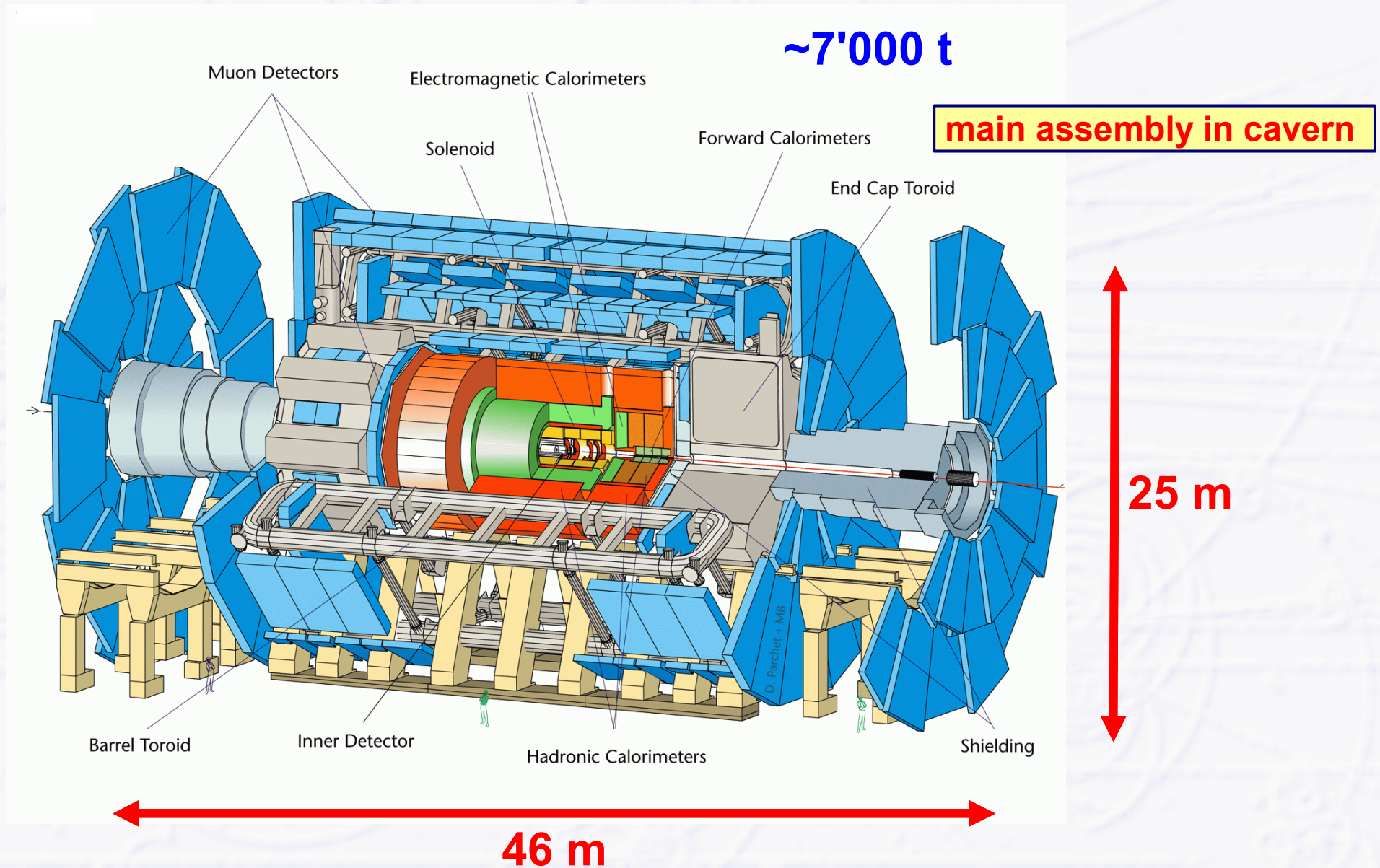

CMS (Compact Muon Spectrometer)

main assembly on surface,
then lowering into cavern in
5 big parts by ~2500 t crane

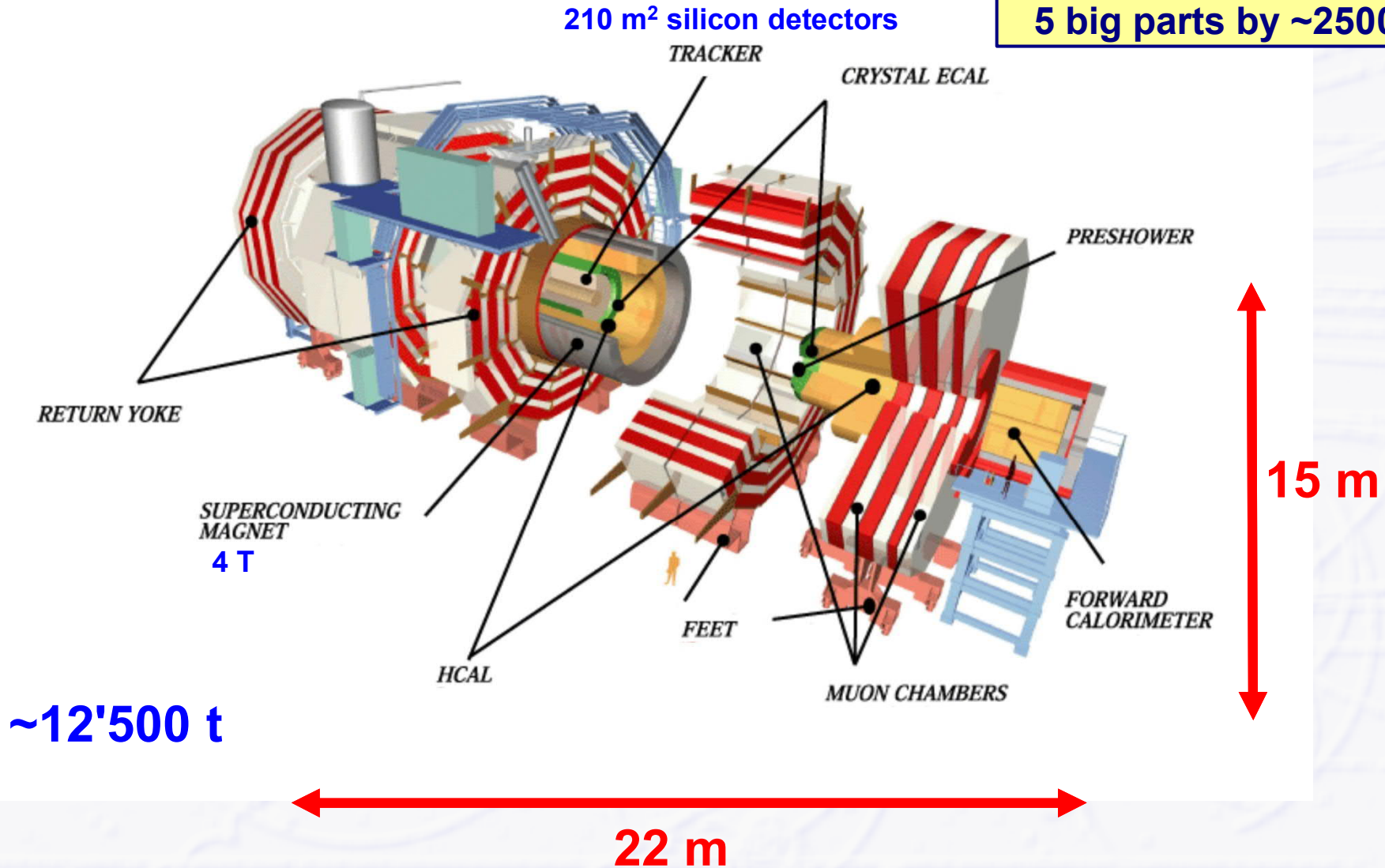

ATLAS/CMS Concept Overview

- The two large LHC detectors have somewhat different concepts

→ ATLAS

- small inner tracker with moderate field (small 2 T solenoid)
- electron identification by transition radiation tracker
- sampling calorimeter with high granularity outside solenoid
- air-core toroid system for good muon momentum measurement

emphasis on granular calorimeter and good muon measurement

→ CMS

- large inner tracker with high B-field (large 4 T solenoid)
- no dedicated particle identification detector
- homogeneous crystal calorimeter with good energy resolution inside solenoid

emphasis on good general tracking and good energy resolution

- However, both detector concepts have very similar performance for Higgs physics (efficiency, mass resolution...)

First Digging started in 1998

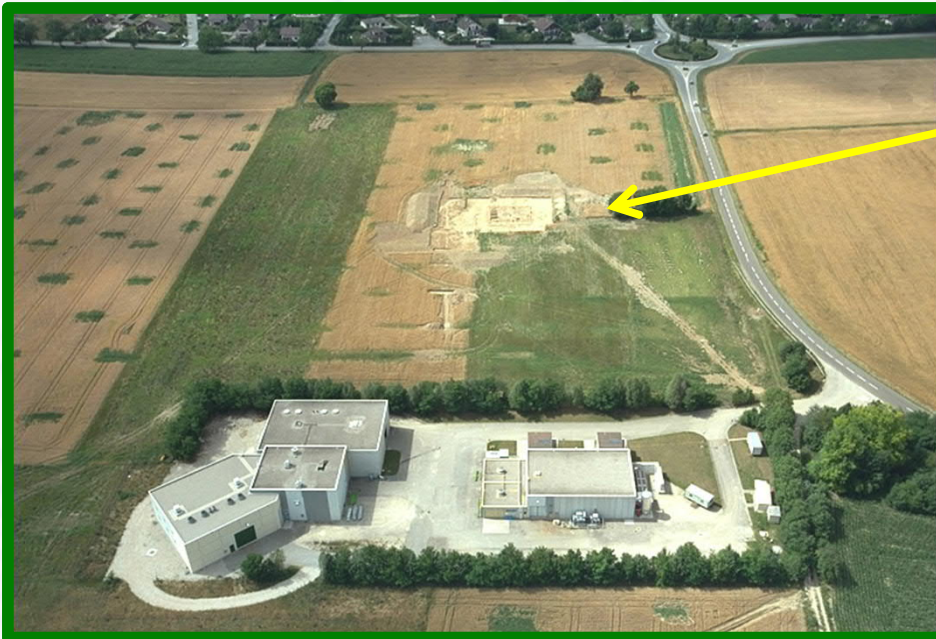

**Gallo-roman remains
on future CMS site**



**Roman
coins**



**ATLAS cavern
September 2000**

Point 1 - UX15 vault demolition of central pillar - September 20, 2000 - CERN ST-CE

The ATLAS Site 2005

CERN Main Entrance B

LHC Cooling Towers

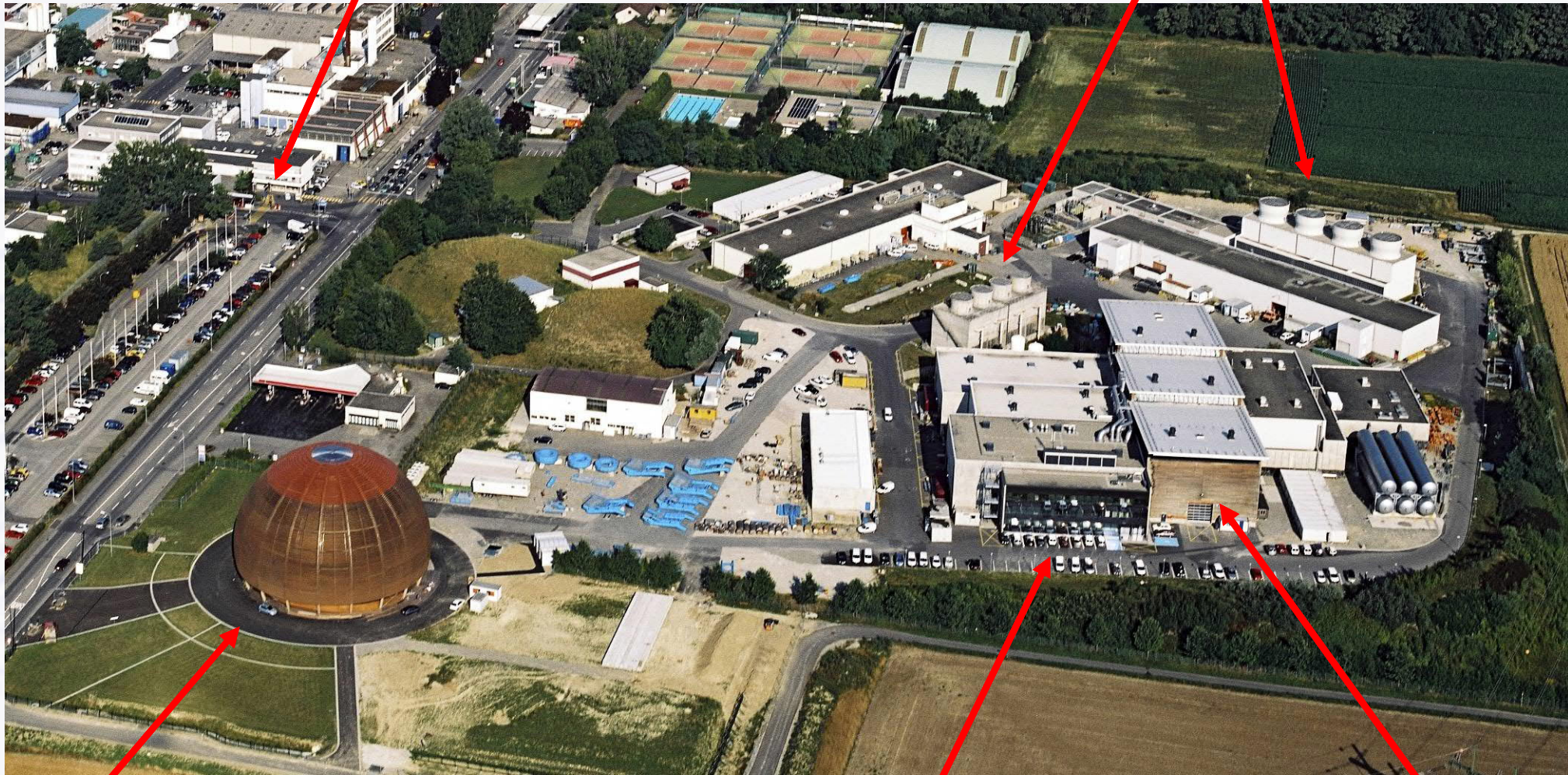

Globe of Innovation & Science

**ATLAS Control Room
and Visitor Centre**

ATLAS Main Hall

ATLAS Underground Cavern

huge cavern + surface buildings,
2 access shafts 18m + 12m Ø,
2 small shafts for elevators + stairs

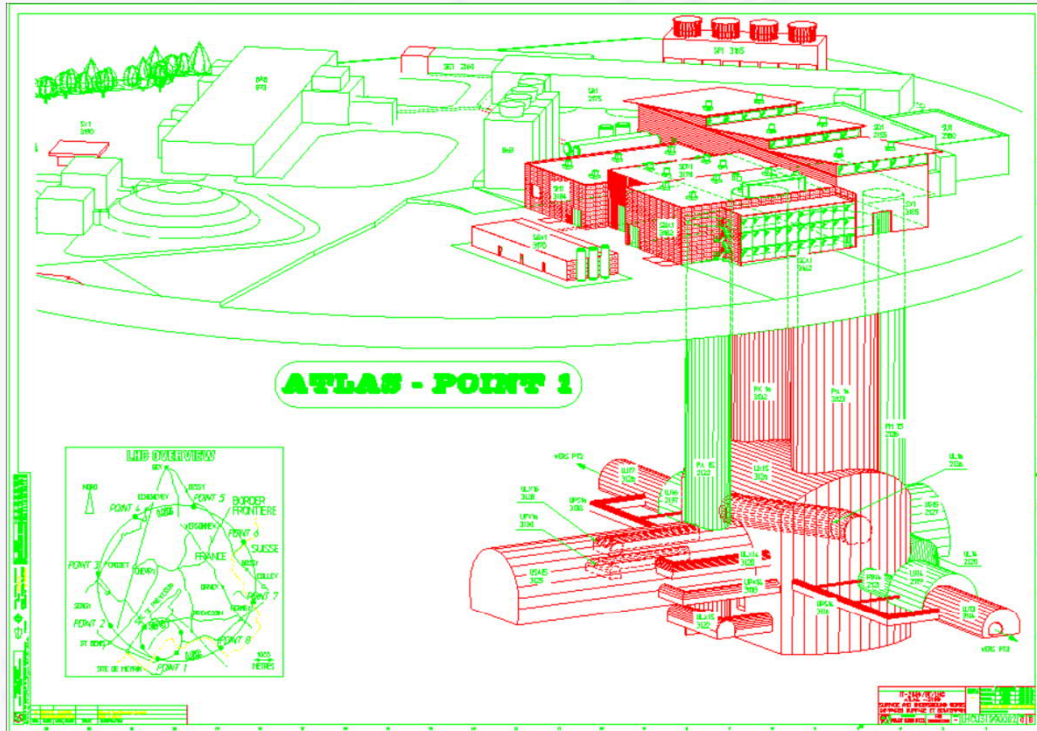

Start of ATLAS Detector Construction



Transport and lowering of first superconducting Barrel Toroid coil



CMS Lowering of 2000 t Central Part

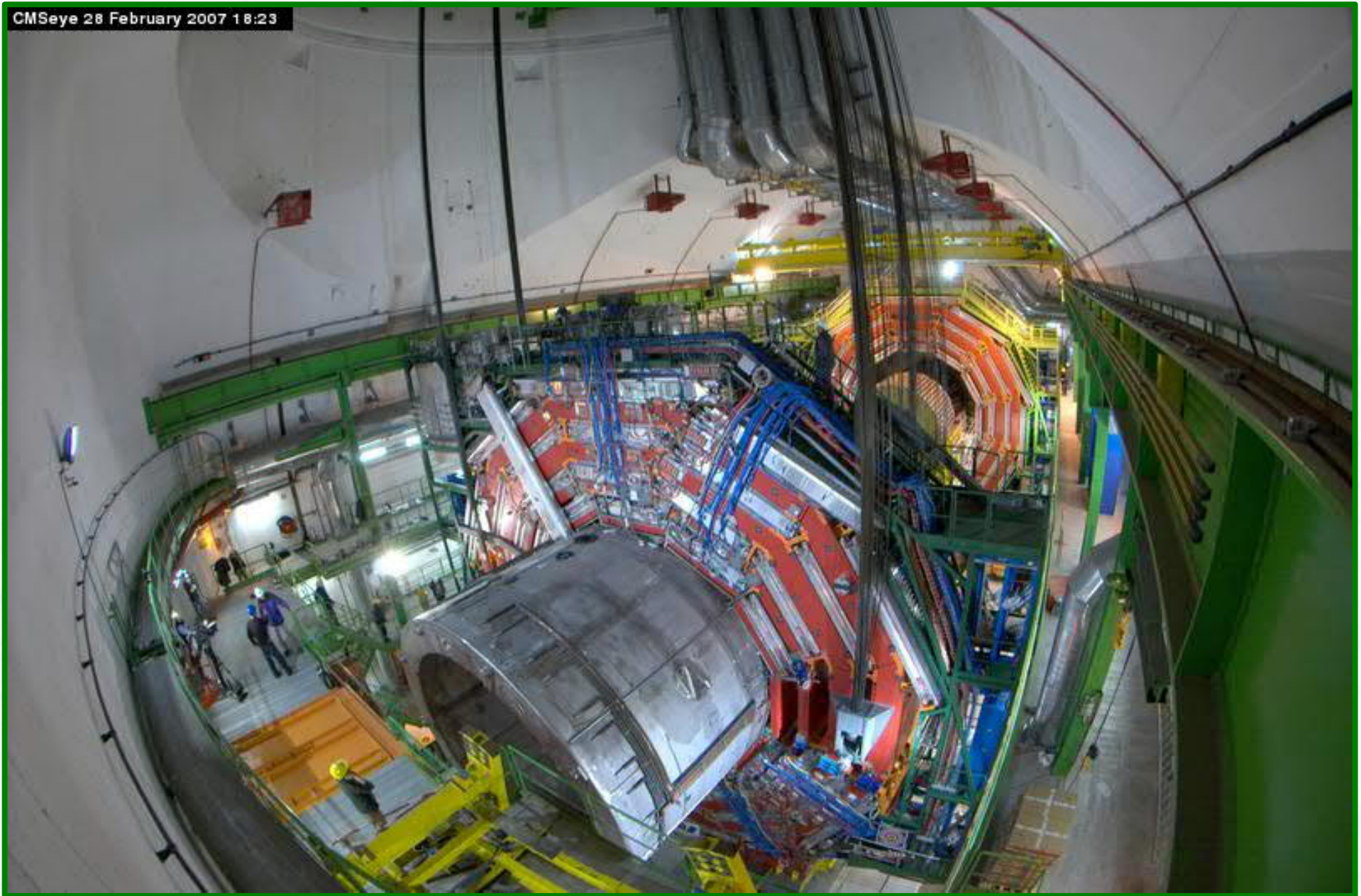

ATLAS Barrel Toroid Complete (Nov 2005)

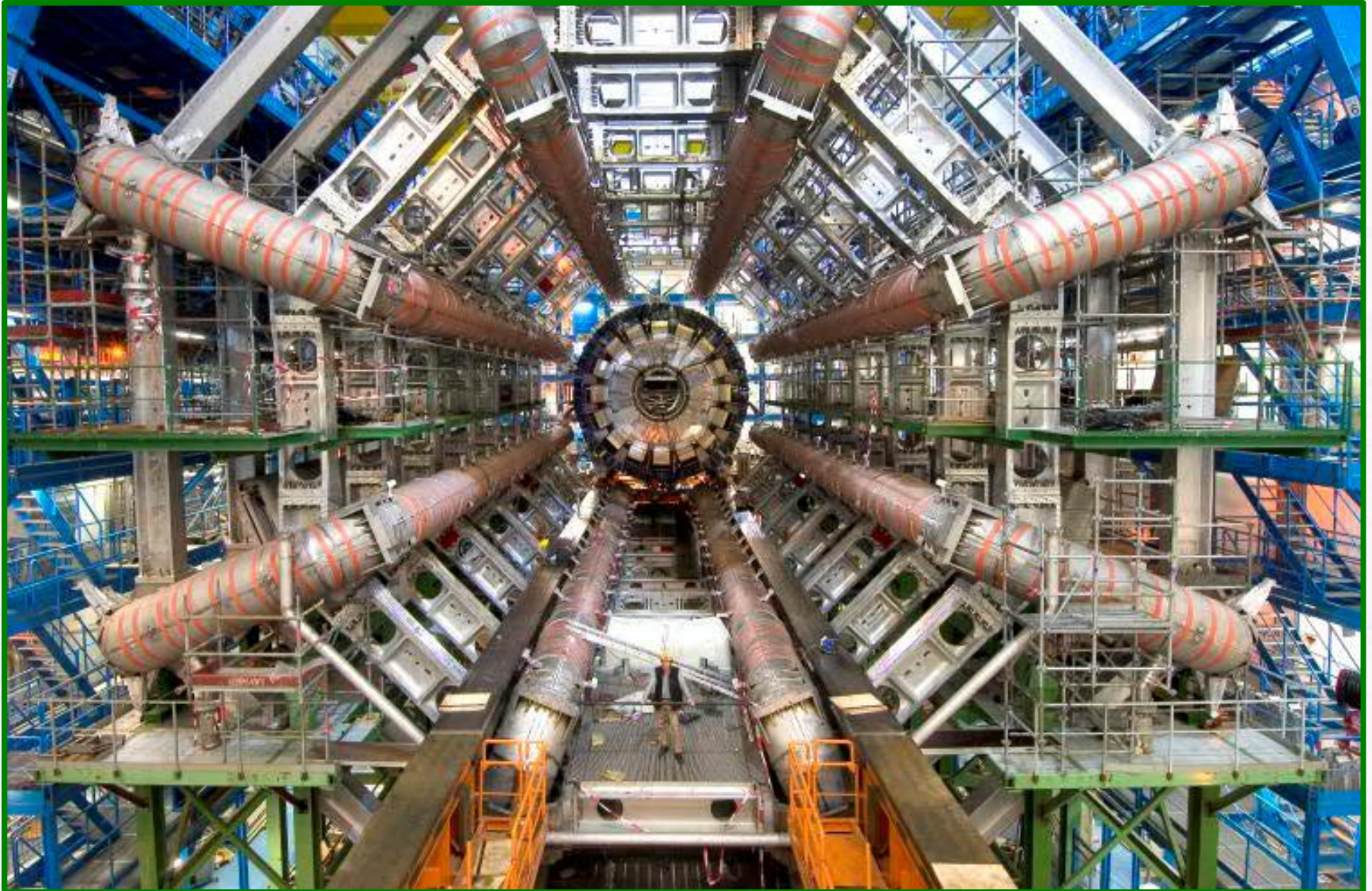

Detector Technology and Arts

Stage Design of Opera “Les Troyens” in Valencia, October 2009

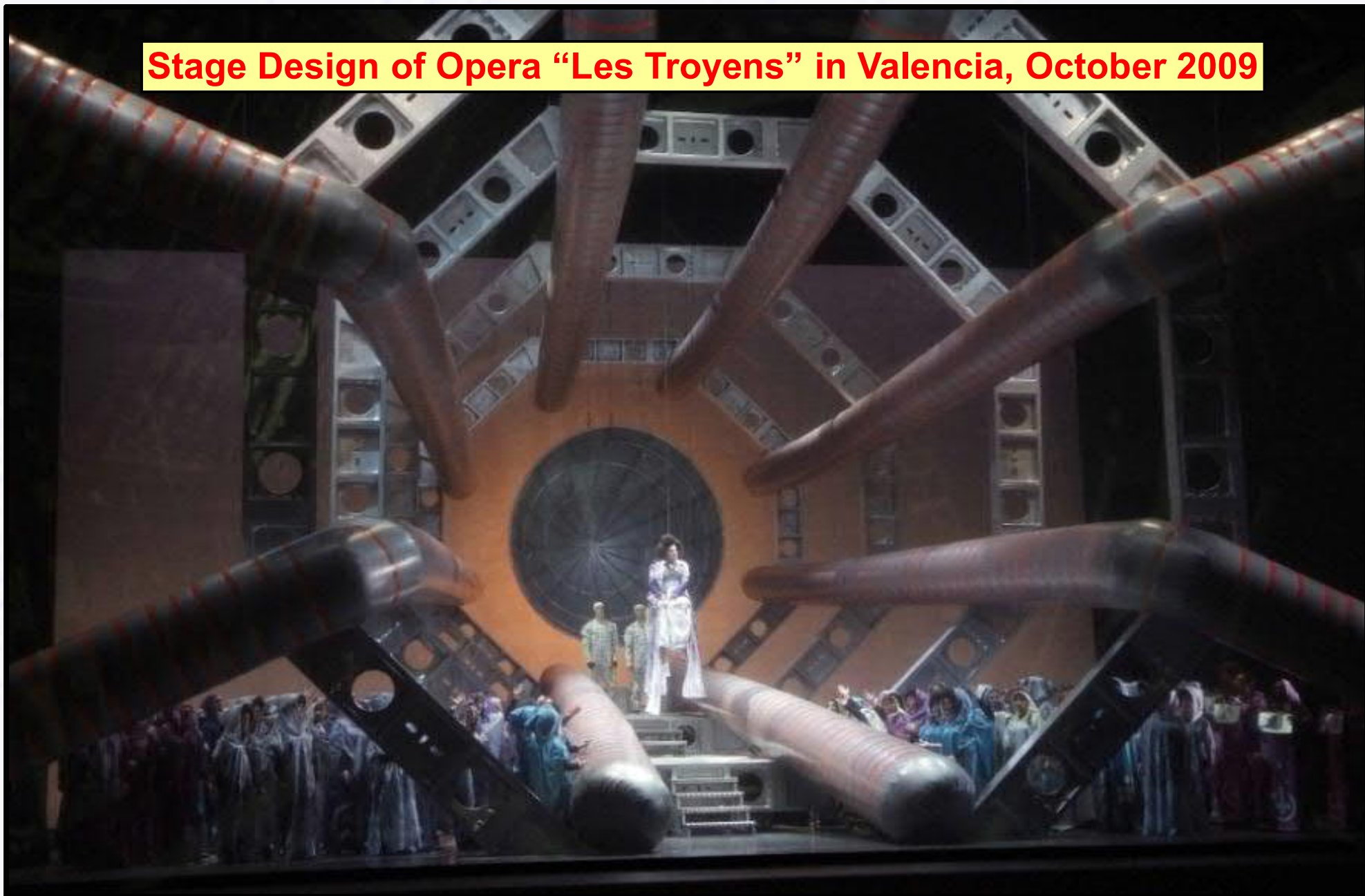

The first Higgs at LHC (4 April 2008)



First LHC Collisions at High Energy

ATLAS Control Room

