

# Type CA-16 Percentage Differential Relay for Bus Protection Class 1E Application



Effective: March 2003  
Supersedes I.L. 41-337.31B, Dated February 1995

( \* ) Denotes Figure Change Since Previous Issue  
( | ) Denotes Text Change Since Previous Issue



**Before putting relays into service, remove all blocking which may have been inserted for the purpose of securing the parts during shipment, make sure that all moving parts operate freely, inspect the contacts to see that they are clean and close properly, and operate the relay to check the settings and electrical connections.**

## 1.0 APPLICATION

These relays have been specially designed and tested to establish their suitability for class 1E applications. Materials have been selected and tested to insure that the relays will preform their intended function for their design life when operated in a normal environment as defined by ANSI standard C37.90-1978, when exposed to radiation levels up to  $10^4$  rads, and when subjected to seismic events producing a Shock Response Spectrum within the limits of the relay rating.

“Class 1E” is the safety classification of the electric equipment and systems in nuclear power generating stations that are essential to emergency shutdown of the reactor, containment isolation, cooling of the reactor, and heat removal from the containment and reactor, or otherwise are essential in preventing significant release of radioactive material to the environment.

The current transformers should not saturate when carrying the maximum external fault current. This requirement is met if the burden impedance does not exceed

$$\frac{N_P V_{CL} - (I_{ext} - 100)R_S}{1.33(I_{ext})} \quad \text{where}$$

$N_P$  = proportion of total ct turns in use

$V_{CL}$  = current transformer accuracy class C voltage

$I_{ext}$  = maximum external fault current in secondary RMS amperes. (let  $I_{ext} = 100$  if max. external fault current is less than 100A)

$R_S$  = current transformer secondary winding resistance, ohms

For example, if the 400:5 tap of 800:5 C400 current transformers are used,  $N_P = 400/800 = 0.50$ , if  $I_{ext} = 120A$ ,  $R_S = 1.0$  ohm the burden should not exceed:

$$\frac{N_P V_{CL} - (I_{ext} - 100)R_S}{1.33(I_{ext})} =$$

$$\frac{0.5 \times 400 - (120 - 100) \times 1.0}{1.33 \times 120} = 1.13 \text{ ohms}$$

The CA-16 relay should not be utilized for transformer differential applications since it is too sensitive for overriding the inrush. Likewise the CA-26 relay should not be used for bus protection with the “four circuit bus” connections of Figure 6.

## 2.0 CONSTRUCTION

The type CA-16 relay consists of an indicating contactor switch, autotransformer, three restraint elements, an operating element, and a sensitive fault detector.

The principal component parts of the relay and their location are shown in Figures 1 to 3.

*All possible contingencies which may arise during installation, operation or maintenance, and all details and variations of this equipment do not purport to be covered by these instructions. If further information is desired by purchaser regarding this particular installation, operation or maintenance of this equipment, the local ABB representative should be contacted.*

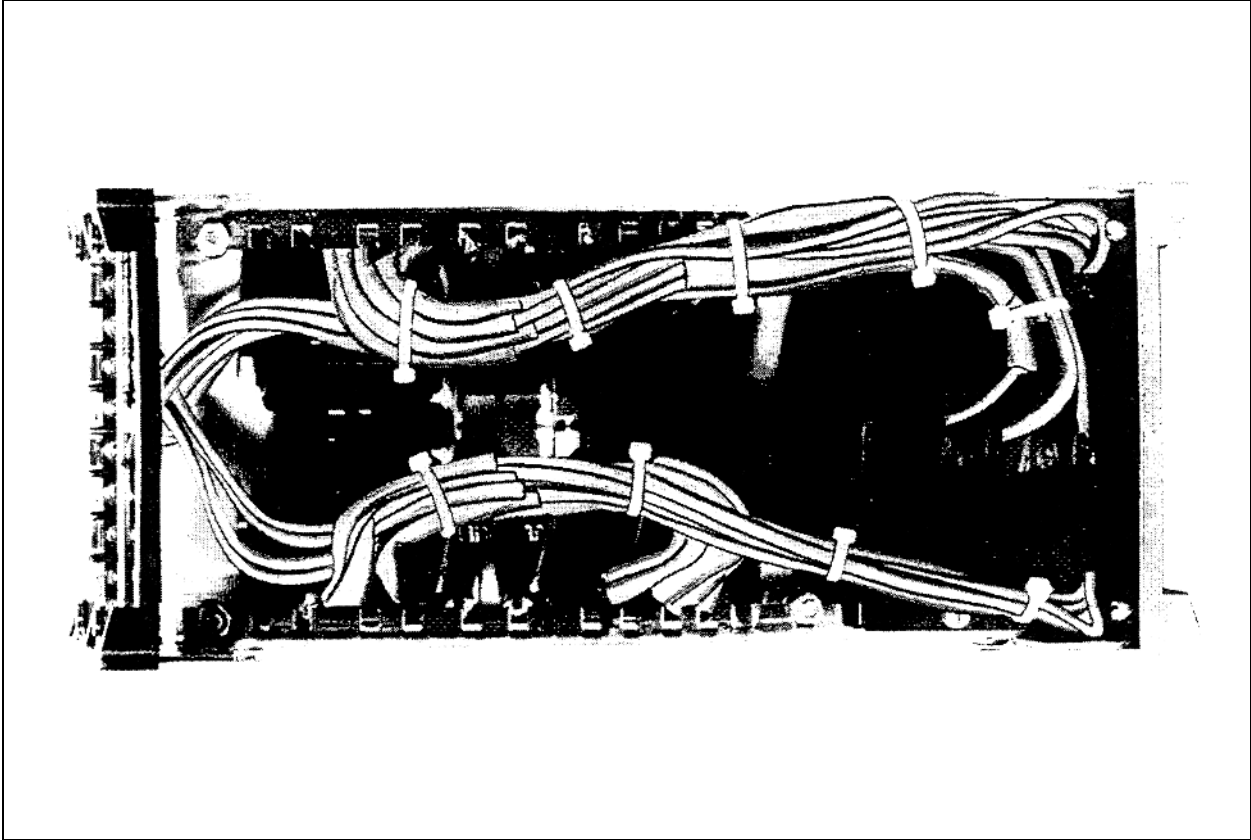

Figure 2. CA-16 Rear View

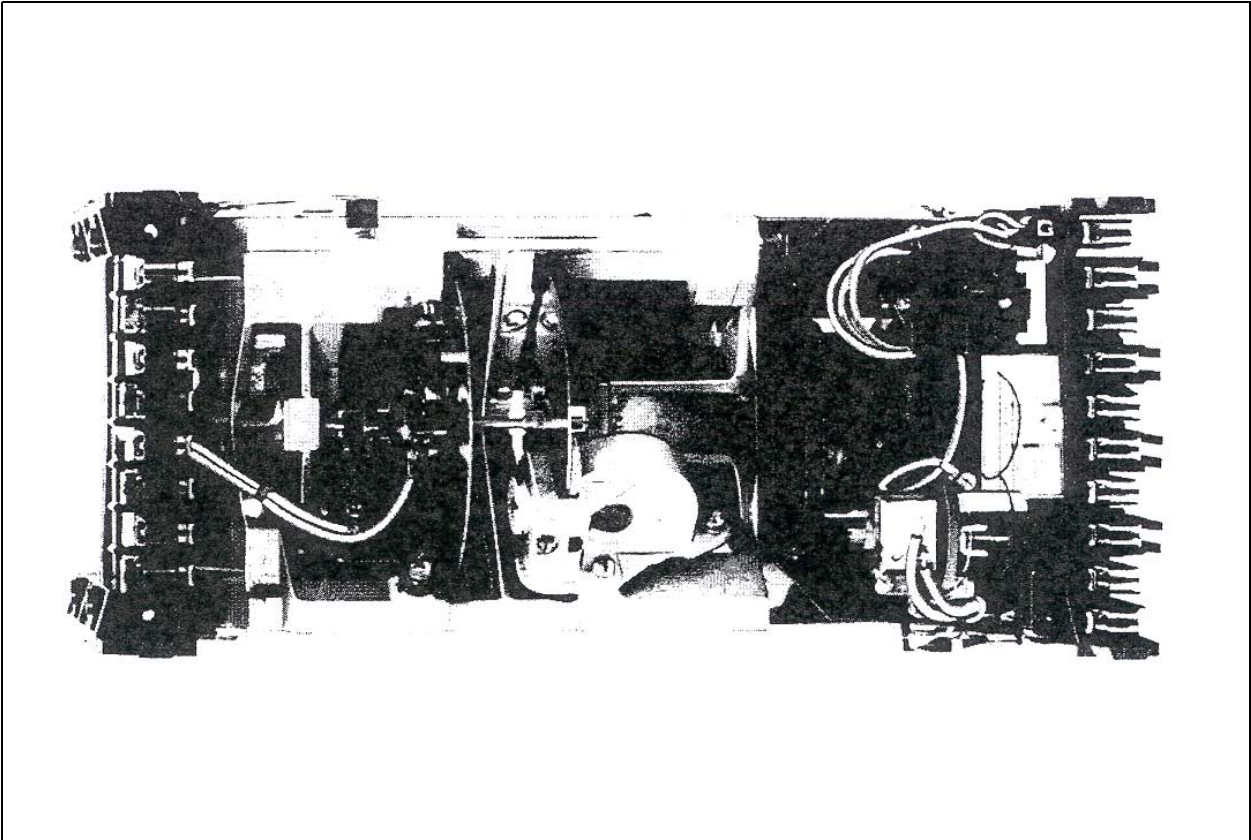

Figure 1. CA-16 Front View

## 2.1. Restraint Elements

Each restraint element consists of an “E” laminated electromagnet with two primary coils and a secondary coil on its center leg. Two identical coils on the outer legs of the laminated structure are connected to the secondary winding in a manner so that the combination of all fluxes produced by the electromagnet results in out-of-phase fluxes in the air gap. The out-of-phase fluxes cause a contact opening torque.

## 2.2. Operating Circuit

The operating circuit consists of an autotransformer and an operating element. The primary of the autotransformer, which is the whole winding, is connected to receive the differential or unbalanced current from the various transformers connected to the bus. The secondary winding of the autotransformer, which is a tapped section of the winding, is connected to the operating element of the relay.

The operating element consists of an “E” type laminated electromagnet with an autotransformer winding on its center leg. Two identical coils on the outer legs of the laminated structure are connected to the secondary (tapped section) of the autotransformer winding in a manner so that the combination of all fluxes produced by the electromagnet results in out-of-phase fluxes in the air gap. The out-of-phase air gap fluxes cause a contact closing torque.

## 2.3. Sensitive Fault Detector Circuit

The sensitive fault detector circuit consists of an autotransformer and a contactor switch. The contactor switch is connected across the secondary (tapped section) of the auto-transformer winding.

The contactor switch is a small solenoid type element. A cylindrical plunger rides up and down on a vertical guide rod in the center of the solenoid coil. The guide rod is fastened to the stationary core, which in turn screws into the unit frame. A silver disc is fastened to the moving plunger through a helical spring. When the coil is energized, the plunger moves upward carrying the silver disc which bridges three conical-shaped stationary contacts. In this position, the helical spring is compressed and the plunger is free to move while the contact remains stationary. Thus, ac vibrations of the plunger are prevented from causing contact bouncing. A micarta disc is fastened to the bottom of the guide rod by two small nuts. Its position determines the pick-up current of the element.

The auto-transformer is designed to saturate at high values of current to limit the amount of current to the contactor switch.

### 2.3.1. Indicating Contactor Switch Unit (ICS)

The dc indicating contactor switch is a small clapper type device. A magnetic armature, to which leaf-spring mounted contacts are attached, is attracted to the magnetic core upon energization of the switch.

When the switch closes, the moving contacts bridge two stationary contacts, completing the trip circuit. Also during this operation two fingers on the armature deflect a spring located on the front of the switch, which allows the operation indicator target to drop. The target is reset from the outside of the case by a push rod located at the bottom of the cover.

The front spring, in addition to holding the target provides a restraint for the armature and thus controls the pick-up value of the switch.

## 3.0 OPERATION

The type CA-16 relay is an induction disc relay with four electromagnets mounted on two discs that are fastened on a common shaft. One of the electromagnets is the operating element while the other three are restraint elements. The restraint elements are energized from the secondaries of current transformers connected to the bus, and the operating circuit is energized in accordance with the current flowing in the differential connection of the current transformers.

A current of 5 amperes in at terminal 18 and out of terminal 19 will produce a definite amount of restraining torque (*see Figure 3.*) Similarly, a current of 5 amperes flowing in at terminal 16 and out of terminal 17 will produce an equal amount of torque. If both of these currents flow at the same time with the polarity as indicated above, their effect will be additive and they will produce the same torque as though 10 amperes are flowing in terminal 16 and out of terminal 17. Conversely, if equal currents flow in these two coils, but in opposite directions, their ampere turns will cancel and no torque will be produced. The same relationship applies for the paired coils of the other two restraining units of the relay. The restraint effect will always be additive if currents flow in the coils which belong to different restraint elements.

**4.0 CHARACTERISTICS**

**4.1. CA-16 Bus Relay**

This relay has variable percentage characteristics which means that the operating coil current required to close the relay contacts, expressed in percent of the total restraint current, varies with the magnitude of the restraint current. The relay sensitivity is high, corresponding to a low percentage ratio, at light currents, and its sensitivity is low, corresponding to high percentage unbalance, at high currents. The relay is made sensitive at low currents in order to detect light internal faults on the bus being protected. At the same time, however, its reduced sensitivity at the higher currents allows the various current transformers involved to depart from their true ratio to a large extent without causing false tripping of the relay for external faults.

The variable percentage characteristics are particularly advantageous when severe saturation of current transformers is caused by the dc component of asymmetrical short circuits. In the case of buses located close to generating stations where the dc components decay slowly, the breakdown in ratio of the current transformers will be much greater than would ever be expected from a consideration of the usual ratio curves of the current transformers involved.

The time of operation of the relay is shown in Figure 4.

The main contacts will safely close 30 amperes at 250 volts dc and the seal-in contacts of the indicating contactor switch will safely carry this current long enough to trip a circuit breaker.

The indicating contactor switch has two taps that provide a pick-up setting of 0.2 or 2 amperes. To change taps requires connecting the lead located in front of the tap block to the desired setting by means of a screw connection.

**4.2. Trip Circuit Constants**

Indicating Contactor Switch (ICS)

0.2 amp rating	8.5 ohms dc
1.0 amp rating	0.37 ohms dc
2.0 amp rating	0.10 ohms dc

**ENERGY REQUIREMENTS**

Burden of each restraint coil at 5 amperes	
VOLT AMPERES	POWER FACTOR
.75	.7
Continuous Rating	14 amperes
1 second rating	460 amperes

**Burden of operating Circuit**

VOLT AMPERES  
VARIABLE (See Figure 5)

Continuous rating 8 amperes  
1 second rating 280 amperes

**4.3. Connections**

**4.3.1. CA-16**

To determine the ac connections, identify each primary circuit as either a "source" or "feeder". As defined here, a feeder contributes only a small portion of the total fault-current contribution for a bus fault. Otherwise, the circuit is a source. Next lump a number of feeders into a "feeder group" by paralleling feeder ct's, taking the precaution that each feeder group has less than 14 amperes load current (restraint coil continuous rating). Also each feeder group should not contribute more than 10% of the total phase or ground-fault current for a bus fault if Figure 7 is to be used.

Connect per Figure 6 with three or four bus "circuit." The term "circuit" refers to a source or to a feeder group. For example, assume a bus consisting of 2 sources and 6 feeders. Further, assume that the feeders are lumped into 2 feeder groups. The bus now reduces to four circuits

If the bus reduces to more than four circuits, parallel source-circuit ct's or source-and feeder circuit ct's until only four circuits remain. Then connect these four sets of ct's to the relays per Figure 6. The exception to this rule occurs when the application consists of three feeder groups. Then Figure 7 applies.

With 3 feeder groups and more than 3 sources, parallel source ct's until the application reduces to 6 circuits; then, connect to the relays per Figure 7.

#### 4.4. Setting Calculations

No calculations are required to set the CA-16.

#### 4.5. Setting The Relay

No settings are required on the CA-16 relay.

### 5.0 INSTALLATION

The relays should be mounted on switchboard panels or their equivalent in a location free from dirt, moisture, excessive vibration and heat. Mount the relay vertically by means of the four mounting holes on the flange for the semi-flush type FT case. The mounting screws may be utilized for grounding the relay. External toothed washers are provided for use in the locations shown on the outline and drilling plan to facilitate making a good electrical connection between the relay case, its mounting screws and the relay panel. Ground Wires are affixed to the mounting screws as required for poorly grounded or insulating panels. Other electrical connections may be made directly to the terminals by means of screws for steel panel mounting.

For detail information on the FT case refer to IL 41-076 for semi-flush mounting.

### 6.0 ADJUSTMENTS AND MAINTENANCE

The proper adjustments to insure correct operation of this relay have been made at the factory. Upon receipt of the relay, no customer adjustments should be required.

#### 6.1. Acceptance Check

The following check is recommended to insure that the relay is in proper working order. The relay should be connected per Figure 8.

##### A. Minimum Trip Current

Apply current to terminals 12 and 13 of the relay. The relay should operate as follows:

CA-16 0.15 amperes  $\pm 5\%$

##### B. Percentage Differential Characteristic

Apply 16 amperes to terminals 9 and 19 of the CA-16 relay. The contacts should close when the following operating current is applied to the relay with connections of Figure 8.

CA-16 17.0 amperes  $\pm 7\%$

Check each individual restraint winding by applying 50 amperes to each winding. Apply sufficient operat-

ing current to the operating circuit until the contacts just close. The operating current should be:

CA-16 3.9 to 5.1 amperes

##### C. Time Curve

Apply 20 amperes to terminals 12 and 13 of the relays. The contacts should close in the following times:

CA-16 58 to 68 Milliseconds

##### D. Indicating Contactor Switch (ICS)

Close the main relay contacts and pass sufficient dc current through the trip circuit to close the contacts of the ICS. This value of current should not be greater than the particular ICS nameplate rating. The indicator target should drop freely.

Repeat above except pass 85% of ICS nameplate rating current. Contacts should not pickup and target should not drop.

##### E. Sensitive Fault Detector

Apply current to terminals 14 and 15 of the relay. The fault detector should operate between the limits of 0.142 to 0.158 amperes.

#### 6.2. Routine Maintenance

All contacts should be periodically cleaned. A contact burnisher is recommended for this purpose. (S#182A836H01). The use of abrasive material for cleaning contacts is not recommended, because of the danger of embedding small particles in the face of the soft silver and thus impairing the contact.

### 7.0 CALIBRATION

Use the following procedure for calibrating the relay if the relay has been taken apart for repairs or the adjustments disturbed. This procedure should not be used until it is apparent that the relay is not in proper working order. (See "Acceptance Check".)

#### 7.1. Contacts

Adjust the adjustable stop screw on the upper disc of the relay so that a contact separation of 0.050 inch is obtained between the moving contact and the stationary contact. Lock the screw with the nut provided for the purpose.

#### 7.2. Minimum Trip

The relay should be level for this test. Minimum trip

current can best be determined with the permanent magnet removed.

Adjust the spring tension until the relay just closes its contacts with the following current applied to terminals 12 and 13 of the relay.

CA-16 0.15 amperes

### 7.3. Percentage Slope Characteristic

Connect the relay per the test circuit of Figure 8.

Pass 20 amperes for the CA-16 relay into terminals 9 and 19 of the relay. Adjust the plug (when used) in the operating electromagnet until the contacts just close with the following currents into the operating circuit of the relays.

CA-16 29.4 to 34 amperes

### 7.4. Time Curve

Place the permanent magnet on the relay and apply 20 amperes to terminals 12 and 13 of the relay. Adjust the keeper of the permanent magnet until the contacts just close in the following times:

CA-16 58 to 68 Milliseconds

These times should be the average of 5 readings.

### 7.5. Indicating Contactor Switch (ICS)

Initially adjust unit on the pedestal so that armature fingers do not touch the yoke in the reset position. (Viewed from top of switch between cover and frame). This can be done by loosening the mounting screw in the molded pedestal and moving the ICS in the downward position.

- a. Contact Wipe – Adjust the stationary contact so that both stationary contacts make with the moving contacts simultaneously and wipe 1/64" to 3/64" when the armature is against the core.
- b. Target – Manually raise the moving contacts and check to see that the target drops at the same time as the contacts make or 1/16" ahead. The cover may be removed and the tab holding the target reformed slightly if necessary. However, care should be exercised so that the target will

not drop with a slight jar.

If the pickup is low, the front cover must be removed and the leaf springs on each side bent outward equally.

### 7.6. Sensitive Fault Detector

Loosen the lock nut at the top of the element and run the core screw down until it is flush with the top of the lock nut. Back off the Micarta disc by loosening the two lock nuts. Apply 0.15 amperes to terminals 14 and 15. Operate the moving element by hand and allow the current to hold the moving contact disc against the stationary contacts. Now, screw up the core screw slowly. This causes the plunger to move up, compressing the spring until a point of maximum deflection is reached. Further upward motion will cause the plunger to drop part way out of the coil, thus diminishing the spring pressure on the contacts. By thus adjusting the core screw up or down the maximum spring deflection for this value of current may be found.

Then lock the core screw in place. Next, adjust the de-energized position of the plunger by raising the Micarta disc until the plunger just picks up electrically at the 0.15 ampere value.

### 7.7. Electrical Checkpoints

Figures 9 and 10 will aid in trouble shooting the CA-16. These curves show the operating current to trip the relay for different restraint current for one restraint element as well as for six restraint elements connected in series.

## 8.0 RENEWAL PARTS

Repair work can be done most satisfactorily at the factory. However, interchangeable parts can be furnished to customers who are equipped for doing repair work. When ordering parts, always give the complete nameplate data.

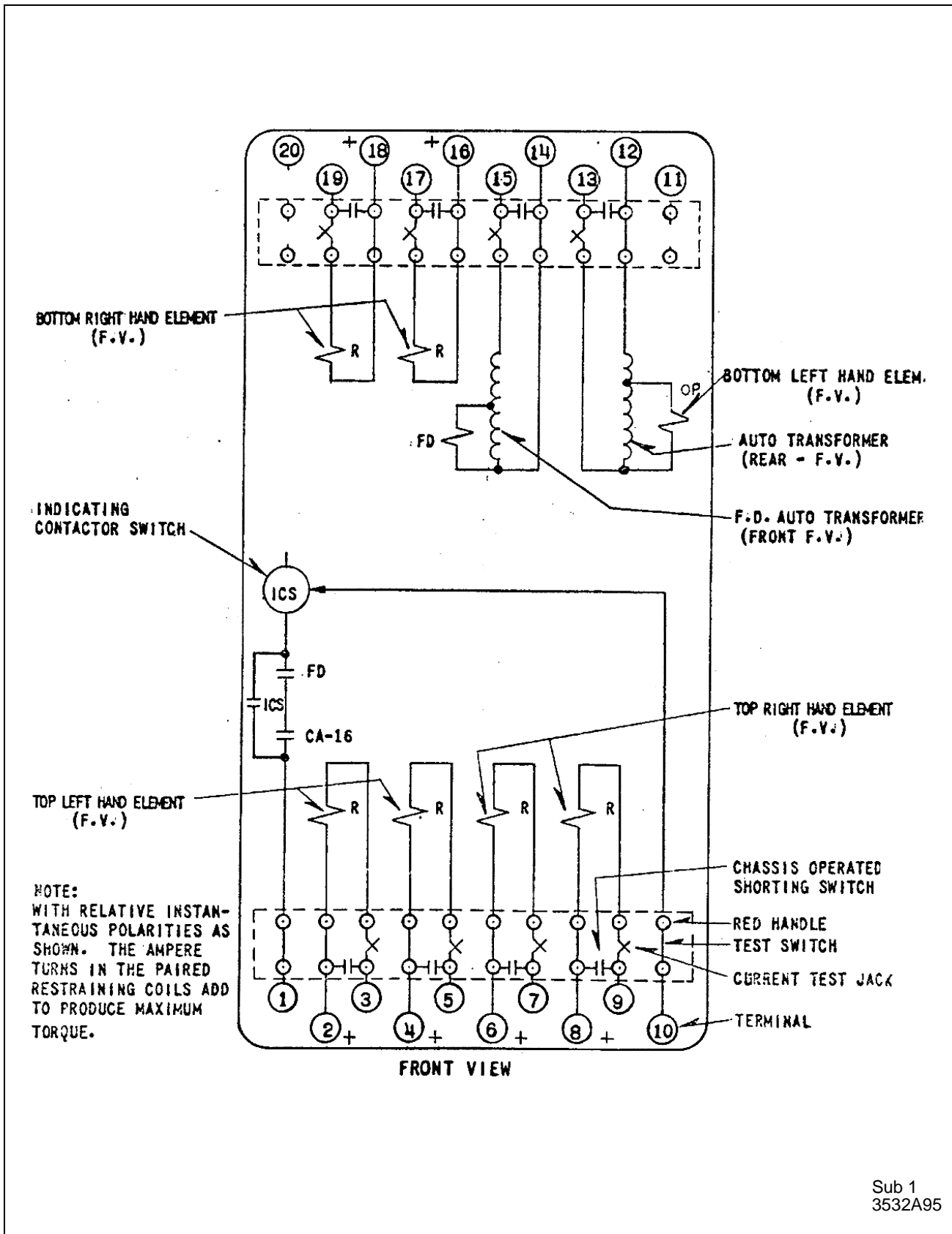

Sub 1  
3532A95

Figure 3. Internal Schematic of the Type CA-16 Bus Relay

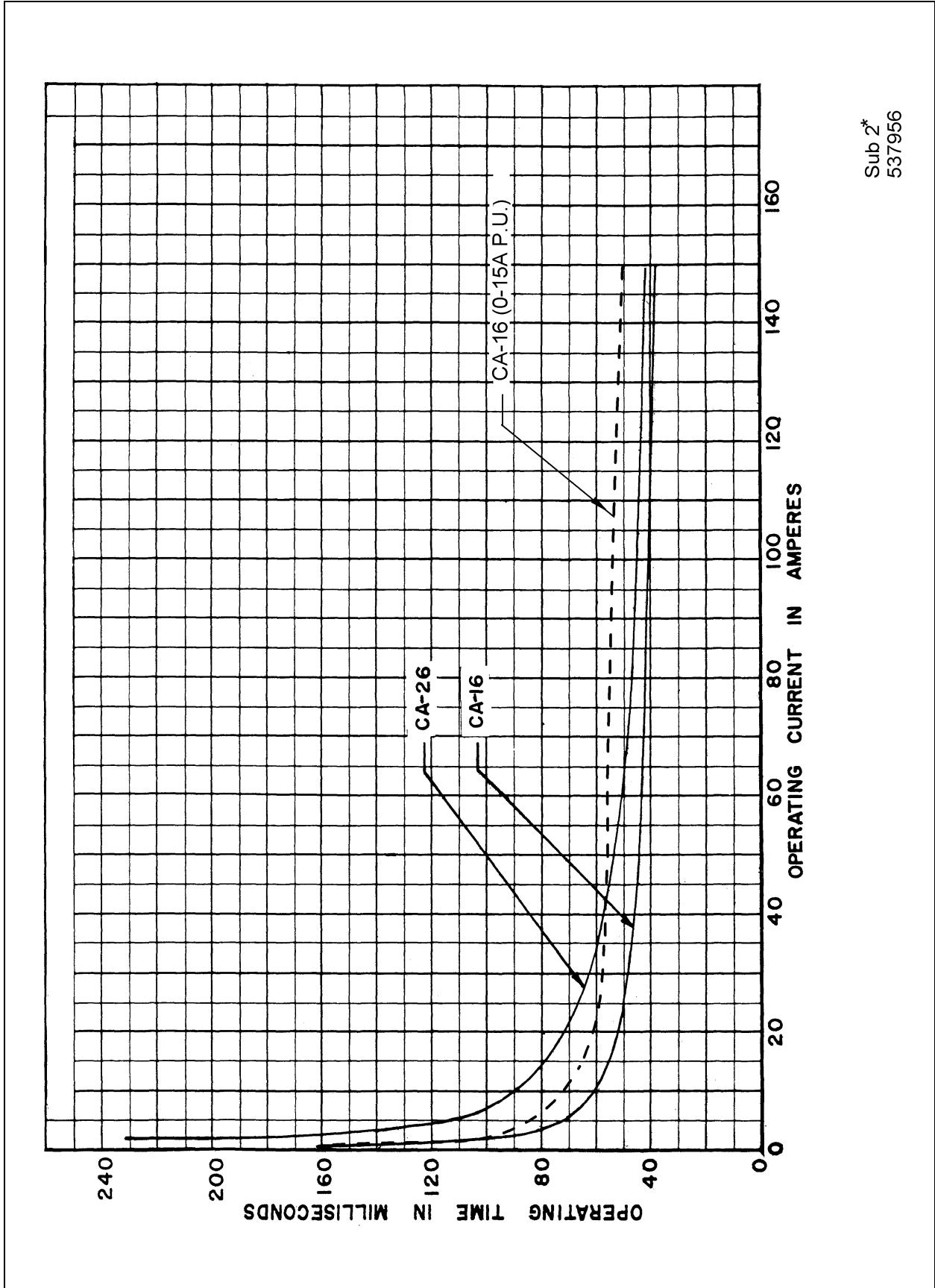

Sub 2\*  
537956

Figure 4. Typical Time Curves of the CA-16 Differential Relay



Curve 537957

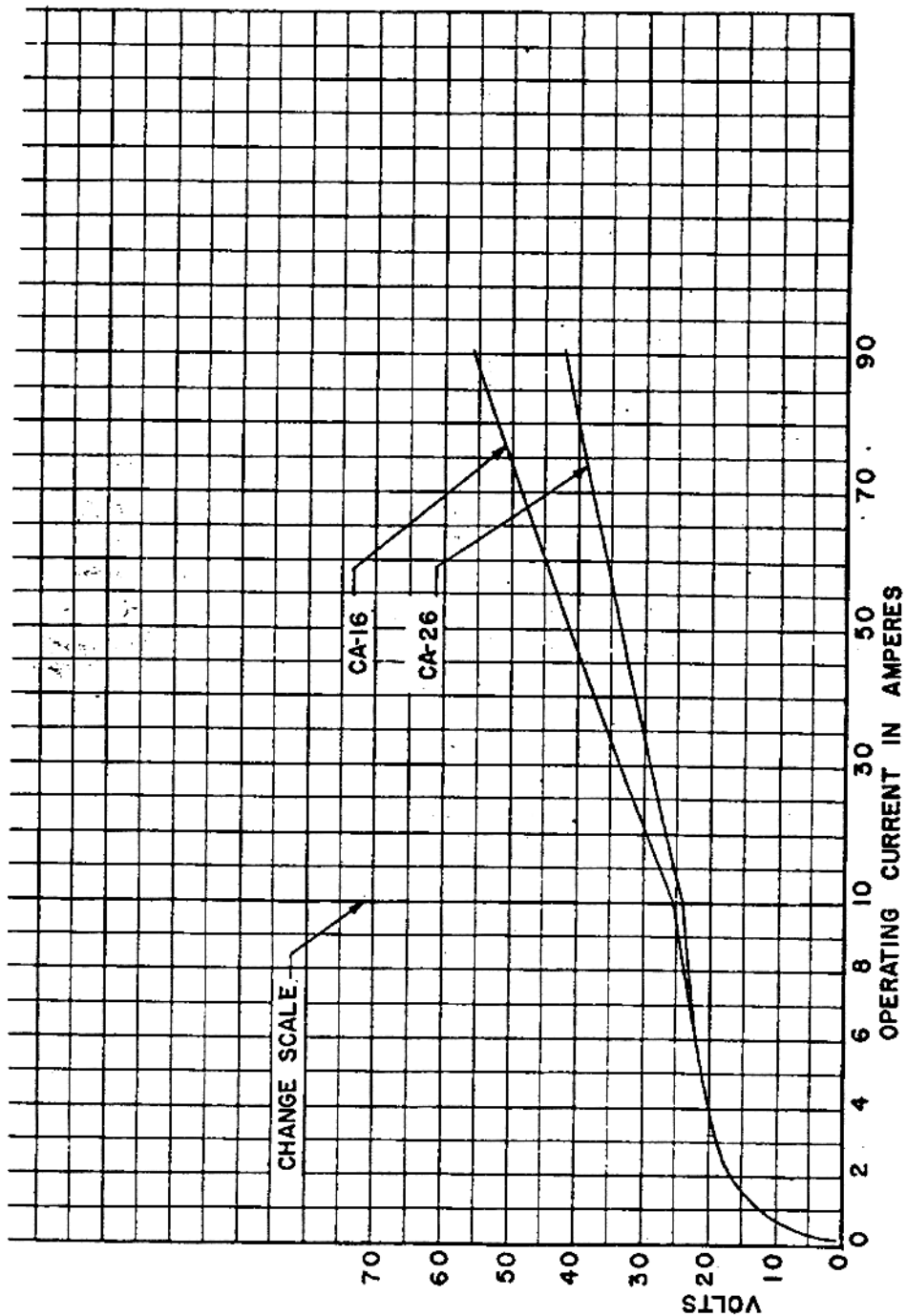

Figure 5. Typical Burden Characteristics of the Types CA-16 and CA-26 Relays

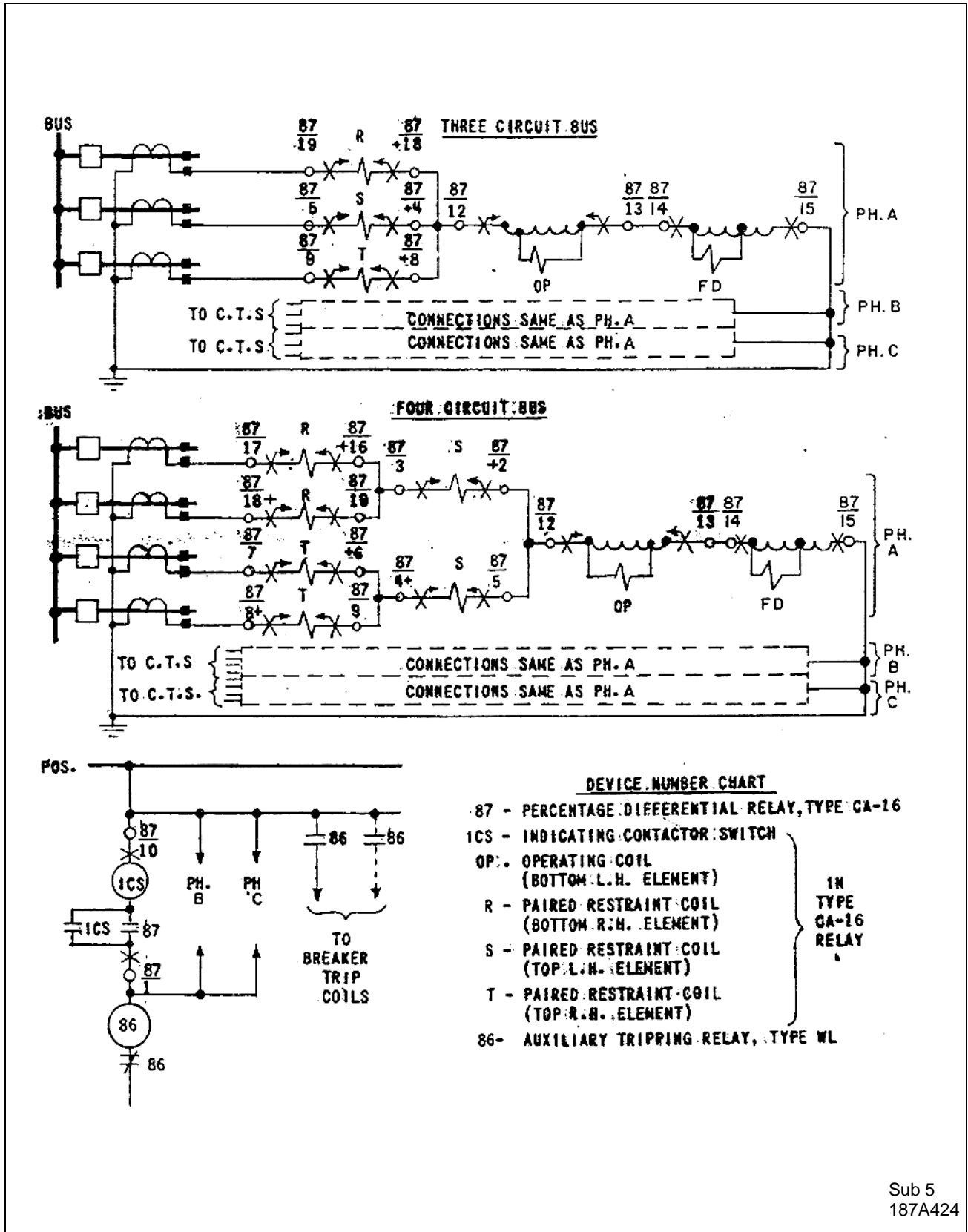

Figure 6. External Schematic of One Set of Type CA-16 Relays for the Protection of a Three and Four Circuit Bus

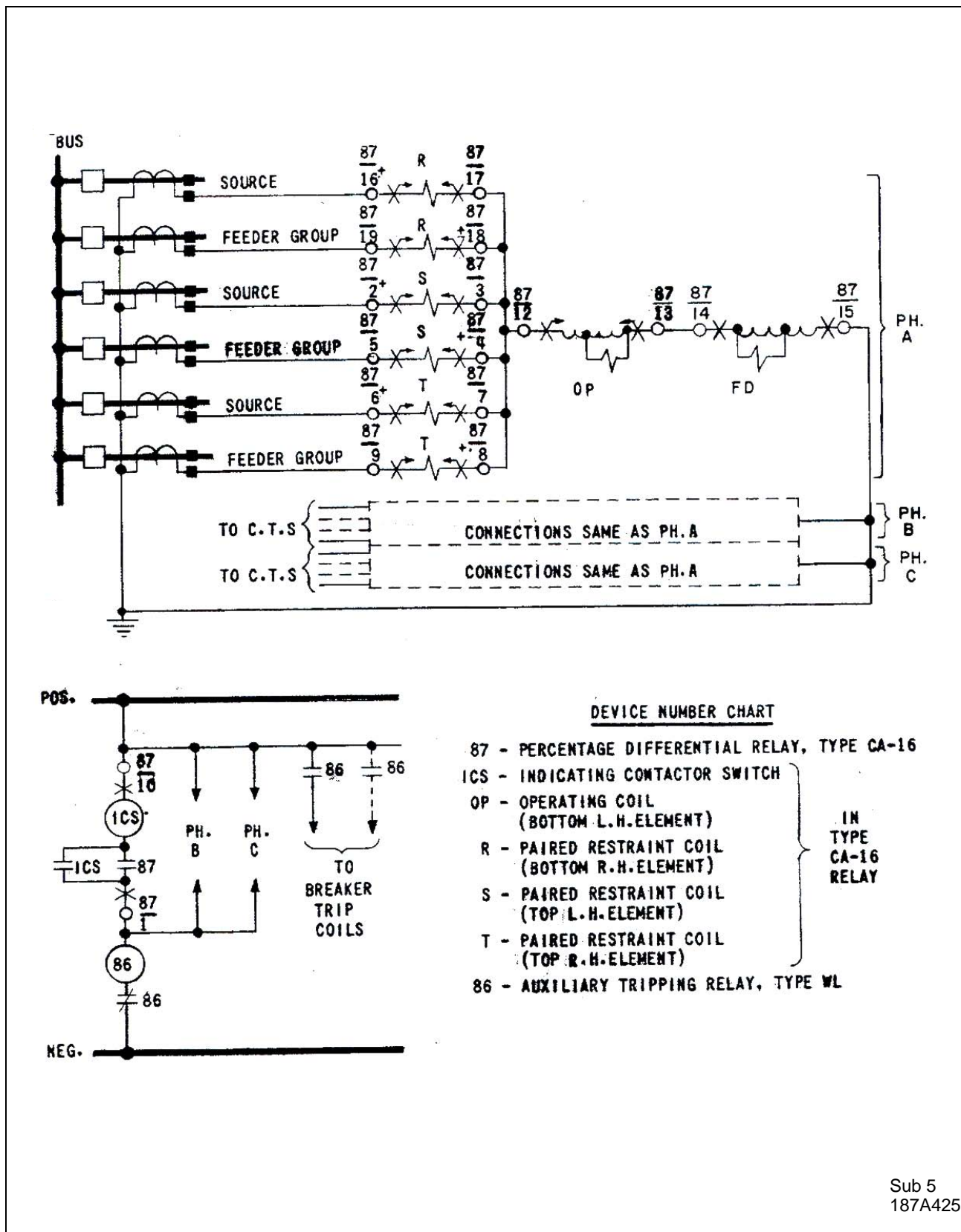
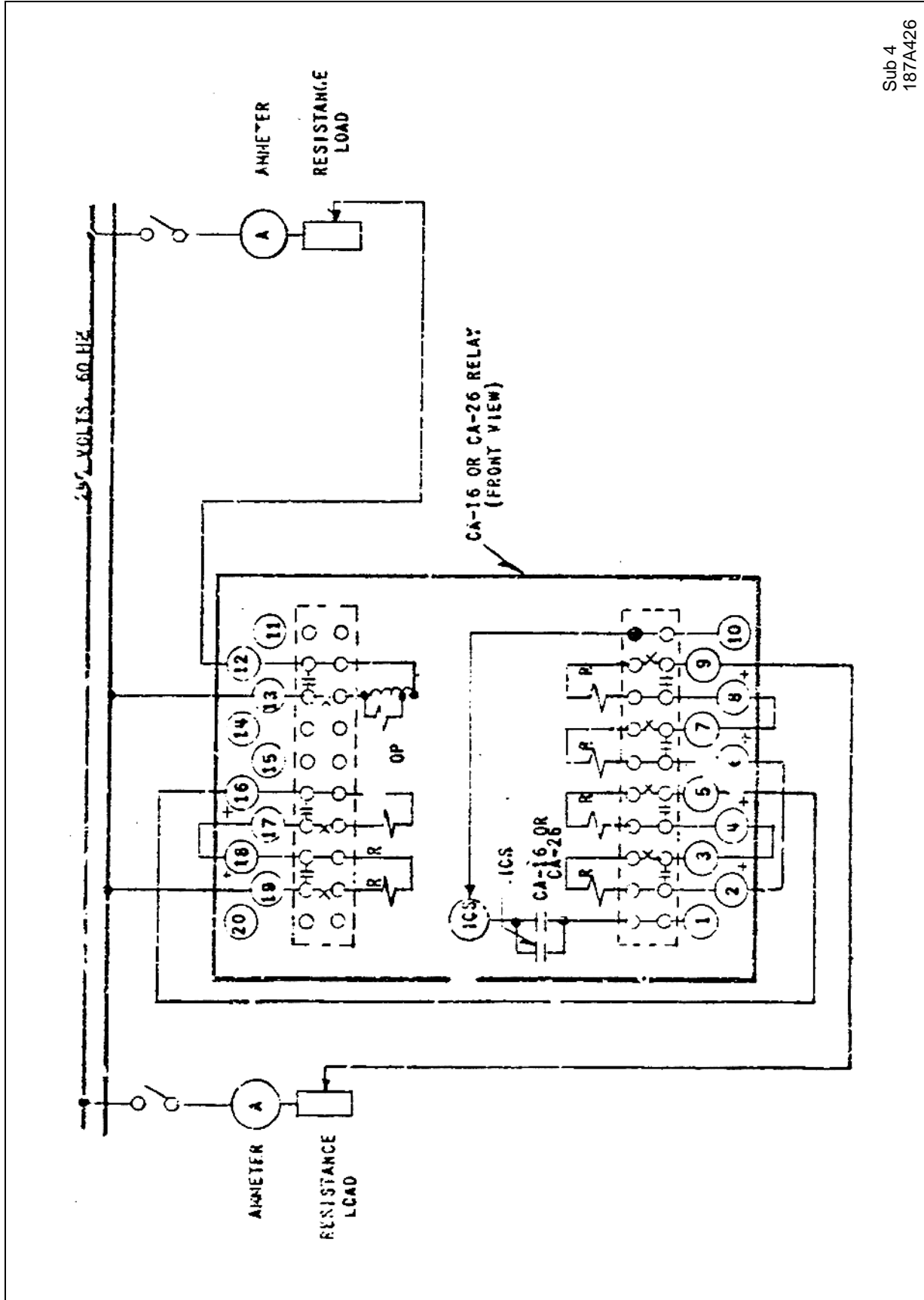
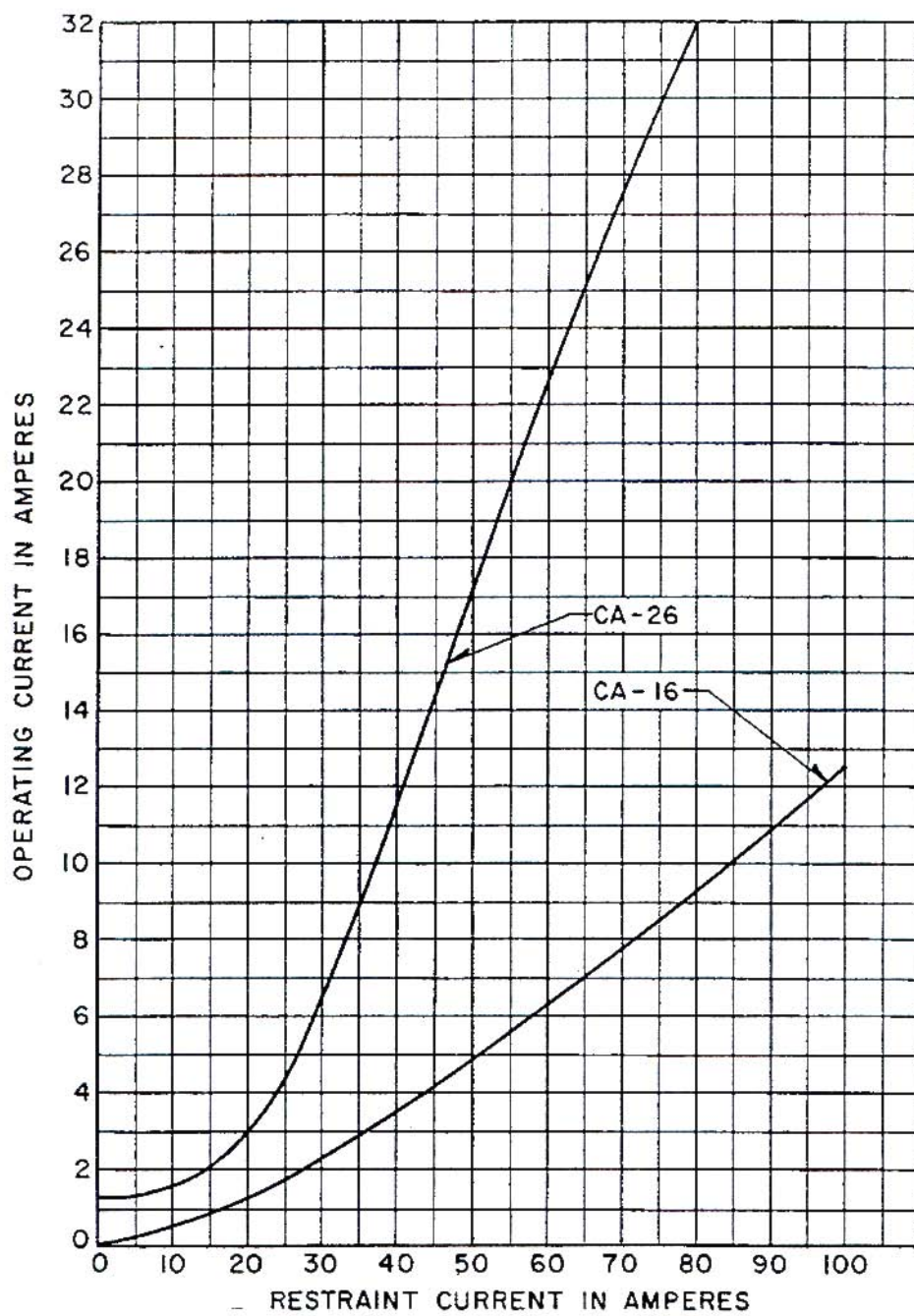

Figure 7. External Schematic of the Type CA-16 Relays for Protection of Six Circuit Bus with Three Feeder Groups



Sub 4  
187A426

Figure 8. Diagram of Test Connections for the CA-16 Relay



Sub 1  
849A450

Figure 9. Percentage Slope Curve of the CA-16 Relay with One Restraint Winding

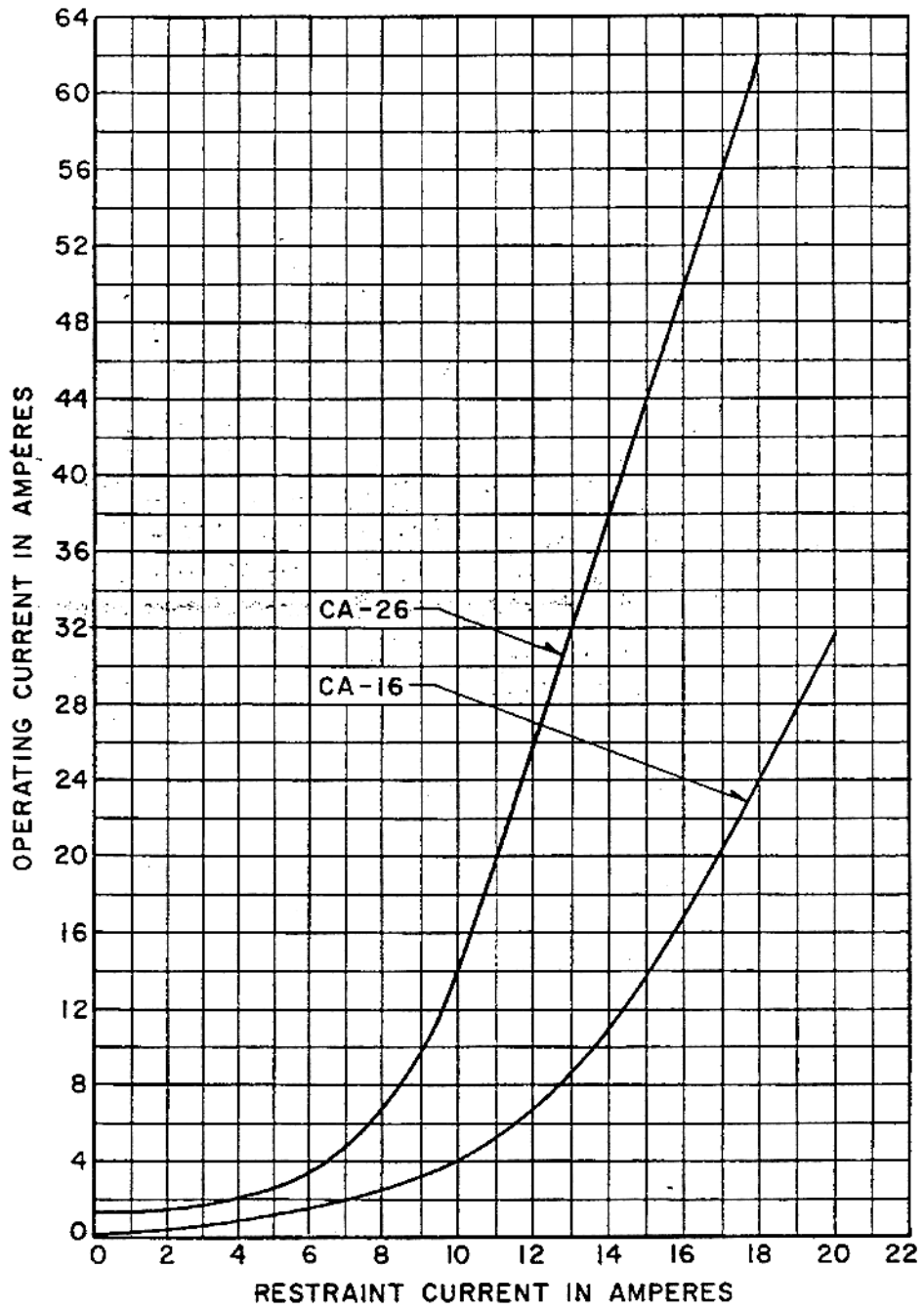

Sub 2  
849A343

Figure 10. Percentage Slope Curve of the CA-16 Relay with Six Restraint Windings in Series

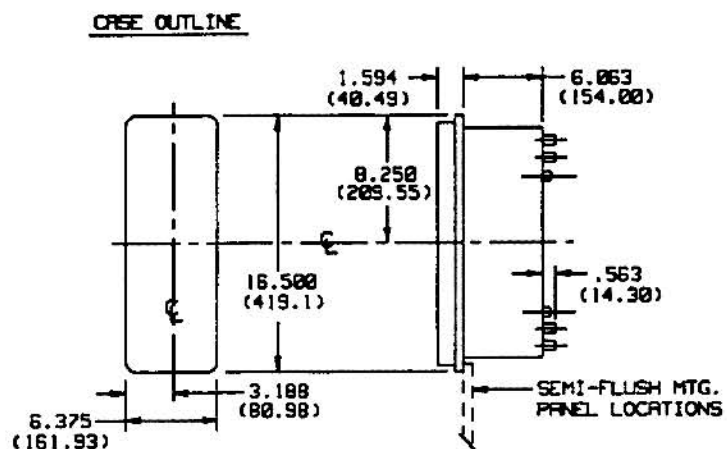

PANEL DRILLING AND CUTOUT  
FOR SEMI-FLUSH MTG.

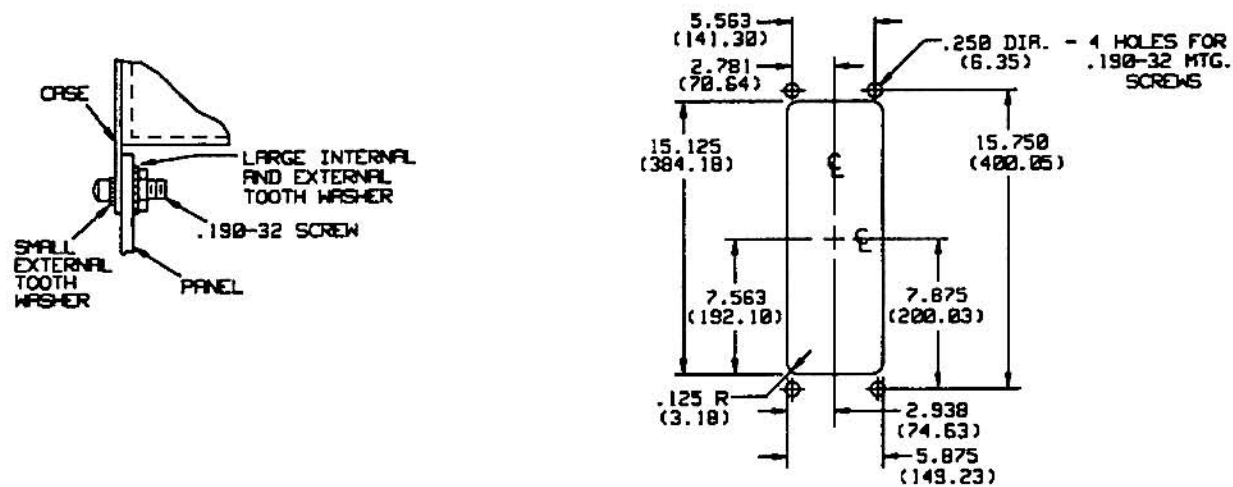

Sub 1  
3519A69

Figure 11. Outline and Drilling for the CA-16 Relay in FT-32 Case



ABB Inc.

4300 Coral Ridge Drive  
Coral Springs, Florida 33065

Telephone: +1 954-752-6700

Fax: +1 954-345-5329

[www.abb.com/substation\\_automation](http://www.abb.com/substation_automation)

IL 41-337.31 - Revision C