



## Instruction Manual

*Enjoy it.*

TravelPilot 43 / 53 / 73  
TravelPilot 54 / 74



**User's Guide**  
**Navigation-Software**  
**Blaupunkt Travel Pilot**  
**English**

**Thank you for buying the Blaupunkt navigation system. A good choice.**

**We wish you a lot of fun and congestion-free kilometres with your new Blaupunkt navigation system. In the worst case we will help you.**

**For technical questions / problems, please contact us: [support@first-servicecenter.de](mailto:support@first-servicecenter.de), [facebook.com/BlaupunktDACH](https://facebook.com/BlaupunktDACH), [www.blaupunkt.de](http://www.blaupunkt.de)**

**The full manual for other languages or additional manuals (depending on your model) can be downloaded at [www.blaupunkt.de](http://www.blaupunkt.de)**

**Please register your product as soon as possible on our website. This will give you benefits such as latest software and the latest map data, etc. – Most of it, of course, for free.**

## Dear Customer,

Thanks for using a navigation system of Blaupunkt.

- Blaupunkt reserves the rights of final interpretation of the manual.
- The product is subject change without notice. Please accept our apology for your inconvenience.
- Please back up your data and information in the GPS navigator. Blaupunkt assumes no responsibility for any loss caused by material loss.
- The manual might contain a few mistakes though it has been checked. If any mistake is found, please contact the Blaupunkt customer service center. Please read the instructions in this manual and use only accessories of Blaupunkt to avoid unpredicted damage. Failure to follow the instructions will invalidate warranty and might endanger personnel safety, for which Blaupunkt assumes no responsibility.
- Data of navigation electronic maps might be inconsistent with actual traffic signals due to transportation development. Please follow traffic regulations and signs and drive according to road situation. Operating the GPS navigator device while driving might cause serious accidents. Blaupunkt assumes no responsibility for accidents and loss due to improper use.
- For information of software update and upgrade, please go to our website **[www.blaupunkt.de](http://www.blaupunkt.de)**

**In case that your navigation-system contains a built-in TMC-receiver for reception of traffic-information, its antenna is integrated into car-charge-cable. For correct reception of traffic-information, the car-charger needs to be connected to the USB-port of the navigation-system!**

**Please use your device to operate ONLY a blunt stylus or fingertip. The screen surface is easily scratched. To operate any sharp objects or long fingernails.**

For your own safety, do not operate the controls of the product while driving.

Use this product prudently. The product is intended to be used only as a navigation aid. It is not for precise measurement of direction, distance, location or topography.

The calculated route is for reference only. It is the user's responsibility to follow the traffic signs and local regulations along the road.

When you get off the car, do not leave your device on the dashboard that is subject to direct sunlight. The overheating of the battery can cause malfunction and /or danger.

GPS is operated by the United States government, which is solely responsible for the performance of GPS.

Any change to the GPS system can affect the accuracy of all GPS equipments.

GPS satellite signal can not pass through solid materials (except glass). When you are inside a tunnel or building, GPS positioning is not available.

A minimum of 4 GPS satellite signal is needed to determine current GPS position. Signal reception can be affected by situations such as bad weather or dense overhead obstacles (e.g. trees and tall buildings).

Other wireless devices in the vehicle might interface with the reception of satellite signals and cause the reception to be unstable.

A car holder is needed when using the device in a car. Be sure to place the device in an appropriate place, so as not to obstruct the driver's view or deployment of air bag.

## Table of contents

<b>1 Warnings and Safety information .....</b>	<b>6</b>
<b>2 Getting started.....</b>	<b>7</b>
2.1 <i>Navigation menu</i> .....	8
2.2 <i>Buttons and other controls on the screen</i> .....	9
2.2.1 Using keyboards .....	10
2.2.2 Beyond single screen tap .....	11
2.3 <i>Map screen</i> .....	12
2.3.1 Navigating on the map.....	12
2.3.2 Position markers .....	14
2.3.2.1 <i>Vehimarker and Lock-on-Road</i> .....	14
2.3.2.2 <i>Selected map location (Cursor) and selected map object</i> .....	14
2.3.3 Objects on the map .....	14
2.3.3.1 <i>Streets and roads</i> .....	14
2.3.3.2 <i>Turn preview and Next street</i> .....	15
2.3.3.3 <i>Lane information and Signposts</i> .....	16
2.3.3.4 <i>Junction view</i> .....	17
2.3.3.5 <i>Motorway exit services</i> .....	17
2.3.3.6 <i>3D object types</i> .....	17
2.3.3.7 <i>Elements of the active route</i> .....	18
2.3.3.8 <i>Traffic events</i> .....	19
2.3.4 Manipulating the map .....	20
2.3.5 Quick menu.....	21
2.3.6 Checking the details of the current position (Where Am I?) .....	24
<b>3 On-road navigation .....</b>	<b>26</b>
3.1 <i>Selecting the destination of a route</i> .....	26
3.1.1 Combined Search.....	26
3.1.1.1 <i>Combined Search - Navigating to a recent destination (History)</i> .....	29
3.1.1.2 <i>Combined Search - Navigating to a Favourite destination</i> .....	30
3.1.1.3 <i>Combined Search - Navigating to an address</i> .....	30
3.1.1.4 <i>Combined Search - Navigating to an intersection</i> .....	31
3.1.1.5 <i>Combined Search - Navigating to a Place of Interest</i> .....	32
3.1.1.6 <i>Combined Search - Navigating to a Place of Interest by its category</i> .....	33
3.1.2 Entering an address or a part of the address.....	34
3.1.2.1 <i>Entering an address</i> .....	34
3.1.2.2 <i>Entering the midpoint of a street as the destination</i> .....	37
3.1.2.3 <i>Selecting an intersection as the destination</i> .....	38
3.1.2.4 <i>Selecting a city/town centre as the destination</i> .....	39
3.1.2.5 <i>Entering an address with a postal code</i> .....	41
3.1.2.6 <i>Tips on entering addresses quickly</i> .....	43
3.1.3 Selecting the destination from the Places of Interest .....	43
3.1.3.1 <i>Quick search for a Place of Interest</i> .....	44

3.1.3.2 Searching for a Place of Interest using preset categories.....	45
3.1.3.3 Searching for a Place of Interest by category.....	47
3.1.3.4 Searching for a Place of Interest by name.....	50
3.1.3.5 Selecting nearby assistance from 'Where Am I?'.....	52
3.1.4 Selecting a map location as the destination.....	54
3.1.5 Selecting the destination from your Favourites.....	55
3.1.6 Selecting one of the most likely destinations (Smart History).....	56
3.1.7 Selecting a recent destination from the History.....	57
3.1.8 Entering the coordinate of the destination.....	58
3.1.9 Navigate to a location stored in a photo.....	59
3.1.10 Building a route from the list of destinations (Create Route).....	60
3.2 Viewing the entire route on the map.....	61
3.3 Checking route parameters and accessing route related functions.....	61
3.4 Modifying the route.....	62
3.4.1 Selecting a new destination when already having a route: New Route, Waypoint or Final Destination.....	62
3.4.2 Setting a new starting position for the route.....	63
3.4.3 Editing the list of destinations (Edit Route).....	64
3.4.4 Pausing the active route.....	65
3.4.5 Cancelling the active route.....	65
3.4.6 Checking route alternatives when planning the route.....	66
3.4.7 Checking route alternatives for an existing route.....	67
3.4.8 Changing the vehicle used in route planning.....	68
3.4.9 Changing the road types used in route planning.....	69
3.5 Saving a location as a Favourite destination.....	70
3.5.1 Editing the details of a Favourite destination.....	71
3.6 Saving a map location as an alert point.....	72
3.7 Editing an alert point.....	73
3.8 Watching the simulation of the route.....	74
<b>4 Off-road navigation.....</b>	<b>76</b>
4.1 Selecting the destination of the route.....	76
4.2 Navigating in off-road mode.....	76
<b>5 Lorry navigation.....</b>	<b>77</b>
5.1 Setting up vehicle parameters.....	77
5.2 Setting up waiting time at waypoints.....	79
5.3 Setting up driving time alerts.....	80
<b>6 Reference Guide.....</b>	<b>81</b>
6.1 Concepts.....	81
6.1.1 Smart Zoom.....	81
6.1.2 Daytime and night colour themes.....	81
6.1.3 Route calculation and recalculation.....	81

6.1.4 Green routing.....	83
6.1.5 Road safety cameras and other proximity alert points .....	84
6.1.6 Speed limit warning .....	85
6.1.7 GPS position quality indicator .....	85
6.1.8 Traffic information in route planning .....	86
6.1.8.1 Historical traffic .....	86
6.1.8.2 Real-time traffic information (TMC).....	87
6.2 'More' menu.....	88
6.3 Settings menu .....	89
6.3.1 Sound and Warnings.....	90
6.3.2 Customise Quick menu .....	92
6.3.3 Driving time management .....	93
6.3.4 Traffic settings .....	93
6.3.5 Route settings.....	94
6.3.6 User profiles.....	98
6.3.7 Map settings.....	98
6.3.8 Visual guidance settings .....	99
6.3.9 Display settings.....	101
6.3.10 Regional settings.....	101
6.3.11 Trip monitor settings.....	102
6.3.12 Log collection settings .....	102
<b>7 Glossary.....</b>	<b>103</b>
<b>8 End User Licence Agreement.....</b>	<b>105</b>
<b>9 Copyright note.....</b>	<b>111</b>

## 1 Warnings and Safety information

The navigation system helps you find your way to your destination with the built-in GPS receiver. TravelPilot does not transmit your GPS position; others cannot track you.

If you accept it when first using the application, TravelPilot collects usage information and GPS logs that may be used for improving the application and the quality and coverage of maps. The data is processed anonymously; no one will be able to track any personal information. If you change your mind later, you can enable or disable the log collection in Settings (page 102).

It is important that you look at the display only when it is safe to do so. If you are the driver of the vehicle, we recommend that you operate TravelPilot before you start your journey. Plan the route before your departure and stop if you need to change the route.

You must obey the traffic signs and follow the road geometry. If you deviate from the recommended route, TravelPilot changes the instructions accordingly.

Never place TravelPilot where it obstructs the driver's view, where it is in the deployment zone of an airbag or where it might cause injuries in an accident.

For more information, consult the End User Licence Agreement (page 105).

## Components

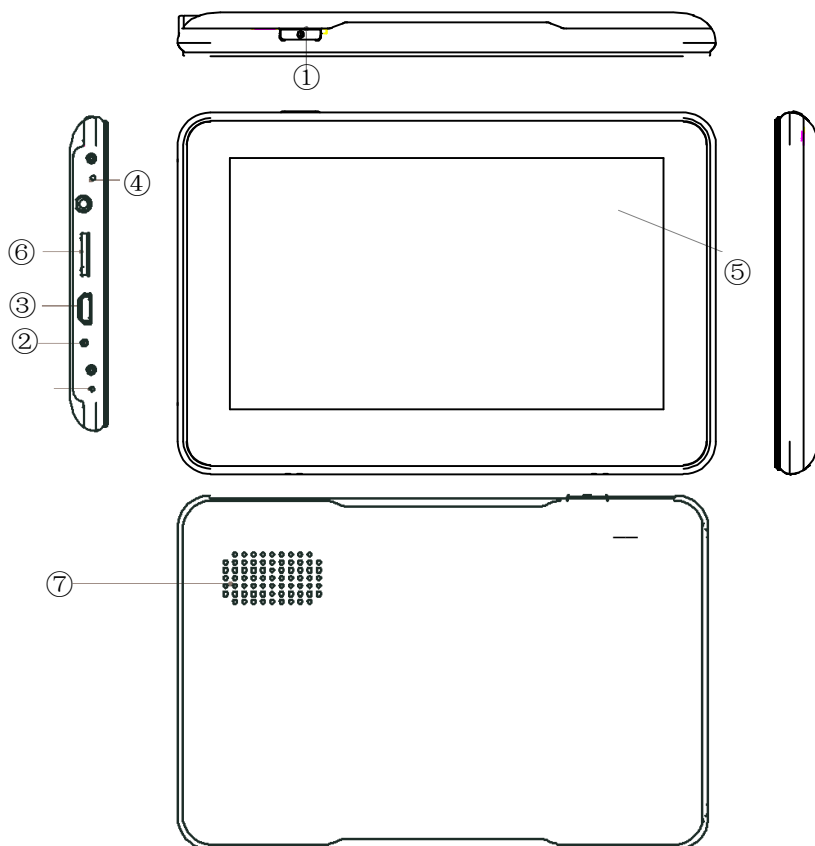

SN	Component	Explanation
1	Power key	Powering on/ off the device or enter sleep mode
2	Reset key	Restart the system
3	USB Port	Exchanging data over MINI USB cable. Charge the GPS
4	Power Indicator	The light is red during charging, it will turn green when the battery is fully charged.
5	Display	Map and control elements
6	Micro-SD slot	For inserting an optional flash-memory-card
7	Speaker	

## 2 Getting started

TravelPilot is optimised for in-car or pedestrian use. There is no need to use a stylus. You can use it easily by tapping the screen buttons and the map with your fingertips.

When using the navigation software for the first time, an initial setup process starts automatically. Do as follows:

1. Select the written language of the application interface. Later you can change it in Regional settings (page 101).



2. Read the End User Licence Agreement. Tap  to continue.

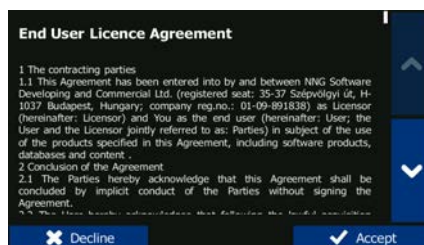

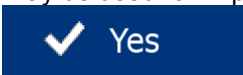
3. You are now asked whether you allow the software to collect usage information and GPS logs that may be used for improving the application and the quality and coverage of maps. Tap  to allow the anonymous statistics or disable this function. Later you can turn them on or off individually in Log collection settings (page 102).

4. The Configuration wizard starts. Tap  to continue.

5. Select the language and speaker used for voice guidance messages. Later you can change it in Sound and Warnings settings (page 101).



6. If needed, modify the time format and unit settings. Later you can change them in Regional settings (page 101).

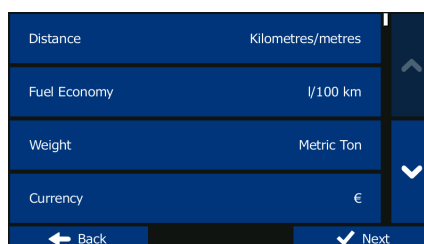



- If needed, modify the default route planning options. Later you can change them in Route settings (page 94).



- The initial setup is now complete. The Configuration wizard can be restarted later from the Settings menu (page 89).







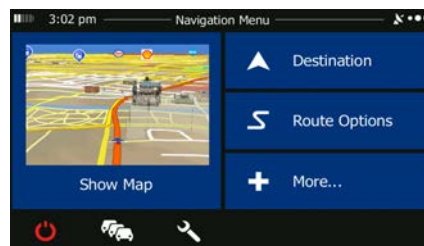

After the initial setup, the Navigation menu appears and you can start using TravelPilot.

## 2.1 Navigation menu

You can reach all parts of TravelPilot from the Navigation menu.



You have the following options:







- 
 Tap **Destination** to select your destination by entering an address or selecting a place of interest, a location on the map or one of your Favourite destinations. You can also look up your recent destinations from the Smart History or enter a coordinate.
- 
 Tap **Route Options** to display the route parameters and the route in its full length on the map. You can also perform route-related actions such as editing or cancelling your route, setting a start point for the route, picking route alternatives, avoiding parts of the route, simulating navigation or adding the destination to your Favourites.
- 
 Tap **More...** to simulate demo routes or to run some additional applications.
- 
 Tap  to customise the way the navigation software works.
- 
 Tap **Show Map** to start navigating on the map. The button itself is a miniature live map that shows your current position, the recommended route and the surrounding map area. Tap the button to enlarge the map to the full screen.
- 
 Tap  to open the Traffic Summary screen.



- Tap  to stop navigation and exit the software.

## 2.2 Buttons and other controls on the screen

When you are using TravelPilot, you usually tap buttons on the touch screen.





You only need to confirm selections or changes if the application needs to restart, it needs to perform a major reconfiguration, or you are about to lose some of your data or settings. Otherwise, TravelPilot saves your selections and applies the new settings without confirmation as soon as you use the controls.





Type	Example	Description	How to use it
Button		Tap it to initiate a function, to open a new screen, or to set a parameter.	Tap it once.
Button with value		Some buttons display the current value of a field or setting. Tap the button to change the value. After the change, the new value is shown on the button.	Tap it once.
Icon		Shows status information.	Some icons also function as a button. Tap them once.
List		When you need to select from several options, they appear in a list.	Grab the list anywhere and slide your finger up or down. Depending on the speed of the sliding, the list will scroll fast or slow, only a bit or till the end.  Alternatively, move between pages with the  and  buttons and tap the value that you want.
Radio button		When there are only a few choices, radio buttons may be used instead of lists. Only one value can be selected.	Tap one of the buttons to select a new value.

Switch		When there are only two choices, a checkmark shows whether the feature is enabled.	Tap it to turn the switch on or off.
Slider		When a feature can be set to different values in a range, TravelPilot shows an indicator on a gauge that displays and sets the value.	<ul style="list-style-type: none"> <li>• Drag the handle to move the slider to its new position.</li> <li>• Tap the slider where you want the handle to appear; the thumb jumps there.</li> </ul>
Virtual keyboard		Alphabetic and alphanumeric keyboards to enter text and numbers.	Each key is a touch screen button.

### 2.2.1 Using keyboards











You only need to enter letters or numbers when you cannot avoid it. You can type with your fingertips on the full-screen keyboards and you can switch between various keyboard layouts, for example English, Greek or numerical.

Task	Instruction
Switching to another keyboard layout, for example from an English keyboard to a Greek keyboard	Tap the  button and select the new keyboard layout from the list.
Correcting your entry on the keyboard	Tap  to remove the unneeded character(s). Tap and hold the button to delete several characters or the entire input string.
Entering a space, for example between a first name and a family name or in multi-word street names	Tap the  button at the bottom centre of the screen.
Entering upper and lower case letters	When entering a text, the first character appears in upper case while the rest of the text is in lower case. Tap  to enter an upper case letter or tap twice to turn on Caps Lock. Tap again and lower case letters return.
Entering numbers and symbols	Tap  to switch to a keyboard offering numeric and symbol characters.

Finalising the keyboard entry (accepting the suggested search result)	Tap 
Finalising the keyboard entry (opening the list of search results)	Tap 
Finalising the keyboard entry (saving your input)	Tap 
Cancelling the keyboard entry (returning to the previous screen)	Tap 

### 2.2.2 Beyond single screen tap

You usually need to tap the screen only once. However, some useful features can be accessed with combined touch screen tapping. Those are the following:

Action	Details
Tapping and holding the screen	<p>Tap and keep pressing the following buttons to reach extra functions:</p> <ul style="list-style-type: none"> <li>• Tap and hold  on list and menu screens: the Map screen appears.</li> <li>• Tap and hold any of the , , , , , and  buttons on the Map screen: you can rotate, tilt or scale the map continuously.</li> <li>• Tap and hold  on keyboard screens: you can delete several characters quickly.</li> <li>• Tap and hold  or  in long lists: you can scroll pages continuously.</li> </ul>
Gestures (drag&drop)	<p>You need to drag and drop the screen only in cases like:</p> <ul style="list-style-type: none"> <li>• Moving the handle on a slider.</li> <li>• Scrolling the list: grab the list anywhere and slide your finger up or down. Depending on the speed of the sliding, the list will scroll fast or slow, only a bit or till the end.</li> <li>• Moving the map in map browsing mode: grab the map, and move it in the desired direction.</li> </ul>

## 2.3 Map screen

### 2.3.1 Navigating on the map

The Map screen is the most frequently used screen of TravelPilot.

A small live map is displayed on the Navigation menu, as a part of the

Show Map

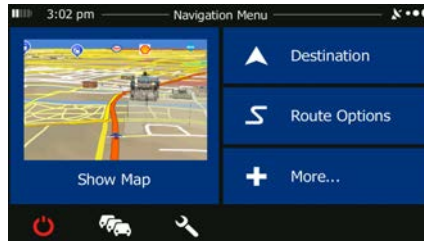

Please NOTE that the map screen can be different depending on the model (for example, 3D buildings)

Show Map

To enlarge this small map and open the Map screen, tap

This map shows the current position (the Vehimarker, a blue arrow by default), the recommended route (an orange line), and the surrounding map area.

When there is no GPS position, the Vehimarker is transparent. It shows your last known position.

You see coloured dots circling around a satellite symbol in the top left corner. The more green dots you see, the closer you are to get the valid GPS position.

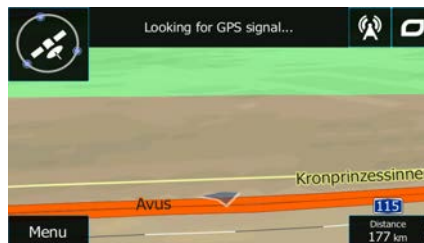

When GPS position is available, the Vehimarker is displayed in full colour, now showing your current position.



Please NOTE that the map screen can be different depending on the model (for example, 3D buildings)

There are screen buttons and data fields on the screen to help you navigate. During navigation, the screen shows route information.

The  button gives quick access to frequently used functions. You can change the available functions in Settings.

By default, only one data field is displayed in the bottom right corner. Tap this field to see all route data fields. Tap any of the data fields to suppress others and display only the selected one.



The data fields are different when you are navigating an active route and when you have no specified destination (the orange line is not displayed).

Default data fields when cruising without a destination (tap and hold any of the fields to change its value):

Field	Description
<b>Speed</b> <b>19</b> km/h	Shows your current speed given by the GPS receiver.
<b>Speed Limit</b> <b>45</b> km/h	Shows the speed limit of the current road if the map contains it.
<b>Time</b> <b>17:11</b>	Shows the current time corrected with time zone offset. The accurate time comes from the GPS satellites, and the time zone information comes from the map or it can be set manually in Regional settings.  (The current time is always displayed in the top left corner of menu screens.)

Default data fields when navigating a route (tap and hold any of the fields to change its value):

Field	Description
<b>Distance</b> <b>16.9</b> km	Shows the distance you need to travel on the route before reaching your final destination.
<b>Time left</b> <b>0:16</b>	Shows the time needed to reach the final destination of the route based on information available for the remaining segments of the route.  If TravelPilot is capable of receiving live traffic information, the calculation takes into account traffic delays affecting your route if they are received. However, this calculation is rarely accurate.  Historical traffic data can also be taken into account if data is available.
<b>Arrival Time</b> <b>17:22</b>	Shows the estimated arrival time at the final destination of the route based on information available for the remaining segments of the route.  If TravelPilot is capable of receiving live traffic information, the calculation takes into account traffic delays affecting your route if they are received. However, this calculation is rarely accurate.  Historical traffic data can also be taken into account if data is available.

## 2.3.2 Position markers

### 2.3.2.1 Vehimarker and Lock-on-Road

When your GPS position is available, TravelPilot marks your current position with the Vehimarker. By default, this marker is a blue arrow, but you can change this icon in Settings.

The exact location of the Vehimarker depends on the vehicle type used for route calculation and the navigation mode. Both can be set in Route settings (page 94).

- If you choose pedestrian and/or off-road navigation: The Vehimarker is at your exact GPS position. The direction of the icon shows your current heading.
- In all other cases: The Vehimarker may not show your exact GPS position and heading. If roads are near, it is aligned to the nearest road to suppress GPS position errors, and the direction of the icon is aligned to the direction of the road.

### 2.3.2.2 Selected map location (Cursor) and selected map object

You can mark a map location in the following ways:

- Tap the map when navigating,
- Tap the map when you are asked to confirm the destination at the end of a search, or
- Tap the map in Find on Map (page 54)

When a map location is selected, the Cursor appears at the selected point on the map. The

Cursor is displayed with a radiating red dot (  ) to make it visible at all zoom levels.

The location of the Cursor can be used as the destination of the route, a new alert point, you can search for Places around it, or you can save this location as one of your Favourite destinations.

You can also select some of the objects on the map. If you tap the map at the icon of a Place of Interest or an alert point, the object will be selected (you see a red circling border around the object), and you can get information about this object or use it as a route point.

## 2.3.3 Objects on the map

### 2.3.3.1 Streets and roads

TravelPilot shows the streets in a way that is similar to how the paper road maps show them. Their width and colours correspond to their importance: you can easily tell a motorway from a small street.

### 2.3.3.2 Turn preview and Next street

When navigating a route, the top section of the Map screen shows information about the next route event (manoeuvre) and the next street or the next city/town.



Please NOTE that the map screen can be different depending on the model (for example, 3D buildings)









There is a field in the top left corner that displays the next manoeuvre. Both the type of the event (turn, roundabout, exiting motorway, etc.) and its distance from the current position are displayed.

A smaller icon shows the type of the second next manoeuvre if it is near the first one. Otherwise, only the next manoeuvre is displayed.









Please NOTE that the map screen can be different depending on the model (for example, 3D buildings)

Most of these icons are very intuitive. The following table lists some of the frequently shown route events. The same symbols are used in both fields:

Icon	Description
	Turn left.
	Turn right.
	Turn back.
	Bear right.
	Turn sharp left.
	Keep left.
	Continue straight in the intersection.
	Go left on the roundabout, 3rd exit (next manoeuvre).
	Enter roundabout (second next manoeuvre).



	Enter motorway.
	Exit motorway.
	Board ferry.
	Leave ferry.
	Approaching a waypoint.
	Approaching the destination.

### 2.3.3.3 Lane information and Signposts

When navigating on multilane roads, it is important to take the appropriate lane in order to follow the recommended route. If lane information is available in the map data, TravelPilot displays the lanes and their directions using small arrows at the bottom of the map. Highlighted arrows represent the lanes and direction you need to take.

Where additional information is available, signposts substitute arrows. Signposts are displayed at the top of the map. The colour and style of the signposts are similar to the real ones you can see above road or by the roadside. They show the available destinations and the number of the road the lane leads to.

All signposts look similar when cruising (when there is no recommended route). When navigating a route, only the signpost that points to the lane(s) to be taken is displayed in vivid colours; all others are darker.

If you want to hide the currently displayed signposts, tap any of them and the normal Map screen returns until new signpost information is received.

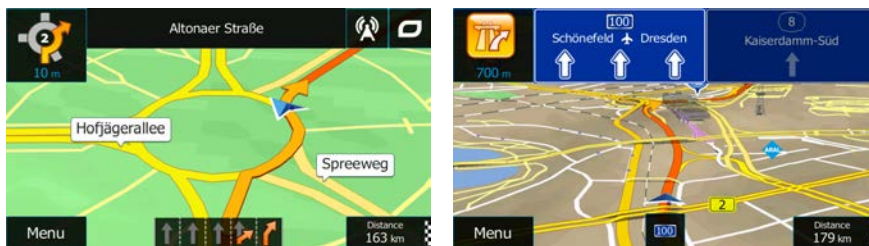

### 2.3.3.4 Junction view

If you are approaching a motorway exit or a complex intersection and the needed information exists, the map is replaced with a 3D view of the junction. The lanes you need to take are displayed with arrows. At the top of the screen road signs show you additional information.

If you want to hide the currently displayed junction, tap the picture and the Map screen returns.



### 2.3.3.5 Motorway exit services

You may need a petrol station or a restaurant during your journey. This feature displays a new button on the map when you are driving on motorways.



Tap this button to open a panel with the details of the next few exits or service stations.



Tap any of them to display the exit area on the map. You can now easily add this exit as a waypoint to your route if needed.

If you want to display other types of Places for the exits, you can change the icons in Visual Guidance settings (page 99).

### 2.3.3.6 3D object types



Daiichi Hyundai i10 supports the following 3D object types:

Type	Description
3D terrain	3D terrain map data shows changes in terrain, elevations or depressions in the land when you view the map in 2D, and use it to plot the route map in 3D when you navigate. Hills and mountains are shown in the background of the 3D map, and illustrated by colour and shading on the 2D map.

Elevated roads	Complex intersections and vertically isolated roads (such as overpasses or bridges) are displayed in 3D.
3D landmarks	Landmarks are 3D artistic or block representations of prominent or well-known objects.
3D buildings	3D block representation of full city building data containing actual building size and position on the map.

### 2.3.3.7 Elements of the active route

Daiichi Hyundai i10 shows the route in the following way:



Symbol	Name	Description
	Current GPS position and Start point	<p>Your current position displayed on the map.</p> <ul style="list-style-type: none"> <li>• In pedestrian mode it is the exact GPS position.</li> <li>• If a vehicle is selected for route calculation and roads are near, the symbol is snapped onto the nearest road.</li> </ul> <p>Normally if GPS position is available, the route starts from the current position. If there is no valid GPS position, TravelPilot uses the last known position as the start point.</p>
	Waypoint (intermediate destination)	An intermediate destination of the route before reaching the final destination.
	Destination (end point)	The final destination of the route.
	Route colour	The route always stands out with its colour on the map, both in daytime and in night colour mode.
	Streets and roads that are excluded from the navigation	You can choose whether you want to use or avoid certain road types (page 94). However, when TravelPilot cannot avoid such roads, the route will include them and it will show them in a colour that is different from the route colour.
	Streets and roads that are affected by traffic events	Road segments may be affected by traffic events received. These streets and roads are displayed in an alternate colour, and small symbols displayed along the route show the type of the traffic event.

### 2.3.3.8 Traffic events

Road segments affected by traffic events are displayed with an alternate colour on the map, and small symbols above the road show the nature of the event:





One of the following icons is displayed on the right side of the screen:

-  When there is an event on your route, the icon shows the type of the next traffic event.
-  Traffic information is received, but there are no events affecting your route.
-  Traffic information is not received.

1. Tap any of the above icons to open the Traffic Summary screen.



2. Tap  to open the list of event categories.

3. Tap the traffic category you are interested in, or tap  to see the list of all events:



4. Now tap any of the list items to see its details, and to display the affected road segment in its full length on the map:



---





 **Note!** If there are traffic events on the recommended route that the application has not bypassed, the traffic icon will open the list of significant traffic events to let you quickly check them.







---

### 2.3.4 Manipulating the map

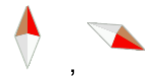
Tap the map anywhere to browse it during navigation. The map stops following the current position (the Vehimarker, a blue arrow by default, is not locked in a fix position on the screen any more) and control buttons appear to help you modify the map view.



Action	Button(s)	Description
Moving the map with drag&drop	No buttons	You can move the map in any direction: tap and hold the map, and move your finger towards the direction you want to move the map.
Zooming in and out		<p>Changes how much of the map is displayed on the screen.</p> <p>Daiichi Hyundai i10 uses high-quality vector maps that let you examine the map at various zoom levels, always with optimised content. It always displays street names and other text with the same font size, never upside-down, and you only see the streets and objects that you need.</p> <p>Map scaling has a limit in 3D map view mode. If you zoom out further, the map switches to 2D view mode.</p> <p>Tap the button once to modify the view in large steps, or tap and hold the button to modify it continuously and smoothly.</p>
Tilting up and down		<p>Changes the vertical view angle of the map in 3D mode.</p> <p>Tap the button once to modify the view in large steps, or tap and hold the button to modify it continuously and smoothly.</p>
Rotating left and right		<p>Changes the horizontal view angle of the map.</p> <p>Tap the button once to modify the view in large steps, or tap and hold the button to modify it continuously and smoothly.</p>
2D or 3D view		Tap this button to switch between the 3D perspective and 2D top-down map view modes.

Compass in 2D map view mode		The direction of the compass shows North. Tap the button to switch to North-up view, and then tap again to rotate the map in the previous direction.
Compass in 3D map view mode		The direction of the compass shows North. Tap the button to switch to North-up view, and then tap again to rotate the map in the previous direction.
Location information		Tap this button to open a new screen with information about the selected map point, the Cursor.
Return to normal navigation		Tap this button to move the map back to follow the current GPS position. Automatic map rotation is also re-enabled.  The map manipulation buttons disappear and navigation continues.
Additional options		Tap this button to open a list of additional features like saving the Cursor as a Favourite destination, or searching for Places around the Cursor.
Select destination		Tap this button to select the Cursor as a new destination. The route is automatically calculated.

### 2.3.5 Quick menu

The Quick menu is a selection of controls and functions that are frequently needed during navigation. It can be opened directly from the Map screen by tapping .

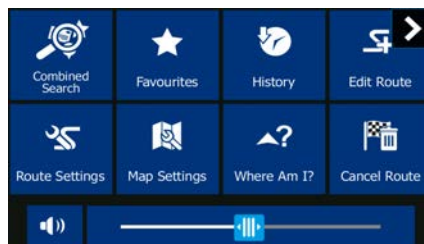













The menu will close after a few seconds of inactivity or if you tap .













The menu will also close if you initiate simple controls like muting the device. In other cases tapping a button will open a new screen with options.

Most of these functions are shortcuts. They are accessible from the menu system.

There are more functions available than the number of buttons in the menu. In Settings, you can choose the function of each button (page 92). The following options are available:

Button	Description	Shortcut for
Master Volume slider	This slider adjusts the sound volume of the device. All sounds of the application are affected.	More / Settings / Sound and Warnings / Volume / Master slider

	<p>This switch mutes all sounds of the application. Tap again to re-enable sounds.</p>	<p>More / Settings / Sound and Warnings / Volume / Master switch</p>
	<p>This button opens the Combined Search function that allows you to search addresses, Places, Favourite and recent destinations by name in one unified environment.</p>	<p>Destination (page 26)</p>
	<p>This function lets you search for a Place by its name. The search is carried out either along your route or around your current location if there is no route calculated.</p>	<p>Destination / Find Places / Quick Search (page 44)</p>
	<p>This button opens the list of your Favourite destinations.</p>	<p>Find / Favourite (page 55)</p>
	<p>This button opens the History list. You can select one of your previous destinations.</p>	<p>Find / History (page 57)</p>
	<p>This button opens the route editing function.</p>	<p>My Route / Edit Route</p>
	<p>This button opens the route related settings.</p>	<p>More / Settings / Route Settings (page 94)</p>
	<p>This button opens the map related settings.</p>	<p>More / Settings / Map Settings (page 98)</p>
	<p>This button opens a special screen with information about the current position and a button to search for nearby emergency or roadside assistance. For details, see the next chapter.</p>	<p>Tap the Current Street field on the Map screen</p>
	<p>This button cancels the route and stops navigation. The button is replaced with the next one if waypoints are given.</p>	<p>My Route / Cancel Route (page 65)</p>
	<p>This button skips the next waypoint from the route.</p>	<p>n/a</p>
	<p>This button opens a 2D map scaled and positioned to show the entire route.</p>	<p>My Route / Overview (page 61)</p>

 Visual Guidance	This button opens the Visual Guidance settings screen.	More / Settings / Visual Guidance (page 99)
 Traffic	This button opens the Traffic Summary screen.	Tap the Traffic icon in the Navigation menu or on the Map screen
 Avoid	This button lets you bypass parts of the recommended route.	My Route / Avoidances
 Trip Monitor	This button opens the Trip Monitor screen where you can manage your previously saved trip logs and track logs.	More / Trip Monitor (page 88)
 Itinerary	This button opens the list of manoeuvres (the itinerary).	Tap the top of the Map screen during navigation.
 Save Route	With this function you can save the active route for later use.	My Route / More / Save Route
 Load Route	With this function you can replace the active route with a previously saved route.	My Route / More / Load Route
 Find Places	With this function you can search for Places of Interest in various different ways.	Find / Find Places (page 43)
 Simulate Navigation	This button opens the Map screen and starts simulating the active route.	My Route / More / Simulate Navigation (page 74)
 GPS Info	This button opens the GPS Information screen with satellite position and signal strength information.	Tap the top of the Map screen when there is no GPS reception
 Vehicle Profile	This button opens the parameters of the selected Vehicle profile.	More / Settings / Route (page 94)
 Configure Driving Timers	This button opens the Driving timer configuration screen.	More / Settings / Lorry / Configure Driving Timers (page 80)



### 2.3.6 Checking the details of the current position (Where Am I?)

This screen contains information about the current position (or about the last known position if GPS reception is not available) and a button to search for useful Places nearby.

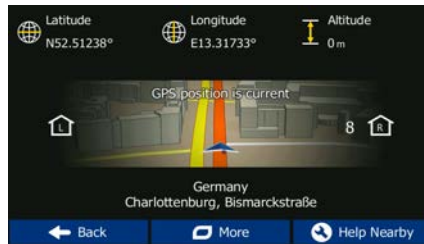





You can access this screen from the map in one of the following ways:

- If the current street is displayed below the Vehimarker (the current position on the map), tap it to open the Where Am I? screen.



- Open the Quick menu and tap the  button.

Information on this screen:

-  : Latitude and Longitude (coordinate of the current position in WGS84 format).
- : Altitude (elevation information coming from the GPS receiver - often inaccurate).
- : House number on the left.
- : House number on the right.
- In the middle of the screen you can see whether the position is current, or the time left since it was last updated.
- Address details (when available) of the current position are displayed at the bottom.

You can also perform some actions on this screen:

 More



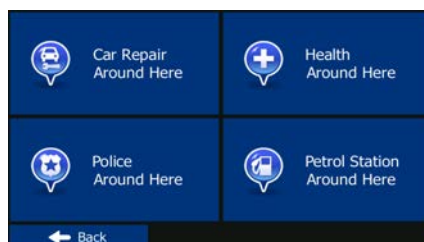

Tap  to save the current position as a Favourite destination.

 Help Nearby

You can also search for assistance near your current position. Tap  to open a new screen for the Quick search:



The following services can be searched around the current position or the last known position:

-  Car Repair Around Here : Car repair and roadside assistance services
-  Police Around Here : Police stations
-  Health Around Here : Medical and emergency services
-  Petrol Station Around Here : Petrol stations

Tap any of the buttons, select a Place from the list, and navigate to it.

### 3 On-road navigation

When first started, TravelPilot calculates routes using the road network of the high quality vector maps provided with the product.

You can set up your route in different ways:

- If you need a route for immediate navigation, you can select the destination and start navigating to it right away (normal navigation).
- You can also plan a route independently of your current GPS position or even without GPS reception. To achieve this you need to set a new starting point in My Route / Edit Route by tapping the flag icon at the current position. This will also turn off the GPS receiver so that the route is not recalculated when a new position is received.

You can plan routes with multiple destinations. Select the first destination. Then select a second destination and add it to your route to create a multi-point route. You can add as many destinations to your route as you like.

You can also use TravelPilot for off-road navigation. For details, see page 76.

#### 3.1 Selecting the destination of a route

TravelPilot offers you several ways of choosing your destination:

- Enter a full address or a part of an address, for example a street name without a house number or the names of two intersecting streets (page 34).
- Enter an address with postal code (page 41). This way you do not need to select the name of the city/town and the search for street names might be faster as well.
- Use a built-in Place of Interest as your destination (page 43).
- Select a location on the map with the Find on Map feature (page 54).
- Use a previously saved Favourite destination (page 55).
- Select a location from the History of previously used destinations (page 57).
- Enter the coordinate of the destination (page 58).
- Use the location where a photo was taken (page 59).

##### 3.1.1 Combined Search

There are several ways to select the destination of the route. You can find buttons in the Destination menu that initiate a separate search for addresses, places, place categories, and favourite or recent destinations. The fastest way to search for any of these is to use the Combined Search. In this section you can find the full description of how this feature works. The below process shows how to carry out the search and the following subsections will help you find specific kinds of results.

1. In the Navigation menu, tap . The button is blue with a white upward-pointing triangle and the word 'Destination' in white text.
2. Tap the horizontal input field above the buttons. The Combined Search screen appears.

3. First you see hints on the screen showing how you can use the function. These hints are only displayed the first time you use this screen.

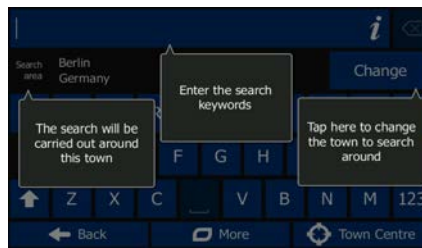

4. Tap anywhere and the hints disappear. Once you get through this screen to the search results, the hints will not appear again when you open this window later but you can see them again if you tap the information button on the right side of the input field.
5. You can see the input field at the top of the screen. Right below that you see the search area, the city/town around which the search is carried out. The default search area is the city/town where you are located. For a local search, skip the next step.
6. (optional) To search in a different area, do as follows:

1. Tap . A new screen opens with a new input field. A hint bubble explains how you can specify the new search centre.

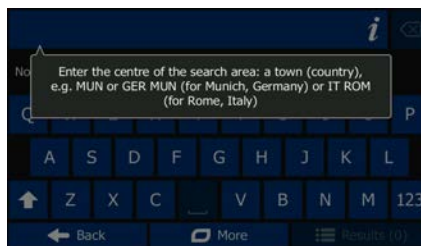

2. Tap anywhere and the hint disappears. If you successfully select a new search area, the hint will not appear again when you open this window later but you can see it again if you tap the information button on the right side of the input field.
3. Start entering the name of the new city/town using the screen keyboard. You only need to enter a few letters to get a result. If the new search area is in a different country, you can narrow the search results if you enter one space and then a few letters of the country of the search area.
4. The most likely result appears below the input field as you enter new letters. Tap to select this as your new search area. If you cannot see your preferred

area after a few letters, tap  and select one from the list.

7. With the proper search area displayed, you can start entering the name, address or category of the destination you are looking for. The number shown in the

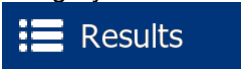
 button shows how many results match the entered text. The background search is carried out while you enter letters so this number may keep on increasing if you wait a few seconds. Keep on entering new letters while this number is high.

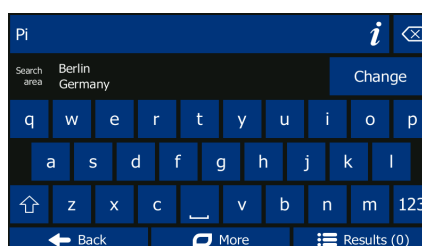

- Once the number of results is acceptable after a few seconds of searching, you can

tap  **Results** to switch to the result screen.

- The result screen also opens with hints. Tap anywhere to suppress them. Once you select a destination, they will not appear again.

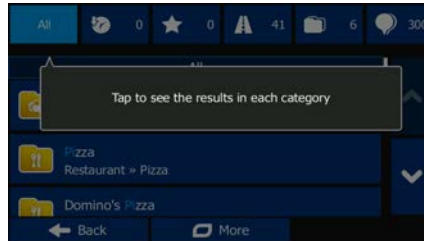

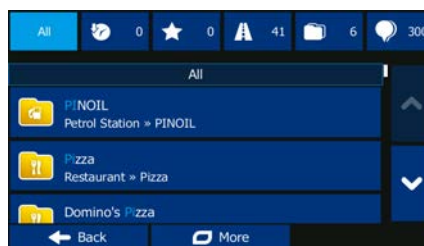

- You see all results in the list, regardless of their type. Addresses, Places, Place categories, Favourite and recent destinations are mixed within one list.



- You have the following options:

- Tap the result you want to use as your destination. Scroll the list if necessary.
- To narrow the search for only one type of result (for example for Places only) you can tap the related button at the top of the screen. See the next sections for details.

- Once the destination is selected, a full screen map appears with the selected point in the middle. If necessary, tap the map somewhere else to modify the destination. The

Cursor (  ) appears at the new location. Tap  to confirm the destination, or tap  to select a different destination.

- After a short summary of the route parameters, the map appears showing the entire route. The route is automatically calculated. Tap  to modify route

parameters, or tap  and start your journey.

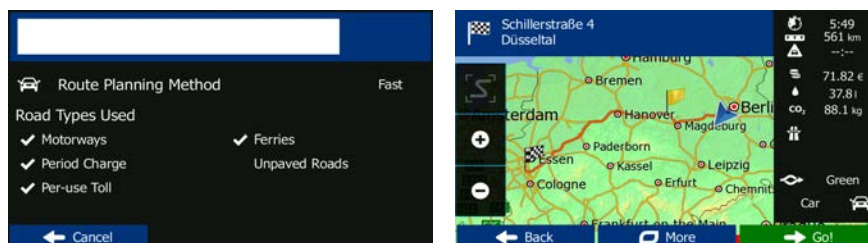

---

If you know that you will use this destination frequently, before tapping

 Next

to confirm the destination, put it on the list of your Favourites

Tip!

 More

then

 Add to Favourites

, give a name for the new

 Done



Favourite, and tap to save the location. The map with the destination returns automatically. Now you can start your journey.

---



### 3.1.1.1 Combined Search - Navigating to a recent destination (History)

To find one of your recent destinations in Combined Search, carry out the search as described earlier. For the input text you can use either a part of the name or a part of the address of the recent destination. When you get to the result screen, do as follows:

1. Tap  at the top of the screen.
2. The list is now filtered. What you see is the list of recent destinations with a matching name or address.
3. Scroll down the list if necessary and then select one of the destinations from the list.
4. Once the destination is selected, a full screen map appears with the selected point in the middle. If necessary, tap the map somewhere else to modify the destination. The

Cursor (  ) appears at the new location. Tap  to confirm the

destination, or tap  to select a different destination.

5. After a short summary of the route parameters, the map appears showing the entire route. The route is automatically calculated. Tap  to modify route parameters, or tap  and start your journey.

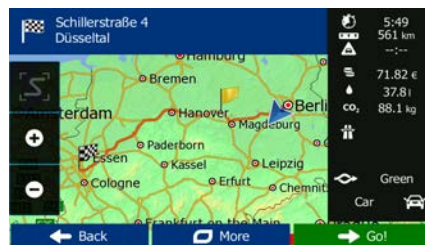
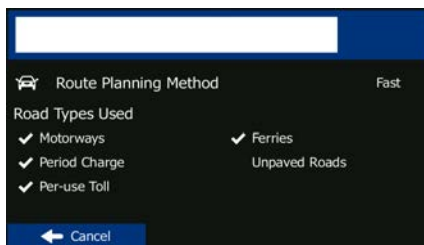







---

Note! The alternative way to search for a recent destination is to tap the  button in the Quick menu or in the Destination menu. The rest of the procedure is similar to the above.

---



### 3.1.1.2 Combined Search - Navigating to a Favourite destination

To find one of your Favourite destinations in Combined Search, carry out the search as described earlier. When you get to the result screen, do as follows:

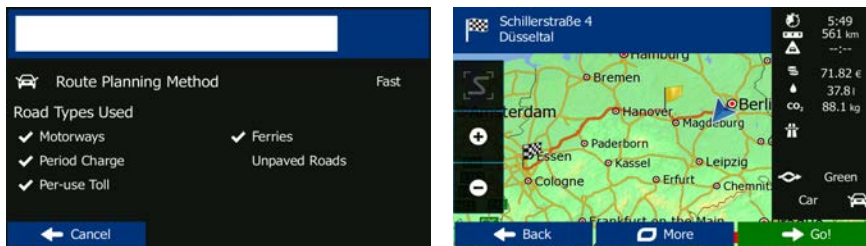
1. Tap  at the top of the screen.
2. The list is now filtered. What you see is the list of your Favourite destinations with a matching name.
3. Scroll down the list if necessary and then select one of the destinations from the list.
4. Once the destination is selected, a full screen map appears with the selected point in the middle. If necessary, tap the map somewhere else to modify the destination. The Cursor (  ) appears at the new location. Tap  to confirm the destination, or tap  to select a different destination.
5. After a short summary of the route parameters, the map appears showing the entire route. The route is automatically calculated. Tap  to modify route parameters, or tap  and start your journey.



---



 **Note!** The alternative way to search for a Favourite destination is to tap the  button in the Quick menu or in the Destination menu. The rest of the procedure is similar to the above.



---

### 3.1.1.3 Combined Search - Navigating to an address

To find an address in Combined Search, carry out the search as described earlier. Use the name of the street alone or combined with the house number as your input text. When you get to the result screen, do as follows:

1. Tap  at the top of the screen.
2. The list is now filtered. What you see is the list of matching addresses.
3. Scroll down the list if necessary and then select one of the addresses from the list.
4. Once the destination is selected, a full screen map appears with the selected point in the middle. If necessary, tap the map somewhere else to modify the destination. The

Cursor (  ) appears at the new location. Tap  to confirm the destination, or tap  to select a different destination.

- After a short summary of the route parameters, the map appears showing the entire route. The route is automatically calculated. Tap  to modify route parameters, or tap  and start your journey.



Note!

The alternative way to search for an address is to tap the  button in the Destination menu. Unlike the Combined Search, this alternative search method is a structured one where you can define the parts of the address separately.

### 3.1.1.4 Combined Search - Navigating to an intersection



To find an intersection in Combined Search, carry out the search as described earlier but use the '&' sign to separate the two intersecting streets. You do not need to use spaces before and after the separator character. For example you can use any of the following input texts to find the intersection of Collins Street and Douglas Avenue (the more precise the input string the fewer false results are expected):



- Collins St & Douglas Ave
- Collins & Douglas
- Coll St & Dou Av
- Col&Doug
- C&D
- Collins St& (this one will give you all the intersections of Collins Street so that you can select the appropriate one from the result list)

When you get to the result screen, do as follows:

- Tap  at the top of the screen.
- The list is now filtered. What you see is the list of matching intersections.
- Scroll down the list if necessary and then select one intersection from the list.
- Once the destination is selected, a full screen map appears with the selected point in the middle. If necessary, tap the map somewhere else to modify the destination. The



Cursor (  ) appears at the new location. Tap  to confirm the destination, or tap  to select a different destination.

- After a short summary of the route parameters, the map appears showing the entire route. The route is automatically calculated. Tap  to modify route parameters, or tap  and start your journey.



Note!

The alternative way to search for an address is to tap the  button in the Destination menu. Unlike the Combined Search, this alternative search method is a structured one where you can define the parts of the address separately.



### 3.1.1.5 Combined Search - Navigating to a Place of Interest

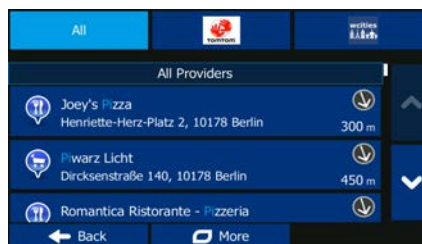

To find a Place of Interest in Combined Search, carry out the search as described earlier. Search for a part of its name. When you get to the result screen, do as follows:

- Tap  at the top of the screen.
- The list is now filtered. What you see is the list of matching Places ordered by their distance from your current location.
- (optional) Should your product contain Places from different data providers, you can further narrow the list by showing Places from one provider only. Look for the provider logos at the top of the screen. Tap one of them to see Places from that provider only.



- Scroll down the list if necessary and then select one of the Places from the list.
- Once the destination is selected, a full screen map appears with the selected point in the middle. If necessary, tap the map somewhere else to modify the destination. The

Cursor (  ) appears at the new location. Tap  to confirm the destination, or tap  to select a different destination.

- After a short summary of the route parameters, the map appears showing the entire route. The route is automatically calculated. Tap  to modify route parameters, or tap  and start your journey.

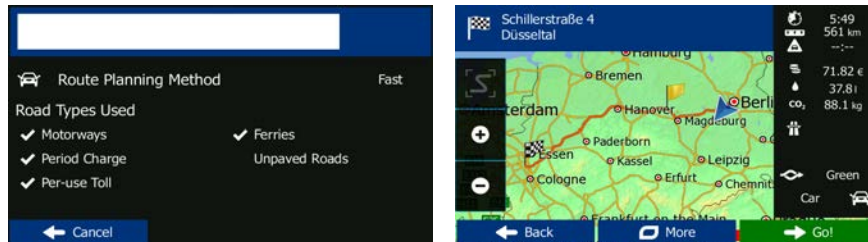

The alternative way to search for a Place is to tap the  button in the Quick



Note!

menu or the  button in the Destination menu. These alternatives are different from the Combined Search. The first one is also a name search but if there is a route planned, it will not be carried out around your current location but along the route. The Place search in the Destination menu is a complex Place search with several options including category search or search around the destination of the current route.



### 3.1.1.6 Combined Search - Navigating to a Place of Interest by its category



To find a Place of Interest in Combined Search by giving its category only, carry out the search as described earlier. Search for a part of the category name. When you get to the result screen, do as follows:

- The list is ordered with Place categories at the beginning but if you want, you can filter the list to contain Place categories only. Tap  at the top of the screen to filter the list.
- Scroll the list and select one of the categories. You get the list of Places in that category ordered by their distance from your current position. If the selected category contains subcategories, you will see all Places in that category mixed into one list.
- (optional) Should your product contain Places from different data providers, you can further narrow the list by showing Places from one provider only. Look for the provider logos at the top of the screen. Tap one of them to see Places from that provider only.





- Scroll down the list if necessary and then select one of the Places from the list.
- Once the destination is selected, a full screen map appears with the selected point in the middle. If necessary, tap the map somewhere else to modify the destination. The

Cursor (  ) appears at the new location. Tap  to confirm the destination, or tap  to select a different destination.

- After a short summary of the route parameters, the map appears showing the entire route. The route is automatically calculated. Tap  to modify route parameters, or tap  and start your journey.



---

The alternative way to search for a Place category is to tap the  button in the Destination menu and then tap . This alternative is different from the Combined Search. When you search for a Place category here, you will go through the whole Place category tree. When you select a category, the list of its subcategories opens.

 **Note!**

---

### 3.1.2 Entering an address or a part of the address

If you know at least a part of the address, it is the quickest way to select the destination of the route.



Using the same screen, you can find an address by entering:

- the exact address, including house number
- the centre of a city/town
- an intersection
- the midpoint of a street
- any of the above, starting the search with the postal code (page 41)

#### 3.1.2.1 Entering an address



To enter an address as the destination, do as follows:

- If you are on the Map screen, tap  to return to the Navigation menu.

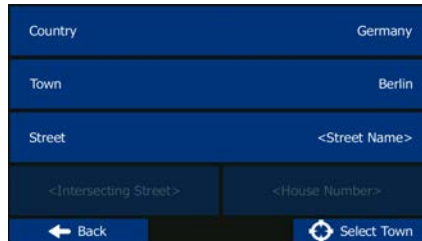
2. In the Navigation menu, tap the following buttons:  .
3. By default, TravelPilot proposes the country and city/town where you are. If needed, tap , enter the first few letters of the country name on the keyboard, and select one country from the list of results.



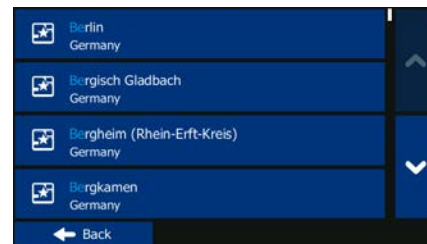
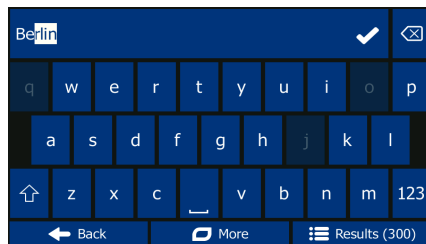

4. If needed, select a new city/town:

- a. Tap .
- b. Start entering the name of the city/town on the keyboard.
- c. Find the city/town you need:
  - The most likely city/town name is always shown in the input field. To accept it, tap .
  - If the desired name does not show up, the names that match the string appear in a list after entering a couple of characters (to open the list of results before it appears automatically, tap ). Select the city/town from the list.





5. Enter the street name:

- a. Tap .
- b. Start entering the street name on the keyboard.
- c. Find the street you need:
  - The most likely street name is always shown in the input field. To accept it, tap .

- If the desired name does not show up, the names that match the string appear in a list after entering a couple of characters (to open the list of results before it appears automatically, tap ). Select the street from the list.







6. Enter the house number:

- Tap .
- Enter the house number on the keyboard. (To enter letters, tap .
- Tap  to finish entering the address. (If the entered house number cannot be found, the midpoint of the street is selected as the destination.)



7. A full screen map appears with the selected point in the middle. If necessary, tap the map somewhere else to modify the destination. The Cursor (  ) appears at the

new location. Tap  to confirm the destination, or tap  to select a different destination.

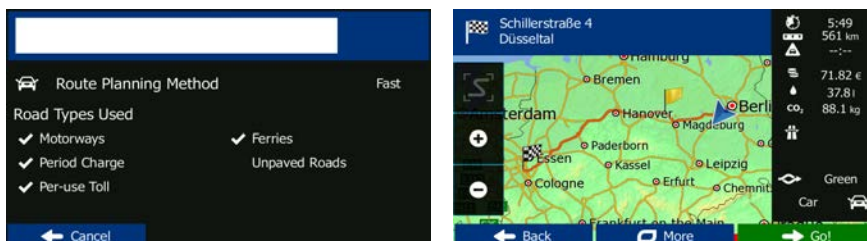

8. After a short summary of the route parameters, the map appears showing the entire route. The route is automatically calculated. Tap  to modify route parameters, or tap  and start your journey.





### 3.1.2.2 Entering the midpoint of a street as the destination

You can navigate to the midpoint of a street if the house number is not available:

1. If you are on the Map screen, tap  to return to the Navigation menu.

2. In the Navigation menu, tap the following buttons: , .
3. If necessary, modify the country and city/town as described earlier (page 34).
4. Enter the street name:



- a. Tap .
- b. Start entering the street name on the keyboard.
- c. Find the street you need:
  - The most likely street name is always shown in the input field. To accept it, tap .
  - If the desired name does not show up, the names that match the string appear in a list after entering a couple of characters (to open the list of results before it appears automatically, tap ). Select the street from the list.





5. Instead of entering the house number, tap . The midpoint of the street is selected as the destination.

Country	Germany
Town	Berlin
Street	Haardtweg
<Intersecting Street>	<House Number>
	

6. A full screen map appears with the selected point in the middle. If necessary, tap the map somewhere else to modify the destination. The Cursor (  ) appears at the

new location. Tap  to confirm the destination, or tap  to select a different destination.



- After a short summary of the route parameters, the map appears showing the entire route. The route is automatically calculated. Tap  to modify route parameters, or tap  and start your journey.





### 3.1.2.3 Selecting an intersection as the destination

To enter an address as the destination, do as follows:

- If you are on the Map screen, tap  to return to the Navigation menu.

- In the Navigation menu, tap the following buttons: , .
- If necessary, modify the country and city/town as described earlier (page 34).
- Enter the street name:



- Tap .
- Start entering the street name on the keyboard.
- Find the street you need:
  - The most likely street name is always shown in the input field. To accept it, tap .
  - If the desired name does not show up, the names that match the string appear in a list after entering a couple of characters (to open the list of results before it appears automatically, tap ). Select the street from the list.





5. Enter the intersecting street name:

1. Tap .
  - If only a few intersecting streets exist, their list appears immediately.
  - In case of a longer street, the keyboard screen appears. Start entering the name of the intersecting street on the keyboard. As soon as the street names that match the entered string can be shown on one screen, their list appears automatically. Select from the list.

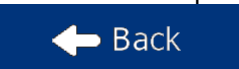

6. A full screen map appears with the selected point in the middle. If necessary, tap the map somewhere else to modify the destination. The Cursor (  ) appears at the new location. Tap  to confirm the destination, or tap  to select a different destination.

7. After a short summary of the route parameters, the map appears showing the entire route. The route is automatically calculated. Tap  to modify route parameters, or tap  and start your journey.

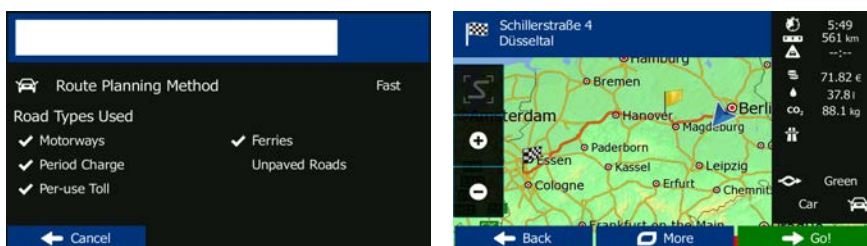

### 3.1.2.4 Selecting a city/town centre as the destination

The city/town centre is not the geometric centre of the city/town but an arbitrary point the map creators have chosen. In towns and villages, it is usually the most important intersection; in larger cities, it is one of the important intersections.



1. If you are on the Map screen, tap  to return to the Navigation menu.

2. In the Navigation menu, tap the following buttons:









3. If necessary, modify the country as described earlier (page 34).
4. Select the destination city/town:

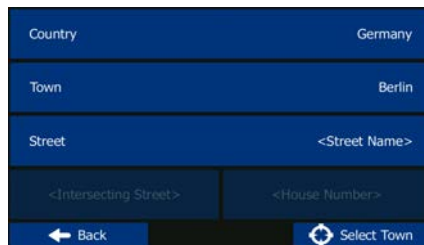

- a. Tap .
- b. Start entering the name of the city/town on the keyboard.
- c. Find the city/town you need:
  - The most likely city/town name is always shown in the input field. To accept it, tap .
  - If the desired name does not show up, the names that match the string appear in a list after entering a couple of characters (to open the list of results before it appears automatically, tap ). Select the city/town from the list.



5. Instead of entering the street name, tap . This way the centre of the displayed city/town becomes the destination of the route.



6. A full screen map appears with the selected point in the middle. If necessary, tap the map somewhere else to modify the destination. The Cursor (  ) appears at the new location. Tap  to confirm the destination, or tap  to select a different destination.

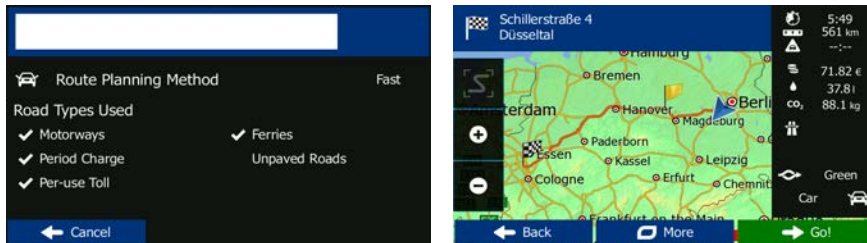

7. After a short summary of the route parameters, the map appears showing the entire route. The route is automatically calculated. Tap  to modify route parameters, or tap  and start your journey.







### 3.1.2.5 Entering an address with a postal code

All of the above address searching possibilities can be performed with entering the postal code instead of the city/town name. Find below an example with a full address:



- If you are on the Map screen, tap  to return to the Navigation menu.

- In the Navigation menu, tap the following buttons: , .
- If necessary, modify the country as described earlier (page 34).
- Enter a new city/town using its postal code:

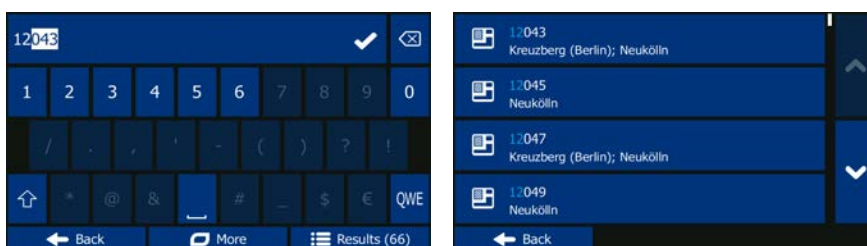
- Tap .
- Tap  to open the numeric keypad.
- Start entering the postal code.
- Find the city/town you need:
  - The most likely postal code is always shown in the input field. To accept it, tap .
  - If the desired number does not show up, open the list of results by tapping . Select the postal code from the list.



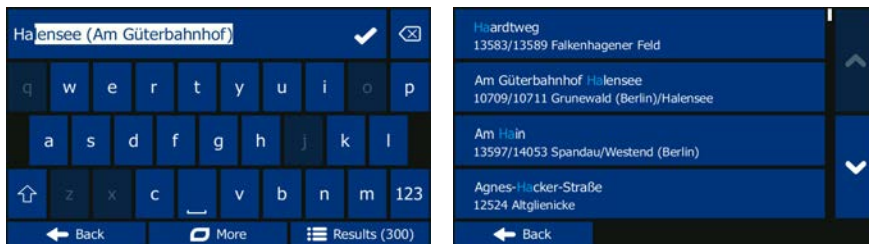

5. Enter the street name:

- a. Tap .
- b. Start entering the street name on the keyboard.
- c. Find the street you need:
  - The most likely street name is always shown in the input field. To accept it, tap .
  - If the desired name does not show up, the names that match the string appear in a list after entering a couple of characters (to open the list of results before it appears automatically, tap ). Select the street from the list.



6. Enter the house number:

- a. Tap .
- b. Enter the house number on the keyboard. (To enter letters, tap .
- c. Tap  to finish entering the address. (If the entered house number cannot be found, the midpoint of the street is selected as the destination.)





7. A full screen map appears with the selected point in the middle. If necessary, tap the

map somewhere else to modify the destination. The Cursor (  ) appears at the



new location. Tap  to confirm the destination, or tap

 to select a different destination.

8. After a short summary of the route parameters, the map appears showing the entire route. The route is automatically calculated. Tap  to modify route parameters, or tap  and start your journey.



### 3.1.2.6 Tips on entering addresses quickly

- When you are entering the name of a city/town or a street:
  - Only those letters are offered on the keyboard that appear in possible search results. All other characters are greyed out.
  - As you are typing, the most likely result is always displayed in the input field. If the guess is correct, tap  to select it.
  - After entering a couple of letters, tap  to list the items that contain the specified letters.
- You can speed up finding an intersection:
  - Search first for the street with a less common or less usual name; fewer letters are enough to find it.
  - If one of the streets is shorter, search for that one first. You can then find the second one faster.
- You can search for both the type and the name of a road. If the same word appears in several names, for example in the name of streets, roads and avenues, you can obtain the result faster if you enter the first letter of the street type: For example, enter 'PI A' to obtain Pine Avenue and skip all Pine Streets and Pickwick Roads.
- You can also search in postal codes. As postal codes consist of only a few characters, this is usually faster than entering the name of the city/town.

### 3.1.3 Selecting the destination from the Places of Interest

You can select your destination from the Places of Interest included with TravelPilot.

Using the same screen, you can find a Place in different ways:

- with the Quick search feature, you can quickly find a nearby Place by its name
- with the Preset search feature, you can find frequently searched types of Places with only a few screen taps
- you can search for a Place by its category
- you can search for a Place by its name



In addition, you can search for special services from the 'Where Am I?' screen.

### 3.1.3.1 Quick search for a Place of Interest

The Quick search feature lets you quickly find a Place by its name. The search is always carried out

- along the recommended route if it exists or
- around your current location if there is no destination given.

1. Start the Quick search function:

- If you are on the Map screen, tap  and then tap .
- If you are in the Navigation menu, tap , tap  and then tap .

2. Using the keyboard, start entering the name of the Place.

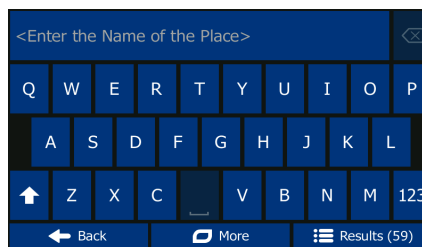



3. After entering a few letters, tap  to open the list of Places with names containing the entered character sequence.







4. (optional) The Places in the list are ordered by the length of the necessary detour (when navigating a route) or by their distance from the current position (when no

destination is given). If you need to reorder the list, tap .

5. Browse the list if necessary and tap one of the list items. A full screen map appears with the selected point in the middle. The name and address of the Place is displayed at the top of the screen.

6. (optional) Tap  to see the details of the selected Place. Tap  to return to the map.

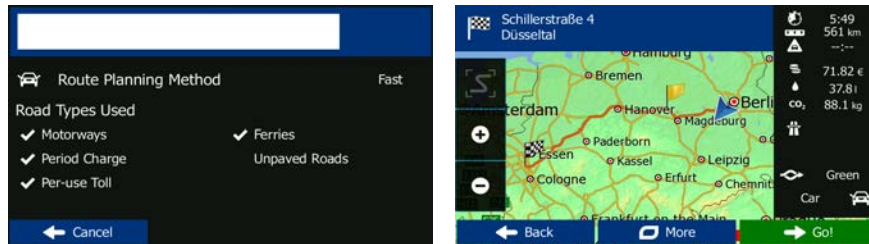

- If necessary, tap the map somewhere else to modify the destination. The Cursor (  ) appears at the new location. Tap  to confirm the destination, or tap  to select a different destination.
- After a short summary of the route parameters, the map appears showing the entire route. The route is automatically calculated. Tap  to modify route parameters, or tap  and start your journey.



### 3.1.3.2 Searching for a Place of Interest using preset categories



The Preset search feature lets you quickly find the most frequently selected types of Places.

- If you are on the Map screen, tap  to return to the Navigation menu.

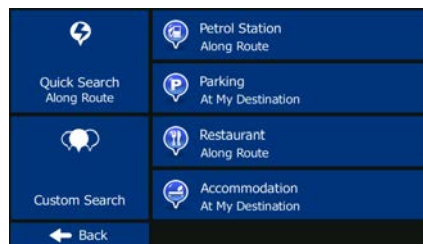
- In the Navigation menu, tap the following buttons:  , .



- The preset search categories appear:

-  :
  - If an active route exists, petrol stations are searched along the route.
  - If there is no active route (destination is not selected), they are searched around the current position.
  - If the current position is not available either (no GPS signal), they are searched around the last known position.
-  :
  - If an active route exists, parking lots are searched around the destination of the route.

- If there is no active route (destination is not selected), they are searched around the current position.
- If the current position is not available either (no GPS signal), they are searched around the last known position.



- If an active route exists, restaurants are searched along the route.
- If there is no active route (destination is not selected), they are searched around the current position.
- If the current position is not available either (no GPS signal), they are searched around the last known position.



- If an active route exists, accommodation is searched around the destination of the route.
- If there is no active route (destination is not selected), they are searched around the current position.
- If the current position is not available either (no GPS signal), they are searched around the last known position.

4. Tap any of the quick search buttons to get an instant list of Places.





5. (optional) The Places in the list are ordered by their distance from the current or last known position, from the destination or by the length of the necessary detour. If you

need to reorder the list, tap



6. Browse the list if necessary and tap one of the list items. A full screen map appears with the selected point in the middle. The name and address of the Place is displayed at the top of the screen.

7. (optional) Tap  to see the details of the selected Place. Tap  to return to the map.



8. If necessary, tap the map somewhere else to modify the destination. The Cursor



( ) appears at the new location. Tap



destination, or tap  to select a different destination.

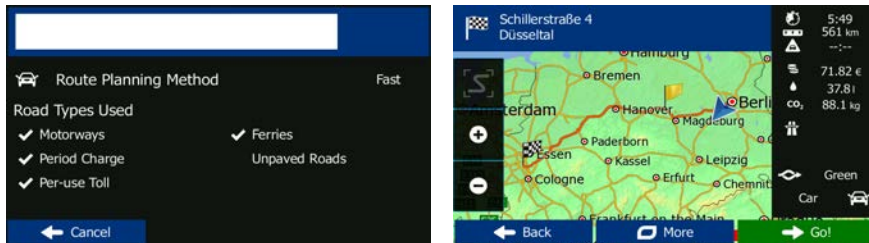

- After a short summary of the route parameters, the map appears showing the entire route. The route is automatically calculated. Tap  to modify route parameters, or tap  and start your journey.



### 3.1.3.3 Searching for a Place of Interest by category



You can search for Places of Interest by their categories and subcategories.

- If you are on the Map screen, tap  to return to the Navigation menu.

- In the Navigation menu, tap the following buttons: , .

- Tap .

- Select the area around which the Place should be searched for:

- Tap  to search around the current position or if it is not available, around the last known position. (The result list will be ordered by the distance from this position.)
- Tap  to search for a place within a selected city/town. (The result list will be ordered by the distance from the centre of the selected city/town.)
- Tap  to search for a place around the destination of the active route. (The result list will be ordered by the distance from the destination.)



- Tap **Along Route** to search along the active route, and not around a given point. This is useful when you search for a later stopover that results in a minimal detour only, such as searching for upcoming petrol stations or restaurants. (The result list will be ordered by the length of the necessary detour.)

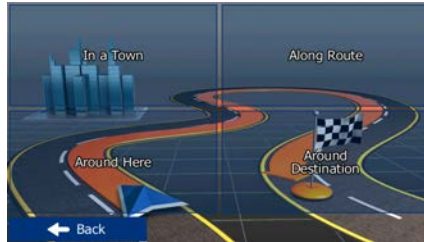

Please NOTE that the map screen can be different depending on the model (for example, 3D buildings)

5. (optional) If you have selected **In a Town**, select the city/town to search in.



6. Select one of the main Place categories (e.g. Accommodation) or tap **List All Places** to list all Places around the selected location or along the route.

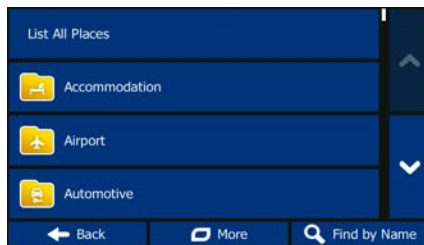

7. Select one of the Place subcategories (e.g. Hotel or Motel) or tap **List All Places** to list all Places in the selected main category around the selected location or along the route.

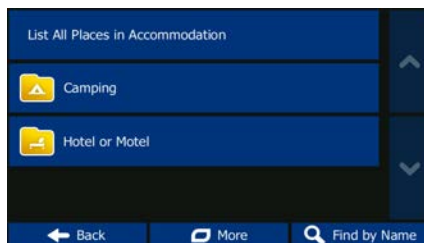

8. Sometimes the list of brands in the selected Place subcategory appears. Select one brand or tap  to list all Places in the selected subcategory around the selected location or along the route.

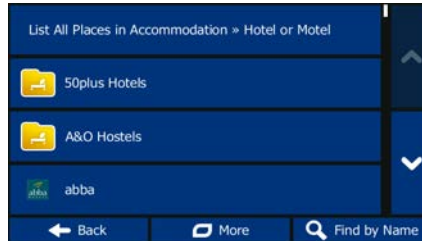





9. Finally, the results appear in a list.





10. (optional) The Places in the list are ordered by their distance from the current or last known position, from the selected city/town, from the destination or by the length of the necessary detour. If you need to reorder the list, tap .

11. Browse the list if necessary and tap one of the list items. A full screen map appears with the selected point in the middle. The name and address of the Place is displayed at the top of the screen.

12. (optional) Tap  to see the details of the selected Place. Tap  to return to the map.

13. If necessary, tap the map somewhere else to modify the destination. The Cursor () appears at the new location. Tap  to confirm the destination, or tap  to select a different destination.

14. After a short summary of the route parameters, the map appears showing the entire route. The route is automatically calculated. Tap  to modify route parameters, or tap  and start your journey.

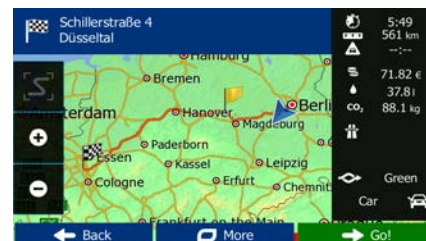
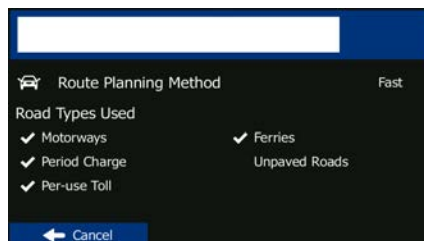

### 3.1.3.4 Searching for a Place of Interest by name



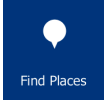

You can search for Places of Interest by their names. You can search around different locations or along your route in the whole Place database or in one Place category or subcategory only.

1. If you are on the Map screen, tap  to return to the Navigation menu.

2. In the Navigation menu, tap the following buttons: , .

3. Tap .

4. Select the area around which the Place should be searched for:

- Tap  to search around the current position or if it is not available, around the last known position. (The result list will be ordered by the distance from this position.)
- Tap  to search for a place within a selected city/town. (The result list will be ordered by the distance from the centre of the selected city/town.)
- Tap  to search for a place around the destination of the active route. (The result list will be ordered by the distance from the destination.)
- Tap  to search along the active route, and not around a given point. This is useful when you search for a later stopover that results in a minimal detour only, such as searching for upcoming petrol stations or restaurants. (The result list will be ordered by the length of the necessary detour.)

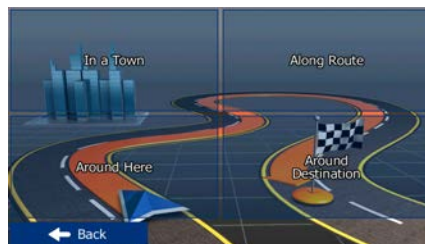

Please NOTE that the map screen can be different depending on the model (for example, 3D buildings)

5. (optional) If you have selected , select the city/town to search in.



- Select one of the main Place categories (e.g. Accommodation) to search in or tap

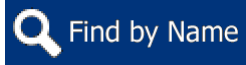

to search among all Places.

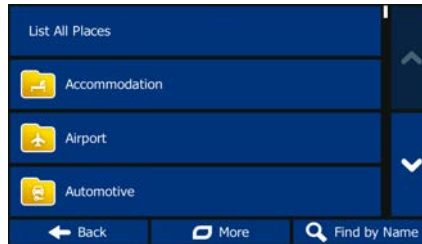

- Select one of the Place subcategories (e.g. Hotel or Motel) to search in or tap



to search in the selected Place category.

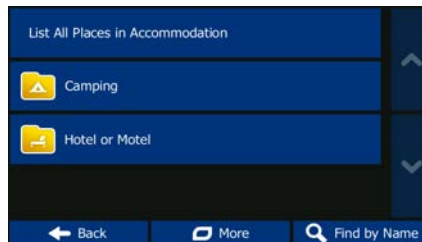

- Tap  if you have not done it before.

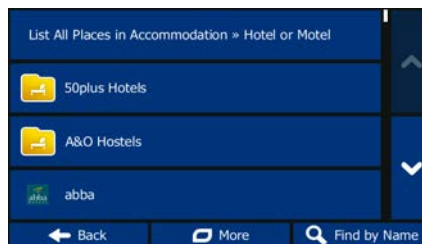



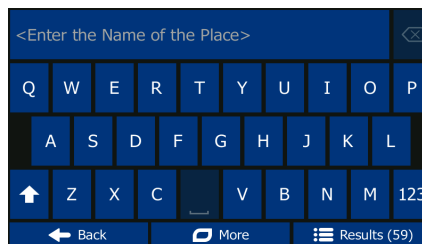





- Using the keyboard, start entering the name of the Place.



- After entering a few letters, tap  to open the list of Places with names containing the entered character sequence.



11. (optional) The Places in the list are ordered by their distance from the current or last known position, from the selected city/town, from the destination or by the length of the necessary detour. If you need to reorder the list, tap .
12. Browse the list if necessary and tap one of the list items. A full screen map appears with the selected point in the middle. The name and address of the Place is displayed at the top of the screen.
13. (optional) Tap  to see the details of the selected Place. Tap  to return to the map.
14. If necessary, tap the map somewhere else to modify the destination. The Cursor () appears at the new location. Tap  to confirm the destination, or tap  to select a different destination.
15. After a short summary of the route parameters, the map appears showing the entire route. The route is automatically calculated. Tap  to modify route parameters, or tap  and start your journey.

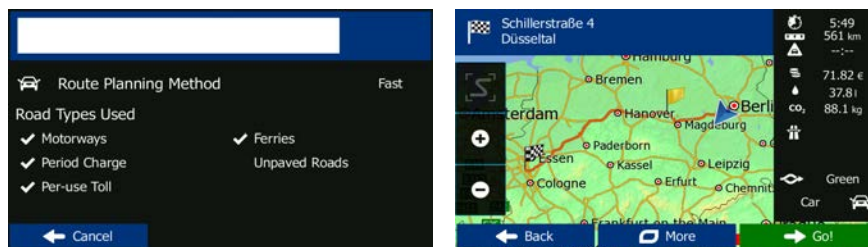

### 3.1.3.5 Selecting nearby assistance from 'Where Am I?'

You can quickly search for nearby assistance from the 'Where Am I?' screen.



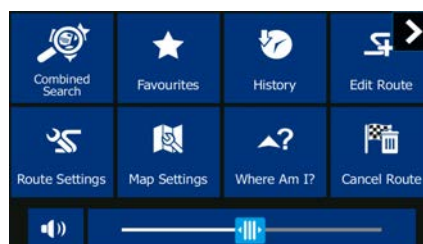

1. On the Map screen, tap  to open the Quick menu.

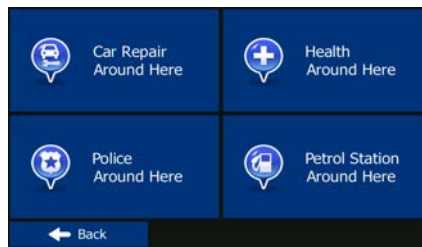

2. Tap  and then .



3. Preset search categories appear, all for searching around the current position (or around the last known position if the current position is not available):

-  : Car repair and roadside assistance services
-  : Medical and emergency services
-  : Police stations
-  : Petrol stations



4. Tap any of the quick search buttons to get an instant list of that type of Places.





5. (optional) The Places in the list are ordered by their distance from the current or last known position, from the selected city/town, from the destination or by the length of the

necessary detour. If you need to reorder the list, tap .



6. Browse the list if necessary and tap one of the list items. A full screen map appears with the selected point in the middle. The name and address of the Place is displayed at the top of the screen.

7. (optional) Tap  to see the details of the selected Place. Tap  to return to the map.

8. If necessary, tap the map somewhere else to modify the destination. The Cursor

() appears at the new location. Tap  to confirm the



destination, or tap  to select a different destination.

- After a short summary of the route parameters, the map appears showing the entire route. The route is automatically calculated. Tap  to modify route parameters, or tap  and start your journey.





### 3.1.4 Selecting a map location as the destination



- If you are on the Map screen, tap  to return to the Navigation menu.

- In the Navigation menu, tap the following buttons:  , .
- Locate your destination on the map: move and scale the map as needed.



- Tap the location that you want to select as your destination. The Cursor (  ) appears there.

- Tap  to select the Cursor as the destination.

- After a short summary of the route parameters, the map appears showing the entire route. The route is automatically calculated. Tap  to modify route parameters, or tap  and start your journey.

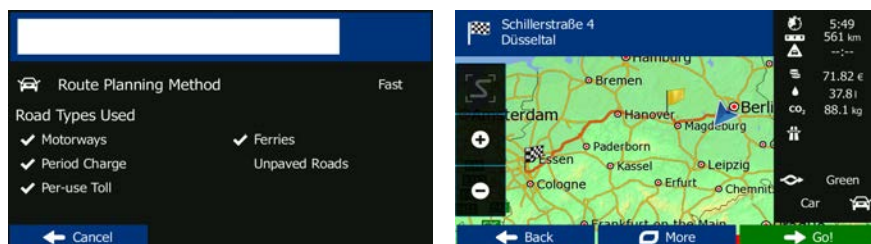

### 3.1.5 Selecting the destination from your Favourites

You can select a location that you have already saved as a Favourite to be your destination. Adding a location to the list of Favourite destinations is described on page 70.

1. Access the list of Favourites:

- If you are on the Map screen, tap  to open the Quick menu.
- If you are in the Navigation menu, tap .

2. Tap . The list of Favourite destinations is displayed.



3. Tap the Favourite that you want to set as your destination. If necessary, browse down

to see more of the list or tap  and enter a few letters from the name of the Favourite destination.

4. A full screen map appears with the selected point in the middle. If necessary, tap the

map somewhere else to modify the destination. The Cursor (  ) appears at the

new location. Tap  to confirm the destination, or tap

 to select a different destination.

5. After a short summary of the route parameters, the map appears showing the entire

route. The route is automatically calculated. Tap  to modify route

parameters, or tap  and start your journey.

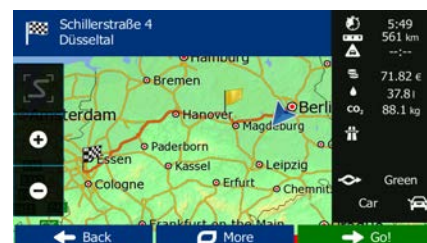
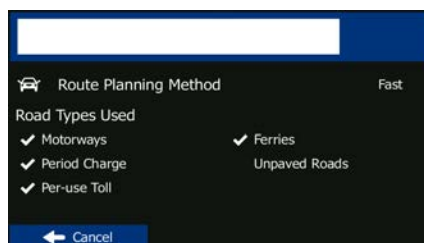





### 3.1.6 Selecting one of the most likely destinations (Smart History)

The destinations that you have set earlier appear in the History list. Two of those recent destinations are shown in the Destination menu for easy access. Smart History offers these locations based on your navigation habits, using parameters like the current time of day, the day of week, and the current location. The more you use the navigation software, the better it can guess your desired destination.

1. If you are on the Map screen, tap  to return to the Navigation menu.

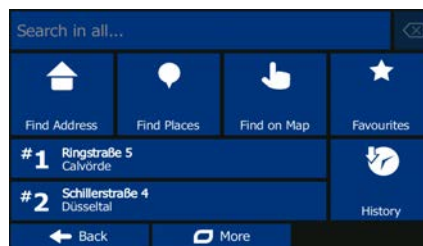
2. In the Navigation menu, tap .





3. Tap the  or the  destination in the History field.
4. A full screen map appears with the selected point in the middle. If necessary, tap the

map somewhere else to modify the destination. The Cursor (  ) appears at the

new location. Tap  to confirm the destination, or tap

 to select a different destination.



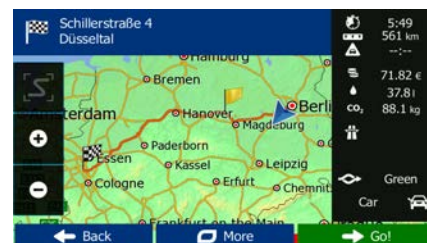
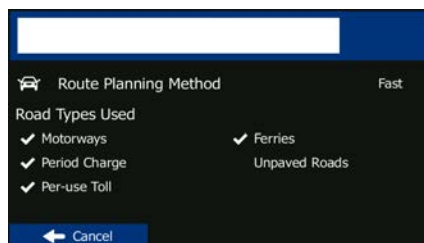

5. After a short summary of the route parameters, the map appears showing the entire route. The route is automatically calculated. Tap  to modify route parameters, or tap  and start your journey.



### 3.1.7 Selecting a recent destination from the History

The destinations that you have set earlier appear in the History.



1. Access the History:

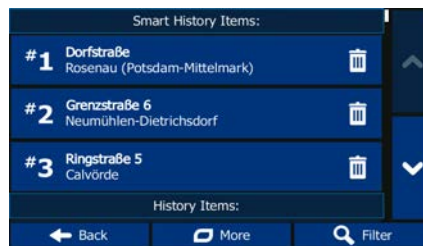

- If you are on the Map screen, tap  and then tap .
- If you are in the Navigation menu, tap  and then tap .

2. The list of recent destinations appears. Smart History promotes three destinations to the first page based on your previous routes (most likely destinations). The rest of the destinations are ordered by time they were last selected. If necessary, scroll the list to see earlier destinations.



3. Select a destination from the list.
4. A full screen map appears with the selected point in the middle. If necessary, tap the



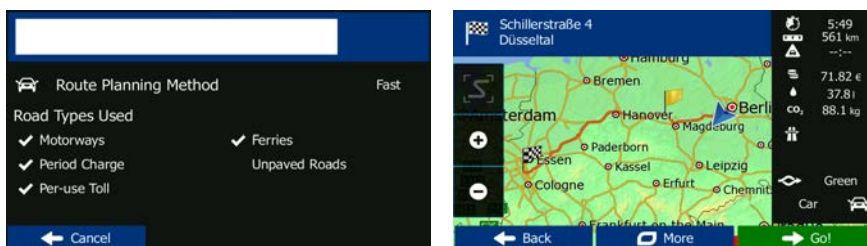

map somewhere else to modify the destination. The Cursor (  ) appears at the new location. Tap  to confirm the destination, or tap  to select a different destination.

5. After a short summary of the route parameters, the map appears showing the entire route. The route is automatically calculated. Tap  to modify route parameters, or tap  and start your journey.



### 3.1.8 Entering the coordinate of the destination





You can also select a destination by entering its coordinate. Do as follows:

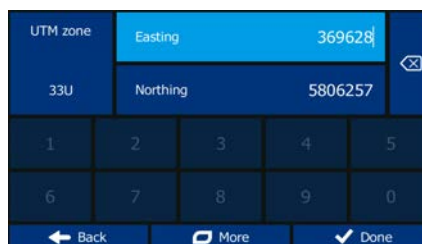

1. If you are on the Map screen, tap  to return to the Navigation menu.
2. In the Navigation menu, tap .
3. Open the  menu and tap .
4. You can enter the latitude and longitude values in any of the following formats: decimal degrees; degrees and decimal minutes; or degrees, minutes and decimal seconds.



5. (optional) If necessary, tap  then  and enter the coordinate in UTM format.









6. When finished, tap .
7. A full screen map appears with the selected point in the middle. If necessary, tap the map somewhere else to modify the destination. The Cursor (  ) appears at the new location. Tap  to confirm the destination, or tap  to select a different destination.

8. After a short summary of the route parameters, the map appears showing the entire route. The route is automatically calculated. Tap  to modify route parameters, or tap  and start your journey.



### 3.1.9 Navigate to a location stored in a photo

You can also set the location stored in a photo as your destination. Do as follows:

- In the Find menu, tap  and then tap .
- A list of the photos stored in the device appear. Select a photo to set its location as the destination.
- A full screen map appears with the selected point in the middle. If necessary, tap the map somewhere else to modify the destination. The Cursor (  ) appears at the new location. Tap  to confirm the destination, or tap  to select a different destination.
- After a short summary of the route parameters, the map appears showing the entire route. The route is automatically calculated. Tap  to modify route parameters, or tap  and start your journey.

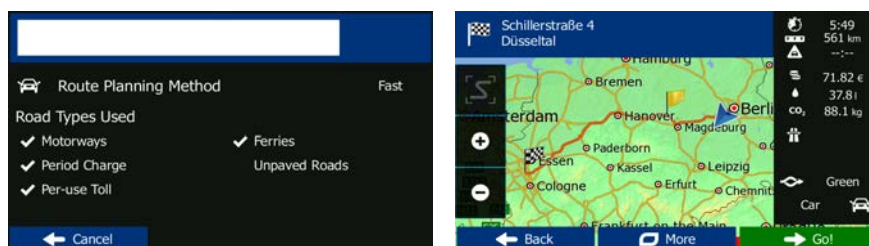

### 3.1.10 Building a route from the list of destinations (Create Route)

You can also build your route destination by destination from the My Route menu.

1. If you are on the Map screen, tap  to return to the Navigation menu.

2. In the Navigation menu, tap .

3. Tap .

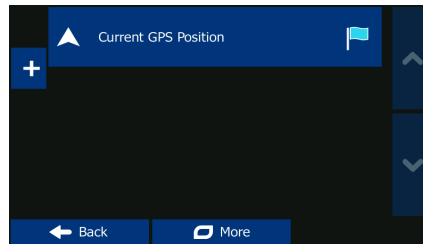

4. There is only one line in the list of route points, the start point of the route, normally the current GPS position.

5. Tap  to select the destination.

6. The Destination menu appears and you can select the destination of the route the same way as described in the previous sections.

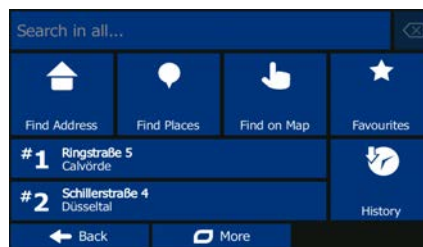



7. When the new destination is selected, the list returns.



8. To add more destinations, tap  where you want to insert the new route point in the list, and repeat the above procedure.

### 3.2 Viewing the entire route on the map

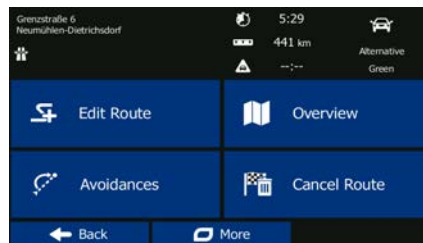

It is easy to get a map overview of the active route. Do as follows:

1. If you are on the Map screen, tap  to return to the Navigation menu.
2. In the Navigation menu, tap .
3. Tap . The active route is displayed in its full length on the map together with additional information and controls.









### 3.3 Checking route parameters and accessing route related functions

You can check different parameters of the route recommended by TravelPilot.

1. If you are on the Map screen, tap  to return to the Navigation menu.
2. In the Navigation menu, tap .
3. The following pieces of information are displayed:
  - The name and/or address of the destination.
  - Warning icons (if any). They provide extra information about your route (e.g. unpaved roads or toll roads to be taken).
  - The total time of the route.
  - The total length of the route.
  - Estimated delay calculated from traffic events on your route.
  - The symbol of the vehicle type used in route calculation.
  - The route planning method (e.g. Fast).



- You have the following options on this screen (for detailed instructions on how to use them, see the next chapter):

- Tap  to edit the route: to add or remove destinations or change their sequence. You can also set a route start point other than your current location. This can be useful to plan and save a future trip.
- Tap  to display the entire route on the map.
- Tap  to bypass a part of the route.
- Tap  to delete the active route.
- Tap  to open a list with more options like selecting from route alternatives, changing route parameters, simulating the route, saving the active route or loading a previously saved route.
- Tap  to return to the Navigation menu.

### 3.4 Modifying the route

When navigation is already started, there are several ways to modify the active route. The following sections show some of those options.

#### 3.4.1 Selecting a new destination when already having a route: New Route, Waypoint or Final Destination

If you already have a recommended route and you select a new destination as described in the above sections, the application will ask you whether to start a new route, add a new waypoint (intermediate destination) to the route or append the newly selected destination at the end of the current route.

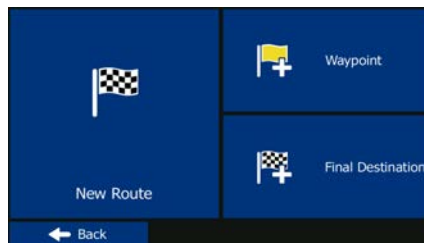

- Tap  to plan a new route to the newly selected location. The previous destination and waypoint(s) are deleted.



- Tap  to add the newly selected location as an intermediate destination to your route. The other destinations of the route remain intact. Note: the new waypoint is placed among destinations to keep the route optimal. To decide where a waypoint to appear, use the Edit Route feature.



- Tap  to append the newly selected destination at the end of the route. The other destinations of the route remain intact. The previous final destination is now the last waypoint.

### 3.4.2 Setting a new starting position for the route

For normal navigation, all routes are planned from the current position. In order to check future routes, simulate them or see their length in time and distance, you can turn off the GPS receiver. Then you can set the starting point of the route to a different location than the current GPS position.

1. If you are on the Map screen, tap  to return to the Navigation menu.

2. In the Navigation menu, tap .

3. If you already have a route, tap . If you are starting a new route, tap .

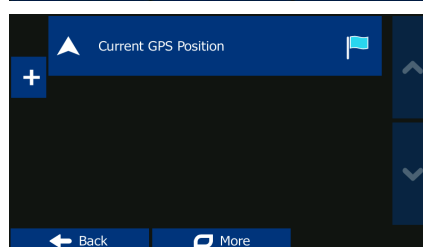



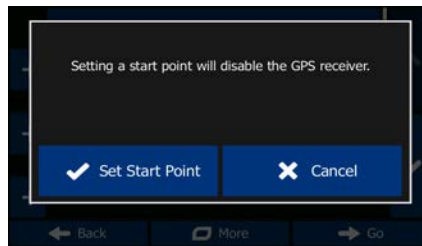

- The first line is the start of the route, normally the current GPS position. Tap  and confirm your action at the warning message.

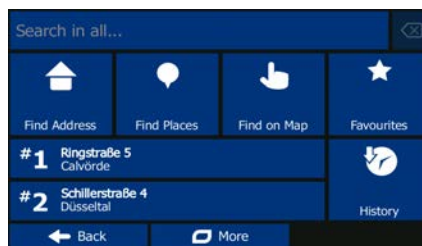

- The Destination menu appears and you can select the start point of the route the same way you select a destination.



- When the new start point is set, tap .
- The map returns with a transparent Vehimarker (showing that there is no GPS reception). If an active route already existed, it is now recalculated starting from the selected location.



Please NOTE that the map screen can be different depending on the model (for example, 3D buildings)



- To return to normal navigation, tap .

### 3.4.3 Editing the list of destinations (Edit Route)

You can edit the route by modifying the list of destinations. You can add or remove destinations, modify the start position or reorder the list.





- If you are on the Map screen, tap  to return to the Navigation menu.

- In the Navigation menu, tap .

3. Tap 



4. You have the following options:





- Tap  to add a new destination.
- Tap  to delete a destination.
- Tap  to modify the start point of the route.
- Tap  to reorder the list. You can do it manually or you can let the application optimise the route for you.

### 3.4.4 Pausing the active route

You do not need to pause the active route: when you start driving again, TravelPilot restarts the voice instructions from your position.

### 3.4.5 Cancelling the active route

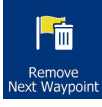
To cancel the navigated route, do one of the following:

- If you are on the Map screen, tap  and then tap . (If you have a route with waypoints, you need to tap  until all waypoints are deleted.)
- In the Navigation menu, tap  and then tap . The active route is deleted with all its waypoints.

### 3.4.6 Checking route alternatives when planning the route

You can select from different route alternatives or change the route planning method after you have selected a new destination. Do as follows:

1. Select a destination as explained earlier, and get to the route confirmation screen.

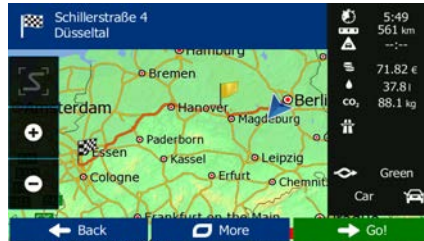

2. Tap

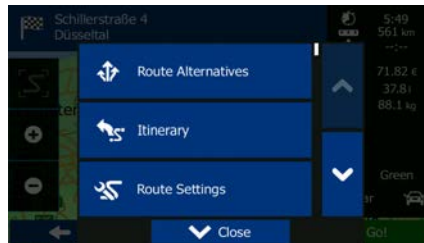

3. Tap



4. You see the basic details of three route alternatives with the selected route planning method. Tap any of them to see it on the map.



5. Or if you cannot find a good alternative, tap



and scroll down for routes with different routing methods.



6. Select one of the route alternatives and tap



to return to the previous screen. TravelPilot recalculates the route. The orange line now shows the new recommended route.

### 3.4.7 Checking route alternatives for an existing route

To recalculate the active route with a different route planning method, you can modify the Route settings (page 94). There is another way to do this and to compare different route alternatives with the same route planning method. Do as follows:

1. If you are on the Map screen, tap **Menu** to return to the Navigation menu.

2. In the Navigation menu, tap **Route Options**.

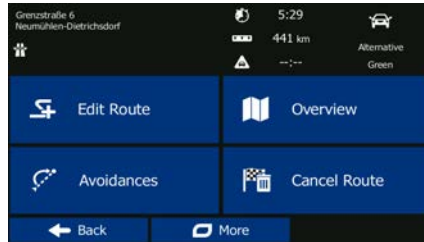

3. Tap **More**.

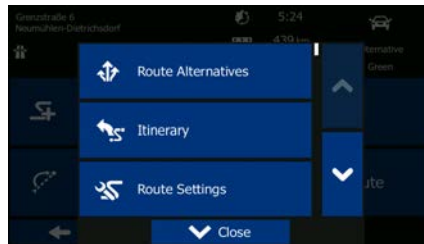

4. Tap **Route Alternatives**.

5. You see the basic details of three route alternatives with the selected route planning method. Tap any of them to see it on the map.



6. Or if you cannot find a good alternative, tap **More Results** and scroll down for routes with different routing methods.



7. Select one of the route alternatives then tap and hold  for a few seconds to return to the Map screen. TravelPilot recalculates the route. The orange line now shows the new recommended route.

### 3.4.8 Changing the vehicle used in route planning

To recalculate the active route for a different vehicle, do as follows. These changes can also be made in Settings (page 94).

1. On the Map screen, tap  and then tap .

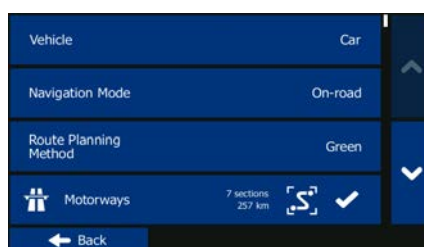





2. Tap  and then tap one of the following:

-  Car
-  Pedestrian
-  Emergency
-  Bus
-  Taxi
-  Lorry

3. TravelPilot recalculates the route optimised for the new vehicle type. The orange line now shows the new recommended route.

---

 **Note!** If you select  and you forget to change it back to a vehicle later, the software warns you when you travel with a speed that is too high for a  pedestrian. You are allowed to switch back instantly to .

---



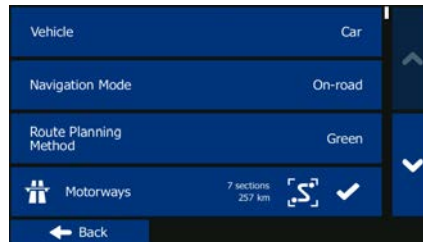

### 3.4.9 Changing the road types used in route planning

To recalculate the active route with different road type preferences, do as follows. These changes can also be made in Settings (page 94).

1. On the Map screen, tap  and then tap .



2. Tap any of the listed road types to modify the route. If needed, scroll the list for all road types. You have the following options (their order depends on the selected vehicle type):

-  - You might need to avoid motorways when you are driving a slow car or you are towing another vehicle.
-  - Charge roads are pay roads where you can purchase a pass or vignette to use the road for a longer period of time. They can be enabled or disabled separately from toll roads.
-  - TravelPilot includes toll roads (pay roads where there is a per-use charge) in the routes by default. If you disable toll roads, TravelPilot plans the best toll-free route.
-  - TravelPilot includes ferries in a planned route by default. However, a map does not necessarily contain information about the accessibility of temporary ferries. You might also need to pay a fare on ferries.
-  - TravelPilot excludes unpaved roads by default: unpaved roads can be in a bad condition and usually you cannot reach the speed limit on them.

3. The route has already been recalculated. Tap  to return to the Map screen. The orange line now shows the new recommended route.

### 3.5 Saving a location as a Favourite destination

You can add any location to Favourites, the list of frequently used destinations. Planning a route to one of the Favourite destinations is described on page 55.

1. Select a destination as described before. It can be an address, a Place, any location on the map, a previously used destination from History, etc.
2. When the full screen map appears with the selected location in the middle, tap

 More

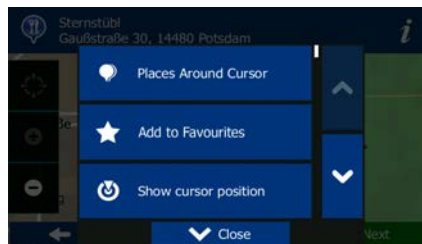

3. Tap  Add to Favourites.
4. (optional) Using the keyboard, you can change the name offered for the Favourite. Tap



to enter numbers or symbols.

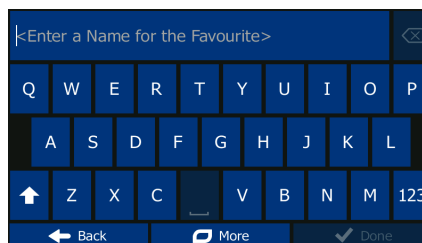





5. Tap  Done to save the location as a new Favourite destination.

### 3.5.1 Editing the details of a Favourite destination



You can select a location that you have already saved as a Favourite and edit its details. Adding a location to the list of Favourite destinations is described on page 70.

1. Access the list of Favourites:

- If you are on the Map screen, tap  and then tap .
- If you are in the Navigation menu, tap  and then tap .

2. The list of Favourite destinations is displayed.



3. Tap the Favourite that you want to edit. If necessary, browse down to see more of the list or tap  and enter a few letters from the name of the Favourite destination.
4. A full screen map appears with the selected point in the middle.
5. Tap  to see the details of the selected Place.
6. Tap any of the data fields and modify its content.
7. Tap and hold  to return to the map.





### 3.6 Saving a map location as an alert point

You can save any map location as an alert point (for example a speed camera or a railway crossing).

1. Browse the map and select a location. The red Cursor appears there.

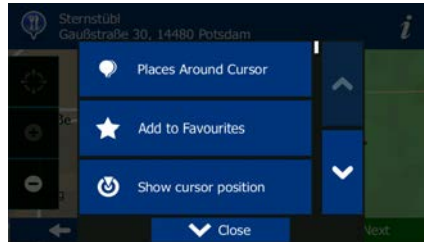
2. Tap .



3. Scroll down the list and tap .

4. On the newly opened screen, select the type of the alert point, the direction from which you expect the alert, and (if applicable) the speed limit for this alert point.

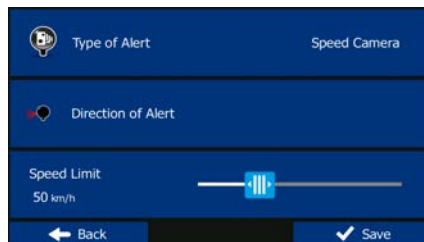

5. Tap  to save the location as a new alert point.

### 3.7 Editing an alert point

You can edit a previously saved or uploaded alert point (for example a speed camera or a railway crossing).

1. Browse the map and select the alert point to edit. The red circle appears around the alert point.

2. Tap .

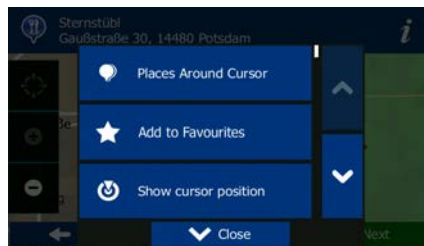

3. Scroll down the list and tap .

4. On the newly opened screen, modify the type of the alert point, the direction from which you expect the alert, or (if applicable) the speed limit for this alert point.

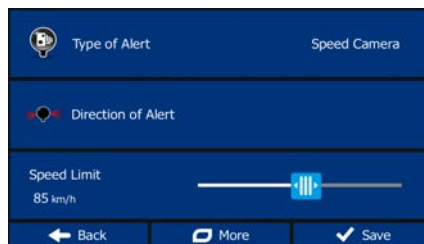

5. Tap  to save the changes to the alert point.

### 3.8 Watching the simulation of the route

You can run a simulated navigation that demonstrates the active route. Do as follows:

1. If you are on the Map screen, tap  to return to the Navigation menu.

2. In the Navigation menu, tap .

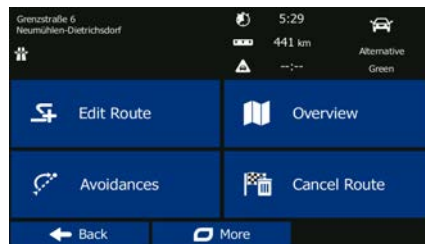



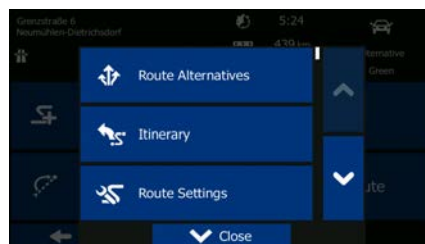

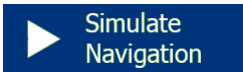
3. Tap .



4. Scroll down the list and tap . The simulation starts from the starting point of the route, and using a realistic speed, it leads you through the whole recommended route.



- a) (optional) You have the following controls during the simulation (the control buttons disappear after a few seconds but you can open them again if you tap the map):
  - : Jump to the next route event (manoeuvre).
  - : Pause the simulation.

- : Jump to the previous route event (manoeuvre).
- : Tap to increase the speed of the simulation to 4, 8 or 16 times faster. Now tap again to return to the normal speed.

b) Tap  to stop the simulation.

## 4 Off-road navigation

When first started, TravelPilot calculates routes using the road network of the high quality vector maps provided with the product. You can switch the application to off-road mode in Route settings in one of the following ways:

- From the Map screen, tap ,  Route Settings and then .

Most of the procedures described for on-road navigation also apply to off-road navigation. However, there are some that are not available in this navigation mode (for example you cannot open the itinerary as you have no manoeuvres just route points and straight lines between them).

### 4.1 Selecting the destination of the route

Selecting the start point or a destination (waypoint or final destination) is the same as described at on-road navigation. The only difference is that route points are linked to form a route with straight lines regardless of the road network and traffic regulations.

### 4.2 Navigating in off-road mode

The real difference between the on-road and off-road modes is the navigation itself. When you are on the Map screen with an off-road route:

- your position and heading is not aligned with the nearest road and
- there is no turn by turn navigation just a recommended direction.

You see a orange line drawn between your current position and the next destination to reach. The Turn Preview field in the top left corner shows a compass with your bearing and the distance of the next destination.



When you reach a waypoint, the orange line will show the direction to the next destination. (Future legs of the route are shown with orange lines.)

When you reach the final destination, navigation ends.

Available only on Lorry models

## 5 Lorry navigation

The navigation software gives more options for lorry drivers:

- You can enter the parameters of your vehicle and TravelPilot calculates your routes with taking available weight, height, etc. restrictions into account (this feature is accurate only if restrictions are available for all roads between your position and the destination)
- Based on the dimensions and other entered parameters of your vehicle, TravelPilot warns you when you are approaching a restricted road segment or such roads must be used in your route.
- You can set a waiting (loading) time for each destination of the route. This way the arrival time calculation can take into account the idle times at intermediate destinations. In addition, time dependent restrictions and statistical traffic information can also be considered for the whole route.
- When selecting lorry as the vehicle type, U-turns are disabled from routes as much as possible.
- You can use countdown timers to alert you when compulsory breaks must be taken (timers can be set for one driver or two alternate drivers)

Warnings are both visual and audible. There are different kinds of warnings:

- When approaching a restricted road segment without a route, you are warned that there is a restricted area ahead.
- Restricted road segments are excluded from your routes but in some cases some restricted roads need to be used to reach the given destination. In this case you receive a warning and you must accept that you have restricted roads in your route or you can stop the navigation and continue without an active route.



Please note that lorry navigation is only as accurate and comprehensive as the restrictions received with the map. Restrictions may not cover lower priority roads and in most cases the coverage changes as you move around your map region. You are obliged to always obey the restrictions displayed on the road.

---

### 5.1 Setting up vehicle parameters

When you use TravelPilot with a lorry, you need to select a lorry type vehicle profile in Route settings and enter the parameters of your vehicle. These parameters are used in route calculation to bypass roads that are restricted for your lorry. Do as follows:

1. If you are on the Map screen, tap  to return to the Navigation menu.

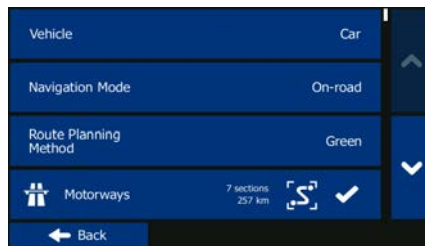

2. In the Navigation menu, tap .

3. Tap  Route Settings



4. Tap 

5. There is one Default Lorry profile at the end of the list. You can either:



- tap the  button at the Default Lorry profile or
- create a new profile by tapping  More then  Add Profile and selecting Lorry as the vehicle type.

6. The list of vehicle profile parameters appear. Scroll the list and tap any of the lines to change the parameters. The parameters are intuitive. In addition, you have the following options:

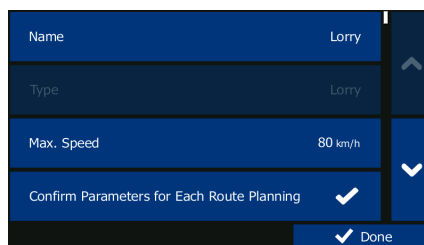
- : When enabled, the list of vehicle parameters always appears before route calculation. This helps you quickly adjust the parameters when some of them (the actual weight for instance) often change.



7. When finished with the vehicle parameters:

- tap  if you have modified an existing vehicle profile or
- tap  if you have created a new profile.

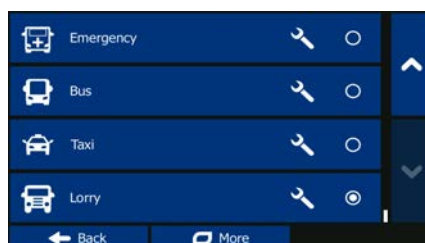

While this profile is selected, the parameters of your vehicle are taken into account when planning routes. Note that this leads to a safe route for your lorry only if map data contains the weight, height, etc. restrictions of the road network in your area.

---

 **Tip!** Speed limits for lorries may not be available for all roads. It is advised to enter the maximum allowed speed in your area for your vehicle instead of the maximum speed your lorry is capable of.

---

 **Tip!** When you often use your vehicle with typical configurations of parameters (for example with or without a trailer that also affects the length, the height, the number of axles and the weight), it is better to create different vehicle profiles for the typical setups and change between the profiles instead of always modifying parameters.

---

## 5.2 Setting up waiting time at waypoints

In order to receive a better arrival time estimation and to be able to use time restrictions and statistical traffic information for future legs of the route, you can enable this feature and specify a waiting time for each stop on your route.

If you enable the feature as described below, the application will ask you to enter the time you will spend at a stopover every time you enter a new destination.

1. If you are on the Map screen, tap  to return to the Navigation menu.

2. In the Navigation menu, tap .

3. Tap .

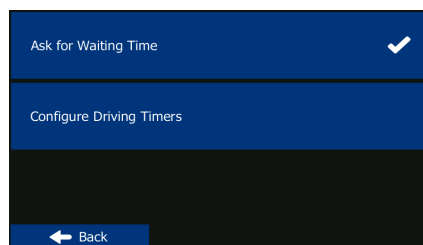

4. Tap  to enable or disable this option.

5. When finished, tap and hold  to return to the Map screen.



### 5.3 Setting up driving time alerts

In order to obey the regulations regarding continuous and daily driving, you can set countdown timers to alert you when you need a break or a sleep. This feature can be set for one driver or two alternate drivers.

1. If you are on the Map screen, tap  to return to the Navigation menu.

2. In the Navigation menu, tap .

3. Tap .

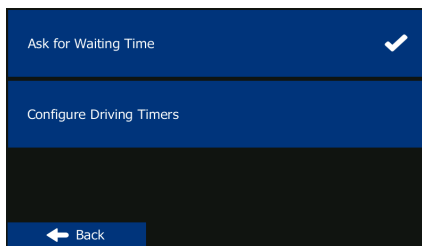

4. Tap  and set the driving timer defaults for the driver.
5. (optional) Tap the switch to use the vehicle with two drivers. The timer defaults are the same but the timers will count down for each driver individually.

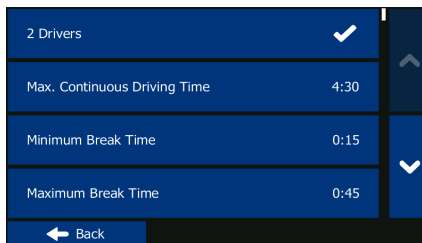

6. When finished, tap and hold  to return to the Map screen.

Whenever the vehicle stops, the current driver receives a message a few minutes later whether this stop means a break.

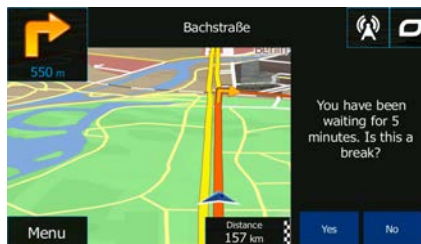

When a break is initiated, the continuous driving timer stops and it is reset to its default value, the daily driving timer also stops, and the break timer starts counting down (the break starts from the moment when the vehicle stopped). When the vehicle is in motion again, the break timer is reset, and both driving timers start counting down again.

## 6 Reference Guide

On the following pages you will find the description of the different concepts and menu screens of TravelPilot.

### 6.1 Concepts

#### 6.1.1 Smart Zoom

Smart Zoom provides much more than just a usual automatic zoom feature:

- **While following a route:** when approaching a turn, it will zoom in and raise the view angle to let you easily recognise your manoeuvre at the next junction. If the next turn is at a distance, it will zoom out and lower the view angle to be flat so you can see the road in front of you.
- **While driving without an active route:** Smart Zoom will zoom in if you drive slowly and zoom out when you drive at high speed.

#### 6.1.2 Daytime and night colour themes

TravelPilot uses different colour themes during the day and during the night for both the map and the menu screens.

- Daytime colours are similar to paper road maps, and the menus are bright.
- The night colour themes use dark colours for large objects to keep the average brightness of the screen low.

TravelPilot offers different daytime and night colour profiles. It can also switch automatically between the daytime and the night schemes based on the current time and GPS position a few minutes before sunrise, when the sky has already turned bright, and a few minutes after sunset, before it becomes dark.

#### 6.1.3 Route calculation and recalculation

Daiichi Hyundai i10 calculates the route based on your preferences:

- Route planning methods:
  - **Fast**: Gives a quick route if you can travel at or near the speed limit on all roads. Usually the best selection for fast and normal cars.
  - **Short**: Gives a route that has the smallest total distance of all possible routes. It can be practical for slow vehicles.

- **Green**: Gives a quick but fuel efficient route based on the fuel consumption data given in Route settings (page 94). Travel cost and CO<sub>2</sub> emission calculations are estimations only. They cannot take elevations, curves and traffic conditions into account.
- **Economical**: For vehicle types where Green routing is not available, this method combines the benefits of Fast and Short: TravelPilot calculates as if it were calculating the Fast route, but it takes other roads as well to save fuel.
- **Easy**: Results in a route with fewer turns and no difficult manoeuvres. With this option, you can make TravelPilot to take, for example, the motorway instead of a series of smaller roads or streets.

- Vehicle types:

When creating a new vehicle profile, select one of the below vehicle types. Besides the below mentioned conditions, dimension, weight and freight hazard restrictions can also be taken into account when planning a route.

-  **Car**:
  - Manoeuvre restrictions and directional constraints are taken into account when planning a route.
  - Roads are used only if access for cars is allowed.
  - Private roads and resident-only roads are used only if they are inevitable to reach the destination.
  - Walkways are excluded from routes.

-  **Pedestrian**:
  - Neither manoeuvre restrictions nor directional constraints are taken into account when planning a route.
  - Roads are used only if access for pedestrians is allowed.
  - Controlled-access roads are excluded from routes.
  - A private road is used only if the destination is there.
  - Speed limits are not used in route calculation and an average walking speed is used when calculating the estimated time of arrival.

-  **Emergency**:
  - All manoeuvres are available in intersections.
  - Directional constraints are taken into account the way that opposite direction is allowed with a low speed.
  - A private road is used only if the destination is there.
  - Walkways are excluded from routes.

-  **Bus**:
  - Manoeuvre restrictions and directional constraints are taken into account when planning a route.

- Roads are used only if access for buses is allowed.
- Private roads, resident-only roads and walkways are excluded from routes.





-  Taxi:

- Manoeuvre restrictions and directional constraints are taken into account when planning a route.
- Roads are used only if access for taxis is allowed.
- Private roads, resident-only roads and walkways are excluded from routes.

-  Lorry:

- Manoeuvre restrictions and directional constraints are taken into account when planning a route.
- Roads are used only if access for lorries is allowed.
- Private roads, resident-only roads and walkways are excluded from routes.
- U-turns are excluded from routes (turning back on a divided road is not considered as a U-turn).

- Road types used or avoided in route calculation:

-  Motorways
-  Period Charge
-  Per-use Toll
-  Ferries
-  Unpaved Roads

Whenever data exist, route calculation takes into account statistical traffic data for the given day of week and time of day (page 87).

Real-time Traffic events are also taken into account and sometimes greatly modify the route.

Daiichi Hyundai i10 automatically recalculates the route if you deviate from the proposed itinerary or if a newly received Traffic event concerns a part of the recommended route.

For further information about Route settings, see page 94.

### 6.1.4 Green routing

Route calculation is not only about finding the quickest or shortest route. For some of the vehicle types, you can also check the fuel consumption and CO<sub>2</sub> emission when planning a route, and you can create cost effective routes with less effect on the environment.

In Route settings, you can edit the parameters of the selected vehicle. Enter the fuel consumption values and the price of the fuel. You can also select whether you want to see

the difference between your route and the green route even if the selected routing method is not Green.

Green

After the above parameters are set, select **Green** as route planning method to get a fast but also fuel efficient route. Note that travel cost and CO<sub>2</sub> emission calculations are estimations only. They cannot take elevations, turns, curves and traffic conditions into account. Also, this routing is not meant to give you the "greenest" route of all. It is still important to travel quickly so the result is a fast route with low fuel consumption and CO<sub>2</sub> emission.

With a vehicle type where green routing is selectable, whichever route planning method is selected, the Green details are also shown when you confirm the route:

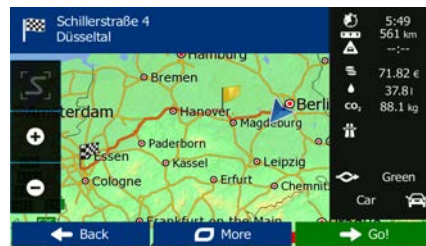

If the selected route planning method is not Green, and you have allowed the application to show the green alternative, the price, fuel consumption and CO<sub>2</sub> emission differences between your selected route and the Green route are also shown on this screen:



Tap the field with these details to switch the route to Green immediately.

### 6.1.5 Road safety cameras and other proximity alert points

There is a special proximity warning for road safety cameras (like speed or red light cameras) and other proximity alert points (like schools or railroad crossings). These alert points are preloaded in TravelPilot. You can download more from [www.naviextras.com](http://www.naviextras.com) or you can upload points in a specific text file if needed.

You can also add your own alert points or edit the preloaded or uploaded points. See page 72 for details.

The application can warn you when you approach road safety cameras like speed cameras or dangerous areas like school zones or railroad crossings. You can set up the different alert types individually in Sound and Warning settings (page 90).

The following alert types are available:

- Audio warning: beeps can be played while you are approaching one of these points, or extra alert sounds if you exceed the given speed limit while approaching.
- Visual warning: the type of the alert point, its distance and the related speed limit appear on the Map screen while you are approaching one of these cameras.

For some of the alert points, the enforced or expected speed limit is available. For these points, the audio alert can be different if you are below or above the given speed limit.

- Only when speeding: The audio alert is only played when you exceed the given speed limit.
- When approaching: The audio alert is always played when approaching one of these alert points. In order to draw your attention, the alert can be different when you exceed the speed limit.

---

 **Note!** The warning for road safety cameras is disabled when you are in a country where road safety camera warning is prohibited. However, you must ensure on your own liability that using this feature is legal in the country where you intend to use it.

---

### 6.1.6 Speed limit warning

Maps may contain information about the speed limits of the road segments. TravelPilot is able to warn you if you exceed the current limit. This information may not be available for your region (ask your local dealer), or may not be fully correct for all roads in the map.

The maximum speed set in the vehicle profile is also used for this warning. TravelPilot alerts you if you exceed the preset value even if the legal speed limit is higher.

Speed warning can be fine-tuned in Sound and Warning settings (page 90).

You can set the relative speed above which the application initiates the warning.

The following alert types are available:



- Audio warning: you receive a verbal warning when you exceed the speed limit with the given percentage.
- Visual warning: the current speed limit is shown on the map when you exceed it (for

example:  ).

You can also choose to see the speed limit sign on the map all the time.

### 6.1.7 GPS position quality indicator

An icon shows the current accuracy of the position information in the top right corner of the Navigation menu:

Icon	Description
	TravelPilot has no connection to the GPS receiver: GPS navigation is not possible.  Devices with a built-in GPS receiver are permanently connected. On such devices, the icon does not appear in normal circumstances.
	TravelPilot is connected to the GPS receiver, but the signal is too weak and the receiver cannot determine the GPS position.  GPS navigation is not possible.
	Only a few satellites are received. Position information is available, but elevation (altitude) cannot be calculated.  GPS navigation is possible, but the position error may be significant.



Altitude information is available, the position is a 3D position.  
GPS navigation is possible.

### 6.1.8 Traffic information in route planning (Not available for all models)

The recommended route is not always the same between two points. Offline statistical traffic information (historical speed information or traffic patterns) can be taken into account in the route calculation based on the time of day and the day of week whenever suitable data exists. In addition, real-time traffic information can help you avoid current traffic events like temporary road closures or a traffic jam caused by an accident. Both functions are subject to data availability.

You can display the historical traffic information on the map if you browse the map and select this option from the More menu. A 2D map is displayed with road segments coloured by the density of the traffic in the given period. The current information is shown when you open the screen. Modify the day of week and the time of day to see the desired period.



You can display the live traffic information on the map if you browse the map and select this option from the More menu. A 2D map is displayed with road segments coloured by the

severity of traffic events. Tap the event type icon at the road segment and then tap the  button to get information about the traffic event.



#### 6.1.8.1 Historical traffic

If statistical traffic information is stored with the map data, TravelPilot can take them into account when planning a route. In normal cases, these statistics help you avoid usual traffic jams on the given day of week in the given hour but in some cases like on public holidays that fall on normal weekdays, they can be misleading. You can disable this feature in Traffic settings (page 93).

You can display statistical traffic information on the map if you browse the map and select this option from the More menu.

### 6.1.8.2 Real-time traffic information (TMC)

TMC (Traffic Message Channel) can provide you with the real-time status of the traffic. Route calculation can avoid road blocks or unexpected traffic jams caused by an accident.

TMC is a specific application of the FM Radio Data System (RDS) used for broadcasting real-time traffic and weather information.

Using traffic information is enabled by default in TravelPilot.

---

 **Note!** TMC is not a global service. It may not be available in your country or region. Ask your local dealer for coverage details.



---

TravelPilot contains the TMC receiver that is needed to receive Traffic events.

If public Traffic data is broadcast at your location, TravelPilot automatically takes into account the traffic events received. You do not need to set anything in the program. The receiver will automatically search the FM radio stations for TMC data, and the decoded information will immediately be used in route planning. When TravelPilot receives traffic information that may affect your route, the program will warn you that it is recalculating the route, and navigation will continue with a new route that is optimal considering the most up-to-date traffic conditions.

To fine-tune this recalculation, you can set the minimum delay that can trigger a route recalculation, or you can instruct TravelPilot to have you confirm the new recommended route before it takes effect. You can do these in Traffic settings (page 93).

One of the following traffic icons is displayed on the right side of the screen:

-  +0:17 When there is an event on your route, the icon shows the type of the next traffic event.
-  Traffic information is received, but there are no events affecting your route.
-  Traffic information is not received.

Road segments affected by traffic events are displayed with an alternate colour on the map, and small symbols above the road show the nature of the event:



1. Tap any of the above mentioned traffic icons to open the Traffic Summary screen:





2. Tap  Event List to open the list of event categories.

3. Tap the traffic category you are interested in, or tap  All events to see the list of all events:





4. Now tap any of the list items to see its details, and to display the affected road segment in its full length on the map:





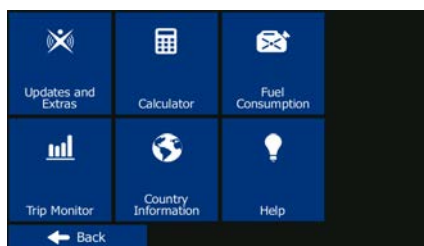

 **Note!** If there are traffic events on the recommended route that the application has not bypassed, the traffic icon will open the list of significant traffic events to let you quickly check them.

## 6.2 'More' menu

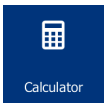
The 'More' menu provides you with various options and additional applications. On the map screen, tap the following buttons:  .



Button	Description
	Visit <a href="http://www.naviextras.com">www.naviextras.com</a> to get additional content, such as new maps or 3D landmarks and useful applications.
	The scientific calculator helps you in all your calculation needs. Tap the Mode button for additional functions and use the memory to save your results.

 Fuel Consumption	The Fuel consumption monitor helps you keep track of the consumption of your car even if you do not use navigation for all your journeys. Set the initial odometer value and then record the distance taken and fuel filled in whenever you fill your car. You can also set reminders for regular car maintenance.
 Trip Monitor	If you save your trip logs when you arrive at some of your destinations or let the application automatically save the trip logs for you, those logs are all listed here. Tap one of the trips to see the trip statistics, speed and altitude profile. If track log has also been saved, you can display it on the map with the selected colour. Track logs can be exported to GPX files for later use.
 Country Information	Select a country from the list and see useful driving information about the selected country. Information may include speed limits on different road types, the maximum blood alcohol level and any compulsory equipment you need to show when stopped by the police.
 Help	Run the Demo and watch sample route simulations to see how navigation works. The About section provides you with product information. Read the Software and Database End User License Agreement, or check the map and other contents of the application. You can also access program usage statistics.



### 6.3 Settings menu





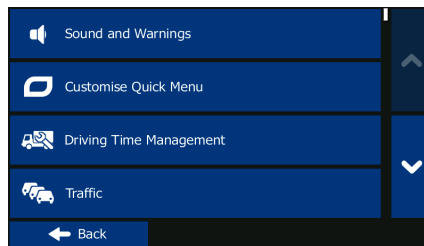





You can configure the program settings, and modify the behaviour of TravelPilot.

In the navigation menu, tap .

The Settings menu has several options. Tap  or scroll with your finger to see the full list.



Button	Description
 Sound and Warnings	Adjust the sound volume, mute your device or change the voice guidance language. In addition, you can enable and set up different warnings and alerts.
 Customise Quick Menu	The content of the Quick menu (page 21) is fully customisable. Tap the button you want to change, and select its new function from the list.
 Driving Time Management	To calculate a better arrival time, it is necessary to include the waiting or loading times spent at each waypoint. Driving timers allow you to be warned when you need a rest or you have driven enough for the day.

 Traffic	The recommended route is not always the same between two points. Whenever suitable data exists, traffic information can be taken into account in the route calculation.
 Route Settings	These settings determine how routes will be calculated. Select the type of vehicle you are driving, the road types used in route planning, and the route planning method.
 User Profiles	If more drivers use TravelPilotfor navigating, their settings can be remembered by using one of the user profiles.
 Map Settings	You can fine-tune the appearance of the Map screen. Adjust the map view to your needs, choose suitable colour themes from the list for both daytime and night use, change the blue arrow to a 3D car model, show or suppress 3D buildings, turn track logging on or off, and manage you Place visibility sets (which Places to show on the map).
 Visual Guidance	Adjust how the software helps you navigate with different kinds of route related information on the Map screen.
 Display	Display related settings include menu animations and separate skins for daytime and night use.
 Regional	These settings allow you to customise the application for your local language, measurement units, time and date settings and formats, as well as to choose the time zone.
 Trip Monitor	Trip logs and track logs contain useful information about your trips. Trip logs can be saved manually when you reach your destination or you can turn on the automatic saving here.
 Log Collection	The application collects usage information and GPS logs that may be used for improving the application and the quality and coverage of maps. Here you can enable or disable collecting these logs.
 Start Configuration Wizard	Modify the basic software parameters set during the initial setup process. For details, see page 7.
 Reset to Defaults	Delete all saved data and reset all settings to their factory defaults.

### 6.3.1 Sound and Warnings

Adjust the sound volume, mute your device or change the voice guidance language. In addition, you can enable and set up different warnings and alerts.

Button	Description
Volume	Tap this button to adjust the volume of the different sounds in the application. A new screen shows the different sound types and their controls. See below for details.

<p><b>Voice Language</b></p>	<p>This button shows the current voice guidance profile. By tapping the button, you can select a new profile from the list of available languages and speakers. Tap any of these to hear a sample voice prompt. Just tap  when you have selected the new spoken language.</p>
<p><b>Verbosity Level</b></p>	<p>Tap this button to set the verbosity of the voice instructions: how much they tell and how often they speak.</p>
<p><b>Speed Warning Settings</b></p>	<p>Maps may contain information about the speed limits of the road segments. TravelPilot is able to warn you if you exceed the current limit. This information may not be available for your region (ask your local dealer), or may not be fully correct for all roads in the map.</p> <p>The maximum speed set in the vehicle profile is also used for this warning. TravelPilot alerts you if you exceed the preset value even if the legal speed limit is higher.</p> <p>This setting lets you decide whether you wish to receive visible and/or audible warnings.</p> <p>Adjust the slider to set the relative speed above which the application initiates the warning.</p> <p>The following alert types are available:</p> <ul style="list-style-type: none"> <li>• Audio warning: you receive a verbal warning when you exceed the speed limit with the given percentage.</li> <li>• Visual warning: the current speed limit is shown on the map when you exceed it.</li> </ul> <p>If you prefer to see the speed limit sign on the map all the time (normally it is shown only if your speed exceeds it), you can set it here.</p>
<p><b>Alert Point Settings</b></p>	<p>This feature allows you to receive a warning when approaching a Road Safety Camera or other alert points like school zones or railroad crossings. You must ensure on your own liability that using this feature is legal in the country where you intend to use it.</p> <p>You can set the alert for the different alert point categories individually. The following alert types are available:</p> <ul style="list-style-type: none"> <li>• Audio warning: beeps can be played while you are approaching one of these points, or extra alert sounds if you exceed the given speed limit while approaching.</li> <li>• Visual warning: the type of the alert point, its distance and the related speed limit appear on the Map screen while you are approaching one of these cameras.</li> </ul> <p>For some of the alert points, the enforced or expected speed limit is available. For these points, the audio alert can be different if you are below or above the given speed limit.</p> <ul style="list-style-type: none"> <li>• Only when speeding: The audio alert is only played when you exceed the given speed limit.</li> <li>• When approaching: The audio alert is always played when approaching one of these alert points. In order to draw your attention, the alert is different when you exceed the speed limit.</li> </ul>

<b>Warning Sign Alerts</b>	Maps may contain driver alert information. Tap this button to turn on or off these warnings and to set the distance from the hazard to receive the warning at. These can be set individually for the different warning types.
----------------------------	---

You can control the volume of the following sound types:

<b>Button</b>	<b>Description</b>
<b>Master</b>	This is the main volume control. These controls affect all below sounds. They can also be accessed from the Quick menu.
<b>Guidance</b>	These controls affect the volume of the guidance sounds (verbal instructions). They can also be accessed from the Quick menu.
<b>Ding</b>	Turn off the attention tone preceding verbal instructions or adjust its volume.
<b>Alert Beeps</b>	These controls affect the volume of the non verbal alert sounds (beeps).
<b>Key</b>	Key sounds provide audible confirmation of tapping the touch screen. These controls affect key sounds.

Controls for each sound type:

<b>Button</b>	<b>Description</b>
Volume slider	Adjusts the volume of the related sound.
	Use the switch to mute the related sound. The slider becomes inactive. Tap again to re-enable.



### 6.3.2 Customise Quick menu

The content of the Quick menu (page 21) is fully customisable. Tap the button you want to change, and select its new function from the list.

The list of available functions and their descriptions are on page 21.





### 6.3.3 Driving time management

To calculate a better arrival time, it is necessary to include the waiting or loading times spent at each waypoint. Driving timers allow you to be warned when you need a rest or you have driven enough for the day. You have the following options:

Button	Description
 Ask for Waiting Time	Turn this switch on to be able to set the waiting time for all waypoints of the route. This way the arrival time calculation can take into account the idle times at intermediate destinations. In addition, time dependent restrictions and statistical traffic information can also be considered for the whole route.
 Configure Driving Timers	Set up and use countdown timers to monitor the continuous and daily driving times as described on page 80.

### 6.3.4 Traffic settings

The recommended route is not always the same between two points. Whenever suitable data exists, traffic information can be taken into account in the route calculation.

Button	Description
 Historical Traffic	Use this switch to enable or disable historical traffic data and traffic patterns. This locally stored information can be very useful in normal circumstances but for example on public holidays it may be better to turn off in order not to take into account normal weekday traffic jams.
 Traffic Receiver	Use this switch to enable or disable the TMC receiver that can receive real-time traffic information. The rest of the buttons below are all related to the TMC function and are available only if the receiver is enabled.
 Detour	This setting determines how TravelPilot uses the received real-time traffic information in route calculation. When calculating a new route, or when recalculation becomes necessary based on the received Traffic events, TravelPilot avoids traffic events if it makes sense.  You can also set the minimum delay that triggers route recalculation, and you can instruct the application if you want to confirm every recalculation.
 Event Types	Tap this button to open the list of traffic event types, and select which events to take into account in route calculation.

### 6.3.5 Route settings





These settings determine how routes will be calculated.

Button	Description
Vehicle	<p>You can set the type of vehicle you will use to navigate the route. Based upon this setting, some of the road types can be excluded from the route, or some of the restrictions may not be taken into account in route calculation.</p> <p>You can edit the parameters of the selected vehicle profile, or you can even create new vehicle profiles if you tap More.</p>
Navigation Mode	<p>On-road navigation creates a turn by turn itinerary using the road network on the map. Switch to off-road navigation to navigate between destinations in a straight line.</p>
Route Planning Method	<p>The route calculation can be optimised for different situations and vehicle types by changing the planning method. See below for details.</p>

To let the route fit your needs, you can also set which road types are to be considered for or to be excluded from the route if possible.

Excluding a road type is a preference. It does not necessarily mean total prohibition. If your destination can only be accessed using some of the excluded road types, they will be used but only as much as necessary. In this case a warning icon will be shown on the My Route screen, and the part of the route not matching your preference will be displayed in a different colour on the map.





In the list of road types you can see in how many segments and what total length of the road type is used in the current route.

Button	Description
 Motorways	<p>You might need to avoid motorways when you are driving a slow car or you are towing another vehicle.</p>
 Period Charge	<p>Charge roads are pay roads where you can purchase a pass or vignette to use the road for a longer period of time. They can be enabled or disabled separately from toll roads.</p>
 Per-use Toll	<p>TravelPilot includes toll roads (pay roads where there is a per-use charge) in the routes by default. If you disable toll roads, TravelPilot plans the best toll-free route.</p>
 Ferries	<p>TravelPilot includes ferries in a planned route by default. However, a map does not necessarily contain information about the accessibility of temporary ferries. You might also need to pay a fare on ferries.</p>
 Unpaved Roads	<p>TravelPilot excludes unpaved roads by default: unpaved roads can be in a bad condition and usually you cannot reach the speed limit on them.</p>

 Calculate Green Alternative	<p>If the selected routing method is not Green, you can have your route compared to the best green alternative on the screen when confirming the route. If this alternative is much better than the selected method, you can quickly switch to Green mode.</p>
---	--

### Vehicle profiles:

When you first tap , you see the list of default vehicle profiles. You have the following options:

Button	Description
	You can edit the parameters of the vehicle profile.
 More	Tap this button to reveal the below options.
 Add Profile	Tap this button to create your own vehicle profile.
 Restore All Profiles	Tap this button to reset all vehicle profiles to their default settings.

When creating a new vehicle profile, first you need to select the vehicle type. Then you need to set the following parameters (some of them may not exist for the selected vehicle type). You can modify the same parameters when you edit an existing profile:



Button	Description
Name	Tap this button to rename the profile for something meaningful.
Fuel Consumption Urban	Enter the average consumption of your vehicle when used in built-up areas. The unit for consumption can be set in Regional Settings.
Fuel Consumption Rural	Enter the average consumption of your vehicle when used on highways. The unit for consumption can be set in Regional Settings.
Engine Type	Select the engine and fuel type of your vehicle. This helps in estimating the CO <sub>2</sub> emission.
Fuel Price	Enter the average fuel price for travel cost calculation. The currency can be set in Regional Settings.
Max. Speed	Set the maximum speed you travel with the vehicle.
Use Extended Settings	Check this box to enable more settings for the below parameters.
Length	Set the total length of the vehicle.
Width	Set the width of the vehicle.





Height	Set the height of the vehicle.
Trailer	Set if there is a trailer attached to the vehicle.
Maximum Allowed Weight	Set the maximum allowed weight of the vehicle.
Actual Weight	Set the actual weight of the vehicle.
Freight	Select one or more hazard types if the vehicle carries dangerous material.

### Vehicle types:

When creating a new vehicle profile, select one of the below vehicle types. Besides the below mentioned conditions, dimension, weight and freight hazard restrictions can also be taken into account when planning a route.

-  Car :
  - Manoeuvre restrictions and directional constraints are taken into account when planning a route.
  - Roads are used only if access for cars is allowed.
  - Private roads and resident-only roads are used only they are inevitable to reach the destination.
  - Walkways are excluded from routes.
-  Pedestrian :
  - Neither manoeuvre restrictions nor directional constraints are taken into account when planning a route.
  - Roads are used only if access for pedestrians is allowed.
  - Controlled-access roads are excluded from routes.
  - A private road is used only if the destination is there.
  - Speed limits are not used in route calculation and an average walking speed is used when calculating the estimated time of arrival.
-  Emergency :
  - All manoeuvres are available in intersections.
  - Directional constraints are taken into account the way that opposite direction is allowed with a low speed.
  - A private road is used only if the destination is there.
  - Walkways are excluded from routes.

-  **Bus**
  - Manoeuvre restrictions and directional constraints are taken into account when planning a route.
  - Roads are used only if access for buses is allowed.
  - Private roads, resident-only roads and walkways are excluded from routes.
-  **Taxi**
  - Manoeuvre restrictions and directional constraints are taken into account when planning a route.
  - Roads are used only if access for taxis is allowed.
  - Private roads, resident-only roads and walkways are excluded from routes.
-  **Lorry**
  - Manoeuvre restrictions and directional constraints are taken into account when planning a route.
  - Roads are used only if access for lorries is allowed.
  - Private roads, resident-only roads and walkways are excluded from routes.
  - U-turns are excluded from routes (turning back on a divided road is not considered as a U-turn).

### Route Planning Method types:

Button	Description
Fast	Gives a quick route if you can travel at or near the speed limit on all roads. Usually the best selection for fast and normal cars.
Short	Gives a short route to minimise the distance to travel. Usually practical for pedestrians, cyclists or slow vehicles. Searching for a short route regardless of the speed, this route type is rarely practical for normal vehicles.
Green	Gives a quick but fuel efficient route based on the fuel consumption data given in Route settings (page 94). Travel cost and CO <sub>2</sub> emission calculations are estimations only. They cannot take elevations, curves and traffic conditions into account.
Economical	For vehicle types where Green routing is not available, this method combines the benefits of Fast and Short: TravelPilot calculates as if it were calculating the Fast route, but it takes other roads as well to save fuel.
Easy	Results in a route with fewer turns and no difficult manoeuvres. With this option, you can make TravelPilot to take, for example, the motorway instead of a series of smaller roads or streets.

### 6.3.6 User profiles

If more drivers use TravelPilot for navigating, their settings can be remembered by using one of the user profiles. Rename the profiles after tapping the edit button on the right so that all users know which profile to use and switch between profiles by tapping its name. If you select a new profile, the application restarts so that the new settings can take effect.









### 6.3.7 Map settings







You can fine-tune the appearance of the Map screen. Adjust the map view to your needs, choose suitable colour themes from the list for both daytime and night use, change the blue arrow to a 3D car model, show or hide 3D buildings, turn track logging on or off, and manage your Place visibility sets (which Places to show on the map).

The map is always shown on the screen so that you can see the effect when you change a setting.





Please NOTE that the map screen can be different depending on the model (for example, 3D buildings)







Button	Description
 View Mode 3D	Switch the map view between a 3D perspective view and a 2D heading-up view. Switch the map view between a 3D perspective view, a 2D heading-up view and a 2D north-up view.
 Viewpoint Normal	Adjust the basic zoom and tilt levels to your needs. Three levels are available.
 Automatic Overview ON	When selected, the map zooms out to show an overview of the surrounding area if the next route event (manoeuvre) is far. When you get close to the event, the normal map view returns.
 Colours Auto	Switch between daytime and night colour modes or let the software switch between the two modes automatically a few minutes before sunrise and a few minutes after sunset.
 Day Map Colour	Select the colour scheme used in daytime mode.
 Night Map Colour	Select the colour scheme used in night mode.

 <b>3D Vehicle Gallery</b>	<p>Replace the default position marker to one of the 3D vehicle models. You can select separate icons for different vehicle types selected for route planning. Separate icons can be used for car, pedestrian and the other vehicles.</p>
 <b>Landmarks ON</b>	<p>Show or suppress 3D landmarks, 3D artistic or block representations of prominent or well-known objects.</p>
 <b>Buildings ON</b>	<p>Show or suppress 3D city models, 3D artistic or block representation of full city building data containing actual building size and position on the map.</p>
 <b>3D Terrain ON</b>	<p>Show or suppress the 3D elevation of the surrounding terrain.</p>
 <b>Track Logs ON</b>	<p>Turn on or off track log saving, that is, saving the sequence of the locations your journeys go through.</p>
 <b>Place Markers</b>	<p>Select which Places to show on the map while navigating. Too many Places make the map crowded so it is a good idea to keep as few of them on the map as possible. For this, you have the possibility to save different Place visibility sets. You have the following possibilities:</p> <ul style="list-style-type: none"> <li>• Tap the checkbox to show or hide the Place category.</li> <li>• Tap the name of the Place category to open the list of its subcategories.</li> <li>• Tap  to save the current Place visibility set or to load a previously saved one. Here you can also revert to the default visibility settings.</li> </ul>

### 6.3.8 Visual guidance settings





Adjust how the software helps you navigate with different kinds of route related information on the Map screen.

 <b>Data Fields</b>	<p>The data fields in the corner of the Map screen can be customised. Tap this button and select the values you want to see. The values can be different when you navigate a route from when you are just cruising without a given destination. You can select general trip data like your current speed or the altitude, or route data related to your final destination or the next waypoint on your route.</p>
 <b>Offer Motorway Services</b>	<p>You may need a petrol station or a restaurant during your journey. This feature displays a new button on the map when you are driving on motorways. Tap this button to open a panel with the details of the next few exits or service stations. Tap any of them to display it on the map and add it as a waypoint to your route if needed.</p>
 <b>Facility Types</b>	<p>Select the service types displayed for the motorway exists. Choose from the POI categories.</p>

 Signposts	<p>Whenever adequate information is available, lane information similar to the real ones on road signs above the road is displayed at the top of the map. You can turn this feature on or off.</p>
 Junction View	<p>If you are approaching a motorway exit or a complex intersection and the needed information exists, the map is replaced with a 3D view of the junction. You can turn this feature on or let the map be displayed for the whole route.</p>
 Route Progress Bar	<p>Turn on the route progress bar to see your route as a straight line on the left side of the map. The blue arrow represents your current position and moves up as you travel. Waypoints and Traffic events are also displayed on the line.</p>
 Offer Congestion Detour on Highways	<p>When you slow down while driving on a motorway, there is a chance that you are in a traffic jam so TravelPilot offers you a detour using the next exit. The message shows you distance of the exit and the difference in distance and estimated time compared to the original route. You can choose from one of the following options:</p> <ul style="list-style-type: none"> <li>• Tap Dismiss or just ignore the message if you want to keep the original route.</li> <li>• Tap Preview to see the overview of the original route and the detour to make the decision. You can accept the detour as offered or increase the bypassed motorway segment before accepting.</li> <li>• Turn to the suggested new direction and the route will be automatically recalculated.</li> </ul>
 Offer Real-time Route Alternatives	<p>Similar to the above possibility, alternative routes can be suggested when driving on normal roads. TravelPilot will select a different turn in the upcoming intersection and offers you a different route for the next section of the route.</p> <p>Your options are the similar as above but you cannot modify the offered detour.</p>
 Offer Parking Around Destination	<p>Parking at the destination may not be easy in city areas. As you approach the destination, TravelPilot can offer parking category Places near your destination. Tap the "P" button to open a top-down map with the destination and the offered parking Places. Select one and modify the route accordingly.</p>
 Offer Hints Upon Detour	<p>If you leave the recommended route and suddenly exit the motorway, the application offers different alternatives near the exit like petrol stations or restaurants. Also, if there are avoidable parts of the original route ahead (like a tunnel, a toll road or a ferry), you will find them in the list in case you want to bypass them with the help of TravelPilot.</p>



### 6.3.9 Display settings

Display related settings include menu animations, separate skins for daytime and night use and the brightness of the display.

 Menu Animations	When animation is turned on, buttons on menus and keyboard screens appear in an animated way. Screen transitions are also animated.
 Day Skin Theme	Select the style and colours of the application used in daytime mode.
 Night Skin Theme	Select the style and colours of the application used in night mode.
 Current Backlight	Adjust the display backlight.

### 6.3.10 Regional settings

These settings allow you to customise the application for your local language, measurement units, time and date settings and formats, as well as to choose the time zone.

Button	Description
 Program Language	This button displays the current written language of the user interface. By tapping the button, you can select a new language from the list of available languages. The application will restart if you change this setting; you are asked to confirm this.
 Units and Formats	<p>You can set the distance units to be used by the program. Daiichi Hyundai i10 may not support all the listed units in some voice guidance languages.</p> <p>Select between 12 and 24 hours time display and the various international date display formats.</p> <p>You can also set other country specific units used to display different values in the application.</p>
 Time Zone	By default, time zone is taken from the map information and adjusted by your current location. Here you can set time zone and daylight saving manually.

### 6.3.11 Trip monitor settings

Trip logs contain useful information about your trips. Trip logs can be saved manually when you reach your destination or you can turn on the automatic saving here. You can access these logs in the Trip monitor. Trip monitor is available from the More menu.

Enable Auto-Saving	Trip monitor can record statistical data of your trips. If you need these logs later, you can let the application save them automatically for you.
Trip database size	This is not a button. This line shows the current size of the trip database, the sum of all trip and track logs saved.
Save track log	Track logs, the sequence of the positions given by the GPS receiver, can be saved together with trip logs. They can later be displayed on the map. You can let the application save the track log whenever it saves a trip.

### 6.3.12 Log collection settings

If you accept this when first using the application, it collects usage information and GPS logs that may be used for improving the application and the quality and coverage of maps. The data is processed anonymously; no one will be able to track any personal information.

Here you can enable or disable collecting these logs.

Application Usage Information	Anonymous statistical information on using the navigation software is collected for later development purposes. Understanding how different people use the application can help us improve the user interface and the program workflow.
 GPS Tracks	Anonymous track logs are collected for later development purposes. Your trips can help us improve the quality and coverage of maps.

## **7 Glossary**

### **2D/3D GPS reception**

The GPS receiver uses satellite signals to calculate its (your) position and needs at least four signals to give a three-dimensional position, including elevation. Because the satellites are moving and because objects can block the signals, your GPS device might not receive four signals. If three satellites are available, the receiver can calculate the horizontal GPS position but the accuracy is lower and the GPS device does not give you elevation data: only 2D reception is possible.

### **Active route**

The currently navigated route. Whenever the destination is set, the route is active until you delete it, reach your destination or you quit TravelPilot. See also: Route.

### **City Centre**

The city/town centre is not the geometric centre of the city/town but an arbitrary point the map creators have chosen. In towns and villages, it is usually the most important intersection; in larger cities, it is one of the important intersections.

### **Colour theme**

Daiichi Hyundai i10 comes with different colour themes for daytime or night use of the map and menu screens. Themes are custom graphic settings and they can have different colours for streets, blocks or surface waters in 2D and 3D modes, and they display shades or shadows in different ways in 3D mode.

One daytime scheme and one night scheme is always selected for the map and for the menus. TravelPilot uses them when it switches from day to night and back.

### **GPS accuracy**

Several factors have impact on the deviation between your real position and the one given by the GPS device. For example, signal delay in the ionosphere or reflecting objects near the GPS device have a different and varying impact on how accurately the GPS device can calculate your position.

### **Map**

TravelPilot works with digital maps which are not simply the computerised versions of traditional paper maps. Similarly to the paper road maps, the 2D mode of digital maps show you streets, roads, and elevation is also shown by colours.

In 3D mode, you can see the altitude differences, for example valleys and mountains, elevated roads, and in selected cities 3D landmarks and 3D buildings are also displayed.

You can use digital maps interactively: you can zoom in and out (increase or decrease the scale), you can tilt them up and down, and rotate them left and right. In GPS-supported navigation, digital maps facilitate route planning.



## **North-up map orientation**

In North-up mode the map is rotated so its top always faces North. This is the orientation for example in Find on Map.

## **Road Safety Camera**

Special alert points for speed, red light or bus lane cameras. Different data sources are available. You can configure TravelPilot to warn you when you approach one of these cameras.

Detecting the location of Road Safety Cameras is prohibited in certain countries. It is the sole responsibility of the driver to check whether this feature can be used during the trip.

The software is capable of showing and warning for more than just cameras. Various other types of proximity alert points like school zones and railway crossings are also available.

## **Route**

A sequence of route events, i.e. manoeuvres (for example, turns and roundabouts) to reach the destination. The route contains one start point and one or more destinations. The start point is the current (or last known) position by default. If you need to see a future route, the start point can be replaced with any other given point.

## **Track-up map orientation**

In Track-up mode the map is rotated so its top always points in the current driving direction. This is the default orientation in 3D map view mode.

## **Vehimarker**

The current position is shown with a blue arrow on the map by default. The direction of the blue arrow shows the current heading. This position marker can be replaced with different 3D vehicle symbols. You can even specify different Vehimarkers for different route types (depending on which vehicle type is selected for route calculation).

## **8 End User Licence Agreement**

### **1 The contracting parties**

1.1 This Agreement has been entered into by and between NNG Software Developing and Commercial Ltd. (registered seat: 23 Bérc utca, H-1016 Budapest, Hungary; company reg.no.: 01-09-891838) as Licensor (hereinafter: Licensor) and You as the end user (hereinafter: User; the User and the Licensor jointly referred to as: Parties) in subject of the use of the products specified in this Agreement, including software products, databases and content .

### **2 Conclusion of the Agreement**

2.1 The Parties hereby acknowledge that this Agreement shall be concluded by implicit conduct of the Parties without signing the Agreement.

2.2 The User hereby acknowledges that following the lawful acquisition (online purchase from authorized vendor or preinstalled on purchased Device) of the software product constituting the object of this Agreement (Section 4), any degree of use, installation into a computer or other hardware equipment (mobile phone, multi-function device, personal navigation device, in-car navigation or multi function head unit, etc.) (hereinafter referred to as: "Device"), installation of such Device into a vehicle, pressing of the "Accept" button displayed by the software during installation or use (hereinafter referred to as: "Use") shall mean that the User has accepted the terms and conditions of this Agreement as legally binding. The time of conclusion of the present Agreement is the time of executing the first action of use (commencement of use).

2.3 This Agreement shall by no means authorize Use of the software product by those persons having unlawfully acquired the software product or having unlawfully installed it on a Device or in a vehicle.

2.4 U.S. Government Users. If you acquire the Software Product by or on behalf of the United States Government or any other entity seeking or applying rights similar to those customarily claimed by the United States Government, you are on notice that the Software Product and the Databases, content and services are commercial items as that term is defined at 48 C.F.R ("FAR") 2.101 and that all use of the Software Product is subject to this Agreement.

### **3 Applicable laws and regulations**

3.1 Any action related to this Agreement will be governed by the laws of the Republic of Hungary, with specific reference to Act IV of 1959 on the Civil Code and to Act LXXVI of 1999 on Copyrights (the "Copyright Act") shall apply. The United Nations Convention on Contracts for the International Sales of Goods is hereby excluded from application to this EULA.

3.2 The parties hereby agree that the courts of the Republic of Hungary will have exclusive jurisdiction to rule on any disputes arising in connection with this Agreement.

3.3 The original language version of this Agreement is the Hungarian version. This Agreement has versions in other languages as well. In case of dispute the Hungarian version shall prevail.

### **4 Object of the Agreement and Termination**

4.1 The object of this Agreement shall be the navigation guidance software product of Licensor (hereinafter referred to as: the "Software Product").

4.2 The Software Product shall include the operating computer program, its complete documentation, the map database pertaining thereto and any third-party contents and services accessible through the Software Product (hereinafter together referred to as: the "Database").

4.3 Any form of display, storage, coding, including printed, electronic or graphic display, storage, source or object code, or any other as yet undefined form of display, storage, or coding, or any medium thereof shall be deemed parts of the Software Product.

4.4 Error corrections, additions, updates or upgrades to the Software Product or the Databases used by the User following the conclusion of this Agreement shall also be deemed parts of the Software Product and Used in accordance with this Agreement.

4.5. Your rights under this Agreement will terminate immediately without notice from Licensor if you materially breach it or take any action in derogation of Licensor's and/or its licensors' rights to the Software Product. Licensor may terminate this Agreement if any Software Product becomes, or in Licensor's reasonable opinion likely to become, the subject of a claim of intellectual property infringement or trade secret misappropriation. Upon termination, you will cease use of, and destroy Software Product and all parts of it and confirm compliance in writing to Licensor, if requested.

#### 5 Rights under copyright

5.1 Unless otherwise provided by law or contractual provisions, the Licensor is the sole and exclusive owner of all material copyrights vested in the Software Product.

5.2 Copyrights extend to the whole Software Product and to its parts separately as well.

5.3 The owner(s) of the copyrights of the Database or certain works protected by intellectual property rights, that are forming part of the Software Product is (are) the Licensor, or natural person(s) or corporate entity(ies) owners of certain Databases (hereinafter referred to as: "Database Owner"). Some Database Owners are listed in the "About" or similar menu item of the Software Product. The Licensor hereby states that it has obtained sufficient usage and representation rights from the Database Owners in order to utilize the Database, to offer it for utilization and to transfer it for utilization as set forth in this Agreement.

5.4 Pursuant to this Agreement, all rights vested in the Software Product shall remain in the ownership of the Licensor, except for those to which the User is entitled under law or by virtue of this Agreement.

#### 6 Rights of the User

6.1 By default the User is entitled to install the Software Product on one Device having a single GPS sensor built in, and to run and use one copy of the Software Product or a preinstalled copy of the Software Product thereon. The Software Product and Database is for the User's personal or internal business use only.

6.2 The User is entitled to make one backup copy of the Software Product. However, if the Software Product operates after installation without the use of the original media copy, then the original media copy shall be deemed to be a backup copy. In all other cases, the User is only entitled to use the backup copy if the original media copy of the Software Product has been ascertainably and unequivocally rendered unsuitable for its lawful and intended use.

6.3 In the event that the Software Product comes preinstalled on- or otherwise licensed together with the Device or purchased online for and installed by the User for a specific Device, the Software Product shall be tied to the Device and may not be separated-, transferred to-, or used with another Device or sold to another User without selling the Device itself.

6.4 The Database, content or services provided to User may only be used together with User's copy of the Software Product and may not be used separately or with another copy of the Software Product.

#### 7 Limitations of use

##### 7.1 The User is not entitled

7.1.1 to duplicate the Software Product (to make a copy thereof) except to the extent allowed by this Agreement or Applicable law;

7.1.2 to resell, sublicense or use it for commercial purposes, use to lease, rent or lend it, or to transfer it to a third person for any reason without transferring the Device on which it was first legally installed on (see section 6.3);

7.1.3 to translate the Software Product (including translation (compilation) to other programming languages);

7.1.4 to decompile, disassemble, or reverse engineer the Software Product;

7.1.5 to evade the protection of the Software Product or to modify, circumvent or obviate such protection through technological or by any other means;

7.1.6 to modify, extend, transform the Software Product (in whole or in part), to separate it into parts, combine it with other products, install it in other products, utilize it in other products, not even for the purpose of achieving interoperability with other devices;

7.1.7 apart from using the computer program, to obtain information from the Database as a part of the Software Product, to decompile the Database, to use, copy, modify, extend, transform the Database in whole or in part or the group of data stored therein, or to install it in other products or otherwise, utilize it in other products or to transfer it, not even with the aim of achieving interoperability with other products.

7.2 The User may only use the Databases, content and services available through the Software Product and provided by third parties and the data received through the services provided by third parties (including but not limited to the traffic data received from the RDS TMC or on-line TMC traffic information service) for his/her own personal benefit and at his/her own risk. It is strictly prohibited to store, to transfer or to distribute these data or contents or to disclose them in full or in part to the public in any format or to download them from the product.

7.3 The User is not entitled to remove, modify or obscure of any copyright, trademark notice, or restrictive legend included in the Software Product, the Database, content or services.

## 8 No warranty, limitation of liability

8.1 The Licensor hereby informs the User that although the greatest care was taken in producing the Software Product, given the nature of the Software Product and its technical limitations, the Licensor does not provide a warranty for the Software Product being completely error-free, and the Licensor is not bound by any contractual obligation whereby the Software Product obtained by the User should be completely error-free.

8.2 THE LICENSED SOFTWARE PRODUCTS, DATABASES, CONTENT AND SERVICES ARE PROVIDED ON AN "AS IS" AND "WITH ALL FAULTS BASIS" (INCLUDING NO WARRANTY FOR THE CORRECTION OF FAULTS) AND LICENSOR, THE DATABASE OWNERS AND THIRD PARTY SUPPLIERS EXPRESSLY DISCLAIM ALL WARRANTIES, EXPRESS OR IMPLIED, INCLUDING BUT NOT LIMITED TO, THE IMPLIED WARRANTIES OF NON-INFRINGEMENT, MERCHANTABILITY, SATISFACTORY QUALITY, ACCURACY, TITLE AND FITNESS FOR A PARTICULAR PURPOSE. NO ORAL OR WRITTEN ADVICE OR INFORMATION PROVIDED BY LICENSOR OR ANY OF ITS AGENTS, DATABASE OWNERS, EMPLOYEES OR THIRD PARTY PROVIDERS SHALL CREATE A WARRANTY, AND USER IS NOT ENTITLED TO RELY ON ANY SUCH ADVICE OR INFORMATION. THIS DISCLAIMER OF WARRANTIES IS AN ESSENTIAL CONDITION OF THE AGREEMENT.

Licensor does not warrant that the Software Product, Database, content or service are capable of interoperating with any other system, Device or product (e.g. software or hardware).

8.3 The Licensor does not assume any responsibility for damages incurred due to an error in the Software Product (including errors of the computer program, the documentation and the Database).

8.4 The Licensor does not assume any responsibility for damages incurred due to the Software Product not being applicable for any defined purpose, or due to the error or incompatibility of the Software Product with any other system, device or product (e.g. software or hardware).

8.5 NEITHER LICENSOR NOR ITS SUPPLIERS SHALL BE LIABLE TO USER FOR ANY INCIDENTAL, CONSEQUENTIAL, SPECIAL, INDIRECT OR EXEMPLARY DAMAGES ARISING OUT OF THIS AGREEMENT, INCLUDING LOST PROFITS OR COSTS OF COVER, LOSS OF USE OR BUSINESS INTERRUPTION OR THE LIKE, REGARDLESS OF WHETHER THE PARTY WAS ADVISED OF THE POSSIBILITY OF SUCH DAMAGES.

NOTWITHSTANDING ANYTHING TO THE CONTRARY CONTAINED HEREIN, THIRD PARTY SUPPLIERS (E.G. DATABASE OWNERS, MAP PROVIDERS) OR AGENTS OF LICENSOR SHALL HAVE NO MONETARY LIABILITY TO THE USER FOR ANY CAUSE (REGARDLESS OF THE FORM OF ACTION) UNDER OR RELATING TO THIS AGREEMENT.

8.6 The Licensor also draws the attention of the User to the fact that, when using the Software Product in any form of vehicle, observing the traffic regulations and rules (e.g. use of obligatory and/or reasonable and suitable security measures, proper and generally expected care and attention in the given situation, and special care and attention required due to the use of the Software Product) is the exclusive responsibility of the User. The Licensor shall not assume any responsibility for any damages occurred in relation to use of the Software Product in a motor vehicle.

8.7 By concluding the Agreement, the User shall, in particular, acknowledge the information stated in Section 8 above.

## 9 Sanctions

9.1 The Licensor hereby informs the User that, if the Licensor finds its rights under the Copyright Act to be breached, the Licensor may

9.1.1 seek judicial recognition of this breach;

9.1.2 demand that the breach cease and order the person in breach to refrain from continuing such actions;

9.1.3 demand that the person under breach give proper compensation (even by way of publicity at the expense of the person in breach);

9.1.4 claim the return of the increase of assets due to the breach;

9.1.5 demand the cease of the wrongful action and, demand restitution to its state before the breach was committed at the expense of the person in breach, and may demand the destruction of instruments and materials used to commit the breach as well as of the products created by the breach;

9.1.6 claim for damages.

9.2 The Licensor hereby also informs the User that the breach of copyrights and related rights is a crime under Act IV of 1978 on the Hungarian Criminal Code, which may be sentenced of two years in prison in basic cases and up to eight years in prison in aggravated cases.

9.3 Content and services provided by third parties. The Licensor hereby excludes any liability of its own for the Database in the Software Product and for any content or service provided by a third party by using the Database. The Licensor does not warrant the quality, suitability, accuracy, fitness for a specific purpose or territorial coverage of the Database, content, product or service or the availability of the Database, content, product or service, and it specifically excludes any liability for the suspension or cancellation of the service, and any damage arising in relation to the service or for complete cancellation of the service. User acknowledges that the mapping data in Databases contains geographical data and other data.

The User hereby acknowledges that (i) inaccurate or incomplete information due to the passage of time, changing circumstances, sources used and the nature of collecting comprehensive geographic data, may each lead to incorrect results; and (ii) that the Database, contents and services provided by third parties may only be used at the risk of the User and for the personal or internal business benefit of the User. User acknowledges that the Databases, content and services are the confidential information of Database Owners and disclosure of the Databases to third parties is prohibited.

USE OF THE SOFTWARE PRODUCT'S REAL TIME ROUTE GUIDANCE FUNCTION IS AT USER'S SOLE RISK AS LOCATION DATA MAY NOT BE ACCURATE.

9.4 Content and services provided by the Licensor or an agent of the Licensor. For certain Software Products the Licensor or a contractual partner may offer various products and services to the User through [www.naviextras.com](http://www.naviextras.com). The User may only use these services when the User has read and understood the relevant end user license agreement(s) at [www.naviextras.com](http://www.naviextras.com) and the User is obliged to use the services in line with the terms and conditions thereof.

9.5 Purchase and acquisition of activation license for the use of certain functions, Databases, content or services may require Internet connection with no alternative way of acquisition offered by Licensor.

## 10 Anonymous data collection

10.1 The User hereby acknowledges that the Software Product may collect, transmit to Licensor or third parties, and in some cases store data connected to the usage of the Software Product by the User (e.g. movement/route data, user interaction data). Such data collection functions may be disabled or enabled by User any time from within the corresponding menu. The collected data is always anonymous, not associated in any way with any personal information of the User or with the User itself.

10.2 The collected data may be uploaded to Licensor's database or transmitted periodically or in real time to a third party partner and used exclusively for the purpose of enhancing and improving the precision and reliability of features and services of the Software Product and the Databases. Uploading is executed through Licensor's special software or by the User navigation device, and the upload may be enabled or disabled by User. After successful data upload, the collected data is deleted from the Software Product storage media.

10.3 Collected data is transmitted, stored and handled anonymously and no connection of the data with the User shall be established by Licensor or any third party.

10.4 Licensor hereby informs the User, that if it accesses the Internet through mobile data service while abroad or otherwise roaming another mobile network the transmission of such data may result in special roaming charges. To avoid such charges it is the responsibility of the User to disable mobile data services while roaming or to turn off the data collection functions of the Software Product.

## 11 Online Content Service Auxiliary Terms

11.1 For online content services the following auxiliary terms shall also apply. Database content (e.g. weather-, traffic info, location based info) may be supplied by Licensor to the User's Device through an Internet connection (hereinafter: "Online Content Services"). Such Content may be granted for a fee or free of charge subject to Licensor's decision. Ensuring access to the Internet is the responsibility of the User.

11.2 Online Content Services in general are not available in all countries, furthermore different conditions and Service characteristics may apply in different countries. Use of certain Online Services may be prohibited in various countries. It is the User's responsibility to comply with country specific regulation. Licensor excludes its liability for the consequences of illegal use of such functions and User shall indemnify and hold Licensor harmless from all claims against Licensor from authorities or third parties due to the illegal use.

11.3 Online Content is downloaded by the Software Product from Service Provider's Online content servers. The Licensor hereby excludes any liability of its own for the Online content. The Licensor does not warrant the quality, suitability, accuracy, fitness for a specific purpose or territorial coverage of the Online content, furthermore no warranty is offered regarding the availability (e.g. uptime) of Online content servers. User acknowledges that in any territory or time, slow- or non-connectivity may be experienced due to capacity limitations of Licensor's servers. The Software Product may allow the User to access and communicate third party servers directly. In such cases use of such servers is for User's own risk entirely. Licensor shall not undertake any liability whatsoever for such servers and services accessed and received directly from third parties.

11.4 User acknowledges that the data or information provided through Online Content Services is not updated in real-time and may not accurately reflect the real life situation or events.

11.5 The User hereby acknowledges that the Online Content Services may only be used at the risk of the User and for the personal benefit of the User. It is the sole responsibility of the User to provide and maintain a connection to the public Internet network. User accepts that the usage of the Online Content Services generates data traffic (up- and downstream) and may result in increased data service fees payable by User.

11.6 Online Content Services may provide data, information or materials supplied and/or licensed by third parties to Licensor. For such materials different terms and conditions imposed by such third parties may apply. Applicable third party terms shall be referred in the "About" section of the Software Product or as part of this Agreement. When first using /

enabling Online Content, User accepts compliance with those third party terms and conditions.

11.7 Discontinuation. Licensor reserves the right to discontinue provision or access to any Online Content Service with or without prior notice to the User. Such discontinuation shall not entail any consequences other than here stated. In case of discontinued Online Content Services that were (i) provided for a pre-paid fee, AND (ii) such fee covers the use of the Online Content Service for a definite term (i.e. pre-paid subscription service), User shall be entitled to a refund proportionate to the term remaining from such definite term from the time of the discontinuation.

11.8. Community Services. Some Online Content Services may be based on data and information uploaded by participating individuals (Users or other persons) or a Database created and maintained by a group of such individuals. Such data may not come from a trusted source and may also be intentionally false or misleading, as Licensor does not have any means to control or verify the credibility or accuracy of such data or the individuals providing the data. Therefore User accepts that community type Online Content Services must be used with extreme care.

By participating in the community by providing data or any information via the Software Product or other means offered by Licensor (e.g. through a website or other software), User shall accept the following:

- (a) Licensor is granted a royalty free right to use the data uploaded, in particular, to modify, display, make available to the public, distribute, copy the data for any purpose;
- (b) User warrants that not third party has any rights that would hinder or render impossible the use of the data as set out in (a) above, and that no third party rights are infringed by uploading the data on those conditions;
- (c) User indemnifies and holds harmless Licensor from any claim from a third party against Licensor due to violation of its rights regarding the uploaded data.

## 12 Third Party Terms

12.1 Google Local Search. User acknowledges that Google Local Search (GLS) functionality is provided by the usage of Google, Inc.'s service to the User. User hereby accepts all conditions of Google's Terms of Service provided at <http://www.google.com/accounts/TOS> . User accepts that the Google Local Search is declared "deprecated" and is not commercially supported by Google, Inc. and also it may be made unavailable without notice by Google in accordance with the relevant terms of service at <http://code.google.com/intl/hu-HU/apis/websearch/terms.html> .

## 9 Copyright note

The product and the information contained herein are subject to change without prior notification.

This manual may not, in whole or in part, be reproduced or transmitted in any form either electronically or mechanically, including photocopying and recording, without the express written consent of BAROS GmbH.

© 2015 - BAROS GmbH

© 2006 – 2015 TomTom. All rights reserved. This material is proprietary and the subject of copyright protection, database right protection and other intellectual property rights owned by TomTom or its suppliers. The use of this material is subject to the terms of a license agreement. Any unauthorized copying or disclosure of this material will lead to criminal and civil liabilities.

All rights reserved.

### Declaration of Conformity

Hereby Baros GmbH, declares, that the Blaupunkt devices TravelPilot 43, 53, 73 and 54, 74 are in compliance with the essential requirements and other relevant regulations of Directive 1999/5/EC.

The Declaration of Conformity can be found at: [www.blaupunkt.com](http://www.blaupunkt.com)

## Guarantee

Please keep the proof of purchase for this device for the entire duration of the guarantee period, as it must be produced in the event of any claim.

You (as the end user) receive a 24-month guarantee from the date of sale. The article has been manufactured using the most modern production methods and subjected to strict quality controls.

Please contact only the **manufacturer (not the dealer where you purchased it) in the event of any defects during the guarantee period.**

The guarantee does not cover damage caused by improper use or external influence (water, falling, sunlight, breakage or impact).

## Userinformation/Contact

If your device has a defect or you have problems with it, please contact our Service & Support Centre

If you need to send your device to us, please attend to the following points:

1. Use only the **original packaging**
2. Add a **detailed error description**
3. Add your **full name and address and a copy of your purchase receipt**
4. Stamp and send the package to us (**sufficient postage**)

### Address of our Service Center:

First Service Center . Kleine Düwelstr 21 . DE-30171 Hannover/Germany

You can get in contact with us by eMail: [support@first-servicecenter.de](mailto:support@first-servicecenter.de),  
[facebook.com/BlaupunktDACH/](https://www.facebook.com/BlaupunktDACH/) and [www.blaupunkt.de](http://www.blaupunkt.de)