

(NASA-CR-158337) SHOULD WE HAVE A NEW  
ENGINE? AN AUTOMOBILE POWER SYSTEMS  
EVALUATION. VOLUME 2: TECHNICAL REPORTS  
(Jet Propulsion Lab.) 547 p

N79-75831

00/37 Unclas  
20421

# Should We Have a New Engine ?

## An Automobile Power Systems Evaluation

### Volume II. Technical Reports

# **Should We Have a New Engine ?**

## **An Automobile Power Systems Evaluation**

### **Volume II. Technical Reports**

**August 1975**



Copyright © 1975 by Jet Propulsion Laboratory  
California Institute of Technology

First printing, August 1975  
Second printing, October 1975

Minor typographical errors corrected on second printing

Library of Congress Cataloging in Publication Data  
Main entry under title:

Should we have a new engine?: An automobile power systems  
evaluation.

"JPL SP 43-17."

Bibliography: v. 1, p.

CONTENTS: v. 1. Summary. - v. 2. Technical reports.

1. Automobiles - Motors - Technological innovations.  
2. Automobiles - Fuel consumption. 3. Automobiles - Exhaust  
gas. 4. Automobiles - Motors - Research. I. California Insti-  
tute of Technology, Pasadena. Jet Propulsion Laboratory.

TL210. S474

629.2'5

75-22231

## ABSTRACT

Alternative automotive powerplants were examined for possible introduction during the 1980-1990 time period. Technical analyses were made of the Stratified-Charge Otto, Diesel, Rankine (steam), Brayton (gas turbine), Stirling, Electric, and Hybrid powerplants as alternatives to the conventional Otto-cycle engine with its likely improvements. These alternatives were evaluated from a societal point of view in terms of energy consumption, urban air quality, cost to the consumer, materials availability, safety, and industry impact.

The results show that goals for emission reduction and energy conservation for the automobile over the next 5-10 years can be met by improvements to the Otto-cycle engine and to the vehicle. This provides time for the necessary development work on the Brayton and Stirling engines, which offer the promise of eliminating the automobile as a significant source of urban air pollution, dramatically reducing fuel consumption, and being saleable at a price differential which can be recovered in fuel savings by the first owner. Specifically, the Brayton and Stirling engines require intensive component, system, and manufacturing process development at a funding level considerably higher than at present.

## PRINCIPAL INVESTIGATOR'S NOTE

This report is the product of a \$500,000 study performed under a grant from the Ford Motor Company. Volume I, Summary, contains a technical summary of our substudies, an integration of results, and a presentation of findings, and recommendations. Volume II, Technical Reports, provides supporting material.

The concept of this study was first expressed by Mr. Lee Iacocca, President of Ford Motor Co., in testimony before the Senate Air and Water Pollution Subcommittee in May 1973. Ford Motor Co. wanted an assessment of the longer-term powerplant options to provide a balanced, independent view of this highly controversial area. After a solicitation of interest from several nonprofit research organizations, Ford selected the Jet Propulsion Laboratory (JPL) to perform this study, and work began in December 1973.

A copy of the agreement with Ford Motor Co. and our mutually agreed-upon statement of objectives is provided in Appendix A of Volume I. Independence from Ford is an important aspect of the agreement. That independence has been achieved; Ford has meticulously avoided any action which might influence the conduct of the study or the conclusions.

It is important to note that the key question stated in the objectives is what "should" be done relative to the introduction of a new powerplant. This requires a value judgment from the points of view of society, the industry, and the consumer. What "should" be done is distinct from what "could" be done: the latter being necessary to the former but limited to technical feasibility. What is "likely" to happen is also a different concept—the safest prediction being that the engine powering our cars in the future will be an improved version of the conventional Otto cycle engine. We set out to answer the key question: Should our cars be powered by a new powerplant? Of course, we realize that the final outcome will depend on the actions of government and industry and, ultimately, the auto-buying public.

The scope of the study is quite broad. We believe we have avoided any arbitrary ground rules or assumptions which would indirectly dictate the answer. The only criteria as to whether to delve into a particular aspect of this fascinating question have been whether it is (a) important to the outcome and (b) the best use of the time and resources available.

The study was conducted by a team of engineers and scientists from JPL and the Caltech Environmental Quality Laboratory (EQL) along with limited use of consultants. A list of participants is included in Appendix B, Volume I. Most of the team members were located in adjoining offices to promote strong interaction among various study areas. The areas into which the team was organized were: Engine Technology (the largest substudy), Vehicle Systems, Energy and Fuels, Materials, Vehicle Use, Industry Practices, and Impact Analysis. The integration of substudies and the generation of overall conditions were iterative team processes.

During the study, surveillance of technical progress was maintained by a Review Board comprised of experienced senior technical and management personnel from JPL and the Caltech campus. A list of Review Board members is given in Appendix C of Volume I. We also invited selective outside review of various substudy reports to obtain additional viewpoints and to enhance the accuracy of the data.

Our study of alternate powerplants involved an intensive review of the literature, visits to engine development laboratories and to automobile manufacturers (see Volume I, Appendix D), and our own analytical extrapolations of engine and vehicle performance into the future. This last step was of critical

importance. Many of the engines currently undergoing tests are deficient in one or more areas (fuel economy, emissions, cost, weight, size, or durability) and are not ready for widespread introduction. Fortunately, the time frame of the study allows up to 10 years of research and development (R&D), through which much can be accomplished. Thus, it was necessary to estimate the future potential of the engine based on fundamental thermodynamic limitations and practical considerations such as materials and producibility.

Several studies in the general area of new engines and/or their impact on society have recently been published; some major investigations are listed in Appendix E, Volume I. While there is obvious overlap between those studies and this one, we have had the opportunity to build on the previous results and go both deeper into engine technology and more broadly into the societal issues surrounding the introduction of a new engine.

The principal authors of and contributors to the various chapters are listed in Appendix A of this volume. A glossary of special terminology and abbreviations is presented in Appendix B of Volume II.

I wish to thank the members of our study team for their deep interest, dedication, and perseverance in grappling with this important, complex, and difficult problem. I acknowledge the management of JPL for freeing the key team members and myself from other responsibilities so that we could concentrate fully on this project. The Project Review Board devoted considerable time to our activities and had an important impact on the conduct and content of this study.

I acknowledge a particular debt of gratitude to Chrysler, Ford, General Motors, and the numerous foreign manufacturers identified in the study for their cooperation and the time they spent providing technical information on the alternate powerplants that they have under development. Information has been exchanged with many inventors and with persons in the auto industry, development laboratories, universities, and the federal government; to these many individuals, I extend my thanks for their valued contributions.

Finally, I would like to thank Ford Motor Company for providing the opportunity to perform this study.

R. Rhoads Stephenson  
Principal Investigator  
August 1975

## CONTENTS

- Chapter 1. Introduction
  - Chapter 2. Fundamental Considerations of Heat Engines for Automotive Propulsion
  - Chapter 3. The UC Otto Automotive Power System (Base-line Engine)
  - Chapter 4. The Intermittent-Combustion Alternate Automotive Power Systems: The Lean-Burning Otto Engine, The Stratified-Charge Otto Engine, The Diesel Engine
  - Chapter 5. The Brayton Automotive Power System (Gas Turbine Engine)
  - Chapter 6. The Stirling Automotive Power System
  - Chapter 7. The Rankine Automotive Power System
  - Chapter 8. Electric Vehicles
  - Chapter 9. Hybrid Vehicles
  - Chapter 10. Vehicle Systems
  - Chapter 11. Manufacturability and Costs
  - Chapter 12. Alternate Heat Engine Research and Development
  - Chapter 13. Scenario Generation
  - Chapter 14. Automobile Use
  - Chapter 15. Industry Practices
  - Chapter 16. Vehicle and Highway Safety
  - Chapter 17. Energy and Fuels
  - Chapter 18. Material Resource Requirements and Supply
  - Chapter 19. Air Quality Impact Study
  - Chapter 20. Ownership Costs and Economic Impact
- Appendices
- A. Authors
  - B. Glossary

## CHAPTER 1. INTRODUCTION

Volume II of this two-volume report constitutes the technical reports or data base upon which Volume I is based. Volume I, in turn, summarizes the material presented in this volume, draws comparisons between alternate engines, and presents conclusions and recommendations. Volume I should be of value to all readers, while Volume II contains material of primary interest to the technical specialist. It is suggested that the reader become familiar with Volume I before pursuing the supporting material of Volume II.

This volume consists of topical chapters which are written to stand alone and can be read selectively or in any order to suit the reader's interest. Each chapter has its own figures, tables, and references as an integral part. Those which contain analytical sections provide definitions within the text for the algebraic symbols used. The principal authors and contributors for each chapter are given in Appendix A. A glossary containing nomenclature and abbreviations common to the chapters is given in Appendix B.

The alternative automotive power systems are treated first in the sequence of chapters. Chapter 2 provides an overview of heat engines from the fundamental standpoint and develops some key concepts which are subsequently applied in the chapters dealing with specific types of heat-engine power systems.

Chapter 3 through 7 discuss the various heat-engine power systems, beginning with the intermittent-combustion types and followed by the continuous combustion types. In these five chapters, each heat-engine power system is appraised on its own merits, given the benefit of equivalent materials and production technologies (see Chapter 2 for the definitions of the Present, Mature, and Advanced levels of technology). Consequently, comparisons between engine types are reserved for Volume I. However, to facilitate such detail-level comparisons, Chapters 3 through 7 are generically organized by section in a uniform manner. This sectional organization scheme is indicated in Table 1-1 wherein 'n' refers to any chapter number in the sequence 3 through 7. So, for example, if one wishes to compare the research and development requirements of the alternative heat engines, one might read only Sections 3.7, 4.7, . . . , and 7.7.

Chapters 8 and 9 treat the Electric and Hybrid automotive power systems, respectively. Chapter 10 then addresses design improvements in the rest of the automobile and also the methodology applied in analyzing the functional interdependencies between the vehicle and its power system. Chapter 10 explains the keystone concept for comparative evaluation of alternative vehicles - the Otto-Engine Equivalent car. The manufacturability considerations and production costing methodology employed are summarized next in Chapter 11, while Chapter 12 presents the approach taken in obtaining industry's estimates of the development funding and time requirements for specific options.

Chapters 13 through 20 document the substudies related to vehicle use patterns, the methodology of generating aggregate fleet effects, air quality impacts, energy and fuels availability, materials availability, industry practices with respect to engine production conversion, and ownership and economic considerations.

Table 1-1. Generic outline of heat-engine powerplant chapters  
(Chapters 3 through 7)

Chapter n	The Automotive Power System
n. 1	Description
n. 1. 1	Introduction
n. 1. 2	Morphology
n. 2	Characteristics
n. 2. 1	Thermodynamics
n. 2. 2	Engine Performance
n. 2. 3	Fuel Requirements
n. 2. 4	Pollutant Formation
n. 3	Major Subassemblies/Components
n. 3. 1	Descriptions
n. 3. 2	Configurational Evolution
	Present Configuration
	Mature Configuration
	Advanced Configuration
n. 3. 3	Materials and Producibility
n. 3. 4	Unit Costs
n. 4	Vehicle Integration
n. 4. 1	Engine Packaging in Vehicle
n. 4. 2	Transmission Requirements
n. 4. 3	Other Vehicle Design Impacts
n. 5	Performance in Vehicle
n. 5. 1	Fuel Economy
n. 5. 2	Chemical Emissions
n. 5. 3	Noise Emissions
n. 5. 4	Drivability Aspects
n. 5. 5	Safety
n. 6	Ownership Considerations
n. 6. 1	Maintenance
n. 6. 2	Incremental Cost of Ownership
n. 7	Research and Development Required
n. 7. 1	Mature Configuration
n. 7. 2	Advanced Configuration

CHAPTER 2. FUNDAMENTAL CONSIDERATIONS OF HEAT  
ENGINES FOR AUTOMOTIVE PROPULSION

2.1	Introduction . . . . .	2-2
2.2	Characterization of Heat Engines for Automotive Propulsion . . . . .	2-2
2.2.1	Heat Engine Parameters . . . . .	2-2
2.2.2	Classification of Heat Engines . . . . .	2-2
2.2.3	Efficiency of Heat Engines . . . . .	2-3
2.3	Definition of Present, Mature, and Advanced Configurations . . . . .	2-4
2.4	Thermodynamic Processes in Heat Engines . . . . .	2-6
2.4.1	Work Processes . . . . .	2-6
2.4.2	Heat Exchange Processes . . . . .	2-8
2.4.3	Combustion Processes . . . . .	2-10
2.5	Attainable Efficiency of Heat Engines . . . . .	2-12
2.5.1	Thermal Efficiency of Heat Engines . . . . .	2-12
2.5.2	Engines with Lower Attainable Efficiency . . . . .	2-13
2.5.3	Engines with Higher Attainable Efficiency . . . . .	2-14
2.5.4	Concluding Remarks . . . . .	2-15
	References . . . . .	2-17
	Figures . . . . .	2-19



## 2.1 INTRODUCTION

The performance of a heat engine is determined by the nature of the thermodynamic processes which it incorporates. Such processes directly affect the engine's power output, fuel consumption and pollutant emission characteristics. The central purpose of this chapter is to identify some of the more important of these processes and to explore their effect on the operation of engines. Two of the most prevalent factors that characterize these thermodynamic processes are the temperatures at which they occur and the uncompensated losses associated with implementation of the processes such as frictional dissipation, unrestrained expansion, and thermal losses. The first of these factors is sensitive to the high-temperature properties of the structural materials from which the engine is fabricated; the second is sensitive to the level of technological development reflected by the performance of the mechanical components comprising the engine. Consequently, an evaluation of different types of engines for automotive propulsion should be made at equivalent levels of materials and component performance technology, considering the application of the engine to automobiles in mass production. This evaluation of engine characteristics at equivalent levels of technological development was accomplished by configuring each of the engines in a Mature and an Advanced version.

The succeeding sections of this chapter are presented as follows: First, the characteristics of heat engines which are pertinent to their use in automobiles will be identified. Second, the technological states denoted as Present, Mature, and Advanced are discussed, with a detailed analysis of the performance which results from the application of these states of technological development to each engine being given in Chapters 3 through 7. Third, a limited consideration of the basic thermodynamic processes of work production or absorption and heat addition or extraction which are common to all heat engines is given. Fourth, an assessment of the influence of these fundamental processes on the emissions and fuel consumption characteristics of the different types of engines is given.

Much of the material presented in this chapter is available in textbooks and in the open literature. Such basic information forms the framework for an evaluation of heat engines; hence, it is of sufficient importance to warrant the brief discussion given herein.

## 2.2 CHARACTERIZATION OF HEAT ENGINES FOR AUTOMOTIVE PROPULSION

### 2.2.1 Heat Engine Parameters

The characteristics of the heat engines under consideration must be expressed in a quantitative manner to permit the performance of a vehicle powered by a particular engine to be appraised. Consequently, the engines are conveniently viewed as black box devices with a set of characteristics which interface with the vehicle. These characteristics were formulated in terms of total power system parameters. The total power system included the engine itself and all associated

components such as the cooling system, transmission, and battery. The power system parameters which were quantitatively considered in the assessment of vehicle performance are:

- (1) Weight (specific power, BHP/lb).
- (2) Maximum power output and maximum output shaft speed.
- (3) Variation of power output with output shaft speed (torque-speed characteristic).
- (4) Fuel consumption over the operating ranges of speed and power.
- (5) Emissions of unburned hydrocarbon compounds, carbon monoxide, and nitrogen oxides, HC/CO/NO<sub>x</sub>, respectively.

The first three parameters were utilized in the determination of the specifications of a vehicle propelled by an alternate power system which is equivalent in performance to today's conventional automobile with an Otto engine. These automobiles powered by alternate engines are called "Otto Engine Equivalent Vehicles." The methodology followed in defining the OEE Vehicles is discussed in Chapter 10. The fuel economy of each of these vehicles over prescribed driving cycles was computed from the fuel consumption of their engines as dependent on power output and engine speed. The emissions characteristics of the vehicles powered by the alternate engines were established from several different types of information reported in the literature, including tests of real vehicles, engine dynamometer tests, simulations and tests with engine components, and analytical predictions, as discussed for each engine in Chapters 3 through 7.

Power system parameters such as durability, drivability, vibration, and noise were not taken as discriminating factors among the different types of engines. Such characteristics were assumed to be developed to the point of acceptability for each of the candidate engines in the Mature version. However, the smaller power systems do offer packaging advantages which are discussed in Chapters 3, 5, and 10.

### 2.2.2 Classification of Heat Engines

The major source of energy for automobile propulsion is the chemical combustion of a fuel carried aboard the vehicle. The energy released as heat during the combustion of the fuel must be transformed into useful work for vehicle propulsion. The transformation of heat released by the combustion of fuel to useful work is the function of a class of machines known as heat engines. The conversion of heat to mechanical work in all types of heat engines considered in this study is accomplished by increasing the thermal energy of a working fluid at elevated pressure confined within the engine and, subsequently, allowing the working fluid to produce mechanical work during a restrained expansion process. Any such heat engine must carry the working fluid through a sequence of thermodynamic states in order to produce the conversion of thermal energy to useful work. The methods of thermodynamic analysis

are applicable to such engines and give insight into the thermodynamic handicap of each type of heat engine when appropriate materials and component performance technology are applied.

A heat engine is usually described according to the thermodynamic cycle on which it operates. A particular thermodynamic cycle is comprised of the sequence of processes that the working fluid undergoes within the confines of the heat engine. In addition to the thermodynamic cycle of a heat engine, it may also be classified as being:

- (1) Open cycle or closed cycle,
- (2) Internal combustion or external combustion,
- (3) Intermittent combustion or continuous combustion.

In an open-cycle machine, the working fluid is inducted into the engine from the surroundings, is passed through the engine, therein absorbing heat and producing work, and is then exhausted to the surroundings. Conversely, in a closed-cycle machine, the working fluid is completely contained within the engine and is recirculated to repeatedly execute the thermodynamic cycle. The heat addition and rejection processes are usually accomplished via heat exchangers.

The distinction between internal and external combustion engines lies in the nature of the heat addition process. The products of combustion at least partially constitute the working fluid in an internal combustion engine; whereas in an external combustion engine a separate working fluid passes through a heat exchanger to receive heat from the products of combustion.

The combustion process in heat engines may occur continuously or intermittently depending on the design of the engine. A continuous combustion engine has a separate and distinct combustion device in which the air/fuel mixture continually passes through a region of sustained combustion from which the products continually flow. Conversely, in an intermittent combustion engine, specific and distinct quantities of air/fuel mixture are repeatedly ignited and burned in the combustion space of the engine; that is, the air/fuel mixture is burned in individual batches.

The evaluative effort of the APSES study was applied most intensely to five basic types of heat engines, identified according to their thermodynamic cycles:

- (1) Otto engine: an open-cycle, intermittent, internal combustion engine with spark ignition in the uniform (homogeneous) charge version or in the stratified (heterogeneous) charge version. Its ideal thermodynamic cycle consists of (a) isentropic compression, (b) constant volume heat addition, (c) isentropic expansion, and (d) constant volume heat rejection.
- (2) Diesel engine: an open-cycle, intermittent, internal combustion engine with compression ignition. Its ideal

thermodynamic cycle consists of (a) isentropic compression, (b) limited pressure heat addition, (c) isentropic expansion, and (d) constant volume heat rejection.

- (3) Brayton engine: an open-cycle, continuous, internal combustion engine with exhaust heat recovery, i. e., thermal regeneration. Its ideal thermodynamic cycle consists of (a) isentropic compression, (b) constant pressure heat addition (partly regenerative), (c) isentropic expansion, and (d) constant pressure heat rejection (partly regenerative). Brayton engines may also be configured without thermal regeneration, and they have been operated as closed-cycle machines.
- (4) Stirling engine: a closed-cycle, continuous, external combustion engine with thermal regeneration. Its ideal thermodynamic cycle consists of (a) isothermal compression with simultaneous heat rejection, (b) constant volume, regenerative heat addition, (c) isothermal expansion with simultaneous heat addition, and (d) constant volume, regenerative heat rejection.
- (5) Rankine engine: a closed-cycle, continuous, external combustion engine utilizing a condensing working fluid. Its ideal thermodynamic cycle consists of (a) isentropic compression (liquid working fluid), (b) constant pressure heat addition (vaporization and superheat), (c) isentropic expansion, and (d) constant pressure heat rejection (including slight regeneration and complete condensation).

More detailed discussions of these thermodynamic cycles are presented in Chapters 3 through 7.

### 2.2.3 Efficiency of Heat Engines

The merit of a heat engine as a thermodynamic machine is quantitatively expressed as the ratio of the output of energy in the form of useful work to the input of energy in the form of heat from the high-temperature source. The concept of measuring the performance of a heat engine in terms of this quantity, known as the thermal efficiency of the heat engine, followed from the work of Carnot (Ref. 2-1). Carnot's fundamental insight into thermomechanical energy conversion was that not all of the energy supplied as heat to an engine can be converted to mechanical work, and that the maximum fraction of the heat energy input that can be transformed into work by any heat engine is irrefutably determined by the temperature at which the heat is supplied to the engine and the temperature at which heat may be rejected from the engine's working fluid to the surroundings. Any of the five types of thermodynamic cycles listed above may be conceptually executed in a manner such that their theoretical thermal efficiencies will be the same, but with differing temperatures which are pertinent to efficiency. However, the factors which must be considered in the practical implementation of any of the five basic thermodynamic cycles, or any others, lead to significant differences in

the thermal efficiency which a real heat engine will display at its output shaft.

The brake thermal efficiency  $\eta_h$  of a heat engine is the ratio of the energy appearing as mechanical work actually available at the output shaft of the engine to the energy released as heat during combustion of the fuel, which may be expressed as  $\eta_h = \dot{w}_s / \dot{Q}_h$  or  $\eta_h = \dot{w}_s / (\dot{m}_f h_f)$ , where  $\dot{w}_s$  is the time rate of mechanical work at the engine's output shaft and  $\dot{Q}_h$  is the time rate of heat input to the engine from the combustion of fuel, which alternatively may be expressed as  $\dot{m}_f h_f$ , where  $\dot{m}_f$  is the mass flowrate of fuel and  $h_f$  is the lower value of the enthalpy of combustion of the fuel. Customarily, the fuel consumption characteristics of an engine are expressed in terms of brake specific fuel consumption (bsfc) or pounds mass of fuel consumed per horsepower-hour of work produced. In British Engineering Units the bsfc is related to  $\eta_h$  by the expression

$$\text{bsfc} = 2545 / (h_f \eta_h)$$

where  $h_f$  is expressed as Btu's per pound mass of fuel. Unless otherwise stated the fuel consumption of the engines (bsfc) and vehicles (miles per gallon) is expressed as if the fuel were gasoline with an energy content of 18,900 Btu/lb.

The brake thermal efficiency obtained from a real heat engine operating on any thermodynamic cycle is determined in part by the performance of the machinery with which the ideal cycle is mechanized. Mechanical or viscous friction between the moving parts of the engine, unrestrained expansion of the working fluid due to leakage or throttling processes, and heat losses from the working fluid during critical processes are three sources of inefficiency in a heat engine which may be minimized by careful engineering design. Another deleterious effect on the thermal efficiency of a heat engine may be imposed by the thermodynamic properties of the working fluid. Particularly in internal combustion engines, changes in working fluid composition occurring during combustion combined with the high temperatures and pressures during combustion usually cause changes in the properties of the working fluid which decrease the work produced during the restrained expansion process.

The indicated thermal efficiency  $\eta_i$  is the ratio of the work actually produced by the working fluid during the restrained expansion process to the energy added to the working fluid as heat from the high-temperature source during the heat addition process. Differences between indicated thermal efficiency and brake thermal efficiency are due only to mechanical frictional losses.

The most significant limitation on the attainable efficiency of heat engines is attributable to the characteristics of the materials from which the engine is constructed. For the maximum thermal efficiency, the engine structure must confine the working fluid at the highest permissible temperature, considering stress levels, mechanical and thermal fatigue, corrosion resistance and other factors affecting the weight, durability, and safety of the engine. The intermittent combustion engines appear to have an advantage

over the continuous combustion engines in that the internal surfaces of the engine are cyclically exposed to the hot combustion gases and to the cooler fresh air or fuel-air charge. Therefore, peak temperatures, which occur for very short time periods in the intermittent combustion engines, may be much higher than the continuously sustained maximum temperature in the continuous combustion engines. However, as will be illustrated in the discussion to follow, the temperature which determines the thermal efficiency of a heat engine is that at which heat addition from the high-temperature source must commence, not the peak temperature. In the absence of regeneration, this is the temperature after the compression process. And since this temperature is usually limited by considerations other than the maximum temperature that structural materials will withstand, the peak temperature advantage of an intermittent combustion engine may not directly translate into higher efficiency. These matters are further discussed in Section 2.6 and in the chapters on the individual engines.

### 2.3 DEFINITION OF PRESENT, MATURE, AND ADVANCED CONFIGURATIONS

The evaluation of the five types of heat engines included a comparison of the performance of the engines at equivalent levels of technology. The approach taken was to evaluate the performance of each engine type in two configurations, which were defined by consistently applying a specified level of technological development of materials characteristics and component performance to each type of engine, considering that the engines are to power automobiles in mass production. These configurations are denoted as Mature and Advanced. The currently existing versions of the engines are denoted as Present.

The Present configuration is defined as the configuration of an engine selected as representative of the heat engine type in whatever form and development state it currently exists. The set of present configurations therefore represents a fixed point in time and a spectrum of development statuses, mostly in the preprototype category, and, in general, not suitable for production for reasons of cost, weight, minor correctable design defects, etc. Performance data is experimental.

The Mature configuration is defined as the relatively near-term improved version of the present configuration, as limited by current technology. Implied are design improvements which permit some optimization in materials, fabrication techniques, and operating parameters and some component development, as well as the requisite design changes to render the engine economically mass producible. No fundamental research is involved, however, and operating parameters, i. e. stress, temperature, etc., which represent the upper limit of current technology are still limiting in the mature configuration, so that materials technology is basically metallic. Performance is projected from that of the present configuration, with improvements obtainable through reduction of thermal and mechanical losses and improved components. Hence, the set of Mature configurations represents an equivalent development status achieved at different points in time, all ostensibly within the 1980's decade.

The Advanced configuration is defined as a longer-term future version of an engine which embodies advantages afforded by extensions of existing technology. As such, it does not require any new basic materials but necessitates some fundamental research in ceramic materials formulation and processing, as well as some component innovation, considerable component development, and several iterations of design. Specifically, these configurations presuppose the fruition of the respective recommended research and development efforts. Liberal use is made of ceramic materials in upgrading and/or replacing metal components. Critical operating parameters are pushed to new limits consistent with the projected extensions in the applicable technologies. The performance projections, consequently, are first-order estimates, and the weights and production costs are highly speculative. The set of Advanced configurations represents an equivalent development status achieved at different points in time, but probably late in, or beyond, the 1980's decade. The Advanced configurations of the five heat engines are not intended to represent their ultimately attainable performance, as the implications of as-yet-undiscovered technologies cannot be forecast and technological breakthroughs cannot be foreseen. However, the performance of the Advanced engines does provide a relative comparison of the five heat engine types when a significantly improved materials technology is consistently applied.

Given the materials technologies assumed in the foregoing definitions, it remains to be determined what operating temperature limitations arise therefrom in the various equivalent technology engine types. For the intermittent combustion engines - the uniform and stratified charge Otto's and the Diesel - considerations other than materials characteristics limit the thermodynamic performance of the engine, and the benefits of advanced materials technology result primarily from reduced heat and friction losses and from lower engine weight. However, for the continuous-combustion alternates - the Brayton, the Rankine and the Stirling - the maximum usable working fluid temperature is key in determining the performance achievable within the given materials technology.

Present automotive-engine-production materials technology may be characterized as "ferrous," which is to say large-scale use of cast iron and carbon steels with limited use of alloy steels where temperature/stress conditions dictate, and with some aluminum application where temperatures permit and it is cost-effective.

For the continuous-combustion engines to be performance-competitive, the metallic-technology of the Mature configurations requires considerable use of stainless steels and more restricted use of superalloys. For the superalloys, a sustained working temperature of about 1900°F under conditions of minimal stress is generally accepted. In the Advanced versions of these engines, incorporation of ceramic technology such as silicon nitride or silicon carbide is assumed for the hot side components, and the corresponding accepted

maximum working temperature is about 2500°F. Neither the 1900°F nor the 2500°F can be defended to precisely represent an absolute maximum limitation, and can be somewhat exceeded in short-term transient excursion, but do represent reasonable design guidelines for sustained exposure. Hence these temperatures have been taken to characterize the two technologies.

To translate these material temperature limits into working fluid temperatures, the specific engine types must be considered. A significant difference in kind is immediately apparent between the open-cycle, internal combustion Brayton engines on the one hand and the closed-cycle, external combustion Rankine and Stirling engines on the other. In the former, the heat of combustion is released directly into the working fluid, whereas in the latter it must be transferred from fluid to fluid across a physical boundary; hence, the achievable working fluid temperatures are higher in the Brayton than in the Stirling or Rankine. There are also certain differences between the high-temperature heat exchangers in the Stirling and Rankine engines. The Rankine vapor generator is a monotube heat exchanger and has a significant temperature change along the direction of flow, while the Stirling heater head is a multitube exchanger operating at nearly constant temperature. The working fluids, hydrogen gas for the Stirling and water for the Rankine, are also different.

A highly simplified and idealized analysis for typical configurations of Stirling and Rankine high temperature heat exchangers which

- (a) assumes combustion-gas-side material temperatures of 1900°F and 2500°F,
- (b) assumes no temperature drop through any intervening wall, i. e., conductance  $\gg$  working fluid film coefficient, and
- (c) does not consider creep, stress rupture, fatigue or other material properties,

gives an indication of an upper-bound of the working fluid bulk temperatures, considering only temperature drops due to gas/surface convection coefficients. These are shown in the rows labeled "Idealized" in Table 2-1. When the temperature-stress limitations of the materials and the realities of building an economically producible engine are superimposed, these academic limits for the Rankine and Stirling engines are reduced.

Actual Stirling working fluid temperature limits were determined through detailed system optimizations by the cognizant purveyors. Limiting design parameters include stress rupture and creep in the heater head tubes, H<sub>2</sub> diffusion through those tubes, pressure drops, etc. It was not the intent of APSES to do an original structural analysis, and only spot checks were made using the manufacturer's heater tube dimensions.

Actual Rankine working fluid temperature limits were obtained from data provided by the cognizant developers. The configuration chart

in Chapter 7 embodies pressure/temperature scheduling<sup>1</sup> in the Mature configuration. This was done to avoid large-scale utilization of superalloy, which would be both prohibitively expensive and unavailable. Using representative tube dimensions, the Rankine engine was pressure/temperature scheduled and, by crude stress analysis, found to be roughly within stainless steel creep and stress rupture limits. Only the valve seat assemblies, valves, and springs are superalloy.

The Brayton working fluid consists of air plus the gaseous combustion products; hence no transboundary temperature differences are incurred. The Brayton components which must continuously sustain the maximum temperature are not large in size and are fabricated of superalloy. Thus, the maximum sustained temperature of 1900°F for superalloys is taken as the actual working fluid temperature.

The actual operating temperatures of the working fluids for equivalent technology engines are shown under the heading "Realistic" in Table 2-1. Further discussion of this subject is given in the individual engine chapters.

## 2.4 THERMODYNAMIC PROCESSES IN HEAT ENGINES

### 2.4.1 Work Processes

The conversion of heat to work in a heat engine is accomplished through the restrained expansion of a working fluid which previously has been elevated in pressure and temperature. The intensive properties of a gaseous working fluid which are directly changed through the action of

the mechanical components of a heat engine are specific volume or pressure, and temperature. The specific volume or pressure of a working fluid is changed through compression or expansion processes such as may be implemented with a positive displacement expander like a piston and cylinder, or a steady flow, dynamic expander like a turbine. The temperature may be changed by means of heat addition processes accomplished through combustion of the working fluid or by passing the working fluid through a heat exchanger. Such operations on a working fluid are conveniently thought of as work processes and heat addition (or rejection) processes, respectively. The working fluid in the following discussion will be treated as an ideal gas which, except for the Rankine, is reasonably appropriate for each of the aforementioned five heat engines. However, the observations to follow are also useful in the consideration of the expansion process of the Rankine cycle with superheat.

Processes involving the transformation of heat to work and vice versa are conveniently considered on temperature-entropy (T-S) coordinates. For an ideal gas, the first and second laws of thermodynamics and the ideal gas equations may be utilized to derive the following relations among the properties of an ideal gas which allow work processes to be shown on T-S coordinates

$$ds = \frac{\bar{R}}{(k-1)M} \frac{dT}{T} + \frac{P}{T} dv \quad (1)$$

or

$$ds = \frac{k\bar{R}}{(k-1)M} \frac{dT}{T} - \frac{v}{T} dP \quad (2)$$

Table 2-1. Sustained<sup>a</sup> working-fluid temperature limits (°F) for continuous-combustion engines

		Brayton turbine inlet temp, °F	Rankine expander inlet temp, °F	Stirling heater outlet temp, °F
Mature configuration, metallic technology (1900°F nominal max. material temperature)	Idealized <sup>b</sup>	~1900	~1800	~1850
	Realistic <sup>c</sup>	~1900	~1400	~1400
Advanced configuration, ceramic technology (2500°F nominal max. material temperature)	Idealized <sup>c</sup>	~2500	~2350	~2450
	Realistic <sup>c</sup>	~2500	~2000	~2000

<sup>a</sup>May be temporarily exceeded in short-term transients.

<sup>b</sup>ΔT through walls = 0; no structural, cost, or producibility considerations.

<sup>c</sup>Includes consideration of structural stress and fatigue, cost, producibility, and other design tradeoffs.

<sup>1</sup>Pressure/temperature scheduling is a control technique to avoid the simultaneous occurrence of maximum temperature and pressure.

where  $s$  is the entropy,  $T$  is absolute temperature,  $P$  is pressure,  $v$  is specific volume,  $k$  is the ratio of the specific heat at constant pressure to the specific heat at constant volume,  $\bar{R}$  is the universal ideal gas constant, and  $M$  is the molecular weight of the ideal gas. These relations are derived and discussed in Refs. 2-2 and 2-3.

Several different processes during which an ideal gas undergoes a change in state are shown in Fig. 2-1 on T-S coordinates with various states of the ideal gas designated by numbered points. The work produced during a restrained expansion process depends on how the process is carried out. The two important extremes in the execution of a process are adiabatic changes in state and isothermal changes in state. For the sake of convenience, the discussion of processes will deal primarily with expansion of the working fluid, during which work is produced. However, the equations and remarks are equally applicable to compression processes during which work is absorbed by the working fluid.

In an adiabatic change of state, absolutely no heat exchange occurs between the working fluid and its surrounding surfaces; whereas, in an isothermal process, heat must be added to or extracted from the working fluid at exactly the same rate at which work is produced or absorbed by the working fluid. An adiabatic process which occurs in a reversible manner is represented by a vertical line on T-S coordinates: that is, the entropy  $s$  is a constant. A reversible process is one executed totally without frictional or hysteresis losses. Such a process can be reversed, thereby returning the system and its surroundings to their original states. The reversible process is an idealization which cannot be realized in practice if a transfer of work or heat occurs across the imaginary boundary between the machine and the working fluid itself, due to the existence of mechanical friction and to heat transfer through non-zero temperature differences. However, the thermodynamic state of the working fluid during an adiabatic process is well represented by the isentropic equations if no intermolecular changes occur, such as changes in composition. The isentropic process provides a convenient and consistent reference to which real processes that either produce or absorb work may be compared.

The work produced in a reversible, adiabatic expansion process, i. e., an isentropic process, between  $T_1$  and  $T_2$  for the steady flow of an ideal gas may be written, from the First Law of Thermodynamics, as

$$w = C_p T_1 (1 - T_2/T_1) \quad (3)$$

where  $C_p$  is the specific heat at constant pressure. The following relations between  $v$ ,  $P$ , and  $T$  for an ideal gas during an isentropic process may be developed from Eq. (1) and the ideal gas equation of state

$$T_2/T_1 = (P_2/P_1)^{k-1/k} = (v_1/v_2)^{k-1} \quad (4)$$

Thus, the work produced may be expressed in terms of the pressure ratio  $P_2/P_1$  or the expansion (or compression) ratio  $v_1/v_2$  by substituting the desired quantity into Eq. (3).

During an isentropic compression process, the path of working fluid states proceeds upward from 2 to 1 in Fig. 2-1. A convenient practice is simply to follow the path of states from the initial to the final, spatially for steady flow processes or temporally for batch processes. If this convention is followed, the work of expansion will be positive and the work of compression will be negative. The adiabatic efficiency  $\eta_c$  of a real compression machine is defined as the ratio of the ideal work which would be required to compress the fluid if the process were isentropic to the work actually required to compress the fluid by the real machine, both processes occurring across the same pressure ratio. Hence

$$w_{\text{actual}} = \frac{1}{\eta_c} w_{\text{isentropic}} \quad (5)$$

An actual compression process would follow the path of states in Fig. 2-1 from 2 to 1'.

The efficiency of an expansion machine is defined as

$$w_{\text{actual}} = \eta_e w_{\text{isentropic}} \quad (6)$$

where  $w_{\text{actual}}$  is the work produced by the expander and  $w_{\text{isentropic}}$  is the work which would be produced if the process occurred isentropically over the same pressure ratio for a steady-flow machine like a turbine, or over the same expansion ratio for a positive displacement machine. In general, the efficiency of expanders is higher and remains high over a wider range of operating variables, such as pressure ratio, shaft speed, and fluid flow rate, than the efficiency for compressors. Good design can result in compressor efficiencies of 80 to 85% for steady-flow dynamic compressors at pressure ratios ranging from 3:1 to 6:1 beginning with ambient air. At comparable pressure ratios, turbine efficiencies range from 85 to 90%. Fewer data are at hand for positive displacement machines; however, with good design to minimize throttling across valves and mechanical friction, they most likely would show comparable efficiencies with a somewhat broader range of operating variables. Compressor and expander efficiencies are further discussed in Chapter 5.

An isothermal work process requires that heat be added or extracted simultaneously and at the same rate at which work is produced or absorbed. Such a process is shown in Fig. 2-1 beginning at state 1 and proceeding to state 3 or 4. The work produced and heat added during either a steady flow or a batch isothermal expansion process is expressed by

$$q_{14} = w_{14} = T_1 (\bar{R}/M) \ln(P_1/P_2) \quad (7)$$

where  $\ln$  denotes the natural logarithm, and noting that for an isothermal process  $(P_1/P_2) = (v_2/v_1)$ .

The enthalpy and internal energy of the working fluid does not change during an isothermal expansion. In contrast to the adiabatic process, work is produced or absorbed and heat is simultaneously added or extracted with no temperature change of the working fluid. An isothermal expansion process occurring over the same pressure ratio  $P_1/P_2$  or expansion ratio  $v_2/v_1$  will produce a greater quantity of work than an adiabatic process; conversely, an isothermal compression process requires a smaller amount of work than an adiabatic process over the same pressure ratio. The difference in work produced is not large, as may be shown by computing the ratio of adiabatic work to isothermal work for an ideal gas during an expansion process. For  $v_2/v_1 = 10$  with an ideal gas for which  $k = 1.4$ , the ratio of adiabatic to isothermal work is 0.91; with  $v_2/v_1 = 20$ , the ratio is 0.82. The isothermal work processes are extremely difficult, perhaps impossible to implement with functional machinery of acceptable size for automotive applications. Since the temperature of the working fluid after expansion is unchanged, a heat engine incorporating isothermal work processes must also incorporate post-expansion heat recovery if a reasonable thermal efficiency is to be obtained. Even though the ideal Stirling cycle includes isothermal work processes, they have not been successfully incorporated in heat engines for automobiles, as will be further discussed in Section 2.7 and Chapter 6.

#### 2.4.2 Heat Exchange Processes

The heat addition process in internal combustion heat engines occurs through combustion of the working fluid within the engine after the compression process and prior to the expansion process. The discussion of combustion processes is deferred to Section 2.4.3. Heat addition processes in closed cycle engines and in open cycle engines with exhaust heat recovery occurs by means of heat exchangers; thus, the performance of heat exchangers is a crucial factor in ascertaining the approach which will result in an efficient and economical heat engine.

The usual analysis of the performance of heat exchangers incorporates an equation of the form

$$q = UA \overline{\Delta T} \quad (8)$$

where  $U$  is the overall heat transfer coefficient,  $A$  is the heat transfer surface area, and  $\overline{\Delta T}$  is an appropriate mean temperature difference, usually the logarithmic mean. This equation is useful in the design of heat exchangers to specified performance when all the initial and terminal temperatures are known. However, when only  $U$  and  $A$  are known or can be estimated, the terminal temperatures and rate of flow cannot be explicitly found via usual techniques. The analysis of the latter situation is greatly facilitated by the method proposed by Nusselt (Ref. 2-4) and Ten Broeck (Ref. 2-5) which avoids reference to a temperature difference across the heat exchange surface.

The maximum attainable rate of heat exchange between two fluids is limited by the smaller of the convective energy transport rates,  $C_s = \dot{m}C_p$  in Btu/hr. In a counterflow heat exchanger of

infinite surface area with no external heat losses, the outlet temperature of the fluid stream with the smaller  $\dot{m}C_p$  will equal the inlet temperature of the stream with the larger  $\dot{m}C_p$ . Figure 2-2 illustrates such a heat exchanger. In this situation, the maximum attainable rate of heat transfer will have occurred. The effectiveness of a heat exchanger  $\epsilon$  is defined as the ratio of the rate of heat transfer actually obtained to the maximum attainable rate of heat transfer, as discussed above. Hence

$$\epsilon = \frac{C_g \Delta T_g}{C_s (T_{h_i} - T_{c_i})} \quad (9)$$

where  $T_{h_i}$  is the inlet temperature of the hot stream,  $T_{c_i}$  is the inlet temperature of the cold stream, and  $C_s$  is as defined above. In Eq. (9),  $C_g \Delta T_g$  may be either the hot stream or the cold stream regardless of which stream is represented by  $C_s$ , as follows:

$$\text{if } C_g = (\dot{m}C_p)_c, \text{ then } \Delta T_g = T_{c_o} - T_{c_i}$$

or

$$\text{if } C_g = (\dot{m}C_p)_h, \text{ then } \Delta T_g = T_{h_i} - T_{h_o}$$

where  $T_{c_o}$  is the outlet temperature of the cold stream, and  $T_{h_o}$  is the outlet temperature of the hot stream.

Equation (9) may be used to find the exit temperature of either the hot stream or the cold stream in terms of  $\epsilon$ ,  $C_s$ ,  $C_g$ , and the inlet temperatures of both the hot and cold streams. Assuming for the moment that  $\epsilon$  has been determined, the rate of heat transfer between the streams is given by

$$q = \epsilon C_s (T_{h_i} - T_{c_i}) \quad (10)$$

Note that the heat transfer rate is now specified in terms of only the inlet temperatures of the two streams and the smaller convective energy transport rate  $C_s$ .

The remaining problem is now to determine the quantity  $\epsilon$  in terms of heat exchanger design parameters. Following Krieth (Ref. 2-6), the differential form of Eq. (8) for a stationary, parallel-flow heat exchanger may be combined with an energy balance over a differential heat exchange area  $dA$  and an overall energy balance for both fluids to obtain an expression which may be integrated over the length of the heat exchanger, yielding

$$\ln \left[ 1 + \left( 1 + \frac{C_c}{C_h} \right) \left( \frac{T_{c_i} - T_{c_o}}{T_{h_i} - T_{h_o}} \right) \right]$$

$$= - \left[ \frac{1}{C_c} + \frac{1}{C_h} \right] UA \quad (11)$$

With  $C_g = C_c$  in Eq. (9), the quantity

$$\left[ \frac{T_{c_i} - T_{c_o}}{T_{h_i} - T_{c_i}} \right]$$

which appears above in Eq. (11) may be replaced by  $(-\epsilon C_s / C_c)$ . On solving for  $\epsilon$  and noting that the minimum and maximum  $C$ 's appear in the same place in the equation whether  $C_c = C_s$  or  $C_h = C_s$ , the following expression for  $\epsilon$  is obtained

$$\epsilon = \frac{1 - \exp \left\{ - \left[ 1 + (C_s / C_1) \right] (UA / C_s) \right\}}{1 + (C_s / C_1)} \quad (12)$$

where  $C_1$  is the larger  $mC_p$ . Hence,  $\epsilon$  for a heat exchanger is expressed in terms of the ratio of the  $mC_p$  products for the fluids and the ratio of the overall conductance  $UA$  to  $C_s$ . Very similar expressions may be derived for counterflow and crossflow heat exchangers. Results of such analyses have been presented by Kays and London (Ref. 2-7) for several different types of heat exchangers. Figure 2-3 shows the variation of  $\epsilon$  with  $UA / C_s$  for a stationary, counterflow heat exchanger for values of  $C_s / C_1 = 0, 0.5, \text{ and } 1.0$ .

Another method of transferring heat between two fluid streams is to alternately pass the hot and cold streams over a matrix of finite heat capacity. Such a heat exchanger is known as a periodic flow regenerator. The fluid streams may be alternately passed in opposite directions through two or more separate matrices by controlling the streams themselves; or the streams may remain fixed in space and the regenerator matrix passed from stream to stream. The cycle regenerator in a Stirling engine is an example of the former, and the rotary regenerator used in open cycle Brayton engines is an example of the latter type. An axial flow, rotary regenerator is illustrated in Fig. 2-4.

The primary advantage of periodic flow regenerators lies in the practicability of using a matrix with an extremely high specific surface area. For instance, 24-mesh wire screen has a specific surface area on the order of  $10^3 \text{ ft}^2/\text{ft}^3$ . Thus, very high values of  $UA$  may be obtained in a heat exchanger of compact dimensions. In addition, since the matrix can be formed of such materials as wire screen, corrugated metal strips, or a porous ceramic, it is usually less expensive than a stationary heat exchanger of equal capacity.

Among the disadvantages of rotary periodic flow regenerators are mixing of the two streams due to carryover and leakage if moving surfaces have to be sealed. However, their compactness and simple configuration make them attractive.

The analytical treatment of periodic flow regenerator performance is a complex subject. The early work of Nusselt, Hausen and others is discussed by Jakob (Ref. 2-17). These considerations of the problem are summarized by Coppage and London (Ref. 2-18); however, comprehensive solutions of the equations describing the operation of periodic flow regenerators were not available until the advent of numerical finite difference methods executed on digital computers. Such solutions are reported by Bahnke and Howard (Ref. 2-19), and these solutions, among others, are presented by Kays and London (Ref. 2-16) in a format suitable for the design of heat exchangers.

The effectiveness  $\epsilon$  of a rotary periodic flow regenerator is shown in Fig. 2-5. The parameter NTU for these regenerators is given by

$$NTU = \frac{1}{C_s} \left( \frac{1}{h_h A_h} + \frac{1}{h_c A_c} \right) \quad (13)$$

where  $h_h$  and  $h_c$  are the convection coefficients between the hot and cold fluids and the heat exchanger matrix, respectively, and where  $A_h$  and  $A_c$  represent the fluid-matrix contact areas. The variation of  $\epsilon$  with NTU in Fig. 2-5 is given for values of  $C_r / C_s$  of  $\infty, 1.5, \text{ and } 1.0$ , with  $C_r$  being the heat transport rate of the regenerator matrix material. The quantity  $C_r$  for a rotary regenerator is given by  $mC_m\omega$ , where  $m$  is the mass of the matrix,  $C_m$  is the specific heat capacity of the matrix, and  $\omega$  is the rotational speed of the matrix in revolutions/unit time. A limiting case exists when  $C_r / C_s = \infty$ , where the variation of  $\epsilon$  with NTU is the same as for a counterflow heat exchanger with the dividing wall between the fluid having no thermal resistance so that NTU is given by Eq. (13). Figure 2-5 shows that  $\epsilon$  increases as  $C_r / C_s$  increases for constant NTU. However, for  $C_r / C_s > 5$ , the gain in  $\epsilon$  is negligible, and values of  $C_r / C_s > 1.5$  give good results. In practice, well-designed rotary regenerators have values of  $\epsilon$  on the order of 0.90 with good pressure loss characteristics. Both metallic and ceramic regenerators have demonstrated  $\epsilon$  greater than 0.9 with a total pressure loss  $\Delta P / P$  (the sum of the hot side and the cold side) of less than 10%.

Values of  $\epsilon$  on the order of 0.9 have been obtained from heat exchangers of reasonable dimensions and with minimal pressure losses, which are suitable for use on automotive heat engines. The precise effect of attainable values of  $\epsilon$  on heat engine performance must be determined from an analyses of the thermodynamic cycle of each particular engine; however, with heat recovery near 90% of what is ideally attainable, the requirement for heat exchange does not of itself significantly detract from the performance of any of the closed-cycle engines, i. e., the Rankine and Stirling, or the open-cycle engine with heat recovery, i. e., the Brayton. However, the bulk, weight, and cost of three or four heat



exchangers with high effectiveness impose a significant handicap on external combustion, closed-cycle heat engines. The open-cycle Brayton engine with heat recovery requires only one such heat exchanger; even then, low-cost, high-temperature materials such as ceramics must be used instead of high-cost metal alloys to render these engines economically feasible for automobile propulsion. A primary difficulty with the regenerated Brayton engine has been the availability of a low-cost, high-temperature material for the regenerator. Recent developments, magnesium-aluminum-silicate (MAS) and lithium-aluminum-silicate (LAS), are promising. Heat exchanger performance and materials are further discussed in Chapter 5.

### 2.4.3 Combustion Processes

The addition of heat to the working fluid in the engines under consideration occurs either directly or indirectly by means of combustion of a hydrocarbon fuel with air. The nature of the combustion process varies with the type of thermodynamic cycle on which the engine operates. Combustion processes common to heat engines are difficult to generally categorize; however, a basic distinction between continuous processes and intermittent batch processes may be drawn. For stationary or batch processes, a further distinction may be made between simultaneous burning, in which combustion occurs throughout the fuel-air mixture at approximately the same time, and progressive burning, in which a flame front initiated at one point, or several points, in the fuel-air mixture propagates from the burned region into the unburned region. In a continuous flow process, simultaneous burning could occur as the fuel-air charge moves through the combustion device; while progressive burning can be thought of as occurring with a stationary flame front through which the fuel air mixture passes, being unburned upstream of the flame front and completely burned downstream of the flame front. The simultaneous burning process may be accomplished by injecting a fuel spray into air which has been heated to a sufficiently high temperature to cause the fuel to ignite. Alternately, a premixed fuel-air charge can be heated to a temperature high enough to cause ignition. The heating can result from an adiabatic compression process over a high pressure ratio or from passage through a heat exchanger.

In the discussion so far, no fundamental characteristic of the various means of effecting combustion has been pointed out which unavoidably must, by physical principle, result in some undesirable side effect. However, the source of combustion exhaust gas constituents has yet to be discussed. The two constituents of the products of combustion of a hydrocarbon fuel with air which are the most difficult to eliminate or control are traces of unburned hydrocarbon compounds HC and oxides of nitrogen NO<sub>x</sub>. The HC results from incomplete oxidation of a trace amount of the fuel, and the NO<sub>x</sub> results from the chemical reaction between nitrogen and oxygen from the air which proceeds rapidly at elevated temperatures. The formation of NO<sub>x</sub> and the source of HC will be further discussed in Chapter 4; however, two basic observations concerning these pollutants are required to proceed with this discussion. Firstly, appreciable formation of NO<sub>x</sub>

in a combustion process will not occur if the maximum temperature during the process does not exceed approximately 3000°F (Refs. 2-21, 2-22). Secondly, appreciable amounts of HC will not be contained in the exhaust gas if the temperature of the gaseous products after combustion is high enough (1500-2500°F) for a sufficient period of time (on the order of milliseconds at higher temperatures) and in the presence of some excess air to provide oxygen for the near complete reaction of the hydrocarbon compounds. Combustion of a hydrocarbon fuel can be accomplished without the formation of undesirable exhaust products if the process occurs within the proper temperature and time constraints. Other means of rendering clean combustion are also possible, an example being after-treatment of exhaust products.

The maximum temperature reached during the combustion of a mixture of gases is dependent on the amount of combustible constituent relative to the inert constituent and on the conditions under which the combustion process is carried out. The importance of the latter aspect has been discussed by Taylor (Ref. 2-7), Blumberg and Kummer (Ref. 2-8), and Clauser (Ref. 2-9). A comparison of the maximum temperature reached during a constant volume combustion process with that reached during a constant pressure combustion process demonstrates the substantial effect of the conditions under which combustion occurs. The difference between constant volume and constant pressure heat addition, i. e., combustion, may be illustrated by again referring to T-S coordinates as shown in Fig. 2-6. The quantity of heat added is represented by equal areas as given by  $Q = \int Tds$ ; however, the different paths followed during the heat addition processes are shown by the constant pressure line and the constant volume line. For typical ideal gas properties, a heat addition Q of 1000 Btu/lb of working fluid results in the bulk temperatures shown in Table 2-2 for complete mixing during heat addition.

Table 2-2. Temperature increase during heat addition

k	1.4
C <sub>p</sub>	0.25
Q	1000 Btu/lb
Initial temperature	500°R
ΔT at P = constant	4000°R
ΔT at v = constant	5600°R

The constant volume heat addition results in a final temperature that is 1600°R higher than if the process occurred at constant pressure. This temperature difference is given by the following relation, which may be derived from the ideal gas equations

$$T_3 - T_2 = (k - 1) \frac{Q}{C_p} \quad (14)$$

The temperature difference above occurs with constant composition, constant properties and complete mixing of the gas during heat addition so that the temperature throughout the gas at any instant during heat addition is uniform. The actual temperature increase during combustion is considerably affected by the real thermodynamic properties of both the fuel-air mixture and the products of combustion and by the change in species from reactants to products. However, as suggested by the comparison of processes with ideal gases to processes with fuel-air mixtures and the products of combustion given by Taylor (Ref. 2-7), the temperature difference between constant pressure and constant volume heat addition for ideal gases is indicative of that which occurs in actual processes.

The temperature increase of the various elements of a fuel-air mixture which progressively burns at nearly constant volume in an Otto engine without mixing is discussed by Blumberg and Kummer (2-8). According to their results, the first element of the charge to burn in the combustion process will experience a temperature rise of about 600°R after combustion due to compression as the remaining elements burn. The substantial differences in the NOx produced by the first and last elements to burn are due to the much longer period of sustained higher temperature that the first element experiences. The ratio of NOx concentration between the first and last elements to burn is also strongly dependent on fuel-air ratio. For mixtures near stoichiometric, the ratio between the NOx production of the first element and the last element to burn is about 6:1, and for lean mixtures ( $\phi \approx 0.7$ ) it increases to about 60:1. For the same cases the overall NOx concentrations after complete burning are 4400 ppm and 1600 ppm, respectively. Blumberg and Kummer also present analytical results for completely mixed combustion. The net effect is to reduce the overall NOx production by up to 15% for lean operation ( $\phi \approx 0.7$ ) because the first elements to burn are quenched via mixing with the balance of gas. In contrast, for near-stoichiometric and slightly richer mixtures, the overall NOx production is higher for mixed combustion.

The overall NOx production which is commensurate with a 0.4 g/mi emission is extremely low. The relationship between engine emissions and vehicle emissions is briefly addressed in Ref. 2-21. The average spatial emission rate of a pollutant from a vehicle in grams per mile traveled may be expressed as

$$\underbrace{(\text{gm/mi})}_{\substack{\text{pollutant} \\ \text{from} \\ \text{vehicle}}} = \underbrace{(\text{gm of pollutant/kg} \\ \text{fuel burned})}_{\substack{\text{engine emissions} \\ \text{index, EI}}} \times \underbrace{(\text{kg fuel burned/mi})}_{\substack{\text{engine/vehicle fuel} \\ \text{consumption}}} \quad (15)$$

For vehicular economy between 10 and 20 mpg an EI for NOx from about 1.4 to 2.8 is required, respectively. The engine EI may be related to the volumetric concentration of a pollutant in the exhaust gas in parts per million (ppm) by the relation  $(\text{EI} \times 10^{-3}) = (\text{ppm} \times 10^{-6}) [(M_p/M_e)(1 + G/F)]$ , where  $M_p$  is the molecular weight of the pollutant,  $M_e$  is the average molecular weight of the exhaust products, and  $G/F$  is the gas (all constituents other than fuel) to fuel mass ratio of the mixture before combustion. For stoichiometric combustion of gasoline and air with no diluents, the average NO<sub>2</sub> concentration in the final exhaust products must be about 56 ppm for a vehicle giving 10 mi/gallon over the FDC-U to have an average NO<sub>2</sub> emission of 0.4 g/mi. For a vehicle giving 20 mi/gal powered by an engine with a 60:1 overall air-fuel mass ratio, the average NO<sub>2</sub> concentration in the exhaust must be about 29 ppm to have an emission of 0.4 g/mi.

The NOx concentration actually present in the untreated exhaust of a typical uncontrolled, near-stoichiometric Otto engine is about 4000 ppm when the engine is under a load. Clearly, the temperature which results from a stoichiometric combustion process of a typical hydrocarbon fuel with air, whether at constant volume or constant pressure, is above the "threshold" temperature for NOx formation; consequently, the temperature must be reduced. It must be emphasized that NOx formation is a complex kinetic problem in which both temperature and time are important, as discussed in Refs. 2-22 through 26. A reduction of the combustion temperature may be accomplished by increasing the inert portion of the fuel-air mixture through burning at fuel-lean mixture ratios, i. e., with excess air, or through introduction of a readily available inert gas, i. e., exhaust gas recirculation. The temperature during combustion may be sufficiently reduced by either or both of those techniques to virtually eliminate NOx formation. However, depending on the type of engine, such a restriction can adversely affect specific power. In particular, the lower heat addition allowable for a limited maximum temperature in a quasi-constant volume combustion process reduces the specific power of Otto engines.

Currently available experimental data (Refs. 2-10, 2-11, and 2-12) shows that as the amount of fuel in a fuel-air mixture is reduced, a value of the fuel-air ratio is reached below which the mixture will not sustain combustion. The lean limit of combustion at atmospheric pressure for typical hydrocarbon-air mixtures initially at room temperature occurs at an equivalence ratio  $\phi$  between 0.5 and 0.6. A flame front will simply not propagate in mixtures which have a greater amount of excess air. The lean limit of combustion is extended as the initial temperature of the mixture is increased; however, experimental data on this effect is limited. The velocity of flame front propagation has been investigated by Clauser (Ref. 2-12) with an apparatus which permits measurements at extremely slow flame front velocities. These measurements suggest that the variation of flame front velocity with  $\phi$  is

<sup>2</sup>The fuel/air mass equivalence ratio is [(actual fuel/air mass ratio)/(stoichiometric fuel/air mass ratio)].

steep in the lean region. A decrease in flame velocity implies that the time for combustion in an intermittent or batch process will be greater, and that the length required for complete combustion in the direction of motion in a steady flow process will increase. Furthermore, the time rate of heat release  $dQ/dt$  is dependent on the rate of flame propagation; thus  $dQ/dt$  will decrease with lean mixtures. A similar effect occurs with exhaust gas recirculation. These observations apply to hydrocarbon fuel and air mixtures only and do not consider the effects of the addition of a combustion-promoting agent such as hydrogen. Lean combustion and exhaust gas recirculation (EGR) are further discussed in Chapters 3 and 4.

The power and thermal efficiency of intermittent combustion, open cycle engines — the Otto and the Diesel — is normally not limited by flame speed or  $dQ/dt$ . However, operation with very lean mixtures or with large amounts of EGR may restrict  $dQ/dt$  such that power and/or thermal efficiency are significantly reduced, unless the time rate of heat release is increased via rapid motion of the mixture (turbulence). The experiments of Bolt and Harrington (Ref. 2-10) and the experimental work with Otto engines reported by Simko et al. (Ref. 2-13) and in Refs. 2-14 and 3-24 offer some confirmation of the beneficial effects of turbulence on flame speed. The most consistently appearing effect of operation with a fuel-air mixture which is sufficiently diluted by excess air or EGR to inhibit NOx formation is an increase in HC emissions. Accompanying the reduced flame speed with severe dilution is, of course, a lower maximum temperature during combustion. The combustion products are rapidly cooled during expansion, which may result in insufficient time at a high enough temperature to oxidize the HC. Consequently, heat engines which incorporate internal, intermittent combustion of highly diluted mixtures have experienced difficulty in simultaneously reducing both HC and NOx to very low levels without loss of power and efficiency.

The continuous, constant-pressure combustion process may be implemented so that the length along the flow path is sufficient to provide the time required for virtually complete oxidation of HC. The length for complete combustion may be reduced by the utilization of grids or screens as flame holders which serve as multiple ignition points as the fuel-air mixture passes through them. If the spatial restrictions on steady-flow combustion devices are not so severe that use of the above techniques is precluded, such combustion devices can be designed to virtually eliminate HC and NOx. There is also evidence that droplet burning must be avoided to prevent excessive NOx formation, at least if considerable exhaust gas recirculation is not to be used. A prevaporizing and premixing, continuous, constant-pressure combustor which burns a lean, homogeneous fuel-air mixture and produces extremely low emissions is discussed in Ref. 2-21. Such a combustor could be used on either a regenerated Brayton or a Stirling engine, since in these engines the combustion air is sufficiently preheated to vaporize the fuel. Other schemes of prevaporization are possible but more complex.

The heat engines which utilize a continuous, constant-pressure combustion process have extremely low emissions, and through proper design such combustion devices can be adequately compact. The simultaneous achievement of high specific power (i. e., low engine weight), excellent thermal efficiency, and extremely low emissions is much less difficult if the thermal efficiency and specific power are decoupled from the time interval required for combustion. This situation occurs with the three continuous combustion alternates — the Brayton, the Stirling, and the Rankine engines. With such decoupling, the attainable thermal efficiency and the specific power are limited by the thermodynamic cycle on which the engine operates and the machinery with which the cycle is implemented, not by the time required for combustion.

## 2.5 ATTAINABLE EFFICIENCY OF HEAT ENGINES

The efficiency attainable by a practical heat engine is the result of a complex interaction among numerous factors, some of which have been mentioned above. In spite of this complexity, basic observations can be drawn which are pertinent to the attainable efficiency of heat engines. Consideration of the constraints involving temperature and time which are applied by pollutant emission and the properties of structural materials is essential to these observations.

### 2.5.1 Thermal Efficiency of Heat Engines

The thermal efficiency of a reversible heat engine with an ideal gas working fluid, no heat losses, and which does not incorporate post-expansion heat recovery may be expressed by the Carnot relation  $[1 - (T_L/T_H)]$ , providing the temperatures at proper points in the cycle are used for  $T_L$  and  $T_H$ . For example, the efficiency of an ideal Otto cycle is given by  $\eta = 1 - (v_1/v_2)^{1-k}$ , where  $v_1/v_2$  is the cycle compression ratio; however,  $(v_1/v_2)^{1-k} = T_1/T_2$ , so the ideal Otto cycle efficiency is  $\eta = 1 - T_1/T_2$ . Similar remarks apply to the ideal simple Brayton cycle where the thermal efficiency is also given by  $1 - (T_1/T_2)$ . In all these cases  $T_1$  may be taken as the prevailing ambient temperature, and  $T_2$  is the temperature at which heat addition from the high-temperature source must begin. The efficiency of cycles in which the isentropic expansion ratio differs from the isentropic compression ratio, such as the limited pressure Diesel cycle, cannot be expressed simply in terms of  $T_1$  and  $T_2$ . But except in extreme cases,  $T_1$  and  $T_2$  dominantly affect the thermal efficiency.

As indicated by the Carnot relation, the thermal efficiency of heat engines may be improved through an increase of the temperature at which heat addition from the high-temperature source begins. Such an increase in  $T_2$  may be accomplished either by increasing the compression or pressure ratio of the engine or by limiting the pressure ratio and utilizing post-expansion heat recovery, i. e., regeneration. These two different approaches are illustrated in Fig. 2-7 on T-S coordinates. A Brayton cycle which incorporates post-expansion heat recovery is shown by the solid lines connecting points 1, 2r,

2e, 3, and 4, while a simple Brayton cycle is shown by solid lines connecting points 1, 2s, 3s, and 4s.

The efficiency of a reversible, perfectly regenerated Brayton engine with an ideal gas working fluid may be shown to be

$$\eta_h = 1 - \frac{T_{2r}}{T_3} \quad (16)$$

Since  $T_{2r}$  is determined by the cycle pressure ratio,  $\eta$  for the regenerated engine increases as  $T_{2r}$  falls, if  $T_3$  is held constant. The minimum value of  $T_{2r}$  occurs with  $P_{2r}/P_1 = 1$  and is the ambient temperature  $T_1$ . Thus, at  $P_{2r}/P_1 = 1$ , which corresponds to zero work output,  $\eta$  has a maximum value of  $1 - (545/2360)$  or 77%. At this point, the ideal cycle efficiency is identical to the Carnot limit at the maximum and minimum temperatures occurring anywhere in the cycle. In contrast, the  $\eta$  of a simple Brayton or Otto cycle is determined not by the maximum cycle temperature  $T_3$  after heat addition but by the temperature at which heat addition must begin, i. e.,  $T_2$ . Obviously, the efficiency of heat engines cannot be usefully compared at zero work output. For various practical considerations, regenerated Brayton engines with  $P_{2r}/P_1$  being about 4 at maximum power have been considered for automobile propulsion. At  $P_{2r}/P_1 = 4$  with a working fluid for which  $k = 1.4$  and  $T_3 = 2360^\circ\text{R}$ , the  $\eta$  for a regenerated cycle is 66%. A simple cycle would have to operate with  $P_{2s}/P_1 = 42$  to have the same efficiency, which corresponds to  $v_1/v_2 = 15$ .

The distinction between the simple Otto and the simple Brayton cycles lies in the nature of the heat addition process. The heat addition occurs at constant volume in the Otto cycle and at constant pressure in the Brayton cycle. Consequently, for a fixed value of  $T_2$ , which determines  $\eta$ , the maximum temperature  $T_3$  for equal heat addition is substantially higher in an Otto cycle engine than in a Brayton cycle engine. These observations apply to cycles with the same work output per mass of working fluid and with the same ambient temperature  $T_1$ . If the constant volume heat addition process is imagined to replace the constant pressure process in Fig. 2-7, the discussion pertaining to regeneration given above applies to the Otto cycle in an exactly analogous manner, with  $T_3$  higher due to the increased  $\Delta T$  for the same heat addition.

The maximum temperature in any heat engine which is to have very low emissions must, first of all, be limited by the temperature at which NOx formation is prevalent. Additionally, the mechanical rupture and/or creep strength of the structural materials used for the high-temperature components must be adequate, and other materials properties such as corrosion resistance and fatigue strength must be considered. The maximum temperature limitation imposed by NOx formation will allow excellent thermal efficiency in an engine whose efficiency is determined by that temperature. Present metallic materials technology imposes a maximum temperature limit for continuous exposure with adequate properties

which is considerably below the threshold of NOx formation. Only with the advent of very-high-temperature materials will the temperature of NOx formation be an efficiency limiting factor for heat engines in which the structural materials must continuously sustain the maximum cycle temperature.

## 2.5.2 Engines with Lower Attainable Efficiency

The Otto and Rankine engines suffer fundamental limitations which cannot be overcome by refinements in the machinery with which the thermodynamic cycle is implemented. These engines are discussed at length in their respective chapters, so only a few remarks are in order here.

The attainable efficiency of the Otto engine is limited by the compression ratio which can be used in practice. The pre-ignition and detonation characteristics of liquid petroleum fuels restrict the Otto engine to compression ratios of about 8:1 to 10:1, which is far below that required for high efficiency. Post-expansion heat recovery is a difficult, perhaps impossible, process to incorporate in an Otto engine of conventional design. The exhaust heat recovery process in any regenerated cycle must occur in the cycle after the compression process and before heat addition from the high-temperature heat source. The physical configuration of the combustion chamber of conventional Otto engines is so spatially restricted and the time interval available for heat exchange is so small that the incorporation of a reduced expansion ratio in conjunction with post-expansion heat recovery is precluded. The Otto engine is further limited in its capability to have low NOx emissions by the constant-volume heat addition process, since such a process results in a large temperature increase of the working fluid for a given quantity of heat addition. Thus, both the attainable thermal efficiency and the low emissions capability of the Otto engine are restricted by the nature of the processes on which it operates.

The Rankine cycle heat engine utilizes a working fluid which changes state between the liquid and the vapor during execution of its path of thermodynamic states. The Rankine cycle, like the Brayton, is made up of constant-pressure heat addition and rejection processes and adiabatic compression and expansion processes. The distinctive features of Rankine cycle are that the fluid is condensed to a liquid during heat rejection, then pumped as a liquid to the maximum cycle pressure and vaporized to a gas during heat addition. Thus, the path of thermodynamic states of the Rankine cycle is superimposed on the diagram of the thermodynamic properties of the working fluid in the liquid-vapor region. On cursory consideration, the virtually negligible work required to pump the liquid working fluid from minimum to maximum cycle pressure seems to be advantageous. But this process must be preceded by condensation of the working fluid with the accompanying heat rejection and is succeeded by vaporization of the working fluid with the accompanying heat addition. Taken as a whole, the detrimental effect of these processes on the thermal efficiency of a Rankine engine may be illustrated by comparing the Rankine cycle

with the Brayton cycle on T-S coordinates, as shown on Fig. 2-8. Each of the cycles has the same maximum working fluid temperature of 1900°F and the same minimum working fluid temperature of 212°F and are executed with water as the working fluid having the properties given in Ref. 2-20. The effect of the condensing working fluid is illustrated by computing the ideal cycle efficiency with perfect regeneration<sup>3</sup> for both Rankine and Brayton cycles operating between the same minimum and maximum pressures. This comparison of Rankine and Brayton cycles is made at a maximum cycle pressure of 59 psia, which corresponds to a cycle pressure ratio of 4:1, and at 2000 psia, which corresponds to a cycle pressure ratio of 136:1. Thus, four different thermodynamic cycles are shown in Fig. 2-8.

Beginning at state 3a (1900°F, 59 psia) or 3b (1900°F, 2000 psia) in Fig. 2-8, the paths of states of the working fluid for the Rankine and Brayton cycles are identical through states 4a and 4b down to state 1. The paths of states thus far have included both expansion and heat rejection for the Brayton cycles. However, at state 1 the Rankine cycle working fluid condenses to point 5 for both the high- and low-pressure cycles. Then the liquid working fluid is pumped to 59 or to 2000 psia, and heat is added from regeneration and from the high-temperature source to carry the working fluid through states 6a or 6b and 7a or 7b to reach state 3a or 3b, respectively.

The processes involving condensation, pumping, and revaporization may be avoided by compressing the working fluid from state 1 directly to state 2a or 2b, respectively, for the low or high pressure Brayton cycle. This isentropic compression process requires a high work input that must be provided from the expansion work. However, the greater compression work of the Brayton cycle does not impose as large a penalty in overall cycle thermal efficiency as does the additional heat required from the high-temperature source to complete the condensation, pumping, and vaporization processes of the Rankine cycle. Therefore, the thermal efficiency of the Rankine cycle heat engine is reduced by the utilization of a condensing working fluid. The comparison of cycle efficiencies is shown in Table 2-3. Improvements in the Rankine cycle which result in higher efficiency, such as reheat during expansion, are either already incorporated in the Brayton or Stirling cycles or can be incorporated with the attendant increase in cycle efficiency.

### 2.5.3 Engines with Higher Attainable Efficiency

#### STIRLING ENGINES

The heat addition process for the regenerated Brayton cycle occurs with no energy being simultaneously deduced as work from the working fluid; consequently, the working fluid must undergo a temperature increase during heat addition. And the thermal efficiency of the cycle was seen to reach a maximum as the cycle work output

Table 2-3. Comparison of the thermal efficiencies of Rankine and Brayton cycles with ideal processes and H<sub>2</sub>O as the working fluid

Cycle	P <sub>max</sub> ' psia	T <sub>max</sub> ' °F	P <sub>min</sub> ' psia	T <sub>min</sub> ' °F	η, %
Rankine	59	1900	14.7	212	25
Brayton	59	1900	14.7	212	61
Rankine	2000	1900	14.7	212	45
Brayton	2000	1900	14.7	212	66

approached zero. Only at this condition was η determined by the ratio of the minimum cycle temperature to the maximum cycle temperature; in all other cases, η was determined by the temperature ratio T<sub>2</sub>/T<sub>3</sub>, not T<sub>1</sub>/T<sub>3</sub>. This situation directly follows from the compression and expansion processes being carried out adiabatically, and may be changed through the utilization of isothermal compression and expansion processes. The result is that the working fluid experiences no temperature increase during heat addition from the high temperature source since expansion is simultaneously occurring. The ideal Stirling cycle incorporates both regeneration and isothermal work processes, resulting in the efficiency of the cycle being determined by the ratio of the minimum to the maximum temperature occurring in the cycle, i.e., T<sub>1</sub>/T<sub>3</sub>, which gives 77% with T<sub>1</sub> = 85 F and T<sub>3</sub> = 1900 F. The ideal Stirling cycle efficiency is the absolute maximum that can be attained between the lowest and highest temperatures which the working fluid experiences. And this efficiency is obtained with a finite work output, in contrast to the situation with adiabatic expansion and compression.

However, the inference given above pertaining to the temperature which the working fluid actually experiences may prevent the theoretical advantage of the Stirling cycle from being realized in practice. The open-cycle heat engines enjoy an advantage in that the heat addition process is not handicapped by having to occur through the surfaces which confine the working fluid at high temperatures and pressures. Hence, in an open-cycle heat engine, the working fluid temperature may be the maximum temperature of combustion, and the maximum combustion temperature can be somewhat greater than the temperature of the engine structure; whereas, in a closed-cycle engine, the maximum working fluid temperature must necessarily be less than that of the heat exchanger structure which is limited by maximum materials temperature. No practical open-cycle implementation of the Stirling cycle has been developed since the early hot air engines, and

<sup>3</sup>Regeneration is not possible for the high pressure Brayton cycle since the temperature after compression is greater than the temperature after expansion.

considerations of power output per system volume and weight make such open-cycle engines unsuitable for automotive propulsion. Consequently, only closed-cycle Stirling engines have been developed for automobile application. Any closed-cycle engine requires multiple stages of heat exchange, and although highly efficient, the temperature drops of such processes handicap the Stirling engine. This handicap in conjunction with the practical difficulty of implementing isothermal work processes makes the highly regenerated or high expansion cycles with adiabatic work processes comparable in overall efficiency, as can be seen by comparing the efficiencies of the different engines in the Mature and Advanced configurations.

### BRAYTON ENGINES

Given the observation that excellent thermal efficiency can be attained through utilization of either high expansion or regeneration, some basis for selection of one of these alternate approaches would be desirable. Unfortunately, thermodynamic considerations provide little information in this regard. However, the experience to date with practical implementation suggests that regeneration may be the more fruitful approach because of the reduced efficiency of compression and the more stringent structural requirements that accompany very high pressure ratios.

Brayton engines which incorporate aerodynamic compressors and turbines are limited to moderate pressure ratios unless expensive multistage axial flow compressors are used. This limitation is imposed by the reduced efficiency which is attainable at high pressure ratios in a single stage of compression. At low pressure ratios of about 3 to 6:1, efficiencies in excess of 80% are attainable over a wide operating range with a single stage of compression; however, at pressure ratios approaching 10:1 the attainable efficiency with a single stage of compression begins to rapidly fall off. Therefore, if economic considerations preclude the use of multistage compressors, aerodynamic machinery cannot be used to reach high pressure ratios. And, as subsequently discussed, even such multistage compressors do not have a sufficiently high efficiency at the pressure ratio required to enable simple cycle engines to achieve thermal efficiencies comparable to regenerated engines. In light of these circumstances, Brayton engines utilizing positive displacement machinery have been proposed to reach the high pressure ratios required for a thermal efficiency near that of low pressure ratio, regenerated engines.

The positive displacement, high-expansion Brayton engine would have the combustion process occur continuously at constant pressure in a single combustion chamber which feeds the expander through inlet valves, as discussed by Warren (Ref. 2-15) and by Clauser (Ref. 2-12). The continuous combustion process could occur via autoignition of injected fuel, or the fuel may be prevaporized and premixed with air before burning. Most likely, the latter process is required, because extremely low levels of NOx formation and simultaneous elimination of HC and particulates may not be attainable with drop-let burning. Such a high-expansion Brayton

engine would suffer from the limited air handling capability of positive displacement machinery, which results in a larger weight and volume for a given power output.

In addition to lower specific power (Bhp/lb), it is likely that, for the same temperature at the beginning of heat addition from the high-temperature source ( $T_2$  or  $T_{2r}$ ), the maximum efficiency which can be reached by increasing the pressure ratio to very high values with positive displacement machinery is lower than that which can be reached by limiting the pressure ratio and utilizing post-expansion heat recovery. This hypothesis follows from the observation that at the very high pressure ratios (>40) required for the simple Brayton cycle engine to have a thermal efficiency comparable to that of a regenerated Brayton cycle engine, the actual heat and friction losses associated with high compression temperatures and pressures preclude the attainment of an adequately high compressor efficiency. The same argument applies to increasing the pressure ratio to similar high values with multistage aerodynamic machinery. Therefore, the low pressure ratio Brayton engine with aerodynamic machinery which incorporates post-expansion heat recovery deserves careful consideration due to its promising thermal efficiency and specific power.

#### 2.5.4 Concluding Remarks

The thermal efficiency and combustion system characteristics for different types of engines are shown in Table 2-4. The ideal thermodynamic cycle efficiencies with actual working fluid properties are shown only for Mature technology temperatures. The brake efficiency of the different engines as estimated by the methods described in Chapters 3 through 7 is given for both the Mature and Advanced technologies. The Brayton, Stirling and Diesel engines stand out as having comparably high efficiencies in the Mature technology, and the Brayton has the highest efficiency in the Advanced technology. The three continuous combustion engines can also have extremely low emissions of both HC and NOx without exhaust gas after-treatment, and the attainment of low emissions in these engines is not coupled to the thermal efficiency.

The regenerated Brayton cycle and the Stirling cycle both have a limited expansion ratio and post-expansion heat recovery. Theoretically, the maximum thermal efficiency occurs with a cycle which incorporates both isothermal expansion/compression processes and perfect regeneration. In practice, the implementation of isothermal work processes has proven to be at odds with any sort of reasonable power-to-size ratio. The work processes in an actual Stirling engine more closely resemble those adiabatic work processes which would occur in an external combustion, closed-cycle, low compression ratio engine with regeneration which operates on the Otto cycle than those of the ideal Stirling cycle.

Effective regeneration is feasible only for those engines whose physical configuration is amenable to the incorporation of heat exchangers through which the working fluid must pass after compression and after expansion. The open-cycle

Table 2-4. Characteristics of heat engines

Engine type <sup>a</sup>	Cycle thermal efficiency, %			Combustion system
	Mature technology temperatures		Advanced technology temperature	
	Ideal <sup>b</sup>	Mature engine <sup>c</sup> (brake)	Advanced engine <sup>c</sup> (brake)	
<u>Brayton (regenerated)</u> Press ratio = 4:1 Ambient temp = 85°F T <sub>3</sub> = 1900°F	66	33	46	Continuous, internal combustion, open cycle
<u>Stirling</u> T <sub>H</sub> = 1400°F T <sub>L</sub> = 160°F	67	36	41	Continuous, external combustion, closed cycle
<u>Rankine</u> Expansion inlet temp = 1400°F Expansion ratio = 12:1 Expansion inlet pressure = 2500 psia	33	24	34	Continuous, external combustion, closed cycle
<u>Diesel (limited pressure)</u> Compression ratio = 15:1 Equivalence ratio = 0.6	55	32	35	Intermittent, internal combustion, open cycle
<u>Otto (spark ignition)</u> Compression ratio = 8:1 Equivalence ratio = 0.8	45	27	29	Intermittent, internal combustion, open cycle

<sup>a</sup> Engine parameters are only for the Mature engine; the Advanced engine parameters are given in Chapters 3 through 7.

<sup>b</sup> Ideal thermodynamic cycle with Mature technology temperatures, reversible processes, and actual working fluid properties.

<sup>c</sup> Component efficiencies and temperatures as defined in Chapters 3 through 7 and Section 2.2.

Brayton engine is well suited for regeneration due to the physical separation of the individual components which perform the thermodynamic functions, and the Stirling engine is a closed-cycle machine with a similar separation of component functions. The low pressure ratio regenerated Brayton engine enjoys the advantages of an open-cycle machine and can be mechanized with aerodynamic compressors and expanders of extremely high air handling capacity and good efficiency. Therefore, such engines are most compact for a given power output.

The regenerated, open-cycle Brayton engine and the Stirling engine have the greatest potential for development of an automotive engine which simultaneously provides superior fuel economy and extremely low emissions. The Brayton engine is a less complex machine than the Stirling engine, while, theoretically, the Stirling cycle offers the highest efficiency for a given maximum temperature of the working fluid in the engine.

Efficiency must be considered in concert with emissions characteristics, weight, and the cost

of producing the engine, among other factors. These characteristics taken together in an engine/vehicle combination are elucidated in the succeeding chapters on each type of power system. The necessity for a balanced consideration of the often conflicting requirements that a heat engine must satisfy is no better stated than by Sadi Carnot (Ref. 2-1) in 1824:

"We should not expect ever to utilize in practice all the motive power of combustibles. The attempts made to attain this result would be far more hurtful than useful if they caused other important considerations to be neglected. The economy of the combustible is only one of the conditions to be fulfilled in heat-engines. In many cases it is only secondary. It should often give precedence to safety, to strength, to the durability of the engine, to the small space which it must occupy, to small cost of installation, etc. To know how to appreciate in each case, at their true value, the considerations of convenience and economy which may present themselves; to know how to discern the more important of these which are only secondary; to balance them properly against each other, in order to attain the best results by the simplest means: such should be the leading characteristics of the man called to direct, to coordinate the labors of his fellow men, to make them cooperate towards a useful end, whatsoever it may be."

#### References

- 2-1. Carnot, Sadi, Reflections on the Motive Power of Fire, Dover Publications, No. S661, 1960, originally published in France in 1824.
- 2-2. Dodge, B. F., Chemical Engineering Thermodynamics, McGraw-Hill Book Co., New York, 1944.
- 2-3. Van Wylen, G. J. Thermodynamics, John Wiley, New York, 1959.
- 2-4. Nusselt, W. "A New Heat Transfer Formula for Cross Flow," Technische Mechanik und Thermodynamik, Vol. 12, 1930.
- 2-5. Ten Broeck, H., "Multi-Pass Heat Exchanger Calculations," End. Eng. Chem., Vol. 30, pp. 1041-1042.
- 2-6. Krieth, F., Principles of Heat Transfer, International Textbook Co., Scranton, Pa., 1965.
- 2-7. Taylor, C. F., and Taylor, E. S., The Internal Combustion Engine, International Textbook Co., Scranton, Pa., 1961.
- 2-8. Blumberg, P., and Kummer, J. T., "Prediction of NO formation in Spark Ignited Engines - An Analysis of Methods of Control," Combustion Sci. Tech., Vol. 4, pp. 73-95, 1971.
- 2-9. Clauser, F. H., personal communication, Dec. 1974.
- 2-10. Belles, F. E., and Sweet, C. C., "Ignition and Flammability of Hydrocarbon Fuels," Chapter III of NACA Report 1300, Basic Considerations in the Combustion of Hydrocarbon Fuels with Air, 1957.
- 2-11. Bolt, J. A., and Harrington, D. L., "The Effects of Mixture Motion Upon the Lean Limit and Combustion of Spark-Ignited Mixtures," SAE Paper 670467.
- 2-12. Clauser, F. H., personal communication, October 1974.
- 2-13. Simko, A., et al., "Exhaust Emission Control by the Ford Programmed Combustion Process - PROCO," SAE Paper 720052.
- 2-14. "Lean Mixture Engines Testing and Evaluation Program," Preliminary Report, Jet Propulsion Laboratory, Pasadena, Calif., January 1975.
- 2-15. Warren, G. B., and Bjerklie, J. W., "Proposed Reciprocating Internal Combustion Engine with Constant Pressure Combustion," SAE Paper 690045.
- 2-16. Kays, W. M., and London, A. L., Compact Heat Exchangers, McGraw Hill, New York, 1964.
- 2-17. Jakob, Max, Heat Transfer, Volume II, John Wiley, New York, 1957.
- 2-18. Coppage, J. E., and London, A. L., "The Periodic Flow Regenerator - A Summary of Design Theory," Trans. ASME, 1953.
- 2-19. Bahnke, G. D., and Howard, C. P., "The Effect of Longitudinal Heat Conduction on Periodic Flow Heat Exchanger Performance," Trans. ASME, 1964.
- 2-20. Keenan, J. H., and Keyes, F. G., Thermodynamic Properties of Steam, John Wiley, New York, 1936.
- 2-21. Wade, W. R., et al., "Low Emissions Combustion for the Regenerative Gas Turbine," Trans. ASME, Jour. Engr. Power, Papers 73-GT-11 and 73-GT-12.



- 2-22. Cornelius, W., and Wade, W. R., "The Formation and Control of Nitric Oxide in a Regenerative Gas Turbine Burner," SAE Paper 700708.
- 2-23. Caretto, L. S., et al., "The Role of Kinetics in Engine Emission of Nitric Oxide," Combustion Sci. Tech., Vol. 3, pp. 53-61, 1971.
- 2-24. Bernhardt, W. E., "Kinetics of Nitric Oxide Formation in Internal Combustion Engines," Paper C149/71, "Air Pollution Control in Transport Engines," Instr. Mech. Engrs., 1971.
- 2-25. Blumberg, P. N., "Nitric Oxide Emissions from Stratified Charge Engines: Prediction and Control," Combustion Sci. Tech., Vol. 8, pp. 5-24, 1973.
- 2-26. Lavoie, G. A., et al., "Experimental and Theoretical Study of Nitric Oxide Formation in Internal Combustion Engines," Combustion Sci. Tech., Vol. 1, pp. 313-326, 1970.

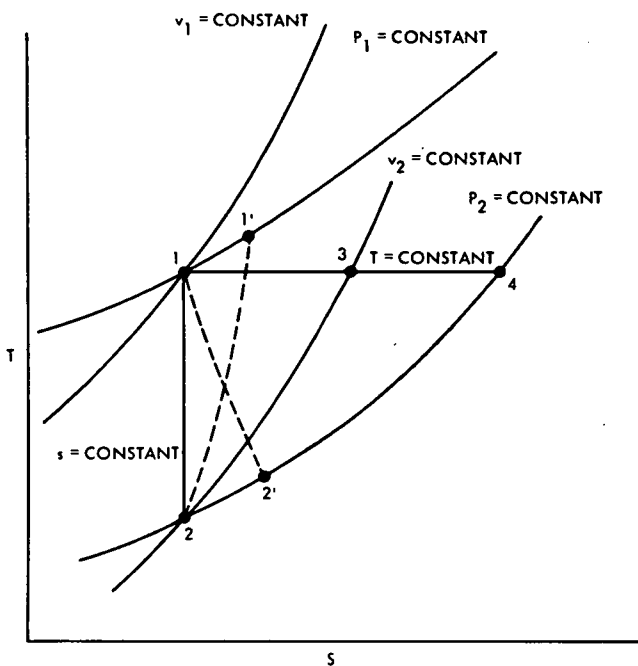

Fig. 2-1. Different processes involving a change in state for an ideal gas

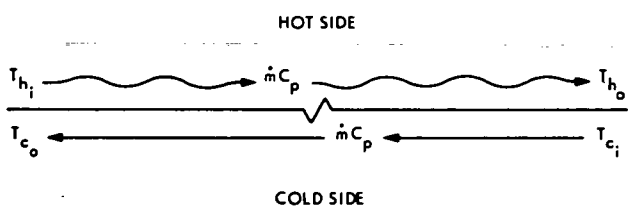

Fig. 2-2. An infinite area counterflow heat exchanger

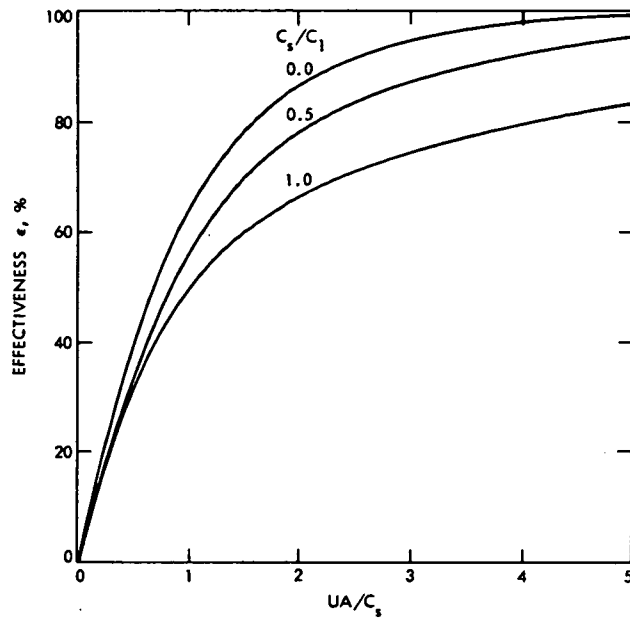

Fig. 2-3. Effectiveness of a counterflow heat exchanger

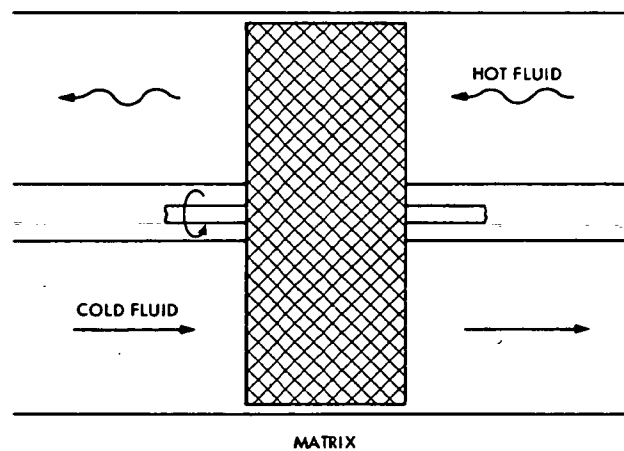

Fig. 2-4. Rotary, periodic flow regenerator

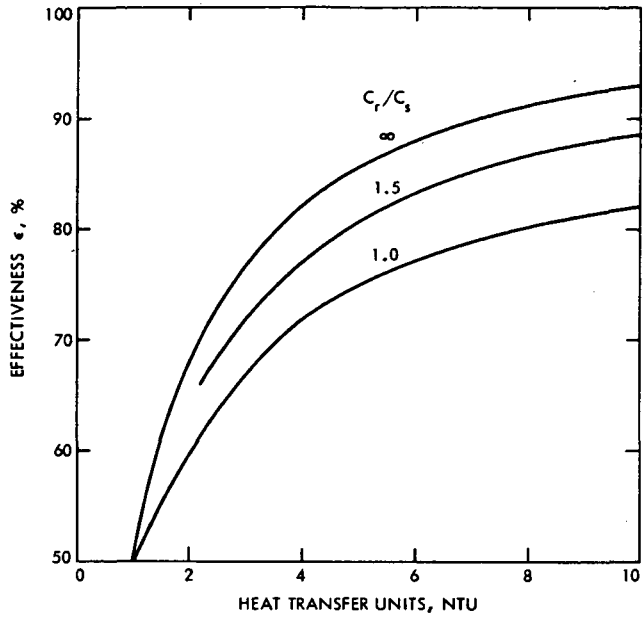

Fig. 2-5. Effectiveness of a periodic flow regenerator with  $C_s/C_1 = 0.95$

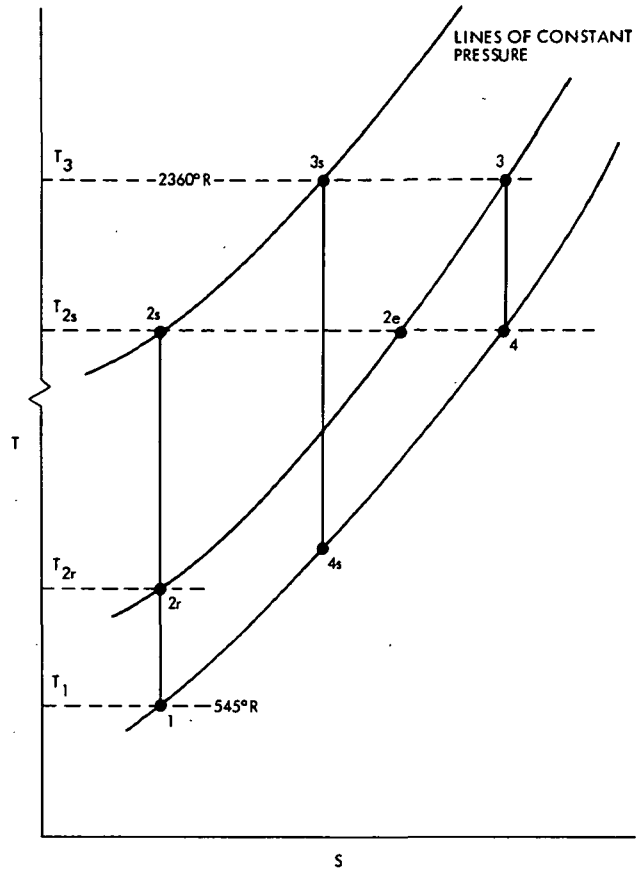

Fig. 2-7. Simple Brayton cycle and the regenerated Brayton cycle on T-S coordinates

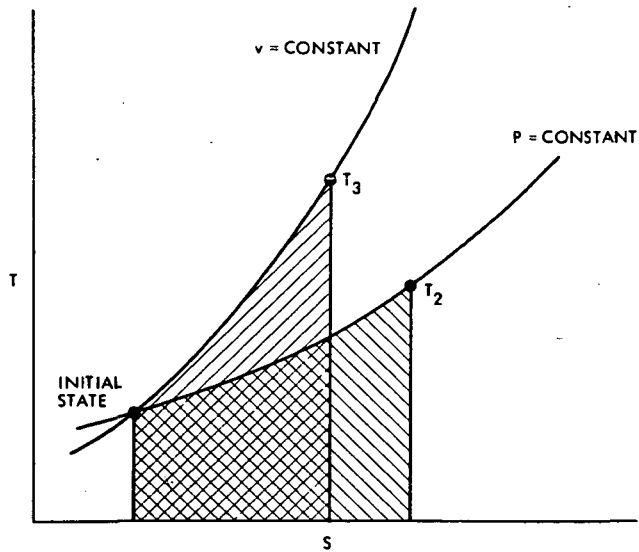

Fig. 2-6. Constant volume and constant pressure heat addition processes with complete mixing

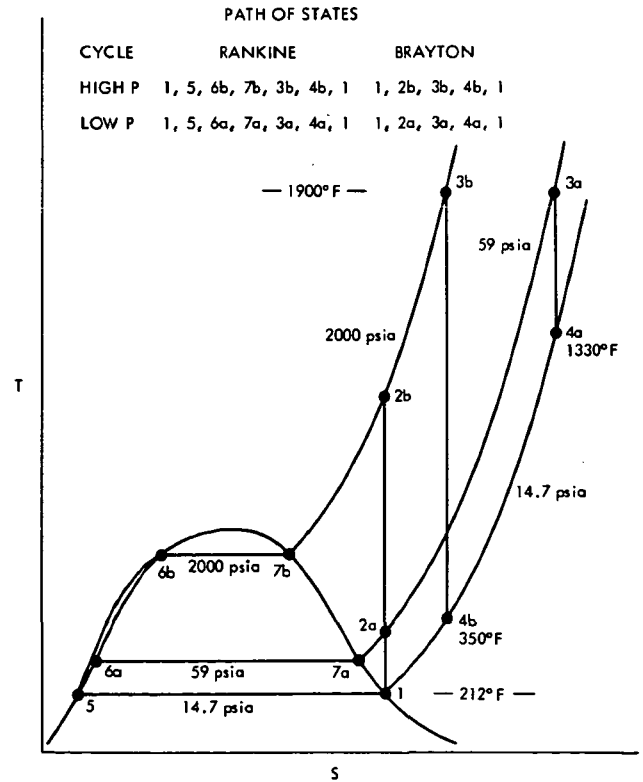

Fig. 2-8. Rankine and Brayton cycles on T-S coordinates with  $H_2O$  as the working fluid

CHAPTER 3. THE UC OTTO AUTOMOTIVE POWER SYSTEM (BASELINE)

3.1	Description . . . . .	3-2
3.1.1	Introduction . . . . .	3-2
3.1.2	Morphology . . . . .	3-2
3.2	Characteristics . . . . .	3-2
3.2.1	Thermodynamics of Otto Cycle Engines . . . . .	3-2
3.2.2	Engine Performance . . . . .	3-4
3.2.3	Fuel Requirements . . . . .	3-5
3.2.4	Pollutant Formation . . . . .	3-6
3.3	Major Subassemblies and Components . . . . .	3-7
3.3.1	Descriptions . . . . .	3-7
3.3.2	Configurational Evolution . . . . .	3-12
3.3.3	Producibility and Cost . . . . .	3-15
3.4	Vehicle Integration . . . . .	3-15
3.4.1	Engine Packaging in Vehicle . . . . .	3-15
3.4.2	Transmission Requirements . . . . .	3-15
3.5	Performance in Vehicle . . . . .	3-16
3.5.1	Fuel Economy . . . . .	3-16
3.5.2	Emissions . . . . .	3-16
3.5.3	Drivability Aspects . . . . .	3-18
3.5.4	Safety . . . . .	3-18
3.6	Ownership Considerations . . . . .	3-18
3.6.1	Maintenance . . . . .	3-18
3.6.2	Cost of Ownership . . . . .	3-18
3.7	Research and Development Required . . . . .	3-18
3.7.1	Mature Configuration . . . . .	3-18
3.7.2	Advanced Configuration . . . . .	3-18
	References . . . . .	3-20
	Figures . . . . .	3-22

### 3.1 DESCRIPTION

#### 3.1.1 Introduction

The engine employed in all but a small percentage of present passenger automobiles is the (near-stoichiometric) uniform-charge, spark ignited, intermittent-internal combustion engine, which has evolved from the four-stroke-cycle internal combustion engine invented by Nikolaus Otto in 1867. Over the past decade, various measures have been adopted to control the air pollutants emitted in its exhaust, culminating in the present catalytic and thermal exhaust converter systems. For brevity, this type of engine is referred to in the remainder of this report as the "UC Otto" engine (other reports use the abbreviation SI-ICE).

A fairly concise history of the engine is given in Ref. 3-1. Although initially competing with steam and electric powerplants, the UC<sup>1</sup> Otto powerplant gained dominance of the passenger automobile application by virtue of its light weight (high specific power) and vehicle range capability (good fuel economy). Its early rapid progress was due largely to the technical and production innovations of Benz, Daimler, and Ford. Today, after more than 90 years of development and refinement, the UC Otto engine is the most well characterized and best understood automotive engine. As such, it is familiar to, and accepted by, the public of all industrialized nations, and lies firmly entrenched in the heart of one of the world's largest industries.

In consequence, were there no exogenous pressures on the automobile industry, the UC Otto engine would continue to be the automotive powerplant of choice throughout the foreseeable future. Even in the face of environmentalist pressures for more stringent emissions control and public demand for better fuel economy (resulting from the recent oil "crisis"), the tremendous economic inertia of the Otto-engined auto industry resists changeover to an alternate engine, meeting these new demands instead with add-on devices to clean the exhaust and (predominantly) vehicle changes to improve fuel economy. For this reason the UC Otto engine, with its evolving exhaust aftertreatment systems and minor efficiency improvements, is taken to be the MOVING BASELINE powerplant - the "titleholder" which all "challengers" must meet - in the context of this study. This chapter is, hence, entirely devoted to exposition of the likely developments of the UC Otto powerplant. More drastic modifications of the Otto-cycle engine, such as stratified charge configurations and other (ultra)lean burning alternatives, are discussed with the Diesel engine in Chapter 4.

#### 3.1.2 Morphology

The basic Otto heat engine cycle consists of the following steps, cyclically repeated:

- (1) Intake of a charge of fresh air and fuel into the working space.

- (2) Compression of the charge.
- (3) Ignition of the air/fuel mixture by a spark near the end of compression, with subsequent combustion at near constant volume.
- (4) Expansion of the hot gas mixture, with extraction of useful work.
- (5) Exhausting the spent gas mixture from the working space.

There can be an almost endless variety of possible mechanizations of this cycle. Required, from a fundamental standpoint, are: a working space or "cylinder" provided with the means to introduce (or produce) the uniform air/fuel charge and vent the combustion products; a compressor/expander mechanism, invested with some sort of periodic motion within that working space, to effect compression/expulsion and extract the useful expansion work; and a properly timed ignition source. Although one such working space would, in principle, serve the purpose, other considerations (e.g., smoothness of power delivery, power density, packaging, etc.) dictate multiple "cylinders" in automotive application. One possible scheme for categorizing the commonly used automotive Otto engines is depicted in the simplified morphological "tree" of Figure 3-1. Here, the major distinction is by type of compressor/expander; whether reciprocating - the conventional piston-cylinder type of engine - or the comparatively recent rotary type. By far the preponderance of automobiles on the road - all American and most foreign - employ reciprocating engines. Small cars typically have had lower power engines of 4 or 6 cylinders in either opposed or inline configuration, while large cars typically have had higher horsepower engines of the V-8 configuration. More recently, two foreign manufacturers - NSU-Audi of Germany and Toyo Kogyo of Japan - have been producing lines of single-rotor and twin-rotor rotary-engined vehicles of the Wankel configuration, and some other manufacturers have considered following suit. Most of these vehicles have carbureted engines, although port fuel injection is presently employed in a few of the reciprocating-engine vehicles. Most of the engines, likewise, are water-cooled, but some of the smaller engines (notably in Volkswagens, Porsches and the now-defunct Corvair) are air-cooled.

### 3.2 CHARACTERISTICS

#### 3.2.1 Thermodynamics of Otto Cycle Engines

The thermodynamic processes that occur in the operation of spark ignition, internal combustion engines are conceptually represented by the ideal Otto cycle. The four processes comprising the ideal Otto cycle are shown on p-V and T-S coordinates in Figure 3-2. These four processes are isentropic compression from state ① to ②, constant volume heat addition from ② to ③, isentropic expansion from ③ to ④, and constant volume heat rejection from ④ to ①. The

<sup>1</sup>The abbreviation "UC" in the term "UC Otto" was derived from Uniform-charge and exhaust Converter system.

thermal efficiency  $\eta_t$  of an ideal Otto engine is given by the ratio of the net work output of the cycle with an ideal gas working fluid to the heat addition during process (2) to (3). Application of the thermodynamic relations describing an ideal gas during each of the four processes, along with the first law of thermodynamics and the definition of  $\eta_t$ , gives the expression

$$\eta_t = 1 - (V_2/V_1)^{\gamma-1} = 1 - r_c^{1-\gamma} \quad (4-1)$$

for the ideal Otto cycle. Equation (4-1) shows that  $\eta_t$  for an ideal Otto cycle with constant volume heat addition is dependent only on the compression (or expansion) ratio of the engine. This observation should not be confused with the erroneous statement that "the efficiency of an Otto engine is not dependent on temperature," because the geometric characteristic of the engine ( $V_1/V_2$ ) and  $\gamma$  determine the temperature  $T_2$  at which heat addition commences.

The operation of an Otto engine is more conveniently idealized by the constant volume fuel-air cycle with the ideal four-stroke induction process. The fuel-air cycle considers the actual thermodynamic properties of the fuel-air mixture, the pressure in the cylinder at the beginning of compression, and the pumping work required during the induction and exhaust processes. Taylor (Ref. 3-2) extensively discusses the fuel-air cycle and makes a comparison with real cycles. The thermal efficiency of both the fuel-air cycle and the ideal air cycle are presented in Figure 3-3 as a function of compression ratio  $V_1/V_2$ , with the fuel-air cycle efficiency given at values of fuel/air equivalence ratio ( $\phi$ ) of 0.8 and 1.0. Figure 3-4 shows an ideal air cycle, a fuel-air cycle, and an actual cycle plotted on p-V coordinates, all cycles with equivalent heat addition. The area enclosed by the p-V trace of the ideal air cycle is larger than that of the fuel-air cycle, and this difference in net work of the cycles (enclosed area) for the same heat addition is reflected in Figure 3-3 by the lower efficiency of the fuel-air cycle. The lower net work of the fuel-air cycle is primarily due to the thermodynamic properties of fuel-air mixtures and to the effects of elevated temperature and pressure on the equilibrium composition of the products of combustion.

The actual pressure-volume trace of the working fluid during one cycle of operation of an Otto engine differs considerably from that of the fuel-air cycle with equivalent thermodynamic parameters, i. e., fuel composition, initial temperature and pressure, and compression ratio. For comparisons of this type, the pumping work of the inlet and exhaust processes is not taken as a part of the fuel-air cycle so that a consistent comparison with engine indicated cylinder work is possible. Taylor attributes this difference to noninstantaneous combustion losses ("time losses"), heat losses, and exhaust blowdown losses. These losses combine to reduce the indicated work produced by an actual Otto cycle engine to about 80% of that of the equivalent

fuel-air cycle, for automotive-size cylinders. The ratio of actual to fuel-air cycle efficiency ranges from about 85% at  $V_1/V_2 = 4$ , through 78% at  $V_1/V_2 = 8$ , to about 75% at  $V_1/V_2 = 10$ . The lower fraction of fuel-air efficiency obtained by the higher compression ratio engines is perhaps due to the increased heat losses associated with the higher temperatures of such engines and to increased frictional losses. Taylor reports the results of tests on a single cylinder engine with  $V_1/V_2 = 8$  in which the time loss, heat loss, and exhaust blowdown loss were found to be 30%, 60%, and 10%, respectively, of the difference between indicated cycle work and fuel-air cycle work, where indicated work was about 80% of fuel-air cycle work. The time loss appears to be relatively unaffected by changes in engine operating conditions or variations within the usual range of design parameters so long as optimum spark timing is maintained, and the exhaust blowdown loss is small but likely required for good mixture scavenging. However, the heat loss is influenced by cylinder size, and ratios of actual to fuel-air cycle efficiency of 0.90 have been observed in large aircraft engine cylinders with  $V_1/V_2 = 6.5$  (Ref. 3-2).

An estimate of the indicated efficiency of Otto cycle engines is also shown in Figure 3-3. Engines with compression ratios of about 8:1 generally have indicated thermal efficiencies ranging from 30% to 34%. The net shaft work of Otto engines is less than the indicated work due to the effects of internal mechanical friction, pumping work during throttled operation, and the work required to drive engine components that usually include the lubricating oil pump, the liquid coolant pump, and the ignition system distributor. The losses due to internal friction and throttling are the most significant of these, and combine to reduce the brake efficiency to a maximum value of about 27% at the point of minimum fuel consumption in the operating range of the engine. Figure 3-5 shows the brake specific fuel consumption characteristics of a typical American passenger car Otto engine. The engine is characterized in terms of brake mean effective pressure (BMEP) and mean piston speed, which correspond to torque and crankshaft speed for an engine of specified bore and stroke. This map is representative of a typical American V-8 engine.

The performance and emissions characteristics of Otto engines are strongly affected by spark timing and valve timing. The optimum position of the piston, for the occurrence of the spark event that ignites the fuel-air mixture, changes with engine speed and other operating variables such as engine load. Spark timing is usually expressed in degrees of crankshaft rotation before or after the topmost position of the piston in the cylinder during the compression stroke. The optimum spark timing for a particular engine under a given set of operating variables is that which results in the maximum torque output. Hence, optimum spark timing is taken as the minimum number of degrees of crankshaft rotation before the top center (BTC) piston position that results in the best torque output, and is therefore called MBT<sup>2</sup> spark timing.

<sup>2</sup>The abbreviation "MBT" was derived from Minimum (number of degrees) for Best Torque output.

The MBT spark timing for Otto engines ranges from about 5° to about 55° BTC depending on the shape of the engine's combustion chamber, crankshaft speed, and other operating variables. The MBT timing for typical passenger car engines during part load operation (50 psi BMEP, 1500 RPM) is 30° to 35° BTC. Engine operation with minimum fuel consumption also occurs at MBT spark timing, and deviations from MBT timing have adverse effect on fuel consumption. However, the HC and NO<sub>x</sub> emissions of an Otto engine at near stoichiometric air/fuel ratios can be simultaneously reduced by retarding the spark event from MBT timing, i. e., having the spark occur nearer to, or after, the top center position. The effects of retarded spark timing are pronounced, both on reducing emissions and increasing fuel consumption, as shown in Refs. 3-18, 3-19, 3-22, 3-23, 3-25, and as discussed further in Chapter 4.

The use of exhaust gas recirculation (EGR) to dilute the intake charge for NO<sub>x</sub> control results in an increase in the MBT spark timing (°BTC) relative to MBT timing without EGR. The brake specific fuel consumption (BSFC) of an engine with EGR at the optimum air/fuel mixture ratio and MBT spark has been observed to be about 6% lower than that for the same engine without EGR at the stoichiometric air/fuel ratio with MBT spark, Refs. 3-18 and 3-19. However, the HC emissions with EGR and MBT spark are higher. If the HC emissions are oxidized in a catalytic converter, as in most model year (MY) 1975 cars, both NO<sub>x</sub> emissions and HC emissions can be reduced with no fuel economy penalty, and, under optimum conditions, can provide better fuel economy than an uncontrolled engine at the stoichiometric mixture ratio. EGR and emissions are discussed further in Section 3.5 and in Chapter 4.

Prior to the advent of emissions standards, inlet and exhaust valve timing for Otto engines was determined by consideration of the torque vs speed characteristic, smoothness of operation, and fuel consumption. The valve timing events for a typical American V-8 passenger car engine are as follows: inlet valve opening, 17° before top center; inlet valve closing, 75° after bottom center; exhaust valve opening, 68° before bottom center; exhaust valve closing, 30° after top center. The results of experiments reported by Siewert (Ref. 3-23) show that a reduction in both HC and NO<sub>x</sub> can be accomplished by modification of valve timing. Such modifications result in an increase of the residual fraction of exhaust gas in the fresh mixture during the compression stroke. Additionally, the exhaust gas that is expelled from the cylinder at the end of the exhaust stroke contains a disproportionately high amount of HC, and a portion of this gas can be reinducted into, or retained within, the cylinder via appropriate valve timing. At high air/fuel ratios (circa 18:1), the "internal EGR" or charge dilution resulting from modified valve timing can degrade combustion to the extent that substantial increases in HC emissions and fuel consumption occur. A similar effect occurs when the spark timing is retarded with very lean mixtures.

Power output control by modulating the inlet valve lift has been investigated by Stivender (Ref. 3-24). In addition to single-cylinder laboratory engine studies, the characteristics of a 400 CID

V-8 engine were mapped, and the engine was installed in a vehicle for road tests. In general, the inlet-valve-throttled (IVT) engine would operate at substantially leaner air/fuel ratios, with somewhat lower fuel consumption, than the same engine with conventional throttling. The IVT engine reached a minimum BSFC at air/fuel ratios near 20:1, the exact value depending on engine load; whereas the conventional engine reached its minimum BSFC at air/fuel ratios near 18:1, the exact value again depending on load. At 20 psi BMEP and 1200 RPM, the IVT engine showed a 5% lower BSFC. The increase in air/fuel ratio for minimum BSFC was attributed to the improvement in mixture turbulence and atomization of the fuel due to the sonic velocities occurring at the inlet valve opening during throttling. The inlet valve lift was small enough to induce sonic flow velocities up to about 2/3 of maximum engine power. These results suggest that improvements in the mixture atomization and increased turbulence in the combustion chamber can extend the lean limit of combustion, with an accompanying reduction in fuel consumption. These matters are also discussed further in Chapter 4.

Modulation of inlet valve timing, instead of lift, also provides a means of regulating the induction of air/fuel mixture into the cylinder. Early closing of the inlet valve at part load operation reduces the amount of air/fuel mixture taken into the cylinder. As discussed by Stivender (Ref. 3-24), the pressure of the mixture in the cylinder at the beginning of the compression stroke (bottom center position) may be taken as an "equivalent manifold pressure", upon which engine power depends. Viewed in this manner, early inlet valve closure does not provide for "overexpansion"; it only constitutes a method of reducing the part-load throttling losses, which result from the pumping work required to maintain intake manifold pressure below ambient. With torque control via variable inlet valve closing, the part load BSFC of the Otto engine could be improved, particularly near idle. However, conventional carburetors and induction systems are not likely to provide satisfactory mixture preparation and distribution in the absence of reduced manifold pressure, as reported in Ref. 3-24, and some type of fuel injection system would probably be required.

### 3.2.2 Engine Performance

The "performance" of an engine involves several considerations that fall into two broad categories: (1) how well the engine performs the mechanical task demanded of it, and (2) how much input energy does it require for given work output. In the first category are the engine's steady-state torque characteristic and its transient response to commands. Through the seventy-odd years of its development as an automotive engine, the UC Otto engine has come to be accepted by the public as the standard of automotive engine performance, admittedly as perceived through interaction with the vehicle via a drive train designed to cope with its idiosyncrasies. Its mechanical performance was therefore, by definition, "adequate", and we need not elaborate here on its torque-vs-speed and response characteristics. However, with the advent of emission standards, engine manufacturers were forced to change engine operating conditions to reduce

pollutant formation and, in the past, these changes have had a deleterious effect upon the engine's mechanical performance. In particular, relative to an uncontrolled engine, retarding the spark from near MBT, in conjunction with recirculation of a fraction of exhaust gas (EGR) for NO<sub>x</sub> and HC suppression, results in more sluggish response to acceleration transients and an overall reduction in torque (through a lower BMEP), along with an increase in fuel consumption. This less-than-customary performance was particularly noticeable in the MY 1973 and 1974 cars. The introduction of catalytic exhaust converters in the MY 1975 vehicles has permitted retuning to a more nearly optimum operating condition. Thus the MY 1975 engine, except for minor losses due to converter back pressure and the parasitic power demand of the ancillary air pump, has essentially the same performance as a precontrolled engine. If the reducing-type converters, currently being developed for NO<sub>x</sub> control, prove likewise successful, future UC Otto engines may also attain nearly the same mechanical performance but with a small fuel consumption penalty incurred by slightly rich operation.

The second performance aspect of the engine is its efficiency (measured by the car owner in terms of its fuel economy). Even the uncontrolled engine was not a very efficient machine in terms of the useful work produced compared with the thermal energy available from combustion of the fuel. Figure 3-6, extracted from Ref. 3-3, shows the typical energy balance for a UC Otto engine as a function of vehicle speed. Combustion inefficiencies and cycle thermodynamics take their toll, right "off the top", of 60 to 80% as energy rejected in the exhaust and cooling system. A smaller, but significant fraction of combustion energy is expended as (primarily viscous) engine friction and as pumping work. Only the small residuum, on the order of 27% at best, is available for propulsion and to drive accessories. The propulsion energy is further reduced by drive train inefficiencies. Over the Federal Urban Driving Cycle (FDC-U), the engine-plus-drive-train of MY 1975 American cars achieve an average propulsive efficiency of 10.5 to 11.5%, relative to idealized inertially- and aerodynamically-equivalent vehicles that could deliver 100% of the thermal (lower heat value) energy of the fuel to the rear wheels.

In the days of plentiful "cheap" gasoline, vehicle efficiency was merely of academic interest. Now that the public has been made forcibly aware of the higher cost and finite availability of petroleum fuels, increasing emphasis is being placed on powerplant efficiency. As the Otto engine is already well developed, startling improvements in efficiency are not to be expected. In seeking the course of future developments, one must therefore look instead to design areas in which smaller, but cost-effective, incremental gains in efficiency can be made — always, of course, against a backdrop of required levels of emission control.

One such area, wherein specific developments are now proceeding, is in the induction process. Poor fuel vaporization, together with large variations in the cylinder-to-cylinder charge distribution, contribute heavily to hydrocarbon and CO emissions in current engines and likewise reduce

efficiency. The effect is particularly severe when the engine is started cold, which is the prevailing situation in the large fraction of short trips characterizing national driving habits. Ideally, one would like to have completely vaporized fuel, uniformly mixed with air, and distributed through warm manifolding to preclude recondensation. Considerable progress toward this ideal is being realized in hardware now under development, as discussed in Section 3.3.

Another area through which some small efficiency gains may be achieved is via improved auxiliaries (alternator, water and fuel pumps, fans, etc.) and accessories (air conditioning equipment, etc.) and their drive mechanisms. The objective here is reduction of parasitic power losses. It should be recognized that use of more efficient auxiliaries/accessories and drives will benefit any powerplant, not just the UC Otto.

Presently-produced Wankel configurations are more inefficient, with higher HC and CO emissions (Refs. 3-4, 3-16), than their reciprocating counterparts. This is, in large measure, attributable to the difficult geometric problem posed by the rotor seals and the tendency of the housing to thermally distort. There have also been claims that heat losses are greater than from equal-horsepower reciprocating configurations, by virtue of the higher surface-to-volume ratio in the Wankel's expansion space. However, it is not clear that these are really "fundamental" problems. At least one major developer (Ref. 3-20) reports that efficiencies comparable to reciprocating engines have been demonstrated in properly designed hardware. Rotary engines apparently produce somewhat lower NO<sub>x</sub> emissions than their reciprocating equivalents. Among UC Otto configurations, the rotary configuration appears most attractive for the long term, providing the present difficulties can ultimately be resolved, because its superior power density and packaging capability would provide better fuel economy as a result of vehicle integration advantages.

### 3.2.3 Fuel Requirements

The key characteristics of UC Otto engine fuels are their volatilities and resistance to premature ignition or detonation as measured by octane rating. Most present engines, with compression ratios in the neighborhood of 8 to 8.5:1 require a gasoline blend with a research octane number (RON) of 90-91. Some older vehicles have high compression engines which require premium fuel with about 98 RON. Introduction of catalytic converters, which are adversely affected by lead, has mandated use of gasolines free of tetraethyl lead, previously used as the most economical antiknock additive. In consequence, current engines and probably all future engines will be designed to operate with lead-free gasolines of circa 91 RON.

Sulfur is also an undesirable trace contaminant in catalyst-controlled engine gasolines for two reasons: first, there is some evidence that it has a deleterious effect upon the catalyst itself; second the oxidizing catalyst tends to emit the exhaust sulfur as SO<sub>3</sub> which hydrolyzes to sulfuric acid — a more hazardous pollutant than the SO<sub>2</sub> emitted by noncatalyst-equipped engines (see



Section 3.2.4). Consequently, "low-sulphur" gasolines are required.

Other troublesome contaminants for catalyst-controlled engines are sodium, halogens, and phosphorus. However, these are not common refinery problems.

UC Otto engines can also be adapted to some alternate fuels, notably methanol and methanol/gasoline blends, subject to the foregoing restrictions on octane rating and contaminants. Some system level (vehicle, as well as engine) development is required. More is said about fuel requirements and problems in Chapter 17.

### 3.2.4 Pollutant Formation

If a hydrocarbon fuel were "perfectly" combusted with air, only innocuous exhaust products would be formed according to the conceptual reaction

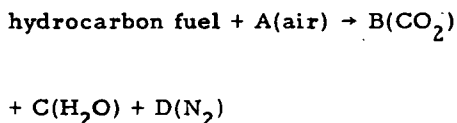

the molar stoichiometric air/fuel ratio being A:1. The occurrence of such an hypothetical reaction presumes: (a) complete combustion (i. e., total oxidation of the carbon and hydrogen); (b) no competing side reactions; and (c) no reactive contaminants in the fuel or air. Although all three of these criteria are, to some extent, violated, and the air/fuel ratio deviates from stoichiometric (both globally and locally) in a real intermittent combustion engine, the actual combustion chemistry approaches this ideal quite closely. The truth of this statement is evinced by measured exhaust concentrations of species other than CO<sub>2</sub>, H<sub>2</sub>O, and N<sub>2</sub>. The most abundant - carbon monoxide - is typically present only to the extent of a few percent by volume, and all other species are measured in parts per million.

#### LEGISLATIVELY-CONTROLLED POLLUTANTS

At present (1975), three types of pollutant are controlled to legislated limits: incompletely oxidized hydrocarbons (HC), carbon monoxide (CO), and oxides of nitrogen (NOx). Of these, the HC and CO are due to incomplete combustion of the fuel (and, to some extent in older cars, uncombusted lubricating oil that leaks by the pistons). HC is a catch-all name for a mixture of various aliphatic, alicyclic and aromatic compounds, and is conventionally reported as if the average molecular constitution of the mixture were hexane (C<sub>6</sub>H<sub>14</sub>). The oxides of nitrogen, on the other hand, are due to a set of competing reactions wherein nitrogen (mainly from air, and possibly from trace azotic contaminants in fuel or lubricants) is oxidized to NO or NO<sub>2</sub>. Most oxidized nitrogen appears as NO (subsequently becoming NO<sub>2</sub> in the atmosphere), but the term NOx is also a collective one for the mixture which is, again by convention, reported as NO<sub>2</sub>. NOx-forming reactions are kinetically sluggish at low

temperatures and occur to a significant extent only during the short high-temperature interval of the combustion process.

Figure 3-7 shows, on a normalized ordinate scale, the relative variation in the exhaust concentrations of these three pollutants as a function of the air/fuel ratio. In a conventionally carburetted engine, nominally calibrated to near-stoichiometric operation, their absolute concentrations vary widely with engine speed and load. Typical ranges within the normal operating regime of UC Otto engines are: 300 to 1000 ppm HC, 0.2 to 8.0% CO, and 800 to 3000 ppm NOx. For a full-size uncontrolled vehicle, such concentration levels translate (Refs. 3-3 to 3-5) into average emission rates on the order of 10/100/4 g/mi of HC/CO/NOx over the FDC-U (hot start), as compared with the current Federal standards of 1.5/15./3.1 g/mi (1975 FTP). Consequently, measures had to be adopted to control these emissions, during the execution of the combustion cycle and/or through post-treatment of the exhaust.

For most engines, both types of cleanup "fixes" have been adopted. To meet the 1975 (3.1 g/mi) control level for NOx, the *in situ* approach is used. Retardation of the spark from MBT, coupled with EGR, results in lower peak combustion temperature and consequent lower NOx formation. The combined approach is employed for HC and CO. Improved carburetion, quick pull-off chokes (to reduce excess fuel throughput under cold-start conditions), and quick-heat manifolds all address the charge preparation/induction problem. These measures alone are not sufficient however, and their effectiveness is further compromised by the NOx-reduction technique, hence aftertreatment is required as well. The basic aftertreatment concept is secondary oxidation of the incompletely oxidized carbonaceous species. This is accomplished by adding supplementary air (to provide an oxidizing environment) to the exhaust mixture in some type of exhaust reactor. One type is a thermal reactor (or "thermactor") in which slow continued oxidation takes place at fairly high temperature. The other commonly used type is a catalytic converter wherein the catalyst-promoted oxidation reactions take place at a somewhat lower temperature. Most American-made cars now employ the catalytic converter.

If future emission standards, with NOx levels below about 1.5 g/mi, are indeed enforced, catalytic aftertreatment of exhaust for NOx will also be required in the UC Otto engines. One way to accomplish this is by providing a reducing environment (somewhat rich exhaust) to a reducing converter and then introducing its effluent, together with supplementary air, to an oxidizing converter. This approach is called the "dual catalyst" system. A second way to achieve the same result is to introduce a very carefully tailored exhaust (tight A/F ratio control) into a single converter that both reduces the NOx to N<sub>2</sub> and oxidizes the HC and CO. This alternative is termed the "3-way catalyst" system. The significant discriminator between these two approaches is air/fuel ratio control. In the dual catalyst system a controlled rich mixture must be fed to the reducing catalyst and its effluent must

subsequently be made lean to feed the oxidizing converter. For the 3-way catalyst system to work properly, only one (the preinduction) adjustment must be made to air-fuel ratio, but it must be held very closely near stoichiometric under all operating conditions. Implementation details are discussed more fully in Section 3.3.

### NONLEGISLATED POLLUTANTS

With the introduction of catalytic converters, two other pollutants — not previously a serious problem — have become a cause for concern. The first of these is sulfur. Sulfur is a trace contaminant in petroleum fuels, both as sulfur per se and bound in mercaptan and ring structures. In precontrolled engine combustion, this sulfur was oxidized to the comparatively stable SO<sub>2</sub> and dispersed as such in the atmosphere, where it slowly oxidized to SO<sub>3</sub>. In the catalytic oxidizing converters now becoming prevalent however, the noble metal catalysts employed can promote the sulfur from its tetravalent state in SO<sub>2</sub> to the hexavalent state, leading to the formation of SO<sub>3</sub>. In the water-containing exhaust environment, the SO<sub>3</sub> quickly hydrates to corrosive and toxic H<sub>2</sub>SO<sub>4</sub>. The latter will tend to condense, coalesce, and drop out of the atmosphere near the point of emission. Large quantities of sulfur throughput adversely affect catalyst life. Refineries have been producing "low-sulfur" (<0.03% national average) fuels, which can be tolerated by the catalyst and result in a small quantity of sulfate emitted. However, the results of recent EPA studies indicate that even such low levels of sulfate may constitute an environmental hazard in regions surrounding major traffic arteries, and sulfate emission standards are being seriously considered. If such sulfate standards are indeed enacted, additional desulfurization of the fuel might provide the most effective solution, the cost being estimated<sup>2</sup> (Ref. 3-21) at "... between a penny and a penny-and-a-half more per gallon". Different types of oxidizing converters, perhaps improved thermal reactors, are a possible alternative solution. Chemical traps have also been suggested.

The second pollutant of potential concern is ammonia (NH<sub>3</sub>). Traces of ammonia are always produced in combustion with air, but are usually insignificant. Catalytic reduction of NO<sub>x</sub> in an hydrogenous environment, however, can produce more significant concentrations of NH<sub>3</sub>, at least under some conditions, depending upon the catalyst. The situation is perhaps less serious in a Dual Catalyst system because the downstream oxidizing converter will reoxidize the ammonia (providing it isn't converted back to nitrogen oxides!). Recent data (Ref. 3-6) seem to indicate that the problem has been overcome.

At the present time, there are no data to indicate that particulate emissions are a problem with gasoline-burning engines. However, the question of nonvisible particulate effects is very much open, and further study is required.

Until a much larger statistical sample of emission data for dual/3-way catalyst equipped

vehicles is available, more definitive health and environmental effects studies have been completed, and the current controversy is resolved, it will not be possible to assess the significance of these pollutants. Several agencies, notably EPA, are now actively pursuing the necessary experimental programs.

### 3.3 MAJOR SUBASSEMBLIES AND COMPONENTS

#### 3.3.1 Descriptions

The general construction and components of basic UC Otto engines are well known. Reciprocating versions are discussed, both analytically and configurationally, in a vast body of literature (e.g., Ref. 3-2); while rotary implementations of the Wankel configuration are thoroughly documented in a somewhat less extensive, but ever growing literature (e.g., Ref. 3-7). It is therefore unnecessary to discuss the basic engine configuration here.

For our purposes, it is worthwhile to discuss briefly those components that are either new to the engine, or are changing significantly, because of current pressures to both increase efficiency (i.e., fuel economy) and reduce noxious emissions. These components fall into two broad classes: induction system components and emission control devices. The two are intimately related, as the latter dictate the requirements of, and must be compatible with, the former.

#### INDUCTION SYSTEM COMPONENTS

The day of the "simple" carburetor has passed. Even the most recent preemission-control carburetors were unable to maintain the degree of air/fuel ratio control required to meet 1975 emission standards. As indicated in Table 3-1, such carburetors could hold the overall air/fuel (A/F) calibration, under steady-state conditions, within ±5 to 10% over the idle-WOT operating range. American car MY 1975 carburetors can hold this calibration within about ±3%.

However, the engine does not operate long at steady-state conditions in real driving patterns, but is rather subjected to a series of accelerations and decelerations of varying intervals and severities. Further, ambient conditions — air temperature, pressure (altitude), and humidity — vary from day to day and place to place. Finally, gasoline composition is not constant; one survey (Ref. 3-8) shows a range of the molecular hydrogen-to-carbon ratio, among fourteen popular products in the Detroit area alone, of 1.64:1 to 2.01:1. All of these influences affect dynamic A/F ratio control.

An even more significant problem (Ref. 3-15) with carbureted induction, from the emission control standpoint, is cylinder-to-cylinder A/F ratio maldistribution. Thus, although the carburetor may exert global (overall) A/F ratio control to ±5%, local cylinder-to-cylinder variations can be much larger. This problem arises from

<sup>3</sup> For sulfur level of 100 ppm, by weight, maximum.

Table 3-1. Comparison of induction systems (without catalysts)

Type	Conventional (typical) carburetor	Variable venturi (Holley) carburetor	Sonic (Dresser) carburetor	Hot Spot (Carter) carburetor	Ultrasonic (Thatcher- McCarter) carburetor	Feedback controlled	
						Mechanical (K Jetronic) fuel injection	(Ultra) Sonic (Conjectural) carburetor
A/F control, %	±5 to 10	±3	±3	±3	N/S <sup>a</sup>	±0.5	±0.3
Vehicle		Dodge	Ford	Dodge	Plymouth	Saab	
Inertia wt, lb		4500	4500	4500	3500	3000	
Engine:		360 V-8	400 V-8	360 V-8	225 I-16	2000 cc	
Spark timing		60° BTDC	N/S <sup>a</sup>	5° BTDC	N/S	N/S	
EGR		10%	(none)	Propor- tional	(none)	N/S	
Fuel economy, mpg		11	N/S	10.7 to 11.2	22	19.3	
Emissions:							
HC, g/mi	2 to 4	1.48	0.70	1.1 to 1.3	0.51	0.9	0.5 to 1.5
CO, g/mi	20 to 30	10.28	3.92	6 to 7.8	0.89	8.1	1 to 5
NOx, g/mi	1.5 to 3	1.8	1.84	2.3 to 2.7	0.7 to 1.3	2.2	1 to 2
Unmodified Carburetor engine comparison:							
UHC, G/mi		2.5	N/S	2.8	4.9	1.9	
CO, g/mi		20	N/S	26	6.6	40.7	
NOx, g/mi		1.8	N/S	2.5 to 2.7	3.0 to 8.0	2.4	
Fuel economy, mpg		11	N/S	11.0	18	17.7	

<sup>a</sup>N/S = Not stated.

the relatively large fuel droplets formed in a fixed venturi carburetor, which tend to agglomerate in the intake manifold. It is aggravated by cold start conditions (which enhance recondensation), idle and low-load operation (low air velocities yield poor atomization), and the length and tortuosity of manifold branches. Cylinder-to-cylinder variations in A/F ratio of 20% and more have been reported (Ref. 3-3).

The ideal objective of the induction system is to meter the exact quantity of fuel and air required,

totally vaporize the fuel, and mix it uniformly with the air for delivery to the cylinders. Several developments have made progress toward this ideal.

#### VARIABLE-VENTURI CARBURETOR

Most of the manufacturers (Weber, Holley et al.) are working on some configuration of the variable-venturi (VV) carburetor. The basic concept involves a moving pintle arrangement to vary the throat area of the venturi, promoting

high air velocities (and, hence, improved atomization) even near low-load conditions. A variable-area fuel orifice is also provided, via a coupled movable tapered metering pin in the fuel orifice, to maintain more precise A/F control. Most developmental VV carburetors are of two-barrel design, one barrel having a fixed venturi. These highly proprietary devices are apparently capable of achieving dynamic A/F control (over the FDC-U) of about  $\pm 3\%$ , and can reduce HC and CO emissions in a full-size car by a factor of 1.6 to 2.0, at equal NOx and fuel economy, relative to the standard conventional 4-barrel carburetor, as shown in column 2 of Table 3-1.

#### ULTRASONIC CARBURETOR

A direct approach to achieving good fuel atomization over the whole range of operating conditions is to decouple the air/fuel metering requirement from the atomization requirement, accomplishing the latter by another means. One feasible way of doing this has been demonstrated (Ref. 3-9) by Drs. A. Thatcher and E. McCarter of Florida Technical University, employing the mechanical agitation of an ultrasonic driver (mounted in the carburetor throat) to break up the injected fuel stream. In principle, this ultrasonic carburetor effects atomization in a manner akin to spraying a liquid on the diaphragm of an operating compression-type hi-fi "tweeter". The transducer used in this carburetor may be either a magnetostrictive type, as illustrated in Figure 3-8, or a piezoelectric type, and is driven at frequencies in the range of 20 to 40 kHz into a half-wave horn. The inventors claim that the ultrasonic unit may be either adapted to a conventionally-metered carburetor or used in conjunction with a pulse-modulated dual injector system. In the latter case, the injected fuel can be directed against the active surface of the horn or ducted thereto through channels within the horn. A similar audio resonator concept is being pursued by Autotronics Inc. Orders-of-magnitude reductions in fuel droplet diameter are claimed. These droplets are so small that little segregation occurs in the intake manifold.

Limited testing of the Thatcher-McCarter design in a Plymouth Duster installation, by General Environment Corp., indicates (Table 3-1 column 5) significant improvement in emission levels over the standard carburetor version. A surprising (and possibly spurious) indication of fuel economy improvement was also reported with this ultrasonic carburetor.

Operating from the car's electrical system, the ultrasonic driver requires a separate power amplifier/conditioner with feedback loop. If the fuel injection mode is employed, the system also requires injector nozzles, metering pump, and an electronic control unit with sensors for manifold vacuum, engine speed and ambient temperature. Major advantages of this type of carburetor over the sonic carburetor to be discussed subsequently, are:

- (1) Function is independent of ambient temperature (will work under cold start conditions).
- (2) Potential durability (7000 miles demonstrated at time of writing Ref. 3-9).

Drawbacks, at present stage of development, are:

- (1) Complexity (may have cost implications).
- (2) Noisiness.
- (3) Power requirement.

#### SONIC CARBURETOR

A sonic carburetor represents a second approach to improving fuel atomization. It is a special type of VV carburetor wherein sonic velocity ( $\sim 800$  ft/s) is achieved at the throat. The air velocity increases to supersonic levels just downstream of the throat, and then abruptly becomes subsonic again before entering the intake manifold, creating essentially a normal shock across the barrel at the transition point. Fuel droplets, already very small due to the sonic air stream, are broken up even further and thoroughly mixed with the air in traversing the shock wave.

The most well developed sonic carburetor is the "Dresserator", being developed by Dresser Industries and tested by the leading auto manufacturers. In this proprietary device, the variable throat area is controlled by a movable mechanically-actuated fuel distribution bar. The incoming fuel is distributed across the (comparatively) large surface of this bar and "scrubbed off" by the near sonic air flow. The principle is illustrated in Figure 3-9. Note that no downstream throttle plate is used in this device. Neither does it have a choke, although some fuel enrichment is required during cold starts.

Viewed from the present state of development, the advantages of this carburetor are:

- (1) Excellent atomization and mixing (comparable to the ultrasonic unit).
- (2) Small parasitic power demand.

Its drawbacks are:

- (1) Altitude (ambient pressure) and temperature compensation required.
- (2) Durability problems (due to sonic operating condition).
- (3) Cold start transient (difficulty in achieving sonic velocity).

HC and CO emissions reductions of up to a factor of 2, over conventional carburetors, have been demonstrated in testing to date, as shown in column 3 of Table 3-1. Fuel economy improvements up to 15% have also been claimed (Ref. 3-3), but this seems overstated.

#### PREVAPORIZATION DEVICES

A completely uniform air/fuel mixture is most easily achieved if the fuel is in the gaseous state. Consequently, considerable attention is being given to prevaporization of the fuel. A number of auto manufacturers are using localized augmentative preheating — "hot spots" or "early fuel evaporation" (EFE) devices — to promote evaporation during cold start; these devices are

disabled when the engine attains normal operating temperature. Thus, such measures do not improve cylinder-to-cylinder charge uniformity in a warm engine. Further, not all of the fuel can be evaporated by the "brute force" electrical heater approach, as the power requirements to do so would be excessive (>1 kW).

Several companies (British Leyland, Ethyl Corp., Shell Laboratories of Great Britain) are developing continuously-operating pre-evaporative systems, which can be integrated with various types of carburetor, and which utilize the waste heat of the exhaust. In the Ethyl concept, the carbureted mixture from the primary barrel is ducted through a heat exchanger buried in the exhaust manifold before returning it to the intake manifold, while flow from the secondary goes directly to the intake manifold. The Shell approach is to attempt to vaporize all the fuel by transferring heat from the exhaust manifold to the carburetor via heat pipes ("vapipes").

Both approaches show considerable improvement in distribution ( $\pm 2$  to 3% A/F ratio spread). This permits leaner operation with an oxidation catalyst system. Again, factors of 2 or better are achieved in reducing HC and CO emissions from conventional four-venturi carburetors as shown in column 4 of Table 3-1. NO<sub>x</sub> emissions are essentially unchanged and some slight improvement in fuel economy is claimed.

Problems to be addressed in development of pre-evaporative systems are:

- (1) Minimization of heating the main air flow (which would lead to losses in volumetric efficiency).
- (2) Prevention of "vapor lock".

#### FUEL INJECTION SYSTEMS

Electronic fuel injection (EFI) has been used for many years on luxury and specialty cars, and has more recently been introduced into more moderately priced imports (e.g., Volkswagen and Volvo). Much of the pioneering work was done by Bendix Corp. in the U.S. and Robert Bosch in Germany.

The most popular and well developed type of port injection system (termed "D-Jetronic" by Bosch) uses sensed engine speed and load (manifold vacuum) and "computed" air density (via sensed ambient temperature) to determine the inducted air mass flow and, hence, the requisite quantity of fuel to be injected. The fuel quantity is varied by pulse-width modulation of the electro-mechanical injector valves. Although this system, in principle, solves the mixture uniformity problem, it suffers from two sources of error:

- (1) Overall A/F ratio error incurred by "computation" of air density from the barometric pressure assumed in the calibration.
- (2) Local A/F ratio error due to pulse-to-pulse injector timing fluctuations (fuel quantity variations).

A more sophisticated version of this system, introduced by Bosch in 1972 as "L-Jetronic", employs a direct air mass flow meter, simultaneous operation of all injectors, and independent monitoring of EGR. It therefore provides improved emission control over the "D-Jetronic" type.

Bosch has also developed a mechanical fuel injection (MFI) system called "K-Jetronic," which obviates the need for electronic signal conditioning and electromechanical injectors. The key to system operation is a fuel distributor, embodying variable-width metering slits, actuated by the balance of pneumatic and hydraulic forces on various pistons and diaphragms in the control unit. Intake air volume is the controlling variable, and secondary temperature corrections are provided by bimetallic element sensing. This system is somewhat similar to the Rochester MFI unit marketed by General Motors Corp. in the late 1950's and early 1960's.

EFI and MFI systems are both more costly than carbureted systems, the latter being somewhat less expensive. Both provide A/F ratio uniformity and HC/CO emission control improvement over conventional carburetors, but small or no improvement in fuel economy. No significant advantage over more advanced carburetors is apparent. An example of feedback-controlled performance with a K-Jetronic system is given in column 6 of Table 3-1.

#### CATALYTIC CONVERTERS AND ACCESSORIES

A catalytic converter (reactor) is essentially a vessel in which a catalyst-promoted chemical reaction is permitted to occur. For catalysts in the solid state (the only case of interest here) they can be grouped into four classes, depending upon the form of the catalyst. The catalyst may be in the form of either: (a) granules or pellets, or (b) a single monolithic mass. The corresponding converters are called "pelleted" (packed bed) or "monolithic," respectively. In either form, the catalyst proper may be distributed on a supporting substrate material, or it may be the only material present, serving as its own support. The former type is referred to as a "supported" catalyst, and the latter as "unsupported". The converter shell is capable of sustaining the required temperatures and chemical species, which contains the catalyst and aids in reagent flow distribution.

The key variables in operation of a catalytic converter are the prevailing temperature and the exposure time (the dwell time of a unit mass or volume of reagents in contact with the catalyst). All chemical reaction rates are highly temperature dependent, usually exponential in the Arrhenius form

$$\text{reaction rate} = (\text{constant}) \exp(-\Delta\mathcal{E}/RT)$$

where  $\Delta\mathcal{E}$  is some "energy of activation",  $R$  is the universal gas constant, and  $T$  is the absolute temperature. Consequently, reaction rates increase by orders of magnitude for comparatively

small increases in temperature. It is common practice to speak of a "light-off" temperature, corresponding to the temperature at which the conversion rate is some percentage (usually 90%) of steady-state value.

The dwell time is usually measured in terms of either: (a) the superficial mass flux (based on geometric flow cross-section) and path length through the catalyst; or (b) the "space velocity" (volume flow rate of reagents per unit volume of catalyst). The latter is most common in automotive emissions application, and is reciprocally related to dwell time. In the catalysis of gas phase reactions by solid catalysts — the case in automotive exhaust — those reactions occur on the surface of the catalytic material, hence, a high surface-to-volume ratio is required. The "specific surface" — defined as the topologically effective surface area per unit volume of catalyst — is the usual figure of merit. For unsupported catalysts, the catalyst itself must be prepared in a geometric form with adequate specific surface. Supported catalysts are distributed in a substrate of high specific surface, frequently a transitional alumina ceramic. In either case, it is easier to achieve high specific surface in granular beds. However, such beds also constitute a physical retention problem and must be carefully designed to minimize pressure drop, hence monolithic types are more convenient if adequate specific surface and durability can be therein obtained.

Automotive emission control catalysts are used to promote: (a) oxidation of HC and CO to CO<sub>2</sub>; and (b) to reduce NO and NO<sub>2</sub> back to N<sub>2</sub>; as selectively as possible, with minimal impact on other species. The catalytic materials employed are of two types — "noble" metals (platinum, palladium, rhodium, ruthenium) used in very small quantities, and "base" metals (chromium, cobalt, copper, iron, nickel) used in greater quantities. In some formulations, traces of noble metals are included in predominantly base-metal catalysts.

It should be noted that oxidation catalysts do a particularly good job on reactive hydrocarbons, which are present in much lower proportions in the total hydrocarbon effluent. For instance, the comparatively unreactive methane comprises about 10 to 15% of the hydrocarbon in untreated exhaust, but is about 40 to 50% of residual hydrocarbon exiting the oxidation catalyst bed. This is significant, since it is the reactive species that contribute most to the formation of photochemical oxidant ("smog").

#### OXIDIZING CONVERTERS

The most successful oxidizing converters, now in use on MY 1975 vehicles, are supported noble-metal types. The majority (GMC, Chrysler, and AMC products) of vehicles employ a single pelleted converter mounted under the floor, near the confluence of the Y-pipe in the case of a V-8 engine. Ford, and some others, use a monolithic converter mounted near the exhaust manifold(s).

Total "catalyst" (including substrate) volume is 80 to 400 in<sup>3</sup> per vehicle, depending upon engine size and type. Typical noble metal usage is circa 1.5 grams of platinum and 0.5 gram of palladium

per vehicle, which is dispersed on high-specific-surface alumina substrate. Light-off temperatures are of the order of 600 to 800°F and maximum safe operating temperature for long intervals is around 1800°F for the catalyst material. This characteristic points up one of the major difficulties with an oxidation catalyst system. Most HC and CO are produced during the cold start transient, which is precisely where the catalyst is also least effective. Various measures — quick heat manifolds, insulation, close converter coupling, etc. — have been adopted to minimize this problem.

The converter must be operated somewhat lean to provide the necessary oxidizing environment (surplus oxygen). The excess air is provided by an ancillary air pump. The exhaust system must be designed to provide a temperature low enough to preserve the integrity of the converter. On this point, it is significant to note that 50,000-mile durability has been demonstrated on these converters. However, even with over-temperature protection (bypass), total or near-total ignition failures can quickly destroy the catalyst.

Noble-metal catalysts are also highly susceptible to "poisoning" (chemical deactivation). The chief offenders in this respect have been lead, phosphorus and sulfur, hence the introduction of lead-free, low-sulfur (and phosphorus) fuels, which must be used in catalyst-equipped vehicles.

#### REDUCTION CONVERTERS

NO<sub>x</sub> reduction reactions can also be promoted by either noble-metal, base-metal, or combination catalysts. The most successful developmental units to date (as typified by the Gould and Questor systems) employ a monolithic base-metal (nickel-based) catalyst.

To do its job, the reduction converter must "see" a reducing environment, hence the engine must be calibrated rich. Further, the CO/O<sub>2</sub> ratio of the inlet gases must be fairly carefully controlled. Gould accomplished this with an oxygen "getter" — a small piece of monolithic noble-metal oxidation catalyst mounted in the converter ahead of the reducing catalyst — to reduce inlet O<sub>2</sub> to the reducing catalyst to a level of about 0.1%. Questor accomplishes the same result with a small rich thermal reactor ahead of the NO<sub>x</sub> catalyst. HC/CO cleanup is effected by an oxidizing converter (or second thermal reactor) downstream of the reducing converter, with supplementary air introduced between the two for the necessary oxidation environment. The getter or prereactor compensate for the vagaries of conventional carburetors, and may not be required with advanced (±3% A/F ratio control) carburetors or feedback controlled induction systems.

The Gould GEM68 system has the best demonstrated (Ref. 3-10) durability history to date (36,000 miles), and appears to be capable of entertaining all but the most severe ignition failures without permanent catalyst damage.

Two operational points are worthy of mention in connection with reducing converters, as

employed in dual catalyst systems. First, during the cold start transient, the oxidizing converter — now perform further thermally isolated from the engine — cannot function efficiently. As a result, the reducing converter (in Gould-type systems) must double as an oxidizing converter during this transient, the secondary air flow being temporarily diverted from downstream to upstream of the "reducing" converter. Secondly, the downstream oxidizing converter has a bigger job to do as a result of the engine's being calibrated rich for the reducing converter. This necessitates a larger volume of oxidizing catalyst and/or higher noble-metal content therein.

Typical light-off temperatures for the Cu-Ni based Gould reducing catalyst are (Ref. 3-11) in the range of 800 to 1000°F, with steady-state operation nominally circa 1300°F. This temperature can be temporarily exceeded, but sustained high temperatures will destroy the catalyst.

EGR is apparently not required with these catalysts, even for large cars, to meet a NO<sub>x</sub> standard down to about 1.0 g/mi. A standard of 0.4 g/mi may necessitate some EGR, and cause further complications in HC control, in full-size and large cars for "end-of-life" (50,000 mi) compliance.

### THREE-WAY CONVERTERS (CLOSED-LOOP INDUCTION CONTROL)

It is possible, within a very narrow range of operating conditions, for a single catalyst bed to effectively do both the oxidation and reduction tasks. A unit that accomplishes all three conversions simultaneously in a single bed is called a 3-way converter. Considerable development effort has been expended in this area, particularly by Universal Oil Products.

Figure 3-10 illustrates the operating regime for acceptable conversion efficiencies. Note that the engine must run stoichiometric, within  $\pm 0.1$  unit air/fuel (A/F) ratio or about  $\pm 0.7\%$ . If one realizes that the stoichiometric air/fuel ratio varies by at least  $\pm 2.0\%$  just due to local variations in gasoline products (as indicated in Section 3.3.1), it is evident that even a "perfect" carburetor or fuel injection system is not equal to the control task. Therefore a 3-way converter can only be considered in conjunction with a closed-loop feedback-controlled induction system that senses, and compensates for, changes in exhaust composition.

The emerging catalyst for the 3-way converter is typically a supported noble-metal type. It is close-coupled to the engine, considerably ameliorating the cold-start problem. Light-off and operating temperatures are comparable to those of the other converters. Adequate durability is yet to be demonstrated, although rapid progress is being made.

Closed-loop A/F ratio control is implementable in either a carbureted or injected induction system and could be combined with any of the previously described units (with varying degrees of difficulty). Most American manufacturers consider some type of electromechanically operated VV carburetor as the most likely candidate. The

key component in the control system is the exhaust composition feedback sensor. Both Bosch and UOP have developed versions of an oxygen level sensor proposed by Robert Bosch in 1971. The sensor is essentially a solid-electrolyte O<sub>2</sub>-concentration cell comprising two concentric cylindrical platinum film electrodes on either side of a zirconia tube. The inner electrode is in contact with the O<sub>2</sub> of atmospheric air, while the outer one, in contact with exhaust, "sees" the partial pressure of oxygen on its surface in the on-going oxidations of HC and CO. As the exhaust mixture crosses the rich-lean threshold, orders of magnitude change occur in oxygen partial pressure at the sensor's electrode surface. Providing the sensor temperature is above about 750°F, there results virtually a 900-mV step change in its output voltage. This signal lends itself admirably to digital control logic. Output voltage slowly decreases again at higher temperatures, but setting the control point at 500 mV or less eliminates temperature sensitivity.

Mechanical durability problems with earlier sensors have evidently been overcome and present useful life is in excess of 12000 miles. However, there is still a problem with electronic stability, which requires further development. These units have been successfully integrated into prototype carbureted, EFI, and MFI closed-loop induction systems, and have demonstrated potential A/F ratio control to  $\pm 0.3\%$  — an order of magnitude improvement over the best open-loop induction system.

Alternative feedback control methods, based upon sensing other engine output parameters, have been proposed. None of these have the advanced development status of the O<sub>2</sub>-sensor-controlled system, however.

Of the two catalytic NO<sub>x</sub> control schemes, the 3-way converter with feedback control is the most desirable. Besides the advantage of a single converter relative to the cold start problem, this system offers

- (1) Self-compensation for variations in engine and fuel parameters.
- (2) Elimination of the need for a secondary air pump.
- (3) Potential elimination of EGR.
- (4) Lower back pressure.
- (5) Some fuel economy improvement (over a dual catalyst system, which must be calibrated rich), but not to the degree attainable with a lean-burning oxidation-catalyst system.
- (6) Lower sulfate emissions than a system employing a separate oxidizing catalyst (Ref. 3-21).

### 3.3.2 Configurational Evolution

The UC Otto engine, like the alternates discussed in subsequent chapters, is evaluated in three states of evolutionary development: Present, Mature, and Advanced configurations. For the UC Otto engine, however, we must interpret

these labels a bit differently from the definitions given in Chapter 2. The reason for this difference is that the basic UC Otto engine is here now and is in no sense experimental. With its long development history, it is already a "mature" engine (in the strictest sense of the word), operating near its attainable efficiency within the context of present mass-production technology.

Unlike the continuous-combustion alternates (which all potentially meet, or better, the current statutory emission standards), the UC Otto engine must be evaluated for performance at the emission level standards it is required to meet. This imposes another dimension of variability in discussing a "moving baseline" engine, as the legislated standards will also change with time, ostensibly becoming more stringent. Hence, in discussing the possible evolution of the UC Otto engine, it is understood that each configuration must meet the emission control standards in effect at the time of its introduction. The expected levels of these standards — particularly the NOx standard — beyond 1977 are subject to much controversy at this time.

The salient features of the configurations termed Present, Mature, and Advanced are presented in Table 3-2. The reasons for these selections are discussed in the following.

## PRESENT CONFIGURATION

As stated previously, it is recognized that the fully-developed UC Otto engine is here now. The Present configuration is consequently epitomized by powerplants in the MY 75 cars. While a few of these are Wankels (and it is acknowledged that the Wankel implementation is one Present engine), most are reciprocating engines. Further, current production Wankels fall short of the fuel economy of their reciprocating equivalents due predominantly to the difficult rotor/housing seal problem. It is therefore believed that the rotary engine does not represent the best of present configurations, and the baseline Present configuration is taken to be a reciprocating engine. Other prominent features are given in Table 3-2. The emission control system is represented schematically by Figure 3-11(a), comprising a conventional carburetor, EGR, secondary air pump, oxidation converter(s), and related minor improvements.

A weight breakdown for a typical 150 hp (300-350 CID V-8) power system is given as the Present configuration in Table 3-3, and plotted as an isolated point on Figure 3-12. The polar moment of inertia (referred to engine output shaft) of such a system is likewise plotted as a single point on Figure 3-13.

Table 3-2. Salient features of evolving UC Otto configuration

Characteristic	Configuration		
	Present	Mature	Advanced
Type	Reciprocating	Reciprocating	Rotary
Fuel/air mix preparation	Conventional carburetor	Advanced carburetor, (ultra)sonic; preheat	Advanced carburetor (ultra)sonic; preheat
Speed range	700 to 4500 rpm	700 to 4500 rpm	1000 to 10000 rpm
Block/housing	Ferrous	Ferrous	Ceramic
Pistons/rotors	Aluminum	Aluminum	Ceramic
Induction/exhaust	Valve-in-head	Valve-in-head	Side and peripheral ports
Cooling system	Conventional	Conventional	(None)
Emission controls	EGR; air pump; oxidizing catalyst; quick-heat manifold; quick pulloff choke; etc.	Advanced carburetion and induction system with aftertreatment <sup>a</sup> of exhaust gas.	Advanced carburetion and induction system with aftertreatment <sup>a</sup> of exhaust gas.

<sup>a</sup>Alternative aftertreatment systems include:

- (1) 3-way catalyst/FB control or dual catalyst/air pump or thermal reactor/reducing catalyst/airpump (either may need EGR) to meet 0.41/3.4/0.40 (g/mi HC/CO/NOx).
- (2) Oxidation catalyst or thermal reactor only, with EGR/air pump or with lean burning, to meet 0.41/3.4/1.-2. (g/mi HC/CO/NOx).



Table 3-3. UC Otto power system weight breakdowns (150 design horsepower)

Subassembly or Component	Configuration		
	Present (1975 Reciprocating V-8) weight, lb	Mature (Reciprocating V-8) weight, lb	Advanced (2-Rotor Rotary) weight, lb
<u>Basic engine assembly</u>	(485)	(490)	(283)
Block/housing assy (including crankshaft assy, water and oil pumps, manifolds, heads, valve train, pistons/rotors)	445	445	225
<u>Induction and carburetor assy</u>	15	20	22
Ignition system	15	15	13
Oil	10	10	8
Oil cooler	—	—	15
<u>Cooling system</u>	(66)	(66)	(8)
Radiator	24	24	—
Fan and shrouds	7	7	8
Coolant	35	35	—
<u>Emission controls</u>	(55)	(54)	(41)
Oxidizing converter system	55	—	—
3-way converter system	—	54	41
<u>Auxiliaries</u>	(35)	(35)	(27)
Starter	20	18	10
Alternator	15	17	17
<u>Total, engine ready-to-run</u>	(641)	(645)	(359)
<u>Transmission</u>	(150)	(150)	(126)
<u>Battery</u>	(45)	(42)	(42)
<u>Total, power system</u>	(836)	(837)	(527)

#### MATURE CONFIGURATION

The Mature configuration, as applied to the UC Otto engine, is a projection of the best-performing engine the designer could initiate if he sat down in the near future with a clean sheet of drafting paper. As such, it incorporates only today's technology as that technology will be applicable in "Job 1" — no novel developments or breakthroughs. Implied is the normal development-production transition period, with some prototype system testing and the normal production engineering cycle, leading to production circa 1978 to 1980. The designer therefore has the opportunity to "clean up" minor deficiencies in the experimental versions presently being tested.

The Mature configuration (outlined in Table 3-2) is taken to be reciprocating, as it is believed that still more development time will be required to solve the problems of the rotary version. (It is also assumed, however, that rotary engine development would continue in parallel, perhaps finding wider introduction to the market.) Based upon data available at this writing, the NOx standard for this engine might be 0.4 g/mi at introduction. Catalytic NOx control is hence incorporated. This 3-way/dual converter system would not be required if, and where, the NOx standard were 1.5 to 2.0 gm/mi. The emission control scheme of choice is a feedback-controlled electronic carburetor of the sonic or ultrasonic type (indicated by the terminology "(ultra)sonic" in Table 3-2), together with a 3-way

converter (Figure 3-11 (c)). Fuel injection could also be used, but it is our opinion that the additional expense is not warranted. Preevaporative measures can also be incorporated in the carburetor. The feedback-controlled induction system is believed to be a desirable end in itself, for reasons of fuel economy and HC/CO control, even if catalytic NOx control is not required. If a developmental snag appears in the 3-way system, the dual converter system provides a "close second" fallback position, albeit at a penalty in fuel economy, and is shown as alternative in Figure 3-11 (b).

Table 3-3 gives a weight breakdown for a 150-hp Mature power system. The variations in weight and moment of inertia with design horsepower are indicated in Figures 3-12 and 3-13, respectively.

### ADVANCED CONFIGURATION

The Advanced configuration UC Otto engine is one that can be produced at some unspecified future date, given additional development and foreseeable extensions of today's technology. Specifically, it would include the benefits of fruition of R&D activity in areas discussed in Section 3.7.

With this definition in mind, we must ask how to get the "most" out of a UC Otto engine from the vehicular standpoint, above and beyond the performance benefits already achieved in the Mature configuration. The rotary (Wankel) configuration offers several possible improvements, once projected far enough into the future to allow resolution of its current rotor-seal and housing distortion problems:

- (1) Lower specific weight (which results in a significantly lower propagated weight in the vehicle).
- (2) Smaller total volume (which provides for additional vehicle weight reduction beyond the propagated effect of engine weight, and some reduction in aerodynamic drag because of improved frontal configuration).
- (3) Higher output shaft rpm (which permits a smaller torque converter, hence lighter transmission).

All of these, except modified aerodynamics, ultimately appear as vehicle weight reductions that translate directly into a fuel economy benefit. A nonperformance-related advantage is potentially lower production cost.

The Advanced configuration is therefore taken to be a Wankel of either one or two rotors (depending upon design horsepower), and is described by Table 3-2. An advanced, feedback-controlled induction system with 3-way converter is incorporated, as in the Mature configuration. Rotor(s) and a housing liner of ceramic material will provide improved dimensional stability and minimum heat losses.

Table 3-3 gives a weight breakdown for an Advanced configuration 150-hp engine, which is plotted for comparison as an isolated point on Figure 3-12. Its moment of inertia is shown on

Figure 3-13, and Figure 3-14 depicts the comparative packaging volume vis-à-vis an equivalent reciprocating V-8.

### 3.3.3 Producibility and Cost

Present UC Otto engines obviously are producible — indeed, set the standard of producibility — at reasonable cost. Since the Mature configuration contains no radical departures from the Present one, it likewise presents no serious producibility problems.

Power system unit costs for the Mature configuration, as a function of design horsepower, are presented in Figure 3-15. These costs are derived from the data base prepared by Rath and Strong for use by the National Academy of Sciences Committee on Motor Vehicle Emissions (Ref. 3-26) and the Transportation System Center of the DOT. These numbers represent unit variable costs, and as such do not include material and labor overhead factors at the plant level. Cooling system, battery, and transmission (but not post-transmission drive train elements) are costed with the "power system". Since the technology is relatively well defined (except for the advanced induction system), the cost uncertainty is relatively low as compared to the cost uncertainty of the alternate engines. No special materials are used, with the exception of the catalyst.

Two versions of the UC Otto were costed, one (the baseline) that meets the statutory limits of 0.41/3.4/0.4 g/mi (HC/CO/NOx), and one that meets a relaxed standard of 0.41/3.4/1.5-2.0 g/mi. A manufacturing cost increment of 40 dollars reflects the difference in equipment selected to meet the differing emissions levels.

Two versions of the UC Otto were costed, one (the baseline) which meets the statutory limits of 0.41/3.4/0.4 g/mi (HC/CO/NOx) and one which meets a relaxed standard of 0.41/3.4/1.5-2.0 g/mi. A manufacturing cost increment of \$40 reflects the difference in equipment selected to meet the differing emissions levels.

A discussion of the materials impact of the catalytic converters is given in Ref. 3-17 (see also Chapter 18). However, it should be noted here that full production would not be expected to tax the nation's resources, nor incur critical shortages.

## 3.4 VEHICLE INTEGRATION

### 3.4.1 Engine Packaging in Vehicle

Packaging of the Mature UC Otto power system is essentially the same as in present vehicles and no significant vehicle modifications would be expected. Some attention would be required to catalytic converter location.

Introduction of the Advanced Wankel configuration would result in major vehicle design changes to exploit its packaging advantages. The volumetric improvement has already been pointed out (Figure 3.14). A pioneer example of using this packaging to advantage is the NSU Ro-80 (Ref. 3-12).

### 3.4.2 Transmission Requirements

Mature UC Otto vehicles can use the conventional automatic and manual transmissions

used in present vehicles. An Advanced high-speed rotary might permit some redesign to lighten the transmission package. Envisioned transmission improvements, such as lock-up torque converters and continuously variable transmissions (Ref. Chapters 5 and 10), will benefit overall vehicle efficiency for any of the UC Otto configurations, and for several alternates as well.

### 3.5 PERFORMANCE IN VEHICLE

Fuel economy and emissions estimates are presented for UC Otto-engined vehicles in six size classes of interest to this study. These size classes, ranging from "Mini" cars to "Large" cars, are defined in Chapter 10 and are based upon the owner-driver's performance and creature-comfort desiderata (acceleration, range, passenger and luggage accommodations, etc.), not vehicle weight. Thus, for each engine type considered in this report, a different set of curb weights and design horsepowers are associated with the same set of vehicle class names.

Since actual in-vehicle FTP test data were available, the VEEP driving cycle simulation computer program (used in analyzing performance of the alternates) was not used for the UC Otto-engined vehicles, except for validation of the program itself.

#### 3.5.1 Fuel Economy

Average urban (FDC-U) and highway (FDC-H) fuel economies for present (MY 1975) UC Otto vehicles in the six size classes are given in Table 3-4. These values are based upon actual EPA test data (Refs. 3-13 and 3-14). Table 3-5 lists the corresponding fuel economy estimates for the Present configuration, which were taken for the best of the MY 1975 vehicles having approximately the APSES baseline horsepower to weight ratio.

For vehicles incorporating Mature configuration engines, the fuel economy estimates shown in Table 3-5 were projected from more limited test data. Fuel consumption (reciprocal fuel economy) was plotted versus curb weight, yielding a gentle, nearly linear curve, shown on Figures 3-16 and 3-17. Experimental fuel consumption data for 3-way-catalyst cars (Ref. 3-3) were found to scatter about the oxidation-catalyst (1975) car curve and, within the accuracy of these data, it appears that fuel economy of the basic 3-way system can be equal to that of the (best) Present oxidizing-converter system. An improvement of 5% was allowed for the superior mixture ratio control of the advanced carburetor (values up to 22% have been claimed) and for optimized EGR and spark timing. Mature UC Otto cars are thus projected to provide a sales-weighted<sup>3</sup> composite fuel economy about 9 to 10% better than that of the MY 1975 cars.

It should be noted that, if a dual converter system must be employed (because the 3-way is not ready in time), fuel economy will suffer somewhat due to rich calibration of the engine for the reducing converter. Conversely, if the actual

Table 3-4. UC Otto vehicle fuel economy in miles/gallon (Average Test Data Reported by EPA for 1975 Cars)

Auto class	Curb wt, lb	FDC-U <sup>a</sup>	FDC-H <sup>b</sup>	Composite <sup>c</sup>
Mini	1600	25.8	37.2	29.9
Small	2100	22.2	32.4	25.9
Sub-compact	2600	19.4	27.5	22.4
Compact	3100	16.9	23.3	19.3
Full-size	4000	13.4	18.2	15.2
Large	5000	10.4	15.2	12.1

<sup>a</sup>FDC-U = Urban Federal Driving Cycle (1975 FTP).

<sup>b</sup>FDC-H = Highway Federal Driving Cycle (1975 FTP).

<sup>c</sup>Composite = 55% FDC-U, 45% FDC-H (weighted harmonic mean fuel economy).

Federal NOx standard in effect at the time of introduction is sufficiently higher than the statutory 0.4 g/mi, with HC and CO remaining at statutory levels, the 3-way converter becomes unnecessary and only an oxidation converter is required. In conjunction with the advanced carburetor, such a lean-calibrated engine could provide a further slight increase in fuel economy over the Mature configuration with an oxidation catalyst. A thermal reactor system, however, would probably not yield fuel economy improvement because of the higher exhaust gas temperature requirement.

The fuel economy of the Advanced configuration given in Table 3-5 was estimated only for the Compact vehicle - the single point reference used throughout this report. This estimate is based upon: (a) resolution of the Wankel rotor/housing seal difficulties; (b) 5% increase for improved induction and reduced heat losses; (c) propagated weight reduction in the vehicle. With regard to item (c), it should be noted that the Compact Wankel vehicle has a curb weight of about 2700 lb and a nominal 110-hp engine, in contrast to the 3100-lb/125-hp reciprocating-engined Compact.

#### 3.5.2 Emissions

Emission level estimates were also made for the six classes with Present and Mature engines and are presented in Table 3-6. These data are for well-maintained cars and represent 50,000-mile values, including a maximum of one catalyst replacement.

<sup>3</sup>Present market distribution.

Table 3-5. UC Otto vehicle fuel economy in miles/gallon (gasoline)  
(Present, Mature and Advanced configurations)

Engine configuration			Present <sup>a</sup> (1975 reciprocating; oxidizing converter)	Mature <sup>b</sup> (reciprocating; 3-way converter)	Advanced (ceramic rotary 3-way converter)			
Driving cycle			FDC-U <sup>c</sup>	FDC-H <sup>d</sup>	FDC-U	FDC-H	FDC-U	FDC-H
Auto class	Curb wt, lb	APSES baseline design maximum power, BHP						
Mini	1600	50	28.4	43.1	29.8	44.6		
Small	2100	70	24.6	37.0	25.8	39.0		
Sub-compact	2600	95	21.0	30.9	22.1	33.0		
Compact	3100	125	17.4	25.8	18.3	27.3	21	30
Full-size	4000	175	13.4	20.0	14.1	21.1		
Large	5000	230	10.7	16.0	11.2	16.8		

<sup>a</sup>Derived from best of 1975 vehicles having approximately the APSES baseline horsepower-to-weight ratio trend, and calibrated to meet the national emissions standards of 1.5/15. /3.1 g/mi (HC/CO/NO<sub>x</sub>).

<sup>b</sup>"MATURE" vehicle fuel economies could be increased by approximately an additional 5% if only an oxidizing catalyst is required by then-current emission standards. However, this additional 5% is probably not attainable with a thermal-reactor-only system at 0.4/3.4/2.0 g/mi (HC/CO/NO<sub>x</sub>) standards.

<sup>c</sup>FDC-U = Urban Federal Driving Cycle (1975 FTP).

<sup>d</sup>FDC-H = Highway Federal Driving Cycle (1975 FTP).

For the Present configuration, scatter diagrams, Figures 3-18 through 3-20, of curb weight versus low-mileage emission rates and degradation factors were prepared from certification data for each emittant. Midband curves fitted to these data were used to compute the listed levels. Actual scatter was large for HC and CO, and more moderate for NO<sub>x</sub>.

Only a few low-mileage data were available for the Mature 3-way catalyst system. These data are shown on Figures 3-18 through 3-20. The HC and CO emissions for the 3-way systems are largely below 0.41 and 3.4 g/mi, respectively, and NO<sub>x</sub> ranges from 0.2 to 0.9 g/mi with the heavier cars all above 0.4 g/mi. A reasonable high mileage conversion efficiency for 3-way systems is 77% for HC and NO<sub>x</sub>, with CO not being a problem, according to developers of such systems. With further development work, the simultaneous conversion efficiency for HC and NO<sub>x</sub> may be even higher; however, even with 77% conversion, 0.41 g/mi HC and 0.40 g/mi NO<sub>x</sub> are attainable with expected engine improvements. At 77% conversion, a catalyst feed gas having 1.73 g/mi of HC and NO<sub>x</sub> is required to result in 0.4 g/mi emitted from the vehicle. Emissions

of less than 1.73 g/mi of HC and of NO<sub>x</sub> have been simultaneously obtained from V-8 engines with 10 to 12% EGR and conventional carburetion/induction systems, as reported by Gumbleton (Ref. 3-18). As previously shown in Table 3-1, a considerable reduction in HC emissions can result from the improved fuel atomization and vaporization of advanced carburetion. Few data are at hand regarding the effect of EGR on the HC emissions of an engine with an advanced carburetor; however, the observed increase in HC emission due to the combined effects of EGR and MBT spark timing (Refs. 3-18 and 3-19) is not expected to be more severe than with a conventional carburetor. In view of these observations, an advanced carburetion system in conjunction with proportional EGR is projected to result in catalyst feed gas that is sufficiently low in HC and NO<sub>x</sub> to allow a vehicle emissions standard of 0.4 g/mi HC and 0.4 g/mi NO<sub>x</sub> to be met.

The emissions projections in Table 3-6 were computed for a catalyst with 77% simultaneous conversion efficiency of HC and NO<sub>x</sub>. The catalyst feed gas composition was taken as 1.5 g/mi HC and 1.3 g/mi NO<sub>x</sub> at 4000-lb vehicle curb weight. These emissions were then scaled with vehicle

Table 3-6. UC Otto vehicle emissions<sup>a</sup> in grams/mile

Engine configuration		Present (1975); EPA data for oxidizing catalyst cars			Mature; projections for 3-way catalyst cars		
Driving cycle		FDC-U <sup>b</sup>			FDC-U		
Auto class	Curb wt, lb	HC <sup>c</sup>	CO	NOx <sup>d</sup>	HC	CO	NOx
Mini	1600	0.34	2.7	1.4	0.26	2.0	0.16
Small	2100	0.34	2.7	1.4	0.26	2.0	0.16
Subcompact	2600	0.34	2.7	1.4	0.26	2.0	0.16
Compact	3100	0.34	2.8	1.5	0.26	2.1	0.21
Full-size	4000	0.46	3.5	1.9	0.35	2.8	0.30
Large	5000	0.52	3.9	2.0	0.40	3.2	0.40

<sup>a</sup> Well-maintained car at 50,000 miles.

<sup>b</sup> FDC-U = Urban Federal Driving Cycle (1975 FTP).

<sup>c</sup> As C<sub>6</sub>H<sub>14</sub>.

<sup>d</sup> As NO<sub>2</sub>.

weight according to trends indicated by actual test data and by VEEP.

No attempt was made to estimate emissions of the Advanced configuration, compliance with prevailing standards at the time of introduction being assumed.

### 3.5.3 Drivability Aspects

With the advent of catalytic emission control, it was possible to retune the engines for improved drivability relative to prior emission-controlled cars. The Mature- and Advanced-engined cars should have drivabilities at least approaching those of uncontrolled cars, and possibly somewhat better due to superior induction systems. No starting or warmup problems are anticipated.

### 3.5.4 Safety

The question of safety is discussed in Chapter 16. As the present UC Otto engine is the standard against which the safety of all alternatives must be compared, there is little to say on this subject. The Otto engine's "track record", from a safety standpoint, is very good. None of the modifications embodied in the Mature or Advanced configurations would materially compromise its current level of safety.

### 3.6 OWNERSHIP CONSIDERATIONS

In addition to performance, comfort, and safety the car owner's concerns in a prospective vehicle purchase are typified by the questions:

(1) "What will it cost me?"

(2) "How often must it be garaged for maintenance?"

These questions are addressed briefly in this section.

### 3.6.1 Maintenance

Each year Otto engine manufacturers make minor modifications to some engine components, many of which are intended to reduce, or even eliminate, certain maintenance requirements. Breakerless ignition, for example, eliminated distributor points and the need for their periodic replacement. Thus, the basic engine maintenance requirements are slowly being reduced. On the other hand, changing emission control regulations have resulted in adding new components (PCV valves, decel valves, EGR valves, charcoal canisters, catalytic converters, etc.). These new components: (a) have their own maintenance requirements due to wear on moving parts, severe operating environments, finite design life, etc.; (b) have not reached the design maturity of basic components from a durability standpoint, due to limited field experience; and (c) may functionally contribute to increased wearout rate of previously long-lived basic engine components. There are thus simultaneous influences in a new model year's engine which tend to both reduce and increase maintenance requirements.

Regularly scheduled engine maintenance for the Mature configuration would probably include the following:

- (1) Replace air cleaner.
- (2) Change oil, replace filter.
- (3) Replace fuel filter.
- (4) Replace PCV valve.
- (5) Replace spark plugs.
- (6) Check compression.
- (7) Check/adjust carburetor control system.
- (8) Check/adjust ignition timing.
- (9) Check catalyst.
- (10) Check O<sub>2</sub> - sensor.

Long-term or as-required maintenance would include:

- (1) Check/adjust valve timing; grind/replace valves.
- (2) Replace piston rings.
- (3) Clean carburetor.
- (4) Replace fuel pump.
- (5) Replace water pump.
- (6) Replace hoses.
- (7) Replace coolant and thermostat.
- (8) Replace belts.
- (9) Replace O<sub>2</sub> - sensor.
- (10) Replace catalyst or converter assembly.

Present maintenance facilities are adequate. Some new equipment (induction system diagnostic, and emission related) will be added, and mechanic/technician skills will have to be updated, but no major retraining is required. Present parts distribution network will be adequate.

### 3.6.2 Cost of Ownership

Here again, the evolving UC Otto-engined vehicle serves as the standard, against which the base ownership cost of alternate-engined vehicles must be compared. The base ownership cost of the vehicle represents the sum of all nonfixed costs (costs like tolls, parking fees, registration fees, nonengine maintenance, insurance, etc., are considered "fixed", independent of engine type) and include:

- (1) Vehicle first cost minus resale (depreciation).
- (2) Total cost of fuel and other (see Table 3-7) engine-expended fluids.
- (3) Engine maintenance cost.

Discussion and details of calculations are given in Chapter 19. The incremental cost of ownership, defined as

$$\Delta \text{ownership cost} = (\text{base cost of vehicle}) - (\text{base cost of equivalent UC Otto vehicle})$$

is, of course, zero by definition for the baseline UC Otto-engined vehicles.

It should be noted that the 3-way-catalyst-equipped car is estimated to be slightly more expensive to maintain than a car requiring only an oxidation catalyst. This additional maintenance cost is less than \$100 (constant 1974 dollars) over the life of the car (10 yr/100,000 mi).

### 3.7 RESEARCH AND DEVELOPMENT REQUIRED

To bring the configurations described as Mature and Advanced to production status, little pure research, as such, is required. Varying degrees of component and process development are necessary, however.

#### 3.7.1 Mature Configuration

The basic components of reciprocating engines have already essentially attained the acme of their development, from a production standpoint. Consequently the basic engine in the Mature Configuration requires virtually no development effort.

The primary areas for development work are, as previously indicated, the induction and emission control systems. Assuming that carbureted induction systems will continue to be more cost-effective, parallel development of feedback-controllable versions of the various advanced carburetors should proceed until at least one is proven to be functionally effective, durable, and economically producible.

Oxygen sensor and catalytic converter development should also proceed along parallel development paths, guided by the actual future course of legislated NO<sub>x</sub> (and possible sulfate) standards. Some supportive research in catalyst materials and fabrication processes may also be required, if current formulations cannot achieve the requisite durability.

#### 3.7.2 Advanced Configuration

In addition to the peripheral developments in induction and emission controls required by the Mature configuration, further basic engine development is required for the Advanced Wankel configuration. Such developments in metallic configurations are being pursued currently by NSU and its licensees (notably Curtiss-Wright, GMC, and Toyo Kogyu). Adaptation of ceramic technology will require a major research and development effort (see Chapter 5).

To be addressed specifically are: optimization of valving/porting and ignition system;

Table 3-7. Cost of engine-related expendable fluids for mature UC Otto vehicles  
(all costs in 1974 dollars)

Auto class	Engine (cyl/hp)	Lubricant			Coolant <sup>a</sup>			Total expendable fluid cost	
		Capacity, qt	Price, \$/qt	Interval, mi	Total capacity, qt	Price <sup>b</sup> , \$/qt	Interval, mi	At 35 kmi ~3 yr, \$	At 100 kmi ~100 yr, \$
Small	4/70	4	0.90	6000 <sup>c</sup>	8	1.25	24,000	27	81
Compact	6/125	5	0.90	6000 <sup>c</sup>	12	1.25	24,000	34	106
Full-size	8/175	6	0.90	6000 <sup>c</sup>	16	1.25	24,000	42	132

<sup>a</sup> Assumed to be 50% by volume of glycol-type antifreeze.

<sup>b</sup> Price of pure glycol-type antifreeze.

<sup>c</sup> Every 3000 mi for first 6000 mi; every 6000 mi thereafter.

improvement of rotor-to-housing seals; and elimination of thermal distortion of the housing in regions of high heat flux. Some additional materials research may be required in connection with rotor seals.

#### References

- |   |   |
|---|---|
| <p>3-1. Report by Environmental Policy Division of Congressional Research Service: "History and Future of Spark Ignition Engines"; Library of Congress (Requested of Sen. E. S. Muskie), S/N 93-10 (Sept. 1973).</p> <p>3-2. Taylor, C. F. and E. S. Taylor: "The Internal Combustion Engine", International Textbook Co. (1961).</p> <p>3-3. Report by the Committee on Motor Vehicle Emissions, Commission on Sociotechnical Systems, National Research Council, NAS (Nov. 1974).</p> <p>3-4. Yamamoto, K. et al: "Combustion and Emission Properties of Rotary Engines", SAE Paper 720357 (1972).</p> <p>3-5(a). Heywood, J. B. and M. K. Martin: "Aggregate Emissions from the Automobile Population", SAE Paper 740536 (June 1974).</p> <p>3-5(b). Fegraus, C. E. et al: "Contribution of the Vehicle Population to Atmospheric Pollution"; SAE Paper 730530 (1975).</p> <p>3-6. Fedor, R. J. et al: "Durability Experience with Metallic NOx Catalysts"; SAE Paper 74 (Oct. 1974).</p> <p>3-7. Ansdale, R. F.: "The Wankel RC Engine"; A. S. Barnes &amp; Co. (1969).</p> | <p>3-8. Roberts, M. A. and L. M. Shewes: "A Technique for the Determination of the Stoichiometric Air/Fuel Ratios of Gasolines", Ford Motor Co. Scientific Research Staff Publication (1972).</p> <p>3-9. Norbye, J. P.: "Ultrasonic Fuel Systems Promise Cleaner Exhaust and Better Mileage from Standard Piston Engines", <u>Pop. Sci.</u> (March 1973).</p> <p>3-10. Status Report: "Current Status of Gould's NOx Reduction Catalyst Technology", Gould Inc. (Sept. 6, 1974).</p> <p>3-11. Chin Ho Lee and M. P. Makowski: "Some Aspects of the Mechanism of NOx Reduction over Nickel Alloy Catalysts", SAE Paper 741080 (Oct. 1974).</p> <p>3-12. Audi NSU Auto Union (Neckarsulm, W. Germany): Fact Finding Visit by APSES Team (3 July 1974).</p> <p>3-13. Austin, T. C. and K. H. Hellman: "Fuel Economy of the 1975 Models", SAE Paper 740970 (Oct. 1974).</p> <p>3-14. Austin, T. C. and K. H. Hellman: "Passenger Car Fuel Economy - Trends and Influencing Factors", SAE Paper 730790 (Sept. 1973).</p> <p>3-15. Robison, J. A. and W. M. Brehob: "The Influence of Improved Mixture Quality on Engine Exhaust Emissions and Performance", WSCI Paper 65-17 (Oct. 1965).</p> <p>3-16. Urban Programs Div., The Aerospace Corp.: Final Report, "Alternate Automotive Power Plants and Fuels", ATR-74(7325)-2 (Dec. 1973).</p> |
|---|---|

- 3-17. Report by Panel of Consultants, MVE, Natl. Acad. of Science: "Evaluation of Catalytic Converters for Control of Automobile Exhaust Pollutants" (Sept. 1974).
- 3-18. Gumbleton, J. G., R. A. Bolton, and H. W. Long, "Optimizing Engine Parameters with Exhaust Gas Recirculation", SAE Paper 740104.
- 3-19. Gupta, R. K., and L. B. Graiff, "Effect of Exhaust Gas Recirculation and Ignition Timing on Fuel Economy and Exhaust Emissions of Several 1973 Model Cars", Paper Presented at the Meeting of the Central States Section of the Combustion Institute, March 26-27, 1974, Madison, Wisconsin.
- 3-20. Curtiss-Wright Corp., Woodridge, N. J., Fact Finding Visit by APSES Team, June 13, 1974.
- 3-21. Automotive News, Detroit, Mich., Feb. 3, 1975, p. 8.
- 3-22. Huls, T. A., and H. A. Nichols, "Influence of Engine Variables on Exhaust Oxides of Nitrogen Concentrations from a Multi-Cylinder Engine", SAE Paper 670482.
- 3-23. Siewert, R. M., "How Individual Valve Timing Events Affect Exhaust Emissions", SAE Paper 710609.
- 3-24. Stivender, D. L., "Intake Valve Throttling (IVT) - A Sonic Throttling Intake Valve Engine", SAE Paper 680399.
- 3-25. Tanuma, T., et. al., "Ignition, Combustion, and Exhaust Emissions of Lean Mixtures in Automotive Spark Ignition Engines", SAE Paper 710159.
- 3-26. "Manufacturability and Costs of Proposed Low Emissions Automotive Engine Systems," Consultant Report to the Committee on Motor Vehicle Emissions, National Research Council, Sept. 1974.



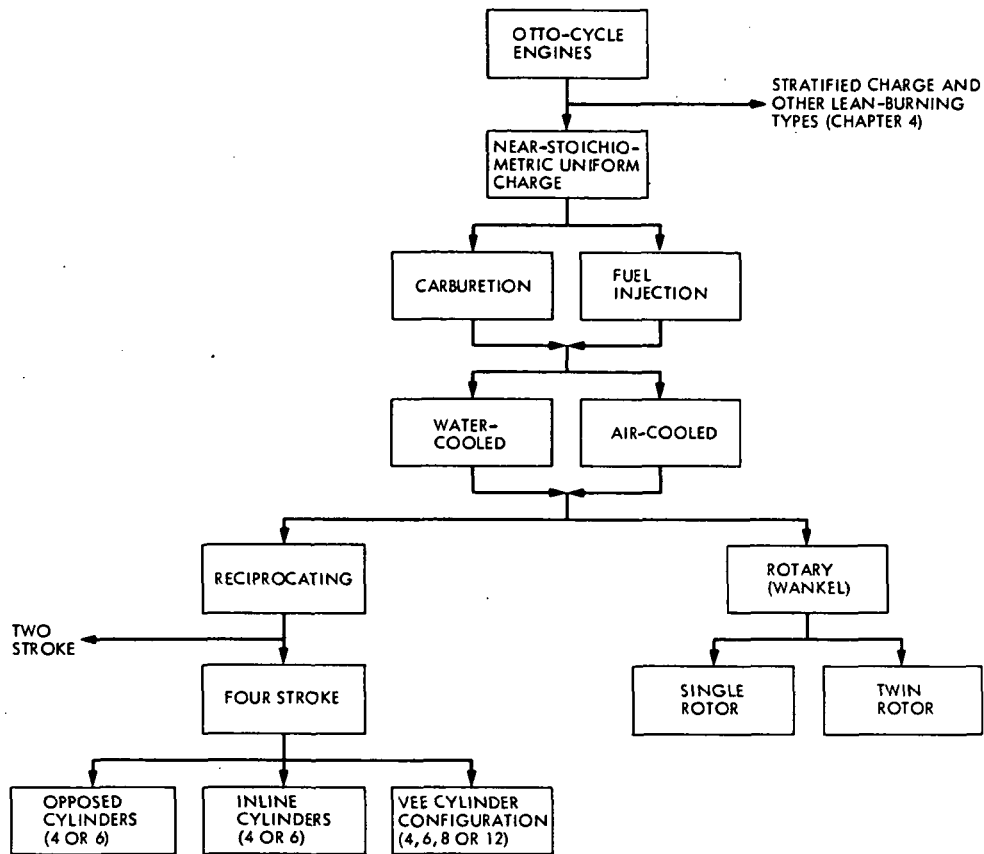

Fig. 3-1. Simplified morphology of common UC Otto engines

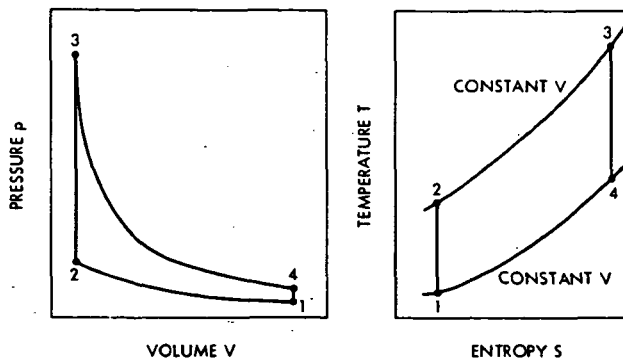

Fig. 3-2. The ideal air Otto cycle on P-V and T-S coordinates

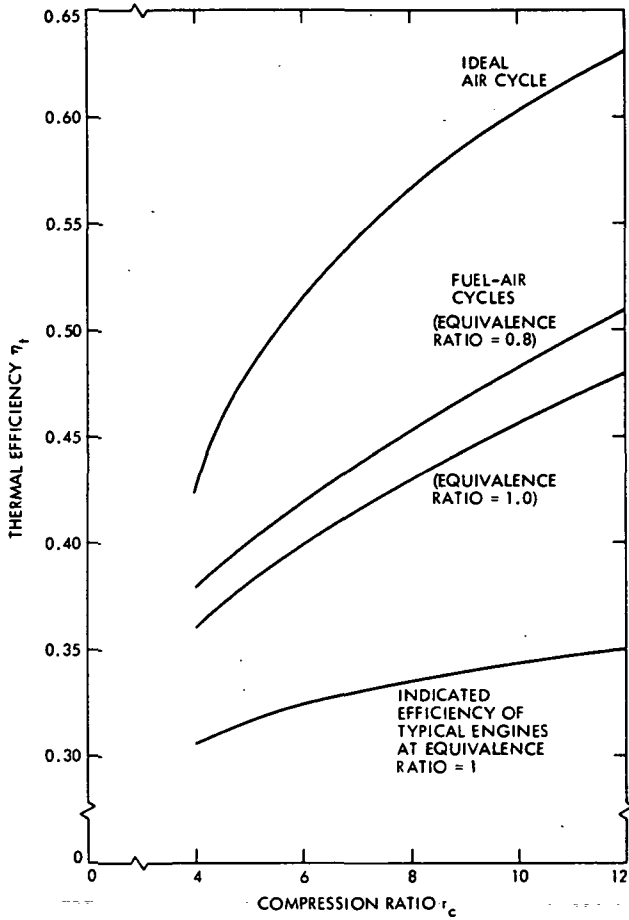

Fig. 3-3. Indicated thermal efficiency of: ideal air Otto cycle; the fuel-air Otto cycle at two different equivalence ratios; and typical indicated efficiency of Otto engines

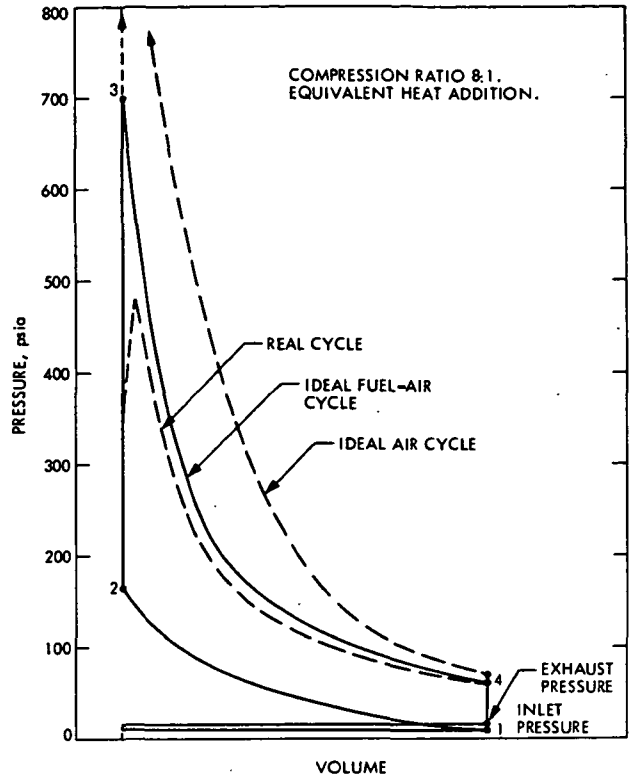

Fig. 3-4. Deviation of real Otto cycle operation from the ideal air cycle, and the ideal fuel-air cycle (compression ratio 8:1; equivalent heat addition)

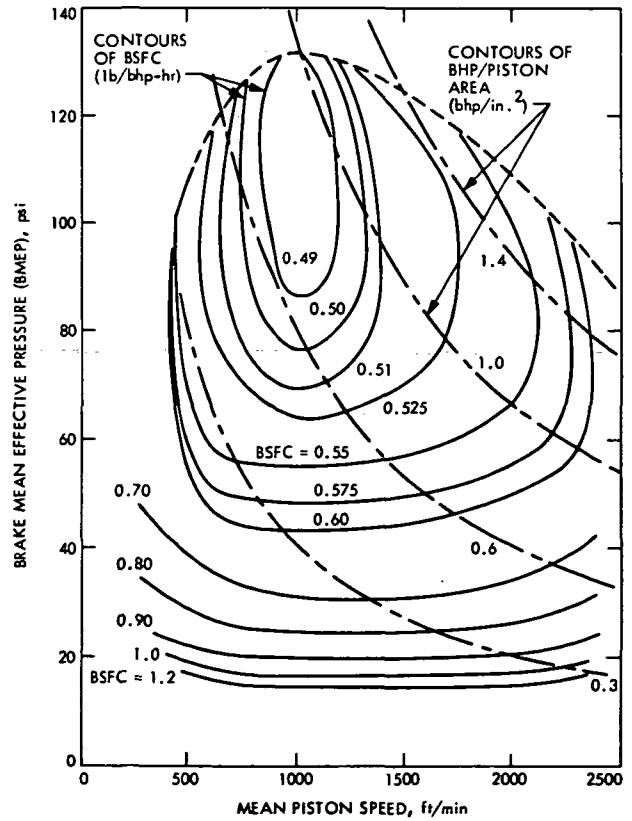

Fig. 3-5. Performance map, typical gasoline engine, 300 in.<sup>3</sup> V-8

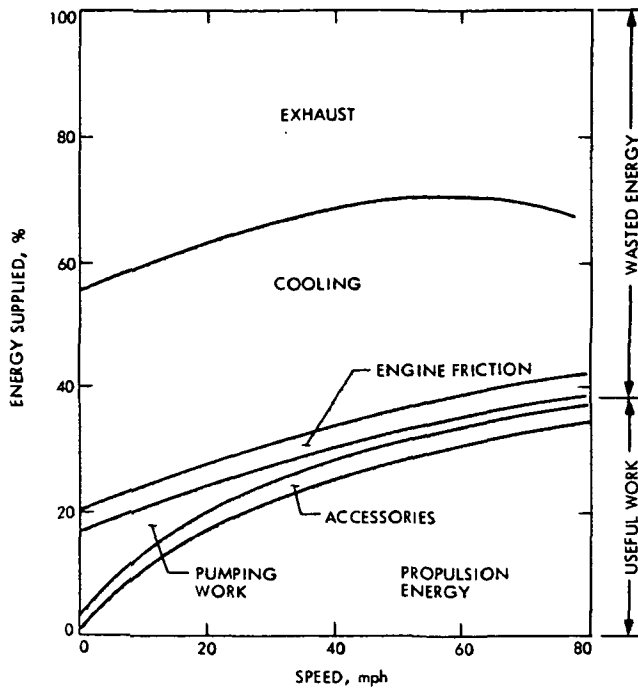

Fig. 3-6. Typical engine energy balance (approximate)

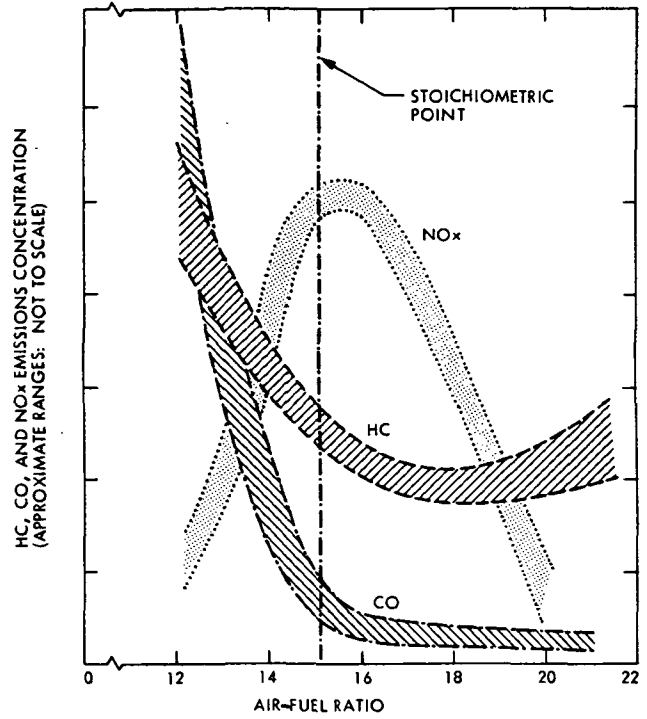

Fig. 3-7. Variation of exhaust pollutant concentrations with air/fuel ratio (typical)

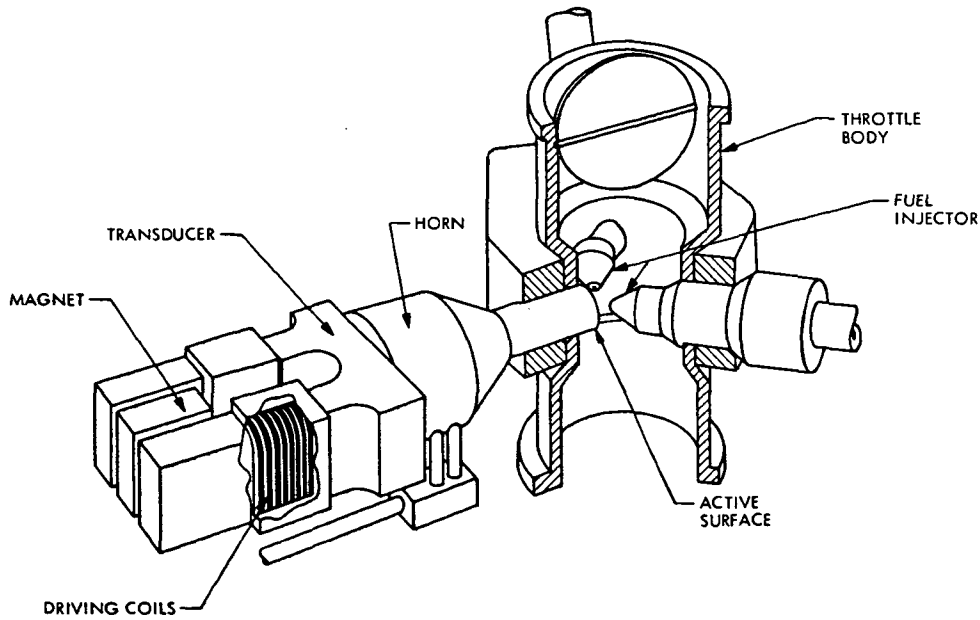

Fig. 3-8. Thatcher-McCarter ultrasonic carburetor (magnetostrictive implementation)

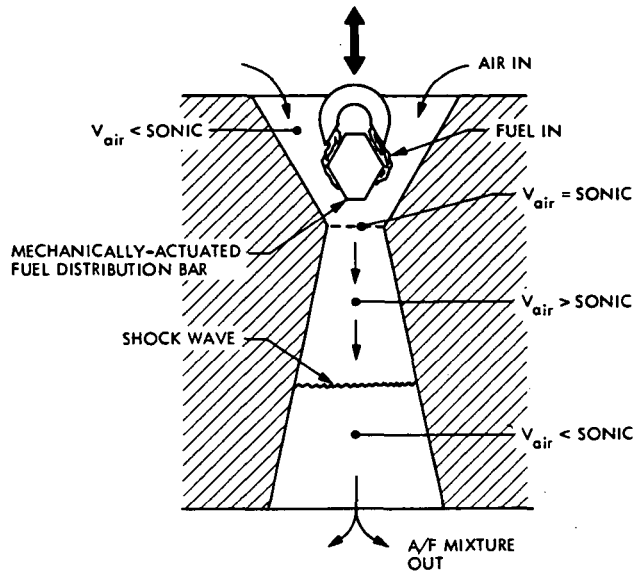

Fig. 3-9. Principle of sonic carburetor (Dresser type)

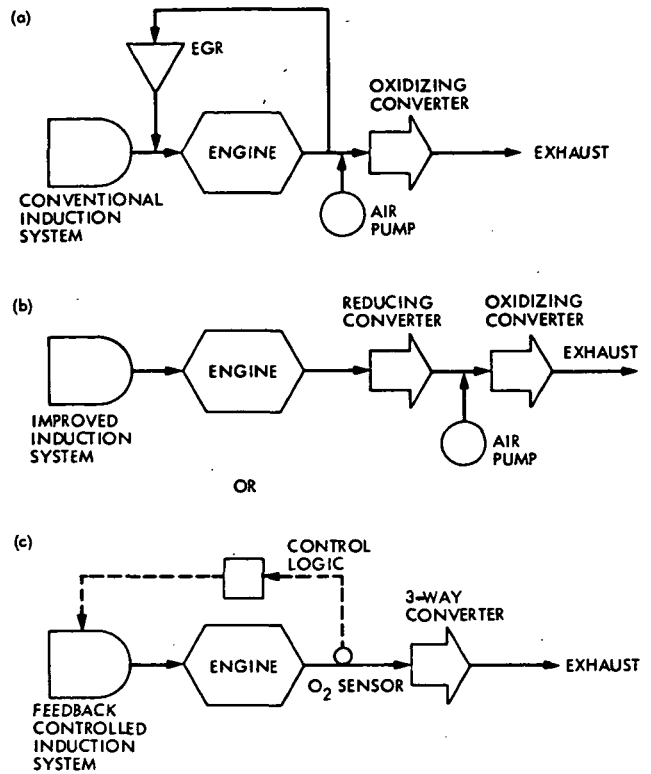

Fig. 3-11. Emission control systems (simplified conceptual): (a) oxidizing converter plus EGR (Present configuration); (b) dual converter approach; (c) 3-way catalyst approach; (b) or (c) is used in Mature and Advanced configurations

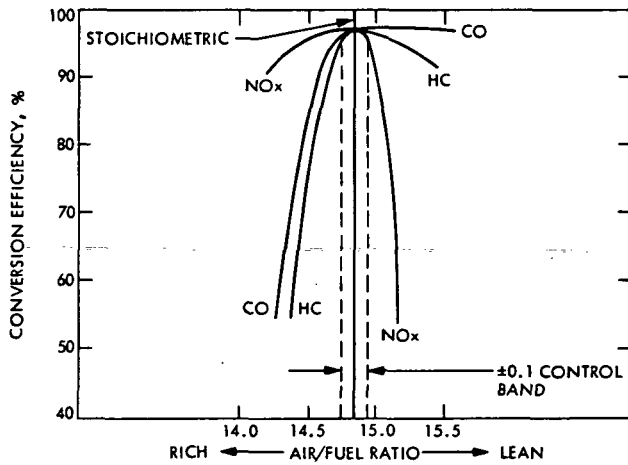

Fig. 3-10. Conversion efficiencies of 3-way catalyst

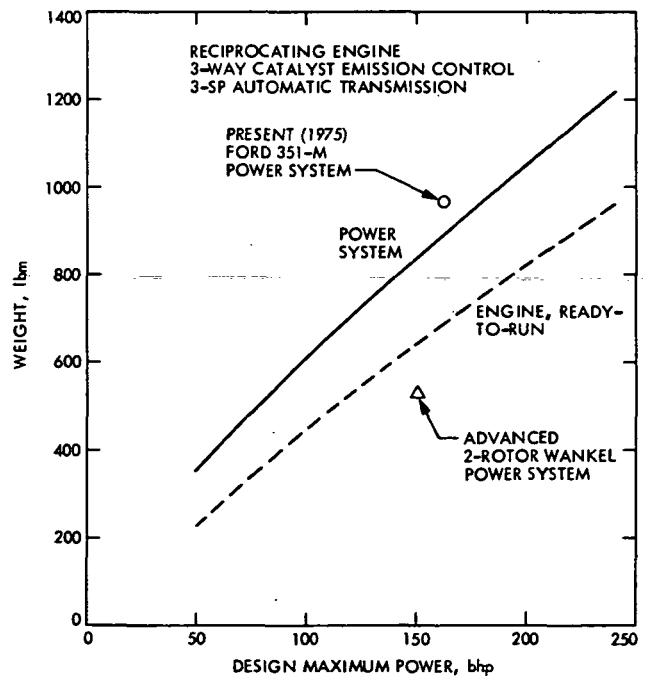

Fig. 3-12. UC Otto engine weights (Mature configuration)

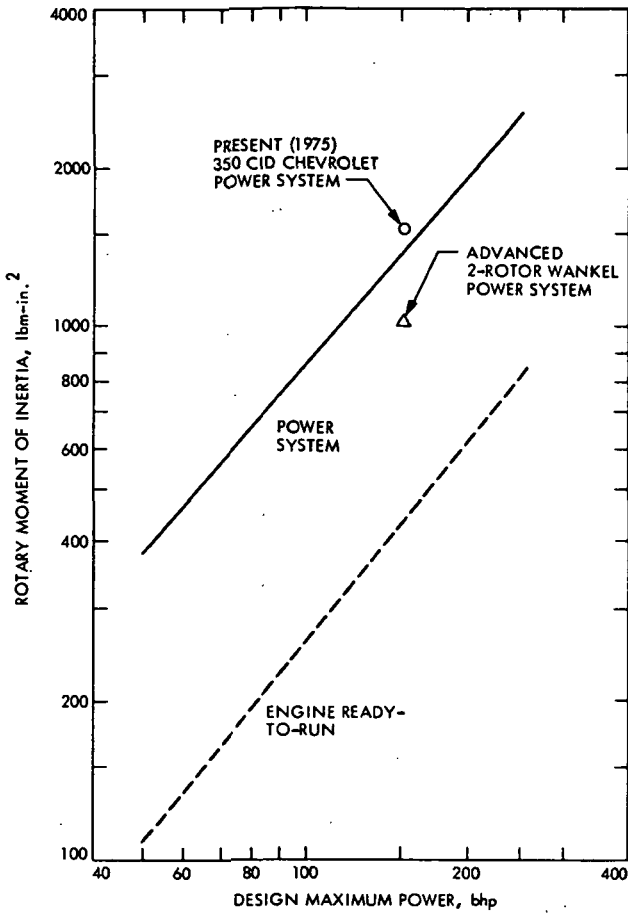

Fig. 3-13. UC Otto engine rotary moment of inertia vs design maximum power

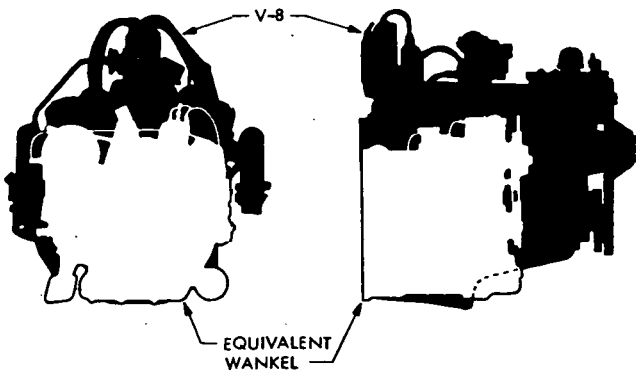

Fig. 3-14. Comparison of volume of 2-rotor Wankel engine with that of reciprocating V-8 of equal horsepower (adapted from Ref. 3-7)

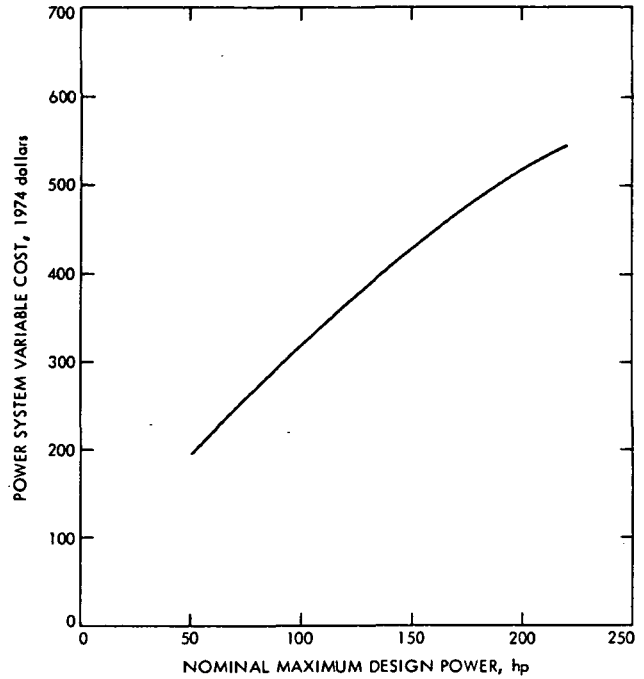

Fig. 3-15. Variable cost vs horsepower, 3-way catalyst UC Otto power system

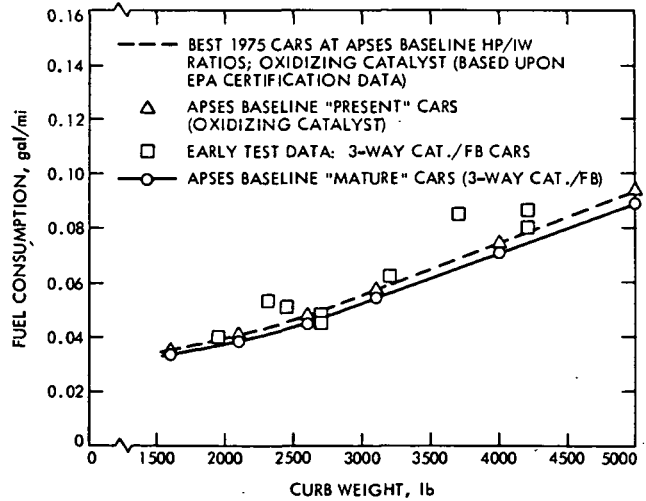

Fig. 3-16. Fuel consumption of UC Otto cars, Federal urban cycle (1975 FTP)

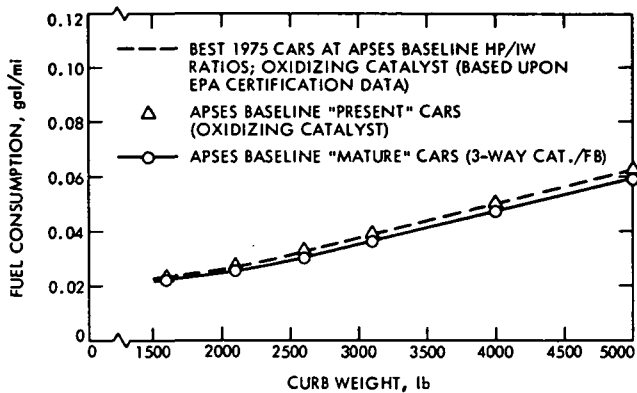

Fig. 3-17. Fuel consumption of UC Otto cars, Federal highway cycle (1975 FTP)

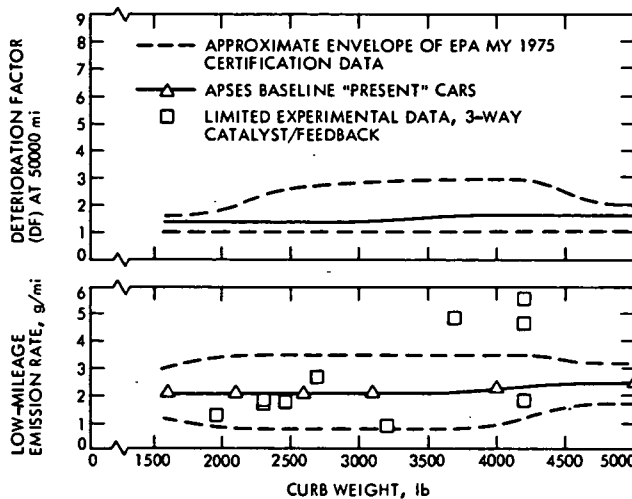

Fig. 3-19. UC Otto vehicle CO emission data, Federal urban cycle

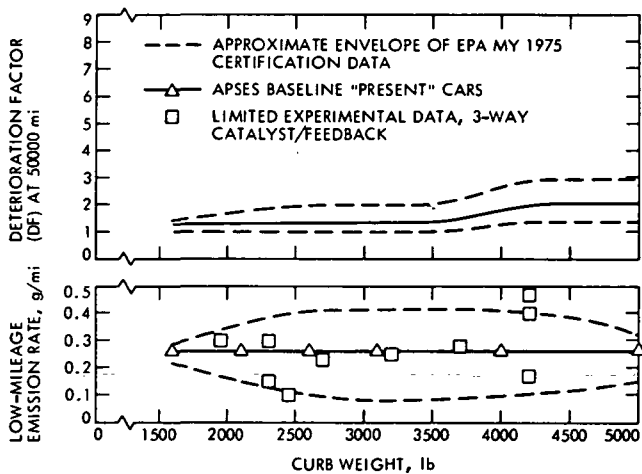

Fig. 3-18. UC Otto vehicle HC emission data, Federal urban cycle

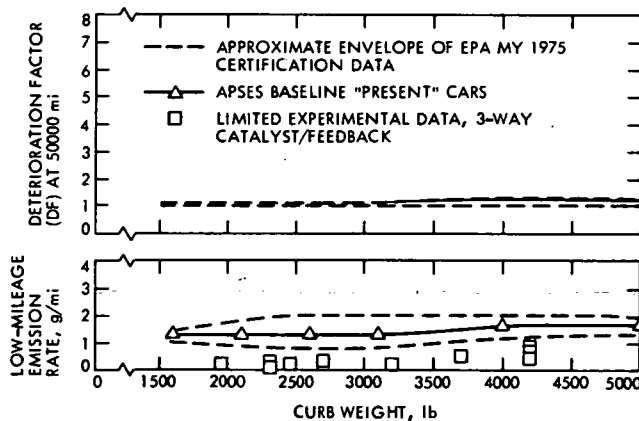

Fig. 3-20. UC Otto vehicle NOx emission data, Federal urban cycle

CHAPTER 4. THE INTERMITTENT-COMBUSTION ALTERNATE  
AUTOMOTIVE POWER SYSTEMS:

The Lean-Burning Otto Engine  
The Stratified-Charge Otto Engine  
The Diesel Engine

4.1	Description . . . . .	4-2
4.1.1	Introduction . . . . .	4-2
4.1.2	Morphology . . . . .	4-2
4.2	Characteristics . . . . .	4-4
4.2.1	Thermodynamics and Pollutant Formation . . . . .	4-4
4.2.2	Engine Performance . . . . .	4-13
4.2.3	Summary and Selection of Engine Types Evaluated . . . . .	4-21
4.2.4	Performance of Mature SC Otto and Diesel Engines . . . . .	4-22
4.3	Major Subassemblies/Components . . . . .	4-22
4.3.1	Descriptions . . . . .	4-22
4.3.2	Configurational Evolution . . . . .	4-25
4.3.3	Materials and Producibility . . . . .	4-30
4.3.4	Unit Costs . . . . .	4-31
4.4	Vehicle Integration . . . . .	4-32
4.4.1	Engine Packaging in Vehicle . . . . .	4-32
4.4.2	Transmission Requirements . . . . .	4-32
4.4.3	Other Vehicle Design Impacts . . . . .	4-32
4.5	Performance in Vehicle . . . . .	4-32
4.5.1	Fuel Economy . . . . .	4-32
4.5.2	Chemical Emissions . . . . .	4-33
4.5.3	Noise Emissions . . . . .	4-37
4.5.4	Driveability Aspects . . . . .	4-37
4.5.5	Safety . . . . .	4-37
4.6	Ownership Considerations . . . . .	4-38
4.6.1	Maintenance . . . . .	4-38
4.6.2	Incremental Cost of Ownership . . . . .	4-38
4.7	Research and Development Required . . . . .	4-39
4.7.1	Mature Configurations . . . . .	4-39
4.7.2	Advanced Configurations . . . . .	4-40
	References . . . . .	4-41
	Figures . . . . .	4-45

## 4.1 DESCRIPTION

### 4.1.1 Introduction

The engines discussed in this chapter are the lean-burning uniform-charge Otto (LB Otto), the stratified-charge Otto (SC Otto), and the Diesel, all of which fall into the category of open-cycle, internal intermittent-combustion engines without thermal regeneration. The ideal thermodynamic cycles of these engines incorporate adiabatic compression and expansion processes and constant-volume heat rejection. The heat addition processes may occur under conditions ranging from constant volume to constant temperature. The ideal thermodynamic cycle may then be taken as the Otto cycle or some version of the limited-pressure Diesel cycle.

The concepts of burning lean fuel/air mixtures and stratification of the charge in the cylinder date from the very early development work on the Otto engine (Ref. 4-1). Historical reviews of Otto and Diesel engines are available from a number of sources, including Refs. 4-2, 4-3, and 4-16. An excellent basic technical treatment of the performance of Otto and Diesel engines is given by Taylor & Taylor (Ref. 4-17).

The development of the Otto and Diesel engines and their subsequent adaptation to automotive and industrial applications during the early 20th century was a consequence of their superior power-to-weight and fuel economy characteristics relative to Rankine (steam) engines and battery-electric systems of the era. As additional performance specifications are added to the requirements which Otto and Diesel engines must satisfy, they must be closely reexamined to assess their capability to meet these more stringent specifications. The LB and SC Otto engines, together with the Diesel engine, have been considered not only for interim service until a more suitable alternate engine can be developed but also as the long-term future power systems of choice. The performance capabilities and production costs of these engines are evaluated in the following sections.

### 4.1.2 Morphology

A simplified categorization of a few selected Otto and Diesel engines is shown in Fig. 4-1. Any of these engines can (at least in principle) be mechanized in either a rotary (Wankel) or reciprocating (piston and cylinder) configuration. Although the details of air motion within the rotary engine differ from those of the reciprocating engine, the basic charge induction and formation schemes can be applied to either type of engine, with the rotary having the size and air handling capacity advantages previously discussed in Chapter 3. Only four-stroke-cycle engines incorporating the processes described in Chapters 2 and 3 are treated herein.

The combustion process in Otto engines is fundamentally different from that in Diesel engines. The Otto engine combustion process is initiated at one or more specific points — the spark plug(s) — in the combustion chamber, and the combustion reaction propagates through the fuel/air mixture from these points; hence the name progressive burning. In contrast,

combustion of the fuel in Diesel engines occurs through autoignition due to the high temperature of the air in the combustion chamber after compression. The actual heat release and burning of the fuel, which is injected into the Diesel engine combustion chamber near the end of the compression process, is a part of a complex chain of preignition and postignition chemical reactions. Nevertheless, the Diesel combustion process may be characterized as simultaneous burning, since each element of fuel injected into the combustion chamber "sees" a local environment which favors spontaneous combustion. In both Diesel and Otto engines the combustion process may be considerably affected by motion of the gas mixture within the combustion chamber, i. e., turbulence. In general, the effect of rapid mixture motion during combustion is to increase the time rate of heat release.

## OTTO ENGINES

The LB Otto engine is a variant of the baseline UC Otto engine discussed in Chapter 3. Lean operation of a uniform-charge engine requires uniform cylinder-to-cylinder and cycle-to-cycle distribution of a homogeneous charge with constant air/fuel ratio. An improved ignition system is also necessary. However, the basic engine hardware is virtually identical to that of the UC Otto. In its simplest configuration, the LB Otto engine has an improved carburetion and induction system, capable of maintaining precise control over the fuel/air mixture ratio, and modified automatic ignition timing. These engines can operate at fuel/air equivalence ratios ( $\phi$ ) down to about 0.65. As discussed subsequently, an exhaust oxidation converter — either thermal or catalytic — is required if an HC emission rate less than about 1 g/mi is to be attained.

The leanest mixture ratio at which an LB Otto engine will satisfactorily operate can be extended through the addition of a combustion-promoting agent such as hydrogen gas to the normal fuel/air mixture. The hydrogen gas can be produced by a reformer, in which a reaction occurs between a portion of the total flow of gasoline and air. The reformer products are principally hydrogen, carbon monoxide and nitrogen, which are then introduced into the engine's induction system. Such a system can extend the fuel/air equivalence ratio for satisfactory operation to values less than 0.5. Hydrogen enrichment systems have been pursued by the International Materials Corporation of Burlington, Massachusetts; Siemens AG of Erlangen, West Germany; and the Jet Propulsion Laboratory in Pasadena, California. A schematic illustration of a reformer/lean-burn system is shown in Fig. 4-2, and engine systems with fuel reformers are described in Refs. 4-8 through 4-12.

A stratified-charge Otto engine is characterized by a significant spatial variation of fuel/air mixture ratio within the combustion chamber at ignition and during at least a portion of the progressive burning process. Stratified-charge engines are usually thought of as lean-burning engines, although this is not necessarily the case. Recent Ford PROCO engines operate with charge stratification at a near-stoichiometric overall mixture ratio. The variation of mixture ratio with respect to location within the



combustion chamber, relative to the point(s) of ignition, usually proceeds from fuel-rich to fuel-lean, and may be continuous or discontinuous. The charge stratification may be accomplished in conjunction with dynamic mixture motion as in PROCOCO, or through the geometric configuration of the combustion chamber as in the prechamber engines. The various combinations of methods of effecting fuel/air charge stratification in Otto engines present a large array of possible engine configurations. However, these engines are not significantly different in operating principle, and the performance characteristics of stratified-charge engines are adequately represented by particular engines which have been carried to a relatively high state of development — the Ford PROCOCO, the Texaco TCCS, the Volkswagen PCI, and the Honda CVCC engines.

Stratified-charge engines are usually classified as either prechamber engines or open-chamber engines. The prechamber engine has a mechanically divided combustion chamber with restricted openings between the individual chamber compartments. Ignition occurs via a spark plug in the prechamber, which is supplied with a richer fuel/air mixture than the main chamber. The contents of the prechamber are expelled into the main chamber as the flame front propagates through the prechamber from the point of ignition.

Two examples of prechamber stratified charge engines are shown schematically in Fig. 4-3 — the Honda CVCC engine and the Volkswagen PCI engine. Both of these engines are provided with a means of forming a fuel-rich mixture in the prechamber prior to ignition. In the CVCC engine, the prechamber has a small auxiliary intake valve through which a fuel-rich mixture is inducted during the intake stroke, while a leaner-than-stoichiometric fuel/air mixture is inducted through the main intake valve. The fuel/air mixtures for both the prechamber and the main chamber are provided by a special "compound" carburetor. In the PCI engine, a lean fuel/air mixture is inducted through the intake valve, and additional fuel is injected directly into the prechamber during the compression stroke to create a locally rich mixture. Several other types of prechamber engines are described in Ref. 4-4. The CVCC and the PCI currently represent the highest state of development of prechamber engines for which data are available; consequently, these two engines are taken as representative of the category. The CVCC and PCI engine are described in Refs. 4-5, 4-6, and 4-7.

Open-chamber stratified-charge engines rely principally on motion of air within the working space and combustion chamber that is coordinated with injection of fuel into the moving air to achieve a spatial variation of mixture ratio. The combustion chamber in an open-chamber engine is essentially a single compartment; hence no pressure differences as large as those across a prechamber opening occur within the fuel/air charge during combustion, and the fuel/air charge is not divided by physical barriers as in prechamber engines. The Ford PROCOCO and Texaco TCCS, among several other open-chamber engine configurations, are described in Ref. 4-4.

The Ford PROCOCO is the most highly developed open-chamber engine for automobiles and is used to exemplify this engine type in what follows.

An illustration of the PROCOCO engine combustion chamber is shown in Fig. 4-4, and the engine is described in Ref. 4-13 and 4-14. Important geometric details of the intake port configuration, which create a circumferential air swirl within the cylinder during the induction process, are not shown. The intake manifold and ports handle only air and, if EGR is used, exhaust gas; therefore, the intake manifold system need not contend with the fuel atomization, vaporization, and distribution problems common in other Otto engines. Fuel is injected into the swirling air under moderate pressure during the compression process, and injection terminates before ignition occurs. The proper timing of fuel injection and ignition events is important to satisfactory operation of the engine. The PROCOCO engine utilizes either one or two spark plugs per cylinder, depending principally on the amount of EGR necessary for NO<sub>x</sub> control. An oxidation catalyst is required if HC emissions are to be less than one to two grams per mile, especially in larger cars.

The Ford direct-injected stratified-charge engine was originally developed to operate at a high compression ratio (~11:1), without detonation or preignition, and at partial loads by controlling only the fuel flow, i. e., without intake manifold throttling. Thus, a fuel economy improvement over conventional throttled Otto engines was obtained through (1) minimization of the part-load intake manifold pumping loss, and (2) the higher indicated thermal efficiency resulting from the increased compression ratio and from combustion of lean fuel/air mixtures. However, the absence of throttling with the subsequent lean combustion at part load resulted in unacceptably high HC emissions. Consequently, the PROCOCO engine now operates with air throttling for fuel/air mixture ratio control and with EGR for NO<sub>x</sub> control. These features are a part of an integrated combustion system which Ford has given the name PROGRAMMED COMBUSTION, hence the acronym.

## DIESEL ENGINES

Diesel engines have also been developed in two combustion chamber configurations — open-chamber and divided-chamber engines. Taylor & Taylor (Ref. 4-17) present an excellent discussion of Diesel combustion and engine characteristics. Basically, the open chamber design is restricted to relatively large cylinders operating over a narrow speed range. The precombustion mixing of fuel and air in an open-chamber Diesel engine is totally dependent on air motion and the spray characteristics of the fuel injector. Due to the sensitive nature of the Diesel ignition and combustion process, proper mixing occurs over only a narrow range of operating variables such as engine speed. Hence, open-chamber engines are restricted to heavy duty applications where their somewhat higher brake efficiency compensates for their limited speed range, often noisy combustion, and generally lower overall fuel/air equivalence ratio at which smoke becomes excessive.

The divided-chamber engine appears in two configurations — the prechamber design, such as developed by Daimler-Benz (Ref. 4-53) and Caterpillar (Ref. 4-56), and the swirl-chamber design developed by Ricardo (Ref. 4-49). Both are illustrated in Figs. 4-5 and 4-6. The divided-chamber Diesel engine was developed to alleviate the aforementioned limitations of open-chamber engines. Taylor and Taylor (Ref. 4-17) enumerate several features of divided-chamber engines relative to open-chamber engines, among which are the following:

- (1) Rapid air motion within the prechamber, due to the proper placement of restrictive throats between the main chamber and the prechamber, extends the speed range for effective mixing of the injected fuel, and minimizes the effect of spray characteristics of the fuel injection nozzles.
- (2) The prechamber structure can be more readily designed with sufficient strength to withstand the high rates of pressure rise and high local pressures which are characteristic of autoignition combustion processes.
- (3) The partially oxidized products of fuel-rich combustion within the prechamber are ejected at high velocity into the main chamber, which induces intensive mixing with the hot air contained therein and results in virtually complete oxidation of the fuel.
- (4) The prechamber insert may be designed via a loose fit to have very hot walls on which the injected fuel impinges. The subsequent fuel vaporization reduces the "ignition delay," i. e., the elapsed time between injection and the onset of combustion. Long delay periods result in extremely high rate of pressure rise.
- (5) The overall effect of staged combustion, in which fuel-rich partial combustion is followed by intensive mixing with excess air, is to reduce the rate of pressure rise in the main chamber and to limit the peak pressure so that the engine structure can be lower in weight.
- (6) Reduced NO<sub>x</sub> emissions are characteristic of divided-chamber engines.

In view of these factors, only divided-chamber engines are deemed suitable for automobiles and, as subsequently discussed, such engines require supercharging to be comparable in specific power (hp/lb<sub>m</sub>) to Otto engines.

#### 4.2 CHARACTERISTICS

The rather large family of intermittent-combustion alternates comprises two major classes of engines, as noted in the previous section: Otto variants — the (ultra) lean-burning uniform charge and the stratified-charge varieties — and Diesel variants. Within each genre, there is a large and growing number of physically different implementations. The differences, from

a performance and emissions standpoint, are often subtle and not of major consequence. Our task, as documented in this section, is: (1) to consider both the theoretical aspects of, and the experimental data from, such candidate implementations, and (2) then to select a tractable number of candidates which best represent the potential of their respective classes for evolutionary evaluation — in consonance with the study methodology for the other alternate engines.

The reader who does not require the wealth of detail presented in the next two subsections (4.2.1 and 4.2.2) may skip to Subsection 4.2.3, in which the key conclusions of the former are summarized and the engine types carried through the study methodology are selected.

##### 4.2.1 Thermodynamics and Pollutant Formation

The efficiency, emissions, and specific power characteristics of Otto and Diesel engines are coupled through the mode of operation of the engine. As discussed in Chapter 2, the heat engines which incorporate intermittent, internal combustion processes have great difficulty in delivering good efficiency and specific power with the simultaneous achievement of low NO<sub>x</sub> and HC emissions. The power output of an engine is the product of the work produced per unit mass of working fluid throughput and the rate of throughput of working fluid. The former quantity is determined by the amount of heat added per unit mass of working fluid and the thermal efficiency of the engine. The peak temperature occurring during heat addition, and thus the NO<sub>x</sub> formation, may be reduced by limiting the quantity of heat addition; however, the engine's power will clearly suffer a corresponding reduction unless the throughput of the working fluid is also increased. Such an increase may be effected via supercharging but, as shown later, the overall benefits are at best marginal. Finally, the use of internal, intermittent combustion in an open-cycle heat engine leads to further difficulties with simultaneous HC and NO<sub>x</sub> control while retaining high thermal efficiency, due to the requirement for a well timed interaction between the heat release of the combustion process and the thermodynamic operation of the engine. This last observation is also made by Agarwal et al. in Ref. 4-21.

The most extensive analytical treatments of the interaction in Otto engines among the combustion process, the thermodynamic operation, and the formation of NO<sub>x</sub> are due to Lavoie et al. (Ref. 4-19), Blumberg and Kummer (Ref. 4-18), and Blumberg (Ref. 4-20), a discussion of which follows. At the time of this writing, the authors were aware of no comparable treatment of the simultaneous Diesel combustion process per se. However, some observations can be drawn from the aforementioned Otto-cycle analytical work, and sufficient experimental data have been accumulated to permit assessment of the emissions vs fuel economy possibilities of Diesel automotive engines.

##### OTTO ENGINES

###### Combustion and NO<sub>x</sub> Formation

The thermal efficiency of Otto-cycle engines has previously been discussed in a somewhat

simplified manner in Chapters 2 and 3. However, the NOx emissions, efficiency, and specific power of Otto engines are closely interrelated; hence, the interaction between the temperature increase during combustion and the kinetics of NO formation and decomposition must be considered. Blumberg and Kummer (Ref. 4-18) have employed the method of Lavoie et al. in a computer simulation program which treats NOx reaction kinetics in conjunction with a generalized thermodynamic analysis of the Otto cycle, considering both mixed and unmixed combustion processes. Among the several engine variables treated in the computations are fuel/air equivalence ratio, fraction of exhaust gas recirculated, engine speed, compression ratio, duration and position of combustion with respect to crank angle, connecting rod length to crank radius ratio, and inlet manifold conditions.

The important assumptions which were made to facilitate the analysis include the following:

- (1) Equilibrium thermochemical properties are used for all species at local temperatures and pressures.
- (2) Compression and expansion processes are adiabatic and reversible.
- (3) The mass fraction  $\alpha^*$  of fuel/air charge which is burned may be expressed as

$$\alpha^* = \frac{1}{2} \left[ 1 - \cos \left( \pi \frac{\theta - \theta_0}{\Delta\theta_c} \right) \right] \quad (1)$$

where  $\Delta\theta_c$  is the duration of combustion in degrees of crank rotation,  $\theta_0$  is the angle at initiation of combustion (actual burning, not the spark event), and  $\theta$  is the crank angle. (Progressive burning according to Eq. 1 is shown in Fig. 4-7.)

- (4) The internal energy of the burned gas varies linearly with temperature, within the range of temperature encountered during combustion.
- (5) The heat loss from the gas during combustion is negligible and combustion occurs isenthalpically.
- (6) The following reactions are pertinent to NOx formation and decomposition:

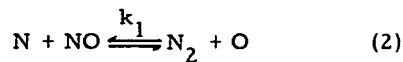

$$k_1 = 1.32 \times 10^{13} \text{ (cm}^3\text{/mole-s)}$$

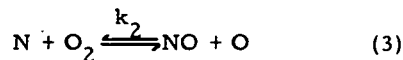

$$k_2 = 1.81 \times 10^8 T^{1.5} \exp(-3000/T) \text{ (cm}^3\text{/mole-s)}$$

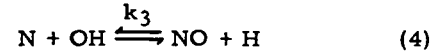

$$k_3 = 4.2 \times 10^{13} \text{ (cm}^3\text{/mole-s)}$$

where  $k_1$ ,  $k_2$ , and  $k_3$  are the forward specific rate constants, with T in Kelvin; and the reverse rate constant is (forward rate constant)/(equilibrium constant).

The reaction rates  $R_1$ ,  $R_2$ ,  $R_3$  are taken as the product of the specific rate constants  $k_1$ ,  $k_2$ ,  $k_3$  and the equilibrium concentrations of the reacting species at the local temperature. The reaction rate equations may be combined with a mass balance on an element of reacting mixture to obtain the expression

$$\frac{d\{NO\}}{dt} = \frac{2R_1}{\bar{p}} \left[ 1 - (\{NO\}/\{NO\}_e)^2 \right] / \left[ 1 + \frac{(\{NO\}/\{NO\}_e)R_1}{(R_2 + R_3)} \right] \quad (5)$$

where  $\{NO\}$  is the mole fraction of NO,  $\{NO\}_e$  is the equilibrium mole fraction of NO, and  $\bar{p}$  is the molar gas density. The derivation of Eq. (5) is given in Refs. 4-18, 4-19, 4-20, and 4-22.

Equation (5) may be integrated at points in the fuel/air charge along the temperature-pressure history of that point, as calculated from the thermodynamic analysis of the progressive burning process using the First Law, mass conservation, and ideal-gas adiabatic process relations. Thus, the NO concentration of individual elements of the charge may be computed as a function of crank angle. The final NO level of each element may then be averaged over the entire charge to obtain the overall NOx concentration.

The physical events which are simulated via the model described above proceed in simplified form as follows. Combustion is initiated in the first elements of the charge to burn at crank angle  $\theta_0$ . As the flame front progressively propagates through the fuel/air charge, a temperature gradient arises within the charge. The pressure, which is assumed to be uniform throughout the charge, increases as the charge burns; thus, the whole charge is compressed as combustion proceeds. However, the temperature increase  $\Delta T$  which an element experiences is proportional to its initial absolute temperature.

Since the first elements to burn are immediately elevated in temperature and then compressed over the entire pressure increase during combustion, they experience the highest temperature for the longest period of time. The final NO level of each element to burn is different, with those that burn first having the highest NO production. The forward NO reactions proceed rapidly as

temperature increases; thus the NO concentration also increases. As the elements are cooled during expansion, the NO concentration is "frozen" at the levels incurred at the high temperatures. "Freezing" is said to have occurred when there exists a nonequilibrium concentration of NO at a low temperature where NO reaction activity has virtually ceased. This phenomenon is described by Eyzat and Guibet (Ref. 4-24). The time available during expansion for the reverse reactions, in which NO is decomposed, is much shorter than the time required to attain equilibrium concentrations. Hence NO is frozen at high concentrations as the temperature drops during expansion.

The essential validity of the uniform-charge model used by Blumberg and Kummer has been verified by Komiyama and Heywood (Ref. 4-22) among others. Komiyama and Heywood also extended the model to utilize an experimentally measured cylinder-pressure-vs-time curve to compute the thermodynamic properties and composition of gas elements that are progressively burned.

The model of the combustion process given in Ref. 4-18, as described above, has been extended by Blumberg (Ref. 4-20) to include a variation of the fuel/air ratio across the charge, i. e., stratification. The stratified fuel/air charge progressively burns with each element of the charge retaining its particular stoichiometry during compression, combustion, and expansion to the point at which the NO concentrations are virtually frozen. At that point, the expanding gas is completely mixed and the remaining expansion occurs with a uniform mixture. Droplet burning is not treated, as the fuel is assumed to be completely vaporized. Hence, if fuel is directly injected into the cylinder, the model rigorously applies only if complete vaporization occurs prior to both compression and the onset of combustion. According to Blumberg, however, the model will yield good results if vaporization is complete when combustion begins.

The stratification function  $\phi$ , which describes the variation of fuel/air equivalence ratio, is defined across the charge in a fashion similar to the propagation of combustion across the fuel/air charge. The overall equivalence ratio  $\bar{\phi}$  is the average of the local equivalence ratios given by the stratification function  $\phi$ , integrated over the entire charge mass. As burning proceeds through the elements of a fuel/air charge, each with a different local  $\phi$ , the rich elements of the charge are not completely oxidized. When initial burning is completed and then the stratified charge is completely mixed, an additional heat release will occur. This heat release is due to the further oxidation of the products of locally rich combustion, primarily CO.

The stratification functions which were evaluated are shown in Fig. 4-8. The local equivalence ratio  $\phi$  is shown as a function of  $\alpha$ , the mass fraction of air in the charge. Thus,  $\phi(\alpha)$  describes the distribution of fuel across the air charge confined within the combustion chamber.  $\alpha = 0$  indicates the first element to burn and  $\alpha = 1$  the last. The stratification function  $\phi$  is

used to describe the unburned gas composition as a function of location within the charge in terms of the mass fraction of air. Results for three different stratification functions — linear, sinusoidal, and step — were reported by Blumberg, with graphical results presented for linear stratification.

A stratification function is characterized by type, as given above, overall equivalent ratio  $\bar{\phi}$ , and width of stratification. The latter is a measure of the severity of stratification expressed as  $\phi_i/\phi_e$ , where  $\phi_i$  is the local  $\phi$  of the first element to burn ( $\alpha = 0$ ) and  $\phi_e$  is the local  $\phi$  of the last element to burn ( $\alpha = 1$ ). For example, a linear stratification function with  $\bar{\phi} = 1.0$  can have a width of 1.1/0.9, or 1.3/0.7, or perhaps 1.6/0.4. The rich and lean limits of combustion place upper and lower bounds on the width of stratification.

The effectiveness of stratification in reducing NO production lies in the minimization of the effect of progressive-burning postcompression on the first elements to burn. In combustion of a uniform charge these elements experience the highest temperatures for the longest period of time. Rich-to-lean stratification can limit the oxygen available for NO production in those elements that contribute heavily to the overall NO production. Late-burning elements have low NO production regardless of the local  $\phi$  because the temperature drop during expansion quickly quenches the NO formation reactions.

This Otto engine combustion model has been employed to evaluate the effects of various techniques of NO control on engine operation.

#### Theoretical Aspects of NOx Control

Charge Dilution. Analytical investigations of NO control via charge dilution are reported in Refs. 4-18, 4-19, 4-20, 4-22, 4-24, and 4-25, and others. The discussion to follow draws on the work of Blumberg and Kummer (Ref. 4-18), using the previously described model.

Charge dilution is accomplished by the addition of either excess air or exhaust gas, thereby increasing the overall gas-to-fuel ratio of the charge to be burned. The dilution results in a lower value of the specific heat release during combustion, i. e., Btu's per total mass of charge. Hence, the temperature increase  $\Delta T$  due to combustion is reduced. A lower peak temperature slows the rate of NO formation; consequently, the overall frozen NO concentration is lower than with an undiluted, stoichiometric charge of air and fuel.

The effect of charge dilution on NO production is shown in Fig. 4-9. Both EGR and lean burning dramatically reduce the NO concentration in the engine exhaust gas. The exhaust gas recirculated is assumed to be cooled to the inlet manifold temperature of 610° R, as hot EGR results in a substantial loss in NO control. Concentrations of NO permissible for vehicular NOx emissions near 0.4 g/mi can be obtained with EGR rates in excess of 20% or by operating at equivalence ratios less than 0.6 without EGR.

Figure 4-10 shows the brake specific NO emission, in grams<sup>1</sup> of NO/BHP-hr, as a function of the total amount of charge dilution. The solid lines represent a constant fraction of total diluent, in terms of the total gas-to-fuel ratio (G/F). At the left vertical axis, dilution is accomplished entirely with air, and at the right vertical axis, entirely with exhaust gas. At the same fractional dilution, the NO levels with exhaust gas are substantially lower than those with air. With a diluent gas-to-fuel ratio of 22:1, the NO concentration with air is about 2 g/BHP-hr, while with exhaust gas as the diluent the NO concentration is less than 0.2 g/BHP-hr. However, in actual engine operation, the lean misfire limit is not the same for excess air as for exhaust gas. At the extremes of charge dilution, a substantial reduction in NO emissions may be achieved by lean combustion or by near-stoichiometric combustion with EGR. Of course, the total diluent may be a mixture of air and exhaust gas as in Fig. 4-10 for values between 0 and 100% of EGR.

The engine performance characteristics most affected by charge dilution are thermal efficiency and specific power. These effects are shown in Fig. 4-11 in terms of BSFC and BMEP, respectively. The solid lines show BMEP as dependent on fuel/air equivalence ratio  $\bar{\phi}$  at 0, 10 and 20% EGR. The dashed lines show BSFC as dependent on  $\bar{\phi}$  at the same EGR rates.

At the same level of NO production and the same intake manifold pressure, the BMEP with EGR is higher than that with lean burning. On Fig. 4-10 at a BSNO level of 1.0 g/BHP-hr, the required dilution with air only may be extrapolated to occur at an air/fuel (or gas/fuel) ratio of about 23.3, corresponding to  $\bar{\phi} = 0.63$ ; while the required dilution with EGR at the stoichiometric air/fuel ratio is a gas/fuel ratio of about 19.1, corresponding to an EGR rate of about 22%. At that EGR rate of 22%, the BMEP may be estimated from Fig. 4-11 as about 53 psia; whereas, at  $\bar{\phi} = 0.63$ , the BMEP is ~45 psia for air dilution only. Thus, at equivalent levels of NO production, and at the same intake manifold pressure, the specific power achieved with lean burning will be 18% lower than with EGR.

The BSFC shown on Fig. 4-11 is subject to the limitations of the computational model. In particular, the omission of heat losses during combustion and expansion reduces the absolute magnitude of the BSFC predictions; however, the relative trends are representative of actual engine characteristics. The omission of heat losses may be viewed as providing insight into the effect of changes in thermochemical properties during combustion and expansion that affect thermal efficiency. The model does include an empirical correlation which introduces engine friction as a function of indicated mean effective pressure and engine speed. All the curves shown on Fig. 4-11 are for an intake manifold pressure of 9.7 psia (10 in. Hg vacuum), so the throttling losses are the same. Of particular importance, the combustion interval with respect to crankshaft rotation is assumed to be constant, with the tendency

of charge dilution (via excess air or exhaust gas) to reduce the flame propagation rate not being considered. An alternate point of view is that the engine design is assumed to compensate for slower flame propagation rates through multiple ignition sources and/or increased charge motion (i. e., turbulence), the net effect being a constant combustion interval  $\Delta\theta_c$ .

Figure 4-11 shows that the change in BSFC, which results from an increase in EGR from 0 to 20% at  $\bar{\phi} = 1.0$ , is virtually nil - about a 1 to 2% increase in fuel consumption. However, at leaner fuel/air ratios ( $\bar{\phi} < 1$ ), EGR has a more deleterious effect on BSFC. Therefore, the combined use of exhaust gas and excess air for charge dilution can cause an appreciable increase in fuel consumption if the fuel/air equivalence ratio is less than about 0.9; but EGR up to 20% does not appreciably affect BSFC, due to thermochemical property changes, if the fuel/air ratio is very near stoichiometric.

The influence of lean burning on BSFC is also shown on Fig. 4-10. The lowermost dashed line is for charge dilution with excess air and no exhaust gas. The BSFC decreases as  $\bar{\phi}$  decreases from 1.0 to 0.8, and then the fuel consumption begins to increase as  $\bar{\phi}$  further decreases. The minimum BSFC which occurs as  $\bar{\phi}$  is reduced corresponds to a reduction in fuel consumption of about 5% relative to the fuel consumption at the stoichiometric fuel/air ratio.

Fuel consumption comparisons between charge dilution with excess air and with exhaust gas should be made at the same NO level. The % EGR and the  $\bar{\phi}$  required to achieve a brake specific NO emission of about 1 g/BHP-hr are 22% and 0.63, respectively, as previously discussed. At these diluent fractions, the corresponding BSFC's may be estimated from Fig. 4-11. The surprising result is that the BSFC's are indistinguishably different. Recall that at 1.0 g of NO/BHP-hr, the specific power with EGR was appreciably higher than with lean burning. Blumberg and Kummer discuss the BMEP and BSFC at 2.1 g of NO/BHP-hr. At this higher NO level, the BMEP with EGR was ~13% higher than that with lean burning; and the BSFC with lean burning was 2% better, i. e., lower than the BSFC with EGR.

The NO level at the minimum BSFC which is attainable through the use of lean burning is of interest. The equivalence ratio for minimum BSFC is 0.8, which corresponds to an air/fuel ratio of 18.4. The BSNO on the left-hand axis of Fig. 4-10 at A/F = 18.4 is about 10 g/BHP-hr. In comparison, the BSNO at  $\bar{\phi} = 0.95$  (A/F = 15.5) is approximately 30 g/BHP-hr, with a corresponding BSFC improvement, relative to  $\bar{\phi} = 1.0$ , of near one-half of the maximum attainable improvement (which occurs at  $\bar{\phi} = 0.8$ ). A vehicular emissions level in the vicinity of two g/mi for near Full-Size cars is commensurate with a BSNO in the range of 2 to perhaps 8 g/BHP-hr over the load range encountered with typical V-8 engines. It should also be noted that comparable levels of NO emission can be achieved at

<sup>1</sup>Grams of "NOx" (conventionally reported as NO<sub>2</sub>) = 1.533 x grams of NO.

$\phi = 0.95$  through the use of small amounts of EGR. Figure 4-10 indicates that less than 8 g of NO/BHP-hr can be achieved with ~10% EGR, and the corresponding BSFC on Fig. 4-11 is virtually identical to the BSFC at  $\phi = 0.95$  without EGR.

All of the foregoing comparisons were made for constant intake manifold pressure. However, engine power decreases as the amount of charge dilution is increased when manifold pressure is held constant. The effects of charge dilution on fuel consumption at constant power are discussed subsequently in Section 4.2.2, along with actual engine performance. However, the analytical considerations above suggest that little difference exists between the fuel consumption effect of NO control by EGR vis-à-vis excess air, with EGR resulting in appreciably higher power at the same NO level. It must be emphasized that all these comparisons are based on a fixed combustion interval of 50 degrees of crankshaft rotation. In an actual engine, a fixed  $\Delta\theta_c$  is difficult to attain with increasing amounts of charge dilution, but the adverse effect of a greater  $\Delta\theta_c$  may be mitigated by employing minimum-for-best-torque (MBT) spark timing. The "bad reputation" of the use of EGR for NO control has resulted from the accompanying use of spark retard. Also, many EGR systems admit hot instead of cooled exhaust gas to the intake manifold, with the resulting loss in NO control and specific power.

**Charge Stratification.** NO control via charge stratification results from the high-NO-producing elements which burn first, being replaced by fuel-rich elements with low oxygen availability. In this manner, the NO-producing tendency of progressive-burning postcompression can be minimized. Through the use of the previously described model of stratified-charge combustion in an Otto engine, Blumberg (Ref. 4-18) has analytically investigated NO control via stratification of the fuel/air charge, and some of his results are described below.

The effects of linear rich-to-lean stratification on the temperature and NO formation in different elements of a stratified charge are shown in comparison with a uniform charge in Fig. 4-12. The maximum temperatures of the first and middle elements of the linearly stratified charge are only slightly lower than those of the uniform charge, as may be seen by comparing Figs. 4-12(a) and 4-12(b). In contrast, the temperature of the last element to burn in the stratified charge is significantly lower than in the uniform charge. The reduction in NO production which stratification provides is not due to the lower temperatures of the elements, but is instead due to the reduced oxygen availability in the first elements to burn. Figures 4-12(c) and 4-12(d) show the NO profiles which correspond to the temperature profiles of Figs. 4-12(a) and 4-12(b), respectively. The effect of rich combustion in the stratified charge on the NO production in the first element to burn is striking. In the uniform charge of Fig. 4-12(c), the frozen NO concentration of the first element is near 7000 ppm, while in the stratified charge of Fig. 4-12(d) the frozen NO concentration of the first element is less than 1000 ppm. The middle elements have about the same frozen NO concentrations; and that of the last element of the stratified charge is nil, while in the uniform charge it

is about 1000 ppm. The overall NO production of the uniform charge at  $\phi = 0.95$  is 4440 ppm and that of the stratified charge is 1447 ppm with  $\phi = 1.0$ . The uniform-charge overall NO would be near 3500 ppm if  $\phi$  had been 1.0, according to Fig. 4-9. Thus, linear stratification alone at the overall stoichiometric fuel/air ratio reduces NO production by a factor somewhat in excess of 2.

The effect of linear stratification on NO production, parametric in % EGR, at equivalence ratios of 0.8, 1.0, and 1.1, is shown in Fig. 4-13. Figure 4-13(b) shows the effect of width of stratification on NO concentration at 0, 10, and 20% EGR for an overall equivalence ratio  $\phi$  of 1.0. The most extreme rich-to-lean stratification is 1.4/0.6, which is near the rich burning limit and probably not far from the lean burning limit. The influence of stratification becomes stronger as more EGR is used. With no EGR, as discussed previously, the NO production at a stratification width of 1.4/0.6 is reduced by a factor somewhat greater than 2 relative to a uniform charge. When the EGR is 10%, the NO production is reduced by a factor of 4 to 5, and an EGR of 20% reduces the NO production by a factor of about 7 relative to the uniform-charge NO level at corresponding EGR rates. The behavior of a linearly stratified charge at a rich overall equivalence ratio is shown in Fig. 4-13(c), and is similar to that at  $\phi = 1.0$ .

The overall NO production as a function of the width of charge stratification at a lean  $\phi$  of 0.8 is shown in Fig. 4-13(a). Stratification in mixtures at lean overall equivalence ratios can cause an increase in NO production relative to uniform-charge operation at the same overall equivalence ratio. For mixtures with  $0.8 \leq \phi \leq 1.0$ , adequately wide stratification will reduce NO relative to a uniform charge. However, with a  $\phi$  of 0.8, NO production is not reduced when EGR is used, even with the rich end of linear stratification near the rich burning limit: i. e., a width of 1.4/0.2. Step stratification gives better NO control than linear stratification and would likely decrease the  $\phi$  at which the NO production of the stratified charge exceeds that of the uniform charge, but not substantially.

Dilution of a stratified charge has a large effect on NO production. The effect of dilution with excess air is described above in reference to Fig. 4-13(a), for which  $\phi$  is 0.8. The surprising phenomenon of an increase in NO production in a lean-burning ( $\phi \leq 0.8$ ) stratified-charge engine is due to the replacement of the lean elements which burn early (but not first) in the uniform charge with elements which are closer to the near-stoichiometric conditions which favor NO production.

In contrast, stratification in conjunction with EGR is extremely effective in reducing NO production, especially near  $\phi = 1$ , as shown in Fig. 4-13(b). The fractional NO reduction due to stratification increases in magnitude as the charge is more diluted with exhaust gas. Dilution via exhaust gas reduces the peak temperatures reached by all the elements of the charge during burning and subsequent post compression, with the result that the frozen NO levels of all the elements are formation-rate limited.

The principal difference between dilution of a stratified charge via EGR, as opposed to excess air, lies in the conditions of temperature and oxygen availability experienced by the middle elements of the charge. With EGR, the temperatures of all the elements are consistently lower with no increase in oxygen availability. With excess air, the temperatures of the near-stoichiometric middle elements will be high after burning, and those elements are subjected to near optimum conditions favoring NO production.

The effectiveness of NO control via stratification is shown in Fig. 4-14(a) as dependent on overall equivalence ratio  $\phi$  at % EGR rates of 0, 10, and 20. The width of linear stratification at each  $\bar{\phi}$  on Fig. 4-14(a) is that resulting in the greatest reduction in NO production, relative to a uniform charge at the same  $\phi$ . For comparison, the NO production of a uniform charge, as predicted by the stratified charge model with a stratification width of 1.0/1.0, is also shown as a function of  $\bar{\phi}$  in Fig. 4-14(a) at identical engine parameters. The differences between the uniform-charge model (Ref. 4-18) and the stratified-charge model (Ref. 4-20) with a flat (i. e., no stratification)  $\phi$ -function results in about a 15% (2100 vs 1800 ppm, respectively) difference in predicted NO production at  $\bar{\phi} = 0.8$ . So the uniform-charge NO levels shown in Fig. 4-14(a) differ slightly from those shown in Fig. 4-9.

In Fig. 4-14(a) at  $\bar{\phi} = 0.8$  without EGR, the uniform-charge NO is a factor of about 1.4 higher than the stratified-charge NO (~1800 vs ~1200 ppm); whereas at  $\bar{\phi} = 1.0$ , the NO level with the uniform charge is a factor of ~2.4 higher than the stratified charge, as previously mentioned in reference to Fig. 4-13. At all EGR rates on Fig. 4-14(a), stratification yields a substantially greater reduction in NO production with  $\bar{\phi}$  near the stoichiometric fuel/air ratio. The NO control due to stratification diminishes rapidly as  $\bar{\phi}$  is reduced toward leaner fuel/air ratios.

Levels of NO production commensurate with vehicular emissions of 0.4 g/mi are achievable at EGR rates in the vicinity of 20% via charge stratification with  $\bar{\phi}$  near stoichiometric, according to Fig. 4-14(a). At any given NO level, stratification may be used to reduce the required amount of EGR relative to a uniform charge. For instance, Blumberg (Ref. 4-20) gives the example that EGR greater than 20% is required for 100 ppm NO production with a uniform charge at  $\bar{\phi} = 1$ , whereas 100 ppm can be achieved with about 15% EGR with a linearly stratified charge of width near 1.2/0.8 at  $\bar{\phi} = 1$ , as shown in Fig. 4-13(b).

If NO production in the vicinity of 300 ppm is permissible — roughly corresponding to a vehicular NOx emission of 1 to 2 g/mi in larger cars — Fig. 4-13(b) shows that, at  $\phi = 1.0$ , sufficiently wide stratification with 10% EGR gives adequate NO control. At a lean overall fuel/air ratio of  $\phi = 0.8$ , Fig. 4-13(a) shows that with 10% EGR extremely wide stratification will not yield the required NO control. A significant observation afforded by Fig. 4-13(a) is that stratification at  $\bar{\phi} = 0.8$  causes a loss of NO control relative to a uniform charge, except in the case of very wide stratification with no EGR.

The theoretical work discussed thus far suggests that charge stratification in conjunction

with EGR is a promising approach for meeting vehicular NOx standards somewhat lower than 2 g/mi. At the 2 g/mi level, uniform-charge engines which operate near the stoichiometric  $\bar{\phi}$  with EGR will yield sufficiently low levels of NO production with no fuel consumption penalty.

The fuel consumption and specific power characteristics of stratified-charge engines must also be considered. Blumberg presented the results shown in Fig. 4-14(b) giving the BSFC and BMEP effects of charge stratification. In itself, stratification at any overall fuel/air ratio results in a loss of both power and efficiency, which accompanies the NO control. The loss in BMEP and BSFC results directly from the delay of complete oxidation of the rich fuel/air elements. In the computational model, the thermal energy release of these elements is delayed until well into the expansion stroke, where NO reaction activity has ceased. Hence, the conversion of the last increment of thermal energy into work via restrained expansion occurs over a reduced expansion ratio, with the resulting loss in efficiency (increased BSFC) and work (decreased BMEP). An analogous delay in the thermal energy release also occurs when the onset of combustion  $\theta_0$  is delayed via spark retard, and a similar loss in work and efficiency follows.

Figure 4-14(b) shows the effect of the width of linear stratification at  $\bar{\phi} = 1$  on BMEP and BSFC. With no EGR, the BMEP at a stratification width of 1.4/0.6 is 74 psia compared with 85 psia in the uniform charge case — a decrease of about 13%. The BSFC at 1.4/0.6 is about 16% higher than for the uniform charge. Increasing the % EGR diminishes the magnitude of the relative performance loss associated with stratification, as can be seen by the "flatter" BSFC and BMEP characteristics shown in Fig. 4-14(b). Blumberg states that these predictions of the deleterious effects of stratification on engine performance may be somewhat exaggerated. In an actual engine, the mixing of the products of rich combustion, with the attendant thermal energy release, would likely occur earlier than assumed in the computational model. Hence, the effective expansion would be somewhat greater than normally allowed in the model. If such earlier mixing occurs at the end of the combustion interval (50° ATC), the NO production is increased by about 20% relative to the minimum NO production which occurs near 70° ATC when no EGR is used. The corresponding BSFC with 70° ATC mixing is less than 2% higher than with 50° ATC mixing. These effects are modified when EGR is used. With 20% EGR, the mixing angle for minimum NO production is about 55° ATC, and the fuel consumption with 55° ATC mixing is about 3% higher relative to 50° ATC mixing. Dissipation of the stratification is an important variable. If mixing occurs too early, the NO reduction achieved through stratification will be adversely affected, and if it occurs too late, both NO control and fuel consumption are adversely affected.

#### HYDROCARBON FORMATION

The exhaust gas of intermittent-combustion engines, particularly spark-ignition engines, contains traces of unburnt or incompletely oxidized fuel. These hydrocarbons (HC) are usually reported as an equivalent amount of hexane,



$C_6H_{14}$ . In contrast to intermittent-combustion engines, the HC content of the exhaust gas from engines utilizing continuous, constant-pressure combustion can be virtually eliminated with careful combustor design. In such combustors, the products are allowed to remain at a sufficiently high temperature for a long enough time interval in the presence of some excess air so that the hydrocarbon fuel is completely oxidized. Adequate mixing of the combustion gas, especially that near confining walls, and the absence of low-temperature confining walls, may also be important. The combustion chamber of a spark-ignition Otto engine provides the antithesis of conditions which eliminate unburned hydrocarbons.

An understanding of the sources of Otto-engine HC emissions, to the same extent as that of NO emissions, is currently not available. The most widely accepted explanation at present is thermal wall quenching, as discussed in Refs. 4-27, 4-28, 4-29, 4-39, and 4-41.

The origin of the wall quench concept is due to Daniel (Ref. 4-29). The existence of a "dark zone" near the cylinder wall of an Otto engine was established by means of photographs taken during the combustion process through a transparent cylinder head of an "L" head engine. This dark zone was interpreted as a layer of low-temperature gas, adjacent to the cylinder wall, into which the flame front did not propagate. The thickness of the dark zone roughly corresponded to quench layer thicknesses obtained from bench tests of burner rigs. Densitometer traces of the photographic negatives illustrating the dark zone are shown in Fig. 4-15.

In subsequent experiments, Daniel and Wentworth (Ref. 4-39) measured the HC concentration over short time intervals during the exhaust process and discovered that the HC concentration varies with time during the exhaust stroke. The average HC concentration in the residual gas remaining in the cylinder after the exhaust stroke was also measured and found to be near 1100 ppm. Also, tests were performed which indicate that, if the exhaust gas temperature is sufficiently high and some excess air is present, appreciable oxidation of HC can occur in the exhaust system.

In experiments by Tabaczynski et al. (Ref. 4-28), a single-cylinder laboratory engine was instrumented so that both exhaust gas mass flow rate and HC concentration could be measured over small time intervals during the exhaust process. These measurements were taken at the locations illustrated in Fig. 4-16. The concentration of HC in the exhaust gas and the mass flow rate of only HC at the sampling location are shown in Fig. 4-17. The amount of HC expelled from the cylinder is seen to vary during the exhaust process. A large spike of HC occurs just after the exhaust valve opens during blowdown, and another spike occurs just before the exhaust valve closes.

The effect of combustion chamber surface temperature on HC concentration in the exhaust gas of an Otto engine was explored by Wentworth (Ref. 4-43). The average surface temperature (AST) of the combustion chamber at the interface with the combustion gas was measured with thermocouples embedded in the combustion chamber surface.

Two types of engine tests were run. First, the AST of the combustion chamber was varied by changing the engine coolant temperature while the engine speed, air flow, and  $\phi$  were held constant. A slight variation in intake manifold pressure was noted during these tests, but its effect on HC concentration ( $\{HC\}$ ) was experimentally determined to be very small. From these tests, the variation of  $\{HC\}$  with AST was established. Typical results are shown in Fig. 4-18(a). The second type of test was conducted by holding coolant temperature constant and changing engine load by varying intake manifold pressure (i. e., throttle position). The variation of  $\{HC\}$  and AST was thus found as a function of indicated horsepower, and typical results are shown in Fig. 4-18(b).

The variation of  $\{HC\}$  with engine load was then separated into that due to the change in AST and that due to other, unidentified causes. Several parameters were explored to attempt to identify the "other causes" responsible for the decrease in  $\{HC\}$  as load was increased. Among these parameters were turbulence, oxidation reactions in the exhaust system, intake manifold pressure (at constant speed) and engine speed (at constant intake manifold pressure). None of these parameters accounted for the decrease in  $\{HC\}$  beyond that attributable to the increased AST at the higher loads.

With regard to the results of Ref. 4-43, the parameter which does vary almost directly with indicated horsepower (IHP) is total gas flow through the engine. Hence, the  $\{HC\}$  concentration is seen to be dependent on AST and total gas flow. The concept of diluent quenching, i. e., the dilution of a fuel/air mixture with either excess air or exhaust gas past the lean limit of combustion, has been suggested by Clauser (Ref. 4-64) as an important source of HC emission from Otto engines. It is possible that a portion of the "dark zone" observed by Daniel (Ref. 4-29) and the "spikes" of  $\{HC\}$  observed in Refs. 4-28 and 4-39 are due to quenching resulting from dilution of the fuel/air charge by residual exhaust gas. The amount of residual gas does not increase in direct proportion to indicated horsepower; hence, as total gas (air + fuel) flow increases, the fractional dilution by residual gas would decrease as IHP increases, with a resultant decrease in  $\{HC\}$ .

In contrast to the embryonic status of theoretical explanations of HC in Otto engine exhaust, the influences of spark timing, air/fuel ratio, compression ratio, and other engine design and operating parameters on exhaust  $\{HC\}$  have been well established experimentally, as reported in Refs. 4-26, -33, -38, -40, -42, -44, -45, -46, -47, and



-48. The effect of  $\phi$  on {HC} from Ref. 4-33<sup>2</sup> is shown in Fig. 4-19, and the effect of spark timing is shown in Fig. 4-20 per Ref. 4-40. Spark retard is particularly effective in reducing {HC}, and was the technique primarily used prior to the advent of catalytic oxidation converters. The combination of spark retard, to raise the exhaust gas temperature, and excess air (supplied by an air pump or through lean burning), is effective in increasing the amount of HC that is oxidized in the exhaust system, especially if large-volume or thermal-reactor exhaust manifolds are used. However, straightforward thermodynamic consideration of energy conservation makes apparent the deleterious effect of an increase in exhaust gas temperature on thermal efficiency. Any engine with a "hot" exhaust operates at a thermodynamic handicap relative to a similar engine at the same  $\phi$  with a higher "effective expansion ratio," which extracts more work during expansion and results in a cooler exhaust gas. In other words, {HC} control achieved through spark retard, or a reduced compression ratio, must inevitably increase fuel consumption. That is why catalytic aftertreatment, which provides effective oxidation of HC at a lower exhaust gas temperature, makes a reduction in fuel consumption possible.

#### DIESEL ENGINES

The efficiency and emissions characteristics of Diesel engines are intimately coupled to the compression-ignition combustion process. The heat release rate, and hence the rate of pressure rise during combustion, in Diesel engines is dependent on the combustion chamber configuration, the injector spray and delivery characteristics, injection timing, air motion, cylinder size, piston speed, and other operating conditions and design parameters. As previously discussed, the performance of divided-chamber engines is much less sensitive to injector characteristics, air motion, and engine speed than open-chamber engines, and the divided-chamber configuration is particularly well suited for automotive size cylinders. However, well designed divided-chamber engines show a higher BSFC than their open-chamber counterparts. This difference in fuel consumption is attributable in part to the higher heat loss of divided-chamber engines which originates in the higher combustion chamber surface area and in the intensive gas motion in divided chambers, and in part to the prolonged heat release with the attendant reduction in the rate of pressure rise during combustion. The latter characteristic is responsible for the "softer" combustion, desirable for automotive applications, of divided-chamber engines vis-à-vis open-chamber engines.

#### Efficiency

The compression ratio  $r_c$  of a Diesel engine must be sufficiently high so that the temperature of the air in the working space is increased during compression to the autoignition temperature of the injected fuel spray. Again, autoignition is

the result of a complex interaction of several parameters. However, the compression ratio is usually determined by engine cold-starting characteristics. Cylinder size has a significant impact on the compression ratio required for satisfactory operation. Very large cylinders in an open-chamber configuration (e.g., 17-in. bore by 22-in. stroke) will satisfactorily operate with autoignition at a compression ratio of 11:1, whereas the Mercedes passenger-car Diesel engine, with a prechamber configuration, has a compression ratio of about 21:1. The combination of cylinder size and configuration effects on autoignition characteristics is responsible for this difference in compression ratio. It may be noted that the optimum compression ratio, which yields highest brake efficiency, is the result of the interaction among theoretical cycle efficiency, changes in thermochemical properties at elevated temperatures, heat loss, and mechanical friction loss. The optimum compression ratio for divided-chamber engines usually lies between 11:1 and 15:1, depending on individual engine characteristics. The general performance requirements that automotive engines must meet, primarily cold-starting capability, dictates the greater-than-optimum compression ratios of near 20.

Large truck-size, open-chamber Diesel engines exhibit fast heat release occurring near minimum working space volume; hence, their ideal, conceptual thermodynamic cycle may be taken as the Otto cycle. However, the prolonged heat release, and the attendant mitigation of the pressure rise, achieved with divided-chamber engines may be represented by the limited-pressure cycle as presented in Ref. 4-17. Typical rates of heat release for different open-chamber combustion systems are shown in Fig. 4-21. The rate of heat release for a divided-chamber engine would be below and more extended than that of the Perkins "squish-lip" system in Fig. 4-21.

A limited-pressure, fuel-air cycle and an air cycle per Ref. 4-17 are shown in Fig. 4-22 on P-V coordinates. The limited-pressure cycle is identical to the Otto cycle as described in Chapters 2 and 3 through the induction, compression, and initial phase of the heat addition processes. The defining feature of the limited-pressure cycle is that the initial portion of the heat addition occurs at constant volume until a specified maximum pressure is reached; then the remainder of the heat addition occurs at constant pressure. The thermal efficiency of an ideal limited-pressure cycle with constant working fluid properties may be shown to be

$$\eta_t = 1 - \left\{ \left( \frac{1}{r_c} \right)^{k-1} \frac{(B^k A) - 1}{A[k(B-1) + 1] - 1} \right\}$$

where  $A = P_3/P_2$ ,  $B = V_3/V_2$ , and  $r_c = V_1/V_2$ , as identified on Fig. 4-20b. Note that if  $B = 1$ ,

<sup>2</sup> A vaporization-tank carburetion system was employed for the investigation of Ref. 4-33. This system incorporates a large steam-heated tank in which fuel is completely vaporized and premixed with air before entering the engine's intake manifold.

$\eta_t$  becomes identical to that for the ideal Otto cycle.

The efficiency of a fuel-air cycle differs from that given above due to the change in the ratio of specific heats  $k$  with temperature and working fluid composition. Figure 4-23 shows the efficiency of fuel-air cycles as a function of compression ratio for  $P_3/P_1 = 70$  and  $90$ , and for constant-volume heat addition, based upon the actual properties of air and the products of combustion according to Ref. 4-17. The total heat input in the limited-pressure cycle is determined if both A and B are specified; usually A and the heat input are taken as independent variables. The total heat input for a particular fuel may be expressed in terms of  $\bar{\phi}$  and the residual fraction of exhaust gas in the cylinder when compression begins. The dominant independent parameters for a limited-pressure fuel-air cycle with a small residual fraction of exhaust gas are  $P_3/P_1$ ,  $r_c$ , and  $\bar{\phi}$ , with the secondary parameters being initial temperature and initial pressure.

The efficiency of a fuel-air cycle as shown in Fig. 4-23 becomes virtually constant as the compression ratio exceeds about 16. The value of the quasi-asymptotic limit of efficiency with respect to  $r_c$  increases as the ratio  $P_3/P_1$  increases, being finally limited by the efficiency for constant-volume heat addition. The significant feature of Fig. 4-23 is that, even without considering frictional and heat losses, the efficiency to be gained by increasing compression ratio beyond 16 for a limited-pressure cycle is small. According to Fig. 4-23, the efficiency of a limited-pressure cycle with  $P_3/P_1 = 90$  and  $r_c = 16$  is only about 6% higher than a constant-volume cycle with  $r_c = 11$ . And if  $P_3/P_1 = 70$ , the efficiency of the constant-volume cycle at  $r_c = 11$  is about 2% lower than that of the limited-pressure cycle at  $r_c = 16$ . The ratio of actual indicated efficiency to fuel-air cycle efficiency decreases as compression ratio increases, as previously discussed in Chapter 3, Section 3.2.1. The increase in frictional and heat losses associated with higher compression ratios reduces the already marginal increase in cycle efficiency derived from higher compression ratios. This tradeoff leads to the aforementioned band of compression ratios in which maximum efficiency occurs. The diminishing effectiveness of increasing compression ratio, as a means of raising the theoretical thermal efficiency of a limited-pressure cycle, is due to a greater portion of the heat addition having to occur at constant pressure. In order not to exceed a given maximum pressure  $P_3$ , the heat addition at constant volume with the attendant pressure increase must be reduced; consequently, for the same total heat addition, the heat addition at constant pressure must extend further into the expansion stroke (i. e., B must increase). The incremental quantities of heat added after the minimum working-space volume point in the cycle experience a reduced expansion ratio; hence the fraction of the thermal energy that is transformed to work is reduced.

#### Pollutant Emissions

The NO<sub>x</sub> emissions characteristics of Diesel engines are the result of a combustion process which is fundamentally different from that of the

progressive-burning, premixed Otto-engine process. The diesel combustion process of a liquid fuel spray burning in air, whose temperature is above the ignition temperature of fuel vapor, is described in Refs. 4-17 and 4-59. It is an autoignition process in which fast chain reactions, which produce active combustion-promoting species in addition to the products of combustion, are prevalent during the period of rapid heat release. This period of rapid heat release is preceded by a delay period during which essentially no heat release occurs but in which preflame reactions essential to the combustion process are taking place. The rapid heat release period is followed by a third, final phase of combustion involving the burning of fuel droplets which were previously in a locally oxygen-deficient environment and which are subsequently mixed due to gas motion with hot, oxygen-rich portions of the combustion gas.

The formation of NO around liquid fuel droplets in an oxidizing environment, where vapor from the droplets burns in a spherical, diffusional flame front, has been analytically investigated in Refs. 4-58 and 4-60. The results are not directly applicable to the prediction of Diesel-engine NO<sub>x</sub> emissions but do indicate some trends of NO formation. The reader is referred to these papers for more information.

Conceptual models of the autoignition of fuel droplets injected into hot, moving air are described in Refs. 4-58, 4-59, 4-60, and 4-61. Generally, fuel vapor is produced as the liquid fuel mist is heated by the hot air. The vapor is transported away from the droplet via diffusional and convective mechanisms, depending on the relative motion between the droplets and the surrounding gas (air and exhaust products). Simultaneously, in this delay period, the aforementioned preflame reactions are occurring which produce active intermediate species, such as aldehydes and peroxides (Ref. 4-59). When a critical level of active intermediates is reached in the heterogeneous mixture (consisting of liquid fuel droplets, fuel vapor, air, exhaust gas, and the intermediate species), multiple points of ignition occur where the local conditions are favorable. The mixture then burns so rapidly as to appear to ignite spontaneously. The period of rapid reaction is markedly extended in divided-chamber engines, leading to the lower rates of heat release and pressure rise.

The droplet burning process in a heterogeneous mixture would seem to allow locally stoichiometric combustion to occur within the mixture. To the extent that such burning can be prevented, the NO formation can be restricted. The divided-chamber engine configuration, in itself, is helpful in mitigating locally stoichiometric combustion through the initial, fuel-rich combustion in the auxiliary chamber and the intensive mixing which occurs as the auxiliary chamber products are ejected into the main chamber. It is a well-established experimental observation that divided-chamber engines produce considerably less NO than those with open chambers (Ref. 4-54, 4-55, 4-57).

The following have been considered as means of reducing the NO<sub>x</sub> emissions of Diesel engines:

- (1) Exhaust gas recirculation.
- (2) Injection timing retard.
- (3) Water injection or water/fuel emulsions.

The magnitudes of the NO reduction achievable through these techniques, both individually and in concert, are discussed in Refs. 4-49, 4-54, 4-55, 4-57, and 4-59. In general, these techniques taken alone or in any combination have not been demonstrated to reduce Diesel emissions to meet the statutory<sup>3</sup> emissions standards without concomitant unacceptable compromises in engine performance.

Studies of the effects of EGR on Diesel emissions have in the past been conducted with no compensation in the amount of fuel injected. As a result, the total-gas-to-fuel ratio remained nearly constant as exhaust gas replaced air, but the overall fuel/air equivalence ratio increased toward a fuel-rich condition as exhaust gas was added. EGR rates up to 30 to 35% have been investigated in divided-chamber engines (Refs. 4-49, 4-54, 4-55). Adding exhaust gas, without derating the engine by reducing the fuel delivery, requires that the EGR rate be load-modulated to prevent heavy smoke and misfire at higher loads. Up to 30% EGR at medium loads will reduce the engine's NO emission by about one-half. However, the HC and CO will double, and smoke increases substantially. At such high EGR rates, NO emissions might be commensurate with a vehicular NO emission rate of 0.5 to 0.7 g/mi for a Full-Size OEE car; but HC would be on the order of 1 to 2 g/mi with high smoke and particulates. Catalytic HC aftertreatment on Diesels has not proven feasible due to the very low-temperature exhaust at part loads, and the presence of particulates and soot which foul the catalyst.

The primary effect of EGR on Diesel NO production occurs through the reduced oxygen availability and not through a change in specific heat of the gas or a reduction in temperature — although both of these latter effects are present to some extent. A brief analysis is presented in Ref. 4-55 which supports this contention. Neither the mean specific heat of the inducted gas nor the total mass of gas inducted changes appreciably as EGR is increased. Since the total gas/fuel ratio does not change, neither does the heat addition per mass of working fluid change, assuming sufficient oxygen is present to burn all the fuel. These remarks neglect the effects of changes in rate of heat release on the peak combustion temperature. EGR does not significantly affect Diesel fuel consumption.

Marginal reductions in NO emissions are achievable through retarding the injection timing on divided-chamber engines. Timing retard is most effective on open-chamber engines, as discussed in Refs. 4-45, 4-55, and 4-57.

The Mature Diesel engine whose performance is given in the succeeding sections of this chapter makes use of EGR and injection timing changes to the extent that NO and HC emissions can be

minimized without adversely affecting engine performance. Water injection was not utilized due to the large amounts of water required for appreciable NO reduction and the practical difficulties attendant upon its use, per Refs. 4-49 and 4-55.

#### 4.2.2 Engine Performance

The brake thermal efficiency of Otto and Diesel engines is the result of a complex interaction of several parameters. As discussed in Chapter 3, the losses associated with the actual compression, combustion, and expansion processes occurring in an engine are conveniently viewed as heat losses, time losses, and exhaust blowdown losses. These losses account for the difference between the theoretical thermal efficiency with actual thermochemical properties and the actual indicated efficiency determined from pressure/crank-angle diagrams. The observed brake efficiency at the output shaft is further reduced by the intake manifold pumping loss and mechanical friction. The relationship between the power, thermal efficiency, and the various losses of Otto and Diesel engines is treated by Taylor and Taylor (Ref. 4-17), and most of the following discussion is based upon their treatment.

#### FACTORS AFFECTING BRAKE EFFICIENCY

##### Mechanical Friction and Pumping

The brake power of an Otto or Diesel engine may be defined as the difference between indicated power and generalized frictional power. The indicated power is the algebraic sum of the power due to the working fluid pressure acting through the volume changes occurring during the compression, combustion, and expansion processes. The generalized frictional power includes all power absorbed by parasitic processes (intake manifold pumping power and mechanical friction between the engine's internal moving parts) and auxiliaries (power absorbed by lubrication, fuel supply, and cooling systems). The frictional power due to intake manifold pumping is most affected by variations in the engine parameters of concern. Mechanical friction within the engine — including lubrication, cooling system and fuel supply pumps — can be reduced by careful design.

The volumetric displacement rate  $\dot{V}_d$  of the engine in ft<sup>3</sup>/s is taken as that occurring in the expansion process. For the four-stroke-cycle engines under consideration,  $\dot{V}_d$  is  $(V_d \cdot \text{rpm}/120)$ , where  $V_d$  is the total swept displacement volume of the engine. Since power is the product  $P_m \dot{V}_d$ , where  $P_m$  is the mean effective pressure, the frictional power loss may be expressed as a mean effective pressure based on  $\dot{V}_d$ . Hence

$$P_b = P_i - P_p - P_f \quad (6)$$

where  $P_b$  is BMEP in psia,  $P_i$  is indicated mean effective pressure with "indicated" as defined

<sup>3</sup>0.41/3.4/0.4 g/mi of HC/CO/NO<sub>x</sub>, respectively.

previously, and where  $P_p$  and  $P_f$  are the net pumping and mechanical friction mean effective pressures, respectively.

The power output  $\dot{w}$  for a 4-stroke Otto or Diesel engine is  $\dot{w} = P_b V_d N / 7.92 \times 10^5$ , where  $\dot{w}$  is BHP,  $N$  is engine speed in rpm,  $P_b$  is BMEP in psia, and  $V_d$  is engine displacement in cubic inches. The torque output of such engines in lb-ft is  $T = P_b V_d / 48\pi$  with  $P_b$  and  $V_d$  as above.

The indicated mean effective pressure may be expressed as

$$P_i = \eta_i \bar{\phi} \rho_a e_v F_s h_c \quad (7)$$

where

$\eta_i$  is the indicated thermal efficiency

$\bar{\phi}$  is the fuel-air equivalence ratio as previously used

$\rho_a$  is the intake manifold air density

$e_v$  is the volumetric effectiveness of the engine which is defined as [actual mass flow rate of gas / ( $\rho_a V_d$ )]

$F_s$  is the stoichiometric fuel-air ratio

and

$h_c$  is the lower value of the enthalpy of combustion of the fuel

The derivation of Eq. (7) is given in Ref. 4-17. Equations (6) and (7) are useful aids in ascertaining the actual effects of charge dilution on the specific power and brake efficiency of Otto and Diesel engines. Equation (7) is valid only for  $\bar{\phi} \leq 1.0$ , but these are the only cases of interest here. The general case of charge dilution may be treated by a modification of Eq. (7). An engine operating with fuel, air, and exhaust gas introduced into the intake manifold is illustrated below.

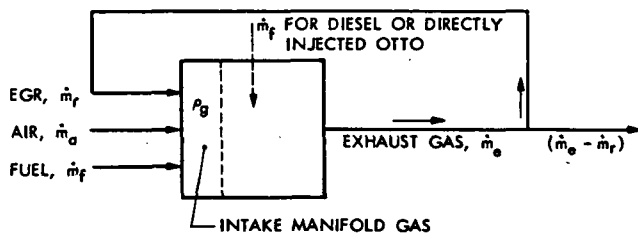

The indicated mean effective pressure of such an engine is given by

$$P_i = \eta_i \bar{\phi} \rho_g (m_a / m_g) e_v F_s h_c \quad (8)$$

where  $\rho_g$  is the density of the gas mixture in the intake manifold. The term  $(m_a / m_g)$  may be derived by applying mass conservation and is

$$\frac{m_a}{m_g} = (1 - f_r) / (1 + \bar{\phi} F_s) \quad (9)$$

where  $f_r$  is the mass fraction of recirculated exhaust gas (i. e., % EGR/100.) relative to the total mass flow into the engine. For a Diesel engine or a directly injected stratified-charge Otto engine, the fuel flow  $\dot{m}_f$  into the intake manifold is zero. The volumetric and mass rates of exhaust gas recirculation are almost the same numerically because the average molecular weight of the gaseous reactants is near that of the products. Equations (5), (8), and (9) may be combined to give

$$P_b = \eta_i \bar{\phi} \rho_g \left[ \frac{1 - f_r}{1 + \bar{\phi} F_s} \right] e_v F_s h_c - P_p - P_f \quad (10)$$

The net pumping loss  $P_p$  is the difference between the mean effective pressures within the cylinder during the exhaust process and during the induction process; hence  $P_p = \bar{P}_x - \bar{P}_m$ . If ideal exhaust and induction processes are assumed,  $\bar{P}_x$  and  $\bar{P}_m$  become the absolute pressures in the exhaust and intake manifolds, respectively. The exhaust manifold pressure is subject to control by the engine designer, by providing adequate flow area for the exhaust gas. For the purpose of rough estimates of pumping losses at part throttle, the exhaust manifold pressure will be taken as ambient pressure. At a  $P_b$  of ~35 psia, the intake manifold pressure for a typical, near-stoichiometric, uniform-charge Otto engine without charge dilution is about 6 psia. A typical pumping loss  $P_p$  is about 8.7 psi at these conditions. The actual power absorbed in maintaining intake manifold pressure below ambient is  $P_p V_d$ , which for a 350 CID engine at 2000 rpm is 7.7 hp. Under the same conditions, and assuming that the engine's stroke is 3.5 in., so that the mean piston speed  $S_p$  is 1167 ft/min,  $P_f$  is estimated to be about 18 psia from experimental information given in Ref. 4-17. Therefore,  $P_i$  would be about 59 psia, implying that about 45% of the work produced within the cylinder is absorbed by pumping and mechanical frictional losses. At this operating point, about 30% of the indicated power is dissipated through mechanical losses and about 15% is dissipated as the pumping loss.

Equation (10) shows that charge dilution via EGR or excess air reduces  $P_i$ . Thus for throttled Otto engines, the use of charge dilution permits a higher absolute intake manifold pressure at a given  $P_b$ . The Diesel engine, or a completely unthrottled SC Otto engine, could produce the same  $P_b$  with a 7.7-psia lower  $P_i$  and the attendant reduction in fuel consumption. The lean-burning Otto engine and the stoichiometric Otto engine with EGR can realize a reduction in fuel consumption due to an increased intake manifold pressure. The amount of charge dilution which can be used is limited by the misfire limit. Dilution with only excess air results in misfire at a  $\bar{\phi}$  near 0.6 to 0.7 if no combustion promoting agents are used, and dilution with exhaust gas causes misfire at EGR rates of from 15 to 25%, depending on the particular engine. The reduction in the pumping loss achievable with excess air is somewhat greater than with EGR, as may be inferred from Fig. 4-11. As previously noted, charge dilution to reach the same NO level with excess air vs exhaust gas results in a lower

BMEP when the intake manifold pressure is held constant. Conversely, at the same BMEP, the intake manifold pressure is higher when the charge is diluted with excess air than with exhaust gas.

A reduction in throttling loss could be realized in Otto engines by controlling BMEP over a limited range with charge dilution via excess air or exhaust gas, subject to the constraints of NO control and the misfire limit. This is the technique being used when a lean-burning engine is "run richer" for higher power. If the engine is of adequate displacement, the power produced in the "richer" (i. e., approaching stoichiometric from the fuel-lean side) operating range will not be required very often in normal driving or during the Federal Urban or Highway Driving Cycles. Therefore, the NO control achievable through charge dilution to the misfire limit can be realized.

The magnitude of the brake efficiency increase which is realizable through reduction of throttling loss may be roughly estimated using Eq. (10). At an operating point of  $P_b \sim 35$  psia, the manifold pressure with  $\bar{\phi} = 1.0$  and  $f_r = 0$  is about 6 psia for a typical engine. According to Eq. (10),  $P_i$  depends directly on  $\bar{P}_m$  which, in turn, is directly dependent on  $\bar{P}_m$ . Now if  $\bar{\phi}$  is reduced to 0.7,  $P_i$  decreases if  $\bar{P}_m$  is constant at 6 psia. However, the required  $P_i$  to overcome friction and the reduced pumping loss to deliver  $P_b$  of 35 psia may be obtained by increasing the manifold pressure from 6 to about 8.3 psia. The pumping loss is simultaneously reduced from 8.7 to 6.4 psia. Hence, the pumping horsepower is reduced by a factor of approximately 0.74 or ~26%. But the reduction in fuel consumption corresponds to the reduction in  $P_i$ , which is slightly less than 4%—a factor of ~0.96. If  $\bar{\phi}$  is reduced to 0.5, the fuel consumption reduction is about 8%. These estimates of the improvement in fuel consumption are optimistic because ideal induction and exhaust processes were assumed. The pressure losses through the port and valve will diminish the beneficial effect of increased intake manifold pressure. Estimates were also made at other brake loads, and the percent improvement was nearly constant. Of course, the maximum  $P_b$  attainable through increasing  $\bar{P}_m$  to ambient pressure becomes smaller as  $\bar{\phi}$  is decreased and  $f_r$  is increased.

### Thermochemical Properties

Charge dilution may further affect engine performance through a change in  $\eta_i$  as given in Eq. (10). The  $\eta_i$  of an engine is dependent upon compression ratio, initiation of combustion  $\theta_0$ , thermochemical properties, heat loss and duration of combustion  $\Delta\theta_c$ . Charge dilution affects predominantly the thermochemical properties, the heat loss, and combustion interval  $\Delta\theta_c$  (i. e., time loss).

The magnitude of the effect of thermochemical properties changes due to charge dilution on engine performance may be inferred from Fig. 4-11. As previously discussed, the computational model of Ref. 4-18 does not consider heat losses. Also, the combustion duration  $\Delta\theta_c$  and the intake manifold pressure are constant in Fig. 4-11. Therefore, the change displayed in BSFC with  $\bar{\phi}$

and % EGR is due predominantly to the effects of thermochemical properties. There is, however, a secondary influence from the greater fraction of indicated power dissipated as friction, due to the decrease of  $P_i$  with  $\bar{\phi}$  at constant intake manifold pressure while  $P_f$  remains more nearly constant. BSFC was previously observed to decrease by a factor of 1.05 (relative to that of  $\bar{\phi} = 1$ ) as  $\bar{\phi}$  is reduced. This minimum BSFC occurs at a  $\bar{\phi}$  near 0.8. EGR was seen to have no appreciable effect on BSFC at  $\bar{\phi}$  near 1.0.

The behavior of engine efficiency as a function of  $\bar{\phi}$ , described in the foregoing, is somewhat different from that for fuel-air cycles given in Ref. 4-17. The fuel-air cycle efficiencies vs  $\bar{\phi}$  as given in Ref. 4-17 were predicted for instantaneous, constant-volume combustion occurring at the minimum working space volume (i. e.; the top-dead-center piston position), which would amplify the effect on  $\eta_i$  of more favorable thermochemical properties. In addition, the properties data of Ref. 4-18 may be somewhat different from those of Ref. 4-17. The improvement per Ref. 4-17 in fuel-air cycle efficiency resulting from  $\bar{\phi}$  decreasing from 1.0 to 0.8 was previously given in Chapter 3 (Fig. 3-3) as 5%, which would correspond to a 5% increase of  $\eta_i$  in Eq. (10). In comparison, Fig. 4-11 gives a 5% increase in brake efficiency, which differs from the indicated efficiency by the frictional losses. However, the most significant disagreement between the two predictions occurs at values of  $\bar{\phi}$  less than 0.8. The fuel-air cycle efficiency of Ref. 4-17 continues to improve as  $\bar{\phi}$  decreases, although at a decreasing rate; at  $\bar{\phi} = 0.5$  the improvement is approximately 11% relative to  $\bar{\phi} = 1.0$ . In contrast, Fig. 4-11 shows the brake efficiency decreasing beyond  $\bar{\phi} = 0.7$  and returning to the value at  $\bar{\phi} = 1.0$  upon reaching a  $\bar{\phi}$  between 0.5 and 0.6. The frictional losses cannot account for this departure; hence, its origin must lie in the effects of a finite combustion interval and the property values. The computational model of Ref. 4-18 used to produce Fig. 4-10 is considered to be more representative of actual engine performance.

### Heat Losses

The heat losses during the combustion and expansion processes are reduced by charge dilution through a decrease in the mean temperature difference between the working fluid and its confining surfaces. A treatment of engine heat losses is given in Ref. 4-17, in which an experimental correlation of the form given below is shown to represent fairly well the total heat transferred to the cooling water and lubricating oil for a variety of Otto and Diesel engines.

$$\dot{Q} = K_1 \left[ k_g B^{0.25} (\dot{m}_g / \mu_g)^{0.75} \right] \overline{\Delta T} \quad (11)$$

where  $K_1$  is a constant,  $k_g$  is the thermal conductivity of the exhaust gas evaluated at the average gas temperature within the engine,  $\mu_g$  is the viscosity at the same temperature,  $B$  is cylinder bore,  $\dot{m}_g$  is the exhaust gas mass flow rate, and  $\overline{\Delta T}$  is the mean temperature difference between the working fluid gas and the engine coolant.

Equation (11) may be expressed in terms of engine parameters as

$$\dot{Q} = \bar{K}_2 k_g \overline{\Delta T} B^{1.75} \left( \frac{e_v \rho_g s_p}{\mu_g} \right)^{0.75} \quad (12)$$

where  $\bar{K}_2$  is a constant,  $e_v$  is the volumetric efficiency,  $s_p$  is the mean piston speed, and the other terms are as previously defined. The  $\overline{\Delta T}$  used in the correlation of Ref. 4-17 is estimated to decrease by about 13% when  $\bar{\phi}$  is reduced to 0.8 and by about 43% when  $\bar{\phi}$  is 0.5. The portion of the reduction in the heat loss that affects efficiency is not as great, since more than half of the heat transfer to the coolant occurs during the exhaust process. The actual heat loss during combustion and expansion has been estimated to be from 7 to 12% of the heat released by combustion of the fuel, according to experimental information given in Ref. 4-17. Therefore, at  $\bar{\phi} = 0.8$  the heat loss is estimated to be 6 to 10%; and at  $\bar{\phi} = 0.5$ , from 4 to 7%. The corresponding decrease in fuel consumption would be 1 to 2% for  $\bar{\phi} = 0.8$ , and 3 to 6% for  $\bar{\phi} = 0.5$ .

These estimates are for relatively low compression ratio Otto engines. The Diesel engine engenders a reduced heat loss due to the lower  $\overline{\Delta T}$  resulting from power control via variation of  $\bar{\phi}$ . However, the high compression ratio of the Diesel, and the attendant high temperature, cause higher heat losses during the compression process. Ricardo (Ref. 4-49) has analytically estimated the fuel consumption improvement realized through a 70% reduction in the heat loss from the working fluid during the power stroke to be about 4.5%. Also noted was an accompanying rise in peak gas temperature during combustion to 2788 from 2658°F, and in exhaust gas temperature to 1300 from 1113°F.

Since the effects of charge dilution on heat losses occur primarily through a reduction of  $\overline{\Delta T}$ , and  $\overline{\Delta T}$  is also closely associated with NO control; it may be expected that the heat losses at the same NO level, whether reached through charge dilution by excess air or exhaust gas, are roughly equivalent. Hence, a reduction in the heat loss with the attendant benefit to indicated thermal efficiency accompanies NO control via charge dilution.

#### Time Losses

The "time loss" is that reduction in indicated efficiency associated only with non-instantaneous heat release. In the ideal Otto cycle, all the heat addition to the working fluid occurs instantly at the minimum working space volume; however, in a real engine, combustion occurs over some finite interval of crankshaft rotation  $\Delta\theta_c$ . Usually the best efficiency and, simultaneously, power output are achieved when the heat release begins before minimum working space volume is reached and continues into the expansion process. In both Otto (spark-ignition) and Diesel (compression-ignition) engines, the onset of combustion is preceded by a delay period during which no appreciable heat release occurs. The delay period begins with either the spark event (Otto

engines) or the beginning of fuel injection (Diesel engines). The optimum timing of these events for best engine operation is usually referred to as "minimum for best torque" (MBT) spark timing or injection timing and is given in degrees of crankshaft rotation before the top center piston position (minimum working space volume). Cook et al. (Ref. 4-37) report that optimum spark timing for a large air-cooled aircraft cylinder is that which results in the maximum rate of pressure rise during combustion occurring at a fixed crank angle of 3 deg after top center over a range of fuel/air ratios from 0.04 to 0.06 (gasoline).

The deleterious effect of non-instantaneous heat release may be minimized by MBT timing, but the indicated efficiency which would occur with instantaneous heat release at the same fuel/air ratio cannot be realized. That is, even with MBT timing, an extended combustion interval  $\Delta\theta_c$  reduces the indicated thermal efficiency. As was discussed in Chapter 2, charge dilution reduces the rate of flame front propagation in a mixture, which reduces the rate of heat release and extends the combustion interval. Some mitigation of the increase in  $\Delta\theta_c$  accompanying charge dilution may be realized through increased motion, i. e., turbulence, of the charge.

Dowdy et al. (Ref. 4-52) have explored the effect of changes in the combustion interval  $\Delta\theta_c$  on fuel consumption by means of the computer program of Ref. 4-18. The  $\Delta\theta_c$  was taken as twice the MBT spark timing in degrees before top center (BTC). The MBT spark timing was experimentally determined for both a V-8 automobile engine and a CFR engine, the CFR engine being of a turbulence-promoting configuration. Values of MBT timing for these engines are shown in Table 4-1.

The speed of the CFR engine was 1200 rpm and that of the V-8 was 1000 to 3000 rpm. The MBT data was used to predict V-8 engine performance at 2000 rpm. The aforementioned computer program was utilized to estimate the effect on fuel consumption of reducing the combustion interval from 70° to 40° at  $\bar{\phi} = 1.0$  and from 100° to 46° at  $\bar{\phi} = 0.85$ , with MBT timing in all cases. The change in  $\Delta\theta_c$  from 70° to 40° caused BSFC to decrease by ~3.4%, and the change in  $\Delta\theta_c$  from 100° to 46° resulted in a 7% decrease in BSFC. Most of the previously described analytical performance estimates from Refs. 4-18 and 4-20 were for a combustion interval of 50° beginning 10° BTC.

Table 4-1. MBT spark timing (in deg BTC)

$\bar{\phi}$	Spark timing $\theta_s$ , deg BTC	
	CFR	V-8
1.0	20°	35°
0.85	23°	50°

Note:  $\Delta\theta_c \equiv 2 \theta_s$

Increased mixture motion (turbulence) does increase the rate of heat release and reduce  $\Delta\theta_c$ , but not without a limit that depends on the equivalence ratio. Turbulence also increases the heat loss due to increased convective heat transfer between the charge and its confining walls. The combustion interval in an actual spark ignition engine remains fairly constant as engine speed varies over a wide range, as discussed in Ref. 4-17. This characteristic is attributable to an increase of flame propagation rate with engine speed, due to the intensified mixture motion (turbulence) afforded by the higher gas flow velocities at greater engine speeds. The fact that MBT spark timing remains fairly constant over a wide range of engine speed is a consequence of this increasing flame propagation rate. The effects of turbulence on time loss and heat loss are difficult to identify separately in an actual engine, but several investigations of the overall effects of charge dilution via excess air and exhaust gas, some of which are in conjunction with changes in engine configuration that affect turbulence, have been reported and will be discussed presently.

### Compression Ratio Effects

The use of charge dilution for NO control may permit the compression ratio of an Otto engine to be raised without requiring higher octane fuel. Such an increase in compression ratio would limit, to some nonzero value, the minimum amount of charge dilution usable without incurring detonation, preignition, or other combustion problems. Hence, the maximum  $P_b$  would be reduced, as can be seen from Eq. (10) when  $\bar{\phi} < 1$  and/or  $f_r > 0$ . With other parameters unchanged, the specific power of such an engine would suffer. The effects of lean burning or exhaust gas recirculation on the tendency towards detonation and preignition are not clearly known, and the conditions under which the compression ratio could be increased are likewise unknown. Nevertheless, the fuel consumption effects of increased compression ratio were also explored by Dowdy (Ref. 4-52) with the computer program of Ref. 4-18. An increase in compression ratio from 8.5 to 11.0 resulted in a decrease in BSFC of about 7%, with an attendant increase in NO production of about 15%. This BSFC improvement stands in contrast to the corresponding estimate of about 3% per the methods of Ref. 4-17 based on generalized engine test data which includes both engine friction and heat losses, while the model of Ref. 4-18 includes only friction as dependent on load and speed. The fuel-air cycle efficiency improvement, per Ref. 4-17 (see Fig. 3-3), for the same compression ratio increase at  $\bar{\phi} = 0.8$  is 7.6%. As previously noted in Chapter 3, the increased heat losses and frictional losses which accompany a compression ratio increase diminish the theoretical improvement.

### ACTUAL PERFORMANCE OF OTTO ENGINES WITH CHARGE DILUTION

The actual impact of charge dilution on fuel consumption and NO emissions of Otto engines depends on the interaction of the individual effects described above. Charge dilution tends to decrease fuel consumption at a given power output through:

- (1) Reduced throttling loss.

- (2) In the case of excess air, more favorable thermochemical properties when  $0.7 \leq \bar{\phi} < 1.0$ .

- (3) Reduced heat losses.

On the other hand, fuel consumption tends to increase due to the extended combustion interval which results from the lower rates of heat release of diluted mixtures. The net effect of these opposing influences on BSFC can only be ascertained through experiments with automotive engines.

Care must also be exercised to characterize clearly the reference to which comparisons are made in terms of BSFC, specific power, and emissions. In particular, the fuel consumption of model-year 1973 and 1974 automobile engines is high because a combination of charge dilution (via exhaust gas) and spark retard was used for simultaneous NO and HC control. The model-year (MY) 1975 engines provide a more meaningful comparison because HC control was essentially removed from the engine itself through the use of an oxidation catalyst. Consequently, the spark timing is near MBT and fuel consumption is appreciably better than in the previous few model years.

The casual application of "percent," or "factors of," improvement due to changes in various parameters can also be misleading. Comparisons of performance are highly dependent on which parameters are held constant and which are varied. The previously discussed case, in which the effect of charge dilution on fuel consumption was influenced by whether BMEP or intake manifold pressure is constant, is an example. Further, some engines show extremely high fractional improvements in fuel consumption when  $\bar{\phi}$  is reduced. Most of this improvement can be due to reduced heat losses if the engine is specifically designed for high turbulence. In making comparisons of this sort, the absolute magnitude of the observed efficiency must also be considered. Indicated efficiencies of 25 to 27%, for  $\bar{\phi} = 1$  at a compression ratio of 8:1, have been observed for laboratory research engines with high turbulence (Refs. 4-8 and 4-97). Whereas, Fig. 3-3 (Chapter 3) shows an indicated efficiency of about 34% for  $\bar{\phi}$  near 1.0 and  $r_c = 8.5$  for typical Otto engines with automotive-size cylinders; such engines would of course have the benefit of catalytic aftertreatment of HC to meet current emissions standards.

The performance of laboratory research (CFR) Otto engines with charge dilution via excess air has been the subject of numerous investigations. The experimental results of Bolt and Holkeboer (Ref. 4-34) and Lee and Wimmer (Ref. 4-30) are representative of the effects of charge dilution on indicated thermal efficiency; Ref. 4-30 also contains emissions information for several different fuels. Their data are consistent regarding the effect of  $\bar{\phi}$  on fuel consumption and the absolute level of  $\eta_i$  for CFR engines (about 33% at  $r_c = 8$  and  $\bar{\phi} = 1.0$ ). The efficiency results of Ref. 4-34 using propane fuel are shown in Fig. 4-24. These data are consistent with the previously discussed trends of  $\eta_i$

with respect to  $\bar{\phi}$ . Note that at a compression ratio of 10, the maximum value of  $\eta_i$  as  $\bar{\phi}$  is decreased occurs at  $\bar{\phi} \approx 0.7$  and is a factor of 1.046, or about 5%, higher than  $\eta_i$  at  $\bar{\phi} = 1.0$ . This experimentally observed increase in  $\eta_i$  does, of course, include the previously discussed effects of changes in time loss, heat loss and thermochemical properties.

Investigations of the effects of lean burning in automobile engines have been reported in Refs. 4-31, 4-33, 4-36, and 4-52. These investigations are fairly consistent as to the magnitude of the fuel consumption decrease to be expected from lean operation, relative to the same engine at

$\bar{\phi} = 1$ , and as to the  $\bar{\phi}$  for minimum fuel consumption. These results are summarized in Table 4-2. The previously discussed analytical prediction of the variation of BSFC with  $\bar{\phi}$  shown in Fig. 4-11 was that the minimum BSFC would occur at  $\bar{\phi} = 0.8$  and would be about 5% lower than the BSFC at  $\bar{\phi} = 1.0$ . The prediction was for constant intake manifold pressure, while BSFC improvements in Table 4-2 are for nearly constant brake load. Realizing that the analytical model did not treat time loss or heat loss, the surprisingly good agreement may be due to approximate compensation of reduced heat losses for increased time losses. A typical example of the variation of ISFC with  $\bar{\phi}$  given in

Table 4-2. Effect of lean burning on fuel consumption for Otto engines

Engine type	Ref.	Engine configuration	$\bar{\phi}$ at lean misfire	$\bar{\phi}$ for best SFC	Maximum <sup>a</sup> reduction in SFC
Inline 4, OHV 3.43 x 3.27 <sup>b</sup>	4-31	Vaned intake valve seats; Heron combustion chamber; improved ignition; MBT timing $\sim 36^\circ$ BTC	$\sim 0.7$	0.85 (1500 rpm, light load)	$\sim 3\%$ <sup>c</sup>
Inline 6, OHV BxS not specified <sup>f</sup>	4-33	Prevaporizing and premixing tank carburetion system, otherwise stock <sup>g</sup> ; MBT timing $\sim 40^\circ$ BTC	0.66	0.80 (2400 rpm road load)	6 to 8% <sup>d</sup>
V-8, OHV 4.12 x 3.75	4-36 <sup>h</sup>	Sonic inlet valve throttling; port fuel injection; MBT timing $\sim 23^\circ$ BTC	0.62 <sup>i</sup>	0.7 to 0.8 (1200 rpm 50 psi BMEP)	$\sim 6\%$ <sup>e</sup>
V-8, OHV 4 x 3.5	4-52	Autotronics carburetor, single plane intake manifold; improved ignition, MBT timing $\sim 50^\circ$ BTC	$\sim 0.75$ <sup>j</sup>	0.85 (2000 rpm 45 psi BMEP)	$\sim 4\%$ <sup>e</sup>
V-8, OHV 4 x 3.5	4-52	Vaned intake valves; higher-turbulence combustion chamber; smaller-area intake manifold runners; improved ignition; MBT timing at $\bar{\phi} = 0.75$ is $\sim 60^\circ$ BTC; MBT timing at $\bar{\phi} = 0.85$ is $\sim 40^\circ$ BTC.	$\sim 0.65$ <sup>j</sup>	0.75 to 0.8 (2000 rpm 45 psi BMEP)	$\sim 6\%$ <sup>e</sup>

<sup>a</sup>Relative to same engine configuration at  $\bar{\phi} = 1.0$ .

<sup>b</sup>Bore and stroke (inches).

<sup>c</sup>Not specified whether BSFC or ISFC.

<sup>d</sup>ISFC

<sup>e</sup>BSFC

<sup>f</sup>Ford I-6's of this vintage are near 3.5 x 3.

<sup>g</sup>MBT data indicates a high-turbulence combustion chamber design.

<sup>h</sup>Also Ref. 3-24 (see Chapter 3.2.1).

<sup>i</sup>Not explicitly stated.  $\bar{\phi} = 0.62$  was leanest operating point given in Ref. 4-36.

<sup>j</sup>Not explicitly stated. Inferred from given test data.



Ref. 4-33 for a 6-cylinder automotive engine with vaporization-tank carburetion is shown in Fig. 4-25. These experimental ISFC data, taken at constant power, clearly support the Blumberg-Kummer model's prediction of  $\bar{\phi}$  for minimum fuel consumption.

The NO emission data of the engines discussed in Ref. 4-52 and the analytical treatment of Ref. 4-18 indicate that operation of the engine at a  $\bar{\phi}$  of near 0.6 would be required to meet a vehicular emissions standard of 2 g/mi of NOx. An equivalence ratio of 0.6 is beyond that for minimum BSFC, and is beyond or borders on the lean misfire limit for the engines of Table 4-2. An alternate approach for meeting a 2-g/mi vehicular emissions standard is to use charge dilution with both excess air and exhaust gas. The MY 1975 California cars rely mostly on EGR for NOx control to meet a 2-g/mi vehicular standard. The experimental data of Refs. 4-50 and 4-51, as discussed in Chapter 3, shows that a 6% decrease in fuel consumption at  $\bar{\phi}$  near stoichiometric can be obtained through the use of EGR with MBT spark timing. This improvement in fuel consumption at the brake load likely results from the reduced throttling losses and heat losses associated with charge dilution.

A thorough experimental characterization of the effects of charge dilution both by exhaust gas and excess air in conjunction with improved mixture preparation is not available in the open literature. The reported reduction in fuel consumption resulting from EGR with MBT timing should be confirmed by an extensive experimental investigation of charge dilution. Such confirmation would lead to the speculation that most of the beneficial effects of charge dilution on fuel consumption occur through a reduction in heat loss and throttling loss, but that the time loss attendant with very large amounts of charge dilution overshadows the beneficial effects. As previously noted, charge dilution via excess air or exhaust gas should theoretically give somewhat lower brake fuel consumption.

#### Lean Limit Extension Through Hydrogen Augmentation

The  $\bar{\phi}$  at which lean misfire occurs due to charge dilution with excess air may be reduced by adding hydrogen gas to the normal gasoline/air mixture. Such a system, using a catalytic reformer to generate hydrogen gas and other products from gasoline, was briefly described in Section 4.1.2 and was shown schematically in Fig. 4-2.

The performance of a 1973 full-size Chevrolet automobile in which the 350 CID V-8 engine was equipped with a carburetion and induction system that supplied hydrogen along with a lean gasoline/air mixture was reported by Hoehn and Dowdy in Ref. 4-10. The mixture control system supplied the engine with pure hydrogen at  $\bar{\phi} = 0.32$  at idle, which required an H<sub>2</sub> flow rate of 1.2 lb/hr. From idle through road load, the fuel (H<sub>2</sub> and gasoline)/air equivalence ratio  $\bar{\phi}$  was 0.53, with the H<sub>2</sub> to gasoline mass ratio being 0.15. The MBT spark timing under these conditions was about 50° BTC. When the power demanded of the engine exceeded that which could be supplied at  $\bar{\phi} = 0.53$ , the mixture supplied to the

engine was enriched in two steps. First, at an intake manifold pressure of 13.1 psia,  $\bar{\phi}$  was increased to 0.63; then, at wide-open throttle, the gasoline flow was increased to give a  $\bar{\phi}$  of 0.93. The H<sub>2</sub> gas flow ranged from 1.2 to 3.0 lb/hr as the engine power varied from idle to full load. This vehicle was tested over the FDC-U on a chassis dynamometer, yielding 2.6/1.5/0.5 g/mi of HC/CO/NOx, respectively. The average energy consumption over the FDC-U was 8361 Btu/mi, which is equivalent to 13.9 mpg of gasoline (115,900 Btu/gal). By comparison, the average fuel economy of 1975 automobiles at 4500 lb inertia weight and 1.9 to 2 g/mi of NOx emission is about 12.7 to 12.8 mpg. The fuel consumption of the bottled hydrogen gas/gasoline car is about 9% lower than the average fuel consumption of MY 1975 cars and is about 8% lower than the best of the MY 1975 cars (vid. Chapter 3, Section 3.5.1).

The development of an on-board catalytic reformer which produces hydrogen gas from a diverted portion of the total gasoline flow is described by Houseman and Cerini in Ref. 4-9, and performance data for the engine/H<sub>2</sub> generator system is given in Refs. 4-8 and 4-11. The catalytic hydrogen reformer operates over a range of mass rates of hydrogen production at an efficiency — the ratio of the total heating value of product output to the total heating value of gasoline input — of near 80%.

An estimate of the effect of the H<sub>2</sub> gas being supplied by the generator (as opposed to bottled gas) may be made as follows: The generator-product/gasoline mass ratio is assumed to be 0.15 — the value of the hydrogen-to-gasoline ratio for the bottled gas car. Then, if the energy supplied by the generator products is taken to be unchanged from that supplied by the H<sub>2</sub> from the gas bottles, the total gasoline flow to the generator and the engine must only be increased to compensate for the 80% generator efficiency. With the average energy consumption unchanged at 8361 Btu/mi, the average fuel economy over the FDC-U decreases to 12.9 mpg. This fuel economy estimate is overstated if the same H<sub>2</sub> flow is required from the generator as from the gas bottles, because the generator products consist of H<sub>2</sub> and CO, along with inert constituents. A typical hydrogen generator operating condition as given in Ref. 4-9 is shown in Table 4-3. The fuel economy of the 4500 lb<sub>m</sub> — inertia-weight vehicle with an H<sub>2</sub> generator system has been estimated at 12 mpg in Ref. 4-62.

In continuing work, an oxidation catalyst has been added to the bottled-gas car and the system retuned. Emissions over the FDC-U of 0.4/0.04/0.39 have been obtained with an energy consumption of 8850 Btu/mi (Ref. 4-63). The equivalent gasoline mileage is 13.1 mpg. The fuel economy of the retuned system with an onboard H<sub>2</sub> generator has been estimated to be unchanged at 12 mpg in Ref. 4-63, which may be somewhat high if the original 12 mpg estimate is reasonable. Planned future work calls for installation and test of an engine/generator system in a vehicle (Ref. 4-62).

Presently available experimental data on the fuel consumption of the engine/generator system

Table 4-3. Typical catalytic generator operating conditions

Input condition		Value	
Airflow rate, lb/h		45.6	
Fuel flow, lb/h		8.9	
A/F		5.15	
Equivalence ratio		2.83	
Generator pressure, psig		1.4	
Catalyst temperature, ° F		1774	

Output condition	Mass fraction	Mole fraction	Mass output, lb/h
H <sub>2</sub>	0.2160	0.0194	1.06
CO	0.2360	0.296	16.19
CH <sub>4</sub>	0.0103	0.0074	0.404
C <sub>2</sub> H <sub>4</sub>	0.0009	0.0011	0.062
CO <sub>2</sub>	0.0123	0.024	1.326
H <sub>2</sub> O	0.0120	0.0097	0.529
N <sub>2</sub>	0.5125	0.0642	35.15
	1.0000	1.000	54.72

Mean molecular weight	22.33
H <sub>2</sub> /hydrocarbon mass ratio	0.12
H/C atomic ratio	1.925
Exit pressure, psig	1.0
Exit temperature, ° F	1527.0
Generator efficiency	0.785

at a H<sub>2</sub> flow of 0.5 lb/hr has been used in a computer simulation of the FDC-U at 4500 lb inertia weight. This simulation, optimized for fuel economy, yielded predictions of about 14 mpg and 1.3 g/mi of NO<sub>x</sub> (Ref. 4-96). Recent dynamometer tests of an engine/generator system with H<sub>2</sub> flowrates from 0.5 to 1.5 lb<sub>m</sub>/hr have shown fuel consumption characteristics markedly similar to those of the direct-injection SC Otto engine as subsequently discussed and shown in Fig. 4-26. Whether or not this engine fuel consumption characteristic results in a comparable fuel economy in the automobile will be manifest when the requirement for simultaneous control of HC and NO<sub>x</sub> is levied against a vehicle incorporating such an engine/generator system.

#### Existing Engines with Charge Stratification

As discussed in Section 4.2.1, rich-to-lean charge stratification, of itself, increases fuel consumption relative to a uniform charge at the

same overall equivalence ratio  $\bar{\phi}$ . In practice, this deleterious effect may be mitigated by the ability of stratified-charge engines to run at somewhat leaner overall equivalence ratios without misfire than their uniform-charge counterparts. However, stratified-charge engines cannot operate at extremely lean fuel/air ratios due to excessively high HC emissions. The actual performance of any Otto engine is affected by the automatic spark timing as dependent on load, speed, and engine temperature, and by the variation of fuel/air ratio with load and speed. These parameters are often not optimized for best fuel economy because HC emissions and driveability must be considered.

The Volkswagen PCI and the Honda CVCC were previously described as representative of divided-chamber stratified-charge engines. These engines differ in that a rich fuel/air mixture is supplied to the CVCC prechamber by a separate venturi of a special compound carburetor, whereas a small amount of fuel is directly injected into the PCI prechamber, with the main chamber being supplied by the usual carburetion or intake-port fuel injection. According to Refs. 4-5 and 4-6, equivalent performance can be obtained from either injection or carburetion for the prechamber; however, a carbureted prechamber provided with a vaporized fuel/air mixture may have some advantage with respect to HC emissions (Ref. 4-67). An important feature of the CVCC engine is late dissipation of stratification, the combustion chamber and intake port being designed to minimize turbulence.

The Honda CVCC has demonstrated emissions performance in a full-size 350 CID V-8 automobile of 0.27/2.88/1.72 g/mi of HC/CO/NO<sub>x</sub>, respectively, over the FDC-U (Ref. 4-7). The fuel consumption at 10.5 mpg is about the same or slightly better than that of typical 1973 automobiles. Further reduction in NO<sub>x</sub> emissions can be obtained through the use of EGR, but only at the expense of fuel economy if HC is not allowed to rise, or at the expense of HC emissions if fuel economy is not sacrificed. As previously discussed (Ref. 4-20), NO control via stratification is most effective at  $\bar{\phi}$  near 1.0. Therefore, additional reductions in NO emissions from the CVCC could be realized through operation at more nearly stoichiometric fuel/air ratios with EGR. However, such measures would surely increase HC emissions and require oxidizing catalytic aftertreatment, but fuel economy could be improved. It is possible that NO emissions could be reduced, per the discussion of Section 4.2.1.1, by earlier dissipation of the charge stratification via increased turbulence. Again some sacrifice in HC control would likely be involved, but BSFC would be improved.

The excellent HC emissions of the CVCC engine are achieved without a catalyst, although such HC control evokes a fuel economy penalty. HC control is effected in the CVCC engine through the higher sustained temperature in the expansion stroke and the higher exhaust gas temperature. In conjunction with the lean  $\bar{\phi}$ , oxidation of HC is accomplished with a "thermal reactor" exhaust manifold. The implication of a higher exhaust gas temperature on thermal efficiency of any heat engine is apparent from a basic consideration of thermodynamic energy conservation. In the

CVCC engine, the decrease in fuel consumption due to the reduced throttling and heat losses and the more favorable thermochemical properties associated with operation at a lean overall mixture ratio is sacrificed to maintenance of an exhaust gas temperature high enough for oxidation of HC in the thermal reactor. The high exhaust gas temperature results partly from the lack of turbulence in the CVCC combustion chamber which delays complete oxidation of the combustion products of the rich elements in the fuel/air charge. The slightly lower than normal compression ratio (7.7 in the 1500 cc CIVIC) and spark timing, if retarded relative to MBT, also contribute to the higher exhaust gas temperature. The net result is fuel consumption roughly equivalent to that of MY 73 and MY 74 engines.

The PROCO direct-injection stratified-charge engine relies on rich-to-lean stratification and EGR, at a very slightly lean equivalence ratio ( $0.9 < \phi < 0.95$ ), for NOx control. A PROCO engine has demonstrated NOx emissions in the range of 0.3 to 0.5 g/mi in a 4500-lb inertia weight vehicle over a 28,000 mi durability test, with the fuel economy averaging about 13.6 mpg on the FDC-U. About 25% EGR is required for NO emission near the 0.4 g/mi level, and high HC emission in the vicinity of 5 g/mi accompanies such extreme charge dilution (Ref. 4-66). After-treatment of this level of HC emission to reach 0.4 g/mi with an oxidation catalyst is extremely difficult because of the requirement for a sustained catalyst conversion efficiency in excess of 90%. In the aforementioned tests, the post-catalyst HC emission ranged from 0.4 to 0.6 g/mi with a 5-in. diameter by 6-in. length monolithic oxidation catalyst for each cylinder bank. The PROCO engine shows better fuel economy and reduced HC emissions when recalibrated to about 12% EGR, which yielded an NOx emission of 1.2 g/mi at 5000 lb inertia weight. The corresponding HC and CO emissions were 1.9 and 12.5 g/mi, respectively, without an oxidation catalyst; and the fuel economy was 14.4 mpg (Ref. 4-68).

The fuel economy characteristic of the PROCO engine derives from its ability to satisfactorily operate at  $r_c = 11:1$  with 86 RON gasoline, as permitted by direct injection of fuel into the cylinder during the compression stroke. Additionally, operation with  $\phi \sim 0.9$  and 12% EGR yields some reduction of intake manifold pumping and heat loss relative to operation at  $\phi = 1.0$  with no EGR. The relatively cool exhaust gas of the PROCO necessitates use of a catalyst to oxidize the HC. In view of the higher fuel economy at a given emissions level and the low emissions capability of the PROCO-type (direct-injected) stratified-charge engine, it is taken as the best representative of the general class of lean-burning and stratified-charge Otto engines and serves as the basis for the evolving SC Otto engine configurations in this study.

#### 4.2.3 Summary and Selection of Engine Types Evaluated

The salient points of the foregoing discussion may be summarized as follows:

- (1) Charge dilution via EGR is the preferred method of reducing the NOx emission of uniform charge Otto engines to

levels in the vicinity of 1.5 g/mi for Large cars. Fuel economy relative to the best uncontrolled near-stoichiometric, Otto engine may be improved if near-MBT spark timing is utilized in conjunction with an oxidation catalyst to control HC.

- (2) The use of a thermal reactor for control of HC evokes an increase in fuel consumption relative to the use of a catalytic converter to achieve the same HC control. This characteristic follows directly from the thermal reactor's requiring a higher exhaust gas temperature for oxidation of HC.
- (3) Both the uniform-charge Otto engine with lean-limit extension and the direct-injection stratified-charge Otto engine have the capability for NOx emissions near 0.4 g/mi for Large cars. However, even at NOx levels up to 2 g/mi, the HC emissions from both engines require the use of an oxidation catalyst to attain 0.4 g/mi of HC.
- (4) The burning of a stratified charge in an Otto engine at near-stoichiometric fuel air ratios yields a substantial reduction in NOx production.
- (5) Charge stratification, in itself, results in a fuel consumption penalty relative to the burning of a uniform charge.
- (6) The fuel consumption penalty resulting from the burning of a stratified charge may be more than offset by other factors associated with charge stratification. In particular, the direct-injection type of SC Otto engine can operate at a significantly higher compression ratio with the accompanying increase in efficiency. Consequently, this engine exhibits lower fuel consumption than the other types of Otto engines, over the entire spectrum of engine sizes and at any emissions level, provided that catalytic aftertreatment of exhaust gas is permitted.
- (7) Since charge stratification is most effective in reducing NOx emissions at near-stoichiometric fuel/air ratios, the direct-injected SC Otto engine with air throttling via a feedback signal from an exhaust gas oxygen sensor may allow the use of a 3-way catalyst for simultaneous HC/CO/NOx control. The higher compression ratio usable with direct injection would provide a fuel economy advantage relative to the uniform charge Otto, and stratification at  $\phi = 1$  would provide a reduction of NOx.
- (8) The specific power of the naturally aspirated Diesel engine is sufficiently low to warrant the use of supercharging for improved performance.

On the basis of these observations and conclusions, the direct injected SC Otto engine was

found to have the greatest potential for simultaneously low fuel consumption and emissions. Likewise, the turbocharged, swirl-chamber Diesel engine best represents its class with respect to fuel economy and emissions under the constraint of OEE vehicle performance. Consequently, these two engine types were selected as representative of the intermittent-combustion alternatives for evaluation in Mature and Advanced configurations.

#### 4.2.4 Performance of the Mature SC Otto and Diesel Engines

A portion of a fuel consumption map, taken from dynamometer tests of a 400-CID V-8 PROCO engine, is shown in Fig. 4-26. The fuel economy projections of Section 4.5.1 were based on such fuel consumption characteristics with interpolation via plots of fuel mass flowrate vs BHP at various engine speeds.

The fuel consumption characteristics of a typical swirl-chamber Diesel engine with automotive-size cylinders is shown in Fig. 4-27 (Ref. 4-69). The fuel economy projections of Section 4.5.1 were based on this map with interpolation as above.

The major advantage of supercharging lies in the increase of indicated mean effective pressure resulting from an increase of  $p_g$  in Eq. (8). If the compression ratio is decreased to limit the maximum pressure during combustion,  $\eta_i$  in Eq. (8) may decrease. The previously mentioned factors affecting optimum compression ratio must be considered. Any increase in brake efficiency due to turbocharging must appear through a higher average pressure on the piston during induction than during exhaust. Such a pumping work characteristic is theoretically possible, since work is extracted from the exhaust gas as it expands through the turbine of the turbocharger. However, when the effects of turbine efficiency, compressor efficiency, and pressure losses across the intake and exhaust valves are considered, the usual outcome is an increase in the pumping work which the engine must supply — not a decrease. These effects may be minimized by proper matching of the turbocharger and engine gas flow characteristics, and through utilization of a wastegate bypass for the exhaust turbine at higher engine speeds. Similar remarks apply to the Comprex® supercharging system. In light of the foregoing discussion, no appreciable difference in fuel consumption would be expected between NA and boosted Diesel engines. Review of the performance of a number of NA and boosted engines corroborated this expectation. Hence, no fuel consumption adjustment was made for boosting the Mature and Advanced configuration Diesel engines. The improved specific power and power-speed characteristics of the wastegate controlled, turbocharged engine were considered in the projected performance of the OEE Diesel powered vehicle.

A similar situation prevails for supercharged Otto engines. If the compression ratio of an Otto engine is reduced to limit maximum pressure during combustion, the indicated efficiency drops according to Fig. 3-3, Chapter 3. At the vehicle performance level, whatever decrease in fuel consumption results from the improved engine specific power afforded by turbocharging an Otto engine will be offset by the reduced engine efficiency which follows from the lower compression ratio. Therefore, only when specific power must be substan-

tially improved is turbocharging advisable. Such is the case with the naturally aspirated Diesel; hence our evolving Diesel configurations incorporate turbo-supercharging while the SC OTTO does not.

The power per unit engine displacement of properly designed direct-injected SC Otto engines is equivalent to that of UC Otto engines, according to Refs. 4-13 and 4-68. The maximum power/displacement ratio in BHP/CID for Otto or Diesel engines is determined by the maximum value of the product of BMEP and volumetric displacement rate  $\dot{V}_d$ . A consideration of the volumetric characteristics of positive displacement, 4-stroke reciprocating machines shows that

$$\dot{V}_d = K n^{1/3} [V_d (B/S)]^{2/3} s_p$$

where  $K = (\pi/256)^{1/3}$ ,  $n$  is the number of cylinders,  $V_d$  is the total cylinder swept displacement,  $(B/S)$  is the cylinder bore-to-stroke ratio, and  $s_p$  is the mean piston speed which is  $(2S \cdot \text{RPM})$ . The engine power  $\dot{w}$  is  $P_b \dot{V}_d$ . Assuming that the engine parameters  $P_b$ ,  $s_p$ , and  $B/S$  are constant, the power per unit total displacement  $\dot{w}/V_d$  is proportional to the quantity  $(n/V_d)^{1/3}$ . However, this theoretical trend does not hold very well in practice, due to differences in  $s_p$ ,  $(B/S)$ , and  $P_b$  for engines of differing total displacement. The BHP/CID of several production engines is shown on Fig. 4-28, along with the curve giving BHP/CID vs CID which was used to determine the maximum power for the Mature SC Otto engine. The BHP/CID for the Mature Diesel engine, which is turbocharged, was taken as constant at 0.56. This estimate is optimistic for the larger engines. The weights and other parameters for typical existing Diesel engines are shown in Table 4-4.

The weights of various Otto and Diesel engines in terms of a plot of pounds per cubic inch (of total swept displacement) vs total swept displacement (CID) are shown in Fig. 4-29. The characteristic curves used to establish the weights of the Mature UC Otto, the Mature SC Otto, and the Mature Diesel engines are presented on Fig. 4-29. The UC Otto weight characteristic ( $lb_m/\text{CID}$  vs CID) was established to represent the lightest of current production automobile engines. The characteristic curves for the SC Otto and the Diesel were then obtained from the UC Otto curve by adjustments for increased section in those portions of the engine structure affected by the higher peak internal pressures associated with the higher compression ratios of these engines. Further reductions in engine weight might be achieved through extensive use of aluminum and thin-wall iron castings wherever feasible throughout the engines, but at some cost impact.

### 4.3 MAJOR SUBASSEMBLIES/COMPONENTS

#### 4.3.1 Descriptions

In this section the major components unique to the direct-injected, stratified-charge Otto engine and the turbocharged Diesel are described. The novel components used in the H<sub>2</sub>-injected,

Table 4-4. Characteristics of typical Diesel engines

Manufacturer	Model	No. cyl.	Bore	Stroke	CID	hp/rpm	BSFC		Weight <sup>c</sup>	lb/CID	BMEP <sup>g</sup>	Piston speed	r <sub>c</sub>	Chamber typed	Identification (see Fig. 4-27)
							a	b							
Caterpillar	1160	V-8	4.5	5.0	636	225/2800	0.36	0.38	1200+	1.88	100	2133		O	1
Chrysler-Nissan	CN4-33	I-4	3.3	3.9	132	48/3200	0.44	0.49	474	3.59	90	2080		P	2
	CN6-33	I-6	3.3	3.9	198	73/3200	0.45	0.53	662	3.34	91	2080		P	3
Ford (Turbocharged)	192D	I-4	4.13	3.6	192	52/2400	0.40	0.45	585	3.04	89	1440	16.5	S	4
	256D	I-4	4.4	4.2	256	81/2500	0.39	0.42	882	3.44	100	1750	16.5	S	5
	401D	I-6	4.4	4.4	401	122/2500	0.41	0.46	1358	3.38	96	1833	16.5	S	6
	401DT	I-6	4.4	4.4	401	153/2500	0.40	0.45	1408	3.51	120	1833	16.5	S	7
MIT Subishi	4DR50	I-4	3.6	3.9	162	57/3000	0.42	0.43	562	3.47	93	1950		S	8
	6DR50	I-6	3.6	3.9	243	84/2800	0.42	0.43	817	3.36	98	1820		S	9
Peugeot	EX-90	I-4	3.5	3.3	129	58/4500	0.43	0.47	415 <sup>b</sup>	3.22	79	2475	22	S	10
Isuzi	C190	I-4	3.39	3.31	119	42/3000	0.46	0.55	452	3.79	93	1655		S	11
	C221	I-4	3.27	4.02	135	48/3000	0.45	0.48	474	3.51	94	2010		S	12
	C240	I-4	3.39	4.02	145	53/3000	0.45	0.49	514	3.54	96	2010		S	13
	C330	I-4	3.86	4.33	203	68/2800	0.44	0.51	717	3.53	95	2020		S	14
	DH478	V-6	5.12	3.86	478	165/2800			950	1.98	98	1801	16.8	O	15
GMC (Marine version) (Marine version)	DH637	V-8	5.12	3.86	637	210/2800			1271	1.99	93	1801	16.8	O	16
	DH478	V-6	5.12	3.86	478	170/3200			950	1.98	88	2059	16.8	O	17
	DH637	V-8	5.12	3.86	637	220/2800			1271	1.99	98	1801	16.8	O	18
	D712	I-4	3.86	4.33	202	85/3200			705	3.48	104	2303		O	19
M. A. N.	D797	I-6	4.02	4.41	335	136/3000			1007	3.00	107	2307		O	20
	D0026M	I-6	3.94	4.92	359	126/2700			1190	3.31	102	2307		O	21
	D0844M	I-4	4.25	5.2	294	90/2500			1058	3.59	97	2166		O	22
	200D	I-4	3.42	3.40	121	55/4200			425	3.50	85	2380	-20	P	26
Mercedes-Benz	220D	I-4	3.42	3.64	134	60/4200			430	3.20	84	2548	-20	P	27
	240D	I-4	3.58	3.64	146	65/4200			448	3.05	83	2548	-20	P	28
	300D	I-5	3.58	3.64	183	80/4000			516	2.81	86	2426	-20	P	29
	e	V-8	3.46	3.86	292	128/4000	0.43	0.5	700	2.40	87	2560	20	S	A
Ricardo Comet V	e	I-6	3.54	3.94	234	128/4000	0.43	0.5	680	2.90	108	2627	19	S	B
	NHC-250	I-6	5.5	6.0	855	250/2100			2500	2.92	110	2100		O	30
Cummins (Turbocharged)	SUPER 250	I-6	5.5	6.5	927	250/2100			2550	2.75	102	2274		O	31
	NTC-355	I-6	5.5	6.0	855	335/2100			2750	3.21	148	2100		O	32
	NTA-400	I-6	5.5	6.0	844	400/2200			2850	3.33	168	2200		O	33
	V-903	V8	5.5	4.75	903	320/2600			2160	2.39	107	2058		O	34
(Turbocharged)	VT-903	V8	5.5	4.75	903	320/2600			2250	2.49	107	2058		O	35

NOTES: <sup>a</sup>Minimum BSFC, diesel fuel. <sup>d</sup>P = prechamber, S = swirl chamber, O = open chamber.

<sup>b</sup>BSFC at maximum power.

<sup>e</sup>Proposed automobile engines, Ref. 4-49.

<sup>c</sup>Weights include accessories.

<sup>f</sup>NO water, oil or starter motor.

<sup>g</sup>At maximum power.

ultralean-burning Otto engine (not further evaluated herein) are also discussed because it may constitute an alternate path to Otto engine improvement. Descriptions of other components used in reciprocating internal-combustion engines are given in Chapter 3, or are well-known current technology.

### DIESEL TURBOCHARGER

The only major component of the Diesel engine which is new to high-volume automotive mass production is the turbocharger. Its purpose is to increase the air-handling capacity (and thus the power of the engine for a given displacement) by increasing the density of the air in the intake manifold. The compressor portion of the turbocharger is powered by a small gas turbine driven by the exhaust gases of the engine.

Turbochargers are frequently used on truck diesels and racing (Otto cycle) engines. The turbochargers for those applications are not applicable to passenger cars because of their high cost and the fact that they are tailored to peak power and a narrow engine rpm range.

An automotive turbocharger must be economically mass-producible, operate over a wide speed range, and provide rapid transient response. The latter is achieved by reducing the moment of inertia of the rotating components and through active control of the turbine or compressor gas flow. The costs and weights of turbochargers have decreased about a factor of 2 in the last 15 years (Ref. 4-70).

To provide a power increase over a wide engine speed range, it is necessary to design for small turbine nozzle area as shown in Fig. 4-30(a). Such a power curve provides low-speed response and improved driveability. However, as shown in Fig. 4-30(b), such a turbine without boost control would seriously overboost the engine at high engine speeds and would overstress the Diesel engine. Thus boost control is needed.

Various methods of boost control are shown in Fig. 4-31. Control can be effected by a simple diaphragm sensing the boost pressure. The various compressor-side controls have the effect of increasing the intake air temperature, thereby reducing charge density and peak power. The exhaust-bypass type ("wastegate") is the preferred method since it does not induce excessive backpressure on the engine.

Design problems of turbochargers include the stability of very slightly loaded journal bearings (Ref. 4-71). This can be overcome by providing damping in another oil film outside the main journal bearing. A good seal system is required to prevent oil leakage into the hot areas of the turbine. Such leakage causes a buildup of coke and may require expensive disassembly for cleaning. The turbine, of course, sees hot exhaust gases and must be made of suitable high-temperature, oxidation-resistant materials.

For a given turbocharger application there are configuration and mounting tradeoffs. The turbine housing is usually flange-mounted directly to the exhaust manifold and supports the whole unit. All other connections to the unit must be

flexible enough not to overstrain the housing. Some turbochargers are able to utilize a portion of the "pulse energy" of the exhaust flow if they are mounted close to the exhaust port (Ref. 4-72) and connected via constant-area passages.

For the large production rates implied by fleet conversion to automotive Diesels, it would be possible to configure an optimized turbocharger for each major engine size. This could result in cost and performance advantages over the current practice of modifying a standard unit to fit a range of diverse applications.

### DIRECT-INJECTED SC OTTO FUEL INJECTION SYSTEM

The major new components in the direct-injected, stratified-charge engine are in its fuel injection system. Minor configurational differences in the engine (such as valve timing, piston shape, and spark plug type and location) are clearly within the current production technology.

The major requirements of the injection pump are to provide repeatable flows to all the cylinders, and to control injection advance up to 50 crank degrees as a function of load and 40 crank degrees as a function of rpm (Ref. 4-14). This range of timing control is large compared to conventional ignition distributor practice and is accomplished by using a sliding helix metering sleeve on the pump shaft. The sliding helix position control is actuated by a conventional rotating weight "governor" (actually a speed sensor) and a control shaft activated by a vacuum diaphragm connected to the intake manifold. A recent design of the injector pump is shown in Fig. 4-32. This design was recently "production engineered" (see Section 4.3.3) by American Bosch under a contract from Ford.

Another important component in the fuel system is the injector itself. Several designs are shown in Fig. 4-33. All incorporate an outward-opening poppet valve with either a tension or compression spring to provide closing force. This design provides a very high frequency (2000-4000 Hz) opening and closing rate which helps improve the fuel atomization and reduces spray penetration. During the closing pressure wave pulse the spring-valve assembly rotates a small amount. This is believed to reduce deposit buildup and leakage, but has not been verified by experiments (Ref. 4-13).

### ULTRALEAN-BURNING, HYDROGEN-INJECTION OTTO ENGINE

The novel components (with the exception of the control system) of the partial-hydrogen-injection concept are shown schematically in Fig. 4-2. Most of the changes are on the upstream (induction) end of the engine. The engine itself could be largely unmodified, although improvements in the lean limit may dictate high-turbulence valves and changes in combustion chamber shape and spark plug location. High-energy ignition is advisable for reliable ignition. Some changes in camshaft timing may also be desirable. A standard catalytic oxidation converter is needed for HC control (see

Chapter 3), but air injection into the exhaust is not required (due to the overall lean mixture). Thus the engine and exhaust system are assembled from standard components which are already mass-producible with currently-used automotive materials.

The new component in the fuel preparation and induction system is the hydrogen generator, shown in Fig. 4-34 (Ref. 4-11). It is an integral unit consisting of a combustor, ignitor, catalyst bed, and fuel/air preheater heat exchanger. Provision is made for fuel preheat and insulation, and a flame detector may be required for safety reasons. In addition, a downstream heat exchanger (radiator-water-cooled) may be required to further cool the generator products to preserve the volumetric efficiency (peak power) of the engine.

The catalytic generator (reformer) requires a stainless steel inner can due to the high-temperature environment. The internal gases constitute a reducing environment while the external portions will be exposed to air in the preheater. The catalyst is a readily available alumina-supported nickel-based type used in commercial steam reforming processes, and does not appear to be sensitive to lead poisoning.

The reformer must be supplied with air and fuel at a mass ratio of about 5:1. The accuracy of control required depends on the degree to which hydrogen generation is maximized while avoiding soot formation.

A constant generator fuel and air flow approach appears feasible. A standard exhaust air pump will suffice, and the fuel flow can be provided by an electrically-driven, positive-displacement pump.

The remainder of the induction system — the carburetor and manifold — must be modified to allow variable fuel/air mixture control, to produce the desired overall mixture ratio. The remaining heat in the generator products may be used to promote full fuel vaporization and mixing — thereby obtaining some of the advantages of the improved induction systems described in Chapter 3.

An integrated control system for the hydrogen injection concept is being developed. Based on preliminary designs, the inputs will include the temperature of the preheated air, fuel flow, engine airflow, ambient air temperature, and throttle position. Outputs include control of the ignition and start/run fuel valve for the reformer, the desired fuel flow rate, and, perhaps, spark timing. These functions may be performed by a small solid-state logic device or, ultimately, be approximately implemented using analog devices.

#### 4.3.2 Configurational Evolution

Both the SC Otto engine and the Diesel engine were evaluated in the three stages of evolution previously defined (in Chapter 2) for alternate engines: the Present configuration(s), a selected Mature (near-term production) configuration, and an Advanced (long-term potential) configuration. For the alternate intermittent-combustion engines discussed in this chapter, it

must be acknowledged that production versions of both SC Otto and Diesel automobile engines currently exist among the Present configurations; hence they are not "experimental" engines in the sense of the continuous-combustion alternates. However, the configurations herein designated Mature, which we believe to offer the maximum capability for their respective types, are not presently in production and would require some additional development. The Advanced configurations are highly conjectural at this time, requiring success in fundamental materials research and considerable development for their realization. The significant difference in design, construction, and operating characteristics of SC Otto and Diesel engines at the three evolutionary stages of interest are discussed in the following sections.

### STRATIFIED-CHARGE OTTO ENGINES

The important features of SC Otto engines at the three stages of development are outlined in Table 4-5. Evolution from the several Present configurations, through the proposed Mature and Advanced configurations, is believed to represent the path of maximum improvement for this class of engines.

#### Present Configurations

Virtually every major automotive engine developer has at least one experimental SC Otto engine under test — either a stratified-charge modification of one of his uniform-charge production engines, an original SC development, or an adaptation under license from another developer. One model, the Honda CVCC, is presently in production and is being sold in MY 75 Civic cars.

All of these are basically conventional uniform-charge reciprocating Otto engines with heads, piston crowns and induction systems appropriately modified to effect and exploit charge stratification. They are conveniently grouped into three categories: the prechamber/3-valve carbureted type, typified by the Honda CVCC implementation; the prechamber indirect-injection type, with both carburetion and fuel injection, represented by the Volkswagen PCI configuration; and the open-chamber direct-injection type, utilizing mechanical fuel injection, epitomized by the Ford PROCO family. Typical characteristics of these engine types are listed in the first three data columns of Table 4-5.

Detail weight data were not available for any of the Present engines. The estimated weight of the current experimental 400 CID PROCO power system is plotted as an isolated point on Fig. 4-33. This is an unduly heavy and nonoptimum system designed for vehicle integration and emissions testing.

#### Mature Configuration

Of the various SC Otto implementations, the direct-injected (DI) open-chamber type was found to offer the greatest potential in vehicle fuel economy with simultaneously low HC and NOx, as discussed in Section 4.2. Consequently, the DI implementation was selected for evaluation in the Mature (and Advanced) configuration.

Table 4-5. Salient features of evolving Stratified-Charge Otto configurations

Characteristic	Present configurations			Mature configuration	Advanced configuration
Type	Prechamber/ indirect injection	Open chamber/ direct injection	Prechamber/ 3-valve	Open chamber/ direct injection	Open chamber/ direct injection
Mechanical implementation	Reciprocating	Reciprocating	Reciprocating	Reciprocating	Rotary (Wankel)
Represented by	PCI (VW)	PROCO (Ford)	CVCC (Honda)	(Conjectured)	(Conjectured)
Fuel delivery	EFI <sup>a</sup> or MFI <sup>c</sup> and carburetion	MFI <sup>c</sup>	Carburetor	MFI <sup>c</sup>	MFI <sup>c</sup>
Compression ratio	~8:1	11:1	~8:1	11:1	8:1 - 11:1
Head and block/housing material	Ferrous	Ferrous	Ferrous	Ferrous	Ceramic
Piston/rotor material	Aluminum	Aluminum	Aluminum	Aluminum	Ceramic
Cooling system	Conventional	Conventional	Conventional	Conventional	None
Emission controls	PCV, <sup>b</sup> oxidation catalyst	PCV, <sup>b</sup> EGR, oxidation catalyst	PCV, <sup>b</sup> thermal reactor exhaust manifold	PCV, <sup>b</sup> EGR, oxidation catalyst	PCV, <sup>b</sup> EGR, oxidation catalyst

<sup>a</sup>EFI = electronic fuel injection.

<sup>b</sup>PCV = positive crankcase vent.

<sup>c</sup>MFI = mechanical fuel injection.

The Mature configuration, by definition, must be producible within the constraints of today's materials and production technology, given some additional component development and one or two additional design iterations for system optimization.

The salient features of the Mature power system are called out in the fourth data column of Table 4-5. With the comparatively short development cycle implied here, the Mature configuration emerges as a conventional reciprocating engine of essentially ferrous, with some adjunctive aluminum, construction.

The direct mechanical fuel injection system incorporated provides several major benefits. First, cylinder-to-cylinder air/fuel ratio control is improved at high load and under transient conditions. Second, preignition- and detonation-limited compression ratio is increased, permitting the cycle efficiency gains derivable from the indicated 11:1 compression ratio with 91 RON gasoline (gasolines down to 86 RON will probably be usable). Third, the cold-start problem is minimized since the intake manifold has to handle only air, obviating the droplet condensation/agglomeration associated with

carbureted engines. This capability to induct cold air also affords slight reductions in BSFC and NOx emissions, as well as a small gain in horsepower.

Aside from the contouring and porting of the head(s), and the "squish-lip" type piston crowns, the basic engine construction is conventional. A dual high-energy ignition (HEI) system is employed to minimize the combustion interval. The dual ignition system may not be necessary for the degree of charge dilution required in an engine calibrated to meet a 1.5-2.0 g/mi NOx standard.

Table 4-6 gives a subassembly weight breakdown for a Mature (DI-type) 150-hp SC Otto engine designed to meet a 1.5-2.0 g/mi NOx standard. The projected variation of weight with design horsepower — for the engine, ready-to-run, and the power system (including battery and transmission) — of such an SC Otto engine family is presented in Fig. 4-35. The effective polar moments of inertia were estimated to be approximately 22% greater than those of the equivalent Mature UC Otto engines, as given in Chapter 3.



Table 4-6. Stratified-charge Otto power system weight breakdowns (lb)

(Design maximum power = 150 bhp)

Subassembly	Mature configuration, direct injection, reciprocating	Advanced configuration, direct injection, ceramic rotary
<u>Basic engine assembly</u>	(513)	(260)
Block assembly, including crank- shaft, pistons, cylinder heads, valve train, manifolds, required auxiliaries, lubricant	503 10	250 10
<u>Fuel and ignition system</u>	(50)	(37)
Air cleaner, integral injectors, pump/distributor, injectors, fuel filter, coils, spark plugs, ignition harness		
<u>Cooling system</u>	(66)	(23)
Radiator	24	
Fan and shrouds	7	8
Coolant	35	
Oil cooler	-	15
<u>Emission control system</u>	(22)	(22)
EGR valve and plumbing	5	5
Oxidation catalyst system	17	17
<u>Auxiliaries</u>	(35)	(27)
Starter	18	10
Alternator	17	17
<b>Total, engine ready-to-run</b>	<b>686</b>	<b>369</b>
<u>Transmission</u>	(150)	(126)
<u>Battery</u>	(42)	(42)
<b>Total, power system</b>	<b>878</b>	<b>537</b>

The Mature configuration described above is the one carried through this study as the SC Otto "baseline," as it would meet the anticipated emission control standards of most of the nation with best possible fuel economy. It must be pointed out, however, that some regions of the United States (notably the South Coast Air Basin) will ultimately require 0.4 g/mi NO<sub>x</sub> and HC standards, and that the DI-type SC Otto engine is indeed capable of being adapted to meet these standards. This adaptation can be accomplished in several ways, with different fuel economy penalties from the 2.0 g/mi NO<sub>x</sub> version. One way, which has been studied in considerable detail, is to increase the degree of charge dilution and adjust the ignition timing to meet the 0.4 g/mi NO<sub>x</sub> requirement and then install oversize exhaust oxidation catalyst(s) to contend with the concomitant increase in feed gas HC. A corresponding fuel economy penalty of about 10% is thereby engendered. An alternative approach to meeting the tighter NO<sub>x</sub> standard, and one that deserves further study because it has potentially

the lowest fuel economy penalty, is similar to the UC Otto control scheme (described in Chapter 3): maintain a globally stoichiometric air/fuel ratio calibration and replace the oxidation catalyst(s) with 3-way catalyst(s). A/F ratio control, in this implementation, would be effected by modulation of the intake air throttle valve with an oxygen sensor feedback signal. This approach seems preferable (assuming the successful development of the 3-way system) since present empirical data suggests that the high HC concentrations, attendant upon the excess air/EGR charge dilution requisite to very low NO<sub>x</sub> levels, may be symptomatic of a fundamental problem of all Otto engines.

#### Advanced Configuration

As with all the alternate engines studied, the Advanced configuration, described by the fifth data column of Table 4-5, is a much more conjectural implementation representing the long-range potential of its class. Its realization in

production requires the fruition of some basic research in materials formulation, processing, and fabrication techniques (but not invention of fundamentally new materials), as well as considerable component and system development, and hence lies in the more remote future. Liberal use is made of ceramic components, of the  $\text{Si}_3\text{N}_4/\text{SiC}$  type, for engine "hot parts."

As indicated in Chapter 3, the rotary (Wankel) engine design offers a significant weight-saving potential over reciprocating designs — both in engine weight per se, and in propagated vehicle weight reduction via improved packaging. This weight reduction potential is even more dramatic if large-scale use of ceramic subassemblies is also feasible because (1) the ceramic assemblies themselves can be lighter than their metallic counterparts, and (2) the higher operating temperatures afforded thereby permit the elimination of the cooling system (radiator, water pump, plumbing, excess housing volume, and coolant). It is assumed that, by the time the requisite ceramic component production technologies were available, current Wankel seal and thermal distortion problems would be solved (the ceramic components perhaps contributing to their solution).

The Advanced SC Otto is therefore an uncooled, open-chamber/direct-injected rotary engine, with ceramic rotor(s) and housing(s) or housing liner(s). The reduced heat losses associated with a ceramically bounded combustion space would probably necessitate some lowering of the compression ratio from that of the Mature configuration. With 86 to 91 RON gasoline, the usable compression ratio might drop as low as 8:1.

## DIESEL ENGINES

Paralleling the configurational stages of the SC Otto described previously are a set of comparable development levels at which the automotive Diesel engine was evaluated. The significant characteristics of these Diesel configurations are listed in Table 4-7 and discussed in the following.

### Present Configurations

Although not current practice in the United States, production automotive Diesel engines are presently supplied as options in some imported passenger cars (e.g., Mercedes, Opel, Peugeot) and are widely used in foreign taxi fleets. The characteristics of Present configuration automotive Diesels are outlined in the first data column of Table 4-7. All of these are naturally aspirated (NA) machines, with a prechamber (Mercedes-type) or swirl-chamber (Peugeot-type) combustion system. Fuel delivery is simply modulated by throttle position. Emission control, in most cases, is limited to retardation of injection timing.

The specific power ( $\text{BHP}/\text{lb}_m$ ) of such NA Diesel engines is significantly less than that of comparable Otto engines. Consequently, Present Diesel-engined automobiles are not acceleration-competitive with Otto-engined cars of equivalent displacement.

Detailed weight breakdown data were not available for Present engines. Table 4-8 lists the estimated subassembly breakdown for a Present (Mercedes-type) power system, which is plotted as an isolated point on Fig. 4-36.

Table 4-7. Salient features of evolving Diesel configurations

Characteristic	Present configuration	Mature configuration	Advanced configuration
Type	Prechamber or swirl chamber	Swirl chamber	Swirl chamber
Represented by	Mercedes, Peugeot	(Conjectural)	(Conjectural)
Induction system	Naturally aspirated	Turbocharged, IMPM <sup>a</sup> wastegate	Turbocharged, IMPM <sup>a</sup> wastegate
Fuel injection system			
Timing	Automatic centrifugal	Automatic centrifugal	Automatic centrifugal
Delivery	Throttle-position modulation	Throttle position, inlet-manifold-pressure, and engine-speed-modulation	Throttle-position, inlet-manifold-pressure, and engine-speed-modulation
Compression ratio	Fixed, 18:1 to 22:1	Fixed, 18:1 to 22:1	Fixed, approx. 15:1
Cylinder head/block material	Ferrous	Ferrous	Ceramic
Piston material	Aluminum	Aluminum	Ceramic
Cooling system	Conventional	Conventional	None
Emission controls	Retarded injection timing	Retarded injection timing, EGR	Retarded injection timing, EGR

<sup>a</sup>IMPM = intake-manifold-pressure-modulated.

Table 4-8. Diesel power system weight breakdowns (lb)

Subassembly	Present configuration (NA), 80 bhp, typical of Mercedes design	Mature configuration (TC), 150 bhp, 270 CID, V8 engine	Advanced configuration (TC), ceramic, reciprocating 150 bhp
<u>Basic engine assembly</u>	 (516)	(530)	(375)
Block assembly		360	250
Cylinder heads and valve train		160	115
Lubricant		10	10
<u>Fuel delivery, induction system, and exhaust system</u>		(138)	(130)
Turbocharger, wastegate, injector modulator, intake manifold(s), air cleaner and exhaust manifold(s)		97	
Fuel injection pump, nozzles, filter and low pressure delivery pump, and glow plugs		41	
<u>Auxiliaries</u>		(52)	(52)
Starter		30	
Alternator		22	
<u>Cooling system</u>	(45) est	(66)	(20)
Radiator		24	
Fan and shrouds		7	
Coolant		35	
<b>Total, engine ready-to-run</b>	<b>561</b>	<b>786</b>	<b>577</b>
<u>Transmission</u>	(120) est	(150)	(150)
<u>Battery</u>	(45)	(60)	(60)
<b>Total, power system</b>	<b>726</b>	<b>996</b>	<b>787</b>

NA = naturally aspirated.

TC = turbocharged.

Mature Configuration

To obtain competitive specific power levels, the Mature Diesel engine is turbocharged (TC) as noted in the second column of Table 4-7. A modest (10 psi, nominal) boost is provided via a state-of-the-art (centrifugal compressor/radial turbine) turbocharger and wastegate. The latter is modulated by intake manifold pressure. A swirl-chamber combustion system of conventional construction is employed, operating at a fixed compression ratio in the range 18:1 to 22:1. Fuel

delivery is more carefully controlled than in Present configuration engines through combined sensing of throttle position, intake manifold pressure, and engine speed. Proportional EGR is used, in conjunction with retarded injection timing, to further control exhaust emissions.

A subassembly weight breakdown for a 150-hp Mature power system is presented in Table 4-8. The projected variation of weight with design horsepower for the Mature configuration Diesels is shown in Fig. 4-36. The variation of

equivalent-technology NA engine weights is plotted on the same figure for comparison, showing the significant improvement obtained in power density — especially in larger engines. The effective polar moments of inertia of the moving components are plotted vs design horsepower in Fig. 4-37.

#### Advanced Configuration

The Advanced Diesel, like the Advanced SC Otto (and the Advanced UC Otto described in Chapter 3) is an uncooled engine with ceramic "hot parts," representing a long-range development which presumes similar progress in ceramic materials technology. The configuration is outlined by the third data column of Table 4-7. A turbocharger/wastegate system is incorporated, as in the Mature configuration.

Unlike the Otto's, a reciprocating implementation is maintained in the Advanced Diesel. While a rotary implementation might indeed be developable in the time scale associated with the Advanced intermittent-combustion engines, it is believed that the high cylinder pressures produced in the TC Diesel would seriously exacerbate the sealing problems which must already be overcome even in the lower-pressure Advanced Ottos. Such a rotary Diesel, if developed, could provide some additional vehicle weight saving by way of further reduction in engine weight per se and its packaging advantages, but the reciprocating version adequately exhibits the potential long-term benefits of ceramic technology for purposes of this study. An estimated weight breakdown for an Advanced reciprocating 150-hp power system is given in Table 4-8 and plotted as an isolated point in Fig. 4-36.

#### AVAILABILITY FOR PRODUCTION

Both the Mature SC Otto and Diesel configurations constitute reasonably straightforward developments under existing technology. As such, given the development funding and assuming no major unforeseen problems were encountered, they could probably be producible in the early or mid-1980's.

The Advanced configurations, on the other hand, were conjectured primarily for the purpose of equal-footing comparison of their performance potential with that of the Advanced-configuration Brayton and Stirling engines, under "parity" of technology (i. e., deriving maximum benefit from presumed future applicability of SiC/Si<sub>3</sub>N<sub>4</sub>-type ceramics). It is acknowledged that these Advanced configurations require the successful completion of additional basic research outside the ceramics area, as well as considerable development, and additional major problems might indeed emerge in their pursuit. Optimistically, production availability in the late 1980's might be predicted, more probably in the following decade (and possibly never!). The requisite research and development efforts for the Mature and Advanced configurations are outlined in greater detail in Section 4. 7.

#### 4. 3. 3 Materials and Producibility

#### PRESENT CONFIGURATIONS

The materials of construction and the basic fabrication processes utilized in the manufacture

of Present configuration automotive Diesel and SC Otto engines are basically the same as those employed in the manufacture of conventional Otto gasoline engines. The mass production techniques proven in the manufacture of conventional Otto automotive engines (transfer line technology, tooling, etc.) have also been successfully applied to the production of these engines. This is borne out by the fact that there have been over one million automotive Diesels produced by Mercedes and Peugeot since World War II and that Honda has an SC Otto engine in production. This does not mean that Diesel and SC Otto engines are identical to conventional Otto engines. There is some parts commonality between Mercedes Diesel and gasoline engines. However, there also are considerable differences in the materials and processes for some specific applications. These design changes have resulted in modifications and additions to the transfer lines for the production of these automotive Diesel engines. In general, the selections of materials and manufacturing processes for the mass production of Present configuration Diesel and SC Otto engines are well established.

#### MATURE CONFIGURATIONS

For the Mature configurations, neither the Diesel nor the SC Otto engines have major material problems. For both of these engines there are some limited, but solvable, manufacturing process improvements required, as discussed in the following paragraphs.

For the Mature configuration Diesel, additional manufacturing processes and automation improvements in the manufacture of the injector and the injector pump are required. These components require tighter-than-normal automotive industry tolerances, automated gauging, and the ability to be mass-produced at the production levels of the automobile industry. Caterpillar (Ref. 4-73) has in production an injector and injector pump suitable for Diesel application. However, the Caterpillar production rate is considerably less than the normal minimum production (~500,000 per year) that would be required for an initial automobile application.

SC Otto injectors and injector pumps should be easier to mass-produce than the Diesel equivalent. As an SC Otto engine operates at a lower peak pressure than a Diesel, the tolerance requirements are not as severe. A detailed study, commissioned by Ford Motor Co., has been completed by American Bosch for mass production of stratified-charge engine injectors and injector pumps at an assumed minimum production rate of 500,000 units in the initial year, with subsequent scale-up. This study (Ref. 4-74) concluded that a stratified-charge injector and injector pump could be produced that would not require an end-of-the-line adjustment/calibration step. It was also found that the plungers could operate directly in the housing without sleeves (as opposed to current Diesel injector pump practice). These simplifications improve producibility considerably and can reduce cost to an acceptable level.

The Mature configuration Diesel utilizes a turbocharger, as was discussed previously. This turbocharger, from the materials standpoint,

would be essentially the same as conventional production turbochargers. However, to allow a major fleet conversion of automobiles to turbocharged Diesel engines, turbochargers would have to be mass-produced at a significantly higher rate than their current production. To accomplish this, automation and process development improvements and scale-up would be required. This will not necessitate significant new technology and should be accomplishable within the normal 42-month period from decision-to-produce to "Job 1" within the automotive industry. As Diesel exhaust gases are lower in temperature than Otto-engine exhaust gases, the material requirements are not as severe for a Diesel turbocharger as they are for a gasoline engine turbocharger.

By comparison, the basic Diesel engine has different tolerance and clearance requirements than either an SC Otto or a conventional Otto engine. The Diesel requirements are more severe. For example, the clearance between the piston and cylinder head must be very carefully controlled in a Diesel engine (Ref. 4-49), necessitating close tolerances on a large number of parts in order to accomplish this control. The SC Otto engine does not require as great a degree of control of clearances and tolerances, but does have tighter tolerance requirements than a conventional Otto. This requirement for much closer manufacturing tolerances on some parts of a Diesel engine contributes to the cost differential between Diesel and gasoline engines (Ref. 4-49).

Diesel injectors also require careful design to minimize the holdup volume to aid in reducing odor and particulate emissions. Hence careful control of clearance and tolerances in this assembly is essential.

Diesel engines are generally heavier than gasoline engines. Engine components are usually designed to one of two criteria. The first is load-limited, wherein the part is sized as a function of the various thermal, mechanical, or other applied loads. The second is the manufacturing limit (i. e., minimum practical gauge). As a Diesel engine operates at a higher peak pressure than a gasoline engine, parts that are sized to the first criterion will generally be heavier. Components designed to the second criterion are basically unaffected by the difference between Diesel and gasoline engine peak cycle pressures.

#### ADVANCED CONFIGURATION STRATIFIED-CHARGE OTTO ENGINE

The Advanced configuration SC Otto (direct-injected) engine has been configured as a ceramic rotary (Wankel) engine design. It does not have a cooling system. The main components, the rotor(s) and housing (or housing liner), are projected to be constructed of advanced ceramic materials such as silicon carbide or silicon nitride.

A major R&D problem, in addition to the ceramics themselves, is the rotor seals. The current Wankel seal leakage and thermal distortion problems will have to be resolved. The high temperature required will necessitate the development of a suitable lubrication system, which does not currently exist. Either a suitable

high-temperature viscous lubricant or a high-temperature solid-film lubricant will have to be developed. Alternatively, an appropriate material (probably also a Si<sub>3</sub>N<sub>4</sub>, SiC, Sialon, or composite) might be used to permit the seals to run dry.

The required ceramics development program is discussed further in Section 4.7, Chapter 5, and Chapter 12. Successful conclusion of the ceramics development program also offers the potential for manufacturing cost reductions.

#### ADVANCED CONFIGURATION DIESEL ENGINE

The Advanced Diesel is configured as a reciprocating engine. Ceramics, such as silicon carbide and silicon nitride, offer potential future advantages here also. Candidate parts for ceramic implementation are the head, which could be made with or without a metal housing, a cylinder liner in a metal block or a complete ceramic block, and the piston crown or the entire piston. Both Cummins (Ref. 4-75) and General Motors (Ref. 4-76) are currently experimenting with silicon nitride and silicon carbide type ceramics for Diesel applications.

A currently unresolved problem in implementing a ceramic reciprocating Diesel is lubrication of the piston rings. The piston rings would have to either run dry, or with a solid film lubricant, or with a viscous lubricant that would not break down at the Diesel operating temperatures.

A ceramic reciprocating Diesel may encounter difficulty from the high-temperature impact loads that occur between the valves and valve seats. This problem could be avoided by considering a rotary ceramic implementation; however, the higher peak cycle pressure in a Diesel would exacerbate the rotor seal problem.

As with the Advanced configuration SC Otto engines, the required ceramics R&D efforts are elucidated in Section 4.7, Chapter 5, and Chapter 12.

#### 4.3.4 Unit Costs

##### SC OTTO ENGINE UNIT COSTS

The Mature SC Otto engine costs, including the high-pressure fuel injection system, are derived from the engine cost data base developed for the National Academy of Sciences (Ref. 4-77) for the Committee on Motor Vehicle Emissions (CMVE) studies. These numbers represent power system unit variable costs and, as such, do not include material or labor overhead factors at either the plant or corporate level.

Power system unit variable costs are shown for a range of horsepower in Fig. 4-38. Cooling system, battery, and transmission are costed in the power system. Costs by major subassemblies and facility costs are given in Chapter 11.

## DIESEL ENGINE UNIT COSTS

Mature Diesel engine unit costs, exclusive of the turbocharger and wastegate system, are derived from the engine cost data base developed for the National Academy of Sciences (Ref. 4-77) for the CMVE studies. These costs are based on presently existing materials and manufacturing process technology.

The turbocharger and wastegate were costed from the configuration described in Section 4.3.2. Power system unit variable costs are shown for a range of horsepower in Fig. 4-39. Costs by major subassembly and facility costs are given in Chapter 11.

### 4.4 VEHICLE INTEGRATION

#### 4.4.1 Engine Packaging in Vehicle

The Mature SC Otto engine is very close in overall envelope to the baseline UC Otto. It uses a separate engine-driven fuel injection pump instead of a carburetor and requires similar emission control hardware; thus its installation in the vehicle will be very nearly identical to that of the UC Otto.

The Mature Diesel engine is slightly bulkier than the equivalent UC Otto because of greater block deck height, better provision for cooling passages, and the prechambers in the cylinder head(s). The turbocharger, which would be 6 to 8 in. in diameter and less than 12 in. long in a Full-Size car, requires additional room in the engine compartment, but this is largely compensated by the absence of an air injection pump and catalyst(s). The Diesel engine should basically fit into the UC Otto engine compartment, with some attention to repackaging.

#### 4.4.2 Transmission Requirements

SC Otto and Diesel engines have rpm ranges and torque curves similar to UC Otto engines and can thus use the same transmission types (i. e., 3- or 4-speed, in automatic or manual versions). Transmission improvements envisaged for UC Otto vehicles, such as lock-up torque converters and CVT's (Ref. Chap. 10), would benefit the SC Otto and Diesel as well.

#### 4.4.3 Other Vehicle Design Impacts

The Diesel-engined car may require better acoustic insulation due to the higher engine noise, with a slight increase in vehicle weight. The better fuel economy of SC Otto and Diesel vehicles will allow a smaller fuel tank for the same range, leading to a decrease in the vehicle curb weight. Overall, the substitution of an SC Otto or Diesel engine for the baseline UC Otto engine would not have significant impact on the configuration of the vehicle.

### 4.5 PERFORMANCE IN VEHICLE

Fuel economy estimates and emissions trends were calculated for Mature SC Otto and

Diesel vehicles in the six Otto-Engine-Equivalent (OEE) automobile classes of interest to this study, using the Vehicle Economy and Emissions Prediction (VEEP) computer program described in Chapter 10. The adjustments for weight propagation effects and torque characteristics are also described in Chapter 10. These computer predictions, together with available test data, constituted the basis for vehicular performance projections. The results are described in the following sections.

#### 4.5.1 Fuel Economy

##### SC OTTO VEHICLES

The predicted fuel economies of Mature SC Otto vehicles in the six OEE size classes, over both the Urban and Highway Federal Driving Cycles, are presented in Table 4-9. These predictions are for cars with engines calibrated to meet 0.4 g/mi HC and 1.5-2.0 g/mi NOx standards. A fuel economy penalty of about 10% would be incurred for engines using EGR and an oxidation catalyst which are calibrated to meet a standard of 0.4 g/mi in both HC and NOx. Actual EPA test data for a Honda CVCC-engined CIVIC car and Ford test data for a PROCO-engined car - both non-OEE vehicles - are listed in the "Present" column for comparison.

The specific power and torque characteristics of the Mature direct-injected SC Otto engines are essentially the same as those of Mature conventional Otto engines. Consequently, the vehicle weights and installed horsepower are likewise comparable, being slightly greater than those of the UC Otto cars in the larger sizes. Relative to the equivalent Mature UC Otto-engined vehicles, these cars show a gain<sup>4</sup> of about 12% over the Urban Federal Driving Cycle and about 3% over the Highway cycle.

For the Advanced configuration, fuel economies were estimated only for the OEE Compact (reference size) vehicle. The propagated vehicle weight reduction afforded by the rotary ceramic engine reduces its fuel consumption to about 85% of that of the Mature automobile. An estimated additional 6% fuel saving is obtained beyond the simple weight effect because of reduced heat losses, optimized mixture and spark timing, and somewhat lower frictional losses. At this level of technology, the SC Otto car delivers approximately 14% higher fuel economy than its Advanced UC Otto counterpart on the urban cycle, and about 7% more over the highway cycle.

##### DIESEL VEHICLES

Fuel economy predictions for Diesel-engine vehicles in the six OEE size classes are given in Table 4-10. They are reported in terms of equivalent gasoline (115,900 Btu/gal) consumption for comparison with other alternates, although Diesel fuel (~45 cetane, minimum) would actually be used.

<sup>4</sup>Based upon sales-weighted fuel consumption, present market mix of car classes.

Table 4-9. Stratified-charge Otto vehicle fuel economy projections  
(in mpg, gasoline)

Driving cycle			Present configuration <sup>b</sup> (various reciprocating)		Mature configuration <sup>c</sup> (open-chamber, direct-injected, reciprocating)		Advanced configuration (open-chamber, direct-injected, rotary)	
OEE <sup>a</sup> class	Curb weight, lb	Design maximum power, hp	FDC-U	FDC-H	FDC-U	FDC-H	FDC-U	FDC-H
Mini	1610	50			31.0	45.7		
Small	2110	70	26.3 <sup>d</sup>	36.7	27.5	40.0		
			(CVCC)					
Subcompact	2620	96			23.7	33.8		
Compact	3150	127			20.0	28.3	24.	32.
Full-Size	4090	179	13.6 <sup>e</sup>	18.3	15.7	21.7		
			(PROCO)					
Large	5130	236			12.7	17.2		

<sup>a</sup>Otto-Engine Equivalent.

<sup>b</sup>"Present" vehicles are not necessarily "Otto-Engine Equivalent."

<sup>c</sup>Calibrated to meet 1.5-2.0 g/mi NO<sub>x</sub> standard.

<sup>d</sup>Average of EPA 1975 test data, California special.

<sup>e</sup>Average of Ford data taken October 1972 through January 1973 on same vehicle with nominal "0.4 g/mi" NO<sub>x</sub> calibration.

Urban-cycle EPA test data, converted to the gasoline basis, are given in the "Present" column for several current naturally aspirated Diesel cars. It is essential to note that these cars, which in some cases appear to yield better fuel economy than the Mature configuration cars, are not OEE-performance vehicles.

Even with turbocharging, the Mature Diesel automobiles are somewhat heavier and require higher design horsepower than the equivalent UC and SC Otto cars. This is the reason for the (apparently anomalous) slight superiority of the mid-sized SC Otto cars on the highway cycle that one observes in comparing Tables 4-9 and 4-10. In fact, the {weight, horsepower} continuum of Mature Diesel vehicles does exhibit a consistently lower fuel consumption characteristic than the corresponding Mature SC Otto continuum. However, this behavior is masked by the fact that the discrete points, representing OEE performance parity for the established car classes, occur at different weights and horsepower for the SC Otto and Diesel vehicles.

From Table 4-10, it may be concluded that the true fuel economy advantage<sup>4</sup> of Mature

Diesel vehicles over baseline Mature UC Otto automobiles, in equivalent gasoline terms, would be about 19% on the urban cycle and 5% on the highway cycle.

In the Advanced configuration, wherein again only OEE Compact car estimates were made, the Diesel's fuel economy advantage over Advanced UC Otto Compact automobiles remains circa 19% on the urban cycle but is increased to about 7% on the highway cycle — roughly comparable with the Advanced SC Otto cars. The improvement may be regarded as the compounded effect of propagated reduction in vehicle weight — reducing fuel consumption to about 94% of the Mature level — and a 10% reduction in BSFC due to lower heat losses and reduced internal friction.

#### 4.5.2 Chemical Emissions HC, CO, AND NO<sub>x</sub>

Estimates were made of the HC, CO, and NO<sub>x</sub> emissions of Mature SC Otto and Diesel vehicles in the six OEE car classes. These projections are presented in Tables 4-11 and 4-12 for the SC Otto and Diesel respectively, and are for the Urban Federal Driving Cycle, which is of

<sup>4</sup>Based upon sales-weighted fuel consumption, present market mix of car classes.

Table 4-10. Diesel vehicle fuel economy projections (in mpg, gasoline equivalent)

Driving cycle			Present configuration	Mature configuration		Advanced configuration	
OEE <sup>a</sup> class	Curb weight, lb	Design maximum power, hp	FDC-U	FDC-U	FDC-H	FDC-U	FDC-H
Mini	1790	53		32.0	45.7		
Small	2310	74	21.4 (Opel <sup>b</sup> )	28.2	38.9		
Subcompact	2830	101	22.6 (Peugeot <sup>c</sup> )	24.2	32.6		
Compact	3340	131	21.2 (Mercedes <sup>d</sup> )	20.7	27.5	25.	32.
Full-Size	4220	182	19.2 (Ford/Chrysler-Nissan <sup>e</sup> )	16.8	22.1		
Large	5160	238		13.9	18.1		

<sup>a</sup>Otto-Engine Equivalent.

<sup>b</sup>EPA Test, Non-OEE 3000 lb inertia weight vehicle, Ref. 4-79.

<sup>c</sup>EPA Test, Non-OEE 3000 lb inertia weight vehicle, Ref. 4-79.

<sup>d</sup>EPA Test, Non-OEE 3500 lb inertia weight vehicle, Ref. 4-79.

<sup>e</sup>EPA Test, Non-OEE 4500 lb inertia weight vehicle, Ref. 4-78.

most significance from the urban air quality standpoint. Gasoline is the SC Otto fuel while Diesel fuel is, of course, used in the Diesel cars. Both sets of data represent well-maintained cars, calibrated to meet HC and NOx standards of 0.4 and 1.5-2.0 g/mi-respectively, at the mid-life (~50,000-mi) point. Comparative data (mostly low mileage) for several non-OEE current vehicles are listed in the "Present" columns of the two tables.

These emissions estimates are necessarily more tentative and subject to greater uncertainty than the corresponding fuel economies, as analytical simulations of emission transients are poor. A semiempirical approach was taken. Emission maps - converted to an emission index basis - for representative engines were input to the VEEP computer program in the driving cycle simulations. The emissions predictions therefrom were normalized to serve as scaling trends with vehicle size class.

For the SC Otto, Ford PROCOCO data (adjusted slightly for vehicle weight) served as the base points. HC and CO emissions were scaled with vehicle size using the same trend as for an oxidation-catalyst UC Otto, while NOx emissions were scaled with the VEEP-generated trend.

Best Mercedes performance in HC and CO were adjusted and adopted as basepoint data for the Mature Diesel, together with Ricardo (Ref. 4-49) NOx data for a 3500-lb car. The basepoint

data were then scaled with car class - linearly for HC, and with normalized VEEP trends for CO and NOx. The results suggest that 0.4 g/mi HC may be difficult to attain in a large OEE car. This projection may be ameliorated by the fact that turbocharging tends to lower HC and increase NOx emissions slightly.

It should be noted that, although the SC Otto data presented are for engines calibrated to meet a 1.5 to 2.0-g/mi NOx standard, these cars could be calibrated to meet a 0.4-g/mi NOx standard, if required, using either the same emission controls (with a modest penalty in fuel economy) or a 3-way converter. This is not true of the Diesel cars. While the absolute lower bound on NOx emissions has not been precisely determined, it appears from the test data that a practical lower limit is in the neighborhood of 1 g/mi for a Full-Size car.

#### SULFUR OXIDES

The potential problem with the SC Otto in regard to sulfurous emissions is similar to that of the oxidation-catalyst-controlled UC Otto car. While the level of sulfur in gasoline is small, the oxidation catalyst used to control the SC Otto's hydrocarbons can convert a significant fraction of this trace sulfur to H<sub>2</sub>SO<sub>4</sub>, which tends to accumulate near heavily travelled traffic arteries. The seriousness of this problem and possible remedy options are currently under study (see Chapter 3).



Table 4-11. Stratified-charge Otto vehicle emissions projections (in g/mi, gasoline)

Driving cycle			Present configuration <sup>b</sup> (1975)			Mature configuration <sup>c</sup> (open-chamber direct-injected, oxidation catalyst)		
			FDC-U			FDC-U		
OEE <sup>a</sup> class	Curb weight, lb	Design maximum power, hp	HC <sup>d</sup>	CO	NOx <sup>e</sup>	HC <sup>d</sup>	CO	NOx <sup>e</sup>
Mini	1610	50				0.24	0.6	0.7
Small	2110	70	0.38	4.0 (CVCC <sup>b</sup> )	1.1	0.24	0.8	0.8
Subcompact	2620	96				0.25	0.9	0.9
Compact	3150	127				0.29	1.1	1.0
Full-Size	4090	179	0.47	0.47 (PROCOE <sup>g</sup> )	0.35	0.35	1.6	1.1
Large	5130	236				0.40	2.0	1.2

<sup>a</sup>Otto-Engine Equivalent.

<sup>b</sup>"Present" vehicles are not necessarily "Otto-Engine Equivalent."

<sup>c</sup>Calibrated to meet 2.0-g/mi NOx standard.

<sup>d</sup>As C<sub>6</sub>H<sub>14</sub>.

<sup>e</sup>As NO<sub>2</sub>.

<sup>f</sup>EPA 1975 test data, California specification, 50,000 mi.

<sup>g</sup>Average of Ford data on same vehicle with nominal "0.4 g/mi" NOx calibration.

Table 4-12. Diesel vehicle emissions projections (in g/mi, diesel fuel)

Driving cycle			Present configuration (1975)			Mature configuration (turbocharged)		
			FDC-U			FDC-U		
OEE <sup>a</sup> class	Curb weight, lb	Design maximum power, hp	HC <sup>b</sup>	CO	NOx <sup>c</sup>	HC <sup>b</sup>	CO	NOx <sup>c</sup>
Mini	1790	53				0.17	0.7	0.8
Small	2310	74	0.4	1.16 (Opel <sup>d</sup> )	1.34	0.22	0.9	0.9
Subcompact	2830	101	3.11	3.42 (Peugeot <sup>e</sup> )	1.07	0.28	1.1	1.0
Compact	3340	131	0.34	1.42 (Mercedes <sup>f</sup> )	1.43	0.32	1.3	1.1
Full-Size	4220	182	1.70	3.81	1.71	0.41	1.8	1.3
Large	5160	238				0.54	2.2	1.5

<sup>a</sup>Otto-Engine Equivalent.

<sup>b</sup>As C<sub>6</sub>H<sub>14</sub>.

<sup>c</sup>As NO<sub>2</sub>.

<sup>d</sup>EPA Test, Non-OEE 3000-lb inertia weight vehicle, Ref. 4-79.

<sup>e</sup>EPA Test, Non-OEE 3000-lb inertia weight vehicle, Ref. 4-79.

<sup>f</sup>EPA Test, Non-OEE 3500-lb inertia weight vehicle, Ref. 4-79.

<sup>g</sup>EPA Test, Non-OEE 4500-lb inertia weight vehicle, Ref. 4-78.

The Diesel situation is different in kind. Percentagewise, diesel fuel contains more sulfur than gasoline, but the Diesel combustion process does not favor the production of H<sub>2</sub>SO<sub>4</sub>. An as yet unsolved problem with Diesels, however, is exhaust odor (which will be discussed later), and sulfur compounds contribute to the exhaust aroma. If widespread use of Diesels is contemplated, fuel desulfurization may be a viable solution.

### SMOKE AND PARTICULATES

Smoke and particulate emissions are not separate entities, the former being included in the latter. Smokes consist of particulates entrained in the exhaust gas stream, said particulates being large enough to cause visible scatter of light. In addition to particulates emitted as smokes, engines can also emit larger/denser particulates (e.g., component attrition fragments) and nonvisible microparticulates. The entire range of particulate emissions – especially the microparticulates – has not been exhaustively studied with respect to particle size distribution, composition, toxicology, etc.

Smoking is not as significant a problem with SC Otto engines, and particulate emissions do not appear to be a problem either. However, microparticulate emissions from SC Otto engines (if any) have not been adequately studied.

Particulate emissions in general, and smokes in particular, are known problems with Diesels. Three categories of Diesel smoke are recognized (Ref. 4-82): "white" smoke, "blue" smoke, and "black" smoke (soot). White smoke comprises small (mean diameter ~1.3 μm) condensed droplets of unburnt or partially burnt fuel and is primarily associated with cold starting, disappearing once the engine has come up to temperature. The intensity (opacity) and persistence of the smoke is strongly dependent on fuel cetane number at low starting temperatures; this dependency weakens at higher start temperatures (Ref. 4-81). Some writers use the term "blue" smoke for the same phenomenon with smaller (circa 0.5 μm) droplets while others reserve the "blue" label for smokes due to partially burnt lubricant bypassing the piston rings in a worn engine. Both white and blue smoke are occasional transient problems (blue smoke, under the second definition, indicates maintenance required) and are not as serious a concern as black smoke.

Black smoke consists predominantly of unoxidized carbon particles associated with operational air/fuel ratio fluctuations induced in the driving cycle. It has generally been considered a nuisance associated with Diesel operation and not a health hazard. Stringent enforcement, pioneered in California, had once motivated Diesel manufacturers to minimize the incidence of black smoke emitted. Recent emphasis on NO<sub>x</sub> emission control has forced some compromise on smoke emission (Ref. 4-84).

In addition to visible smoke, microparticulates (average diameter ~1 μm) are a potential problem with Diesels, according to Ref. 4-85 and work done at GMRL (Ref. 4-80). These sub-micron particles can be chemically and biologically active (Ref. 4-93) and may constitute a health hazard. The typical generation rate found

during nonsmoking operation was of the order of 1 g/bhp-hr. Density and size distribution remain to be determined. At present, these particulate emissions are believed to be associated with the droplet-burning characteristic of Diesels, particularly the heavy ends of the fuel. Much further study is warranted to determine whether microparticulates are significant in other engines and what health/environmental problems are posed thereby.

Table 4-13 lists representative particulate emissions from various vehicles with intermittent-combustion engines. Naturally aspirated (NA) Diesel emissions are seen to be virtually an order of magnitude greater than those of intermittent-combustion gasoline engines. The environmental significance thereof in a conjectural all-Diesel fleet needs further study. Turbocharging, as herein proposed for the Mature and Advanced Diesels, tends to eliminate smoke (Ref. 4-84) and perhaps would also reduce microparticulates, although this has not been demonstrated. Injector improvements, in timing control and minimization of holdup volume, further reduce particulate emissions. Afterburning has also been suggested (Ref. 4-83).

### ODOR

Objectionable exhaust odor is a perennial complaint against Diesel vehicles, but has also been occasionally remarked in the limited experience with some SC Ottos (and some gas turbines). It must be recognized that odor, like color and taste, is not an intrinsic objective property of substances, but rather the complex subjective response of a uniquely conditioned human nervous system to ongoing physical/physiological reactions with those substances, against a background of previous short-term exposure history. This makes the human nose the final authority in odor characterization. Although the olfactory sense is not totally synthetic (like the visual color response), neither is it as analytic as the ear. This characteristic makes it difficult to clearly identify all the malodorous species in the Diesel exhaust mixture. Thus, while comprehensive

Table 4-13. Particulate emissions for various vehicles<sup>a</sup> (FDC-U, 1975 Federal Test Procedure)

Gasoline (unleaded)	Particulate emissions, g/mi
Capri, PROCO	0.10
Pontiac, Catalyst + Air	0.04
Ford, New Catalyst + Air	0.03
Ford, Aged Catalyst + Air	0.08
<b>Diesel</b>	
Mercedes	0.58
Opel	0.43
Peugeot	0.55

<sup>a</sup>Ref. 4-94.

odor characterizations of individual compounds have been accomplished (e. g., Ref. 4-91), correlations of objective measures of species concentrations with human responses (Refs. 4-86, 4-88, 4-89, 4-90) have been only moderately successful. The Turk kit (Ref. 4-92) method has been widely employed and some useful insights obtained.

Incompletely oxidized hydrocarbons — especially acrolein, formaldehyde, and aliphatic aldehydes — have been singled out as major offenders. However, the exhaust concentrations of CO and CO<sub>2</sub>, total hydrocarbons, certain light hydrocarbons, NO, and the oxidation products of mercaptan and ring-bound contaminant sulfur have been found to contribute significantly to perceived odor. While the formation of trace quantities of acrolein and aldehydic species is undoubtedly not unique to the Diesel engine, the heterogeneous, high-pressure, droplet-burning Diesel combustion process seems to favor their production. Results of one study (Ref. 4-87) indicate that these partial oxidation products are produced in regions of fuel/air mixtures too lean to burn at the inception of combustion. Fuel properties, such as cetane number, are only weakly correlated with exhaust odor.

It should be noted that the human nose is a very sensitive instrument and the concentrations of species that can induce an odor reaction are usually (depending upon species, background, and prior exposure) far smaller than health hazard concentration levels for those species. Hence odor is essentially a psychological nuisance problem, although an important one from the public acceptance standpoint. Trained panels of judges rate odor in terms of quality and intensity at constant dilution on predetermined psychophysical scales against established standards. The components of Diesel odor quality are frequently designated "smoky-burnt," "oily," "aromatic," and "pungent" on Fechner/Weber-type quasilogarithmic intensity scales. Evaluation of exhaust odor from a Mercedes 220D under various operating conditions is described in Ref. 4-85.

Given that aforementioned oxygenates are representative of the odoriferous species, the same kinds of measures that could be adopted to reduce smoke and particulate emissions should also ameliorate the odor problem. Improved injectors and close air/fuel ratio control appear to offer measurable improvement (Ref. 4-86). Sulfurous species are a somewhat separate problem, one solution of which is greater desulfurization. Limited test data (Ref. 4-86) indicate that the form in which the fuel sulfur is present is more significant than the total sulfur content.

The exhaust odor question must be resolved in a fleet conversion to any combustion engine having such a potential problem. In the case of the Diesel, however, the problem does not appear to be yielding rapidly to technology, probably because it is fundamental to the combustion process. Considerable attention would have to be devoted to this area before fleet conversion can be contemplated.

#### 4.5.3 Noise Emissions

Direct-injected SC Otto engines are similar acoustically to the high-compression UC Otto engines of yesteryear, and one would, in general, expect engine-related vehicle noise to be comparable. Some noise problems were encountered with early PROCO configurations, but these have been eliminated through redesign. Production SC Otto cars should be as quiet as conventional ones.

Diesel engine noise is greater than that of comparable spark-ignition intermittent-combustion engines, the major contributor being high-pressure combustion transients. This is not to say noise is a major problem, however, as adequate muffling can be provided through careful acoustic design. The very acceptable noise levels associated with the Mercedes 220 Diesel sedan (Ref. 4-85) are a good example of what can be readily accomplished. A maximum level of 77 dBa (9 dB below the SAE recommended standard) was obtained in the exterior drive-by measurement for the right-to-left acceleration mode.

#### 4.5.4 Driveability Aspects

A Mature SC Otto vehicle would have a driveability rating at least comparable to that of an equivalent conventional car. Under the OEE concept, their sustained acceleration capabilities are, of course, equal, but even the initial "get-away" feel of the Mature SC Otto can will be indistinguishable to the driver. Direct-injection materially shortens the startup interval and, in this sense, the SC Otto is superior to its conventional carbureted brother. Throttle response is brisk, and "stumble" has been eliminated in the evolution of the engine.

The OEE Diesel car also has a sustained acceleration capability equivalent to the UC Otto car. Startup interval is somewhat longer, cranking time being dependent upon starting temperature and, in cold climates, sensitive to fuel cetane number.

#### 4.5.5 Safety

The SC Otto and Diesel vehicles do not impose any additional safety hazards over conventional cars. From this standpoint, the SC Otto is just another Otto engine variant and benefits from the design practice derived from historical experience with such engines.

Diesel-engined vehicles, too, have an excellent "track record" for safety, and previous design experience is directly applicable to the Mature configuration. From the collision fire hazard standpoint, Diesel cars are still safer than Otto cars because Diesel fuel has lower volatility than gasoline. Some design safety attention will have to be devoted to introduction of the turbocharger into a passenger-car Diesel, with provision of automatic relief on manifold pressure to preclude inadvertent overboost.

Further discussion of engine and vehicle safety is presented in Chapter 16.

#### 4.6 OWNERSHIP CONSIDERATIONS

The vehicle owner is generally indifferent to the specific mechanization of his automobile's powerplant. Already accustomed to conventional Otto-engined car ownership, his major concerns in considering an SC Otto or Diesel car are: "How does it perform?"; "Is it as safe as a conventional (Otto) car?"; "What will it cost me?"; and "How often must it be garaged for maintenance?." The first two questions have been answered in the foregoing sections. The latter two are addressed in this section.

##### 4.6.1 Maintenance

A production direct-injected SC Otto engine will probably have maintenance requirements (and maintenance cost) equivalent to those of a comparable catalyst-controlled UC Otto engine. On the basis of the characteristics of present NA Diesel engines, it is also reasonable to assume that Mature Diesel engine maintenance would be similar. Diesel engines require more frequent oil changes than Ottos, and turbocharged Diesels may require additional minor periodic adjustments. Regularly scheduled maintenance items (analogous to a tuneup) would probably include the following:

###### SC Otto (DI)

- (1) Replace air cleaner.
- (2) Change oil/replace filter.
- (3) Change fuel filter.
- (4) Check/adjust induction and injection system.
- (5) Check/adjust ignition timing.
- (6) Replace spark plugs.
- (7) Check catalyst.
- (8) Replace PCV valve.
- (9) Check compression.

###### Diesel (TC)

- (1) Replace air cleaner.
- (2) Change oil/replace filter.
- (3) Change fuel filter.
- (4) Check/adjust induction and injection system.
- (5) Clean injectors.
- (6) Replace ignitors.
- (7) Check compression.
- (8) Check wastegate system.
- (9) Replace PCV valve.

Long-period, as-required maintenance items would include

###### SC Otto (DI)

- (1) Check/adjust valve timing, grind/replace valves.
- (2) Replace piston rings.
- (3) Replace water pump.
- (4) Replace fuel pump.
- (5) Clean injectors; replace injection pump
- (6) Replace hoses and thermostat.
- (7) Replace coolant.
- (8) Replace catalyst.
- (9) Replace EGR valve.
- (10) Replace belts.

###### Diesel (TC)

- (1) Check/adjust valve timing, grind/replace valves.
- (2) Replace piston rings.
- (3) Replace water pump.
- (4) Replace fuel pump.
- (5) Replace hoses and thermostat.
- (6) Replace coolant.
- (7) Replace EGR valve.
- (8) Replace belts.

Minor retraining of mechanics will be required, as well as introduction of some new types of diagnostic and repair equipment in maintenance garages. With a protracted introduction period, this transition is easily accommodated. Phase-in of new parts into the existing aftermarket distribution system is likewise easily accomplished. Maintenance for the rest of the vehicle would be identical to that of a conventional Otto-engined vehicle.

##### 4.6.2 Incremental Cost of Ownership

Assuming that the SC Otto or Diesel vehicle owner would operate his car in essentially the same manner as an equivalent conventional automobile, the increment in ownership cost comprises the difference between the sums of depreciation, fuel and engine-expended fluids cost, and maintenance cost between the SC Otto or Diesel and the conventional cars. Although it is believed that SC Otto and Diesel maintenance costs should be roughly comparable with those for the equivalent UC Otto engine, it is difficult to predict what the actual maintenance requirements and corresponding maintenance charges will be for the hardware that would ultimately be mass-produced. These engines would probably not be released for production unless their maintenance costs were projected to be comparable to that of the Otto engine. Hence they are assumed to be equal for purposes of this calculation.

Projected engine expendable fluid (other than fuel) requirements and their corresponding costs are given in Table 4-14 for Mature SC Otto vehicles and in Table 4-15 for Mature Diesel cars. Data are presented for three OEE size classes - Small, Compact, and Full-Size.

The incremental cost of ownership then is simply the present value (7% annual discount rate assumed) of the difference between the sums of depreciation plus fuel cost plus engine-expended fluids cost for the Mature OEE SC Otto or Diesel vehicles and their UC Otto counterpart cars. Details of the calculations are given in Chapter 20. Representative values are shown in Tables 4-16 and 4-17. It can be seen that both SC Otto and Diesel cars "pay back" their initial price differential over their life cycle, in fuel savings, even at equal maintenance cost. The differentials for

the SC Otto are very small, however, and within the uncertainty of the calculations probably represent parity.

#### 4.7 RESEARCH AND DEVELOPMENT REQUIRED

To bring the configurations described as Mature and Advanced to production status, little basic research, as such, is required. Varying degrees of component and process development are necessary, however.

##### 4.7.1 Mature Configurations

The basic components of reciprocating intermittent-combustion engine block assemblies have already essentially attained the acme of their development, from a production standpoint.

Table 4-14. Cost of engine-related expendable fluids for mature SC Otto vehicles (all costs in 1974 dollars)

Auto class	Engine (cyl/hp)	Lubricant			Coolant <sup>a</sup>			Total expendable fluid cost	
		Capacity, qt	Price, \$/qt	Interval, mi x 10 <sup>3</sup>	Total capacity, qt	Price, <sup>b</sup> \$/qt	Interval, mi x 10 <sup>3</sup>	At 35 kmi, 3 yr, \$	At 100 kmi, 10 yr, \$
Small	4/70	4	0.90	6 <sup>c</sup>	8	1.25	24	27	81
Compact	6/127	5	0.90	6 <sup>c</sup>	12	1.25	24	34	106
Full-Size	8/179	6	0.90	6 <sup>c</sup>	16	1.25	24	42	132

<sup>a</sup>Assumed to be 50% by volume of glycol-type antifreeze.

<sup>b</sup>Price of pure glycol-type antifreeze.

<sup>c</sup>Every 3000 mi for first 6000; every 6000 mi thereafter.

Table 4-15. Cost of engine-related expendable fluids for Mature Diesel vehicles (all costs in 1974 dollars)

Auto class	Engine (cyl/hp)	Lubricant			Coolant <sup>a</sup>			Total expendable fluid cost	
		Capacity, qt	Price, \$/qt	Interval, mi x 10 <sup>3</sup>	Total capacity, qt	Price, <sup>b</sup> \$/qt	Interval, mi x 10 <sup>3</sup>	At 35 kmi, 3 yr, \$	At 100 kmi, 10 yr, \$
Small	4/74	4	0.90	3 <sup>c</sup>	8	1.25	24	48	142
Compact	6/131	5	0.90	3 <sup>c</sup>	12	1.25	24	62	183
Full-Size	8/182	6	0.90	3 <sup>c</sup>	16	1.25	24	75	224

<sup>a</sup>Assumed to be 50% by volume of glycol-type antifreeze.

<sup>b</sup>Price of pure glycol-type antifreeze.

<sup>c</sup>Every 1500 mi for first 3000; every 3000 mi thereafter.

Table 4-16. Incremental<sup>a</sup> cost of ownership<sup>b</sup> for Mature SC Otto vehicles (constant 1974 dollars)

OEE auto class	Incremental ownership cost <sup>c</sup>	
	35,000 mi, 3 yr <sup>d</sup>	100,000 mi, 10 yr <sup>d</sup>
Small	-50	-50
Compact	0	-50
Full-Size	50	0

<sup>a</sup>Relative to equivalent baseline UC Otto cars.

<sup>b</sup>Present value, at 7% annual discount rate, of depreciation plus fuel cost plus expendable fluids cost. Gasoline at 52¢/gal.

<sup>c</sup>Negative numbers indicate savings to SC Otto car owner (to nearest \$50).

<sup>d</sup>Median driver's experience.

Table 4-17. Incremental<sup>a</sup> cost of ownership<sup>b</sup> for Mature Diesel vehicles (constant 1974 dollars)

OEE auto class	Incremental ownership cost <sup>c</sup>	
	35,000 mi, 3 yr <sup>d</sup>	100,000 mi, 10 yr <sup>d</sup>
Small	-50	-150
Compact	-50	-150
Full-Size	0	-150

<sup>a</sup>Relative to equivalent baseline UC Otto cars.

<sup>b</sup>Present value, at 7% annual discount rate, of depreciation plus fuel cost plus expendable fluids cost. Diesel fuel at 49¢/gal ( $\approx$  gasoline at 52¢/gal).

<sup>c</sup>Negative numbers indicate savings to Diesel car owner (to nearest \$50).

<sup>d</sup>Median driver's experience.

Consequently, the basic SC Otto and Diesel engines in the Mature configuration require virtually no development effort.

For the SC Otto, present emission controls and catalysts appear to be adequate for a 1.5 to 2.0-g/mi NO<sub>x</sub> car. However, if a 0.4-g/mi NO<sub>x</sub> vehicle is contemplated (with HC also at 0.4 g/mi), further development is needed. The feasibility and fuel economy of a feedback-controlled-air-throttle, 3-way-catalyst version should be evaluated against the current recalibrated, oxidation-catalyst-only version.

The Mature Diesel would require some final development work in providing a suitable fuel injection system. It is acknowledged that an economical Diesel injection system represents a difficult production engineering problem in high-volume automotive mass production. A design and development effort would be required to size and configure the turbocharger system, both in sub-assembly development and engine integration. An essentially state-of-the-art turbocharger/wastegate system is assumed in the Mature configuration. Alternate approaches which might be pursued from the performance and economics standpoints are: (1) the Compresx-type supercharger and (2) a variable-area turbocharger sans wastegate.

#### 4.7.2 Advanced Configurations

To make either of the Advanced engines a reality, research in ceramics and lubrication technologies is required. Although the actual ceramic materials are already identified (invention of a novel material is not implied), the applications to specific components do raise some fundamental questions in four general categories:

- (1) **Material Formulation:** Determine appropriate compositions and impurity levels for optimum properties in:
  - (a) Piston crown/rotor and block/head/housing/liner application (SiC; Si<sub>3</sub>N<sub>4</sub>; Sialon; ceramic composites; others?).
  - (b) Piston-ring/rotor-seal application (Si<sub>3</sub>N<sub>4</sub>; ceramic composites; Sialon; others?).
- (2) **Ceramic Raw Material Processing:** Determine the optimum tradeoff between properties achieved at given impurity levels and the cost of refining the abundant raw materials to attain these impurity levels; demonstrate the cost-effectiveness of producing the ceramic material in a pilot plant scalable to mass production quantities.
- (3) **Ceramic Structure Fabrication Processes:** Demonstrate the production of formed parts, with adequate properties and high reproducibility and yields, from production grade raw materials; develop processes to permit concrescence<sup>5</sup> of simple-shape components into a complex monolithic structure, on a mass

<sup>5</sup>The term "Concrescence," as used in this study, is a generic one referring to any existing or potential fabrication process which yields a completed ceramic shape or integral structure.

production basis; demonstrate integrated ceramic design, testing, and nondestructive evaluation techniques suitable for mass production.

- (4) **Ceramic/Metallic Structures Joining and Bonding:** Develop techniques for joining or bonding ceramic materials of the selected compositions to contiguous metallic structures; techniques should emphasize strength of joint, sealing (as required), and alleviation of stress concentrations.

In addition to the peripheral developments in injection system and emissions controls required by the Mature SC Otto configuration, further basic engine development is required for the Advanced Wankel configuration. Such developments in metallic configurations of UC Otto engines are being pursued currently by NSU, Curtiss-Wright, GMC, and Toyo Kogyo. Adaptation of ceramic technology will require a major research and development effort. To be addressed specifically are: optimization of valving/porting and ignition system; improvement of rotor-to-housing seals; and elimination of thermal distortion of the housing in regions of high heat flux. Some additional development may also be required in connection with emission controls, as the then-current NOx standard may be more difficult to meet with the higher operating temperatures of the ceramic engine.

The Advanced Diesel, although configured as reciprocating, is still a radical technological departure and would require extensive basic engine development. In addition to the head, block, and piston design and production problems, the higher cycle temperatures incurred will probably necessitate considerable development in the areas of valves, piston rings/lubricant, and emission controls. Given the difficulty of NOx control in the Mature configuration, it becomes even more problematic in the uncooled ceramic configuration under anticipated HC, particulate, and odor constraints.

#### References

- 4-1. Ricardo, H. R., "Recent Research Work on the Internal Combustion Engine," J. SAE, Vol. 10, No. 5, May 1922, pp. 305-347.
- 4-2. Obert, E. F., Internal Combustion Engines, International Textbook Co., Scranton, Pa., 1950.
- 4-3. Lichty, L. C., Internal Combustion Engines, McGraw-Hill, New York, 1951.
- 4-4. "Current Status of Alternative Automotive Power Systems and Fuels, Volume II - Alternative Automotive Engines," Aerospace Corporation, El Segundo, Ca., United States EPA-460/3-74-013-6, July 1974.
- 4-5. Heitland, H., "A Status Report on the Prechamber Injection (PCI) Volkswagen Stratified Charge Engine," Paper, First Symposium on Low-Pollution Power Systems Development, United States EPA, Oct. 1973.
- 4-6. Brandstetter, W. R., et al., "The Volkswagen Stratified Charge Concept - Results from the 1.6 liter Aircooled Engine," SAE 741173, Oct. 1974.
- 4-7. Date, T., et al., "Research and Development of the Honda CVCC Engine," SAE 740605, Aug. 1974.
- 4-8. "Hydrogen Enrichment for Internal Combustion Engines," Presentation by JPL to EPA, AAPS Division, Ann Arbor, Mich., Dec. 3, 1974.
- 4-9. Houseman, J., and Cerini, D. J., "On-Board Hydrogen Generator for a Partial Hydrogen Injection Internal-Combustion Engine," SAE 740600, Aug. 1974.
- 4-10. Hoehn, F. W., and Dowdy, M. W., "Feasibility Demonstration of a Road Vehicle Fueled with Hydrogen-Enriched Gasoline," 9th Intersociety Energy Conversion Engineering Conf., Aug. 1974.
- 4-11. Houseman, J., and Hoehn, F. W., "A Two-Charge Engine Concept: Hydrogen Enrichment," SAE 741169, Oct. 1974.
- 4-12. "SEGAS TM Fuel Gasification for Mature Emission Control," Report, International Materials Corp., Burlington, Mass., Dec. 1973.
- 4-13. Bishop, I. N., and Simko, A., "A New Concept of Stratified Charge Combustion - The Ford Combustion Process (FCP)," SAE 680041.
- 4-14. Simko, A., et al., "Exhaust Emission Control by the Ford Programmed Combustion Process - PROCO," SAE 720052, Jan. 1972.
- 4-15. Jones, C., "A Progress Report on Curtiss-Wright's Rotary Stratified Charge Engine Development," SAE 741206, Oct. 1974.
- 4-16. "History and Future of Spark Ignition Engines," Report by Environmental Policy Division of Congressional Research Service, Library of Congress, SN 93-10, Sept. 1973.
- 4-17. Taylor, C. F., and Taylor, E. S., "The Internal Combustion Engine," International Textbook Co., Scranton, Pa., 1961.
- 4-18. Blumberg, P., and Kummer, J. T., "Prediction of NO Formation in Spark-Ignited Engines - An Analysis of Methods of Control," Combustion Science and Technology, Vol. 4, 1971, pp. 73-95.

- 4-19. Lavoie, G. A., Heywood, J. B., and Keck, J. C., "Experimental and Theoretical Study of Nitric Oxide Formation in Internal Combustion Engines," *Combustion Science and Technology*, Vol. 1, 1970, p. 313.
- 4-20. Blumberg, P., "Nitric Oxide Emissions from Stratified Charge Engines: Prediction and Control," *Combustion Science and Technology*, Vol. 8, 1973, pp. 5-24.
- 4-21. Agarwal, P. D., Mooney, R. J., and Toepel, R. R., "Stir-Lec I, A Stirling Electrid Hybrid Car," SAE 690074, Jan. 1969.
- 4-22. Komiyama, K., and Heywood, J. B., "Predicting NOx Emissions and Effects of Exhaust Gas Recirculation in Spark-Ignition Engines," SAE 730475, May 1973.
- 4-23. Lavoie, G. A., and Blumberg, P. N., "Measurement of NO Emissions From a Stratified Charge Engine: Comparison of Theory and Experiment," *Combustion Science and Technology*, Vol. 8, 1973, pp. 25-37.
- 4-24. Eyzat, P., and Guibet, J. C., "A New Look at Nitrogen Oxides Formation in Internal Combustion Engines," SAE 680124.
- 4-25. Bernhardt, W. E., "Kinetics of Nitric Oxide Formation in Internal Combustion Engines," Paper No. C149/71, Conference Volume: Air Pollution Control In Transport Engines, Instn. Mech. Engrs., 1971.
- 4-26. Eltinge, L., Marsee, F. J., and Warren, A. J., "Potentialities of Further Emissions Reduction by Engine Modifications," SAE 680123, 1968.
- 4-27. Brehob, W. M., "Mechanisms of Pollutant Formation and Control from Automotive Sources," SAE 710483, published in SAE SP-365, Engineering Know-How in Engine Design, June 1971.
- 4-28. Tabaczynski, R. J., Heywood, J. B., and Keck, J. C., "Time-Resolved Measurements of Hydrocarbon Mass Flowrate in the Exhaust of a Spark-Ignition Engine," Department of Mechanical Engineering, Mass. Institute of Tech., Publication No. 71-10, April 1971, NTIS Accession No. N71-26004.
- 4-29. Daniel, W. A., "Flame Quenching at the Walls of an Internal Combustion Engine," Sixth Symposium (International) on Combustion, Yale University, New Haven, Conn., Reinhold Publishing Co., New Yor, 1956.
- 4-30. Lee, R. C., and Wimmer, D. B., "Exhaust Emission Abatement by Fuel Variations to Produce Lean Combustion," SAE 680769.
- 4-31. Tanuma, T., Sasaki, K., Kaneko, T., and Kawasaki, H., "Ignition, Combustion, and Exhaust Emissions of Lean Mixtures in Automotive Spark Ignition Engines," SAE 710159.
- 4-32. Belles, F. E., and Sweet, C. C., "Ignition and Flammability of Hydrocarbon Fuels," Chapter III of NACA Report 1300, Basic Considerations in the Combustion of Hydrocarbon Fuels with Air, 1957.
- 4-33. Robinson, J. A., and Brehob, W. M., "The Influence of Improved Mixture Quality on Engine Exhaust Emissions and Performance," WSCE 65-17, Western States Combustion Institute Meeting, Santa Barbara, Calif., Oct. 1965.
- 4-34. Bolt, J. A., and Holkeboer, D. H., "Lean Fuel-Air Mixtures for High Compression Spark Ignition Engines," Paper 380-D, SAE Trans., Vol. 70, 1962, p. 195.
- 4-35. Bolt, J. A., and Harrington, D. L., "The Effects of Mixture Motion Upon the Lean Limit and Combustion of Spark-Ignited Mixtures," SAE 670467.
- 4-36. Stivender, D. L., "Intake Valve Throttling (IVT) - A Sonic Throttling Intake Valve Engine," SAE 680399.
- 4-37. Cook, H. A., Heinicke, O. H., and Haynie, W. H., "Spark Timing Control Based on Correlation of Maximum-Economy Spark Timing, Flame-Front Travel, and Cylinder Pressure Rise," NACA Report No. 886, 1946.
- 4-38. Wentworth, J. T., "Effects of Combustion Chamber Shape and Spark Location on Exhaust Nitric Oxide and Hydrocarbon Formation," SAE 740529.
- 4-39. Daniel, W. A., and Wentworth, J. T., "Exhaust Gas Hydrocarbons - Genesis and Exodus," Published in SAE Technical Progress Series, Vol. 6, "Vehicle Emissions - Part I," 1964, pp. 192-205.
- 4-40. Jackson, M. W., Wiese, W. M., and Wentworth, J. T., "The Influence of Air-Fuel Ratio, Spark Timing, and Combustion Chamber Deposits on Exhaust Hydrocarbon Emissions," Published in SAE Technical Progress Series, Vol. 6, "Vehicle Emissions - Part I," 1964, paper No. 486-A.
- 4-41. Daniel, W. A., "Why Engine Variables Affect Exhaust Hydrocarbon Emissions," SAE Trans, Vol. 79, 1970, paper No. 700108.
- 4-42. Wentworth, J. T., "The Piston Crevice Volume Effect on Exhaust Hydrocarbon Emissions," *Combustion Science and Technology*, Vol. 4, No. 2, October 1971, pp. 97-100.



- 4-43. Wentworth, J. T., "Effect of Combustion Chamber Surface Temperature on Exhaust Hydrocarbon Concentration," SAE Trans, Vol. 80, 1971, Paper No. 710587.
- 4-44. Wentworth, J. T., "More on the Origins of Exhaust Hydrocarbons - Effects of Zero Oil Consumption, Deposit Location, and Surface Roughness," SAE Trans, Vol. 81, 1972, Paper No. 720939.
- 4-45. Quader, A. A., "Effects of Spark Location and Combustion Duration on Nitric Oxide and Hydrocarbon Emissions," SAE Paper No. 730153, January 1973.
- 4-46. Huls, T. A., Myers, P. S., and Uyehara, O. A., "Spark Ignition Engine Operation and Design for Minimum Exhaust Emissions," SAE Publication PT-12, "Vehicle Emissions - Part II," 1967, SAE Paper No. 660405.
- 4-47. Hagen, D. F., and Holiday, G. W., "The Effects of Engine Operation and Design Variables on Exhaust Emissions," SAE Paper 486-C, March 1962.
- 4-48. Scheffler, C. E., "Combustion Chamber Surface Area, A Key to Exhaust Hydrocarbons," SAE Trans, Vol. 75, 1966, Paper No. 660111.
- 4-49. Monaghan, M. L., French, C. C. J., and Freese, R. G., "A Study of the Diesel as a Light-Duty Powerplant," Ricardo and Company Engineers, Shoreham-by-Sea, Sussex, England, BN4 5FG, U.S. EPA Publication No. EPA-460/3-74-011.
- 4-50. Gumbleton, J. J., Bolton, R. A., and Lang, H. W., "Optimizing Engine Parameters with Exhaust Gas Recirculation," SAE Paper No. 740104.
- 4-51. Gupta, R. K., and Graiff, L. B., "Effect of Exhaust Gas Recirculation and Ignition Timing on Fuel Economy and Exhaust Emissions of Several 1973 Model Cars," paper presented at the Meeting of the Central States Section of the Combustion Institute, March 26-27, 1974, Madison, Wisconsin.
- 4-52. Dowdy, M. W., Hoehn, F. W., and Vanderbrug, T. C., "Lean Mixture Engines Testing and Evaluation Program, Preliminary Report for U.S. Dept. of Transportation - Transportation Systems Center, Prepared by the Jet Propulsion Laboratory, Pasadena, Calif., Jan. 13, 1973.
- 4-53. Eisele, E., "Daimler-Benz Passenger Car Diesel Engines - Highlights of 30 Years of Development," SAE 680089, Jan. 1968.
- 4-54. Oblander, K., and Schmidt, H. G., "The Mercedes-Benz LDV Diesel Engine," Preprint for 2nd NATO-CCMS Symposium, Dusseldorf, Nov. 1974.
- 4-55. Wilson, R. P., Jr., Muir, E. B., and Pellicciotti, F. A., "Emissions Study of a Single Cylinder Diesel Engine," SAE 740123, Feb. 1974.
- 4-56. Bosecker, R. E., and Webster, D. F., "Precombustion Chamber Diesel Engine Emissions - A Progress Report," SAE 710672, Aug. 1971.
- 4-57. Bascom, R. C., Broering, L. C., and Wulfhorst, D. E., "Design Factors That Affect Diesel Emissions," SAE 710484.
- 4-58. Kesten, A. S., "Analysis of NO Formation in Single Drop Combustion," Combustion Science and Technology, Vol. 6, 1972, pp. 115-123.
- 4-59. Bertodo, R., Downes, T. W. E., Middlemiss, I. D., and Brear, F., "Development of the Perkins "Squish Lip" Combustion System," Preprint for 2nd NATO-CCMS Symposium, Dusseldorf, Nov. 1974.
- 4-60. Altenkirch, R. A., Shahed, S. M., and Sawyer, R. F., "Nitric Oxide Formation Around Droplets Burning at Elevated Pressures," Combustion Science and Technology, Vol. 5, 1972, pp. 147-154.
- 4-61. Henein, N. A., "Kinetic Considerations in the Autoignition and Combustion of Fuel Sprays in Swirling Air," ASME paper No. 72-DGP-8, Apr. 1972.
- 4-62. "Hydrogen Injection for Internal Combustion Engines," Briefing presented to the Council on Environmental Quality Advisory Committee on Alternative Automotive Power Systems, June 13-14, 1974, by the Jet Propulsion Lab, Pasadena, Calif.
- 4-63. "Hydrogen Enrichment for Internal Combustion Engines," Briefing presented at the ERDA Contractors Coordination Meeting, May 6-8, 1975, Ann Arbor, Michigan by the Jet Propulsion Laboratory, Pasadena, Calif.
- 4-64. Clauser, F. H., Caltech, Personal Communication, Nov. 1974.
- 4-65. Fact-finding visit by APSES Team members, Ford Motor Co., Dearborn, Mich. (June 1974).
- 4-66. Fact-finding visit by APSES Team members, Ford Motor Co., Dearborn, Mich. (Oct. 1974).
- 4-67. Fact-finding visit by APSES Team member, Honda Research and Development Ltd., Saitama, Japan (Sept. 1974).
- 4-68. Personal communication: A. Simko, Ford Motor Co., to APSES Team (23 Apr. 1975).

- 4-69. Fact-finding visit by APSES Team members, Ricardo and Co. Engineers Ltd., Shoreham-by-Sea, Sussex, England (July 1974).
- 4-70. "Turbocharging Diesel Engines," presentation viewgraphs from Garrett Corp., 1974.
- 4-71. Cazier, J. M., and Larg, W. S., "Developing the Turbocharger for Its Application," SAE, Nov. 2, 1960.
- 4-72. Goodlet, I. W., "Turbocharging of Small Engines," The Institution of Mechanical Engineers, Jan. 1974.
- 4-73. Personal communication with APSES consultant, Rath & Strong, Inc., (Oct. 1974).
- 4-74. Personal communication with Ford Motor Co. (May 1975).
- 4-75. Personal communication with Cummins Engine Co., Inc. (Jan. 1975).
- 4-76. Various articles, Metalworking News (1974).
- 4-77. "Manufacturability and Costs of Proposed Low-Emissions Automotive Engine Systems," Consultant Report to the Committee on Motor Vehicle Emissions, National Research Council, EPA (September 1974).
- 4-78. "Emissions from a Pick-up Truck Retrofitted with a Nissan Diesel Engine," Report 74-1 RBM, EPA/OAWP, July 1973.
- 4-79. "Exhaust Emissions from Three Diesel-Powered Passenger Cars," Report 73-19 AW, EPA/OAWP, Mar. 1973.
- 4-80. Fact-Finding Visits by APSES Team members, General Motors Research Laboratories (1974).
- 4-81. Broering, L. C., and Holtman, L. W., "Effect of Diesel Fuel Properties on Emissions and Performance," SAE Paper 740692, Sept. 1974.
- 4-82. Springer, K. J., "Smoke," Heavy Duty Equipment Maintenance, Jan./Feb. 1973.
- 4-83. Metz, N. and Muller, W., "Russreduzierung bei Dieselmotoren durch Abgasnachbehandlung," Daimler-Benz A. G., Stuttgart-Unterturkheim, 1974.
- 4-84. Springer, K. J., "Control of Visible Emissions," Presentation to 3rd Annual North American Motor Vehicle Emission Control Conference, San Antonio, Texas, Sept. 1974.
- 4-85. Springer, K. J., and Ashby, H. A., "The Low Emission Car for 1975 - Enter the Diesel;" Paper No. 739133, 8th Annual Intersociety Energy Conversion Engineering Conference, Philadelphia, Pa., Aug. 1973.
- 4-86. Springer, K. J., and Stahman, R. C., "Control of Diesel Exhaust Odors," Paper No. 26, Conference on Odors, N. Y. Academy of Sciences, New York, N. Y., Oct. 1973.
- 4-87. Barnes, G. J., "Relation of Lean Combustion Limits in Diesel Engines to Exhaust Odor Intensity," SAE Paper 680445, 1968.
- 4-88. Dietzmann, H. E., Springer, K. J., and Stahman, R. C., "Diesel Emissions As Predictors of Observed Diesel Odor," SAE Paper 720757, Sept. 1972.
- 4-89. Kendall, D. A., Levins, P. L., and Leonardos, G., "Diesel Exhaust Odor Analysis by Sensory Techniques," SAE Paper 740215, Feb. 1974.
- 4-90. Levins, P. L., et al., "Chemical Analysis of Diesel Exhaust Odor Species," SAE Paper 740216, Feb. 1974.
- 4-91. Hellman, T. M., and Small, F. H., "Characterization of the Odor Properties of 101 Petrochemicals Using Sensory Methods," J. Air Pollution Control Assoc. V. 24, No. 10, Oct. 1974.
- 4-92. Turk, A., "Selection and Training of Judges for Sensory Evaluation of the Intensity and Character of Diesel Odors," PHS Publication No. 999-AP-32, U. S. Dept. of HEW, 1967.
- 4-93. Natusch, D. F. S., and Wallace, J. R., "Urban Aerosol Toxicity: The Influence of Particle Size," Science, Vol. 186, No. 4165, Nov. 1974.
- 4-94. Report TAEB 75-21: "Summary Report on the Evaluation of Light Duty Diesel Vehicles," EPA, Ann Arbor, Mar. 1975.
- 4-95. Eisle, E., Hiereth, H., and Poltz, H., "Investigation Into Use of the Comprex Supercharger System on a High-Speed Diesel Car Engine," Daimler-Benz AKG.
- 4-96. Private communication, J. F. Stocky, Jet Propulsion Laboratory, Pasadena, Calif., Jan. 1975.
- 4-97. Houseman, J., Molinari, L. F., and Dowdy, M. W., "Lean Combustion of Hydrogen/Gasoline Mixtures," Presented at Symposium on Chemistry of Combustion in Engines, American Chemical Society, April 6-11, 1975.

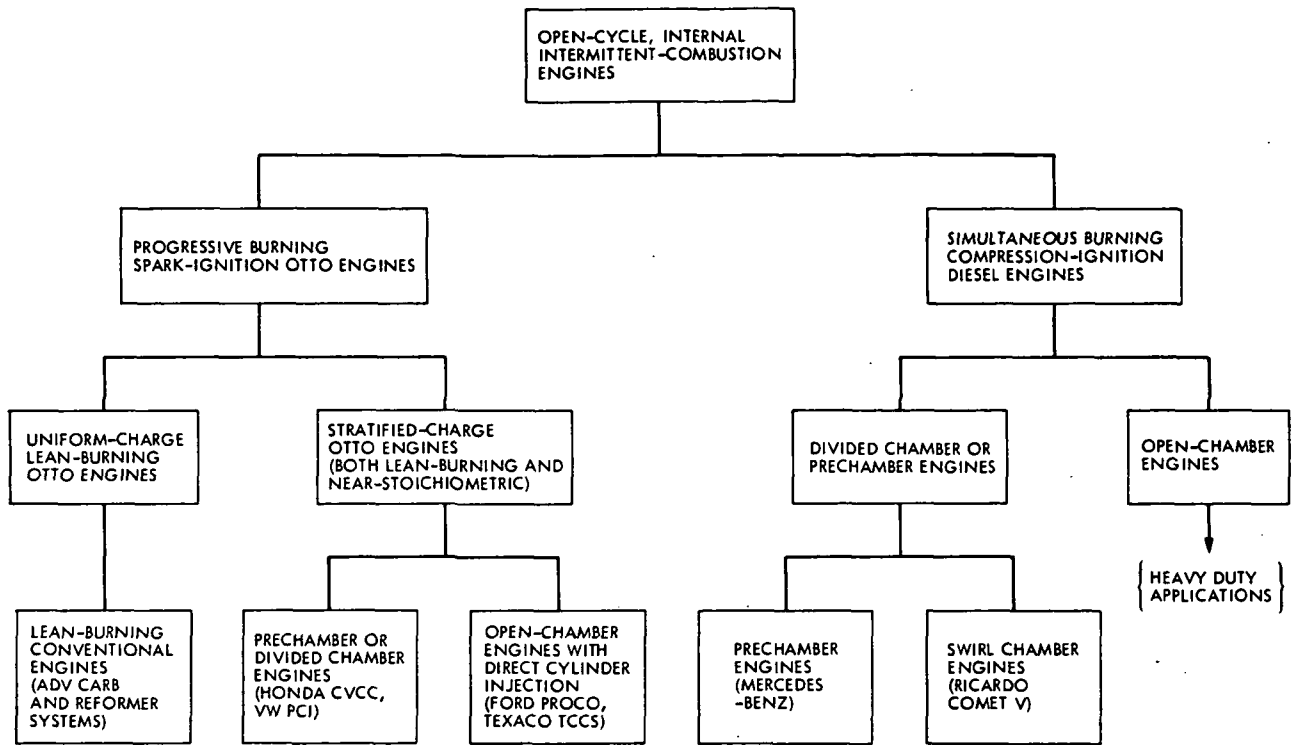

Fig. 4-1. Simplified morphology of lean-burning and stratified-charge Otto engines and Diesel engines

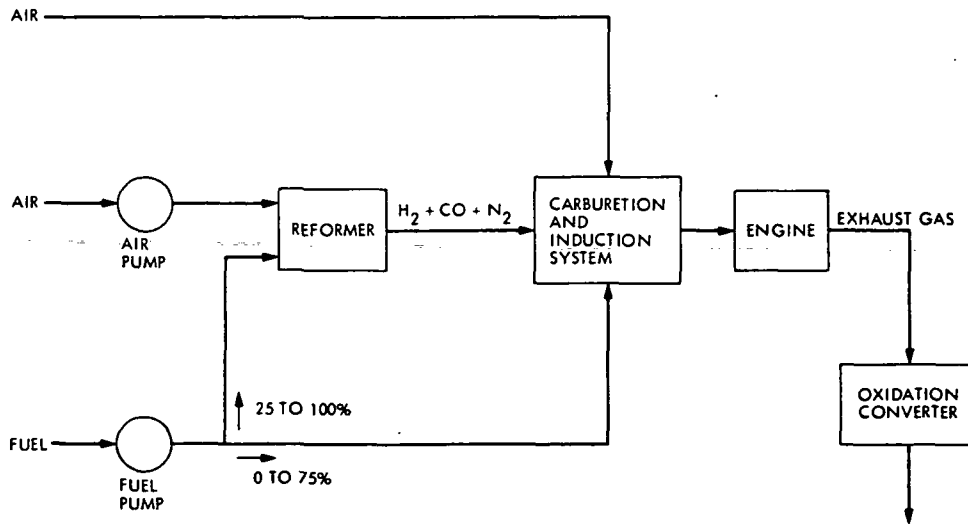

Fig. 4-2. Schematic illustration of reformer/lean-burning Otto engine system

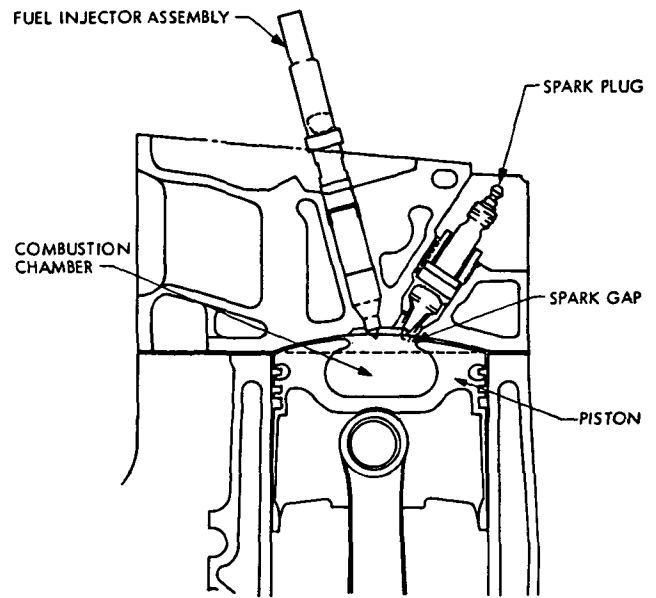
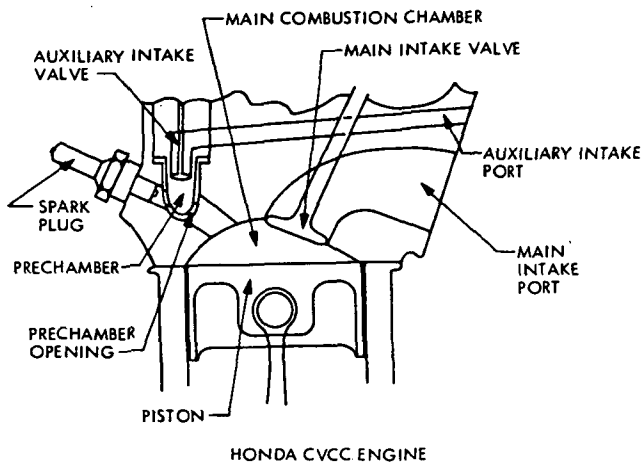

Fig. 4-4. PROCO stratified-charge engine combustion chamber configuration

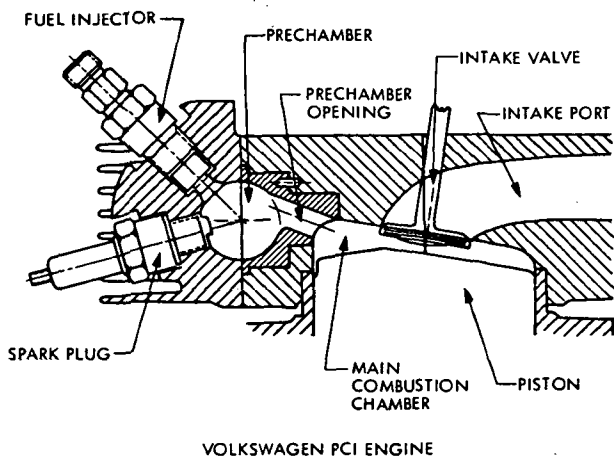

Fig. 4-3. Prechamber stratified-charge engine combustion chamber configurations

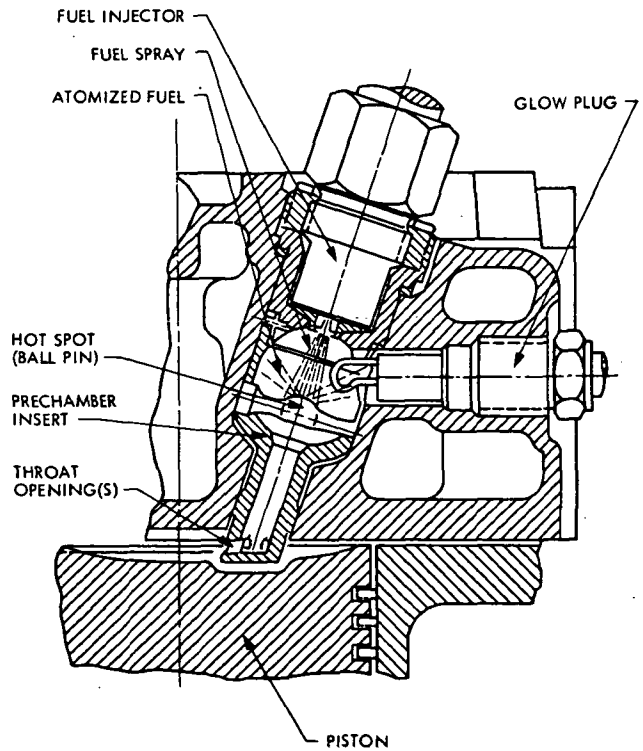

Fig. 4-5. Divided-chamber Diesel engine (Mercedes prechamber type)

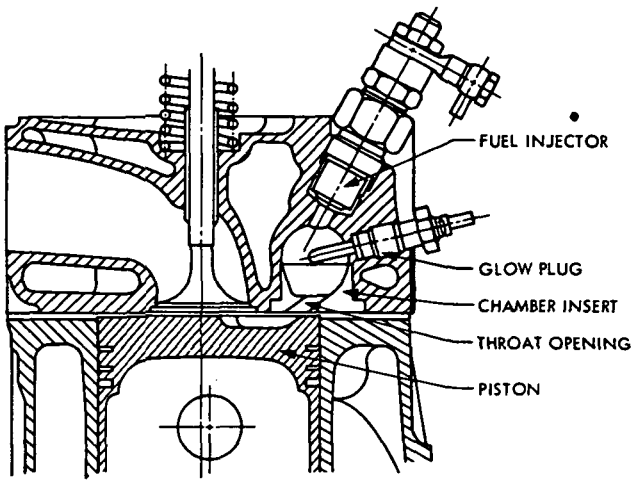

Fig. 4-6. Divided-chamber Diesel engine (Ricardo "comet" swirl-chamber type)

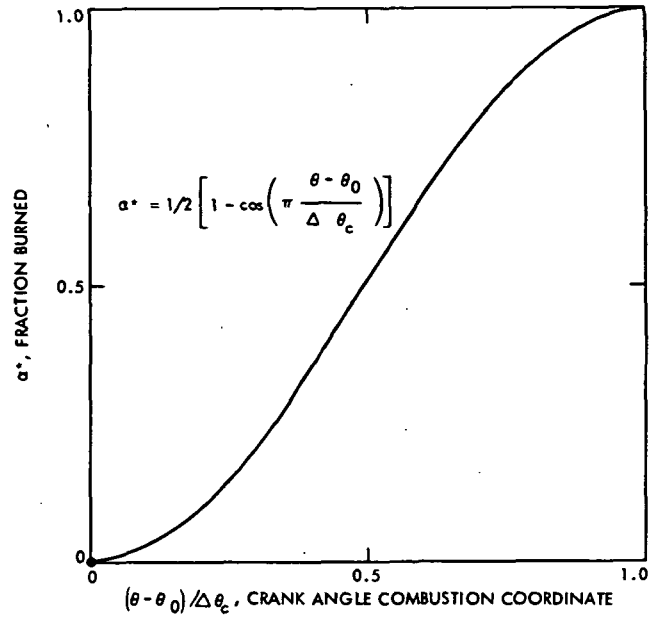

Fig. 4-7. Progressive burning of the fuel/air charge (from Ref. 4-18)

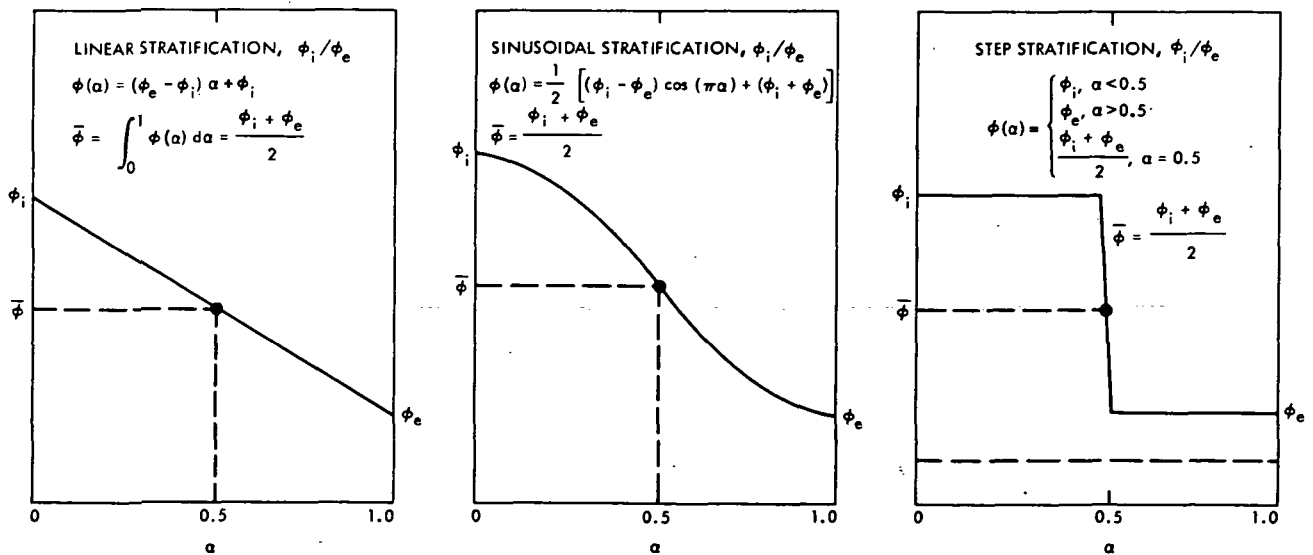

Fig. 4-8. Stratification functions (from Ref. 4-20)

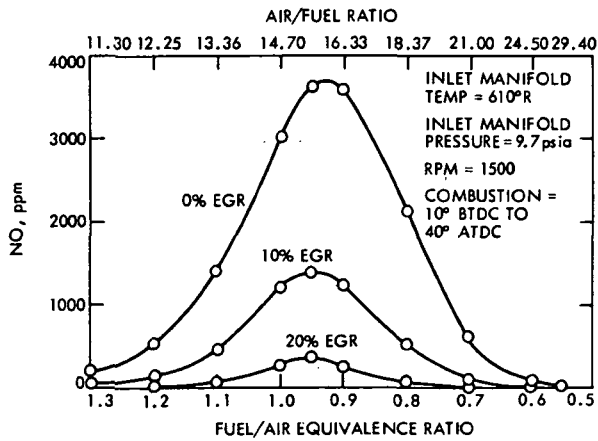

Fig. 4-9. NO concentration as affected by % EGR and fuel/air equivalence ratio (from Ref. 4-18)

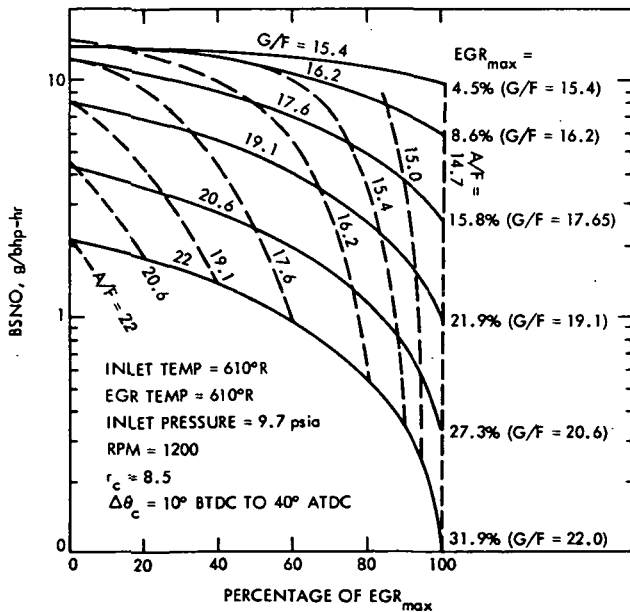

Fig. 4-10. NO concentration as affected by % EGR and air/fuel ratio (A/F) at constant ratios of total diluent to fuel (G/F) (from Ref. 4-18)

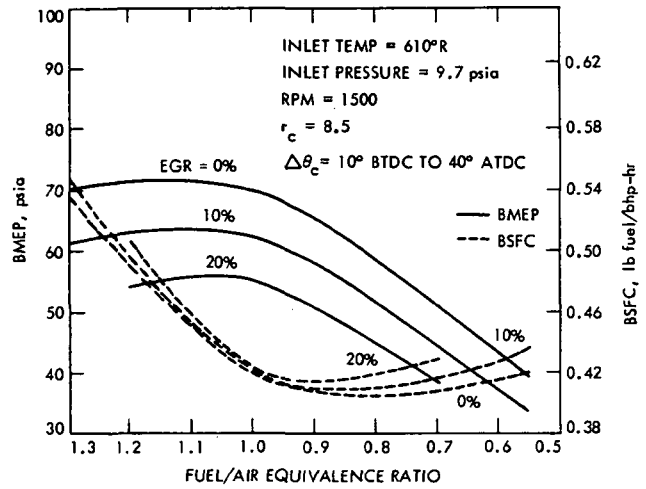

Fig. 4-11. BMEP and BSFC as affected by fuel/air equivalence ratio  $\phi$  and % EGR;  $\phi = 1.0$  corresponds to A/F = 14.7 (from Ref. 4-18)

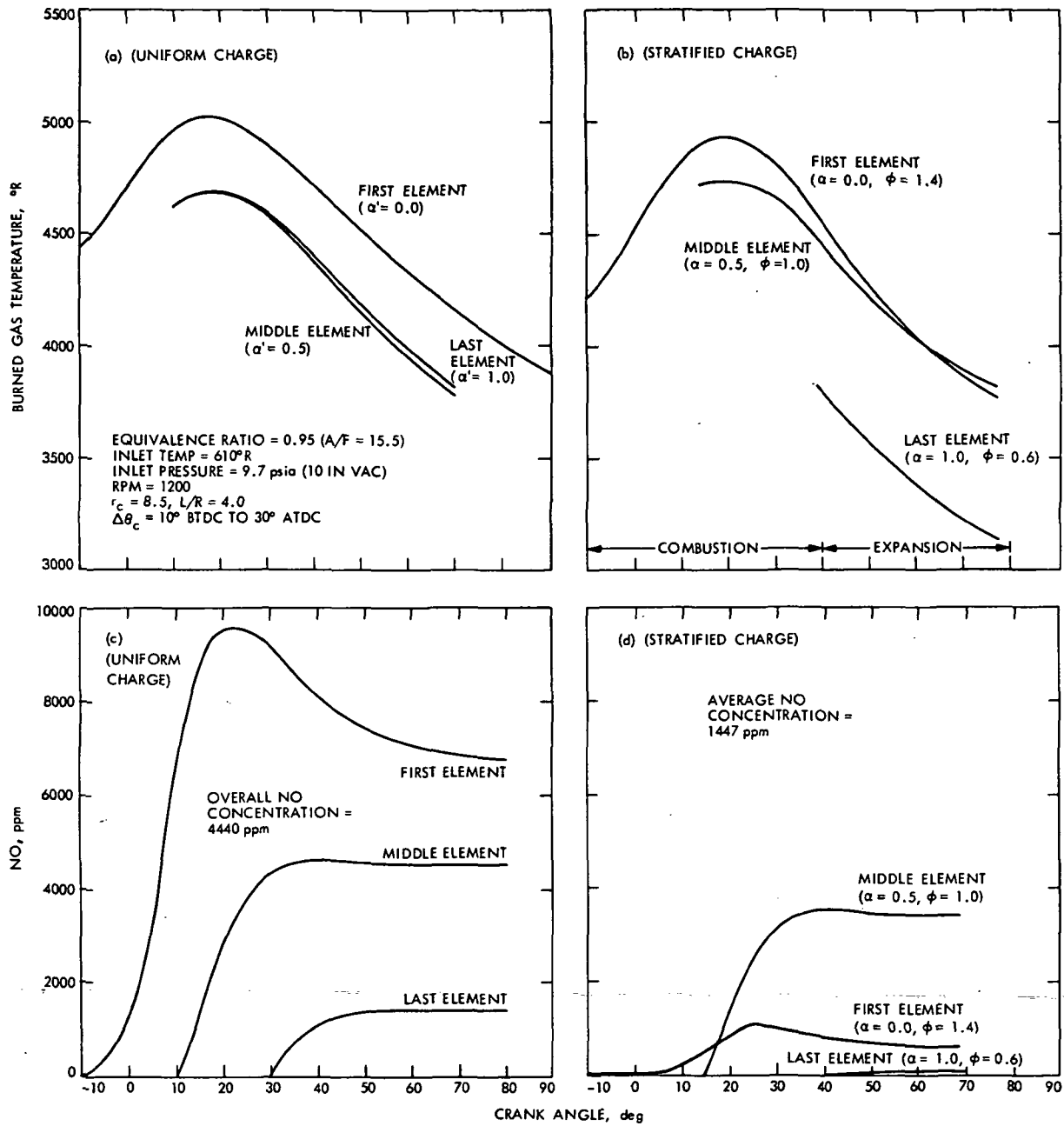

Fig. 4-12. Comparison of temperature and NO profiles for uniform-charge and linearly stratified-charge Otto engines with similar operating and design parameters (from Refs. 4-18 and 4-20): (a) Temperature profiles for uniform charge at  $\phi = 0.95$ . (b) Temperature profiles for linearly stratified charge of width = 1.4/0 and  $\phi = 1.0$ . (c) NO profiles for uniform charge as above. (d) NO profiles for linearly stratified charge as above.

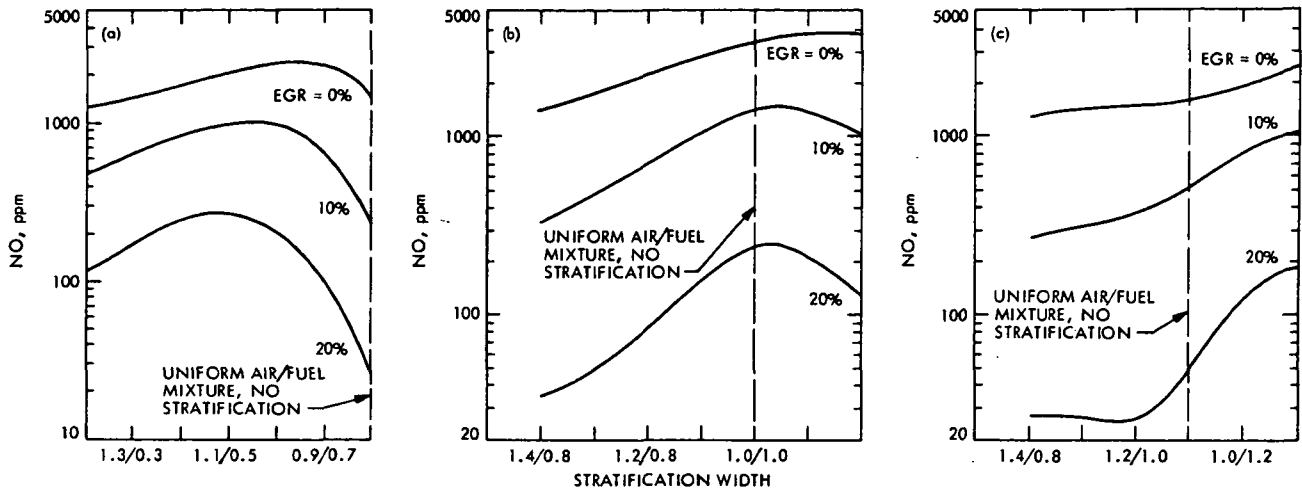

Fig. 4-13. Effect of linear stratification on total NO production at three EGR rates for three overall equivalence ratios (from Ref. 4-20). Engine parameters: EGR temperature =  $610^{\circ}\text{R}$ , intake manifold temperature =  $610^{\circ}\text{R}$ , intake manifold pressure = 9.7 psia, RPM = 1500,  $r_c = 8.5$ ,  $L/R = 4.0$ ,  $\Delta\theta_c = 10^{\circ}\text{ BTDC to } 40^{\circ}\text{ ATDC}$ . (a) Effect of linear stratification on NO production for  $\phi = 0.8$ ,  $\bar{A}/\bar{F} = 18.4$ . (b) Effect of linear stratification on NO production for  $\phi = 1.0$ ,  $\bar{A}/\bar{F} = 14.7$ . (c) Effect of linear stratification on NO production for  $\phi = 1.1$ ,  $\bar{A}/\bar{F} = 13.4$

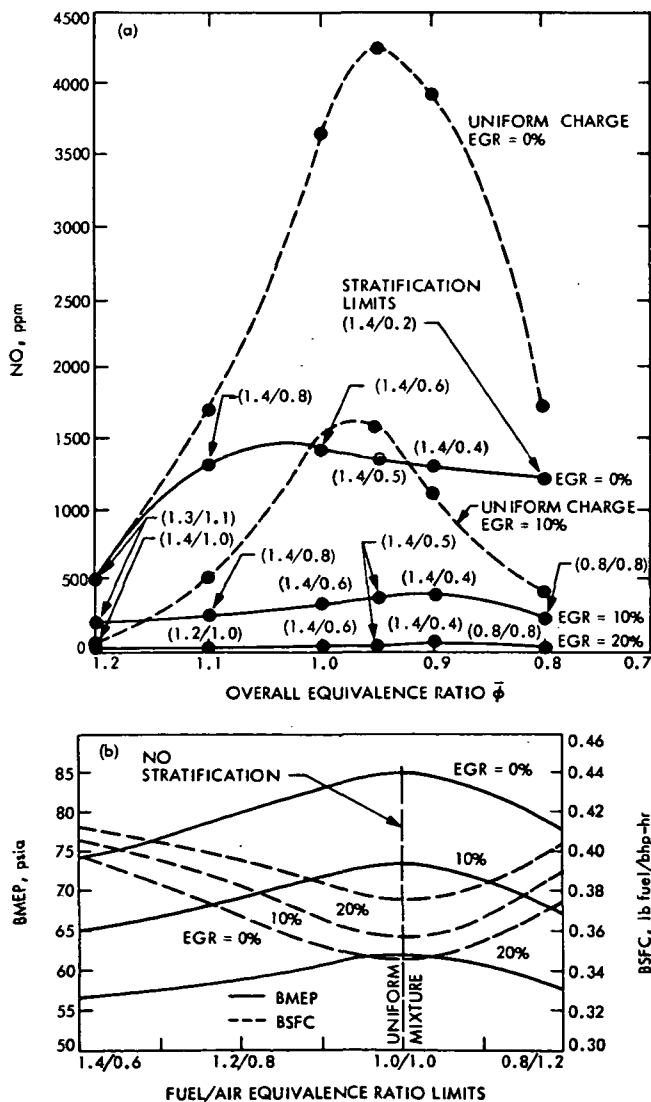

Fig. 4-14. Effects of linear charge stratification: (a) NO production with linear stratification as dependent on overall equivalence ratio at three EGR rates. (b) Effect of linear stratification on engine performance with  $\phi = 1$  (engine parameters as in Fig. 4-12)



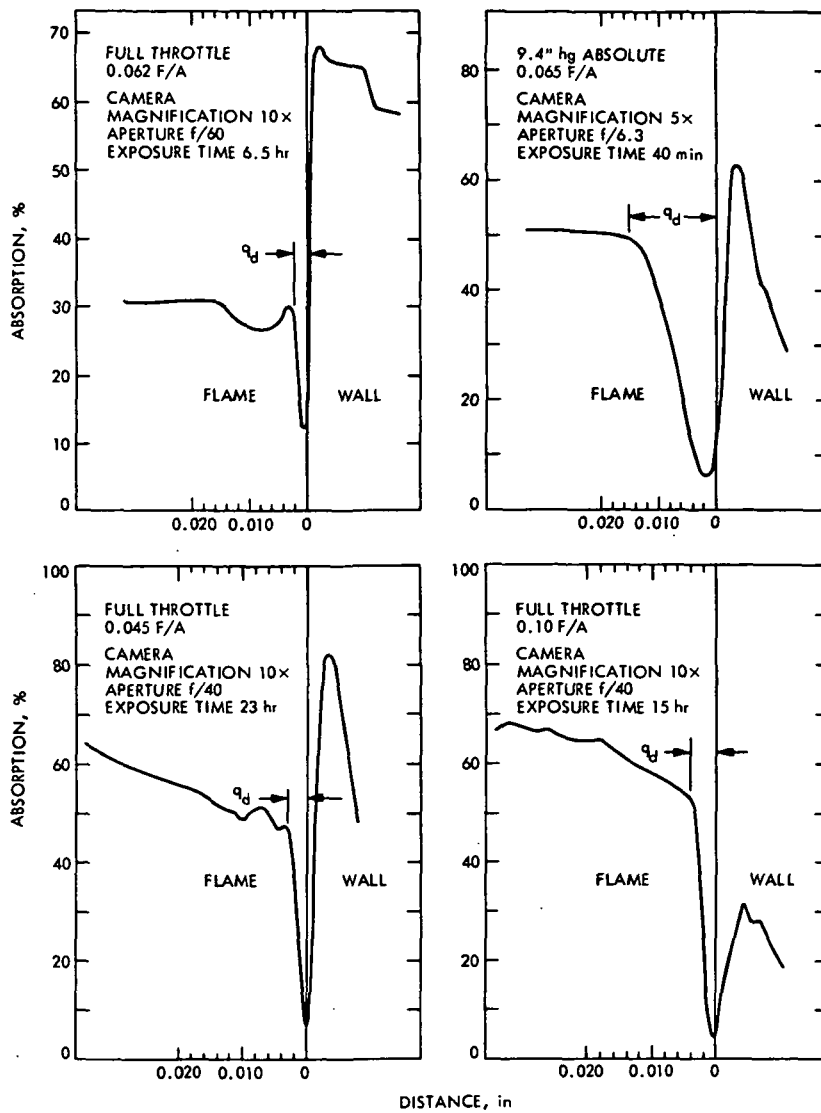

Fig. 4-15. Densitometer traces of the negatives of photographs of the quench zone near the cylinder wall (from Ref. 4-29)

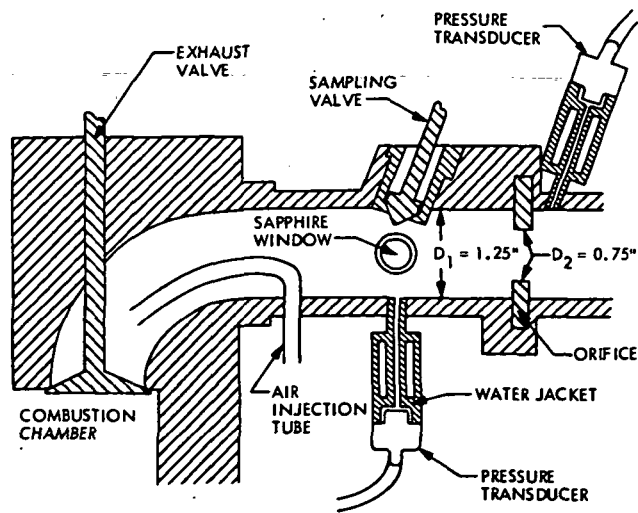

Fig. 4-16. Schematic of test section used by Tabaczynski et al. (from Ref. 4-28)

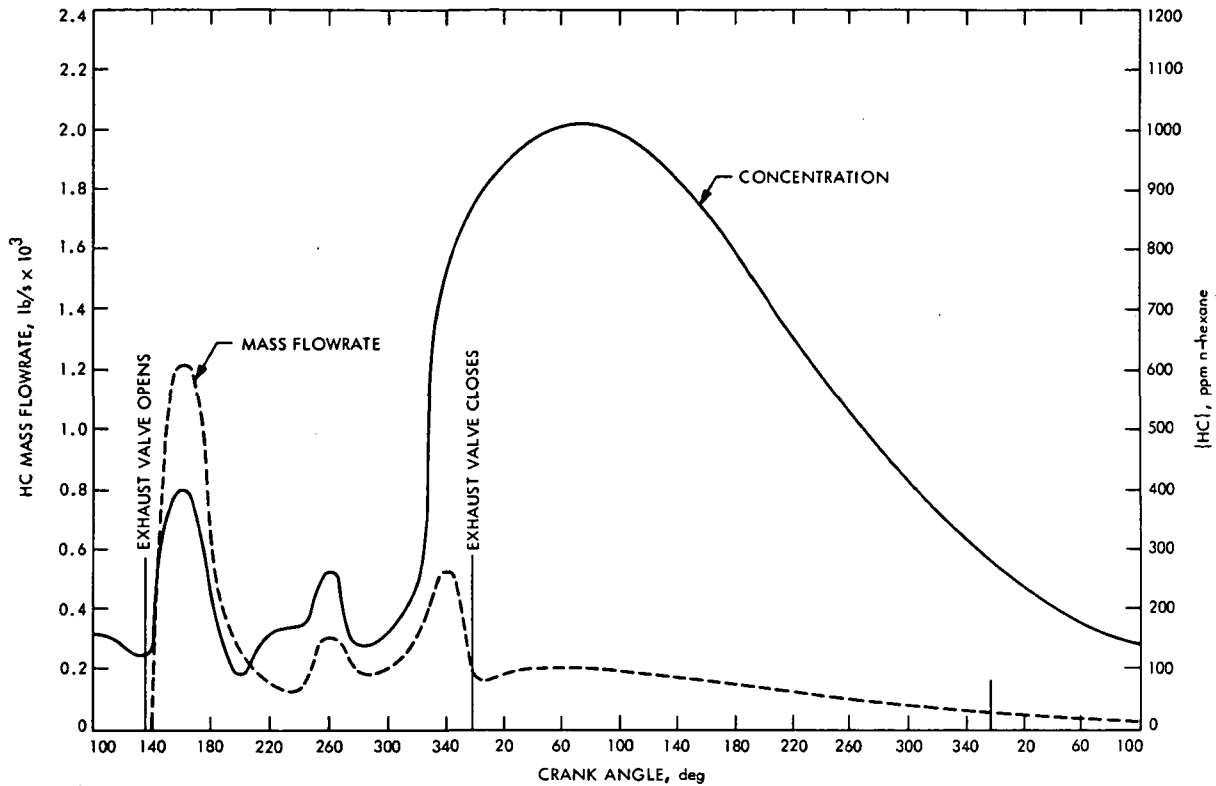

Fig. 4-17. Variation of hydrocarbon concentration and hydrocarbon mass flowrate with crank angle; measured at the sampling station for an air purge rate of 140 liters/min, an equivalence ratio of  $\phi = 1.2$ , and an engine speed of 1200 rpm (from Ref. 4-28)

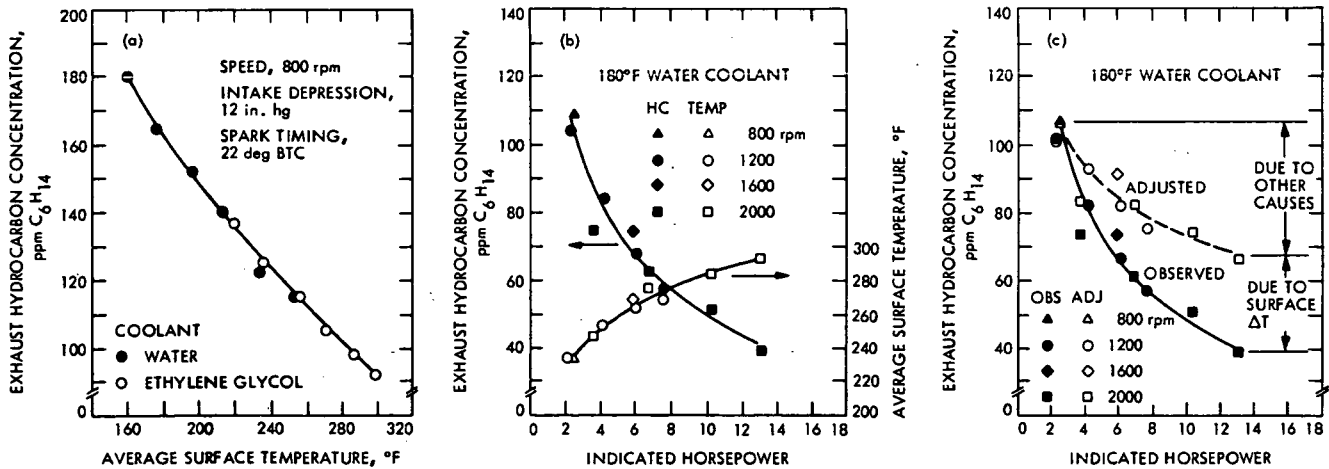

Fig. 4-18. Exhaust hydrocarbon concentration as affected by surface temperature and indicated power: (a) Effect of average surface temperature on exhaust hydrocarbon concentration-varying coolant temperature. (b) Exhaust hydrocarbon concentration and average surface temperature variation with indicated power. (c) Hydrocarbon concentrations adjusted to a constant average surface temperature of 234°F (from Ref. 4-43)

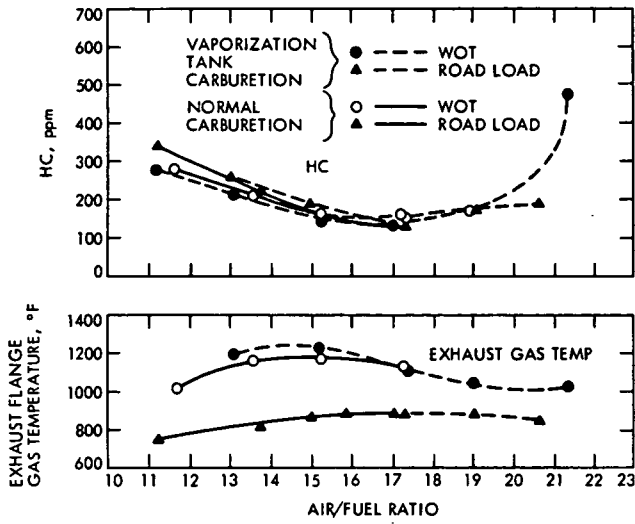

Fig. 4-19. Effect of air-fuel ratio on exhaust HC emissions and exhaust gas temperature: premixing, prevaporizing, tank-carburetion vs normal carburetion; 1200 rpm (from Ref. 4-33)

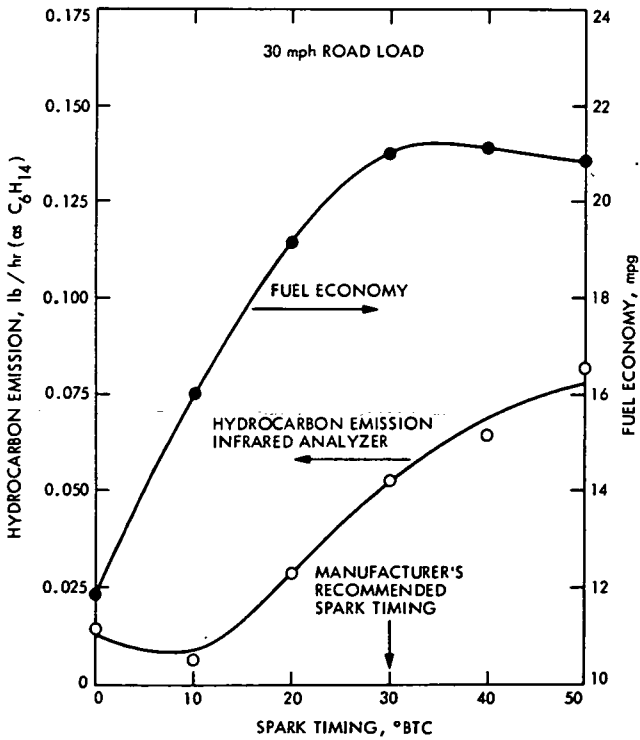

Fig. 4-20. Effect of spark timing on HC emission of a typical automobile engine (from Ref. 4-40)

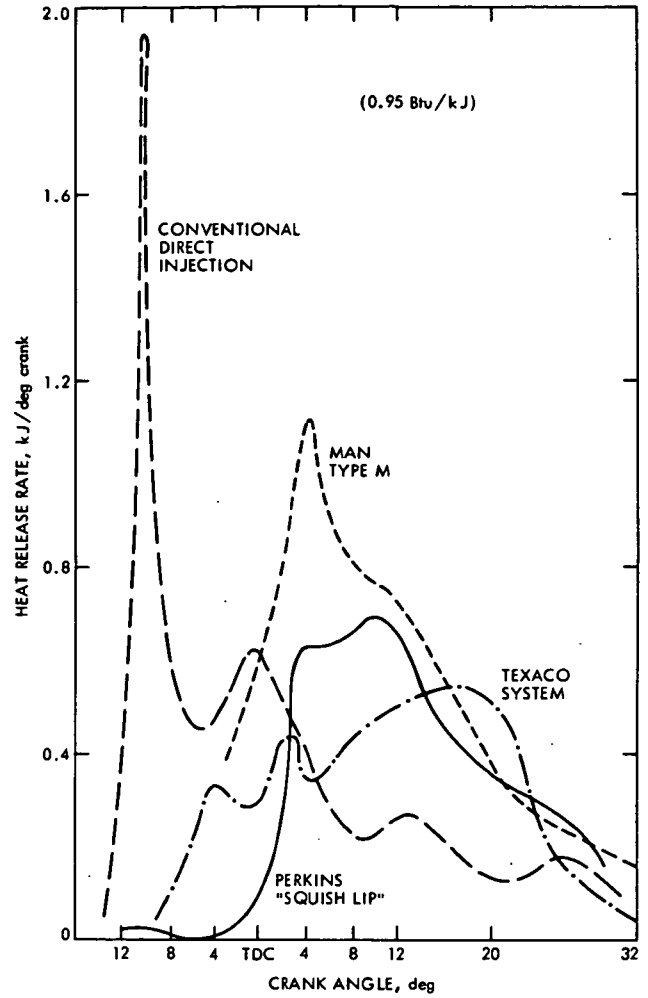

Fig. 4-21. Heat release rates for different open-chamber Diesel combustion systems (from Ref. 4-59)

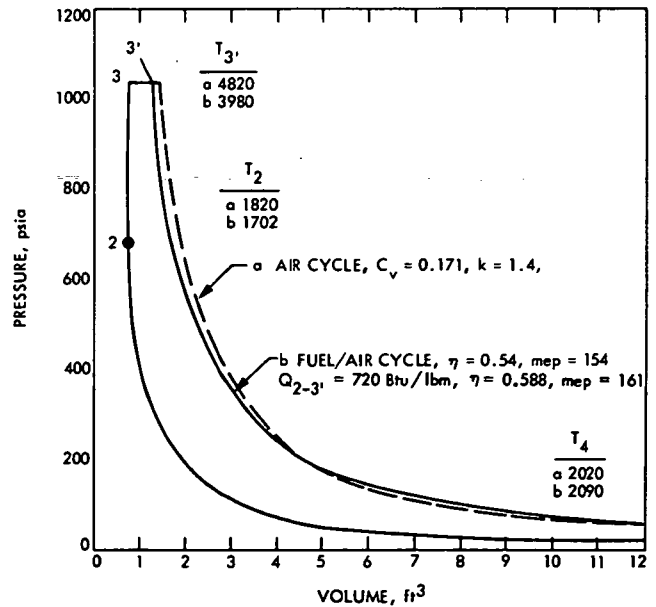

Fig. 4-22. Limited-pressure fuel/air cycle;  $r_c = 16$ ,  $\phi = 0.6$ ,  $p_1 = 14.7$ ,  $T_1 = 600$ ,  $p_3/p_1 = 70$ ; temperatures are in degrees Rankine (from Ref. 4-17)

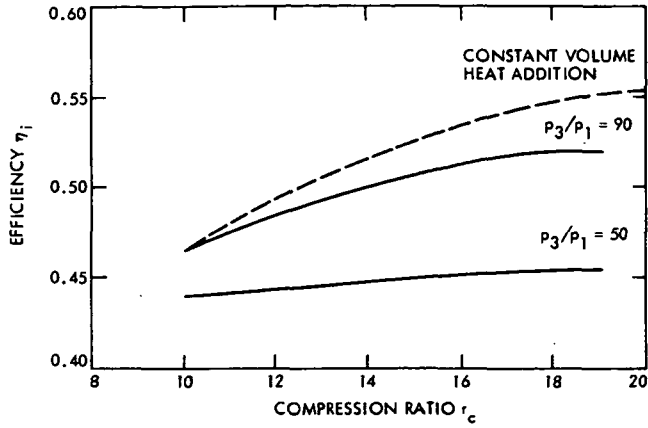

Fig. 4-23. Efficiency of limited-pressure, ideal fuel/air cycles with  $\phi = 0.9$  and ambient temperature = 520°R

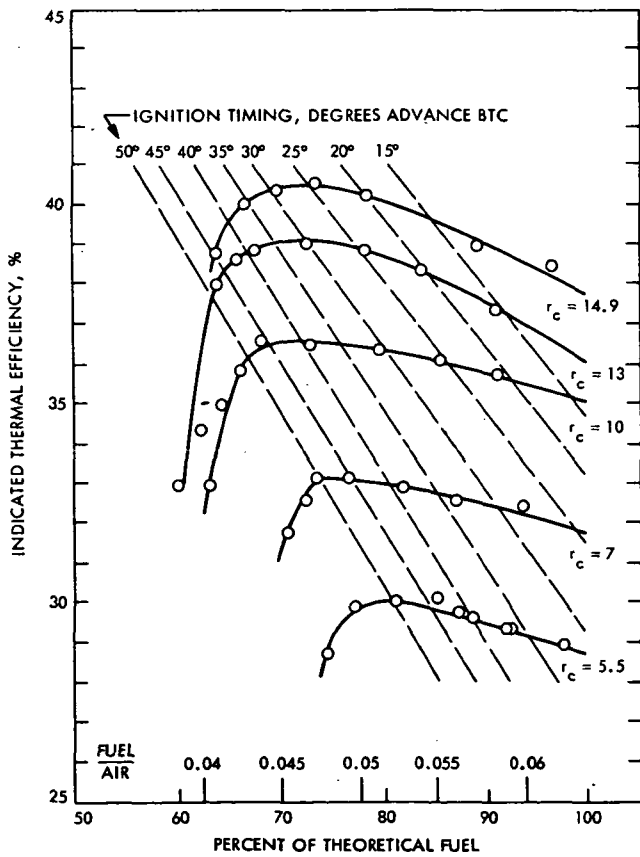

Fig. 4-24. Indicated thermal efficiency of a CFR engine as affected by compression ratio and fuel-air equivalence ratio while maintaining MBT spark timing (from Ref. 4-34)

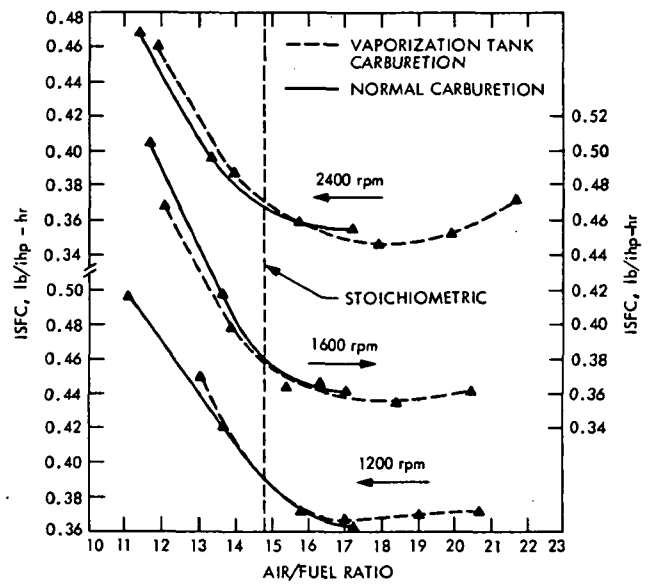

Fig. 4-25. Indicated specific fuel consumption of an automobile engine at road load as a function of  $\bar{\phi}$  (from Ref. 4-33)

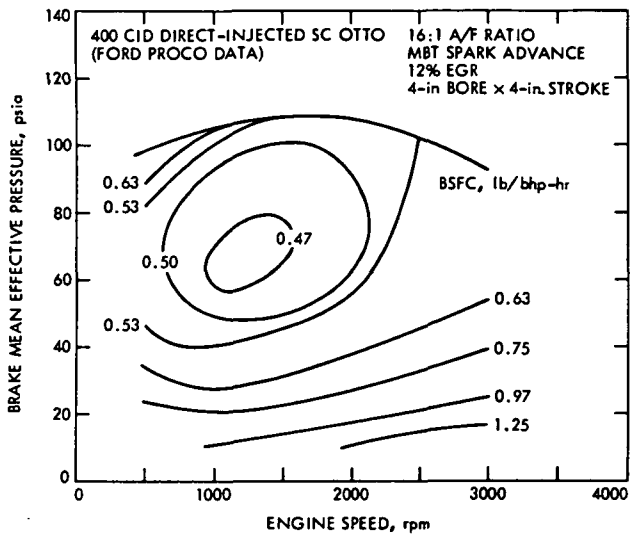

Fig. 4-26. Fuel consumption map for the Mature SC Otto engine - the maximum BMEP curve is not for the Mature engine (from Ref. 4-66)

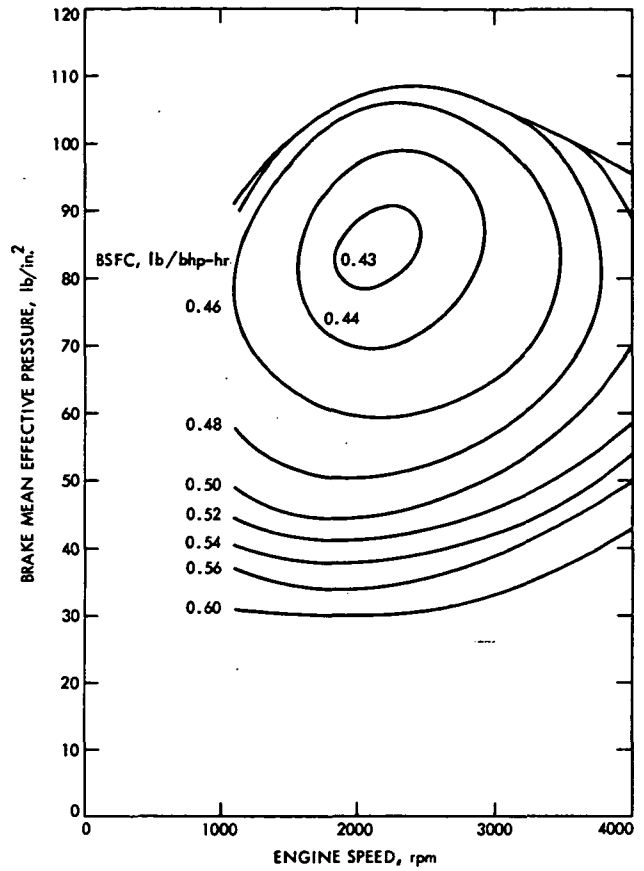

Fig. 4-27. Fuel consumption map for the Mature Diesel engine - the maximum BMEP curve is not for the turbocharged engine (from Ref. 4-69)

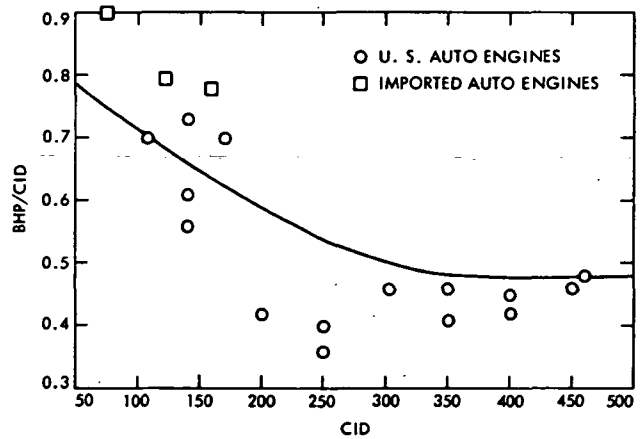

Fig. 4-28. BHP/CID for various U.S. and imported automobile engines - the solid line represents the Mature SC Otto engine

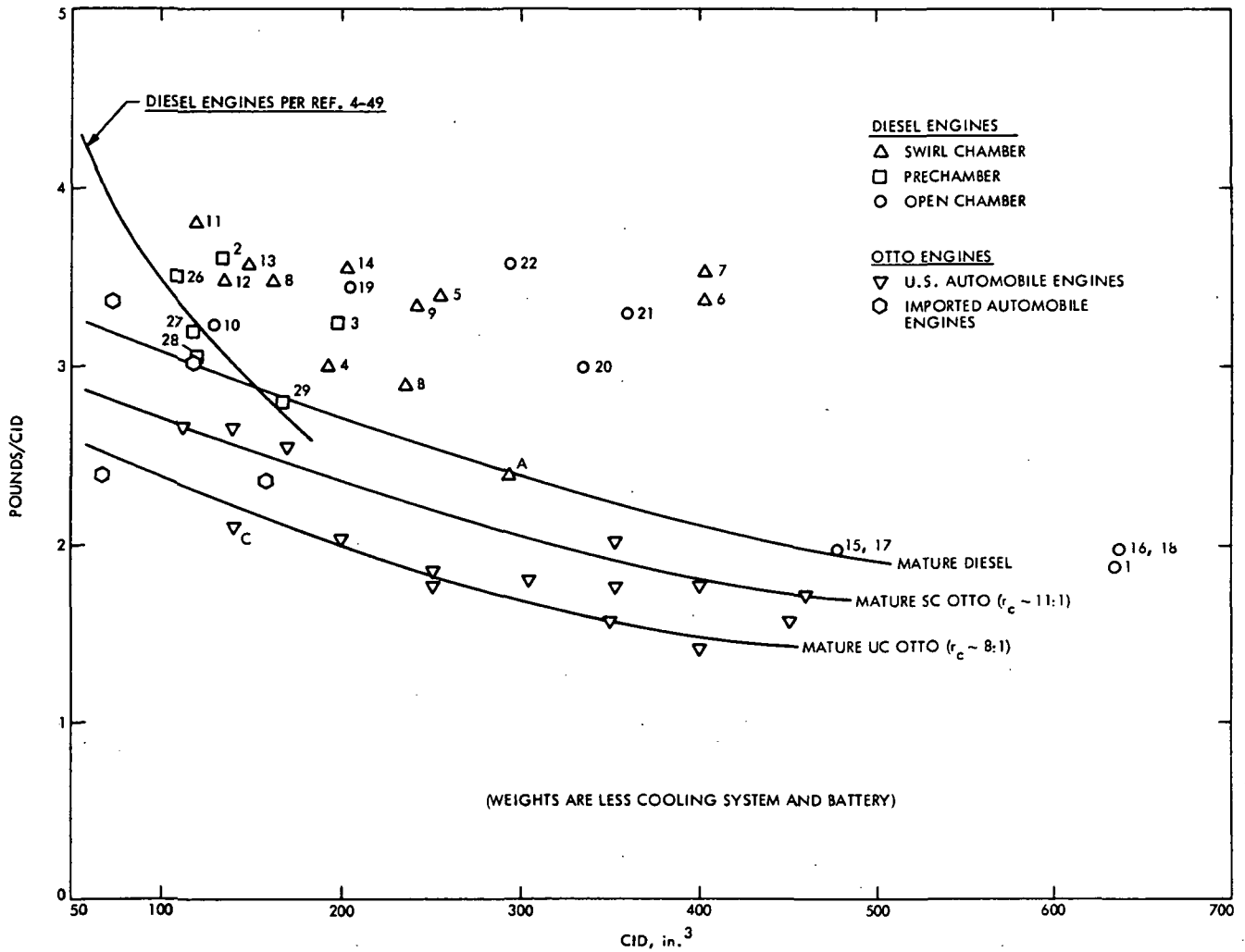

Fig. 4-29. LBS/CID vs CID for various Diesel and Otto engines (see Table 4-4 for manufacturer and model identification number)

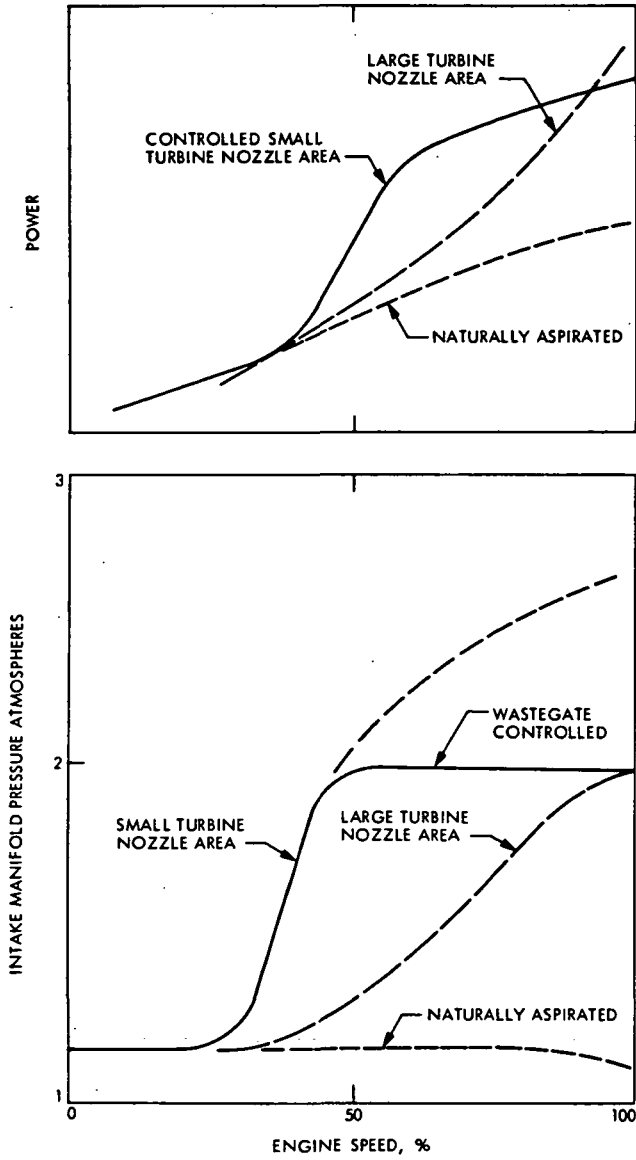

Fig. 4-30. Illustrations of turbocharged Diesel power-speed curves and manifold pressure-speed curves (from Ref. 4-70)

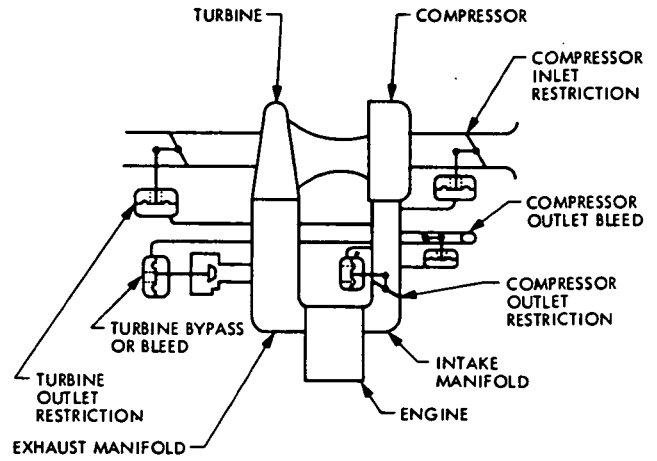

Fig. 4-31. Different methods of boost control (from Ref. 4-70)

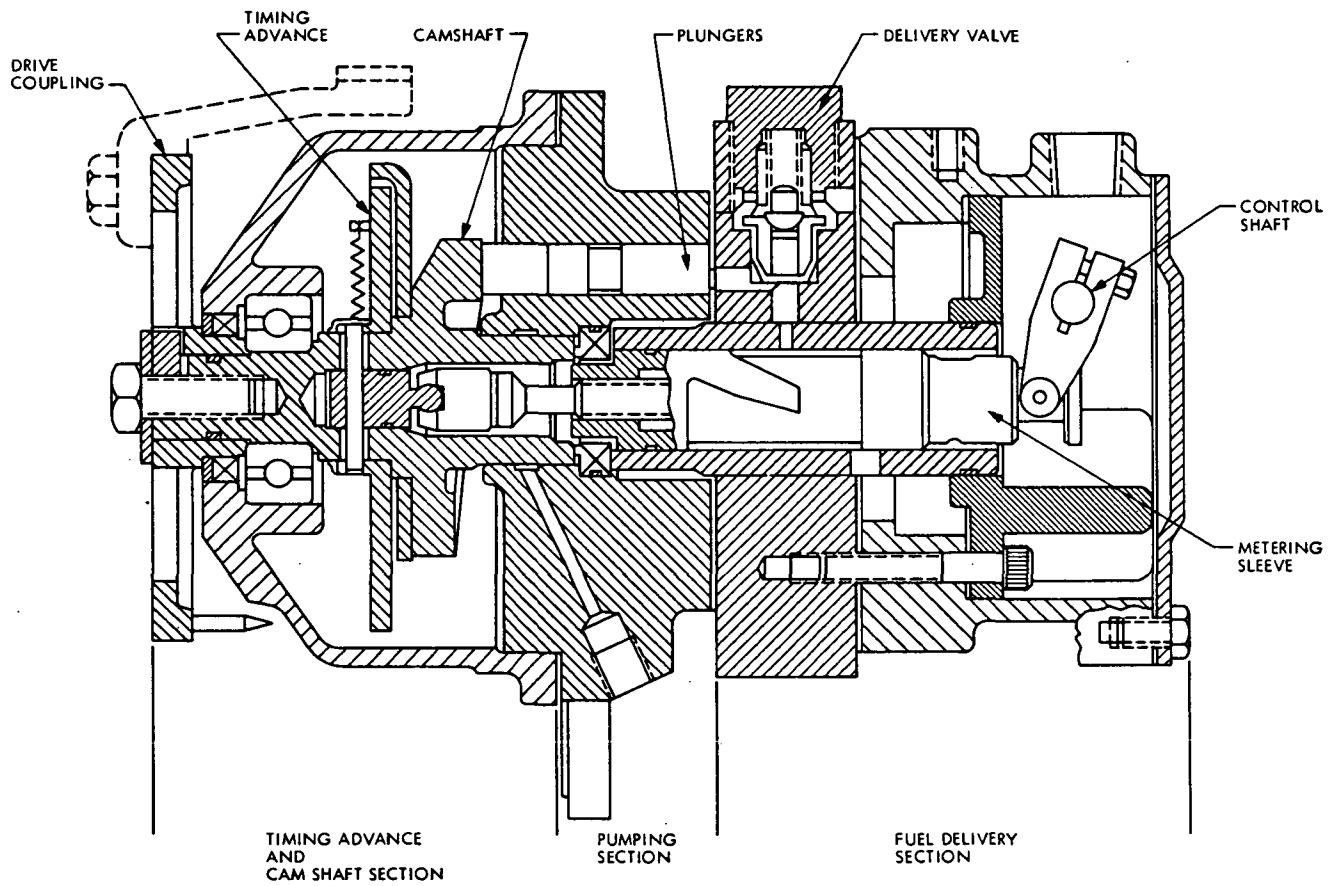

Fig. 4-32. PROCO injection pump



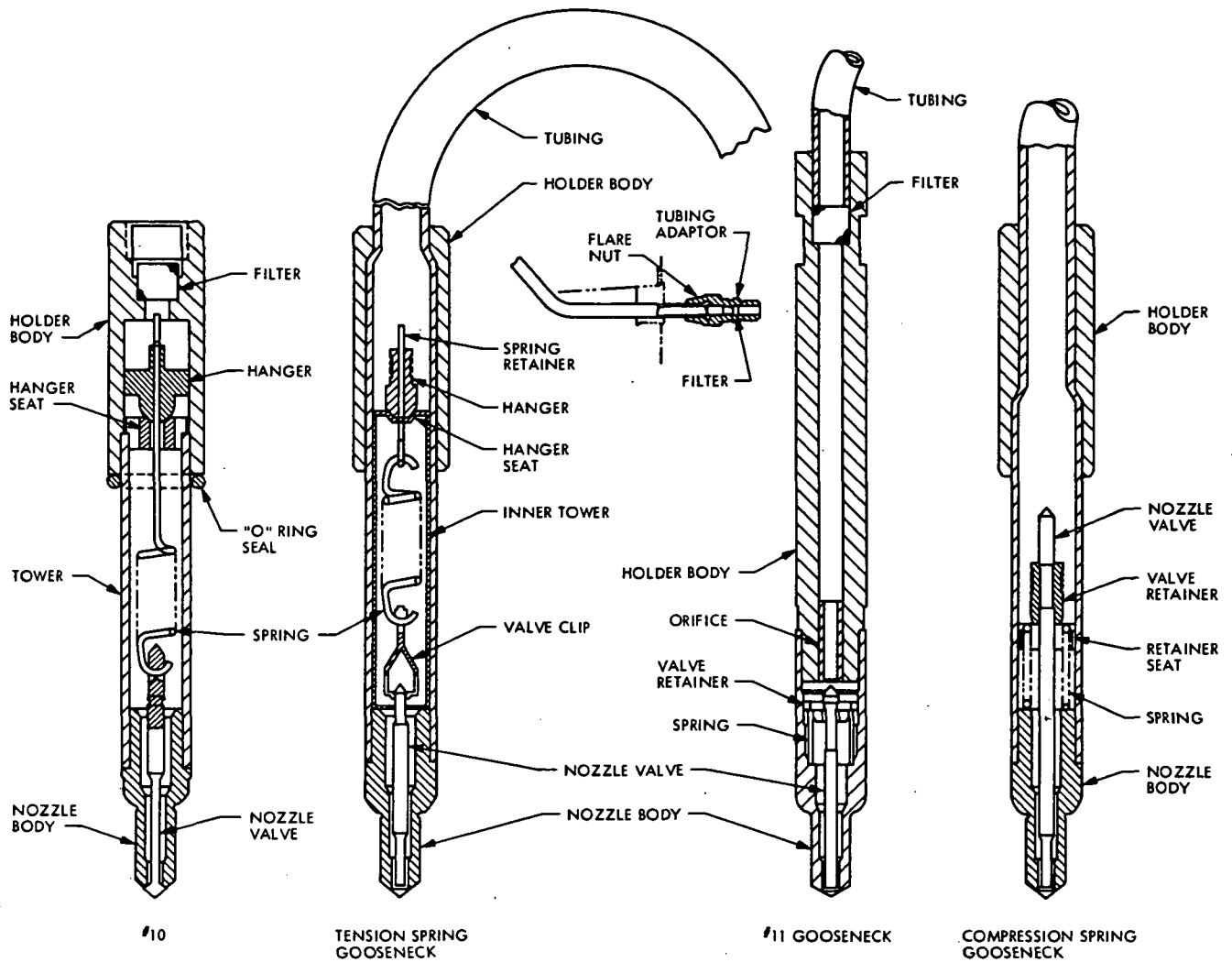

Fig. 4-33. Low-cost gasoline injectors for the direct-injected SC Otto engine

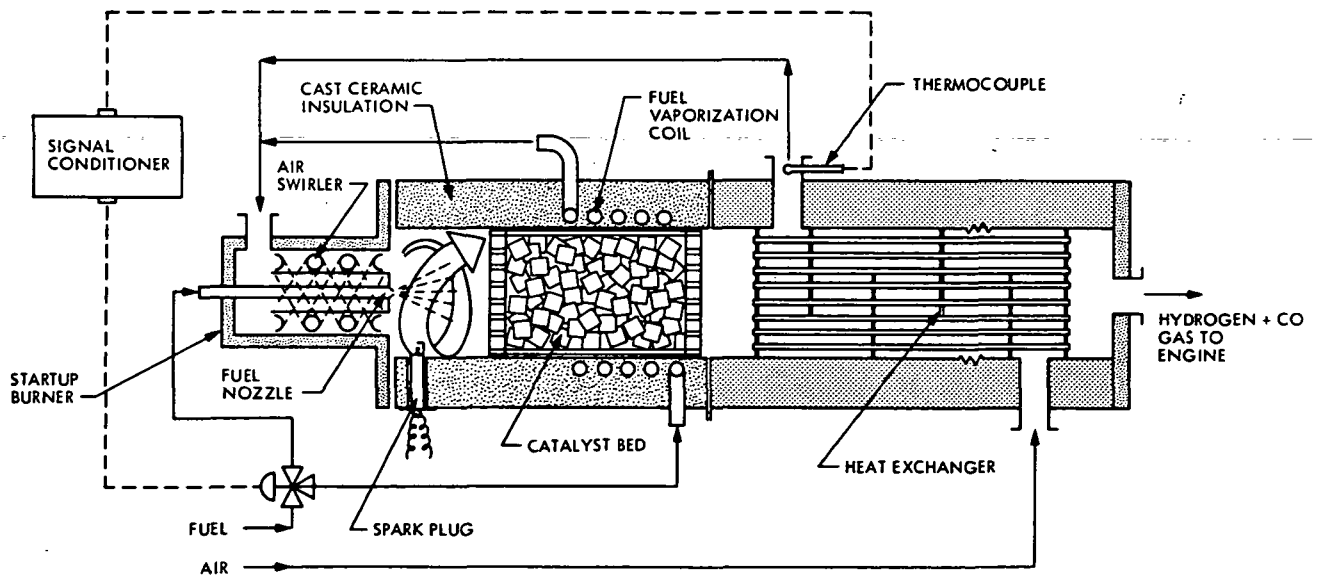

Fig. 4-34. Catalytic hydrogen generator

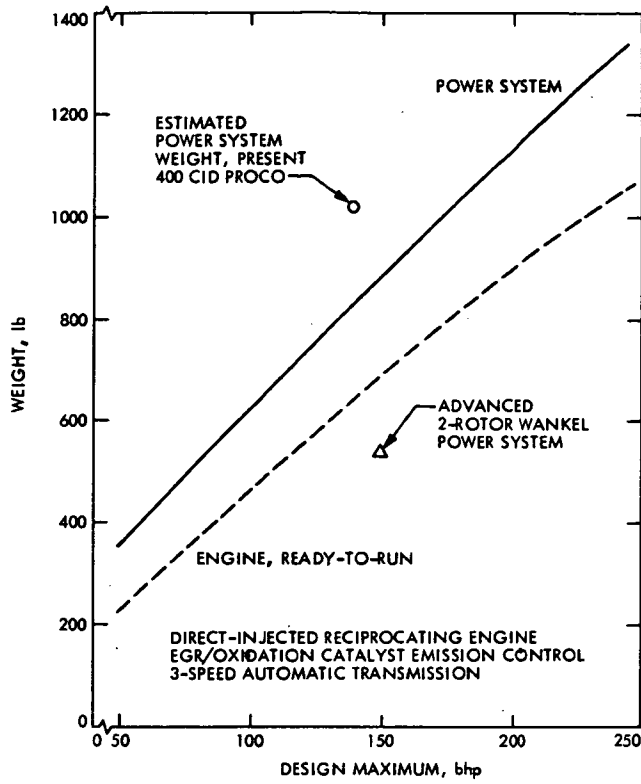

Fig. 4-35. Stratified-charge Otto engine weights (Mature configuration)

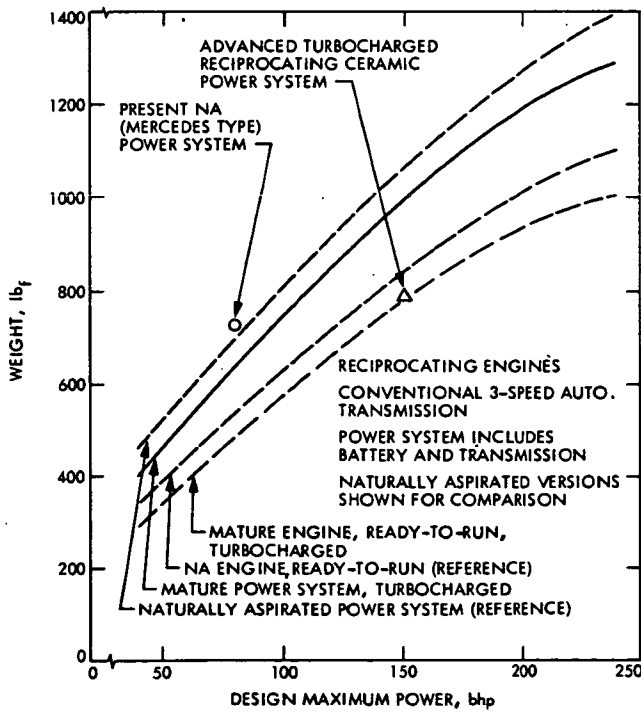

Fig. 4-36. Diesel engine weights (Mature configuration, except as noted)

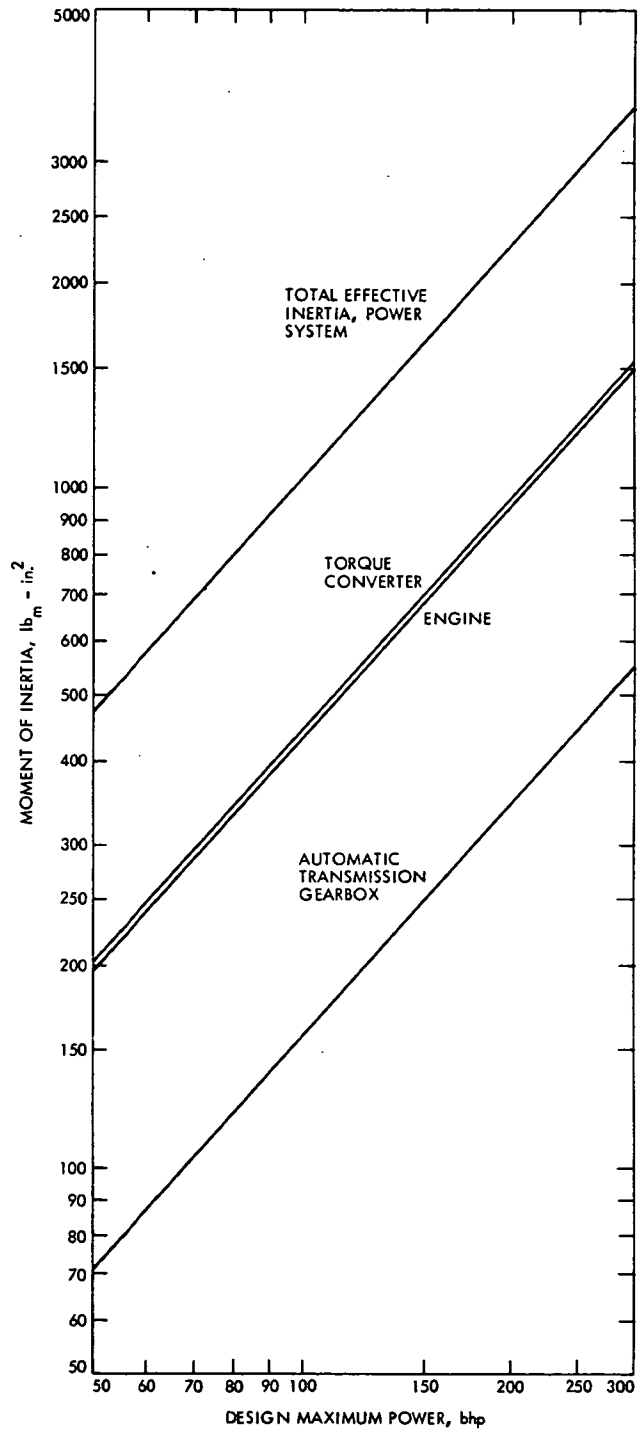

Fig. 4-37. Diesel engine moments of inertia

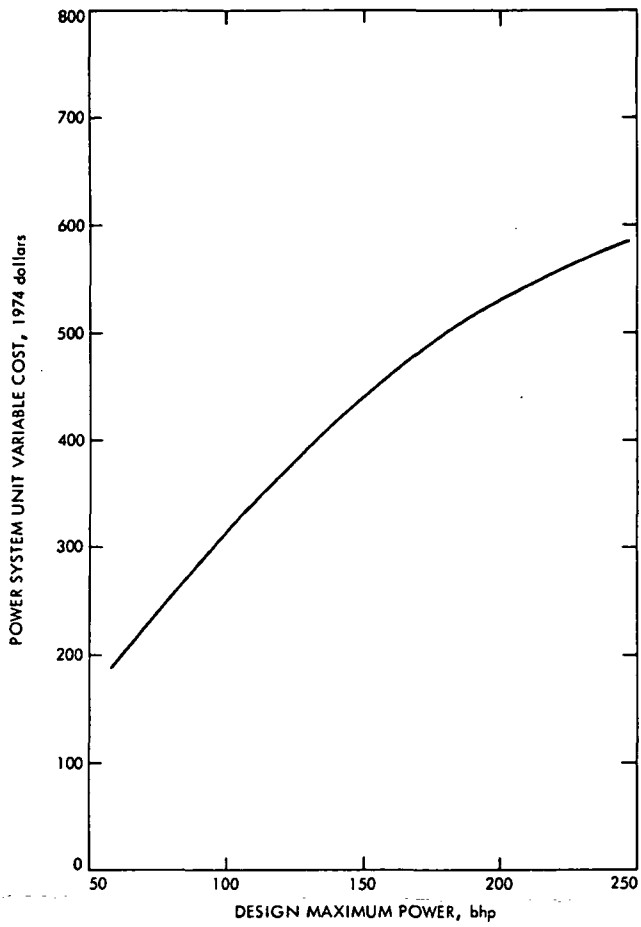

Fig. 4-38. Mature SC Otto power system variable cost (direct-injected)

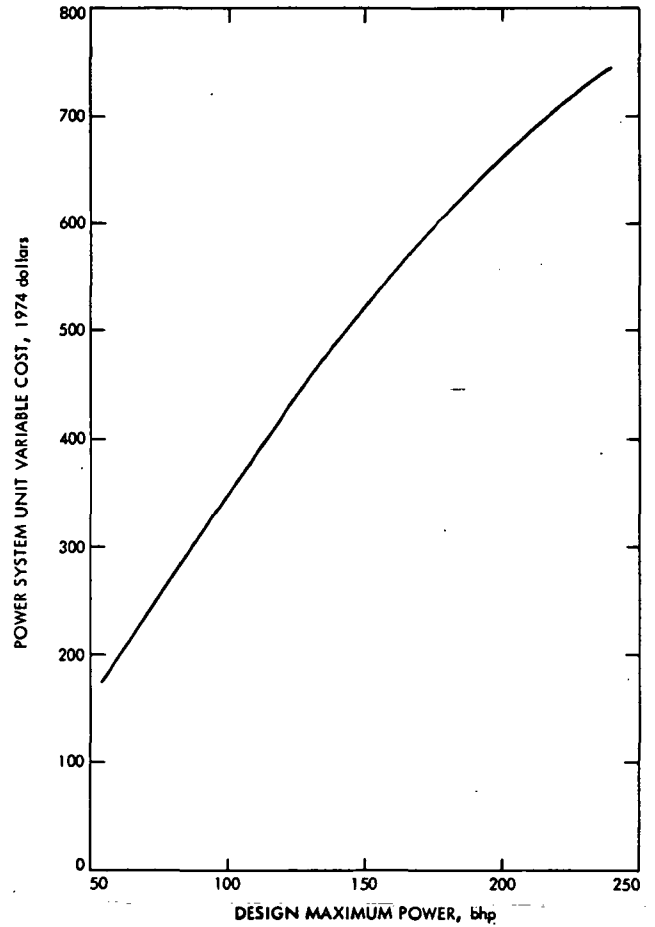

Fig. 4-39. Mature Diesel power system variable cost (turbocharged)

CHAPTER 5. THE BRAYTON AUTOMOTIVE POWER SYSTEM  
(GAS TURBINE ENGINE)

5.1	Description . . . . .	5-2
5.1.1	Introduction . . . . .	5-2
5.1.2	Morphology . . . . .	5-2
5.2	Characteristics . . . . .	5-3
5.2.1	Thermodynamics . . . . .	5-3
5.2.2	Performance . . . . .	5-7
5.2.3	Fuel Requirements . . . . .	5-7
5.2.4	Pollutant Formation . . . . .	5-8
5.3	Major Subassemblies/Components . . . . .	5-9
5.3.1	Component Descriptions . . . . .	5-9
5.3.2	Configurational Evolution . . . . .	5-13
5.3.3	Materials and Producibility . . . . .	5-15
5.3.4	Unit Costs . . . . .	5-24
5.4	Vehicle Integration . . . . .	5-24
5.4.1	Engine Packaging in Vehicle . . . . .	5-24
5.4.2	Transmission Requirements . . . . .	5-24
5.4.3	Other Vehicle Design Impacts . . . . .	5-25
5.5	Performance in Vehicle . . . . .	5-25
5.5.1	Fuel Economy . . . . .	5-25
5.5.2	Chemical Emissions . . . . .	5-26
5.5.3	Noise Emissions . . . . .	5-28
5.5.4	Drivability Aspects . . . . .	5-28
5.5.5	Safety . . . . .	5-28
5.6	Ownership Considerations . . . . .	5-28
5.6.1	Maintenance . . . . .	5-29
5.6.2	Incremental Cost of Ownership . . . . .	5-29
5.7	Research and Development Required . . . . .	5-29
5.7.1	Mature Configuration . . . . .	5-29
5.7.2	Advanced Configuration . . . . .	5-30
5.7.3	Production Availability . . . . .	5-31
	References . . . . .	5-31
	Figures . . . . .	5-34

## 5.1 DESCRIPTION

### 5.1.1 Introduction

George Brayton invented the heat-engine cycle which bears his name in 1873. The original Brayton engine was a reciprocating 2-cylinder engine, with compression of fuel/air mixture occurring in a smaller cylinder and expansion of combustion products in a much larger second cylinder. The cylinders were interconnected through a plenum and ignition/combustion took place as the compressed mixture left the plenum.

Today, the term "Brayton-cycle engine" is virtually synonymous with "gas turbine engine," the positive-displacement Brayton engine being all but forgotten. Since only the turbine type has been seriously pursued for vehicular application, we hereafter use simply the term "Brayton" in this report as a shorthand way of referring to a Brayton-cycle gas turbine engine. The abbreviation GTE is also used for Gas Turbine Engine.

Early gas turbines, such as Moss's experiments at Cornell (Ref. 5-1), could barely produce enough power to turn their own compressors. Continued development led to the exhaust turbo-supercharger prevalent in World War II piston engine aircraft. At present, the GTE is the engine of choice in large commercial aircraft and in many stationary applications, where its proclivity to run efficiently over only a narrow speed range is not a handicap. However, this same near-constant-speed characteristic has been one major factor in its previous unsuitability for automotive applications. Still, the GTE's attractive simplicity, high specific power, multifuel capability, smoothness of power delivery, potential for low fuel consumption, and (of more recent interest) potential for low pollutant emissions have continued to hold the eye of automotive manufacturers. Developments in variable-speed-ratio coupling techniques — aerodynamically, via a second turbine, or mechanically/hydraulically, via unconventional transmissions — and in component operating temperatures and speed ranges have brought the automotive GTE into the realm of practicability. Several experimental versions have been tested and used in racing cars with excellent mechanical performance. Rover demonstrated the world's first gas turbine passenger car in 1950. The Chrysler Corporation has also been seriously pursuing development of passenger car gas turbines since 1950, and tried out a prototype 50-car fleet on the public in the 1964-1966 time period. General Motors announced its first automotive turbine in 1954 and unveiled its experimental Firebird II regenerative GTE sedan in 1955. Ford, Williams Research, Volkswagen, and others have likewise embarked upon turbine passenger car development programs. None of these programs have, as yet, resulted in a mass-production version of the automotive gas turbine.

### 5.1.2 Morphology

The basic Brayton heat engine cycle includes the following steps:

- (1) Compression of the working fluid from ambient pressure to elevated pressure.

- (2) Addition of heat to the working fluid at the constant elevated pressure.
- (3) Expansion of the working fluid back to ambient pressure, with extraction of useful work.

There are many ways to mechanize this cycle. In this chapter, there is no intent to treat the subject of Brayton engines exhaustively, but rather to limit discussion to implementations pertinent to automotive use. To this end, Fig. 5-1 presents a simplified morphological "tree" showing the primary derivatives considered for the automotive application. As previously noted, turbomachines provide a practical way to implement the cycle with high air-handling capacity and light weight.

One major distinction between Brayton machines lies in whether they operate on an open cycle or closed cycle. In an open-cycle machine, the working fluid is predominantly the ambient medium — i. e., air — which flows through the machine and out. Heat addition is effected by mixing fuel with the compressed air and combusting that fuel with part of the oxygen present, yielding a working fluid that is a mixture of combustion products (mainly CO<sub>2</sub>, H<sub>2</sub>O and N<sub>2</sub>) and surplus air. Such open-cycle Brayton machines are therefore, by definition, internal-combustion engines since the combustion process is internal to the cycle, even though physically divorced from the compressor/expander mechanism.

In closed-cycle machines, the working fluid is a separate medium totally confined to the engine and cyclically recirculated through the basic processes. In this case, heat is added to the working fluid through a heat exchanger and, although the source of heat is frequently an external (to the cycle) fuel/air combustion process, any convenient heat source (electrical, nuclear, etc.) would do as well. Any noncondensable gas — including air — could be used as a working fluid, but good efficiency and high power density dictate that the gas be selected for superior thermodynamic properties, and it is usually helium or hydrogen.

In principle, both open- and closed-cycle Braytons could be used in automotive applications. With current technology and foreseeable developments, however, there is little to recommend the closed-cycle machines. They offer no significant performance or efficiency advantage over well-designed open-cycle machines, and yet are heavier and much more complex by virtue of the multiplicity of flow paths and heat exchangers that must be provided. These practical considerations bar the closed-cycle machine from the low-cost, high-production-volume automotive engine milieu.

Hence we are left with open-cycle gas turbines. For a given pre-expansion gas temperature, high thermal efficiency can be obtained in two ways. One way is to obtain a very high expansion ratio across the turbine(s), such that a minimum amount of energy is left in the exhaust. This is the so-called "simple" (or "simple-cycle") configuration. The other approach entails a more moderate expansion ratio across the

turbine(s), together with effective post-expansion scavenging of residual heat from the exhaust. The scavenged heat energy is returned to the inducted air after compression, through a heat exchanger, and this type of configuration is called "regenerated."

The final categorical distinction we wish to make among automotive Brayton engines derives from the means of coupling the engine to the vehicle's drive train. In the single-shaft (SS) version the expander turbine is mounted on a common shaft with the compressor, and the net motive power it produces is taken from this same shaft (hence the designation). This version provides the simplest engine configuration, but requires a sophisticated coupling mechanism — a continuously-variable transmission (CVT) — to match the narrow speed range of the engine to the broad range of speed variation demanded by the vehicle's drive shaft. This problem is solved alternatively, in the free-turbine (FT) version through the use of a second expander turbine called the "power" turbine, mounted on a separate shaft. In this case, the first turbine (usually referred to as the "gasifier" turbine) and compressor make up the "gasifier" (or "gas generator") package, which is essentially a single-shaft engine. The gasifier is then aerodynamically coupled to the drive train by directing the gasifier turbine's exhaust to the power turbine. The broad operating speed range of the latter permits a conventional automotive transmission to be employed.

Figure 5-2 illustrates schematically the four combinations — simple or regenerated cycle, with either a single-shaft or free-turbine implementation — which are potentially applicable to automobiles. The heavy arrows show the flow path of the working fluid. These four classes of Brayton engines are treated in detail in the subsequent sections of this chapter.

## 5.2 CHARACTERISTICS

### 5.2.1 Thermodynamics

The thermodynamic processes executed within Brayton cycle engines are amenable to convenient mathematical representation. Consequently, the performance of Brayton engines may be adequately estimated via analytical techniques. The utilization of such techniques is usually limited only by the availability of performance data on individual components of the engine. The Brayton engine differs fundamentally from the intermittent internal-combustion engines in that the processes of compression, heat addition, and expansion occur continuously within the separate and distinct components which make up the basic engine. A simplified development of the performance of the gas turbine engine may be obtained by applying the appropriate thermodynamic equations and efficiency definitions to those engine components. The parameters which describe the performance of the major Brayton engine components — such as compressors, turbines, and heat exchangers — are given in Chapter 2, and the ideal simple and regenerated Brayton cycles are shown in Fig. 2-7 therein.

The net work output of Brayton engines may be obtained by algebraically summing the work

produced (or absorbed) by the various components of the engine over the prescribed thermodynamic path of the working fluid. Considering the heat addition from the high-temperature source only, in conjunction with the definition of thermal efficiency given in Chapter 2, yields the cycle efficiency  $\eta_e$  as

$$\eta_e = \frac{w_t + w_c}{q_h} \quad (1)$$

where  $w_t$  is the work produced in the expansion process,  $w_c$  is the work absorbed in the compression process (a negative quantity), and  $q_h$  is the heat added from the high-temperature source. Computationally convenient expressions for  $w_c$ ,  $w_t$ , and  $q_h$  will be developed in the following paragraphs.

Compressor performance at a given operating point, which is defined by mass flow, shaft speed, and pressure ratio, is usually described in terms of the compressor efficiency  $\eta_c$ , defined as

$$\eta_c = \left[ \frac{\Delta h_s}{\Delta h} \right]_c \quad (2)$$

Here,  $\Delta h$  is the actual enthalpy increase of the working fluid as it passes through the compressor from inlet pressure to outlet pressure, and  $\Delta h_s$  is the enthalpy increase which would result if the compression process between the same initial and final pressures occurred isentropically. This definition is for compression process with no appreciable heat transfer to, or from, the working fluid. The relations for isentropic changes of state of an ideal gas, the foregoing definition of  $\eta_c$ , and the steady-flow energy equation, may be employed to obtain the work of compression per unit mass of working fluid  $w_c$  as

$$w_c = \frac{1}{\eta_c} T_{c_i} C_{p_a} \left( 1 - r_{p_c}^\lambda \right) \quad (3)$$

where  $r_{p_c} = p_{out}/p_{in}$ ;  $T_{c_i}$  is the inlet absolute temperature,  $C_{p_a}$  is the average specific heat at constant pressure of air during the compression process; and  $\lambda$  is the quantity  $(k - 1)/k$ ,  $k$  being the ratio of specific heats for air during compression (nominally  $k = 1.4$ ). The compressor work  $w_c$  will appear as a negative quantity, indicating that shaft work was absorbed.

Turbine performance may be described in a manner similar to that of compressor performance. The efficiency  $\eta_t$  of a turbine, through which a gas is expanded over a pressure ratio  $r_{p_t} = p_{out}/p_{in}$ , may be expressed as

$$\eta_t = \left[ \frac{\Delta h}{\Delta h_s} \right]_t \quad (4)$$

where  $\Delta h$  is the actual enthalpy decrease of the working fluid as it expands through the turbine,

and  $\Delta h_s$  is the theoretical enthalpy decrease of the working fluid for an isentropic expansion process. This definition is also for an essentially adiabatic expansion process. The relations for isentropic changes of state in an ideal gas, the steady-flow energy equation, and the efficiency definition (4) may be utilized to obtain the turbine work per unit mass of expanding fluid  $w_t$  as

$$w_t = \eta_t T_{t_i} C_{p_g} \left(1 - r_{p_t}^\psi\right) \quad (5)$$

where  $T_{t_i}$  is the turbine inlet absolute temperature;  $C_{p_g}$  is the average constant-pressure specific heat of the working fluid during the expansion process; and  $\psi$  is the quantity  $(k - 1)/k$ ,  $k$  being here the average ratio of specific heats of the gas during expansion (nominally about 1.35 for products of combustion of hydrocarbon fuel with air at gas turbine operating conditions). The turbine pressure ratio  $r_{p_t}$  may be given in terms of the pressure loss factor  $\eta_p$  and the compressor pressure ratio  $r_{p_c}$ ; thus  $r_{p_t} = (1/\eta_p r_{p_c})$ .

The heat release in the combustor  $q_h$  may be represented as

$$q_h = C_{p_b} \frac{(T_{t_i} - T_{b_i})(1 + F)}{\eta_b} \quad (6)$$

where  $C_{p_b}$  is an effective specific heat representative of the heat required to increase the temperature of the total gas flow from  $T_{b_i}$  to  $T_{t_i}$ ;  $T_{b_i}$  is the combustor inlet temperature;  $T_{t_i}$  is the turbine inlet temperature;  $F$  is the fuel-to-air mass ratio and  $\eta_b$  is the overall efficiency of heat addition including heat loss. This description of combustor performance is approximate in nature, but gives sufficient accuracy when appropriate values of  $C_{p_b}$  and  $\eta_b$  are used.

The effect of post-expansion heat recovery on the thermal efficiency of a Brayton engine may be estimated using the concept of heat exchanger effectiveness as discussed in Chapter 2, Section 2.4.2. For this simplified analysis, the effectiveness of the heat exchanger will be taken as

$$\epsilon = \frac{T_{b_i} - T_{c_0}}{T_{t_0} - T_{c_0}} \quad (7)$$

where  $T_{b_i}$  is the combustor inlet temperature;  $T_{c_0}$  is the compressor exit temperature, and  $T_{t_0}$  is the expander exhaust temperature.

The value of  $T_{b_i}$  in a regenerated Brayton engine is determined by the temperature rise during compression and the temperature rise during regeneration; hence  $T_{b_i}$  may be expressed in terms of the parameters which describe the performance of the compressor and the regenerator, and in terms of the temperatures  $T_{c_i}$  and  $T_{t_i}$ , which are taken as independent variables. The

expression for  $T_{b_i}$  in terms of  $\epsilon$ ,  $T_{c_0}$ , and  $T_{t_0}$  is

$$T_{b_i} = T_{c_0} (1 - \epsilon) + \epsilon T_{t_0} \quad (8)$$

where  $T_{c_0}$  may be expressed as

$$T_{c_0} = T_{c_i} \left[1 + \frac{1}{\eta_c} (r_{p_c}^\lambda - 1)\right] \quad (9)$$

and

$$T_{t_0} = T_{t_i} \left\{1 + \eta_t \left[\left(\frac{1}{\eta_p r_{p_c}}\right)^\psi - 1\right]\right\} \quad (10)$$

The component parameter remaining to be defined is regenerator leakage. The use of a rotating, periodic flow regenerator for exhaust heat recovery must inevitably result in some carryover and mixing of combustion products with air. Also, the flow passages must be sealed at the regenerator interface, and no perfect, non-leaking seal has yet been devised. The total regenerator leakage is given in terms of a leakage factor  $e_L$  as

$$e_L = \frac{\dot{m}_g}{\dot{m}_a (1 + F)} \quad (11)$$

where  $\dot{m}_g$  is the actual mass flow rate of gas through the turbine,  $\dot{m}_a$  is the mass flow rate of air through the compressor, and  $F$  is the fuel/air mass ratio.

Equations (6), (8), and (11) may be combined to yield the heat input  $q_h$  per unit mass of air taken into the engine as

$$q_h = \left(e_L C_{p_g} \frac{1 + F}{\eta_b}\right) \left[T_{t_i} \left(1 - \epsilon \frac{T_{t_0}}{T_{t_i}}\right) - T_{c_i} (1 - \epsilon) \frac{T_{c_0}}{T_{c_i}}\right] \quad (12)$$

where  $(T_{c_0}/T_{c_i})$  and  $(T_{t_0}/T_{t_i})$  are found from Eqs. (9) and (10), respectively.

An expression for the thermal efficiency of a Brayton cycle engine according to Eq. (1) requires that  $w_c$ ,  $w_t$  and  $q_h$  all be given relative to the same base. The mass flow of air through the compressor is arbitrarily chosen as that base, so the expressions for  $w_c$  and  $q_h$  according to Eqs. (3) and (12), respectively, may be used as given. However, the turbine work must be

expressed relative to the air mass flow, as follows

$$w_t = e_L (1 + F) \eta_t T_{t_i} C_{p_g} \left[ 1 - \left( \frac{1}{\eta_p r p_c} \right)^\lambda \right] \quad (13)$$

The cycle thermal efficiency may now be estimated from Eq. (1) by computing  $w_c$ ,  $w_t$ , and  $q_h$  according to Eqs. (3), (12), and (13), respectively. The fuel-to-air mass ratio  $F$  may be approximated by  $F = 1.46 \times 10^{-5} \Delta T_b$ , where  $\Delta T_b$  is the temperature rise across the burner (in  $^\circ F$ ).

The thermal efficiency computed in this manner is a function of the following independent engine parameters:

- $r_{p_c} \equiv$  compressor pressure ratio
- $T_{t_i} \equiv$  turbine inlet temperature (absolute)
- $\eta_c \equiv$  compressor efficiency
- $\eta_t \equiv$  turbine efficiency
- $\epsilon \equiv$  regenerator effectiveness
- $\eta_p \equiv$  pressure loss factor
- $e_L \equiv$  leakage factor
- $T_{c_i} \equiv$  compressor inlet temperature (assumed constant at  $545^\circ R = 85^\circ F$ ).

Table 5-1 shows the thermal efficiency  $\eta_e$  of several different engine configurations as defined by values of the independent engine parameters. The sensitivity of  $\eta_e$  to changes in these parameters is shown in Figs. 5-3(a) through 5-3(h). These plots were obtained by holding all independent engine parameters constant at the values given in Table 5-1, except the parameter of interest (the abscissae of Figs. 5-3(a) through 3(h)). The curves labeled A, B, and C on Figs. 5-3 correspond to the engine configurations identically labeled in Table 5-1.

The thermal efficiency predicted as described above is subject to the limitations of the basic "lumped parameter" method of describing the performance of the individual engine components and of treating frictional and heat losses. The engine parameters used in such a method may be adjusted so that the computed  $\eta_e$  exactly corresponds to the actual performance of an engine at a fixed operating point, but this contrived correspondence does not necessarily imply that all physical phenomena pertinent to engine performance have been considered or adequately described by the mathematics employed. A more sophisticated treatment of Brayton engine performance would involve subdividing the engine into "finer lumps," the thermodynamic state of the

working fluid being computed at many additional stations along the flow path. More detailed analyses may also consider transient, and off-design-point performance through maps of compressor and turbine performance. Engine maps and performance information generated through such analyses (executed via engine simulation computer programs) are reported in Refs. 5-2, 5-3, and 5-4. The simplified analysis described herein was used to predict performance at various operating points, and the results agreed quite well with those predicted by the more sophisticated techniques at the same operating points. Further, component performance, as determined from actual engine test data given in the open literature (such as Refs. 5-5 and 5-6 and in Ref. 5-7) were used in the simplified analysis, and values of  $\eta_e$  were obtained within a few percent —  $(\eta_{\text{computed}} - \eta_{\text{test}})/\eta_{\text{test}}$  — of the empirical values. The simplified analysis is therefore considered satisfactory for establishment of efficiency trends as component performance parameters are changed, and for estimating the performance of a Brayton engine at its design point, providing of course that the assumed levels of component performance are attained in practice.

It was conjectured in Chapter 2, Section 2.5.3, that, in heat engines with adiabatic work processes, a greater thermal efficiency is attainable through utilizing a limited expansion ratio in conjunction with post-expansion heat recovery rather than through utilizing a high expansion ratio without heat recovery. This conjecture is supported by the derived cycle efficiency estimates shown in Table 5-1. Simple cycle engines require compressor and expander efficiencies of 85% or greater at pressure ratios of 15:1 to 30:1 in order to approach the thermal efficiency of low-pressure-ratio, highly regenerated engines. With both compressor and turbine efficiency at 85%, the maximum thermal efficiency of a simple-cycle engine occurs near a pressure ratio of 15:1 and is about 28%, as shown in Table 5-1. By comparison, the thermal efficiency of the fully regenerated engine at a pressure ratio of 4:1 is about 35%. In order to attain a thermal efficiency of 35% at a pressure ratio of 15:1 with a simple cycle engine, the compressor and turbine efficiencies would both have to be about 90%. Such efficiencies are probably not attainable, even with the best positive displacement compressors and expanders, whereas the component efficiencies shown in Table 5-1 for the fully regenerated, low-pressure-ratio engines have already been demonstrated. In addition, the aerodynamic compressors and turbines which operate at high efficiencies in low-pressure-ratio engines are also much smaller, and lower in weight, than their positive displacement counterparts. Hence, the low-pressure-ratio, fully regenerated Brayton engines with aerodynamic compressors and expanders (in both the single-shaft and free-turbine versions) were selected as our Mature<sup>1</sup> configurations. Only the single-shaft version was evaluated as our Advanced<sup>1</sup> configuration engine, in view of its slightly higher brake efficiency and mechanical simplicity relative to a free-turbine engine.

<sup>1</sup> See definitions in Chapter 2 and Section 5.3.2 of this chapter.



Table 5-1. Cycle performance<sup>a</sup> parameters of Brayton engines

Candidate configuration	Hot-side material	Maximum continuous $T_{t1}$ , °F	Type <sup>b</sup>	Pressure ratio $r_{pc}$	Compressor efficiency $\eta_c$ , %	Turbine <sup>c</sup> efficiency $\eta_t$ , %	Combustor heat loss $(1 - \eta_b)$ , %	Regenerator effectiveness $\epsilon$ , %	Overall pressure loss $(1 - \eta_p)$ , %	Leakage efficiency $(1 - e_L)$ , %	Cycle thermal efficiency $\eta_e$ , %	Brake efficiency $\eta_0$ , % <sup>d,e</sup>
Present	Metal	1850	FR	4.1:1	76	81 <sup>f</sup>	2	89	16	6	26.8	25.5
Mature (A)	Metal with ceramic regenerator	1900	FR	4:1	80	85	2	90	15	5	34.8	33.1 (SS)
		1900	SC	10:1	75	85	2	None	9	0	22.4	21.3 (SS)
(B)	Metal	1900	SC	15:1	85	85	2	None	9	0	28.0	
		1900	PR	10:1	75	85	2	50	12	1	23.8	22.6 (SS)
Advanced	Ceramic	2500	FR	4:1	83	88	2	90	12	3	48.3	45.9 (SS)
		2500	SC	30:1	90	90	2	None	9	None	38.9	

<sup>a</sup>Compressor inlet temperature = 85° F.

<sup>b</sup>FR = fully regenerated, SC = simple cycle, PR = partly regenerated.

<sup>c</sup>All component efficiencies are total-to-total.

<sup>d</sup> $\eta_0 = \eta_m \eta_e$ , where  $\eta_m$  is mechanical efficiency (95% assumed for the SS engine, 93% for the FT engine).

<sup>e</sup>SS = single shaft, FT = free turbine.

<sup>f</sup>Weighted average of gasifier and power turbines.

### 5.2.2 Performance

The design-point fuel consumption for each of the Brayton engine configurations shown in Table 5-1 was estimated via the method of Section 5.2.1 using the values given for the engine parameters. These parameters were chosen to reflect the Mature and Advanced engine configurations according to these concepts as discussed in Chapter 2. The component performance parameters of the Present engine were based on information given in Refs. 5-2, 5-3, 5-4, and 5-7 and represent existing automotive gas turbine engine design practice.

The component performance parameters for the Mature Brayton engine designated (A) in Table 5-1 result from an appraisal of the current state of the development of compressors and turbines, based primarily upon information given in Refs. 5-2, 5-4, and 5-8. The Mature Brayton engine incorporates a compressor and a turbine with broad operating ranges over which their efficiencies remain high. Such compressors and turbines are discussed in Ref. 5-4. As shown in Table 5-1, the Mature SS engine has a slightly higher brake efficiency  $\eta_0$  than the FT engine. In the FT engine the overall efficiency of expansion through the radial flow, gasifier turbine and subsequently through the axial-flow power turbine is somewhat lower than that through the single radial-flow turbine in the SS engine. The factors which contribute to this difference are the efficiency characteristics of the variable-nozzled, axial-flow power turbine, the pressure and heat losses associated with the connecting passage between the gasifier turbine discharge and the power turbine inlet, and the additional mechanical loss of the FT design. The pressure losses for all Brayton engines can be reduced if careful attention is paid to flow passage design. However, as shown in Fig. 5-3f, minor changes in  $\eta_p$  do not substantially effect cycle efficiency  $\eta_e$ .

The regenerator effectiveness, seal leakage at the beginning of life, and pressure loss for the Mature Brayton engine are all soundly based in existing technology. However, the maximum sustained turbine exhaust temperature, which the regenerator will tolerate with acceptable life, is subject to some conjecture at the present time. The regenerator inlet temperature at full load is about 1400°F but increases as load is reduced, reaching about 1800°F at light load operation. As subsequently discussed in Sections 5.3.3 and 5.7, ceramic regenerators capable of sustaining such temperatures are expected to be available for the Mature engine.

In the event that a maximum regenerator inlet temperature of 1600°F (which is compatible with current ceramic regenerators) is still limiting at the time the Mature Brayton engine is ready for introduction, a revised turbine inlet temperature schedule could be implemented at light load. The regenerator inlet temperature could be restricted to a maximum of 1600°F through a reduction in  $T_{t1}$  of about 150 to 200°F under light load operation. A fuel consumption increase of about 7% would be incurred only at light loads. Relative to the projected Mature Brayton engine vehicle, the fuel economy penalty over the FDC-U would be less than 7%, and no appreciable loss in fuel economy would be

incurred over the FDC-H. As a point of reference, current metallic (stainless steel) regenerators are limited to maximum temperatures of 1200 to 1400°F, with an unacceptably adverse effect on fuel consumption.

The compressor and turbine efficiencies for the Advanced engine are very conservative for a pressure ratio of 4:1; efficiencies of these values have already been demonstrated on test rigs. However, a regenerator inlet temperature capability near 2000°F is required for the projected part-load fuel consumption characteristic. The turbine inlet temperature could be reduced at part-load operating conditions so as to maintain regenerator inlet temperature at 1800°F, but with some penalty in part-load fuel consumption.

The fuel consumption characteristics of both the SS and the FT Mature Brayton engines closely resemble those of proposed engines having similar configurations (e.g., Ref. 5-4). The fuel consumption maps of Ref. 5-4 for such SS and FT engines are shown in Figs. 5-4 and 5-5, respectively. The fuel consumption characteristics used to predict vehicle fuel economy were derived from these maps with adjustments for the effects of maximum engine horsepower on brake efficiency and for an assumed schedule of turbine inlet temperature vs engine load. The compressor efficiency for Brayton engines of less than about 100 bhp was reduced in accordance with the rig test data presented in Refs. 5-4 and 5-20. The variation of cycle efficiency  $\eta_e$  with engine size was then established from the  $\eta_e$  vs  $\eta_c$  characteristic shown in Fig. 5-3c. The performance of other engine components was not penalized for the smaller engine sizes.

### 5.2.3 Fuel Requirements

Since the combustor in a gas turbine is a constant-pressure continuous-combustion device, physically isolated from the compression/expansion processes, it is quite flexible with respect to the fuel employed. From the combustion standpoint, any fluid fuel which will burn with air could be utilized. This includes gaseous fuels such as propane and LPG, natural and synthetic liquid fuels, and (perhaps, in the future, if the packaging and transport problems can be solved) even fluidized solid fuels. Unlike the intermittent-combustion engines, the continuous-combustion Braytons impose no octane number or cetane number restrictions on their fuels.

There are some fuel constraints due to other considerations, however. Operational safety requires a minimum flashpoint limit to preclude an explosion hazard or inordinate fire hazard. Pollutant emission characteristics also narrow the choice of fuels. Tetraethyl lead and relatively large concentrations of certain trace contaminants - notably sulfur, phosphorus, and halogens - are undesirable, because of possible high-temperature attack upon the ceramic regenerator and/or combustor and/or turbomachinery.

Within the context of this study, practical Brayton fuels include: (unleaded) gasoline, methanol, methanol/gasoline blends, kerosene, JP-4, diesel fuels, and "broad-cut" distillate. Broad-cut distillate (see Chapter 17) could

ultimately become the fuel of choice for cost and process energy saving reasons.

With regard to contaminants, it should be noted that the air stream as well as the fuel supply are of concern in automotive Brayton engines. The high-speed turbomachinery is extremely susceptible to the abrasive effects of airborne dust and grit. Further, species chemically deleterious to the compressor and/or "hot parts" can also enter via the inducted air stream. Protection from salt, used to control road ice during winter months in many locales and prevalent in the air of coastal cities, may be required in the design.

#### 5.2.4 Pollutant Formation

In the Brayton engine, as in any engine wherein a carbonaceous fuel is burnt with air, slight departures from perfect combustion result in trace quantities of carbon monoxide (CO) and incompletely oxidized hydrocarbons (HC) in the exhaust. At the same time, the high temperatures of combustion also permit side reactions, involving the nitrogen from the air, to occur and yield oxides of nitrogen (NO<sub>x</sub>) in the exhaust. Although the concentrations of these emittants are small in absolute magnitude, they can be significant from the environmental standpoint.

#### LEGISLATIVELY CONTROLLED POLLUTANTS

Formation of HC and CO can be minimized in a properly designed continuous combustor. Relevant aspects of the continuous combustion process are discussed in Chapter 2. Most experimental turbines and combustor rig tests have demonstrated HC and CO exhaust concentrations well below the levels required for certification to statutory emission standards, even in the largest cars.

Control of NO<sub>x</sub> emissions requires much more careful design. NO<sub>x</sub> formation is limited kinetically by the combustion gas temperature-time history, as indicated in Fig. 5-6. Ford (Ref. 5-10) and others have shown that NO<sub>x</sub> formation levels only become significant at about 3000° F and above. Such temperatures do prevail in the primary combustion zone of combustors for Brayton engines with acceptable efficiency. Indeed, in combustors wherein droplet burning occurs, there is considerable evidence that localized combustion occurs more-or-less stoichiometrically, irrespective of the global air/fuel ratio, resulting in very high local combustion temperatures and unacceptable NO<sub>x</sub> formation. Since, however, the gas admitted to the turbine must be cooled to a lower temperature — circa 1900° F for current metal-turbine technology and about 2500° F for advanced ceramic-turbine technology — there is considerable design latitude in how the primary zone mixture is prepared, in how secondary zone dilution is effected, and in residence times in both zones. Many developers (Refs. 5-8 through 5-16) have designed and tested "low-NO<sub>x</sub>" combustors with varying degrees of success. Their accomplishments have confirmed the feasibility of achieving low NO<sub>x</sub> levels with a high-efficiency engine. A more sophisticated combustor than the conventional spray-type

fixed-orifice burner is evidently required, probably with variable air-orifice geometry.

A convenient measure of the emission characteristic of an engine (or burner) for a given pollutant *x* is the emission index *E<sub>x</sub>*, defined as

$$E_x = \frac{\text{mass units of pollutant } x \text{ emitted}}{\text{thousand mass units of fuel throughput}}$$

and is usually expressed as grams of *x* per kilogram of fuel (g/kg is equivalent to mg/g or lb/1000 lb). The emission index is related to the molar exhaust concentration *C<sub>x</sub>* (in parts per million) via the relation

$$E_x = 10^{-3} \frac{M_x}{M_e} (1 + r_{AF}) C_x$$

where

*M<sub>x</sub>* is the molecular weight of *x*

*M<sub>e</sub>* is the molecular weight of the exhaust

and

*r<sub>AF</sub>* (= 1/*F*) is the air/fuel ratio (by weight)

The vehicle's spatial emission rate of pollutant *x* can be simply expressed as a function of the emission index

$$\text{emission rate } (x) = \frac{\rho_f E_x}{f} \text{ (g/mi)} \quad (14)$$

where

*ρ<sub>f</sub>* is the fuel density (kg/gal)

and

*f* is the fuel economy (mi/gal)

The relationship expressed in Eq. (14) does not presume to indicate that *f* and *E<sub>x</sub>* are completely independent variables. (Both are determined by how the engine is loaded, through the combination of vehicle characteristics and driving cycle.) However, the design flexibility afforded by a separate continuous-combustion chamber does permit engine efficiency (reflected primarily in fuel economy) to be decoupled to a large extent from pollutant formation. In this context, relation (14) does show that a more efficient vehicle (one with higher fuel economy) can also tolerate a combustor which produces higher emissions indices and still meet legislated standards.

Typical HC, CO and NO<sub>x</sub> emission characteristics are presented in Fig. 5-7 for a conventional Brayton engine combustor and a more sophisticated premixing/prevaporizing combustor (Ref. 5-17). These data are representative of steady-state operation in a burner test rig. A single "average" value, representing imposition

of the Federal Urban Driving Cycle (FDC-U) on an engine in a vehicle, would include not only the integrated mean of these steady-state emissions indices, but also a significant contribution due the cold start and some rapid transients. The latter can easily be 30% or more of the former, especially in HC and CO. If air/fuel ratio is not closely controlled during rapid transients, NOx emissions can also be increased significantly.

### NONLEGISLATED POLLUTANTS

Particulate emissions, a known problem with Diesel engines, could also pose a problem with Brayton engines using diesel-like fuels (#1 or #2 diesel, JP-4, kerosene) without a prevaporizing combustor. Formation of visible particulates is normally associated with droplet burning of comparatively low-volatility fuels (see Chapter 4) and has not been reported as a categorical problem with Braytons. However, the production of nonvisible microparticulates by Brayton engines has not been studied thoroughly and is an open question at the moment. Use of prevaporizing/premixing combustors should circumvent the problem, and gasoline could be the fuel of choice, if necessary.

Sulfur emissions, primarily as SO<sub>2</sub>, may be higher from Brayton engines than from conventional Otto engines because of the higher trace sulfur content of the usual Brayton fuels. Excessive H<sub>2</sub>SO<sub>4</sub> emission is not anticipated since catalysts are not employed in Brayton engines. Fuel desulfurization is one approach to reducing sulfurous emissions, if required.

## 5.3 MAJOR SUBASSEMBLIES/COMPONENTS

The major elements of fully regenerated Brayton power systems are the compressor assembly, turbine assembly (assemblies), regenerator assembly, combustor assembly, speed reducer(s), control system, and transmission. Several of these – the compressor, combustor, regenerator, and speed reducer assemblies – are essentially identical (except perhaps for housings and mounting) in both the SS and FT implementations. Other elements – like the SS turbine assembly, the FT gasifier turbine assembly, and the two engine control systems – are similar, but embody some significant differences related to their respective functional requirements. Finally, the FT power turbine assembly and the transmissions are totally specific to the engine type. Details are discussed in the following sections.

### 5.3.1 Component Descriptions

The major components of the Brayton power system are the compressor, turbine(s), regenerator, combustor, fuel and startup controls, and the transmission.

### COMPRESSOR

The basic performance requirement that the Mature and Advanced Brayton engines demand of their compressors is high efficiency at pressure

ratios ranging from about 2:1 to 5:1. Either positive-displacement or aerodynamic compressors can meet this requirement. Since the high-pressure-ratio capability of the positive-displacement compressor is not required, the high air handling capacity of aerodynamic compressors can be exploited to minimize size and weight for an engine of a specified maximum power.

Aerodynamic compressors have been developed in two configurations: axial-flow and centrifugal. The pressure ratio per stage for axial-flow compressors must be limited to values which are typically less than 1.2:1 to achieve high stage efficiency. Hence, multistage axial-flow compressors are commonly used in gas turbine engines. Their advantages lie in their extremely high air flow capacity for a given size machine and in their high overall efficiency, which is attainable even at overall pressure ratios of 15:1 and above. For automotive application, however, their small efficiency advantage over centrifugal compressors at pressure ratios near 4:1 does not compensate for their high cost and large rotary moment of inertia incurred by the requirement for eight to ten stages.

The compressor of the Mature and Advanced Brayton engines is of the single-stage, centrifugal type described in Refs. 5-18 and 5-2. The Mature Brayton engine compressor incorporates backward-curved impeller blades and variable inlet guide vanes to achieve high efficiency over wide operating ranges of pressure ratio, shaft speed, and air flow. A performance map for such a compressor, as given in Ref. 5-2, is shown in Fig. 5-8. This compressor has a broad operating region wherein the efficiency (total-to-total<sup>2</sup>) is greater than 0.82.

### TURBINE

The performance requirements for the expander of Brayton engines are similar to those of the compressor, with the additional requirement of continuous operation at temperatures commensurate with expander inlet temperatures of 1900 and 2500°F for the Mature and Advanced engines, respectively. Considerations of pressure ratio and gas handling capacity of expanders comparable to those for compressors lead to the selection of aerodynamic turbine expanders. However, the choice between axial-flow and radial-flow turbines is not as clear. Discussions of the factors to be considered in deciding between axial-flow or radial-flow turbines are given in Refs. 5-4, 5-8, 5-19, and 5-21.

The radial-flow turbine was selected for the SS Brayton engine and for the gasifier turbine of the FT Brayton engine, in both the Mature and Advanced engine configurations. In general, well-designed radial-flow turbines provide higher efficiency over a wider operating range than axial-flow turbines of the small sizes required for automotive application. Radial turbines may also be capable of slightly higher inlet temperatures or improved durability at the same inlet temperature, and they can operate at somewhat

<sup>2</sup>Total inlet pressure to total outlet pressure of the diffuser.

higher tip speeds. These advantages are related to the shape and configuration of radial turbines. However, the radial turbine has a somewhat higher moment of inertia than an axial turbine, but this does not offset the efficiency and durability advantages of radial turbines.

Various aspects of radial and axial-flow turbine performance and efficiency are discussed in Refs. 5-19 through 5-24. A comparison of typical efficiency characteristics of radial and axial-flow turbines of automotive engine size is shown in Fig. 5-9. The efficiency characteristics of the radial-flow turbine used in computation of the fuel consumption map for the Mature Brayton engine is shown in Fig. 5-10. Part-load fuel consumption could be improved further if the turbine were designed for peak efficiency at a pressure ratio near 2:1.

### REGENERATOR

The performance of heat exchangers, including periodic flow regenerators, was discussed in Chapter 2. A rotary periodic-flow regenerator suitable for the Mature and Advanced Brayton engines can be designed for an effectiveness greater than 0.9, with a total pressure loss (air + gas sides) of less than 10%, and a total leakage (carryover + seal) of less than 5%. A matrix with specifications similar to those shown in Table 5-2 will give such performance when the dimensions of the air and gas flow paths through the regenerator are properly matched to engine air flow characteristics.

The effectiveness characteristic of a Brayton engine regenerator with a ceramic matrix is shown in Fig. 5-11. As previously stated, the major problem with Brayton engine regenerators is durability at sustained high gas-side inlet temperatures. Further discussion of ceramic regenerators appears in Section 5.3.3.

### COMBUSTOR ASSEMBLY

The combustor is basically a can in which high-pressure air from the compressor —

Table 5-2. Matrix specifications for typical regenerator core (CERCOR®) (from Ref. 5-2)

Porosity $p$	0.6367
Specific surface $A_s$	1548 ft <sup>2</sup> /ft <sup>3</sup>
Hydraulic diameter $4r_h$	0.001645 ft
$L/r_h$	575.2
Specific heat $c_p$	0.200 Btu/(lb-F)
Density, solid, $\rho$	138 lbm/ft <sup>3</sup>
Thermal conductivity $k$	0.42 Btu/(hr-ft-F)
Cells/unit area $N$	1041.6 in <sup>-2</sup>
Cell height/cell width $d/c$	0.853

preheated by the regenerator — is mixed and burned with fuel delivered by the fuel pump. The fuel is atomized and dispersed in the air stream by an atomizer nozzle, making use of the fluid-dynamic shear effects of the interacting streams, and evaporates in the warm air. Ignition is initiated by means of an electrically activated ignitor or spark plug and, once initiated, is self-sustaining.

Only part of the air influx is used for combustion, the balance being diverted somewhat downstream to dilute and reduce the temperature of the combustion products. Hence, at least two relatively distinct zones are discussed in common combustor parlance: a "primary" (or "combustion") zone, in which the preponderance of deflagration takes place; and a "dilution" (or "secondary") zone, wherein the major occurrence is mixing of the primary zone's efflux with additional air, and only limited reaction takes place. Some combustion analysts differentiate a third "transition" (or "intermediate") zone between the two, which is more realistic physically since the boundary is ill-defined.

A simple can-type combustor — with fixed, staged air orifices and a conventional spray nozzle — could provide adequate combustion efficiency from a purely functional standpoint. However, the fuel economy requirements of present and future automotive power systems, coupled with ever-tightening emission standards, dictate a much more carefully controlled combustion/dilution process than can be attained in such a simple combustor. The dominant requirements are those of (a) low NO<sub>x</sub> emissions with high cycle temperatures, and (b) low HC emission, including the contribution from the start transient. The chemical kinetic considerations have been discussed in Chapters 2 and 4 and in Section 5.2.4.

In hardware terms, a high-performance low-NO<sub>x</sub> combustor is a device in which: zonal and global air/fuel ratios are carefully controlled; primary zone residence time is minimized; pressure drop is small; and fuel vaporization, mixing, and combustion are effected as nearly perfectly as possible under all operating conditions. Several developers (Ref. 5-10 through 5-16 and 5-25) have designed and tested experimental combustors to meet these goals. Various fuel admission schemes (vortex cups, air blast nozzles, porous plates, etc.) have been used, all with the objective of minimizing droplet size and maximizing dispersal. Recirculation or controlled vortex flow have been induced to promote mixing. Variable air orifice geometry is generally required to maintain control of air/fuel ratio and prevent lean blowout.

It would be premature to select a particular combustor configuration at this time. Results to date point to a prechamber-type of premixing/prevaporizing combustor with variable-geometry orifices as a promising candidate. Further development is required to arrive at a fully-responsive, reliable, and economically producible configuration.

### SPEED REDUCERS

Turbine speeds typically are several tens of thousands of rpm to over a hundred thousand rpm,

while conventional automotive drive trains and accessories are designed for input speeds of 600-4000 rpm. Consequently a speed reduction mechanism is a vital part of a Brayton power system. Depending upon whether the engine is a single-shaft or free-turbine type, and upon how power is extracted for auxiliaries and accessories, one or two speed reducers may be employed. Either a more conventional precision gearbox or, if bearing configuration permits, a planetary roller traction drive (Ref. 5-26) will serve the purpose. Both approaches are state-of-the-art, the former having greater flexibility with respect to speed ratio and the latter offering somewhat greater potential in efficiency, reduced noise and vibration, and operating life. The choice will also be affected by the need to minimize the rotational inertia of the speed reducer in order to achieve optimum engine acceleration response.

### CONTROL SYSTEM

The control system for a GTE involves two basic subfunctions: mixture (air/fuel ratio) control and power control. Details of the control loops are highly specific to the particular engine implementation, but there are certain commonalities to all configurations. The primary sensed data are (gasifier) turbine speed, turbine inlet and/or outlet temperature(s), ambient temperature, and the power-level command (throttle position). Ambient pressure may also be sensed for altitude compensation. Controlled variables include: compressor inlet guide vane position; combustor fuel flow; combustor air orifice area (if variable geometry); and either power-turbine nozzle position (FT engine), or the corresponding CVT function (SS engine), such as stator vane position in a VSTC-type<sup>3</sup> CVT. An automatic startup sequence — turn-key to drive-enable, via detection of ignition and attainment of (gasifier) turbine idle speed — is included, as well as automatic shutdowns for flameout, overtemperature, temperature-sensor failure, and rotor overspeed.

Most proposed control systems are either hydromechanical or electromechanical. Integrated hydromechanical systems are the simplest and have the lowest cost potential. Mechanization of the automatic startup and shutdown functions is difficult, however, and hybrid systems usually result from addition of supplementary ad hoc electromechanical loops to the basic hydromechanical package for this purpose.

The electromechanical package, while probably somewhat more costly, offers the greatest flexibility. It can handle the startup/shutdown sequences, using the same basic sensors as in the operating mode. Adequate self-diagnostic capability (for sensor or actuator failures) and some redundancy (e.g., multiple sensors with majority-vote logic) can be readily incorporated. Operating logic (digital or analog) best suited to each component can be used, and the necessary A/D/A interfaces conveniently handled electronically. Recent progress in development of LSI microprocessors have direct relevance to Brayton control circuitry.

Fluidic control systems, utilizing gas flow diverted from the engine, have also been considered. At present, all-fluidic systems pose difficult interface problems, are highly susceptible to contamination, and require complex "signal conditioning" units. Their applicability to Brayton engine controls therefore remains highly conjectural for the foreseeable future.

The engineering allure of an all-electronic closed-loop system with electromechanical actuators is very great, particularly because of the flexibility needed in development. Indeed, if increasing sophistication is required in the control of the evolving GTE, and with continuing progress in increasing the reliability and reducing the cost of such systems, the integrated all-electronic approach may eventually be the only viable approach. Until the need for such a system is clearly established, however, the simpler and more rugged hydromechanical basic control package (with some electrical add-ons) will be a strong competitor.

### TRANSMISSIONS

#### Free-Turbine Engine

The FT Brayton engine has power/speed characteristics similar to the Otto engine, but with greater low-speed torque. Conventional manual or automatic transmissions are therefore quite suitable and, with the better low-speed torque, will give improved drivability. It has been suggested that the power turbine could behave enough like a torque converter to make the latter unnecessary in the transmission, allowing the use of only a simple automatic-shift gearbox at reduced cost. This potential simplification was not assumed in this evaluation, however.

#### Single-Shaft Engine

The torque curve of the SS Brayton engine decreases sharply from its maximum value at maximum engine speed to zero net output at about 50% of engine speed. For satisfactory vehicle performance, this engine must thus operate over a much narrower speed range than all other types, and hence the transmission must be capable of a larger range of input-to-output speed ratios than available with currently used transmissions.

In addition, the transmission must provide means for adjusting the engine operating point, maintaining turbine inlet temperature (within the allowable range) for low SFC; and for obtaining input/output ratio control or "power split." The latter affects the vehicle acceleration behavior by determining the portion of engine power available to accelerate the vehicle versus that utilized to further accelerate the engine, balancing higher available power level later against reduced immediate response. (It may be worth noting that the no-load engine acceleration time, from idle to maximum speed, for a well-designed Brayton engine can be roughly one second.) Finally, to give a driving feel similar to current

<sup>3</sup> Variable stator torque converter.

cars, the transmission should furnish "engine braking," that is, vehicle retardation when the throttle is closed.

A variety of transmission designs have been proposed to provide the broad ratio range required. Some use a large number of fixed ratios, while most implement an essentially stepless ratio change and are therefore called continuously variable transmissions (CVT). The major means of power transmission employed are mechanical, which includes gear and friction drives, and hydraulic, either hydrokinetic or hydrostatic. Many CVT's employ a combination of these principles to achieve best operating efficiency and smoothness. Electric drive trains and associated hybrid operation have also been considered.

An 8-speed automatic gearbox equipped with a controlled slipping clutch has been proposed (Ref. 5-60). The considerable heat generated in the clutch during standing-start accelerations and at each shift must be dissipated, probably by a liquid cooling system similar to that of current automatic transmissions. Driver acceptance of the frequent gear shifts and associated sharp changes in acceleration is unlikely. Since the clutch will be locked-up during steady driving, overall efficiencies should be reasonably high, but the cost and weight of such a transmission system will be somewhat higher than current 3-speed automatics.

A fluid coupling could be an alternative to the slipping clutch for this 8-speed transmission. It would act to smooth out the acceleration steps felt by the occupants and should offer good durability. A variable-fill system would prevent excessive "creep" at the high idle speed but might present fluid foaming problems. Due to the separate oil reservoir and filling pump, cost would probably be higher than for the slipping clutch.

Among the friction-type mechanical transmissions, much attention has recently been focussed on rolling-element traction transmissions. The Tracor transmission (Ref. 5-27) achieves a 9:1 ratio range by varying the radii of the points of contact on power rollers operating between the toroidal driving and driven plates. It requires a clutch for starting from rest. General Motors has also tested similar transmissions. Current development is oriented toward use with Otto-cycle engines, and the size, weight, cost and efficiency are claimed to be competitive with conventional automatic transmissions. Present versions need further control systems improvement. The durability problem, due to wear and contact fatigue at the heavily loaded contact areas, is reported to be improving with the development of better lubricating fluids.

Belt-drive transmissions achieve a variable ratio by controlling the spacing between the sides of each pulley, causing the V-belt to run at the desired radius. To maintain constant belt tension, the spacing is controlled differentially in the two pulleys of each pair, and a wide range of drive ratios is easily achieved. In the up-to-20 hp range, such transmissions are commonly used in industrial drives and in vehicles such as garden tractors and snowmobiles. The Dutch

DAF mini-car has used a similar transmission, with a 30-40 hp engine, for years. Due to the characteristics of the friction interface, major up-scaling of belt-drives is probably not feasible, and in fact a recent, larger DAF model with about 60 hp uses two parallel belt drives where one larger single drive would certainly be cheaper. Belt-drive transmissions are thus judged unsuitable for typical American cars.

Hydraulic power transmission includes both hydrostatic and hydrokinetic versions. "Pure" hydrostatic drives consist of a pump at the engine and hydraulic motor(s) to drive the wheels. Such systems have been repeatedly tested in cars but found to suffer from hydraulic noise, low overall efficiency, and high weight and bulk.

Combining a hydrostatic drive with an epicyclic gear train results in a hydromechanical transmission (HMT), which is a "split-path" type in which the majority of the power passes through the gears. The hydraulic path is used only at low vehicle speeds and to provide a smooth transition between the gear steps. Good efficiency is achieved because only a small power fraction goes through the high-loss hydraulic components, which can therefore be of modest capacity. Development of HMT's has been carried out by Orshansky (Ref. 5-28), General Electric (Ref. 5-2), and Sundstrand Corp. (Ref. 5-17).

The HMT is one of the more attractive types of CVT for the near term. Its complexity is partially offset by its utilization of components with a long history of commercial use, and it appears to have no fundamental development problems. The cost and weight of projected automotive production versions are expected to be competitive with current automatic transmissions.

Hydrokinetic components include fluid couplings and torque converters and are usually used in combination with a multispeed gearbox to achieve a satisfactory ratio range. A fluid coupling provides no torque multiplication and thus requires more gear ratios; it has been proposed for the aforementioned 8-speed transmission.

A torque converter (TC) is a more versatile device because of its ability to multiply the input torque by a factor of 2:1 to 5:1 at stall. TC's are used in virtually all present automatic transmissions. They are reliable, inexpensive, and relatively efficient. Torque-speed characteristics of the TC would have to be changed from current designs to make it compatible with the unique characteristics of the SS engine, which could involve some performance compromises (Ref. 5-2).

Better compatibility and active control of engine load and power split can be achieved by modifying the TC to incorporate variable-angle stator vanes (Ref. 5-29). Such a VSTC is expected to have an efficiency characteristic similar to that of a fixed-vane TC (Ref. 5-29), but would have a somewhat higher cost. It is of interest that a similar design was used in the Buick Dynaflo automatic transmission in the 1950's. In combination with a 3- or 4-speed automatic gearbox, the VSTC is a promising transmission alternative for the SS Brayton engine.

An electric drive system completely uncouples the vehicle speed from the engine speed and thus constitutes a type of CVT. Here the engine drives a generator (or alternator) which produces electrical power for the traction motor(s) that propel the vehicle. Such systems have been widely used in off-road equipment and railroad locomotives, but their overall efficiency is low and the cost, weight and bulk appear excessive for automotive application.

In summary, the SS-Brayton engine requires some kind of CVT to allow favorable application in automotive use. For the near-term, both the VSTC transmission and the HMT are attractive because they appear to have no major development problems; the VSTC is favored herein for use with the SS engine because of its expected lower cost. The traction-type may give better efficiency but presently has durability and control-system problems. Since CVT's can improve the fuel economy of cars equipped with any heat engine (see Section 10.6.2), their development is strongly encouraged.

### 5.3.2 Configurational Evolution

Like the other alternate engines, the Brayton is evaluated in three states of evolution: the Present (developmental) configuration; a Mature (first production) configuration; and an Advanced (long-term potential) configuration. These distinctions are defined in Chapter 2. In consonance with the earlier discussion in Section 5.2.1, only regenerated configurations were evaluated for reasons of attainable automotive fuel economy, despite the allure of simple-cycle machines from the production standpoint.

Specifically because of the CVT problem, it is believed premature to decide between the single-shaft and free-turbine versions of the regenerated Brayton engine. Both types are currently under development and both have advantages and drawbacks. Since their performance characteristics and projected costs differ significantly, it was decided to carry both the SS and FT versions through the evolutionary evaluation. The significant differences in design, construction, and operating characteristics of the SS and FT Brayton powerplants at the three evolutionary stages of interest are indicated in Table 5-3 and discussed in the following paragraphs.

#### PRESENT CONFIGURATIONS

Currently, there are no automotive Brayton engines in production, but several preprototypes are under test. All of these are moderate-pressure-ratio (~4:1) regenerated machines, mostly of the FT variety, employing aluminum compressors and superalloy metallic turbines. Those with perhaps the greatest visibility are the Chrysler passenger car turbine, now in its "6-1/2th" generation of development, and the Ford industrial/truck turbine, launched somewhat prematurely, of which approximately 200 were built in a preproduction run which has been discontinued.

The Chrysler FT machine incorporates twin stainless steel regenerators, limiting the regenerator inlet temperature to circa 1300°F. This limitation is one major factor in the poor fuel economy delivered by the vehicle. Other areas in which improvements can be made are in rotary component (compressor and turbine) efficiencies and in minimization of heat losses and regenerator leakage. It should be noted that the Chrysler package was designed before<sup>4</sup> fuel economy became a national issue, and was intended to provide information on emissions, vehicle integration, drivability, durability, etc.

The Ford FT engine attempted to achieve improved fuel economy, via higher allowable operating temperatures, by recourse to a ceramic regenerator. Specifically, lithium aluminum silicate (LAS) disks were employed. Unforeseen weaknesses in the design (discussed in Section 5.3.3) resulted in structural failures.

The preponderance of FT implementations derives from the fact that most developers prefer to use a conventional transmission and to solve the operating-range problem within the engine package. For passenger car application, this approach requires high efficiency in the gasifier/power turbine coupling over a wide range of power turbine speed. Some developers, notably Ford, believe that an economically mass-producible CVT of adequate efficiency is near enough to relegate the coupling problem to the transmission.

Most present experimental Braytons use simple fixed-geometry combustors which do a creditable job of meeting the statutory HC and CO standards, but are marginal with respect to NOx.

Detailed weight data were not available for most of the current experimental GTE's. The estimated weight of the Chrysler FT power system is plotted as an isolated point on Fig. 5-12.

#### MATURE CONFIGURATIONS

The Mature configurations of the SS and FT engines, represented by the second data column of Table 5-3, constitute projected production versions (under today's technology). As such, they will operate at essentially the same pressure ratios and maximum turbine inlet temperatures as their Present analogs, but with reduced fuel consumption. Design point brake efficiencies of about 33% (SS) and 30% (FT) are obtained, based upon the component efficiencies discussed in Section 5.2.

Maximum compressor and turbine efficiencies should occur in the neighborhood of 40-60% of maximum horsepower for improved part-load fuel economy, an efficiency penalty being accepted in the rarely used operating range near full power. Configurational details differ somewhat from the Present configuration to obtain the widest possible range of high operating efficiencies from the components, to minimize heat and flow losses, to permit reduction in quantity of,

<sup>4</sup>An improved 7th-generation machine is presently being configured.



Table 5-3. Salient features of evolving single-shaft and free-turbine Brayton configurations

Characteristic	Configuration					
	Present		Mature		Advanced	
	SS	FT	SS	FT	SS	FT
Maximum Pressure Ratio	4:1		4:1		4:1	
Maximum Turbine Inlet Temperature, °F	1850		1900		2500	
<u>Compressor</u>						
Type	Centrifugal		Backswept centrifugal		Backswept centrifugal	
Material	Aluminum		Aluminum		Aluminum	
VIGV's?	No		Yes		Yes	
Design point efficiency, %	76		80		85	
<u>Gasifier turbine</u>						
Type	Axial		Radial		Radial	
Material	Superalloy		Superalloy		Ceramic	
Design point efficiency, %	85		85		88	
<u>Power turbine</u>						
Type		Axial		Axial		Axial
Material	(None)	Superalloy	(None)	Superalloy	(None)	Ceramic
Variable nozzles?		Yes		Yes		Yes
Design point efficiency, %		70		85		88
<u>Combustor</u>						
Type	Fixed geometry		Premix/prevaporizing (variable geometry)		Premix/prevaporizing (variable geometry)	
Material	Steel and superalloy		Steel and superalloy		Steel and ceramic	
<u>Regenerator</u>						
Material	Stainless steel		Magnesium aluminum silicate (MAS)		MAS or advanced ceramic	
Maximum inlet temperature, °F	1300		1800		2000	
Leakage, %	5		3		3	
Design point efficiency, %	87-90		90		90	
<u>Controls</u>						
Type	Discrete		Integrated		Integrated <sup>a</sup>	
Actuation	Some mechanical, some electrical		Hydromechanical		Electromechanical <sup>a</sup>	
Logic	Some analog, some A/D/A		Analog		A/D/A <sup>a</sup> (LSI signal conditioner)	
<u>Transmission</u>						
Type	Continuously variable (VSTC) <sup>b</sup>	Conventional 3-speed automatic	Continuously variable (VSTC) <sup>b</sup>	Conventional 3-speed automatic	Continuously variable (VSTC) <sup>b</sup>	Conventional 3-speed automatic

<sup>a</sup>May be simple hydromechanical (as in Mature), if response is adequate.

<sup>b</sup>VSTC = variable-stator torque converter.

and/or substitution for, some costly materials, and to allow changes in fabrication processes. One major objective of these changes was reduction of projected weight and cost. To this end, discussions were held with many of the cognizant engine developers - British Leyland, Chrysler, Daimler-Benz, Ford, Garrett, General Motors, Nissan, Toyota, United Aircraft, Volkswagen, and Williams Research (Refs. 5-29, 5-48 through 5-59) - with some iteration. It is recognized that some of these "design decisions" may not be reflected in the engine(s) ultimately produced. All-in-all, however, it is believed that the stated configurations are reasonably representative of changes that could be implemented to make Brayton engines economically viable in production. Major differences from the Present configurations are in quantity and kind of materials employed.

Both the SS and FT Mature Braytons employ a backswept aluminum centrifugal compressor with variable inlet guide vanes (VIGV's), a superalloy radial (gasifier) turbine, a steel and superalloy premixing/prevaporizing combustor (probably requiring variable flow geometry), and a magnesium aluminum silicate (MAS) regenerator core capable of 1800° F inlet temperature. Air bearings are used in the (gasifier) rotor assembly. The compressor discharge air flows over the external surface of the (gasifier) turbine inlet scroll and discharge shroud, thus providing sufficient material temperature margin for the avoidance of superalloy construction, per the concept of Ref. 5-4. The Mature FT Brayton engine also contains a superalloy axial power turbine assembly (with lubricated bearings) fed by variable-geometry nozzles. The latter allow higher cycle temperatures and, hence, higher efficiency in off-design-point operation, as well as providing engine braking under vehicle deceleration. A speed reducer and conventional 3-speed automatic transmission complete the FT engine package. The Mature SS Brayton is coupled, via a speed reducer, to a continuously variable transmission, currently envisioned as a variable-stator torque converter (VSTC) type. Somewhat analogous to the variable-nozzled power turbine in the FT version, this type of CVT accomplishes several things in the SS version: (1) solution of the obvious torque/speed-match problem in the drive train, (2) provision of engine braking capability, (3) cycle temperature control to minimize specific fuel consumption.

The specific type of control system to be used with each version remains uncertain at this time. Cost and producibility considerations would seem to favor an analog-type integrated hydromechanical package for the basic control system, and this approach is reflected in Table 5-3. Some safety interlocks (e.g., flame-out, overspeed detection) may be incorporated as add-on electromechanical functions.

The projected variation of engine and power system weights with design horsepower is presented in Fig. 5-12 for both types, and Fig. 5-13 shows the corresponding estimated variation in polar moments of inertia for their rotating components. Some further weight reductions, not assumed here, may be possible by designing the transmissions to operate at higher input speeds, with subsequent gear reduction.

## ADVANCED CONFIGURATIONS

The Advanced configurations, described in the third column of Table 5-3, constitute plausible projections of how the SS and FT Braytons could evolve if the research and development efforts described in Sections 5.3.3, 5.7, and Chapter 12 are successful. They represent a production technology which may be achieved in the late 1980's or beyond. The most significant difference from the corresponding Mature configurations is in the use of monolithic ceramic components of the silicon nitride or silicon carbide type, in lieu of superalloy or stainless steel components, for critical "hot parts." Specifically, the turbine(s), nozzles, and some elements of the combustor can advantageously exploit the properties of these materials. These same materials may also be applicable to the regenerator core, if current aluminosilicates (like MAS) are not compatible with the higher cycle temperatures afforded by the ceramic turbomachinery, and to rotor housings (or as liners thereof) on a selective basis. Employment of such ceramic structures offers potential GTE improvement in three areas:

- (1) Increased brake efficiency approaching 46% (SS) at the design point, via higher operating temperature (circa 2500° F turbine inlet temperature) capability.
- (2) Lower production cost.
- (3) Lower total engine weight and rotor inertia.

It must be recognized that, although some substitution of ceramic for metallic elements may occur incrementally (as happened historically with the regenerator, for instance), change-over to a 2500° F cycle temperature ceramic machine requires major redesign. Hardware differences incurred by the peculiarities of (1) fabricating the appropriate monolithic ceramic structures and (2) attachment to contiguous metallic elements preclude simple one-for-one substitution of identical ceramic parts into an otherwise unchanged metallic machine.

A variable-geometry premixing/prevaporizing combustor will almost certainly be required in the Advanced Braytons to maintain low NOx emissions. An integrated electro-mechanical control system is envisioned, exploiting the rapid pace of developments in LSI electronic packaging for signal conditioning/computing functions.

The power system total weights for nominal 150-hp Advanced engines are plotted as isolated points on Fig. 5-12 for comparison with the corresponding Mature power systems.

### 5.3.3 Materials and Producibility

#### COMPONENTS, MATERIALS, PROCESSES, AND WEIGHT BREAKDOWNS

Tables 5-4 and 5-5 list the single-shaft and the free-turbine Brayton engine parts breakdowns respectively, for 150-hp engines of the Present

Table 5-4. 150-hp single-shaft Brayton engine parts breakdown

Component/subassembly	Mature configuration			Advanced configuration		
	Weight, lb	MTL <sup>a</sup>	PROC <sup>b</sup>	Weight, lb	MTL <sup>a</sup>	PROC <sup>b</sup>
<b>A. Turbine assembly</b>	(95)			(60)		
Turbine wheel	4.1	H	62	1.9	I	76
Shaft	0.5	E	69	0.5	E	69
Inlet scroll	8.0	E	61	3.9	I	76
Discharge shroud	8.0	E	62	3.6	I	76
Housing	61	A	61	37	I	76
Bearing	(incl. in compressor assy.)			(incl. in compressor assy.)		
Fasteners, seals, spacers	{ 11	Z	07	{ 11	Z	07
	{ 2	G	07	{ 2	G	07
<b>B. Combustor assembly</b>	(39)			(29)		
Liner	1.0	H	54	0.5	I	76
Atomizer/vaporizing dome assembly	2.2	E	24	2.2	E	24
Secondary air control	0.5	E	34	0.3	I	76
Housing	30	A	61	20	A	61
Sensors and actuators	2.1	Z	00	3.2	Z	00
Ignition assembly	2.2	Z	07	2.2	Z	07
Seals and fasteners	1.0	G	07	1.0	G	07
<b>C. Compressor assembly</b>	(55)			(39)		
Impeller	1.0	J	62	1.0	J	62
Shaft	0.6	G	69	0.6	G	69
Diffuser	15	A	61	9	I	76
VIGV assembly	{ 2	A	61	3	Z	00
	{ 1	F	00			
Actuator	1	Z	00	2.5	Z	00
Housing	21	A	61	10	I	76
Bearings	2	D	07	2	D	07
Seals, fasteners, etc.	11	Z	07	11	Z	07
<b>D. Regenerator assembly</b>	(61)			(52)		
Core	20	I	76	20	I	76
Housings and ductings	30	A	61	20	I	76
Seals	3	Z	07	4	Z	07
Rim, gear	3	D	61	3	E	61
Motor, fasteners	5	Z	07	5	Z	07
<b>E. Accessory drive</b>	(19)	Z	80	(19)	Z	80
<b>F. Control system</b>	(37)			(31)		
Electronics and sensors	—	—	—	5	Z	07
Fuel valves, pump, filter	21	Z	07	21	Z	07
Misc. components	16	Z	07	5	Z	07
<b>G. Air inlet assembly</b>	(9)			(9)		
Housing and ducting	5	L	07	5	L	07
Air cleaner	4	Z	07	4	Z	07
<b>H. Reduction drive assembly</b>	(25)			(25)		
Gears, shafts, bearings	7	D	80	7	D	80
Housing	18	A	61	18	A	61
<b>I. Auxiliaries</b>	(26)			(26)		
Starter	9	Z	07	9	Z	07
Alternator	17	Z	07	17	Z	07
<b>Total, engine ready-to-run</b>	(366)			(290)		
<b>J. Battery</b>	(42)	Z	07	(42)	Z	07
<b>K. Transmission</b> (continuously variable VSTC)	(130) <sup>c</sup>	A, J	80	(130) <sup>c</sup>	A, J	80
<b>Total, power system</b>	(538)			(462)		

<sup>a</sup>MTL = Material type code (from Table 5-6).

<sup>b</sup>PROC = Process code (from Table 5-7).

<sup>c</sup>Transmission weights shown in Tables 5-4 and 5-5 for Mature and Advanced engines are projected to be somewhat less than for equivalent Otto-engined power systems. By utilizing a (perhaps 50%) higher range of input rpm, the resultant lower torque levels permit a reduction in the physical size of gears and components; the final-drive (rear axle) ratio can be increased correspondingly to give the required overall gear reduction.

Table 5-5. 150-hp free-turbine Brayton engine parts breakdown

Component/subassembly	Present configuration (e.g., Chrysler)	Mature configuration			Advanced configuration		
	Weight, lb	Weight, lb	MTL <sup>a</sup>	PROCB	Weight, lb	MTL <sup>a</sup>	PROCB
<b>A. Power turbine assembly</b>		(110)			(72)		
Turbine wheel		2.4	H	62	1.1	I	76
Shaft		1.0	E	69	1	E	69
Inlet housing		5.4	H	62	3.9	I	76
Discharge shroud		6.0	E	34	2.7	I	76
Outer housing		62	A	61	36	I	76
Bearings (3)		0.5	D	07	1.5	(?)	07
Variable nozzles		2.0	H	62	1.0	I	76
		1.2	G	69	1.2	G	69
		2.5	F	08	2.5	F	08
Actuator		3.5	E	69	3.5	E	69
		2	Z	07	3	Z	07
Lubricant, pump, tank		6.7	Z	07	-	-	-
Fasteners, seals, etc.		12	Z	07	13	Z	07
		2	G	07	2	G	07
<b>B. Gasifier turbine assembly</b>		(27)			(20)		
Turbine wheel		4.7	H	62	2.2	I	76
Shaft		1.2	G	08	1.2	G	08
Inlet scroll		6.0	E	61	3	I	76
Discharge shroud		2.5	E	62	1.1	I	76
Outer housing							
Bearing							
Fasteners, seals, etc.		12	Z	07	12	Z	07
		1	G	07	1	G	07
<b>C. Combustor assembly</b>		(39)			(29)		
Liner		1.0	H	54	0.5	I	76
Atomizer/vaporizer dome assembly		2.2	E	24	2.2	E	24
Secondary air control		0.5	E	74	0.3	I	76
Housing		30	A	61	20	A	61
Sensors and actuators		2.1	Z	00	3.2	Z	00
Ignition assembly		2.2	Z	07	2.2	Z	07
Seals, fasteners, etc.		1	G	07	1.0	G	07
<b>D. Regenerator assembly</b>		(61)			(52)		
Core	(Dual in Chrysler config.)	20	I	76	20	I	76
Housing and ducting		30	Z	61	20	I	76
Seals		3	Z	07	4	Z	07
Gear		3	D	61	3	E	61
Motor, fasteners		5	Z	07	5	Z	07
<b>E. Compressor assembly</b>		(58)			(41)		
Impeller		1.0	J	62	1.0	J	62
Shaft		0.6	G	69	0.6	G	69
Diffuser		15	A	61	9	I	76
VIGV assembly		3	Z	00	3	Z	00
Actuator		1	Z	00	2.5	Z	00
Housing		24	A	61	11.4	I	76
Air bearings		2	D	07	2	D	07
Seals and fasteners		11	Z	07	11	Z	07
<b>F. Accessory drive</b>		(19)	Z	80	(19)	Z	80
<b>G. Control system</b>		(39)			(34)		
Electronics and sensors		-			5	Z	07
Fuel valves, pump, filter		21	Z	07	21	Z	07
Misc. components		18	Z	07	8	Z	07
<b>H. Air inlet assembly</b>		(9)			(9)		
Housing and ducting		5	L	07	5	L	07
Air cleaner		4	Z	07	4	Z	07
<b>I. Reduction drive assembly</b>		(25)			(25)		
Gears, shafts, bearings		7	D	80	7	D	80
Housing		18	A	61	18	A	61
<b>J. Auxiliaries</b>		(26)			(26)		
Starter		9	Z	07	9	Z	07
Alternator		17	Z	07	17	Z	07
<b>Total, engine ready-to-run</b>	(600) (Chrysler)	(413)		.	(327)		
<b>K. Battery</b>	(42)	(42)	Z	07	(42)	Z	07
<b>L. Transmission</b> (Conv. 3-speed auto.)	(150)	(130) <sup>c</sup>	A, J	80	(130) <sup>c</sup>	A, J	80
<b>Total, power system</b>	(792)	(585)			(499)		

<sup>a</sup>MTL = Material type code (from Table 5-6).

<sup>b</sup>PROC = Process Code (from Table 5-7).

<sup>c</sup>Transmission weights shown in Tables 5-4 and 5-5 for Mature and Advanced engines are projected to be somewhat less than for equivalent Otto-engined power systems. By utilizing a (perhaps 50%) higher range of input rpm, the resultant lower torque levels permit a reduction in the physical size of gears and components; the final-drive (rear axle) ratio can be increased correspondingly to give the required overall gear reduction.

(where applicable), Mature, and Advanced configurations. For each subassembly and component, there is an estimate of the weight, together with an indication of material of construction and manufacturing process. The primary material for critical components is listed by material family (Table 5-6), and a process coding technique (Table 5-7) is employed to signify the dominant manufacturing process. These configurations are APSES projections, based partly upon Ref. 5-4 and information derived from numerous industrial contacts.

Table 5-8 exhibits both the single-shaft and the free-turbine Brayton weight breakdowns by material types. Unlike a conventional auto engine, both Brayton engines require the use of high-temperature materials such as stainless steel and/or superalloys and/or ceramics for the turbine assemblies, the combustor assemblies and the regenerators. The balance of the engine components do not require this high-temperature capability and may be fabricated with more-or-less readily available, conventional automotive materials and processes. The critical high-temperature components are discussed individually in the following sections.

Component and engine weights shown herein are net weights without an allowance for scrap. Scrapage has been allowed for in the unit costs presented later in this chapter. The details of

Table 5-6. Material type codes

A.	Cast iron (all types, gray, malleable, nodular, ductile, GM-60, NIRST, etc.)
B.	Carbon steel (AISI grades, etc.)
C.	High carbon steel (AISI grades, etc.)
D.	Alloy steel (AISI grades, includes carburizing and nitriding grades, etc.)
E.	Austenitic stainless steel (300 series, 200 series, special modifications such as CRM-6D, etc.)
F.	Ferritic or martensitic stainless steel (400 series, etc.)
G.	Precipitation hardening stainless steel (A-286, 17-4 PH, 15-5 PH, etc.)
H.	High-temperature superalloy (Inconels, Hastalloys, Waspalloys, Renes, INs, 713LC, Multimetts, other specialty alloys, etc.)
I.	Ceramic
J.	Aluminum alloy
K.	Copper alloy
L.	Plastic or Teflon or Rulon
M.	Rubber or elastomeric material
Z.	Nonhomogeneous or miscellaneous

Table 5-7. Process codes

10	Brazed	01	Casting
20	Welded	02	Investment casting
30	Formed	03	Forging
40	Unassigned code	04	Sheet
50	Stamped	05	Plate
60	Machined	06	Ceramic concrescence <sup>a</sup>
70	Fabricated	07	Purchased
80	Mechanically assembled	08	Tubing
00	Nonhomogeneous assembly or miscellaneous	09	Bar stock

<sup>a</sup>The term "concrecence," as used in this study, is a generic one referring to any existing or potential fabrication process which yields a completed ceramic shape or integral structure.

the costing methodology are discussed in Chapter 11. The current situation with regard to scrap recycling, the potential for increased future scrap recycling, and the effects of scrap on aggregate material consumption are discussed in Chapter 18.

Implicit in the Mature configuration (metallic) Brayton engines are the assumptions that they will operate with uncooled rotors and without special high-temperature coatings. The assumption of not utilizing turbine blade cooling systems, such as those employed in aircraft or stationary powerplants, is based on current cost and size considerations. However, some developers (e. g., Refs. 5-48, 5-55) have estimated that the efficiency loss associated with the air flow (effectively "leakage") required to cool the turbine blades would essentially offset any potential efficiency gain afforded by the allowed increase in cycle temperature, rendering the additional complexity unwarranted. In any case, the development of a cost-effective automotive-size blade cooling system would be a significant advancement in the current state-of-the-art.

Protective coating systems allow a metal to be operated at temperatures above its normal oxidation resistance limit, which may be important mainly for lightly loaded stationary components for which oxidation resistance is the limiting design parameter. Such coating systems have been under development for many years in the aircraft, aerospace and rocketry fields. The development of a high-reliability, inexpensive coating system suitable for mass production has remained an elusive goal. Further, although coating systems improve oxidation resistance, they do not significantly increase the low-cycle-fatigue or creep resistance of a material. The interaction of creep and low-cycle-fatigue is the

Table 5-8. Brayton weight breakdowns by material type

Material type	Material code	Mature 150-hp single-shaft quantity, lb	Mature 150-hp free-turbine quantity, lb	Advanced 150-hp single-shaft quantity, lb	Advanced 150-hp free-turbine quantity, lb
Cast iron	A	177	179	38	38
Carbon steel	B	—	—	—	—
High-carbon steel	C	—	—	—	—
Alloy steel	D	12	12	9	9
Austenitic stainless steel	E	19.2	21.7	5.7	9.7
Ferritic or martensitic stainless steel	F	1.0	2.5	—	2.5
Precipitation-hardening stainless steel	G	3.6	7.0	3.6	7.0
Superalloy	H	5.1	15.5	—	—
Ceramic	I	20	20	106	112
Aluminum alloy	J	1	1	1	1
Copper alloy	K	—	—	—	—
Plastic or Teflon or Rulon	L	5	5	5	5
Not broken down (conventional auto materials <sup>a</sup> ), nonhomogeneous, or miscellaneous	Z	122	149	122	143
Total, engine ready-to-run <sup>b</sup>		366	413	290	327

<sup>a</sup>Conventional auto materials do not include E, F, G, H, and I, but do include additional quantities of some of the others explicitly listed.

<sup>b</sup>Does not include transmission or battery.

usual design-limiting parameter for the high-speed rotating components.

The analyses of this chapter show the Brayton engines to be viable contenders without blade cooling or coatings. If effective blade cooling or coatings are developed in the future, the Brayton engines could look even more promising, as either of two strategies could be pursued: (1) a performance strategy could allow the existing high-temperature materials to operate with an even higher turbine inlet temperature, or (2) a producibility option could be considered wherein lower-temperature capability, more economical materials could be utilized at the same turbine inlet temperature. As there is no way of predicting when, or if, either of these breakthroughs may occur, they have not been assumed in the Brayton configurations.

Figure 5-14 shows an exploded view and a schematic diagram of the Chrysler Corporation sixth-generation, dual-regenerated, free-turbine Brayton engine, illustrating its main components

and their functional interrelationship. This engine is representative of the Present configuration (Ref. 5-30).

#### MATURE CONFIGURATION TURBINE ASSEMBLIES

As may be observed from Tables 5-4 and 5-5, a major difference between the Mature free-turbine and the single-shaft Brayton engines is that the free-turbine Brayton engine requires both a power and a gasifier turbine assembly, whereas the single-shaft Brayton engine requires only one turbine assembly. Thus, from strictly a materials point-of-view, there is a considerable advantage to the single-shaft Brayton engine, as it requires smaller quantities of high-temperature materials (such as superalloys and stainless steels). The magnitude of this materials difference is clearly shown in Table 5-8, and the implications of these requirements on aggregate materials consumption are discussed in Chapter 18.

For the single-shaft Brayton engine, the turbine wheel has been configured as an investment cast superalloy. The inlet scroll and discharge shroud may be fabricated from stainless steel (based upon compressor efflux air cooling, as noted in Section 5.3.2), as well as the shaft and some fasteners.

In the case of the free-turbine Brayton engine, the turbine wheel, inlet housing, and part of the variable nozzle assembly of the power turbine have been configured from investment-cast superalloy. The shaft, discharge shroud, other parts of the variable nozzle assembly and some fasteners will require stainless steel. The gasifier turbine will also utilize an investment-cast superalloy wheel. The inlet scroll and discharge shroud, as in the single-shaft turbine assembly, as well as the shaft and some fasteners, can be fabricated from stainless steel.

The current state-of-the-art can produce an uncooled, uncoated superalloy turbine wheel which can operate at a sustained turbine inlet temperature (TIT) in the range of 1900° F, with short term TIT transients in excess of 1900° F. These wheels, as well as some stationary components that experience approximately the same temperature ranges, currently are made from cast superalloys. The general term "superalloy" refers to a rather large family of specialty alloys that have high-temperature strength capabilities, as well as suitable creep, low-cycle-fatigue, and oxidation resistance at elevated temperatures. These alloys are largely an outgrowth of the aircraft jet engine technology and include the general families of high-nickel and/or cobalt alloys known as the Inconels, Hastalloys, Waspalloys, Renes, IN's, and other related alloys. A specific alloy that probably best describes the current state-of-the-art is the Inconel 713LC casting alloy, for which considerable engineering data is available. The newly developed IN 792 alloy, with a small hafnium addition, has a slightly higher temperature capability and is likely to see increased future usage, although current experience with this alloy is limited. The superalloys contain elements such as nickel, chromium, cobalt, tungsten, and other elements to varying degrees, depending on the specific alloy selected. Due to the utilization of these more expensive alloying elements, the basic material cost of the superalloy, in automotive quantities, would be roughly an order of magnitude higher, on a per-pound basis, than the cast iron traditionally used in the automotive industry. For some of these alloying elements, the United States is dependent upon imports. The questions of world-wide material availability, and the reliance on imported raw materials, are discussed in Chapter 18, along with the requirements for the increase in mill production capability of superalloys that would be required for a conversion to an annual mass production rate of millions of Brayton engines.

Future increases in the operating temperature of the superalloy family are expected to be slowly evolutionary, rather than sudden and dramatic. Superalloy technology has been heavily investigated since World War II; hence the technology is rather mature. A reasonable expectation of temperature capability increase, due to improved alloying and production techniques

and/or compositional variation, is about 10 to 15° F per year. Thus a modest increase in the uncooled, uncoated superalloy TIT may be expected within the time frame of this study. However, it is probably more fruitful to look to other materials, such as ceramics, to provide a dramatic increase in turbine inlet temperature.

With regard to the raw material cost for superalloys on a per pound basis, there are no compelling reasons to expect any significant reductions in cost of the basic ingredients. In fact, if there is a relative change in the cost differential between superalloys and cast iron, it is more likely that superalloys will become relatively more expensive over the next 5 to 15 years. There is potential for reductions in the unit costs of superalloy components, both from decreases in their fabrication costs and by increased recycling of scrap superalloy. These are much more likely to occur than reductions in the per-pound cost of virgin superalloy.

Since the greatest opportunity for reduction in manufacturing cost of a finished superalloy component lies with improved manufacturing processing, the major present and future materials and processes efforts are expected to remain concentrated in this area. The general fabricating method for superalloy turbine components is investment casting, although other techniques are currently being investigated. Significant improvements in reducing the cost of finished cast superalloy parts may result from processes such as the AIREFRAC® process being developed by the Garrett Corporation. This process was developed specifically for the purpose of mass producing turbine and compressor wheels at a lower cost than the current investment casting techniques. The process principle involves a rubber pattern with reusability of some previously expendable foundry materials. The result is a process that is more amenable to mass production, faster, requires fewer labor hours, and is more economical. The details of this process have been described in Ref. 5-31.

Another approach to reducing the cost of fabricated superalloy parts is the GATORIZING® process being developed by the Pratt and Whitney Division of United Technologies, Inc. This is a creep forging technique which allows the fabrication of finished complex shapes to very close tolerances with little or no afterwork and fewer rejections, thus offering the possibility of reducing both the raw material required and subsequent machining costs. The reader is referred to Ref. 5-32 for further elucidation of the GATORIZING process.

Increased recycling of superalloys is another method whereby the cost of finished superalloy parts may be reduced. Some specifications currently require superalloy parts to be made solely of virgin materials. This approach may make sense for low-volume, high-reliability spacecraft, aircraft, or military applications. However, if superalloys are utilized in alternate automobile engines, it is assumed that the automotive specifications will permit and encourage recycling of superalloy scrap in order to reduce both costs and mining requirements of superalloy constituents. This topic is discussed further in Chapter 18.

The various current R&D fabrication and processing programs are directed toward reducing the manufacturing cost of a completed superalloy turbine wheel in mass production down to the range of \$8 to \$15 (1974 dollars) per unit, depending on the weight of the wheel. This goal is considered achievable over the time span considered in this study. A study by Williams Research Corp. in 1973 (Ref. 5-33) indicated a potential OEM selling price of less than \$10 for a 2.7-lb turbine wheel casting, sans final machining, from alloy 713LC in production runs of over a million units per year. Also, in cases where investment-cast superalloy is now considered for some stationary components, it seems highly probable that, prior to a full conversion to a Brayton engine, the automobile industry would develop the technology to allow cheaper, more available materials (such as cast iron) to be used with a ceramic liner for some of these applications. Additional discussion of potential future improvements to reduce the requirements for critical materials is found in Chapter 18.

#### ADVANCED CONFIGURATION CERAMIC COMPONENTS

In discussing the current state-of-the-art and projected future for ceramic turbine materials, one must first differentiate between two basic classes of ceramics. First are the ceramics used in regenerators, such as lithium aluminum silicate (LAS) and magnesium aluminum silicate (MAS). These materials are discussed in the regenerator section. The second major class of ceramic materials includes silicon carbide, silicon nitride, Sialons and potentially other ceramics designed for hot-section structural components (such as turbine wheels, housings, combustor liners, variable nozzles and other other components as conjectured in Table 5-4 and 5-5) in the Advanced configurations. This section discusses these latter materials and components.

With respect to the turbine hot-section components, such as wheels, it is most significant to note that, to date, there has not been a complete ceramic turbine hot section, or wheel, operated in a small automotive type gas turbine in the temperature range of 2000 to 2500° F. There are programs currently underway with the goal of developing and testing a 2500° F ceramic turbine wheel and associated hot section. The most significant is the ARPA/Ford/Westinghouse program, wherein ARPA has funded Westinghouse to develop ceramic materials for stationary Brayton applications, and Ford to develop ceramic materials for automotive turbine applications. As presently constituted, this is a six-year program, over half complete. The expressed goal of the automotive portion of the program is the development and testing of ceramic turbine wheels and other hot-section components at a turbine inlet temperature of 2500° F for 200 hours. This program is currently government-funded at approximately \$15 million total and involves some funding from industry. Regular six-month progress reports have been issued on this project, the most recent of which are Refs. 5-34 and 5-62.

The bulk of the current ceramics R&D effort is in, and projected improvements are most likely to come from, the fabrication of silicon carbide and silicon nitride. Development effort

is centered in these ceramics for turbine hot-section components, as their high-temperature strength, thermal conductivity, and expansion properties are more conducive to withstanding thermal shock than those of the more traditional oxide ceramics. The potential of silicon carbide and silicon nitride for automotive applications has been discussed in Refs. 5-35 and 5-36.

Although silicon carbide and silicon nitride have been known for some time, they have not received widespread usage because suitable methods of parts fabrication have not yet been developed. Historically, fabrication has been accomplished by two basic methods: hot pressing and reaction sintering. In hot pressing techniques (often isostatic), parts can be made only one at a time, under the application of both high temperature and pressure. These silicon carbide and silicon nitride parts have had high quality density and good mechanical properties, but the fabrication process is expensive and does not lend itself to mass production. The second basic fabrication technique has been reaction sintering, wherein the shapes are fabricated in antecedent materials and subsequently nitrided or carburized in situ. This fabrication technique is more amenable to mass production; however, the historical-attained percent of theoretical density and the resulting mechanical properties have not been as satisfactory as in hot-pressed materials.

A recent research advancement that appears to lead the way to better fabrication techniques of silicon carbide has been developed by Dr. Prochazka and his associates at General Electric (Refs. 5-37, 5-38, and 5-39). They have demonstrated, on a laboratory scale, a method of a specific boron addition which allows the in situ sintering process to develop a high percentage of theoretical density and correspondingly good mechanical properties. While this has only been demonstrated on a laboratory basis thus far, it opens an approach wherein major developments can be expected to occur over the next several years. As this technology is immature, additional formulation improvements are likely to result in the future. The use of sintering aids is normally to be expected and offers considerable opportunity for technology advancement.

This improved in situ sintering technique for silicon carbide, wherein a part can be injection-molded, slip-cast, extruded, or die-pressed into a shape, clearly lends itself to automated mass-production operations. Formed "green" parts could be conveyor-belted into a zone-controlled furnace and sintered. This approach has yet to be fully proven, and there is still risk in forecasting the course of its development. Nevertheless, this is a highly desirable area for future funding. Increased funding is a necessary but not sufficient condition for the development of automotive ceramic hot section components for a 2500° F turbine inlet temperature. The exceedingly high payoff from successful development of ceramics fully warrants accepting the risk, which must be recognized and acknowledged a priori in this type of program.

A major advantage of ceramics is that the raw materials are inexpensive and readily available domestically. However, it should be noted that current, admittedly experimental,



fabrication techniques require high-purity starting materials and, as discussed in Section 5.7, optimization of raw material preparation still requires additional R&D.

A major ceramics R&D problem is in the aforementioned development of fabrication techniques that will result in high-structural-reliability parts on a mass-production basis. Ceramic knowledge has advanced far enough that a reasonable development program can be outlined for a 2500° F ceramic turbine automotive engine. Such a program would entail a 5- to 10-year period of basic ceramic technology development, as well as a series-parallel automotive component development and demonstration-in-a-vehicle program. This latter effort would probably take from 5 to 7 years. It is highly important to emphasize that the successful development of a 2500° F turbine inlet temperature ceramic gas turbine engine requires an integrated engine design effort and not just the simple substitution of ceramic parts for metal parts. It seems reasonable that a prototype ceramic automotive Brayton engine could be developed in a 7- to 10-year time frame, at a development cost of the order of \$100 million. After the completion of this technology development and demonstration program, the normal 42-month time cycle and costs from decision-to-produce to "Job 1" would have to be added for fleet introduction. Whether or not this will happen depends upon adequate funding levels and the success of the program.

It is assumed that government funding would have to be provided to assist the development of ceramics. In spite of the high potential payoff, it is unlikely, based on the current practices of the automotive industry (see Chapter 15), that the industry will, on its own, commit the requisite R&D resources in a timely manner. As a 2500° F ceramic technology has applications in many other areas besides automobile gas turbines, it is considered a rational and desirable national goal to expend resources in its development. Ceramic technology is a high-payoff technology with some associated risk — a type for which there are past precedents for government involvement in accelerating development. Ford has proposed an acceleration of, and follow-on to, the current ARPA ceramics program (Ref. 5-29). Also, the Army Materials and Mechanics Research Center (the program monitors for the ARPA program) have proposed to ERDA a follow-on automotive ceramics program (Ref. 5-40) to commence after the completion of the current ARPA program. Action should be taken to implement a program containing the best features from these proposals, the APSES R&D recommendations, and any other proposals that either have been or will be made by other organizations in order to provide both continuity and a vigorous follow-on after the completion of the current ARPA program.

One reason for stressing the necessity of an integrated design effort on a ceramic turbine engine is the problem of brittleness. Ceramic materials are usually limited by brittleness rather than temperature. While much R&D effort is being expended attempting to improve the toughness of silicon carbide and silicon nitride ceramics, this is a very difficult problem. Some improvement may be expected, but dramatic

improvements are not very likely and ceramics will remain, relative to most metals, brittle materials. Learning to design with brittle materials is essential. Brittle material design technology includes the quality and reliability assurance areas which, in turn, require development of flaw-detection methods, proof-testing procedures, and nondestructive evaluation techniques applied to the mass-production environment. Ceramics technology is only in its infancy, and considerable progress is probable in the future. The basic characteristics of ceramics will not greatly change, but man's ability to intelligently and effectively utilize these materials can certainly improve greatly.

In the quest for a one-piece, mass-producible turbine wheel, various techniques are being investigated. In the duo-density approach, the high strength of hot pressed silicon nitride is utilized in the disc or hub region, where the stresses are the highest but the temperatures are moderate. Silicon nitride can be formed by injection-molding or slip-casting and then sintered to produce the parts that are exposed to the highest temperatures but lower stress levels, such as the blades. Figure 5-15 shows an experimental silicon nitride rotor blade ring, illustrative of the present state-of-the-art (Ref. 5-34). Figure 5-16 illustrates thermal shock testing of a silicon nitride rotor blade ring, also from Ref. 5-34. Techniques such as the duo-density approach are intermediate steps in the development of ceramic technology. The ultimate goal, of course, is the ability to mass-produce high-reliability, one-piece turbine wheels at an acceptable fabrication cost.

In the Advanced configurations of both Brayton engines, careful attention will also have to be devoted to development of joining techniques between structural ceramics, such as silicon carbide and silicon nitride, and contiguous metallic components, such as stainless steel shafts.

For completeness, two additional ceramic fabrication techniques that are under investigation should also be mentioned. Hillig and his associates at General Electric (Ref. 5-41) have recently announced a ceramic composite material, formed by converting carbon filaments into aligned silicon carbide crystals by reacting them with molten silicon. The process is somewhat analogous to a foundry operation. The temperature capability of this type of material is fundamentally limited by the melting point of the matrix (~1370°C for solidus melting under stress). In an engineering sense, the composite's useful temperature range under load is, of course, less than its melting point. Thus, this composite's useful temperature capability is potentially in the 2100 to 2400°F range. It is therefore not a substitute for the previously mentioned silicon nitride or silicon carbide ceramics at the 2500°F TIT of the Advanced configuration Brayton engines. As only a few laboratory samples have been made by this technique so far, it is not possible at this time to assess the quality, reproducibility, reliability, and economic viability, or to fully characterize the material's properties. Whether or not there is a place for such an intermediate-temperature-capability ceramic composite in automotive GTE's remains to be determined. Chemical vapor deposition of silicon carbide

turbine rotors also has been proposed (Ref. 5-61). Again, only a few laboratory samples have been produced. Quoting from Ref. 5-61: "The work to date has been encouraging in the area of shape but has not yet demonstrated the chemical vapor deposited test bar strengths in the rotor configuration." As the state of development of this technique is so rudimentary, there is currently no reasonable basis for projecting any significant advancements. This process is clearly a long way from demonstrating anything approaching economic viability in mass production. In our opinion, neither of the two ceramic fabrication techniques discussed in this paragraph warrants a significant research priority such as has been previously recommended for the more promising silicon nitride and silicon carbide fabrication processes.

In the very long term, other ceramic systems, such as Sialons, may be developed. The upper limit which might eventually be obtained through the use of ceramic technology could conceivably be as high as 3000°F, based on both basic material property limitations and the possibility of a fundamental NOx formation limit.

Additional discussions of specific design requirements, goals, and needs of the ceramics R&D program are given in Section 5.7 of this Chapter and are further discussed in Chapter 12 (funds and time scales required) and Chapter 18.

#### BEARINGS

For both the Mature and Advanced configuration single-shaft Brayton engines, the bearings are included in the compressor assembly. These bearings are of conventional construction. The Mature free-turbine Brayton engine also uses conventional bearings in the power turbine and compressor assemblies. The Advanced free-turbine Brayton has a potential problem in the power turbine bearings. For conventional bearings to be used, design ingenuity will be required to locate them in an area that is within their temperature limits. Alternatively, a silicon nitride bearing system, currently under development (Ref. 5-42), could provide a future option.

#### COMBUSTOR ASSEMBLY

The combustor is basically of can-type construction. Because of the very high temperatures involved, the combustor liner for both Mature configuration Brayton engines may be fabricated from superalloy. The atomizer/vaporizing dome assembly, as well as the secondary-air control components, can be fabricated from austenitic stainless steel. The remainder of the components — such as the housing, sensors, actuators, and ignition assemblies — are of conventional automotive construction. Some precipitation hardening stainless steel fasteners would likely be employed.

The combustor liner is subjected to the highest temperature generated in the engine, but it experiences very low mechanical stresses. As was noted, the Present and Mature configurations employ combustor liners fabricated from superalloy; however, the low mechanical stress level makes the burner can a prime candidate for manufacture from ceramic materials. Silicon carbide

or silicon nitride are possibilities for this application in the Advanced configuration. Figure 5-17 shows an experimental silicon carbide combustor component currently under development (Ref. 5-34).

#### COMPRESSOR ASSEMBLY

For both the single-shaft and free-turbine Mature and the Advanced configuration compressor assemblies, a 4:1 compression ratio has been selected. As the operating temperature is a function of the compression ratio, and the compression ratio is relatively low, an investment cast aluminum impeller is satisfactory for the anticipated temperature range of 300-400°F. For the Mature configurations, there are considerable cost advantages to maintaining the much more economical aluminum impeller as opposed to the more expensive, but higher-temperature-capability titanium compressor components that are often used in aircraft applications. Stainless steel is likely to be used for the shaft and possibly for part of the variable inlet guide vane assembly. The remainder of both Mature configuration compressor assemblies is of conventional construction as noted in Tables 5-4 and 5-5.

In the Advanced configuration compressors, ceramics such as silicon carbide or silicon nitride are proposed for the diffuser and the housing. The aluminum impeller has been retained, although it also could be made from a ceramic, if this became cost-effective. A ceramic impeller could have some advantage, in that it may be lighter in weight and thus have a lower moment of inertia.

#### REGENERATORS

The Brayton regenerators are rotating ceramic discs of the type manufactured by Corning and others. The early ceramic regenerator core material utilized was a lithium aluminum silicate (LAS) ceramic system. The ability to make a reliable regenerator has been a problem in the past, as exemplified by truck turbine regenerators. Significant progress towards resolution of these problems has been reported in Ref. 5-43. The LAS regenerator material was attacked by sodium and sulfur. Magnesium aluminum silicate (MAS) systems, as well as some variants of LAS, are not as susceptible to attack. Chemical attack and degradation of the hub and drive gear were also encountered. These problems can be solved by design changes (e.g., current design deletes the hub support). A more detailed discussion of the chemical, thermal, and mechanical problems associated with ceramic regenerator components and current work in progress is given in Ref. 5-43.

Another ceramic regenerator difficulty has been the cost and yield. The process used in winding the core is somewhat analogous to attempting to wind damp bathroom tissue under tension. The resulting yields were extremely low, resulting in excessive cost. Ford (Ref. 5-29) has since run in-house producibility studies, using one of its vinyl upholstery lines, and has developed a proprietary technique for core winding that they believe will solve the yield problem and produce ceramic cores at a reasonable cost in mass production.

As an example of the progress being made in ceramic regenerator development, it has been reported (Refs. 5-29, 5-40, 5-62, 5-63) that service lifetimes up to 298 hours at a temperature of 1840°F have been obtained in laboratory tests on an improved experimental low-expansion LAS regenerator core. This temperature is in the same range as that required for the Mature configuration single-shaft or free-turbine Brayton engine. It is the projection of the APSES team, as well as the consensus of most of the cognizant automotive engine manufacturers and government agencies contacted, that an MAS system offers even greater temperature/service-life potential, in addition to the aforementioned improved resistance to chemical attack. Therefore, based on our current information (which includes some proprietary and unpublished data), an MAS system has been selected for the Mature configuration SS and FT Brayton engines. Of course, improved variants of either the LAS or MAS material families could be developed in the future.

In the case of Advanced configuration Brayton engines, it is not presently known whether an MAS system, or improved variants of either MAS or LAS, could be pushed to 2000°F. The ability to make a 2000°F regenerator may require either significant improvements in existing technology or the ability to develop a successful silicon nitride or silicon carbide regenerator. In the more distant future, the Sialon-type ceramic systems may be considered in the search for a higher-temperature core.

It has also been reported (e.g., Ref. 5-29) that suitable proprietary regenerator seals have been developed. They do not contain any nickel oxide, thus avoiding the possible health effects (Ref. 5-64) of particulate attrition from seals containing nickel oxide.

#### OTHER SUBASSEMBLIES

The remaining subassemblies of both the single-shaft and free-turbine Brayton engines, consisting of the accessory drive, control system, air inlet assembly, speed reducer assembly, and auxiliaries are all of conventional automotive construction. None of these systems require any exotic materials or processes.

#### 5.3.4 Unit Costs

The Brayton free- and single-shaft turbine unit costing is for the APSES-derived configurations which were based in part on Ref. 5-4 and industrial contacts. Material costs and labor rates reflect the mass production environment peculiar to the automobile industry. The material types and weights stipulated for these configurations are representative of viable production turbines. The labor content in terms of machining and assembly times are compatible with the type of automation required for a yearly production rate of 400,000 units. References 5-44 and 5-45 give details of the automation required in terms of transfer line machinery, special and standard machines and final assembly.

Material costs are somewhat higher than for an equivalent-power Otto engine, due to the requirement for superalloys and stainless steels in the high-temperature areas of the engines.

The requirement for an automatic start sequence and closely controlled fuel-air ratio in a variable-geometry burner also adds cost.

The increased labor in fabricating and machining the superalloys is somewhat compensated by reduced assembly time. The total labor content of the free-turbine engine is comparable to that of the Otto engine, while the single-shaft engine may require 10-20% fewer hours per unit. Further cost details for each of these engines are given in Chapter 11.

The single-shaft engine requires a continuously variable transmission, whereas the free-turbine engine can operate with a nearly standard three-speed automatic transmission. The unit cost increment between these two transmissions is estimated to be zero (Refs. 5-46, 5-47). Therefore, the power system unit cost includes a transmission unit cost equivalent to that of a conventional three-speed automatic for both turbine configurations.

Power system unit variable costs are shown in Figs. 5-18 and 5-19, as a function of horsepower, for the free-turbine and single-shaft Brayton power systems respectively.

### 5.4 VEHICLE INTEGRATION

#### 5.4.1 Engine Packaging in Vehicle

The primary power-producing components (turbine wheels) of Brayton engines are quite small, but a complete automotive installation must allow for the housings, heat exchanger(s), and the ducting required for handling the high gas flow rates, as well as auxiliaries and accessories. A 6-in.-diameter exhaust duct is projected for a 150-hp engine (Ref. 5-2) which, even if flattened onto an oval shape under the car, would represent a definite design impact on the body layout. The intake duct will have to include an air filter sized for the Brayton's air flow rate.

Past prototype installations have filled the engine compartments of their originally-Otto-engine-powered cars rather tightly. Optimum packaging, however, is seldom achieved (or even sought) with prototypes, and the Mature Brayton engine in both single-shaft and free-turbine versions is expected to be somewhat more compact than the equivalent Otto engine. Whether this will result in a smaller engine compartment depends upon details of the configuration, and for the present study we have conservatively assumed no net benefit in engine compartment volume for the Brayton engine relative to the baseline UC Otto.

#### 5.4.2 Transmission Requirements

The free-turbine engine can use the same transmission types as are currently used with Otto engines (i.e., 3- or 4-speed gearboxes in either manual or automatic versions). The characteristics of the power turbine may eventually allow elimination of the torque converter from the transmission, with attendant cost savings. As with Otto engines, but to a lesser extent, introduction of a CVT should allow better engine/vehicle matching and improve fuel economy with equal performance.

The single-shaft engine, because of its unique torque/speed curve, needs a CVT for successful automotive application. Of the various types of CVT described in detail in Section 5.3.1, the most promising are the hydromechanical and the variable-stator torque converter transmissions, with the latter probably producible at lower cost. With further development, traction-type transmissions may provide better efficiency at competitive cost.

#### 5.4.3 Other Impacts

Accessories and auxiliaries have to be driven from a continuously rotating shaft. The output drive shaft is normally used for this purpose in either the SS or FT configuration. In the FT Brayton, the accessories and auxiliaries could be driven by the gasifier section, but in recent designs this has been avoided to improve response time (moment of inertia and load) and to reduce bearing loads.

Incorporating a heater may involve problems. To avoid exhaust gas leaks into the passenger compartment, a two-stage hot gas/air/air heat exchanger may be necessary, which could be bulky, costly, and inefficient. An alternative might be a single-stage housing-to-air unit using heat pipes, although this may be too expensive. An air conditioner will require an exterior heat exchanger (and possibly fan) even though the engine itself needs none.

Because of its expected lower fuel consumption, the Brayton-engined car will carry a proportionately smaller fuel tank for the same range, reducing its curb weight.

#### 5.5 PERFORMANCE IN VEHICLE

Fuel economy estimates and emissions trends were calculated for Mature Brayton-engined vehicles in the six Otto-Engine-Equivalent

(OEE) automobile classes of interest to this study, using the Vehicle Economy and Emissions Prediction (VEEP) computer program described in Chapter 10. The methodology of adjustments for weight propagation effects and torque characteristics is also described in Chapter 10. Specific fuel consumption and emissions index data presented in Sections 5.2.2 and 5.2.4 were used in the computation. Typical 3-speed automatic transmission efficiencies were employed in the FT Brayton vehicle calculations. For the SS Brayton vehicles, the hydromechanical CVT efficiencies shown in Fig. 5-20 were used, since comparably detailed data for the preferred VSTC-type transmission were not available. These computer predictions, together with limited available emission test data, constituted the basis for vehicular performance projections. The results are described in the following sections.

#### 5.5.1 Fuel Economy

Predicted fuel economies for SS and FT Brayton-engined vehicles in the six OEE size classes are given in Tables 5-9 and 5-10, respectively. They are reported at a standardized ambient temperature of 85° F in terms of equivalent gasoline consumption for comparison with other alternates, although diesel or "broad-cut" distillate would probably be the fuel of choice. Only a single entry is shown for the Present FT Brayton in Table 5-10, corresponding to an experimental Chrysler vehicle (which would not be produced as such). Experimental data were not available at this writing for a "Present" SS Brayton vehicle, hence the blank column in Table 5-9.

The Mature configurations are optimized at low load and operate within essentially the same pressure and temperature limits as the Present configuration. Their specific power and torque characteristics permit some reduction in design

Table 5-9. SS Brayton vehicle fuel economy<sup>a</sup> projections in mpg (gasoline)

OEE <sup>c</sup> auto. class	Curb weight, lb	Design maximum power, hp	Present configuration <sup>b</sup>		Mature configuration		Advanced configuration	
			FDC-U	FDC-H	Driving cycle		FDC-U	FDC-H
					FDC-U	FDC-H		
Mini	1500	36			32.2	48.7		
Small	1880	49			28.9	42.7		
Subcompact	2270	66			25.5	37.3		
Compact	2660	86			22.9	33.4	32	46
Full-Size	3400	118			18.9	27.8		
Large	4220	152			15.8	23.5		

<sup>a</sup>85° F day.

<sup>b</sup>No data available for "Present" SS configurations.

<sup>c</sup>Otto-engine equivalent.

Table 5-10. FT Brayton vehicle fuel economy<sup>a</sup> projections in mpg (gasoline)

OEE <sup>b</sup> auto. class	Curb weight, lb	Design maximum power, hp	Present configuration		Mature configuration		Advanced configuration	
					Driving cycle			
			FDC-U	FDC-H	FDC-U	FDC-H	FDC-U	FDC-H
Mini	1550	37			29.2	43.8		
Small	1920	51			26.2	38.6		
Subcompact	2310	69			23.2	33.8		
Compact	2710	89			20.8	30.1	29	42
Full-Size	3470	123	8.9	c	17.2	24.9		
Large	4330	158			14.3	21.1		

<sup>a</sup>85° F day.

<sup>b</sup>Otto-engine equivalent.

<sup>c</sup>"Sixth generation" (nonoptimum) engine; non-OEE intermediate vehicle.

horsepower in the OEE vehicles – about 32% (SS) and 30% (FT) – with concomitant weight reduction. The result is a significant gain in fuel economy, as indicated in Tables 5-9 and 5-10. Relative to the equivalent Mature Otto-engined vehicles, these cars show a fuel economy improvement<sup>5</sup> of about 33% (SS) and 21% (FT) on the urban Federal Driving Cycle, and about 30% (SS) and 17% (FT) on the highway cycle.

In the Advanced configuration, fuel economies were estimated for the reference size (OEE Compact) vehicle only. At this level of technology, the SS Brayton vehicle betters the fuel economy of an equivalent Advanced Otto-engined Compact car by 52%, and the FT version by 38%, on the FDC-U. The corresponding gains over the FDC-H are about 53% (SS) and 40% (FT).

These results clearly indicate that the single-shaft Brayton offers greater fuel economy potential than the free-turbine implementation at any level of technology, provided that the required CVT, with comparable efficiency, can indeed be produced. The computational inaccuracy in the fuel economy estimates is small, and the unquantifiable uncertainty lies in developmental attainment of stipulated component performance.

### 5.5.2 Chemical Emissions

Emissions projections for vehicles with Mature SS and FT Brayton engines, in the six OEE car classes, are given in Tables 5-11 and 5-12, respectively. These projections are for the urban Federal Driving Cycle (1975 FTP) – of most significance from the urban air quality standpoint – and for well-maintained cars at 50,000 miles. It should also be noted that these

emissions data are for diesel fuel, which is reasonably representative of the denser distillates (diesel, kerosene, JP-4, "broad-cut") likely to be used in Brayton-engined cars. These estimates were derived from results of combustor rig tests simulating the FDC-U. Scaling across the spectrum of vehicle classes was accomplished by means of trends established with the VEEP computer program, using stepwise integration of steady-state emission index data (see Section 5.2.4), adjusted for cold-start effects. The same emission characteristics were used for both the SS and FT types, the differences in the resulting estimates reflecting only the corresponding disparity in their fuel economies. Also cited in Table 5-12 for comparison are experimental results for the sixth-generation Chrysler and GT-225 General Motors FT engines, both nonoptimum preprototype units – the former employing a simple, fixed, spray-burning combustor.

While it is acknowledged that the Mature-engine vehicle emissions projections are fairly rough estimates, and subject to greater uncertainty than the fuel economies, they are far enough below the statutory emission standards (0.41/3.4/0.4 g/mi of HC/CO/NO<sub>x</sub>) to make a convincing argument that Mature Brayton vehicles delivering the projected fuel economies will pose no emissions problems. It is also reasonably clear that a relatively sophisticated combustor is required to meet the statutory NO<sub>x</sub> standard but might not be required to meet a 2.0-g/mi NO<sub>x</sub> standard.

There do not appear to be any significant problems with the Brayton engines in the realm of unregulated chemical pollutants (SO<sub>2</sub>, particulates, smoke, and odor) at this writing. Since no oxidizing catalyst is used, nor such use envisioned,

<sup>5</sup>Based upon sales-weighted fuel consumption, present market mix of car classes.

Table 5-11. SS Brayton vehicle emissions projections in g/mi (diesel fuel) over the Urban Federal Driving Cycle (1975 FTP)

OEE <sup>c</sup> auto. class	Curb weight, lb	Design maximum power, hp	Present configuration <sup>a</sup> (1975)			Mature configuration <sup>b</sup>		
			HC <sup>d</sup>	CO	NOx <sup>e</sup>	HC <sup>d</sup>	CO	NOx <sup>e</sup>
Mini	1500	36				0.06	0.21	0.04
Small	1880	49				0.07	0.29	0.06
Subcompact	2270	66				0.08	0.39	0.07
Compact	2660	86				0.09	0.49	0.09
Full-Size	3400	118				0.11	0.68	0.13
Large	4220	152				0.13	0.90	0.17

<sup>a</sup>No Present vehicle data available.

<sup>b</sup>Variable geometry premix/prevaporizing combustor.

<sup>c</sup>Otto-Engine Equivalent.

<sup>d</sup>As C<sub>6</sub>H<sub>14</sub>.

<sup>e</sup>As NO<sub>2</sub>.

Table 5-12. FT Brayton vehicle emissions projections in g/mi (diesel fuel) over the Urban Federal Driving Cycle (1975 FTP)

OEE <sup>b</sup> auto. class	Curb weight, lb	Design maximum power, hp	Present configuration (1975)			Mature configuration <sup>a</sup>		
			HC <sup>c</sup>	CO	NOx <sup>d</sup>	HC <sup>c</sup>	CO	NOx <sup>d</sup>
Mini	1560	37				0.06	0.23	0.04
Small	1920	51				0.07	0.32	0.07
Subcompact	2310	69				0.08	0.43	0.08
Compact	2710	89				0.10	0.54	0.10
Full-Size	3470	123	0.3	3.4	2.7	0.12	0.75	0.14
				(Chrysler) <sup>e</sup>				
Large	4330	158	0.18	2.0	0.38	0.14	1.0	0.20
				(General Motors) <sup>f</sup>				

<sup>a</sup>Variable-geometry premix/prevaporizing combustor.

<sup>b</sup>Otto-engine equivalent.

<sup>c</sup>As C<sub>6</sub>H<sub>14</sub>.

<sup>d</sup>As NO<sub>2</sub>.

<sup>e</sup>"Sixth generation" (nonoptimum) engine in non-OEE vehicle; fixed spray-burning combustor.

<sup>f</sup>GT-225 engine with prechamber combustor; experimental installation in 5000-lb effective inertia weight (non-OEE) test bed.

there will be no agency to promote any trace sulfur in the fuel to the hexavalent state, hence the absence of a significant sulfate problem. Further, in the continuous-combustion regenerated Braytons, cycle temperatures and pressures are lower than in the conventional Otto engine, further ameliorating any concern over sulfur emissions as SO<sub>4</sub>. However, most turbine fuels contain more trace sulfur than gasoline, and in the absence of desulfurization, the total sulfur emissions (i. e., SO<sub>x</sub>) would increase. Since sulfur can be deleterious to engine hot parts as well, some desulfurization of fuels may provide an effective approach to both problems.

With the advent of non-spray-burning combustors, smoke and odor should not pose serious problems. Aside from sulfurous compounds, most odorous species are incompletely oxidized hydrocarbons (e. g., aldehydes). Although olfactory detection limits are, in many cases, considerably lower than the statutory HC limit, combustion systems which provide effective HC control will probably be acceptable from the odor (and also smoke) standpoints as well.

Very limited particulate emission data are reported in the Brayton literature, its ostensible cleanliness in this regard probably being assumed by virtue of its observed smokelessness with a well-designed combustor. However, microparticulate emissions do tend to be a problem, which may pass unobserved, in any droplet-burning engine using heavy-fraction (e. g., diesel fuel) fuels. This concern therefore deserves some attention in all diesel-fuel-burning engines, including the Braytons. If it turns out to be a de facto problem, several expedients are at hand: (1) use gasoline, (2) use a pre-vaporizing combustor (already recommended for NO<sub>x</sub> control), or (3) use a monocomponent or nonpetroleum fuel.

Further study of all four questions — sulfur, odor, smoke, and particulates — is required during development.

### 5.5.3 Noise Emissions

Turbine noise is different in kind (i. e., spectral distribution) from that of a conventional engine, characterized by a dominance of high-frequency whine. In a fully-regenerated GTE, a good air filter in the intake and a high-effectiveness regenerator in the exhaust seem to provide adequate muffling of the gas streams. Some design attention is required for mechanical sources, such as the output shaft speed reducers (especially if gears are employed) but no insurmountable problems are apparent. The directional and absorptional characteristics of high audio frequencies make for easier acoustic insulation than for the relatively low frequencies associated with conventional engines. With good acoustic design, GTE's can be quieted at least as well as conventional engines. Vehicle-related road noise for Brayton-engined cars will, of course, be comparable with that of conventional cars. A road-test noise level below 77 dBA should be readily attainable.

### 5.5.4 Drivability Aspects

The throttle response of a Brayton-engined car is largely a matter of rotor inertia

and of engine/transmission controls implementation. Even now, the overall acceleration response of experimental GTE cars is at least no worse than that of emission-controlled Otto cars. The "feel" is different from an Otto car, however, in that the Brayton's initial getaway is sluggish since much of the power developed is diverted to accelerating the turbomachinery. As the rotors come up to speed, the Brayton car's acceleration becomes increasingly brisk and in the "long haul" — say to 60 mph, or over a 10-second interval — it is at least comparable to the equivalent Otto car. With a suitable CVT, the SS Brayton may have a shorter acceleration lag than the FT Brayton, since a greater fraction of the SS turbine power can be made available to accelerate the compressor. Within limits, the acceleration "feel" is within the designer's control in that the power split between rotor acceleration and vehicle drive train can be adjusted to some extent. This compromise must be worked out in vehicle level testing.

Startup time from a cold condition can be much shorter for GTEs than for an Otto. In the earliest production of GTE cars the turn-key-to-driveaway interval is expected to be less than 10 seconds.

### 5.5.5 Safety

The production Brayton-engined car will be at least as safe — and, if diesel or "broad-cut" fuel is used, more safe — to operate than a conventional Otto-engined car. This is not to say that there are no potentially hazardous aspects of the engine. However, careful design, validated by failure-mode testing in development, will eliminate any concern to the owner. The most obvious area where such attention is required is in the turbomachinery housings. The high-speed rotors could fail either: (1) under normal conditions due to a structural flaw, or (2) under an abnormal (overspeed) condition due to some other malfunction which permits rotor runaway. Careful quality control should minimize the incidence of the former and appropriate safety interlocks in the control system will help prevent the latter. However, the housings must, in any case, be suitably designed to contain possible high-kinetic-energy fragments in the unlikely event of a failure.

Combustor ignition and unscheduled flame-out detection, as well as overtemperature protection, must also be provided in the control system safety provisions. Some use of redundant sensors and majority-vote logic may be warranted.

Further discussion of engine and vehicle safety is presented in Chapter 16.

## 5.6 OWNERSHIP CONSIDERATIONS

The vehicle owner is generally indifferent to the specific mechanization of his automobile's powerplant. Already accustomed to Otto-engined car ownership, his major concerns in considering a Brayton car are: "How does it perform in use?"; "Is it as safe as a conventional (Otto) car?"; "What will it cost me?"; and "How often must it be garaged for maintenance?". The first two questions have been answered in the foregoing

sections. The latter two are addressed in this section.

### 5.6.1 Maintenance

A production Brayton engine can have significantly lower maintenance requirements (and maintenance cost) than a comparable catalyst-controlled Otto engine. On the basis of the characteristics of present designs, it is reasonable to assume that the FT engine oil sump will be sealed, hence no regular oil filter replacement or oil change is required. Speed reducers and ancillary motors can also be lifetime-lubricated, sealed units. Regularly scheduled maintenance items (analogous to a minor tuneup) would probably include the following:

- (1) Replace air cleaner.
- (2) Inspect regenerator core and seals.
- (3) Change fuel filter.
- (4) Check/adjust air-fuel control system.
- (5) Check/adjust power control system.
- (6) Replace ignitor.
- (7) Clean atomizer nozzle.

Long-period, as-required maintenance items would include

- (1) Replace regenerator seals.
- (2) Replace fuel pump.
- (3) Repair/replace power control components.
- (4) Replace temperature sensor(s).
- (5) Replace belts (if any).

Some retraining of mechanics will be required, as well as introduction of new types of diagnostic and repair equipment in maintenance garages. With a ten-year phased introduction period, this transition is easily accommodated. Phase-in of new parts into the existing after-market distribution system is likewise easily accomplished.

Maintenance for the rest of the vehicle would be virtually identical to that of an Otto-engined vehicle.

### 5.6.2 Incremental Cost of Ownership

Assuming that the Brayton vehicle owner would operate his car in essentially the same manner as an equivalent Otto-engined automobile, the increment in ownership cost comprises the difference between the sums of depreciation, fuel and engine-expended fluids cost, and maintenance cost between the two types of cars. Although it is believed that Brayton maintenance costs should be lower (vid. Section 5.6.1) than for the equivalent Otto engine, it is difficult to predict what the actual maintenance requirements and corresponding maintenance charges will be for the hardware that would ultimately be mass-produced. The

engine would probably not be released for production unless its maintenance cost was projected to be comparable to that of the Otto engine. Hence they are conservatively assumed to be equal for purposes of this calculation.

No engine-expendable fluids (other than fuel) are required, since Brayton engines have no liquid cooling system, and lubricant systems, where necessary, will be factory-filled and sealed. There is therefore no associated cost for oil changes.

The incremental cost of ownership, then, is simply the present value (7% annual discount rate assumed) of the difference between the sums of depreciation plus fuel cost plus engine-expended fluids cost for the Mature OEE Brayton vehicles and their UC Otto counterpart cars. Details of the calculations are given in Chapter 20. Representative values are shown in Table 5-13. It can be seen that both SS and FT Brayton cars "pay back," in fuel and expended fluid savings, their initial price differential, even at equal maintenance cost. If their maintenance cost is indeed lower than that of equivalent Otto-engine automobiles, the case for the Braytons becomes even more favorable.

Table 5-13. Incremental<sup>a</sup> cost of ownership<sup>b</sup> for Mature Brayton vehicles (constant 1974 dollars)

OEE auto class	Incremental ownership cost <sup>c</sup>			
	35,000 mi, ~3 yr <sup>d</sup>		100,000 mi, ~10 yr <sup>d</sup>	
	SS	FT	SS	FT
Small	-150	-50	-300	-150
Compact	-250	-100	-600	-300
Full-Size	-350	-150	-850	-450

<sup>a</sup>Relative to equivalent baseline UC Otto cars.

<sup>b</sup>Present value, at 7% annual discount rate, of depreciation plus fuel cost plus expendable fluids cost. "Broad-cut" fuel at 48¢/gal (≈ gasoline at 52¢/gal).

<sup>c</sup>Negative numbers indicate savings to Brayton car owner (to nearest \$50).

<sup>d</sup>Median driver's experience.

## 5.7 RESEARCH AND DEVELOPMENT REQUIRED

### 5.7.1 Mature Configuration

To produce the Mature Brayton engines, no fundamental research is required. There remains, however, considerable component, process, and system development to be done. Specific developments needed include the following:

- (1) Compressor Assembly. Configure an economically mass-producible aluminum



- compressor with wide high-efficiency operating range; verify performance at component level; develop appropriate mass-production techniques and facilities; configure and test compressor/housing/guide vane assembly; finalize actuation mechanism.
- (2) Turbine (SS or FT Gasifier) Assembly. Configure economically mass-producible superalloy centrifugal turbine wheel with wide high-efficiency operating range (best-efficiency point for engine to be 40-60% of maximum power); finalize selection of alloy for cost, producibility, and compatibility with a maximum sustained inlet temperature of at least 1900°F; verify performance at component level; develop appropriate production techniques and facilities; finalize housing/nozzle configuration and bearing selection; integrate and test with compressor, combustor, and regenerator assemblies.
  - (3) Combustor Assembly. Configure and rig test alternative low-NOx combustors; select most producible configuration with acceptable performance, response and emissions; demonstrate performance with range of candidate fuels including gasoline, diesel, broad-cut, and methanol; finalize actuation mechanism and control scheme, if variable geometry required; integrate for subsystem testing.
  - (4) Regenerator Assembly. Fabricate and test alternative regenerator configurations; finalize selection of core material, seal composition/configuration and drive mechanization for effectiveness and durability with maximum inlet temperature capability of 1800°F; develop appropriate production facility; integrate for subsystem testing.
  - (5) Turbine (FT Power Turbine) Assembly. Configure economically mass-producible superalloy axial turbine wheel with wide high-efficiency operating range; finalize alloy selection (as for gasifier turbine); develop appropriate production techniques and facilities; verify performance at component level with variable nozzle packages; finalize nozzle material selection, actuation geometry, and mechanization; finalize bearing selection and lubrication scheme; perform integrated subsystem testing with gasifier package.
  - (6) Control System. Develop alternate breadboard control systems, with emphasis on reliable sensors (redundant majority-vote logic, if required) and safety interlocks, and test with subassemblies; finalize approach for economically mass-producible integrated package; develop supply sources; verify performance in all-up system tests.
  - (7) Speed Reducers. Develop appropriate mass-producible speed reducers; verify performance, durability at component level; integrate in subsystem and system tests.
  - (8) Continuously Variable Transmission (SS Engine). Configure and test alternate CVT mechanizations; finalize selection for producibility, efficiency, and compatibility with control scheme; integrate for subsystem testing with compressor/turbine package; system test in vehicle.
  - (9) Heater (Passenger Compartment). Develop suitable mass-producible heat exchanger unconstrained by exhaust-gas-leakage failure mode; verify performance in subsystem and system testing.
- System tests, in addition to performance and durability, should demonstrate operational and impact safety. Final configuration should exploit low maintenance potential to maximum degree compatible with producibility.

### 5.7.2 Advanced Configuration

To make the Advanced engine a reality, research in ceramics technology is required. Although the actual ceramic materials are already identified (invention of a novel material is not implied), the applications to specific components do raise some fundamental questions in four general categories:

- (1) Material Formulation. Determine appropriate compositions and impurity levels for optimum properties in
  - (a) Turbine wheel, nozzle, housing/liner, and combustor application (SiC; Si<sub>3</sub>N<sub>4</sub>; Sialon; ceramic composites; others?).
  - (b) Regenerator core application (MAS; improved LAS variants; Si<sub>3</sub>N<sub>4</sub>; ceramic composites; others?).
- (2) Ceramic Raw Material Processing. Determine the optimum tradeoff between properties achieved at given impurity levels and the cost of refining the abundant raw materials to attain these impurity levels; demonstrate the cost-effectiveness of producing the ceramic material in a pilot plant scalable to mass production quantities.
- (3) Ceramic Structure Fabrication Processes. Demonstrate the production of formed parts, with adequate properties and high reproducibility and yields, from production grade raw materials; develop processes to permit concrescence of simple-shape components into a complex monolithic structure, on a mass production basis; demonstrate integrated ceramic design, testing, and nondestructive evaluation techniques suitable for mass-production.
- (4) Ceramic/Metallic Structures Joining and Bonding. Develop technique for joining or bonding ceramic materials of the

selected compositions to contiguous metallic structures; techniques should emphasize: strength of joint, sealing (as required) and alleviation of stress concentrations.

Successful completion of such research would then lead into a list of developments paralleling many of those for the Mature configuration:

- (1) Turbine Assemblies. Developments required as for Mature configurations, except ceramic hardware with 2500°F sustained turbine inlet temperature capability; joining and seal problems to be solved; some bearing development may also be required.
- (2) Combustor Assembly. Developments required as for Mature configuration, except partly ceramic hardware and higher outlet temperature; joining and seal problems to be solved; control probably more critical and may require new variable-geometry system.
- (3) Regenerator Assembly. Redevelopment, as for Mature, may be required if Mature core and seal assembly not compatible with higher cycle temperatures.
- (4) Control System. Probable redevelopment, as for Mature, due to greater criticality with higher cycle temperatures; Mature temperature sensors may not be usable; advances in electronics technology may render all-digital signal processing system more cost-effective.

### 5.7.3 Production Availability

It is believed that the Mature configuration(s) could be ready for production in the early-to-middle 1980's, depending largely upon the development funding committed. The Advanced configuration (which relies partly upon some Mature configuration component developments, e.g., CVT) may not appear until the late 1980's, or beyond, even given adequate funding, as the solutions of presently known problems may uncover new unanticipated difficulties. It should be emphasized that the transition between the configurations herein designated as Mature and Advanced will probably require a major redesign. It is also possible (under an accelerated program) that the ceramics research and development could be successful soon enough to put an engine resembling the Advanced configuration into production first, effectively "leapfrogging" the Mature configuration. The potential savings in production costs alone serve as incentive to pursue this option vigorously.

The viability of a SS version should be addressed early by initial emphasis on the CVT problem. While it is recognized that any candidate CVT must be tested in intimate association with an engine package, the test engine used need not be performance-optimized. Early attention should also be paid to the regenerator with the Advanced-level cycle temperatures as targets in component testing, to obviate (if possible) a serial redevelopment program. More detailed information on the proposed R&D effort, including

applicability to other engine types, is given in Chapter 12.

### References

- 5-1. Lichty, L. C., "Internal-Combustion Engines," McGraw-Hill, 1951.
- 5-2. Wright, E. S., et al., to EPA/OAP, "Automotive Gas Turbine Configuration Study," Final Report L-971249-7, United Aircraft Research Laboratories, May 1972.
- 5-3. Wright, E. S., et al., to EPA/OAP, "Manufacturing Cost Study of Selected Gas Turbine Automotive Engine Concepts," Final Report K-971017-4, United Aircraft Research Laboratories, August 1971.
- 5-4. Engineering Staff to EPA/OAP, "Automotive Gas Turbine Optimization Study," Final Report AT-6100-R7, AiResearch Mfg. Co. of Arizona, Garrett Corp., July 1972.
- 5-5. Hesse, W. J., and Mumford, W. V. S., Jr., Jet Propulsion for Aerospace Applications, Pitman Publishing Co., New York, 1964.
- 5-6. Sorensen, H. A., Gas Turbines, Ronald Press, New York, 1951.
- 5-7. Wagner, C. E., "Baseline Gas Turbine Development Program, Quarterly Progress Reports," Contract No. 68-01-0459, Chrysler Corp., prepared for EPA/AAPS Div., Jan. 1973.
- 5-8. Collman, J. S., et al., "The GT-225 - An Engine for Passenger-Car Gas Turbine Research," General Motors Research Laboratories Publication No. GMR-1726, GMRL, Warren, Michigan, Mar. 1975.
- 5-9. Amann, C. A., "An Introduction to the Vehicular Gas Turbine Engine," GMR-1330, General Motors Research Laboratories, Apr. 1973.
- 5-10. Wade, W. R., et al., "Low Emissions Combustion for the Regenerative Gas Turbine," ASME Paper (2 parts) No. 73-GT-11, Ford Motor Co., Apr. 1973.
- 5-11. White, D. J., et al., to EPA/AAPS, "Low NOx Emission Combustor for Automobile Gas Turbine Engines," APTD-1441, Solar Div. of International Harvester Co., prepared for EPA/AAPS, Feb. 1973.
- 5-12. White, D. J., et al., to EPA/AAPS, "Solar JIC-B Combustor Development for Baseline Gas Turbine Engine," RDR 1755-3, Solar Div. of International Harvester Co., prepared for EPA/AAPS, Oct. 1973.

- 5-13. Williams, S., et al., to EPA/AAPS, "Low NOx Combustor for Automobile Gas Turbines," Williams Research Corporation, prepared to EPA/AAPS, Dec. 1972.
- 5-14. Demetri, E. P., et al., to EPA/AAPS, "Low NOx Emission Combustor for Automobile Gas Turbine Engines," NTIS PB 222340, Northern Research & Engineering Corp., Feb. 1973.
- 5-15. "Development of Low Emission Porous Plate Combustor for Automotive Gas Turbine Engine," General Electric Co., G. E. Briefing to EPA/AAPS, Dec. 1972.
- 5-16. Ford, O. I., "Low Emission Automotive Gas Turbine Combustor Development Program," Technical Paper for 4th Gas Turbine Contractors' Coordination Meeting, Aerojet Liquid Rocket Co., Dec. 1972.
- 5-17. Personal communication, Wright, E. S., United Aircraft Research Laboratories, to N. Moore, JPL/APSES, May 1974.
- 5-18. Sheridan, D. C., Nordenson, G. E., and Amann, C. A., "Variable Compressor Geometry in the Single Shaft Automotive Turbine Engine," SAE 740166, 1974.
- 5-19. Shepherd, D. G., Principles of Turbomachinery, Macmillan Co., New York, 1956.
- 5-20. Wosika, L. R., "Radial Flow Compressors and Turbines for the Simple Small Gas Turbine," ASME Trans., Nov. 1952, p. 1337.
- 5-21. Balje, O. E., "A Study on Design Criteria and Matching of Turbomachines: Part A - Similarity Relations and Design Criteria of Turbines," ASME Trans., J. Eng. for Power, Jan. 1962, p. 83.
- 5-22. Smith, S. F., "A Simple Correlation of Turbine Efficiency," J. Royal Aeronaut. Soc., Vol. 69, July 1965, p. 447.
- 5-23. Amann, C. A., and Sheridan, D. C., "Comparison of Some Analytical and Experimental Correlations of Axial Flow Turbine Efficiency," ASME paper No. 67-WA/GT-6, Winter Annual Meeting of the ASME, Nov. 1967.
- 5-24. Rahnke, C. J., "The Variable-Geometry Power Turbine," SAE 690031, 1969.
- 5-25. Eatock, H. C., et al., to EPA/AAPS, "Low NOx Emission Combustor for Automobile Gas Turbine Engines," Final Report NTIS PB-222075, United Aircraft of Canada Ltd., Feb. 1973.
- 5-26. Hewko, L. O., "Roller Traction Drive for Quiet, High-Speed Power Transmission," SAE Paper 690572, Sept. 1969.
- 5-27. Lindsley, E. F., "Tracor - Tomorrow's Stepless Transmission," Popular Science, Mar. 1975.
- 5-28. Orshansky, E., Huntley, P., and Weseloh, W. E., "Automobile Fuel Economy with Hydro-Mechanical Transmission by Simulation Studies," SAE Paper No. 740308, 1974.
- 5-29. Fact-Finding Visit to Ford Motor Co. by members of APSES team, (Oct. 1974).
- 5-30. Personal Communication, Chrysler Corporation to APSES team, 1974.
- 5-31. "Low Cost, Mass Produced Automotive Turbine Wheel Castings," Garrett AiResearch Casting Company, Presented at EPA-Sponsored Gas Turbine Contractors Meeting, Ann Arbor, Mich., Dec. 1972.
- 5-32. "Cost and Feasibility of Gatorizing<sup>®</sup> Automotive Gas Turbine Rotors," Pratt & Whitney Division of United Technologies, Inc., EPA 68-01-0477, Oct. 1973.
- 5-33. "Investment Cast Turbine Wheel Study," performed for EPA by Williams Research Corporation, Walled Lake, Michigan, Contract EPA-460/9-73-001, 1973.
- 5-34. McLean, A. F., et al., "Brittle Materials Design of High Temperature Gas Turbines," Interim Report, Contract No. DAAG-46-71-C-0162, performed by Ford Motor Co. for ARPA, Sept. 1974.
- 5-35. Fisher, E. A., and McLean, A. F., "Current Status of High Temperature Ceramic Gas Turbine Research and Development," SAE Paper No. 741047, Oct. 1974.
- 5-36. Torti, M. L., "Ceramics for Gas Turbines, Present and Future," SAE Paper No. 740242, Mar. 1974.
- 5-37. "Silicon Carbide Parts Formed Easily Without High Pressure," Product Engineering, May 1974.
- 5-38. "Fabrication of Ceramic Parts From Silicon Carbide," Metalworking News, March 11, 1974.
- 5-39. Aviation Week and Space Technology, Feb. 11, 1974, p. 64.
- 5-40. "Ceramic Materials and Components for Small Automotive Gas Turbine Engines," AMMRC, Apr. 1975.
- 5-41. Hillig, W. B., et al., "Silicon/Silicon Carbide Composites," General Electric Report 74CRD282, Nov. 1974.
- 5-42. Baumgartner, H. R., "Evaluation of Roller Bearings Containing Hot Pressed Silicon Nitride Rolling Elements," 2nd

- Army Materials Technology Conference, Ceramics for High Performance Applications, Nov. 1973.
- 5-43. Anderson, D. H., et al., "First Quarterly Progress Report, Automotive Gas Turbine Ceramic Regenerator Design and Reliability Program," Contract No. 68-03-2150, submitted by Ford Motor Co. to Environmental Protection Agency, Jan. 15, 1975.
- 5-44. Rath & Strong, Inc., "Task 1, Free Turbine Engine Data Base," JPL Contract No. 954072, Dec. 23, 1974.
- 5-45. Rath & Strong, Inc., "Task 1, Single Shaft Turbine Engine Data Base," JPL Contract No. 954072, Mar. 23, 1975.
- 5-46. "A Study of Technological Improvements to Automotive Fuel Consumption," Contract DOT TSC 628, Southwest Research Institute, Dec. 1974.
- 5-47. "A Study of Technological Improvements in Automobile Fuel Consumption," Contract DOT TSC 627, Arthur D. Little, Dec. 1974.
- 5-48. Fact-finding visit to British Leyland, Birmingham and Coventry, England, by members of APSES team, July 1974.
- 5-49. Fact-finding visits to Chrysler Corporation, Detroit, Mich., by members of APSES team, 1974.
- 5-50. Fact-finding visit to Ford Motor Company, Dearborn, Mich., by members of APSES team, June 1974.
- 5-51. Fact-finding visit to General Motors, Warren, Mich., by members of APSES team, June 1974.
- 5-52. Fact-finding visit to General Motors, Warren, Mich., by members of APSES team, Oct. 1974.
- 5-53. Fact-finding visits to Garrett Corporation, Los Angeles, California, and Phoenix, Arizona by members of APSES team, 1974.
- 5-54. Fact-finding visit to United Aircraft Research Laboratories, East Hartford, Conn., by member of APSES team, 1974.
- 5-55. Fact-finding visit to Volkswagen Research Labs, Wolfsburg, West Germany, by members of APSES team, July 1974.
- 5-56. Fact-finding visit to Williams Research, Detroit, Mich., by members of APSES team, Mar. 1974.
- 5-57. Fact-finding visit to Daimler-Benz, Stuttgart, West Germany, by members of APSES team, July 1974.
- 5-58. Fact-finding visit to Nissan Motor Co., Ltd., Yokosuka, Japan, by member of APSES team, Sept. 1974.
- 5-59. Fact-finding visit to Toyota Motor Company, Ltd., Nagoya, Japan, by member of APSES team, Sept. 1974.
- 5-60. Liddle, S. G., Sheridan, D. C., and Amann, C. A., "Acceleration of a Passenger Car Powered by a Fixed-Geometry Single-Shaft Gas Turbine Engine," SAE Paper No. 720758, 1972.
- 5-61. Engdahl, R. E., "Chemical Vapor Deposited Silicon Carbide Turbine Rotors," SAE Paper No. 740184, 1974.
- 5-62. McLean, A. F., et al., "Brittle Materials Design, High Temperature Gas Turbine," AMMRC CTR 75-8, Contract No. DAAG-46-71-C-0162, Apr. 1975.
- 5-63. Fact-finding visit to Army Materials and Mechanics Research Center, Watertown, Mass., by member of APSES team, 1975.
- 5-64. "The Potential Health Hazard of Nickel Compound Emissions from Automotive GTE's Using Nickel Oxide Base Regenerator Seals," Presentation by U. S. EPA, May 1974.

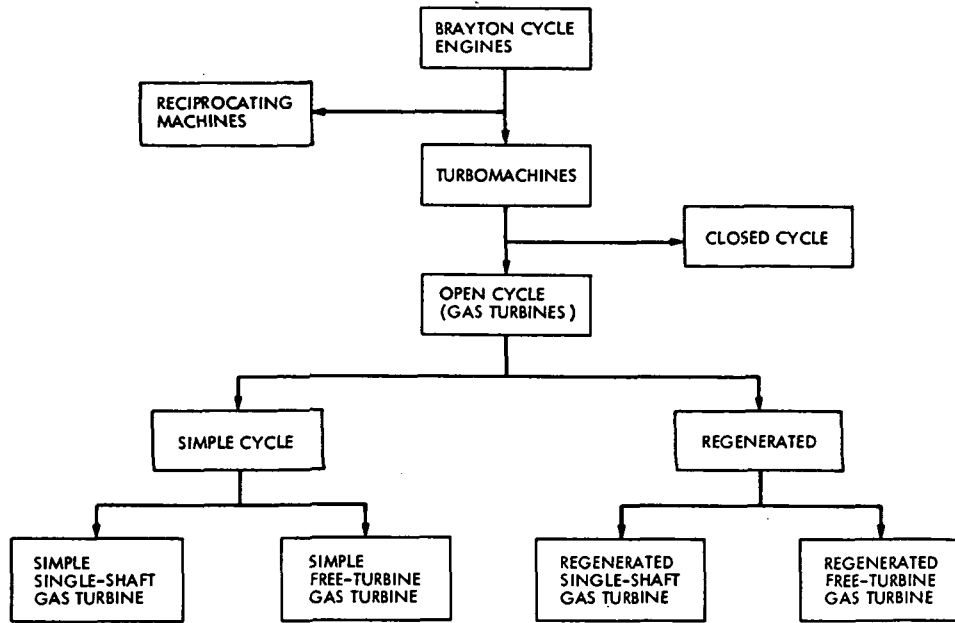

Fig. 5-1. Simplified morphology of automotive Brayton engines

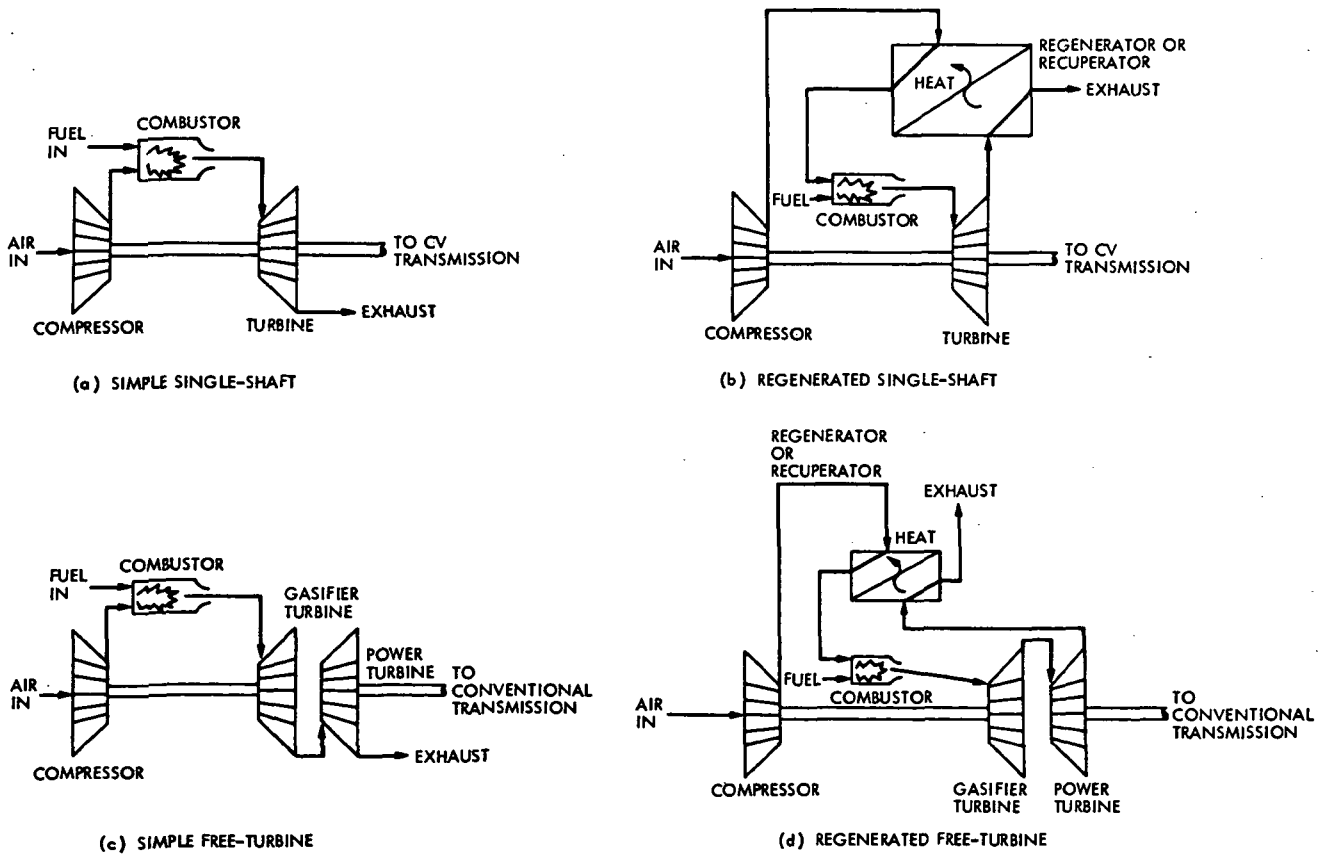

Fig. 5-2. Classification of automotive Brayton engines

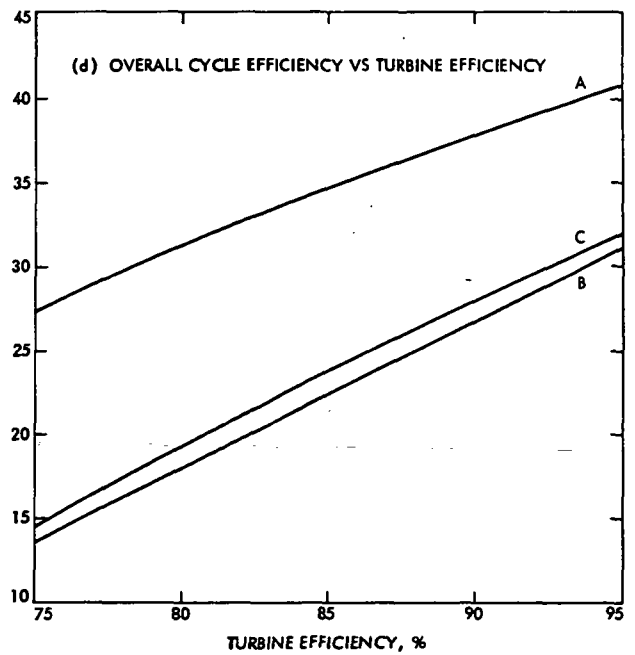
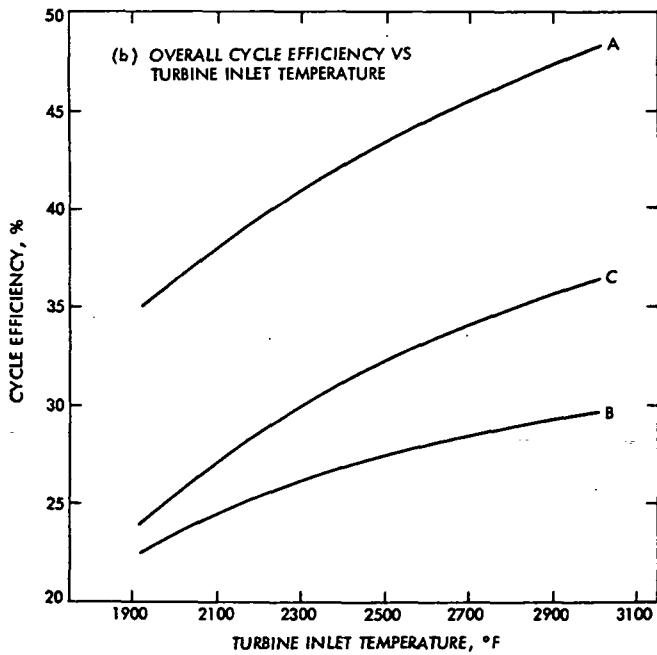
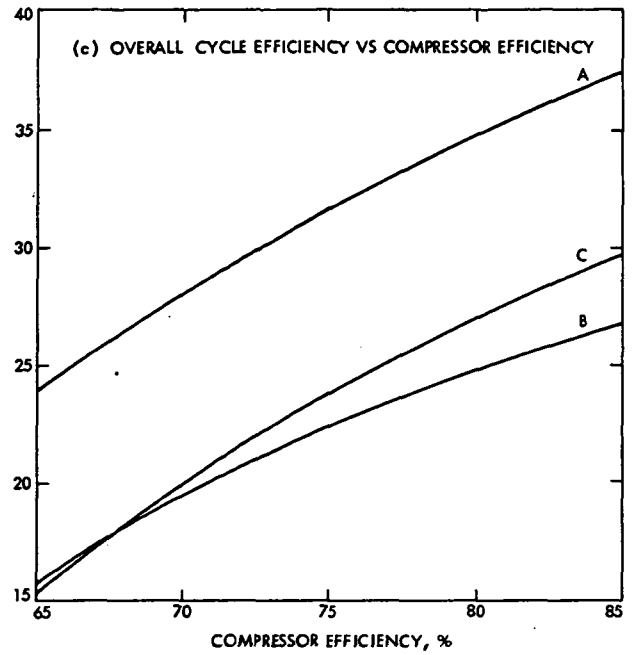
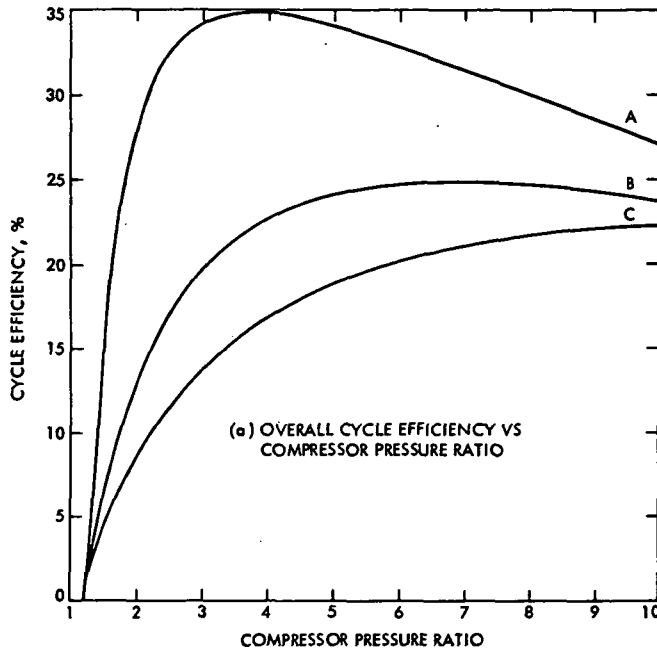

Fig. 5-3. Cycle efficiency characteristics of Brayton engines (see Table 5-1 for parameters corresponding to configurations A, B, C)

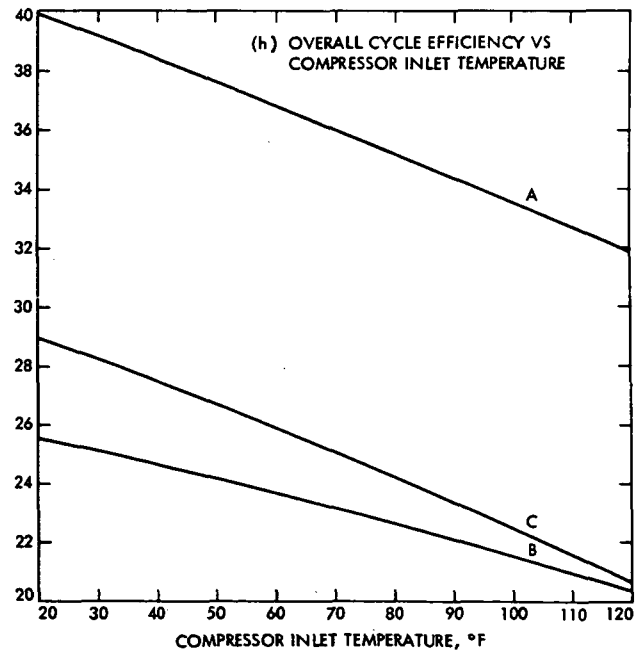
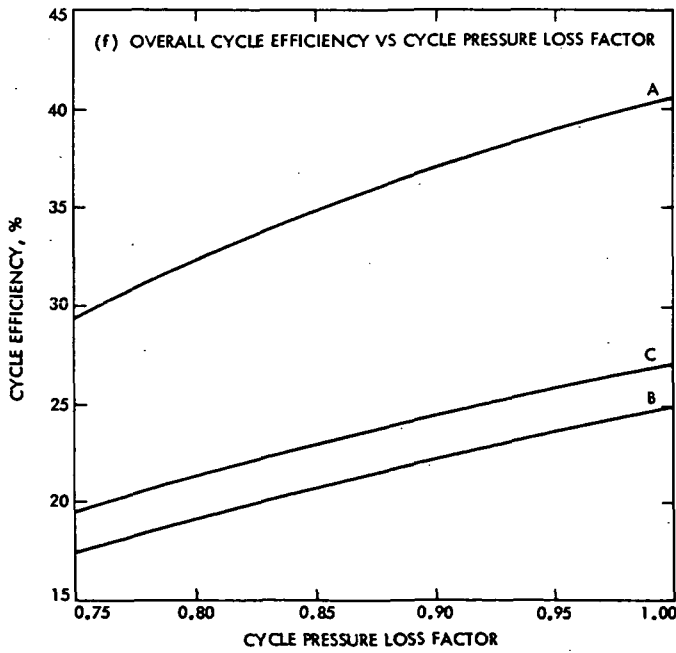
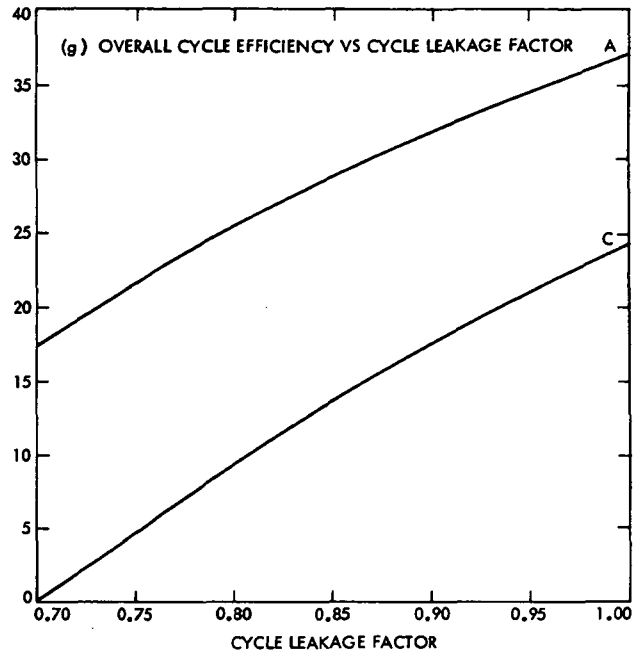
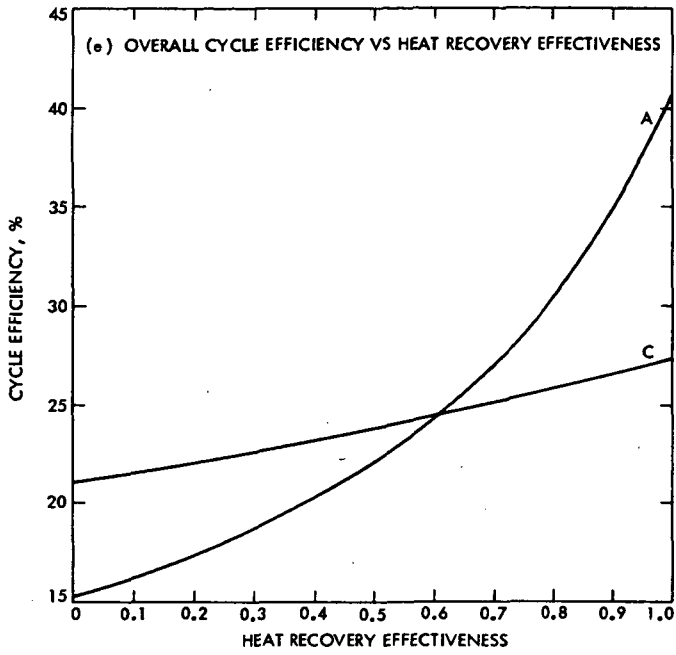

Fig. 5-3 (contd)

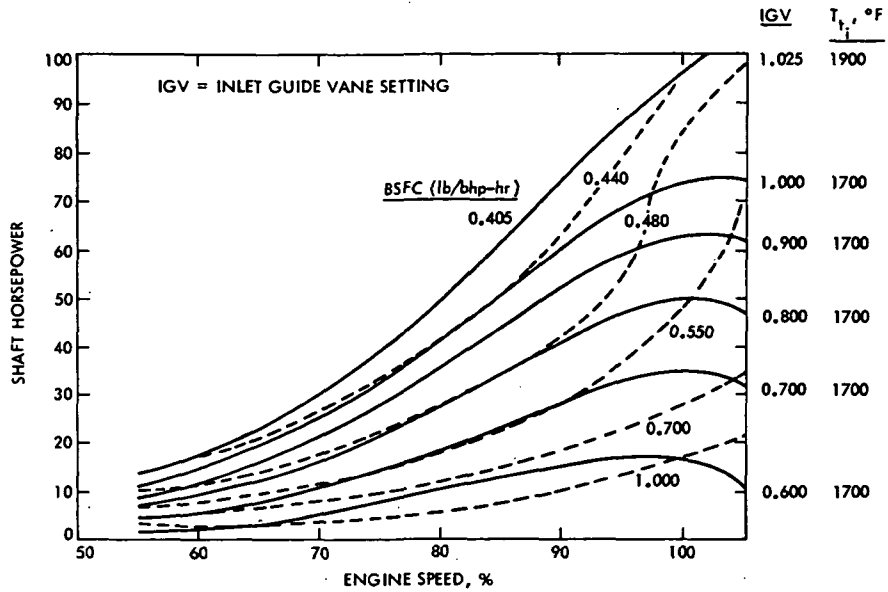

Fig. 5-4. Fuel consumption map for a regenerated, single-shaft Brayton engine with compressor variable inlet guide vanes. Engine parameters similar to Mature engine (A) of Table 5-1 (from Ref. 5-4)

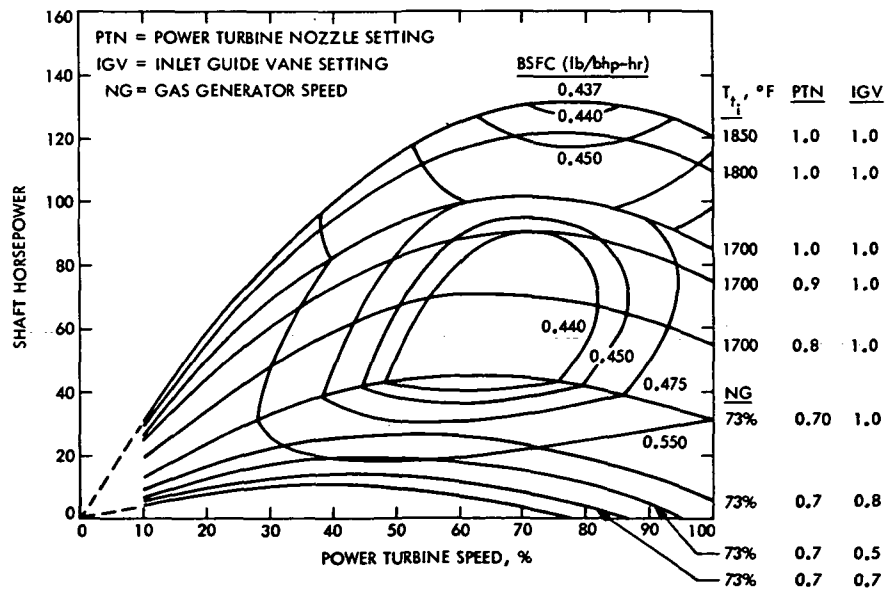

Fig. 5-5. Fuel consumption characteristics of a regenerated free-turbine engine with variable power turbine nozzles and compressor variable inlet guide vanes (from Ref. 5-4)



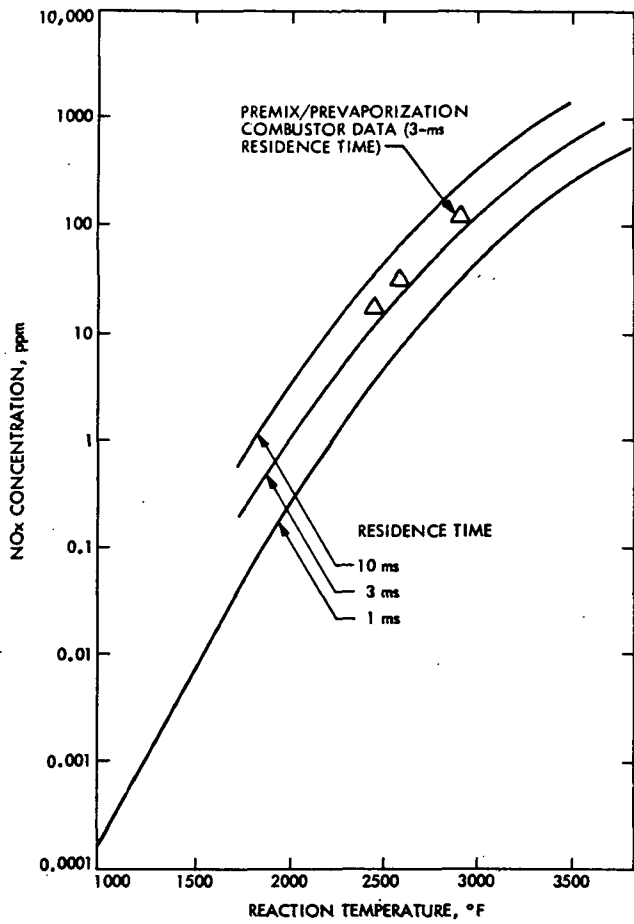

Fig. 5-6. Effect of residence time and reaction temperature on NO<sub>x</sub> formation (adapted from Ref. 5-8)

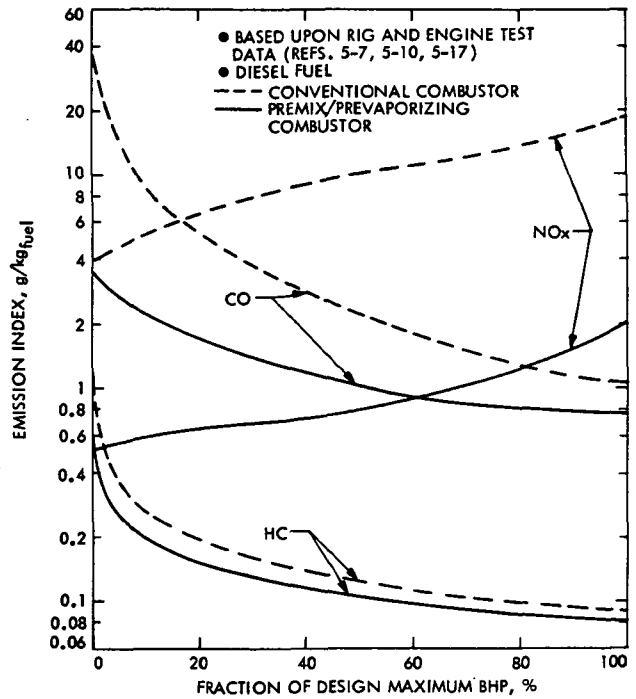

Fig. 5-7. Typical emission characteristics of combustors for regenerated low-pressure-ratio Brayton engines

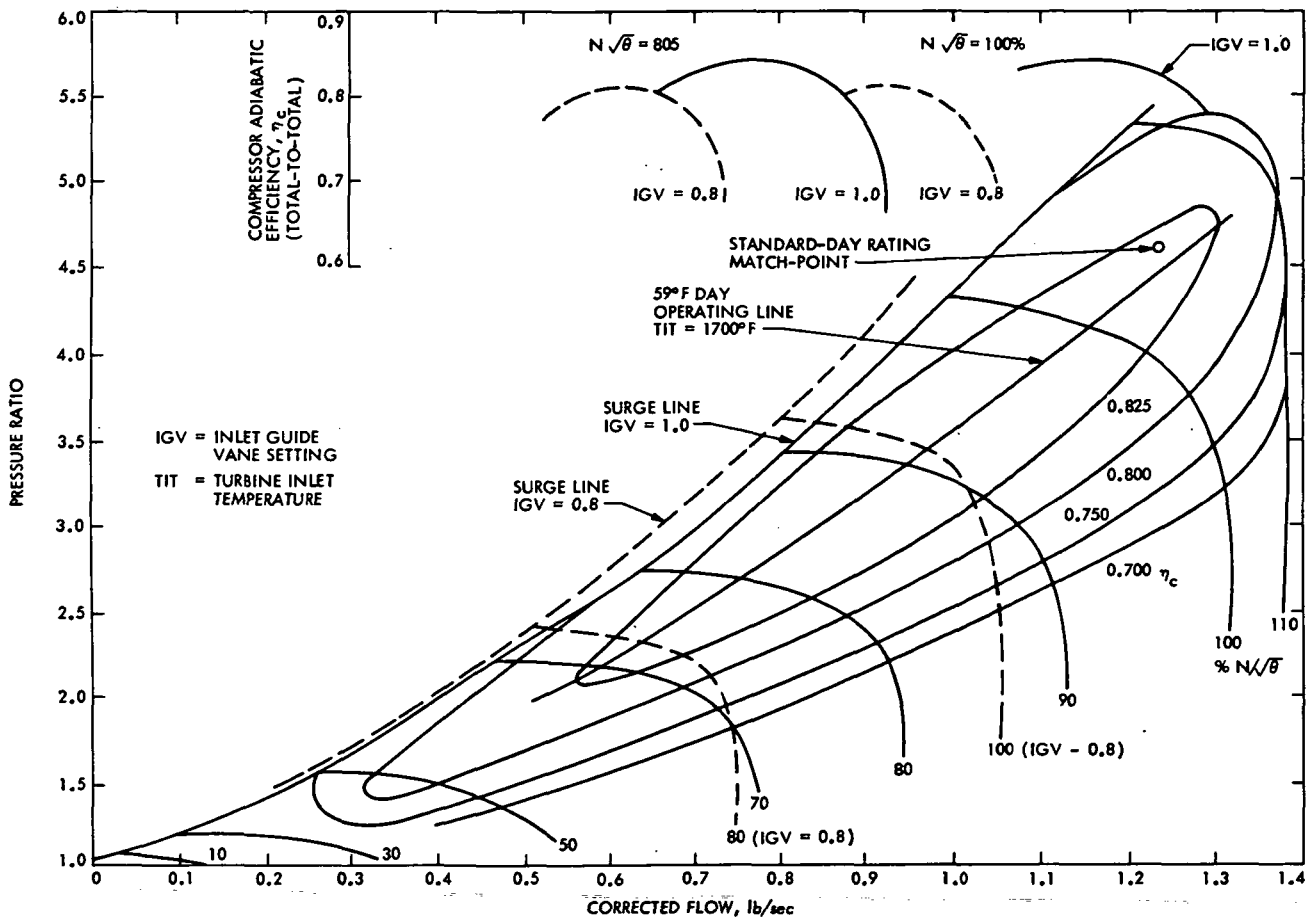

Fig. 5-8. Compressor performance map for Mature Brayton engine (from Ref. 5-4)

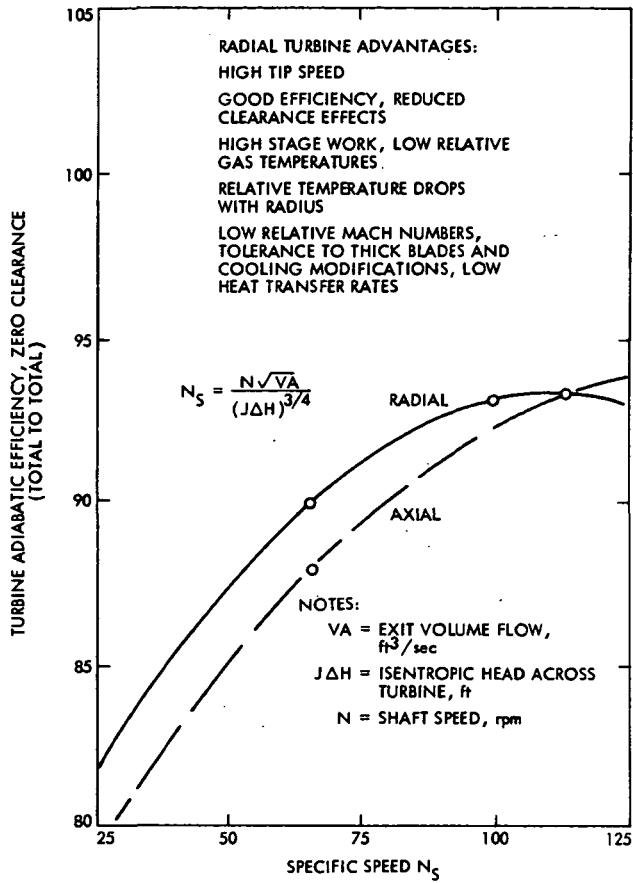

Fig. 5-9. Comparison of efficiency of radial and axial flow turbines (from Ref. 5-4)

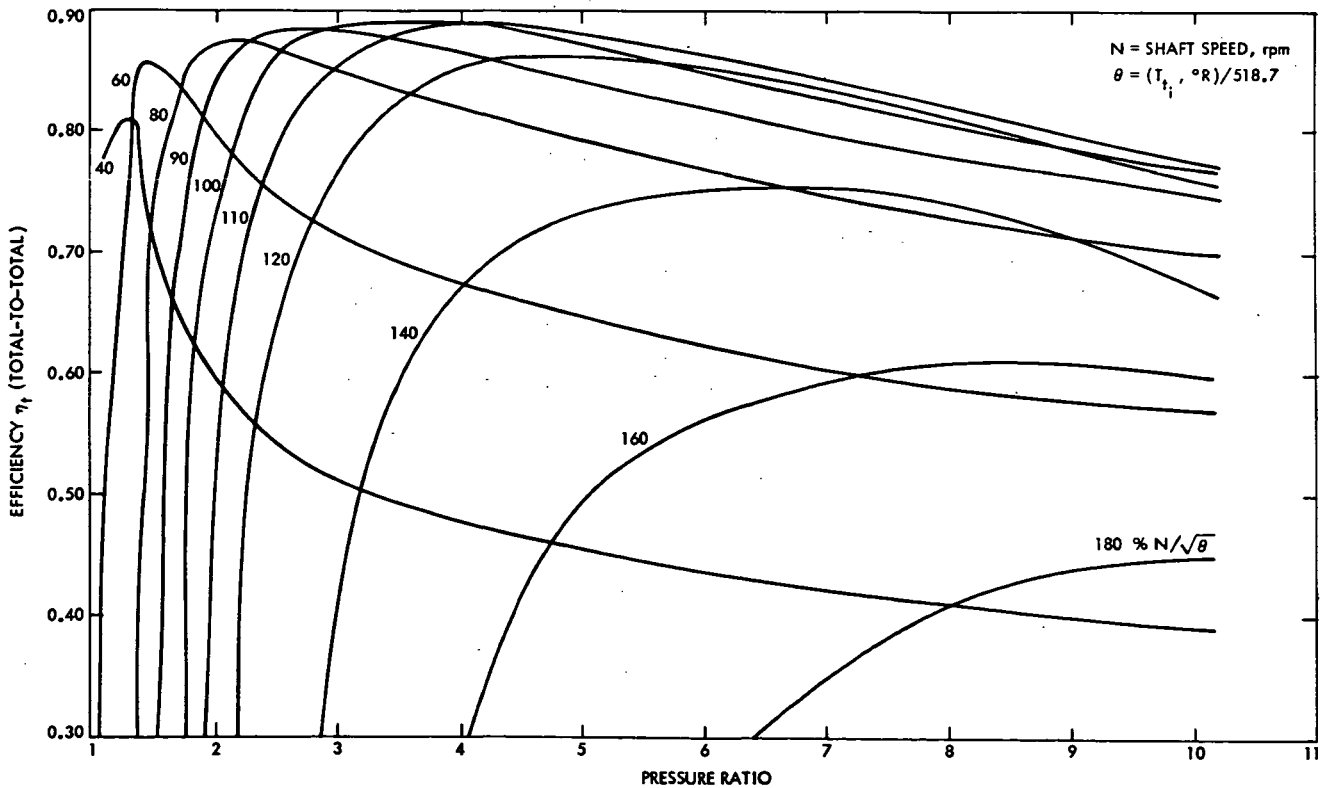

Fig. 5-10. Efficiency characteristics of the radial-flow turbine used in the Mature Brayton engine

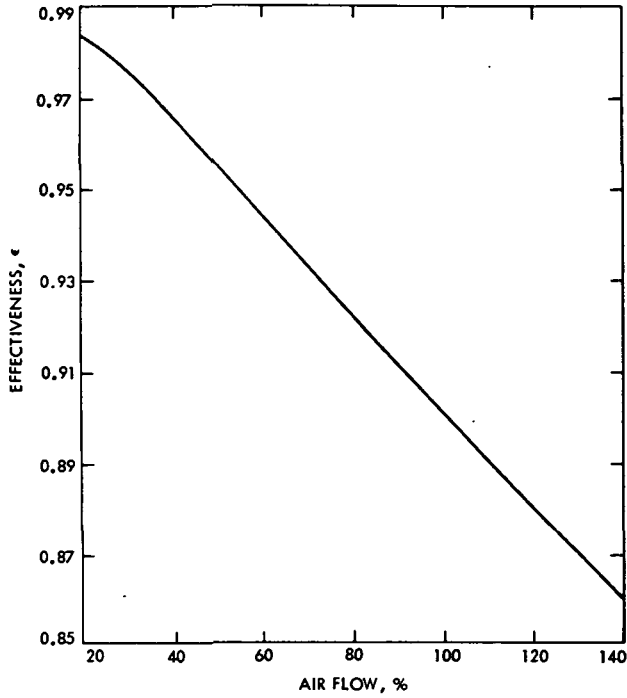

Fig. 5-11. Regenerator effectiveness vs engine air flow

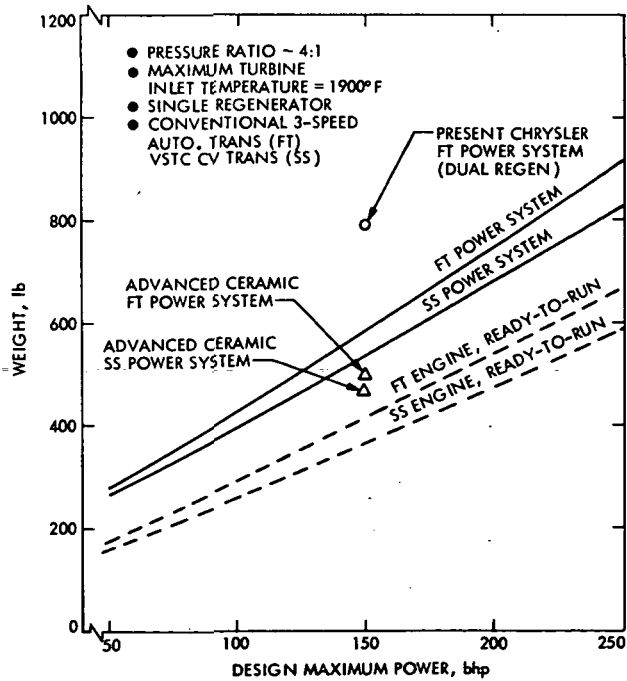

Fig. 5-12. Open-cycle Brayton engine weights (Mature configuration)

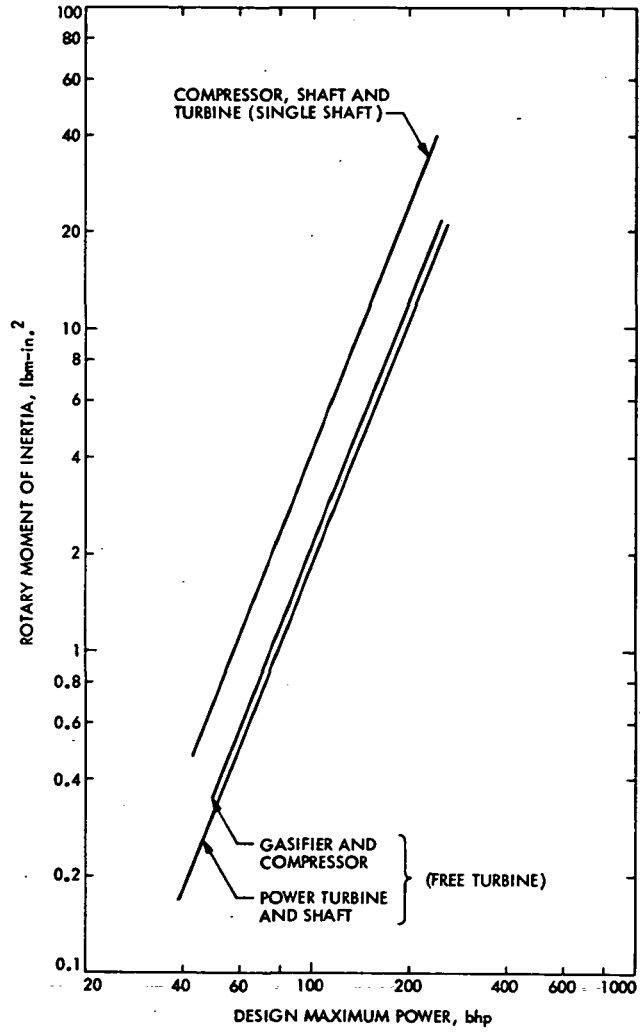

Fig. 5-13. Brayton rotor moments of inertia vs design maximum power (free-turbine and single-shaft versions)

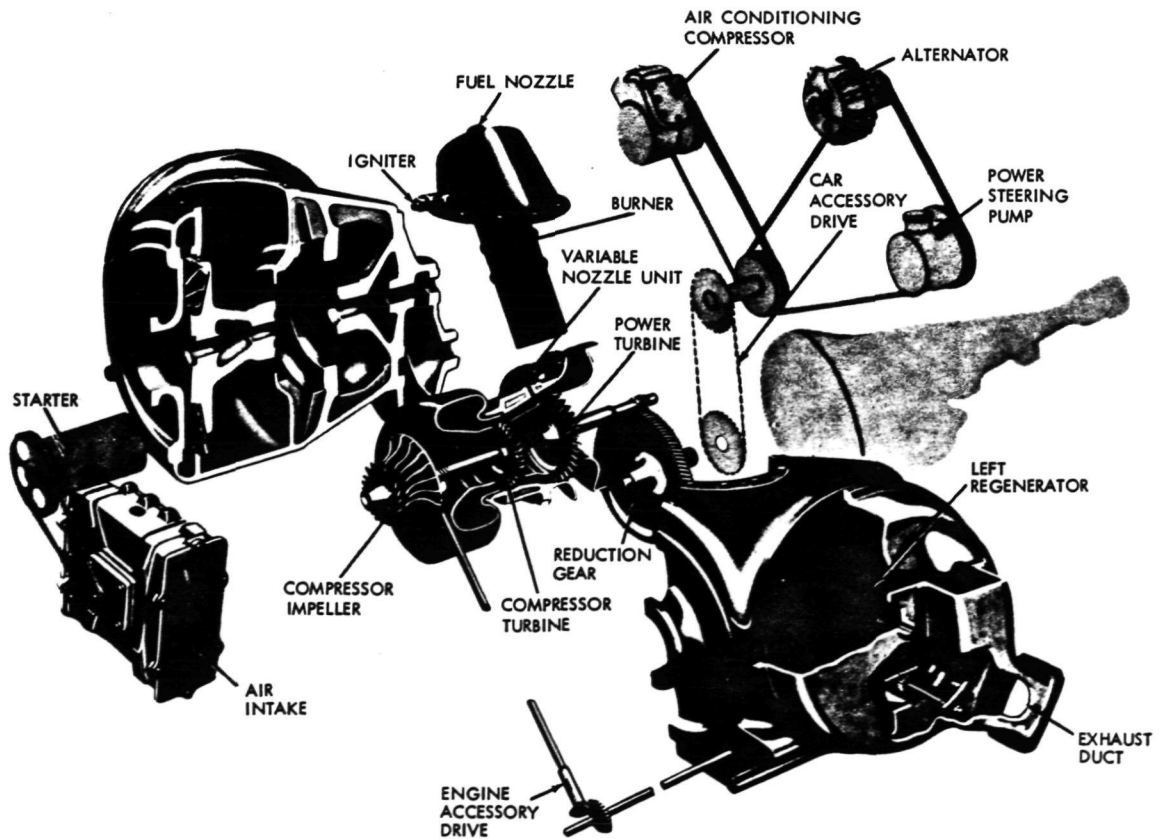
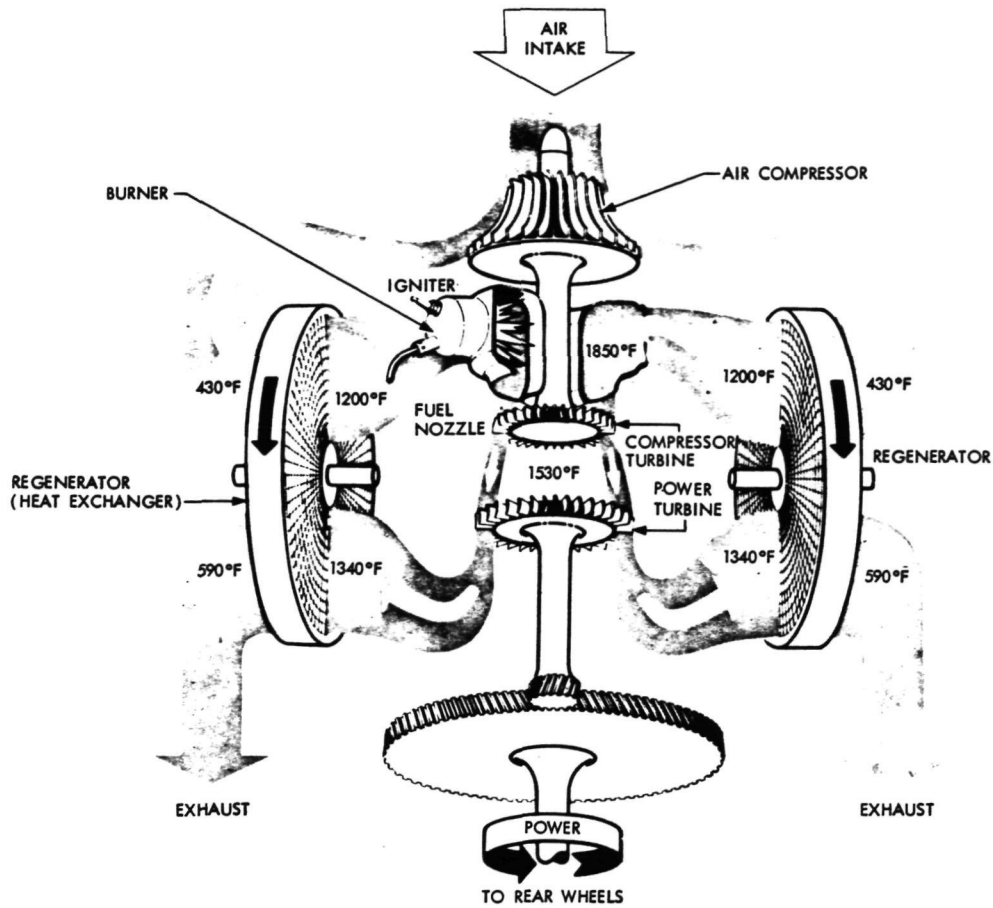

Fig. 5-14. Chrysler Corporation sixth-generation gas turbine engine

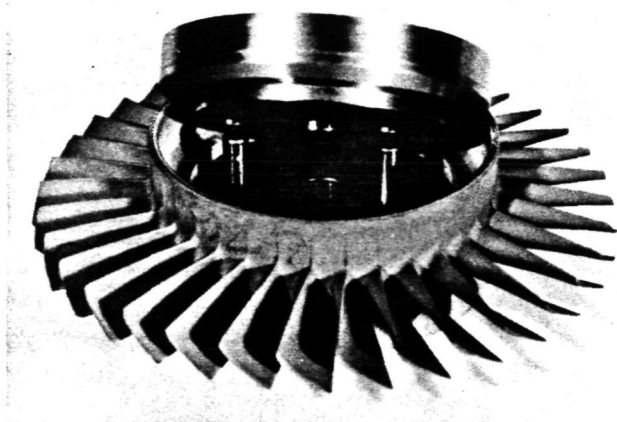

Fig. 5-15. Example of an experimental silicon nitride rotor blade ring

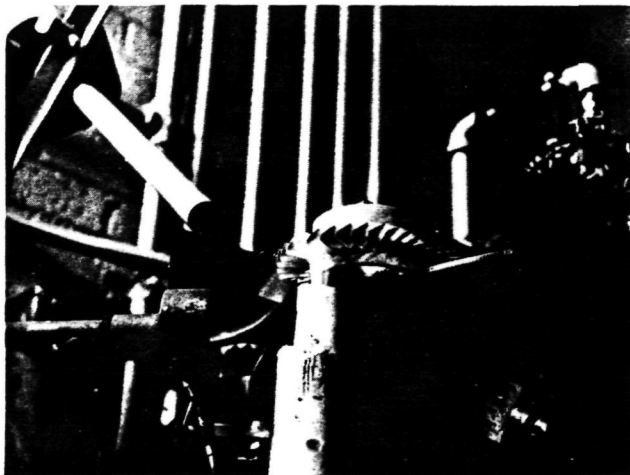

Fig. 5-16. Thermal shock testing of experimental silicon nitride rotor blade rings

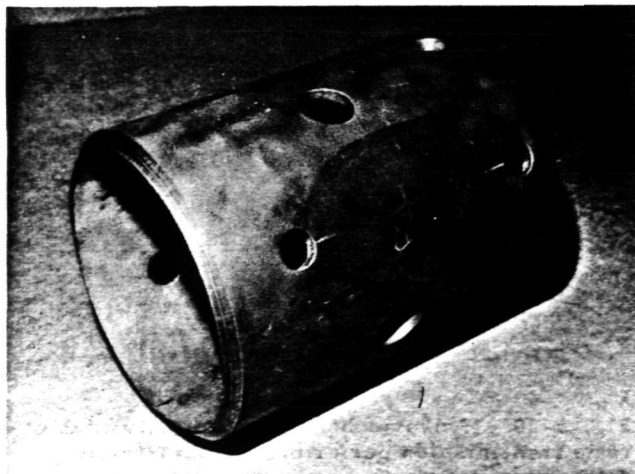

Fig. 5-17. Experimental silicon carbide combustor component

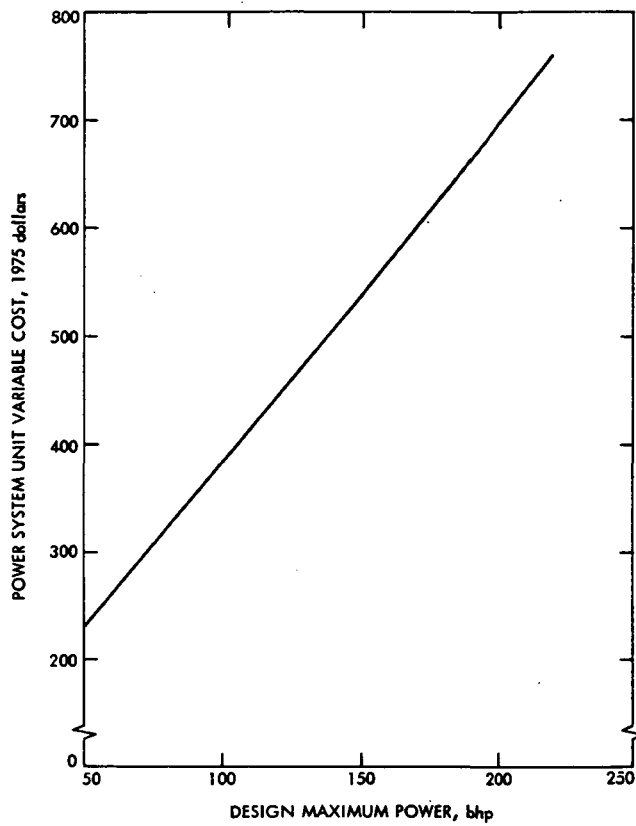

Fig. 5-18. Mature Brayton power system unit variable cost (free-turbine type)

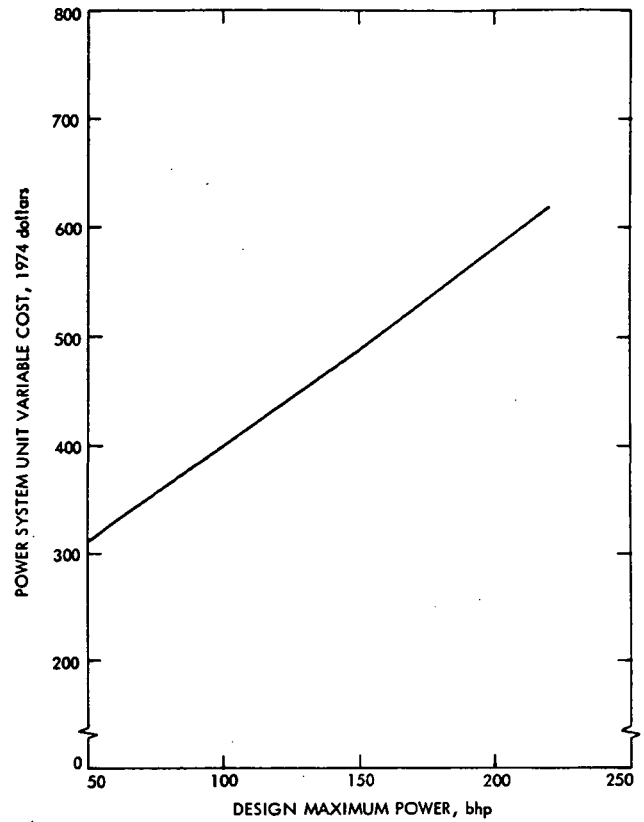

Fig. 5-19. Mature Brayton power system unit variable cost (single-shaft type)

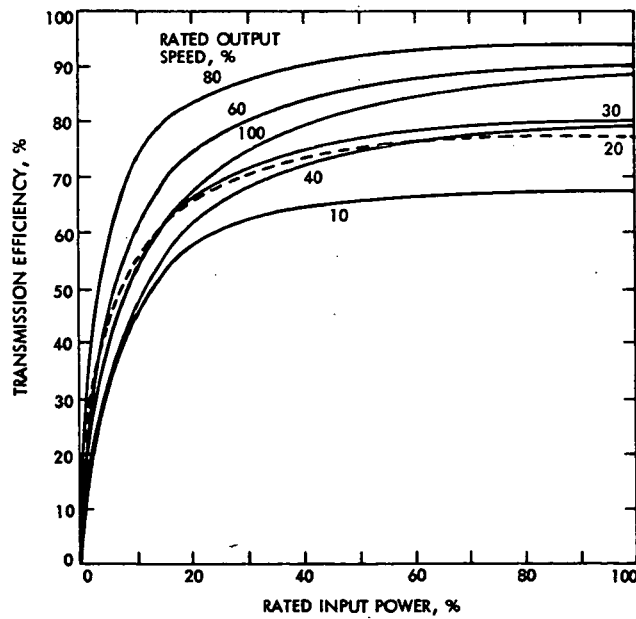

Fig. 5-20. Hydromechanical infinitely variable ratio transmission performance (Sundstrand data, from Ref. 5-4)

CHAPTER 6. THE STIRLING AUTOMOTIVE  
POWER SYSTEM

6.1	Description . . . . .	6-2
6.1.1	Introduction . . . . .	6-2
6.1.2	Morphology . . . . .	6-2
6.2	Characteristics . . . . .	6-4
6.2.1	Thermodynamics . . . . .	6-4
6.2.2	Performance . . . . .	6-7
6.2.3	Fuel Requirements . . . . .	6-9
6.2.4	Pollutants . . . . .	6-10
6.3	Major Subassemblies/Components . . . . .	6-10
6.3.1	Descriptions . . . . .	6-10
6.3.2	Configurational Evolution . . . . .	6-13
6.3.3	Materials and Producibility . . . . .	6-16
6.3.4	Unit Costs . . . . .	6-22
6.4	Vehicle Integration . . . . .	6-24
6.4.1	Engine Packaging in Vehicle . . . . .	6-24
6.4.2	Transmission Requirements . . . . .	6-24
6.4.3	Other Impacts . . . . .	6-24
6.5	Performance in Vehicle . . . . .	6-24
6.5.1	Fuel Economy . . . . .	6-24
6.5.2	Chemical Emissions . . . . .	6-24
6.5.3	Noise Emissions . . . . .	6-26
6.5.4	Drivability Aspects . . . . .	6-26
6.5.5	Safety . . . . .	6-26
6.6	Ownership Considerations . . . . .	6-26
6.6.1	Maintenance . . . . .	6-26
6.6.2	Incremental Cost of Ownership . . . . .	6-27
6.7	Research and Development Required . . . . .	6-27
6.7.1	Mature Configuration . . . . .	6-27
6.7.2	Advanced Configuration . . . . .	6-28
	References . . . . .	6-29
	Figures . . . . .	6-31



## 6.1 DESCRIPTION

### 6.1.1 Introduction

A Stirling engine is a machine in which the conversion of heat to work occurs through the alternate compression and expansion of a confined working fluid, which is at a lower temperature during compression than during expansion. The distinctive characteristics of the Stirling engine which set it apart from other heat engines are:

- (1) The cyclic flow of the working fluid within the machine is achieved solely through geometric volume changes and without the use of intermittently-closed valves or ports.
- (2) Thermal regeneration is accomplished via an intermittent flow heat exchanger, which stores a large portion of the heat of the working fluid after expansion and subsequently returns it to the working fluid after compression.

The first heat engines operating on such a regenerative cycle were constructed around 1816 by Robert Stirling. Excellent historical reviews of the Stirling Engine are given in Refs. 6-1 and 6-2. These engines used air as the working fluid and were early competitors of the steam engine for ship propulsion and water pumping. However, after some development the superior power-to-weight (and volume) characteristics of the steam engine resulted in the Stirling engine's being abandoned, except as an academic curiosity. However, interest in the Stirling engine continued throughout the 19th century and stemmed from the unique feature that, if the ideal Stirling thermodynamic cycle were practically realizable, the efficiency of a frictionless Stirling engine would be the same as that of a Carnot cycle engine (i. e., the maximum theoretically attainable in any heat engine).

The potentially high thermal efficiency of the Stirling engine, coupled with the fact that an almost endless variety of mechanical implementations are possible, led N. V. Philips Gloeilampenfabrieken of The Netherlands to begin a research and development effort in about 1938. Over the years, significant progress (Ref. 6-41) in improving the performance and durability of Stirling engines resulted from the efforts of Philips and the General Motors Research Laboratories. Their work culminated in the basic design of the four-cylinder, double-acting, swashplate configuration of the engine.

Since 1968, Maschinenfabrik Augsburg-Nürnberg, jointly with Motoren-Werke Mannheim (MAN-MWM) (Refs. 6-44, 45, 46), and United Stirling of Sweden (USS) have been carrying out Stirling engine development as licensees of Philips.

In 1971, Philips and The Ford Motor Co. began a joint effort to evaluate the feasibility of a Stirling engine for automotive propulsion. The preliminary phase of this project resulted in a 170-bhp (SAE net) Stirling engine's being selected for testing in a 1975 Ford Torino vehicle in the 5000-lb inertia weight class. This particular implementation is an external combustion,

closed-cycle, 4-cylinder, double-acting, swashplate drive engine using hydrogen as the working fluid (additional data are given in Section 6.3). The basis for the decision of the Ford Motor Co. to pursue a Stirling development program was the assessment that a Stirling-engine-powered vehicle has the potential for simultaneously delivering excellent fuel economy, extremely low emissions, low noise level, and performance comparable to that of a pre-emission-controlled Otto engine with good driveability. Present estimates are that the 170-hp Stirling-engine-powered test vehicle should be operational in CY 1975, assuming no significant changes in the program.

### 6.1.2 Morphology

The physical operation of the Stirling engine may be explained with the aid of a simple two-piston mechanism such as shown in Fig. 6-1. The direction of crank rotation is clockwise and the crank angle  $\beta$  is measured from the reference position where the expansion space volume  $V_e$  is maximum. The volume variation of the compression space  $V_c$  with respect to the crank angle  $\beta$  lags behind that of  $V_e$  by the angle  $\alpha$  as determined by the connecting linkage. As will be illustrated later, values for  $\alpha$  usually lie between  $45^\circ$  and  $135^\circ$ , with  $90^\circ$  being near optimum. Clearly, both cranks could be on the same shaft and displaced by the angle  $\alpha$ . As the crank rotates, the total volume of the system,  $V_t = V_e + V_c + V_D$ , varies from  $V_{min}$  to  $V_{max}$  according to the relation

$$V_t = \frac{1}{2} \left\{ V_C [1 + \cos(\beta - \alpha)] + V_E [1 + \cos \beta] \right\} + V_D \quad (1)$$

where  $V_D$  is the dead volume (which includes the volume of heater tubes, cooler, regenerator, and connecting passages). Written in terms of the geometric engine parameters  $\delta = V_D/V_E$  and  $\xi = V_C/V_E$ , Eq. (1) becomes

$$V_t = (V_E/2) \left\{ \xi [1 + \cos(\beta - \alpha)] + \cos \beta + 2\delta + 1 \right\} \quad (2)$$

providing that the motion of the piston can be adequately represented by simple harmonic expressions.

The variation of the total working space volume  $V_t$  with crank angle  $\beta$  as determined from Eq. (2) with  $\alpha = 90^\circ$ ,  $\xi = 1$ , and  $\delta = 1$  is shown in Fig. 6-2. The maximum working space volume,  $V_t = 2.71 V_E$ , occurs at  $\beta = 45^\circ$ , and the minimum,  $V_t = 1.29 V_E$ , occurs at  $\beta = 225^\circ$ . The volume changes which occur within the expansion and compression spaces are phased such that the working fluid is located primarily in the hot space of the engine as the total working space volume increases and, conversely, located primarily in the cold space of the engine as the total

working volume decreases. Therefore, one revolution of the crankshaft produces a sequence of four processes which are not distinctly separated but which, nevertheless, can be identified. As shown on Fig. 6-2, the four processes are:

- (1) A transfer of the working fluid from the hot space through the heater, regenerator, and cooler to the cold space, which occurs with a relatively small change in total working space volume.
- (2) A compression process occurring with the working fluid located primarily within the cold space and the adjacent cooler.
- (3) A transfer of the working fluid from the cold space through the cooler, regenerator, and heater to the hot space, with a relatively small change in total working space volume.
- (4) An expansion process occurring with the working fluid located primarily within the hot space and the adjacent heater.

The work output of the engine is produced during the expansion process which occurs during each revolution of the crankshaft.

These four processes, which in ideal form comprise the Stirling cycle, can be executed by a variety of mechanical systems as discussed by Walker (Ref. 6-2, 6-21); however, two basic types of mechanisms, the two-piston and the piston-displacer, have received most of the developmental effort applied to Stirling engines in the past. The nature of the variation of total volume  $V_t$  with crank angle  $\beta$  does not affect thermal efficiency  $\eta_c$  so long as the compression and expansion processes are isothermal and the regenerative process occurs with high effectiveness. The thermal efficiency of various mechanizations of the four processes comprising the Stirling cycle is affected by the specific shape of the  $V_t$  vs  $\beta$  curve, such as shown in Fig. 6-2, only to the extent that the rate of volume change with respect to crank angle causes nonisothermal expansion and compression processes and non-ideal regeneration. The upshot of these observations is that the Stirling engine can be optimized to attain a high fraction of the theoretical thermal efficiency of the Stirling cycle in a wide variety of mechanical configurations. However, the power delivered by the engine per unit swept volume of expansion space is affected by the mechanical configuration of the engine. Hence the designer is free to select a mechanization of the engine which provides the best combination of characteristics, such as specific weight and volume, power vs speed relation, packaging shape, and output shaft speed range for a specific application. Several examples of the versatility of the Stirling engine are evident from the applications described in Refs. 6-3, 6-4, 6-5 and 6-6, which range from a stationary power supply, through underwater torpedo propulsion, to an automobile engine.

#### THE PISTON-DISPLACER ENGINE

The basic configuration of the piston-displacer arrangement is illustrated in Fig. 6-3 and is discussed in Refs. 6-1, 6-2, 6-7, and 6-8,

among others. The cylinder of a piston displacer engine is divided into a hot expansion space and cold compression space. The power piston, located as shown in Fig. 6-3, executes reciprocating motion within the lower or cold portion of the cylinder, while the displacer executes reciprocating motion in the upper or hot portion of the cylinder. The displacer piston does not necessarily make a gas tight seal with the cylinder wall. In fact, it should not fit tightly enough to cause appreciable friction with the cylinder wall. Also, the external gas flow passages (consisting of the heater, regenerator and cooler) are designed so that the pressure difference across the displacer is quite low as the working fluid is shuttled between the hot and cold spaces. The relative motion of the piston and displacer is such that the sequence of positions I, II, III, and IV (shown in Fig. 6-3) is obtained. The four processes comprising the Stirling cycle are executed as the piston and displacer move through these positions. At position I in Fig. 6-3, the displacer has moved into the hot space and, in so doing, forced the working fluid through the heater, regenerator, and cooler into the cold space, while the power piston remains stationary at the bottom of the cold space; this process corresponds to (1) in Fig. 6-2. At position II, the displacer has remained stationary at its uppermost position in the hot space, while the power piston has compressed the working fluid, corresponding to process (2) in Fig. 6-2. At position III, the power piston has remained stationary at its uppermost location while the displacer has moved down toward the power piston and, in so doing, forced the working fluid to flow through the cooler, regenerator, and heater into the hot space, corresponding to process (3) in Fig. 6-2. During this step, the pressure of the confined working fluid increases as its temperature increases by contact with the hot space. At position IV, the expansion, or work-producing, process has occurred as the power piston and displacer have both moved downward, increasing the total working space volume. Thus, the working fluid has expanded while located primarily in the heater and hot space, corresponding to process (4) in Fig. 6-2. The piston and displacer must be connected with some mechanical linkage that approximates the movements described above as the output shaft rotates (free piston implementations excluded).

Many different mechanisms can be designed to give the proper phase relationship to the reciprocating motion of the displacer and of the power piston. However, two mechanisms are prominent: the crankshaft with displaced throws and the rhombic drive. A crankshaft drive for a piston-displacer cylinder is shown in Fig. 6-4. The displacer is driven via a rod extending through the power piston, and the power piston is driven with two connecting rods to provide symmetry of forces. The optimum angle  $\alpha$ , by which the displacer motion leads the piston motion, varies from about 35 to 90°, depending on several other parameters. Optimum combinations of such design parameters have been investigated by Kirkley (Ref. 6-9).

The rhombic drive mechanism was invented by Meijer in 1953. This drive mechanism, illustrated in Figs. 6-5a and 6-5b, is discussed in Refs. 6-7, 6-8, and 6-10. A basic attribute

of the rhombic drive is the requirement for two seals per cylinder — shown at locations 11 and 12 in Fig. 6-5a — to isolate the high-pressure working fluid from the crankcase. Also, the rhombic drive mechanism may be readily designed to transmit extremely high torque loads with no side thrust on the displacer or piston rods. The motion of the displacer and piston with a rhombic drive is not simple harmonic, but it does provide an excellent approximation to the Stirling cycle, with considerable freedom to optimize both the amplitude and phase relationship of the piston and displacer. An important feature of the rhombic drive is the buffer space, shown as location 13 on Fig. 6-5a. This buffer space provides a torque-impulse-smoothing cushion for the engine. The gas in the buffer space is compressed during the expansion stroke of the power piston, and the energy of compression is returned during the upstroke of the power piston. Therefore, the torque impulse produced during expansion is delivered in both the downstroke and the upstroke of the power piston.

### THE TWO-PISTON ENGINE

The single-acting, two-piston engine is illustrated in Fig. 6-1 and its operation has been previously described. A more compact version of the two-piston engine may be constructed by utilizing double-acting (DA) piston/cylinder arrangements, with expansion occurring on one side of the piston and compression on the other. An arrangement which gives the necessary phase lead of the expansion space, when DA cylinders are interconnected as shown in Fig. 6-6, was invented at Philips, as reported by Rinia (Ref. 6-11), in 1942. Development work on this engine, carried out from about 1945 to 1953, was virtually stopped with the advent of the rhombic drive, piston-displacer engine. The Rinia (Philips) arrangement requires multicylinder engines, which are expensive for laboratory test work. Further, the Rinia engine is more complex fluid-dynamically and thermodynamically, making it more difficult to optimize for high efficiency. However, with the more sophisticated understanding of the Stirling engine processes developed during the years of work on rhombic drive engines, the problems with DA engines are yielding to renewed developmental effort such as the work initiated at GMRL with a 4-cylinder, in-line Rinia engine (Ref. 6-4).

A four cylinder Rinia engine with  $\alpha = 90^\circ$  may be constructed in either an in-line-crankshaft drive or a circular-swashplate drive configuration. The latter configuration is of particular interest since it packages quite compactly. The work on swashplate drive mechanisms for Stirling engines was initiated by GMRL (Refs. 6-4, 6-12) and pursued by Philips (Refs. 6-5, 6-13). A four-cylinder Rinia engine with a swashplate drive is illustrated in Fig. 6-7. The DA-Rinia cylinder arrangement may also be used with the cylinders arranged in a V-configuration. In such an engine the angle between the cylinders forming the V can provide proper phasing if the connecting rods of a cylinder pair are connected to the same crankshaft throw. Of course, a crankshaft similar to an in-line four may also be used (as GMRL finally decided to make) but the V arrangement provides more compact packaging than an in-line engine.

Like the other heat engines, the Stirling also admits of a rotary (Wankel-type) implementation. One such possible rotary configuration is shown conceptually in Fig. 6-8 and is briefly discussed in Ref. 6-14. Daimler-Benz has also patented a one-rotor Stirling rotary configuration. To date, no significant experimental effort has been devoted to rotary Stirling engines. They could be plagued by the same problems (leakage, distortion, etc.) besetting Otto-Wankels, probably more so because of the higher  $\Delta P$  across chamber seals and possible contamination of the working fluid by lubricant. However, if development of Wankels is continued to the point where their configurationally peculiar problems are solved, the Stirling-Wankel may become an attractive implementation at a future date.

## 6.2 CHARACTERISTICS

### 6.2.1 Thermodynamics

The processes shown in Fig. 6-2 may be conceptualized to an ideal Stirling thermodynamic cycle. The ideal Stirling cycle, shown in Fig. 6-9 on temperature-entropy coordinates, consists of four processes: isothermal compression  $w_{1-2}$  with simultaneous heat rejection  $Q_{1-2}$ , constant volume regenerative heat addition  $Q_{2-3}$ , isothermal expansion  $w_{3-4}$  with simultaneous heat addition  $Q_{3-4}$ , and constant volume regenerative heat removal  $Q_{1-4}$ .

The thermal efficiency of any heat engine is defined as the ratio of network output to heat addition from the high-temperature source, hence  $\eta_h = w_n/Q_H$ . This definition may be applied to the idealized Stirling cycle of Fig. 6-9 by computing the net work output of the cycle with an ideal gas working fluid in terms of characteristic cycle parameters. The isothermal work of compression, where heat is extracted at  $T_L$  at the same rate at which work is absorbed by the fluid, is given by

$$-Q_{1-2} = -w_{1-2} = -\frac{mR T_L}{M} \ln(V_2/V_1) \quad (3)$$

noting that  $Q_{1-2} = Q_L$ , which is the heat rejected during one cycle of operation. The constant volume regenerative heat addition process and the constant volume regenerative heat removal process both involve the same quantity of heat

$$Q_r = Q_{2-3} = -Q_{4-1} \quad (4)$$

which may be expressed as

$$Q_r = m c_V (T_H - T_L) \quad (5)$$

The quantity of heat  $Q_r$  is simply stored in the regenerator during process (Fig. 6-9) ④→① and recovered from the regenerator during process ②→③;  $Q_r$  is transferred entirely within the overall system boundary and is not associated with  $Q_H$  or  $Q_L$ . The work of expansion, which

results in the useful work output of the engine, is produced during process ③→④, during which simultaneous heat addition  $Q_H$  occurs at the same rate at which work is produced by the fluid. It is given by

$$w_{3-4} = Q_{3-4} = m \frac{R}{\mathcal{M}} T_H \ln(V_4/V_3) \quad (6)$$

Noting that  $\ln(V_4/V_3) = -\ln(V_2/V_1)$ , and that  $w_n = w_{23} + w_{34}$ , the thermal efficiency becomes

$$\eta_h = \frac{\frac{mR}{\mathcal{M}} \ln(V_4/V_3) (T_H - T_L)}{\frac{mR}{\mathcal{M}} T_H \ln(V_4/V_3)}$$

or

$$\eta_h = 1 - \frac{T_L}{T_H} = 1 - \tau \quad (7)$$

Thus the efficiency of the ideal Stirling cycle, which by definition includes perfect regeneration and isothermal compression and expansion processes, is seen to be dependent only on the temperatures  $T_H$  and  $T_L$  and independent of all other parameters. Also, the  $\eta_c$  for an ideal Stirling cycle is identical to that of the Carnot cycle. This characteristic is due, first, to the compression and expansion processes being carried out isothermally and, second, to the ideal regenerative processes ④→① and ②→③ during which  $Q_r$  is stored and then recovered. The specific path of working fluid thermodynamic states during the regenerative processes does not affect  $\eta_c$  so long as the process is reversible.

The classical analysis of the Stirling engine with continuous harmonic variations of hot space and cold space volume is due to Schmidt (Ref. 6-15), and this analysis is discussed in Ref. 6-2. The Schmidt analysis provides insight into how the design parameters  $\delta$ ,  $\xi$ , and  $\alpha$  should be chosen for various values of the temperature ratio  $\tau = T_L/T_H$ . Briefly, the Schmidt analysis consists of applying mass conservation to the hot, dead, and cold volumes as represented by Eq. (2). The total mass of working fluid in the engine may be written as

$$m_C + m_E + m_D = m_t \quad (8)$$

where the subscripts C, E, D indicate the masses of fluid in the compression, expansion, and dead spaces, respectively, and t indicates the total mass in the engine. Equation (8) may be manipulated to include the engine design parameters  $\tau$ ,  $\delta$ ,  $\xi$ , and  $\alpha$  by application of the following conditions and definitions: (1) the working fluid is an ideal gas, (2) the temperature of the dead space varies linearly from  $T_H$  to  $T_L$ , and has been assigned a mean value ( $T_D$ ) according to  $T_D = (1 + 1/\tau)(T_L/2)$ ; (3) the parameter  $y$  is defined by  $y = (2\delta\tau)/(\tau + 1)$ ; (4) the volume variations

are represented by Eq. (2); (5) the quantity  $\Pi = 2m_t RT_L/\mathcal{M}V_E$  is a constant where  $m_t$  is the total mass of working fluid, R is the ideal gas content,  $\mathcal{M}$  is the molecular weight of the working fluid,  $T_L$  is the temperature of the cold space, and  $V_E$  is the maximum swept volume of the hot space. After substitution and rearrangement, Eq. (8) becomes

$$\tau(1 + \cos \beta) + \xi[1 + \cos(\beta - \alpha)] + 2y = \Pi/p \quad (9)$$

where p is the instantaneous pressure of the working fluid which is uniform throughout the entire internal volume of the engine  $V_t$ . Equation (9) may be put into a more convenient form by utilizing several trigonometric substitutions. Hence

$$p = \Pi/(B_1 \cos(\beta - \theta) + B_2) \quad (10)$$

where

$$B_1 = \tau^2 + \xi^2 + 2\tau\xi\cos\alpha$$

$$B_2 = \tau + \xi + 2y$$

$$\theta = \arctan[(\xi \sin \alpha)/(\tau + \xi \cos \alpha)]$$

The cycle pressure ratio,  $r = (\text{maximum pressure})/(\text{minimum pressure})$ , may be found from Eq. (10) by noting that  $p(\pi) = p_{\min} = \Pi/(B_2 + B_1)$  and  $p(0) = p_{\max} = \Pi/(B_2 - B_1)$ ; therefore,

$$r = \frac{B_2 + B_1}{B_2 - B_1} \quad (11)$$

The mean or average pressure inside the total working space during one complete cycle, i. e., one revolution of the drive shaft, is

$$\bar{p} = \frac{1}{2\pi} \int_0^{2\pi} p \, d(\beta - \theta)$$

which on substitution of Eq. (10) and integration can be expressed in terms of r as

$$\bar{p} = \Pi/[(B_2 - B_1) \sqrt{r}] \quad (12)$$

The equations for the instantaneous system pressure p, the mean system pressure  $\bar{p}$ , and the instantaneous system volume  $V_t$  may be utilized to find the shaft work delivered by the engine.

The shaft work produced per cycle of operation is

$$w = \int_{V(0)}^{V(2\pi)} p \, d(V_t)$$

or

$$w = \pi \bar{p} V_E (1 - \tau) \frac{\xi}{1 + \sqrt{1 - \xi^2}} \sin \theta \quad (13)$$

where  $\xi = B_1/B_2$ .

The shaft power is

$$P = w\omega \quad (14)$$

where  $\omega$  is the angular speed of the shaft. The net quantity of heat supplied isothermally at  $T_H$  is equivalent to the work done in the hot space during one cycle of operation. Thus

$$Q_H = w_E = \int_{V(0)}^{V(2\pi)} p \, dV_e$$

So

$$Q_H = \pi \bar{p} V_E \frac{\xi}{1 + \sqrt{1 - \xi^2}} \sin \theta \quad (15)$$

And since the cycle efficiency is the ratio of net cycle work (14) to the heat supplied per cycle (15), the efficiency is seen to be  $\eta_c = (1 - \tau)$ , which is identical to that of the Carnot cycle between the same two temperatures and is shown in Fig. 6-10. The details of the Schmidt analysis and considerations of optimum engine configurations may be found in Refs. 6-2, 6-9, 6-15, and 6-16. The Schmidt analysis as outlined above is valid only for two-piston type engines with either single-acting or double-acting pistons and with the following simplifying assumptions: (a) isothermal compression and expansion processes; (b) perfect reversible regenerative processes; (c) no fluid friction losses, hence the instantaneous pressure is uniform throughout the system; and (d) the working fluid is an ideal gas. For piston displacer engines the expressions for  $V_E$  and  $V_C$  must be modified to account for the overlapping strokes of the piston and displacer, as given by Kirkley (Ref. 6-9).

The optimum configuration of two-piston Stirling engines based on the Schmidt analysis may be defined by maximizing a dimensionless power output parameter, as reported by Kirkley (Ref. 6-9) and Finkelstein (Ref. 6-17). Kirkley defines such a parameter as

$$Z = \frac{(\text{cycle work})}{(p_{\max} V_T)} \quad (16)$$

and reports the results of an optimization study based on  $Z$ . An engine optimized on  $Z$  would have the greatest power output for a given maximum cycle pressure. The rationale for this choice is that the engine must be structurally designed to withstand the maximum internal pressure of the working fluid  $p_{\max}$ ; consequently, specified values of  $p_{\max}$  and internal volume  $V_T$  determine the weight and volume of the engine. Hence, for highest specific power, the ratio of shaft work to the product  $p_{\max} V_T$  should be maximized. The optimum value of an engine design parameter is that at which the maximum value of the ratio of work output  $w$  to the product  $p_{\max} V_T$  is obtained when, in turn, each of the four engine design parameters  $\tau$ ,  $\delta$ ,  $\xi$ , and  $\alpha$  is varied while the other three are held constant. The power parameter  $Z$  increases continuously with both  $\tau$  and  $\delta$ ; hence no optimum values of these parameters exist. The value of  $\tau$  should be as small as possible, and the value of  $\delta$  should also be as small as design constraints involving factors such as pressure losses and heat losses permit. However, at given values of  $\tau$  and  $\delta$ , a maximum value of  $Z$  occurs as the phase angle  $\alpha$  or the swept volume ratio  $\xi$  varies, while the other parameter ( $\alpha$  or  $\xi$ ) is held constant. Therefore, optimum values of  $\alpha$  and  $\xi$  do exist at which  $Z$  is maximized. The results of an optimization study by Kinkley (Ref. 6-9) are shown in Fig. 6-11. The optimum values of  $\alpha$  and of  $\xi$  are shown as dependent on the independent parameters  $\tau$  and  $\delta$ . It must be noted that  $\alpha$  and  $\xi$  in Fig. 6-11 are specifically the optimum value of these parameters for given  $\tau$  and  $\delta$ . And the optimum power parameter shown in Fig. 6-11 is the optimum value of  $Z$  which results from a choice of  $\tau$  and  $\delta$  when the optimum values of  $\alpha$  and  $\xi$  are used.

In practice, Stirling engines do not exhibit theoretical performance as predicted by the Schmidt analysis. The primary difference between that actually obtained along the thermodynamic path of states of the working fluid in a Stirling engine and that assumed by the Schmidt analysis lies in four nonideal processes: nonisothermal expansion and compression; irreversible regeneration; heat loss from the working fluid; and frictional flow of the working fluid through the heater, regenerator, and cooler. These four factors are responsible for the "indicated" performance of a Stirling engine being less than the "ideal" performance. Other performance losses are attributable to the mechanical friction of the engine drive mechanism.

Analytical procedures to simulate the actual processes occurring in a Stirling engine have been developed. One such procedure by Finkelstein (Refs. 6-17, 6-18, 6-19, 6-20) requires that the engine be divided into a nodal network and that numerical techniques (similar to those used in thermal analyzer programs for digital computers) be utilized to solve the finite difference equations representing the internal processes of the engine. Such an analysis may be applied to a particular engine design to estimate the performance of the engine. However, for the purposes of generalized design optimization, a simplified theoretical approach can yield useful information.

The actual expansion and compression processes in a Stirling engine occur between the extreme limits of being isothermal or adiabatic. Finkelstein (Ref. 6-17) treats these processes for the Stirling engine over a range of operations at limited rates of heat transfer to the working fluid, bounded by the two extremes cited above. Using Finkelstein's equations, Walker and Kahn (Ref. 6-24) computed the performance of Stirling engines with no fluid friction losses, no heat losses, perfect regeneration, and adiabatic expansion and compression processes. These results are shown in Fig. 6-12 as plots of the cycle efficiency  $\eta_c$  and the work parameter,  $wM/m_t R T_H$ , as functions of the temperature ratio  $\tau = T_L/T_H$ , swept volume ratio  $\xi = V_C/V_E$ , and phase angle  $\alpha$  at several different values of the dead volume ratio  $\delta = V_D/V_E$ . The thermal efficiency shown in Fig. 6-12 for  $\tau = 0.3$ ,  $\xi = 1.0$ ,  $\delta = 1.0$ , and  $\alpha = 90^\circ$  is about 62%. The brake efficiency of a real engine is reduced from this value by fluid pumping losses, heat losses from the hot space and the regenerator (including axial conduction), and mechanical friction. The performance of real engines is discussed in the following section.

Several important observations may be drawn from Figs. 6-11 and 6-12. For both isothermal and adiabatic engines, the power parameter increases as  $T_H$  is increased and/or as  $T_L$  is decreased; also, the power parameter increases as the dead volume ratio  $\delta$  decreases. The phase angle  $\alpha$  for the maximum power parameter is strongly dependent on the dead volume ratio  $\delta$  and nearly independent of all other parameters. The power parameter is also relatively unaffected by the swept volume ratio  $\xi$ , especially for the adiabatic engine. The information of Figs. 6-11 and 6-12 suggests that for  $\tau = 0.33$ , which is typical, fixed values of  $\alpha$  somewhat greater than  $90^\circ$  along with a  $\xi$  of near 0.8 would give good performance. However, the dead volume ratio  $\delta$  has a dramatic effect on power for both isothermal and adiabatic engines; and for the adiabatic engine, the cycle efficiency  $\eta_c$  increases as the dead volume of the engine is increased. In actual Stirling engines, particularly engines of high specific power, the expansion and compression processes are nearly adiabatic. Therefore, subject to the limitations of the foregoing analysis, power control by means of dead volume change is desirable on an engine with nonisothermal compression and expansion processes. However, practical implementations are lacking at present.

### 6.2.2 Performance

The performance characteristics of the Stirling engine which make it attractive for automobile propulsion are its high brake efficiency, Otto-comparable specific power, desirable output shaft maximum-to-idle speed ratio, low noise, and low emissions.

The high brake efficiency of the Stirling engine originates in the basic thermodynamic

character of the engine. Even if the ideal isothermal expansion and compression are replaced by adiabatic processes, the thermal efficiency of the engine is still very high. For instance, referring to Fig. 6-12 with  $\delta = 1$ ,  $\xi = 1$ ,  $\alpha = 90^\circ$ , and  $\tau = 0.3$ , the thermal efficiency of an adiabatic engine is 89% of that of an isothermal engine. A Stirling engine with adiabatic compression and expansion processes is identical in efficiency to a low-compression-ratio, regenerated Otto-cycle engine. With the aforementioned design parameters, the "compression ratio" of a Stirling engine is about 2.1:1, (i.e.,  $V_{\max}/V_{\min} = 2.1$ ). Such an engine exhibits extremely high thermal efficiency because, with perfect regeneration, the efficiency of an Otto or a Brayton cycle engine approaches that of the ideal Stirling cycle as the expansion ratio or pressure ratio, respectively, approaches unity. With those observations, a nonregenerated Otto-cycle engine, utilizing a working fluid with a specific heat ratio of 1.3,<sup>1</sup> would require an expansion ratio of about 25:1<sup>2</sup> to have the same theoretical efficiency as the 2:1 "regenerated Otto" (Stirling) engine with adiabatic work processes.

The experimental and analytical work of Philips, GMRL, and others has resulted in computer simulation programs with the capability to accurately predict the performance of Stirling engines. The characteristics of several different engines, as determined from actual tests and from Philip's analytical techniques, are shown in Table 6-1. Most of the remainder of this discussion of Stirling engines will be devoted to the 170-bhp, 4-215 DA engine and its envisioned Mature configuration. Table 6-1 shows this engine in its present configuration in perspective with other designs of the Stirling engine. The Philips 4-215 engine, which is to be installed in a 1975 Ford Torino vehicle, has a specific power of about 0.21 bhp per pound, which is competitive with an automotive V-8 Otto engine at about 0.23 bhp per pound.

The output shaft torque-speed characteristic of Stirling engines is well suited to automotive applications. A Stirling engine typically displays a maximum-to-idle output shaft speed ratio of about 9:1, with maximum torque occurring from 20 to 35% of output shaft speed and dropping to about 70% of maximum torque at maximum output shaft speed. With such a flat torque-speed characteristic, the maximum output power occurs at near maximum shaft speed. Figure 6-13 shows the projected<sup>3</sup> torque-speed characteristic of the 4-215 engine, and Fig. 6-14 shows its corresponding part load fuel consumption characteristic.

The Stirling engine must provide power to drive auxiliaries, including the combustion air blower, radiator fan, and fuel and coolant pumps. The performance and fuel consumption maps for the 4-215 engine include the power demands of all required auxiliaries. These power demands are

<sup>1</sup> Approximate value for the products of combustion of typical fuel-air mixtures.

<sup>2</sup> Usually referred to as compression ratio.

<sup>3</sup> Preliminary dynamometer test data, recently received from Philips/Ford, tend to confirm computer-predicted efficiencies and powers.

Table 6-1. Engine characteristics

Manufacture	Philips 4-215	Philips	United Stirling	GMRL GPU-3	Philips 4-235	Philips 40 hp	United Stirling	MAN- MWM 4-400
Status	Proto (Ford)	Analy. (opti- mized)	Proto	Proto	Proto	Proto	Analy. phase I	Proto
Type	Two piston	Piston- disp	Two piston	Piston- disp	Piston- disp	Piston- disp	Two piston	Piston- disp
Working fluid	H <sub>2</sub>	He	H <sub>2</sub>	H <sub>2</sub>	He	H <sub>2</sub>	H <sub>2</sub>	H <sub>e</sub>
Max press. $\bar{P}$ , psi	2850	3200	2100	1000	3200	2058	2100	1570
No. of cylinders	4	4	4	1	4	1	8	4
Max bhp	170	275	49	11	200	40	200	120
RPM at max power,	4000-4200	1600	3400	3600	3000	1500	2400	1500
Max torque, ft-lbs	300	1287	120	19	253	108	520	475
RPM at max torque	1400	400	955	1200- 2400	1000	900	600	700
Gas temp (hot), °F	1300	~1400	1275	1400 <sup>a</sup>	1260	1200	1325	1170
Gas temp (cold), °F	175	160	160	180	108	60	160	105
Efficiency at max BHP (%)	24	30	24	25	30	30	30	29
Max efficiency, %	32 <sup>b</sup>	43 <sup>b</sup>	30	26.5 <sup>b</sup>	31	38	35	32
Power at max efficiency, BHP	75	100	35	~7	175 (approx)	23	76	88
RPM at max efficiency	1100-2000	600	2000	1900	1800	725	1200	1000
Weight, <sup>c</sup> lb	750	N/D	N/D	165 <sup>d</sup>	1272	N/D	1435	N/D
Dimensions, <sup>c</sup> ft.	N/D	4.9 x 4.3 x 2.2	N/D	1.3 x 1.3 x 2.4 <sup>e</sup>	4.1 x 1.7 x 3.6	N/D	3.7 x 2.7 x 3.1	5.0 x 2.3 x 4.3
Applications	Auto	Bus	Auto	EPS	Bus	LRE	Bus, truck	LRE
References	6-6, 13, 22, 27	6-5	6-25, 28	6-3, 26, 38	6-39	6-8, 10	6-25	6-24

<sup>a</sup>Heater tube wall temperature.

<sup>b</sup>Net brake efficiency accounting for all auxiliaries including cooling fan, combustion blower, and water pump, among others.

<sup>c</sup>Includes all auxiliaries except cooling system with fan and transmission.

<sup>d</sup>Engine and auxiliaries less electrical power generator.

<sup>e</sup>Engine only.

Abbreviations:

Proto: operating prototype engine; LRE: Laboratory Research Engine; Analy: computer design projection; N/D: no date; EPS: electric power supply.

significant since almost all of the heat rejected by the engine must be dissipated through the radiator, while the external combustion blower must provide air for the burner. The cooling system for a Stirling engine must have about 2.0 to 2.5 times the capacity of a conventional Otto or Diesel engine. Adequate cooling system capacity is essential, since the power and efficiency of a Stirling engine are extremely sensitive to  $T_L$ , as suggested by Fig. 6-10.

The mechanical configuration of the present 4-215 engine is illustrated in Figs. 6-15 and 6-16. This engine has four double-acting cylinders with a swashplate drive and incorporates a rotating combustion air preheater and rollsock seals. The individual components of this engine are described in greater detail in Section 6.3.

The high specific power of the present 4-215 engine is a consequence of its high maximum output shaft speed of 4200 rpm, its high maximum internal working fluid pressure of 2850 psia, and the relatively compact swashplate drive arrangement. The total swept expansion space volume for all four cylinders is 53 in<sup>3</sup>. The brake mean effective pressure for an engine with one power stroke per revolution of the output shaft which produces 170 bhp at 4000 rpm is 312 psi, and the maximum bmep is 427 psi at 1400 rpm. Thus, the Stirling engine drive is relatively highly stressed in comparison to a conventional V-8 Otto engine of 350 CID whose maximum bmep is about 130 psia at 2600 rpm. Also, the Stirling engine achieves approximately the same maximum torque as a V-8, but at a much lower speed. The rapid torque rise of the Stirling can be advantageously utilized to simplify (see Section 6.3) the 3-speed automatic transmission with torque converter, currently used with Otto engines.

The performances of the Mature and Advanced configurations of the Stirling engine are based on conservatively estimated improvements in the engine design. The present 4-215 engine has a fairly wide range of operation at a maximum brake efficiency of 32% or higher, as shown in Fig. 6-13. Appropriate changes in the design of the Mature (also to be incorporated in the Advanced) engine will result in an increase of the maximum brake efficiency by a factor of about 1.13. The present 4-215 engine was optimized, according to Philips (Ref. 6-22), for best efficiency at maximum power. However, for automobile propulsion, an engine should be optimized for best efficiency at about 20 to 30% of maximum power. Comparison of the 4-215 and the 275-hp engines of Table 6-1 provides some indication of the increase attainable in engine maximum brake efficiency under part load optimization. Such a reoptimization at part load conditions would result in some sacrifice in efficiency near maximum power, where the engine is rarely operated. In addition, some relaxation in engine size constraints may be required, but will be offset by lower design horsepower required in Stirling-powered vehicles (see Section 6.5).

The present 4-215 engine also utilizes mean-pressure-level variation for power control. As noted earlier, a suitable dead volume control system can offer improved part-load efficiency for Stirling engines with nonisothermal expansion and compression processes. Continuous dead

volume control over a wide range could be accomplished via changing the angle of the swashplate with respect to the main shaft. Variation of the swashplate angle from 10 to 25° would change  $\delta$  by a factor of about 2.4, which would, in turn, decrease the cycle work by a factor on the order of 2. Variation of swashplate angle combines the efficiency benefits of increasing dead volume and decreasing flow losses. The actual factor of power control via a variable-angle swashplate depends on the minimum dead volume of the engine. Such an increase in dead volume would increase the thermal efficiency per Fig. 6-12 by a factor of 1.10 to 1.15, again depending on the minimum dead volume of the engine.

The Mature Stirling engine will likely show a substantial improvement in the already good part-load thermal efficiency of the present engine. This improvement can result from a combination of engine design reoptimization and dead volume control (preferably by means of a variable-angle swashplate). The maximum brake efficiency of the Mature engine incorporating these improvements was conservatively estimated as 36%, on the basis of reoptimization (as previously discussed), coupled with some degree of dead volume control.

A third technique which could further improve the part load bsfc of a given Stirling engine, but is not embodied in the Mature configuration, is utilization of mean-cycle-pressure vs hot-side-temperature scheduling. The maximum operating temperature of the heater tubes and hot side cylinder walls is limited by high-temperature stress-rupture and creep. The mean pressure level in the working spaces of the engine is varied to control the power output of the engine. At the lower working fluid pressures corresponding to lower output power levels, the hot side components (i.e., heater tubes, cylinder walls, and regenerator housing) can operate at higher temperatures, because their internal stresses are lower, and not exceed the material creep, stress rupture, and oxidation limits. Thus, the hot side temperature  $T_H$  can be increased at part load and reduced at full load to improve the part load fuel economy by a factor of about 1.04. The same technique could be used instead to permit substitution of lower-cost materials, while maintaining current levels of part load efficiency.

The Advanced Stirling engine can attain a further increase in efficiency, resulting from the higher temperatures which become possible with ceramic hot side components. An increase in  $T_H$  from 1400 to 2000°F will increase the thermal efficiency of the engine by a factor of 1.13. With this increase in  $T_H$ , the maximum efficiency of the advanced engine becomes 41%. Variable angle swashplate control is assumed.

Both the Mature and Advanced engines would likely show a part-load thermal efficiency characteristic somewhat similar to that of the present engine, with a more rapid efficiency decrease near maximum load due to the reoptimization for part load efficiency.

### 6.2.3 Fuel Requirements

Since the Stirling engine is a continuous combustion device, it utilizes a constant-pressure



burner with all the combustion flexibility that implies. In principle, the operation of such a burner can be tailored to any fluid fuel, that is, to any fluid which will maintain self-sustaining combustion with air. Philips Laboratories has demonstrated this capability in a conclusive, if somewhat histrionic, manner by operating a laboratory model engine with an unusual spectrum of substances, including comestible oil and potable alcohol, as well as more conventional fuels. From the standpoint of this study, it is clear that the Stirling engine can use almost any (within safe flash-point limits) petroleum fraction, methanol, or blends thereof. However, materials considerations (e.g., corrosion) mandate a fuel essentially free of lead, sodium, sulfur, and vanadium contaminants. Further, not all fuels produce the same pollutant emission levels. Present suitable fuels are gasoline, diesel fuel, and "broad-cut" distillate (no octane or cetane number requirements). Hence, this type of engine possesses the desirable characteristic of adaptability to changing fuel availability, should that become important in the future.

#### 6.2.4 Pollutants

The heat source for the Stirling engine is a continuous burner which operates at near atmospheric pressure. Considerable work on continuous-combustion constant pressure burners — and particularly Stirling burners — has shown them to be capable of extremely low levels of exhaust gas pollutants (Refs. 6-36, 6-37, 6-38, 6-39).

Exhaust gas emissions from the Stirling engine burner are controlled through the use of excess air (overall lean burning) and exhaust gas recirculation (EGR). The combustion system currently used is shown schematically in Figs. 6-17 and 6-18. The excess air is about 40% at idle, and is maintained near 30% throughout the operating range of the engine. About 1/3 of the exhaust gas is recirculated at low loads, while at high loads, outside the power range of the Federal Driving Cycle, the EGR may be cut off. Emissions indices, determined from experiments with the burner for the 4-215 engine, are shown in Fig. 6-19. These emissions characteristics were used as a basis for predicting the vehicle emissions presented later in this report.

In addition, simulated tests over the Federal Urban Driving Cycle (FDC-U) have been performed with actual Stirling engine burners and the emissions measured (Ref. 6-40). These tests are described in Refs. 6-6 and 6-23. The most recent results of these tests, in accordance with the CVS-CH procedure for a 5000 lb IW vehicle, are 0.2/2.0/0.2 grams/mile for HC/CO/NO<sub>x</sub>, respectively. Consideration of the deviations from actual engine operation introduced by the simulation procedure suggests that an actual engine might produce even lower HC and CO emissions than the simulation test rig.

### 6.3 MAJOR SUBASSEMBLIES/COMPONENTS

#### 6.3.1 Descriptions

The major components of the Stirling power-plant are the combustor assembly, heater head, block/pistons subassembly, preheater, cycle

regenerators and coolers, linkage mechanism, seals, control system, cooling system, and transmission. Many of these are similar to counterpart hardware in more conventional engines, albeit of somewhat different size or geometry, and some are peculiar to Stirling engines. Details are given in the following. The rhombic drive configuration is not considered favorable for automotive application because of larger size and higher cost and is consequently not discussed.

#### COMBUSTOR

To date, most Stirling-relevant combustor work has been centered on comparatively simple fixed-geometry combustors. These utilize the interaction of fuel stream momentum, as issuing from a spray nozzle, and air stream momentum, as imparted by a centrifugal blower, to achieve reasonably effective fuel atomization and mixing. Air flow is staged to the primary and dilution zones to achieve a near-optimum compromise among combustion efficiency, NO<sub>x</sub> formation, and HC/CO formation. EGR is employed to further reduce NO<sub>x</sub> formation.

These fixed-geometry combustors result in a vehicle that can meet the statutory 1978 standards (0.41/3.4/0.4 g/mi) and, hence, little effort has been expended on the development of more exotic combustors. In an advanced Stirling engine designed to operate at much higher temperatures (say circa 2000°F), variable geometry might be required to maintain low NO<sub>x</sub>. However, lean combustion systems with exhaust gas recirculation have been developed and tested (Ref. 6-29) with very encouraging results with respect to emissions, as well as temperature and velocity distribution. There could also be direct technology carryover from gas turbine combustor work in this area.

#### HEATER HEAD

Perhaps the most critical area in the Stirling engine is the heater head assembly. It contains the key heat exchanger, wherein the thermal energy of the combustor effluent must be transferred to the working fluid. This is a very tightly constrained design problem.

From the heat transfer standpoint a material is required with high thermal conductivity and wall sections should be as thin as possible. To achieve reasonable film coefficients on the working fluid side, small passages are needed to give high scrubbing velocities and hence high Reynolds numbers. Many small passages are also advantageous in producing a high surface-to-volume (S/V) ratio, thus maximizing heat transfer area. This implies a configuration equivalent (at least topologically) to a tube bundle which is, not surprisingly, the currently employed configuration. On the combustion products side, there is likewise a need for high film coefficient and surface area. This in turn dictates small passages between the tubes and, in fact, necessitates some finning to extend the specific external surface.

Recognizing the thin-wall, tube-bundle type configuration implicit in the heat transfer requirements, the heater-head designer must simultaneously face the stress and materials constraints.

Stresswise, the head must remain within creep and stress-rupture limits at an operating temperature in the neighborhood of 1400°F, with a maximum differential pressure of about 3000 psi across the section. The heat exchanger material itself must be relatively impervious to H<sub>2</sub> or He diffusion and not subject to H<sub>2</sub> embrittlement.

Finally, it must be mass-producible at reasonable cost. This is probably the major heater head problem in the Stirling today. More is said on this subject in Sections 6.3.2 through 6.3.4.

Current heater heads are, in fact, assemblages of partly finned tubes coupled to the upper cylinder head (expansion space). The Philips Torino engine head employs (Ref. 6-22) an essentially cylindrical brazed assembly of twisted tubes. The MAN-MWM engine head is made up (Ref. 6-24) of planar arrays of precision-cast U-shaped tubes with cast-on fins.

### BLOCK AND PISTONS

What would be called the "block" in conventional engine parlance consists of the cool portions of the cylinders (including the compression space) and primary engine structure. The double acting pistons are arranged either in a four-in-a-circle configuration, as in the Philips swashplate design, or in a more conventional in-line (MAN-MWM) or V-block (USS) configuration (Ref. 6-43). Suitable mounting provisions, insulation, and interconnect passages are provided for the cycle heat exchangers and their throughput fluids.

The pistons, which are double-acting, are somewhat longer than conventional Otto engine pistons. Thin-wall, hollow construction is used to minimize heat losses from the hot end. Elastomeric piston rings are fitted at the cool end.

### PREHEATER

The preheater is a heat exchanger used to scavenge some of the residual heat in the exhaust gases and return it to the combustor's inlet air. Two types are currently employed. United Stirling (Ref. 6-25) and MAN-MWM (Ref. 6-24) have opted for a fixed-boundary, plate-type metallic recuperator. Philips has also used this type of preheater in earlier engines, but will employ a rotary ceramic preheater (à la gas turbines) in the Torino engine. Ceramic preheaters can withstand a higher temperature than currently available metallic preheaters and offer an economically acceptable solution to the high-temperature heat recovery problem. Rotary preheaters of either type offer a weight advantage at high effectiveness but have thermal stress cracking problems, similar to those encountered in gas turbines. However, in contrast to the gas turbine application, the pressure differences and absolute levels are much lower, which reduces the sealing problem and results in lower weight.

### CYCLE REGENERATORS

The cycle regenerator is a small energy-storage device whose function is to abstract and hold heat from the working fluid as it exits the expansion space and to return it to the working fluid as it leaves the compression space.

Thermally, the regenerator material must have an adequate internal thermal conductance and thermal capacity ( $\rho C_p$  product). Getting the heat in and out likewise dictates a high specific surface and small flow passages (for high film coefficient via high Reynolds number and to reduce dead volume). Structurally, the total porosity must also be large to minimize pressure drop, and the strength of the material must be such as to retain its integrity under that differential pressure at the high operating temperature. Taken together, these constraints lead to a porous, high-temperature metal structure. To date, bonded screen stacks and monolithic (Ref. 6-24) sintered metal fiber ("Feltmetal" or "Snipper") structures have been used successfully. Foam metal configurations are being investigated.

The matrix and its container, as a whole, must have a low thermal conductance in the flow direction to maintain high effectiveness. One unit is required in each connecting path between a compression space and an expansion space (i. e., one per double-acting piston). In the Torino engine, two parallel smaller units per piston were found to be more optimum (from a packaging, thermal stress, and  $\Delta P$  standpoint) than one larger unit.

### CYCLE COOLERS

The cycle cooler is another small heat exchanger in the working fluid path between compression and expansion spaces. Its function is to extract heat during the "compression" portions of the cycle (in an endeavor to approach the isothermal compression of the ideal cycle). This heat is subsequently rejected to the environment in the radiator.

The design requirements are similar to those of the heater head, major differences being a much lower mean operating temperature and the use of an aqueous liquid on the coolant side. As a result, a configuration topologically equivalent to a shell-and-tube heat exchanger arises here too.

In practice, a true cross-flow shell-and-tube heat exchanger is universally used at present, the working fluid passing axially through an array of parallel small-diameter thin-walled tubes and the coolant flowing transversely at normal incidence to the tube bundle. Finning is not required. Current units are brazed assemblies of individual tubes, headers, and casing. Investigations of more economically producible designs are underway. As with the cycle regenerators, one cooler is required in each connecting path between a compression space and an expansion space.

### LINKAGE MECHANISMS AND BEARINGS

Several different types of linkage mechanisms have been successfully demonstrated in various Stirling engines. The object is to maintain a 90° phase angle between the displacer piston stroke and power piston stroke (whether these strokes are of two different pistons in one cylinder or a single double-acting piston related to two different cylinders). The rhombic drive is an ingenious mechanization of the

piston-displacer system (for nonautomotive applications).

In the Stirling engines being considered for automotive use two different schemes are being employed. The United Stirling and MAN-MWM (Refs. 6-25, 6-24) concepts employ a crankshaft/connecting-rod and crosshead mechanism, the double-acting pistons being deployed either in a V-block (USS) or in-line (MAN-MWM) configuration. The Philips implementation for the Ford Torino has its four axiparallel double-acting pistons driven by a swashplate (a disk-like rotor mounted concentrically with, but at a skew angle to, the engine drive shaft). When the swashplate is rotated, an eccentrically attached axial rod (i. e., a piston rod) will execute simple harmonic motion. Peripheral positioning of the piston rod contacts (90° apart) provides the requisite phasing.

Paper studies (Ref. 6-14) have indicated that a two-rotor Wankel-type configuration, with phasing accomplished by appropriate rotor positioning, can also provide a suitable mechanization.

Conventional bearing technology is used throughout both types of configuration, except for the slider bearings required at the piston/washplate interface in the Philips design.

### SEALS

The key seals in the double-acting Stirling configurations are the piston rings and the piston rod seals. Of the two, the piston ring problem has been far more amenable to simple solution for three reasons: comparatively low (several hundred psi) maximum differential pressure to sustain; location in a cooler part of the cylinder; and reasonable allowable leakage. It has been found (Ref. 6-7) that simple fluorocarbon elastomeric rings (presently "Rulon," a material similar to Teflon) are more than adequate to meet the life goals.

The rod seal problem is much more difficult. Assuming an unpressurized crankcase (none of the developers proposes otherwise), this seal must maintain positive isolation between the high-pressure (several thousand psi) working fluid and the ambient-pressure crankcase. Flow of working fluid across the seal should ideally be zero and must, at least, be kept to an absolute minimum to minimize loss of performance. Flow of lubricant in the opposite direction must be absolutely precluded because introduction of even small quantities of oil into the working space will seriously inhibit operation of the engine by pyrolysis-product fouling and require expensive overhaul. Fortunately, this seal too is located in the cool region of the block. One solution in the present implementations is the so-called "rollsock" seal — a thin, flexible (elastomeric), oil-supported, cylindrical (slightly conical) tube — which is rigidly affixed to both the piston rod and the adjacent wall, providing an hermetic seal. As the piston rod moves, the rollsock telescopes back and forth over itself. Since the rollsock proper does not have great structural strength, the crankcase side of its confining cavity must be filled with sufficient oil to permit a carefully controlled gas-to-oil positive  $\Delta P$ . This  $\Delta P$  must be adequate to prevent dynamic creasing of the rollsock but not great enough to induce rupture. The

oil pressure follows the gas pressure maintaining this differential. However, since the exact oil pressure cannot be absolutely maintained either in this dynamic environment and since, further, the rollsock is slightly permeable to the working fluid, some oil must be continuously pumped and bled off. Thus the rollsock seal must not be conceived as simply a "rubber tube," but rather as a complete little subsystem comprising the rollsock proper, an oil pumping ring assembly, a regulating valve, and the associated interconnecting passages, as illustrated in Fig. 6-20.

The functioning of the pumping ring, illustrated in Fig. 6-21, is described in Ref. 6-7:

(It) operates simultaneously as a pump and as a sealing ring for the oil. This component consists of a small metal ring, with a layer of bearing metal on the inside asymmetrically pressed against the piston rod by a crown spring. Oil spray reaching the piston rod from the crankcase is then pumped into the oil space by the wedge action of the pumping ring. If the piston rod is extremely smooth, such an arrangement permits a pumping pressure of over 1000 atm.

An external oil pump could also be used.

The regulating valve assembly, shown in Fig. 6-22, actually consists of two spring-loaded poppet valves mounted back-to-back in a spring-loaded piston. The gas valve portion serves to relieve excess gas pressure when the seal pressure differential exceeds design maximum, while the oil bleeder valve vents excess oil back to the crankcase.

The rollsock sealing scheme has been favored by Philips and GM (Ref. 6-26), and is currently being employed (Ref. 6-29) in the Philips/Ford Torino engine. Its major virtue is that it represents a true hermetic seal (discounting small  $H_2$  or He diffusion). To date, 30,000 hr of successful operation in a special test rig, and 5500 hr in a continuous full-load engine test, have been demonstrated (Ref. 6-23). The life goal is 10,000 hr of maintenance-free operation. The potential problem with this type of seal is that its failure mode is sudden and totally disables the engine. Not only would the working fluid be vented, but oil can be admitted to the hot space, and the engine may thus be contaminated by the time shutdown is completed. The key to obviating such an occurrence is high quality control of the rollsocks (total elimination of infant mortality) and scrupulous cleanliness in the fabrication, assembly, and operation of the rollsocks and their associated oil pumping/return circuit.

One rod seal alternative to the rollsock scheme is a multiple sliding seal arrangement currently favored by United Stirling (Ref. 6-25) and being used in the USS/Ford Pinto project. Here, unsupported fluorocarbon rings are placed in the rod guides and bear upon a microfinished rod. This scheme is characterized by a built-in "acceptable" leakage of the working fluid under dynamic (i. e., engine running) conditions. The advantages of this approach are its simplicity and a comparatively "graceful" failure mode (continuous decrement in performance). The disadvantage

is a finite minimum leakage rate, which mandates periodic recharging. Recharging is acceptable if it is not required more than once yearly (Ref. 6-30). Demonstrated life to date is about 25000 hr total, 4000 hr on a single seal assembly. The life goal (Ford) is 10,000 hr.

The question of a production-type rod seal has yet to be seriously addressed. The foregoing represent only two possible approaches which work — more or less successfully. Either one, both, or possibly some other alternative may eventually be found most suitable for production.

### CONTROL SYSTEMS

Two major control systems are required in any Stirling engine mechanization: a closed loop air/fuel control system driven by heater head temperature, and a power level control system. Implementations are discussed briefly in the following paragraphs.

#### Air/Fuel Control

Combustion heat release is regulated through heater head temperature. The current engine is designed to run at essentially constant heater head temperature, the control signal being derived from a sensor arrangement in the heater tubes. Air flow is supplied by the combustion blower and is modulated by the temperature signal through a throttle valve upstream of the blower. Fuel, pumped from the tank, is flow-governed by a fuel/air ratio controller. The latter is physically located in the fuel feed line, between the fuel pump and the combustor, and can be linked to the air throttle valve. In the 4-215 system, fuel/air ratio control is driven by independent air and fuel flow measurement.

#### Power Control

Engine output power is controlled in one of, or a combination of, two basic ways, both of which result in varying the effective cycle pressure. In one scheme, called mean-pressure-level (MPL) control, the working fluid pressure level is reduced or increased by actually pumping fluid back into, or admitting high-pressure fluid from, a storage cylinder. This mechanization (Fig. 6-23) requires a compressor, check valve, and inlet and dump valves — the latter being coupled to the accelerator pedal.

The alternate power control scheme is called dead-volume control, and involves increase or reduction in the peak-to-peak cycle pressure excursion through variation of the total dead volume (viz. Section 6.2). Presently, this technique is implemented (Fig. 6-24) by switching external volumes into, and out of, the working fluid space on throttle command via appropriate valving. A more direct and elegant approach, presently being studied, is through control of the piston stroke by means of a variable-angle swashplate (VASP). The VASP would be coupled, either mechanically or hydraulically, to the accelerator pedal. Minimum cant angle limitations on such a VASP would probably necessitate a simple augmentative MPL system in addition.

### COOLING SYSTEM

The dominant mode of waste heat rejection in the Stirling engine is via the liquid cooling system. This characteristic imposes a considerably higher heat load on the radiator and fan of a Stirling-powered vehicle than that of an Otto-engined counterpart of equivalent design horsepower. As a result, the Stirling radiator must have a much larger effective surface, and a larger fan is required with proportionately greater parasitic power demands.

Fortunately, the state of radiator design technology has advanced to the point that the additional effective surface can be packaged in essentially the same transverse envelope as a conventional (Otto) radiator and with an acceptable total system weight. This has been demonstrated experimentally by Ford (Ref. 6-27). Philips has also developed a compact "folded-front" radiator (Ref. 6-47). While the cooling fan parasitic power requirement is significantly greater than (2 to 2.5 times) that of the equipotent Otto engine, the absolute impact of this potentially large penalty is considerably mollified by declutching the fan at higher vehicle speeds (where it would be most noticeable) and taking advantage of aerodynamic cooling of the radiator.

### TRANSMISSION

The Stirling configurations proposed for automotive use operate over essentially the same speed range as their Otto counterparts. Their torque-speed characteristics are, in fact, somewhat superior to those of Otto engines. Consequently, the Stirling engine has no peculiar transmission requirement and will function more than adequately with a conventional 3-speed automatic, or a conventional 3- or 4-speed manual, transmission. A potential additional advantage, that could be realized in the design of an advanced Stirling vehicle wherein a variable-angle-swashplate (VASP) power control scheme is employed, is simplification of the transmission.

#### 6.3.2 Configurational Evolution

The Stirling engine, like the other candidate alternates, is evaluated in three states of evolution: the "Present" (developmental) configuration; the "Mature" (first production) configuration; and an "Advanced" (long-term potential) configuration. The reader should keep the Chapter 2 definitions of these terms clearly in mind.

Throughout this evaluation, the 4-cylinder swashplate implementation (à la Philips) is assumed. This is not to say that the V-block (United Stirling) or in-line (MAN-MWM) concepts could not, or would not, be produced. With proper design the bsfc and emissions characteristics of all three could be comparable. However, the swashplate version is distinctly advantageous from a packaging standpoint. It also lends itself to a particularly convenient advanced control scheme — the variable angle swashplate. Consequently, the 4-cylinder swashplate version is currently the implementation of choice. The significant differences in design, construction,

and operating characteristics of the Stirling powerplant at the three evolutionary stages of interest are indicated in Table 6-2 and discussed in the following paragraphs.

### PRESENT CONFIGURATION

The Present (swashplate) version of the engine might properly be termed a developmental preprototype. Under an agreement between the Ford Motor Co. in the USA and the Philips Laboratories in The Netherlands, a nominal 170-hp engine has been constructed, and is currently being tested, at the Philips Laboratories. When engine testing is completed, the engine will be integrated into a Torino car for vehicle test at Ford.

The *raison d'être* of this engine is performance, fuel economy, emissions, and drivability demonstration, cost and producibility considerations being secondary. Production engineering is yet to be done, once the performance capability is established. Consequently, the engine is probably overconservative in design and embodies

certain design/fabrication characteristics which may be incompatible with mass-production methods. These potential problem areas will have to be resolved, prior to production, through some combination of alternative design, selection of alternate materials, and development of fabrication methods. It should also be noted that, although this is a "performance" engine, it has been designed for best efficiency at 100% of nominal horsepower. Under these conditions, a peak brake efficiency of 31-32% is actually attained in part load operation. This figure can be bettered in redesign, but at some sacrifice in full-load best efficiency and powerplant envelope.

The Philips/Ford prototype employs hydrogen — the ne plus ultra of working fluids — as do all of the configurations considered. Helium and other gases could be used as well, as shown in Fig. 6-25, but only at a power-density and/or efficiency penalty which would render the Stirling engine unattractive as a potential alternative to the conventional Otto engine. Hence, H<sub>2</sub> is the undisputed choice of working fluid for automobiles, and He-containing engines are not considered further.

Table 6-2. Salient features of evolving Stirling configurations

Characteristic	Configuration		
	Present (Phillips/Ford Torino)	Mature (first production)	Advanced (considerable development)
Working fluid	H <sub>2</sub>	H <sub>2</sub>	H <sub>2</sub>
Max temp, °F	1400	1400	2000
Max press., atm	200	200	200
Heater head	High superalloy; tube bundle construction	Minimum superalloy; tube bundle or investment cast construction	Ceramic; monolithic construction
Cycle regenerator	Screen stack	Porous metal monolith	Ceramic monolith
Cycle cooler	Steel cross-flow heat exchanger	Al cross-flow heat exchanger	Al cross-flow heat exchanger
Pistons	Stainless steel	Stainless steel	Ceramic
Rod seal	Rollsock system	Rollsock system with sliding backup	Sliding
Block	Aluminum	Aluminum	Aluminum
Swashplate	Fixed; alloy steel	Fixed; nodular iron	Variable; nodular iron
Preheater	Cercor <sup>®</sup>	Magnesium aluminum silicate (MAS)	MAS (or advanced ceramic)
Power cont. sys.	Mean-pressure-level regulation	Mean-pressure-level regulation augmented with dead volume control	VASP with mean-pressure-level augmentation
Transmission	Conventional	Conventional	Conventional

In the Present configuration (Ref. 6-22) the heater head is almost entirely of high-temperature material construction, including the heat exchanger, cylinder heads, and cycle regenerator/cooler housings. The heat exchanger itself comprises a brazed bundle of formed tubes, portions of which are finned. The cycle regenerator is a bonded stack of stainless steel screen discs, and the cooler constitutes a tubular heat exchanger. Both devices are integrated into a unitized module, eight of which are required in the engine.

The combustor is a more-or-less conventional "can-type" burner fitted with an atomizer, with inflow of preheated air from a driven blower. The preheater is similar to the rotating heat exchangers used in gas turbine engines (vid. Chapter 5).

The rollsock system, described in Section 6.3.1, is used for the rod seals. Power takeout is through the main shaft, driven by a fixed swash-plate which interfaces with the reciprocation of the pistons.

Power control is effected through regulation of the level of mean operating pressure. The pressure is regulated by pumping H<sub>2</sub> out of, or admitting H<sub>2</sub> into, the working space. Interim storage is in a small reservoir (high-pressure bottle). Appropriate valving and a small control compressor comprise the remainder of the transfer system.

The weight of the current 170-hp preprototype engine "ready-to-run" (see Section 6.3.3), and the effective polar moment of inertia of its rotating parts are shown as single point values on Figs. 6-26 and 6-27, respectively.

For sake of completeness, it should be noted that the United Stirling/Ford engine (Ref. 6-25), which is installed into a Pinto, is also a "present" configuration. This project, however, is of the nature of a feasibility demonstration to determine the physical problems of vehicle integration. Consequently, this V-block Pinto engine has not been included in the performance evaluation.

#### MATURE CONFIGURATION

The Mature configuration of the engine, represented by the second data column of Table 6-2, constitutes a projected production (under today's technology) version of the present configuration. As such, it will operate at the same pressure and temperature levels as the present, configuration, but has better projected fuel consumption and somewhat improved emissions characteristics. The design point is set at about 20% of maximum horsepower and, with carefully tailored auxiliaries, a brake efficiency of 36% should be attainable at that point.

Configurational details are somewhat different to permit reduction in quantity and/or substitution of some materials and changes in fabrication processes. The ultimate objective of these changes is to reduce weight and cost. To arrive at this configuration is tantamount to preproduction engineering of a very preliminary nature and, to this end, discussions were held with the cognizant engine developers (MAN-MWM, Philips, United Stirling) and an auto manufacturer (Ford),

with some iteration. Considering the present development status, it must be recognized that some of these "design decisions" are necessarily tentative. All in all, however, it is believed that the configuration specified is reasonably representative of the changes which could be implemented to make the Stirling engine economically viable in production.

The major differences from the present configuration are in quantity and kind of materials, especially in the heater head assembly. Recognizing that an automotive engine is rarely operated at or near full power, one can design a pressure-regulated engine for maximum efficiency at part load and accept an efficiency penalty near full load without grossly affecting the vehicle fuel economy in normal use.

Experimental results (Ref. 6-24) have already demonstrated that the discrete screen disc stacks in the cycle regenerators can be replaced with porous monoliths (sintered metal fibers or metal foams). Likewise, alloy aluminum tubes are adequate for the low-temperature cycle coolers. Both of these changes have been adopted in simplifying/cheapening the regenerator-cooler modules.

For purposes of this evaluation, the rollsock seal system is retained. However, to obviate the potential catastrophic failure mode, a "backup" (redundant) sliding seal is incorporated as well. The backup seal is not to be construed as equivalent to the sophisticated United Stirling (Ref. 6-28) configuration, but merely an adjunctive oil barrier to permit some engine operability until replacement of a failed rollsock system could be effected. In actuality, a totally novel rod seal system may be devised by the time the Stirling first enters production. Indeed, an unsupported "graceful failure" seal is most desirable. The impact upon performance of the selected rod seal concept is virtually nil.

The mean-pressure-level type power control system has been retained, but could be replaced with a less complex system, if developed in time. It is possible that a firm commitment could result in the early introduction of variable-angle swash-plate (VASP) control, augmented by a simpler pressure-level control loop. The VASP-controlled engine would show some improvement in both efficiency and response.

Figure 6-26 shows the projected weight of the Mature configuration as a function of design horsepower. The solid (upper) curve represents the total power system weight — including battery and transmission — while the dashed (lower) curve is for the engine "ready-to-run." The corresponding equivalent moments of inertia for the engine alone, and engine-plus-transmission, are given in Fig. 6-27 as functions of design horsepower.

#### ADVANCED CONFIGURATION

The Advanced configuration, epitomized by the final column in Table 6-2, constitutes our estimate of how the engine could evolve if the research and development effort recommended is successful. It represents a production technology which may be achieved only in the late 1980's or

beyond. The most significant difference from the Mature configuration is widespread use of monolithic ceramic components (of the silicon nitride/carbide variety) in place of stainless steel or superalloy subassemblies. Incorporation of ceramic components offers three areas of potential improvement: weight reduction, increased cycle efficiency via higher (ca. 2000° F H<sub>2</sub>) operating temperature, and lower cost. The 2000° F hydrogen temperature results in an estimated brake efficiency of about 41% at the (part load) design point, due to the increased cycle temperature ratio. Other improvements assumed are simplified seals (elimination of the rollsock system) and VASP power control.

A weight estimate was made only for a nominal 170-hp engine of the advanced configuration and is shown as an isolated point on Fig. 6-26.

#### PRESSURIZED CRANKCASE DESIGN ALTERNATIVE

An interesting configuration of the Stirling engine, which incorporates a pressurized crankcase, a variable swashplate, diaphragm oil barriers for the working spaces, and a GMRL hydrodynamic screw seal (Ref. 6-4) for the output shaft, is shown in Fig. 6-28. Although not specifically evaluated for performance in this report, this configuration incorporates some attractive departures which could be applicable to either a metallic or ceramic implementation. The primary feature of this engine is elimination of a high-pressure-differential rolling diaphragm seal. Here, the diaphragm seals function only to keep crankcase oil from entering the working spaces of the engine. The elimination of a  $\Delta P$  across the seal is accomplished by utilizing single-acting pistons on both sides of the swashplate in the Philips/Rinia arrangement in conjunction with the pressurized crankcase. The expansion cylinders and pistons are shown with sufficient length to isolate the piston rings from the high-temperature portion of the cylinder. The compression cylinders are shown on the opposite side of the swashplate, being driven by the same crosshead sliders that serve the expansion cylinders. The pressurized crankcase incorporates the cylinders, regenerator housings, and cooler housings as structural members.

#### 6.3.3 Materials and Producibility

##### COMPONENTS, MATERIALS, PROCESSES, AND WEIGHT BREAKDOWNS

Table 6-3 shows the Stirling engine parts breakdown for 170-hp engines of Present, Mature and Advanced configuration. For each subassembly and component, there is an indication or estimate of the weight, material of construction, and manufacturing process. The primary material for critical components is listed by material family (Table 6-4), and a process coding technique (Table 6-5) is employed to delineate the dominant manufacturing process.

Table 6-6 exhibits the Stirling weight breakdown by material types. Unlike a conventional Otto engine, the Stirling engine requires the use of high-temperature materials such as stainless

steels and/or superalloys and/or ceramics for certain components. The ability to withstand high temperatures is required in three heat exchangers (preheater, heater head and cycle regenerator) plus the combustion chamber. The balance of the engine components do not require the high-temperature capability and may be fabricated with readily available, conventional automotive materials and processes. The high-temperature components are discussed individually in the following sections.

Component and engine weights shown herein are net weights without an allowance for scrap. Scrapage has been allowed for in the unit cost presented later in this chapter. The details of the costing methodology are discussed in Chapter 11 ("Manufacturability and Cost"). The current situation with regard to scrap recycling, the potential for increased future scrap recycling, and the effects of scrap on aggregate material consumption are discussed in Chapter 18 ("Material Resource Requirements and Supply").

The rollsock seal system, functionally described previously, involves a specialized materials application that is unique to Stirling engines. The requirements for the polyurethane rubber seals and life testing data are discussed in a following section.

Figure 6-29 is a photograph of the component parts from a Philips prototype 60-hp Stirling engine to which the reader may refer for a visualization of the general geometry of Stirling components. (It is important to note that this photograph is not the current Stirling engine, but rather the only one for which we have a detailed component photograph.)

#### HEATER-HEAD ASSEMBLY

The heater head is probably the most critical component of the Stirling engine. It consists of cylinders linked to regenerator outlet housings by means of thin-wall tubes. Combustion gases flow past the tubes and give up their heat to the pressurized hermetically sealed hydrogen gas. The heater tubes are the most heavily creep and stress-rupture limited component in the engine. The alloy selected for the heater tubes must have good high-temperature creep and stress-rupture properties, good oxidation resistance, and not be susceptible to hydrogen embrittlement. The iron-base superalloy, Multimet N-155, is used by Philips (Ref. 6-22) in their present configuration. This alloy was selected primarily on the basis of cost, as it is about the least expensive of the superalloy family which meets the technical requirements. The N-155 alloy has essentially equivalent mechanical properties to some of the better known Inconels or the cobalt-base superalloys, such as Haynes 25, but a slightly lower oxidation resistance. As the N-155 alloy is approximately half iron, it can be made more cheaply than the Inconels or Hastalloys, which require larger percentages of expensive elements such as nickel, chromium, and cobalt. The present Philips configuration Stirling engine uses approximately 9 lb (Ref. 6-23) of N-155 superalloy tubing.

Table 6-3. Stirling parts breakdown for 170-hp engine

Subassembly/ component	Present configuration			Mature configuration			Advanced configuration		
	Weight, lb	Material <sup>a</sup>	Process <sup>b</sup>	Weight, lb	Material <sup>a</sup>	Process <sup>b</sup>	Weight, lb	Material <sup>a</sup>	Process <sup>b</sup>
<u>Heater head subassembly</u>	(170)	—	18	(128)	—	12	(95)	—	76
Cylinders (4)	28	H	02	20	E	63			
Regenerator housing (8)	43	H	02	36	E	63			
Heater tubes	9	H	08	9	H	08	70	I	76
Fins	8	E	54	8	E	54			
Bottom plate and ring	58	E	65	30	B	65			
Manifold	—	—	—	—	—	—			
Heater housing	29	B	63	25	B	63	20	B	63
Ceramic insulation	—	—	—	—	—	—	6	I	76
<u>Combustor subassembly</u>	(4)		80	(4)		80	(4)		
Burner can	1	H	54	1	H	54	1	I	76
Atomizer assembly	3	Z	80	3	Z	80	3	Z	80
<u>Top cover, insulation, attachment and misc.</u>	(19)	B	54	(19)	B	54	(19)	B	54
<u>Internal cycle regenerator/cooler assembly (8)</u>	(42)			(39)			(28)		
Regenerator (8)	8	E	07	8	E	07	3	I	76
Cooler (8)	18	E	18	15	J	18	15	J	18
Attachment and misc.	16	B	07	16	B	07	10	Z	07
<u>Piston assembly (4)</u>	(16)			(16)			(13)		
Dome (4)	4	E	02	4	E	02	3	I	76
Ring (4)	Neg.	L	07	Neg.	L	07	Neg.	L	07
Foot (4)	7	E	22	7	E	22	5	I	76
Attachment and misc.	5	B	07	5	B	07	5	B	07



Table 6-3 (contd)

Subassembly/ component	Present configuration			Mature configuration			Advanced configuration		
	Weight, lb	Material <sup>a</sup>	Process <sup>b</sup>	Weight, lb	Material <sup>a</sup>	Process <sup>b</sup>	Weight, lb	Material <sup>a</sup>	Process <sup>b</sup>
<u>Rod seal assembly</u>	(2)			(2)			(2)		
Guides (4)	2	J	69	2	J	69	2	J	69
Rollsocks (4)		M	07		M	07	—	—	—
Pump rings (4)		Z	07		Z	07	—	—	—
Regulator valves (4)		B	07		B	07	—	—	—
Sliding seals (8)	—	—	—	Negl.	M	07	Negl.	M	07
<u>Swashplate drive assembly</u>	(28)			(24)			(23)		
Crossheads (4)	22	D	69	18	A	61	18	A	61
Sliders	6	D	69	6	D	69	5	D	69
<u>Main shaft assembly</u>	(63)			(61)			(61)		
Shaft	22	B	69	22	A	61	22	A	61
Swashplate	38	A	61	36	A	61	36	A	61
Main bearing	3	D	07	3	D	07	3	D	07
<u>Cylinder block assembly</u>	(107)			(112)			(112)		
Cross head block	35	J	61	31	J	61	31	J	61
High pressure block	57	E	61	65	J	61	65	J	61
Cylinder liners (4)	—	—	—	2	D	68	2	D	68
Oil pump	5	Z	07	4	Z	07	4	Z	07
Misc. attach	4	B	07	4	B	07	4	B	07
Oil	6	Z	07	6	Z	07	6	Z	07
<u>Combustor auxiliaries</u>	(47)			(47)			(46)		
Ignitor plug and safety valve	2	Z	07	2	Z	07	2	Z	07
Blower ducts	4	J	04	4	B	04	4	B	04
Blower and pulley	17	Z	07	17	Z	07	17	Z	07
Blower motor	18	Z	07	18	Z	07	18	Z	07
Air silencer and filter	3	Z	07	3	Z	07	3	Z	07
Misc.	3	Z	07	3	Z	07	2	Z	07

Table 6-3 (contd)

Subassembly/ component	Present configuration			Mature configuration			Advanced configuration		
	Weight, lb	Material <sup>a</sup>	Process <sup>b</sup>	Weight, lb	Material <sup>a</sup>	Process <sup>b</sup>	Weight, lb	Material <sup>a</sup>	Process <sup>b</sup>
<u>Preheater assembly</u>	(76)			(68)			(60)		
Core	22	I	76	22	I	76	22	I	76
Gears and drive	16	Z	07	8	Z	07	8	Z	07
Cover	22	B	54	22	B	54	17	B	54
Seals and misc.	16	Z	07	16	Z	07	13	Z	07
<u>Coolant pump and drive</u>	(10)	J	61	(10)	J	61	(10)	J	61
<u>Power control system</u>	(50)			(35)			(25)		
Pressure control	50	Z	07	35	Z	07	10	Z	07
Swashplate actuation	—	—	—	—	—	—	15	Z	07
<u>Fuel supply controls</u>	(12)	Z	07	(12)	Z	07	(10)	Z	07
<u>Accessory drive system</u>	(51)	Z	07	(45)	Z	07	(40)	Z	07
<u>Engine auxiliaries</u>	(52)			(41)			(41)		
Starter	17	Z	07	9	Z	07	9	Z	07
Alternator	17	Z	07	17	Z	07	17	Z	07
Misc.	18	Z	07	15	Z	07	15	Z	07
<u>Radiator assembly</u>	(123)			(131)			(131)		
Radiator	60	K	18	55	J	18	55	J	18
Fan and shroud	25	B	54	24	B	54	24	B	54
Coolant	38	Z	07	52	Z	07	52	Z	07
Total, engine ready-to-run	(877)			(794)			(721)		
<u>Battery (77 A-hr)</u>	(50)	Z	07	(42)	Z	07	(42)	Z	07
<u>Transmission 3-speed automatic</u>	(150)	B, J	80	(150)	B, J	80	(150)	B, J	80
Total, power system	(1077)			(986)			(913)		

<sup>a</sup>Material = material type code (from Table 6-4).

<sup>b</sup>Process = process code (from Table 6-5).

Table 6-4. Material type codes

Code	Material type
A	Cast iron (all types, gray, malleable, nodular, ductile, GM-60, NIRST, etc.)
B	Carbon steel (AISI grades, etc.)
C	High-carbon steel (AISI grades, etc.)
D	Alloy steel (AISI grades, includes carburizing and nitriding grades, etc.)
E	Austenitic stainless steel (300 series, 200 series, special modifications such as CRM-6D, etc.)
F	Ferritic or martensitic stainless steel (400 series, etc.)
G	Precipitation hardening stainless steel (A-286, 17-4 PH, 15-5 PH, etc.)
H	High-temperature superalloy (Inconels, Hastalloys, Waspalloys, Renes, INs, 713LC, Multimet, other specialty alloys, etc.)
I	Ceramic
J	Aluminum alloy
K	Copper alloy
L	Plastic or Teflon or Rulon
M	Rubber or elastomeric material
Z	Nonhomogeneous or miscellaneous

Table 6-5. Process Codes

10	Brazed	01	Casting
20	Welded	02	Investment Casting
30	Formed	03	Forging
40	Unassigned Code	04	Sheet
50	Stamped	05	Plate
60	Machined	06	Ceramic Concrecence <sup>a</sup>
70	Fabricated		
80	Mechanically Assembled	07	Purchased
00	Nonhomogenous Assembly or Miscellaneous	08	Tubing
		09	Bar stock

<sup>a</sup>The term "concrecence," as used in this study, is a generic one referring to any existing or potential fabrication process which yields a completed ceramic shape or integral structure.

The present configuration requires fins for heat transfer control purposes. The 8 lb (Ref. 6-23) of heater tube fins can be fabricated from a 25% chromium, 20% nickel alloy, such as a type 310 austenitic stainless steel.

The cylinders and regenerator housings are fairly cool for most of their length, with high-temperature capability only required in the area where the hydrogen working gas enters. Philips informed the APSES team (Refs. 6-22, 6-29) that Philips' prototype Stirling engines have cylinders and regenerator housings fabricated from Haynes 25 superalloy. However, from additional studies (Ref. 6-30) it is believed that these components can be produced from conventional austenitic stainless steel rather than the more expensive superalloy. As the cylinders and regenerator housings weigh 71 lb in the present configuration, the change in these components from superalloy to austenitic stainless steel represents a considerable cost saving as well as a significant reduction in the amount of critical raw materials, such as nickel, chromium, and cobalt, that would be required for a production application. Philips has concluded (Refs. 6-22, 6-30, 6-31) that the modified austenitic 300 series stainless steel CRM-6D would be used for the cylinders and regenerator housings in production. CRM-6D is the least expensive alloy in the austenitic stainless steel family, as manganese is substituted for part of the nickel, thus reducing the alloy cost.

It may be possible in the future (although not assumed in the Mature configuration) to completely eliminate the need for superalloy in the heater head if a pressure/temperature (P-T) scheduling ploy, explained previously, can be successfully implemented. In this concept, the maximum pressure (hence maximum stress on the creep, and stress-rupture, limited heater tubes) and the maximum operating temperature need not occur at the same time. By having the maximum operating temperature only occurring at relatively low pressures, and the maximum pressure being only allowed to occur at below the peak operating temperature, it then becomes potentially feasible to design the complete heater head assembly to be within the established creep/stress-rupture limits (Refs. 6-32) for stainless steels. As the success of this approach relative to the tubes is not yet proven, Table 6-3 shows the Mature Stirling configuration still to have the 9 pounds of Multimet N-155 heater tubes (although they may not be needed).

The N-155 heater-head tubes are currently hand assembled and brazed with a Nicrobraz 30 brazing alloy. This is a very time-consuming operation which is probably not adaptable to mass production, and considerable process improvement will have to be made for a production application. In addition to considering improved automated brazing designs, other processing techniques such as integrally investment casting the fins and the heater tubes are being considered. MAN-MWM has started to investigate this technique. The MAN-MWM investment cast heater tube assembly (Fig. 6-30) uses Haynes 31 superalloy. Another production processing concept worth evaluating is a variable-composition powder metallurgy heater head assembly.

Table 6-6. Stirling weight breakdown by material type

Material type	Material code	Weight, lb		
		Present	Mature	Advanced
Cast iron	A	38	76	76
Carbon steel	B	142	149	93
High-carbon steel	C	—	—	—
Alloy steel	D	31	11	10
Austenitic stainless steel	E	160	83	—
Ferritic or martensitic stainless steel	F	—	—	—
Precipitation hardening stainless steel	G	—	—	—
Superalloy	H	81	10	—
Ceramic	I	22	22	110
Aluminum alloy	J	51	181	178
Copper alloy	K	60	—	—
Plastic, Teflon, or Rulon	L	Negl. <sup>c</sup>	Negl. <sup>c</sup>	Negl. <sup>c</sup>
Not broken down (conventional auto materials <sup>a</sup> ), nonhomogeneous or miscellaneous	Z	292	262	254
Total, engine ready-to-run <sup>b</sup>		877	794	721

<sup>a</sup>"Conventional auto materials," do not include E, F, G, H and I, but do include additional quantities of the others explicitly listed.

<sup>b</sup>Does not include transmission or battery.

<sup>c</sup>Negl. = negligible (<0.5 lb).

One of the basic functions that the heater head must accomplish is to adequately contain the working fluid without excessive leakage or diffusion losses. The heater head tube walls are the most critical component for hydrogen diffusion losses. Diffusion of hydrogen through the cylinder walls is not as significant a problem since the cylinder walls are thicker and cooler. A hydrogen loss of 10% per year would be an acceptable limit (Ref. 6-30). Actual hydrogen loss data on the present Philips Stirling engine were not available to this study. Both Philips (Ref. 6-23) and Ford (Ref. 6-30) expressed confidence that the hydrogen leakage rate can be adequately controlled. The concept of barrier coatings has been addressed. Philips and others have considered the use of a silicon nitride diffusion barrier in the event of leakage problems. However, Philips declined to provide any specific details of their coating, as they consider it proprietary.

The question of hydrogen embrittlement is often raised in discussions of Stirling engines. All of the stainless steels used in the Stirling engine are single-phased, face-center-cubic structured austenitic alloys which are not susceptible to hydrogen embrittlement. Likewise, there is no evidence of hydrogen embrittlement susceptibility for the specific superalloys previously discussed. Philips actual operating experience

(Ref. 6-22) with Stirling engines has not evidenced any hydrogen embrittlement.

The Advanced configuration of the Stirling engine heater head is envisioned as a monolithic ceramic component. This is predicated on the successful completion of the ceramics technology R&D program as discussed in Section 6.7 and Chapter 5. Although the H<sub>2</sub>-permeation resistance of ceramics such as silicon nitride is known to be superior to that of the superalloys, it has yet to be demonstrated that even silicon nitride can adequately contain H<sub>2</sub> at 2500°F material temperature.

#### COMBUSTION CHAMBER

The Stirling engine combustion chamber is the burner can, which mounts inside the cage of heater tubes. The burner experiences the highest temperature generated in the engine, but is mechanically unstressed. The Present and Mature configurations employ a burner can fabricated from superalloy; however, the essentially unstressed condition makes the burner can suitable for manufacture from ceramic materials (when they are available). Silicon carbide or silicon nitride are likely candidates for this application.

## INTERNAL CYCLE REGENERATOR/COOLER ASSEMBLY

The Present cycle regenerators are fabricated from sintered stacks of a type 301 stainless steel gauze. This sintered metal gauze is a relatively expensive component to manufacture. Alternative structures (bonded metal fiber monoliths) have already been tried (Ref. 6-24) with considerable success, and metal foam monoliths have potential applicability. Consequently, a simpler monolithic structure is assumed in the Mature configuration. For the advanced configuration, it may be possible to develop a suitable porous ceramic material for the cycle regenerator.

The tubes in the cycle cooler assembly were reported (Ref. 6-22) to be made of stainless steel for laboratory engines. Philips, however, plans to change to a copper-1% chromium alloy for the Ford demonstration, and ultimately to aluminum. In the Mature and Advanced configurations these cooler tubes are made from aluminum alloy, with a manufacturing engineering resolution of appropriate joining technology. Plate-type coolers, using brazing and/or adhesive joining techniques, may be considered (Ref. 6-30) for additional cost reduction.

## PISTON ASSEMBLY

Current Philips pistons have a stainless steel dome, electron-beam-welded to a stainless steel foot. These stainless steels, of the austenitic 300-series type, are retained in the Mature configuration. In the Advanced configuration, the pistons would probably be fabricated from a ceramic material.

The piston rings are made from Rulon, and adequate wear characteristics have been reported (Refs. 6-7, 6-22). Rulon piston rings can be mass-produced at a reasonable cost (Refs. 6-22, 6-30) for a production Stirling engine.

## PREHEATER

The Philips Stirling preheater is a rotating ceramic disc of the type manufactured by Corning and others. It is similar to the "regenerator" cores used in gas turbine applications. The early ceramic core material utilized was a lithium aluminum silicate (LAS) ceramic system. The ability to make a reliable preheater or gas turbine "regenerator" has been a problem in the past, as exemplified by truck turbine "regenerators." Significant progress towards resolution of these problems has been reported in Ref. 6-48. The LAS material was attacked by sodium and sulfur. Magnesium aluminum silicate (MAS) systems, as well as some variants of LAS, are not as susceptible to attack. Chemical attack and degradation of the hub and drive gear were also encountered. These problems can be solved by design changes (e.g., current design deletes the hub support). A more detailed discussion of the chemical, thermal, and mechanical problems associated with rotary ceramic heat exchanger components and current work in progress is given in Ref. 6-48.

Another ceramic core difficulty has been the cost and yield. The process used in winding the core is somewhat analogous to attempting to wind

damp bathroom tissue under tension. The resulting yields were extremely low, resulting in excessive cost. Ford (Ref. 6-30) has since run in-house producibility studies using one of its vinyl upholstery lines, and has developed a proprietary technique for core winding that they believe will solve the yield problem and produce ceramic cores at a reasonable cost in mass production.

As an example of the progress being made in ceramic core development, it has been reported (Refs. 6-30, 6-49, 6-50, 6-51) that service lifetimes up to 298 hours at a temperature of 1840°F have been obtained in laboratory tests on an improved experimental low-expansion LAS core. This temperature is in the same range as that required for the Mature configuration Stirling preheater. It is the projection of the APSES team, as well as the consensus of most of the cognizant automotive engine manufacturers and government agencies contacted, that an MAS system offers even greater temperature/service-life potential, in addition to the aforementioned improved resistance to chemical attack. Therefore, based on our current information (which includes some proprietary and unpublished data), an MAS system has been selected for the Mature configuration Stirling preheater. Of course, improved variants of either the LAS or MAS material families could be developed in the future.

In the case of the Advanced configuration Stirling engine, it is not known whether or not an MAS system, or improved variants of either MAS or LAS, could be pushed to 2000°F. The ability to make a 2000°F preheater may require either significant improvements in existing technology or the ability to develop a successful silicon nitride or silicon carbide core. In the more distant future, the Sialon-type ceramic systems may be considered in the search for a higher-temperature core.

It has also been reported (e.g., Ref. 6-30) that suitable proprietary seals have been developed. They do not contain any nickel oxide, thus avoiding the possible health effects (Ref. 6-52) of particulate attrition from seals containing nickel oxide.

## CYLINDER BLOCK ASSEMBLY

The cylinder block assembly consists of the crosshead block and high-pressure block. Both of these can be fabricated from a conventional AA-390 aluminum alloy die casting. The current Philips high-pressure block is made from a 300 series austenitic stainless steel. In the Mature and Advanced configurations, cylinder liners, fabricated from alloy steel, can be used in the aluminum high-pressure block. These components are all within the conventional automotive state-of-the-art.

## SWASHPLATE DRIVE ASSEMBLY AND MAIN SHAFT ASSEMBLY

As shown in Table 6-3, these components are all of conventional construction. The crossheads in the present Philips configuration are made of alloy steel and are assumed, in the Mature and Advanced configurations, to be fabricated from cast iron. Similarly, the shaft, which is presently made from steel, could be mass produced more economically from nodular iron.

## ROD SEAL ASSEMBLY

As discussed in Section 6.3.1, the rod seal is one of the critical components in the Stirling engine. One solution, in the present Philips

configuration, is the so-called "rollsock" seal subsystem, shown in Fig. 6-20. The material selected for the rollsock seals must be immune to chemical attack by either the oil or the working fluid as well as possess a high creep and fatigue resistance. Current rollsocks are made from polyurethane rubber.

The polyurethane rollsocks have been demonstrated for hundreds of millions of cycles and continuous operating lives in excess of one year (Fig. 6-31).

#### 6.3.4 Unit Costs

The unit costs developed in this section for the Stirling engine are the variable costs only, i.e., the costs to build one more engine given a production environment. The unit costs are based on a production volume of 400,000 units per year. The basic methodology is presented in Chapter 11.

Material costs are based on November 1974 data, where available, and estimates, where materials not presently available in quantity are utilized. Labor content is derived, where possible, from the labor content of similar pieces presently in mass production. Where there are no readily available parallels in the automobile industry, other industries' experience has been searched; and where no other experience is available in mass production, internal estimates were made. Assembly labor is estimated from the number and nature of those operations which are not automated in present practice.

### ENGINE SPECIFICS

All three Stirling engine configurations are costed. Table 6-7 shows the cost estimates by major subassembly for the engine configuration. Areas where major cost reductions are anticipated are the heater head, through material substitution and process improvement, and the swashplate and mainshaft assembly, through material substitution.

There are five identifiable assemblies which constitute significant deviations from present practice and represent the higher risk and cost. These are the heater head, the cycle regenerator, the air preheater, the power control system, and rod seal assembly. Developments which can affect the cost and manufacturability of these assemblies are as follows:

#### Heater Head

Potential material cost savings of over \$200 can be realized between the Present and Mature Stirling heater heads. An additional cost reduction can be realized via efficient production processes, which decrease labor costs. The Advanced configuration is envisioned to have a ceramic heater head. A further reduction of about \$100 is anticipated through this development. Although not required for performance in the Mature Stirling engine, the ceramic heater head could be used for reasons of cost savings in this configuration, if developed in time.

#### Cycle Regenerator and Cooler

Major changes to be made in the cycle regenerator are in the area of assembly labor. Presently the coolers and regenerators are hand assembled, of stainless steel screen packs and tube bundles, respectively. Aligning the tubes with the headers and brazing are time-consuming operations that

Table 6-7. Unit variable cost for the present, mature and advanced 170-hp Stirling engine (all values in 1974 dollars)

Assembly	Present	Mature	Advanced
Heater head	545	215	150
Cycle regenerator	50	15	13
Piston assembly	20	20	10
Rod seal assembly	50	50	10
Swashplate drive assembly	40	10	10
Main shaft assembly	50	10	10
Cylinder block assembly	75	75	60
Combustor auxiliaries	30	30	30
Preheater assembly	125	75	60
Coolant pump and drive	40	30	30
Power control system	50	50	35
Fuel supply controls	20	20	20
Accessory drive system	30	30	30
Auxiliaries	47	47	47
Radiator assembly	80	45	45
Total engine ready-to-run	<u>1260</u>	<u>720</u>	<u>540</u>

will probably not be used in the mass production environment. It is assumed that the cooler cores will be one-piece extrusions or castings of aluminum, eliminating all subassembly labor. This results in a cost reduction of approximately \$30 per engine.

#### Air Preheater

The preheater is functionally similar to a gas turbine "regenerator." Therefore, some of the production engineering is shared. Rapid strides have been made recently for modest expenditures. The state-of-the-art in aluminosilicate ceramic (LAS or MAS) fabrication is such that this component is projected to be in production circa 1985. Cost reduction between the Present and Mature engine is achieved only because of the learning curve. No basic process changes are anticipated.

#### Power Control System

The major departure from the power control system of the Present design is anticipated in the Advanced Stirling engine. Here, a dead-volume variation is obtained through a variable-angle swashplate. No significant cost change is anticipated for this innovation.

#### Rod Seal Assembly

It is possible that the rod seal assembly, consisting of a rollsock seal proper and accompanying

oil-pressure-compensation system, is the most demanding assembly from a process point of view. Since a failure in this system is catastrophic and causes immediate power loss, no in-service defects are allowable. This indicates very high quality control and possible in-service warranty problems. Since the oil pressure compensating system is highly particle-contaminant-susceptible, special care during assembly is required. Once assembled, continuing protection until the engine is assembled and sealed is required. These requirements are quite distinct from any present automotive engine practice, although automatic transmission assembly has similar problems.

Owing to these stringent requirements, a redundant sliding seal is proposed as a failure-mode backup for the production engine. This design has the failure attribute of a slow leak rather than a rapid venting.

Ultimately, it is assumed that the rollsock-plus-backup system will be replaced by a simpler unsupported seal of some type, perhaps an evolutionary improved version of the United Stirling sliding seal. The cost of sliding seals is significantly lower than the rollsock seal assembly, and given that acceptable leakage rates can be obtained, the cost can be reduced approximately \$50 per engine.

#### UNIT COSTS

The unit costs and cost totals are developed in Chapter 11 for the engine configurations. Explanations of the major configuration differences were given in Section 6.3.2 and the major material differences in Section 6.3.3. Unit cost variation with horsepower is shown for the Mature Stirling engine in Fig. 6-32.

### 6.4 VEHICLE INTEGRATION

#### 6.4.1 Engine Packaging in Vehicle

The swashplate Stirling engine is similar in bulk to the current Otto engine, although accommodating and driving the various auxiliaries and accessories requires attention in detail. The radiator required for Stirling engines has a greater surface than that for Ottos, but can be satisfactorily packaged in the vehicle. Overall, the Stirling engine installation space requirement is comparable to an equipotent Otto engine. Figure 6-33 shows the feasibility of a small car installation, potentially the most difficult packaging problem.

#### 6.4.2 Transmission Requirements

Stirling engines, compared to Ottos, have a similar rpm range and a more favorable torque curve, and can thus use the same transmission types (i. e., 3- or 4-speed in automatic or manual versions). Transmission improvements envisaged for Otto vehicles, such as lockup torque converters and CVT's (ref. Chapter 10), would benefit the Stirling engine as well. The Advanced, variable-angle swashplate engine could use a simplified transmission with some attendant cost and weight savings.

### 6.4.3 Other Impacts

Because of its expected lower fuel consumption, the (Mature configuration) Stirling car will carry a fuel tank about 25% smaller than an Otto car for the same range, which would decrease the vehicle curb weight. Other differences have negligible impact.

### 6.5 PERFORMANCE IN VEHICLE

Fuel economy and emissions estimates were calculated for Stirling-powered vehicles in the six Otto-Engine Equivalent (OEE) automobile classes of interest to this study, using the Vehicle Economy and Emissions Prediction (VEEP) computer program described in Chapter 10. The adjustments for weight propagation effects and torque characteristics are also described in Chapter 10. Specific fuel consumption and emissions index data described in Sections 6.2.2 and 6.2.4 were the basis for computation. The results are described in the following sections.

#### 6.5.1 Fuel Economy

Predicted fuel economies for Mature engine Stirling vehicles in the six OEE size classes are given in Table 6-8. Only a single entry is shown for the Present configuration (which would not be produced as such), corresponding to the actual Torino installation. Philips/Ford data (Ref. 6-6) indicates a fuel economy of 15.5 mi/gal of No. 2 diesel fuel, corresponding to 13.9 mi/gal of gasoline, over the FDC-U with a vehicle inertia weight of 5000 lb. This economy is attained with a nominal 170-hp engine having a brake efficiency of 32% at full load with off-the-shelf auxiliaries.

The Mature configuration is optimized at low load with specifically tailored auxiliaries and, operating within the same pressure and temperature limits as the present configuration, achieves a design point efficiency of about 36%. The torque characteristics of the Stirling also permit some reduction in design horsepower in the OEE vehicles (typically about 22%) with concomitant weight reduction. The result is a dramatic gain in fuel economy as indicated in Table 6-8. Relative to the equivalent Mature Otto-engined vehicles, these cars show a fuel economy improvement<sup>a</sup> of about 49% on the Urban Federal Driving Cycle and about 44% on the Highway Cycle.

In the Advanced configuration, the design point brake efficiency was increased to 41% — a value believed achievable through careful design optimization coupled with the increase in H<sub>2</sub> operating temperature from about 1400 to 2000°F. Fuel economies were estimated for the reference size (OEE "Compact") vehicle only, which achieves about 30 and 42 mpg over the FDC-U and FDC-H respectively, corresponding to 43% and 40% improvement<sup>a</sup> over the corresponding Advanced UC Otto car.

#### 6.5.2 Chemical Emissions

Table 6-9 presents projections of the emissions (HC, CO, NO<sub>x</sub>) of Mature Stirling engine cars in the six OEE vehicle classes, over the Federal Urban Driving Cycle (1975 FTP). These data were derived from results, reported by Philips/Ford, of actual test simulations. Scaling across the spectrum of vehicles was accomplished by means of trends established with the VEEP computer program, using stepwise integration of

<sup>a</sup>Based upon sales-weighted fuel consumption for present market mix of car classes.

Table 6-8. Stirling vehicle fuel economy projections in miles/gallon (gasoline)

OEE <sup>a</sup> auto class	Curb wt., lb	Design max. power, hp	Engine configuration					
			Present			Mature		Advanced
			Driving cycle					
			FDC-U	FDC-U	FDC-U	FDC-H	FDC-U	FDC-H
Mini	1660	42			39.7	56.1		
Small	2140	57			33.9	47.2		
Subcompact	2600	76			29.5	41.4		
Compact	3050	99			26.3	37.0	30	42
Full-size	3890	137			21.2	30.6		
Large	4820	177	13.9 <sup>b</sup>		17.2	25.8		

<sup>a</sup>Otto-engine equivalent

<sup>b</sup>Philips/Ford data; 5000 lb inertia weight; non-OEE car; gasoline equivalent.

Table 6-9. Stirling vehicle emissions projections in grams/mile (gasoline fuel)

OEE <sup>a</sup> auto class	Curb wt., lb	Design max. power, hp	Engine configuration					
			Present			Mature		
			Driving cycle					
			FDC-U			FDC-U		
HC <sup>b</sup>	CO	NO <sub>x</sub> <sup>c</sup>	HC <sup>b</sup>	CO	NO <sub>x</sub> <sup>c</sup>			
Mini	1660	42				0.09	0.47	0.06
Small	2140	57				0.11	0.64	0.08
Subcompact	2600	76				0.12	0.79	0.10
Compact	3050	99				0.14	0.90	0.11
Full size	3890	137				0.17	1.2	0.15
Large	4820	177	0.2	2.0	0.2	0.20	1.6	0.19
			(Philips/Ford) <sup>d</sup>					
1975 Federal Std.			1.5	15.	3.1			
1975 California Std.			0.9	9.	2.0			

<sup>a</sup>Otto-engine equivalent.

<sup>b</sup>As C<sub>6</sub>H<sub>14</sub>.

<sup>c</sup>As NO<sub>2</sub>.

<sup>d</sup>5000 lb inertia weight non-OEE car; gasoline; Philips/Ford data (Ref. 6-6).



steady-state emission index data provided by Philips (see Section 6.2.4), adjusted for cold-start effects. The projections are for well-maintained cars at 50,000 miles, and for gasoline fuel. It is encouraging to note that the predicted emission levels are all well below the statutory U.S. standards (0.41/3.4/0.4 g/mi of HC/CO/NO<sub>x</sub>).

Also cited in Table 6-9 for comparison is the reported (Ref. 6-6) Philips/Ford estimate for the present Torino engine.

There do not appear to be any significant problems with the Stirling engine in the realm of unregulated chemical pollutants (SO<sub>4</sub>, particulates, smoke, and odor) at this writing. Since no oxidizing catalyst is used, nor such use envisioned, there will be no agency to promote any trace sulfur in the fuel to the hexavalent state, hence the absence of a significant sulfate problem. Dynamometer tests at GMR (Ref. 6-33) indicated no detectable smoke by a Bosch meter, over the full range of power levels, at air/fuel ratios of 20:1 and 25:1. Separate tests on a burner rig showed no lean mixture smoke on light-off at air/fuel ratios less than 35:1. Therefore, smoking should not be a problem with Stirling combustors. In the same test series, GMC determined (using the ASTM threshold dilution technique) that the Stirling produces at worst only a slight, unobjectionable odor. At normal atmospheric dilutions, this odor was totally undetectable.

No particulate emission data are reported in the Stirling literature, its apparent cleanliness in this regard probably being related to its observed smokelessness. However, particulate emissions do tend to be a problem, which may pass unobserved, in any droplet-burning engine using heavy-fraction (e.g., diesel fuel) fuels. This concern therefore deserves some attention in all diesel-fuel-burning engines, including the Stirling. If it turns out to be a de facto problem, several expedients are at hand: (1) use gasoline (which may be the fuel of choice for other reasons anyway); (2) use a prevaporizing combustor; or (3) use a mono-component or nonpetroleum fuel.

### 6.5.3 Noise Emissions

Stirling engines are quieter than Otto engines because of their continuous combustion and smooth cylinder pressure variation. Completely unsilenced Stirling engines are 10 to 15 dBA quieter than Ottos on the test stand (Refs. 6-34, 6-42). In a vehicle, the combustion air blower and radiator fan are the major noise sources, but the overall noise level should be below the (already quite good) values for current production cars.

### 6.5.4 Drivability Aspects

Warmup time to driveaway condition is about 19 sec for current engines, with a realistic near-term development goal of 15 sec at 70°F ambient. Once started, the Stirling engine's transient response to sudden power demands should be satisfactory. With the present mean-pressure-level power control system, the torque increases to 90% of its steady-state value within 0.6 sec in response to step function command given with the engine at idle.

### 6.5.5 Safety

There is some concern over the danger of fire or explosion due to escape of the hydrogen working fluid in the Stirling engine. An extensive automobile test program (Ref. 6-35) has evaluated the potential seriousness of this problem. Hydrogen has a high rate of diffusion, and its upper flammability limit (75% hydrogen in air) is above its upper detonability limit (59%). As a result, slow leaks do not result in ignitable mixtures at all, and for a rapid escape (e.g., within 10 sec) of 30 grams of hydrogen in the engine, a minor fire rather than explosion results if an ignition source is present in the engine compartment or just above the louvered hood. Explosions occur only: (1) if a detonable mixture is artificially prepared and deliberately ignited while confined in a balloon; or (2) if, at the start of the leakage, no ignition source is available, but one is then introduced within less than 10 sec. An ignition source introduced from 10 to 20 sec after leak start would again cause only a small fire; further delay results in no ignition. The location of the ignition sources is critical. Study of this potential problem continues.

In practical terms, the factors of leak rate, ignition source location, and ignition time delay must interact in a very specific pattern to cause a fire and in a much more limiting way for an explosion. When compared to the nominal danger of the conventional gasoline-fueled Otto-engine car, the addition of a hydrogen system could contribute a real, but small, additional hazard. It is believed that the safety of Stirling vehicles can be made comparable to that of conventional Otto-engine cars through careful design. A diesel-fueled Stirling vehicle, like any other diesel-fueled vehicle, could actually be safer than a conventional car from the fire/explosion hazard standpoint. Further discussion of automotive safety is presented in Chapter 16.

## 6.6 OWNERSHIP CONSIDERATIONS

The vehicle owner is generally indifferent to the specific mechanization of his automobile's powerplant. Already accustomed to Otto-engined car ownership, his major concerns in considering a Stirling car are: "How does it perform?"; "Is it as safe as a conventional (Otto) car?"; "What will it cost me?"; and "How often must it be garaged for maintenance?". The first two questions have been answered in the foregoing sections. The latter two are addressed in this section.

### 6.6.1 Maintenance

A production Stirling engine can have significantly reduced maintenance requirements (and maintenance cost) than a comparable catalyst-controlled Otto engine. On the basis of the characteristics of present designs, it is reasonable to assume that the crankcase will be sealed, hence no regular oil filter replacement nor oil change is required. The blower motor can also be a lifetime-lubricated, sealed unit. Regularly scheduled maintenance items (analogous to a minor tuneup) would probably include the following:

- (1) Replace air cleaner.
- (2) Inspect preheater core and seals.
- (3) Change fuel filter.
- (4) Recharge/replace hydrogen cylinder.
- (5) Check/adjust air-fuel control system.
- (6) Check/adjust power control system.
- (7) Replace ignitor.
- (8) Clean atomizer nozzle.
- (9) Clean/adjust EGR valve.

Long-period, as required maintenance items would include

- (1) Replace preheater seals.
- (2) Replace fuel pump.
- (3) Repair/replace power control components.
- (4) Replace temperature sensor(s).
- (5) Replace belts.
- (6) Replace hoses.
- (7) Replace water pump.
- (8) Replace coolant.

It should be noted that, if major maintenance of working-fluid-space parts is necessary, clean facilities are required. This will result in either a change in repair garage procedures or a pull-and-replace-with-factory-rebuilt overhaul philosophy. Maintenance for the rest of the vehicle would be identical to that of an Otto-engined vehicle.

#### 6.6.2 Incremental Cost of Ownership

Assuming that the Stirling vehicle owner would operate his car in the same manner as an equivalent Otto-engined automobile, the increment in ownership cost comprises the difference between the sums of depreciation, fuel and engine-expended fluids cost and maintenance cost between the two types of cars. Although it is believed that Stirling maintenance costs should be lower (vid. Section 6.6.1) than for the equivalent Otto engine, it is difficult to predict what the actual maintenance requirements and corresponding maintenance charges will be for the hardware that would ultimately be mass-produced. The engine would probably not be released for production unless its maintenance cost were projected to be less than, or equal to, that of the Otto engine. Hence they are conservatively assumed to be equal for purposes of this calculation.

The estimated costs of engine expendable fluids (other than fuel) are given in Table 6-10. Note that a sealed crankcase is assumed and there is therefore no associated cost for oil changes.

The incremental cost of ownership then is simply the present value (7% annual discount rate assumed) of the difference between the sums of depreciation plus fuel cost plus engine-expended fluids cost for the Mature OEE Stirling vehicles and their UC Otto counterpart cars. Details of the calculations are given in Chapter 20. Representative values are shown in Table 6-11. It can be seen that the Stirling cars "pay back," in fuel and expended fluid savings, their initial price differential, even at equal maintenance cost. If their maintenance cost is indeed lower than that of equivalent Otto-engine automobiles, the case for the Stirling becomes even more favorable.

#### 6.7 RESEARCH AND DEVELOPMENT REQUIRED

##### 6.7.1 Mature Configuration

To produce the Mature Stirling engine, no fundamental research, as such, is required. There is, however, considerable component and process development to be done. Specific developments needed include the following:

- (1) Heater head — finalize pressure/temperature scheduling; determine minimum superalloy design (with low-permeability coating requirements, if any); develop appropriate mass-production fabrication processes and facilities.
- (2) Burner — finalize minimum superalloy configuration for acceptable emissions and cost; develop appropriate fabrication processes and facilities.
- (3) Preheater — continue core and drive development; finalize core and seal materials selection for durability and acceptable cost; develop appropriate production processes and facilities.
- (4) Regenerator/cooler — finalize configuration for performance/durability at acceptable cost; develop appropriate production processes and facilities.
- (5) Rod seal system — continue development of alternative seals; finalize configuration for acceptable reliability and cost and for "graceful" failure mode; develop appropriate production and QC methods.
- (6) Power control system — continue development of alternative power control techniques toward minimum weight, volume, complexity and parasitic loss goals (VASP development should be accelerated, if implementation in Mature configuration appears feasible); conduct system-level tests in vehicles; finalize design configuration; develop requisite production methods.
- (7) Air/fuel control system — select implementation scheme (compatible with pressure/temperature scheduling, if required); conduct vehicle-level development and integration tests; finalize configuration; develop appropriate component sources.

Table 6-10. Cost of engine-related expendable fluids for Mature Stirling vehicles (all costs in 1974 dollars)

Auto class	Engine, hp	Lubricant			Coolant <sup>a</sup>			Total expendable fluid cost	
		Capacity, qt	Price, \$/qt	Interval, mi	Total Capacity, qt	Price, <sup>b</sup> \$/qt	Interval, mi	at 35,000 mi ~3 yr, \$	at 100,000 mi ~10 yr, \$
Small	57	3	0.90	- <sup>c</sup>	12	1.25	24,000	8	30
Compact	99	3.5	0.90	- <sup>c</sup>	20	1.25	24,000	12	50
Full-size	137	4	0.90	- <sup>c</sup>	26	1.25	24,000	16	65

<sup>a</sup> Assumed to be 50% by volume of glycol-type antifreeze.

<sup>b</sup> Price of pure glycol-type antifreeze.

<sup>c</sup> Sealed crankcase; no scheduled replacement of oil.

Table 6-11. Incremental<sup>a</sup> cost of ownership<sup>b</sup> for Mature Stirling vehicles (constant 1974 dollars)

OEE auto class	Incremental ownership cost <sup>c</sup>	
	35,000 mi, ~3 yr <sup>d</sup>	100,000 mi, ~10 yr <sup>d</sup>
Small	-100	-250
Compact	-150	-450
Full-size	-200	-600

<sup>a</sup> Relative to equivalent baseline UC Otto cars.

<sup>b</sup> Present value, at 7% annual discount rate, of depreciation plus fuel cost plus expendable fluids cost. "Broad-cut" fuel at 48¢/gal ( $\approx$  gasoline at 52¢/gal).

<sup>c</sup> Negative numbers indicate savings to Stirling car owner (to nearest \$50).

<sup>d</sup> Median driver's experience.

### 6.7.2 Advanced Configuration

To make the Advanced engine a reality, research in ceramics technology is required. Although the actual ceramic materials are already identified (invention of a novel material is not implied), the applications to specific components do raise some fundamental questions in three general categories:

- (1) Material formulation - determine appropriate compositions and impurity levels for optimum properties in:

(a) Heater head, piston, cycle regenerator, and burner application (SiC; Si<sub>3</sub>N<sub>4</sub>; Sialon; ceramic composites, other?).

Preheater application (MAS; Si<sub>3</sub>N<sub>4</sub>; improved LAS variants; Sialon; ceramic composites; other?).

- (2) Ceramic raw material processing - determine the optimum tradeoff between properties achieved at given impurity levels and the cost of refining the abundant raw materials to attain these impurity levels; demonstrate the cost-effectiveness of producing the ceramic material in a pilot plant scalable to mass production quantities.
- (3) Ceramic structure fabrication processes - demonstrate the production of formed parts, with adequate properties and high reproducibility and yields, from production grade raw materials; develop processes to permit concrescence of simple-shape components into a complex monolithic structure on a mass production basis; demonstrate integrated ceramic design, testing, and nondestructive evaluation techniques suitable for mass-production.
- (4) Ceramic/metallic structures joining and bonding - develop techniques for joining or bonding ceramic materials of the selected compositions to the contiguous metallic structures; techniques should emphasize strength of joint, sealing (as required) and alleviation of stress concentrations.

Successful completion of such research would then lead into a list of developments paralleling those for the Mature configuration:

- (1) Heater head - finalize configuration for performance and cost; develop appropriate mass production methods.
- (2) Burner - continue development (to variable-geometry configurations, if required, to maintain low NO<sub>x</sub> emissions);

- select final configuration for emissions, durability, and cost; develop appropriate production capability.
- (3) Preheater – continue development of high-temperature core and seals; finalize configuration for adequate durability and cost; develop necessary fabrication techniques.
  - (4) Heater housing – evaluate alternative housing/insulation/seal configurations; finalize configuration; develop production techniques.
  - (5) Regenerator – evaluate alternative core materials; finalize configuration for durability/effectiveness and cost; develop manufacturing facilities.
  - (6) Rod seal system – continue development of simplified seal system, and develop requisite production techniques (if simple seal not achieved in Mature design).
  - (7) Power control system – continue development (toward simplification) of alternative power control systems, (if not accomplished in Mature design).

Although not required for the implementation conceived here, development of an unlubricated, high-temperature piston ring (possibly of refractory alloy) would benefit many of the alternate engines' Advanced configurations, including the Stirling. Specifically desired is a ring that can run unlubricated, against a ceramic wall, in a 2000° F gas environment (actual ring temperature would be somewhat lower).

It is anticipated that the Mature configuration could be ready for production in the early-to-mid 1980's, depending largely upon the development funding committed. The Advanced configuration may not appear until the late 1980's, or beyond – even given adequate funding – as the solutions of presently obvious problems (which themselves cannot be precisely scheduled) may uncover new unanticipated difficulties. It should also be emphasized that the transition between those configurations herein designated as Mature and Advanced need not represent a total redesign – although it could happen that way – but might occur through a chronological continuum of product improvements. More information on the proposed R&D effort, including applicability to other engine types is given in Chapter 12 (q. v.).

#### References

- 6-1. Flynn, G., Percival, W. H., and Heffner, F. E., "GMR Stirling Thermal Engine – Part of the Stirling Engine Story – 1960 Chapter," SAE Trans., Vol. 68, pp. 665-683, 1960.
- 6-2. Walker, G., Stirling Cycle Machines, Clarendon Press, Oxford, G. B., 1974.
- 6-3. Heffner, F. E., "Highlights From 6500 Hours of Stirling Engine Operation," SAE paper 650254.
- 6-4. Mattavi, J. N., Heffner, F. E., and Miklos, A. A., "The Stirling Engine for Underwater Vehicle Applications," GMR-936; SAE paper 690731, 1969.
- 6-5. Meijer, R. J., "The Philips Stirling Engine as a Propulsion Engine," Report prepared for "FISITA" Meeting, Brussels, 1969.
- 6-6. Postma, N., et al., "The Stirling Engine for Passenger Car Application," SAE paper 730648.
- 6-7. Meijer, R. J., "The Philips Stirling Engine," De Ingenieur, 621-41, 1967.
- 6-8. Meijer, R. J., "The Philips Hot-Gas Engine with Rhombic Drive Mechanism," Philips Tech. Rev., Vol. 20, No. 9, pp. 245-276, May 1959.
- 6-9. Kirkley, D. W., "Determination of the Optimum Configuration for a Stirling Engine," J. Mech. Eng. Sci., Vol. 4, No. 3, pp. 204-212, 1962.
- 6-10. Meijer, R. J., "The Philips Stirling Thermal Engine," thesis, Technische Hogeschool Delft, November, 1960.
- 6-11. Rinia, H. R., and duPre, F. K., "Air Engines," Philips Tech. Rev., Vol. 8, No. 5, pp. 129-136, 1946.
- 6-12. Maki, E. R., and DeHart, A. O., "A New Look at Swash-Plate Drive Mechanisms," SAE paper 710829.
- 6-13. Meijer, R. J., "Prospects of the Stirling Engine for Vehicular Propulsion," Philips Tech. Rev., Vol. 31, No. 5/6, pp. 168-185, 1970.
- 6-14. Walker, G., "The Stirling Engine," Sci. Amer., Aug. 1973, pp. 80-87.
- 6-15. Schmidt, G., "Theorie der Lehmann'schen calorischen Maschine," Z. Ver. dtsh. Ing., Vol. 15, 1871.
- 6-16. Walker, G., "An Optimization of the Principle Design Parameters of Stirling Cycle Machines," JMES, Vol. 4, No. 3, 1962.
- 6-17. Finkelstein, T., "Generalized Thermodynamic Analysis of Stirling Engines," SAE Annual Meeting, Paper 118B, Detroit, Mich., Jan 11-16, 1960.
- 6-18. Finkelstein, T., "Cyclic Processes in Closed Regenerative Gas Machines Analyzed by a Digital Computer Simulating a Differential Analyzer," ASME Trans., pp. 165-179, Feb. 1962.
- 6-19. Finkelstein, T., "Thermodynamic Analysis of Stirling Engines," J. Spacecraft, Vol. 4, No. 9, pp. 1184-1189, Sept. 1967.
- 6-20. Finkelstein, T., "Optimization of Phase Angle and Volume Ratio for Stirling Engines," SAE Annual Meeting, Paper 118C, Detroit, Mich., Jan 11-16, 1960.
- 6-21. Walker, G., and Khan, M. I., "Theoretical Performance of Stirling Cycle Engines," SAE paper 949A, 1965.

- 6-22. N. V. Philips Gloeilampenfabrieken Eindhoven, Netherlands, fact-finding visit by APSES Team, 26 June 1974.
- 6-23. Van Beukering, H. C. J., Philips Research Laboratories, private communication, October 1974.
- 6-24. M. A. N. Werk (Augsburg, Germany), fact-finding visit by APSES Team, July 1, 1974.
- 6-25. United Stirling Research Laboratories, Malmö, Sweden, fact-finding visit by APSES Team, June 1974.
- 6-26. General Motors Corp., Research Laboratories, Warren, Mich., fact-finding visit by APSES Team, June 1974.
- 6-27. Ford Motor Co., Dearborn, Mich., fact-finding visit by APSES Team, June 1974.
- 6-28. Ortegren, L. G., et al., "Development of Stirling Engines in Sweden," United Stirling, Conference on Low Pollution Power Systems Development, Ann Arbor, Mich., Oct. 14-19, 1973.
- 6-29. Lynch, B., Philips Research Laboratories, private communication, 1974.
- 6-30. Ford Motor Co., Dearborn, Mich., fact-finding visit by APSES Team, Oct. 1974.
- 6-31. Meijer, R. J., Philips Research Laboratories, private communication, 1974.
- 6-32. Stainless Steel Handbook, The Allegheny Ludlum Steel Corp., p. 57.
- 6-33. Lienesch, J. H., and Wade, W. R., "Stirling Engine Progress Report," SAE paper 680081.
- 6-34. Ortegren, L. G., "Noise Emission of Stirling Engines and Overall Vehicle Noise," Conference on Low Pollution Power Systems Development, Ann Arbor, Mich., Oct. 1973.
- 6-35. Goodale, T. C., "Hydrogen Safety Tests of the Stirling Engine," Stanford Research Institute Report to the Ford Motor Co., Dec. 1973.
- 6-36. Agarwal, P. D., et al., "Stir-Lec I., A Stirling-Electric Hybrid Car," SAE paper 690074, 1969.
- 6-37. Davis, S. R., et al., "Combustion and Emission Formation in the Stirling Engine with Exhaust Gas Recirculation," SAE paper 710824.
- 6-38. Heffner, F. E., "GMR Stirling Engines - G. P. U. 3," Information Sheet, GMRL, Jan. 1969.
- 6-39. Meijer, R. J., et al., "Towards Cleaner Air - A Passenger Coach Powered by a Philips Stirling Engine," Information Sheet, Philips Research Laboratories, Eindhoven, The Netherlands, Jan. 1971.
- 6-40. Michels, A. P. J., "C. V. S. Test Simulation of a 128-kW Stirling Passenger Car Engine," IECEC paper 729133, Sept. 1972.
- 6-41. VanBeukering, H. C. J., and Fokker, H., "Present State-of-the-Art of the Philips Stirling Engine," SAE paper 730626; June 1973.
- 6-42. Aerospace Corp., "Alternate Automotive Power Systems and Fuels," U. S. EPA Publication No. 460/3-74-013-b, July 1974.
- 6-43. Alm, Carlqvist, Kuhlmann, Silverqvist, and Zacharias, "Environmental Characteristics of Stirling Engines and Their Present State of Development in Germany and Sweden," paper 28, CIMAC Washington, 1973.
- 6-44. Kuhlmann, P., "Das Kennfeld des Stirlingmotors," MTZ 34 (1973) H. 5, S. 135-139.
- 6-45. Zacharias, F., "Betrachtungen zum äusseren Verbrennungssystem des Stirling-Heissgasmotors," MTZ 31 (1971), H. 1, S. 1-5.
- 6-46. Zacharias, F., "Der Stirlingmotor für Aufgaben der Meerestechnik," Schiffstechnik 18 (1971) H. 92, S. 39-45.
- 6-47. Asselman, G. A. A., et al., "A High Performance Radiator," 7th IECEC, 1972, paper 729132.
- 6-48. Anderson, D. H., et al., "First Quarterly Progress Report, Automotive Gas Turbine Ceramic Regenerator Design and Reliability Program," Contract No. 68-03-2150, submitted by Ford Motor Co. to EPA, Jan. 1975.
- 6-49. "Ceramic Materials and Components for Small Automotive Gas Turbine Engines," AMMRC (Apr. 1975).
- 6-50. McLean, A. F. et al., "Brittle Materials Design, High Temperature Gas Turbine," AMMRC CTR 75-8, by Ford Motor Co. on Contract No. DAAG-46-71-C-0162 (Apr. 1975).
- 6-51. Fact-Finding Visit to Army Materials and Mechanics Research Center, Watertown, Massachusetts, by member of APSES team (1975).
- 6-52. "The Potential Health Hazard of Nickel Compound Emissions from Automotive GTE's Using Nickel Oxide Base Regenerator Seals" Presentation by EPA (May 1979).

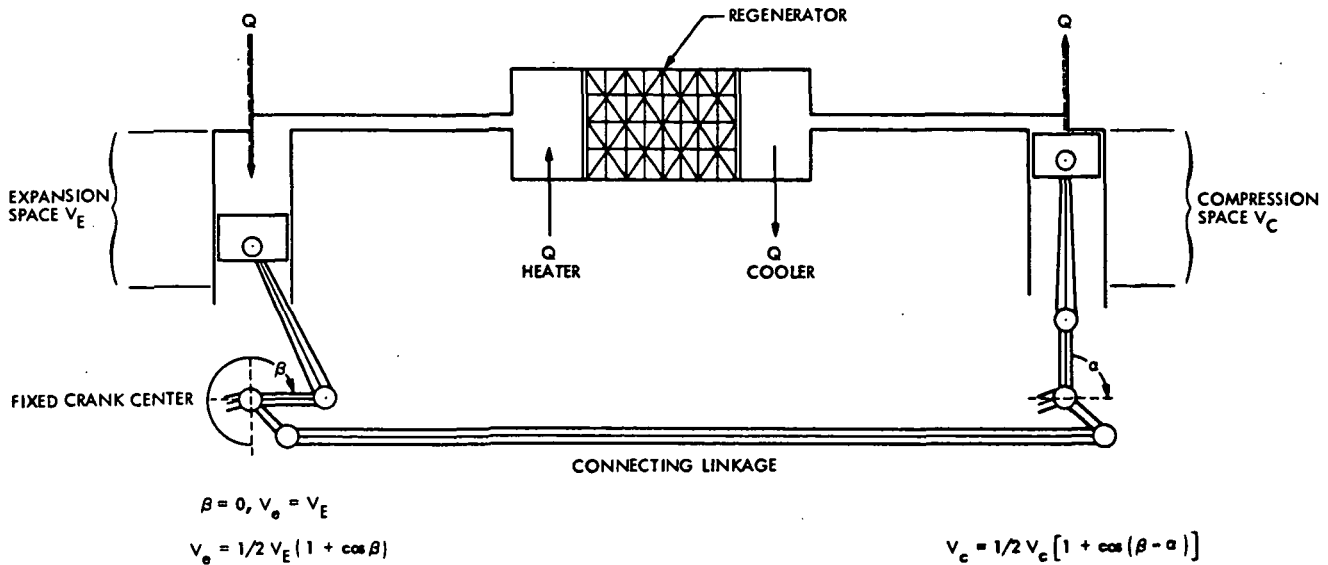

Fig. 6-1. Two-piston mechanism illustrating the operation of a Stirling engine

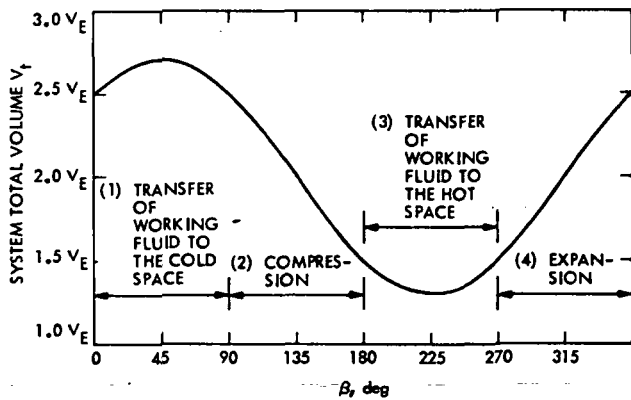

Fig. 6-2. Variation of total working space volume with crank rotation angle  $\beta$ , with  $\xi = 1$ ,  $\delta = 1$ , and  $\alpha = 90^\circ$

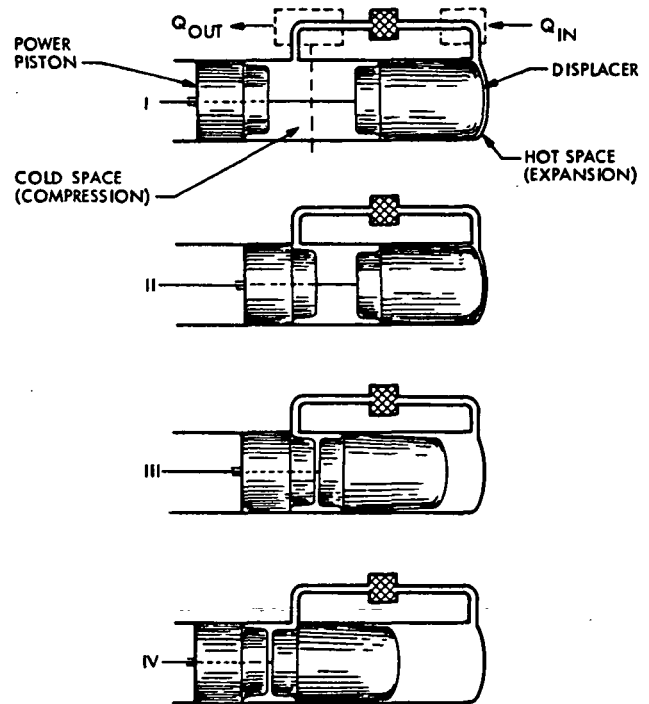

Fig. 6-3. Piston displacer diagram showing Stirling cycle: I. Piston at bottom dead center. Displacer at top dead center. All gas in cold space. II. Displacer remaining at top dead center. Piston has compressed gas at lower temperature. III. Piston remaining at top dead center. Displacer has shifted gas through cooler regenerator and heater into hot space. IV. Hot gas expanded. Displacer and piston have reached bottom dead center together. With piston stationary, displacer now forces gas through heater, regenerator and cooler into cold space, thus re-attaining situation I

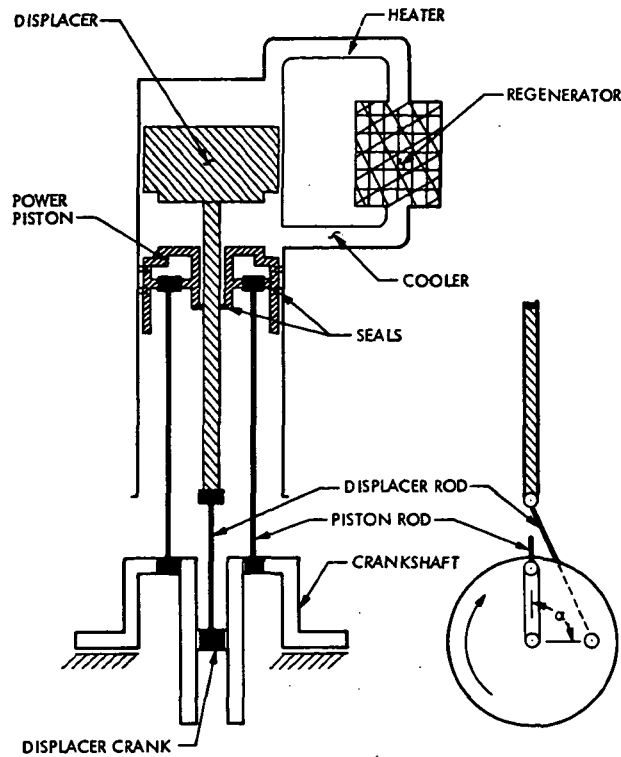

Fig. 6-4. Crankshaft drive for a piston displacer Stirling engine

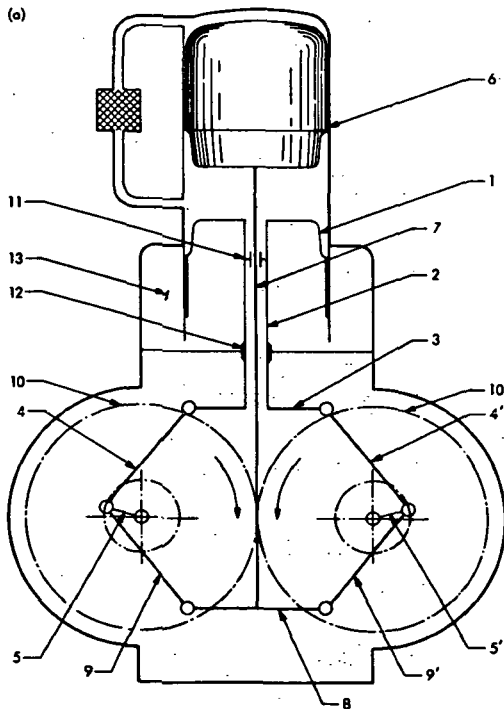

Fig. 6-5. (a) Schematic diagram of rhombic drive mechanism (Ref. 6-8). 1 = power piston. 6 = displacer piston. 5-5' = cranks in two shafts rotating in opposite senses and coupled by gears 10 - 10'. 4-4' = con-rods pivoted from ends of yoke 3 fixed to the hollow power-piston rod 2. 9-9' = con-rods pivoted from ends of yoke 8 fixed to displacer-piston rod, which runs through the hollow power-piston rod. 11 and 12 = gas-tight stuffing-boxes. 13 = buffer space containing gas at high buffer pressure

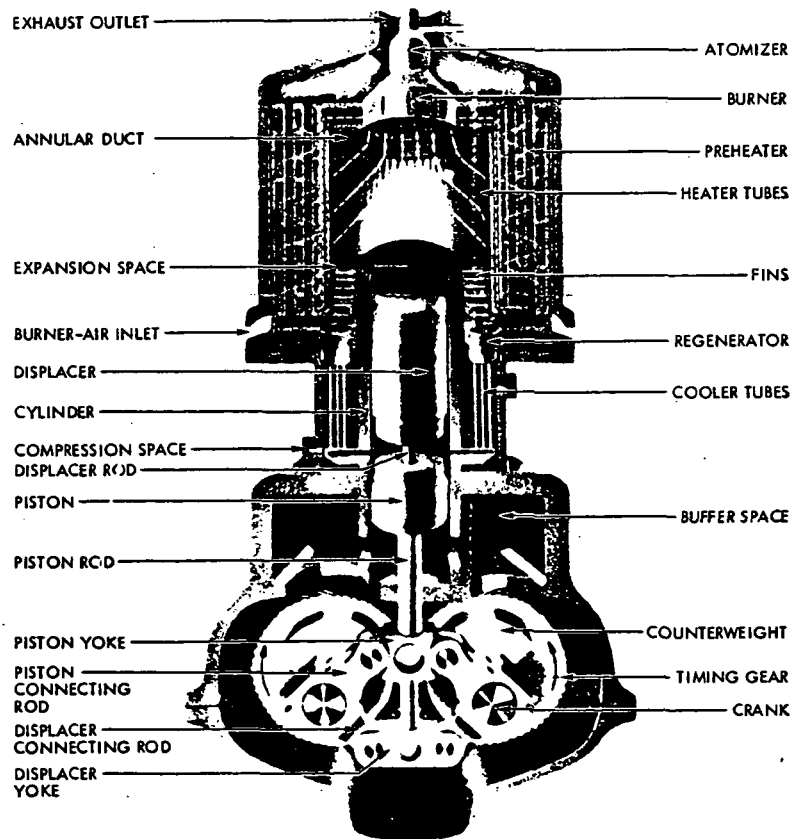

Fig. 6-5. (b) Piston displacer with rhombic drive (Ref. 6-5)

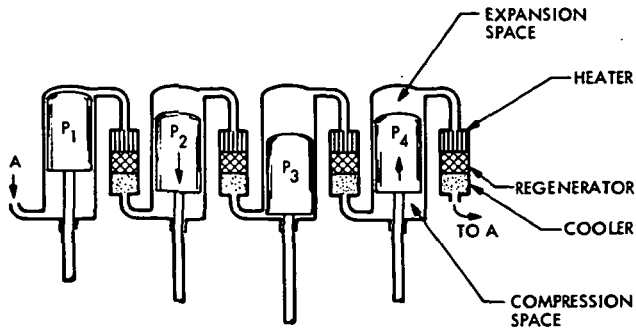

Fig. 6-6. The Philips Rinia arrangement for two-piston type double-acting Stirling engines (Ref. 6-5)

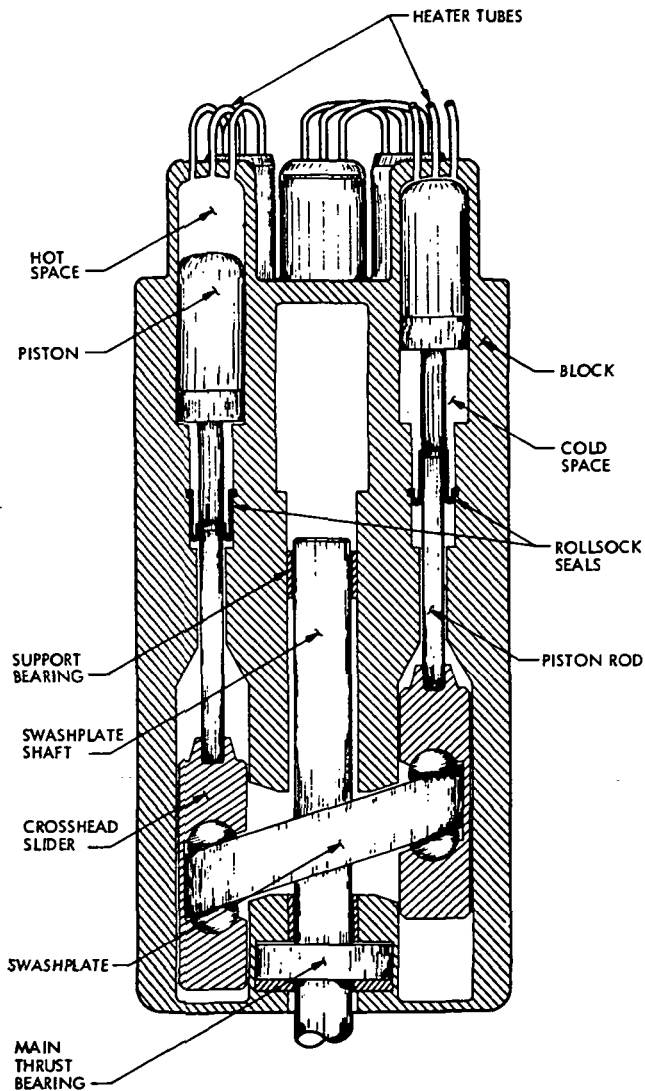

Fig. 6-7. Double-acting Philips/Rinia engine with swashplate drive (Ref. 6-13)

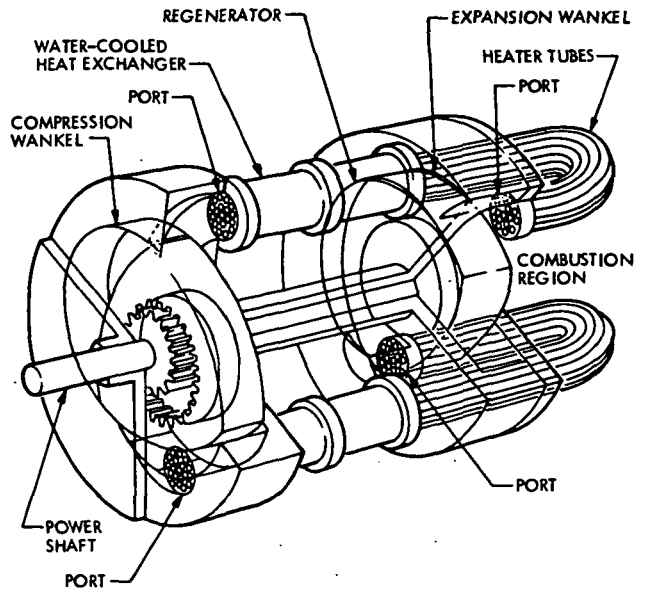

Fig. 6-8. Rotary expander Stirling engine (Ref. 6-14)

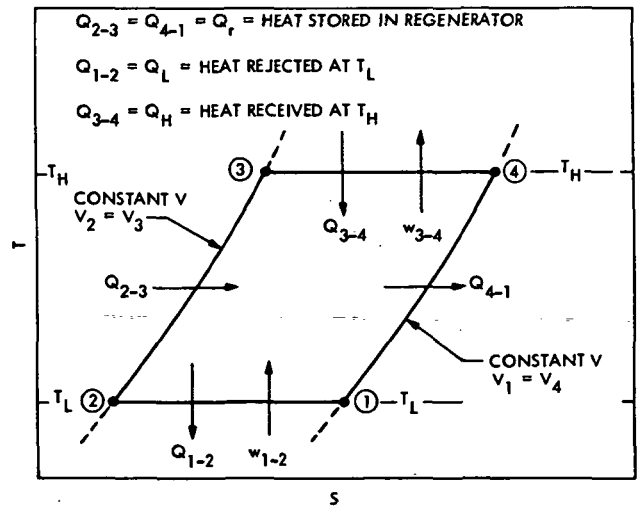

Fig. 6-9. Ideal simple Stirling cycle



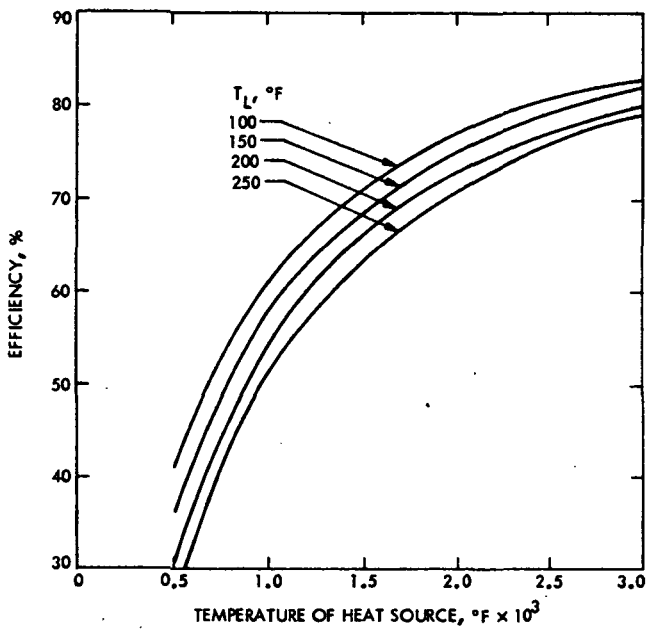

Fig. 6-10. Variation of ideal Stirling cycle efficiency with heat source ( $T_N$ ) and heat sink ( $T_L$ ) temperatures

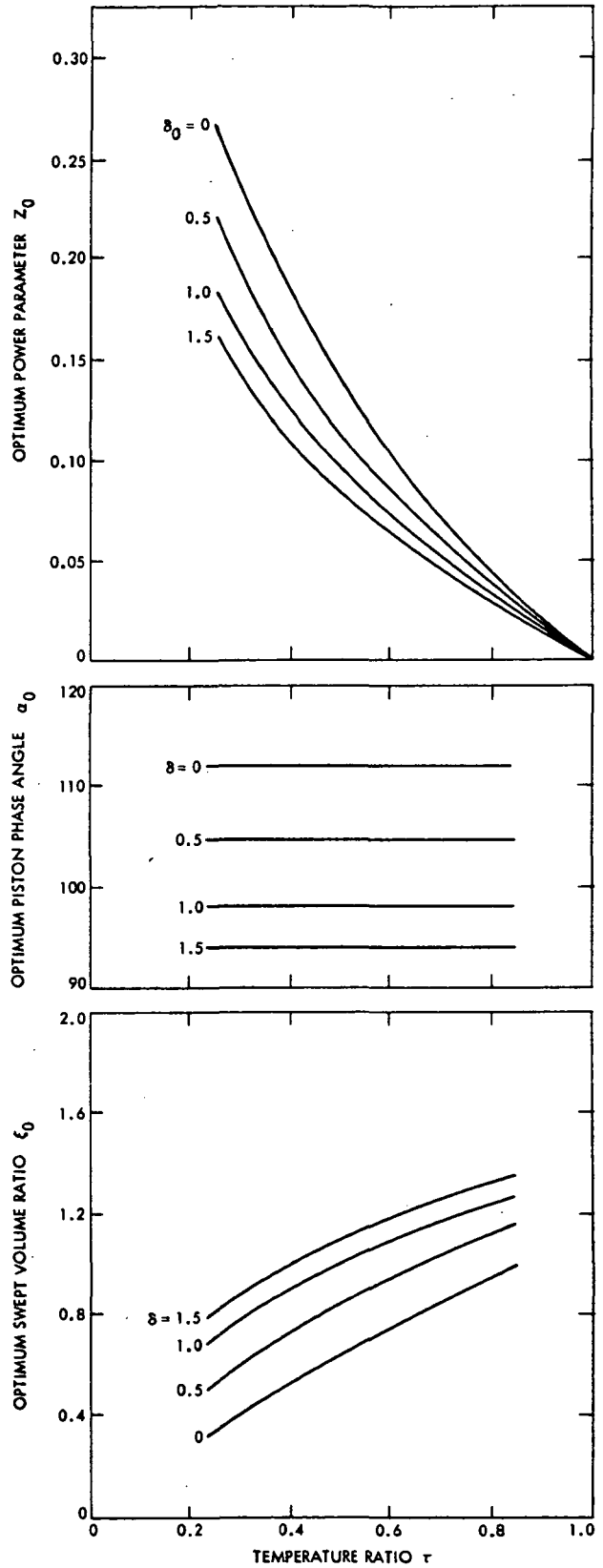

Fig. 6-11. Stirling engine optimization (Ref. 6-9)

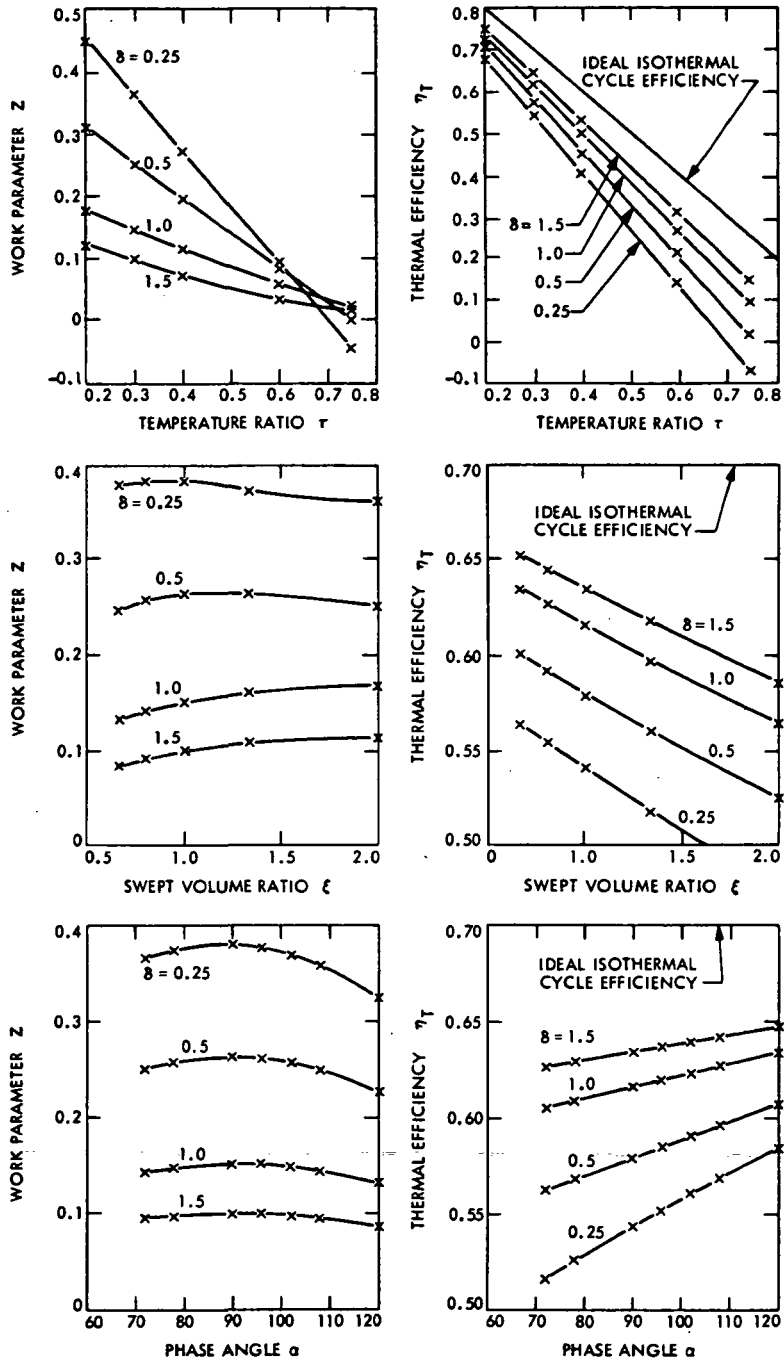

Fig. 6-12. Effect of  $\delta$ ,  $\xi$ ,  $\alpha$ , and  $\tau$  on the operation of a Stirling engine with adiabatic expansion and compression processes (Ref. 6-19)

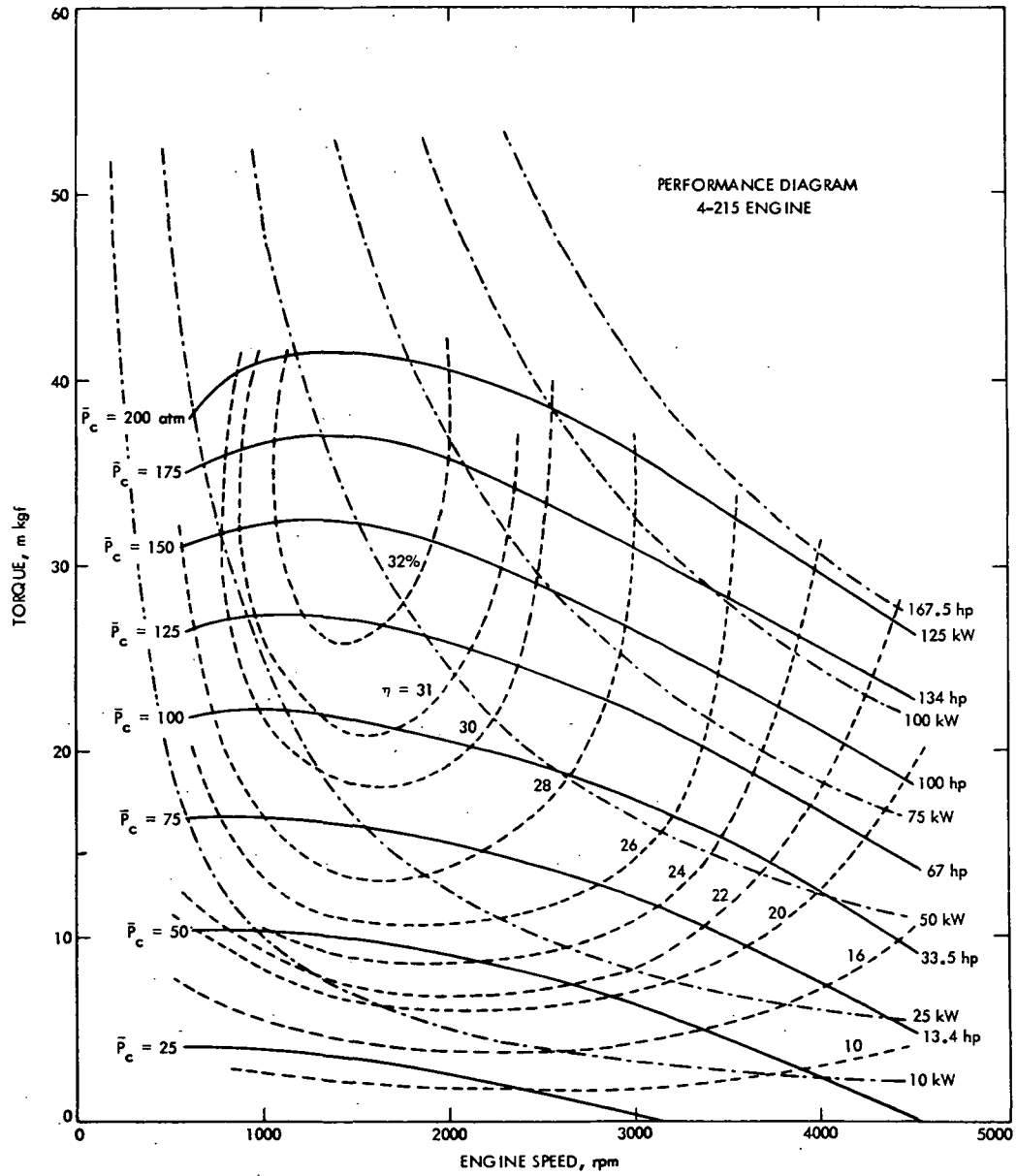

Fig. 6-13. Torque vs engine speed (courtesy Philips Research Laboratories, Eindhoven, The Netherlands)

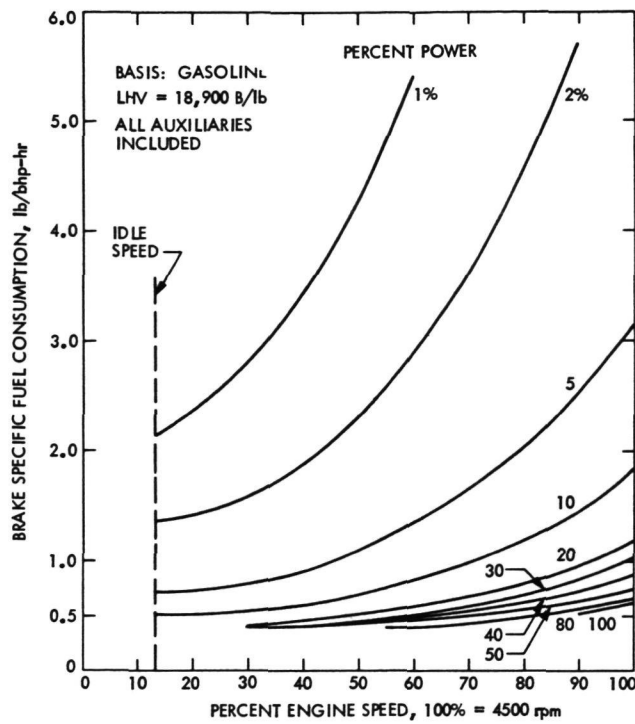

Fig. 6-14. Specific fuel consumption vs percent engine speed at constant percentage design horsepower for Philips 4-215 Stirling engine

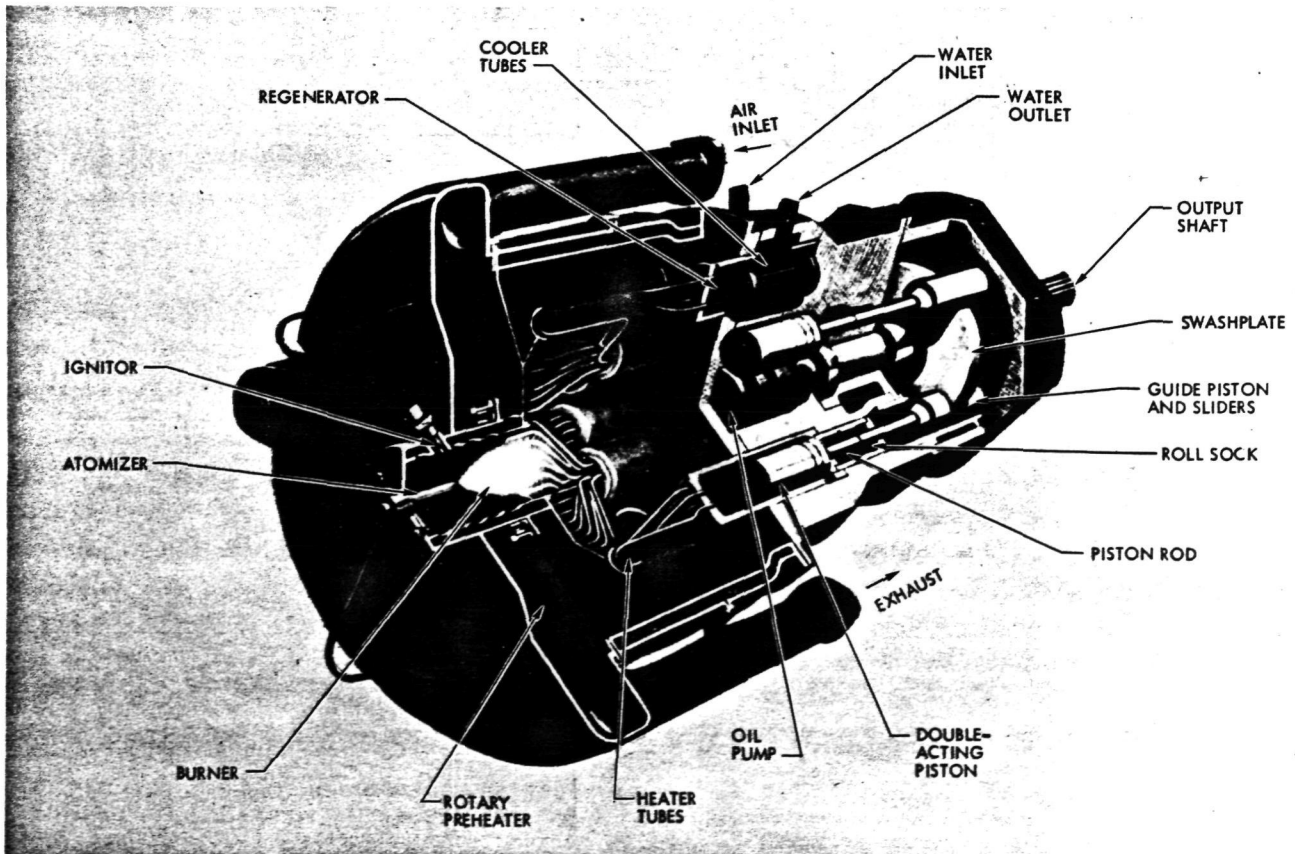

Fig. 6-15. Philips/Ford 4-215 engine (artist's rendering) (courtesy of Philips Research Laboratories, Eindhoven, The Netherlands)

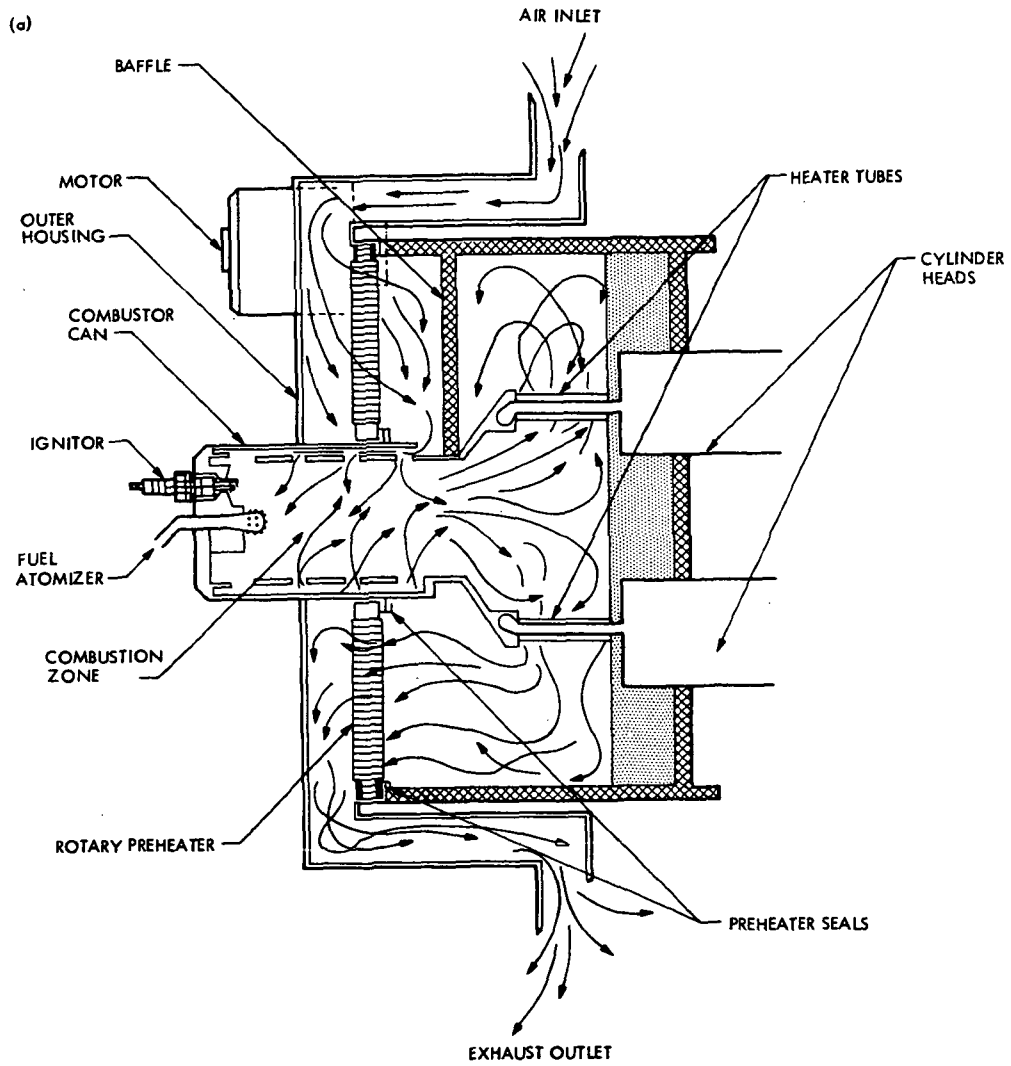

Fig. 6-16. (a) Rotary-preheater Stirling heater head

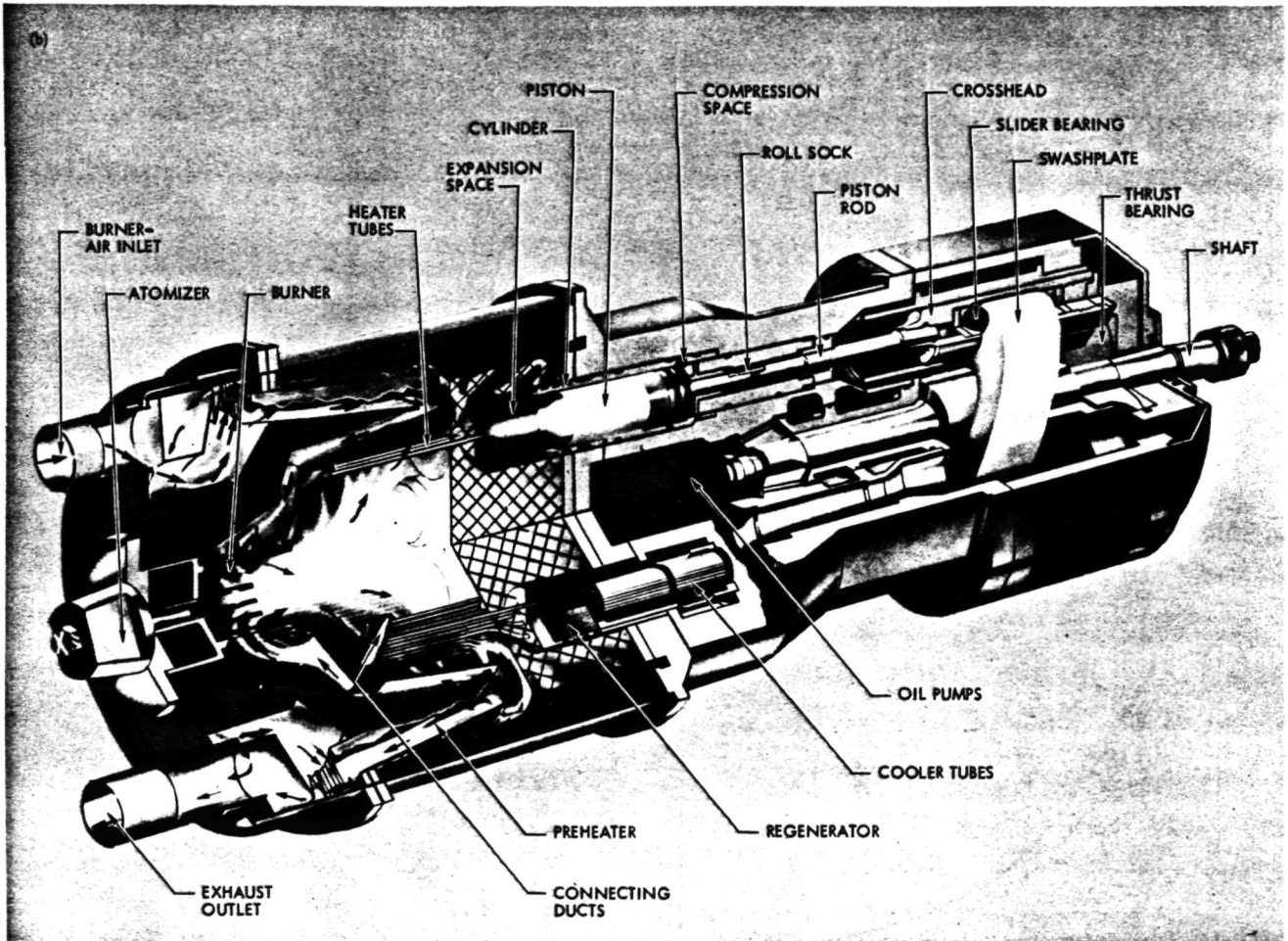

Fig. 6-16.(b) Earlier configuration of double-acting swashplate engine

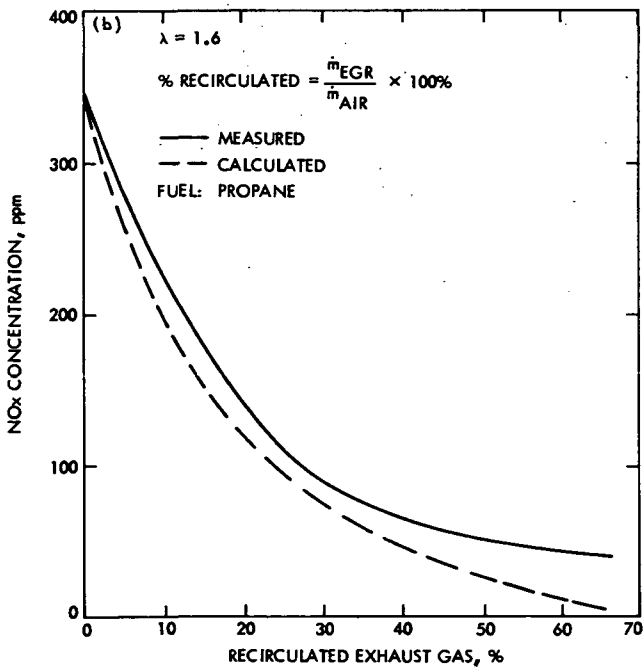
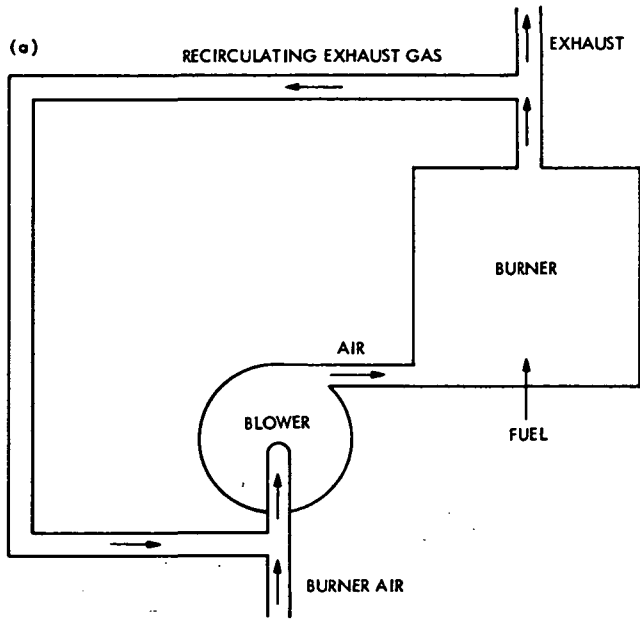

Fig. 6-17. Stirling engine combustor system schematic (Ref. 6-40): (a) Sketch of recirculation of exhaust gas, (b) NO<sub>x</sub> content as a function of percent EGR

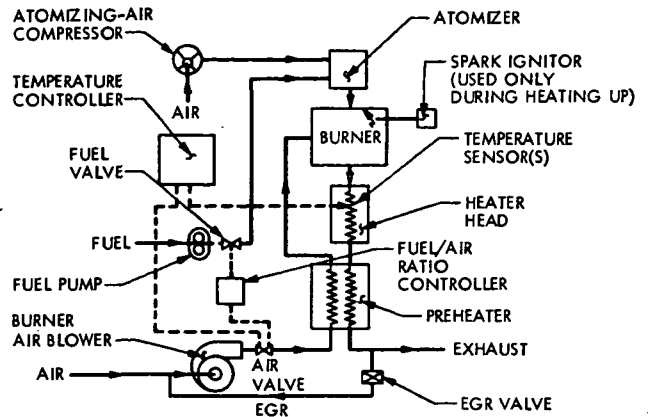

Fig. 6-18. Component schematic of combustion system (Ref. 6-7)

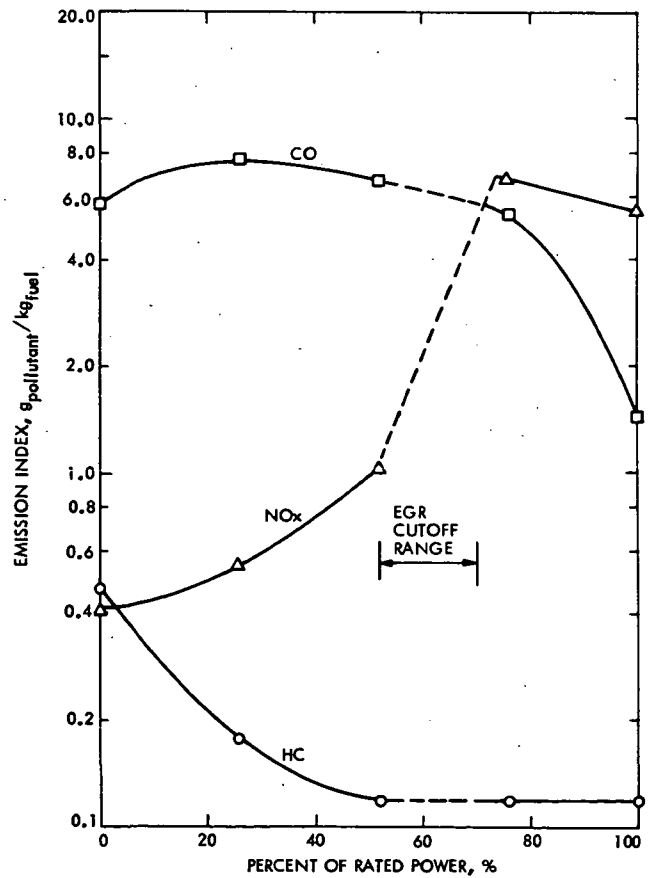

Fig. 6-19. Stirling engine emissions indices based on Philips 4-215 engine (Ref. 6-23)

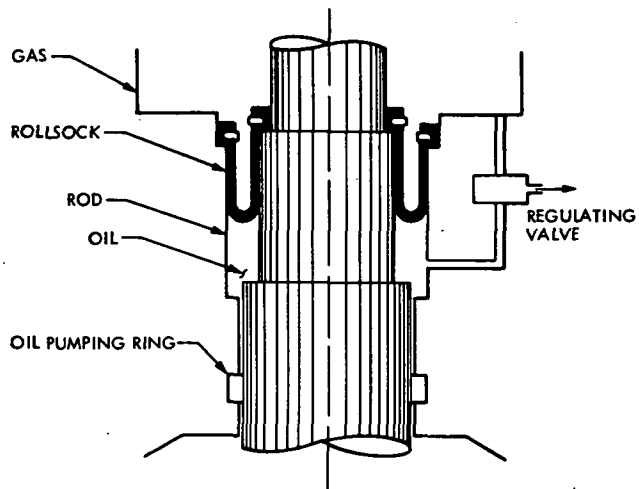

Fig. 6-20. Rollsock seal subsystem (Philips Laboratories)

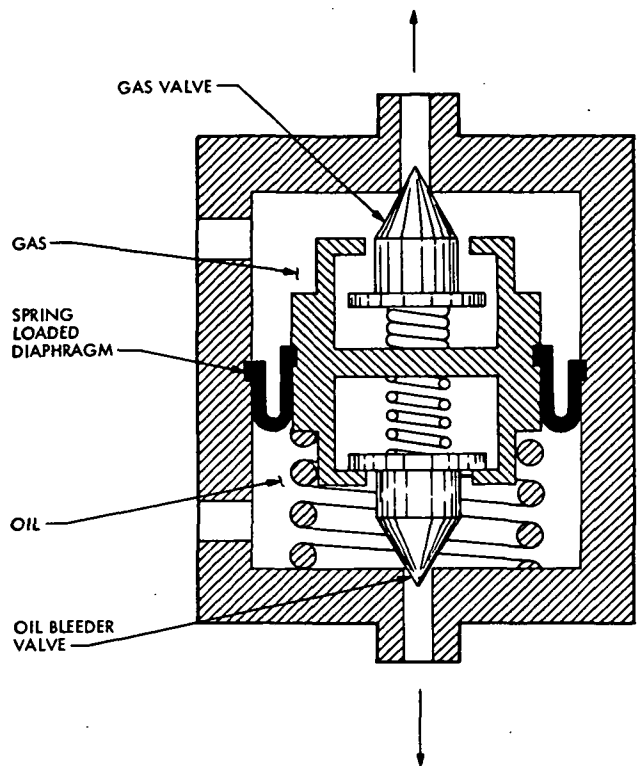

Fig. 6-22. Regulating valve (Philips Laboratories)

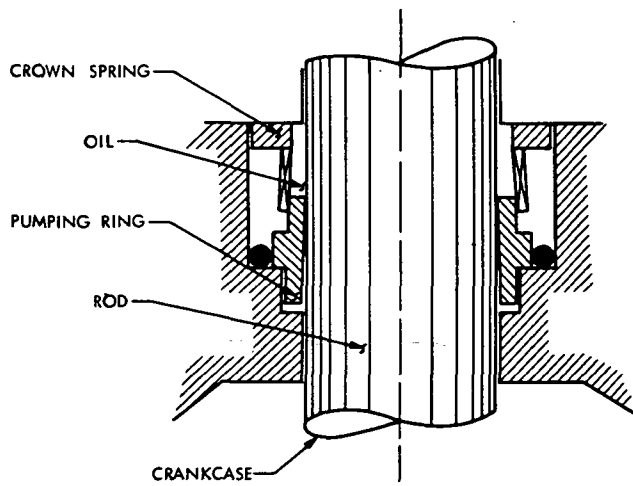

Fig. 6-21. Oil pumping ring (Philips Laboratories)

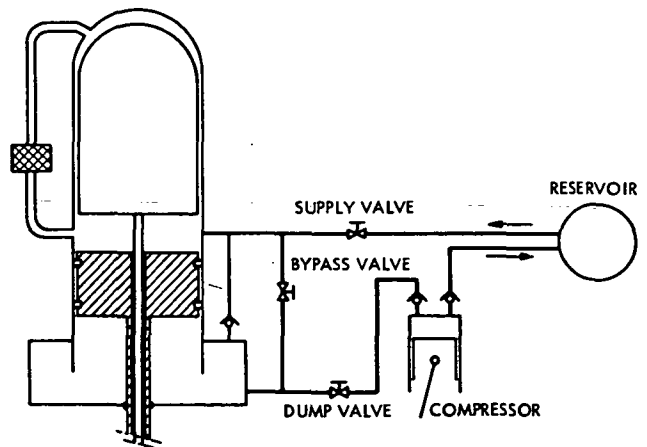
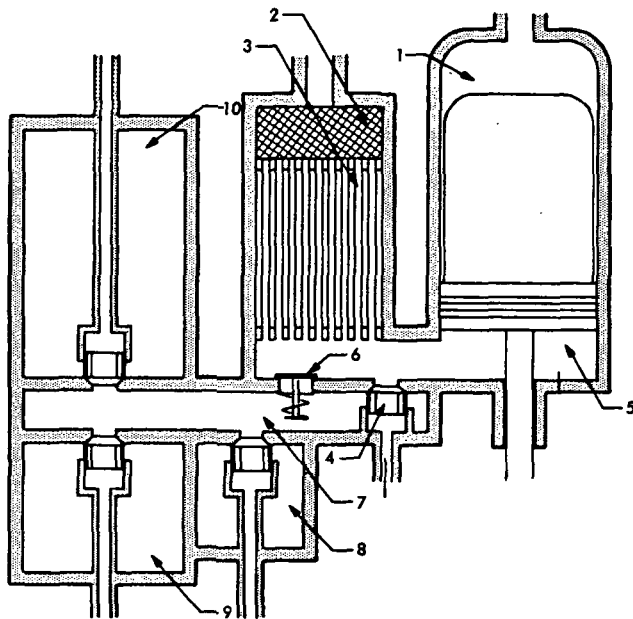

Fig. 6-23. Pressure level control (shown for piston displacer engine)





- |                     |                      |
|---------------------|----------------------|
| 1 HOT SPACE         | 6 EQUALIZATION VALVE |
| 2 REGENERATOR       | 7 DEAD SPACE No. 1   |
| 3 COOLER            | 8 DEAD SPACE No. 2   |
| 4 DEAD SPACE VALVES | 9 DEAD SPACE No. 3   |
| 5 COLD SPACE        | 10 DEAD SPACE No. 4  |

Fig. 6-24. Power control by means of amplitude variation

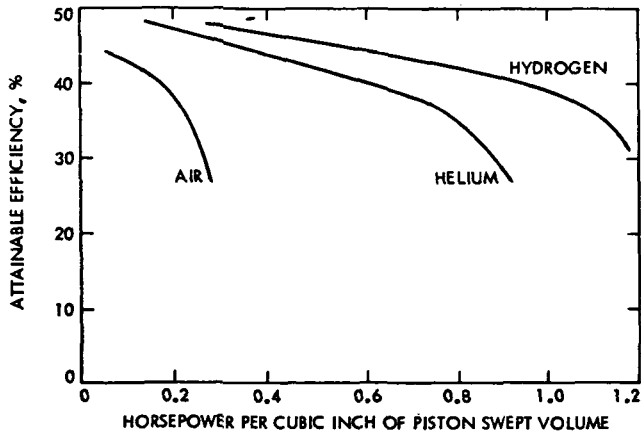

Fig. 6-25. Stirling engine efficiency comparison for alternate working fluids as a function of power density

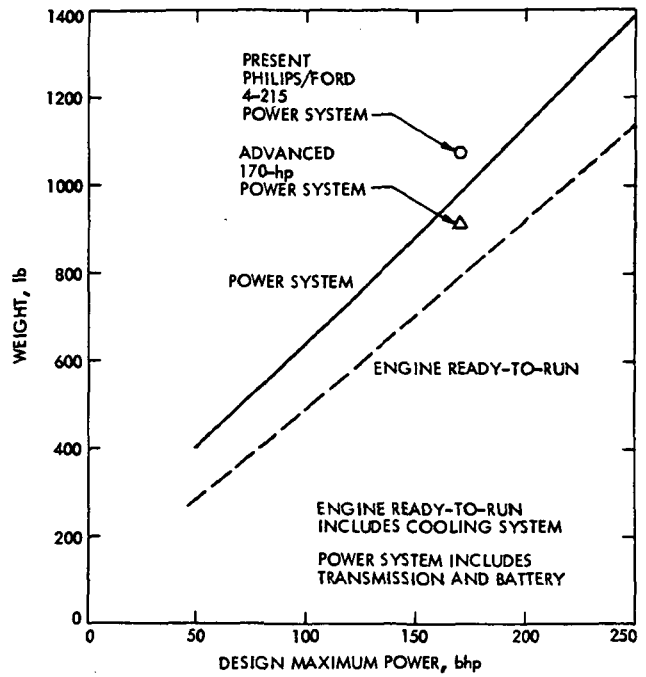

Fig 6-26. Stirling powerplant weight (Mature configuration)

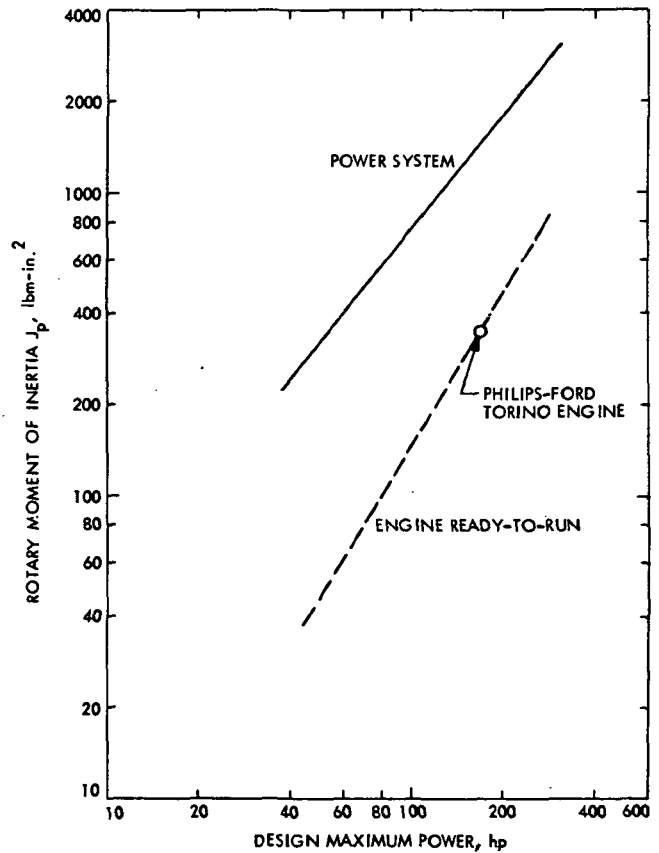
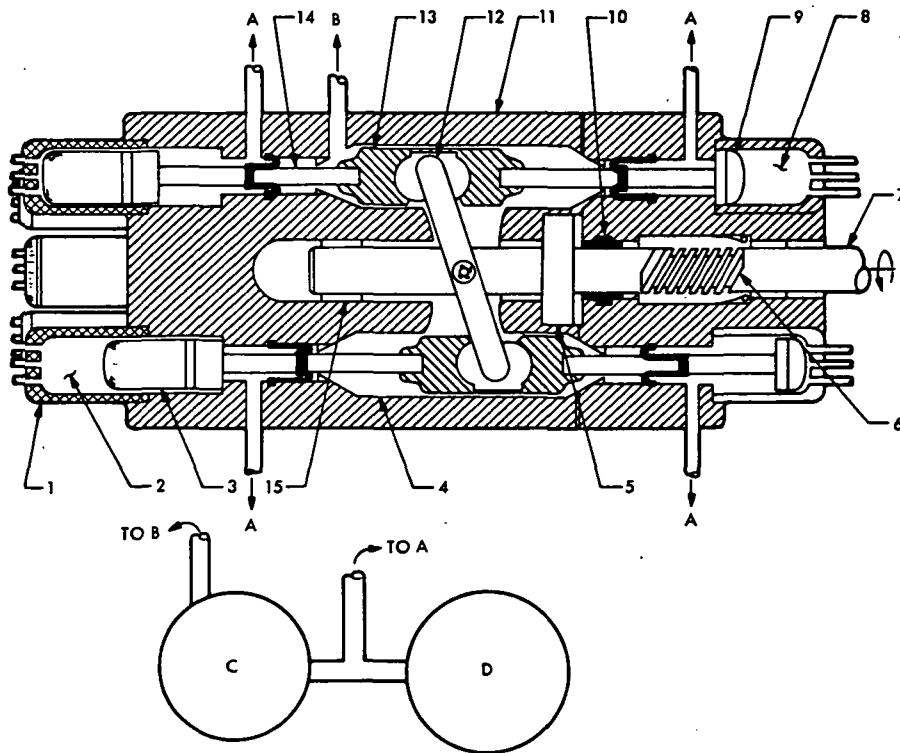

Fig. 6-27. Stirling power train moments of inertia (Mature configuration)



- 1 METALLIC OR CERAMIC HEATER HEAD
  - 2 HOT SPACE (EXPANSION)
  - 3 EXPANSION PISTON
  - 4 PRESSURIZED CRANKCASE
  - 5 MAIN THRUST BEARING
  - 6 GMRL HYDRODYNAMIC SCREW SEAL
  - 7 POWER OUTPUT SHAFT
  - 8 COLD SPACE (COMPRESSION)
  - 9 COMPRESSION PISTON
  - 10 STATIC SEAL
  - 11 BLOCK CASTING
  - 12 VARIABLE ANGLE SWASHPLATE
  - 13 CROSSHEAD SLIDER
  - 14 DIAPHRAGM OIL BARRIER (NO  $\Delta P$ )
  - 15 SHAFT BEARING
- A DIAPHRAGM SEAL PRESSURE VENT
  - B CRANK CASE PRESSURE VENT
  - C OIL SEPARATOR
  - D PRESSURE CONTROL SYSTEM

Fig. 6-28. Illustration of a pressurized crankcase Stirling engine, with diaphragm oil barriers and a GMRL hydrodynamic screw seal for the output shaft

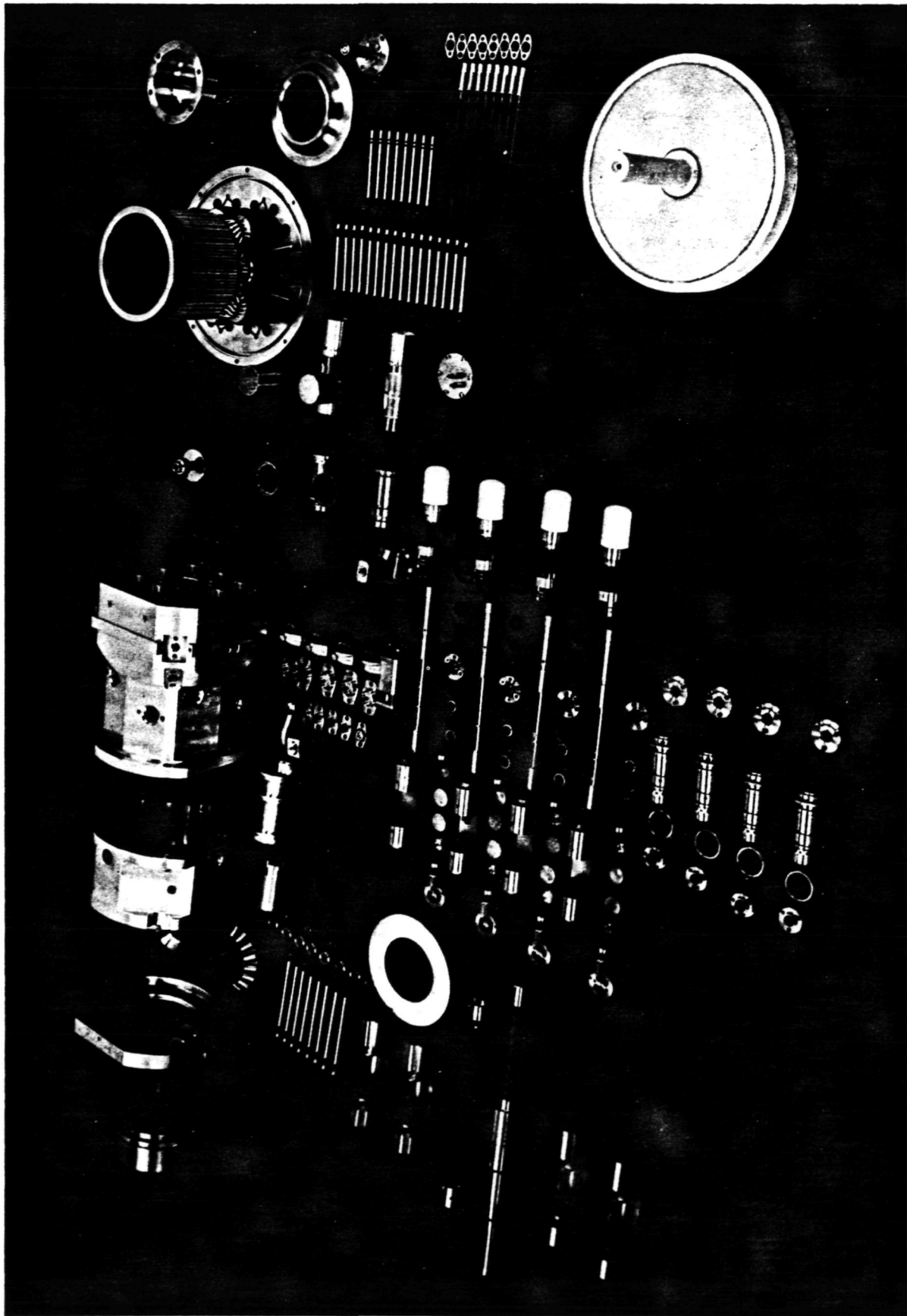

Fig. 6-29. Stirling Engine Components (60 hp prototype) (courtesy Philips Research Laboratories, Eindhoven, Netherlands)

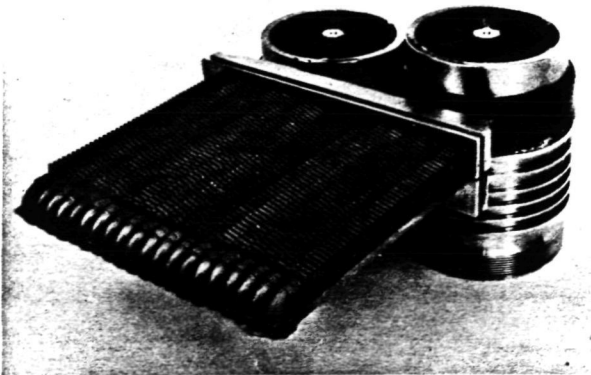
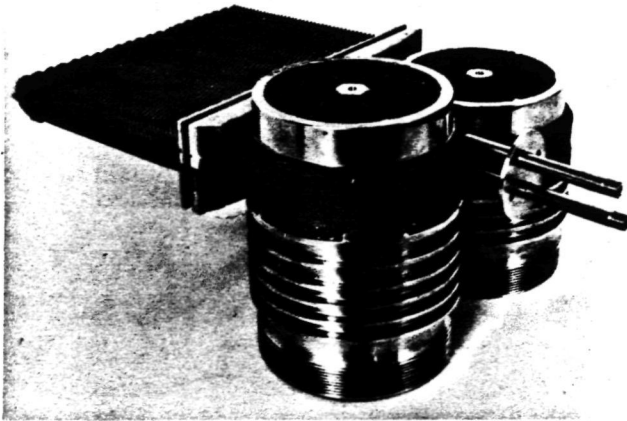

Fig. 6-30. MAN-MWN investment cast Haynes 31 heater head design

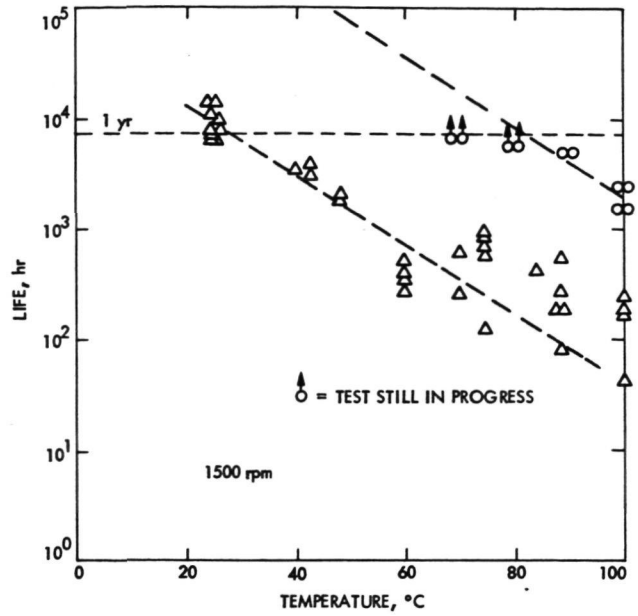

Fig. 6-31. Life of polyurethane-rubber roll-socks tested as a function of temperature; speed 1500 rpm; stroke 65 mm

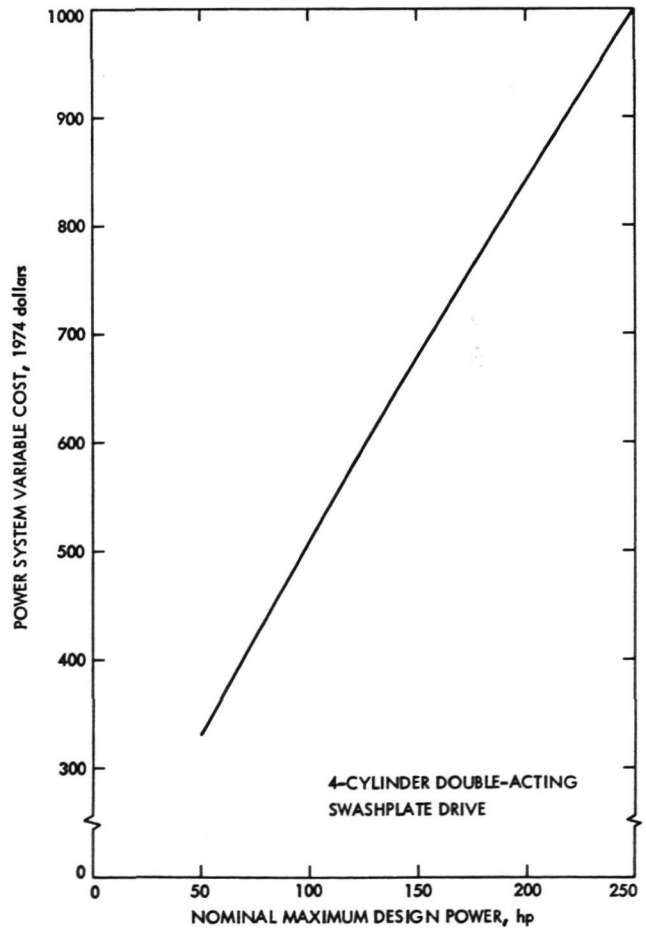

Fig. 6-32. Variable cost of Mature Stirling power systems

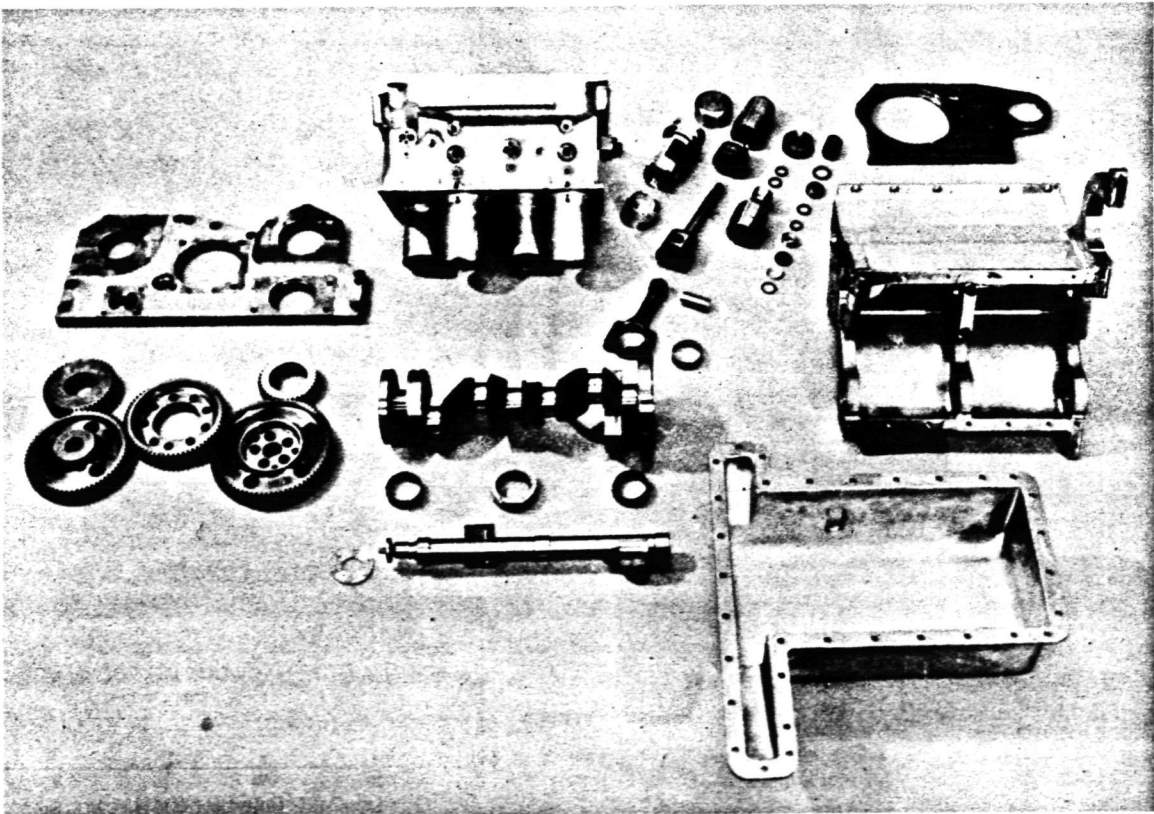
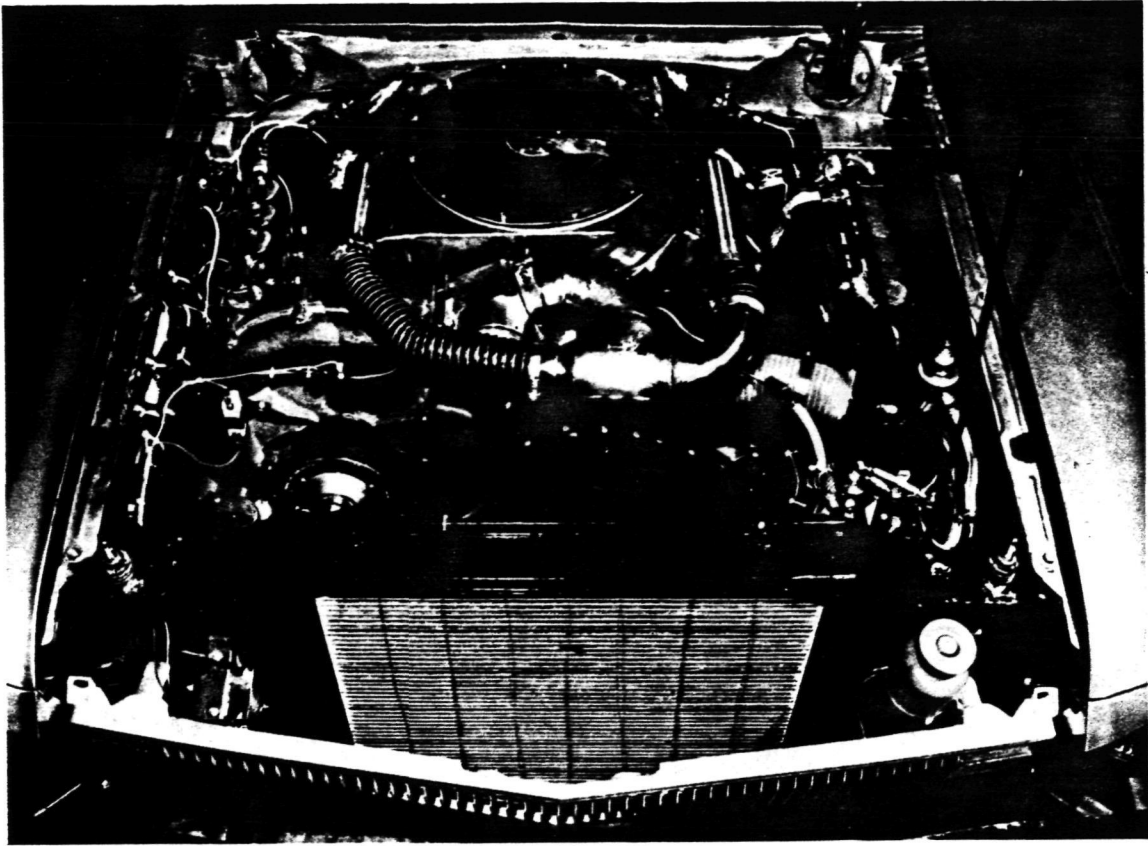

Fig. 6-33. United Stirling/Ford Pinto engine and installation

## CHAPTER 7. THE RANKINE AUTOMOTIVE POWER SYSTEM

7.1	Description . . . . .	7-2
7.1.1	Introduction . . . . .	7-2
7.1.2	Morphology . . . . .	7-2
7.1.3	Selection of Working Fluid . . . . .	7-2
7.1.4	Selection of Expander . . . . .	7-3
7.2	Characteristics . . . . .	7-3
7.2.1	Thermodynamics . . . . .	7-3
7.2.2	Engine Performance . . . . .	7-6
7.2.3	Fuel Requirements . . . . .	7-8
7.2.4	Pollutant Formation . . . . .	7-8
7.3	Major Subassemblies and Components . . . . .	7-9
7.3.1	Description of Major Components . . . . .	7-9
7.3.2	Configurational Evolution . . . . .	7-11
7.3.3	Materials and Producibility . . . . .	7-14
7.3.4	Unit Costs . . . . .	7-19
7.4	Vehicle Integration . . . . .	7-19
7.4.1	Engine Packaging in Vehicle . . . . .	7-19
7.4.2	Transmission Requirements . . . . .	7-19
7.4.3	Other Vehicle Design Impacts . . . . .	7-19
7.5	Performance in Vehicle . . . . .	7-19
7.5.1	Fuel Economy . . . . .	7-19
7.5.2	Chemical Emissions . . . . .	7-20
7.5.3	Noise Emissions . . . . .	7-22
7.5.4	Drivability Aspects . . . . .	7-22
7.5.5	Safety . . . . .	7-22
7.6	Ownership Considerations . . . . .	7-22
7.6.1	Maintenance . . . . .	7-22
7.6.2	Incremental Cost of Ownership . . . . .	7-23
7.7	Research and Development Required . . . . .	7-23
7.7.1	Mature Configuration . . . . .	7-23
7.7.2	Advanced Configuration . . . . .	7-24
7.7.3	Availability for Production . . . . .	7-25
	References . . . . .	7-25
	Figures . . . . .	7-27

## 7.1 DESCRIPTION

### 7.1.1 Introduction

A Rankine cycle heat engine is a machine which utilizes a change in phase of the working fluid between liquid and vapor in the conversion of heat into mechanical work. The ideal Rankine cycle consists of four processes: constant-pressure heat addition, isentropic expansion, constant-pressure heat rejection, and isentropic compression. The distinguishing characteristic of the Rankine cycle is that the pressure of the working fluid is increased while it is in the liquid state. In the remainder of this report, heat engines employing the Rankine thermodynamic cycle are referred to simply as Rankine engines.

Rankine engines have a long and varied history, starting in the early 1800's when the first steam engines were designed and built by engineering pioneers such as Newcomer, Watt and Carnot. Applications including marine vessels, railroad locomotives and modern electric power generating plants are well known. In the early 1900's steam-powered vehicles were produced by several companies such as Stanley Steamer, Doble, and White. These cars competed directly with Otto-engined cars; but due to high weight, limited range, high manufacturing cost, and low overall economy of operation, significant production of steam vehicles ceased in the 1920's.

The Rankine engine in modern dress has recently been resurrected and considered as a low-exhaust-emission alternative to the contemporary spark-ignited, intermittent internal combustion (Otto) engine for use in automobiles. In the past five years, Federal and California State government-sponsored programs have been aimed at developing Rankine automotive power systems. In 1970, the Advanced Automotive Power Systems Division (AAPS) of the Environmental Protection Agency (EPA, now ERDA) began a problem-solving and component development program, to provide a technology base for future efforts. A larger-scale program to develop complete engine systems through the demonstration phase was initiated in mid-1972, and four independent contractors were selected: Aerojet-Liquid Rocket Co. (ALRC), Thermo Electron Corp. (TECo), Lear Motor Co., and Scientific Energy Systems Corp. (SES), each performing major preprototype system development (Ref. 7-1). At present, work is being done only at SES, with completion of the current program set for mid-1975. The State of California sponsored a steam bus development program (1970-72), culminating in three test vehicles, and from 1972-74 the California Clean Car Project (CCCP) resulted in the development of two compact-size prototype steam vehicles by Steam Power Systems (SPS) and Aerojet. Major recent private development efforts are limited to those of Jay Carter Enterprises and Saab-Scania of Sweden. The Carter steam-powered Volkswagen was the first to meet the original 1976 Federal emission standards without add-on devices (Ref. 7-2).

This chapter evaluates the capability of the Rankine engine as an alternative automotive powerplant to meet the requirements of the 1980-1990 time period. The evaluation rests on a

basic analysis of the fundamental characteristics of the Rankine cycle power system and on the results of recent engineering and development programs.

### 7.1.2 Morphology

Rankine engines, generally, embody a closed path for the working fluid; in which the liquid → vapor → liquid phase change cycle is executed. The physical implementation of the Rankine cycle therefore requires four major engine components: a feedpump to raise the pressure of the fluid in the liquid state; a vapor generator (boiler) to impart heat to the fluid, changing its phase; an expander to extract work from the vapor and convert it to a mechanically useful form; and a condenser to condense the fluid from vapor back to the liquid state. An enormous variety of components, operating conditions, and basic design features have been employed over the approximately 150 years that engines have converted heat to shaft work via the Rankine cycle. Recent automotive applications have proved to be no exception to this trend.

The Rankine engines applicable to automotive propulsion can be conveniently categorized within the simplified morphological "tree" presented in Fig. 7-1. The most significant discriminators among such engines are the type of working fluid and the type of expander used.

In principle, any substance which would change phase from liquid to vapor and back, within the engine cycle's pressure and temperature ranges, could be used as working fluid. However, only water and a limited number of organic liquids are candidate working fluids for automobile engines, as discussed in Section 7.1.3.

The other major classification factor is the type of expander employed. Useful work can be extracted from the hot, high-pressure gas exiting the vapor generator by expanding it either through a steady flow turbine (turboexpander) or through a more conventional positive-displacement (PD) expander. For any working fluid, either a PD expander or turboexpander could be used, as discussed in Section 7.1.4.

### 7.1.3 Selection of Working Fluid

The general shape of the Rankine vapor cycle on temperature-entropy (T-s) coordinates is shown in Fig. 7-2 for two different types of working fluid. The actual shape of the cycle diagram is determined by the type of components utilized in the system, the operating conditions, and the fluid properties. A Rankine vapor cycle for a working fluid with a "drying" saturated vapor line is shown in Fig. 7-2(a) and is typical of organic fluids. Such a fluid becomes more superheated as it expands isentropically. A working fluid such as water with a "wetting" saturated vapor line approaches saturation as it expands; it is shown in Fig. 7-2(b).

Rankine engines have traditionally used water as the working fluid. For specific applications, primarily where the boiler exit temperature,  $T_3$  in Fig. 7-2, is limited to less than 700°F, other working fluids may be attractive. Percival discusses such power systems in

detail (Ref. 7-3). Alternate working fluids are also discussed in Ref. 7-22. Some of the organic fluids can theoretically give slightly higher cycle efficiencies than water operating at the same maximum boiler temperature. Typical results are presented in Ref. 7-3 where, with  $T_3 = 447^\circ\text{F}$ , the difference in theoretical cycle efficiency is 1.1 percentage points. However, organic fluids have two significant problems. First, they are thermally unstable at or above temperatures ranging from  $600$  to  $700^\circ\text{F}$ . Second, the available work per unit mass of working fluid is significantly lower than for water. Consequently, maximum cycle temperature for organic systems is limited to less than  $700^\circ\text{F}$ , and the mass flow rate of working fluid through the system must be a factor of 7 to 10 higher than that of water. Rankine cycle efficiency is strongly dependent on  $T_3$ . The much higher temperature capabilities of water and the resulting higher attainable efficiencies make it more attractive for automotive application than organic fluids. In addition to its thermal stability, water is readily available, nontoxic, nonflammable, and otherwise environmentally innocuous. Further discussion and analysis in this chapter is addressed specifically to Rankine engines utilizing water as the working fluid (i. e., steam engines).

#### 7.1.4 Selection of Expander

A turbine expander can ideally achieve a higher degree of expansion than the PD type; however, its implementation in automotive sizes is very difficult due to the low specific volume of the steam at design temperature and pressure which calls for a turbine with an extremely small flow area. A turbine of this type has low efficiency over its entire operating range. Partial admission impulse turbines have been utilized in prototype designs, but they have severely limited efficiency. Multiple-stage, full-admission reaction turbines also suffer from high losses associated with the small turbine size required for automotive applications.

Within the category of PD expanders, a distinction may be drawn between two modes of power control. In the fixed-admission mode, vapor is always admitted to the expansion space over the same volumetric interval, and the work produced in expansion is controlled by varying the inlet pressure of the vapor. Alternatively, in the variable-admission mode, the inlet pressure of vapor is maintained essentially constant, and the work produced in expansion is controlled by varying the period during which vapor is admitted to the expansion space. Several types of positive displacement expanders were considered, including the rotary vane and Wankel configurations. However, the fixed admission, uniflow, piston-and-cylinder expander was found to offer the highest expander efficiency over the widest operating ranges of speed and load. The particular type of fixed-admission expander selected for the Mature Rankine engine also has the capability for high crankshaft speeds, which results in substantial weight and size reductions and in reduced thermal losses. These advantages can be traced to the large, piston-actuated, inlet valve and the generous steam chest flow areas. This expander configuration is further discussed in Section 7.3.

A variable-admission, positive-displacement expander may be designed to have higher low-speed torque than its fixed-admission counterpart. However, this advantage is more than offset by the lower cycle efficiency which results from the lower expansion ratio accompanying extended admission, and by the increased cost associated with a variable-admission mechanism. Additionally, the expander speed may be limited by the operation of a variable-admission valve actuation system, with the attendant reduction in specific power and increase in expander weight.

The cycle efficiency of Rankine engines can be improved through multiple stages of expansion with reheat of the steam between stages. Such engines are unacceptably high in cost due to additional flow paths through the high-temperature section of the vapor generator and to the complexity of a multistage expander. Therefore, Rankine engines incorporating reheat are not suitable for automotive use.

Thus, in light of the foregoing discussion, the most promising Rankine engine type for automotive use among the six general classes shown at the bottom of Fig. 7-1 is the fixed-admission, positive-displacement expander with power control via variable boiler pressure.

## 7.2 CHARACTERISTICS

### 7.2.1 Thermodynamics

The actual performance of Rankine engines may be estimated via analytical techniques in which the non-ideal processes executed by the engine's components are appropriately represented. Irreversibilities internal to the working fluid include friction, heat loss through system boundaries, and unrestrained expansion, all of which tend to increase the entropy of the fluid. Losses external to the working fluid in a Rankine engine include boiler and expander heat losses, and mechanical friction in the expander and feed-pump. These disparities from the previously mentioned ideal processes which constitute the Rankine cycle are taken into account by assigning component efficiencies based on actual performance. The cycle efficiency calculations were performed for the preferred Rankine engine, that system configuration which incorporates a fixed-admission, uniflow, PD piston expander; exhaust steam regenerator; variable pressure boiler, and utilizes water for the working fluid.

The thermal efficiency of the Rankine heat engine is defined by

$$\eta_c = \frac{w_s}{q_h} \quad (1)$$

where the total quantity of energy available as heat from combustion of fuel in the Rankine engine's vapor generator corresponds to  $q_h$ , and the total work produced by the expander less the work required to drive the feed pump is the net work output of the engine  $w_s$ . The cycle efficiency  $\eta_c$  for a Rankine engine can be calculated from the efficiencies of the individual engine



components, the specified values of operating pressure and temperature of the boiler, the properties of the working fluid, the condenser pressure or temperature, and the expansion ratio of the positive displacement expander. Since the Rankine cycle operates through both the liquid and vapor states of the working fluid, the ideal gas approximations which greatly facilitate analyses of other engine cycles cannot be used; therefore, tables of the thermodynamic properties of the working fluid near and through the saturation states are required.

The quantities  $w_s$  and  $q_h$  in Eq. (1) may be numerically computed by applying the steady-state energy equation to each of the components of the engine and matching the working fluid states between the components, using the steam properties given in Ref. 7-36. Proceeding around the thermodynamic cycle with enthalpy per unit mass of working fluid as the basis of calculation, the feed pump shaft work is

$$w_p = (h_1 - h_5)/\eta_p \quad (2)$$

where the subscripted enthalpies correspond to the state points on the  $T$ - $s$  diagram illustrated in Fig. 7-3. The feedpump efficiency is  $\eta_p$ , and  $(h_1 - h_5)$  is the enthalpy increase of the water in an isentropic pumping process between condenser pressure and boiler inlet pressure. The losses result in higher pump shaft work required to achieve the same pressure rise.

At the pump exit, state ①, the fluid flows through the regenerator at constant pressure and receives heat from the hot expander exhaust steam. The temperature, and thus the enthalpy, at state ② is calculated by the following equation,

$$T_2 = T_1 + \epsilon_0 (T_{4e} - T_1) \quad (3)$$

where  $\epsilon_0$  is the regenerator performance parameter, and  $T_{4e}$  is the exhaust temperature, which is calculated as subsequently described. If, in an ideal regenerator, the total energy extracted in cooling the vapor from state ④<sub>e</sub> to the saturated vapor state at condenser pressure is transferred to the liquid at state ①, the rise in temperature of the liquid would be approximately one-half the vapor temperature decrease. This is due to the difference in specific heat of the fluid in the liquid and vapor states. The regenerator performance parameter is about one-half the value of the regenerator effectiveness attainable when both hot and cold fluids have the same heat capacity rates.

From state ② to state ③, the fluid is heated in the vapor generator at constant pressure from the liquid state to a superheated vapor state. The total heat release required of the combustion process to accomplish this heat addition can be expressed as

$$q_h = \frac{(h_3 - h_2)}{\eta_b} \quad (4)$$

The boiler efficiency  $\eta_b$  accounts for inefficient combustion, heat losses from the boiler housing, and exhaust heat loss.

The state of the superheated steam at ③ is the boiler exit condition, and state ③ is assumed to be the condition of the steam in the expansion space at inlet valve closure. The process occurring when the inlet steam mixes with the recompressed steam already in the cylinder will not be explicitly treated. The throttling loss associated with the inlet process, the work of steam inflow, and the recompression/reexpansion work are all assumed to be accounted for in the expander efficiency.

From state ③ to state ④ the steam is assumed to expand isentropically in the cylinder. The major losses in a well-designed PD expander are due to mechanical inefficiencies, thus they are external to the state of the fluid. The expander shaft work is defined as

$$w_{ex} = \eta_{ex} (h_3 - h_4) \quad (5)$$

where state ④ is determined by the expansion ratio  $R$  and is the point where the piston has just finished the expansion stroke and the exhaust ports are about to open. The total usable shaft work of the expander is produced during the expansion from state ③ to state ④. The expander efficiency  $\eta_{ex}$  is defined as the actual shaft work divided by the ideal work of the isentropic expansion through the expansion ratio,  $R = v_4/v_3$ .

As the piston uncovers the exhaust ports, the steam in the cylinder flows out due to the pressure differential between the steam at state ④ and the condenser pressure. This blowdown process is an irreversible, adiabatic process, which results in a decrease in the enthalpy and an increase in the entropy of the exhausted steam. The total mass of steam in the cylinder at the instant the exhaust port is uncovered may be subdivided into two portions: that which flows from the cylinder, and that which remains in the cylinder after the cylinder pressure falls to the condenser pressure. The final state of the steam exhausted from the cylinder lies between the isenthalpic path from state ④ to ④<sub>h</sub> and the isentropic path from state ④ to ④<sub>s</sub>.

The actual state of the exhaust steam at ④<sub>e</sub> is determined by a relatively simple First-Law analysis of the process. The numbers assigned to the control masses refer to the states on the  $T$ - $s$  diagram, Fig. 7-3. The initial and final stages of the blowdown process are shown on Fig. 7-4(a) and 7-4(b), respectively. The steam that remains within the cylinder after blowdown has expanded isentropically from state ④ to state ④<sub>s</sub> and is subsequently recompressed as the piston completes one revolution. The equation for the enthalpy of the exhausted steam at state ④<sub>e</sub> is

$$h_{4e} = \left( \frac{u_4 - u_{4s}}{\frac{v_{4s}}{v_4} - 1} \right) + u_4 \quad (6)$$

where the  $u$ 's are the internal energies and the  $v$ 's are the corresponding specific volumes at the respective states.

The general path of the irreversible process from ④ to ④<sub>e</sub> is represented by a dashed line in Fig. 7-3. Determination of the enthalpy of the exhaust steam allows the temperature at state ④<sub>e</sub> to be defined. This is the hot side temperature of the steam as it enters the regenerator and is used in Eq. (3) to calculate the amount of feed-water preheat. As the fluid leaves the regenerator it enters the condenser and is condensed at constant pressure to state ⑤.

The cycle thermal efficiency can now be calculated using Eq. (1).

$$\eta_c = \frac{w_s}{q_h} = \frac{w_{ex} - w_p}{q_h}$$

$$= \frac{\eta_{ex}(h_3 - h_4) - (h_1 - h_5)/\eta_p}{\frac{(h_3 - h_2)}{\eta_b}} \quad (7)$$

The steam conditions and component efficiencies used in calculating Rankine engine thermal efficiencies for the Present, Mature, and Advanced configurations<sup>1</sup> are presented in Table 7-1. The cycle thermal efficiency, given in the last column for each of the configurations, does not include any additional losses other than those mentioned in the preceding discussion. Thus the power absorbed by accessories, condenser fans, and the combustor blower must be accounted for in vehicle fuel consumption calculations.

## CYCLE IMPROVEMENTS

Increasing the boiler exit temperature markedly increases the cycle efficiency, as shown in Fig. 7-5. An increase in boiler temperature from 700°F to 2000°F results in almost a three-fold increase in cycle efficiency. The practical limits on maximum system temperature are determined by the properties of the materials used (see Chapter 2 and Section 7.3) and by expander lubrication requirements (Ref. 7-4).

The condenser temperature should ideally be as low as possible. Lower temperatures and the correspondingly lower pressure facilitate the uniflow exhaust process. A condenser pressure of about 10 psia is utilized by several developers and seems to represent a near-optimum in the tradeoff between cycle efficiency and increased condenser surface area and weight.

The variation of cycle efficiency with expander inlet pressure, as determined from cycle calculations for a PD expander with expansion ratio fixed at 12:1, is presented in Fig. 7-6. The efficiency decreases slightly from 700 to 1400 psia and then remains virtually constant up to 2500 psia. As expander inlet pressure continues to rise, the function of the regenerator becomes increasingly important since the expander exhaust steam is at a higher energy state. Perhaps the most important advantage of operating at high inlet pressures is the reduction in the specific volume of the steam which allows a smaller-displacement expander to produce the same power as one of a larger displacement at lower pressures. Reducing the expander displacement permits higher shaft speeds which result in less engine weight and lower thermal losses.

An increase in expansion ratio  $R$  increases cycle efficiency as shown in Fig. 7-7, if expander

Table 7-1. Cycle performance parameters of Rankine engines<sup>a</sup>

Config-uration	Boiler temper-ature T <sub>3</sub> , °F	Boiler pressure P <sub>3</sub> , psia	Boiler effi-ciency η <sub>b</sub> , %	Expan-sion ratio R	Expander efficiency η <sub>ex</sub> , %	Regenerator performance parameter ε <sub>0</sub> , %	Pump efficiency η <sub>p</sub> , %	Condenser pressure P <sub>5</sub> , psia	Cycle thermal efficiency, %
Present	1000	1000	90	12	74	None	75	20	19
Mature	1400	2500	90	12	85	45	75	10	24
Ad-vanced	2000	2500	90	12	85	45	75	10	34

<sup>a</sup>Working Fluid is H<sub>2</sub>O; expander is positive-displacement, fixed-admission, uniflow-type.

<sup>1</sup>See Chapter 2 and Section 7.3.2 for definitions.

efficiency remains constant. However, as  $R$  is increased in an actual expander, the expander efficiency decreases due to higher inlet process losses and thermal losses. The optimum expansion ratio at which cycle efficiency is maximized is usually near  $R = 12:1$ , and further increases in  $R$  actually diminish overall cycle efficiency. Even if improved expander design could increase the optimum  $R$  beyond 12:1, the effect on  $\eta_c$  is not dramatic as shown on Fig. 7-7. Reducing the expansion ratio below 12:1 results in a significant loss in cycle efficiency.

### 7.2.2 Engine Performance

The performance characteristics of the Rankine engine which are beneficial in automotive application include: small variation of specific fuel consumption over the engine's operating range, a wide torque-speed range, and low emissions. The engine performance map for a Rankine steam engine utilizing a fixed-admission, positive displacement expander is shown in Fig. 7-8. This map was derived from computer simulations and actual performance data presented in Ref. 7-5 when treated for fixed admission. The specific fuel consumption is based on fuel with a lower heating value (LHV) of 18,900 Btu/lbm (equivalent to gasoline) and includes feedpump work, but does not include the work of condenser fans, condensate pump, or automotive accessories. The map represents the Present Rankine engine with a maximum cycle thermal efficiency of 19%. The fuel consumption characteristics of the Mature and Advanced Rankine engines having higher cycle efficiencies were approximated by multiplying the entire matrix of Present engine SFC's by the ratio of the cycle efficiencies. Characteristics thus obtained were used in the Vehicle Emissions and Economy Prediction Program (VEEP) to generate the vehicle fuel consumption described in Section 7.5.1. Idle fuel flow was 3.5 lb/hr for a 150 horsepower engine.

The specific fuel consumption of the Rankine engine is nearly independent of maximum design power. As the design power changes, the major parasitic losses attributable to the feedpump, condenser fans, and boiler drives vary in a nearly linear manner and thus consume essentially a constant fraction of the total power. Thus the cycle efficiency and resulting SFC remain virtually constant. In this regard, the Rankine engine is suited to the wide range of automotive peak power requirements.

The method of controlling the power output of the Rankine engine system has a large impact on the expander and boiler design, system weight, and performance. Power is directly proportional to the mass flow rate of working fluid through the expander and to the work of expansion per unit mass of working fluid. Therefore, power control can be attained by varying one or both of these parameters. At present there are two methods of accomplishing this: variable admission and variable inlet pressure.

The maximum power envelope of a Rankine engine with a fixed-admission PD expander is as shown in Fig. 7-8. A fixed-admission expander operating at maximum inlet pressure has a relatively constant shaft torque output as

shaft speed increases; therefore, the engine's power is almost directly proportional to the expander speed.

The maximum power envelope of a variable-admission expander can be "fatter" than that of a fixed-admission type. Increasing the duration of steam admission at maximum pressure increases the map, thus the torque produced is greater. This allows a Rankine engine of the variable-admission type to deliver acceleration performance equivalent to that of a fixed-admission engine with a somewhat greater peak horsepower. However, the overall efficiency of the variable-admission expander is lower than that of a fixed-admission expander, with the accompanying adverse effect on fuel consumption. The advantage of reduction in weight via lower design peak power of the variable-admission expander is more than offset by its lower efficiency, and in some designs, its poorer specific power (BHP/lb).

The design and performance parameters and the weights of the various manufacturers' current and projected Rankine automotive power systems are given in Tables 7-2 and 7-3. There are six companies represented by prototype and/or preprototype versions: Aerojet Liquid Rocket Co. (ALRC), Jay Carter Enterprises, Inc., Lear Motor Co., Scientific Energy Systems (SES), Steam Power Systems (SPS), and Thermo Electron Corp. (TECo). In addition, Carter, SES, and TECo also have made projections of advanced versions (labeled "Projected" on Tables 7-2 and 7-3). Water is the working fluid for all of the systems, except the ALRC and TECo preprototypes which use organic fluids. System performance is characterized by maximum brake horsepower (BHP), maximum torque, and brake specific fuel consumption (BSFC). In all cases, the parameters given in Tables 7-2 and 7-3 are the manufacturers' reported values, and some variation in the consistency of comparison is to be expected.

Weight breakdown by component group is shown in Table 7-3. The vapor generator includes the boiler tubes, housing, and combustor assembly. The total weight is the sum of the listed component groups and does not include batteries, air conditioner, or transmission.

Schematics of the Aerojet CCCP powerplant and Carter's projected powerplant are shown in Figs. 7-9 and 7-10. These are representative of the working-fluid flow and controls layout typical of modern automotive Rankine engines (Refs. 7-6 and 7-7). The control system is a vital part of the engine, as it must accurately control fuel flow, air/fuel ratio, and feedpump flow to maintain desired system temperatures and pressures and to provide adequate transient response. Rankine engine builders have solved the control problems with varying degrees of complexity and success.

Development programs for the Rankine engine have usually stipulated adaptation of conventional automobiles for vehicle application. The TECo organic engine layout in a Ford Galaxie is shown in Fig. 7-11, and the SES steam engine mock-up in a Plymouth is shown in Fig. 7-12. Both of these systems were developed

Table 7-2. Design and performance parameters of current and projected Rankine automotive power systems

Manufacturer Version Working Fluid	ALRC Preproto AEF-78	ALRC Proto H <sub>2</sub> O	Carter Proto H <sub>2</sub> O	Lear Proto H <sub>2</sub> O	SES Proto H <sub>2</sub> O	SPS Proto H <sub>2</sub> O	TECo Preproto FL-50	Carter Projected H <sub>2</sub> O	SES Projected H <sub>2</sub> O	TECo Projected H <sub>2</sub> O
<b>Vapor generator</b>										
Rated temp, °F	650	1000	1000	1100	1000	800	625	1050	1000	650
Rated pressure, psia	1000	500	2000	1100	1000	1000	700	2500	1000	800
<b>Expander</b>										
Type	Turbine SS	Turbine SS	Recip-Uni Radial-4	Turbine SS	Recip-Uni IL-4	Recip-DAC IL-4	Recip-Uni V-4	Recip-Uni IL-2	Recip-Uni IL-4	Recip-Uni IL-4
Configuration	N/A	N/A	PAP	N/A	Series-P	Spool	HAP	PAP	Series-P	HAP
Valve type	N/A	N/A	Fixed	N/A	Variable	Variable	Variable	Fixed	Variable	Variable
Admission	N/A	N/A	35	N/A	135	49	184	30	68	50
Disp. vol. (in <sup>3</sup> )	N/A	N/A	11.3:1	35:1	Variable	Variable	Variable	12:1	Variable	Variable
Exp. ratio	N/D	N/D	5000	65,000	2500	2400	1800	6000	3200	2000
Max. rpm	42,000	60,000								
<b>Condensator</b>										
Inlet temp, °F	246	198	193	225	228	244	210	193	228	212
Inlet pressure, psia	33	11	10	19	20	27	35	10	20	32
<b>Comp't efficiencies</b>										
Feedwater pump, %	71	N/D	N/D	N/D	N/D	N/D	75	N/D	N/D	75
Vapor generator, %	85	90	90	N/D	N/D	N/D	87	N/D	N/D	87
Expander, %	68	N/D	86	62	68	N/D	75	N/D	N/D	75
<b>System performance</b>										
Max. bhp	106	60	70	107	150	65	145	90	90	60
Max. torque, ft-lb	N/D	N/D	N/D	620	755	N/D	N/D	N/D	600	N/D
Min. BSFC, lb/hp-hr	1.3	0.95	0.70	0.76	0.77	1.03	0.79	0.55	0.67	0.79
<b>References</b>	7-23, 7-24	7-24, 7-25	7-7, 7-14, 7-26	7-27, 7-28, 7-29	7-30, 7-31	7-25	7-32, 7-33	7-7, 7-14	7-10, 7-35, 7-34, 7-31	7-32, 7-33

N/D = no data available  
 N/A = not applicable  
 Recip-Uni = reciprocating uniflow  
 Recip-DAC = double-acting compound  
 SS = single shaft  
 Series-P = series poppet  
 PAP = piston-actuated poppet  
 HAP = hydraulically-actuated poppet  
 Preproto type = test stand version  
 Prototype = operational version  
 IL = in-line cylinder configuration  
 V = vee cylinder configuration

Table 7-3. Weights or current and projected Rankine automotive power systems<sup>a</sup>

Manufacturer Version	ALRC Preproto	ALRC Proto	Carter Proto	Lear Proto	SES Proto	SPS Proto	TECo Preproto	Carter Projected	SES Projected	TECo Projected
a) Vapor generator	N/D	160	126	300	125	185	256	98	52	N/D
b) Expander	80	86	84	72	320	320	438	76	225	N/D
c) Condenser	N/D	145	80	170	113	150	225	35	55	N/D
d) Feedwater pump	N/D	incl. in (f)	34.5	35	35	incl. in (f)	55	18	16	N/D
e) Fans and	N/D	incl. in (c)	28	188	85	incl. in (c)	incl. in (c)	31	40	N/D
f) Controls, pipes and other	N/D	274	73	incl. in (e)	179	180	194	80	132	N/D
Total	N/D	665	425.5	765	857	835	1168	338	520	N/D
Packaging	73 Chev. Impala	73 Chev. Vega	64 VW Square-back	73 Chev. Chevy.	73 Plym. Fury III	Special construction	72 Ford Galaxie 500	74 VW Dasher	75 Plym. Valiant	74 Ford Pinto
Vehicle weight	4460	2905	2750	4450	4237	3030	4318	3000	3170	2543
References	7-23 7-24	7-25	7-7	7-29	7-30, 7-31	7-25	7-32, 7-33	7-7	7-35	7-33

<sup>a</sup>All weights are given in lb. N/D = no data available. Total includes working fluid and alternator; does not include battery, air conditioner, and transmission.

as part of the Alternate Automotive Power Systems program of the EPA (Refs. 7-8 and 7-9).

### 7.2.3 Fuel Requirements

The Rankine engine incorporates a continuous (steady-flow) combustor, operating at essentially atmospheric pressure. The operation of such a burner can be tailored to virtually any fuel, including light and heavy petroleum distillates, alcohols, and blends thereof. Specifically, any gasoline or diesel fuel could be used, and probably would be, in a mixed-powerplant fleet. For an all-Rankine fleet, a "broad-cut" distillate fuel would be more desirable from the standpoint of refinery process energy efficiency and cost.<sup>2</sup>

### 7.2.4 Pollutant Formation

The heat source in the vapor generator of a Rankine engine is a continuous burner which operates at near-atmospheric pressure. Considerable work on continuous-combustion, constant-pressure burners has shown them to be capable of extremely low exhaust emissions.

Low levels of CO and HC are achievable in a well-designed continuous burner utilizing fuel well mixed with an excess of combustion air and a combustion chamber designed to allow virtually complete combustion of the reacting gases before they are quenched by heat-exchange surfaces (Ref. 7-10). The chief advantage of the Rankine system is the low level of NOx emissions. The formation rate of NOx is strongly dependent on combustion gas temperature. By restricting the maximum combustion gas temperature and limiting the time available for NOx production, the emission of NOx is restricted to very low values. Judicious placement of the heating, vaporizing, and super-heating tube segments in the vapor generator permits planned step-quenching of the combustion products. Such step-quenching can be very effective in controlling exhaust NOx levels (but no more so than charge dilution in continuous combustors). In addition, varying degrees of exhaust gas recirculation (EGR) have been used to reduce the formation of NOx.

Emission indices determined from experimental tests by SES are shown in Fig. 7-13. It

<sup>2</sup>The fuel discussions of Chapters 5 and 6, Sections 5.2.3 and 6.2.3, are also applicable here, except for those portions pertaining to aluminosilicate-type heat exchangers.

is important to note that all of the automotive Rankine-cycle systems are in the early prototype stage, and future refinement of controls and design technology would probably lead to even lower emissions (Ref. 7-10).

### 7.3 MAJOR SUBASSEMBLIES AND COMPONENTS

#### 7.3.1 Description of Major Components

The major components of the Rankine powerplant are briefly described in this section. General discussions of Rankine-cycle design features and components can be found in Refs. 7-11, 7-12, 7-13, and 7-14, and the major components of the Present, Mature and Advanced Rankine engines are subsequently discussed in Section 7.3.2.

#### VAPOR GENERATOR

The vapor generator (boiler) is a heat exchanger between the hot combustion gases at near atmospheric pressure and the high-pressure working fluid. The working fluid pressure of the Mature Rankine engine is up to 2500 psi at the outlet and somewhat higher at the inlet due to the pressure drop within the vapor generator. The high-pressure working fluid is contained within a single tube for which the material, inside diameter, and wall thickness are changed along the direction of flow to accommodate the local temperatures and pressures experienced through the boiler from inlet to outlet. The preheater and evaporator portions of the tube require external fins to increase the effective heat transfer area on the combustion-gas side.

Various boiler geometries and tube arrangements have been tried in the past. It is desirable to minimize the working fluid volume within the vapor generator to allow fast response to acceleration/deceleration commands and to minimize the energy release in the event of a system rupture. Modern boiler design is based on confining a small amount of working fluid in a single small-diameter tube - the monotube design. The monotube boiler is preferred because there is no chance of flow instability, as there would be between parallel paths. In the event of a tube rupture, the volume of vapor released would be well within capacity of the combustion gas exhaust ducting. Such a boiler rupture would not constitute a significant safety hazard in a properly designed system.

#### COMBUSTOR

The combustor is integrated with the vapor generator; these two components are therefore designed as a package. The fuel may be supplied by a variable-flow pump, and the air by a blower. The latter may be controlled with a throttle valve and/or a variable-speed motor.

In order to keep blower power requirements down, it is necessary to minimize the air-side

pressure drop in the combustor and boiler. The combustor itself can be of a variety of designs to provide low emissions. A simple spinning-cup atomizer was found adequate to meet the statutory emission standards by Carter (Ref. 7-14). Lean burning and EGR can be used, in conjunction with the low-temperature feedwater tube quench, to cool the flame rapidly and reduce the formation of NOx.

#### EXPANDER

The two major expander categories as previously represented in Section 7.1.2 are turbine expanders and positive-displacement (PD) expanders. The turbine expanders used by ALRC and Lear are both axial, single-stage, impulse types and are represented schematically in Fig. 7-14(a). The PD expanders of the Mature and Advanced configurations are of the unflow, piston-and-cylinder type in which steam is exhausted at the bottom of the piston stroke by a circular array of ports in the cylinder wall. However, the method of admitting steam to the cylinders in the Present configurations is unique to each device. SES' approach typifies the variable-admission expander, using a reverse series poppet valve arrangement, Fig. 7-14(b). The duration of steam admission is controlled by mechanically varying the sequence of valve operation. The fixed-admission type is epitomized by Carter's expander in which a large admission poppet valve is located centrally above the piston and is opened by an extension on the piston head, Fig. 7-14(c). The admission valve in TECo's variable-admission expander is also centrally located above the piston head, but the operation is controlled hydraulically. SPS designs have used a double-acting compound reciprocating expander with piston slide spool valves, also providing variable duration of steam admission, Fig. 7-14(d).

The fixed-admission, unflow, piston-and-cylinder expander provides high efficiency over a wide load range, with the capability for significantly higher expander speeds and the attendant reductions in weight and thermal losses. The large central valve may be designed to minimize throttling at high crankshaft speeds. The maximum crankshaft speed of the Mature Rankine expander is 5000 RPM and maximum power is developed at that speed.

#### FEEDWATER PUMP

Due to the very high pressures involved (1000-3000 psi), feedwater pumps are of the positive-displacement type. The rate of water delivery is controlled by varying either: the pump speed; by varying the pump displacement through a variable swashplate; or by utilizing a fill-and-spill valve to effect a variable displacement. The feedpump is basically a variable-flow-rate device, and the outlet pressure results from the flow resistance of the downstream components. Pressure control can be accomplished by sensing the pump outlet pressure and using that to control the variable flow.

Feedpumps have been developed in a variety of configurations, radial or in-line, with differing numbers of cylinders. Gear pumps have also been considered. Water temperatures are low and present no major problems. Materials must be chosen to avoid corrosion. Care must be taken to ensure proper lubrication of the pump without contaminating the water if the feedpump is downstream of the oil-water separator. In variable-pressure systems, the feedpump has an additional requirement for rapid flow rate changes for power control. The feedpump can be mechanized for direct drive off the expander shaft. Electric power may be used for feedpump flow during startup, or one may "crank" (with a starter motor) the entire expander/feedpump unit.

#### FEEDWATER PREHEATER (REGENERATOR)

The feedwater preheater is a small heat exchanger for transferring heat from the expander exhaust to the boiler feedwater. Its purpose is to increase the system efficiency by reducing the amount of heat addition required in the boiler. A secondary benefit is that the condenser size may be reduced slightly because there is less heat to reject to the atmosphere. This heat exchanger will most likely be of the shell-and-tube type, since the water must be contained at high pressures (up to 3000 psia) and large flow areas are required for the steam.

#### CONDENSER

The total amount of heat which must be rejected by the condenser is large; hence it is important to have very good air-side heat-exchange characteristics in order to minimize the size (and cost) of the condenser. Under warmup and some cruise conditions, no power need be supplied to the condenser fans to provide the large flows of cooling air required for heat rejection. Under other conditions, the fan(s) are required to augment the air flow. Since these fans consume a significant amount of power, it is important to minimize upstream and downstream air-flow restrictions. A direct mechanical drive may be preferred over an electrical drive because of the smaller losses associated with the former. A thermostatically controlled (or condenser-pressure-controlled) fan clutch may also be desirable to minimize fan usage.

The pressure inside the condenser is determined by the working fluid temperature (via its vapor-pressure characteristic). Under many operating conditions the condenser will be at less than atmospheric pressure. Care must thus be exercised to prevent leakage of air into the system. The condensate pump raises the water pressure above atmospheric and, to allow for slight air leakage, a noncondensable-vapor relief valve is incorporated in the separator subsystem (see Fig. 7-10).

The Garrett Corporation has performed a condenser design analysis (Ref. 7-15) for EPA (now ERDA), considering the design tradeoffs for both the air and water/steam sides of the heat exchanger. The final configurations are similar to present automotive radiator practice, but with higher fin densities (fins per inch) and deeper cores. An aluminum alloy condenser, fabricated by fluxless brazing, was the recommended

approach. Considerable care was given by Garrett to the design of the fan and associated cooling.

#### OIL/WATER SEPARATOR

The purpose of this component is to remove the oil from the condensate before it is pumped into the vapor generator. The temperatures in the vapor generator are high enough to cause oil decomposition and possibly cause fouling (deposits on the tube walls).

The separation is accomplished by a small centrifuge, the water flowing to the outside by virtue of its higher density and the oil being drawn off the center and returned to the expander crankcase. The power requirements for the separator are minimal, and its rotating component can be driven either directly (mechanically) or by electric motor (the direct drive may offer lower cost and far higher efficiency). As mentioned earlier, a vent for noncondensable vapor is also necessary and can be incorporated in the separator unit. The temperatures and pressures in the separator are low and no materials problems are anticipated.

#### FREEZE PROTECTION

Since potential fouling of vapor generator tubes precludes use of an antifreeze additive, freeze protection becomes a more weighty consideration for a Rankine engine than for a conventional Otto engine. While freeze protection is not a single component of the system, it is an important design consideration for a general-purpose vehicle. There are two general approaches to freeze protection. The first relies on insulation and auxiliary heat to prevent freezing. The second allows freezing to occur — but without damage.

In the first approach, the components containing water are compactly packaged together and well insulated. Insulation alone is adequate to prevent freezing for one or two days at  $-20^{\circ}\text{F}$  ambient temperature. Beyond that, a small (pilot light-sized) flame, thermostatically controlled, would be required to keep those components warm. An energy equivalent of 2 gallons of fuel/month would be required to prevent freezing (Ref. 7-7). Unfortunately, it may be difficult to burn a liquid fuel at such low rates (catalytic burning may be a possibility). A gaseous fuel such as propane or butane might also be employed but would require a separate tank.

The approach which allows freezing is implemented by ensuring that the water will drain from all the components into a water sump. The sump itself can then be protected by building-in a compressible element (a segment of rubber hose is said to be sufficient) to absorb the expansion of the water. SES (Ref. 7-10) has studied this type of system. Once the system is frozen, special start-up procedures must be employed to prevent damage. The water must be thawed before the feedwater pump, and other components, are torqued.

Perhaps some combination of these two systems would be ideal: good insulation to hold the heat, with or without an auxiliary heater, and with components designed so that freezing will

not cause damage. The extra insulation is also useful to reduce heat losses under normal driving conditions.

## CONTROLS

The control system requirements for steam engines depend very strongly on the particular system concept chosen. In general, the controllable elements of the system are:

- (1) Feedwater pump flow (or outlet pressure).
- (2) Expander valve cutoff (variable-admission expander only).
- (3) Steam throttle valve position.
- (4) Fuel flow rate into combustor.
- (5) Air flow rate into combustor.
- (6) Condensor fan clutch.

Some of the parameters which can be sensed for control includes:

- (1) Items (1), (4) and (5) from above list for feedback control.
- (2) Boiler outlet pressure.
- (3) Boiler outlet temperature.
- (4) Condensate temperature or pressure (for condenser fan control).

Additional controls, and logic, must be supplied for the startup sequence, with special provisions for a "frozen" start (if permitted).

For the fixed-admission expander, several "nested" and interrelated closed-loop control networks are required. Primary power control is effected through varying the flow rate of the working fluid, with a high-response, vapor-generator-temperature sensor modulating fuel flow and another loop maintaining air/fuel ratio.

The control system must also have independent backup safety devices. A pressure sensor set above the normal boiler outlet operating pressure can be used to cut off fuel flow via a solenoid valve (this would be a normally closed valve so that an electrical failure would also cause safe shutdown). At a still higher pressure, a poppet-type relief valve would vent steam to prevent rupture. Also, a redundant temperature sensor would be set a small margin above the normal operating temperature and used to shut off fuel flow.

### 7.3.2 Configurational Evolution

As in the case of the other alternate power systems, the Rankine power system was evaluated in three states of evolution: the Present (developmental) configurations; a Mature (first production) configuration; and an Advanced (long-term potential) configuration. The criteria upon which these evolutionary status labels are based are discussed more extensively in Chapter 2.

Only steam Rankine power systems are deemed applicable to automobiles, since the cycle temperature limitations of organic systems limit attainable fuel economy, as discussed in Section 7.1.3. Likewise, in the remainder of this chapter, our attention is further restricted to power systems employing positive-displacement (PD) expanders, because of the inevitable lower cycle efficiency implicit in automobile-size steam turbine systems.

Table 7-4 outlines the salient features of two existing Present configurations, together with those of conjectural Mature and Advanced configurations formulated for purposes of evaluation within the APSES methodology. The latter necessarily embody certain fabricability decisions and design tradeoffs, tantamount to very preliminary production engineering. Establishment of these configurations was facilitated by technical discussions with the cognizant engine developers - ALRC, Carter, Lear, SES, SPS, and TECo (Refs. 7-16 through 7-21). While it is acknowledged that such engines, if ever produced, will differ in details from the configurations conjectured, it is believed that the latter are nevertheless adequately representative for the derivation of comparative performance potential, emissions, costs, and research/development requirements. The specific configurations are discussed in the following.

## PRESENT CONFIGURATIONS

Of the Present configurations of the Rankine engine, those of Carter and SES represent the best of today's operational automotive power systems. Both systems utilize water as the working fluid and have positive-displacement type expanders. Their characteristics are summarized in the first two data columns of Table 7-4.

The SES expander, designed and built by Ricardo Ltd. of England under contract to SES (Ref. 7-34), is a variable-admission, reverse series inlet valve, PD uniflow expander. Considerable effort has been put forth in designing and optimizing this expander. Computer studies were made to select optimum configurations and to model the thermodynamic processes. The final configuration evolved as the results of extensive testing of various inlet valve sequences, cam profiles, and piston ring materials, and probably represents something near the upper limit of achievable efficiency for this type of expander.

The Carter expander incorporates some innovative features and is a departure from traditional expander design. Steam is admitted to the cylinders via a large-diameter piston-actuated poppet valve. Since the duration of the valve opening is fixed by the piston geometry and stroke, the mean effective pressure, and thus the power output of the engine, is controlled by varying the pressure supplied to the expander. A characteristic of this type of expander is the ability to operate at high rotational speeds (circa 5000 rpm) due to the large flow area during admission which reduces the throttling losses.

The Carter lubrication system supplies excess oil to the piston rings which "... virtually



Table 7-4. Salient features of evolving Rankine configurations

Characteristic	Configuration			
	Present (Jay Carter)	(SES)	Mature	Advanced
<u>Vapor generator:</u>				
type	Metal monotube	Metal monotube	Metal monotube	Ceramic structure
location	Discrete	Discrete	Discrete	Integral with expander
max. outlet press, psia	2500	1000	2500	2500
max. outlet temp, °F	1100	1000	1400	2000
efficiency, %	90	90	90	90
press./temp. scheduling	No	No	Yes	No
<u>Combustor:</u>	Fixed geom. metallic	Fixed geom. metallic	Fixed geom. metallic	Var. geom. (?) ceramic
<u>Expander: type</u>	Uniflow recip.	Uniflow recip.	Uniflow recip.	Uniflow recip.
cylinder config.	Radial-4	IL-4	V-4 <sup>a</sup>	V-4 <sup>a</sup>
max. power, hp	70	150	150 (typical)	150 (typical)
efficiency, %	~78	~74	85	85
valve type	Piston/poppet	Reversed series	Piston/poppet	Piston/poppet
valve material	Superalloy	Superalloy	Superalloy	Refractory metal (?)
hot-side components	Stainless steel/superalloy	Stainless steel	Stainless steel/superalloy	Ceramic
piston rings	Conventional	Conventional	Conventional	{ Refractory metal (?) or conventional + high-temp. lubr. (?)
<u>Condenser: type</u>	Conventional	Conventional	Conventional	Conventional
pressure, psia	10	20	10	10
<u>Regenerator (feedwater preheater):</u>	(None)	(None)	Shell and tube ( $\epsilon_0 = 0.45$ )	Shell and tube ( $\epsilon_0 = 0.45$ )
<u>Lubricant Separator:</u>	Centrifugal	(None)	Centrifugal	(Centrifugal, if required)

<sup>a</sup>V-6 for large engines.

bathes the rings in oil... (Ref. 7-7), but this also contaminates the steam with excess oil. A centrifugal separator, located at the low-pressure condensate pump exit, removes the oil from the water, preventing oil decomposition and the resulting deposits on the boiler tube walls.

Power control of the SES engine is accomplished by varying the duration of steam admission to the cylinder, which varies the mass flow rate of working fluid and the mean effective pressure. Fuel flow responds to increase in mass flow rate, maintaining constant pressure and temperature at the boiler exit. In the Carter engine, power is controlled by varying the boiler pressure, while temperature is maintained at a constant level. A throttling valve is used between the boiler and expander to reduce pressure in transient and low-power situations.

The relatively high freezing point of the water working fluid requires antifreeze protection for the steam engine in cold-weather locales. SES has engineered antifreeze protection into its design; Carter has left this aspect for future development.

The total weight of the present Carter and SES power systems (as previously described in Table 7-4) are shown as single point values on Fig. 7-15. The effective polar moment of inertia for the SES system is shown as a single point value in Fig. 7-16.

#### MATURE CONFIGURATION

The Mature configuration of the Rankine engine, represented by the third data column of Table 7-4, constitutes a projected production

version (under known technology) of the Present configurations. It operates at somewhat higher maximum expander inlet temperatures and pressures than the Present analogs for reduced fuel consumption and increased power density. Present Rankine engines suffer from what was once only an academic drawback — low efficiency. The national importance of fuel economy today mandates that the Mature configuration embody operating characteristics which yield maximum efficiency. Hence the evolution of the Mature configuration was based on two principles: first, select components that have the highest current efficiency and realistic potential for still higher efficiency; second, make necessary design improvements toward higher efficiency within the constraints of presently available materials and design technology at reasonable cost.

The strongest single influence on Rankine cycle efficiency is maximum operating temperature. The practical limit of available temperature increase is dictated by the type and amount of material used in the boiler superheater and the expander hot parts and by lubricant considerations.

To reduce the quantity of high-cost superalloy required, pressure-temperature (P-T) scheduling is incorporated in the Mature configuration. Recognizing that an automotive engine is rarely operated at, or near, full power, one can design a pressure-temperature program into the engine controls for maximum efficiency at part load and accept an efficiency penalty near full load. This control schedule provides the capability to operate the boiler and expander at maximum temperatures at lower cycle pressures and to allow that temperature to drop somewhat (on the order of 200° F) at maximum pressure. Since maximum pressure and temperature are not permitted to occur simultaneously, the results are reduced creep and stress-rupture limitations on the design. This permits a significant decrease in the quantity of superalloy employed. While the high operating pressure has only a small effect on system efficiency, it does significantly improve power density. As design maximum pressure increases, expander displacement decreases, which results in lower system weight.

Thus, at temperatures up to about 1400° F, superalloy content in high-temperature parts can be minimized. Using the aforementioned P-T scheduling, it is possible to operate within the creep, stress-rupture, and oxidation-resistance limits of stainless steel in the vapor generator tubing, steam chests, and vapor-generator/expander (interconnect) piping. Even with P-T scheduling, a Rankine engine designed for maximum temperatures much in excess of 1400° F, with vapor-generator maximum outlet pressures in the 2000-3000 psia regime and realistic component section thicknesses, would require extensive use of costly superalloys in these comparatively heavy components, and would not provide sufficient improvement in efficiency (at 1600° F,  $\Delta\eta_c \sim 3\%$ ) to justify the increased materials cost.

The Mature configuration utilizes a fixed-admission (piston-actuated poppet valve), PD uniflow expander with cylinders in a V arrangement. Four cylinders would serve for all but the highest design horsepowers (two cylinders might

be used in very small engines). This type of expander was selected based on the requirements of high mechanical and thermal efficiency, minimum complexity, and light weight. An individual isotensoid (near-uniform-stress shape) steam chest is provided for each cylinder to reduce weight and material cost. The valve operation is simplified over a variable-admission type by eliminating camshafts, associated variable drives, and valve lifters. This reduces weight and mechanical losses. Proper design of the inlet poppet valve, i. e., large flow area and negligible leakage, reduces irreversible steam throttling at high mass flow rates — a typical source of inefficiency in Rankine expanders. In addition, efficient, large-inlet-area, piston-actuated valves allow high rotational speeds (5000+ rpm) which reduce the time available for heat transfer from the expanding steam to the piston and cylinder walls. An expander of this type is estimated to have an overall efficiency of 85%. This assumption is based on present performance data and projected design refinements/improvements.

It is interesting to note that SPS has recently directed its expander research and development effort toward developing a large-area poppet-valve, PD uniflow expander. (The SPS expander used in the California Clean Car Project was a double-acting compound, variable-admission type.)

Utilization of a fixed-admission expander necessitates a highly responsive variable-pressure boiler. Recent design practice of varying expander inlet pressure via a throttle valve causes large irreversible losses by the very nature of the process. This is unacceptable from the standpoint of overall cycle efficiency and tends to negate the high efficiency of the fixed-admission expander. Acceptable pressure response requires a highly responsive feedwater flow control system together with a correspondingly responsive fuel-flow control system.

Lubrication of the piston rings in the Mature expander is a potential problem due to the high temperatures involved, although oil injected into the piston rings would see substantially lower temperatures than the maximum steam inlet temperature. In any case, the oil would experience its maximum-temperature environment only for small fractions of a second, reducing the amount of carbonizing and decomposition. A centrifugal separator is needed in this system due to the presence of oil in the exhaust steam.

Figure 7-15 shows the projected weight of the Mature configuration as a function of design horsepower. The solid (upper) curve represents the total power system weight — including battery and transmission — while the dashed (lower) curve is for the engine "ready-to-run." The corresponding equivalent moments of inertia for the engine alone, and the power system, are given in Fig. 7-16 as functions of design horsepower.

#### ADVANCED CONFIGURATION

The Advanced configuration, conceptually defined by the fourth data column of Table 7-4, constitutes a projection of how the Rankine engine could evolve if the research and development efforts described in Sections 7.3.3 and 7.7 were

successfully executed. It represents a production technology which might only be achieved in the late 1980's or beyond. The most significant difference from the Mature configuration is in the use of monolithic ceramic components of the silicon nitride or silicon carbide type, in lieu of superalloy or stainless steel components, for critical "hot parts" in the vapor generator, expander and their interconnect passages. Employment of such ceramic structures offers potential improvement in three areas:

- (1) Increased cycle thermal efficiency, approaching 34% at the design point, via higher operating temperature (circa 2000° F boiler exit temperature) capability.
- (2) Lower production cost.
- (3) Lower total engine weight.

Additional improvements include integrating the ceramic boiler with the expander, reducing heat losses, and maintaining maximum boiler exit temperature at 2000° F without pressure-temperature scheduling. The fixed-admission piston/poppet expander is retained, with ceramic hot-side components and high-temperature valves. The system also includes a conventional aluminum condenser and a shell-and-tube regenerator.

Weight and inertia estimates were made only for a nominal 150-hp engine of the Advanced configuration. These are shown as isolated points in Figs. 7-15 and 7-16.

### 7.3.3 Materials and Producibility

#### COMPONENTS, MATERIALS, PROCESSES AND WEIGHT BREAKDOWNS

Table 7-5 lists the Rankine engine parts breakdown for 150-hp engines of Present, Mature and Advanced configuration. For each subassembly and component, there is an estimate of the weight, together with an indication of material of construction and manufacturing process. The primary material for critical components is listed by material family (Table 7-6), and a process coding technique (Table 7-7) is employed to signify the dominant manufacturing process.

Table 7-8 exhibits the Rankine weight breakdowns by material types. Unlike a conventional Otto engine, the Rankine engine requires the use of high-temperature materials such as stainless steels and/or superalloys and/or ceramics for certain components. The ability to withstand high temperatures is required in the vapor generator and expander assemblies. The balance of the engine components do not require this high-temperature capability and may be fabricated from more-or-less readily available, conventional automotive materials and processes. The critical high-temperature components are discussed individually in the following sections.

Component and engine weights shown herein are net weights without an allowance for scrap. Scrapage has been allowed for in the unit costs presented later in this chapter. The details of the costing methodology are discussed in Chapter 11 ("Manufacturing and Cost"). The current

situation with regard to scrap recycling, the potential for increased future scrap recycling, and the effects of scrap on aggregate material consumption are discussed in Chapter 18.

In the Rankine cycle the thermal efficiency increases with maximum working-fluid temperature, and the normal constraints or limits on this parameter are the operating temperature limits of the containment materials and the thermal stability of the working fluid and lubricants.

Materials of construction used to date in the development of Present configuration automotive Rankine engines have been conventional in terms of mass-production availability and producibility. These primary materials — cast iron, conventional steels, and aluminum alloys — have proven adequate at steam temperatures up to 1000° F at 1000 psi.

However, off-the-shelf motor oils cannot be used for piston lubrication because of some of their additives and their high detergency, which results in the rapid formation of a heavy emulsion in contact with steam. Oil cannot, of course, be allowed to enter the boiler, where it would be decomposed and produce detrimental deposits. A specially formulated lubricant, based on natural hydrocarbons with special additives, has been developed for steam systems at 1000° F and 1000 psi. It should be remembered that the oil temperature is lower than the steam temperature. Carter has reported (Ref. 7-16) that by bathing the piston rings in oil, and through use of an inlet valve design that does not require lubrication, such tailored oils can be utilized at steam temperatures in excess of 1000° F. A 1000° F steam temperature corresponds to an oil temperature of about 700° F.

#### MATURE CONFIGURATION VAPOR GENERATOR

For the Mature configuration, wherein P-T scheduling has been employed as discussed previously, superalloy has been eliminated from the vapor generator tubing. Austenitic stainless steel (preferably 316L for its corrosion resistance and weldability) has been selected for the vapor generator tubing. For reasons of economy, aluminum fins could be used in the preheater section of the vapor generator, with steel fins in the evaporator section. The superheater section in the Mature configuration is not finned. In a Rankine engine, high material temperature occurs at the flame side of the superheater tubing. For a 1000° F steam temperature, the wall temperature of the superheater tube could be in the range of 1050-1100° F, and the fins (if employed) could reach as high as 1200° F. For the Mature configuration, with a maximum outlet steam temperature of 1400° F, the material temperature in the wall will likewise be somewhat higher. The Mature configuration superheater tube is not finned, thus avoiding a fin temperature problem.

While a sophisticated stress analysis was beyond the scope of this study, a cursory design concept analysis indicated the feasibility of P-T scheduling to permit our Mature configuration superheater tubing to stay within the creep, stress-rupture, and oxidation resistance limits for stainless steel while maintaining a reasonable

Table 7-5. Rankine engine parts breakdowns

Component or subassembly	Present configurations		Mature configuration			Advanced configuration		
	J. Carter (90 hp) Weight, lb	SES (150 hp) Weight, lb	Conjectural (150 hp) Weight, lb	Mtl. <sup>a</sup>	Proc. <sup>b</sup>	Conjectural (150 hp) Weight, lb	Mtl. <sup>a</sup>	Proc. <sup>b</sup>
<u>Vapor generator assembly</u>	(98)	(165)	(164)			(128)		
Preheater and evaporator tube fins			{ 5 J 10 B }		10	80	I	76
Vapor generator tubing			99	E	28			
Vapor generator housing			25	E	54	20	E	54
Insulation			3	Z	07	5	Z	07
Combustor atomizer			3	E	80	3	E	80
Combustor blower			2	J	01	2	J	01
Combustor liner			1	H	54	2	I	76
Ignition assembly			5	Z	00	5	Z	00
Air cleaner ducts, diffuser, etc.			11	Z	00	11	Z	00
<u>Expander Assembly</u>	(76)	(428)	(221)			(172)		
Cylinder block			68	A	61	65	A	61
Steam chest(s)			27	E	63	Manifold, steam chest and head integral with boiler subassembly		
"Head"/valve/valve seat/spring subassemblies			10	H	80	3	(?)	(?)
Cylinder liners			6	E	68	6	I	78
Vapor generator to expander, piping			8	E	28	--	--	--
Piston crowns			2	E	63	1	I	76
Skirts and rings			10	A	61	{ 3 A 4 I }		{ 76 61 }
Connecting rod subassemblies			12	D	63	12	D	63
Crankcase			25	J	61	25	J	61
Bearings			5	D	07	5	D	07
Crankshaft			30	A	63	30	A <sup>2</sup>	63
Lubricant pump and filter			11	Z	07	11	Z	07
Lubricant			7	Z	07	7	Z	07
<u>Condenser Assembly</u>	(41)	(113)	(88)			(88)		
Condensor			70	J	14	70	J	14
Fan and shrouds			18	Z	00	18	Z	00
<u>Fuel control system</u>	incl. in vapor generator	(12)	(12)	Z	00	(12)	Z	00
<u>Power control system</u>	(13)	(10)	(15)			(15)		
Throttle valve			5	Z	00	5	Z	00
Electronic components			10	Z	00	10	Z	00
<u>Water feed system</u>	(67)	(90)	(198)			(198)		
Feed and condenser pumps			30	Z	07	30	Z	07
Feedwater preheater	none	none	35	B	78	35	B	78

Table 7-5 (contd)

Component or subassembly	Present configurations		Mature configuration			Advanced configuration		
	J. Carter (90 hp) Weight, lb	SES (150 hp) Weight, lb	Conjectural (150 hp) Weight, lb	Mtl. <sup>a</sup>	Proc. <sup>b</sup>	Conjectural (150 hp) Weight, lb	Matl. <sup>a</sup>	Proc. <sup>b</sup>
Centrifugal separator		none	20	Z	00	20 <sup>c</sup>	Z <sup>c</sup>	00 <sup>c</sup>
Condensate tank			6	B	34	6	B	34
Freeze protection	none		35	Z	00	35	Z	00
Accumulator and piping			30	B	78	30	B	78
Water			42	Z	07	42	Z	07
<u>Auxiliary drives</u>	included above	(65)	(30)	Z	07	(30)	Z	07
<u>Engine auxiliaries</u>	(34)	(34)	(26)			(26)		
Starter			9	Z	07	9	Z	07
Alternator			17	Z	07	17	Z	07
<b>Total, engine, ready-to-run</b>	<b>(329)</b>	<b>(917)</b>	<b>(754)</b>			<b>(669)</b>		
<u>Transmission</u>	(120)	(150)	(150)	D,J	80	(150)	D,J	80
<u>Battery</u>	(35)	(50)	(50)	Z	07	(42)	Z	07
<b>Total, power system</b>	<b>(484)</b>	<b>(1117)</b>	<b>(954)</b>			<b>(861)</b>		

<sup>a</sup>Mtl = Material Type Code (from Table 7-6).

<sup>b</sup>PROC = Process Code (from Table 7-7).

<sup>c</sup>Not required if self-lubricating parts, or solid lubricant could be employed.

wall thickness. If P-T scheduling was not used, then a portion of the vapor generator tubing would have to be made from superalloy.

The vapor generator housing and the combustion atomizer can be fabricated from austenitic stainless steel. With the exception of the combustor liner, the rest of the Mature vapor generator assembly employs conventional materials and processes. The combustor liner also experiences a high temperature and, in the Mature configuration, is of superalloy. It operates at low stress levels as compared to the steam generator tubes. Resistance to oxidation and embrittlement is more critical than maximum strength for this component.

#### MATURE CONFIGURATION EXPANDER

The most critical subassembly in the expander assembly, from a materials standpoint,

is the "head"/valve/valve seat/spring sub-assembly. Its components have been configured to be fabricated from superalloy, even with the utilization of P-T scheduling. This subassembly is subject to impact loading, a cyclic high stress from the differential pressure between the steam reservoir and the exhausted cylinder, requirement for minimum heat dissipation, and necessity of low valve mass (to allow the valve to actuate at high engine RPM).

P-T scheduling permits the steam chests and the vapor generator-to-expander interconnect piping to be of austenitic stainless steel. Type 316L is again the likely candidate due to its good corrosion resistance and weldability. The absence of P-T scheduling would require both of these major parts to be of superalloy at the Mature configuration temperatures and pressures (Table 7-4).

Table 7-6. Material type codes

A.	Cast iron (all types, gray, malleable, nodular, ductile, GM-60, NIRST, etc.)
B.	Carbon steel (AISI grades, etc.)
C.	High-carbon steel (AISI grades, etc.)
D.	Alloy steel (AISI grades, includes carburizing and nitriding grades, etc.)
E.	Austenitic stainless steel (300 series, 200 series, special modifications such as CRM-6D, etc.)
F.	Ferritic or martensitic stainless steel (400 series, etc.)
G.	Precipitation-hardening stainless steel (A-286, 17-4 PH, 15-5 PH, etc.)
H.	High-temperature superalloy (Inconels, Hastalloys, Waspalloys, Renes, INs, 713LC, Multimetts, other specialty alloys, etc.)
I.	Ceramic
J.	Aluminum alloy
K.	Copper alloy
L.	Plastic or Teflon or Rulon
M.	Rubber or elastomeric material
Z.	Nonhomogeneous or miscellaneous

Table 7-7. Process codes

10	Brazed	01	Casting
20	Welded	02	Investment casting
30	Formed	03	Forging
40	Unassigned code	04	Sheet
50	Stamped	05	Plate
60	Machined	06	Ceramic Concrecence <sup>a</sup>
70	Fabricated	07	Purchased
80	Mechanically assembled	08	Tubing
00	Nonhomogeneous assembly or miscellaneous	09	Bar stock

<sup>a</sup>The term "concrecence", as used in this study, is a generic one referring to any existing or potential fabrication process which yields a completed ceramic shape or integral structure.

Table 7-8. Rankine weight breakdowns by material type

Material type	Material code	Mature quantity, lb	Advanced quantity, lb
Cast iron	A	108	98
Carbon steel	B	81	71
High-carbon steel	C	--	--
Alloy steel	D	17	17
Austenitic stainless steel	E	170	23
Ferritic or martensitic stainless steel	F	--	--
Precipitation-hardening stainless steel	G	--	--
Superalloy	H	11	--
Ceramic	I	--	93
Aluminum alloy	J	102	97
Copper alloy	K	--	--
Plastic or Teflon or Rulon	L	--	--
Not broken down (conventional auto materials <sup>a</sup> ), non-homogeneous, or miscellaneous)	Z	265	270
Total, engine ready-to-run <sup>b</sup>		754	669

<sup>a</sup>Conventional auto materials do not include E, F, G, H, and I, but do include additional quantities of the others explicitly listed.

<sup>b</sup>Does not include transmission or battery.

The piston crowns are likely to be fabricated from austenitic stainless steel regardless of P-T scheduling. The cylinder liners also have been chosen to be of austenitic stainless steel for corrosion resistance. However, an alloy steel may be satisfactory for the temperature and stress levels encountered, if adequate corrosion protection is provided. In either case, channel chrome plating may be used to improve the liner wear characteristics. The liner choice is also independent of P-T scheduling.

Antifriction bearings may be required on both ends of the connecting rods, and for the crankshaft main bearings, due to the high loads imposed and limited space available in a compact expander design. Such bearings are state-of-the-art technology and mass-producible, but are more costly than conventional automotive engine journal bearings.

#### MATURE CONFIGURATION P-T SCHEDULING CONSTRAINT

The importance to the Mature configuration of successfully implementing the P-T scheduling technique cannot be overemphasized. Without such P-T scheduling, the sustained operation at a cycle temperature of 1400°F and pressure of 2500 psia, in a machine having reasonable component wall thicknesses, would require exorbitant quantities of superalloy. Inspection of Table 7-5 indicates that, if the steam chests, applicable portions of the vapor generator tubing, and interconnect piping had to be fabricated of superalloy (in addition to those components already shown as superalloy), the Mature Rankine engine's total consumption could be in the range of 60-90 pounds per unit. This would be unacceptable in mass production from both the cost and materials availability standpoints.

#### MATURE CONFIGURATION LUBRICATION

Lubrication of the expander pistons becomes increasingly problematical as inlet steam temperature is increased, due to the thermal stability limitation of available oils. Satisfactory lubrication has been demonstrated at 1000°F steam temperatures (believed to correspond to a maximum oil temperature of circa 700°F) in Present steam engines, as has been noted previously. From preliminary indications, it appears to be within the capability of tailored hydrocarbon/synthetic lubricant technology to develop (by the mid 1980's) a lubricant compatible with the maximum steam temperatures encountered in the Mature configuration. However, this contention is tentative and somewhat controversial, awaiting further laboratory and in-engine testing.

#### ADVANCED CONFIGURATION

The Advanced configuration is conceived as having a monolithic ceramic structure for the vapor generator hot parts such as the preheater, evaporator, superheater, and integral fins (if they are employed). The manifolding, steam chests, and heads also are integral with the boiler assembly and of ceramic. Silicon carbide or silicon nitride are the likely candidate materials. The reader should refer back to Chapter 5 for a detailed discussion of the potential of these ceramic materials, and to Section 7.7 and Chapter 12 for the requisite R&D.

The combustor liner — a lightly mechanically loaded component — is also a prime candidate for fabrication from silicon carbide or silicon nitride. Additional Advanced configuration components for which ceramic construction is believed advantageous are parts of the piston subassembly (Table 7-5).

The question of piston ring lubrication must be resolved. At least three parallel paths seem

open at this point to implement the Advanced configuration:

- (1) Dry-running (self-lubricative) pistons, perhaps ceramic-on-ceramic or refractory metal (neither yet demonstrated).
- (2) High-temperature solid lubricant impregnant such as molybdenum disulfide (also not yet demonstrated for the operating environment of the Advanced configuration).
- (3) Ultrahigh-temperature capability synthetic lubricating oil (not yet developed).

Also, a suitable inlet valve and spring materials system will have to be developed. A ceramic valve, although not yet demonstrated, might prove a viable candidate from the standpoint of the hot (2000°F) aqueous environment. It is uncertain, however, whether the brittleness of ceramic materials will ever be compatible with the sustained high-frequency impact loading implicit in this application. Uncoated refractory metals might tentatively be considered as alternate materials, but may prove susceptible to degradation by oxidation, as well as being very costly and of questionable availability in mass production quantities. Coated refractory metals would be exceedingly difficult to implement in this application, again due to the impact loading. For the springs, ceramics are almost certainly unusable, and (coated?) refractory metals might conceivably be an option, provided the cost and availability problems could be tolerated.

It should be emphasized that the Advanced Rankine configuration, and the supporting materials and processes embodied therein, were conjectured solely for the purpose of estimating the long-term performance potential of the Rankine power system under parity of technology with the other Advanced alternates. It is acknowledged that the myriad technological problems to be overcome in actually attempting to produce such a configuration are indeed formidable — probably more so than the Advanced configurations of the other alternate engines. These discussions should therefore not be construed as endorsements of, nor recommendations for, development.

#### FEEDWATER PUMP

The feedwater pump for both the Mature and Advanced configurations is a positive-displacement, reciprocating, variable-flow pump. It does not require any exotic materials, but it is necessarily a complex component from a producibility standpoint and therefore costly.

#### OTHER ASSEMBLIES

Other assemblies, such as the fuel and power control, auxiliary drive, and engine auxiliaries for both the Mature and Advanced power systems, while still requiring finalization of their specific configurations, are basically state-of-the-art relative to materials and processes. The condenser could be made from either aluminum or copper. A fluxless brazed aluminum design has been selected herein. The water feed system, with the exception of the previously discussed feed pump, is straightforward.

For general corrosion and scale control purposes, it will be necessary to use distilled water in a closed system.

#### 7.3.4 Unit Costs

The Rankine engine unit costs are based on the configuration and materials presented in preceding sections. Material costs and labor rates are consistent with those used in estimating the costs of the other alternate engines and reflect the mass-production environment particular to the automobile industry. Labor content is estimated based on representative automation for a production rate of 400,000 units per year.

The material content of the Mature Rankine engine is marked by a high proportion of stainless steel, predominantly in the vapor generator, and a small amount of superalloy in the high-temperature, high-stress area of the expander assembly. Comparison of the material content of the Rankine and the Stirling engines show that the Rankine has over twice the weight of stainless steel and approximately the same weight of superalloy. Approximately one-fourth of the weight of the Rankine engine is in these metals, accounting for the relatively high unit cost and the high slope of the cost vs horsepower curve (compared to the Mature UC Otto engine).

Specific subsystems which are cost-intensive are: the vapor generator, due to its high stainless steel weight; the feedwater pump, which is a 3000-psi, controllable-output device; and the high-temperature components of the expander, due to the cast stainless steel steam chests and the investment-cast superalloy inlet valve and valve seat assemblies. Controls for Rankine engines, notably power control and automatic start sequencing, are also relatively costly subsystems.

The labor content of the Rankine engine is slightly higher than that of the Otto engine due to the increased number of component systems. Cost details of the Rankine engine at the subsystem level are given in Chapter 11.

Power system unit variable costs as a function of horsepower are shown in Fig. 7-17.

### 7.4 VEHICLE INTEGRATION

#### 7.4.1 Engine Packaging in Vehicle

Rankine engines are generally considered to be bulkier than equivalent Otto engines; but the Jay Carter prototype installation in the rather confined engine compartment of a subcompact (Ref. 7-14) demonstrates the feasibility of packaging the Rankine engine in about the same volume as an Otto engine. (One segment of the condenser was mounted in the front of the rear-engined vehicle.) Careful attention will have to be devoted to accommodating and driving the accessories and numerous auxiliaries within the available engine compartment space. The Rankine engine requires an exterior heat exchanger (condenser) of considerably larger capacity than an equivalent Otto-engine radiator. Overall, the Rankine engine installation is judged to fit the same engine compartment as the equivalent Otto

engine, so that no net change in vehicle size results.

#### 7.4.2 Transmission Requirements

Fixed-admission Rankine engines have an rpm range similar to that of Otto engines, with somewhat better low-speed torque, and can thus use the same transmission types (i.e., 3- or 4-speed, in automatic or manual versions). Transmission improvements envisaged for Otto-engined cars, such as lock-up torque converters and CVT's (Ref. Section 10.6.2), would benefit the Rankine engine to a lesser extent because of its "flatter" BSFC map (see Fig. 7-8).

#### 7.4.3 Other Vehicle Design Impacts

As in decades past, the Rankine's startup time may cause unfavorable customer reaction. The time from key-on to either sufficient net power to drive away (say 20% of maximum), or substantially full power, is important to the driver. For the Mature Rankine engine in 70°F ambient temperature, these times are expected to be about 15 sec and <60 sec, respectively. These compare with 2-10 sec for both cases with an Otto engine. (As the ambient temperature decreases, startup interval lengthens for all heat engines.)

Protection against freezing will also require special attention in the Rankine-engined car. Since the working fluid must be pure water, the usual glycol antifreeze compounds cannot be used. One suggestion is to drain the water to a well-insulated central sump where it can be kept sufficiently heated (and from which it would have to be pumped back into the engine at startup). The amount of fuel required for this would be about 2 gallons per month with an average ambient temperature of -20°F (Ref. 7-7).

### 7.5 PERFORMANCE IN VEHICLE

Fuel economy estimates and emissions trends were calculated for Mature Rankine-engined vehicles in the six Otto-engine-equivalent (OEE) automobile classes of interest to this study, using the Vehicle Economy and Emissions Prediction (VEEP) computer program described in Chapter 10. The adjustments for weight propagation effects and torque characteristics are also described in Chapter 10. Specific fuel consumption and emissions index data presented in Sections 7.2.2 and 7.2.4, respectively, were used in the computation. These computer predictions, together with limited available emission test data, constituted the basis for vehicular performance projections. The results are described in the following sections.

#### 7.5.1 Fuel Economy

Predicted fuel economies for Rankine engine vehicles in the six OEE size classes are given in Table 7-9. They are reported in terms of equivalent gasoline consumption for comparison with other alternates, although diesel or "broad-cut" distillate would probably be the future fuel of choice. Three entries shown for the Present Rankine, in Table 7-9, correspond to the prototype (non-OEE) Aerojet, Carter, and SPS vehicles (which would not be produced as such).



Table 7-9. Rankine vehicle fuel economy projections in mi/gal (gasoline) over the urban (FDC-U) and highway (FDC-H) Federal Driving Cycles

OEE <sup>a</sup> auto. class	Curb weight, lb	Design maximum power, hp	Present configuration		Mature configuration		Advanced configuration	
			FDC-U	FDC-H	FDC-U	FDC-H	FDC-U	FDC-H
Mini	1720	48			27.1	36.0		
Small	2220	66	14.6 <sup>b</sup>	17.3 <sup>b</sup>	22.4	29.7		
Subcompact	2710	90	8.5 <sup>c</sup>		19.2	25.4		
			5.8 <sup>d</sup>					
Compact	3200	119			16.8	22.3	24	31
Full-Size	4130	166			13.3	18.2		
Large	5160	215			10.7	15.1		

<sup>a</sup>Otto-engine equivalent.

<sup>b</sup>Non-OEE 2750-lb inertia weight vehicle, Carter.

<sup>c</sup>Non-OEE 3000-lb inertia weight vehicle, Steam Power Systems.

<sup>d</sup>Non-OEE 3000-lb inertia weight vehicle, Aerojet.

The Mature configuration, as specified in Section 7.3, operates within somewhat higher pressure and temperature limits than the Present configuration and, hence, at higher efficiency. Its torque characteristics permit about a 5% reduction in design horsepower in the OEE vehicles below those of Otto-engined cars, but the Rankine cars are heavier. The net result of the efficiency and weight effects is fuel economies better than those of Present Rankine vehicles, but not as good as those of Mature Otto-engined cars (see Chapter 3). Relative to the Mature Otto-engined vehicles, the OEE Rankine cars show a fuel economy disadvantage<sup>3</sup> of about 6% on the urban Federal Driving Cycle, and about 14% on the highway cycle.

In the Advanced configuration, fuel economies were estimated for the reference size (OEE Compact) vehicle only. At this level of technology, the situation is reversed, and the Rankine vehicle betters the fuel economy of an Advanced Otto-engined Compact car by 14% over the FDC-U, and by about 3% over the FDC-H.

The computational inaccuracy in these fuel economy estimates is small, and the unquantifiable uncertainty lies in developmental attainment of the stipulated component performance.

#### 7.5.2 Chemical Emissions

Emissions projections for vehicles in the six OEE car classes with Mature Rankine engines are given in Table 7-10. These projections are for the Urban Federal Driving Cycle (1975 FTP) — of most significance from the urban air quality standpoint — and for well-maintained cars at 50,000 miles. It should also be noted that these data are for gasoline, but should be reasonably representative even for the denser distillates (diesel, kerosene, JP-4, "broad-cut") likely to be used in Rankine-engined cars. These estimates were based upon vehicle test results, corrected for Present/Mature differences in fuel consumption. Scaling across the spectrum of vehicle classes was accomplished by means of trends established with the VEEP computer program, using stepwise integration of steady-state emission index data (see Section 7.2), adjusted for cold-start effects. Also cited in Table 7-10 for comparison are experimental results for the Aerojet, Carter, and S.P.S. cars — all nonoptimum preprototype units.

While it is acknowledged that the Mature Rankine-engined vehicle emissions projections are fairly rough estimates, and subject to greater uncertainty than the fuel economies, they are far

<sup>3</sup>Based upon sales-weighted fuel consumption, present market mix of car classes.

Table 7-10. Rankine vehicle emissions projections in g/mi (gasoline) over the urban Federal Driving Cycle, FDC-U (1975 FTP)

OEE <sup>a</sup> auto. class	Curb weight, lb	Design maximum power, hp	Present configuration			Mature configuration		
			HC <sup>b</sup>	CO	NO <sub>x</sub> <sup>(2)</sup>	HC <sup>b</sup>	CO	NO <sub>x</sub> <sup>c</sup>
Mini	1720	48				0.11	0.47	0.13
Small	2220	66	(0.41	1.10	0.34) <sup>d</sup>	0.13	0.62	0.15
Subcompact	2710	90	(0.31	3.00	0.30) <sup>e</sup>	0.14	0.83	0.19
			(0.13	2.98	0.54) <sup>f</sup>			
Compact	3200	119				0.16	1.0	0.21
Full-Size	4130	166				0.19	1.5	0.28
Large	5160	215				0.22	1.8	0.35

<sup>a</sup> Otto-engine equivalent.

<sup>b</sup> As C<sub>6</sub>H<sub>14</sub>.

<sup>c</sup> As NO<sub>2</sub>.

<sup>d</sup> Non-OEE 2750-lb inertia weight vehicle, Carter.

<sup>e</sup> Non-OEE 3000-lb inertia weight vehicle, Steam Power Systems.

<sup>f</sup> Non-OEE 3000-lb inertia weight vehicle, Aerojet.

enough below the statutory emission standards (0.41/3.4/0.4 g/mi of HC/CO/NO<sub>x</sub>) to make a convincing argument that Mature Rankine vehicles delivering the projected fuel economies would pose no emissions problems. It is also reasonably clear that additional attention is required in burner design to meet the statutory NO<sub>x</sub> standard, especially in larger cars. This should be manageable relatively easily through judicious use of step-quenching, lean burning, and EGR.

There do not appear to be any significant problems with the Rankine engines in the realm of unregulated chemical pollutants (SO<sub>4</sub><sup>-</sup>, particulates, smoke, and odor) at this writing. Since no oxidizing catalyst is used, nor such use envisioned, there will be no agency to promote any trace of sulfur in the fuel to the hexavalent state, hence the absence of a significant sulfate problem. Further, in the low-pressure continuous-combustion Rankine engine, maximum combustion temperatures and pressures are lower than in the conventional Otto engine, further ameliorating any concern over sulfur emissions as SO<sub>4</sub><sup>-</sup>. However, most of the denser distillate fuels, which might also be used in Rankine cars, contain more trace sulfur than gasoline. If these fuels are used, the question of general sulfur emissions (i.e., SO<sub>x</sub>) will have to be addressed. Since sulfur can be deleterious to engine hot parts, some desulfurization of fuels may provide an effective approach to both problems.

On the basis of current Rankine-engine behavior, smoke and odor do not appear to pose serious problems. Aside from sulfurous compounds, most odorous species are incompletely oxidized hydrocarbons (e.g., aldehydes). Although olfactory detection limits are, in many cases, considerably lower than the statutory HC limit, combustion systems which provide effective HC control will probably be acceptable from the odor (and also smoke) standpoints as well.

No particulate emission data were reported in the available Rankine engine literature, its ostensible cleanliness in this regard probably being assumed by virtue of its observed smokelessness with a well-designed burner. However, microparticulate emissions do tend to be a problem, which may pass unobserved, in any droplet-burning engine using heavy-fraction fuels (e.g., diesel fuel). This concern therefore deserves some attention if use of diesel fuel is contemplated in Rankine vehicles. If this problem were to arise, several expedients are at hand: (1) use gasoline; (2) use a prevaporizing burner (which may be easy to implement in a vapor generator); or (3) use a monocomponent or nonpetroleum fuel.

Further study of all four questions — sulfur, odor, smoke, and particulates — would be required during development, depending upon the selected fuel.

### 7.5.3 Noise Emissions

With good acoustic design, Rankine power systems can be quieted at least as well as conventional engines, and probably more so. Some design attention is required for mechanical sources, such as the expander valves, fans, and feed pump, but no difficult problems are apparent. Vehicle-related road noise for Rankine-engined cars will, of course, be comparable with that of conventional cars.

### 7.5.4 Drivability Aspects

The response of a Rankine-engined car is largely a matter of controls development/implementation. Even now, the overall acceleration response of experimental Rankine cars is at least no worse than that of emission-controlled Otto cars. With suitable matching of the engine and drive train, the Rankine car's initial getaway can be somewhat more brisk than that of the equivalent Otto car because of the Rankine torque characteristics.

The engine start-up characteristics of the modern Rankine automotive engine have been improved to an acceptable level. Jay Carter estimates startup times of approximately 15 sec for his second-generation steam car, and other recent designs start up in one minute or less (Ref. 7-7).

### 7.5.5 Safety

A production Rankine-engined car would be at least as safe — and, if diesel or "broad-cut" fuel is used, more safe — to operate than a conventional Otto-engined car. This is not to say that there are no potentially hazardous aspects of the engine. However, careful design, validated by failure-mode testing in development, will eliminate any concern to the owner. The most obvious area where such attention is required is in the high-pressure portions of the working fluid loop. The pressurized components could fail either: (1) under normal conditions due to a structural flaw, or (2) under an abnormal (overstress) condition due to some control system malfunction. Careful quality control should minimize the incidence of the former, while appropriate control-system safety interlocks and steam system relief valves will help prevent the latter. High-pressure lines would be routed for maximum shielding; pressurized volumes would be minimized; and appropriately designed housings would be provided, where necessary, to contain the high-kinetic-energy fragments in the unlikely event of a burst failure.

Combustor ignition and unscheduled flameout detection, as well as overtemperature protection, must also be provided in the control system safety provisions. Some use of redundant sensors and majority-vote logic may be warranted.

Further discussion of engine and vehicle safety is presented in Chapter 16.

## 7.6 OWNERSHIP CONSIDERATIONS

The vehicle's owner is generally indifferent to the specific details of how his automobile's power system operates. Already accustomed to

Otto-engined car ownership, his major concerns in considering a Rankine car would be: "How does it perform in use?"; "Is it as safe as a conventional (Otto) car?"; "What will it cost me?"; and "How often must it be garaged for maintenance?". The first two questions have been answered in the foregoing sections. The latter two are addressed in this section.

### 7.6.1 Maintenance

A production Rankine engine could have maintenance requirements (and maintenance cost) comparable to those of a catalyst-controlled Otto engine. On the basis of repetitive exposure to the high-temperature aqueous environment, it is reasonable to assume that regular oil changes and oil filter replacement will probably be required as frequently as for a conventional Diesel engine. Pure (distilled) water would have to be added periodically, as make-up working fluid. Regularly scheduled maintenance items (analogous to a minor tuneup) would probably include the following:

- (1) Replace air cleaner.
- (2) Change oil/replace filter.
- (3) Change fuel filter.
- (4) Check/adjust air-fuel control system.
- (5) Check/adjust EGR valve (if any).
- (6) Check/adjust pressure control system.
- (7) Replace ignitor.
- (8) Clean atomizer nozzle.
- (9) Add make-up to, or drain/refill, water system.

Long-period, as-required maintenance items would include:

- (1) Service expander valves and piston rings.
- (2) Replace fuel pump.
- (3) Replace condensate pump.
- (4) Service feedwater pump.
- (5) Service/replace oil separator.
- (6) Repair/replace pressure control components.
- (7) Replace temperature sensor(s).
- (8) Replace belts.
- (9) Replace hoses.
- (10) Service freeze protection system.

Some retraining of mechanics would be required, as well as introduction of new types of diagnostic and repair equipment in maintenance garages. With a ten-year phased introduction period, this transition could be easily

accommodated. Phase-in of new parts into the existing aftermarket distribution system could likewise be easily accomplished.

Maintenance for the rest of the vehicle would be identical to that of an Otto-engined vehicle.

### 7.6.2 Incremental Cost of Ownership

Assuming that the Rankine vehicle owner would operate his car in essentially the same manner as an equivalent Otto-engined automobile, the increment in ownership cost comprises the difference between the sums of depreciation, fuel and engine-expended fluids cost, and maintenance cost between the two types of cars. It is difficult to predict what the actual maintenance requirements and maintenance charges would be for a Rankine power system that would ultimately be mass-produced. The engine would probably not be released for production unless its maintenance cost were projected to be comparable to that of the Otto engine. It is reasonable to assume that they are equal (and therefore not a discriminator) for purposes of this calculation.

The engine-expendable fluids (other than fuel) required are oil and make-up water. Usage of these fluids has been estimated and is listed, together with corresponding cost, in Table 7-11 for three vehicle classes.

The incremental cost of ownership then is simply the present value (7% annual discount rate assumed) of the difference between the sums of depreciation plus fuel cost plus engine-expanded fluids cost for the Mature OEE Rankine vehicles and their UC Otto counterpart cars. Details of the calculations are given in Chapter 20. Representative values are shown in Table 7-12. It can be seen that the Rankine-engined cars do not "pay

back," in fuel savings, their initial price differential, even at equal maintenance cost, and the situation worsens with increasing fuel price. If their maintenance cost was much lower than that of equivalent Otto-engine automobiles, the Rankine cars could become life-cycle-cost competitive with Otto cars, whereas if their maintenance cost is higher the comparison becomes more unfavorable to the Rankine vehicle.

### 7.7 RESEARCH AND DEVELOPMENT REQUIRED

#### 7.7.1 Mature Configuration

If it were decided to produce the Mature Rankine engines, no fundamental research, as such, is required. There would remain, however, considerable component, process, and system development to be done. Specific developments needed include the following:

- (1) Vapor Generator Assembly. Configure economically mass-producible boiler-tube assembly; verify performance at component level; configure and test alternate low-emissions burners; select most producible configuration with acceptable performance, response and emissions; integrate into "vapor-generator" assembly and demonstrate performance with range of candidate fuels including gasoline, diesel fuel, "broad-cut," and methanol; develop supplier source(s).
- (2) Expander Assembly. Configure economically mass-producible fixed-admission, uniflow, PD expander; life-test alternate inlet valve and seat materials/configurations; finalize valve/seat/steam chest details and lubrication

Table 7-11. Cost of engine-related expendable fluids for Mature Rankine vehicles (all costs in 1974 dollars)

OEE auto. class	Engine design, hp	Lubricant			Distilled water			Total expendable fluid cost <sup>c</sup>	
		Capacity, qt	Price, \$/qt	Change interval, mi	Total Capacity, qt	Price, \$/qt	Make-up rate mi/qt	At 35,000 mi ~3 yr <sup>d</sup> , \$	At 100,000 mi ~10 yr <sup>d</sup> , \$
Small	66	4	0.90	3000 <sup>a</sup>	10	0.32 <sup>b</sup>	8000	44	126
Compact	119	5	0.90	3000 <sup>a</sup>	16	0.32 <sup>b</sup>	6000	56	158
Full-size	166	6	0.90	3000 <sup>a</sup>	28	0.32 <sup>b</sup>	4000	67	191

<sup>a</sup>Every 1500 mi for first 3000 mi; every 3000 mi thereafter.

<sup>b</sup>Based upon distilled water cost for battery service.

<sup>c</sup>Sum of lubricant and distilled water costs.

<sup>d</sup>Median driver's experience.

Table 7-12. Incremental<sup>a</sup> cost of ownership<sup>b</sup> for Mature Rankine vehicles (constant 1974 dollars)

OEE auto. class	Incremental ownership cost <sup>c</sup>	
	35,000 mi ~3 yr <sup>d</sup>	100,000 mi ~10 yr <sup>d</sup>
Small	150	350
Compact	250	400
Full-Size	350	550

<sup>a</sup>Relative to equivalent baseline UC Otto cars.

<sup>b</sup>Present value, at 7% annual discount rate, of depreciation plus fuel cost plus expendable fluid cost. "Broad-cut" fuel at 48¢/gal ( $\approx$  gasoline at 52¢/gal).

<sup>c</sup>Positive numbers indicate additional cost to Rankine car owner (to nearest \$50).

<sup>d</sup>Median driver's experience.

system; verify performance at component level; integrate with vapor-generator assembly and finalize manifolding configuration; develop requisite production techniques and facilities.

- (3) Feed Pump Assembly. Configure economically mass-producible, high-pressure, variable-flow feed pump; verify performance at component level; develop supply source(s).
- (4) Condensor Assembly. Configure economically mass-producible condenser assembly with emphasis on minimum weight and packaging volume; verify component-level performance.
- (5) Control System. Develop alternate breadboard control systems, with emphasis on high-response, reliable sensors (redundant majority-vote logic, if required), safety interlocks, and automatic startup system; test with subassemblies, demonstrating successful pressure-temperature scheduling; finalize approach for economically mass-producible integrated package; develop supply sources; verify performance in all-up system tests.
- (6) Freeze Protection. Should be considered from the beginning in the design of all components and the system; if a special ancillary assembly is required, configure for minimum energy consumption, as well as producibility.

System tests, in addition to performance and durability, should demonstrate operational and impact safety. A foolproof automatic start

sequence - including freezing-weather start - must be achievable. Accessory drives must be optimized to reduce parasitic losses to the maximum degree compatible with acceptable cost.

### 7.7.2 Advanced Configuration

To make the Advanced Rankine engine a reality, much preliminary fundamental work needs to be done. Research in ceramics technology is required. Although the actual ceramic materials are already identified (invention of a novel material is not implied), the applications to specific components do raise some fundamental questions in four general categories:

- (1) Material Formulation. Determine appropriate compositions and impurity levels for optimum properties in:
  - (a) Expander piston (crown), block/liner, steam chest, and inlet valve seat application (SiC, Si<sub>3</sub>N<sub>4</sub>, Sialon, ceramic composites, others?).
  - (b) Vapor-generator tube and manifold application (Si<sub>3</sub>N<sub>4</sub>, SiC, Sialon, ceramic composites, other?).
- (2) Ceramic Raw Material Processing. Determine the optimum tradeoff between properties achieved at given impurity levels, and the cost of refining the abundant raw materials to attain these impurity levels; demonstrate the cost-effectiveness of producing the ceramic material in a pilot plant scalable to mass production quantities.
- (3) Ceramic Structure Fabrication Processes. Demonstrate the production of formed parts, with adequate properties and high reproducibility and yields, from production-grade raw materials; develop processes to permit concrescence of simple-shape components into a complex monolithic structure, on a mass production basis; demonstrate integrated ceramic design, testing, and nondestructive evaluation techniques suitable for mass-production.
- (4) Ceramic/Metallic Structures Joining and Bonding. Develop technique for joining or bonding ceramic materials of the selected compositions to contiguous metallic structures. Techniques should emphasize: strength of joint, sealing (as required), and alleviation of stress concentrations.

In addition to the requisite ceramics development, the piston ring lubrication problem must be resolved. Three possible approaches to this problem were discussed in Section 7.3.3. Further, a suitable inlet valve and spring materials system would have to be developed to bring the Advanced Rankine engine into being. Ceramics and/or (coated?) refractory metals, as discussed in Section 7.3.3, might be considered.

Additional amplification of Rankine R&D requirements, funding, and time scales, is given

in Chapter 12, and ceramics development is discussed more fully in Chapter 5.

If and when such research efforts were successfully completed, vapor-generator and expander development paralleling those of the Mature configuration would have to be accomplished. To exploit the ceramic technology and minimize heat losses, a totally redesigned integrated vapor-generator/expander-head package is necessary. Some improvements in the control system would likely be required as well.

### 7.7.3 Availability for Production

If future conditions warrant continued pursuit of an automotive Rankine power system, it is anticipated that the Mature configuration could be ready for production in the early-to-middle 1980's, depending largely upon the development funding committed.

The Advanced configuration, on the other hand, was conjectured in this study primarily to assess long-range performance potential, given comparable (i. e., ceramic) technology to that proposed in the other Advanced alternates. The technological problems appear quite difficult at this point, however. Consequently, the Advanced configuration might not be producible until beyond 1990 (possibly never) — even given adequate interest and funding — as the solutions of presently known problems may uncover new unanticipated difficulties.

### References

- 7-1. Brogan, J. J., and Thur, G. M., "Advanced Automotive Power Systems Development Program," paper presented at 7th Intersociety Energy Conversion Engineering Conference, San Diego, Calif. (Sept. 1972).
- 7-2. "Exhaust Emissions of the Carter Steam Car," EPA Test Report 74-3, Technology Assessment and Evaluation Branch, EPA: Ann Arbor, Mich., June 1974.
- 7-3. Percival, W. H., "Fluorochemical Vapor Engine," SAE Paper 931B, Oct. 1964.
- 7-4. Burton, R. L., "Thermal Efficiency of the Uniflow Steam Expander at 850 to 1400 F Inlet Temperature," 9th Intersociety Energy Conversion and Engineering Conference, Aug. 1974.
- 7-5. Hoagland, L. C., Scientific Energy Systems, private communication to APSES team (Oct. 1974).
- 7-6. Hauck, R. W., Wenstrom, M., and Renner, R. A., "The California Clean Car Project," California Assembly Office of Research, Nov. 15, 1974.
- 7-7. Carter, J., Jr., "A New Approach for a Steam Powered Automobile," Jay Carter Enterprises, Burkburnett, Texas, 1974.
- 7-8. Doyle, E. F., Thermo Electron Corp., private communication to APSES team (Sept. 13, 1974).
- 7-9. Thirteenth Quarterly Progress Report, Scientific Energy Systems, prepared for EPA/AAPS, June 15, 1974.
- 7-10. Hoagland, L. C., Demler, R. L., and Gerstmann, J., "Design Features and Initial Performance Data on an Automotive Steam Engine Part I — Overall Powerplant Description and Performance," SAE paper 740295, Feb. 1974.
- 7-11. Vickers, P., et al., "The Design Features of the GM SE-101 — A Vapor Cycle Powerplant," GM Research Labs, SAE Paper 700163, 1970.
- 7-12. Hoagland, L. C., et al., "Design Features of Low Exhaust Emission Automotive Steam Powerplant," SAE Paper 72941, 1972.
- 7-13. "Current Status of Advanced Alternative Automotive Power Systems and Fuels, Volume II, Alternative Automotive Engines," The Aerospace Corp., El Segundo, California, EPA 460/3-74-013b, Vol. II, July 1974.
- 7-14. Carter, J., Jr., "Proposed Steam System for 3000 lb Automobile," Jay Carter Enterprises, Burkburnett, Texas, 1974.
- 7-15. "Compact Condensor for Rankine Cycle Engines," AiResearch Manufacturing Company, Garrett Corp., EPA Contract EHS 70-123, Aug. 1971.
- 7-16. Fact-finding visit to J. Carter by members of APSES team, Nov. 1974.
- 7-17. Fact-finding visit to Aerojet Liquid Rocket Co. by members of APSES team, Apr. 1974.
- 7-18. Fact-finding visit to Lear Motor Co. by members of APSES team, Apr. 1974.
- 7-19. Fact-finding visit to Thermo Electron Corp. by members of APSES team, Apr. 1974.
- 7-20. Fact-finding visit to Scientific Energy Systems, Corp. by members of APSES team, Apr. 1974.
- 7-21. Fact-finding visit to Steam Power Systems, Corp. by members of APSES team, Apr. 1974.
- 7-22. Bjerklie, J., and Luchter, S., "Rankine Cycle Working Fluid Selection and Specification Rationale," SAE Paper 690063, 1969.
- 7-23. "Organic Rankine Cycle Automotive Propulsion System Turbine Expander," Aerojet Liquid Rocket Co., Contractor's Meeting, EPA, Ann Arbor, Mich., Dec. 1972.

- 7-24. Kreeger, A., Aerojet Liquid Rocket Co., personal communication, June 17, 1974.
- 7-25. Renner, R. A., and Wenstrom, M., "Experience with Steam Cars in California," SAE paper draft, Nov. 1974.
- 7-26. Carter J., Jr., Jay Carter Enterprises, Inc., personal communication, May 30, 1974.
- 7-27. "Water Base Rankine Vapor Turbine System," Lear Motors Corp. presentation, 1973.
- 7-28. Barber, R. E., Bond, J. C., and Alford, E. H., "The Design and Development of a Turbine-Gearbox for Use in an Automotive Organic Rankine Cycle System," SAE Paper 710564, 1971.
- 7-29. Wildermuth, D., Lear Motors Co., personal communication, Sept. 1974.
- 7-30. Scientific Energy Systems Corp., System Presentation, Rankine Cycle Contractors Coordination Meeting, EPA, June 1973.
- 7-31. Hoagland, L. C., Scientific Energy Systems Corp., personal communication, 1974.
- 7-32. "Rankine Cycle Power System with Organic-Based Working Fluid and Reciprocating Expander for Passenger Vehicles," Report TE4-57-117-74, Thermo Electron Corp., presented at Advanced Auto Power Systems Meeting, EPA, Ann Arbor, Mich., May 1974.
- 7-33. Doyle, E. F., Thermo Electron Corp., personal communications Sept. 1974.
- 7-34. Syniuta, W. D., and Palmer, R. M., "Design Features and Initial Performance Data on an Automotive Steam Engine Part II - Reciprocating Steam Expander - Design Features and Performance," SAE paper 740296, 1974.
- 7-35. Demler, R., Scientific Energy Systems Corp., personal communication, June 1974.
- 7-36. Keenan, J. H., Keyes, F. G., Thermodynamic Properties of Steam, John Wiley, New York, 1936.

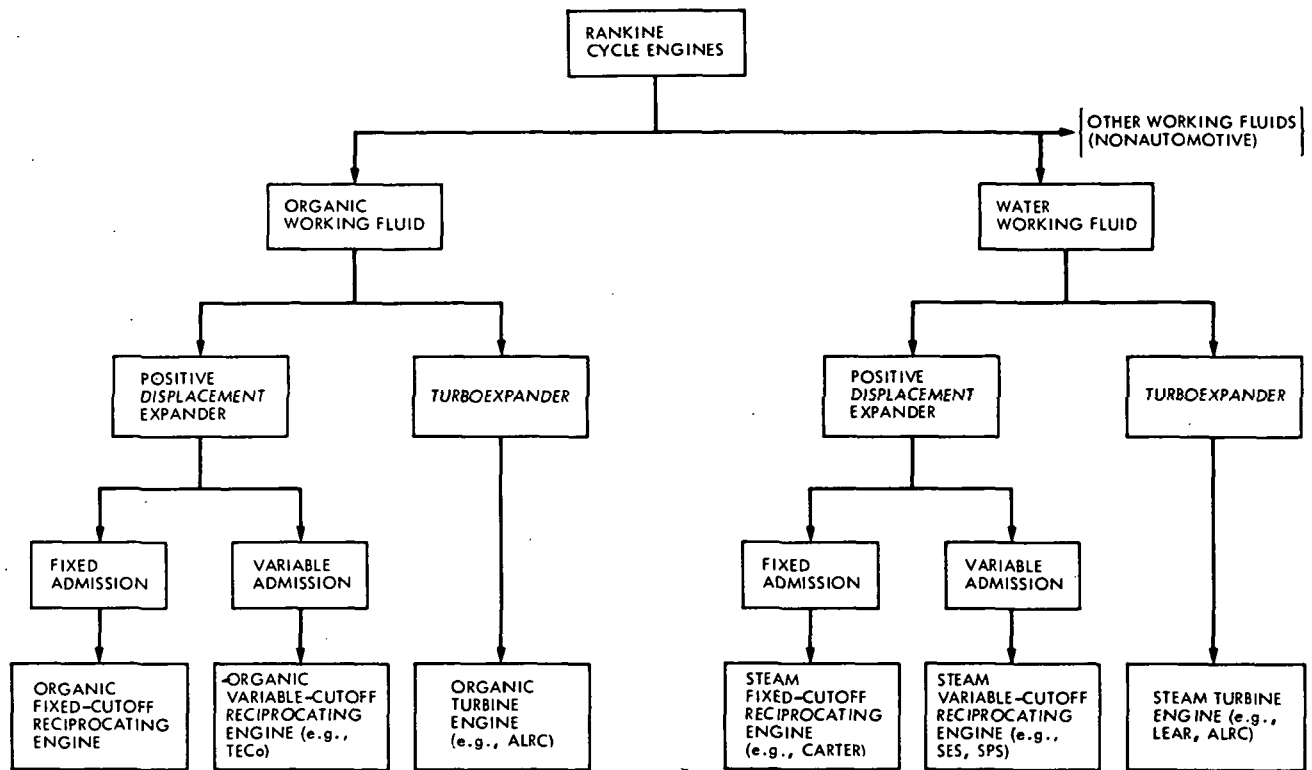

Fig. 7-1. Simplified morphology of automotive Rankine powerplanes



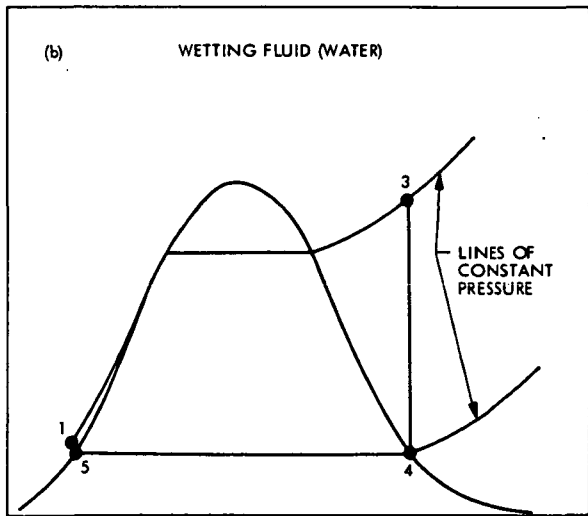
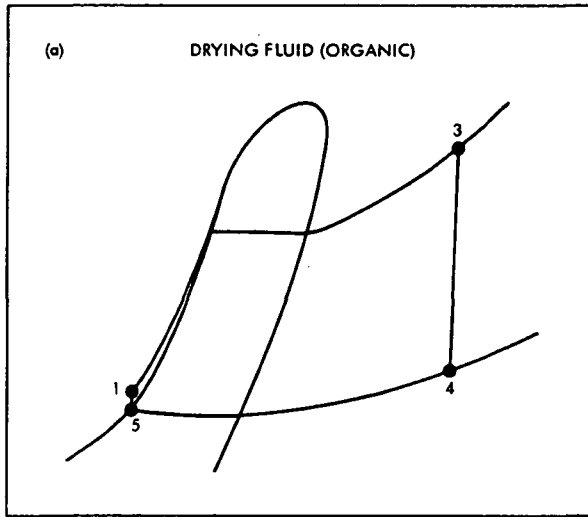

Fig. 7-2. Rankine cycles for "drying" and "wetting" working fluids

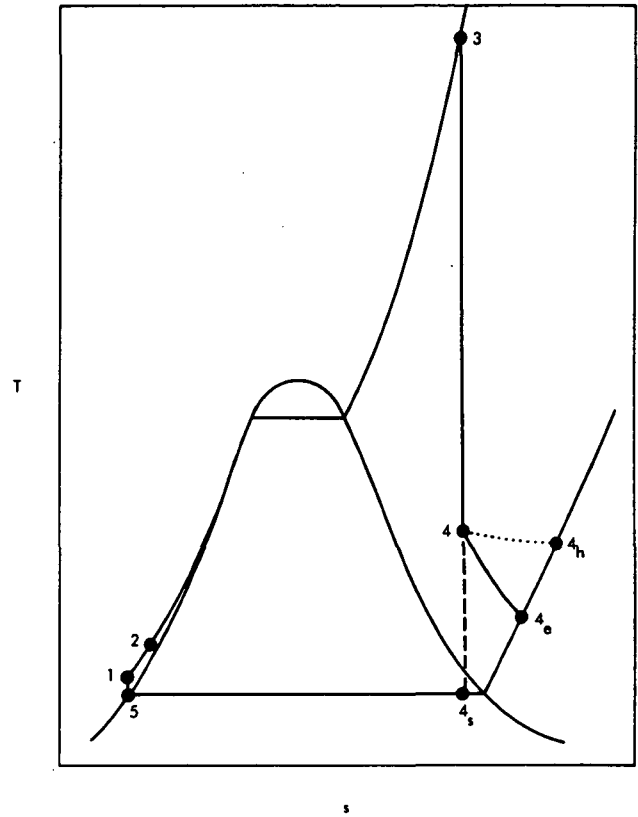

Fig. 7-3. Rankine cycle process, representation of temperature - entropy diagram

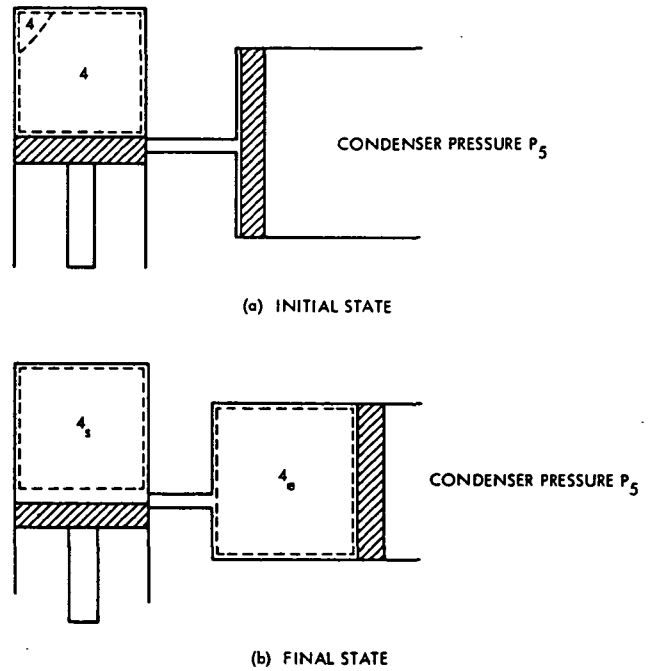

Fig. 7-4. Steam blowdown process

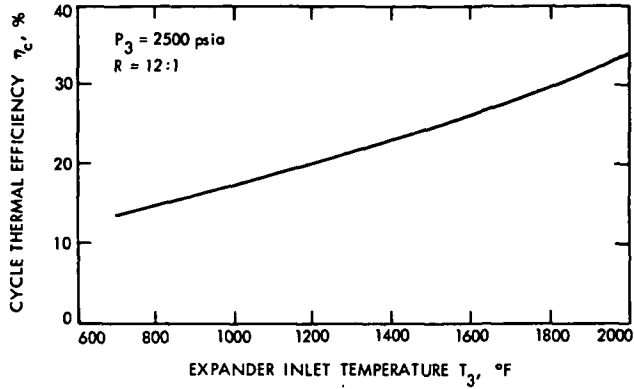

Fig. 7-5. Cycle thermal efficiency vs expander inlet temperature

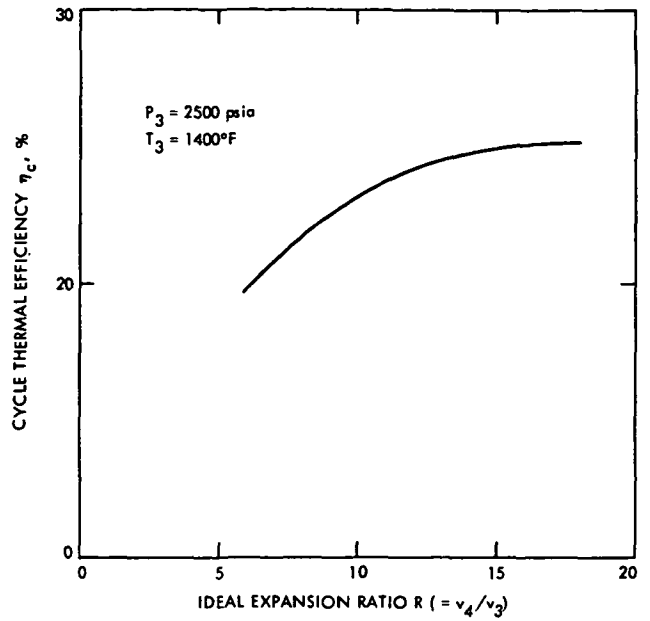

Fig. 7-7. Cycle thermal efficiency vs "ideal" expansion ratio

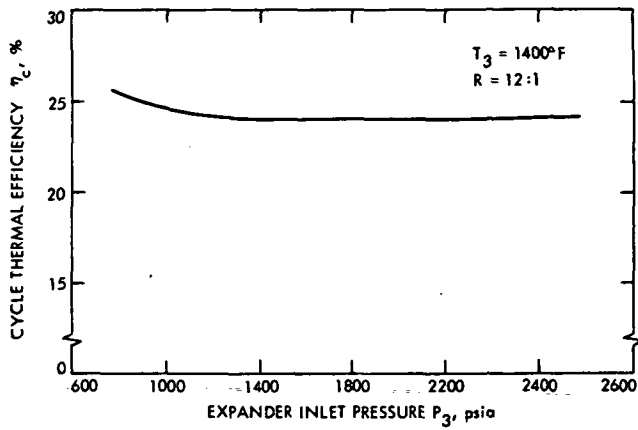

Fig. 7-6. Cycle thermal efficiency vs expander inlet pressure

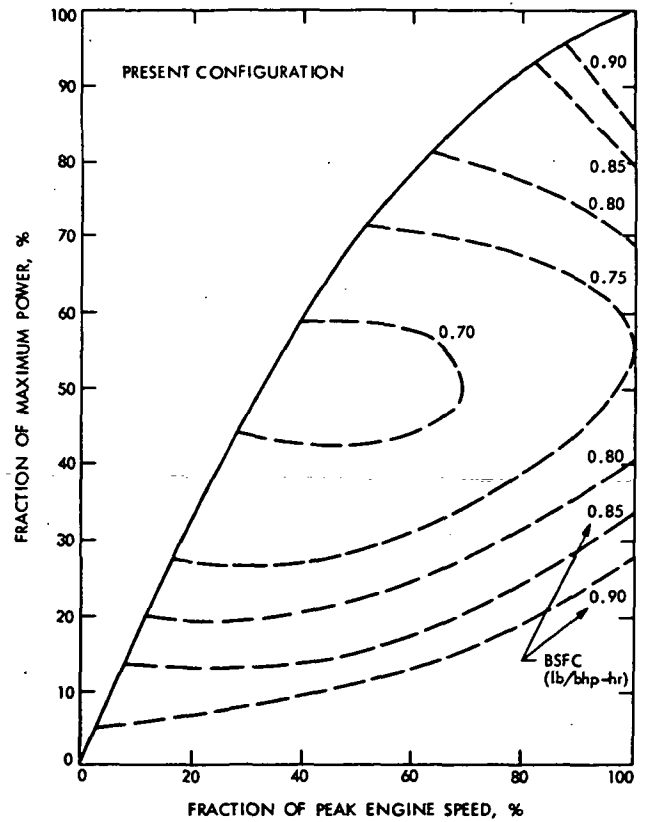

Fig. 7-8. Performance map for Rankine engine utilizing fixed-cutoff PD expander

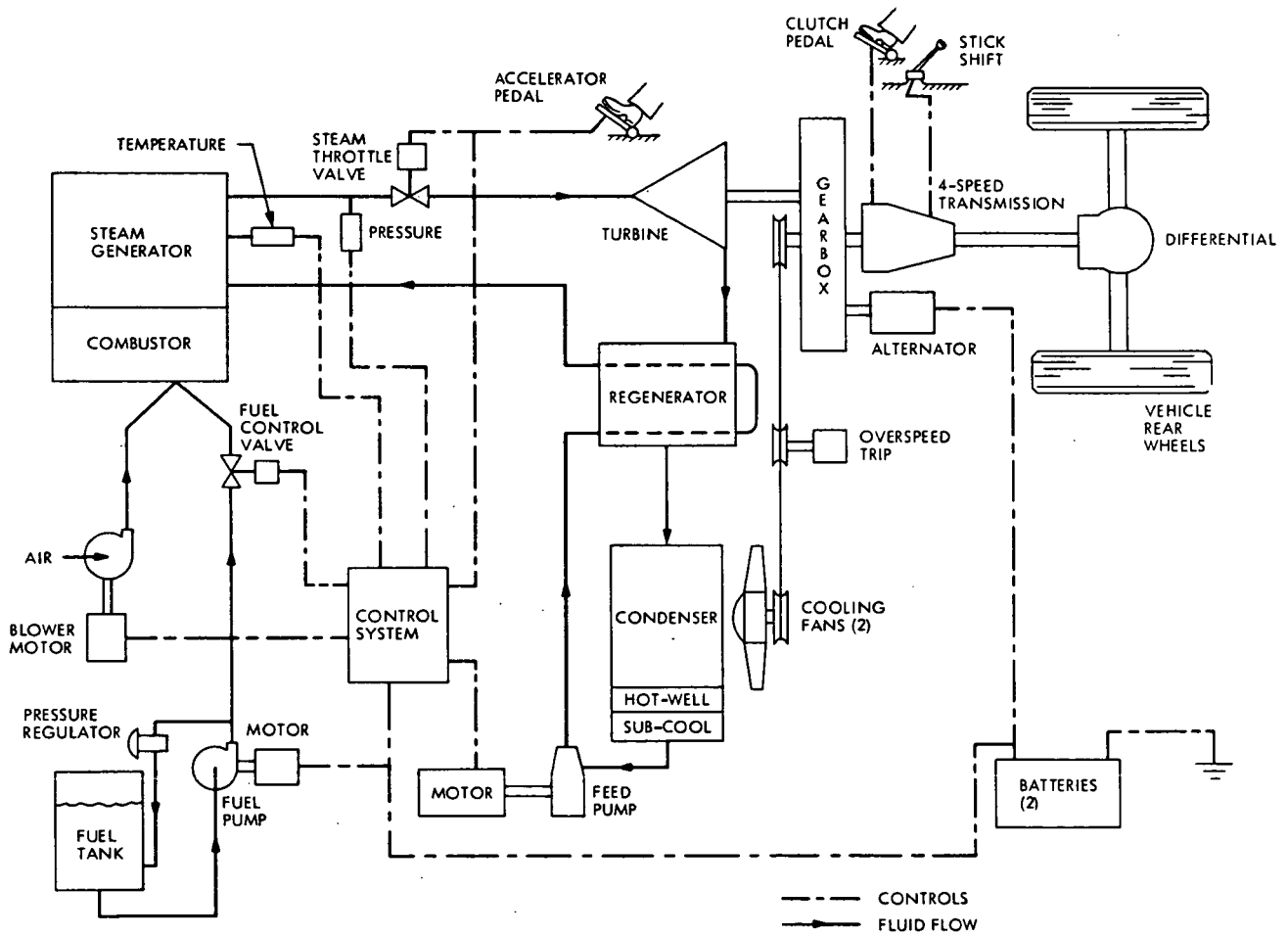

Fig. 7-9: Aerojet California clean car powerplant schematic

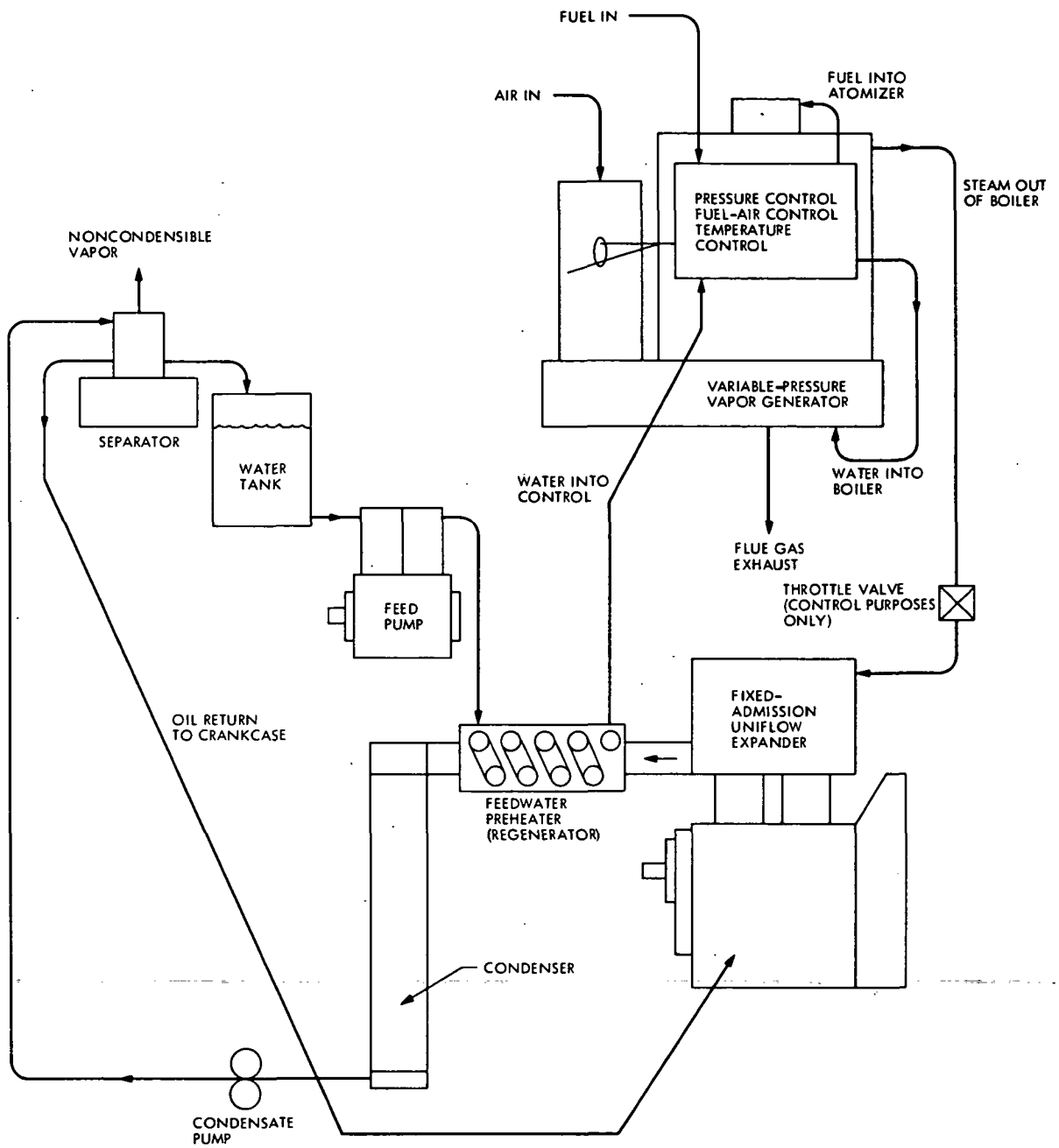

Fig. 7-10. Carter projected powerplant schematic

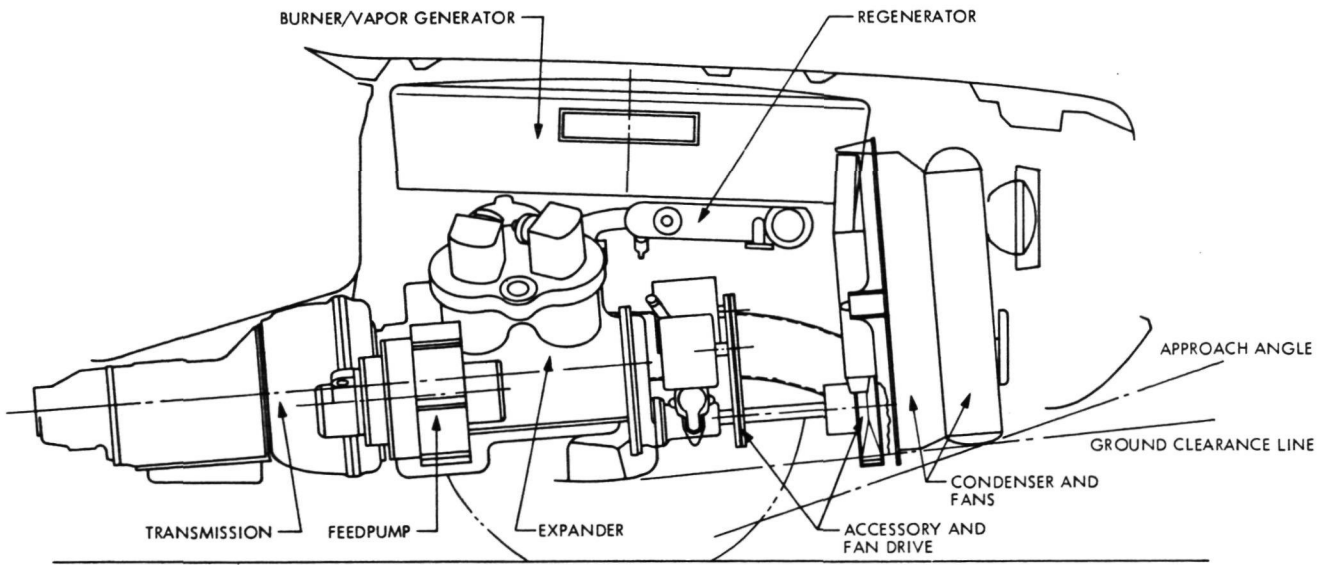

Fig. 7-11. Thermo-Electron Corp. organic Rankine cycle engine layout

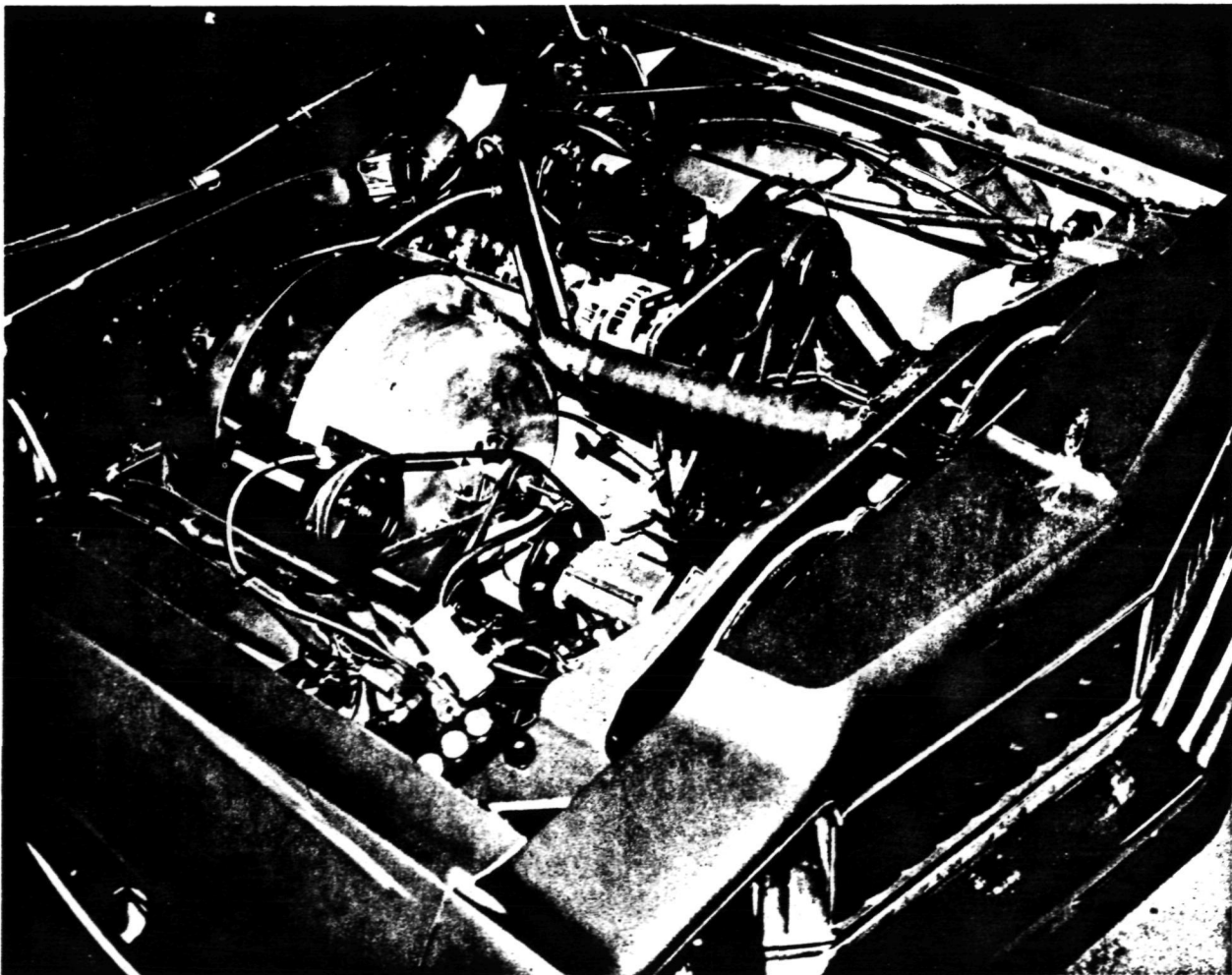

Fig. 7-12. Scientific Energy Systems automotive steam system mockup

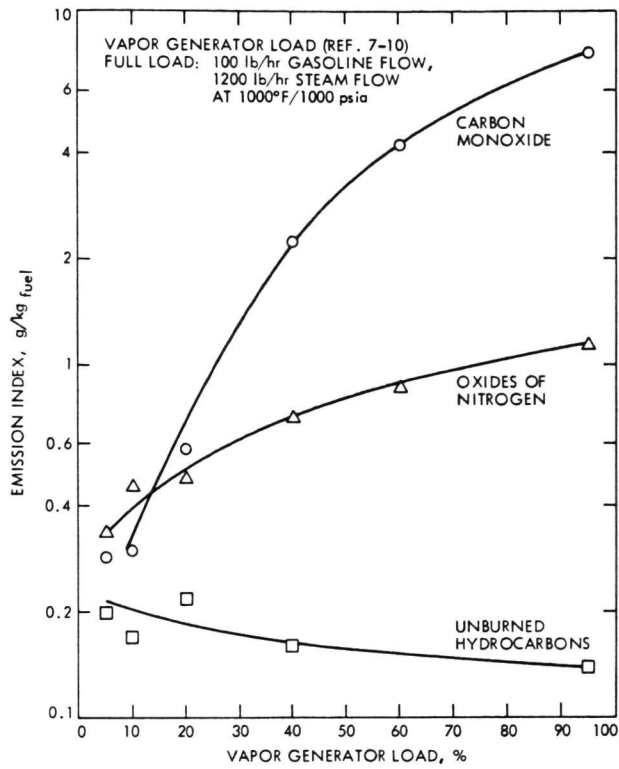
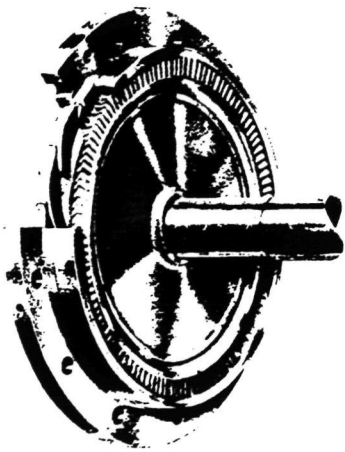
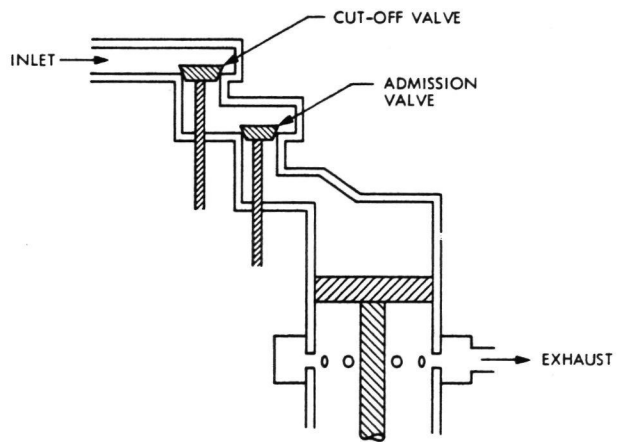

Fig. 7-13. Emission indices for Rankine engines



(a) IMPULSE TURBINE



(b) REVERSE SERIES VALVE UNIFLOW

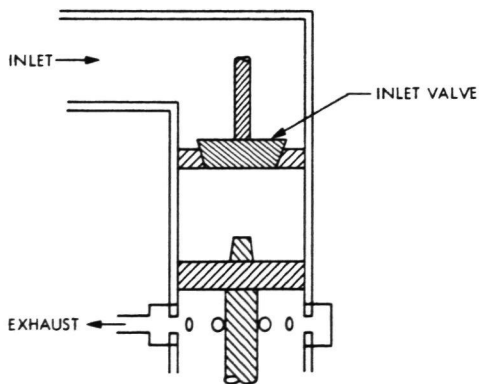

(c) PISTON-ACTUATED VALVE UNIFLOW

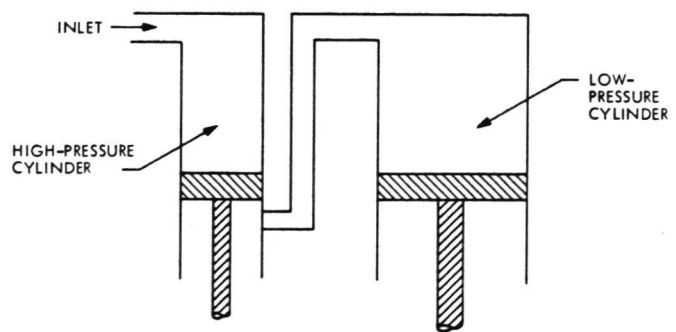

(d) DOUBLE-ACTING COMPOUND

Fig. 7-14. Schematic diagrams of expander configurations

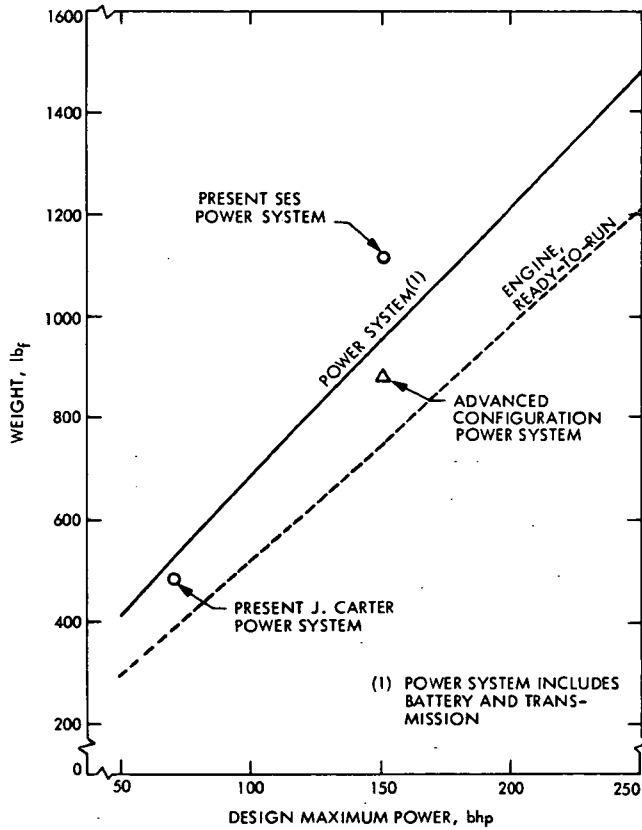

Fig. 7-15. Projected Rankine engine weights (Mature configuration)

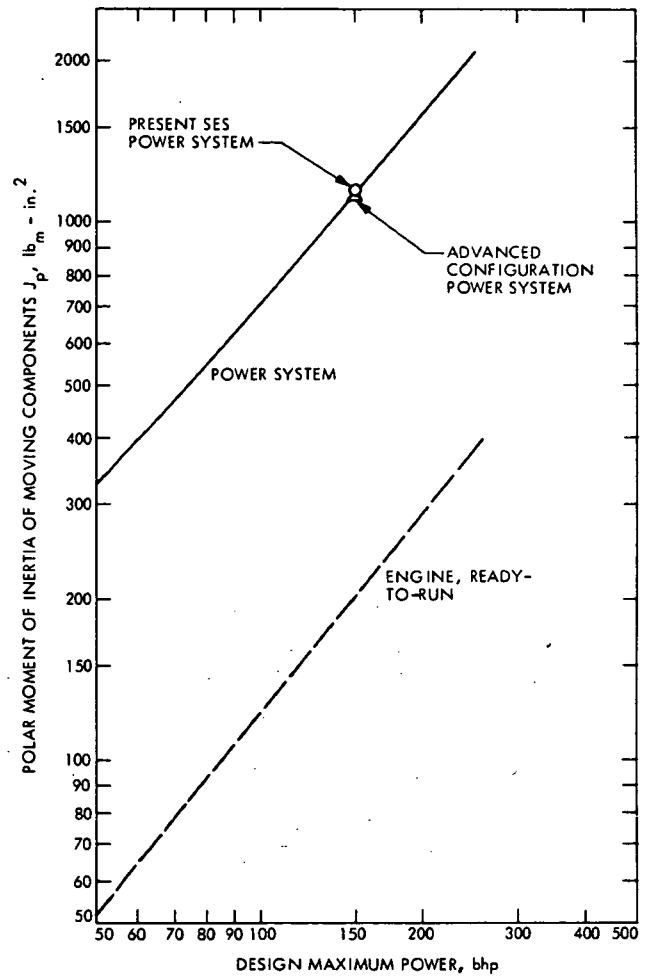

Fig. 7-16. Projected Rankine engine inertias (Mature configuration)

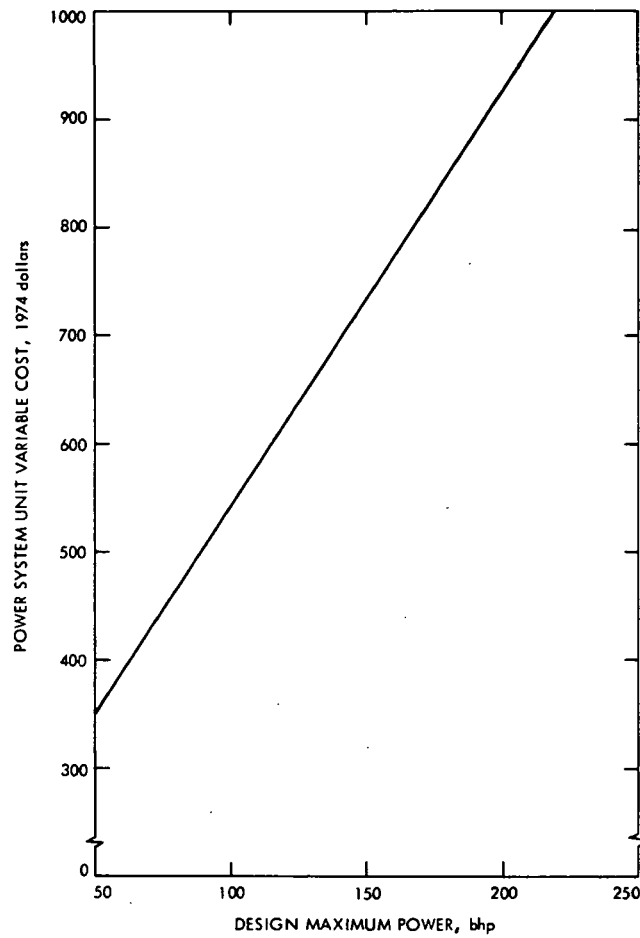

Fig. 7-17. Mature Rankine power system variable cost



## CHAPTER 8. ELECTRIC VEHICLES

8.1	Introduction . . . . .	8-2
8.1.1	Background . . . . .	8-2
8.1.2	System Block Diagram . . . . .	8-2
8.1.3	Vehicle Performance Comparison Baselines . . . . .	8-2
8.2	System Performance Characteristics . . . . .	8-3
8.2.1	Energy Economy . . . . .	8-3
8.2.2	Range Performance . . . . .	8-6
8.2.3	Road Performance . . . . .	8-9
8.2.4	Emissions Performance . . . . .	8-10
8.2.5	Performance Summary . . . . .	8-10
8.3	Components. . . . .	8-12
8.3.1	Traction Motor-Controller . . . . .	8-12
8.3.2	Battery Systems . . . . .	8-13
8.3.3	Materials Requirements . . . . .	8-15
8.4	Vehicle Integration . . . . .	8-16
8.5	Ownership Considerations . . . . .	8-16
8.5.1	Maintenance . . . . .	8-16
8.5.2	Incremental Cost of Ownership. . . . .	8-16
8.6	Research and Development Recommendations . . . . .	8-18
8.6.1	Battery Research and Development . . . . .	8-18
8.6.2	Drive Train Research and Development . . . . .	8-19
8.7	Conclusions . . . . .	8-19
	References . . . . .	8-20
	Figures . . . . .	8-22

## 8.1 INTRODUCTION

### 8.1.1 Background

The electric or purely flywheel-powered vehicle is a promising but limited alternative for achieving both emission and energy economy objectives simultaneously. It is more flexible than external combustion multifuel systems since it can effectively (though indirectly) utilize nearly all energy sources including nuclear, solar, and wind energy as well as fossil fuels for its operation.<sup>1</sup> Because the most critical energy conversion process takes place at large fixed installations, the overall energy efficiency can be more readily optimized and automotive-related pollutant emissions are concentrated at point sources where they can be more easily monitored and controlled. Electric propulsion systems are more compatible with the engine load profiles presented by urban and suburban driving than are internal combustion engines because high torque can be delivered at low speed. Most battery systems suffer no idling losses, and the kinetic energy normally wasted by conventional vehicles during deceleration or downhill braking can be partly recovered and reused by the electric car.

The major limitations of battery and flywheel-powered vehicles are their extremely poor range, due to insufficient energy storage capacity, and the long time required to recharge batteries or the high power required to recharge flywheels. Whereas the energy density of gasoline is 1130 W-hr/lb, the highest value projected for batteries is only 140 W-hr/lb. (Ref. 8-2). Current lead-acid batteries are limited to an energy density of 18-20 W-hr/lb, and the highest value demonstrated to date in flywheel subscale rotor tests is 28 W-hr/lb (Ref. 8-22). Of less concern because solutions can be developed or limitations accepted are problems of poor road performance due to low battery power density, vehicle handling due to heavy battery or flywheel system weights, occupant crash safety, power network loading, large demand for critical materials, etc. Important questions of initial and life-cycle cost and overall energy economy have only been partially studied because detailed cost evaluation must await the successful development of batteries or flywheels with suitable range and recharge characteristics and because energy economy has not been an important issue until recently. A comprehensive review of recent electric vehicle studies and developments is given in Ref. 8-1.

Because of its severe range and recharge limitations, the battery or flywheel powerplant cannot presently be regarded as an Otto Engine Equivalent (OEE) vehicle (see Volume I or Chapter 10 of Volume II for a definition of the OEE concept).

### 8.1.2 System Block Diagram

The block diagram of Fig. 8-1 shows the energy supply chain as well as the on-board components of the battery/flywheel vehicle. A large amount of work has been done on battery-powered vehicles and a much lesser amount on flywheel-powered cars to date. Very limited efforts have been undertaken on other concepts such as

pneumatic storage systems, mostly with regard to their application to heat-engine hybrid vehicles.

### 8.1.3 Vehicle Performance Comparison Baselines

To assess the merits of electric and hybrid vehicles relative to each other and to conventional cars, comparisons of energy economy, range, road performance, emissions, cost and maintenance are developed for a number of system configurations in this and the Hybrid Vehicle chapter (Chapter 9). A 2100-lb-curb-weight Small vehicle, exclusive of batteries or flywheel is assumed as the baseline for these comparisons. A 20-hp electric motor and controller are included in the baseline electric and hybrid vehicle configuration whose combined weight is roughly equivalent to that of the gasoline engine (including fuel tank, cooling system and exhaust system) in a conventional car. In addition, a 3-speed manual transmission and differential are assumed in all variations. A 40% weight propagation factor (see Chapter 10) is included in calculations involving the addition or removal of weight for batteries or other components. Gear train efficiencies are as shown adjacent to the blocks of Fig. 8-1, and motor and controller efficiencies are shown in Fig. 8-11. A 300-lb payload weight is added to the basic 2100-lb vehicle curb weight to establish the "test weight" used in all comparisons. Unless otherwise indicated, lead-acid battery characteristics are those of the Electric Storage Battery, Inc. (ESB) model LEV-115 traction battery. This battery is a 6-volt unit which weighs 65 lb. Energy and power density values of 18 W-hr/lb and 60 W/lb are assumed for the battery in analyses of lead-acid battery powered vehicles. Range calculations include the effects of power loading on battery energy density performance. These are illustrated in Fig. 8-7, Section 8.2.2.

Electrical generation and distribution efficiencies are shown adjacent to the blocks in the energy supply chain of Fig. 8-1. Fossil fueled (petroleum) electrical generating plants are assumed for the purpose of comparing electric with hybrid and gasoline powered vehicles. Since gasoline refining and distribution losses are greater than those involved in the production of boiler fuel for electric generating plants, a factor of 0.94 has been included for this difference in order to make comparisons on the basis of the amount of crude oil required. Using a gasoline energy content of 125,000 Btu/gal (higher heating value), an equivalence factor of 12.5 kW-hr/gal between gasoline at the pump and electricity at the wall plug is used in comparisons of energy economy between electric and gasoline powered conventional or hybrid vehicles.

Plots of combined tire and aerodynamic loads used for calculations given in this and the Hybrid Vehicle chapter are shown in Fig. 8-2. (These are consistent with the equations incorporated in the VEEP computer program described in Chapter 10). For convenience in analysis, the speed-time mission profile shown in Fig. 8-3 is used in performing urban driving energy economy calculations for all vehicle variations. This profile duplicates (within 1%) the energy requirements of the SAE J-227 Metropolitan driving cycle (Ref. 8-3).

<sup>1</sup>In principle, these energy sources could also be used in synthesizing a liquid fuel (such as methanol) from air and water for powering a heat engine vehicle.

The SAE cycle was chosen as the basis for comparison because most electric vehicle performance estimates and tests have been made over this profile. The energy requirements of this cycle closely approximate those of the Federal Urban Driving Cycle (Ref. 8-2), although the peak acceleration is lower ( $3.1 \text{ ft/sec}^2$  vs  $4.8 \text{ ft/sec}^2$ ).

## 8.2 SYSTEM PERFORMANCE CHARACTERISTICS

### 8.2.1 Energy Economy

Figure 8-4 shows an energy economy comparison of a number of actual and "paper design" electric vehicles with each other and with Mature UC Otto-engine-powered conventional cars based on present vehicle technology (from Chapter 3). Since the data points represent different driving cycles, performance levels, ranges, passenger accommodations and vehicle design sophistication, comparisons must be made with caution. For example, the Arthur D. Little calculations are based on the Public Health Service Cycle (Ref. 8-5) driving cycle (average speed,  $v_{ave.} = 23.9 \text{ mph}$ ), the Salihi calculations on the Federal Driving Cycle ( $v_{ave.} = 19.6$ ), the Electric Fuel Propulsion (EFP) tests on a Cornell Aeronautical Laboratory "urban" driving cycle ( $v_{ave.} = 19.3 \text{ mph}$ ), and the remainder on the SAE J-227 metropolitan driving cycle ( $v_{ave.} = 23.9 \text{ mph}$ ). While the overall road performance of the electrics is roughly comparable to that of equivalent Otto-engine-powered vehicles, all electrics are limited in range depending on the types and sizes of batteries used. (The average battery-to-vehicle weight fractions of the "paper design" electrics is less than 0.30, whereas the two "real electrics" have an average battery-to-vehicle weight fraction of over 0.40 and thus have greater range than the paper design lead-acid powered electric vehicles.) The cars weighing less than 1500 lb (exclusive of batteries) accommodate only two passengers, whereas those weighing over 1500 lb hold 4 passengers. The McKee-ESB, A. D. Little, Minicars and Salihi designs are based on lightweight vehicle design techniques in contrast to the others which employ conventional construction.

It can be concluded from the figure that the energy economy of electric vehicles is slightly superior to that of conventional vehicles. Since the comparisons are made on the basis of "dry" (without batteries) weight, the accommodations of both electric and conventional cars having similar weights are equivalent although the luggage capacity of the electrics is likely to be less than that of the conventional cars because of the space taken by battery packs. The use of regenerative braking (not included in the designs shown) would further enhance electric vehicle energy economy by about 10%.

A number of component limitations and system design choices affect the energy economy as well as other system performance characteristics. Included among these are the use of a multispeed transmission, controller induced losses, parasitic system losses, accessory loads, range-energy economy tradeoffs, and regenerative braking. Their effects on energy economy are summarized below.

#### MOTOR-BATTERY EFFICIENCIES

The effect of a multispeed transmission on average motor and battery efficiencies during

acceleration and deceleration maneuvers is shown in Fig. 8-5 for a lead-acid powered baseline electric vehicle with a 1000-lb battery having power density values of 30, 60, and 90 W/lb. The calculations are based on the  $2 \text{ ft/sec}^2$  acceleration and deceleration ramps of Fig. 8-3. To establish a rated torque for the 20-hp traction motor, a maximum vehicle speed of 60 mph at rated motor voltage was assumed.

The use of a multispeed transmission reduces motor  $I^2R$  losses by reducing the high motor torque demand required for low-speed accelerations. In contrast to a 13% improvement in motor efficiency, the battery efficiency improves only slightly with the addition of a transmission. The use of a chopper type controller relieves the battery of supplying high motor currents by smoothly transforming the high current, low voltage motor power demand during accelerations to a low current load at the high battery voltage. A similar function is performed in a flywheel-powered vehicle by the use of a continuously variable transmission between the flywheel and drive shaft which matches rapidly varying vehicle speed changes to the slowly varying flywheel speed with corresponding torque transformations. Thus, the battery current or flywheel torque is almost directly proportional to road power, and even at the high torque levels demanded during low-speed acceleration maneuvers, the overall road power remains low, and little battery current is drawn. The chopper controller thereby replaces the function of a transmission as far as the battery is concerned, and the addition of a multispeed transmission in the drive train has little further effect on battery performance.

Similar curves are shown in Fig. 8-5(b) for motor and battery efficiencies during the deceleration (regenerative braking) segments of the driving cycle. Because the tire and aerodynamic resistance forces aid in stopping the car during deceleration, they subtract from the kinetic energy that would otherwise be available to charge the battery through regenerative braking. As a result, battery charging currents are lower during deceleration than are the battery discharge currents during acceleration and, despite the characteristically higher internal resistance in the charging mode, the battery efficiency remains relatively high throughout the deceleration segment.

The battery efficiency curves shown in Fig. 8-5(b) represent lead-acid battery internal resistance characteristics at the 65% charge state. At lower or higher charge states, the charging efficiency will increase or decrease respectively. To account for irreversible battery losses that are not related to charge or discharge rates (voltage and ampere-hour efficiencies), the maximum charging efficiency is assumed to be 85%.

Further battery losses can result from the high charging rates which occur during regenerative braking. Significant outgassing can occur at rates that cause the battery terminal voltage to exceed its open circuit voltage by over 20%. In the fully charged state, the maximum charge rate is obviously zero, but it rises rapidly to about 16% of the rated power capacity at 95% charge, and 32% at 75% charge. For the mild

deceleration profile of the simulated metropolitan driving cycle, a 30 kW battery can accept all available regenerative braking energy at the 75% charge level, but at higher charge states or deceleration rates, a significant portion of the braking energy may be sacrificed.

Examination of the results of Fig. 8-5(a) suggests that greater improvement might be gained by providing more transmission gear change ratios. Figure 8-5(c) shows the effect of direct-drive, 2-speed, 3-speed, and 10-speed transmissions on average motor-controller-transmission efficiency over the acceleration segment of the driving cycle. Because little improvement occurs for gear change capabilities between the 3- and 10-speed cases, the 10-speed calculation is considered to be representative of a continuously variable transmission. The curve shows that while a 2- or 3-speed transmission offers up to 13% energy economy improvement over that of a direct drive system, greater gear change capability or the use of a continuously variable transmission cannot be justified on this basis.

#### CONTROLLER INDUCED LOSSES

In 1969, Amato (Ref. 8-11) pointed out that while solid state controllers handle high load powers at high switching efficiencies,  $I^2R$  losses can be induced into other portions of the system because of the large alternating current component of the control voltage and current. Paralleling the controller input with a large, low-loss, low-inductance capacitor was recommended as one means of averting battery and cable  $I^2R$  losses. More recently, excessive losses in DC series-wound traction motors have been observed which are attributed to eddy currents in the solid field pole structure. "Dual" and "two phase" chopper systems proposed by Rippel (Ref. 8-13) and Reimers (Ref. 8-14) alleviate the problem of controller-induced losses on motor performance, but require the addition of high current inductors. Further addition of capacitors at the controller and motor inputs would completely eliminate the effects.

#### PARASITIC SYSTEM LOSSES

Battery self-discharge and the heat losses of high temperature batteries, together with the spindown, bearing, seal drags or suspension power requirements of flywheels, represent power consumed by the electric or flywheel vehicle during periods of inactivity as well as at times when the vehicle is on the road. To illustrate the effect of self-discharge on overall vehicle energy economy, a 50 kW-hr battery which self-discharges at a daily rate of 1% represents a continuous discharge power of 20 W. The total energy loss over a 24-h period is approximately 500 W-hr, which corresponds to about 1.5 miles of metropolitan driving, or about 5% of the average daily vehicle use. Typical room temperature self-discharge rates of lead-acid, nickel-cadmium, and nickel-zinc batteries are 0.3, 0.2, and 0.2 per day, respectively, due to internal resistive leakage and chemical combination effects. Energy

Development Associates (EDA) (Ref. 8-15) estimates that the zinc-chlorine battery self-discharge rate is approximately 1% per day due to thermal losses from the chlorine hydrate storage system.

High temperature Na-S and Li-S batteries operating at 300-350°C can sustain case thermal losses of 80 W with vacuum super-insulation and up to 800 W with conventional insulating materials (Ref. 8-8). Argonne National Laboratories (Ref. 8-20) estimates that the battery internal losses resulting from 30-40 miles of daily use would provide from 150-200 W for battery heat loss make-up. The extent to which battery thermal case losses are not supplied by internal dissipation or cannot be recovered for interior heating or other useful purposes represents a potential increase in overall energy consumption of from 25% (for the 80-W loss case) to nearly 3 times (for the 800-W loss case) the amount required for the average daily driving of 30-35 miles. Such losses, of course, would directly reduce the gasoline equivalent mpg as shown on Fig. 8-4.

Based on the results of Lockheed (Ref. 8-16) and Applied Physics Laboratory (Ref. 8-22) analyses and tests, the spindown losses of flywheels using mechanical bearings and seals can run into the hundreds of watts. Evacuation of the flywheel housing virtually eliminates windage losses, and bearing losses can be reduced to 10-20 W by the use of magnetic bearings.<sup>2</sup> While the stiffness of magnetic bearings is much higher than that of ball or roller bearings, their load-carrying capacity is much less. Thus, gimbaling of the flywheel assembly might be required to minimize bearing loads due to precession torques, and free rotating mechanical stops may be needed to contain shaft overtravel under vibratory loads. The weight of a set of magnetic bearings is approximately half that of the wheel they support, and this detracts from the energy density of the overall system.

#### ACCESSORY LOADS

Vehicle accessories fall into four groups as follows:

- (1) Engine (motor) auxiliaries which are essential to the operation of the power-plant such as motor-controller cooling blowers, overload cutouts, and panel instruments.
- (2) Safety-related accessories which are necessary for operation of the vehicle under all lighting and weather conditions such as headlights, taillights, turn signals, horn, windshield wipers, defroster, etc.
- (3) Driving assists such as power steering and power brakes.
- (4) Comfort and convenience accessories such as heater, air conditioner, radio, power windows, power seat, etc.

<sup>2</sup> Personal Communication, J. Dohogne, Sperry Phoenix.

Of these, the power requirements of the first and third group are highly dependent on the particular design of the powerplant and vehicle. Estimates for the power requirements of the second group range from 250 to 350 W, most of which occur during night and inclement weather driving. The high power requirements of the last group present the driver with a tradeoff between driving range and comfort level.

In this, and most other electric vehicle studies, the only accessory loads included in driving economy and range calculations are those of the first group. In general, during those times when safety-related accessories are in use (headlights, taillights, windshield wipers, defroster), the overall range and energy economy will be reduced by 2-3% for the simulated metropolitan driving cycle, and a smaller amount for highway driving conditions.

#### RANGE VS ENERGY ECONOMY

The curves of Fig. 8-6 illustrate the tradeoff between energy economy and design range for a lead-acid powered electric vehicle. The calculations include a battery recharge efficiency of 80%, which is made up of charge-discharge voltage and ampere-hour differentials of 7.5% each, I<sup>2</sup>R losses of 2.5%, and charger losses of 2.5%, which is representative of an 8-hr overnight recharging period. No regenerative braking is included in these curves.

The dependence of energy economy on range, as determined by the weight of lead-acid battery required to achieve the design range, is shown in the figure for constant speeds from 20 to 60 mph (dashed lines) and for the simulated metropolitan driving cycle (solid line). The lightweight (positive slope) curves connecting the points on the level road constant speed curves represent lines of constant battery/vehicle weight fraction. The battery/vehicle weight fraction values as well as the battery and vehicle weights are given at the top of these lines.

It is apparent from the driving cycle curve that attempts to "force" the range beyond 30 to 40 miles by continued increases in battery size result in a sharp dropoff of the energy economy. This is due to the extraordinary weight increases for the battery plus the associated weight propagation into the vehicle. All of the vehicles have the same physical accommodations as a 2100-lb-curb-weight Otto-engine-powered car.

In general, energy economy (in mi/kW-hr) tends to be an inverse function of vehicle weight for driving cycle or high-speed operation. Advanced batteries offer the potential of higher energy densities (kW-hr of storage for a given battery weight) than the lead-acid batteries used in preparing Fig. 8-6. Although the use of these will permit an extension in range, the energy efficiency of cars powered by advanced batteries will be comparable to that of the same weight lead-acid powered vehicle (provided that the power density is adequate to allow the vehicle to meet the acceleration ramps).

#### REGENERATIVE BRAKING

The benefits of regenerative braking have been a subject of controversy. Proponents cite

improved range, reduced service brake wear, the added safety of the redundant braking system, and beneficial effects on battery performance as advantages that can be gained at nominal cost. Opponents contend that the additional cost and complexity and adverse internal physical effects on the battery overshadow its limited improvement in range and the braking features. Published estimates and measurements of range extension vary widely depending on the particular vehicle system design, battery performance, and test profiles. These range from 5 to 40%.

The amount of energy that can be recovered and stored as a result of stopping depends on the amount of energy available, as well as the efficiencies of the motor, controller and battery in the generator-charging mode. Reuse of this energy for subsequent acceleration is again subject to the efficiencies of the same components, but this time in the motor-discharge mode. Therefore, to recover and return kinetic energy to the vehicle entails two passes through the system with substantial losses incurred during each pass.

The amount of energy which is available for recovery during a stop is related to the vehicle initial speed and mass (kinetic energy), the stopping time and the road load function. The fraction of recoverable energy diminishes as stopping time increases because an increasing portion of the initial kinetic energy is consumed by road resistance while the car advances forward to the final stopping point under its own momentum. By increasing stopping time, the car is allowed to coast a greater distance and thereby make greater direct use of its initial kinetic energy. For the 27-sec stopping time of the simulated driving cycle of Fig. 8-3, 69% of the vehicle kinetic energy is available for recovery. For a shorter stopping time of 10 sec, for example, nearly 90% of the energy would be recoverable.

An estimate of the performance improvement is given below for the baseline car over the simulated driving cycle. Combining the recoverable energy fraction of 69% with the motor-battery efficiency shown in Fig. 8-5(b) for the driving cycle braking segments, the fraction of the initial kinetic energy that can conceivably be recovered per stop is  $0.69 \times 0.56 = 0.39$ . This is further reduced to 0.36 by the average transmission differential gearing efficiency of 0.94.

While this fraction is theoretically available at the battery terminals, battery charge characteristics may limit the amount of energy that can be accepted. Battery charge acceptance falls off rapidly as the charge state approaches 100%, and at about 85% of full charge the battery cannot accept the full regenerative braking power available during the initial portion of the deceleration maneuver. Since the major portion of recoverable energy is available only at this time for a normal stopping profile, it follows that the energy saved will decline rapidly at charge states above the 85% level. Furthermore, the battery is considered to be discharged at about 30% of its full capacity, e. g., at the 70% depth of discharge (DOD) level, because it can no longer supply adequate power for acceleration. Therefore, the

operational capacity of the battery is only 55% of its rated capacity (85% max., 30% min.) for regenerative braking purposes, and the ratio of regenerative braking operational range to total operational range is  $0.55/0.70 = 0.79$ . When this factor is applied to the recharge energy available at the battery terminals, the total energy fraction accepted by the battery becomes  $0.79 \times 0.36 = 0.28$ . Since the deceleration segments comprise only about 65% of the total driving cycle energy, the improvement in energy economy referred to the total cycle energy consumption is  $0.65 \times 0.28 = 0.182$ , or 18%.

This value represents the maximum improvement in energy economy that might be expected. Factors that can reduce the amount of energy recovery include:

- (1) Shorter stopping time. While slightly greater energy can be recovered, the higher available regenerative braking power may exceed the battery acceptance level, particularly at high battery charge states.
- (2) More frequent charging. By recharging the battery before it has reached the 70% DOD level, the operational capacity is reduced and the 85% upper level for effective regenerative energy recovery becomes a larger fraction of the total battery capacity.
- (3) Lower battery power density performance.

Of these, the second item has the greatest effect on energy economy improvement, since it is unlikely that the battery will consistently be discharged to the 70% DOD level in regular service. Taking these factors into account, it is likely that about 10% improvement in energy economy can be expected by regenerative braking during average daily use of an electric vehicle.

Because flywheel vehicles can accept regenerative energy at all speeds up to the limit of their storage capacity, greater energy economy and range improvement can be expected from regenerative braking. Flywheels also do not have voltage and ampere-hour recharge efficiency limitations or over-charge requirements as do batteries.

### SUMMARY

To achieve the optimum energy economy for an electric vehicle, a 2- or 3-speed transmission should be used, controller-induced losses should be eliminated, energy storage system parasitic losses should be minimized and regenerative braking should be used. With these features, a baseline electric vehicle containing 1000 lb of batteries should provide an energy economy of 2.86 mi/kW-hr during clear weather daylight urban driving and 2.79 mi/kW-hr at night within its limited range of approximately 30 miles. These values correspond to equivalent gasoline fuel economies of 35.8 and 34.9 mpg, which are superior to those of the same small size Otto engine powered conventional car. However, these cars cannot be considered equivalent to the Otto

powered vehicles in terms of range, top speed, or rapid refueling (recharge) capability.

Extensive use of comfort accessories such as interior heaters or air conditioning will substantially reduce the energy economy (and range) of the electric vehicle as will attempts to increase range by the addition of more batteries. Future improvements in electric power generating plant efficiency will reflect directly on the energy economy of the electric vehicle. Other devices, such as the addition of a flywheel component (see Section 8.2.2) might further improve energy economy by up to 30%.

### 8.2.2 Range Performance

The range and road performance of a number of experimental electric vehicles built during the past decade is shown in Table 8-1 (from Ref. 8-2). The extremely limited range and top speed, as well as the typically poor acceleration and hill climbing performance of most of the cars listed are clearly inferior to the performance expected of lowest performing conventional cars. The ranges indicated represent the maximum daily driving range since, for most cars, overnight recharge is necessary before driving can be resumed.

Methods which reduce system losses help range performance both by reducing the portion of stored battery energy which is dissipated as internal system losses and by reducing the effect of high load demand on battery energy capacity performance. This latter effect is particularly severe in lead-acid batteries and is evidenced by the high dependence of battery energy density on load power density as shown in Fig. 8-7. From the figure, it can be seen that the effect of high discharge rates on the energy density of advanced batteries is much less severe than that of lead-acid. For example, the energy density of a lead-acid battery at the 1-hr discharge rate is only about one-third of its value at a 20-hr discharge rate, whereas the energy density of the advanced batteries tends to be independent of discharge rate. This indicates that up to 3 times the range can be expected of Ni-Cd batteries, even though they have nearly the same energy density as lead-acid batteries at the 20-hr discharge rate.

Extension of range under urban driving conditions has been attempted by employing battery-battery hybrid and battery/flywheel hybrid concepts. The aim of these is to minimize the high transient load power demands of stop-and-go driving on the main (usually lead-acid) battery supply. The General Electric Delta (Ref. 8-18) battery-battery hybrid vehicle uses a small nickel-cadmium battery for providing transient load demands in combination with a larger lead-acid battery for supplying the average driving load and recharging the Ni-Cds during nontransient periods. Use of the dual battery system in the Delta car results in a two-fold improvement in range over that achieved by lead-acid batteries alone on a four-stop-per-mile driving cycle at a 30-mph cruise speed. While no measurements of energy economy are reported, it is estimated that some improvement is gained as a result of the lower battery internal resistance of the Ni-Cds.

Table 8-1. Electric cars of the last decade (from Ref. 8-2)

	Vehicle curb weight, lb	Drive motor(s)	Maximum speed, mph	Energy source and capacity	Range, mi
Comuta	1,200	Two 5 hp; series dc	40	Lead-acid 48 V (384 lb)	37 at 25 mph
GM 512	1,250	8-1/2 hp; series dc (54 lb)	40	Lead-acid 84 V (329 lb)	47 at 30 mph
Sundancer, ESB	1,600	--	--	Lead-acid 86 V (750 lb)	70-75 on SAE resi- dential
Marquette, Westinghouse	1,730	Two 4-1/2 hp, dc (45 lb)	25	Lead-acid 72 V (800 lb) 8 kWh	50
Henney Kilowatt, Union Electric	2,135	7.1 hp; series dc	40	Lead-acid (800 lb) 8 kWh	40
Yardney	1,600	7.1 hp; series dc	55	Silver-zinc 12 kWh (240 lb)	77
Allectric, West Penn Power Co.	2,160	7.1 hp; 72 V dc	50	Lead-acid 72 V (900 lb) 9 kWh	50
"Mini" GE	2,300	10.9 hp; dc motor	55	Lead-acid and nickel cadmium	100 at 40 mph
American Motors and Gulton Ind.	1,100	--	50	Lithium- nickel fluoride (150 lb) and nickel cadmium (100 lb)	150 with regener- ation
ESB, Renault	--	--	40	Lead-acid (72 V)	25-35
Rowan Electric	1,300	2 dc compound	40	Lead-acid	100
Allectric II, West Penn Power Co.	2,300	7.1 hp; dc motor	50	Lead-acid (900 lb)	50
Super-Electric Model A, Carwood and Stelber Ind.	--	Two 2 hp	52	Lead-acid (520 lb)	--
Cortina, Estate Car	3,086	40 hp; 100 V (150 lb)	60	Nickel- cadmium (900 lb)	39.9 at 25 mph
Comet Ford	3,800	85 hp	70	Sodium-sulfur (1086 lb)	--
City Car Pinto	3,200	40 hp	50	Lead-acid (956 lb)	39 at 40 mph
Mars II, Electric Fuel Propulsion, Inc.	3,640	15 hp; dc	60-65	Lead-acid 96 V (1700 lb) 30 kWh	70-120
Electrovair, GM	3,400	100 hp; ac induction	80	Silver-zinc 530 V (680 lb) 19.5 kWh	40-80

Table 8-1 (contd)

	Vehicle curb weight, lb	Drive motor(s)	Maximum speed, mph	Energy source and Capacity	Range, mi
Electrovan, GM	7,100	125 hp; ac induction	70	Hydrogen-oxygen fuel cell 180-270 kWh	100-150
Allis Chalmers, Karmann-Ghia	3,440	--	--	Lead-acid 120 V (1534 lb)	60 at 60 mph
Chrysler-Simca	--	--	--	Lead-acid (1400 lb)	40
Electric Fuel Propulsion, Inc.	3,400	--	85	Lead-acid cobalt	150-175
Falcon, Linear-Alpha	--	25 hp; ac induction motor	60	Lithium-nickel fluoride (360 lb)	75 at 80 mph

In a follow-on program to the Sundancer effort, ESB (Ref. 8-2) is pursuing the development of a battery-flywheel hybrid power train in which a battery powered motor drives a flywheel that is connected to the drive shaft through a continuously variable hydrostatic transmission. The 20-in. -diameter flywheel is sized to permit one 0-60 mph stop-start cycle.<sup>3</sup> The CVT is an adaptation of an Allgaier industrial unit which is being modified to ESB's specifications by Hydro Stationary Drives. A target of 95% transmission efficiency at rated power has been set with similarly high goals at high torque, low speed levels. ESB expects a 30% improvement in range by the use of this hybrid combination. The effect of the tradeoff between added transmission, flywheel bearing and windage losses vs motor-battery  $I^2R$  losses on overall energy economy has not been indicated. Despite these losses, however, it is reasonable to expect that the more efficient recovery of regenerative braking energy will offset the losses and result in improved overall energy economy under urban driving conditions.

While improvements in system efficiency and reduction of battery loading can enhance energy economy and provide some improvement in range, the major inadequacy of battery or flywheel vehicle range stems from the limited energy density of batteries and flywheels in comparison to that of gasoline. Because acceptable road performance and energy economy depend upon high-power, lightweight batteries, improved battery energy density cannot be utilized at the expense of power density. Thus a balance must be maintained between the two. Target specifications for advanced battery developments are generally as follows:

Energy density	100 W-hr/lb
Power density	100 W/lb

Cycle life	2000 cycles at 70% DOD
Service life	5 yr
Cost	10-20 \$/kW-hr

Substantial progress in battery technology has been made over the past 10 years, and a number of promising battery systems are under development. Each has significant problems or limitations, and the target specifications are far from being met by a single concept.

As a part of the Minicars (Ref. 8-2) study, projections of the ultimate performance characteristics of advanced batteries were made, and from these, driving cycle ranges were computed for a 2-passenger commuter-type vehicle and a 4-passenger sub-compact vehicle. The results of the 4-passenger vehicle computations are shown by the solid curves of Fig. 8-8 normalized on the basis of the battery/vehicle weight fraction. In addition to the Minicars computations, the dashed curves represent the estimated range of the same or similar battery types based on measured battery performance or nearer-term battery development program goals. For the most part, the estimated range performance shown by the dashed curves is based on single points of data from other sources.

The 1973 Pb-acid (dashed) curve is taken from Ford (Ref. 8-8) computations for a modified Pinto electric vehicle using measured battery data from an ESB EV-106 battery. Minicars (Ref. 8-2) 1980 Pb-acid range (solid) curve is based on a composite of General Motor's 512 and ESB's EV-140 battery characteristics as being a representative projection of the ultimate energy density performance for a long-life lead-acid battery. The 1974 sealed Ni-Zn range curve

<sup>3</sup> Personal communication, Geo. Kugler, ESB Inc.



is estimated from data on a recently introduced line of 7- and 25-A-hr sealed cells by Energy Research Corporation (Ref. 8-19). The restricted cycle life (200-250) and high cost of these cells limit their superiority over high-performance lead-acid traction batteries to that of improved performance (energy density = 25-30 W-hr/lb, and power density = 100 W/lb) and range, but not cost. The (solid) range curve for the 1978 vented Ni-Zn battery computed by Minicars is based on Gould projections of the availability of production Ni-Zn batteries having 40-50 W-hr/lb energy density and cycle life in excess of 400 before 1980. The (dashed) range curve for the 1980 Li-S reflects the goal of the Argonne National Laboratory program to install and test a 500 lb, 68 W-hr/lb battery in a 2800-lb vehicle by 1980 with industry participation (Ref. 8-20). The vehicle is expected to have a range of 100 miles. Minicars computations for the range of a Zn-Cl powered vehicle are based on battery performance projections by Energy Development Associates (Ref. 15). A mechanically rechargeable system used for vehicle tests in 1972 demonstrated a range of over 150 miles at 50 mph constant speed in a subcompact car. The battery program calls for the development of a 50 kW-hr prototype battery having an energy density of 71 W-hr/lb and a constant rate discharge power density of 18 W/lb with a 30-sec peak power capability of 57 W/lb. The 700 lb prototype is expected to be ready for test by the end of 1975 and the overall development completed by 1978-79. The 1973 Na-S (dashed) range curve is based on Ford (Ref. 8-21) computations for a Comet-size vehicle using performance figures of 40 W-hr/lb and 100 W/lb for the battery from laboratory measurements of actual cells at 300°C operating temperature. Minicars computations for the range of a vehicle using a Li-S battery at its ultimate state of development are shown by the (solid) curve for the 1990 Li-S system.

From the curves, it can be concluded with reasonable confidence that the driving cycle range of electric vehicles for battery/vehicle weight fractions around 0.2 will exceed 80 miles in the 1980-1990 period and, depending on the success of the more speculative battery developments, could be as high as 150-250 miles. While the more conservative range projections still fall short of the range of conventional automobiles, a sizeable portion of the transportation needs of the private sector could be met by an electric vehicle with 80 miles range assuming that all other factors such as energy economy, cost of ownership and road performance are acceptable. It is unlikely, however, that electric vehicles would completely replace conventional vehicles while liquid fuels are still available because of the lengthy recharge time required before driving can be resumed. Quick recharge, battery exchange and electrolyte replacement methods have been explored as solutions to the recharge problem, but until such time as a successful battery development emerges, the details of quick charge schemes cannot be defined. Should quick recharge techniques prove feasible, a large infrastructure will have to be developed to provide this capability.

The ultimate range performance of flywheel-powered vehicles is more difficult to estimate. Subscale experiments have demonstrated that

energy density capabilities of 28 W-hr/lb are possible (Ref. 8-28) for the rotor alone, but much work needs to be done to extend these results to full size rotors, and then to complete powerplant systems.

### 8.2.3 Road Performance

Most of the electric vehicles developed to date have been typified by generally poor acceleration, top speed and hill climbing performance. These road performance characteristics are limited by the power delivery capabilities of the motor and battery, and of the two, the battery capability limitations are the most fundamental.

Because the motor can be overloaded for short periods of time, its sizing is typically determined on the basis of the sustained power requirements for level road operation. Normal accelerations can usually be made within the power-time overload tolerance of a motor sized on this basis, but sustained hill climbing or fast accelerations can easily exceed the permissible motor overload ratings. Therefore the traction motor power rating and overload capabilities place an additional constraint on the best road performance that can be achieved by the electric vehicle.

The effect of battery weight and power density on the maximum effort acceleration performance is shown in Fig. 8-9 for the baseline electric vehicle with 20- and 40-hp motors and from 500 to 2000 lb of batteries. Battery power density values of  $\rho_p = 30, 60$  and  $90$  W/lb are shown. The curves show the minimum time required to accelerate from 0-30 mph and 0-60 mph on level road. The solid lines indicate the minimum acceleration time based on battery power limitations, whereas the dashed lines represent the least time based on a 350% motor current overload constraint. The minimum acceleration time is therefore the highest of the two at any particular values of battery weight and motor power.

It can be seen from the curves that, for a 1000-lb battery having a power density of 60 W/lb, the minimum time to accelerate to 30 mph is constrained by the overload rating if a 20-hp motor is used, whereas the battery power delivery capacity is the limiting factor if a 40-hp motor is used. Similarly, for a 0-60 mph acceleration, the battery power delivery constraint governs for battery pack weights of less than 1500 lb (for a 40-hp motor and 60-W/lb battery).

The 0-60 mph acceleration performance is inferior to that of a conventional automobile for batteries having a power density of less than 90 W/lb. To compare with the performance of a conventional car, a 40-hp motor would be required with 90 W/lb batteries.

The maximum climbing range on a 6% grade for the baseline electric car is shown in Fig. 8-10 for speeds of 60, 45, and 30 mph, respectively. The curves show the maximum power delivery capability of 30, 60 and 90 W/lb lead-acid batteries weighing from 500 to 2000 lb (solid lines) and motor thermal overload limits (dotted lines). Except for the use of heavy, low-power-density batteries, the hill climbing performance

should be adequate for urban uses of electric vehicles.

#### 8.2.4 Emissions Performance

The emissions of air pollutants chargeable to electric or flywheel vehicle use may be significant, small or nonexistent, depending on whether the source of electric generating plant energy is coal, oil or non-fossil (e.g., nuclear) fuel. Table 8-2 summarizes the projected emissions of a small electric car with battery weights ( $W_b$ ) of 500, 1000, and 1500-lb based on power provided by an oil-fired generating plant. EPA AP-42 (Ref. 8-6) emission factors for oil-fired plants are shown on the top line of the table. On the second line, the NOx emission factor has been adjusted to represent plants in the Los Angeles air basin, and for SO<sub>2</sub> and SO<sub>3</sub>, the sulfur content of residual fuel is assumed to be 0.5% by weight in accordance with the Air Pollution Control District Rule 62. The values on the second line are based on the typical heat content of residual fuel of  $6.29 \times 10^6$  Btu/42-gallon barrel, powerplant efficiency of 35%, and distribution efficiency of 91%. These values represent the weight of pollutants produced by the powerplant in delivering each kilowatt-hour of electricity to the electric vehicle charger input. In the lines below, these values are converted to equivalent g/mi emissions of electric vehicles based on the values taken from Fig. 8-6 for the energy economy of various weight battery-powered cars.

From the table, it can be seen that the powerplant NOx emissions are comparable to the statutory Federal automobile emission standard of 0.4 g/mi. The equivalent CO and HC emissions are negligible compared to the Federal automotive standards. The SO<sub>2</sub> and particulate emissions are currently uncontrolled for autos, but these levels could be significant in certain air basins. The SO<sub>2</sub> emissions attributable to electric vehicle use exceed the values of 0.15-0.20 g/mi typical of conventional automobiles. For coal-fired plants the equivalent NOx, SO<sub>2</sub> and particulate emissions will be still higher than for oil-fired plants. Of course, nuclear energy generating plants will relieve the electric vehicle of any responsibility for air pollution. Thus, the desirability of electric cars from an emissions point of view will depend on the type of powerplant and its location (a point source) and the nature of the local air pollution problem.

#### 8.2.5 Performance Summary

Table 8-3 shows a comparison between three battery powered cars and a generally equivalent Otto-engine-powered conventional car with 40- and 80-hp engines based on the results of Mini-cars (Ref. 8-2) and Ford (Ref. 8-8) studies for advanced battery systems. Because of the large volume taken by batteries, the payload accommodations for the five examples vary somewhat, with the compact Comet offering slightly more room (passenger plus luggage), and the

Table 8-2. Electric vehicle emission performance

	NOx	CO	HC	SO <sub>2</sub>	SO <sub>3</sub>	Particulates	Aldehydes
Emissions from input fuel per EPA guideline, <sup>a</sup> lb/10 <sup>3</sup> gal	105	3	2	157S	2S	8	1
Emissions from input fuel in Los Angeles, <sup>b</sup> g/kW-hr	1.23	0.097	0.065	2.55	0.032	0.258	0.032
Electric vehicle emissions, g/mi							
$W_b = 500$ lb, $W_v = 2800$ lb, 3.1 mi/kWh <sup>c</sup>	0.40	0.03	0.02	0.82	0.01	0.08	0.01
$W_b = 1000$ lb, $W_v = 3500$ lb, 2.7 mi/kWh	0.45	0.03	0.02	0.93	0.01	0.09	0.01
$W_b = 1500$ lb, $W_v = 4200$ lb, 2.4 mi/kWh	0.53	0.04	0.03	1.11	0.01	0.11	0.01

<sup>a</sup>All entries are from EPA guideline (Ref. 8-6). S stands for sulfur percentage in oil by weight.

<sup>b</sup>Data on NOx emissions are adjusted for Los Angeles powerplants (0.96 → 1.5, ave. = 1.23). Other entries are directly calculated from line above, with S = 0.5; heat content of residual fuel =  $6.29 \times 10^6$  Btu/42-gal barrel; overall generation and distribution; efficiency of 32%.

<sup>c</sup>Based on simulated metropolitan driving cycle, Small size vehicle, regenerative braking not included.

Table 8-3. Performance summary

	Battery systems			Otto-Engine-Equivalent car	
	Pb-acid, "Pinto" (Ref 8-8)	Ni-Zn, "4-Pass.," (Ref 8-2)	Na-S, "Comet" (Ref 8-8)		
Otto engine horsepower	-	-	-	40	80
Electric motor power (peak hp)	40	85	85	-	-
Traction battery weight, lb	960	1090	1090	-	-
Vehicle curb weight, lb	2900	3230	3500	1960	2100
10-sec accel. distance, ft	335	370	445	285	405
50-mph range, 6% grade, mi	5.6	60	55	215	230
Driving cycle range, mi	30 <sup>a</sup>	145 <sup>a</sup>	235 <sup>a</sup>	445 <sup>b</sup>	325 <sup>b</sup>
Driving cycle fuel econ., mpg (with regenerative braking)	35 <sup>a</sup>	32 <sup>a</sup>	31 <sup>a</sup>	37 <sup>b</sup>	27 <sup>b</sup>
60-mph fuel econ., mpg	26	25	25	33	28
Emissions (g/mi): <sup>c</sup>					
HC	0.03	0.03	0.03	0.41	
CO	0.04	0.04	0.04	3.40	
NOx	0.44	0.48	0.49	0.40	
SO <sub>2</sub>	0.91	0.99	1.02	0.15-0.20	
Particulates	0.09	0.10	0.10	0.15-0.40	

<sup>a</sup>Based on SAE J-227 Metropolitan Driving Cycle.

<sup>b</sup>Based on JPL Electric/hybrid vehicle driving cycle.

<sup>c</sup>Equivalent emissions for oil-fired generating plants.

sub-compact Pinto and 4-passenger Minicars models being less spacious than the sub-compact Otto engine cars.

The poorer level road acceleration of the lead-acid powered electric reflects, in part, the use of a direct drive in contrast to the 2-speed transmissions used in the other electrics. In general, the acceleration performance of all cars is acceptable, with most of the differences being largely the result of design choices. More fundamental differences show up in comparisons of grade and driving cycle range performance among the electric cars and between the electric and

conventional vehicles. The grade range of the advanced battery electrics is 10 times that of the lead-acid vehicle because of the combined effects of higher battery energy density and less dependence of the energy density on battery power loading. At that, the grade range of the best of the electrics is only one-quarter that of a conventional car (with a 12-gallon gasoline tank). A similar, but less striking effect can be seen in comparisons of driving cycle range because of the lighter average battery loading of urban driving.

The electric vehicle driving cycle fuel economy is seen to be about 20% better than that of

the 80-hp conventional car, but at constant high speed the electrics are about 10% poorer in fuel economy. Variations between the electrics are largely attributable to differences in curb weight rather than system performance characteristics. The relatively small differences in fuel economy of conventional vehicles between urban and constant high speed driving are due to a combination of improved engine efficiency under the higher loading of high speed driving and the absence of stop-and-go and idling energy losses of urban driving. Whereas the efficiency of an electric drive system decreases with increased loading, that of the internal combustion engine improves at loads approaching its maximum torque rating.

Based on emissions from oil-fired generating plants, HC and CO emissions attributable to electric vehicles are insignificant in comparison with those of advanced conventional vehicles, with NOx being roughly equivalent. For presently uncontrolled auto emission species, the table shows that SO<sub>2</sub> emission contributions resulting from the generation of power for electric vehicles are substantially greater than those of conventional cars, with particulate emissions being somewhat lower.

### 8.3 COMPONENTS

#### 8.3.1 Traction Motor-Controller

A choice of four or more basic motor types, each with a large number of variations, is available for electric car propulsion, and many of these have been tried in experimental vehicles. By far the most widely used is the series-wound dc commutator motor. However, others that have performed or promise to perform satisfactorily include dc separately excited (shunt), transistor commutated dc, printed circuit dc, permanent magnet dc, polyphase ac induction, and hysteresis and reluctance synchronous motors. With respect to efficiency, only the squirrel cage induction motor is substantially inferior. The brush-type motors are inferior in rotor speed, weight and overload capability because of the composite structure, added weight and limited current capacity of their commutator systems. Because of its low thermal capacity, the printed circuit motor cannot be overloaded. Otherwise the most significant differences between motor types relate to the combined cost of the motor and its controller, and here, too, differences tend to average out because the most expensive and heaviest motors require the least expensive and lightest controllers. Typical dc commutator motor efficiency curves are shown in Fig. 8-11(a).

The torque-speed characteristics of the series-wound dc commutator motor adapt well to the road requirements of electric vehicles by producing high torque for low speed acceleration and moderate torque at high motor speeds. Since the armature and field are both connected in series, the system logic requirements are minimal and the controller must provide only one output to the motor. The armature or field windings can be reversed for backing; thus no reverse gear is required in the transmission. Series traction motors require the use of a contactor or

pulse-width-modulator (PWM) type of controller for handling the high armature currents.

Contractor controllers use stepwise battery switching, resistance switching or a combination of the two for control. To minimize complexity, relatively few steps are employed, and as a result, control tends to be jerky. Where battery switching is used as the main mode of control, the battery pack is divided into two or four equal voltage groups which the controller connects in series or parallel combinations to provide the correct motor voltage over the speed range. Series resistance is added to limit current surges following battery switching and thereby smooth torque transients. In both this and the resistance-type contactor controllers, significant losses occur as a result of the series resistance required for smooth control.

Chopper (PWM) type controllers overcome the lack of smoothness and the resistive losses of contactor controllers by cyclicly connecting the battery to the motor at a rate or duty cycle in proportion to the motor speed and driver torque command. The combination of the field (or external) inductance and a "free-wheeling" diode effectively transforms the fixed battery voltage to the varying motor voltage, providing smooth and efficient control at all speeds. At their rated power level, PWM controller efficiencies typically exceed 95%, and although the efficiency falls off under high-current, low-voltage operation, the average efficiency remains above 90% over the wide dynamic load range normally encountered in electric vehicle operation. PWM controller performance characteristics derived from loss data supplied by Thornton Power Systems<sup>4</sup> are shown in the controller efficiency map of Fig. 8-11(b). By the nature of its operation, the chopper controller must work into an inductive load which may be provided by the motor field inductance or by an external inductor. While the efficiency of the chopper controller itself is high, its mode of operation may induce losses into the battery and motor field structure.

Separately excited dc commutator motors provide for greater control flexibility by permitting individual control of both the field and armature windings (Ref. 8-23). A combination of gear shifting and low power field control (Ref. 8-24) can provide smooth torque control over the range of from about 10% of the vehicle speed to the maximum speed. Only the lower 10% of the speed range must be handled by armature control. Since a multispeed transmission has been shown to be desirable from an energy economy standpoint, this method of control would not impose an additional constraint on the system design. Attention is required in the design of the motor to assure that the field time constant does not impair driver control or shifting smoothness by power response delays. Within its speed range, field control offers the advantages of smooth control, high efficiency, low-power/low-cost hardware, freedom from losses induced into other portions of the system by the controller, and ease of regenerative braking recovery.

<sup>4</sup>Personal communication, Henry Coyne, Thornton Power Systems.

In trade for their low weight, cost and maintenance, the ac induction and synchronous motors require a more complex, heavier, and costlier controller. To obtain satisfactory torque characteristics, ac motors used for traction drives must be polyphase, and thus polyphase controllers are required to condition the fixed voltage dc battery supply. Both variable power and variable frequency drive signal control are required for ac motors, and the induction types require a controlled slip frequency to provide optimum torque over the speed range. While the system logic tends to be complex, the availability of low-cost integrated circuit chips permits the logic function to be performed at very little cost penalty to the overall system. The major controller cost is associated with the high power stages which must be duplicated for each motor phase winding.

The rich harmonic content of switch-type controllers results in lower motor efficiencies than are typically measured with sinusoidal inputs, and the high speeds at which these motors run require reduction gearing with its attendant losses. Compounding these are higher switching losses in the controller due to the higher operating frequencies. Despite the added losses, however, the overall efficiency of ac induction and synchronous motor-controller combinations is comparable to that of a dc motor-controller system because the higher motor efficiency offsets the increased electrical and gearing losses. Most ac motor-controller systems can provide regenerative braking at little added system complexity or cost.

Pertinent motor-controller system data taken from the results of Ref. 8-8 are summarized in Table 8-4. The disc motor referred to in the table is a Ford development which is classified as a polyphase reluctance-synchronous machine. Data for the squirrel cage induction motor are based on the experimental motor-controller system developed by General Motors for the Electrovair II silver-zinc battery-powered Corvair (Ref. 8-25); data for the dc commutator motor represent experimental and physical measurements taken from the Ford Cortina (Ref. 8-26) nickel-cadmium battery-powered Estate Wagon system. In general, the data are characteristic of very high performance systems.

A breakdown of material weights based on the results of the Minicars study (Ref. 8-2) is included in Table 8-5. As a rule of thumb, copper normally constitutes approximately 25% of the overall weight of conventional motors.

### 8.3.2 Battery Systems

While present plate-type batteries including lead-acid, nickel-zinc and nickel-cadmium systems do meet specific power requirements of electric vehicles, they do not have sufficient energy storage capacity and lifetime for traction applications and are generally too expensive to compete with conventional automobiles.

The capacity to store energy is a function of the molecular weights of the battery reactants as well as the weights of the case, electrode supports and excess reactants or electrolyte. The theoretical maximum energy per unit weight is:

$$E = 12170 nV/M$$

where

$E$  = energy density in W-hr/lb

$n$  = number of electrons transferred in the cell reaction

$V$  = cell voltage

$M$  = sum of the molecular weights of the products or reactants

For lead-acid, nickel-cadmium and nickel-zinc batteries, the theoretical energy densities are 79, 110 and 184 W-hr/lb, respectively, but practical energy densities amount to only 10-20% of these values. Clearly, approaches to new batteries with higher energies can be centered on improved utilization of reactive materials relative to the peripheral materials or by utilizing very high energy chemical systems for which the low utilization is acceptable. Both methods are currently being explored, but the prospects for either being successful in the immediate future are dim.

It is convenient to separate the different types of batteries because of the different research problems and possibilities associated with each. The major types of secondary batteries are (1) cells in aqueous electrolytes, (2) ambient temperature cells in nonaqueous electrolytes, (3) fused-salt, elevated temperature systems, (4) systems containing ion-exchange or ion-conducting membranes, and (5) fuel cell systems. Examples of each type are either practically applied or have been the subject of extensive research.

### CELLS IN AQUEOUS ELECTROLYTES

All the common secondary batteries operate at ambient temperature using electrolytes consisting of highly conducting acid or alkaline solutions. The lead-acid battery is the most common battery of this type, and it does possess adequate power and cost characteristics for the electric vehicle (Ref. 8-27). It has an inherently low energy density, and it is generally believed that the maximum practical energy density for the lead-acid system is about 20 W-hr/lb. Nickel-cadmium batteries are too high in cost and also too low in energy to be considered, although either system may be suitable for battery-battery hybrid vehicles in conjunction with high-energy, low-power batteries.

Metal-oxygen or metal-air cells such as the zinc-air system possibly can meet the energy requirements of an all-electric car, but excessively costly electrodes (air or oxygen) limit the power available from the system (Ref. 8-28). This problem is a common restriction on gas electrodes in general, where the size of the electrodes may become very large.

The remaining system which operates at ambient temperature in alkaline solution is the nickel-zinc cell. With a maximum projected energy density of 40-50 W-hr/lb, this battery could be a strong candidate for limited use (based on cost and nickel availability) in automobiles and delivery vans.

Table 8-4. Motor-controller typical data (from Ref. 8-8)

	DC commutator	Squirrel cage induction	Synchronous induction	Disc motor
Specific weight (lb/hp) at (speed)	6.1 (8000)	1.5 (12,000)	1.0 (24,000)	2.4 (6,000)
Specific cost, \$/hp	\$5.00	\$3.00	\$2.75	\$2.50
Max. speed (rpm) based on stress limits of 4.5 in. rotor	12,000	30,000	92,000	40,000
Efficiencies:				
Maximum torque @ rated speed	92	90	86	90
35% torque @ 35% speed	87	65	75	82
Maximum torque @ 5% rated speed	55	33	52	60
Controller specific cost, \$/hp (without regenerative braking)	\$5.00 (\$2.50)			\$5.80
Motor-controller combined cost (without regenerative braking)	\$10.00 (\$7.50)		(\$8.30)	
Motor-controller combined weight, lb/hp	7.3	5.6		6.0

#### AMBIENT TEMPERATURE CELLS IN NONAQUEOUS ELECTROLYTES

The nickel-zinc cell provides only marginally sufficient energy for electric vehicle needs, and higher energy systems are required in order to make electric propulsion competitive with conventional power systems. Cells consisting of different but similarly heavy metallic components are unlikely to give substantially higher energies, and thus there is interest in new high-energy systems which can use light, reactive metals in order to lower the weight and raise the cell voltage. Since these metals react violently with water, non-aqueous electrolytes must be used. These are usually organic electrolytes with relatively low electrical conductivities, and, as a result, the batteries are usually low power devices.

The most promising of the ambient temperature systems are the rechargeable lithium cells. Various systems are possible with differing electrolytes and positive electrode reactants, with theoretical energy densities greater than 500 W-hr/lb and practical energy densities estimated to lie between 50 and 200 W-hr/lb (Ref. 8-29). Perhaps the best understood is a class based on lithium and metal halide cathodes such as Ag-Cl, Cu-Cl and Cu-Cl<sub>2</sub> with organic electrolytes. These have been shown to be rechargeable and to deliver up to 3.5 volts per cell. Their major problem is self-discharge caused by

dissolution of the cathode material and subsequent chemical reaction with the lithium anode. The problem is being investigated in the area of additives to the electrolyte which may impede or eliminate the dissolution process at the anode.

Another class of nonaqueous cells employs organic electrolytes and new types of cathodes based on transition metal chalcogenides such as niobium selenide (Nb-Se<sub>3</sub>). These systems, developed by Bell Telephone Laboratories (Ref. 8-30) and others (Ref. 8-31) were only recently considered applicable to small power supplies and have not been completely evaluated for their potential to electric vehicles.

#### FUSED-SALT HIGH-TEMPERATURE CELLS

Recently, much of the work on high-energy secondary batteries has been centered on highly reactive anodes, such as lithium, and the use of organic electrolytes stable towards lithium. High-power batteries can, in principle, be obtained from these reactive metals by using fused salt electrolytes which have very high electrical conductivities. Unfortunately, these salts or salt mixtures are usually high-temperature melts because the lower melting mixtures lack the ionic character necessary to give the high conductivity. Efforts to produce highly conductive lower temperature cells by

using eutectic salt mixtures have met with difficulty because of the tendency of the eutectic to change composition and melting point during charge and discharge.

The lithium-sulfur cell is currently the most prominent of the molten salt types and is being developed by Argonne National Laboratories (Ref. 8-32). It is presently being run with an iron sulfide cathode to solve some of the sulfur containment problems. The electrolyte is a eutectic mixture of lithium and potassium chlorides with the anode being either lithium or lithium-aluminum mixtures. The major developmental problem centers on the high cell temperature (about 700°F), which causes severe corrosion and technical problems in sealing. The practical problem of above-ambient temperature operation is also of some concern relative to stand time. Argonne projects the completion of their program and the demonstration of lithium-sulfur systems by 1980, by which time a better evaluation can be made of this and other high-temperature systems.

#### CELLS WITH ION-EXCHANGE OR ION-CONDUCTING MEMBRANES

The advent of ion-conducting ceramics and plastics allows the removal of some of the solubility and reactivity restrictions that are inherent to secondary battery designs. The sodium-sulfur battery, which uses a sodium-conducting ceramic electrolyte, is an example of the use of normally incompatible materials in an electrochemical cell. In principle, sodium could even be in contact with aqueous electrodes such as nickel, for example, to give a 4-V cell with very high energy density.

The sodium-sulfur cell has received a great deal of attention and is currently being studied in systems utilizing both ceramic (Ref. 8-33) and glass membrane electrolytes. The former case has been limited by failure of the ceramic, while the latter appears to be limited by the high electrical resistance of the glass electrolyte. The problems of handling very reactive chemicals at high temperature (550°F) are critical in the cost and engineering aspects of this particular system.

The development of new ion-conducting media is an attractive goal and may represent the only means to achieve batteries which supply energy sufficient to drive a compact-size automobile. Both cation-transferring materials (such as B-Al<sub>2</sub>O<sub>3</sub>) and anion-transferring materials (hydroxyl ions, for example) are of great interest in developing new battery designs.

#### FUEL CELL CONCEPTS

Fuel cells are presently too low in power density to be considered as the only energy source for an electric car but may be promising as a part of a battery-battery hybrid system (Ref. 8-34). The hydrogen-air fuel cell has not been considered viable for automotive use, partly because of the requirement to store hydrogen and partly because of the relative complexity of the system itself. Research on hydrogen production from reformed hydrocarbons may remove the hydrogen storage problem, and it is possible for advances to be made in increasing the effectiveness of the electrodes that limit power in the fuel cell. The

main problem is that of reducing or replacing the noble metal catalysts that are currently required for both fuel and air electrodes. This problem has been under study for years without success, but there remain several unexplored areas. New compounds based on semiconductor materials appear to be the only promising class of substitutes. New techniques such as application of ultrasonic, radiative, and electromagnetic stimulation may lower the need for catalysts (Ref. 8-10). A reduction of fuel cell costs coupled with improved on-board hydrogen production could make the fuel cell a possible candidate for an electric vehicle energy source.

#### 8. 3. 3 Materials Requirements

The current production and reprocessing capacity of unique battery materials would have to be expanded for a substantial conversion of the passenger car fleet to electric vehicles. Since it is unlikely that more than 30% of the fleet (second-car component) would be converted because of the range and recharge limitations of even advanced battery powered vehicles, an estimate of material demands can be made and compared with the current production capacity for these materials. Table 8-5 shows the major inorganic material requirements for motors, controllers and various battery types as determined in the Minicars (Ref. 8-2) study. The battery size (weight) shown for each battery type in the table has been selected on the basis of a 145-mile urban driving range for all except the lead-acid battery powered vehicle, which has an urban driving range of 54 miles according to Minicars computations. Since the materials requirements shown for advanced batteries represent current estimates based on early research program results, it is expected that fully mature systems will be optimized from the standpoint of materials utilization and that less critical material substitutions will be made wherever possible.

Table 8-6 shows the estimated world reserves (based on the grades of ores mined in 1968), the current United States annual consumption, the present import fraction of primary materials, and the compound growth rate in consumption that would occur for the buildup and maintenance of a 30-million-car electric vehicle fleet over a 20-year period. The growth rate percentages are based on building up a 3-million-unit per year production capacity over a 10-year period, which results in a 16.5-million-vehicle population at the end of that period. During the next 10-year period, the production rate would continue at 3 million cars per year, with 13.8 million new cars being added to the road population during that time and 16.5 million cars produced to replace vehicles sold during the first 10-year period (based on a 10-year vehicle service life). Demand for primary materials would peak by the end of the first 10-year period at the value shown as the peak percentage of 1968 U. S. consumption (second column of the motor-controller and each battery tabulation) and would decline to about 10% of that value after 20 years, assuming a constant vehicle population of 30 million vehicles and a 90% material recycling rate. (The current recycling rate for battery lead is 80%.)

For the ambient temperature batteries (Pb-acid and Ni-Zn) the table shows that sizable

Table 8-5. Materials for electric vehicle components

Lead-acid battery		Nickel-zinc battery		Zinc-chlorine battery	
Lead	481	Nickel	362	Zinc	64
Lead-oxide	489	Zinc-oxide	328	Chlorine	69
Antimony	24	KOH	109	Titanium	40
Electrolyte	426	Copper	11	Structure	17
Other	80	Other	280	Other	380
	<u>1500 lb</u>		<u>1090 lb</u>		<u>570 lb</u>
Lithium-sulfur battery		85-hp (peak) electric motor		Controller	
Lithium	17	Copper	47	Copper	9
Sulfur	66	Iron	189	Steel	30
Stainless Stl	51	Steel	40	Aluminum	21
Aluminum	7	Aluminum	32	Semiconductor	9
Other	159	Other	7	Other	16
	<u>300 lb</u>		<u>315 lb</u>		<u>85 lb</u>

increases in consumption would occur, with lead and nickel rates increasing by factors of 2 and 4, and with much of the increase relying on imported primary materials. These factors may be so severe as to preclude the widespread adoption of electric cars powered by these battery types. The zinc-chlorine battery places a more moderate load on material consumption, although a very substantial growth in titanium metal processing capacity would be required. (Most titanium consumed in the U. S. is used for paint pigments and very little is reduced to metal.) A similarly large-capacity growth would be required for lithium refining in the event that the lithium-sulfur battery becomes feasible for electric vehicle propulsion. Although not listed in the materials breakdowns of Tables 8-5 and 8-6, the sodium-sulfur battery weight and composition would be generally equivalent to that of the lithium-sulfur battery based on equally optimistic performance projections. (The battery performance on which the calculations of Table 8-3 are based uses measured results obtained from laboratory tests of experimental batteries rather than ultimate projections for the battery type.) In the latter cases, very little reliance must be placed on imported materials, although if extensive use of stainless steel battery cases is made, a significant impact on nickel and chromium supply could result.

#### 8.4 VEHICLE INTEGRATION

The effects of the battery weight and size on payload capacity, vehicle handling and drivability, and vehicle powerplant safety considerations are common to both the electric/flywheel and hybrid vehicle. These are discussed in the Hybrid Vehicle chapter under Section 9.4.

### 8.5 OWNERSHIP CONSIDERATIONS

#### 8.5.1 Maintenance

The substitution of an electric motor for the internal combustion engine removes many of the routine engine-related service and repair operations typical of conventional automobiles. Periodic electrolyte inspection and refilling is the only frequent service which is common to almost all electric vehicles. However, occasional contactor service, traction motor cleaning and lubrication, and motor cooling system service may also be required depending on the particular electric vehicle design. Traction motor brushes and batteries are the major life-limited components which require routine replacement. Typical replacement intervals range from 30,000 to 50,000 miles for brushes and batteries, or 3 to 5 years for batteries in vehicles which receive less usage. Electromechanical devices such as the accelerator pedal potentiometer, battery charge state instrument, power connection cord and plug, and external charger controls are the most likely items subject to unpredictable failures.

#### 8.5.2 Incremental Cost of Ownership

As a part of the Ford study (Ref. 8-8), estimates of the initial fuel and maintenance costs of electric vehicles were made and compared with published data for similar costs of conventional vehicle ownership. Initial costs for electrics were estimated on the basis of production rates of 1,000,000 units per year. Costs of conventional cars had the benefit of a substantial statistical base. Fuel costs for conventional cars were based on statistical data for the 1960-1970 period, whereas the cost of electricity for



Table 8-6. Materials consumption increase (%) for 20-year conversion to a 30-million-car electric vehicle population

	Material									
	Al	Cl	Cu	Li	Ni	Pb	S	Sb	Ti	Zn
Estimated world reserves x 10 <sup>6</sup> ton (Ref. 8-12)	1168	Unlimited	308	6	75	100	2500	4	140	123
1968 U. S. annual consumption x 10 <sup>6</sup> ton (Ref. 8-12)	4.7	8.4	2.8	0.003	0.187	1.45	9.0	0.044	0.025	1.4
Import fraction (1968), % (Ref. 8-12)	94	0	33	0	91	60	0	84	100	60
1500-lb lead-acid battery										
lb/vehicle						970		24		
Peak % 1968 U. S. consumption						100		82		
% annual growth rate						7.2		6.2		
1090-lb nickel-zinc battery										
lb/vehicle			11		362					328
Peak % 1968 U. S. consumption			0.6		290					35
% annual growth rate			0.006		14.6					3.0
570-lb zinc-chlorine battery										
lb/vehicle		69							40	64
Peak % 1968 U. S. consumption		1.2							240	7.0
% annual growth rate		0.12							13	0.7
300-lb lithium-sulfur battery										
lb/vehicle				17			66			
Peak % 1968 U. S. consumption				850			1.1			
% annual growth rate				25			0.11			
Motor controller										
lb/vehicle	53		56							
Peak % 1968 U. S. consumption	1.7		3.0							
% annual growth rate	0.2		0.3							

electric vehicles was based on that of the early 1970s. The results (with fuel tax added) are shown in Table 8-7 for lead-acid powered electric and conventional subcompacts and sodium-sulfur/disc motor powered electric and conventional compacts. The lead-acid battery is assumed to be replaced at 27,000-mile intervals, with the owner obtaining replacements at retail prices prevailing in 1972. These results indicate that the incremental cost of ownership for the electric vehicle is about \$1300-\$1400 greater over the 100,000-mile, 10-year lifespan of vehicle ownership.

Table 8-7. Vehicle costs in cents per mile (from Ref. 8-8)

	Subcompact		Compact	
	ICE <sup>a</sup>	Elec- tric <sup>b</sup>	ICE <sup>a</sup>	Elec- tric <sup>c</sup>
Vehicle initial cost	2.1	3.3	2.7	6.8
Drive train only		(1.2)		(4.2)
Fuel cost (excluding tax) <sup>d</sup>	1.4	1.1	1.8	1.3
Tax	0.6		0.8	
Maintenance	2.1	3.2	2.2	0.7
Total	6.2	7.6	7.5	8.8

<sup>a</sup>From U. S. Department of Transportation Publication, May 4, 1972.

<sup>b</sup>Lead-acid battery.

<sup>c</sup>Sodium-sulfur battery.

<sup>d</sup>Fuel costs for the electric vehicles based on Ford Suburban Economy Route driving cycle.

Since the base period of the Ford study, the price of gasoline has risen at a greater rate than that of electricity. Throughout the first quarter of 1975, gasoline prices had stabilized at about 175% of those during the base period. In comparison, residential electricity rates in the Los Angeles area had increased to 153% and retail battery prices had risen to 140% over the same interval. This suggests that the gap in ownership cost between electric vehicles and conventional cars has narrowed since the base period.

Several factors are likely to narrow this gap further and can ultimately result in lower life-cycle cost for the electric than for the conventional car. The battery replacement costs shown in Table 8-7 amount to 1.7 ¢/mi, or over 50% of the total maintenance costs for the lead-acid powered electric vehicle. Cycle life projections used in arriving at this figure are somewhat conservative based on current battery technology, and further improvements are possible (see Section 9.3.2). Eliminating the need for battery replacement over the life of the vehicle would more than make up the difference in incremental ownership cost between current electric and conventional cars.

Secondly, the present fuel cost of power generated by oil combustion is 1.99 ¢/kW-hr as contrasted to 0.57 ¢/kW-hr for natural gas, 0.29 ¢/kW-hr for coal, 0.12 ¢/kW-hr for nuclear energy, and 0.45 ¢/kW-hr for other energy sources including hydroelectric. While the cost of oil and natural gas can be expected to climb rapidly as reserves dwindle, the cost of other sources of energy should remain fairly stable. Thus, the present 2:1 electric vehicle fuel cost advantage can be expected to widen with time.

## 8.6 RESEARCH AND DEVELOPMENT RECOMMENDATIONS

### 8.6.1 Battery Research and Development

As shown in Fig. 8-12, the recommended battery technology research and development activity is divided into aqueous and nonaqueous electrolyte systems. The former are low-temperature systems which are limited to practical energy densities of less than 50 W-hr/lb because of the low cell voltage and the high molecular weight of the negative electrode. The aqueous electrolyte precludes the use of high-energy lightweight metals. Nonaqueous electrolytes allow the use of these metals but result in electrolyte conductivity problems in lower temperature systems and corrosion, self-discharge and rechargeability problems in higher temperature systems. These systems, however, appear to offer the only means of obtaining electrically powered automobiles comparable in range to moderately sized gasoline powered vehicles.

### AQUEOUS ELECTROLYTE BATTERIES

The basic battery types of this class are the acid (lead-acid) and alkaline (nickel-cadmium, nickel-zinc, silver-zinc) electrolyte systems. The lead-acid battery has been and is the object of a large research effort both in this country and abroad, and it is believed that ample incentive exists for industry to advance its development. The nickel-zinc battery is increasingly of interest as a next generation system but requires substantial effort and research. The main areas of required research and development involve:

- (1) Improved utilization of electrode materials to improve capacity.
- (2) Development of low-cost nickel cathodes.
- (3) Improved separator lifetime and performance.
- (4) Redistribution of zinc on the anode for improved lifetime.
- (5) Low cost packaging, including seals.

These activities are all directed at improving an existing concept to bring it into wider use. They require extensive experimental work on materials, designs and processes.

### NONAQUEOUS SYSTEMS

The basic battery types in this class are the ambient temperature lithium cells (with organic

electrolytes), fused-salt cells (such as lithium-sulfur) and solid electrolyte systems (such as sodium-sulfur). All are similar in that they require routine handling of highly reactive materials and must be perfectly sealed from environmental contamination. They are capable, in principle, of supplying 100 W-hr/lb or more of energy storage, and represent a considerable advance over aqueous cells.

#### Lithium Cells, Ambient Temperature

The lithium anode cells with organic electrolytes suffer self-discharge at an unacceptable rate, although evidence appears favorable that rechargeability is good. They are basically low-power cells because of the low electrical conductivity of the electrolyte. The main areas of research are related to:

- (1) Improved electrolyte with high conductivity.
- (2) Improved cathode materials with low solubility in electrolyte.

The former area is necessary to obtain higher power output so that the cells can be used for primary motive power. The latter area approaches the rechargeability and lifetime limitations which limit the battery performance even in low power applications.

#### High-Temperature Fused Salt Cells

The most prominent cell of this type is the lithium-sulfur battery developed at Argonne National Laboratories which is now operated with an iron-sulfide cathode. As with all high-temperature systems, the power characteristics are excellent, but problems of high-temperature sealing, safety and corrosion by lithium (in this case) and sulfide compounds are critical. Research on the lithium-sulfur concept is extensive, and it may be advantageous to direct new research into other concepts, possibly those operating at lower temperatures (under 200°C) where materials and corrosion problems are much less severe. Suggested areas of research include:

- (1) Batteries utilizing low-melting inorganic salts as electrolytes.
- (2) Development of highly conductive low-temperature molten salts.
- (3) Lightweight cathodes suitable for lower-temperature fused-salt systems including sulfide, bromide and chloride salts.

Each of these topics addresses a particular problem in development of batteries such as the aluminum-bromine cell (studied at JPL), in which operating temperatures of less than 125°C were possible. These cells were limited by the high weight of the cathode, a situation typical of most fused salt concepts.

#### CELLS WITH ION-CONDUCTING MEMBRANES

The use of ion-conducting membranes in a battery frees the normal battery concept from

certain restrictions of solubility and reactivity that limit the construction of some promising cells. The most prominent system is the sodium-sulfur cell in which  $\beta$ -alumina is used to separate normally incompatible cell components. The development of the membrane is the critical factor and is made difficult by the requirements of high conductivity and low reactivity in the presence of powerful chemical agents. The major areas of research should be concentrated on the development of new ion-conducting materials including:

- (1) An  $\text{OH}^-$  conducting membrane for applications to alkaline cells.
- (2) A lower temperature sodium-conducting membrane suitable for applications near the melting point of sodium.
- (3) A chloride or bromide-conducting membrane for aqueous electrolytes.

Each of these materials would allow the design of new battery types which may offer a simple and reliable high-energy cell.

#### 8.6.2 Drive Train Research and Development

The technologies involved in the design and construction of electric motors and mechanical drive train components are well developed and easily adapted to the needs of electric vehicles. The advanced controller art is a relatively new one in which minor technical and cost-related problems still exist. However, controllers now available are adequate to the basic needs of electric cars, and it is expected that evolutionary improvements will be made by industry once a widespread vehicle market develops. Weight reduction of all components including the vehicle body structure is desirable because of the large effect of weight on overall performance. It is expected, however, that once a promising battery concept emerges from the research laboratories, ample time will remain for industry to optimize component and system configuration concepts in preparation for the large-scale manufacture of electric vehicles.

An issue that remains unresolved is the energy economy of electric vehicles. The results of studies range over a 4 to 1 ratio and little test data is available that is accurately measured over a known driving cycle. A comprehensive test and evaluation program based on existing vehicles is recommended to determine the present and ultimate energy economy offered by electric vehicles.

#### 8.7 CONCLUSIONS

Electric vehicles can be powered by any source of electricity. Herein lies the greatest incentive for their continued development.

The energy economy of lead-acid powered electric cars is presently competitive or slightly superior to that of conventional cars so long as their design range lies within their region of economical operation, e.g., 30-50 miles. Attempts to "force" design range beyond this region by increasing battery weight result in a sharp reduction in energy economy with very little improvement in range. While the projected energy density

performance of advanced battery concepts promises a substantial improvement in range, little improvement in energy economy is to be expected by their use. To realize the full energy economy potential of the electric vehicle, a 2- or 3-speed transmission should be used, controller induced losses should be eliminated, parasitic losses should be minimized (by the use of ambient or well-insulated higher temperature batteries or flywheels contained in evacuated housings with nearly drag-free magnetic bearings), overall vehicle weight should be held to a minimum, and regenerative braking should be used.

The flexibility and convenience of electric vehicle operation is presently inferior to that of the conventional automobile and promises to remain so in the foreseeable future. Range, recharge time and road performance limitations imposed by present and projected battery characteristics will likely confine the role of the electric vehicle to second-car status for the indefinite future. These factors rule out the electric vehicle powerplant as a direct Otto-engine-equivalent but do not rule out its usefulness for private urban and suburban transportation purposes which comprise a large percentage of automotive travel in the United States each year.

The emissions performance of electrics as reflected back to oil fired stationary power generating stations promises to be generally superior to that of equivalent Otto engine powered vehicles with the exception of NO<sub>x</sub>. However, SO<sub>2</sub>, SO<sub>3</sub>, particulates and aldehydes not currently controlled by vehicle emission regulations will be produced at the powerplant and must be added to the pollution budget of the electric car.

The initial and life-cycle cost of electric vehicle ownership is presently greater than that of conventional passenger cars. Initial cost is likely to remain higher, but current trends indicate that the gap in life-cycle cost is closing. Improvements in battery cycle-life and operational life could enhance this trend since battery replacement costs currently account for a major part of electric vehicle operating costs. Other maintenance and operational costs are projected to be substantially lower for the electric vehicle than for the Otto engine powered car.

A breakthrough in battery (or flywheel) technology is needed before electric vehicles can be expected to capture a significant fraction of the automotive market. Research should be concentrated on low self-discharge systems (ambient or near-ambient temperature nonaqueous chemical systems are considered most promising) which use abundant materials and produce energy and power densities of 100 W-hr/lb and 100 W/lb or more. Present motor, controller and transmission technology is adequate to the basic needs of electric vehicles, and cost and performance improvements are likely to evolve through industry product improvement efforts once a promising battery technology emerges.

Materials availability may present a serious obstacle to the widespread adoption of the electric vehicle, even as a second car. Expansion in the production and reprocessing capacity of the materials industry is likely to be required for production of the unique battery materials in quantities

sufficient to build up and sustain a substantial electric vehicle fleet. Nearly total recycling of battery materials will be essential.

#### References

- 8-1. Final Report. Current Status of Advanced Alternative Automotive Power Systems and Fuels - Vol. IV - Electrical and Hybrid Power Systems, Aerospace Corp., Report No. ATR-74(7325)-2 to EPA Office of Mobile Source Air Pollution Control.
- 8-2. Characterization of Battery-Electric Cars for 1980-2000, D. Friedman and J. Andon, Minicars, Inc. with W. Hamilton, General Research Corp., RM-1931, Aug. 1974.
- 8-3. Electric Vehicle Test Procedure, SAE J-227, SAE Handbook, p. 939, 1973.
- 8-4. Salihi, J. T., Energy Requirements for Electric Cars and Their Impact on Electric Power Generation and Distribution Systems, EPA, IEEE Industry and Applications., Sept./Oct. 1973.
- 8-5. Prospects For Electric Vehicles - A Study of Low-Pollution-Potential Vehicles, Arthur D. Little Inc., Final Report No. APTD 69-52 to Nat. Air Pollution Control Administration, Oct. 1967.
- 8-6. Compilation of Air Pollution Emission Factors, 2nd Edition, EPA AP-42, April 1973.
- 8-7. McKee, R. S., Borisoff, B., Lawn, F. and Norberg, J. F., Sundancer: A Test Bed Electric Vehicle, SAE Auto. Eng. Congress, Jan. 10, 1972, SAE Paper No. 720188.
- 8-8. Foote et al., L. R., Electric Vehicle Systems Study, Ford Motor Co., Report No. SR-73-132., Oct. 1973.
- 8-9. Gelb, G. W., et al., Cost and Emission Studies of a Heat-Engine/Battery Hybrid Family Car, TRW, Report APTD-1355 to FPA Office of Air Programs, Apr. 1972.
- 8-10. Bockris, J. and Srinivasan, S., Fuel Cells: Their Electrochemistry, McGraw-Hill Book Co. 1969, pp. 289-350.
- 8-11. Amato, C. J., Controller Induced Losses in Electric Vehicle Drives, IEEE IGA 3rd Annual Meeting of the Industry and Gen. Appl. Group Conf. Record, Sept. 29, 1969.
- 8-12. Mineral Facts and Problems, Bureau of Mines Bulletin No. 650, U.S. Dept. of Interior, 1970 Edition.
- 8-13. Rippel, W., Dual SCR Chopper as a Motor Controller for an Electric Car, IEEE Trans. on Vehicular Tech., Vol. VT-20, No. 2, May 1971.

- 8-14. Reimers, E., Application of Two Phase Chopper Motor Drive, USAMERDC, IAS 7th Annual Meeting of the IEEE Industry Appl. Soc. Conf. Record, 1972.
- 8-15. Symons, P. C., Performance of Zinc-Chloride Batteries, Energy Dev. Associates, Proc. 3rd International Electric Vehicle Symposium, Feb. 1974.
- 8-16. Gilbert, R., et al., Flywheel Feasibility Study and Demonstration, Lockheed Missiles and Space Company, Report No. LMSC D007915 to EPA Air Pollution Control Office under Contract EHS 70-104, Apr. 1971.
- 8-17. Batteries: Prospects for Electric Vehicles, E. W. Brooman and J. E. Clifford, Battelle Columbus Labs., and D. E. Semones, Gould Inc., Automotive News, Jan. 1974.
- 8-18. Laumeister, B. R., The GE Electric Vehicle, Gen. Elect. Corp., Report No. 68-C-128, April 1968.
- 8-19. NiVolt Brochure, Energy Research Corp.
- 8-20. Nelson, P. A., et al., ANL High-Energy Batteries for Electric Vehicles, Argonne Nat. Lab., Proc 3rd International Electric Vehicle Symposium, Feb. 1974.
- 8-21. Electric Vehicle Systems, Electric Vehicle News, May 1974.
- 8-22. Dugger, G. L., et al., Heat-Engine/Mechanical-Energy-Storage Hybrid Propulsion Systems for Vehicles, Johns Hopkins Univ., Applied Physics Lab., Report No. APTD-1344 to EPA Office of Air Programs.
- 8-23. Henry, G. F., A Vehicle Control System for Urban Electrics, Georgia Inst. Tech., Proc. 3rd International Electric Vehicle Symposium, Feb. 1974.
- 8-24. Wouk, V., Simplified Electronic Speed Control for Heat Engine/Battery Hybrid Automobile, Petro-Electric Motors, Ltd., IAS 7th Annual Meeting of the IEEE Industry Appl. Soc. Conf. Record, 1972.
- 8-25. Johnson, R. W., Modulating Inverter System for Variable-Speed Induction Motor Drive (GM Electrovaiv II), GM Res. Labs., IEEE Trans. on Power Apparatus and Systems, Vol. PAS-88, No. 2, Feb. 1969.
- 8-26. Foote, L. R., and Hough, J. R., An Experimental Battery Powered Ford Cortina Estate Car, Ford Motor Co., SAE Paper No. 700024.
- 8-27. High Charge and Discharge Rate Lead/Acid Battery Technology, TRW, Inc., Document No. 18353-6006-RO-00, to EPA under Contract No. 68-04-0028, Apr. 1972.
- 8-28. Power Systems for Electric Vehicles, U.S. Dept. HEW, Nat. Center for Air Pollution Control, Apr. 1967, p. 231, USPHS Publication No. 999-AP-37.
- 8-29. Gilman, S., An Overview of the Primary Lithium Battery Program, 26th Power Sources Symposium, p. 28-31, April 29, 1974.
- 8-30. Broadhead, J., Transition Metal Chalcogenide Cathode Materials for Lithium Non-Aqueous Batteries, Fall Meeting of the Electr-Chemical Soc., Oct. 1973
- 8-31. Scanning Electron Microscopic Studies of Lithium Non-Aqueous Cells with Transition Metal Chalcogenide Cathodes, 9th International Power Sources Symp., Brighton, England, 1974.
- 8-32. Gay, E. C., et al., The Development of Lithium/Sulfur Cells for Application to Electric Vehicles, 9th Intersociety Energy Conv. Eng. Conf., 1974.
- 8-33. Gratch, S., et al., Recent Developments of the Ford Sodium-Sulfur Battery, 7th Intersociety Energy Conv. Eng. Conf., 1972.
- 8-34. Evans, G. E., Hydrogen-Air Fuel Cells for Vehicle Propulsion, Symposium on Power Systems for Electric Vehicles, U. S. P. H. S. Publication No. 999-AP-37, 1967.

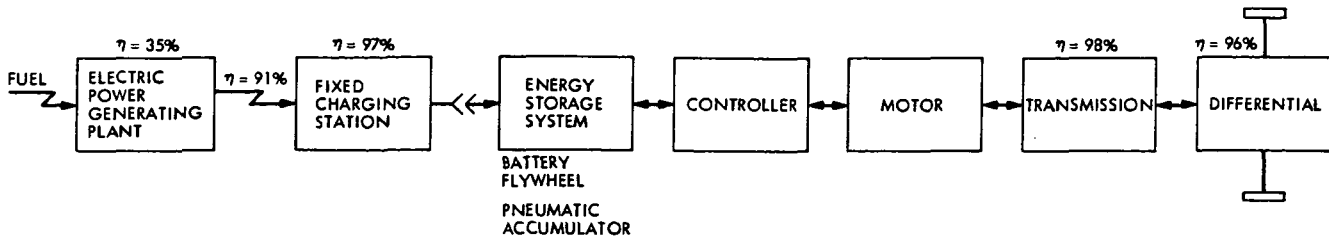

Fig. 8-1. Battery/flywheel system block diagram

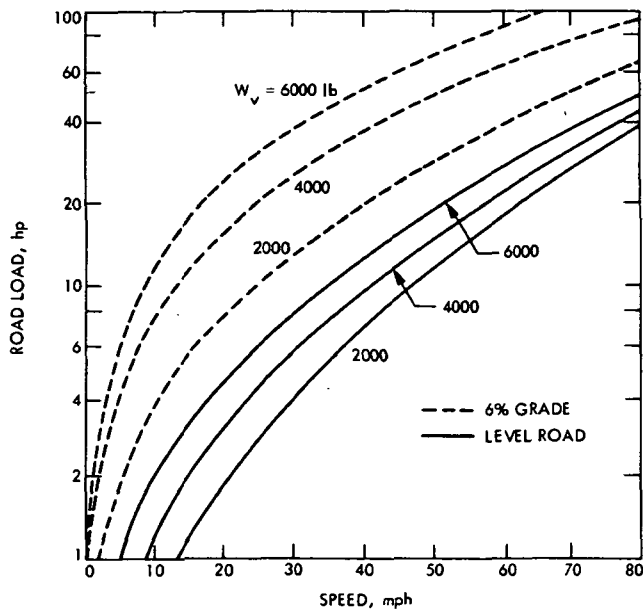

Fig. 8-2. Road level for Small car

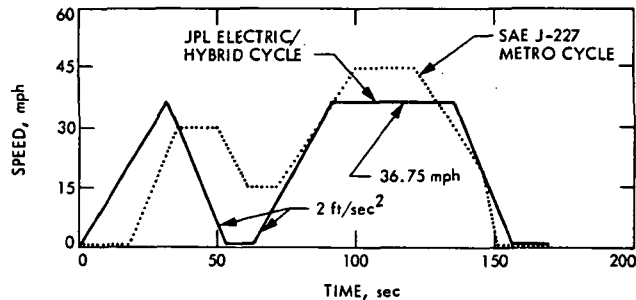

Fig. 8-3. Speed-time profile

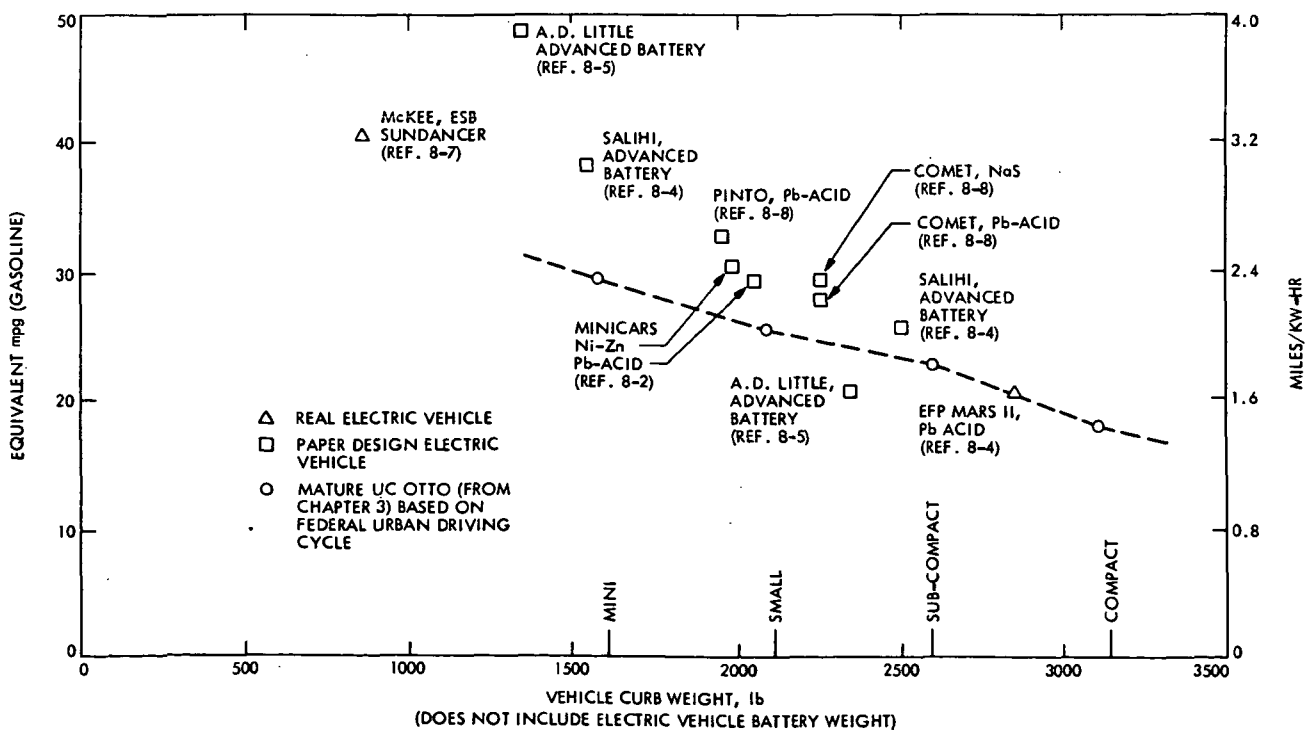

Fig. 8-4. Energy economy comparisons

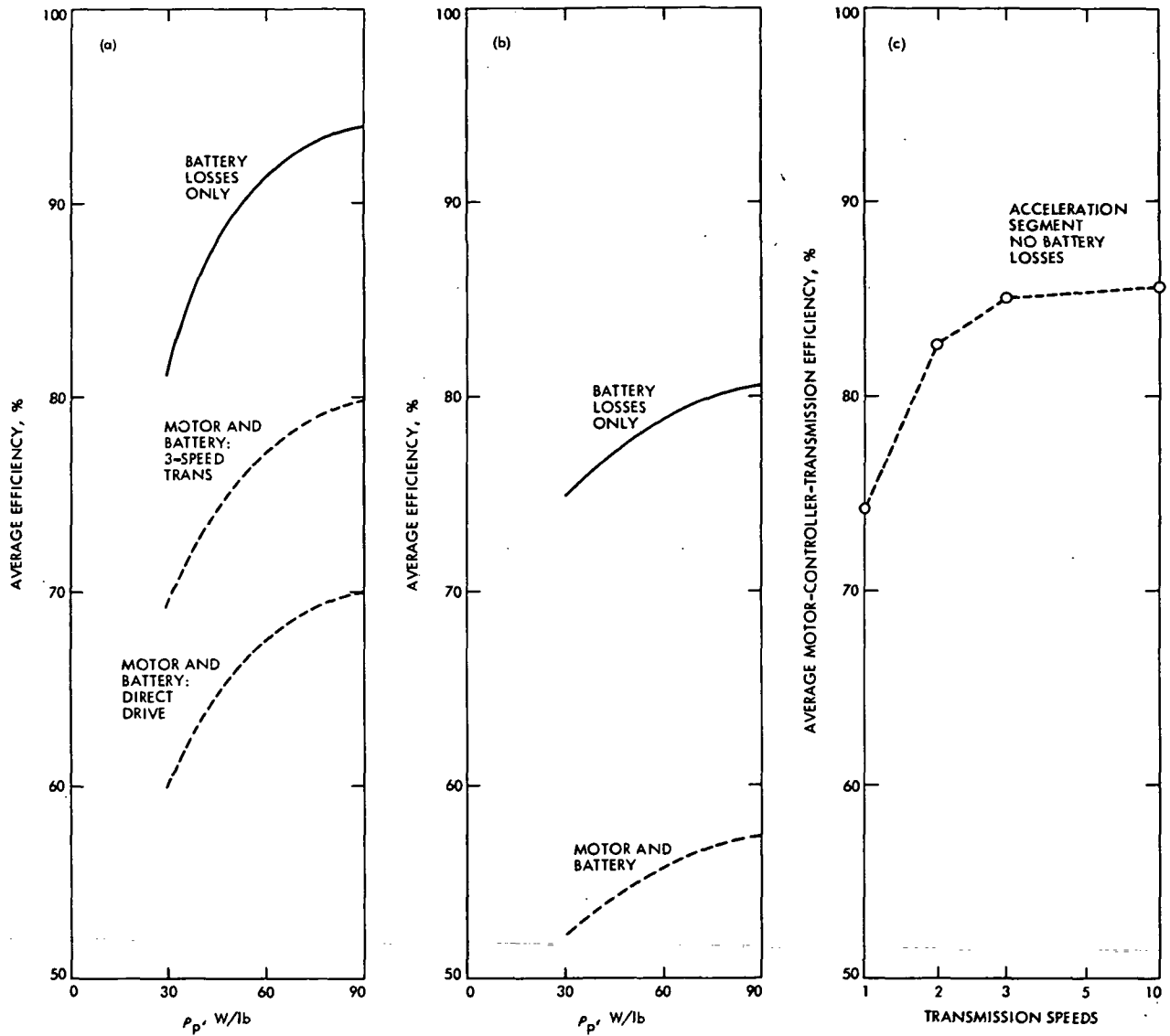

Fig. 8-5. Average subsystem efficiencies during acceleration and regenerative braking segments: (a) average efficiency during acceleration segment, (b) average efficiency during regenerative braking segment, (c) motor-controller-transmission efficiency vs number of transmission speeds.

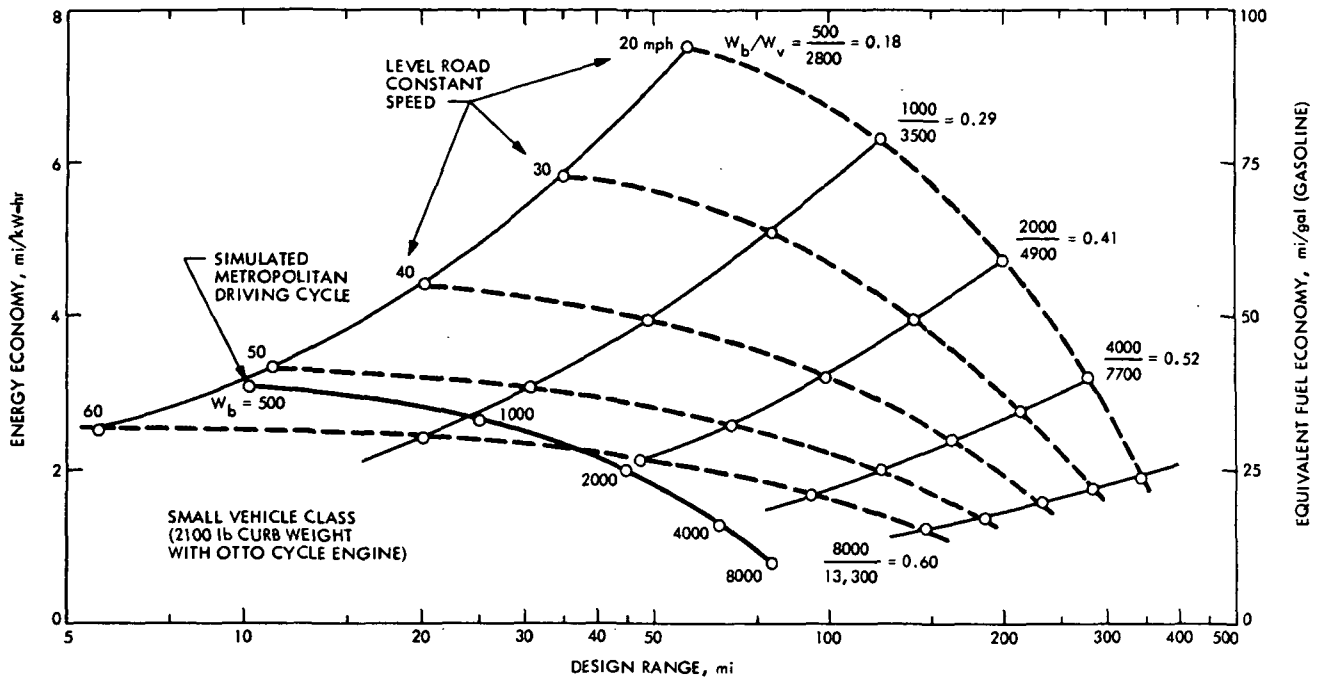

Fig. 8-6. Energy economy vs range for lead-acid electric car

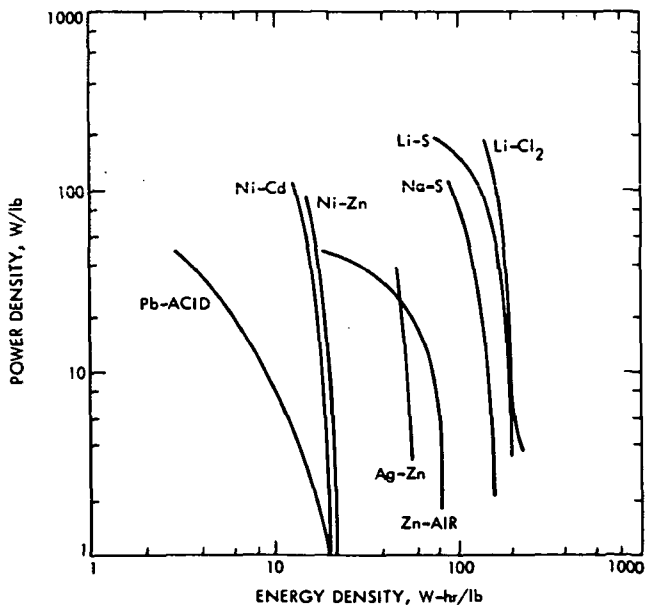

Fig. 8-7. Battery characteristics (from Ref. 8-17)

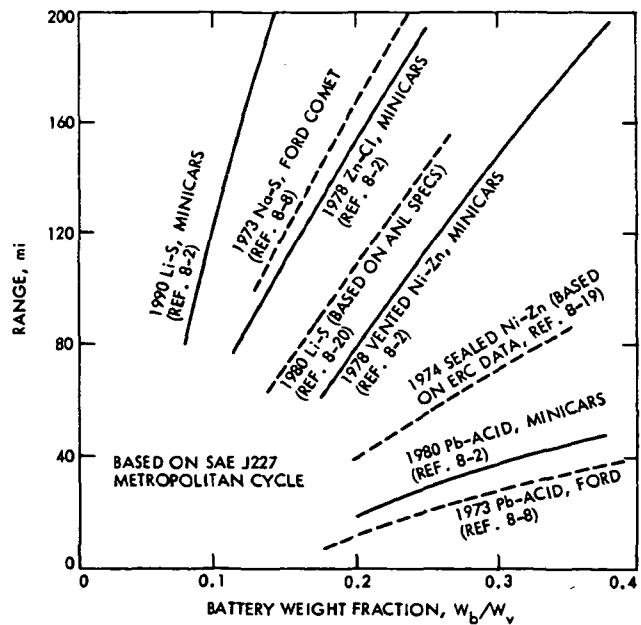

Fig. 8-8. Vehicle range vs battery weight fraction



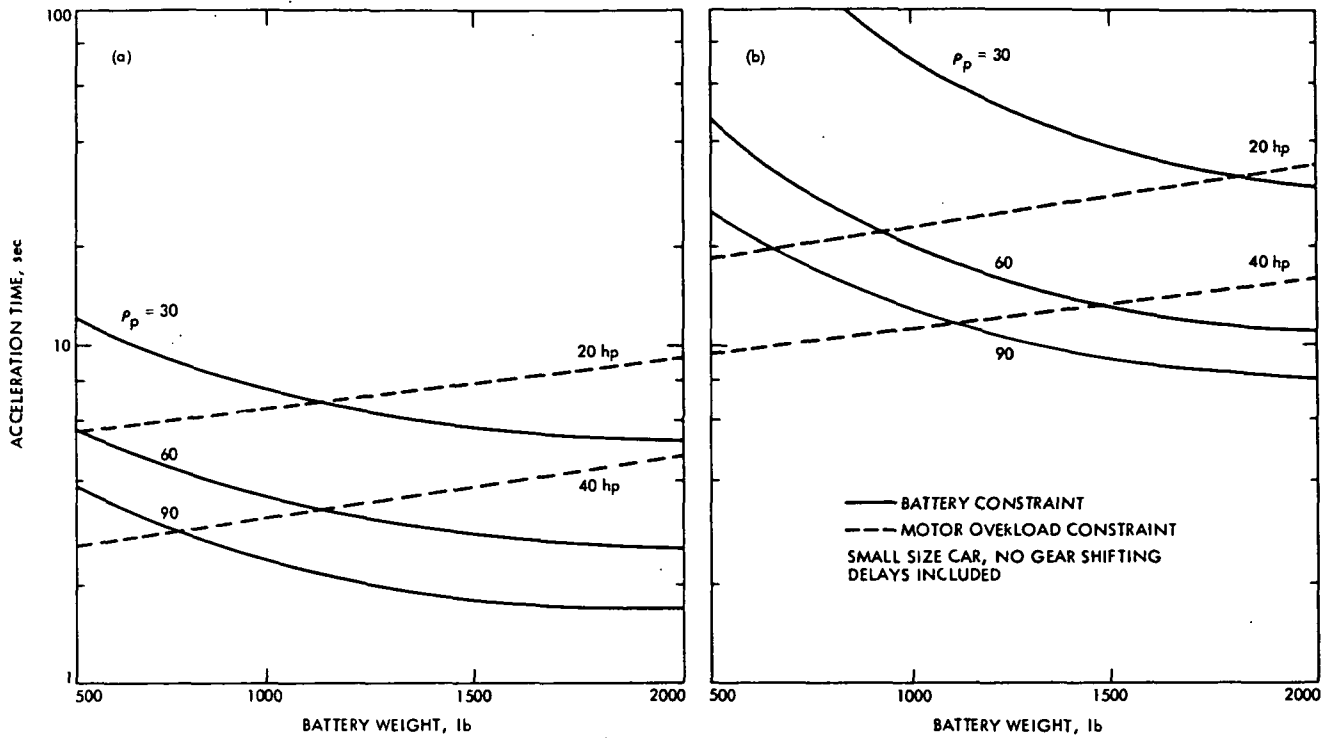

Fig. 8-9. Maximum effort acceleration capability: (a) acceleration time, 0-30 mph, (b) acceleration time, 0-6 mph

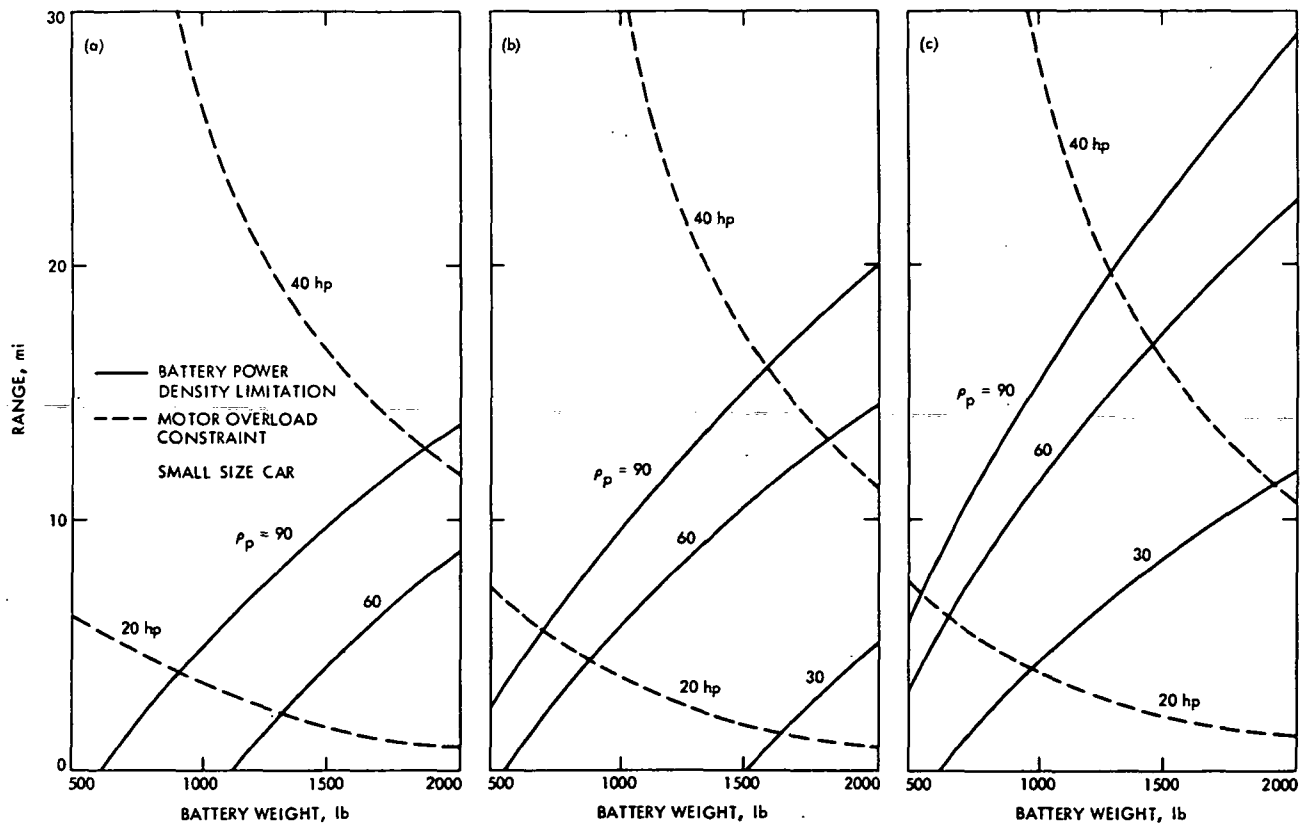

Fig. 8-10. Grade climbing performance, 6% grade: (a) max. range at 60 mph, (b) max. range at 45 mph, (c) max. range at 30 mph

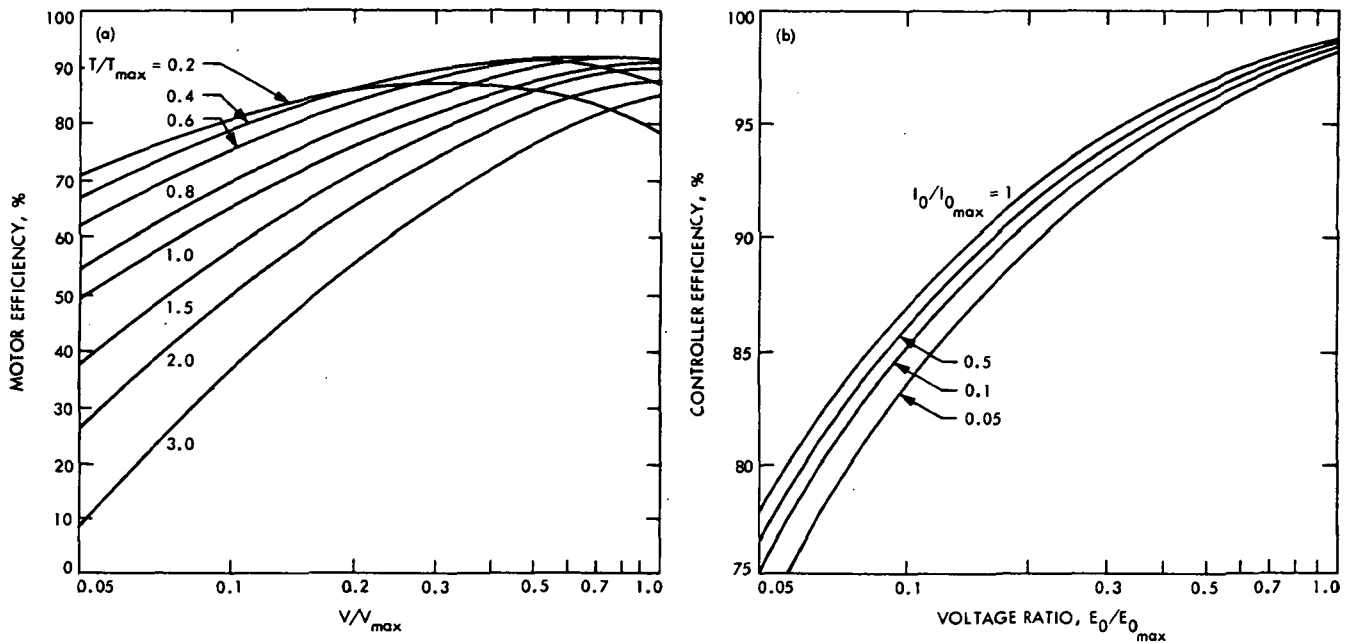

Fig. 8-11. Typical motor and controller efficiencies: (a) motor generator efficiency (from Ref. 8-9), (b) chopper-type controller efficiency

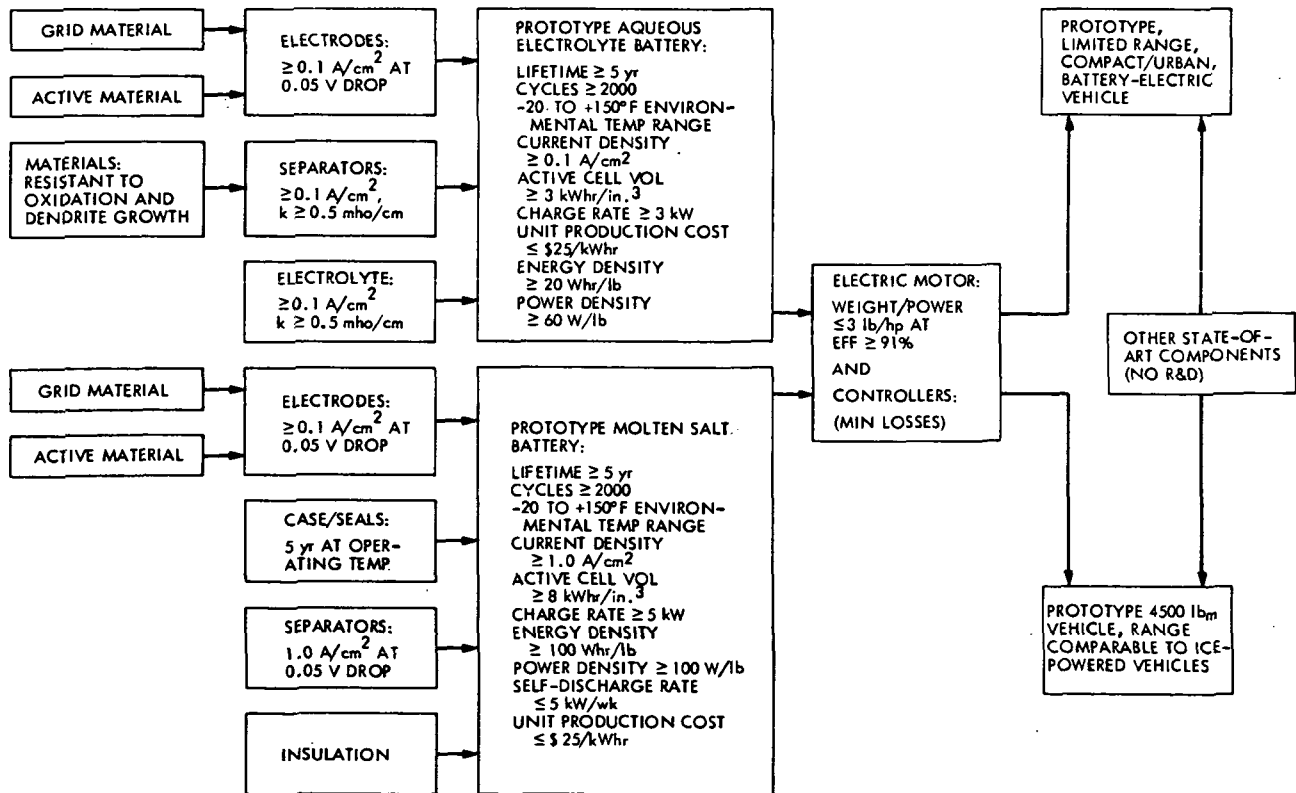

Fig. 8-12. Electric vehicle research and development network

## CHAPTER 9. HYBRID VEHICLES

9.1	Description . . . . .	9-2
9.1.1	Background . . . . .	9-2
9.1.2	Hybrid System Concepts . . . . .	9-2
9.1.3	Current State-of-the-Art . . . . .	9-3
9.2	Performance Projections . . . . .	9-5
9.2.1	Fuel Economy . . . . .	9-5
9.2.2	Road Performance . . . . .	9-9
9.2.3	Emission Performance . . . . .	9-11
9.3	Major System Components . . . . .	9-11
9.3.1	Heat Engines . . . . .	9-11
9.3.2	Energy Storage Systems: Batteries . . . . .	9-11
9.3.3	Energy Storage Systems: Flywheels . . . . .	9-14
9.3.4	Traction Motors and Generators . . . . .	9-14
9.3.5	Power Control Systems . . . . .	9-15
9.4	Vehicle Design and Integration . . . . .	9-15
9.4.1	Weight, Weight Distribution, and Handling . . . . .	9-15
9.4.2	Packaging Flexibility . . . . .	9-15
9.4.3	Volume Constraints . . . . .	9-16
9.4.4	Powerplant Safety . . . . .	9-16
9.5	Ownership Considerations . . . . .	9-16
9.5.1	Maintenance Requirements . . . . .	9-16
9.5.2	Incremental Cost of Ownership . . . . .	9-17
9.6	Conclusions . . . . .	9-18
	References . . . . .	9-19
	Figures . . . . .	9-20

## 9.1 DESCRIPTION

### 9.1.1 Background

In 1969, the Environmental Protection Agency began a three-year program to evaluate various hybrid vehicle concepts for their potential in meeting 1976 emission standards with a minimum of engine modifications or exhaust after-treatment devices. System level contracts were awarded to Aerospace (Ref. 9-1) and TRW (Ref. 9-2) for heat engine/battery hybrids, and to Lockheed (Ref. 9-3) and the Applied Physics Laboratory (Ref. 9-4) for heat engine/flywheel hybrids for system analyses and component and subsystem level evaluations. In addition, component evaluation contracts were given to Sundstrand (Ref. 9-5) and Mechanical Technology Inc. (Ref. 9-6) for continuously variable transmission (CVT) studies, and to Tyco Laboratories (Ref. 9-7) and TRW-Gould (Ref. 9-8) for battery studies. Minicars Inc. (Ref. 9-9) also received a contract to upgrade and evaluate an existing battery hybrid initially developed for another program. The development and evaluation of a Stirling-electric series hybrid by General Motors (Ref. 9-10) under their own funding and the development and recent testing of a Wankel-electric parallel hybrid by Petro-Electric Motors Inc. (Ref. 11) with their own funds under a Federal Clean Car Incentives agreement with EPA are other efforts that have been carried out in this country. Elsewhere in the world, the major hybrid vehicle development effort has been concentrated in Germany (Refs. 12 and 13) and Japan. A comprehensive summary of most of these activities is given in Ref. 14. In all but the most recent of the programs, attention has been focussed on emissions performance and less emphasis has been placed on fuel economy.

### 9.1.2 Hybrid System Concepts

Hybrid vehicles are normally classified according to their mechanical configuration, e. g., series or parallel. Other classifications can also be made based on the number of energy storage elements (fuel only, fuel plus battery or flywheel, fuel plus battery plus flywheel), types of energy storage components (electrochemical, electrokinetic, mechanokinetic, hydropneumatic, etc.) and modes of operation (engine idling during no power demand, engine shut off during no power demand, etc.). Because of the large number of possible combinations and the limited effort applied to their evaluation in the past, the ultimate performance of all hybrid configurations has not been fully assessed.

Figure 9-1 shows a general block diagram which is applicable to conventional as well as heat engine/hybrid and battery/flywheel powered vehicles. To provide a common basis for comparison, chemical fuel is assumed to be the primary energy source for all systems. For the conventional automobile, the energy storage elements in the center of the figure are omitted and the primary energy converter is the heat engine itself, whose mechanical output is directly clutched through change gearing and final gearing (via the dashed line) to the traction wheels. In heat-engine/hybrid systems, a reversible energy storage system plus the primary and intermediate energy converters are all contained on board the vehicle.

The primary energy converter is contained in a stationary power generating station for the battery/flywheel vehicle system, the elements to the left of the cut line of Fig. 9-1 are omitted from the vehicle, and the energy is distributed by transmission line to a charging station where it is delivered to the vehicle as electricity. Thus the hybrid is seen to be a combination of both systems, containing the on-board primary energy converter of the conventional automobile and the reversible storage and conversion systems of the electric vehicle.

The use of an on-board reversible energy storage system distinguishes hybrid and electric powered vehicles from conventional cars. A conventional vehicle configuration may employ an electric, hydraulic, or pneumatic generator/motor combination as a variable ratio transmission, but without reversible energy storage, these are only substitutes for conventional manual or automatic transmissions. The reversible energy storage system has two major functions: (1) to permit optimum engine operation over the wide vehicle load range by sharing the vehicle power demand between the heat engine and the reversible energy storage system, and (2) to exchange energy with the vehicle during acceleration and deceleration (regenerative braking). In the electric vehicle, the reversible storage system serves the additional function of storing all on-board energy, whereas in the heat engine/hybrid, chemical fuel is the principal form of on-board stored energy.

Power control requirements and strategies vary widely among the potential system configurations, ranging from full manual control of all functions in a conventional vehicle with manual transmission to complete automation of all functions (except driver commands), including heat engine throttle and braking control, in an on-off heat-engine hybrid system. Figure 9-2 shows block diagrams of a number of hybrid systems which have been constructed or analyzed to date. Figure 9-3 shows typical road force, engine torque, and reversible energy storage system energy profiles of a conventional vehicle and various hybrid systems for a two-stop-per-mile mission used in system comparison calculations. The mission speed profile, illustrated in Fig. 9-3(a) is the same as the simulated metropolitan cycle described in Chapter 8 except that acceleration, deceleration, and constant speed segments have been rearranged to better illustrate the energy exchange relationships of hybrid vehicles.

Figure 9-3(b) shows the road force and engine torque profiles for a conventional vehicle. During deceleration and waiting periods, the engine power returns to idle and provides the power drawn by engine auxiliaries and accessories as well as that required to overcome engine internal friction losses.

Figures 9-3(c) through (f) show the road force, engine load, and stored energy profiles for four heat engine/hybrid configurations. The block diagram of Fig. 9-2(d) corresponds to the "Continuous Hybrid: Series Operation" system of Fig. 9-3(c). All engine power passes through the intermediate and final converters. During deceleration, vehicle kinetic energy is partially recovered, and the stored energy is reused to

help accelerate the car back to its original speed at the end of the stopping period. Since the intermediate conversion system component losses are greater than those associated with conventional drive trains, the average engine output must be greater than that for conventional vehicles.

Therefore, to provide competitive fuel economy, the series hybrid must capitalize on improved engine loading and regenerative braking, and conversion losses must be held to a minimum. Various control strategies involve operating the heat engine at slowly varying programmed or computed power levels which track the road demand or which are sufficient to provide the average road load requirements throughout the spectrum of driving conditions. The series mode of operation requires that all major power train components be sized to handle the maximum road power demand (plus the losses of downstream elements).

The "Continuous Hybrid: Parallel Operation" system is similar to the series configuration except that a portion or all of the engine power mechanically bypasses the intermediate and final converter output either continuously or when predetermined load or speed values are exceeded. Figures 9-2(b), (c), and (g) show block diagrams of systems which normally operate in this manner. Figure 9-3(d) shows that the storage and intermediate conversion systems are operative principally during significant speed changes, and their losses are avoided during constant and high-speed operation by the parallel mechanical drive path. The reversible energy storage system provides supplementary power for acceleration, hill climbing, and high-speed passing maneuvers.

A variety of control strategies have also been developed for this system to accommodate the wide spectrum of driving demands. The parallel hybrid system has the advantage that components can be sized for their particular function; e.g., not all road power must be handled by all system components.

On-Off or intermittent operation of a heat engine/hybrid presents the possibility of avoiding poor heat engine fuel economy at low engine output power levels. Nearly all of the hybrid systems shown in Fig. 9-2 can be operated in this manner. In this mode of operation, the heat engine charges the reversible energy storage system at an optimum power level to a charge state which is sufficient to supply road load demands for an appreciable period of time. Between charging times, the engine returns to idle or is shut off. This control strategy can be applied to both series and parallel hybrid systems. In Fig. 9-3(e), series operation is shown in which engine startup is controlled by a battery charge state or flywheel speed sensor. Figure 9-3(f) shows the operation of a parallel configuration in which the engine does not operate at speeds below 15-25 mph, all traction power in this range being supplied by the reversible energy storage system.

Road power and energy profiles for a battery- or flywheel-powered system are shown in Fig. 9-3(g). The operation of this system is identical to that of the On-Off series hybrid, in which the engine is shut off at all times when sufficient energy is contained in the reversible storage

system to operate the vehicle. Since battery- and flywheel-powered systems contain no on-board provision to recharge the reversible energy storage system, all energy must be supplied at stationary charging stations.

### 9.1.3 Current State-of-the-Art

The hybrids built to date have all been experimental vehicles with no stated intent on the part of the developers to manufacture them in volume. In this country, the General Motors Stir-Lec I series hybrid (Ref. 9-10), and the Petro-Electric Motors Ltd (Ref. 9-11) and Minicars (Ref. 9-9) parallel hybrids represent the major industry or government sponsored efforts which have been carried to a state of completion that permitted quantitative chassis dynamometer or road testing of complete four-passenger type cars. The primary emphasis of these developments has been to investigate or demonstrate alternate ways of meeting federal emission standards. In addition to efforts in the United States, several important developments have been carried out abroad.

#### STIR-LEC I

The General Motors Stir-Lec I (Ref. 9-10) is a series battery hybrid which uses a previously developed 8-hp Stirling engine weighing 450 lb with approximately 500 lb of starting-lighting-ignition (SLI) lead-acid batteries. The total power train weight of 1700 lb including batteries results in a vehicle curb weight of 3200 lb when mounted in an Opel Kadett body. The original Kadett weighs just under 2000 lb with its production power train. A 20-hp lightweight liquid-cooled induction motor drives the differential directly without the use of a transmission. A three-phase controller regulates power to the motor from the batteries. Both the controller and motor are of advanced designs that were originally developed for the Electrovaire I battery-electric vehicle. Engine power is delivered to the battery through a 25-hp 3-phase alternator-rectifier system, which is greatly overrated for the 8-hp Stirling engine output. The road performance characteristics are shown in Table 9-1.

The system produces excellent performance with respect to CO and HC emissions, but NOx emissions exceeded expectations. General Motors feels that acceptable NOx performance can be achieved by engine modifications. The block diagram of the configuration is shown in Fig. 9-2(d).

Table 9-1. Stir-Lec performance

	Battery only	Engine and battery
Level road fuel economy at 30 mph	-	30-40 mpg
Level road driving cycle range	15-30 mi	-
Top speed	30 mph	55 mph
Range at top speed (55 mph)	-	30-40 mi
0-30 acceleration time	6 sec	6 sec

## PETRO-ELECTRIC MOTORS LTD

EPA tests were recently completed on the Petro-Electric Motors parallel hybrid (continuous operation) (Ref. 9-11), whose development was begun in 1971 under the Federal Clean Car Incentives Program. The powerplant for this vehicle consists of a 300-lb lead-acid battery which supplies (or is charged by) a motor-generator which in turn is directly coupled to the output shaft of a 130-hp Mazda rotary engine. The configuration of the system is shown in Fig. 9-2(b), in which the clutch shown to the left of the motor-generator is omitted. The system powers the rear wheels through a four-speed Chevrolet Vega manual transmission. The 1972 Buick Skylark sedan in which the system is installed weighs 4150 lb. The battery pack contains eight 12-V SLI batteries and can provide a maximum output current of 600 A. The motor-generator weighs 240 lb and delivers 60 hp on peak demand.

The Mazda engine has a 70-in.<sup>3</sup> displacement and is equipped with a thermal reactor and exhaust gas recirculation system. The throttle is controlled to maintain constant manifold vacuum. Although the results of tests completed in November 1974 demonstrated that the hybrid met the contractual emission performance requirements of the incentives program agreement, the fuel economy delivered by the test configuration falls short of that expected of a full size (4000-lb curb weight) vehicle powered by a Mature UC Otto engine (estimated at 14.1 mpg on the urban cycle and 21.1 mpg on the highway cycle). The Petro-Electric test results are shown in Table 9-2. The acceleration performance improved by 25-30% with the addition of battery power. One Federal Urban driving cycle was run with the engine shut down during long idle periods to determine the effect on fuel economy and emissions, but no attempt was made to optimize emission control for this type of (Engine-Off) operation. A 30% improvement in fuel economy was obtained.

Table 9-2. Petro-Electric Motors results

	Emissions, g/mi			Economy, mpg	
	HC	CO	NOx	Urban cycle	Highway cycle
Requirement	0.41	3.40	1.00	-	-
Test results	0.38	2.41	0.76	8.8	15.6
Engine-off mode	2.22	9.02	0.84	11.6	-

Petro-Electric Motors plans to continue the development of the hybrid concept, placing greater emphasis in the future on fuel economy. Engine-Off mode operation is one of the techniques being considered.

### MINICARS

The Minicars (Ref. 9-9) parallel hybrid was an adaptation of a previously developed battery

electric vehicle which was modified by the addition of a heat engine for demonstration purposes. Under EPA sponsorship the hybrid was subjected to a series of emission tests, with modifications introduced as the program progressed to improve emission performance. In its final configuration, the power train contained a Chevrolet Corvair air-cooled horizontally opposed six-cylinder engine and Lear-Siegler 20-hp shunt-wound electric motor with both shafts connected as a common unit. This combination provided power to the rear wheels of the specially designed vehicle through a torque converter and two-speed automatic transmission. 640 lb of batteries are distributed throughout the vehicle. Except for the use of an automatic transmission, the Minicars vehicle is similar in configuration and operation to the Petro-Electric Motors car.

In the final version, a spring-damper system was used to prevent rapid throttle valve operation, and the difference between the throttle command and throttle valve position was sensed and used to control the field current of the drive motor.

Tests were performed using the California 7-mode cycle for various engine air-fuel ratios and simulated vehicle weights. On the basis of the results, it was concluded that hybrid operation alone, while it permits a reduction in emissions, is not sufficient to meet the original 1976 emission standards. Since fuel economy performance was not stressed in the design of the system, poorer economy resulted in the system which was optimized for emissions performance.

### ROBERT BOSCH

Two systems of particular interest have been developed in the Federal Republic of Germany within the past year. The Robert Bosch system (Ref. 9-12) is an on-off battery/heat engine hybrid in which the engine is shut off below a speed of 20 mph. The system has been installed and tested in a Ford Escort Station Wagon. The 44-hp conventional Otto engine and 21.5-hp electric motor-generator are mounted in-line but separated by an automatically operated dry friction clutch with manual override. The electric motor takes the position formerly occupied by the transmission, which is not used in the hybrid modification. A manually operated jaw-type clutch couples the electric motor-generator output to the propeller shaft. To compensate for the loss of low-speed torque resulting from the removal of the transmission, the rear axle ratio has been changed from 4.11:1 to 5.83:1, which decreases the maximum speed from 80 to 68 mph. 445 lb of nickel-cadmium batteries are recessed into the floor pan on each side of the drive tunnel ahead of the rear axle. The total conversion adds 882 lb to the overall vehicle weight.

In urban driving, the car may be operated on battery power alone or in the hybrid mode. In the latter case, the engine starts automatically at 20 mph vehicle speed and stops automatically when the speed falls below 15 mph. Battery recharging while in this mode can be adjusted during intermittent periods of engine operation to maintain a nominally constant battery charge state, or at least reduce the rate of battery discharge. During constant-speed driving, the battery is

recharged by operating the motor-generator as a generator and absorbing excess engine power. If the battery becomes discharged due to sustained operation in congested traffic, the car must be stopped, the propeller shaft jaw clutch disengaged, and the battery recharged by the engine through the motor-generator. The battery has sufficient storage capacity to operate the car over a range of 13 mi in stop-and-go uphill and downhill driving without engine assist.

The 67-in.<sup>3</sup> four-cylinder engine is equipped with a "low emission" carburetor and exhaust thermal reactor. Urban driving emissions in the hybrid mode are 2.83 g/mi for HC, 5.52 g/mi for CO, and 3.67 g/mi for NOx. With further engine modifications, improvements in emission performance to 2.5/5.5/2.0 g/mi are expected to be possible. Figure 9-2(f) shows the basic blocks of this system.

#### INSTITUT FÜR KRAFTFAHRWESEN: IKA

The IKA hybrid (Ref. 9-13) has a three-component storage system consisting of liquid fuel, a battery, and a flywheel. The flywheel is geared directly to the output shaft of a 20-hp single rotor Wankel engine. The engine shaft is connected to one side of a differential gear assembly, and an 11-hp electric traction motor drives the other side. The combined output is taken from the differential carrier and fed through a transmission to the drive wheels. A block diagram of the configuration is shown in Fig. 9-2(g). The flywheel weighs approximately 110 lb and spins at a maximum speed of 18,000 rpm. At this speed, the total stored energy is 468,000 ft-lb. Discharging the flywheel to half this energy level is equivalent to the kinetic energy of the 4630-lb Volkswagen van in which the system has been tested at a speed of 28 mph.

The flywheel-differential-motor combination acts as an electric torque converter, permitting the output torque to be regulated from zero to an amount greater than that produced by the engine. This occurs even though the engine is physically connected in series with the other power train components. The characteristics of the system differ from those of the conventional hydrodynamic torque converter in that power conversion takes place at all engine and output shaft speeds and torques so long as the average engine power exceeds the average load power. The flywheel absorbs load fluctuations, thereby permitting the engine to operate in a low response mode. Rapid power response is provided by the electric motor, which reacts against the flywheel inertia and extracts or augments its energy, as well as that of the battery, during transient load changes. To compensate for variations in average road conditions, engine speed may be adjusted over a relatively narrow range to maintain the battery charge state within an acceptable band.

The system has been tested under simulated urban driving conditions. Test results indicated that a 45% reduction in fuel consumption can be achieved for a 3-stop-per-mile profile in which cruise speeds reach approximately 30 mph. 14% of the fuel consumption reduction is attributed to regenerative braking, and the remaining 31% is provided by improved engine loading. The overall fuel economy improved from 9.4-11.7 mpg for

the conventionally powered van to 18.2-22.4 mpg for the hybrid conversion. During acceleration tests, a speed of 30 mph was reached in 10.8 sec. The system has been designed as a powerplant for a much smaller vehicle and, although not reported, it is expected that the large drag coefficient, frontal area, and weight in combination with the small engine of the experimental van installation severely limit sustained high-speed performance.

## 9.2 PERFORMANCE PROJECTIONS

Optimization of a hybrid vehicle design involves a large number of complex tradeoffs. The vehicles described above represent only a few isolated experiments in a wide spectrum of potential configurations, control strategies and component applications. In most cases, experimental developments have not been carried to a point of maturity that would permit a demonstration of the ultimate performance potential of concepts, and in all cases, the experimental designs have not been developed to a degree of refinement that would make them marketable in competition with conventional vehicles. Quantitative performance comparisons between hybrids developed by various organizations are difficult to make because vehicle size, road performance and test conditions are not standardized, and because of the immaturity of individual system developments. On the whole, then, the current hybrid vehicle state-of-the-art must be regarded as embryonic and unstructured, and even actual road test data must be evaluated with care.

In the discussion that follows, analytical comparisons of the fuel economy and road performance of some of the more fundamental hybrid system configurations are developed to assess their relative merits on the basis of a common engine type, vehicle size and test profile. Conventional and battery powered vehicle cases are included to provide a basis of comparison between hybrids and other alternatives. While the analyses introduce some degree of commonality among the systems, many uncontrolled variables still remain which result in differences of specific road performance characteristics, range, payload capacity (weight and volume), cost, etc. among vehicle types. Since some of these are intrinsic to the basic system concepts, direct, one-to-one performance comparisons between all systems are not possible.

The main goal in the design of a hybrid is to provide acceptable road performance (acceleration, gradability and high-speed) while at the same time maintaining near-optimum engine operation from the standpoints of fuel economy and exhaust emissions. The usual design approach is to use a relatively small heat engine and to buffer it from the wide road power demand excursions by providing an alternate high-efficiency load power conditioner with reversible energy storage capability. By controlling the engine operation within tighter speed and torque bounds, it is expected that simpler or less efficient emission control devices will suffice, and that the engine will operate in a more favorable fuel economy regime.

### 9.2.1 Fuel Economy

The extent to which improvements in fuel economy might be anticipated is illustrated in the

torque-speed BSFC map of Fig. 9-4, which shows loci of constant speed BSFC for high-gear operation of 40- and 80-hp engines mounted in a 2100-lb curb weight baseline small vehicle (including 80-hp engine), described in Chapter 8. This map is representative of current automotive emission controlled Otto engines. Superimposed on the map are lines of constant power.

Although the trajectory of the 40-hp conventionally powered car passes nearer the minimum BSFC region of the map, its road performance is generally unacceptable by today's standards, lacking in mid-speed acceleration, gradability, and high-speed passing performance. The 80-hp configuration, while delivering acceptable road performance for a small car, falls short of the fuel economy provided by the 40-hp version of the same car. From this, it can be concluded that the load conditioning function of the hybrid vehicle system is to operate the heat engine as close as possible to the minimum region of the torque-speed BSFC curve under all operating conditions.

Examination of Fig. 9-4 shows that the best fuel economy is obtained when the engine is operated at relatively high torque levels (60-70%) in the engine mid-speed range. Because the BSFC is more sensitive to engine torque than speed, better fuel economy will be obtained if engine speed is reduced in response to decreased road load, with engine torque maintained at a high level. This strategy is generally unacceptable from a drivability (and engine durability) standpoint, however, since it results in poor throttle response, particularly under low-speed conditions. Consequently, conventional vehicles invariably use a multispeed transmission to improve acceleration and engine smoothness at low vehicle speeds.

The optimum control strategy for hybrids involves setting the heat engine operating point at its best value consistent with average road load conditions. Transient loads are then handled by the electric or flywheel portions of the system which absorb excess engine power at times when the road load falls below the average value and provide additional torque at times when the commanded engine torque is insufficient. At constant speeds, the engine must be throttled back to the road power value once the reversible energy storage system is recharged to its full capacity.

A second goal in the design of a hybrid is to recover as much regenerative braking energy as possible. The extent to which this can be accomplished and the factors which govern the efficiency of recovery are similar to those for electric vehicles and are discussed in Section 8.2.2 (Chapter 8).

The effects of the load conditioning and regenerative braking functions on fuel economy are illustrated in the calculations summarized in Table 9-3 for two conventional vehicles, six hybrid variations, a battery-powered electric, and a conventional car configuration with a continuously variable transmission (CVT). While all systems analyzed use the baseline body and drive train, differing power components result in variations of road weight and performance. A 40% weight propagation factor (see Chapter 10) relative to the weight of the 80-hp baseline conventional vehicle (Variation A) is included to make all

configurations structurally comparable. The analyses are based on the driving cycle of Fig. 9-3(a). The three-speed manual transmission included in the drive train of all vehicles (except the CVT) has ratios of 3.4:1, 1.7:1, and 1:1 and shift points of 15 and 30 mph.

Line (a) of the table shows the initial vehicle kinetic energy ( $1/2 mV^2$ ) prior to the first stop of the driving cycle. In line (b), the 24% energy recovered during the first stop for the hybrids is calculated on the basis of 69% of the initial kinetic energy being available for recovery, motor-battery charge/discharge efficiencies of 53% and 69% for a 500-lb lead-acid battery having a power density of 60 W/lb (the same as for the 1000-lb, 30-W/lb battery of Fig. 8-5, Chapter 8), and a controller efficiency of 97%. For the battery electric vehicle, a value of 16% is used based on motor-battery efficiencies of 56% and 78% for the larger 60-W/lb battery, battery operational capacity of 55%, recovered energy fraction of 69%, and controller efficiency of 97% (see discussion in Section 8.2.1, Chapter 8). Line (c) lists the net energy required to accelerate each vehicle back to its initial speed before the stop. Line (d) shows the amount of aerodynamic and tire resistance energy consumed during the acceleration period. The total energy required to accelerate the cars to their initial speed is shown on line (e).

A comparison of the energy required to accelerate each class of car indicates that, because of its greater weight and limited energy recovery, the most economical of the hybrids (Variation F) requires more net energy to accelerate to the original speed than does the 80-hp baseline vehicle. From this, it can be concluded that the addition of a regenerative braking system for this function alone cannot be justified on a fuel economy basis.

In order to accomplish the load conditioning function, hybrid systems require a throttle controller for the heat engine as well as power controllers for the generator/alternator and traction motor. For the calculations of Table 9-3, the following control schedules were assumed for the various configurations:

Parallel Hybrid: Continuous Operation (Variations C and D). The TRW parallel hybrid system shown in the block diagram of Fig. 9-2(c) is used as the model for parallel hybrid calculations. During deceleration, the engine returns to idle or is shut off, and regenerative braking is applied by charging the battery through the traction motor operating as a generator. During acceleration, the heat engine throttle is controlled to provide a preprogrammed or computed manifold vacuum level. Engine torque and speed remain constant throughout the acceleration period. During the early part of the acceleration segment when excessive engine power is developed, the surplus is absorbed by the generator and stored in the battery for later use. Later in the acceleration segment when the programmed throttle opening produces insufficient engine torque, the traction motor assists by drawing power from the battery. The calculations assume that the energy provided by the heat engine during the acceleration period just



Table 9-3. Fuel economy performance comparison

	A	B	C	D	E	F	G	H	J	K
Body and drive train weight, lb	1750	1750	1750	1750	1750	1750	1750	1750	1750	1750
Otto engine weight, lb	350	350	350	250	350	250	300	300	300	300
Electric motor weight, lb	-	140	140	140	140	140	260	260	260	260
Generator/alternator weight, lb	-	70	70	70	-	-	210	210	-	-
Controller weight, lb	-	60	60	60	60	60	80	80	80	80
Battery weight, lb	-	500	500	500	500	500	500	500	1200	1200
Weight propagation factor (40%), lb	0	310	310	270	280	240	400	400	480	0
Payload weight, lb	300	300	300	300	300	300	300	300	300	300
Total (test weight), lb	2400	3480	3480	3340	3380	3240	3800	3800	4070	2400
(a) Initial kinetic energy, lb-ft	108,000	102,000	157,000	151,000	152,000	146,000	171,000	171,000	184,000	108,000
(b) Recovered kinetic energy, lb-ft	-	38,200	38,200	36,600	37,000	35,500	41,700	41,700	29,400	-
(c) Net K. E. needed for acceleration, lb-ft	108,000	102,000	119,000	114,000	115,000	111,000	130,000	130,000	154,000	108,000
(d) Acceleration aero and road energy, lb-ft	33,900	32,600	43,600	42,300	42,000	41,400	46,400	46,400	48,800	33,900
(e) Total energy for each acceleration, lb-ft	142,000	135,000	162,000	156,000	158,700	152,000	176,000	176,000	203,000	142,000
(f) Energy supplied by ICE, lb-ft	142,000	135,000	162,000	156,000	68,400	46,000	0	0	-	142,000
(g) Average BSFC during acceleration, lb/hp-hr	0.762	0.631	0.690	0.550	0.510	0.510	-	-	-	0.552
(h) Total fuel for each acceleration, gal	0.009	0.007	0.009	0.008	0.003	0.002	0.002	0.002	0.002	0.006
(i) Electrical system losses, lb-ft	-	-	87,000	83,800	96,200	114,000	471,000	517,000	348,000	-
(j) Electrical makeup energy, lb-ft	-	-	0	0	87,700	106,000	-	-	-	-
(k) Road energy at constant speed lb-ft	154,000	150,000	186,000	182,000	183,000	179,000	195,600	195,600	204,000	154,000
(l) Total constant speed energy, lb-ft	154,000	150,000	361,000	350,000	555,000	619,000	1,019,000	1,065,000	958,000	154,000
(m) BSFC at constant speed, lb/hp-hr	1.000	0.710	0.590	0.530	0.535	0.510	0.520	0.510	0.510	0.560
(n) Total fuel at constant speed, gal	0.0123	0.009	0.018	0.015	0.024	0.026	0.043	0.045	0.045	0.007
(o) Total cycle fuel, gal (kW-hr)	0.032	0.024	0.040	0.032	0.032	0.030	0.046	0.048	(0.392)	0.025
(p) Fuel economy Engine-Off mode, mpg	30.8	41.3	24.8	30.4	31.2	33.5	21.6	21.0	31.9	40.7
(q) Idle fuel, gal	0.005	0.002	0.005	0.003	0.008	0.004	0.003	0.005	0.003	0.003
(r) Total cycle fuel, Engine Idle mode, gal	0.037	0.027	0.045	0.035	0.040	0.034	0.050	0.053	0.028	0.028
(s) Fuel economy for Engine Idle mode, mpg	26.7	37.4	22.1	28.2	25.0	29.6	20.2	18.9	36.1	36.1
(t) Total road energy	438,000	419,000	587,000	568,000	574,000	554,000	632,000	632,000	669,000	438,000
(u) Road energy differential	0	-19,300	149,000	130,000	135,000	116,000	193,000	193,000	231,000	0
(v) Constant speed fuel economy	28.4	51.8	32.2	46.9	30.7	49.2	42.2	32.4	60.0	53.2
30 mph	35.4	47.6	33.3	43.5	33.8	44.2	36.5	27.5	47.5	49.3
40 mph	32.2	41.0	30.1	37.3	30.3	37.2	29.5	23.7	36.3	38.3
50 mph	28.6	33.4	26.5	30.9	26.8	31.2	24.2	20.8	30.0	30.4
60 mph										

equals the total energy required for the acceleration segment. Only the electrical system energy losses remain to be made up during the constant-speed segment of the driving cycle.

#### Parallel Hybrid: On-Off Operation

(Variations E and F). The Robert Bosch system of Fig. 9-2(f) is used as a model for the On-Off parallel hybrid. On deceleration, the engine shuts off and regenerative braking is accomplished by charging the battery through the traction motor operated as a generator. When accelerating, the engine clutch is disengaged and the engine remains off until the vehicle speed reaches 30 mph (the Robert Bosch system engine starts at 20 mph), during which time all road power is supplied by the battery. On reaching the 30-mph high-gear shift point, the engine starts, the engine clutch engages, and the engine takes over the full road load under manual throttle control. When the constant speed segment is reached, the battery is recharged automatically from excess available engine power by overexcitation of the motor field winding until the battery is recharged to its initial condition. Electrical system losses are made up by the engine during this period. Once the battery is recharged, the field excitation drops back and the engine throttle opening is decreased to maintain constant cruise speed.

Series Hybrid: Continuous Operation (Variation G). The block diagram of Figure 9-2(d) applies to this system. During deceleration, the engine returns to idle to minimize the possibility of excessively high battery charging rates, and the battery accepts regenerative braking energy through the traction motor excited as a generator. Throughout all other portions of the driving cycle, the engine throttle and the generator/alternator field are controlled to provide the average road power requirements (including system losses) at an engine speed and manifold pressure that will produce minimum BSFC for the required power. In performing calculations for this system, the instantaneous engine power requirement (road power plus system losses) was determined and the best BSFC for that level was obtained from the constant power curves superimposed on the engine map of Fig. 9-4. Engine rpm was maintained above 25% of its maximum value during all power delivery portions of the cycle.

Series Hybrid: On-Off Operation (Variation H). The block diagram of Fig. 9-2(d) also applies to this system; only the mode of operation differs from that of the continuous series hybrid. This system operates as a battery electric vehicle until the battery is discharged. When the battery reaches a preset discharge level, the heat engine is turned on to recharge it at a high rate. During the recharge time, the engine also provides the road power directly through the generator and motor, thus bypassing the battery and avoiding its charge/discharge losses. During the recharge period, the engine is operated at speed and torque values

for minimum BSFC until a signal is given by a battery charge level indicator that the battery has reached a predetermined charge state, at which time the engine automatically shuts down. At continuous speeds above 40 or 50 mph the engine should normally be turned on and automatically controlled to the proper conditions for best fuel economy as in Variation G. However, to show the effect of system losses on fuel economy in this mode, constant speed economy calculations for Variation H are shown for On-Off operation. A battery charge/discharge efficiency of 0.58 is used in these calculations based on a voltage and ampere-hour differential of 0.85 and efficiencies of 0.72 during high rate charge and 0.95 during discharge due to resistive battery losses.

Battery Electric Vehicle (Variation J). A block diagram for the battery electric vehicle is shown in Fig. 8-1 (Chapter 8). Since the battery of the electric vehicle is not subjected to the high charge rates and generator losses of the hybrids except during regenerative braking, a recharge efficiency of 80% is included in calculations for 8-hour overnight recharge (see Section 8.2.1, Chapter 8).

Conventional Car with CTV (Variation K). The load conditioning function of the hybrid vehicle is similar to that provided by a continuously variable transmission except that no reversible energy storage capacity is available in the latter. The calculations for variation K are based on a 50-hp Otto engine operating with an assumed 85% transmission efficiency. The calculations are based on controlling the engine speed to deliver the required road power at minimum BSFC, which in turn means operating the engine under near-lugging conditions throughout much of the driving cycle. To minimize excessive lugging, the engine speed is not allowed to fall below 25% of its maximum value. To compensate for added engine wear in this type of operation, the 350-lb engine weight allowance (a 50-lb increase) is intended to include provisions for structural modifications that would provide comparable durability to that of a conventional vehicle engine.

Based on these control schedules, the energy supplied by the heat engine (line f), average BSFC (line g), and the total fuel (line h) consumed by each of the variations during the acceleration period are entered into Table 9-3. The fuel consumption calculations were first made by a step-wise integration process in which average road load values were computed at 3-sec intervals throughout the acceleration ramp, engine speed and torque ratios determined, BSFC values read from Fig. 9-4, fuel consumption during each interval calculated, and the individual fuel consumption values summed to obtain the total fuel used over the ramp. Average BSFC was then determined by dividing the total fuel consumed by engine energy provided during the acceleration period (line f) and converting to BSFC units. For the series hybrid and battery electric cases, these calculations are deferred to the end of the cycle, since the heat engine is assumed to operate at a constant speed and power level (either

continuously or at a controlled duty cycle) throughout the driving cycle.

The electrical system charge/discharge losses incurred during acceleration are shown for the parallel hybrids in line (i), whereas the total cycle charge/discharge losses are listed for the other variations on this line. Motor and generator efficiencies are 85% for all parallel hybrids and the electric vehicle, but 85 and 88%, respectively, for the series hybrids, since the generators operate in a more favorable speed and power range. Controller efficiencies for all electrical systems are 97%. Battery charge and discharge resistive efficiencies are 90% for parallel hybrids with an added factor of 85% included to account for charge ampere-hour and voltage efficiency. The battery resistive efficiency components for both charge and discharge were obtained by stepwise integration for one of the parallel hybrids and applied to all, since the power profiles are similar.

Integration of the series hybrid systems was performed individually, and average values for the battery resistive component during charge were not obtained. Instantaneous values ranged from 72 to 85%. During those portions of time when the power developed by the engine exceeds the road power demand, power is transmitted at the combined efficiency of the motor-generator ( $0.85 \times 0.88 = 0.75$ ), and the surplus is used to charge the battery.

For the electric vehicle, battery resistive discharge efficiencies were computed to be 97% during the cruise segment and 91% during the acceleration segments (from Fig. 8-5, Chapter 8). A traction motor efficiency of 89% was used during low-power cruise segments. Overnight battery recharge efficiency is 80% (see Section 8.2.1) and is included as a part of these losses shown in line (i).

Line (j) itemizes the acceleration energy not supplied directly via the direct mechanical path by the heat engine in the parallel hybrids during the acceleration periods which, therefore, must be made up during the constant speed segments of the cycle. (In the series hybrid cases, this energy as well as the charge/discharge losses are supplied during the cycle, whereas these are furnished at the beginning or end of the cycle in the battery electric vehicle.)

The road energy consumed during the constant speed segments is tabulated in line (k) and summed with the makeup and loss energies for the two acceleration phases of the cycle in line (l). Line (m) shows the BSFC for the constant-speed segments from which the total fuel consumed during these segments is calculated and listed in line (n). The total cycle fuel is the sum of the constant-speed segment consumption and the fuel used in the two acceleration periods. This value is divided by the average transmission and differential gear efficiencies of 98 and 96%, respectively (see Chapter 10) for all systems except the CVT (Variation K), in which a value of 85% is used for the transmission. In addition, the engine-motor planetary differential used in the TRW type parallel

hybrids (Variations C and D) is responsible for another factor of 95% (TRW used 80%) which is included in line (n). The overall fuel economy is then shown in lines (p) and (s) for Engine-Off (during deceleration and stopping times) and Engine-Idle modes of operation. While no restart fuel penalty is assumed for the Engine-Off calculations, U. S. Postal Service experience indicates that a 20-sec equivalent idle fuel penalty is typical.<sup>1</sup> The idle fuel consumption for all systems is based on 0.020 lb/hp<sub>max</sub>-hr. The total cycle fuel for the battery electric is converted to kW-hr/mile in line (o) and then to miles per gallon in line (p), using a conversion factor of 12.5 kW-hr/gal (see Section 8.1.3, Chapter 8). The boxed fuel economy values shown in lines (p) and (s) indicate the intended mode of vehicle operation.

The total cycle energy consumption for all of the variations shown in line (t) is composed of  $2(a) + 2(d) + (l)$ , where the letters in parentheses refer to the values given in lines (a), (d), and (l), respectively, and represent the total kinetic energy imparted to the vehicles during the two acceleration segments and the tire and aerodynamic resistance energy for the whole cycle. The differences between the energy consumed by the baseline 80-hp conventional car and all other variations shown in line (u) indicate the energy handicap that each of the alternatives must overcome by more efficient engine operation and regenerative braking recovery in order to successfully compete with the conventional vehicle on a fuel economy basis. Constant speed fuel economies for speeds from 30 to 60 mph are shown for comparison in line (v).

In evaluating the results of the calculations, a point that stands out clearly is that fuel economy is strongly dependent on the maximum power of the heat engine for a vehicle having a given payload capacity; i. e., fuel economy suffers as heat engine power increases. This is true for both conventional vehicles and hybrid cars. Also, most hybrid variations which have the same size engine as a conventional car deliver poorer fuel economy, even for Engine-Off operation. Series hybrids are inferior to all other variations, even with engines of half the size. Finally, a conventional car equipped with a continuously variable transmission and small engine outperforms all hybrids with regard to fuel economy.

These conclusions agree in general with those obtained in the Aerospace (Ref. 9-1) and TRW (Ref. 9-2) studies and are consistent with the early test results of the Petro-Electric Motors experimental hybrid. Based on the results of Lockheed, Applied Physics Laboratory, Sundstrand Aviation, and Mechanical Technology Inc. studies, these conclusions are generally applicable to flywheel hybrids also (Ref. 9-14). In contrast, the Robert Bosch battery hybrid is reported to have very good fuel economy, and the IKA tests of their heat engine battery hybrid with flywheel component have resulted in a 45% reduction in fuel consumption (Ref. 9-13). However, not enough is known about the acceleration or sustained load performance of these vehicles to make thorough comparisons with conventional

<sup>1</sup> Comment by Lewis Gerlach at 3rd Electric Vehicle Symposium.

vehicles or the hybrid analyses contained in this chapter.

### 9.2.2 Road Performance

Table 9-4 tabulates the vehicle road performance characteristics for the systems analyzed for fuel economy in Table 9-3. Urban, constant-speed, and mixed driving fuel economy data derived from Table 9-3 are repeated for ease in comparing total system performances. In preparing Table 9-4, the simplifying assumption was made that the maximum engine torque is constant over the entire engine speed range. To establish the maximum engine torque, a top speed (in high gear) of 100 mph was assumed for cars with 80-hp heat engines and 80 mph for cars with 40- and 50-hp engines.

The acceleration time calculations in the table are based on the use of a three-speed transmission with gear ratios of 3.33:1, 1.67:1, and 1:1, and shift speeds of 24 and 48 mph for the 40- and 50-hp cars and 30 and 60 mph for the 80-hp heat engine cars. An average electric motor-controller efficiency of 65% was used in these computations because of the very heavy motor loads experienced under maximum effort accelerations. This value was determined for a specific system where the instantaneous motor efficiency was found to range between 41 and 71% over the acceleration profile. However, the higher efficiency value occurs at high vehicle speeds where the sensitivity of vehicle acceleration to available drive power is the greatest; thus the average efficiency lies closer to the high value. Motor overload considerations were not accounted for in the calculations, although current overloads of 600% occur in the mid-speed range and even greater currents can be drawn for short periods at takeoff. In performing the calculations, a closed-form solution to the acceleration equation was developed for constant torque configurations (conventional vehicles), but systems with a constant power component in the acceleration equation required stepwise integration for each gear ratio segment in the acceleration profile. The listings shown in Table 9-4 do not include gear shift times.

Calculations for sustained grade climbing performance on a 6% grade at 55 mph are based on the power obtained from the heat engine alone. For that reason, no value is shown for the battery electric vehicle. Transmission losses are included for the Parallel Hybrid: Continuous Operation vehicles to account for the assumed motor-engine planetary differential efficiency of 95%, and for the conventional vehicle with CVT, an 85% transmission efficiency is used. A 75% overall transmission efficiency is assumed in the series hybrid cases based on an 88% generator efficiency and an 85% motor efficiency at the near-rated loads this climb places on the systems. The table shows that the 40-hp conventional vehicle and all hybrids are incapable of sustaining a 6% grade climb at 55 mph.

By augmenting the heat engine with battery power, the hybrids can climb the 6% grade at 55 mph for a limited (transient) range. Calculations for the transient hill climbing range are based on the efficiency values given above, and

load power effects on the battery energy delivery performance are included in the range computations. The battery is assumed to have been charged to the 85% charge state prior to the start of the hill climb (to allow for regenerative braking under normal stop-and-go driving conditions) and is considered to be discharged at the 30% charge state (70% DOD) at the end of the climb. The results show that all hybrids can provide adequate hill climbing range (few high-speed 6% grades are longer than 5 miles) and therefore that all are superior to the conventional 40-hp vehicle in this respect. However, the 40-hp conventional car could easily climb the grade in second gear at 48 mph and, like the CVT and conventional 80-hp cars, would have effectively unlimited range.

The level road top speed of all cars is seen to be well above the current 55-mph national speed limit. Since the calculations are based on the sustained power delivered by the heat engine, no value is shown for the electric vehicle.

The maximum acceleration performance at 60 mph gives an indication of high-speed passing performance. The results show that nearly all hybrids are superior to the baseline vehicle and that only the 40-hp conventional vehicle is substantially inferior.

In summary, Table 9-4 shows that all hybrid configurations can provide adequate (in some cases superior, but not identical) road performance in comparison with the baseline 80-hp conventional car with engines of half its size. When combining fuel economy performance with the road performance results, the best of the hybrids (Variation F) offers only 25% improvement in fuel economy under mixed driving conditions in trade for its greater complexity. With relatively minor sacrifices in road performance, the conventional vehicle with CVT appears to offer the best overall performance of all alternates.

### 9.2.3 Emission Performance

In a general study of the emission reduction potential of hybrids, Liddle (Ref. 9-18) found that emissions from uncontrolled hybrid engines are strongly dependent on the particular power control schedule and throttle response method employed and may result in increases or decreases of specific species.

Throttle response is defined in relation to the Minicars spring-damper controller engine throttling method in which zero throttle response represents constant engine speed and power with no direct driver throttle control. Unity response corresponds to a direct linkage to the accelerator as in conventional vehicles. Power control schedules ranging from a heavy throttle opening mode to a minimum NO<sub>x</sub> (low torque) schedule were also examined.

The best overall emission performance of series hybrids occurs at near zero throttle response (constant power and speed). For parallel hybrids, HC and CO emissions reach a minimum at 0.19 throttle response and increase for lesser and greater values. Of the two effects, HC and CO emissions were found to be more sensitive to the degree of throttle response employed,

Table 9-4. Road performance comparisons

	A	B	C	D	E	F	G	H	J	K
	Conventional vehicle	Conventional vehicle	Parallel Hybrid: Continuous Operation	Parallel Hybrid: Continuous Operation	Parallel Hybrid: On-Off Operation	Parallel Hybrid: On-Off Operation	Series Hybrid: Continuous Operation	Series Hybrid: On-Off Operation	Battery/Electric	Conventional car with CVT
Otto engine horsepower	80	40	80	40	80	40	50	50	-	50
Electric motor horsepower	-	-	20	20	20	20	40	40	40	-
Battery weight, lb	-	-	500	500	500	500	500	500	1200	-
Vehicle test weight, lb	2400	2260	3480	3340	3380	3240	3800	3800	4070	2400
Road performance										
Acceleration time:										
0-30 mph, sec	3.67	7.04	2.09	2.61	3.52	3.50	3.13	3.13	2.88	3.75
0-60 mph, sec	12.13	31.14	8.34	14.30	9.24	14.08	15.44	15.44	13.93	19.37
Hill climb:										
Max. grade at 55 mph (high gear)										
Sustained, %	7.6	3.4	4.4	1.6	5.1	2.0	3.7	3.7	N/A	7.2
Transient, %	7.6	3.4	>6.0	>6.0	>6.0	>6.0	>6.0	>6.0	>6.0	7.2
Transient range, miles on 6% grade at 55 mph	a	b	17.3	8.1	84.0	10.0	7.0	7.0	5.6	a
Level road top speed, mph	101	79	93	72	99	77	76	76	N/A	79
Max. acceleration at 60 mph, ft/sec <sup>2</sup>	2.26	0.89	3.16	2.14	3.51	2.61	2.79	2.79	2.71	1.81
Fuel economy										
Simulated metro cycle:										
Engine-Off mode, mpg	30.8	41.3	24.8	30.4	31.2	33.5	21.6	21.0	31.9	40.7
Engine-Idle mode, mpg	26.7	37.4	22.1	28.2	25.0	29.6	20.2	18.9	-	36.1
Constant speed:										
30 mph	28.4	51.6	32.2	46.9	30.7	49.2	42.2	32.4	60.0	53.2
40 mph	35.4	47.4	33.3	43.5	33.8	44.2	36.5	27.5	47.5	49.3
50 mph	32.2	41.0	30.1	37.3	30.3	37.2	29.5	23.7	36.3	38.31
60 mph	28.6	33.4	26.5	30.9	26.8	31.2	24.2	20.8	30.0	30.4
Mixed driving (60% urban + 40% at 55 mph constant speed), mpg	28.0	37.3	24.4	30.3	30.1	33.8	22.4	21.5	32.4	35.4

<sup>a</sup>Unlimited except by fuel tank capacity.

<sup>b</sup>Cannot reach 55 mph on a 6% grade.

whereas power scheduling was determined to affect NOx emissions the most. The effects of throttle response and engine loading on exhaust emissions for the parallel hybrid configuration are illustrated in Fig. 9-5 for the 1972 Federal Test Procedure under warm start conditions.

The study concluded that hydrocarbon emission reduction may be as great as 76% by minimizing low power engine operation. CO emissions may increase by 23% or decrease by 40% depending on the throttle response. NOx emissions may increase or decrease, but at best, improvement

of only 7% over the performance of a conventional vehicle with the same installed power can be expected. The parallel hybrid offers lower emissions if the throttle response is greater than 0.3, but the series hybrid is better if the throttle response is less than 0.1. Within this range, either may be slightly superior, depending on the particular engine power schedule and pollutant.

A summary of the emission performance of the various hybrid vehicle configurations analyzed or developed to date is compiled in Table 9-5. The table shows an interesting comparison made

Table 9-5. Hybrid vehicle emissions

	Curb weight	ICE, hp, max	Electric motor, hp, rated	Battery/flywheel weight and type	Hybrid type and configuration	Emission control system	Test driving cycle	HC, g/mi	CO, g/mi	NO <sub>x</sub> , g/mi	Fuel economy, mpg
Petro-Electric <sup>a</sup>	4150	130 rotary	20	300 Pb-acid	Continuous Parallel, battery	Thermal converter, EGR	FDC	0.41	2.46	0.80	10.5
Robert Bosch <sup>a</sup>	3310	44	21.5	445 Ni-Cd	On-Off Parallel, battery	Thermal converter, carburetor modifications (EGR-ign mods)	-	2.83 (2.50)	5.52 (5.50)	3.67 (2.00)	-
Minicars Inc. <sup>a</sup>	3000	40	20	640 Pb-acid	Continuous Parallel, battery	Carburetor damper, lean mix, manifold heat	DHEW <sup>b</sup>	60% reduction	60% reduction	25% reduction	-
IKA <sup>a</sup>	4630 (van)	20 rotary	11	330/110 Pb/steel	Continuous Series, battery, flywheel	-	-	-	-	-	22.4
GM Stir-Lec <sup>a</sup>	3200	8 Stirling	20 induction	500 Pb-acid	Continuous Series, battery	None	30 mph continuous speed	0.24	4.00	40.0	30-40
TRW <sup>c</sup>	4300	110	30	500 Pb-acid	Continuous Parallel EMT battery	Catalytic converter, fuel injection (HC accum)	DHEW <sup>b</sup>	1.15 (0.29)	3.69 (3.20)	0.31 (0.32)	19
Aerospace <sup>d</sup>	4300	84	38	460 Pb-acid	Continuous Parallel, battery	A/F = 19(22), catalytic converter, EGR	DHEW <sup>b</sup>	0.9 (0.3)	1.3 (0.4)	5.7 (0.5)	12.5
Lockheed <sup>d</sup>	4300	100	61	400 Pb-acid	Continuous Series, battery	A/F = 19(22), catalytic converter, EGR	DHEW <sup>b</sup>	1.0 (0.38)	1.4 (0.4)	6.0 (0.5)	11
	4300	93	-	42-steel 24000 RPM	Continuous Series, flywheel	EGR ox. cat.	DHEW <sup>b</sup>	0.38	1.12	1.21	7.3-13.7
	4300	350 CID conventional transmission	-	350 CID conventional vehicle with automatic transmission	Continuous Series, flywheel	EGR ox. cat.	DHEW <sup>b</sup>	0.39	0.95	3.98	11-12
Applied Physics Laboratory <sup>d</sup>	4300	94	-	163 lb composite at 30000 rpm	On-Off Series, flywheel	All	DHEW <sup>b</sup>	0.13	1.97	0.69	14.4

<sup>a</sup> Full-scale vehicle tests.  
<sup>b</sup> Same as Federal Driving Cycle (Urban).  
<sup>c</sup> Power train tests only.  
<sup>d</sup> Analytical study results.

by Lockheed between a 350 CID Otto cycle engine powered conventional car with automatic transmission and a flywheel hybrid which uses the same engine with a power splitting transmission. Based on the particular configuration analyzed by Lockheed, it is seen that NOx reduction is the only substantial improvement.

### 9.3 MAJOR SYSTEM COMPONENTS

#### 9.3.1 Heat Engines

Because cost, weight, and volume constraints are even more stringent in hybrids than in conventional automobiles, the most promising hybrid engines are those which not only excel in these respects, but which by virtue of their limited speed, torque, or part load efficiency ranges are less competitive for direct use in conventional vehicle systems. The Otto engine and the Brayton (gas turbine) most closely fit these criteria, and between these, the conventional piston engine is presently the preferred type because of its lower specific fuel consumption. (However, the mature Brayton is projected to have a lower BSFC than the mature UC Otto engine, and thus may be a better candidate for hybrid operation.) The Diesel, by reason of its high cost, weight, volume, and good part load efficiency is not well adapted to hybrid operation. The performance, cost materials usage and emissions aspects of each of the candidate heat engines are discussed at length in Chapters 3 through 7 of this report.

#### 9.3.2 Energy Storage Systems: Batteries

In contrast to the need for high energy density batteries for electric vehicles, the emphasis in hybrid battery design is on high power density to handle the high peak power involved in acceleration, regenerative braking, grade climbing, and high-speed passing maneuvers. The heat engine supplies the primary energy requirements but displaces space and weight that is otherwise available for batteries in the battery-powered vehicle. Therefore, the hybrid battery must provide the same or greater power delivery capability as the electric vehicle battery at half or less than half its weight. The energy storage requirements for the hybrid battery are less severe than those for electric vehicles and are limited to supplying short bursts of high power for periods of up to 5 or 10 min maximum.

Experimental car experience has demonstrated that conventional aqueous storage batteries can marginally meet hybrid vehicle power and energy density requirements, and battery studies have indicated that further improvements in each of these parameters are possible. Cycle life under the high charge/discharge rates of hybrid car power demands poses the largest technical problem remaining to be solved for all battery systems.

Lead-acid, nickel-cadmium and nickel-zinc batteries have been used in experimental and analytical hybrid car designs to date. While nickel-cadmium is technically the most attractive choice on the basis of its high cycle life and power density and has adequate energy density for hybrid applications, the high cost, toxicity, and limited availability of cadmium rules out this system as a serious candidate for mass-produced

cars. Nickel-zinc has similarly high power and improved energy density characteristics but has not yet achieved the cycle life requirements for hybrid (or electric) vehicle applications. Further, the large amount of nickel required for both nickel-zinc and nickel-cadmium batteries (approximately 30-35% of the battery weight) would require about a fourfold expansion of current nickel production rates in order to fully convert the present 10 million per year passenger car production to hybrids (on the basis of 500 lb of battery per passenger car). This factor raises serious doubts as to the feasibility of converting the entire passenger car fleet to Ni-Zn battery-powered hybrid (or electric) vehicles.

Other cell types such as the high-temperature metal-alkali, metal-air and metal-halogen cells are less suited for hybrid vehicle use because of high cost, low power density, or excessive thermal losses. Of all the candidates, therefore, lead-acid remains the most promising on the basis of performance, cost, and materials availability.

Hybrid vehicle battery performance requirements were developed as a part of the EPA hybrid vehicle study program. These are shown in Table 9-6. Studies by Tyco (Ref. 9-7) and TRW-Gould (Ref. 9-8) established that modifications in the design and materials of construction can upgrade the performance of existing SLI lead-acid batteries to meet the performance and cost objectives, but cycle life still remains a major problem. While costs were not determined in detail as a part of the study efforts, estimates indicate that the goal of \$10/kW is within reach for high-rate production batteries.

The major problem related to cycle life and shelf life (3-5 years) is premature failure of the positive (Pb-O<sub>2</sub>) plate, either by corrosion of the thin metallic grids or by shedding of the active positive material. Shedding is primarily attributed to stresses that occur during cycling, owing to the difference in densities of the oxidized and reduced form of the positive materials. It has been shown that this problem can be minimized by use of a cylindrical plate design developed by Bell Telephone Laboratories (BTL) (Ref. 9-16). Because of the poorer space utilization of the cylindrical plate configuration which leads to an increased case-to-active material weight fraction for the battery, the power and energy density of these designs is about 25% less than that of conventional flat plate configurations. Although the BTL research has not been aimed toward traction battery applications, it suggests that a substantial improvement in shelf life (10 years in float service) and cycle life (1000-2000 cycles) may be feasible through design refinements.

A highly effective metal recycling effort is a necessity for maintaining a sufficient inventory of critical materials required to support the production and operation of a substantial passenger car fleet of hybrids (or electric). The experience of the lead industry indicates that the current recycling rate for all lead is high at 50%, and the rate for automotive battery lead is even higher at 80%. Assuming that the rate can be even further improved to 85-90%, the peak yearly production output for lead would still have to increase from 1.45 to 3 million tons/yr for total

Table 9-6. Hybrid vehicle battery preliminary requirements (Ref. 9-14)

Parameters	Specification		
Power	55 kW discharge for 25 sec, twice within 60 sec		
	30 kW recharge for 90 sec after above two discharges		
Voltage, V	200 to 220 open circuit, 150 minimum		
Life	5 yr; 200,000 cycles		
Number of cycles	Rate, kW		Discharge energy per cycle W-hr
	Discharge	Charge	
500	55	30	380
3000	55	30	130
3000	55	30	80
Balance of 200,000	10	5	30
Weight, lb			
Maximum	550		
Goal	450		
Cost	\$550		
Operation	Safe		
	No undue care or maintenance		

fleet conversion. Critical material requirements for 100% fleet conversion to hybrid vehicles is similar to that for 30-35% conversion to electric vehicles, since lesser battery weight is used. These are discussed in Section 8.3.3 of Chapter 8.

### 9.3.3 Energy Storage Systems: Flywheels

The very high power densities and moderate energy densities achievable with flywheels provide a good match to the requirements of hybrid vehicles. In separate tests, Lockheed (Ref. 9-3) determined that the power density of a steel flywheel rotor could exceed 5000 W/lb, and Applied Physics Laboratory (Ref. 9-4) obtained 28 W-hr/lb rotor energy density in subscale experiments with bar-type filamentary flywheels. While these performance values compare favorably with those of advanced lead-acid batteries, it should be noted that they apply only to the rotor (equivalent to the active material in a battery) and that the weight added by the housing, power coupling system, bearings and ancillary components detracts from the overall energy and power density of the complete storage system assembly. Since the rotor is the most critical component, most work done to date has concentrated on improving its performance.

The Lockheed work concentrated on metal flywheels of various materials and configurations. Pierced and solid disk and conical and constant stress exponential cross-section designs were examined. Materials considered included maraging steel, 1020 and 1040 steel, 4340 steel, and 2021-T81 and 2024-T851 aluminum. Several experiments were also conducted with E-glass and S-glass bar type composite wheels. On the basis of minimum weight and cost, Lockheed selected 4340 steel in a modified exponential constant-stress disk configuration as the best among the combinations analyzed. Two 46-lb wheels designed to operate at 24000 rpm were built and tested. One of these was tested to destruction after spindown and acoustic tests were conducted. Disintegration occurred at a speed in excess of 35000 rpm at a stored kinetic energy level of 1.1 kW, which represents an energy density of 26.1 W-hr/lb for the 20.4-in. diam., 42.4-lb wheel.

Work at the Applied Physics Laboratory was confined to an investigation of composite wheels using boron, graphite, E-glass, and R-glass fibers. A large number of early tests were performed on small rod configurations using epoxy, RTV, acrylic and tube-supported mounting systems to evaluate the ultimate performance of the materials and to verify the operation of the test instrumentation. In these tests, a 0.004-in. diam. boron filament weighing 0.00035 lb displayed the highest energy density of all the materials tested at 48 W-hr/lb without failing. For reasons of lower ultimate cost, subsequent 1-lb bar tests were limited to graphite/polyester, graphite/epoxy, and S-glass/epoxy composites. In the best of a series of five tests, a 30-in.-diam. S-glass epoxy wheel exhibited a 28 W-hr/lb energy density. APL found that wheel failures occurred at 71% of the static tensile stress failure levels measured for S-glass/epoxy composites and at 81% of those measured for graphite/epoxy systems. The premature failure stress is attributed to fabrication practices used in the preparation of experimental specimen which resulted in fiber misalignment and cut surface fibers.

While the difference in energy density between metal disk and composite bar rotors is seen to be small, the containment ring required for the metal rotors must be much heavier to resist the large chunks which are characteristic of the failure of homogeneous rotors. Lockheed found that a 192-lb steel ring was required to contain a 0.86-hp-hr steel rotor burst and that a 167-lb composite ring could contain a 0.46-hp-hr burst. APL did not perform burst containment tests of full-scale wheels, but found that the 1/4-in.-thick rings used in their bar test series successfully contained the bursts of the experimental composite wheels. They concluded that the very low energy which apparently transfers to the containment ring is due to the fact that the composite rotors dissipate a significant portion of their kinetic energy by microfracture or vaporization of the matrix material. As part of their test series, APL observed that bursts of the graphite/epoxy composite rotors produced greater deformation of the containment ring than did bursts of S-glass epoxy composites. This difference was attributed to the rate at which disintegration occurs in the two materials. Thus,



while both homogeneous and composite rotors constructed of low-cost materials exhibit nearly the same rotor specific energy, composite rotors appear to offer superior overall storage system energy density due to the lower weight required for burst protection.

The sustaining power required to maintain the rotor within its operational speed range also detracts from the overall performance of fly-wheel energy storage systems. Both Lockheed and APL system designs use a mechanical coupling between the rotor and hybrid drive system, and both are evacuated to a vacuum of  $10^{-2}$  -  $10^{-3}$  torr to reduce windage losses to a negligible level. However, the required support bearings and vacuum seal can be responsible for sustained power losses of up to 3 hp at the maximum stored energy level according to Lockheed calculations and measurements. These parasitic losses are similar in effect to, but much higher than, the self-discharge properties of ambient temperature batteries or the thermal losses of high-temperature battery systems.

#### 9. 3. 4 Traction Motors and Generators

Except that the traction motor power required for certain hybrid vehicles is substantially less than that needed in electric vehicles, the characteristics of the various available motor types and their selection considerations are similar to those for electric vehicles. These are discussed in Section 8. 3. 1.

Generators or alternators are used in some but not all hybrid configurations. Series hybrids require a generator/alternator as an integral part of the system concept. Because the heat-engine generator/alternator operates independently of the traction motor, however, both the engine and generator/alternator can operate at nearly their optimum efficiency speed/power points in the series system. The generator/alternator must be rated to handle the maximum heat engine power since all power flows through the generator and traction motor in the series configuration.

In contrast, the generator/alternator used in parallel hybrids must operate over the full speed range of the heat engine at torque levels varying from zero to a mid-range value determined by the design of the control system. As a result, the generator/alternator must operate in less efficient speed/power regimes for parallel hybrids than for series hybrids.

The characteristics of generators are similar to those of motors, and the efficiency curves of Fig. 8-11(a) and application considerations of Section 8. 3. 1 are generally applicable.

#### 9. 3. 5 Power Control Systems

The most critical component (from a technological standpoint) of the control system required for hybrid vehicles is the traction motor controller. Generator charging control, throttle control and engine startup/shutdown control may also be required, depending on the particular hybrid configuration and operational concept. Recovery and control of regenerative braking energy is almost universally accomplished via the traction motor, operated as a generator, and

its controller. Contactor, battery switching/field control, and chopper controllers similar to those developed for electric vehicle systems are equally applicable to the control of hybrid vehicle traction motors. The performance of these is discussed in Section 8. 3. 1.

Although detailed descriptions of generator charging and throttle controllers used in the few hybrid vehicles developed to date have not been published, simple low power field control circuits with armature cutout relays or diodes are suitable for the generator charging function. Depending on the particular control schedule, throttle controller mechanization may range from a simple manifold pressure feedback servo operating the throttle valve to a complex electromechanical system which uses a programmed input based on road speed and power, manifold pressure, energy storage system charge state and other parameters.

The most complex of the hybrid vehicle concepts will require a small special-purpose computer to process driver inputs for the various engine and electrical power system controllers. While the control functions may be complex, the availability of low-cost integrated circuit packages permits the designer to concentrate on achieving the best system energy performance without appreciable regard to the cost and reliability associated with the mechanization of the computational functions. The greatest cost and reliability impacts are those of the sensors and actuators which transform physical parameters and control signals to high power control levels or mechanical motions.

### 9. 4 VEHICLE DESIGN AND INTEGRATION

#### 9. 4. 1 Weight, Weight Distribution, and Handling

The greater weight of hybrid power system components leads to increases in structural and suspension system weights to retain structural integrity, body flexure, and suspension and braking margins equivalent to those of conventional vehicles. While the added weight can be used to advantage in improving vehicle ride quality, it can also become a handicap to vehicle handling if not carefully distributed.

The distribution of batteries throughout the vehicle requires attention to the penalty their location imposes on handling characteristics and overall vehicle weight. (The 40% weight propagation penalty used in the calculations of Table 9-3 is based on equivalent peak drive torques for all variations and a weight distribution typical of conventional vehicles; see Chapter 10.) Locating heavy battery packs ahead of the front axle or behind the rear axle is likely to impose a greater weight propagation penalty to account for stiffening and strengthening the overhang and/or axle clearance areas than will mid-chassis mounting. It will also adversely affect handling characteristics by increasing the pitch and yaw moments of inertia (Ref. 9-14). As in conventional vehicles, the power train should be a part of the suspended vehicle weight, and heavy components should be located near, or balanced around, the effective suspension system rotational axes to prevent excessive pitch or sway. Placing batteries low in the chassis can help lower the center of gravity

of the suspended mass and further improve roll and dive characteristics. Power-assisted steering and braking systems are more likely to be needed because of the greater weight of the hybrid.

Gyroscopic torques in flywheel hybrids have been determined to be of relatively minor concern. The Lockheed study (Ref. 9-3) concluded that the precession torques produced by the 0.5 kW-hr wheel used in their designs for passenger cars are sufficiently small that flywheel spin axis orientation should be based on packaging consideration rather than on minimizing cross coupling forces. Applied Physics Laboratory (Ref. 9-4) arrived at essentially the same conclusion but, because of the larger maximum angular momentum of flywheels used in their designs, recommended that the subject be given further study. The extent of gyroscopic effects on vehicle handling on slippery pavement has not been investigated.

#### 9.4.2 Packaging Flexibility

While the packaging flexibility of one hybrid configuration may be superior to that of another, the larger number of power train components along with their greater weight and space requirements results in greater complexity of all hybrids in comparison with that of conventional automobiles.

The series hybrid configuration offers more flexibility than does the parallel arrangement for both battery and flywheel hybrids because the power train can be divided into two mechanically separable units. This enables the design of the power train assemblies to be more easily tailored to vehicle weight distribution requirements dictated by handling considerations. Of the various hybrid system configurations conceived to date, series configurations have been preferred for flywheel hybrids because of packaging considerations, whereas parallel arrangements have been required for battery systems due to component efficiency limitations.

Battery hybrids offer somewhat greater packaging flexibility since batteries do not have the specific mechanical alignment requirements that flywheels have, and thus can be distributed throughout the vehicle where space permits. Although they can be placed in otherwise unneeded or unusable locations, access provisions must be made for routine service and replacement. Further, locations must be selected with consideration for collision safety, since the battery weight constitutes a significant portion of the overall vehicle weight, and because the possibility exists of high-temperature or corrosive electrolyte spillage and high-power electrical short circuits. Distributing batteries around the vehicle at large distances from each other or from the motor controller will also result in greater cabling losses and costs.

#### 9.4.3 Volume Constraints

Figures 9-6(a) to (f) illustrate various packaging configurations used in typical hybrid vehicles proposed or developed to date. In most cases, the installation of hybrid components intrudes on trunk space which is otherwise available for payload in conventional cars.

#### 9.4.4 Powerplant Safety

The heat engine and fuel tankage safety aspects of hybrids are equivalent to those of conventional vehicles.

Hydrogen gas evolution during battery charging and the presence of lethal voltage levels in cabling and connections throughout the vehicle are unique operational safety hazards associated with battery hybrids. Battery enclosures must be vented and provisions may be required for forced ventilation. Typical power transmission voltages range from a minimum of 36 volts to 200 volts or more and can pose personnel hazards. Electrical fires, which are a major cause of non-collision damage in conventional automobiles, are a greater hazard in electric and hybrid vehicles because of the long high-power cable runs. Because of the vibration environment, cable insulation must be tough and must be protected from abrasion. Insulation must also resist acids, solvents, and aging. The addition of electrical circuit protection devices (fuses, circuit breakers, or solid-state current limiters) may result in greater system losses as well as greater weight, volume, cost, and maintenance requirements.

Flywheel burst containment is the major safety item associated with flywheel hybrid powerplants. Both metal and composite rings are feasible for containing wheel fragments resulting from flywheel overspeed or structural defect failures. Because of safety considerations, composite flywheels are preferable to homogeneous metal wheels since much of the burst energy is dissipated by the fragmentation of the composite material and only 1-2% is transmitted to the containment ring. The weight of the containment ring adds to the overall assembly weight and thereby contributes to the relatively low energy density of flywheel systems.

### 9.5 OWNERSHIP CONSIDERATIONS

#### 9.5.1 Maintenance Requirements

The complexity of the hybrid vehicle is such that its routine care and repair represents more than the sum of the maintenance requirements of both an electric vehicle and a conventional Otto engine powered car. The battery hybrid contains a complete Otto cycle powerplant package, including cooling, lubrication, fuel, and exhaust systems (with emission control equipment), as well as a complete electric vehicle propulsion package containing batteries, motor, and motor controller. Only the transmission and differential are common to the two powerplant systems. Based on the designs of hybrid vehicles conceived to date, at least one and possibly more of the following components will also be incorporated:

- (1) Throttle controller.
- (2) Automatic engine startup and/or shutdown system.
- (3) Bevel or planetary gear differential coupler (in addition to those ordinarily used in conventional cars).
- (4) Engine decoupling or other clutches or brakes, including associated automatic or manual actuation system.

- (5) Battery charge state indicator and/or sensor.

Except for occasional motor brush and battery replacement, the electrical power components add little to the routine service operations related to hybrid vehicle maintenance. Also, due to their high reliability, these components detract only slightly from the overall vehicle reliability. Routine battery electrolyte inspection and refilling could become a service cost item, however, rather than one of the several under-hood courtesy checks currently performed during refueling because of the large number of cells that must be checked at frequent intervals.

In the flywheel hybrid concepts proposed to date, the flywheel units have been considered to be sealed evacuated assemblies which are not serviceable in the field. As such, no routine service is foreseen and assemblies would be replaced as they fail by new or factory-rebuilt units.

Accessory systems are likely to require the same level of maintenance that similar systems receive on conventional automobiles. Electro-mechanical or pneumatic control systems will require occasional visual and/or operational checks to verify their proper operation. Cleaning and lubrication or hose replacement may be required at periodic intervals. Service of these devices is likely to be done as a part of regular engine tune-up procedures. Inspection of accessory gear boxes will be accomplished as one of the regular periodic lubrication procedures. Accessory friction clutches or brakes will require replacement at intervals of 50,000 to 100,000 mi as is the case for similar devices in conventional cars.

The higher load levels imposed on the heat engine of a hybrid vehicle are likely to produce higher wear rates on journal bearings and piston and cylinder wall surfaces unless the engine is specially designed for hybrid operation. Valve reconditioning may also be required at more frequent intervals. Tailoring the engine design to the hybrid operation requirements will most likely result in somewhat greater weight and initial cost.

#### 9.5.2 Incremental Cost of Ownership

Aerospace (Ref. 9-1) and TRW (Ref. 9-2) developed initial cost estimates of the added major components of both series and parallel hybrids based on prices then in effect (1971). A direct comparison between the two is difficult to make because TRW did not include costs for batteries and emission control equipment and based estimates on costs at the OEM level whereas Aerospace costed at the consumer level. Table 9-7 shows a comparison of the two based on the assumptions that the battery and emission control equipment costs are the same for both systems and that a factor of two represents the markup from OEM to retail prices.

Uncertainties exist in the estimates themselves (Aerospace estimated  $\pm 20\%$ ). These are compounded by the manner in which comparisons are made in Table 9-7 as well as by the fact that the TRW and Aerospace designs differ in many

Table 9-7. Hybrid system added costs (1971 dollars)

	TRW OEM	TRW retail	Aerospace retail	Average retail
<b>Series hybrid</b>				
Major components	768	1536		
Batteries		560		
Emission controls		125		
Total		2220	1645	1930
<b>Parallel hybrid</b>				
Major components	600	1200		
Batteries		560		
Emission controls		125		
Total		1885	1940	1910

respects. In the absence of more precise data, an average of the two sets of estimates serves as a guide in comparing the costs associated with hybrid vehicle ownership with those of a conventional automobile. Based on the consumer cost of \$3250 (used by Aerospace) for a conventional car of the same class and model year as the hybrid, the ratio of hybrid-to-conventional car initial cost to the consumer is 1.6.

To date, no studies have been reported which compare the operational costs of hybrid vs conventional cars. From the rationale developed in Section 9.5.1, it can be expected that the maintenance costs of a hybrid will approximate the sum of the costs for both a conventional and electric vehicle. A rough estimate of the latter can be obtained from an analysis of the initial and maintenance costs of an electric vehicle that has been performed by Ford (Ref. 9-15) and compared with similar cost data published by the Department of Transportation for a conventional subcompact car. This comparison is shown in Table 8-7 of Chapter 8. It is interesting to note that the ratio of initial costs (1.57) for the battery electrics is nearly identical to that developed on the basis of the Aerospace and TRW estimates for battery hybrids.

Of the total 3.2¢/mi maintenance cost for the electric vehicle given in Table 8-6, 1.7¢/mi relates to battery maintenance and replacement costs. From this, an average cost of 0.002¢/mi per pound of battery weight can be derived on the basis of the 920-lb battery used in the Pinto electric vehicle design. (This value neglects motor and controller associated maintenance costs as being insignificant in comparison to those for the batteries.)

Based on an initial cost ratio of 1.6 and battery maintenance and replacement costs of 0.002¢/lb-mi (for the 460-lb battery used in the Aerospace hybrid design), the variable ownership costs for hybrid vehicles are summarized and compared with those of the conventional and battery electric cars in Table 9-8 (assuming equal fuel economy for the conventional and hybrid cars). The totals in the table show that, at 1973 fuel prices, no amount of improvement in hybrid vehicle fuel economy will completely offset its greater initial and maintenance costs, since the sum of these is greater for the hybrid than for the conventional car by an amount larger (2.2¢/mi) than the total cost of fuel used by either car. Relating these results to the differential cost of ownership over the lifetime of the hybrid, the hybrid would cost as much as \$2200 more than the equivalent conventional vehicle over the projected 10-year, 100,000-mi life span, based on the continued availability of low-cost fuel and no significant hybrid fuel economy advantage.

Table 9-8. Variable ownership costs (cents/mile)

	Conventional car	Battery electric	Electric hybrid <sup>a</sup>
Vehicle initial	2.1	3.3	3.4
Fuel cost	2.0	1.1	2.0
Maintenance cost	2.1	3.2	3.0
	6.2	7.6	8.4

<sup>a</sup> Assumes same fuel economy as conventional car.

However, fuel costs have already risen above those used in Ref. 9-15 and can be expected to rise further as petroleum reserves dwindle. Also, Table 9-3 indicates, and the IKA experimental car has demonstrated, that a substantial fuel economy improvement can result through hybrid operation. Combining these factors, a region can be found in which higher fuel costs coupled with improved fuel economy can result in fuel cost savings that are sufficient to offset the higher initial and maintenance costs of the hybrid over its lifetime. This region is shown in Fig. 9-7. From the figure, it can be seen that the life-cycle cost of the hybrid is competitive with that of the conventional car at a fuel cost of \$1.70 per gallon when the overall hybrid fuel economy is higher by 25% or more. (These calculations do not discount the fuel cost savings back to present value as was done in Chapter 20. Thus an even higher, and unlikely, fuel price is required to break even.)

## 9.6 CONCLUSIONS

Hybrids do not offer greater adaptability to changing fuel availability than do conventional vehicles. The same engine types are used in each, and similar considerations of cost, weight, volume, and BSFC govern the selection of heat engines for each application.

While the exhaust emissions of hybrids are somewhat lower than those of a conventional vehicle for equivalent road performance, the magnitude of the reduction is not sufficient to meet the 1977 federal emission standards by hybrid operation alone, and no substantial decrease in the number, weight, cost, size, or performance of engine modifications or exhaust aftertreatment devices can be expected by hybrid operation.

The road performance of hybrids can be made comparable (but not identical) to that of conventional vehicles in all important respects. Greater on-board total peak power capability is required to overcome the greater weight of the hybrid, but less of the total power capacity must be supplied by the heat engine. Thus, smaller, harder working heat engines suffice for normal passenger car usage. Since reduced heat engine power capacity is essential to achieving the fuel economy advantages of hybrid operation, continuous high power is not available for nontypical driving demands such as trailer towing or sustained high speed (in excess of 80 mph) or hill climbing operation.

Based on the calculations in this chapter, the most optimistic projection of fuel economy improvement of hybrids over conventional cars is about 25% under urban driving conditions assuming that each type of vehicle uses an Otto cycle engine and that the road performance of the two is comparable. Under high-speed highway driving conditions, the fuel economy advantage of hybrids nearly disappears, and improvements of 10% may be expected at best. Of the two basic hybrid configurations, the parallel system offers the best performance in all respects including fuel economy and life-cycle cost. The development of advanced engines such as the Stirling which have improved part load fuel economy over the Otto engine will not greatly benefit hybrid operation, but will improve the fuel economy of conventional vehicles. Thus, the comparative advantages of hybrid operation will further diminish. Finally, the combination of a small engine (like that used in hybrids) with a CVT in a conventional vehicle configuration will provide generally equivalent road performance to that of a hybrid (somewhat poorer instantaneous acceleration and short grade hill climbing power, but better sustained high speed and long grade hill climbing performance) at improved overall fuel economy. In comparison with a conventional car with the same small size engine, the CVT vehicle will produce substantially improved road performance with only slightly poorer fuel economy.

A rapid buildup of the battery hybrid population would produce a severe impact on the materials industry. Substantial production rate increases for critical materials such as lead, nickel, or zinc would be required for a buildup

in hybrid production to 10 million vehicles/year. Flywheel hybrids, on the other hand, place minimal requirements on critical material supplies.

The initial cost of all types of hybrids will remain higher than that of conventional vehicles of equal performance and accommodations due to their added weight and complexity. The life-cycle cost will also remain substantially greater until such time as fuel cost savings which result from improved fuel economy exceed the amortized increase in the initial cost plus the additional maintenance costs. Based on the estimates in this chapter, this point will not be reached until the cost of gasoline increases beyond \$1.70 per gallon.

#### References

- 9-1. Lapedes, D. E., Hybrid Heat-Engine/Electric Systems Study, Aerospace Corp., Report No. TOR-0059(6769-01)-2 to EPA Div. of Advanced Automotive Power Systems Development, Vols. I and II, June 1971.
- 9-2. Gelb, G. H., et al., Cost and Emission Studies of a Heat-Engine/Battery Hybrid Family Car, TRW, Report APTD-1355 to EPA Office of Air Programs, Apr. 1972.
- 9-3. Gilbert, R. R., et al., Flywheel Drive Systems Study, Lockheed Missiles and Space Co., Report LMSC-D246393 to EPA, July 1972.
- 9-4. Dugger, G. L., et al., Heat-Engine/Mechanical Energy Storage Hybrid Propulsion Systems for Vehicles, Johns Hopkins University, Applied Physics Laboratory, Report No. APTD-1344 to EPA Office of Air Programs, Mar. 1972.
- 9-5. Gordon, M. A., and Grimm, D. H., Hybrid Propulsion System Transmission Evaluation, Sundstrand Aviation, Report AER-640, Feb. 1972.
- 9-6. Feasibility Analysis of the Transmission for a Flywheel/Heat Engine Hybrid Propulsion System, Mechanical Technology Inc., Nov. 1971.
- 9-7. Giner, J., et al., Lead/Acid Battery Development for Heat Engine/Electric Hybrid Vehicles, Tyco Laboratories, Report APTD-1346 to EPA Division of Advanced Auto. Power Systems Development, Nov. 1971.
- 9-8. Develop High Charge and Discharge Rate Lead/Acid Battery Technology, TRW Systems Group, Report 18353-6006-RO-00, Apr. 1972.
- 9-9. Andon, J., and Barnal, I., Emission Optimization of Heat Engine/Electric Vehicle, Minicars Inc., Report EHS 70-107 to EPA Air Pollution Control Office, Jan. 1971.
- 9-10. Agarwal, P. D., et al., Stir-Lec I. A Stirling-Electric Hybrid Car, General Motors Research Laboratory, SAE 690074, 1969.
- 9-11. The Petro-Electric Motors Hybrid Vehicle (Federal Clean Car Incentive Program Candidate Vehicle, Test Report 75-14, EPA Office of Air and Waste Programs, Jan. 1975.
- 9-12. Fersen, O. G. W., Bosch Investigates Hybrids, Automotive Industries, Apr. 1974.
- 9-13. Helling, J., et al., Hybrid Drive with Flywheel Component for Economic and Dynamic Operation, Institut für Kraftfahrwesen Technische Hochschule Aachen, Proc. 3rd International Electric Vehicle Symposium, Feb. 1974.
- 9-14. Topedas, D. E., Current Status of Alternative Automotive Power System and Fuels (Vol. IV: Electric and Hybrid Power Systems), Aerospace Corp., Report EPA-460/3-74-013-d, July 1974.
- 9-15. Electric Vehicle Systems Study, Scientific Research Staff, Ford Motor Co., Report No. SR-73-132, Oct. 1973.
- 9-16. Cannone, A. G., Positive Grid Design Principles, Bell System Tech. Journal, Sept. 1970, pp. 1279-1305.
- 9-17. Brooman, E. W., et al., Batteries: Prospects for Electric Vehicles, Automotive Engineering, Jan. 1975.
- 9-18. Emissions from Hybrid Vehicles, S. G. Liddle., General Motors Research Labs., Intersociety Energy Conv. Eng. Conf., Aug. 1973, Paper 739115.

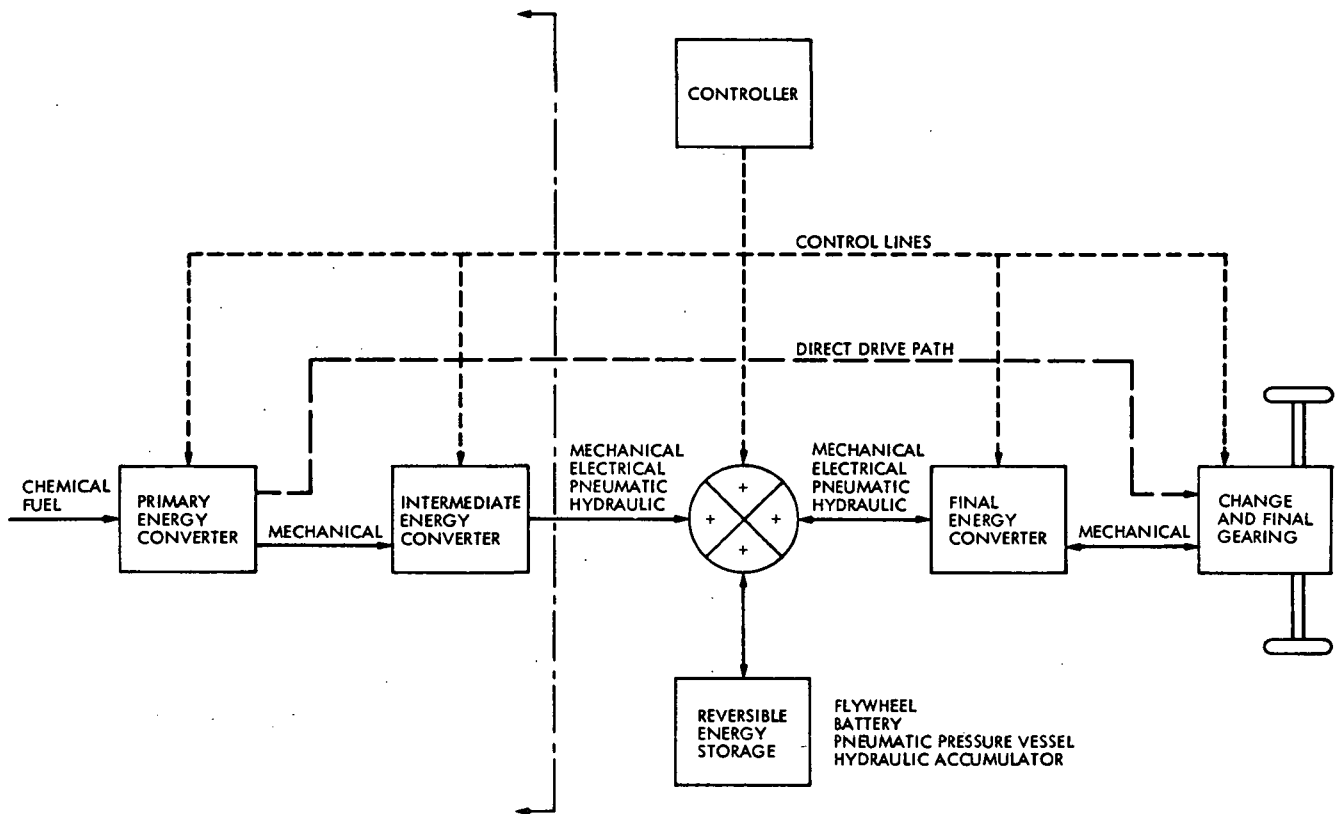

Fig. 9-1. General hybrid vehicle block diagram

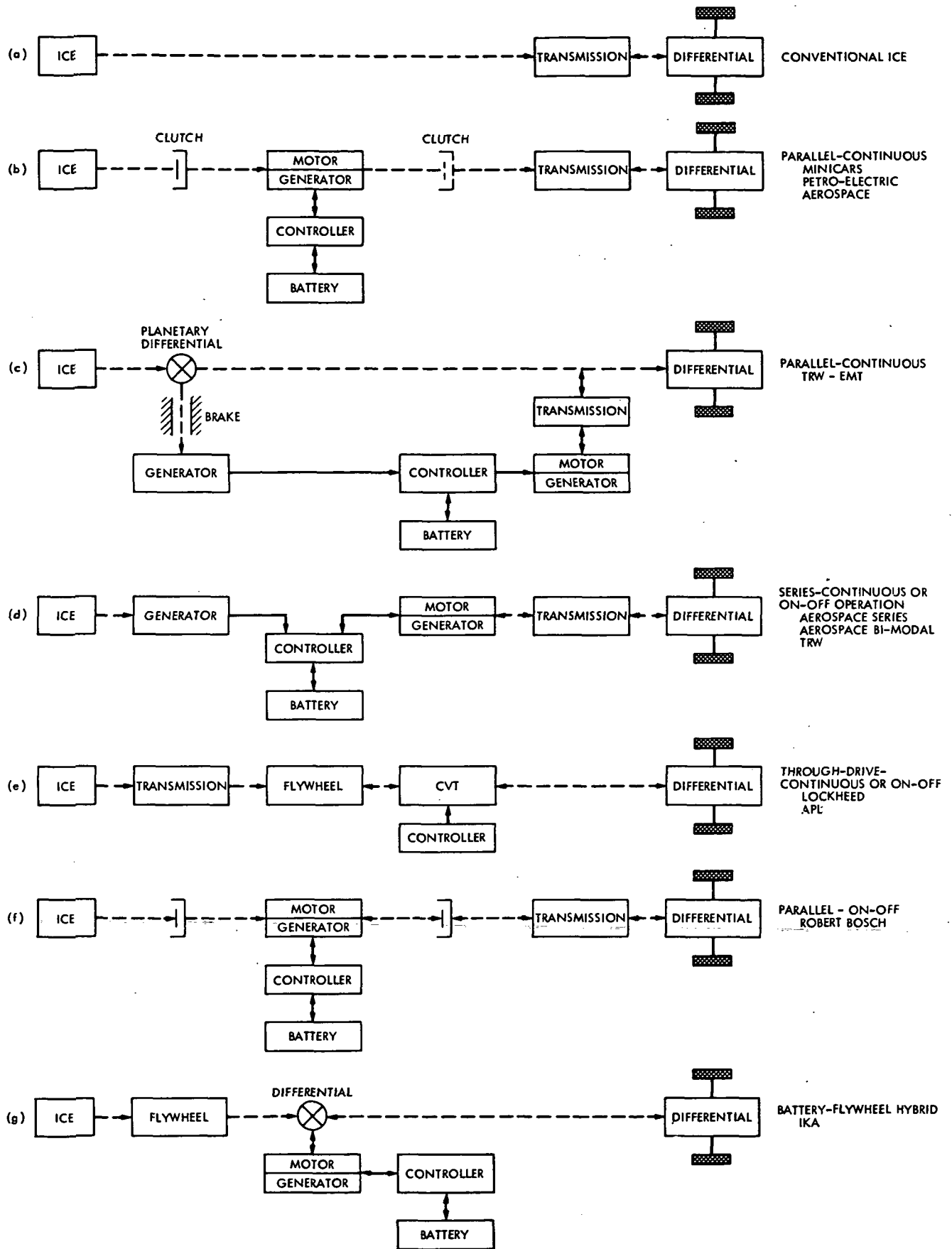

Fig. 9-2. Hybrid configurations

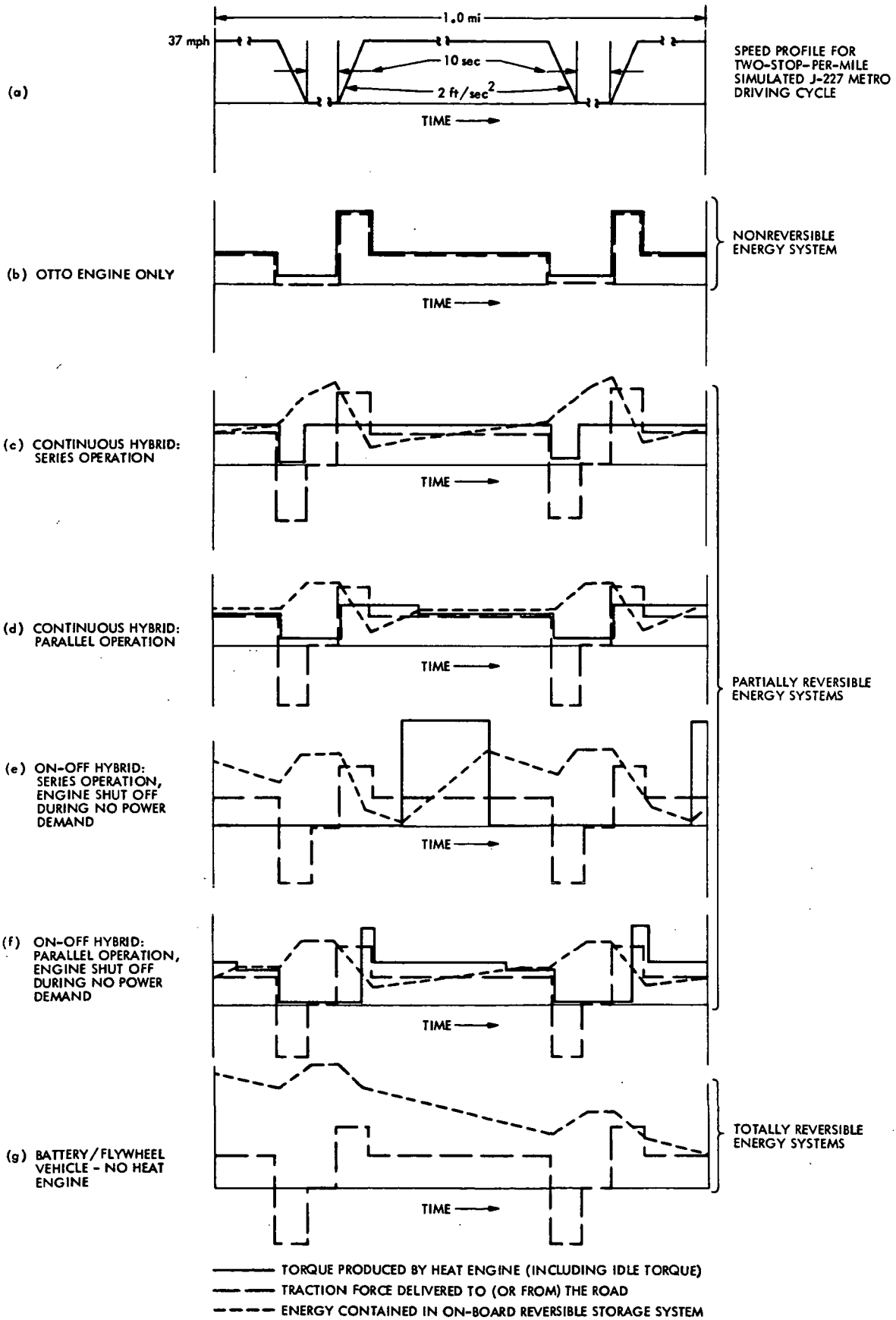

Fig. 9-3. Typical torque-energy profiles for hybrid configuration



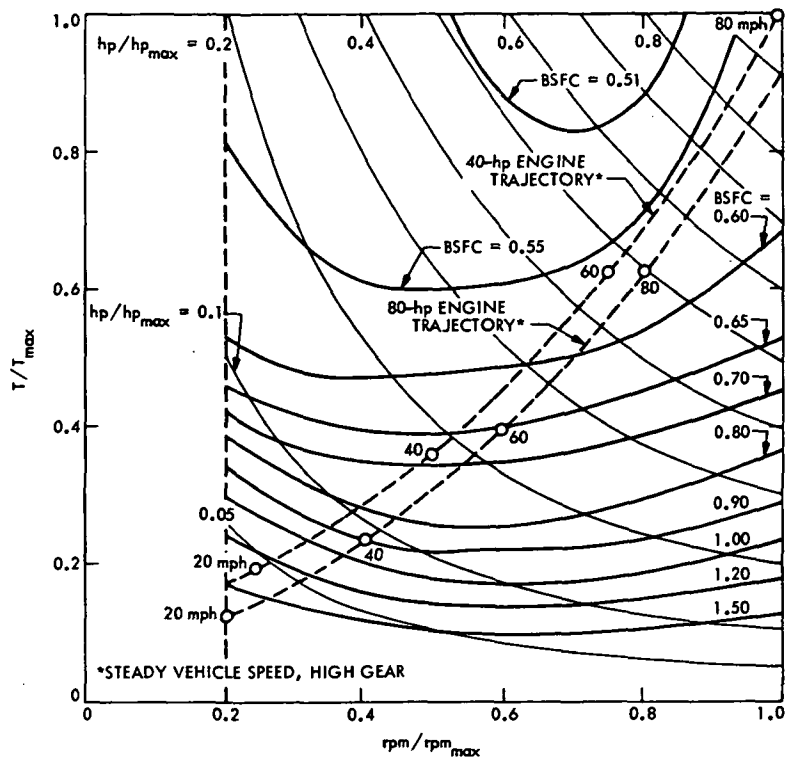

Fig. 9-4. Otto engine torque speed BSFC map

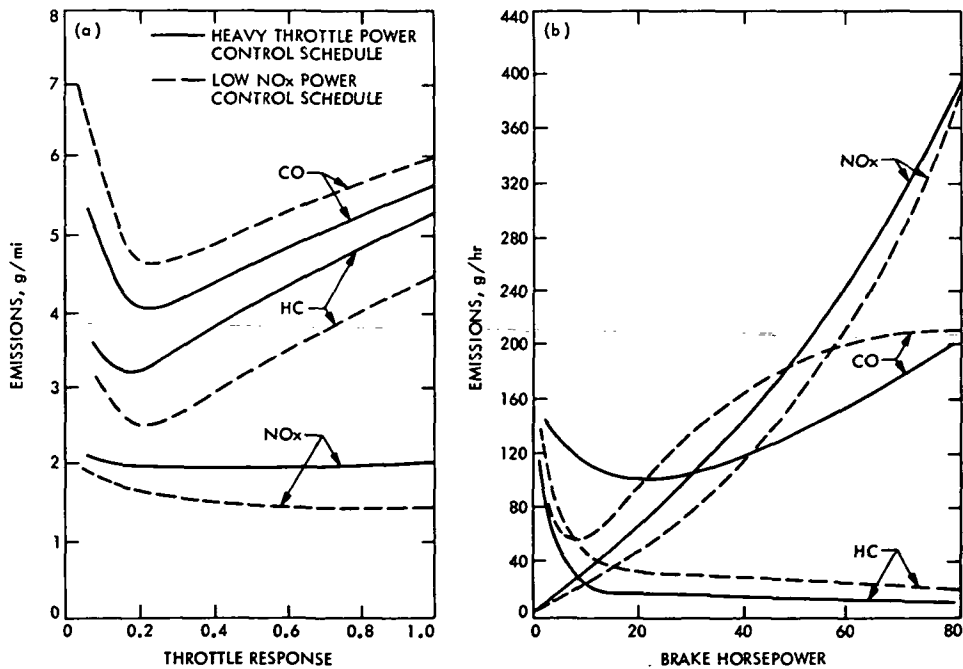
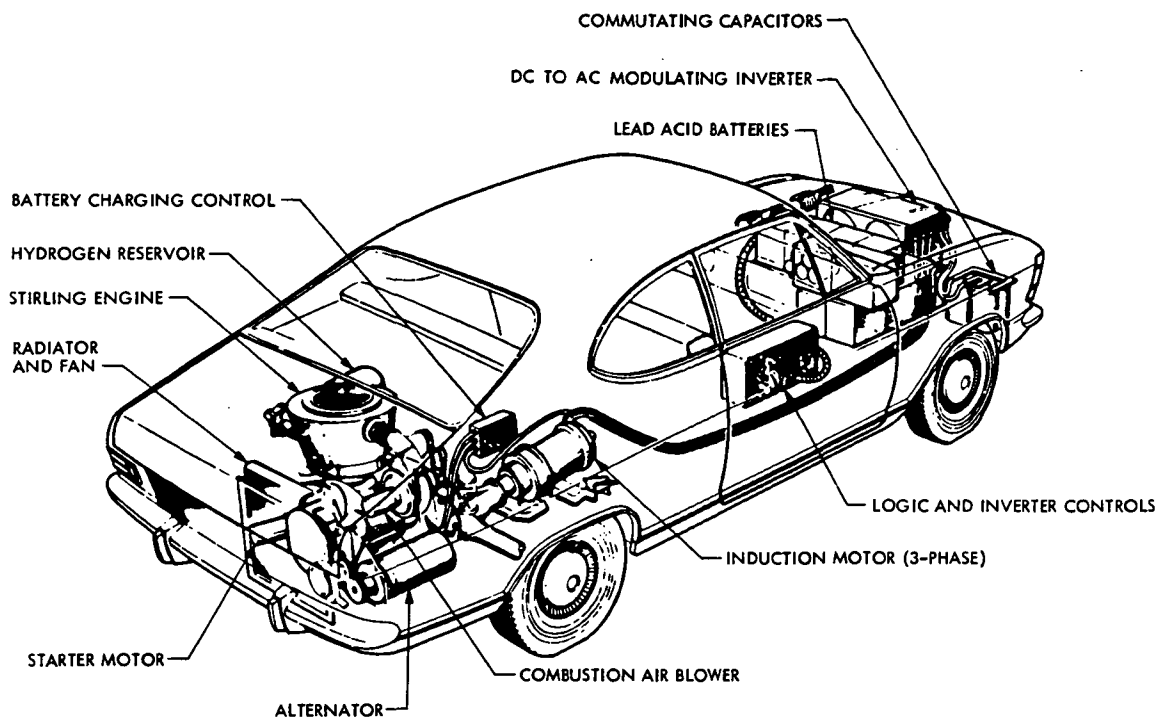
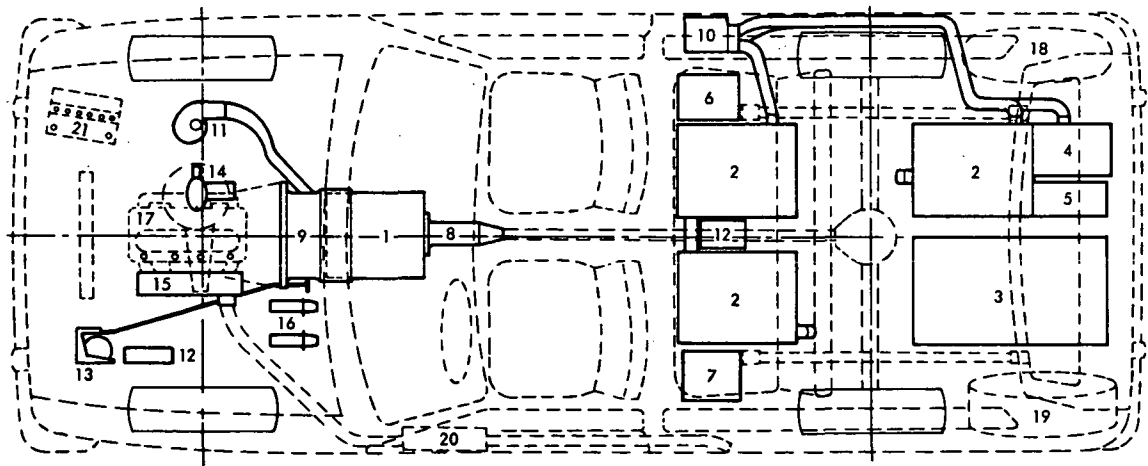

Fig. 9-5. Effect of engine control parameters on emission production (from Ref. 9-18): (a) effect of the throttle response (parallel hybrid); (b) effect of engine horsepower



(a) GENERAL MOTORS STIR-LEC I CONFIGURATION



- |                            |                                      |                                  |
|----------------------------|--------------------------------------|----------------------------------|
| 1. ELECTRIC MOTOR 16 kW    | 8. JAW CLUTCH COUPLING               | 15. THERMAL REACTOR              |
| 2. BATTERIES 144 V 40 A-hr | 9. CLUTCH HOUSING                    | 16. ACCELERATOR AND BRAKE PEDALS |
| 3. SCR CONTROL             | 10. COOLING BLOWER FOR BATTERY CASES | 17. COMBUSTION ENGINE            |
| 4. 144 V - 12 V CONVERTER  | 11. COOLING BLOWER FOR E-MOTOR       | 18. FUEL TANK                    |
| 5. CHOKE COIL              | 12. AUXILIARY RELEASE                | 19. SPARE WHEEL                  |
| 6. BATTERY FUSES           | 13. CLUTCH RELEASE MECHANISM         | 20. EXHAUST SYSTEM               |
| 7. MAIN CONTACTOR          | 14. ALTERATION ON CARBURETOR         | 21. 12 V BATTERY                 |

(b) ROBERT BOSCH BATTERY HYBRID

Fig. 9-6. Battery hybrid packaging configurations

CURB WEIGHT: 1400 lb  
 LOADED WEIGHT: 1700 lb  
 HEAT ENGINE: 32 bhp  
 FLYWHEEL SYSTEM: 70-lb ROTOR  
 2 kW-hr

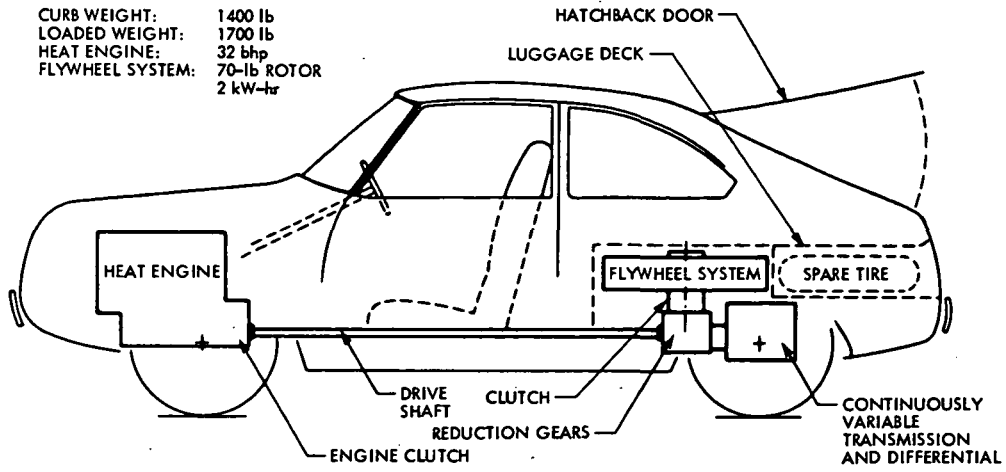

(c) APPLIED PHYSICS LABORATORY FLYWHEEL HYBRID

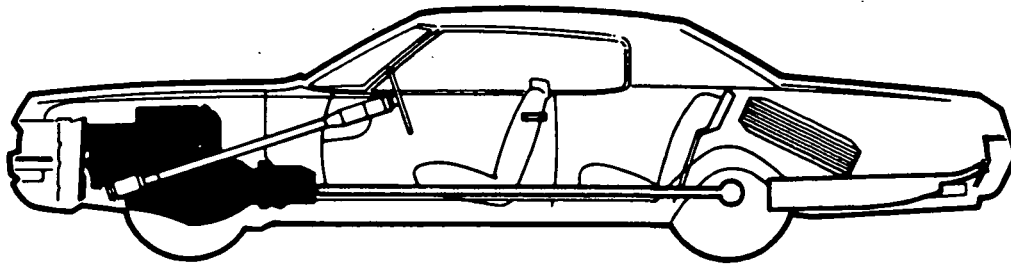

(d) LOCKHEED ENGINE MOUNTED FLYWHEEL CONFIGURATION

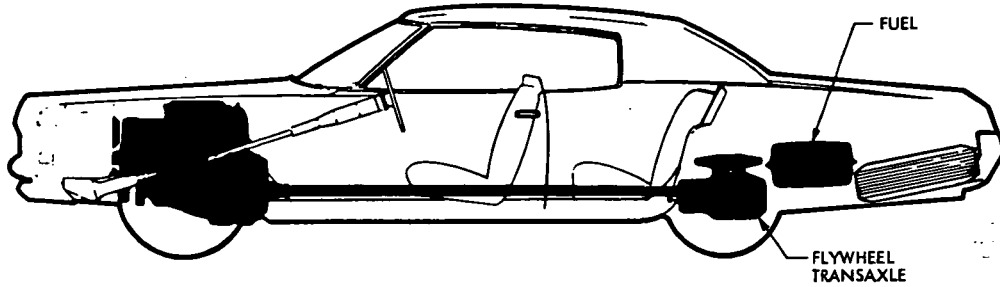

(e) LOCKHEED TRANSAXLE FLYWHEEL CONFIGURATION

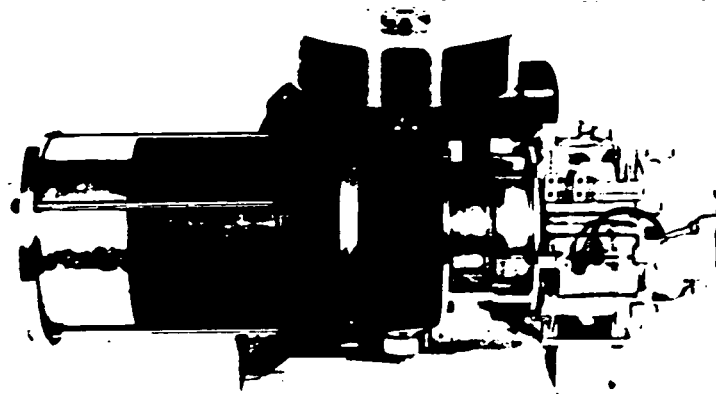

(f) IKA ENGINE-MOTOR-FLYWHEEL ASSEMBLY

Fig. 9-6 (contd)

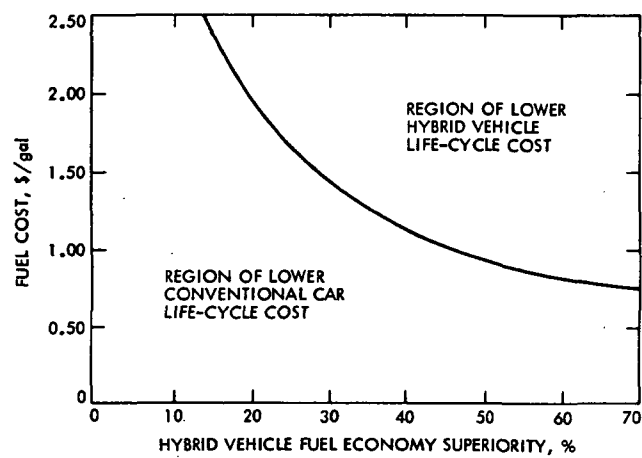

Fig. 9-7. Life-cycle cost as a function of fuel cost and system efficiency

## CHAPTER 10. VEHICLE SYSTEMS

10.1	Overview .....	10-2
10.2	Vehicle Classification .....	10-2
10.3	Engine/Vehicle Interactions – The OEE Vehicle .....	10-3
	10.3.1 Weight Propagation .....	10-3
	10.3.2 Equivalent Performance .....	10-4
	10.3.3 Synthesizing the OEE Vehicle .....	10-5
10.4	Driving Cycle Simulation Program (VEEP) ....	10-6
	10.4.1 Program Description .....	10-6
	10.4.2 Program Logic .....	10-6
	10.4.3 Program Inputs .....	10-7
	10.4.4 Program Outputs .....	10-8
10.5	Vehicle Size, Weight, and Passenger Space ....	10-8
	10.5.1 Car Size and Seating Comfort .....	10-8
	10.5.2 Car Size and Weight .....	10-9
	10.5.3 The Potential for Weight Reduction ...	10-12
	10.5.4 Reduction of Exterior Vehicle Size ....	10-13
	10.5.5 Total Vehicle Weight Reduction .....	10-14
	10.5.6 Fleet Weight Reduction .....	10-15
10.6	Vehicle Modifications and Fuel Economy .....	10-15
	10.6.1 Vehicle Weight .....	10-15
	10.6.2 Transmissions .....	10-16
	10.6.3 Effect of Engine Size – Reduced Performance .....	10-18
	10.6.4 Aerodynamic Drag .....	10-18
	10.6.5 Tires .....	10-19
	10.6.6 Improved Accessories and Accessory Drives .....	10-19
	10.6.7 Fuel Economy Measurement .....	10-21
	References .....	10-23
	Figures .....	10-25

## 10.1 OVERVIEW

One of the major incentives for the development of alternate engines is the promise of decreased fuel consumption compared to cars equipped with current engines. In view of the development effort required for these new engine types, it is appropriate to explore changes in the vehicle which might contribute to the improvement in energy efficiency.

This chapter describes modifications in the vehicle and in component designs, such as transmissions, which can sharply reduce the fuel consumption of equivalent automobiles. The development cost and technical risks of these vehicle changes are small, and most of the improvements can be incorporated in new cars within the next five years. The benefits are largely independent of engine type, so that the fuel consumption savings from the eventual introduction of alternate engines will be additive (although not directly, in the algebraic sense) to those from these vehicle changes. In many cases these improvements entail no new technology, and implementation requires only a go-ahead decision.

To evaluate the effects of alternate engines and changes in vehicle characteristics and components, a computer program has been developed which can simulate operation of an automobile over any specified sequence of driving maneuvers (a "driving cycle"). Six discrete car classes were established to represent the range of cars available in the marketplace, because the effects of changes vary with car size and weight.

Automobile weight, not size, is the single major determinant of fuel economy. With the current concern over energy and fuel resources, reducing the average weight of cars sold is being emphasized. This does not have to imply that everyone will be driving cars with the accommodations of present domestic subcompacts.

Moderate changes to current styling constraints and earnest design effort can bring space utilization up to the level of common European cars. In more efficiently designed cars, weight can be sharply reduced while the passenger space, trunk room and performance of current domestic cars are maintained.

## 10.2 VEHICLE CLASSIFICATION

Six vehicle classes were established to cover the entire spectrum of private automobiles, as shown in Table 10-1. Vehicle size categories are needed to evaluate the effects of alternate engines and vehicle modifications for various car sizes, and for a piecewise characterization of the vehicle fleet which can be used for scenario generation. The particular categories were chosen to provide roughly equal increments over the range of car sizes.

The names given to the several car classes in this study correspond only approximately with current industry usage. This is not very uniform, anyway, because of the differences among similarly classed cars of various manufacturers and the strong tendency towards weight growth with time, which can be seen in Table 10-5. The intent was not to group cars into the current market classes, but to give reasonably descriptive names to the vehicle classes which had been chosen for this study.

Characteristics of typical cars were determined from data for substantially all domestic and foreign sedan-type vehicles sold in the U.S., mostly for 1974 model-year cars. The primary descriptive parameter of each vehicle class is weight. Since actual car weights are distributed over a broad range, representative values for the vehicle parameters associated with each weight class were determined from scatter plots. Thus, for example, the 125-horsepower value for compact cars reflects the fact that domestic compacts

Table 10-1. Baseline vehicle classification

Vehicle class	Curb weight, lb	Maximum engine horsepower, SAE net	Wheel base, in.	Length, in.	Width, in.	Aero-dynamic area product, $C_d A_f$ , ft <sup>2</sup>	Test weight <sup>a</sup> per hp, lb/hp	Passengers	1975 fuel economy <sup>b</sup> composite cycle, mpg
Mini	1600	50	90	152	57	8.5	38.0	2+2	29.9
Small	2100	70	97	169	63	9.4	38.3	4	25.9
Subcompact	2600	95	105	183	70	10.2	30.5	4	22.4
Compact	3100	125	112	197	75	10.9	27.2	4-5	19.3
Full-size	4000	175	123	217	80	12.0	24.6	5-6	15.2
Large	5000	230	130	230	80	12.8	23.0	5-6	12.1

<sup>a</sup>Test weight = curb weight + 300 lb.

<sup>b</sup>Composite driving cycle = 55% EPA Urban, 45% EPA Highway.

are typically equipped with either 6-cylinder (100-105 hp) or small V-8 (145-155 hp) engines.

Table 10-1 shows the engine horsepower and major dimensions for the six vehicle classes. Interior and trunk space are implicitly assumed to correlate with weight. While such a correlation is roughly true for the average car in each category, there are large individual differences among cars within any one class. These will be further explored in Section 10.5.

### 10.3 ENGINE/VEHICLE INTERACTIONS - THE OEE VEHICLE

For purposes of evaluating alternate-engine vehicles, we have established the concept of an Otto-Engine Equivalent (OEE) car. For a given vehicle name class, e.g., Compact, the OEE car with alternate power plant has:

- (1) Identical passenger and luggage accommodations.
- (2) Identical accessories (air conditioning, power steering, power brakes).
- (3) Identical drag coefficient and frontal area, except for engine-caused changes.
- (4) Identical range.
- (5) Equivalent performance based on 10-sec acceleration distance and 0-60 mph time.
- (6) Equally acceptable drivability and safety.

An OEE vehicle is synthesized by figuratively removing the original power train and installing the alternate engine system. The passenger compartment and trunk capacity remain unchanged, but the size and weight of the engine and its auxiliaries, the transmission and the fuel tank may cause configurational and weight changes in the vehicle. The fuel tank size will reflect the predicted fuel economy for the same range, and the aerodynamic drag may be incremented, for instance, by larger radiators. But the primary effect of the engine replacement will be on the vehicle weight.

#### 10.3.1 Weight Propagation

In addition to the weight change due to the engine weight difference, further weight increases in the vehicle result from changes necessary to accommodate the new engine. For instance, a larger or smaller engine may cause increases or decreases in the weight of frame and suspension, wheels and tires, driveline, cooling system, exhaust, fuel tank, etc. Nearly every major vehicle system is affected by such a change. In general, the additional vehicle weight caused by a unit weight change in any one component is described by the weight propagation factor (WPF). A value of WPF = 0.7 means that increasing the engine weight (e.g., by 100 lb) causes a further weight increase in the rest of the vehicle of 70% of the engine weight change (i.e., 70 lb).

The concept of weight propagation requires some elaboration. It implicitly assumes that the vehicle is designed to the same degree of optimality in all cases, so that even small changes in,

say, engine size will be reflected in equivalent changes in all the affected vehicle systems.

This is, of course, not the way cars are built in the real world. Starting out with a given production automobile, there is a strong cost incentive to change the fewest possible parts extraneous to the initial change. Many vehicle components, such as transmissions or brakes, are made in perhaps three to five sizes and used as appropriate throughout a manufacturer's entire product line. Even when some part is designed specifically for a certain new car, it will generally not be optimally designed for that application, but incorporate some allowance for weight growth based on past experience and future expectations.

As a result, data made available by U.S. manufacturers show WPF to vary from 0.1 to 1.2 in actual case histories. The higher values have occurred with the smaller cars when engines larger than envisaged during the original design had to be accommodated (e.g., V-8's in subcompacts). These cases should give a fairly true picture of realistic weight propagation effects. In large cars, WPF values have been smaller. These cars are designed initially for a wide range of engine sizes; many components are sized for the largest-engined version and then used with all engines because production considerations militate against taking full advantage of the weight reduction possibilities with the smaller engines.

With alternate powerplants, weight propagation requires further analysis. In the case of current production Otto engines, the weight and power change approximately together, and historical WPF data reflect this. But some of the propagated weight is due to engine power and the rest due to engine weight, and since power and weight are related differently for the alternate engines than for an Otto engine, these effects had to be separated and quantified.

Working with a detailed component breakdown of a typical Otto-engined vehicle, the effects of both engine weight and power increments on each vehicle subsystem were estimated. The conclusion was that a total WPF of between 0.7 and 1.0 (based on Otto engine weight) is reasonable, with the power effect somewhat larger than the weight effect. With a view to previous studies (see e.g., Ref. 10-1), a value of 0.7, which is at the conservative end of this range, is adopted in the present work. Of this total, the weight effect is taken as 0.3 and the power effect as 0.4, based, of course, on Otto engine weight/hp characteristics.

The power-related WPF can be also stated based on vehicle weight rather than engine weight. This facilitates the calculations when working with the various alternate engines of differing power-to-weight ratio.

In comparing alternate-engined vehicles, we concluded that the most rational basis for comparison is to look at the total power system, defined as the engine with all auxiliaries (pumps, fans, alternator, etc.) plus cooling system, battery and transmission. This removes the latter three items from the vehicle components list and increases the engine system weight

correspondingly, lowering the numerical value of this redefined WPF.

The weight propagation formulas resulting from these considerations and used in this study are:

$$\Delta W \text{ due to engine weight} = 0.22 \times \text{total power system weight increment}$$

$$\Delta W \text{ due to engine power} = 0.045 \times \text{vehicle weight} \times \text{power increment fraction}$$

For illustration, a 100-lb change in power system weight, but with unchanged horsepower, will cause an additional 22-lb vehicle weight; a 50% power increase, with power system weight unchanged, gives a 2.25% vehicle weight increase, which for a compact car with base weight of 3100 lb is 70 lb. Generally, of course, some combination of these effects will occur. The new total vehicle weight is then given by the formula

$$W_{V_1} = W_{V_0} \left[ 1 + 0.045 \left( \frac{P_{PS_1}}{P_{PS_0}} - 1 \right) \right] + 1.22 \left( W_{PS_1} - W_{PS_0} \right)$$

To return now to the question of weight propagation in real cars: It is acknowledged that, as engine size increases, actual vehicle components increase in weight in a stepwise manner. But considering the numerous subsystems affected and the fact that their weight steps will occur at different points on the vehicle weight scale, the sum of all the step functions approximates fairly well a smooth curve. Thus the most reasonable basis for evaluation of various-engined vehicles is the assumption of true proportional weight propagation. This treats the alternate-engined vehicles as if they, at least on the average, are built to the same degree of optimality as current Otto-engined vehicles.

### 10.3.2 Equivalent Performance

Numerous measures of performance have been used over the years to describe different aspects of vehicle response, such as standing-start acceleration, passing maneuvers (acceleration from an initial speed) including distance covered, hill-climbing ability at steady speeds, and top speed. Except for top speed, these generally correlate well for all but extreme examples. Top speed varies with the other measures if engine horsepower is changed; but top speed can vary inversely with acceleration if the overall gearing or final-drive (rear axle) ratio is altered. The tradeoff in this case is engine operating speed, which affects fuel economy, engine durability and operating noise level. Some test runs with the VEEP computer program (see Section 10.4) showed that little fuel economy benefit is available through changes from the rear axle ratios usually installed in current cars, if engine horsepower is also adjusted to maintain equal performance.

In comparing acceleration of alternate-engined vehicles with the VEEP program, the shape of the engine power/rpm curve was discovered to have a strong effect. Fig. 10-1 shows these curves for all the candidate engines. Given engines with the same peak horsepower, the one with the "fatter" power curve will yield higher acceleration, since even in the maximum acceleration mode (and with an automatic transmission) engine rpm is well below maximum rpm in the lower speed ranges. Thus the OEE vehicle with such an engine can have an engine of lower rated horsepower while achieving the same performance, giving further benefits in engine and propagated vehicle weight.

Zero-to-60 mph acceleration time has been the popular standard for performance comparison by car magazines and the public. The auto industry uses distance covered in the first 10 seconds as a better measure of customer-perceived acceleration. Typical values for both acceleration measures are given in Table 10-2 for current

Table 10-2. Acceleration of baseline vehicles

Vehicle class	Curb weight, lb	Horsepower	3-speed auto. trans.		4-speed manual trans.	
			0-60 mph, sec	10-sec distance, ft	0-60 mph, sec	10 sec distance, ft
Mini	1600	50	—	—	16.5	410
Small	2100	70	17.0	390	15.0	440
Subcompact	2600	95	15.0	420	13.5	460
Compact	3100	125	13.5	440	12.5	470
Full-Size	4000	175	11.5	470	—	—
Large	5000	230	10.5	500	—	—



cars in the six vehicle classes. These form the baseline performance requirements for OEE vehicles.

Acceleration is seen to be faster with the 4-speed manual transmission than the 3-speed automatic, with small cars showing the largest difference. Manual-transmission cars also cover a slightly greater distance for the same 0-60 mph time due to their quicker initial acceleration. In the U.S. market, the majority of cars are equipped with automatics; only in the small-car class does the manual transmission predominate. For consistency in the comparisons, all cars in this study are assumed to have 3-speed automatic transmissions.

With different combinations of weight and horsepower, and for alternate-engined cars with different power/rpm curves, the two performance parameters do not always maintain the same relationship. In such cases the OEE horsepower was chosen by balancing the excess in the (relatively) higher index with the shortfall in the lower; 10-second distance was given somewhat more weight than 0-60 mph time in this tradeoff.

### 10.3.3 Synthesizing the OEE Vehicle

In this section, the steps involved in establishing the characteristics of the alternate-engined OEE vehicle are described. This procedure was carried out for three vehicle sizes - Small, Compact and Large - from which the results for other car sizes can be interpolated by scaling the differences from the original cars.

First, the Otto engine is figuratively removed and the alternate power system of equal horsepower installed. From the engine weight difference, weight propagation effects are calculated.

At this point, the potential configuration impacts on the vehicle due to the size or shape of the alternate power system should be evaluated.

These are discussed in detail in Section 4 of each of the engine chapters (Chapters 3-7). Briefly, nearly satisfactory accommodation of SC Otto, Diesel, Stirling and Rankine engines in current UC Otto engine compartments has already been demonstrated, and packaging will improve as feasibility prototypes evolve toward production engines. The Brayton (gas turbine) is generally considered more compact, but complete engines with regenerator(s) and all auxiliaries have so far proven to have at least equal bulk to the equivalent UC Otto engine. Thus it was conservatively assumed that none of the alternate engines causes a quantifiable effect on the vehicle due to configuration effects.

The next step is to take a look at the shape of the power/rpm curve, assess its differences from the Otto engine and, based on previous findings, estimate the expected effect on acceleration performance. This gives a first guess at an equal-acceleration horsepower rating; typically two values are chosen to bracket the expected range. The weight propagation is calculated for these new engine sizes and the acceleration capabilities determined using the VEEP computer program. From these results, the equal-performance horsepower and the corresponding vehicle weight are determined. A confirming acceleration "run" is made, and these vehicle characteristics are then used in the Driving Cycle calculations (see description in Section 10.4) to predict the fuel consumption.

Finally, if the fuel economy of the OEE vehicle turns out to be different from that of the original car, the fuel tank is resized for equal range (which falls between 300 and 330 miles for all baseline vehicle classes). With this new fuel weight, the weight propagation and new engine horsepower are found, and the runs are repeated. The final results are shown for the alternate-engined OEE vehicles in Table 10-3.

Table 10-3. Weight and horsepower of OEE vehicles

Engine type	Vehicle class					
	Small		Compact		Full-size	
	Curb weight, lb	Design max. power, hp	Curb weight, lb	Design max. power, hp	Curb weight, lb	Design max. power, hp
UC Otto (baseline)	2100	70	3100	125	4000	175
SC Otto	2110	70	3150	127	4090	179
Diesel	2310	74	3340	131	4220	182
Brayton (single shaft)	1880	49	2660	86	3400	118
Brayton (free turbine)	1920	51	2710	89	3470	123
Stirling	2140	57	3050	99	3890	137
Rankine	2220	66	3200	119	4130	166

#### 10.4 DRIVING CYCLE SIMULATION PROGRAM (VEEP)

A meaningful comparison of the various alternate engines must go beyond looking merely at engine characteristics and consider the performance of the engine in a vehicle over various driving cycles. To facilitate this, a computer program for Vehicle Economy and Emissions Prediction (VEEP) was developed. Serious consideration was given to using one of the several programs developed elsewhere, but none seemed to offer the desired combination of accuracy of simulation and versatility without excessive complication and computing cost.

As implied in the name, VEEP was originally intended to calculate emissions as well as fuel economy. Engine transients are a major contributor to emissions, and our calculations confirmed that, especially for intermittent-combustion engines, emission indices based on steady-state measurements are not adequate for simulating total emissions over a driving cycle. For continuous-combustion engines, an indication of the trend of emissions with vehicle weight can be obtained.

##### 10.4.1 Program Description

Briefly, VEEP breaks up each driving cycle into 1-second increments, calculates the power required and numerous other quantities for each second, and then sums these over the cycle or any designated segments thereof. The EPA Urban and Highway cycles are stored as part of the program, but any desired driving cycle may be input as a velocity-time profile. When the velocity is not given every second, the program interpolates linearly between the given points. Constant-speed and 0-60 mph acceleration capability is also incorporated.

For clarity of organization and ease of "debugging" and modification, VEEP consists of 14 subroutines. The primary one (DRIVE) calls the others, such as TRANS, which determines the appropriate gear ratio, transmission efficiency, and engine speed; VEEMAX, which calculates the vehicle maximum speed as well as a reference velocity for gear-shifting in TRANS; POWACC, for accessory power consumption; and FDCDATA, which contains the federal driving cycle information. The program is written in FORTRAN V.

In its final form, VEEP takes up about 1700 cards; input data for the first case of a group requires about 50 cards, with as few as 3 cards needed to define additional related cases. The program occupies about 19,000 words of core and gives an execution time and total cost of roughly 45 seconds (\$6.00) for the EPA Urban (CVS-CH) cycle, 20 seconds (\$3.00) for the Highway cycle, and 2.5 seconds (\$1.00) for a 0-60 mph acceleration run on JPL's UNIVAC 1108 system.

##### 10.4.2 Program Logic

For an illustration of the computation process, let us follow through the major steps for a typical second in a driving cycle. Engine and vehicle characteristics are evaluated at conditions corresponding to the midpoint of each second; since the maximum acceleration during the EPA

driving cycles is only 3.3 mph/sec, this is a negligible cause of error.

The acceleration is the difference of the next and previous car velocity; let us assume now that it is positive. The power required for rolling friction, aerodynamic drag and vehicle acceleration are added and, allowing for rear axle efficiency, give the required power out of the transmission. From this and vehicle speed, the proper gear ratio, engine speed and transmission efficiency are computed. From the latter, the required transmission input power is found and added to the engine acceleration (inertial) power and accessory power to give the total power the engine must produce.

This total is compared to the maximum power the engine can produce at that engine speed by interpolating on the engine boundary map. If the total is less than this maximum, this second of the driving cycle is satisfied and, after calculating all the quantities of interest such as BSFC, emissions, energies, etc., the program can go on to the next second.

If the total power exceeds the available maximum, the acceleration is adjusted until the powers match and the insufficient acceleration is noted. The number of times this happens during the driving cycle is divided by the total driving cycle duration and printed on the output page as Percent Slow. The next second then uses the actual velocity reached at the end of the previous second as its initial point and proceeds as before.

This latter feature underlies the 0-60 mph acceleration mode: The vehicle is commanded to reach 75 mph in 1 second. Each second it accelerates at its maximum rate from the previous second's terminal velocity. After the vehicle surpasses 60 mph, the acceleration is terminated and the last second's results ratioed to the 60 mph point. The distance reached at the 10-sec point is also retained and printed out.

The program can simulate either normal road operation (road load) or operation on the EPA-prescribed dynamometer (dyno load). On the road, rolling friction and aerodynamic drag determine the total steady-speed propulsion power, which is given (in hp) by

$$P_T = 2.667 \times 10^{-3} C_R (W_C + 300) V + 6.676 \times 10^{-6} C_D A_F V^3$$

where

$C_R$  = rolling resistance coefficient

$W_C$  = curb weight, lb

$V$  = velocity, mph

$C_D$  = aerodynamic drag coefficient

$A_F$  = frontal area, ft<sup>2</sup>

On dyno load, the prescribed power dissipation settings (Ref. 10-2), with tare losses added, represent the wind resistance and part of the tire losses, since the front tires are stationary. However, the losses of the rear tires are difficult to assess. Since they ride on two very small diameter (8.65-in.) rollers, the tire deformation at the contact patches is much greater than on a flat surface (i. e., road), and the associated rolling friction losses are thus higher even though the EPA recommends increasing the inflation pressure to 45 psi to avoid tire damage due to overheating. Concerted inquiries failed to turn up any measurements of rolling resistance on small-diameter rollers. A correction factor of 1.4 to the level-surface rolling coefficients was found to result in equal total power dissipation at the 50 mph calibration speed for dyno load and road load; this factor has been incorporated in the VEEP program.

Specifying dyno load also adjusts the vehicle weight to the proper EPA inertia weight class. This procedure will either mask or exaggerate the effects of vehicle weight changes. In addition, the dynamometer power dissipation is an imperfect simulation of actual road losses since it assumes some average (and unstated) aerodynamic characteristics. To be certain of accurate simulation for all vehicle weights, conditions and speeds, all the comparative and alternate-engine runs were done with the road load simulation.

The second-by-second simulation employed in the VEEP program is inherently more accurate than the practice of approximating a driving cycle by groups of steady-velocity and constant-acceleration segments, as sometimes done in an attempt to keep computer programs simple. The EPA driving cycles have many small, sharp speed variations which require deliberate driver action to follow on a dynamometer test and must not be averaged away. In fact, it may be argued that a second-by-second simulation is almost too severe in that it requires complete and exact velocity matching at each second, whereas the actual driver of the dynamometer car typically varies fractions of both miles-per-hour and seconds from the prescribed trace, which may result in a slight smoothing effect. Experience with VEEP indicates the present second-by-second simulation yields consistent and numerically reliable results.

#### 10.4.3 Program Inputs

Perhaps the most critical area of a simulation program is the quality of the input data. The results can at best be only as good as the accuracy of the underlying parameters, and a considerable effort was made in gathering the information required for the vehicle characterization. Multiple sources were sought in all cases to minimize aberrations in the data. While not intended to be comprehensive, a description of the important input quantities is given in this section.

The major sources of power dissipation are rolling friction, aerodynamic drag, transmission losses and engine-powered accessories. Tire rolling resistance is described by a fourth-order polynomial plus exponential term best-fit to the average of three tire manufacturer's rolling

resistance coefficient curves as a function of velocity for bias-ply, belted-bias and radial-ply tires (Refs. 10-3, 10-4, 10-5). The data, plotted in Fig. 10-2, shows rather large differences, which illustrate the importance of multiple data sources. (One is led to wonder whether such differences can represent equivalent measurements for tires of substantially identical construction.)

Tire sizes suitable to each vehicle size were established; they provide the values for wheel-tire moment of inertia, which affects the acceleration power of the vehicle, and rolling diameter, which enters into the rpm vs mph relationship, or overall "gearing." Radial construction tires were presumed in all cases except when specific tire effects were modelled.

Aerodynamic drag coefficients for current cars range roughly from 0.45 to 0.55, and we have assumed a representative value of 0.50 in combination with frontal areas derived from averages over several cars in each vehicle size class.

The 3-speed automatic transmission with torque converter is used in most of our simulations. The torque ratio, speed ratio, and efficiency of the torque converter as a function of output rpm and power, and gearbox efficiencies in each gear are incorporated in the VEEP program. Data was similarly developed for the 4-speed manual transmission with clutch. Gear ratios are typical values derived from the nearly identical ratios employed by the three major U. S. manufacturers in the first case and from averaging eight Small and Subcompact car sets of ratios for the manual gearbox.

Operational and efficiency parameters for a continuously variable transmission (CVT) are based on a hydromechanical implementation (data from Ref. 10-6) which was chosen for its good efficiency over a broad operating range.

Very high-rpm engines (i. e., gas turbines) require a reduction gearbox to reduce transmission input speeds to the normal range. The ratio is chosen as the quotient of peak rpm and equivalent Otto engine peak rpm.

Rear axle ratio is generally changed from the baseline vehicle value only when the engine peak rpm differs from that of the original engine, and then by their ratio. Thus the alternate engines are operating in the same portion of their speed range as the Otto engine. As mentioned earlier, with current Otto-engined cars, changing the rear axle ratio (within 10-20% of the usual value) and adjusting the engine horsepower for equal performance gives little fuel economy change. Some spot checks indicated that this is also true for the alternate-engined cars; so the exact choice of final-drive ratio is not critical to the results of the simulation. Rear axle efficiency was taken as a constant 96%.

Auxiliaries and accessories represent a sizable power absorption, which is discussed in greater detail in Section 10.6.6. For use in the VEEP program, representative data were used to establish horsepower variation with engine rpm for current cars with V-8 engines (Ref. 10-7)

and are shown in Fig. 10-3. Auxiliaries, defined as components essential to engine functioning, are usually included in the basic engine operating map except for the radiator cooling fan in some cases. The fan is then applied as a separate load with the proper multiplier for that engine (relative to the Otto engine). The power steering pump losses assume straight-ahead driving, and alternator power demand is based on a partial charging rate. Some of the continuous-combustion alternate engines require air supply blowers for their burners, which would increase the load on the electrical system. The effect should not be large, and no explicit allowance was made in the alternator power absorption.

The curve for the air conditioning compressor is based on high-load operation. Under EPA dyno load simulation, the air conditioner is turned off and is represented by a rather small (10%) increase in the dynamometer dissipation setting. For road load, the compressor power has been multiplied by a factor of 0.2 to arrive at a roughly average power, considering the unit is not always working at high load and is not turned on at all a good deal of the time. Only the full-size and large cars are assumed to have air conditioners in this simulation.

The fan loss is assumed to vary linearly with engine power for both the baseline and alternate engines. The other auxiliary and accessory loads are taken to vary as the 3/4-power of engine horsepower, since they are correlated more nearly with vehicle size and weight than engine size.

The engine brake specific fuel consumption (BSFC) matrix was generated for each engine type from available engine maps (see, e.g., Fig. 10-9; detailed data are given in the engine chapters, Chapters 3-7). Such maps are typically very poorly defined in the low-power region which, however, is extremely important to the accuracy of the simulation, since much of the engine operation during the Federal Driving Cycle is in this region. Contours in this area were established by fairing the zero-net-power ("idle") fuel flow at all engine speeds smoothly into the given data in the upper portion of the map.

The abscissa and ordinate of the BSFC map were non-dimensionalized so that the resulting % speed vs % power matrix is applicable to all engine sizes. To include the efficiency improvements of the Mature and Advanced engines, the fuel consumption modification factor multiplies all values in the BSFC matrix by that constant. This factor also permits inclusion of the efficiency penalty for small gas turbines without using a different BSFC map.

A typical input printout is shown in Figs. 10-4 and 10-5. Most of the entries are self-explanatory. Engine Thermal Capacity, Idle Equilibrium and Ambient Temperatures, and Thermal Time Constant are used for calculating warm-up fuel. Originally, it was thought that warm-up losses might equal the heat required to bring the working parts of the engine up to temperature. This turned out to be erroneous (see discussion in Section 10.6.7) but, with the correlation between Thermal Capacity and Warm-up

Fuel determined, this procedure is still used to quantify the warm-up penalty.

#### 10.4.4 Program Outputs

A typical output printout is shown in Fig. 10-6, in this case for the EPA Urban driving cycle (1975 FTP). Segment 1, the first 505 seconds, with a cold start, is repeated in Segment 3 with a hot restart, hence the cycle name CVS-CH; the two are then weighted 43% and 57%, as prescribed by the 1975 FTP, and the resulting values added to Segment 2 for the cycle-weighted totals.

#### 10.5 VEHICLE SIZE, WEIGHT, AND PASSENGER SPACE

To assess the potential for future improvements in automobile function and efficiency, we must first understand the present characteristics of cars and the effects of possible changes on those features that are important to the purchaser and operator. To this end we concern ourselves here only with sedan-type automobiles, which would include station wagons, and omit mention of the various types of specialty or "sporty" cars, where mere utilitarian function takes a back seat to other considerations. However, since such cars are generally derivatives of sedans, they also stand to benefit from the vehicle improvements discussed here.

The market class (e.g., subcompact, full-size) assigned to American automobiles has generally been based on wheelbase, and because of the similarities in design tradeoffs and construction features of domestic cars, this has proved adequate at any given point in time. Along with wheelbase, competing cars are quite similar in exterior length and width and interior space and weight. Comparing domestic vehicles of different market classes, we find that all these parameters typically increase or decrease together.

##### 10.5.1 Car Size and Seating Comfort

With the basic layout and construction of domestic cars having remained essentially unchanged in the last 15 years, wheelbase turns out to be a fundamental determinant of available passenger space. The engine establishes the forward limit of the passenger compartment, where considerations of weight distribution and handling preclude moving the engine further forward. At the rear, the wheel housings and the space required for the universally employed solid ("live") rear axle and its suspension movement determine the rear seat location limits.

With a passenger compartment of a given length, the usable space can still be greatly varied by changing the height. If we picture for a moment a person on a driver's seat of fixed dimensions and then lower the roofline by, say, 3 inches, it is clear that this requires the seat to be tilted backwards since the feet on the pedals are at a fixed point. At least within limits, such a reclining seating position can be equally comfortable and has in fact been utilized by car designers for years to allow the fashionably low rooflines. One drawback is that many people find it harder to get out of the seat. But it has another much more important effect: by leaning

the seat backwards, a greater longitudinal space is required, by roughly the same amount as the roofline was lowered (this is a function of the initial seat geometry). Now consider the rear seat, and let us assume that initially the occupant was just comfortably accommodated as measured by leg room. Since the roofline here was also lowered 3 inches, one needs greater length measured forward from the fixed backrest and, with the front seat having moved rearwards, this leaves legroom short by double the dimensional increment.

Faced with this problem, the designer has several ways to create the appearance of more space. To add headroom, the simplest remedy is to lower the seat cushion; and the measured leg room can be increased by pushing back the lower part of the backrest, making it more upright. This solution is incorporated in most small cars to varying degrees and results at its extreme in a seat which forces the occupant into a jack-knifed, knees-to-the-chin seating position with a discomfort unrelieved by the catalogued leg room and head room dimensions.

Studies in the aircraft and automobile industries have established the importance of the angles of the hip and knee joints to long-term seating comfort. A comparison of seats in two typical domestic cars with the ideal angles is shown in Table 10-4 (Ref. 10-8). Comparable data on imported cars was not available, but an indication that the tradeoffs between compartment length, height and seating comfort are evaluated differently overseas can be seen from Fig. 10-7 (Ref. 10-8). The height of imported compacts and subcompacts is 2 to 5 inches greater than for similar domestic cars, with the corresponding benefits in interior accommodations. (There is, of course, no way of assessing the sales that are lost due to such lack of low, sporty styling.)

In view of the preceding discussion, the conventional measures of head, leg, and hip room are seen to be at best imperfect indicators of seating room and comfort, tending to understate the differences between large and small cars. A

Table 10-4. Seating: actual and ideal

	Ideal	Compact		Full-size	
		Front	Rear	Front	Rear
Backrest angle, deg	20 - 25 (from vertical)	26	23	24	25
Hip angle, deg	110 - 115 (105 min)	94	84	94	91
Knee angle, deg	110 - 120	124	92	124	108
Foot angle, deg	110 - 130	86	123	83	117

weighted combination of dimensional and angular measurements would appear to hold promise of providing a meaningful "accommodation index," especially since the dummy presently used for seat measurements already incorporates angular scales at its joints.

### 10.5.2 Car Size and Weight

When we look at the history of domestic automobile size and weight (Table 10-5), we can see some definite trends: While overall length and curb weight have gone up inexorably, wheelbase has increased much more slowly. Thus, usable interior space has not kept pace with the exterior bulk and weight of the cars, since the designers' insistence on low rooflines has continued unabated. The 1975 compact and intermediate cars are heavier than the intermediate and full-size cars, respectively, of 12 years earlier, and the 1975 subcompacts are nearly as heavy as the much larger 1963 compacts. The long-term increases stem not so much from weight growth in existing cars, but mostly from the periodic introduction of new models in the same market class with sometimes over 400 lb greater weight. The sharp changes in the last 3 years reflect the typically 200 lb weight and 6 in. length increases for all car classes which resulted from Federal safety and damageability standards; this topic is discussed further in Section 16.3.

Imported cars show evidence of a different evaluation of design constraints and tradeoffs. For a given exterior size and weight, their space utilization in terms of passenger room and usable trunk capacity is generally superior to that of domestic cars. This is greatly aided by their previously mentioned higher rooflines, but also results from more careful detail design; one looks in vain for such instances as a spare tire located so that it obstructs half the useful trunk volume, as again in one new domestic compact design.

Some extreme contrasts in space utilization are shown in Table 10-6; the data are for 1974 model cars and were collated from Ref. 10-10 and 10-11; they are presented here with full acknowledgment of the limitations of such dimensions as discussed above. The only major difference in interior dimensions is in width and is but a fraction of the exterior width difference. While no claim is made that these pairs of cars are necessarily comparable in all other aspects of passenger accommodation, such as ride comfort and what might be called "customer-perceived luxury" (perhaps primarily a function of interior trim), the startling contrast between the vehicle sizes and weights gives some indication of the possible space utilization improvements. And although the Audi Fox is a front-wheel-drive car, which allows more efficient "packaging" than the usual front-engine/rear-drive layout, the Volvo is a thoroughly conventional solid-rear-axle design.

Data on several compact and subcompact size cars are cited in Tables 10-7 and 10-8; respectively. In addition to providing interesting individual comparisons, the tables show that comparison can be made from two aspects: either the large weight variations with equal passenger

Table 10-5. Trends in U.S. car size and weight (Wheelbase and overall length; Data from Ref. 10-9)

Model year	Full-size cars (V-8)								
	Chevrolet			Ford			Plymouth		
	Curb wt., lb	WB, in.	L, in.	Curb wt., lb	WB, in.	L, in.	Curb wt., lb	WB, in.	L, in.
1963	3590	119	210	3835	119	210	3735	118	210
1966	3775	119	213	3740	119	210	3920	119	210
1969	3915	119	216	3910	121	214	3870	120	215
1972	4340	122	220	4200	121	218	4065	120	217
1975	4450	122	223	4655	121	224	4500	122	222
Intermediates (V-8)									
Model year	Chevelle			Fairlane/Torino			Satellite		
	Curb wt., lb	WB, in.	L, in.	Curb wt., lb	WB, in.	L, in.	Curb wt., lb	WB, in.	L, in.
1963	—	—	—	3135	116	198	3440	116	205
1966	3275	115	197	3154	116	197	3327	116	200
1969	3390	116	201	3295	116	201	3345	116	203
1972	3435	116	202	3840	118	211	3510	117	205
1975	4015	116	210	4265	118	218	3885	118	218
Compacts (6-cyl)									
Model year	Chevy II/Nova			Falcon/Maverick			Valiant		
	Curb wt., lb	WB, in.	L, in.	Curb wt., lb	WB, in.	L, in.	Curb wt., lb	WB, in.	L, in.
1963	2695	110	183	2510	110	181	2720	106	186
1966	2773	110	183	2696	111	184	2811	106	188
1969	3015	111	189	2805	111	185	2860	108	188
1972	3070	111	189	2755	110	186	2890	108	188
1975	3480	111	197	3100	110	194	3170	111	199
	(1975 Granada)			3350	110	198			
Subcompacts (4-cyl)									
Model year	Vega			Pinto					
	Curb wt., lb	WB, in.	L, in.	Curb wt., lb	WB, in.	L, in.	Curb wt., lb	WB, in.	L, in.
1972	2265	97	170	2110	94	163			
1975	2500	97	176	2590	95	169			

Table 10-6. Vehicle comparisons

Make/model	Audi Fox VW Dasher	Chevrolet Chevelle 6-cyl.	Continental Mk. IV	Volvo 144	Ford LTD
Curb weight, lb	2125	3840	5335	2860	4605
Length, in.	172	211	229	188	223
Width, in.	65	77	80	67	80
Interior width, in.	53.5	57.5	60.5	54.5	59.0
Front leg room, in.	42.0	40.5	42.0	42.5	41.5
Rear knee room, in.	28.0	29.0	28.0	30.5	30.0

Table 10-7. Vehicle comparisons: Compacts

Make/model	Dodge Dart	Ford Maverick	Ford Granada	Mercedes 280	Volvo 144
Curb weight, lb	3280	3150	3420	3440	2860
Length, in.	202	197	198	196	188
Width, in.	70	70.5	74	70	67
Interior width, in.	55.5	52.5	53.0	56.5	54.5
Front leg room, in.	41.7	40.2	41.1	41.1	42.5
Rear leg room, in.	36.0	36.2	36.0	35.3	38.0

Table 10-8. Vehicle comparisons: Subcompacts (4-cyl)

Make/model	Chevrolet Vega	Ford Pinto	Audi Fox	Saab 99	Mustang II (V-8)
Curb weight, lb	2500	2590	2125	2500	3265
Length, in.	176	169	172	174	175
Width, in.	66	70	65	67	70
Interior width, in.	51.5	52.5	53.5	53	52.5
Front leg room, in.	41.5	41	42	41.5	41.5
Rear knee room, in.	23.5	26	28	27.5	23

space, or roominess differences for the same vehicle weight.

The better space utilization and weight efficiency of imported cars may be largely a result of the higher fuel prices and lower discretionary incomes in overseas countries. These factors form a more deliberate customer vehicle choice than in the U. S. A., where high incomes, historically cheap fuel and a much lower selling price per pound have allowed the widespread

ownership of the typical Full-Size car — larger, heavier and more fuel-thirsty than any cars built overseas. Under these conditions, there was little pressure from the customer and hence little incentive for the domestic industry to produce more efficiently designed smaller cars. The family automobile was the full-size car. By designing their smaller cars to the same guidelines as the large ones, the industry reduced the possibility of offering equivalent features in their smaller cars and thus of drawing sales away from

the full-sized cars, which were the mainstay of their profitability (Ref. 10-12).

Many customers, for reasons of fuel economy, simple personal preference, or compatibility with their driveway or garage, did not wish the increasingly large and heavy full-size car. They had a choice of buying a smaller, less roomy domestic car or an import with better space utilization but not infrequently the problems of uncertain reliability and potential servicing or parts difficulties. The market share of full-sized cars decreased from 55% in 1963 to 25% in 1974, while smaller cars gained and imports grew from 5 to 15% of the market. (Note that this is for market classes according to industry usage; our terminology differs somewhat, as discussed in Section 10.2). In spite of this shift to cars with "smaller" names, the weight growth in all the market classes has caused the sales-weighted average weight to increase from 3450 to 3650 lb over this time span (Ref. 10-13).

In recent years overseas manufacturers, especially in Japan, have evidenced a tendency toward adding stronger styling features in the hope of improving the cars' appeal to U.S. customers. This trend is regrettable since many of these changes have resulted in decreased space efficiency in the newer models.

### 10.5.3 The Potential for Weight Reduction

In the discussion of vehicle weight reductions, it is most important to define at the outset the assumptions and constraints implicit in the evaluations. Obviously the weight savings possible with no changes in any car dimension are far less than if a decrease in some or all measurements is allowed, and the degree to which the owner is expected to compromise his original expectations should be a primary factor in the assessment of the proposed changes.

In the present discourse, we will generally consider design refinements or changes in a car's outward characteristics which do not affect performance, passenger accommodation and trunk space. When such an impact is possible or even intended, it will be stated explicitly. The emphasis will be on improvements to the space utilization which are acceptable and desirable to an owner/operator concerned with efficient transportation.

Not all the weight in a vehicle can necessarily be associated with some quantifiable parameter. Fancier trim, better seat cushioning and soundproofing are examples of items which are not reflected on a specifications sheet but add value to a car along with their weight. And even though each pound of material used must be paid for, the cost savings from weight reduction may also be offset by the extra fabrication complexity required to obtain them.

Attainable weight savings are fairly limited if all vehicle dimensions are to remain the same and no changes in technology, such as materials substitutions, are assumed. They depend on how optimally the vehicle is designed in the first place, which can be a problematical judgment to make, but comparison with other cars of similar size can give a guide. Table 10-7 shows, for

example, that the Ford Maverick and Granada are very similar in exterior size but have an 8% weight difference; these cars use the same wheel-base and engine. So perhaps some of this weight could be saved, given appropriate incentives. Altogether, it may be realistic to postulate a 3% maximum weight saving for large luxury cars from more weight-conscious detail design, decreasing with car size to no saving at all for small cars.

Materials substitutions can result in significant weight savings, and here great potential is offered by aluminum alloys. Although they are only one-third the density of steel, not all the apparent difference can be realized. In fabricated parts, rigidity and strength considerations can lead to somewhat greater bulk, and for sheet metal applications, requirements for dent resistance necessitate use of a heavier gage than the steel being replaced; typically, a weight saving of 40-50% relative to steel is considered practical (Ref. 10-7). This is very attractive when the large number of potential applications are considered, and the domestic auto industry is moving toward greater use of aluminum.

In the early 1960's, Chrysler and AMC cast some of their 6-cylinder engine blocks out of aluminum but soon terminated the experiment, perhaps because of corrosion and service problems or lack of marketplace appreciation for the weight savings. These engines were installed interchangeably with ordinary cast-iron ones and the aluminum engine cost was undoubtedly higher. GM also built a small V-8 engine with aluminum block for several years. Most recently, Chevrolet and Reynolds Aluminum developed a new die casting alloy that gives good durability without the previously mandatory iron cylinder liners. This alloy is used in the Vega cylinder block, but the weight advantage is offset to some extent by the heavier-than-usual cast-iron cylinder head which is necessary to impart adequate rigidity to the engine assembly.

An initial automotive use of aluminum sheet is in the Oldsmobile Toronado hood, where the inner panel has been replaced by aluminum at a weight saving of 30 lb. This is evidently a pilot project to gain experience with this material on a regular production basis. Construction of an entire aluminum body duplicating an existing steel body (Ref. 10-14) resulted in a weight savings of 39%. This included many parts where the use of aluminum was not advantageous, at least without an overall redesign which was outside the constraints of the project; some of the parts showed 60% weight reduction relative to the steel originals.

The widespread use of aluminum is awaiting resolution of several problems associated with this material. Presently developed alloys do not draw as well as steel and require either multi-step forming, which increases cost, or greater styling restrictions to avoid deeply drawn surfaces and sharp radii. Joining of panels by either welding or adhesive bonding is still being developed by the auto industry (Ref. 10-7), and galvanic corrosion between the steel and aluminum parts of a composite structure can be a problem, especially in areas inaccessible for cleaning.



Current aluminum use averages about 85 lb per car and accounts for 9% of the national production. Doubling this amount is feasible, with a concurrent expansion of refining capacity. Proposals for replacing the majority of the automotive steel by aluminum, however technically sound, are impractical for the near-term because of metal supply limitations.

High-strength low-alloy (HSLA) steels with good formability are a fairly recent development. They can typically provide over twice the yield strength of conventional hot-rolled mild steel at roughly a 40% cost premium per pound (Ref. 10-15), resulting with careful design in both weight and cost savings. They are suitable for use in frame and suspension components, structural reinforcements and mounting brackets. HSLA steels appear to have no serious disadvantages and will certainly see increasing use in the future.

Nonmetallic materials of diverse types generally referred to as "plastics" have seen their use rise in the last 15 years from 22 lb, mostly trim items, to over 150 lb per typical vehicle. In spite of their generally rising prices, they will probably be used increasingly in the future because their lighter weight will help offset the tendency toward weight increases due to safety and damageability standards. In bumpers and "soft" front ends, for example, the use of cellular elastomers results in weight savings of 24 lb per car and lower cost compared to metallic components (Ref. 10-16).

A major new application is in external body parts. Several cars already use one-piece moldings for the front panel that surrounds the grille and includes the headlamp housings, for a weight reduction of 10-15 lb and reduced assembly cost compared to the numerous separate steel stampings previously employed (Ref. 10-17). Plastics applications are projected to at least double the present use per car in the next 10 years in spite of possible price and availability problems (petroleum feedstocks), with each pound of plastic replacing two to four pounds of steel.

The potential for overall weight reduction of present cars through material substitution has been conservatively estimated at 10-12% (Ref. 10-7) with a cost estimate of about 4% traceable largely to the aluminum used. The weight savings associated with only HSLA and plastic components, estimated at 3-5%, should involve little cost impact and may thus be expected to occur both sooner and with greater likelihood than large-scale utilization of aluminum.

#### 10.5.4 Reduction of Exterior Vehicle Size

The passenger accommodations and trunk space characteristic of current American cars can be incorporated in properly designed cars of substantially smaller exterior size. More efficient space utilization through careful engineering is the primary requirement. The attainable improvements are evident in comparing European sedans with American cars, of which the compact class can be considered closer to optimum than either the larger cars or the current sub-compacts. The emphasis in the size/space trade-off should probably shift from reduced size with

equal space for large cars to equal size with increased space for small cars.

Achieving greater interior space may require some compromises to current styling trends. Minimizing door thickness, within the limits of functional and strength requirements, and "tumble-home," the inward tilt of the side windows, will yield the least exterior width for a given interior dimension. The width values listed in Tables 10-7 and 10-8 illustrate the variations between cars and thus the practicable improvements.

Longitudinal room has been adversely affected by the long-hood styling with steeply raked windshield, which tends to push the front seat further aft than necessitated by the front wheel and engine location. The importance of a moderate increase in passenger compartment height was described earlier in this section. This, combined with re-proportioning of the seating space, can bring about a marked improvement in interior roominess within the same exterior envelope. A longer wheelbase in proportion to the overall length also expands the passenger compartment size and should have little weight or cost impact while improving the ride and handling of the vehicle.

In total, the several ways to improve the space utilization in the car are estimated to allow exterior size reduction (with equal interior room) and resultant weight savings ranging from 5% for small cars to 15% for large cars.

Domestic compact cars are typically equipped with 6-cylinder in-line engines. These are well suited to the power demands but require a long engine compartment, while the comparable European cars are generally somewhat lighter so they can be adequately powered by 4-cylinder engines, for which the maximum practicable displacement is just over 2 liters. Their shorter length helps reduce the overall length of the car, which keeps down the weight and allows the use of the 4-cylinder engine . . . the cumulative effect of weight-begets-weight is here amplified by this discontinuity. An engine of V-6 configuration should be the optimum choice for a compact; it would be roughly a foot shorter, much of which can be utilized for either decreasing the exterior length or improving the roominess. American engines, especially the 6-cylinder ones, also exhibit lower specific output (horsepower per displacement) than European engines, leading to larger size and greater weight for the same power; this is presumably offset by lower cost and perhaps greater longevity, although available data do not substantiate this point (Ref. 10-18).

Introduction of rotary engines would permit some weight savings additional to the engine weight difference by decreasing the engine compartment size and thus the vehicle length in cars that currently use larger than 4-cylinder or V-6 engines. However, the magnitude of this effect is easy to overestimate if proper allowance is not made for the space requirements of auxiliaries and accessories. Also the output shaft is located higher up on the engine than for piston engines, which leads to a taller driveshaft tunnel in the conventional front-engine rear-drive car and reduces passenger space; this effect is already

seen in current cars designed to accept rotary engines (e.g., Chevy Monza, AMC Pacer). When combined with front-wheel drive (see below), rotary engines are quite attractive from a "packaging" viewpoint (e.g., NSU-Audi Ro 80).

Chassis design changes can further enhance the space utilization. Independent rear suspension eliminates the vertical movement of the driveshaft and differential assembly, allowing a smaller driveshaft tunnel for better rear seat space and an increase in trunk volume. Its somewhat higher cost can be balanced against the improved ride comfort due to the lower unsprung weight.

Eliminating the driveshaft altogether by concentrating all the drive components at one end of the car, with the attendant possibilities for repackaging them, can result in notably greater passenger room. The rear-engine rear-drive layout (e.g., VW Beetle) has, from handling and crash safety considerations, gradually given way to front-wheel drive (e.g., VW Dasher), which is becoming dominant in European small cars. In combination with careful attention to detail design, it has resulted in cars with a markedly better proportion between interior space and exterior size and weight than any domestic automobile. Front-wheel drive has generally been considered to be more expensive than the conventional arrangement. However, the current opinion among European engineers is that, at least for small cars, there is no net cost difference when all the component changes are accounted for (Ref. 10-19).

Ride comfort would tend to decrease as cars become lighter. To provide the customer with the ride quality currently associated with a given amount of interior space, extra engineering effort and some higher-cost design features will be required. Examples might include the addition of

sway bars to many smaller cars, which would allow softer main springs, or the adoption of independent rear suspension. The cost savings from the lower vehicle weight should more than compensate for such higher-cost components.

#### 10.5.5 Total Vehicle Weight Reduction

The distinction between technically possible and practicable weight savings must be firmly kept in mind. It will certainly prove incorrect to assume that all conceivable means of lightening cars can in fact be implemented. As in many other fields, cost effectiveness tends to decrease as the changes get more drastic. The postulated weight reductions are therefore held to a conservative level which should truly be achievable. These are based on the preceding discussions and are shown in Table 10-9. The percentages are relative to current cars but would still apply if legislated safety standards cause overall weight increases.

Two levels of weight reduction are considered. "Intermediate" improvements require only application of known methods and materials, involving no technical risk and probably even a favorable cost impact. They can be implemented within 5-6 years. At the "longer-term" level, substantial aluminum use and more thorough redesign including the adoption of front-wheel drive in a majority of the cars are called for; these would involve some development work, so that more time would be needed for implementation, but have little technical uncertainty. Some specific cost increases may be unavoidable but the overall cost should be favorable since more of the weight is saved by redesign than by the incorporation of expensive materials.

Table 10-9 shows quite a difference in the degree of weight reduction between small and large cars. This reflects the differences in the

Table 10-9. Practicable weight savings (%)

Weight saving due to:	Vehicle class					
	Small	Subcompact			Compact	Large
	(Imports)	(Imports 20%)	(U.S. 80%)	Avg.	(All U.S.)	(All U.S.)
1. Exterior size reduction	5	5	10	9	10	15
2. Materials: HSLA <sup>a</sup> and plastics	3	3	3	3	4	5
3. Design details	0	0	2	2	2	3
4. V-6 engine	—	—	—	—	4	—
"Intermediate" total	8			13	19	22
5. Materials: aluminum (additional to item 2.)	6	7	7	7	7	7
6. Front-wheel drive	2	3	5	4	5	5
"Longer-term" total	15			26	28	31

<sup>a</sup>High-strength low-alloy steels.

design optimality of the current cars making up each class and the improvements which can be reasonably achieved.

#### 10.5.6 Fleet Weight Reduction

Making lighter, more efficient cars available in the market-place does not automatically assure a reduction in the fleet average weight. These redesigned, lighter-weight cars should appear equivalent to the potential owner as well as to the designer. Given freedom of choice, however, the purchaser may negate part of the weight reductions by buying a car in a higher weight class. For unless one is willing to postulate a sharp and permanent decrease in the standard of living, the preference of the customer for other features besides space and weight efficiency will surely continue.

Many cars are not bought to provide maximum transportation value for a large family. Multiple-car and childless owners frequency have little concern for rear-seat room and buy cars even less optimally designed than current sedans, such as two-door hardtops and specialty cars, examples of which are shown in Tables 10-6 and 10-8. Many purchasers will continue to prefer larger and heavier cars than they "need" for reasons of status, comfort or habit. In the upper price ranges, the purchaser expects some perceptible luxury in appointments and trim, which adds weight. And styling considerations will continue to conflict with optimal design to some degree.

There is a dilemma in the interaction between car design and sales: The industry promotes the cars that sell, and the cars that get promoted get sold. Apart from exterior styling, the great majority of car buyers consider the car as an appliance for transportation and are not interested in its technical details any more than in their refrigerator's. Habit and advertising are two main factors influencing their choice. Both of these have historically exerted an influence towards large cars.

In spite of the recent fuel shortages and price rises, good fuel economy has not been the only motivation for the customer. The market share of small cars has increased, but there has been little correlation between sales of individual makes and the EPA fuel mileage data which have been made public for the past two years and show sharp differences between similar cars of various makes. Useful consumer information has not always been readily available; cars carry stickers giving fuel economy not for the specific car, but the average for a given inertia weight class, which is hardly a familiar concept to most buyers.

In this milieu, the automobile industry has introduced new cars — the "luxury compacts" (Granada/Monarch) and "luxury/sports subcompacts" (Monza, Mustang II) — which offer little or no interior space improvement over previous cars of their size while adding several hundred pounds of weight. Partly because of this weight, they typically also have larger engines, with the predictable adverse effect on fuel consumption. However, the emphasis on luxury may aid the buyers' transition away from large cars while the industry tools up for more efficiently designed

small cars. If such cars are to be sold, their more practical features will have to be promoted so the customer will in fact choose to buy them.

In terms of industry lead times for entirely new car designs, there has certainly not been sufficient time to respond to the recent gasoline shortage and price increase. The subcompacts introduced five years ago in response to market-place demand for small cars give evidence that, at that time, good space utilization ranked low on the list of design objectives. At present, new models of the compact and larger cars, to be introduced in 1977-78, are planned for a 500- to 800-lb weight reduction (Ref. 10-20). This could be easily and instantly accomplished by shifting all nameplates to the next smaller car line. But if the customer is not to be asked to needlessly compromise his transportation values, a drastic reordering of design priorities is obligatory. Cars of the scheduled reduced weights will in fact be smaller on the outside, but with proper design they can offer at least equal passenger accommodations, trunk space and road performance as present domestic cars of the same market class.

#### 10.6 VEHICLE MODIFICATIONS AND FUEL ECONOMY

Major reductions in fuel consumption of cars equipped with current engines can be achieved through changes in vehicle characteristics and components.

To assess the potential of various modifications, it is useful to understand the several areas of energy consumption associated with automobile operation. A typical breakdown is shown in Fig. 10-8 (Ref. 10-21) for a compact car operated over the EPA Composite driving cycle, which is a 55/45% weighted combination of the EPA Urban and Highway cycles. In this presentation, fuel economy is always given for this Composite driving cycle unless stated otherwise. (Driving cycles, which are a prescribed combination of vehicle operating conditions, and their interaction with fuel economy measurements are discussed in Section 10.6.7.)

Such an analysis of the energy requirements of a vehicle can illuminate the most promising avenues to reduced fuel consumption. Because the efficiency of heat engines generally decreases as the percentage of load decreases, not all the reductions in energy can be realized as fuel savings, the degree depending upon the interaction of the operating conditions and the characteristics of the particular engine and the vehicle components involved. The improvements in fuel economy obtainable from practicable changes in vehicle design and components are reviewed in this section.

##### 10.6.1 Vehicle Weight

The weight of the car is the single most important fuel consumption factor. The tire rolling friction and the power to accelerate the vehicle, which is reflected in the kinetic energy dissipated by the brakes, are directly proportional to weight. In addition, the fuel required by the engine while coasting and idling is a function of engine horsepower, which is made roughly

proportional to vehicle weight in order to give the required level of performance. Transmission losses, even at a constant percentage, will be of smaller magnitude when the power transmitted is less. Aerodynamic drag area also varies, although not proportionately, with vehicle weight. Thus we see that, according to Fig. 10-8, over two-thirds of the energy required is associated with the weight of the car, and weight reduction should accordingly offer the most fruitful area for reducing fuel consumption.

The potential for weight reduction of automobiles was investigated in the previous section and is summarized in Table 10-9. Data for recent model-year cars indicates that fuel consumption (gallons per mile) increases linearly with weight, but this also includes the hidden effects of higher power-to-weight ratio and more accessories in the larger cars. Allowing for these factors, this study conservatively assumes a fuel consumption reduction equal to 80% of the vehicle weight reduction (in percent) while maintaining the features of the car's original class, including engine size scaled to maintain equal performance. This value has been verified with the VEEP program and is used in Table 10-10.

If vehicle weight is changed with horsepower kept constant, only 25-30% of the percentage weight change is reflected in fuel consumption, according to VEEP analysis. As an example, a typical large car (5000 lb curb weight) carrying 500 lb (10%) extra load will have its fuel economy reduced by about 3% or from 12.1 to 11.7 mpg; but it also is a lower-performance vehicle than it was without the extra load. This topic is further discussed in Section 10.6.3.

Plotting the 1975 fuel economy (see Table 10-1) as fuel consumption vs weight gives a nearly constant slope of 0.000014 gal/mi/lb throughout the weight range. Assuming that the customer, on the average, maintains equal performance by choosing a higher percentage of optional engines, we can see that the recent safety and damage-ability weight increases of typically 200 lb per car have increased the fuel consumption by 0.0028 gal/mi or 280 gallons over the 100,000-mile average car life. Both from the overall cost-benefit and energy-consumption viewpoints, this impact deserves more careful consideration.

#### 10.6.2 Transmissions

The conventional 3-speed automatic transmission with torque converter is taken as the baseline for the simulation since the vast majority of American cars are so equipped. A typical 4-speed manual transmission should be more efficient since a fully engaged clutch has no losses, whereas the torque converter has some slippage at all times. Also, the extra gear ratio allows better matching between vehicle power requirements and engine characteristics, resulting in more efficient engine operation. (Because of this, fuel consumption reduction due to transmission changes is not limited to the 12.1% power loss in the transmission itself shown in Fig. 10-8.) Thus it seems reasonable to predict a considerable fuel economy advantage for a car equipped with a 4-speed manual transmission; a typical value is 11% (Ref. 10-7). Inspection of the EPA fuel economy test results (Ref. 10-22) reveals that cars with the same engine, inertia weight and axle ratio show only small average differences in urban fuel economy but 15-20% in highway

Table 10-10. Fuel consumption reductions (%)  
(EPA Composite Driving Cycle)

Reduction due to:	Vehicle class			
	Small	Subcompact	Compact	Large
1. "Intermediate" weight reduction	6	10	15	18
2. 4-speed auto. transmission w/lockup	3	6	7	8
3. Reduced acceleration <sup>a</sup>	2	2	5	10
4. Lower aerodynamic drag	3	3	3	2
5. Improved accessories and acc. drives	1	1	2	3
"Intermediate" improvements total	14	20	29	35
6. "Longer-term" weight reduction (replaces item 1)	12	21	23	25
7. Continuously variable transmission (CVT) (replaces item 2)	10	13	14	15
"Longer-term" improvements total	26	35	40	45

<sup>a</sup>Increase in 0-60 mph acceleration time ranging from 1 second for Small cars to 3 seconds for Large cars.

mileage, for a Composite cycle mileage improvement of 7-10%.

Since the market-place acceptability of manual transmissions is limited in all but small cars, it is useful to consider ways of improving present automatic transmissions. Not surprisingly, the feasible changes all tend to make them more like manual transmissions without compromising their main advantage, which is the automatic shifting. Due to resource limitations, the VEEP program was not adaptable enough to simulate these changes, so the projected fuel economy improvements are quoted from other reliable studies.

The number of gears, gear ratios, engine size and axle ratio are all interrelated to varying degrees in determining both performance and fuel economy, and appropriate changes in engine size or axle ratio can be used, for instance, for moderate adjustments to acceleration capability. Adding an additional gear ratio to the 3-speed automatic transmission allows better matching of engine properties to vehicle requirements due to the smaller steps between gears and also results in slightly better performance. Depending upon the exact gear ratios chosen, one of them could be an overdrive, which is in any event an artificial distinction except perhaps in the sense that a downshift into the next lower gear can be assumed for passing acceleration if the two ratios are fairly close. This would yield both lower fuel consumption and somewhat higher acceleration capability. For a car with equivalent performance, a 4-speed automatic transmission is forecast to give 4% better fuel economy than a 3-speed (Ref. 10-23).

The effects of torque converter slippage can be ameliorated in several ways. A "tighter" torque converter is easily achieved by changing the internal flow geometry, but the trade-off for the decreased slippage is lower torque multiplication and thus slightly poorer acceleration, especially from a stop, as well as a decrease in shift smoothness. The fuel consumption benefit is about 3% (Ref. 10-24).

Carrying this idea further, converter slip might be eliminated entirely by installing lock-up clutches that are actuated in one or several of the upper gears when the vehicle reaches a preset speed, or stops accelerating as measured by the degree of converter slip, or by some other logic which would have to be carefully worked out. Potential drawbacks are again decreased shift smoothness, which could result in higher transient loads on the drivetrain, and lower performance at low speeds depending upon the actuation logic, while acceleration at highway speeds might be improved. Some additional hardware complexity and cost would be incurred for the fuel consumption improvement, estimated at anywhere from 0.6% (Ref. 10-7), which seems rather low, to 4% (Ref. 10-23).

The several transmission improvements can be combined into a Mature (used in the same sense as with engines) 4-speed automatic transmission with torque converter lock-up in the upper three gears provided by some threshold logic. The lock-up feature would allow retaining a fairly "loose" converter for good initial

acceleration, although the extra gear ratio decreases the need for it. Such a transmission gains most of the efficiency advantages of a manual gearbox while still retaining the automatic-shift feature and should give about 8% lower fuel consumption than current models in full-sized cars.

Substantially greater benefits are promised by the continuously variable transmission (CVT). This allows operation of the engine at its most efficient operating points independent of vehicle speed, to which the engine speed is usually tied through the fixed gear ratios of ordinary transmissions. The principle is illustrated in Fig. 10-9, which is developed from Ref. 10-25; at constant legal speeds, operation at 20% lower BSFC is typical. The difference is diminished during acceleration, when the operating point with a conventional transmission moves to higher power (and thus lower BSFC) with little rpm increase from the constant-velocity value.

The CVT's decoupling of engine speed from vehicle velocity makes possible higher power outputs at low vehicle speed and thus faster acceleration, permitting a reduction of engine size for equivalent performance. The magnitude of this effect is also affected by the transmission efficiency and is estimated at up to 20% relative to the original 3-speed automatic transmission vehicle (Ref. 10-26).

There are two principal types of CVT, one relying wholly on mechanical power transmission and one partially on hydraulic power conversion. The Tracor traction drive transmission (Ref. 10-27) varies the radii of the points of contact on power rollers operating between the toroidal driving and driven plates. It has a ratio range of 9:1, wider than present transmissions, to allow low engine speed at high vehicle velocity, and needs a clutch for starting from rest. Size, weight, cost and efficiency are claimed to be competitive with current automatic transmissions. One of its main problems has been durability, due to wear at the heavily loaded contact areas, which is said to be improving with better lubricating fluids.

The Orshansky hydromechanical transmission (HMT) is a split-path type which transmits the majority of the power through planetary gear sets, using the hydraulic pump and motor at low vehicle speeds and to provide a smooth transition between the gear steps (Ref. 10-28). Good efficiency is claimed because only a small power fraction goes through the higher-loss hydraulic components. The HMT's complexity is partially offset by its utilizing components with a long history of commercial use and service.

The variable-stator-angle torque converter (VSTC), which is the favored CVT for the single-shaft Brayton (see Chapter 5), is not suitable for Otto engines. Because its torque capacity varies as the square of the input rpm, it becomes unacceptably large at the desired low Otto-engine operating speeds.

All types of CVT have several problem areas when automotive application is planned. Perhaps the most severe of these is loss of engine durability due to operation at the high-torque low-speed

conditions necessary to remain in the low-BSFC region of the engine map. Current engines are not intended for such service and may require major redesign, with increased weight and cost. Control systems which combine best-fuel-economy scheduling with acceptable response to driver demands need further development. And the HMT's use of high-pressure hydraulic components causes a high operating noise level which must be mitigated.

Both of these transmission types are in the prototype development stage, and evaluations of fuel economy improvements have so far been limited to computer simulation. Working with data from the same sources, a wide range of results has been obtained, depending at least in part on assumptions about the vehicle used and the performance scaling criteria, as well as the representation of efficiency maps and details of the computer programs. The Tracor CVT is generally estimated to give fuel consumption reductions of 15% in urban driving and 22% in highway, or about 18% over a composite driving cycle (Ref. 10-7, 10-26, 10-29). The HMT predictions range from 1% urban or about 7% composite (Ref. 10-29) to a 25% fuel consumption reduction for urban driving (Ref. 10-28) for vehicles scaled to have equal acceleration, with a value around 16% for a case where the HMT was substituted directly for the 3-speed automatic transmission without taking advantage of performance scaling (Ref. 10-26).

In view of the uncertainties regarding the practical implementation of all the desirable features of CVTs and some likely tradeoffs between complexity or cost and efficiency, the net fuel consumption reduction resulting from use of a CVT has herein been conservatively assumed to be 15%. Smaller cars, to the extent that they are presently equipped with manual transmissions, will derive less benefit from the introduction of improved transmissions; this is reflected in the values entered in Table 10-10. With the development pace spurred on by the fuel crisis, projections of first volume production by 1982 seem reasonable.

#### 10.6.3 Effect of Engine Size: Reduced Performance

It is a common observation that larger engines installed in otherwise identical cars give lower fuel economy. The fundamental reason can be seen from the engine map in Fig. 10-9. A more powerful engine will be operating at a lower percentage of power during a given maneuver and thus will be generating the same number of horsepower at a higher specific fuel consumption.

In the 1975 EPA test results (Ref. 10-22), the clearest comparisons are for compact cars with 6- vs 8-cylinder engines, which show that fuel consumption is increased 15-20% for a 40-60% hp increase. For full-sized cars, the difference between the standard V-8 of about 350 CID and the largest available engines (450-500 CID) is typically 15%. VEEP simulation for small cars similarly showed 10% lower fuel consumption for a 25% hp decrease.

Somewhat lower performance than is common in current American full-sized cars may be

an acceptable tradeoff to many customers in the quest for better fuel economy. While large engines need to be available for trailer towing and other special uses, the average power of compact and larger domestic cars could be reduced to about the level of their current standard engines. Some of the new small sedans also have quite fast acceleration and could gain further fuel economy from slightly smaller engines.

The fuel economy improvements shown in Table 10-10 imply a corresponding increase in 0-60 mph time ranging from 1 second for small cars to 3 seconds for large cars, allowing the latter to retain much of their historical performance advantage over the smaller cars (cf Table 10-2).

#### 10.6.4 Aerodynamic Drag

Greater emphasis on this aspect of design would have a beneficial effect on fuel economy. Aerodynamic drag increases with the third power of velocity and is thus more important in highway driving than in the city. Its magnitude is proportional to both the frontal area ( $A_F$ ) and the drag coefficient ( $C_D$ ) of the vehicle. The frontal area is essentially determined by the cross-sectional area of the passenger compartment. Improved interior space utilization, with somewhat greater height and more upright side glass in the upper vehicle body, will cause a slight increase (not over 5%) in cross-sectional area in the smaller cars. Decreased exterior width will offset this in the larger cars.

Aerodynamic drag reduction must therefore be achieved through a lower drag coefficient. For recent-model cars, typical  $C_D$  values are in the range 0.45 - 0.55. The literature is replete with discussions of drag reduction; thorough treatments are given, for example, in Ref. 10-30 and 10-31 and a summary of recent work in Ref. 10-32. The lowest-drag production cars, the Citroen DS-19, NSU-Audi Ro-80, and Porsche 356 coupe, have  $C_D$  values reported as 0.31 - 0.33, and the new Citroen Cx sedan claims 0.29.

Such low values are unrealistic to expect for the typical sedan. They involve some compromise with the body shape for best roominess and require fairing-in of the forward underbody and careful design treatment of all protuberances, such as mirrors and rain gutters, window glass flush with the sheet metal, and so on. Considering all the factors involved, however, a reduction of 25% from the present average  $C_D$  of 0.50 to 0.38 should certainly be practicable for most cars.

The fuel consumption decrease resulting from this 25% drag reduction was computed with the VEEP program and is shown in Table 10-11. Other estimates range from somewhat less (Ref. 10-26) to nearly double the magnitude (Ref. 10-33); this is sensitive to the details of vehicle parameters, such as BSFC map, engine size, etc. Two factors make the effect larger for small cars: (1) Frontal area does not decrease with car size as fast as weight, and aerodynamic drag is thus a higher percentage of the total power requirement for small cars.

Table 10-11. Effect of 25% aerodynamic drag reduction

Car	Curb weight, lb	A <sub>F</sub>	% reduction in fuel consumption		
			FDC-U	FDC-H	Comp.
Small	2100	18.8	2.2	7.1	4.4
Compact	3100	21.8	1.4	5.7	3.3
Large	5000	25.5	0.9	4.2	2.4

(2) The engine in the smaller car is operating at a higher relative power level; when the load decreases, the operating point moves into the higher-BSFC area on the engine map (see Fig. 10-9) faster for a large car than a small one, which tends to negate the fuel consumption benefit expected from the load reduction.

For the compilation of total vehicle fuel consumption improvement in Table 10-10, the VEEP results are used, with the small-car value reduced one percentage point. This reflects the greater difficulty of reducing the total drag in small cars, where A<sub>F</sub> will rise somewhat, and improving the space utilization should take precedence over decreasing the aerodynamic drag. Even though the benefit is not large, it is worthwhile since it requires no compromise with other vehicle parameters, at least to the extent envisioned here, and should entail no additional cost.

#### 10.6.5 Tires

All the baseline vehicles are assumed to have radial-ply tires, but as a matter of interest, the differences between tire types were investigated. Much has been said about the fuel economy advantage of radial tires over conventional bias-ply tires, and popular expectations have perhaps become excessive. The VEEP results for the difference between these two tire types are shown in Table 10-12 and agree closely with other studies (Ref. 10-23, 10-26). The 25% difference in rolling friction results in less than 3% change in fuel consumption.

Typical tire rolling friction coefficients used in this study were shown in Fig. 10-2. Results of tire tests are extremely sensitive to details of tire construction, tire aspect ratio (cross-sectional height-to-width), tread rubber compound,

Table 10-12. Effect of change from bias-ply to radial tires

Car	Curb weight, lb	% reduction in fuel consumption		
		FDC-U	FDC-H	Comp.
Small	2100	2.1	3.8	2.9
Compact	3100	1.7	3.5	2.5
Large	5000	1.6	3.6	2.5

tread depth and width, inflation pressure, heat and pressure buildup during the test, and many lesser factors (Ref. 10-34). For instance, as the tire wears down, there is less energy dissipated in the tread rubber, so that worn-smooth tires have 30% lower rolling resistance than new tires.

For a given type of construction (i. e., radial), tire characteristics are a careful balance of conflicting considerations. Sizable reductions in rolling resistance could be obtained only at the expense of tread life, ride, handling and traction, or high-speed safety. Some of these may be acceptable for low-speed electric vehicles, as an example, but for normal automobile use, the best of today's tires are unlikely to be significantly improved upon.

#### 10.6.6 Improved Accessories and Accessory Drives

The power-consuming components attached to and driven by the engine in current cars are of two kinds. Auxiliaries are necessary to the functioning of the engine itself and include the oil pump, fuel pump, water pump, distributor and emission control equipment such as the air injection pump, all of which have fairly low and not easily reduced power consumption. Their higher operating speed with increasing rpm is appropriate since their output must increase with rpm to supply the engine's requirements. These components are included on the engine when it is tested to determine the net horsepower and the engine (BSFC) map. Little scope for improvement is available here.

Accessories are items driven by the engine which benefit the vehicle and its occupants, the two main ones being the air conditioner and the power steering pump. Intermediate between the two categories are the alternator and radiator fan, without which the engine can be run for the short term and, on the test stand where electrical power and cooling water can be externally provided, often is. In a vehicle, though, the engine must drive these components to provide a stable operating condition. The power absorption of these accessories is shown in Fig. 10-3 based upon data from Ref. 10-7 for cars with medium-sized (318-360 CID) V-8 engines. As a point of reference, engine idle speed is 600-800 rpm, and the highest operating speed in normal urban or highway driving seldom exceeds 2500 rpm for American 6- or 8-cylinder engines and 3000-3500 rpm for engines in small cars.

The radiator fan has to be designed to draw enough air through the radiator at engine idle with the vehicle stopped, when there is no external air flow to aid the cooling air motion. This problem is aggravated in the typical modern car because there is little room for an air exhaust path through the crowded engine compartment. As engine and vehicle speed increase, the fan power absorption goes up even though vehicle motion tends to help the cooling process. With air conditioning installed, the higher load on the cooling system requires a still bigger fan.

In addition to consuming power, large fans generate a lot of noise, and it was this problem that led to the universal adoption on air-conditioned cars of the thermally actuated viscous

fan clutch. This disengages the fan unless the cooling-water temperature is above normal, thus incidentally saving power at a slight cost penalty, but it is not installed on non-air-conditioned cars. Some of those use a plastic fan with blades sufficiently flexible so they decrease their pitch somewhat at high rotational speed. Use of a fan clutch on all cars would sharply reduce the fan power dissipation in most driving conditions and additionally provide quieter running, even with a bigger fan for greater cooling margin.

The same effect is achieved, but primarily for "packaging" reasons (e. g., with transverse-mounted engines), on some foreign cars by using an electrically driven radiator fan. While probably more expensive, removing the fan from the (flexibly mounted) engine allows the fan shrouding to fit more closely and gives much better fan efficiency, so the power consumption is less and the electric motor required is quite small.

Alternators offer little scope for improvement. Their power absorption is largely determined by output current and rises fairly slowly with engine speed; the curve in Fig. 10-3 is for a moderate charging rate (30 amp). The average power level is usually lower except when air conditioning and electrical accessories are heavily used. Alternator efficiency could be improved somewhat at increased cost and bulk, but the potential benefits are small.

The power steering pump is sized by the requirement for adequate wheel-turning torque when the vehicle is stopped with the engine idling. It supplies hydraulic oil to the steering mechanism at a pressure tailored to the demand. The control circuit employs an open-centered control valve which allows continuous oil flow, but with very low back pressure on the pump unless turning power is required. Thus the pump may require as much as 3 hp for low-speed steering, but since its duty cycle is quite low in normal driving, the average power dissipation is in the range shown in Fig. 10-3.

Power steering is necessary on the larger cars to allow a satisfactory combination of steering effort (which could also be achieved by a high gear-reduction ratio) and good maneuverability (which requires a low reduction ratio). Its necessity and installation rate are fairly low on subcompact and smaller cars. No practical proposals exist for reducing the power requirements of the power steering system. In view of its relatively modest losses at normal engine speeds, the application of some type of variable-ratio drive is probably not worthwhile.

Air conditioning (A/C) has by far the highest peak power requirement of all automotive accessories. In considering ways of reducing this, the performance should not be compromised from the present level. Air conditioning is considered virtually a necessity in many parts of the country; it is installed in about 90% of new full-size cars and even in 30% of domestic subcompacts, where it can represent 15% of the purchase price.

Air conditioning operated at maximum output will increase full-sized car fuel consumption by 10%, and at moderate output from 6% (Ref. 10-7).

However, averaged over all regions of the country, over all times of day and over the year, A/C is only turned on perhaps 20-40% of the time, leading to an overall fuel consumption increase of 2-3%. This is additional to the 2-3% extra fuel use due merely to the approximately 100-lb weight of the A/C installation, if equal performance is maintained by increasing the average engine horsepower. For small cars, these percentages would be nearly doubled since the output of the A/C unit is scaled to the passenger compartment size, which decreases less quickly than car weight.

Like other accessories, air conditioning is designed to operate satisfactorily at the low engine speeds typical of urban driving. The highest load occurs during the initial cool-down of a hot parked car and is at least twice the load needed to maintain comfort once the car is cool. At highway speeds, greater heat transfer from the sheet metal and air leakage into the passenger compartment cause the steady-state load to rise to nearer the cool-down level.

Earlier models of factory A/C, and most current aftermarket units, have an on-off magnetic clutch that actuates the compressor when the car interior temperature exceeds the set level. The later original-equipment models are more comprehensive "climate control" systems which may be energized even when the outside temperature is below normal. In this mode, a dehumidifying action is achieved by cooling the incoming air to condense out moisture and then reheating it to the desired level. Once set, the controls require no adjustment by the driver regardless of the outside weather. Temperature fluctuations are eliminated along with the on-off cycling of the earlier units, which could be perceptible to the driver through variations in engine power. Needless to say, the average power consumption of these "re-heat" systems is considerably higher for the same net cooling effect.

All present A/C systems use the vapor compression cycle, similar to residential A/C and refrigerators. Cost, weight and bulk constraints result in their being only 20-40% as efficient as the best stationary units (Ref. 10-7), and the possibilities for improvement are limited. Compressor efficiency is 80% at idle and low speeds and drops to 50% at high speeds. Some current models use a swashplate drive (see Section 6.1) which could be modified to yield a variable-displacement feature with better efficiency at high speeds. Variable-angle swashplate drives are widely used in industrial hydraulic motors and should entail no technical risk with only a modest cost impact.

Other proposed means for reducing compressor speed variation include driving it with an electric motor or a two-speed belt drive. The former would be costly, would require a much larger alternator than presently installed and, considering the normal range of operating conditions and the losses from the double energy conversion, would not result in improved overall efficiency. A two-speed belt drive should introduce no offsetting efficiency penalties and have an acceptable cost. A prototype is currently under development.



Use of other cooling methods than the vapor compression cycle has also been suggested. Thermoelectric cooling has very low efficiency and a low power density. Absorption cycle cooling would use engine exhaust heat as the primary energy source. This is obviously attractive and helps to make up for the low unit efficiency, but for automotive application the equipment is rather bulky and the available capacity is only about half the cool-down load (Ref. 10-7).

A promising recent development is the ROVAC (rotary-vane air cycle) A/C system. It uses the circulated air as the working fluid in a reverse Brayton cycle. Presently in the prototype demonstration stage, its efficiency is already claimed to be better than conventional automotive A/C units (Ref. 10-35). By drawing less power from the engine at a given cooling rate, it can reduce the fuel consumption penalty associated with A/C if final development and production engineering are successful.

A/C in cars is clearly important to the majority of owners. Major reductions in power demand are unlikely without compromising the cooling performance. However, as concern over fuel economy increases, public awareness of the power consumption of the "re-heat" type of system could be fostered and might result in lower usage under marginal conditions. Also, the fuel economy benefits of the on-off cycling system should be publicized, thus leading to renewed acceptance, at least in the smaller cars.

All accessories combined can account for up to 30% (for large cars) of the total energy consumption over the Urban driving cycle. While no large improvements are to be expected, detail changes in the design and drives of the components can have a favorable effect on fuel consumption.

#### 10.6.7 Fuel Economy Measurement

To characterize the fuel consumption of automobiles and evaluate the effects of changes in vehicle components, some consistent test procedure must be utilized. Until recently, no standardized test methods were available. Each automobile manufacturer had his own set of procedures and each car magazine its individual gas mileage measurement, all giving different results.

A meaningful comparison of fuel economy requires testing over a full range of vehicle operating conditions, as occurs in normal driving. A specified sequence of driving maneuvers is called a "driving cycle." In 1970 the Environmental Protection Agency (EPA) developed the LA-4 driving cycle for the purpose of measuring exhaust emissions during a typical urban trip. This cycle was then also used, starting in 1973, for measurements of urban fuel economy to allow consumer comparison among automobiles. For the 1975 model year, a highway fuel economy cycle was added to better characterize all aspects of automobile operation.

Meanwhile, the major U. S. car companies and the Society of Automotive Engineers (SAE) developed three driving cycles - Urban, Suburban, and Interstate - for uniform testing throughout the

industry. Some characteristics of all these driving cycles are described in Section 14.2.1.

The EPA and SAE test procedures differ in several important ways. The EPA test cycle was originally developed to measure exhaust emissions, and the procedure is greatly facilitated if the vehicle is stationary in a laboratory. The driving wheels are positioned on a pair of dynamometer rollers, which are connected both to a hydrodynamic power absorber, which simulates the rolling friction and aerodynamic resistance of a moving car, and to a set of large flywheels, which represent the inertia of the vehicle. Since there are but a finite number of flywheels, the test weight of the car (curb weight + 300 lb) must be rounded off to the nearest "inertia weight" category (Ref. 10-2), the steps between which range from 8 to 15%. With vehicle weight (i. e., inertia) the strongest single factor in urban fuel economy, this rounding-off adds an error to the measurement.

The dynamometer power absorber is set to a prescribed value at 50 mph for all light-duty motor vehicles according to their weight class. This masks all differences due to aerodynamics and allows, for example, advertising claims of EPA highway mileage of 26 mpg for a big square van (Ref. 10-36), which is surely far above its actual on-the-road mileage. In addition, lack of accuracy and reproducibility of the power absorber setting may cause fuel economy errors up to 10% for small cars (Ref. 10-37).

The SAE test procedures, derived from the industry's historical proving-ground practices, are free from the above problems because they are based on actual road tests, but they are subject to the vagaries of the weather. Ambient temperature will cause fuel economy to change 0.3-1.0% for every 5°F (Ref. 10-37), road conditions will change (e. g., rain), and wind will also affect the results. Even on a closed course, and assuming the wind is uniform, this effect does not average out because aerodynamic drag varies as the third power of the relative wind speed. Thus the weather can sharply limit the opportunities for obtaining valid road test results.

The fuel consumed is measured directly in the SAE test procedure. The EPA dyno test uses the "carbon balance" method, in which the total carbon content of the HC, CO and CO<sub>2</sub> emissions (which are being collected anyway) is analyzed. Under the assumptions that all the carbon in the exhaust comes from the fuel and that all the carbon in the fuel used is represented by these products, the fuel economy is computed. Results based on the carbon balance method yield a fuel economy 3-4.5% higher than direct measurement (Ref. 10-37).

Another fundamental difference in the two sets of procedures is the treatment of the cold-start effects which cause increased fuel consumption until the affected components of the car reach their steady-state operating temperature; this topic is further discussed below. The SAE tests are oriented toward engineering evaluation of vehicles and components, and in order to obtain comparable data, all tests are started with fully warmed up cars. The EPA tests seek to simulate actual operating fuel economy. The

urban cycle therefore assesses the effects of cold starts by beginning the test with a "cold" (minimum storage time of 12 hr at 68-86° F) vehicle, then repeating the first segment with the car fully warmed up, and combining the results to weight the cold start 43% and the hot start 57%. The EPA highway cycle, run subsequent to the urban cycle, always starts with a warmed-up car.

The variability of fuel economy test results is also important. In the EPA procedure, repeated tests on one vehicle in the same test cell have differed by 1-8%, averaging about 2.5% for the standard deviation (S. D.) as a percentage of the mean (Ref. 10-38). Repeating the tests at different laboratories raised that value to 6% (Ref. 10-37).

The SAE test procedure specifies that the results from two successive runs shall be within 2%, or the test is to be repeated. The reported low average value of S. D. as 1.1% of the mean is thus expected, but gives no information on the actual range of variability of road tests. Both test methods are also subject to car-to-car and driver-to-driver variations, which have been assessed at S. D. = 3.5% of the mean.

Clearly, a single test on a single car can give fairly erroneous results due to the above factors. It has been estimated that establishing the fuel economy of a particular car within ±3% of the true mean at 90% confidence level would require testing of 5 vehicles in the road test or 14 vehicles in the laboratory dynamometer test (Ref. 10-37), yet single-car tests are the basis for the EPA-reported fuel economies to which so much importance is attached. A change to multiple-car testing is certainly warranted for "official" fuel economy measurements.

The accuracy with which the EPA dynamometer measurements represent real-world fuel economies is not well established, although it seems to be generally conceded that the EPA values are high. In urban driving, where the

inertial forces and idling fuel predominate, the dyno should give results similar to road tests, but no direct data is available. In the highway cycle, where about two-thirds of the energy is consumed in rolling resistance and aerodynamic drag, dyno runs give 4-16% higher fuel economies than road tests also using the EPA cycle; road tests comparing the EPA Highway and SAE Interstate-55 cycles give nearly identical results (Ref. 10-37), so that these driving cycles can be considered equivalent.

The contention that the EPA values overestimate the actual fuel economy seems to be supported by the results of the Union Oil mileage tests (Ref. 10-39) summarized in Table 10-13. Direct comparisons are hindered by differences in the cars tested and the disparities between the SAE driving cycles used in the Union Oil tests and the EPA driving cycles. Thus the SAE Urban fuel mileage is lower than the EPA Urban at least partly because of the lower average speed. This effect may be compensated by combining the results from the SAE Urban (average speed 15.6 mph) and Suburban (41.1 mph) tests; a ratio of 80:20, respectively, is used here to roughly match the EPA Urban driving cycle (average speed 19.6 mph). The differences among the cars tested should average out by considering all cars in each inertia weight class as a group.

It is evident from Table 10-13 that the EPA mileages are consistently higher than the adjusted SAE results, by 8-16% in urban and 3-18% in highway driving; note that the latter values closely match the 4-16% range cited above. The differences would be 3-4% larger if the SAE urban test also included the cold-start effects (see below) on the 45:37 weighted basis. Overall, these data indicate that the EPA tests overestimate actual fuel economy by around 10-15%.

This conclusion is further reinforced by the finding (Ref. 10-41) that the National average fuel economy estimated by DOT (from fuel use

Table 10-13. Comparison of 1975 fuel economy using EPA and SAE (Union Oil) Tests<sup>a</sup>

	Inertia weight class, lb					
	3000	3500	4000	4500	5000	5500
SAE Urban, mpg	16.14	13.87	12.46	10.17	9.73	8.66
SAE Suburban, mpg	22.50	19.23	17.23	15.73	14.29	12.65
SAE 80:20 Composite, mpg	17.11	14.69	13.19	10.94	10.39	9.24
EPA Urban, mpg	18.7	16.7	14.5	12.7	11.2	10.1
% Difference: Urban	9.3	13.7	9.9	16.1	7.8	9.3
SAE Interstate 55, mpg	22.52	19.75	18.08	16.99	15.67	14.00
EPA Highway, mpg	26.55	23.05	19.58	17.53	16.24	15.05
% Difference: Highway	17.9	16.7	8.3	3.2	3.6	7.5

<sup>a</sup>Data derived from Refs. 10-39, 10-40, and 10-41.

and VMT data) is duplicated within 2% by considering solely EPA Urban driving cycle results, sales-weighted by model year and inertia weight class. With average highway fuel economy equal to 1.40 times urban, the 55/45 split gives composite mpg 15% higher than urban, indicating the discrepancy between the DOT and EPA data.

The reasons why the EPA results seem to overstate actual fuel economy are not clear. There are no obvious flaws in the dynamometer setup and calibration. Real-world effects due to out-of-tune engines, trailer towing, ambient temperature range, hills, winds, and fuel handling and spillage would not be expected to add up to the total difference cited in the preceding paragraph; they certainly do not explain the differences between the EPA results and the Union Oil (SAE) tests. It appears that the 10-15% overestimate in the EPA results, which lead to corresponding consumer overexpectations of new-car fuel economy, must remain largely unexplained at present.

#### START-UP AND WARM-UP FUEL CONSUMPTION

The additional fuel consumed by a car while it is warming up after a cold start can be calculated from available data. For 1966-71 model year cars, comparing the fuel flow during the first (cold) 505 seconds of the FDC-U with that during the (warmed up) repeat (Ref. 10-42) indicates 0.05 gal of extra fuel is consumed during the cold-start portion for a typical 4000-lb IW car with a 350 CID V-8 engine. The ratio established by EPA for converting 1972 FTP results (all cold start) to the 1975 FTP basis (weighted cold/warm starts) similarly yields a value of 0.045 gal. In contrast, curves of cumulative fuel economy vs trip length based on actual road tests (Ref. 10-43) can be analyzed to give a warmup fuel quantity of 0.105 gal, roughly twice the EPA values. Starting a cold engine can typically consume 0.10 lb = 0.016 gal during the first 3 seconds (Ref. 10-7).

An attempt is sometimes made to correlate the warm-up fuel with the energy required to raise the engine mass from ambient to operating temperature. A more accurate description is that engine warm-up is accomplished primarily from heat which is normally rejected through the cooling and exhaust systems, and the warm-up fuel consumption is caused by cold-engine combustion inefficiencies and increased cold-drivetrain losses. The latter include higher engine and drivetrain friction and additional drag due to higher lubricant viscosity when cold. These factors have a fairly long time-constant and are probably the most important, whereas the engine combustion spaces reach equilibrium temperature fairly quickly.

The importance of the long-time-constant warm-up factors is underlined by EPA Highway cycle tests showing that cold-start fuel economy is only 89% of the fully warmed up level, but repeating the test after allowing the car to cool off for one hour yields still 98% of that value (Ref. 10-44). Better understanding of the factors involved may lead to ways of diminishing the cold-start fuel economy penalty.

In conclusion, it may be said that present fuel economy testing procedures provide a consistent measurement technique with fairly repeatable results, but care must be employed in relating the numerical values obtained to real-world automobile fuel economy.

#### References

- 10-1. Artinian, L., and Terry, S. L., "The Total Cost of Weight," presented at 1961 SAE National Automobile Week, Paper No. 325 D, Mar. 1961.
- 10-2. Federal Register, Vol. 37, No. 221, 15 Nov. 1972.
- 10-3. Walter, J. D., "Energy Losses in Tires," Caltech Seminar Series on Energy Consumption in Private Transportation, Pasadena, Calif., Dec. 1973.
- 10-4. Morton, G. F., Dunlop Tyre Division, private communication, Aug. 1974.
- 10-5. Elliott, D. R., Klamp, W. K., and Kraemer, W. E., "Passenger Tire Power Consumption," SAE Paper No. 710575, 1971.
- 10-6. "Automobile Gas Turbine Optimization Study," AiResearch Mfg. Co. for EPA, Contract No. 68-04-0012, July 1972.
- 10-7. Coon, C. W., et al., "Technological Improvements to Automobile Fuel Consumption," Southwest Research Institute, Report No. DOT-TSC-OST-74-39, Dec. 1974.
- 10-8. Pond, J. B., "Packaging People," Automotive Industries, Apr. 1, 1974.
- 10-9. Consumer Reports, Annual Auto Issue (Apr.), 1963-1975.
- 10-10. "1974 Cars - Specifications," Consumer Reports, Apr. 1974.
- 10-11. Dinkel, J., "Technical Analysis: Ford Granada and Mercury Monarch," Road & Track, Aug. 1974.
- 10-12. Lindgren, L. H., "Supplemental Report on Manufacturability and Costs of Proposed Low-Emission Automotive Engine Systems," Committee on Motor Vehicle Emissions, National Academy of Sciences, January 1973.
- 10-13. "Passenger Car Weight Trend Analysis," The Aerospace Corp., El Segundo, Calif., Contract No. EPA-68-01-0417, January 1974.
- 10-14. Glaser, K. F., and Johnson, G. E., "Construction Experience on Aluminum Experimental Body," SAE Paper No. 740075.

- 10-15. Maloney, J. P., Heimbuch, R. A., and Rose, L. J., "HSLA Steels for Auto Parts," Automotive Engineering (SAE), 82, 7, July 1974.
- 10-16. Frey, S. N., "Automotive Use of Plastics," Automotive Engineering, 82, 1, Jan. 1974.
- 10-17. Chemical & Engineering News, p. 11, May 20, 1974.
- 10-18. "Automobile Repair Incidence Records," Consumer Reports Yearbook, 1975.
- 10-19. Norbye, J. P., "The New Logic in Small-Car Engineering," Popular Science, Feb. 1975.
- 10-20. General Motors Supplemental Information, Pursuant to Application for Suspension of 1977 Emission Standards, 16 January 1975.
- 10-21. Pierce, J. R., "The Fuel Consumption of Automobiles," Scientific American, Jan. 1975.
- 10-22. "1975 Gas Mileage Guide for New Car Buyers," U.S. Environmental Protection Agency, October 1974.
- 10-23. "Potential for Motor Vehicle Fuel Economy Improvement," U.S. Dept. of Transportation and U.S. Environmental Protection Agency, 24 October 1974.
- 10-24. Huebner, G. J., Jr., and Gasser, D. J., "General Factors Affecting Vehicle Fuel Consumption," SAE Paper No. 730518, 1973.
- 10-25. "Comments Regarding the Comparison of Alternative Automotive Engines," Scientific Energy Systems Corp. to APSES Team, Aug. 1974.
- 10-26. Hurter, D. A., et al., "A Study of Technological Improvements in Automobile Fuel Consumption," Arthur D. Little, Inc., Report No. DOT-TSC-OST-74-40, December 1974.
- 10-27. Lindsley, E. F., "Tracor - Tomorrow's Stepless Transmission," Popular Science, March 1975.
- 10-28. Orshansky, E., Huntley, P., and Weseloh, W. E., "Automobile Fuel Economy with Hydro Mechanical Transmission by Simulation Studies," SAE Paper No. 740308, 1974.
- 10-29. Beachley, N. H., and Frank, A. A., "Increased Fuel Economy in Transportation Systems by Use of Energy Management," Univ. of Wisconsin, Report No. DOT-TST-75-2, December 1974.
- 10-30. White, R. G. S., "A Method of Estimating Automobile Drag Coefficients," SAE Paper No. 690189, 1969.
- 10-31. Hoerner, S. F., "Fluid-Dynamic Drag," published by the author, 1958.
- 10-32. Marte, J. E., Weaver, R. W., Kurtz, D. W., and Dayman, B., Jr., "A Study of Automotive Aerodynamic Drag, Phase I," JPL Report No. DOT-TSC-SP-43-23, 1975.
- 10-33. Marks, C., "Which Way to Achieve Better Fuel Economy?" Caltech Seminar Series on Energy Consumption in Private Transportation, Pasadena, California, Dec. 1973.
- 10-34. Curtiss, W. W., "Low Power Loss Tires," SAE Paper No. 690108, 1969.
- 10-35. Lindsay, E. F., "ROVAC," Popular Science, Feb. 1975.
- 10-36. Advertisement, Wall Street Journal, Mar. 13, 1975.
- 10-37. Matula, R. A., "Emissions and Fuel Economy Test Methods and Procedures," Consultant Report to the CMVE, National Research Council, Sept. 1974.
- 10-38. Paulsell, C. D., and Kruse, R. E., "Test Variability of Emission and Fuel Economy Measurements Using the 1975 Federal Test Procedure," SAE Paper No. 741035, Oct. 1974.
- 10-39. Automotive News, Nov. 25, 1974.
- 10-40. Austin, T. C., and Hellman, K. H., "Passenger Car Fuel Economy - Trends and Influencing Factors," SAE Paper No. 730790, Sept. 1973.
- 10-41. Austin, T. C., and Hellman, K. H., "Fuel Economy of the 1975 Models," SAE Paper No. 740970, Oct. 1974.
- 10-42. Williams, M. E., White, J. T., Platte, L. A., and Domke, C. J., "Automobile Exhaust Emission Surveillance - Analysis of the FY 72 Programs," EPA Report EPA-460/2-74-001, Feb. 1974.
- 10-43. Scheffler, C. E., and Niepoth, G. W., "Customer Fuel Economy Estimated from Engineering Tests," SAE Paper No. 650861, 1965.
- 10-44. Austin, T. C., Hellman, K. H., and Paulsell, C. D., "Passenger Car Fuel Economy During Non-Urban Driving," SAE Paper No. 740592, Aug. 1974.

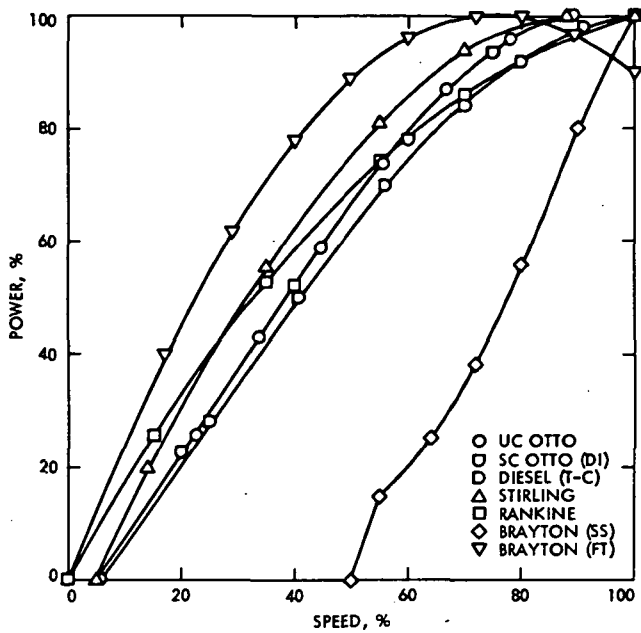

Fig. 10-1. Power vs rpm boundary curves

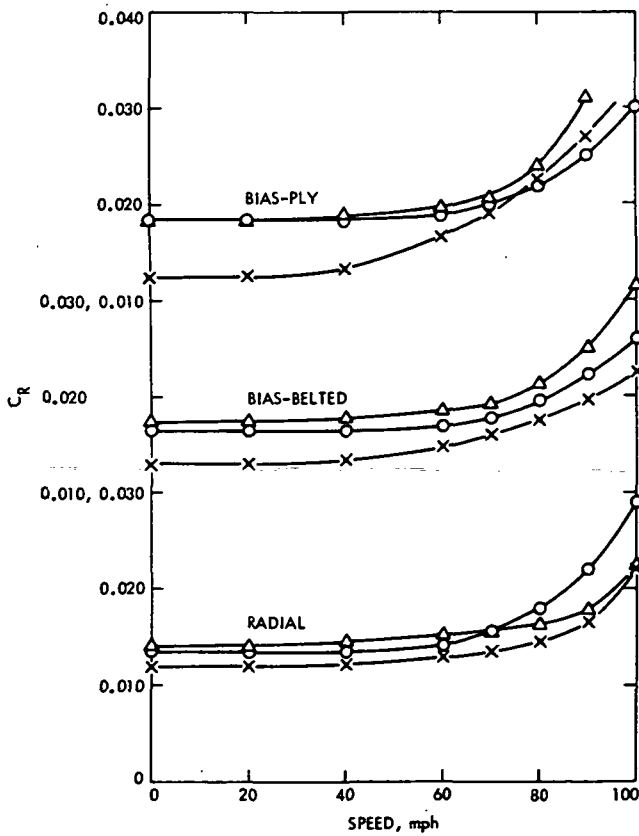

Fig. 10-2. Coefficient of rolling resistance vs speed for three types of automotive tires

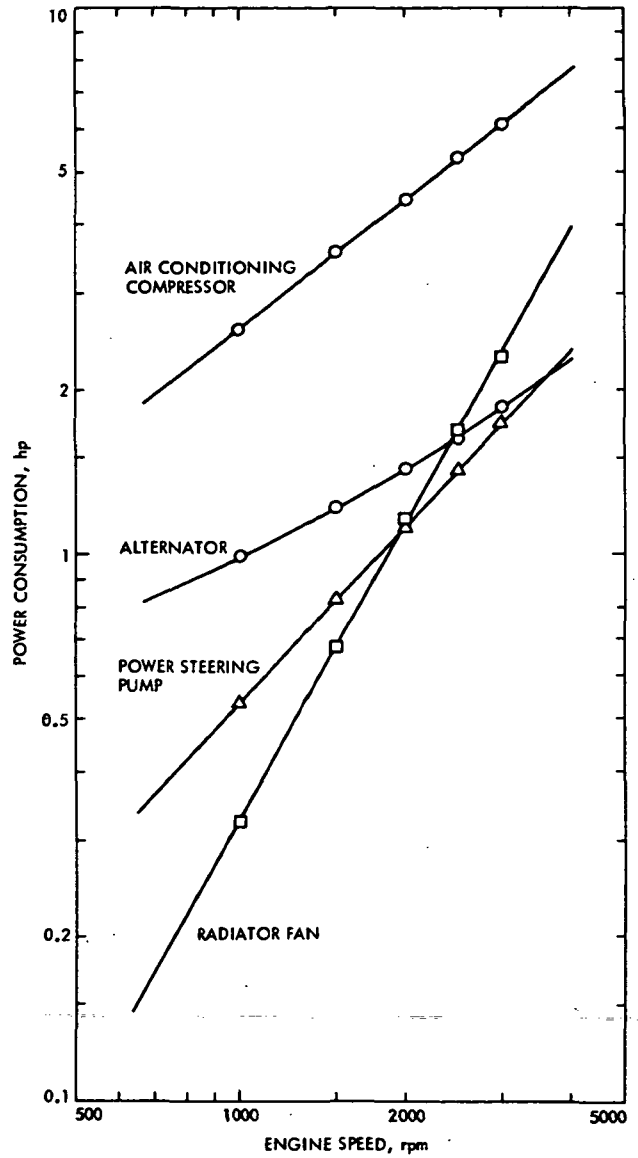

Fig. 10-3. Accessory horsepower

STIRLING ENGINE RUNS, ROAD LOAD		CVS-CH, COMPACT CAR,		ROAD LOAD LUXURY CAR					
E N G I N E M A P									
BOUNDARY									
SPEED (PCT)	MAX POWER (PCT)	REF. ENG. SPD. (PCT)	1.0	2.0	5.0	10.0	20.0	50.0	100.0
SPECIFIC FUEL CONSUMPTION (LB/BHP-HR (COMB.) OR PCT. EFFIC. (ELECT.))						REF. MP. (PCT)			
.0	.0	13.3	2.070	1.370	.705	.510	.480	.517	.582
5.0	.0	20.0	2.380	1.430	.705	.510	.445	.454	.493
14.0	20.0	30.0	2.810	1.580	.770	.540	.430	.423	.445
35.0	50.0	40.0	3.420	1.870	.915	.615	.448	.420	.430
55.0	81.0	50.0	4.280	2.310	1.100	.700	.500	.432	.436
70.0	94.0	60.0	5.400	2.880	1.330	.815	.570	.462	.458
88.0	100.0	70.0	6.850	3.600	1.640	.970	.665	.508	.486
100.0	100.0	80.0	8.760	4.500	2.020	1.180	.788	.570	.523
.0	.0	90.0	11.300	5.720	2.530	1.460	.950	.650	.570
.0	.0	100.0	13.600	7.150	3.190	1.868	1.196	.760	.630

EMISSION INDICES (E-3)		TRIP SEGMENT		INPUT FLAGS AND CODES					
PCT. MP.	UHC	CO	NOX	END PTS (SEC)	TRANS. TYPE	ENGINE TYPE	DRIVING CYCLE	OUTPUT FORMAT	LOAD
1.0	.054	.720	.113	0.	3	3SP/A	4	3	STIML
10.0	.035	.835	.113	0.	4	3	3	3	FDC-CH
30.0	.018	.880	.159	0.	0	0	0	0	0
50.0	.014	.760	.260	0.	0	0	0	0	0
60.0	.014	.670	.350	0.	0	0	0	0	0
65.0	.014	.620	.410	0.	0	0	0	0	0
70.0	.014	.660	1.000	0.	0	0	0	0	0
75.0	.014	.640	1.820	0.	0	0	0	0	0
80.0	.014	.540	1.760	0.	0	0	0	0	0
90.0	.014	.330	1.600	0.	0	0	0	0	0
100.0	.014	.167	1.450	0.	0	0	0	0	0

Fig. 10-4. VEEP engine input data

STIRLING ENGINE RUNS,		CVS-CH,	ROAD LOAD
SMALL CAR,		COMPACT CAR,	LUXURY CAR
INPUT PARAMETERS			
AMBIENT TEMPERATURE	=	70.0	DEG F
FUEL DENSITY	=	6.13	LBM/GAL
FUEL LOWER HTG. VALUE	=	18900.	B/LBM
'ENGINE' EFFECTIVE PARAMETERS			
THERMAL CAPACITY	=	20.00	B/DEG
AV. IDLE EQUIL. TEMP.	=	220.	DEG F
IDLE THERM. TIME CON.	=	3.00	MIN
MOMENT OF INERTIA	=	390.00	LBM-IN**2
DESIGN HORSEPOWER	=	59.	HP
IDLE SPEED	=	600.	RPM
IDLE FUEL FLOW	=	1.59	LBM/HR OR KW (ELEC. CAR)
ENGINE MAXIMUM RPM	=	4500.	RPM
FUEL CONS. MOD. FACTOR	=	.930	
HYDROCARBON MOD. FACTOR	=	1.000	
CARB. MONOXIDE MOD. FACT.	=	1.000	
OXIDES NITROG. MOD. FACT.	=	1.000	
TRANS. INP. RED. RATIO	=	1.00	
REAR AXLE RATIO	=	3.00	
TRANSMISSION GEAR RATIOS			
1ST, 2ND, 3RD, 4TH	=	2.460, 1.46, 1.00, .00	
EFF. ROLLING RADIUS	=	11.30	IN
COEFFICIENTS IN ROLLING RESISTANCE EQUATIONS			
K0	=	1.240-02	
K1	=	1.679-06	MPH(E-1)
K2	=	-6.431-08	MPH(E-2)
K3	=	0.676-10	MPH(E-3)
K4	=	0.000	MPH(E-4)
KPRE	=	2.574-05	
KEX	=	6.070-02	MPH(E-1)
WEIGHT ON DRIVE WHEELS	=	50.0	PCT
COEFFICIENT OF ADHESION	=	.85	
WHEEL MOMENT OF INERTIA	=	2300.00	LBM-IN**2
VEHICLE CURB WEIGHT	=	2152.	LBF
VEHICLE DRAG COEFFICIENT	=	.50	
VEHICLE FRONTAL AREA	=	18.80	FT**2
REAR END EFFICIENCY	=	96.00	PCT
STARTUP NONCALCULABLE PARAMETERS			
FUEL	=	.00	GAL OR KW-HR (ELEC. CAR)
EMISSIONS			
UHC	=	.00	GM
CO	=	.00	GM
NOX	=	.00	GM
ACCESSORY FLAGS , 1. FOR YES , 0. FOR NO			
POWER STEERING/BRAKES	=	.0	
AIR CONDITIONER	=	.0	
FAN	=	.0	
ELECTRIC HEATER	=	.0	
METRIC UNIT OUTPUT FLAG	=	.0	

Fig. 10-5. VEEP vehicle input data

STIRLING ENGINE RUNS, CYS-CH, ROAD LOAD															
SHALL CAR,			COMPACT CAR,			CYS-CH,			LUXURY CAR			ROAD LOAD			
VMAX = 87.1															
SEG. NO.	PCT. SLOW (PCT)	DIST. TRAV. (MI)	ELAPSED TIME (SEC)	FUEL ECON. (MPG)	FUEL UHC (G/MI)	TOTAL EMISSIONS UHC (G/MI)	CO (G/MI)	NOX (G/MI)	FUEL (GAL)	UHC (G)	CO (G)	NOX (G)	WARM-UP CONTRIBUTIONS CO (G)	NOX (G)	BRAKE ENERGY (HP-MR)
1	.00	3.59	505.0	26.54	.00	.08	.08	.02	.03	.00	.00	.01	.06	.01	1.24
2	.00	3.86	867.0	35.94	.00	.06	.06	.01	.00	.00	.00	.00	.00	.00	1.16
3	.00	3.59	505.0	35.93	.00	.06	.06	.02	.00	.00	.00	.00	.00	.00	1.24
CYC-WTD.	.00	7.45	1372.0	34.10	.00	.07	.07	.01	.03	.00	.00	.01	.06	.01	2.39

AVERAGE VALUES OF PARAMETERS - - -															
SEG. NO.	VBAR (MI/HR)	VRMC (MI/HR)	TIME EFFECT. IN. WT. (LBF)	TRANS. EFFIC. (PCT)	BRAKE POWER (HP)	ACCES. POWER (MP)	UHC (E-03)	CO (E-03)	NOX (E-03)	EMISSION INDICES UHC (E-03)	CO (E-03)	NOX (E-03)	INERT. RESIST. (PCT)	ROLLING RESIST. (PCT)	AERO. RESIST. (PCT)
1	25.60	34.90	2498.	83.51	8.81	.57	.03	.82	.18	.82	.82	.18	44.21	21.33	28.01
2	16.02	20.92	2500.	77.96	4.81	.48	.03	.82	.13	.82	.82	.13	55.42	23.86	10.55
3	25.60	34.90	2498.	83.51	8.81	.57	.03	.82	.19	.82	.82	.19	44.21	21.33	28.01
CYC-WTD.	19.55	27.78	2499.	80.87	6.28	.51	.03	.82	.16	.82	.82	.16	49.64	22.55	19.56

MAXIMUM VELOCITY ATTAINED = 56.7 MPH

Fig. 10-6. VEEP output format



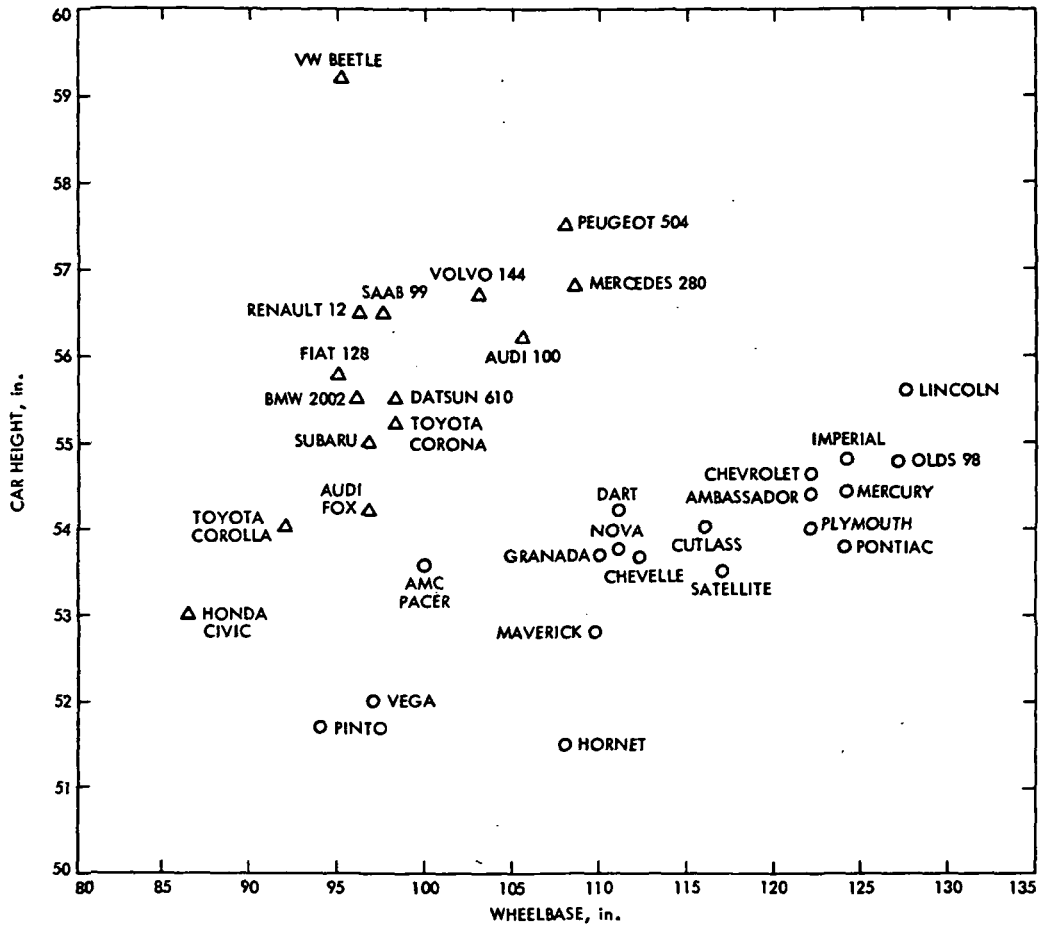

Fig. 10-7. Wheelbase vs height: popular domestic and imported sedans

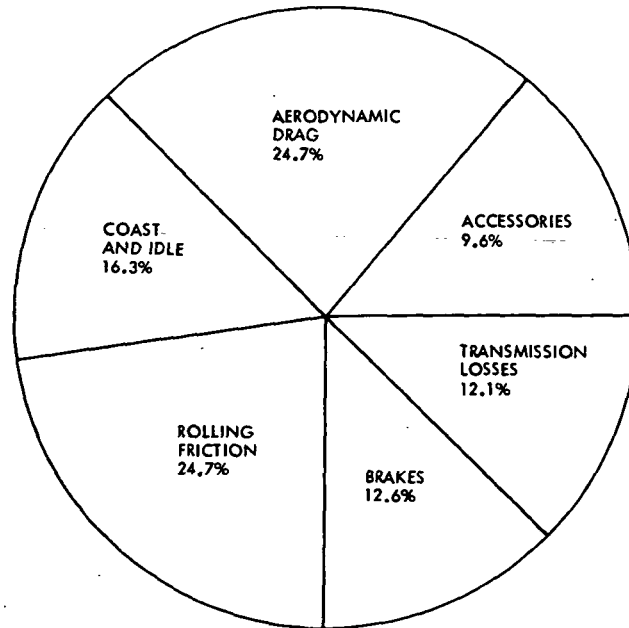

Fig. 10-8. Typical automobile energy requirements for EPA composite driving cycle

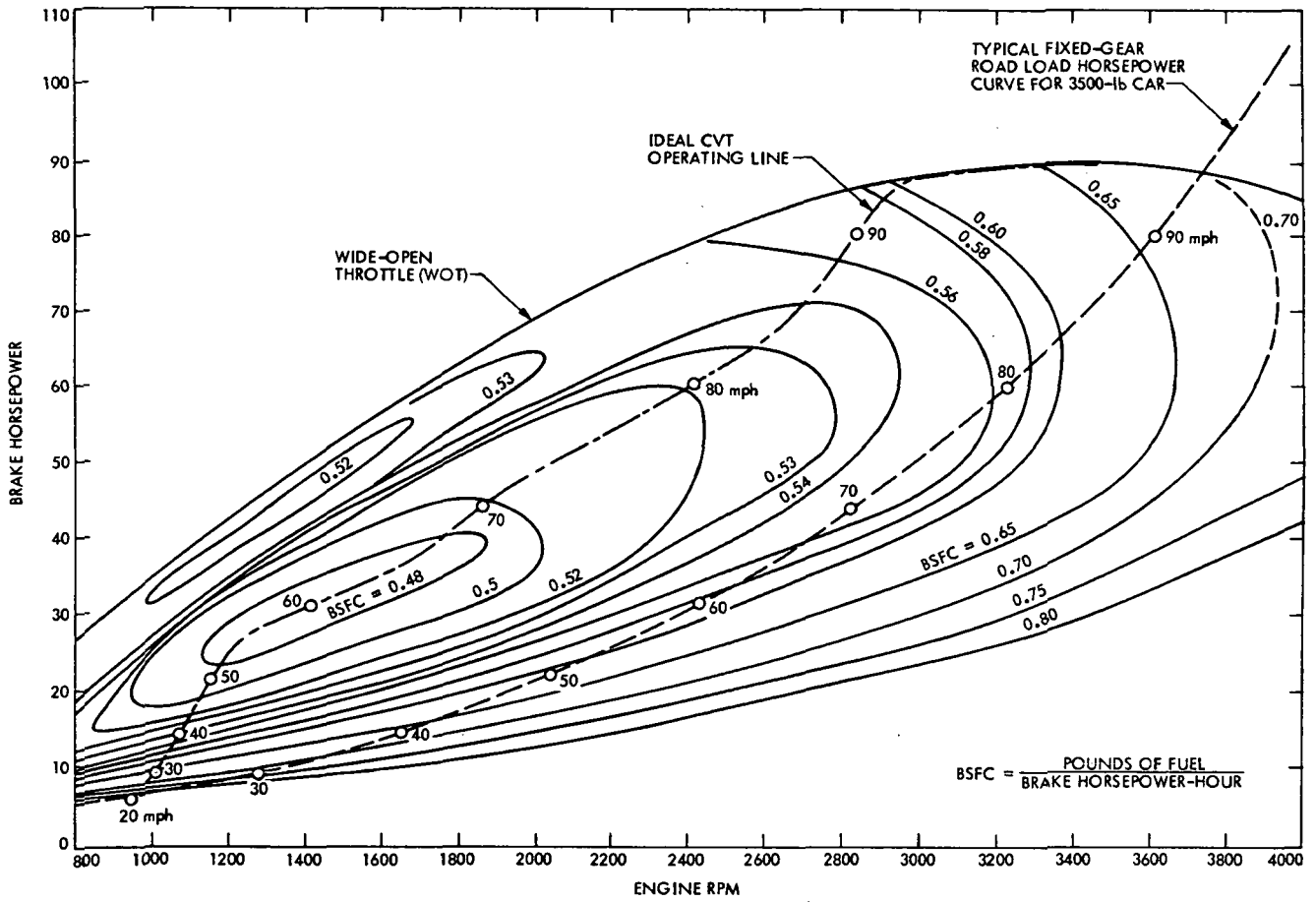

Fig. 10-9. Typical fuel consumption map for Otto-cycle engine

CHAPTER 11. MANUFACTURABILITY  
AND COSTS

11.1	Introduction .....	11-2
11.2	Methodology .....	11-2
11.3	Cost Structure .....	11-3
11.4	Costs .....	11-4
11.4.1	Variable Costs .....	11-4
11.4.2	Resource Costs .....	11-5
11.4.3	Return on Investment .....	11-7
11.4.4	Unit Costs .....	11-8
11.5	Discussion of Results .....	11-11
11.5.1	Unit Costs .....	11-11
11.5.2	Resource Costs .....	11-12
11.5.3	Cost Findings Summary .....	11-13
References	.....	11-13
Figures	.....	11-14

## 11.1 INTRODUCTION

To the automotive industry, feasibility of production of alternate automobile powerplants rests on the demonstration<sup>1</sup> of two essential characteristics: (1) technological superiority in the performance measures (power-to-weight ratio, brake-specific fuel consumption, packaging efficiency, potential for meeting future emission standards) and (2) manufacturing superiority in terms of simplicity of automation, low labor content, low-cost materials and low total cost. An engine which exhibits these superior manufacturing characteristics is said to be manufacturable. Other chapters of this report are directed to the technological evaluation of alternate engine performance parameters; this chapter is dedicated to alternate engine manufacturability and a measure of the manufacturability — the cost. Key to manufacturing superiority is the feasibility of mass production. Quoting from Ref. 11-1:

The fundamentals of mass production have been defined as precision, standardization, interchangeability, synchronization, and continuity — . . . To achieve low cost at the end of the process, a heavy investment in plant, machinery, and tools must be made at the beginning. The technique cannot be economically employed under any and all conditions; the investment is justified only if a mass market exists. In other words, mass production and mass consumption are completely interdependent; . . .

Mass production thus provides the economic feasibility of a product through the substitution of machinery investment costs for direct labor costs. Mass production also presupposes the existence of a synchronized, continuous process to economically produce the alternate engines. It is important that the investment in automation required for mass production not be so large as to raise the price of the product higher than essentially equivalent products. One of the potential problems in the use of high technology materials and designs is that both the unit variable cost (direct labor and materials) and the production facility and machine tool costs may be higher than the comparable costs for present-day technology. If this is the case, then either a higher selling price or lower profit must result.

Since we are concerned with feasibility of alternative engines in a future market environment, key in the decision to pursue the development of a particular alternate engine implementation are the projected cost elements of the engine in a mass production environment.

This chapter presents estimates of the selling price of various engines which are built up from unit variable costs, production facility and tooling costs and industry overheads.

## 11.2 METHODOLOGY

The preparation of unit variable costs is based on evaluation of an engine configuration with reasonable design characteristics. Each of the engines costed is the Mature version detailed in the relevant engine chapter. The bases for the designs are outlined in those chapters and are not repeated here. A key assumption is that the R&D program has been successfully completed and a production prototype engine is in hand.

Each engine was broken down into major subassemblies. The material and labor content of each subassembly was estimated by utilizing a "similar to" methodology. Where there are assemblies that are functionally similar from engine to engine, the unit cost was left unchanged. This ensures comparability of the alternate engine costs. In order to obtain comparability of the alternate engine costs to the Otto engine and its variants, the methodology was applied to them. Thus, although the UC Otto 3-way catalyst engine costs may not reflect precisely the costs as will be experienced by the automobile industry, the increments in costs are accurate.

In cost estimating the non-Otto or non-diesel engine subassemblies, material weights are derived from prototype designs reduced (or increased) to reflect estimates of production engineering changes. The labor content (machining and assembly) is derived from the labor content of similar pieces in mass production. Where there are no readily available parallels in the automobile industry, other industries' experience has been searched<sup>2</sup>; and where no other experience is available in mass production, internal estimates have been made. Over 90% of the cost of subassemblies of the Otto engine and its variants was obtained from the first category — the pieces presently in mass production. Although there are no Stirling, Rankine or Brayton engines in mass production, analogous subassemblies have been found for the majority of components in these engines. Relatively high cost subassemblies that did not have available examples include the Stirling heater head, rod seal assembly and power control system; the Rankine power control system; and the Brayton power control system. Material costs are based on November 1974 data where appropriate, and where materials not yet produced in large quantities are used, estimates of the material cost are made. Table 11-1 lists the costs used.

The facility, labor and automation (i. e., resource) costs have been derived for the free turbine Brayton through the detailed examination of the processes, machining times, tool wearout rates and quantity required on a piece-by-piece basis. The other alternate engines were then related to the resource costs for the Brayton free turbine and the present-day Otto engine. Factors such as new foundry requirements, new materials,

<sup>1</sup> A demonstration would require that an engine has been carried through the R&D phases into prototype production. See Chapter 12 for further details.

<sup>2</sup> The aircraft industry experience with the gas turbine and turbochargers are examples (see Ref. 11-2).

Table 11-1. Material cost<sup>a</sup> by code structure, 1974 dollars

Material type	Cost range, \$/lb
A. Cast iron	0.20 - 0.25
B. Carbon steel	0.25 - 0.30
C. Alloy steel	0.40 - 0.50
D. Austenitic stainless steel	0.65 - 0.75
E. Ferritic stainless steel	0.55 - 0.65
F. Precipitation hardening steel	0.60 - 0.70
G. Superalloy <sup>b</sup>	2.50 - 3.70
H. Ceramic <sup>b</sup>	0.75 - 1.25
I. Aluminum alloy	0.50 - 0.55
J. Copper alloy	0.65 - 0.75

<sup>a</sup>Obtained from issues of American Metal Market/Metalworking News, October and November 1974. No price premium for special shapes.

<sup>b</sup>Cost estimates for material type in mass production quantities.

and increased machining time were estimated to relate the costs. The free turbine Brayton engine was taken as an upper bound in terms of resource requirements because it is the most unusual engine in terms of new materials, increased machining time and new assembly techniques. Overhead, both at the engine plant and the corporate levels, has been derived from the industry experience for the Otto engine.

Where point design data were not available, notably for the alternate continuous combustion designs, engine costs were scaled with horsepower using the following rules. Weight was scaled linearly with horsepower, thus material costs scale directly with horsepower. Labor costs vary with three factors: foundry labor, assumed to vary directly with weight of materials; assembly labor, a function of the number of pieces and held constant due to the assumption of design invariance with horsepower; and machining labor, a function of the number of pieces, a constant, and the surface area of the pieces which varies approximately as the two-thirds power<sup>3</sup> of the horsepower. The point design data for the Otto engine and its variants, the 3-valve and direct-injected stratified charge, and the diesel were obtained from that data base in Ref. 11-7.

Resource costs also were scaled with engine horsepower. The machine tool and facility costs vary with the surface to be machined, hence vary

with the square root of the horsepower as noted above. The foundry and forge costs vary directly with the weight of material produced, thus directly with horsepower, and the tooling setup and vendor tooling vary the same as the machine tools.

### 11.3 COST STRUCTURE

Figure 11-1 shows the cost structure as presented in Ref. 11-3. For the purposes of this study, there are three points on this figure which are of interest. They are the variable costs, which are at the box labelled ①, the manufacturing costs (sometimes called OEM or factory transfer price) at the box labelled ②, and the selling price, or customer's cost, which is at the box labelled ③.

The unit variable costs are just those costs which are fixed, independent of the volume produced. Variable cost is made up of labor and material component costs. For a typical engine, the bill of materials includes raw castings such as block, heads, crankshaft, camshaft as well as rocker arms, valves, springs, alternators, starters and carburetors. One important component of variable cost are those parts which are delivered to the engine assembly plant already assembled. The costs of these parts are also listed under material costs. For the purposes of this cost comparison, all emissions-related equipment is charged to the engine, even though it might be located elsewhere. These costs are presented for ready-to-run engines only, and do not include any special power transmission equipment.

Unit manufacturing costs are derived by adding to the variable costs, direct costs (including material and labor overhead), special tooling costs and factory profit amortized over the year's production of units. Based on industry data, for a well-balanced factory running at its optimum economic quantity, manufacturing costs are between 1.6 and 1.8 times the variable costs. It is most important to note that this ratio is volume-sensitive since the total variable costs change directly with volume but the total overhead costs do not. For a plant running below optimum quantity, the total variable costs drop, but the total fixed costs do not, thus causing the ratio to rise.

The unit consumer cost or sticker price is obtained from the unit manufacturing costs by adding corporate overheads and profit distribution, return on investment in tooling and facilities, dealer profit, emissions inspection costs and taxes amortized over the year's unit production. Studies (see Refs. 11-3, 11-7) of the industry have shown that the unit sticker price for Otto engine powered automobiles ranges from 1.7 to 2.4 times the unit manufacturing costs.

In order to allow for the potential variation in material overhead, special tooling and facilities and tooling costs, the ratios for the Otto engine are reduced to proportional and fixed

<sup>3</sup>For the stress-limited Brayton engine, the surface area was taken to vary linearly with the horsepower.

costs. Those costs which are a function of tooling, facilities and investment costs are allowed to vary. Those costs which are probably fixed for all engines are kept at the values derived for the Otto engine. R&D costs are assumed to be equivalent for all alternative engines, and the same level as presently being expended.<sup>4</sup> A specific example is shown in Section 11.4.4 describing the method of derivation of selling price from variable cost, corporate overheads, and return on investment.

#### 11.4 COSTS

##### 11.4.1 Variable Costs

Alternate engine costs are built up from variable cost through manufacturing cost to selling price. The first cost that is estimated is the unit variable cost. It is derived in this study using two different methods. In the first method, each engine is broken down into major subassemblies. Each subassembly is costed as a unit, in terms of its material and labor content, including the amount of labor required to assemble it to the engine. An error bound is placed on each subassembly cost. The total engine variable cost is obtained by summing the individual subassemblies, and the total engine error bound is obtained by root-sum-squaring the individual error bounds. Where there are similar subassemblies, in terms of size, materials, and machining, the cost is kept the same for all engines. Error bounds are assumed to be smaller in the case of subassemblies that are fairly standard in terms of materials or process, and larger in the case of more exotic materials or designs such as a superalloy heater head or an electronic control system. The results of the first method are shown in Tables 11-2 through 11-9. In each case, two or more engine sizes are costed to allow cost curve-fit approximation of other than the point designs. These off-design-point costs are used in the life-cycle costing developed in Chapter 20. Figure 11-2 shows the variation of each engine variable cost with horsepower.

A second method of costing is summarized for five engines in Table 11-10. The first step entails separating out major materials categories and calculating the total material cost. Weights by material type are taken from the respective engine chapters (3-7). Material type costs are as shown in Table 11-1. Miscellaneous purchased parts which appear as assemblies delivered to the engine plant (such as carburetors, electronic fuel control devices, in-manifold catalysts) are costed separately and added to the material costs. Any emissions-related hardware which is not attached to the engine is also included in this category. Variable labor, which includes foundry labor, machining labor, and assembly labor is then added at a cost of \$7.50 per hour. The total cost thus derived is comparable to the variable costs derived from the major subassembly breakdowns. These costs agree well with the costs in Tables 11-2 through 11-9. The engines costed in Table 11-10 are equivalent performance alternates;

Table 11-2. Variable costs, 3-way catalyst-controlled Otto engine

	Cost, \$		
	85 hp	150 hp	220 hp
A. Basic engine	90 ±10	160 ±10	230 ±10
B. Ignition system	5	10	10
C. Induction and fuel system	70 ±20	90 ±20	110 ±30
D. Emission control	60 ±20	80 ±25	80 ±25
E. Cooling system	20	30	40
F. Auxiliaries	20	30	30
	265 ±30	400 ±35	500 ±40

Table 11-3. Variable costs, 3-valve stratified charge Otto engine

	Cost, \$		
	85 hp	150 hp	200 hp
A. Basic engine	105 ±20	175 ±20	250 ±30
B. Induction system	65 ±10	85 ±10	100 ±10
C. Ignition system	5	10	10
D. Emission control	40 ±5	65 ±5	80 ±5
E. Auxiliaries (incl. battery)	20	30	30
F. Cooling system	20	30	40
	255 ±25	395 ±25	510 ±35

that is, they are scaled to the horsepower that gives equivalent highway performance for a specific car size. For a discussion of the derivation of equivalent performance horsepower, see Chapter 10.

The labor hours for the 3-way catalyst Otto cycle engine are derived from three sources: Refs. 11-3, 11-5, and industry interviews. Those figures have been increased by approximately 1 direct labor hour per engine to account for the added complexity of the emissions system, its assembly, calibration and in-plant testing.

<sup>4</sup>Chapter 12 presents data that shows the R&D for alternate engines comprising 7 to 8% of total yearly R&D budget compared against 2.5% for the present-day expenditures on alternate engines. This difference is small, and does not affect the cost conclusions significantly.

Table 11-4. Variable costs, diesel (turbo-charged) engine

	Cost, \$		
	85 hp	150 hp	200 hp
A. Basic engine	120 ±30	220 ±40	320 ±40
B. Induction system	85 ±25	155 ±30	200 ±30
C. Start-assist system	2	4	4
D. Emission control	15	20	25
E. Auxiliaries (inc. battery)	35	55	75
F. Cooling system	20	30	40
	275 ±40	495 ±50	665 ±50

Table 11-5. Variable costs, fuel-injected stratified charge Otto engine

	Cost, \$		
	85 hp	150 hp	220 hp
A. Basic engine Block, heads, valve train	95 ±10	165 ±10	235 ±15
B. Induction system Manifold, injection pump injectors, air cleaner, fuel pump and filter	55 ±20	95 ±40	100 ±40
C. Ignition system Electronic distributor, dual coils and plugs	20 ±5	25 ±5	25 ±5
D. Emission control system In-manifold catalyst, PEGR, PCV	40 ±5	65 ±10	80 ±10
E. Auxiliaries	20	30	30
F. Cooling system	20	30	40
	250 ±25	410 ±25	510 ±45

Table 11-6. Variable costs, 150-hp Brayton engine (single-shaft)

	Cost, \$
A. Turbine assembly	110 ±40
B. Combustor assembly	50 ±20
C. Compressor assembly	45 ±20
D. Regenerator assembly	100 ±30
E. Accessory drive	20 ±10
F. Control system	55 ±20
G. Air inlet assembly	15 ±5
H. Reduction drive assembly	30 ±10
I. Auxiliaries	35
Total engine ready-to-run	460 ±55

Single-shaft turbine cost/power scaling

Engine size, hp	50	150	250
Engine cost, \$	290 ±35	460 ±55	625 ±90

The 3-way catalyst shown is for an Otto engine configuration that meets the 0.41/3.1/0.40 emissions level. Also shown is the cost for an oxidizing catalyst Otto cycle engine that meets the 0.41/3.4/2.0 emissions standards.

The labor content of the Brayton free turbine is based on an estimate from Ref. 11-4, scaled down from the 150-hp figures to reflect the decreased casting and machining time for a 107-hp engine. The labor hours in the Stirling are estimated to be equivalent to the gas turbine. The amount of material handled in the Rankine is 40% greater, and the labor time is increased accordingly. Table 11-11 summarizes the labor content for each engine by scaling category.

11.4.2 Resource Costs

Resource costs are defined to be the costs in 1974 dollars of the total production facilities required to produce 400,000 units per year of a given engine type. The resource cost estimates are broken into four categories: (1) direct production equipment, consisting of transfer lines, standard and special machines and material handling equipment; (2) foundry capacity, divided into three subcategories i) cast iron and steel forgings, ii) cast superalloys and stainless steels, and iii) aluminum die-castings; (3) launching costs, consisting of tooling setup costs and vendor tooling; and (4) facility costs - the costs of the buildings that house the production and foundry equipment. Table 11-12 presents the

Table 11-7. Variable costs, 150-hp Brayton engine (free turbine)

	Cost, \$		
A. Power turbine assembly	150 ±50		
B. Glassifier turbine assembly	110 ±40		
C. Combustor assembly	50 ±20		
D. Regenerator assembly	100 ±30		
E. Compressor assembly	45 ±30		
F. Accessory drive	20 ±10		
G. Control system	55 ±20		
H. Air inlet assembly	15 ±5		
I. Reduction drive assembly	30 ±10		
J. Auxiliaries	35		
<b>Total engine ready-to-run</b>	<b>610 ±70</b>		
Free turbine cost/power scaling			
Engine size, hp	50	150	250
Engine cost, \$	320 ±35	610 ±70	900 ±115

costs for the alternate engines broken down into the four categories outlined above.

Detailed data on the resources for the Otto engine was obtained from the data base used to produce the National Academy of Sciences Committee on Motor Vehicle Emissions report. This data was updated to account for the change in the dollar value due to inflation and the emissions equipment added since the construction of the data base. Emissions equipment costs were obtained from Mr. LeRoy Lindgren of Rath & Strong, Inc.

The resource costs for the SC Otto and turbo-charged diesel engines were derived using the UC Otto as a baseline. The costs of transfer lines for the injectors and high-pressure pumps were added, and foundry capacity was increased to reflect the higher weight of the engines and the requirement for forged rather than cast crankshafts.

The mature Brayton free turbine is costed in detail in Ref. 11-4 and forms the data basis for both the free turbine and single-shaft resource costs shown in Table 11-12. The data presented in Ref. 11-4 is based on a 150-hp engine and was scaled according to the rules presented in Section 11.2. The resource costs for the single-shaft Brayton engine were derived by subtracting out the costs of the transfer lines and special and standard machines not used to produce the single-shaft version of the engine. To be strictly cost-equivalent to the other engines, the incremental

Table 11-8. Variable costs, 4-cylinder double acting swashplate Stirling engine

Assembly	Cost, \$	
	170 Bhp	90 Bhp
A. Heater head assembly	215 ±75	120 ±60
B. Cycle regenerator and cooler	15 ±5	13 ±5
C. Piston assembly	50 ±15	30 ±10
D. Rod seal assembly	50 ±15	30 ±15
E. Swashplate	10 ±5	6 ±3
F. Main shaft	10 ±5	6 ±3
G. Cylinder block	75 ±10	40 ±5
H. Combustion auxiliaries	30 ±10	15 ±10
I. Preheater assembly	75 ±10	40 ±10
J. Coolant pump and drive	30 ±10	15 ±10
K. Power control system	50 ±25	40 ±25
L. Fuel supply controls	20 ±5	15 ±5
M. Accessory drive system	30 ±10	15 ±10
N. Engine auxiliaries	35	20
O. Radiator assembly	45 ±5	30 ±5
<b>Engine ready-to-run</b>	<b>710 ±85</b>	<b>435 ±70</b>

resources required to produce a continuously variable transmission over a standard three-speed automatic should be added to the cost of single-shaft turbine resources. Since this was not done, the implicit assumption is that the additional resources required are negligible.

The tooling costs to produce the Mature configuration of the Brayton free turbine — essentially an all-metal engine with the exception of an LAS or MAS ceramic regenerator — are over 3 times higher than the tooling required to produce the same volume vehicle performance equivalent Otto engines. The primary reason for this is seen in Table 11-13, which gives the machining rates for cast iron, carbon steels, stainless steels and superalloys. This table is based on data abstracted from Ref. 11-6. In order to obtain the cutting speeds indicated for superalloys, carbide tools must be used, whereas for the other metals, standard high-speed steel tools are used. In order to maintain the 400,000 unit per year throughput, several side-by-side lines are required. For example, it is estimated that



Table 11-9. Variable costs, 150-hp unflow positive displacement expander Rankine

Assembly	Cost, \$
A. Vapor generator	170 ±45
B. Expander assembly	220 ±40
C. Condenser assembly	75 ±15
D. Fuel control system	20 ±5
E. Power control system	50 ±25
F. Water feed subsystem	105 ±35
G. Auxiliary drives	30 ±10
H. Engine auxiliaries	35
Subtotal engine ready-to-run	705 ±75

Rankine cost vs horsepower scaling	
Engine size, hp	Engine cost, \$
50	335 ±40
150	705 ±75
250	1130 ±120

the transfer line for the 713LC superalloy turbine wheel requires \$25 million worth of tooling.

There are two superalloy wheels in the free turbine, the power turbine and the gasifier turbine, and between them they constitute over 20% of the tooling cost of the Brayton free turbine. Typical operations in these transfer lines include precision-boring the wheel for concentricity, shrink-fit on shaft, machining shaft for concentricity, machining key ways, finish grind and balancing. For the purposes of setting required machining tolerances, it was assumed that there would be total interchangeability of parts; any wheel can go with any bearing, stator housing or plenum. This means that there is no requirement for fitting or selective assembly. It is quite possible that machining costs can be reduced by relaxing the tolerances and allowing for graded fitting as is done with pistons and bores in present-day Otto engine assembly.

Foundry costs for the Brayton free turbine were derived from Ref. 11-4 using the material weight scaling shown in Section 11.2. The superalloy and stainless steel investment casting facility and equipment costs are based on data obtained on a Russian plant designed for totally automated precision-casting turbine wheels.<sup>5</sup> The superalloys content of the single-shaft

turbine is one-third that of the free turbine engine, hence the foundry costs are scaled to one-third. The cast iron content of both the free turbine and the single-shaft Brayton is slightly less than one-third that of the UC Otto engine; hence the costs are reduced proportionately.

Derivation of the Stirling and Rankine tooling costs entailed choosing transfer line costs from either the Otto cycle (example: in the case of the Stirling mainshaft and swashplate or the Rankine crankshaft and rod assemblies, the Otto engine crankshaft and rod transfer line costs were used) or the Brayton transfer line costs (example: the Stirling preheater housing and the Rankine vapor generator housing transfer line costs were derived from the Brayton free turbine regenerator housing transfer line costs). In this manner, 21 transfer lines were identified for the Rankine engine, 22 for the Brayton free turbine, and 18 for the Stirling engine. There are nine transfer lines at the equivalent component level for the UC Otto engine.

Foundry costs for aluminum die-casting the Stirling cylinder block and the Rankine crankcase are identified as well as superalloy and stainless steel foundry requirements comparable in cost to the Brayton free turbine.

The major vendor tooling requirements for the two Brayton engines and the Stirling are for the ceramic regenerator/preheater. This cost is estimated to be on the order of \$20 million. Vendor tooling to produce adequate supplies of stainless steel tubing for the vapor generator is included in the Rankine costs.

Facility costs are related to the amount of machinery required to be housed and the size of the material handled. Facility requirements are high for the Brayton due to the amount of machinery, although the bulk of material handled is quite small. Facility costs for the Rankine are high due both to the large number of assemblies required and the large size of the assemblies. Facility cost variations as a function of engine horsepower for the engines considered are shown in Fig. 11-3.

The rows of Table 11-11 labeled "direct production equipment" and "foundry and forge capacity" are summed and entered in the column labeled "foundry and tooling" in Table 11-14. The rows of Table 11-12 headed "facility costs" and "launching" are summed and entered into the column headed "launching and facilities" in Table 11-13. This is done to permit different life horizons for return-on-investment calculations.

#### 11.4.3 Return on Investment

Since the resource costs for the alternate engines differ in magnitude, some method of accounting for this difference in the selling price is required. It is assumed for simplicity that the capital investment is borne fully out of retained earnings. This assumption makes little difference in the selling price. The standard present

<sup>5</sup>Private communication with LeRoy Lindgren.

Table 11-10. Variable costs of equivalent-performance alternate engines

Material type	Stirling (119 hp)		Rankine (141 hp)		Brayton free turbine (107 hp)		3-way catalyst (0.41/3.4/0.4) Otto cycle (150 hp)		Oxidizing catalyst 0.41/3.4/2.0 Otto cycle (150 hp)	
	Weight, lb	Cost, \$	Weight, lb	Cost, \$	Weight, lb	Cost, \$	Weight, lb	Cost, \$	Weight, lb	Cost, \$
Cast iron	53	13	102	25	127	32	250	50	250	50
Carbon steel	104	31	76	21	—	—	250	75	250	75
Alloy steel	8	4	16	8	9	5	5	3	5	3
Austenitic stainless	58	43	160	120	15	11	—	—	—	—
Ferritic stainless	—	—	—	—	2	1	—	—	—	—
Precipitation hardening stainless	—	—	—	—	5	3	—	—	—	—
Superalloy	7	26	10	37	11	41	—	—	—	—
Ceramic	15	15	—	—	14	14	—	—	—	—
Aluminum alloy	126	70	96	53	1	1	20	11	20	11
Copper alloy	—	—	—	—	—	—	20	15	20	15
Miscellaneous <sup>a</sup>	183	247	249	307	109	300	120	143	125	102
Variable material <sup>b</sup>	554	449	709	571	293	408	695	319	700	278
Variable <sup>c</sup> labor (hrs)	10	75	13	98	10	75	10	75	9	68
Total variable cost		524		669		483		394		346

<sup>a</sup>Not broken down (conventional auto materials), non-homogeneous or miscellaneous and purchased parts. Includes power and fuel control, auxiliaries and emissions control, where applicable.

<sup>b</sup>No material or labor overhead.

<sup>c</sup>Includes foundry labor.

value formula for return C on an investment I at a rate R over an horizon t is given by

$$C = I \frac{R}{1 - (1 + R)^{-t}}$$

where C corresponds to the amount of yearly capital that must be generated over the life of the investment I to return both the capital and a yearly return R. It is assumed that the horizon for the tooling and foundry equipment is 10 years, and the facility costs have a 20-year horizon. The rate of return is taken to be 15%. No investment credit is taken on taxes. Table 11-14 shows the results of this calculation for each of the alternate engines under consideration.

#### 11.4.4 Unit Costs

Since details of the cost structure of the automotive industry are not readily available to the level shown in Fig. 11-1, some simplifying assumptions have been made to derive the net selling price from the variable cost. Figure 11-4 shows the simplified cost structure. The information that is available is the approximate plant and corporate overhead factors for the present-day Otto engine. As presented in Section 11-3, these factors are approximately 1.7 and 2.0 respectively at the design production rate.

Based on the Otto engine variable cost of \$394, we can calculate a manufacturing cost of (1.7) x (394) or \$660. This manufacturing cost is composed of two factors, one assumed to be

Table 11-11. Per unit direct labor hours by category

Engine type <sup>a</sup>	Foundry	Machining	Assembly and Test	Total
UC Otto, oxidizing catalyst	6	2	1	9
UC Otto, 3-way catalyst	6	2	2	10
SC Otto, 3-valve	6	2	1	9
Diesel	7	2	2	11
Brayton single shaft	2	4	1	7
Brayton free turbine	3	5	2	10
Stirling	6	1	3	10
Rankine	6	3	4	13

<sup>a</sup>Otto engine equivalent size.

Table 11-12. Alternate engine facility costs<sup>a</sup> (1974 \$ millions)

Cost category	Engine type						
	UC Otto	Diesel (turbocharged)	Stratified charge (direct injected)	Brayton (single-shaft)	Brayton (free turbine)	Stirling	Rankine
Direct production machinery	70	90	90	155	205	135	135
Facility costs	70	75	75	65	80	80	110
Foundry and forge capacity							
Cast iron and steel forgings	50	60	55	15	15	10	15
Superalloys and stainless steel	0 <sup>b</sup>	0	0 <sup>b</sup>	15	40	40	35
Aluminum	5	Small	5	Small	Small	60	10
Launching costs, tooling setup and vendor tooling	50	50	50	50	50	50	50
Total costs	245	275	275	300	390	375	355
Incremental cost over UC Otto	—	30	30	55	145	130	110

<sup>a</sup>Each facility is sized to produce 400,000 units per year.

<sup>b</sup>Stainless steel in catalyst container not included.

Table 11-13. Machining speeds for various metals

Metal	Cast iron	Carbon steel	Stainless steel	Super-alloys
Speed <sup>b</sup>	1	0.3-0.6	0.4-0.7	0.2-0.4
$\frac{\text{FPM (metal)}}{\text{FPM (cast iron)}}$				
<sup>a</sup> Assumes use of carbide tools.				
<sup>b</sup> Cast iron normalized to unity.				

fixed for all engines and one proportional to the amount of tooling. The second category represents the special tooling as a portion of the material overhead utilized and exhausted within one year's production. If there are twice as many machine tools, it is assumed that there will be twice as much special tooling and proportional material overhead. Special tooling and material overhead costs are on the order of \$60 per engine<sup>6</sup> for the Otto engine. For the purposes of this study, \$30 was adopted as the proportional portion of material overhead.

The first, or fixed, category represents the fixed labor and material overhead used in operating an engine plant: the electric carts, loading machinery, indirect workers such as tool shop men, white collar workers, and materials in support of the plant such as paper, pencils, light

bulbs and the water and light bill. This is assumed to be the same for any type of engine plant. Subtracting the variable cost of \$394 and the special tooling and proportional material overhead cost of \$30, we arrive at a fixed plant overhead cost of \$236 per unit. This cost is represented by the double box labeled "factory fixed costs" in Fig. 11-4 and is the same for all engines.

The Otto engine manufacturing cost is multiplied by a factor of 2 to obtain the selling price. The wholesale price is then derived by dividing by a factor of 1.3. The 30% difference between wholesale and retail prices covers the dealer markup, transportation, excise taxes, and dealer preparation. This markup factor is held constant for all engines and is represented by the double box labeled "1.3 markup factor" in Fig. 11-4.

The next step is to derive the fixed corporate overhead. The difference between the wholesale selling price and manufacturing cost (\$355) is composed of two parts, the "fixed" corporate overhead and the "variable" return on investment. The terms "fixed" and "variable" refer to the dependency of these costs on the engine type. From Table 11-14, we find that the cost increment return on investment for the UC Otto engine is \$115 per engine. The remainder of the \$355, or \$240, is assumed to be the fixed corporate overhead and is independent of engine type. Sufficient information has now been generated to obtain the selling prices of each of the alternate engines from the respective variable costs, tooling costs and return on investment. The results of these calculations are shown for each of the alternatives in Table 11-15.

Table 11-14. Facilities, tooling amortization and investment costs of alternate engines

Engine	Foundry and tooling	Launching and facilities	Total	Tooling investment	Facility investment	Return on investment
	Cost, \$ millions					
Otto cycle	125	120	245	65	50	115
Diesel	150	125	275	75	50	125
Fuel-injected stratified charge	150	125	275	75	50	125
Brayton single-shaft	185	115	300	95	45	140
Brayton free turbine	260	130	390	135	50	185
Stirling	245	130	375	125	55	180
Rankine	195	160	355	100	65	165

<sup>6</sup> Reference 11-5 gives a range of values from 57 to 90 dollars for the material overhead for uncontrolled and the controlled UC Otto.

Table 11-15. Unit cost breakdown for alternate engines.

Engine	Variable cost, \$	Material overhead and special tooling	Factory fixed cost, \$	Manufacturing cost, \$	Corporate overhead, \$	Return on investment, \$	Wholesale price, \$	Selling price, \$
Otto cycle	394	30	236	660	240	115	1015	1320
Diesel	505	40	236	781	240	125	1146	1489
Fuel-injected stratified charge	418	40	236	694	240	125	1059	1377
Brayton single shaft	385	70	236	691	240	140	1071	1392
Brayton free turbine	483	90	236	809	240	185	1234	1604
Stirling	524	60	236	820	240	180	1240	1612
Rankine	669	60	236	965	240	165	1370	1781

## 11.5 DISCUSSION OF RESULTS

### 11.5.1 Unit Costs

A summary of the variable unit costs and their uncertainties and the derived selling prices and their uncertainties is shown in Table 11-16. The selling price uncertainty for the alternates is derived from the variable cost uncertainty by root-sum-squaring the uncertainty of the Otto cycle price estimate with the variable cost uncertainty of each alternate.<sup>7</sup> The Otto cycle uncertainty is derived by multiplying the variable cost uncertainty by the ratio of the selling price to the variable cost.

The columns adjacent to the variable cost column and to the selling price column show the incremental cost in percent over the 3-way catalyst UC Otto engine. The variable costs lie within 70% of the baseline Otto costs, and the selling prices fall within 31% of the baseline Otto engine price. This is a fairly narrow spread, and is attributable primarily to three factors.

The first factor is the increase in the cost of the Otto cycle baseline engine due to the equipment required for meeting the 0.41/3.1/0.4 emissions standards. Prior to the introduction of controls, and after having undergone years of cost reduction, the variable cost of an equivalent performance Otto engine was approximately \$250. The additional systems required to control emissions to the ultimate (0.41/3.4/0.4) levels have increased the variable cost by 60% to a cost of \$400. The selling price of a pre-emissions engine was approximately \$800, while the 3-way catalyst controlled engine is estimated to be over \$500 higher. It must be recalled that this figure

includes all cost increments due to emissions, including vehicle changes.

The second factor which tends to group the variable costs of the engines more closely than might otherwise be the case is the normalization of the engine designs and costs to equivalent performance levels. This factor is of significant benefit to both the Stirling and Brayton engines. If these engines were costed on an equivalent horsepower basis rather than an equivalent vehicle performance basis, their costs would be significantly higher. Interpolating the variable costs from Fig. 11-2, a 150-hp Stirling engine's variable cost would be \$635 or 59% more than the 150-hp Otto engine. This variable cost would result in a selling price of approximately \$1850 or 40% more than the selling price of the 150-hp Otto engine.

The Braytons benefit even more than the Stirling from the equivalent performance scaling. Again obtaining the variable cost from Fig. 11-2, with horsepower, the 150-hp single shaft turbine's variable cost would be \$460, or 17% more than the 150-hp Otto, rather than essentially the same. Carrying this calculation through the increased tooling costs and the various fixed costs results in a selling price of \$1580 or 20% more than the 150-hp Otto engine.

Other engines such as the Diesel and the direct-injected stratified charge Otto are somewhat penalized by the normalization to equivalent performance. Thus, the lower priced engines tend to be pushed up in cost by the performance normalization and, with the exception of the Rankine, the higher cost engines tend to be lowered in cost.

<sup>7</sup> This is done because the method used to derive the "fixed" costs causes the magnitude of these costs to be a function of the variable cost of the Otto engine. An error in the variable cost estimate is reflected in an error in the "fixed" costs used to generate the Otto selling price. Since this error in these costs is independent of the alternate engine variable cost error, the two error sources are root-sum-squared.

Table 11-16. Variable costs and selling price of 150-hp equivalent performance<sup>a</sup> engines

Engine	Variable cost, \$	% OC	Selling price, \$	% OC
UC Otto, oxidizing catalyst, 150 hp	346 ±35	-12	1255 ±120	-5
UC Otto, 3-way catalyst, 150 hp	394 ±35	DNA <sup>b</sup>	1320 ±120	DNA
SC Otto cycle, 3-valve 150 hp	395 ±35	-	1320 ±120	-
Diesel, 156 hp	505 ±50	28	1489 ±130	13
SC Otto, direct injection, 153 hp	418 ±45	6	1377 ±130	4
Brayton single shaft, 103 hp	385 ±70	-2	1392 ±140	5
Brayton free turbine, 107 hp	483 ±70	22	1604 ±140	22
Stirling 119 hp	524 ±75	33	1619 ±140	23
Rankine 141 hp	669 ±75	69	1781 ±140	35

<sup>a</sup>See Chapter 10 for definition of equivalent performance.

<sup>b</sup>DNA: does not apply.

<sup>c</sup>Requires a continuously variable transmission; at no cost increment over 3-speed automatic. (Refs. 11-8, 11-9).

The third factor which tends to group the prices is the methodology employed to derive the fixed costs for the UC Otto engine and the assumption that these costs are the same for all engine types. If, for example, it was assumed that the ratio of manufacturing cost to variable cost was constant and that the ratio of selling price to manufacturing cost was also constant, then the selling prices of the alternate engines would have the same percentage increment over the Otto engine as the variable costs.

The first two effects, the increase in the Otto engine costs to meet emission standards and the relative performance advantage enjoyed by the Stirling and Brayton over the Otto engine in equivalent performance vehicles, are the largest factors in closing the cost gap between the engines.

In conclusion, the unit manufacturing cost increments of some of the alternate engines are found to be only moderately higher than the all-up emission-controlled Otto engine. However, in the case of the Stirling, Brayton and Rankine, significantly higher investment costs in the foundry and machine tools are anticipated. Stainless steels and superalloys increase the selling price of the engines through two avenues: first by the increase in variable costs due to increased material costs, and second by the increased cost required for return on investment due to higher machine tool and foundry costs.

Of particular interest and promise from a production cost point of view is the Brayton cycle in its two implementations, the single shaft and the free turbine. The single shaft turbine engine can be sold for approximately the same price as an equivalent performance Diesel engine. It must be mentioned that the single shaft turbine requires a continuously variable transmission (CVT) in order to achieve adequate performance.<sup>8</sup> The single shaft, free turbine and Stirling engine all group at between 10 and 25% more costly than the equivalent performance Otto cycle engine. Since the engine cost is between one-fourth and one-third the cost of the automobile, the increased sale price due to the increased engine cost would range between 6 and 8%. Whether the increased price of an alternate engine is warranted by its other features is the subject of Chapter 20.

#### 11.5.2 Resource Costs

In the introduction, we saw a quote saying that mass production requires a large initial investment in machinery and facilities to realize cost reductions due to the economies of large-scale production. How do we know when we have a product that is manufacturable? To answer that question, we resort to what has proved to be manufacturable in the past, the UC Otto engine.

One measure of a product that requires a large investment to produce is the capital/output ratio: the incremental capital investment required for direct production machinery per incremental dollar of sales. This ratio is one measure of the risk of a particular venture. The higher the ratio, the more capital intensive the venture is, and the more unrecoverable losses there would be if no mass market were to exist.

The alternate engines are seen to exhibit both higher selling price and higher capital/output ratios. The sales price of the Brayton single-shaft turbine is near enough to that of the Otto engine to encourage search for alternate designs

<sup>8</sup>All engines considered can benefit by the addition of a CVT. However, the Brayton single shaft requires it.

which require less capital investment. Such designs are under research now by the industry, both in the single shaft and free turbine versions of the Brayton engine.

By the capital/output ratio measure, the alternate engines exhibit poorer manufacturability than the familiar UC Otto. However, no allowance has been made for any learning curve in the alternates. One must remember that the Otto engine has had many years of process improvement that have resulted in the low price and capital/output ratio.

Reference 11-5 gives a range of 0.12 to 0.15 for this ratio for existing industry engine plants. Taking the sales price of \$1320, the rate of 400,000 engines per year, and the tooling investment of  $\$70 \times 10^6$  for the UC Otto engine, we arrive at a capital/output ratio of 0.13, in good agreement with the historical data. The capital/output ratio is shown for the other alternate engines in Table 11-17.

It is clear from this table that the alternates which employ stainless steels and superalloys, i. e., the Braytons, the Stirling and the Rankine, are more capital-intensive than the Otto engine-like alternates: the diesel and the SC Otto.

### 11.5.3 Cost Findings Summary

This section states in concise form the findings of the cost chapter.

- (1) The 3-way catalyst UC Otto engine controlled to 0.41/3.4/0.4 emissions levels is over 60% more costly to manufacture than the pre-emissions Otto engine.
- (2) The alternate powerplants costs lie within 35% of the all-up emissions-controlled UC Otto engine for equivalent performance vehicles.
- (3) The capital/output ratios for the production of the Rankine, Stirling and Brayton engines are from 50 to 150% higher than

Table 11-17. Capital/output ratios for alternate engines

Engine	Sales price, \$	Direct production machinery, \$ millions	Capital/output ratio
UC Otto	1320	70	0.13
SC Otto	1377	90	0.16
Diesel	1489	90	0.15
Brayton single shaft	1392	155	0.28
Brayton free turbine	1604	205	0.32
Stirling	1619	135	0.21
Rankine	1781	135	0.19

the Otto engine. This indicates that these engines are significantly more capital-intensive than the UC Otto engine.

- (4) Equivalent performance vehicles scaling due to the unique specific power and torque-speed characteristics of the Stirling and the Brayton engines allows an installed power reduction and hence an equivalent reduction in engine cost.
- (5) Direct production machinery costs for the Stirling, Rankine and Brayton engines are two to three times higher than for the Otto engine due to the stainless steel and superalloy content of these engines. Stainless steels and superalloys increase both the variable cost (through the increased material costs) and the selling price (through increased tooling and foundry investment). The requirements for these alloys is the major cost discriminator between these three alternates and the Otto engine and its variants.
- (6) A vehicle with a Brayton or Stirling engine will cost about 10% more than a vehicle of equivalent performance with an Otto engine.

### References

- 11-1. Technology in Western Civilization, Vol. II, Edited by M. Krausberg, and C. W. Pursell, Jr., Oxford Univ. Press. 1967.
- 11-2. "Automotive Gas Turbine Optimization Study," AiResearch Manufacturing Company of Arizona, Report No. AT-6100-R7.
- 11-3. Lindgren, L. H., Fitzgibbon, R. G., Rath & Strong, Inc., Contract DOT/TSC 803, Task A-1, A-2, A-3 and A-4, July 15, 1974.
- 11-4. Rath & Strong, Inc., Task 1, Free-Turbine Engine Data Base, Jet Propulsion Laboratory Contract No. 954072.
- 11-5. Ayres, R. U., and Noble, S., "Economic Impact of Mass Production of Alternate Low Emission Automotive Power Systems," DOT-05-2003 (amended), March 1973.
- 11-6. Machining Data Handbook, Machinability Data Center; Metcut Research Associates, Inc., Cincinnati, Ohio, 1972.
- 11-7. Lindgren, H., "Supplemental Report on Manufacturability and Costs of Proposed Low-Emission Automotive Engine Systems," prepared for the Committee on Motor Vehicle Emissions, National Academy of Sciences, Jan. 1973.
- 11-8. "Technological Improvements to Automotive Fuel Consumption," DOT-TSC-OST-74-39, Southwest Research Institute, Dec. 1974.
- 11-9. "A Study of Technological Improvements in Automobile Fuel Consumption," DOT-TSC-OST-74-40, Arthur D. Little, Inc., Dec. 1974.

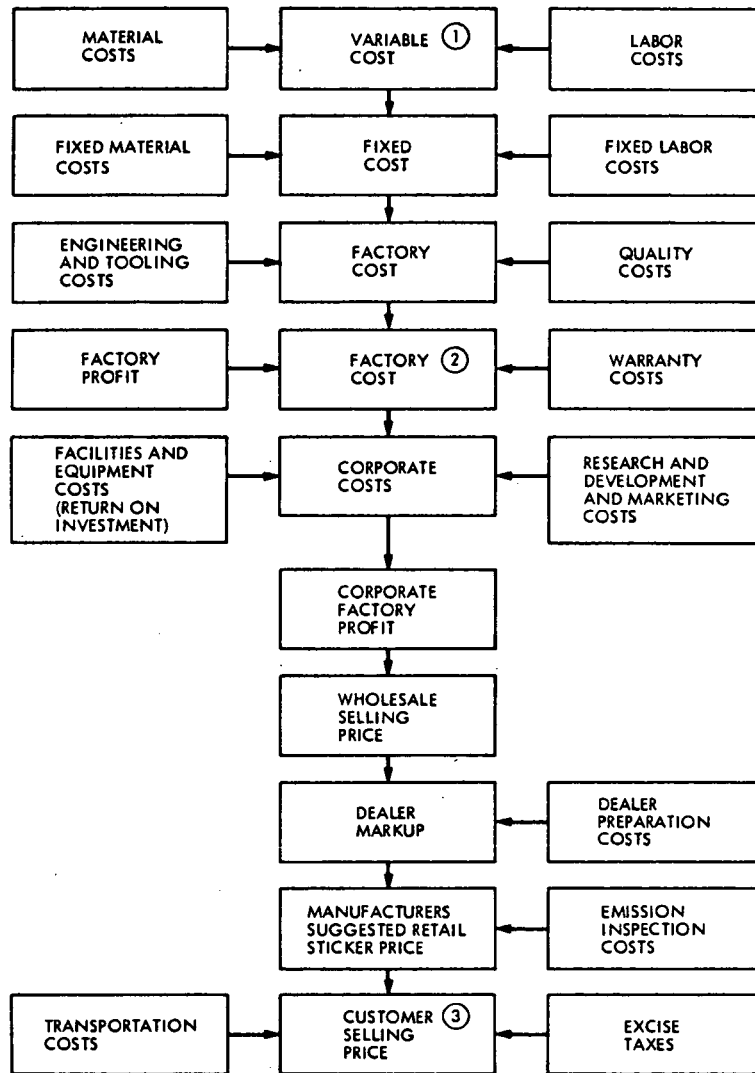

Fig. 11-1. Automotive manufacturing cost structure



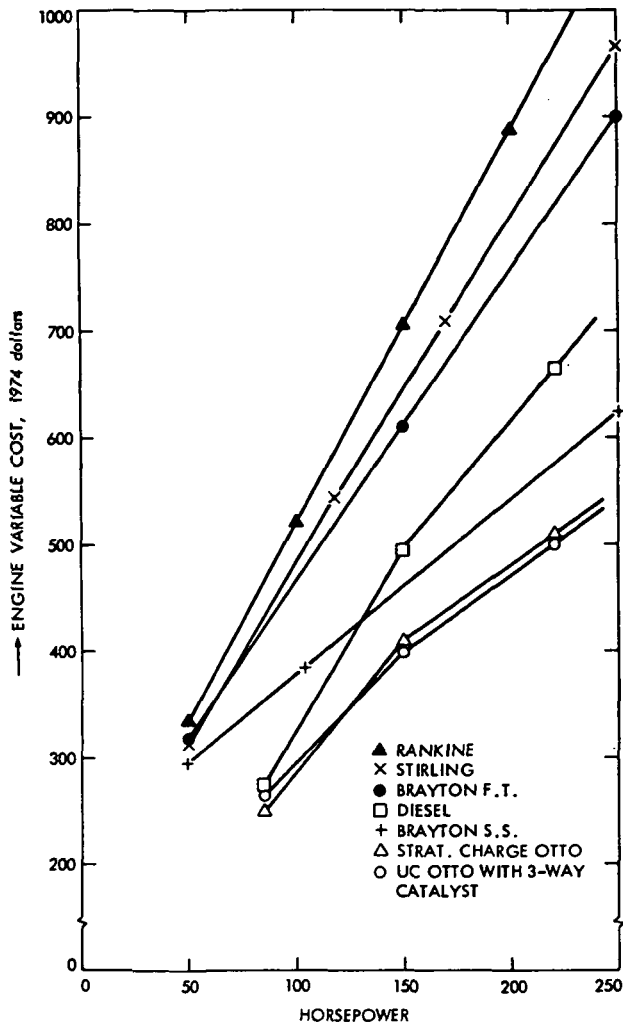

Fig. 11-2. Engine variable cost vs design maximum horsepower

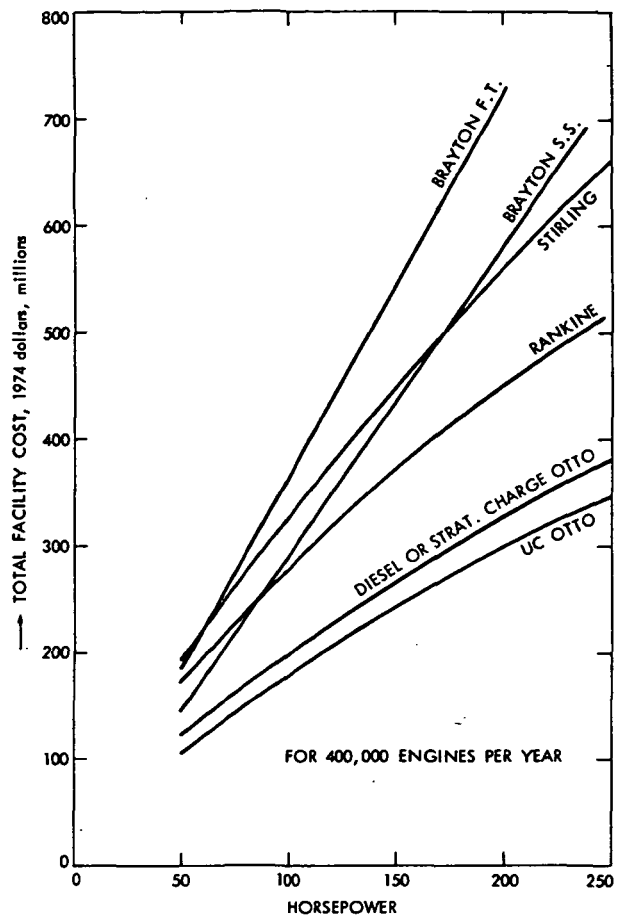

Fig. 11-3. Facility cost vs design maximum horsepower

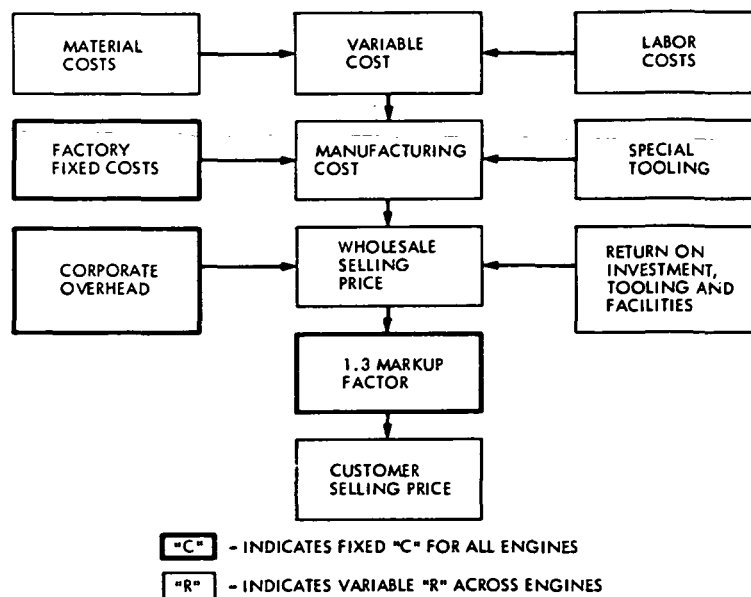

Fig. 11-4. Simplified automotive cost structure

CHAPTER 12. ALTERNATE HEAT ENGINE RESEARCH  
AND DEVELOPMENT

12.1	Objectives . . . . .	12-2
12.2	Scope . . . . .	12-2
12.3	Categories of Research and Development . . . .	12-2
12.4	Approach . . . . .	12-2
12.5	Results . . . . .	12-3
	12.5.1 The Stirling Engine . . . . .	12-3
	12.5.2 Brayton (Gas Turbine) Engines . . . .	12-5
	12.5.3 The Mature Rankine Cycle Engine . .	12-7
	12.5.4 Overall Comparison for the Three Heat Engines . . . . .	12-8
12.6	Discussion of Results . . . . .	12-8
	References . . . . .	12-9
	Figures . . . . .	12-10

## 12.1 OBJECTIVES

The objectives of this segment of the Study were to 1) identify critical research and development tasks which need to be completed if a viable alternative to the present-day internal combustion engine is to become a practical reality in the 1980-1990 time period, 2) estimate the lengths of time and funds required to attain these R&D goals, and 3) determine if the successful attainment of any R&D goals is so dubious that they might prevent the commercial introduction of mass-produced alternative engines in this time frame.

## 12.2 SCOPE

This Chapter addresses only the questions of what R&D tasks should be carried out, how long they may be expected to take, and approximately how much they may be expected to cost. Questions such as "Who should do the R&D?" and "Who should pay for it?" are matters of national policy which are beyond the scope of this Chapter. The reader is referred to Ref. 12-1 for a thoughtful discussion of the role of the Federal Government in R&D on alternate automotive power systems, and to Volume I of this report for the views of the study team.

This Chapter also restricts its focus to alternate heat engines that appear to be viable candidates for introduction in the 1980-1990 time period. We did not prepare R&D plans for Otto, Diesel, stratified charge or lean-burning engines, because these are very similar in design to the present Otto cycle engine, and because the R&D presently under way on these configurations is likely to be pursued independent of our recommendations. Thus, in this Chapter, emphasis is placed on R&D needed to implement the so-called "mature" versions of the Stirling and Rankine engines, and the "mature" and "advanced" Gas Turbine.

The reader will find discussion of R&D needed for non-heat-engine alternatives, such as battery, hybrid, and energy-storage devices, in Chapters 8 and 9 of this report.

## 12.3 CATEGORIES OF RESEARCH AND DEVELOPMENT

Heywood, et al. (Ref. 12-1) have catalogued the commonly-accepted definitions of the different phases of "research and development", and the institutions where they are most appropriately carried out. We have reproduced the essence of this compilation in Table 12-1.

Our definition of the "mature" versions (see Chapter 2) of the alternate automotive heat engines places them at a stage of development that is at or beyond the "Advanced Development" stage. Hence the term "R&D", as used in this chapter, implies primarily Advanced and Engineering Development. Certain developments needed for the "advanced" engine versions (e. g., ceramics) are at the "Applied Research" stage.

## 12.4 APPROACH

Based on our continuous combustion heat-engine studies, the results of which are reported

in Chapters 5, 6, and 7, the critical components or assemblies for each of the three alternative heat-engine powerplants, along with their required functional performance and estimated maximum allowable mass-production manufacturing costs, were established. The attainment of these functional and cost targets became, for each such component or assembly, an R&D goal or milestone. These milestones were then arranged into logical networks of events leading to "Job One", or the start of mass production. The networks were examined for first-order interactions, common elements, decision points, etc.

Probabilistic estimates of the costs and times associated with the achievement of each key R&D event in each network were made using a modified DELPHI technique (Ref. 12-2). This methodology has been used with some success to predict future outcomes when no other precise means exist to do this objectively or quantitatively (Ref. 12-3).

After prior telephone verification of their willingness to participate, approximately five noted experts in each engine field were polled by mail and asked to estimate the maximum and minimum effective expenditure rates, the probability of meeting the R&D goal by each of several years at the maximum rate, and, for each of several R&D goals, the probable cumulative cost of the R&D through each of several years at the maximum rate. Each goal had associated with it a quantitative functional requirement and a maximum allowable mass production unit cost. Only direct costs, excluding overhead, were estimated, and these costs were estimated in 1974-75 dollars. The questionnaire asked that costs be estimated on the basis of joint development between an engine specialty house and an automotive manufacturer, in the event the respondent was associated with one of the former. Each respondent completed his questionnaire in anonymity, without collaborating with the other experts.

The probability  $E(P)$  of achieving each given R&D goal by a particular year was calculated as the simple mean of all responses. The most optimistic and most pessimistic estimates were also recorded. The mean probable cost  $E(C)$  of achieving each R&D goal by a certain year, and the corresponding most optimistic and pessimistic estimates were obtained in similar fashion.

The collectively-estimated mean probability  $E(P)$  and cost  $E(C)$  of attaining each R&D goal, along with the maximum and minimum expenditure rates and the range between the most optimistic and most pessimistic estimates, were returned to the members of the Gas Turbine and Stirling engine expert groups. They were then invited to reanswer the same questions in light of their knowledge of the group's mean results on the first iteration and to explain why their estimates fell beyond  $\pm 20\%$  limits if this were the case. Two iterations were conducted for these engines, and reasonable convergence was attained for most R&D tasks. Exceptions are noted below. Only one iteration was conducted for the Rankine engine because of time constraints, so that the exercise is more properly called a "questionnaire" than a DELPHI iteration.

Table 12-1. Categories of research and development

Type	Nature of activity	Where performed
Basic research	Studies of fundamental concepts; advancement of scientific knowledge.	Universities, private and non-profit research laboratories, government laboratories, and in a few auto industry research laboratories.
Applied research	Exploration of scientific feasibility and problem solving directly or indirectly related to automotive technology — including, for example, basic engine design and performance, emissions control, fuel economy improvements, alternative engine systems and alternative fuels.	Government laboratories, chemical and oil company laboratories, universities, R&D firms, vendors, and in auto industry research laboratories.
Exploratory development	Proving technical feasibility of scientific concepts by building and testing a few engines, either on a dynamometer or in a vehicle.	Primarily in R&D divisions of auto manufacturers; also by oil companies, vendors, R&D firms, and to a limited extent by universities and government laboratories.
Advanced development	Proving engineering feasibility by building several engines and testing in several vehicles, and then making engineering changes in engine design, subsystems, or components to improve operating and emissions characteristics.	Primarily within the auto industry, as a necessary step in transfer of technology from R&D divisions to engineering divisions.
Engineering development	Proving manufacturability and economic feasibility, "soft tooling," and extensive testing of prototype vehicles with special attention to improving performance characteristics within cost constraints, making modifications that reduce production costs, and evaluating problems of marketability.	Within the engineering divisions of the auto manufacturers, with staff assistance from R&D and production divisions.
Product improvement	Refinements made in the product which may add to marketing appeal (e. g., improved fuel economy) and/or reduced production cost.	Within the production divisions of the auto manufacturers, with staff assistance from the engineering divisions.

The final results provided expert estimates of the probability and cost of reaching each of the several R&D goals by each of several years in the future. These results and their interpretation are presented in later paragraphs.

Application of these costs and probable times to the R&D networks enabled identification of the most costly and time-consuming tasks, and a determination of whether R&D was a limiting factor impacting the commercial availability of the engine by the end of 1990.

## 12.5 RESULTS

### 12.5.1 The Stirling Engine

The network of R&D tasks which must be accomplished to have in hand a prototype Stirling Engine is diagrammed in Fig. 12-1. This is intended only to show first-order relationships at a high degree of agglomeration, and should not be interpreted as a rigorous PERT/CPM-type network. The principal difference between the mature and advanced versions of this engine, as

noted elsewhere in this report, is that the latter requires a ceramic heater head.

Certain R&D goals, from among those shown in Fig. 12-1, were considered to be critical to the production implementation of the Stirling Engine. These events are listed separately in Table 12-2. They were determined by consensus of the study team, based upon detailed analyses presented elsewhere in this report. Non-critical events, such as state-of-the-art or off-the-shelf-components, have not been included in Table 12-2. Note the functional and manufacturing cost requirements associated with each event. Table 12-2 formed the basis of the DELPHI questionnaire sent to the Stirling Engine experts.

Estimates for the maximum effective total direct expenditure rate (in 1974 dollars), beyond which any additional expenditures buy no further development progress, are presented for each component (the top bar of each pair) in Fig. 12-2. These and subsequent Stirling Engine results are based on two DELPHI iterations. The center line of each bar represents the mean of all the

Table 12-2. R&D goals for Stirling Engines

Preheater, excluding drive mechanism but including seals, capable of production rate of 250,000 units/yr <sup>a</sup> at $\leq$ \$20/unit <sup>b</sup> , and 2000 hours of operation at $\geq$ 90% effectiveness at design point
Metallic heater head, capable of production rate of 250,000 units/yr at $\leq$ \$250/unit, with hydrogen loss $\leq$ 5% at full throttle over 200 hours
Ceramic heater head, meeting same requirements as metallic, except at unit cost $\leq$ \$120/unit
Cycle regenerator, capable of production rate of 10 <sup>6</sup> units/yr at $\leq$ \$3/unit, 2000 hr. durability
Cycle cooler, capable of production rate of 10 <sup>6</sup> units/yr at $\leq$ \$3/unit, with no degradation in currently attainable levels of performance
Control system, capable of production rate of 250,000 units/yr at $\leq$ \$50/unit, weight $\leq$ 20 lb <sup>m</sup> , and negligible parasitic power loss
Improved rollsock or rod seal configuration, capable of production rate $\geq$ 10 <sup>6</sup> units/yr and $\geq$ 2000 hour life
Mature prototype Stirling Engine

<sup>a</sup>Or most economic quantity, if higher.

<sup>b</sup>Direct labor plus materials, not selling price.

estimates, while the width of each bar represents the range between the most optimistic and most pessimistic estimates. Note that a logarithmic scale has been used to accommodate the wide range of estimates obtained. The bottom bar of each pair presents similar information obtained with respect to the minimum effective total direct expenditure rates, below which insufficient development progress could be made.

Estimates include development to the prototype stage only. They do not include the additional costs and times associated with the intervening test, evaluation, component improvement, and production engineering leading up to Job One.

The estimated probability of accomplishment at the estimated maximum effective expenditure rate is plotted vs time for each critical R&D task in Fig. 12-3. The estimated cumulative total direct R&D cost at the maximum expenditure rate is similarly plotted for each key R&D goal in Fig. 12-4. Each figure displays the mean, most optimistic, and most pessimistic estimates, based on two DELPHI iterations. Note that the cumulative costs are not necessarily simple multiples of the maximum rates and the number of years. In some cases, one-time initial costs may be included in the first year, while in others, expenditure rates may decline below the maximum as the program approaches completion.

There was no correlation between the nature of the respondent's business (e.g., automaker or development laboratory) and his degree of optimism or pessimism. Three out of the four respondents tended toward the optimistic side, however. One automaker was optimistic on both times and costs, while another was pessimistic on both. One development laboratory was optimistic on both times and costs, while another was optimistic on times and pessimistic on costs. Some respondents were optimistic on one particular component and pessimistic on another. The results do not, therefore, show any consistent bias on the part of industry grouping.

Hardly any comments or explanations were received from the Stirling Engine experts polled. One respondent felt the functional requirement for hydrogen loss (see Table 12-2) would be difficult to meet, and that the unit production cost requirement for the preheater was "too low" (amount unspecified).

There was relatively little change in estimated mean values of expenditure rates, times, or total direct costs between the first and second DELPHI iterations, but the spread on many estimates narrowed considerably. The greatest collective pessimism, and the largest uncertainty, were associated with the ceramic heater head (required for an "advanced" engine).

Assuming the maximum effective expenditure rate, beyond which any additional expenditures cause no further progress in a joint automotive/engine company development program, and that a probability E(P) of 0.75 is tantamount to "successful" attainment of each R&D goal, it was possible to estimate the length of time and amount of direct costs associated with the accomplishment of each R&D event, in the collective opinion of the Stirling Engine experts polled. The selection of 0.75 was arbitrary, the spread at E(P) = 0.50 being quite large. The most time-consuming events identified below are, however, independent of E(P) for all values of E(P)  $\geq$  0.5.

In this manner, the two most time-consuming paths for the mature Stirling Engine were determined, and are illustrated by heavy lines on Fig. 12-1. The metallic heater head and the preheater appear as the most time-consuming R&D items, requiring about 5 years beyond January 1, 1975 at estimated maximum effective expenditure rates of \$3.6 and 2.2 million/year, respectively. The addition of the four-year industry average time span for test, evaluation, component improvement, and production engineering, places Job One for the mature Stirling Engine vehicle in 1984 at a 75% probability of accomplishment. The heater head is also forecast to be the most costly component to develop, its cumulative development cost over this five-year period being on the order of \$25-30 million. The preheater, at about \$14 million, is the next most expensive.

The experts estimated that it would be 8-1/2 years (mid-1983) before a mature Stirling prototype engine would be achieved at a 75% probability of success. This is somewhat longer than the 5-year estimate for the limiting components. In

any event, it may not be necessary to pursue the other components at the maximum funding rates, since this would result in considerable slack until the heater head and preheater were ready. The overall cost of achieving a mature Stirling Engine prototype at  $E(P) = 75\%$  by 1983 was estimated to be \$130 million. The forecast minimum and maximum effective expenditure rates were \$9 and 16 million/year, respectively.

At all values of  $E(P) \geq 0.5$ , the ceramic heater head is the limiting factor for an "advanced" Stirling Engine. At  $E(P) = 0.75$ , a prototype is not forecast to be available until 1992, which places Job One for such an engine near the end of the century (about 1996). Further discussion here will be restricted to the "mature" Stirling Engine.

### 12.5.2 Brayton (Gas Turbine) Engines

A similar network of R&D tasks needed for commercial implementation of automotive gas turbine engines, and the first-order relationships between them is given in Fig. 12-5. The path indicated by the heavy lines has the same meaning as before. Note the dependence of the "advanced" gas turbine engine on ceramic components — turbine wheel and regenerator — as discussed elsewhere in this report. It was assumed in developing the DELPHI questionnaire that the "mature" engine would use a metallic wheel and a metallic regenerator.

Note that variable nozzles would be used only with the free turbine, while a continuously variable transmission (CVT) is needed only for the single shaft engine. The CVT, if developed, would be applicable to conventional and other alternate engines, as well.

The critical R&D goals, selected by consensus of the study team, and used as the basis for the DELPHI questionnaires sent to the gas turbine engine experts, are listed separately in Table 12-3.

Estimates of the maximum and minimum total direct expenditure rates (in 1974 dollars), based on two DELPHI iterations, are presented for each key gas turbine engine component in Fig. 12-6. The qualifying comments made previously concerning the analogous Stirling results apply here as well.

The estimated probability of accomplishment at the estimated maximum effective expenditure rate is plotted vs time for each critical R&D task in Fig. 12-7. The estimated cumulative total direct R&D cost at the maximum expenditure rate is similarly plotted for each key R&D goal in Fig. 12-8. Each figure displays the mean, most optimistic, and most pessimistic estimates, based on two DELPHI iterations.

There was no correlation between the nature of the respondent's business (e.g., automaker or aerospace company) and his degree of optimism or pessimism. Three out of the five respondents tended toward the optimistic side, however. Most respondents were either optimistic on both times and costs or pessimistic on both, although one respondent was optimistic on times and pessimistic on costs. Some respondents were optimistic on one particular component and pessimistic

Table 12-3. R&D goals for gas turbine engines

Continuously-variable transmission with weight, drivability, efficiency, cost, and reliability all comparable to those of 1974 production automatic transmission
Variable nozzle assembly, capable of production rates of 250,000 <sup>a</sup> units/yr at $\leq \$15/\text{assembly}^b$
Burner assembly, metallic, capable of $\leq 0.4$ gm/mi HC, $\leq 3.4$ gm/mi CO, $\leq 0.4$ gm/mi NO <sub>x</sub> over FDC and production rate of 250,000 units/yr at $\leq \$5/\text{unit}$
Burner assembly, ceramic, or metallic/ceramic composite, meeting same requirements as metallic burner
Turbine wheel, metallic, capable of 1900°F T. I. T. and production rate of 250,000 units/yr at $\leq \$8/\text{unit}$
Turbine wheel, ceramic, capable of 2500°F T. I. T. and production rate of 250,000 units/yr at $\leq \$8/\text{unit}$
Regenerator, metallic, capable of 2000 hours at $\leq 2.5\%$ leakage, 1500°F inlet temp. $\geq 90\%$ efficiency at design point, and unit production equivalent to 250,000 engines/yr at $\leq \$50/\text{unit}$
Regenerator, ceramic, meeting same requirements as metallic except at $\leq \$35/\text{unit}$ and 1850°F inlet temperature
Complete control system, exclusive of power source and engine components actually controlled. Capable of production rate of 250,000 units/yr at $\leq \$60/\text{unit}^c$
Mature metallic gas turbine engine prototype
Mature ceramic gas turbine engine prototype

<sup>a</sup>Or most economic quantity, if higher.

<sup>b</sup>Direct labor plus materials; not selling price.

<sup>c</sup>Includes sensors, logic, power conditioning unit, and actuators.

on another. The results do not, therefore, show any consistent bias on the part of any one company or industry grouping.

Relatively few comments or explanations of deviations from the collective mean were received from the Gas Turbine Engine experts. One optimist thought that regenerators and ceramic turbine wheels were not critical R&D tasks at all. A pessimist thought that the maximum allowable production costs established by our Industry Practices Task were too low (and therefore unattainable) by factors of from 2 to 5. Another pessimist expressed serious doubt that a successful, competitive ceramic turbine wheel could ever be developed.

There was apparently only minimal misinterpretation of the questions. One respondent

on the first iteration interpreted "probability of accomplishment" to mean "production readiness" instead of "completion of R&D leading to prototype", as intended.

It may be noted that prototype costs have been estimated to be less than the sum of the estimated cost of the individual components. One possible explanation of this anomaly is that there is more interdependence between the critical R&D tasks than shown in the simplified representation of Fig. 12-5, which may have a synergistic effect on total costs.

There was considerable change upward in estimated mean cost values between the first and second DELPHI iterations, but the spread on many estimates did not narrow appreciably. Examination of Figs. 12-7 and 12-8 will indicate that the spread remains very high for the ceramic components, both kinds of regenerators\*, and the control system, reflecting uncertainty among the experts.

The Stirling preheater and the Gas Turbine ceramic regenerator are similar in configuration, and it is therefore often assumed that once development goals have been reached for one they will automatically have been reached for the other. It is interesting, therefore, to examine the DELPHI results for these two components.

In any given year, the estimated probability of accomplishment of the Stirling ceramic preheater is higher than that for the Gas Turbine ceramic regenerator. The spread between the most optimistic and most pessimistic estimates is greater for the Gas Turbine regenerator.

The maximum effective expenditure rate for the turbine's ceramic regenerator is estimated to be at least four times that of the Stirling's preheater, and the forecast probable total direct development cost for the turbine's ceramic regenerator is at least three times that of the Stirling's preheater.

The experts clearly do not view the Stirling preheater and the Gas Turbine ceramic regenerator as identical components. One reason for this may be that the Stirling preheater encounters significantly lower pressure differences than the Gas Turbine ceramic regenerator, which implies a more readily soluble sealing problem with the first than with the second.

Again assuming the maximum effective expenditure rate and that  $E(P) = 75\%$  equivalent to successful attainment of the R&D goal, the length of time and magnitude of direct costs associated with the accomplishment of each R&D event were estimated.  $E(P) = 0.75$  was chosen because at a value of 0.5 the spread between the most optimistic and most pessimistic estimates was still very large, and because the mean results for some components indicated a value of  $E(P) = 0.9$  could "never" be achieved.

The most time-consuming paths for the "mature" and "advanced" Gas Turbine Engines are

illustrated by heavy lines in Fig. 12-5. For the mature engine with a metallic regenerator, the control system emerges as the most time-consuming R&D project, requiring about 7 years beyond Jan. 1, 1975 at the estimated maximum effective expenditure rate of \$2 million/year. The addition of the four-year industry average time span for test, evaluation, component improvement, and production engineering places Job One for this mature Gas Turbine vehicle in 1986 at a 75% probability of accomplishment.

Subsequent to the dissemination of the first DELPHI questionnaire, however, the study team redefined the "mature" Brayton engine as one incorporating a ceramic, not a metallic, regenerator. For a mature engine so defined, the ceramic regenerator is the most time-consuming R&D project, requiring about 10 years beyond January 1, 1975, at an estimated maximum effective expenditure rate of \$9.4 million/year. The addition of the four-year industry average time span for test, evaluation, component improvement, and production engineering places Job One for this "mature" Brayton vehicle in 1989 at a 75% probability of accomplishment. The ceramic regenerator is also forecast to be the most costly component to develop, its cumulative development cost over this 10-year period being on the order of \$70 million. Adjusting the data of Fig. 12-8(j) by subtracting out the cost of a metallic regenerator and adding in the cost of a ceramic regenerator gives \$95 million as the estimated cost of developing a "mature" Brayton engine with a ceramic regenerator at  $E(P) = 75\%$  by 1985. This figure represents only direct (labor and materials) cost in constant 1975 dollars.

For the "advanced" engine (incorporating a ceramic turbine wheel) the ceramic components are again the pacing items. The wheel is estimated to take 10-1/2 years and \$50 million to attain  $E(P) = 75\%$  at the maximum effective expenditure rate of \$6.0 million per year. The addition of the four-year industry average time span for test, evaluation, component improvement, and production engineering places Job One for the "Advanced" Gas Turbine Vehicle in 1989 at a 75% probability of accomplishment.

The overall direct cost of achieving an "advanced" ceramic Gas Turbine Engine prototype at an  $E(P)$  of 75% by mid-1985 was estimated to be \$130 million. The corresponding forecast minimum and maximum effective expenditure rates were \$5 and 14 million per year, respectively.

It should be noted that the collective pessimism on the ceramic regenerator was not shared by all respondents. Considerably more optimistic time and cost estimates on this component were received from one automaker who allegedly has solved the major problems and is planning to enter truck turbine engine production by the end of the 1970's. The collective mean was shifted in a more pessimistic direction by the responses of other experts who did not share his confidence.

\* Our "mature" version, as described in Chapter 5, uses a ceramic regenerator.

### 12.5.3 The Mature Rankine-Cycle Engine

Similar critical R&D goals (in terms of component functional and manufacturing direct cost requirements) identified by the study team for the mature Rankine cycle engine are listed in Table 12-4. The first-order relationships between them are diagrammed in Fig. 12-9, which also shows R&D tasks for an "advanced" Rankine engine. For reasons explained in the Rankine Cycle chapter of this report (Chapter 7), these goals are predicated on a reciprocating expander and water as the working fluid. The feedwater pump, control system, and a number of state-of-the-art components are common to both the "mature" and "advanced" engines. The Rankine experts polled were asked to make estimates only for the "mature" engine and its components.

Table 12-4. R&D goals for mature Rankine cycle engine

Reciprocating expander assembly (block, pistons, valves, etc.), max. speed $\geq 4500$ rpm, efficiency $\geq 85\%$ at design point, capable of continuous operation at $\geq 1400^\circ\text{F}$ ., mass-producible in quantities $\geq 250,000^{\text{a}}$ units/yr. at a unit cost $\leq \$220^{\text{b}}$
Burner assembly producing $\leq 0.4$ gm/mi HC, $\leq 3.4$ gm/mi CO, and $\leq 0.4$ gm/mi $\text{NO}_x$ over FDC at the heat load required by a $1500^\circ\text{F}$ vapor generator for a full-size car; mass producible in quantities $\leq 250,000$ units/yr at a unit cost $\leq \$30$
Vapor generator assembly, producing $1500^\circ\text{F}$ steam at inlet and outlet pressures of 3100 and 2500 psia, respectively, mass-producible in quantities $\geq 250,000$ units/yr at a unit cost $\leq \$125$
Control system assembly <sup>c</sup> , idle to 90% steam flow in $\leq 1$ sec. at rated temp. and press.; mass-producible in quantities $\geq 250,000$ units/yr. at a unit cost $\leq \$70$
Feedwater pump assembly, efficiency $\geq 75\%$ at 3300 psia outlet pressure; mass-producible in quantities $\geq 250,000$ units/yr at a unit cost $\leq \$20$
Mature reciprocating steam engine prototype, meeting or exceeding above emission standards over FDC, with fuel economy $\geq 17$ mpg over FDC in 3100 lb curb-weight vehicle.

<sup>a</sup>Or most economic quantity, if higher.

<sup>b</sup>Direct labor plus materials, not selling price.

<sup>c</sup>Includes sensors, logic, power conditioning unit, and actuators.

Estimates of the maximum and minimum total direct expenditure rates (in 1974 dollars), based on one questionnaire and no feedback to participants, are presented for each key component of the mature Rankine engine in Fig. 12-10. The qualifying comments made previously concerning the analogous Stirling and Gas Turbine engine results apply here as well. Note that the estimates range over three orders of magnitude in some cases. This may be due to the lack of iterative feedback. It may also reflect the fact that most of the experts polled (4 out of 5) were nonautomotive manufacturers or private entrepreneurs not accustomed to estimating automotive R&D costs.

The estimated probability of accomplishment at the estimated maximum effective expenditure rate is plotted vs time for each critical R&D task in Fig. 12-11. The estimated cumulative total direct R&D cost at the maximum expenditure rate is similarly plotted for each key R&D goal in Fig. 12-12. Each figure displays the mean, most optimistic, and most pessimistic estimates, based on the one questionnaire.

There was a stronger relationship for the Rankine engine between the nature of the respondent's business (e.g., automaker, nonautomotive manufacturer or entrepreneur, or private consultant) and his degree of optimism or pessimism. The three nonautomotive industrial respondents were quite optimistic with respect to both probability of accomplishment and probable total cost. The automaker was pessimistic on accomplishment of the R&D goals but estimated relatively low costs. The consultant was optimistic on accomplishment, but extremely pessimistic on costs. Even with a weighting factor of only 20%, his pessimistic cost estimates influenced the collective mean considerably. It is not known to what extent this divergence would have been lessened had a second iteration, with information feedback, been carried out. The uncertainty in this data should be kept in mind during the discussion that follows.

A number of comments were received from the Rankine Engine respondents. More than one pessimist indicated doubt that a 4500 rpm expander with an 85% brake efficiency could be built because of valving problems and the lack of a lubricant operational at the corresponding steam temperatures. Another pessimist expressed doubt that a  $1500^\circ\text{F}$ , 2500 psia vapor generator could be built because of creep-limited design stresses in the tube walls. Another expert challenged our transient requirement for idle to 90% steam flow in  $\leq 1$  sec. Collectively, the experts doubted that a burner assembly could ever be made for  $\leq \$30$ /unit, a vapor generator for  $\leq \$125$ , a control system for  $\leq \$70$ , or a feedpump for  $\leq \$20$ . It should be noted, however, that these cost and functional requirements were established as necessary to a viable, competitive Rankine Engine. Documentation of the analyses substantiating these contentions may be found elsewhere in this report (Chapter 7).

Again assuming the maximum effective expenditure rate and (somewhat arbitrarily



Table 12-5. Estimated time and cost comparisons for prototype alternate heat engine development

Alternate engine	Year prototype development complete <sup>a</sup>	Maximum (minimum) effective expenditure rate, \$ million/year		Total direct cost to develop, \$ million <sup>a</sup>
Mature stirling	1983	16	(9)	130
Mature gas turbine <sup>b</sup>	1985	14	(6)	95
Advanced gas turbine	1985	14	(5)	130
Mature rankine	1984	15	(3)	180

<sup>a</sup> At  $E(P) = 0.75$ .

<sup>b</sup> With ceramic regenerator.

because of the spread of the data) that  $E(P) = 75\%$  is equivalent to successful attainment of each R&D goal, the length of time and magnitude of direct costs associated with the accomplishment of each R&D event were estimated.

The most time-consuming path for the "mature" Rankine (steam) engine is illustrated by the heavy lines on Fig. 12-9. The reciprocating expander emerges as the most time-consuming and costly R&D task, requiring about 9-1/2 years and \$48 million of direct costs beyond January 1, 1975 at the estimated average maximum effective expenditure rate of \$5 million/year. The addition of the four-year industry average time span for test, evaluation, component improvement, and production engineering places Job One for the "mature" Rankine vehicle in 1988 at a 75% probability of accomplishment, based on estimates with a very broad uncertainty band.

The overall direct cost of achieving a "mature" Rankine Engine prototype at an  $E(P)$  of 75% by 1988-89 was estimated to be \$260 million. The corresponding forecast minimum and maximum effective expenditure rates were \$3 and 19 million, respectively. However, the latter figure is so heavily biased by the astronomical cost estimate of one pessimist, that we have reduced it to \$15 million by discounting the pessimist's estimate.

#### 12.5.4 Overall Comparison for the Three Heat Engines

The results of two DELPHI iterations each for the Stirling and Gas Turbine Engines, and of one questionnaire for the Rankine Engine, are summarized and compared in Table 12-5. These figures are for total direct costs in uninflated, 1974-75 U. S. Dollars, and do not include overhead expenses or estimated times or costs for an approximate four-year period of test, evaluation, component improvement, and production engineering prior to "Job One."

## 12.6 DISCUSSION OF RESULTS

The results indicate that mass production of the "mature" Stirling Engine, and of both Gas Turbine Engines can begin before the end of the 1980-90 decade, following direct R&D costs of about \$130 million each for the mature Stirling and the advanced turbine, and \$95 million for the mature turbine, if the R&D is carried out at the maximum effective expenditure rate, and if  $E(P) = 75\%$  is taken to mean "successful achievement". This is interesting, because these results were obtained from two completely different and independent groups of experts. Since there is no significant difference in the estimated time, expenditure rate, or cost to achieve a 75% chance of success in the needed R&D, it appears that these are not strong discriminators in choosing among "mature" Stirling or "advanced" Gas Turbine powerplants. Note that the "mature" Gas Turbine cannot be ready before the "advanced" version. Note also that a "mature" Stirling prototype could be available somewhat sooner than either gas turbine prototype, all meeting the performance and cost targets assumed here.

It would seem wise to emphasize R&D for the advanced turbine engine, since its functional and cost benefits heavily outweigh those of the mature engine. The needed ceramics breakthrough, when and if it comes, could be beneficial to stationary turbines, and to preheaters and heater heads for Stirling Engines.

Actual direct (labor plus materials) expenditures on alternate automotive propulsion system R&D can be found in the auto manufacturers' Applications for Suspension of the 1976 Automobile Exhaust Emissions Standards. They have also been cited in the testimony of various concerned individuals before the House Subcommittee on Space Science and Applications. See, for example, Refs. 12-4 and 12-5. This information is summarized in Table 12-6 for 1973, the latest year for which complete actual data are available as we go to press.

Table 12-6. Alternate engine expenditures

Manufacturer	Alternate engine R&D expenditure, \$ million	Alternate engine R&D expenditure as a percent of total R&D expenditures
General Motors	23.7	2.4
Ford	24.5	2.4
Chrysler	3.5 <sup>a</sup>	2.4 <sup>a</sup>

<sup>a</sup>Does not include EPA-funded gas turbine engine R&D of approximately \$2.5 million/year.

If one recalls that during the early 1970's both GM and Ford were conducting R&D on about 4 alternate engines, it can be seen that each was spending about \$6 million per engine type per year. Chrysler's efforts were entirely on the gas turbine, so their total was also about \$6 million per engine per year.

The AEC's Energy R&D Program for Transportation Systems (Ref. 12-6) suggested average funding of about \$27 million per year for advanced development of alternate automotive heat engines, although the basis of the recommended funding levels is not reported. Since these figures were for three alternate engines, the AEC's plan calls for about \$9 million per engine type per year for R&D.

Inspection of Table 12-5 shows that the average maximum and minimum effective expenditure rates for the "mature" Stirling and Rankine, and the "advanced" Gas Turbine Engines, as estimated by the experts, are about \$15 and 6 million per year, respectively. The industry average, however, has been \$6 million, or just about the minimum effective expenditure rate, below which insufficient progress can be made. The engine experts' DELPHI forecasts of what maximum effective R&D expenditure rates should be are running some 2 to 3 times what the actual industry rates have been. Expenditures at the maximum rates are necessary to make the viable candidate(s) available before 1990 and are the basis of the discussion of this section. The AEC's estimated expenditure rates of about \$9 million/engine/year are about half way in between the maximum and minimum estimates of the experts polled in this study. With only about 2-1/2% of total annual R&D expenditures devoted to alternate engines, the automakers may have been pursuing the

alternates at or near the minimum effective expenditure rates.

In order to make superior alternate engines such as the Stirling and Gas Turbine a production reality by 1990, the automakers may need to increase R&D expenditures for development of prototypes to something on the order of \$15 million per year. They can do this by concentrating their efforts on only one engine (instead of 3 or 4), or by increasing engine R&D expenditures to a somewhat higher percentage of total R&D than 2.4%. The probability of success could also be improved by the involvement of more than one manufacturer (and associated subcontractors) per engine. Such expenditure rates and strategies appear to be entirely within the financial capabilities of the U. S. automotive industry. A mere shift in priorities among internal R&D projects would seem to be all that is necessary to fund alternate engine R&D at levels sufficient to assure mass-production of Stirling or Gas Turbine Engines before 1990. While it is beyond the scope of this Chapter to say who should pay for the R&D there seems to be little doubt that the industry itself can pay for it - in its entirety (which includes the necessary ceramics R&D).

#### References

- 12-1. Heywood, J. B., et al., "The Role for Federal R&D on Alternative Automotive Power Systems", Report No. MIT-EL 74-013, Energy Laboratory, Massachusetts Institute of Technology, Cambridge, Mass., November, 1974.
- 12-2. Martino, J. P., "Technological Forecasting for Decisionmaking", New York: American Elsevier Publishing Co., Inc., 1972, Ch. 2.
- 12-3. Golding, E. I., et al., "Technological Forecast, 1975-2000: A Descriptive Outlook", Washington, D. C.: Dept. of Transportation, May, 1970 (AD-754 178), Appendix 3.
- 12-4. Testimony of Eric O. Stork, EPA, before the Subcommittee on Space Science and Applications of the U. S. House of Representatives, February 4-6, 1974.
- 12-5. Testimony of C. E. Nash and C. M. Ditlow of Ralph Nadar's Public Interest Group before Hearing of the House Subcommittee on Space Science and Applications, June 11, 1974.
- 12-6. Table E-1-5, Appendix E, Energy R&D Program for Transportation Systems, prepared by Sub-Panel XIII, Oct. 27, 1973.

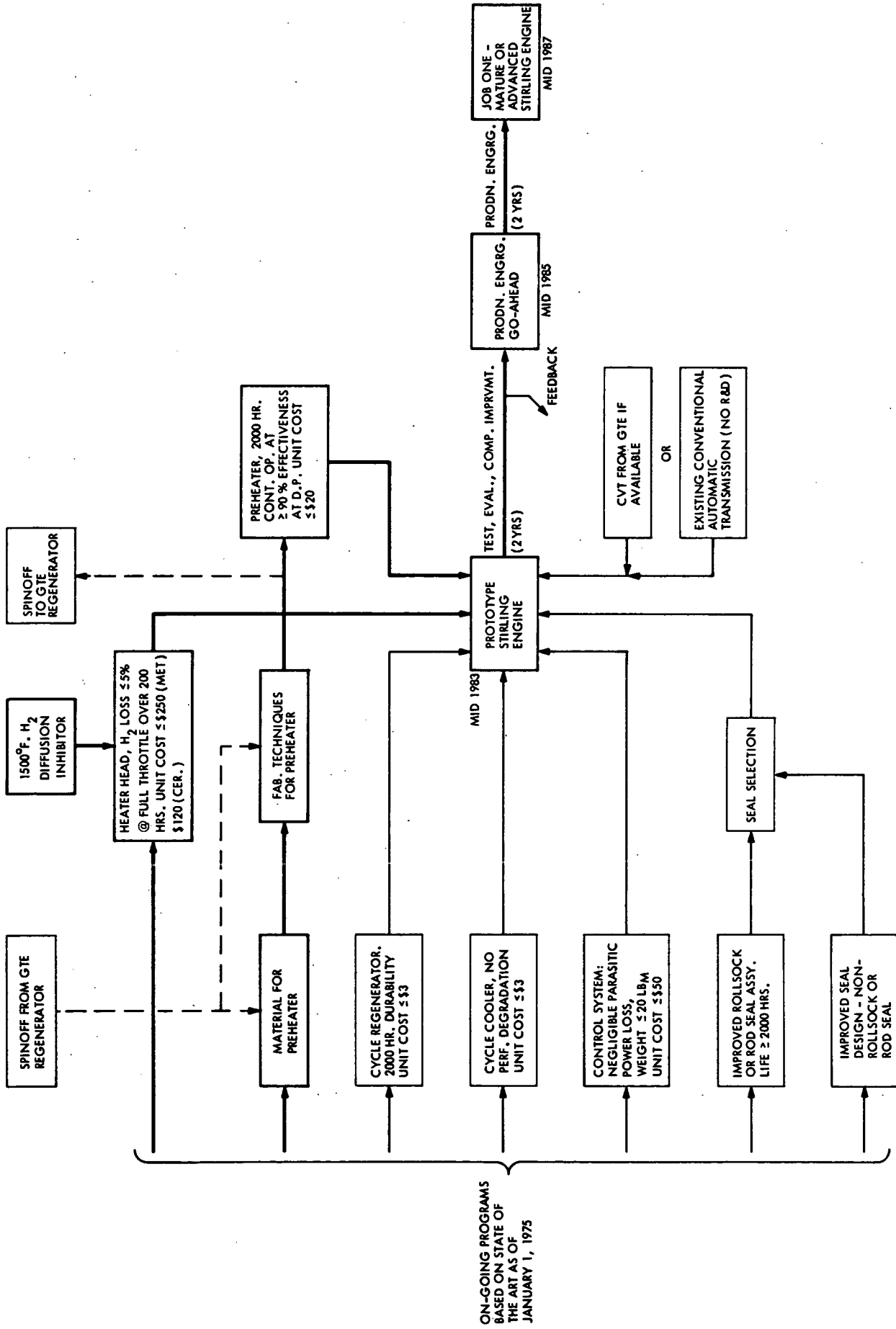

Fig. 12-1. Stirling Engine R&D network

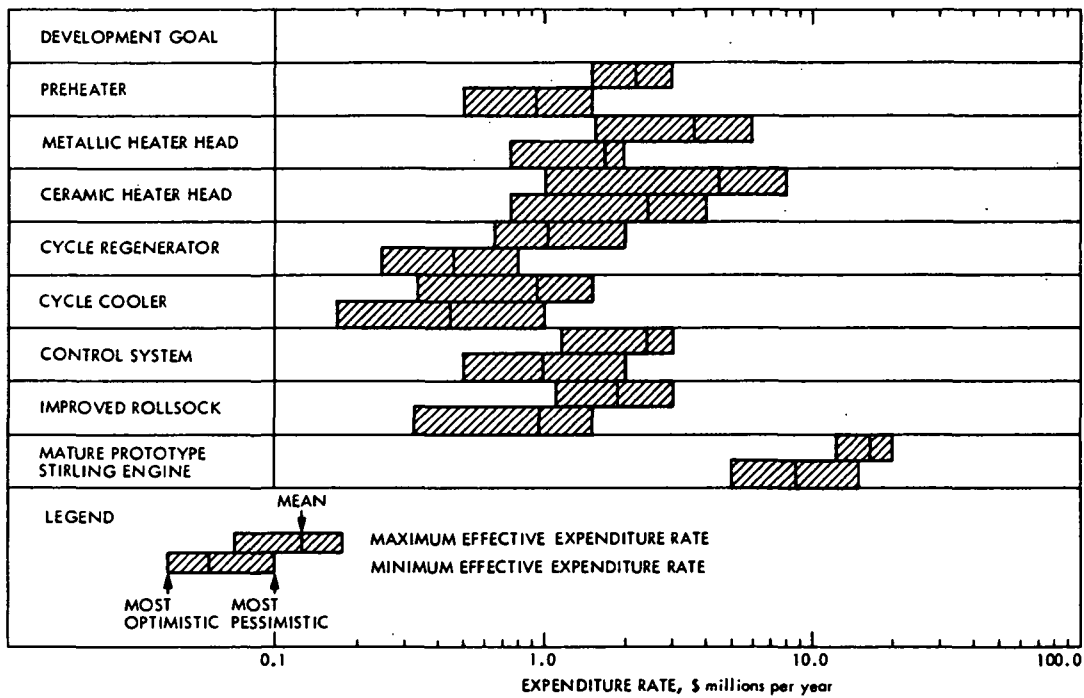

Fig. 12-2. Estimated effective expenditure rates for Stirling Engine development

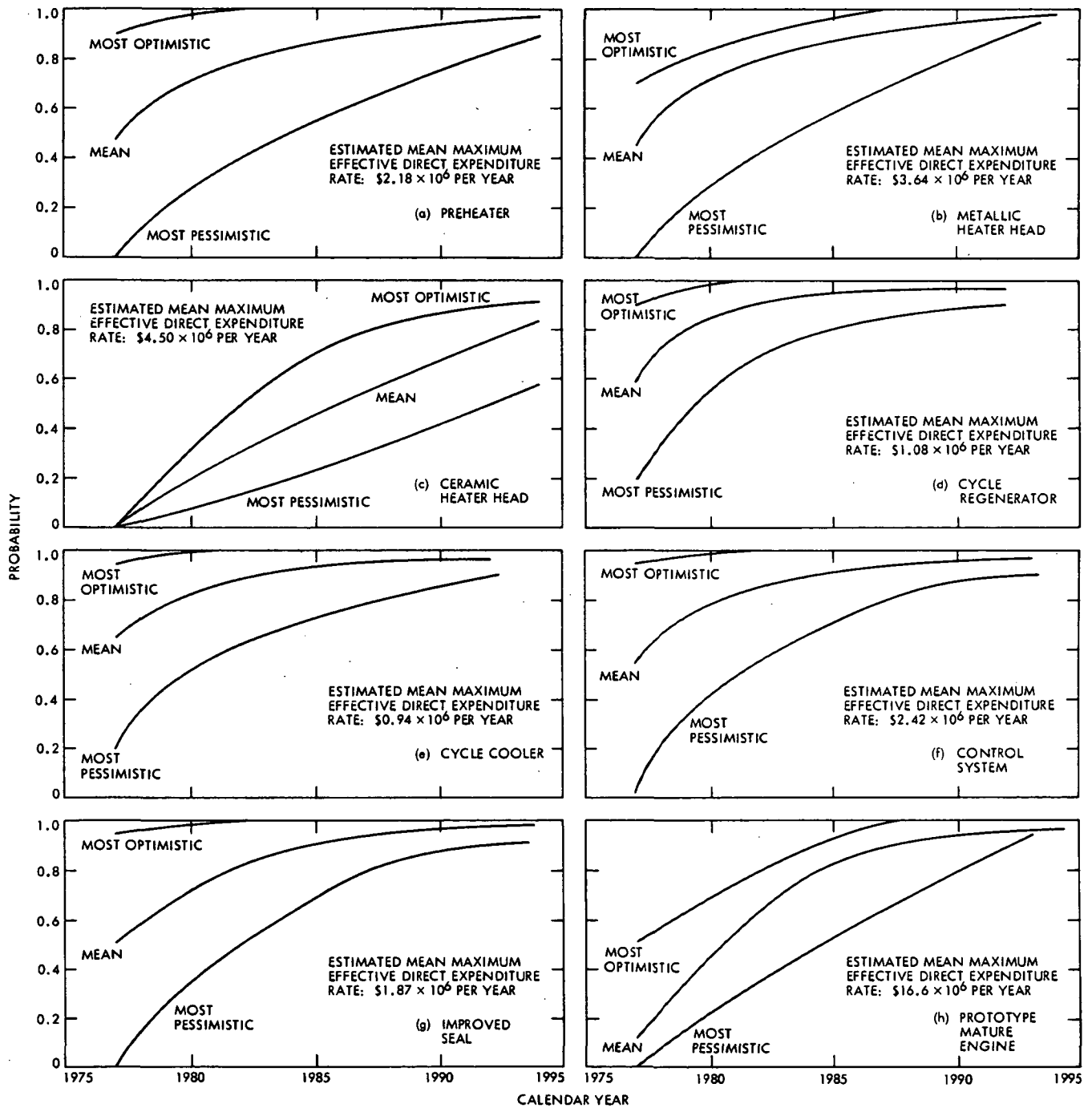

Fig. 12-3. Estimated probability of accomplishment of critical Stirling Engine R&D tasks at mean estimated maximum effective expenditure rates

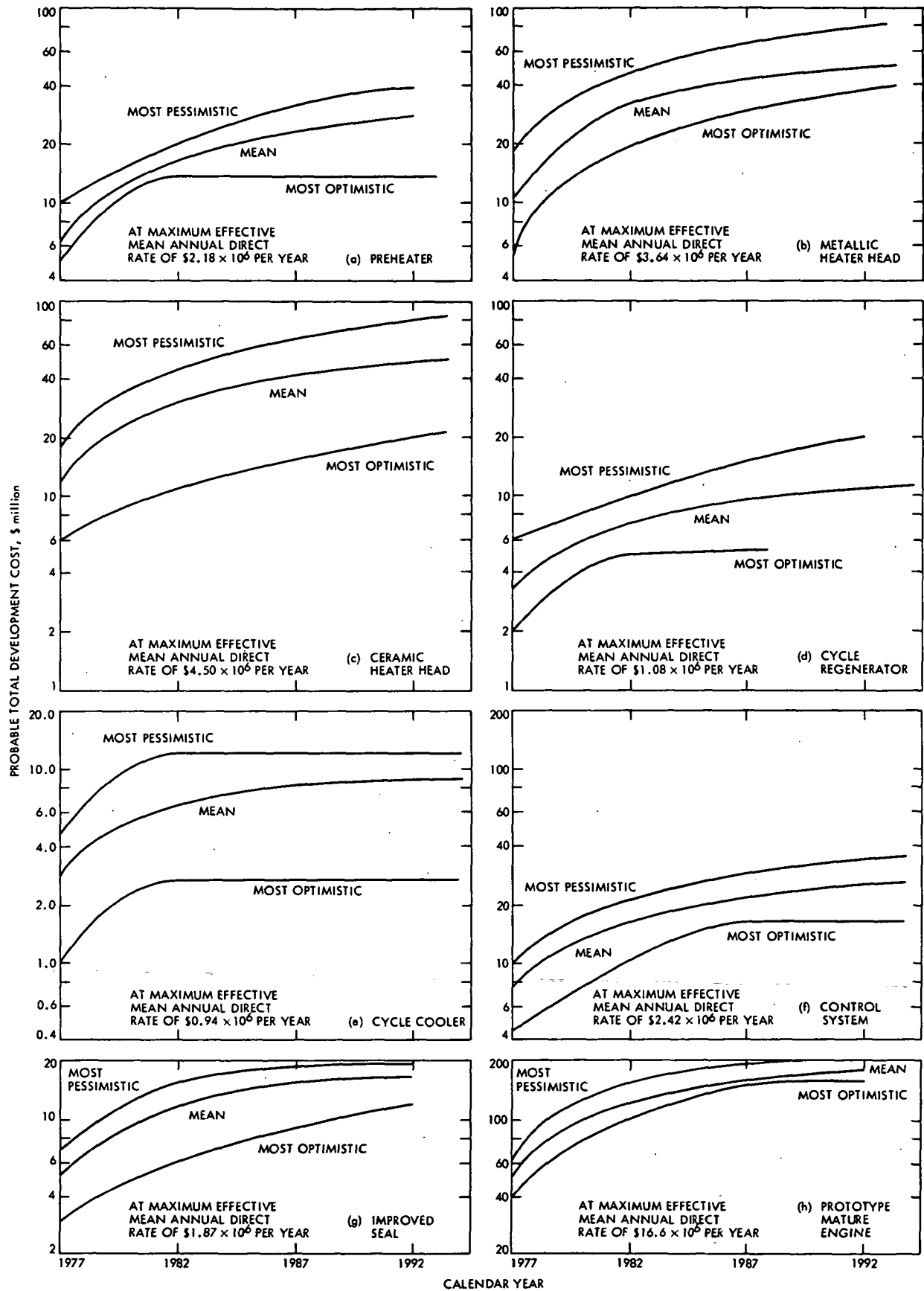

Fig. 12-4. Estimated cumulative total direct costs for accomplishment of critical Stirling Engine R&D tasks at estimated maximum effective expenditure rates (1974 U. S. dollars)

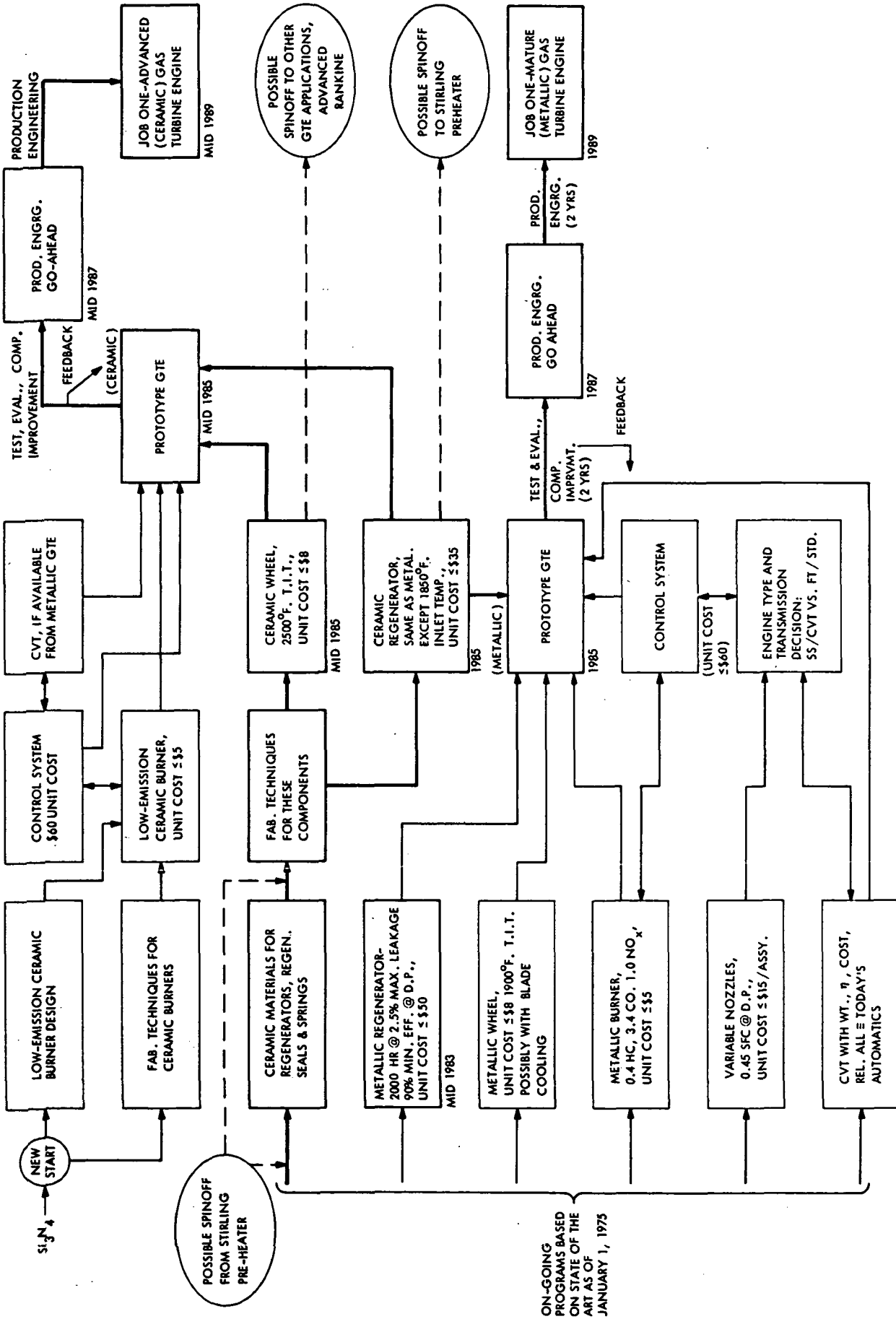

Fig. 12-5. Gas Turbine Engine R&D network

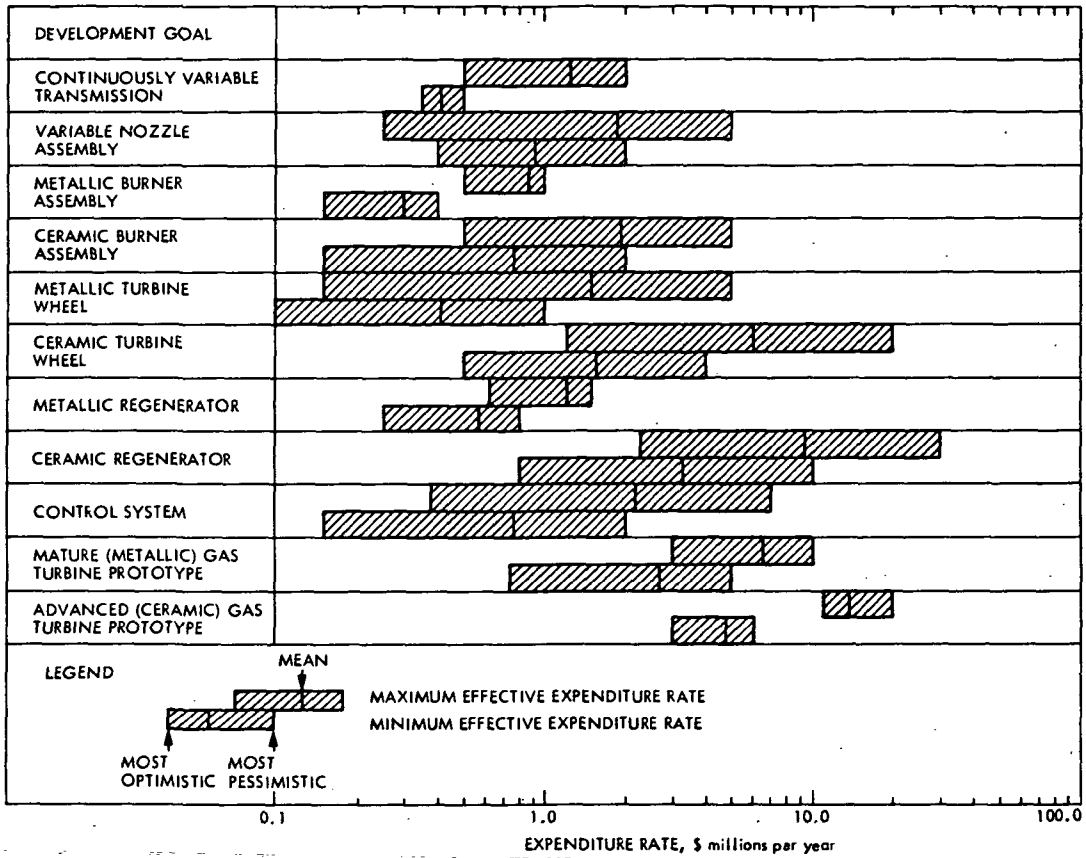

Fig. 12-6. Effective expenditure rates estimated for gas turbine development



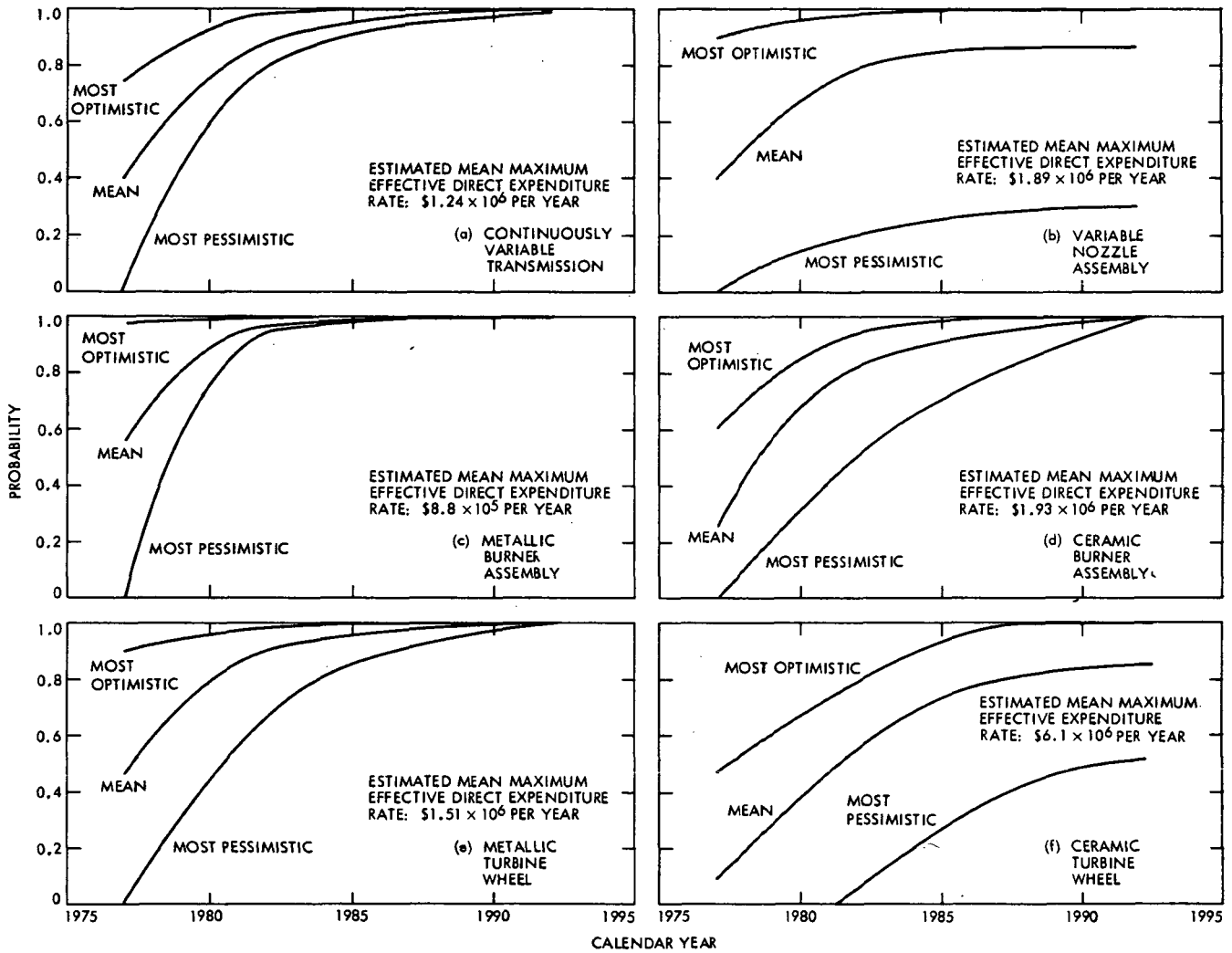

Fig. 12-7. Estimated probability of accomplishment of critical Gas Turbine Engine R&D tasks at estimated maximum effective direct expenditure rates

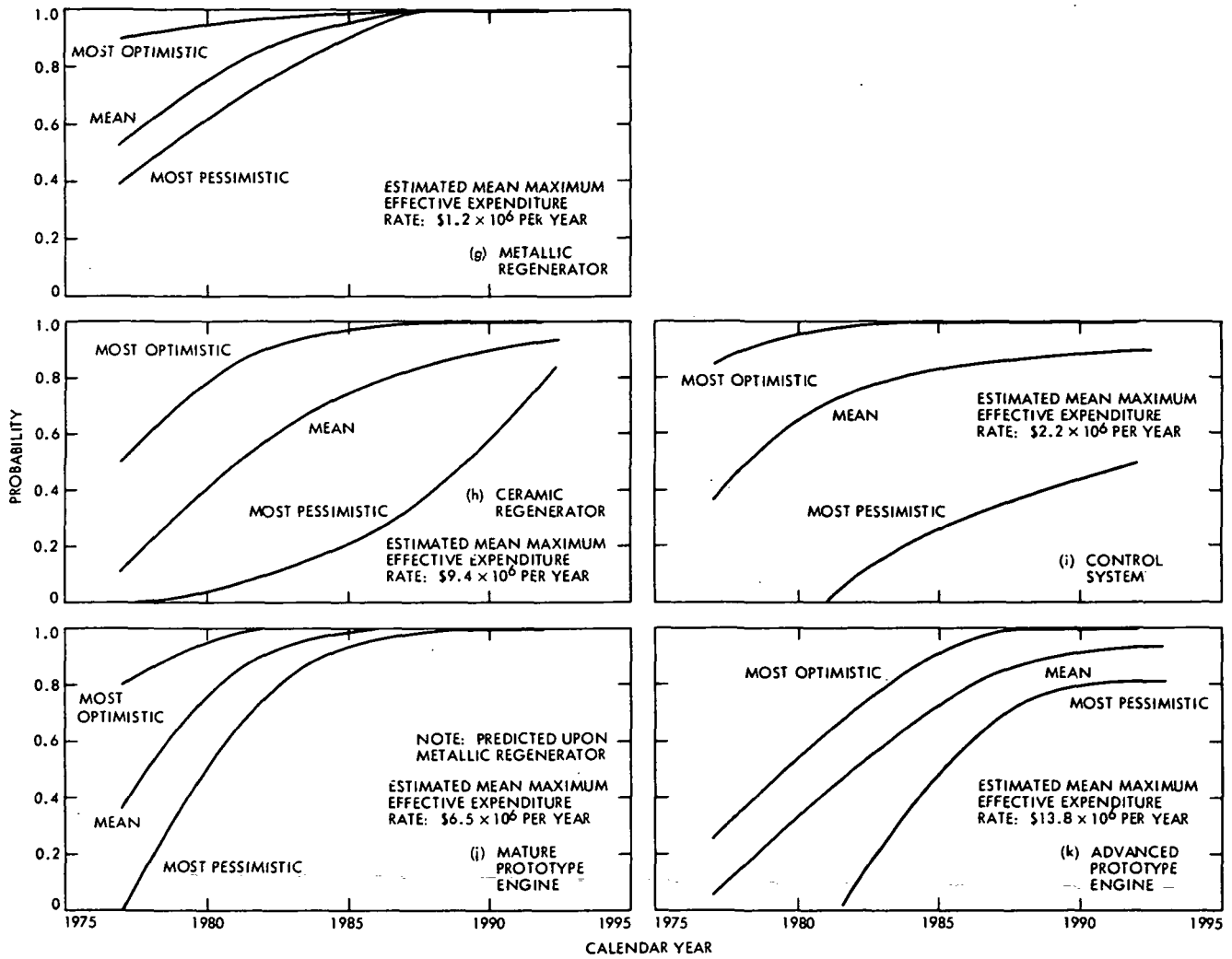

Fig. 12-7 (contd)

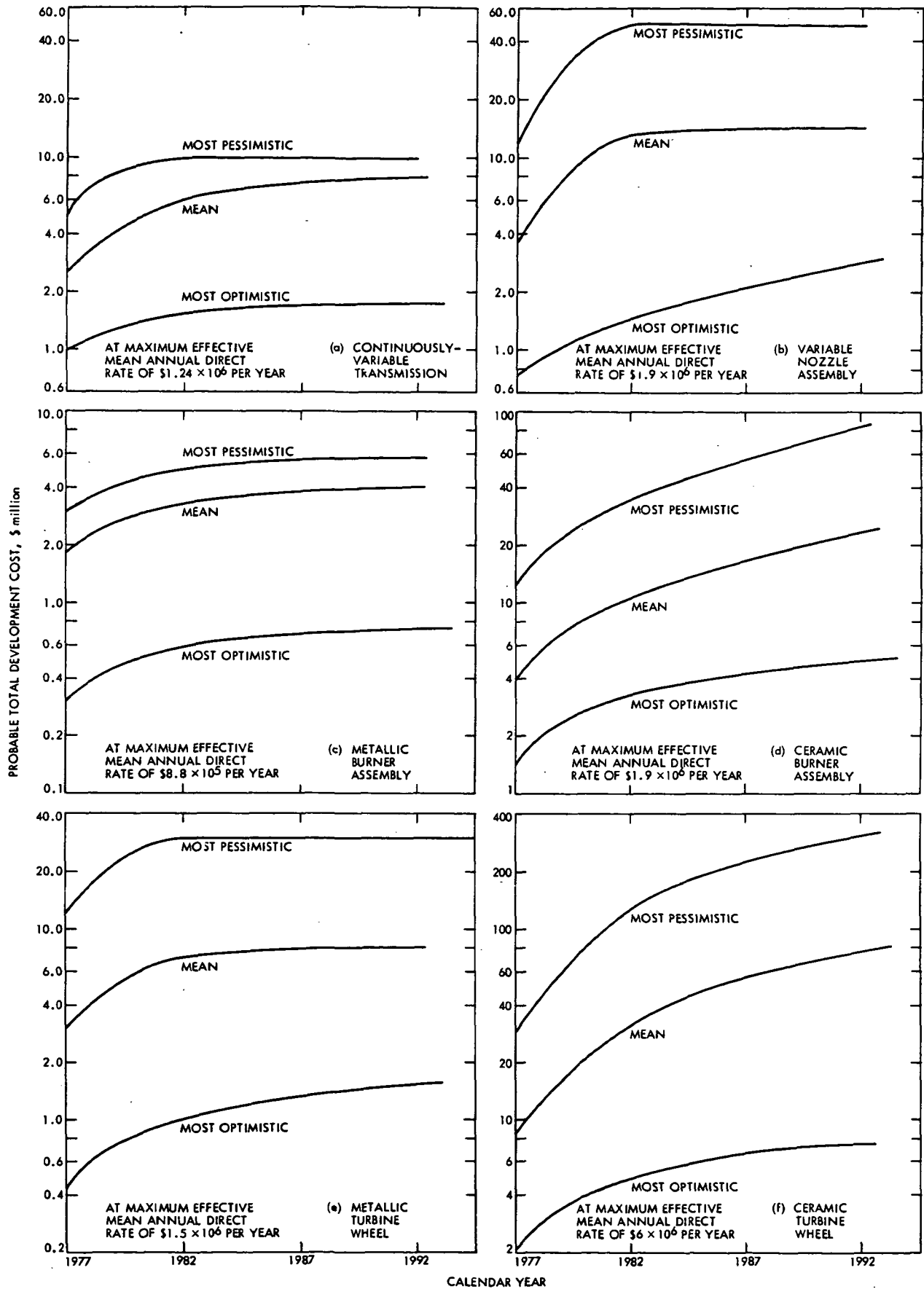

Fig. 12-8. Estimated cumulative total direct costs for accomplishment of critical Gas Turbine Engine R&D tasks at estimated maximum effective expenditure rates (1974 U. S. dollars)

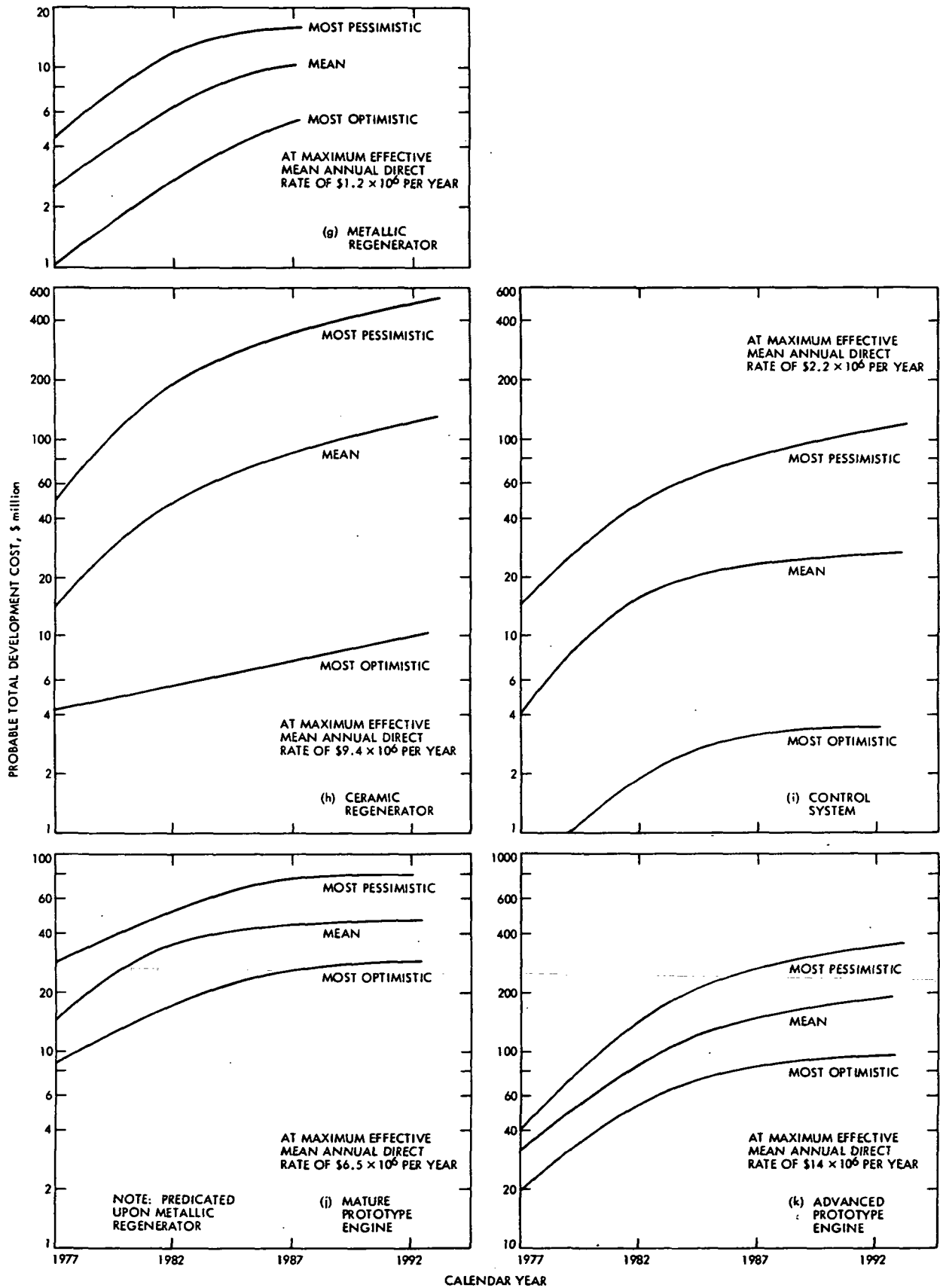

Fig. 12-8 (contd)

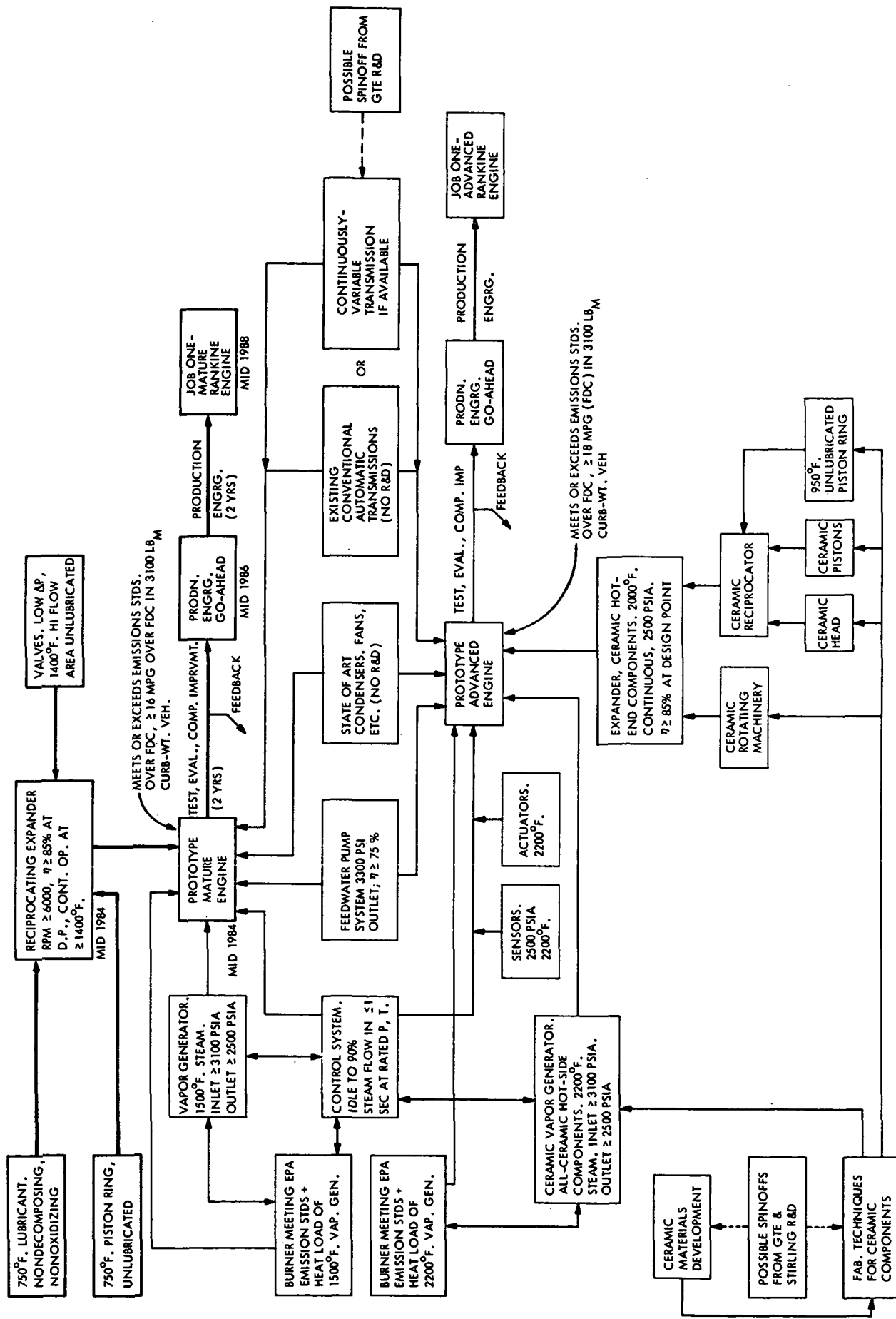

Fig. 12-9. Mature Rankine Engine R&D network

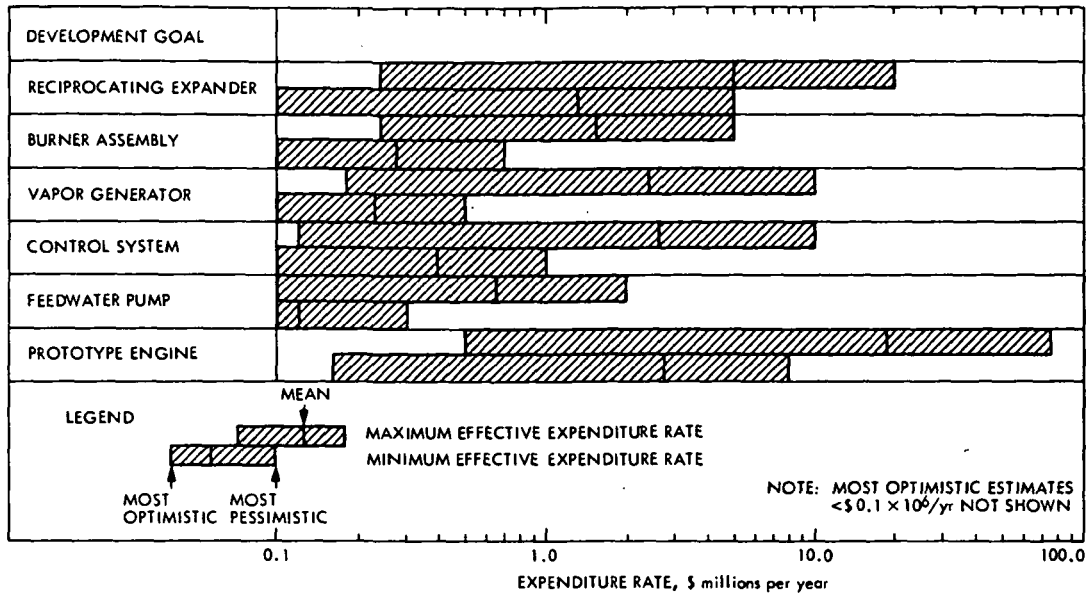

Fig. 12-10. Estimated effective expenditure rates for mature Rankine Engine development

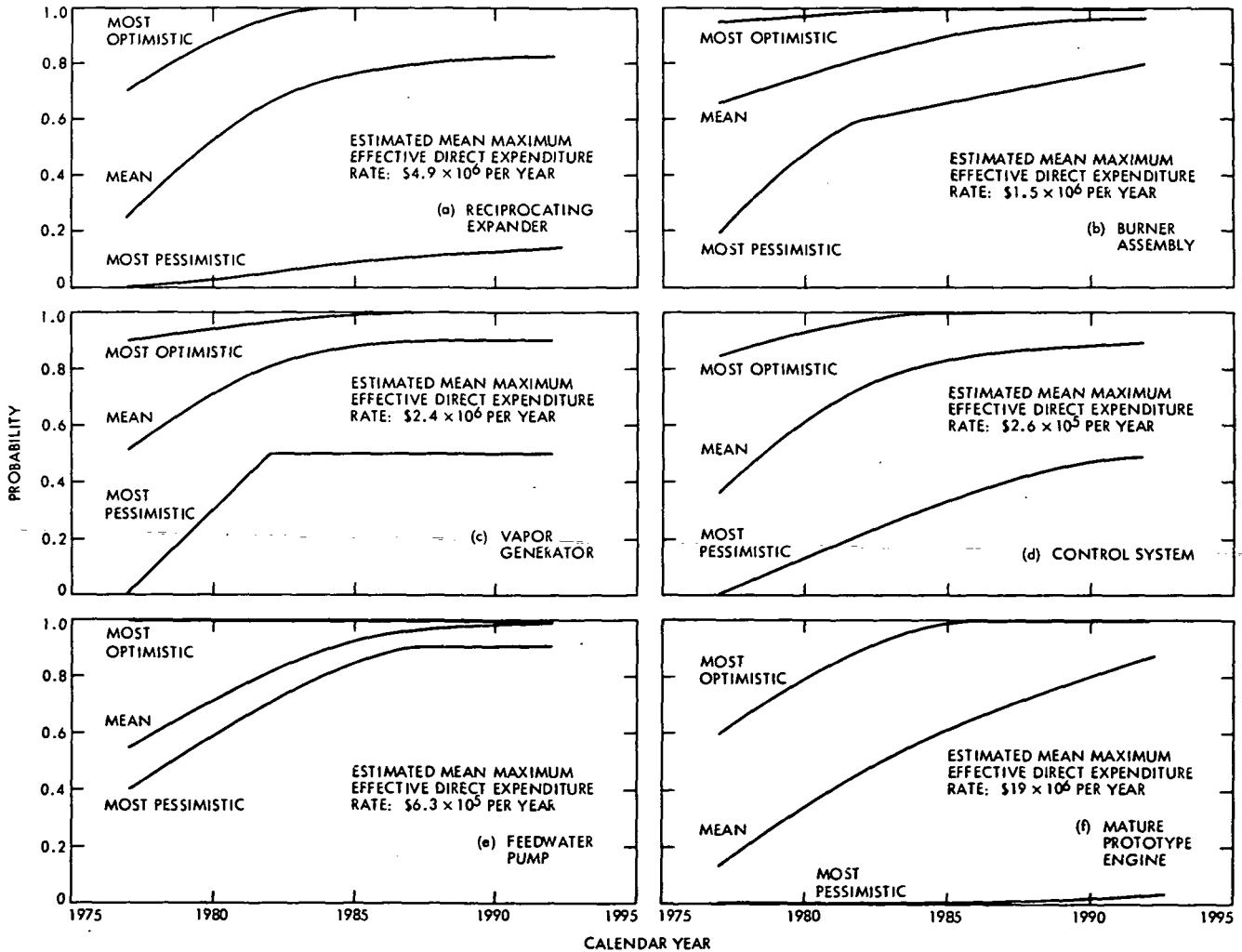

Fig. 12-11. Estimated probability of accomplishment of critical mature Rankine Engine R&D tasks at estimated maximum effective expenditure rates

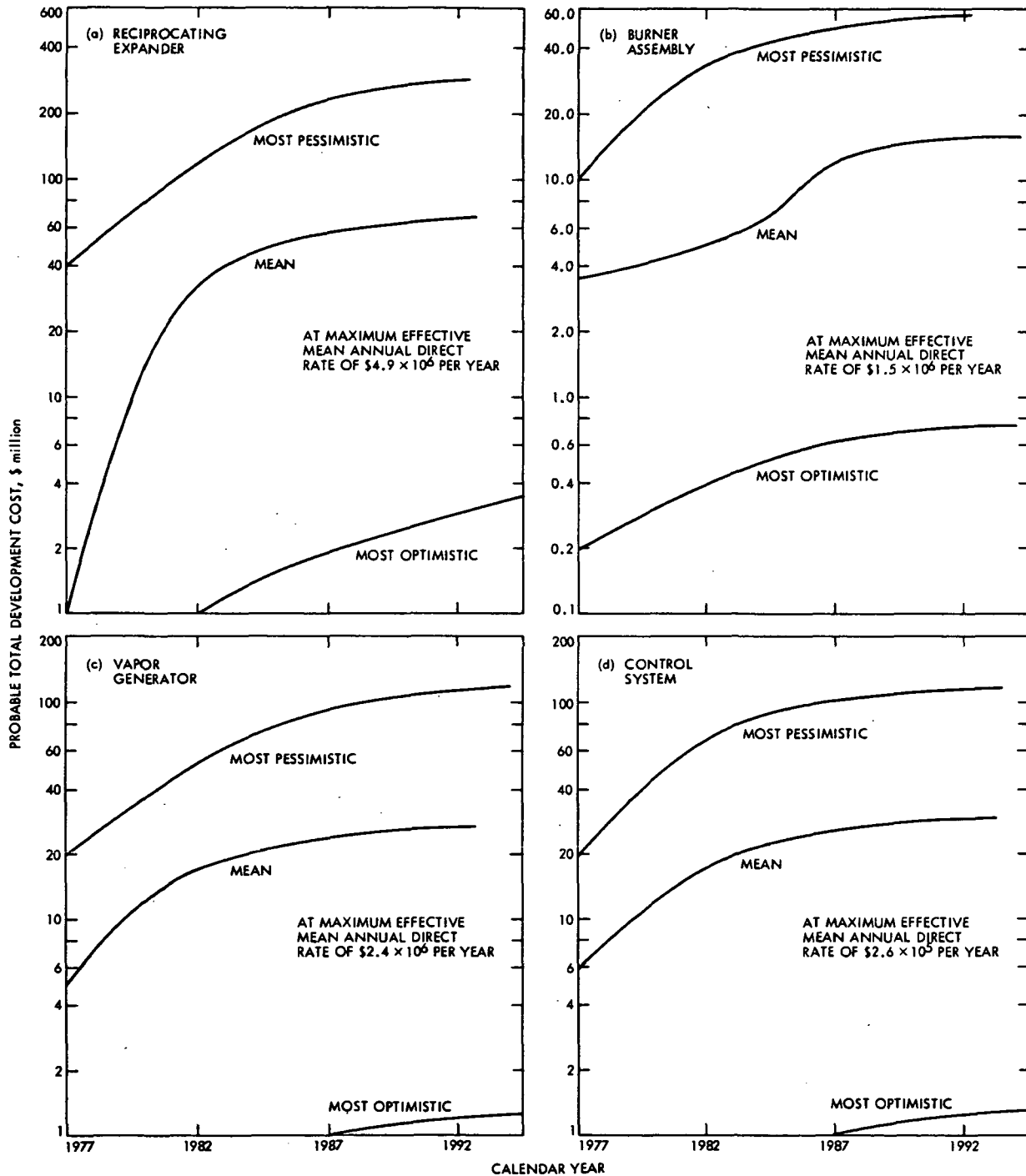

Fig. 12-12. Estimated cumulative total direct costs for accomplishment of critical mature Rankine Engine R&D tasks at estimated maximum effective expenditure rates (1974 U. S. dollars)

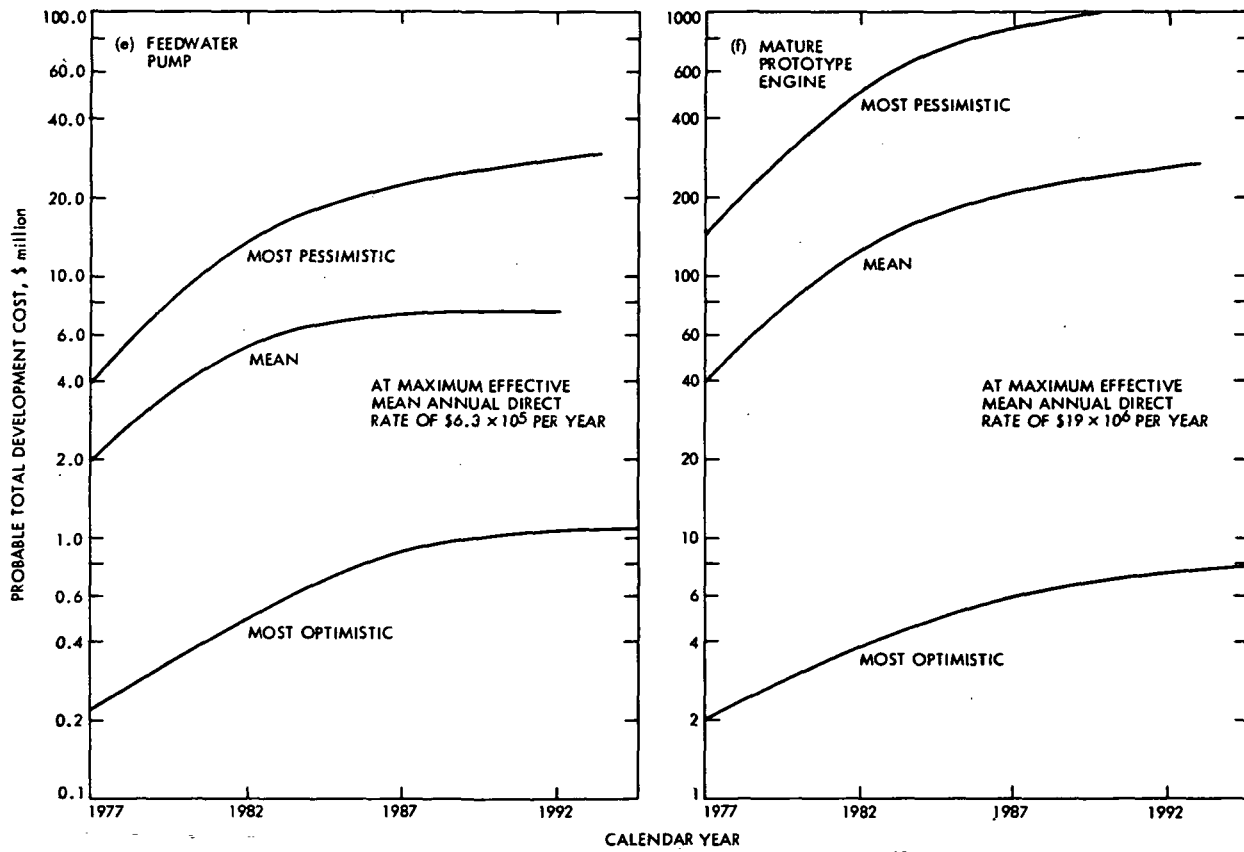

Fig. 12-12 (contd)



CHAPTER 13. SCENARIO GENERATION

Discussion ..... 13-1  
References ..... 13-3  
Figures ..... 13-4

In this section we briefly discuss the methodology used for the scenario calculations for future vehicle fuel consumption and emissions. Similar general methodologies have been described elsewhere (Refs. 13-1 and 13-2) so we will only discuss the specifics of our calculations.

To facilitate the analysis of alternative scenarios, a computer program was designed to calculate the amount of fuel consumed and pollutant emissions generated (HC, CO, NO<sub>x</sub>) assuming different futures. The program requires that the following data be supplied for each year of interest.

- (1) Estimated passenger car vehicle miles traveled (VMT) (national and for selected air basins).
- (2) Estimated total passenger car registrations.
- (3) New car production mix (percent of production for each engine-vehicle combination) for the scenario of interest.

The first two parameters, as discussed in Section 14.1 (Figs. 14-9 and 14-10), are determined by the choice of the alternate future. That is, we used the specific VMT and fleet size projection associated with the future we were calculating. The properties of the new car production, in terms of (1) the mix of vehicle categories, (2) the level of technology used for the vehicles, and (3) the level of technology used for the engines, are entered for each year in accordance with the scenarios being run (see Section 17.3.2).

In addition, the program uses several parameters which are independent of the year:

- (1) Survival probability according to vehicle age (Table 13-1).
- (2) Average VMT's per vehicle per year as a function of vehicle age (see Fig. 14-7).
- (3) Btu's/mile on the urban and highway cycle and emission characteristics of each engine-vehicle combination considered (see Chapters 3 to 9).

The first two factors are based on historical data and, as discussed in Section 14.1 (Fig. 14-7), depend on future vehicle use and fleet turnover occurring much as it has in the past. We have assumed these parameters will remain constant over the period of interest.

The third set of parameters, the specific energy consumption and emission characteristics of the engine-vehicle combinations, are assumed to remain constant throughout the life of the vehicle. (This assumption for emissions is discussed in Chapter 19, Appendix A-1.) By convention, these energy consumption calculations are based upon the higher heating value of gasoline, 125,000 Btu/gal.

Table 13-1. Mean survival probabilities by age, 1965 - 1972

Vehicle age	Survival probability <sup>a</sup>
1	1.0 (assumed)
2	0.9922
3	0.9894
4	0.9829
5	0.9733
6	0.9567
7	0.9253
8	0.8735
9	0.8218
10	0.7589
11	0.7236
12	0.7053
13	0.7004
14	0.7010
15	0.7104
≥16	0.7424

<sup>a</sup>Arithmetic mean of seven years data (Ref. 13-3).

The program uses 15 years of historical data (1960-1974) to obtain the present fuel economy and emissions characteristics of the vehicle fleet (Ref. 13-4).

The program begins with 1975 and calculates the mean fuel consumption and emissions characteristics of the production mix (the weighted mean of the engine-vehicle combinations specified assuming 55% urban driving and 45% highway driving for fuel consumption calculations and 100% urban driving for emissions calculations). When more than one fuel is used, a separate value is stored for each fuel. The emissions levels are, of course, categorized by pollutant. This process is then repeated for 1976 and all successive years.

The program next estimates the distributions of VMT's by vehicle age for each year (i.e., the percentage of VMT's by new cars, one-year-old cars, etc.). This is done by first calculating the expected number of vehicles in each age bracket (0-1 yr, 1-2 yrs, etc.), using a somewhat modified cohort analysis. That is, given the vehicle distribution for 1974 and historical survival probabilities, the 1975 vehicle distribution is determined by subtracting the appropriate numbers of scrapped cars and adding in new production. New car production is held at approximately 11% of the total fleet (historically this has been relatively constant)<sup>1</sup>. Using 1975 as a base, the 1976 distribution is determined, and so on. With the

<sup>1</sup>The percentage of new cars and the survival probabilities were reduced slightly when necessary to account for slower than historical growth in the total fleet size (medium and low fleet projections). This method is only approximate and is intended to represent average, long-term responses to changes in fleet growth trends.

number of vehicles in each age bracket known, historical estimates of VMT's per vehicle per year (as a function of vehicle age) (see Chapter 14, Fig. 14-8) are used to calculate the percentage of total VMT's attributable to vehicles of a particular age.

The program next calculates the mean fuel consumption and emissions characteristics of the entire fleet of cars in 1975. The fleet mean is the weighted average of the new car production values for 1975 and the 15 years prior to 1975 (the production values are weighted according to the percentage of VMT's attributable to vehicles of that production year). The fleet mean fuel consumption and emissions are then calculated for 1976 and so on. It is important to note that all averages were computed using Btu's per mile rather than miles per gallon to avoid calculation errors (Ref. 13-4).

The final steps of the program calculate the national energy consumption for automobiles and the emissions contribution of the automobiles for specific air basins. The former is simply the product of the total VMT (a national statistic) times the average energy use rate (Btu/mile) for the vehicle fleet in that year. The emissions in each air basin can be calculated by multiplying the average vehicle emissions level (g/mi) by the projected use of vehicles in that air basin (VMT/day).

An analysis of fuel consumption using the 1975 Federal Test Procedure (Ref. 13-4) has shown that the urban driving cycle alone reproduces quite accurately historical fuel consumption figures published by the Federal Highway Administration (Ref. 13-5). However, in Section 14.2.1 we argued that a 55-45 composite of the urban and highway cycles is more representative of actual driving habits. But this method, when compared to historical data, underestimates fuel consumption by about 13%. Thus the computed fuel consumption must be increased by a factor of 1.15 to match the historical data. This correction factor was derived as the mean correction factor for 1970-1973. 1974 was excluded because it was an anomalous year<sup>2</sup> and because only a preliminary estimate of actual (FHWA) fuel consumption was available.

Part of this discrepancy may arise out of the procedure used to test the vehicles. Test cars are well tuned and functioning at peak efficiency. The average vehicle on the road is not as carefully maintained and thus operates somewhat less efficiently. In addition, the effects of hills, wind, and other environmental factors tend to further reduce actual fuel economy (mpg) as compared with that measured on test vehicles. It thus appears that although the 55-45 composite cycle is more representative of actual driving, these other effects reduce actual fuel economy (mpg) to that obtained by test vehicles on the urban cycle alone. This topic is further explored in Section 10.6.7.

A simplified flow chart of the scenario generation program is given in Fig. 13-1.

#### References

- 13-1. Harvey, D. G., and Menchen, W. Robert, A Technology Assessment of the Transition to Advanced Automotive Propulsion Systems, Vol. II, Hittman Associates, Columbia, Maryland, May 1974.
- 13-2. "Predicting Urban Air Quality -- A Macroanalysis of Pollution Control Strategies," from The Automobile and the Regulation of Its Impact on the Environment, Legislative Drafting Research Fund, Columbia University, Grant-NSF-GI-29765, June 30, 1974.
- 13-3. Automotive News, Almanac Issue, April 1974; also Ward's Automotive Reports, Vol. 49, No. 44, Nov. 4, 1974.
- 13-4. Austin, T. C., and Hellman, K. H., "Fuel Economy of the 1974 Models," SAE Paper 740970, 1974.
- 13-5. U. S. Department of Transportation, FHWA, Office of Highway Planning, Tables VM-1 and VM-201.
- 13-6. Preliminary estimate by the Federal Highway Administration assuming the 1973 split between passenger car VMT's and total VMT's (personal communication).

---

<sup>2</sup>Preliminary estimates of VMT's and fuel consumption for 1974 (Ref. 13-6) indicate that while passenger car VMT's have decreased slightly (about 1%), fuel consumption has decreased by over 2%. Considering that the new 1974 cars got fewer miles per gallon than 1973 cars makes this even more surprising. We have postulated that the difference is due to better maintenance, lower speeds, consolidation of shorter trips, and perhaps other changes.

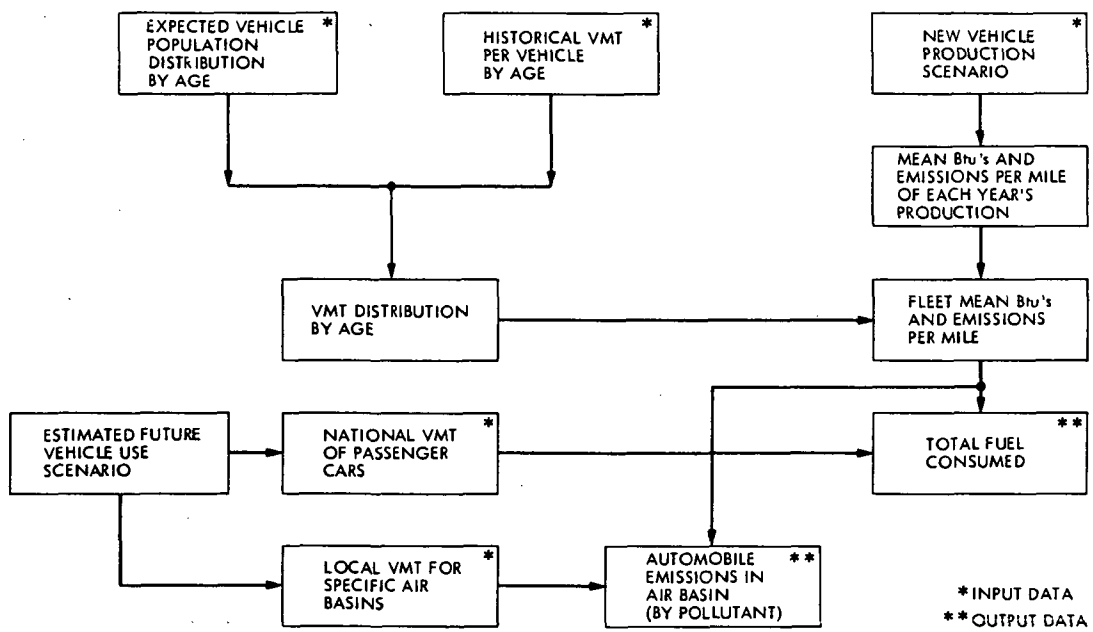

Fig. 13-1. Flowchart of scenario generation programs

CHAPTER 14. AUTOMOBILE USE

14.1	Macropatterns of Automobile Use . . . . .	14-2
14.1.1	Factors Underlying Future Vehicle Use . . . . .	14-2
14.1.2	Alternate Projections of Vehicle Use . . . . .	14-5
14.1.3	Vehicle Use Data for Specific Urban Basins . . . . .	14-8
14.1.4	Research Needs in Macropatterns of Vehicle Use . . . . .	14-10
14.2	Micropatterns of Automobile Use . . . . .	14-11
14.2.1	Driving Cycles . . . . .	14-11
14.2.2	Other Micropatterns of Interest . . . . .	14-14
14.2.3	Research Needs for Micropatterns of Vehicle Use . . . . .	14-15
	References . . . . .	14-15
	Figures . . . . .	14-18

## 14.1 MACROPATTERNS OF AUTOMOBILE USE

In order to understand what the future impacts of the automobile will be, we must understand the relationship between the automobile's use patterns and the impacts, as well as how factors external to the choice of automotive technology will affect the impacts via changes in auto use.

The purpose of this section is to explore those external factors that are likely to affect automotive use and illustrate the wide range of "futures" possible over the next 10-15 years. We cautiously have refrained from trying to make explicit estimates of future auto use patterns from well defined models using historical data, because we believe there are strong uncertainties in underlying factors governing both the rate and direction of change.

The uncertainties come from at least two sources: first, technological uncertainties in alternate technologies for both energy supply and utilization, as well as environmental controls and alternate transportation and communication systems; second, uncertainties in government policies relating to energy management, environmental and consumer protection, and the general economy, just to name a few areas which will affect automobile use patterns.

We feel it is important that choices be tested under a wide variety of futures, as a basis for realistic decision-making. Even then, when new information is gathered (as time passes), some decisions will be seen to be in error. Thus, we consider it important that many alternatives be carried along as the high level of uncertainty requires. Of course, there are additional costs involved in keeping more alternatives available, but they could well be smaller than the costs involved in not having suitable alternatives for a particular future.

### 14.1.1 Factors Underlying Future Vehicle Use

In this section we discuss a series of factors that we feel will affect vehicle use in the next 10-20 years and, as much as possible, what the effect of those factors will be. We will measure vehicle use as the total annual vehicle miles traveled (VMT) in the U.S. This can then be used to calculate vehicle energy use by multiplying by appropriate fuel consumption figures. Individual VMT projections will be made for several "example" air basins in order to illustrate the effects of vehicular emissions on the region's air quality problems. (These will be presented in Section 14.1.3.)

#### THE POPULATION OF DRIVING AGE

One "fundamental" consideration underlying the total amount of driving (or vehicle use) is the population level, more specifically, the number of licensed drivers who would make use of motor vehicles. Figure 14-1 shows the "official" population projections for persons of driving age (taken as 16 years or older) (Ref. 14-1). Note that there is little divergence in the population projections until 1990 because these potential drivers have already been born. Even by the year 2000 the spread in the alternative population

projections is only about  $\pm 2\%$ . (Official census numbers have a tolerance of about  $\pm 1\%$ .)

The important consideration here is that because of the decreasing overall birthrate, the number of persons "eligible" to drive will increase more slowly than it has in the past. Even if the birthrate begins to rise again, there will be a considerable "lag time" for this to affect the driving population. Secondly, as Figure 14-1 shows, the number of actual licensed drivers has increased more rapidly than the eligible population, but by the mid 70's will approach 85% of the eligible.

Figure 14-2 shows this data for California (Ref. 14-2). It seems likely that a saturation in the number of licensed drivers as a fraction of the eligible population will have to occur fairly soon, simply because a certain fraction of the population will be too old or have health problems that prevent them from driving. In any event, if we assume saturation at the 85% level, our estimates can at worst be 15% low.

Our conclusion is that the number of licensed drivers is not as likely to increase as rapidly in the future as it has in the past, as nearly all the eligible drivers are licensed.

#### SATURATION OF VEHICLE OWNERSHIP

If we compare the number of drivers with the vehicle population, we find that a second saturation effect is taking place. That is, the total number of vehicles is approaching the number of registered drivers. Data from California shown in Figure 14-3 indicates a saturation being reached in the number of passenger vehicles per licensed driver at about 85%. Trends in national data shown in Figure 14-4 do not reflect saturation effects as clearly.

Other investigators have come to similar conclusions (Ref. 14-3), as we have shown on Figure 14-4, but still others have postulated quite different futures (Ref. 14-4). Actually, part of the problem is that the percentage of automobiles in the total vehicle fleet has been dropping (Ref. 14-5), as shown in Figure 14-5. This is compensated by growth in light trucks (see Section 14.1.2 - LIGHT TRUCKS).

#### ECONOMIC FACTORS

A great deal of effort has gone into trying to examine economic factors that would affect vehicle use, especially as it relates to the price of gasoline (Refs. 14-4, 14-6, 14-7). These studies have tried to use historical data to establish a relationship between the demand for gasoline and its price, and then to investigate the effect of price changes on demand.

We have reviewed these and other studies of this question in an attempt to understand these effects, but find there is such considerable uncertainty in the basic variables as to question the value of formal models in predicting vehicle use.

First, econometric models themselves do give widely varying results for both the short and long term elasticities of gasoline demand versus price. Second, there is considerable uncertainty

as to what price the supply of gasoline (or other fuels) may have, both due to market forces (reflecting technological, political, and economic uncertainties in the supply), as well as the effect of direct government policies (such as gasoline taxes or quotas). On the demand side, there is uncertainty in certain economic factors (disposable income), technological factors (improved automobile fuel consumption), and other government policy factors (improved alternate transportation, restrictions on vehicle use to reduce air pollution, etc.).

In summary, these factors contribute to a very high degree of uncertainty, which we feel can only be dealt with by considering a wide range of possible futures.

#### INCREASED USE OF ALTERNATE TRANSPORTATION SYSTEMS

Although the automobile plays a very major role in the present transportation system (in terms of moving people), considerable attention recently has been given to the question of alternate transportation systems because of their potentially higher energy efficiency, reduced pollution production, lower costs, etc. Historically, public transportation played a much greater role, but has declined in recent years in favor of the automobile. Only air travel has steadily increased, probably because it could provide significantly shorter travel times on longer trips.

Exactly how much diversion of automobile use can and will be made to alternate transportation will largely be a function of public policy, as well as changes in the technologies available for the alternate systems (as previously mentioned in ECONOMIC FACTORS). Thus, it is difficult to predict exactly what will be the role of these alternate systems.

However, to gain some understanding about what sort of changes could take place, assuming significant shifts to alternate transit systems, we have examined some possible changes and their consequences for vehicle use. We will look at past trends in public transit and then attempt to estimate the possible diversion of auto traffic to alternative modes in the 1980 to 1990 time frame. Three major areas are examined: urban bus systems, urban rail/subway systems, and intercity travel. In each case we have attempted to estimate reasonable improvements in the alternative modes.

#### Urban Bus Travel

For the past 20 years urban bus travel has steadily declined. Between 1960 and 1970 passenger miles of urban bus travel decreased 25% (Ref. 14-8), driving the average load factor of urban buses from 19 passengers/vehicle in 1960 to 13 passengers/vehicle in 1970 (Ref. 14-9). While passenger volume was falling, the total number of urban buses owned by transit companies remained roughly constant (49,000 to 50,000 vehicles (Ref. 14-10)), and vehicle miles operated fell only about 10% (from 1,576.4 million in 1960 to 1,409.3 million in 1970).

If bus travel is going to significantly affect automotive VMT's in urban areas, the current

passenger trends must be reversed. We will assume that the average load factor will climb to 25 passengers/vehicle and that sufficient buses will be produced to allow a considerable increase in the urban bus fleet. To estimate the effect of such a change on automotive VMT's, all increases in bus travel will be taken to be passenger miles diverted from automobiles.

In 1971 there were 49,150 urban buses owned by transit companies (Ref. 14-10) in the U.S. Annual production of new buses is about 6,000 units per year and serves to replace worn-out buses only. Current practice is to operate the production facilities on a one-shift basis. Thus, presumably output could be tripled in the short run by simply expanding to a three-shift operation. This would provide 12,000 additional buses to the fleet each year (over the next few years, anyway). Eventually, some of this additional capacity must be used to replace the new vehicles as they wear out. Thus, if the fleet is to continue to expand, additional capacity must be built. If construction began in 1974, it is estimated that four new 3,000 unit/year plants could be in operation by 1979 (Ref. 14-9). Thus, in 1979 the current plant could simply produce replacement vehicles while the new plants would continue expanding the fleet. In this way 12,000 new buses could be added to the fleet each year. The assumption that the 1970 average of 28,000 miles per bus per year (Ref. 14-10), will continue (historically it has been dropping) gives the estimates of urban bus travel shown in Table 14-1.

Table 14-1. Historical and projected<sup>a</sup> urban bus PMT's

	1960	1970	1980	1985	1990
Urban bus PMT's (millions)	28,300	20,900	84,700	126,700	168,700
PMT's diverted from autos <sup>b</sup> (millions)	-	-	63,800	105,800	147,800

<sup>a</sup> Projected PMT's = (49,000 + 12,000/(Year - 1974)) × 25 pass/bus × 28,000 miles/yr.

<sup>b</sup> Diverted PMT's = Projected PMT's - 1970 PMT's.

#### Urban Rail/Subway Travel

Since its peak in the late 1940's and early 1950's, urban rail/subway travel has been declining steadily. Between 1960 and 1970 urban rail PMT's have decreased from 18.504 billion to 16.928 billion (Ref. 14-8). If rail/subway systems are to have an impact on automotive VMT's, drivers must be diverted from automobiles to these systems. As an estimate of the diversion of drivers, we will assume a modest increase in the load factor of each vehicle, a major increase in new railway car production, and the building of several new transit systems.

During peak periods the average railway car is filled to 125% of its seating capacity and thus increases in peak hour loading are difficult. The base load or off-peak periods on the other hand carry only 60% to 70% of the seating capacity (Ref. 14-11). At least some increases in off-peak loading are thus possible.

Between 1960 and 1970 the average load factor for railway cars was 38-40 passengers/car (Refs. 14-8, 14-10). With the above considerations a 10%-15% increase in the average load is all that could be reasonably expected. New railway cars are currently delivered to existing systems at a rate of about 400 per year (Ref. 14-10), which is used to maintain a fleet of about 10,600 cars (fleet size is actually slowly dropping). Assuming current output of new railway cars is tripled (adding 800 cars/year to the fleet) and old systems are expanded or new ones built to accommodate the new cars, an additional 16.6 million VMT's of railway car travel could be added to the system each year.<sup>1</sup>

Assuming all new passengers are diverted automobile drivers<sup>2</sup> (as an upper limit), the new railway cars and increased load on old railway cars could divert 26.1 billion PMT's from auto use in 1990 (see Table 14-2).

Table 14-2. Passenger miles traveled by urban railway

	1960	1970	1980	1985	1990
Urban railway PMT's (millions) <sup>a</sup>	18,504	16,928	28,128	35,528	43,028
PMT's diverted from autos (millions) <sup>b</sup>	-	-	11,200	18,600	26,100

<sup>a</sup>PMT's diverted = 5 × old VMT's + (year - 1974) × 45 pass/car × 41,500 miles/car × 800 cars/yr.

<sup>b</sup>Total PMT's = diverted PMT's - 1970 PMT's.

### Intercity Travel

Intercity travel is in a different category from the urban travel situation in that one mode, airplanes, has expanded very rapidly in "competition" with the automobile (see Table 14-3 and Ref. 14-12).

Of total intercity passenger travel (greater than 200 miles round trip), 69% is currently by auto or truck, 27% by air, with the remaining 3%

Table 14-3. Passenger-miles-traveled by air (scheduled air carriers)

	1950	1955	1960	1965	1970
Domestic passenger-miles (billions)	8.007	19.852	30.567	51.887	104.156
Domestic passenger-miles per capita	52.6	119.7	169.2	267.2	508.3

going by bus, rail, and other (Ref. 14-13). As Figure 14-6 shows, the shorter trips are predominantly by auto or truck, while the longer trips are split between air and auto/truck travel (Ref. 14-13). It is difficult to estimate exactly what sort of changes will take place in the next 10-15 years. A diversion of 20% of the auto/truck intercity travel to buses over the next 10 years is currently believed to be extremely optimistic but possible (Ref. 14-9). Perhaps a more realistic estimate would be a 20% to 30% diversion of auto/truck travel to air, rail, and bus combined over the next 15 years.

We have assumed that a significant diversion (20%) of the projected intercity travel is diverted to other modes, to produce the estimates shown in Table 14-4.

Table 14-4. Projected diversion of intercity auto/truck passenger travel

	1975	1980	1985	1990
Auto/truck PMT's diverted to other modes (millions)	-	35,000	82,200	144,000

### Total Diversion of Automotive VMT's

To transform the estimates of PMT's diverted from auto travel to other modes into reductions in projected auto VMT's an estimate of auto occupancy is needed.<sup>3</sup> As discussed in VEHICLE OCCUPANCY, we currently feel that auto occupancy will level off at about 1.6 passengers/auto. Based on this assumption, Table 14-5 summarizes our estimates of the possible reduction in auto VMT's due to diversion to other modes of travel.

<sup>1</sup>Using 41,000 miles/car/year (Ref. 14-11).

<sup>2</sup>A load factor of 45 passengers/car will be used in our diversion estimates, five of which will be assumed to be diverted drivers added to the old cars. Forty-five diverted drivers will be assumed for each new rail car.

<sup>3</sup>VMT = PMT/Occupancy.



Table 14-5. Diversion of auto VMT's to other modes of travel (billions)

	1980	1985	1990
Urban bus	39.9	66.1	92.4
Urban rail/ subway	7.0	11.6	16.3
Intercity	21.9	51.4	90.0
Total	66.8	129.1	198.7

This diversion will be compared to the projections of total automobile VMT's in ALTERNATE PROJECTIONS OF VEHICLE MILES TRAVELED (VMT).

#### LAND USE AND RELATED FACTORS

The coupling between the automobile use and land use patterns is something that is readily acknowledged, but not well understood. Historically older central cities have been spreading out with their suburban regions growing rapidly. Newer cities simply never develop high densities, but spread out horizontally (Ref. 14-14). The automobile is the transportation system that has primarily developed with this land use pattern, but it is difficult to say which is the cause and which is the effect.

The land use and transportation patterns are a response to a wide array of economic, political, social and technological factors that are not well understood. Even in trying to cope with problems of energy use, air pollution, congestion and other costs, it is not clear exactly what new land use patterns will emerge as a desirable response. Most land use planning has remained in the hands of local governments, and often reflecting very local concerns. Regional problems such as air pollution and global problems such as energy use have rarely directly affected land use decisions, except as they affected a particular local concern (Ref. 14-15).

Two factors would seem to suggest that the land use patterns will be slow to change. First, the normal rate of change in land use patterns is historically slow. The rate of building new residences has been about 3% per year, coupled with about a 1% per year demolition rate (Ref. 14-16). Some data for the rapidly growing Los Angeles region indicated commercial floor space was growing more rapidly, i.e., about 6% per year, but this also probably included renovated space (Ref. 14-17). A national estimate would be closer to the number given for houses. Both numbers are a reflection that building structures have very long useful lives and sufficiently high first cost so they are not replaced rapidly. Thus in the next 10-20 years, land use patterns are not likely to change dramatically unless considerable effort is applied in that direction.

Secondly, until it is more clearly established what changes in land use patterns are most

beneficial, no new institutions or mechanisms, either public or private, will be formed to deal with these problems.

As an example of the often conflicting values involved, take the decision of a community (or a region) to allow a new central shopping center to be built. Arguments for the center would say that its central location would allow people to do all of their shopping in one trip. It could also be conveniently served by public transportation, and, in general, this would be advantageous from an energy and pollution viewpoint. However, it could be argued that the center might also attract people from much greater distances than they traveled to shop previously, and thus seemingly have adverse effects in energy and pollution evaluations.

At present these sorts of problems are not being effectively addressed, and as long as they are not understood or accounted for, land use patterns are unlikely to change and the future is likely to resemble the past.

In the short run, however, people will adopt their patterns of vehicle use within the constraints allowed by the present land use patterns. They will move the location of their homes relative to where they work, shop, and go for recreation as a means of modifying their total amount of vehicle use as discussed in Economic Factors. The time scales for these changes is more rapid, with people moving on the average of once every several years. Such changes could affect both the total vehicle use, as well as the micropatterns discussed in Section 14.2.

#### 14.1.2 Alternate Projections of Vehicle Use

In this section we examine some alternate "futures" of automobile use, based on the factors discussed in the previous section (14.1.1). (We remind the reader that our objective again is not to predict the future precisely, but rather to understand the range of possibilities as a basis for testing design choices for future vehicles.)

#### ANNUAL USE PER VEHICLE

The annual use of the average motor vehicle has changed very little in the last 25 years (see Figure 14-7) (Ref. 14-18). The average use of the motor vehicle has increased very slowly, from about 9,000 miles per year in 1950 to slightly over 10,000 miles per year at present. The growth in total vehicle miles seems to almost be entirely due to growth in the total vehicle fleet.

More recent data (1963-73) indicates that mileage per vehicle may be growing more rapidly; that is, mileage per vehicle is increasing as the number of vehicles grows more slowly. However, other futures are possible.

It may be that rising costs associated with vehicle operation, or other nonmonetary costs, may cause a decline in vehicle use per vehicle. People may still elect to own vehicles for uses where the vehicle is best or essential. However, they may well substitute alternate transit or reduce the number of nonessential trips.

It should be noted that this data is for the average vehicle, and covers the entire vehicle population, regardless of age. However, annual mileage has been found to vary strongly with age. Although data from different sources varies (Refs. 14-19, 14-20, 14-21), Figure 14-8 shows the basic use patterns. A new vehicle is likely to be driven several times as far as an older one.

Since some of our future scenarios will show a different mix of small and large cars, it is important to know about the relative use levels.

Available data from surveillance programs (Ref. 14-39), shows virtually no difference in the total mileage accumulated by small versus large vehicles. We have used this assumption in calculating future vehicle use and in understanding the effects of the turnover in the vehicle fleet in VEHICLE FLEET TURNOVER.

#### ALTERNATE PROJECTIONS OF VEHICLE MILES TRAVELED (VMT)

In Figure 14-9 we show three estimates of total future vehicle use. We will use these scenarios to calculate the impacts of the automobile in later sections, especially to estimate its aggregate fuel consumption (Section 17. 3. 2).

Briefly, each scenario can be associated with a different "future".

1. The High VMT Scenario is predicated on continued growth of VMT at the historical rate by a combination of high VMT's per vehicle and an increasing vehicle fleet. It would probably result from situations where the cost of fuel was not sufficiently high to restrict the use of vehicles, though this could come about in different ways, i. e., low fuel price, high fuel economy vehicles, large disposable incomes, etc. It was calculated from an extrapolation of the historical growth data, and is similar to other "high" projections.
2. The Medium VMT projection is a reflection of the slowing down in the population growth rate, the number of drivers, and the saturation of vehicle ownership. It could also reflect changes in other factors, such as fuel price, or some diversion to alternate transportation systems. The specific projection shown was based on the saturation projections of the automobile fleet; that is, passenger vehicles projected at 85% of the licensed drivers, which are in turn projected at 85% of the eligible population. This median projection for the vehicle fleet is combined with the long-term trend in the average annual vehicle mileage to give the Medium VMT projection.
3. The Low VMT projection reflects a situation in which vehicle use per vehicle (and/or per person) would decrease from present levels of use. This could reflect much higher fuel prices, or a very substantial shift to alternate transit systems (as indicated in INCREASED USE OF ALTERNATE TRANSPORTATION SYSTEMS). It is uncertain, of course,

whether this type of situation would result in a smaller fleet of automobiles or a reduction in annual vehicle use. (In Figure 14-7 we show the annual mileage decrease for a fixed fleet size projection.) It has arbitrarily been shown as giving total vehicle use constant between now and 1990 (a "no growth" projection).

It should be noted that the future does not have to smoothly progress along any of these curves, but rather the curves give some indication of the range of possibilities available.

#### PROJECTION OF THE VEHICLE FLEET SIZE

Different scenarios can be postulated for the total vehicle fleet size as part of the different VMT scenarios. As indicated earlier there are factors tending to saturate and reduce the rate of growth in the total vehicle fleet, and data for some areas (California) reflects this trend. However, increases in multiple ownership, especially of special purpose or speciality vehicles, could lead to a larger vehicle fleet, though the total VMT would not grow as rapidly.

Conversely, if overall vehicle use (VMT) should remain constant or even decline, this would not have to reflect a decrease in the fleet size, but could well reflect reduced per vehicle use. Thus there is a considerable degree of uncertainty in the size of the future vehicle fleet, as well as the total use of that fleet.

In Figure 14-10 we have indicated three "futures" for the vehicle fleet size corresponding roughly to the three VMT futures we have shown. We will use these as the basis for calculating certain properties of the vehicle fleet as well as estimating new vehicle production requirements.

#### VEHICLE FLEET TURNOVER

Each year a certain percentage of the vehicle fleet is scrapped, and a certain percentage of new vehicles are bought. The historical data has suggested that there is a correlation between sales and scrappage; that is, if more cars are added to the fleet in a given year through new sales, it means a large number of older vehicles have been scrapped (Ref. 14-22). Thus, the net additions to the vehicle fleet are relatively constant, although the new vehicle sales fluctuate (see Figure 14-11).

If one examines the distribution of vehicle age, in registration data, the data is also "bumpy" (Refs. 14-19, 14-20, 14-21), but a smooth curve passed through the data is generally used to make calculations about the future vehicle fleet (see Figure 14-12). This, of course, hides the year-to-year fluctuations, but also assumes that the historical growth trends will continue.

As we have observed, the vehicle fleet may not grow as fast in the future. Thus, the historical data can only serve as a very approximate model for future changes in the vehicle fleet. We will use this model to illustrate changes in the vehicle fleet and use the derived data of Figure 14-13 to calculate fuel economy and emissions for future vehicle fleets. An average between the "slow" and "fast" rates of transition was used in subsequent calculations.

## IMPORTED VEHICLES

In the last 10 years imported vehicles have made up an increasing fraction of the sales of new vehicles (Ref. 14-23). This is shown in Figure 14-14. For the purposes of this report it is necessary to calculate certain requirements for domestically produced vehicles. In those cases we have assumed the present level of imports (15% of the total domestic sales) continues through the 1975-90 time period. We acknowledge there is a wide range of futures possible here.

### PROJECTION OF FUTURE DOMESTIC PRODUCTION

The future of domestic automotive production for the domestic market depends on several factors already discussed; that is, the total vehicle fleet required, the turnover rate and lifetime of the vehicles themselves, and the degree to which imported vehicles successfully compete against domestic products (Ref. 14-24).

We have shown in Figure 14-11 three production projections simply based on the possible changes in the fleet size, assuming the other two key factors do not change. We will use these estimates for calculating industry changeover costs, etc., in other parts of this study.

### LIGHT TRUCKS

Light trucks are defined as trucks under 6,000 pounds gross vehicle weight. In many cases they utilize power plants, as well as other vehicle components very similar to passenger automobiles. However, in most states they are registered with heavy duty (over 6,001 pounds) trucks, often obscuring detailed data on their numbers and use. Thus data on light trucks is not as well established as it is for automobiles (Ref. 14-25).

As shown in Table 14-6, the light truck has increased its share of the light duty vehicle population, probably at the expense of the passenger automobile. However, detailed data on the size and weight of these trucks makes it difficult to say exactly what their fuel consumption, etc., characteristics are likely to be, though they should be similar to passenger automobiles of the same size and weight.

Some data indicates that the mileage distribution of light trucks is different than for automobiles, and they tend to be longer lived (see Table 14-7) (Ref. 14-26).

Since our detailed calculations in other sections of the report, especially those for fuel consumption, have not specifically included light duty trucks, the numbers are probably low by about 10-15%; i.e., the light duty truck population adds about that amount to the passenger vehicle population and to the VMT.

More detailed calculations will require much more complete data on truck use than is now available.

## VEHICLE OCCUPANCY

We think that we can translate our knowledge of how the vehicle population will change into crude estimates of vehicle occupancy. Unfortunately, we have not been able to locate any

Table 14-6. Domestic production of passenger vehicles vs light duty trucks

Year	Passenger car factory sales	Light duty truck factory sales	Light duty trucks as a % of all light duty vehicles
1966	8,598,326	1,020,158	10.6
1967	7,436,764	899,986	10.8
1968	8,822,158	1,136,059	11.4
1969	8,223,715	1,121,222	12.0
1970	6,546,817	950,252	12.7
1971	8,584,592	1,196,544	12.2
1972	8,823,938	1,414,551	13.8
1973	9,884,446	1,735,645	14.9
		Mean % =	12.3

direct data on vehicle occupancy vs. time, except for the Nationwide Personal Transportation Study (NPTS), which found an average occupancy of 1.9 persons in 1970. This agrees fairly well with our occupancy estimates based on total population divided by total vehicles (see Figure 14-15).

Table 14-7. Fraction of mileage versus vehicle age for light trucks

Age of vehicle (years)	Fraction of mileage
1	0.100
2	0.095
3	0.090
4	0.085
5	0.080
6	0.075
7	0.070
8	0.065
9	0.060
10	0.055
11 and older	0.225

The important effect is to notice that average occupancy will probably saturate at about 1.6 persons per vehicle, simply because of the ratio of drivers to nondrivers in the population. (For comparison data from the National Petroleum Council Auto Demand Estimates are shown (Ref. 14-27); the source of their data is not known.)

Of course, if the number of drivers does not increase as rapidly as we have shown, or saturates at a different level than we have shown, then the occupancy rates will shift to account for these changes. A considerable effort to change automobile use patterns by increased 'carpooling' could also affect the trends shown in Fig. 14-15.

#### 14.1.3 Vehicle Use Data for Specific Urban Basins

In order to provide a basis for our air quality evaluations of three urban air basins, Los Angeles, St. Louis, and New York, we have prepared individual vehicle use estimates for each of these basins. This is because vehicle use is an important contributor of the major pollutants, hydrocarbons, carbon monoxides and oxides of nitrogen, in these basins. Thus, long term changes in vehicle use will have an important effect on the total amount of pollution emitted and the resulting air quality.

It should be pointed out that our projections for each air basin should be considered as mean projections, in which only certain changes in underlying conditions, such as considered in population of driving age and the number of vehicles, are included. Larger uncertainties in economic factors or alternate transportation systems also could be applied to these projections to make them higher or lower.

In addition, for certain specific basins with significant automotive emissions, the EPA has proposed (Ref. 14-28) even more drastic measures, such as reducing vehicle use by a factor of five. While such drastic reductions are unlikely because of the "side" effects, programs to reduce vehicle use by more reasonable amounts in order to improve air quality have been contemplated elsewhere (Refs. 14-29, 14-30). Thus, in certain areas such as the Los Angeles basin, a degree of VMT reduction is likely to take place beyond what we have shown in our projections. However, when all the uncertainties in compiling emissions inventories are considered, we feel these projections are adequate for the purposes we will use them. (There is some variation in the format for presenting this data, because it has come from many diverse sources.)

#### LOS ANGELES

The official Air Quality Control Region (AQCR) for the Los Angeles area is called the South Coast Air Basin, shown in Figure 14-16. We will use this area for our analyses of emissions and air quality in the Los Angeles area.

The Los Angeles area has experienced very rapid growth in the 1950's and 1960's. However, more recently in-migration has slowed, and the total basin population has tended to follow a slower (1.0% per year) growth rate than the historical higher rates (2.7% per year). The official

SCAG (Southern California Association of Governments) projection is a compromise between the present low rate and the historical past. We will carry both projections forward in our calculations (see Figure 14-17).

We have calculated the potential vehicle drivers for each of these two population projections by examining the overall U.S. population age distribution projections (Figure 14-18). We have taken the potential driving population to be those 17 years and older for California. The potential drivers are calculated for the "medium" and "low" population projection, assuming the age distribution is the same, since the growth will be largely controlled by migration patterns. At present, the actual number of licensed drivers is about 85% of the potential drivers. We have not done a detailed analysis of the remaining 15% to see what factors keep them from becoming drivers.

However, in Figure 14-19 we see that the number of total vehicles seems to be essentially the same as the number of actual drivers. (Though automobiles are somewhat less, the difference is partially made up of trucks used as personal vehicles.) We thus felt projecting continued growth of use of vehicles at the historical rate would probably be too high; we have assumed vehicle use (and the number of vehicles) would bend over with the population projections, though we allowed a small (0.3% per year) increase in per vehicle annual mileage.

Figure 14-20 summarizes our VMT projections and those of others (Refs. 14-31, 14-32, 14-33). Although there are some small differences in the data ( $\pm 15\%$ ), at present this is about the same order of accuracy as many of the other numbers in the emissions inventory.

#### ST. LOUIS

The area selected for consideration is termed the "Urban-in-Fact" area of St. Louis (Figure 14-21). It comprises seven jurisdictions (six counties and St. Louis city) and approximates the St. Louis Standard Metropolitan Statistical Area (SMSA). This is the region used for transportation planning, land use planning, and air quality modeling of the St. Louis area. Although this area does not encompass the complete EPA Air Quality Control Region (AQCR), it does cover the areas where the major air quality problems exist.

Between 1970 and 1995, it is estimated that the population will increase from 2.2 million to 3.3 million (1.69% per year) (Ref. 14-34). While St. Louis City and County will continue to be the major population centers, the outlying areas in the other counties will experience rapid growth (rising to 35% of the area's population).

In parallel with population, employment in the area is also growing at about 1.69% per year. Again, the major increases will probably occur in the outlying areas (an estimated increase of over 2,000% in Monroe County).

In view of this projected economic development, St. Louis is currently planning an area-wide rail/bus/highway transportation network to

handle its transportation needs. The public transit segment of the proposed system will carry a projected 9% of the passenger traffic by 1995 (Ref. 14-34). However, whether or not such an integrated system will actually become a reality is still undetermined. Further uncertainty is introduced due to variations in the base 1972 VMT data. Depending on the source, estimates range from 26.2 million VMT's per day to 30.1 million VMT's per day in 1972 (Ref. 14-35).

Historically, VMT's have been growing at about 2.45% per year in the majority of the region. However, due to the recent increases in transportation costs it has been estimated that the 1972 and 1977 VMT's will be approximately equal with growth resuming thereafter.

To cover the full range of possibilities, we can make three estimates of VMT's in the St. Louis region:

Estimate 1 -- Growth continues (after 1977) at the rate of 2.45% per year with no diversion to public transit (assuming  $30.1 \times 10^6$  VMT's/day in 1972).

Estimate 2 -- 2.45% per year growth in travel demand, but some is diverted to public transit (3% in 1980-85, 6% in 1985-90). In this case we will assume a base of  $29.0 \times 10^6$  VMTs/day in 1972.

Estimate 3 -- Due to saturation effects and continued high prices for transportation, travel demand will only increase at the population/economic growth rate (1.69%/year) and some will be diverted to public transit (Estimate 2, using 1.69%/year rather than 2.45%/year).

Table 14-8. Projected VMT demand for St. Louis 1975-1990

	1975	1980	1985	1990
Estimate 1 (Millions/day)	30.1	32.37	36.53	41.23
Estimate 2 (Millions/day)	29.0	30.24	30.09	37.29
Estimate 3 (Millions/day)	26.2	26.7	28.16	30.63

The VMT projection given in Table 14-8 includes all traffic (autos, trucks, etc.). Historically the breakdown by class has been the following:

Light duty vehicles	87.3%
Medium duty vehicles	6.7%
Heavy duty vehicles (diesel and gasoline)	6.0%

This breakdown is assumed to be applicable in the 1975 to 1990 time period as well.

#### NEW YORK CITY

The study area selected corresponds to the area used in the NYC transportation control plan (Ref. 14-36). A grid was superimposed over the central portion of NYC to define the precise area (see Figure 14-22).

While most of the study area can be treated as a single unit, we will isolate the downtown and midtown areas of Manhattan for special treatment due to the extreme traffic problems in these two areas.

Study area VMT estimates were not available. Thus to assign VMT's to the study area we divided total VMT's per county according to the fraction of that county that was within the study area.<sup>4</sup> (See Table 14-9.) (Ref. 14-37.)

Table 14-9. 1973 VMT's in New York City study area (millions/day)

	Total VMT's in county	Fraction of county in area	VMT's in study area
Manhattan			
Midtown	1.08	1.0	1.08
Downtown	0.59	1.0	0.59
Other	4.52	1.0	4.52
Bronx	5.56	0.63	3.5
Brooklyn	7.86	0.45	3.54
Queens	13.21	0.29	3.83
New Jersey	-	-	15.57

<sup>4</sup>e.g., Queens = 115 sq. miles, 33 of which are in the study area.  
 Brooklyn = 77 sq. miles, 35 of which are in the area.  
 Bronx = 43 sq. miles, 27 of which are in the area.  
 Manhattan is entirely within the study area.  
 New Jersey traffic density estimated as 60% of the traffic density in the Bronx.

Table 14-10. VMT projection for the New York City study area 1975-1990 (millions/day)

	1973	1975	1980	1985	1990
<b>I. Slow growth:</b>					
Midtown Manhattan	1.08	1.09	1.11	1.17	1.23
Downtown Manhattan	0.59	0.60	0.62	0.64	0.65
Other - Manhattan	4.52	4.56	4.68	4.80	4.92
N. Y. C. (except Manhattan)	10.87	11.09	11.66	12.25	12.87
New Jersey	15.57	15.87	16.68	17.53	18.42
<b>TOTAL</b>	<b>32.63</b>	<b>33.21</b>	<b>34.75</b>	<b>36.39</b>	<b>38.09</b>
<b>II. No growth:</b>					
Midtown Manhattan	1.08	1.08	1.08	1.08	1.08
Downtown Manhattan	0.59	0.59	0.59	0.59	0.59
Other - Manhattan	4.52	4.52	4.52	4.52	4.52
N. Y. C. (except Manhattan)	10.87	10.87	10.87	10.87	10.87
New Jersey	15.57	15.57	15.57	15.57	15.57
<b>TOTAL</b>	<b>32.63</b>	<b>32.63</b>	<b>32.63</b>	<b>32.63</b>	<b>32.63</b>

Due to the extremely congested traffic conditions in much of the study area, major growth in VMT's is impossible. VMT's are expected to grow at about 0.5% per year in Manhattan and 1.0% per year in the rest of the area. If increasing costs and future transportation controls (pedestrian malls, etc.) are considered, even these low growth rates may be too high. Thus, an alternative hypothesis would be no growth in VMT's within the study area. Such an hypothesis is reasonable in the study area, because of the general shift away from the central city. While the population of the inner city is increasing (slowly), the growth is taking place on the outer edges at the expense of the central city. In addition, business is also moving out of central city further reducing the possibility for VMT growth.

To bound the possibilities we will thus use two projections: slow growth (as defined above) and no growth. Table 14-10 summarizes the VMT projection for the New York City Study area.

The vehicle split in New York City is fairly complicated; vehicles are broken down by auto,

bus (diesel, D, and Gas, G), taxi (fleet medallion, F-M; nonfleet medallion, NF-M; and non-medallion, N-M, and trucks (diesel and gas) (Ref. 14-38).

The estimates given in Table 14-11 are taken from a recent update of the New York City Air Quality Implementation Plan (Ref. 14-37). No data is available to project changes in vehicle split in the 1980-1990 time period; thus, the vehicle splits given in Table 14-11 will be used for all future years.

#### 14.1.4 Research Needs in Macropatterns of Vehicle Use

There are several areas in which additional work needs to be done, in order to clarify vehicle use patterns. There are also areas where there is a need to gather basic data in a more consistent manner. Finally, there probably will be a need for more work in trying to understand the relationship between "economic man", to the degree he does exist and the decisions he makes about the use of his automobile.

Table 14-11. Vehicle split for the New York study area, %

	Autos and light trucks	Taxi (FM)	Taxi (NFM)	Taxi (N-M)	Truck (D)	Truck (Gas)	Bus (D)	Bus (Gas)
Midtown	50.8	22.6	10.5	1.7	1.0	9.3	3.7	0.4
Downtown	78.5	4.6	2.1	0.4	1.2	11.5	1.6	0.2
Other areas	87.4	1.5	0.7	0.1	0.6	5.9	3.4	0.4

As we have pointed out in Section 14.1.2 - LIGHT TRUCKS, data for light trucks is often aggregated with data for heavy duty trucks in a manner that makes a separate analysis impossible. Most likely, all registration data will have to be reprocessed to include some more detailed information of this nature so these separate and distinct vehicle categories can be inventoried correctly. Data on licensed drivers is also suspect or obscured by multiple licensing (more than one state) and inaccurate accounting of total active licenses. Of course, difficulties with census, traffic count, vehicle odometer surveys, etc. are similar problems. If there is a greater desire to understand these problems, more effort will have to be devoted to such information gathering in an accurate and meaningful manner.

Future work on the economic aspects of these problems, as well as the pragmatic considerations of evaluating policies that may be tried with very high uncertainties, will probably require a better understanding of consumer attitudes and reactions. More methods of measuring such reactions are needed so that valid ones hopefully can be discovered.

For individual air basins, there is also a need for more complete data than is presently available. Each basin has individual characteristics and information needs to be gathered relevant to those particular problems.

In all of this work there is usually a need for a broader perspective, so that the many complex relationships between the social, economic, and technical aspects of this problem are clearly understood.

#### 14.2 MICROPATTERNS OF AUTOMOBILE USE

In order to understand the relationship between the design of the automobile and certain of its characteristics, such as how much energy it consumes, or how much pollution it emits, we must examine the use patterns of individual vehicles (how they are driven). Furthermore, because the automobile has had certain characteristics, the use patterns have reflected those capabilities. Thus, in trying to understand the implications of changing automobile technology, we must understand these use patterns, both as a basis for evaluating new technologies and to understand how the new technologies might modify the use patterns.

##### 14.2.1 Driving Cycles

The most important micropattern of automotive use is the driving cycle; that is, how the vehicle is driven. Details on the trip such as its length, the type of driving (city, suburban, or highway) and the ambient conditions are important. Driving cycles were first constructed to aid in evaluating automobile exhaust emissions. This has been extended to include other important characteristics of the vehicle, such as how much fuel or energy it will use, noise it will emit, etc.

The use of such cycles is essential because of the complexity of the engine and vehicle systems, and their interaction as the vehicle is driven. Fuel consumption rates, and emissions

vary sharply as the vehicle idles (at rest), accelerates, cruises at constant velocity, and decelerates to rest again. Only by actually simulating these changes can a realistic assessment be made.

Of course, driving cycles can also provide more realistic assessments of other questions relating to vehicle design, such as wear patterns and replacement life of subcomponents, such as batteries in electric vehicles.

#### ENVIRONMENTAL FACTORS IN DRIVING CYCLES

These use patterns often mean the vehicle is subjected to a wide range of environmental conditions, such as different ambient operating temperatures, pressures (determined by altitude), relative humidity, and wind or road conditions. Our present driving cycle evaluation does not account for these factors at present, although some data exists showing these factors have an effect on emissions (Ref. 14-39) and possibly fuel economy. This will be especially critical in working fluid cycles such as the Rankine or Stirling engines, where the ambient temperature could affect heat rejection performance. Also, for a gas turbine engine, a high inlet temperature (or low working fluid density) limits both output power and efficiency.

All current evaluation procedures are performed at some nominal average temperature in the range 60-86°F and usually at sea level pressure (i.e., one atmosphere). An attempt is made to correct for the effect of different relative humidities that may be encountered in the test procedure, (Refs. 14-40, 41) as this affects the mass emissions of oxides of nitrogen (NO<sub>x</sub>). Some data we have for present vehicle operation at lower temperatures (Ref. 14-42) indicates that emissions change significantly (HC and CO increase) during the start-up transient, especially at much lower temperatures, but return to normal "controlled" levels as the vehicle warms up. There is also an associated transient penalty in fuel economy.

#### DRIVING MODES AFFECTING ENERGY USE AND EMISSIONS

One of the most important use characteristics affecting a vehicle's energy use and its emissions is the mode of operation. These different modes, depending on if the vehicle is driven on local, urban or suburban streets (under different traffic conditions) or on open (controlled or limited access) highways, have been recognized in different attempts to assess data collected on driving patterns. Such data is collected by instrumenting vehicles to carefully record their motions as they are driven in typical traffic situations.

The results show that the different modes of driving, summarized in Tables 14-12, 14-13, and Figure 14-23 (Ref. 14-43), have different characteristic average speeds and number of

Table 14-12. Principal characteristics of major urban driving cycles

Urban cycles	Average cycle speed (mph)	Average cycle stops (stops per mile)
<b>I. Central business district</b>		
1. GMC central business district	15.6	4.0
2. SAE urban (tentative)	15.6	4.0
<b>II. Suburban</b>		
1. GMC suburban	24	1.6
2. SAE suburban	41.1	0.4
<b>III. General urban</b>		
1. EPA urban	19.6	2.4
2. Scott composite #1 (urban portion)	20.2	2.1

Table 14-13. Principal characteristics of major highway and interstate driving cycles

Highway and interstate cycles	Average cycle speed (mph)	Average cycle stops (stops per mile)
1. GMC highway	48	0.3
2. EPA highway	48.2	0.1
3. Scott composite #2 highway portion	50.8	0.3
4. SAE interstate I	55	0
5. SAE interstate II	70	0
6. GMC interstate	70	0

stops per mile.<sup>5</sup> However, there is a definite relationship between the number of stops per mile and the average speed in most observed driving (curve represents summary of many data points).

Furthermore, the different driving cycles proposed by the automobile manufacturers, the Society of Automotive Engineers (Ref. 14-45), the Federal Environmental Protection Agency (Refs. 14-46, 47) and the Coordinating Research Council (Scott Labs) (Ref. 14-48) are plotted on this graph; they are all found to lie on the curve (or close to it). Of course, no one driving cycle or mode represents all driving.

The key question is how much of each of these cycles represents the overall pattern of vehicle use. That is assuming that data on fuel economy and emissions is available for vehicles operating on these individual cycles, how does one weight the results to obtain overall values summarizing all vehicle use?

Because most of the fuel economy and emissions data available to us were gathered on the EPA Urban cycle (1975 Test Procedure) and the more recent EPA Highway cycle, we elected to use these two cycles for our evaluations. This does not preclude the construction of more complete evaluation schemes representing driving patterns by additional modes. We feel the EPA Urban cycle is a good representation of urban driving. It essentially contains elements of the Central Business District cycles proposed by the SAE and GMC. It also contains elements similar to their Suburban cycles. This is indicated in Table 14-14 and Figure 14-24 where we have illustrated how the EPA Urban cycle may be 'split' into two portions, one which has the characteristics of a CBD cycle, the other having the characteristics of a Suburban cycle.

The EPA Highway cycle represents high speed driving (unrestricted by other traffic) similar to that found in the SAE Interstate cycles and the GMC Highway and Interstate cycles.<sup>6</sup> The question, of course, remains what is the split in mileage driven between these two EPA cycles. The EPA has "guesstimated" about 40 to 50 percent of the total vehicle miles is highway mileage (Ref. 14-47). Federal Highway Administration Statistics (1969) give 54 percent of the vehicle miles as urban and the remainder as rural, though it is not clear the definition is consistent with the ones used here (Ref. 14-49).

A third source of confirmation is the separate Vehicle Operations Study (done for the Coordinating Research Council by Scott) (Ref. 14-48). These studies were independent (from those done by EPA) and aimed at producing a

<sup>5</sup> (Stops per mile is really a crude measure of the ratio of energy required to accelerate the vehicle which is dissipated in braking to the energy the vehicle would require to simply cruise at the average speed of that mode of driving. Unfortunately, this varies from vehicle to vehicle, as a function of the vehicle's rolling resistance coefficient, and aerodynamic drag coefficient, and is not a unique number for the driving cycle. Furthermore, regenerative vehicles could potentially recover some of the acceleration energy on braking, reducing this ratio for the same driving cycle (Ref. 14-44).

<sup>6</sup> It should be noted (Refs. 14-47, 48) that because of limitations in most of the present chassis dynamometers available for laboratory work, some of these cycles (EPA, Scott) have been limited to a maximum speed of 60 mph and acceleration rates of 3.3 mph/sec.



Table 14-14. Breakdown of EPA Urban cycle  
(as per Table 3 in Ref. 14-46)

Overall cycle characteristics	
Total time	-- 1372 sec.
Total distance	-- 7.486 miles
Average speed	-- 19.6 mph
Average stop	-- 2.4 stops per mile

Suburban portion is taken as segments B, C, and P

Segment	Distance miles	Time (including idle) sec.
B	0.67	123.9
C	1.941	205.8
P	1.374	191.8
<b>Totals</b>	<b>3.985</b>	<b>521.5</b>
Average speed		27.5 mph
Average stops		0.75 stops per mile
Portion of total cycle 53% (by distance) •		

Remaining portion of cycle is taken as CBD portion. Its characteristics are:

Average speed	15.0 mph
Average stops	4.3 stops/mile

driving cycle to represent all driving patterns in six areas of the country.

The reports (Ref. 14-48) indicate 32%-40% of the total survey miles on freeways and the three composite driving cycles that were created to represent the overall driving patterns have 37.6, 45.0 and 34.0 percent of their mileages in freeway type driving (see Table 14-15). In fact, when the freeway segments are split out and separated from the urban portions, their characteristics are very similar to the EPA Highway cycle and EPA Urban cycle, respectively. (It is the split cycles that are shown in Figure 14-23 and Tables 14-12, 13. A recent joint evaluation by DOT and EPA (Ref. 14-51) suggested that 55% of the driving was city, 45% highway.

For the purposes of this study, we elect to weigh driving as 55 percent on the Urban cycle and 45 percent on the Highway cycle, acknowledging that the split may actually lie within  $\pm 10$  percent of these values. However, we feel these errors are as difficult to account for at present as those involved in neglecting the environmental factors mentioned earlier. Additional discussion of driving cycles may be found in Section 10.6.7.

Table 14-15. Summary of CRC - Scott composite driving cycles

Cycle No.	Average speed (mph)		Percent of distance in highway portion
	Urban portion	Highway portion	
1	20.2	50.8	37.6
2	18.4	47.5	45.0
3	49.4	20.4	34.0

For emissions purposes, the EPA uses only the data from the Urban cycle. For this study, we use the Urban cycle as the basis of our emissions evaluation, acknowledging that emissions at high speed operation might be evaluated more carefully in the future.

#### TRIP LENGTH PATTERNS AND TRANSIENT EFFECTS

A final consideration in establishing driving cycles is that actual driving is in trips of finite length and that some fraction of trips are started with the engine and power system in a "cold" condition, i.e., the components are not at their normal operating temperatures.

During this cold start transient, the vehicle requires additional fuel to bring the engine and power system components to operating temperature (Ref. 14-52). Data from different sources varies, but the value is about 0.05-0.10 gallons of gasoline for an average present-day vehicle started from 70°F. Experience with actual vehicles also shows that exhaust emissions may increase substantially during this transient (Ref. 14-42).

To account for this in urban driving, the Federal Light Duty Vehicle Test Procedures tests the vehicle from a cold start, follows it through a transient phase, and then restarts the vehicle hot. The mass emissions are collected separately from these three phases and weighted to represent 57 percent of the starts as being hot, and 43 percent cold. The same test basis is used for both emissions and fuel economy.

Since the average trip length (8.9 miles) (Ref. 14-53) is very close to the urban driving cycle length (7.5 miles), this would seem to approximately account for the cold start problem if we only consider the urban cycle driving. However, when we include the Highway cycle portion of the total driving, the weighting for the cold start is probably underestimated since the Highway cycle is run hot start. We suggest this question be reexamined and perhaps a different weighting of cold and hot starts be used to calculate overall fuel economy.

At present, since most ICE's seem to have similar cold start losses, we will not concern ourselves overly with this issue. However, more attention should be paid to this question for

other engine technologies, where almost no data exists at present.

### CHANGES IN DRIVER BEHAVIOR

Our entire basis for driving cycles is based on historical data. As part of the changing environment, some changes in the driving cycle behavior of drivers might well occur. Trip lengths might change, drivers will drive more slowly and/or avoid very rapid accelerations. We think those changes, however, will be small, and that the present driving cycles will serve as an adequate basis for evaluating technology for the time frame of this study.

### SPECIAL EVALUATIONS

#### Evaporative Emissions Testing

For vehicles using volatile hydrocarbon fuels, such as gasoline, emissions of hydrocarbons take place simply because a certain small percentage of the fuel evaporates while the vehicle is standing and when it is in use.

Current test procedures (Ref. 14-54) are intended to model two phases of evaporative emissions generation in a very empirical manner. They include a diurnal cycle test, to simulate the breathing of the fuel tank during the day as ambient temperature rises and then falls again in the evening. (Conditions are supposed to represent summer months.)

A second phase of the test is to run the vehicle through the urban driving cycle on a chassis dynamometer to simulate the vehicle making a trip. This is immediately followed by a one hour hot soak, during which time it is expected that a certain amount of vapor will be boiled off by the virtue of the high temperature of certain engine components.

The evaporative emissions gathered in these two phases (by either carbon canister traps or a SHED (Sealed Housing for Evaporative Determination)) thus represent the emissions emitted by one car in one day (diurnal cycle) and in one trip (i. e., one hot soak), and are treated accordingly in emissions calculations.

Presently, there is considerable discrepancy between measurements made by the trap and SHED methods. The traps are used in the official certification procedures and indicate that evaporative emissions equipment is meeting the legislated standards. The EPA's surveillance tests, however, have used the SHED method and found only a modest reduction in evaporative emissions as a result of the control equipment (Ref. 14-39). (See Table 14-16.) We have elected to use the SHED values in our emissions calculations, acknowledging the need for further work to resolve this problem.

#### Electric Vehicle Driving Cycles

An entirely separate set of driving cycles has been defined by the SAE (Ref. 14-55, 56) for electric vehicles. In order to show the relationship between these cycles and cycles used for present vehicles, we have summarized their principle characteristics in Figure 14-25. The so called

"Residential" and "Metropolitan" cycles used for the last few years, as well as the proposed Electric 'D', are seen to fall into the suburban range, while Electric 'C' and 'B' are more representative of central business district type driving. In general, the electric cycles lie to the left and below the line of observed driving, indicating they reflect reduced performance (acceleration) in the driving cycle.

Table 14-16. Mean Los Angeles evaporative emission levels using SHED technique

	HC - gm/test	
	Pre-Control	1970-1971 Controlled
Diurnal Mean	25.97	16.28
Hot Soak Mean	14.67	10.92
Combined Loss	40.64	27.20

By the trap technique, the 1970-71 controlled vehicles had to show emissions (combined loss) of no more than 6.0 gms/test.

Since most of the data that has been collected for electric vehicles has been on the electric cycles, we have used this as a basis for comparison, even though they have somewhat lower energy requirements than the EPA Urban cycle. We acknowledge the need to put the energy consumption of all vehicles on a single basis for comparison as well as to understand the relationship between decreased performance (acceleration capability) and energy consumption.

#### 14.2.2 Other Micropatterns of Interest

##### DAILY RANGE REQUIREMENTS FOR ENERGY STORAGE VEHICLES

Clearly one of the key parameters affecting the use of electric or other energy storage vehicles is whether their present limited range would prevent them from providing transportation service similar to that of present vehicles. Conversely, if one has available a vehicle with a limited range, what does that imply in terms of modified use patterns. Present day ICE vehicles essentially have very large ranges (200 plus miles) compared to the average trip length (about 7-8 miles) or the average daily vehicle use (about 30 miles). Thus present vehicle use patterns are probably essentially determined by the user's needs and considerations such as the cost (in time and per mile expenditure) of operating the vehicle. Thus, if we look at data on how these vehicles are being used, we can possibly draw some conclusions about vehicles with limited range capability, and possible changes in the usage patterns.

Figure 14-26 shows one way of summarizing vehicle use patterns; a cumulative distribution of

the trip lengths, and the average daily driver travel. (Refs. 14-57, 14-58) (The latter is assumed roughly synonymous with daily vehicle travel.) It is seen that most trips are very short in themselves and a vehicle with a 50 mile range would handle most (~96%) of the trips. However, the daily trip making patterns of most drivers involve a certain number of days when considerably more driving is involved.

Of course, not all of this driving is done at once, i. e., it may well involve several trips. Thus, the potential of recharging between trips is available and the daily range of the vehicle can be increased considerably, depending upon the availability of recharge facilities and the vehicle's recharge rates.

However, much thinking about energy storage vehicle (specifically electric) use is directed towards utilizing off peak power capabilities of electric utilities, that is, overnight charging. (Done at home or wherever the vehicle is garaged.) To truly make this a reality in terms of providing a vehicle that could handle most daily use (~95 percent or better) a range of 100 to 120 miles seems to be required.

Of course, with 30% of the households having two or more vehicles, the electric vehicle might look more attractive as a second car, where the longer trips could be taken in the conventional vehicle. Thus a 50-60 mile vehicle would be attractive only for limited use, but if that range could be doubled, the vehicle could begin to realistically compete with present vehicles.

#### 14.2.3 Research Needs for Micropatterns of Vehicle Use

There are definite gaps in our knowledge about many aspects of vehicle operation that probably should be looked at in order to gain a better understanding of how vehicle use effects vehicle fuel consumption and emissions. The most direct gap is a better understanding of the effects of ambient conditions, especially temperature, on vehicle operation. The low temperatures found in many parts of the U. S. a good part of the year simply do not seem to be represented in the present evaluation scheme.

Another knowledge gap exists in understanding the transient behavior of different engine technologies in 'cold' start, and what are the fuel economy and emission penalties. A more realistic reassessment of the test procedures is needed to see that this transient behavior is evaluated in a reasonably accurate manner.

Finally, we feel it is very important that the methods of assessing evaporative emissions be reviewed, so potentially very high emissions from this source can be controlled properly.

#### References

- 14-1. Statistical Abstract of the United States 1971, Bureau of Census, U.S. Dept. of Commerce. Section 1 - Population.
- 14-2. California Statistical Abstract 1970 p. 234 -- data from California Dept. of Motor Vehicles, Research and Statistics Section.

- 14-3. "The Automobile - Energy and the Environment", D. G. Harvey, W. R. Menchen, Hittman Associates Inc., Columbia, Maryland, March 1974.
- 14-4. "How to Save Gasoline", S. Wildhorn et. al. Rand Corporation, Santa Monica, Calif. R-1560-NSF, Oct. 1974.
- 14-5. "Automotive Industries" - Statistical Issue 1971, 1972, and 1973.
- 14-6. The Effect of Tax and Regulatory Alternatives on Car Sales and Gasoline Consumption, by Chase Econometric Associates, Inc., May 1974.
- 14-7. "Consumer Demand in the United States 1929-1970" H. S. Hauttakker and L. Taylor, Cambridge, Mass. Harvard U. Press 1966.
- 14-8. "1972 National Transportation Report" U. S. Dept. of Transportation, Office of the Secretary, July 1972.
- 14-9. "Transportation Energy Options" Dept. of Transportation, TSC Report No. DP-SP-11, Oct. 1973.
- 14-10. "'72-'73 Transit Fact Book" American Transit Association.
- 14-11. Personal communication with the American Transit Association, 3 July 1974.
- 14-12. "FAA Statistical Handbook of Information", Department of Transportation, Federal Aviation Administration.
- 14-13. "1972 Census of Transportation" U. S. Dept. of Commerce, Bureau of the Census, Sept. 1973.
- 14-14. "Suburbanization and Its Implications for Urban Transportation Systems" J. D. Ward and N. G. Paulhus, Report No. DOT-TST-74-8, Nov. 1973. Department of Transportation.
- 14-15. "Land Use and Transportation: Future Patterns of Living" Notes from Caltech Seminar Series on Energy Conservation in Private Transportation J. R. Pierce, Caltech, Pasadena, Calif. July 30, 1974.
- 14-16. "Time Factors in Slowing Down the Rate of Growth of Demand for Primary Energy in the United States", Lester Lees and M. P. Lo, EQL Report No. 7, Caltech, Pasadena, Calif. June 1973.
- 14-17. "Implications of the Growth in Demand for Commercial and Industrial Electrical Energy in the South Coast Air Basin" L. Lees, EQL Report No. 2, Caltech, Pasadena, Calif., Nov. 1971.
- 14-18. "Highway Travel Forecasts Related to Energy Requirements" A. French et. al., F. H. W. A. DOT Dec. 1972.
- 14-19. "Compilation of Air Pollution Emission Factors" Second Edition AP-42, U. S. Environmental Protection Agency.
- 14-20. "The State of California Implementation Plan for Achieving and Maintaining the National Ambient Air Quality

- Standards" January 30, 1972 by The California Air Resources Board.
- 14-21. "The Automobile and the Regulation of Its Impact on the Environment" by the Legislative Drafting Research Fund, Columbia University - draft dated Jan. 15, 1974.
- 14-22. "A Methodology for the Determination of Average Urban Automotive Emissions", M. Scott Mingledorff, thesis, Dept. of Mech. Eng., MIT, June 1972.
- 14-23. "Total Registrations", Automotive Industries, Vol. 148, No. 7 (March 15, 1972) p. 32.
- 14-24. "Automotive News, Almanac Issue" April 1974; also "Ward's Automotive Reports" Vol. 49, No. 44, Nov. 4, 1974.
- 14-25. "1974 Motor Truck Facts", Motor Vehicle Manufacturers Association.
- 14-26. Data from "An Economic Analysis of Proposed Schedules for Removal of Lead Additives from Gasoline," Bonner and Moore Associates, Inc., June, 1971, Houston, Texas.
- 14-27. "U.S. Energy Outlook - An Initial Appraisal 1971-1985" National Petroleum Council 1971.
- 14-28. Federal Register, Nov. 12, 1973 "Metropolitan Los Angeles Intrastate Air Quality Control Region, Transportation Control Plan Final Promulgation. (and associated Technical Support Document) and "Can vehicle Travel be Reduced 20 percent in the South Coast Air Basin?" R. O. Watkins, et. al., California Dept. of Transportation, Sacramento, Calif., January, 1973.
- 14-29. "SMOG, A Report to the People", by L. Lees, et. al., EQL, Caltech, Pasadena, California, September 1972.
- 14-30. "San Diego Clean Air Project: Summary Report" R-1362-SD, Bruce F. Goeller, et. al., December 1973. Rand, Santa Monica.
- 14-31. "SCAG 1990 Transportation Study - Phase One", draft dated December, 1972, Southern California Association of Governments.
- 14-32. Data from Advanced Planning Dept. District 7, Division of Highways, State of California, November 1972, as referenced in APTD-1372. EPA, Research Triangle Park, North Carolina.
- 14-33. Data from Federal Highway Administration, "Highway Statistics", 1967-70.
- 14-34. "The Proposed 1995 Highway and Transit Plan for St. Louis", East-West Gateway Coordinating Council, March 1974.
- 14-35. "Attainment of National Air Quality Standards for CO and Oxidant in St. Louis AQCR", PED Co. Environmental Specialists, March 1974.
- 14-36. "Transportation Control Strategy Development for New York Metropolitan Area". TRW Transportation and Environmental Operations, December 1972.
- 14-37. "New York City Metropolitan Area Air Quality Implementation Plan Transportation Controls," New York State Department of Environmental Conservation, October 1974.
- 14-38. "Proposed Plan for Meeting Federal Air Quality Standards Relating to CO, HC, NO<sub>x</sub>, and Oxidant in New York City", New York City Department of Air Resources, Bureau of Motor Vehicle Pollution Control, January 1972.
- 14-39. "Automobile Exhaust Emissions Surveillance, A summary", prepared by Calspan Corp. for EPA, Certification and Surveillance Division, Ann Arbor, Michigan, May 1973 APTD-1544.
- 14-40. Federal Register, Wed., Nov. 15, 1972, Vol. 37, No. 221, EPA New Motor Vehicle Engines, Control of Air Pollution.
- 14-41. S. R. Krause, "Effect of Engine Intake-Air Humidity, Temperature, and Pressure on Exhaust Emissions" SAE Paper 710835.
- 14-42. Grinberg, L. and Morgan, L. "Effect of Temperature on Exhaust Emissions" SAE Paper 740527.
- 14-43. General Motor Corporation "Fuel Economy vs Exhaust Emissions" A statement submitted to the U.S. Senate Committee on Public Works. Nov. 4, 1973.
- 14-44. J. R. Pierce, "Regenerative Cars - A Simple View" personal communication dated January 29, 1974.
- 14-45. Society of Automotive Engineers "SAE Recommended Practice - Fuel Economy Measurement - Road Test Procedure SAE XJ1082", received in draft form April 3, 1974.
- 14-46. Kruse, R. E. and Huls, J. A., "Development of the Federal Urban Driving Schedule" SAE Paper 730553.
- 14-47. Kruse, R. E. and Paulsell, C. D., "Development of the Federal Urban Driving Cycle for Fuel Economy Measurement" March 1974, EPA Office of Air Programs, Ann Arbor, Michigan.

- 14-48. System Development Corporation "A Summary of Average Driving Patterns in Six Urban Areas of the United States: Summary Report" January 29, 1971, Santa Monica, Calif.

also

Smith, M. and Weston, D. M. "Construction of Chassis Dynamometer Test Cycles" Vols. I and II, Scott Research Laboratories, Nov. 1971, San Bernardino, Calif.

- 14-49. Federal Highway Administration, "Highway Statistics" as summarized in Table No. 837 Statistical Abstract of the United States, 1970, published in U.S. Department of Commerce.

- 14-50. Huls, T. A. "Evaluation of Federal Light-Duty Mass Emissions Regulations" SAE Paper 730554.

- 14-51. "Potential for Motor Vehicle Fuel Economy Improvement", Report to Congress by DOT and EPA dated Oct. 24, 1974.

- 14-52. Scheffler, C. E. and Niepoth, G. W., "Customer Fuel Economy Estimated from Engineering Tests" SAE Paper 650861.

- 14-53. Federal Highway Administration, "Nationwide Personal Transportation Study", Vol. 10, Purposes of Automobile Trips and Travel", May 1974.

- 14-54. Society of Automotive Engineers, "Measurement of Fuel Evaporative Emissions from Gasoline Powered Passenger Cars and Light Trucks SAE J170a.

also

"Measurement of Fuel Evaporative Emissions from Gasoline Powered Passenger Cars and Light Trucks Using the Enclosure Technique, SAE 171a.

- 14-55. Electric Vehicle Test Procedure, SAE J277 - from 1972 SAE Handbook.

- 14-56. Memo from G. J. Gaudaen, Manager, Detroit Branch of SAE to SAE Electric Vehicle Technical Committee dated February 14, 1974.

- 14-57. "Seasonal Variations of Automobile Trips and Travel", Report No. 3, National Personal Transportation Study, FHWA, DOT, April 1972.

- 14-58. "Impacts of Electric Car Use in Los Angeles", W. R. Hamilton, General Research Corp., Santa Barbara, California, preprint for Second NATO CCMS Symposium received from author, October 30, 1974.

- 14-59. "Drivers Licenses - 1973", U. S. Department of Transportation, F. H. W. A., Washington, D.C. p. 3.

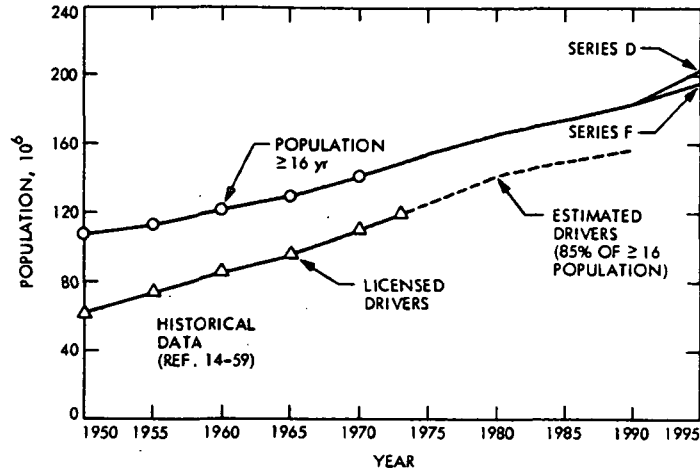

Fig. 14-1. Projection of driving age population and licensed drivers

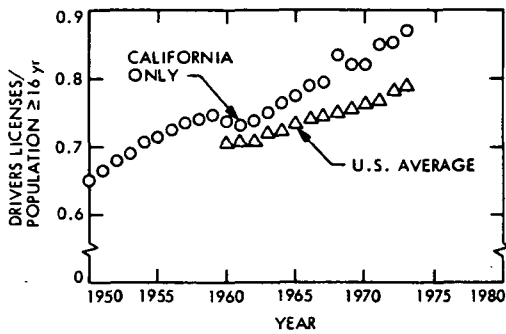

Fig. 14-2. Licensed drivers per person of driving age

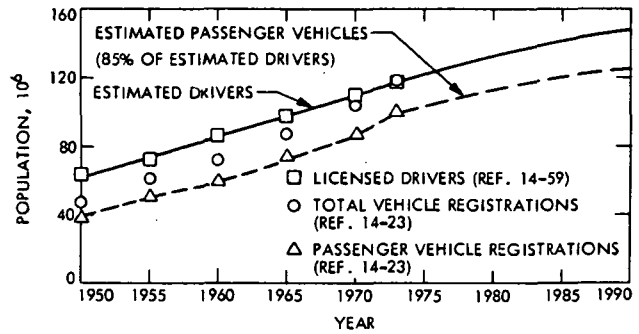

Fig. 14-4. Projection of vehicle population

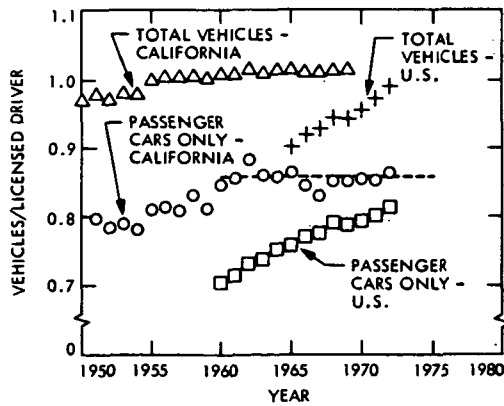

Fig. 14-3. Vehicles per licensed driver

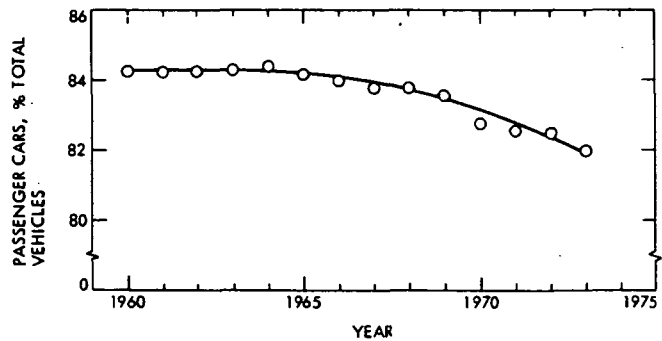

Fig. 14-5. Passenger vehicles as a percentage of total vehicles

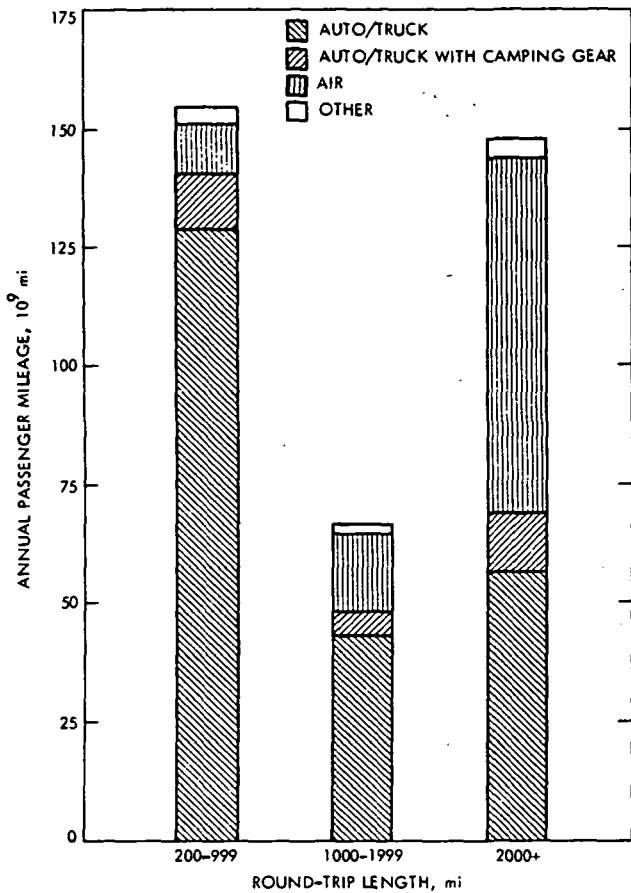

Fig. 14-6. Mode choice for intercity trips - 1972

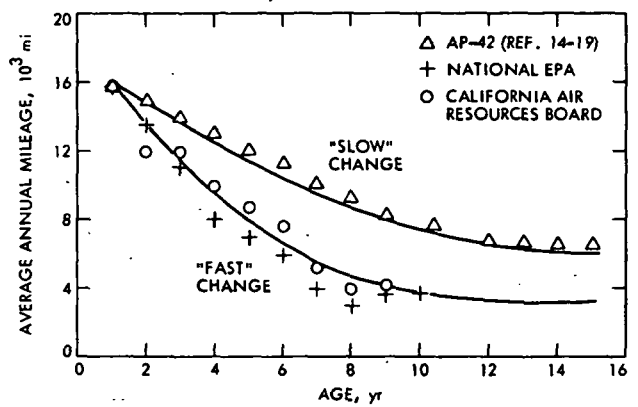

Fig. 14-8. Annual passenger vehicle mileage vs. age

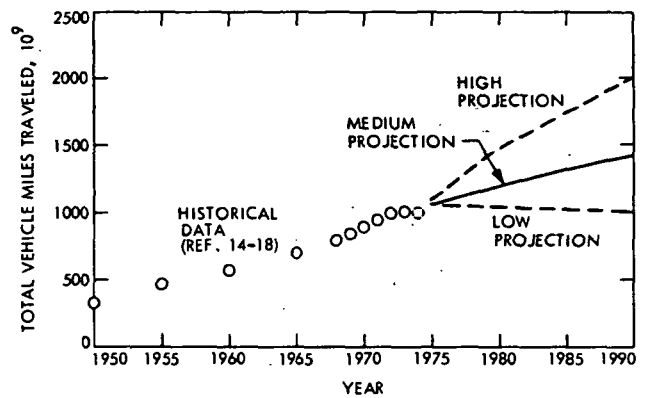

Fig. 14-9. Total passenger vehicle miles traveled

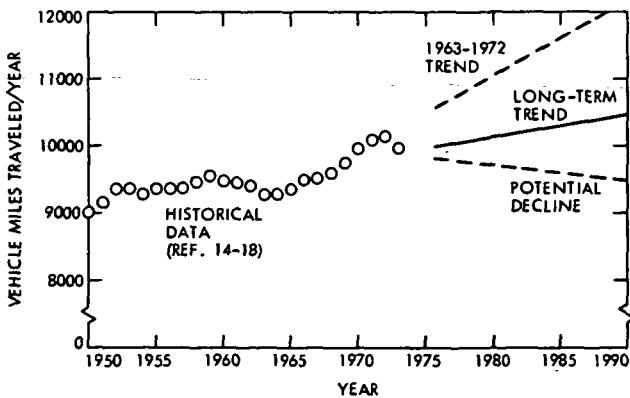

Fig. 14-7. Annual vehicle miles traveled by passenger vehicles

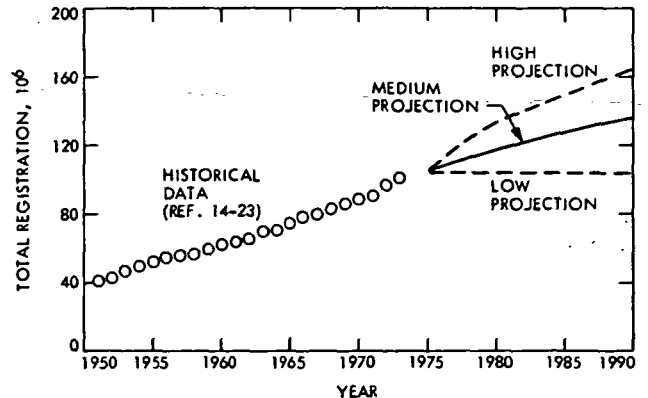

Fig. 14-10. Total passenger vehicle registrations

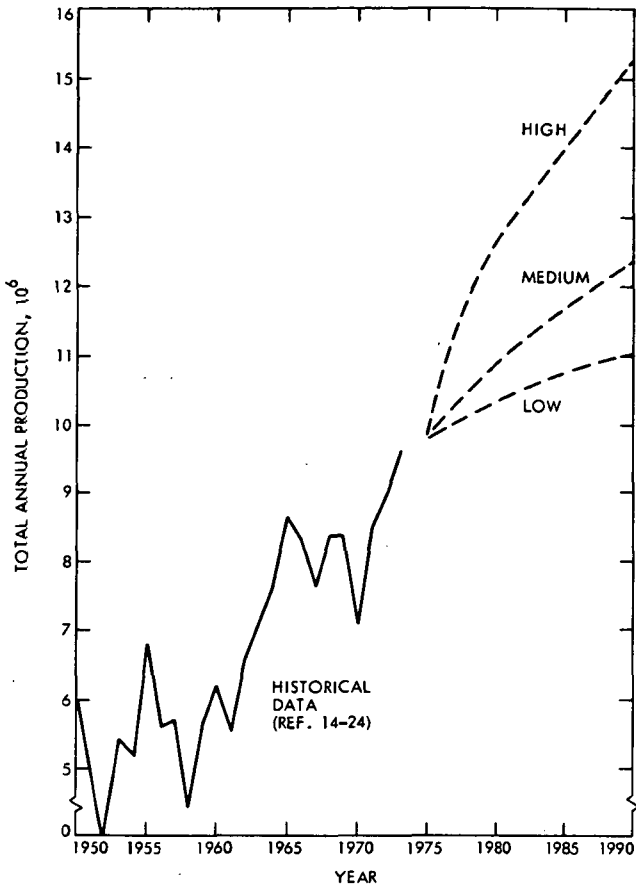

Fig. 14-11. Total new passenger vehicle production for the domestic market

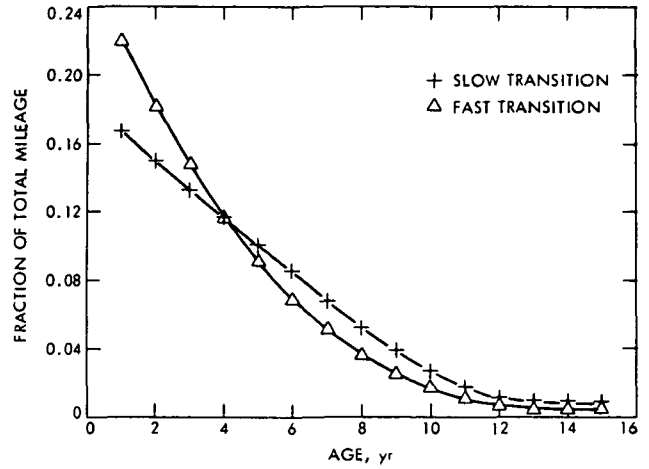

Fig. 14-13. Total mileage distribution of passenger vehicles

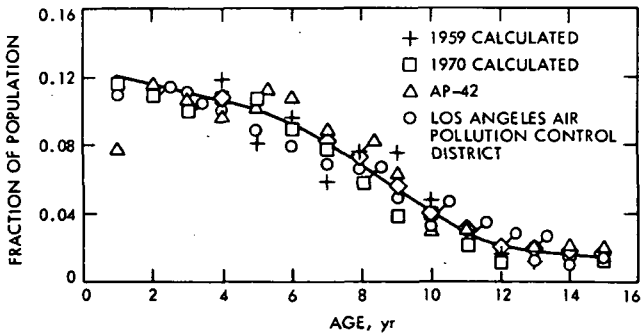

Fig. 14-12. Age distribution of passenger vehicles

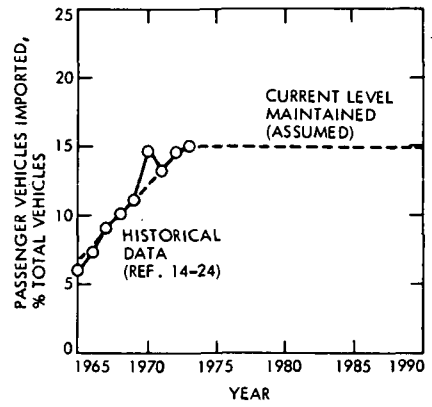

Fig. 14-14. Percentage of imported passenger vehicles



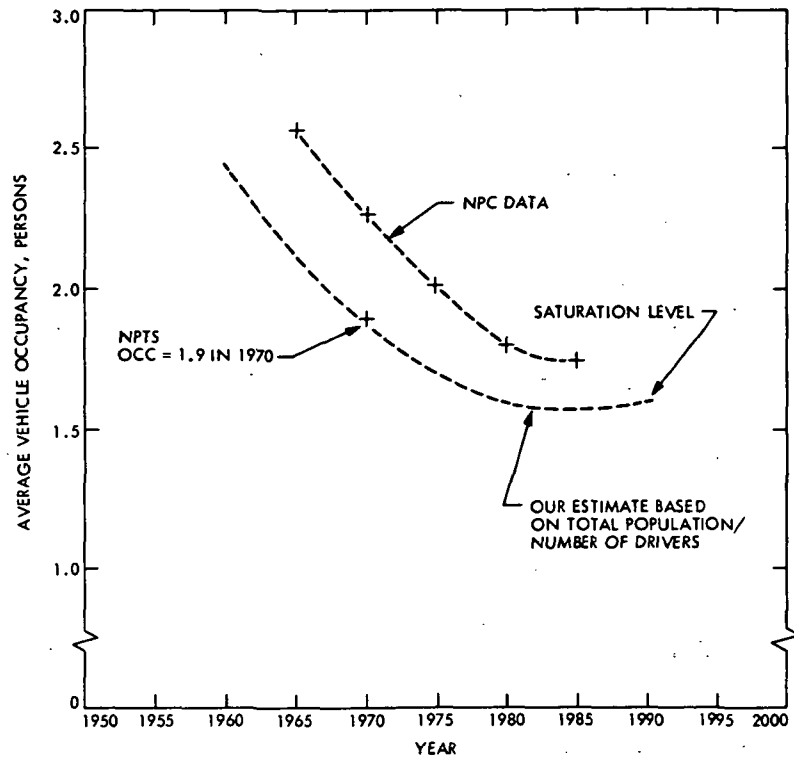

Fig. 14-15. Vehicle occupancy projections

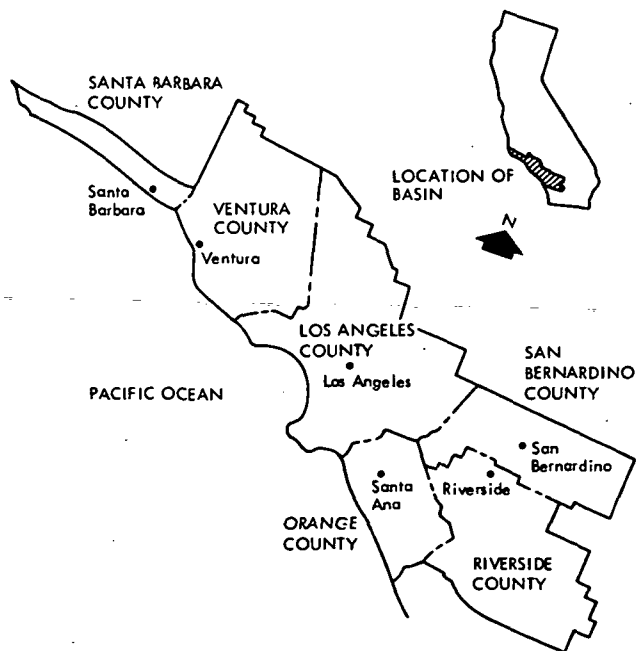

Fig. 14-16. The South Coast Air Basin

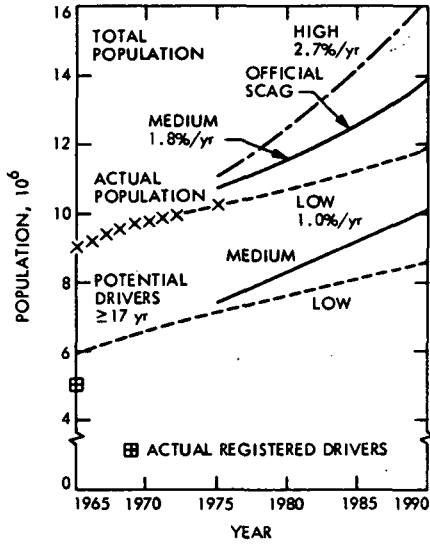

Fig. 14-17. Alternative population projections for Los Angeles (SCAB-LARTS area)

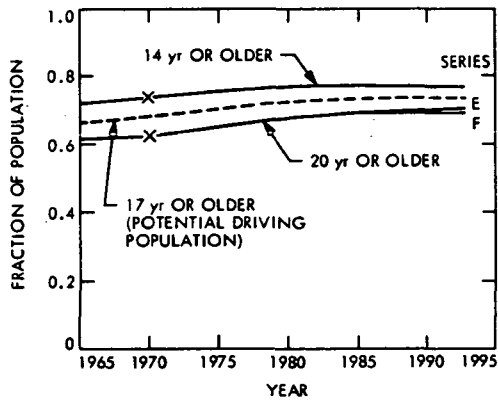

Fig. 14-18. Fraction of population of driving age

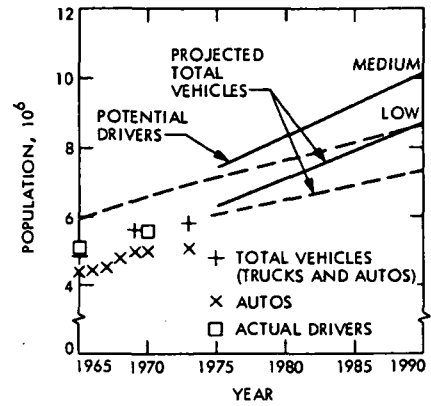

Fig. 14-19. Alternative vehicle and driver projections for Los Angeles (SCAB-LARTS area)

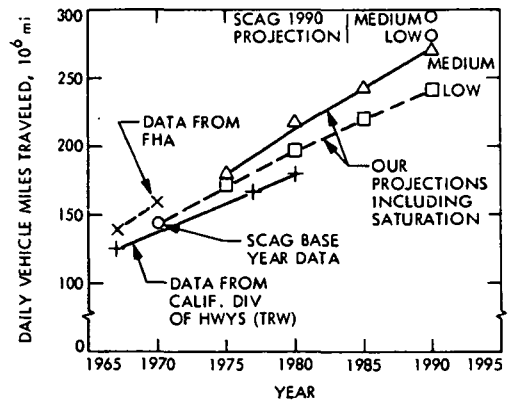

Fig. 14-20. Alternative vehicle miles traveled projections for Los Angeles (SCAB-LARTS area)

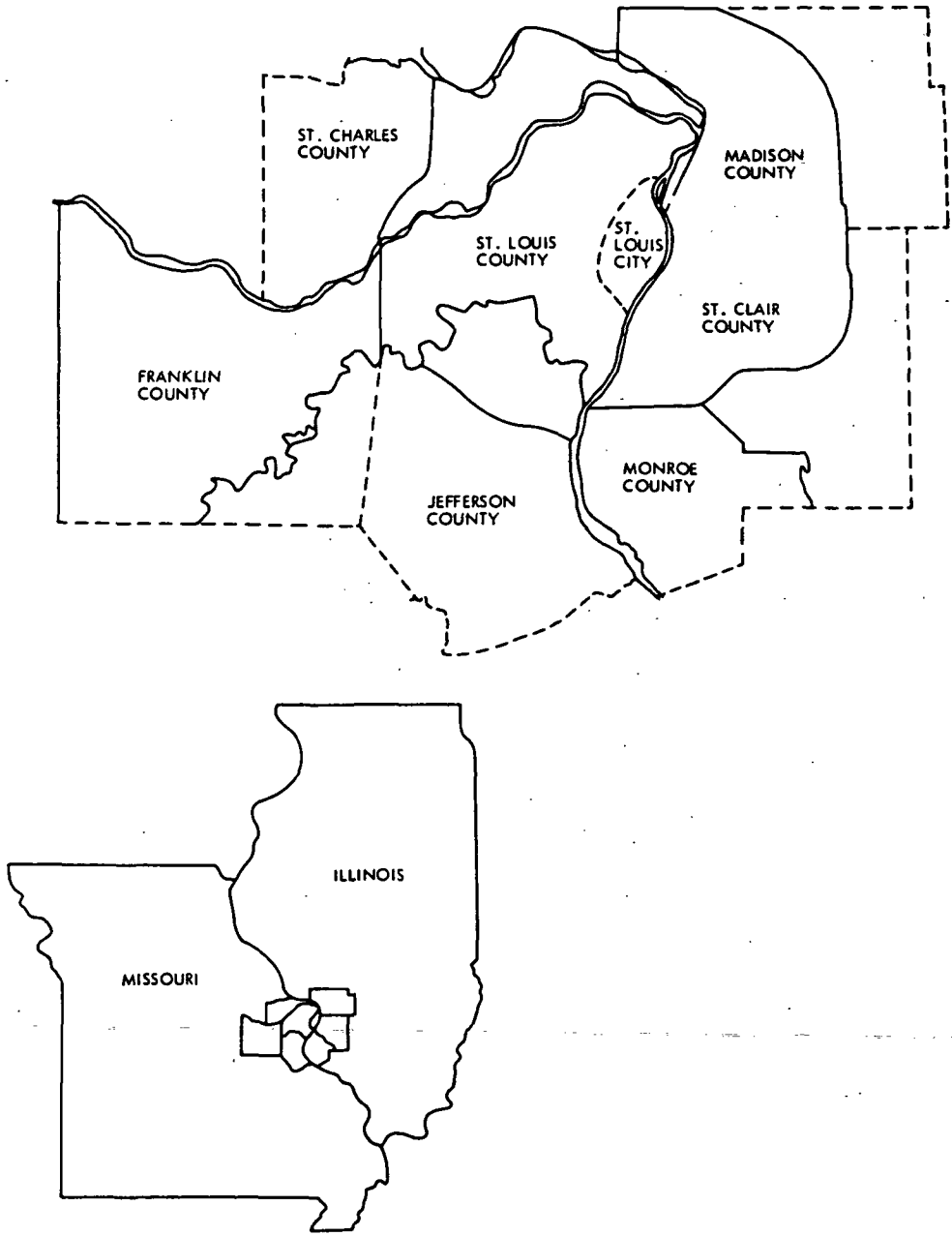
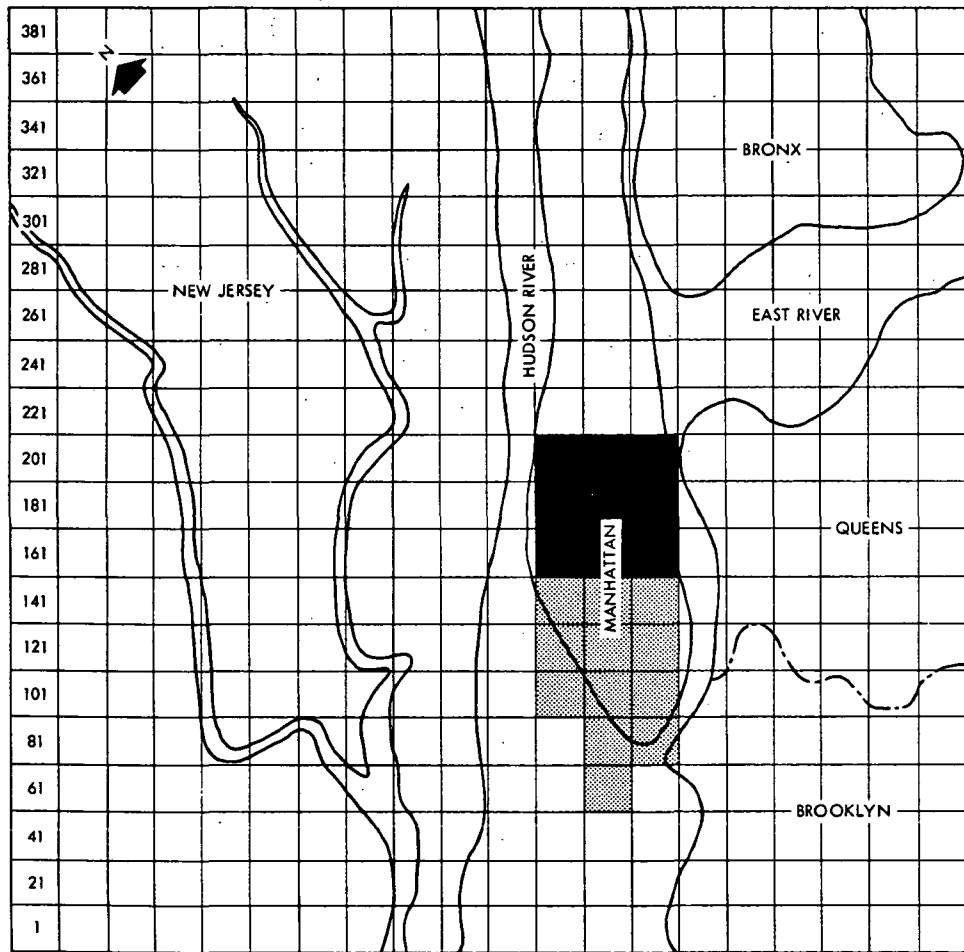

Fig. 14-21. The St. Louis "Urban-in-Fact" Area



LEGEND:

- DARK = MIDTOWN
- LIGHT = DOWNTOWN
- WHITE = REST OF NYC GRID

Fig. 14-22. The New York City analysis area

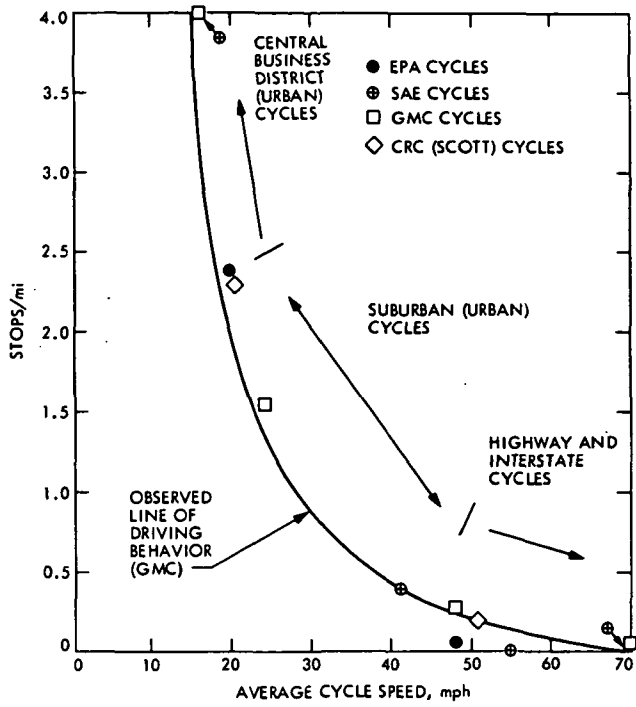

Fig. 14-23. A summary of driving modes and driving cycles

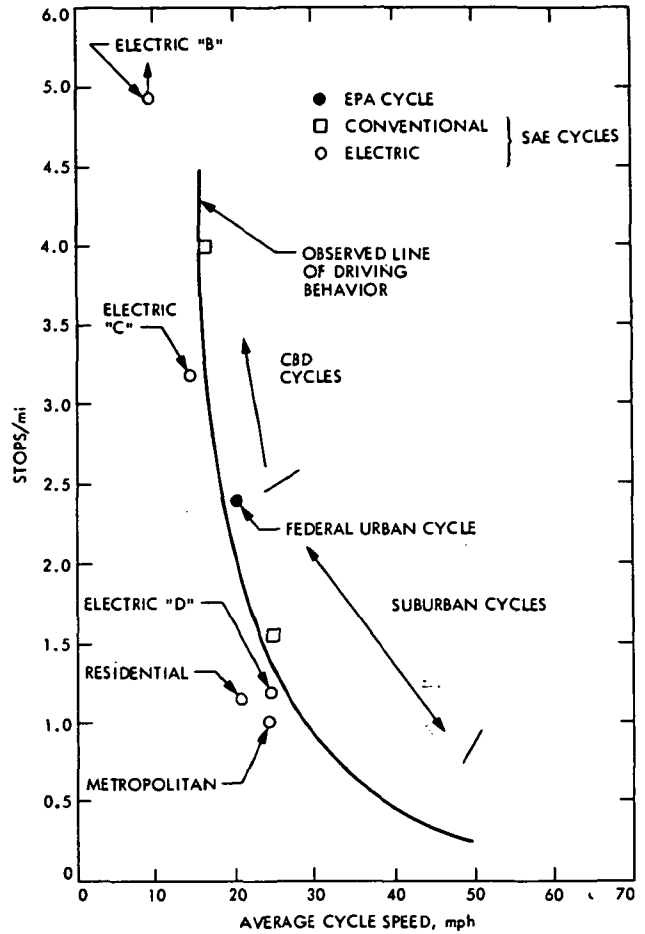

Fig. 14-25. Electric vehicle driving cycles compared to conventional driving cycles

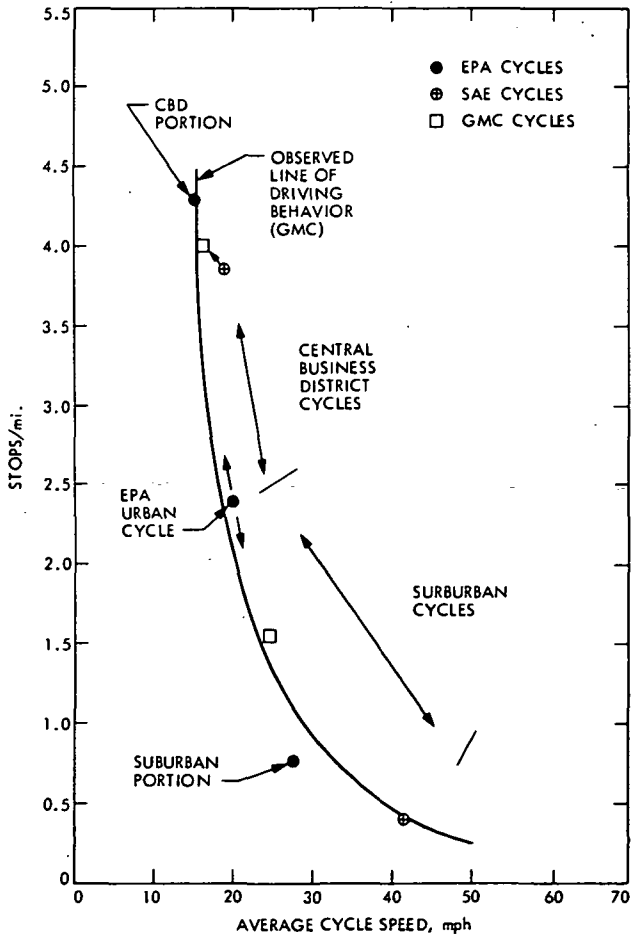

Fig. 14-24. Split of EPA Urban Cycle into CBD and suburban portions

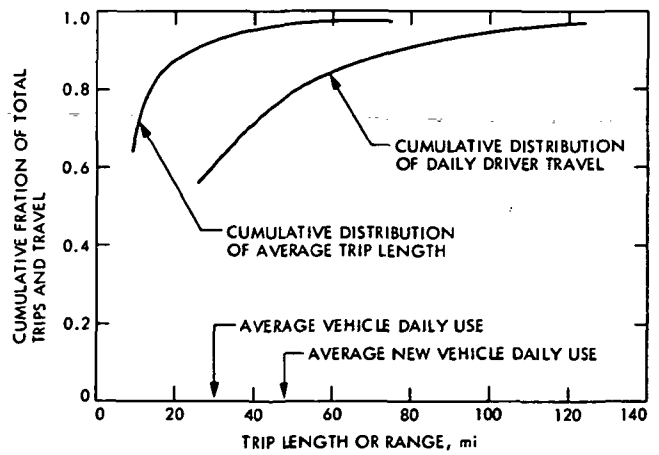

Fig. 14-26. Cumulative distribution of vehicle use by average trip length and daily driver travel

CHAPTER 15. INDUSTRY PRACTICES

15.1	Introduction .....	15-2
15.2	The Auto Industry: Technology, R&D, and Product Introduction .....	15-2
15.3	Conversion to Alternate Engines .....	15-3
15.3.1	Change Strategies and Costs .....	15-4
15.3.2	Automobile Industry Capital Expenditures .....	15-4
15.3.3	Automotive Tooling Production Capacity .....	15-6
15.4	The Ford Truck Turbine: A Short History of an Alternative Engine .....	15-8
15.5	Conversion Decision Factors .....	15-9
15.5.1	Relevant Factors .....	15-9
15.5.2	Development Expenditures .....	15-10
15.6	Conclusions .....	15-11
	References .....	15-12

## 15.1 INTRODUCTION

The term "industry practices" is used here in reference to two areas of automobile industry activity: those activities related to the future decision to produce an alternate to the present Otto engine, and those activities that relate to the elapsed time of production conversion once the decision has been made to produce an alternate engine.

Of major concern are both the magnitude of impact of the introduction of an alternate engine — a characteristic of the level of engine and vehicle performance — and the timeliness of the impact — whether alternate engines can be developed and produced in sufficient quantities before the petroleum-fueled heat engine becomes a candidate for the historical display in a science museum. Thus we are concerned both with the time to the production decision and the time for conversion of productive facilities given a production-ready prototype engine (or engines). These two periods added together provide a rough estimate of the time that will elapse before there can be enough alternate-engine-powered vehicles on the road to make a major impact in fuel consumption or air quality.

Since the activities of the automobile industry are, relative to a particular engine program, significantly different before and after the decision to put an engine into production, these areas will be discussed in separate sections of this chapter.

Actions prior to the decision to produce are developmental in nature and are directed, as are all R&D programs, toward the reduction of the risk associated with a production decision through the acquisition of information. The time and money to be expended in this phase are difficult to estimate because of the large number and diversity of technical problems. However, an estimate of the programs required based on demand is presented in Chapter 12. We will develop estimates in this chapter from a different point of view: justified expenditures. The major technical inputs to the production decision are the number and type of unsolved or partially solved problems with the engine undergoing development. Engine programs have as a primary focus the development of a reliable, durable, high-performance<sup>1</sup> unit that can be produced at competitive costs. The results of a successful engine development program, and the signal for a production go-ahead, is the existence of a number of production prototype engines that have been integrated and tested in vehicles.

Once the decision to produce has been made, a relatively orderly process is envisioned<sup>2</sup> in which the preproduction prototype engine is engineered for mass producibility, tooling is designed and ordered, facilities are built, foundry capacity is identified or built and vendors are selected. In the past, introduction of new Otto engine designs has required from 24 to 42 months

for this period. There is some reason to suspect that this period may be too short for a low-risk introduction of an alternate engine. Recent experience in the introduction of a turbine for truck use is presented in Section 15.4.

As is true in any complex problem, not all information relevant to the production decision is technical. Some of the nontechnical factors are presented in Section 15.5. These factors are important in that they cannot be addressed through development programs but yield only to policy or institutional changes.

The major thrust of this chapter is to examine those factors which are relevant to the time of introduction of alternate engines in order to ascertain whether there are any significant barriers, technological or institutional, to their production and utilization.

## 15.2 THE AUTO INDUSTRY: TECHNOLOGY, R&D, AND PRODUCT INTRODUCTION

Table 15-1 shows four subcategories of R&D that are relevant to technology development in the automobile industry. They proceed in a time-sequence fashion from the initial application of a general technical concept to a specific application through various stages of development into mass production.

The first phase shown is Research, a relatively low funded, long-duration period whose major function is to develop sufficient information on the technical characteristics of the engine to enable a decision on whether to further pursue or drop the development. This activity primarily takes place in the R&D divisions of automobile companies such as the General Motors Research Laboratories or the Product Planning and Research Division of Ford Motor Company. Some independent research is done by smaller firms such as Williams Research on the Brayton engine or Carter on the Rankine engine. All of the Present<sup>3</sup> versions of the engines discussed in Chapters 2-7 have been or are presently in this stage of development.

An engineering prototype engine representing the proof of technical feasibility is the major product of this phase. Several design options may be available as solutions to particular component problems, but there are by definition no unsolvable technical problems remaining by this time. If the engine concept proves technically sound, it is carried into the next phase of development, Advanced Engineering.

In the Advanced Engineering period, engineering feasibility is proved by building several engines and integrating them into vehicles to resolve engine control problems and installation and component placement and to improve overall vehicle operating characteristics. The costs incurred in this phase are significantly higher than the research phase because of the larger

<sup>1</sup> Dominant measures of performance are specific power, fuel consumption and emissions.

<sup>2</sup> We say "envisioned" since the model of introduction is based on the Otto engine programs and no alternates have yet been introduced.

<sup>3</sup> See Chapter 2 for definition.

Table 15-1. Single engine development program phasing

Phase	Elapsed time to end of phase, yr	Number of engines produced	Approximate total costs, \$ millions	Activities
I Research	7-10	10's	10-20	Proof of technical feasibility
II Advanced Engineering	9-12	20-50	20-150	Proof of engineering feasibility. Some vehicle integration and improvements in operating characteristics
Initial production decision				
III Production Engineering	12-16	100	300-500 per engine line	Proof of manufacturing and economic feasibility. Final stage includes facility and tooling procurement
Initial production				
IV Full-Scale Production and Product Improvement	22-26	5 x 10 <sup>6</sup>	100-200 per engine line	Mass production and product refinements to increase durability, reduce production costs

staff, increased engine and vehicle hardware procurement and fabrication, and the extensive test facilities and support required. Experience with Otto engine development has shown expenditure rates from 10 to 25 times as high as in the Research phase and total cost from 2 to 7 times Research amounts. There is no reason to suspect that Advanced Engineering of alternate engines would cost less than the Otto engine. Limited direct data are available on actual costs; some are given in a brief study presented in Section 15.4. This experience shows that alternate engine Advanced Engineering can cost a factor of 2 or 3 more than the Otto engine.

The Research and Advanced Engineering costs are one-time costs and are to be amortized over the total production life of the engine technology. If, for example, only one engine line was constructed based on the engine technology and it produced engines at a rate of 400,000 per year over 10 years, the amortization base for the research and advanced engineering costs would be 4 million engines. Discounting the revenue stream from producing and marketing the engine to the end of the advanced engineering program — assumed to be four years from the start of production — a revenue increment of approximately \$90 per engine is required to return 15% on each \$100 million research and advanced engineering program costs. If all 30 engine lines were converted, the increment would be \$3 per engine per \$100 million spent. More realistic and detailed analysis is done in Section 15.5.2 on the question of research and development expenditures and profits.

Upon successful completion of the Advanced Engineering period, a preproduction prototype engine has been designed and several have been manufactured and integrated into a vehicle. Virtually all of the components have had preliminary cost and manufacturability evaluation, and the engine is allegedly ready for production engineering. At this point, the performance of the engine in a vehicle has been exhaustively mapped; emissions and economy under the full range of operating environments have been obtained for many vehicles (possibly in simulated or actual customer use), and the durability and maintainability of the engine have been established to the extent that the number under test statistically allow. It is this point in the development process that we have labelled the "initial production decision."

The next, and final, preproduction phase is Production Engineering. It is this phase that is most finely defined in terms of program steps by the auto industry. Table 15-2 shows one set of steps used by one of the major manufacturers for a 42-month production engineering development cycle. During this period in the engine development program there are significant requirements for auto industry capital and manpower. This factor as well as external constraints such as tooling supply warrant more in-depth consideration and are discussed in the subsequent section.

### 15.3 CONVERSION TO ALTERNATE ENGINES

Two possible constraints on the time of conversion of the total U. S. automobile engine



Table 15-2. Production engineering schedule

Time to first automobile produced	Activity
42 months	Definition of program objectives
37 months	Advanced product design details finished
34 months	Manufacturing sourcing, plant layout, automation
32 months	Engine design manufacturing engineering (details of cost available accurately for first time)
30 months	Long-lead-time plant engineering funds made available
28 months	Final program and finance approval
27 months	Start facilities
25 months	Mechanical prototype available on production tooling
23 months	Vendor selection on long-lead facilities
18 months	Final product description and manufacturability feasibility
14-15 months	Production engineering cutoff freeze date
10-12 months	Purchased parts approved drawing
7-8 months	Signoff of production tooling
4-5 months	Emissions signoff, EPA certification
14 weeks	Full production
0 weeks	Job 1

production capacity are investigated: availability of automobile industry capital for plants and production machinery and the availability of tooling industry capacity to produce the special machinery and transfer lines required for alternate engine mass production.

In order to proceed in an orderly fashion, we will first define changeover strategies that might be followed by the auto industry. These changeover strategies are used in conjunction with the facility and tooling costs developed in Chapter 11 to yield total tooling and facility costs for the particular assumptions of each strategy. Then, yearly automotive capital expenditure rates and tooling volume are derived, assuming a fixed, planned changeover period. The yearly rates are

then compared with historical capital expenditures and automotive tooling volume to ascertain the realism of the assumed changeover time.

### 15.3.1 Change Strategies and Costs

There are two extreme strategies that can be considered in order to establish bounds on the cost of conversion. The first strategy — chosen not for realism, but to provide an upper cost bound — would be to start from scratch, build a whole industry full of engine lines in one year and then produce all alternate engines. This strategy obviates the possibility of converting any facilities, since each plant and foundry must be built in addition to the operating production facilities. The total cost of this changeover strategy is given in Table 15-3 for each engine type.

At the other extreme would be the strategy to idle all facilities, install the new tooling, build the new superalloy foundry capacity, if required, and convert the available cast iron foundry as required. This would provide full utilization and conversion of existing facilities. Either alternative conceptually could be carried out within one year, although both are so massively disruptive to automobile production that their sole utility lies in giving upper and lower cost bounds. The cost of this changeover strategy is a lower bound, given in Table 15-3.

A possibly more realistic change strategy would be the case where one engine line is duplicated while the Otto equivalent size engine remains in production. One facility is duplicated for each of the auto manufacturers, and upon initiation of production of the alternate engine, the duplicated facility is idled. Then another alternate engine line is put in its place, and so on. This process could take place for a single line in six months, given that the tooling and foundry castings were available. Assuming that the six months' conversion time was the only constraint (which it is not), the largest manufacturer would take the longest time to convert, about seven years. Under this change strategy, the idled Otto engine line is also assumed to have associated with it excess cast iron foundry capacity, which can be converted at essentially no cost to producing the new castings. The changeover cost of this strategy is given in Table 15-3.

Of these strategies, the third is the most realistic and will be used to calculate the yearly capital requirements and the yearly tooling volume.

### 15.3.2 Automobile Industry Capital Expenditures

Historical trends in the automobile capital expenditures will now be developed to provide a context for the conversion cost magnitudes presented in Table 15-3. If the capital expenditure rates for alternate engine production facilities prove to be approximately the same magnitude as for Otto engines, then one is justified in saying that capital expenditures will not present any new problems.

Data on total yearly capital expenditures for the period 1964-1973 inclusive for the three largest domestic automobile companies were abstracted

Table 15-3. Summary of changeover costs (\$ billions)<sup>a</sup>

Engine	Tooling costs	Total costs		
		Upper bound	Lower bound	Realistic
Diesel	2.7	8.3	4.7	5.0
SC Otto	1.5	8.3	3.3	3.8
Brayton single shaft	4.7	9.0	6.2	6.4
Brayton free turbine	6.2	11.7	8.0	8.3
Stirling	4.1	11.3	7.5	7.9
Rankine	4.1	10.7	5.9	6.3

<sup>a</sup>Tooling and total costs based on Table 11-12. Capacity is 30 lines or 12 million engines per year.

from annual reports and summarized in Table 15-4. It must be noted that these are worldwide figures, since the expenditures for domestic production were not readily available.

The capital expenditures, expressed as a percent of sales in constant 1974 dollars, range

between a high of 7% in 1965 to a low of 3.7% in 1971, with a 10-year average of 4.9%. The long-term trend, through 1973, shows automobile sales growing in constant dollar volume at about 6% per year.

The capital expenditures for 1964-1975 in constant 1974 dollars range between \$1.9 and

Table 15-4. Automotive sales and capital expenditures 1964-1973 (sales and capital expenditures, \$ billions)

Year	Sales volume		Capital expenditures		Capital expenditures as a percent of sales
	Current dollars	1974 constant dollars <sup>a</sup>	Current dollars	1974 constant dollars <sup>b</sup>	
1964	30.9	34.9	1.7	2.4	6.9
1965	37.6	43.0	2.2	3.0	7.0
1966	38.0	44.3	2.2	3.0	6.8
1967	36.8	42.2	1.8	2.3	5.5
1968	44.3	49.4	1.5	1.9	3.8
1969	46.1	50.4	2.0	2.4	4.8
1970	40.7	43.2	1.9	2.2	5.1
1971	52.7	53.6	1.8	2.0	3.7
1972	60.4	61.7	1.8	1.9	3.1
1973	70.6	71.7	2.4	2.5	3.8
10-year average		49.4		2.4	4.9

Historical data from GM, Ford, and Chrysler: 1973 Annual Reports

<sup>a</sup>Derived from Table C-6 and C-7, Economic Report of the President, 1974.

<sup>b</sup>Derived from a weighted sum of nonresidential structures and producers' durable equipment price deflators (ibid, Table C-3).

3 billion. These expenditures are the totals for capital items (including special tooling). Included in this category is tooling for both engines and bodies. Of this total, approximately 20% is engine-related, including both the engine facility and tooling costs, representing an average yearly expenditure rate of \$480 million.

To place the required conversion costs in context, Table 15-5 is constructed. The columns are derived as follows: for each engine, the total realistic conversion cost from Table 15-3 is divided by the number of years proposed for the conversion period, 10 and 15 years. These numbers are shown in the columns headed "Engine expenditures," "10 year" and "15 year," respectively, in Table 15-5.

The Otto engine facilities also must be maintained during the changeover period. Assuming a linear transition to the alternate engine, on the average there will be half the yearly expenditures over the 10-year period on Otto facilities. Thus, \$240 million per year will be spent on Otto facility maintenance in addition to the engine changeover costs. The average yearly total capital expenditures required for the Otto engine facility maintenance, alternate engine conversion, and vehicle facilities is calculated and shown in the columns headed "Total capital."

For a 10-year transition, the average total capital expenditures range from a low of \$2.5 billion per year during the SC Otto engine conversion to a high of \$3 billion per year during the Brayton free-turbine conversion. All of these average yearly expenditures are higher than the absolute 1964-1973 average yearly expenditures from 6 to 25% higher. However, the absolute magnitude of the yearly capital expenditures is not the only measure to be considered. Although trend extrapolation of sales to the 1980 decade is subject to inaccuracy due to many factors, including uncertainty in the availability of fuel, some

increase in average sales for that decade is anticipated. Using the low limit of the APSES production projection from Chapter 13, an average yearly sales volume of approximately \$80 billion for the 1981-1990 time period is derived. Thus, expressed as a percent of projected sales, the capital expenditures during the conversion to alternate engines range between 3.1 and 3.5%<sup>4</sup> for the 10-year conversion and between 3.0 and 3.4% for the 15-year conversion. Both of these percentages are significantly lower than the 1964-1973 average capital expenditures of 4.9%.

### 15.3.3 Automotive Tooling Production Capacity

The second possible conversion constraint investigated is the match between the tooling requirements for conversion to alternate engines and the capacity for producing the requisite tooling for the automotive sector. The required tooling volume is calculated and compared to the historical production rates to ascertain whether any large changes in capacity would be required for conversion in the proposed period - 10 or 15 years.

Manufacturing analyses (Refs. 15-1, 15-2) of the alternate engines have shown that metal-cutting production machinery is substantially similar to that used to mass-produce the Otto engine. The major single difference lies in the utilization of multiple similar side-by-side transfer lines operating at slower rates (due to the hardness of the metals) to maintain the required throughput of 400,000 engines per assembly line per year. Thus we are not faced with starting a new supporting industry to supply the metal-cutting tooling for alternate engine production, but we must consider the supply of this new tooling in the context of the existing competing demands.

First, the historical data on tooling shipments, orders and order backlog will be reviewed to place the future tooling demands in context. Table 15-6 shows the total orders, shipments and

Table 15-5. Capital expenditure rates for engine facility conversion (millions of 1974 dollars)

Engine	10-year conversion, yearly average		15-year conversion, yearly average	
	Engine expenditures	Total capital	Engine expenditures	Total capital
Diesel	500	2700	333	2500
SC Otto	380	2500	253	2400
Brayton single shaft	640	2800	427	2600
Brayton free turbine	830	3000	553	2700
Stirling	790	3000	527	2700
Rankine	630	2800	420	2600

<sup>4</sup> A key assumption in this calculation is that the gross automotive product sector and the nonresidential structures and producers' durable equipment sectors inflate at the same rate.

Table 15-6. Metal cutting industry: orders, shipments and backlogs  
(millions of current dollars)

Year	New orders	Shipments	Order backlog (end of year)
1960	535.3	541.5	343.8
1961	591.8	541.2	394.4
1962	572.1	612.4	353.6
1963	759.8	638.5	474.9
1964	1039.2	844.7	669.4
1965	1215.7	1022.5	898.6
1966	1629.9	1221.8	1306.7
1967	1135.0	1353.1	1088.5
1968	1079.4	1358.3	809.6
1969	1195.3	1192.5	812.4
1970	651.3	993.0	470.7
1971	609.3	672.0	408.0
1972	1244.0	712.0	840.0 (approx)
1973	1588.0	1074.0	1454
1974 (est)	(1,325)	(1325)	(1454)

backlogs for the years 1960-1974. These figures, obtained from Ref. 15-3, represent the total shipments to all sectors of the economy as well as exports, and as such are greater than any reasonable upper limit of volume shipped to the automobile industry. A recent survey of the tooling industry was done as background for the National Academy of Sciences Committee on Motor Vehicle Emissions Study II (Ref. 15-4). Data from this survey allow segmentation of the total metal-cutting tooling industry capacity into that production relevant to the automobile industry.

Of the total metal-cutting tooling shipped in 1974, approximately \$260 million was in metal-cutting transfer lines that are termed automobile engine type. This tooling was produced for export, heavy-duty truck, tractor, off-highway equipment and stationary engines, as well as domestic automotive engines (see Table 15-7). Since the automotive-type tooling is most relevant, the

allocation of that capacity is shown in Table 15-8. In 1974, the United States automobile manufacturers obtained 35% of the automotive-type tooling shipments.

If the tooling industry was supplied with the appropriate incentives such as long-term contracts or favorable pricing, it is probable that the domestic automobile industry could command a significantly larger portion of the tooling output, conceivably up to the total automotive-type tooling volume of \$260 million. In order to produce yearly volume beyond this point, the tooling industry would either have to convert some of its other metal-cutting production to machines of transfer line type or add capacity. Again, where faced with a long-term backlog of several billions of dollars in transfer line machinery, some change in structure is quite likely. It seems reasonable that the tooling industry is capable of delivering between \$250 and \$350 million.

Table 15-7. Metal-cutting tooling capacity allocation, 1974

	Total shipments	Metal-cutting transfer lines	Automotive type	Domestic automotive	Export	Non-auto
Millions of dollars	1,325	335	260	92	46	122
Percent of total	100	25	19	7	3	9

Table 15-8. Automotive-type metal-cutting tooling capacity allocation

	Automotive-type tooling	Domestic automotive	Export	Non-auto
Millions of dollars	260	92	46	122
Percent of automotive-type tooling	100	35	18	47

yearly volume in automotive-type transfer line equipment.

In order to develop the demand side for alternate engine tooling, we refer to the column headed "Tooling costs" in Table 15-3. Not all tooling costs are in metal-cutting transfer lines, the proportion varying from 65% for the Rankine to over 85% for the Diesel. Table 15-9 lists the total conversion engine tooling costs, metal-cutting transfer line costs, and the yearly volume required for a 10-year and a 15-year conversion transition. The 10-year conversion requires tooling volume at or above historical rates for all of the alternates except the SC Otto. The Brayton free turbine has the largest requirement, averaging half a billion dollars a year for the 10-year conversion period. The single-shaft Brayton is next, requiring \$380 million per year for the 10-year conversion. The remainder of the alternates fall within the \$250-350 million supply estimate range.

In the case of the 15-year conversion, all of the alternates fall within the supply estimate range, although the two Brayton engines are still somewhat higher than the historical supply rates.

#### 15.4 THE FORD TRUCK TURBINE: A SHORT HISTORY OF AN ALTERNATIVE ENGINE

Although the automobile industry in general is strongly resistant to externally imposed

structural change such as that required by the passage of the emissions standards, where it sees a potential profit opportunity, it is not at all hesitant to commit large amounts of resources. This was perceived to be the situation when in 1968 the engine research staff of Ford Motor Company briefed top management on the performance of their new model gas turbine (at that time called the 707). According to their tests, the specific fuel consumption and power-to-weight ratio of this regenerated turbine made it an excellent competitor to the diesel as a heavy-duty truck powerplant. The staff felt that it had a reasonable design which incorporated adequate solutions to most of the high-temperature materials problems, control problems, and sealing problems. On the basis of this speculation, it was felt that a sufficient market share could be commanded to warrant the risk. Thus the Ford management decided to enter into a production engineering program, with the intent of placing several thousand turbines in the hands of users for direct evaluation.

A staff of several hundred people was assembled and a facility was converted in Toledo to the limited production of the turbine engine. It became operational in 1970. The manufacturing was done in a job center fashion rather than using a mass production transfer line. The tooling was vendor-supplied, and at full production rate could have produced about 400 units per year. Approximately \$12-15 million was expended on tooling.

The initial variable cost estimate was \$7000-8000 per unit, with an anticipated cost reduction of 80% when volume production was obtained. Major cost items that were vended included the two large ceramic rotating regenerator discs that Corning Glass quoted for low volume production at \$700-800 apiece and high-temperature seals to separate intake and exhaust gas flow at \$150 apiece. At these costs, it was judged feasible to go into low-volume production and market the gas turbine for truck applications.

Approximately 225 turbines of two types termed models 3600 and 4200 were produced, and a number of these were placed in the field in applications such as heavy cross-country trucks and fire engines. During the "production" run, there were significant problems in the yield of the regenerator discs, and as a result Corning raised the price from \$700 to \$1400. The seals also went up in cost from the original \$150 to over \$700. The sum total of these cost increases raised the manufacturing parts cost of the turbine from its original \$7000-8000 to on the order of \$14,000. In addition, there were failures of

Table 15-9. Metal-cutting transfer line volume required shipments (millions of 1974 dollars)

Engine	Total	10-year conversion, yearly average	15-year conversion, yearly average
Diesel	2300	230	153
SC Otto	1300	130	87
Brayton single shaft	3800	380	275
Brayton free turbine	5000	500	333
Stirling	3300	330	220
Rankine	2900	290	193

certain components in the field which caused, at first, significant warranty costs and, ultimately, recall of the gas turbines and replacement at Ford's cost with equivalent diesel powerplants. The total amount expended on this effort has been estimated at \$150 million. The plant was shut down in June 1973.

Opinions as to the cause of this failure vary. However, it can be seen that the estimate of the readiness of the technology was incorrect with respect to the critical regenerator discs. This alone was probably not sufficient cause to warrant abandonment of the project. This is the type of problem that the auto manufacturer can direct talent and resources into to get a solution if it is the only area of concern. However, these are not the types of problems that are characteristic of the Production Engineering phase.

Additional problems lay in the design readiness of the engine. In the words of one executive: "We had to change 200 pieces instead of two. By the end of the program, the manufacturing development was accomplished. We were too ambitious. It was too high a risk in terms of the market share we set out to get. We should have spread out the program (for the same total dollars) over a longer period of time. This engine still has promise."

From this description, it can be seen that although the participants thought that they were in the Production Engineering phase of the engine development, the reality - defined by the types of problems remaining to be solved - was that they were in a very expensive and time-compressed Advanced Engineering phase.

It is most likely that the discrepancy between expectations and actuality in this alternate engine development program was preordained by the application of experience from Otto engine development programs. Since the automobile industry has no direct experience in the mass production (and limited<sup>5</sup> experience in the programs leading to the mass production) of other than reciprocating Otto engines, this is an obvious observation. However, the lesson that is contained in this brief case study is unmistakable. There are mistakes to be made; they will be expensive, and the automobile industry must be prepared for setbacks in these programs similar to the experiences of the past.

As an aside: the gas turbine was popular among the users. Its characteristics of instant start with no warmup (compared to a diesel), very low noise and vibration and high power made it the powerplant of choice among those operators who were fortunate enough to have it as an option.

## 15.5 CONVERSION DECISION FACTORS

### 15.5.1 Relevant Factors

What constitutes proof to the potential producers of a "better" engine and how much better

must it be to cause the go-ahead to initial production? What are the characteristics of an engine that must be obtained at the end of its development program to ensure that it be introduced as a replacement for the Otto engine? The exposition in Section 15.3 was conditioned on the decision to proceed with conversion having been made, and presented the concomitant requirements in terms of industry capital and tooling capacity. These factors relate somewhat to the decision whether or not to produce any particular alternate engine, but are more relevant to the rate of conversion once conversion to production has been commenced. What are other relevant factors?

The majority of the APSES report is dedicated to what is considered to be important engine and vehicle parameters. Chapters 2 through 9 present configurations and performance parameters of various alternate vehicle powerplants with emphasis on their potential fuel economy and emissions. Chapter 10 discusses vehicle changes made necessary or possible by the incorporation of alternate powerplants. Chapter 11 presents costs of production equipment, materials, and labor content for the alternate powerplants. Chapter 18 presents the materials requirements of alternate engines given they are mass-produced in the proposed configurations. Each of these chapters addresses an area or issue which is thought to be relevant to the automobile industry's decision to introduce an alternate to the Otto engine. Each of the chapters mentioned presents estimates of parameter values relevant to the internal decision to produce.

Chapters 16 (Highway and Vehicle Safety), 17 (Energy and Fuels), 19 (Air Quality), and 20 (Ownership Costs and Economic Impact) address issues which have been external to the automobile industry but through government action and legislation of performance standards have been somewhat translated into design constraints. Chapters 16 and 17 address themselves to costs and benefits internally recognized by the industry and utilized in their rational decision-making process. Chapters 19 and 20 reflect another set of costs and benefits - those recognized by society, and indirectly by the auto industry through the medium of government or activist group pressure and legislated performance standards.

At some juncture, one must pose the question: why all the fuss about alternate engines? The simple answer is that the existing Otto engine technology and its foreseeable improvements do not represent a "good" solution to the set of internal and external criteria outlined above. A direct measure of this is the amount of time and talent that the automobile industry has put into testifying before Congressional committees to obtain delays or changes in the emission standards embodied in the Clean Air Act. If the Otto engine could have easily met these standards, it would have been done. The minimum cost solution as interpreted from the auto industry actions appears to be to reluctantly

---

<sup>5</sup> GM's experience with the Wankel is the major item of historical note.

carry the Otto engine to its emissions/economy limit and then dig in and hold the performance standards to that limit.

Given that the performance and cost projections contained in this report are reasonably accurate, these actions seem to be, at best, rational only in the short term. If the cost and performance values predicted in this report for the better alternate engines can be obtained, and if the automobile industry is profit-oriented, then their eventual production, in a rational world, seems guaranteed. Why can't they be produced now? Because the requisite development programs have not been completed. Thus we are led to the conclusion that proving or disproving the alternate engine cost and performance projections through continued development of the more promising alternates is all that can be done at the present time towards a production decision. The only proof lies in the experiment.<sup>6</sup>

### 15.5.2 Development Expenditures

Certainly, the dollar magnitude of the engine development program should be related to the profits that would result from a successful program outcome. One method to estimate the magnitude of expenditures that might be justified internal to the industry would be to calculate the present value of the increased profit stream due to the production and sale of an alternate engine. This calculation does not account for any of the social benefits that might be obtained from the use of alternate engines.

In order to perform this calculation, we will use the data from Chapter 20 on the present-valued savings of operating costs. We repeat the table in this chapter as Table 15-10 for

Table 15-10. Present-valued savings in 3-year operating costs relative to vehicles with UC Otto baseline engines

Engine types	Vehicle class		
	Small	Compact	Full-Size
UC Otto baseline	0	0	0
SC Otto	30	50	30
Diesel	90	150	190
Brayton single shaft	150	270	350
Brayton free turbine	110	220	290
Stirling	190	310	400
Rankine	-20	20	20

<sup>6</sup>Dr. Burt Klein, California Institute of Technology.

<sup>7</sup>This simplified model ignores the competitive structure of the automobile industry, which may make other pricing policies more applicable.

convenience. Where there is a manufacturing cost increment over the UC Otto engine, this amount is subtracted from the operating cost savings. The remainder is increased profit to the automobile industry. Table 15-11 gives the increased profit for each of the alternate engines in vehicles of representative size.

The conversion is postulated to take place over 10 years, with 10% conversion per year. We shall assume that the retail price increment that is charged for the improved alternate vehicle is exactly equal to the present value of the three-year operating savings. With this pricing policy, the consumer is economically indifferent to the alternate engined vehicle, and direct substitution can take place without a shift in total demand.<sup>7</sup>

Discounting the profit increment generated during the 10-year conversion back to the end of the development period, taken to be four years prior to the realization of the first profit increment, the present discounted value of the increased profit stream is given by:

$$PDV = 1.2 \times 10^5 (E) \sum_{i=1}^{10} \frac{i}{(1+k)^{4+i}}$$

where

E = per unit profit increment for a given engine

i = 1 for first year, 2 for second year, etc.

k = discount rate

Table 15-11. Profit increase per vehicle (values in 1974 dollars per vehicle)

Engine type	Profit increase (decrease)		
	Small	Compact	Full-size
UC Otto baseline	0	0	0
SC Otto	40	0	-60
Diesel	20	-40	-40
Brayton single shaft	100	270	380
Brayton free turbine	-30	40	60
Stirling	-10	40	100
Rankine	-300	-410	-410

This form allows calculation of the factor within the sum independent of engine type and also shows that the yearly expenditure for alternate engine development — under this model — is directly proportional to the profit generated.

Table 15-12 shows the result of this calculation for each of the alternates in a full-size car for two assumed discount rates — 7 and 15%. The entries in the table for each engine represent the upper limit of the amount that should<sup>8</sup> have been spent by the end of a successful development program for that engine. The higher discount rate may be interpreted as an assumed higher risk program. The constant for the 15% discount rate shows that approximately 1.5 million dollars per dollar of increased profit is warranted in R&D expenditures, and the analogous figure for the 7% discount rate is 3.2 million dollars per dollar of increased profit. These factors could be considerably larger if the profit accumulation period were longer than the 10 years allowed for this example. The 10-year period was chosen to reflect the decay in the relevance of the development with time, and is quite conservative.<sup>9</sup>

These numbers are derived as though each engine were the only one introduced, so the development expenditures should not be summed if more than one engine program were to be pursued. In the event of multiple simultaneous development programs, a typical strategy might be to average the warranted development expenditures and allocate them to each program according to its expected present discounted value.<sup>10</sup>

Assuming that the two Braytons and the Stirling have equal probability of success, a total of 573 million development dollars at the 7% discount rate is warranted. Assuming a 15% discount rate, the warranted development expenditures are \$272 million. Recall that these are industry internal justified calculations. Any outside social benefit should be added if it can be expressed in development dollars.

Comparing these figures with the proposed development expenditures in Volume 1 of \$190 million for the Brayton and \$260 million for the Stirling, we can see that there is agreement between the estimated development program costs and their potential benefits in terms of future profits.

Table 15-12. Total development program expenditures warranted by increased profitability of alternate engines (millions of 1974 dollars; total expenditures at the completion of the development program)

Engine type	Expenditures	
	7% discount	15% discount
UC Otto baseline	0	0
SC Otto	0	0
Diesel	0	0
Brayton single shaft	1208	574
Brayton free turbine	192	91
Stirling	318	151
Rankine	0	0

## 15.6 CONCLUSIONS

Under a normally expanding economy, the automobile industry should be able to generate sufficient capital to effect the conversion of their engine production facilities to any of the alternates considered. For the 10-year period 1981-1991, the capital expenditures for normal facility and tooling maintenance plus the conversion amount to 3.5% of projected sales. This compares to the historical 1964-1973 capital expenditures of 4.9% of sales.

Although the conversion to alternate engines would require a larger share of the metal-cutting tooling market for the automobile industry than has been the case, there exists sufficient capacity in the tooling industry to convert the engine lines within a 15-year period. Total metal cutting shipments to the automobile industry have been as high as \$200 million, and with the promise of long-term commitments, this yearly volume could probably be increased as high as \$350 million. At this level, total conversion to even the most expensive engine lines could be accomplished within 15 years.

<sup>8</sup> This calculation is done from an internal to the industry point of view. If there are social benefits that accrue to the use of some specific alternative, they are external to this calculation. These benefits could be internalized through government funding of some specifically desirable alternative. The values derived here give an estimate of the magnitude of funding required to make an alternate like the Rankine or Diesel desirable.

<sup>9</sup> The 1972-1973 Economic Handbook of the Machine Tool Industry quotes 68% of the metal cutting tooling in the transportation sector as being over 10 years old. Since new engine technology requires new production machinery, this figure reflects the maturity of the engine technology.

<sup>10</sup> This strategy assures that a less risky, lower payoff engine would receive about the same development dollars as a more risky, higher payoff engine.



Since there are no production-ready engines available at this time, the decision to produce is moot. What is more relevant is the calculation, internal to the automobile industry, of how the improved performance of the alternate engines can yield increased profitability. These potential profits alone justify, to the industry, the expenditure of development dollars. For the engine costs and operating savings derived in this report, the industry can justify expenditures on three engines: the Brayton free turbine, the Brayton single shaft turbine, and the Stirling. Based on the assumption of starting production in 1985 and totally converting production in the subsequent 10 years, expenditures on the order of \$200 million to over \$1 billion are warranted for engine development programs between the present and 1981.

In summary, there appear to be no barriers to conversion to alternate engines. Furthermore, given the performance and cost figures derived in this study, there appears significant reason for the automobile industry to develop the Brayton in its two versions and the Stirling engine for earliest possible sale.

It is just possible that the best of all worlds is available to us, that there is an alternate engine that satisfies the industry criteria of greater profit and marketability and also satisfies the social criteria of greater fuel economy and much lower emissions.

#### References

- 15-1. Rath & Strong, Inc., "Task 1, Free-Turbine Engine Data Base," JPL Contract No. 954072, December 23, 1974.
- 15-2. Rath & Strong, Inc., "Task 1, Single Shaft Turbine Engine Data Base," JPL Contract No. 954072, March 26, 1975.
- 15-3. 1972-1973 Economic Handbook of the Machine Tool Industry.
- 15-4. "Manufacturability and Costs of Proposed Low-Emissions Automotive Engine Systems," Consultant Report to the Committee of Motor Vehicle Emissions, National Research Council, Appendix D, Sept. 1974.

CHAPTER 16. VEHICLE AND HIGHWAY SAFETY

16.1 Introduction . . . . . 16-2

16.2 Engine Safety Aspects . . . . . 16-2

    16.2.1 Intermittent-Combustion Engines . . . . . 16-2

    16.2.2 Continuous-Combustion Engines . . . . . 16-2

    16.2.3 Electric Powerplants . . . . . 16-2

    16.2.4 Hybrid Powerplants . . . . . 16-2

16.3 Vehicle Safety Aspects . . . . . 16-3

16.4 Fleet Safety Aspects . . . . . 16-4

    16.4.1 Mass Introduction of Alternate Engines . . . . . 16-4

    16.4.2 Shift of Vehicle Weight and Fleet Weight  
        Distribution . . . . . 16-4

    16.4.3 Use of Safety Restraints . . . . . 16-6

16.5 Conclusions . . . . . 16-7

References . . . . . 16-7

Figures . . . . . 16-9

## 16.1 INTRODUCTION

In recent years (1971-1973) the national highway death toll has averaged 55,000 fatalities per year with injuries at 50 times that level. Vehicle design features and occupant protection systems affect the highway safety problem. The possible introduction of alternate engines brings up questions about their safety both in normal operation and with respect to any characteristics which may influence the accident rate or their performance in a crash.

With forecasts of vehicle weight reductions in the near future, the impact of all these changes on highway casualties needs to be evaluated. Research on highway safety problems can yield improvements in the future, but there are presently known methods capable of greatly reducing the high human cost of accidents, which lack only meaningful application and vigorous enforcement.

## 16.2 ENGINE SAFETY ASPECTS

None of the candidate power plants considered in this study poses a serious, insurmountable safety hazard. Each does embody some facets which could cause harm to a person or property if adequate safety measures are not incorporated in its construction. Good design practice, coupled with legal safety codes and ordinances, will ensure design attention to obvious areas. The efficacy of such safety provisions will be proven, and nonobvious weaknesses exposed and corrected, in the intensive prototype and fleet tests which precede introduction of any automotive innovation. Some of the more obvious areas which may require attention are discussed in the following.

### 16.2.1 Intermittent-Combustion Engines

General design safety practice has long been established and proven for the intermittent-combustion engines - the Ottos (uniform- and stratified-charge types) and the Diesel. The blocks of Otto engines are generally not stress-limited, cylinder operating pressures are moderate, and the engine failure modes are nonhazardous. In this regard, the historical record of Otto engines speaks for itself, and the changes required to effect charge stratification do not alter the picture. The safety history of the automotive Diesel engine is likewise excellent, although the statistical base is admittedly smaller.

The more sophisticated versions of these engines evaluated in this study do require some relatively new additional components. The Diesel engines would require a turbocharger which, of course, must be built with the same care as any high-speed rotary machinery.

### 16.2.2 Continuous-Combustion Engines

All of the continuous-combustion engines - Braytons, Rankine, and Stirling - use external (to the expander) combustors in which: (a) combustion must be maintained during operation, and (b) an explosive air/fuel mixture must not be permitted to accumulate before initiation of ignition. Suitable sensors and shutoffs will be incorporated in the control system. Use of lower-volatility fuel - one of the cardinal advantages of these engines - will further minimize this safety aspect.

The Rankine and Stirling engines employ a high-pressure (2000-3000 psia) working fluid, requiring adequate attention to pressure-vessel design practice and appropriate routing of ducting which is vulnerable to rupture. Pressure relief valving will also be incorporated. It should be noted that comparatively small masses of high-pressure gases are involved.

The Stirling engine's working fluid is hydrogen, which is flammable over a wide range of air mixture ratios. Such mixtures could be detonatable (under improbable conditions) if permitted to accumulate in a confined region. The engine compartment design will therefore have to provide for quick hydrogen dissipation in the event of massive leakage. This should not require any drastic measures, since the diffusion rate of hydrogen in air is very rapid.

Brayton (gas turbine) engines are high-speed machines turning at tens to hundreds of thousands of rpm. The resulting high kinetic energies of their compressor and turbine wheels must be absorbed, and their rotor fragments contained, in the unlikely event of structural failure. This will be accomplished through care and conservation in the design of both rotors and housings, the latter (together with the engine compartment walls) providing more-than-adequate shielding.

There has also been some concern about the potential toxicity of fine nonmetallic particulates which could be abraded from rubbing seals, in the Brayton regenerator or Stirling preheater, and emitted in the exhaust. Certain candidate materials - notably nickel oxide - are claimed to be carcinogenic if ingested into the lungs. Care will thus have to be exercised in the selection and application of such materials, and their safety demonstrated in prototype testing.

### 16.2.3 Electric Powerplants

Electric prime movers and their controllers present no special safety problems beyond the normal design considerations implicit in their use in any commercial application. Sizes and routing of conductors, and the type and quantity of insulation provided, must be compatible with the currents and voltages used, as well as the maximum expected prevailing temperatures. Adequate grounding provisions will be made in conductors and cases, with accessible circuit breakers as required in appropriate circuit legs.

Battery safety considerations will depend largely upon the type of cell ultimately developed. Appropriate measures will be adopted in the design of the battery case. Thermal, as well as electrical, insulation may be required. Depending upon the toxicity of electrode materials and/or electrolyte, the vehicle design will have to provide the necessary degree of protection from impact damage vulnerability.

### 16.2.4 Hybrid Powerplants

Hybrid powerplant safety considerations obviously depend upon the kind of heat engine, and the kind of energy-storage system used. These considerations are covered in the foregoing discussion of specific heat engine types, and in the general remarks made therein relating to

high-speed rotating machinery, high-pressure vessels and ducting, and electric systems.

### 16.3 VEHICLE SAFETY ASPECTS

Occupant safety is a complex interplay of vehicle design features and the occupant restraint system. In a crash, the vehicle has to perform two basic functions - it must dissipate the energy of the collision and provide an environment in which the occupant can survive.

The energy absorption must be gradual enough so that the maximum decelerations involved are within the capability of the occupants to survive with minimal injury. Bigger cars have an inherent advantage in this respect because they have a longer crush distance over which the deceleration takes place.

Deformation of the passenger compartment or intrusion by foreign objects must be minimized. For frontal collisions, the ends of the car can be deliberately designed as deformable structures and the engine mountings and firewall shape arranged to deflect the engine under the car instead of allowing it to be displaced straight back toward the occupants. Door strengthening is the main method for resisting intrusion during side impacts, which fortunately have much lower average energy. Adequate roof crush strength is important in accidents involving roll-over. Body structural design has only recently been carried out with these considerations as a major factor.

As public concern over vehicle safety has increased in recent years, performance standards have been imposed by governmental agencies with respect to safety and also damageability of cars. The latter arose from concern over the high repair costs incurred from even minor accidents and resulted in regulations concerning bumper height and ability of a vehicle to sustain front and rear impacts without major damage. The impact test speed, initially 2.5 mph and currently 5 mph, was proposed to rise to 10 mph in future years.

The weight impacts of present and proposed regulations tend to be a higher percentage for small cars, with the absolute numerical values fairly similar for all sizes. More effort is required with small cars to meet most safety standards, where large cars have an initial advantage because of their greater size and mass. In one particular case, a weight increase of 315 lbs or 18% was incurred in modifying a small car currently in production abroad to meet U. S. standards (Ref. 16-1). Smaller weight impacts can be achieved by adopting less conventional construction techniques, although at increased cost (Ref. 16-2).

Cost-benefit analysis is the policy maker's primary tool in evaluating the worth of a proposed regulation, but the monetary values associated with both the costs and the benefits are difficult to determine. Cost estimating must surmise first the means of implementing the standard and then the cost thereof. Benefits depend on the degree of effectiveness of the standard and the monetary value assigned to the improvement. In the case of safety, this difficulty is well illustrated by the 3:1 difference used by two Federal agencies (NSC, NHTSA) in costs for fatalities and injuries (Ref. 16-3, 16-4).

Damageability should permit more precise evaluation if sufficiently accurate and detailed statistics are available. As an example, the incremental costs of the 5-mph bumper systems initially appeared to make the elimination of all damages from under-5-mph front and rear crashes worthwhile. After some experience with cars built to this standard, it developed that damages in over-5-mph crashes were more severe than before because the more rigid structure transmitted damaging stresses further in the vehicle and the new bumper systems had much higher replacement costs in accidents where they did get damaged. This standard is now under review.

With the recent concern over gasoline consumption, the importance of the additional vehicle weight caused by safety and damageability regulations has been newly recognized. Such weight increases, including weight propagation and use of larger engines to maintain performance, have totaled 200-300 lbs in the last 3 years (Ref. Chapter 10, Section 5). On an equivalent-performance basis, 200 lbs of weight added to the vehicle increases the fuel consumption by 0.0028 gal/mile (Ref. Chapter 10, Section 6) or 308 gal over the 110,000-mile average life of a car. This is clearly an important impact either from the cost-benefit standpoint or from the broader view of total automobile energy consumption.

Regulatory agencies by their very nature are usually charged with responsibility in one specific area and have often not considered the overall systems aspects in carrying out their mandate. The argument that "a second-best solution vigorously carried out is better than the best decision too late arrived at" (Ref. 16-5) does not benefit the public welfare or improve the faith in the regulatory process if a hasty decision later turns out to be wrong.

Both crash resistance and damageability standards work in the direction of making the car's extremities more rigid, so that in a collision the struck object will sustain more damage. This increased aggressiveness is detrimental when the struck object is a smaller car or a pedestrian and more than offsets the benefits to the striking vehicle. A balance must be obtained between these effects, and differing means of meeting the requirements must be explored. This point is valid in general and means that, since the cost-effectiveness is implementation-related, time may be a factor in the evaluation.

Time can also lead to a better understanding of problems. Because domestic cars have historically had a monotonic relationship between size and weight, these two words have frequently been used interchangeably in safety discussions. Some imported cars combine lower weight with greater size, and recent investigations have pointed out that vehicle weight is primarily a hostile characteristic whereas vehicle size is basically protective (Ref. 16-6). It gives not only increased crush distance for more gradual energy absorption but the greater interior space allows the restraint devices more room to "catch" the occupant before his "second collision" with the car interior, which is the primary cause of injuries. Since a spacious passenger compartment

is desirable to the customer anyway, the industry should emphasize the building of large but light-weight cars. The recent trend has unhappily been in the opposite direction (Ref. Chapter 10, Section 5).

#### 16.4 FLEET SAFETY ASPECTS

To analyze this problem we have adopted the approach of examining accident involvement rate and accident injury rate separately. The former represents the chance of highway accident per unit amount of vehicle driving (e. g., number of accidents per thousand vehicle registration-months or per million vehicle-miles). The latter represents the chance of severe or fatal injury in an accident. A typical value of the accident injury rate in recent years is 6.1% for unbelted drivers in two-car crashes, based on the New York State data (Ref. 16-11).

The evaluation concerning alternate engines is based upon our assessment of engine and vehicle characteristics and performance as discussed in the previous sections of this chapter. Evaluations of the effect of weight change and a safety restraint system are made after reviewing recent publications.

##### 16.4.1 Mass Introduction of Alternate Engines

The accident involvement rate of the fleet should not be affected by the introduction of alternate engines. This is because future vehicles with alternative engines for large-scale use on highways will have size, performance<sup>1</sup> (acceleration, cruising speed, hill climbing power), and handling (ease of maneuver), comparable to present automobiles. The weight differences between the vehicles in a given size category are minor. Thus to the driver and to the existing highway system they act the same as present vehicles.

The accident injury rate depends heavily on engine and vehicle design. As discussed in the previous sections of this chapter, none of the candidate engines considered in this study pose a potentially serious or insurmountable safety problem. In response to safety codes and the demand for safe products, careful design practice and intensive prototype and fleet testing will precede mass introduction to assure an acceptable level of safety. We therefore expect no significant impact on the accident injury rate when the alternate engines are introduced.

##### 16.4.2 Shift of Vehicle Weight and Fleet Weight Distribution

#### ACCIDENT INVOLVEMENT RATE

There is no consistent evidence that the frequency of accident involvement is statistically related to vehicle size (Ref. 16-7 to Ref. 16-11). Although some variations exist in accident rates between different vehicle models they appear to be insignificant compared with the difference in driving habits of the typical drivers of these models

<sup>1</sup>The horsepower of our alternate-engine-powered vehicles was chosen to provide equivalent performance.

(Ref. 16-7, 11). We therefore expect no significant change in the accident involvement rate when the average vehicle weight and weight distribution vary.

#### ACCIDENT INJURY RATE

For accidents involving only one car there is a trend toward less injury in larger cars, but the statistical evidence is not definitive (Ref. 16-8, 10). The North Carolina data reported in Reference 16-10 shows only a slight negative relationship between injury rate and car weight, with weak statistical correlation. For the purpose of analysis, we shall assume, as in Ref. 16-11, that the accident injury rate in a single car crash will not change significantly with car weight.

There is, however, consistent evidence that in accidents involving more than one car, the drivers in the smaller cars have a higher chance of being seriously or fatally injured than the drivers in the bigger cars (Ref. 16-7 to 16-11). A typical example is the New York State data as shown in Figure 16-1.

The New York State accident data for unbelted drivers in two-car crashes during calendar years 1969-71 was analyzed by Mela (Ref. 16-11). His model is very convenient for analyzing the effect of fleet weight shift on the overall injury rate. In Ref. 16-11, the New York State accident data was first categorized into five weight classes. From the accident data file one could find the percentage of unbelted drivers of vehicle weight class  $j$  who were injured in a collision with a vehicle of weight class  $i$ . These data were statistically smoothed in Ref. 16-11 with the following analytical model:

$$R_{ij} = 16.6 (1.018)^{\frac{W_i}{100}} (0.951)^{\frac{W_j}{100}} \quad i, j = 1, \dots, 5$$

where  $W_i, W_j$  are representative vehicle weights in each weight class:  $W_1 = 1650$  lbs,  $W_2 = 2600$  lbs,  $W_3 = 3100$  lbs,  $W_4 = 3600$  lbs,  $W_5 = 4250$  lbs. These equations imply that if the weight of a car is reduced by 100 lbs, its unbelted driver has a 5% higher chance of being injured in a two-car crash. The unbelted driver of the second car in the accident will have a 1.8% lower chance of injury because of the weight reduction of the first car. The combined chance of injury occurrence in the accident will therefore be increased by 3.2%.

Table 16-1 is based on this model and represents a good approximation to the actual data. With this analytical model it is possible to estimate the change in overall accident injury rate corresponding to a change in fleet weight distribution. The algorithm used for the calculation of overall accident injury rate is

$$A = \sum_{i=1}^5 \sum_{j=1}^5 P_i P_j R_{ij}$$

Table 16-1. Serious injury rates in two-car crashes<sup>a</sup>-New York State 1969-71, unbelted drivers (source: Ref. 16-11, based on 32,980 accidents) (smoothed values of original data, in %)

Weight class, vehicle 2 (target)	Weight class, vehicle 1 (containing injured person)					Average <sup>b</sup> injury caused
	1	2	3	4	5	
1 (1000-1999)	9.7	6.0	4.7	3.7	2.6	4.4
2 (2000-2749)	11.5	7.1	5.6	4.3	3.1	5.1
3 (2750-3249)	12.6	7.8	6.1	4.7	3.4	5.6
4 (3250-3999)	13.8	8.5	6.6	5.2	3.7	6.1
5 (4000-5499)	15.5	9.6	7.5	5.8	4.2	6.9
Average <sup>c</sup> Injury suffered	13.3	8.2	6.4	5.1	3.6	5.9 <sup>d</sup>

<sup>a</sup>Source: Mela (Ref. 16-11, based on 32,980 accidents).

<sup>b</sup>Average injury rate in all classes in collision with class i.

<sup>c</sup>Average injury rate in class j vehicle in collision with all classes.

<sup>d</sup>Overall accident injury rate.

Table 16-2. Injury rate projections for various assumed future vehicle weight distributions, unbelted drivers

Weight class, lbs	Base <sup>a</sup> period 1969-71	Possible future percent in weight class <sup>a</sup>					1975 <sup>b</sup> market estimate	APSES <sup>b</sup> assumed future market
		A	B	C	D	E		
1000-1999	5.95	10	12	15	17	0	4	7
2000-2749	11.39	15	22	28	32	33	12	28
2750-3249	21.76	30	30	35	35	34	11	19
3250-3999	44.96	30	25	16	11	33	24	20
4000-5499	15.94	15	11	6	5	0	49	26
Average weight, lbs	3360	3170	3070	2890	2810	3100	3840	3275
Accident injury, %	5.94	6.35	6.63	6.96	7.13	6.22	5.48	6.28
Relative injury rate	100	107	112	117	120	105	92	106

<sup>a</sup>Source: Mela (Ref. 16-11, Table 5).

<sup>b</sup>Data here correspond to the APSES assumed scenarios in Chapter 17, Subsection 3.2 of this volume.

where  $P_i$ ,  $P_j$  are the portions of the total fleet with vehicle weight in class  $i$ ,  $j$  respectively. The assumption here is that the product  $P_i P_j$  represents the probability that in a two-car accident, one is in class  $i$  and the other is in class  $j$ . This assumption is consistent with the assumption that the accident involvement rate is independent of vehicle weight. Justification for the assumption that the joint probability can be represented by the product  $P_i \cdot P_j$  is given in Ref. 16-11.

Likewise, the average injury rate for unbelted drivers in all vehicle classes when colliding with a vehicle in class  $i$  is

$$B_i = \sum_{j=1}^5 P_j R_{ij}$$

The average injury rate for unbelted drivers in a vehicle in class  $j$  when colliding with a vehicle in any weight class is

$$C_j = \sum_{i=1}^5 P_i R_{ij}$$

Based on the 1969-1971 weight distribution, Mela obtained the calculated overall crash injury rate of 5.9% as shown in Table 16-1, which compares with the actual value of 6.1% shown in Ref. 16-11. Table 16-2 shows the scenarios of weight change and change of distribution which have been studied in Ref. 16-11. These scenarios have demonstrated the general trend of increased injury with decreased average vehicle weight. Scenario E further shows the effect of reduced injury rate with a more concentrated weight distribution in a fleet.<sup>2</sup>

In the last two columns of Table 16-2 we show the accident injury rates of our estimated 1975 fleet mix and a possible future market mix as presented in Chapter 17, Subsection 3.2. Our intention here is to compare the overall injury rate for two possibilities, resulting from pressure for conservation of automobile fuel. With the Mature Otto-cycle engine, the fleet average fuel economy would be about 20 miles per gallon if the Future Market mix weight reduction is achieved. However, with a full fleet of vehicles powered with an efficient alternate engine like the Stirling, a fleet average fuel economy of about 25 miles per gallon can be achieved even with the 1975 market mix. It is observed from Table

<sup>2</sup> Although the broad spectrum of vehicle weights causes more crash injuries, restricting sales or use of very large or very small cars would only have a limited effect on safety. It was estimated in Ref. 16-11 that if every car in the fleet weighed 3170 lbs uniformly, the fleet would have an overall accident injury rate of 5.94%. However, a fleet with the same average weight, but with a distribution as in Column A of Table 16-2, would have an overall accident injury rate of 6.35%, only 7% more than the fleet with uniform weight.

16-2 that the accident injury rate for the 1975 market estimate is about 5.5%, while the injury rate for the assumed future market is about 6.3%, a 15% increase from the 1975 market injury level. Thus, the introduction of energy-efficient alternate engines can contribute to highway safety by allowing people to drive heavier cars without the fuel consumption penalty paid with Otto-engined cars.

#### 16.4.3 Use of Safety Restraints

Seat belts have been found to reduce the chances of fatal or serious injury in cars of any size. The New York State data of 1971-72 presented in Figure 16-1 shows that in a two-car crash the driver has 50% better chance of avoiding serious or fatal injury if he wears a seat belt. This study did not distinguish between those using a lap belt only and those with lap and shoulder belts. However, according to a recent study by Calspan Corporation (Ref. 16-12), based on data from western New York since 1969, the shoulder belt usage was only one or two percent of total drivers prior to the introduction of the ignition-interlock-equipped 1974 model year cars. We can therefore assume that the 50% improvement shown in Figure 16-1 is a contribution of lap belt usage alone.

The North Carolina data discussed in Ref. 16-14 also support the effectiveness of seat belts. The fatal and serious injury rate was reduced by 30 - 35% with seat belts, and the fatality rate was reduced by about 70%. Here the data base consisted of cars of 1970 to 1973 model-years. The percentage of lap-belt users wearing a shoulder belt is also expected to be negligible.

The effect of using the combined lap-and-shoulder belts is very significant. The Calspan study (Ref. 16-12) reported that, among approximately 500 users of lap and shoulder belts in the 30,000 accidents investigated since 1969, there was not a single death reported and only one motorist was seriously injured. A study by Volvo (Ref. 16-13) has shown that in 28,000 Swedish road accidents none of the drivers wearing the three-point lap and shoulder belts was killed in impacts at below 60 mph. The Volvo study also estimated 40 to 90% injury reduction among those wearing the lap-and-shoulder belts. Other studies, based in part on laboratory tests, have predicted lower effectiveness (Ref. 16-5). Better data should become available with the 1974 model year interlock-equipped cars on the road.

While estimates vary, the value of the lap-shoulder belt as a cost-effective way of improving occupant safety in a crash is established. However, the usage rate will have to increase from the present level of about 20 to 30% (Ref. 16-8, 11, 12) to enhance the effect. Foreign countries like France, Czechoslovakia, Australia, and New Zealand have already made belt use mandatory in driving. From the standpoint of highway safety this is certainly a worthwhile action, especially when the fleet-average vehicle weight may decrease in the near future for energy conservation reasons.

Some states in the U. S. are also proposing mandatory lap-shoulder belt use laws (Ref. 16-7). Many people consider this as an invasion of

personal freedom- and politicians tend to shun the issue, but the preventable injuries and deaths affect others through the societal costs and insurance premiums. With a single-buckle three-point belt, the shoulder strap is visible from outside a moving vehicle, making enforcement of belt use laws practicable. Courts have recently found that failure to use available belts constitutes contributory negligence in an accident (Ref. 16-15). In the absence of compulsory belt laws, insurance companies could offer policies contingent upon belt usage which would reduce their liability if failure to use belts in an accident is established, with the premium savings passed on to the driver.

Passive restraint systems, such as air bags and passive seat belts, have also been considered by government and industry. Although they can guarantee usage of close to 100% in crashes of cars equipped with them, their life-saving performance compared to the conventional lap-shoulder belt has not been shown to be superior (Ref. 16-4) and they cost more to the consumer. There is also a serious question whether air bag systems, with their complex sensing and control mechanisms, can be expected to remain reliable as the car gets old and maintenance becomes highly sporadic. The condition of a lap-shoulder belt can be checked visually.

#### 16.5 CONCLUSIONS

- (1) None of the alternate engine systems inherently constitute a major safety problem. It is axiomatic that an alternate engine will be introduced only when its safety aspects are at least comparable to present engines.
- (2) Vehicle safety does not have to imply weight increases. What is needed is a frontal structure designed for energy absorption and a roomy interior to allow restraint devices to arrest the occupants before the "second collision" with the car interior.
- (3) A shift to lower weight cars by an average of 500 lbs with no changes in vehicle design or restraint usage will increase the present highway accident injury rate by 15%. Introduction of fuel-economical alternate engines can save fuel without vehicle weight reduction, allowing more flexibility in the compromise between fuel savings, consumer vehicle choice, and highway safety.
- (4) Restraint systems such as lap and shoulder belts can reduce the chance of severe accident injury by over 50%. At present lap belt use is limited (~25%) and shoulder belt use is rare. Possible car weight reduction in the near future makes legislation of belt laws imperative.
- (5) The single largest contributor to highway casualties is alcohol. About 50% of drivers at fault in fatal crashes are drunk (Ref. 16-16). Effective control of drunk driving is essential to the future improvement of highway safety.

#### References

- 16-1. C. Marks, R. G. Fischer, and E. E. Stewart, "Impact of Safety, Energy and Emission Requirements on Vehicle Design," Proceedings of the 3rd Int. Congress on Automotive Safety, National Motor Vehicle Safety Advisory Council, July 1974.
- 16-2. D. Friedman and R. Tanner, "Subcompact Car Crashworthiness," 54th Annual Meeting of the Transportation Research Board, January 1975.
- 16-3. Status Report, Insurance Institute for Highway Safety, 16 August 1974.
- 16-4. Status Report, IIHS, 9 September 1974.
- 16-5. C. Y. Warner, "Benefits and Costs of Automobile Crash Injury Countermeasures," Proceedings, Institute of Environmental Sciences.
- 16-6. B. O'Neill, H. Joksch, and W. Haddon, Jr., "Relationships between Car Size, Car Weight, and Crash Injury in Car-to-Car Crashes," Proc. of the 3rd Int'l. Congress on Automotive Safety, San Francisco, California, July 1974.
- 16-7. B. Y. Scott, "A Safety-Comparison of Compact and Full Size Automobiles," Proceedings of the 3rd International Congress on Automotive Safety, Vol. 1, National Motor Vehicle Safety Advisory Council, July 1974.
- 16-8. J. O. Day, D. H. Colomb and P. Cooley, A Statistical Description of Large and Small Car Involvement in Accidents, HIT Lab Report Vol. 3, November 9, University of Michigan Highway Safety Research Institute, May 1973.
- 16-9. J. K. Kihlberg, E. A. Narragon, B. J. Campbell, Automobile Crash Injury in Relation to Car Size, Cornell Aeronautical Lab Report VJ-1823-R11, November 1964.
- 16-10. B. J. Campbell and D. W. Reinfurt, Relationship Between Driver Crash Injury and Passenger Car Weight, University of North Carolina Highway Safety Research Center, November 1973.
- 16-11. D. F. Mela, "How Safe Can We Be in Small Cars," Proceedings of the 3rd International Congress on Automotive Safety, Vol. 2, San Francisco, California, July 1974.
- 16-12. "Safety Belts Curb Auto Death Toll," Automotive News, page 10, December 30, 1974.
- 16-13. N. L. Bohlin, Statistical Analysis of 28,000 Accident Cases with Emphasis on Occupant Restraint Value, Gothenberg, Sweden.



- 16-14. B. J. Campbell, B. O'Neill, and B. Tinley, "Comparative Injuries to Belted and Unbelted Drivers of Subcompact, Compact, Intermediate, and Standard Cars," Proceedings of the 3rd International Congress on Automotive Safety, San Francisco, California, July 1974.
- 16-15. Automotive News, 20 January 1975.
- 16-16. Department of Transportation, 1968 Alcohol and Highway Safety Report, submitted to the House Committee on Public Works (90-34), August 1968.

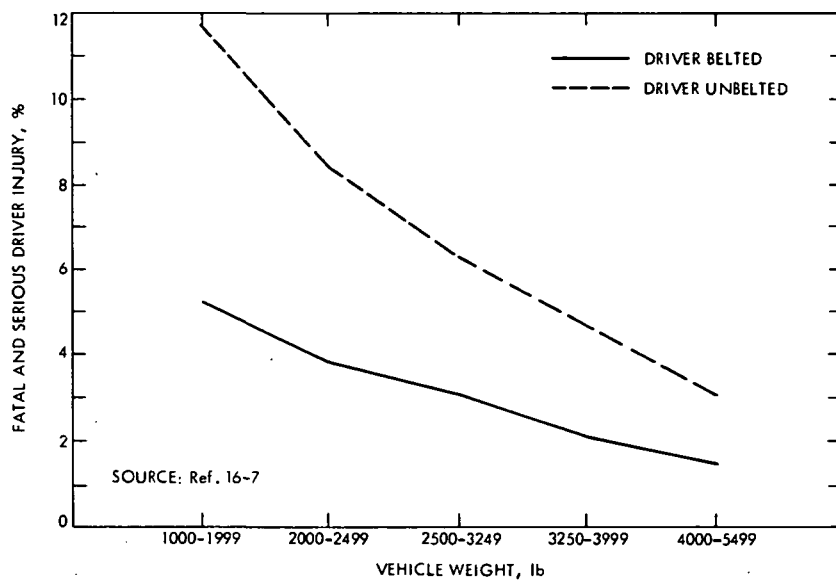

Fig. 16-1. Fatal and serious driver injury and vehicle weight (two-vehicle accidents, 1971 and 1972 data, state of New York)

CHAPTER 17. ENERGY AND FUELS

17.1	Evaluation of Alternative Energy Sources . . . .	17-2
17.2	Projection of Total Domestic Energy Supply and Demand Situations . . . . .	17-4
17.2.1	The Current Energy Balance and Basis for Projections . . . . .	17-4
17.2.2	Projection of Likely Domestic Supply . . . . .	17-5
17.2.3	Projection of Total Non-Automotive Energy Demand . . . . .	17-9
17.3	Projections of Capability for Satisfying Petroleum Demand . . . . .	17-10
17.3.1	Range of Non-Automotive Demand for Petroleum . . . . .	17-11
17.3.2	Scenarios for Automobile Fuel Consumption . . . . .	17-17
17.3.3	Comparison of Projected Domestic Petroleum Supply and Demand . . . .	17-23
17.4	Consideration of Demand for Specific Petroleum Products . . . . .	17-25
17.4.1	Characteristics of Fuels Demanded by Engine Types . . . . .	17-25
17.4.2	Factors Affecting Supply of Specific Products . . . . .	17-26
17.4.3	Methanol and Methanol Blends . . . .	17-28
17.5	Availability of Electrical Energy for Vehicles . . . . .	17-28
17.6	Conclusions . . . . .	17-29
	References . . . . .	17-29
	Figures . . . . .	17-32

17.1 EVALUATION OF ALTERNATIVE ENERGY SOURCES

The use of fuel for passenger cars, present and future, is only one part of this country's complex and interrelated energy system. Any assessment of the availability of fuels for the automobile market must begin with an examination of what the whole energy picture is likely to look like over the time period in question. To do this in the context of the present study, we can draw from a wide menu of energy supply-demand projections available in the open literature. A detailed analysis of supply possibilities and the pressures that would be brought to bear by competing demands for every conceivable automotive fuel is neither possible nor desirable in a project of this scope, however. In order to simplify and direct the general fuel analysis, we must first narrow the range of alternate fuels that can be considered serious candidates for widespread use in the decade of the 1980's. This involves an initial quick-scan evaluation of a list of fuels with reasonable apparent potential.

A large number of fuels for on-board combustion in automobiles has been investigated in more or less detail over the years. The ones that have been considered here are:

- (1) Gasoline
- (2) Distillates
  - (a) Kerosene
  - (b) Diesel fuel
  - (c) No. 2 fuel oil
- (3) Methanol
- (4) Methanol/gasoline blends
- (5) Natural gas and synthetic natural gas (methane)
- (6) Propane/butane (LPG)
- (7) Hydrogen
- (8) Ammonia

Inclusion on this list already implies some pre-selection on the basis of reasonable physical and chemical properties, some measure of engine compatibility, and current knowledge of manufacturability at (relatively) moderate cost. This first evaluation of the fuel alternatives was based on the following parameters:

- (1) Supply potential
- (2) Toxicity and safety
- (3) Cost and energy efficiency of production
- (4) Handling, storage and distribution

(5) Emissions effects

Three extensive reports on alternate fuels, prepared by the Aerospace Corporation (Ref. 17-1), Exxon Research and Engineering (Ref. 17-2) and the Institute of Gas Technology (Ref. 17-3), provided much of the data on which our conclusions are based. Those conclusions, briefly stated, are that viable fuels for automobiles through the 1980's and into the 1990's are limited to liquid hydrocarbons derived primarily from petroleum and supplemented to some extent with synthetic liquids. Though all of the criteria by which the fuels were evaluated are important in deciding their suitability, it turns out that supply potential (or lack of it) is an overriding factor.

Natural gas is a scarce fuel already hard-pressed by established markets, even considering the contribution that might be made to supply by synthetic methane. Propane and LPG are petroleum-derived; limited amounts will always be produced in refining operations, but increasing their production to satisfy any substantial portion of automotive demand would require more severe (energy consumptive) processing of crude oil than already employed to make auto fuel. Under current technology, methanol, hydrogen, and ammonia are made from natural gas and petroleum fractions. In future, they could be derived from coal, as can liquid hydrocarbons. Ammonia offers no advantages that outweigh its extreme toxicity, and hydrogen presents severe problems in on-board storage of enough fuel to allow a satisfactory driving range.

Methanol and coal liquids, to a first approximation, enjoy the same supply potential.<sup>1</sup> Process components for a plant producing methanol from coal are commercially available now, while a fully satisfactory large-scale coal liquefaction process is several years away. Some data are available allowing a comparison of costs and energy efficiencies to be expected in synthesis of the two fuels from coal. Both the Exxon (Ref. 17-2) and IGT (Ref. 17-3) studies present detailed economic analyses of production and distribution for several synthetic fuels including gasoline, distillates, and methanol from coal. Their analyses are based on different process choices and slightly different cost calculations, and so are not strictly comparable. Within each study, however, relative comparisons between products are valid. Table 17-1 shows the cost and efficiency figures as given in the two reports. In the Exxon study the evolution of costs over time was also projected. The wide variation in production costs appearing in Table 17-1 points up the uncertainties inherent in comparing a variety of processes in different stages of development. From the figures given, it cannot be said that methanol production from coal must be significantly more expensive than gasoline/distillate synthesis. Distribution of the alcohol will be more costly, owing to its lower energy density, so at the pump in a conventional motor fuel distribution system methanol would be the more expensive fuel.

<sup>1</sup>Both methanol and syncrude can be made as well from waste material, which could supply some of our energy needs. Detailed data are not available to make cost and efficiency comparisons as has been done for coal as a starting material.

Table 17-1. Comparison of costs and efficiencies for production of synthetic liquid fuels from coal

Study	Fuel produced	Costs, \$/10 <sup>6</sup> Btu (in 1973 dollars, lower heating value)			Energy efficiency
		Production and refining	Transportation and distribution	Total	
Exxon (Ref. 17-2)	Gasoline alone				
	1982	2.40	0.95	3.35	0.65 <sup>a</sup>
	1990	2.15	1.00	3.15	
	2000	1.65	1.00	2.65	
	Distillate (co-produced with gasoline at 1:2 ratio distillate: gas)				
	1982	1.80	0.95	2.75	0.70 <sup>a, b</sup>
	1990	1.50	1.00	2.50	
	2000	1.10	1.00	2.10	
	Methanol				
1982	1.95	1.90	3.85	0.65 <sup>a, c</sup>	
1990	1.90	1.50	3.40		
2000	1.55	1.40	2.95		
IGT (Ref. 17-3)	Gasoline alone	2.81	1.06	3.87	0.42 <sup>d</sup>
	Gasoline and distillate co-produced in 1:1 ratio	2.51	1.06	3.57	0.46 <sup>e</sup>
	Methanol	3.88	1.34	5.22	0.40-0.45 <sup>f</sup>

<sup>a</sup>Energy in total product/total input energy.

<sup>b</sup>Efficiency of making gasoline and distillate as co-products.

<sup>c</sup>Assumes by-products of gasification steps can be used for process heat. If not, overall efficiency drops to 0.55.

<sup>d</sup>Energy in gasoline/energy in input coal.

<sup>e</sup>Energy in gasoline plus distillate/energy in input coal, estimated.

<sup>f</sup>Energy in methanol/energy in input coal. The higher efficiency figure would presumably lead to lower production cost.

In terms of resource utilization, co-production of gasoline and distillate fuel from coal appears to be slightly more energy-efficient than production of methanol.

Neither hydrocarbon fuels nor methanol from coal are likely to be available for use by a major fraction of the automotive population through the 1980's, though there are circumstances under which they could be making a significant contribution by 1990 (Section 17.3.2). The synthetic hydrocarbons (which will include those derived from oil shale as well) can be blended with the more conventional petroleum products. Methanol might be handled as a blend with gasoline or as a straight fuel for limited applications. More detailed discussion of that question will be presented in Section 17.4.3.

Three fuels remain, then, after quick-scan evaluation: gasoline, distillates, and methanol. The last will, because of supply considerations, be a relatively minor contributor in the 1980's. Our overall energy system analysis should be directed primarily to assessing supply and demand for natural and synthetic petroleum products, with some attention paid to the possibility of utilizing coal and waste material for methanol synthesis. The relative availability of the chosen fuels will depend on what supplies are obtainable through refinery practice and what other uses will be competing for the same supplies. Their relative use will be determined by engine compatibility and should be affected strongly by the costs and energy efficiency of the fuel production/automobile use system.

17.2 PROJECTION OF TOTAL DOMESTIC ENERGY SUPPLY AND DEMAND SITUATIONS

Having decided that petroleum will remain the key component of our energy system as far as automotive use is concerned, we now turn to an overview of the general domestic energy supply-demand picture and what it might look like for the next 15 years. Energy forecasting has been a popular pastime in the recent past. Nearly 100 forecasts, projections, and models dealing with energy supply and consumption in various states of aggregation are reviewed in one survey publication (Ref. 17-4). Few of these studies are directly comparable with each other (Ref. 17-4, 17-5). They differ in their degree of comprehensiveness, the geographical area to which they apply, and the range of energy sources they consider, for example. More importantly, there are wide variations in the assumptions, both explicit and implicit, made in the course of constructing projections. We have chosen a small number of publications to serve as a basis for our evaluation of future energy trends. Each of these reference studies deals with all the current and emerging sources of primary energy and considers the resources and consumption patterns for the entire United States. The data are presented in comparable categories; key assumptions regarding the future course of conditions determining energy production and use are also more or less comparable. The projections start at 1970 or 1971 and extend at least through 1985. Over this 15-year period, variations between the sets of projections are relatively small. For those studies that extend beyond 1985, the discrepancies between them become larger and the analyses become more uncertain.

Our primary reference is the very detailed and comprehensive analysis done by the National Petroleum Council between 1970 and 1972. The results were presented in preliminary form in 1971 (Ref. 17-6) and in final form in December of 1972 (Ref. 17-7). Both reports were supported by task group documents, also published. This study possesses several features advantageous to our work. It contains large amounts of basic data, the manipulation of which is generally well documented. The analysis is parameterized over a reasonable range of several key variables, and underlying assumptions are for the most part clearly outlined. The time period covered is 1971 to 1985; rough estimates of a range of supply-demand situations for the year 2000 are included. For supplementary information, we have used a Department of the Interior document, "U. S. Energy Through the Year 2000" (Ref. 17-8).

17.2.1 The Current Energy Balance and Basis for Projections

Energy consumption in the United States is conveniently categorized into three sectors: residential/commercial, industrial, and transportation. Each shows a fundamentally different set of end use requirements, though there are overlaps. In the residential/commercial sector, energy input is converted into either direct heat or mechanical drive; both applications are directed toward providing comfort and/or convenience for the individuals occupying dwellings or commercial establishments. The industrial

sector uses its energy to produce goods. Toward that end, the input goes to raise steam (some of which is used for internal generation of electricity), to provide direct process heat, and to run mechanical and electrolytic equipment. Energy is used in transportation to provide mechanical drive for moving goods and people from place to place. Part of the energy used by industry and transportation obviously goes for space conditioning, but this is not itemized separately.

Primary input to our energy system today is provided by coal, petroleum, natural gas, nuclear energy, and hydropower. It is clear that all of these energy sources are not equally capable of fulfilling all of the consuming sectors' end use requirements, at least in their original forms. Each fuel can be converted into a secondary energy form, electricity, that does find application to a greater or less extent in each sector. Figure 17-1 illustrates the flow of energy in the United States, from primary sources on the left through conversion to secondary sources and on to their utilization to perform work in the various sectors. The magnitudes in each segment correspond to 1970 energy consumption figures. Note the contribution of each sector to the waste energy segment. Table 17-2 lists 1970 data for fuel consumption according to sector.

Table 17-2. 1970 energy consumption by sector, 10<sup>15</sup> Btu (Ref. 17-8)

	Coal	Petro- leum	Gas	Elec- tricity	Total
Residential/ commercial	0.4	6.4	7.1	3.0	17.0
Transportation	—	15.6	0.7	—	16.4
Industrial	5.0	5.3	10.2	2.2	22.6

The energy distribution described above forms the baseline from which our projections of the U. S. supply-demand situation will be constructed. Analysis of potential supply is drawn in large part from the work of the National Petroleum Council. Their reports deal mainly with the supply question, and represent what is probably the greatest concentration of expertise available in that field. Their initial appraisal was a set of projections "... based on optimistic assessments of what would occur without major changes in the political and economic (1970) climate" (Ref. 17-6). Followup studies (Ref. 17-7) indicated that the initial conclusions may have been too optimistic; they then tried to evaluate quantitatively the effects of government policies and industry actions that would bear on the future magnitude of domestic energy supplies.

Four supply cases were developed for each primary fuel, reflecting the sensitivity of fuel availability to varying degrees of activity in exploitation of each. Case I is the projected result of maximum development effort, unhampered by environmental or economic restrictions. Case IV represents the most pessimistic prognosis, assuming continuation of the exploration and development trends experienced over the past few

years as well as persisting environmental constraints. The other two cases are intermediate. Table 17-3 summarizes the gross assumptions underlying each case for each fuel. Figure 17-2 illustrates the range of potential total domestic energy production projected by NPC using these assumptions. This study seeks to narrow that range by judging the effects of trends appearing since publication of the NPC studies.

After estimating energy supply trends, the next task will be to project the demand picture. To do that, the NPC looked at the effects of four key variables (economic activity, energy cost, population, and environmental controls) on energy consumption in five sectors. Their consuming sectors were residential/commercial, industrial, transportation, electrical generation, and non-energy uses. Two projections, high and low, were made for each variable; the demand projection from the initial appraisal formed an intermediate case. Two explicit assumptions were made governing the whole range of demand projections (Ref. 17-7). The first, that "... the Nation will continue to rely on private enterprise and free consumer choice . . .," is innocuous enough. The second, however, says "... they do not contemplate reduced energy consumption because of supply limitations or political decisions." In the light of events occurring since late 1973, it is clear that ambient conditions in the U. S. are no longer consistent with that premise. Interior's single demand projection (Ref. 17-8) is based on similar premises. Neither source, then, provides a projection of energy demand that can be considered realistic in the current economic and political climate. Here we will use the demand projections from Interior (since they do not stop at 1985, as do the NPC's) as a baseline to be modified in order to construct more reasonable estimates of future demand in all areas except personal transportation. Automotive fuel demand projections are done independently in this study (Section 17.3.2).

With supply and demand projections in hand, the task of reconciling them remains. That is, an energy balance must be drawn estimating the distribution of primary fuels among consuming sectors. This is complicated by the fact that projected potential supply does not correspond to actual usable supply, owing to the lack of complete interchangeability between all fuels.

The approach to reconciliation taken herein is predicated on the judgment that the factors of primary interest are the availability of petroleum liquids (including synthetics) and the likely demand for such liquids. Projection of total domestic energy supply is followed by projection of total energy demand in all sectors except transportation. Next, the fossil fuel component of non-transportation demand is estimated. Projections of the contributions to be made to non-transportation fossil fuel demand by coal and natural gas follow, giving estimates of non-transportation petroleum demand. Then demand curves for the non-automotive part of the transportation sector (which is assumed to run essentially entirely on petroleum products) are constructed. Estimates of automotive demand are then combined with the projections for non-automotive petroleum demand and compared with projected domestic petroleum liquids production.

#### 17.2.2 Projection of Likely Domestic Supply

At this writing, three years have elapsed since the beginning of the NPC projection period. Analysis of energy trends within that time allow some cautious judgment of where in the range of supply cases our domestic energy production is likely to fall. Such judgment is mostly qualitative; the time since 1970 has been too short to extract quantitative trends capable of distinguishing between alternatives that do not diverge greatly for several more years. Moreover, it has been a turbulent period, and not all of the conditions occurring recently will persist. We

Table 17-3. Major assumptions in NPC supply projections (Ref. 17-7)

	Cases			
	I	II	III	IV
Oil and gas annual drilling increase	5.5%	3.5%	3.5%	Continued decrease
Oil and gas finding rate	High	High	Low	Low
Coal annual production increase	5%	3.5%	3.5%	Present trend
Nuclear development	All base-load plants 1971-1985 are nuclear	Problems solved quickly	Follows AEC's most favorable forecast	Current problems continue
Synthetic fuels	Maximum possible development rate	Moderate development	Moderate development	
Environmental restrictions	None			Severe

will assume that a rapid approach to energy self-sufficiency will remain a matter of national policy. Other assumptions will be detailed as the construction of our reference case proceeds fuel by fuel.

### PETROLEUM

The major determinants of conventional petroleum production are drilling rate and finding rate. Drilling rate, commonly expressed as feet of well drilled per year, is the sum of exploratory footage and development activity. The extent of development drilling is dependent on the finding rate, or success of the exploratory effort expressed as oil-in-place found per foot of exploratory drilling. Thus, the two variables are correlated to some extent, though a high drilling rate does not necessarily imply a high finding rate. The product of the two leads to calculation of yearly primary reserve additions. It is the size of the remaining reserves at year end (previous year's remaining reserves minus production plus primary reserve additions and additions resulting from improved recovery techniques) that determines the magnitude of the next year's production.

Three trends were projected in the NPC study for exploratory footage, ranging from Case I with an overall 7.5% annual growth rate to Case IV, characterized by an annual decrease of 3%. Case IV is a simple extrapolation of the past 15 years' experience. For finding rate, two alternatives were considered. The low finding rate corresponds to a semi-log extrapolation of past trends, while the high one seems to be purely judgmental.

Comparisons with actual performance are available for 1971 and 1972 projections of several oil production variables. Drilling footage for the two years, both total and exploratory, was below the most pessimistic Case IV (low drilling and low finding), as was the total number of wells completed. Productive well completions, however, approximated the more optimistic Case I, IA projections. Reserve additions were significantly below those predicted by Case IV. Production figures for the whole range of cases vary little in the early years of the projection, reflecting the lag times inherent in the system, and actual production in 1971 and 1972 was quite close to them. These comparisons are all listed in Table 17-4.

Table 17-4. Comparison of oil industry performance with NPC projections, 1971 and 1972

Drilling rates, 10 <sup>6</sup> ft						
	Exploratory			Total		
	NPC I <sup>a</sup>	NPC IV <sup>a</sup>	API <sup>b</sup>	NPC I <sup>a</sup>	NPC IV <sup>a</sup>	API <sup>b</sup>
1971	21.9	21.9	21.3	91.2	89.6	79.9
1972	24.7	22.7	21.0	93.7	82.4	80.8

Wells drilled									
	Productive			Dry			Total		
	NPC I <sup>a</sup>	NPC IV <sup>a</sup>	API <sup>b</sup>	NPC I <sup>a</sup>	NPC IV <sup>a</sup>	API <sup>b</sup>	NPC I <sup>a</sup>	NPC IV <sup>a</sup>	API <sup>b</sup>
1971	11802	11548	11858	7550	7452	6814	19352	19000	18672
1972	11742	10226	11306	7827	6976	6742	19570	17202	18048

Reserve additions, 10 <sup>6</sup> bbl			
	NPC I <sup>a</sup>	NPC IV <sup>a</sup>	API <sup>c</sup>
1971	2596	2489	2317
1972	2658	2315	1559

Annual production, 10 <sup>9</sup> bbl			
	NPC I <sup>a</sup>	NPC IV <sup>a</sup>	API <sup>c</sup>
1971	3.32	3.32	3.26
1972	3.23	3.22	3.28

<sup>a</sup>Projections, from Ref. 17-10.

<sup>b</sup>Actual figures, Ref. 17-11.

<sup>c</sup>Actual figures, Ref. 17-12.



It was not until late 1973, of course, that the Arab oil embargo took place. The push toward energy independence that resulted will act to increase exploratory drilling, especially as lease sales in the outer continental shelf are accelerated beyond the schedule considered in the NPC analysis. Acting to moderate the drilling increase will be the shortage of drilling personnel and equipment already being felt. There is no evidence suggesting that the finding rate trend shown in the past few years will be reversed, however. On the basis of all these considerations, we judge that NPC's Case IA, involving a high exploratory drilling rate and a low finding rate, best approximates our "likely" projection for conventional petroleum production capability. The same sorts of arguments, elaborated below in the natural gas section, lead to selection of Case IA for production of natural gas liquids.

Over the time period in which this study is interested, synthetic liquid fuels will begin to supplement our petroleum supplies. We will assume that these will be brought into the picture as rapidly as possible. Two sources of syncrude are available, coal and oil shale; technology for utilization of oil shale is the more advanced. We have chosen the NPC's Case I projections for syncrude from both sources. In the case of oil shale, that assumes a maximum feasible development rate under non-emergency conditions with adequate prices (Ref. 17-7). For coal liquefaction, where technology is presently just in the pilot plant stage, Case I represents a high risk course of action, with a 30,000-barrel-per-day plant coming on line by early 1978 (Ref. 17-7). Even with a crash program this will be nearly impossible. The contribution of synthetic liquids to overall petroleum supply through the 1980's is so small, however, that it doesn't really matter which case we assume.

Our projection of a reference case for liquid fuels production through 1985 is outlined in Table 17-5, including the projected values of the components that go to make it up.

### GAS

Conventional natural gas is derived from two sources. Some of it is produced in conjunction with petroleum liquids, as associated-dissolved gas. Future production in this category was projected by the NPC using historical gas-to-oil ratios and their projections of petroleum production. Marketed production of associated-dissolved gas differs from wellhead production by about 13%; that portion of the original gas produced corresponds to lease use, pump fuel, and losses.

Most of our natural gas is non-associated, coming from reservoirs containing gas only. Production rates for non-associated gas, like petroleum, depend on a combination of drilling rate and finding rate. The NPC's method for developing projections for non-associated gas is analogous to that employed for petroleum. The trends used for drilling rate were: Case I, 5.4% average annual increase nationwide, peaking at 9% in 1980; Cases II-III, 3% average annual increase peaking at 5% in 1980; Case IV, 4% average annual decrease, following a trend established from 1961 through 1970. High and low

Table 17-5. Reference case projection, domestic energy production

	Production, 10 <sup>15</sup> Btu/yr			
	1970 actual	1975	1980	1985
Conventional petroleum	21.05	20.01	24.95	27.05
Shale syncrude	0	0	0.30	1.48
Coal syncrude	0	0	0.18	1.49
Total liquids	21.05	20.01	25.43	30.02
Conventional gas	22.45	21.94	20.50	23.48
Nuclear stimulation	0	0	0	0
Syngas from coal	0	0	0.51	2.27
Syngas from liquids	0	0.62	1.34	1.34
Total gas	22.45	22.56	22.35	27.09
Coal	13.06	16.65	21.20	27.10
Nuclear	0.24	1.66	6.79	16.13
Hydropower	2.68	2.99	3.24	3.32
Geothermal	0.01	0.12	0.78	1.40
Total production	59.49	63.99	79.79	105.06

finding rates were again assumed, the low rate reflecting a 15-year historical trend. For non-associated gas, an average of 6.5% of well head production goes for lease use and fuel.

Looking at actual gas industry performance in 1971 and 1972, we see the comparisons listed in Table 17-6. Drilling activity turned out to be much higher than projected, in terms of both footage drilled and productive wells completed. Reserve additions fell below the lowest anticipated figures, while production (as expected) remained very close to the volumes projected. Again we choose the NPC's Case IA to determine the contribution of conventional natural gas to our reference projection.

Possible supplements to conventional natural gas supply may be found in nuclear stimulation of tight gas formations and conversion of coal and petroleum liquids to synthetic gas. Mid-1974 press reports (Ref. 17-13) indicate that work on stimulation is at a standstill; we expect no utilization of that technique before 1985, consistent with

Table 17-6. Comparison of gas industry performance with NPC projections, 1971 and 1972

Total drilling rates, 10 <sup>6</sup> ft			
	NPC I <sup>a</sup>	NPC IV <sup>a</sup>	API <sup>b</sup>
1971	41.25	40.68	44.32
1972	43.31	39.05	49.84
Productive wells			
	NPC I <sup>a</sup>	API <sup>b</sup>	
1971	3318	3830	
1972	3432	4928	
1973	3565	6315	
Total reserve additions, TCF			
	NPC I <sup>a</sup>	NPC IV <sup>a</sup>	API <sup>c</sup>
1971	15.30	11.30	9.82
1972	16.19	10.49	9.63
Total wellhead production, TCF			
	NPC I <sup>a</sup>	NPC IV <sup>a</sup>	API <sup>c</sup>
1971	21.91	21.91	22.08
1972	22.31	22.10	22.51

<sup>a</sup>Projections, from Ref. 17-10.  
<sup>b</sup>Actual, from Ref. 17-14.  
<sup>c</sup>Actual, from Ref. 17-15.

NPC's Case IV estimate. Production of syngas from coal will be pursued vigorously. At least two plants to make high-Btu gas are near construction, and there is much activity in the area of low-Btu gas production for power generation. Synthetic gas from liquids (propane and naphtha) is more problematical. Several projects that were announced to produce pipeline quality gas from liquids are now in limbo owing to problems in assuring feedstock supplies. Overall, however, we judge that Case I will apply to syngas manufacture. As can be seen in Table 17-5 the contribution of synthetics to gas supply will be small up to 1985.

#### COAL

The projections offered in the NPC reports for coal production were not so clearly based on the analysis of physical details as those for oil and gas. Unlike oil and gas, coal production rates will not be limited by the availability of reserves for many years to come. Rather, the limiting factors in exploitation of coal will be such things as manpower and restrictions governing

surface mining and allowable sulfur content. The NPC's Coal Task Group felt that "... a maximum growth rate of 5% per year could be sustained by the coal industry." Case I assumes that growth rate for coal supplied to conventional markets (fuel and coke production). Inclusion of coal for synthetic fuels brings the Case I expansion to 6.7% annually. Development of coal capability is a high-priority item in Operation Independence, the Federal plan for achieving energy self-sufficiency by 1980. Whether or not that strategy can or will be carried out to its full extent, we feel Case I is the best approximation in the NPC range for coal's contribution to our reference case.

#### NUCLEAR POWER

Use of nuclear energy to generate electricity presently provides a very small part of our energy budget. It is the segment, however, that is expected to carry a large portion of projected growth. The availability of nuclear power between now and 1985 will certainly not be resource-limited (Ref. 17-16). Major constraints on expansion of nuclear generating capacity lie in a complex mixture of problems centered around public acceptance in the realm of technical reliability, siting and environmental impacts, and licensing and regulation. Of the four growth cases considered by the NPC, the second most pessimistic closely approximates recent AEC and FPC forecasts. Of that it is said "The present legal and regulatory turmoil delaying nuclear plant licensing and operation will have to be at least substantially resolved in the near future, either through legislation or procedural improvement, if even the Case III projection is to be realized." (Ref. 17-7). Two years later these problems are still very much with us (Ref. 17-11), and in fact the official AEC forecast of installed nuclear generating capacity by 1980 has just been revised downward by 23% (Ref. 17-12). We choose Case IV to represent growth of nuclear energy.

#### HYDROPOWER AND GEOTHERMAL

Few usable sites remain in this country for hydroelectric development, and all of them that are economically and environmentally feasible will probably be used by 1985. Only one projection is made for hydropower. Success in large-scale exploitation of geothermal energy is very much an open question at this point; much of the presently known resource base is without technology to harness it. Interest is high, though, and the idea of geothermal power generation enjoys great public popularity. Case I assumes that technology for hot water systems will be available by 1977.

#### TOTAL

The composition of our reference domestic energy supply projection is shown in Table 17-5. Figure 17-2 illustrates our projection in comparison with the range considered by the NPC and the supply forecast made by Interior (Ref. 17-8). These projections all represent analyses of production trends based on judgments of primarily physical limitations; they did not explicitly

consider price elasticity of supply. At least one study, done at MIT, that is based more heavily on econometric analysis comes out somewhat more optimistic (Ref. 17-17). There, overall prices of about \$1.20/million Btu are estimated to bring about total domestic energy production of 75 to 84 x 10<sup>15</sup> Btu by 1980, depending on what concomitant policy changes are invoked. This range brackets our reference projection for that year, but the relative contributions from the various energy sources differ. That result is not surprising, since fuel mix as defined by uniform prices will not necessarily be the same as fuel mix determined other ways. The MIT group projected lower production of petroleum liquids, coal, and nuclear and hydropower than we did, and much higher production of natural gas. Prices of \$1.90/million Btu were projected to stimulate total domestic production from 91 to 100 x 10<sup>15</sup> Btu by 1980. Petroleum production was most sensitive to the price increase, while coal and natural gas production responded to both price and policy changes.

Detailed comparison of econometric projections and those, such as ours, that are made more on the basis of physical judgment is difficult at best. The underlying premises differ markedly, and each approach leaves out key characteristics of the system. We have chosen to rely on assessment of more or less physical limitations in projecting energy supply, realizing that in the last analysis even physical limitations are economically determined.

### 17.2.3 Projection of Total Non-Automotive Energy Demand

We now proceed to estimate what total energy consumption is likely to look like over the next 15 years. The amount of energy actually used in our society depends on many economic and technical variables whose future course is uncertain. In the face of this we have projected demand under two sets of conditions in each of the consuming sectors except transportation. Consideration of the transportation sector is deferred to Section 17.3, where demand for petroleum is treated explicitly as estimates are made of how the primary fuels might be distributed among the various sectors. It will be seen that one of the demand cases outlined here (Case C) is the projection of "what might have been" that has already been labeled unrealistic. It does, however, provide a point of departure for viewing a case with more moderate growth in demand.

### ELECTRICITY

Demand for electrical energy is used here as a cornerstone for analysis of demand and for subsequent energy balance calculations. The decision to use this approach is based on two factors: (1) several detailed projections of demand for electricity as far out as the year 2000 are available, many of which are comparable in their underlying assumptions, and (2) electrical generation is the one sector that utilizes all of the primary fuels.

Examination of a wide range of projections of demand for electricity (Refs. 17-6, 17-7, 17-8, 17-18, 17-19, and 17-20) reveals that they fall roughly into three categories, characterized by

high, intermediate, and low growth rates. The high growth case, designated Case C from now on, is representative of utility industry projections as of April, 1973 (Ref. 17-18), that made by Interior (Ref. 17-8), and the NPC Intermediate Demand projection (Ref. 17-6). Case C projections are predicated on the following explicit assumptions: (1) consumption will not be supply-limited; (2) population growth will be 1 (Ref. 17-8) to 1.1% (Ref. 17-6) per year; (3) real energy prices will show little (Ref. 17-6) to some (unspecified) (Ref. 17-8) increase; (4) technology for fuel substitution (i. e., increased coal utilization) will advance; and (5) GNP growth of about 4.2% per year will occur. Case C looks exponential, with an average annual increase of 6.1%. In following analyses, the projection given in "Energy through the Year 2000" (Ref. 17-8) will represent Case C.

The medium growth category (Case B) is drawn from an econometric study by Tyrrell (Ref. 17-19). Case B's representative projection corresponds to the base case projection in that analysis; that reflects a population increase to 300 million by 2000, per capita income growth of 2.9% annually, natural gas price increases of 6.7% per year, and a 2.8% annual decrease in electrical appliance prices. The key assumption underlying Case B is a moderate increase in electricity prices, averaging 0.8% per year.

Another case is presented in Tyrrell's study, based on the same assumptions as Case B except that electricity price is allowed to double by the year 2000 (average annual increase of about 2.3%). This low growth example (Case A) is very close to the 4-4.5% demand increase now foreseen by Southern California Edison over the next 10 years (Ref. 17-20).

Projected U. S. electricity demand, in terms of Cases A, B, and C, is shown in Table 17-7 and Figure 17-3. Projections and/or data comparable to Case A conditions turned out to be unavailable for the other consuming sectors, so numerical analysis of that case could not be carried further. It should be borne in mind, however, that the sort

Table 17-7. Projected total U. S. electricity demand, three cases

Year	Case A, <sup>a</sup> 10 <sup>15</sup> Btu	Case B, <sup>b</sup> 10 <sup>15</sup> Btu	Case C, <sup>c</sup> 10 <sup>15</sup> Btu
1975	7.0	7.4	7.3
1980	8.1	9.4	10.2
1985	8.7	11.3	14.1
1990	9.1	13.2	
1995	9.4	15.2	
2000	9.7	17.2	30.7

<sup>a</sup>Ref. 17-19, lowest case.

<sup>b</sup>Ref. 17-19, base case.

<sup>c</sup>Ref. 17-8.

of low demand growth suggested by Case A remains a reasonable possibility. Electricity price increases expected between 1973 and mid-1975 are certainly larger than those presumed for that time span in either Case B or Case A.

### OTHER SECTORS

In the residential/commercial, industrial, and non-fuel sectors there is good agreement between the NPC's intermediate demand projections (Ref. 17-6) and those made by Interior (Ref. 17-8). Carryover of Case C assumptions to these sectors is straightforward, then, and we may simply adopt the average of the two to represent that case in manipulations to follow.

Construction of Case B for the residential/commercial and industrial sectors proved somewhat troublesome. Price elasticities were considered in the projections prepared by the NPC, but the econometric model they used was not comparable to Tyrrell's, and attempts to generate Case B projections based on their estimates of elasticity led to inconsistent results. The assumption was therefore made that the response to price increase predicted by Tyrrell's model in the electricity sector would be functionally equivalent to the exercise by the consumer of most or all of the reasonable energy conservation options available to him in the other sectors. Estimates of the conservation potential that might be reasonably expected in each sector are available (Ref. 17-21). To arrive at Case B projections for residential/commercial and industrial demand, the Case C ones were reduced by amounts consistent with those estimates.

The non-fuel sector is a small but rapidly expanding component of total demand for energy resources. Projections of its growth in the various references show considerable scatter, and it is not always defined or treated in the data consistently from study to study. Thus no rationale was readily available for adjusting the Case C estimate to our assumed Case B conditions. The same projection was used for both cases.

Table 17-8 and Figs. 17-4 and 17-5 summarize the range of projected total demand for energy in the residential/commercial, industrial, and non-fuel sectors. It should be noted that these figures are not intended to be predictive. Rather they are meant to illustrate the trends that might be expected to arise under the two rough sets of outside conditions used above to define the Cases B and C.

### 17.3 PROJECTIONS OF CAPABILITY FOR SATISFYING PETROLEUM DEMAND

Given a set of projections for total energy demand by the non-transportation sectors, we must extract from them estimates of what petroleum demand might be. To do this, we first estimate fossil fuel consumption by sector, then disaggregate the projections of fossil fuel demand into demand for the primary fuels. To these can be added the transportation fuel requirements expected to correspond with several scenarios for automobile use and characteristics. After identifying a range of estimates for petroleum consumption, comparison with projected domestic petroleum production is possible.

Table 17-8. Energy demand projections by sector

	Demand, 10 <sup>15</sup> Btu						
	1970 <sup>a</sup>	1971 <sup>b</sup>	1975	1980	1985	1990	2000
Residential/commercial							
Case C			18.9 <sup>d</sup>	22.5 <sup>d</sup>	26.5 <sup>d</sup>		38.0 <sup>e</sup>
Case B <sup>c</sup>	15.8	16.3	17.6	19.3	20.2	21.2	
Industrial							
Case C			22.8 <sup>d</sup>	26.0 <sup>d</sup>	30.6 <sup>d</sup>		40.6 <sup>e</sup>
Case B <sup>c</sup>	20.1	19.8	21.0	22.1	25.7	29.3	
Non-fuel	4.1	4.0	5.0 <sup>d</sup>	6.1 <sup>d</sup>	7.5 <sup>d</sup>		10.7 <sup>e</sup>

<sup>a</sup>Historical figures, Ref. 17-6.

<sup>b</sup>Historical figures, Ref. 17-8.

<sup>c</sup>Projections were generated from Case C by subtracting following amounts: Residential/commercial: 14% in 1980, 30% in 1990; Industrial: 15% in 1980, 20% in 1990 (see Ref. 17-21).

<sup>d</sup>Average of figures from Refs. 17-6 and 17-8.

<sup>e</sup>Reference 17-8.

17.3.1 Range of Non-Automotive Demand for Petroleum

FOSSIL FUEL DEMAND BY SECTOR

Electrical Generation

To estimate the fossil fuel required to meet projected demands for electricity, we need to know the breakdown of utility generating capacity by prime mover over the projection period. Given that information, a variant of the protocol used by the NPC (Ref. 17-22) can be used to calculate fuel needs. The rationale assumes the following: that what nuclear capacity there is will be applied to base load and its load factor can be predicted; that remaining baseload will be supplied by conventional steam plants; that load factors for hydro-power and peaking capacity (pumped storage, gas turbines, and internal combustion generators) can be projected; and that swings in demand that can be met within the capability of installed equipment will be followed by conventional fossil-fired steam plants.

For each prime mover

$$\text{Output} \left( \frac{\text{Btu}}{\text{yr}} \right) = \text{Capacity (kW)} \times \text{Load Factor} \\ \times 8760 \frac{\text{hr}}{\text{yr}} \times 3412 \frac{\text{Btu}}{\text{kWh}}$$

Then

Projected Demand (Btu)

- Nuclear Output
- Hydropower Output (including Pumped Storage)
- Gas Turbine Output
- Internal Combustion Output
- + Output to Supply Pumped Storage (1.65 x Pumped Storage Output)

Conventional Steam Output Required

For the fossil-fired plants

Fuel Requirement (Btu) = Output (Btu)

$$\times \text{Average Heat Rate} \left( \frac{\text{Btu in}}{\text{kWh out}} \right) \\ \times \frac{1}{3412} \left( \frac{\text{kWh out}}{\text{Btu out}} \right)$$

and the fossil fuel requirement for electrical generation is the sum of those for gas turbine, internal combustion, and conventional steam plants.

Table 17-9 contains the load factors and heat rates used in these computations. These are the same as those used by the NPC (Ref. 17-22) through 1985, with the 1985 values arbitrarily assumed to extend through 1992. In the nuclear case, however, the figures in parentheses are used. This choice was based on the observation that fully operating nuclear plants were working

Table 17-9. Load factors and heat rates (Ref. 17-22)

	Load factors, %				
	1975	1980	1985	1990	1992
Nuclear	70 (60)	74 (70)	74 (70)	(70)	(70)
Hydro	52.5	50	45	45	45
Pumped storage	7.5	7.5	7.5	7.5	7.5
Gas turbine	7.5	7.5	7.5	7.5	7.5
Internal combustion	7.5	7.5	7.5	7.5	7.5
	Average heat rates (Btu/kWh)				
Gas turbine	16000	16000	16000	16000	16000
Internal combustion	12000	12000	12000	12000	12000
Conventional steam	10300	10100	10000	10000	10000

at a load factor of only 48% in 1970 (Ref. 17-22). Even by 1974 they fell short of the expected 70%, reaching only 60% (Ref. 17-23). The AEC's assumed nuclear load factors for 1980 have been revised downward, from 80 to 75% (Ref. 17-24).

Capacity projections for Case C demand conditions were derived primarily from the same utility industry planning reports used to define the case in the first place. The actual "data base" used, shown in Table 17-10, is fragmented and incomplete, owing to the large number of sources from which it was compiled. However, the numbers are as consistent as can be expected under those conditions, and provide enough information to allow a reasonable estimate of capacity distribution through 1992 under Case C conditions (Table 17-11). Table 17-12 summarizes the steps leading to Case C fossil fuel requirements for electrical generation.

Some assumptions are necessary to assign a capacity distribution corresponding with Case B conditions. The ones used are reasonable, but by no means the only possible set. Specifically, a Case B capacity projection was made under the following guidelines. It was assumed that development of hydro capacity would be the same as in Case C. Nuclear capacity growth was derived from a linear projection of the 1972-1980 behavior including the AEC's revised 1980 point (Ref. 17-24); the plants represented in that segment are already committed and in development, and the current expansion rate seems to be as much as the nuclear industry can sustain for a while. The figures used for internal combustion are the same as Case C, and gas turbine capacity (to which the

Table 17-10. Collected projections of utility capacity by prime mover (Case C conditions)

Year	Capacity, MW						Total <sup>a</sup>
	Hydro	Pumped storage	Conventional steam	Nuclear	Internal combustion	Gas turbine	
1970 <sup>b</sup>	51,459	3,600	259,000	6,493	4,321	15,480	340,353
1971 <sup>c</sup>	53,400	2,498 <sup>d</sup>	276,571 <sup>e</sup>	8,687	4,466	21,774	367,396
1971-72 <sup>f</sup>	53,500	3,900					
1972		57,000 <sup>g</sup>	310,000 <sup>g</sup>	10,769 <sup>h</sup>	5,000	28,000	399,606 <sup>i</sup>
1973 <sup>j</sup>	54,000	8,000	318,000	21,000		38,000	
				25,758 <sup>k</sup>			
1974				40,016 <sup>k</sup>			
1975				52,035 <sup>k</sup>			
1976				58,298 <sup>k</sup>			
1977				69,251 <sup>k</sup>			
1978				81,352 <sup>k</sup>			
1979				98,129 <sup>k</sup>			
1980				125,574 <sup>k, l</sup>			
1981				151,880 <sup>k</sup>			
1982	68,009 <sup>m</sup>	24,680 <sup>m</sup>	512,213 <sup>m, n</sup>	174,380 <sup>m</sup>	5,218 <sup>m</sup>	55,763 <sup>m</sup>	872,684 <sup>m, o</sup>
1992 <sup>p</sup>		132,468	832,434 <sup>q</sup>	646,983			1,622,564

<sup>a</sup>Owing to diversity of sources, totals recorded do not correspond to sum of components.

<sup>b</sup>Reference 17-22.

<sup>c</sup>Reference 17-25, p. 15.

<sup>d</sup>Estimated using total hydropower capacity of 55,898 MW (Ref. 17-25, p. 15) and estimate of 53,400 MW for capacity excluding pumped storage (Ref. 17-25, p. 27).

<sup>e</sup>Includes 203 MW geothermal.

<sup>f</sup>Reference 17-25, p. 27.

<sup>g</sup>Statistical Abstract, U. S.

<sup>h</sup>Estimated by subtracting planned 1973-1982 increment (Ref. 17-26, p. 8) from projected 1982 nuclear capacity (Ref. 17-26, p. 10).

<sup>i</sup>Reference 17-27.

<sup>j</sup>Reference 17-28.

<sup>k</sup>Reference 17-26, p. 10.

<sup>l</sup>AEC revised forecast says 102,000 MW (Ref. 17-24).

<sup>m</sup>Calculated from 1973-1982 increments reported in Ref. 17-26, p. 8.

<sup>n</sup>Includes combined cycle and geothermal capacity.

<sup>o</sup>Increment includes 44,000 MW of unspecified capacity.

<sup>p</sup>Derived from Ref. 17-18.

<sup>q</sup>Includes gas turbine and internal combustion capacity.

Table 17-11. Projected generating capacity, Case C

	Capacity (MW)				
	1975	1980	1985	1990	1992
Nuclear	52,000	126,000	285,000	530,000	647,000
Total hydropower	60,000	87,000	100,000	130,000	132,000
Regular	55,000	64,000	73,000	95,000	97,000
Pumped storage	5,000	23,000	27,000	35,000	35,000
Gas turbine	34,400	48,500	68,300	87,200	96,100
Internal combustion	5,000	5,200	5,300	5,400	5,500
Conventional steam	353,000	469,000	561,000	682,000	731,000

Table 17-12. Calculation of fossil fuel requirements for electrical generation, Case C  
(all entries are in  $10^{15}$  Btu)

	1975	1980	1985	1990	1992
Projected demand	7.3	10.2	14.1	19.6	21.7
Projected output					
Nuclear	0.9	2.6	6.0	11.1	13.5
Hydropower	0.9	1.0	1.0	1.3	1.3
Pumped storage	0.01	0.05	0.06	0.08	0.08
Gas turbine	0.08	0.11	0.15	0.20	0.22
Internal combustion	0.01	0.01	0.01	0.01	0.01
	<u>1.9</u>	<u>3.8</u>	<u>7.2</u>	<u>12.7</u>	<u>15.1</u>
- Pumped storage supply	0.02	0.08	0.10	0.13	0.13
	<u>1.9</u>	<u>3.7</u>	<u>7.1</u>	<u>12.5</u>	<u>15.0</u>
Required conventional steam output	5.4	6.6	7.1	7.1	6.7
Derived load factor <sup>a</sup>	(0.51)	(0.47)	(0.42)	(0.35)	(0.31)
Fossil fuel required					
Conventional steam	16.3	19.4	20.7	20.8	19.6
Gas turbine	0.4	0.5	0.7	0.9	1.0
Internal combustion	<u>0.04</u>	<u>0.04</u>	<u>0.04</u>	<u>0.04</u>	<u>0.04</u>
	<u>16.7</u>	<u>20.0</u>	<u>21.5</u>	<u>21.8</u>	<u>20.6</u>

Totals may not agree because of rounding.

<sup>a</sup>Output  $\left(\frac{\text{Btu}}{\text{yr}}\right) / 3412 \left(\frac{\text{Btu}}{\text{KWH}}\right) \times 8760 \left(\frac{\text{hr}}{\text{yr}}\right) \times \text{capacity from Table 17-11 (KW)}$ .

outcome of the calculation is quite insensitive anyway) is a linear extension from Case C's 1975 figure to an estimated 1992 capacity. Tables 17-13 and 17-14 contain the figures used to arrive at a projection of the electrical generation sector's consumption of fossil fuels consistent with Case B conditions.

Comparison of the Case B and Case C fossil fuel requirement projections (Fig. 17-6) shows that there is no real difference between them up to 1992. The slower demand growth characteristic of Case B is just compensated for by the postulated low rate of expansion in nuclear capacity. The outcome of the fuel requirement calculation is sensitive primarily to the nuclear capacity assumed; Table 17-15 shows how required conventional steam output varies with a 20% change in projected post-1980 Case B nuclear capacities. Variation of hydropower capacity within any physically reasonable range has little effect.

#### Other Sectors

The references from which total Case C energy demand in the residential/commercial and industrial sectors was taken provided also projections for the electricity component. Subtraction of those figures from the total demand numbers yields Case C projections for residential/commercial and industrial fossil fuel demand (Table 17-16). For Case B the same exercise was repeated, except that the electricity demands by sector were derived from those projected by Tyrrell (Ref. 17-19), corresponding to Case B total electricity demand. His disaggregated projections were made on a 48-state basis; the figures in Table 17-17 were scaled up to represent 50 states.

#### Summary

Fossil fuel demand projections for all non-transportation sectors and the two demand cases are collected in Table 17-18, and illustrated in Figs. 17-7 and 17-8. The total fossil fuel demands for each case are included in Table 17-18 for comparison with our reference projection for

domestic fossil fuel supply. In both cases there is an excess of absolute fossil fuel supply over projected requirements. The next step is to allocate the various fuels and draw a fossil fuel balance to determine how much of the absolute supply is actually available.

#### FUEL ALLOCATIONS

Electrical generation, using all of the fossil fuels, is again the pivotal sector. Trends in utility fuel consumption over the last few years are presented in Table 17-19, as is a breakdown of 1973 fossil-fired capacity by fuel. From the 1973 figures, assuming a load factor of 7.5% for gas turbine and internal combustion generators and average heat rates of 10300 Btu/kWh for steam plants and 15,500 Btu/kWh for peaking units (Table 17-9), we can calculate an average load factor of 67% for coal-burning plants and 44% for oil/gas-burning plants. The task remains to break projected conventional steam capacities (Tables 17-11 and 17-13) down in terms of fuel used.

Of the estimated 1973 generating capacity burning oil and gas, 30 GWe represent conversions from coal (Ref. 17-28). The authors of the NAE report judge that 20 GWe will be reconverted, and that some of the gas-fired plants can be adapted to coal use by installation of medium-Btu gasification units (Ref. 17-28). We judge that the latter step will make no significant contribution before 1980 (Ref. 17-29). Assuming that conversion of the 20 GWe back to coal will take place by 1980, that another 10 GWe will be diverted to coal use via gasification units by 1985, and that essentially no new capacity requiring oil and gas will be installed, the projections in Table 17-20 can be generated. As a consequence of these assumptions, we are left with Cases B and C that differ from each other only in the amount of coal-burning generating capacity postulated.

Deciding what load factor to use for the coal plants over the period of our projection is not an easy job. One problem arises because the Case B projection for conventional steam capacity given here was made on a different basis than that for

Table 17-13. Projected generating capacity, Case B

	Capacity, MW				
	1975	1980	1985	1990	1992
Nuclear	52,000	102,000	164,000	222,000	245,000
Total hydropower	60,000	87,000	100,000	130,000	132,000
Regular	55,000	64,000	73,000	95,000	97,000
Pumped storage	5,000	23,000	27,000	35,000	35,000
Gas turbine	34,400	39,000	43,600	48,200	50,000
Internal combustion	5,000	5,200	5,300	5,400	5,500
Conventional steam <sup>a</sup>	342,000	387,200	423,200	448,000	465,300

<sup>a</sup>Derived from required conventional steam output assuming an average load factor of 54%.



Table 17-14. Calculation of fossil fuel requirement for electrical generation, Case B  
(all entries in  $10^{15}$  Btu)

	1975	1980	1985	1990	1992
Projected demand	7.4	9.4	11.3	13.2	14.0
Projected output					
Nuclear	0.9	2.1	3.4	4.6	5.1
Hydropower	0.9	1.0	1.0	1.3	1.3
Pumped storage	0.01	0.05	0.06	0.08	0.08
Gas turbine	0.08	0.09	0.10	0.11	0.11
Internal combustion	0.01	0.01	0.01	0.01	0.01
	1.9	3.2	4.6	6.1	6.6
- Pumped storage supply	0.02	0.08	0.10	0.13	0.13
	1.9	3.2	4.5	6.0	6.5
Required conventional steam output	5.5	6.2	6.8	7.2	7.5
Fossil fuel required					
Conventional steam	16.7	18.5	20.0	21.2	22.0
Gas turbine	0.4	0.4	0.5	0.5	0.5
Internal combustion	0.04	0.04	0.04	0.04	0.04
	17.1	19.0	20.5	21.8	22.6

Totals may not agree because of rounding.

Case C. The Case C conventional steam capacity figures come from industry projections and represent what they foresee the capacity to be under the demand conditions characteristic of Case C. Under the assumptions used in this study's analysis of output and fuel requirements (Table 17-12), it turns out that the average load factor calculated for conventional steam capacity to meet projected demand falls steadily throughout the forecast period. The conventional steam capacity projected in Case B, however, is a derived value,

calculated from the required output and an assumed constant average load factor (Table 17-13). To treat the two cases consistently, we can assume that the ratio of coal load factor to oil/gas load factor occurring in 1973 ( $0.67/0.44 = 1.5$ ) will remain constant, so the applicable coal load factor for any year will be

Coal Load Factor = Average Load Factor

$$\times \left( \frac{\text{Coal Capacity} + \text{Oil/Gas Capacity}}{\text{Coal Capacity} + 0.67 \text{ Oil/Gas Capacity}} \right)$$

The coal load factors so derived are shown in Table 17-21, and the projections of coal consumption in electrical generation calculated from them in Table 17-22.

After electrical generation, only the commercial and industrial sectors use any coal to speak of. Recent historical consumption in those areas is shown in Table 17-23. It seems reasonable to expect commercial coal use to continue its decline of about 8% per year. In the industrial sector we can postulate resumption of about a 2% annual increase, in line with NPC's projection for coking coal demand (Ref. 17-22). The resulting projection for coal use in the two sectors is contained in Table 17-24. Adding the coal consumption projections for residential/commercial-industrial and electrical generation together and subtracting the sum from the projected total

Table 17-15. Sensitivity of Case B conventional steam output to projected nuclear capacity

	Required steam output, $10^{15}$ Btu		
	1985	1990	1992
Nuclear capacity projected			
Case B	6.8	7.2	7.5
Case B + 20%	6.2	6.3	6.5
Case B - 20%	7.5	8.2	8.6

Table 17-16. Energy demand projections by sector, Case C

	Demand, 10 <sup>15</sup> Btu					
	1970 <sup>a</sup>	1971 <sup>b</sup>	1975 <sup>c</sup>	1980 <sup>c</sup>	1985 <sup>c</sup>	2000 <sup>d</sup>
<u>Residential/commercial</u>						
Total	15.8	16.3	18.9	22.5	26.5	38.0
- Electricity	<u>2.8</u>	<u>3.2</u>	<u>4.2</u>	<u>5.9</u>	<u>7.8</u>	<u>15.1</u>
Fossil fuel	13.0	13.1	14.7	16.6	18.7	22.9
<u>Industrial</u>						
Total	20.1	19.8	22.8	26.0	30.6	40.6
- Electricity	<u>2.3</u>	<u>2.3</u>	<u>3.1</u>	<u>4.3</u>	<u>6.3</u>	<u>15.6</u>
Fossil fuel	17.8	17.5	19.7	21.7	24.3	33.0
<u>Non-fuel</u>						
Fossil fuel	4.1	4.0	5.0	6.1	7.5	10.7

<sup>a</sup>Historical figures, Ref. 17-6.<sup>b</sup>Historical figures, Ref. 17-8.<sup>c</sup>Average of figures from Refs. 17-6 and 17-8.<sup>d</sup>Ref. 17-8.

Table 17-17. Energy demand projections by sector, Case B

	Demand, 10 <sup>15</sup> Btu				
	1970 <sup>a</sup>	1975	1980	1985	1990
<u>Residential/commercial</u>					
Total	15.8	17.6 <sup>c</sup>	19.3	20.2 <sup>c</sup>	21.2
- Electricity <sup>b</sup>	<u>2.8</u>	<u>4.2</u>	<u>5.6</u>	<u>6.9</u>	<u>8.4</u>
Fossil fuel	13.0	13.4	13.7	13.3	12.8
<u>Industrial</u>					
Total	20.1	21.0 <sup>c</sup>	22.1	25.7 <sup>c</sup>	29.3
- Electricity <sup>b</sup>	<u>2.3</u>	<u>3.2</u>	<u>3.9</u>	<u>4.4</u>	<u>4.9</u>
Fossil fuel	17.8	17.8	18.2	21.3	24.4
<u>Non-fuel</u>					
Fossil fuel	4.1	5.0	6.1	7.5	8.6 <sup>c</sup>

Projections for totals were generated from Case C by subtracting following amounts (see Ref. 17-21): Residential/commercial: 14% in 1980, 30% in 1990; Industrial: 15% in 1980; 20% in 1990.

<sup>a</sup>Historical figures, Ref. 17-6.<sup>b</sup>Projection from Ref. 17-19, scaled up to 50 states.<sup>c</sup>Interpolated values.

Table 17-18. Projected non-transportation demand for fossil fuel, by sector and demand case ( $10^{15}$  Btu)

	Case C			
	1975	1980	1985	1990
Residential/commercial	14.7	16.6	18.7	20.1
Industrial	19.7	21.7	24.3	27.2
Electrical generation	16.7	20.0	21.5	21.8
Non-fuel use	5.0	6.0	7.5	8.6
	56.1	64.3	72.0	77.7
	Case B			
	1975	1980	1985	1990
Residential/commercial	13.4	13.8	13.3	12.8
Industrial	17.8	18.2	21.3	24.4
Electrical generation	17.1	19.0	20.5	21.8
Non-fuel use	5.0	6.0	7.5	8.6
	53.3	57.0	62.6	67.6
Reference projection, Fossil fuel supply (domestic) <sup>a</sup>	59.22	68.98	84.21	(81.5-95)

<sup>a</sup>From Table 17-5; 1990 range is from interpolation between 1985 reference projection and range estimated by NPC (Ref. 17-7) for 2000.

non-transportation demands for fossil fuels (Table 17-18) gives us projections for non-transportation demand for oil and gas. This procedure is summarized in Table 17-25. One final assumption, that all natural gas produced will be used, gives us two projections for non-transportation petroleum demand through 1990 (Table 17-25).

The requirement for oil projected in Table 17-25 is very sensitive to the assumed coal-burning electrical generating capacity and the load factor assigned to its operation. The latter component especially has been treated in a rather arbitrary way in this analysis, but it is beyond the scope of this project to do more. Any reader is free to provide his own assumptions about that or any other component of the analysis; as it is presented, revised projections can be generated with investment of only a few minutes of calculations.

Dissection of demand in the transportation sector is the next task to be approached. Available data include a historical breakdown of fuel consumption by mode of transport (Ref. 17-31)

Table 17-19. Utility fuel consumption and generating capacity

	Utility Consumption of Fossil Fuels, <sup>a</sup> $10^{15}$ Btu		
	Coal	Gas	Oil
1970	7.29	4.05	1.94
1971	7.45	4.11	2.30
1972	7.97	4.10	2.86
1973	8.70	3.92	3.43
1973 U.S. Fossil-fired Generating Capacity by Fuel, <sup>b</sup> GW <sub>e</sub>			
Coal			143
Oil/gas-fired steam			145
Oil/gas-fired, converted from coal			30
Gas turbine and internal combustion			38

<sup>a</sup>Sources: Refs. 17-7, -25, -28.

<sup>b</sup>Reference 17-28.

and a projection of petroleum demand by product in the transportation market under conditions corresponding to demand Case C (Ref. 17-32). In 1970,  $88.7 \times 10^9$  gallons of gasoline and  $6.0 \times 10^9$  gallons of highway distillate were consumed (Ref. 17-32). Consumption of gasoline for passenger cars and taxis in that year amounted to  $65.6 \times 10^9$  gallons (Ref. 17-31). From this data, we can deduce that about 76% of the motor gasoline used in 1970 went to power passenger cars and taxis. If this percentage holds constant we can use 24% of the NPC's projected gasoline demand, plus their projection of demand for all other products, to define a Case C projection of non-automobile transportation demand (Table 17-26).

To construct a Case B projection, we look at opportunities for conservation in non-automotive transportation. The OEP, considering such categories as improved mass and intercity surface transit service, improved freight handling and trends to better land use, projected savings amounting to  $6 \times 10^{15}$  Btu by 1985 (Ref. 17-21). Using 80% of their savings figures and a guess for 1990, we reach the Case B projection in Table 17-27. Table 17-28 shows the combination of these and previous projections to yield Case B and Case C projections for non-automotive petroleum demand.

### 17.3.2 Scenarios for Automobile Fuel Consumption

In this section we discuss the effects of the four main factors which we believe will affect automotive fuel consumption over the next 10 - 15 years. There are three external factors aside from the choice of alternate engines that we feel can have an important effect on total automotive fuel consumption. First is the amount of total

Table 17-20. Projected fossil-fueled generating capacity by cases

	Case C				
	1973	1975	1980	1985	1990
Gas turbine	38,000	34,400	48,500	68,300	87,200
Internal combustion		5,000	5,200	5,300	5,400
Conventional steam					
Coal	143,000	188,000	314,000	416,000	537,000
Oil/gas	175,000	165,000	155,000	145,000	145,000
	Case B				
	1973	1975	1980	1985	1990
Gas turbine	38,000	34,400	39,000	43,600	48,200
Internal combustion		5,000	5,200	5,300	5,400
Conventional steam					
Coal	143,000	177,000	232,200	278,200	303,000
Oil/gas	175,000	165,000	155,000	145,000	145,000

automobile use, measured as vehicle miles traveled (VMT) (as discussed in Section 14.1). The consumer's choice of automobile type is the second factor - that is, what percentages of the future automotive market will be made up of vehicles of different categories (as discussed in Section 10.2) The third is improvements to the design of the vehicle and changes in the technology used for vehicle components other than the engine (Section 10.6).

These factors are, of course, very much interrelated. Future use patterns and choices of vehicle category will be affected by improvements in the vehicle's future fuel consumption arising from changes in engine and vehicle technology. However, the degree of interaction is highly uncertain and (as observed in Section 14.1) cannot be modeled in a definitive manner. We do, however, feel it is important to understand what the effects of each of these variables (and combinations thereof) are on automobile fuel consumption. This section serves to illustrate those relationships so that future automotive fuel consumption patterns can be examined in the context of the national petroleum energy problem.

Table 17-21. Derived coal load factors

	1975	1980	1985	1990
Case B	0.64	0.62	0.61	0.60
Case C	0.60	0.53	0.46	0.38

VEHICLE USE CHANGES

As discussed in Section 14.1, future vehicle use will be affected by a great number of variables, such as the population of driving age and the gradual saturation of vehicle ownership, possible increased use of alternate transportation, and economic factors reflecting many other market and policy variables. Thus vehicle use was summarized in three future scenarios for vehicle use as given in Fig. 17-9. The high estimate represents a continuation of the rapid growth in VMT's/vehicle experienced from 1962 to 1973 and is considered an upper bound. The medium estimate assumes a slower growth trend in VMT's/vehicle along with a saturation in the number of vehicles. The low estimate represents a large diversion of automotive travel to public transit and some reduction in personal mobility.

We have also shown a curve 15% lower (in 1990) than the medium projection to illustrate the effect of a large diversion to public transit, but without loss in total mobility.

Total vehicle fuel consumption will, of course, be proportional to vehicle use since

Table 17-22. Projected consumption of coal for electrical generation (10<sup>15</sup> Btu)

	1975	1980	1985	1990
Case B	10.2	12.7	14.9	15.9
Case C	10.2	14.7	16.8	17.9

<sup>2</sup>This figure is the upper (gross) heating value for representative gasoline and is consistent with the definition of the energy content in a barrel of crude. For engine thermodynamic calculations, the lower (net) heating value of 115,900 Btu/gallon is used.

Table 17-23. Commercial and industrial direct coal use (10<sup>15</sup> Btu)

	1960 <sup>a</sup>	1968 <sup>a</sup>	1973 <sup>b</sup>
Commercial	1.0	0.6	0.4
Industrial	4.9	5.6	4.4

<sup>a</sup>Reference 17-30.

<sup>b</sup>Reference 17-28.

Total Annual Energy Consumption = Fleet Average Mileage (Btu's/mile, Using 125,000 Btu's per gallon<sup>2</sup> of Gasoline) x Total Fleet VMT

To serve as baselines for other scenarios, we have shown in Fig. 17-10 the fuel consumption for vehicles with the Present technology, and present vehicle category mix continuing for the next 15 years, with the medium VMT projection and the 15% diversion.

#### CHANGES IN CONSUMER CHOICE OF VEHICLE TYPE

Since a wide variety of vehicle categories is available to the consumer, a question of great interest in the future of the automotive market is what the future automotive sales mix will be. Briefly, two factors seemed to have operated which influenced the market's history. First, while the individual vehicle categories have grown in characteristic size and weight, the shift to smaller categories of vehicles and (smaller) imported vehicles essentially kept average vehicle weight almost constant from 1958 to 1973 (Ref. 17-33). We doubt, therefore, that this fundamental variable will tend to increase further. Secondly, as observed in Section 14.1.2, vehicle occupancy has been dropping and is likely to continue to decline as the ratio of vehicles to drivers and/or passengers increases. Thus, in terms of accommodating passengers, it is doubtful again whether there will be a trend towards larger vehicles on the average.

For the purposes of examining the sensitivity of fuel consumption to future vehicle category mix, we have assumed that the vehicles in each category will remain at their present weight. (Weight reductions are considered as improvements in vehicle technology and are discussed in the next section.) Two different futures are postulated for the market shares held by the

Table 17-24. Projected commercial and industrial direct coal use (10<sup>15</sup> Btu)

	1975	1980	1985	1990
Commercial	0.30	0.20	0.13	0.09
Industrial	4.6	5.1	5.6	6.2
	4.9	5.3	5.7	6.3

Table 17-25. Derivation of non-transportation projections of demand for petroleum, by cases

	Demand (10 <sup>15</sup> Btu)			
	1975	1980	1985	1990
<u>Case C</u>				
Non-transportation fossil fuel demand	56.1	64.3	72.0	77.7
- Coal consumption	15.1	20.0	22.5	24.2
Oil/gas demand	41.0	44.3	49.5	53.5
- Domestic gas production <sup>a</sup>	22.6	22.4	27.1	26.2
Petroleum demand	18.4	21.9	22.4	27.3
<u>Case B</u>				
Non-transportation fossil fuel demand	53.3	57.0	62.6	67.6
- Coal consumption	15.1	18.0	20.6	22.2
Oil/gas demand	38.2	39.0	42.0	45.4
- Domestic gas production <sup>a</sup>	22.6	22.4	27.1	26.2
Petroleum demand	15.6	16.6	14.9	19.2

<sup>a</sup>From Table 17-5; 1990 value by linear interpolation between 1985 reference projection and maximum estimated by NPC (Ref. 17-7) for 2000.

different vehicle categories. The first scenario projects no change in the market shares from the expected (1975) division (Present Market). This is shown in the second column of Table 17-29. A "future" market is also shown depicting a shift to smaller categories of vehicle.

It is characterized by a linear shift in the vehicle categories between 1975 and 1980. It begins with the present (1975) mix, whose average curb weight is about 3840 lb and shifts by 1980 to an average curb weight of 3275 lb. The final mix is shown in the third column of Table 17-29.

In Fig. 17-11 we summarize the effect of the postulated shifts in the new vehicle market on the fuel consumption for the medium VMT estimate, with no change in either vehicle or engine technology.

#### VEHICLE TECHNOLOGY IMPROVEMENTS

Improvements can be made in the energy consumption of vehicles of different sizes. These are discussed in detail in Section 10.6 and summarized in Table 17-30. Most of the improvement can come from weight reductions and improved transmissions, while the rest comes from a series of small but meaningful design

Table 17-26. Projected demand for petroleum in the transportation sector, exclusive of automobiles, Case C<sup>a</sup> (10<sup>15</sup> Btu)

Product	1975 1980 1985 1990 <sup>b</sup>			
	Motor gasoline	3.2	3.8	4.2
Aviation gasoline	0.1	0.1	0.2	0.2
Jet fuel-naphtha	0.4	0.4	0.4	0.4
Kerosine	2.4	3.6	5.0	6.9
Distillate-highway	1.1	1.5	1.9	2.4
Vessel	0.1	0.1	0.1	0.1
Railroad	0.6	0.7	0.8	0.9
Residual-bunkers	0.6	0.7	0.7	0.8
LPG, LNG	0.2	0.3	0.4	0.6
	8.7	11.2	13.7	17.0

<sup>a</sup>Source: Ref. 17-32.

<sup>b</sup>Extrapolated using 1980-1985 average annual increase.

changes. When translated to our standard categories, the results are summarized in Table 17-31.

We will consider three scenarios for vehicle technology changes. In the first, present vehicle technology will be assumed to continue throughout the study time frame. We will call this "no change." In Table 17-31, we give the time scales thought possible for the Intermediate and Advanced vehicle technology. The scenarios 'Intermediate' and 'Advanced' vehicle are thus defined by the linear introduction for these changes in the time frame indicated in Table 17-31.

To illustrate the effect of vehicle technology changes alone, Fig. 17-12 shows the fuel consumption projected to result from changing to different levels of vehicle technology with the medium VMT estimate, no changes in the vehicle market, or in engine technology.

Table 17-27. Case B demand for petroleum in the transportation sector, exclusive of automobiles (10<sup>15</sup> Btu)

	1975	1980	1985	1990
Case C projection	8.7	11.2	13.7	17.0
- Savings from conservation	0.3	1.8	4.8	6.0
Case B projection	8.4	9.3	8.9	11.0

Table 17-28. Non-automotive petroleum demand projections (10<sup>15</sup> Btu)

	Case C			
	1975	1980	1985	1990
Non-transportation demand	18.4	21.9	22.4	27.3
Transportation without autos	8.7	11.2	13.7	17.0
	27.1	33.1	36.1	44.3
Case B				
Non-transportation demand	15.6	16.6	14.9	19.2
Transportation without autos	8.4	9.3	8.9	11.0
	24.0	25.9	23.8	30.2

#### ENGINE TECHNOLOGY IMPROVEMENTS

The possibilities for improvements in engine technology are discussed in detail in Chapters 2 through 9. Our purpose here is to summarize the essentials of possible changes in engine technology in order to see its effect on overall fuel

Table 17-29. New car production market shares (imports and domestic)

Vehicle class	Estimated 1975 market, %	Assumed future market, %
Mini	1	3
Small	8	12
Sub compact	8	25
Compact	18	25
Full size	36	20
Large	29	15
Total	100	100
Mean curb weight for Otto engine vehicles	3840 lb	3275 lb
Sales-weighted fuel economy (mpg) for 1975 Otto engine vehicles (composite cycle)	15.6 mpg	18.1 mpg

Table 17-30. Fuel consumption reductions, %  
(composite driving cycle: 55% urban, 45% highway)

Reduction due to	Vehicle class			
	Small	Subcompact	Compact	Large
Reduced weight: Intermediate <sup>a</sup>	6	10	15	18
Long-term <sup>b</sup>	12	21	23	25
Transmissions: 4-speed auto w/lockup	3	6	7	8
*Continuously variable (CVT)	10	13	14	15
Reduced acceleration	2	2	5	10
Lower aerodynamic drag	3	3	3	2
Improved accessories and drive	1	1	2	3
<sup>a</sup> "Intermediate" improvements, total	14	20	29	35
<sup>b</sup> "Long-term" improvements, total	26	35	40	45

Table 17-31. Vehicle technology improvements in fuel economy  
(composite driving cycle: 55% urban, 45% highway)

Mature Otto Engine Vehicles

Vehicle class	Reduction in fuel consumption for intermediate technology, %	Reduction in fuel consumption for advanced technology, %
Mini	12	22
Small	14	26
Sub-compact	20	35
Compact	29	40
Full size	32	43
Large	35	45

The Intermediate Technology improvements begin in 1976 and require six years for completion. The Advanced Improvements also begin in 1976 but require 10 years.

Mature Stirling Engine Vehicles

Intermediate vehicle technology: same as Otto engine

Advanced vehicle technology: 90% of Otto engine values

Mature FT Brayton Engine Vehicles

Same as Stirling

Mature SS Brayton Engine Vehicles

Intermediate vehicle technology: 85% of Otto engine values

Advanced vehicle technology: 75% of Otto engine values

consumption. To this end we have greatly simplified the vast amount of fuel economy data contained in the engine technology reports. Table 17-32 gives the basic fuel economy data for the different engine types. A "baseline" technology would be to keep the UC Otto engine forever, but improve it to the Mature level. A more complex change would be to introduce one of the alternates in significant quantities. As can be seen from Table 17-32, the Brayton (single shaft) and Stirling engines have the most significant advantages in the Mature configuration, so we will only illustrate transitions to them. (The advanced versions of these engines are not likely to be ready for significant mass production in the 1980's decade.) Of course, the time of initial introduction and the rate of introduction play an important role in determining the impact of any transition. Figure 17-13 shows the impact of the 1985 introduction of the Stirling engine, with a 10-year transition to the new technology. No change is considered in the VMT projection, market shares, or vehicle technology. We consider this transition a bounding case on what change in engine technology could do, though many other scenarios are possible.

#### VARIATIONS AND COMBINATION SCENARIOS

From the four scenario variables explored in the previous paragraphs a considerable number of combination scenarios could be displayed. In addition, many small variations could be developed for each scenario variable by varying dates of technology introduction or more closely defining the degrees of improvement.

We feel it is important to explore some of the reasonable and "bounding" choices of combinations of the scenarios, because it illustrates

the wide variety of futures possible as well as the many ways of achieving them. On the other hand, while there are many detailed changes possible within the scenarios, we think this set illustrates the major choices that have to be made. Only the choice of time scales could seriously alter these results, and we believe choices used in the illustrative examples to be reasonable.

We can examine roughly the range of potential savings from automotive changes in Fig. 17-14. The baseline scenario shows no changes. The second scenario shows the cumulative effects of changes in the vehicle market and vehicle and engine technology. (In reality, the savings would never be this large because VMT would undoubtedly increase in response to the lower cost per mile. But we expect these effects to be small, so this curve represents a reasonable upper bound on the fuel savings.) It is seen that such cumulative changes could drastically alter the automobile's demand for petroleum fuel.

While it is possible to calculate many combinations of the factors influencing automotive fuel consumption, the few illustrated here are sufficient to support a few key conclusions. First, it is obvious that a given level of fuel consumption can be reached in a variety of ways, assuming the goal sought is not extreme. A second and less obvious conclusion is that early introduction of a change has its largest effect at a later date, because of the turnover time required for the vehicle fleet (5-7 years).

It is also possible to get to given goals by different paths. Figure 17-15 illustrates two scenarios that reduce automotive fuel consumption sharply. One involves using advanced vehicle technology but keeping the Otto engine. The other involves an engine change but only the intermediate

Table 17-32. Composite cycle<sup>a</sup> fuel economy of OEE<sup>b</sup> vehicles (miles/gallon, gasoline equivalent)

Engine type	Mature technology				Advanced technology Compact vehicle
	Vehicle category			Sales weighted	
	Small	Compact	Full	Present market	
UC Otto (baseline)	30	21	17	17.2	24
SC Otto	32	23	18	18.6	27
Diesel	32	23	19	19.5	28
Brayton (single shaft)	34	27	22	22.7	37
Brayton (free turbine)	31	24	20	20.5	34
Stirling	39	30	25	25.2	34
Rankine	25	19	15	15.6	27

55% Urban, 45% Highway Driving cycles. Present vehicle technology.

Otto Engine Equivalent.



vehicle technology. In the long run, the latter has a greater effect by a small amount, but both strategies are equivalent until the early 1990's.

### 17.3.3 Comparison of Projected Domestic Petroleum Supply and Demand

Total U. S. petroleum demand is the sum of non-automotive and automotive components. Up to this point, this analysis has made two estimates of the future course of demand in the non-automotive sectors and a wide range of projections for consumption by automobiles. Not all combinations need be considered in comparison with supply. For example, the high extreme case for automobile demand, involving as it does continuing rapid increase in VMT's and no compensating improvements in vehicle or engine technology, reflects the same unrealistic extrapolation of past trends as the general demand Case C. Those two projections can be logically paired to illustrate a worst case forecast for petroleum demand - worst case, that is, in the sense of pressure exerted on the producing system.

Of the two non-automotive demand projections, Case B comes from the more realistic assessment. It was generated assuming external conditions consistent with those leading to medium growth in VMT's, and might even be considered a very rough upper limit on non-automotive demand for petroleum. It is instructive, then, to combine Case B with some of the variants on automobile consumption based on medium VMT projections. Table 17-33 contains the four total petroleum demand situations selected for examination.

The differences (or margin) between the four petroleum demand projections and our reference projection of domestic production of petroleum are presented in Table 17-33 and shown graphically in Fig. 17-16. Probably the most striking thing about Fig. 17-16 is the wide range of margin values that show up. Depending on what conditions obtain over the next 15 years, the country's current petroleum shortfall could be seriously aggravated or essentially eliminated by 1990. Looking only at the more probable curves (those associated with Case B general demand), considerable uncertainty still remains not only in the component demand estimates but also in projected availability of petroleum producing capacity. The reference projection described in Section 17.2 is fairly ambitious in the context of the last several months' economy and might not be attained. If petroleum production went according to the NPC's Case IV, for example, the whole family of curves would be lowered.

In general, however, it appears that the petroleum supply-demand margin will become slightly more negative, then begin to get more positive sometime between 1975 and 1980. This picture has physical reality, of course, only as long as actual consumption can match demand. Specifically, for Fig. 17-16 to represent a real characteristic of our energy system, imported crude or petroleum products must be available to match the negative margins (as they are now). In a time of uncertain and expensive imports the margin is a measure of national discomfort, both mental and economic - the more negative the margin, the more uneasy our situation. To

reduce the discomfort the system must move the margin on which it operates closer to zero, if not above. The question is how. The changing conditions assumed in estimating our demand projections under Case B seem to be moving in that direction, albeit slowly. Can the process be speeded up?

Supply-demand margin for petroleum can be made more positive either by increasing oil supply or reducing demand. It has already been concluded that the projected supply is about as optimistic as one can get. Petroleum demand can be reduced two ways: by absolute reduction of demand in the petroleum-consuming markets and by using another energy source that is not supply-limited to satisfy some of the demand for petroleum in those markets. The energy balance analysis in Section 17.3 that led to predictions of non-automotive petroleum demand showed sensitivity to assumptions about use of competing fuels at several points. The outcome of the calculations was sensitive primarily to the assumed coal and nuclear capacities for electrical generation and to the load factors under which they operated. For example, nuclear capacity 20% larger than that projected for 1985 and 1990 under Case B conditions would lead to a 15% reduction in projected non-automotive petroleum demand in those years. For reasons already discussed in Section 17.3, it is not advisable to count on such a capacity increase. However, if the Case B projected capacity were able to operate at an 80% load factor instead of the projected 70%, the 1985 and 1990 projected non-automotive petroleum demands would be reduced by 13%. Running the Case B projected coal-burning capacity at an average 70% load factor (the factors used in the analysis were 61% for 1985 and 60% for 1990) would cut projected oil demand by 15 and 13% for the two years respectively. Similar oil savings would accrue from installation of 15 to 20% more coal-burning powerplants than projected in Case B. These estimates represent potential savings on a nationwide average basis. Further study would be necessary to estimate how much of that potential could be feasibly realized, and on what time scale.

Direct substitution of coal for oil in the industrial sector offers the possibility for further petroleum savings, as would any increases in gas availability for all sectors. The latter circumstance is not likely. An upper limit for the degree of substitution by coal would be reached when all excess productive capacity for that fuel would be utilized; that would represent a reduction in Case B non-automotive petroleum demand of 27% by 1990 under the coal capacity assumptions used here. A 20% increase in industrial coal consumption over Case B projections would lower projected non-automotive oil demand by 6 to 7% between 1985 and 1990; 15% of 1990 Case B petroleum demand is  $3.2 \times 10^{15}$  Btu.

The latitude available for reduction of petroleum demand for automobile use is discussed in Section 17.3.2. From the figures given there it can be seen that the potential in that sector for reducing the magnitude of the petroleum supply-demand margin is comparable to the most effective factors discussed above and could offer double their effect. The measures considered to moderate automotive fuel consumption should involve, in addition, less capital cost and less

Table 17-33. Comparison of projected domestic petroleum production with selected demand situations

I. Non-automotive Case C Medium VMT, no vehicle change	10 <sup>15</sup> Btu			
	1975	1980	1985	1990
Domestic production	20.0	25.4	30.0	37 <sup>a</sup>
Demand				
Case C non-auto	27.1	33.1	36.1	44.3
Auto medium VMT	10.3	11.3	12.2	13.1
Margin	-17.4	-19.0	-18.3	-20.4

II. Non-automotive Case B Medium VMT, no vehicle changes	10 <sup>15</sup> Btu			
	1975	1980	1985	1990
Domestic production	20.0	25.4	30.0	37 <sup>a</sup>
Demand				
Case B non-auto	24.0	25.9	23.8	30.2
Auto medium VMT	10.3	11.3	12.2	13.1
Margin	-14.3	-11.8	-6.0	-6.3

III. Non-automotive Case B Medium VMT, Intermediate Vehicle Technology, Stirling Engine	10 <sup>15</sup> Btu			
	1975	1980	1985	1990
Domestic production	20.0	25.4	30.0	37 <sup>a</sup>
Demand				
Case B non-auto	24.0	25.9	23.8	30.2
Auto medium VMT, intermediate vehicle technology, Stirling	10.3	9.7	8.3	7.4
Margin	-14.3	-10.3	-2.1	-0.6

IV. Non-automotive Case B Maximum change auto demand (medium VMT)	10 <sup>15</sup> Btu			
	1975	1980	1985	1990
Domestic production	20.0	25.4	30.0	37 <sup>a</sup>
Demand				
Case B non-auto	24.0	25.9	23.8	30.2
Maximum change (medium VMT)	10.3	9.4	7.5	6.0
Margin	-14.3	-9.9	-1.3	+0.8

<sup>a</sup> Estimated by interpolation between 1985 reference projection and maximum estimated by NPC (Ref. 17-7) for 2000.

environmental damage than drastically increasing use of coal.

In summary, it appears that implementation of reasonable conservation measures in all sectors coupled with feasible modifications in use and energy consumption characteristics of personal vehicles can bring petroleum demand into fairly close balance with domestic production by 1990. The energy system offers other options, principally in the electrical generation sector, that if prudently exercised might shorten the time taken to approach satisfactory independence from oil imports while maintaining a non-disruptive level and pattern of energy consumption. It must be emphasized, though, that the measures described here as reasonable and feasible will not be the easy results of casual or halfhearted attempts at conservation. Nor will they represent a one-time effort. They must be seriously and continuously implemented, and form the basis of a transition to a national situation where continual growth in energy use is accepted as neither necessary nor desirable.

## 17.4 CONSIDERATION OF DEMAND FOR SPECIFIC PETROLEUM PRODUCTS

Up to this point, only a general comparison of overall supply and demand for petroleum has been carried out, without regard for the breakdown of petroleum products. Now it is time to examine what supply implications specific fuel requirements for specific engine types might have.

### 17.4.1 Characteristics of Fuels Demanded by Engine Types

All the automotive powerplants considered in this study (except for the electric) can be grouped into three classes as far as general fuel requirements are concerned. These are shown in Table 17-34. Engines employing the Otto cycle (spark ignited) are octane-dependent. Though the more advanced versions are not likely to need gasoline with octane ratings as high as demanded by present vehicles, detonation resistance (indicated by

Table 17-34. Summary of fuel combustion characteristics required by alternate powerplants<sup>a</sup>

Engine type	State of development		
	Present	Mature	Advanced
Uniform charge Otto <sup>b</sup>	91 - 100 RON	~ 90 RON lead-free	~ 90 RON lead-free
Carburetted stratified <sup>c</sup> charge Otto	90 RON	~ 90 RON	~ 90 RON
Cylinder injected stratified <sup>c</sup> charge Otto	85-90 RON	85 RON	85 RON
Lean burning Otto <sup>c</sup>	~ 90 RON	~ 90 RON	~ 90 RON
Diesel <sup>c</sup>	45 CN minimum	50 CN minimum	50 CN minimum
Rankine <sup>d</sup>	No special requirements		
Gas turbine <sup>e</sup>	No special requirements		
Stirling <sup>f</sup>	No special requirements		

<sup>a</sup>RON = research octane number, CN = cetane number.

<sup>b</sup>Section 3. 2. 3.

<sup>c</sup>Section 4. 2. 3.

<sup>d</sup>Section 7. 2. 3.

<sup>e</sup>Section 5. 2. 3.

<sup>f</sup>Section 6. 2. 3.

octane number) will remain an important fuel characteristic. This means a gasoline containing a substantial proportion of branched chain hydrocarbons and/or aromatics or octane-raising additives such as tetraethyl lead or methanol. Use of lead alkyls is being phased out; discussion of methanol as an additive is contained in Section 17.4.3. Volatility is another important fuel characteristic. For Otto engines, enough low-boiling components must be present to facilitate starting, warmup, and acceleration. Carburetted versions need gasoline with a top boiling point less than about 400° F (Ref. 17-2), but some upward extension may be possible for the engines using cylinder injection.

Diesel engines are compression-ignited rather than spark-ignited, and, in general, fuel good for use in a spark ignition engine is not the least bit suitable for running a diesel. The salient characteristic of diesel fuel is ignition delay (measured by cetane number), or the time required after injection for the fuel to ignite spontaneously. If this is too long, excess fuel will be injected before ignition and the excessively high pressure developed afterward causes knock (Ref. 17-34). Thus cetane requirements become more and more stringent as engine speed increases. Fuels with high cetane number have low octane ratings and tend to have relatively low spontaneous ignition temperatures (cetane's is 235°C, compared with 300°C for 75 octane gasoline (Ref. 17-34)). Cetane number correlates roughly with hydrogen content, implying limited tolerance for unsaturated (olefinic and aromatic components. Being fuel-injected, diesel engines tolerate less volatile fuels than required in carburetted engines; the boiling range of diesel fuel is about 350 - 650° F. Available burning time (engine speed) determines the upper boiling point limit (Ref. 17-2).

External or continuous combustion engines comprise the last group. There are no fundamental restrictions on the chemical nature of the fuels they burn, as long as those fuels are sufficiently pure, i. e., free of metals and sulfur. Specifications of physical properties like viscosity and density would be dependent on the design of fuel handling systems, while major determinants of volatility limits would be burner configuration and safety requirements for storage and handling. In principal, the powerplants in the external combustion class should be able to operate on a wide range of fuels. Even fluidized coal, if it could be made ash- and sulfur-free, might some day serve.

#### 17.4.2 Factors Affecting Supply of Specific Products

The menu of products turned out by any petroleum refinery (or any aggregate of them) is determined by a whole complex of considerations.

These include the composition of input crude, what markets exist for the various products and what prices they command, and the costs, capabilities, and capacities of the component processes used. Crude composition depends on where it comes from. Product markets and prices are impacted heavily by competition from non-petroleum fuels as well as general economic and political conditions. Process costs will be affected by technological progress and the state of the economy, while political impact will be felt in the price of crude. To answer the question of how much gasoline or how much automotive diesel fuel will be available in the 1980's or beyond thus becomes a matter of analyzing complex interactions between a large number of determinants that themselves have uncertain futures.<sup>3</sup> In gross projections of energy supply and demand this study has already made a range of guesses for those sorts of factors. To reiterate that process at the next greater level of detail would only compound the range of uncertainty, so this discussion will be limited to a few general considerations.

Refining petroleum begins with separation of the mixture by distillation into a series of components with different boiling ranges. Then a variety of chemical processes are employed to remove contaminants and change the properties of the various fractions. The products of these processes can then be recombined in various ways, depending on what ultimate products are desired. The combination of operations used in a specific refinery is determined by the nature of the crude fed in and the specifications of the desired products. The relative yields of products can be varied within a range determined by crude quality and refinery configuration; somewhere within that range the refinery output is optimized with respect to some set of criteria, usually including profit.

There is no "typical" refinery to use as representative, but one can get some idea of the latitude of refinery activities available by looking at national average figures. In 1972, domestic refinery yields of fuel products were those shown in Table 17-35. Of the 57 vol % yield of gasoline, about 35% (20 vol %, very roughly, of crude) comes from straight run gasoline - that fraction of the crude with a boiling range corresponding to gasoline. The rest comes from processing middle distillates and gas oils. Figure 17-17 shows the boiling ranges characteristic of the various fractions, while illustrating the nature of a sample refinery. Automotive diesel fuel is part of the middle distillate fraction. The remaining distillates go to jet fuel (kerosene) and such uses as gas turbine fuel, heating, and heavy transport. Gasoline production and automotive diesel production, then, compete for middle distillate starting materials. Diesel could be displaced by gasoline, but the natural gasoline component of crude cannot be made into diesel fuel with current

<sup>3</sup> Illustration of the complexity involved and extreme dependence on assumptions is provided in Refs. 17-35 and 17-36.

technology. Within limits, tradeoffs can be made between gasoline and diesel production from the portion of crude already allotted to automobile fuel, and between diesel production and other products made from the heavier petroleum fractions. The upper bounds that can be estimated for automotive diesel availability will depend heavily on what constraints are assumed in making the tradeoffs.

Two studies are available that consider the question of how much diesel fuel production could be expanded at the expense of gasoline yield. One, done by Bonner and Moore for the Army (Ref. 17-36), utilized a detailed mathematical model of the refining industry to project the compositions, availabilities, and prices of gasolines and distillate fuels under several scenarios between 1975 and 1985. The model included projections of refinery capacity and configuration as well as specifications of raw material availability and considered projected demands for all petroleum products (their demand projections were based in part on the NPC initial appraisal). One of their conclusions was that 15% of gasoline production could be diverted to making diesel fuel by 1985 with only minor impact on the whole system.

The other analysis, performed for EPA by Exxon Research and Engineering, examines the cost and energy effects of producing various gasoline/diesel ratios in a newly constructed

refinery to begin operation after 1990 (Ref. 17-35). There it was shown that a hypothetical grass-roots refinery designed to produce the same total yield of automotive fuel from "average" domestic crude would show cost and energy savings over current practice if distillate production were increased relative to gasoline. The optimum ratio with respect to those parameters was found to be about 1:1; their model showed that the physical maximum percentage of automotive distillate was attained at a diesel/gasoline ratio of about 73/27. Changing the relative yields of the two fuels as much as postulated in the Exxon study will impact the other products as well, even though the proposed process changes make no additional demands on the heavier fractions for feedstock. Their report contains a qualitative discussion of these effects.

Quantitatively, the Exxon results apply only when all the constraints underlying their study are satisfied. Syncrudes, for example are expected to behave significantly differently. Some general trends are evident in their results, however. As gasoline production was diverted to diesel fuel production, process energy and cost savings increased, hitting a maximum with roughly equal proportions of each fuel. That condition was attained when none of the middle distillate occurring naturally in the crude oil was fed to catalytic cracking units (which produce mostly gasoline blendstock). Beyond the 1:1 ratio, diesel production is augmented by shifting vacuum gas oil from catalytic cracking to the more expensive hydrocracking process, which shows selectivity toward distillate. That is, for the given product specifications, greatest economy in terms of both energy consumption and cost corresponded to relative yields arising from as little processing as possible and, where processing was necessary, use of the least severe option.

Some conclusions about the general availability of diesel fuel for automobiles can be drawn now, without going so far as to specify exact quantities. Unless a larger proportion of the higher-boiling petroleum fractions than currently used is dedicated to motor fuel production, the potential for making automotive diesel cannot match that for manufacturing gasoline. For that to happen, a mechanism would have to be found for substituting gasoline-range products in the uses deprived of heavier fuels by their diversion to diesel production. In addition, that substitution must be cost-effective enough to compensate for the fact that it is more expensive and less energy-efficient to convert heavy fractions to distillate than to gasoline. Therefore, it seems impractical to envision a situation where the whole automobile fleet would require diesel fuel. Insofar as the overall complexity of the country's refinery system can be reduced, however, it would be desirable to increase the relative amount of automotive distillate consumed. From the standpoint of minimizing costs and process energy consumption, the data now in hand suggest that a

Table 17-35. Fuel product yields from domestic refineries, 1972<sup>a</sup>

Product	Volume percent
LPG	3.2
Motor gasoline	57.0
Aviation turbo fuel	9.2
Automotive distillate (diesel)	5.6
Other middle distillate	17.9
Fuel oil	7.2

<sup>a</sup>From Ref. 17-35.

practical upper limit for diesel production is about half the motor fuel yield.<sup>4</sup>

The rough limits deduced above assume gasoline and diesel fuel specifications pretty much the same as currently in effect. It seems reasonable to expect that the costs and energy requirements experienced by the refining industry could be further reduced by shifting toward a fuel with fewer constraints on allowed properties (like octane number or cetane number). Refinery operations for production of motor fuel could be limited to distillation, sulfur removal and other cleanup, and whatever cracking processes would reduce the necessary amount of vacuum gas oil to the right boiling range without worrying about specificity for yielding any particular molecular structures. Such a fuel, to meet safety requirements, would have a volatility range from that of gasoline at the low end to roughly that of diesel fuel at the top (Ref. 17-35). Such a wide-cut fuel, which might be a mixture of gasoline and diesel fuel in a transition period, would not burn in current conventional internal combustion engines, but would present no problems to an external-combustion alternative.

#### 17.4.3 Methanol and Methanol Blends

A great deal of attention has been paid recently to the fuel potential of methanol (Ref. 17-38). This renewed interest has been sustained by the feeling on the part of many investigators that its use can lead to lower emissions and, in vehicles, greater energy economy than petroleum-derived fuels. Tests have established that methanol is indeed an excellent clean boiler fuel (Ref. 17-39). For the automotive market, methanol could contribute in two ways — either straight, as a fuel by itself, or blended with gasoline. Production of methanol in 1973 was  $7.1 \times 10^9$  lb (Ref. 17-40) or  $1.1 \times 10^9$  gal, using mostly natural gas as feedstock. The 1973 production represents  $6.3 \times 10^{13}$  Btu, a small fraction of energy needs for personal transportation. Any increase in capacity to provide methyl alcohol as motor fuel would be based on coal conversion (or possibly solid waste conversion). One can estimate that this capability might amount to  $1.5 - 2 \times 10^{15}$  Btu/yr between 1985 and 1990 if projected production of syncrude from coal were displaced (Section 17.2.2). This could provide roughly from 10 to 50% of the automobile energy consumption figures projected for 1990 in the previous section. Several potential problems with use of methanol as an automotive fuel have been identified, however.

Straight methanol can be a good fuel for spark-ignition engines, but it is not really compatible with those currently designed to burn gasoline (Refs. 17-38, 17-41). Its use would require special carburetors and intake manifolds and corrosion-resistant materials in the fuel delivery systems (Ref. 17-38). Incorporation of the vehicle modifications necessary to burn methanol might be desirable in situations where the resulting lower emissions are particularly important. Methanol's high spontaneous ignition

temperature rules out use in conventional compression-ignition engines, but it offers no disadvantages for burning in external-combustion powerplants.

In the case of methanol/gasoline blends, it is not yet clear that any overall advantage really exists for the whole vehicle population (Ref. 17-42). On the average, their use may reduce carbon monoxide emissions somewhat, but other emissions and fuel economy will probably not be significantly different from those of gasoline (Ref. 17-38). Gasoline and methanol are not miscible to any great extent, and the methanol content of blends would be limited. Even at low percentages of methanol, small amounts of water, especially at low temperatures, will cause phase separation (Ref. 17-41). Addition of methanol to a concentration of 10% in unleaded gasoline increases road octane number by a modest increment of 3 (Ref. 17-38). Another effect of adding methanol to gasoline is a striking rise in vapor pressure, which would require a reformulating of the gasoline part of the blend. This suggests that occasional use of methanol to supplement available motor fuel supplies would not be practical (Ref. 17-41). Even in general use, addition of methanol would not extend gasoline supplies, since the butanes and pentanes that would have to be removed to control volatility represent about the same energy as provided by the alcohol, if not a little more (Ref. 17-42). Methanol should probably be regarded only as a potential substitute gasoline component, contributing about the same volatility as butanes and perhaps a slight improvement over them in octane blending values. Use of methanol in blending gasoline would act to extend overall energy supplies if another use could be made of the butanes released.

#### 17.5 AVAILABILITY OF ELECTRICAL ENERGY FOR VEHICLES

Electric vehicles suffer no limitations as far as primary fuel characteristics are concerned, but their use does depend on existence of sufficient energy conversion and power transmission capability. Recent studies (Refs. 17-43, 17-44) indicate that capacity for electric power generation is not likely to be a constraining factor in the utilization of electric cars, and nothing has appeared in our analysis to contradict that feeling. We can work through an example, based on Case B demand conditions in 1980, for illustration.

Projected installed generating capacity for Case B in 1980 adds up to 707,400 MW. Now electrical demand is cyclical, on both a seasonal and a daily basis. The highest peak load nationwide falls during the summer, coinciding with the greatest demand for air conditioning. Thus, looking at the diurnal demand cycle for a high-consumption summer day provides a conservative view of what excess generating capacity is likely to be available year-round. Even on a peak summer day, about 20% of total capacity (assuming that peak load is about 80% of installed capacity) is free during the nighttime hours (Ref. 17-45).

<sup>4</sup>This point remains valid even if the national average refinery production shifts from the current gasoline-heavy pattern to one with increased heavy fuel oil yields, matching our consumption patterns more closely (Ref. 17-35).

So if one assumes that 20% of generating capacity is available for eight hours each night, in 1980 under Case B conditions about  $1.13 \times 10^9$  kWh would be available for charging electrical vehicles every day, on the average.

An electric car with propulsion requirements of about 0.4 kWh/mi, assuming transmission efficiency of 0.9, charging efficiency of 0.7 and motor/control efficiency of 0.8 (Ref. 17-43) would require power production of 0.8 kWh/mi. At this rate the excess off-peak capacity estimated above would supply, in an 8-hour overnight charging period, energy for  $1.4 \times 10^9$  mi daily. A medium projection for vehicle-miles traveled in 1980 is  $1.2 \times 10^{12}$  mi (see Fig. 14-9) or an average of  $3.3 \times 10^9$  mi/day. For a projected  $117 \times 10^6$  cars in that year (Fig. 14-10), that works out to an average daily use of about 28 miles for each car.

On first examination, then, it appears that the projected 1980 Case B generating capacity could support on the average about 40% of projected daily vehicle-miles traveled. The next question to ask is whether or not electrically driven cars themselves would be likely to satisfy that much of the country's demand for mobility by 1980. Electric vehicles tend to be characterized by limited comfort, short range and low performance, and the battery developments necessary to change that situation are not likely to be ready for extensive production in the next five years (see Chapter 8). Electrics will therefore probably not be considered as a household's only vehicle.

Battery-operated vehicles with ranges of 50 to 100 miles could handle up to 80 or 94%, respectively, of daily driver travel (see Fig. 14-26), however, and might be used as second cars for those occasions when their range and performance sufficed. Assuming continuance of the present pattern, where about 30% of households own more than one car, one can estimate a maximum of about  $33 \times 10^6$  electric "second" cars for 1980. If all these were used for 94% of daily driving needs at an average of 28 mi/day they would log total average daily travel amounting to  $0.87 \times 10^9$  miles and present an average daily electricity demand of  $0.69 \times 10^9$  kWh nationwide. Even this unreasonably high estimate of possible electric vehicle demand falls well within the conservatively estimated potential for satisfying it. If, in the years beyond 1980, electric cars should begin to enter the vehicle population at a significant rate, the electrical industry will have plenty of time to respond to any extra capacity demands that might arise.

There is another facet to the question of availability of electrical energy for vehicles that deserves some exploration. That has to do with the availability of primary fuel to provide the extra generation required. If the overall efficiencies of the two modes are the same, it makes no difference whether petroleum products are burned in a vehicle or in a power plant, and no fuel penalty would be incurred with electric vehicles. Use of electric cars does offer the potential for substituting otherwise unsuitable fuels (coal, uranium, water) in the transportation sector. Whether or not that potential could be realized, or do anything to increase efficiency of total fuel utilization, depends on factors not yet analyzed.

Such things as geographical and age distribution of generating capacity by prime mover and load factor — i. e. what fuels are burned with what efficiency what percent of the time and where — coupled with the ultimate real efficiencies of both acceptable electrical vehicles and combustion-driven ones will determine whether or not electric vehicles are desirable in terms of overall energy utilization. More detailed analysis than has heretofore been done with harder data than are now available is required to answer that question.

## 17.6 CONCLUSIONS

The viable fuels for automobiles through the 1980's and into the 1990's will be liquid hydrocarbons. These will be derived primarily from petroleum and supplemented with synthetic liquids, either methanol or hydrocarbons, that can be produced from coal. Considerable uncertainty characterizes projections of domestic petroleum supply and demand, but several areas can be identified where action might be taken to bring our oil demand and domestic production capability into closer balance. Implementation of reasonable conservation measures in all sectors coupled with feasible modifications in the use and energy consumption characteristics of personal vehicles could virtually eliminate the need for imported oil by 1990. The contribution made to that petroleum saving by the automotive sector can be quite large without imposing disruptive changes in the country's driving habits.

Looking at availability of specific hydrocarbon fuels, we find that refining costs and process energy consumption could be reduced if more diesel fuel were produced relative to gasoline than is current practice. It would be impractical in terms of costs and energy use, however, to make enough diesel fuel to run the whole automobile fleet. Methanol-gasoline blends seem to offer no distinct advantage over gasoline at the stage to which investigations of that fuel have progressed so far. In the long run, engines that do not impose specific requirements on the chemical structure of their fuel would be likely to face (or generate) fewer problems with energy availability than those demanding specific fuel characteristics.

Capacity for electric power generation is not likely to be a constraining factor in the rate of introduction of electric cars.

## References

- 17-1. Aerospace Corporation, Alternative Automotive Power Plants and Fuels, ATR-74(7325)-2, December 15, 1973.
- 17-2. EXXON Research and Engineering Company, Feasibility Study of Alternative Fuels for Automotive Transportation, EPA-460/3-74-009-a, June 1974.
- 17-3. Institute of Gas Technology, Feasibility Study of Alternative Fuels for Automotive Transportation, EPA Contract No. 68-01-2111, June 1974.
- 17-4. Limaye, D. R., Ciliano, R., and Sharko, J. R., Quantitative Energy

- Studies and Models: A State of the Art Review, Decision Sciences Corporation, Jenkintown, Pennsylvania, 1973.
- 17-5. Batelle Memorial Institute, Pacific Northwest Laboratories, A Review and Comparison of Selected U. S. Energy Forecasts, December 1969.
- 17-6. "U. S. Energy Outlook: An Initial Appraisal 1971-1985," National Petroleum Council, November 1971.
- 17-7. "U. S. Energy Outlook," National Petroleum Council, December 1972.
- 17-8. Dupree, W. G., Jr. and West, J. A., "United States Energy Through the Year 2000," U. S. Department of the Interior, December 1972.
- 17-9. Cook, Earl, "The Flow of Energy in an Industrial Society," Sci. Am., September 1971.
- 17-10. "U. S. Energy Outlook: Oil and Gas Availability," National Petroleum Council, 1973.
- 17-11. Energy Resources Report, April 19, 1974, p. 155; Chem. and Eng. News, May 13, 1974, p. 4.
- 17-12. Energy Resources Report, May 3, 1974, p. 174.
- 17-13. For example, Chem. and Eng. News, April 22, 1974, p. 4.
- 17-14. American Petroleum Institute, "Quarterly Review of Drilling Statistics for the United States."
- 17-15. American Petroleum Institute, "Reserves of Crude Oil, Natural Gas Liquids, and Natural Gas in the United States and Canada and United States Productive Capacity as of December 31, 1972," Vol. 27, May 1973.
- 17-16. Holdren, J. P., "Uranium Availability and the Breeder Decision," EQL Memorandum No. 8, Caltech, 1973.
- 17-17. MIT Energy Laboratory Policy Study Group, "Project Independence: An Economic Evaluation," March 15, 1974.
- 17-18. "Bulk Power Supply Planning Information Reported September 1, 1973 by the Regional Reliability Councils Under Order 383-3 (Docket R-362)," Bureau of Power Staff Report, Federal Power Commission, reprinted in FPC News.
- 17-19. Tyrrell, T. J., "Projections of Electricity Demand," ORNL-NSF-EP-50, November 1973.
- 17-20. Energy Resources Report, March 22, 1974, p. 117.
- 17-21. "The Potential for Energy Conservation," Office of Emergency Preparedness, October 1972.
- 17-22. "U.S. Energy Outlook: Coal Availability," Appendix E, National Petroleum Council, 1973.
- 17-23. Gakner, Alexander, EPRI Conference Proceedings, "Power Generation - Clean Fuels Today," April 8-10, 1974, p. 17.
- 17-24. Energy Resources Report, May 3, 1974, p. 174.
- 17-25. FPC 1972 Annual Report.
- 17-26. FPC News, Vol. 6, No. 37, September 14, 1973.
- 17-27. FPC News, Vol. 6, No. 22, June 1, 1973, p. 11.
- 17-28. "U. S. Energy Prospects: An Engineering Viewpoint," NAE, 1974.
- 17-29. EPRI Conference Proceedings, "Power Generation - Clean Fuels Today" April 8-10, 1974, is cited in support of this contention.
- 17-30. "Patterns of Energy Consumption in the United States," Office of Science and Technology, January, 1972.
- 17-31. "Energy Statistics: A supplement to the Study of National Transportation Statistics," DOT-TSC-OST-73-34, September 1973.
- 17-32. "U. S. Energy Outlook Interim Report: Initial Appraisal by the Oil Demand Task Group, 1971-1985," National Petroleum Council, 1972.
- 17-33. "Passenger Car Weight Trends Analysis" Aerospace Corporation Report No. ATR-74 (7326)-1 January 1974, El Segundo, California.
- 17-34. Brame, J. S. S., and King, J. G., Fuel: Solid, Liquid and Gaseous, 6th Ed., Revised by J. G. King, Edward Arnold, Ltd., 1967. Chapter 14.
- 17-35. Kant, F. H., Cunningham, A. R., and Farmer, M. H., "Effects of Changing the Proportions of Automotive Distillate and Gasoline Produced by Petroleum Refining," EXXON Research and Engineering Co., EPA Contract No. 68-01-2112, July, 1974.
- 17-36. Projected Availability of Motor Gasoline and Distillate Fuels 1975-1985, Bonner and Moore Associates, Inc. prepared for Army Coating and Chemical Laboratory, January 1974.
- 17-37. "Factors Affecting U. S. Petroleum Refining: A Summary" National Petroleum Council, May 1973.



- 17-38. Emissions Control of Engine Systems, Chapter 13, "Alternative Fuels," Consultant Report to the Committee on Motor Vehicle Emissions, National Research Council, Sept. 1974.
- 17-39. Reed, T. B., and Lerner, R. M., Science 182, 1299 (1973).
- 17-40. Chem and Eng. News, June 3, 1974, p. 27.
- 17-41. Hurn, R. W., "Alternative Fuels - Methanol," Presented at Second Symposium on Low Pollution Power Systems Development, Sponsored by Committee on Challenges of Modern Society, NATO, Nov. 4-8, 1974, Dusseldorf, Germany.
- 17-42. Wigg, E. E., Science 186, 785 (1974).
- 17-43. Emissions Control of Engine Systems, Chapter 12, "Alternative Power Plants for Automobiles," Consultant Report to the Committee on Motor Vehicle Emissions, National Research Council, Sept. 1974.
- 17-44. Hamilton, W. F., "Impacts of Electric Car Use in Los Angeles," preprint, 2nd NATO-CCMS Symposium (Rec'd Oct. 30, 1974).
- 17-45. Estimated from Fig. 3, Ref. 17-44.

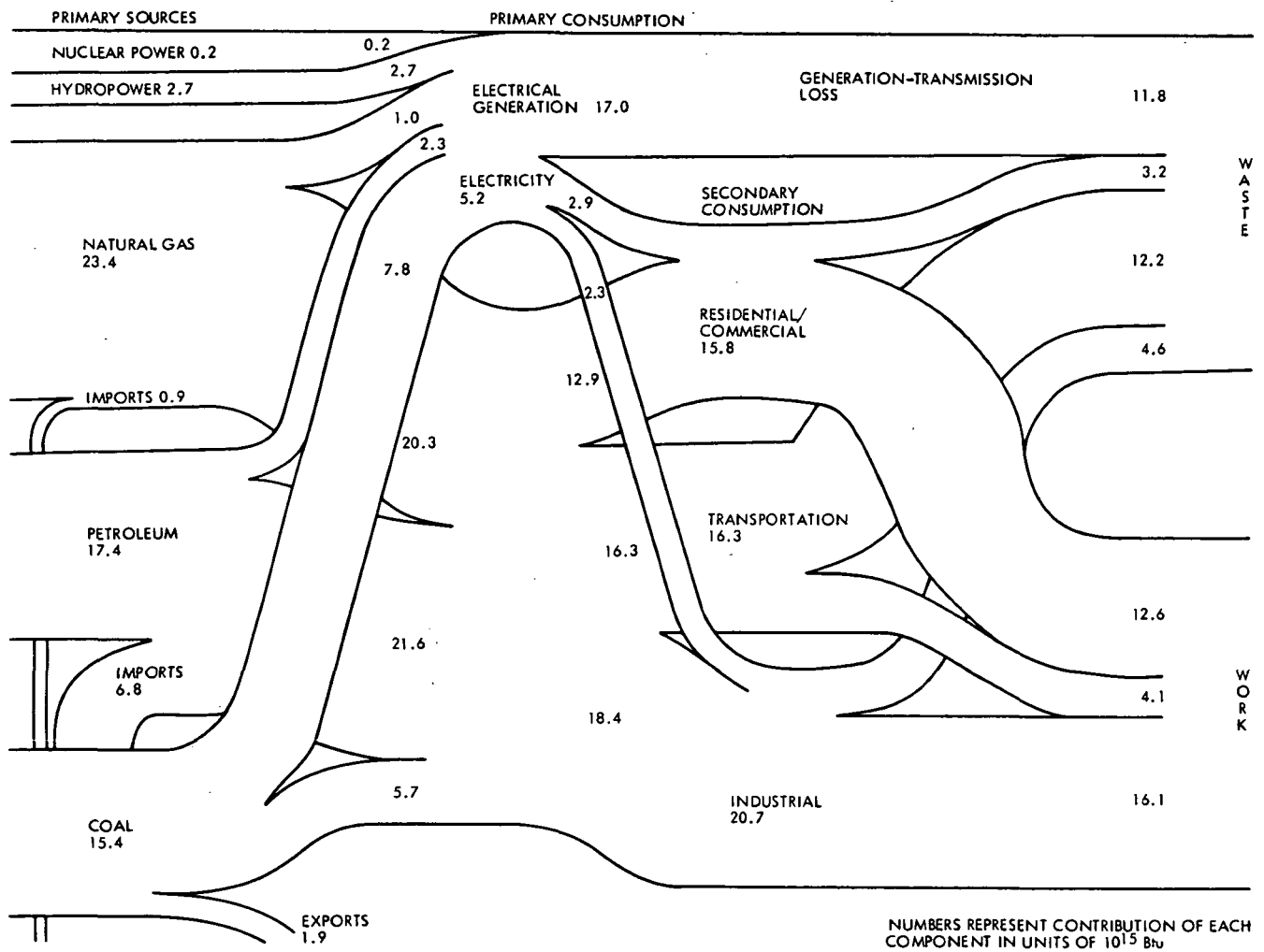

Fig. 17-1. 1970 U. S. energy flow (Ref. 17-9)

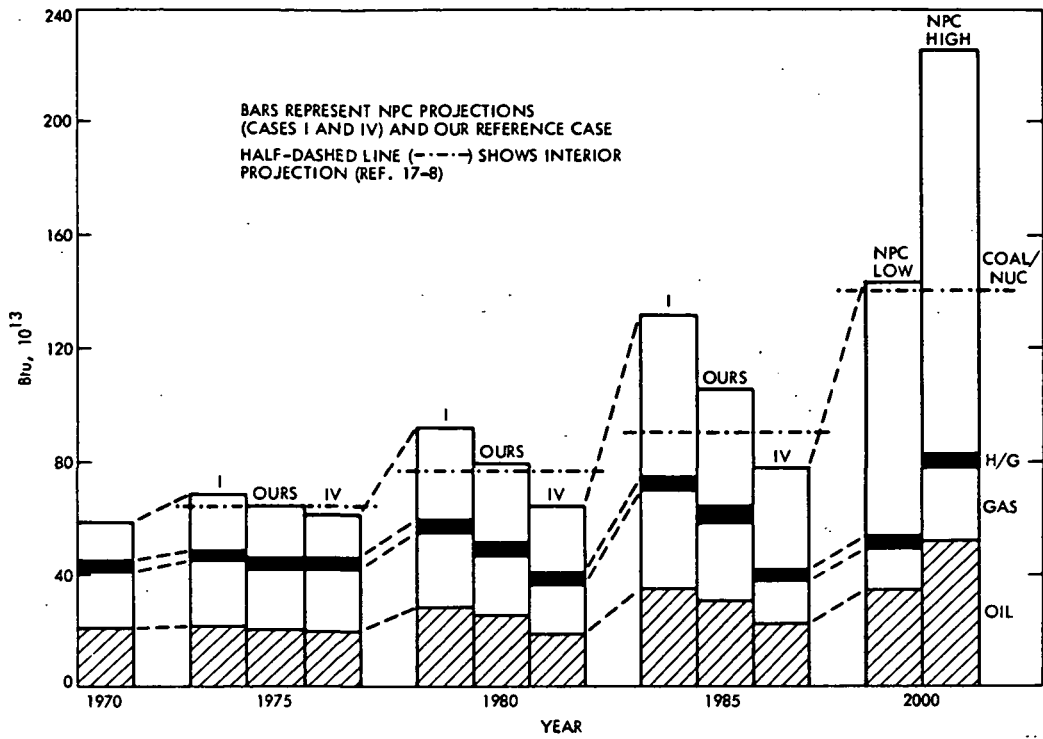

Fig. 17-2. Range of potential domestic supply projections

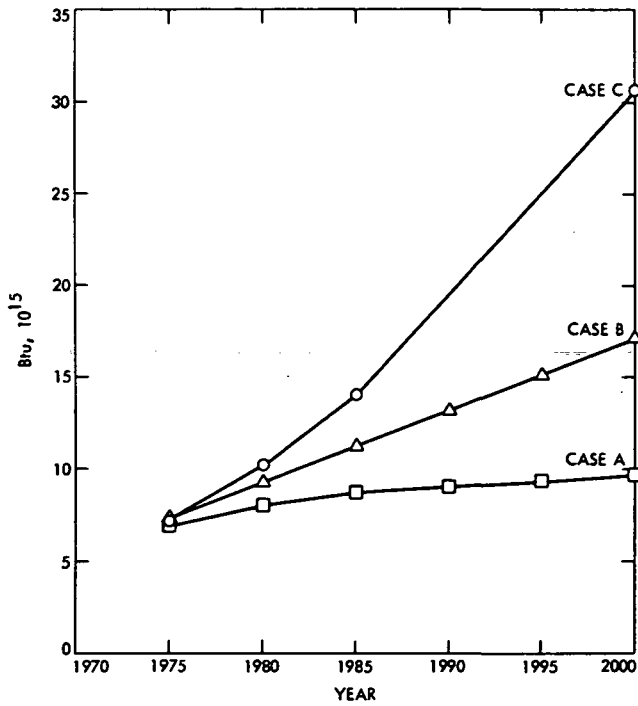

Fig. 17-3. Projected total U.S. electricity demand, three cases

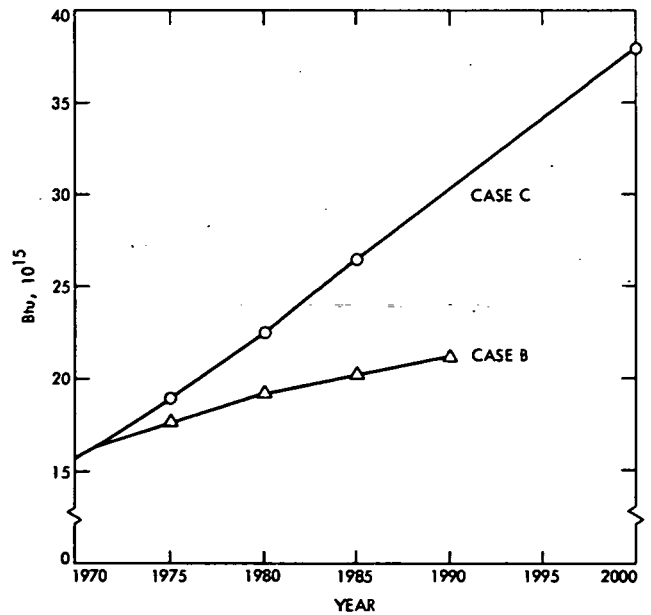

Fig. 17-4. Projected total residential/commercial energy demand, by cases

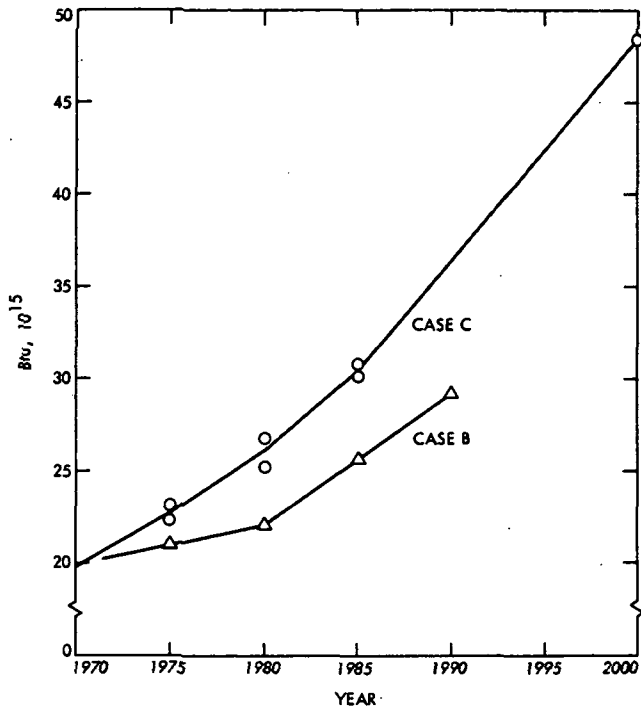

Fig. 17-5. Projected total industrial energy demand, by cases

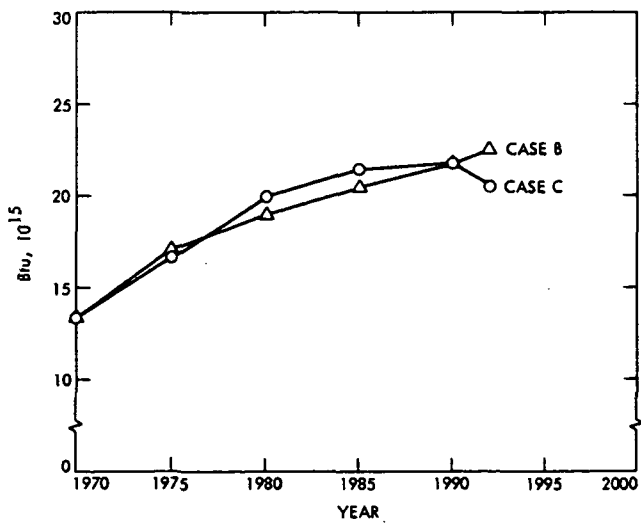

Fig. 17-6. Fossil fuel requirements for electricity generation, by electricity demand cases

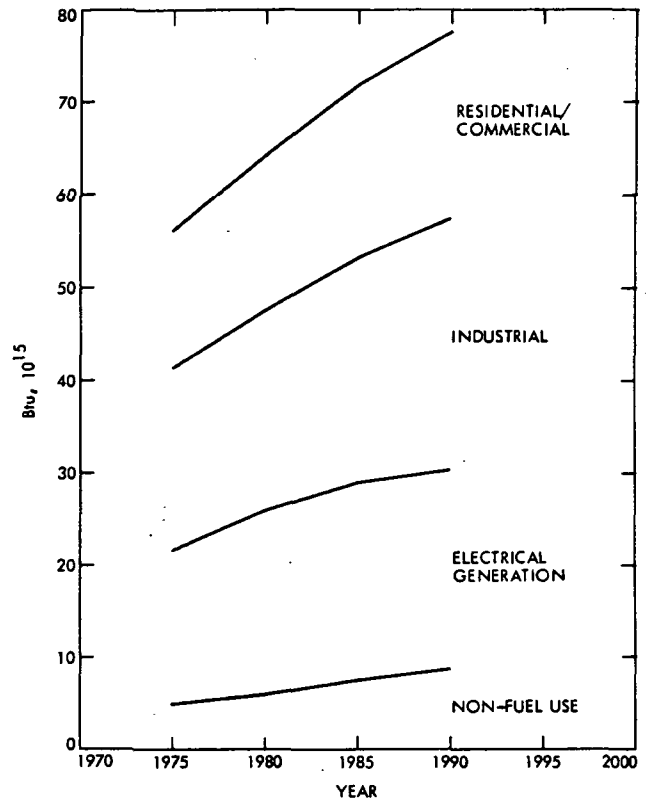

Fig. 17-7. Non-transportation demand for fossil fuel, case C

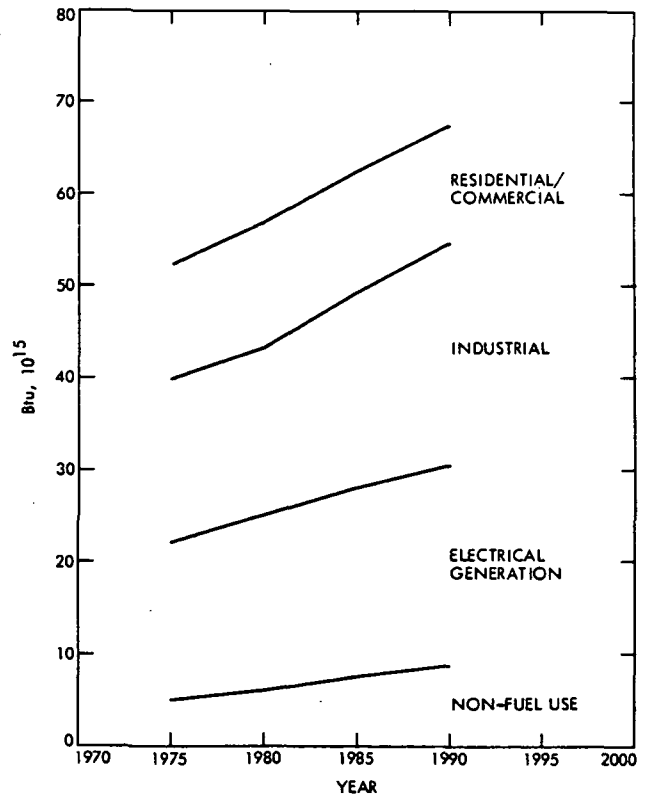

Fig. 17-8. Non-transportation demand for fossil fuel, case B

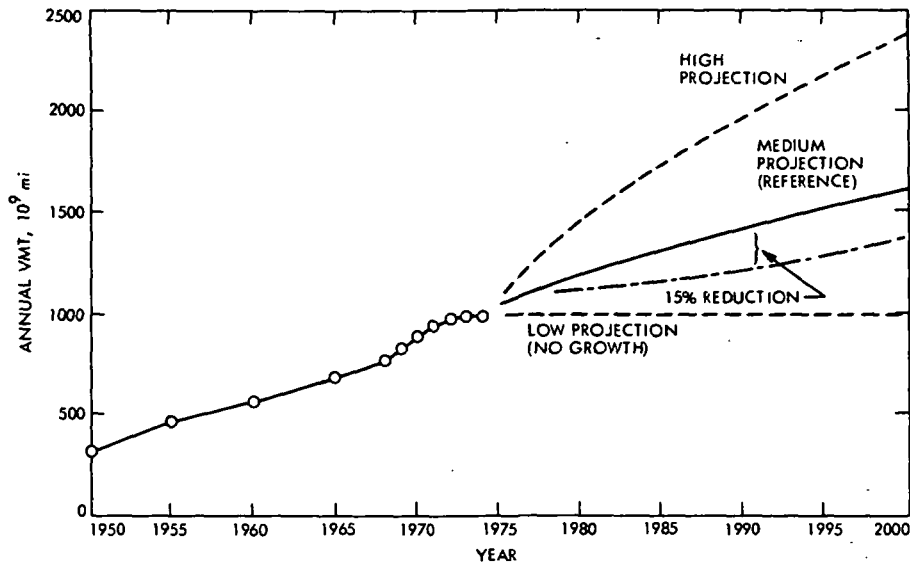

Fig. 17-9. Total annual vehicle miles traveled by passenger cars

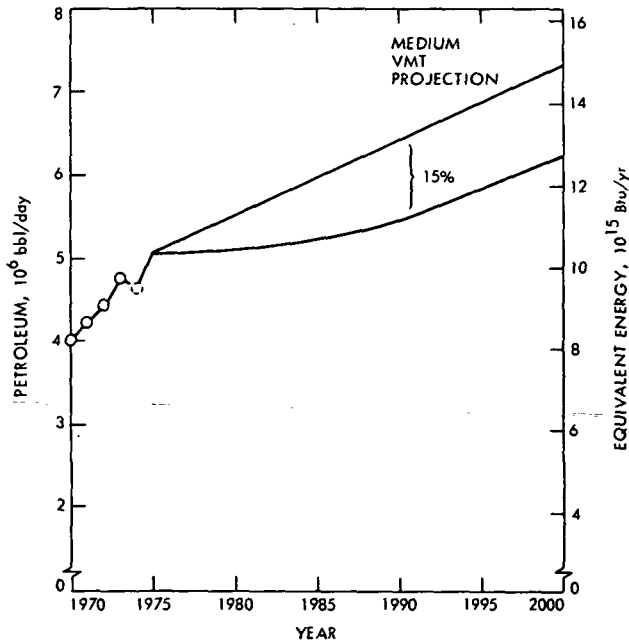

Fig. 17-10. Total automobile fuel consumption as affected by VMT (current market, "Present" UC Otto engine, current vehicle technology)

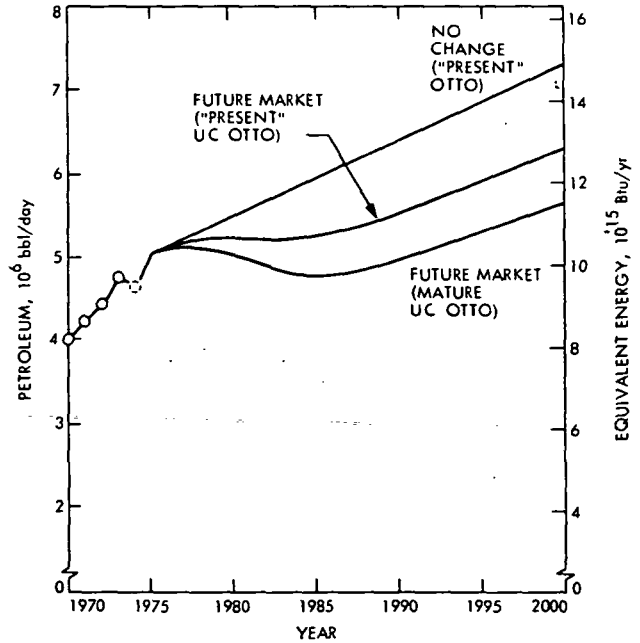

Fig. 17-11. Total annual fuel consumption as affected by choice of vehicle category (medium VMT, UC Otto engine, and current vehicle technology)

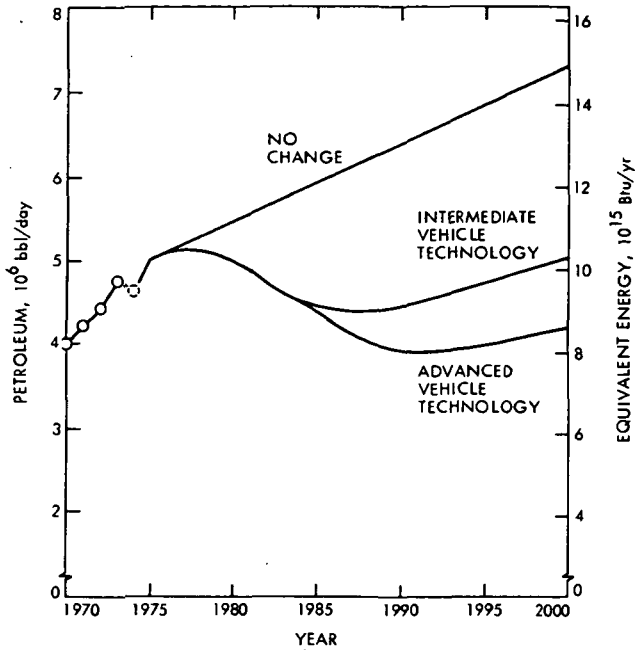

Fig. 17-12. Total automobile fuel consumption as affected by changes in vehicle technology (medium VMT, current market, present UC Otto engine)

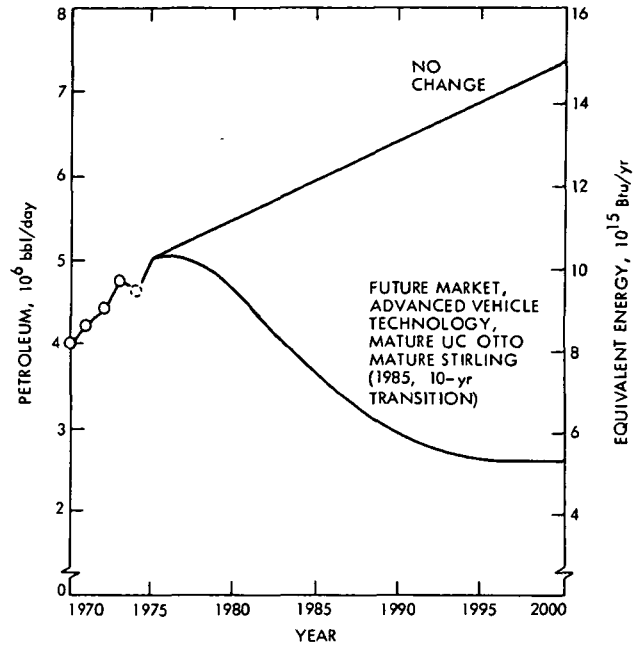

Figure 17-14. Total automotive fuel consumption assuming maximum change (medium VMT)

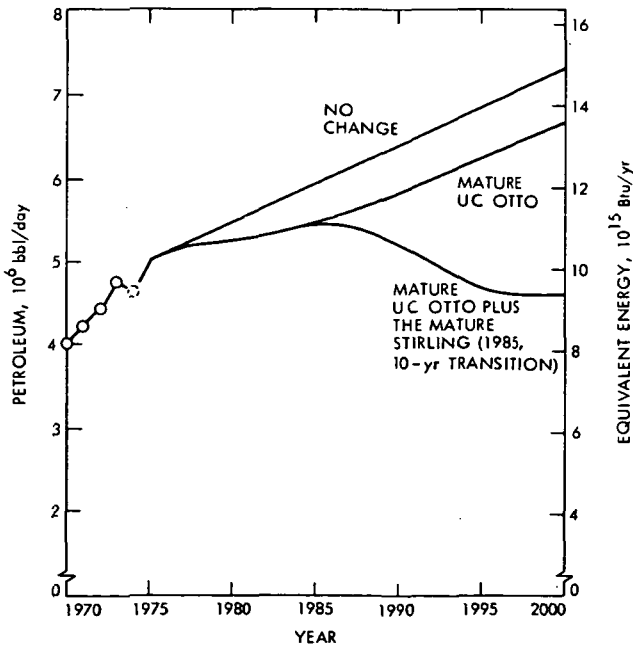

Fig. 17-13. Total automobile fuel consumption as affected by engine technology (medium VMT, current market, and current vehicle technology)

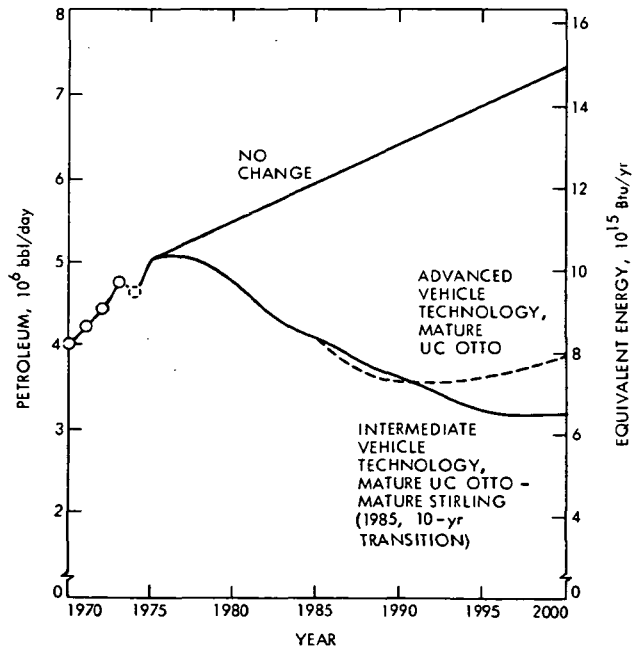

Fig. 17-15. Alternate scenarios for total automobile fuel consumption (medium VMT, current market)

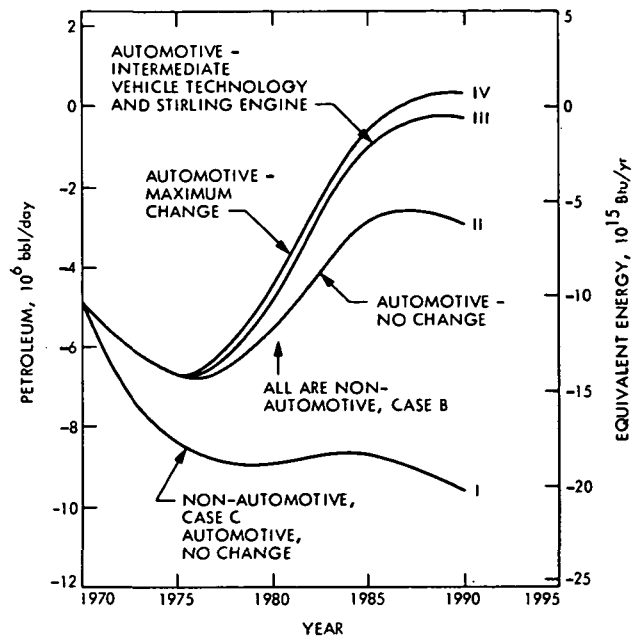

Fig. 17-16. Projections of the difference between domestic petroleum production and various demand alternatives

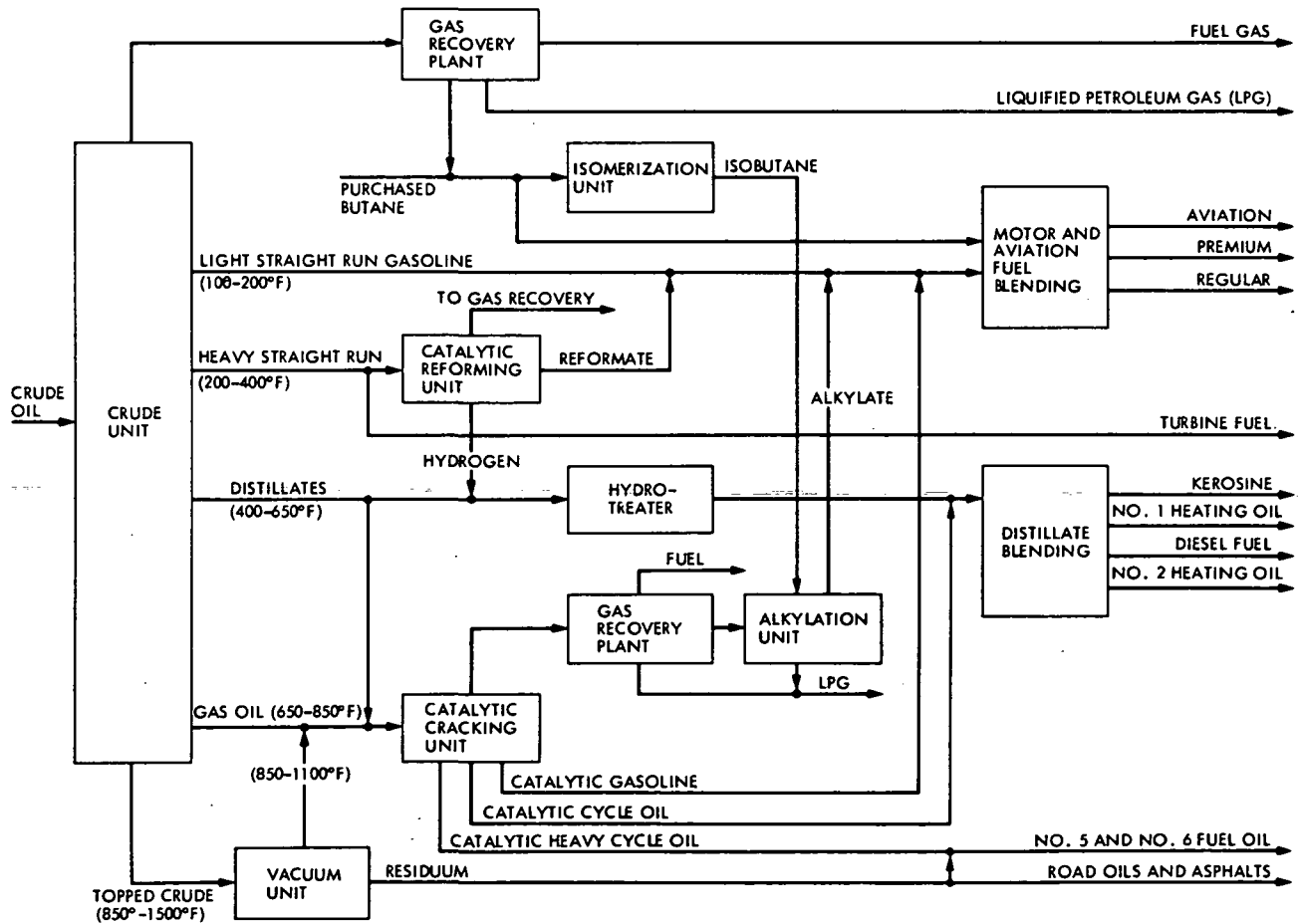

Fig. 17-17. Sample refinery

CHAPTER 18. MATERIAL RESOURCE REQUIREMENTS  
AND SUPPLY

18.1	Introduction . . . . .	18-2
18.2	"Energy Crisis" vs "Materials Crisis" . . . . .	18-3
18.3	Substitutability of Materials . . . . .	18-3
18.4	Current Automobile Materials Usage . . . . .	18-4
18.5	Materials Requirements for Alternate Engines . . . . .	18-7
18.6	Potential To Reduce Automotive Demand for Materials . . . . .	18-11
18.6.1	Potential To Reduce Materials Usage . . . . .	18-11
18.6.2	Recycling of Materials . . . . .	18-13
18.7	Potential To Increase the Supply of Materials . . . . .	18-14
18.8	The Potential for Increasing the Supply of Specific Key Materials . . . . .	18-15
18.8.1	Nickel . . . . .	18-15
18.8.2	Chromium . . . . .	18-15
18.8.3	Cobalt . . . . .	18-16
18.8.4	Tungsten . . . . .	18-17
18.9	Policy Factors Affecting Supply and Demand of Materials . . . . .	18-18
	References . . . . .	18-22
	Figures . . . . .	18-24



## 18.1 INTRODUCTION

The objective of this chapter is to evaluate the material resources required to produce alternate-engined automotive vehicles. The examination of candidate alternate heat engine technology in Chapters 2 to 7 revealed that they will require greater amounts of specialty materials, such as stainless steels and superalloys, to allow engine components to operate at higher temperatures than current conventional automotive practice. Each alternate engine was evaluated in terms of a Present, Mature and Advanced configuration, as defined in Overview of Powerplants, Chapter 2. As the Present configurations of many alternate engines are not suitable for mass production, material requirements for these configurations are of limited concern. The Advanced configuration requires the successful completion of the recommended research and development programs. Thus the material requirements can only be discussed in general terms, as the ability to successfully develop the required advanced technology and the actual knowledge of the final design details of such an Advanced configuration are at this time highly speculative. The main thrust of this chapter, therefore, concerns the Mature configuration. The Mature configuration is the implementation that could be mass-produced utilizing more-or-less available technology, although significant adaptation would be required to apply this technology to the automobile industry.

Over the last year or so, considerable concern has been raised as to the availability and cost of virtually all materials. Is a "materials crisis" to be the next crisis after the "energy crisis"? To a manufacturer who has had projects delayed due to unavailability of materials, or who has had to resort to black market procurements to complete existing projects at grossly inflated prices, a materials crisis has occurred. However, when one looks at reserve figures and other estimates of what is in the ground, the situation is not at all bleak. Problems arise because of the location and ownership of these materials, as well as the appropriate policy decisions to allow them to be produced in a timely manner to support the needs of our technologically based economy.

Under the current situation, domestic supply (production) does not equal the domestic consumption of many items. This deficit is made up by imports for which, as in oil, there is the overhanging risk possibility of the producers attempting to withhold supply on a cartel basis for the purpose of raising the material's price. There also is an adverse balance of payments situation with regard to the importation of large quantities of raw materials. Policy questions significantly affect both the domestic and world-wide production of materials. Growing ecological concern has influenced "when, where and how" and consequently the cost of material production. The entire range of policy questions such as profit incentives, taxes, prices, stockpile policy, balance of payments, environmental restrictions, trained manpower, tariffs, import restrictions,

depletion, and risks of expropriation of foreign holdings all come into play with regard to the ability of the nation to satisfactorily supply the materials needs of its economy.

The scope of the APSES study does not encompass detailed consideration of all the world's materials problems, and, as stated previously, the main thrust of this chapter will be to look at the specific material requirements for production of Mature configuration, alternative heat engines.<sup>1</sup> Thus, the ability of the auto industry to continue (essentially "forever": at least through the year 2000) producing conventional Otto engined automobiles with currently used materials and processes is not the point in question. (Incidentally, there is no basis to predict that they cannot.) Considering the great importance of the domestic auto industry in the U.S. economy (it accounts directly or indirectly for approximately 1/6 of the U.S. GNP), a major conversion in the auto industry is of extreme significance. When projected consumption demands for various materials are evaluated from the literature, the important thing to note is that such projected consumption requirements assume the existing automotive technology, as opposed to the possibility of a major change to an alternate engine technology. The time frame of this chapter is limited to approximately the year 2000 as the credibility of projections beyond that point is highly questionable. The "limits to growth" type arguments for the world's being required to reduce consumption in the longer term future are not germane to the time period of this chapter relative to automobiles. To the extent that the "limits to growth" type arguments come true in the future (counter arguments consider the "limits to growth" invalid as present day Malthus), they would apply to both current Otto engines or alternate heat engines. Thus such arguments do not affect the decision of whether or not to introduce an alternate automotive engine.

The possible introduction scenarios for an alternate automobile engine all involve a significant lead time from a decision to produce until the inception of actual production. Any new engine would be introduced initially on a limited basis and conversion would proceed with time, as the introduction proceeded. Thus the complete conversion to an alternate engine, to the degree of market dominance the Otto engine currently enjoys, would take many years. The key factor in such a changeover is timely implementation of the appropriate policy decisions that would allow the required materials to be available in adequate supply at a reasonable price when they are required. A simple and often used, but clearly invalid, argument to retain the status quo and defer the introduction of anything is to say that the required materials are not available, i. e. that the changeover would require materials which are today in short supply. This argument, while true today, has no bearing on the real question of the material needs of alternate engines as any complete conversion will not be a step function at a point in time, but rather gradual over a time interval. The major objectives then are to assess the capability for intelligently using the built-in lead times to have the appropriate materials available

<sup>1</sup>Discussion of vehicle improvements by increased usage of materials of construction such as aluminum, HSLA steel, and plastics is given in Chapter 10, Vehicle Systems.

at a reasonable price when they are required, and to determine what policies are necessary to allow this to occur.

## 18.2 "ENERGY CRISIS" VS "MATERIALS CRISIS"

Since the OPEC petroleum boycott, hardly a day goes by without a media reference to the "energy crisis." It also has become popular to use the term "materials crisis" for a host of both real and imaginary problems. The Wall Street Journal often quotes corporate officials as blaming poor profit performance on the "energy crisis," a "materials crisis," "materials inflation," or "lack of material availability." Reports in the media imply that the "materials crisis" is a monolithic phenomenon, analogous to the petroleum shortage. While there are some similarities between the materials and the petroleum situations, the differences are of far greater significance. The first and most obvious distinction is that when a gallon of gasoline or other petroleum derivative is burned, it is gone. Materials, however, are generally capable of being recycled. Materials currently are recycled when it is profitable to recycle them. If commodity prices increase, there is a natural economic incentive to increase the fraction recycled. Intelligent policies can be established to encourage an increase in recyclability of most materials to whatever extent this may be desirable. (Specifics of recycling are discussed in Section 18.6.2.)

The general term "materials crisis" is a misnomer, in that the materials situation is not monolithic. There is considerable variation from material to material. Some materials are very abundant throughout the world, including the U.S., while with other materials the U.S. domestic consumption exceeds production and they must be imported from a small group of countries. The case for each material is different and distinct. When considering the possibility of a petroleum-like cartel in a material, one must evaluate whether a group of countries possessing a critical material resource have a sufficient common bond (economic, political or religious), to act effectively together as have the Arab nations of OPEC. One must also ask whether these countries can reduce their material production to drive up the price without injuring their own economies — especially in view of the fact that the United States has a strategic stockpile that for many materials represents several years domestic consumption (as opposed to the mere 30- to 60-day inventory of petroleum prior to the OPEC embargo). The OPEC petroleum situation also is unusual in that it is problematical whether the Arab countries could effectively use the significantly increased revenues for their internal development. This is not the case in many undeveloped countries which are current or potential material suppliers. (The risks of dependence on foreign sources of materials and what can be done about it are discussed further in later sections.)

The price of petroleum has approximately quadrupled over the last several years. This has occurred with some inflationary increases in costs of production as well as some increase in more expensive secondary recovery techniques and off-shore production. However, these increases in production costs are minor in

comparison to the increases in selling price. The major beneficiaries, of course, have been the OPEC countries; nevertheless, the multinational oil companies have also increased their profits. According to the oil industry, increased profits are required to provide the necessary incentives to increase production. Others have used more colorful language such as "obscene profits." While the appropriate level of oil industry profits is left to the reader's judgment, there is an important lesson in the recent petroleum experience. Industry pricing practices to the consumer are generally on a profit margin basis (percentage of the selling price), not on a profit-per-quantity-of-commodity (\$/bbl or \$/lb) basis nor a return-on-investment basis. If an industry can maintain its profit margin through a "crisis" as the petroleum industry did, the increase in selling price may more than offset the decrease in the quantity of commodity sold. Thus the "crisis" becomes a crisis for the consumer, not the producer. The governmental public policies of attempting to control inflation and prohibit private price fixing do not necessarily coincide with a corporate strategy of short-run profit maximization. This lesson will not be lost on the materials or other industries. It would be naive to assume that other countries or industries will not attempt to emulate the petroleum experience. Whether they can be successful, of course, is another question. However, the signs are clear that it will be necessary to pursue intelligent national policies to cope with attempted price manipulations of domestic or foreign origin.

The question as to "true" value of a natural resource such as petroleum is a policy matter. Price and value are not necessarily synonymous. Historically, prior to the OPEC cartel, petroleum (as well as other mineral and metal) prices have largely reflected the costs of production, transportation, marketing, profit, and some payment to the owner of the resource. However, the actual payments to the owner (private or governmental) have rarely been a high percentage of the final product's selling price to the ultimate consumer. The concept of a "true" value implies a judgment as to the resource's highest and best usage. In the case of petroleum, which is a finite resource, combustion in an automobile or utilization as stationary source boiler fuel is an irreversible process and it is gone forever. Applications such as plastics and other petrochemicals, which currently offer some opportunity for recycling and the potential for greater future recycling, are more prudent usages. A case can be made that most natural resources, and petroleum in particular, have historically been priced beneath their "true" value, thus promoting waste, excessive consumption, adverse environmental effects, and inadequate attention to recycling. The pricing mechanism could be used, as a matter of policy, to encourage conservation of natural resources.

Another distinction between petroleum fuels and materials is that of substitutability. One currently has no choice of fuel for his automobile, if gasoline is unavailable. With materials, there are some possibilities of substitution, as discussed in the next section.

## 18.3 SUBSTITUTABILITY OF MATERIALS

There are many applications where one material may be directly substituted for another, while

for other applications any form of substitution would be extremely difficult or impossible. An example of where substitutability has occurred in the current automotive industry is the intense competition between zinc die castings, plastics and aluminum alloys. There has been considerable variation from year to year and model to model on which materials are utilized. The huge volume of automobile production is a sufficient incentive for the material producers to make major efforts to increase their market share. Functionally, they will all serve the purpose. The decision as to which to use has been based primarily on cost and secondarily on styling factors. If one of these materials became either unavailable or noncompetitive on a price basis, the auto industry would switch to the others. Thus the shortage in one material may be offset by increased usage of other, more readily available, material(s).

Another example of the substitutability influence is the historical management policy of the copper industry. Domestic price, during periods of shortage and high world prices, has generally been held beneath the spot London Metal Exchange world price and domestic allocation has been used. This policy of not extracting the short-term maximum the market will bear, when copper has been in short supply, has been deliberately pursued in fear of permanently losing market share to aluminum.

Another area of substitutability of materials is in the metallurgical field of specific alloy composition. There is some latitude in which alloying elements are used for many applications. For standard alloy steels there is generally more than one American Iron and Steel Institute (AISI) classification alloy that may be employed in a specific application. Decisions often are dominated by cost. Within the stainless steel family, chromium is required to provide oxidation resistance. While the chromium composition limit may be varied slightly, there is no fully satisfactory substitute that provides equivalent properties. The nickel content in stainless steel may be varied depending upon the properties required. There have been special modifications (e.g., CRM-6D) where the nickel content has been reduced by the substitution of manganese. Approximately the same properties can be obtained in the superalloy family with various compositions of nickel, chromium, cobalt, iron and other elements. For heat-treatable superalloys, the small additions that act as precipitation or secondary hardeners can sometimes be varied. However, these are not necessarily direct substitutions and may not always be made without some loss of the desirable material properties.

Examples of substitution within alloys have occurred through both natural economic incentives and by fiat. An example of fiat substitution was the situation during World War II when the product mix of the domestic metals industry was controlled by government action. Priority users got the alloys containing the then-critical materials which were in short supply. Various alloy substitutions were made in the rest of the product mix, and lower-priority users were forced to live with these substitutions.

The natural economic incentive encourages substitution of cheaper alloying ingredients

whenever possible. Alloy compositions are patentable. The company that can develop a material which will provide properties equivalent to those of a currently used material at a reduced cost, due to changes in compositional makeup, gains a market advantage. Again, the large economic size of the auto industry is a very significant factor. For most small manufacturers, their choice of materials is limited to those alloys currently produced and stocked. The auto industry, with its enormous mass production, provides sufficient tonnage demand that alloy compositions can be tailor-made with the specific properties required for the application at minimum cost. This built-in economic incentive provides a means for the automobile industry to minimize the usage of expensive and/or critical supply materials in the production of any automotive part.

Over the long term, material substitutability also occurs through development and application of new types of materials. The widespread introduction of structural ceramics fabricated from abundant, domestically-available raw materials is a potential future example of this kind of materials substitution.

While material substitutability is not a panacea, nor always possible, it certainly reduces the dependency on any one critical and/or expensive and/or foreign-supplied material and provides more latitude of policy options as compared to petroleum. Thus our dependency upon any one material is not nearly as great as our dependency upon petroleum.

#### 18.4 CURRENT AUTOMOBILE MATERIALS USAGE

Current automobile materials utilization can be looked at from two viewpoints. They are (1) on a per-car basis from data collected by disassembling an automobile, and (2) from aggregate consumption data tabulated by the Bureau of Mines (Refs. 18-1, 18-2), Trade Sources (Refs. 18-3, 18-4) and the Motor Vehicle Manufacturers' Association.

On a per-car basis, Armco Steel (Ref. 18-5) has completely disassembled a 1972 Chevrolet Impala V-8 automobile. The results, shown in Tables 18-1 and 18-2 and Fig. 18-1, provide the material breakdowns. It is seen that 61% by weight is steel. Cast iron, aluminum, zinc and copper are also used to a significant extent. Within the steel category, Table 18-2 gives a more detailed breakdown. Of the 2555 lb of steel only 361 lb are alloy steel and only 19 lb are stainless steel. These numbers will be important later when we consider nickel and chromium consumption for the production of alternate engines, as both of these material families contain nickel and chromium.

The second approach to automobile materials consumption is via the statistics compiled by the Motor Vehicles Manufacturers' Association, shown in Table 18-3. Although the materials quantities in tons vary considerably from year to year with the general status of the economy and auto production, the automobile percentages have actually been relatively constant. Current automobiles use about 20% of U.S. steel consumption and between 8 and 10% of aluminum and copper. Nickel has been running between 11 and 12% of

Table 18-1. Materials breakdown for a typical 1972 two-door V-8 automobile (from Ref. 18-5)

Material	No. of parts	% of total	Weight, lb (kg)		% of total
Miscellaneous <sup>a</sup>	114	3.46	149.78	(67.94)	3.6
Aluminum	65	1.97	108.41	(49.17)	2.6
Cast iron	84	2.55	711.92	(322.92)	17.1
Rubber	116	3.52	119.54	(54.22)	2.9
Composite <sup>b</sup>	56	1.70	124.78	(56.60)	3.0
Plastics	198	6.00	189.54	(85.97)	4.6
Zinc	41	1.24	33.61	(15.25)	0.8
Copper and brass	30	0.91	56.29	(25.53)	1.4
Asbestos	4	0.12	0.66	(0.30)	0
Cardboard	9	0.27	8.37	(3.80)	0.2
Fabric	14	0.42	2.21	(1.00)	0
Glass	27	0.82	99.90	(45.31)	2.4
Steel	2,540	77.02	2,554.68	(1,158.78)	61.4
<b>Total</b>	<b>3,298</b>	<b>100.00</b>	<b>4,159.69</b>	<b>(1,886.80)</b>	<b>100.0</b>

<sup>a</sup>Examples include speaker, spark plugs, lights, brake pads, air cleaner element.

<sup>b</sup>Examples include seat cushions, grill, fan shroud, heater duct, inner door trim panels.

U.S. consumption; rubber and zinc are also heavily used in automobiles.

Note that the Motor Vehicle Manufacturers' Association compiles only aggregate statistics for U.S. total production of cars, trucks, and buses, rather than automobiles alone. It is also observed that the metals statistics are generally collected on a calendar year basis, whereas some automobile statistics are tabulated on a model year basis. The Armco car-stripping project addressed a full-sized car. As the product mix has shifted to a greater percentage of smaller cars, an appropriate adjustment may be made.

It is next necessary to compare the Armco per-car figures with the aggregate industry figures for consistency. In the case of stainless steel, the industry consumption figures divided by unit sales indicate approximately 24 lb per unit, versus the Armco figure of 19 lb per unit. However, the aggregate figures presumably also include spare parts and scrapage; and trucks and buses may be assumed to have more stainless than an automobile. Therefore, it is reasonable to consider the fleet average auto (precatalyst) to contain approximately 20 lb of stainless steel.

In the case of alloy steel, the aggregate consumption figures imply a slightly lower alloy steel

Table 18-2. Steel types specified by automakers (from Ref. 18-5)

	No. of parts	% of total	Weight, lb (kg)		% of total
Hot-rolled	277	8.40	1,048.04	(475.38)	25.2
Cold-rolled grade 1	51	1.55	341.37	(154.84)	8.2
Cold-rolled grade 2	379	11.49	617.14	(279.93)	14.8
Galvanized	54	1.64	105.21	(47.72)	2.5
Aluminized	4	0.12	27.34	(12.40)	0.6
Terne	5	0.15	35.73	(16.21)	0.9
Stainless	68	2.06	19.08	(8.65)	0.5
Alloy	1,702	51.61	360.77	(163.64)	8.7
<b>Subtotal</b>	<b>2,540</b>	<b>77.02</b>	<b>2,554.68</b>	<b>(1,158.78)</b>	<b>61.4</b>

Table 18-3. Materials consumption, 1972<sup>a</sup>

	U. S. total consumption, tons	Automotive consumption, tons	Automotive percentage
<b>Steel:</b>			
Alloy steel (excluding stainless)	7,776,685	1,576,431	20.3
Stainless steel	854,663	116,748	13.7
Steel (including carbon, alloy, stainless):			
Hot rolled bars	9,299,286	2,580,343	27.7
Cold finished bars	1,674,893	222,589	13.3
Total bar	10,974,179	2,802,932	25.5
Hot rolled strip	1,533,416	603,636	39.4
Cold rolled strip	1,253,231	199,683	15.9
Total strip	2,786,647	803,319	28.8
Hot rolled sheet	14,036,222	4,938,093	35.2
Cold rolled sheet	16,122,737	6,915,157	42.9
Total sheet	30,158,959	11,853,250	39.3
Galvanized (sheet and strip)	5,517,141	900,112	16.3
Total all steel	91,804,568	18,216,755	19.8
Aluminum	5,710,000	502,000	8.8
Copper and copper alloys	3,340,500	275,000	8.2
Cotton	1,920,480	37,289	1.9
Rubber: <sup>b</sup>			
Natural	717,250	517,440	72.1
Reclaimed	210,092	127,571	60.7
Synthetic	2,566,694	1,631,105	63.5
Zinc	1,430,000	471,900	33.0
Nickel	200,000	22,500	11.2
Chromium	500,000	41,000	8.2

<sup>a</sup>Compiled by Motor Vehicle Manufacturers' Association of the U. S., Inc. and from various trade sources (Ref. 18-3).

<sup>b</sup>Includes all rubber products classified "Transportation Products", but excludes "Mechanical Rubber Goods," i. e., rubber weather stripping, grommets, motor mounts used in automobiles.

content than the Armco figure. As the Armco figure was based on a full-size car and by making other adjustments, an estimate of about 350 lb of alloy steel per average vehicle is justified.

For nickel, industry consumption figures indicate approximately 4.5 lb per unit. The Armco data does not provide a specific nickel estimate. However, by applying the normal percent nickel compositions to the stainless and alloy steels, and making an estimate of nickel used in plating, as an alloying addition in nodular iron and in other areas, one can arrive at a reasonable estimate of 4 to 5 lb of nickel per unit for a pre-catalyst automobile.

It has been reported (Ref. 18-2) that an average car contains 8 lb of chromium per unit and that 41,000 tons of chromium were used in the manufacture of automobiles in the year of the 8-lb estimate. The Armco data does not list chromium. However, one can apply the chromium content percentages to the stainless and alloy steel and make an estimate of plating usage to convince himself that the range of 7-9 lb per average vehicle is plausible for chromium. Another way of getting

at automotive chromium utilization is to review the Bureau of Mines industry utilization figures (Refs. 18-1, 18-2) for transportation and plating and then estimate automobile usage therefrom. This method also implies approximately 40,000 to 45,000 tons of chromium for pre-catalyst automobiles.

The addition of catalysts in 1975 models has made a significant difference in automotive chromium consumption. The aggregate figures for this year are not yet available, as the metal statistics are published a year or so later. However, there is adequate information available on the 1975 catalyst system to infer the effect on chromium consumption in automobiles.

In a recent interview (Ref. 18-6), the General Motors catalyst plant manager stated that the G. M. Model 260 converter contained 17.5 lb of Type 409 stainless steel per unit. Additionally, the Y-pipes that are used to connect the engine to the converter are also made of the same material. From the plant stainless steel consumption figures provided in the article, it is inferable that the average Y-pipe weighs 8 lb. Thus, an

oxidation catalyst system uses about 25 lb of Type 409 stainless steel, which is equivalent to 2.8 lb of chromium per unit.

The increase in chromium used in the stainless steel that goes into the current oxidation catalyst system is quite significant. This 2.8 lb of chromium per unit represents an increase, per catalyst-equipped automobile, of from 8 lb of chromium per unit to 10.8 lb per unit (Table 18-4). The 2.8 lb of chromium content per converter is equivalent to another 14,000 tons of chromium consumed in automobiles, assuming a nominal 10 million converters per year production. Thus the automobile chromium consumption has been raised from about 41,000 tons per year to about 55,000 tons per year. In one year the automobile usage of chromium has increased from about 8% to about 11% of domestic consumption. On a world basis, the figures are smaller, going from about 2.3% to about 3.1% of world consumption. (Chromium is discussed in greater detail in a later section.)

The first and most significant observation of the catalyst experience is that it was accomplished. In spite of all the prior automobile industry's warnings to the contrary, the chromium, the stainless steel, and the precious metals used in the current oxidation catalyst system were obtained, and the increased production rates clearly can be maintained. The incremental yearly increase attained for the catalyst system materials should be kept in mind for reference as we examine the material requirements of alternate engines.

The details of the catalyst development for 1975 automobiles are not strictly germane to this chapter as they are a fait accompli of current technology rather than alternate engine technology. Yet it is useful to consider the implications. In order to virtually double the domestic consumption of the precious metals used in the 1975 catalysts, General Motors and other automobile manufacturers contracted with precious metal suppliers several years in advance of initial deliveries. The contracts also were a commitment for annual purchases over a long-term basis of up to 10 years. This both reduced the risk to the metal suppliers and provided an adequate lead time to

develop the desired supply of precious metals. The catalyst experience provides a historical precedent that shows what can be done with a little lead time, some intelligent planning, and a commitment to do it. This is of significance, as will be seen later in this chapter, because the annual percentage increases required to support an alternative engine technology are, by comparison to the precious metals accomplishment, much more modest.

It is safe to assume that the auto industry's increased utilization of stainless steel to manufacture converters did not occur completely at the expense of other stainless steel consumers, and therefore it is clear that there had to be an increase in stainless steel production during 1974. Since the production figures available to this study do not yet reflect this increase, our stainless steel total domestic consumption figures are slightly low. Converter production can also help explain why the stainless steel producers and consumers have been concerned with a tight supply situation for both finished stainless steel and the ferro-chromium raw material used in its manufacture.

It is common knowledge that the United States is dependent upon imports (Ref. 18-7) to varying extents to satisfy its current consumption of materials. Figure 18-2 shows this dependence. The recycling of materials (Refs. 18-7, 18-8) and possible accelerations thereof are also of interest to the problem at hand. Figure 18-3 shows current U.S. scrap recycling. These two tables are shown here to give the reader an overview of the import and recycling situation. Individual materials will be discussed in detail in following sections.

The background information on current automobile materials consumption having been provided, the distinctive material requirements for alternate engines can now be discussed.

#### 18.5 MATERIALS REQUIREMENTS FOR ALTERNATE ENGINES

Table 18-5 shows the weight breakdowns for the various alternate heat engines by material type. This table is a compilation of the weights established in the previous heat engine chapters and is shown for both our previously-defined Mature and Advanced configurations. Rankine, Stirling, and Brayton (both free turbine and single shaft) engine requirements are exhibited. Diesels, stratified-charge Ottos, lean burning Ottos, and possible future configurations of UC Otto engines are not shown, as they do not require significantly different quantities of strategic materials (e.g., stainless steels or superalloys). The only minor exception to this is the possible use of additional catalysts for NOx control. Descriptions of proposed 3-way and dual catalyst systems are given in Chapter 3. Materials requirements for these systems, which are supportable, have been studied by the National Academy of Sciences (Ref. 18-9). Electric and hybrid vehicles are another special case. If they come into widespread usage, it will probably be later than the time period of this chapter and after major battery technology breakthroughs are accomplished. At this time, the evolution of a Mature configuration electric or hybrid vehicle is not defined well

Table 18-4. Current automotive nickel and chromium consumption per unit

	Nickel, lb/unit	Chromium lb/unit
Precatalyst Otto vehicle	4.5	8.0
1975 catalyst <sup>a</sup> Otto vehicle	4.5	10.8

<sup>a</sup> Assuming one General Motors Model 260 catalyst per vehicle.

Table 18-5. Alternate engine weight breakdowns by material type, in pounds

Material type	Material code	150-hp Rankine		170-hp Stirling		150-hp Brayton			
		Mature	Advanced	Mature	Advanced	Single shaft		Free turbine	
						Mature	Advanced	Mature	Advanced
Cast iron	A	108	98	76	76	177	38	179	38
Carbon steel	B	81	71	149	93	--	--	--	--
High carbon steel	C	--	--	--	--	--	--	--	--
Alloy steel	D	17	17	11	10	12	9	12.5	9
Austenitic stainless steel	E	170	23	83	--	19.2	5.7	21.7	9.7
Ferritic or martensitic stainless steel	F	--	--	--	--	1	--	2.5	2.5
Precipitation-hardening stainless steel	G	--	--	--	--	3.6	3.6	7	7
Superalloy	H	11	--	10	--	5.1	--	15.5	--
Ceramic	I	--	93	22	110	20	106	20	112
Aluminum alloy	J	102	97	181	178	1	1	1	1
Copper alloy	K	--	--	--	--	--	--	--	--
Plastic, Teflon or Rulon	L	--	--	--	--	5	5	5	5
Not broken down (conventional auto materials <sup>a</sup> ), non-homogeneous, or miscellaneous	Z	265	270	262	254	122	122	149	143
Total engine ready-to-run <sup>b</sup>		754	669	794	721	366	290	413	327

<sup>a</sup>Conventional auto materials do not include E, F, G, H, and I, but do include some of the other material types.

<sup>b</sup>Does not include transmission or battery.

enough to generate a detailed weight breakdown by material for analysis in the same manner as the heat engines.

As compared to present Ottos, two observations are immediately apparent from Table 18-5. First, the Stirling, Brayton, and Rankine engines in the Mature configuration require more stainless steel and introduce requirements for superalloys that are not currently utilized in automotive construction.

The second observation is that the Advanced configuration engines, which assume the successful introduction of ceramics on a wide scale, do

not need a significant quantity of stainless steels or superalloys. The nation's ceramic needs clearly could be satisfied on a domestic basis, thus eliminating the risk of foreign source dependency and the balance of payments effect of some metal imports to satisfy automobile consumption.

As Table 18-5 shows, the major effect of alternate heat engines is on stainless steels and superalloys — hence nickel and chromium in particular. Next, it is necessary to convert the superalloys and stainless steels into their respective chemical constituents on a per-engine basis, to then add back the nickel and chromium utilized

elsewhere in a vehicle, and to compare these projections with current domestic and world-wide consumption and production figures for these materials. This has been done for the Mature configurations of the alternate heat engine vehicles considered. The tabulation was synthesized from the weight breakdowns in the individual engine chapters, the materials and processes discussion in the heat engine chapters where specific alloys were identified, and through application of metallurgical assumptions listed herein. Some Brayton component weights and materials are taken from Refs. 18-10 and 18-11. The reader wishing to modify the design of an engine, using different materials from the APSES Mature configuration, may do so by minor modifications of the following data base.

In the Mature Stirling engine, the 10 lb of superalloy was configured as 9 lb of Multimet N-155 and 1 lb of HS-25. Of the 83 lb of stainless steel, 8 lb of fins are Type 310, with 56 lb as CRM-6D and 19 lb of standard 300-series, austenitic 18-8 type stainless.

For the Rankine engine, the 11 lb of superalloy again was configured as Multimet N-155, with the 170 lb of stainless steel divided into 150 lb of standard 18-8 type, 300-series and 20 lb of CRM-6D.

The free turbine Brayton engine was configured to require the following superalloy: alloy 792 - 7.1 lb, 713LC - 2.0 lb, HS-31 - 5.4 lb, HS-25 - 1.0 lb; and the following stainless steel: 300 series austenitic - 21.7 lb, 400 series - 2.5 lb, A-286 - 3.5 lb, 17-4 PH - 3.5 lb.

The single shaft Brayton engine was configured to require the following superalloy: alloy 792 - 4.1 lb, HS-25 - 1 lb; and the following stainless steel: 300-series austenitic - 19.2 lb, 400-series - 1 lb, A-286 - 1.8 lb, 17-4 PH - 1.8 lb.

Having the per-engine material requirements, it is next necessary to consider the nonengine (vehicle) contribution. In the cases of all of the continuous-combustion alternate engines, a catalyst will not be required. Therefore, when considering nickel, chromium and stainless steel for automobiles, the precatalyst data is used for the addition of the vehicle components to the engine components. For chromium, all alternate engine contents have 6.4 lb added for the vehicle contribution, while for nickel, 2.9 lb have been added to the engine nickel content to determine total vehicle utilization. Current vehicles do not contain any significant amount of cobalt or tungsten, so there is no addition of a vehicle component for these materials. These data are shown in Table 18-6 for the alternate engine vehicles. The addition of the vehicle nickel and chromium contents as a constant addend at their current estimated fleet average values is a conservative treatment. While Chapter 10 discusses improved materials utilization in vehicle construction, this study primarily concerns engines. The design of a vehicle from the standpoint of minimizing nickel and chromium material resource utilization was not attempted. Vehicle nickel and chromium content can be reduced in the future. These materials are used in some optional styling areas, such as plating of decorative trim and for plating of bumpers, as well as in more difficult to

reduce applications dictated by metallurgical requirements.

Table 18-6 also includes columns for 150-hp Otto-engine-equivalent (OEE) Mature, alternate vehicles. This is done to compare alternate engine vehicles on the basis of equal performance. The comparison point of 150 hp was selected as being indicative of the Otto-engined fleet average. The shape of the torque curve, the weight of the engine, and the weight propagation factor allow different horsepower engines to give equivalent performance for alternate engine vehicles. (The details of the derivation of the performance scaling are given in Chapter 10, Vehicle Systems.) After linearly normalizing the 170-hp Stirling engine to the reference 150 hp, to be consistent with the other alternate engines, the engine material weight (but not vehicle material contribution) was linearly scaled using performance scaling factors of 0.79 for Stirling, 0.94 for Rankine, and 0.70 for both Braytons. Thus the 150-hp OEE alternate engine vehicles weight comparisons are the most representative of potential material requirements.

The implications of Table 18-6 are clear. In terms of rank order on an OEE basis, the introduction of the Mature configuration single-shaft Brayton requires the least pounds of chromium followed by the free-turbine Brayton, the Stirling, and the Rankine. For nickel, the single-shaft Brayton again requires the least additional material; the Stirling and free-turbine Brayton require about the same amount; and the Rankine requires the most.

A useful way to look at potential material utilization is to compare it to present U. S. and world consumption on a percentage basis. Assuming hypothetical (and clearly impossible) scenarios of complete domestic transition to each of the alternate engine vehicles this year, the necessary percentages of U. S. and world consumption are shown in Table 18-6. On an OEE basis for chromium, there would be a slight decrease for the single-shaft Brayton (remember that catalysts are not required for these alternate engine vehicles). Automobile consumption as a percentage of total U. S. consumption of chromium would rise from the current 11% to 12% for the free turbine, 19% for the Stirling and 37% for the Rankine. On a world basis, the figures are of course more modest, with the maximum being 11%. For nickel, the present 11% of U. S. consumption would rise to 15% for OEE single-shaft Braytons, 21% for both Stirlings and free-turbine Braytons, and 43% for Rankines. On a world basis the maximum consumption would be 18% for Rankine vehicles, with the other three types all using less than 10%. These consumption percentages for chromium and nickel (especially for Stirling and Brayton vehicles, which are the leading contenders for other reasons as well as material consumption) are certainly not unreasonably high when compared to current automotive consumption of other materials as shown in Table 18-3.

In addition to nickel and chromium, the introduction of alternate engines will require materials not currently used in automobiles in any significant quantity, such as cobalt and tungsten, which are contained in some superalloys. The poundage



Table 18-6. Key elements required for Mature configuration alternate engined vehicles

Material	Pre-1975 catalyst Otto	Vehicle type							
		170-hp Stirling	OEE <sup>c</sup> 119-hp Stirling	150-hp Rankine	OEE <sup>c</sup> 141-hp Rankine	150-hp free turbine Brayton	OEE <sup>c</sup> 105-hp free turbine Brayton	150-hp single shaft Brayton	OEE <sup>c</sup> 105-hp single shaft Brayton
Chromium lb/unit	8.0	24.6	19.2	39.2	37.2	14.5	12.1	11.0	9.6
% U.S. consumption	8.0	25	19	39	37	15	12	11	10
A (see Note 1)	--	0.76	0.45	1.6	1.5	0.16	0.06	0	0
% world consumption	2.3	7.0	5.5	11	11	4.1	3.5	3.1	2.9
B (see Note 2)	--	0.26	0.16	0.51	0.50	0.07	0.03	0	0
Nickel lb/unit	4.5	10.8	8.5	18.7	17.8	11.5	8.9	7.5	6.1
% U.S. consumption	11	26	20.8	46	43	28	21	18	15
A (see Note 1)	--	0.94	0.63	2.0	1.9	1.1	0.65	0.45	0.16
% world consumption	4.5	10.8	8.5	19	18	11.5	8.8	7.5	6.1
B (see Note 2)	--	0.41	0.26	0.89	0.85	0.45	0.30	0.20	0.11
Cobalt lb/unit	Neg.	2.2	1.5	2.2	2.1	3.9	2.7	0.60	0.40
% U.S. consumption	--	147	101	147	140	260	180	40	27
A (see Note 1)	--	6.2	4.7	6.2	6.0	8.9	7.1	2.3	1.6
% world consumption	--	44	30	44	42	78	54	12	8.0
B (see Note 2)	--	2.4	1.8	2.4	2.3	3.9	2.9	0.76	0.51
Tungsten lb/unit	Neg.	0.37	0.26	0.27	0.26	0.80	0.56	0.25	0.18
% U.S. consumption	--	23	16	16	16	50	35	16	11
A (see Note 1)	--	1.4	1.0	1.0	1.0	2.8	2.0	1.0	0.7
% world consumption	--	5.0	3.3	3.3	3.3	10	7.0	3.3	2.3
B (see Note 2)	--	0.3	0.2	0.2	0.2	0.6	0.4	0.2	0.15

<sup>a</sup>Assumes 1 G.M. Model 260 catalyst per unit and 10<sup>7</sup> annual catalyst production.

<sup>b</sup>Assumes 10<sup>7</sup> annual production.

<sup>c</sup>OEE alternates use a 150-hp Otto as the comparison standard.

Note 1. A = Maximum additional compound annual rate of increase in domestic consumption, all used for alternate engined vehicles, required over a 15-year time period from the decision to produce until full domestic conversion transition scenario. This is over and above whatever rate of increase which will take place in the absence of an automotive conversion to an alternate engined vehicle. A is an additive factor. Thus if the rate of growth is X for no conversion, then the rate of growth for conversion is X+A.

Note 2. B = Same as A but on a world basis.

requirements for these materials as shown in Table 18-6 is small. However, considering the size of the automobile industry and the low base of consumption of these materials for other applications, the percentage of consumption figures can be both very large (cobalt) and partially misleading. (Cobalt and tungsten will be further discussed later.)

To evaluate the real significance of the projected material needs requires the assumption of a reasonable transition scenario. Clearly, materials in these quantities are not available today. When are they likely to be required? From our definition of a Mature engine configuration in Chapter 2, the most optimistic scenario would be introduction on a limited basis (say an engine line per major manufacturer) no sooner than 1980, with the initial production being less than a million units. A full conversion (assumed linear) would then take another 5 to 15 years based on the capacity of the machine tool industry and other factors. (See Chapter 15, *Industry Practices*.) Thus, the earliest year for a full conversion to an alternate engine vehicle requiring the amount of materials shown in Table 18-6 could be about 1990.

Under such a transition scenario, we may look at the data in Table 18-6 in terms of the rate of compound annual increase required (assumed linear), starting now, to supply the required materials incrementally as required over the 15-year transition scenario, using this additional increase for alternate engine vehicles. Table 18-6 shows these calculations as A on a domestic basis and B on a world basis. These figures are the additional increase for alternate engine vehicles over and above whatever will be required in the absence of an automotive conversion. Thus if free world nickel production and consumption, for example, continues at its post World War II historical growth rate of about 6.5% per year from now to 1990, and it is desired to fully convert to, say, OEE Stirling engine vehicles by the defined transition scenario, then the nickel growth rate would have to be increased additively by 0.26% per year, with the increase used for alternate engine vehicles resulting in a new total compound annual rate of growth of 6.76%.

The advantage of presenting the data in this fashion is that it shows the effect of changing one variable — production of alternate engine vehicles — as an additive factor without having to make complete predictions of the future in the absence of a conversion. If there is no conversion, the only implicit assumption in Table 18-6 is that automobile unit sales increase at the same percentage rate as consumption of metals, so that the automobile contribution remains constant on a percentage basis. This is a conservative assumption. Historical rates of growth of domestic auto sales are predicted to slow down in the future due to saturation, possible urban driving restrictions, possible increased mass transit, fuel cost and conservation, and other factors as discussed in Chapter 14. The APSES future automobile unit sales projection (Chapter 14) is about a 2.2% per year compounded annual rate. Consumption of many materials is expected to increase at a considerably faster rate than 2.2% per year. Thus the domestic automobile contribution to domestic materials consumption, in the absence of a conversion to an alternative technology or

the addition of more catalysts, is likely, at the most, to remain constant, or more probably to decline on a percentage basis. The calculations of the A and B factors in Table 18-6 are thus conservative and can be looked upon as maxima from this standpoint.

It is further apparent in dealing with a transition scenario of about 15 years, that many manufacturing improvements will be made along the way. The alternate engine vehicle as ultimately produced can be safely assumed to contain less critical materials than has been shown in this analysis. This tends to make the figures presented in Table 18-6 even more conservative and representative of a worst-case condition.

The reader wishing to use his own projection of domestic automobiles sales and total domestic and world consumption of, say, nickel or chromium in 1990, assuming present technology automobiles, can make use of the Table 18-6 data base of pounds of material per alternate engine vehicle and calculate his own growth rate projections for alternate engine vehicle materials. It is believed that the APSES projections in Table 18-6 represent sufficiently conservative estimates, such that reasonable reader projections will not exceed these projections.

It is interesting to note that by the time we reach 1990 (which is considered the earliest for a full conversion to an alternate engine vehicle), there is the distinct probability that success will be achieved in the recommended ceramics development programs. With the advent of ceramics, there is the potential of implementing the Advanced configurations without fully converting to the Mature configurations. If this happens, it will not be necessary for automobiles to consume the projected stainless steel and superalloy requirements shown in Tables 18-5 and 18-6 for Mature configuration alternate engine vehicles.

By inspection of Table 18-6, the additional growth rates of all materials, except cobalt, required to support an alternate engine vehicle conversion are modest. The following sections will discuss the means by which the desired materials may be made available to support the conversion to alternate engine vehicles, if the national interest makes this desirable because of fuel, emissions, cost or other considerations. The possibility of increasing supply and reducing demand of key materials, as well as material reserves and their location, will be discussed along with a host of policy factors.

## 18.6 POTENTIAL TO REDUCE AUTOMOTIVE DEMAND FOR MATERIALS

There is considerable potential to reduce materials demand. Methods of accomplishing this are discussed in Section 18.6.1; the recycling of materials is addressed in Section 18.6.2.

### 18.6.1 Potential to Reduce Materials Usage

There is great opportunity for the automotive industry to develop improved designs and fabrication processes to reduce the amount of critical material required for the manufacture of an automobile. The APSES Mature configuration engines — for which part breakdowns, weights, materials,

processes and costs were developed in the individual heat engine chapters — constitute the most representative designs with our present knowledge. However, as explained in Chapter 15 (Industry Practices), there is an approximate 42-month time period between the decision to produce and the occurrence of "Job 1" for major changes. During this time period extensive manufacturing engineering efforts are executed to reduce the cost and improve the manufacturability of any engine. Cost-effective deviations from the APSES Mature configurations will undoubtedly result. The data presented in this chapter is hopefully in a form which can remain useful. As individual designs are changed, it is a relatively simple matter to reduce the material weights shown in Tables 18-5 and 18-6. It is the opinion of this author that there is potential for a 15 to 35% across-the-board reduction in key materials, such as nickel, chromium and tungsten, as well as potential reduction in cobalt of up to 60%, from an all-out manufacturing engineering effort on any of these alternate engined vehicles.

Another area of possible reduced automotive demand for key materials is in alloy composition. If an alternate engined vehicle is likely to be introduced, the sheer size of the market will provide a large incentive for the metals-producing industry to tailor its research and development on specialty compositions for specific alternate engine applications. This has been done in the past for current automotive components. There are ongoing research and development programs in progress on metals, and it is highly likely that these projects would be accelerated if the introduction of an alternate engine appeared imminent. This type of improvement may come at any time. The industry cannot achieve a full conversion much prior to 1990. Thus, there are 10 to 15 years for technology improvement to be effected in the area of metallurgical alloy compositions.

Another method of reducing materials usage is to adjust the sales-weighted product mix to a large number of smaller cars and/or to reduce the weight of existing cars across the board. As explained in Chapter 10, there is a weight propagation factor by which a pound of weight removed from the engine also allows a weight reduction elsewhere in the vehicle. The auto industry's pledge to the Ford Administration in the fall of 1974 to increase the average gas mileage of their automobiles is based partially on the assumption that they will produce lighter weight cars and probably have a sales-weighted mix of more smaller cars. The "Big Three" have in-house high-strength low alloy (HSLA) steel programs as well as aluminum and plastic substitution research and development programs in progress. There is considerable possibility for significant weight reductions as is further discussed in Chapter 10.

Turning from strictly automotive material requirements to the materials demand situation of the overall U. S. economy, one finds that current (circa 1974) emphasis is on the lack of supply and shortages (e. g., "materials crisis," "energy crisis," etc.). In historical perspective, periods of excess material capacity and supply also have occurred with about the same frequency as periods of material shortages. There is a school of thought that considers the last few years to have

been an abnormal situation of excess material demand that is not likely to soon repeat or be a permanent situation. Quoting from First National City Bank's Monthly Economic Letter of July 1974 (Ref. 18-12):

"As the economic slowdown progresses, this year's famine may turn out to be next year's feast.

"Thomas Robert Malthus and other classical economists of the 19th Century predicted that future economies would run down like unwound clocks for want of raw materials. They were wrong. Their vision of a stationary state was shattered by technological advance. But the forecasts of ever worsening shortages by latter-day Malthusians will founder for another reason — a preoccupation with the supply side of the supply-demand equation.

"In fact, there is little evidence that the world is running out of such raw materials as bauxite, iron ore, or even oil. Where the shortage lies — if indeed there is one — is in the capital facilities for processing these raw materials. A look at the demand side of the equation provides useful insights as to why these apparent shortages emerged — and why they are unlikely to become endemic.

"These industries are extremely capital-intensive manufacturers of commodity-like goods, demand for which is quite sensitive to changes in the business cycle. New capacity tends to appear in large, discrete increments due in part to significant economies of scale and in part to long lead times for the construction of new facilities. Expansion programs tend to produce new capacity to meet expected future demand as well as existing demand. Consequently, these industries tend to move back and forth between capacity famines and feasts, and prices tend to vary substantially at different stages of the expansion cycle as relative supply-demand conditions change."

First National City Bank's scenario (Fig. 18-4) indicates that high capital spending of the 1960's led to a glut of capacity in the early 1970's which pushed profits down to a sufficiently low level that future capital investment was not warranted at that time. In addition, many metal prices were at relatively low points, suffering from the effects of this excess capacity, when price controls were imposed and they were caught at artificially low levels, which exacerbated the situation and further reduced the incentive for new capital investment. Quoting further:

"The amount of excess capacity available in 1971 suggests that if demand had grown at or even slightly above trend rates, existing capacity would very likely have been adequate in 1973. As it happened, demand for basic commodities grew far more rapidly during 1972 and 1973 than

would have been expected on the basis of postwar trends. "

Between 1972 and 1973 the demand for many metals grew on the order of five times their historical growth rate.

"This unusually strong growth in demand suggests that the analysis should focus, not on the shortfall in capacity, but on the excess of demand. Under the best of circumstances, price controls disturb the free-market price mechanism by creating a gap between the actual price of an item and a higher equilibrium price of that item that would be needed to clear the markets. Consequently, buyers tend to shift their consumption forward in time to avoid the price increases that are inevitable when controls are removed. "

As the current economic downturn continues, the excess demand should be eliminated as the incentives for hedge buying are greatly diminished. In fact, substantial quantities of goods purchased for speculative gain in 1973 and early 1974 may well be put on the market along with the normal recessionary correction in inventory levels. Thus it is not at all clear and, in fact, highly unlikely that the material shortages experienced during 1973 are a long-term endemic situation in our economy.

There are, of course, actions the government could take to reduce automotive material demand by fiat. These decisions are by their nature political, public-policy decisions. Examples of these would be mandatory increased utilization of rapid transit, restrictions on automobile driving in urban areas, prohibitive automotive gasoline taxation, or other such policies that would cause less automobiles to be produced and hence utilize less raw materials. Desirability of these policies is not within the purview of this chapter; however, it is necessary to acknowledge that they are possibilities.

#### 18.6.2 Recycling of Materials

Recycling is another area that could reduce automotive demand in the longer term. The figures for the percent of U. S. materials consumption derived from scrap are shown in Fig. 18-3. In the case of nickel and chromium, recycling is already significant, primarily in stainless steels; however, improvements are possible. The ability to recycle scrap is highly dependent on its being successfully segregated by type and knowing its composition. For a mass production industry, such as automobiles, the scrap developed in the production of an alternate engine would be premium scrap (prompt industrial) that would be easy to recycle. As a conversion to alternate engined vehicles progresses, one would expect to observe a corresponding increase in automotive scrap recycling of stainless steel and superalloys. However, recycling does not offer very much in the initial stages of the production of an alternate engine. The ability to significantly increase nickel and chromium recycling is dependent upon advances in technology to make additional sources economically viable and/or increases in price of these materials to allow existing technology to

be more economically competitive. Significant quantities of cobalt or tungsten are probably not available to recycle for an initial fleet introduction of alternate engined vehicles. As the fleet is introduced and replaced, scrap recycling of alloys containing cobalt and tungsten will increase.

Scrap is generally classified into three types: in-house, prompt industrial, and obsolete. In-house scrap is that developed by the metal producer. It is essentially 100% recycled now, so significant improvement is not possible. Prompt industrial scrap is the clean, segregated scrap of a large industrial user, such as an automotive machining facility. This type of scrap also is efficiently recycled as (1) it can usually be processed in rather large batches, (2) there is an economic incentive, (3) there are negligible sorting costs as it is segregated by alloy, and (4) the metal producer is reasonably confident that it will not contain detrimental impurities that will adversely affect the quality of the subsequent metal production. The third category is obsolete scrap - commonly called junk. It is this area that offers the possibility of significant improvements in recycling. To recycle it in an economically efficient manner, it must be collected, sorted and transported. By its nature it is the most expensive of the three types of scrap to recycle. It also serves a sort of peaking function in that it is used to satisfy the remaining scrap demand after the available scrap of the other two categories is utilized. The ability of the U. S. to significantly increase its scrap recycling requires improvements in the obsolete scrap handling system.

There is an economic problem in attempting to increase recycling of obsolete scrap that concerns the action of primary metal producers vs secondary producers. When business is good, primary producers tend to manufacture the premium alloys that provide the highest profit margins, leaving certain lower-quality, lower-margin areas to secondary producers. However, during a recessionary period, primary producers have excess capacity and tend to compete more vigorously in the lower-margin alloys. The secondary producers are often economically squeezed. This has happened over several economic cycles in aluminum, for example. Primary producers, supply patterns are more fixed and less dependent on recycling than secondary producers. Thus, there is a tendency of metal recycling to follow the economic cycle. Scrap metal is a classical volatile-priced commodity, varying from shortage to glut, depending on the point in the economic cycle.

There are several policy areas relative to recycling wherein relief would reduce unnecessary barriers to recycling. For example, some aerospace specifications require superalloy parts to be made solely from virgin material. This may make sense for low-volume, high-reliability spacecraft or aerospace applications. However, if superalloys are utilized in alternate engines, it is assumed that automotive industry specifications would permit recycling.

Another policy area concerns transportation costs. There is currently a law suit meandering through the appellate courts that alleges railroad

shipping rates have been set at discriminatory levels for transporting recycled materials as opposed to virgin materials. If this is in fact true, it would be a clear-cut example of a policy problem, as transportation costs are a major item in a recycling program.

For the longer term, alternate-engined automotive vehicles offer a possibility of component recycling in addition to scrap recycling. For example, the inherent value and expected life of a superalloy Stirling engine heater head could provide an adequate economic incentive to salvage and rebuild the heater head component.

The Mature configuration weights shown in Tables 18-5 and 18-6 are net weights. As previously discussed, they are considered overconservative for the eventual requirements of mass-production. This conservatism is due to the numerous aforementioned reasons (e.g., expected design and process improvements, compositional substitution within alloys, new alloy compositions using less critical materials, specifications to encourage superalloy recycling, across-the-board increased recycling, reduced performance-better producibility options, substitutability of material types, shift to smaller size and weight cars, etc.). Thus for these engineering estimates, it is unnecessary to add an arbitrary scrap allowance to the weights in Table 18-6. Scrap, however, has been considered in the cost projections (see Chapter 11).

#### 18.7 POTENTIAL TO INCREASE THE SUPPLY OF MATERIALS

The National Security Council (Ref. 18-13) completed a study in the fall of 1974 entitled "The Critical Materials Report," which was prepared for the White House and Congress. The report concludes: "The best available data and analysis indicates that there are ample materials in the earth's crust to meet the world's needs for nearly every material well beyond the turn of the century."

The report also lists examples of the unusually high demand for materials experienced in the United States in 1973. This increase in demand over the historical trend caused temporary shortages. To the current widespread view that raw material shortages are a permanent function of our national economy, it predicts the following "These forecasts . . . . do not stand up to close scrutiny. For one thing, they make no allowance for the function of price as a motive to economize on use of natural resources, to develop substitutes, or to recycle scrap material. . . . Proven reserves are constantly increasing through price changes, the discovery of new mineral deposits

and the development of technology allowing the exploitation of previously uneconomical deposits."

Table 18-7 lists the reserves of key minerals in terms of number of years at projected consumption. Reserve figures also have been tabulated in Refs. 18-1 and 18-2. Items of greatest concern to alternate automotive engine production (nickel, chromium, and cobalt) are in the 50- to 100-year reserve class.

The term "reserve" must also be carefully defined as it is an often misinterpreted figure. Quoting from Ref. 18-14: "Most descriptions of mineral resources include only the material that would be mined at today's prices with today's technology - what is properly termed reserves - and thus they understate the availability of these resources. The difference between reserves and resources becomes critically important when one is dealing with the so-called life index - the ratio of reserves to some element of its current consumption. The resulting figure is best regarded as a sort of inventory of stock on the shelf, so to speak, but it is sometimes mistakenly taken to mean the years remaining until exhaustion. In fact, the ratio tends to remain stable over time." Reserves are simply the amount of minerals found to the present time (much of the world hasn't been explored) that are economically recoverable at today's price with today's technology. There is a strong tendency for mineral resources to increase in quantity as the ore quality that can be recovered is reduced (i.e., there is usually more low-grade ore than high grade ore for any given mineral). Quoting again from Ref. 18-14: "Almost every bit of evidence we have indicates the existence of vast quantities of mineral resources that could be mined and further, that either as their price goes up or as their cost goes down (which is to say as technology of extraction improves) the volume of mineable material increases significantly - not by a factor of 5 or 10 but by a factor of 100 or 1000. The real question then is not whether resources exist but at what rate different sources of supply will become available to man in the sense of becoming economically feasible to recover. Natural materials do not become resources until they are combined with man's ingenuity. Over time the record is impressive. Mineral resources have become more and more widely available despite (and partly because of) growing rates of consumption."

The future of ocean mining is another factor not considered in reserve figures. The potential for extracting manganese, copper, nickel, cobalt, and other materials from ocean nodules is high. As ocean extraction technology increases with

Table 18-7. Time that currently known reserves of materials will last at projected rates of consumption (from Ref. 18-13)

10-15 years	15-25 years	26-50 years	51-100 years	100+ years
Mercury	Copper	Manganese	Iron ore	Columbium
Silver	Lead	Bauxite	Chromite	Potash
	Tin	Platinum	Nickel	Phosphorus
	Zinc	Molybdenum	Vanadium	Magnesium
	Tungsten	Titanium	Cobalt	
	Barite	Antimony		

Table 18-8. World production of nickel, in short tons (from Ref. 18-3)

Country	1968	1969	1970	1971	1972
Albania	N. A. <sup>a</sup>	N. A.	N. A.	N. A.	N. A.
Brazil	1,186	1,200	2,762	3,500	1,588
Burma	32	33	23	20	—
Canada	264,358	213,611	305,296	293,947	265,000
Cuba (estimated)	37,150	38,800	38,800	40,000	40,000
Finland	3,751	4,207	4,600	5,133	5,689
Greece	4,769	6,400	10,000	11,600	—
Indonesia	8,663	8,404	19,842	29,762	—
Morocco	335	311	152	220	—
New Caledonia	88,018	99,731	116,143	112,751	101,444
Poland	1,650	1,650	1,650	2,000	—
Rep. of So. Africa	6,100	10,000	12,739	14,067	38,400
U. S. A. <sup>b</sup>	13,124	13,096	12,649	13,073	17,000
U. S. S. R. (est)	110,000	116,000	121,000	130,000	135,000
World total <sup>c</sup>	547,960	532,537	685,186	706,069	602,533

<sup>a</sup>N. A. = data not available.

<sup>b</sup>Recovery from domestic ore refined and by-product of copper refining.

<sup>c</sup>Includes small quantities from Southern Rhodesia and other areas.

time and the price of these materials increases in the future, the process of ocean mining may well become economically viable. When this happens, reserve figures of the previously mentioned materials take a huge increase.

Now that the adequacy of minerals in the ground has been established, the next question is: where are they located and who owns them? Individual materials will be analyzed in the subsequent section.

#### 18.8 THE POTENTIAL FOR INCREASING THE SUPPLY OF SPECIFIC KEY MATERIALS

This section discusses the identified key materials for the conversion to alternative automotive engines. These are nickel, chromium, cobalt and tungsten.

##### 18.8.1 Nickel

Current free world nickel consumption is about a billion pounds per year, with U. S. domestic consumption being about 40% or 400 million pounds per year as shown in Tables 18-8 and 18-9. Current U. S. usage for 1975 automobiles is about 11% of domestic consumption and about 4.5% of world consumption. World production of nickel by country of origin is shown in Table 18-8. The rate of growth of free world nickel consumption is shown in Fig. 18-5. Nickel consumption has grown at a compound annual rate of 6 to 6-1/2% per year and has been predicted by the president of INCO (Ref. 18-15) to continue at this rate for the foreseeable future. The supply-demand relationship for nickel is shown in Fig. 18-6, and the consumption patterns by end usage are shown in Table 18-9. Reserves (Table 18-10) presently known are of the order of magnitude of 100 years' consumption, conservatively stated. Country of origin of these reserves is shown in Table 18-10. It should be noted that our main

source of current imports is Canada, which is a friendly country. Domestic nickel production is small (under 10% of domestic consumption), as only one area is economically competitive. However, this does not mean that the United States does not have any long-term nickel potential. Lower grade ore is found in the U. S. In the longer term, with a significant improvement in extraction technology, a considerable amount of this resource could be converted to a reserve. The possibility of ocean mining of manganese nodules that also contain nickel is another longer term potentiality for increased domestic nickel self-sufficiency. It has been estimated (Ref. 18-16) that, on a long-run basis, the United States could be domestically self-sufficient in nickel if world conditions required us to undertake a "Project Independence" program in nickel. Today, it is economically desirable (cheaper) to import our nickel. However, if improved technology is made available, it would allow other options if they are later desired. Nickel is not currently stockpiled.

##### 18.8.2 Chromium

World production of chromium is about 1,800,000 tons per year, based on chromium content of chromite ore. About 500,000 tons of chromium per year are consumed in the United States, consisting of about 425,000 tons from new production and about 75,000 tons from recycled scrap. The auto industry used about 8% of domestic consumption and about 2.3% of world consumption for precatalyst cars. From 1975 on, assuming a production of 10,000,000 General Motors Model 260 type catalysts, an additional 14,000 tons of chromium or 2.8 lb per unit is required. This raises the chromium consumption by the auto industry to about 11% of domestic and 3.1% of world consumption.

Chromite is not mined in the United States. Production by country of origin is shown in

Table 18-9. U.S. consumption of nickel, exclusive of scrap, by uses, as reported by the U. S. Bureau of Mines, in short tons (from Ref. 18-3)

	1962	1963	1964	1965	1966	1967	1968	1969	1970
<b>Ferrous:</b>									
Stainless steel	29,711	34,140	48,301	51,700	65,910	53,936	44,858	39,458	40,769
Other steels	18,608	19,727	24,679	27,009	27,807	23,661	29,014	23,864	20,874
Cast iron	5,503	5,901	6,605	6,937	7,286	6,596	6,322	5,588	4,934
<b>Non-ferrous<sup>a</sup></b>	28,215	24,794	23,639	37,082	57,303	47,400	47,048	48,974	42,333
<b>High-temperature<sup>b</sup> and electrical-resistance alloys</b>	12,862	13,505	15,291	18,464	5,423 <sup>b</sup>	4,311 <sup>b</sup>	3,886 <sup>b</sup>	12,709 <sup>c</sup>	11,626
<b>Electroplating:</b>									
Anodes	16,953	18,621	19,446	19,450	13,828	23,721	21,914	20,031	25,525
Solutions <sup>d</sup>	904	1,050	1,645	2,037	1,925	4,041	3,522	20,031	25,525
Catalysts	1,566	1,613	2,167	2,241	e	e	e	e	e
Ceramics	439	554	529	501	e	e	e	e	e
Magnets	910	777	664	828	807	896	748	N. A. <sup>f</sup>	2,430
Other	3,006	3,796	3,954	5,835	7,544	6,019	8,319	8,348	7,228
<b>Total, partly estimated</b>	118,677	124,478	146,920	172,084	187,833	173,798	159,306	141,737	155,719

<sup>a</sup>Comprises copper-nickel alloys, nickel-silver, brass, bronze, beryllium alloys, magnesium and aluminum alloys, Monel, Inconel and malleable nickel.

<sup>b</sup>Hi-temp. alloys under non-ferrous alloys or with heat-resisting under stainless.

<sup>c</sup>Now superalloys.

<sup>d</sup>Figures do not cover all consumers.

<sup>e</sup>Now included in "other" group.

<sup>f</sup>N. A. = data not available.

Table 18-11. Reserves are of the order of magnitude of 100 years' consumption as shown by country of origin in Table 18-12. The supply-demand relationship for chromium is exhibited in Fig. 18-7. Chemical, metallurgical, and refractory chromite are maintained in the national stockpile (Table 18-13) along with chromium metal and ferrochromium in amounts considerably in excess of what has been listed as the national

Table 18-10. Nickel reserves by country of origin (from Ref. 18-2)

Country	Nickel, 10 <sup>6</sup> lb
Australia	2,000
Canada	20,000
Cuba	36,000
Dominican Republic	1,600
Guatemala	2,000
Indonesia	16,000
New Caledonia	33,000
Philippines	9,000
U. S. S. R.	20,000
United States	400
Other	7,000
<b>Total</b>	<b>147,000</b>

objective. The excess chromium stockpiled over the stated national objective is equal to about 4 years' domestic consumption. The United States has some lower grade chromium-bearing ore which could be put into production only with a significant government subsidy or a huge increase in the world price. The United States will remain dependent on foreign sources for chromium over the foreseeable future. Quoting from Ref. 18-2, "chromium is a strategic and critical commodity . . . whose importance to defense and industrial needs is unlikely to diminish by the year 2000. Stockpiles of both ore and alloys will remain a necessity, and foreign relationships with producing countries will remain essential to insure a continued supply. Some substitution for chromium in stainless and alloy steels will continue by metals such as molybdenum, vanadium, and columbium. However, these are not as satisfactory as chromium for most uses and cannot be expected to decrease its demand greatly."

### 18.8.3 Cobalt

Current world production of cobalt is approximately 50,000,000 lb per year. Table 18-14 shows the country of origin of cobalt production. Current United States domestic consumption (Table 18-15) is about 15,000,000 lb per year.

Table 18-11. World production of chromite, in short tons  
(from Ref. 18-3)

Country	1968	1969	1970	1971	1972
Albania	360,000	473,000	516,000	590,000	671,000
Cuba	N. A. <sup>a</sup>	N. A.	N. A.	N. A.	N. A.
Greece	14,300	27,000	29,000	27,000	26,000
India	226,698	250,000	299,000	288,000	310,000
Iran (Est.)	99,000	165,000	220,000	220,000	198,000
Japan	30,745	33,000	36,000	35,000	27,000
Pakistan	28,683	25,000	32,000	27,000	36,000
Philippines	446,282	517,000	624,000	476,000	388,000
So. Rhodesia (Est.)	420,000	400,000	400,000	400,000	400,000
Turkey	459,000	500,000	572,000	665,000	710,000
So. Africa Rep.	1,270,667	1,320,000	1,573,000	1,812,000	1,635,000
U. S. S. R. (Est.)	1,820,000	1,874,000	1,930,000	1,980,000	2,040,000
Total (Est.) <sup>b</sup>	5,335,610	5,865,000	6,672,000	6,936,000	6,841,000

<sup>a</sup>N. A. = data not available.

<sup>b</sup>Includes Guatemala, Yugoslavia, Cyprus, Egypt, Australia, Bulgaria, Malagasy, Brazil, Colombia, and Rumania.

The supply-demand relationship for cobalt is shown in Fig. 18-8. The usage of cobalt in current automobiles is negligible. Cobalt reserves are huge, with reserves by country of origin shown in Table 18-16. Domestic reserves of cobalt are minimal and of relatively low quality. Hence, it is unlikely the U.S. could be self-sufficient in cobalt in the foreseeable future. Dependence on the foreign sources listed in Table 18-14 will continue. However, there is a large amount of cobalt in the national stockpile. In early 1974, there was approximately 60 million lb of cobalt stockpiled versus a national goal of 11 million lb. Thus 49 million lb, or better than 3 years' domestic consumption, is classified as excess. In the longer term, ocean mining of cobalt is a possibility. Increased production of cobalt, in conjunction with selective release from the excess in the national stockpile, if required, is more than adequate to provide the amount of cobalt

required for the production of alternate engine vehicles. As in the case of chromium, an adequate stockpile of cobalt should be maintained to alleviate the threat of disruptions by cartels or other exogeneous factors. The cobalt weights required by the alternate engine vehicles as listed in Table 18-6 also are considerably higher than what is likely to be needed. When performing research and development programs to develop a new technology, it is rational to first select the best technically performing alloy. Later, when going into mass production, producibility options that consider availability are maximized. Nickel and cobalt have a certain amount of substitutability in superalloys. If cobalt became in short supply in the future, it would probably be possible to formulate superalloys with more nickel and less cobalt. Also, cobalt is shown as being used in applications such as high-temperature investment cast HS-31 turbine inlet housings. It seems highly probable that, prior to a full conversion, the automobile industry would develop the technology to allow cheaper, more available materials such as cast iron to be used with a ceramic liner for some of these applications.

Table 18-12. Chromium reserves by country  
(from Ref. 18-2)

Country	Chromium, thousand short tons
Republic of South Africa	575,000
Southern Rhodesia	175,000
U. S. S. R.	15,000
Turkey	3,000
United States	2,000
Finland	2,000
Philippines	1,000
Canada	1,000
India	1,000
Total	775,000

#### 18.8.4 Tungsten

Current world production of tungsten is about 80,000,000 lb per year as shown in Table 18-17. Current U. S. domestic consumption is about 16,000,000 lb per year. The supply-demand relationships for tungsten as well as the countries of origin are shown in Fig. 18-9. Tungsten reserves by country of origin are displayed in Table 18-18. Domestic production accounts for over 50% of domestic consumption of tungsten. There is a huge amount of tungsten in the national stockpile. In early 1974, there was approximately 79,000,000 lb of tungsten stockpiled vs a national goal of 4,000,000 lb. Thus,



Table 18-13. National stockpile objectives as of Jan. 1, 1974 (from Ref. 18-3)  
Source: General Services Administration

Commodity	Unit	Objective	In stockpile early 1974
Aluminum	ST	0	456,530
Aluminum oxide	ST	50,905	50,905
Antimony	ST	0	40,702
Bauxite, metal, Jamaica	LDT	4,638,000	8,858,881
Bauxite, metal Surinam	LDT	0	5,300,000
Bauxite, refractory	LCT	0	173,000
Beryl	ST	0	17,988
Bismuth	LB	950,900	2,101,061
Cadmium	LB	4,446,500	8,442,119
Chromite, chemical	SDT	8,400	568,138
Chromite, metallurgical	SDT	44,710	1,952,802
Chromite, refractory	SDT	54,000	970,973
Chromite, metal	ST	0	6,957
Chromium, ferro, high carbon	ST-E	11,476	402,001
Chromium, ferro, low carbon	ST-E	0	298,570
Chromium, ferro, silicon	ST-E	0	55,608
Cobalt	LB	11,945,000	60,123,614
Columbium	LB	0	4,365,219
Copper (oxygen)	ST	0	60,112
Lead	ST	65,100	829,063
Manganese, battery, natural	SDT	10,700	253,451
Manganese, battery, synth. diox.	SDT	0	14,114
Manganese ore, chemical, A	SDT	12,800	146,586
Manganese ore, chemical, B	SDT	12,800	100,238
Manganese, metallurgical	SDT	750,500	3,705,400
Mercury	FL	42,700	200,007
Molybdenum	LB	0	38,007,478
Nickel	ST	0	0
Platinum group, iridium	TrOZ	1,800	16,990
Platinum group, palladium	TrOZ	328,500	1,253,994
Platinum group, platinum	TrOZ	187,500	452,645
Rutile	SDT	0	42,651
Silicon carbide, crude	ST	0	196,452
Silver, fine	TrOZ	21,663,000	139,500,000
Tantalum	LB	45,000	201,033
Thorium Oxide	ST	0	3,519,847
Tin	LT	40,500	231,012
Titanium Sponge	LB	0	27,708
Tungsten	LB	4,234,000	79,535,612
Vanadium	ST	0	540
Zinc	ST	202,700	639,251

Unit abbreviations: FL—flask; LB—pound; LCT—long calcined tons; LDT—long dry tons; SDT—short dry tons; ST—short tons; TrOZ—troy ounces.

75,000,000 lb, or about 5 years' domestic consumption, is classified as excess. Increased production of tungsten in conjunction with selective release from the excess in the national stockpile, if required, is more than adequate to provide the amount of tungsten required for the production of alternate-engined vehicles.

#### 18.9 POLICY FACTORS AFFECTING SUPPLY AND DEMAND OF MATERIALS

The preceding sections have shown that there are adequate reserves of all of the required minerals in the world to implement a conversion to an alternate engined vehicle fleet. The question now becomes one of what policies are

required to have the desired materials available when they are needed.

Lead times required for opening new, or expanding old, mines and for constructing smelting, refining, and rolling mill capabilities for stainless steels and superalloys are generally within the 42-month cycle for an initial automobile engine introduction.

A possible problem is how much risk the metals industry will be willing to bear. It is important to note that from the point of view of the metal-producing industry, the problem of excess capacity and oversupply has been about as frequent as periods of shortage, and has posed more severe problems for the industry. When

Table 18-14. World production of cobalt, in pounds (from Ref. 18-3)  
Source: American Bureau of Metal Statistics and, in recent years, Bureau of Mines

	Canada <sup>a</sup>	U. S. S. R.	Zambia <sup>b</sup>	Zaire <sup>b</sup>	French Morocco <sup>c</sup>	Cuba <sup>d</sup>	United States	World Total <sup>e</sup>
1957	3,922,649	28,000	3,166,000	17,890,329	992,070	N. A.	4,143,988	31,800,000
1958	2,710,429	34,000	2,062,000	14,322,105	2,204,600	N. A.	4,844,083	29,200,000
1959	3,150,027	32,000	4,814,000	18,586,983	2,660,952	198,000	2,993,709	34,600,000
1960	3,568,811	28,000	3,860,000	18,348,886	2,802,047	136,000	f	31,400,000
1961	3,236,323	28,000	3,402,000	18,356,000	2,844,000	N. A.	f	31,800,000
1962	3,481,922	36,000	1,896,000	21,230,000	3,166,000	362,000	f	34,200,000
1963	3,024,965	38,000	1,556,448	16,093,580	3,022,507	1,040,000	f	32,000,000
1964	3,184,983	38,000	1,426,000	17,062,000	3,700,000	1,600,000	f	35,000,000
1965	3,648,332	164,000	3,766,000	18,468,000	4,078,000	1,760,000	f	37,700,000
1966	3,427,926	214,000	3,566,000	24,818,000	4,298,000	2,020,000	f	44,200,000
1967	3,604,000	3,000,000	3,208,000	21,424,000	4,250,000	2,300,000	f	44,028,000
1968	4,030,000	3,200,000	2,964,000	22,924,000	3,324,000	2,800,000	f	41,968,000
1969	3,256,000	3,300,000	3,994,000	23,360,000	3,108,000	3,400,000	f	43,338,000
1970	3,700,000	3,400,000	4,907,000	30,128,000	666,000	1,700,000	f	50,358,000
1971	4,323,000	N. A.	4,158,000	N. A.	2,156,000	N. A.	f	N. A.
1972	3,748,000	N. A.	4,500,000	N. A.	2,400,000	N. A.	f	N. A.

<sup>a</sup>Metal recovered from smelter products plus content of residues exported. Prior to 1967, Australian output recovered from zinc concentrate.

<sup>b</sup>Cobalt content of alloys.

<sup>c</sup>Content of ore.

<sup>d</sup>Recovered from sulfide slurry.

<sup>e</sup>Totals include Finland, Australia, W. Germany.

<sup>f</sup>Not available, but small.

materials are in tight supply and prices are up, profits are usually satisfactory and creditors and stockholders are reasonably satisfied. Management may possibly be criticized for not having maximized their profits had they had a greater capacity, but from a risk standpoint, this situation is minimal. However, the case of overcapacity, declining prices, and low or non-existent profits may often lead to stockholders and creditors taking action to replace management. Thus the bias in the practice of the metals industry dictates that management be conservative in its expansion plans. For the metals industry to significantly increase production in one of the minor elements, such as cobalt, in order to support the production of an alternate engine, and then for that engine to be cancelled or delayed would result in a large inventory of a material for which no other ready market exists (other than a possible bailout to the national stockpile).

The experience of implementing catalysts on 1975 automobiles provides a possible model. Precious metals were contracted for annual purchases over a long-term basis of up to 10 years by General Motors and other automobile manufacturers several years in advance of initial delivery, thus shifting some of the risk off the metal producers. It is logical to assume that metal producers will expect some assurances that alternate engines will be introduced and some sharing of the risk by contract prior to expanding production of a material for which little other market exists.

The ability of the metals industry to expand production depends on its earning an adequate rate of return to attract new investment capital. Of course, there are other competing demands on capital. Capital also must be available to be attracted. It is obvious that a business or lender should expect a higher rate of return on foreign investments that run a potential risk of nationalization. The challenge to national policy is to provide an adequate framework of policies under which the metals industry will have an adequate business incentive to increase capacity by the desired amount and for the required capital to be available.

The general concern with the dependence on foreign sources of supply for minerals has been shown not to be analogous to the petroleum situation. As previously discussed in Section 18.2, no one individual metal is dependent upon a group of countries with anywhere near the same unity of purpose as the Arab states of OPEC, or with the same lack of need for additional revenue to develop their countries as the Arab states. Attempted cartels in copper have occurred previously in history and have failed. The most recent attempted cartel in copper also has failed. As of this writing (January 1975), the world price of copper has already fallen back to approximately its 1971 to 1972 level as may be observed by inspection of a graph of spot copper prices on the London Metal Exchange.

Table 18-15. Consumption of cobalt in the United States, in thousands of pounds (from Ref. 18-3) Consumption by uses, and comprising metal, oxide, purchased scrap, cobalt-nickel compound salts and driers, and ore used directly in magnets and other industrial applications. Reported by U. S. Bureau of Mines

Use	1969	1970	1971	1972 <sup>a</sup>	1973
<b>Metallic uses:</b>					
High-speed steel	570	534	318	325	N. A.
Other steel	360	250	247	248	N. A.
Permanent-magnet alloys	2,560	2,374	2,278	3,422	N. A.
Cast cobalt - chromium - tungsten - molybdenum alloys	3,675	N. A.	N. A.	N. A.	N. A.
Alloy hard-facing rods and materials	302	181	246	185	228
Cemented carbides	660	N. A.	N. A.	N. A.	N. A.
Other metallic, incl. non-ferrous alloys	1,147	981	902	1,273	N. A.
<b>Total metallic (incl. not specified)</b>	<b>11,021</b>	<b>10,751</b>	<b>9,006</b>	<b>N. A.</b>	<b>N. A.</b>
<b>Non-metallic uses:</b>					
Ground-coat frit	133	129	137	143	163
Pigments	191	155	146	122	136
Catalysts, other non-metallic	1,385	402	536	142	177
<b>Total non-metallic</b>	<b>1,709</b>	<b>686</b>	<b>819</b>	<b>407</b>	<b>476</b>
Salts and driers: lacquers, varnishes, paints, inks, pigments, enamels, glazes, feed, electroplating, etc. (est.)	2,577	2,616	2,744	1,987	2,673
<b>Grand total<sup>b</sup></b>	<b>15,390</b>	<b>13,367<sup>a</sup></b>	<b>12,500</b>	<b>11,448</b>	<b>15,133</b>

<sup>a</sup>Estimated by AMM. N.A. = data not available.

<sup>b</sup>Includes some items not listed.

For those materials for which the U. S. is heavily dependent upon foreign sources of supply, the U. S. policy since WW II has been to maintain a protective stockpile. The overhang of this stockpile has been effective over the last 30 years in prohibiting any severe disruptions to our economy

Table 18-16. Principle cobalt reserves of the world (from Ref. 18-2)

Country	Million pounds
Canada	386
Congo (Kinshasa)	1,500
Cuba	744
Morocco	28
New Caledonia	880
U. S. S. R.	450
United States	56
Zambia	766
<b>Total</b>	<b>4,810</b>

from foreign cartels in metals. (The reader is encouraged to look carefully at Fig. 18-2, which shows the countries of origin of key materials.) The national stockpile has been adjusted in accordance with the government's assessment of supply risks. There certainly is no reason that this cannot continue to be done in the future in an effective manner. The presence of several years' domestic consumption of a mineral in the stockpile is a powerful policy weapon to protect the U. S. economy from any supply disruptions. In the event world conditions change, the stockpile may be adjusted accordingly. It has been estimated by Osborne (Ref. 18-16) and others that the U. S. could, if need be, become self-sufficient in iron ore and aluminum. The verdict is still to be rendered on the success, or lack thereof, of the bauxite cartel currently being attempted. Long-term price limits on aluminum are probably less than doubling, say 50% increase, at which time it becomes economical to consider major domestic mining efforts in the aluminum-bearing clays prevalent in the U. S. In considering the countries of origin of our foreign supply

Table 18-17. Salient tungsten statistics (from Ref. 18-1)  
 Thousand pounds of contained tungsten and thousand dollars

	1967	1968	1969	1970	1971
United States:					
Concentrate:					
Production	8,465 <sup>a</sup>	8,663 <sup>a</sup>	7,805	9,625	6,900
Shipments	7,842	9,042	7,910	9,312	6,827
Value	\$14,574	\$20,293	\$18,770	\$23,790	\$20,184
Consumption	13,860	11,038	13,053	16,700	11,622
Releases from Government stocks	6,393	3,225	38,314	15,066 <sup>a</sup>	1,381
Exports <sup>b</sup>	974	623	7,151	19,470	2,006
Imports, general	2,004	1,824	1,534	1,299	577
Imports for consumption	1,699	1,743	1,503	1,284	418
Stocks, Dec. 31:					
Producers	1,007	626	519	787	863
Consumers	1,134	574	1,066	1,467	2,657
Primary products:					
Production	12,604	10,538	13,334	17,605	11,730
Consumption	13,663	13,108	16,056	15,352	11,159
Stocks, Dec. 31:					
Producers	5,168	4,747	3,392	4,569	3,722
Consumers	2,518	2,364	1,778	2,698	2,541
World:					
Ore and concentrate:					
Production	62,725	68,380	71,754	75,554	80,728
Consumption	62,628	64,410	76,650	83,574	65,859

<sup>a</sup>Revised.

<sup>b</sup>Estimated tungsten content.

of raw materials, the reader is invited to reflect upon our foreign policies relative to some of these countries. Foreign policy is not the subject of this study; however, one can consider what extent our policy with regard to the Rhodesian chromium import ban is influenced by having about 4 years' domestic consumption of chromium in the strategic stockpile. The United States clearly has within its capability the power and the tools to prevent our economy from being seriously disrupted by foreign metal cartels.

Another area that is often mentioned as a possible restriction on increasing production of

Table 18-18. Reserves of tungsten by country of origin (from Ref. 18-2)

Country	Million pounds (tungsten content)
Australia	25
Bolivia	87
Brazil	40
Burma	70
Canada	24
China (mainland)	2,100
Korea, South	101
Malaysia	32
Portugal	22
U. S.	190
U. S. S. R.	27
Other	105
Total	2,823

metals is that of trained manpower. It is true that the college enrollments in mining engineering (Ref. 18-17) have generally been static or decreasing in the United States. There has been a general shift to "material science" with a high percentage of graduates finding employment in electronics, aircraft, aerospace, chemicals and other industries generally perceived to be more "glamorous." Traditionally, metal production often involves employment in remote areas of the world, or in less-than-desirable domestic living areas. As engineering graduates have traditionally been imbued with a bit of the spirit of the "world's oldest profession," if the proper incentives (i. e., money) are made available, the required manpower will become available. The reader should make his own interpretation as to what extent industry or university manpower requirement forecasts are self-serving, with the intention of industry to maintain an overabundance of qualified workers relative to the available needs (i. e., forecasts of scientific and engineering needs during the height of major aerospace unemployment) or professors to justify their department. There is no reason that increased metal production to support the needs of any alternative automotive engine need be restricted for lack of trained manpower.

The Bureau of Mines has estimated (Ref. 18-16) a potential 100 billion dollar cumulative deficit in our balance of payments for 90 commodities (excluding oil) by extrapolation to the year 2000. This deficit in balance of payments for raw materials is not undesirable if raw material imports can be balanced by exports of manufactured

goods and services. Quoting from Ref. 18-18: "Self-sufficiency is not available in total and may not even be desirable — other countries need our markets and trade with them is mutually advantageous." When looking at the dollar value of the balance of payments deficit for raw materials, (excluding petroleum), the largest component is iron ore followed by bauxite. About 30% of iron ore is imported (because it is cheaper — not because the U.S. could not be self-sufficient, if that became necessary). To the extent that future economic conditions make it mandatory for the United States to reduce its balance of payments deficit on raw materials, an increased domestic self-sufficiency in conventional materials, such as iron and aluminum, would be needed to make a significant impact. The amount of additional imports of metals such as nickel, chromium and cobalt to produce alternate-engined automobiles is insignificant in the overall balance of payments situation when compared to petroleum, or the more widely used conventional automotive materials. To the extent that domestic mineral production is increased when it is economically viable, the nation gains additional leverage in international markets and an increased material security.

Another way of looking at automotive materials consumption is to put it into perspective. It has been estimated (Ref. 18-19) that the entire world's fleet of automobiles represents approximately 6 months of world production of metals on an aggregate basis. From this perspective, the automobile's contribution to metal consumption looks much smaller, considering the economic importance of the world automotive industry to our society.

Increased production of minerals has both energy and environmental implications. The production of more of any material requires additional energy. However, improvements in extraction technology may reduce the requirement. There also is a general trend that energy requirements increase as lower grade ores are worked. Recycling has been reported (Ref. 18-20) to be a means of reducing energy requirements. This is particularly true in the cases of magnesium and aluminum, where theoretical thermodynamic energy requirements of secondary production can be as low as 5% of primary production. Little is known about the energy utilized in the collection, transportation, separation, and mechanical processing of the material to be recycled, although this is being given increased attention. The energy expended in these operations, of course, partially offsets the energy savings obtained in refining. Because of this, the optimum amount of recycling will always be smaller than the physically possible maximum. To put energy requirements in perspective, it may be estimated that direct automotive energy usage is in the range 85-90% for fuel, 7-10% for materials production and 3-5% for fabrication and assembly of the automobile, based on a 10-year, 100,000-mile life of current fleet average cars. Thus, the greatest potential for energy conservation is in improving automobiles' miles-per-gallon fuel economy.

With regard to the environment, metal producers have been highly criticized as a source of air and water pollution. Producers, on the other

hand, have countered that environmental restrictions have caused delays, increased prices, and contributed to shortages. There is, of course, some validity to both arguments. The optimum balance to society becomes a value judgment, and the challenge to policy makers is to provide safeguards that adequately protect the environment while allowing reasonable growth to continue. Quoting from Ref. 18-14: "Population growth and monetary income growth lead to demands for national resources that necessitate their being found and produced regardless of the implications. Since such high rates of production are geologically and economically sustainable, we should choose among alternative paths of growth, and hence among alternative rates of mineral resource development according to what we like or dislike about these implications. The key information will not be found in tables comparing reserves and consumption, but in preferences and ethics."

It may be concluded that the world is capable of supplying the required materials to produce any of the alternate heat-engined vehicles discussed herein, in virtually any quantity desired, if a real commitment is made to do so.

#### References

- 18-1. Osborn, E. F., et al., Minerals Yearbook, Vol. I, Metals, Minerals, and Fuels, 1971, U.S. Dept. of Interior/Bureau of Mines.
- 18-2. Vogely, W. A., et al., Mineral Facts and Problems, 1970, U.S. Department of Interior/Bureau of Mines.
- 18-3. American Metal Market Staff, Metal Statistics — 1974, Fairchild Publications Inc., 7 E. 12th St., New York, N. Y. 10003.
- 18-4. American Bureau of Metal Statistics, Staff, Yearbook of American Bureau of Metal Statistics — 1973, A. B. M. S., 50 Broadway, New York, N. Y. 10003.
- 18-5. Metal Progress, September 1974, pp. 7.
- 18-6. Metal Progress, November 1974, pp. 46.
- 18-7. Klaff, J. L., Caldwell, L. K., et al., Material Needs and the Environment - Today and Tomorrow, Final Report of the U.S. National Commission on Materials Policy, June 1973, L. C. N., 73-600202.
- 18-8. Mining and Minerals Policy Act, Second Annual Report, Department of Interior/Bureau of Mines, 1970.
- 18-9. Hightower, J. W., et al., "An Evaluation of Catalytic Converters for Control of Automobile Exhaust Pollutants," Committee on Motor Vehicle Emissions, National Research Council, September 1974.
- 18-10. "Manufacturing Cost Study of Selected Gas Turbine Automobile Engine Concepts," United Aircraft Laboratories, August 1971.

- 18-11. "Automotive Gas Turbine Optimization Study," The Garrett Corp., AiResearch Division, July 1972.
- 18-12. "Monthly Economic Letter," First National City Bank, July 1974.
- 18-13. The Critical Materials Report, National Security Council, 1974, as summarized in USN&WR, December 9, 1974.
- 18-14. Brooks, D. B. and Andrews, P. W., "Mineral Resources, Economic Growth, and World Population," Science, July 5, 1974.
- 18-15. Iron Age, December 9, 1974.
- 18-16. Osborn, E., "Mineral Resources Problem and What We Can Do About It," Memorial Lecture at Caltech, October 1974.
- 18-17. Business Week, October 5, 1974.
- 18-18. McKelvey, V. E., "Approaches to the Mineral Supply Problem," Technology Review, March 1974.
- 18-19. Leach, G., "The Motor Car and Natural Resources," Organization for Economic Cooperation and Development, Paris, 1973.
- 18-20. Bever, M. B., "Raw Materials: Energy and Environmental Constraints," Science, July 12, 1974.

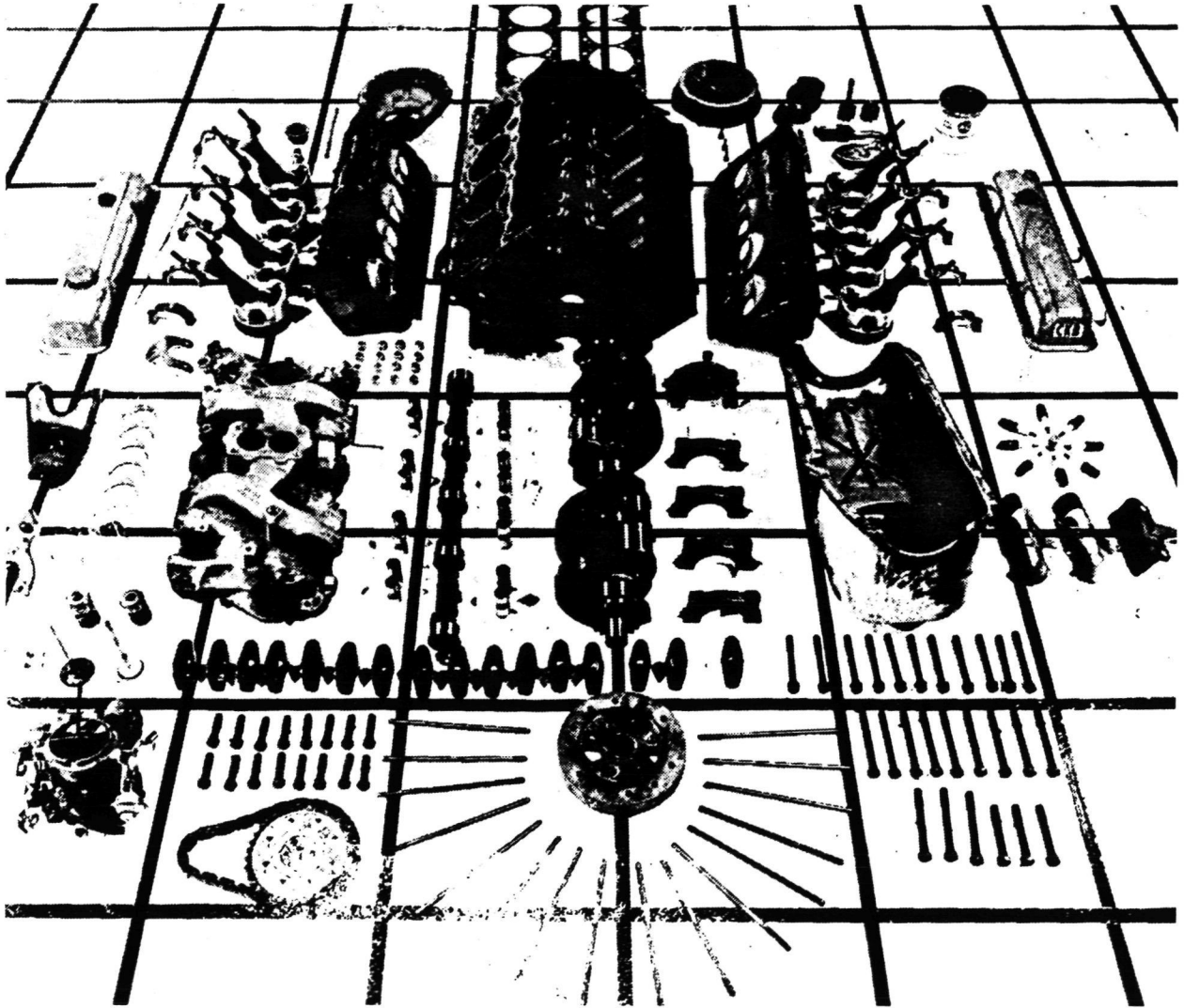
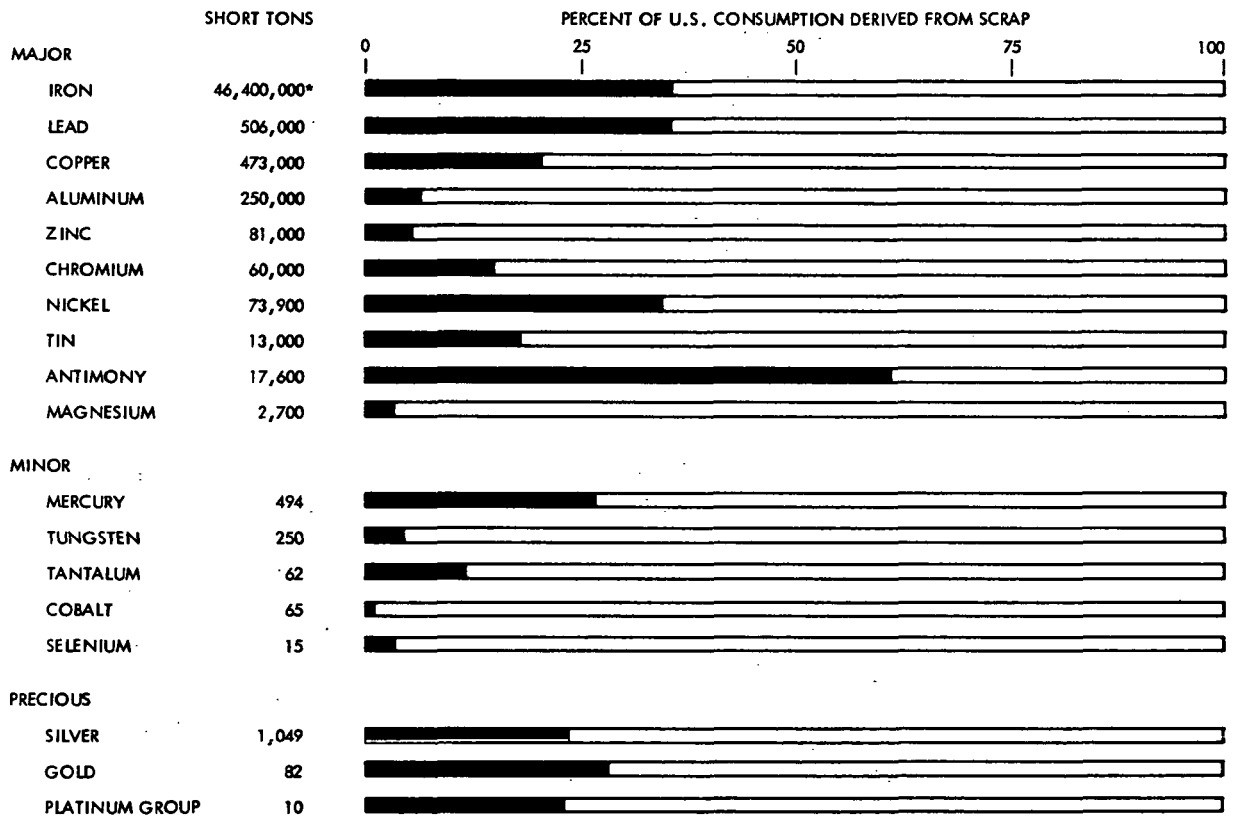

Fig. 18-1. Disassembled 1972 V-8 automobile engine



Fig. 18-2. Percentage of U.S. mineral requirements imported during 1972 (from Ref. 18-7)





BUREAU OF MINES: 1973

\*INCLUDES EXPORTS

Fig. 18-3. Scrap recycling in the U.S. (Refs. 18-7, 18-8)

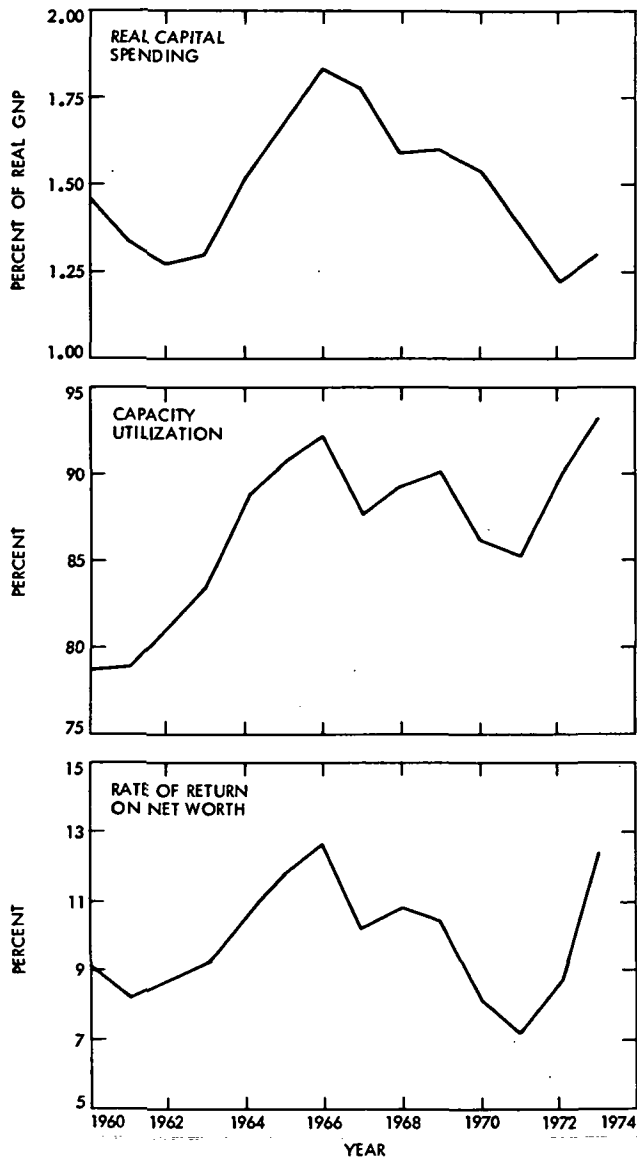

Fig. 18-4. Capital spending, capacity utilization, and return on investment for basic processing industries (from Ref. 18-12). These series on basic processing industries include data for primary metals, paper, chemicals, textiles and petroleum. (Sources: Department of Commerce, Federal Reserve Board, Citibank)

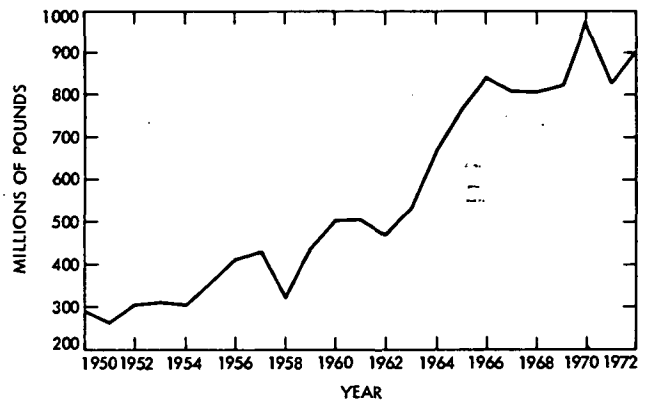

Fig. 18-5. Free world nickel consumption (from Ref. 18-3)

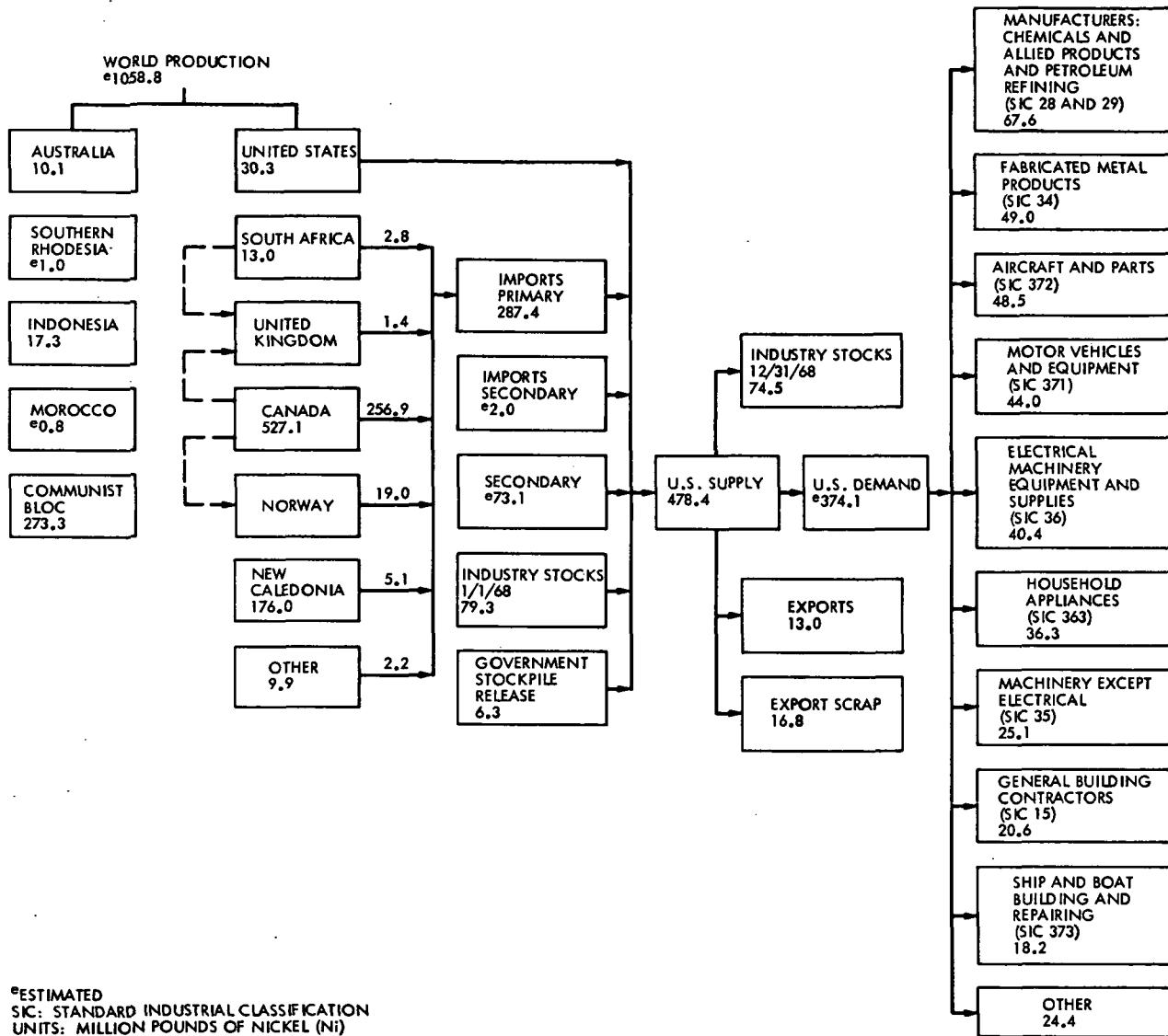

Fig. 18-6. Supply-demand relationship for nickel, 1968 (from Ref. 18-2)

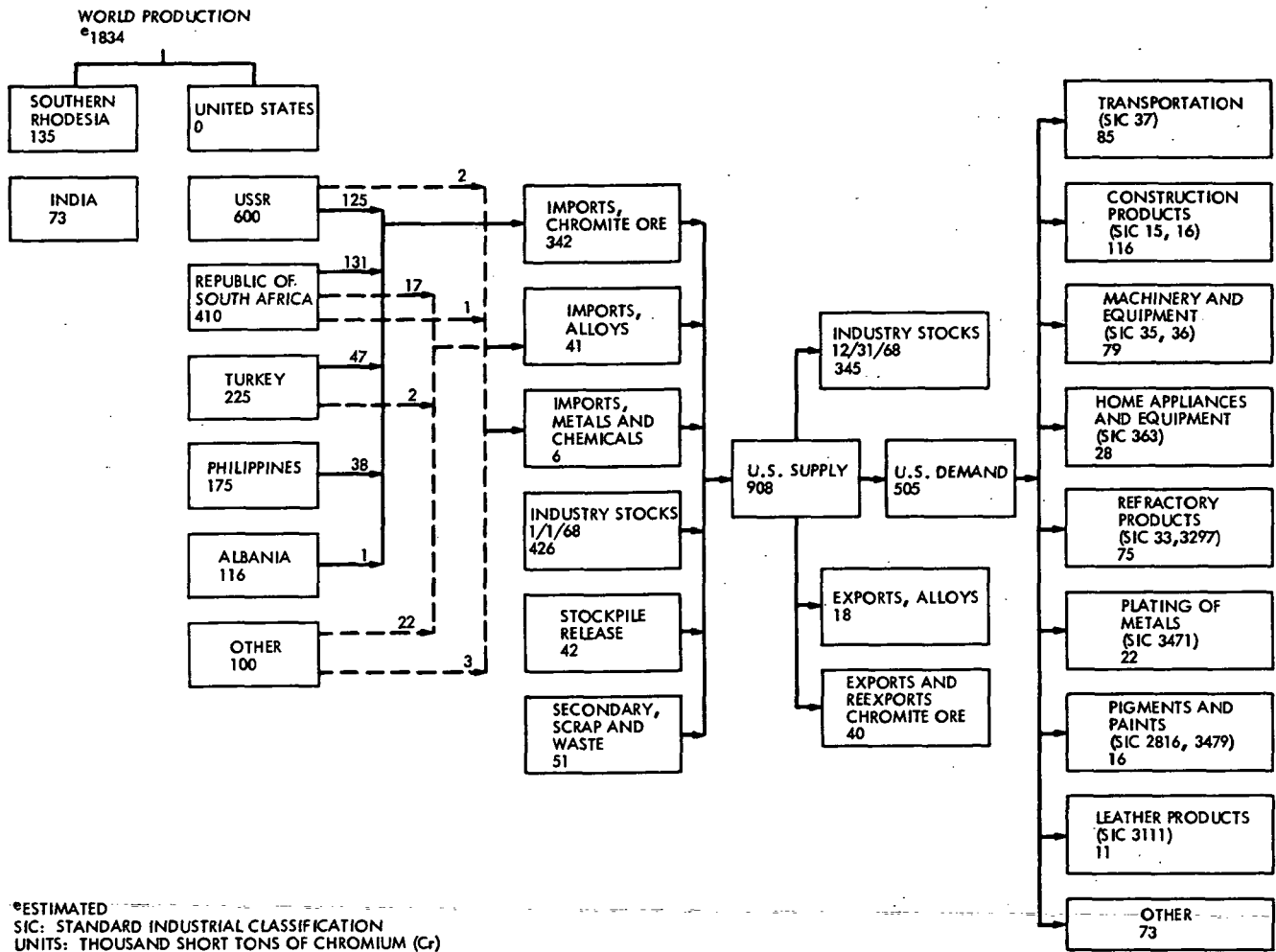

Fig. 18-7. Supply-demand relationship for chromium, 1968 (from Ref. 18-2)

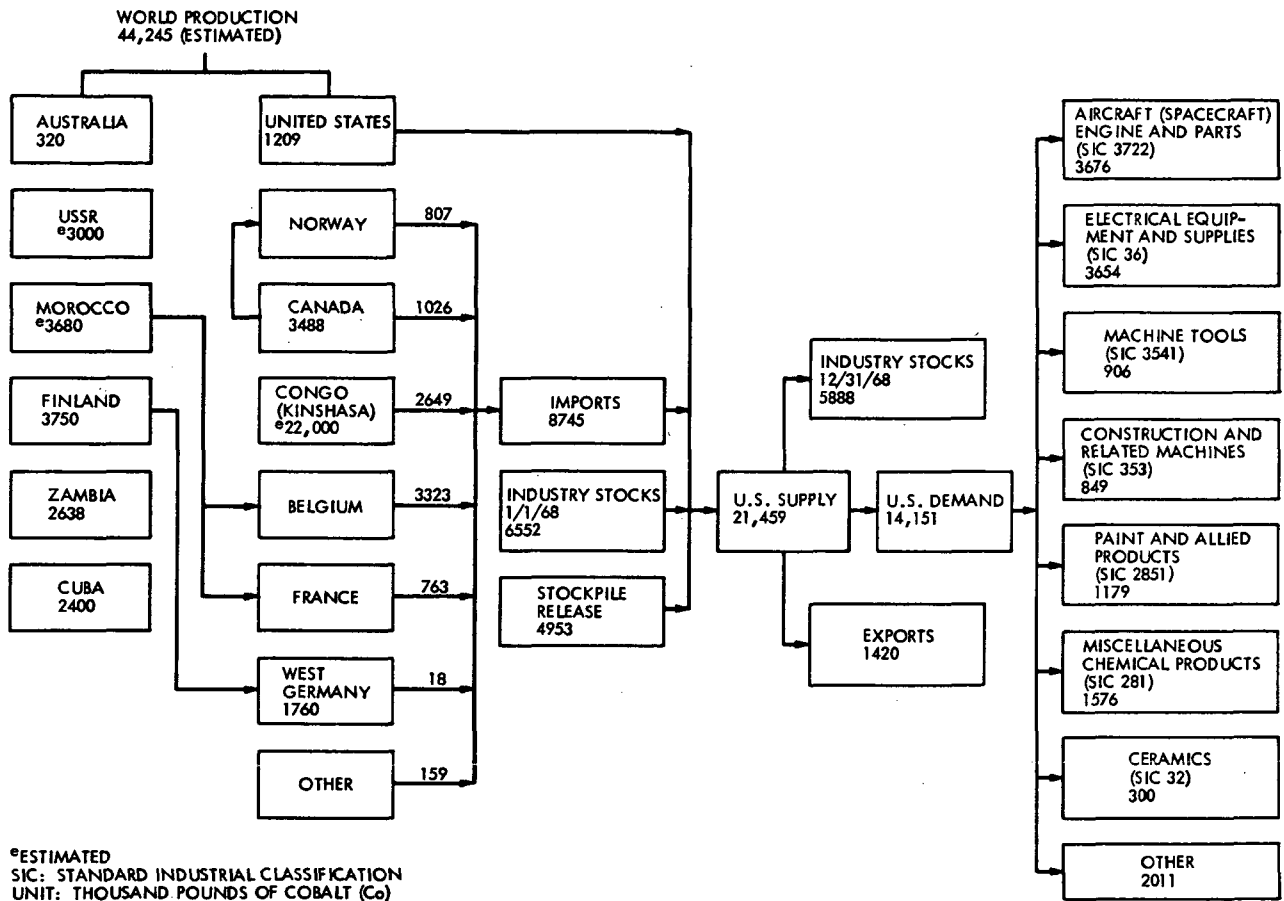

Fig. 18-8. Supply-demand relationship for cobalt, 1968 (from Ref. 18-2)

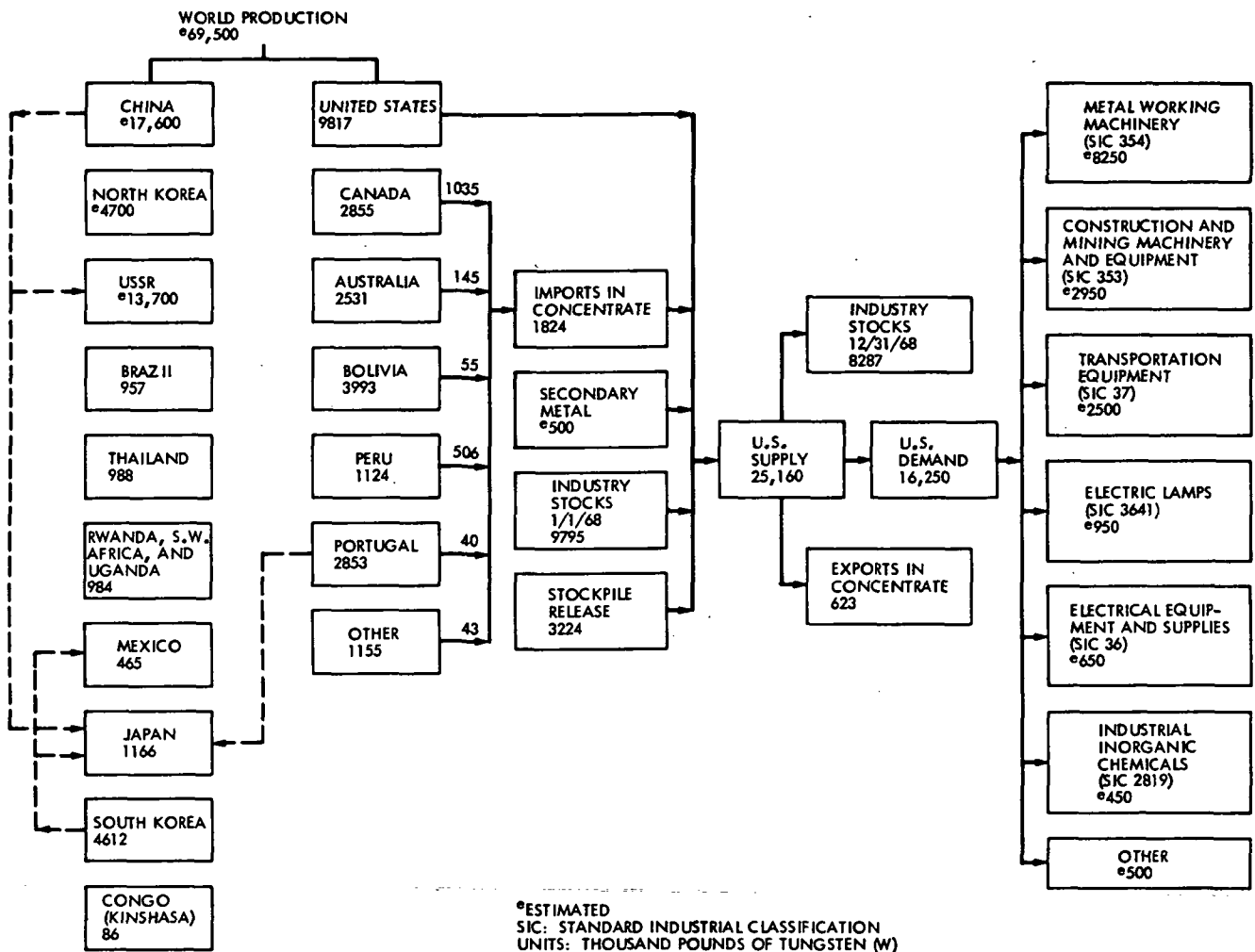

Fig. 18-9. Supply-demand relationship for tungsten, 1968 (from Ref. 18-2)

CHAPTER 19. AIR QUALITY IMPACT STUDY

19.1	Introduction . . . . .	19-2
19.1.1	Effect of Auto-Related Air Pollution . . . . .	19-2
19.1.2	National Ambient Air Quality Standards . . . . .	19-2
19.1.3	Present Air Quality and Percentage of Auto-Generated Emissions in Various Cities . . . . .	19-2
19.1.4	Relationship Between Emissions and Air Quality . . . . .	19-3
19.1.5	Study Approach . . . . .	19-4
19.2	Air Quality Impact of New Car Emission Control in Selected Regions . . . . .	19-5
19.2.1	Los Angeles . . . . .	19-5
19.2.2	New York . . . . .	19-12
19.2.3	St. Louis . . . . .	19-14
19.3	Summary of Regional Emission Controls Required to Meet Air Quality Standards . . . . .	19-17
19.3.1	Carbon Monoxide (CO) Emission Control . . . . .	19-17
19.3.2	Oxides of Nitrogen (NO <sub>x</sub> ) Emission Control . . . . .	19-18
19.3.3	Reactive Hydrocarbon (RHC) Emission Control . . . . .	19-21
19.4	Unregulated Auto Emissions . . . . .	19-21
19.5	Uncertainties and Limitations . . . . .	19-22
19.6	Conclusions . . . . .	19-24
	References . . . . .	19-25
	Appendix 19-A. Emission Inventory and Projection Assumptions . . . . .	19-27
	Figures . . . . .	19-35

## 19.1 INTRODUCTION

This chapter deals with the impact of mass introduction of alternative engines on urban air quality. This section will briefly review the present air pollution problem in urban areas and define the study approach.

### 19.1.1 Effect of Auto-Related Air Pollution

In most urban areas of the United States where air pollution problems persist, automobile emissions account for 60 to 85% of carbon monoxide (CO), 50 to 75% of reactive hydrocarbon (RHC) emissions and about 20 to 50% of total nitrogen oxides (NO<sub>x</sub>) emissions. These emissions, either by themselves or through their secondary products from atmospheric chemical processes, are harmful to human health if their concentrations in the ambient air reach certain levels for certain periods of time. Carbon monoxide interferes with oxygen transport in the body by displacing oxygen from hemoglobin. Nitrogen dioxide (NO<sub>2</sub>), which results from NO<sub>x</sub> emissions, may cause pulmonary symptoms in chronic or acute exposure. Photochemical oxidants (O<sub>x</sub>), which result from RHC and NO<sub>x</sub> emissions participating in photochemical reactions, contain mainly ozone (O<sub>3</sub>) and a small amount of other accompanying oxidants. Ozone may reduce pulmonary function, and other accompanying products are believed to cause eye irritation. Clinical and epidemiological studies have been documented in the HEW air quality criteria series (Refs. 19-1, 2, 3, 4) and in a comprehensive review by the National Academy of Science (Ref. 19-5).

In addition to the gaseous emissions discussed above, automobiles also emit suspended particulate matter and sulfur dioxide (SO<sub>2</sub>), which may cause pulmonary symptoms (Refs. 19-5, 6, 7). However, since the automobile presents a less serious problem for suspended particulate matter and SO<sub>2</sub>, compared with stationary sources, we have not included suspended particulate matter and SO<sub>2</sub> in the main stream of the following analysis. We shall address this problem later in the chapter.

Aside from health effects, there is also air pollution damage to plants and property. Although the economic impact may be large, this damage has been considered as less urgent compared with health effects. A review of available studies can be found in Ref. 19-8.

### 19.1.2 National Ambient Air Quality Standards

The Federal Environmental Protection Agency promulgated National Primary Ambient Air Quality Standards on April 30, 1971, for protection of public health, based on earlier findings (Refs. 19-1 through 19-7). Regarding CO, NO<sub>2</sub> and oxidants, the standards establish the following allowable upper limits of concentration:

Carbon monoxide (CO):	9 parts per million (ppm), 8 hour average, not to be violated more than once a year,
-----------------------	---

Nitrogen dioxide (NO <sub>2</sub> ):	0.05 ppm, annual arithmetic mean,
Oxidants (O <sub>x</sub> ):	0.08 ppm, one hour average, not to be violated more than once a year.

The recent NAS study has confirmed the present air quality standards (Ref. 19-5), but the need for more studies is emphasized. It also suggests consideration of an additional hourly standard for NO<sub>2</sub> because of the evidence of its acute effect on health. It does not consider the effect of oxides of nitrogen (NO<sub>x</sub>) on the photochemical smog formation, which involves reactive hydrocarbon, oxides of nitrogen, and, possibly, carbon monoxide (Ref. 19-55).

The EPA has also promulgated a set of secondary ambient air quality standards for protection of plants and property. We have not included them in our considerations since they are intended to solve problems which are considered to be less urgent than the health-related problem.

In what follows, we shall take national air quality standards as referring to the health-related primary air quality standards.

### 19.1.3 Present Air Quality and Percentage of Auto-Generated Emissions in Various Cities

Based on the 1972 air quality data compiled by the EPA (Ref. 19-9 and NADB<sup>1</sup>), the urban areas with highest maximum concentrations of pollutants and with enough data from statistically reliable measurements are presented in Table 19-1. The number of times (or days) in 1972 that the national air quality standards were violated in these cities can be estimated by using the frequency distribution curves (Ref. 19-10).

It is apparent from Table 19-1 that all these cities violated the O<sub>x</sub> standard of 0.08 ppm and the CO standard of 9 ppm in 1972. The NO<sub>2</sub> standard of 0.05 ppm was violated only in Los Angeles, New York, and Chicago, with St. Louis and San Diego being just under the standard. The indication that NO<sub>2</sub> standard violations exist only in a few cities is reflected in the recent EPA reclassification of 42 out of 47 regions originally designated as NO<sub>2</sub> problem areas (Ref. 19-11). This follows the Agency's realization that the previous reference monitoring method for NO<sub>2</sub>, the Jacob-Hochleiser method, was in error (Ref. 19-12).

The present percentage contributions of automobile emissions in these cities are indicated in Table 19-2. Since automobile engines are also used in light duty trucks (trucks

<sup>1</sup>National Aerometric Data Bank at Research Triangle Park, North Carolina, operated by EPA.



Table 19-1. Maximum pollutant concentrations in 1972 in metropolitan areas

Area	Oxidants ppm, 1-hour ave.	CO <sup>a</sup> ppm, 8-hour ave.	NO <sub>2</sub> <sup>a</sup> ppm, annual mean
Los Angeles	0.50	38	0.088
New York	0.21	57	0.062
San Diego	0.26	16	0.045
St. Louis	0.16	17	0.049
Denver	0.18	26	0.044
Chicago	0.14	19	0.062
Philadelphia	0.14	27	b
Washington, D. C.	0.13	33	0.047
Boston	b	15	b
Baltimore	b	17	b

<sup>a</sup> Derived from 1-hour data in (Ref. 19-9) by Larson method (Ref. 19-10).

<sup>b</sup> Insufficient data.

under 6000 lb gross vehicle weight), we have shown the percentage emissions from all light duty-vehicles in Table 19-2 (about 90% of the light-duty-vehicle emissions comes from the automobiles alone). Also shown in Table 19-2 are total regional emissions from all sources as a reference. Total regional emissions should not be used to compare the severity of the problem in these regions since the populations and land areas are different. The percentage contribution of light duty vehicles helps to indicate the difference in emission patterns from region to region.

It is clear from Table 19-2 that light duty vehicles are the major source of RHC and CO emissions in all areas listed. They are a major contributor of NO<sub>x</sub> in Los Angeles and a minor contributor of NO<sub>x</sub> in Manhattan, New York (where power plants and heavy duty trucks emit more), with NO<sub>x</sub> contributions in other areas falling in between.

#### 19.1.4 Relationship Between Emissions and Air Quality

Models relating air quality to regional emissions are needed to assess the effect of emission reduction strategies on the ambient air quality. Since carbon monoxide is a relatively stable gas in the atmosphere we can assume its concentration will be directly proportional to CO emissions (Ref. 19-23). Maximum nitrogen dioxide (NO<sub>2</sub>) concentrations also appear to be proportional to oxides of nitrogen (NO<sub>x</sub>)

emissions in the smog chamber or in the atmosphere. However, oxidant (O<sub>x</sub>) concentrations have a highly non-linear relationship to the precursor pollutants: reactive hydrocarbon (RHC) and NO<sub>x</sub> (Ref. 19-24). Laboratory data have also shown (Ref. 19-25) that NO<sub>x</sub> inhibits the formation of O<sub>x</sub> in the short term (2 hours) but increases O<sub>x</sub> formation over a longer reaction time (6 hours)<sup>2</sup>.

In the atmosphere over an urban region, this relationship is much more complicated than in a smog chamber, because of the meteorological effects as well as the spatial and temporal variations of emission sources. Atmospheric emissions/air quality models are still evolving, especially in the area of relating O<sub>x</sub> formation to emissions of RHC and NO<sub>x</sub> precursors. Mathematical models have been proposed with various degrees of sophistication (e. g., Refs. 19-26 to 19-29). A comprehensive review of the state of the art can be found in the recent National Academy of Sciences study (Ref. 19-23).

For this study, we have chosen to use the linear rollback models in relating the ambient CO concentrations in the regional CO emissions, and the ambient NO<sub>2</sub> concentrations to the regional NO<sub>x</sub> emissions. Since linear rollback models neglect changes in the spatial distributions of emission sources, we shall choose, wherever necessary, a subregion surrounding the monitoring station with the highest recorded pollutant concentrations in the studied region as a basis for emission inventory. We shall also base our calculations on the entire frequency distribution of pollutant concentrations in a

<sup>2</sup> This phenomenon helps to explain why a small increase in NO<sub>x</sub> emissions in Los Angeles may increase the O<sub>x</sub> concentration in downwind areas such as Riverside, while decreasing the O<sub>x</sub> concentration in downtown Los Angeles (Ref. 19-25).

Table 19-2. Contribution of light duty vehicle (LDV) emissions in various regions, 1970-1973

Region	RHC		CO		NO <sub>x</sub>	
	All sources, tons/day <sup>a</sup>	LDV, %	All sources, tons/day <sup>a</sup>	LDV, %	All sources, tons/day <sup>a</sup>	LDV, %
Los Angeles <sup>b</sup>	1880	65	13670	79	1370	52
New York <sup>c</sup>	440	66	330	72	860	16
San Diego <sup>d</sup>	190	70	1200	85	170	46
St. Louis <sup>e</sup>	270	71	2210	72	80	42
Denver <sup>f</sup>	200	73	1320	79	220	38
Chicago <sup>f, g</sup>	1300	54	7250	62	1630	27
Philadelphia <sup>f</sup>	870	58	5500	64	--	--
Washington, D.C. <sup>f</sup>	400	75	2630	80	500	34
Boston <sup>f</sup>	470	70	2430	83	460	33
Baltimore <sup>f</sup>	290	65	1950	68	470	23

<sup>a</sup>Total regional emissions are presented here for reference only. They should not be used to compare the severity of the problem in various regions since the land areas and populations are different.

<sup>b</sup>L. A. Air Quality Control Region (AQCR), also known as the South Coast Air Basin in California, about 8670 square miles. Estimates based on Refs. 19-13 through 19-16.

<sup>c</sup>For RHC and NO<sub>x</sub>, the region is a 400-square-mile area surrounding Manhattan. For CO, Midtown and Downtown Manhattan. Estimates based on Refs. 19-16 through 19-19.

<sup>d</sup>San Diego County. Estimation based on Ref. 19-20.

<sup>e</sup>For RHC and CO, the region is the St. Louis Urban-in-Fact Area including the city, the county, and others, about 2700 square miles. For NO<sub>x</sub>, the region is St. Louis City only. Estimation based on Ref. 19-21, 22.

<sup>f</sup>Regions are the AQCR's as defined by EPA. Emission data are from the EPA National Emission Data System (NEDS), which contains much larger uncertainty than data for the first 4 areas. They only serve to indicate the nature of the problem. Estimation of RHC was made assuming 0.8 reactivity for moving source HC emissions and 0.3 reactivity for stationary source HC emissions.

<sup>g</sup>NEDS CO data adjusted per information from Chicago official.

year (i. e., the Larson approach, Ref. 19-10) to ensure that a single anomalous maximum concentration does not bias our results.

We have also chosen to use the modified, non-linear rollback curves of Barth (Ref. 19-30) and Schuck and Papetti (Ref. 19-31) to indicate the influence of RHC emissions on the maximum ambient O<sub>x</sub> concentrations. Here the same care is exercised in selecting subregions for emission inventory and in utilizing the frequency distribution of a year's concentration data for statistical consistency. These curves relate empirical maximum daily O<sub>x</sub> concentrations to the corresponding early morning non-methane hydrocarbon concentrations. But they have not included the effect of NO<sub>x</sub> emission changes on the O<sub>x</sub> air quality. As discussed in the NAS study (Ref.

19-23), further research in oxidant air quality modeling is needed so that future evaluations can be based on sounder principles.

#### 19. 1. 5 Study Approach

Although our original question concerns the effect of alternative auto engines on the air quality, we found it more relevant to define our approach in a broader framework which includes other sources of emissions as well. Stationary source emissions have been significantly reduced in the past. While the federal and local new-car emission standards are expected to reduce effectively light-duty-vehicle emissions in the near future, control of other moving sources-such as heavy duty vehicles-and further reduction of emissions from stationary sources have not received comparable attention.

It therefore appears that non-auto emissions will become more important in the future for urban areas where air pollution problems continue to exist.

It is also important to realize that the air pollution problem in each urban region is unique. The relation between air quality and emission depends on the meteorological and geographical features of the region, as well as the composition of its total emissions from various emission sources, as indicated in Table 19-2. It is very difficult to define "typical" cities in this respect, and it will not serve our purpose to consider total emissions on a nationwide basis, although such an emission study on a nationwide or worldwide basis may be useful for other purposes.

We have therefore chosen three cities, Los Angeles, New York and St. Louis, for detailed study. These are cities with large populations, serious air pollution problems, different emission patterns, and extensive data on air quality and emission inventory, which is of practical importance to the study. The lessons gained from study of these cities should also shed light on the nature of the problem and possible solutions for other urban areas.

In each of the three cities we first select the monitoring station with the highest reading of pollutant concentration (and with statistically valid data as judged by the method of measurement and the amount of data gathered). We then obtain the emission inventory for a reference year (1970 for Los Angeles and New York, 1972 for St. Louis) and identify the contribution from every source type. A level of allowable regional emissions can then be estimated by the modified rollback models discussed in the previous section. These estimates, even with their uncertainties, serve as a planning goal for attaining the national ambient air quality standards.

The projected emissions into the 1980's are obtained as follows: The baseline stationary source emissions, as well as emissions from airplanes, ships, and railroad trains, are projected mainly based on existing and planned actions documented by local agencies (Ref. 19-13, 14, 17), projections of previous studies (Ref. 19-18, 21), and projections of private utility companies (Ref. 19-32). Emissions from heavy duty vehicles are projected based on local vehicle-miles-travelled (VMT) growth rates and emission factors in grams-per-mile as provided by the EPA (Ref. 19-16). Emissions from motorcycles are projected for Los Angeles only, based on Ref. 19-15 and Ref. 19-33, since no information is available for the other two cities. Emissions from other moving sources, such as airplanes, ships, and railroads, are obtained from the same information sources as the stationary emissions.

The emissions from light duty vehicles are estimated based on statistical data in grams per

mile for the present fleet and on planned new car emission standards for the future fleet. Projections of vehicle-miles-travelled by light duty vehicles were estimated in Ref. 19-34. They are used, together with emission grams-per-mile data for cars of each model year, to calculate the total light-duty-vehicle emissions in a future year with the standard method as suggested by the EPA (Ref. 19-16).

In discussing various emission reduction strategies, we have assumed no VTM-restricting transportation control measures, nor have we assumed hardware retrofit (since we are interested in the 1980's). Only new car emission control is considered.

Having obtained a clear picture of how the regional emissions will change in the future due to various auto emission control levels, we shall subsequently evaluate additional non-auto source controls (and their costs) based on available information.

## 19.2 AIR QUALITY IMPACT OF NEW CAR EMISSION CONTROL IN SELECTED REGIONS

Figures 19-1, 2, 3 show the study areas in Los Angeles, New York, and St. Louis where emission inventory and air quality data are collected. The regional characteristics concerning land area, population, and total VMT (by both light duty vehicles and heavy duty vehicles) are given in Table 19-3. It is seen that although Los Angeles has the highest per-capita VMT, New York has the highest per-square-mile VMT and the highest population density.

The average summer afternoon mixing height is about 600 to 800 meters in Los Angeles, 1300 to 1500 meters in New York, and 1600 to 1800 meters in St. Louis (Ref. 19-35). The low inversion layer and intense solar radiation in Los Angeles help to explain why the Los Angeles basin experiences the worst levels of photochemical smog, even though New York and its surrounding areas have greater VMT and population densities.

### 19.2.1 Los Angeles

#### AIR QUALITY DATA

The frequency distributions of the one-hour averages of the NO<sub>2</sub> and O<sub>x</sub> measurements at the most polluted locations in the basin (Ref. 19-36) are given in Figs. 19-4, 5 for the year 1970, which is the year used as the reference year for control planning by the State of California (Refs. 19-14, 15). The highest 1970 annual arithmetic mean of NO<sub>2</sub> concentration in the basin was 0.093 ppm, recorded at Pasadena. The highest 1970 one-hour maximum O<sub>x</sub> concentration in 1970 was 0.61 ppm, recorded at Azusa<sup>3</sup>. Both peak measurements are consistent with other points on

<sup>3</sup> Recently, it was realized that O<sub>x</sub> measurement using the EPA and California Air Resources Board (CARB) procedure (neutral buffered KI) gives about 30% higher readings than the Los Angeles Air Pollution Control District (LAAPCD) method (neutral unbuffered KI). Official investigation (Ref. 19-37) indicates that the APCD method is about 5% too low and the EPA-ARB method is about 25 to 30% too high. The 1970 recorded highest O<sub>x</sub> reading in the basin was 0.62 ppm at Riverside, using the EPA-ARB method. The actual reading should have been 0.48 ppm using a suggested correction factor of 0.78 (Ref. 19-37). The 1970 highest O<sub>x</sub> concentration should have been 0.61 ppm recorded at Azusa, where the highest recorded concentration was 0.58 ppm using the LAAPCD method.

Table 19-3. Regional statistics

	Population, 10 <sup>6</sup>	Land area, 1000 mi <sup>2</sup>	VMT <sup>a</sup> 10 <sup>6</sup> mi/day	Population density, 10 <sup>3</sup> /mi <sup>2</sup>	VMT <sup>a</sup> density, 10 <sup>3</sup> mi/day/mi <sup>2</sup>	VMT <sup>a</sup> per capita, mi/day/person
Los Angeles AQCR	9.72	8.7	163	1.12	18.7	16.8
St. Louis Urban-in- Fact area	2.20	2.7	29	0.81	10.7	13.2
New York study area	7.22	0.4	32	18.05	80	4.4
New York- New Jersey- Connecticut AQCR	18.7	8.0	182	2.34	22.7	9.7

<sup>a</sup>Total vehicle-miles-travelled including both light duty vehicles (LDV) and heavy duty vehicles (HDV).

the frequency distribution curves in Figs. 19-4, 5. For CO concentrations, only the 1-hr averages are contained in the summary statistics published by the California Air Resources Board (Ref. 19-36) or the Environmental Protection Agency (Ref. 19-9). We have estimated the frequency distribution of 8-hr average concentrations based on the 1-hr-average concentration data by the Larson method (Ref. 19-10). The highest recorded 8-hr average concentration of CO in the basin in 1970 was 41 ppm at Reseda. This reading is used to adjust the absolute level of estimated frequency distribution by a slight amount (about 10% lower). The resultant frequency distribution curve for 8-hr CO concentration is given in Fig. 19-6.

#### REQUIRED EMISSION REDUCTION

Assuming negligible background concentrations of CO and NO<sub>2</sub>, the linear rollback models call for 78% CO emission reduction and 46% NO<sub>x</sub> reduction from the 1970 levels in order to satisfy the national ambient air quality standards. Neglecting background concentration of O<sub>x</sub>, the Shuck-Papetti (Ref. 19-31) rollback curve as shown in Fig. 19-7, requires 95% reduction of RHC from the 1970 level based on the Azusa measurement.

The natural background levels of CO and NO<sub>2</sub> are believed to be too small (1 ppm of CO and 0.004 ppm of NO<sub>2</sub> according to Ref. 19-38) to affect the estimated required reduction of CO and NO<sub>x</sub> in any essential way. The natural background level of O<sub>x</sub> has been put at 0.04 ppm (Ref. 19-38). Other estimates have indicated the existence of a sizable amount of RHC emissions previously unaccounted for in Los Angeles County (Ref. 19-39, 40). If these background effects prove to be true, the effort of O<sub>x</sub> abatement in Los Angeles to achieve the 0.08 ppm air quality standard will be considerably more difficult.

#### EMISSION INVENTORY AND PROJECTIONS

The CO, NO<sub>x</sub>, and RHC emissions in the Los Angeles AQCR are estimated for the period 1970-1990. In general, the initial inventory of stationary source and aircraft, ship, railroad emissions in 1970 is based on Table VI-3-1 of the State Implementation Plan (Ref. 19-13). The projections are calculated based on appropriate annual compound growth rates and controls presently planned by the State and the EPA (Refs. 19-13, 14). For emissions from light duty vehicles (LDV, including automobiles and light duty trucks), heavy duty vehicles (HDV), and motorcycles the estimate is made using VMT projections, emission factors in grams per mile (for each model year car), fleet age distribution, and considerations of the effects of speed and performance deterioration. The procedure of computation follows the method acceptable to EPA (Ref. 19-16). See Chapter 13 for a description of our scenario generation computer program.

The assumptions on these basic parameters are listed in the appendix of this chapter for stationary sources, aircraft, ships, and railroads first, followed by the assumptions on gasoline HDV, diesel HDV, motorcycles and LDV.

Some important assumptions which make this inventory different from previously published ones are worth mentioning here. First, the heavy duty vehicle population was recently revised by the Air Resources Board (Ref. 19-39, 42) to almost 3 times the previous estimates, after a previous misunderstanding of truck registration data was uncovered. This change is reflected in the present inventory. The diesel truck emission from the ARB study (Ref. 19-39) corresponds to about 150 miles/day; we have lowered this number to reflect diesel truck driving specific to the Los Angeles basin. Second, power plant NO<sub>x</sub> emissions are changed to reflect about 3% per year demand growth, a recent switch from gas to oil due to gas shortage, and the planned nuclear power plant expansion at San Onofre which is expected to start operation in 1981 (Refs. 19-32,

43) and is estimated to reduce NOx emissions from oil-fired power plants in the basin by about 70 tons/day.

For each pollutant, several scenarios of new car emission controls are considered. The carbon monoxide (CO) control scenarios are presented in Table 19-4, where case 1 represents present control followed by the Federal statutory control; case 2 represents the present standard held constant all through 1990; and case 3 represents Federal statutory control from 1978 with further reduction in 1983.

The hydrocarbon (HC) emission control scenarios are presented in Table 19-5 for both the exhaust emission control and the evaporative emission control. Case 1 represents the present emission level through 1977 and Federal statutory standard of exhaust emission and compliance of evaporative emission at 0.2 m/mi (corresponding to the level of evaporative emission standard of 2 g/test) from 1978. Case 2 represents the 1975 model-year exhaust emission standard of 0.9 g/mi and the estimated actual evaporative emission of 2.1 g/mi (Ref. 19-8), to be held constant through 1990. Case 3 is similar to Case 2 except that the evaporative emission is controlled since 1978 - to illustrate the effect of evaporative control. Case 4 is similar to Case 1 except for further tightening of the exhaust emission standard since 1982.

The oxides of nitrogen (NOx) emission control scenarios are presented in Table 19-6. Case 1 represents the present emission level through 1977 and Federal statutory standard from 1978. Case 2 is the present level of emission held constant through 1990. Case 3 represents a medium level of control, at 1 g/mi from 1978. Case 4 is similar to case 1 except for further standard tightening after 1983.

The projected emission inventory for each pollutant is shown in Tables 19-7, 8, 9, where the light duty vehicle emissions correspond to the Federal statutory standard control (Case 1 in Tables 19-4, 5, 6) for each pollutant.

The effect of various control scenarios listed in Tables 19-4, 5, 6 are depicted in Figs. 19-8, 9, 10, where the emissions from other sources are plotted from data in Tables 19-7, 8, 9. In addition to a vertical axis showing emissions in tons-per-day we have also included axes showing the approximate levels of pollutant concentrations corresponding to the emission levels (based on the assumed air quality/emission models) and the approximate frequencies of standard violations (based on the Larson analysis model, Ref. 19-10).

The purpose here is to indicate the degree of air quality improvement and is not to make precise prediction of air quality in the future since the air quality models contain considerable uncertainty.

## EMISSION CONTROL STRATEGY DISCUSSIONS FOR LOS ANGELES

### Carbon Monoxide (CO) Emission Control

It is apparent from Fig. 19-8 and Table 19-7 that, with the present planned control, gasoline HDV will contribute most of the CO emissions in the basin after 1980. Under this condition, the air quality standard can never be met by the LDV CO control Case 1 (3.4 g/mi after 1978) alone, although the number of violations of the air quality standard will be reduced to less than 5 per year.

It appears that Case 1 control of LDV is needed rather than the relaxed Case 2 (9 g/mi through 1990) to help approach the CO air quality standard. Case 3 (1 g/mi after 1983) only reduces CO by 300 tons/day in 1990; this is small compared with estimated air-standard allowable emission of about 3000 tons/day. Without proven technology (except for electric cars) it should not be considered needed, realizing that other sources (e. g., HDV) can be controlled more effectively to meet the CO standard.

Some feasible controls for gasoline HDV are discussed in Ref. 19-50 (Section 5). It was estimated that with a catalyst system, HDV CO emissions can be reduced to about 20 g/mi (while HC is simultaneously reduced to about 2 g/mi). This represents a 75% reduction from the presently planned goal of 81 g/mi as indicated in the EPA guideline (Ref. 19-16). The initial and maintenance cost of the HDV catalyst system amounts to about \$30 per ton of CO removed from the present level, which is lower than the cost of the CO control in light duty vehicles (Ref. 19-50).

If gasoline HDV's are further controlled to 50% in 1985 and 75% in 1990 of the level of HDV emissions shown in Fig. 19-8, then Case 1 LDV control will be able to keep total CO emissions below the allowable level in 1985-90 with a considerable safety margin.

### Oxides of Nitrogen (NOx) Emission Control

From Fig. 19-9 it is seen that no LDV control plan can satisfy the national NO<sub>2</sub> air quality standard of 0.05 ppm annual-arithmetic-mean or the California state NO<sub>2</sub> air quality standard of 0.25

Table 19-4. Los Angeles AQCR automobile carbon monoxide (CO) emission scenarios (g/mi, 1975 CVS/CH)

Model year	1976-77	1978-82	1983-90	Remarks
Case 1	9	3.4	3.4	Federal statutory standard from 1978
Case 2	9	9	9	Present California standard
Case 3	9	3.4	1.0	Severe control from 1983

Table 19-5. Los Angeles AQCR automobile hydrocarbon (HC) emission scenarios (g/mi, 1975 CVS-CH)

Model year	1976-77		1978-82		1982-90		Remarks
	Exh. <sup>a</sup>	Ev. <sup>b</sup>	Exh.	Ev.	Exh.	Ev.	
Case 1	0.9	2.1	0.41	0.2	0.41	0.2	Federal statutory standard from 1978 with Evaporative control
Case 2	0.9	2.1	0.9	2.1	0.9	2.1	Present California standard maintained
Case 3	0.9	2.1	0.9	0.2	0.9	0.2	Evaporative control
Case 4	0.9	2.1	0.41	0.2	0.1	0.2	Severe control from 1983

<sup>a</sup>Exhaust emissions

<sup>b</sup>Evaporative emissions, present test data

ppm one-hour-average<sup>3</sup> if other sources are not controlled further. The allowable NOx emission level to satisfy the national standard is about 740 tons/day, and the sum of sources other than LDV exceeds this level alone. To meet the California standard, the emission level would have to be reduced to 460 tons/day.

It appears that LDV NOx control of at least Case 1 (0.4 g/mi since 1978) is needed for the national NO<sub>2</sub> standard. The advantage of Case 4 (0.2 g/mi) over Case 1 is about 60 tons/day more NOx removed. The 0.2 g/mi NOx cannot be realized with the traditional automobile engines (see Chapters 3 and 4), and compared with 740 tons/day of allowable NOx emission this amount of 60 tons/day is not too important unless reduction from other sources is proved to be more difficult or costly.

Further controls of other NOx sources are necessary to achieve the air quality standards. Data on control effectiveness and cost are limited. Recent discussions on stationary sources (Ref. 19-51)<sup>4</sup> were still based on the original information gathered in Ref. 19-29. They are listed in Table 19-10 in the order of ascending marginal cost. The extent of these controls is also given. Using a linear programming model, this list is also the most cost-effective order of stationary source emission control.

Not included in the list is nuclear powerplant expansion. The capital expenditure estimated for San Onofre No. 2 and No. 3 is about \$2 billion based on \$700 per kw.<sup>5</sup> This amount amortized over 35 years at a discount rate of 5% gives an annual capital cost of \$115 million. Based on the estimated NOx control efficiency of about 67 tons/

Table 19-6. Los Angeles AQCR automobile oxides of nitrogen (NOx) emission scenarios (g/mi, 1975 CVS-CH)

Model year	1976-77	1978-82	1983-90	Remarks
Case 1	2.0	0.4	0.4	Federal statutory standard from 1978
Case 2	2.0	2.0	2.0	Present California standard maintained
Case 3	2.0	1.0	1.0	Medium level of control
Case 4	2.0	0.4	0.2	Severe control from 1983

<sup>3</sup>The state standard is tougher to meet in Los Angeles than the national standard based on the slope of the frequency distribution line shown in Fig. 19-4. This observation may not be true in other regions.

<sup>4</sup>A more thorough study of NOx emissions and control alternatives was recently completed for Los Angeles by KVB Engineering for the California ARB. These results were not available soon enough for incorporation in this study.

<sup>5</sup>Per information from Professor Lester Lees of the Environmental Quality Laboratory, California Institute of Technology.

Table 19-7. Los Angeles AQCR carbon monoxide (CO) emissions, 1970-90 (tons/day)

Source	1970	1975	1980	1985	1990
Light duty vehicle <sup>a</sup>	10,800	5159	1942	838	666
Gasoline heavy duty vehicle	2390	2460	2170	2130	2300
Diesel heavy duty vehicle	70	73	64	63	68
Motorcycle	101	149	169	28	37
Aircraft/ship/railroad	208	191	175	188	201
Stationary source <sup>b</sup>	103	65	69	73	77
Total emissions	13,670	8100	4590	3320	3350

<sup>a</sup>Based on Federal statutory standard (Case 1 in Table 19-3) - 9 g/mi before 1978, 3.4 g/mi for 1978-90.

<sup>b</sup>Mainly from incineration and agricultural burning.

Table 19-8. Los Angeles AQCR reactive hydrocarbon (RHC) emissions, 1970-90 (tons/day)

Source	1970	1975	1980	1985	1990
Light duty vehicle <sup>a</sup>	1211	804	389	159	111
Gasoline heavy duty vehicle	295	264	159	114	106
Diesel heavy duty vehicle	12	11	7	5	5
Motorcycles	27	39	49	3	4
Aircraft/ship/railroad	83	76	70	75	81
Stationary source					
Petroleum marketing	138	15	17	18	20
Organic solvent	110	66	70	74	79
Others	10	10	11	12	13
Subtotal	258	91	98	104	112
Total	1880	1290	770	460	420

<sup>a</sup>Based on Federal statutory standard (Case 1 in Table 19-4):

Exhaust hydrocarbon: 0.9 g/mi for model years before 1978,  
0.41 g/mi for 1978-90.

Reactivity factor: 0.77 for pre-1975 model year cars,  
0.64 for 1975-90 model year cars equipped with catalyst.

Evaporative hydrocarbon: 2.1 g/mi for model year before 1978,  
0.2 g/mi for 1978-90.

Reactivity factor: 0.93.

day in Los Angeles as described before, the equivalent marginal cost is about \$4700/ton of NOx removed, on capital cost alone. It is certainly the most expensive option when compared with the controls listed in Table 19-10 (of course, the plant was not justified on the basis of NOx reduction, but to provide additional power).

For comparison, the marginal cost of reducing LDV NOx emissions from 2 to 0.4 g/mi is calculated here. The assumed vehicle configurations are an oxidizing catalyst car at 2 g/mi and a 3-way catalyst car at 0.4 g/mi as studied in the NAS report (Ref. 19-52). Assuming an 11,000 miles per year driving, the NOx reduction per car is 0.019 tons/year. The additional cost is \$183 in initial price, \$21 in catalyst change at 50,000 miles, \$6/year less in maintenance, and \$3/year less in fuel (13.2 mpg vs 13.1 mpg, at \$0.55/gal.), resulting in an amortized additional cost of \$17 per year. The marginal cost from 2 g/mi to 0.4 g/mi is therefore \$17/0.019 = \$900/ton removed. All the options discussed before (Table 19-10), except for medium industrial boilers control and nuclear power plant expansion, are cheaper than the LDV NOx control to be implemented in 1978. However, the effect of this LDV control is about 300 tons/day of NOx reduction in 1990 (Case 1 and Case 2 in Fig. 19-9), which is a much larger effect than the combined effect of 162 tons/day of NOx reduction from these stationary sources as shown in Table 19-10.

California already has an HDV control plan allowing 2.8 g/mi NOx from gasoline HDV

(about 30% of 1970 level) and 8 g/mi NOx from diesel HDV (about 25% of 1970 level). Information is not available to suggest whether any further control is feasible.

With the additional controls listed in Table 19-10, the basin emissions in 1990 will be 798 tons a day (960-162), which is still about 60 tons/day, or about 8%, above the allowable level. With the uncertainty in our emission projection and the relationship between NO2 air quality and NOx emissions in the ambient air, this difference appears to be too small to require further lowering of the LDV emission standard of NOx in the region, especially when the LDV will be emitting 126 tons/day in 1990, only 17% of the allowable total emissions of 740 tons/day. However, this difference does expose the difficulty of achieving the NO2 standard in Los Angeles and the requirement that other emission sources be further controlled.

In short, the control of LDV NOx will be the key factor in improving NO2 air quality from 0.093 annual arithmetic mean in 1970 to around 0.06 annual arithmetic mean in 1990. As shown in Fig. 19-9, stationary sources are the prime target for further NOx reduction in the 1980's.

#### Reactive Hydrocarbon (RHC) Emission Control

Following the path of RHC reduction, we can see in Fig. 19-10 that the present LDV control

Table 19-9. Los Angeles AQCR oxides of nitrogen (NOx) emissions, 1970-90 (tons/day)

Source	1970	1975	1980	1985	1990
LDV <sup>a</sup>	710	712	370	169	126
Gasoline HDV	160	168	113	86	87
Diesel HDV	116	111	70	52	48
Motorcycle	1	1	12 <sup>b</sup>	3	4
Aircraft/ship/railroad	27	25	24	26	27
Stationary source					
Power plants <sup>c</sup>	135	202	234	204	237
Other fuel combustion	149	204	236	274	316
Miscellaneous	76	83	91	100	110
Subtotal	360	489	561	578	663
Total	1370	1510	1150	910	960

<sup>a</sup>Federal statutory standard (Case 1 in Table 19-5): 2.0 g/mi before 1978, 0.4 g/mi for 1978-90.

<sup>b</sup>Effect of large NOx allowance for easier CO and RHC reduction (Ref. 19-33).

<sup>c</sup>Oil-fuel replacing gas-fuel in 1970-76 period and San Onofre No. 2, 3 nuclear powerplants operating from 1980.



Table 19-10. Further NO<sub>x</sub> control from stationary sources in Los Angeles AQCR<sup>a</sup>

Source	Marginal cost, \$/ton removed	Maximum effect, in 1975, tons/day removed	Maximum effect in 1990, tons/day removed
Petroleum production compressor	13	12	16
Refinery compressor	13	9	12
Large refinery heater	27	6	8
Petroleum marketing compressor	37	9	12
Large industrial boiler	195	22	34
Small refinery heater	226	5	7
Small utility boiler	450	16	25
Medium industrial boiler	2700	31	48
Total NO <sub>x</sub> removed in 1990 = 162 tons/day.			
Total annual cost = \$32 million.			

<sup>a</sup>Source, marginal cost, and maximum effect in 1975 estimated from Ref. 19-51. The maximum effect in 1990 is obtained from a growth rate of 2% per year in petroleum and 3% per year in utility and fuel combustion.

plan will greatly improve the oxidant air quality<sup>6</sup> if the Case 1 control (0.41 g/mi exhaust HC and 0.2 g/mi evaporative HC) is followed.

Case 3 (0.9 g/mi exhaust HC and 0.2 g/mi evaporative HC) represents a great improvement over the current level of Case 2 (0.9 g/mi exhaust HC and 2.1 g/mi evaporative HC), demonstrating the urgency of correcting test procedures for evaporative emissions. New cars are still emitting evaporative HC at the level of 2.1 g/mi (Ref. 19-8).

It is seen from Fig. 19-10 and Table 19-8 that gasoline HDV, aircraft, and stationary sources all have to be further controlled. According to a Rand study (Ref. 19-51), organic solvent RHC emissions can be further controlled by 50% (coating substitution, vapor absorption, etc.) with available technology at about \$80/ton, resulting in about 33 tons of RHC removed per day from the 1975 level. At 1.2% annual growth rate, this reduction leads to about 40 tons/day of RHC removed in 1990.

According to the same study (Ref. 19-51), piston and jet aircraft can be further controlled by 80% with engine modification and jet-towing on the ground, at a cost of about \$2800 per ton removed. This measure results in about 50 tons/day of RHC removed from aircraft before 1980 and grows to 56 tons/day removed in 1990.

The planned reduction of HDV emission in California is to reach 4.1 g/mi exhaust HC on the 1978 model year. According to a study of the Aerospace Corporation (Ref. 1950), exhaust HC can be controlled in gasoline HDV from 10 g/mi to about 2 g/mi using a catalytic converter; the cost is estimated at \$350/ton of HC removed. It therefore appears feasible to further reduce RHC from gasoline HDV by a further 51% (2.1/4.1). The effect in 1990 is 52 tons/day removed.

The cost-effective priority of the measures follows in the order of ascending marginal cost:

<sup>6</sup>Here we have used the modified rollback curve in Fig. 19-7, which is based on Ref. 19-31, to relate the oxidant air quality to the total RHC emissions. As discussed in Section 19.1.4, this oxidant air quality model has not included the effect of NO<sub>x</sub> emissions.

Measure	Marginal cost, \$/ton	Maximum effect in 1990, tons/day
Further organic solvent control	80	40
Further gasoline HDV control	350	52
Further aircraft control	2820	56

The maximum effect of these measures is about 148 tons/day of RHC reduced in 1990.

For comparison, the marginal cost of LDV control is also estimated based on the assumption that California new cars are to be reduced from the 1975 level of 0.9 g/mi to the 1977 level of 0.41 g/mi of HC exhaust emission and that present Otto cycle engines with catalyst converters are used. The NAS study (Ref. 19-52) vehicle configurations No. 46 (0.9/9/2.0) and No. 53 (0.4/3/4/2.0) are used as representative technology. Vehicle No. 53 emits 0.0038 tons/year less than No. 46, based on 11,000 miles per year driving and 0.64 reactivity. Vehicle No. 53 costs \$26 more in initial price and the same in catalyst change, fuel, and maintenance. The amortized cost increase is 4.1 \$/year based on a 12% annual discount rate. The marginal cost of LDV RHC control is therefore \$1080/ton removed (4.1/0.0038). An additional benefit is that about 17 tons of CO are removed when a ton of RHC is removed. The effect of this control in the basin is about 60 tons/day of RHC reduction as shown in Fig. 19-10. It appears desirable that these further controls on organic solvent and gasoline HDV be exercised since they appear to be more cost-effective than the 1978 RHC control of LDV. The control of aircraft, although expensive, deserves serious consideration because the Los Angeles oxidant air quality still exceeds the standard even with the aircraft control.

It appears to be extremely difficult for Los Angeles to ever meet the national  $O_x$  air quality standard. As shown in Fig. 19-10, the projected non-LDV emissions of RHC are 308 tons/day in 1990. With the known measures of further control discussed here, 148 tons/day can be removed with 160 tons/day remaining. Other ways of non-LDV emission reduction will have to be found since the estimated total allowable RHC emission level is only 70 to 130 tons/day (based on the Shuck-Pappeti rollback model).

As concluded in Chapters 5, 6, and 7, the LDV exhaust and evaporative emissions can be reduced by adopting continuous combustion engines (Stirling, Brayton and Rankine) or electric cars. The total RHC emissions from the continuous combustion engine cars can be reduced to about 0.2 g/mi, all from exhaust, if heavier fuel is used to eliminate evaporative emissions. With an electric car (Chapter 8) the total RHC indirectly emitted from power plant can be reduced to about an equivalent of 0.05 g/mi. Potentially, a fleet of all-continuous-combustion-engine cars could

reduce the LDV emission in 1990 from the projected 111 tons/day to 53 tons/day; a fleet of all-electric cars could achieve 13 tons/day. But electric cars are not expected to replace the present fleet by 1990 because battery technology is inadequate (Chapter 8). Cost-competitive continuous combustion engines such as the Stirling and the Brayton (gas turbine) need long development time and face market uncertainty, which makes total fleet conversion by 1990 very doubtful.

In short, drastic measures beyond the presently planned control of LDV and non-LDV sources will have to be exercised to meet the oxidants air quality standard in Los Angeles in 1990. These measures may have to include non-technological controls such as traffic restriction. Compounding the difficulty is the possible existence of natural background ozone and considerable amounts of background RHC emissions as discussed previously. More attention will have to be given to studies in this area to assess the possibility of meeting the oxidant air quality standard as presently stated.

In spite of the difficulty in meeting the present national air quality standard for oxidants, the LDV emission control of both exhaust HC and evaporative HC is essential in bringing the number of oxidant air quality standard violations down from about 1800 hours/year in 1970 to about 800 hours/year in 1990, as shown in Fig. 19-10.

Although the air quality model used here has not included the effect of nitrogen oxides ( $NO_x$ ) in oxidant formation, the role of  $NO_x$  cannot be neglected. Further study is needed to improve oxidant air quality modeling, as suggested by the NAS (Ref. 19-23). It is possible that further  $NO_x$  reduction will be required for oxidant control.

#### 19.2.2 New York

The New York study area (depicted in Fig. 19-2) includes Manhattan and parts of the surrounding counties in New York and New Jersey. This 400-square-mile area is located at the center of the New York-New Jersey-Connecticut Tri-State AQCR. It was chosen by a previous EPA-sponsored study (Ref. 19-18) as an area in which the emissions adequately account for the air pollution in Manhattan. Other key data sources available are the New York City implementation plan and its revisions (Ref. 19-17, 47, 48).

#### AIR QUALITY DATA

New York City has limited  $NO_2$  and oxidants data. Continuous measurements of  $NO_2$  and oxidants are made on Welfare Island (see data in Figs. 19-11, 12), where the highest readings in the study area have been recorded.

One-hour measurements of CO in Midtown, Downtown and Uptown Manhattan for 1972 are presented in Fig. 19-13. The concentration of CO is very dependent upon local traffic conditions. The local planning agency believes that the high readings at 59th street and the Queensborough Bridge are representative of an exceptional location where traffic is usually congested. The high readings do indicate, however, the severity of

the CO problem at that locality, which is part of the Midtown area. The sources of these data are the EPA 1972 Summary (Ref. 19-9) and the EPA National Aerometric Data Bank (NADA) in North Carolina.

Using the Larson analysis method, the 8-hr CO concentrations and frequency distributions are plotted in Fig. 19-14. The highest 8-hr concentration is estimated to be 55 ppm in Midtown, 38 ppm in Downtown and about 11 ppm in other areas.

#### REQUIRED EMISSION REDUCTION

Using linear rollback models for CO and NO<sub>2</sub>, we estimate the required CO emission reduction from the 1972 level to achieve a 9 ppm 8-hr average is about 84% in the Midtown area, 76% in the Downtown area and about 18% in other areas. The required NO<sub>x</sub> emission reduction in the entire area is about 19%. The reason for considering the total area as the reference area for NO<sub>x</sub> reduction is twofold: our preliminary inventory shows the NO<sub>x</sub> emission pattern from various sources to be quite uniform from zone to zone and there appears to be only one station offering good data in the region.

Adopting the Barth curve<sup>7</sup> (Ref. 19-30) as a planning guide, our estimate of the required RHC reduction from all sources is 79% from the 1972 emission level. The reference area for RHC reduction is the entire study area because the photochemical smog problem covers a larger area than the immediate vicinity.

#### EMISSION INVENTORY AND PROJECTION

Our data base of emissions came from a TRW study (Ref. 19-18) and a New York City implementation plan (Ref. 19-17, 47, 48). The latest version of the implementation plan (Ref. 19-48) contains a very significant update of the VMT modal split. Trucking VMT was revised to a much smaller portion of the total VMT than in previous versions. Passenger car VMT was revised to represent a much larger portion of total VMT. To make the terms more relevant in local planning, the latest version redefines "Midtown" to be between 39th and 59th Streets in Manhattan, and "Downtown" to be south of Canal Street. Both updated features have been incorporated in our study.

Other data remain unchanged. These include stationary source emission estimates from the TRW Study (Ref. 19-18, 19), basic vehicle emission factors from the EPA guideline (Ref. 19-16), and vehicle speed, truck age, and taxicab age information from the earliest implementation on the plan (Ref. 19-17).

The assumptions on new car emissions are the following:

CO: 15 g/mi for 1975-77, 3.4 g/mi after 1978.

NO<sub>x</sub>: 3.1 g/mi for 1975-77, 2 g/mi after 1978.

HC exhaust: 1.5 g/mi for 1975-77, 0.41 g/mi after 1978.

HC evaporative: 2.1 g/mi for 1971-77, 0.2 g/mi after 1978.

We used 2 g/mi for NO<sub>x</sub> in our scenario instead of the statutory standard of 0.4 g/mi because the NO<sub>2</sub> situation in New York does not appear to require the stringent standard.

The growth rate of VMT in Manhattan is assumed to be 0.5% per year as per the latest implementation plan (Ref. 19-48). The growth rate for other areas is assumed to be 1% per year. Detailed documentation of the emission inventory assumptions is left to the appendix of this chapter.

The emissions of RHC and NO<sub>x</sub> for the entire study area are presented in Tables 19-11, 12. The emissions of CO in Midtown, Downtown, and other areas are given in Tables 19-13, 14. These calculations are summarized and plotted in Figs. 19-15 to 19-19. The impact on air quality is estimated by the vertical axes on the right-hand side of each graph.

#### EMISSION CONTROL STRATEGY DISCUSSIONS FOR NEW YORK

##### Carbon Monoxide (CO) Emission Control

As seen in Fig. 19-17, the 9-ppm air quality standard is easily met in areas other than Midtown and Downtown Manhattan by the late 70's. As seen in Figs. 19-15, 16, the CO air quality in Midtown and Downtown Manhattan cannot be met with the 3.4 g/mi standard if no further control is applied to other sources. However, gasoline HDV will be the major CO contributor in the future. With 50-75% gasoline HDV control, a LDV control of 3.4 g/mi will be sufficient to meet the air quality standard in the 1985-90 period.

The cost of HDV CO control appears to be moderate (<\$50/ton based on Ref. 19-50), as discussed in Section 19.2.1 for Los Angeles.

##### Oxides of Nitrogen (NO<sub>x</sub>) Emission Control

It appears that stationary sources are the overwhelming contributor of NO<sub>x</sub> in the study area, according to Fig. 19-19 and Table 19-12. The assumed LDV control of 2 g/mi in Fig. 19-19 is sufficient in this area as it reduces the LDV emission to about 12% of allowable emission level of 650 tons/day. Further reduction of NO<sub>x</sub> from power plants and other stationary sources is needed. It is also observed that a 1-hr NO<sub>2</sub> standard of 0.25 ppm is harder to meet than the 0.05 ppm annual average - similar to Los Angeles.

<sup>7</sup>Similar in general shape to the Shuck-Papetti curve shown in Fig. 19-7, but the exact levels of the curves differ because the Barth curve was based on the data for a number of cities but the Shuck-Papetti curve was based on Los Angeles data alone.

Table 19-11. New York study area reactive hydrocarbon (RHC) emissions<sup>a</sup> (tons/day)

	1970	1975	1980	1985	1990
Autos and light duty trucks	266.8	161.0	69.0	25.5	18.5
Taxicabs <sup>b</sup>	25.3	10.7	1.7	1.4	1.5
Heavy duty vehicles <sup>c</sup>	65.9	60.1	56.4	54.6	56.8
Stationary sources <sup>d</sup>	81	79	79	79	79
<b>Total</b>	<b>439</b>	<b>311</b>	<b>206</b>	<b>161</b>	<b>156</b>

<sup>a</sup>Sum of Manhattan and non-Manhattan emissions. Modal split is different in the two areas (see Appendix 19-A).

<sup>b</sup>Most of them in Manhattan. They have faster rate of replacement.

<sup>c</sup>Including gasoline HDV and diesel HDV. Gasoline HDV contributes more than 80%.

<sup>d</sup>Average reactivity of stationary source emissions assumed to be 30% based on Los Angeles data.

Table 19-12. New York study area oxides of nitrogen (NO<sub>x</sub>) emissions<sup>a</sup> (tons/day)

	1970	1975	1980	1985	1990
Autos and light duty trucks	128.1	104.0	77.0	70.5	70.4
Taxicabs <sup>b</sup>	11.1	5.6	3.5	3.6	3.8
Heavy duty vehicles <sup>c</sup>	64.1	66.6	67.6	72.9	76.2
Stationary sources <sup>d</sup>	656	551	551	551	551
<b>Total</b>	<b>859</b>	<b>727</b>	<b>699</b>	<b>698</b>	<b>701</b>

<sup>a</sup>Sum of Manhattan and non-Manhattan emissions. Modal split is different in the two areas (see Appendix 19-A).

<sup>b</sup>Most of them in Manhattan. They have faster turnover rate.

<sup>c</sup>Including gasoline and diesel trucks and buses. Diesel vehicles contribute more than 50%.

<sup>d</sup>About 50% contributed by power plants.

Table 19-13. Midtown/downtown Manhattan carbon monoxide (CO) emissions (tons/day)

	Midtown <sup>a</sup>				
	1970	1975	1980	1985	1990
Autos and light duty trucks	95.5	60.2	14.3	6.7	5.9
Taxicabs	53.4	17.1	3.4	3.3	3.6
Gasoline heavy duty vehicles	47.9	50.1	49.3	48.9	53.3
Diesel heavy duty vehicles	3.5	3.5	3.5	3.5	3.5
Stationary sources <sup>b</sup>	3.0	3.0	3.0	3.0	3.0
<b>Total</b>	<b>203</b>	<b>134</b>	<b>73</b>	<b>65</b>	<b>70</b>

Downtown<sup>c</sup>

Autos and light duty trucks	80.1	49.6	12.1	5.5	4.6
Taxicabs	6.0	2.0	0.4	0.4	0.4
Gasoline heavy duty vehicles	33.5	31.9	31.3	31.1	31.1
Diesel heavy duty vehicles	1.4	1.4	1.4	1.4	1.4
Stationary sources <sup>b</sup>	2.0	2.0	2.0	2.0	2.0
<b>Total</b>	<b>123</b>	<b>87</b>	<b>47</b>	<b>40</b>	<b>39</b>

<sup>a</sup>39th to 59th Street. VMT and model split data are shown in Appendix 19-A.

<sup>b</sup>Data based on TRW study (Ref. 19-19) reapportioned by land area.

<sup>c</sup>South of Canal Street. VMT and model split data are shown in Appendix 19-A.

#### Reactive Hydrocarbon (RHC) Emission Control

It appears that the 0.41 g/mi for LDV assumed for Fig. 19-18 is sufficient, although HDV and stationary sources will have to be further controlled to meet the oxidant air quality standard.

The HDV RHC can be reduced by 80% from the present level using catalysts at a cost of \$350/ton removed (Ref. 19-51).

Stationary source control may include petroleum marketing and storage vapor recovery and control of solvent use according to Los Angeles experience. Based on Fig. 19-18, the allowable emission of regional RHC is about 80 tons/day. With LDV emitting 19 tons/day in 1990, and HDV reduced to 21 tons/day (80% reduced from projected level), the allowed emission from stationary sources is about 49 tons/day. This requires about 38% further reduction from stationary sources.

#### 19.2.3 St. Louis

The St. Louis study area is a subregion of the EPA St. Louis Air Quality Control Region.

Table 19-14. Carbon monoxide (CO) emissions in New York study area, excluding Midtown and Downtown Manhattan<sup>a</sup> (tons/day)

	1970	1975	1980	1985	1990
Autos and light duty trucks	2162	1398	342	160	136
Taxicabs	189	60	12	12	12
Gasoline heavy duty vehicles	462	458	472	491	513
Diesel heavy duty vehicles	57	60	63	66	69
Stationary sources <sup>b</sup>	262	243	243	243	243
<b>Total</b>	<b>3130</b>	<b>2220</b>	<b>1130</b>	<b>970</b>	<b>970</b>

<sup>a</sup>VMT and model split data are shown in Appendix 19-A.

<sup>b</sup>Data based on TRW study (Ref. 19-19) re-allocated by land area.

It was chosen by the local air quality study project (Ref. 19-21) to enclose most of the densely populated areas (urban and suburban areas with heavier traffic and industrial development) surrounding the city of St. Louis. The area corresponds very closely to the local planning region, the "Urban-in-Fact Area" (Ref. 19-49), which is shown in Fig. 19-3.

The study region has an area of about 2700 square miles and a population of about 2.2 million people who drive about 29 million miles a day. Compared with Los Angeles and New York, the St. Louis study area has a lower population density and a lower VMT density. But per capita driving in St. Louis is greater than in New York, although it is less than in Los Angeles. The comparison was shown in Table 19-3.

#### AIR QUALITY IN THE STUDY AREA

The air quality in St. Louis can be represented by the measurements at the CAMP (Continuous Air Monitoring Program) station in the city of St. Louis. The station is known to have credible data, and the concentrations recorded are close to the maximum recorded in the whole area (Ref. 19-21, pp. 2-3, 2-4). In 1972, the CAMP station highest CO reading was 14.5 ppm 8-hr average (the highest was around 17 at another station). The highest oxidant reading was 0.16 ppm 1-hr average. The highest NO<sub>2</sub> reading was 0.15 ppm 1-hr average, and the yearly arithmetic mean was 0.049 ppm. The sample distributions are shown in Figs. 19-20 to 19-23.

#### REQUIRED EMISSION REDUCTION

Emission reduction is needed to satisfy the O<sub>x</sub> and CO standards. Based on the modified rollback models, the air quality standards require a 38% reduction of total CO emission (linear

rollback) and a 57% reduction of total reactive HC (Barth rollback,<sup>8</sup> Ref. 19-30). The national NO<sub>2</sub> standard would allow a 2% increase of NO<sub>x</sub> emission before violation.

#### EMISSION INVENTORY AND PROJECTIONS

The 1972 emission inventory was obtained from the PEDCO study (Ref. 19-21) and the local transportation plan (Ref. 19-49). In Ref. 19-21, the point source emissions from major industrial sources and the non-auto area source emissions from residential use, smaller plants, gas stations, etc., were given for CO and HC. The total VMT data was given in Ref. 19-49 and summarized in Ref. 19-34. The percentage breakdown of light duty vehicle and heavy duty vehicle VMT is given in Ref. 19-21.

NO<sub>x</sub> emissions were not discussed in Ref. 19-21, and emission data from the EPA National Emission Data System printout have not been carefully certified (the power plant emission does not appear reasonable). Since NO<sub>2</sub> pollution occurs within St. Louis City, we have chosen to obtain direct information (Ref. 19-22) about power plant emissions from the city and its immediate neighborhood. We have also estimated emissions from other sources in this reduced region. The uncertainty here is greater than in the case of CO and RHC.

Detailed assumptions are given in Appendix 19-A. In short, they include a 1.7% per year growth for area stationary sources, a 2-5% per year growth of point (industrial) stationary sources, and about 2.65% per year growth of VMT with a minor mass transit role in 1980-90. Heavy duty vehicles contribute 6% of total VMT, with minimum planned control as shown in the EPA guideline (Ref. 19-16). Light duty vehicle emission factors for the existing fleet are based on data contained in the EPA guideline (Ref. 19-16). Emission factors for 1978 and later model year cars are assumed to be 0.41/3.4/2.0 for HC/CO/NO<sub>x</sub> exhaust emissions. Evaporative HC emissions are assumed controlled after the 1978 model year to a 0.2 g/mi equivalent.

The emission projections for RHC and CO in the Urban-in-Fact Area and for NO<sub>x</sub> in St. Louis City are given in Tables 19-15, 16, 17. They are also plotted in Figs. 19-24, 25, 26 to show the dynamic change over the years. The corresponding air quality indicators are shown on the vertical axis on the right-hand side of the graphs.

#### EMISSION CONTROL STRATEGY DISCUSSION FOR ST. LOUIS

##### Carbon Monoxide (CO) Emission Control

It appears from Fig. 19-24 that the 3.4 g/mi LDV control is more than sufficient, even with no further control on other sources, to meet the 9-ppm air quality standard.

<sup>8</sup>The effect of NO<sub>x</sub> emissions on the oxidant air quality is not included in the model.

Table 19-15. St. Louis Urban-in-Fact Area RHC emissions (tons/day)

	1972	1975	1980	1985	1990
Light duty vehicles	191.9	137.9	57.5	23.2	17.7
Heavy duty vehicles	32.0	28.1	26.1	26.9	30.0
Non-auto area sources <sup>a</sup>	30.0	31.6	34.4	37.4	40.6
Point sources (stationary) <sup>b</sup>	20.5	20.3	25.0	30.0	34.8
<b>Total</b>	<b>274</b>	<b>218</b>	<b>143</b>	<b>117</b>	<b>123</b>

<sup>a</sup>Including petroleum marketing (about 26%), solvent use, etc. Reactivity for emissions from petroleum marketing = 0.93; from others = 0.2.

<sup>b</sup>Industrial sources, reactivity assumed = 0.2.

Table 19-16. St. Louis Urban-in-Fact Area CO emissions (tons/day)

	1972	1975	1980	1985	1990
Light duty vehicles	1631	1109	265	130	120
Heavy duty vehicles	232	226	233	253	286
Stationary sources <sup>a</sup>	416	262	301	340	381
<b>Total</b>	<b>2580</b>	<b>1600</b>	<b>800</b>	<b>720</b>	<b>790</b>

<sup>a</sup>Including point sources and non-auto area sources.

#### Oxides of Nitrogen (NOx) Emission Control

It appears from Fig. 19-25 that the 2 g/mi assumed LDV control is sufficient to keep the NO<sub>2</sub> air quality below the 0.05 ppm standard through 1990 if power plant and other non-LDV sources are further controlled by about 15%. Power plants are already controlled to some extent (Ref. 19-22). We have no information concerning the control of industrial point sources in St. Louis. Since the required reduction is moderate, there should not be too much difficulty.

Table 19-17. St. Louis City NOx emissions (tons/day)

	1972	1975	1980	1985	1990
LDV <sup>a</sup>	36.0	30.0	19.6	18.8	20.3
HDV <sup>a,b</sup>	6.5	6.4	6.7	7.2	8.2
Non-auto area source <sup>c</sup>	10.0	10.9	12.7	14.7	17.0
Power-plants <sup>d</sup>	15.0	16.4	19.0	22.0	25.5
Industrial point sources <sup>e</sup>	15.0	16.4	19.0	22.0	25.5
<b>Total</b>	<b>83</b>	<b>80</b>	<b>77</b>	<b>85</b>	<b>97</b>

<sup>a</sup>VMT in the city assumed to be 25% of total AQCR as estimated from data in Ref. 19-21.

<sup>b</sup>Ratio of gasoline HDV VMT and diesel HDV VMT assumed to be 5:1.

<sup>c</sup>Assumed to be 20% of total AQCR based on projected population distribution (Ref. 19-49).

<sup>d</sup>As emitted by Ashley, Cahokia and Venice plants (Ref. 19-22), 3% annual growth.

<sup>e</sup>Assumed to be 20% of total AQCR, 3% annual growth.

Heavy duty vehicles can be further controlled by more than 50%, with similar procedures as in the control discussions for Los Angeles.

#### Reactive Hydrocarbon (RHC) Emission Control

It appears the 0.41 g/mi exhaust emission and 0.2 g/mi evaporative emission standards are required in St. Louis to satisfy the oxidant air quality standard based on the Barth rollback model.

Further control of stationary sources also appears to be needed. Controls for industrial point sources are discussed in Ref. 19-21. They are expected to reduce HC emission by 80 tons/day. Using a 20% average reactivity for stationary point source HC, the RHC reduction amounts to about 16 tons/day in 1975. The potential reduction in 1990 is about 24 tons/day due to growth.

Based on Fig. 19-26, the further reduction of 24 tons/day will bring the total emission to the allowable level of about 100 tons/day. Some further reductions of HDV emissions would provide a safety margin.

19.3 SUMMARY OF REGIONAL EMISSION CONTROLS REQUIRED TO MEET AIR QUALITY STANDARDS

In the previous sections we have seen the important role of light duty vehicle emission control in improving the air quality in various regions. We have also seen the increased importance of non-LDV emissions from stationary sources, HDV, and others, especially in the 1980-1990 period. These non-LDV sources will become dominant if no further controls are applied.

We shall summarize below, for Los Angeles, New York, and St. Louis, the effect of various LDV emission standards toward meeting the air quality standards in 1990 and the emission reductions required of non-LDV sources for each candidate LDV emission standard. We shall then evaluate the 0.41/3.4/0.4 statutory standards for HC/CO/NOx to see whether any of these standards could be tightened or relaxed for each region. We have adopted the following criteria of evaluation:

- (1) Any tightening of the standard is justified only if the projected air quality in 1990 cannot meet the air quality standard without further reducing the LDV emissions.

- (2) Any relaxation of the standard is justified only if a relaxed LDV emission standard would promise to reduce the LDV emissions to a minor portion of the total allowable emission in the region<sup>9</sup> by 1990. While the relaxation is expected to benefit auto manufacturing it should not impose too costly or too difficult a requirement on non-LDV emission sources, which will have to reduce emissions to an acceptable level to offset the LDV emission increase.

We shall also extend the discussion of emission standard for each pollutant to other regions in the nation as well.

19.3.1 Carbon Monoxide (CO) Emission Control

We have compared three emission standards for CO in Table 19-18: 9 g/mi, 6 g/mi, and 3.4 g/mi, all assumed to be effective from the 1978 model year. The first row gives the estimated LDV emission in 1990 in tons/day based on the same VMT projection for each case. The second row gives the allowable emission in the region based on the linear rollback model as calculated in previous sections. The third row gives the allowable non-LDV emission, which equals

Table 19-18. Required further reduction of non-LDV emissions of CO to meet national CO air quality standard in 1990 under various light duty vehicle emission assumptions (tons/day)

LDV control cases <sup>a</sup>	Los Angeles AQCR			New York: Midtown Manhattan			St. Louis: Urban-in-Fact-Area		
	A	B	C	A	B	C	A	B	C
LDV emissions in 1990	1710	1140	670	23	16	10	300	200	120
Allowed total <sup>b</sup> regional emissions	3000	3000	3000	28	28	28	1370	1370	1370
Allowed <sup>c</sup> non-LDV emissions	1290	1860	2330	5	12	18	1070	1170	1250
Projected non-LDV <sup>d</sup> emissions	2680	2680	2680	60	60	60	670	670	670
Required further non-LDV emission reduction	1390	820	350	55	48	42	0	0	0

<sup>a</sup>Case A: 9 g/mi from 1978.  
Case B: 6 g/mi from 1978.  
Case C: 3.4 g/mi from 1978.

<sup>b</sup>Based on linear rollback model.

<sup>c</sup>Allowed total regional emission minus LDV emission in 1990.

<sup>d</sup>Based on presently planned control; see Tables 19-7, 13, 16.

<sup>e</sup>Projected non-LDV emissions minus allowed non-LDV emissions.

<sup>9</sup>Allowable emission level based on an assumed relationship between air quality and emission.

the regional allowable emission minus the LDV emission in 1990. The fourth row gives the projected non-LDV emission levels in each region as developed in previous sections. The last row gives the required further reduction of non-LDV emissions in tons/day, which equals the projected non-LDV emission minus allowed non-LDV emission, and zero if the value is negative.

For each of the candidate emission standards, two percentages are calculated in Table 19-19 based on the emission data presented in Table 19-18. The first row in Table 19-19 is obtained by taking the ratio of 1990 LDV emissions to the regional allowable emissions. The second row is obtained by taking the ratio of required further reduction of non-LDV emissions to the projected non-LDV emission. Both ratios are converted to percentage, as presented in the table.

It is seen in Table 19-19 that a 3.4 g/mi LDV emission standard is more than necessary in St. Louis. It is sufficient in Los Angeles with minor reduction from non-LDV sources, mainly gasoline HDV. It also appears sufficient in New York since the LDV contribution will be only 36% of allowed emission, and gasoline HDV emission of CO can be reduced by 75% without great difficulty (Ref. 19-50). If desired, this standard can be relaxed to about 6 g/mi with further restrictions on non-LDV emissions in New York and Los Angeles.

The same conclusion can be extended to all other cities listed in Table 19-1. For example, the third city with a high CO concentration is Washington, D. C., which has better CO air quality than Los Angeles but a similar emission pattern, with LDV contributing about the same

percentage as seen in Table 19-2. The sufficiency of a 3.4 g/mi standard and the possible relaxation which applies to Los Angeles should also apply to Washington, D. C.

### 19.3.2 Oxides of Nitrogen (NOx) Emission Control

We have compared three LDV emission standards for NOx: 2, 1, and 0.4 g/mi, all from the 1978 model year. Table 19-20 presents the corresponding LDV emission of NOx in tons/day in 1990 and the required non-LDV emission reduction in each case. The entries in each row are calculated the same way as in Table 19-18 for CO. Similarly to Table 19-19 for CO we have derived the percentage of LDV NOx emissions of total allowable emission and the percentage of required reduction from projected non-LDV emission levels. They are presented in Table 19-21.

It is seen in Table 19-21 that the 2-g/mi standard will reduce LDV emissions to less than 25% of allowable emission in St. Louis and New York, with required reduction from other sources at less than 15%. Based on available information on power plant and industrial source control as discussed in Section 19.2.1, this amount of reduction should not be too difficult.

It is also observed in Table 19-21 that Los Angeles needs 0.4 g/mi, which keeps the LDV contribution to less than 20% of total allowable emission and still requires a 27% reduction of non-LDV emissions from the projected level. As discussed in Section 19.2.1, the known technology of power plant and industrial source control can essentially achieve this level of reduction. Unless new technology is developed to practically reduce

Table 19-19. Required further control<sup>a</sup> of CO emissions from other sources<sup>b</sup> for various light duty vehicle (LDV) CO control assumptions (percentage)

LDV control cases <sup>c</sup>	Los Angeles AQCR			New York: Midtown Manhattan			St. Louis: Urban-in-Fact-Area		
	A	B	C	A	B	C	A	B	C
LDV emission as percentage <sup>d</sup> of total allowed emission in the region, %	57	38	22	82	57	36	28	19	11
Required further non-LDV <sup>b</sup> CO reduction as percentage of projected non-LDV CO level, %	52	30	13	92	80	70	0	0	0

<sup>a</sup>To meet the national primary ambient air quality standard for CO.

<sup>b</sup>Other sources than LDV, mainly heavy duty vehicle emissions.

<sup>c</sup>Case A: 9 g/mi from 1978.  
Case B: 6 g/mi from 1978.  
Case C: 3.4 g/mi from 1978.

<sup>d</sup>Based on data in Table 19-18.



Table 19-20. Required further reduction of non-LDV emissions of NO<sub>x</sub> to meet national NO<sub>2</sub> air quality standards in 1990 under various LDV emission standards (tons/day)

LDV control case <sup>a</sup>	Los Angeles AQCR			New York Study Area			St. Louis City		
	A	B	C	A	B	C	A	B	C
LDV emission in 1990	550	300	130	75	40	20	20	10	5
Allowed total <sup>b</sup> regional emission	740	740	740	650	650	650	85	85	85
Allowed <sup>c</sup> non-LDV emission	190	440	610	575	610	630	65	75	80
Projected non-LDV <sup>d</sup> emission	830	830	830	630	630	630	76	76	76
Required further <sup>e</sup> non-LDV emissions	640	390	220	55	20	0	11	1	0

<sup>a</sup>Case A: 2 g/mi from 1978.  
Case B: 1 g/mi from 1978.  
Case C: 0.4 g/mi from 1978.

<sup>b</sup>Based on linear rollback model.

<sup>c</sup>Allowed total regional emission minus LDV emission in 1990.

<sup>d</sup>Based on presently planned control, see Tables 19-8, 11, 17 for year 1990.

<sup>e</sup>Projected non-LDV emission in 1990 minus allowed non-LDV emission for 1990.

Table 19-21. Required further control<sup>a</sup> of NO<sub>x</sub> emissions from other sources<sup>b</sup> for various light duty vehicle (LDV) NO<sub>x</sub> control assumptions (percentage)

LDV control case <sup>c</sup>	Los Angeles AQCR			New York Study Area			St. Louis City		
	A	B	C	A	B	C	A	B	C
LDV emission in 1990 as percentage of total allowed emission in the region, <sup>d</sup> %	74	40	18	12	6	3	24	12	6
Required further non-LDV <sup>d</sup> NO <sub>x</sub> reduction as percentage of projected non-LDV NO <sub>x</sub> emission level, %	77	47	27	9	3	0	15	4	0

<sup>a</sup>To meet the national primary ambient air quality standard for NO<sub>2</sub>.

<sup>b</sup>Other sources than LDV, mainly stationary combustion sources.

<sup>c</sup>Case A: 2 g/mi from 1978.  
Case B: 1 g/mi from 1978.  
Case C: 0.4 g/mi from 1978.

<sup>d</sup>Based on data in Tables 19-20.

power plant or industrial source emissions to a much lower level, this standard of 0.4 g/mi should not be relaxed in Los Angeles.

Table 19-21 suggests that a LDV emission standard of 2 g/mi from 1978 may be sufficient for all areas outside the Los Angeles air basin. To evaluate the impact of this emission standard on other areas, data for the cities with higher NO<sub>2</sub> annual arithmetic mean concentration (see Table 19-1) are presented in Table 19-22. The first column comes from the 1972 data presented in Table 19-1, except for Los Angeles, where the 1970 data is used. The 2nd and 3rd columns give the base-year and the 1990 LDV emissions as percentage of allowable NO<sub>x</sub> emissions, which is calculated based on the linear rollback model. The 4th and 5th columns give the same information for heavy-duty vehicles. The 1990 projections for LDV and HDV emissions are determined on the basis of the following assumptions: Projections for Chicago and Washington D. C. follow the ratio already determined for St. Louis. The projection for San Diego follows the ratio determined for Los Angeles. The difference exists because the State of California has earlier NO<sub>x</sub> control programs for LDV and more stringent NO<sub>x</sub> control programs for HDV than other states. The 6th and 7th columns record the NO<sub>x</sub> emissions from other sources in 1972 and the projected NO<sub>x</sub> emissions in 1990. (The major emitting sources in this category are the utility plants and other stationary fuel-combustion sources).

While the 1990 projections for Los Angeles, New York, and St. Louis are directly obtained from previous discussions, the 1990 projections for other cities are based on a 3% per year growth rate (Ref. 19-43). The last column estimates the percentage reduction from the sum of the projected 1990 emissions from HDV and other sources (columns 5 and 7) that will be needed if the levels of the total allowable emissions are to be reached in 1990.

In Los Angeles, a 2-g/mi standard would require 77% further reduction of non-LDV sources in order to meet air quality standards, which will be very difficult with present technology since these sources are already controlled in the basin.

Chicago appears to need a 45% reduction from non-LDV sources, based on the 1972 air quality and emission inventory and a 3% annual growth rate. Large reductions of NO<sub>x</sub> appear to be needed from coal-fired power plants. Without further information we cannot be sure whether this reduction for Chicago represents a severe implementation problem.

In all other regions considered, the LDV NO<sub>x</sub> emissions will be reduced to below 35% of the total allowable NO<sub>x</sub> emissions, if the 2-g/mi standard is adopted. The required non-LDV NO<sub>x</sub> reduction in all other regions appears to be reasonable based on the Los Angeles experience.

Table 19-22. Effect of 2-g/mi NO<sub>x</sub> emission standard for light duty vehicles (LDV) in regions with higher NO<sub>2</sub> concentrations

Regions	Base year <sup>a</sup> NO <sub>2</sub> concentrations, annual arithmetic mean	LDV		HDV		Other-source emissions as percentage of total allowed emissions, %		Required additional non-LDV emission reduction as percentage of projected non-LDV emissions, %
		emissions as percentage of total allowed emissions, %		emissions as percentage of total allowed emissions, %				
		1972 <sup>a</sup>	1990	1972 <sup>a</sup>	1990	1972 <sup>a</sup>	1990	
Los Angeles AQCR	0.093	96	74	37	18	52	94	77
New York Study Area	0.062	18	12	9	12	95	85	9
St. Louis City	0.049	42	24	8	10	47	80	15
Chicago AQCR	0.062	33	19 <sup>b</sup>	15	19 <sup>b</sup>	76	129 <sup>d</sup>	45
San Diego County	0.045	41	33 <sup>c</sup>	14	7 <sup>c</sup>	35	63 <sup>d</sup>	4
Washington D. C.	0.047	32	18 <sup>b</sup>	11	14 <sup>b</sup>	51	87 <sup>d</sup>	19

<sup>a</sup>Data shown represent the 1970 data for Los Angeles and the 1972 data for all other cities.

<sup>b</sup>Rate of growth and control assumed to be the same as for St. Louis.

<sup>c</sup>Rate of growth and control assumed to be the same as for Los Angeles.

<sup>d</sup>Assuming 3% annual growth. Major contributors are the stationary fuel-combustion sources, such as electric power plants.

From the available 1972 national summary of air quality data (Ref. 19-9), other major urban areas have better NO<sub>2</sub> air quality than Chicago and New York when measured with a reliable method (continuous Salzman or chemiluminescent). We therefore conclude that 2 g/mi, with further controls on utility and other combustion sources, will be sufficient for all other areas than the Los Angeles AQCR.

This assessment has taken no account of the NO<sub>x</sub> influence in the oxidant formation. Further reduction of NO<sub>x</sub> emissions may be required when the role of NO<sub>x</sub> in the ambient oxidant formation is better understood (Ref. 19-23).

### 19.3.3 Reactive Hydrocarbon (RHC) Emission Control

We have not used the allowable-emission approach for RHC because the Barth-Shuck-Papetti curve relating O<sub>x</sub> to RHC is very uncertain — especially near the lower part of the curve close to 0.08 ppm oxidant.

We have seen in Section 19.2.1 that the oxidant (O<sub>x</sub>) air quality projection in Los Angeles is pessimistic. The 0.41 g/mi exhaust HC and 0.2 g/mi evaporative HC will cause the LDV emissions to bring the maximum O<sub>x</sub> level above the 0.08 ppm standard alone. Including emissions from all other sources, it appears that even lower RHC emissions from LDV are desirable,

although a target is not possible to estimate rationally at this point.

From Sections 19.2.2 and 19.2.3 we have seen that 0.41 g/mi exhaust HC and 0.2 g/mi evaporative HC for LDV is also needed in New York and St. Louis. We feel that this standard cannot be relaxed for many cities in the nation. It is not low enough in the Los Angeles basin.

## 19.4 UNREGULATED AUTO EMISSIONS

Although automobile emissions of particulate matter and SO<sub>2</sub> have not been regulated so far, they cannot be ignored for two reasons. First, the automobile is still an important contributor of man-made suspended particulate (those of 10 microns or less) emissions. It also contributes to SO<sub>2</sub> emissions in a minor way. Second, these emissions and other gaseous precursors such as RHC and NO<sub>x</sub>, together with background pollutants, result in a suspended particulate concentration in the ambient air which exceeds the national air quality standards for particulate matter<sup>10</sup> by a wide margin in many parts of the country. This is shown in Table 19-23.

A detailed study of the particulate matter problem was recently conducted by TRW for the lower four counties of the Los Angeles AQCR (Ref. 19-53). Although considerable uncertainties exist concerning emission inventory data and the

Table 19-23. Particulate pollution including constituents largely of secondary origin<sup>a</sup>

City	Annual geometric mean, µg/m <sup>3</sup>				
	Total <sup>b</sup>	SO <sub>4</sub> <sup>2-</sup>	NO <sub>3</sub> <sup>-</sup>	Org	NH <sub>4</sub> <sup>+</sup>
Boston	93	16.0	1.0	---	1.3
Chicago Site 01	112	10.7	---	7.4	0.8
Detroit	134	12.5	3.5	7.4	0.5
Los Angeles	129	10.8	7.7	15.0	0.8
New York	118	18.6	---	9.3	---
Philadelphia	112	18.4	2.1	8.5	1.8
Pittsburgh	161	14.2	2.5	9.3	0.8
San Francisco	84	7.6	2.9	7.7	0.2

<sup>a</sup>Source: Friedlander (Ref. 19-54).

<sup>b</sup>Standard for total suspended particulate matter is 75 µg/m<sup>3</sup> annual geometric mean.

<sup>10</sup>75 µg/m<sup>3</sup> annual geometric mean and 260 µg/m<sup>3</sup> maximum 24-hr concentration not to be violated more than once a year.

air quality/emission relationship, the report does contain a great deal of information on the nature of the particulate problem in Los Angeles. It makes it possible to overview the air quality and emission inventory in the region and to assess the role of automobiles in the near future. One can then assess the constraints on the choice and development of alternative engines.

Based on the TRW study, the light duty vehicle contribution of primary suspended particulates and gaseous precursors (SO<sub>2</sub>, NO<sub>x</sub>, RHC) is given in Table 19-24. A detailed breakdown of sources of suspended particulates and SO<sub>2</sub> is given in Table 19-25. It appears that automobiles are a major candidate for control of primary particulates, next only to stationary combustion sources in magnitude of emission. Automobiles are the fourth largest contributor of SO<sub>2</sub>, although the magnitude of stationary combustion sources is overwhelming in this category.

The other two precursors, NO<sub>x</sub> and RHC, have been regulated for NO<sub>2</sub> and oxidant air quality. The federal statutory emission standard will reduce the new car emissions to about 10% of the 1970 model-year car level.

Based on the "linear" model used in the TRW study, the expected air quality of suspended particulates in downtown Los Angeles is calculated in Table 19-26 in terms of annual arithmetic mean

Table 19-24. Light duty vehicle contribution to particulate and precursor emissions<sup>a</sup> (for the Los Angeles 4-county region)

		1972	1977	1980
Primary particulates (suspended)	LDV Em. <sup>b</sup>	47.5	35.1	33.6
	S.S. <sup>c</sup> Em.	91.8	133.6	133.3
	Total Em.	178	223	233
	LDV %	27%	16%	14%
SO <sub>2</sub> sulfur dioxide	LDV Em.	39.8	35.6	35.7
	S.S. Em.	380.5	461.8	468.8
	Total Em.	444	524	535
	LDV %	9%	7%	7%
NO <sub>x</sub> oxides of nitrogen	LDV Em.	747	580	427
	Total Em.	1345	1614	1434
	LDV %	56%	36%	30%
RHC reactive hydrocarbons	LDV Em.	827	335	188
	Total Em.	1095	547	419
	LDV %	76%	61%	46%

<sup>a</sup>Data from TRW study (Ref. 19-53).

<sup>b</sup>Em. = emissions (in tons per day).

<sup>c</sup>S.S. = stationary sources (mainly fuel combustion).

(AAM). The result is graphed in Fig. 19-27. A reference primary air quality standard of 80 mg/m<sup>3</sup> AAM is used as shown and corresponds to the original standard of 75 mg/m<sup>3</sup> annual geometric mean in this region (Ref. 19-53).

It is clear from Fig. 19-27 that the air quality standard requires a large reduction of man-made suspended particulates and gaseous precursor emissions. Control strategies have been proposed in the TRW study. It is pointed out there that a control strategy to meet the air quality standard would require a drastic emission control strategy. Even to achieve a less ambitious goal of improving particulate air quality, strong measures would be needed including transportation controls.

Reduction of SO<sub>2</sub> from automobile emissions can be done by further desulfurization of gasoline and diesel fuel as discussed in the TRW study. The recent EPA concern over accelerated sulfate formation in the automobile catalytic converters has made fuel desulfurization an attractive option. However, its practicality is contingent upon the cost and required level of sulfur removal.

Faced with the particulate air quality problem in many cities and a sizeable contribution of emissions from automobiles, the automobile is an important target for particulate emission control. Government regulation of motor vehicle particulate emissions is desirable. Also, alternative engines chosen for mass production in the future should not be allowed to emit excessive particulates.

## 19.5 UNCERTAINTIES AND LIMITATIONS

### Uncertainties

- (1) The relation between air quality and emissions in the ambient air over a region is uncertain, especially in the case of oxidant formation.
- (2) Emission inventory data are subject to uncertainties. Estimates of vehicle emission factors have improved. But transportation data (VMT and modal split) in a base year may be revised from time to time. Much more uncertain is the estimate of stationary source emissions, especially those from the present National Emission Data System.
- (3) Uncertainties exist in the air quality data due to imperfect measurement and reporting. Discrepancies in the calibration of instrument may still exist in many places (e.g., the ozone measurement discrepancies recently discovered in Los Angeles). Agency-reported aerometric data are still incomplete in most cities (e.g., the annual arithmetic mean concentrations of NO<sub>2</sub> is needed to show compliance with the national NO<sub>2</sub> air quality standard, but the supporting NO<sub>2</sub> hourly concentrations reported usually show an insufficient number of measurements). Furthermore, the important statistics of the 8-hr average concentrations of CO, which are needed to show compliance with the national CO air quality standard, are usually not included in

Table 19-25. Projected particulate emission inventory for the four-county area<sup>a</sup>

Process category	Suspended particulates			SO <sub>2</sub>		
	1972	1977	1980	1972	1977	1980
<b>Stationary sources</b>						
Petroleum	3.0	3.0	3.0	60.0	60.0	60.0
Organic solvent	7.2	7.7	7.8	-	-	000
Chemical	10.2	10.7	11.1	97.0	10.0	10.0
Metallurgical	12.3	13.4	14.0	13.0	15.0	15.9
Mineral	10.2	11.0	11.5	1.4	1.7	1.8
Incineration	2.0	2.3	2.3	-	-	-
Fuel combustion	44.7	82.6	80.7	208	374	380
Agriculture	2.2	2.9	2.9	1.1	1.1	1.1
<b>Mobile sources</b>						
Light duty vehicle	47.5	35.1	33.6	39.8	35.6	35.7
Heavy duty vehicles	1.4	1.6	1.7	0.6	0.8	0.9
Diesels	3.3	3.9	4.1	8.5	9.7	10.4
Aircraft	14.2	25.7	37.0	3.6	6.5	9.6
Motorcycles and miscellaneous	4.7	5.6	6.2	-	-	-
Motor vehicle tire wear	15.2	17.4	18.6	-	-	-
Ships and railroads	1.2	1.2	1.2	10.8	10.8	10.8
<b>Total inventory</b>	<b>178</b>	<b>223</b>	<b>233</b>	<b>444</b>	<b>524</b>	<b>535</b>

<sup>a</sup>Data from TRW study (Ref. 19-53).

the reports published by the agencies (Ref. 19-9, -36). Because of the lack of direct information, these data have been estimated, in some cases in this study, from the published one-hour CO concentrations based on the Larson statistical method (Ref. 19-10).

- (4) The levels of natural background oxidants and background RHC emissions, as well as their implication on the ambient oxidants air quality, are uncertain and need further study.
- (5) The health effects of air pollutants, as well as other damage effects, still need further research to be firmly established (Ref. 19-5).

Limitations

- (1) With the uncertainties discussed above, our results only serve to illuminate the nature of the air quality problem and indicate the approximate level of control

needed in various regions. We are more positive about the substantial improvement of air quality as a result of new-car emission control than the actual achievement of air quality standards, especially in the case of oxidants.

- (2) This study is not to be considered as a regional implementation plan. The methodology adopted for the present study aims at analyzing the aggregate effect of new-car emission reduction in a region. The results obtained here serve as a gross indicator of the degree of control needed in each region to meet air quality requirements in the late 1980's - which is the time when fleet turnover will show the full effect of new car emission standards. No considerations of other controls - such as retrofits or non-technological control measures - are included here. Neither have we investigated all possibilities in stationary source emission control.

Table 19-26. Calculated particulate level for downtown Los Angeles with "linear" model<sup>a</sup>

Component	Year		
	1972 level, mg/m <sup>3</sup> (AAM)	1977 level, mg/m <sup>3</sup> (AAM)	1980 level, mg/m <sup>3</sup> (AAM)
Background, primary and secondary	44	44	44
Non-background			
Primary particulate	54	67.5	70.7
Secondary particulate			
SO <sub>4</sub> <sup>=</sup>	10	11.8	12.0
NO <sub>3</sub> <sup>-</sup>	11	13.2	11.7
NH <sub>4</sub> <sup>+</sup>	1	1	1
Organics	20	10.0	7.5
Total suspended particulate	140	147.5	146.9

<sup>a</sup>Based on TRW study (Ref. 19-53).

- (3) The regional air quality/emission model is a gross one. Although we have been careful in selecting zones in a region to characterize the emissions affecting an air quality monitoring station, we have not taken the spatial distribution of air quality and emissions into explicit consideration. Spatial and temporal distribution should be considered to accurately predict the air quality variation measured at a station.

## 19.6 CONCLUSIONS

It is realized in this study that concerted emission controls of not only automobiles but also other pollutant emitting sources, especially heavy duty vehicles and stationary sources, are necessary for meeting the national air quality standards by 1990. Any relaxation of emission control in one sector often requires corresponding tightening of emission controls in other sectors, if the air quality standards are to be met. With this understanding, we have arrived at the following conclusions:

- (1) To meet the present air quality standard for carbon monoxide (CO) the statutory auto mission standard of 3.4 g/mi CO is adequate through 1990. At this level of light-duty-vehicle emission control, most regions can expect substantial safety margin below the air quality standard. But a few regions – such as the Los Angeles air basin and Manhattan New York – will require further CO emission control from heavy duty vehicles.
- (2) The air quality of the photochemical oxidants can be significantly improved nationwide with a moderate auto-exhaust hydrocarbon (HC) emission standard – such as the 1975 California standard of 0.9 g/mi – provided that the auto-evaporative HC emission can be effectively reduced to about 0.2 g/mi equivalent.<sup>11</sup> But the statutory auto-exhaust HC emission standard of 0.41 g/mi, coupled with the 0.2 g/mi-equivalent emission level of auto-evaporative HC (effectively achieved), is needed in many regions in order to meet the present national air quality standard for oxidant. These control measures must also be complemented by reductions of HC emissions from other sources such as the heavy duty vehicles and the stationary sources.

Even at this level the air quality standard for oxidant cannot be met in the Los Angeles air basin. Reactive HC emissions, and possibly oxides of nitrogen and carbon monoxide emissions, must be further reduced from all sources if the oxidant air quality is ever to approach the present national standard in the basin. The target level for eventual reductions of auto emissions in this region is very difficult to establish rationally at the present state of knowledge.

Current test and reporting procedures should be revised, as recommended by the EPA, to monitor nonmethane hydrocarbons (NMHC) rather than total hydrocarbons (HC) for two reasons: (1) oxidant pollution is more directly related to reactive hydrocarbon emissions, and methane (which comprises a significant fraction of HC emissions) is at worst only slightly reactive; (2) the nonmethane fraction of total exhaust HC varies among present cars, those employing oxidizing catalysts producing a smaller fraction of the nonmethane type.

It must be reiterated here that the current test procedure for auto evaporative

<sup>11</sup>The standard for auto-evaporative HC emission is 2 g/test, corresponding to a level of 0.2 g/mi. But the current EPA test procedure (carbon canister) allows evaporative emissions equivalent to about 2 g/mi.

HC emissions has been inadequate, permitting late model-year cars to emit evaporative HC at an actual rate about 10 times higher than the standard would allow (2 g/test). Improved test procedures (e.g., the Shield House for Evaporation Determination, or SHED, procedure) are needed to allow for effective enforcement.

- (3) To meet the present national air quality standard for nitrogen dioxide (NO<sub>2</sub>), an automobile emission level of 2 g/mi oxides of nitrogen (NO<sub>x</sub>) is adequate for almost all regions except for Los Angeles, where the 0.4 g/mi-NO<sub>x</sub> statutory emission standard for automobiles is necessary. The higher emission level of 2 g/mi NO<sub>x</sub> can be allowed for two reasons: First, only a few regions are currently violating the standard and, among them, only the Los Angeles air basin has NO<sub>2</sub> measurements significantly above the standard. Second, in the other regions violating the standard, the light-duty vehicles are a minor contributor to the total regional NO<sub>x</sub> emissions compared to the stationary combustion sources; the emissions from these are sizeable and growing. The effect of a 2 g/mi-NO<sub>x</sub> emission level for automobiles is shown in Table 19-22 and Fig. 7 of Volume I.

It must be emphasized that the NO<sub>x</sub> emissions from the stationary combustion sources should be contained with high priority, in both Los Angeles and other regions.

- (4) The light-duty vehicle emission standards discussed here are expected to improve the CO, NO<sub>2</sub> and oxidant air quality significantly throughout the nation in the 1980-90 period. Stationary sources and other moving sources - such as heavy-duty vehicles, aircraft, and motorcycles - will have to be further controlled. Otherwise, they will become major polluters in the 1980-90 period.
- (5) Any automotive engine with which the car can meet the stated emission standards is compatible with urban air quality requirements through 1990. Introduction of cleaner engines, however, will eliminate the automobile from the list of primary polluters.
- (6) In many regions, particulates are a significant air quality problem to which the automobile is a significant contributor. Legislation of suitable automotive particulate emission standards is desirable and recommended. It also follows that any alternate powerplant considered for future mass production should not be an emitter of excessive particulates.
- (7) In some urban areas, automobiles emit close to 10% of urban sulfur dioxide (SO<sub>2</sub>) pollutants. With the possibility

of increased use of distillate fuel, it is important to prevent increase of SO<sub>2</sub> emissions. The sulfur content in automobile fuels should be restricted, if practical, to prevent increases of SO<sub>2</sub> emissions.

- (8) As engine and fuel technology changes, it is important to be alert to new types of air pollution problems. Examples include certain specific hydrocarbons, odor, sulfates, and metallic emissions from the engine systems.

#### References

- 19-1. U.S. Department of HEW, "Air Quality Criteria for Carbon Monoxide," AP-62, Washington, D.C., March, 1970.
- 19-2. U.S. Department of HEW, "Air Quality Criteria for Photochemical Oxidants," AP-63, Washington, D.C., March, 1970.
- 19-3. U.S. Environmental Protection Agency (EPA), "Air Quality Criteria for Nitrogen Oxides," AP-84, Washington, D.C., January, 1971.
- 19-4. U.S. Department of HEW, "Air Quality Criteria for Hydrocarbons," AP-64, Washington, D.C., March, 1970.
- 19-5. National Academy of Sciences, "Health Effect of Air Pollutants, Volume 2 of Air Quality and Automobile Emission Control," Washington, D.C., August, 1974.
- 19-6. U.S. Department of HEW, "Air Quality Criteria for Particulate Matter," AP-49, Washington, D.C., January, 1969.
- 19-7. U.S. Department of HEW, "Air Quality Criteria for Sulfur Oxides," AP-50, Washington, D.C., January, 1969.
- 19-8. Grad, F. P., et al., "The Automobile and the Regulation of Its Impact on the Environment," Draft Report, Columbia University, New York, February, 1974.
- 19-9. U.S. EPA, "Air Quality Data - 1972 Annual Statistics," Office of Air Quality

- Planning and Standards, Research Triangle Park, North Carolina, March, 1974.
- 19-10. Larson, R. L., "A Mathematical Model for Relating Air Quality Measurements to Air Quality Standards," EPA AP-89, November, 1971.
- 19-11. Federal Register, Vol. 39, No. 90, May 8, 1974.
- 19-12. Federal Register, Vol. 38, No. 110, June 8, 1973.
- 19-13. California Air Resources Board, "The State of California Implementation Plan for Achieving and Maintaining the National Ambient Air Quality Standards," January 30, 1971.
- 19-14. California Air Resources Board, "The State of California Implementation Plan for Achieving and Maintaining the National Ambient Air Quality Standards, Revision 4," December 31, 1973.
- 19-15. U. S. EPA, "Technical Support Document for Los Angeles AQCR Transportation Control Plan Final Promulgation," Federal Register, November 12, 1973.
- 19-16. U. S. EPA, "Compilation of Air Pollutant Emission Factors," AP-42, 2nd Edition, April 1973.
- 19-17. New York City Department of Air Resources, "Proposed Plan for Meeting Federal Air Quality Standards Relating to CO, HC, NO<sub>x</sub> and Oxidant in New York City," January, 1972.
- 19-18. TRW, "Transportation Control Strategy Development for New York Metropolitan Area," EPA APTD 1371, December, 1972.
- 19-19. McCoy, Billy C., Project Engineer of TRW McLean, Virginia, private communication, August 2, 1974.
- 19-20. Goeller, B. F., et al., "San Diego Clean Air Project Summary Report," Rand Corporation, Santa Monica, California, December 1973.
- 19-21. PEDCO Environmental Specialists, "Attainment of National Air Quality Standards for CO and Oxidants in the St. Louis AQCR," prepared for EPA, Cincinnati, Ohio, March, 1974.
- 19-22. Wootten, J., Missouri Union Electric Co., telephone conversation on utility NO<sub>x</sub> emission in St. Louis city and neighboring area, October 4, 1974.
- 19-23. National Academy of Sciences, "The Relationship of Emissions to Ambient Air Quality, Volume 3 of Air Quality and Automobile Emission Control," Washington, D. C., August, 1974.
- 19-24. Dimitriadis, B., "On the Function of Hydrocarbon and Nitrogen Oxides in Photochemical Smog Formation," Bureau of Mine Report No. 7433, U. S. Dept. of Interior, 1970.
- 19-25. Johnston, H. S., "A Review of the CMVE Panel Report," in the NAS Report - A Critique of the 1975-1976 Federal Automobile Emission Standards for Hydrocarbons and Oxides of Nitrogen, pp. 28-39, May, 1973.
- 19-26. Gifford, F. A., and Hanna, S. R., "Urban Air Pollution Modeling," 2nd International Clean Air Congress, Washington, December, 1970.
- 19-27. Tiao, G. C., Box, G. E. P., and Hamming, W. J., Analysis of Los Angeles Photochemical Smog Data: A Statistical Overview," 66th Annual Meeting of the Air Pollution Control Association, June 24-28, 1973.
- 19-28. Reynolds, S. D., Liu, M. K., Hecht, T. A., Roth, P. M., and Seinfeld, J. H., Mathematical Modeling of Photochemical Air Pollution. III. Evaluation of the Model," Atmospheric Environment, Vol. 8, pp. 563-596, Pergamon Press, 1974.
- 19-29. Trijonis, J. C., "Air Economic Air Pollution Control Model - Application: Photochemical Smog in Los Angeles County in 1975," Ph. D. Thesis, California Institute of Technology, Pasadena, California, 1972.
- 19-30. Shuck, E.A., Altshuller, A.P., Barth, D.S., and Morgan, G. B., "Relationship of Hydrocarbons to Oxidants in Ambient Atmospheres," J. Air Pollution Control Association, Vol. 20, No. 5, May, 1970.
- 19-31. Shuck, E. A., and Papetti, R. A., "Examination of the Photochemical Air Pollution Problems in the Southern California Area," internal EPA document.
- 19-32. Southern California Edison Company, "1973 Financial and Statistical Report," Los Angeles, California, April, 1974.
- 19-33. Hare, C. T., Springer, K. J., Oliver, W.R., Hautman, W. H., and Huls, T. A., "Motorcycle Emissions, Their Impacts and Possible Control Techniques," Society of Automotive Engineers, Paper 740627, August, 1974.
- 19-34. Vehicle Use Patterns, this volume, Chapter 14.
- 19-35. U. S. Environmental Protection Agency, "Mixing Heights, Wind Speeds, and Potential for Urban Air Pollution Throughout the Contiguous United States," EPA AP-101, Office of Air Programs, January, 1972.



- 19-36. State of California, "Ten-Year Summary of California Air Quality Data 1963-1972," Air Resource Board, January, 1974.
- 19-37. California Air Resources Board, "ARB Bulletin," Vol. 5, No. 11, Sacramento, California, December, 1974.
- 19-38. California Air Resources Board, "1973 Annual Report," page 6, January, 1974.
- 19-39. California Air Resources Board, "The Effects of Proposed Light-Duty Motor Vehicle Emission Standards on Air Quality," Staff Report 74-21-4A, November 13, 1974.
- 19-40. Telephone conversation with Dr. James Crabtree of California ARB at El Monte Laboratory, December 10, 1974.
- 19-41. W. T. Mikolowsky, et. al., "The Regional Impacts of Near-Term Transportation Alternatives: A Case Study of Los Angeles," Rand Corporation, Santa Monica, California, June, 1974.
- 19-42. California ARB information entitled "Motor Vehicle Population and Model Year Distribution," dated 2-13-74, supplied by Howard Linnard of ARB in October, 1974.
- 19-43. Personal communication from Professor Lester Lees of California Institute of Technology, "Kaiparowits Project Energy Analysis - Comments on Working Draft III," October 22, 1974.
- 19-44. Private information from Don Bratton of California ARB, September, 1974.
- 19-45. TRW, "Transportation Control Strategy Development for the Metropolitan Los Angeles Region," Redondo Beach, California, prepared for EPA, APTD-1372, December, 1972.
- 19-46. Los Angeles Regional Transportation Study, "LARTS Base Year Report - 1967 Origin - Destination Survey," Los Angeles, California, December, 1971.
- 19-47. New York City Department of Environmental Conservation, "New York City Metropolitan Area Air Quality Implementation Plan Transportation Controls," April, 1973.
- 19-48. New York State Department of Environmental Conservation, "New York City Metropolitan Area Air Quality Implementation Plan Transportation Controls," Amendment, October, 1974.
- 19-49. East-West Gateway Coordinating Council, "The Proposed 1995 Highway and Transit Plan for St. Louis," St. Louis, Missouri, March, 1974.
- 19-50. The Aerospace Corporation, "Final Report - Medium Duty Vehicle Emission Control Cost Effectiveness Comparisons, Volume 2: Technical Discussion," prepared for EPA, El Segundo, California, January, 1974.
- 19-51. Goeller, B.F., et al., "Strategy Alternatives for Oxidant Control in the Los Angeles Region," prepared for EPA, Rand Corporation, Santa Monica, California, December, 1973.
- 19-52. National Academy of Sciences, "The Costs and Benefits of Automobile Emission Control, Volume 4 of Air Quality and Automobile Emission Control," Washington, D. C., August, 1974.
- 19-53. TRW, "A Particulate Implementation Plan for the Los Angeles Region, Final Report," (preliminary) prepared for EPA Region IX, TRW Transportation and Environmental Operation, Redondo Beach, California, October, 1974.
- 19-54. Friedlander, S.K., "Small Particles in Air Pose A Big Control Problem," Environmental Science and Technology, Vol. 7, December, 1973.
- 19-55. Bodkin, L. D., "Carbon Monoxide and Smog," Environment, Vol. 16, No. 4, May 1974.

#### APPENDIX 19-A

#### EMISSION INVENTORY AND PROJECTION ASSUMPTIONS

This appendix contains the detailed assumptions from which the emission inventories in the three metropolitan areas - Los Angeles, New York, and St. Louis - are derived. In general, the same methodology was used in developing the emission inventories for all three areas. However, the depth of data available on certain emission sources varies from area to area.

##### 19. A. 1 Los Angeles

The area concerned is the total AQCR. We shall discuss emissions for each source category.

##### STATIONARY SOURCES AND AIRCRAFT/SHIPS/RAILROADS

For aircraft/ships/railroads, the following assumptions apply to all three pollutants:

- (1) 1.4% annual growth rate (Ref. 19-41, page 68).
- (2) 30% Federal control of aircraft emission by 1980 (Ref. 19-14, page 38).

For the stationary sources, we will discuss assumptions for the major sources of each pollutant.

- (1) CO - The major sources are incineration and agricultural burning.
  - (a) 1.2% annual growth rate (Ref. 19-41, page 68).
  - (b) State implementation plan control (Ref. 19-13, page 119).

- (2) RHC — The major sources are petroleum marketing and organic solvent users.
- (a) 1970 Initial inventory on petroleum marketing was based on Table VI-3-1 of Ref. 19-13 corrected by a higher reactivity factor of 0.93 per EPA information (Ref. 19-15, page 11 of Appendix A). Emission from agriculture in 1970 is also adjusted to 2.4 tons/day per EPA information (Ref. 19-15, page 1 of Appendix A).
  - (b) The annual growth rate is 2% for petroleum marketing and 1.2% for solvent use (Ref. 19-41, page 68) and other minor sources, except for 3% for combustion and -1% for agriculture.
  - (c) State implementation plan control (Ref. 19-13, 14), including 90% control of petroleum marketing emissions by 1976-78 and 51 tons/day control of organic solvent by 1975 (Ref. 19-14).
  - (d) No further control on minor contributors such as petroleum refining, incineration, fuel combustion, agricultural processing, etc. (Refs. 19-13, 14).
- (3) NOx — The major source is fuel combustion emissions from power plants and other industrial sources.
- (a) The annual growth rate of demand of fuel for power plant and other combustion sources is assumed to be 3% (Ref. 19-43, page 2).
  - (b) Natural gas use in power plants decreases from 56.6% in 1970 to 1.5% in 1976. Oil use in power plant grows from 14.8% in 1970 to 65.8% in 1976. This is because of the projected shortage of natural gas supply. The data source is the Southern California Edison Company (Ref. 19-32, Tables 22, 27). Assuming a 225:125 ratio of NOx emissions per unit heat consumed from oil versus from gas (LA APCD Rule 68), this switch from gas to oil increases the NOx emission from power plant by an additional 45% from 1970 to 1976.
  - (c) Nuclear power plants (San Onofre No. 2 and No. 3) are expected to reduce the load of oil-fired power plants in the basin, starting from 1980-1981 (Ref. 19-43, page 4), thereby reducing NOx emission. According to SCE (Ref. 19-23, Table 26) the combined capacity of the two plants is 2280 megawatts. Assuming they are going to be operated at 80% load, the generated electricity is  $2.00 \times 10^{10}$  kWh per year. Assuming further that this is the load taken away from oil-fired power plants, which have an average thermal efficiency of 35% and a NOx emission factor of fuel-oil at

0.25 lb/10<sup>6</sup> Btu, the reduction of NOx from oil-fired power plants is calculated to be 24,370 tons/year or about 67 tons/day. We therefore assume that the NOx emissions from power plants in this basin will be reduced by 67 tons/day from 1980 to 1985 because of this factor.

- (d) A 25-ton/day reduction of power plant NOx emission is planned (Ref. 19-13) for 1970-1975.
- (e) NOx emission from petroleum industry grows at 2% per year (Ref. 19-41, page 68), and at 1.2% per year from other sources. No further control planned.

#### Gasoline Heavy Duty Vehicles

- (1) The 1970 fleet-average VMT per vehicle per day was calculated from the fleet-age distribution and vehicle VMT/year data from EPA (Ref. 19-15, page 6). Six-day week is assumed. The number is 39.5 miles/vehicle/day.
- (2) The 1970 HDV population in the AQCR was estimated from the original ARB estimate of 137,784 (Ref. 19-15, page 3) multiplied by a factor of 2.84. This factor arises from the newly corrected ARB estimate (Ref. 19-42) of 841,000 gasoline HDV in use in California in 1972, as compared to the number 296,300 for 1972, which appeared in Ref. 19-15 and was found to be mistaken (Ref. 19-42). This correction is also reflected in the latest ARB inventory of Los Angeles County (Ref. 19-39). The total 1970 gasoline HDV vehicle mileage in the AQCR is therefore  $39.5 \times 137784 \times 2.84 = 15.5 \times 10^6$  miles/day.
- (3) Growth rate of VMT assumed to be the same as for LDV (Ref. 19-34) — about 2.5% per year.
- (4) The emission factors for gasoline heavy duty vehicles are listed in Table 19-A-1 for California.
- (5) The reactivity factor of HC is 0.79 for exhaust and 0.93 for evaporative (Ref. 19-15). Reactivity of crankcase emission lies between these two levels. But since crankcase emissions are being controlled we have used 0.93 for them as well, for simplicity.
- (6) Mild age-deterioration is expected to occur for post-1975 model-year gasoline HDV. But since we have used standards for emission factors which are expected to be met at 50,000 miles, in the spirit of the Clean Air Act Amendment of 1970, we have neglected this deterioration in our calculation.
- (7) The speed adjustment factor is also neglected. This is because the HDV speed in Los Angeles is not as slow as in

Table 19-A-1. California gasoline heavy duty vehicle emission factors (g/mi)

Model year	CO	HC		NO <sub>x</sub>
		Exhaust	Evaporative <sup>c</sup> and crankcase	
Pre-1970 <sup>a</sup>	140	17	3	9.4
1970-71 <sup>a</sup>	130	16	3	9.2
1972-74 <sup>a</sup>	130	13	2	9.2
1975-76 <sup>b</sup>	98	8.1	2	5.8
1977-90 <sup>b</sup>	81	4.1	0.2	2.8

<sup>a</sup>Data from EPA (Ref. 19-16, Table 3.1.4-1).

<sup>b</sup>Data from ARB (Ref. 19-44).

<sup>c</sup>Pre-1972 data from EPA (Ref. 19-16, Page 3.1.4-1). Data from 1972 on are based on more realistic surveillance data as shown in Ref. 19-8 for LDV.

New York City, and the only available speed adjustment data in Ref. 19-16 is, basically, for LDV.

#### Diesel Heavy Duty Vehicles

- (1) Diesel trucks are mainly used for inter-city hauling, with the mileage of a new truck estimated over 200 miles a day (Ref. 19-15). There is no data on the amount of diesel truck VMT actually driven in the Los Angeles AQCR. We have assumed that the total VMT for diesel HDV is 1/5 of total VMT for gasoline HDV, based on a 1967 National Bureau of Highway Estimates for Urban Areas (Ref. 19-17, Appendix 2, page 8). The 1970 diesel HDV mileage is therefore  $3.1 \times 10^6$  miles/day in the Los Angeles AQCR. This number corresponds to about 30 miles per vehicle per day in Los Angeles AQCR if we assume that the total VMT is contributed by the 100,000 registered diesel HDV (Ref. 19-42) in California.
- (2) Growth factor of VMT is assumed to be the same as for LDV - 2.5% per year (Ref. 19-35).
- (3) The emission factors for diesel HDV are listed in Table 19-A-2 for California.
- (4) Reactivity factor for diesel exhaust is 0.99 per EPA information (Ref. 19-15).
- (5) No speed factor or age deterioration is assumed.

#### Motorcycles

- (1) The 1970 motorcycle population in the Los Angeles AQCR is about 107,500

Table 19-A-2. California diesel heavy duty vehicle emission factors (g/mi)

Model year	CO	HC <sup>c</sup>	NO <sub>x</sub>
Pre-1973 <sup>a</sup>	20.4	3.4	34
1973-74 <sup>b</sup>	19	2.6	26
1975-76 <sup>b</sup>	14	1.6	16
1977-90 <sup>b</sup>	12	0.8	8

<sup>a</sup>Data from EPA (Ref. 19-16, Table 3.1.5-1)

<sup>b</sup>Data from ARB (Ref. 19-44)

<sup>c</sup>Diesel fuel evaporative is negligible, and crankcase blowby is controlled. These numbers for exhaust only.

2-stroke motorcycles and 175,500 4-stroke motorcycles (Ref. 19-42, 11, N-11, 12). They are driven an average of 4,000 miles per vehicle per day (Ref. 19-16). Their population is estimated to grow at 8% per year from 1970-75, about 6% per year from 1975-80 (Ref. 19-15), and 6% per year thereafter.

- (2) The average life is 6 years and average age is 2.3 years (Ref. 19-33).
- (3) Emission factors are given in Table 19-A-3.

#### Light Duty Vehicles

- (1) The light duty vehicles discussed here include automobiles and light duty trucks, which are trucks not over 6000 lb in gross vehicle weight. We have neglected making special corrections for diesel-powered LDV's since they are negligible in number compared with the gasoline-powered LDV's.
- (2) The VMT estimates of LDV's in the Los Angeles AQCR, as well as the age distribution of the fleet and the age-dependent annual mileage driven per car, are given in Chapter 14, Automobile Use Patterns. The 1970 mileage is  $145 \times 10^6$  miles per day, growing at about 2.5% per year and arriving at 240 miles per day in 1990.
- (3) The emission factors for existing vehicles are presented in Table 19-A-4, using the historical data as summarized in Ref. 19-16 for exhaust emissions and the test data as shown in Ref. 19-8 for evaporative and crankcase emissions. For future vehicles we have used the promulgated Federal and California standards and other emission control scenarios for comparative study. The scenarios for each pollutant have been presented in Tables 19-4, 5, 6 of Section 19.2.1.

Table 19-A-3. Motorcycle emission factors (g/mi)

Model year	2-stroke					4-stroke				
	CO	HC			NO <sub>x</sub>	CO	HC			NO <sub>x</sub>
		Exh.	Ev. <sup>d</sup>	CC. <sup>c</sup>			Exh.	Ev. <sup>d</sup>	CC. <sup>c</sup>	
Pre-1976 <sup>a</sup>	27	16	0.36	0	0.12	33	2.9	0.36	0.6	0.24
1976-78 <sup>b</sup>	27	8	0.36	0	1.9	27	8	0.36	0.6	1.9
1979-90 <sup>b</sup>	3.4	0.4	0	0	0.4	3.4	0.4	0	0	0.4

<sup>a</sup>Data from EPA (Ref. 19-16, Table 3.1.7-1).

<sup>b</sup>Tentative Federal Regulation (Ref. 19-33, Table 25) on exhaust emissions.

<sup>c</sup>The 4-stroke crankcase is easily controllable (Ref. 19-33).

<sup>d</sup>The evaporative emission in 1979 is assumed negligible if the control is in proportion to LDV control (3 gm/mi to 0.2 gm/mi for LDV).

(4) The reactivity of HC exhaust emissions is assumed to be 0.77 for pre-1975 model year cars and 0.64 for post-1975 model year cars (suggested in Ref. 19-16 for cars equipped with oxidizing catalyst). The reactivity of gasoline vapor from HC evaporative emissions is 0.93. These numbers are the EPA estimates in Ref. 19-15.

(5) The average speed in Los Angeles AQCR is assumed to be about 28 mph, which is the work-trip average estimated by LARTS (Ref. 19-46). The speed adjustment factor based on Ref. 19-16 is about

0.79 for HC, 0.72 for CO and 1.13 for NO<sub>x</sub>.

(6) Deterioration factors for pre-1972 model year cars are based on EPA data (Ref. 19-16). They are not used for post-1972 model year cars since emission standards are used as emission factors in Tables 19-A-4. These standards are expected to be met at half-life mileage of 50,000 miles and therefore serve as a conservative estimate of actual vehicle emissions before the vehicle reaches 50,000 miles. They also serve as an estimate for post-50,000 mile

Table 19-A-4. California light duty vehicle (LDV) emission factors for existing vehicles<sup>a</sup> (g/mi, 1975 CVS-CH)

	Model year									
	Pre-1966	1966	1967	1968	1969	1970	1971	1972-73	1974	1975
CO	87	51	50	46	39	36	34	28	28	9
NO <sub>x</sub>	3.6	3.4	3.4	4.3	5.5	5.1	3.5	3.0	2.0	2.0
Exhaust HC	8.8	6.0	4.6	4.5	4.4	3.6	2.9	2.8	2.8	0.9
Crankcase and evaporative HC	3.0 <sup>b</sup>	3.0	3.0	3.0	3.0	2.1 <sup>c</sup>	2.1 <sup>c</sup>	2.1 <sup>c</sup>	2.1 <sup>c</sup>	2.1 <sup>c</sup>

<sup>a</sup>Data for pre-1972 vehicles from surveillance data, as shown in the EPA guideline (Ref. 19-16). Data for post-1972 vehicles based on the California state emission standards for passenger cars. The light duty truck standards are somewhat higher for years 1975-77. This difference in a short period of time has negligible impact on the total light duty vehicle emissions in the 1980's.

<sup>b</sup>7.1 g/mi for pre-1961 cars, 3.8 g/mi for 1961-63, 3.0 g/mi for 1964-65 cars.

<sup>c</sup>Data from Columbia study (Ref. 19-8, Chapter 6, Tables 10, 11) which were derived from actual SHED (Shield House for Evaporation Determination) test data. Crankcase emissions are assumed to be 100% controlled.

vehicles if their emission control performance does not deteriorate drastically. At present an average new car coming off the production line has lower emission factors than the standard to take care of two factors: age deterioration and statistical dispersion of performance in actual production.

19. A. 2 New York

The data base of the New York study area emission inventory is composed of a TRW study (Ref. 19-18, 19) and a New York City implementation plan (Refs. 19-17, 47, 48). Assumptions are the following:

- (1) The reference area for RHC and NOx emission is the whole study area. For CO emissions, Midtown Manhattan, Downtown Manhattan, and other areas are separately considered for the difference in air quality in these areas. Midtown is defined as the area from 39th to 59th Street and Downtown is defined as south of Canal Street. This is the definition used in the latest version of the implementation plan (Ref. 19-48). The previous TRW definition of downtown (south of 50th Street) and Midtown (50th to 125th Street) is not used here.
- (2) The VMT distribution over the area and the modal split of VMT are obtained from Ref. 19-48 and shown in Tables 19-A-5, 6. This latest modal split is significantly different from the previous estimate in Refs. 19-17, 18.
- (3) Basic emission factors of light duty vehicles are shown in Table 19-A-7 based on EPA AP-42 (Ref. 19-16), recent standards, statutory HC and CO standards to be satisfied in 1978, and 2.0 g/mi NOx emission.

Table 19-A-5. New York study area VMT projection (10<sup>6</sup> miles/day)

	1970 <sup>a</sup>	Growth rate <sup>b</sup> (% per year)
Total Manhattan	6.10	0.5
Midtown	1.06	
Downtown	0.59	
Others in Manhattan	4.45	
Total Non-Manhattan <sup>c</sup>	25.6	1.0
Bronx portion	3.40	
Brooklyn portion	3.47	
Queens portion	3.68	
New Jersey portion	15.1	

<sup>a</sup>Based on a recent local study (Ref. 19-48, Table 4-2).

<sup>b</sup>Based on Ref. 19-48 for Manhattan, the rate for non-Manhattan is more conservative than the number used in Ref. 19-18.

<sup>c</sup>From New York City data in Ref. 19-48 proportioned by land area. The average traffic density in New Jersey side is estimated to be about 60% of the traffic density in Bronx, based on a Tri-State 1963 study data.

- (4) The fleet-average emission factors in g/mi for various vehicles are shown in Table 19-A-8, -9 for Manhattan and non-Manhattan areas, reflecting various speed factors, age mix, and deterioration. The taxicabs are noted for their faster turnover rate and deterioration rate. The buses are noted for their low speeds.

Table 19-A-6. New York study area VMT modal split<sup>a</sup> (%)

Mode description	1	2	3	4	5
	Auto and TR ≤ 6000	T-FM	T-NFM	HDV-G	HDV-D
Manhattan	63.9	19.1	8.8	6.2	2.1
Non-Manhattan	89.7	-	-	6.3	4.0
Midtown Manhattan	52.5	22.6	10.5	9.7	4.7
Downtown Manhattan	78.9	4.5	2.1	11.7	2.8

- Mode 1: Passenger cars and light duty trucks (gross vehicle weight less than 6000 lb).  
 2: Fleet medallion taxicabs.  
 3: Non-fleet medallion taxicabs.  
 4: Gasoline heavy duty vehicles (trucks and buses).  
 5: Diesel heavy duty vehicles (trucks and buses).

<sup>a</sup>Simplified modal split based on Table 4-5 in New York Implementation Plan (Ref. 19-48).

Table 19-A-7. Basic emission factors for automobiles for various model years (g/mi, low altitude, non-California)<sup>a</sup>

	Pre-1968	1968	1969	1970	1971	1972	1973-74	1975-77	1978
CO	87	46	39	36	34	28	28	15	3.4
NO	3.6	4.3	5.5	5.1	4.8	4.8	3.1	3.1	2.0
HC exhaust	8.8	4.5	4.4	3.6	2.9	2.9	3.0	1.5	0.41
HC crankcase and evaporative	3.8	3.0	3.0	3.0	2.1	2.1	2.1	2.1	0.2

<sup>a</sup>The pre-1973 numbers are based on EPA data (Ref. 19-16).  
 1973 and post-1973 numbers are based on emission standards except for NOx after 1978.  
 HC crankcase and evaporative numbers are based on a Columbia study (Ref. 19-8, Chap. 6, Table 11).

(5) The stationary source emissions are estimated according to the TRW study (Ref. 19-18, 19). The CO emissions in Midtown and Downtown Manhattan are estimated based on their relative land area compared with the previously defined Midtown and Downtown land areas on which the emission data are available in Refs. 19-18, 19.

#### 19. A. 3 St. Louis

Our data base includes the PEDCo report (Ref. 19-21), local transportation planning (Ref. 19-49), EPA AP-42 (Ref. 19-16) and private communication (Ref. 19-22). The following are the detailed assumptions:

- (1) The non-auto area sources emissions are growing at 1.7% per year according to Ref. 19-21; there is no planned control on these sources.
- (2) The point source emissions are growing at an annual rate of 2-5% according to the growth rates of various industries in St. Louis (page 6-27 in Ref. 19-21), except that from 1972 to 1975, the local implementation plan requires the major industrial sources to reduce their emissions to an admissible level (Ref. 19-21, Appendix B).
- (3) The total VMT in the study region was 29 million miles per day in 1972. It is projected to be 29.0, 30.2, 33.1 and 37.3 million miles per day in 1975, 1980, 1985, 1990, respectively. The growth rate here is a 2.45% per year with a minor mass transit role in 1980-1990. These projections came from Ref. 19-34, Estimate 2.
- (4) Heavy duty vehicles are assumed to contribute 6% of total VMT, now and in the future (Ref. 19-21). The emission factors and VMT age distribution for the heavy duty vehicles were obtained from the EPA guideline (Ref. 19-16).

(5) Passenger car emission factors and deterioration factors were taken from EPA guideline (Ref. 19-16) for model years up to 1972. For 1973 and later model year cars we have used the federal emission standards for emission factors as shown in Table 19-A-7. The deterioration factors are neglected for 1973 and later cars partly because available data is insufficient, and partly because the standard is a good lifetime average since the law intends compliance with the standard when the cars are at their half life of 50,000 miles.

(6) NOx emission is estimated for St. Louis City only due to data limitations. Power plant emissions include the Ashley, Cahokia and Venice plants which are either in the city or in its close vicinity. Emissions are calculated based on yearly coal and oil consumption information from Ref. 19-22, with emission factors obtained from EPA guideline (Ref. 19-16). For non-vehicle area sources we assume that 20% of the emissions from the AQCR come from the City, based on the estimated population ratio in the 1980 decade. For vehicles, the VMT in St. Louis City is assumed to be about 25% of the total AQCR, based on data in Ref. 19-21. For non-power point sources we have used 20% of the total amount from the AQCR, which came from EPA NEDS data.

(7) The basic LDV emission factors are the same as used in New York. The statutory standards on HC and CO emissions are used for the 1978 model year and after. But 2.0 g/mi is assumed for NOx. The fleet-average emission factors for various vehicles, which take into account age mix, speed factor, and deterioration, are presented in Table 19-A-10.

Table 19-A-8. Manhattan fleet-average vehicle emission factors<sup>a</sup>  
(g/mi)

	1970	1975	1980	1985	1990
<b>RHC<sup>b</sup></b>					
Auto and light duty truck	13.1	7.6	2.9	1.1	0.74
Fleet-medallion taxicab	9.95	5.23	0.71	0.71	0.71
Non-fleet medallion taxicab	11.9	6.23	1.25	0.71	0.71
Gasoline HDV	38.8	34.1	29.9	27.9	27.9
Diesel HDV	8.3	8.3	8.3	8.3	8.3
<b>CO</b>					
Auto and light duty truck	155	96	22.4	10.0	8.0
Fleet-medallion taxicab	129	50	7.9	7.9	7.9
Non-fleet medallion taxicab	160	28	9.3	7.9	7.9
Gasoline HDV	435	414	407	404	404
Diesel HDV	63	63	63	63	63
<b>NOx</b>					
Auto and light duty truck	3.9	3.1	2.2	1.9	1.8
Fleet-medallion taxicab	4.7	2.8	1.8	1.8	1.8
Non-fleet medallion taxicab	4.2	3.2	1.8	1.8	1.8
Gasoline HDV	9.4	9.3	9.2	9.2	9.2
Diesel HDV	34	34	34	34	34

<sup>a</sup>Reactivity of HC based on EPA guideline (Ref. 19-15).

<sup>b</sup>Basic emission factors per EPA AP-42 (Ref. 19-16), and 0.41/3.4/2.0 standard after 1978. Assumed speed in Manhattan: 7 mi/hr for LDV, 4 mi/hr for HDV (See New York Implementation Plan, Ref. 19-17).

Table 19-A-9. New York study area non-Manhattan fleet-average vehicle emission factors<sup>a</sup> (g/mi)

	1970	1975	1980	1985	1990
<b>RHC</b>					
Auto and light duty truck	8.3	4.9	2.0	0.72	0.49
Gasoline HDV <sup>b</sup>	22.8	19.3	16.9	15.7	15.7
Diesel HDV <sup>b</sup>	6.3	6.3	6.3	6.3	6.3
<b>CO</b>					
Auto and light duty truck	66.3	41.0	9.4	4.2	3.5
Gasoline HDV <sup>b</sup>	187	177	174	173	173
Diesel HDV <sup>b</sup>	45	45	45	45	45
<b>NO<sub>x</sub></b>					
Auto and light duty truck	4.4	3.4	2.4	2.1	2.0
Gasoline HDV	9.4	9.3	9.2	9.2	9.2
Diesel HDV	34	34	34	34	34

<sup>a</sup>Basic emission factors from EPA AP-42 (Ref. 19-16) and 0.41/3.4/2.0 standard after 1978.

<sup>b</sup>Weighted average of trucks (average speed 15 mph) and buses (average speed 7 mph).

Table 19-A-10. Fleet average vehicle emission factors for various calendar years (g/mi), St. Louis

	1972	1975	1980	1985	1990
<b>Light duty vehicle</b>					
CO	54.4	37	8.5	3.8	3.1
RHC (exhaust)	3.6	2.4	0.84	0.34	0.24
RHC (evaporative)	2.8	2.2	1.0	0.34	0.22
NO <sub>x</sub>	4.8	4.0	2.5	2.2	2.1
<b>Heavy duty vehicle</b>					
CO	121	118	117	116	116
RHC (exhaust)	12	11	9.9	9.5	9.4
RHC (evaporative)	4.7	3.7	3.2	2.8	2.8
NO <sub>x</sub> (gasoline)	9.4	9.3	9.2	9.2	9.2
NO <sub>x</sub> (diesel)	34	34	34	34	34





Fig. 19-1. Los Angeles Air Quality Control Region (also known as South Coast Air Basin)

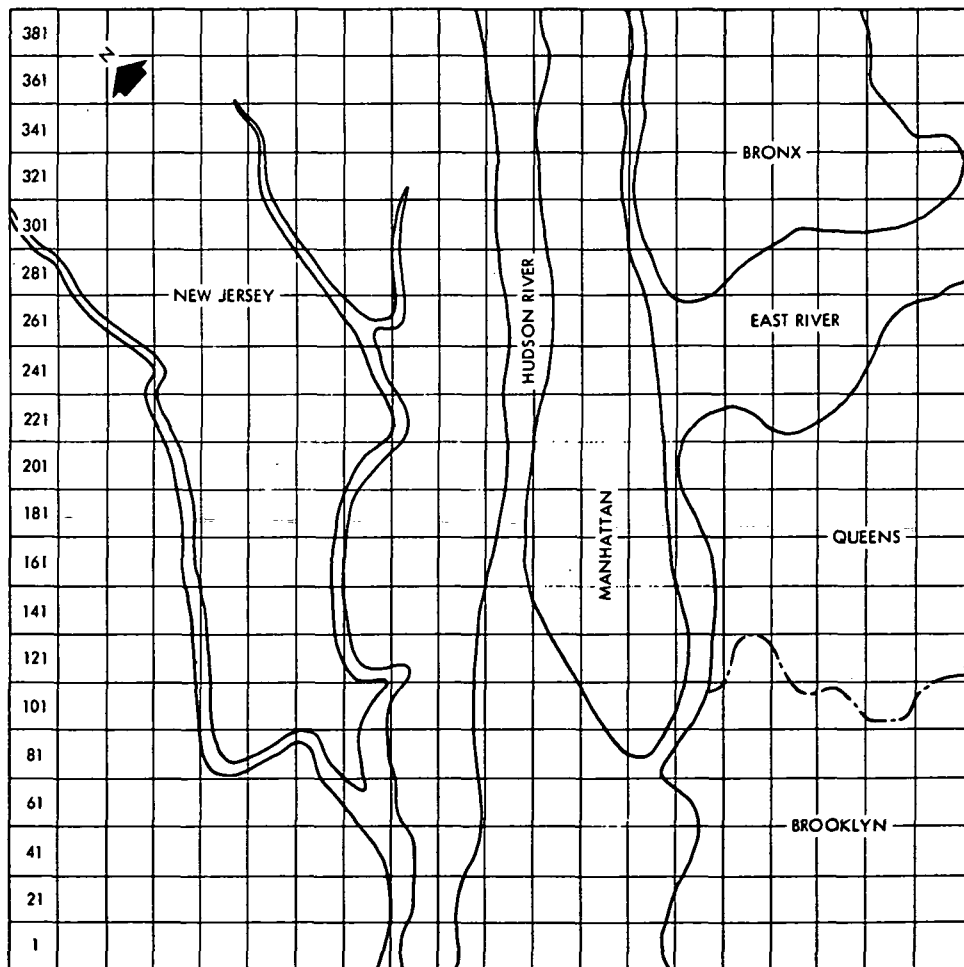

Fig. 19-2. New York study area

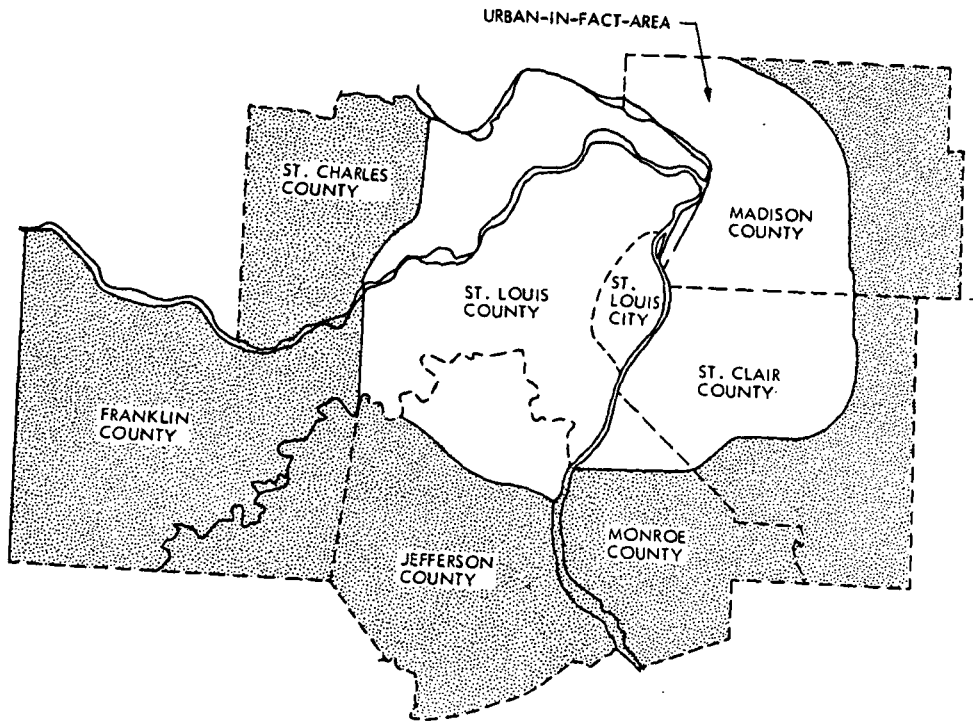

Fig. 19-3. St. Louis study area

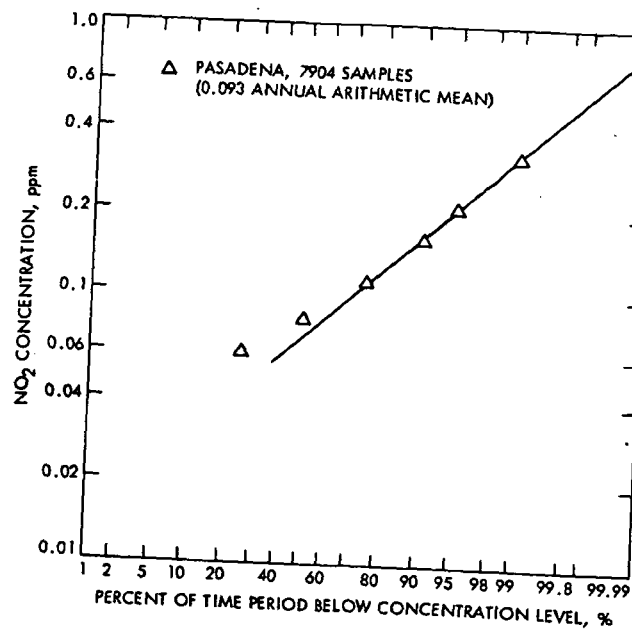

Fig. 19-4. Frequency distribution of nitrogen dioxide (NO<sub>2</sub>) measurements, 1-hr average, Los Angeles Air Basin, 1970 data

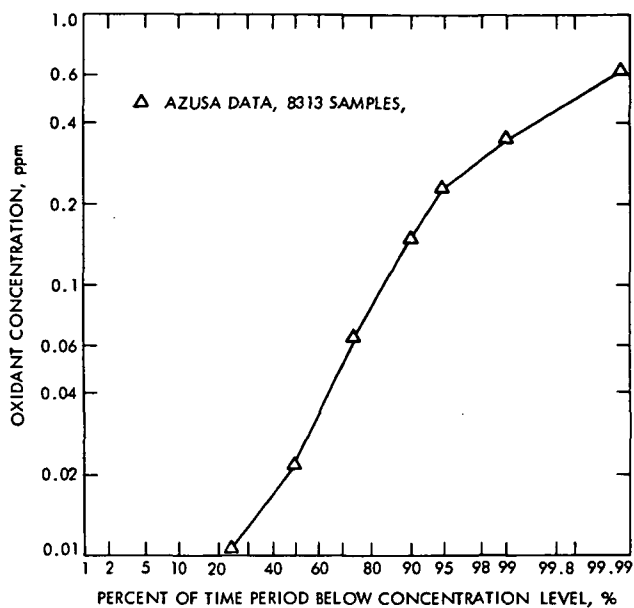

Fig. 19-5. Frequency distribution of oxidant ( $O_x$ ) measurements, 1-hr average, Los Angeles Air Basin, 1970 data

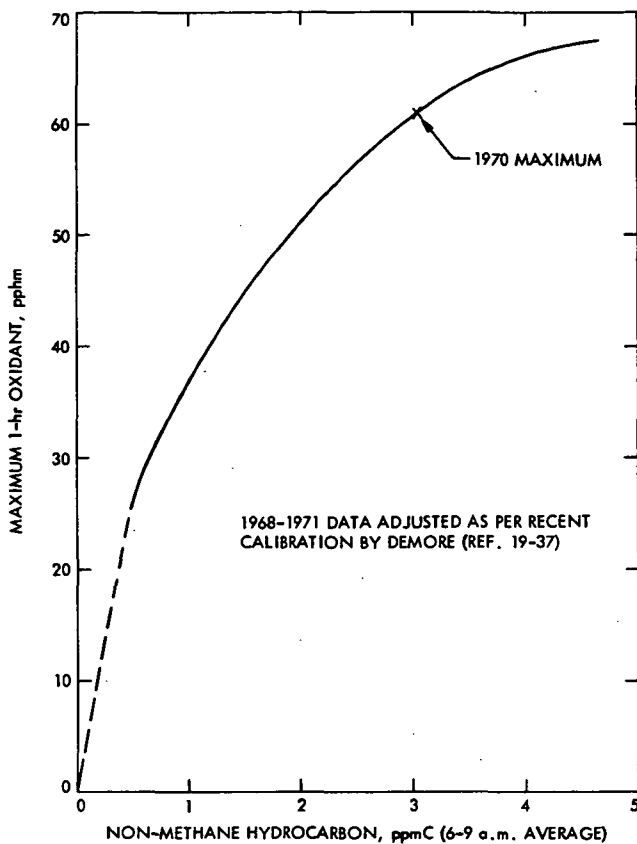

Fig. 19-7. Upper limit 1-hour oxidant curve for Azusa station

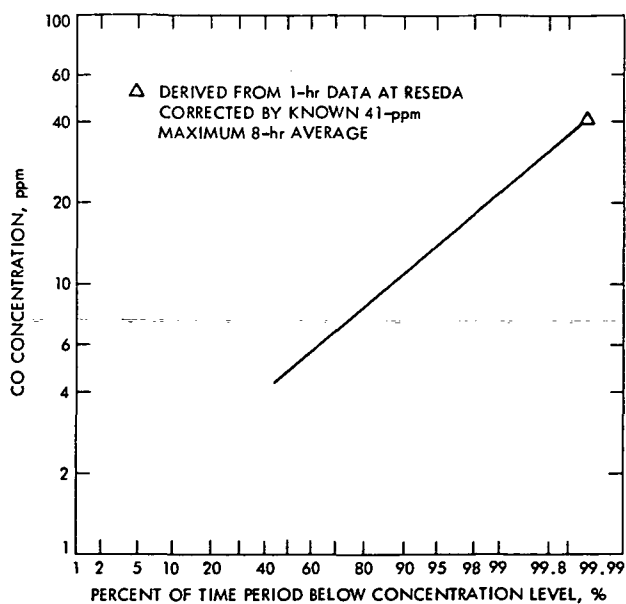

Fig. 19-6. Frequency distribution of carbon monoxide (CO) measurements, 8-hr average, Los Angeles Air Basin, 1970 data

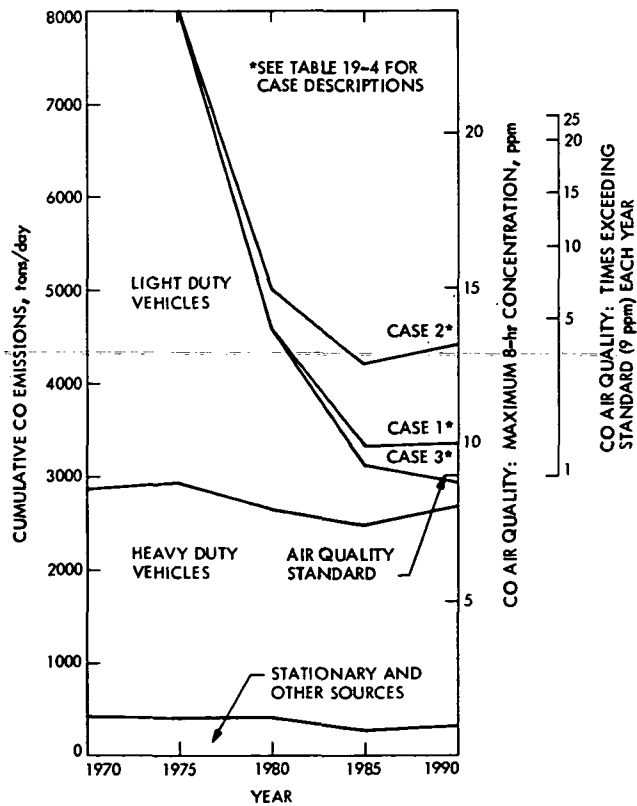

Fig. 19-8. Los Angeles AQCR carbon monoxide (CO) emissions projection

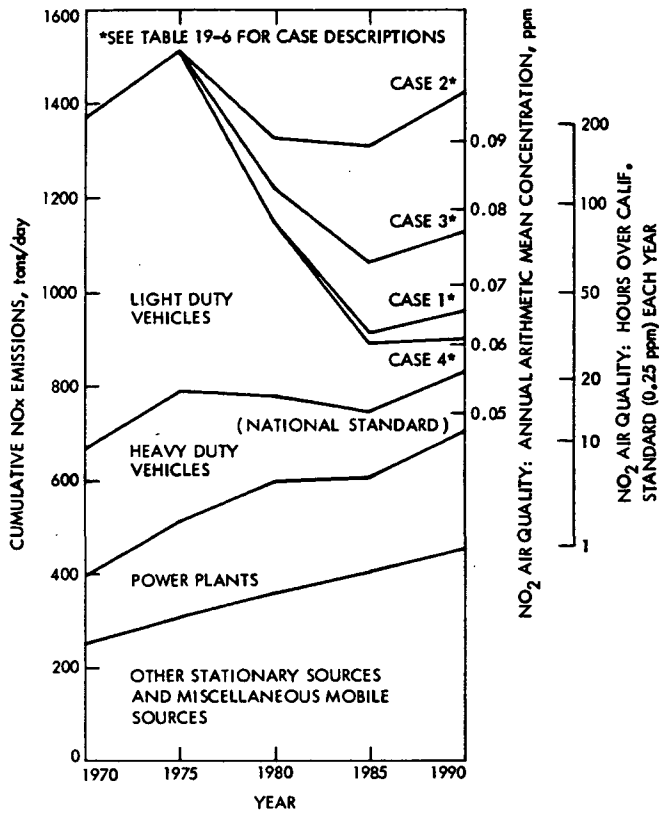

Fig. 19-9. Los Angeles AQCR oxides of nitrogen (NO<sub>x</sub>) emissions projection

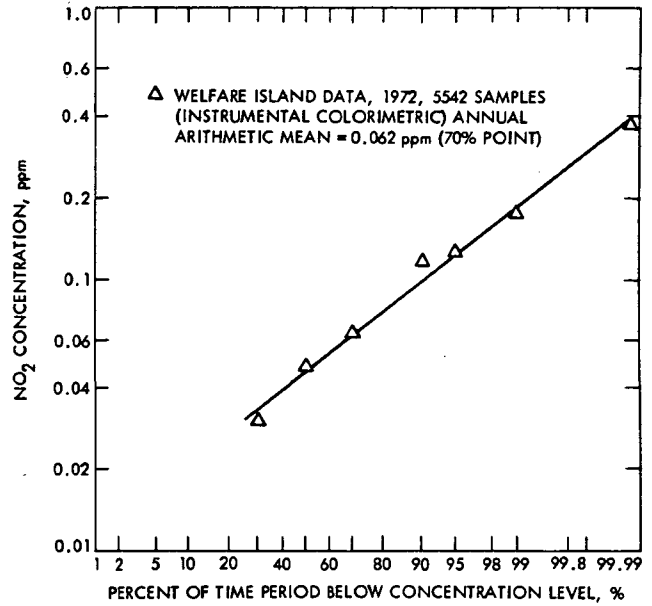

Fig. 19-11. Frequency distribution of nitrogen dioxide (NO<sub>2</sub>) measurements, 1-hr average, New York City

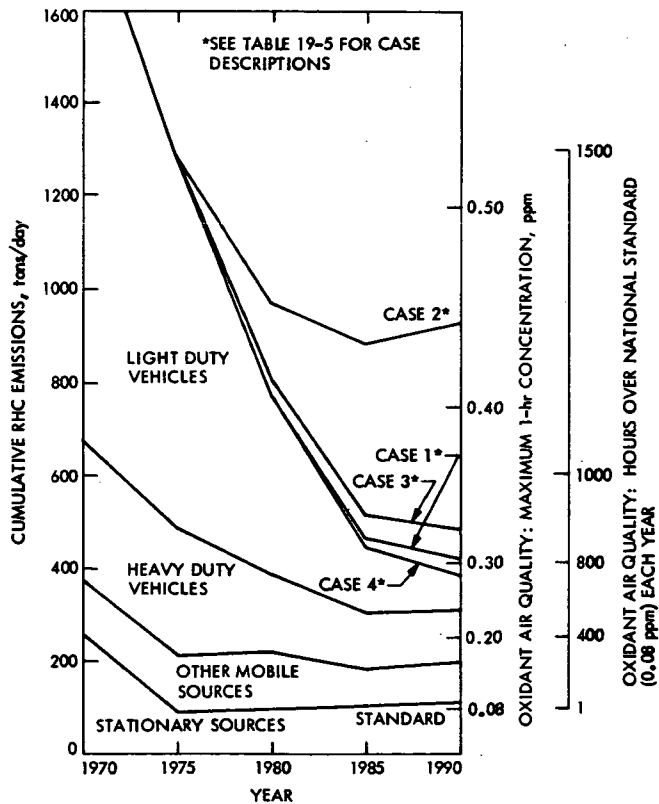

Fig. 19-10. Los Angeles AQCR effective hydrocarbon (RHC) emissions projection

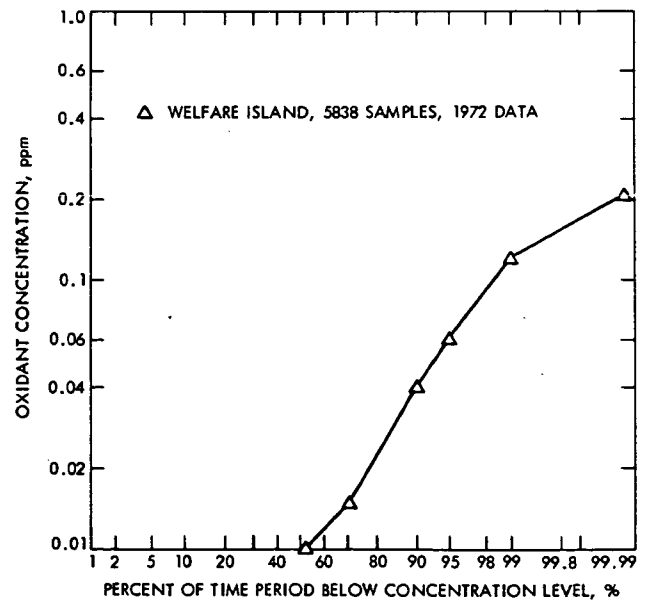

Fig. 19-12. Frequency distribution of oxidant (O<sub>x</sub>) measurements, 1-hr average, New York City

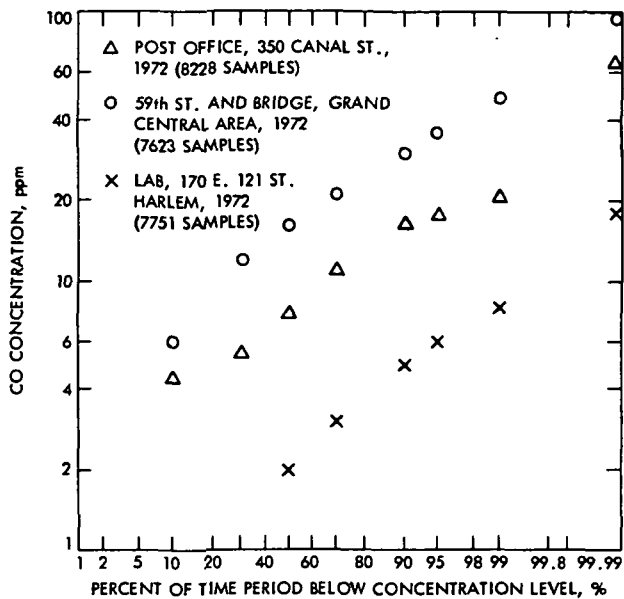

Fig. 19-13. Frequency distribution of carbon monoxide (CO) measurements, 1-hr average, New York City

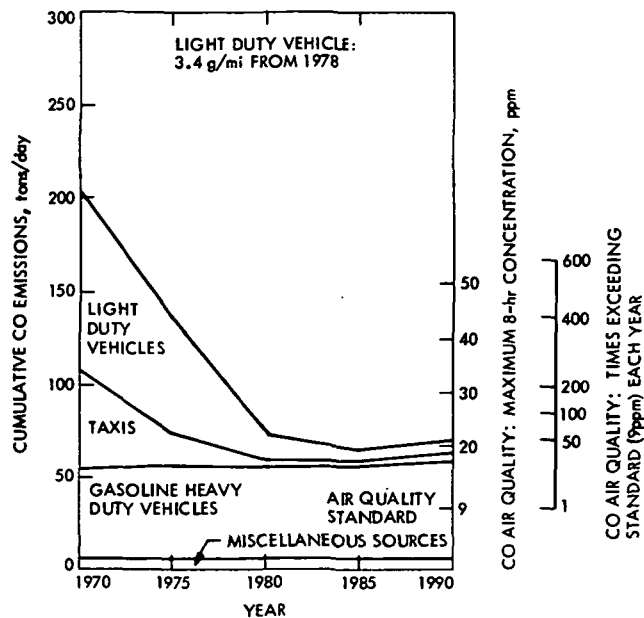

Fig. 19-15. Midtown Manhattan carbon monoxide (CO) emissions projection

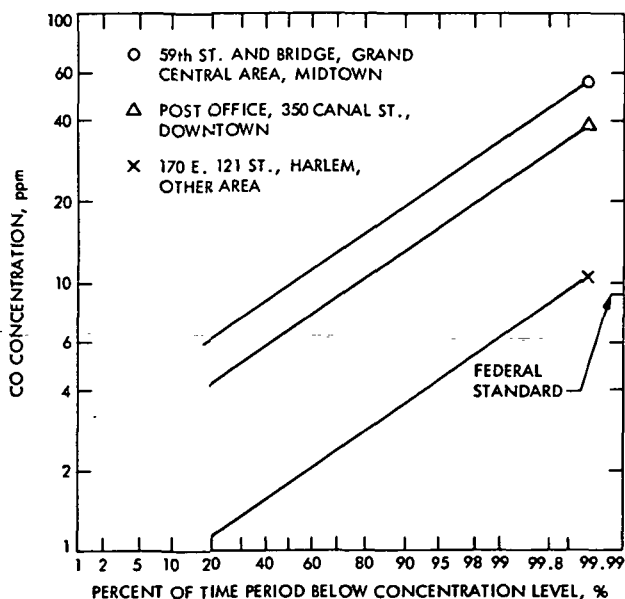

Fig. 19-14. Frequency distribution of carbon monoxide (CO) measurements, 8-hr average, New York City (derived from 1-hr data by Larson method)

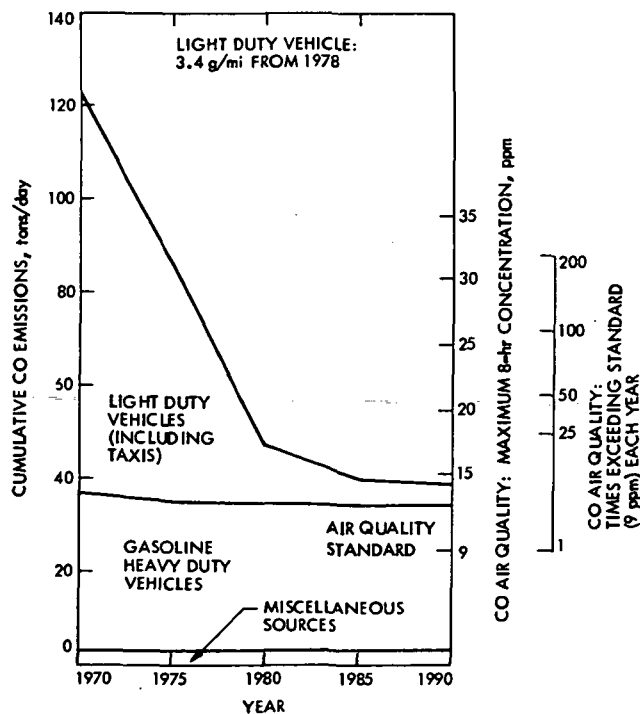

Fig. 19-16. Downtown Manhattan carbon monoxide (CO) emissions projection

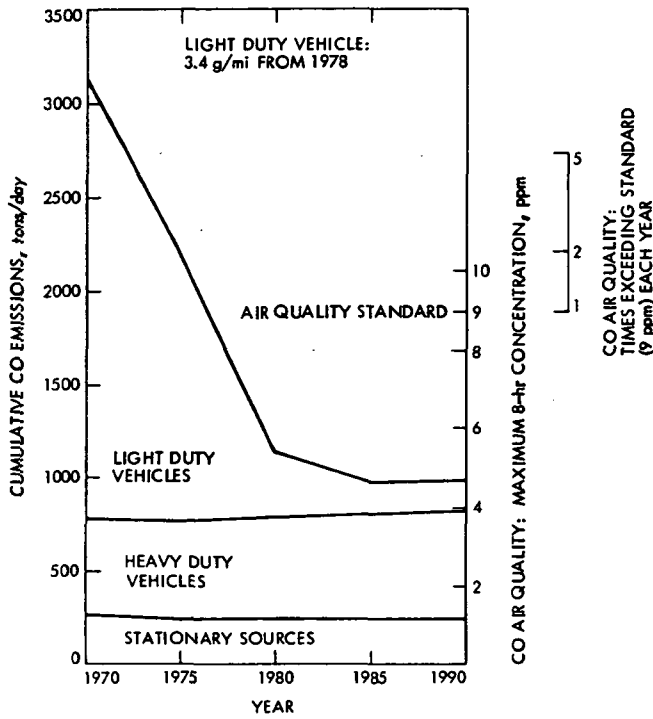

Fig. 19-17. New York study area, excluding Midtown and Downtown Manhattan, carbon monoxide (CO) emissions projection

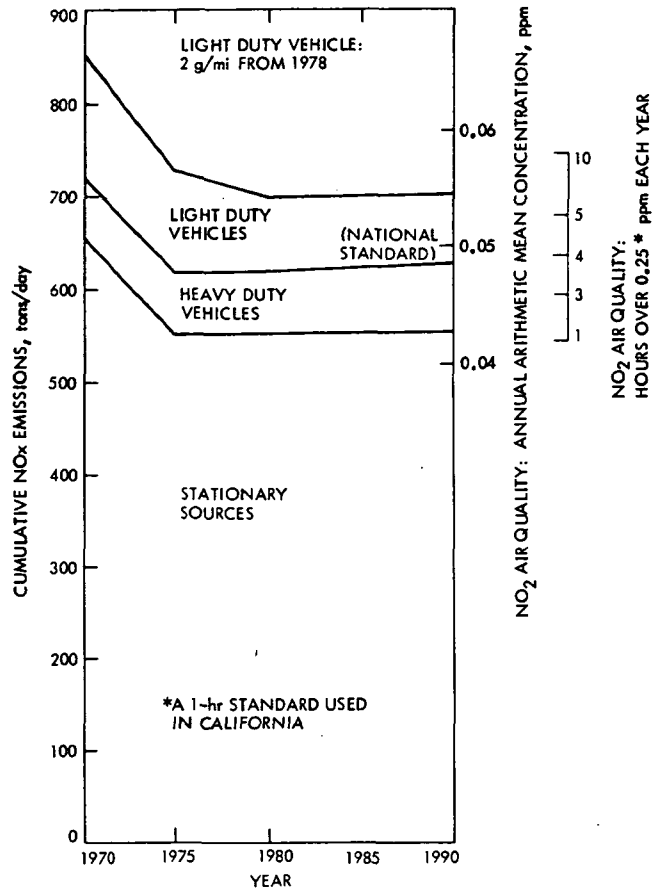

Fig. 19-19. New York study area oxides of nitrogen (NOx) emissions projection

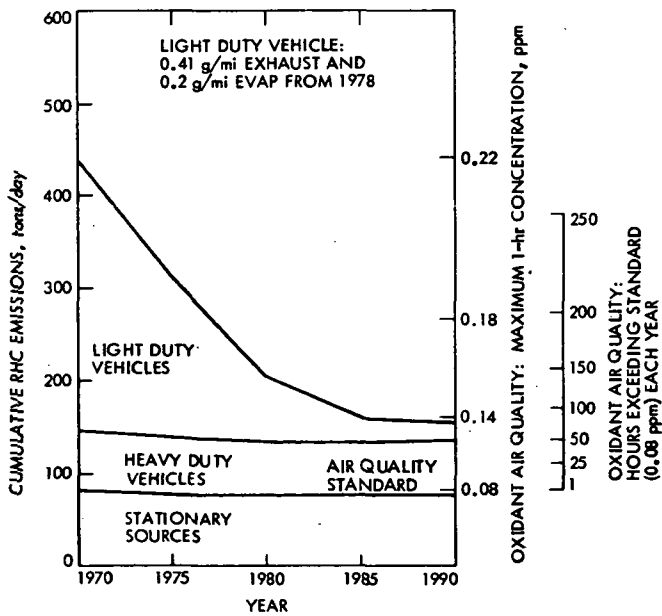

Fig. 19-18. New York study area effective hydrocarbon (RHC) emissions projection

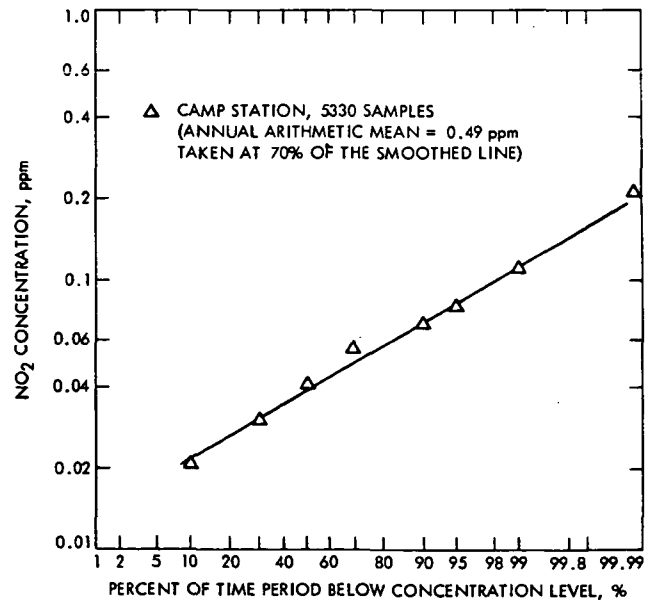

Fig. 19-20. Frequency distribution of nitrogen dioxide (NO<sub>2</sub>) measurements, 1-hr average, St. Louis, 1972 data

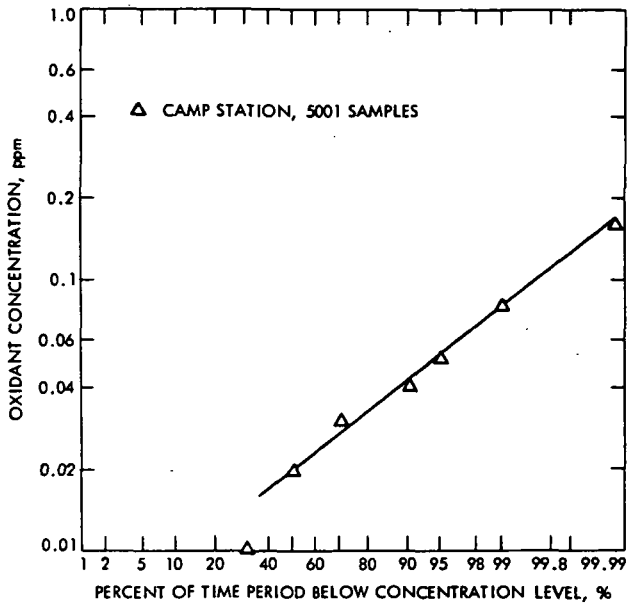

Fig. 19-21. Frequency distribution of oxidant ( $O_x$ ) measurements, 1-hr average, St. Louis, 1972 data

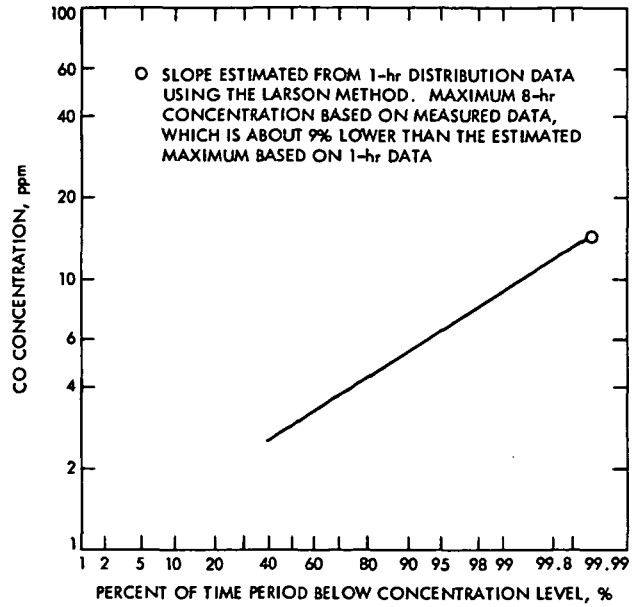

Fig. 19-23. Frequency distribution of carbon monoxide (CO) measurements, 8-hr average, St. Louis, 1972 data

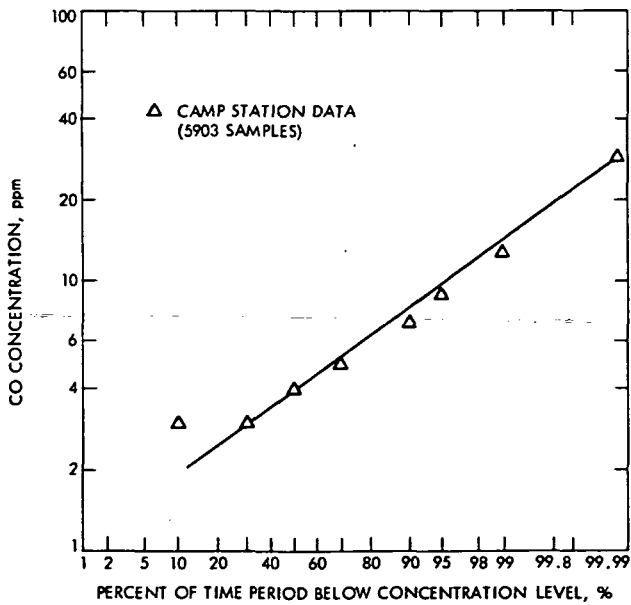

Fig. 19-22. Frequency distribution of carbon monoxide (CO) measurements, 1-hr average, St. Louis, 1972 data

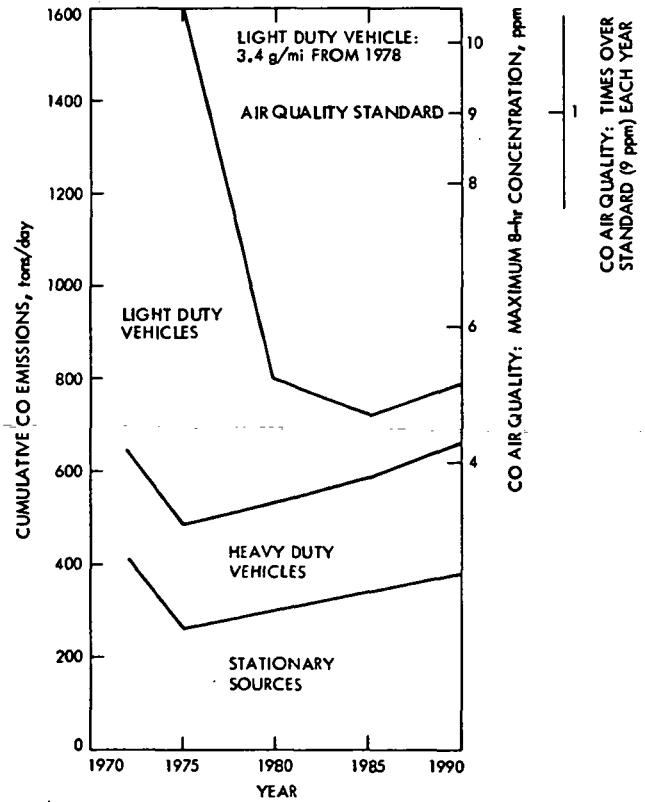

Fig. 19-24. St. Louis Urban-in Fact Area carbon monoxide (CO) emissions projection

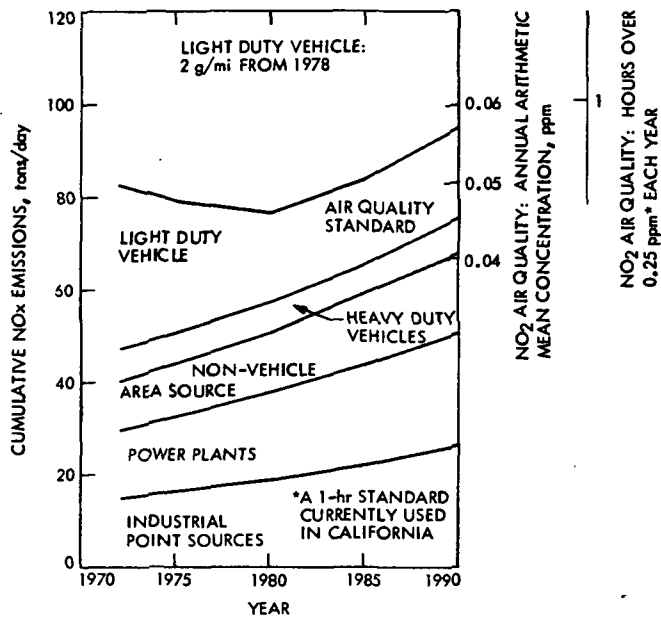

Fig. 19-25. St. Louis City oxides of nitrogen (NOx) emissions projection

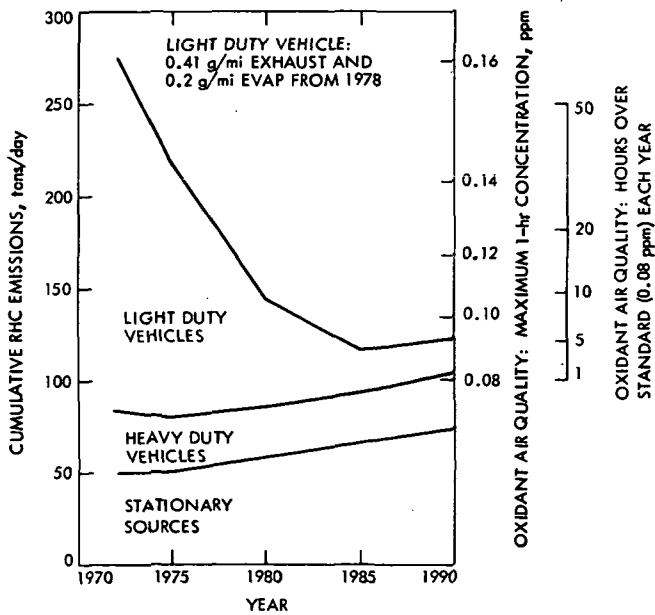

Fig. 19-26. St. Louis Urban-in Fact-Area reactive hydrocarbon (RHC) emissions projection

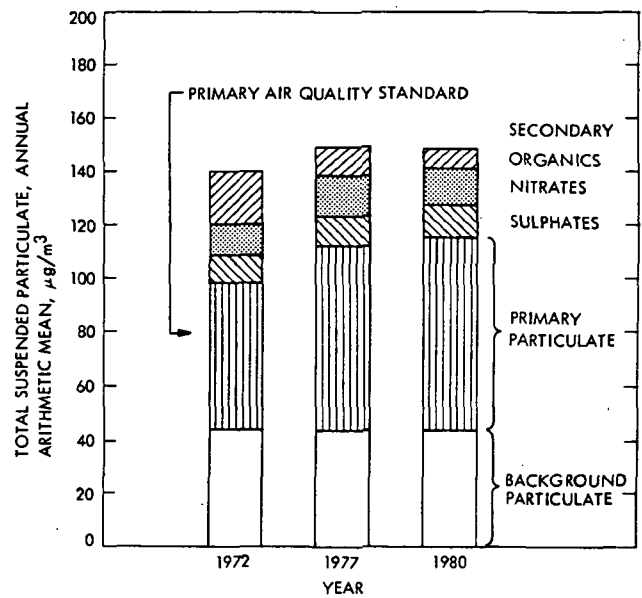

Fig. 19-27. Projected particulate air quality for Downtown Los Angeles



CHAPTER 20. OWNERSHIP COSTS AND  
ECONOMIC IMPACT

20.1	Introduction . . . . .	20-2
20.2	Costs of Ownership . . . . .	20-3
20.2.1	Data, Uncertainties, and Approach . . . . .	20-3
20.2.2	Changes in Owner's Capital and Operating Costs . . . . .	20-8
20.2.3	Break-Even Mileages and Price Targets . . . . .	20-9
20.2.4	Total Ownership Costs . . . . .	20-11
20.3	Aggregate Economic Impact . . . . .	20-11
20.4	Potential Effects on Nation's Balance of Payments . . . . .	20-13
20.5	Conclusions . . . . .	20-14
	References . . . . .	20-14
	Figures . . . . .	20-16

## 20.1 INTRODUCTION

The automobile is an important part of the American economy. From the consumer standpoint, automobile-related expenditures constitute a sizable item in the budget of an average American family. Out of the median family income of about \$13,000 per year estimated for 1974 (based on Ref. 20-1, Table C-22), approximately 10% was spent in owning and operating an automobile (Ref. 20-2). On a broader scale, the automotive and related industries that produce, distribute, and service the automobiles also contribute heavily to the economic activities of the nation. As shown in Table 20-1, consumer net purchase of cars, fuel, maintenance, insurance, and payment of tolls totaled \$94 billion in 1972, about 13% of the total personal consumption expenditures and 8% of the Gross National Product.

Some 3.5 million people, about 4% of the total civilian labor force in the country, were employed in 1972 in manufacturing, selling, and servicing automobiles. Among them, about 800,000 workers were involved in manufacturing vehicles and parts (Ref. 20-3, page 51). In addition, half a million employees in other industries (such as rubber, metal, machinery, and glass)

Table 20-1. Personal consumption expenditures related to automobiles, 1972 (\$ billions)<sup>a</sup>

New cars and net purchase of used cars	45.7
Gasoline and oil	25.5
Automobile repair, greasing, washing, parking, storage and rental	10.4
Tires, tubes, accessories and parts	7.1
Automobile insurance premium less claims paid	4.6
Bridge, tunnel, ferry and road tolls	0.6
Total user-operated transportation	93.9
For comparison:	
Total purchased transportation (taxi, bus, railways, airlines, etc.)	6.2
Total U. S. personal consumption expenditures	726.5
Gross National Product	1155.2

<sup>a</sup>U.S. Department of Commerce data as given in "1973/74 Automobile Facts and Figures," Motor Vehicle Manufacturers Association.

also work to supply parts and services to the motor vehicle manufacturers (Ref. 20-3, page 54).

The use of automobiles also requires that merchandise be imported from foreign countries, and this affects the U. S. balance of payments. The nation is importing about 15% of its automobiles, with a payment bill totaling \$8.8 billion in 1972 (\$5.7 billion for new cars and \$3.1 billion for auto parts, based on Ref. 20-3, page 55). A much more serious problem is the recent increase in the payment for imported crude and refined oil. The imported oil amounted to 6 million barrels per day in 1974 at an annual payment of about \$24 billion. It was 4.7 million barrels per day in 1972 at an annual payment of about \$6 billion.<sup>1</sup> Although this large increase in import payments was the result of price-setting by the cartel of the Organization of Petroleum Exporting Countries, it nevertheless exposes the large appetite of American automobiles, which are currently consuming about 5 million barrels of gasoline each day.

With the introduction of a new engine technology, automobile ownership cost to the consumers will change. Consequently, car sales will probably change; output and employment in auto and related industries may be perturbed; labor skills in engine manufacturing and service industries may have to shift; the automobile's demand for imported oil may decrease; and new engines may demand more imported materials. We shall investigate these effects in varying degrees of detail.

Using the results of previous chapters on engines and vehicles, the purchase and operating costs of an automobile with various engines are derived in Section 20.2. These costs represent a comparison of total material, manpower, and capital resources needed to produce, operate, and maintain the car. They also demonstrate the potential for customer acceptance in a free market, assuming the same utility in personal transportation.

The growth and stability of national output and employment is controlled by the government. Impact on the national economy due to changes in one industry is usually limited in size and temporary in duration, compared with the effects of normal variations in government policy. In Section 20.3, we shall only discuss whether the marketing of alternate-engined vehicles would result in a large drop of auto industry production or labor dislocation.

Section 20.4 evaluates the potential impact on import requirements based on the changing demands for petroleum and raw materials as developed in Chapters 17 and 18. The questions concerning production conversion in the auto industry - such as tooling constraints, capital requirement, availability of funds, and feasible conversion schedules - are discussed in Chapter 15.

<sup>1</sup>Amount of imports in barrels per day from Gas and Oil Journal. Price of imported oil assumed to be \$3.7/bbl in 1972 per National Petroleum Council estimates (U.S. Energy Outlook, 1972) and \$11/bbl in 1974.

Some promising alternate engines use broad-cut distillate fuels which require less energy to refine and are cheaper to make than gasoline (as discussed in Chapter 17). The lowered supply curve of these fuels would benefit the consumers with lower fuel prices (and, to a lesser extent, the refining industry with a slightly increased fuel demand). If a major fraction of the automobile fleet is converted to these more efficient engines, the demand for fuel will decrease considerably due to significantly reduced energy consumption. However, the conversion of the automobile fleet will be gradual due to tooling constraints (Chapter 15). The employment impact in the highly automated refining industry in any single year is, therefore, expected to be small (Ref. 20-4).

## 20.2 COSTS OF OWNERSHIP

This section deals with the effect upon a consumer if he replaces his baseline UC Otto car (a vehicle with the Mature uniform-charge Otto cycle engine, as described in Chapter 3) with a performance-equivalent car powered by an alternate heat engine. The comparison is made assuming that vehicles in the same size class are designed to have the same accommodations, acceleration, range, drivability and durability. This is the Otto-Engine-Equivalent (OEE) concept defined in Chapter 10. The following questions are discussed:

- (1) What are the expected changes in a consumer's capital and operating costs? If his new alternate-engined car promises to realize savings in operating costs, how many miles must be driven before the savings can balance any increase in the purchase price of the car? Since the production cost and selling price are difficult to predict accurately at the present stage of development, can a price target be established, based on expected savings in operating costs?
- (2) If the consumer considers resale of the car, what will be his total differential ownership costs, including depreciation of the value of the car and the operating costs over the years?

The heat engines considered here are assumed to be the Mature versions as defined and described in detail in Chapters 2 through 7. The Mature versions, in this context, only require further development work before production; no fundamental research is needed. These engines are:

UC Otto (baseline):	Uniform-charge Otto engine equipped with 3-way catalyst, using gasoline.
Stratified-charge Otto:	Direct-injected stratified-charge Otto-cycle engine, using gasoline.
Diesel:	Turbocharged Diesel engine, using diesel fuel.

Brayton:	Gas turbine engine, using broad-cut fuel. Two configurations are considered: single shaft and free turbine.
Rankine:	Steam engine, using broad-cut fuel.

All these engines are expected to produce less pollutant emissions than present engines. A car with the baseline UC Otto engine or a stratified charge Otto engine can meet the stringent statutory standards (1970 Clean Air Act Amendment) of 0.41/3.4/0.4 g/mi in HC/CO/NO<sub>x</sub>. The same car with one of the continuous-combustion engines—Brayton, Stirling, or Rankine—is capable of emissions well below the statutory levels. Diesel engines can meet the 0.41/3.4 g/mi standards for HC/CO, but would emit NO<sub>x</sub> at 1 to 1.5 g/mi level, and with relatively higher particulates and odor than others. For comparison, the costs of a UC Otto engine with only an oxidation catalyst, meeting 2 g/mi NO<sub>x</sub>, is also considered because many areas in the country may not need a 0.4 g/mi NO<sub>x</sub> standard, as discussed in Chapter 19. Details of emission performance of these engines are given in Chapters 3 through 7.

Three size classes of vehicles, Small, Compact, and Full-Size cars (around 2100, 3100, 4000 lb curb weight, respectively), are considered for comparison. Actual curb weights vary slightly among engine types for equivalent cars of the same class.

### 20.2.1 Data, Uncertainties, and Approach

Our analysis of a car owner's capital and operating costs depends on three categories of input data: technical characteristics, future economic conditions, and the owner's driving requirements. As expected, these data are subject to varying degrees of uncertainty. Hence, a sensitivity analysis is presented. These inputs and their ranges of uncertainty are discussed as follows:

#### TECHNICAL CHARACTERISTICS

##### Engine Price Differential

Data are presented in Table 20-2 based on results of Chapter 11. This differential includes changes in direct material and labor cost, in capital cost of tooling and facility amortization, and in markup to the retail level. As discussed in Chapter 11, the uncertainties in these data exist mainly in the uncertainty of final configuration which will result from future development and production engineering processes. We shall provide information on price targets so that later, when progress in development work allows for revisions of cost estimates, the benefit of the new engines can be readily accessed. Nevertheless, the estimates show cost levels of the alternate engines which are likely to be achievable with the chosen configurations.

##### Price Differential of the Vehicle Less Engine

Data are presented in Table 20-3 based on information from Chapter 10. Changes are made in the vehicle systems, excluding the power

Table 20-2. Composition of automobile retail price differential due to changes in engine manufacturing costs (Per unit, in 1974 dollars)

Engine type	Vehicle class	①	②	③	④	⑤	⑥	⑦	⑧
		OEE horsepower	Variable cost (direct material and labor)	Amor-tized tooling	Amor-tized facility	Special tools	Total ②+③ +④+⑤	Cost differential with respect to UC Otto baseline	Retail price differential
UC Otto baseline	Small	70	235	35	30	20	320	0	0
	Compact	125	350	55	40	25	470	0	0
	Full-Size	175	435	70	55	35	595	0	0
Diesel	Small	74	235	40	30	25	330	10	15
	Compact	131	425	65	45	35	570	100	130
	Full-Size	182	570	85	55	45	755	160	210
Stratified charge Otto	Small	70	210	40	30	25	305	-15	-20
	Compact	127	350	65	45	35	495	25	30
	Full-Size	179	450	85	55	45	635	40	50
Brayton (single shaft)	Small	49	295	45	20	35	395	70	90
	Compact	86	355	80	40	60	535	65	85
	Full-Size	118	410	110	55	80	655	60	80
Brayton (free turbine)	Small	51	320	65	25	45	455	135	175
	Compact	89	430	110	45	75	660	190	250
	Full-Size	123	530	155	60	105	850	255	330
Stirling	Small	57	340	70	30	35	475	155	200
	Compact	99	480	110	45	55	690	220	285
	Full-Size	137	600	140	55	65	860	265	345
Rankine	Small	66	395	55	40	35	525	205	265
	Compact	119	590	90	55	55	790	320	415
	Full-Size	166	765	115	70	65	1015	420	545

- ① Horsepower for performance-equivalent vehicles.
- ② From Chapter 11.
- ③ Based on machining, foundry and forge costs given in Chapter 11.
- ④ Based on facility and launching costs given in Chapter 11.
- ⑤ Tools that wear out in a year. Estimates based on machine tool cost given in Chapter 11.
- ⑦ Since other additive overhead costs are relatively independent of engine type, this column is the engine price differential at the wholesale level.
- ⑧ 30% above column ⑦ to cover dealer's costs and profits, as explained in Chapter 11. Rounded to the nearest \$5.

system, to accommodate engine changes. Most of this is due to weight (and power) propagation effects. The magnitude of change and degree of uncertainty are both relatively small.

#### Fuel Consumption per Mile

Data are presented in Table 20-4 in terms of miles per gasoline-heat-equivalent gallon,

based on results from previous chapters. Composite characteristics were derived for a combined operating mode, consisting of 55% driving on the Federal Urban Cycle and 45% driving on the Federal Highway Cycle (see Chapter 14). Although the miles-per-gallon estimates are quite accurate ( $\pm 5\%$ ) on this particular driving cycle, there are wide variations in individual driving habits and in traffic and road conditions

Table 20-3. Automobile retail price differential due to engine-induced vehicle changes<sup>a</sup>

Engine type	Weight differential, lb			Corresponding price differential (1974 \$) <sup>b</sup>		
	Small	Compact	Full-Size	Small	Compact	Full-Size
UC Otto baseline <sup>c</sup>	0	0	0	0	0	0
Stratified-charge Otto	3	22	41	5	20	40
Diesel	51	54	48	50	55	50
Rankine	15	11	10	15	10	10
Brayton (single shaft)	-42	-86	-116	-40	-85	-115
Brayton (free turbine)	-34	-74	-99	-35	-75	-100
Stirling	0	-20	-50	0	-20	-50

<sup>a</sup>Changes in vehicle weight due to changes of engine weight and engine power, excluding changes in the power system, i. e., engine proper, electric, transmission, and cooling systems. Data from G. Klose, author of Chapter 10.

<sup>b</sup>Based on \$1/lb, rounded to the nearest \$5. Detailed calculation by the engine/vehicle tasks gives 99.2¢/lb.

<sup>c</sup>Mature UC Otto engine with 3-way catalyst, meeting 0.4 g/mi NOx. No change is expected if the vehicle is equipped with oxidation catalyst only, meeting 2 g/mi NOx.

around the country. Since the rank order of these engines (in terms of fuel economy) stays the same whether one drives on the Federal Urban Cycle or on the Federal Highway Cycle, we have neglected this variation in our ownership-cost sensitivity analysis.

#### Costs of Expendable Fluids and Maintenance Requirements

The requirements for expendable fluids, including engine lubricant and coolant (as applicable), are shown in Table 20-5 based on the estimates of Chapters 3 through 7. At the present moment, it is impossible to predict the requirements of scheduled maintenance of the alternate engines which are accurate enough for inclusion in our calculation. It is a fair assumption that no novel engine would be released for production unless its maintenance requirements are assessed to be, at worst, comparable with the conventional Otto engine. We have conservatively assumed equal costs for maintenance (parts, plus labor) over the life cycle for all engine types. However, the Brayton and Stirling (and to a lesser extent, the Rankine) engines should, in our opinion, require less maintenance expense than the baseline UC Otto engine.

#### FUTURE ECONOMIC CONDITIONS

##### Fuel Prices

The assumed price levels of automotive fuels are shown in Table 20-6. Also shown is the comparison of the energy content of a gallon of each fuel. Broad-cut fuels, which can be used in the continuous-combustion engines (Stirling, Brayton, and Rankine), are not currently marketed but are expected to have a processing cost lower than gasoline and diesel fuel (Chapter 17 and Ref. 20-4). We have assumed a conservative 1¢/gal reduction in price from the price of diesel fuel. It is worth noting that diesel fuel and the broad-cut fuels not only cost less per gallon due to lower refinery processing costs, but each gallon also contains more energy than gasoline.

It is extremely difficult to predict fuel prices in the future because of the nation's reliance on imported oil, the price of which is currently set by the OPEC cartel. However, it is generally believed that fuel prices are not likely to drop much below the present levels (Ref. 20-9). On the contrary, it is quite probable that the price of petroleum-based fuel may rise because of the need to accelerate the growth of domestic supply

Table 20-4. Automobile fuel economy<sup>a</sup> (Miles per gasoline-equivalent gallon<sup>b</sup>)

Engine type	Vehicle class		
	Small	Compact	Full-Size
UC Otto baseline <sup>c</sup>	30.4	21.5	17.3
Stratified-charge Otto	32.0	23.0	17.9
Diesel	32.2	23.3	18.8
Brayton (single shaft)	33.8	26.7	22.1
Brayton (free turbine)	30.6	24.2	20.0
Stirling	38.8	30.2	24.6
Rankine	25.2	18.9	15.1

<sup>a</sup> Measured on composite cycle (55% on Federal Urban Cycle, 45% on Federal Highway Cycle).

<sup>b</sup> Containing same number of Btu's as in a gallon of gasoline.

<sup>c</sup> Mature UC Otto with 3-way catalyst capable of meeting 0.4 g/mi NOx. About 5% better mpg for a Mature UC Otto with oxidation catalyst only, meeting 2 g/mi NOx.

Table 20-5. Cost of engine expendable fluids<sup>a</sup> (Per 1000 miles, in 1974 dollars)

Engine type	Vehicle class		
	Small	Compact	Full-Size
UC Otto baseline <sup>b</sup>	0.81	1.06	1.32
Stratified-charge Otto	0.81	1.06	1.32
Diesel	1.42	1.83	2.24
Brayton (single shaft)	0	0	0
Brayton (free turbine)	0	0	0
Stirling	0.30	0.50	0.65
Rankine	1.26	1.58	1.91

<sup>a</sup> Including scheduled changes of lubricant (90¢/qt) and coolant (\$1.25/qt), averaged over 100,000 miles. Detailed assumptions on maintenance frequencies are presented in Chapters 3 through 7.

<sup>b</sup> Mature UC Otto engine with 3-way catalyst meeting 0.4 g/mi NOx. A UC Otto engine with oxidation catalyst meeting only 2 g/mi NOx would use the same amount of expendable fluid.

Table 20-6. Automotive fuel data

	Required in	Usable in	Avg. lower heating value, hp-hr/gal	Energy equivalent conversion factor, $\left(\frac{\text{gal fuel}}{\text{gal gasoline}}\right)$	\$0.52/gal gasoline	\$1.00/gal gasoline
Gasoline (~91 research octane number, unleaded, low-S)	UC Otto, Stratified charge	All but Diesel	45.6	1.000	0.40 <sup>a</sup> 0.12 tax 0.52	1.00
Diesel fuel (~49 cetane number, low-S)	Diesel	Diesel, Brayton, Stirling, Rankine	51.7	0.882	0.37 <sup>b</sup> 0.12 tax 0.49	0.97
Broad-cut (low-S)	None	Brayton, Stirling, Rankine	50.0	0.912	0.36 <sup>c</sup> 0.12 tax 0.48	0.96

<sup>a</sup> Based upon data in *Oil and Gas Journal*, December 30, 1974: 39.1 - 44.9¢/gal untaxed; national average, August 1974 to December 24 = 40.4¢/gal.

<sup>b</sup> Based upon refinery cost difference of 3 to 4¢/gal between diesel and gasoline, according to reliable petroleum industry source.

<sup>c</sup> Our own assumption, based on relaxed processing requirement (1¢/gal cheaper than diesel fuel).

and to curb the growing demand for energy. We have chosen to use the present fuel price level as our reference case and a \$1/gal gasoline level as a possible future case for sensitivity analysis.

The price of auto fuel may be a few percent lower after a large fraction of the fleet is converted to energy-saving engines, which can reduce auto fuel consumption without reducing miles driven. This relation is explained in Fig. 20-1. With a demand elasticity of -0.2 to -0.8 (Refs. 20-8, 20-9) and a supply elasticity of 2 to 3,<sup>2</sup> it can be shown that the percentage price drop should be 26 to 45% of the percentage reduction in consumption due to technology improvement. Since the reduction in consumption after a full-fleet conversion is expected to be 26% if the Brayton engines are used, and 32% if the Stirling engines are used (Vol. I, Table 5), the eventual price drop is at least 6%. The actual price drop, however, will be gradual due to the slow conversion of the vehicle fleet on the highway. We have included the effect of this price drop in the sensitivity analysis.

#### Interest Rates

In considering auto-related expenses, a car buyer views a dollar in future operating expenses

as less important to him than a dollar in the price of the car, for two reasons: (1) the future dollar will be worth less due to inflation, and (2) interest must be paid (for most consumers) for the initial capital cost. The first factor is accounted for by adopting a constant-dollar basis for comparison. The second factor is taken into account by "discounting" future expenses to the present time based on an appropriate interest rate, so that future operating expenses can be compared with capital cost on a "present value" basis. As shown in Table 20-7, the interest on a new car loan in recent years (which determines a car buyer's monthly payment for the first few years) ranges from 6 to 9% per year in real term (actual interest minus inflation). In comparison, the interest rate on a home mortgage, which represents a true societal discount rate, stays mostly below 4% per year for the lower risk in mortgage loan. We shall use 7% per year as our nominal discount rate for automobile expenses and include 4% per year in the sensitivity analysis.

#### OWNER'S DRIVING REQUIREMENTS

##### Distribution of Vehicle-Miles-Traveled Over the Population

Since the savings of a fuel-economical car depend on the amount of driving, it is important

Table 20-7. New car and new home mortgage interest rates (% per annum)

Year	① Home mortgage <sup>a</sup>	② New car finance <sup>b</sup>	③ Change in CPI <sup>c</sup> over previous year	① - ③ Real mortgage	② - ③ Real car loan
1965	5.81	d	1.72	4.09	d
1966	6.25	d	2.86	3.39	d
1967	6.46	d	2.88	3.58	d
1968	6.97	d	4.20	2.77	d
1969	7.81	d	5.37	2.44	d
1970	8.44	d	5.92	2.52	d
1971	7.74	12.1	4.30	3.44	7.8
1972	7.60	11.9	3.30	4.30	8.6
1973	7.95	12.1	6.23	1.72	5.9
1974	8.90	12.5	10.07	-1.17	2.4

<sup>a</sup>FHLBB series, New Homes, Federal Reserve Bulletin.

<sup>b</sup>36-month new car loan, from finance companies, Federal Reserve Bulletin.

<sup>c</sup>Consumer Price Index (Ref. 20-1).

<sup>d</sup>Data not available.

<sup>2</sup>Reference 20-9 implies a crude oil supply elasticity of about 2. The supply elasticity of auto fuel should be higher because of flexibility in blending the refined oil product. A range of 2 to 3 is used here per suggestion of Dr. Roger Noll of the Department of Humanities, Caltech.

to know the driving patterns of the population to assess the benefits of any new engine technology to the driving public. A recent nationwide survey of personal transportation conducted by the Department of Transportation (Ref. 20-10) shows that the median miles-driven per vehicle per year generally decreases with the age of the vehicle. The numbers (in thousands of miles) from the first year to the tenth year are: 12.1, 12.4, 10.7, 10.1, 9.5, 8.6, 8.5, 7.4, 6.7, 6.3, respectively. The cumulative mileages for the first 3 years, and over 10 years, are distributed over the population of automobiles as shown in Figs. 20-2 and 20-3. Not surprisingly, the mean number of miles-driven over either the first 3 years, or after 10 years, are higher than the median number of miles, being at about the 60th percentile of the distribution curves. We have used the median mileages as our nominal mileages, and discuss the effect of higher or lower driving in the sensitivity analysis.

### Depreciation

In addition to the input data discussed above, estimates of automobile resale values are also required to calculate depreciation<sup>3</sup> costs as a portion of the total ownership cost. There is no data base from which we can predict the relative resale value of cars with alternate engines compared to cars with the baseline UC Otto engines. However, knowing that the promising alternates – the Brayton and the Stirling – will give better fuel economy and probably reduced maintenance costs, one might expect them to have higher resale values, since performance and durability are assumed to stay unchanged in our comparison. Historically, resale value depends on the weight of the vehicle as shown in Fig. 20-4 (which is based on current-dollar resale values from the Kelley Blue Book, Ref. 20-11, and the used car price index in Ref. 20-1). It is seen that larger cars traditionally depreciate more rapidly than smaller cars. We choose to use these depreciation curves for all vehicles according to their size classes, knowing that this is a conservative estimate of the value of the promising alternate-engine-powered vehicle.

### 20.2.2 Changes in Owner's Capital and Operating Costs

#### CHANGES IN CAPITAL COSTS

The expected automobile retail price differentials for cars in a given class are shown in Table 20-8. The effects of engine changes and engine-induced vehicle changes (shown in Table 20-2 and Table 20-3) are included. Representative total retail prices for 1974 cars are also

Table 20-8. Automobile retail price differential<sup>a</sup> relative to performance-equivalent vehicles equipped with UC Otto baseline engines<sup>b</sup> (per unit, in 1974 dollars)

Engine type	Vehicle class		
	Small	Compact	Full-Size
UC Otto baseline <sup>b</sup>	0	0	0
Stratified-charge Otto	-10	50	90
Diesel	70	190	260
Brayton (single shaft)	50	0	-30
Brayton (free turbine)	140	180	230
Stirling	200	270	300
Rankine	280	430	560
Typical retail price of 1974 model year cars <sup>c</sup>	2700	3200	4100

<sup>a</sup>Including the effects of engine change (Table 20-2) and the effects of associated vehicle change (Table 20-3), rounded to the nearest \$10. There is no appreciable difference in the cost of the transmission, which is considered as a part of the power system, for cars in the same size-class. A CVT transmission required by a conventional transmission (Chapter 11).

<sup>b</sup>Mature UC Otto engine with 3-way catalyst capable of meeting 0.4 g/mi NOx. A UC Otto engine using oxidation catalyst only, capable of meeting 2 g/mi NOx, will cost about \$50 less.

<sup>c</sup>Data from Consumer Reports, April 1974, presented here as a reference for comparison.

<sup>3</sup>Defined to be the constant-dollar, present-value difference between the price of the new car and its resale value at the end of an ownership period.



given. These typify the price levels of our baseline UC Otto vehicles and provide a reference for comparison. It is noted that, except for vehicles with Rankine engines, all other vehicles could be priced within 10% of the prices of the baseline vehicles. It is also noted that the single-shaft Brayton engines could be sold at very competitive prices. This is due to the relative simplicity of the Brayton engine, requiring less material and labor in manufacturing, and to the fact that lower-horsepower Brayton engines can deliver the same level of performance in any vehicle size class.

#### CHANGES IN THE COSTS OF FUEL AND EXPENDABLE FLUIDS

The present value of the cumulative fuel costs of a vehicle after  $n$  years of driving is expressed as follows:

$$\text{Present-valued fuel cost for } n \text{ years} = \sum_{i=1}^n \left( \frac{FP \cdot CF}{MPG} \right) \cdot \frac{VMT_i}{(1+r)^i}$$

where  $FP$  is the constant-dollar price of fuel in \$/gal (assumed to be time invariant);  $MPG$  is the number of miles per gasoline-equivalent gallon (values shown in Table 20-4);  $CF$  is a fuel-dependent factor converting the number of gasoline-equivalent gallons to the number of gallons of the fuel actually used (the values of  $CF$  are listed in Table 20-6;  $VMT_i$  is the number of vehicle-miles-travelled in the  $i$ th year; and  $r$  is the annual discount rate.

Likewise, the present value of cumulative expenses on expendable fluids (oil and coolant) after  $n$  years is:

$$\text{Present-valued cost of expendable fluids for } n \text{ years} = \sum_{i=1}^n \frac{CEF}{1000} \cdot \frac{VMT_i}{(1+r)^i}$$

where  $VMT_i$  and  $r$  are as previously defined, and  $CEF$  is the constant-dollar average cost of expendable fluids per thousand miles as shown in Table 20-5.

Using these equations, differential costs of fuel and expendable fluids for vehicles with alternate engines, relative to vehicles with baseline UC Otto engines, are presented in Figs. 20-5, 20-6, and 20-7 for Full-Size, Compact, and Small cars, respectively. The  $VMT_i$  used here are the national median  $VMT_i$  given in Section 20.2.1. The annual discount rate used is 7%, the average real interest rate of new-car loans. The present levels of fuel prices, i. e., 52¢/gal for gasoline, 49¢/gal for diesel fuel, and 48¢/gal (estimated) for broad-cut fuels, are used for the nominal case. The costs are plotted against cumulative mileages. The resulting curve falls off because future expenses are discounted. Without discounting, the curve would be linear, with the same slope as at the origin.

It is seen that the Stirling, Brayton, and Diesel engines have a clear advantage in operating cost savings, while the Rankine and stratified-charge Otto engines cost essentially the same as the baseline vehicles. It is also observed that larger savings can be realized in larger cars than in smaller cars.

The sensitivity of operating costs with respect to fuel and oil prices, interest rates, and number of miles driven per year is shown in Figs. 20-8 and 20-9. For simplicity, only Full-Size cars with the Stirling and the single-shaft Brayton engines are shown. It is observed that the dominant variation in operating costs would come from the change in fuel price. The influence of the other factors is more limited.

Furthermore, these figures do not include any maintenance cost differentials other than lubricant oil and coolant. We believe that actual maintenance and repair costs could favor alternate engines, especially the Brayton and the Stirling engines. We can say, therefore, that our nominal-case estimate is a conservative estimate of the potential of the promising alternate engines to realize cost savings in operating an automobile.

#### 20.2.3 Break-Even Mileages and Price Targets

##### BREAK-EVEN MILEAGE

Since four alternate engines, Stirling, Single-Shaft Brayton, Free-Turbine Brayton, and Diesel, have clear savings advantages in vehicle operating costs, and the savings increase with mileage, as shown in Figs. 20-5 to 20-9, we can estimate the number of miles which must be driven for the savings in operating cost to offset the increment in the initial capital cost. Based on our estimates of the differential purchase costs from Table 20-8, and the mileage-dependent savings in operating costs from Figs. 20-5, 20-6, and 20-7, the break-even mileages for the three size classes are presented in Table 20-9. Also given in the table are the break-even mileages under two other conditions: (1) fuel prices rise to the level of \$1/gal of gasoline and the price of lubricant oil is doubled, and (2) initial costs are \$100 more per vehicle for all but the baseline UC Otto engine.

The results for the single-shaft Brayton and the Stirling engines are depicted in Fig. 20-10, where the break-even mileages and their corresponding years of driving, at the national median annual vehicle-miles-travelled, are given for the three size classes. It is seen that, based on the present price levels and our vehicle price estimates, Stirling cars will balance before 40,000 miles and Brayton (single shaft) cars will balance in less than 15,000 miles. At a higher fuel-price level, \$1/gal gasoline, the break-even mileages can be reached within 20,000 miles by Stirling cars and within 5,000 miles by Brayton cars. Even if the initial prices are increased by \$100 per vehicle, all except Small cars with Stirling engines can break even well within 50,000 miles.

It is worth noting that larger size cars can break even sooner than smaller size cars, and

Table 20-9. Break-even mileages for savings in operating costs to balance initial cost differential: Stirling, Brayton, and Diesel vs UC Otto baseline (mi x 10<sup>3</sup>)

Fuel price at 52¢/gal gasoline	Vehicle class		
	Small	Compact	Full-size
Fuel price at 52¢/gal gas			
Stirling	37	30	26
Brayton, S. S.	11	0	0
Brayton, F. T.	45	29	27
Diesel	26	46	50
Fuel price at \$1/gal gas			
Stirling	20	16	14
Brayton, S. S.	2	0	0
Brayton, F. T.	27	15	15
Diesel	16	26	28
Fuel price at 52¢/gal gas and additional \$100/engine for alternate engines			
Stirling	58	42	35
Brayton, S. S.	34	12	6
Brayton, F. T.	90	47	40
Diesel	70	77	75

that the larger size cars with the single-shaft Brayton engines can break even at especially low mileages.

#### PRICE TARGETS

The uncertainties in initial vehicle prices can be treated as a price-target problem in which the savings in operating costs allow some increase in

the price.<sup>4</sup> The savings in operating costs under our nominal-case assumptions have been given in Figs. 20-5, 20-6, and 20-7. However, it is a matter of policy which criterion one chooses in determining price targets. For example, a consumer driving 30,000 mi per year would accept a higher price increase than would a consumer driving 10,000 mi per year. Auto manufacturers may limit a price increase according to the near-term operating-cost savings to a customer, while government planners may judge by benefits in the long term.

The reader can easily use Figs. 20-5 to 20-9 to obtain price targets based on any reasonable amount of driving. As an example, the price targets to match the savings in operating costs in 35,000 mi (a median driver's experience in 3 years) at the present fuel price levels are determined on Figs. 20-5, 20-6, and 20-7, at the intersections of the operating-cost curves with a vertical line passing through the 35,000-mi point in the horizontal axis. The numbers are presented in Table 20-10. Comparing these price targets with the estimated retail price differential (Table 20-2) shows that there is a considerable margin for the single-shaft Brayton and a small margin for the free-turbine Brayton.

Table 20-10. Allowable differential retail prices<sup>a</sup> to offset the present-valued savings of operating costs<sup>b</sup> in 3 years, relative to vehicles with UC Otto baseline engine (in 1974 dollars)

Engine types	Vehicle class		
	Small	Compact	Full-Size
UC Otto baseline	0	0	0
Stratified-charge Otto	30	50	30
Diesel	90	150	190
Brayton (single shaft)	150	270	350
Brayton (free turbine)	110	220	290
Stirling	190	310	400
Rankine	-20	20	20

<sup>a</sup> As price targets under the stated criteria, rounded to the nearest \$10.

<sup>b</sup> Based on the present fuel price level of 52¢/gal of gasoline and 7% annual discount rate.

<sup>4</sup> The allowable increase in manufacturing and capital costs, or the cost-target, can then be determined after knowing the price target.

#### 20.2.4 Total Ownership Costs From Purchase (as a New Car) to Resale

The majority of new car buyers trade in their cars after a few years of ownership. The median time period from purchase-as-new to resale-as-used is estimated to be about 3.5 years (Ref. 20-5, pp. 92, 96). With an alternate engine, the depreciation cost of a car may be different from a baseline car due to different maintenance and operating costs. Assume that the historical depreciation curves in Fig. 20-4 apply to all vehicles in the same size class (as explained in Section 20.2.1, this is a conservative estimate of the resale potential of the vehicles with Stirling or Brayton engines). The difference in the depreciation costs of a vehicle from the baseline vehicle after several years is calculated as the initial cost differential given in Table 20-8 minus the present worth of the resale value differential, which is calculated from data in Fig. 20-4. These depreciation-cost differentials are subtracted from the operating cost savings shown in Figs. 20-5, 20-6, and 20-7 to give the total ownership-cost differentials as a function of ownership periods. These results are presented in Figs. 20-11, 20-12, and 20-13.

It is observed in Figs. 20-11 and 20-12 that, at the present fuel price levels and based on our initial price estimates, the most advantageous engines in operating cost comparisons, as shown in Figs. 20-5, 20-6, and 20-7, also offer the greatest gains in the comparison of total ownership costs. Single-shaft Brayton engines take the lead over Stirling engines due to their low capital depreciation costs even though Stirling engines are more fuel-economical. The savings in total ownership costs increase with the size of the vehicle, following the trend in operating costs. These figures also demonstrate the potentials of the promising alternate engines, especially the Stirling and the Brayton engines, for total cost savings, even if the owner plans to sell the car in less than 2 years.

These results probably represent conservative estimates of the potential benefits of the Brayton or the Stirling cars. As previously discussed, higher fuel prices, inclusion of maintenance costs other than expendable fluids, and possible higher resale values all tend to favor the Brayton and the Stirling engines. An increase in initial cost of \$100 will not lower the savings by more than \$100, as shown in Figs. 20-14 and 20-15. Also shown in Figs. 20-14 and 20-15 are the moderate reductions in cost savings for vehicles driven at the lower 25 percentile mileages (i. e., 75% of personal vehicles in the nation are driven more in the same period of time).

Ownership-cost differentials for vehicles with the Rankine or the stratified-charge Otto engines are given in Fig. 20-13. These vehicles yield higher or comparable ownership costs because

their depreciation costs are higher and their fuel-consumption costs are comparable to those of the vehicles with baseline UC Otto engines.

To summarize these comparisons of total ownership costs (including resale), we have listed the differential costs of vehicles with alternate engines in Table 20-11, where negative signs represent savings. Two ownership periods are considered: a life cycle of 100,000 mi covered by a median driver in a little over 10 years, and the first 35,000 mi covered by a median driver in 3 years.<sup>5</sup> The total ownership costs of the baseline vehicles with the UC Otto engines (depreciation, fuel plus tax, maintenance, insurance, garage, parking, tolls and title) are also given in Table 20-11 for reference. Detailed breakdowns are given in Table 20-12.

The ownership cost differentials shown in Table 20-11 all appear to be within 7% of the total automobile ownership cost. However, if one would take the retail price of the car and the fuel cost (including fuel tax) over the life-cycle as a basis for comparison, instead of the total life-cycle ownership cost (which includes much of the engine-independent cost as shown in Table 20-12), the range of cost differential would be 14%.

It is seen that the Brayton and the Stirling cars promise to be the most cost-effective alternatives to the baseline UC Otto cars, especially in larger size classes. The Rankine-engined cars show higher ownership cost than the baseline UC Otto car.

#### 20.3 AGGREGATE ECONOMIC IMPACT

It was concluded in the previous section that vehicles equipped with the Mature Stirling or Brayton engines promise significant total savings in the long run, over the vehicles with performance equivalent Mature UC Otto engines. The possible effect of large-scale introduction of these engines on auto sales, industry employment, and the economy are discussed here.

Although the prices of these new cars are likely to be higher (by less than 10%, Table 20-8) due to higher manufacturing costs, the sales revenue of the auto industry should not be adversely affected. On the contrary, the sales revenue may even increase. Car buyers should be willing to pay more for new engine technologies which yield lower operating costs without sacrificing performance and comfort. The consumer's sensitivity to operating costs is reflected in the inclusion of fuel prices in some recent demand models (Ref. 20-8). In addition, the magnitude of the elasticity of demand is near unity,<sup>6</sup> which preserves the amount of dollar sales because the percentage price increase of a car will compensate for the percentage drop of sales. The net effect of the higher demand curve and the unity demand elasticity is a prospective

<sup>5</sup>60% of new car buyers own their new cars longer than 3 years according to White (Ref. 20-5). Therefore, 60% of the new car buyers will realize larger savings than the numbers shown in Table 20-11.

<sup>6</sup>Early studies of the elasticity of demand have been summarized in White (Ref. 20-5) with values around -1. Recent studies include Hymans (Ref. 20-6), with elasticity estimated at -1.36, Chase Econometric (Ref. 20-7), with elasticity estimated at -0.88, and Rand Corporation (Ref. 20-8), with elasticity estimated at -0.32. The last one explicitly took account of used car sales. The lower-magnitude Rand value would actually strengthen our conclusions.

Table 20-11. Ownership cost differential<sup>a</sup> for Mature Otto-Engine-Equivalent cars (increment above baseline vehicle; per vehicle, in 1974 dollars)

Engine type	Vehicle class					
	Small		Compact		Full-Size	
	35,000 miles <sup>c</sup> , 3 years	Life-cycle, 100,000 miles in about 10 years	35,000 miles, <sup>c</sup> 3 years	Life cycle, 100,000 miles in about 10 years	35,000 miles, <sup>c</sup> 3 years	Life cycle, 100,000 miles in about 10 years
Baseline UC Otto	0	0	0	0	0	0
UC Otto (oxidation catalyst only) <sup>b</sup>	-50	-150	-100	-200	-100	-200
SC Otto	-50	-50	0	-50	50	0
Diesel	-50	-150	-50	-150	0	-150
Brayton (single shaft)	-150	-300	-250	-600	-350	-850
Brayton (free turbine)	-50	-150	-100	-300	-150	-450
Stirling	-100	-250	-150	-450	-200	-600
Rankine	150	350	250	400	350	550
Reference cost <sup>d</sup> of baseline vehicle	3500	8400	4300	9700	5700	11700

<sup>a</sup>Present value at 7% annual discount rate; 52¢/gal gasoline, 49¢/gal diesel fuel, and 48¢/gal broad-cut fuel. All incremental costs rounded to the nearest \$50.

<sup>b</sup>Mature UC Otto engine meeting 2.0 g/mi NO<sub>x</sub> standard.

<sup>c</sup>This approximates the ownership cost to the first owner and is based on an assumed constant resale percentage (for each car class). In actuality, the high-fuel-economy, low-maintenance car would be expected to have higher resale value and look even more attractive.

<sup>d</sup>Including depreciation, fuel, maintenance, insurance, garage, parking, tolls, and taxes. Data from DOT estimates with our adjustments for depreciation, fuel, and present value calculations. Rounded to the nearest \$100.

sales revenue which would be higher than the previous levels.

Employment opportunities in the auto and related industries should not decrease, since the dollar volume of auto sales is not expected to drop. Some labor relocation and change of skill is likely to happen (but slowly) in the auto manufacturing, auto service industries, as discussed in Ref. 20-4.

The general growth, employment, and price movements in the U.S. economy are principally controlled by government policy. The effect of any perturbations in the auto industry on the economy is expected to be neither sizable nor lasting compared with the effect of government fiscal and monetary policy variations.<sup>7</sup> In addition, the improved engine technology will benefit the consuming public with lower-cost personal transportation and the auto-related industry with a possibly

<sup>7</sup>The modest and transient effects of auto industry disruptions on the national economy have been previously demonstrated by the Chase econometric model (Ref. 20-7).

Table 20-12. Total ownership costs of baseline vehicles (present value at 7% annual discount rate, in 1974 dollars)

	Vehicle class		
	Small	Compact	Full-Size
	Life-cycle cost		
Retail price <sup>a</sup>	2700	3200	4100
Fuel <sup>b</sup> over 100,000 miles	1210	1700	2120
Other (maintenance, etc.) <sup>c</sup>	4520	4810	5440
<b>Total life-time cost<sup>d</sup> (rounded to nearest \$100)</b>	<b>8400</b>	<b>9700</b>	<b>11700</b>
	3-year ownership cost		
3-year depreciation <sup>e</sup>	1350	1820	2750
Fuel <sup>b</sup> over 35,000 miles <sup>f</sup>	530	740	930
Other costs in 3 years <sup>c</sup>	1570	1770	1970
<b>Total 3-year cost (rounded to nearest \$100)</b>	<b>3500</b>	<b>4300</b>	<b>5700</b>

<sup>a</sup>Data from Consumer Reports, April 1974, for typical 1974 model year cars. Actual cost of baseline vehicles may be \$200 - \$300 higher due to the additional 3-way catalyst emission control system.

<sup>b</sup>Fuel price at 52¢/gal gasoline, MPG from Table 20-4.

<sup>c</sup>Data from DOT for typical 1974 cars (Ref. 20-2). Cost figures are discounted to the initial year, including maintenance, replacement, insurance, garaging, parking, tolls, titling, etc.

<sup>d</sup>Based on 100K miles over approximately 10 years with no resale value left.

<sup>e</sup>Data from Fig. 20-4.

<sup>f</sup>National median VMT in 3 years, according to DOT 1972 survey.

stronger market demand. The introduction of these novel engines is not likely to have any adverse effect on the general economy.

#### 20.4 POTENTIAL EFFECT ON THE NATION'S BALANCE OF PAYMENTS

Oil, raw materials, and automobiles are the major items in the present list of imported merchandise which may be directly affected by a change of engine type. The largest expected effect is in reducing the payment for imported oil.

At the present market mix of vehicle size classes, a fleet of Stirling-engined cars will have a sale-weighted average fuel economy of about 25 mpg compared with 17 mpg for a fleet of baseline UC Otto cars, promising a fleet-total fuel saving of 32% (Vol. I, Table 5) for the same amount of driving. Considering the scenario of complete production conversion in 10 years starting in 1985, the potential fuel savings, assuming the same amount of driving, is about 25% in 1995 and grows to the full 32% in later years when all the fleet is converted to Stirling-engined cars (Vol. I, Fig. 17). The actual fuel saving in 1995 would be about 18 to 23% (72 to 94% of the original fuel saving<sup>8</sup>) because of the increased driving encouraged by lower fuel cost. With the baseline UC Otto fleet estimated to consume 6 million barrels of auto fuel per day in 1995, the potential saving of the Stirling fleet would therefore be about 1.25 (with a range of 1.1 to 1.4) million barrels per day (MBPD) in 1995. The saving of demand for crude oil is reduced by at least this much.<sup>9</sup>

The reduction in auto fuel demand can only strengthen the nation's balance-of-payments position. Although the future of the domestic energy shortfall and international oil prices in the 1990 decade is uncertain, it is generally believed that energy will still be tight, and that the crude oil price will not be much below the present level. Reduced demand for imported oil not only reduces the number of barrels imported but also strengthens the bargaining position in negotiating oil prices with the oil exporting countries. At the present price level of \$11/bbl, the previous example of 1.25 MBPD saving would amount to an annual saving of \$5 billion in payments to the oil exporting countries. Fuel saving due to vehicle technology improvements (See Chapter 10 and Vol. I), which is applicable to all engine types, would further increase those savings.

As shown in Chapter 18, a representative Stirling engine requires about 8.4 lb of chromium, 4.1 lb of nickel, 1.8 lb of cobalt, and 0.2 lb of tungsten, more than the comparable Otto engine. At an estimated cost<sup>10</sup> of 75¢/lb for chromium,

<sup>8</sup> Calculated based on a demand elasticity of -0.2 to -0.8 (Refs. 20-8 and 20-9) and a supply elasticity of 2 to 3, as discussed in Section 20.2.1.

<sup>9</sup> Present gasoline yield in the refinery averages 48%; i. e., about 2 barrels of crude oil is needed to produce 1 barrel of gasoline, the rest is sold for other uses. When the gasoline demand is reduced, the refineries can reduce crude oil input by approximately the same amount and reduce the percentage gasoline yield in the mix of output.

<sup>10</sup> Estimates of W. Edmiston, author of Chapter 18.

\$2/lb for nickel, \$4/lb for cobalt, and \$10/lb for tungsten, the total potentially imported raw materials in the Stirling engine costs \$24 more. At the assumed yearly production of 10 million units, the total potential payment for imported materials used in the Stirling cars amounts to \$240 million per year. This is much smaller than the impact of fuel savings on the balance of payments.

If Brayton engines are used instead of Stirling engines, the potential savings in oil imports are about \$4 billion per year in the same scenario. The increased payment for raw materials used in the Brayton cars is negligible.

There is no obvious basis for us to predict changes in the market share of imported automobiles due to domestic introduction of alternate engines. It is obvious, however, that domestic production of vehicles with energy-efficient engines can only strengthen the competitive position of American-made cars in a market currently penetrated by fuel-economical foreign cars.

## 20.5 CONCLUSIONS

We have seen that several alternate auto engines — the two versions of the Brayton and the Stirling — can be economically beneficial to the consumer. All of these vehicles are likely to have a higher, or at least comparable, initial purchase price (sticker price) than the Mature version of the present vehicles powered by uniform-charged Otto-cycle-engines (Table 20-8). However, the potential savings in the present values of operating costs can exceed the initial cost differences in just a few years (Table 20-9).

The Stirling-engined vehicles deliver the best fuel economy while the Brayton-engined vehicles, second only to the Stirling vehicles in fuel economy, can potentially be produced at the lowest cost (in the single-shaft engine configuration) among alternate-engined vehicles. Both can balance the initial cost differences within a moderate amount of driving (Fig. 20-10) and, when resale is considered, realize savings in total ownership costs, even if the car is to be sold after only one or two years (Fig. 20-11 and 20-12). The results also demonstrate the more prominent advantage of these alternate engines in larger-size cars than in smaller cars (Fig. 20-10 and Table 20-11).

The assessments are conservative since these alternate engines may prove to be still more favorable in the future (Figs. 20-10, 20-14, and 20-15). The likely increase in fuel prices, higher resale values, and lower maintenance costs are not included in our present calculations. Uncertainties in the estimates of engine costs may work in either direction, but the conservative estimates of the savings in operating costs allow cost targets substantially higher than the present estimates.

Owing to the superior cost-effectiveness to the consumers, together with a historical demand elasticity with magnitude near unity, it is likely that these promising alternate engines can be marketed without economic support from the

government and yet maintain or better the dollar volume of automobile sales.

There should be no adverse effect on the nation's economy. Although the auto-related industries contribute heavily to the nation's output and employment, the economy is essentially controlled and regulated by the government. Any macro impact of what happens in the auto industry is likely to be of a transient nature, limited in size and duration.

Imported raw materials required for use in these alternate engines would only increase the nation's annual foreign payments by less than \$300 million. This sum is trivial compared to the potential savings in the annual payments to the oil-exporting countries which, at the present price and in the likely future of continued short-fall of fuel oil, will amount to billions of dollars.

## References

- 20-1. "Economic Report of the President," delivered to the U. S. Congress in February 1974.
- 20-2. Cost of Operating an Automobile, Federal Highway Administration, Washington, D. C., April 1974.
- 20-3. Automobile Facts and Figures, Motor Vehicle Manufacturers Association, Detroit, Michigan, 1973/74.
- 20-4. Agres, R. U., and Noble, S., Economic Impact of Mass Production of Alternative Low Emission Automotive Power Systems, International Research and Technology Corporation, prepared for U.S. Dept. of Transportation, March 1973.
- 20-5. White, L. J., The Automobile Industry Since 1954, Harvard University Press, Cambridge, Mass., 1971.
- 20-6. Hymans, S. H., "Consumer Durable Spending: Explanation and Predicted," Brookings Papers on Economic Activity, Vol. 2, page 173, 1970.
- 20-7. "The Effect of Tax and Regulatory Alternatives on Car Sales and Gasoline Consumption," Chase Econometric Associates, prepared for Council on Environmental Quality, April 1974.
- 20-8. Wildhorn, S., et al., How to Save Gasoline — Public Policy Alternatives for the Automobile, Rand Corp., Santa Monica, Calif., October 1974.
- 20-9. Project Independence Report, Federal Energy Administration, November 1974.

20-10. National Personal Transportation Study—  
Annual Miles of Automobile Travel,  
Report No. 2, U.S. Dept. of Transporta-  
tion, Federal Highway Administration,  
April 1972.

20-11. Kelley Blue Book - Used Car  
Values, Western edition, Kelley  
Blue Book, Long Beach,  
Calif., September-October  
1974.

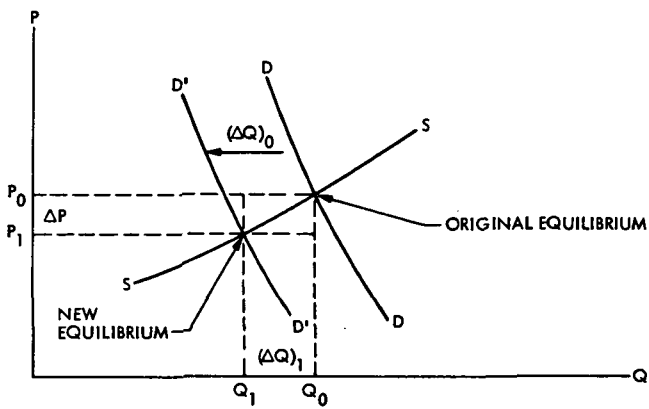

Fig. 20-1. Change of demand and price of auto fuel due to conversion of the auto fleet to fuel-saving engines

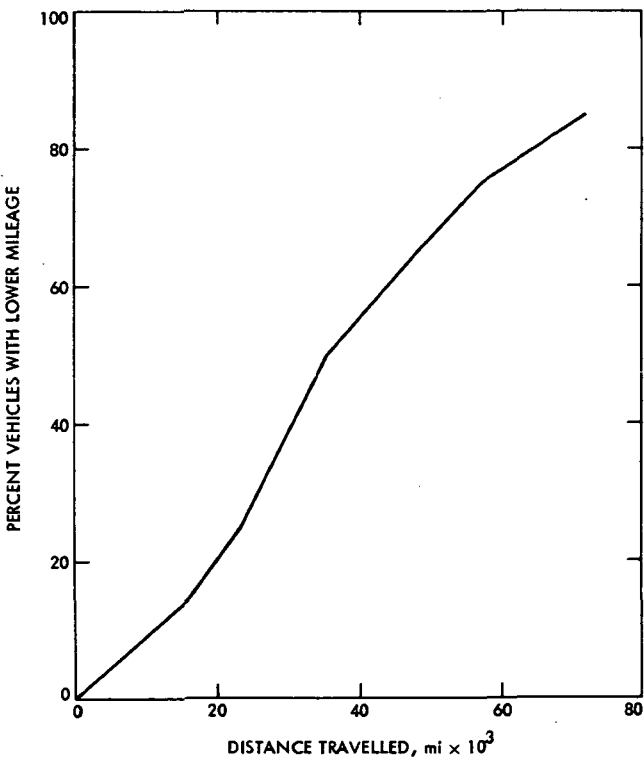

Fig. 20-2. Personal vehicle mileage during first 3 years (data from Ref. 20-10)

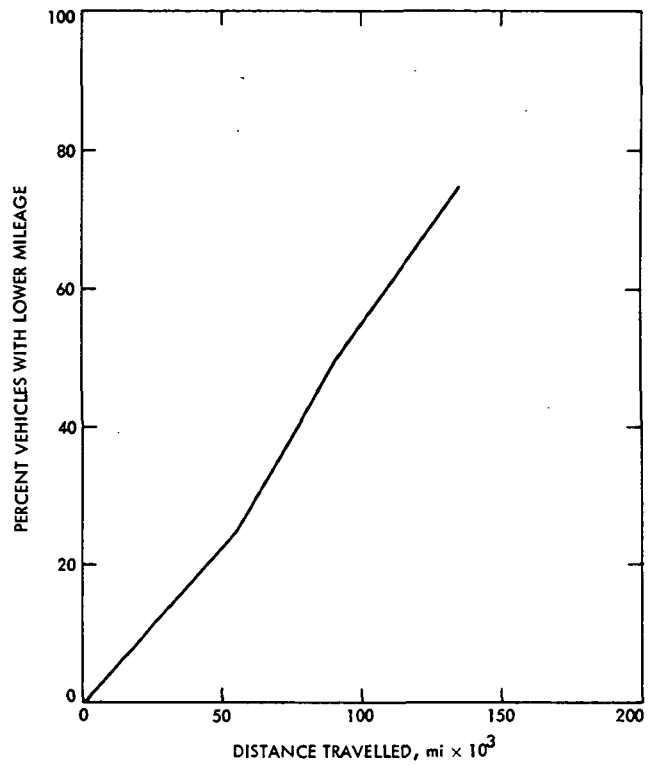

Fig. 20-3. Personal vehicle mileage during first 10 years (data from Ref. 20-10)

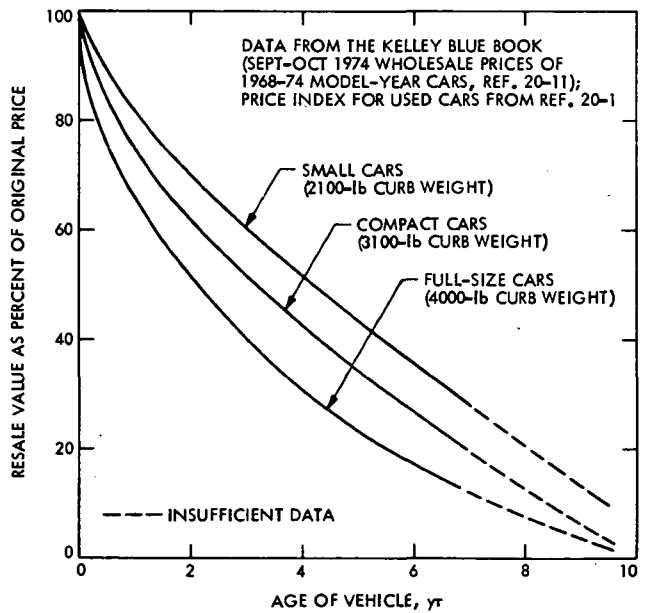

Fig. 20-4. Approximated depreciation curves based on constant dollars



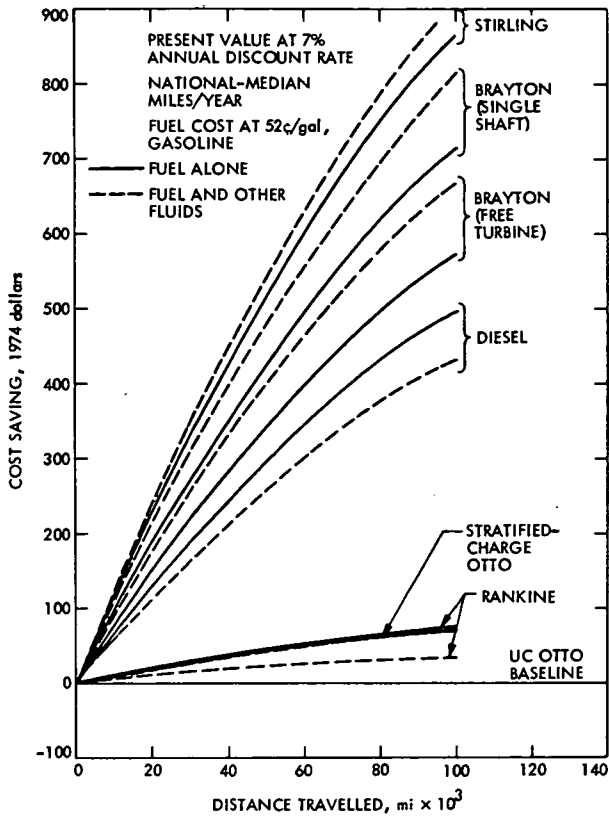

Fig. 20-5. Differential costs of fuel, oil, and coolant over equivalent UC Otto baseline vehicle: full-size cars

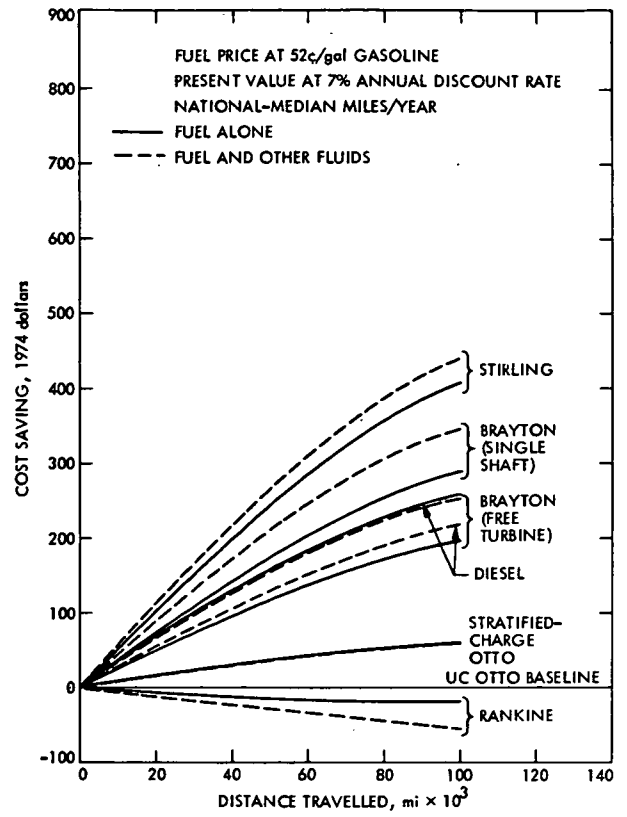

Fig. 20-7. Differential costs of fuel, oil, and coolant over equivalent UC Otto baseline vehicle: small cars

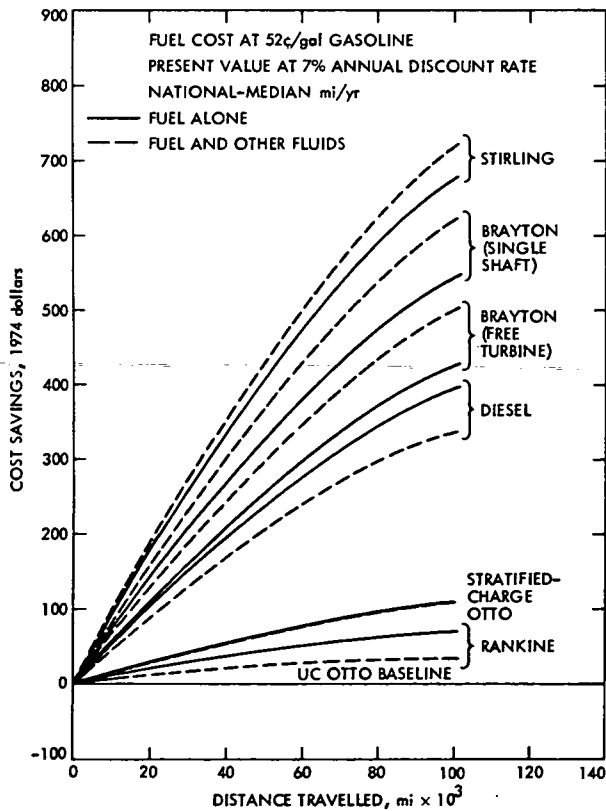

Fig. 20-6. Differential costs of fuel, oil, and coolant over equivalent UC Otto baseline vehicle: compact cars

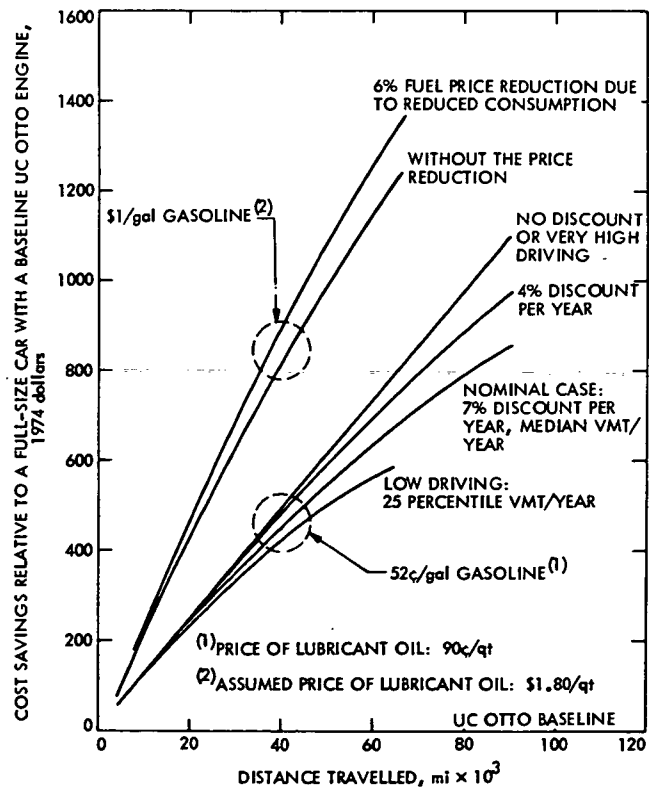

Fig. 20-8. Sensitivity of operating cost differentials: fuel, oil, and coolant for a full-size vehicle with Stirling engine

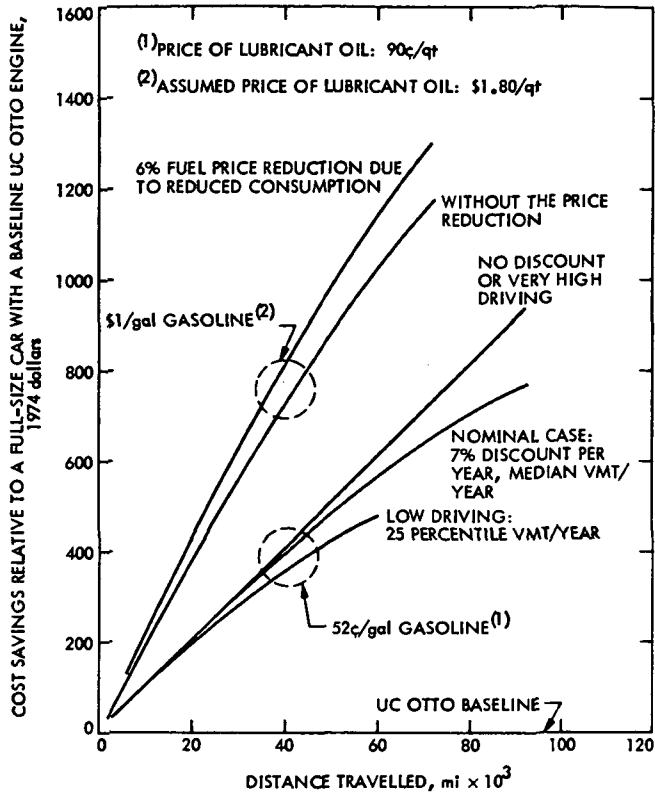

Fig. 20-9. Sensitivity of operating cost differentials: fuel, oil, and coolant for a full-size vehicle with single-shaft Brayton engine

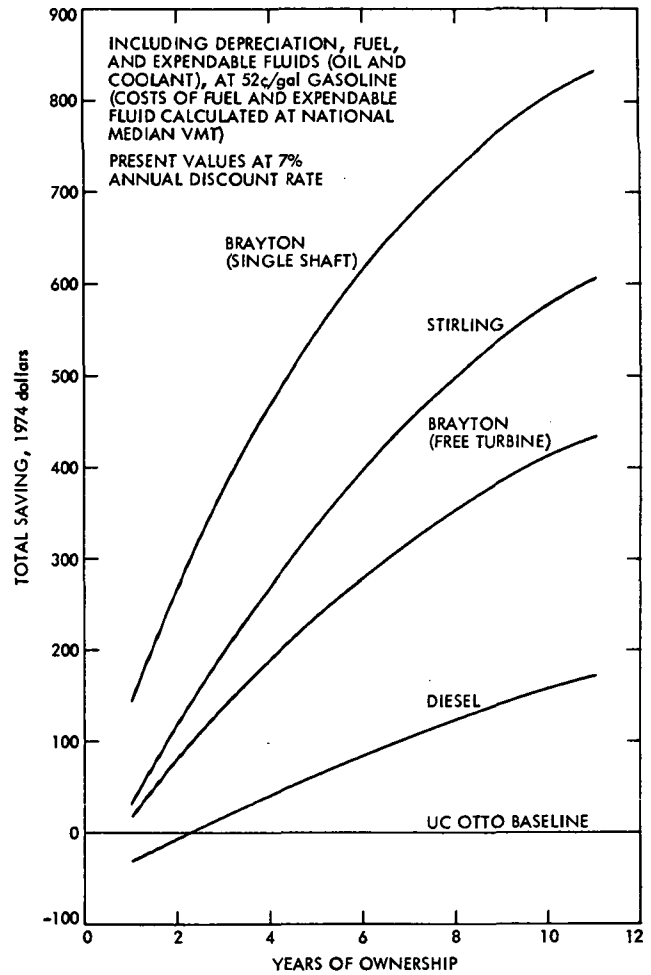

Fig. 20-11. Savings in total ownership costs relative to UC Otto baseline vehicle: full-size cars

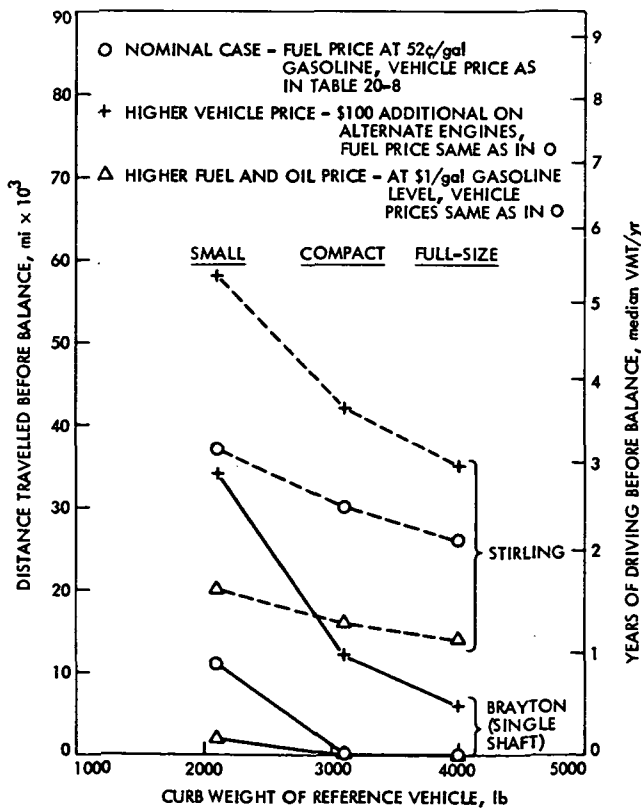

Fig. 20-10. Break-even mileage for Stirling and single-shaft Brayton engines vs baseline UC Otto vehicles

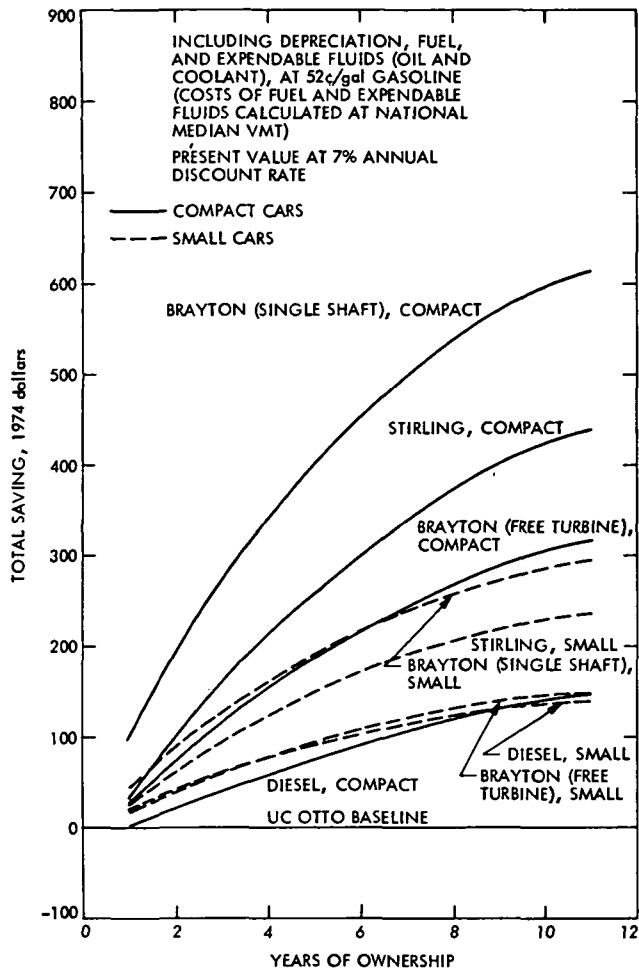

Fig. 20-12. Savings in total ownership costs relative to UC Otto baseline vehicle: compact and small cars

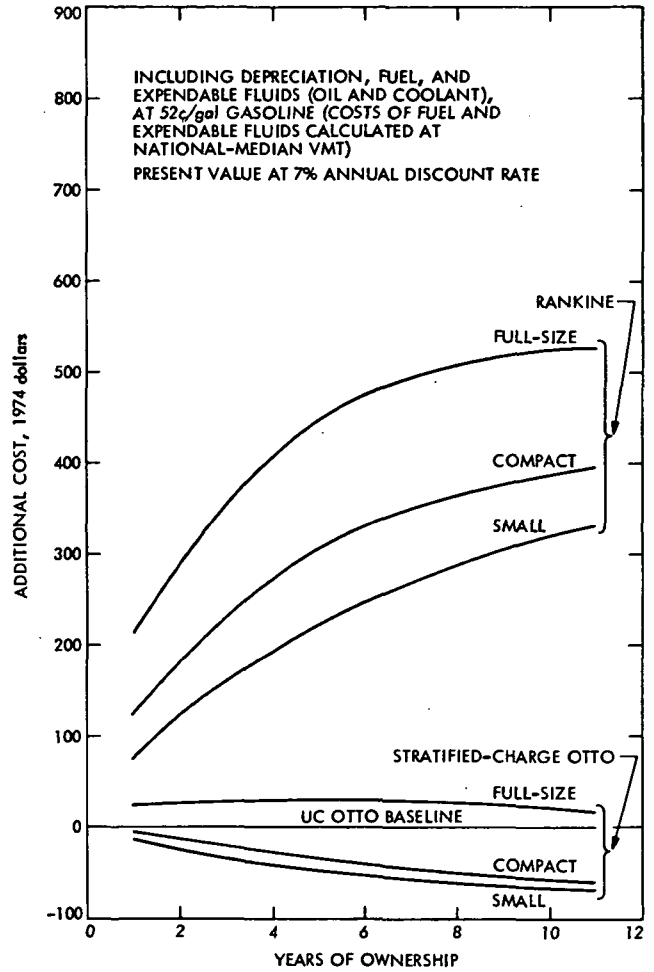

Fig. 20-13. Increase in total ownership costs of Rankine and stratified-charge Otto vehicles over UC Otto baseline vehicles

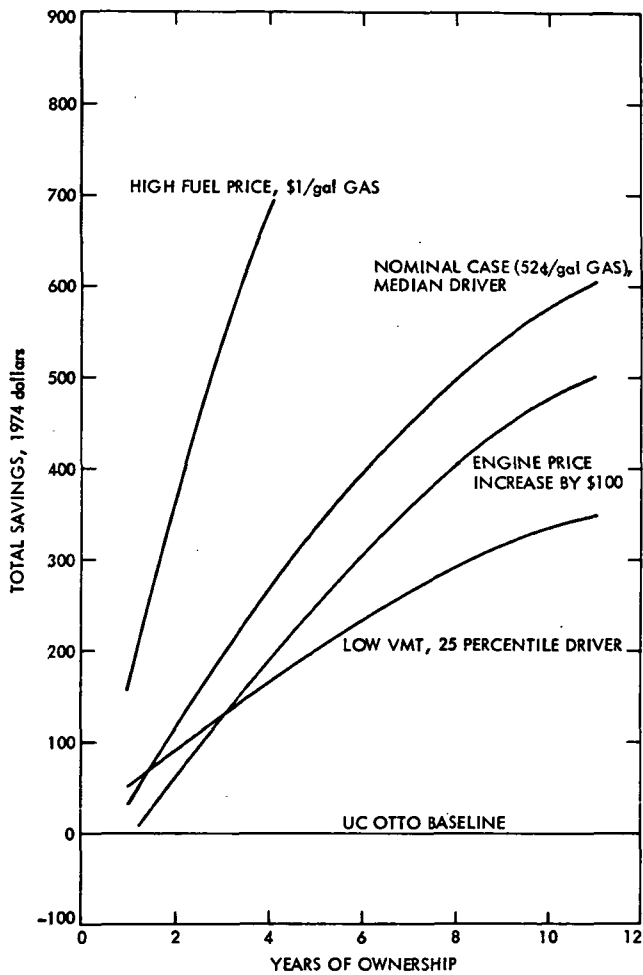

Fig. 20-14. Sensitivity of total ownership-cost differentials for full-size cars: Stirling engine vs UC Otto engine

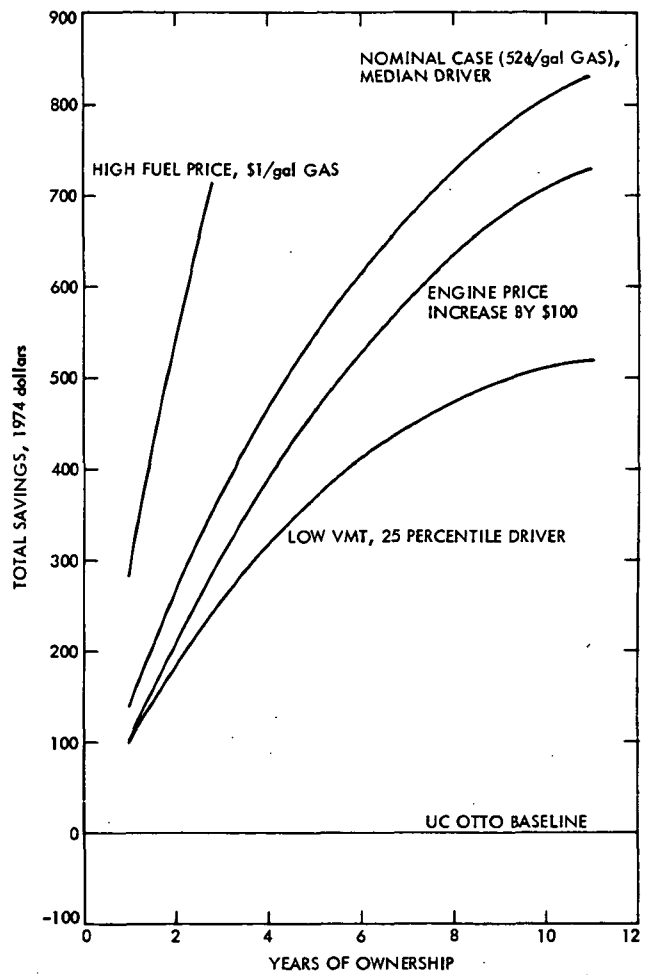

Fig. 20-15. Sensitivity of total ownership-cost differentials for full-size cars: single-shaft Brayton vs UC Otto engine

## APPENDIX A

## AUTHORS

Chapter		Principal Author	Contributors
1.	Introduction	R. R. Stephenson	
2.	Fundamental Considerations of Heat Engines for Automotive Propulsion	N. R. Moore	G. J. Nunz
3.	The UC Otto Automotive Power System	G. J. Nunz/ N. R. Moore	
4.	The Intermittent-Combustion Alternate Automotive Power Systems: The Lean-Burning Otto Engine, The Stratified-Charge Otto Engine, The Diesel Engine	N. R. Moore/ G. J. Nunz	G. J. Klose/ W. A. Edmiston/ T. A. Barber
5.	The Brayton Automotive Power System	G. J. Nunz/ N. R. Moore	G. J. Klose/ W. A. Edmiston/ T. A. Barber
6.	The Stirling Automotive Power System	G. J. Nunz/ N. R. Moore	G. J. Klose/ W. A. Edmiston/ T. A. Barber
7.	The Rankine Automotive Power System	G. J. Nunz/ N. R. Moore/ S. P. DeGrey	G. J. Klose/ W. A. Edmiston/ T. A. Barber
8.	Electric Vehicles	H. C. Vivian	C. England
9.	Hybrid Vehicles	H. C. Vivian	
10.	Vehicle Systems	G. J. Klose	
11.	Manufacturability and Costs	T. A. Barber	
12.	Alternate Heat Engine Research and Development	R. W. Riebling	
13.	Scenario Generation	S. D. Foulkes	K. L. Heitner
14.	Automobile Use	K. L. Heitner/ S. D. Foulkes	
15.	Industry Practices	T. A. Barber	
16.	Vehicle and Highway Safety	T. K. C. Peng/ G. J. Nunz/ G. J. Klose	
17.	Energy and Fuels	C. L. Hamilton	K. L. Heitner/ S. D. Foulkes
18.	Material Resource Requirements and Supply	W. A. Edmiston	
19.	Air Quality Impact Study	T. K. C. Peng	
20.	Ownership Costs and Economic Impact	T. K. C. Peng	

## APPENDIX B

### GLOSSARY

#### I. Emission Levels and Standards

Emissions are quoted on a grams-per-mile basis on the 1975 Federal Test Procedure (which includes both a cold and hot start). Levels are abbreviated 0.41 HC/3.4 CO/0.4 NO<sub>x</sub> to indicate the hydrocarbon (HC), carbon monoxide (CO), and nitrogen oxides (NO<sub>x</sub>) levels in grams per mile.

For reference, the following levels are currently in effect or proposed:

"1975 Federal Interim"	1.5 HC/15.0 CO/3.1 NO <sub>x</sub>
"1975 California"	0.9 HC/9.0 CO/2.0 NO <sub>x</sub>
"1977 Federal Interim"	0.41 HC/3.4 CO/2.0 NO <sub>x</sub>
"1978 Federal" or "Statutory" or "original 1976"	0.41 HC/3.4 CO/0.4 NO <sub>x</sub>

These designations for the emission standards are used to indicate the levels of control independent of the year the standards are actually enforced.

In March 1975, the EPA Administrator delayed the "1977 Federal Interim" emission standards for HC and CO by one year. In addition he recommended the following emission standard timetable:

1977-1979	1.5 HC/15.0 CO/2.0 NO <sub>x</sub>
1980-1981	0.9 HC/9.0 CO/2.0 NO <sub>x</sub>
1982 on	0.41 HC/3.4 CO/2.0 NO <sub>x</sub>

Also the California ARB has petitioned EPA to impose standards of 0.41 HC/9.0 CO/1.5 NO<sub>x</sub> beginning in 1977.

#### II. Levels of Engine Technology

"Present"	powerplant performance currently demonstrated on an engine test stand or in a vehicle.
"Mature"	the level of powerplant performance achievable with known technology and with time to do necessary development.
"Advanced"	the level of powerplant performance achievable with major technological advances in materials and fabrication processes.

#### III. Abbreviations

A/C	air conditioner
AEC	Atomic Energy Commission
AISI	American Iron and Steel Institute

API	American Petroleum Institute
APSES	Automobile Power Systems Evaluation Study
AQCR	air quality control region
ARPA	Advanced Research Projects Agency of the Department of Defense
bb1	barrel (42 gallons) of petroleum
(B)MEP	(brake) mean effective pressure
(B) SFC	(brake) specific fuel consumption
Btu	British thermal units (a quantity of energy)
CARB	California Air Resources Board
CID	cubic inch displacement
CN	cetane number
CO	carbon monoxide
CVT	continuously variable transmission
CW	vehicle curb weight
CY	calendar year
DOT	Department of Transportation
EFI	electronic fuel injection
EGR	exhaust gas recirculation
EI	emission index
EPA	Environmental Protection Agency
EQL	Environmental Quality Laboratory (of Caltech)
ERDA	Energy Research and Development Administration
FDC-H	Federal Driving Cycle - Highway
FDC-U	Federal Driving Cycle - Urban
FPC	Federal Power Commission
FT	free-turbine (a type of Brayton engine)
ft	feet
FTP	Federal Test Procedure
g/mi	grams per mile
HC	hydrocarbons
HDV	heavy duty vehicle
HEI	high energy ignition
HP	engine maximum net horsepower

ICE	Internal Combustion Engine
IGT	Institute of Gas Technology
IW	vehicle inertia weight
JPL	Jet Propulsion Laboratory
kWh	kilowatt hours
LAAPCD	Los Angeles County Air Pollution Control District
LAS	lithium aluminum silicate (a ceramic)
LDV	light duty vehicle
LNG	liquified natural gas
LPG	liquid petroleum gas
MAS	magnesium aluminum silicate (a ceramic)
MBT	minimum for best torque (spark timing)
MFI	mechanical fuel injection
mi	miles
mi/gal	miles per gallon
mpg	miles per gallon
mph	miles per hour
MW	megawatts
MY	model year
NA	naturally aspirated (diesel)
NAE	National Academy of Engineering
NAS	National Academy of Sciences
NMHC	non-methane hydrocarbons
NOx	nitrogen oxides
NPC	National Petroleum Council
NSF	National Science Foundation
OEE	Otto-engined equivalent (a vehicle with equivalent performance to a current Otto cycle engine powered car)
OPEC	Organization of Petroleum Exporting Countries
OX	oxidant
PCV	positive crankcase ventilation
P-D	positive displacement
PMT	passenger miles travelled
R&D	Research and Development
RHC	reactive hydrocarbons



RON	research octane number
SAE	Society of Automotive Engineers
SC	stratified charge
sec	second(s)
SI	spark-ignited
SiC	silicon carbide (a ceramic)
Si <sub>3</sub> N <sub>4</sub>	silicon nitride (a ceramic)
SLI	spark; lighting, and ignition battery
SS	single-shaft (a type of Brayton engine)
TC	turbocharged (diesel)
TIT	turbine inlet temperature
UC Otto	near-stoichiometric uniform- charge, catalyst-controlled Otto cycle engine (current engines are mostly of this type)
ULB	ultra lean burning uniform charge engine
VASP	variable-angle swashplate
VEEP	Vehicle Economy and Emissions Projection Computer program
VIGV	variable inlet guide vanes (Brayton engine)
VMT	vehicle miles travelled
VSTC	variable-stator torque converter
VV	variable-venturi (carburetor)
WOT	wide open throttle

**U.S. Department of Commerce  
National Technical Information Service**



**N79 75831**

**SHOULD WE HAVE A NEW ENGINE?  
AN AUTOMOBILE POWER SYSTEMS EVALUATION  
VOLUME II. TECHNICAL REPORTS**

**JET PROPULSION LABORATORY  
PASADENA, CA**

**AUG 75**