

Notes VIII

Normal faults and extensional tectonics 1

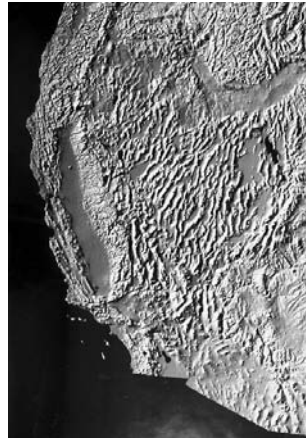

Fall 2005

1 Reading assignment

Read Chapter 5. This is also required reading for the lab of Wednesday, October 26.

2 Growth strata

Although not particular to normal faults, relative uplift and subsidence on either side of a surface breaking fault leads to predictable patterns of erosion and sedimentation. Sediments will fill the available space created by slip on a fault. Not only do the characteristic patterns of stratal thickening or thinning tell you about the style of faulting, but by dating the sediments, you can tell the age of the fault (since sediments were deposited during faulting) as well as the slip rates on the fault.

3 Models of extensional faults

The simplest model of a normal fault is a planar fault that does not change its dip with depth. Such a fault does not accommodate much extension. (Figure 1)

3.1 Listric faults

A listric fault is a fault which shallows with depth. Compared to a simple planar model, such a fault accommodates a considerably greater amount of extension for the same amount of slip. Characteristics of listric faults are that, in order to maintain geometric compatibility, beds in the hanging wall have to rotate and dip towards the fault. Commonly, listric faults involve a number of *en echelon* faults that sole into a low-angle master detachment. (Figure 2)

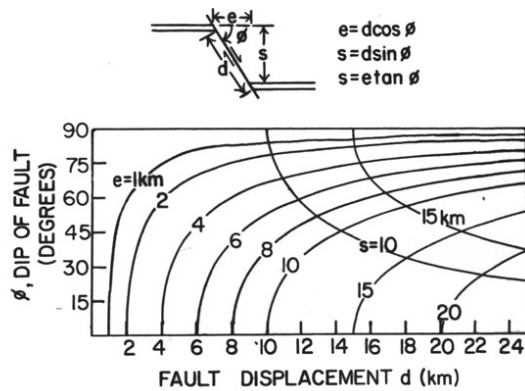

Figure 1: Model for a simple, planar fault

3.2 Planar, rotating fault arrays

An array of parallel, normal faults slipping on a sub-horizontal detachment will rotate with fault slip, much like books on a book shelf. As they rotate, the dip of the faults will get shallower, and the beds between the faults will also rotate. Again, the amount of extension can be calculated for a given angle between beds and the fault, and the total amount of slip on the fault.

Sometimes, normal fault systems are, in fact, best described as a combination of listric faults with rotating, planar faults bounding rotating blocks in the hanging wall. The "master fault" – called a **detachment fault** is a listric fault, with a set of rotating planar faults in its hanging-wall or **upper plate**. The steep part of the detachment is sometimes called the **break-away fault**. Figure 4

3.3 Stratigraphic signature of normal faults and extension

If, prior to extensional faulting, stratigraphy was undeformed, then the characteristic of normal faulting is that younger rocks will be juxtaposed over older rocks, but with "missing section" at the fault.

Particularly where the normal faults are low-angle, this relationship is often mis-interpreted. Prior to the recognition that low angle normal faults are widespread features of the extended crust, they were often mapped as thrusts (which makes no sense) or unconformities. Where low angle faults are common, a "stratigraphic section" will show many apparent gaps. Figure 5

3.4 Core complexes

A common feature of highly extended terrains is that large amounts of extension on relatively low angle normal faults juxtaposes rocks of high metamorphic grade against unmetamorphosed rocks and even surficial deposits. The exposure of high grade rocks typically domal, or antiformal geometry, with normal faults completely bounding the high-grade rocks. Rocks in the immediate footwall of the bounding normal faults show a characteristic series of fabrics: since rocks are brought up from depth, fabrics reflecting progressively colder and more brittle deformational environments are superimposed upon one another. So, walking from the interior of the core complex out towards the low-grade upper plate rocks ductile fabrics and mylonites will be overprinted by brittle-ductile transitional fabrics, which themselves are often overprinted by thick gouge and breccia and then a discrete, brittle fault.

The conceptual model of core complexes – high grade rocks brought to the surface along low angle detachments has some important implications for how extension is accommodated in the lower crust or mantle. In figure 6, large amounts of slip on a detachment obviously creates a great deal of "space" in the lower crust. The question then is: does the detachment offset the Moho, and accommodation is then taken up by flow of mantle rocks. Or does the detachment sole into the middle or lower crust, with lower crustal flow solving the space problem. See figure 7.

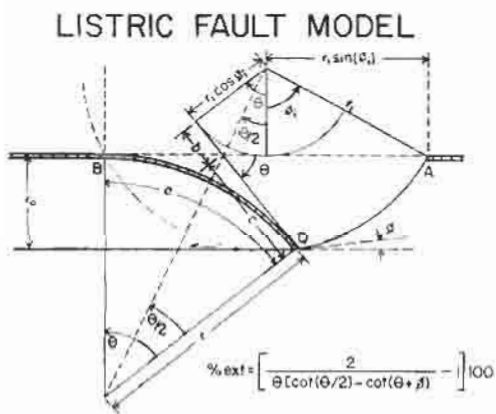
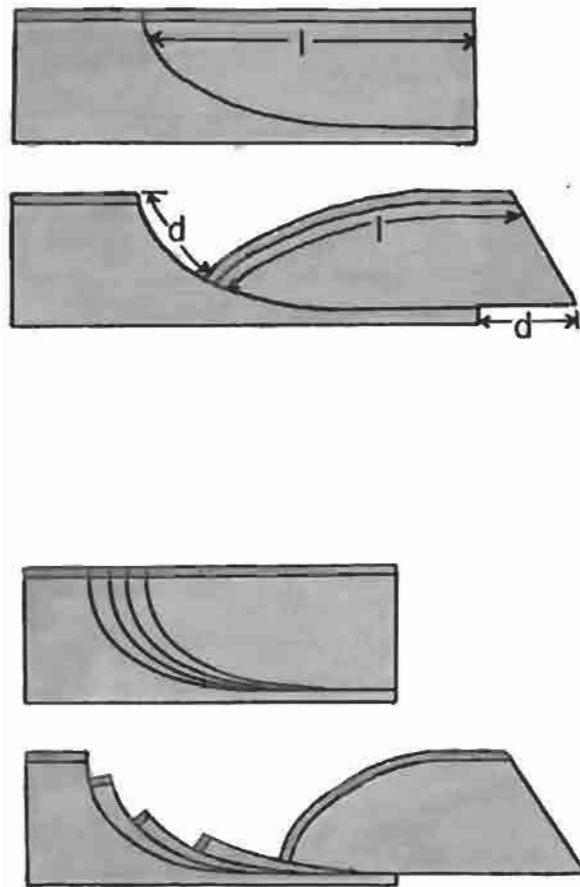
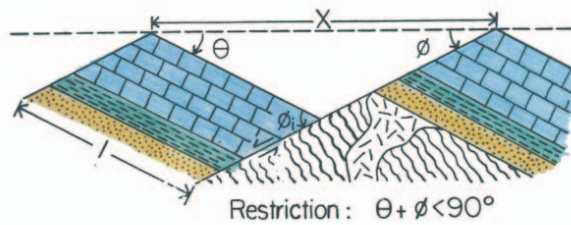
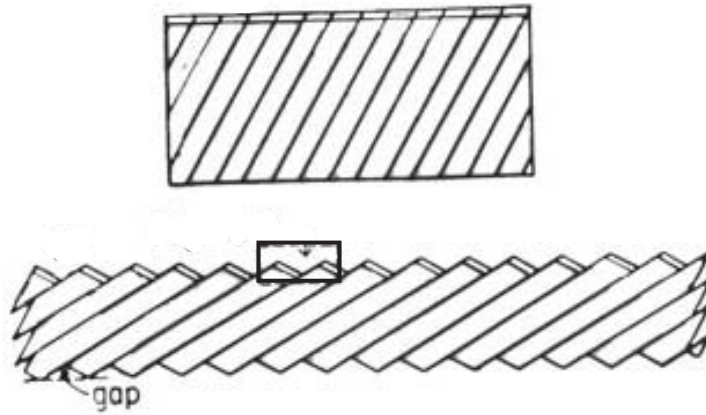

Figure 2: Geometry of listric normal faults. The bottom figure shows the geometric relations for calculating the amount of extension, given the angle between beds and the fault, and the total fault slip



Restriction: $\theta + \phi < 90^\circ$

$$\% \text{ ext.} = (X-1)100 = \left[\frac{\sin(\phi + \theta)}{\sin \phi} - 1 \right] 100$$

$$\text{alternatively, } \% \text{ ext.} = \left[\frac{\sin \phi_i}{\sin(\phi_i - \theta)} - 1 \right] 100$$

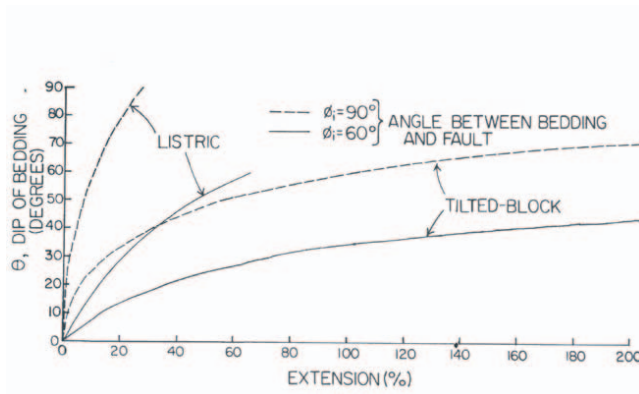

Figure 3: A system of rotating, planar faults. The bottom figure shows how this geometry compares to simple listric normal faults in terms of the amount of extension that can be produced

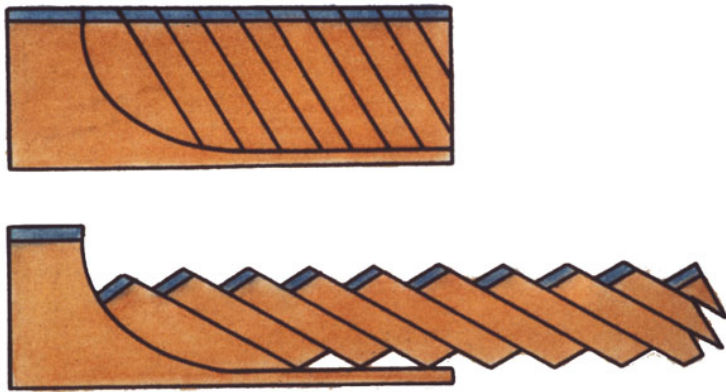

Figure 4: Listric fault, with rotating upper plate blocks and breakaway fault



Figure 5: Stratigraphic signature of extensional tectonics where low angle faults are present

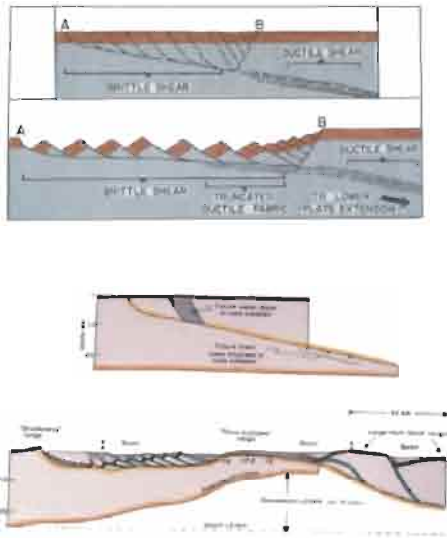

Figure 6: Model for core complex formation along a low angle detachment

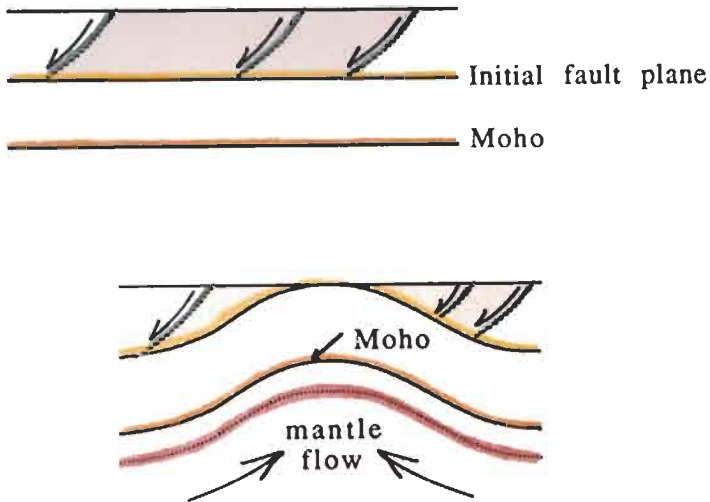
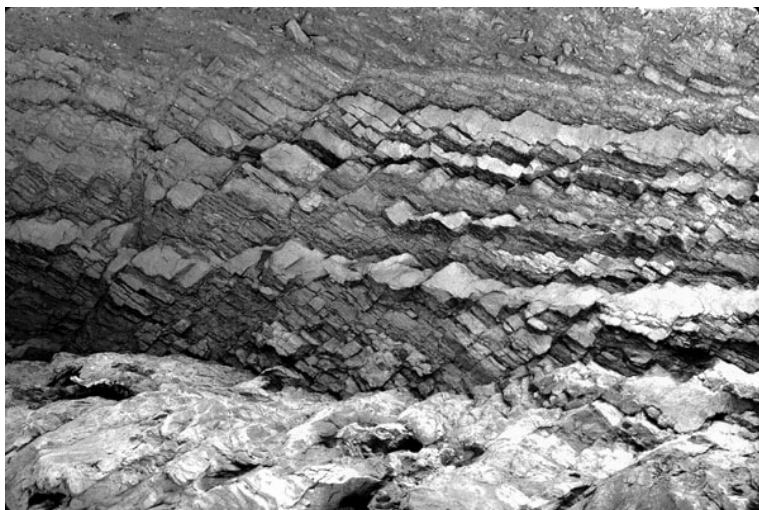

Figure 7: Two models for accommodating large amounts of extension in the upper crust. From Block and Royden 1984

4 Slides

4.1 Rotated blocks



4.2 Listric faults



4.3 Low angle faults

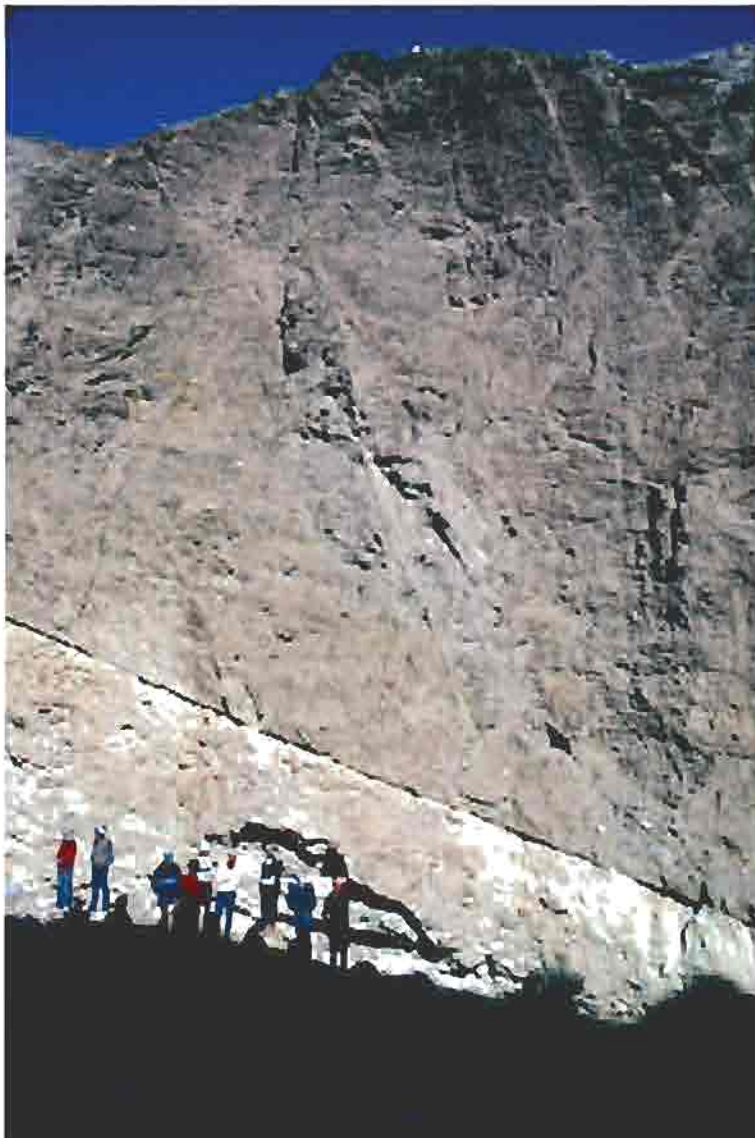

4.4 Whipple mountains core complex

The Whipple mountains are one of the archetypical core complexes of the western U.S. extensional provinces. This is a cross-section from the work of Lister and Davis:

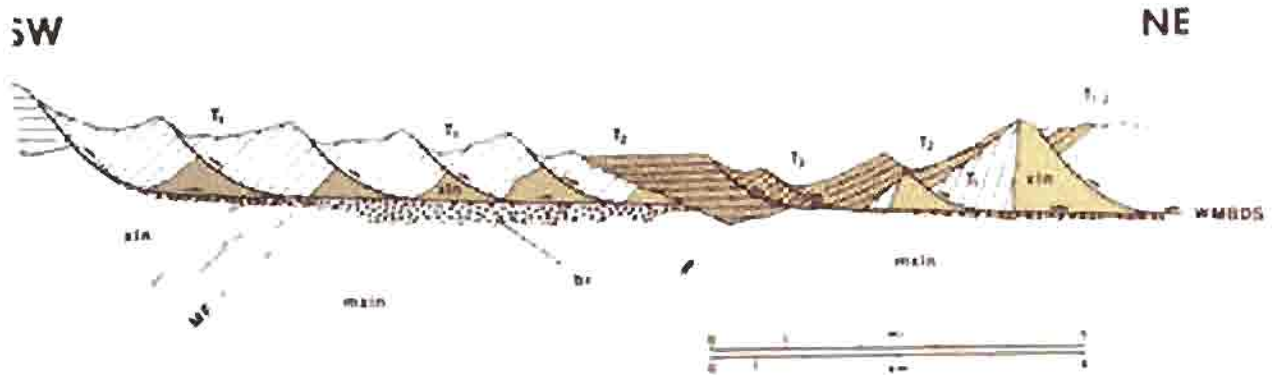

A view of the Whipples: lower plate high grade rocks to the left, upper plate rocks on the right.



Another view. Dark rocks are Tertiary aged sediments and volcanic rocks. Pale rocks are mylonites.



Spot the low angle detachment.



The detachment surface.



4.5 Fabrics

High grade fabrics I



High grade fabrics II



High grade extensional shear fabrics.



Ductile C/S fabric



Low grade gouge and breccia.



Fault gouge (low-grade), Tucki mountain core complex.

