



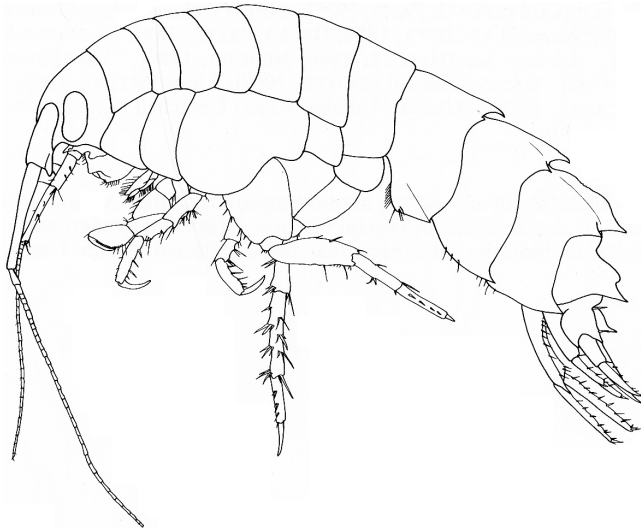
LSD

Laboratoire de  
Systématique  
& Diversité  
animale  
ULg



University of Liège  
Faculty of Sciences  
Department of Environmental Sciences and Management  
Laboratory of Systematics and Animal Diversity

# Multidisciplinary study of trophic diversity and functional role of amphipod crustaceans associated to *Posidonia oceanica* meadows



Dissertation written by Loïc MICHEL  
for the fulfillment of the degree of PhD in Sciences  
Academic year 2010-2011



Cover Image: adult female of *Dexamine spiniventris*.

From RUFFO S., BELLAN-SANTINI D., KARAMAN G., KRAPP-SCHICKEL G., LEDOYER M., MYERS A. A. & SCHIECKE U. (1982): Part 1: Gammaridea (Acanthonozomatidae to Gammaridae). in *The Amphipoda of the Mediterranean*, RUFFO S. (Eds.): 1-364.



# TABLE OF CONTENTS

---

REMERCIEMENTS/ACKNOWLEDGEMENTS	I
SUMMARY	V
RÉSUMÉ	VII
LIST OF ABBREVIATIONS	XI

## **CHAPTER 1: GENERAL INTRODUCTION**

<b>I. SEAGRASSES</b>	<b>1</b>
<b>I.1. DEFINITION</b>	<b>1</b>
<b>I.2. SYSTEMATICS</b>	<b>1</b>
<b>I.3. ADAPTATIONS TO MARINE LIFE</b>	<b>2</b>
<b>I.4. SEAGRASSES IN THE MEDITERRANEAN SEA</b>	<b>3</b>
<b>II. <i>POSIDONIA OCEANICA</i> MEADOWS</b>	<b>4</b>
<b>II.1. <i>POSIDONIA OCEANICA</i> (L.) DELILE</b>	<b>4</b>
<b>II.2. STRUCTURE OF <i>P. OCEANICA</i> MEADOWS</b>	<b>6</b>
II.2.A. THE FOLIAR STRATUM	7
II.2.B. THE ROOT/RHIZOME SYSTEM AND THE MATTE	8
II.2.C. THE LITTER	9
II.2.D. <i>POSIDONIA OCEANICA</i> EPIPHYTES	10
II.2.D.a. Microepiphytes (periphyton)	10
II.2.D.b. Epiflora	11
II.2.D.c. Epifauna	12
II.2.E. THE VAGILE FAUNA: DEFINITION AND IMPORTANCE	12
<b>II.3. ECOLOGICAL IMPORTANCE OF <i>P. OCEANICA</i></b>	<b>13</b>
II.3.A. IMPORTANCE AS A PRIMARY PRODUCER	13
II.3.B. IMPORTANCE AS A COASTAL ENGINEER	15
II.3.C. IMPORTANCE AS AN HABITAT PROVIDER	16
II.4.D. IMPORTANCE AS A FOOD SUPPLIER	17
<b>III. AMPHIPOD CRUSTACEANS</b>	<b>18</b>
<b>III.1. SYSTEMATIC POSITION</b>	<b>18</b>
<b>III.2. ANATOMY AND MORPHOLOGY</b>	<b>19</b>
<b>III.3. GENERAL BIOLOGY AND ECOLOGY</b>	<b>20</b>
<b>IV. OBJECTIVES OF THIS STUDY</b>	<b>21</b>
<b>REFERENCES</b>	<b>22</b>

## **CHAPTER 2: GENERAL MATERIAL & METHODS**

<b>I. DESCRIPTION OF STUDY SITE</b>	<b>29</b>
I.1. CALVI BAY: GENERAL LOCATION	29
I.2. PERMANENT FRAMES	30
I.3. DATES OF SAMPLING EVENTS	32
<b>II. AMPHIPOD SAMPLING METHODS</b>	<b>32</b>
II.1. HAND-TOWED NET	32
II.2. LITTER COLLECTION	33
II.3. LIGHT TRAPS	34
<b>III. DATA PROCESSING</b>	<b>34</b>
III.1. BASIC STATISTICS AND COMPARISON PROCEDURES	34
III.2. HIERARCHICAL AGGLOMERATIVE CLUSTERING	36
III.3. SIMPER ANALYSES	37
<b>REFERENCES</b>	<b>38</b>

## **CHAPTER 3: STRUCTURE AND TEMPORAL DYNAMICS OF COMMUNITIES OF AMPHIPODS ASSOCIATED TO *POSIDONIA OCEANICA* MEADOWS IN CALVI BAY**

<b>I. INTRODUCTION</b>	<b>41</b>
I.1. AMPHIPODS IN THE VAGILE FAUNA OF <i>P. OCEANICA</i> MEADOWS	41
I.2. REMINDER OF THE SPECIFIC OBJECTIVES OF THIS CHAPTER	44
<b>II. MATERIAL &amp; METHODS</b>	<b>44</b>
II.1. SAMPLING STRATEGY	44
II.2. SAMPLE CONDITIONING AND ANALYSIS	45
II.3. DATA PROCESSING	45
II.3.A. GENERAL COMMUNITY DESCRIPTORS	45
II.3.B. UNIVARIATE DIVERSITY INDEXES	46
II.3.B.a. Margalef's specific richness (d)	46
II.3.B.b. Shannon-Wiener's diversity index (H')	46
II.3.B.b. Pielou's evenness index (J')	47
II.3.B.D. Simpson's evenness index (1-λ')	48
II.3.C. HIERARCHIZED AGGLOMERATIVE CLUSTERING AND SIMPER ANALYSES	48
II.3.D. 2D ORDINATION VIA NON-METRIC MULTIDIMENSIONAL SCALING	48
<b>III. RESULTS</b>	<b>49</b>
III.1. GENERAL DESCRIPTORS AND UNIVARIATE INDEXES	49

III.1.A. HAND-TOWED NET SAMPLES	53
III.1.B. LITTER SAMPLES	53
III.1.C. LIGHT TRAPS	54
<b>III.2. HIERARCHIZED AGGLOMERATIVE CLUSTERING</b>	<b>55</b>
<b>III.3. BIDIMENSIONAL ORDINATION (NON-METRIC MDS)</b>	<b>57</b>
<b>III.4. HIGHLIGHTING INDICATOR SPECIES</b>	<b>58</b>
III.4.A. DESCRIPTIVE ANALYSIS	58
III.4.B. SIMPER ANALYSES	60
III.4.B.a. Categorization by sampling season or period	60
III.4.B.b. Categorization by sampling method	60
<b>IV. DISCUSSION</b>	<b>62</b>
<b>IV.1. STRUCTURE AND VARIATION OF THE STUDIED COMMUNITY</b>	<b>62</b>
IV.1.A. HAND-TOWED NET SAMPLES	62
IV.1.B. LITTER SAMPLES	68
IV.1.C. LIGHT TRAPS SAMPLES	70
<b>IV.2. COMPARISON OF SAMPLING METHODS</b>	<b>72</b>
<b>IV.3. DOMINANT TAXA AND POTENTIAL INDICATOR SPECIES</b>	<b>75</b>
<b>V. CONCLUSIONS</b>	<b>76</b>
<b>REFERENCES</b>	<b>77</b>

## **CHAPTER 4: MULTIDISCIPLINARY STUDY OF THE TROPHIC DIVERSITY AMONG AMPHIPODS ASSOCIATED TO MEDITERRANEAN *POSIDONIA OCEANICA* MEADOWS**

<b>I. INTRODUCTION</b>	<b>83</b>
<b>I.1. DELINEATING ANIMAL DIETS: DIFFERENT STRATEGIES</b>	<b>83</b>
I.1.A. CLASSICAL METHODS VS. TROPHIC TRACERS	83
I.1.B. STABLE ISOTOPES RATIOS	84
I.1.B.a. Stable isotopes: definition and natural abundance	84
I.1.B.b. Use of C & N stable isotopes as trophic markers	85
I.1.C. FATTY ACIDS	88
I.1.C.a. Structure & nomenclature	88
I.1.C.b. Fatty acid function and metabolism	90
I.1.C.c. Fatty acid as trophic markers	91
<b>I.2. TROPHIC ECOLOGY OF AMPHIPODS FROM <i>P. OCEANICA</i> MEADOWS: PREVIOUS STUDIES AND OBJECTIVES OF THIS CHAPTER</b>	<b>93</b>
<b>II. MATERIAL &amp; METHODS</b>	<b>94</b>
<b>II.1. TARGET SPECIES</b>	<b>95</b>
<b>II.2. GUT CONTENTS</b>	<b>95</b>

II.2.A. SAMPLE COLLECTION	95
II.2.B. SLIDE PREPARATION	95
II.2.C. GUT CONTENT EXAMINATION	96
<b>II.3. STABLE ISOTOPES</b>	<b>96</b>
II.3.A. SAMPLE COLLECTION	96
II.3.B. SAMPLE CONDITIONING AND PROCESSING	97
II.3.C. ANALYTICAL MEASUREMENTS	98
II.3.D. SIAR ISOTOPIC MIXING MODEL	100
<b>II.4. FATTY ACIDS</b>	<b>100</b>
II.4.A. SAMPLE COLLECTION & CONDITIONING	100
II.4.B. TOTAL LIPID EXTRACTION & TRANS-ESTERIFICATION OF FATTY ACIDS	101
II.4.C. FATTY ACID ANALYSIS	102
<b>III. RESULTS</b>	<b>102</b>
<b>III.1. GUT CONTENT ANALYSIS</b>	<b>102</b>
<b>III.2. FATTY ACID ANALYZES</b>	<b>107</b>
III.2.A. FATTY ACID COMPOSITION OF FOOD ITEMS	107
III.2.B. FATTY ACID COMPOSITION OF AMPHIPODS	114
<b>III.3. STABLE ISOTOPE RATIOS</b>	<b>119</b>
III.3.A. $\delta^{13}\text{C}$ VALUES OF FOOD SOURCES AND AMPHIPODS	119
III.3.B. LINKING $\delta^{13}\text{C}$ and $\delta^{15}\text{N}$ DATA	122
III.3.C. C & N ELEMENTAL CONTENT OF SOURCES	125
III.3.D. USE OF SIAR ISOTOPIC MIXING MODEL	127
<b>IV. DISCUSSION</b>	<b>135</b>
<b>IV.1. GUT CONTENTS</b>	<b>135</b>
<b>IV.2. FATTY ACIDS</b>	<b>138</b>
IV.2.A. FATTY ACID COMPOSITION OF FOOD SOURCES	138
IV.2.B. TROPHIC ECOLOGY OF AMPHIPODS DEPICTED BY FA ANALYSIS	141
<b>IV.3. STABLE ISOTOPES</b>	<b>144</b>
IV.3.A. ISOTOPIC & ELEMENTAL CHARACTERIZATION OF FOOD SOURCES	144
IV.3.B. ISOTOPIC RATIOS OF AMPHIPODS: DIETARY INSIGHTS	148
<b>IV.4. TROPHIC STATUS OF THE DOMINANT SPECIES: MULTIDISCIPLINARY OVERVIEW</b>	<b>154</b>
IV.4.A. <i>APHERUSA CHIEREGHINII</i>	154
IV.4.B. <i>AORA SPINICORNIS</i>	156
IV.4.C. <i>DEXAMINE SPINIVENTRIS</i>	157
IV.4.D. <i>AMPHITHOE HELLERI</i>	157
IV.4.E. <i>CAPRELLA ACANTHIFERA</i>	158
IV.4.F. <i>GAMMARELLA FUCICOLA</i>	160
IV.4.G. <i>GAMMARUS AEQUICAUDA</i>	160
<b>V. CONCLUSIONS</b>	<b>162</b>
<b>REFERENCES</b>	<b>165</b>



**CHAPTER 5: FUNCTIONAL ROLE OF AMPHIPOD GRAZING IN THE DYNAMICS OF THE EPIPHYTIC COVER OF *POSIDONIA OCEANICA* LEAVES**

<b>I. INTRODUCTION</b>	<b>175</b>
<b>I.1. THE PLACE OF AMPHIPODS IN THE SEAGRASS ECOSYSTEMS</b>	<b>175</b>
<b>I.2. THE SEAGRASS/EPIPHYTE/GRAZER SYSTEM</b>	<b>175</b>
I.2.A. IMPACTS OF SEAGRASSES	175
I.2.A.a. On epiphytes	175
I.2.A.b. On grazers	177
I.2.B. IMPACTS OF EPIPHYTES	177
I.2.B.a. On seagrass	177
I.2.B.b. On grazers	178
I.2.C. IMPACTS OF GRAZERS	179
I.2.B.a. On epiphytes	179
I.2.B.b. On seagrass	180
<b>I.3. OBJECTIVES OF THIS CHAPTER</b>	<b>180</b>
<b>II. MATERIAL &amp; METHODS</b>	<b>181</b>
<b>II.1. CHOICE OF TARGET SPECIES</b>	<b>181</b>
<b>II.2. DETERMINATION OF GRAZER BIOMASS</b>	<b>182</b>
<b>II.3. <i>IN VITRO</i> EXPERIMENTAL DESIGN</b>	<b>183</b>
II.3.A. EXPERIMENTAL SET-UP	184
II.3.B. SEAGRASS MIMICS AS A SUBSTRATUM FOR EPIPHYTES	184
II.3.C. ADDITION OF EPIPHYTES AND GRAZERS TO MICROCOSMS	185
II.3.D. SAMPLING STRATEGY	186
<b>II.4. <i>IN SITU</i> EXPERIMENTAL DESIGN</b>	<b>187</b>
II.4.A. EXPERIMENTAL SET-UP	187
II.4.B. GRAZER ADDITION, MAINTENANCE AND FINAL SAMPLING	188
<b>II.5. SAMPLE PROCESSING</b>	<b>189</b>
II.5.A. EPIPHYTE COLLECTION	189
II.5.B. BIOMASS MEASUREMENTS	189
II.5.C. STABLE ISOTOPE RATIOS & RELATIVE ELEMENTAL CONTENTS	190
<b>III. RESULTS</b>	<b>190</b>
<b>III.1. <i>IN VITRO</i> GRAZING EXPERIMENTS</b>	<b>190</b>
III.1.A. COMPOSITION OF THE EPIPHYTIC COVER OF SEAGRASS MIMICS	190
III.1.B. BIOMASS OF EPIPHYTIC GROUPS	191
III.1.C. ELEMENTAL CONCENTRATIONS OF EPIPHYTES	194
III.1.D. ASSIMILATION OF EPIPHYTIC ORGANIC MATTER BY GRAZERS	194
III.1.D.a. Set 1: Natural abundances	194
III.1.D.b. Set 2: Isotopic labelling	196
III.1.E. GRAZER SURVIVAL	200
<b>III.2. <i>IN SITU</i> GRAZING EXPERIMENTS</b>	<b>203</b>

III.2.A. BIOMASS OF EPIPHYTIC GROUPS	203
III.2.B. ELEMENTAL CONCENTRATIONS OF <i>P. OCEANICA</i> LEAVES & EPIPHYTES	207
III.2.C. ISOTOPIC RATIOS OF EPIPHYTES AND GRAZERS	210
III.2.D. GRAZER SURVIVAL, BIOMASS & SECONDARY PRODUCTION	211
<b>IV. DISCUSSION</b>	<b>214</b>
<b>IV.1. METHODOLOGICAL CONSIDERATIONS</b>	<b>214</b>
IV.1.A. <i>IN VITRO</i> VS. <i>IN SITU</i> EXPERIMENTAL DESIGNS	214
IV.1.B. ADEQUACY OF SEAGRASS MIMICS FOR EXPERIMENTAL PURPOSES	216
<b>IV.2. RESOURCE DEPLETION: EVOLUTION OF EPIPHYTIC BIOMASSES</b>	<b>218</b>
<b>IV.3. C/N RATIOS OF EPIPHYTES: IMPLICATIONS OF GRAZING ACTIVITY FOR NUTRIENT CYCLING</b>	<b>222</b>
<b>IV.4. ASSIMILATION OF CONSUMED EPIPHYTIC MATERIAL</b>	<b>223</b>
<b>IV.5. ORGANIC MATTER TRANSFERS AND SECONDARY PRODUCTION</b>	<b>225</b>
<b>IV.6. IMPORTANCE OF AMPHIPOD GRAZERS IN <i>P. OCEANICA</i> MEADOWS</b>	<b>227</b>
<b>V. CONCLUSIONS &amp; PERSPECTIVES</b>	<b>230</b>
<b>REFERENCES</b>	<b>232</b>

## **CHAPTER 6: GENERAL DISCUSSION, CONCLUSIONS AND PERSPECTIVES**

<b>I. IMPORTANCE OF <i>POSIDONIA OCEANICA</i> AS A HOST PLANT</b>	<b>239</b>
<b>II. THE EPIPHYTE/AMPHIPOD RELATIONSHIP: TROPHIC AND FUNCTIONAL INSIGHTS</b>	<b>242</b>
<b>III. THE <i>P. OCEANICA</i> LITTER AMONG THE MEADOW: TROPHIC VS. STRUCTURAL ROLE</b>	<b>246</b>
<b>IV. DETERMINANTS OF AMPHIPOD COMMUNITIES IN <i>P. OCEANICA</i> MEADOWS OF CALVI BAY</b>	<b>248</b>
<b>V. THE PLACE OF AMPHIPODS IN TROPHIC AND FUNCTIONAL INTERACTIONS OF <i>POSIDONIA OCEANICA</i> MEADOWS</b>	<b>249</b>
<b>VI. FURTHER RESEARCH: SUGGESTIONS AND PERSPECTIVES</b>	<b>252</b>
<b>REFERENCES</b>	<b>255</b>

## REMERCIEMENTS / ACKNOWLEDGEMENTS

---

Au terme de ce travail de recherche, il m'est agréable de remercier tout ceux qui y ont contribué, de près ou de loin. La liste qui suit n'ayant pas d'ordre particulier, il est inutile d'y chercher une quelconque hiérarchie, ou même une suite logique. Je m'excuse d'entrée de jeu auprès de ceux que j'aurais malencontreusement oubliés...

Commençons par **Patrick Dauby**, qui a accepté d'être le promoteur de ce travail et m'a accueilli au sein de son (grand) laboratoire, me permettant ainsi d'accéder au monde merveilleux (ou en tous cas particulier) de la recherche scientifique.

Je remercie **Gilles Lepoint** pour m'avoir aidé et accompagné depuis la rédaction de mon projet de thèse jusqu'à la rédaction de cette dissertation. Merci de m'avoir initié à l'étude des isotopes stables et au périlleux maniement de l'appareillage IRMS. Jusque là, je n'avais pas idée qu'il était possible de développer une relation amour/haine aussi intime avec des machines... Merci aussi pour les nombreuses discussions scientifiques et moins scientifiques pour ta présence quasi-permanente, pour les bières de décompression et pour ta haute résistance à mon humour pénible, mon caractère de cochon et ma "musique de yéyés".

Je remercie tout **Sylvie Gobert** (alias "Mme Chef") pour son aide précieuse et son efficacité, notamment lors des missions de prélèvement, pour sa bonne humeur et son entrain, et pour son légendaire sens de l'orientation sous-marine.

Une bonne partie du travail décrit dans cette dissertation a été réalisé en vampirisant, de manière plus ou moins éhontée, les installations et le matériel du laboratoire d'Océanologie. Il convient donc de remercier son chef, **Jean-Marie Bouquegneau**, pour avoir toléré ça.

Je n'oublie pas non plus **Fabienne Nyssen**, qui, en plus d'avoir été ma seule collègue officielle et permanente, a su se rendre utile sur des sujets divers et variés, et a accepté de me faire profiter de son réseau de collaborations internationales. Fabienne, je ne te souhaite pas de vivre heureuse et d'avoir beaucoup (plus) d'enfants, mais l'idée est là.

The fatty acid analyses presented in this study have been realized at the Alfred Wegener Institute (AWI) of Bremerhaven, under the competent supervision of **Martin Graeve** (Marine Chemistry Group). Vielen dank Martin for welcoming me in Bremerhaven, and for your help with the analyses.

Ni la préparation des lames pour l'examen des contenus stomacaux, ni les errements, mises au point et chipotages qui l'ont précédée n'auraient été possibles sans l'aide de **Nicolas Thelen** (Unité de Biologie Cellulaire et Tissulaire, ULg). Merci Rossê, et à charge de revanche.

**Julien Jacquemart** m'a été d'une aide précieuse lors des déterminations de macroalgues épiphytes, me permettant ainsi d'avoir un point de vue qualitatif sur certaines problématiques malgré mon ignorance quasi-totale en la matière. Grâce lui en soit rendue.

Une partie des résultats du chapitre 5 sont issus du travail de stage d'**Alessandra Dupont**. Je la remercie donc pour le soin et l'efficacité qu'elle a mis dans son travail, et lui souhaite bonne chance pour la suite de sa carrière scientifique.

Ma gratitude va aussi à **Renzo Biondo** pour son aide en ce qui concerne les questions techniques. Ses idées lumineuses et ses insondables capacités de bricoleur sont à la base de bien des ustensiles et appareillages utilisés dans le cadre de ma thèse... À côté de lui, Angus McGyver peut retourner au vestiaire.

Je profite du fait que les bricolages et le DIY soient à l'ordre du jour pour remercier ma grand-mère, **Jeanne Michel**, pour avoir réalisé sans rouspéter tous les travaux de couture sur maille en nylon que je lui ai demandé, aussi saugrenus soient-ils.

Une bonne partie de ma thèse a eu pour cadre la station de recherches STARESO. Je remercie donc son directeur, **Pierre Lejeune**, d'avoir mis à ma disposition les moyens offerts par cette station.

Je remercie également le personnel passé et présent de la STARESO pour leur aide dans des domaines allant de l'échantillonnage sous-marin à la compréhension de la mentalité corse, en passant par la découverte des produits locaux.

Merci aussi à mes nombreux compagnons de palanquée, sans qui mon échantillonnage aurait été impossible. Ils ont toujours effectué sans rechigner les tâches que je leur avais confiées, aussi ingrates soient-elles. Certains ont même acceptés de se lever au milieu de la nuit pour s'immerger dans de l'eau froide dans le seul but de tenir une lampe pour me permettre de voir ce que je faisais. J'espère sincèrement avoir été aussi utile à leurs recherches qu'ils ne l'ont été aux miennes.

En recherche comme malheureusement dans beaucoup de domaines, l'argent est le nerf de la guerre, et un chercheur n'est pas grand-chose sans ses sources de financement. Ce travail a été rendu possible grâce à l'aide financière du Fonds de la Recherche Scientifique (Bourse d'Aspirant FNRS n°FC074734). J'ai également bénéficié d'une bourse du Fonds de Solidarité de l'Université de Liège. Je suis profondément reconnaissant à ces deux organismes.

Je remercie bien évidemment l'ensemble des membres passés et présents des Laboratoires de Systématique et Diversité animale (ce sera vite fait) et d'Océanologie. Mille mercis à tous pour votre bonne humeur, pour l'excellente ambiance que vous contribuez faire régner au sein de notre lieu de travail, et bien sûr pour les Friday drinks.

Dans ce registre, je tiens à remercier tout particulièrement **Dorothée Pête**, **Joseph Schnitzler** et **Olivier Drouguet** pour les innombrables cafés (C'est au tour de qui de les faire ?), les salvatrices digestive walks (Is it a kind of belgian expression ?), les p'tites bières de 17h (Nom di Dju, que l'air est sec dans ce bâtiment !) et les Guinness au Shamrock d'un peu plus tard.

Sans un arrière-plan musical constant pour me motiver, bien peu d'amphipodes auraient été identifiés, bien peu de biomasses auraient été mesurées, bien peu de cupules auraient été encupulées, et bien peu de lignes auraient été écrites. Une énumération complète de mon panthéon musical n'intéresse sans doute que moi (et encore), mais je tiens tout de même à remercier Joe Strummer, Joey et Dee Dee Ramone, Al Barr et Ken Casey, Shane McGowan, Dave King, Eugene Hütz, Manu Chao, Greg Graffin, Bruce Springsteen, Jack White, Franck Black, Mike Patton, Damon Albarn, Thom Yorke, Kurt Cobain, Dave Grohl, Tom Waits, Mark Everett et Johnny Cash pour leur excellente musique.

Enfin ("last but not least" comme diraient nos voisins d'outre-Manche), je tiens à remercier ma famille et mes amis. Ici, je vais éviter l'énumération, de peur d'en oublier l'un ou l'autre. Ils se reconnaîtront, et savent de toutes façons déjà que je leur suis reconnaissant pour tout, et pour le reste.

A ce sujet, je remercie tout particulièrement mes parents, **Christian** et **Gloria Michel**, pour leur support constant durant mes (longues) études et ma (toute aussi longue) thèse de doctorat, mais aussi avant (et après, j'espère).



# SUMMARY

---

*Posidonia oceanica* is the most abundant seagrass of the Mediterranean Sea. It can cover extensive areas with monospecific formations, called meadows. These meadows, whose extent is estimated to about 40,000 km<sup>2</sup>, are critical features of the Mediterranean coastal zones. Moreover, they shelter important biomass and biodiversity of vagile invertebrates. Among these invertebrates, **amphipod crustaceans** are, alongside gastropod mollusks and polychaete annelids, one of the dominant groups.

Amphipods are **key-features** of other temperate seagrass systems. As they are generally primary consumers, they are important in the **transfers of organic matter** from producers to higher rank consumers. In addition, their grazing activity on the epiphytes that grow on the seagrasses influence the **dynamics of the epiphytic cover**, and therefore the functioning of the whole meadow as an ecosystem.

However, the situation in Mediterranean *Posidonia oceanica* meadows is still unclear. In particular, several lacks of information limit the comprehension of actual trophic ecology of amphipods, and of the impact of their feeding activity on the meadow functioning. In this context, the main goal of this work was to enhance the knowledge of the **trophic diversity** and the **functional role** of amphipods associated to *Posidonia oceanica* meadows. To achieve this, we structured our research in three main tasks. For each of these tasks, we chose **Calvi Bay** (NW Corsica, France) as study site, and all sampling and experimentation was undertaken from the STARESO research station (University of Liège).

The first task (chapter 3) was the study of the precise composition of the amphipod **community structure** at our study site, and its temporal variation at day/night and seasonal scale. Our results show that the fauna of *Posidonia oceanica* meadows of Calvi Bay is **abundant** and **diverse**. The density and the structure of the community were different in each **season** (November, March and June), probably in relation with meadow parameters such as foliar surface, epiphytic biomass and abundance of litter in the meadow. Moreover, **day/night** variations were very important. Most amphipods performed **vertical migrations** that could be a mechanism to avoid predation and/or competition for food and habitat. The comparison of three **sampling techniques** (hand-towed net, litter collection and light traps) yielded deeply different results, suggesting that each of them only collects a subset of a complex assemblage. **Combination** of several sampling methods is therefore advised to have a holistic and accurate view of the community. These faunistic data also allowed highlighting the most abundant and/or **representative** species of the studied community. These include *Apherusa chiereghinii*, *Aora spinicornis*, *Dexamine spiniventris*, *Amphithoe helleri*, *Caprella acanthifera*, *Gammarella fucicola* and *Gammarus aequicauda*. These species were therefore chosen as target species for the second task.

The second task (chapter 4) was the assessment of the extent of **interspecific trophic diversity** among the studied community. This phenomenon could

indeed be important to limit food competition. We tried to perform a full **reconstruction of the diet** of the dominant species of the community and to evaluate the contribution of each of the **potential food items** offered by the meadow (animal and vegetal epiphytes from the leaves, rhizomes and litter fragments, SPOM, BPOM, living and dead *P. oceanica* material). To have an accurate view of the dietary habits of the dominant species, we used a triple strategy based on the joint use of traditional methods (gut content examination) and trophic markers (stable isotopes of C & N, fatty acids). The combination of these three methods proved to be successful, as each method had specific strengths and weaknesses. Overall, results indicate that all dominant species relied on **macroalgal epiphytes** for a large part of their diet. Our insights were unfortunately limited by the poor discrimination between potential food items, due to **high inter-source similarity**. Considerable interspecific differences could nonetheless be highlighted, notably concerning preferences of epiphytes from leaves or litter fragments vs. epiphytes from rhizomes. In addition, most species had a **mixed diet**, and relied on several food items. None of the examined species seemed to graze on their seagrass host, but *Gammarus aequicauda* partly relied on seagrass leaf detritus. Contribution of microepiphytes (*e.g.* diatoms) to the diet of amphipods was apparently anecdotal. Our data also suggested the existence of a certain extent of **intraspecific trophic diversity** that should be taken into account for future work.

In the third and final task (chapter 5), we aimed to put the data obtained in the first two parts of this study in the wider context of the functioning of the *Posidonia oceanica* meadow as an ecosystem. We used *in vitro* and *in situ* **microcosms experiments** to characterize the interaction between epiphytes and amphipods from a triple point of view (resource depletion, resource assimilation by the consumer and secondary production), and to understand how amphipod **grazing** could influence the **dynamics of the epiphytic cover** of the leaves of *P. oceanica*.

Amphipod grazing had no effect on the total epiphytic biomass, or on the encrusting epiphytes' biomass. However, all three taxa (*A. chierighinii*, *D. spiniventris* and *Gammarus* spp.) consumed significant amounts (45 to 90 % of total biomass) of erected epiphytes, both vegetal and animal. This **selective top-down control** might influence the structure and biomass-specific productivity rates of the epiphytic cover. In addition, amphipod grazing caused an increase in N availability and residence time. Through epiphyte removal and **N enrichment**, amphipods could boost seagrass production. Overall, amphipods of *Posidonia oceanica* meadows could be seen as **ecosystem engineers**. Assimilation of the consumed epiphytes was clear for all taxa. However, the utilization of this biomass for secondary production was hard to measure, due to low survival rates of animals.

*In fine*, by combining *in situ* sampling and microcosm experimentation, and through the joint use of traditional and innovative techniques, we showed that feeding activity of amphipods influence their biotope through several effects, and that they could be pivotal items of *Posidonia oceanica* meadows. In doing so, we improved, to some extent, the understanding of these critically important, yet endangered ecosystems.



# RÉSUMÉ

---

*Posidonia oceanica* est la phanérogame marine la plus abondante de Méditerranée. Elle peut former de vastes étendues monospécifiques, appelées herbiers. Ces herbiers, dont la surface est estimée à 40000 km<sup>2</sup>, sont des éléments primordiaux des zones côtières méditerranéennes. De plus, ils abritent une importante biomasse et biodiversité d'invertébrés vagiles, parmi lesquels les **crustacés amphipodes** forment, avec les mollusques gastéropodes et les annélides polychètes, l'un des groupes dominants. Les amphipodes sont des **éléments-clés** dans d'autres herbiers de milieu tempéré. Etant généralement des consommateurs primaires, ils sont importants dans les **transferts de matière organique** des producteurs aux consommateurs de rang supérieur. De plus, leur activité de broutage des épiphytes qui poussent sur les phanérogames influence la **dynamique de la couverture épiphytique**, et de ce fait l'intégralité des herbiers en tant qu'écosystèmes.

Néanmoins, la situation dans les herbiers de posidonies méditerranéens reste obscure. Seules des informations fragmentaires et partielles sont disponibles, limitant ainsi la compréhension de l'écologie trophique réelle de ces amphipodes, et de l'impact de leur activité alimentaire sur le fonctionnement de l'herbier. Dans ce contexte, l'objectif principal de ce travail est d'améliorer la connaissance de la **diversité trophique** et du **rôle fonctionnel** des amphipodes associés aux herbiers de posidonies. Pour mener à bien cet objectif, nous avons structuré nos recherches selon 3 axes principaux. Dans chacun des cas, la **baie de Calvi** (Nord-Ouest de la Corse, France) a été choisie comme site d'étude, et tout l'échantillonnage et l'expérimentation ont été entrepris depuis la station de recherche STARESO (Université de Liège).

Le premier axe (chapitre 3) était l'étude de la **composition** de la **communauté** d'amphipodes présente à notre site d'étude, ainsi que de sa variation temporelle aux échelles saisonnières et nycthémérales. Nos résultats indiquent que la faune des amphipodes des herbiers de posidonies de la baie de Calvi est **abondante** et **diversifiée**. La densité et la structure de la communauté étaient différentes à chaque saison (novembre, mars et juin), vraisemblablement en relation avec certains paramètres de l'herbier comme la surface foliaire, la biomasse épiphyte et l'abondance de litière au sein de l'herbier. De plus, les variations nycthémérales étaient fortement marquées. La plupart des amphipodes réalisent des **migrations verticales** qui pourraient être un mécanisme d'évitement de la prédation et/ou de la compétition pour la nourriture. La comparaison de trois **techniques de prélèvement** (filet fauchoir, ramassage de litière et pièges à lumière) a mené à des résultats profondément différents, ce qui suggère que chaque méthode ne représente qu'une fraction partielle d'un assemblage plus complexe. La meilleure manière d'avoir une vue globale et précise de la communauté est donc probablement la **combinaison** de plusieurs méthodes. Ces données faunistiques ont également permis de mettre en évidence les espèces les plus abondantes et/ou **représentatives** de la communauté étudiée. Celles-ci sont *Apherusa chiereghinii*, *Aora spinicornis*, *Dexamine spiniventris*, *Amphithoe helleri*,

*Caprella acanthifera*, *Gammarella fucicola* et *Gammarus aequicauda*. Ces espèces ont été choisies comme espèces-cibles pour le second axe.

Ce second axe (chapitre 4) consistait en l'évaluation du degré de **diversité trophique interspécifique** existant au sein de la communauté étudiée. Ce phénomène pourrait en effet être très important pour limiter la compétition pour la nourriture. Nous nous sommes attachés à la réalisation d'une **reconstruction du régime alimentaire** des espèces dominantes de la communauté, ainsi qu'à l'évaluation de la contribution de chacune des **sources de nourriture potentielle** (épiphytes animaux ou végétaux des feuilles, rhizomes ou fragments de litière, SPOM, BPOM, tissus morts ou vivants de posidonie). Pour avoir une vue aussi adéquate que possible des préférences alimentaires de chaque espèce, nous avons utilisé une triple approche basée sur l'usage conjoint d'une technique traditionnelle (examen des contenus digestifs) et de marqueurs trophiques (isotopes stables du C et du N, acides gras).

La combinaison de ces trois méthodes s'est montrée fructueuse, chaque technique ayant ses forces et faiblesses spécifiques. Globalement, nos résultats montrent que le régime alimentaire de toutes les espèces dominantes est constitué en grande partie de **macroalgues épiphytes**. Notre analyse s'est malheureusement trouvée limitée par l'importante **similarité** entre les **sources de nourriture** potentielles, et l'impossibilité de les séparer efficacement. De considérables différences interspécifiques ont cependant pu être mises en évidence, notamment concernant la consommation des épiphytes poussant sur les feuilles, les fragments de litière ou les rhizomes. De plus, la plupart des espèces ont un **régime alimentaire varié**, et dépendent de plusieurs sources de nourriture. Aucune des espèces étudiées ne consomme apparemment les tissus vivants de sa phanérogame-hôte, mais *Gammarus aequicauda* tire une partie de sa subsistance des feuilles de posidonies mortes. La contribution des microépiphytes (*e.g.* diatomées) au régime alimentaire des amphipodes est apparemment anecdotique. Nos données suggèrent également l'existence d'un certain degré de **diversité trophique intraspécifique** qui devrait être pris en compte lors de travaux futurs.

Le troisième et dernier axe de recherche (chapitre 5) visait à replacer les données obtenues lors des deux premiers volets de cette étude dans le contexte plus large du fonctionnement de l'herbier de posidonies en tant qu'écosystème. Nous avons utilisé des **expériences en microcosmes *in vitro*** et ***in situ*** pour caractériser l'interaction entre épiphytes et amphipodes d'un triple point de vue (déplétion de la ressource, assimilation de la ressource par le consommateur et production secondaire), et pour comprendre comment le **brouillage** peut influencer la **dynamique de la couverture épiphyte** des feuilles de *P. oceanica*.

Le brouillage par les amphipodes n'a pas eu d'effet sur la biomasse épiphyte totale, ni sur la biomasse d'épiphytes encroûtant. Toutefois, les trois taxons considérés (*A. chierighinii*, *D. spiniventris* et *Gammarus* spp.) se sont montrés capables de consommer des quantités importantes (de 45 à 90 % de la biomasse disponible) d'épiphytes érigés, tant animaux que végétaux. Ce **contrôle "top-down" sélectif** pourrait influencer la structure et la productivité

de la couverture épiphyte. De plus, le broutage par les amphipodes semble causer une **augmentation de la disponibilité** et du temps de résidence de l'**azote**. En éliminant ses épiphytes et en enrichissant le milieu ambiant en azote, les amphipodes pourraient permettre une augmentation de la production de *P. oceanica*. Ils pourraient donc être considérés comme des **ingénieurs de l'écosystème**. L'assimilation des épiphytes consommés était claire pour tous les taxons. Par contre, l'utilisation de la biomasse assimilée pour la production secondaire s'est montrée difficile à mesurer, en raison des faibles taux de survie des animaux.

*In fine*, en combinant échantillonnage *in situ* et expérimentation en microcosmes, et via l'utilisation de techniques traditionnelles et innovantes, nous avons montré que l'activité alimentaire des amphipodes influence leur biotope à travers différents effets, et qu'ils pourraient être des éléments-clés des herbiers à *Posidonia oceanica*. Ce faisant, nous avons amélioré, à notre manière, la compréhension de ces écosystèmes d'importance cruciale, mais néanmoins menacés.



# LIST OF ABBREVIATIONS

commonly used over the course of this dissertation

---

- 1- $\lambda'$ : Simpson's evenness index  
14:0: myristic acid  
16:0: palmitic acid  
16:1(n-7): palmitoleic acid  
18:0: stearic acid  
18:1(n-7): *cis*-vaccenic acid  
18:1(n-9): oleic acid  
18:2(n-6): linoleic acid  
18:3(n-3):  $\alpha$ -linolenic acid  
20:4(n-6): arachidonic acid  
20:5(n-3), EPA: eicosapentaenoic acid  
22:6(n-3), DHA: docosahexaenoic acid  
AC, *A. chierighinii*: *Apherusa chierighinii*  
AH, *A. helleri*: *Amphithoe helleri*  
AS, *A. spinicornis*: *Aora spinicornis*  
BPOM: benthic particulate organic matter  
C: carbon  
CAC: *Caprella acanthifera*  
d: Margalef's specific richness index  
DM: dry mass  
DV, *D. spiniventris*: *Dexamine spiniventris*  
FA: fatty acid  
GA, *G. aequicauda*: *Gammarus aequicauda*. Alternatively, G: *Gammarus* spp.  
H': Shannon-Wiener's diversity index  
Ind.: individual  
J': Pielou's evenness index  
MUFA: monounsaturated fatty acid  
N: number of individuals in a sample, or nitrogen, depending on the context  
NMMDS: non-metric multidimensional scaling  
PUFA: polyunsaturated fatty acid  
S: number of species  
SAFA: saturated fatty acid  
SD: standard deviation  
SI: stable isotope  
SPA: submerged phytodetritus accumulation  
SPOM: suspended particulate organic matter



# Chapter 1

## General introduction

Every story has to start somewhere.

(J.R.R. Tolkien)





## **I. Seagrasses**

### **I.1. Definition**

Seagrasses are higher plants (phanerogams) that are strictly confined to marine coastal areas. They are angiosperms (flowering plants), and belong to group of monocotyledons, or monocots, but are typically regarded as an ecological group rather than a true taxonomic entity.

They are fully adapted to the marine environment, and share five common features: the capacity to grow underwater, the possession of an efficient anchoring system (roots and rhizomes), the capacity to survive a saline environment, the possession of an adapted hydrophilic pollination mechanism, and the ability to perform their full vegetative and reproductive cycles in seawater (Kuo & Den Hartog, 2000 ; Den Hartog & Kuo, 2006).

They are usually not found isolated, but rather in large formations, called meadows, that are common and important features of coastal areas in most world regions. These formations can cover large areas. Meadows can be formed by a single species of seagrass (monospecific meadows, the most common situation in temperate zones), several species of seagrass (polyspecific meadows, often encountered in tropical and subtropical biomes) or even several species of seagrass and macroalgae (Den Hartog, 1970 ; Den Hartog & Kuo, 2006).

### **I.2. Systematics**

As mentioned in the previous paragraph, seagrasses are angiosperms. The most recent developments in angiosperm systematics (APG III) classify them in the Monocots clade, and more precisely in the Alismatales order (The Angiosperm Phylogeny Group, 2009).

The "classical" view of seagrasses systematics, mostly based on morphological features, acknowledges 64 species, distributed over 4 families (Den Hartog & Kuo, 2006). A number of phylogenetic studies were recently published, sometimes suggesting partial revision of this classification. They will not be considered here.

**Zosteraceae** are a family consisting exclusively of seagrasses. 3 genera belong to this family: *Zostera* (11 species), *Phyllospadix* (5 spp.) and *Heterozostera* (4 spp.).

The **Cymodoceaceae** family also contains only seagrasses. It counts 5 genera: *Halodule* (7 spp.), *Cymodocea* (4 spp.), *Syringodium* (2 spp.), *Thalassodendron* (2 spp.) and *Amphibolis* (2 spp.).

---

## General introduction

*Posidonia* is the only genus of the **Posidoniaceae** family. It contains 9 species, including the Mediterranean *Posidonia oceanica* L. (Delile) and 8 species from Australian coasts.

These three families that contain strictly seagrasses were previously subfamilies included in the Potamogetonaceae, and this term is sometimes found in older literature. However, it should be considered obsolete (DEN HARTOG & KUO, 2006 ; THE ANGIOSPERM PHYLOGENY GROUP, 2009).

Besides these four families, **Hydrocharitaceae** regroup 17 genera of aquatic plants. Most of them live in freshwater environments, but three are seagrasses: *Halophila* (15 spp.), *Thalassia* (2 spp.) and *Enhalus* (only one species, *E. acoroides*).

The status of a number of other plants, notably from the families Ruppiaceae and Zannichelliaceae is debated. Some of their representatives actually colonize the marine environment, but they are not restricted to it, and are also found in freshwater ecosystems. They are therefore usually not regarded as "true" seagrasses (DEN HARTOG & KUO, 2006).

### **1.3. Adaptations to marine life**

Seagrasses are organisms that evolved from terrestrial plant ancestors. Therefore, they share a number of derived features in relation with their life conditions.

The morphology of seagrasses varies widely, notably in terms of size of leaves, of number of leaves per shoot, of relative importance of above- and belowground tissues, etc. However, most seagrass species (with the exception of several *Halophila* species) have linear, ribbon-shaped leaves. This particular shape can be regarded as an adaptation to life in demanding marine conditions. It has an important surface/volume ratio, therefore maximising photosynthetic surface and exchanges of gases and nutrients with the water column (HEMMINGA & DUARTE, 2000 ; KUO & DEN HARTOG, 2000 ; KUO & DEN HARTOG, 2006).

Seagrass blades also show important differences with those of terrestrial monocots. The cuticle is extremely thin, to limit resistance to diffusion. The epidermis bears no stomata. The mesophyll shelters numerous lacunae that allow stocking and diffusion of gases, and enhance buoyancy of the leaves. In addition, the lacunar system is continuous throughout all parts of the plants (from the leaves to the roots), and parenchymatous septa regulate diffusion of gases in the plant (DEN HARTOG, 1970 ; KUO & DEN HARTOG, 2000 ; KUO & DEN HARTOG, 2006).

As mentioned in section 1.1, all seagrasses possess a well-developed anchoring system that involves the presence of rhizomes (underground or creeping stems). These rhizomes act as a mechanical support for the seagrass shoots, and allow them to resist adverse effects of currents and waves. They are also

stocking organs for various compounds, and play a part in the regulation of seagrass growth, since they are links between different shoots. They are also responsible for a significant part of the meadow development. Horizontal vegetative growth is indeed often more important than propagation through seeds (HEMMINGA & DUARTE, 2000 ; KUO & DEN HARTOG, 2006).

Finally, seagrasses are adapted to marine sexual reproduction. Floral structures are often relatively simple (absence of biologic pollination), and several hydrophilic pollination mechanisms exist. Pollen grains (or associated formations) typically have a filamentous shape, favouring their aquatic dissemination (ACKERMAN, 2006)

#### **I.4. Seagrasses in the Mediterranean Sea**

Despite their relatively low specific diversity, seagrasses grow in the shallow marine and estuary environments of all the world's continents, except Antarctica. In the Mediterranean, five species can be encountered.

- *Zostera noltii* grows from the intertidal zone to a few meters deep, on sandy and muddy substrates. It seems to be relatively tolerant to water turbidity, high organic loads of sediments, and salinity variations. It is also present in enclosed and sheltered areas, where it can form mixed meadows with *Cymodocea nodosa* (LIPKIN *et al.*, 2003 ; PROCACCINI *et al.*, 2003).

- *Zostera marina* is considered to be a relict species in the Mediterranean. Like *Z. noltii*, it forms meadows on sandy and muddy substrates, from the intertidal zone to depths of a few meters. It is also present in lagoons. It is rare in the Western part of the Mediterranean, and even more rare and maybe extinct in the Eastern Mediterranean (LIPKIN *et al.*, 2003 ; PROCACCINI *et al.*, 2003).

- *Posidonia oceanica* is the most abundant seagrass of the Mediterranean. Its features and importance will be extensively discussed in the next section.

- *Cymodocea nodosa* is more common at shallow depths, although discontinued beds can occur until 30 to 40 m. It seems to prefer sandy substrates and sheltered sites, but is fairly tolerant to a number of factors including sediment grain size and organic content. It is traditionally regarded as a pioneer species, able to colonize bare substrates, and part of the succession leading to climatic *Posidonia oceanica* meadows. It also grows in areas previously covered by *P. oceanica* meadows and characterized by dead matte. In the eastern Mediterranean, it can even form mixed meadows with *P. oceanica* and/or *Caulerpa prolifera* (DEN HARTOG, 1970 ; LIPKIN *et al.*, 2003 ; PROCACCINI *et al.*, 2003).

- *Halophila stipulacea* is a tropical alien species. It was introduced from Red Sea when Suez Canal was built (lessepsian migration). It is found in various locations throughout the Eastern Mediterranean, where its ecological

range is apparently much narrower than it is in its native area. In the Mediterranean, *H. stipulacea* indeed grows only on soft substrates, at shallow depths, and only one of its ecotypes is encountered (LIPKIN *et al.*, 2003). Its presence in the western Mediterranean has been reported since 1988, and it now seems to spread until the Tyrrhenian Sea, where it notably colonizes dead *P. oceanica* mat (GAMBI *et al.*, 2009).

In addition, reports of *Ruppia maritima* and *Ruppia cirrhosa* in various locations along the Mediterranean coasts exist. However, they are not true seagrasses, but rather salt-tolerant freshwater plants (LIPKIN *et al.*, 2003 ; PROCACCINI *et al.*, 2003 ; DEN HARTOG & KUO, 2006).

## **II. *Posidonia oceanica* meadows**

### **II.1. *Posidonia oceanica* (L.) Delile**

As mentioned earlier, *Posidonia oceanica* is the most abundant seagrass from the Mediterranean Sea. It forms patchy and continuous meadows from the surface to maximal depths of 45 m in very clear waters, and grows on sandy and rocky bottoms. *P. oceanica* meadows are typically regarded as one of the climax communities of the Mediterranean coastal area (PROCACCINI *et al.*, 2003).

*Posidonia oceanica* is a stenoeious species, and its ecological amplitude is narrower than other Mediterranean seagrasses. It is not tolerant to water turbidity (that often limits its depth extent), or to desiccation. It usually does not grow in zones whose salinity is below 33 (but see MEINESZ *et al.*, 2009). This sensitivity to environmental factors explains that it is absent from estuaries. Its temperature interval is wider, ranging from 9 to 29°C (GOBERT *et al.*, 2006).

*Posidonia oceanica* is typically regarded as a Mediterranean endemic. However, recent description of beds from the Dardanelles Strait and the Marmara Sea questions this status (MEINESZ *et al.*, 2009).

Distribution of *P. oceanica* (cf. fig. 1.1) is limited to the West by the Almeria-Oran front. Surface waters closer to the Strait of Gibraltar are under Atlantic influence, and *P. oceanica* does not grow in it. Eastern extent of the distribution ends on the coasts of Syria, Israel and Lebanon, where *P. oceanica* is absent. Between these two limits, distribution of *P. oceanica* is almost continuous, and it is only missing in zones under the influence of large estuaries (Po, Rhone, Nile) (GOBERT *et al.*, 2006).

In total, *P. oceanica* meadows cover  $25.10^3$  to  $50.10^3$  km<sup>2</sup>, i.e. 1-2 % of the Mediterranean (PASQUALINI *et al.*, 1998).



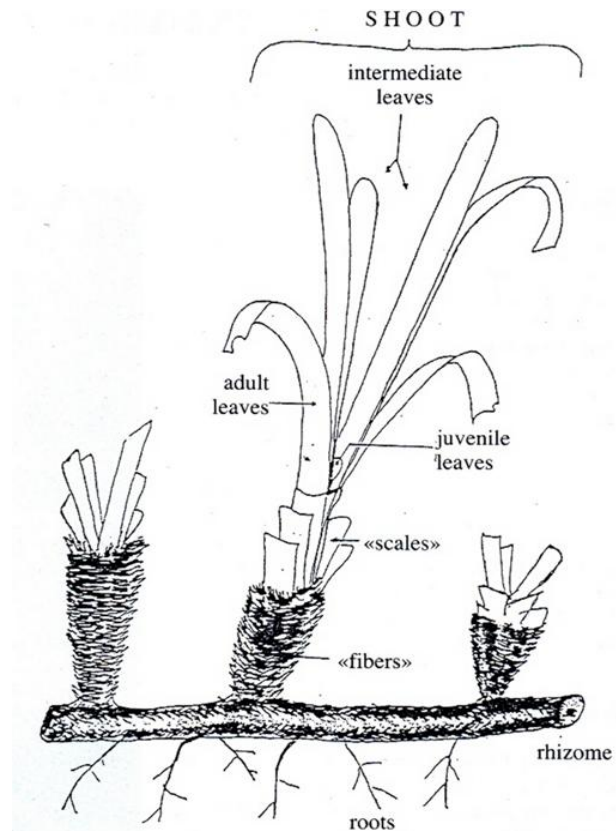
**Fig. 1.1:** Geographical distribution of *Posidonia oceanica* (solid black line, redrawn using data from LIPKIN *et al.*, 2003 ; PROCACCINI *et al.*, 2003 ; BOUDOURESQUE *et al.*, 2006 ; GOBERT *et al.*, 2006 ; MEINESZ *et al.*, 2009). Map Outline used courtesy of the University of Alabama. 1: Gibraltar; 2: Almeria; 3: Oran; 4: Coasts of Syria, Israel and Lebanon; A: Rhone estuary; B: Po estuary; C: Nile estuary.

Shoots of *P. oceanica* are directly fixed to strong rhizomes, which also bear roots. Shoots consist of 4 to 8 ribbon-shaped leaves (cf. fig. 1.2). Leaves are attached to the rhizome by a strong, lignified petiole. Three kinds of leaves can be distinguished according to their morphology and degree of maturity. Juvenile leaves, whose length is inferior to 5 cm, grow to become intermediate leaves, and ultimately adult leaves, that feature a ligule between the blade itself and the petiole. Adult leaves stop to grow, but their biomass can nonetheless increase due notably to lignification of the blade (CINELLI *et al.*, 1995 ; HEMMINGA & DUARTE, 2000 ; GOBERT, 2002).

Width of the leaves generally ranges from 8 to 11 mm, and their length often ranges from 20 to 100 cm, even if it can exceptionally reach 150 cm. Blades have parallel nervures, linked by frequent transversal junctions. Like in all species of the *Posidonia* genus, leaves are reinforced by supportive structures, (linear groups of fibrous cells with thickened walls). They allow the plant to withstand hydrodynamic forces, while keeping considerable flexibility (CINELLI *et al.*, 1995 ; HEMMINGA & DUARTE, 2000 ; BOUDOURESQUE *et al.*, 2006).

*Posidonia oceanica* is a perennial, deciduous plant. When leaves shed, they break at the level of the ligule, and leave scales on the shoots. These scales, that are in fact petioles of old abscised blades, form a sheath around the new leaves. These scales are resistant to degradation, and even when most of the tissues are decomposed, ligneous fibres remain on the rhizome (PERGENT & PERGENT-MARTINI, 1991 ; CINELLI *et al.*, 1995).

**Fig. 1.2:** Structure of a *Posidonia oceanica* shoot, also showing the root/rhizome system (from CINELLI *et al.*, 1995).



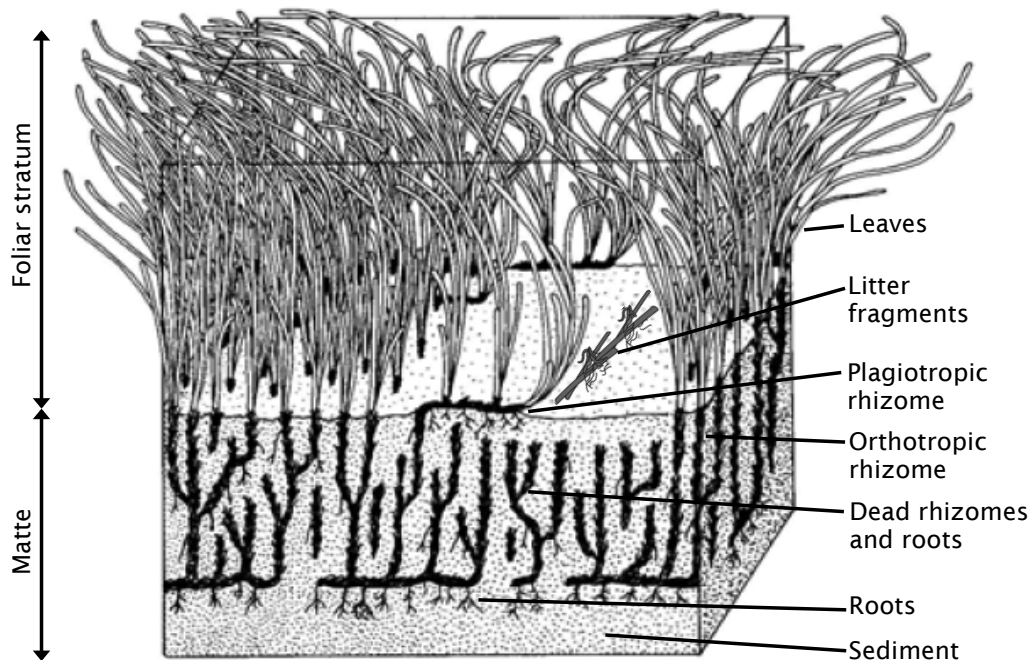
Two reproduction mechanisms co-exist. Vegetative, clonal reproduction by is the most common one. Sexual reproduction, with production of flower and fruits, is more rare, but crucial to maintain sufficiently high genetic diversity (GOBERT *et al.*, 2001).

## **II.2. Structure of *P. oceanica* meadows**

As mentioned earlier, *Posidonia oceanica* is able to form large meadows that can sometimes cover several km<sup>2</sup>. These meadows can be continuous or patchy, and peculiar formations can occur, such as hill-like structures, fringing or barrier reefs meadows, atoll-like patches, etc. (BORG *et al.*, 2005 ; BOUDOURESQUE *et al.*, 2006).

In the vast majority of cases, meadows are monospecific, although mixed meadows where *P. oceanica*, *Cymodocea nodosa* and sometimes *Caulerpa prolifera* are found in association exist. *P. oceanica* generally colonizes shallow, sheltered soft-bottom areas. Settlement can be facilitated by presence of pioneer, less demanding macrophytes (*Caulerpa prolifera*, *Cymodocea nodosa*) that cause sediment enrichment. After initial settlement, meadows can grow horizontally and reach less sheltered or deeper zones as well as rocky bottoms (BOUDOURESQUE & MEINESZ, 1982 ; BOUDOURESQUE *et al.*, 2006).

*Posidonia oceanica* meadows are complex and heterogeneous ecosystems, featuring several compartments (cf. fig. 1.3) that are linked by numerous interactions and processes. The next sections describe the most important of these compartments.



**Fig. 1.3:** Schematic representation of the structure of a *Posidonia oceanica* meadow (after BOUDOURESQUE & MEINESZ, 1982, modified).

## II.2.A. The foliar stratum

The aboveground biomass of *Posidonia oceanica* consists of leaves, which are the photosynthetic organs. The foliar stratum (or canopy) is the most visible and exposed of *P. oceanica* compartments.

Shoot density of meadows can vary greatly according to a number of factors, notably depth. Values range from 150-300 shoots.m<sup>-2</sup> (very scarce beds) to over 700-1000 shoots.m<sup>-2</sup> (very dense beds) (BUIA *et al.*, 2000 ; PROCACCINI *et al.*, 2003). Shoot density does not vary much throughout the year (GOBERT *et al.*, 2006).

Foliar biomass (175-670 gDM.m<sup>-2</sup>) and production (162-722 gDM.m<sup>-2</sup>.year<sup>-1</sup>) are high, and exhibit strong seasonal variabilities (BUIA *et al.*, 2000 ; GOBERT *et al.*, 2006). Maximal foliar growth rates are recorded during the summer months, in relation with optimal light availability and high water temperature. Nutrient availability is also important, but is apparently a secondary factor (ALCOVERRO *et al.*, 1995 ; GOBERT, 2002).

Foliar stratum is a dynamic compartment, as new juvenile leaves continuously appear at the centre of the shoot. This happens all year round, but is more common during autumn (September to November). Leaves have a life span of 7 to 12 months, possibly the highest value of all seagrasses.

Old adult leaves senesce and typically shed during autumn, where massive abscission events occur. Hydrodynamic forces (waves, storms, etc.) also cause apical erosion of adult leaves throughout the year, and may accelerate leaf breakage and fall. Grazing can also be an important factor. At a depth of 10 m, the average annual turnover rate of leaves is 1.1 to 1.8 % per day, suggesting complete replacement of the canopy could happen in 55 to 90 days (BAY, 1984 ; HEMMINGA & DUARTE, 2000 ; GOBERT, 2002 ; GOBERT *et al.*, 2006).

## II.2.B. The root/rhizome system and the matte

As mentioned earlier, the roots and the rhizomes are essential features of all seagrasses, and *Posidonia oceanica* is no exception to this rule.

The primary functions of the roots are anchoring the seagrass to its substrate, and assimilating nutrients present in the sediment. This process can be crucial for *P. oceanica* growth in oligotrophic Mediterranean ecosystems where nutrients are rare in the water column (HEMMINGA & DUARTE, 2000 ; LEPOINT *et al.*, 2002 ; ROMERO *et al.*, 2006).

Rhizomes participate in seagrass anchoring. They are also stocking and transport organs, providing a link between seagrass shoots, and are therefore important in the regulation of various ecophysiological processes, and in the response of seagrass to environmental changes. Finally, they are involved in vegetative growth (HEMMINGA & DUARTE, 2000 ; KUO & DEN HARTOG, 2006 ; ROMERO *et al.*, 2006).

Two types of rhizomes are found in *P. oceanica* meadows. **Plagiotropic rhizomes** are responsible for the horizontal growth of the meadow. They allow the seagrass to colonize all available and adapted adjacent areas. **Orthotropic rhizomes**, on the other hand, grow vertically. As seagrass leaves enhance deposition of particulate matter, it progressively buries the shoots. Vertical growth of orthotropic rhizomes is therefore important to maintain efficient levels of photosynthetic activity and foliar production (GOBERT *et al.*, 2006 ; KUO & DEN HARTOG, 2006).

The important growth of rhizomes and the progressive deposition of suspended particulate matter result in the formation of a typical terraced structure: the **matte**. It is made of several strata of intertwined rhizomes and roots, and of vast amounts of trapped sediment (BOUDOURESQUE *et al.*, 2006 ; GOBERT *et al.*, 2006). Accumulation of material in the matte can be important, and can even raise shallow beds to the surface level. Since rhizome and roots are refractory organic material, their detritus can remain in the matte for long periods (up to 3000 years, MATEO *et al.*, 1997).



Belowground biomass of *P. oceanica* can be huge. BUJA *et al.*, (2000) report values as high as 6526 gDM.m<sup>-2</sup> of meadow. CHAMPENOIS, (2009) estimated that, at 10 meters in Calvi bay, biomass of living rhizomes and roots was about 10 times higher than the one of leaves. DUARTE & CHISCANO, (1999) give lower, but still high estimates (1610 gDMm<sup>-2</sup>, 3.2 times more than foliar biomass).

Rhizome production, on the other hand, is relatively low, and much lower than foliar production. It ranges from 20 to 85 gDM.m<sup>-2</sup>.year<sup>-1</sup>. Contrary to the foliar production, it does not seem to follow a consistent seasonal pattern. Net rhizome elongation ranges from 1.1 to 7.4 cm.year<sup>-1</sup> (PERGENT *et al.*, 1994 ; DUARTE & CHISCANO, 1999 ; BUJA *et al.*, 2000).

### II.2.C. The litter

Detrital pathways are prominent in the fate of *P. oceanica* production. Estimates vary widely, notably in relation of bed depth and macrograzer abundance, but up to 90 % of *P. oceanica* biomass leaves the ecosystem under detrital form (CEBRIAN & DUARTE, 2001).

Most of the belowground organs are accumulated as refractory material and buried in the matte. This organic matter sink concerns 25-35 % of total *P. oceanica* production (ROMERO *et al.*, 1994 ; PERGENT *et al.*, 1997).

Dead leaves, on the other hand, tend to sink to the bottom and accumulate alongside other detrital material, mainly macroalgal debris. Together with the detritus-colonizing bacteria and fungi, they form a highly heterogeneous compartment called litter (HEMMINGA & DUARTE, 2000 ; BOUDOURESQUE *et al.*, 2006).

Detritus export is an important link between seagrass meadows and other ecosystems. A significant part of the litter can indeed be exported to adjacent, unvegetated areas, and accumulate in vast amounts to form submerged phytodetritus accumulations. Litter can also be exported on beaches, forming large beach wrack accumulations called "banquettes". Exportation to pelagic and deep-sea systems can also occur. Extent of the export varies widely according to several environmental factors, the most prominent being hydrodynamism. It ranges from 10-20 to 80 % of leaf detritus (PERGENT *et al.*, 1997 ; CEBRIAN & DUARTE, 2001 ; MATEO *et al.*, 2003).

The part of the litter that is not exported accumulates in the meadow, between *P. oceanica* shoots. This compartment is important for a number of processes, including nutrient cycling and food webs (GALLMETZER *et al.*, 2005 ; BOUDOURESQUE *et al.*, 2006 ; LEPOINT *et al.*, 2006). Litter necromass in the meadow typically ranges from 25 to 200 % of leaf biomass (BOUDOURESQUE *et al.*, 2006)

Litter is a very transient and dynamic part of the meadow, and new detritus is constantly deposited, while old detritus is degraded either chemically (action of decomposers) or physically (mechanical fragmentation by herbivores and water movements). Since it contains important amounts of refractory

---

## General introduction

compounds (structural carbohydrates), decomposition of *P. oceanica* detritus is a rather slow process, and can take several months (PERGENT *et al.*, 1994).

Litter necromass standing stocks show seasonal trends, in direct relationship with those of foliar biomass and production. During spring and summer, foliar production of *Posidonia oceanica* is important. During these periods, erosion of the apexes of old leaves cause constant litter accumulation. At the beginning of autumn, old leaves massively shed. The litter cover is therefore maximal at this period. During winter, litter is degraded or exported, and since seagrass production is low, it is not replaced. As a result, litter is scarce at the end of winter and beginning of spring, and then starts to accumulate again (VELIMIROV, 1987 ; GALLMETZER *et al.*, 2005)

### II.2.D. *Posidonia oceanica* epiphytes

Like all available underwater surfaces, seagrasses are readily colonized by organisms that settle on it. The organisms, called epiphytes (because they grow on a plant) form an extremely important compartment of the meadow, because they are involved in numerous processes. The importance of seagrass epiphytes from a functional point of view will not be discussed in detail here, but rather in the topical introduction of chapter 5.

The development of the epiphytes (both in terms of biomass and specific diversity) varies according the life span of the seagrass. *Posidonia oceanica*, as mentioned earlier, is on the longest-lived seagrasses. As a result, its epiphytic communities show a unique development. It is one of the most diverse and well-structured communities of all seagrasses, and can represent up to 40 % of the foliar biomass (MAZZELLA *et al.*, 1989 ; HEMMINGA & DUARTE, 2000). Epiphytes can be classified in 3 major ecological groups: the periphyton (or microepiphytes, or “feutre epiphyte” in French), the epiflora and the epifauna.

#### II.2.D.a. Microepiphytes (periphyton)

Microepiphytes are the first organisms to settle on *P. oceanica* leaves. They are able to colonize the bare leaves, from the basis to the apex. They act as pioneer taxa, and their installation likely helps later settlement macroepiphytes. They can be found on all the leaves, regardless of the position in the shoot or age, but their abundance and diversity is maximal on the basis of leaves, where they are the only epiphytes able to develop (MAZZELLA, 1983 ; NOVAK, 1984).

A significant part of the microepiphytes are prokaryotes (cyanobacteria and other groups). The eukaryotes are mostly represented by benthic microalgae. Most of the microepiphytes of *Posidonia oceanica* are diatoms, some of them being regarded as obligate epiphytes. Pennatae are the best represented groups, and diatom communities are dominated by prostrate forms of *Cocconeis* sp. (MAZZELLA, 1983 ; BUIA *et al.*, 2000).

### II.2.D.b. Epiflora

Macroalgae are typically the most abundant component of *P. oceanica* leaves' epiphytic community. They are mostly found on the median and apical parts of the leaves, and are distributed in these two zones according to their photophilic affinities. The macroalgal flora of the leaves is mostly composed of ephemeral algae, whose settlement is dictated by environmental features. While some species can be considered characteristic of *P. oceanica* leaves, no real exclusive taxa exist (BUJA *et al.*, 2000).

From a taxonomic point of view, Rhodophyta show the highest qualitative dominance. Phaeophyta are abundant as well, but occurrence of Chlorophyta is usually anecdotal. From a morpho-functional point of view, crustose species are dominant, constituting up to 75 % of the biomass. Most of the cover is constituted of encrusting Rhodophyta (Corallinaceae such as *Pneophyllum* and *Hydrolithon* spp.) and Phaeophyceae (*Myrionema orbiculare*). They form a layer on which other algae can develop (secondary epiphytism) (MAZZELLA *et al.*, 1989 ; CEBRIÁN *et al.*, 1999 ; BUJA *et al.*, 2000 ; BOROWITZKA *et al.*, 2006).

These general patterns show important spatio-temporal variations, in relation with environmental factors. Fast-growing brown erected algae, for example, reach their maximum biomass on 150 days-old leaves (CEBRIÁN *et al.*, 1999). As a result, they can be very abundant, and sometimes dominant, in late spring communities. This moment of the year is the one where epiphytic biomass and production are maximal (MAZZELLA & OTT, 1984 ; MAZZELLA *et al.*, 1989). However, later in the season, a community shift occurs, as encrusting red algae continue to develop to outgrow the erected brown algae. Encrusting red algae are dominant in late summer, when epiphytic specific diversity and coverage are maximal (MAZZELLA & OTT, 1984 ; MAZZELLA *et al.*, 1989 ; JACQUEMART, 2009). However, these seasonal patterns can be deeply influenced by spatial and depth-related variations (LEPOINT *et al.*, 1999 ; BALATA *et al.*, 2007)

Leaves are not the only parts of *Posidonia oceanica* to be covered with macroalgal epiphytes. Rhizomes bear important amounts of crustose and foliose sciaphilous algae, mainly Rhodophyceae. Numerical abundance and specific diversity of epiphytes from rhizomes generally exceeds those of epiphytes from leaves. Rhizome epiflora contains many large, long-lived species, and exhibits little seasonal variation, probably because rhizomes are a more stable environment than leaves, due to slow growth rates and lack of seasonal variations in rhizome production. However, while leaf epiphytes are a characteristic and adapted community, epiflora of the rhizomes appears to be mostly constituted of ubiquitous sciaphilic macroalgae. This could be linked with the similarity between rhizome layer of *Posidonia oceanica* and other sciaphilous Mediterranean biotopes such as (pre-) coralligene bottoms (BUJA *et al.*, 2000 ; PIAZZI *et al.*, 2002)

### II.2.D.c. Epifauna

Albeit they are generally less abundant than macroalgae, sessile invertebrates are an important part of *Posidonia oceanica* epiphytic cover. Most of them are suspension feeders. Bryozoans dominate the assemblages, but hydrozoans, foraminiferans, sedentary polychaetes (notably Serpulidae), sponges and tunicates are also found. Like for algae, crustose morphotypes are more common than erected ones, at least in shallowest stands (TEMPLADO, 1984 ; BUJA *et al.*, 2000).

A particularly common animal epiphyte of the leaves is the bryozoan *Electra posidoniae*, which is exclusively found in this biotope. This flexible and poorly calcified species makes large colonies that grow parallel to the plant's nervure. They are therefore able to follow blade movements, limiting colony breakage (BOUDOURESQUE & MEINESZ, 1982 ; BOUDOURESQUE *et al.*, 2006). Besides this particular species, communities are neither particularly specific, nor very well defined. They consist of organisms that can also be found on other biotic and abiotic submerged items (PESSANI *et al.*, 1989).

Animal epiphytes grow quickly, and are therefore important representatives of the spring epiphytic communities. They are later outgrown by macroalgae, and in late summer communities, they are often restricted on basal or median parts of the leaves. They are also very abundant in deep meadows, where light limitation releases them from competition for space with vegetal epiphytes, and on rhizomes. Epifauna of rhizomes is distinct of the one present on the leaves, but bears resemblance with fauna from other sciaphilic zones (TEMPLADO, 1984 ; LEPOINT *et al.*, 1999 ; BUJA *et al.*, 2000).

### II.2.E. The vagile fauna: definition and importance

The **vagile fauna** can be defined as "a group of benthic motile animals that spend significant amounts of time in association with their substratum, or in its direct proximity". It is different from the sessile fauna that is fixed on its substratum, and of benthonektonic or benthopelagic species that spend important parts of their time in the water column, without real, durable association with the substratum (PERES & PICARD, 1964 ; LEDOYER, 1968). In its usual meaning, the term refers to animals associated with the leaves, rhizomes and litter fragments, and endofauna of the mat is considered a different and unrelated assemblage (BIANCHI *et al.*, 1989)

The vagile fauna of *Posidonia oceanica* meadows is mostly constituted of gastropod mollusks, amphipod crustaceans and polychaete annelids. Besides these dominant groups, it contains various crustaceans (copepods, mysids, cumaceans, tanaids, isopods and decapods), but also chelicerates (hydracarians, pycnogonids), echinoderms, chaetognaths, and even fishes (RIEDL, 1983 ; GAMBI *et al.*, 1992).

Vagile organisms are often classified in functional guilds according to their feeding modes or preferred food items (micro- and macroepiphyte grazers,

deposit feeders, suspension feeders, micro- and macro-detritus feeders, scavengers, etc.).

They can also be classified in size groups, although such classification is rather loose and debated. **Meiofauna** is composed of organisms that can pass through a 1 mm mesh but will be retained by a fine mesh, whose size can vary, according to the authors, between 42 and 63  $\mu\text{m}$ . Organisms smaller than meiofauna (mostly unicellular organisms) form **microfauna**, while organisms bigger than meiofauna form **macrofauna** (HIGGINS & THIEL, 1988 ; GAMBI & DAPPIANO, 2004). However, in ecological literature, macrofauna is commonly refined and divided in **mesofauna** whose constituents are larger than an average copepod, but smaller than 2.5 cm, and actual **macrofauna**, whose body size exceeds 2.5 cm (JERNAKOFF *et al.*, 1996).

Vagile fauna of the leaf stratum is abundant and diverse. The composition of communities varies widely according to local, seasonal and depth-related variations of the meadow parameters (shoot density, leaf length, abundance of epiphytes, etc.). An even higher degree of biodiversity is recorded at the rhizome level. In this layer, influence of physical factors is buffered, and microclimatic conditions are more homogeneous. As a result, depth-related and seasonal variation of vagile fauna communities is not as important as in the foliar stratum (GAMBI *et al.*, 1992 ; SCIPIONE *et al.*, 1996 ; BUIA *et al.*, 2000). The precise composition of amphipod fauna from *Posidonia oceanica*, to which this work is devoted, will be discussed in the topical introduction of chapter 3.

Vagile invertebrate form an important compartment of the *Posidonia oceanica* meadow and its associated food webs. They are mostly primary consumers, or detritus feeders *sensu lato*. Therefore, they hold a crucial role in the fluxes of organic matter from producers to higher trophic levels (BUIA *et al.*, 2000).

### **II.3. Ecological importance of *P. oceanica***

DAYTON (1972) defined **foundation species** as "single species that define much of the structure of a community by creating locally stable conditions for other species, and by modulating and stabilizing fundamental ecosystem processes". Their importance in ecosystems is critical and, although they are typically abundant, their depletion can have dramatic effect. *Posidonia oceanica*, like all seagrasses, is a foundation species (VALENTINE & DUFFY, 2006). Several ecological inter-correlated roles explain this statement.

#### **II.3.A. Importance as a primary producer**

Even though the surface covered by seagrass meadows are relatively low compared to other biomes, they are among the most productive ecosystems of our planet. Mean net production of seagrass meadows is estimated to 817  $\text{gC}\cdot\text{m}^2\cdot\text{year}^{-1}$ . In the marine environment, only mangroves have higher production (see table 1.I). Of these 817  $\text{gC}\cdot\text{m}^2\cdot\text{year}^{-1}$ , the seagrasses themselves are responsible for 420  $\text{gC}\cdot\text{m}^2\cdot\text{year}^{-1}$ , while the rest of the

## General introduction

production is caused by other producers associated to the meadow, such as epiphytic, benthic and planktonic micro- and/or macroalgae (MATEO *et al.*, 2006).

**Table 1.1:** Comparison of selected marine and terrestrial ecosystems in terms of distribution and primary production (after MATEO *et al.*, 2006, modified).

System	Area covered (10 <sup>6</sup> km <sup>2</sup> )	Net primary production (gC.m <sup>-2</sup> .year <sup>-1</sup> )	Total net annual production (10 <sup>15</sup> gC.year <sup>-1</sup> )
<b>Marine environment</b>	<b>359</b>	<b>132</b>	<b>47.5</b>
Open ocean (phytoplankton)	332	130	43
Coastal waters	27	167	4.5
Mangroves	1.1	1000	1.1
Seagrass meadows	0.6	817	0.5
Macroalgae	6.8	375	2.5
Microphytobenthos	6.8	50	0.3
<b>Terrestrial environment</b>	<b>148</b>	<b>200</b>	<b>29.6</b>
Continental waters	1.9	100	0.2
Forests	41	400	16.4
Crops	15	350	5.2
Deserts	40	50	2

The reader's attention is drawn to the fact that net primary production values are global means, and can be unadapted to specific situations. The net production of kelp fields, for example, is much greater than the mean value given here for macroalgae.

Besides these general estimates, seagrass production can vary widely according to the considered species. In addition, *Posidonia oceanica* production can show local, seasonal and depth-related variations (MAZZELLA & OTT, 1984 ; MATEO *et al.*, 2006). As a result, ranges of production can be huge, and values vary widely. According to BUIA *et al.*, (2000) foliar production can range from 162 to 722 gDM.m<sup>-2</sup>.year<sup>-1</sup> (roughly 60 to 250 gC.m<sup>-2</sup>.year<sup>-1</sup>). The meta-analysis of gives mean overall values of 876 gDM.m<sup>-2</sup>.year<sup>-1</sup> (about 300 gC.m<sup>-2</sup>.year<sup>-1</sup>) for aboveground production and 84 gDM.m<sup>-2</sup>.year<sup>-1</sup> for belowground production. At 10 m in Calvi Bay, leaf production has been recorded as being 603 gDM.m<sup>-2</sup>.year<sup>-1</sup> (about 210 gC.m<sup>-2</sup>.year<sup>-1</sup>), while rhizome production was 34 gDM.m<sup>-2</sup>.year<sup>-1</sup> (BAY, 1984). Despite these great variations, *Posidonia oceanica* could always be considered one of the dominant macrophytes, and one of the highest contributing coastal producers (*e.g.* BAY, 1984 ; MAZZELLA & OTT, 1984 ; PERGENT *et al.*, 1994 ; DUARTE & CHISCANO, 1999 ; GOBERT, 2002 ; MATEO *et al.*, 2006).

As mentioned earlier, a very important vegetal biomass results of this production. It can reach values of 900 gDM.m<sup>-2</sup> for leaves, and 5500 gDM.m<sup>-2</sup> for scales, rhizomes and roots. This places *P. oceanica* meadows, alongside

kelp forests and mangroves, among the marine ecosystems where vegetal biomass is the highest (BOUDOURESQUE *et al.*, 2006).

### II.3.B. Importance as a coastal engineer

The presence of *Posidonia oceanica* deeply influences the Mediterranean coastal zones through physical and chemical processes. They are therefore autogenic ecosystem engineers (*sensu* JONES *et al.*, 1994).

*Posidonia oceanica* foliar stratum reduces hydrodynamism and acts as a sediment trap, therefore enhancing particle deposition and causing matte accumulation. It also reduces the importance of normal (waves) and extreme (storms) erosion events. It is therefore important for stability of coastlines, and its removal or loss can cause substantial changes in littoral geomorphology (HEMMINGA & DUARTE, 2000 ; BOUDOURESQUE *et al.*, 2006).

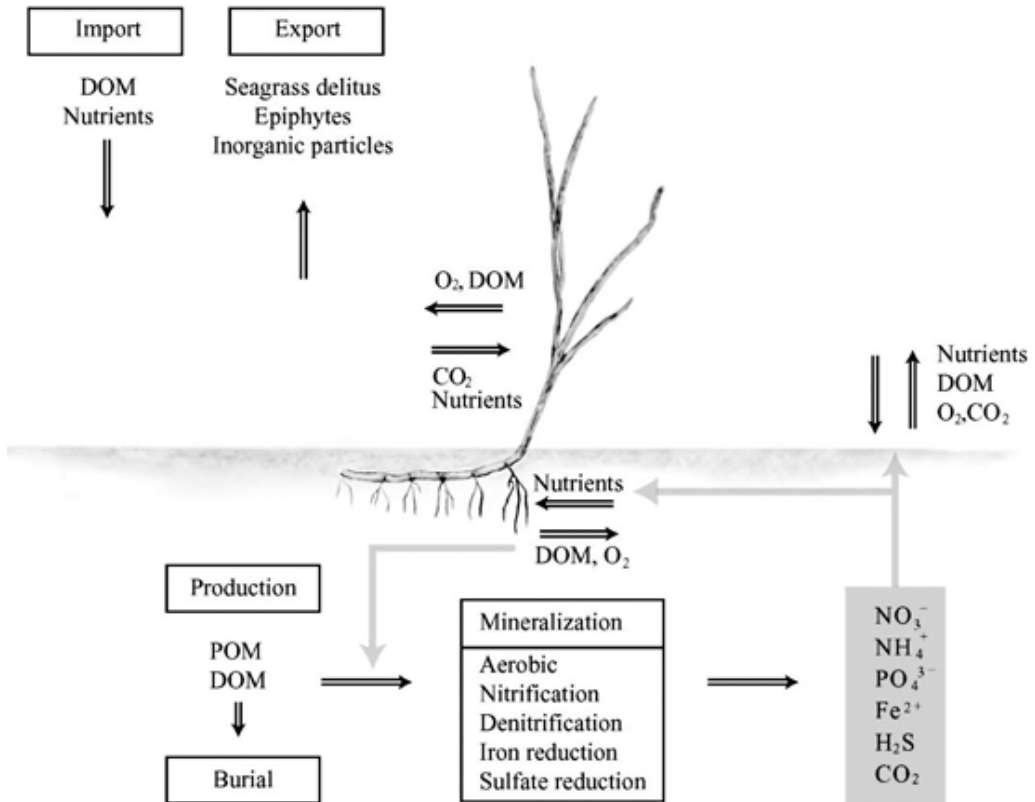
By trapping particles, it also reduces water turbidity, enabling important benthic production. In addition, its stabilizing action is not only important for meadows areas. Terrestrial export and formation of "banquettes" is crucial to stabilize Mediterranean beaches, and maintain their erosion at acceptable levels (MATEO *et al.*, 2003).

Besides these physical actions, *P. oceanica* has an important role to play in coastal biogeochemical cycles (cf. fig. 1.4). Its action modifies chemical properties (nutrient, oxygen, organic matter and dissolved inorganic carbon concentrations) of both water column and sediment concentrations (MARBA *et al.*, 2006).

Oxygen production is particularly important. Meadows growing at 10 m in Calvi Bay are responsible for production of 14 litres of O<sub>2</sub> per m<sup>2</sup> per day, therefore supporting respiration of a significant amount of heterotroph organisms living in the meadow (BAY, 1978).

Presence of seagrasses in general, and of *P. oceanica* in particular, also enhances bacterial activities such as organic matter mineralization (cf. fig. 1.4). The increased nutrient recycling associated to these activities can boost producers' (seagrass, phytoplankton, benthic micro- and macroalgae photosynthetic activity). *Posidonia oceanica* is therefore important for carbon, nitrogen, phosphorus and sulphur cycles in coastal areas (MARBA *et al.*, 2006).

Finally, the important formation of matte, and associated long-term burial of organic matter, is a significant carbon sink. This ability to cause carbon sequestration has a renewed importance in the present context of global climatic change and associated CO<sub>2</sub> problematics (MATEO & ROMERO, 1997 ; BOUDOURESQUE *et al.*, 2006).



**Fig. 1.4:** Conceptual model of biogeochemical interactions between a generic seagrass, the water column, and the sedimentary compartment (from MARBÀ *et al.*, 2006).

### II.3.C. Importance as an habitat provider

From a global perspective, *Posidonia oceanica* meadows can appear as homogeneous environments, constituted by numerous repetitions of similar seagrass units. This is far from true, and *Posidonia oceanica* meadows are actually structurally complex ecosystems, made of horizontal and vertical successions of deeply different microhabitats, therefore providing adequate life conditions for an important number of organisms characterized by widely different ecological niches (HEMMINGA & DUARTE, 2000).

In addition of being diverse, the habitat offered by *Posidonia oceanica* meadows is abundant. Each square meter of meadow offers 6 to 29 m<sup>2</sup> of leaves available for secondary colonization by organisms. This value exceeds by far those of other Mediterranean seagrass. This estimation clearly underestimates the total habitat area, as it does not take either rhizomes, or litter, or mat, into account. Moreover, the habitat is rather stable, as all parts of the plant have relatively long time spans, allowing development of abundant and diverse communities (BUJA *et al.*, 2000).



As a result, *Posidonia oceanica* meadows are Mediterranean biodiversity hotspots. Several thousands of species live together among them. These include bacteria and protozoans, fungi, benthic micro- and macroalgae, phyto- and zooplanktonic organisms, invertebrates from various sizes (from less than a mm to several cm) and fishes. Associated organisms colonize all zones of the meadows. They can grow on the leaves or rhizomes of the plant (epiphytes) or simply lie on them. They can be found in the water of the foliar stratum, or in the sediment pore water. They live among the litter fragments, or inside the mat itself. Even species that do not spend their whole life cycle in the meadows can use them as mating and nursery areas. *P. oceanica* meadows indeed support growth of larval or juvenile fishes, including commercially harvested species (BOUDOURESQUE *et al.*, 2006)

#### II.4.D. Importance as a food supplier

In addition of being a shelter for numerous living organisms, *Posidonia oceanica* also support important food webs throughout the Mediterranean.

Direct herbivory is generally regarded as limited, and only 10 % of *P. oceanica* organic matter would enter the food webs under its living form (CEBRIAN *et al.*, 1996). However, recent work showed that seagrass herbivory exhibits important spatio-temporal variation, and that its local importance can reach 70 % of seagrass biomass (TOMAS *et al.*, 2005 ; HECK & VALENTINE, 2006). In either case, direct consumption of *P. oceanica* only concerns a few grazers, including the fish *Sarpa salpa*, the urchin *Paracentrotus lividus* and a few minor invertebrate consumers (decapods, crustaceans and polychaetes). The reasons for this limited consumption include poor nutritional value, low palatability (abundance of lignic or cellulosic compounds) and chemical defence through polyphenolic compounds (VIZZINI, 2009).

Most of *Posidonia oceanica* production is channelled to higher trophic levels through leaf detritus. Since a large part of detritus is exported (see section II.2.C.), detritus also support food webs in non-meadow ecosystems. Those include beaches covered with banquettes, and unvegetated areas covered by large submerged phytodetritus accumulations (MATEO *et al.*, 2003 ; LEPOINT *et al.*, 2006 ; CARDONA *et al.*, 2007 ; STURARO *et al.*, 2010). In the meadows, or in these receiving systems, a wide assemblage of animals consumes the litter. Those include gastropods, amphipod, isopod and decapod crustaceans, as well as echinoid, ophiuroids and holothuroid echinoderms (MAZZELLA *et al.*, 1992 ; BUIA *et al.*, 2000 ; VIZZINI, 2009)

The interest of *Posidonia* litter as a food source is questionable. Since structural carbohydrates are refractory to chemical degradation, appreciable amounts remain in the litter fragments. Nutritional quality is even worse than the one of living tissues, as most labile organic C, N and P is lost by remobilization from the senescent leaves or by decomposition after tissue death (ROMERO *et al.*, 1992). It is commonly accepted that detritivores feeding on litter rely on micro-organisms colonizing detritus to achieve nutritional balance (VIZZINI, 2009).

---

## General introduction

Another indirect, yet very important pathway in the food web supported by *Posidonia oceanica* is the one based on epiphytes. As mentioned earlier, epiphytes are an abundant and widely available. They cover all parts of the plant, and can represent more than 40 % of the total foliar biomass of the meadow (MAZZELLA & OTT, 1984). Their nutritional value is higher than the one of seagrass leaves or detritus (e.g. this study, chapter 4). Their palatability is also better, since they usually contain less structural compounds (RAVEN *et al.*, 2005, for macroalgae). In addition, the diversity of epiphytic structures and functions makes them adequate for a different feeding techniques and food intake mechanisms of consumers (BUJA *et al.*, 2000)

As a result, numerous animals feed on *Posidonia oceanica* epiphytes. A lot of small vagile invertebrates are regarded as epiphytes grazers. These include polychaetes (e.g. *Platynereis dumerilii* but also some Exogoninae syllids), gastropods (notably *Gibbula* spp., *Rissoa* spp., *Bittium reticulatum*, and opisthobranchs), amphipods, isopods (e.g. *Idotea* spp.), and small decapods (e.g. *Hyppolite inermis*). These small invertebrates are then consumed by higher rank consumers, and are therefore key items of *Posidonia oceanica* food webs (MAZZELLA *et al.*, 1992). In addition, epiphytes also constitute significant parts of the diets of larger consumer that feed on *P. oceanica* material but also ingest and assimilate its epiphytes. These include *Sarpa salpa* and *Paracentrotus lividus* (TOMAS *et al.*, 2005 ; PRADO *et al.*, 2007).

In *Posidonia oceanica* meadows, epiphytes are likely higher contributors to secondary production than the seagrass itself. General estimates for seagrass meadows state that 20 to 60 % of the consumed organic matter is derived of epiphytic material. Benthic macroalgae would be responsible for 33 to 42 % of this organic matter pool, benthic microalgae for 18 to 56 %, and seagrasses only for 24 to 38 % (MATEO *et al.*, 2006).

## **III. Amphipod crustaceans**

### **III.1. Systematic position**

The subphylum of crustaceans contains, according to recent estimations, more than 65,000 species, most of them living in marine environments. Marine crustaceans are present in all ecosystems, at all latitudes and all depths (RUPPERT *et al.*, 2003).

Peracarid malacostraceans are a group of crustaceans that is typically regarded as a super-order. Its status is however debated, and it could be polyphyletic. Their most striking common feature is the presence of a thoracic marsupium that allows condensed and direct development of juveniles. Other minor morphological common characters exist (HESSLER & WATLING, 1999).

In the classical view of crustacean classification, this super-order contains 8 (sometimes 9) orders. The most numerically important of these orders is Amphipoda, that counts more than 8000 described species (BELLAN-SANTINI,

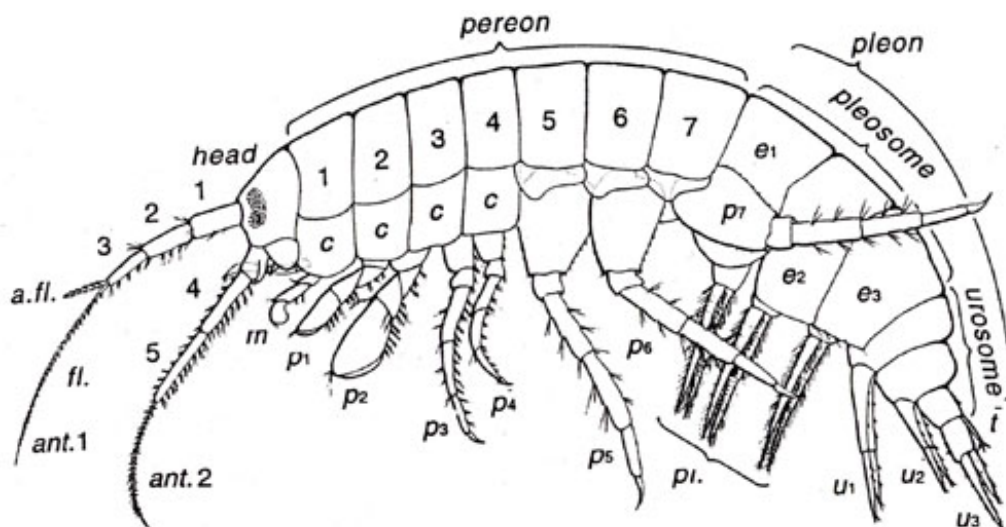
1999). Their precise number is hard to estimate, but the World Register of Marine Species dataset currently recognizes 9274 taxa as accepted and valid species of amphipods (APPELTANS *et al.*, 2011). Other widespread and well-known orders include isopods (Isopoda), mysids (Mysidacea), tanaids (Tanaidacea) and cumaceans (Cumacea).

Amphipoda are traditionally subdivided in four sub-orders: Gammaridea (that regroups more than 80 % of the species), Caprellidea (that feature a peculiar morphology), Hyperiidea (strictly planktonic organisms characterised by important development of the eyes), and Ingolfiellidea (strictly interstitial, and anecdotal in terms of specific diversity) (BARNARD & KARAMAN, 1991)

More recent work however suggests that this classification should be replaced by a new one, featuring three sub-orders: Gammaridea (most of the "classic" gammarids, and ingolfiellids), Hyperiidea and Corophiidea (caprellids and some gammarids) (MARTIN & DAVIS, 2001).

### III.2. Anatomy and morphology

Considerable morphological variation exists among amphipods. It is nevertheless possible to describe a general "type amphipod" possessing all basic features of the order and to which all species can be linked, at least partially. This type amphipod (see fig. 1.5) is a small crustacean (about 10 mm), with an arched, laterally flattened body.



**Fig. 1.5:** Typical morphology of an amphipod crustacean (after BARNARD & KARAMAN, 1991). *Ant.*: antennae, *a.fl.*: accessory flagellum, *c.*: coxa, *f.*: flagellum, *m.*: maxilliped, *p<sub>1</sub> - p<sub>7</sub>*: pereopods (or thoracic legs) 1 to 7 (pereopods 1 and 2 are respectively the first and second gnathopods), *e<sub>1</sub> - e<sub>3</sub>*: epimeres, *pl.*: pleopods, *u<sub>1</sub> - u<sub>3</sub>*: uropods, *t*: telson.

---

## General introduction

The body of the type amphipod can be divided in three main parts. The **head** is actually a cephalothorax, since it results of the fusion of the head *sensu stricto* and the first thoracic segment. The head itself bears a pair of sessile compound eyes and five pairs of appendages. These appendages include two pairs of uniramous antennae and three pairs of mouthparts (mandibles and two pairs of maxillae). The first thoracic segment bears the maxillipeds, prehensile appendages involved in food handling (BELLAN-SANTINI, 1999).

The thoracic part, or **pereon**, is composed of 7 segments. Each of them bears a pair of pereopods. Each pereopod is composed of 7 articles, *i.e.* (starting from the body towards the terminal end) the coxa, the basis, the ischium, the merus, the carpus, the propodus and the dactylus. The pereopods of the first two segments are modified to be prehensile appendages, the gnathopods. The 5 other pairs are adapted for locomotion. In most cases, each of the pereopods of the 6 last segments bear a gill. When the animal is resting, pereopods are pointed towards both ends of the animal: the first four pairs forwards, and the last four pairs backwards. It is this peculiar stance that gives its name to the order, "amphi-" meaning "both" and "poda" meaning "foot, leg" (BELLAN-SANTINI, 1999).

In mature females, the coxa of pereopods can borne large ventral lamellar projections, the oostegites. They participate in the formation of the marsupium, a mid-ventral brood pouch characteristic of the peracarids. Fertilized eggs hatch in this marsupium, and most larval stages occur there too. Young amphipods are released in the environment under the form of juveniles (condensed development), which are morphologically close to adults (BARNARD & KARAMAN, 1991).

The abdominal part, or **pleon**, is composed of the last 6 segments of the body. It can be divided in two parts. The first one is the **pleosome** (or epimeron, and is constituted of 3 segments (the epimers) bearing each a pair of locomotive appendages (the pleopods). The second part is the **urosome**, and also contains 3 segments. Each of them bears a pair of appendages (uropodes) who are sometimes involved in the mating process. Finally, pleon is ended by the telson, which is not a segment *sensu stricto* (BELLAN-SANTINI, 1999).

### III.3. General biology and ecology

While terrestrial forms, living in damp biotopes, exist (*e.g.* Talitridae), most amphipods live in aquatic environments. They are found in rivers, ponds and lakes, and in interstitial or underground waters. They are abundant in coastal marine environments, but are also found in abyssal trenches and hydrothermal vents. They are able of various symbiotic associations with vertebrates and invertebrates. This habitat diversity is correlated with feeding type diversity. Amphipods can be herbivores, suspension or deposit feeders, scavengers, parasites, predators, detritivores, etc. (BELLAN-SANTINI, 1999).

This important adaptative radiation led the amphipods to become one of the dominant groups of marine invertebrates in numerous ecosystems, including

Mediterranean *P. oceanica* meadows (see section II.4 of this chapter and topical introduction of chapter 3).

## IV. Objectives of this study

As mentioned earlier, Mediterranean *Posidonia oceanica* meadows shelter high biomass and biodiversity of vagile invertebrates. They are traditionally regarded as key-features of the ecosystem, notably because of their importance in transfer of organic matters from producers to higher rank consumer. Amphipod crustaceans are, alongside gastropod molluscs and polychaete annelids, one of the dominant groups of vagile invertebrates (GAMBI *et al.*, 1992).

However, the ecology of these amphipods remains poorly known. The question of their feeding preferences, notably, is still mostly unanswered, due to the lack of information. Moreover, the understanding of their impact on the functioning of *P. oceanica* meadows is deficient, due to the lack of precise data. In this context, the general goal of this study, as its title implies, is to enhance the knowledge of trophic diversity and functional role of amphipods associated to *P. oceanica* meadows. To achieve this goal, we structured our research into three main tasks. In each case, we chose Calvi Bay (NW Corsica, France) as study site, and all sampling and experimentation was undertaken from the STARESO research station (see chapter 2).

The first task (developed in chapter 3) was the study of the **precise composition of the amphipod community at our study site**, as well as its temporal variation at day/night and seasonal scale. This task was based on *in situ* collection of samples using three methods: the hand-towed net, litter collection and light traps. The specific objectives of this task were triple.

First, we aimed to compile an **accurate and reliable dataset**, taken on our study site, concerning the abundance and specific diversity of amphipods associated with *P. oceanica* meadows. Second, we tried to standardize an easy to use, efficient, and possibly quantitative **sampling method**. As ecological studies considered in the two other tasks requires large numbers of individuals, an efficient and well-designed sampling strategy is indeed crucial. Third, we wanted to highlight the **dominant species of the community**. Since analyses from the second and third tasks are time-consuming and demand important amounts of biological material, the goal was to select a representative subset of the actual community, to later focus on it only.

The second task (developed in chapter 4) was the precise study of **trophic diversity** among the studied community. Amphipods from *P. oceanica* meadows are usually regarded as vegetal epiphytes grazers, or generalist deposit-feeding detritivores. However, information on these issues is rare and incomplete. In this context, we focused on two particular objectives.

First, we wanted to highlight the degree of **interspecific trophic diversity**, present among the taxocenosis, and to understand its potential importance in the limitation of food competition. Second, we tried to assess the **importance**

---

 General introduction

**of alternative food sources** (*P. oceanica* leaves and litter, SPOM, BPOM, epifauna from the leaves and the litter fragments, epiflora from rhizomes and the litter fragments) vs. the putative main food source of most amphipod species, *i.e.* epiflora from the leaves.

To achieve these goals, we tried to perform a full reconstruction of the diet of the studied animals. Our approach relied on *in situ* sampling of amphipods and potential food items. The applied techniques combined traditional methods (gut content observation) and use of trophic markers, such as measurements of C and N stable isotopes ratios and fatty acid composition analysis.

In other temperate seagrass systems, such as Atlantic *Zostera marina* meadows, the amphipods mesograzers play an important part in the functioning of the ecosystem, and can notably exert top-down control on epiphyte biomass (JERNAKOFF *et al.*, 1996 ; DUFFY & HARVILICZ, 2001). However, the situation in *Posidonia oceanica* meadows remains unclear. In this context, the objective of the third and last task of our work (chapter 5) was to quantify the **impact of amphipod feeding on the dynamics of the epiphytic cover** of the leaves.

To fulfill this objective, we used *in vitro* and *in situ* microcosm experiments to study the trophic interaction between amphipods and epiphytes from a triple point of view (resource depletion, resource assimilation by the consumer and secondary production). By quantifying the parameters associated to this interaction, our purpose was to put back the results obtained in the first two parts into a wider context, *i.e.* the functioning of the *Posidonia oceanica* meadow as an ecosystem.

*In fine*, by combining *in situ* sampling and microcosm experimentation, and through the joint use of traditional and innovative techniques, we tried to enhance the knowledge of the trophic diversity and the functional role of amphipod crustaceans associated with Mediterranean *Posidonia oceanica* meadows, and therefore to improve our understanding of these critically important, yet endangered ecosystems.

## References

ACKERMAN J. D. (2006): Sexual reproduction of seagrasses: pollination in the marine context. in *Seagrasses : Biology, Ecology and Conservation*, LARKUM A. W. D., ORTH R. J. & DUARTE C. M. (Eds.): 89-109.

ALCOVERRO, T., DUARTE, M. C., ROMERO & J. (1995): Annual growth dynamics of *Posidonia oceanica*: contribution of large-scale versus local factors to seasonality. *Mar. Ecol. Progr. Ser.*, **120**: 203-210.

APPELTANS W., BOUCHET P., BOXSHALL G. A., FAUCHALD K., GORDON D. P., HOEKSEMA B. W., POORE G. C. B., VAN SOEST R. W. M., STÖHR S., WALTER T. C. & COSTELLO M. J. (2011). World Register of Marine Species.

- BALATA D., NESTI U., PIAZZI L. & CINELLI F. (2007): Patterns of spatial variability of seagrass epiphytes in the north-west Mediterranean Sea. *Mar. Biol.*, **151** (6): 2025-2035.
- BARNARD J. L. & KARAMAN G. S. (1991): The families and genera of marine gammaridean Amphipoda (except marine gammaroids). Part 1. *Records of the Australian Museum, Suppl.* **13** (1): 1-417.
- BAY D. (1978): Etude *in situ* de la production primaire d'un herbier de posidonies (*Posidonia oceanica* (L.) Delilie) de la baie de Calvi, Corse. PhD in Sciences thesis, University of Liège, Liège, 251 pp.
- BAY D. (1984): A field study of the growth dynamics and productivity of *Posidonia oceanica* (L.) Delile in Calvi Bay, Corsica. *Aquat. Bot.*, **20** (1-2): 43-64.
- BELLAN-SANTINI D. (1999): Ordre des Amphipodes (Amphipoda Latreille, 1816). in *Traité de Zoologie - Anatomie, Systématique, Biologie* (Pierre-P. Grassé). Tome VII, Fascicule III A : Crustacés Pérecarides, FOREST J. (Ed.): 93-176.
- BIANCHI C. N., BEDULLI D., MORRI C. & OCCHIPINTI AMBROGI A. (1989): L'herbier de posidonies : écosystème ou carrefour éco-éthologique ? in *International Workshop on Posidonia Beds*, BOUDOURESQUE C. F., MEINESZ A., FRESI E. & GRAVEZ V. (Eds.), **2**: 257-272.
- BORG J. A., ATTRILL M. J., ROWDEN A. A., SCHEMBRI P. J. & JONES M. B. (2005): Architectural characteristics of two bed types of the seagrass *Posidonia oceanica* over different spatial scales. *Estuar. Coast. Mar. Sci.*, **62** (4): 667-678.
- BOROWITZKA M. A., LAVERY P. & VAN KEULEN M. (2006): Epiphytes of seagrasses. in *Seagrasses : Biology, Ecology and Conservation*, LARKUM A. W. D., ORTH R. J. & DUARTE C. M. (Eds.): 441-461.
- BOUDOURESQUE C. F., BERNARD G., BONHOMME P., CHARBONNEL E., DIVIACCO G., MEINESZ A., PERGENT G., PERGENT-MARTINI C., RUITTON S. & TUNESI L. (2006): Préservation et conservation des herbiers à *Posidonia oceanica*. Ramoge, Marseille, 202 pp.
- BOUDOURESQUE C. F. & MEINESZ A. (1982): Découverte de l'herbier de posidonies. Cahiers du Parc National de Port-Cros, 80 pp.
- BUIA M. C., GAMBI M. C. & ZUPO V. (2000): Structure and functioning of mediterranean seagrass ecosystems: an overview. *Biol. Mar. Medit.*, **7**: 167-190.
- CARDONA L., REVELLES M., SALES M., AGUILAR A. & BORRELL A. (2007): Meadows of the seagrass *Posidonia oceanica* are a significant source of organic matter for adjoining ecosystems. *Mar. Ecol. Progr. Ser.*, **335**: 123-131.
- CEBRIAN J. & DUARTE C. (2001): Detrital stocks and dynamics of the seagrass *Posidonia oceanica* (L.) Delile in the Spanish Mediterranean. *Aquat. Bot.*, **70** (4): 295-309.
- CEBRIAN J., DUARTE C. M., MARBA N., ENRIQUEZ S., GALLEGOS M. & OLESEN B. (1996): Herbivory on *Posidonia oceanica*: magnitude and variability in the Spanish Mediterranean. *Mar. Ecol. Progr. Ser.*, **130**: 147-155.
- CEBRIÁN J., ENRIQUEZ S., FORTES M., AGAWIN N., VERMAAT J. E. & DUARTE C. M. (1999): Epiphyte accrual on *Posidonia oceanica* (L.) Delile leaves: implications for light absorption. *Bot. Mar.*, **42**: 123-128.

## General introduction

- CHAMPENOIS C. (2009): Etude des parties souterraines de l'herbier à *Posidonia oceanica* L. (Delile) en baie de Calvi. Master in Oceanography thesis, University of Liège, Liège, 51 pp.
- CINELLI F., PARDI G. & PAPI I. (1995): Plant biology. in *La Posidonia oceanica - A contribution to the preservation of a major Mediterranean marine ecosystem*, CINELLI F., FRESI E., LORENZI C. & MUCEDOLA A. (Eds.): 21-24.
- DAYTON P. K. (1972). Towards an understanding of community resilience and the potential effects of enrichment to the benthos at McMurdo Sound, Antarctica. *Proceedings of the Colloquium on Conservation Problems in Antarctica*, Lawrence, Kansas.
- DEN HARTOG C. (1970): The seagrasses of the world. *Verh. Kon. Ned. Akad. Wetens. Afd. Naturk. Ser. 2*, **59** (1): 1-275.
- DEN HARTOG C. & KUO J. (2006): Taxonomy and biogeography of seagrasses. in *Seagrasses : Biology, Ecology and Conservation*, LARKUM A. W. D., ORTH R. J. & DUARTE C. M. (Eds.): 1-23.
- DUARTE C. M. & CHISCANO C. L. (1999): Seagrass biomass and production: a reassessment. *Aquat. Bot.*, **65** (1-4): 159-174.
- DUFFY J. E. & HARVILICZ A. M. (2001): Species-specific impacts of grazing amphipods in an eelgrass-bed community. *Mar. Ecol. Progr. Ser.*, **223**: 201-211.
- GALLMETZER I., PFLUGFELDER B., ZEKELY J. & OTT J. A. (2005): Macrofauna diversity in *Posidonia oceanica* detritus: distribution and diversity of mobile macrofauna in shallow sublittoral accumulations of *Posidonia oceanica* detritus. *Mar. Biol.*, **147** (2): 517-523.
- GAMBI M. C., BARBIERI F. & BIANCHI C. N. (2009): New record of the alien seagrass *Halophila stipulacea* (Hydrocharitaceae) in the western Mediterranean: a further clue to changing Mediterranean Sea biogeography. *Marine Biodiversity Records*, **2**: e84.
- GAMBI M. C. & DAPPIANO M. (2004): Mediterranean Marine Benthos : A manual of methods for its sampling and study. Societa Italiana de Biologia Marina, Genova, 604 pp.
- GAMBI M. C., LORENTI M., RUSSO G. F., SCIPIONE M. B. & ZUPO V. (1992): Depth and seasonal distribution of some groups of the vagile fauna of the *Posidonia oceanica* leaf stratum: Structural and trophic analyses. *P.S.Z.N. I: Mar. Ecol.*, **13** (1): 17-39.
- GOBERT S. (2002): Variations spatiale et temporelle de l'herbier à *Posidonia oceanica* (L.) Delile (Baie de la Revellata - Calvi - Corse). PhD in Sciences thesis, University of Liège, Liège, 207 pp.
- GOBERT S., CAMBRIDGE M. L., VELIMIROV B., PERGENT G., LEPOINT G., BOUQUEGNEAU J. M., DAUBY P., PERGENT-MARTINI C. & WALKER D. I. (2006): Biology of *Posidonia*. in *Seagrasses : Biology, Ecology and Conservation*, LARKUM A. W. D., ORTH R. J. & DUARTE C. M. (Eds.): 387-408.
- GOBERT S., DEFAWE O., LEPOINT G., DEMOULIN V. & BOUQUEGNEAU J. M. (2001): Anthesis effects on *Posidonia oceanica* (L.) Delile phenology in the Bay of Calvi (Corsica, Mediterranean Sea). *Hydrobiologia*, **455**: 121-125.



- HECK J. K. L. & VALENTINE J. F. (2006): Plant-herbivore interactions in seagrass meadows. *J. Exp. Mar. Biol. Ecol.*, **330** (1): 420-436.
- HEMMINGA M. A. & DUARTE C. M. (2000): Seagrass Ecology. Cambridge University Press, Cambridge, 298 pp.
- HESSLER R. R. & WATLING L. (1999): Les pércarides : un groupe controversé. in *Traité de Zoologie - Anatomie, Systématique, Biologie* (Pierre-P. Grassé). Tome VII, Fascicule III A : Crustacés Pércarides, FOREST J. (Ed.), **7**: 1-10.
- HIGGINS R. P. & THIEL H. (1988): Introduction to the study of meiofauna. Smithsonian Institution Press, Washington D.C., 488 pp.
- JACQUEMART J. (2009): Etude de la communauté des macroalgues épiphytes de *Posidonia oceanica* (L.) Delile et comparaison avec celle de *Cystosera balearica* Sauv. - Approche expérimentale visant à élucider les effets de l'eutrophisation sur ces communautés. PhD in Sciences thesis, University of Liège, Liège, 393 pp.
- JERNAKOFF P., BREARLEY A. & NIELSEN J. (1996): Factors affecting grazer-epiphytes interactions in temperate seagrass meadows. *Oceanogr. Mar. Bio. Ann. Rev.*, **34**: 109-162.
- JONES C. G., LAWTON J. H. & SHACHAK M. (1994): Organisms as ecosystem engineers. *Oikos*, **69**: 373-386.
- KUO J. & DEN HARTOG C. (2006): Seagrass morphology, anatomy and ultrastructure. in *Seagrasses : Biology, Ecology and Conservation*, LARKUM A. W. D., ORTH R. J. & DUARTE C. M. (Eds.): 51-87.
- KUO J. C. & DEN HARTOG C. (2000): Seagrasses: a profile of an ecological group. *Biol. Mar. Medit.*, **7**: 3-17.
- LEDOYER M. (1968): Ecologie de la faune vagile des biotopes méditerranéens accessibles en scaphandre autonome (région de Marseille principalement). IV : Synthèse de l'étude écologique. *Rec. Trav. St. Mar. End.*, **44** (60): 126-295.
- LEPOINT G., COX A. S., DAUBY P., POULICEK M. & GOBERT S. (2006): Food sources of two detritivore amphipods associated with the seagrass *Posidonia oceanica* leaf litter. *Mar. Biol. Res.*, **2** (5): 355-365.
- LEPOINT G., HAVELANGE S., GOBERT S. & BOUQUEGNEAU J.-M. (1999): Fauna vs flora contribution to the leaf epiphytes biomass in a *Posidonia oceanica* seagrass bed (Revellata Bay, Corsica). *Hydrobiologia*, **394**: 63-67.
- LEPOINT G., MILLET S., DAUBY P., GOBERT S. & BOUQUEGNEAU J.-M. (2002): Annual nitrogen budget of the seagrass *Posidonia oceanica* as determined by in situ uptake experiments. *Mar. Ecol. Progr. Ser.*, **237**: 87-96.
- LIPKIN Y., BEER S. & ZAKAI D. (2003): The seagrasses of the eastern Mediterranean and the Red Sea. in *World Atlas of seagrasses*, GREEN E. P. & SHORT F. T.: 65-73.
- MARBÀ N., HOLMER M., GACIA E. & BARRON C. (2006): Seagrass beds and coastal biogeochemistry. in *Seagrasses : Biology, Ecology and Conservation*, LARKUM A. W. D., ORTH R. J. & DUARTE C. M. (Eds.): 135-157.
- MARTIN J. W. & DAVIS G. E. (2001): An updated classification of the recent Crustacea. *Sci. Ser. Nat. History Mus. Los Angeles County*, **39**: 1-124.

## General introduction

- MATEO M. A., CEBRIAN J., DUNTON K. & MUTCHLER T. (2006): Carbon Flux in Seagrasses. in *Seagrasses : Biology, Ecology and Conservation*, LARKUM A. W. D., ORTH R. J. & DUARTE C. M. (Eds.): 159-192.
- MATEO M. A. & ROMERO J. (1997): Detritus dynamics in the seagrass *Posidonia oceanica*: Elements for an ecosystem carbon and nutrient budget. *Mar. Ecol. Progr. Ser.*, **151** (1-3): 43-53.
- MATEO M. A., ROMERO J., PEREZ M., LITTLER M. M. & LITTLER D. S. (1997): Dynamics of Millenary Organic Deposits Resulting from the Growth of the Mediterranean Seagrass *Posidonia oceanica*. *Estuar. Coast. Mar. Sci.*, **44** (1): 103-110.
- MATEO M. A., SANCHEZ-LIZASO J. L. & ROMERO J. (2003): *Posidonia oceanica* 'banquettes': a preliminary assessment of the relevance for meadow carbon and nutrients budget. *Estuarine Coastal and Shelf Science*, **56** (1): 85-90.
- MAZZELLA L. (1983): Studies on the epiphytic diatoms of *Posidonia oceanica* (L.) Delile leaves. *Rapp. Comm. int. Mer Médit.*, **28**: 123-124.
- MAZZELLA L., BUIA M. C., GAMBI M. C., LORENTI M., RUSSO G. F., SCIPIONE M. B. & ZUPO V. (1992): Plant-animal trophic relationships in the *Posidonia oceanica* ecosystem of the Mediterranean Sea : a review. in *Plant-Animal Interactions in the Marine Benthos*, JOHN D. M., HAWKINS S. J. & PRICE J. H. (Eds.): 165-187.
- MAZZELLA L. & OTT J. A. (1984): Seasonal changes in some features of *Posidonia oceanica* (L.) Delile leaves and epiphytes at different depths. in *International Workshop on Posidonia oceanica Beds*, BOUDOURESQUE C. F., JEUDY DE GRISSAC A. & OLIVIER J. (Eds.), **1**: 119-127.
- MAZZELLA L., SCIPIONE M. B. & BUIA M. C. (1989): Spatio-temporal distribution of Algal and Animal communities in a *Posidonia oceanica* meadow. *P.S.Z.N. I: Mar. Ecol.*, **10** (2): 107-129.
- MEINESZ A., CIRIK S., AKCALI B., JAVEL F., MIGLIACCIO M., THIBAUT T., YÜKSEK A. & PROCACCINI G. (2009): *Posidonia oceanica* in the Marmara Sea. *Aquat. Bot.*, **90**: 18-22.
- NOVAK R. (1984): A study in ultra-ecology: microorganisms on the seagrass *Posidonia oceanica* (L.) Delile. *P.S.Z.N. I: Mar. Ecol.*, **5**: 143-190.
- PASQUALINI V., PERGENT-MARTINI C., CLABAUT P. & PERGENT G. (1998): Mapping of *Posidonia oceanica* using aerial photographs and side scan sonar : application off the island of Corsica (France). *Estuar. Coast. Mar. Sci.*, **47**: 359-367.
- PERES J.-M. & PICARD J. (1964): Nouveau manuel de bionomie benthique de la mer Méditerranée. Edition revue et augmentée. Station Marine d'Endoume, Marseille, 137 pp.
- PERGENT G. & PERGENT-MARTINI C. (1991): Leaf renewal cycle and primary production of *Posidonia oceanica* in the bay of Lacco Ameno (Ischia, Italy) using lepidochronological analysis. *Aquat. Bot.*, **42**: 49-66.
- PERGENT G., RICO-RAIMONDINO V. & PERGENT-MARTINI C. (1997): Fate of primary production in *Posidonia oceanica* meadows of the Mediterranean. *Aquat. Bot.*, **59** (3-4): 307-321.

- PERGENT G., ROMERO J., PERGENT-MARTINI C., MATEO M.-A. & BOUDOURESQUE C.-F. (1994): Primary production, stocks and fluxes in the Mediterranean seagrass *Posidonia oceanica*. *Mar. Ecol. Progr. Ser.*, **106**: 139-146.
- PESSANI D., CALTAGIRONE A., PONCINI F. & VETERE M. (1989): Confronto tra due praterie di *Posidonia oceanica* della riviera ligure di levante e di ponente. 2. La fauna epifita. in *International Workshop on Posidonia Beds*, BOUDOURESQUE C. F., MEINESZ A., FRESI E. & GRAVEZ V. (Eds.), **2**: 161-173.
- PIAZZI L., BALATA D. & CINELLI F. (2002): Epiphytic macroalgal assemblages of *Posidonia oceanica* rhizomes in the western Mediterranean. *Eur. J. Phycol.*, **27**: 69-76.
- PRADO P., ALCOVERRO T., MARTINEZ-CREGO B., VERGES A., PEREZ M. & ROMERO J. (2007): Macrograzers strongly influence patterns of epiphytic assemblages in seagrass meadows. *J. Exp. Mar. Biol. Ecol.*, **350** (1-2): 130-143.
- PROCACCINI G., BUIA M. C., GAMBI M. C., PEREZ M., PERGENT G., PERGENT-MARTINI C. & ROMERO J. (2003): The seagrasses of the western Mediterranean. in *World Atlas of seagrasses*, GREEN E. P. & SHORT F. T. (Eds.): 48-58.
- RAVEN P. H., EVERT R. F. & EICHHORN S. E. (2005): *The Biology of Plants*. W.H. Freeman & Co., New York, 944 pp.
- RIEDL R. (1983): *Fauna y flora del mar Mediterraneo*. Ediciones Omega, Barcelona, 858 pp.
- ROMERO J., LEE K.-S., PÉREZ M., MATEO M. A. & ALCOVERRO T. (2006): Nutrient Dynamics in Seagrass Ecosystems. in *Seagrasses : Biology, Ecology and Conservation*, LARKUM A. W. D., ORTH R. J. & DUARTE C. M. (Eds.): 227-254.
- ROMERO J., PEREZ M., MATEO M. A. & SALA E. (1994): The belowground organs of the Mediterranean seagrass *Posidonia oceanica* as a biogeochemical sink. *Aquat. Bot.*, **47**: 13-19.
- ROMERO J., PERGENT G., PERGENTMARTINI C., MATEO M. A. & REGNIER C. (1992): The detritic compartment of a *Posidonia oceanica* meadow - Litter features, decomposition rates and mineral stocks. *Mar. Ecol.-Pubbl. Stn. Zool. Napoli*, **13** (1): 69-83.
- RUPPERT E. E., FOX R. S. & BARNES R. D. (2003): *Invertebrate Zoology: A Functional Evolutionary Approach* (7th edition). Thomson-Brooks/Cole, Stamford, 1008 pp.
- SCIPIONE M. B., GAMBI M. C., LORENTI M., RUSSO G. F. & ZUPO V. (1996). Vagile fauna of the leaf stratum of *Posidonia oceanica* and *Cymodocea nodosa* in the Mediterranean Sea. *Seagrass Biology : Proceedings on an internaional workshop*, Rottnest Island, Western Australia.
- STURARO N., CAUT S., GOBERT S., BOUQUEGNEAU J.-M. & LEPOINT G. (2010): Trophic diversity of idoteids (Crustacea, Isopoda) inhabiting the *Posidonia oceanica* litter. *Mar. Biol.*, **157** (2): 237-247.
- TEMPLADO J. (1984): Las praderas de *Posidonia oceanica* en el sureste español y su biocenosis. in *International Workshop on Posidonia oceanica Beds*, BOUDOURESQUE C. F., JEUDY DE GRISSAC A. & OLIVIER J. (Eds.), **1**: 159-172.

## General introduction

THE ANGIOSPERM PHYLOGENY GROUP (2009): An update of the Angiosperm Phylogeny Group classification for the orders and families of flowering plants: APG III. *Botanical Journal of the Linnean Society*, **161** (2): 105-121.

TOMAS F., TURON X. & ROMERO J. (2005): Seasonal and small-scale spatial variability of herbivory pressure on the temperate seagrass *Posidonia oceanica*. *Mar. Ecol. Progr. Ser.*, **301**: 95-107.

VALENTINE J. F. & DUFFY J. E. (2006): The central role grazing in seagrass ecology. in *Seagrasses : Biology, Ecology and Conservation*, LARKUM A. W. D., ORTH R. J. & DUARTE C. M. (Eds.): 463-501.

VELIMIROV B. (1987): Organic matter derived from a seagrass meadow : origin, properties, and quality of particles. *P.S.Z.N. I: Mar. Ecol.*, **8** (2): 143-173.

VIZZINI S. (2009): Analysis of the trophic role of Mediterranean seagrasses in marine coastal ecosystems: a review. *Bot. Mar.*, **52** (5): 383-393.



# Chapter 2

## General material and methods

A robust methodology is a key difference between actual science and purely speculative twiddling.

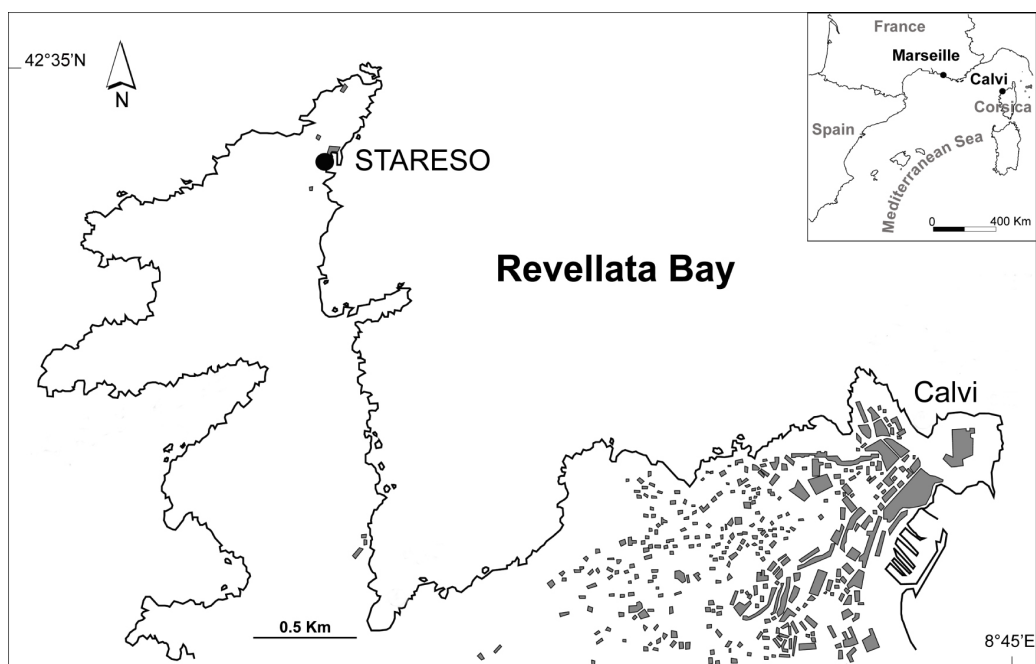
(Niels Bohr)



## I. Description of study site

### I.1. Calvi Bay: general location

Calvi Bay lies in the western Mediterranean, on the northwestern coast of Corsica (42°35'N, 8°45'E, cf. figure 2.1). Its western limit is Punta Revellata Cape, and its eastern limit is Punta Spano Cape. Distance between the two capes is 6.3 km, and total area of the bay is 22 km<sup>2</sup>. The city of Calvi itself is located on a small peninsula, inside the bay. This peninsula divides Calvi bay in Revellata Bay (to the west) and Gulf of Calvi (to the east). The STARESO (STation de REcherches Sous-marines et Océanographiques) research station (University of Liège) is located on the Punta Revellata, at the western border of the bay.



**Fig. 2.1:** Map of the western portion of Calvi Bay, *i.e.* Revellata Bay (after VERMEULEN *et al.*, 2011, modified), displaying Calvi and the STARESO research station. The insert shows the general location of Revellata Bay in the Mediterranean.

Salinity of the water of Calvi Bay is around 38, and is relatively invariant throughout the year. Temperature of water varies between minima of 12°C (February) and maxima of 26°C (August), with a notable vertical thermal stratification from May to September. Amplitude of tidal variation is weak. Nutrient concentrations (N, P) and particle load in the water column are typically low and characteristic of oligotrophic areas (GOBERT, 2002).

## General material and methods

*Posidonia oceanica* meadows cover about 50 % of the area of the bay, and reach depths of nearly 40 m (cf. fig. 2.2). Meadows show, in most places, a continuous extension, but local erosion ("intermattes") occurs. The vast majority of meadows grow on soft bottoms, but they seldom colonize rocky substrates. Meadows of Calvi Bay are relatively dense, and show an important foliar biomass and production (BAY, 1984 ; GOBERT, 2002).

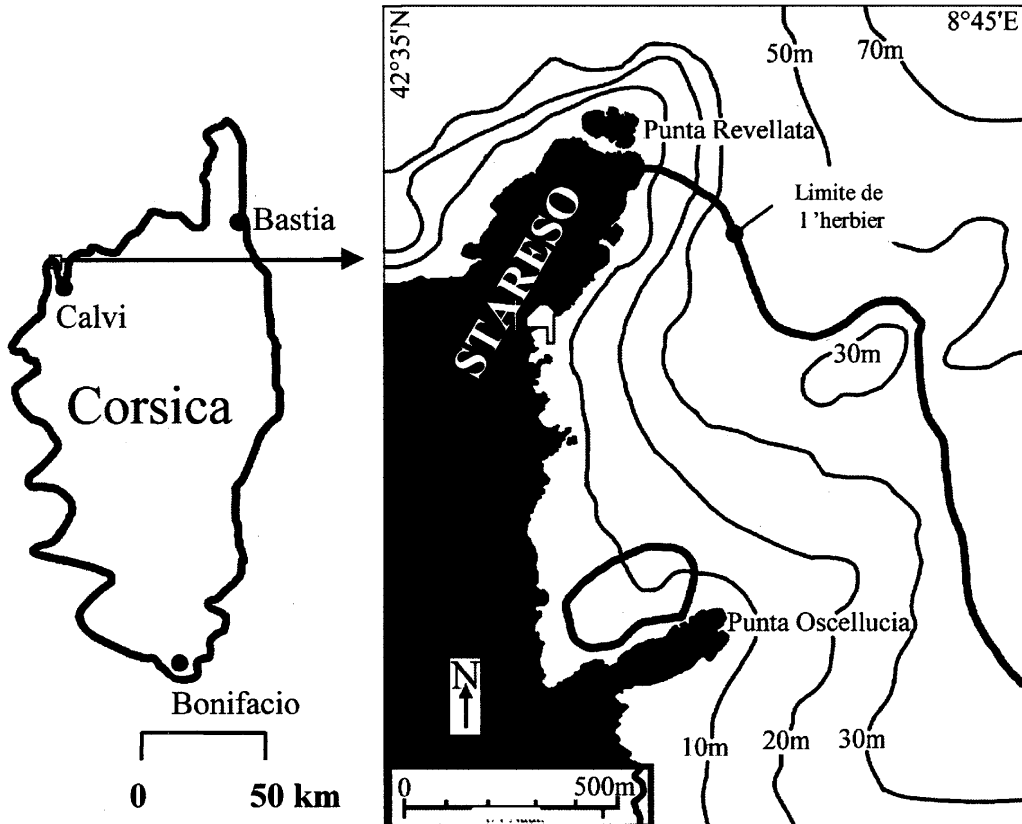


Fig. 2.2: Left: general situation of Calvi Bay in Corsica. Right: Zoom on the surroundings of the STARESO research station, showing 10, 20, 30, 50 and 70 m isobaths, as well as the lower limit of the meadow ("limite de l'herbier") (from GOBERT *et al.*, 2003).

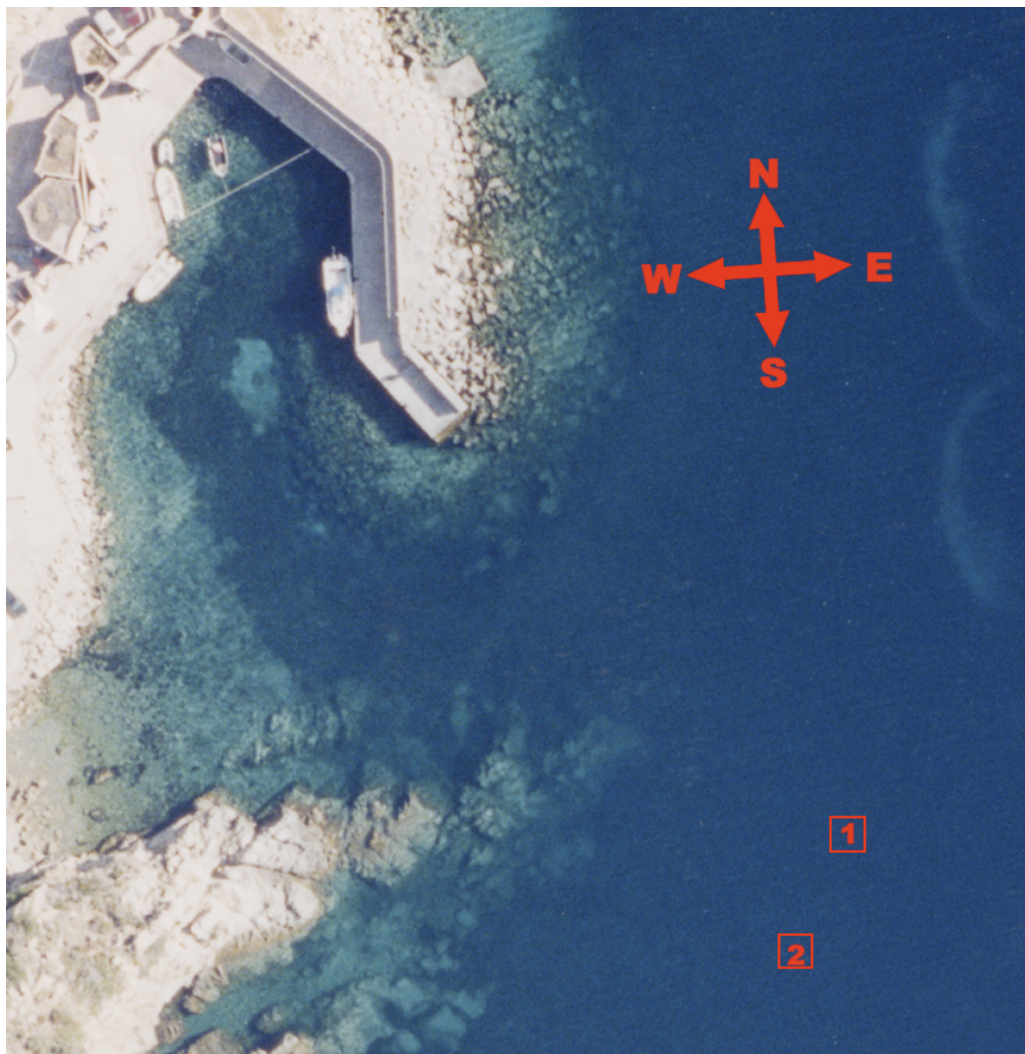
## 1.2. Permanent frames

All sampling was undertaken by scuba diving in the surroundings of the STARESO research station. To avoid (or at least limit) the adverse effects of spatial variation of meadow parameters and faunistic communities, we chose to take all samples at the same precise locations. To do this, we set up two permanent frames in the *Posidonia oceanica* meadow. They were made of 16 mm diameter circular PVC rods, anchored to the bottom using lead weights and metal stakes. Each frame was square-shaped, and composed of 4 3m-long rods, therefore circumscribing an area of 9 m<sup>2</sup>.



The precise location of the two permanent frames is shown on figure 2.3. We placed them in continuous meadow zones, outside the STARESO harbor. This location was a good compromise between low to nil anthropogenic influence and proximity to the STARESO and its infrastructure. They were separated by approximately 10 meters, and the precise position of a point located between the two frames was measured as being  $42^{\circ}34'47''$  N and  $8^{\circ}43'30''$  E. The frames were placed at a depth of 10 metres. This depth was chosen to be relatively shallow and characteristic of *Posidonia oceanica* meadows, but relatively free from hydrodynamism effects.

After their initial setup, all sampling was realized in these permanent frames or in their direct surroundings (*i.e.*, between them, or at a distance of a few meters).



**Fig. 2.3:** Position of the two permanent frames set up for this study. Frames are pictured by red squares, in the lower right corner of the figure. In the upper left corner, the STARESO harbor is visible.

### **I.3. Dates of sampling events**

In total, 9 sampling campaigns were realized, for a total of 156 days of fieldwork. Table 2.I summarizes the dates of these sampling events, and lists the main purpose of each campaign.

**Table 2.I:** Dates and main purposes of sampling campaigns realized during this study.

<b>Dates</b>	<b>Main purpose</b>
12/11/06 - 20/11/06	- Permanent frames setup - Community composition (chap.3)
22/03/07 - 30/03/07	- Community composition (chap.3)
27/05/07 - 05/06/07	- Community composition (chap.3)
04/11/07 - 13/11/07	- Gut contents (chap. 4) - Stable isotopes (data not shown here, see MICHEL <i>et al.</i> , 2008)
06/03/08 - 15/03/08	- Gut contents (chap. 4) - Stable isotopes (data not shown here, see MICHEL <i>et al.</i> , 2009)
30/05/08 - 11/06/08	- Gut contents (chap. 4) - Stable isotopes (chap. 4)
05/11/08 - 15/11/08	- Stable isotopes (chap. 4) - Fatty acids (chap. 4)
02/03/09 - 14/03/09	- Stable isotopes (chap. 4) - Fatty acids (chap. 4)
24/05/09 - 04/08/09	- Stable isotopes (chap. 4) - Fatty acids (chap. 4) - Grazing experiments (chap. 5)

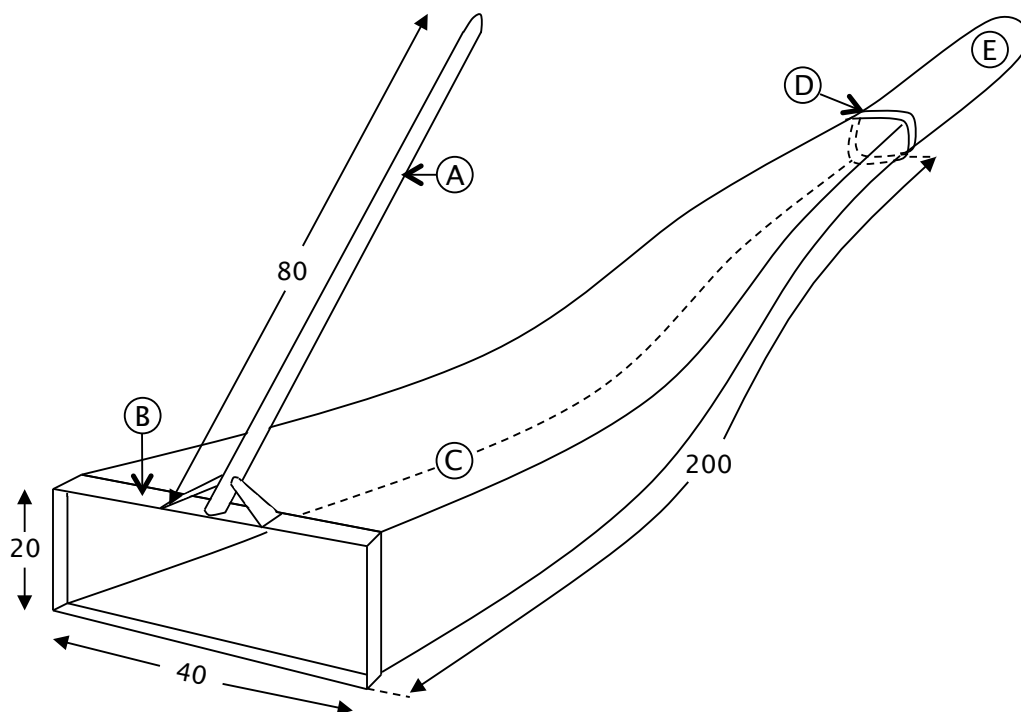
## **II. Amphipod sampling methods**

### **II.1. Hand-towed net**

The hand-towed net technique was initially created by PERES & PICARD (1964), then was widely used and improved by LEDOYER (*e.g.* 1968, 1969), and was finally standardized by RUSSO *et al.* (1985). The technique used here was based on the latter publication.

The net itself is shown in fig. 2.4. It featured a rectangular opening of 40 x 20 cm. The body of the net was made of 400 µm nylon mesh, and its length was important (200 cm), to prevent the sampled animals to escape by climbing towards the opening. The body had a conical shape, and its distal end was a rigid plastic ring. Sampled animals accumulate in a nylon stocking attached to the terminal ring.

It can be held and operated by a single diver, who operates the net using a metallic handle of about 80 cm long. Sampling consisted in a series of brief strokes, given in order to shake the *P. oceanica* leaves from the basis and to



**Fig. 2.4:** Schematic representation of the hand-towed net used in this study (from MICHEL *et al.*, 2010, modified). All measurements are expressed in centimetres. A: aluminium handle, B: aluminium rectangular frame, C: net body (mesh size 400  $\mu\text{m}$ ), D: rigid plastic ring, E: nylon stocking.

collect the associated vagile fauna. The net must be held in order to form an angle of circa  $45^\circ$  with the bottom. A smaller angle indeed reduces the area of contact between the opening of the net and the meadow foliar stratum, therefore limiting sampling efficiency. On the other hand, a too large angle reduces sampling speed, allowing the sampled fauna to escape. In addition, the diver must be careful to position oneself above the foliar stratum, and to avoid abrupt movements, to limit disturbance of the fauna (Russo *et al.*, 1985).

## **II.2. Litter collection**

In this study, litter fragments were handpicked. A 25 x 40 cm quadrat was randomly thrown in the meadow, to estimate sampling area, and all litter present among this meadow patch was handpicked by fistfuls, and quickly placed in a container. By doing so, vagile organisms associated to litter fragments were also collected. This procedure was repeated until a sufficient amount of litter was sampled. From November 2007 on (*i.e.*, 4<sup>th</sup> sampling event) a standardized container of 2 litres was used, to ensure that all samples were of comparable size.

---

## General material and methods

It is important to stress the fact that the litter sampled in this study always originated from the sparse cover present in the meadow itself, between the shoots.

Massive litter accumulations indeed frequently occur in unvegetated sand areas, either surrounded by meadow patches ("intermattes") or adjacent to meadows. The volume of these submerged phytodetritus accumulations (SPA) can exceed several m<sup>3</sup>. They could be regarded as the underwater equivalents of large beach wrack accumulations found all along Mediterranean coasts ("banquettes"). Physico-chemical conditions in SPA are totally different from those found in *P. oceanica* meadows, and so are the animal communities living in them (*e.g.* GALLMETZER *et al.*, 2005 ; DIMECH *et al.*, 2006). These formations were not considered in the present study.

### **II.3. Light traps**

First light traps were made of transparent 1.5 litre plastic bottles, placed in reverse position (*cf.* fig. 2.5). Each trap presented vertical rectangular slits (1 cm wide x 15 cm long) in its upper part. They were anchored to the bottom using a 2 kg lead weight, and a float attached to the top of the trap insured that it remained vertical in the meadow canopy. A diving emergency light stick was fixed in the bottleneck of each trap. These sticks emit light for >12 hours, and the vagile invertebrates, attracted by the light, entered the trap through the slits, and gathered in the bottleneck. Traps were placed at twilight and recovered the next morning.

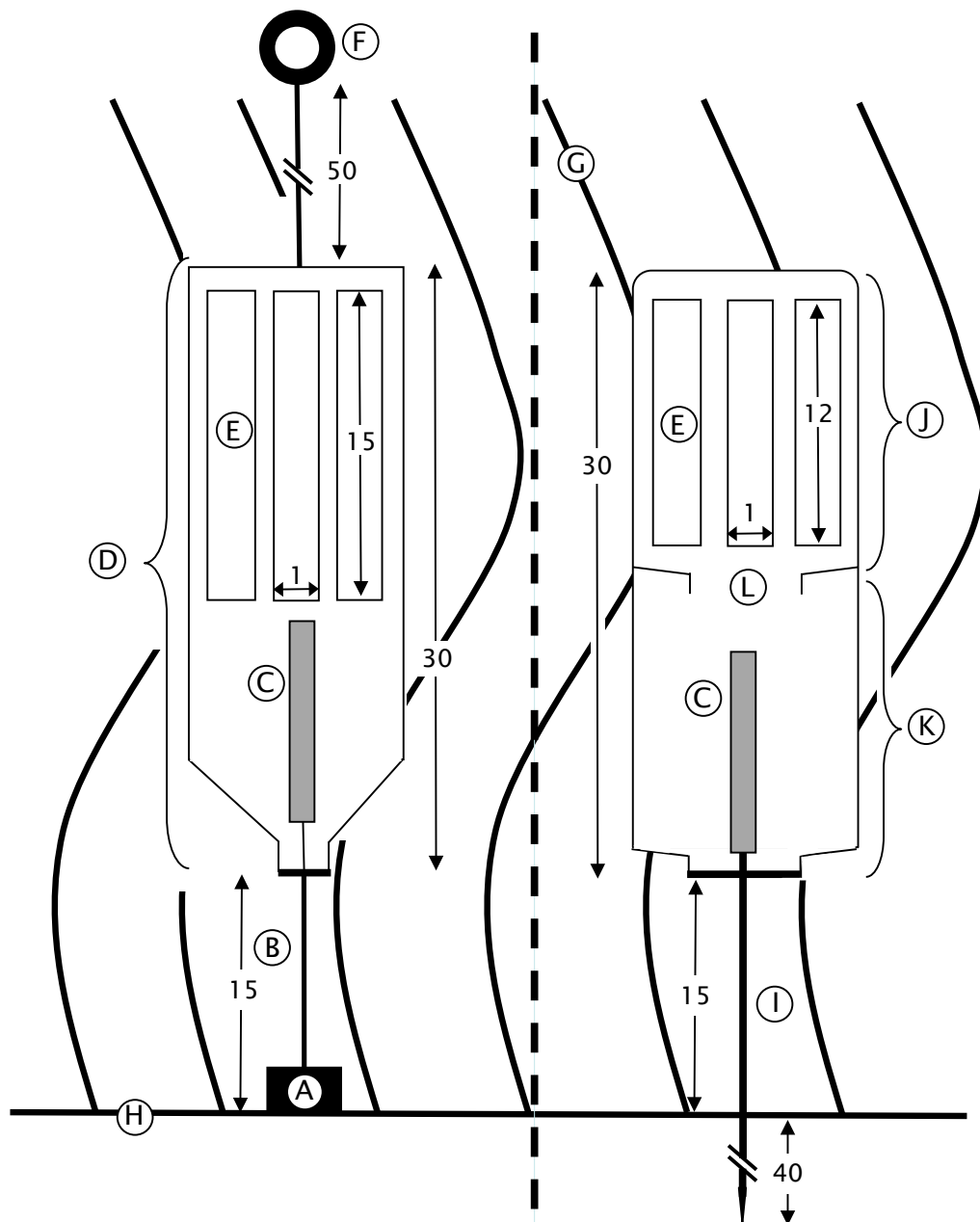
From June 2007 on, we used a slightly different model of light trap (*cf.* fig. 2.5). They were made of two nested 1 litre translucent plastic containers. The top container was pierced with slits, and was then inserted in the bottom one. In addition, they were not anchored to the bottom by using lead weights. Instead, we used metal stakes ( $\emptyset$ : 3mm) that were directly stuck in the mat. This model was preferred to the old one for three reasons. First, these traps were much more robust, and withstood numerous successive re-uses. Second, since they are made of translucent plastic, the light was only emitted through the entrance slits, thus maximizing the attraction of animals towards the "useful" part of the trap. Third, the presence of an additional bottleneck in the middle of the trap limits the potential escape of animals.

## **III. Data processing**

### **III.1. Basic statistics and comparison procedures**

All position and dispersion parameters were calculated using Prism v5.0c for MacOS X (GraphPad Software, La Jolla, U.S.A.). This software was also used to draw most graphical representations.

In a number of cases, we wanted to test if values of specific variables were significantly different in two or several groups. In these cases, we first ensured



**Fig. 2.5:** Schematic representation of the light traps used in this study. Left: light trap model used during the first two sampling events (from MICHEL *et al.*, 2010, modified). Right: model used during from June 2007 on. All measurements are expressed in centimetres. A: 2 kg lead weight, B: nylon anchoring rope ( $\varnothing$ : 2mm), C: diving emergency light stick, D: 1.5 litre plastic bottle, E: vertical slits, F: float, G: *Posidonia oceanica* leaves, H: bottom, I: metal stake, J: top container, K: bottom container, L: bottleneck.

---

## General material and methods

that data followed a Gaussian distribution, by examining frequency distribution plots and by applying D'agostino and Pearson & Shapiro-Wilk normality tests. We also checked that variances were homogeneous, using Bartlett's test.

In a lot of cases, most populations followed Gaussian distributions, or were close to. However, in nearly all comparisons, one or several datasets were not normal. We therefore chose to apply non-parametric comparison procedures. When applicable, we used Mann-Whitney to test differences between two groups. When three or more groups were compared, we used Kruskal-Wallis test, and subsequently applied Dunn's post-hoc test to compare pairs of groups.

In all tests, the significance level was set to  $\alpha = 0.05$ .

### **III.2. Hierarchical agglomerative clustering**

The purpose of this multivariate technique is to investigate relationships between items by gathering them in "natural" groups called clusters. These clusters are built in such fashion that items within a cluster are more similar to each other than they are to samples from different groups.

The input data of this analysis is the resemblance matrix associated to the data of interest. For each pair of items, this matrix contains the value of a similarity coefficient. Items are then fused into groups (hence the term "agglomerative" in the name of the technique), starting with the highest mutual similarity. Clusters are then merged into larger clusters (hence the term "hierarchical") by gradually lowering the similarity level at which groups are formed. The process is complete when all items are grouped in a single cluster, typically at low similarity levels. The result is a dendrogram where the x-axis represents the items (without an unique particular continuous order) and the y-axis gives the level of inter-item similarity (CLARKE & WARWICK, 2001).

In this study, hierarchical agglomerative clustering analyses were performed to investigate relationships between samples collected for community composition analysis (chapter 3), between gut contents of dominant species of amphipods (chapter 4) and between fatty acid composition of food items and amphipods (chapter 4). They were realized using PRIMER v6.0 for Windows (PRIMER-E Ltd., Luton, U.K.).

In all cases, the total values (*i.e.*, the total abundance of amphipods, the total size of the gut content, or the total fatty acid content) varied widely from an item to another. To avoid analytical biases caused by these variations, we chose to work with relative contributions rather than with raw data. All data were therefore standardized by the related total. In other terms, effectives of each amphipod species were divided by the total effective of the sample, area occupied by each food item was divided by the total area of the gut content, and abundance of each fatty acid was divided by the total fatty acid content.

In addition, standardized data were square root-transformed. This moderate transformation is very common in this type of analyses. Its purpose is to slightly down-weight the dominant variables, to allow the less common ones to be taken into account. The resemblance matrix was built using Bray-Curtis similarity coefficients, and clusters were assembled using group-average linking of similarities. The combination of these two methods has been proven efficient and robust in numerous ecological studies (CLARKE & WARWICK, 2001).

### **III.3. SIMPER analyses**

The purpose of one-way SIMPER (SIMilarity PERcentage) analyses is to highlight the variables best explaining the differences between two groups of items, or best explaining the resemblance between items forming a single group.

A typical one-way SIMPER analysis has two parts. The first one is a breakdown of the total inter-group dissimilarity. The program first calculates the Bray-Curtis dissimilarity between each pair of inter-groups items (*i.e.* first item from group 1 linked with first item of group 2, then second item from group 1 linked with first item of group 2, etc.). After that, it computes the mean inter-group dissimilarity ( $\bar{\delta}$ ). This mean total dissimilarity is then broken down into separate relative contributions from each variable, which are expressed in percentage of the total inter-group dissimilarity. For each of the  $i$  variables, two values are in fact calculated: the mean contribution of the variable to dissimilarity ( $\bar{\delta}_i$ ) and the standard deviation associated to this mean ( $SD_i$ ). When a variable not only contributes much to the dissimilarity between groups (high  $\bar{\delta}_i$  value), but also does so consistently in inter-comparisons of all items in the two groups (important  $\bar{\delta}_i/SD_i$  ratio), it means that it is a good discriminating variable, *i.e.*, an useful variable to explain differences between the two groups (CLARKE & WARWICK, 2001).

In parallel to this dissimilarity breakdown, it is a common custom to perform a breakdown of the total intra-group similarity. The procedure is comparable to the one described in the previous paragraph, but is based on the average similarity between all pairs of items of a group. In this case, a variable featuring both high  $\bar{\delta}_i$  and  $\bar{\delta}_i/SD_i$  values will be useful to explain resemblance between the items that form a group (good typifying or typical variable, CLARKE & WARWICK, 2001)

1-way SIMPER analyses can be used to study differences between groups of items that are separated by intrinsic features. Such *a priori* analyses have been realized in the chapter 3 of this study, where we compared samples collected in different seasons, in different periods of the day, and with different methods.

SIMPER analyses can also be realized after a hierarchical clustering analysis, to explore differences between clusters and understand which variables influence

the patterns of items grouping. Such *a posteriori* analyses were performed in chapter 4, to compare clusters obtained by analyses concerning gut contents of amphipods, and fatty acids of food sources and amphipods.

In all cases, analyses were performed using PRIMER v6.0 for Windows and standardized,  $\sqrt{}$ -transformed data were used as inputs.

## **References**

- BAY D. (1984): A field study of the growth dynamics and productivity of *Posidonia oceanica* (L.) Delile in Calvi Bay, Corsica. *Aquat. Bot.*, **20** (1-2): 43-64.
- CLARKE K. R. & WARWICK R. M. (2001): Change in marine communities : an approach to statistical analysis and interpretation - 2nd edition. Primer-E, Plymouth, 165 pp.
- DIMECH M., BORG J. A. & SCHEMBRI P. J. (2006): Motile macroinvertebrate assemblages associated with submerged *Posidonia oceanica* litter accumulations. *Biol. Mar. Medit.*, **13** (4): 130-133.
- GALLMETZER I., PFLUGFELDER B., ZEKELY J. & OTT J. A. (2005): Macrofauna diversity in *Posidonia oceanica* detritus: distribution and diversity of mobile macrofauna in shallow sublittoral accumulations of *Posidonia oceanica* detritus. *Mar. Biol.*, **147** (2): 517-523.
- GOBERT S. (2002): Variations spatiale et temporelle de l'herbier à *Posidonia oceanica* (L.) Delile (Baie de la Revellata - Calvi - Corse). PhD in Sciences thesis, University of Liège, Liège, 207 pp.
- GOBERT S., KYRAMARIOS M., LEPOINT G., PERGENT-MARTINI C. & BOUQUEGNEAU J. M. (2003): Variations at different spatial scales of *Posidonia oceanica* (L.) Delile beds; effects on the physico-chemical parameters of the sediment. *Oceanol. Acta*, **26** (2): 199-207.
- LEDOYER M. (1968): Ecologie de la faune vagile des biotopes méditerranéens accessibles en scaphandre autonome (région de Marseille principalement). IV : Synthèse de l'étude écologique. *Rec. Trav. St. Mar. End.*, **44** (60): 126-295.
- LEDOYER M. (1969): Ecologie de la faune vagile des biotopes méditerranéens accessibles en scaphandre autonome. V - Etude des phénomènes nyctéméraux. *Tethys*, **1** (2): 291-308.
- MICHEL L., LEPOINT G., DAUBY P. & STURARO N. (2010): Sampling methods for amphipods of *Posidonia oceanica* meadows: a comparative study. *Crustaceana*, **83** (1): 39-47.
- MICHEL L., LEPOINT G., GOBERT S. & DAUBY P. (2008): Trophic diversity among amphipod crustaceans from *Posidonia oceanica* meadows : A stable isotope assessment. Oral communication presented at the 15th Benelux Congress of Zoology, Liège, Belgium on 31/10/2008.
- MICHEL L., LEPOINT G., NYSSSEN F., GOBERT S. & DAUBY P. (2009): Use of C & N stable isotopes to evaluate interspecific trophic diversity among amphipods from *Posidonia oceanica* meadows. Poster presented at the Advancing the Science of



Limnology and Oceanography Aquatic Sciences Meeting 2009, Nice, France on 27/01/2009.

PERES J.-M. & PICARD J. (1964): Nouveau manuel de bionomie benthique de la mer Méditerranée. Edition revue et augmentée. Station Marine d'Endoume, Marseille, 137 pp.

RUSSO G. F., FRESI E. & VINCI D. (1985): The hand-towed net method for direct samplign in *Posidonia oceanica* beds. *Rapp. Comm. int. Mer Médit.*, **29**: 175-177.

VERMEULEN S., STURARO N., GOBERT S., BOUQUEGNEAU J.-M. & LEPOINT G. (2011): Potential early indicators of anthropogenically derived nutrients: a multiscale stable isotope analysis. *Mar. Ecol. Progr. Ser.*, **422**: 9-22.





## Chapter 3

### Structure and temporal dynamics of communities of amphipods associated to *Posidonia oceanica* meadows in Calvi Bay

Taxonomical classifications are theories about the basis of natural order, not dull catalogues compiled only to avoid chaos.

(Stephen Jay Gould)



## **I. Introduction**

### **I.1. Amphipods in the vagile fauna of *P. oceanica* meadows**

The abundance of amphipods *P. oceanica* meadows has been established for a long time. Amphipods are indeed, alongside gastropods and polychaetes, one of the dominant groups in the vagile fauna. Depending on the season, amphipods can represent 17 % to 34 % of the vagile fauna in terms of numerical abundance, and 22 % to 31 % in terms of number of species (MAZZELLA *et al.*, 1989 ; GAMBÌ *et al.*, 1992).

Numerical abundance and specific diversity of amphipods is higher in *Posidonia oceanica* meadows than in unvegetated sand bottom areas. In addition, the structure of the communities is different in the two types of habitats (SÁNCHEZ-JEREZ *et al.*, 1999a ; VAZQUEZ-LUIS *et al.*, 2009). The amphipod taxocenosis of *P. oceanica* is also different, more abundant and/or more diverse than the one found in other common soft-bottom Mediterranean macrophytes, such as *Cymodocea nodosa* (SCIPIONE *et al.*, 1996 ; SÁNCHEZ-JEREZ *et al.*, 1999a ; COMO *et al.*, 2008 ; VAZQUEZ-LUIS *et al.*, 2009 ; SCIPIONE & ZUPO, 2010), *Caulerpa prolifera* (VAZQUEZ-LUIS *et al.*, 2009) and *Zostera marina* (SCIPIONE & ZUPO, 2010).

The important development of the amphipod community sheltered by *P. oceanica* meadows is generally linked with the abundance and the important structural complexity of the habitat they offer. Leaf Area Index of *Posidonia oceanica* is indeed high, and each m<sup>2</sup> of meadow offers 6 to 29 m<sup>2</sup> of leaves available for colonization by amphipods (BUÌA *et al.*, 2000). Furthermore, these numbers only concern the foliar stratum, and the presence of the rhizome layer, the litter cover and the matte increase the size, the complexity and the diversity of this habitat. However, diversity and structural complexity of the habitat are not the only factors to influence invertebrate diversity (ATTRILL *et al.*, 2000). In *Posidonia oceanica* meadows, the abundance of leaf epiphytes is apparently another important factor driving patterns of amphipod community structure (ZAKHAMA-SRAIEB *et al.*, 2011).

While the amphipod fauna of *P. oceanica* meadows is particular, and even if a lot of species can be considered characteristic of this biotope, no real exclusive taxa exist (BUÌA *et al.*, 2000). The meadow-associated community can be regarded as a **complex assemblage** of species encountered in other biotopes. The fauna of the foliar stratum has many features in common with biocenoses encountered in photophilous algae on rocky shores. The fauna of the rhizome layer matte, on the other hand, is comparable to the fauna of precoralligene and coralligene bottoms, or marine caves. Finally, communities of the matte are somehow similar to those associated to sediment on detrital soft bottoms (RUFFO *et al.*, 1998). These different compartments are often considered different habitats supporting different biocenoses that are poorly related (*e.g.* KIKUCHI, 1980 ; BIANCHI *et al.*, 1989). However, interactions between these biocenoses exist, and animals are capable of vertical migrations

(see further in this chapter), causing partial overlap of the assemblages, and making such distinctions unclear (BORG *et al.*, 2006)

The fauna of the **foliar stratum** is, by far, the most studied. Literature data shows that these communities are diverse and abundant, but are also highly variable. Spatial, temporal and depth-related variations are indeed far from negligible.

Studies of **bathymetric variation** suggest that amphipod communities are structured in 3 assemblages. The shallowest one, situated between the surface and 1-2 meters, is very similar to fauna of photophilous algae. The intermediate one, ranging from 5-10 to 20-25 meters, is the most diverse, and is considered the most typical of *Posidonia oceanica* meadows. It is notably characterised by the abundance of *Apherusa chierighinii*, *Aora spinicornis*, *Dexamine* spp., *Phtisica marina* and *Ischyrocerus inexpectatus*. Finally, the third assemblage, found in depths greater than 25 meters, is close to those found in bare soft bottoms (SCIPIONE & FRESI, 1984 ; MAZZELLA *et al.*, 1989 ; GAMBI *et al.*, 1992)

**Spatial variation** is also important, albeit less structured. Studies performed in Spanish (SÁNCHEZ-JEREZ *et al.*, 1999a, 2000 ; VAZQUEZ-LUIS *et al.*, 2009), continental French (LEDOYER, 1968), Corsican (DEGARD, 2004 ; STURARO, 2007), Sardinian (COMO *et al.*, 2008 ; STURARO, Unpubl. data), Tyrrhenian Italian (SCIPIONE & FRESI, 1984 ; CHIMENZ *et al.*, 1989 ; MAZZELLA *et al.*, 1989 ; GAMBI *et al.*, 1992 ; SCIPIONE *et al.*, 1996), Adriatic Italian (SCIPIONE & ZUPO, 2010) and Tunisian (ZAKHAMA-SRAIEB *et al.*, 2006 ; ZAKHAMA-SRAIEB *et al.*, 2011) meadows show that, while common features can be highlighted, generalization is difficult, if not impossible. Local differences in the meadow parameters probably explain a major part of this variability, which concerns not only the total abundance and the specific diversity of the communities, but also the identity of the dominant species. These are not always the same, although some taxa, such as *Apherusa chierighinii*, *Phtisica marina*, *Aora spinicornis*, *Dexamine spinosa*, *Dexamine spiniventris*, *Hyale schmidtii*, *Ischyrocerus inexpectatus*, *Amphilocheus neapolitanus* and *Amphithoe helleri* are frequently cited.

Moreover, studies considering several sampling sites in a common general location suggest that spatial variation could exist at a smaller scale (*e.g.* GAMBI *et al.*, 1992 ; SÁNCHEZ-JEREZ *et al.*, 1999a ; DEGARD, 2004 ; ZAKHAMA-SRAIEB *et al.*, 2011). Moreover, amphipods apparently follow patchy distributions, as small-scale variations (*i.e.*, 1 to 10 m) in amphipod abundance seem to exist. Larger scale variations (about 100 m), on the other hand, rather concern amphipod specific richness and diversity (STURARO, 2007).

**Temporal variation** can also be considered at several scales. Nychthemeral variation is strong, and amphipod abundance in the foliar stratum is higher during the night than during the day (LEDOYER, 1969 ; SÁNCHEZ-JEREZ *et al.*, 1999b). In addition, seasonal variations exist. Amphipod abundance and diversity is generally maximal in late summer and autumn, and minimal in

winter and early spring (MAZZELLA *et al.*, 1989 ; GAMBI *et al.*, 1992 ; SCIPIONE *et al.*, 1996).

The fauna of amphipods from the **litter cover** present in the meadow has, to our knowledge, never been the subject of any exclusive specific study. On the other hand, the fauna of large submerged phytodetritus accumulations (SPA) received some attention. However, these two systems should not be confused, as they are completely different. Litter cover from the meadow is typically a dynamic, transient and unstable habitat, in direct connection with other compartments of the meadow (see sections III and IV of this chapter). SPA are longer-lived, more stable structures, often isolated from vegetated areas. In addition, their physical and chemical conditions can drastically move away from those usually encountered in *P. oceanica* meadows (hypoxia or anoxia, abundance of reducing compounds, etc.).

Besides these considerations, it is interesting to note that their fauna is extremely variable.

Amphipod communities of SPA are generally less diverse than those of meadows. COMO *et al.* (2008) studied Sardinian SPA, and report presence of 8 species (vs. 16 in *P. oceanica* meadows), the most common being *Corophium sextonae* and caprellids (*Pseudolirius kroyeri*, *Phtisica marina*).

In Maltese SPA, amphipods were by far the dominant group (82 % of the fauna). Abundant taxa include *Gammarus* spp. (59 % of the total fauna), *Atylus swammerdami* (14 %), *Atylus guttatus* (4 %) and *Melita hergensis* (1.1 %) (DIMECH *et al.*, 2006).

In Calvi bay, GALLMETZER *et al.* (2005) sampled 10 species, and amphipod fauna seemed strongly dominated by *Gammarella fucicola*, whose density sometimes neared 300 individuals per dry kg of litter. Strong dominance of *G. fucicola* in SPA from Calvi Bay has since then been confirmed (55 % of the total fauna; REMY, 2010).

These important differences probably originate, at least partially, from differences in the habitat offered by SPA (loose vs. dense packing, differences in litter fragment size, etc.)

Specific fauna of the **rhizome layer** did not receive much attention either. Small crustaceans, including amphipods, are apparently very important in this compartment, both in terms of abundance (KIKUCHI, 1980) and specific diversity (BUIA *et al.*, 2000). However, precise data are lacking. According to CHIMENZ *et al.* (1989), *Erichtonius punctatus*, *Leptocheirus pilosus* and *Photis longicaudata* would be characteristic species of the rhizome fauna. Species from the genera *Erichtonius* and *Leptocheirus* are indeed found in large numbers in studies considering the fauna associated to the whole plant (both foliar stratum and rhizome layer; VAZQUEZ-LUIS *et al.*, 2009 ; ZAKHAMA-SRAIEB *et al.*, 2011)

Finally, amphipod fauna of the **matte** seems rather scarce. BORG *et al.* 2006 sampled only 5 species, and dominance *Ampelisca rubella* was strong (83 % of the amphipod fauna). In another location, *Siphonocetes dellavallei* drastically dominated the assemblages (28 to 76 % of the total fauna; HARRIAGUE *et al.*, 2006)

## **I.2. Reminder of the specific objectives of this chapter**

Data and concepts from this chapter fit in the wider framework of the main objective of this dissertation, *i.e.* the study of trophic diversity and functional role of amphipod crustaceans from *Posidonia oceanica* meadows.

A clear comprehension of these phenomena require a good knowledge of the composition of the studied community, and of its variability. Such data are indeed necessary to understand how experimentally measured effect can be realized *in situ*. However, as exposed in the previous section, literature data on these matters is not exhaustive and, in addition, can be partly conflictual. Our first objective was therefore to obtain a robust and reliable dataset, taken at our precise study site, and concerning the structure of amphipod communities (abundance, diversity). We also considered the temporal dynamics of the community at seasonal (November/March/June) and nycthemeral (day/night) scales, since it is one of the main factors influencing the composition of assemblages.

Studies of trophic ecology imply collection of large amounts of biological material. In this context, our second objective was to standardize an efficient, easy to use and possibly quantitative sampling methodology. To achieve this, we compared three techniques (hand-towed net, litter collection and light traps).

Finally, the considered measurements and experiments are time-consuming and logistically demanding. As a result, it seems more realistic to concentrate experimental effort on a few species rather than on the whole taxocenosis. Our third objective was therefore to highlight the most representative species of the community, to build a relevant subset of species on which most subsequent work will be focused.

## **II. Material & Methods**

A complete description of the study site and of the sampling methods (hand-towed net, litter collection, light traps) can be found in chapter 2.

### **II.1. Sampling strategy**

For the **hand-towed net**, samples were taken during the day and the night at each season. For each sample, one of the permanent frames (9 m<sup>2</sup> of meadow, see chapter 2) was completely sampled, executing several passes in order to insure as complete as possible collection of the vagile fauna.

Daytime samples were taken at 2 P.M. on 17/11/2006, at 2.30 P.M. on 22/03/2007 and at 2 P.M. on 02/06/2007. Night samples were taken at 8 P.M. on 18/11/2006, at 9.30 P.M. on 25/03/2006 and at 11.00 P.M. on 01/06/2007.



**Litter collection** was also performed during both night and day. Sampling dates and times were the same than for hand-towed net. In each case, litter was collected within the permanent frames or in their direct surroundings.

**Light trap** sampling was only possible during the night. For each sample, 8 traps were scattered in one of the permanent frames, and care was taken to place them in such fashion that the distance between two successive traps was comparable. Traps were set up at 6.30 P.M. on 15/11/2006 (retrieval on 16/11 at 8 A.M.), at 6.30 P.M. on 24/03/2007 (retrieval on 25/03 at 8 A.M.) and at 8 P.M. on 03/06/2007 (retrieval on 04/06 at 7 A.M.)

## **II.2. Sample conditioning and analysis**

After collection, all samples were sieved on a 500 µm mesh and bulk fixed for at least 24 hours in a formaldehyde solution (4 % in 0.22 µm filtered seawater). Amphipods were then sorted and transferred in a stocking solution composed of 70 % ethanol to which 1 % of glycerine was added to prevent evaporation.

We used the keys and monographs of RUFFO *et al.* (1982, 1989, 1993, 1998) and MYERS *et al.* (2001) to identify the sampled amphipods. In some situations, more recent systematic correctives and/or diagnoses of new species were also used. This was notably the case for the genera *Apherusa* (KRAPP-SCHICKEL & SORBE, 2006) and *Caprella* (KRAPP-SCHICKEL & TAKEUCHI, 2005 ; KRAPP *et al.*, 2006).

In the vast majority of cases, amphipods were identified until the species level. Three taxa nonetheless constitute exceptions.

First, some individuals of the genus *Apherusa* were damaged, and could not be identified to species level with sufficient precision. They were therefore labelled as "*Apherusa* sp. – damaged individuals".

Second, a number of juvenile individuals of the genera *Apherusa* and *Dexamine* were found in the samples. These animals often lacked the morphological features necessary to link them with a precise species, and were therefore recorded as "*Apherusa* sp. – juveniles" or "*Dexamine* sp. – juveniles", respectively.

Third, *Caprella acanthifera* has two morphotypes, regarded as subspecies. These two morphotypes were relatively easily identifiable, and we therefore separated *Caprella acanthifera acanthifera* from *Caprella acanthifera discrepans*. When no precision is given, *C. acanthifera* refers to *C. acanthifera acanthifera*, that was much more abundant than the other subspecies.

## **II.3. Data processing**

### **II.3.A. General community descriptors**

Several parameters were regrouped under this term. Those included the number of individuals (N), of species (S) present in each sample, as well as community densities (*i.e.*, standardized abundance).

Community densities were expressed in number of individuals per square meter of meadow for hand-towed net samples. For litter samples, it was expressed in number of individuals per gram of dry mass (gDM) of litter and, when possible, in number of individuals per square meter of litter. Finally, for light traps, it was expressed in number of individuals per trap.

### II.3.B. Univariate diversity indexes

Diversity indexes are measures whose purpose is to reduce the specific composition of a biocenosis to one or a few single number(s). In doing so, they allow to characterize a complex and multivariate phenomenon by a few values that can easily be interpreted and manipulated (*e.g.* for statistical analyses). They are therefore useful proxies, and are widely used to assess biodiversity of communities (KREBS, 1999).

Three main groups of diversity indexes can be distinguished. The first one contains the **specific richness indexes** that consist in a standardized measure of the number of species found in the sample. The second one is composed of ***sensu stricto* diversity indexes** that take into account the number of species and the number of individuals of each of these species. The last group gathers **evenness indexes**. They take into account the number of species, the number of individuals of each species, and the way in which the individuals are distributed among the present species (JØRGENSEN *et al.*, 2005).

All the indexes used in this study were computed using the "DIVERSE" routine of PRIMER for Windows (v6.0).

#### II.3.B.a. Margalef's specific richness (d)

As its name implies, this index belongs to the first category of indexes. It is a measurement of the number of species found in the sample, standardized by the total number of individuals of the sample. It is written

$$d = \frac{S - 1}{\log(N)}$$

where  $S$  is the number of the species of the sample, and  $N$  the total effective of this sample. Margalef's  $d$  widely varies with sample size, in a non-linear way, and it is therefore not possible to directly compare samples of different sizes using this index (CLARKE & WARWICK, 2001).

#### II.3.B.b. Shannon-Wiener's diversity index (H')

This parameter is a *sensu stricto* diversity index, and therefore takes into account the number of species, as well as the effective of each species present in the sample. It is calculated using

$$H' = \sum_i p_i \cdot \ln(p_i)$$

where  $p_i$  is the proportion of the total effective belonging to the  $i$  species (*i.e.*, the number of specimens of the  $i$  species divided by the total number of specimens of the sample). The value of this index is minimal when the sample only contains one species. Its maximal value is theoretically infinite, because it increases with the number of species present in the sample. This maximal value is  $H'_{\max} = \ln(S)$ , with  $S$  being the number of species present in the sample (CLARKE & WARWICK, 2001).

As for Margalef's  $d$ , comparison of values of  $H'$  between samples of different size is not possible. A general scale however exists. It defines putatively objective and universally applicable classes of values. It is accepted by the "Water" framework directive (EU directive 2000/60) and can be found in table 3.1.

**Table 3.1:** Classes of  $H'$  values, as accepted by the 2000/60 directive (from JØRGENSEN *et al.*, 2005).

Inferior limit	Superior limit	$H'$ class
0	0.69	Very low
0.69	1.39	Low
1.39	2.08	Moderate
2.08	2.77	High
2.77	$\ln(S)$	Very high

### II.3.B.b. Pielou's evenness index ( $J'$ )

$J'$  belongs to the third class of diversity indexes, the evenness indexes. Evenness is a feature of a sample that described the way in which the abundances are distributed among the different species. An even sample is a sample where each species is represented by a comparable number of individuals, and where specific dominance phenomena are rare.

Pielou's index in fact compares observed diversity with maximal, theoretical diversity. It is written

$$J' = \frac{H'}{H'_{\max}} = \frac{H'}{\ln(S)} = \frac{\sum_i p_i \cdot \ln(p_i)}{\ln(S)}$$

with  $H'$  being the observed value of Shannon-Wiener's index,  $H'_{\max}$  the maximal possible value of Shannon-Wiener's index,  $p_i$  the relative proportion of the total effective of the sample belonging to the  $i$  species, and  $S$  the total number of species in the samples.

The minimum value of  $J'$  is 0, and its maximal value of 1 is reached when the same number of specimens are found for all species. As in the two previous cases, it is not possible to directly compare samples of different sizes (CLARKE & WARWICK, 2001).

### II.3.B.D. Simpson's evenness index ( $1-\lambda'$ )

$1-\lambda'$  also belongs to the evenness indexes family, and like Pielou's index, its values range from 0 to 1. It is calculated using

$$1-\lambda' = 1 - \left( \sum_i \frac{n_i \cdot (n_i - 1)}{N \cdot (N - 1)} \right)$$

where  $n_i$  is the number of individuals of the  $i$  species, and  $N$  the total effective of the sample. This index does not give any extra information relative to Pielou's  $J'$ , and the values of  $J'$  and  $1-\lambda'$  are usually close. However, an advantage of Simpson's index is that its variation with sample size is low. Samples of different sizes can therefore be compared.

### II.3.C. Hierarchized agglomerative clustering and SIMPER analyses

All necessary background information for these analyses can be found in chapter 2. It will therefore not be repeated here.

The hierarchical agglomerative clustering analysis from this chapter was realized using square root transformed, standardized abundances as input. The resemblance matrix was built by calculating Bray-Curtis similarity coefficients. The dendrogram was made using group-average linkage of pairs of samples.

In this chapter, three *a priori* 1-way SIMPER analyses were performed on square-root transformed, standardized abundances. The first one used the sampling method as categorizing factor, another used the season as categorizing factor, and the last one used the period of the day as categorizing factor. In each case, both intra-group similarity and inter-group dissimilarity breakdowns were realized.

### II.3.D. 2D ordination via non-metric multidimensional scaling

Hierarchize agglomerative clustering allows to group the samples according to the similarity, but does not represent the relationships between them on a continuous scale. In addition, it implies a number of shortcuts and approximations.

To understand the relations between our samples and to picture their variation patterns as accurately as possible, we therefore decided to conjugate clustering with an ordination method. An ordination is a map of the samples, generally in two or three dimensions. The position of the samples and the distances that separate them reflect the inter-sample similarity (*i.e.*, close samples share a high percentage of similarity). When insights drawn from the ordination match those of the clustering analysis, data interpretation is usually

intuitive and straightforward, and risks of misinterpretations are low (CLARKE & WARWICK, 2001).

One of the most reliable ordination techniques is the non-metric multidimensional scaling (NMMDS). This technique is based on an iterative procedure. For a given number of dimensions, a high number of iterations are computer-generated. Each of these iterations corresponds to a possible ordination. A “stress” value is calculated for each attempt. This stress is in fact a way to express the error associated to the ordination procedure, *i.e.* the mismatch between theoretical inter-sample similarities and actual distances between those samples, measured on the ordination. The iteration that shows the lowest stress value is then considered as being the best way to map the samples.

In this study, we performed a 2D NMMDS using the “MDS” routine of PRIMER for Windows (v6.0). We used square-root transformed, standardized abundances as input. The resemblance matrix was built by calculating Bray-Curtis similarity coefficients. The number of iterations was set to 50, and the minimum stress level at 0.01.

### **III. Results**

#### **III.1. General descriptors and univariate indexes**

In total, 3670 amphipods have been collected and identified to species level (with a few exceptions, see section II.2). We catalogued 45 different species, distributed over 25 different families. The detailed composition of each sample can be found in table 3.II.

**Table 3.II:** Full composition of the analyzed samples. Each sample is abbreviated with a three-letter code, the first one standing for the sampling method (T=light traps, N=hand-towed net, L=Litter collection), the second one for the sampling period (D=day, N=night) and the third one for the sampling season (N=November 06, M=March 07, J=June 07).

The number before each species corresponds to the family to whom it belongs. 1: Ampeliscidae, 2: Amphilochidae, 3: Amphithoidae, 4: Aoridae, 5: Calliopidae, 6: Caprellidae, 7: Corophidae, 8: Dexaminidae, 9: Eusiridae, 10: Gammaridae, 11: Hyalidae, 12: Iphimediidae, 13: Isaeidae, 14: Ischyroceridae, 15: Leucothoidae, 16: Lysianassidae, 17: Megalurotidae, 18: Melitidae, 19: Oedicerotidae, 20: Opisidae, 21: Phoxocephalidae, 22: Phtisicidae, 23: Stenothoidae, 24: Uristidae, 25: Urothoidae.

## Structure and dynamics of communities

	Species	TN	TM	TJ	NDN	NDM	NDJ	NNN	NNM	NNJ	LDN	LDM	LDJ	LNN	LNM	LNJ
1	<i>Ampelisca rubella</i>	1	1	4	0	0	0	0	0	0	6	5	6	4	1	5
	<i>Amphilochus neapolitanus</i>	0	2	9	0	1	2	3	3	21	0	0	0	0	0	0
2	<i>Amphilochus manudens</i>	0	0	2	0	0	0	0	0	3	0	0	0	0	0	0
	<i>Peltocoxa marioni</i>	0	0	0	0	0	0	0	1	0	0	0	0	0	0	0
3	<i>Amphithoe helleri</i>	4	1	29	1	0	1	2	0	39	4	0	1	6	0	7
	<i>Aora gracilis</i>	0	0	2	0	0	2	0	1	4	1	0	0	0	0	0
4	<i>Aora spinicornis</i>	3	6	69	2	0	4	43	7	101	5	0	4	4	0	2
	<i>Apherusa chierighinii</i>	15	14	129	35	15	41	231	539	788	12	7	14	6	2	4
5	<i>Apherusa</i> sp. - damaged	0	0	0	11	4	9	22	13	16	1	0	1	0	0	0
	<i>Apherusa</i> sp. - juveniles	2	11	22	2	3	4	17	54	21	2	0	0	0	0	0
	<i>Caprella acanthifera acanthifera</i>	0	41	46	0	1	12	3	0	47	2	1	2	6	1	0
6	<i>Caprella acanthifera discrepans</i>	0	0	1	0	0	1	0	0	2	0	0	0	0	0	0
	<i>Caprella equilibra</i>	0	0	2	1	0	1	0	1	1	0	0	1	0	0	0
7	<i>Corophium acutum</i>	0	0	0	0	0	0	0	0	1	1	0	0	0	0	0
	<i>Atylus guttatus</i>	5	13	14	0	0	0	0	0	0	0	1	0	0	0	0
	<i>Atylus massiliensis</i>	2	5	2	0	0	0	0	0	0	0	0	2	0	0	0
	<i>Atylus vedlomensis</i>	0	0	0	0	0	0	0	0	0	0	0	1	0	1	0
8	<i>Dexamine spiniventris</i>	5	6	53	1	0	5	19	3	91	0	0	3	2	0	0
	<i>Dexamine spinosa</i>	1	4	20	0	0	2	7	2	24	0	0	0	0	0	0
	<i>Dexamine</i> sp. - juveniles	0	0	47	0	0	3	0	0	67	0	0	2	0	0	2
	<i>Guernea coalita</i>	0	4	7	0	0	1	0	0	2	0	0	0	0	0	0
9	<i>Eusiroides dellavallei</i>	0	0	0	0	0	0	0	0	0	0	0	0	1	0	0
	<i>Gammarus crinicornis</i>	0	0	2	0	0	1	0	0	2	0	0	2	0	0	1
10	<i>Gammarus insensibilis</i>	0	0	4	0	0	0	0	0	0	0	0	2	0	0	0
	<i>Gammarus aequicauda</i>	0	12	24	0	0	3	0	0	7	0	0	9	0	0	4
11	<i>Hyale schmidtii</i>	0	0	4	0	0	3	0	0	36	0	0	0	0	0	1
12	<i>Iphimedia minuta</i>	0	0	0	0	0	0	3	4	5	2	0	0	0	0	0
13	<i>Gammaropsis maculata</i>	2	0	0	0	0	0	0	0	0	2	0	0	0	0	0

	Species	TN	TM	TJ	NDN	NDM	NDJ	NNN	NNM	NNJ	LDN	LDM	LDJ	LNN	LNM	LNJ
14	<i>Ischyrocercus inexpectatus</i>	0	0	0	1	0	0	0	0	0	0	0	0	0	0	0
	<i>Microjassa cumbrensis</i>	0	0	0	0	0	0	0	0	0	0	1	0	0	0	0
15	<i>Leucothoe spinicarpa</i>	0	0	0	0	0	0	1	1	0	0	0	0	0	1	0
	<i>Hippomedon massiliensis</i>	5	0	0	0	0	0	0	0	0	0	0	0	0	0	0
	<i>Hippomedon oculatus</i>	8	0	0	0	0	0	0	0	0	0	0	0	0	0	0
16	<i>Lysianassa costae</i>	0	0	2	0	0	0	0	0	0	0	0	0	0	0	0
	<i>Orchemene similis</i>	0	5	9	0	0	0	0	0	0	0	0	0	0	0	1
	<i>Orchemene humilis</i>	12	1	25	0	0	0	1	0	0	0	0	0	0	1	0
17	<i>Megaluropus massiliensis</i>	0	0	0	0	0	1	0	1	9	0	0	1	0	0	0
18	<i>Gammarella fucicola</i>	0	2	26	0	0	1	0	0	3	4	2	11	6	2	13
	<i>Monoculodes griseus</i>	0	1	0	0	0	0	0	0	0	0	0	0	0	0	0
19	<i>Periculodes aequimanus</i>	7	8	12	0	0	0	4	0	0	0	0	0	0	0	0
	<i>Synchelidium haplocheles</i>	1	0	0	0	0	0	0	0	0	0	0	0	0	0	0
	<i>Synchelidium longidigitatum</i>	1	0	11	0	0	0	0	0	0	0	0	0	0	0	0
20	<i>Normanion chevreuxi</i>	14	5	19	0	0	0	1	1	2	0	0	1	0	1	1
21	<i>Metaphoxus simplex</i> ♂	2	1	0	0	0	0	0	1	1	0	0	0	0	0	0
22	<i>Phthisica marina</i>	0	2	7	1	1	6	2	1	34	1	0	2	4	0	1
23	<i>Stenothoe cavimana</i>	0	3	0	0	0	0	0	0	0	0	0	0	0	0	0
24	<i>Tmetonyx nardonis</i>	7	0	22	0	0	0	0	8	0	0	0	0	0	0	0
25	<i>Urothoe elegans</i>	0	0	2	0	0	0	0	0	0	0	0	0	0	0	0
	Undetermined	5	0	4	4	2	3	16	9	19	7	0	1	1	0	1
	<b>Total</b>	<b>102</b>	<b>148</b>	<b>631</b>	<b>59</b>	<b>27</b>	<b>106</b>	<b>375</b>	<b>650</b>	<b>1346</b>	<b>50</b>	<b>17</b>	<b>66</b>	<b>40</b>	<b>10</b>	<b>43</b>

## Structure and dynamics of communities

Tables 3.III and 3.IV give, for each sample, the values of general community descriptors (number of individuals and species, community density) and of the univariate diversity indexes.

**Table 3.III:** Number of individuals (N), number of species (S), and values of diversity indexes ( $d$ ,  $H'$ ,  $J'$ , and  $1-\lambda'$ ) for each sample. The asterisk next to the light trap sample of June 07 reminds of the different methodology used for this season.

Method	Season	Period	N	S	$d$	$H'$	$J'$	$1-\lambda'$
Net	11/2006	Day	55	8	1.96	1.29	0.59	0.60
		Night	349	14	2.36	1.40	0.52	0.59
	03/2007	Day	25	5	1.52	1.24	0.69	0.64
		Night	641	16	2.48	0.68	0.25	0.28
	06/2007	Day	103	19	4.07	2.24	0.75	0.82
		Night	1327	24	3.33	1.72	0.54	0.64
Litter	11/2006	Day	43	12	3.07	2.30	0.89	0.89
		Night	39	10	2.44	2.16	0.94	0.90
	03/2007	Day	17	5	1.76	1.48	0.82	0.76
		Night	10	7	3.04	2.03	0.97	0.96
	06/2007	Day	65	18	4.30	2.51	0.85	0.90
		Night	42	12	3.19	2.16	0.84	0.86
Light traps	11/2006	Night	97	19	4.11	2.69	0.90	0.92
	03/2007	Night	148	21	4.20	2.57	0.83	0.89
	06/2007*	Night	627	31	4.81	2.85	0.82	0.92

**Table 3.IV:** Community density estimate. Units differ the hand-towed net (number of individuals per  $m^2$  of meadow), litter collection (number of individuals per gram of dry mass of litter and, when applicable, number of individuals per  $m^2$  of litter) or light traps (number of individuals per trap). The asterisk next to the light trap sample of June 07 reminds of the different methodology used for this season.

Season	Period	Sampling method			
		Net (Ind. $m^{-2}$ )	Litter (Ind.gDM $^{-1}$ )	Litter (Ind. $m^{-2}$ )	Light traps (Ind.trap $^{-1}$ )
November	Day	6.55	0.65	-	-
	Night	41.67	0.54	-	12.75
March	Day	3.00	0.61	11.3	-
	Night	72.22	0.18	7.1	18.50
June	Day	11.78	0.68	165	-
	Night	149.55	0.45	86	78.87*



### III.1.A. Hand-towed net samples

The hand-towed net was the most efficient method used in this study. In 6 samples, 2563 amphipods (69.8 % of the total N of the study), belonging to 28 (62.2 % of the total S) species were collected. 2.1 % of these amphipods were too damaged to be precisely identified.

For each season, it was easy to notice that values of all **general community descriptors** are higher in nighttime samples than in the daytime ones. Night samples contained much more individuals (6-fold increase of community density for November, 25-fold increase for March and 12-fold increase for June) but also more species than day samples.

Seasonal variation was not as clear as nycthemeral changes. June samples contained much more amphipods (higher N and S) than the two other seasons. However, no consistent differences could be highlighted concerning the differences between the samples from March and November. Community density is indeed higher in November during daytime, but the opposite can be said for nighttime. Moreover, while S is lower in March for daytime, it is relatively similar for the two seasons at nighttime.

Margalef's d values were relatively low in March and November. In these two seasons, d showed a nocturnal increase. On the other hand, in June, d values were notably higher, and were lower during the night.

H' values could be classified as moderate or high for June (see point II.3.B.b.), but low or very low for November and March. Community diversity therefore seemed higher in late spring than in other seasons.

H' values were higher in daytime samples for March and June, but an opposite trend was seen in November.

Both evenness indices ( $J'$  and  $1-\lambda'$ ) generally had low values, except for the day sample of June 07. In March and June, values of  $J'$  and  $1-\lambda'$  were lower during the night, indicating a greater dominance of the most abundant taxa during this period.

### III.1.B. Litter samples

In total, the 6 litter samples contained 226 amphipods (6.2 % of total N), distributed over 27 species (60.0 % of total S). 4.4 % of these animals were damaged and therefore unidentifiable.

The total sample sizes differed between seasons, and sometimes between periods of the day. In November, it was 76.7 g DM for the daytime sample, and 73.8 g DM for nighttime sample. In March, it was 28 g DM for the daytime sample, but nearly twice higher for the nighttime sample (54.2 g DM). In June, sample sizes were 97.01 g DM (day) and 95.45 g DM (night).

---

 Structure and dynamics of communities

Most of the parameters considered here ( $N$ ,  $S$ ,  $d$ ,  $H'$  and  $J'$ , see section II.3.B) are subject to sample-size related variations. Sample of different sizes could therefore not be compared directly, at least for these variables.

In November, the diurnal sample contained more individuals and species, and had a slightly higher community density than the nocturnal one. Margalef's  $d$  was also moderately higher during the day, but values of  $J'$  and  $1-\lambda'$ , very high in both cases, were similar.  $H'$  values were also comparable, and high in the two samples.

In March, the day/night variation of the community density was more marked than in November. For the daytime sample,  $d$  was relatively low, and  $H'$  was moderate. On the other hand, evenness indexes both had quite high values. For the nighttime sample,  $H'$  was moderate to high, and evenness was very high ( $J'$  and  $1-\lambda'$  values close to 1).

The nocturnal sample of June 07 had lower values of  $N$ , of community density, of  $S$ , and of  $d$ .  $H'$  was also lower, although both samples were found in the "high" class.  $J'$  and  $1-\lambda'$  values were high and did not show day/night variation.

Seasonal changes in community density expressed in  $\text{ind.gDM}^{-1}$  were unclear. Daytime estimates are comparable in November, March and June. However, nighttime estimates were much lower in March than in June or November. Values of the same parameter, but expressed in  $\text{ind.m}^{-2}$  showed a strong increase from March to June, in both periods.

### III.1.C. Light traps

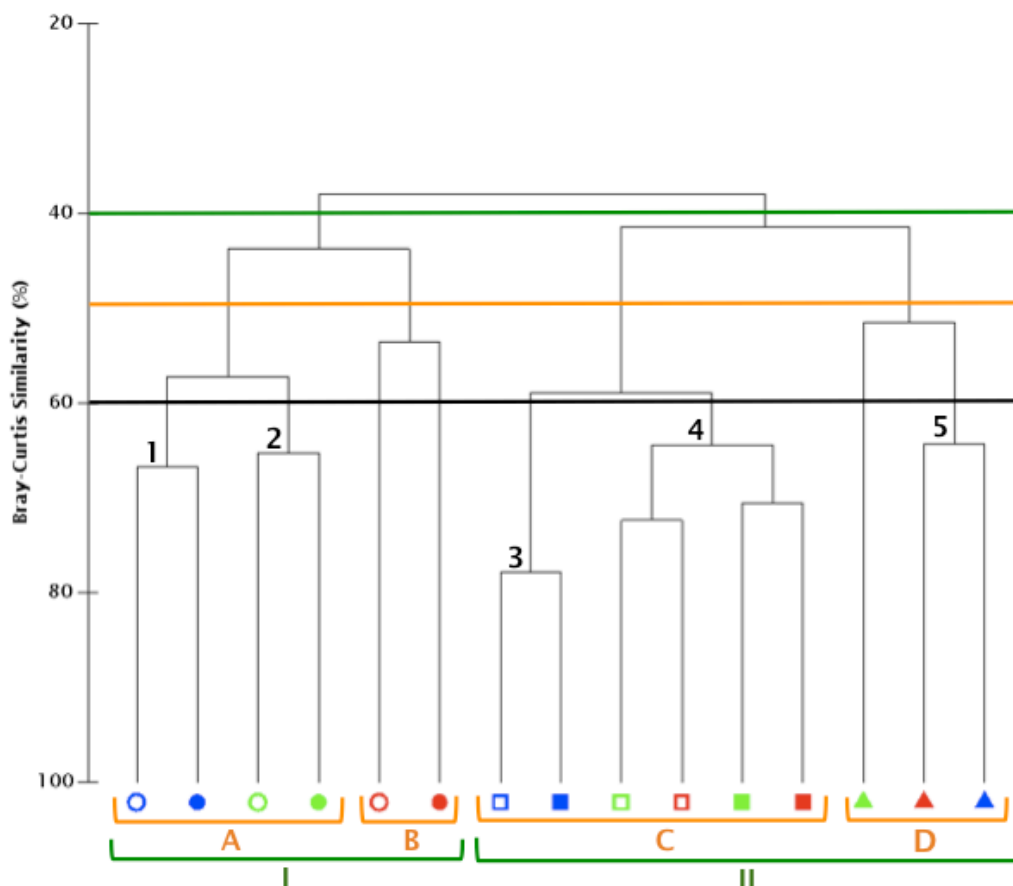
Light traps only allowed night sampling. Unfruitful trials have indeed proved that they are completely inefficient during the day (data not shown). Nevertheless, in total, we collected 881 amphipods (24.0 % of total  $N$ ) belonging to 36 different species (80.0 % of total  $S$ ) using this method. 1.0 % of these amphipods could not be identified due to physical damage.

Since the design of the traps used has changed, it was unfortunately impossible to directly compare the samples of June with those of March or November.

The March sample had a higher  $N$ , and therefore a higher community density, than the November one. However, values for all other parameters were very similar. Values of  $d$ ,  $H'$ ,  $J'$  and  $1-\lambda'$  were high in both cases.

The June sample was the single sample containing the most species from all our study ( $S=31$ ), and also had a very high  $d$ . Evenness indexes both showed high values, and the  $H'$  could be classified as "very high".

### III.2. Hierarchized agglomerative clustering



**Fig. 3.1:** Dendrogram of the samples obtained by hierarchized agglomerative clustering, using group-average linkage of Bray-Curtis similarities computed on square-root transformed, standardized abundances

Each sample is pictured by a symbol. Different shapes of symbols indicate different sampling methods (squares: hand-towed net, circles: litter collection, triangles: light traps). Different colors of symbols indicate different sampling seasons (light green: November 06, red: March 07, Blue: June 07). Open symbols indicate daytime sampling, and solid symbols indicate nighttime sampling.

The Y-axis is the level of relative inter-sample Bray-Curtis similarity (expressed in percentage). Solid dark green line indicates a similarity level of 40 %, and dark green brackets and Roman numerals designate clusters sharing more than 40 % of similarity. Solid orange line indicates a similarity level of 50 %, and orange brackets and capital letters designate clusters sharing more than 50 % of similarity. Solid black line indicates a similarity level of 60 %, and clusters designated by black Arabic numerals share more than 60 % of similarity.

To understand the relations between the samples, and to highlight the factors responsible for their differences and similarities, we performed a hierarchized agglomerative clustering analysis. The resulting dendrogram is pictured in figure 3.1 (previous page).

Overall similarity was rather low, and few clusters shared more than 70 % of resemblance. This indicates an important inter-sample variability.

A cut-off at 40 % of similarity (dark green lines and brackets on fig. 3.1) separated the samples in two main groups. The first group (numbered I) contained all litter samples (circles) that shared 43.68 % of similarity. The other group, numbered II, regrouped samples collected by hand-towed net (squares) and light traps (triangles), which shared 41.33 % of similarity.

At 50 % of similarity (orange lines and brackets on fig. 3.1), cluster I subdivided in two. Cluster A (57.19 % of similarity) grouped litter samples from June and November (blue and green circles), while cluster B (53.46 % of similarity) contained those from March (red circles).

Cluster II also subdivided in two at this level of similarity. Cluster C contained all the hand-towed net samples (squares, 58.84 % of similarity), while cluster D consisted only of the three light traps samples (triangles, 51.38 % of similarity).

Placing the cut-off at 60 % of similarity (black lines and Arabic numerals on fig. 3.1) allowed delineating 5 clusters. Two of them were parts of cluster A: the cluster 1 (litter samples from June, 66.63 % of similarity) and 2 (litter samples from November, 65.16 % of similarity). The cluster D (light traps samples) refined in cluster 5, therefore separating light trap samples from March and June (red and blue triangles, respectively) that shared more resemblance with each other (64.2 %) than they did with the light trap sample from November (green triangle).

Finally, cluster C (hand-towed net samples) further divided in two clusters. The cluster 3 (77.81 % of similarity, *i.e.* the more resembling pair of samples of our study) contained the night (solid blue square) and day (open blue square) of June 08. The cluster 4 (64.32 % of similarity) contained hand-towed net samples from March and November. This cluster could be subdivided in two, but in this case, the discriminating factor was not the season, but the period of the day. Night samples of November (solid green square) and March (solid red square) indeed shared more similarity with each other than day samples of their respective seasons (open green and red squares, respectively).

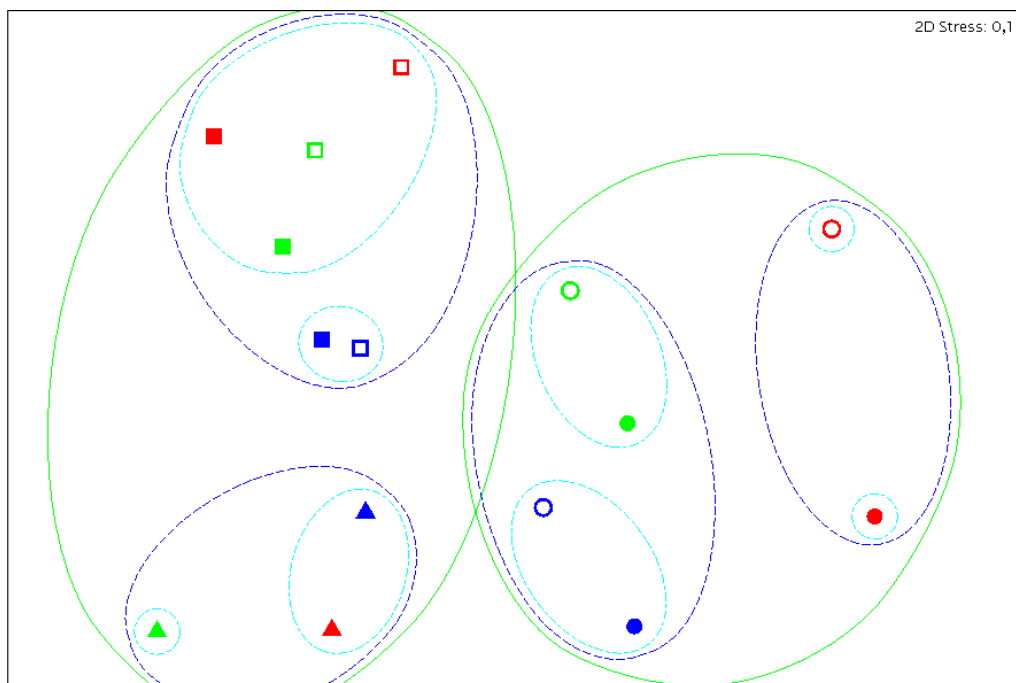
Overall, the main factor explaining the differences between our samples clearly seemed to be the sampling method, as samples from different methods were readily separated by the clustering analysis.

The importance of other factors depended on the considered method. For litter samples, seasonal variation seemed more important than day/night changes in the structure of the communities. For the hand-towed net samples, the situation was less clear. June samples were very similar, and well separated

from the others, suggesting that seasonal variation occurred. On the other hand, in March and November, the day/night variability seemed more important than the one caused by the sampling season.

The amount of “intra-method” variability also differed from one case to another. It was the highest for litter samples (43.68 % of similarity), intermediate for light traps samples (51.68 % of similarity) and the lowest for hand-towed net samples (58.84 % of similarity).

### III.3. Bidimensional ordination (Non-metric MDS)



**Fig. 3.2:** 2D ordination of samples obtained via non-metric multidimensional scaling, using Bray-Curtis similarities computed on square-root transformed, standardized abundances.

Each sample is pictured by a symbol. Different shapes of symbols indicate different sampling methods (squares: hand-towed net, circles: litter collection, triangles: light traps). Different colors of symbols indicate different sampling seasons (light green: November 06, red: March 07, Blue: June 07). Open symbols indicate daytime sampling and solid symbols indicate nighttime sampling.

Samples are grouped according to their level of similarity. Solid green lines indicate 40 % of similarity, dashed dark blue lines indicate 50 % of similarity, and dashed turquoise blue lines indicate 60 % of similarity.

In order to assess the adequacy of the relations between samples that were highlighted by the clustering analysis, we performed an ordination of our samples using non-metric multidimensional scaling (NMMDS). This ordination is pictured in figure 3.2 (previous page).

The stress value associated with our 2D NMMDS was 0.1. This value was relatively low, ensuring that the ordination can be regarded as satisfying, and that the risk of data misinterpretation was small.

To facilitate the examination of inter-samples relationships, we superposed to figure 3.2 the arbitrary level of similarities that were used in section 3.2. (40, 50 and 60 %). It was then easy to notice that the trends delineated by the NMMDS exactly matched those highlighted by the clustering analysis. Each clusters from figure 3.1 could be matched with a group on figure 3.2.

As in the previous section, the main factor that drove the relative position of each sample was the sampling method. Moreover, the litter samples (circles) were more scattered than the hand-towed net (squares) and light traps (triangles) samples, emphasizing higher variability in this method. The seasonal and/or day/night variations also corresponded to the pattern described by the clustering analysis. For concision's sake, they will not be repeated here. The correspondence of the results obtained via these two independent technique stresses the reliability of the inter-samples relationships as they are depicted here.

### **III.4. Highlighting indicator species**

#### **III.4.A. Descriptive analysis**

Table 3.V displays the relative abundance of dominant species for all the samples, as well as for each method, season or period of the day taken separately.

*Apherusa chiereghinii* was the most abundant species in all the categories. More than half of the total of the collected amphipods belonged to this species. The extent of this dominance varied widely according to the considered group of samples. It was notably high for samples collected using the hand-towed net, at night and in March 2007.

Other very abundant species included *Aora spinicornis*, *Dexamine spiniventris* and *Caprella acanthifera acanthifera*. These species, even if they were much less prevalent than *A. chiereghinii*, were very common in most categories. These 4 species alone summed up for two thirds (66.8 %) of the collected amphipods.

The inter-method comparison reveals that some species seemed to be abundant only in the litter samples. Those included *Gammarella fucicola*, *Ampelisca rubella* and *Amphithoe helleri*.

On the other hand, lysianassoid amphipods *Normanion chevreuxi* and *Orchomene humilis* were abundant in the light trap samples, but rare in those

**Table 3.V:** Relative abundances (expressed in percentage of the total effective of the category) of dominant species of the studied community. Top part display values for all the samples. Second, third and fourth part give values for each sampling method, season and period, respectively.

*A. chiereghinii*: *Apherusa chiereghinii* ; *A. helleri*: *Amphithoe helleri* ; *A. rubella*: *Ampelisca rubella* ; *A. spinicornis*: *Aora spinicornis* ; *Apherusa* sp. (dam.): damaged individuals of the genus *Apherusa* ; *Apherusa* sp. (juv.) : juvenile individuals from the genus *Apherusa* ; *C. acanthifera*: *Caprella acanthifera acanthifera* ; *D. spiniventris*: *Dexamine spiniventris* ; *Dexamine* sp. (juv.): juvenile individuals from the genus *Dexamine* ; *G. aequicauda*: *Gammarus aequicauda* ; *G. fucicola*: *Gammarella fucicola* ; *N. chevreuxi*: *Normanion chevreuxi* ; *O. humilis*: *Orchomene humilis*.

TOTAL	Species	%
	<i>A. chiereghinii</i>	50.46
	<i>A. spinicornis</i>	6.81
	<i>D. spiniventris</i>	5.12
	<i>C. acanthifera</i>	4.41

METHOD	Net		Litter		Traps	
	Species	%	Species	%	Species	%
	<i>A. chiereghinii</i>	64.34	<i>A. chiereghinii</i>	19.91	<i>A. chiereghinii</i>	17.93
	<i>A. spinicornis</i>	6.13	<i>G. fucicola</i>	16.81	<i>C. acanthifera</i>	9.87
	<i>D. spiniventris</i>	4.64	<i>A. rubella</i>	11.95	<i>A. spinicornis</i>	8.85
			<i>A. helleri</i>	7.96	<i>D. spiniventris</i>	7.26
			<i>A. spinicornis</i>	6.64	<i>Dexamine</i> sp. (juv.)	5.33
			<i>G. aequicauda</i>	5.75	<i>N. chevreuxi</i>	4.31
			<i>C. acanthifera</i>	5.31	<i>O. humilis</i>	4.31
					<i>G. aequicauda</i>	4.08

SEASON	November		March		June	
	Species	%	Species	%	Species	%
	<i>A. chiereghinii</i>	47.76	<i>A. chiereghinii</i>	67.72	<i>A. chiereghinii</i>	44.52
	<i>A. spinicornis</i>	9.10	<i>Apherusa</i> sp. (juv.)	7.98	<i>A. spinicornis</i>	8.21
	<i>Apherusa</i> sp. (dam.)	5.43	<i>C. acanthifera</i>	5.16	<i>D. spiniventris</i>	6.93
	<i>D. spiniventris</i>	4.31			<i>Dexamine</i> sp. (juv.)	5.52
					<i>C. acanthifera</i>	4.88

PERIOD	Day		Night	
	Species	%	Species	%
	<i>A. chiereghinii</i>	38.15	<i>A. chiereghinii</i>	51.66
	<i>Apherusa</i> sp. (dam.)	8.00	<i>A. spinicornis</i>	7.02
	<i>C. acanthifera</i>	5.54	<i>D. spiniventris</i>	5.35
	<i>G. fucicola</i>	5.54	<i>C. acanthifera</i>	4.30
	<i>A. rubella</i>	5.23		
	<i>A. spinicornis</i>	4.61		

collected with other methods. *Gammarus aequicauda* was common in light traps and litter samples, but rare in the hand-towed net ones.

---

 Structure and dynamics of communities

Besides this, 2 infrequent species (*Peltocoxa marioni* and *Ischyrocerus inexpectatus*, only one collected individual each) were exclusively present in hand-towed net samples. 3 equally rare species were found only in litter samples: *Atylus vedlomensis* (2 inds.), *Eusiroides dellavallei* (1 ind.) and *Microjassa cumbrensis* (1 ind.).

Contrastingly, for the light traps, the number of exclusive taxa was higher (8 taxa), and some were more frequent. These species were *Synchelidium longidigitatum* (12 inds.), *Hippomedon oculus* (8 inds.), *Hippomedon massiliensis* (5 inds.), *Stenothoe cavimana* (3 inds.), *Lysianassa costae* (2 inds.), *Urothoe elegans* (2 inds.), *Synchelidium haplocheles* (1 ind.) and *Monoculodes griseus* (1 ind.).

Inter-seasons and inter-periods differences were less clear, and it was difficult to highlight indicator species for these categories. However, it is interesting to note that juveniles of *Apherusa* sp. were prevalent in March, while juveniles of *Dexamine* sp. were abundant in June.

### III.4.B. SIMPER analyses

In parallel with the descriptive analysis, we performed several 1-way SIMPER (SIMilarity PERcentage) to highlight species responsible for intra-category resemblance, or explaining inter-category differences.

#### III.4.B.a. Categorization by sampling season or period

Inter-seasons or inter-periods SIMPER analyses were rather inconclusive. In either case, no single taxon could explain more than 6 to 7 % of the inter-group dissimilarity. Moreover,  $\bar{\delta}$  /SD ratios were always low, and never exceeded 2.

In addition, no strong typifiers of a given season or period could be identified. Mean contributions to intra-group similarity were sometimes high (up to 50 % in some cases), but the  $\bar{\delta}$  /SD ratios were always low (never > 2).

Differences between seasons or periods of the day could therefore not be linked with variations in the abundance of single species. For concision's sake, the detailed results of these analyses are not displayed here.

#### III.4.B.b. Categorization by sampling method

Results of SIMPER intra- and inter-group analysis are given in tables 3.VI and 3.VII

Two taxa could be seen as typifiers for hand-towed net samples: *Apherusa chiereghinii* and, to a lesser extent, juveniles individuals of the genus *Apherusa*. Taken together, these taxa explained 65.3 % of the similarity between samples collected using the hand-towed net.



**Table 3.VI:** Results of the 1-way intra-group SIMPER analysis of samples using categorization by sampling method. For each method, the table gives the average intra-group similarity, and lists the species best explaining this intra-group similarity. For each of these, relative  $\bar{\delta}_i$  (%) and  $\bar{\delta}_i/SD_i$  are given between brackets.

Method	Similarity (%)	Typifying species ( $\bar{\delta}_i$ , $\bar{\delta}_i/SD_i$ )
Hand-towed net	63.2	<i>Apherusa chiereghinii</i> (42.7 %, 4.6) <i>Apherusa</i> sp. (juveniles) (16.6 %, 2.39)
Litter collection	50.9	<i>Apherusa chiereghinii</i> (24.9 %, 4.5) <i>Gammarella fucicola</i> (22.2 %, 5.5) <i>Ampelisca rubella</i> (20.3 %, 7.2)
Light traps	55.7	<i>Apherusa chiereghinii</i> (13.8 %, 8.84)

**Table 3.VII:** Results of the 1-way inter-group SIMPER analysis of samples using categorization by sampling method. For each pair of methods, the table gives the average inter-group dissimilarity, and lists the species most contributing to this inter-group dissimilarity. For each of these, relative  $\bar{\delta}_i$  (%) and  $\bar{\delta}_i/SD_i$  are given between brackets.

METHOD	Litter	Traps
Net	62.5 % <i>Gammarella fucicola</i> (10.7 %, 3.4) <i>Ampelisca rubella</i> (10.3 %, 2.8)	58.7 % <i>Apherusa chiereghinii</i> (9.6 %, 2.9)
Litter	-	61.4 % <i>Gammarella fucicola</i> (6.6 %, 2.4) <i>Ampelisca rubella</i> (6.1 %, 2.5)

*Apherusa chiereghinii* also was a typifying species for the litter samples, alongside *Gammarella fucicola* and *Ampelisca rubella*. Those 3 species were responsible for 67.4 % of the similarity between litter samples.

Light traps sample, on the other hand, didn't seem to have any typifiers other than the ubiquitous *Apherusa chiereghinii*.

Interestingly, *Gammarella fucicola* and *Ampelisca rubella*, in addition of being typifying species of litter samples, were also the most useful to explain differences between litter and hand-towed net samples or, to a lesser extent, between litter and light traps samples. These species were indeed abundant in the litter, but scarce in samples collected using other methods.

Overall dissimilarity between light traps and hand-towed net samples was high, but could hardly be linked with patterns of abundance of single species. The only moderate discriminator was *Apherusa chiereghinii*, which was more abundant in net-collected samples.

## IV. Discussion

### IV.1. Structure and variation of the studied community

Section III clearly points out that results yielded by the three methods do not fully agree. In addition, multivariate analyses (Clustering, NMMDS) show that the sampling method is the most useful variable to explain differences between samples. We therefore chose to examine each method separately, and to compare them later.

#### IV.1.A. Hand-towed net samples

The hand-towed net was the most efficient of the methods, and allowed collection of a large number of amphipods. However, samples had relatively low diversity, specific richness and evenness. This could be explained by the fact that the hand-towed net is only efficient to collect species that are associated with the foliar stratum. The depicted community could therefore be a “sub-sample” of the actual community of amphipods associated to *Posidonia oceanica* meadows.

Nevertheless, the hand-towed net is by far the most commonly used method to sample vagile invertebrates of the studied ecosystem. It has been used in studies realized on Italian (*e. g.* SCIPIONE & FRESI, 1984 ; MAZZELLA *et al.*, 1989 ; GAMBI *et al.*, 1992 ; SCIPIONE *et al.*, 1996 ; SCIPIONE & ZUPO, 2010), Spanish (SÁNCHEZ-JEREZ *et al.*, 1999b, 1999a, 2000), continental French (LEDOYER, 1968, 1969) and even Corsican (DEGARD, 2004) coasts.

Important **day/night variation** of the samples was noted, especially in March and November, where nycthemeral variability exceeded the seasonal one (see figures 3.1 and 3.2). Moreover, in all seasons, more amphipods belonging to more different species were collected during the night (table 3.III and 3.IV). When all seasons were considered together, a more than 10-fold increase of community density was noted during the night (87.8 ind.m<sup>-2</sup>, vs. 7.1 ind.m<sup>-2</sup> during the day).

**Table 3.VIII:** Essential data of studies assessing day/night variation of communities of amphipods from *Posidonia oceanica* meadows using the hand-towed net method. For each study, table gives the date (month/year), sampling depth and location, the ratio between day/night abundances (N) and number of species (S), and the dominant species (and their relative abundance, expressed in percentage of the total N of the sample). References: [1]: Ledoyer (1969); [2]: Sanchez-Jerez *et al.* (1999b); [3]: Degard (2004) (2 different sampling sites); [4]: This study.

Date [Ref]	Depth (m)	Location	N (night/day ratio)	S (night/day ratio)	Dominant species	
					Day (% of total N)	Night (% of total N)
09/1965 [1]	9	Marseille (FR)	7.3	3.4	<i>Apherusa bispinosa</i> (66.7) <i>Aora typica</i> (13.8)	<i>Apherusa bispinosa</i> (60.1) <i>Aora typica</i> (26.2)
06/1966 [1]	9	Marseille (FR)	19.8	5.3	<i>Aora typica</i> (55.6) <i>Apherusa bispinosa</i> (22.2) <i>Dexamine spinosa</i> (22.2)	<i>Dexamine spinosa</i> (33.1) <i>Apherusa bispinosa</i> (17.4) <i>Aora typica</i> (12.9) <i>Dexamine spiniventris</i> (12.9)
05/1996 [2]	10-12	Alicante (ES)	4.5	-	-	-
03/2004 [3]	7	Calvi (FR)	3.8	5.3	<i>Apherusa</i> sp. (80) <i>Amphiloachus neapolitanus</i> (12.9) <i>Dexamine spinosa</i> (7)	<i>Apherusa</i> sp. (48.2) <i>Apherusa chiereghinii</i> (20.1) <i>Amphiloachus neapolitanus</i> (15.5) <i>Aora spinicornis</i> (8.2)
03/2004 [3]	7	Calvi (FR)	3.8	2.9	<i>Apherusa</i> sp. (64.5) <i>Dexamine spinosa</i> (12.5) <i>Amphithoe helleri</i> (8.33)	<i>Apherusa</i> sp. (31.8) <i>Apherusa chiereghinii</i> (18.5) <i>Aora spinicornis</i> (12.1) <i>Amphiloachus neapolitanus</i> (11.3)
11/2006 [4]	10	Calvi (FR)	6.4	1.7	<i>Apherusa chiereghinii</i> (59.3) <i>Apherusa</i> sp. (22)	<i>Apherusa chiereghinii</i> (61.6) <i>Aora spinicornis</i> (11.5)
03/2007 [4]	10	Calvi (FR)	25.6	3.2	<i>Apherusa chiereghinii</i> (55.6) <i>Apherusa</i> sp. (25.9)	<i>Apherusa chiereghinii</i> (82.9) <i>Apherusa</i> sp. (10.3)
06/2007 [4]	10	Calvi (FR)	12.9	1.3	<i>Apherusa chiereghinii</i> (38.7) <i>Apherusa</i> sp. (12.3) <i>Caprella acanthifera</i> (11.3)	<i>Apherusa chiereghinii</i> (61.6) <i>Aora spinicornis</i> (11.5)

This phenomenon has already been reported by a number of previous workers. Essential data from these studies are presented, alongside ours, in table 3.VIII (next page).

Table 3.VIII show that the nocturnal increase of abundance (N) that we recorded was high, particularly in March 2007. The increase of the number of species (S), on the other hand, was relatively low. However, in both cases, our results are comparable to previous findings, and values are found in similar overall ranges.

This nycthemeral variation is likely explained by a greater nocturnal activity of amphipods. This activity increase has been proved experimentally in several, amphipod taxa living in various environments (BELLAN-SANTINI, 1999). In the case of seagrass meadow, it has been described as a mechanism of predation avoidance.

A lot of predators of vagile invertebrates are fish (*Labrus merula*, *Symphodus rostratus*, etc.). These fish mostly feed during the day, and hunt their prey using visual stimuli (BELL & HARMELIN-VIVIEN, 1983). Amphipod crustaceans, like other groups of vagile invertebrates, would have developed a mechanism of vertical migration as a behavioural strategy to avoid this predation. During the day, they would preferentially stay in the lower layers of the meadow (rhizomes, matte). They would only rise to the foliar stratum, where they are more vulnerable, during the night, when predation pressure is lower (LEDOYER, 1969). Moreover, these vertical migrations could also limit the competition for food or habitat, by allowing the animals to exploit available resources in all compartments (foliar stratum, rhizome layer and litter cover) (SÁNCHEZ-JEREZ *et al.*, 1999b).

It is also interesting to note (table 3.VIII) that the dominant species are generally the same in day and night samples. Moreover, among these taxa, some are found in most of the studies. Those include the species from the genera *Apherusa* (*A. chiereghinii*, *Apherusa* sp.) and *Dexamine* (*D. spinosa*, *D. spiniventris*), as well as *Aora spinicornis*.

The study of LEDOYER (1969) deserves a quick note about systematics. Its dominant species were *Apherusa bispinosa* and *Aora typica*. However, authors questioned the validity of the separation between *Apherusa bispinosa* and *Apherusa chiereghinii*, and they might belong to a single species (RUFFO *et al.*, 1982). The same authors also report than in a number of previous studies, the species *Aora typica* has been subject to widespread confusion, and that a lot of specimens could in fact belong to the species *Aora spinicornis*. The dominant species of this study could therefore be the same as the one recorded in subsequent works.

Besides these day/night changes, **seasonal variation** was also important. June samples were notably clearly separated from others in both clustering analysis (fig. 3.1) and NMMDS (fig. 3.2). Net samples from June indeed contained more amphipods belonging to more species, and their specific richness, diversity and evenness values were higher.

To understand this variation, we compiled essential results of our study and literature data in table 3.IX. For each season, we selected data of sampling

**Table 3.IX:** Essential data of studies assessing composition of communities of amphipods from *Posidonia oceanica* meadows using the hand-towed net method during **November/December (top part)**, **February to April (middle part)** or **May to July (bottom part)**. For each study, table gives the date (month/year), reference, sampling depth and location, the community density (expressed in number of individuals per net stroke and in number of individuals per square meter) the number of species (S), and the dominant species (and their relative abundance, expressed in percentage of the total N of the sample). Community densities values in italics and between parentheses indicate values that were not directly measured, but calculated using a conversion factor (see text).

Date	Reference	Depth (m)	Location	Density		S	Dominant species (% of total N)
				Ind.m <sup>-2</sup>	Ind.str <sup>-1</sup>		
11/1979	Mazzella <i>et al.</i> , 1989	1-30	Ischia (IT)	(6.77)	2.59	35	<i>Apherusa chierghinii</i> (52.9) <i>Phitsica marina</i> (12.7)
11-12/1979	Scipione & Fresi, 1984	10	Ischia (IT)	(7.74)	2.97	12	<i>Apherusa chierghinii</i> (46.1) <i>Phitsica marina</i> (18.8) <i>Aora spinicornis</i> (7.3)
11/1981	Gambi <i>et al.</i> , 1992	1-25	Ischia (IT)	(5.53)	2.12	-	<i>Apherusa chierghinii</i> <i>Aora spinicornis</i>
11/1981	Scipione <i>et al.</i> , 1996	3	Ischia (IT)	(7.64)	2.93	22	-
11/2004	Degard, 2004	7	Calvi (FR)	(1.70)	0.65	3	<i>Aora spinicornis</i> (69.2)
11/2004	Degard, 2004	7	Calvi (FR)	(2.74)	1.05	3	<i>Apherusa chierghinii</i> (71.4) <i>Aora spinicornis</i> (19)
11/2006	This study	10	Calvi (FR)	6.55	-	8	<i>Apherusa chierghinii</i> (59.3) <i>Apherusa</i> sp. (22)
02/1982	Gambi <i>et al.</i> , 1992	1-25	Ischia (IT)	(3.51)	1.34	-	<i>Apherusa chierghinii</i> <i>Aora spinicornis</i>
03/1982	Scipione <i>et al.</i> , 1996	3	Ischia (IT)	(5.48)	2.10	15	-
04/1995	Sanchez-Jerez <i>et al.</i> , 1999a	10	Alicante (ES)	3.45	-	18	<i>Dexamine spiniventris</i> (21.6) <i>Hyale schmidtii</i> (11.6) <i>Ischyrocerus inexpectatus</i> (11.1)

## Structure and dynamics of communities

Date	Reference	Depth (m)	Location	Density		S	Dominant species (% of total N)
				Ind.m <sup>2</sup>	Ind.str <sup>-1</sup>		
02/1996	Sanchez-Jerez <i>et al.</i> , 1999a	10	Alicante (ES)	20.17	-	15	<i>Dexamine spiniventris</i> (29.8) <i>Ischyrocerus inexpectatus</i> (21.5) <i>Hyale schmidtii</i> (16.5) <i>Apherusa chierrehinii</i> (15.7)
03/2004	Degard, 2004	7	Calvi (FR)	(4.56)	1.75	3	<i>Apherusa</i> sp. (80) <i>Amphilochus neapolitanus</i> (12.9) <i>Dexamine spinosa</i> (7)
03/2004	Degard, 2004	7	Calvi (FR)	(3.13)	1.20	7	<i>Apherusa</i> sp (64.5) <i>Dexamine spinosa</i> (12.5) <i>Amphithoe helleri</i> (8.33)
03/2007	This study	10	Calvi (FR)	3.00	-	5	<i>Apherusa chierrehinii</i> (55.6) <i>Apherusa</i> sp. (25.9)
05/1981	Mazzella <i>et al.</i> , 1989	1-30	Ischia (IT)	(2.33)	0.89	36	<i>Phtisica marina</i> (19.0) <i>Dexamine spinosa</i> (16.6) <i>Amphithoe helleri</i> (14.2)
07/1981	Gambi <i>et al.</i> , 1992	1-25	Ischia (IT)	(3.72)	1.43	-	<i>Dexamine spinosa</i> <i>Phtisica marina</i>
05/1982	Gambi <i>et al.</i> , 1992	1-25	Ischia (IT)	(5.56)	2.13	-	<i>Amphithoe helleri</i>
07/1981	Scipione <i>et al.</i> , 1996	3	Ischia (IT)	(6.65)	2.55	12	-
05/1982	Scipione <i>et al.</i> , 1996	3	Ischia (IT)	(8.43)	3.23	17	-
05/1997	Scipione & Zupo, 2010	6.5	Otranto (IT)	(1.65)	0.63	16	<i>Apherusa chierrehinii</i> (21.05)
06/2007	This study	10	Calvi (FR)	11.78	-	19	<i>Apherusa chierrehinii</i> (38.7) <i>Apherusa</i> sp. (12.3) <i>Caprella acanthifera</i> (11.3)

events that occurred in the same month, or in the previous or next month as ours. Only daytime values were used.

Each of our samples corresponded to a precise meadow surface (9 m<sup>2</sup>). However, in most studies, sampling was not performed relative to a given surface. Instead, each sample consisted of an identical number of strokes (generally 40 or 60, depending on the study). To compare amphipod abundances in the two types of samples, we converted the community densities expressed in number of amphipods per stroke to community densities expressed in number of amphipods per square meter of meadow. To do this, we used the conversion factor of RUSSO & VINCI (1991), who estimated that a sample of 60 strokes covers approximately 23 m<sup>2</sup> of meadow. However, this estimation relies on a limited number of samples, and is subject to variation from one experimenter to another. Caution is therefore advised when comparing values in italics in the table 3.IX.

In **November**, our community density estimates were comparable to data from the literature. One exception was the study of DEGARD (2004). However, in their case, the unusually low density of amphipods could be explained by bad weather conditions. The number of species (S) identified in this study (8) was lower than most previous records. The dominant taxon in most of the studies, including ours, was the genus *Apherusa*.

In **March**, the density of amphipods tended to be lower in a lot of studies, including ours. Once again, the number of species that we recorded (5) was lower than in most previous work. Like in November, dominance of the genus *Apherusa* was common in Italian and French meadows. On the other hand, *Dexamine spiniventris* was more abundant in Spanish meadows (SÁNCHEZ-JEREZ *et al.*, 1999a).

In **June**, it was not possible to delineate a consistent trend. Some values were low, and comparable with those of March, while other were higher, and comparable with those of November. The community density that we measured nevertheless was higher than any previous estimate. As previously mentioned, it was also the highest of our 3 sampling seasons. In this case, our S matched or exceeded most literature data. The only exception is the study of MAZZELLA *et al.* (1989), where S was nearly twice higher.

The dominance of the genus *Apherusa* was less marked in late spring. It was sometimes even outnumbered by *Phthisica marina*, *Dexamine spinosa* or *Amphithoe helleri*. In our samples, however, it was still by far the most numerically abundant taxon.

In the Gulf of Naples, maximal abundance and diversity of amphipods occurs in late summer or autumn. It is the lowest in spring, and is intermediate in early summer (MAZZELLA *et al.*, 1989 ; GAMBÌ *et al.*, 1992 ; SCIPIONE *et al.*, 1996). Meadow parameters cannot explain this, and these authors therefore link the autumnal maximum with seasonal differences in other abiotic and biotic (predation pressure and individual taxon dynamics of vagile invertebrates) factors.

However, in our case, amphipod abundance was twice higher in June than in November. Habitat features could explain this. In Calvi bay, November is indeed the annual minimum of foliar biomass, and the volume of foliar stratum available for colonisation by vagile invertebrates is therefore reduced (GOBERT, 2002).

In addition, the maximum abundance in June could be linked with trophic resource availability. In *P. oceanica* meadows, at 10 m, epiphyte diversity and covering indeed maximal in late summer, but values of biomass and production are at their highest in late spring/early summer (May/June). In addition, at this season, a large part of the epiphytic communities is constituted of erected brown algae (MAZZELLA & OTT, 1984 ; CEBRIÁN *et al.*, 1999 ; LEPOINT *et al.*, 1999). This abundant amount of readily available, easily palatable epiphytes could support important grazing invertebrate communities.

There is nevertheless a discrepancy between our results and literature data that is hard to explain. Sampling depth and location could be determining factors, since they can influence meadow parameters. Long-term temporal variation could also occur, but this is beyond the scope of this study.

The low *S* values in March and November could be linked with a sub-sampling effect. *Posidonia oceanica* meadows are well known for their small-scale spatial heterogeneity (patchiness of the communities). In the present case, our design involved sampling of a relatively large area, to avoid adverse effects of this patchiness on diversity of the samples. However, 9 m<sup>2</sup> of meadow may not have been sufficient for this purpose, leading to an under-evaluation of the actual diversity. This should be taken into account when planning future sampling events.

This putative sub-sampling effect could also have an adverse effect on the reliability of community density estimates. While we executed several passes to collect as many amphipods as possible, we cannot be sure that all specimens present in the area were captured, nor that the area was large enough to be regarded as representative. In this context, it appears more sensible to consider the hand-towed net as a “semi-quantitative” (*i.e.*, leading to the collection of samples that can be compared with each other) method. It would be interesting to perform community density estimates on samples resulting for increasing number of passes on increasingly large areas, to determine at which point a hand-towed net sample could be regarded as truly quantitative.

#### IV.1.B. Litter samples

We believe that it is important to begin this section by a quick reminder about terminology. In this study, we studied only the litter present in the meadow, and scattered among living shoots of *Posidonia oceanica*.

It should not be confused with submerged phytodetritus accumulations. These features are very common in the Mediterranean, and are often found in the



direct surroundings of *P. oceanica* meadows, but are completely different ecosystems (cf. chapter 1).

Litter samples shared less intra-group resemblance than the ones collected with the hand-towed net, or the light traps. This may be linked with the nature of the litter *per se*. It is indeed a heterogeneous compartment composed of dead *Posidonia oceanica* leaves, but also of decaying drift algae and other detrital items. Moreover, it is a highly dynamic environment, which is constantly modified by input of new material, while older elements disappear by degradation, burial or dispersion under hydrodynamic forces.

The main factor driving this important variation between litter samples was the sampling season. Figure 3.1 shows that the samples are distributed among 3 clusters, each one corresponding to one of the seasons. Moreover, samples from November and June shared more similarity with each other (57.2 %) than they did with the samples of March (43.7 %). Samples from November and June also contained more individuals, and more species, especially the June one.

This could be linked with the overall importance of the litter cover among the meadow. During spring and summer, foliar production of *Posidonia oceanica* is important, as well as development of epiphytes. During these periods, litter constantly accumulates, notably via erosion of the apexes of the leaves. This erosion is increased under heavy epiphytic loads or when blade grazing occurs. At the end of September (or the beginning of October), senescent leaves massively fall. The important development of epiphytes, as well as the increasing water movements, probably play a part in this phenomenon. The beginning of autumn is therefore the moment where the litter cover is the most important. During late autumn and winter, most of this litter will be either degraded or exported, but will not be immediately renewed, as *P. oceanica* production is low during this period. The litter will thus be scarce in early spring, and then will accumulate again during spring and summer (MATEO & ROMERO, 1997 ; GOBERT, 2002 ; GALLMETZER *et al.*, 2005).

According to this “litter cycle”, the litter cover should be more abundant in November and in June than in March. It was indeed the case for June (203.07 g DW.m<sup>-2</sup>, vs. 59.88 g DW.m<sup>-2</sup> in March). No precise data were collected in November, but from a qualitative point of view, litter was also more abundant than in March. Since litter is scarcer in the meadow in March, the volume for amphipods is lower, and so is habitat complexity. In addition, in this season, litter is more degraded, and bears less epiphytes (data not shown). Seasonal variation is likely linked with these phenomena.

Even if they are less important than seasonal changes, nycthemeral variations could be seen in the values of several parameters. N, S, D and H' were generally lower at night. When looking at all seasons taken together, the community density was higher during the day (0.66 ind.gDM<sup>-1</sup>) than during the night (0.42 ind.gDM<sup>-1</sup>).

Most of the dominant species followed the general trend of the community, and were more abundant during the day. These included *Apherusa chiereghinii* (0.16 ind.gDW<sup>-1</sup> during the day vs. 0.05 ind.gDM<sup>-1</sup> during the night), *Aora spinicornis* (0.09 ind.gDM<sup>-1</sup> during the day vs. 0.04 ind.gDM<sup>-1</sup> during the night.)

or, to a lesser extent, *Ampelisca rubella* (day: 0.07 ind.gDM<sup>-1</sup>, night: 0.05 ind.gDM<sup>-1</sup>), *Gammarus aequicauda* (day: 0.04 ind.gDM<sup>-1</sup>, night: 0.02 ind.gDM<sup>-1</sup>) and *Caprella acanthifera* (day: 0.03 ind.gDM<sup>-1</sup>, night: 0.01 ind.gDM<sup>-1</sup>).

As mentioned before, amphipods are much more abundant in the foliar stratum of *P. oceanica* meadows during the night. However, the question of their behaviour and position during the day is rarely discussed. LEDOYER (1969) suggested that animals probably spend the day among the mat. However, studies of the invertebrate fauna of the mat do not report presence of the dominant species of the fauna of the foliar stratum. For example, BORG *et al.* (2006) did not record a single individual from the genera *Apherusa* or *Aora*, and only collected one *Dexamine spiniventris* in their study, even though they extensively sampled the mat from Maltese meadows, collecting more than 850 amphipods in the process.

In the light of our results, the thin litter cover that constitutes the “interface” between the foliar stratum and the mat seems to be a better candidate as a preferential habitat for amphipods during the day. This has to be confirmed by further work, as our study only concerns a relatively small number of samples and animals. However, it would emphasize the importance of the litter cover in the structural complexity of the habitat offered by the meadow to amphipod crustaceans.

The situation is more complicated than it could appear, as all species did not leave litter at night. *Gammarella fucicola* apparently spends most of its time there, as no differences of population density between the two periods of the day could be seen (0.09 ind.gDM<sup>-1</sup> in both cases). *Amphithoe helleri* even showed an opposite pattern, and was more abundant in the litter at night (0.06 ind.gDM<sup>-1</sup> than during the day (0.02 ind.gDM<sup>-1</sup>). This last fact is puzzling, and difficult to explain, as this species is also more abundant in the foliar stratum at night. Individuals of this partly tubicolous species may simply more active at night, while they could rest in their tubes during the day, therefore avoiding sampling.

To our knowledge, this study is the only one that deals with the vagile invertebrate community specifically associated to litter fragments among the meadow itself. Future work will probably help to fully understand the structure and dynamics of this community, and the relations between this heterogeneous compartment and the other zones of the meadow.

#### IV.1.C. Light traps samples

Light traps have been used, with contrasted efficiencies, to collect marine invertebrates in various pelagic or benthic environments (notably tropical seagrass meadows, see VONK *et al.*, 2008). To our knowledge, they have never been used in *Posidonia oceanica* meadows. As it was the case for litter samples, no direct comparison with literature data is possible.

The light traps proved to be efficient. Samples contained a large number of individuals, and showed important diversity, specific richness and evenness. This was especially true for the June sample. Seasonal variation undoubtedly explains a part of this trend. It can nonetheless be hypothesized that the change of trap model (cf. chapter 2) also had a positive effect on all the mentioned parameters. This new model was therefore retained for use in successive sampling events.

The most original feature of the light trap samples was their specific composition. They collected several species that were totally absent from the other methods. In addition, some taxa that were very rare in hand-towed net or litter samples were more common in light traps. They could therefore be seen as a mean to capture animals from all layers *Posidonia oceanica* meadow, and not only from the foliar stratum or the litter cover.

This particular specific composition nonetheless raises the question of the representativeness. Since they involve active movement from the animals, the species exclusively or preferentially collected by the traps could be artificially attracted from other adjacent biotopes. Sampling of such animals would be an undesired side effect.

Classifying these animals as rare but desirable components of the community or unwanted contaminating organisms is a complicated task. The case of each species is particular.

Dexaminids *Atylus guttatus*, *Atylus massiliensis* and *Guernea coalita*, as well as *Orchomene* spp., *Tmetonyx nardonis* or are mentioned in the literature as being “characteristic of Mediterranean seagrass meadows” (RUFFO *et al.*, 1982 ; RUFFO *et al.*, 1989 ; RUFFO *et al.*, 1993). Some of them have indeed been found in Mediterranean seagrass meadows (VAZQUEZ-LUIS *et al.*, 2009 ; SCIPIONE & ZUPO, 2010). These species can therefore be regarded as rare, but seagrass-associated amphipods.

Some cases are not that clear. For example, Oedicerotids like *Perioculodes aequimanus* have been suggested as indicators of unvegetated sand areas (SÁNCHEZ-JEREZ *et al.*, 1999a). On the other hand, presence of this species has been recorded in Mediterranean *Posidonia oceanica*, *Zostera marina* and *Cymodocea nodosa* meadows (VAZQUEZ-LUIS *et al.*, 2009 ; SCIPIONE & ZUPO, 2010).

Another unclear case is the one of *Normanion chevreuxi*, which was collected in significant amounts in light traps. This species is typically found on detrital (*e.g.* coralligene) or muddy bottoms, and always at depths generally greater than 40 m (RUFFO *et al.*, 1989). Its presence in *Posidonia* meadows is therefore surprising. However, it is also present, in small amounts, in hand-towed net and litter samples, indicating that it can be found in several compartments of the meadow. It could be associated to the rhizomes, as they are often regarded as a pre-coralligene habitat (PERES & PICARD, 1964).

Finally, the situation of other taxa, notably *Synchelidium longidigitatum* or *Hippomedon* spp. is even harder to assess, due to the lack of literature data.

Caution is therefore advised, as the question of the representativeness of these animals as amphipods from *Posidonia oceanica* meadows remains open.

## **IV.2. Comparison of sampling methods**

The section IV.1 clearly points out that each of the used methods as pros and cons.

The **hand-towed net** allowed collection of a large number of animals, thanks to the relatively large surface covered in each sample. This efficient technique is widely used and accepted, allowing comparison with literature data. In addition, the method is at least semi-quantitative and samples collected using hand-towed net are readily comparable.

However, the organisms collected via this technique were sometimes damaged, which complicates their identification. Moreover, samples collected by hand-towed net sometimes showed low  $S$ ,  $d$  and  $H'$  values. Hand-towed net samples were very strongly dominated by individuals belonging to the genus *Apherusa*, and often had low  $J'$  and  $1-\lambda'$  values. It is likely that the hand-towed net collected mainly species directly associated with the foliar stratum of the meadow, and is rather inefficient in capturing animals from the lower layers of the meadow. This could cause the hand-towed net samples to be merely “sub-samples” of the actual community, explaining their low diversity. The hand-towed net nevertheless remains a quick and easy way to collect a large number of individuals from the dominant species of the community.

The **litter** samples generally had a moderate to high diversity, and a high evenness. It also allowed collection of notable amounts of species that were rare in samples from other methods (e.g. *Gammarella fucicola*, *Gammarus aequicauda*).

However, they contained few amphipods, and handpicking of litter does not seem to be a very time-effective method. More complex sampling devices (e.g. Van Veen or Ekman grabs) have been used in submerged phytodetritus accumulations and proved to be efficient (COMO *et al.*, 2008). However, the complex physical structure of the *Posidonia oceanica* meadow makes them hardly appropriate in our case.

In addition to these methodological issues, this method is only suitable for the collection of animals spending an appreciable amount of time in the lower horizons of the meadow.

The amount of damaged, identifiable amphipods was the highest for this method (over 4 %). However, this number could be an over-estimation. Dead amphipods indeed probably sink to the bottom, and could be collected alongside living amphipods found among the litter fragments. Some of the physical damage observed here could come from normal decay of dead animals, and have no relation with the sampling process itself.

**Light traps** proved to be an interesting sampling method. It was less efficient than the hand-towed net, but nevertheless allowed collection of a large number of amphipods. The light trap samples contained a lot of species (high  $S$  values), a number of them being exclusive to this technique. Samples also

always showed a high diversity and evenness. Dominance of *Apherusa* was indeed lower than in the two other methods (under 20 % of the individuals). Moreover, the collection process damaged very few individuals. The use of light traps therefore seems to be a suitable method for studying amphipod specific diversity in *Posidonia oceanica* meadows. In addition, this method integrates data over a whole night, whereas the others only give a snapshot of the composition of the community. It also requires relatively little underwater work, and makes night sampling much easier than the hand-towed net or the litter collection. This could be crucial in situations where sampling sites are not easily available during the night.

This method nevertheless has its drawbacks. First, it is completely inefficient during the day. Moreover, it implies active movement by the animals. This questions the representativeness of the method, and raises the question of the “contamination” of the samples by animals coming from adjacent habitats. Finally, as the action radius of a light stick is unknown, and likely to vary widely according to several factors, no quantitative considerations are possible.

Unfortunately, none of the used methods can be regarded as truly quantitative. This questions the reliability of the community density estimates recorded in this study.

Other sampling techniques of course exist. Some authors notably have used the air-lift (STURARO, 2007 ; COMO *et al.*, 2008 ; VAZQUEZ-LUIS *et al.*, 2009 ; SCIPIONE & ZUPO, 2010). This device is a sort of underwater aspirator, allowing collection of vagile invertebrates with an apparently greater efficiency than a hand-towed net (GAMBI & DAPPIANO, 2004). Its efficiency makes it an interesting method to near quantitative estimates.

However, this technique is not perfect either. It has important technical and human requirements. Its set-up is therefore relatively complicated, which is in contradiction with our objectives. Moreover, it is a somehow brutal technique, and the risk to damage the collected specimens is high (MICHEL *et al.*, 2010). Finally, this technique was initially developed for sampling of biocenosis of rock substrata. In the case of soft-bottom environments, such as *P. oceanica* meadows of Calvi Bay, sampling seem to inevitably involve collection of vast amounts of sediment that complicates the sorting process (DARCHAMBEAU, 1995).

ZAKHAMA-SRAIEB *et al.* (2006, 2011) developed another technique. They set up a box quadrat (30 cm wide x 30 cm length x 25 cm height) on a portion of meadow, and insert in the matter. They subsequently uproot all *P. oceanica* shoots contained in it, and place them in a bag made of 0.3  $\mu\text{m}$  nylon mesh. Similarly, VAZQUEZ-LUIS *et al.* (2009) place a quadrat of 20 cm x 20 cm to which 0.3  $\mu\text{m}$  nylon mesh bag is attached on the meadow, and scrape all the enclosed area using a trowel.

These techniques are apparently efficient, but their destructive impact raises ethical questions. Such methods are by no means compatible with extensive sampling of a single site on successive events, like the one we plan here. In

addition, the set-up of the quadrats could cause displacement of some of the invertebrates due to immediate escape reactions.

Besides the methodological considerations, the question of the actual structure of the studied community is raised. The “classical” conception of the composition of invertebrates communities associated to *P. oceanica* meadows involves two components. The first one is the interstitial fauna of the sediment trapped between the roots and rhizomes of *Posidonia oceanica* (the “matte”). The second one is the vagile fauna strictly speaking, which is associated to the foliar stratum, and possibly to the aboveground part of the rhizomes. These two components are traditionally regarded as clearly individualized and different, but directly juxtaposed (BIANCHI *et al.*, 1989).

According to this “classical” conception, the amphipod fauna from the foliar stratum would be related to communities associated to photophilous algae on rocky substrata. The amphipod fauna from the matte, on the other hand, would be close to the one of coralligene bottoms, with an additional component of species characteristics of unvegetated areas, that would vary according to sediment grain size (RUFFO *et al.*, 1998).

In the case of highly motile invertebrates, such as amphipods, the situation could be more complex. Past work indeed shows the importance of vertical migrations as a structuring process for amphipod communities (*e.g.* LEDOYER, 1969 ; SÁNCHEZ-JEREZ *ET AL.*, 1999B ; DEGARD, 2004).

Moreover, more recent studies tend to show that the actual situation would be closer to an ecological continuum than to two different, separated communities. Some species are found only among the foliar stratum and/or the litter fragments scattered among the shoots. Those include *Apherusa chiereghinii*, *Aora spinicornis* or *Amphilocheus neapolitanus*. At the other end of the continuum, species such as *Siphonoecetes dellavallei*, *Leptocheirus guttatus* and some burrowing taxa (notably the genera *Urothoe*, *Bathyporeia* and *Haustorius*) seem confined to the rhizomes and the matte (BORG *et al.*, 2006 ; HARRIAGUE *et al.*, 2006).

Between these two extremes, there seems to be a number of species that can be found in several compartments. These include *Caprella acanthifera*, *Iphimedia minuta*, as well as several Dexaminidae (*Atylus* spp., *Dexamine* spp.) and Lysianassoidea (*Orchomene* spp., *Tmetonyx nardonis*). Some of these species likely spend most of their time in the lower zones of the meadow, while others preferentially live in the upper ones. However, to our knowledge, no precise data allowing classification of the species using this criterion are available.

The vagile invertebrate biocenosis of *Posidonia oceanica* meadows therefore appears to be complex and dynamic. In this context, the deep differences observed in samples collected using the different methods might come from the fact that they reflect different partial aspects of a more complex community. In this context, the most accurate, and the only realistic way to sample the whole fauna of amphipods from *P. oceanica* meadows could be to

combine several methods, keeping in mind their specific strengths and weaknesses, and to adapt the sampling design to the aim of the study.

### **IV.3. Dominant taxa and potential indicator species**

One of the objectives of this study was to identify the most representative and/or essential taxa of the studied community, and therefore to highlight potential “indicators” of the *Posidonia oceanica* meadows of Calvi Bay. A few species can be pointed out.

*Apherusa chiereghinii* is by far the most abundant amphipod species collected in this study. It was dominant in all sampling methods, at all seasons, and in both night and day samples. SIMPER analyses revealed that it was a good typifier of all methods. In addition, it is also commonly reported as being very abundant in previous studies.

Its dominance could even be higher than depicted here. Individuals from the genus *Apherusa*, either juvenile or too damaged to be identified precisely, were also very abundant. Since *A. chiereghinii* is the only accurately identified species encountered in our study, it can be hypothesized that most of the unidentifiable animals actually belong to this species.

In any case, *Apherusa chiereghinii* clearly stands out as the most representative taxon of the community, and should definitely be a target species for ecological investigations.

The same considerations can be applied, to a lesser extent, to other abundant species, such as *Aora spinicornis*, *Dexamine spiniventris*, *Caprella acanthifera* and *Amphithoe helleri*. Taken together with *Apherusa chiereghinii*, these 5 species represent 70 % of collected amphipods. Considering this subset of species could therefore be relevant from an ecological perspective, and would reduce the logistical demands to acceptable levels.

Other, less abundant, species could also be interesting candidates. For example, the occurrence of *Gammarella fucicola* and *Gammarus aequicauda* at the scale of the whole study is rather anecdotal (1.91 % and 1.61 % of the total amphipods, respectively). However, they can be very abundant in the lower aboveground layers of the meadow, notably *Posidonia oceanica* litter fragments scattered among the living shoots (cf. table 3.V). *Gammarella fucicola* is even a strong typifier of the litter samples.

These two species are important actors of the degradation of the litter in submerged phytodetritus accumulations (LEPOINT *et al.*, 2006). The detrital pathway is very important in organic matter fluxes associated to *Posidonia oceanica* meadows (PERGENT *et al.*, 1994 ; BUIA *et al.*, 2000). It would therefore be interesting to assess whether or not these species are involved in litter degradation amidst the meadow itself.

## **V. Conclusions**

The faunistic study presented in this chapter could be regarded as a necessary prerequisite to the ecological work exposed in chapters 4 and 5 of this dissertation. In this context our objectives were 1) to assess the precise composition and temporal dynamics of the community of amphipods associated to *Posidonia oceanica* meadows of Calvi Bay, 2) to set up a simple, efficient and, if possible, quantitative sampling protocol and 3) to highlight the most representative species of this community.

Our results point out that the studied **community** is rather complex. It is rich in individuals and species, and overall shows an important diversity. The assemblages are generally dominated by a few very abundant species.

**Day/night variations** were considerable. Amphipods apparently spend most of the daytime in the litter cover at the interface between the foliar stratum and the mat, and rise in the foliar stratum at night. This vertical migration could be a mechanism to avoid predation and/or competition for food and habitat.

**Seasonal variation** also occurred, even though the patterns are less clear than in the previous case. Our results partly disagree with literature data, and seem to point out that the community is more developed (more individuals from more species) in June. November samples came second in terms of abundance and number of species, and March was apparently the time of the year when amphipods were the less present. These variations are likely linked with changes in meadow parameters (foliar surface, epiphytic biomass, importance of the litter cover).

To fulfill the second objective, we compared three non-destructive **sampling methods**: the hand-towed net, the litter collection and the light traps. Each method had pros and cons, and, unfortunately, none of them could be seen as fully quantitative. We suggested a few clues to improve them.

Samples collected using the three methods were deeply different. In our opinion, each method only captures a subset of a more complex, larger assemblage. To have an accurate view of the total community, we recommend the joint use of several sampling techniques. In addition, since amphipods seem to be more active during the night, night sampling should be, whenever possible, considered. Those recommendations were taken into account in the sampling strategies for chapter 4 and 5.

Concerning the last objective, our results highlight that *Apherusa chiereghinii*, *Aora spinicornis*, *Dexamine spiniventris*, *Caprella acanthifera*, *Amphithoe helleri*, *Gammarella fucicola* and *Gammarus aequicauda* are interesting potential target-species for subsequent ecological work.

Full understanding of the structure of the abundant community of amphipods associated to *Posidonia oceanica* meadows and of its temporal dynamics would require examination of a number of samples much further investigation.



Seagrass meadows are indeed spatially heterogeneous ecosystems, featuring complex successions of numerous microhabitats. This intricate structure favours a patchy distribution of invertebrates. In the case of highly motile animals such as amphipods, the situation is further complicated by vertical and horizontal migration patterns. A complete description of this large and transient taxocenosis would require a solid sampling design, featuring important replication and taking complexity of the ecosystem into account (*e.g.*, hierarchized nested designs featuring several spatial scales).

However, such a description was not the purpose of this study. Here, we presented a relatively robust dataset, taken at the precise sites (location and depth) where our subsequent work was realized. These reliable data did not fully agree with past literature. It allowed us to tackle our assessment of the trophic diversity (chapter 4) and functional role (chapter 5) of the amphipods as efficiently and accurately as possible

## References

- ATTRILL M. J., STRONG J. A. & ROWDEN A. A. (2000): Are macroinvertebrates communities influenced by seagrass structural complexity ? *Ecography*, **23**: 114-121.
- BELL J. D. & HARMELIN-VIVIEN M. L. (1983): Fish fauna of French mediterranean *Posidonia oceanica* seagrass meadows. 2. Feeding habits. *Tethys*, **11**: 1-14.
- BELLAN-SANTINI D. (1999): Ordre des Amphipodes (Amphipoda Latreille, 1816). in *Traité de Zoologie - Anatomie, Systématique, Biologie* (Pierre-P. Grassé). Tome VII, Fascicule III A : Crustacés Pécararides, FOREST J. (Ed.): 93-176.
- BIANCHI C. N., BEDULLI D., MORRI C. & OCCHIPINTI AMBROGI A. (1989): L'herbier de posidonies : écosystème ou carrefour éco-éthologique ? in *International Workshop on Posidonia Beds*, BOUDOURESQUE C. F., MEINESZ A., FRESI E. & GRAVEZ V. (Eds.): 257-272.
- BORG J. A., ROWDEN A. A., ATTRILL M. J., SCHEMBRI P. J. & JONES M. B. (2006): Wanted dead or alive: high diversity of macroinvertebrates associated with living and "dead" *Posidonia oceanica* matte. *Mar. Biol.*, **149**: 667-677.
- BUIA M. C., GAMBI M. C. & ZUPO V. (2000): Structure and functioning of mediterranean seagrass ecosystems: an overview. *Biol. Mar. Medit.*, **7**: 167-190.
- CEBRIÁN J., ENRIQUEZ S., FORTES M., AGAWIN N., VERMAAT J. E. & DUARTE C. M. (1999): Epiphyte accrual on *Posidonia oceanica* (L.) Delile leaves: implications for light absorption. *Bot. Mar.*, **42**: 123-128.
- CHIMENZ C., TARAMELLI E., CIRONI R., CONTESSINI A., GRAVINA F., MAGGIORE F. R., MAJ R. L. C., MOTTA M. G. & SOMASCHINI A. (1989): Studies on animal populations of leaves and rhizomes of *Posidonia oceanica* (L.) Delile on the rocky bottom of Torvaldaliga. in *International Workshop on Posidonia Beds*, BOUDOURESQUE C. F., MEINESZ A., FRESI E. & GRAVEZ V. (Eds.): 145-155.

CLARKE K. R. & WARWICK R. M. (2001): Change in marine communities : an approach to statistical analysis and interpretation - 2nd edition. Primer-E, Plymouth, 165 pp.

COMO S., MAGNI P., BAROLI M., CASU D., DE FALCO G. & FLORIS A. (2008): Comparative analysis of macrofaunal species richness and composition in *Posidonia oceanica*, *Cymodocea nodosa* and leaf litter beds. *Mar. Biol.*, **153** (6): 1087-1101.

DARCHAMBEAU F. (1995): Importance des invertébrés vagiles dans l'herbier de posidonies de la baie de Calvi (Corse). Master in Zoology thesis, Université de Liège, Liège, 46 pp.

DEGARD C. (2004): Variation spatio-temporelle de la faune vagile associée à *Posidonia oceanica* (L.) Delile en baie de Calvi. Etude préliminaire de l'effet des conditions environnementales sur la composition spécifique. Master in Animal Biology thesis, University of Liège, Liège, 53 pp.

DIMECH M., BORG J. A. & SCHEMBRI P. J. (2006): Motile macroinvertebrate assemblages associated with submerged *Posidonia oceanica* litter accumulations. *Biol. Mar. Medit.*, **13** (4): 130-133.

GALLMETZER I., PFLUGFELDER B., ZEKELY J. & OTT J. A. (2005): Macrofauna diversity in *Posidonia oceanica* detritus: distribution and diversity of mobile macrofauna in shallow sublittoral accumulations of *Posidonia oceanica* detritus. *Mar. Biol.*, **147** (2): 517-523.

GAMBI M. C. & DAPPIANO M. (2004): Mediterranean Marine Benthos : A manual of methods for its sampling and study. Societa Italiana de Biologia Marina, Genova, 604 pp.

GAMBI M. C., LORENTI M., RUSSO G. F., SCIPIONE M. B. & ZUPO V. (1992): Depth and seasonal distribution of some groups of the vagile fauna of the *Posidonia oceanica* leaf stratum: Structural and trophic analyses. *P.S.Z.N. I: Mar. Ecol.*, **13** (1): 17-39.

GOBERT S. (2002): Variations spatiale et temporelle de l'herbier à *Posidonia oceanica* (L.) Delile (Baie de la Revellata - Calvi - Corse). PhD in Sciences thesis, University of Liège, Liège, 207 pp.

HARRIAGUE A. C., BIANCHI C. N. & ALBERTELLI G. (2006): Soft-bottom macrobenthic community composition and biomass in a *Posidonia oceanica* meadow in the Ligurian Sea (NW Mediterranean). *Estuar. Coast. Shelf Sci.*, **70**: 251-258.

JØRGENSEN S. E., XU F.-L., SALAS F. & MARQUES J. C. (2005): Application of indicators for the assessment of ecosystem health. in *Handbook of ecological indicators for assessment of ecosystem health*, JØRGENSEN S. E., COSTANZA R. & XU F.-L. (Eds.): 5-66.

KIKUCHI T. (1980): Faunal relationships in temperate seagrass beds. in *Handbook of seagrass biology - An ecosystem perspective*, PHILLIPS R. C. & McROY C. P. (Eds.): 153-172.

KRAPP T., LANG C., LIBERTINI A. & MELZER R. R. (2006): *Caprella scaura* Templeton, 1836 sensu lato (Amphipoda: Caprellidae) in the Mediterranean. *Org. Divers. Evol.*, **6** (Electr. Suppl. 3): 1-18.

- KRAPP-SCHICKEL G. & TAKEUCHI I. (2005): A new species of *Caprella* (Amphipoda: Caprellidae) from the Cape Verde Islands (Atlantic), with note on Mediterranean *Caprella liparotensis*. *J. Mar. Biol. Ass. U.K.*, **85**: 93-100.
- KRAPP-SCHICKEL T. & SORBE J.-C. (2006): *Apherusa delicata* n. sp., a new suprabenthic amphipod (Crustacea, Eusiroidea, Calliopiidae) from the northern Bay of Biscay, with a discussion of the genus. *Org. Divers. Evol.*, **6**: 57-65.
- KREBS C. J. (1999): Ecological methodology - 2nd edition. Benjamin/Cummings Ltd., Menlo Park (Californie, USA), 620 pp.
- LEDOYER M. (1968): Ecologie de la faune vagile des biotopes méditerranéens accessibles en scaphandre autonome (région de Marseille principalement). IV : Synthèse de l'étude écologique. *Rec. Trav. St. Mar. End.*, **44** (60): 126-295.
- LEDOYER M. (1969): Ecologie de la faune vagile des biotopes méditerranéens accessibles en scaphandre autonome. V - Etude des phénomènes nyctéméraux. *Tethys*, **1** (2): 291-308.
- LEPOINT G., COX A. S., DAUBY P., POULICEK M. & GOBERT S. (2006): Food sources of two detritivore amphipods associated with the seagrass *Posidonia oceanica* leaf litter. *Mar. Biol. Res.*, **2** (5): 355-365.
- LEPOINT G., HAVELANGE S., GOBERT S. & BOUQUEGNEAU J.-M. (1999): Fauna vs flora contribution to the leaf epiphytes biomass in a *Posidonia oceanica* seagrass bed (Revellata Bay, Corsica). *Hydrobiologia*, **394**: 63-67.
- MATEO M. A. & ROMERO J. (1997): Detritus dynamics in the seagrass *Posidonia oceanica*: Elements for an ecosystem carbon and nutrient budget. *Mar. Ecol. Progr. Ser.*, **151** (1-3): 43-53.
- MAZZELLA L. & OTT J. A. (1984): Seasonal changes in some features of *Posidonia oceanica* (L.) Delile leaves and epiphytes at different depths. in *International Workshop on Posidonia oceanica Beds*, BOUDOURESQUE C. F., JEUDY DE GRISSAC A. & OLIVIER J. (Eds.): 119-127.
- MAZZELLA L., SCIPIONE M. B. & BUIA M. C. (1989): Spatio-temporal distribution of Algal and Animal communities in a *Posidonia oceanica* meadow. *P.S.Z.N. I: Mar. Ecol.*, **10** (2): 107-129.
- MICHEL L., LEPOINT G., DAUBY P. & STURARO N. (2010): Sampling methods for amphipods of *Posidonia oceanica* meadows: a comparative study. *Crustaceana*, **83** (1): 39-47.
- MYERS A. A., MCGRATH C. C. & KING R. (2001): Keys to the North-East Atlantic and Mediterranean amphipods. Interactive identification keys available at <http://www.amphipoda.com>, accessed on 23/08/2006.
- PERES J.-M. & PICARD J. (1964): Nouveau manuel de bionomie benthique de la mer Méditerranée. Edition revue et augmentée. Station Marine d'Endoume, Marseille, 137 pp.
- PERGENT G., ROMERO J., PERGENT-MARTINI C., MATEO M.-A. & BOUDOURESQUE C.-F. (1994): Primary production, stocks and fluxes in the Mediterranean seagrass *Posidonia oceanica*. *Mar. Ecol. Progr. Ser.*, **106**: 139-146.
- REMY F. (2010): Structure trophique et diversité des macro-organismes associés aux litières de *Posidonia oceanica* (L.) Delile, dans la baie de Calvi en Corse.

Master in Biology of Organisms and Ecology thesis, University of Liège, Liège, 54 pp.

RUFFO S., BELLAN-SANTINI D., DIVIACCO G., KRAPP-SCHICKEL G. & MYERS A. A. (1989): Part 2 : Gammaridea (Haustoridae to Lysianassidae). in *The Amphipoda of the Mediterranean*, RUFFO S. (Eds.): 365-576.

RUFFO S., BELLAN-SANTINI D., KARAMAN G., KRAPP-SCHICKEL G. & LEDOYER M. (1993): Part 3 : Gammaridea (Melphidippidae to Talitridae), Ingolfiellidea, Caprellidea. in *The Amphipoda of the Mediterranean*, RUFFO S. (Eds.): 577-813.

RUFFO S., BELLAN-SANTINI D., KARAMAN G., KRAPP-SCHICKEL G., LEDOYER M., MYERS A. A. & SCHIECKE U. (1982): Part 1 : Gammaridea (Acanthonozomatidae to Gammaridae). in *The Amphipoda of the Mediterranean*, RUFFO S. (Eds.): 1-364.

RUFFO S., BELLAN-SANTINI D., KARAMAN G., LEDOYER M., MYERS A. A. & VADER W. (1998): Part 4 : Localities and Map, Addenda to Parts 1-3, Key to Families, Ecology, Faunistics and Zoogeography, Bibliography & Index. in *The Amphipoda of the Mediterranean*, RUFFO S. (Eds.): 814-959.

RUSSO G. F. & VINCI D. (1991): The hand-towed net method in *Posidonia oceanica* beds : 1. A preliminary study on the sample size for gastropod taxocene in a shallow stand. *Posidonia Newsletter*, 4 (1): 27-31.

SÁNCHEZ-JEREZ P., BARBERÁ-CEBRIÁN C. & RAMOS-ESPLÁ A. A. (1999a): Comparison of the epifauna spatial distribution in *Posidonia oceanica*, *Cymodocea nodosa* and unvegetated bottoms: Importance of meadow edges. *Acta Oecol.*, 20 (4): 391-405.

SÁNCHEZ-JEREZ P., BARBERÁ-CEBRIÁN C. & RAMOS-ESPLÁ A. A. (1999b): Daily vertical migrations in the epifauna associated with *Posidonia oceanica* meadows. *J. Mar. Biol. Ass. U.K.*, 79: 971-977.

SÁNCHEZ-JEREZ P., BARBERÁ-CEBRIÁN C. & RAMOS-ESPLÁ A. A. (2000): Influence of the structure of *Posidonia oceanica* meadows modified by bottom trawling on crustacean assemblages : comparison of amphipods and decapods. *Sci. Mar.*, 64 (3): 319-326.

SCIPIONE M. B. & FRESI E. (1984): Distribution of amphipods crustaceans in *Posidonia oceanica* (L.) Delile foliar stratum. in *International Workshop on Posidonia oceanica Beds*, BOUDOURESQUE C. F., JEUDY DE GRISSAC A. & OLIVIER J. (Eds.): 319-329.

SCIPIONE M. B., GAMBI M. C., LORENTI M., RUSSO G. F. & ZUPO V. (1996). Vagile fauna of the leaf stratum of *Posidonia oceanica* and *Cymodocea nodosa* in the Mediterranean Sea. *Seagrass Biology : Proceedings on an internaional workshop*, Rottnest Island, Western Australia.

SCIPIONE M. B. & ZUPO V. (2010): Crustacean amphipods from the seagrasses *Zostera marina*, *Cymodocea nodosa* and *Posidonia oceanica* in the Adriatic Sea (Italy): a first comparison. *Zoologica baetica*, 21: 15-32.

STURARO N. (2007): Approche préliminaire de la variabilité spatiale multiéchelle de la structure de la communauté de crustacés amphipodes associée aux herbiers à *Posidonia oceanica*. DEA in Oceanology thesis, University of Liège, Liège, 39 pp.

VAZQUEZ-LUIS M., SANCHEZ-JEREZ P. & BAYLE-SEMPERE J. T. (2009): Comparison between amphipod assemblages associated with *Caulerpa racemosa* var. *cylindracea* and those of other Mediterranean habitats on soft substrate. *Estuar. Coast. Shelf Sci.*, **84**: 161-170.

VONK J. A., CHRISTIANEN M. J. A. & STAPEL J. (2008): Redefining the trophic importance of seagrasses for fauna in tropical Indo-Pacific meadows. *Estuar. Coast. Shelf Sci.*, **79** (4): 653-660.

ZAKHAMA-SRAIEB R., SGHAIER Y. & CHARFI-CHEIKHROUHA F. (2006): Is amphipod diversity related to the quality of *Posidonia oceanica* beds ? *Biol. Mar. Medit.*, **13** (4): 174-180.

ZAKHAMA-SRAIEB R., SGHAIER Y. & CHARFI-CHEIKHROUHA F. (2011): Community structure of amphipods on shallow *Posidonia oceanica* meadows off Tunisian coasts. *Helgol. Mar. Res.*, **65** (2): 203-209.





## Chapter 4

Multidisciplinary study of the trophic diversity among amphipods associated to Mediterranean *Posidonia oceanica* meadows

Truth is often found at the crossroads of independent lies.

(Sir Ernest Rutherford)





## I. Introduction

The study of trophic relationships has been a central topic in ecology for decades, and still receives much attention nowadays. Trophic niche is indeed a very useful set of parameters to characterize relationships between animals and their environment, or between animals themselves (BOLNICK *et al.*, 2003 ; BEARHOP *et al.*, 2004). However, sensible and complete understanding of realized animal diets can be a complex and delicate task.

### I.1. Delineating animal diets: different strategies

#### I.1.A. Classical methods vs. trophic tracers

The most widespread "classical" method of study of trophic ecology is undoubtedly **gut content examination**. This is generally done by direct dissection of the animal, to remove digestive organs and examine their content. Identifying and quantifying diet items then becomes possible. In specific situations, it can be done by emptying the gut of live animals to obtain the content without sacrificing the subjects. Alternatively, examination of digestive by-products (faeces) can also be informative (*e.g.* CAUT *et al.*, 2008a). However, gut content examination suffers from **major caveats**. First, it only gives a snapshot of the diet of the considered animal at a given moment, although diet of animals can show important spatial and temporal variations at all scales (DALSGAARD *et al.*, 2003).

Second, it focuses on food that has been ingested, but gives no information about whether this food is actually assimilated and exploited by the consumer or not. Presence of food items of contrasting palatability and digestibility therefore causes experimental bias, *i.e.* over-estimation of the importance of hard, refractory items (*e.g.* LEPOINT *et al.*, 2006).

Other techniques can be applied. Direct and indirect observations of animal feeding can be enlightening. However, like gut contents, it only gives a snapshot of the feeding habits, and no information about assimilation of food can be collected this way. Feeding choice experiments can, under certain circumstances, provide useful insights. Nevertheless, they consist in artificial feeding of animals, and can barely be related to actual, field-realized situations.

As a result of these limitations, in a significant number of situations, classical methods are not sufficient to have a clear overview of animal diets. This statement led the development of trophic markers (sometimes called trophic tracers). **Trophic markers** are consumer parameters that provide indirect information about its trophic ecology. DALSGAARD *et al.* (2003) defined the perfect trophic marker as "a compound whose origin can be uniquely and easily identified, that is inert and non-harmful to the organisms, that is not selectively processed during food uptake and incorporation, and that is metabolically stable and hence transferred from one trophic level to the next

## Multidisciplinary study of trophic diversity

in both a qualitative and quantitative manner". As stressed by the same authors, such compounds are rare, and probably do not exist at all. Studies therefore rely on less ideal tracers, possibly in combination. Stable isotopes ratios and fatty acid composition are among the most widely used of these imperfect, yet powerful trophic markers.

### I.1.B. Stable isotopes ratios

#### I.1.B.a. Stable isotopes: definition and natural abundance

**Isotopes** of a chemical element are atoms that have the same number of protons and electrons (hence, the same atomic number), but a different number of neutrons (and therefore a different mass number, and different atomic masses). Isotopes can be **radioactive**. Radioactive isotopes are unstable, and their nucleus tends to disintegrate into smaller, more stable nuclei, generating energy in the process. Isotopes can also be **stable**, and show no tendency to disintegration (TCHERKEZ, 2010).

All major elemental constituents of organic matter but phosphorus have at least two naturally occurring stable isotopes. Natural abundances of these isotopes can be found in table 4.I.

**Table 4.I:** Mean natural relative abundances of stable isotopes of major biogenic elements (after FRY, 2006 and TCHERKEZ, 2010, modified). Table also gives the international standards used to express the stable isotope composition under the "δ" notation.

Element	Stable isotope	Relative abundance (%)	Standard
Carbon	<sup>13</sup> C	1.11	Pee-Dee Belemnite (PDB)
	<sup>12</sup> C	98.89	
Nitrogen	<sup>15</sup> N	0.36	Atmospheric Air
	<sup>14</sup> N	99.64	
Oxygen	<sup>18</sup> O	0.2	Standard Mean Oceanic Water (SMOW)
	<sup>17</sup> O	0.04	
	<sup>16</sup> O	99.76	
Hydrogen	<sup>2</sup> H (D)	0.02	Standard Mean Oceanic Water (SMOW)
	<sup>1</sup> H	99.98	
Sulfur	<sup>36</sup> S	0.01	Canyon Diablo Troilite (CDT)
	<sup>34</sup> S	4.20	
	<sup>33</sup> S	0.75	
	<sup>32</sup> S	95.04	

Absolute abundances are rarely informative. The most useful parameter is generally the ratio between abundances of two isotopes of an element. By convention, this isotopic ratio is written

$$R = \frac{[*I]}{[I]}$$

where I is the lighter isotope of an hypothetical element, and \*I its heavier isotope. In the case of all the abovementioned major biogenic elements, the heavy isotope is much more rare than the light one, and values of R are very low. Since working with very low values is counterintuitive, it is common custom to express isotopic ratios using "δ" notation. This relative notation, expressed in per mil (‰), is calculated using

$$\delta *I = \frac{R_{\text{sample}} - R_{\text{standard}}}{R_{\text{standard}}} \cdot 10^3$$

This notation also has the advantage to position all values on a common scale, by comparing them to internationally recognized standard materials (cf. table 4.1). It is interesting to note that since relative abundance of  $^{13}\text{C}$  in PDB is high,  $\delta^{13}\text{C}$  values are often negative.

These naturally occurring stable isotopes of C, N, O, H and S are useful tools for a wide array of biogeochemical and ecological applications (see FRY, 2006 ; TCHERKEZ, 2010 for extensive reviews of biological uses). Here, we applied one of them: the use of C and N stable isotopes to study food web interactions.

#### 1.1.B.b. Use of C & N stable isotopes as trophic markers

In their seminal papers of 1978 (for carbon) and 1981 (for nitrogen), DENIRO & EPSTEIN summarized the principle underlying the use of stable isotopes as trophic tracers in a single well-known sentence: "You are what you eat, plus a few per mil".

In other terms, for a given element, the isotopic ratio of a consumer is a **proportional mixture** of the isotopic ratios of each of its food sources, plus a generally small difference called "isotopic fractionation". Since this is true for each element taken alone, it is also true for the complete set of isotopic ratios ( $\delta^{13}\text{C}$ ,  $\delta^{15}\text{N}$ , etc.), termed "isotopic signature". The **isotopic signature** of a consumer is therefore a direct reflection of those of its food items.

To use stable isotopes ratios efficiently, it is critical to understand the processes that dictate **isotopic fractionation**. Fractionation does not happen randomly, but is dictated by physical, chemical and biological factors. Since different isotopes of an element have the same electronic structure, they will have the same chemical behaviour, and undergo the same reactions. However, since they have different masses, their physical behaviour is different, and they react at different rates. As a result, isotopic ratios of a compound will be different before and after a chemical reaction, or a physical state change. This effect is called "isotopic fractionation" (FRY, 2006).

In food webs, the net result of the multiple fractionations taking place in organisms is usually a moderate enrichment towards the heavier isotope,

## Multidisciplinary study of trophic diversity

called **trophic shift**, or trophic enrichment (or trophic enrichment factor, TEF). For a hypothetical element I, it is written

$$\Delta^*I = \delta^*I_{\text{consumer}} - \delta^*I_{\text{source}}$$

Physiological processes involved in trophic shift differ for each element. Its importance therefore varies widely.

Most of the **carbon** isotopic fractionation occurs at the base of food webs, and is linked with biophysical and biochemical (isotopic discrimination by enzymes) processes involved in assimilation of inorganic carbon and photosynthesis (TCHERKEZ, 2010).

In terrestrial plants,  $\delta^{13}\text{C}$  is different between plants relying on the Calvin cycle ( $\text{C}_3$ ), the Hatch–Slack pathway ( $\text{C}_4$ ) or the crassulacean acid metabolism (CAM).  $\text{C}_3$  plants rely only on ribulose biphosphate carboxylase (RuBisCO) to fix the  $\text{CO}_2$ . This enzyme has a strong discrimination against  $^{13}\text{C}$ , resulting in low  $\delta^{13}\text{C}$  of their organic carbon (–35 to –21 ‰).  $\text{C}_4$  plants, on the other hand, rely on both RuBisCO and phosphoenolpyruvate carboxylase (PEP), that causes less discrimination against  $^{13}\text{C}$ . Global net discrimination against  $^{13}\text{C}$  is thus lower than in  $\text{C}_3$  plants, resulting in higher  $\delta^{13}\text{C}$  (–14 to –10 ‰; O'LEARY, 1988).

In aquatic plants, the situation is much more complicated, due to fractionations notably caused by diffusion of inorganic carbon through boundary layers, and the existence of several pools of DIC. A lot of aquatic plants can indeed use either  $\text{HCO}_3^-$  or  $\text{CO}_2$  present in the water. Since  $\text{CO}_2$  has much lower  $\delta^{13}\text{C}$ , it has an important impact on the  $\delta^{13}\text{C}$  of plant tissues (RAVEN *et al.*, 2002)

After this initial fixation in organic matter, carbon undergoes many processes causing fractionation, but their impact is generally much weaker than the one of photosynthesis.  $\Delta^{13}\text{C}$  between two successive trophic levels is often low to nil (0-1 ‰). Much of this net trophic fractionation can be explained by enzymatic reactions associated with respiration.

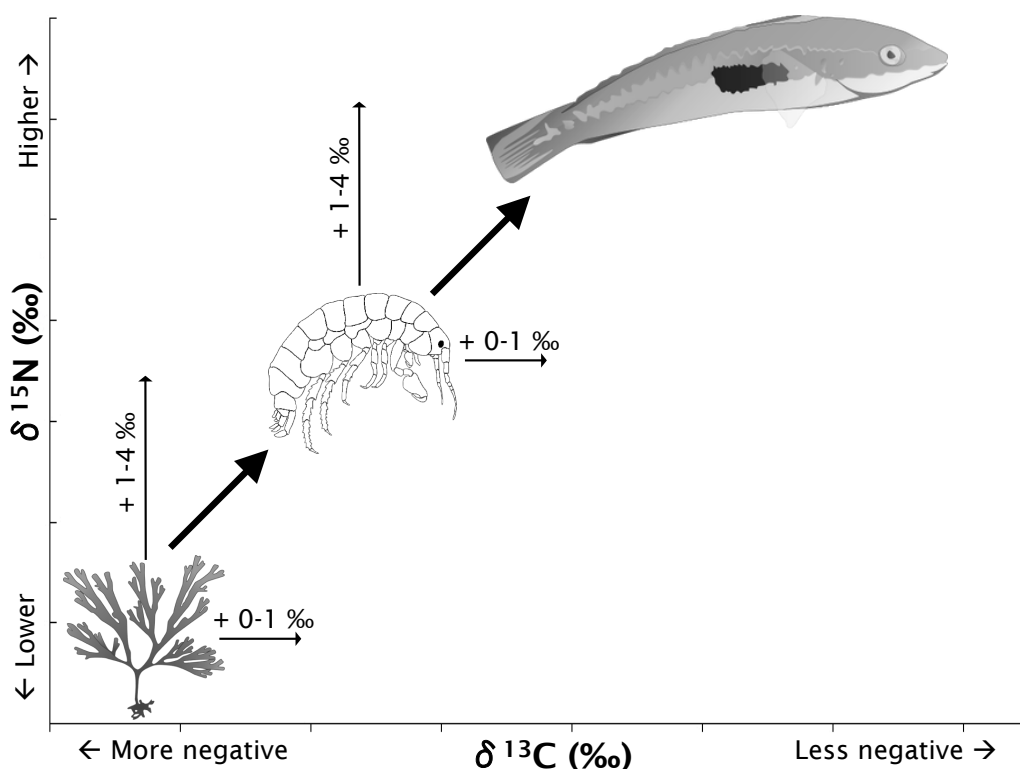
A direct consequence of this small fractionation is that the  $\delta^{13}\text{C}$  of a consumer will be close to the one of its food source. It is therefore possible to track organic carbon originating from different primary producers along the food web, and to **identify the main food sources** of a consumer (DENIRO & EPSTEIN, 1978 ; HOBSON & WELCH, 1992).

Patterns of isotopic fractionation of nitrogen at the base of food webs are unclear, in relation with the diversity of inorganic (and occasionally organic) nitrogen pools used by producers, and the various existing mechanisms of intake. Contrary to carbon, nitrogen fractionation by consumers is highly variable and far from negligible. It is mainly caused by protein metabolism and excretion of nitrogenous waste products (FRY, 2006 ; TCHERKEZ, 2010).

$\Delta^{15}\text{N}$  is therefore generally higher and more variable than  $\Delta^{13}\text{C}$ . In most situations, a trophic enrichment of 1 to 4 ‰ between two successive trophic levels is seen, but this is not a general rule (MCCUTCHAN *et al.*, 2003 ; VANDERKLIFT & PONSARD, 2003).

Besides this, since  $\delta^{15}\text{N}$  increases throughout the food web, it can be used to estimate the trophic level of an animal: low  $\delta^{15}\text{N}$  is typical of primary consumers, and high  $\delta^{15}\text{N}$  values indicate high trophic levels (secondary or upper order consumers; DENIRO & EPSTEIN, 1981 ; HOBSON *et al.*, 1995).

Information about stable isotopes of carbon and nitrogen in food webs is summarized in figure 4.1. It depicts an extremely simplified web consisting of a single primary producer (a macroalgae), a single primary consumer (an amphipod) and a single predator (a fish).



**Fig. 4.1:**  $\delta^{13}\text{C}$  vs.  $\delta^{15}\text{N}$  biplot of a theoretical 3-level food web. Some sizes and scales are exaggerated for graphical purposes. Symbols used courtesy of the Integration and Application Network ([ian.umces.edu/symbols/](http://ian.umces.edu/symbols/)).

The reader's attention is drawn to the fact that fig. 4.1 is a trivial oversimplification of the reality, for two reasons. First, most consumers have several food sources. Second, as mentioned earlier, values of trophic shift are not constant, and can vary widely, especially for nitrogen. Factors such as age, type of diet, composition of food, nutritional status, life environment, identity of nitrogenous waste product or taxonomical position can have a deep influence on trophic fractionation (MINAGAWA & WADA, 1984 ; ADAMS & STERNER, 2000 ; FOCKEN, 2001 ; VANDER ZANDEN & RASMUSSEN, 2001 ; MCCUTCHAN *et al.*, 2003 ; VANDERKLIFT & PONSARD, 2003 ; CAUT *et al.*, 2010).

---

 Multidisciplinary study of trophic diversity

Stable isotopes are powerful trophic markers, and they have several advantages. First, they focus only on the fraction of the diet that is actually assimilated. In addition, because their atoms do not disintegrate, they provide time-integrated information about the diet of animals. Since isotopic turnover is different according to the tissue considered, it is possible to study the variation of the diet at different time scales. Finally, since the isotopic signature of a consumer is a proportional mixture of the isotopic signature of its food sources, quantitative considerations are possible (*e.g.* mixing models, cf. further in this chapter).

However, they are not perfect. For example, they require the food items to have different isotopic composition. However, two completely different food sources can have a similar isotopic signature, therefore preventing discrimination. As a result, the importance of these two items in the diet of a consumer is difficult or impossible to estimate.

In addition, their use is complicated by the currently rather poor understanding of the influence of ecophysiological processes on the isotopic ratios of consumers (notably fractionation and isotopic routing; GANNES *et al.*, 1997 ; MARTÍNEZ DEL RIO *et al.*, 2009).

For these reasons, they are best used in combination with other trophic markers, such as fatty acid composition (NYSSSEN *et al.*, 2005).

### I.1.C. Fatty acids

#### I.1.C.a. Structure & nomenclature

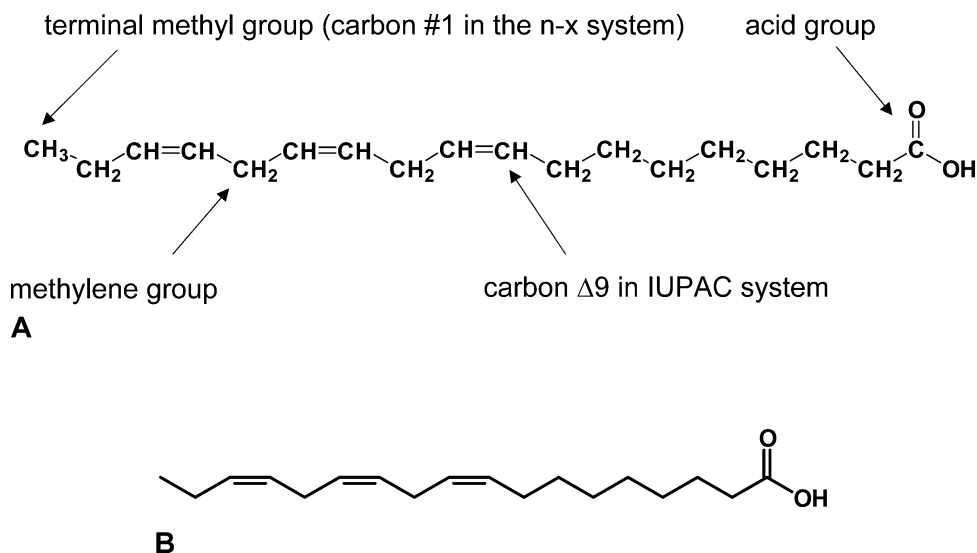
Fatty acids (FA) are ubiquitous organic molecules typically consisting of a long aliphatic chain, ended by an acid (carboxyl) group. They form a diverse and complex group of compounds, and giving a simple definition highlighting their common characteristics is a difficult exercise.

CHRISTIE (2010b) states that fatty acids are "[...] compounds synthesised in nature via condensation of [derivatives of] coenzyme A units by a fatty acid synthase complex. They usually contain even numbers of carbon atoms in straight chains (commonly C<sub>14</sub> to C<sub>24</sub>), and may be saturated or unsaturated, and can contain a variety of substituent groups."

The degree of saturation mentioned in this definition is the number of double bonds present in the aliphatic chain of the fatty acid. A saturated fatty acid (SAFA) does not contain any double bond, while a monounsaturated fatty acid (MUFA) contains one, and a polyunsaturated fatty acid (PUFA) contains two or more (usually less than 6) double bonds (BUDGE *et al.*, 2006). Figure 4.2 pictures an example of polyunsaturated fatty acid, the  $\alpha$ -linolenic acid.

The International Union of Pure and Applied Chemistry (IUPAC) gave recommendations for FA nomenclature. According to the IUPAC, the short notation for a fatty acid should be A:B $\Delta$ X,Y,Z,... where A is the number of carbons of the aliphatic chain, B the number of double bonds present in this chain, and X, Y, Z,... the position of the double bonds relative to the terminal acid group. The  $\alpha$ -linolenic acid should therefore be referred as 18:3 $\Delta$ 9,12,15.

Despite its official status, IUPAC nomenclature is seldom used in ecological literature. Workers generally prefer the most common shorthand notation A:B(n-X), where A is the number of carbons of the aliphatic chain, B the number of double bonds present in this chain, and X indicates the position of the first double bond relative to the terminal methyl group (BUDGE *et al.*, 2006). The  $\alpha$ -linolenic acid is therefore abbreviated to 18:3(n-3). This notation will be used in the rest of this study.



**Fig. 4.2:** Structure of a polyunsaturated fatty acid, the  $\alpha$ -linolenic acid. The first part of figure (A) shows the full structure of the FA, with all atoms indicated. It points the terminal acid and methyl groups. Part B of the figure depicts the same molecule using a most common "condensed" representation where atoms of C and N are omitted (After BUDGE *et al.*, 2006).

A number of authors, especially those working in the agro-alimentary and dietary sectors, use a notation close to this one, but prefer A:B $\omega$ X instead of A:B(n-X). Using this notation, the  $\alpha$ -linolenic acid would be abbreviated 18:3 $\omega$ 3. This notation is undoubtedly the most widespread among the general public.

The vast majority of PUFA are "methylene-interrupted", *i.e.* one methylene (-CH<sub>2</sub>-) group is present between each pair of double bonds (see fig. 4.2). However, marine invertebrates and algae sometimes contain "non-methylene-interrupted" (NMI) fatty acids, in which more than one methylene group separates two double bonds (BARNATHAN, 2009).

Finally, the aliphatic chain of some FA is not linear, but bears a methyl branch on the second or third carbon closest to the terminal methyl group. If the methyl branch is on the second carbon, the term "iso" ("*i*-" in shorthand notation) will precede the name of the FA, while a FA bearing a methyl group on the third carbon will be qualified of "anteiso" (abbreviated "*a*-"). Significant

---

Multidisciplinary study of trophic diversity

amounts of odd-numbered, branched fatty acids are notably found in marine bacteria (DALSGAARD *et al.*, 2003 ; BUDGE *et al.*, 2006).

### I.1.C.b. Fatty acid function and metabolism

Fatty acids are rarely found free in living tissues. Usually, they are parts of bigger compounds, the lipids. CHRISTIE (2010) defines lipids as being "[...] fatty acids and their derivatives, and substances related biosynthetically or functionally to these compounds." The most common lipids in the tissues of marine animals include triacylglycerols (TAG), wax esters (WE) and phospholipids.

Triacylglycerols (TAG) are the major form of storage lipids. They consist of 3 fatty acid molecules esterified to a glycerol backbone. Animals are able to mobilize TAG if their FA requirements are not met through their diets, or to deposit dietary FA when their dietary FA intakes exceed their requirements. TAG composition is therefore highly dynamic, and tends to be similar FA composition of the diet of animals (BUDGE *et al.*, 2006).

TAG can have several roles in organisms. In homeotherm organisms, subcutaneous depots serve as insulation against cold. In marine mammals and fish, the lipids, less dense than water, participate in buoyancy. However, in marine invertebrates, such as amphipods, their primary role is energy storage. TAG breakdown, catalyzed by lipases, provide free FA that can be oxidized by cells and used as a source of energy (CHRISTIE, 2010c).

Wax esters consist of a fatty acid esterified to a fatty alcohol. Their metabolism and function are far less documented than those of TAG, but they seem to be involved in energy storage, and therefore have a dynamic composition as well. They can be very abundant in certain crustaceans (copepods), fishes and marine mammals (BUDGE *et al.*, 2006).

Phospholipids are structural components of all cellular membranes. They consist of two FA molecules esterified to a glycerol backbone (diacylglycerol) linked with a phosphate group ( $\text{PO}_4^{3-}$ ). The phosphate group is generally itself linked with a small polar organic molecule (such as a choline, for example). The phosphate group and its small organic molecule constitute a polar "head" with hydrophilic affinities, while the FA make up a hydrophobic "tail". This amphipathic character underlies the structure of cellular membranes, that typically consist of a bilayer of phospholipids (ACKMAN, 1989).

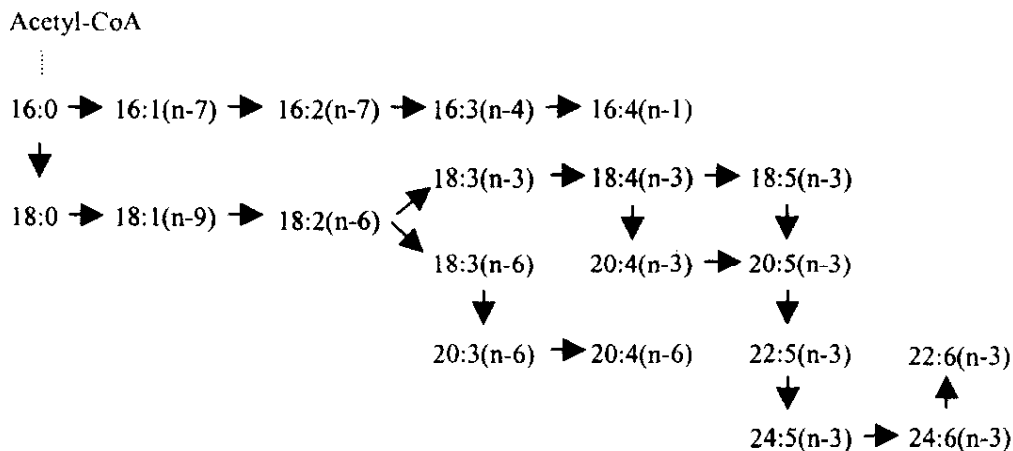
Since phospholipids have specialized structures and functions, organisms tend to conserve the FA forming phospholipids, except under conditions of extreme stress. This lipid class is therefore quite robust to changes in dietary FA inputs (BUDGE *et al.*, 2006).

Other lipid classes of course exist, but they tend to be minor contributors to the total FA pool of most marine organisms. We will therefore not discuss them extensively here.

In marine systems, the major part of *de novo* biosynthesis of FA is realized by primary producers (phytoplankton and/or macroalgae), which lay down the



basic pattern of FA composition in the subsequent food web. Synthesis of FA generally follows a common pathway, involving type I fatty acid synthase (FAS I). FAS I uses derivatives of the coenzyme A (Acetyl-CoA, Malonyl-CoA) and its primary end product is the palmitic acid (16:0), that is consequently the most common FA in the vast majority of living organisms (ACKMAN, 1989 ; DALSGAARD *et al.*, 2003). Figure 4.3 summarizes the major FA biosynthetic pathways for marine algae.



**Fig. 4.3:** Major pathways of FA biosynthesis in marine algae. (After DALSGAARD *et al.*, 2003, modified after GURR & HARDWOOD, 1991 and COOK, 1996).

Fig. 4.3 clearly illustrates the complexity of FA metabolic pathways in living organisms. Besides this, most reactions can be grouped in two families: elongations (addition of two carbons to the aliphatic chain, catalyzed by an elongase) and desaturations (introduction of a double bond in the aliphatic chain, catalyzed by a desaturase). It is worth noting that 18:3(n-3) and 18:2(n-6), that are important metabolic intermediates, can only be synthesized by plants and by some protozoans. For consumers, who are unable to synthesize them and rely on dietary intakes for these compounds, they are termed "essential" fatty acids (DALSGAARD *et al.*, 2003 ; CHRISTIE, 2010c).

#### 1.1.C.c. Fatty acid as trophic markers

As it has been mentioned in the previous section, most FA are synthesized at the base of the food webs. Moreover, storage lipids are dynamic tissues whose FA composition reflects those of the food. Indeed, when a consumer digests its food, dietary lipids (TAG, wax esters...) are hydrolyzed and broken down to their constituting FA, but most FA are generally deposited in the lipids of the consumer in a conservative manner. These two assumptions underlie the use of fatty acid composition as a trophic marker (DALSGAARD *et al.*, 2003 ; BUDGE *et al.*, 2006).

The concept of fatty acids being transferred in a conservative manner along food webs is not new. It was first suggested by LOVERN (1935), working on

---

Multidisciplinary study of trophic diversity

copepods and their fish predator. It was later proved experimentally using a simple, linear, 3-level food web consisting of a diatom, a herbivorous branchiopod crustacean and a predator fish (KAYAMA *et al.*, 1963). Since these pioneer works, the use of FA as trophic markers has not ceased to increase.

FA trophic markers can be used to study foraging ecology in different ways. A first use is the assessment of changes in FA composition ("signatures") of the consumers alone to answer qualitative questions about plasticity of the diet (temporal & spatial variation) at both individual or population level (BUDGE *et al.*, 2006).

A more recent development is the quantitative estimation of the contribution of each food item to the diet of the consumer. These methods, such as QFASA (Quantitative Fatty Acid Signature analysis), require an advanced knowledge of the physiology and biochemistry of lipids in the consumers, as well as strong individual datasets to assess variability of the diet. These methods have been proven useful and efficient when working with top predators, especially marine mammals (see IVERSON *et al.*, 2004). However, they are not readily applicable in our case, since the small size of the studied species prevents individual measurements and limits the number of analyzes, and therefore the sizes of the datasets. Moreover, knowledge on the FA digestion and metabolism in amphipods is not sufficient to use such a model and expect realistic results.

Finally, another qualitative application is the use of FA markers, or tracers. The ideal case of this application involves the existence of unique FA found in a consumer's tissues, and that can be traced to a single food item. This case is rarely, if ever, encountered, but the concept can be extended. Unusual (high or low) contents of specific FA, or ratios among FA that can be linked with a specific food source (or group of food sources) can be indicative of their significance in the consumer diet (see KHARLAMENKO *et al.*, 2001 ; LEBRETON *et al.*, 2011 for examples). This approach is often used in conjunction with other trophic markers, such as stable isotopes ratios (DALSGAARD *et al.*, 2003). It is this way that we used FA in the present study, where we investigated the FA composition of both food sources and consumers, in order to delineate amphipod feeding habits.

The use of FA composition as trophic marker is of course not perfect. This technique suffers from several caveats.

First, the composition of all lipids does not reflect the dietary intake of FA in the same way. As it has been mentioned before, while TAG and wax esters can readily be deposited/mobilized by the animals, it is not the case of phospholipids that are quite robust to dietary changes. This would suggest that FA analysis would be more informative by working with storage lipids only. However, for benthic amphipods, differences between the FA composition of structural (phospholipids) and storage (TAG) lipids are small, so we chose to analyze the total lipid content, in agreement with recommendations from GRAEVE *et al.*, (2001).

Moreover, digestion of FA is not completely conservative. While *de novo* biosynthesis is generally thought of as being relatively insignificant in

comparison of dietary intakes in animals in good physiological and nutritional conditions, modification of FA (elongation, desaturation) can take place in the consumer's tissues. Even if these reactions are typically limited to SAFA and MUFA, they must be kept in mind when analyzing the data (BUDGE *et al.*, 2006). Finally, no single FA can be linked uniquely to a single species, and the temporal dynamics of FA (turnover rates of lipids) are often species-specific, and can be influenced by the metabolic condition and/or reproductive status of the consumer (DALSGAARD *et al.*, 2003).

These inherent limitations justify the conjoint use of other techniques (stable isotopes, gut contents) and encourage the use of caution and critical thinking in the interpretation of the results. The analysis of the FA composition nevertheless remains an interesting and powerful tool to study trophic ecology of consumers.

## **1.2. Trophic ecology of amphipods from *P. oceanica* meadows: previous studies and objectives of this chapter**

As mentioned in chapter 1, amphipods are one of the dominant groups of vagile invertebrates from *P. oceanica* meadows. Our results (cf. chapter 3) confirm that this taxocenosis is abundant and diverse.

Vagile invertebrates in general, and amphipods in particular, are often regarded as key-components of seagrass systems, notably because of their importance in food webs. They are generally considered to be primary consumers and/or detritivores, therefore constituting a trophic link between producers and higher rank consumers. However, the understanding of their trophic ecology is still poor.

In ecological literature, amphipods are traditionally regarded as generalist herbivores, feeding on leaves' vegetal epiphytes (diatoms and macroalgae) and associated detritus. However, we believe that these assumptions rarely rely on precise and adequate data. Instead, in a lot of cases, they are considered so by analogy with other, better-known seagrass systems or animal groups (*e.g.* KIKUCHI, 1980 ; MAZZELLA *et al.*, 1992), or because they are sampled in association with seagrass epiphytes (*e.g.* CHIMENZ *et al.*, 1989).

These views are of course sensible and plausible, but accurate studies supporting them are rare. A notable exception is the study of SCIPIONE & MAZZELLA (1992), who showed that *Dexamine spinosa* selectively fed on mobile diatoms by brushing the surface of the leaves. This suggests the existence of trophic specialization in some of those amphipods.

GAMBI *et al.* (1992) classified the amphipods of the foliar stratum in trophic guilds, providing more global data on the subject. Their work suggests that most amphipods are herbivores/deposit feeders (35.8 %) or herbivores (30.2 %). Minor trophic categories include deposit/suspension feeders (10.5 %), omnivores (6.7 %), deposit feeders (6.1 %), deposit feeders/carnivores (2.9 %) and detritus feeders (0.8 %). 7 % of the amphipods could not be linked with a trophic category. Such exhaustive classification is informative, and

---

## Multidisciplinary study of trophic diversity

acknowledges the existence of trophic diversity among the amphipod community. However, it relies on literature data and observations of trophic behaviour. The lack of actual diet data (gut contents, etc.) unfortunately limits the insights that can be drawn from this study.

Actual studies of the diet of amphipods using stable isotopes of C and N have been performed (LEPOINT *et al.*, 2000 ; VIZZINI *et al.*, 2002). They confirmed the importance of epiphyte-derived organic matter in diet of amphipods. However, they considered the amphipods as a whole group, without distinction of species. Their datasets are therefore not adapted to the study of trophic diversity among amphipods.

Overall, information about the trophic ecology of amphipods from *P. oceanica* meadows seems partial and limited. In this context, the main objective of this chapter was to fill some of these gaps by improving the understanding of the feeding habits of these animals.

More precisely, we wanted to assess the extent of interspecific trophic diversity existing among the taxocenosis. This phenomenon could indeed be important in the perspective of interactions between amphipod taxa, as it could be important in the limitation of competition for food.

In addition, vegetal epiphytes from the leaves are not the only food item available for amphipods in *P. oceanica* meadows. Therefore, we tried to estimate the importance of "alternative" food sources (*P. oceanica* leaves and litter, SPOM, BPOM, epifauna from the leaves and the litter fragments, epiflora from rhizomes and the litter fragments) for amphipod nutrition.

To achieve these goals, we tried to perform a full reconstruction of the diet of the most representative species of the community. We sampled amphipods and food sources at several seasons, to take the seasonal variation of the feeding habits into account.

To be as efficient as possible, we combined several methods, including "traditional" techniques (gut content examination) and trophic tracers. We chose to use C and N stable isotope ratios and fatty acids. These trophic markers are among the most widely used, and their joint use has already proven to be efficient (*e.g.* KHARLAMENKO *et al.*, 2001 ; NYSSSEN *et al.*, 2005 ; LEBRETON *et al.*, 2011).

## **II. Material & Methods**

The study site has been described extensively in chapter 2, as well as the data processing and analysis procedure. The interested reader is thus advised to refer to this part of the manuscript for further information.

## **II.1. Target species**

All 3 techniques (gut content analysis, stable isotope ratios, fatty acid analysis) were applied to study the feeding habits of the most representative species of the community. 7 species were previously identified as interesting candidates, mostly because of their numerical abundance (see chapter 3, section IV.3): *Apherusa chiereghinii*, *Aora spinicornis*, *Dexamine spiniventris*, *Amphithoe helleri*, *Caprella acanthifera*, *Gammarella fucicola* and *Gammarus aequicauda*.

During the extensive sampling necessary to collect these animals in sufficient amounts for laboratory analyzes, we also captured a number of other species. The sampled effectives for these species were generally too low to study their diet using the three techniques, but were in some cases far from negligible. We therefore chose to analyse stable isotopic ratios of carbon (the less material-demanding and time-consuming method) of these animals, keeping in mind that insights drawn from this method only would be much less clear than for the 7 dominant species. 14 “minor”, less frequent species were investigated: *Dexamine spinosa*, *Ampelisca rubella*, *Orchomene humilis*, *Megaluropus massiliensis*, *Tmetonyx nardonis*, *Perioculodes aequimanus*, *Synchelidium longidigitatum*, *Phtisica marina*, *Atylus guttatus*, *Leucothoe spinicarpa*, *Amphilochus neapolitanus*, *Iphimedia minuta*, *Normanion chevreuxi* and *Metaphoxus simplex*.

## **II.2. Gut contents**

### **II.2.A. Sample collection**

Amphipod specimens used for gut content examination were sampled in November 2007, March 2008 and June 2008 (see chapter 2 for precise dates). Sampled animals were fixed in a formaldehyde solution (4% in seawater), and subsequently transferred to 70% ethanol for long-term conservation. 20 well-preserved individuals were selected for each of the 7 studied species.

### **II.2.B. Slide preparation**

The technique used is based on the one from GUERRA-GARCIA & TIERNA DE FIGUEROA (2009), that is itself a modification the method of BELLO & CABRERA (1999). This technique, that has been proven efficient on a number of terrestrial and aquatic insects and crustaceans, involves body wall discoloration using Hertwig's liquid. After discoloration, gut content can be observed throughout the tissues of the whole animal.

Hertwig's liquid was prepared by mixing 270 g of chloral hydrate (Acros Organics, 98.5% pure), 19 ml of 1M chloridric acid, 150 ml of distilled water and 60 ml of glycerin. Each amphipod was placed in a vial containing 2 ml of Hertwig's liquid. The vials were placed in an oven and maintained at 60°C for 7 to 10 days, to achieve suitable discoloration. Transparency was visually

---

## Multidisciplinary study of trophic diversity

checked daily to ensure that all samples were in a comparable discoloration state.

Once transparent, amphipods were mounted *in toto* on previously cleaned microscopic slide. We used Hoyer's mounting medium, consisting of 50 ml of distilled water, 30 g of arabic gum, 200 g of chloral hydrate and 16 ml of glycerin. Slides were then dried for 48 h at 60°C, and then cast with nail varnish.

### II.2.C. Gut content examination

Slides were examined in the Laboratory of Animal Ecology and Ecotoxicology (ULg) using an Olympus BX50 microscope. Photographs were taken at 100X (for measurement of the total size of the gut content) and 400X or 1000X (to identify and measure precise food items) magnifications. Photographs were taken using an Olympus XC50 Camera and the cell<sup>®</sup> software (Olympus Europa GmbH, Germany), while measurements were performed using Axiovision<sup>®</sup> software for Windows XP (Carl Zeiss MicroImaging GmbH, Germany).

The surface occupied by each food item was expressed using relative units, in percentage of the total area occupied by the gut content.

### II.3. Stable isotopes

#### II.3.A. Sample collection

**Amphipods** were sampled using a hand towed-net or light traps, as described in chapter two. They were euthanatized by freezing, then identified using a binocular microscope.

*Posidonia oceanica* shoots were manually uprooted, and litter fragments were handpicked. **Leaves** and **litter fragments** were scraped using a scalpel blade, and their animal and vegetal **epiphytes** were sorted under a binocular microscope. **Rhizome epiflora** was separated from the shoots using fine scissors. All the scraped leaves of each shoot were processed as a single sample. For litter, circa 10 g (wet mass) of scraped fragments were pooled and considered as a unique sample.

**Benthic particulate organic matter (BPOM)** was sampled by collecting the first cm of sediment between *Posidonia* shoots, using a plastic container. Sediment was then sieved to eliminate the coarser debris (> 1 cm)

**Suspended particulate organic matter (SPOM)** was collected by filtering seawater on glass fibre filters (Whatman GF/F, sieve size 0.7 µm). The seawater was collected in the meadow, among the leaves, using 5 litres Niskin bottles. Like sediment for BPOM analysis, water was pre-sieved to remove items larger than one cm. It was then filtered on previously precombusted (4 hours at 400°C) filters until clogging.

### II.3.B. Sample conditioning and processing

After collection, all samples were directly processed or, if not possible, were stored at  $-20^{\circ}\text{C}$  for later treatment.

All samples were oven-dried at  $60^{\circ}\text{C}$  for 72 hours. Amphipods were analyzed whole, but all food items were ground into a homogeneous powder. This was done manually, using mortar and pestle, for some items (epiphytes from leaves, litter and rhizomes, SPOM). The tougher tissues of *Posidonia* leaves and litter, as well as sediments collected for BPOM analysis required mixer milling. This was done using a Retsch<sup>®</sup> MM301, with cycles of 120 seconds at 25 Hz.

Inorganic carbon present in the samples can be a bias for  $\delta^{13}\text{C}$  analysis. Carbonates are generally precipitated directly from seawater by marine organisms, using non-dietary processes. Therefore,  $\delta^{13}\text{C}$  of carbonates cannot be linked with  $\delta^{13}\text{C}$  of diet. It is thus a common practice to remove carbonates by acidification (*e.g.* MAZUMDER *et al.*, 2010). This was done using different techniques according to the amount of carbonates present in each tissue.

Tissues containing little or no carbonates (*Posidonia* leaves and litter) were not acidified. Tissues containing moderate amounts of carbonates (animal and vegetal epiphytes, SPOM, amphipods) were acidified using HCl vapours. Samples were placed in a tight container alongside a beaker containing fuming 12M HCl for 48 hours. Vapours spreading from the concentrated chlorhydric acid were sufficient to eliminate carbonates present in the tissues.

This was not the case for sediment sampled for BPOM analysis, that required direct addition of HCl 1N. We took subsamples of approximately 1 g, to which 10 ml of HCl were slowly and progressively added, in order to avoid excessive bubbling and sample loss. After 2 hours of acidification, samples were centrifuged at 5000 rpm for 10 minutes, and the supernatant was discarded. Acidification was then repeated, and samples were rinsed thrice with distilled water afterwards.

In both cases, samples were weighed before and after acidification, in order to account for weight loss while computing C and N elemental contents.

Lipids are more depleted in  $^{13}\text{C}$  (lower  $\delta^{13}\text{C}$ ) than carbohydrates and proteins, and can therefore influence the global  $\delta^{13}\text{C}$  of the consumer tissue. This led POST *et al.*, 2007 to recommend lipid removal if C/N ratios of animals are superior to 3.5 and/or if lipid content exceeds 5 % of the wet mass. This was the case for our amphipods (C/N ratios between 5 and 7, lipid content usually ranging from 8 to 14 % of the wet body mass).

However, the lipid content and C/N ratios were similar in all the sampled species. Moreover, preliminary tests showed that lipid removal did not seem to significantly affect the  $\delta^{13}\text{C}$  of one of the sampled amphipod species (*Apherusa chiereghinii*, data not shown). This has already been pointed out by previous workers (*e.g.* PINNEGAR & POLUNIN, 1999). In addition, we believe that since lipid content and composition is linked to the diet of animals, contrasting strategies of lipid stocking and/or metabolism could arguably be seen as mechanisms

## Multidisciplinary study of trophic diversity

involved in the global expression of trophic diversity. In this study, lipids were therefore not removed prior to analysis.

### II.3.C. Analytical measurements

All stable isotopes measurements were performed using the CF-EA-IRMS (Continuous Flow - Elemental Analysis - Isotope Ratio Mass Spectrometry) equipment of the Laboratory of Oceanology (ULg).

Adequate amounts of material were placed in tin cupules, and then flash combusted using a Carlo Erba NA 1500 elemental analyzer. CO<sub>2</sub> and N<sub>2</sub> resulting of this combustion were then transferred to an Isoprime Optima mass spectrometer for the measurement of the C and N stable isotope ratios (<sup>13</sup>C/<sup>12</sup>C and <sup>15</sup>N/<sup>14</sup>N). All these analyses were fully automated, and the machines were operated via a computer interface (EA 1.62 software for IBM OS/2, Isoprime Ltd., Manchester). This software was also used for data processing and calculations of isotopic ratios and elemental contents.

Acidified samples were analyzed in two runs: one for C, using decarbonated material, and one for N, using native material, as acidification is known to alter δ<sup>15</sup>N by acid leaching. For amphipods, individual measurements were performed for carbon isotopic ratios. However, due to their low body mass, specimen had to be pooled for N analysis. Depending on the considered species, pools contained two to 20 individuals. The numbers of replicates analyzed for each item are pictured in table 4.II (for nitrogen) and 4.III (for carbon).

**Table 4.II:** Effectives (n) for the measurements of δ<sup>15</sup>N and N elemental concentration for each sampling event. For amphipods, numbers between parentheses are the number of individuals pooled for each replicate measurement.

	06/2008	11/2008	03/2009	07/2009
<i>Apherusa chieraghinii</i>	10 (20)	10 (20)	10 (20)	10 (20)
<i>Aora spinicornis</i>	8 (15)	8 (15)	7 (15)	9 (15)
<i>Dexamine spiniventris</i>	10 (3)	10(3)	10 (3)	10 (3)
<i>Amphithoe helleri</i>	5 (20)	6 (20)	6 (20)	8 (20)
<i>Caprella acanthifera</i>	5 (20)	5 (20)	5 (20)	7 (20)
<i>Gammarella fucicola</i>	7 (3)	6 (3)	9 (3)	10 (3)
<i>Gammarus aequicauda</i>	10 (2)	10 (2)	10 (2)	10 (2)
<i>Posidonia</i> leaves	15	15	15	15
<i>Posidonia</i> litter	15	15	15	15
Leaves epifauna	7	6	7	11
Leaves epiflora	9	8	9	12
Litter epifauna	6	5	7	7
Litter epiflora	7	6	7	8
Rhizome epiflora	10	10	10	10
SPOM	7	5	8	7
BPOM	10	10	10	10



**Table 4.III:** Effectives (n) for the measurements of  $\delta^{13}\text{C}$  and C elemental concentration for each sampling event.

	06/2008	11/2008	03/2009	07/2009
<i>Apherusa chieraghinii</i>	20	20	20	20
<i>Aora spinicornis</i>	20	20	20	20
<i>Dexamine spiniventris</i>	20	20	20	20
<i>Amphithoe helleri</i>	20	20	20	20
<i>Caprella acanthifera</i>	20	20	20	20
<i>Gammarella fucicola</i>	20	20	20	20
<i>Gammarus aequicauda</i>	20	20	20	20
<i>Dexamine spinosa</i>	14	9	12	13
<i>Ampelisca rubella</i>	9	11	7	12
<i>Orchomene humilis</i>	12	14	9	10
<i>Megaluropus massiliensis</i>	11	8	6	9
<i>Tmetonyx nardonis</i>	7	9	9	11
<i>Perioculodes aequimanus</i>	10	6	6	9
<i>Synchelidium longidigitatum</i>	9	9	7	11
<i>Phtisica marina</i>	14	19	16	20
<i>Atylus guttatus</i>	11	14	12	11
<i>Leucothoe spinicarpa</i>	8	6	7	6
<i>Amphilochus neapolitanus</i>	14	14	12	16
<i>Iphimedia minuta</i>	13	11	17	14
<i>Normanion chevreuxi</i>	10	9	11	7
<i>Metaphoxus simplex</i>	7	7	14	9
<i>Posidonia</i> leaves	15	15	15	15
<i>Posidonia</i> litter	15	15	15	15
Leaves epifauna	7	6	7	11
Leaves epiflora	9	8	9	12
Litter epifauna	6	5	7	7
Litter epiflora	7	6	7	8
Rhizome epiflora	10	10	10	10
SPOM	7	5	8	7
BPOM	10	10	10	10

Sucrose (IEAE-CH6,  $\delta^{13}\text{C} = -10.80 \pm 0.47 \text{ ‰}$ ) and Ammonium Chloride (IAEA-N1,  $\delta^{15}\text{N} = 0.40 \pm 0.30 \text{ ‰}$ ) were used as standards for the measurement of isotopic ratios. Both of these standards are calibrated against the international isotopic references Vienna Pee-Dee Belemnite (for carbon) and Atmospheric air (for nitrogen). In addition, Glycine (Merck, [C] = 31.98 % of total dry mass and [N] = 18.72 % of total dry mass) was used as a standard for elemental contents measures. Analytical precision was 0.2 ‰ for  $\delta^{13}\text{C}$  and 0.3 ‰ for  $\delta^{15}\text{N}$ . For elemental contents measurements, it was 2 % of the relative content of samples (*i.e.*, 0.6 % for a sample containing 30 % of a given element).

Isotopic ratios were expressed using the widespread "δ" notation (cf. section I.1.B.a. of this chapter). Standards were Vienna Pee-Dee Belemnite for  $^{13}\text{C}$  analysis and Atmospheric Air for  $^{15}\text{N}$  analysis.

### II.3.D. SIAR isotopic mixing model

To numerically estimate the contribution of each food item in the diet of the studied species, we used an isotopic mixing model. We chose to use the recently developed SIAR (Stable Isotope Analysis in R) model. It consists of an open-source package that is used via the R framework, and can be downloaded freely at <http://cran.r-project.org/web/packages/siar/index.html>. This model, based on bayesian methods, has proven to be an efficient ecological modelling tool, capable of dealing with uncertainties and variabilities of input data, even in underdetermined systems (PARNELL *et al.*, 2010).

We used  $\delta^{13}\text{C}$  and  $\delta^{15}\text{N}$ , and relative elemental concentrations (organic C and N, expressed in percentage of the total dry mass) of consumers and sources as input data. Since our data for amphipod consumers are based on different measurements for C and N, it was impossible to make scatter plots of individual signatures using the traditional  $\delta^{13}\text{C}$  vs.  $\delta^{15}\text{N}$  graphs. Therefore, we had to use a single "global" signature for each species (mean isotopic deltas) rather than the full distribution of individual signatures.

Moreover, since some sources had really close or identical signatures, we aggregated them in three groups. More information about that can be found in section III.3.D of this chapter.

Isotopic fractionation linked with food digestion and assimilation (trophic shift) is a critical data to use mixing models efficiently. In marine amphipods, their values are typically low and highly variable (see sections III.3.B. and IV.3.B. of this chapter). Therefore, rather than using general fractionation factors coming from literature reviews, we chose to follow the recommendations of CAUT *et al.* (2008) and to use or own trophic enrichment values. They were measured during our *in vitro* grazing experiments (see chapter 5, sections III.1.D.a. and IV.4.) for 2 of the 7 dominant taxa (*Dexamine spiniventris* and *Gammarus* spp.). Values were  $0.2 \pm 0.6$  ‰ for  $\Delta^{13}\text{C}$  and  $1.2 \pm 0.5$  ‰ for  $\Delta^{15}\text{N}$ .

## II.4. Fatty acids

### II.4.A. Sample collection & conditioning

The sample collection *sensu stricto* was identical to the one described on section II.3.B for stable isotopes. The interested reader is therefore sent back to this section for further information.

At the STARESO Research Station, tissues were conditioned directly after collection in order to avoid lipid degradation. In November 2008 and March 2009, this was done by placing them in cryotubes and deep-freezing them in liquid nitrogen. Once back in Liège, they were transferred to an  $-80^\circ\text{C}$  freezer for later extraction of lipids.

In July 2009, we had no access to liquid nitrogen, so we conditioned the samples directly in the extraction solvent (dichloromethane:methanol, 2:1 by vol.) to which we added 0.01% of butylated hydroxytoluene (BHT) to prevent

lipid oxidation. Samples were placed in previously rinsed amber glass vials, covered with solvent and stocked at  $-30^{\circ}\text{C}$  prior to extraction of lipids and analysis.

Because of their low biomass and lipid content, amphipods had to be pooled for fatty acid analysis. This was done in a way that each sample contained 20 to 50 mg (fresh weight) of amphipod tissue, and pools contained 2 to 40 animals, depending on the species. The pooling strategy and the number of replicates are detailed in table 4.IV.

**Table 4.IV:** Effectives (n) for the fatty acid analysis for each sampling event. For amphipods, numbers between brackets are the number of individuals pooled for each replicate measurement.

	11/2008	03/2009	07/2009
<i>Apherusa chiereghinii</i>	2 (30)	2 (30)	6 (30)
<i>Aora spinicornis</i>	-	1 (20)	5 (20)
<i>Dexamine spiniventris</i>	1 (3)	1 (3)	9 (3)
<i>Amphithoe helleri</i>	1 (35)	-	-
<i>Caprella acanthifera</i>	-	-	1 (40)
<i>Gammarella fucicola</i>	-	1 (4)	-
<i>Gammarus aequicauda</i>	2 (2)	2 (2)	5 (2)
<i>Posidonia</i> leaves	3	3	-
<i>Posidonia</i> litter	3	3	-
Leaves epifauna	-	-	2
Leaves epiflora	-	-	7
Leaves bulk epiphytes	2	2	-
Litter bulk epiphytes	2	-	-
Rhizome epiflora	-	1	4
SPOM	-	-	2

Samples of sediments for BPOM analysis, of *Posidonia* leaves and of *Posidonia* litter were taken in July 09, but due to stocking issues during the transportation from Corsica to Belgium, they unfortunately had to be discarded.

#### II.4.B. Total lipid extraction & trans-esterification of fatty acids

These steps were realized at the Laboratory of Systematics and Animal Diversity (ULg). Our methodology for both steps was similar to the ones used by GRAEVE *et al.* (2001) and NYSSSEN *et al.* (2005). Tricosanoic acid methyl ester (23:0, Sigma-Aldrich T9900) was used as an internal standard for these preparations steps.

For total lipid extraction, we first recorded wet (after elimination of all solvent for the samples stored at  $-30^{\circ}\text{C}$ ) and dry (after lyophilisation) mass.

---

## Multidisciplinary study of trophic diversity

Samples were then homogenised directly in the extraction solvent, consisting of a mixture of dichloromethane & methanol (2:1 by vol., FOLCH *et al.*, 1957), using a Potter-Elvehjem type tissue grinder.

Extraction step was repeated thrice, and between each repetition, the samples were sonicated in an ultrasonic bath for 30 seconds to ensure maximal recovery of the lipids present in the tissues.

We subsequently added a 0.88 % KCl to the raw lipidic extracts, centrifuged the extracts for 10 minutes at 2000 rpm, and discarded the upper phase to obtain the lower phase containing lipidic compounds. After evaporating the solvent with nitrogen flow, we measured total lipid content.

The cleaned, dried lipidic extracts were then transferred in a methanol mixture containing 3 % H<sub>2</sub>SO<sub>4</sub>. They were placed at 80°C for 4h for conversion to fatty acid methyl esters (FAME) by trans-esterification. FAME were then transferred to hexane for later analysis.

### II.4.C. Fatty acid analysis

Fatty acids were analyzed using gas chromatography. All analyzes were carried out at the Alfred Wegener Institut für Polar- und Meeresforschung (AWI, Bremerhaven, Germany), using the equipment of the Marine Chemistry group (prof. G. Kattner), under competent supervision of Dr. Martin Graeve. Like in the previous section, our methodology for both steps was similar to the ones used by GRAEVE *et al.* (2001) and NYSEN *et al.* (2005).

Fatty acid methyl esters were dosed with a Hewlett-Packard 6890 gas chromatograph equipped with a DB-FFAP fused silica capillary column (30 m x 0.25 mm inner diameter; 0.25 µm film thickness), using temperature programming (160-240°C at 4°C per minute, hold 15 minutes). Fatty acids were identified by comparing retention times with those of commercial (Supelco® 37 Component FAME Mix, 47885-U) and natural lab standards (mix of arctic copepods) of known composition. When a doubt subsisted on the nature of a peak, identification was checked using mass spectrometry.

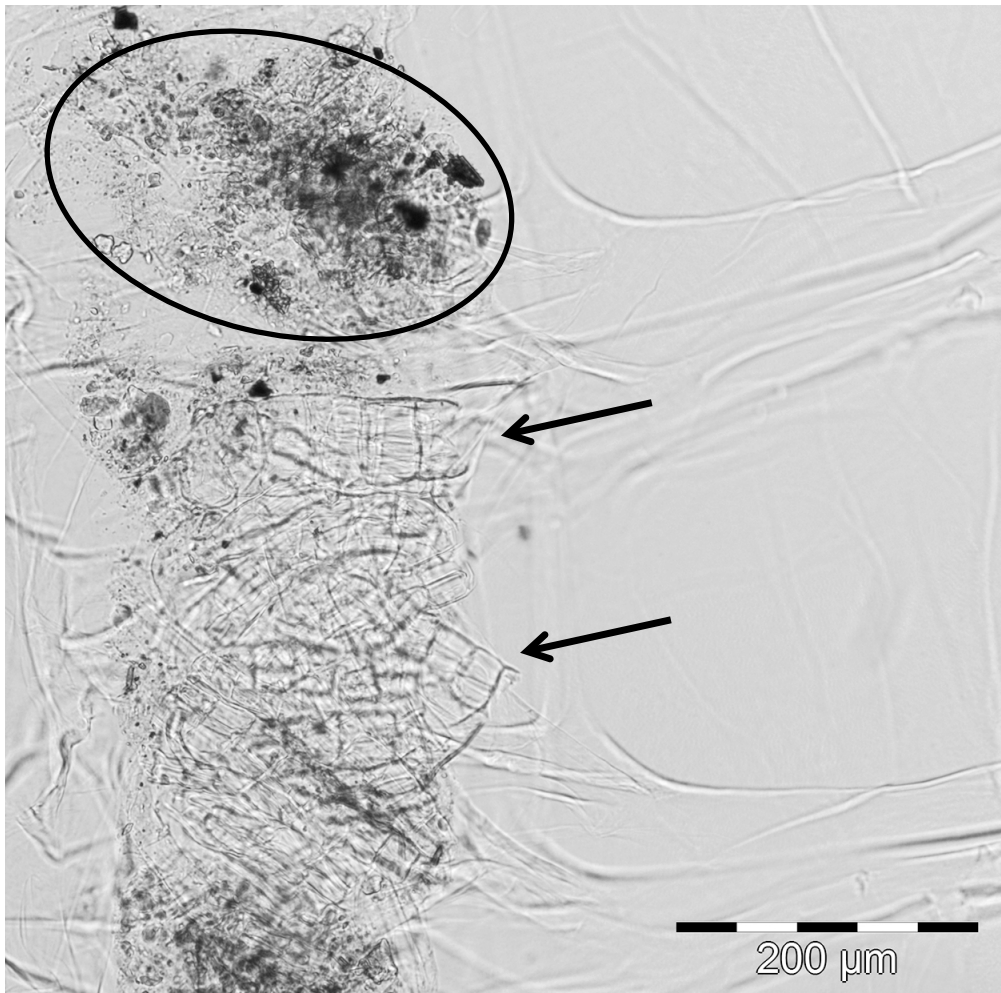
Relative concentrations of each detected fatty acid were computed using the surface of their corresponding peaks on the output chromatograph, and were expressed as a percentage of the total fatty acids present in the tissue.

## III. Results

### III.1. Gut content analysis

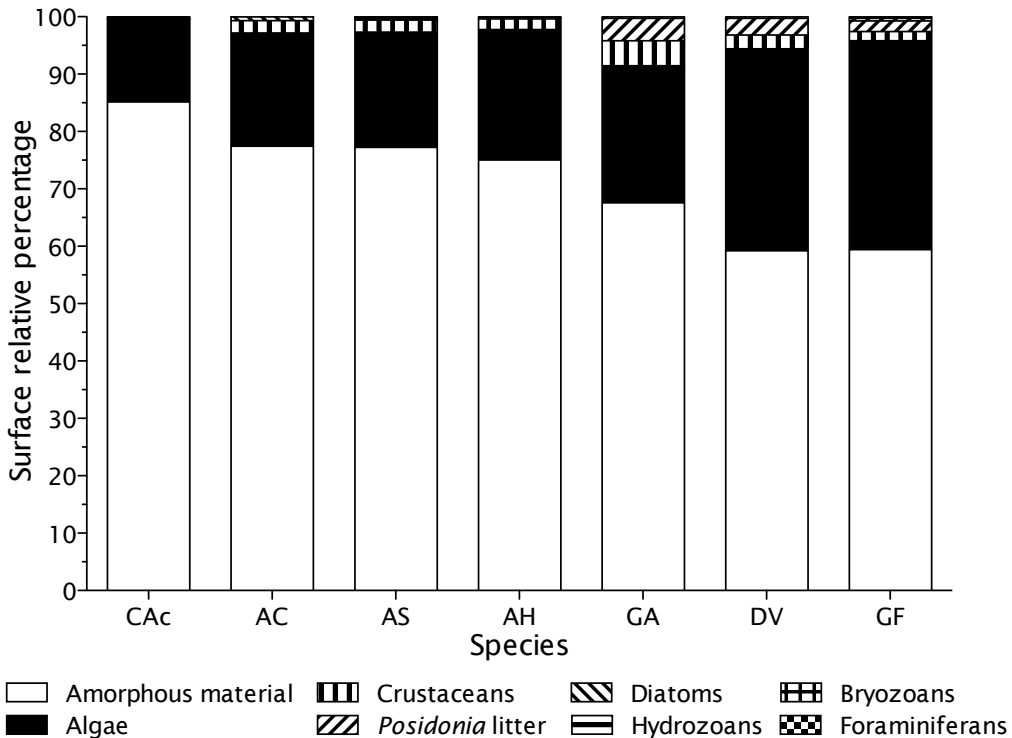
The majority of observed guts contained food items. Depending on the species, the occurrence of empty guts ranged from 0 to 15 % (3 of the 20 analyzed individuals). Seven food items were identified during gut content

analysis: algal remains, crustaceans parts, *Posidonia* litter fragments, diatoms, bryozoan zooids, pieces of hydrozoan perisarc, and foraminiferans. Figure 4.4 pictures an example of gut content, as observed using the chosen methodology.



**Fig. 4.4:** Example of gut content of *Dexamine spiniventris*. In the top of the figure, a patch of unidentifiable amorphous material is circled in black. In the bottom part, solid black arrows point algal fragments. On the left part of the figure, it is possible to see the transparented body wall of the amphipod.

All percentages mentioned hereafter are under the form mean  $\pm$  standard deviation. Figure 4.5 displays the relative contributions of these food items to the diet of the 7 studied species. It clearly shows that most of the gut content of all species was categorized as “amorphous material” due to the lack of identifiable structures allowing to link them to one of the functional groups mentioned above. This fraction’s occupied area ranged from 60 % ( $59.2 \pm 24.2$  % for *D. spiniventris*,  $59.4 \pm 15.8$  % for *G. fucicola*) to more than 80 % ( $85.2 \pm 9.77$  % for *C. acanthifera*).



**Fig. 4.5:** Mean relative contributions of each food item, expressed in percentage of the surface occupied by the total gut content. CAc: *Caprella acanthifera*, AC: *Apherusa chierighinii*, AS: *Aora spinicornis*, AH: *Amphithoe helleri*, GA: *Gammarus aequicauda*, DV: *Dexamine spiniventris*, GF: *Gammarella fucicola*.

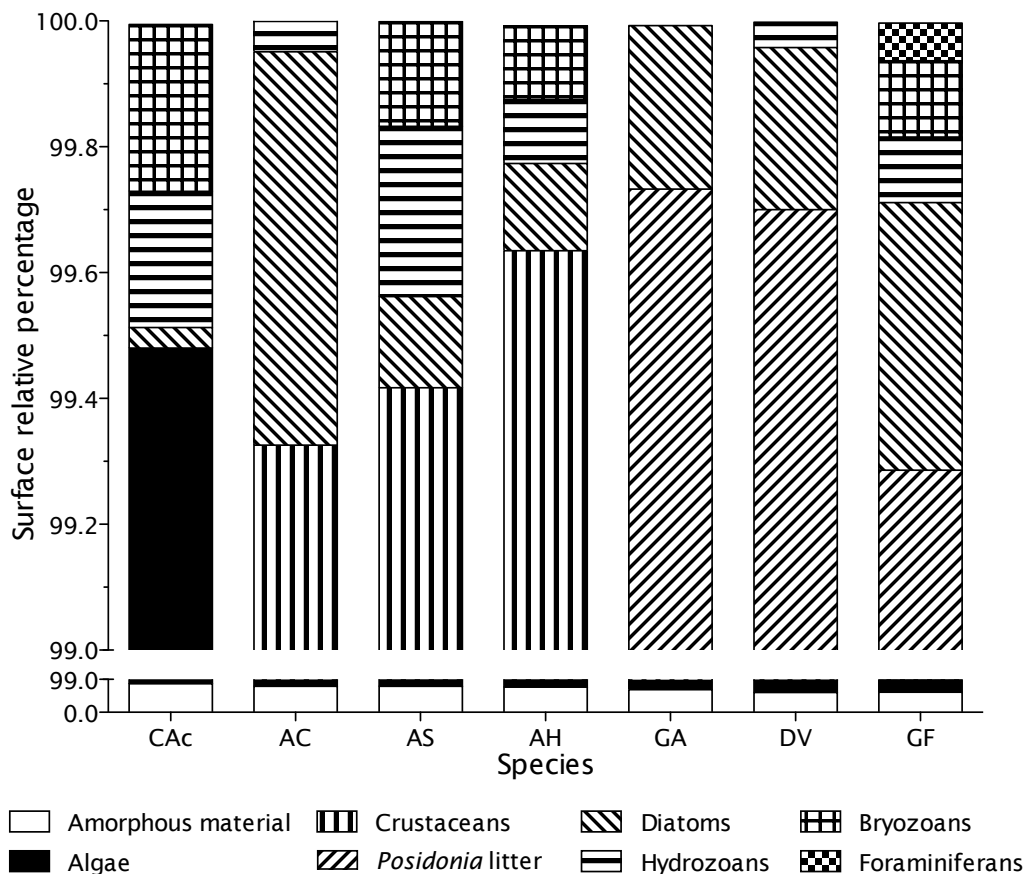
Among the identifiable fraction, algal remains were the most present for all species, constituting 15 % ( $14.3 \pm 9.95$  % for *C. acanthifera*) to over 35 % ( $35.2 \pm 25.9$  % for *D. spiniventris*,  $36.4 \pm 15.4$  % for *G. fucicola*) of the content of the digestive tractus.

Crustacean parts (mostly legs, but also mandibles and antennas) were present in all species but *Caprella acanthifera*. Their contributions were typically comprised between 1.5 and 2.5 %, with the exception of *Gammarus aequicauda* ( $4.3 \pm 7.8$  %).

*Posidonia* litter fragments were only present in 3 species: *G. aequicauda*, *D. spiniventris* and *G. fucicola*. In all 3 species, they were relatively rare ( $3.9 \pm 3.2$  %,  $2.9 \pm 11.5$  % and  $1.9 \pm 4.3$  %, respectively).

No recognizable fragment of live *Posidonia oceanica* leaves or rhizomes occurred in the gut content of any species.

The 4 remaining food items yielded anecdotic contributions, and they always summed for less than 1 %. Figure 4.6 displays the last percent of gut occupation shown in a suitable for reading scale.



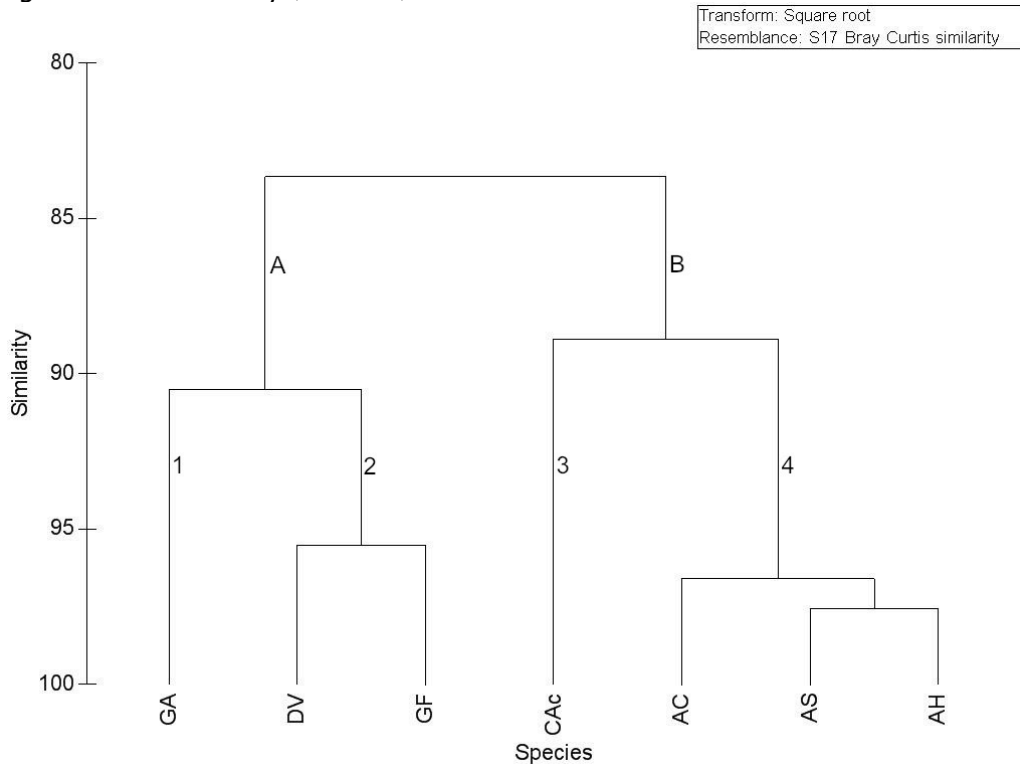
**Fig. 4.6:** Mean relative contributions of minor food items, expressed in percentage of the surface occupied by the total gut content. CAc: *Caprella acanthifera*, AC: *Apherusa chiereghinii*, AS: *Aora spinicornis*, AH: *Amphithoe helleri*, GA: *Gammarus aequicauda*, DV: *Dexamine spiniventris*, GF: *Gammarella fucicola*.

As shown in figure 4.6, diatoms were the only minor food item found in all 7 species. Its relative contributions were inferior to 0.5 % in all species but *A. chiereghinii* ( $0.6 \pm 1.2$  %). Hydrozoans were absent from *G. aequicauda* guts, and neither *G. aequicauda* nor *G. fucicola* contained any identifiable bryozoan zoids. Foraminiferans, on the other hand, were only present in *G. fucicola*.

Standard deviations associated to relative percentages of food items were always high, and often much greater than the mean in the case of minor sources. This stresses an important inter-individual variation in the feeding habits of each species.

## Multidisciplinary study of trophic diversity

To investigate the relations between the studied species, we performed a hierarchical clustering analysis (cf. chapter 2). Results of this analysis are shown in figure 4.7. It clearly emphasizes the fact that all species shared a high level of similarity (83.66 %).



**Fig. 4.7:** Dendrogram of the 7 studied species, computed using group-average linkage of Bray-Curtis similarities on  $\sqrt{\cdot}$ -transformed mean relative contributions to total gut content area. Cac: *Caprella acanthifera*, AC: *Apherusa chierghinii*, AS: *Aora spinicornis*, AH: *Amphithoe helleri*, GA: *Gammarus aequicauda*, DV: *Dexamine spiniventris*, GF: *Gammarella fucicola*.

Nevertheless, two major clusters appear, both sharing near 90 % of similarity: A is composed of *G. aequicauda*, *D. spiniventris* and *Gammarella fucicola*, while B contains *C. acanthifera*, *A. chierghinii*, *A. spinicornis* and *A. helleri*. An inter-group one-way SIMPER analysis (cf. chapter 2) revealed that the variable that contributes the most to dissimilarity between these two clusters is the percentage of gut content occupied by litter fragments, which are present in cluster A, but absent in all the species from cluster B. Indeed,  $\bar{\delta}_{\text{litter}}$  is high (5.05, or 30.92 % of the total dissimilarity between the two clusters), and so is  $\bar{\delta}_{\text{litter}}/SD_{\text{litter}}$  (6.17).

At a 95 % of similarity threshold, cluster A further subdivides in cluster 1 (only composed of *G. aequicauda*) and cluster 2 (*D. spiniventris* & *G. fucicola*). SIMPER analysis points the occurrence of algae, more abundant in cluster 2



than in cluster 1, as the best discriminating variable ( $\overline{\delta}_{\text{algae}} = 32.58\%$  of total dissimilarity,  $\overline{\delta}_{\text{algae}}/SD_{\text{algae}} = 17.31$ ).

Cluster B can also be split in two clusters sharing more than 95 % of Bray-Curtis similarity: the monospecific cluster 3, containing only *Caprella acanthifera*, and the cluster 4, containing the 3 remaining species. In this case, the proportion of crustacean remains, absent in *C. acanthifera* but present in all the other species, is responsible for most of the dissimilarity between the clusters ( $\overline{\delta}_{\text{crustaceans}} = 42.55\%$ ,  $\overline{\delta}_{\text{crustaceans}}/SD_{\text{crustaceans}} = 26.01$ ).

Finally, the attention of the reader is drawn to the fact that all clusters suitable for intra-group SIMPER analysis (A, B, 2 & 4) share the proportion of amorphous material as a strong common typifying variable. Table 4.V shows the key results of this analysis.

**Table 4.V:** Summary of the results of intra-group SIMPER analyses concerning the proportion of gut content occupied by amorphous material. For each cluster, table gives the mean relative contribution of this variable to the total intra-group similarity ( $\overline{\delta}_{\text{AM}}$ , expressed in %), as well as the ratio between the mean contribution to the total intra-group similarity and the standard deviation associated with this measure ( $\overline{\delta}_{\text{AM}}/SD_{\text{AM}}$ ).

Cluster	$\overline{\delta}_{\text{AM}}$ (%)	$\overline{\delta}_{\text{AM}}/SD_{\text{AM}}$
A	60.70	29.16
B	47.10	223.92
2	45.35	-
4	56.39	181.57

As cluster 2 contains only 2 species, it is impossible to compute a standard deviation, explaining the missing  $\overline{\delta}_{\text{AM}}/SD_{\text{AM}}$  values. However, table 4.V clearly shows that relative abundance of amorphous material can be regarded as a major factor driving the resemblance between the species constituting clusters A, B, 2 and 4.

## III.2. Fatty acid analyzes

### III.2.A. Fatty acid composition of food items

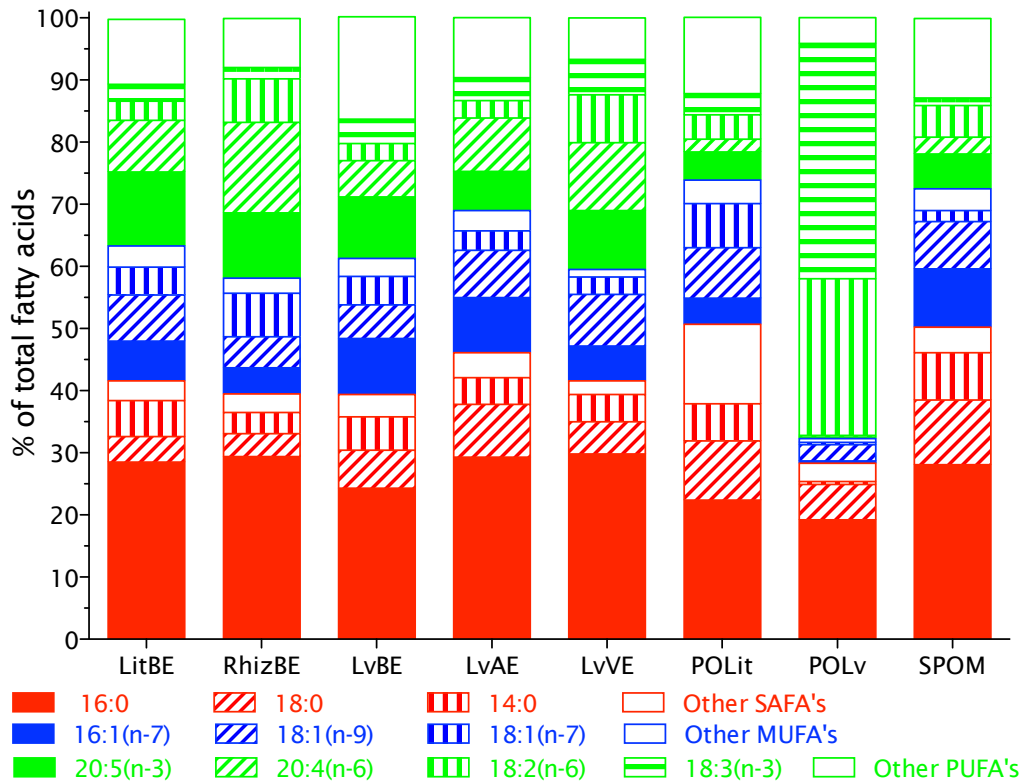
In total, 43 fatty acids (FA) were identified in at least one of the 8 analyzed food sources. Table 4.VI lists all significant FA of each food source (*i.e.*, all compounds accounting for at least 0.5 % of the total FA content of one of the sources). In addition, figure 4.8 shows the relative contributions of the dominant FA of these sources, classified according to their degree of saturation.

**Table 4.VI:** Relative fatty acid composition of total lipids of food sources, in percentage of the total FA content. All values are means  $\pm$  standard deviation. Only FA contributing to more than 0.5 % in at least one source are listed. LitBE: Litter bulk epiphytes, RhizVE: Rhizomes vegetal epiphytes, LvBE: Leaves bulk epiphytes, LvAE: Leaves animal epiphytes. n.d.: not detected.

Fatty acid	LitBE	RhizVE	LvBE	LvAE
12:0	0.28 $\pm$ 0.09	0.15 $\pm$ 0.07	0.17 $\pm$ 0.06	0.16 $\pm$ 0.03
14:0	5.79 $\pm$ 0.66	3.37 $\pm$ 0.85	5.42 $\pm$ 1.39	4.31 $\pm$ 0.44
a15:0	0.55 $\pm$ 0.11	0.79 $\pm$ 0.32	0.61 $\pm$ 0.20	0.51 $\pm$ 0.07
15:0	0.80 $\pm$ 0.05	0.39 $\pm$ 0.26	0.44 $\pm$ 0.30	0.58 $\pm$ 0.01
16:0	28.5 $\pm$ 2.26	29.3 $\pm$ 3.42	24.2 $\pm$ 2.99	29.3 $\pm$ 1.74
16:1(n-7)	6.40 $\pm$ 1.53	4.23 $\pm$ 1.98	8.96 $\pm$ 1.51	8.94 $\pm$ 2.06
16:1(n-5)	1.32 $\pm$ 0.12	0.76 $\pm$ 0.20	1.04 $\pm$ 0.21	0.61 $\pm$ 0.15
16:2(n-4)	0.37 $\pm$ 0.11	0.26 $\pm$ 0.16	0.49 $\pm$ 0.07	0.25 $\pm$ 0.00
17:0	0.47 $\pm$ 0.56	0.69 $\pm$ 0.23	0.93 $\pm$ 0.28	1.43 $\pm$ 0.28
16:3(n-4)	0.38 $\pm$ 0.04	0.37 $\pm$ 0.35	0.53 $\pm$ 0.35	0.37 $\pm$ 0.02
18:0	4.12 $\pm$ 0.11	3.72 $\pm$ 0.56	6.08 $\pm$ 2.21	8.46 $\pm$ 0.12
18:1(n-9)	7.39 $\pm$ 0.68	5.01 $\pm$ 0.81	5.38 $\pm$ 0.29	7.60 $\pm$ 0.07
18:1(n-7)	4.51 $\pm$ 0.47	6.96 $\pm$ 2.40	4.60 $\pm$ 2.49	3.11 $\pm$ 0.25
18:2(n-6)	3.13 $\pm$ 0.25	7.03 $\pm$ 4.42	2.77 $\pm$ 1.18	2.84 $\pm$ 4.02
18:3(n-6)	0.80 $\pm$ 0.14	0.98 $\pm$ 0.11	0.65 $\pm$ 0.22	0.79 $\pm$ 0.03
18:3(n-3)	2.73 $\pm$ 0.13	1.80 $\pm$ 0.77	3.88 $\pm$ 0.84	3.65 $\pm$ 1.09
18:4(n-3)	2.91 $\pm$ 0.05	0.92 $\pm$ 0.33	1.99 $\pm$ 1.52	2.20 $\pm$ 0.55
20:0	0.35 $\pm$ 0.18	0.39 $\pm$ 0.20	0.43 $\pm$ 0.10	0.64 $\pm$ 0.05
20:1(n-9)	0.44 $\pm$ 0.08	0.42 $\pm$ 0.11	0.81 $\pm$ 0.42	0.29 $\pm$ 0.06
20:2(n-6)	1.18 $\pm$ 0.15	0.89 $\pm$ 0.24	1.04 $\pm$ 0.19	1.21 $\pm$ 0.03
20:3(n-6)	0.23 $\pm$ 0.33	0.89 $\pm$ 0.21	0.41 $\pm$ 0.28	0.29 $\pm$ 0.41
20:4(n-6)	8.34 $\pm$ 0.87	14.6 $\pm$ 2.34	5.81 $\pm$ 2.79	8.59 $\pm$ 1.19
20:4(n-3)	1.61 $\pm$ 1.86	0.28 $\pm$ 0.12	1.27 $\pm$ 0.44	0.40 $\pm$ 0.06
20:5(n-3)	11.9 $\pm$ 3.40	10.5 $\pm$ 2.30	9.91 $\pm$ 0.90	6.26 $\pm$ 2.13
22:0	0.16 $\pm$ 0.22	0.36 $\pm$ 0.08	0.64 $\pm$ 0.20	0.50 $\pm$ 0.04
22:1(n-7)	0.11 $\pm$ 0.16	0.16 $\pm$ 0.22	0.09 $\pm$ 0.08	0.01 $\pm$ 0.02
22:5(n-3)	1.09 $\pm$ 0.08	1.40 $\pm$ 0.51	1.75 $\pm$ 0.69	0.95 $\pm$ 0.15
22:6(n-3)	1.25 $\pm$ 0.26	1.77 $\pm$ 1.16	7.75 $\pm$ 6.84	2.82 $\pm$ 3.88

**Table 4.VI (cont.):** Relative fatty acid composition of total lipids of food sources, in percentage of the total FA content. All values are means  $\pm$  standard deviation. Only FA contributing to more than 0.5 % in at least one source are listed. LvVE: Leaves vegetal epiphytes, POLit: *Posidonia oceanica* litter, POLv: *Posidonia oceanica* leaves, SPOM: Suspended particulate organic matter. n.d.: not detected.

Fatty acid	LvVE	POLit	POLv	SPOM
12:0	0.14 $\pm$ 0.08	1.43 $\pm$ 0.46	0.17 $\pm$ 0.03	0.53 $\pm$ 0.02
14:0	4.35 $\pm$ 0.26	5.97 $\pm$ 4.55	0.51 $\pm$ 0.17	7.58 $\pm$ 0.60
a15:0	0.32 $\pm$ 0.17	5.53 $\pm$ 1.41	0.70 $\pm$ 0.19	0.51 $\pm$ 0.00
15:0	0.43 $\pm$ 0.19	1.77 $\pm$ 0.52	0.25 $\pm$ 0.07	1.05 $\pm$ 0.05
16:0	29.7 $\pm$ 2.20	22.3 $\pm$ 4.46	19.2 $\pm$ 1.29	28.1 $\pm$ 0.27
16:1(n-7)	5.59 $\pm$ 1.10	4.22 $\pm$ 2.00	0.37 $\pm$ 0.06	9.41 $\pm$ 0.81
16:1(n-5)	0.39 $\pm$ 0.19	0.96 $\pm$ 0.73	n.d.	0.50 $\pm$ 0.03
16:2(n-4)	0.14 $\pm$ 0.10	0.81 $\pm$ 1.32	n.d.	0.70 $\pm$ 0.05
17:0	0.57 $\pm$ 0.07	0.90 $\pm$ 0.12	0.42 $\pm$ 0.12	0.45 $\pm$ 0.10
16:3(n-4)	0.15 $\pm$ 0.10	0.52 $\pm$ 0.23	0.17 $\pm$ 0.33	0.47 $\pm$ 0.03
18:0	5.24 $\pm$ 0.62	9.46 $\pm$ 0.59	5.70 $\pm$ 0.88	10.4 $\pm$ 0.13
18:1(n-9)	8.28 $\pm$ 0.71	8.08 $\pm$ 5.45	2.55 $\pm$ 1.51	7.59 $\pm$ 0.03
18:1(n-7)	2.78 $\pm$ 0.17	7.10 $\pm$ 1.83	0.37 $\pm$ 0.10	1.77 $\pm$ 0.26
18:2(n-6)	7.67 $\pm$ 0.70	3.86 $\pm$ 1.41	25.1 $\pm$ 3.97	5.07 $\pm$ 0.12
18:3(n-6)	0.56 $\pm$ 0.25	1.14 $\pm$ 0.34	0.23 $\pm$ 0.24	0.63 $\pm$ 0.02
18:3(n-3)	5.69 $\pm$ 1.40	3.36 $\pm$ 1.52	37.9 $\pm$ 6.03	1.23 $\pm$ 0.04
18:4(n-3)	2.47 $\pm$ 0.53	0.41 $\pm$ 0.25	0.06 $\pm$ 0.03	2.28 $\pm$ 0.12
20:0	0.41 $\pm$ 0.22	1.05 $\pm$ 0.44	0.42 $\pm$ 0.35	0.79 $\pm$ 0.20
20:1(n-9)	0.21 $\pm$ 0.10	0.75 $\pm$ 0.29	0.42 $\pm$ 0.20	1.13 $\pm$ 1.03
20:2(n-6)	0.68 $\pm$ 0.06	0.26 $\pm$ 0.10	0.22 $\pm$ 0.07	1.08 $\pm$ 0.26
20:3(n-6)	0.38 $\pm$ 0.26	0.81 $\pm$ 0.21	0.38 $\pm$ 0.31	0.27 $\pm$ 0.12
20:4(n-6)	10.9 $\pm$ 1.39	2.11 $\pm$ 0.74	0.29 $\pm$ 0.17	2.72 $\pm$ 0.31
20:4(n-3)	0.30 $\pm$ 0.13	0.28 $\pm$ 0.31	n.d.	0.16 $\pm$ 0.00
20:5(n-3)	9.54 $\pm$ 0.97	4.50 $\pm$ 2.93	0.21 $\pm$ 0.19	5.61 $\pm$ 0.17
22:0	0.22 $\pm$ 0.16	1.48 $\pm$ 0.82	0.66 $\pm$ 0.32	0.50 $\pm$ 0.12
22:1(n-7)	0.02 $\pm$ 0.02	0.78 $\pm$ 0.57	0.13 $\pm$ 0.30	0.11 $\pm$ 0.10
22:5(n-3)	0.59 $\pm$ 0.04	6.13 $\pm$ 4.01	2.79 $\pm$ 2.23	2.06 $\pm$ 1.28
22:6(n-3)	1.19 $\pm$ 0.59	1.42 $\pm$ 0.73	0.05 $\pm$ 0.06	3.89 $\pm$ 0.13



**Fig. 4.8:** Mean relative contributions of the dominant fatty acids of food sources, expressed in percentage of the total FA content. Red bars: saturated fatty acids (SAFA), blue bars: monounsaturated fatty acids (MUFA), green bars: polyunsaturated fatty acids (PUFA). LitBE: Litter bulk epiphytes, RhizVE: Rhizomes vegetal epiphytes, LvBE: Leaves bulk epiphytes, LvAE: Leaves animal epiphytes. LvVE: Leaves vegetal epiphytes, POLit: *Posidonia oceanica* litter, POLv: *Posidonia oceanica* leaves, SPOM: Suspended particulate organic matter.

As it can be seen on fig. 4.8 and table 4.VI, all epiphytic sources were quite similar in composition. Saturated (SAFA) and polyunsaturated (PUFA) fatty acids were generally present in comparable amounts (usually around 40 % of the total fatty acids), except in the epifauna from the leaves, where SAFA were more abundant than PUFA (46.1 % vs. 31.0 %, respectively). Monounsaturated compounds (MUFA) were always the less abundant fatty acid class, with relative contributions typically around 20 %.

The most abundant SAFA (as well as the most abundant FA) was palmitic acid (16:0), with contributions ranging from 24.3 % (bulk epiphytes from leaves) to 29.8 % (vegetal epiphytes from leaves). Other abundant SAFA included, stearic (18:0) and myristic (14:0) acids. Stearic acid was particularly abundant in animal epiphytes from leaves (8.5 %).

The three most current MUFA were palmitoleic (16:1(n-7)), oleic (18:1(n-9)) and *cis*-vaccenic (18:1(n-7)) acids. 18:1(n-7) was remarkably abundant in vegetal

epiphytes from rhizomes, where it was the most abundant MUFA (7 %, vs. 5 % for 18:1(n-9) and 4.2 % for 16:1(n-7)).

Eicosapentaenoic (20:5(n-3), or EPA) and arachidonic (20:4(n-6)) acids dominated the PUFA class in all epiphytic groups. 20:4(n-6) was particularly abundant in vegetal epiphytes from rhizomes, accounting for as much as 14.6 % of the total FA. Linoleic (18:2(n-6)) and  $\alpha$ -linolenic (18:3(n-3)) acids were also, to a lesser extent, abundant PUFA.

The FA composition of *Posidonia* leaves was completely different from any other source. It was drastically dominated by PUFA (67.7 % of the total), notably 18:3(n-3) (37.9 %) and 18:2(n-6) (25.2%). Contrastingly, 20:5(n-3) and 20:4(n-6) were very scarce, and only added up to 0.5 %. SAFA were rarer than in any other source (28.4 %). 16:0 and 18:0 amounts were significant (19.2 and 5.7 %, respectively), but 14:0 relative contribution was low (only 0.5 %). MUFA were nearly absent, and accounted for less than 4 %. This class was mostly represented by 18:1(n-9) (2.6 %).

Strikingly, the FA composition of *Posidonia* litter widely mismatched the one of the living leaves. PUFA were rather rare (26.2 %), and 18:2(n-6) and 18:3(n-3) contributed to less than 4 %. 22:5(n-3), on the other hand, was quite abundant (6.13 %).

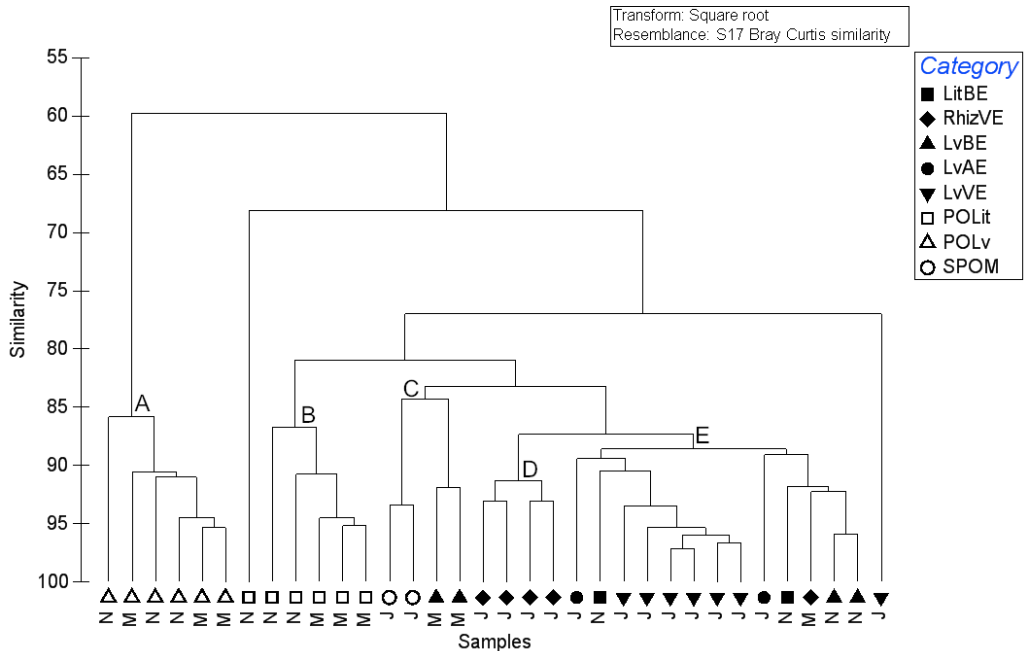
MUFA amounts were much higher than in leaves, and dominant species were comparable to the ones found in the epiphytes (palmitoleic, oleic and *cis*-vaccenic acids).

Moreover, most of the litter lipid content was constituted of SAFA (more than 50 %). In addition to the previously cited 16:0, 18:0 and 14:0, some SAFA that were rare or absent in other sources were quite abundant in the *Posidonia* litter. Those include a 15:0 (5.54 %) and, to a lesser extent, 15:0 (1.77 %), 22:0 (1.49 %) and 12:0 (1.43 %).

Suspended particulate organic matter was dominated by SAFA (50.2 %), and was somehow similar to *Posidonia* litter in terms of FA composition. One big difference between these two sources was the relative concentration of 18:1(n-7), which was rare in SPOM (only 1.8 %) while accounting for 7.1 % in the litter.

To further investigate the relations between the different food sources, we used hierarchical clustering. Figure 4.9 shows the dendrogram obtained via this method. It reveals that most samples are grouped in 5 clusters.

Cluster A contains all *Posidonia* leaves samples. Cluster B includes most *Posidonia* litter samples, with the exception of one who does not belong to any cluster. Cluster C is made of the SPOM samples, as well as the bulk epiphytes from leaves collected in March 09. Cluster D contains 4 out of 5 samples of vegetal epiphytes from rhizomes. Finally, cluster E contains all the remaining epiphytic samples.



**Fig. 4.9:** Dendrogram of all food items, computed using group-average linkage of Bray-Curtis similarities on  $\sqrt{\text{}}$ -transformed relative contributions to the total FA content (%). LitBE: Litter bulk epiphytes, RhizVE: Rhizomes vegetal epiphytes, LvBE: Leaves bulk epiphytes, LvAE: Leaves animal epiphytes. LvVE: Leaves vegetal epiphytes, POLit: *Posidonia oceanica* litter, POLv: *Posidonia oceanica* leaves, SPOM: Suspended particulate organic matter. The letter under each sample refers to the sampling season (N: November 08, M: March 09, J: July 09).

We performed a SIMPER analysis, in order to point out the FA responsible for these clustering patterns. Table 4.VII shows the intra-group results and lists, for each cluster, the most typical FA, while table 4.VIII shows the inter-group results and lists the ones responsible for the inter-cluster differences.

Unsurprisingly, cluster A, containing all *Posidonia* leaves samples, is well separated from all the others (about 40 % of dissimilarity).  $\alpha$ -linolenic and linoleic acids, which are very abundant in the leaves' tissues, are the strongest typifiers of this cluster. They're also responsible for much of the dissimilarity between cluster A and the others.

Cluster B (*Posidonia* litter) is closer to C, D and E (about 19 % of dissimilarity than to A). Arachidonic acid, much more abundant in the epiphytes from clusters D and E than in litter, is the strongest discriminator between these two clusters and cluster B

Even if it is not one of the strongest "litter-typifying" FA, a15:0, which is more abundant in litter than in any other source, also explains a lot of dissimilarity between cluster B and clusters C, D and E.

**Table 4.VII:** Results of the 1-way intra-group SIMPER analysis. For each cluster, the table gives the average intra-group similarity, and lists the FA best explaining this intra-group similarity. For each of these, relative  $\bar{\delta}_i$  (%) and  $\bar{\delta}_i/SD_i$  are given between brackets.

Cluster	Similarity (%)	Typifying FA ( $\bar{\delta}_i$ , $\bar{\delta}_i/SD_i$ )
A	89.95	18:3(n-3) (21.6 %, 11.1) 18:2(n-6) (17.6 %, 11.7) 16:0 (15.9 %, 21.07)
B	90.36	16:0 (11.9 %, 28.9) 18:0 (7.7 %, 33.6) 18:1(n-9) (6.1 %, 16.9) 18:1(n-7) (6.1 %, 23.9)
C	87.13	16:0 (13.0 %, 17.7) 18:0 (7.8 %, 14.2) 16:1(n-7) (7.7 %, 11.3)
D	91.96	16:0 (14.5 %, 31.4) 20:4(n-6) (9.6 %, 14.0) 20:5(n-3) (8.1 %, 10.3)
E	90.43	16:0 (14.1 %, 21.2) 20:4(n-6) (8.0 %, 14.9) 20:5(n-3) (7.7 %, 9.6)

**Table 4.VIII:** Results of the 1-way inter-group SIMPER analysis. For each pair of clusters, the table gives the average inter-group dissimilarity, and lists the FA most contributing to this inter-group dissimilarity. For each of these, relative  $\bar{\delta}_i$  (%) and  $\bar{\delta}_i/SD_i$  are given between brackets.

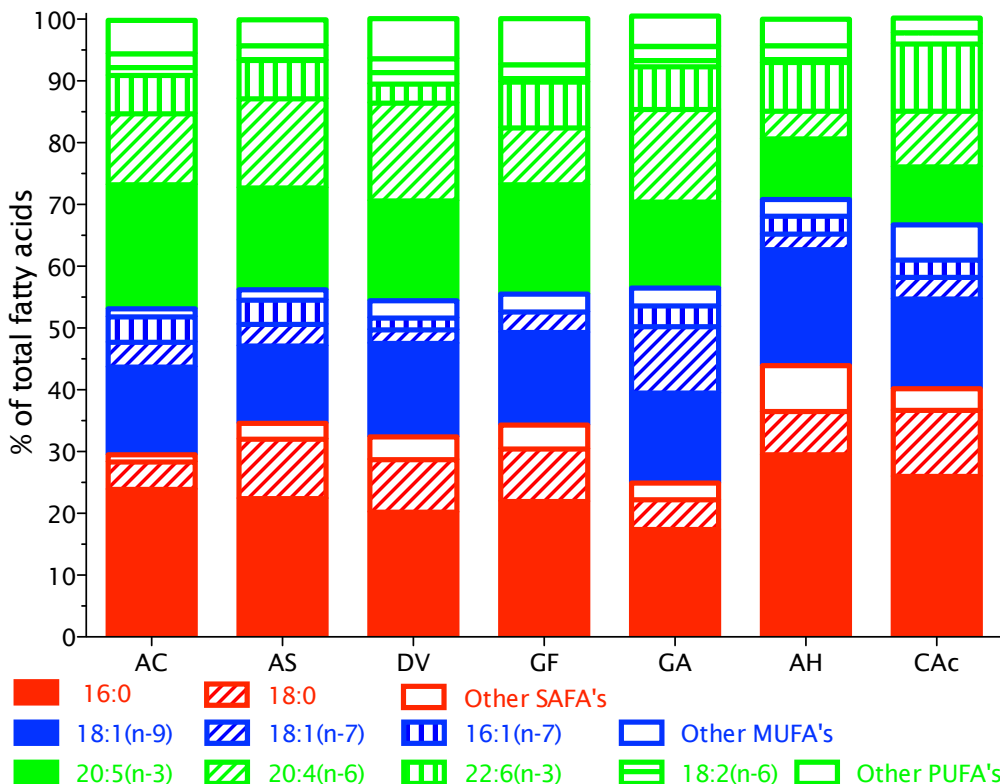
Cluster	A	B	C	D	E
A	-	38.71 %	41.55 %	39.66 %	40.10 %
		18:3(n-3)	18:3(n-3)	18:3(n-3)	18:3(n-3)
		(15.1 %, 6.2)	(15.7 %, 7.2)	(17.4 %, 8.1)	(14.2 %, 6.3)
		18:2(n-6)	18:2(n-6)		18:2(n-6)
		(10.4 %, 6.1)	(10.7 %, 5.2)		(10.0 %, 3.4)
B	-	-	18.53 %	18.96 %	19.10 %
			a15:0	20:4(n-6)	20:4(n-6)
			(9.8 %, 6.7)	(14.1 %, 6.6)	(9.9 %, 4.6)
			22:6(n-3)	a15:0	a15:0
		(9.8 %, 1.8)	(8.9 %, 4.7)	(9.5 %, 5.6)	
C	-	-	-	20.22 %	15.71 %
				20:4(n-6)	22:6(n-3)
				(12.2 %, 5.4)	(12.2 %, 1.7)
				22:6(n-3)	20:4(n-6)
		(10.2 %, 1.9)	(10.7 %, 3.6)		
D	-	-	-	-	12.62 %
					18:2(n-6)
					(8.8 %, 1.1)
					18:3(n-3)
					(8.0 %, 1.8)

Cluster C is relatively close to D and E. The most useful FA to explain the differences between these clusters are, once again, arachidonic acid (more abundant in D and E than in C) and 22:6(n-3), more abundant in C than in the two others.

Finally, clusters D and E are very close (nearly 90 % of similarity). They share the same typificators (20:4(n-6), 20:5(n-3) and 16:0), and the C<sub>18</sub> PUFA that explain most of their differences are not strong discriminators (relatively low  $\overline{\delta}_i$  and  $\overline{\delta}_i/SD_i$ )

### III.2.B. Fatty acid composition of amphipods

Thirty-six different fatty acids were identified in at least one of the 7 studied amphipod species. Table 4.IX lists all significant FA found in amphipods (*i.e.*, all compounds accounting for at least 0.5 % of the total FA content of one of the sources). In addition, figure 4.10 displays the relative contributions of the dominant FA of these animals, classified according to their number of double bonds.



**Fig. 4.10:** Mean relative contributions of the dominant fatty acids of amphipods, expressed in percentage of the total FA content. Red bars: saturated fatty acids (SAFA), blue bars: monounsaturated fatty acids (MUFA), green bars: polyunsaturated fatty acids (PUFA). AC: *Apherusa chieraghinii*, AS: *Aora spinicornis*, DV: *Dexamine spiniventris*, GF: *Gammarella fucicola*, GA: *Gammarus aequicauda*, AH: *Amphithoe helleri*, CAc: *Caprella acanthifera*.



**Table 4.IX:** Relative fatty acid composition of total lipids of amphipods, expressed in % of the total FA. Values are means, or means  $\pm$  SD if  $n \geq 3$ . Only FA contributing to more than 0.5 % in at least one species are listed. AC: *Apherusa chierieghinii*, AH: *Amphithoe helleri*, AS: *Aora spinicornis*, CAC: *Caprella acanthifera*, DV: *Dexamine spiniventris*, GA: *Gammarus aequicauda*, GF: *Gammarella fucicola*. n.d.: not detected.

Fatty acid	AC	AH	AS	CAC	DV	GA	GF
14:0	0,99 $\pm$ 0,30	2,61	1,71 $\pm$ 0,40	2,81	1,60 $\pm$ 0,80	0,52 $\pm$ 0,45	1,14
16:0	23,9 $\pm$ 3,58	29,45	22,3 $\pm$ 1,53	25,98	20,1 $\pm$ 2,37	17,4 $\pm$ 5,03	21,86
16:1(n-7)	4,12 $\pm$ 0,91	2,92	3,94 $\pm$ 0,82	2,77	1,85 $\pm$ 1,04	3,35 $\pm$ 1,89	n.d.
16:1(n-5)	0,14 $\pm$ 0,24	n.d.	0,23 $\pm$ 0,51	n.d.	0,59 $\pm$ 0,39	1,28 $\pm$ 0,88	0,42
i-17:0	0,02 $\pm$ 0,09	n.d.	n.d.	n.d.	n.d.	0,76 $\pm$ 0,87	n.d.
17:0	0,05 $\pm$ 0,16	1,76	0,31 $\pm$ 0,43	n.d.	0,72 $\pm$ 0,64	0,44 $\pm$ 0,61	1,36
18:0	4,41 $\pm$ 0,84	7,01	9,59 $\pm$ 1,29	10,69	8,47 $\pm$ 1,87	4,78 $\pm$ 2,27	8,53
18:1(n-9)	14,2 $\pm$ 2,35	18,83	12,5 $\pm$ 0,34	14,49	15,1 $\pm$ 1,40	14,6 $\pm$ 1,59	14,96
18:1(n-7)	4,02 $\pm$ 0,86	2,48	3,50 $\pm$ 0,67	3,48	2,20 $\pm$ 0,86	10,6 $\pm$ 5,93	3,33
18:1(n-5)	n.d.	0,36	0,09 $\pm$ 0,12	n.d.	0,14 $\pm$ 0,10	0,86 $\pm$ 1,10	n.d.
18:2(n-6)	3,46 $\pm$ 1,60	2,71	2,41 $\pm$ 0,63	1,80	4,11 $\pm$ 1,05	3,30 $\pm$ 0,81	2,81
18:3(n-3)	1,84 $\pm$ 0,22	0,48	0,41 $\pm$ 0,41	n.d.	2,40 $\pm$ 1,82	1,56 $\pm$ 1,62	0,95
18:4(n-3)	1,49 $\pm$ 0,25	0,49	0,87 $\pm$ 0,30	n.d.	1,05 $\pm$ 0,57	0,16 $\pm$ 0,26	0,64
20:1(n-11)	n.d.	n.d.	n.d.	1,63	n.d.	0,08 $\pm$ 0,25	n.d.
20:1(n-9)	0,87 $\pm$ 0,34	2,37	1,00 $\pm$ 0,61	1,47	1,39 $\pm$ 0,50	0,23 $\pm$ 0,29	1,50
20:1(n-7)	0,21 $\pm$ 0,28	n.d.	0,10 $\pm$ 0,14	1,88	0,32 $\pm$ 0,19	0,16 $\pm$ 0,31	0,49
20:2(n-6)	0,03 $\pm$ 0,10	0,98	0,40 $\pm$ 0,55	n.d.	0,63 $\pm$ 0,51	0,16 $\pm$ 0,30	n.d.
20:3(n-6)	n.d.	0,41	0,26 $\pm$ 0,37	n.d.	0,60 $\pm$ 0,41	0,84 $\pm$ 2,24	5,02
20:4(n-6)	11,5 $\pm$ 3,93	4,55	14,3 $\pm$ 4,42	8,95	15,7 $\pm$ 1,66	15,0 $\pm$ 3,92	9,18
20:5(n-3)	20,1 $\pm$ 8,80	9,78	16,5 $\pm$ 3,93	9,45	16,1 $\pm$ 3,82	13,8 $\pm$ 2,23	17,70
22:5(n-3)	1,02 $\pm$ 0,43	n.d.	1,72 $\pm$ 1,97	1,65	0,79 $\pm$ 1,08	1,64 $\pm$ 1,87	n.d.
22:6(n-3)	6,17 $\pm$ 1,69	7,86	6,21 $\pm$ 1,46	10,87	3,12 $\pm$ 1,30	6,86 $\pm$ 2,47	7,43

## Multidisciplinary study of trophic diversity

SAFA accounted to 30-35 % in 4 of the 7 species (*A. chiereghinii*, *A. spinicornis*, *D. spiniventris* and *G. fucicola*). They were more rare in *G. aequicauda* (24.9 %), but more abundant in *A. helleri* and *C. acanthifera* (43.9 % and 40.2 %, making them the predominant class in these two species). In all cases, 16:0 was the most abundant SAFA (17.4 to 29.5 %, depending on the species considered), always followed by 18:0 (4.4 to 10.7 %).

MUFA were relatively rare in 4 of the 7 species (*A. chiereghinii*, *A. spinicornis*, *D. spiniventris* and *G. fucicola*), accounting for little more than 20 %. They were more abundant in *G. aequicauda* (31.6 %), and, to a lesser extent, in *A. helleri* (27 %) and *C. acanthifera* (26.4 %). Oleic acid was always the most common MUFA, accounting for 12.5 (in *A. spinicornis*) to 18.8 % (in *A. helleri*). 18:1(n-7) was also present in moderate amounts (2.2 to 4 %), with the exception of *Gammarus aequicauda*, where it reached more than 10 %. 16:1(n-7) concentrations ranged from 1.9 to 4.1 % in 6 of the 7 species, but was totally absent from *Gammarella fucicola*.

PUFA accounted for about 45 % of the total lipid content of 5 of the studied species (*A. chiereghinii*, *A. spinicornis*, *D. spiniventris*, *G. fucicola* and *G. aequicauda*), thus making them the most abundant FA class in these species. In these 5 species, most of the PUFA pool was made of 20:5(n-3) and 20:4(n-6). PUFA were not that abundant in tissues of *A. helleri* (29.2 %) and *C. acanthifera* (33.5). Moreover, in these two species, 20:4(n-6) and 20:5(n-3) were scarcer, and their contributions were comparable with those of 22:6(n-3). This FA was particularly abundant in *C. acanthifera*, accounting for more than 10 % of the total lipid content.

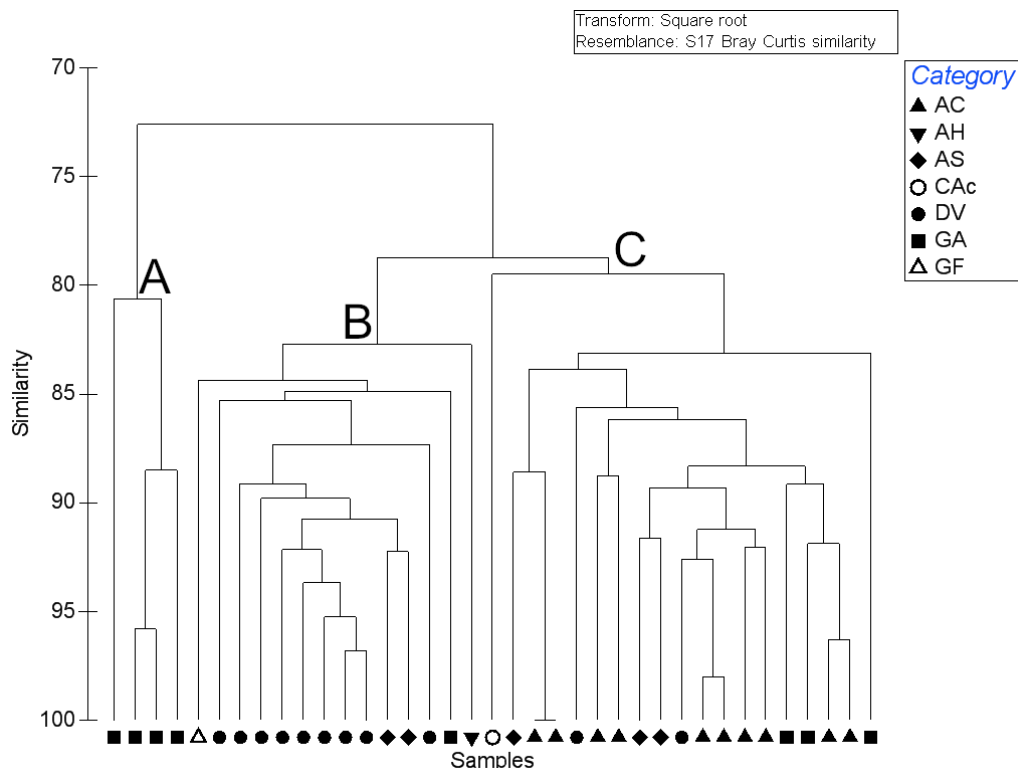
Figure 4.11 depicts the dendrogram obtained via a hierarchical clustering of all amphipod samples. It clearly shows that amphipod samples can be distributed among 3 big clusters, labelled A, B and C. Cluster A is the only monospecific one, containing 4 of the 8 *Gammarus aequicauda* samples.

Cluster B gathers most *D. spiniventris* samples, as well as one *G. aequicauda*, and the only *Amphithoe helleri* and *Gammarella fucicola* pools. It also includes 2 out of 5 *A. spinicornis* samples.

Finally, cluster C contains all *A. chiereghinii* pools, but also the 2 last *D. spiniventris*, 3 *A. spinicornis* and 3 *G. aequicauda* samples. The only *C. acanthifera* sample is also found in this cluster.

We performed an *a posteriori* one-way SIMPER analysis, to understand which FA drive these clustering patterns. Results concerning the intra-cluster part of this analysis form table 4.X, and results of the inter-cluster part are displayed in table 4.XI.

According to table 4.XI, it is the *cis*-vaccenic acid that explains most of the dissimilarity between the 4 *G. aequicauda* samples of cluster A and all the other amphipods. This FA is also one of the strongest typicators of cluster A (table 4.X). It is indeed much more abundant in cluster A (average abundance = 16.2 %) than in clusters B (av. abund. = 2.6 %) or C (av. abund. = 3.8 %).



**Fig. 4.11:** Dendrogram of all amphipods, computed using group-average linkage of Bray-Curtis similarities on  $\sqrt{\cdot}$ -transformed relative FA concentrations (% of total FA). AC: *Apherusa chiereghinii*, AS: *Aora spinicornis*, DV: *Dexamine spiniventris*, GF: *Gammarella fucicola*, GA: *Gammarus aequicauda*, AH: *Amphithoe helleri*, Cac: *Caprella acanthifera*.

Dissimilarity between clusters B and C, although considerable (more than 20%), doesn't seem to be driven by any of the major FA, whose concentrations are comparable in the two clusters. No FA seem to act as a strong discriminator, and many of the differences appear to be caused by the 20:3(n-6) and the 17:0, which are absent from cluster C, and rare, yet present, in cluster B.

Table 4.X also stress the fact that, put aside the aforementioned 18:1(n-7), typical FA are the same for all clusters. Those are the dominant 16:0, 18:1(n-9), 20:4(n-6) and 20:5(n-3). This emphasizes the overall similarity between all amphipod species.

**Table 4.X:** Results of the 1-way intra-group SIMPER analysis of amphipods. For each cluster, the table gives the average intra-group similarity, and lists the FA best explaining this intra-group similarity. For each of these, relative  $\bar{\delta}_i$  (%) and  $\bar{\delta}_i/SD_i$  are given between brackets.

Cluster	Similarity (%)	Typifying FA ( $\bar{\delta}_i$ , $\bar{\delta}_i/SD_i$ )
A	85.81	20:4(n-6) (14.2 %, 12.8) 18:1(n-7) (13.3 %, 14.1) 18:1(n-9) (12.2 %, 16.53) 20:5(n-3) (11.9 %, 7.0) 16:0 (11.9 %, 15.7)
B	87.26	16:0 (13.2 %, 17.8) 18:1(n-9) (11.1 %, 22.1) 20:5(n-3) (10.7 %, 11.2) 20:4(n-6) (10.2 %, 5.77)
C	85.81	16:0 (16.0 %, 19.0) 20:5(n-3) (12.7 %, 4.6) 18:1(n-9) (12.5 %, 14.8) 20:4(n-6) (10.7 %, 5.3)

**Table 4.XI:** Results of the 1-way inter-group SIMPER analysis of amphipods. For each pair of clusters, the table gives the average inter-group dissimilarity, and lists the FA most contributing to this inter-group dissimilarity. For each of these, relative  $\bar{\delta}_i$  (%) and  $\bar{\delta}_i/SD_i$  are given between brackets.

Cluster	A	B	C
A	-	28.01 % 18:1(n-7) (11.8 %, 8.0)	26.98 % 18:1(n-7) (11.2 %, 5.3)
B	-	-	21.25 % 20:3(n-6) (6.7 %, 1.7) 17:0 (6.1 %, 3.2)

### III.3. Stable isotope ratios

#### III.3.A. $\delta^{13}\text{C}$ values of food sources and amphipods

During each of the 4 sampling seasons, 21 amphipod species and 9 food sources were collected for carbon stable isotope ratio analysis. Figure 4.12 (pp. 120 & 121) gives the  $\delta^{13}\text{C}$  values (means  $\pm$  SD) of all these items.

As shown on figure 4.12 A, food sources sampled in June 2008 can be separated in 3 major groups. *Posidonia* leaves and litter are by far the less negative sources ( $\delta^{13}\text{C} = -12.2 \pm 0.7 \text{‰}$ , and  $-13.1 \pm 0.5 \text{‰}$  respectively). On the other hand, SPOM ( $\delta^{13}\text{C} = -26.0 \pm 0.8 \text{‰}$ ) and rhizome epiflora ( $\delta^{13}\text{C} = -27.9 \pm 0.9 \text{‰}$ ) are the most  $^{13}\text{C}$ -depleted food items. Between these two groups, BPOM and epiphytes of leaves and litter form an overlapping group, approximatively ranging from  $-18$  to  $-21 \text{‰}$ .

Most of the amphipod species gather in the  $-18$  to  $-21 \text{‰}$  interval as well, and their carbon signatures clearly overlap. However, *Gammarus aequicauda* tissues appear to be less  $^{13}\text{C}$ -depleted ( $\delta^{13}\text{C} = -15.4 \pm 0.7 \text{‰}$ ) than any of the other species.

The 2 species of the genus *Dexamine*, *D. spiniventris* ( $\delta^{13}\text{C} = -26.5 \pm 0.6 \text{‰}$ ) and, to a lesser extent, *D. spinosa* ( $\delta^{13}\text{C} = -24.1 \pm 2.4 \text{‰}$ ), are more negative than most of the others. Moreover, *Gammarella fucicola* ( $\delta^{13}\text{C} = -22.1 \pm 0.5 \text{‰}$ ) seems to hold an intermediate position between the "more negative" and the "median" species.

**Fig. 4.12 (pp. 120 & 121):**  $\delta^{13}\text{C}$  values of all amphipod species and food sources, expressed in per mil (‰). Values are means, error bars are standard deviations. All amphipod data come from individual measurements. Figure is split in 4 parts, each concerning one sampling season (A: June 08, B: November 08, C: March 09, D: July 09). On each part, the square dots under the solid black line are food sources, while the circle dots over the line are amphipods. AC: *Apherusa chiereghinii*, AS: *Aora spinicornis*, DV: *Dexamine spiniventris*, AH: *Amphithoe helleri*, Cac: *Caprella acanthifera*, GF: *Gammarella fucicola*, GA: *Gammarus aequicauda*. DS: *Dexamine spinosa*, ARu: *Ampelisca rubella*, OH: *Orchomene humilis*, MM: *Megaluropus massiliensis*, TN: *Tmetonyx nardonis*, PA: *Perioculodes aequimanus*, SL: *Synchelidium longidigitatum*, PhM: *Phtisica marina*, AtG: *Atylus guttatus*, LS: *Leucothoe spinicarpa*, AmN: *Amphilocheus neapolitanus*, IM: *Iphimedia minuta*, NCh: *Normanion chevreuxi*, MeS: *Metaphoxus simplex*, SPOM: suspended particulate organic matter, BPOM: benthic particulate organic matter, LitAE: animal epiphytes from *Posidonia* litter, LvAE: animal epiphytes from *Posidonia* leaves, LitVE: vegetal epiphytes from *Posidonia* litter, LvVE: vegetal epiphytes from *Posidonia* leaves, RhizVE : vegetal epiphytes from *Posidonia* rhizomes, POLv: *Posidonia oceanica* leaves, POLit: *Posidonia oceanica* litter.

Multidisciplinary study of trophic diversity

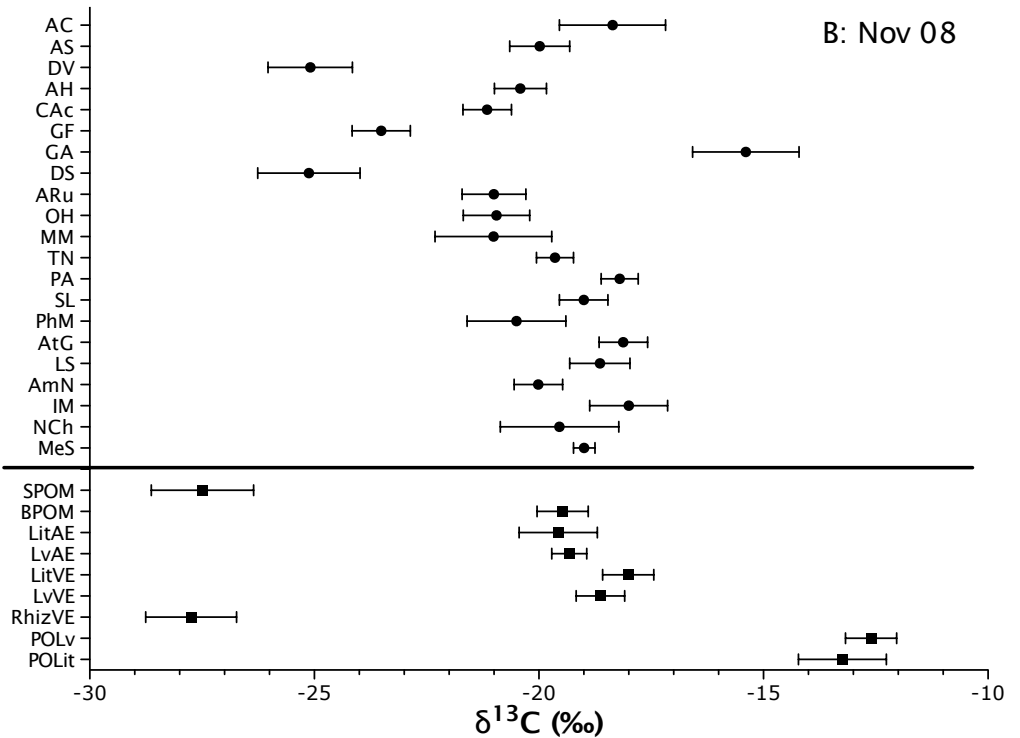
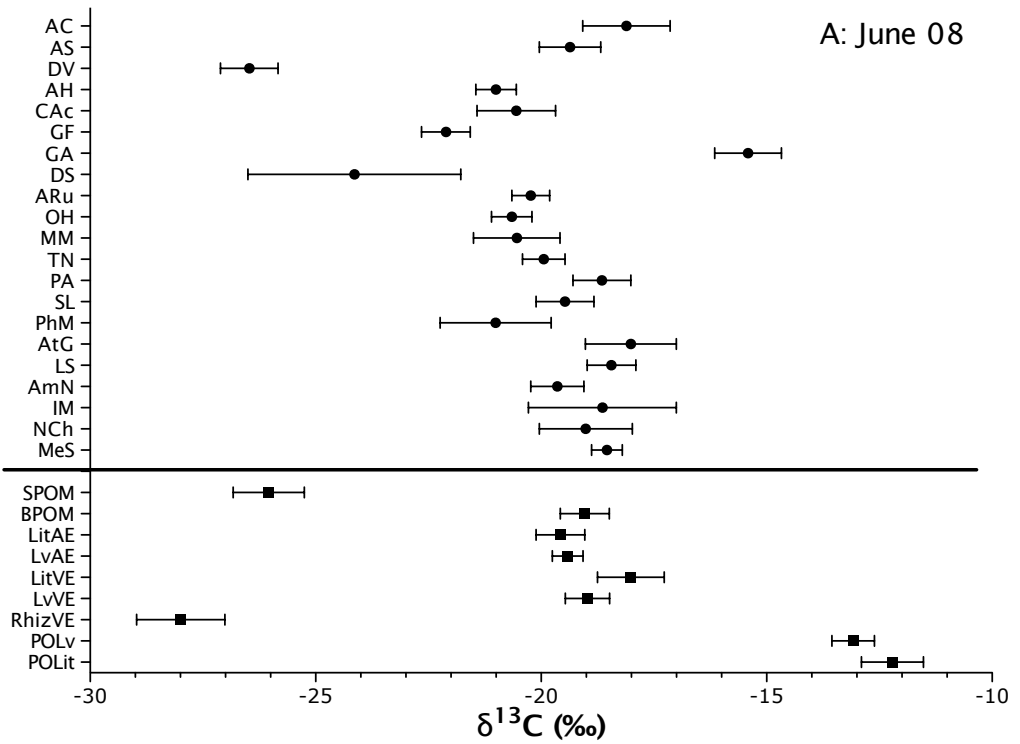


Fig. 4.12: Legend on p. 119. Parts A-B.

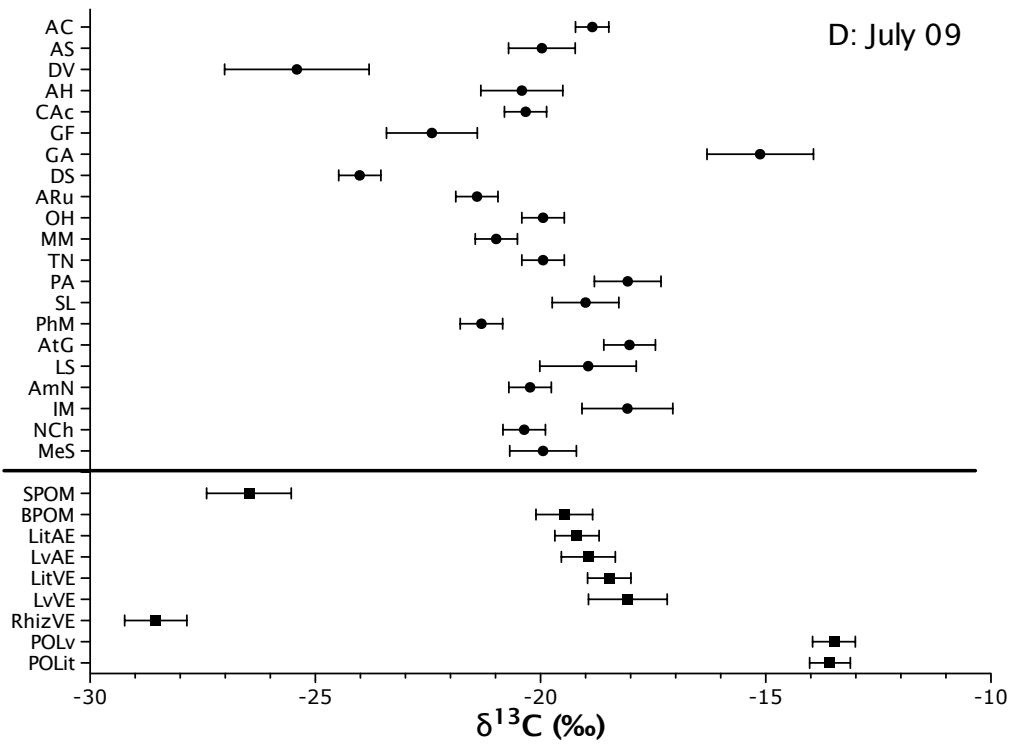
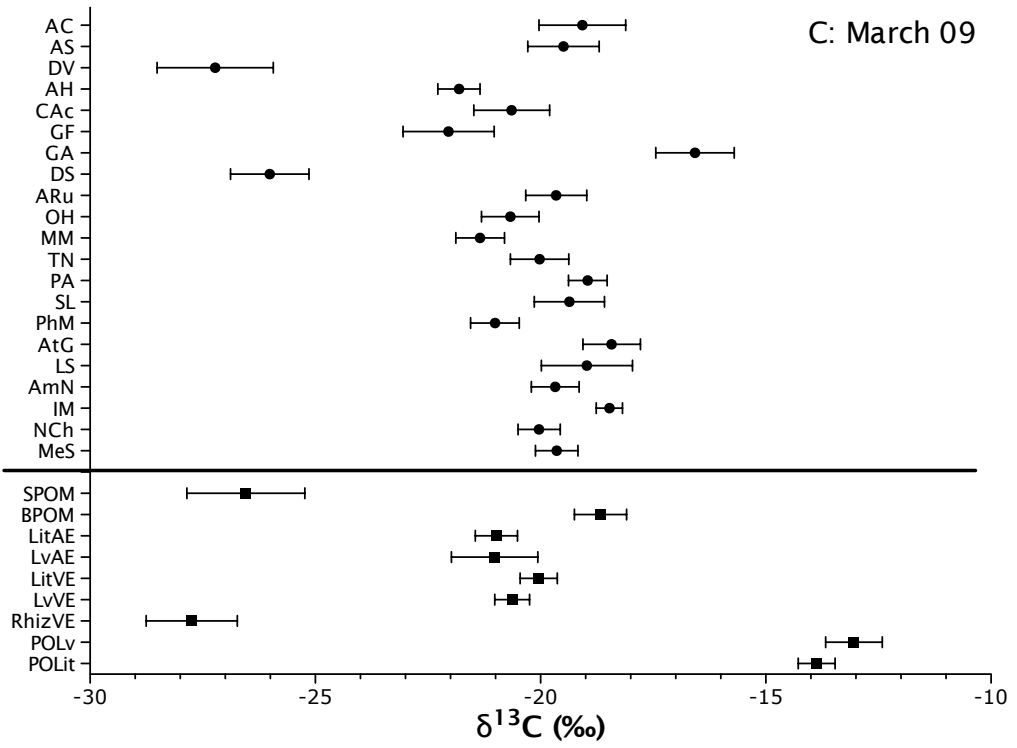


Fig. 4.12: Legend on p. 119. Parts C-D.

## Multidisciplinary study of trophic diversity

The situation for November 2008 (fig. 4.12 B) is quite similar. Here as well, it is possible to easily distinguish more negative SPOM ( $\delta^{13}\text{C} = -27.5 \pm 1.1 \text{‰}$ ) and rhizome epiflora ( $\delta^{13}\text{C} = -27.7 \pm 1.0 \text{‰}$ ) from less negative *P. oceanica* leaves ( $\delta^{13}\text{C} = -12.6 \pm 0.6 \text{‰}$ ) and litter ( $\delta^{13}\text{C} = -13.2 \pm 1.0 \text{‰}$ ), while all the remaining food sources range from -18 to -20 ‰.

As in June 08, the most positive species from November 2008 is *G. aequicauda* ( $\delta^{13}\text{C} = -15.4 \pm 1.2 \text{‰}$ ). *D. spiniventris* and *D. spinosa* signatures are once again the most  $^{13}\text{C}$ -depleted, this time completely overlapping ( $\delta^{13}\text{C} = -25.1 \pm 0.9 \text{‰}$  and  $-25.1 \pm 1.1 \text{‰}$ , respectively). All of the remaining species are found in the -18 to -21‰, with the exception of *G. fucicola*, whose "intermediate" position is more marked than in June 08 ( $\delta^{13}\text{C} = -23.5 \pm 0.6 \text{‰}$ ).

The plots for March (fig. 4.12 C) show the same global patterns that are described for June and November 08. Sources can also be classified in 3 groups, and most amphipods are found overlapping in the -18 to -21 ‰ interval. *Gammarus aequicauda* is once again the less  $^{13}\text{C}$ -depleted amphipod ( $\delta^{13}\text{C} = -16.6 \pm 0.9$ ), while *Dexamine spiniventris* and *D. spinosa* show the most negative  $\delta^{13}\text{C}$  values. This is particularly marked here, and their  $\delta^{13}\text{C}$  are the lowest, all seasons taken together ( $-27.2 \pm 1.3 \text{‰}$  for *D. spiniventris*,  $-26.0 \pm 0.9 \text{‰}$  for *D. spinosa*).

On the other hand, *G. fucicola* carbon signature is slightly less negative ( $-22.0 \pm 1.0 \text{‰}$ ) than in the other seasons, positioning it nearer to the "median" species. Contrastingly, *Amphithoe helleri* exhibits in March 09 its lowest  $\delta^{13}\text{C}$  values ( $-21.8 \pm 0.5 \text{‰}$ ), and its carbon signature overlaps *G. fucicola*'s one.

Finally, the  $\delta^{13}\text{C}$  values and trends for July 09 (Fig. 4.12 D) are extremely similar to the ones mentioned for June 08. For concision's sake, they will therefore not be discussed here any longer.

### III.3.B. Linking $\delta^{13}\text{C}$ and $\delta^{15}\text{N}$ data

While all food sources were analyzed for nitrogen stable isotope ratios, only 7 of the 21 aforementioned amphipod species were selected to pool several individuals (see point II.3.C.) and perform  $\delta^{15}\text{N}$  measurements. Data resulting from these analyses are featured on figure 4.13.

**Fig. 4.13 (pp. 123 & 124):**  $\delta^{13}\text{C}$  vs.  $\delta^{15}\text{N}$  plots values of amphipods and food sources, expressed in per mil (‰). Values are means, error bars are standard deviations. All amphipod data come from pooled measurements. Figure is split in 4 parts, each concerning one sampling season (A: June 08, B: November 08, C: March 09, D: July 09). On each part, the square dots are food sources, while the circle dots are amphipods. AC: *Apherusa chierighinii*, AS: *Aora spinicornis*, DV: *Dexamine spiniventris*, AH: *Amphithoe helleri*, Cac: *Caprella acanthifera*, GF: *Gammarella fucicola*, GA: *Gammarus aequicauda*, SPOM: suspended particulate organic matter, BPOM: benthic particulate organic matter, LitAE: animal epiphytes from *Posidonia* litter, LvAE: animal epiphytes from *Posidonia* leaves, LitVE: vegetal epiphytes from *Posidonia* litter, LvVE: vegetal epiphytes from *Posidonia* leaves, RhizVE: vegetal epiphytes from *Posidonia* rhizomes, POLv: *Posidonia oceanica* leaves, POLit: *Posidonia oceanica* litter.



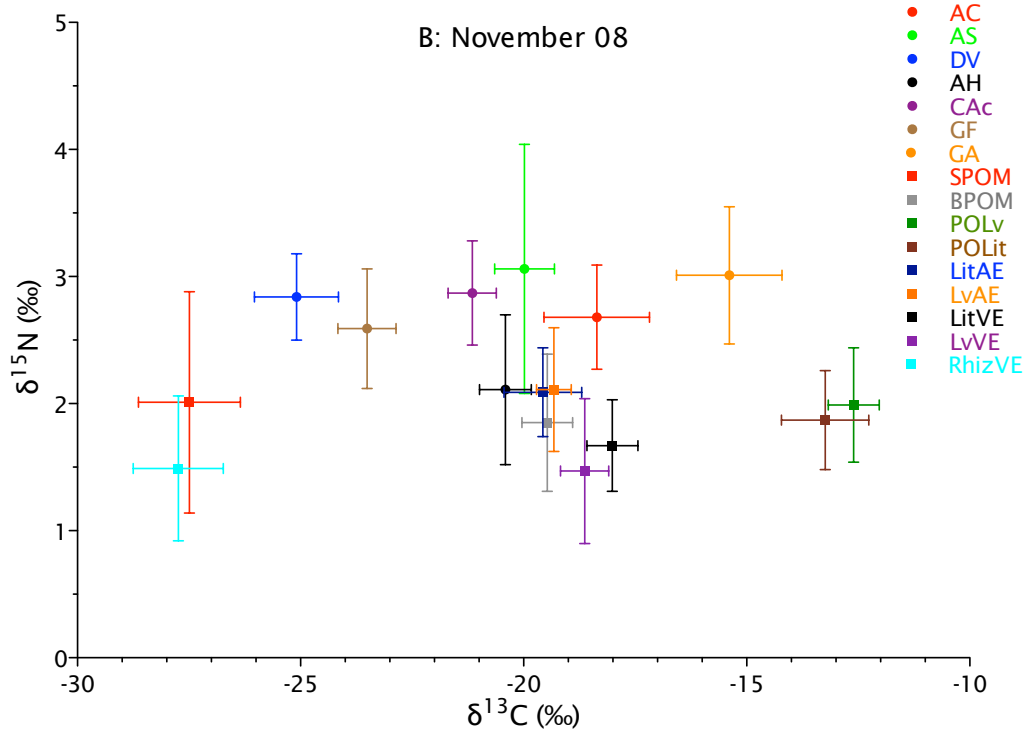
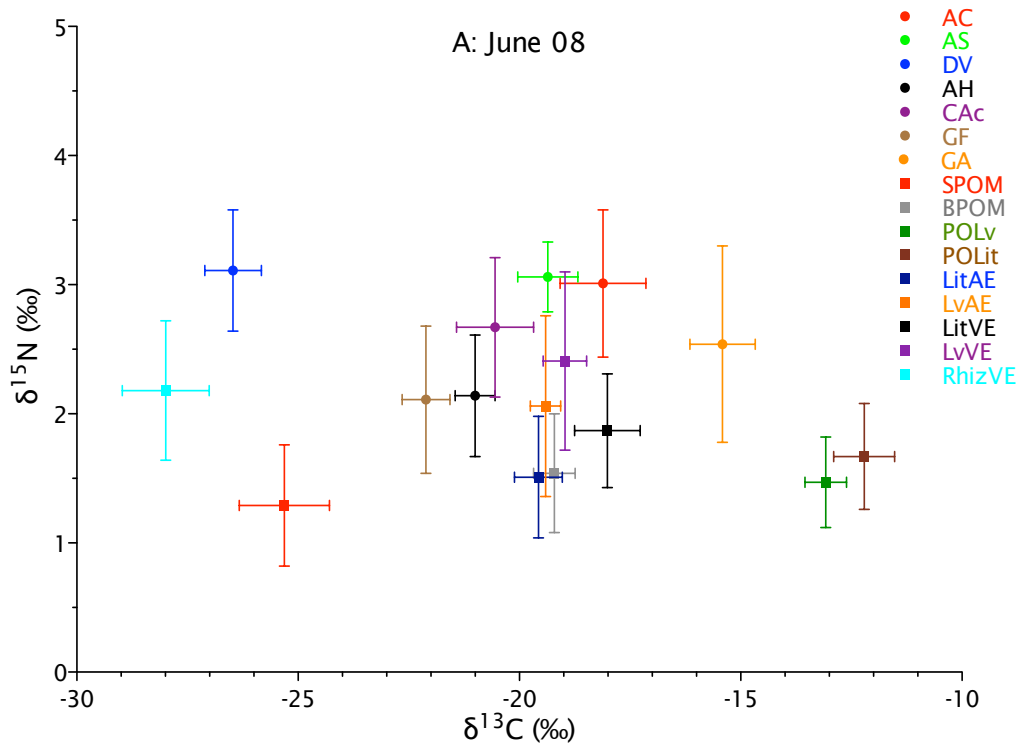


Fig. 4.13: Legend on p. 122. Parts A-B

Multidisciplinary study of trophic diversity

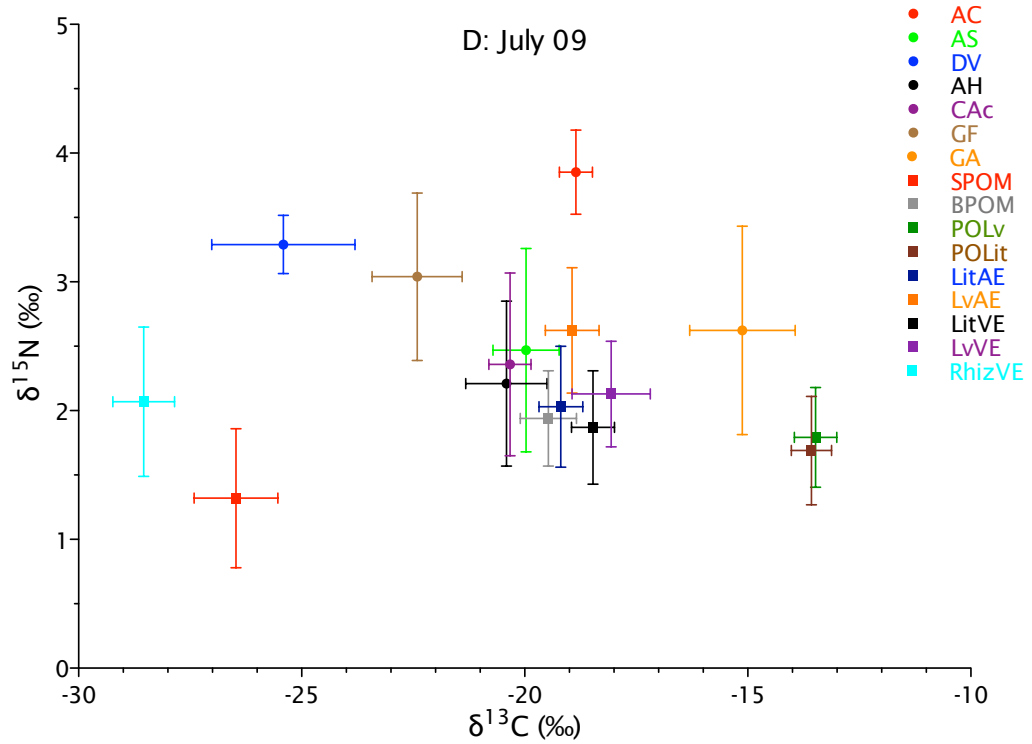
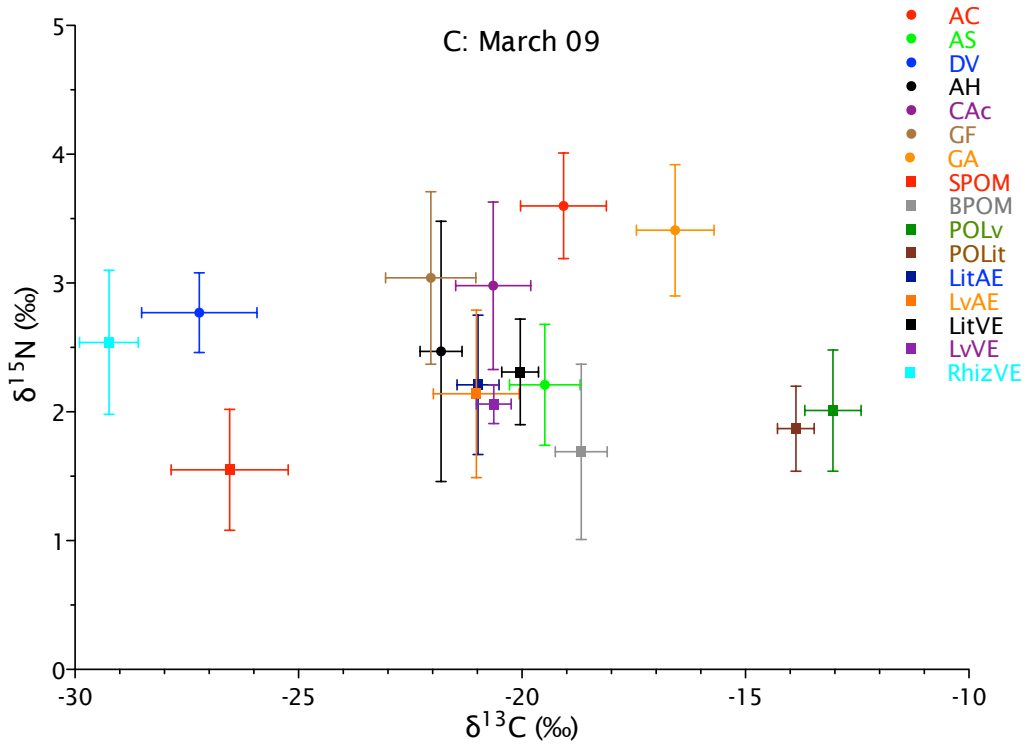


Fig 4.13 (cont.): Legend on p. 122. Parts C-D.

In all four seasons, the food items filled a rather narrow  $\delta^{15}\text{N}$  interval, ranging from 1 to 3 ‰. Inside this interval, the signatures from food sources broadly overlapped, and no clear differences could be made between them (Kruskal-Wallis test, p-values ranging from 0.2134 to 0.4335, depending on the season). Even putting statistics aside to directly look at the  $\delta^{15}\text{N}$  values and the relations between them, no consistent trends could be distinguished.

Amphipods'  $\delta^{15}\text{N}$  typically ranged from 1.5 to 4 ‰. Using Kruskal-Wallis test, no inter-species differences were found in either June or November 2008 ( $p = 0.3907$  and  $0.4118$ , respectively).

In March 09, *A. chierighinii* ( $\delta^{15}\text{N} = 3.6 \pm 0.4$ ) and *G. aequicauda* ( $\delta^{15}\text{N} = 3.4 \pm 0.5$ ) were significantly more  $^{15}\text{N}$ -enriched than *A. helleri* ( $\delta^{15}\text{N} = 2.5 \pm 1.0$ ;  $p = 0,0171$  for *A. chierighinii* and  $0,0243$  for *G. aequicauda*).

In July 09, Kruskal-Wallis test pointed out that *A. chierighinii*'s  $\delta^{15}\text{N}$  ( $3.8 \pm 0.3$ ) was significantly higher than the one of *A. helleri* ( $2.2 \pm 0.6$ ;  $p = 0,0097$ ), *C. acanthifera* ( $2.4 \pm 0.7$ ;  $p = 0,0149$ ) and *A. spinicornis* ( $2.5 \pm 0.8$ ;  $p = 0,0191$ ).

In a lot of cases, amphipod signatures overlapped those of food sources. When they were higher, trophic enrichments factors ( $\Delta^{15}\text{N}$ ) were always low (from 0.5 to 1.5 ‰, depending on the species/food source pair considered).

Despite the overall similitude of the values,  $\delta^{15}\text{N}$  data should not be disregarded. Comparison of figures 4.12 and 4.13 shows that adding a second isotopic axis helps to reduce the overlapping issues (even if it does not suppress them), and allows a better discrimination between food sources and amphipods.

### III.3.C. C & N elemental content of sources

In order to characterize the composition of each food source, we analyzed their organic carbon and nitrogen content. The results of these analyses are presented in table 4.XII. The reader's attention is drawn to the fact that since BPOM was not separated from its inorganic sedimentary matrix, the relative organic C and N contents, expressed in percentage of the total (organic + inorganic) dry mass are widely underestimated. Therefore, we chose not to use them, and we preferred to only use the C/N ratio, that corrects this bias.

Carbon content of *P. oceanica* leaves and litter was the highest of all food items. It was generally comprised between 35 and 40 % of the total dry mass. Epiphytes from rhizomes contained 10 to 14 % of carbon, and the content of epiphytes from leaves and litter was slightly lower (9 to 11%). SPOM C content was low, and highly variable. SD was high in all seasons, sometimes reaching 50 to 60% of the mean.

Relative nitrogen content was comparable in rhizome epiflora, epifauna from leaves and litter, and living *Posidonia* leaves, ranging from 1.2 to 2 %, depending on the season. N concentrations were lower in leaves' and litter's epiflora, as well as in the litter itself (0.6 to 1.1 %). SPOM showed low and highly variable N contents.

**Table 4.XII:** Elemental contents of food sources. Table shows the relative concentrations of organic carbon, [C], and organic nitrogen, [N], (both expressed in percentage of the total dry mass), and the carbon to nitrogen ratio (C/N). All values are means  $\pm$  standard deviations.

Source	Season	[C] (%)	[N] (%)	C/N
<b><i>Posidonia</i> leaves</b>	June 08	37.40 $\pm$ 1.40	1.82 $\pm$ 0.24	20.55 $\pm$ 0.67
	November 08	36.70 $\pm$ 1.64	1.42 $\pm$ 0.31	25.01 $\pm$ 0.94
	March 09	38.14 $\pm$ 1.54	2.04 $\pm$ 0.47	18.72 $\pm$ 0.84
	July 09	39.47 $\pm$ 2.10	1.86 $\pm$ 0.39	21.22 $\pm$ 0.59
<b><i>Posidonia</i> litter</b>	June 08	38.11 $\pm$ 1.47	0.64 $\pm$ 0.13	60.01 $\pm$ 1.21
	November 08	39.14 $\pm$ 2.01	0.57 $\pm$ 0.14	68.64 $\pm$ 1.44
	March 09	40.17 $\pm$ 2.21	0.94 $\pm$ 0.32	42.75 $\pm$ 2.23
	July 09	38.58 $\pm$ 1.94	0.69 $\pm$ 0.21	55.91 $\pm$ 0.87
<b>BPOM (see p. 125)</b>	June 08	-	-	9.75 $\pm$ 0.24
	November 08	-	-	16.00 $\pm$ 0.67
	March 09	-	-	9.18 $\pm$ 0.37
	July 09	-	-	10.57 $\pm$ 0.19
<b>SPOM</b>	June 08	1.57 $\pm$ 0.88	0.21 $\pm$ 0.11	7.48 $\pm$ 2.21
	November 08	2.24 $\pm$ 1.01	0.14 $\pm$ 0.07	15.37 $\pm$ 1.98
	March 09	2.65 $\pm$ 1.54	0.44 $\pm$ 0.21	6.11 $\pm$ 3.47
	July 09	1.01 $\pm$ 0.44	0.24 $\pm$ 0.99	4.21 $\pm$ 2.84
<b>Litter epifauna</b>	June 08	10.31 $\pm$ 0.94	1.91 $\pm$ 0.34	5.68 $\pm$ 0.31
	November 08	10.01 $\pm$ 1.14	1.67 $\pm$ 0.41	5.94 $\pm$ 0.27
	March 09	10.69 $\pm$ 0.98	1.74 $\pm$ 0.47	6.21 $\pm$ 0.34
	July 09	9.41 $\pm$ 0.84	1.44 $\pm$ 0.34	6.31 $\pm$ 0.27
<b>Leaves epifauna</b>	June 08	9.98 $\pm$ 0.84	1.84 $\pm$ 0.41	5.4 $\pm$ 0.19
	November 08	10.44 $\pm$ 1.01	1.74 $\pm$ 0.39	6.13 $\pm$ 0.47
	March 09	10.07 $\pm$ 0.86	1.61 $\pm$ 0.51	6.28 $\pm$ 0.37
	July 09	9.64 $\pm$ 0.71	1.51 $\pm$ 0.41	6.21 $\pm$ 0.29
<b>Litter epiflora</b>	June 08	9.66 $\pm$ 0.74	0.91 $\pm$ 0.28	10.63 $\pm$ 0.51
	November 08	8.88 $\pm$ 0.58	0.59 $\pm$ 0.21	14.84 $\pm$ 0.69
	March 09	10.61 $\pm$ 0.84	1.11 $\pm$ 0.29	9.91 $\pm$ 0.41
	July 09	9.78 $\pm$ 0.68	0.94 $\pm$ 0.19	10.42 $\pm$ 0.48
<b>Leaves epiflora</b>	June 08	10.01 $\pm$ 1.06	0.84 $\pm$ 0.27	11.47 $\pm$ 0.79
	November 08	9.41 $\pm$ 0.64	0.66 $\pm$ 0.23	14.29 $\pm$ 0.54
	March 09	9.96 $\pm$ 0.67	0.98 $\pm$ 0.34	10.16 $\pm$ 0.45
	July 09	9.11 $\pm$ 0.59	0.87 $\pm$ 0.14	10.51 $\pm$ 0.53
<b>Rhizomes epiflora</b>	June 08	12.27 $\pm$ 2.01	1.69 $\pm$ 0.31	7.26 $\pm$ 0.51
	November 08	13.04 $\pm$ 1.97	1.22 $\pm$ 0.34	10.31 $\pm$ 0.47
	March 09	12.41 $\pm$ 2.4	2.04 $\pm$ 0.41	6.08 $\pm$ 0.29
	July 09	11.72 $\pm$ 1.84	1.91 $\pm$ 0.47	6.13 $\pm$ 0.38

It is also worth noting that for all food sources, the same seasonal trend can be outlined. Values are always close in June 2008 and July 2009, and tend to be lower in November 2008 and higher in March 2009.

C/N ratios (see table 4.XII) widely differed according to the food source and/or sampling seasons. Epifauna from the leaves and the litter had the lowest C/N of all food sources (5.5 to 6.5). Rhizome epiflora and SPOM also had low C/N ratios, but it was more variable, and was notably much higher in March 09. BPOM and vegetal epiphytes from leaves and litter had higher C/N ratios (9-12 for most seasons, more in March 09). *Posidonia* leaves' C/N were even higher, and *Posidonia* litter showed the biggest values for this parameter, reaching a maximum of nearly 70 in November 2008.

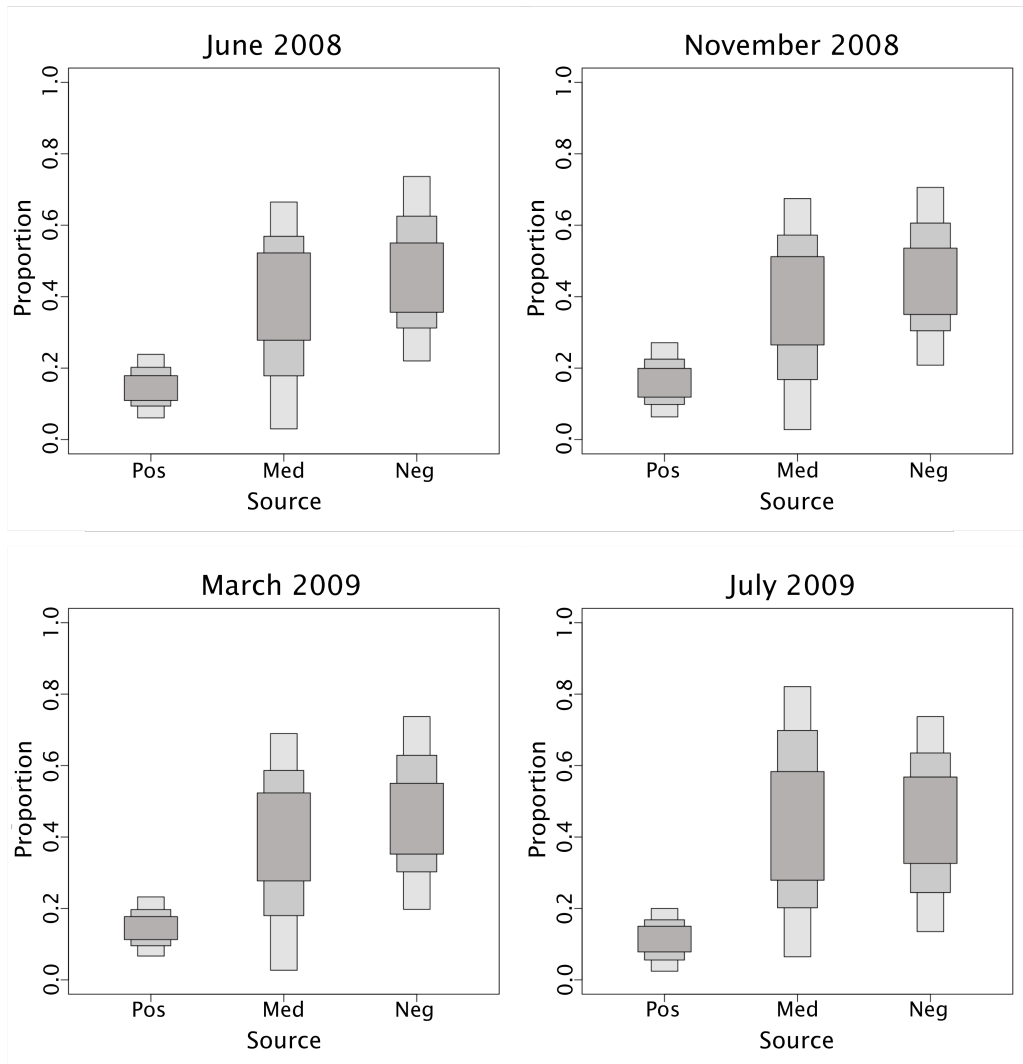
### III.3.D. Use of SIAR isotopic mixing model

In order to estimate the relative contributions of food sources to the diet of each of the 7 dominant species, we ran the SIAR (Stable Isotope Analysis in R) mixing model, using  $\delta^{13}\text{C}$ ,  $\delta^{15}\text{N}$  and elemental concentrations data.

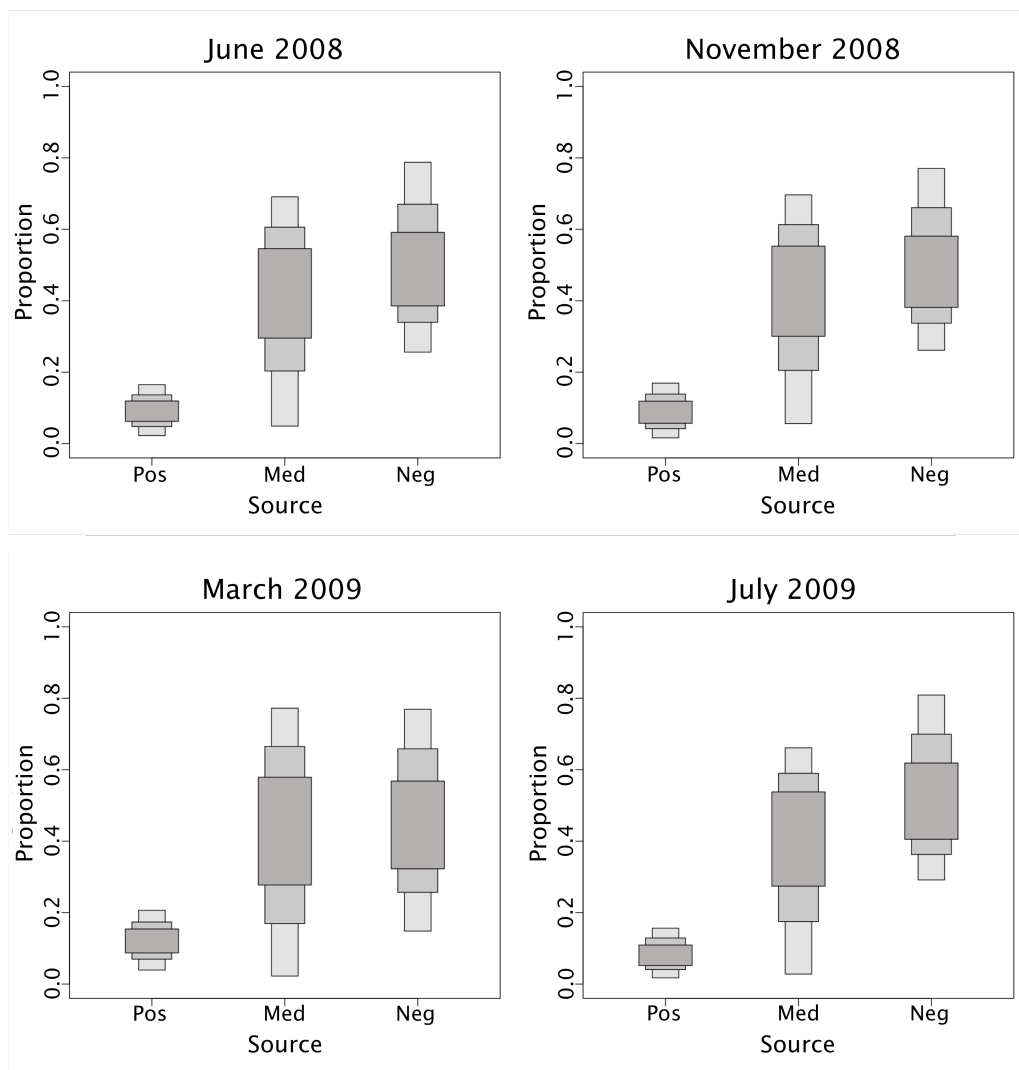
Sources were overall very similar in terms of isotopic ratios. Therefore, they were lumped in three groups that had markedly different isotopic signatures in all seasons. These groups were the "less negative" sources (*P. oceanica* leaves, *P. oceanica* litter), the "median" sources (benthic particulate organic matter, epifauna from the *P. oceanica* leaves and litter) and the "more negative" sources (epiflora from *P. oceanica* rhizomes, suspended particulate organic matter). Additional information about methodological considerations can be found in section II.3.D of this chapter. Figures 4.14 to 4.20 display the outputs of the mixing model. For each species, 4 graphs are shown, each of them displaying the situation in a particular season.

*Posidonia*-derived organic matter was the lowest contributing group to the diet of *Apherusa chieraghinii* (fig. 4.14) in all seasons. The 75 % credibility interval ( $\text{CI}_{75}$ ) ranged from 10 to 20 % for June 08 and March 09, from 10 to 23 % in November 2008, and from 6 to 17 % in July 09. This species seemed to rely in comparable amounts on the median and more negative food sources, the latter generally being a little more important than the former. Credibility intervals were always very wide, indicating an important variability in the contributions of these two sources. In the first 3 sampling seasons,  $\text{IC}_{75}$  ranged from 20 to 60 % for the median sources, and from 30 to 60 % for the more negative sources. In July 2009, they were even broader ([20 %, 70 %] for the median sources, [24 %, 64 %] for the negative ones).

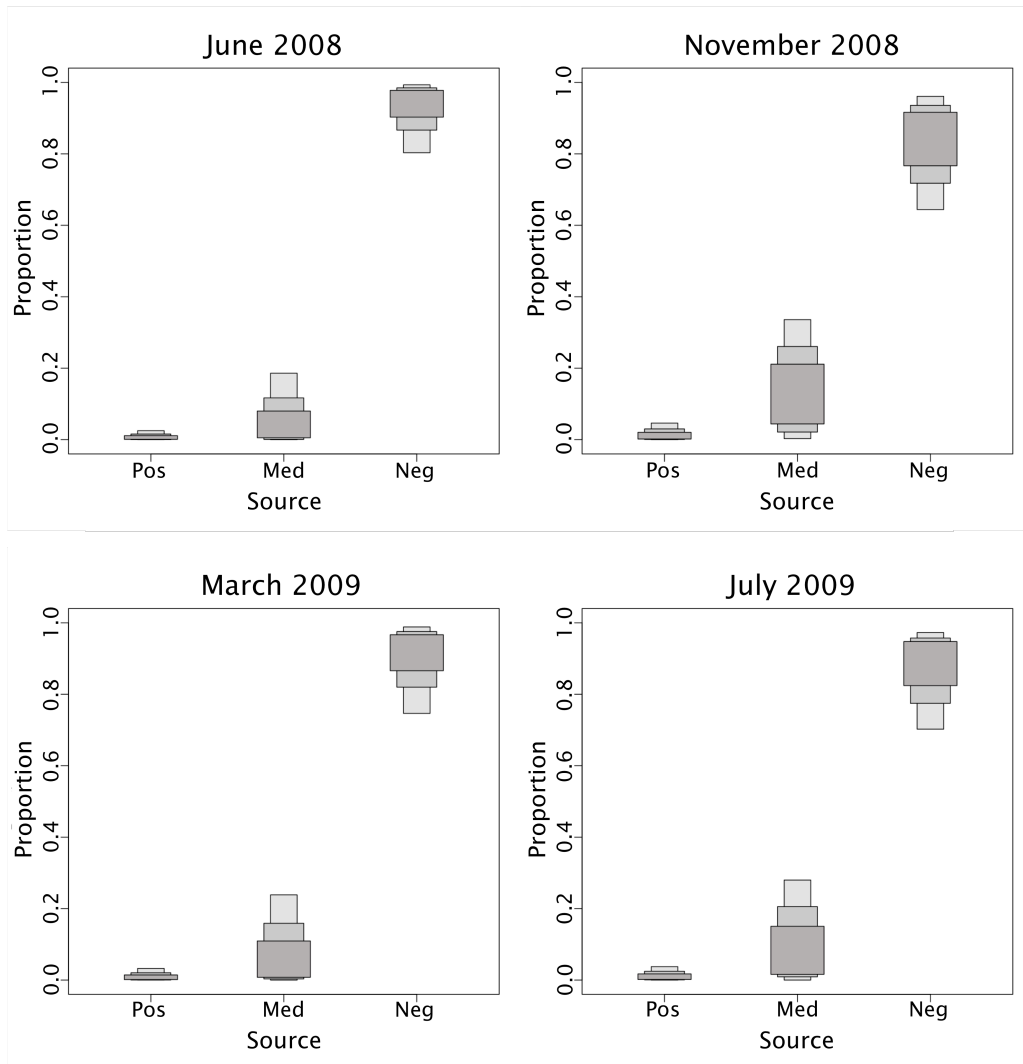
The situation for *Aora spinicornis* (fig. 4.15) is somehow similar to the pattern described for *Apherusa chieraghinii*. However, the less negative sources' (*Posidonia* leaves and litter) contributions were lower than in *A. chieraghinii* ( $\text{CI}_{75}$  = [4 %, 14 %] for all seasons), while the contributions of the more negatives sources were slightly higher ( $\text{CI}_{75}$  ranging from 35 to 65-70 %). Median sources' importance was the same than in the diet of *A. chieraghinii*, with  $\text{CI}_{75}$  extending from 20 to 60 % in all seasons.

*Apherusa chieraghinii*

**Fig. 4.14:** Boxplot of relative contributions of each group of food sources to the diet of *Apherusa chieraghinii*. Pos: less negative sources (*Posidonia* leaves and litter), Med: median sources (epifauna & epiflora from leaves and litter, benthic particulate organic matter), Neg: more negative food sources (rhizome epiflora, suspended particulate organic matter). Dark grey boxes are the 50 % credibility intervals, medium grey boxes are the 75 % credibility intervals, and light grey boxes are the 95 % credibility intervals.

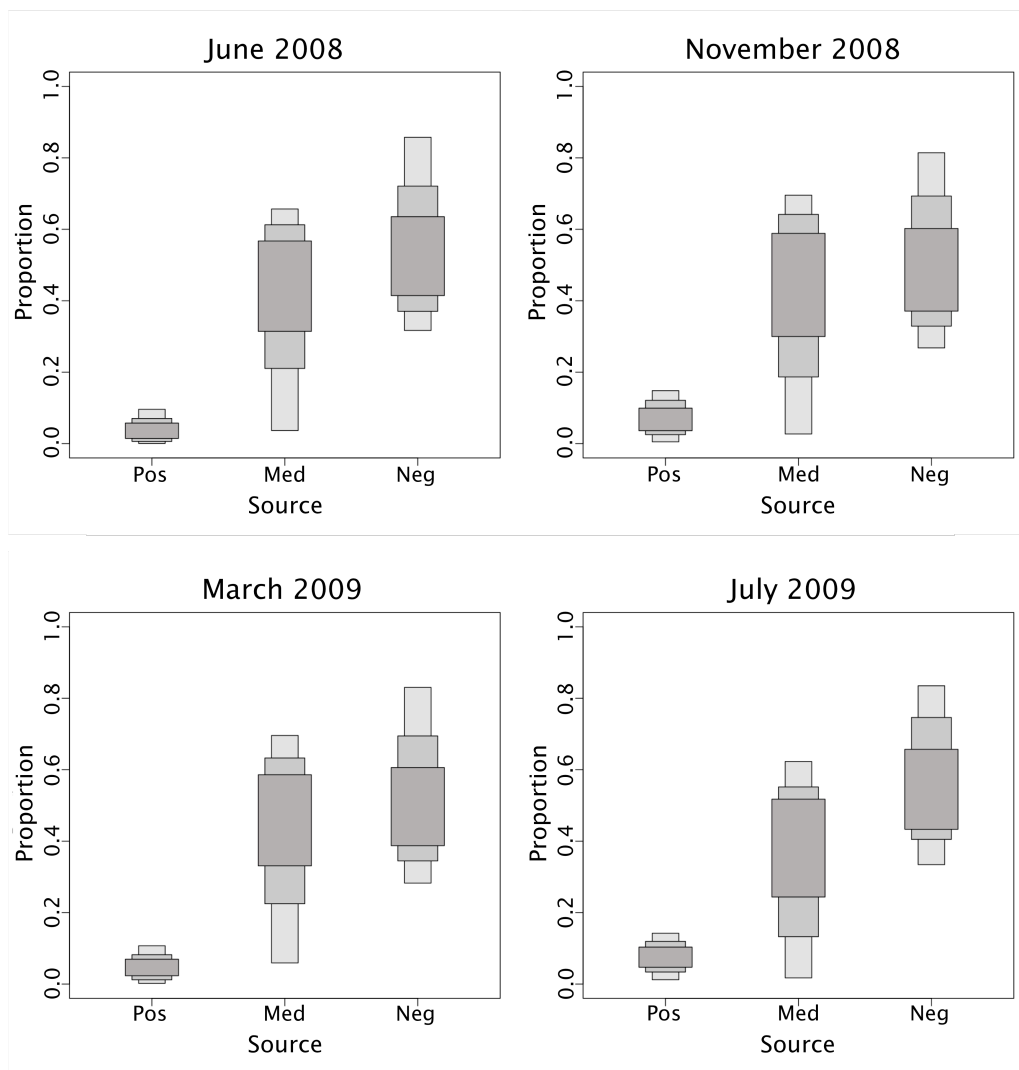
*Aora spiniornis*

**Fig. 4.15:** Boxplot of relative contributions of each group of food sources to the diet of *Aora spiniornis*. Pos: less negative sources (*Posidonia* leaves and litter), Med: median sources (epifauna & epiflora from leaves and litter, benthic particulate organic matter), Neg: more negative food sources (rhizome epiflora, suspended particulate organic matter). Dark grey boxes are the 50 % credibility intervals, medium grey boxes are the 75 % credibility intervals, and light grey boxes are the 95 % credibility intervals

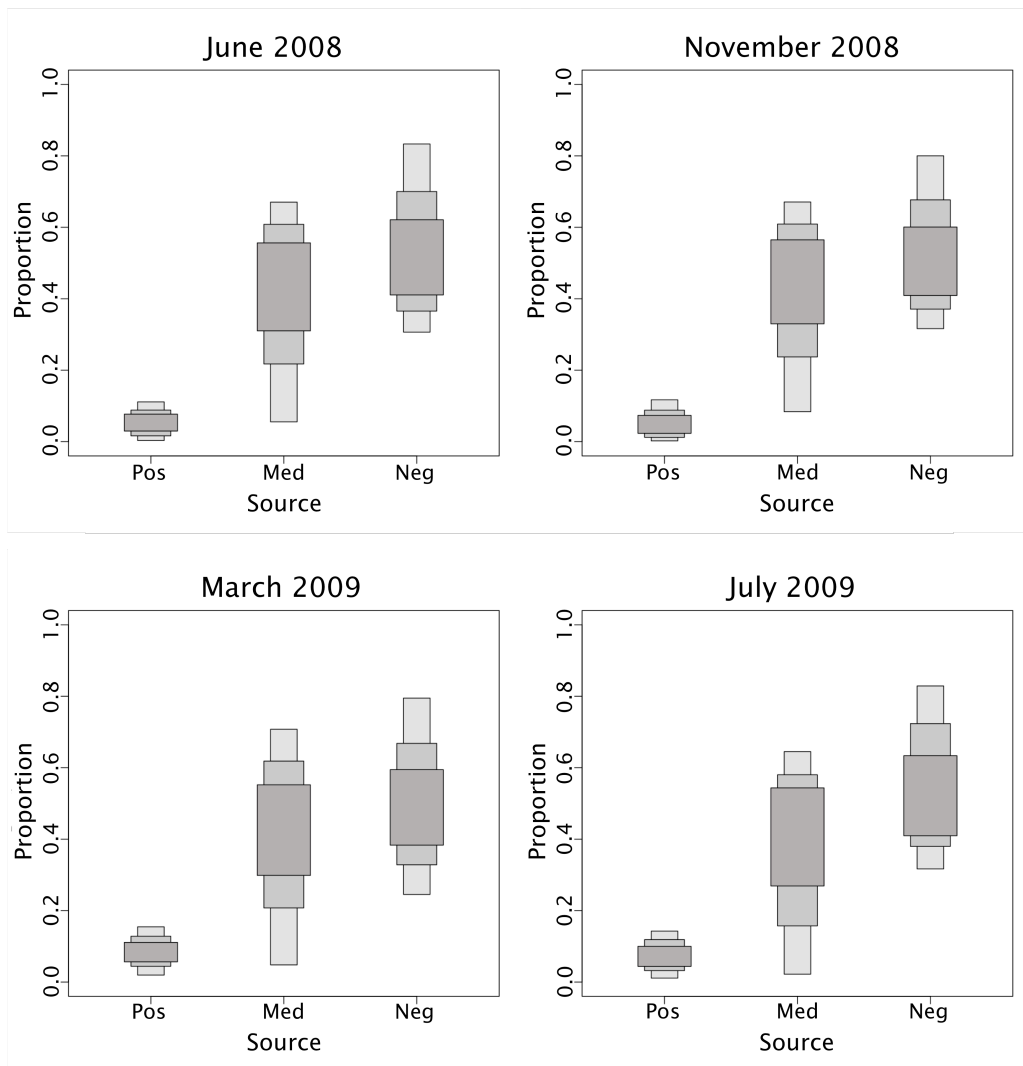
*Dexamine spiniventris*

**Fig. 4.16:** Boxplot of relative contributions of each group of food sources to the diet of *Dexamine spiniventris*. Pos: less negative sources (*Posidonia* leaves and litter), Med: median sources (epifauna & epiflora from leaves and litter, benthic particulate organic matter), Neg: more negative food sources (rhizome epiflora, suspended particulate organic matter). Dark grey boxes are the 50 % credibility intervals, medium grey boxes are the 75 % credibility intervals, and light grey boxes are the 95 % credibility intervals.

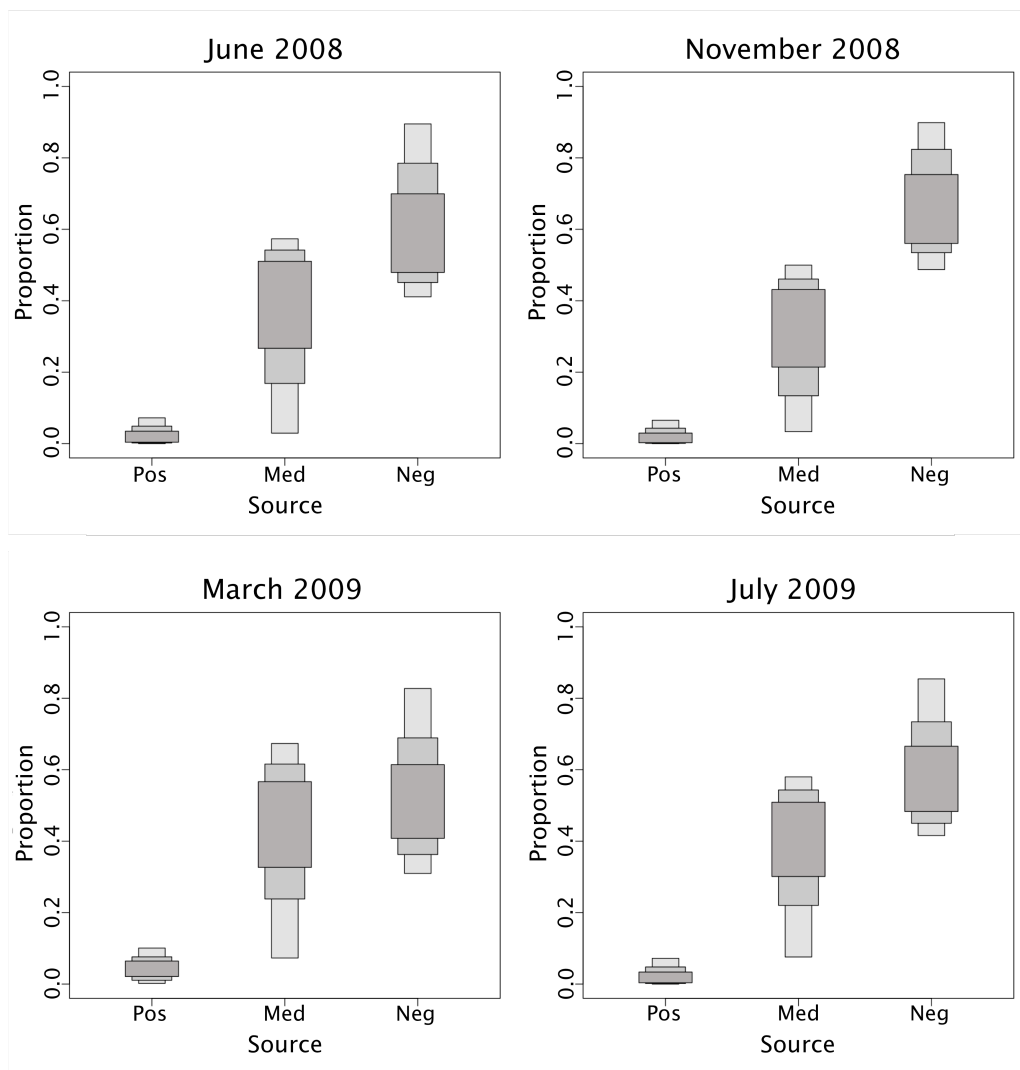


*Amphithoe helleri*

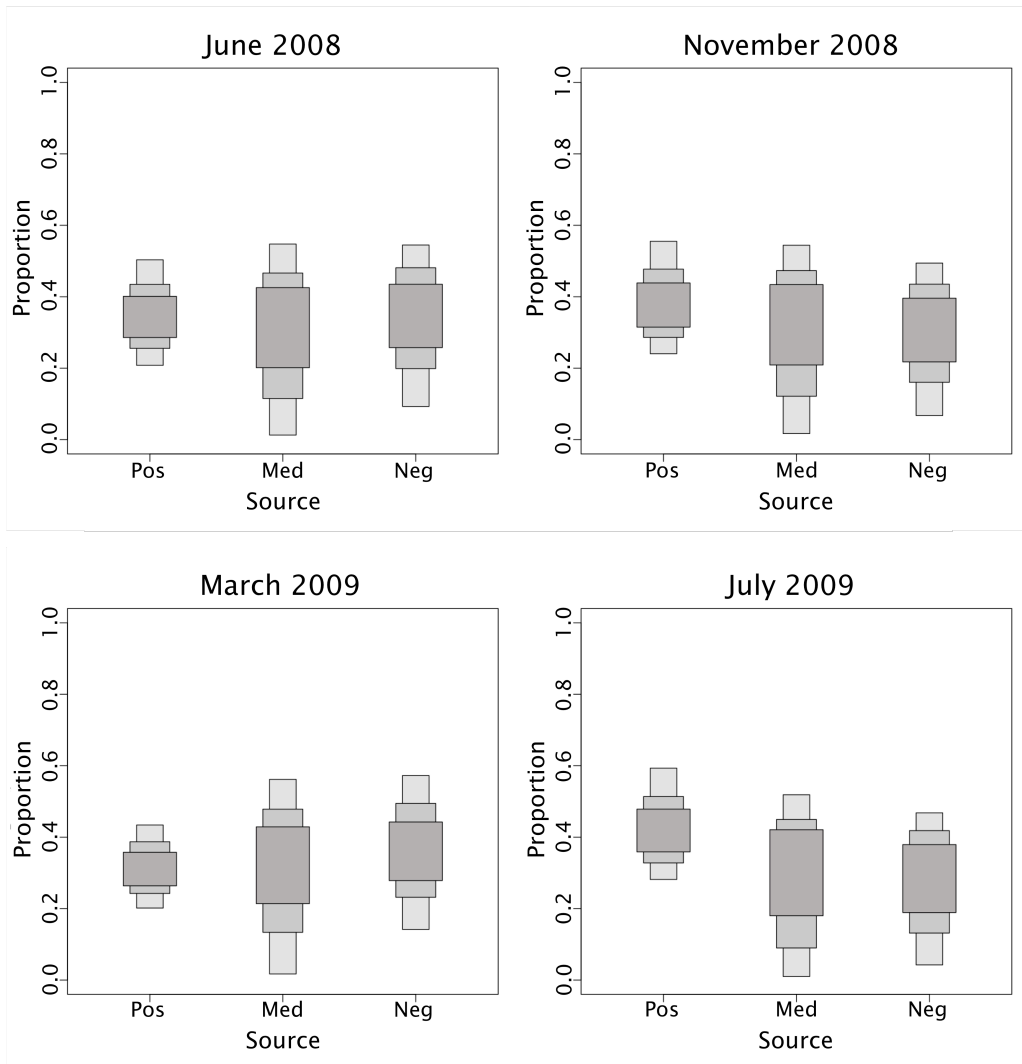
**Fig. 4.17:** Boxplot of relative contributions of each group of food sources to the diet of *Amphithoe helleri*. Pos: less negative sources (*Posidonia* leaves and litter), Med: median sources (epifauna & epiflora from leaves and litter, benthic particulate organic matter), Neg: more negative food sources (rhizome epiflora, suspended particulate organic matter). Dark grey boxes are the 50 % credibility intervals, medium grey boxes are the 75 % credibility intervals, and light grey boxes are the 95 % credibility intervals.

*Caprella acanthifera*

**Fig. 4.18:** Boxplot of relative contributions of each group of food sources to the diet of *Caprella acanthifera*. Pos: less negative sources (*Posidonia* leaves and litter), Med: median sources (epifauna & epiflora from leaves and litter, benthic particulate organic matter), Neg: more negative food sources (rhizome epiflora, suspended particulate organic matter). Dark grey boxes are the 50 % credibility intervals, medium grey boxes are the 75 % credibility intervals, and light grey boxes are the 95 % credibility intervals.

*Gammarella fucicola*

**Fig. 4.19:** Boxplot of relative contributions of each group of food sources to the diet of *Gammarella fucicola*. Pos: less negative sources (*Posidonia* leaves and litter), Med: median sources (epifauna & epiflora from leaves and litter, benthic particulate organic matter), Neg: more negative food sources (rhizome epiflora, suspended particulate organic matter). Dark grey boxes are the 50 % credibility intervals, medium grey boxes are the 75 % credibility intervals, and light grey boxes are the 95 % credibility intervals.

*Gammarus aequicauda*

**Fig. 4.20:** Boxplot of relative contributions of each group of food sources to the diet of *Gammarus aequicauda*. Pos: less negative sources (*Posidonia* leaves and litter), Med: median sources (epifauna & epiflora from leaves and litter, benthic particulate organic matter), Neg: more negative food sources (rhizome epiflora, suspended particulate organic matter). Dark grey boxes are the 50 % credibility intervals, medium grey boxes are the 75 % credibility intervals, and light grey boxes are the 95 % credibility intervals.

As displayed by figure 4.16, the diet of *Dexamine spiniventris* is completely different from the two former species. Here, the more negative food sources (Rhizomes' epiflora and SPOM) have huge contributions ( $CI_{75} = [87 \%, 98 \%$ ] for June 08,  $[72 \%, 94 \%$ ] for November 08,  $[82 \%, 98 \%$ ] for March 09 and  $[77 \%, 96 \%$ ] for July 09). Most of the remaining part was occupied by the median sources, and the *Posidonia*-derived sources yielded low to negligible contributions ( $CI_{75}$  upper limit always inferior to 3 %).

The diets of *Amphithoe helleri* (fig. 4.17) and *Caprella acanthifera* (fig. 4.18) seemed to be similar, and they were both close to *A. spinicornis*' one. In both cases, the less negative sources were the lowest-contributing group, with  $CI_{75}$  typically ranging from 1.5 - 3 % to 10 - 12 %. Median sources were much more abundant, with relative contributions ranging from about 20 to 60 % in 70 % of the model's solutions. In both species, the top-contributing group was the negative sources, whose 70 % credibility intervals stretch from 35 - 40 % to 65 - 70 %.

The case of *Gammarella fucicola* (fig. 4.19) looks like an intermediate situation between *Dexamine spiniventris* and the 4 other aforementioned species. Negative sources were always the most important group ( $CI_{75} = [45 \%, 79 \%$ ] for June 08,  $[53 \%, 82 \%$ ] for November 08 and  $[45 \%, 73 \%$ ] for July 09), but it was not as dominant as it was in *D. spiniventris*. This is particularly true for March 09, where its contribution was lower than in other seasons ( $CI_{75} = [36 \%, 69 \%$ ). Median sources were clearly less important than negative ones in June 08 ( $CI_{75} = [17 \%, 54 \%$ ), November 2008  $[13 \%, 46 \%$ ] and July 09 ( $CI_{75} = [22 \%, 54 \%$ ). This remains true for March 09, but it was less marked ( $CI_{75} = [24 \%, 62 \%$ ). Less negative *Posidonia* leaves and litter showed only anecdotic contributions.  $CI_{75}$  upper limit was 7.5 % in March 09, and was inferior to 5 % in the 3 other seasons.

Finally, *Gammarus aequicauda*'s diet (fig. 4.20) was unique among the studied species. Here, the less  $^{13}C$ -depleted sources (*Posidonia* leaves and litter) had important contributions in all seasons ( $CI_{75} = [26 \%, 43 \%$ ] in June 08,  $[29 \%, 48 \%$ ] in November 08, and  $[24 \%, 39 \%$ ] in March 09), and were even the highest contributing group in July 09 ( $CI_{75} = [33 \%, 51 \%$ ).

The two other groups had similar contributions, even though the median sources' credibility interval were generally broader. These scattered from 9 - 13 to about 45 % (75 % credibility intervals). The negative sources' contributions were slightly different from season to season, and  $IC_{75}$  ranged from 20 to 48 % in June 08, from 16 to 44 % in November 08, from 23 to 49 % in March 09, and from 13 to 42 % in July 09.

## IV. Discussion

### IV.1. Gut contents

As stated in section III.1, 60 to 80 % of the gut content of the studied species was composed of **amorphous material**, *i.e.* degraded organic elements,

presumably of biogenic origin, but lacking identifiable structures, which prevents linking them with a functional group of food items. A similar situation has been described by a recent study on caprellids (GUERRA-GARCIA & TIerna DE FIGUEROA, 2009). In this study, most of the gut content (86 %) of the 62 species of amphipods was labelled as "detritus", leading the authors to classify most caprellids as detritivores.

However, typical feeding mechanism of amphipods implies that an important part of the mechanical digestion of the aliments is performed prior to the ingestion of food items. Mandibles bear an incisor process that is used to bite food items and cut fragments, which are then triturated and crushed by the mandibular molar process. Food pieces are then gathered and brought to the mouth for ingestion (BELLAN-SANTINI, 1999). It is highly likely that these steps severely damage the food items, and notably their soft tissues.

Therefore, while a part of the unidentifiable material present in the gut content really originates from the ingestion of dead and decaying animal and/or vegetal material (detritivory *sensu stricto*), it is probable that another significant part results of the impairment of food items that were alive at the moment of the consumption. Since we have no way to discriminate between these two parts, and since some of the studied species ingested identifiable dead *Posidonia* fragments (detritivory *sensu stricto*), it is unfortunately difficult to use the amounts of amorphous material to make assumptions about the diet of the animals.

**Algal fragments** were the identifiable item most frequently occurring in the gut content of all species. This suggests that all studied species can be seen, to a certain extent, as herbivores.

Most algal fragments were too damaged to be associated to a precise algal group. The few ones that could mostly originated from erected macroalgae, usually Phaeophyceae (*Myrionema* sp., Sphacelariales) and Rhodophyceae (notably Ceramiales).

The question of the origin of these algae remains unanswered. They could have been epiphytes from the leaves and rhizomes of *Posidonia*, or part of the epiflora of the litter fragments, or come from the drift algal fraction associated to *Posidonia* litter (LEPOINT *et al.*, 2006). In this study, the gut content examination did not enable discrimination between these algal compartments. On the other hand, diatom frustules and fragments of living *Posidonia oceanica* leaves were always scarce or absent. This indicates that reliance of animals on microherbivory or seagrass consumption is low.

All species but *Caprella acanthifera* also exhibited carnivorous behaviour. **Crustacean remains** (legs, antennae, mouthparts) were indeed frequently present, even if they always were a minor food item. Most of them seemed to originate from other amphipods, or at least from other peracarids.

Occasional carnivory or necrophagy is common in a lot of marine herbivore invertebrates, and is often thought of as a way to achieve an adequate nutrition, and to compensate for nutrient-poor and non-digestible material-rich diets. It has even been shown that, for some amphipods, mixed diets even

improved consumer fitness (CRUZ-RIVERA & HAY, 2000). Moreover, consumption of smaller amphipods and cannibalism are well documented in a number of amphipod species (HUNTE & MYERS, 1984 ; BELLAN-SANTINI, 1999 ; Pers. obs.). Consumption of shed exuviae could also occur, although it does not seem to be generalized in marine amphipods (BELLAN-SANTINI, 1999)

**Pieces of *P. oceanica*** litter were only present in 3 of the 7 species. Litter consumption had already been mentioned in the past for *Gammarella fucicola* and *Gammarus aequicauda*, as well as for another species of the genus *Dexamine* (*D. spinosa*; LEPOINT *et al.*, 2006 ; REMY, 2010). In these studies, amphipods from submerged litter accumulations showed to ingest the litter they live in vastly bigger amounts than our individuals, which were collected in the *Posidonia* meadow. It sometimes was the most food item in their guts. Even if it was, in our case, rare, the presence of *Posidonia* litter in these three species underlines an inclination towards detritivory as well as benthic feeding in the lower horizons of the meadow.

All **other items** were nearly absent from the guts of the studied species. This is particularly striking for the sessile animals (bryozoans, hydrozoans), since some amphipods, notably caprellids, have been described as heavily preying on them in past studies (RUFFO *et al.*, 1993). It is possible that their relatively soft tissues are destroyed by the mechanical digestion, making them impossible to identify, and leading to an underestimation of their contribution to the diet. However, even if their occurrence is underestimated, they seem unlikely to be major, or even only significant, food items.

Gut content examination suffers from well-known caveats. It merely gives a snapshot of the diet of the studied animals, and tends to over-estimate the importance of the hard, poorly digestible items (*e.g.* DALSGAARD *et al.*, 2003). The method used here is also subject to criticisms. The use of *in toto* preparations makes fine observations at high magnifications (1000 X) difficult. In these conditions, some otherwise identifiable items might have been improperly labelled as amorphous material.

On the other hand, this technique gave us a global, quantitative view on the gut content of small animals (total body length often inferior to 1 cm). Dissection of these amphipods would more than probably have resulted in the loss of a part of the gut content, thus creating analytical error in the contribution of each food source. Moreover, it is a rapid and cost-efficient method that allowed the processing of many samples (20 specimen per species, for a total of 140 amphipods), and therefore made a better replication possible. This replication putatively makes our estimates more robust and trustable.

These methodological considerations put aside, the gut contents of all species seemed to be quite similar (fig. 4.7), and, based on this method only, trophic diversity among the studied community seemed low. Nevertheless, gut content examination highlighted the ingestion of *Posidonia* litter by three species (*G. aequicauda*, *G. fucicola*, *D. spiniventris*). It also tends to show that most of studied species are not strict herbivores, but rely on other detrital or animal food sources as well.

## **IV.2. Fatty acids**

### **IV.2.A. Fatty acid composition of food sources**

As stated in section III.2.A of this chapter, all food items had similar fatty acids compositions, with the exception of *Posidonia oceanica* living leaves.

All 4 groups of **vegetal and/or bulk epiphytes** (bulk epiphytes from litter and leaves, vegetal epiphytes from leaves and rhizomes) had high polyunsaturated fatty acid (PUFA) content. The most abundant compounds were generally arachidonic acid, or 20:4(n-6), and eicosapentaenoic acid, or 20:5(n-3). These fatty acids are known to be abundant in most red and brown algae, in a great variety of ecosystems (*e.g.* FLEURENCE *et al.*, 1994 ; GRAEVE *et al.*, 2002). Relative concentrations of single species vary widely, but Rhodophyta tend to be richer in 20:5(n-3) than Phaeophyta. Overall, the concentrations found in our study are consistent with the dominance of these two groups in the epiphytic cover of *Posidonia* leaves, rhizomes and litter (MAZZELLA *et al.*, 1989 ; JACQUEMART, 2009).

Other less abundant PUFA include 18:2(n-6) and 18:3(n-3). Although they are often found in small amounts in red and brown algae, these are rather characteristic of green algae and higher plants (GRAEVE *et al.*, 2002). This is not surprising either, since Chlorophyta are also present in the epiphytic cover of *Posidonia*.

Monounsaturated fatty acids (MUFA) were moderately abundant. As in most algae, C<sub>18</sub> MUFA were preponderant. Relatively high contents of palmitoleic acid (16:1(n-7)) were also found. This compound is often found in macroalgae, and it is extremely abundant in diatoms, that are part of the epiphytic cover as well (KAYAMA *et al.*, 1989 ; KHARLAMENKO *et al.*, 1995 ; GRAEVE *et al.*, 2002).

Saturated fatty acids (SAFA) were drastically dominated by the 16:0, or palmitic acid. 18:0 and 14:0 were also present, in much lesser concentrations. This situation is common in algae, but also in most living organisms whatsoever (ACKMAN, 1989 ; CHRISTIE, 2010b).

This study is, to our knowledge, the first to measure the fatty acid composition of epiphytes from Mediterranean *Posidonia oceanica*. NICHOLS *et al.* (1985) analyzed the FA content of epiphytes of *Posidonia australis* from the meadows of Corner Inlet (Australia). They found comparable amounts of 18:1(n-9), 18:1(n-7), 14:0 and 18:0, but low concentrations for C<sub>18</sub> and C<sub>20</sub> PUFA (0.7 to 2.5 %). On the other hand, their samples contained a lot of 16:0 (35.7 %) and 16:1(n-7) (27.8 %). This may be explained by the different composition of the epiphytic cover which was, in their case, mostly bryozoans, diatoms and fungi.

The FA composition of the **epifauna from the leaves** was very close to those of vegetal and bulk epiphytes (around 90 % of Bray-Curtis similarity with most samples, see fig. 4.8). Fig. 4.7 and table 4.VI emphasize the fact that it contained a bit more SAFA and a bit less PUFA, but the relative concentrations are in the same range of values. This could indicate that epifauna rely on macroalgal organic matter, but experimental issues in the collection of



samples (notably secondary epiphytism) complicate the interpretation of these data.

The living *Posidonia oceanica* leaves had a thoroughly different composition. Apart from the ubiquitous 16:0 and 18:0, most of the FA pool was constituted of the C<sub>18</sub> PUFA linoleic (18:2(n-6)) and  $\alpha$ -linolenic (18:3(n-3)) acids. This has already been reported by former workers (Viso *et al.*, 1993). A comparable composition has been recorded for a number of other seagrasses, including *Posidonia australis*, *Heterozostera tasmanica*, *Thalassia testudinum*, *Syringodium filiforme* and *Zostera marina*. High contents of C<sub>18</sub> PUFA are also documented for marine Chlorophyta, as well as for terrestrial higher plants (KAYAMA *et al.*, 1989 ; KHARLAMENKO *et al.*, 2001).

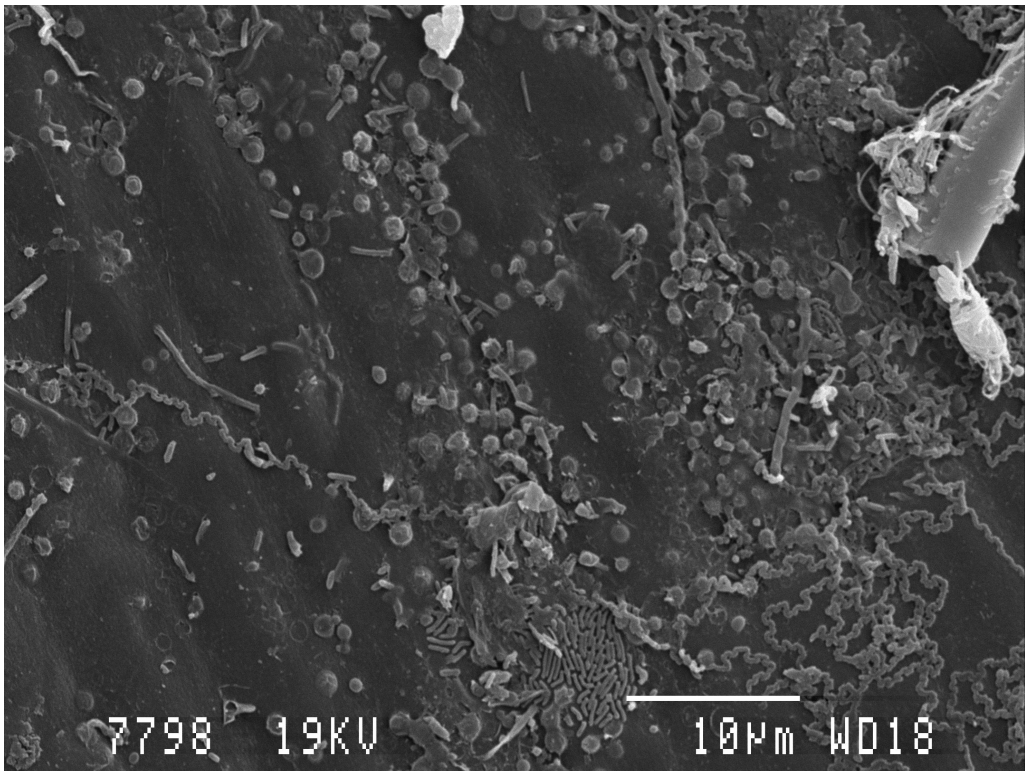
Linoleic and  $\alpha$ -linolenic are intermediate products of biosynthetic pathways for C<sub>20</sub> compounds like 20:4(n-6) and 20:5(n-3). Preferential use of C<sub>18</sub> over C<sub>20</sub> PUFA in membrane lipids is generally thought of as a derived trait common to all Chlorobionta (GRAEVE *et al.*, 2002 ; GUSCHINA & HARWOOD, 2006).

*Posidonia* litter fragments' composition was markedly different from the one of living leaves. It showed very low concentration of C<sub>18</sub> PUFA, a phenomenon already described by KHARLAMENKO *et al.* (2001) for *Zostera marina* detritus. This could be a hint that degradation of litter fragments had already taken place, despite their relatively fresh condition (early age and low fragmentation status). Most litter samples actually shared more similarity with the epiphytes or the SPOM (around 80 %, see figure 4.8) than they did with *Posidonia* leaves (only 60 %).

More than half of the litter FA were saturated compounds. Some of the SAFA of litter were absent or rare in other sources. These included anteisopentadecanoic acid (a15:0), an uncommon odd-chain branched fatty acid typically found in bacteria. Presence of this FA is most likely caused by the bacterial colonization of dead *Posidonia* litter fragments. This is supported by the levels of 15:0 and 18:1(n-7) that are higher in litter than in other sources. These fatty acids, while they can be found in other sources, are major constituents of bacterial lipids (NICHOLS *et al.*, 1985 ; CHRISTIE, 2010a). Dead *Posidonia* leaves are indeed known to bear great numbers of prokaryote (bacteria) and eukaryote (fungi) decomposing microorganisms. An example of this is pictured in figure 4.21. These microorganisms are typically regarded as important for the diet and nutritional balance of detritivores (VIZZINI, 2009).

Finally, **suspended particulate organic matter (SPOM)** lipids mostly consisted of saturated fatty acids, essentially the usual 16:0, 18:0 and 14:0. It also contained fairly high amounts of 16:1(n-7), which could originate from diatoms, known to show important concentrations of palmitoleic acid.

SPOM concentrations for 18:2(n-6) and 18:3(n-3) were low, suggesting that live seagrass tissues are not a prominent part of it. Hierarchical clustering analysis (fig. 4.8) confirms this, and clearly indicates that SPOM is more similar to litter or epiphytes (more than 80 %) than it is to seagrass leaves (60 %). This view is in good agreement with the work of NICHOLS *et al.* (1985) who found that the FA composition of SPOM from a *Posidonia australis* meadow had much in common with the one of seagrass epiphytes.



**Fig. 4.21:** Scanning Electron Microscope view of the surface of a *Posidonia* litter fragment, showing the heavy colonization by coccus and bacillus-shaped bacteria. Magnification: 2000X, scale bar in the lower right is 10  $\mu\text{m}$ . Photograph by F. Remy, Laboratory of Oceanology, ULg.

PUFA pool of SPOM contained 20:5(n-3) and 20:4(n-6). While 20:5(n-3) could originate from microalgae (notably diatoms), 20:4(n-6) is generally rare in these organisms, suggesting a contribution of macroalgal material to SPOM (Cook *et al.*, 2010.)

We also found relatively high amounts of docosahexaenoic acid, 22:6(n-3). 22:6(n-3) is known to be a common constituent of some marine animals, and also to be especially abundant in dinoflagellates (JOSEPH, 1989 ; NELSON *et al.*, 2001). Since dinoflagellates can be an important part of phytoplankton in Calvi Bay, they could be responsible for the DHA content of SPOM (DAUBY, 1989).

Overall, while it is possible to highlight specific trends concerning the FA composition of food items, it is impossible to neglect its general similarity. Apart from *Posidonia* leaves, all producers seemed to have close FA signatures, which complicate our task. While FA analysis is undoubtedly informative about the feeding ecology of the studied amphipods (cf. next section), these results alone do not allow complete discrimination between the sampled food sources.

### IV.2.B. Trophic ecology of amphipods depicted by FA analysis

First of all, it is important to underline the relatively high overall similarity of FA composition of amphipods. In total, we analyzed 37 samples, belonging to 7 species, and they all share more than 70 % of similarity (see fig. 4.11). While this suggest a certain extent of trophic redundancy among the studied community, it is possible to outline specific trends.

C<sub>18</sub> and C<sub>20</sub> PUFA are abundant in a most marine plants, either macro- and microalgae or seagrasses. Total concentration of C<sub>18</sub> and C<sub>20</sub> PUFA could therefore be seen as a fatty acid marker for herbivory (KAYAMA *et al.*, 1989 ; KHARLAMENKO *et al.*, 1995). Table 4.XIII gives these summed concentrations for the studied species.

**Table 4.XIII:** Sums of the relative concentrations of C<sub>18</sub> and C<sub>20</sub> PUFA (% of the total FA content). AC: *Apherusa chiereghinii*, AS: *Aora spinicornis*, DV: *Dexamine spiniventris*, AH: *Amphithoe helleri*, CAC: *Caprella acanthifera*, GF: *Gammarella fucicola*, GA: *Gammarus aequicauda*.

	AC	AS	DV	AH	CAC	GF	GA
$\Sigma [C_{18} \text{ PUFA}] + [C_{20} \text{ PUFA}] (\%)$	39.2	35.8	41.6	21.3	21.0	37.2	35.1

C<sub>18</sub> and C<sub>20</sub> PUFA are very abundant in *G. aequicauda*, *G. fucicola*, *A. spinicornis* and especially in *A. chiereghinii* and *D. spiniventris*. This suggests that herbivory is very important feeding mode for these studies. *A contrario*, *A. helleri* and *C. acanthifera* contains a lot less of these compounds, and while vegetal consumption occur in these species, it seems less widespread than in the 5 other.

As mentioned earlier, C<sub>18</sub> PUFA 18:2(n-6) and 18:3(n-3) are particularly abundant in all Chlorobionta, but generally rather rare in Phaeophyta and Rhodophyta. This statement led KHARLAMENKO *et al.* (2001) to propose the ratio between C<sub>18</sub> and C<sub>20,22</sub> PUFA as a marker for seagrass consumption. Values of this FA marker are given in table 4.XIV.

**Table 4.XIV:** Ratios of relative concentrations of 18:2(n-6) and 18:3(n-3) to relative concentrations of C<sub>20</sub> and C<sub>22</sub> PUFA in consumers. All concentrations are in % of the total FA content, so the ratio is unitless. AC: *Apherusa chiereghinii*, AS: *Aora spinicornis*, DV: *Dexamine spiniventris*, AH: *Amphithoe helleri*, CAC: *Caprella acanthifera*, GF: *Gammarella fucicola*, GA: *Gammarus aequicauda*.

	AC	AS	DV	AH	CAC	GF	GA
$\frac{[18:2(n-6)] + [18:3(n-3)]}{\Sigma [C_{20} \text{ PUFA}] + [C_{22} \text{ PUFA}]}$	0.14	0.07	0.18	0.09	0.13	0.13	0.06

The ratio is very low for all species, emphasizing the lack of seagrass consumption. In comparison, NICHOLS *et al.* (1986) found a ratio of 1.43 for the

## Multidisciplinary study of trophic diversity

southern garfish *Hyporhamphus melanochir*, known to feed on *Posidonia australis* leaves.

Since FA composition of Chlorophyceae is close to the one of seagrasses (GRAEVE *et al.*, 2002), it can be hypothesized that their consumption is rare as well. The large herbivore part in the diet of the amphipods is therefore likely mostly consists of Rhodophyceae and Phaeophyceae.

Palmitoleic acid (16:1(n-7)) is an important component of diatoms, sometimes constituting nearly half of the total FA pool (COOK *et al.*, 2010). In diatoms, it generally outnumbers the otherwise usually dominant palmitic acid (16:0), and the ratio of 16:1(n-7) to 16:0 concentrations can therefore be used as a marker for a diatom-based diet (KHARLAMENKO *et al.*, 2001). Table 4.XV gives values of this ratio for the studied species.

**Table 4.XV:** Ratios of relative concentrations of 16:1(n-7) to relative concentrations of 16:0 in consumers. Both concentrations are in % of the total FA content, so the ratio is unitless. AC: *Apherusa chiereghinii*, AS: *Aora spinicornis*, DV: *Dexamine spiniventris*, AH: *Amphithoe helleri*, CAc: *Caprella acanthifera*, GF: *Gammarella fucicola*, GA: *Gammarus aequicauda*.

	AC	AS	DV	AH	CAc	GF	GA
$\frac{[16:1(n-7)]}{[16:0]}$	0.17	0.18	0.09	0.10	0.11	0.00	0.20

This ratio typically has values close to or greater than 1 for consumers relying heavily on either pelagic or benthic diatoms (KHARLAMENKO *et al.*, 1995 ; GRAEVE *et al.*, 1997 ; GRAEVE *et al.*, 2001). Here, these ratios were much lower, and always inferior to 0.2. This suggests a limited contribution of diatoms to the diet of the studied amphipods.

Moreover, if 20:5(n-3), abundant in the tissues of all animals, is typical of both micro- and macroalgae, arachidonic acid (20:4(n-6)) is generally rather associated with macroalgae (GRAEVE *et al.*, 2002). This component was present in significant amounts in all species. Together with the scarcity of palmitoleic acid, these high contents of arachidonic acid point out that microherbivory must be rare in the studied species. Therefore, the important plant-based part of their diets probably consists of red and brown macroalgae. These could be epiphytes from the leaves, the litter fragments and/or the rhizomes, but also drift algae found among the litter.

Bacterial lipids have uncommon features. They are notably rich in branched (iso- and anteiso-) saturated fatty acids. In addition, whereas the common C<sub>18</sub> monounsaturated compound for most eukaryotes is oleic acid (18:1(n-9)), for bacteria it is 18:1(n-7) (*cis*-vaccenic acid) (CHRISTIE, 2010a). This has led KHARLAMENKO *et al.* (2001) to propose the summed concentrations of i17:0 and a17:0, as well as the ratio of 18:1(n-7) to 18:1(n-9) as fatty acid markers for bacteria. The values of these markers for the sampled organisms can be found in table 4.XVI.

**Table 4.XVI:** Values of two bacterial fatty acid markers for the studied amphipods: i) ratio of relative concentrations of 18:1(n-7) to relative concentrations of 18:1(n-9) and ii) Sum of the relative concentrations of C<sub>17</sub> branched fatty acids. All concentrations are in % of the total FA content, so the ratio is unitless. AC: *Apherusa chieraghinii*, AS: *Aora spinicornis*, DV: *Dexamine spiniventris*, AH: *Amphithoe helleri*, CAc: *Caprella acanthifera*, GF: *Gammarella fucicola*, GA: *Gammarus aequicauda*.

	AC	AS	DV	AH	CAc	GF	GA
$\frac{[18:1(n-7)]}{[18:1(n-9)]}$	0.30	0.28	0.15	0.13	0.24	0.22	0.77
$\Sigma [i17:0] + [a17:0] (\%)$	0.03	0.00	0.00	0.00	0.00	0.00	0.85

Bacterial contributions only seemed significant for *Gammarus aequicauda*. The values of these markers were nowhere near as the ones reported for invertebrates bearing high amounts of bacterial symbionts, or benthic animals grazing on microbial mats from hydrothermal systems (KHARLAMENKO *et al.*, 1995 ; POND *et al.*, 1997). Nevertheless, bacterial input in *G. aequicauda* is a striking feature that could be linked with two phenomena. First, bacteria colonizing detritus (notably *P. oceanica* litter) could be ingested concomitantly with the substrate they grow on. It has indeed been mentioned in section IV.2.A that *Posidonia* litter contained high amounts of *cis*-vaccenic acid, probably originating from the micro-decomposers that colonize it. Second, these bacteria could be digestive symbionts, helping the digestion of *Posidonia* detritus. This will be further discussed later.

As mentioned earlier, two species, *Amphithoe helleri* and *Caprella acanthifera*, had weaker inclinations towards plant consumption than the other. The question of their dietary preferences therefore remains open. Two fatty acid markers could give partial information about this topic, at least for *C. acanthifera*. These are the concentrations of 22:6(n-3) (DHA) and the summed concentrations of monounsaturated C<sub>20</sub> and C<sub>22</sub> compounds. Table XVII shows their values.

**Table 4.XVII:** Relative concentrations of 22:6(n-3) and sum of the concentrations of C<sub>20</sub> and C<sub>22</sub> MUFA. All concentrations are in % of the total FA content. AC: *Apherusa chieraghinii*, AS: *Aora spinicornis*, DV: *Dexamine spiniventris*, AH: *Amphithoe helleri*, CAc: *Caprella acanthifera*, GF: *Gammarella fucicola*, GA: *Gammarus aequicauda*.

	AC	AS	DV	AH	CAc	GF	GA
[22:6(n-3)] (%)	6.2	6.2	3.1	7.9	10.9	7.4	6.9
$\Sigma [C_{20} \text{ MUFA}] + [C_{22} \text{ MUFA}] (\%)$	1.2	1.4	2.1	2.4	5.7	2.4	0.8

Concentrations of DHA are similar in most species, ranging from 6 to 8 % of the total FA. However, it is rare in *D. spiniventris*, and particularly abundant in

---

 Multidisciplinary study of trophic diversity

*Caprella acanthifera*. DHA is very abundant in dinoflagellates, and in turn in a lot of zooplanktonic species feeding on them (DALSGAARD *et al.*, 2003). Although this FA is not only found in planktonic items (it is also found in a lot of marine benthic invertebrates and fish, it was indeed more abundant in SPOM than in any other source (cf. section IV.2.A).

Moreover, *C. acanthifera* contained more than twice as much long chain (C<sub>20</sub> and C<sub>22</sub>) monounsaturated FA than any other species. These fatty acids are notably known to be abundant in herbivorous calanoid copepods (GRAEVE *et al.*, 1997).

The higher levels of these FA markers in *C. acanthifera* therefore suggest that SPOM and/or zooplankton could be more prevalent in the diet of this species than in others'. It could also come from indirect inputs of these FA via organisms that feed on these items (notably members of the sessile epifauna).

To conclude with this section, the reader's attention is drawn to the fact that intraspecific variation in the FA composition of amphipods can be considerable. For example, by looking at figure 4.11 (p. 117), it is easy to see that samples from *Gammarus aequicauda* are scattered among the 3 clusters. Similarly, while most *D. spiniventris* samples gather in cluster B, two of them are found in cluster C. *A. spinicornis* samples are also found in both B and C clusters. While our sampling may not be representative enough to draw any definitive conclusions, this could be a hint that intraspecific trophic diversity among the studied species could sometimes be more important than interspecific trophic diversity among the studied taxocenosis.

### **IV.3. Stable isotopes**

#### **IV.3.A. Isotopic & elemental characterization of food sources**

**Seagrass tissues** (living and dead leaves) were the most <sup>13</sup>C-enriched food item for each sampling event. Isotopic ratios found in this study are comparable with those coming from literature about *Posidonia oceanica* meadows.

LEPOINT *et al.* (2000) reported that *Posidonia* leaves sampled at the same site in 1996-97 had δ<sup>13</sup>C of -13.9 ± 1 ‰ and δ<sup>15</sup>N of 2.6 ± 1 ‰. Leaves collected in September 1998 in Sicily showed similar ratios (δ<sup>13</sup>C = -11.3 ± 0.3 ‰ and δ<sup>15</sup>N = 2.8 ± 0.4 ‰; VIZZINI *et al.*, 2002). Other studies focusing only on carbon also found close δ<sup>13</sup>C values for *P. oceanica* living leaves (COOPER & DENIRO, 1989 ; DAUBY, 1989).

Literature data concerning dead *P. oceanica* litter also gives similar isotopic ratios. DAUBY, (1989) reported δ<sup>13</sup>C of -13.2 ‰, while dual-isotope studies of LEPOINT *et al.*, (2006) and STURARO *et al.*, (2010) measured δ<sup>13</sup>C of -12.1 ± 1.4 ‰ and -13.3 ± 0.8 ‰, and δ<sup>15</sup>N of 1.3 ± 0.4 ‰ and 1.3 ± 0.6 ‰, respectively.

*Posidonia* leaves and litter were significantly less <sup>13</sup>C-depleted than other macrophytes (epiphytic algae) in all seasons. These relatively high δ<sup>13</sup>C are typical in other seagrasses as well. This is probably mostly caused by the

preferential use of  $\text{HCO}_3^-$  (less negative than  $\text{CO}_2$ ) for photosynthesis. Other phenomena, such as irradiance conditions, contrasting photosynthesis rates and taxonomically-related differences in enzymatic discrimination might play a part, but this is beyond the scope of our study (RAVEN *et al.*, 2002).

C/N ratios of living leaves are a bit lower than previously recorded in the Calvi Bay (31; LEPOINT, 2001), but are within the range of 15 to 30 that is generally found in most Mediterranean studies (VELIMIROV, 1987 ; ALCOVERRO *et al.*, 1995 ; VIZZINI *et al.*, 2002 ; GOBERT *et al.*, 2006). These high C/N are explained by the high C content of the *Posidonia* leaves, which is related to the abundance of structural carbohydrates in their tissues (GOBERT *et al.*, 2006)

C/N ratios of litter were higher than those of *Posidonia* leaves in all seasons. In fact, organic C contents were similar, but organic N content were 2 to 3 times lower. Data from STURARO *et al.* (2010) also points to that (C/N ratio of 55 for dead *P. oceanica* leaves). This could be caused by differential degradation of the *Posidonia* litter. Organisms responsible for it may preferentially use labile N and C over refractory structural C, especially since N can be a limiting nutrient in the oligotrophic NW Mediterranean.

**Epiphytes from leaves and litter** showed similar  $\delta^{13}\text{C}$  and  $\delta^{15}\text{N}$  values in all the seasons. Our data is in general accordance with the literature. Past studies focusing on *Posidonia* litter recorded epiphytic  $\delta^{13}\text{C}$  of  $-19.6 \pm 2.3$  ‰ and  $-20.3 \pm 0.6$  ‰, as well as  $\delta^{15}\text{N}$  of  $1.6 \pm 0.7$  ‰ and  $1.9 \pm 0.5$  ‰ (LEPOINT *et al.*, 2006 ; STURARO *et al.*, 2010).

LEPOINT *et al.* (2000) sampled epiphytes from the *Posidonia* leaves in the Revellata Bay at depths of 5 to 15 m. They found  $\delta^{13}\text{C}$  of  $-19.4 \pm 0.8$  ‰ for bulk epifauna and  $-18.6 \pm 1.9$  ‰ for bulk epiflora, and  $\delta^{15}\text{N}$  of  $3.4 \pm 0.6$  ‰ for bulk epifauna and  $3 \pm 0.9$  ‰ for bulk epiflora. These carbon isotopic ratios are similar to the range of values that we measured but their samples were slightly more  $^{15}\text{N}$ -enriched. Contrastingly, VIZZINI *et al.* (2002) recorded  $\delta^{13}\text{C}$  of  $-14.9 \pm 0.1$  ‰ and  $\delta^{15}\text{N}$  of  $5.2 \pm 0.4$  ‰ for epiflora from the leaves. The differences could be explained by the fact that these authors worked at very shallow depths (average depth of 1.5 m). It is therefore likely that the epiphytic communities they sampled were different from ours, taken at depths of about 10 m. Moreover, the light availability is much higher at shallow depths, and this may have influenced the photosynthetic rates and, in turn, the  $\delta^{13}\text{C}$  of the epiflora.

While isotopic signatures of these 4 epiphytic groups were similar or identical, elemental concentrations differed. All groups contained ca. 10 % of organic carbon, but epifauna contained twice more nitrogen, leading to C/N ratios much lower (5-6 vs. 10-12). This is not surprising, since animal tissues are typically richer in nitrogen (notably due to their higher protein content). However, it stresses the fact that nutritional quality of epifauna is higher than all other sampled sources, making it a potentially attractive food item.

Literature estimates of the C/N ratio from epiphytes vary widely. ALCOVERRO *et al.* (1997) reports values ranging from 8.8 to 17 for bulk epiphytes (epiflora +

epifauna) from the leaves. This range is wider, but similar, to the one measured by LEPOINT (2001) for the bulk epiphytes from the leaves in Calvi Bay (9-11). VIZZINI *et al.* (2002) report a lower C/N ratio ( $7.4 \pm 1.5$ ) for the leave's epiflora. On the other hand, STURARO *et al.* (2010) report C/N ratios as high as 27.6 for the bulk epiphytes of the *Posidonia* litter. Methodological differences (in the method of acidification and/or of measurement) might be involved, but these discrepancies are probably mostly caused by the heterogeneity of the epiphytic compartment, that is a complex and dynamic assemblage of algae, sessile animals and microorganisms (BOROWITZKA & LETHBRIDGE, 1989).

**Epiflora from the rhizomes** was the most negative food source at all seasons. This is not surprising, since samples were composed mostly of various sciaphilous red algae, and to a much lesser extent, of the sciaphilous green algae *Udotea petiolata* and *Halimeda tuna*. A number of past investigators have already noted very negative values for coastal Mediterranean sciaphilous algae. LEPOINT *et al.* (2006) and STURARO *et al.* (2010) both measured isotopic ratios of drift sciaphilous algae associated to *Posidonia* litter, and both found  $\delta^{13}\text{C}$  of  $-29.7 \pm 4.5$  ‰, and  $\delta^{15}\text{N}$  of  $1.8 \pm 1$  ‰ and  $1.8 \pm 0.7$  ‰, respectively. Other studies focusing on single species of sciaphilous algae from the same locations also noted very low  $\delta^{13}\text{C}$  values, sometimes even lower than -30 ‰ (e.g. DAUBY, 1989 ; LEPOINT *et al.*, 2000).

The reasons for this  $^{13}\text{C}$ -depletion are multiple. The main factor is probably the preferential (and sometimes quasi-exclusive) use of  $\text{CO}_2$  over  $\text{HCO}_3^-$  for photosynthesis. However, taxonomical (red algae are notorious for important  $^{13}\text{C}$  depletion) and physiological (altered photosynthetic capabilities due to low light availability) phenomena could also be involved (COOPER & DENIRO, 1989 ; RAVEN *et al.*, 2002).

C/N ratios of epiflora from the rhizomes were lower than those of the epiflora from the leaves and the litter. Once again, this could be linked with the fact that most of the samples consisted of sciaphilous red algae. These algae are known to contain high amounts of protein-based accessory pigments (phycocyanin, phycoerythrin), which could explain their relatively high N contents (RAVEN *et al.*, 2005).

**Suspended particulate organic matter** was also a very negative source, although it was generally less  $^{13}\text{C}$ -depleted than rhizome epiflora. Previous workers have already noted this, to a lesser extent. SPOM  $\delta^{13}\text{C}$  from *Posidonia* meadows usually range from -21 to -23 ‰ (DAUBY, 1989 ; LEPOINT *et al.*, 2000 ; VIZZINI *et al.*, 2002), while in our study it was rather in the -25 to -27 ‰ range. A previous study noted similar values for POM in a French coastal lagoon, and linked that with inputs of riverine organic matter in the lagoon (VIZZINI *et al.*, 2005). This is however very unlikely to happen in our case. Concerning nitrogen isotopic ratios, LEPOINT *et al.* (2000) measured  $\delta^{15}\text{N}$  of  $1.9 \pm 0.5$  ‰ (comparable to our values), while VIZZINI *et al.* (2002) report much higher values ( $6.0 \pm 0.8$  ‰).

In Mediterranean *P. oceanica* meadows, SPOM is generally a heterogeneous compartment, and comprises a number of detrital items (both benthic and



pelagic) as well as phyto- and zooplankton (VELIMIROV, 1987 ; LEPOINT, 2001). Since we did not assess its precise composition in this study, differences with literature are hard to interpret. However, our  $\delta^{13}\text{C}$  results agree with the view that living or dead seagrass fragments have a low contribution to the total SPOM pool (VIZZINI *et al.*, 2002).

This hypothesis is further supported by the C/N ratios of SPOM that, even if they were highly variable, were much lower than those of *Posidonia*-derived organic matter. In addition, insights drawn from fatty acid analyzes concur with these views (see section IV.2.A).

Finally, **benthic particulate organic matter** had isotopic signatures very close, and sometimes confounding, with those of epiphytes from leaves and litter. Our values are comparable with those of DAUBY (1989), who measured a mean  $\delta^{13}\text{C}$  of -18 ‰ in the *Posidonia* meadow of the Calvi Bay. On the other hand, VIZZINI *et al.* (2002) had more positive values ( $\delta^{13}\text{C} = -11.8 \pm 0.9$  ‰,  $\delta^{15}\text{N} = 2.4 \pm 1.6$  ‰), and propose that *Posidonia*-derived organic matter is abundant in the first cm of the sediment, leading to high  $\delta^{13}\text{C}$  values. In our case, it is more likely that most BPOM is a complex mixture originating from SPOM, *Posidonia* tissues, microphytobenthos and, for a great part, epiphytes. This is further supported by the fact that BPOM C/N ratios (9-16) matched those of litter & leaves' epiflora (10-15) much better than those of *Posidonia* tissues (19-25).

This discrepancy between our results and the literature could partly originate in the sampling methodology. We discarded large detrital items (> 1 cm), to focus on smaller organic items that are more likely to be ingested by amphipods. Since seagrass fragments can be large, their importance in our BPOM samples could be underestimated.

As stated in section III.3.C of this chapter, The C/N ratios seemed to fluctuate seasonally, as nitrogen contents of all food sources were lower in November 2008, and higher in March 09. This has already been noted in the past for *Posidonia* leaves, as well as for the epiphytes growing on them (ALCOVERRO *et al.*, 1995 ; ALCOVERRO *et al.*, 1997 ; LEPOINT, 2001). Since this trend is, in our case, common to all items, it could be related to the seasonal fluctuations in general nutrient availability.

In Calvi Bay, nutrient concentrations in the meadow canopy water are low at the end of the summer and in autumn, because most of the available nutrients have been consumed by the intense summer production in the upper layers of the thermally-stratified water column. However, they are high at the end of the winter and in spring, because of winter mixing and hydrodynamics (LEPOINT *et al.*, 2004). This higher N availability in the water column could, alongside other phenomena, result in higher N contents in the producers.

*A contrario*, isotopic signatures of food sources did not change much over the 4 sampling events. The only real, marked difference concerned SPOM, which was more  $^{13}\text{C}$ -depleted in November 2008. This low temporal variability of the primary producers is surprising.

A number of seasonal factors can affect stable isotope ratios of primary producers.  $\delta^{13}\text{C}$  can vary in relation with the dominant inorganic carbon sources, with temperature or with light intensity (HEMMINGA & MATEO, 1996).  $\delta^{15}\text{N}$  variation patterns are often less clear. They can generally be linked with

---

Multidisciplinary study of trophic diversity

changes in the DIN or DON pools, sometimes in relation to coastal eutrophication (COSTANZO *et al.*, 2001 ; FOURQUREAN *et al.*, 2005). In addition, compartments such as epiphytes show important seasonal structural variations. Communities vary both in their abundance and functional composition over the course of the year (MAZZELLA *et al.*, 1989). These differences could have an impact, since isotopic ratios can differ in relation with the considered epiphytic taxon (LEPOINT *et al.*, 2000).

Seasonal variation of isotopic ratios of producers is indeed far from negligible in shallow tropical seagrass meadows (*e.g.* ANDERSON & FOURQUREAN, 2003 ; FOURQUREAN *et al.*, 2005). In temperate meadows, the seasonal variations seems to be less marked. In a recent study performed in Atlantic *Zostera noltii* meadows, LEBRETON *et al.* (2011) noted, like in our study, few variations in the signatures of primary producers, except for the SPOM. Other workers reported greater variations, but they generally work in very shallow locations with important and seasonally driven terrestrial inputs (VIZZINI & MAZZOLA, 2003 ; VIZZINI *et al.*, 2005 ; CARLIER *et al.*, 2007), which is not the case of our study site.

Overall, while seasonal variations of isotopic ratios probably occurred in the studied food sources, they appeared to be relatively small. In addition, they could be partly hidden by the sometimes high intra-source variability. This stability of producers in turns influence stable isotope ratios of consumers, but it will be discussed later.

#### IV.3.B. Isotopic ratios of amphipods: dietary insights

As stated in section III.3.A, 17 of the 21 amphipod species tend to gather in a  $\delta^{13}\text{C}$  interval ranging from -18 to -21 per mil. Food sources found in this area include leaves and litter epiflora & epifauna, as well as BPOM. This suggests that these species rely on these food items as primary organic matter sources.

Past work already documents this. LEPOINT *et al.* (2000) sampled bulk amphipods from the meadow canopy, without specific distinction, and measured a global  $\delta^{13}\text{C}$  of  $-20.1 \pm 1.0$  ‰, slightly more negative but comparable to those of epiphytes from the leaves ( $\delta^{13}\text{C} = -19.4 \pm 0.8$  ‰ for the epifauna,  $-18.6 \pm 22.5$  ‰ for the epiflora). Similarly, pooled amphipods (presumably several species) from a Sicilian meadow showed  $\delta^{13}\text{C}$ , that, even if it was much less negative than ours, perfectly coincided with the one of *Posidonia* vegetal epiphytes ( $\delta^{13}\text{C} = -14.9 \pm 0.1$  ‰ in both cases; VIZZINI *et al.*, 2002).

Nevertheless, it is important to underline that some species'  $\delta^{13}\text{C}$  show a relatively high dispersion. This suggests that trophic diversity could occur in these amphipods, at a sub-specific level (individual specialisation), although our lack of knowledge concerning non-dietary variation of  $\delta^{13}\text{C}$  in these invertebrates prevents any definitive conclusion (MATTHEWS & MAZUMDER, 2004).

Moreover, the carbon signature of a lot of these "median" species encompasses  $\delta^{13}\text{C}$  values that are similar with those of the 5 median food sources, but also more negative values. This is the case of *Caprella*

*acanthifera*, *Amphithoe helleri*, *Phtisica marina* and *Ampelisca rubella*, as well as *Orchomene humilis* in June and November 2008. This could be explained by a mixed diet involving more negative sources (notably SPOM or rhizome epiflora). In the case of *A. helleri* and *C. acanthifera*, this is supported by the mixing model estimates, as shown on figures 4.16 and 4.17.

It is also worth noting that interspecific differences sometimes occur inside the range. For example, in November 2008 (fig. 4.11 A), the carbon signatures of *Tmetonyx nardonis* (TN,  $\delta^{13}\text{C} = -19.6 \pm 0.6 \text{‰}$ ) and *Atylus guttatus* (AtG,  $\delta^{13}\text{C} = -18.1 \pm 0.5 \text{‰}$ ) are both within the range of the median sources, suggesting that both species mainly feed on them. Nevertheless, the signatures are different, and *T. nardonis* is more negative.

None of the "median" sources are monospecific. Epiphytic groups are complex communities, consisting of numerous different taxonomical and/or morphological entities, and BPOM is heterogeneous *per se*. The various items constituting each food source may have different isotopic signatures. Therefore, it is possible that the interspecific differences are caused by the fact that these species perform selective feeding. *T. nardonis* may specialize in consuming the more negative items, while *Atylus guttatus* may preferentially eat the most positive epiphytic species and/or BPOM parts. Trophic diversity could thus occur at a finer level, whose assessment using only the data of this study is unachievable.

Since their isotopic signatures overlap, it is not possible to distinguish grazers consuming leaves and litter epiphytes from deposit feeders/detritivores consuming the BPOM using only isotopic data.

Gut content and/or fatty acid analysis tend to show that the dominant species (*A. chiereghinii*, *A. spinicornis*, *A. helleri* & *C. acanthifera*) are probably mainly grazers. This will be further discussed in section IV.4 of this chapter. Concerning the other species, assumptions can only be done using life habits and/or mouthpart morphology data. These assumptions are not as robust or insightful as actual diet studies, but can nevertheless be informative.

Leucothoidea all lack a mandibular molar, and various Mediterranean species of the genus *Leucothoe* are often found associated with fine or coarse sands (RUFFO *et al.*, 1989). *Leucothoe spinicarpa* is therefore more likely to be a deposit feeder than a grazer.

Lysianassoidea are typically regarded as deposit-feeding detritivores and/or scavengers (GAMBI *et al.*, 1992 ; NYSSSEN *et al.*, 2002). The three species sampled in our meadow (*Normanion chevreuxi*, *Orchomene humilis* and *Tmetonyx nardonis*) also have small and/or relatively weak (setulose or poorly ornamented) molars, and can be found in a number of detritic or muddy environments (RUFFO *et al.*, 1989). Deposit feeding therefore seems to be their preferential feeding habit.

Oedicerotidae (*Perioculodes aequimanus*, *Synchelidium longidigitatum*) also have reduced and conical mandibular molars, and are commonly found on soft, sandy bottoms (RUFFO *et al.*, 1993). This is consistent with deposit

## Multidisciplinary study of trophic diversity

feeding. They have previously been classified as "omnivores" (SCIPIONE, 1998). These two views are not necessarily mutually exclusive.

Life habits and mouthpart morphology of *Metaphoxus simplex* (Phoxocephalidae) and *Iphimedia minuta* (Iphimedidae) suggest, once again, deposit feeding as a main feeding mode (RUFFO *et al.*, 1982 ; RUFFO *et al.*, 1993). The diet of the former has been previously been classified as "unknown", while the one of the latter was characterized as "carnivore" (SCIPIONE, 1998). Once again, this is not necessarily incompatible with our results.

The caprellid *Phtisica marina* is generally found in association with seagrasses, algae (green or brown) or sessile animals (hydrozoans, bryozoans) (RUFFO *et al.*, 1993). This suggests this species could be, at least in *Posidonia* meadows, an epiphytic grazer. However, its mandibular molar is lacking, and past work tended to classify it as an opportunistic predator/detritivore (GUERRA-GARCIA & TIERNA DE FIGUEROA, 2009) or an omnivore (GAMBI *et al.*, 1992). Overall, this species' diet seems complex and it is difficult to link it with a precise feeding type.

SCIPIONE (1998) classified *Ampelisca rubella* as a deposit/suspension feeder. However, it has typical, strong mouthparts and, unlike the previous species that live in soft, detritic bottoms, it is generally found in *Posidonia oceanica* meadows or associated to algae growing on rocky substrates (RUFFO *et al.*, 1982). It could therefore be a grazer rather than a deposit feeder. This is also true for *Amphilocheus neapolitanus* (often found among algae and sessile animals) and *Megaluropus massiliensis* (typically associated with Mediterranean seagrasses or algae; RUFFO *et al.*, 1982).

Finally, *Atylus guttatus*, characteristic of phanerogam meadows and bearing strong, heavily-toothed mouthparts, is probably an epiphyte grazer (RUFFO *et al.*, 1982). This species, and another one of the same genus (*A. vedlomensis*), also typical of *P. oceanica* meadows, have been reported in the past as mainly feeding on dead *Posidonia* detritus (GAMBI *et al.*, 1992 ; SCIPIONE, 1998), but  $\delta^{13}\text{C}$  data clearly indicate that this is not its main carbon source in our study.

This brings us to another interesting point: despite their huge available biomass, *Posidonia* tissues only seem to be a major source of carbon for one of the 21 sampled amphipod species, *Gammarus aequicauda*.

This has already been reported in the past, for amphipods as well as for other primary consumers (DAUBY, 1989 ; LEPOINT *et al.*, 2000 ; VIZZINI *et al.*, 2002). Reasons why so few consumers seem to feed on seagrass material probably include its low palatability (hard tissues containing a lot of structural carbohydrates) and low nutritional quality (high C/N ratios). Moreover, living *Posidonia* leaves contains high amounts of phenolic compounds that could act as herbivore repellents (GOBERT *et al.*, 2006).

*Gammarus aequicauda* seems to be an exception to this rule. Its  $\delta^{13}\text{C}$  typically ranges from -14 to -16.5 ‰, indicating a significant contribution of seagrass

tissues to its diet. These ratios are comparable to those of idoteid isopods, who partially feed on live *Posidonia* leaves (LEPOINT *et al.*, 2000).

Mixing model outputs indicates that *Posidonia* tissues could account for 25 to sometimes 50 % of the diet of *G. aequicauda* (fig. 4.16). While no other studies has, to our knowledge, attempted to assess those parameters for this species in *Posidonia* meadows, some have done this for *G. aequicauda* living in *Posidonia* litter accumulations (LEPOINT *et al.*, 2006 ; REMY, 2010). They found similar or less negative  $\delta^{13}\text{C}$ , and even higher contribution of the seagrass carbon (45 to 55 %). This specialization of *G. aequicauda* for consuming the *Posidonia*-derived matter could be linked with the presence of digestive symbionts, but that will be discussed later (section IV.4).

On the other hand of the  $\delta^{13}\text{C}$  spectrum, the two species of the genus *Dexamine* had very negative carbon signatures. It suggests their main carbon source is the negative items, *i.e.* SPOM or sciaphilous algae growing on rhizomes. This confirmed by the mixing model estimates for *D. spiniventris*, which indicate very high (80–100 %) contributions for the negative sources.

Mean  $\delta^{13}\text{C}$  of *D. spinosa* are less negative of those of *D. spiniventris* for 3 of the 4 sampling events. This possibly indicates a greater level of mixing of its diet, and less predominant contributions of the negative sources. Past studies have emphasized the importance of epiphytic diatoms from leaves in the diet of *D. spinosa* (SCIPIONE & MAZZELLA, 1992). They could be one of the food items of this species, although fatty acids show that they are rare in the diet of *D. spiniventris* (cf. table 4.XV)

Such negative  $\delta^{13}\text{C}$  are uncommon for vagile invertebrates from *P. oceanica* meadows. The most negative consumers are generally the suspension-feeding copepods that usually range from -22.5 to -24 ‰ (DAUBY, 1989 ; LEPOINT *et al.*, 2000 ; VIZZINI *et al.*, 2002). High  $^{13}\text{C}$ -depletion has also been recorded in the sea hare *Aplysia punctata* ( $\delta^{13}\text{C} = -24.2$ ; LEPOINT *et al.*, 2000). Various species of the genus *Aplysia* are known to be herbivores, feeding on benthic macroalgae (*e.g.* ROGERS *et al.*, 2003). In *Posidonia* meadows, they could therefore graze the sciaphilous algae from the rhizomes.

In our study, the SPOM showed very negative  $\delta^{13}\text{C}$  that were often close or identical to those of rhizome epiflora. Using only isotopic data, it is therefore not possible to discriminate between these two sources. This situation is even further complicated by the intra-source heterogeneity. For example, the sessile epifauna from the leaves is classified in the median sources because its global, mean  $\delta^{13}\text{C}$  is in the -18 to -21 ‰ range. However, when examined alone, some components of this fauna can show high  $^{13}\text{C}$  depletion. The bryozoan *Electra posidonae* was recorded at -22.6 ‰, while didemnid tunicates'  $\delta^{13}\text{C}$  could be as low as -25.3 ‰ (LEPOINT *et al.*, 2000). Selective feeding on these items could therefore lead to  $\delta^{13}\text{C}$  more negative than the mean values for median sources, and lead to misinterpretation of the actual results.

*Gammarella fucicola* held an intermediate position between the median and negative food sources. This suggests a mixed diet made of these items. This is supported by the mixing model results that give major contributions of the

## Multidisciplinary study of trophic diversity

negative food sources (40 to sometimes nearly 80 %), but also important contributions for the median sources (15 to 60 %, depending on the season). This widely mixed diet could be a sign of opportunistic feeding behaviour, as it will be discussed later.

As it has been mentioned earlier,  $\delta^{15}\text{N}$  values were very similar in all species and all seasons. Apart from punctual differences (highlighted in section III.3.C),  $\delta^{15}\text{N}$  of amphipods typically overlapped in the 1.5 to 4 ‰ interval. These  $\delta^{15}\text{N}$  values were close to those of producers, and  $\Delta^{15}\text{N}$  were always low. All  $\Delta^{15}\text{N}$  values were comprised between -0.3 and +2.4 ‰, and most of them ranged from +0.5 to +1.5 ‰. Overall, nitrogen isotopic ratios clearly indicate that all the sampled species belong to the same trophic level, and confirm that they are mostly primary consumers.

Low  $\delta^{15}\text{N}$  and  $\Delta^{15}\text{N}$  are typical for herbivores and detritivores invertebrates from seagrass meadows in general, and for amphipods in particular. LEPOINT *et al.* (2000) measured the nitrogen isotopic ratios of a pool of several species of amphipods from the *P. oceanica* meadow from Calvi bay. They found a  $\delta^{15}\text{N}$  of 2.6 ‰, and consequently mean  $\Delta^{15}\text{N}$  of -0.8 ‰ for leaf epifauna, -0.4 ‰ for leaf epiflora and +0.7 ‰ for SPOM. Also working on a mixed species assemblage, VIZZINI *et al.*, (2002) reported a  $\delta^{15}\text{N}$  of 4.5 ‰, and  $\Delta^{15}\text{N}$  of -0.7 ‰ for leaf epiflora, -1.5 ‰ for SPOM and + 2.1 for BPOM.

Low  $\Delta^{15}\text{N}$  are also typical for herbivore/detritivore amphipods from other marine systems. In a recent study focusing on amphipods from Californian *Zostera marina* meadows, FARLIN *et al.* (2010) reported trophic enrichments of +0.8 ‰ to +1.7‰ for various amphipods feeding on live or detrital seagrass and/or filamentous epiphytic algae. MACKO *et al.* (1982) performed experimental measurements of isotopic fractionation for two species of amphipods fed on algal diets (fresh/detrital *Ulva* sp., *Gelidium* sp.). They obtained contrasting results for each species ( $\Delta^{15}\text{N}$  = -0.1 to -0.7 ‰ for *Amphithoe valida*, +2.2 to +2.7 for *Parhyale hawaiiensis*), emphasizing the interspecific variability in this parameter. CRAWLEY *et al.* (2007) also obtained low  $\Delta^{15}\text{N}$  (from -1 to +1‰) when feeding *Allorchestes compressa* various algae (*Sargassum* sp., *Hypnea ramentacea*, fresh or decomposed *Ecklonia radiata*). Contrastingly, the same authors recorded high  $\Delta^{15}\text{N}$  (+3 ‰) when feeding this amphipod with fresh or decomposed *Posidonia sinuosa*.

Several factors can explain low  $\Delta^{15}\text{N}$  such as the one we recorded. First, nitrogen excretion product of amphipods is ammonium. Ammonotelic animals are known to have low nitrogen fractionation factors since production of ammonium from catabolized proteins is straightforward and requires few enzymatic reactions. Second, a number of their potential food sources being poor in organic N, their N assimilation efficiency is likely high, leading to  $\delta^{15}\text{N}$  close to those of the food. This is the case of many detritivores, and of some herbivores as well. Finally, taxonomic position and life environment seem to play a role, and marine molluscs and crustaceans are notorious for their low N enrichment (MCCUTCHAN *et al.*, 2003 ; VANDERKLIFT & PONSARD, 2003).

**Mixing models** allow adding a quantitative dimension to the dietary trends pictured by carbon and nitrogen isotopic ratios, and can therefore help to infer a consumer's diet. These useful tools are increasingly used in stable isotope ecology, and over the past few years, they evolved from simple equation systems to conceptually simple but extremely sophisticated and efficient models (PHILLIPS *et al.*, 2005 ; PARNELL *et al.*, 2010). However, the reader should keep in mind that the situation described in this study somehow moves away from the "ideal" case for which the SIAR model was designed, and that its results should be regarded with caution.

One reason for that is that all the sources themselves are complex mixtures of several items rather than single monospecific (or homogeneous) items. Their isotopic signatures are therefore characterized by relatively large standard deviations that cannot easily be explained by intra-source variability only. Although these standard deviations are taken into account by the model, they inevitably complicate the calculations and lower the performance of the model. This cause uncertainty on the estimates and makes them less robust.

Another issue is that all our sources are not isotopically different. Even after *a priori* aggregation, the groups of food items differ in terms of  $\delta^{13}\text{C}$ , but are similar in terms of  $\delta^{15}\text{N}$ . This low nitrogen discrimination weakens one of the fundamental equations of the model, and can therefore have deleterious effects on the outputs. Theoretically, this situation could be improved by the addition of a third set of stable isotope ratios (*e.g.* sulfur).

These issues concerning the basic assumptions of SIAR have two consequences. The first one is the high dispersion of the model solutions. The credibility intervals are often wide, particularly for median sources. This complicates the interpretation of the results, and sometimes limits the insights drawn from the model outputs.

In addition, the model solutions often showed high positive correlations between the more negative and less negative groups (data not shown). It was the case for all species but *Dexamine spiniventris* and *Gammarella fucicola*. This indicates that SIAR cannot fully resolve the problem using the input data. Therefore, in a lot of solutions, the high contribution of negative items is mostly dictated by the need to counterbalance the contribution of the positive sources (arbitrary simulated by the model) to achieve a sensible mixing value, and vice versa (INGER *et al.*, 2010). This can lead to overestimation of the contributions of the extreme sources, to the detriment of the median ones. Despite those methodological problems, mixing model outputs provide interesting information. They highlight the fact that all species have a widely mixed diet, except *Dexamine spiniventris* that seems to rely almost exclusively on the negative sources. They also point out the fact that *Posidonia* contributions are only important for *Gammarus aequicauda*. Diet of the remaining species is dominated either by median sources (*Apherusa chiereghinii*, *Aora spinicornis*) or negative sources (*Gammarella fucicola* and, to a lesser extent, *Caprella acanthifera* and *Amphithoe helleri*). The mixing model results for each species will be further discussed later, in section IV.4.

---

## Multidisciplinary study of trophic diversity

Another conspicuous feature of the studied trophic interactions are their apparent **temporal stability**. In all sampling seasons, isotopic ratios of consumers were relatively similar, and their position in relation to food items' signatures did not change substantially over time. In addition, mixing models estimates were comparable in each season. The feeding habits of the main species of the community are apparently the same throughout the year. This can probably be explained mostly by the temporal stability of the food sources (section IV.3.A.).

However, even if the isotopic ratios of sources seem to be fairly constant throughout the year, the availability of some food items is subject to changes. Epiphytic communities from the leaves, for example, are rare in winter, and develop in spring to reach their full extent in summer (MAZZELLA *et al.*, 1989). Litter follows a somehow similar cycle, and its occurrence is maximal at the end of the summer or the beginning of the autumn, and minimal in early spring (ROMERO *et al.*, 1992). SPOM abundance also varies seasonally, and it is maximal in spring (LEPOINT *et al.*, 2004 ; Pers. Obs.)

Despite these temporal fluctuations in resource availability, the trophic interactions are apparently stable, and feeding habits did not seem to change from one season to another. However, caution must be taken, as the similarity between sources could hide, to some extent, seasonal variability. For examples, epiphytes from leaves and litter fragments and drift photophilous epilithic algae have similar  $\delta^{13}\text{C}$  and  $\delta^{15}\text{N}$ . When epiphyte abundance is low (in winter), consumers relying on this resource could shift their diet to fragments of drift algae found among the litter. Such subtle changes would not be detected by stable isotopes ratios, resulting in apparent temporal stability of the consumer.

### **IV.4. Trophic status of the dominant species: multidisciplinary overview**

Over the last sections of this manuscript, a number of insights concerning the studied amphipods' diets have been developed. This is especially true for the 7 dominant species, whose sampled effectives were sufficient to apply the 3 methods. The aim of this section is therefore to synthesize the concepts expressed in the previous parts of the discussion, and especially to cross data coming from the different techniques to delineate the dominant species' diet. A brief summary of the information developed in this section can be found in table 4.XVIII, on next page.

#### **IV.4.A. *Apherusa chiereghinii***

In our study, as in most studies concerning the amphipod fauna from *Posidonia oceanica*, *Apherusa chiereghinii* was by far the most abundant species (for more information, see chapter 3).

Data from gut content and fatty acid analyzes seem to point out that macroalgae constitute an important part of the diet of this species. However, algal material is omnipresent in *Posidonia oceanica* meadows. Macroalgae are



Table 4.XVIII: Summary of trophic diversity data for the dominant species of the community.

Species	Main food sources			Conclusions
	Gut contents	Fatty acids	Stable isotopes	
<i>Apherusa chierighinii</i>	Macroalgae	Macroalgae	Epiphytes (leaves/litter) - BPOM Epiphytes (rhizomes) - SPOM	Epiphyte grazer (leaves/litter)
<i>Aora spiniornis</i>	Macroalgae	Macroalgae	Epiphytes (leaves/litter) - BPOM Epiphytes (rhizomes) - SPOM	Epiphyte grazer (leaves/litter)
<i>Dexamine spiniventris</i>	Macroalgae <i>Posidonia</i> litter	Macroalgae	Epiphytes (rhizomes) - SPOM	Epiphyte grazer (rhizomes)
<i>Amphithoe helleri</i>	Macroalgae	Macroalgae ?	Epiphytes (leaves/litter) - BPOM Epiphytes (rhizomes) - SPOM	Epiphyte grazer (leaves/litter/rhizomes)
<i>Caprella acanthifera</i>	Macroalgae	Macroalgae SPOM/Zooplankton	Epiphytes (leaves/litter) - BPOM Epiphytes (rhizomes) - SPOM	Epiphyte grazer (leaves/litter/rhizomes) SPOM ?
<i>Gammarella fucicola</i>	Macroalgae <i>Posidonia</i> litter	Macroalgae	Epiphytes (rhizomes) - SPOM Epiphytes (leaves/litter) - BPOM	Epiphyte grazer (rhizomes & litter)
<i>Gammarus aequicauda</i>	Macroalgae <i>Posidonia</i> litter	Macroalgae Bacteria/ <i>Posidonia</i> litter	Epiphytes (leaves/litter) - BPOM <i>Posidonia</i> litter	Epiphyte grazer (leaves/litter) Detritivore ( <i>Posidonia</i> litter)

---

Multidisciplinary study of trophic diversity

very abundant in the epiphytic cover of seagrass leaves and rhizomes, but drift algae are also components of the *Posidonia* litter.

Stable isotopes suggest that it mostly feeds on epiphytes from the leaves and the litter and/or on BPOM, although this species has a mixed diet. This is in general accordance with the study of GAMBI *et al.* (1992) that classifies this species as a herbivore/deposit feeder, feeding on algal epiphytes and the trapped organic matter associated to them.

No gut content from any of the 20 examined individuals contained inorganic sediment particles. Deposit feeding generally implies the inevitable ingestion of such particles that are generally abundant, or at least present, in the gut contents of deposit feeders (*e. g.* DAUBY *et al.*, 2001 ; GRAEVE *et al.*, 2001). Their total absence in the case of *Apherusa chiereghinii* suggests that deposit feeding is probably not a major type of feeding, and that epiphytes are probably a more important source than BPOM. Detritivory could nevertheless occur, and ingestion of dead algal material cannot be excluded.

Overall, *Apherusa chiereghinii* clearly seems to be a grazer, mostly feeding on vegetal items present among the epiphytic cover of the litter fragments and/or the leaves.

Significance of the epifauna in the diet is hard to estimate, since it is not possible to clearly separate vegetal and animal epiphytes using either stable isotopes or fatty acids. Animal items were rare in the gut contents, but a large part of them were unidentifiable organic matter, which could as well originate from epifauna than from other sources. Animal epiphytes are an often abundant, nutritionally interesting food source (low C/N ratio, and close to the one of the amphipods), closely associated to the epiflora. Their consumption is therefore likely to happen, but our study unfortunately fails to settle this question.

Finally, it is important to underline that even if epiphyte grazing seems to be the preferential feeding type for *A. chiereghinii*, the diet of this species is complex, and probably relies on several food items. This is notably emphasized by the mixing model outputs that estimate the contribution of epiphytes from leaves and litter to be equal or inferior to 60 % of the diet. Even in the hypothesis of an under-estimation (see section IV.3.B) of this contribution, this means that a wide part of the diet consists of other items.

#### IV.4.B. *Aora spinicornis*

*Aora spinicornis* is another typical species from the *P. oceanica* meadows. Although it is much less abundant than *A. chiereghinii*, it is usually one of the dominant species of the taxocenosis (cf. chapter 3). It is reported in literature as a "common infralittoral to circalittoral [amphipod], found among hydroids, phanerogams and algae, and on sandy bottoms." (RUFFO *et al.*, 1982).

DIXON & MOORE (1997) studied the life habits and feeding activity of *A. spinicornis* living on *Laminaria* holdfasts from Scotland. They noticed that this species was able to build light, flimsy tubes out of "amphipod silk". They

accepted various food items (particulate detritus, dead or alive amphipods, fragment of algae), suggesting a mixed diet. In *P. oceanica* meadows, SCIPIONE (1998) classified it as detritus/suspension feeder.

According to our results, the diet of *A. spinicornis* was close to the one of *A. chiereghinii*. Gut contents and fatty acid results were very similar.  $\delta^{13}\text{C}$  were often slightly lower for *A. spinicornis*, suggesting that "median" sources (epiphytes from leaves and litter and/or BPOM) were less important than for *A. chiereghinii*. This is supported by the mixing model estimates, which point out a somewhat more mixed diet than in *A. chiereghinii*.

All in all, most of the things that have been said for *A. chiereghinii* are also true for *A. spinicornis*. Our results indicate that this species is also an epiphyte grazer that occasionally feeds on other items.

#### IV.4.C. *Dexamine spiniventris*

*Dexamine spiniventris* was also an important contributor to the total effective of the studied amphipod community, and is generally abundant in vegetal biotopes all around the Mediterranean Sea (RUFFO *et al.*, 1982). GAMBÌ *et al.* (1992) classified it as herbivore/deposit feeder, like *Apherusa chiereghinii*.

Stable isotope ratios, as well as mixing model estimates indicated that the diet was dominated by the "negative" sources, *i.e.* epiphytic algae from rhizomes and/or SPOM. Algal content of the guts was high (over 35 %), suggesting that herbivory is a major type of feeding. On the other hands, guts hardly contained any planktonic items (less than 0.3 % of diatoms), suggesting suspension feeding is unlikely to happen.

Fatty acids results also indicate an herbivorous, macroalgal-based diet rather than suspension feeding. 20:5(n-3) and 20:4(n-6) were indeed very abundant, while planktonic markers (16:1(n-7) for diatoms, 22:6(n-3) for dinoflagellates & zooplankton) values were among the lowest for all species.

*Posidonia* litter fragments were present in the guts, but the very negative  $\delta^{13}\text{C}$ , as well as mixing model estimates, clearly indicate that their assimilation was weak, and that their actual contribution to the diet of the species was low to nil. These fragments might have been accidentally ingested while feeding on other benthic items from the lower horizons of the meadow.

*In fine*, *Dexamine spiniventris* seems to rely almost exclusively on algae from the rhizomes. This apparent specialization clearly distinguishes this species from *A. chiereghinii* or *A. spinicornis*, that seem to have a mixed diet dominated by epiphytes from the leaves or litter fragments.

#### IV.4.D. *Amphithoe helleri*

Amphipods belonging to the genus *Amphithoe* are notorious to build tubes made out of amphipod silk and various detrital items on algal thalli. While this

## Multidisciplinary study of trophic diversity

life habit could, at first sight, suggest suspension feeding, even very early works clearly indicate that species of *Amphithoe* frequently left their tubes, and that they avidly fed on algae (HOLMES, 1901 ; SKUTCH, 1926 for *A. longimana* and *A. rubricata*, respectively). Algal consumption has since then been widely documented, either by gut content examination or by stable isotopes ratios (e.g. for *A. valida*, MACKO *et al.*, 1982).

*Amphithoe helleri* is described as an "infralittoral [amphipod, found from surface], to 50 m. In phanerogams (*Posidonia*, *Zostera* [...]), *Cystoseira* with epiphytes, *Halopteris* and other algae with soft, floating thalli" (RUFFO *et al.*, 1982). GAMBI *et al.* (1992) classified it as an herbivore species.

Gut contents were very similar to those of *A. chierighinii* and *A. spinicornis*, and indeed contained a lot of algal fragments.

Stable isotope ratios and mixing models highlighted a mixed diet, made of comparable amounts of the most negative (rhizome epiflora/SPOM) and median (leaves & litter epiphytes/BPOM). Mixing model outputs often had higher contributions for the negative sources but, as it has previously been mentioned, it could be linked with methodological issues.

Since sediment particles and planktonic items are respectively absent and extremely scarce in gut contents, and planktonic fatty acid markers are rare, epiphytes from leaves, litter and rhizomes might be the primary food source.

FARLIN *et al.* (2010) measured stable isotope ratios from mixed Amphithoidae (dominated by *Amphithoe* sp.) from Californian *Zostera marina* meadows. Using mixing models, they estimated that their diet was made of 40 % of epiphytic filamentous algae, and of 60 % of seagrass material (living & detrital). This situation is totally different from ours, where none of the three techniques pointed out seagrass ingestion and/or assimilation.

Surprisingly, "vegetal" fatty acids (C<sub>18</sub> and C<sub>20</sub> PUFA) were less abundant in *Amphithoe helleri* than in most other species. While this situation suggests a more mixed diet, other dominant fatty acids (essentially the ubiquitous 16:0, 18:0 and 18:1(n-9)) were not very informative about the diet of this species. Moreover, only one sample could be analyzed using this technique, preventing us to draw any conclusions on this point.

Overall, *A. helleri* seems to be a generalist epiphyte grazer, whose diet exhibit a greater degree of mixing than *A. chierighinii* or *A. spinicornis*.

#### IV.4.E. *Caprella acanthifera*

*Caprella acanthifera* was the only caprellid collected in sufficient amounts to apply all 3 techniques. Species of the genus have often been described as preying on sessile animals (hydrozoans, bryozoans), and *C. acanthifera* in particular is often encountered clinging on *Bugula* colonies (RUFFO *et al.*, 1993).

Gut contents of *C. acanthifera* were the only one completely lacking crustacean parts. They were mostly (85 %) occupied by amorphous material, and algae constituted nearly all the remaining part. GUERRA-GARCIA & TIERNA DE FIGUEROA (2009), using the same technique on individuals from the Gibraltar Strait coasts, found 93.2 % of unidentifiable items (labelled as "detritus"), 6.6 % of polychaete remains and 0.2 % of diatoms, and therefore classified this species as a detritivore. We expressed our concerns about this point earlier. However, this suggests important inter-environment variability in the diet of this species.

Gut contents and stable isotope ratios both show that *Posidonia*-derived organic matter seemed to hold a negligible proportion in the diet of this species. These results differ from the ones obtained for mixed Caprellidae (essentially belonging to the genus *Caprella*) from *Zostera marina* meadows, who rely on seagrass material for about 50 % of their diet (FARLIN *et al.*, 2010).

Stable isotope ratios were close to those of *Amphithoe helleri*, suggesting a mixed diet composed of comparable parts of median (epiphytes from leaves and litter/BPOM) and more negative (epiphytes from rhizomes/SPOM) sources. The absence of sediment in the gut contents once again suggests that BPOM was not a dominant food item. The case of the SPOM is more complex.

As it has been mentioned earlier, total lipids of *C. acanthifera* contains less C<sub>18</sub> and C<sub>20</sub> PUFA than most of the other species, suggesting less predominance of macroalgae in the diet. On the other hand, 22:6(n-3) and C<sub>20</sub> and C<sub>22</sub> MUFA, often considered as markers for planktonic items (dinoflagellates/zooplankton and calanoid copepods, respectively), were more abundant than in any other species. Contrastingly, 16:1(n-7), widely used as a marker for diatom feeding, was rare.

GUERRA-GARCIA *et al.* (2004) analyzed the FA composition of *Caprella acanthifera* collected among algae on the coasts of the strait of Gibraltar. They found high concentrations of 20:4(n-6) and 20:5(n-3), suggesting an herbivore diet, and their results were closer to the ones obtained for other species (*A. chiereghinii*, *A. spinicornis*, *D. spiniventris*, *G. fucicola*, *G. aequicauda*) than for *C. acanthifera* in this study. These differences are surprising, and could suggest an inclination towards suspension feeding in *C. acanthifera*. On the other hand, contribution of "planktonic" fatty acids could also be indirect, and come from animal epiphytes from leaves and litter, as some of them are suspension feeders.

Since biomass of *C. acanthifera* individuals is typically very low, we had to pool all the collected individuals in one sample. It would therefore be dangerous to draw any conclusions concerning the diet of this species using only FA, and it seems safer to classify it as an epiphyte grazer consuming epiphytes from leaves, litter and rhizomes as well. The question of the contribution of SPOM to the diet of *C. acanthifera* in seagrass meadows therefore remains open.

#### IV.4.F. *Gammarella fucicola*

*Gammarella fucicola*'s usual biotopes are "shallow coastal waters (0-55 m), among algae (*Ectocarpus*, *Lithophyllum*, etc.) and seagrass (*Zostera*, *Posidonia*). [...]" (RUFFO *et al.*, 1982). It is particularly abundant among *Posidonia* detritus. This is true for litter fragments scattered in the meadow, between the shoots (this study, chapter 3) but also for large, submerged accumulation (SPA, GALLMETZER *et al.*, 2005).

It has been previously classified as a plant detritus feeder (SCIPIONE, 1998). LEPOINT *et al.*, (2006) studied the diet of *Gammarella fucicola* sampled in litter accumulations from Calvi Bay. They found that litter was abundant in the gut contents, but that its assimilation was limited. Using mixing model, they estimated its contribution to  $20 \pm 7$  % of the diet, while  $10 \pm 5$  % were sciaphilous algae, and  $70 \pm 12$  % drift photophilous algae and epiphytes (means  $\pm$  SD, in each case). A posterior study led in the same general area had more variable and slightly different results, but drew similar conclusions (REMY, 2010).

The situation for the animals we sampled in the *Posidonia* meadow is quite different. *Posidonia* litter, although rare (less than 2 %), was found in the gut contents. However, the very negative  $\delta^{13}\text{C}$ , and consequently the mixing model estimates, clearly state that the contribution of litter to the diet was negligible or nil. *Posidonia* litter, like for *D. spiniventris*, is more likely accidentally ingested while feeding on other items. Our results therefore disagree with the view of GAMBI *et al.*, (1992), that classify this species as a detritivore, feeding on dead *P. oceanica* material.

On the other hand, both the gut contents and the fatty acid analyzes point out that, as it has been mentioned earlier for other species, the majority of the diet is composed of algae. Stable isotopes ratios show that, like for *D. spiniventris*, diet is essentially epiphytes from rhizomes. However, unlike this species, that seems to rely almost exclusively on rhizome epiflora, *G. fucicola* shows a mixed diet, in which epiphytes of the leaves and/or the litter apparently hold an important part as well. Since this species is apparently associated with the litter cover and is rarely found among the foliar stratum (cf. chapter 3), it can be hypothesized that epiphytes from litter would be more readily consumer than epiphytes from living leaves.

This species can therefore be seen as a generalist epiphyte grazer, preferentially feeding on sciaphilous algae from rhizomes.

#### IV.4.G. *Gammarus aequicauda*

*Gammarus aequicauda* is a widespread amphipod, common in the shallow coastal waters of all the Mediterranean Sea (RUFFO *et al.*, 1982). Like *G. fucicola*, it is often found in association with *Posidonia* litter, among the meadows (this study) and especially in submerged litter accumulations, where it can be very abundant (DIMECH *et al.*, 2006).

In their previously mentioned study of 2006, LEPOINT *et al.* found that the guts of *G. aequicauda* from submerged litter accumulations contained large amounts of litter. Isotopic mixing models showed that litter constituted  $50 \pm 4$  % of the food of the animals (mean  $\pm$  SD), the remaining part consisting of photophilous/epiphytic ( $44 \pm 6$  %) and sciaphilous algae ( $6 \pm 3$  %). Another study, also performed in Calvi Bay, reported similar findings (REMY, 2010).

Contrary to *G. fucicola*, the situation for *G. aequicauda* sampled in *P. oceanica* meadows seems to be, relatively speaking, comparable to the one described for litter accumulations.

*Posidonia* litter was found in small amounts (less than 5 %) in the guts of this species. However, moderately negative  $\delta^{13}\text{C}$  indicated that *Posidonia*-derived organic matter assimilation was far from negligible. Mixing model estimates, that gave contributions of 25 to 50 % for the less negative sources, supports this. Since neither gut contents, nor fatty acids pointed out consumption of living leaves, *Posidonia* litter can be held responsible for this high contribution.

Even if it is not as important as it is in litter accumulations, consumption and assimilation of *Posidonia* detritus suggest a specialization of *G. aequicauda* to exploit efficiently this poorly digestible material. This is probably linked with mutualistic association with bacterial symbionts. This kind of association is common in different species of *Gammarus* (notably the freshwater herbivore *Gammarus pulex*). GENIN (2007) found bacterial symbionts in the gut of *G. aequicauda* from Calvi Bay, and showed that they enhanced the litter degradation capabilities of this species.

Both gut contents and fatty acids analyzes showed that algae were an important part of the diet of this species. According to the stable isotopes ratios, the most likely source would be the epiphytes from litter fragments and leaves, but rhizome epiflora could also play a part.

Presence of bacterial fatty acids in *G. aequicauda* is hard to interpret. The bacteria could come from the ingested *Posidonia* litter, and therefore act as food sources, or they could be durable symbiotic inhabitants from the gut of the animals.

Past work studying the FA composition of *G. aequicauda* feeding on the green alga *Chaetomorpha linum* showed that the animals had high 18:1(n-7) to 18:1(n-9) ratios, similar to the one measured here (0.84, BIANCOLINO & PRATO, 2006). Since this ratio was much lower in the amphipod's food source, the important amounts of 18:1(n-7) seem to have another origin. It could be, in their case as in ours, bacterial symbionts, but this is beyond the scope of our study.

In conclusion, *Gammarus aequicauda* seems to be a herbivore/detritivore amphipod, feeding mostly on epiphytes from leaves and litter, and on the *Posidonia* litter itself.

## **V. Conclusions**

In this chapter, our main goal was to assess the degree of trophic diversity between the dominant species of the amphipod community associated to *Posidonia oceanica* meadows. Reconstructing feeding habits of invertebrates is a difficult task, and we therefore chose to combine traditional methods (gut content examination) and trophic tracers (stable isotope ratios and fatty acids).

The combination of these three techniques proved to be successful, and crossing data obtained using different methods allowed us to draw insights that would not have been clear otherwise. Each method was critical for specific aspects. Stable isotope ratios, for example, were very useful to discriminate consumption of epiphytic organisms from the leaves and from the rhizomes. On the other hand, gut contents and fatty acid analyzes allowed us to separate micro- and macro-herbivory.

Our results show a certain extent of overlapping in the diets of the dominant species, suggesting a notable amount of trophic redundancy. All species indeed rely for a significant part of their organic matter intakes on macroalgae. These macroalgae were presumably epiphytes from the *Posidonia oceanica* leaves, rhizomes and litter fragments, but drift photophilous epilithic algae found among the litter could also be consumed.

Interspecific differences were nevertheless visible. Some of the species consumed preferentially epiphytes from the leaves and/or litter fragments (*Apherusa chierghinii*, *Aora spinicornis*, *Gammarus aequicauda*), while *Dexamine spiniventris* apparently specializes in grazing of the sciaphilous epiflora from rhizomes. Other species seemed to feed on both of these groups, either in fairly equal amounts (*Amphithoe helleri*, *Caprella acanthifera*) or with a predominance of epiphytes from rhizomes (*Gammarella fucicola*).

Moreover, most species had a mixed diet, and none of them seemed to feed only on one food item. Besides the various epiphytic groups, alternative food sources included *Posidonia* litter (for *Gammarus aequicauda*). In addition, number of minor species could also be deposit-feeding detritivores. Consumption of sessile animals present among the epiphytic cover could also occur, as these organisms are an interesting food source from a nutritional point of view (important N contents). However, neither of the used trophic markers allowed settling this question, due to high similarity between these food items and others.

This overall similarity of some of the potential food items was a problem on several aspects, therefore limiting the insights drawn from our work on various points. In particular, the use of our two trophic markers, although it is a powerful approach, was not sufficient, to perform satisfying discrimination between all epiphytic groups (*e.g.* epifauna and epiflora from the leaves and the litter fragments). Two suggestions to improve this situation can be made.



First, sampling strategy could be refined. Instead of sampling whole epiphytic groups, caution could be taken to perform functional (*e.g.* erected vs. encrusting morphotypes), taxonomical (*e.g.* Rhodophyceae vs. Phaeophyceae vs. Chlorophyceae) or even specific (*e.g.* by collecting monospecific populations of the dominant species) distinctions. This would complicate sampling and increase sample processing time and costs, but could be informative. In addition, it would help to deal with the large intra-source variability, another issue encountered in this study. However, it would increase the number of potential food items, limiting the use of tools such as mixing models.

Another potential improvement would be the use of additional trophic markers to collect additional data and improve discrimination. A somewhat logical way to combine the two types of tracers used here would be the use of compound-specific isotope ratio mass spectrometry to measure  $^{13}\text{C}/^{12}\text{C}$  ratios of specific fatty acids. Interesting candidates would be the very abundant 20:4(n-6) and 20:5(n-3). These fatty acids are commonly found in most algae, but metabolic pathways involved in their synthesis can vary from an algal taxon to another. In addition, environmental factors (mostly light availability and temperature) can influence biosynthetic activity (GUSCHINA & HARWOOD, 2006). These parameters are likely to cause different isotopic fractionations. It would be interesting to assess whether these factors induce significant variations in the  $\delta^{13}\text{C}$  of single fatty acids, and if these potential differences could help to delineate the diet of amphipods more precisely.

Moreover, adding stable isotope ratios from a third element could increase inter-source discrimination. Sulfur is a good candidate, since  $\delta^{13}\text{C}$ ,  $\delta^{15}\text{N}$  and  $\delta^{34}\text{S}$  can be measured using the same methods. Its use in trophic ecology is less common than carbon or nitrogen, but it has nonetheless been useful in a number of studies (*e.g.* KHARLAMENKO *et al.*, 2001 ; LEDUC *et al.*, 2006).

Contrary to epiphytic groups, the seagrass-derived organic matter was clearly distinguishable. Its use by amphipods was limited. Gut contents and fatty acid analyzes clearly point out that none of the studied species consume living *Posidonia oceanica* tissues. This is in good agreement with previous workers that stress the fact that this seagrass is only grazed by few consumers. Those include the fish *Sarpa salpa*, the urchin *Paracentrotus lividus* and isopods from the genus *Idotea* (*e.g.* MAZZELLA *et al.*, 1992).

On the other hand, *Gammarus aequicauda* partly relies on *Posidonia* litter. By consuming dead seagrass material, it participates in the fragmentation and the recycling of this abundant material, and could therefore play a significant role in the detrital pathway, that is the fate of most *Posidonia oceanica* production (PERGENT *et al.*, 1997). This particular trophic activity has been documented in large submerged litter accumulations, but our results indicate that it already takes place directly inside the meadow, and therefore as soon as the litter starts to accumulate. Organisms that feed in the lower layers of the meadow, such as *Dexamine spiniventris* or *Gammarella fucicola*, could also enhance litter degradation, but their impacts must be low, since they ingest small amounts of litter and do not seem to assimilate it.

---

Multidisciplinary study of trophic diversity

Despite variations in the availability of the resources, seasonal variations in the diet of the consumers seem low, and trophic interactions are apparently temporally stable. Since the diets of the dominant species seem to be partially overlapping, when major resources (notably epiphytes) supplies are low, interspecific competition could occur. The implications of this competition for the growth of the populations will be discussed in chapter 6.

However, caution is advised, as temporal variability and interspecific diversity could occur at finer levels, that could not be taken into account by our study. In addition, long-term (*i.e.*, inter-annual) temporal variations, as well as spatial variations in the trophic interactions should be assessed before generalization of our results.

In this study, we focused on interspecific trophic diversity. However, all techniques point out that considerable intraspecific diversity also exists. This is pointed out by the large standard deviations of relative proportions of food items in gut contents. It is also underlined by figure 4.10 that shows that most species are scattered among the clusters based on fatty acid compositions. Stable isotope ratios of C and N also showed considerable dispersion. All these statements could be hint that feeding habits may be different for different individuals of the same species. However, since few of our measurements were performed on single individuals, it is difficult to distinguish "inter-group" variation (*e.g.* between different age classes, sexes, or molt cycle conditions) from actual individual feeding preferences.

The gut content examinations were performed on single individuals, of recorded size (and hence age class). Sex determination, although it was not performed here, is possible, since individuals are stocked in preservation fluids. This technique could therefore be useful to study the extent of individual specialization by using procedures such as those proposed by BOLNICK *et al.*, (2002). However, the part occupied by unknown items that cannot be linked with a given resource was extremely large, ranging from 60 to 85 % of gut contents. In this context, estimations of individual specialization would be strongly biased, and their reliability would be too low to draw any robust conclusions.

Methods to assess intra-population trophic niche variability and inter-individual specialization using stable isotopes ratios also exist. Recent developments of the methods described by LAYMAN *et al.* (2007) or NEWSOME *et al.* (2007) proved useful in various situations. However, they rely on the use of individual estimates of isotopic ratios of several (at least 2) elements, while in our case, such data was only available for C. The use of newer, more sensitive instruments could solve this problem.

The procedure of MATTHEWS & MAZUMDER (2004), on the other hand, only uses individual values of  $\delta^{13}\text{C}$ . However, it implies as a necessary prerequisite that isotopic sources are clearly distinguishable, which is not the case here.

Overall, our dataset seems rather inadequate for assessment of the inter-individual variations of feeding habits. This parameter should be taken into

account for future work, since it could be one important factors explaining trophic diversity of the considered community.

At the end of this chapter, we showed that the abundant community of amphipods from *Posidonia oceanica* meadows exhibited considerable differences in their feeding habits from one species to another, but that epiphytes seemed to be a central item in most cases. In this context, it would be interesting to understand the impact of these common consumers on the development of the epiphytic cover. These functional matters will be the topic of the next chapter.

## References

- ACKMAN R. G. (1989): Fatty acids. in *Marine biogenic lipids, fats and oils - Vol. I*, ACKMAN R. G. (Ed.): 103-137.
- ADAMS T. S. & STERNER R. W. (2000): The effect of dietary nitrogen content on trophic level  $^{15}\text{N}$  enrichment. *Limnol. Oceanogr.*, **45** (4): 601-607.
- ALCOVERRO, T., DUARTE, M. C., ROMERO & J. (1995): Annual growth dynamics of *Posidonia oceanica*: contribution of large-scale versus local factors to seasonality. *Mar. Ecol. Progr. Ser.*, **120**: 203-210.
- ALCOVERRO T., DUARTE C. M. & ROMERO J. (1997): The influence of herbivores on *Posidonia oceanica* epiphytes. *Aquat. Bot.*, **56**: 93-104.
- ANDERSON W. T. & FOURQUREAN J. W. (2003): Intra- and interannual variability in seagrass carbon and nitrogen stable isotopes from south Florida, a preliminary study. *Org. Geochem.*, **34** (2): 185-194.
- BARNATHAN G. (2009): Non-methylene-interrupted fatty acids from marine invertebrates: Occurrence, characterization and biological properties. *Biochimie*, **91** (6): 671-678.
- BEARHOP S., ADAMS C. E., WALDRONS S., FULLER R. A. & H. M. (2004): Determining trophic niche width: a novel approach using stable isotope analysis. *Journ. Anim. Ecol.*, **73**: 1007-1012.
- BELLAN-SANTINI D. (1999): Ordre des Amphipodes (Amphipoda Latreille, 1816). in *Traité de Zoologie - Anatomie, Systématique, Biologie* (Pierre-P. Grassé). Tome VII, Fascicule III A : Crustacés Pécararides, FOREST J. (Ed.): 93-176.
- BELLO C. L. & CABRERA M. I. (1999): Uso de la tecnica microhistologica de Cavender y Hansen en la identificacion de insectos acuaticos. *Bol. Entom. Venez.*, **14**: 77-79.
- BIANDOLINO F. & PRATO E. (2006): A preliminary investigation of the lipids and fatty acids composition of *Gammarus aequicauda* (Crustacea: Amphipoda) and its main food source. *J. Mar. Biol. Ass. U.K.*, **86**: 345-348.
- BOLNICK D. I., SVANBÄCK R., FORDYCE J. A., YANG L. H., DAVIS J. M., DARRIN HUSLEY C. & FORISTER M. L. (2003): The ecology of individuals: Incidence and implications of individual specialization. *Am. Natural.*, **161** (1): 1-28.

## Multidisciplinary study of trophic diversity

- BOLNICK D. I., YANG L. H., FORDYCE J. A., DAVIS J. M. & SVANBÄCK R. (2002): Measuring individual-level resource specialization. *Ecology*, **83** (10): 2936-2941.
- BOROWITZKA M. A. & LETHBRIDGE R. C. (1989): Seagrass epiphytes. in *Biology of seagrasses - A treatise on the biology of seagrasses with special reference to the Australian region*, LARKUM A. W. D., MCCOMB A. J. & SHEPHERD S. A. (Eds.): 458-489.
- BUDGE S. M., IVERSON S. J. & KOOPMAN H. N. (2006): Studying trophic ecology in marine ecosystems using fatty acids: A primer on analysis and interpretation. *Mar. Mammal Sci.*, **22** (4): 759-801.
- CARLIER A., RIERA P., AMOUROUX J.-M., BODIQUO J.-Y., ESCOUBEYROU K., DESMALADES M., CAPARROS J. & GRÈMARE A. (2007): A seasonal survey of the food web in the Lapalme Lagoon (northwestern Mediterranean) assessed by carbon and nitrogen stable isotope analysis. *Estuar. Coast. Shelf Sci.*, **73** (1-2): 299-315.
- CAUT S., ANGULO E. & COURCHAMP F. (2008a): Dietary shift of an invasive predator: rats, seabirds and sea turtles. *J. Appl. Ecol.*, **45**: 428-437.
- CAUT S., ANGULO E., COURCHAMP F. & FIGUEROLA J. (2010): Trophic experiments to estimate isotope discrimination factors. *J. Appl. Ecol.*, **47** (948-954)
- CAUT S., ANGULO H. & COURCHAMP F. (2008b): Caution on isotopic model use for analyses of consumer diet. *Can. J. Zool.*, **86**: 438-445.
- CHIMENZ C., TARAMELLI E., CIRONI R., CONTESSINI A., GRAVINA F., MAGGIORE F. R., MAJ R. L. C., MOTTA M. G. & SOMASCHINI A. (1989): Studies on animal populations of leaves and rhizomes of *Posidonia oceanica* (L.) Delile on the rocky bottom of Torvaldaliga. in *International Workshop on Posidonia Beds*, BOUDOURESQUE C. F., MEINESZ A., FRESI E. & GRAVEZ V. (Eds.): 145-155.
- CHRISTIE W. W. (2010a): Lipid compositions of plants and microorganisms. in *The American Oil's Chemist Society (AOCS) Lipid Library*, CHRISTIE W. W. (Ed.). Web Page available at [http://lipidlibrary.aocs.org/Lipids/comp\\_plant/index.htm](http://lipidlibrary.aocs.org/Lipids/comp_plant/index.htm), accessed on 26/10/2010.
- CHRISTIE W. W. (2010b): What is a lipid ? in *The American Oil's Chemist Society (AOCS) Lipid Library*, CHRISTIE W. W. (Ed.). Web Page available at <http://lipidlibrary.aocs.org/Lipids/whatlip/index.htm>, accessed on 26/10/2010.
- CHRISTIE W. W. (2010c): What lipids do: their biological functions. in *The American Oil's Chemist Society (AOCS) Lipid Library*, CHRISTIE W. W. (Ed.). Web Page available at <http://lipidlibrary.aocs.org/Lipids/whatdo/index.htm>, accessed on 26/10/2010.
- COOK E. J., SHUCKSMITH R., ORR H., ASHTON G. V. & BERGE J. (2010): Fatty acid composition as a dietary indicator of the invasive caprellid, *Caprella mutica* (Crustacea: Amphipoda). *Mar. Biol.*, **157** (1): 19-27.
- COOK H. W. (1996): Fatty acid desaturation and chain elongation in eukaryotes. in *Biochemistry of lipids, lipoproteins and membranes*, VANCE D. E. & VANCE J. E. (Ed.): 129-152.

- COOPER L. W. & DENIRO M. J. (1989): Stable Carbon isotope variability in the seagrass *Posidonia oceanica*: evidence for light intensity effects. *Mar. Ecol. Progr. Ser.*, **50**: 225-229.
- COSTANZO S. D., O'DONOHUE M. J., DENNISON W. C., LONERAGAN N. R. & THOMAS M. (2001): A new approach for detecting and mapping sewage impacts. *Mar. Poll. Bull.*, **42** (2): 149-156.
- CRAWLEY K. R., HYNDES G. A. & VANDERKLIFT M. A. (2007): Variation among diets in discrimination of  $\delta^{13}\text{C}$  and  $^{15}\text{N}$  in the amphipod *Allorchesttes compressa*. *J. Exp. Mar. Biol. Ecol.*, **349** (2): 370-377.
- CRUZ-RIVERA E. & HAY M. E. (2000): The effects of diet mixing on consumer fitness: macroalgae, epiphytes, and animal matter as food for marine amphipods. *Oecologia*, **123** (2): 252-264.
- DALSGAARD J., ST. JOHN M., KATTNER G., MÜLLER-NAVARRA D. & HAGEN W. (2003): Fatty acid trophic markers in the pelagic marine environment. *Adv. Mar. Biol.*, **46**: 225-340.
- DAUBY P. (1989): The stable carbon isotope ratios in benthic food webs of the Gulf of Calvi, Corsica. *Cont. Shelf. Res.*, **2**: 181-195.
- DAUBY P., SCAILTEUR Y. & DE BROYER C. (2001): Trophic diversity within the eastern Weddell Sea amphipod community. *Hydrobiologia*, **443** (1-3): 69-86.
- DENIRO M. J. & EPSTEIN S. (1978): Influence of diet on the distribution of carbon isotopes in animals. *Geochim. Cosmochim. Ac.*, **42**: 495-506.
- DENIRO M. J. & EPSTEIN S. (1981): Influence of diet on the distribution of nitrogen isotopes in animals. *Geochim. Cosmochim. Ac.*, **45**: 341-351.
- DIMECH M., BORG J. A. & SCHEMBRI P. J. (2006): Motile macroinvertebrate assemblages associated with submerged *Posidonia oceanica* litter accumulations. *Biol. Mar. Medit.*, **13** (4): 130-133.
- DIXON I. M. T. & MOORE P. G. (1997): A comparative study on the tubes and feeding behaviour of eight species of corophioid Amphipoda and their bearing on phylogenetic relationships within the Corophioidea. *Phil. Trans. Roy. Soc. London B*, **352**: 93-112.
- FARLIN J., LEWIS L., ANDERSON T. & LAI C. (2010): Functional diversity in amphipods revealed by stable isotopes in an eelgrass ecosystem. *Mar. Ecol. Progr. Ser.*, **420**: 277-281.
- FLEURENCE J., GUTBIER G., MABEAU S. & LERAY C. (1994): Fatty acids from 11 marine macroalgae of the French Brittany coast. *J. Appl. Phycol.*, **6** (5-6): 527-532.
- FOCKEN U. (2001): Stable isotopes in animal ecology: The effect of ration size on the trophic shift of C and N isotopes between feed and carcass. *Isotopes Environ. Health Stud.*, **37**: 199-211.
- FOLCH J., LEES M. & STANLEY G. H. S. (1957): A simple method for the isolation and purification of total lipids from animal tissues. *J. Biol. Chem.*, **226** (1): 497-509.
- FOURQUIREAN J. W., ESCORCIA S. P., ANDERSON W. T. & ZIEMAN J. C. (2005): Spatial and seasonal variability in elemental content, delta C-13, and delta N-15 of

## Multidisciplinary study of trophic diversity

*Thalassia testudinum* from South Florida and its implications for ecosystem studies. *Estuaries*, **28** (3): 447-461.

FRY B. (2006): Stable Isotope Ecology. Springer, New York, 308 pp.

GALLMETZER I., PFLUGFELDER B., ZEKELY J. & OTT J. A. (2005): Macrofauna diversity in *Posidonia oceanica* detritus: distribution and diversity of mobile macrofauna in shallow sublittoral accumulations of *Posidonia oceanica* detritus. *Mar. Biol.*, **147** (2): 517-523.

GAMBI M. C., LORENTI M., RUSSO G. F., SCIPIONE M. B. & ZUPO V. (1992): Depth and seasonal distribution of some groups of the vagile fauna of the *Posidonia oceanica* leaf stratum: Structural and trophic analyses. *P.S.Z.N. I: Mar. Ecol.*, **13** (1): 17-39.

GANNES L. Z., O'BRIEN K. & MARTINEZ DEL RIO C. (1997): Stable Isotopes in Animal Ecology: Assumptions, Caveats, and a Call for More Laboratory Experiments. *Ecology*, **78** (4): 1271-1276.

GENIN A. (2007): Approche pluridisciplinaire des stratégies alimentaires de quelques crustacés amphipodes inféodés à la litière de *Posidonia oceanica* (L.) Delile. Master in Animal Biology thesis, University of Liège, Liège, 49 pp.

GOBERT S., CAMBRIDGE M. L., VELIMIROV B., PERGENT G., LEPOINT G., BOUQUEGNEAU J. M., DAUBY P., PERGENT-MARTINI C. & WALKER D. I. (2006): Biology of *Posidonia*. in *Seagrasses : Biology, Ecology and Conservation*, LARKUM A. W. D., ORTH R. J. & DUARTE C. M. (Eds.): 387-408.

GRAEVE M., DAUBY P. & SCAILTEUR Y. (2001): Combined lipid, fatty acid and digestive tract content analyses: a penetrating approach to estimate feeding modes of Antarctic amphipods. *Polar Biol.*, **24**: 853-862.

GRAEVE M., KATTNER G. & PIEPENBURG D. (1997): Lipids in Arctic benthos: does the fatty acid and alcohol composition reflect feeding and trophic interactions? *Polar Biol.*, **18** (1): 53-61.

GRAEVE M., KATTNER G., WIENCKE C. & KARSTEN U. (2002): Fatty acid composition of Arctic and Antarctic macroalgae: indicator of phylogenetic and trophic relationships. *Mar. Ecol. Progr. Ser.*, **231**: 67-74.

GUERRA-GARCIA J. M., MARTINEZ-PITA I. & PITA M. L. (2004): Fatty acid composition of the Caprellidea (Crustacea : Amphipoda) from the Strait of Gibraltar. *Sci. Mar.*, **68** (4): 501-510.

GUERRA-GARCIA J. M. & TIerna DE FIGUEROA J. M. (2009): What do caprellids (Crustacea: Amphipoda) feed on? *Mar. Biol.*, **156** (9): 1881-1890.

GURR M. I. & HARDWOOD J. L. (1991): Lipid biochemistry: an introduction. Chapman, London, 416 pp.

GUSCHINA I. A. & HARWOOD J. L. (2006): Lipids and lipid metabolism in eukaryotic algae. *Progr. Lip. Res.*, **45** (2): 160-186.

HEMMINGA M. A. & MATEO M. A. (1996): Stable carbon isotopes in seagrasses: variability in ratios and use in ecological studies. *Mar. Ecol. Progr. Ser.*, **140**: 285-298.

HOBSON K. A., AMBROSE W. G. J. & RENAUD P. E. (1995): Sources of primary production, benthic-pelagic coupling, and trophic relationships within the

Northeast Water Polynya: insights from  $\delta^{13}\text{C}$  and  $\delta^{15}\text{N}$  analysis. *Mar. Ecol. Progr. Ser.*, **128**: 1-10.

HOBSON K. A. & WELCH H. E. (1992): Determination of trophic relationships within a high Arctic marine food web using  $\delta^{13}\text{C}$  and  $\delta^{15}\text{N}$  analysis. *Mar. Ecol. Progr. Ser.*, **84**: 9-18.

HOLMES S. J. (1901): Observations on the habits and natural history of *Amphithoe longimana* Smith. *Biol. Bull.*, **2**: 165-193.

HUNTE W. & MYERS R. A. (1984): Phototaxis and cannibalism in gammaridean amphipods. *Mar. Biol.*, **81** (1): 75-79.

INGER R., JACKSON A., PARNELL A. & BEARHOP S. (2010): SIAR (Stable Isotope Analysis in R) v4: An Ecologist's Guide. Online workbook available at <http://www.tcd.ie/Zoology/research/research/theoretical/siar.php>, accessed on 21/11/2010.

IVERSON S. J., FIELD C., DON BOWEN W. & BLANCHARD W. (2004): Quantitative fatty acid signature analysis: A new method of estimating predator diets. *Ecol. Monogr.*, **74** (2): 211-235.

JACQUEMART J. (2009): Etude de la communauté des macroalgues épiphytes de *Posidonia oceanica* (L.) Delile et comparaison avec celle de *Cystosera balearica* Sauv. - Approche expérimentale visant à élucider les effets de l'eutrophisation sur ces communautés. PhD in Sciences thesis, University of Liège, Liège, 393 pp.

JOSEPH J. D. (1989): Distribution and composition of lipids in marine invertebrates. in *Marine biogenic lipids, fats and oils - Vol. II*, ACKMAN R. G. (Eds.): 49-143.

KAYAMA M., ARAKI S. & SATO S. (1989): Lipids of Marine Plants. in *Marine biogenic lipids, fats and oils - Vol. II*, ACKMAN R. G. (Ed.): 3-48.

KAYAMA M., TSUCHIYA Y. & MEAD J. F. (1963): A model experiment of aquatic food chain with special significance in fatty acid conversion. *Bull. Jap. Soc. Sci. Fish.*, **29**: 452-458.

KHARLAMENKO V. I., KIYASHKO S. I., IMBS A. B. & VYSHKVARTZEV D. I. (2001): Identification of food sources of invertebrates from the seagrass *Zostera marina* community using carbon and sulfur stable isotope ratio and fatty acid analyses. *Mar. Ecol. Progr. Ser.*, **220**: 103-117.

KHARLAMENKO V. I., ZHUKOVA N. V., KHOTIMCHENKO S. V., SVETASHEV V. I. & KAMENEV G. M. (1995): Fatty acids as markers of food sources in a shallow water hydrothermal ecosystem (Kraternaya Bight, Yankich Islands, Kurile Islands). *Mar. Ecol. Progr. Ser.*, **120** (1-3): 231-241.

KIKUCHI T. (1980): Faunal relationships in temperate seagrass beds. in *Handbook of seagrass biology - An ecosystem perspective*, PHILLIPS R. C. & McROY C. P. (Eds.): 153-172.

LAYMAN C. A., ARRINGTON D. A., MONTANA C. G. & POST D. M. (2007): Can stable isotope ratios provide for community-wide measures of trophic structure? *Ecology*, **88** (1): 42-48.

## Multidisciplinary study of trophic diversity

- LEBRETON B., RICHARD P., GALOIS R., RADENAC G., PFLÈGER C., GUILLOU G., MORNET F. & BLANCHARD G. F. (2011): Trophic importance of diatoms in an intertidal *Zostera noltii* seagrass bed: Evidence from stable isotope and fatty acid analyses. *Estuar. Coast. Shelf Sci.*, **92** (1): 140-153.
- LEDUC D., PROBERT P. K., FREW R. D. & HURD C. L. (2006): Macroinvertebrate diet in intertidal seagrass and sandflat communities: a study using C, N, and S stable isotopes. *N. Z. J. Mar. Freshw. Res.*, **40** (4): 615-629.
- LEPOINT G. (2001): Compétition pour l'azote inorganique entre le pelagos et le benthos d'un milieu côtier oligotrophe. Effets sur la dynamique de l'écosystème. PhD in Science thesis, University of Liège, Liège, 199 pp.
- LEPOINT G., COX A. S., DAUBY P., POULICEK M. & GOBERT S. (2006): Food sources of two detritivore amphipods associated with the seagrass *Posidonia oceanica* leaf litter. *Mar. Biol. Res.*, **2** (5): 355-365.
- LEPOINT G., GOBERT S., DAUBY P. & BOUQUEGNEAU J. M. (2004): Contributions of benthic and planktonic primary producers to nitrate and ammonium uptake fluxes in an nutrient-poor shallow coastal area (Corsica, NW Mediterranean). *J. Exp. Mar. Biol. Ecol.*, **302**: 107-122.
- LEPOINT G., NYSSSEN F., GOBERT S., DAUBY P. & BOUQUEGNEAU J.-M. (2000): Relative impact of a seagrass bed and its adjacent epilithic algal community in consumer diets. *Mar. Biol.*, **136**: 513-518.
- LOVERN J. A. (1935): C. Fat metabolism in fishes. VI. The fat of some plankton crustacea. *Biochem. J.*, **27**: 847-849.
- MACKO S. A., LEE W. Y. & PARKER P. L. (1982): Nitrogen and Carbon Fractionation by two species of marine amphipods : laboratory and field studies. *J. Exp. Mar. Biol. Ecol.*, **63**: 145-149.
- MARTÍNEZ DEL RIO C., WOLF N., CARLETON S. A. & GANNES L. Z. (2009): Isotopic ecology ten years after a call for more laboratory experiments. *Biol. Rev.*, **84** (1): 91-111.
- MATTHEWS B. & MAZUMDER A. (2004): A critical evaluation of intrapopulation variation of  $\delta^{13}\text{C}$  and isotopic evidence of individual specialization. *Oecologia*, **140**: 361-371.
- MAZUMDER D., ILES J., KELLEWAY J., KOBAYASHI T., KNOWLES L., SAINTILAN N. & HOLLINS S. (2010): Effect of acidification on elemental and isotopic compositions of sediment organic matter and macroinvertebrate muscle tissues in food web research. *Rapid Commun. Mass Spectrom.*, **24** (20): 2938-2942.
- MAZZELLA L., BUIA M. C., GAMBI M. C., LORENTI M., RUSSO G. F., SCIPIONE M. B. & ZUPO V. (1992): Plant-animal trophic relationships in the *Posidonia oceanica* ecosystem of the Mediterranean Sea: a review. in *Plant-Animal Interactions in the Marine Benthos*, JOHN D. M., HAWKINS S. J. & PRICE J. H. (Eds.): 165-187.
- MAZZELLA L., SCIPIONE M. B. & BUIA M. C. (1989): Spatio-temporal distribution of Algal and Animal communities in a *Posidonia oceanica* meadow. *P.S.Z.N. I: Mar. Ecol.*, **10** (2): 107-129.
- MCCUTCHAN J. H. J., LEWIS W. M. J., KENDALL C. & MCGRATH C. C. (2003): Variation in trophic shift for stable isotope ratios of carbon, nitrogen, and sulfur. *Oikos*, **102**: 378-390.



- MINAGAWA M. & WADA E. (1984): Stepwise enrichment of  $^{15}\text{N}$  along food chains: Further evidence and the relation between  $\delta^{15}\text{N}$  and animal age. *Geochim. Cosmochim. Ac.*, **48**: 1135-1140.
- NELSON M. M., MOONEY B. D., NICHOLS P. D. & PHLEGER C. F. (2001): Lipids of Antarctic Ocean amphipods: food chain interactions and the occurrence of novel biomarkers. *Mar. Chem.*, **73** (1): 53-64.
- NEWSOME S. D., DEL RIO C. M., BEARHOP S. & PHILLIPS D. L. (2007): A niche for isotopic ecology. *Front. Ecol. Environ.*, **5** (8): 429-436.
- NICHOLS P. D., KLUMPP D. W. & JOHNS R. B. (1985): Lipid components of the epiphyte material, suspended particular matter and cultured bacteria from a seagrass, *Posidonia australis*, community as indicators of carbon source. *Comp. Biochem. Physiol.*, **80B** (2): 315-325.
- NICHOLS P. D., KLUMPP D. W. & JOHNS R. B. (1986): Lipid components and utilization in consumers of a seagrass community: an indication of carbon source. *Comp. Biochem. Physiol.*, **83B** (1): 103-113.
- NYSSSEN F., BREY T., DAUBY P. & GRAEVE M. (2005): Trophic position of Antarctic amphipods enhanced analysis by a 2-dimensional biomarker assay. *Mar. Ecol. Progr. Ser.*, **300**: 135-145.
- NYSSSEN F., BREY T., LEPOINT G., BOUQUEGNEAU J. M., DE BROYER C. & DAUBY P. (2002): A stable isotope approach to the eastern Weddell Sea trophic web: focus on benthic amphipods. *Polar Biol.*, **25** (4): 280-287.
- O'LEARY M. H. (1988): Carbon isotopes in photosynthesis. *BioScience*, **38**: 328-336.
- PARNELL A. C., INGER R., BEARHOP S. & JACKSON A. L. (2010): Source Partitioning Using Stable Isotopes: Coping with Too Much Variation. *PLoS One*, **5** (3): e9672.
- PERGENT G., RICO-RAIMONDINO V. & PERGENT-MARTINI C. (1997): Fate of primary production in *Posidonia oceanica* meadows of the Mediterranean. *Aquat. Bot.*, **59** (3-4): 307-321.
- PHILLIPS D. L., NEWSOME S. D. & GREGG J. W. (2005): Combining sources in stable isotope mixing models: alternative methods. *Oecologia*, **144**: 520-527.
- PINNEGAR J. K. & POLUNIN N. V. C. (1999): Differential fractionation of  $\delta^{13}\text{C}$  and  $\delta^{15}\text{N}$  among fish tissues: implications for the study of trophic interactions. *Funct. Ecol.*, **13**: 225-231.
- POND D. W., SEGONZAC M., BELL M. V., DIXON D. R., FALICK A. E. & SARGENT J. R. (1997): Lipid and lipid carbon stable isotope composition of the hydrothermal vent shrimp *Mirocaris fortunata*: evidence for nutritional dependence on photosynthetically fixed carbon. *Mar. Ecol. Progr. Ser.*, **157**: 221-231.
- POST D. M., LAYMAN C. A., ARRINGTON D. A., TAKIMOTO G., QUATTROCHI J. & MONTANA C. G. (2007): Getting to the fat of the matter: models, methods and assumptions for dealing with lipids in stable isotope analyses. *Oecologia*, **152** (1): 179-189.
- RAVEN J. A., JOHNSTON A. M., KÜBLER J. E., KORB R., MCINROY S. G., HANDLEY L. L., SCRIMGEOUR C. M., WALKER D. I., BEARDALL J., VANDERKLIFT M., FREDRIKSEN S. &

## Multidisciplinary study of trophic diversity

- DUNTON K. H. (2002): Mechanistic interpretation of carbon isotope discrimination by marine macroalgae and seagrasses. *Funct. Plant Biol.*, **29**: 355-378.
- RAVEN P. H., EVERT R. F. & EICHHORN S. E. (2005): The Biology of Plants. W.H. Freeman & Co., New York, 944 pp.
- REMY F. (2010): Structure trophique et diversité des macro-organismes associés aux littorales de *Posidonia oceanica* (L.) Delile, dans la baie de Calvi en Corse. Master in Biology of Organisms and Ecology thesis, University of Liège, Liège, 54 pp.
- ROGERS C. N., NYS R. D. & STEINBERG P. D. (2003): Ecology of the sea hare *Aplysia parvula* (Opisthobranchia) in New South Wales, Australia. *Mollusc. Res.*, **23** (3): 185-198.
- ROMERO J., PERGENT G., PERGENT-MARTINI C., MATEO M. A. & REGNIER C. (1992): The detritic compartment of a *Posidonia oceanica* meadow - Litter features, decomposition rates and mineral stocks. *P.S.Z.N. I: Mar. Ecol.*, **13** (1): 69-83.
- RUFFO S., BELLAN-SANTINI D., DIVIACCO G., KRAPP-SCHICKEL G. & MYERS A. A. (1989): Part 2 : Gammaridea (Haustoriidae to Lysianassidae). in *The Amphipoda of the Mediterranean*, RUFFO S. (Ed.): 365-576.
- RUFFO S., BELLAN-SANTINI D., KARAMAN G., KRAPP-SCHICKEL G. & LEDOYER M. (1993): Part 3 : Gammaridea (Melphidippidae to Talitridae), Ingolfiellidea, Caprellidea. in *The Amphipoda of the Mediterranean*, RUFFO S. (Ed.): 577-813.
- RUFFO S., BELLAN-SANTINI D., KARAMAN G., KRAPP-SCHICKEL G., LEDOYER M., MYERS A. A. & SCHIECKE U. (1982): Part 1 : Gammaridea (Acanthonozomatidae to Gammaridae). in *The Amphipoda of the Mediterranean*, RUFFO S. (Ed.): 1-364.
- SCIPIONE M. B. (1998). Amphipod biodiversity in the foliar stratum of shallow-water *Posidonia oceanica* beds in the Mediterranean Sea. *Proceedings of the 4th Crustacean Congress: Crustacean and Biodiversity Crisis*, Amsterdam.
- SCIPIONE M. B. & MAZZELLA L. (1992): Epiphytic community in the diet of crustacean amphipods of *Posidonia oceanica* leaf stratum. *Oebalia*, **suppl. 17**: 407-412.
- SKUTCH A. F. (1926): On the habits and ecology of the tube-building amphipod *Amphithoe rubricata* Montagu. *Ecology*, **7** (4): 481-502.
- STURARO N., CAUT S., GOBERT S., BOUQUEGNEAU J.-M. & LEPOINT G. (2010): Trophic diversity of idoteids (Crustacea, Isopoda) inhabiting the *Posidonia oceanica* litter. *Mar. Biol.*, **157** (2): 237-247.
- TCHERKEZ G. (2010): Isotopie biologique: Introduction aux effets isotopiques et à leurs applications en biologie. Lavoisier, Paris, 237 pp.
- VANDER ZANDEN M. J. & RASMUSSEN J. B. (2001): Variation in  $\delta^{15}\text{N}$  and  $\delta^{13}\text{C}$  trophic fractionation: Implications for aquatic food web studies. *Limnol. Oceanogr.*, **46** (8): 2061-2066.
- VANDERKLIFT M. & PONSARD S. (2003): Sources of variation in consumer-diet  $\delta^{15}\text{N}$  enrichment: a meta-analysis. *Oecologia*, **136**: 169-182.
- VELIMIROV B. (1987): Organic matter derived from a seagrass meadow : origin, properties, and quality of particles. *P.S.Z.N. I: Mar. Ecol.*, **8** (2): 143-173.

VISO A. C., PESANDO D., BERNARD P. & MARTY J. C. (1993): Lipid components of the Mediterranean seagrass *Posidonia oceanica*. *Phytochemistry*, **34** (2): 381-387.

VIZZINI S. (2009): Analysis of the trophic role of Mediterranean seagrasses in marine coastal ecosystems: a review. *Bot. Mar.*, **52** (5): 383-393.

VIZZINI S. & MAZZOLA A. (2003): Seasonal variations in the stable carbon and nitrogen isotope ratios (C-13/C-12 and N-15/N-14) of primary producers and consumers in a western Mediterranean coastal lagoon. *Mar. Biol.*, **142** (5): 1009-1018.

VIZZINI S., SARÀ G., MICHENER R. H. & MAZZOLA A. (2002): The role and contribution of the seagrass *Posidonia oceanica* (L.) Delile organic matter for secondary consumers as revealed by carbon and nitrogen stable isotope analysis. *Acta Oecol.*, **23**: 277-285.

VIZZINI S., SAVONA B., CHI T. D. & MAZZOLA A. (2005): Spatial variability of stable carbon and nitrogen isotope ratios in a Mediterranean coastal lagoon. *Hydrobiologia*, **550**: 73-82.





## Chapter 5

### Functional role of amphipod grazing in the dynamics of the epiphytic cover of *Posidonia oceanica* leaves

Every living being is important, and sometimes those you think the most insignificant, in fact are very special and remarkable.

(Old Jewish maxim)



## **I. Introduction**

### **I.1. The place of amphipods in the seagrass ecosystems**

Amphipods from *Posidonia oceanica* meadows are traditionally regarded as epiphytes grazers (e.g. MAZZELLA et al., 1992). Our results from the previous chapter partly confirm this view, and showed that amphipods seem to largely rely epiphytes growing on various parts of the seagrass, with species-specific preferences.

By consuming epiphytes, that can represent up to 40 % of the foliar biomass of *P. oceanica* meadows (MAZZELLA & OTT, 1984), amphipods make the organic matter constituting them available to upper trophic levels. Since many fishes rely on amphipod preys (BELL & HARMELIN-VIVIEN, 1983 ; PINNEGAR & POLUNIN, 2000), they hold a central role in the food webs associated to *P. oceanica* meadows.

However, this importance in food webs is not the only ecological role of amphipods from seagrass meadows. In other seagrass systems, their feeding activity is known to influence the dynamics of the epiphytic cover. In doing so, they have a critical impact on the whole ecosystem, via the so-called "seagrass/epiphyte/grazer system" (JERNAKOFF et al., 1996)

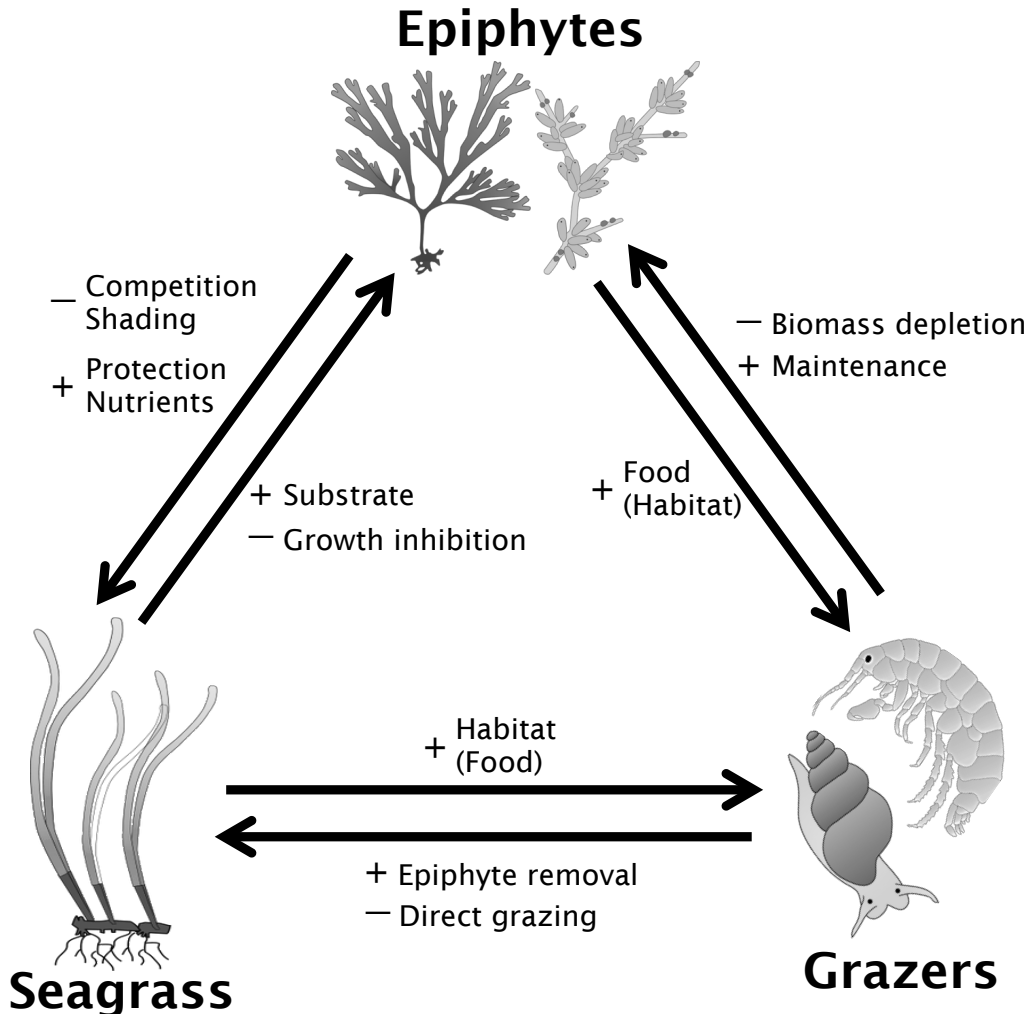
### **I.2. The seagrass/epiphyte/grazer system**

In several (putatively all) seagrass meadows, the seagrass, the epiphytes that grow on it and the grazers able to consume either the seagrass or its epiphytes are linked by a complex interplay of reciprocal interactions and feedbacks, termed seagrass/epiphyte/grazer system. Fluctuations in this system can influence the functioning of the whole meadow (JERNAKOFF et al., 1996 ; VALENTINE & DUFFY, 2006). Over the next section, we will briefly present the key processes that rule this system. Most of these interactions are graphically summarized in figure 5.1. The discussion will be focused on mesograzers, i.e. grazers whose body size is larger than the one of a copepod, but smaller than 2.5 cm (JERNAKOFF et al., 1996), because amphipods fall in that category.

#### **I.2.A. Impacts of seagrasses**

##### **I.2.A.a. On epiphytes**

Seagrass leaves and parts of rhizomes that stand above ground level offer an important substrate area that is available for colonization of all kinds of epiphytes. The structure, extent and diversity of epiphytic communities depends on seagrass life span, but also on leaf size (Leaf Area Index) and morphology (BOROWITZKA et al., 2006).



**Fig. 5.1:** Schematic representation of the seagrass/epiphytes/grazer system, featuring the most important positive and negative interactions (drawn from concepts developed in JERNAKOFF *et al.*, 1996). Symbols used courtesy of the Integration and Application Network ([ian.umces.edu/symbols/](http://ian.umces.edu/symbols/)).

In addition of providing a settlement surface, seagrass could provide nutrients for epiphytic growth through secretion of dissolved nitrogen- or phosphorus-based compounds. This effect is largely debated but could, in specific situations, be important (JERNAKOFF *et al.*, 1996).

Besides these positive effects, seagrass can also have negative impact on the development of epiphytes. They can indeed inhibit epiphyte growth through release of chemical compounds, notably polyphenolic molecules such as tannins (BOROWITZKA *et al.*, 2006). Abscission of old leaves has also a negative impact on epiphytes covering them (BORUM, 1985)



### I.2.A.b. On grazers

As mentioned in chapter 1 and 3, the foliar stratum, rhizome layer and detritus cover present in seagrass meadows constitute a widely available and structurally complex habitat, able to support the growth of large and diverse communities of invertebrate grazers (*e.g.* SÁNCHEZ-JEREZ *et al.*, 1999). The abundance and diversity of invertebrates, as well as their community structure, can vary from one meadow to another, notably in relation with differences in canopy size (leaf area index) and structural complexity (*e.g.* SCIPIONE *et al.*, 1996 ; VAZQUEZ-LUIS *et al.*, 2009). In addition of being a suitable life habitat, seagrass meadows are a shelter from predation (JERNAKOFF *et al.*, 1996).

In addition, some mesograzers directly consume the tissues of the seagrass, either under living or dead, decaying form. However, direct consumption of seagrass is often limited to a few species, and the primary role of seagrass host for mesoinvertebrates is generally regarded as being habitat-related (KIKUCHI, 1980). The extent of seagrass grazing can nonetheless vary in relation to its palatability and/or its nutritional content (KLUMPP *et al.*, 1989).

Negative effects of seagrass on grazers are rare. Polyphenolic compounds acting as herbivores deterrents can have a deleterious effect of grazer digestion and physiology. However, few grazers consume only seagrass tissue, and most of them have a mixed diet, therefore limiting the effect of these compounds (VALENTINE & DUFFY, 2006).

### I.2.B. Impacts of epiphytes

Settlement and development of epiphytes depends on many biotic and abiotic factors. It can vary according to seagrass leaf size and morphology (TRAUTMAN & BOROWITZKA, 1999), to seagrass life span, to the vertical zonation of the meadow (intertidal vs. fully submerged), to presence of epiphyte grazers (BOROWITZKA & LETHBRIDGE, 1989) and even to nutrient load in the water column (*e.g.* JACQUEMART, 2009).

As a result, the biomass, coverage, diversity and community structure of the epiphytic cover will be deeply different from a meadow to another. In some cases, it can be limited to occurrence of periphyton on the leaves (*e.g.* LEBRETON *et al.*, 2009 for *Zostera noltii*). In others, it can be a long-lived, diverse and structured community (*e.g.* MAZZELLA & OTT, 1984 ; MAZZELLA *et al.*, 1989 for *Posidonia oceanica*). Between these two extreme situations, a wide array of different conditions exist (see BOROWITZKA *et al.*, 2006 for review). However, a few common, widespread features can be highlighted.

#### I.2.B.a. On seagrass

For some reason, most of the past work focused on the deleterious effects of epiphytes on seagrass. Under certain circumstances, competition for nutrients from the water column can indeed occur between the seagrass and its autotrophic epiphytes. Fast-growing epiphytes, that have high uptake rates, are often more competitive. In addition, presence of epiphytes creates a

---

## Functional role of amphipod grazing in epiphyte dynamics

boundary layer that interferes with uptake of inorganic carbon and nutrients by the seagrass. This negative effect of epiphytes on seagrass growth is however buffered by the ability of seagrasses to use their roots to assimilate nutrients from sediment (JERNAKOFF *et al.*, 1996 ; ROMERO *et al.*, 2006 ; LEPOINT *et al.*, 2007).

The epiphytic cover can also cause shading, therefore limiting the photosynthetic activity of its seagrass host. This process can limit the depth extent of seagrasses (CEBRIÁN *et al.*, 1999 ; GLASBY, 1999).

In long-lived seagrasses, important accumulation of leaf epiphytes can also lead to apical erosion of the leaves under action of hydrodynamic forces. In certain cases, over-epiphytism can cause loss of blade flexibility. Leaves stiffened by this process will be more likely to be ripped off and lost during extreme water movement events (storms, etc.; BOROWITZKA & LETHBRIDGE, 1989).

Presence of epiphytes can also have positive effects on the seagrass. Under usual conditions, "normal" coating of the seagrass by epiphytes can have a protective effect. Embossments and micro-contours caused by the presence of epiphytes reduce water movement (dissipation of wave energy by creation of micro-eddies), therefore attenuating its adverse effects on seagrass leaf. In intertidal seagrasses, epiphytes also limit the physiological stress caused by desiccation and excessive insolation (JERNAKOFF *et al.*, 1996).

Epiphytes can assimilate nutrients present in the water column with greater efficiency than seagrasses (LEPOINT *et al.*, 2007). In certain cases, they are also able to use nutrient species unavailable for the seagrass itself (*e.g.* atmospheric N<sub>2</sub> for cyanobacteria; BOROWITZKA *et al.*, 2006).

Since epiphytes have shorter life times than seagrasses, they decay and die sooner. Passive leaching and breakdown of their tissues by decomposers then cause local nutrient enrichment. These nutrients could boost seagrass production (JERNAKOFF *et al.*, 1996).

Overall, like a lot of ecological interactions, the seagrass/epiphyte relationship can be positive or negative according to the situation. Under normal conditions, presence of epiphytes likely benefits their seagrass host. However, when epiphytic loads become abnormally high (*e.g.* in eutrophicated systems), this interaction can become negative, and epiphytes can literally outgrow the seagrass, sometimes causing its death (BOROWITZKA *et al.*, 2006).

### 1.2.B.b. On grazers

At this stage of the dissertation, it would be redundant to mention once again that epiphytes can be an important trophic resource supporting large populations of mesograzers. Epiphytes could also play a role in habitat features of seagrass meadows, since they can enhance its structural complexity. However, experimental evidence suggests that this effect would be less important for mesofauna than their role as food source (BOLOGNA & HECK, 1999).

Negative effect on grazers could occur, like for the seagrass, through chemical protection against herbivory. The actual significance of this phenomenon for epiphytes of seagrass is hard to assess, since it received little attention.

### I.2.C. Impacts of grazers

The magnitude and outcome of the impact of grazers on the two other compartments depends on many parameters. These include grazer density (often limited by predation; see HECK & ORTH, 2006 for review), and identity, as species-specific grazing preferences and differences in consumption rates exist (*e.g.* ZIMMERMAN *et al.*, 1979 ; MAZZELLA & RUSSO, 1989 ; DUFFY & HARVILICZ, 2001).

Biodiversity of grazer assemblages can also be important. This includes specific diversity, *i.e.* the number of grazer species (DUFFY *et al.*, 2001 ; DUFFY *et al.*, 2003 ; CARDINALE *et al.*, 2006), but also functional diversity, *i.e.* the degree of ecological redundancy present among the community.

Ecological redundancy (sometimes termed functional compensation) is indeed also an important phenomenon to take into account. Within an ecosystem, it is common that several "ecologically redundant species are able to perform a single, important functional role. This phenomenon is thought to increase stability and resilience of ecosystems, and increase its resistance to disturbance and stress. For example, if one of the species is suppressed, it can be replaced by another ecologically redundant taxon (WALKER, 1992).

The extent of ecological redundancy among grazers from seagrass meadows can vary, and its impact on ecosystem functioning is still poorly understood (VALENTINE & DUFFY, 2006 ; DUFFY, 2009).

#### I.2.B.a. On epiphytes

The most obvious effect of mesograzers on epiphytes is of course the depletion of their biomass by consumption. As a result, grazing has a global, overall, negative effect on the epiphytic cover (JERNAKOFF *et al.*, 1996 ; VALENTINE & DUFFY, 2006 and numerous references therein).

However, grazing is not a purely negative interaction. It can indeed be selectively targeted on specific epiphytic taxa or functional groups. Removal of these species can release other epiphytes from competition for space, light and/or nutrients. Grazing could therefore have an influence on the structure and diversity of epiphytic communities. This selective top-down effect could be important to allow the epiphytic cover to reach its maximal development, and therefore its maximal biomass-specific productivity. This effect could be crucial during initial settlement of epiphytes, but could also persist throughout the whole lifetime of the phorophyte. By constantly feeding on epiphytes, grazer could perform "maintenance" of the epiphytic cover (JERNAKOFF *et al.*, 1996 ; JASCHINSKI & SOMMER, 2010).

### 1.2.B.b. On seagrass

Grazers can consume epiphytes and maintain their biomasses and coverage at "normal", acceptable levels. By doing so, they release the seagrass from competition for nutrients and/or light, and limit the adverse effects of over-epiphytism. They are therefore generally regarded as having an overall positive, indirect effect on seagrass production (JERNAKOFF *et al.*, 1996 ; VALENTINE & DUFFY, 2006).

However, direct grazing on seagrass tissues can occur. In this case, the positive interaction can turn antagonistic. Actual negative impacts of mesograzers on seagrass biomass are rare, but can occur under given conditions (*e.g.* absence of alternative food source; DUFFY *et al.*, 2001 ; VALENTINE & DUFFY, 2006).

### 1.3. Objectives of this chapter

As exposed in the previous sections, mesograzers can have important influences on the functioning of seagrass meadows ecosystems. More precisely, in temperate meadows, amphipod crustaceans can have significant negative impacts on epiphytic biomass, and are therefore important items of the seagrass/epiphyte/grazer system. This is true for Atlantic *Zostera marina* meadows (NECKLES *et al.*, 1993 ; DUFFY & HAY, 2000 ; DUFFY & HARVILICZ, 2001), as well as for Australian *Posidonia sinuosa* (JERNAKOFF & NIELSEN, 1997) and *Heterozostera tasmanica* (HOWARD, 1982) beds.

In Mediterranean *Posidonia oceanica* meadows, amphipods are, alongside gastropods and polychaetes, one of the most abundant groups of vagile invertebrates (*cf.* chapter 3 ; GAMBI *et al.*, 1992). The dominant species feed on epiphytes, and rely, at least partially, on this resource (*cf.* chapter 4 ; LEPOINT *et al.*, 2000 ; VIZZINI *et al.*, 2002). However, no data exist concerning the impact of the epiphyte/amphipod relationships on the meadow functioning (BUJA *et al.*, 2000). In this context, the general aim of this chapter is to quantify the impact of amphipod feeding on the dynamics of the epiphytic cover of the leaves of *Posidonia oceanica*.

To fulfill it, we tried to characterize the epiphyte/amphipod trophic relationships from a triple point of view. First, we studied the impact of amphipod feeding on epiphytic biomass, community structure (*i.e.*, relative importance of functional groups) and eco-physiological parameters (organic C and N contents). Second, using stable isotope tracers, we investigated assimilation of epiphytic carbon and nitrogen by consumers, and its incorporation in their tissues. Third, we tried to quantify the transfer of epiphytic organic matter to the next trophic level, by measuring amphipod growth (*i.e.*, secondary production).

All these measurements were performed using *in vitro* and *in situ* microcosm experiment. The purpose of this double strategy was to combine the advantages, and to compensate for specific caveats associated with each type

of experiment. Assays were realized using three different amphipod taxa (*Apherusa chieraghinii*, *Dexamine spiniventris* and *Gammarus* spp.). Each of these taxa had different dietary preferences (cf. chap. 4), and we wanted to assess if they were linked with different impacts on epiphytic communities, or if these taxa could be considered as functionally redundant.

By doing so, our ultimate objective was to put back the results obtained in chapters 3 and 4 in the wider framework of the functioning of the *Posidonia oceanica* meadow as an ecosystem.

## **II. Material & Methods**

A full description of the study site, the sampling method for amphipods and the data processing procedures can be found in chapter 2.

### **II.1. Choice of target species**

As mentioned in section I.3, we performed the experiments on three different taxa characterized by partly different diets, in order to assess the degree of ecological redundancy existing among the studied community.

*Apherusa chieraghinii* is by far the most abundant amphipod in *Posidonia oceanica* meadows of Calvi Bay (50-55 % of the total effective of sampled amphipods, cf. chapter 3). This choice is therefore self-explanatory. This species has a mixed diet, and feeds preferentially on macroalgal epiphytes from leaves and litter fragments (cf. chapter 4).

*Dexamine spiniventris* is also one of the most abundant species of the studied community (about 5 % of all collected amphipods, cf. chapter 3). It also relies heavily on macroalgal organic matter, but contrary to *A. chieraghinii*, seems to specialize in consumption of epiflora from rhizomes. Its relatively large size (7 to 15 mm of total body size) makes it an interesting candidate, because it limits the number of individuals that have to be pooled for specific measurements, notably stable isotope ratios.

*Gammarus aequicauda* is a less frequent species (less than 2 % of sampled animals, cf. chapter 3). However, it has several interesting characteristics. First, contrary to the two precedent species, its life history, and the one of other species of the genera *Gammarus*, is relatively well described (KEVREKIDIS & KOUKOURAS, 1989a, 1989b ; PRATO & BIANCOLINO, 2003 ; PRATO *et al.*, 2006). Second, literature suggests that it is possible to maintain this amphipod alive in artificial systems for long periods (PRATO *et al.*, 2006, 2008). Third, it is even bigger than *D. spiniventris*, making both handling and measurements easier. In *P. oceanica* meadows of Calvi Bay, it feeds on algal epiphytes from leaves and litter fragments and on *P. oceanica* detritus (chap. 4). However, this species and close relatives are known to feed on various items in both artificial (CRUZ-

---

Functional role of amphipod grazing in epiphyte dynamics

RIVERA & HAY, 2000 ; PRATO *et al.*, 2006) and natural conditions (BIANDOLINO & PRATO, 2006).

Before the experiments, *a priori* identification of amphipods was performed using observation of live animals and photographs. This method can unfortunately lead to taxonomic confusions. The accuracy of identifications was checked *a posteriori*, on the animals collected and sacrificed for experimental purposes. No problems were apparently present concerning *A. chiereghinii* or *D. spiniventris*. However, a minor proportion (5-10 %, depending on the experiment) of animals considered as being *G. aequicauda* actually belonged to the morphologically close *G. crinicornis* or *G. subtypicus*. Consequently, we chose to be cautious, and to use the term "*Gammarus* spp." over the course of this chapter.

Taken together, these three species represent about 60 % of total abundance of amphipods in Calvi Bay as depicted in chapter 3. Their contribution to total amphipod biomass is likely even higher, in relation with the large size of the two latter taxa.

## **II.2. Determination of grazer biomass**

Since we wanted to measure initial grazer biomass at the beginning of the experiments, we needed a way to estimate this parameter without sacrificing the animals. We therefore investigated the relations between amphipod body mass and length.

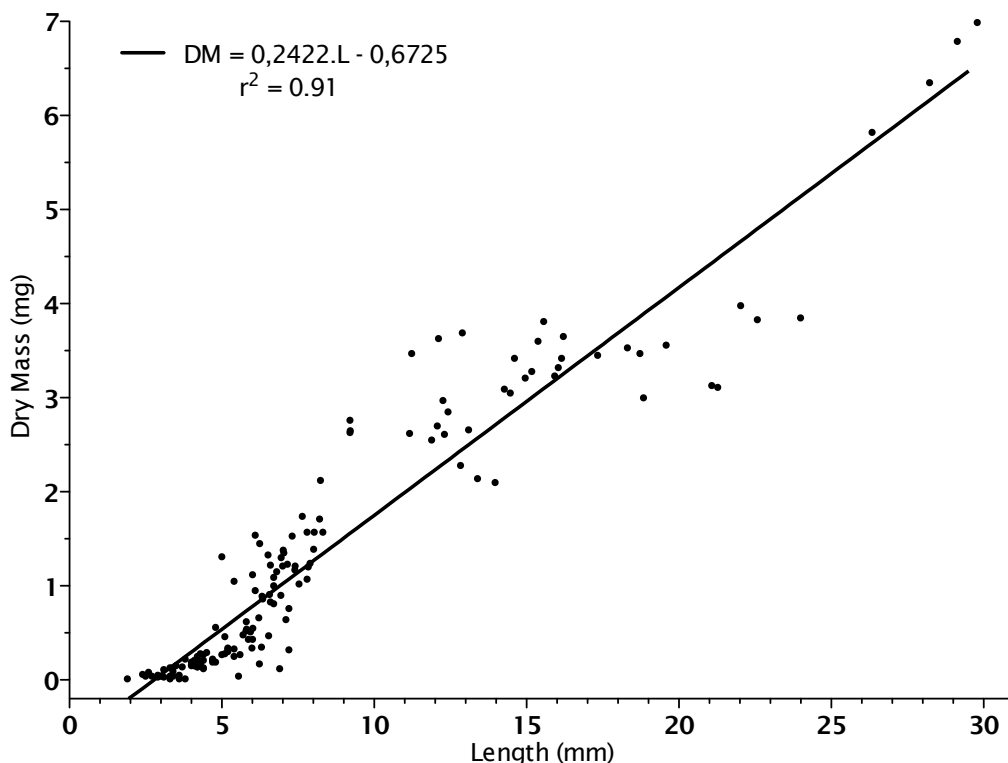
Our dataset included 151 amphipods (56 *Apherusa chiereghinii*, 57 *Dexamine spiniventris* and 38 *Gammarus* spp.), collected in November 2008, March 2009 and May 2009. All these animals were photographed alive using a Zeiss DV4 binocular microscope fitted with a DeltaPix DP200 camera. Images were taken using DeltaPix View Pro AZ v1.10.1 for Windows. Using the same software, we measured total body length (from the basis of the antennas to the basis of the telson) and head length of all amphipods. Animals were then euthanatized and their wet mass was recorded. They were subsequently oven-dried for 72 hours at 60°C, and their dry mass was measured.

Using Prism v5.0c for Mac OS X, we tested several linear regressions, including total body length vs. dry mass, head length vs. dry mass, total body length vs. wet mass and head length vs. wet mass. For all these parameters, we tested global regressions (using the total dataset) as well as taxon-specific ones. In all cases, we assessed linear, quadratic, and polynomial regressions. Of all of these attempts, the best fit (highest  $r^2$ ) was found for the linear regression of total body length vs. dry mass using complete dataset. This relation is pictured in figure 5.2.

Data were a little scattered, but the Pearson's correlation coefficient was very high (0.91), and we therefore considered this empirical relation satisfying for experimental purposes. We subsequently explored its reliability by measuring both total body length and dry mass of amphipods at the end of the

experiments. It proved to be efficient, as actual (*i.e.*, measured by weighing) dry mass and theoretical (*i.e.*, calculated using the linear regression) dry mass usually differed by less than 10 % in the almost all cases.

Since this method was proven reliable, we used it to compute all initial and final biomasses for secondary production estimates. Biomasses of grazers for stable isotopes ratios and elemental contents analysis, on the other hand, were directly and precisely measured.



**Fig. 5.2:** Linear regression (solid black line) between dry body mass (DM, expressed in mg) and total body length (in mm) of studied amphipods. Each point is an individual amphipod.

### **II.3. *In vitro* experimental design**

*In vitro* experiments allow delineating clear effects, as simplified systems feature controlled conditions, therefore excluding most secondary sources of variations in the parameters. They also allow direct observations on the behaviours of the animals, and make intermediate sampling easy. However, they have drawbacks, the biggest being the lack of representativeness. Conditions in artificial systems can indeed move away from those actually present in the field. Therefore, it is often hard to understand how the observed effects are realized *in situ*.

### II.3.A. Experimental set-up

Each of the 8 *in vitro* microcosms consisted of two nested 15 L plastic boxes. The top one constituted the actual microcosm. It received constant supply of seawater, dispensed by the seawater circuit of the STARESO Research station. The supplied seawater was filtered on 400 µm nylon mesh, to prevent potential contamination by grazers and/or large detritus. The bottom of the top container was removed and replaced with 400 µm nylon mesh. This mesh size allowed water to flow and fine detritus to sink in the bottom plastic box, but confined the grazers in the top part. The bottom container was merely a discharge chamber, and was equipped with a tube to evacuate the water out of the microcosm. The purpose of this design was to set up a continuous flow system that does not suck the grazers out of the tanks, nor submits them to constant aspiration forces that could harm them or disturb their behaviour.

The permanent water flow was regulated in such way that the total volume contained in each microcosm was renewed in about one hour. Over the course of the experiments, oxygen was supplied permanently, and temperature was checked twice a day. In all treatments, it was slightly higher than the one recorded *in situ* (generally by 1-2°C), but matched its temporal variation. Photoperiods of artificial light supply coincided with actual day/night cycles. The nylon mesh filter of the water supply was cleaned twice a day to avoid clogging.

### II.3.B. Seagrass mimics as a substratum for epiphytes

For this experiment, we wanted to keep the design as simple as possible. One ideal set-up would have been tanks containing only *Posidonia oceanica* leaves covered with natural population of epiphytes, and amphipod grazers. However, seagrass leaves are organs that cannot survive alone. The use of full seagrass shoots implies the use of a sediment layer to root the plants, and large volumes of water. Even in such conditions, survival of *Posidonia oceanica* can be weak, and plant stress is important, resulting in increased leaf necrosis and decay (JACQUEMART, Pers. Comm. ; Pers. Obs.).

Besides issues linked to the physiological status of the host plant, such set-up would have been tremendously complicated to control. In particular, growth of the numerous populations of bacteria and microorganisms associated to some part of the plants (*e.g.* small contours and anfractuosités of the rhizomes) could have been unpredictable.

Since we wanted to provide living epiphytes, and nothing else, as a food source for amphipod grazers, we used seagrass mimics as substratum for epiphytes.

Artificial *Posidonia oceanica* leaves consisted in black, rectangular plastic pieces of 50 cm X 1 cm. One of these mimics is included with each copy of this dissertation, to be used as a bookmark. 220 mimics were tied to plastic frames, each one being spaced from the next by 5 cm. We fastened two 2 ml



ependorf tubes at the top end of each mimic, to act as floats and ensure adequate position of the artificial leaf in the water column.

The frames bearing the virgin seagrass mimics were immersed among the *Posidonia* meadow, at a depth of 10 meters, for 76 days (from 12/03/2009 to 27/05/2009) to allow development of epiphytes on their surface (see fig. 5.3). At the end of the colonization period, 12 mimics were collected to estimate initial biomass, isotopic ratios and elemental contents of C and N of epiphytes, and 5 other to examine the structure of the epiphytic cover.



**Fig. 5.3:** Seagrass mimics covered with epiphytes at the moment of retrieval (27/05/2009).

### II.3.C. Addition of epiphytes and grazers to microcosms

The microcosms were separated in two sets of 4. In the first one, the **epiphytes** were unmodified, and in the other, they were artificially labelled with  $^{13}\text{C}$  and  $^{15}\text{N}$ .

In the case of the first set (natural isotopic abundances), 20 seagrass mimics were simply placed in each tank.

In the case of the second set (isotopic labelling), 90 seagrass mimics were placed in a common tank. We labelled them for 24 hours with  $^{13}\text{C}$ -enriched

---

 Functional role of amphipod grazing in epiphyte dynamics

NaHCO<sub>3</sub> (Sodium Bicarbonate - 99% <sup>13</sup>C, Cambridge Isotope Laboratories) supplied at a concentration of 200 µM. During the last hour, we added <sup>15</sup>N-enriched NH<sub>4</sub>Cl (Ammonium Chloride - 99% <sup>15</sup>N, Cambridge Isotope Laboratories) at a concentration of 1 µM. After labelling, 20 seagrass mimics were placed in each of the 4 tanks, and the last 10 were processed for stable isotope ratios measurement, in order to determine the efficiency of our isotopic labelling.

**Grazers** were sampled using light traps (see chapter 2). This method was chosen because it was less likely to cause physical damage to the animals than the hand-towed net. Amphipods indeed enter the light traps actively, and the whole trap is then collected, without direct handling of the animals. *A contrario*, when using a hand-towed net, animals are in immediate contact with the sampling device, which can hurt or sometimes even kill them (Pers. Obs.).

In each of the two sets, one of the tanks was set up as a different treatment: one control (no grazers), one containing *Apherusa chiereghinii* (150 individuals), one containing *Dexamine spiniventris* (50 individuals) and one containing *Gammarus* spp. (40 individuals). Each of the grazer was photographed individually to estimate its initial biomass (see section II.2. of this chapter). We used different population effectives to account for the different individual biomasses of each taxon, as our aim was to have similar total grazer biomasses in each treatment.

The addition of grazers to the microcosms coincided with the beginning (T<sub>0</sub>) of the experiment. This T<sub>0</sub> was on 31/05/2009 for the first set of microcosms, and on 01/06/2009 for the second set of microcosms.

### II.3.D. Sampling strategy

In the **first set** of experiments, we sampled 3 seagrass mimics after 7 days (T<sub>7</sub>), 3 others after 14 days (T<sub>14</sub>), and 3 others after 21 days (T<sub>21</sub>). The purpose of these samples was to monitor the evolution of epiphytic biomass, stable isotope ratios and C and N elemental contents over time.

At the end of this set of experiments (after 28 days, T<sub>28</sub>), we collected 5 seagrass mimics for biomass/stable isotopes ratios/C & N content of epiphytes measurements, and 3 for epiphyte community structure examination. We also sampled the remaining grazers in each microcosm, to assess secondary production.

In the **second set** of experiments, sampling occurred after 3 (T<sub>3</sub>), 7 (T<sub>7</sub>), and 14 days (T<sub>14</sub>). At each time, we collected epiphytes (4 seagrass mimics) and grazers (20 *Apherusa chiereghinii*, 8 *Dexamine spiniventris* and 5 *Gammarus* spp.). The aim of these intermediary sampling events was to assess 1) evolution of epiphytic biomass and C/N ratio and 2) kinetics of assimilation of epiphytes by grazers, by measuring stable isotopic ratios of amphipods and artificially labelled epiphytes.

The experiments ended after 21 days ( $T_{21}$ ). Final sampling event consisted of 5 seagrass mimics and all the remaining grazers. Its purpose was identical to the intermediary ones.

## **II.4. *In situ* experimental design**

Since they occur directly in the field, biotic and abiotic conditions of *in situ* experiments are close or identical to actual situations. Their representativeness is therefore undoubtedly higher than the one of *in vitro* ones. On the downside, they have much higher logistical demands, and sampling and maintenance can get complicated. In addition, the vast arrays of phenomena occurring concomitantly in an isolated portion of a real ecosystem can complicate the interpretation of observed variations in the parameters of interest.

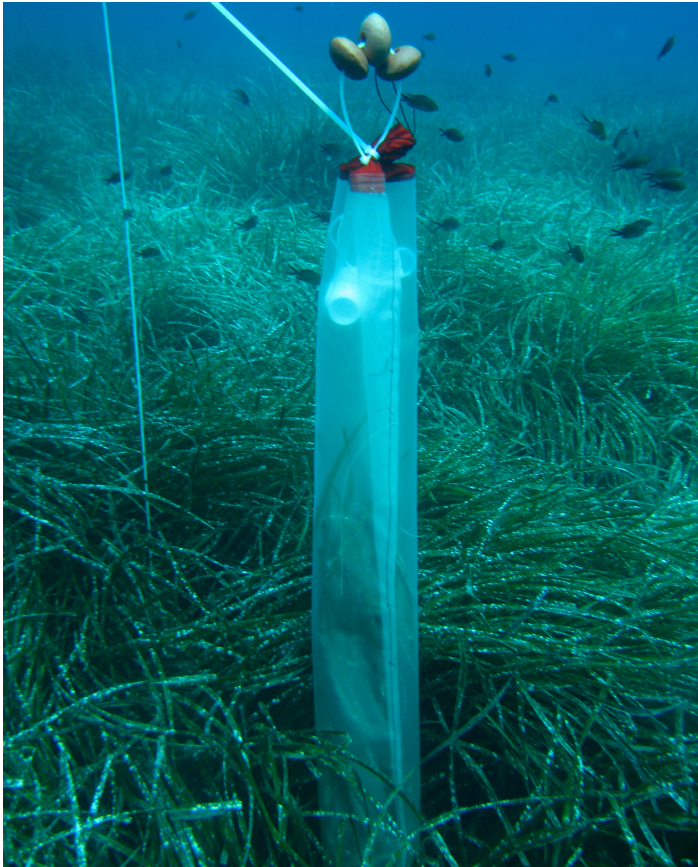
### **II.4.A. Experimental set-up**

The *in situ* microcosms consisted of cylinders of 20 cm diameter X 180 cm length. The main part of the microcosms was made of 400  $\mu\text{m}$  nylon mesh, but the terminal portion (last 15 cm) of each end was made of elastic fabric, to facilitate manipulations such as opening, closing and sealing of the microcosms.

Each microcosm was set up directly in the *Posidonia* meadow, at a depth of 10 m, on 08/06/2009. A patch of circa 10 shoots (8 to 11, depending on the cases) was randomly selected. We eliminated the vagile fauna by gently shaking the seagrass leaves, in order to cause grazer displacement without destroying the epiphytic cover. Each microcosm was then placed around the leaves. The bottom elastic part was tied around the rhizomes of the shoots, so that amphipods only had access to the foliar stratum. We sealed the microcosms as tight as possible using large plastic cable ties. In addition, each microcosm was anchored to the ground using 2 metallic stakes.

The top part was closed, and a float was attached to it to ensure adequate position of the microcosm in the water column. This, combined with the flexible nature of nylon mesh microcosm, reduced potential adverse effects of hydrodynamic forces. Figure 5.4 pictures on of the microcosms after placement

Four treatments were realized: one control without grazers, and three containing each a grazer taxon (*Apherusa chierighinii*, *Dexamine spiniventris* and *Gammarus* spp.). Each treatment was replicated twice, giving a total of 8 microcosms. In addition, we realized a procedural control (later referred to as "double control") consisting of a patch of 10 shoots without microcosm. The purpose of this procedural control was to ensure that the microcosm itself had no effect on the epiphyte community or the seagrasses (notably by light limitation).



**Fig. 5.4:** One of the microcosms during the *in situ* grazing experiment.

#### II.4.B. Grazer addition, maintenance and final sampling

As for the *in vitro* experiment, grazers were sampled using light traps. They were identified and individually photographed for biomass estimation. Population sizes were 50 individuals for *Apherusa chieraghinii*, and 20 individuals for *Dexamine spiniventris* and *Gammarus* spp.

Each population was placed in a 150 ml plastic container filled with oxygen-saturated seawater. The containers were closed, and grazers were immediately transferred to the *in situ* microcosms.

The top of the microcosms was opened, and the full, closed containers were inserted inside. The microcosms were then tightly closed, and only at this stage, the containers were opened and the grazers released. This was done by handling the container indirectly, through the flexible microcosm mesh wall. This operation was made easier by the fact that containers had a small rope handle attached to their lid. Pulling this handle was sufficient to open the container, and this design insured that no grazer could escape the microcosm during the addition step.

T<sub>0</sub> of the *in situ* experiments was on 09/06/2009 for one replicate of each treatment, and on 10/06/2009 for the other replicate. During the course of the experiment, maintenance dives were performed twice a week to ensure that metal stakes remained in place, and gently scrub off the epiphytes that developed on the microcosm mesh with a brush. Temperature was monitored permanently.

The experiment was ended after 21 days. At this stage, all *P. oceanica* shoots were cut at the rhizome level, and the microcosms were brought back to the lab unopened. They were then opened, and we collected the *Posidonia oceanica* leaves of each shoot (and therefore the epiphytes that they beared) and the remaining amphipod grazers.

## **II.5. Sample processing**

### **II.5.A. Epiphyte collection**

In the case of biomass, stable isotope ratios and elemental contents measurements, seagrass mimics or leaves were either processed directly or frozen at -28°C. Their epiphytes were scraped under a binocular microscope, using a scalpel blade. They were separated in 4 functional groups: erected algae, encrusting algae, erected animals and encrusting animals.

In the case of samples collected during the *in vitro* experiment for epiphyte community structure assessment, seagrass mimics were fixed with a formaldehyde solution (4% in seawater) for 48 hours, and then transferred to 70 % ethanol for preservation. They were later examined qualitatively under a binocular Zeiss DV4 microscope.

### **II.5.B. Biomass measurements**

Epiphytes were oven-dried at 60°C for 72 h after their separation in functional groups. Their biomass was subsequently determined at a precision of 0.01 mg using an analytical balance (Mettler-Toledo AX105 DeltaRange). Reproducibility range of successive weighing was  $\pm 0.04$  mg.

*Posidonia oceanica* leaves from the *in situ* experiment were measured (total length and total width), checked for potential grazing marks, and then oven-dried and weighed in the same way as epiphytes.

Grazer biomass was determined via an identical procedure of oven drying and weighing for stable isotope ratios and elemental contents. However, for estimation of secondary production and growth rates, it was inferred using total body length measurements. More information can be found in section II.2 of this chapter.

### II.5.C. Stable isotope ratios & relative elemental contents

Stable isotope ratios and relative elemental contents of C and N were determined using a Carlo Erba NA1500 elemental analyser coupled to an Isoprime Optima isotope ratio mass spectrometer. The analytical methodology was similar to the one described in sections II.3.C and II.3.D of chapter 4. In some cases (notably erected algae from the late treatments of *in vitro* experiments, or erected animals of *in situ* experiments), the biomass was low, and we had to pool epiphytes from several items (mimics or shoots) to perform reliable measurements.

## III. Results

### III.1. *In vitro* grazing experiments

#### III.1.A. Composition of the epiphytic cover of seagrass mimics

We examined the composition of the epiphytic cover of seagrass mimics at the T<sub>0</sub> of the experiment, after they spent 76 days immersed among a real *Posidonia oceanica* meadow at a depth of 10 m.

The most striking feature was the scarcity of epifauna. Erected sessile animals were completely absent. Crustose epifauna was rare, and consisted only of foraminiferans (mostly *Cibicides* sp.) and polychaetes (*Spirorbis* sp.). No bryozoans were found on any examined seagrass mimics, not even *Electra posidonae*, extremely common on *P. oceanica* leaves. Due to their insignificance in the epiphytic cover, animal epiphytes will not be considered in the following of this section.

Algae, on the other hand, were abundant on all seagrass mimics. We found crustose algae, essentially Corallinales (notably *Pneophyllum* sp.). Erected algae were drastically dominated by *Ectocarpus silicosus* (Phaeophyceae), whose thalli formed long filaments (sometimes several cm). Other abundant taxa included *Sphacelaria cirrosa* (Phaeophyceae), *Acrochaetium* sp. and *Polysiphonia* sp. (Rhodophyceae).

Other algae, such as *Dictyota dichotoma*, *Castagnea* spp. (Phaeophyceae), *Chondria* sp. and *Ceramium* spp. (Rhodophyceae), were occasionally encountered, but were less abundant.

*Giraudya sphacelarioides*, *Myrionema orbiculare* (Phaeophyceae), *Pringsheimiella* sp. and *Bryopsis* sp. (Chlorophyceae) were present, but rare on the examined *P. oceanica* mimics.

It is also worth noting that secondary epiphytism (*i.e.*, epiphytes using other epiphytes as substratum) was relatively limited, and that third or upper order epiphytism was not reported.

At the end of the 1<sup>st</sup> set of experiments (after 28 days), erected algae were less abundant on the artificial leaves of the control treatment. In addition, some leaves showed a low, but frequent colonization by *Enteromorpha* sp.

Occurrence of encrusting algae, on the other hand, seemed to be similar at  $T_{28}$  and  $T_0$ .

At  $T_{28}$  in treatments containing grazers, erected algae were scarce or nearly absent. As in the control treatment, occurrence of encrusting algae was apparently unchanged.

### III.1.B. Biomass of epiphytic groups

Figure 5.5 shows the temporal evolution of the biomasses of erected algae during the two sets of experiments. By looking at the top part of figure 5.5, one can easily notice that biomass of erected algae decreased over time in the control treatment of the first set of experiments.

This decrease was important, as a three-fold reduction was noted over the 28 days of the experiment (mean biomass dropping from 43.85 mg/artificial leaf to 14.76 mg/artificial leaf).

Besides this, the biomass of erected epiflora was significantly lower in all treatments containing grazers, at all sampling events (Kruskal-Wallis test followed by Dunn's post-hoc test,  $p$  always  $< 0.01$ ).

On the other hand, biomass was similar in all grazer treatments at all sampling events but  $T_{28}$ . At this time, the biomass was lower in the treatment containing *Gammarus* spp. than in the ones containing *Apherusa chiereghinii* and *Dexamine spiniventris* (Kruskal-Wallis test followed by Dunn's post-hoc test,  $p = 0.028$  and  $0.032$ , respectively).

In the second set of experiments (bottom part of fig. 5.5), the global trend was similar to the one seen in the first set for all treatments. However, it is worth noticing that after 3 days ( $T_3$ ), biomasses were not significantly different between control and grazed treatments yet (Kruskal-Wallis test,  $p = 0,084$ ).

Figure 5.6 shows the evolution of the biomass of the crustose part of the epiflora over time. In neither of the two sets is it not possible to delineate a consistent temporal trend in any treatment. Moreover, in all treatments of both sets of experiments, biomasses of crustose algae at the beginning and at the end ( $T_{21}$  or  $T_{28}$ ) were statistically identical (Mann-Whitney tests,  $p$  always  $> 0.05$ ).

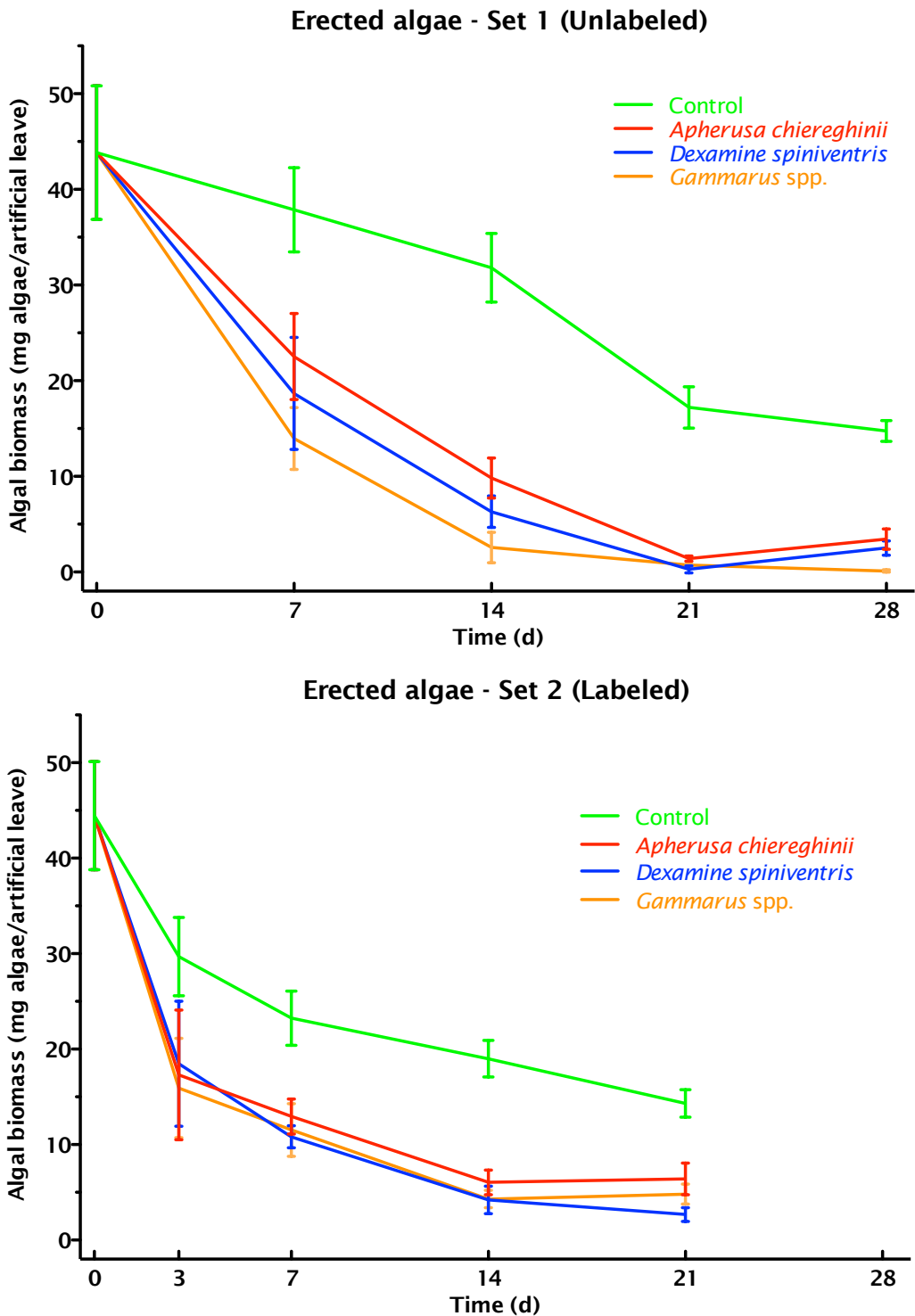


Fig. 5.5 Evolution of the biomasses of erected algae in the first (top) and second (bottom) set of grazing experiments. Biomasses are expressed in mg per artificial leaves, and data are pictured as means  $\pm$  standard deviations.



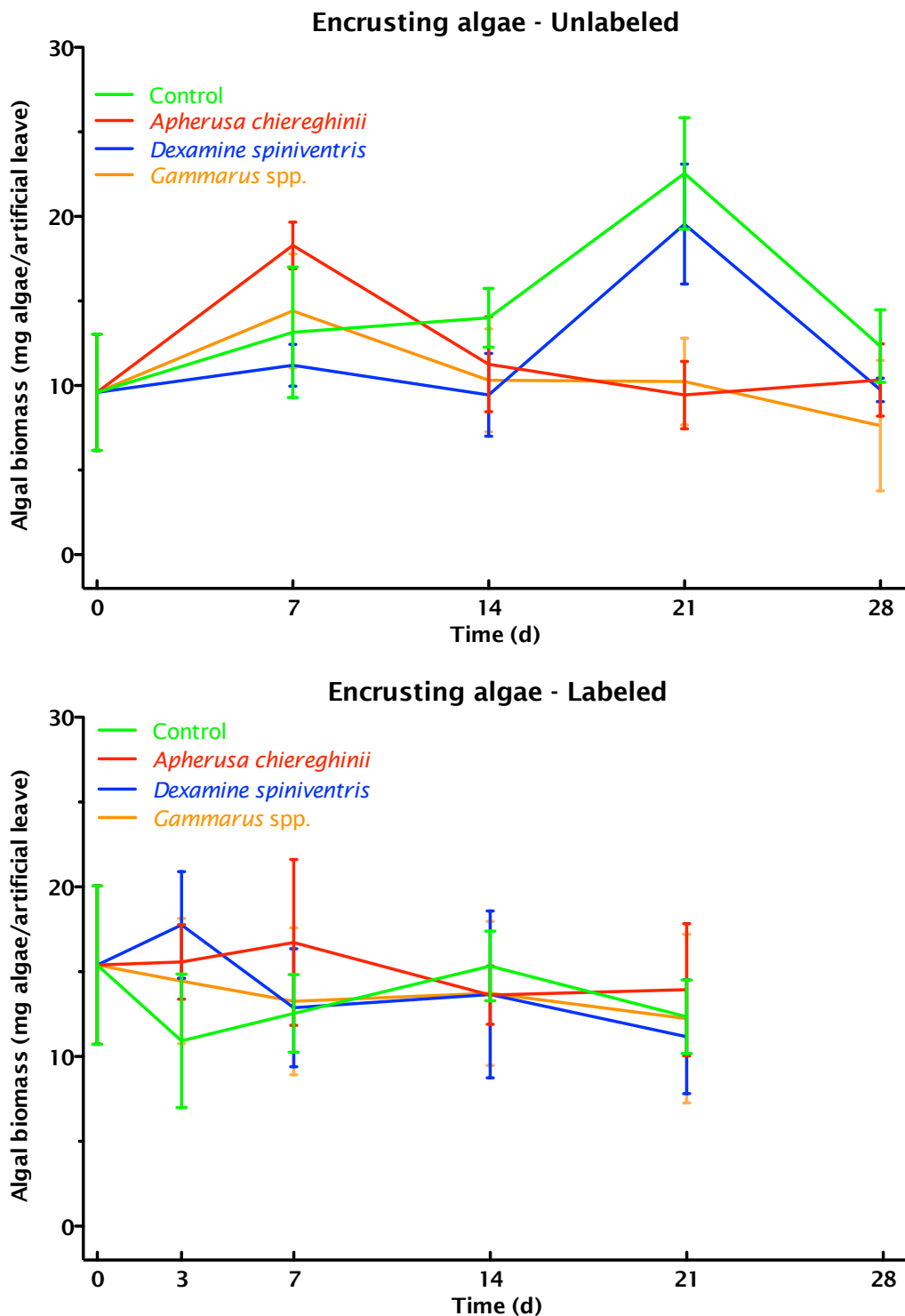


Fig. 5.6: Evolution of the biomasses of encrusting algae in the first (top) and second (bottom) set of grazing experiments. Biomasses are expressed in mg per artificial leaves, and data are pictured as means  $\pm$  standard deviations.

### III.1.C. Elemental concentrations of epiphytes

Figure 5.7 pictures the changes of elemental concentrations of epiphytes' tissues across the 21 days of the second set of experiment. All elemental concentrations were expressed as C to N ratios, calculated using relative elemental concentrations of organic C and N ([C] and [N], expressed in percentage of the total dry mass of the sample).

Sampling strategy from the 1<sup>st</sup> set of experiment (see section II of this chapter) did not provide enough material to compute consistent C to N ratios for all times, resulting in partial datasets, even after pooling. They are therefore not displayed here.

Erected algae from the control treatment (top part of fig. 5.7, green line) show a progressive decrease of the C/N ratio that is linked with higher N contents in the algae. This decrease was more important in treatments where grazer were present. The difference is not significant at T<sub>3</sub> (Kruskal-Wallis test,  $p = 0.074$ ), but all "grazed" treatments had lower C/N ratios at T<sub>7</sub> and T<sub>14</sub> (Kruskal-Wallis test followed by Dunn's post-hoc test,  $p$  always  $< 0.05$ ). At T<sub>21</sub>, three statistically different groups could be distinguished (Kruskal-Wallis + Dunn's tests,  $p = 0.027$ ). The control treatment had the highest C/N ratios, and the treatments containing *Dexamine spiniventris* and *Gammarus* spp. the lowest. The *Apherusa chiereghinii* treatment had intermediate, yet different from all others, C/N ratios.

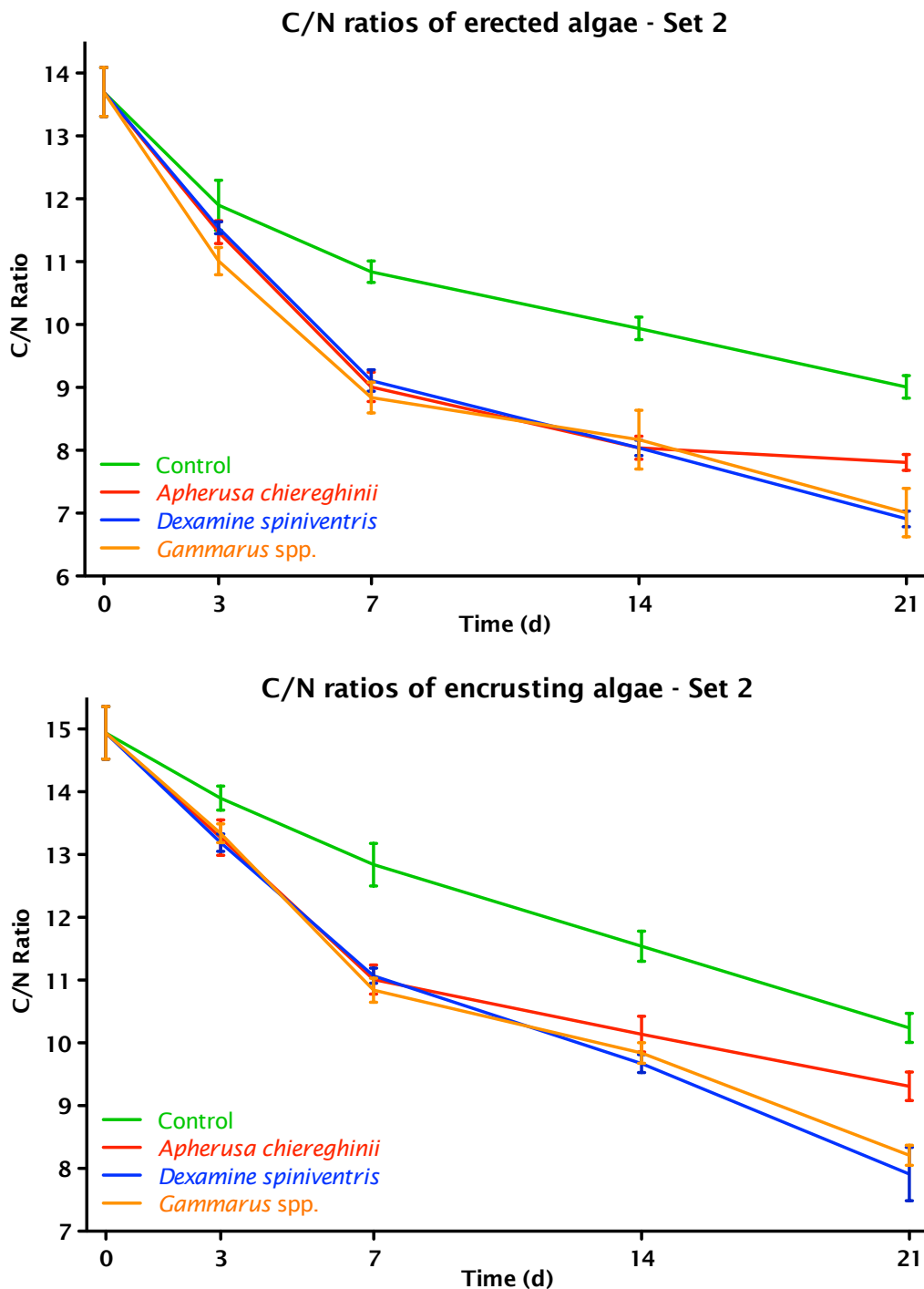
The C/N ratios of crustose algae (fig. 5.7, bottom part) showed an exactly similar trend as those of the erected ones. Ratios from all treatments were undistinguishable at T<sub>3</sub>, but all grazer treatments had lower ratios at T<sub>7</sub> and T<sub>14</sub>. At T<sub>21</sub>, it was possible to discriminate between three groups (C/N Control  $>$  C/N *Apherusa chiereghinii*  $>$  C/N *Dexamine spiniventris* & C/N *Gammarus* spp.).

### III.1.D. Assimilation of epiphytic organic matter by grazers

#### III.1.D.a. Set 1: Natural abundances

Figure 5.8 (p. 196) shows the isotopic ratios of epiphytes and grazers during the first set of experiments, using the classic  $\delta^{13}\text{C}$  vs.  $\delta^{15}\text{N}$  biplot. Since encrusting and erected animals had similar signatures at both T<sub>0</sub> and T<sub>28</sub> (Kruskal-Wallis test,  $p = 0.547$ ), we used global values of  $\delta^{13}\text{C}$  and  $\delta^{15}\text{N}$  (means of all samples, without distinction of category or time).

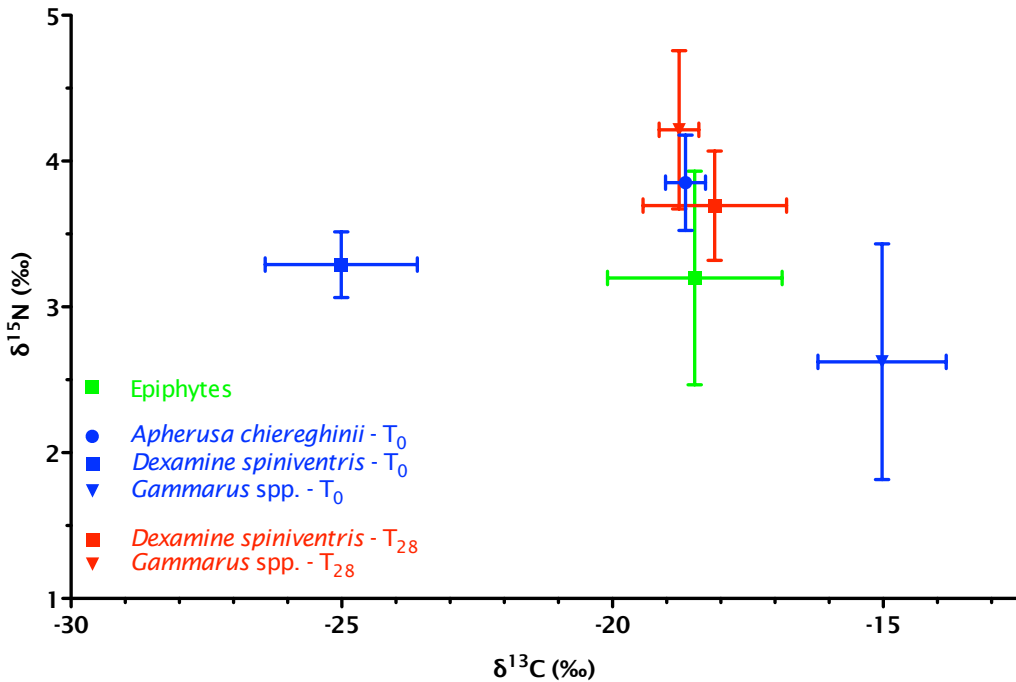
At T<sub>0</sub>, the  $\delta^{13}\text{C}$  of *Dexamine spiniventris* ( $-25.0 \pm 1.4$  ‰) was significantly different than the one of epiphytes ( $-18.5 \pm 1.6$  ‰, Mann-Whitney test,  $p < 0,001$ ). At T<sub>28</sub>, the  $\delta^{13}\text{C}$  of *D. spiniventris* had shifted towards the less negative value of  $-18.1 \pm 1.4$  ‰. At this time, it was different from the initial signature (Mann-Whitney test,  $p = 0.009$ ), but identical to the epiphytes' signature (Mann-Whitney test,  $p = 0.621$ ).  $\delta^{15}\text{N}$  of *D. spiniventris* at T<sub>0</sub> and T<sub>28</sub>, as well as  $\delta^{15}\text{N}$  of epiphytes, were not statistically different (Kruskal-Wallis test,  $p=0.143$ ).



**Fig. 5.7:** Evolution of the C to N ratios of erected (top) and encrusting (bottom) epiphytic algae in the second set of grazing experiments. C/N ratios are unitless, and data are pictured as means  $\pm$  standard deviations.

## Functional role of amphipod grazing in epiphyte dynamics

At  $T_{28}$ , the mean  $\delta^{13}\text{C}$  and  $\delta^{15}\text{N}$  for *D. spiniventris* were  $+0.4\text{‰}$  and  $+0.6\text{‰}$ , respectively.



**Fig. 5.8:** Isotopic ratios ( $\delta^{13}\text{C}$  &  $\delta^{15}\text{N}$ , expressed in ‰) of epiphytes (green square) and grazers for the 1<sup>st</sup> set of experiments. Blue symbols are signatures of amphipods at  $T_0$  (blue circle: *A. chiereghinii*, blue square: *D. spiniventris*, blue triangle: *Gammarus* spp.) and at  $T_{28}$  (red square: *D. spiniventris*, red triangle: *Gammarus* spp.). All values are means, all error bars are standard deviations.

The situation for *Gammarus* spp. was comparable. Its  $\delta^{13}\text{C}$  at  $T_0$  ( $-15.0 \pm 1.2\text{‰}$ ) is different from the one of epiphytes, but slide towards more negative values over the 28 days of the experiment to reach a final  $\delta^{13}\text{C}$  identical to the one of epiphytes ( $\delta^{13}\text{C} = -18.8 \pm 0.4\text{‰}$  at  $T_{28}$ ; Mann-Whitney test,  $p = 0.789$ ). No significant shift in  $\delta^{15}\text{N}$  was observed for this species either. At  $T_{28}$ , the mean  $\delta^{13}\text{C}$  was  $-0.3\text{‰}$ , and the mean  $\Delta^{15}\text{N}$  was  $+1\text{‰}$ .

$\delta^{13}\text{C}$  and  $\delta^{15}\text{N}$  of *Apherusa chiereghinii* were already merged with those of epiphytes at the beginning of the experiment. Unfortunately, no data are available for this species at the end of the experiment, due to the low survival rate (see section III.1.E for further information).

### III.1.D.b. Set 2: Isotopic labelling

For the second set of experiments, epiphytes were labeled with  $^{13}\text{C}$  and  $^{15}\text{N}$  prior to the introduction of grazers. Figure 5.9 (next and following pages) displays the evolution of the isotopic ratios of these labeled epiphytes.

The  $\delta^{13}\text{C}$  values of erected epiphytes of the control treatment (fig. 5.9 A, top part, green line) showed a global decreasing trend over the 21 days of the experiment, indicating dilution of the initial labeling. In the treatments containing grazers, this decrease was more important, and the  $\delta^{13}\text{C}$  were significantly lower in all grazed treatments for  $T_3$ ,  $T_7$ ,  $T_{14}$  and  $T_{21}$  (Kruskal-Wallis + Dunn's tests,  $p$  always  $< 0.05$ ).

Differences between grazed treatments did not follow a clear temporal pattern. At  $T_3$ , the treatment containing *Apherusa chiereghinii* showed lower  $\delta^{13}\text{C}$  than the two others, while at  $T_7$  it was the treatment containing *Gammarus* spp. that was in this case. At  $T_{14}$  and  $T_{21}$  all grazed treatments had statistically identical  $\delta^{13}\text{C}$  (Kruskal-Wallis test,  $p > 0.05$ ).

Evolution of the  $\delta^{15}\text{N}$  of the erected epiphytes over time (fig. 5.9 A, bottom part) was completely different. The control treatment also showed a drop of  $\delta^{15}\text{N}$  over time, but in this case all grazed treatment exhibited a lesser decrease, and had higher  $\delta^{15}\text{N}$  at all times.

Temporal trends in inter-grazer differences were more consistent in the case of  $\delta^{15}\text{N}$  than in the one of  $\delta^{13}\text{C}$ . Here, the  $\delta^{15}\text{N}$  of erected epiphytes from all grazed treatments coincided at  $T_3$ . However, at  $T_7$ ,  $T_{14}$  and  $T_{21}$ , epiphytes from the *A. chiereghinii* had lower  $\delta^{15}\text{N}$  than the two other ones (Kruskal-Wallis + Dunn's test,  $p < 0.05$ ), therefore occupying an "intermediate" position.

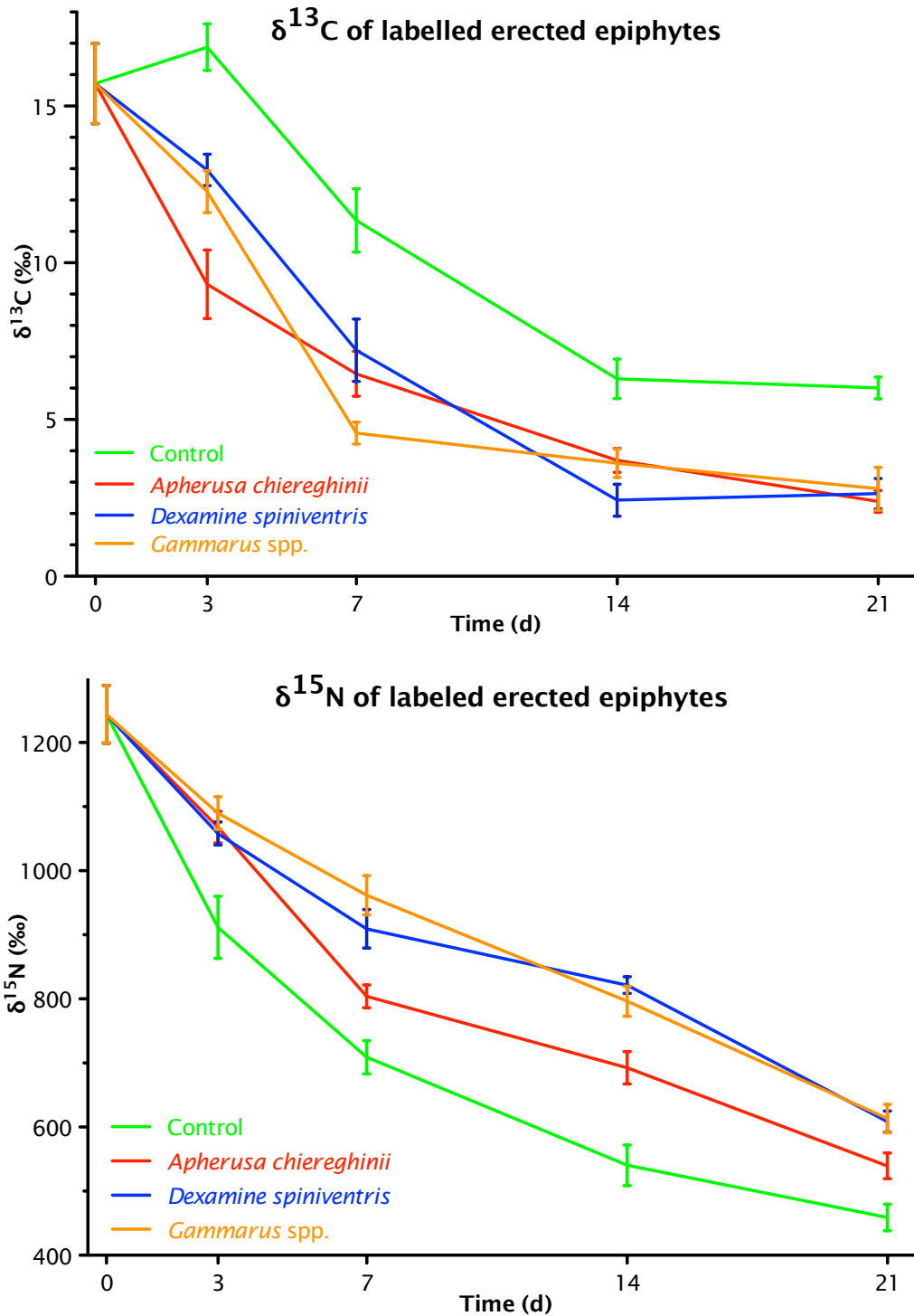
The situation was partly different for encrusting epiphytes.  $\delta^{13}\text{C}$  decreased similarly in all treatments, grazed or not.  $\delta^{15}\text{N}$  temporal patterns were mostly similar to those described for erected epiphytes, although labeling was not as efficient in this case (lower initial  $\delta^{15}\text{N}$ ).

We estimated the incorporation of  $^{13}\text{C}$  and  $^{15}\text{N}$  from labeled epiphytes into the tissues of the amphipod grazers. However, biomasses of grazers were different from a taxon to another, as well as between individuals of a single taxon. To account for inter- and intra-specific differences in body mass, we chose to express these quantities in mg of heavy isotope assimilated per mg of grazer rather than to use the raw  $\delta^{13}\text{C}$  and  $\delta^{15}\text{N}$ .

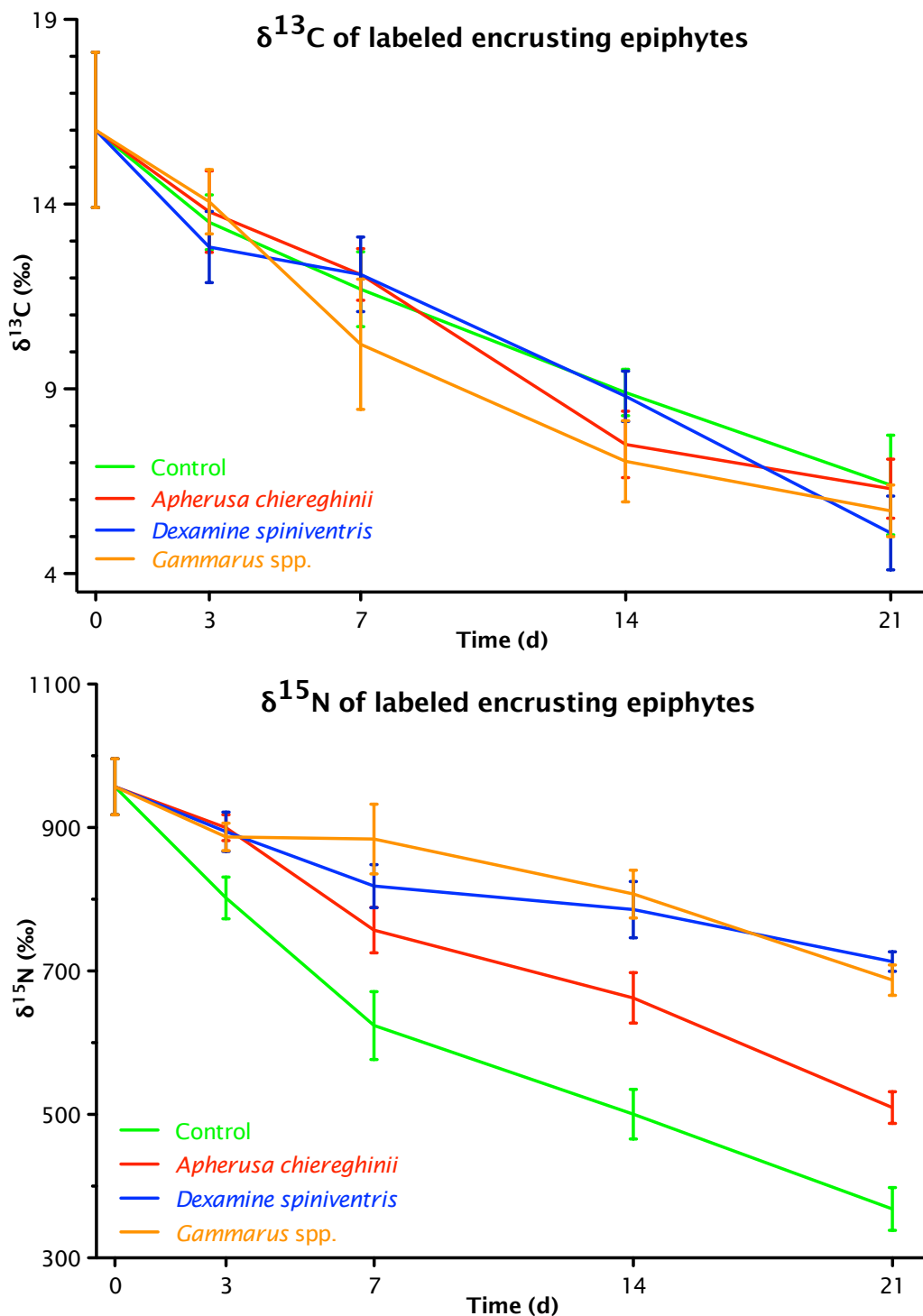
This value was calculated using

$$\text{Inc. } *I = \frac{*I_f - *I_0}{M_{gr}}$$

where "Inc. \*I" is the quantity of heavy isotope ( $^{13}\text{C}$  or  $^{15}\text{N}$ ) incorporated (expressed in mg of heavy isotope per mg of grazer),  $*I_f$  is the final quantity of heavy isotope present in grazer tissue (in mg),  $*I_0$  is the initial quantity of heavy isotope present in grazer tissue (in mg) and  $M_{gr}$  is the mass of grazer tissue analyzed (also in mg).



**Fig. 5.9 A:** Evolution of isotopic ratios of carbon (top part) and nitrogen (bottom part) of labeled erected algae over time during the second set of experiments. Isotopic ratios are expressed using  $\delta$  notations, in per mil. All points are means, all error bars are standard deviations.



**Fig. 5.9 B:** Evolution of isotopic ratios of carbon (top part) and nitrogen (bottom part) of labeled encrusting algae over time during the second set of experiments. Isotopic ratios are expressed using  $\delta$  notations, in per mil. All points are means, all error bars are standard deviations.

## Functional role of amphipod grazing in epiphyte dynamics

Assimilation of epiphytic-derived  $^{13}\text{C}$  and  $^{15}\text{N}$  is pictured in fig. 5.10 (pp. 201 and 202). It clearly shows that intra-specific dispersion of the values was extremely important in the case of both elements. This high variability prevents us to delineate any consistent temporal trend. Incorporation of  $^{15}\text{N}$  seemed to be more important for *Apherusa chiereghinii* (higher values at  $T_{3, 7}$  and  $T_{14}$ ), while incorporation was apparently lower in this species than in the two others, especially at  $T_{21}$ . However, due to low replication these observations are barely qualitative assumptions.

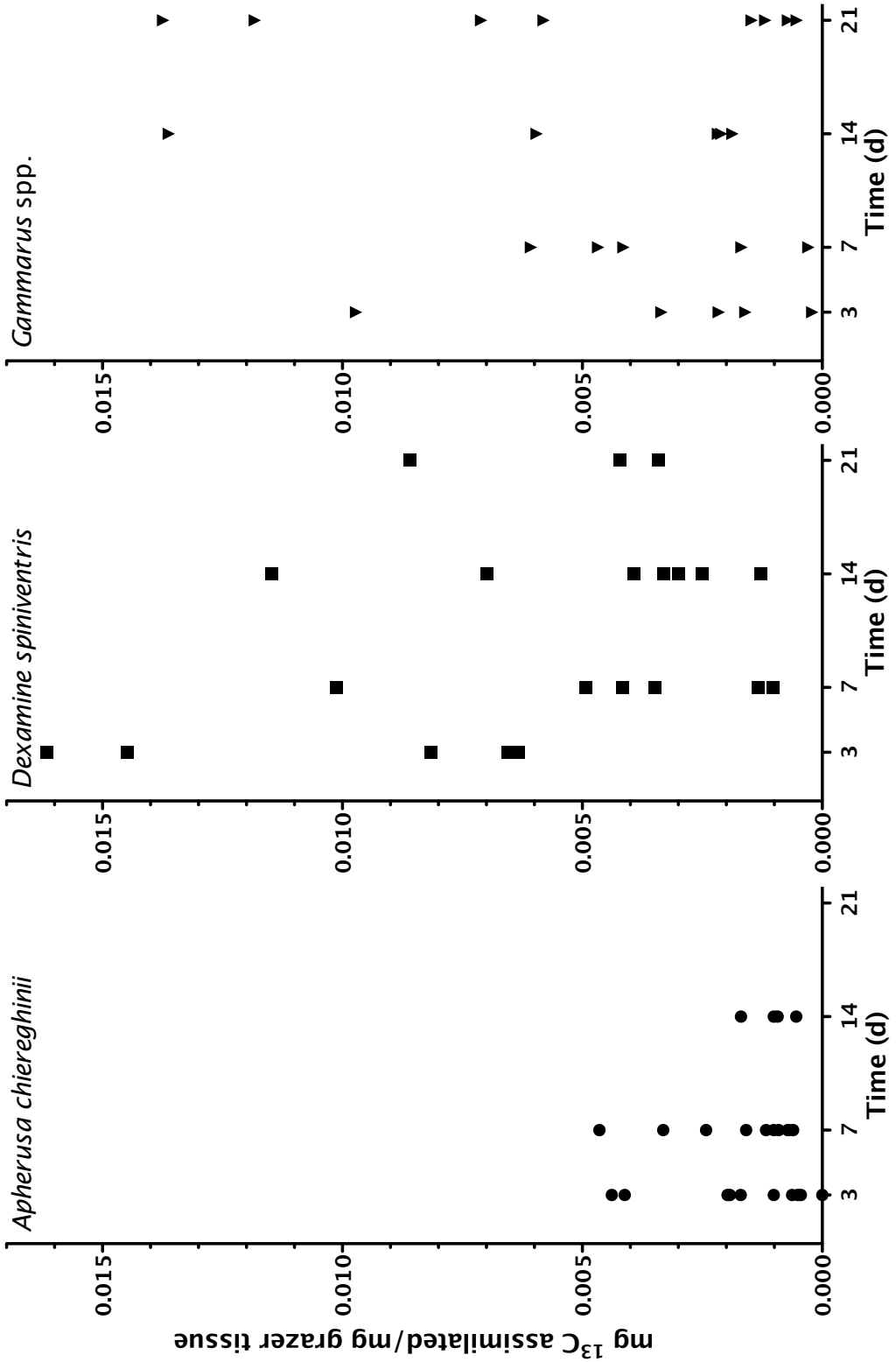
### III.1.E. Grazer survival

As stated in the material & methods section, 2 x 150 individuals of *Apherusa chiereghinii* (total dry biomass of 98.56 mg for the 1<sup>st</sup> set of experiment, and 104.21 mg for the 2<sup>nd</sup> one), 2 x 50 individuals of *Dexamine spiniventris* (total dry biomasses of 103.37 mg and 96.16 mg) and 2 x 40 individuals of *Gammarus* spp. (total dry biomasses of 108.64 mg and 101.99 mg) constituted the initial grazer biomass for these sets of experiments. Figure 5.11 gives the survival rates of amphipods for all treatments.

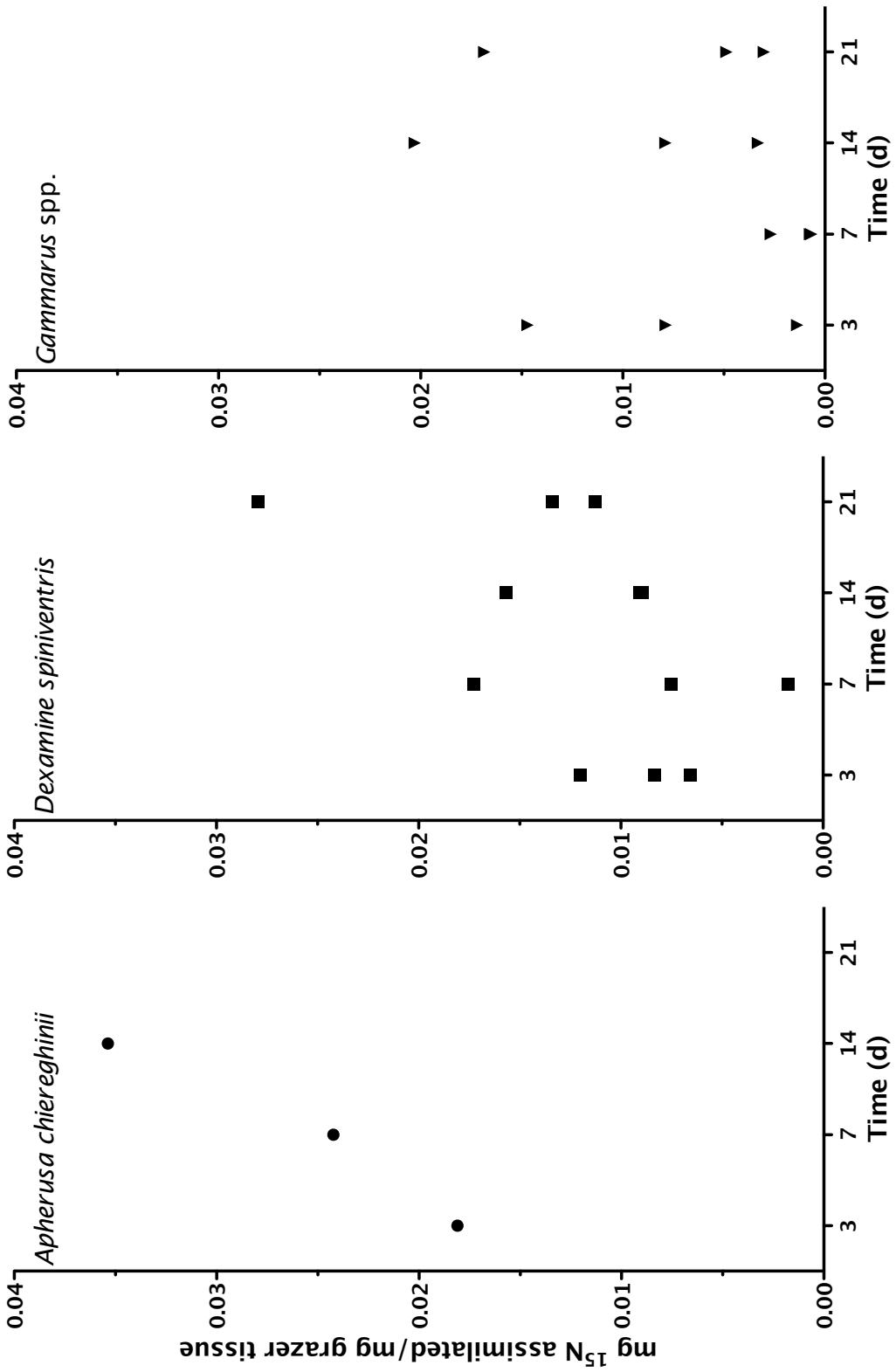
It clearly shows that the survival rates of amphipods were very low. The most extreme situation is the one of *Apherusa chiereghinii* treatments, where no amphipod survived past  $T_{21}$ , in neither of the sets. Even for *Gammarus* spp., the taxon that had the best survival rates, values remained under 40 %. Under these circumstances, we do not believe it is realistic to try to compute any secondary production estimates.

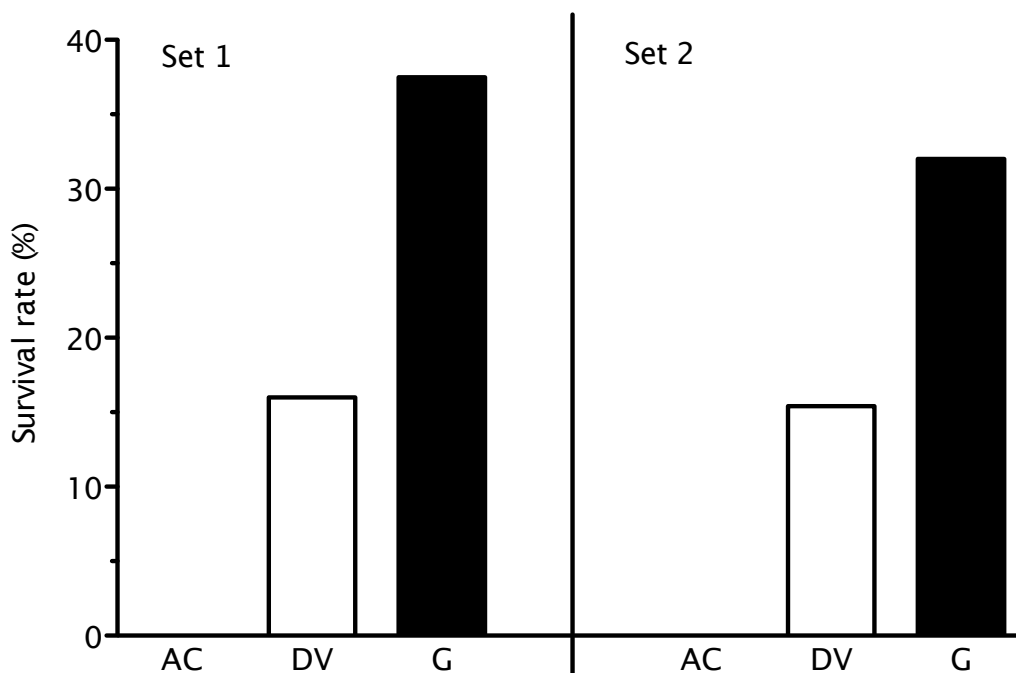
**Fig. 5.10:** Incorporation of  $^{13}\text{C}$  (next page) and  $^{15}\text{N}$  (p. 202) in grazer tissues during the second set of experiment. Circles: *Apherusa chiereghinii*, squares: *Dexamine spiniventris*, triangles: *Gammarus* spp. Incorporated quantities are expressed in mg of heavy isotope per mg of amphipod. All points are single measurements, of single individual measurement (for carbon) or pooled measurements (for nitrogen). Reader's attention is drawn to the different scales for the two parts of the figure.





## Functional role of amphipod grazing in epiphyte dynamics





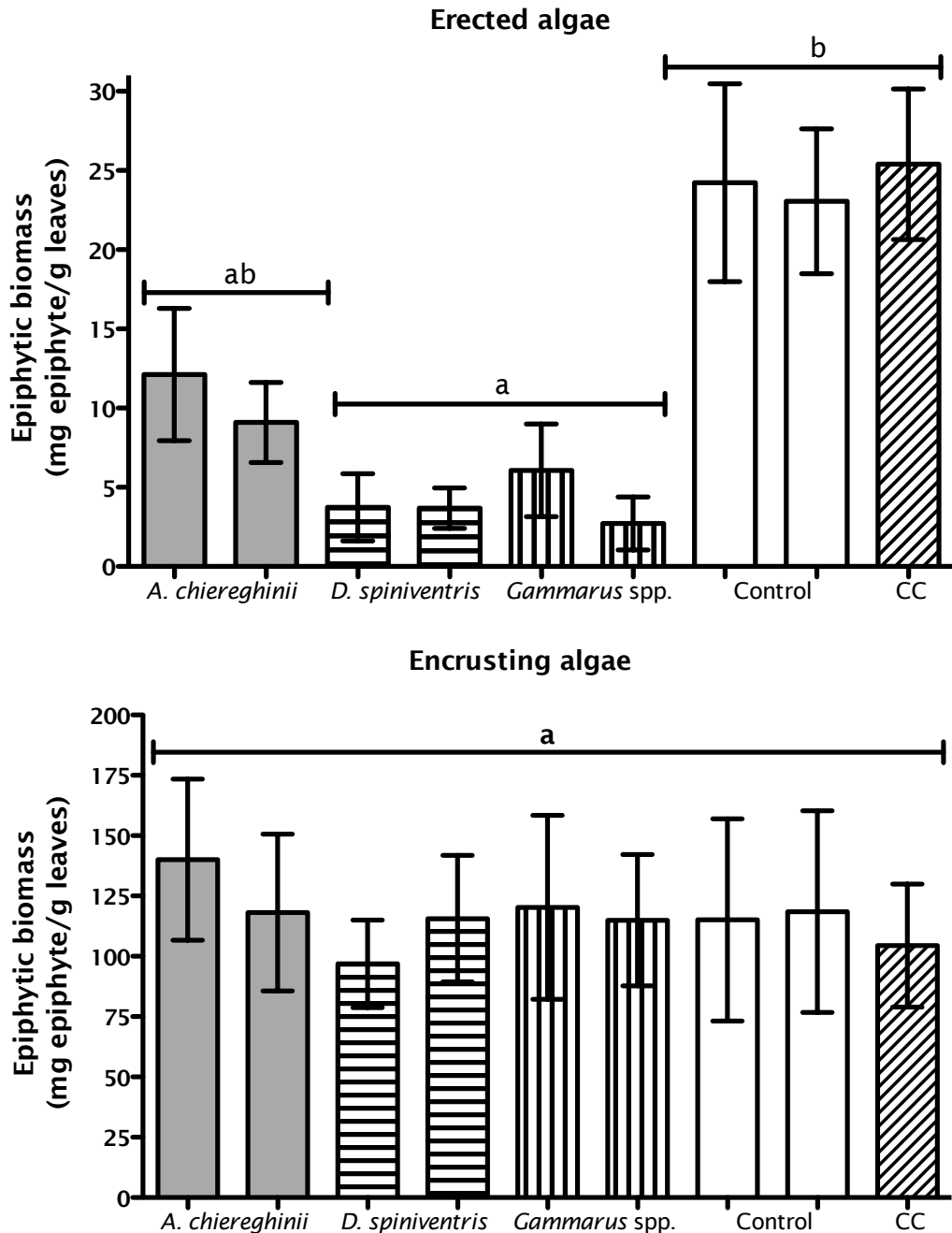
**Fig. 5.11:** Survival rates of amphipods during the grazing experiment. Left: survival rates during the first set of experiments (28 days), expressed in percentage of the initial effective. Right: survival rates during the second set of experiments (21 days), expressed in percentage of the actual effective (initial effective minus sampled effective). AC: *Apherusa chiereghinii*, DV: *Dexamine spiniventris*, G: *Gammarus* spp.

### **III.2. In situ grazing experiments**

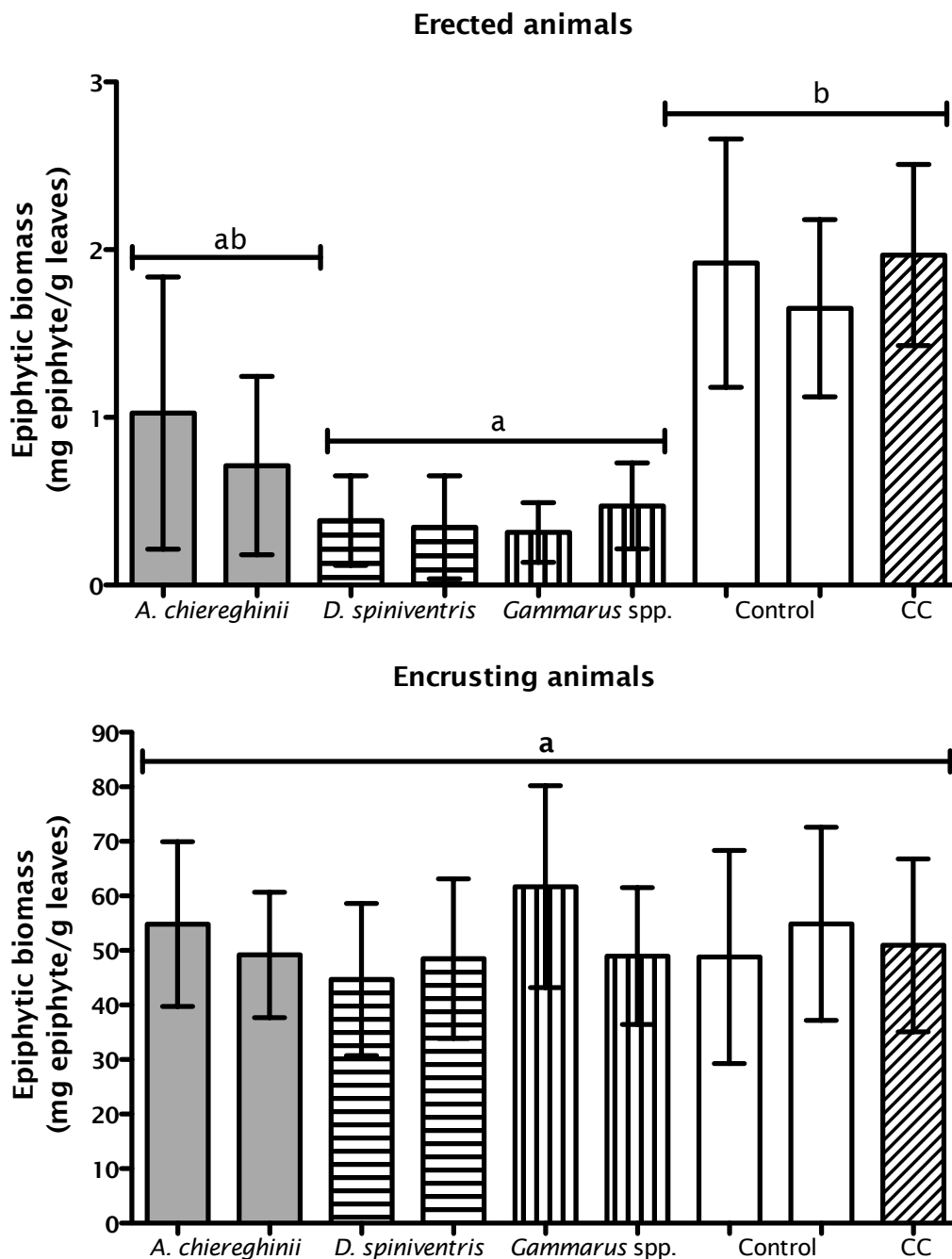
#### **III.2.A. Biomass of epiphytic groups**

Figures 5.12 (next page) and 5.13 (two pages ahead) display the biomasses of the 4 functional groups of epiphytes from *Posidonia oceanica* leaves at the end of the *in situ* grazing experiment (21 days). In all the cases, the biomasses of each group were measured for each *P. oceanica* shoot, and then means and standard deviation were calculated for each treatment.

Biomasses of erected algae (fig. 5.12, top part) showed a trend towards lower values in treatments containing grazers. This trend was significant (Kruskal-Wallis + Dunn's post hoc tests,  $p < 0.05$ ) for *D. spiniventris* and *Gammarus* spp. Biomasses in each of the two treatments of these species were lower than in the 3 control treatments. For *Apherusa chiereghinii*, the trend was strong, but marginally non-significant ( $0.1 > p > 0.05$ ). Treatments containing *A. chiereghinii* were not statistically different from either the "control" group or the "*D. spiniventris* / *Gammarus* spp." group.



**Figure 5.12:** Biomasses of erected (top) and crustose (bottom) algae at the end of the *in situ* grazing experiments. Biomasses are expressed in mg of epiphytes per mg of *P. oceanica* leaf. Different letters indicate different groups according to the Kruskal-Wallis 1-way analysis of variance followed by the Dunn's post-hoc multiple comparison procedure ( $p < 0.05$ ). Values are means, error bars are standard deviations. CC: double control.



**Figure 5.13:** Biomasses of erected (top) and crustose (bottom) animals at the end of the *in situ* grazing experiments. Biomasses are expressed in mg of epiphytes per mg of *P. oceanica* leaf. Different letters indicate different groups according to the Kruskal-Wallis 1-way analysis of variance followed by the Dunn's post-hoc multiple comparison procedure ( $p < 0.05$ ). Values are means, error bars are standard deviations. CC: double control.

## Functional role of amphipod grazing in epiphyte dynamics

Biomasses of encrusting algae (fig. 5.12, bottom part), on the other hand, were statistically identical in each treatment (Kruskal-Wallis test,  $p = 0.611$ ).

The situation for epifauna (fig. 5.13) was similar. While biomasses crustose animals showed no inter-treatment variation (Kruskal-Wallis test,  $p = 0.725$ ), grazer presence seemed to cause a trend towards lower biomasses of erected animals for all three taxa. Once again, this trend was significant for *Dexamine spiniventris* and *Gammarus* spp., but marginally non-significant ( $0.1 > p > 0.05$ ) for *Apherusa chiereghinii*.

No significant differences between the two replicates of a single treatment were noted for any groups of epiphytes. No seagrass consumption seemed to occur, and no grazing marks or other damage to seagrass leaves was noted.

For each treatment, we computed grazing rates, using

$$GR = \frac{EP_{\text{control}} - EP_{\text{grazed}}}{21 \cdot M_{\text{gr}}}$$

where GR is the grazing rate (expressed in mg of epiphytes consumed per g of *Posidonia* leaf per mg of grazer per day),  $EP_{\text{control}}$  is the mean biomass of epiphytes in the two controls and the double control (expressed in mg per g of *P. oceanica* leaf),  $EP_{\text{grazed}}$  is the mean biomass of epiphytes in each grazed treatment (also expressed in mg per g of *P. oceanica* leaf), 21 is the duration of the experiment in days and  $M_{\text{gr}}$  is the biomass of grazers initially present in each treatment (in mg). All relevant parameters are given in table 5.I.

**Table 5.I:** Parameters used for calculation of grazing rates in each treatment (AC: *Apherusa chiereghinii*, DV: *Dexamine spiniventris*, G: *Gammarus* spp). A: animal erected epiphytes, V: vegetal erected epiphytes, T: total erected epiphytes, ep: epiphytes, lf: *P. oceanica* leaf, grz: grazer. Details of the calculations are given in the text.

		AC1	AC2	DV1	DV2	G1	G2
<b>Epiphytic biomass</b> (mg ep.g lf <sup>-1</sup> )	A	1.03	0.71	0.38	0.34	0.31	0.47
	V	12.12	9.07	3.73	3.69	6.07	2.71
	<b>T</b>	<b>13.15</b>	<b>9.78</b>	<b>4.11</b>	<b>4.03</b>	<b>6.38</b>	<b>3.18</b>
<b>Net consumption</b> (mg ep.g lf <sup>-1</sup> )	A	0.81	1.13	1.46	1.50	1.53	1.37
	V	12.10	15.15	20.49	20.53	18.15	21.51
	<b>T</b>	<b>12.91</b>	<b>16.28</b>	<b>21.95</b>	<b>22.03</b>	<b>19.68</b>	<b>22.88</b>
<b>Grazer biomass</b> (mg grz)		28.95	31.02	34.44	37.11	51.52	41.27
<b>Grazing rate</b> (mg ep.g lf <sup>-1</sup> .mg grz <sup>-1</sup> .d <sup>-1</sup> )	A	0.0013	0.0017	0.0020	0.0019	0.0014	0.0016
	V	0.0199	0.0233	0.0283	0.0263	0.0168	0.0248
	<b>T</b>	<b>0.021</b>	<b>0.025</b>	<b>0.030</b>	<b>0.028</b>	<b>0.018</b>	<b>0.026</b>

Interestingly, the use of "standardized" grazing rates (*i.e.*, rates accounting for the differences of grazer biomass) tends to lessen the differences between treatments. While the absolute depletion of the resources, and therefore the epiphytic biomasses at T<sub>21</sub> seemed to be lower in the treatments grazed by *A. chiereghinii*, this effect is apparently linked with lower biomasses in these treatments. Grazing rates were indeed quite comparable, with a slight trend towards higher values in treatments grazed by *Dexamine spiniventris*. In all taxa, rates of consumption of erected algae were at least an order of magnitude higher than those of consumption of sessile erected animals.

### III.2.B. Elemental concentrations of *P. oceanica* leaves & epiphytes

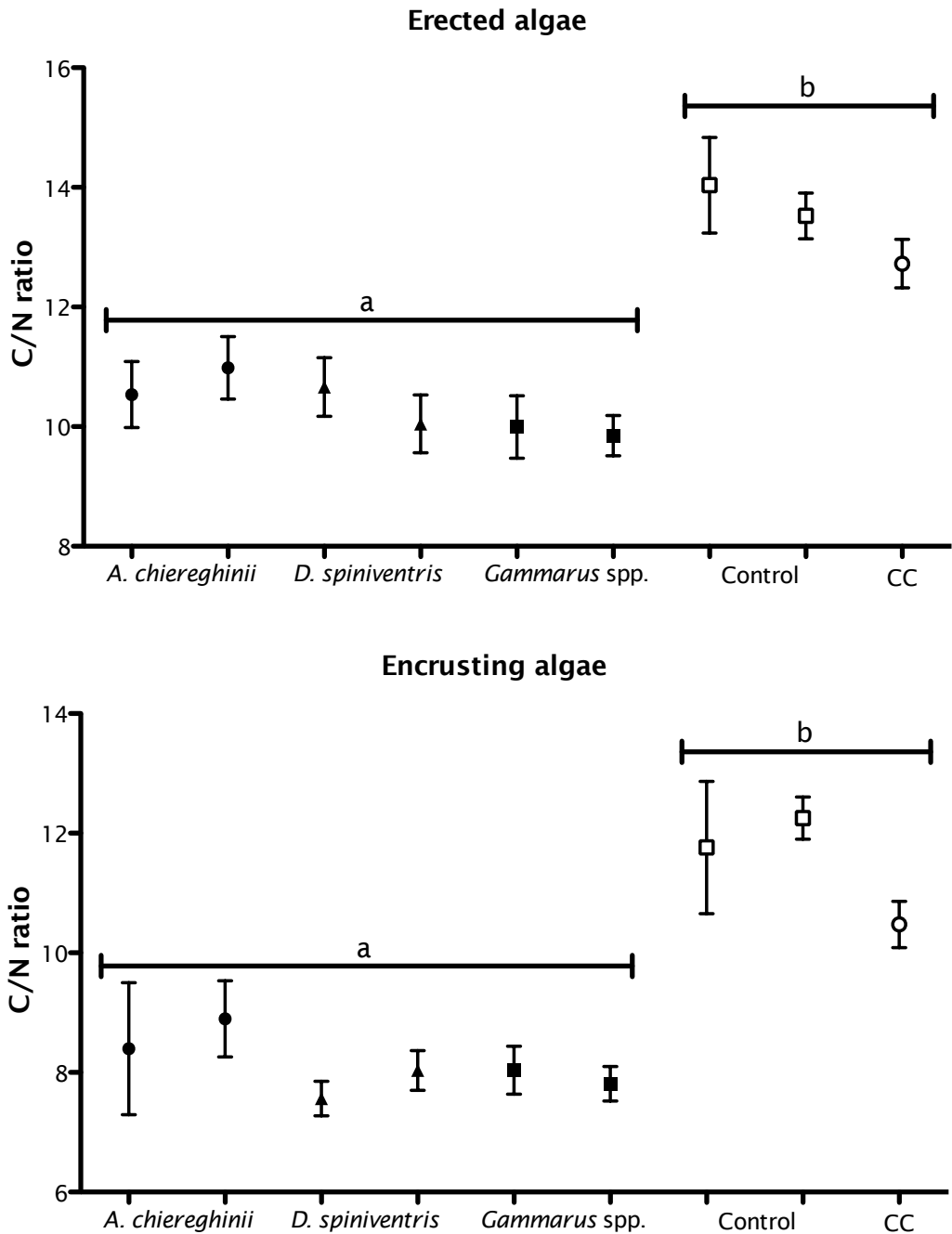
Elemental concentrations of the 4 functional groups of epiphytes and of *Posidonia oceanica* leaves are displayed in figures 5.14 (erected & crustose algae, p. 208), 5.15 (erected and crustose animals, p. 209) and 5.16 (*P. oceanica* leaves, p. 210). In all figures, elemental concentrations are expressed as unitless C/N ratios, calculated using the relative organic C and concentrations (expressed in percentage of the total dry mass). C/N ratios of each item were measured for each *P. oceanica* shoot, and then means and standard deviation were calculated for each treatment.

C/N ratios of animals, either erected or encrusting, showed no inter-treatment variation (Kruskall-Wallis test,  $p > 0.05$  in both cases).

*A contrario*, C/N ratios all vegetal items (erected algae, encrusting algae and *P. oceanica* leaves) were lower in all 3 grazed treatments than in both control treatments (Kruskall-Wallis test followed by Dunn's test,  $p < 0.05$  in each case).

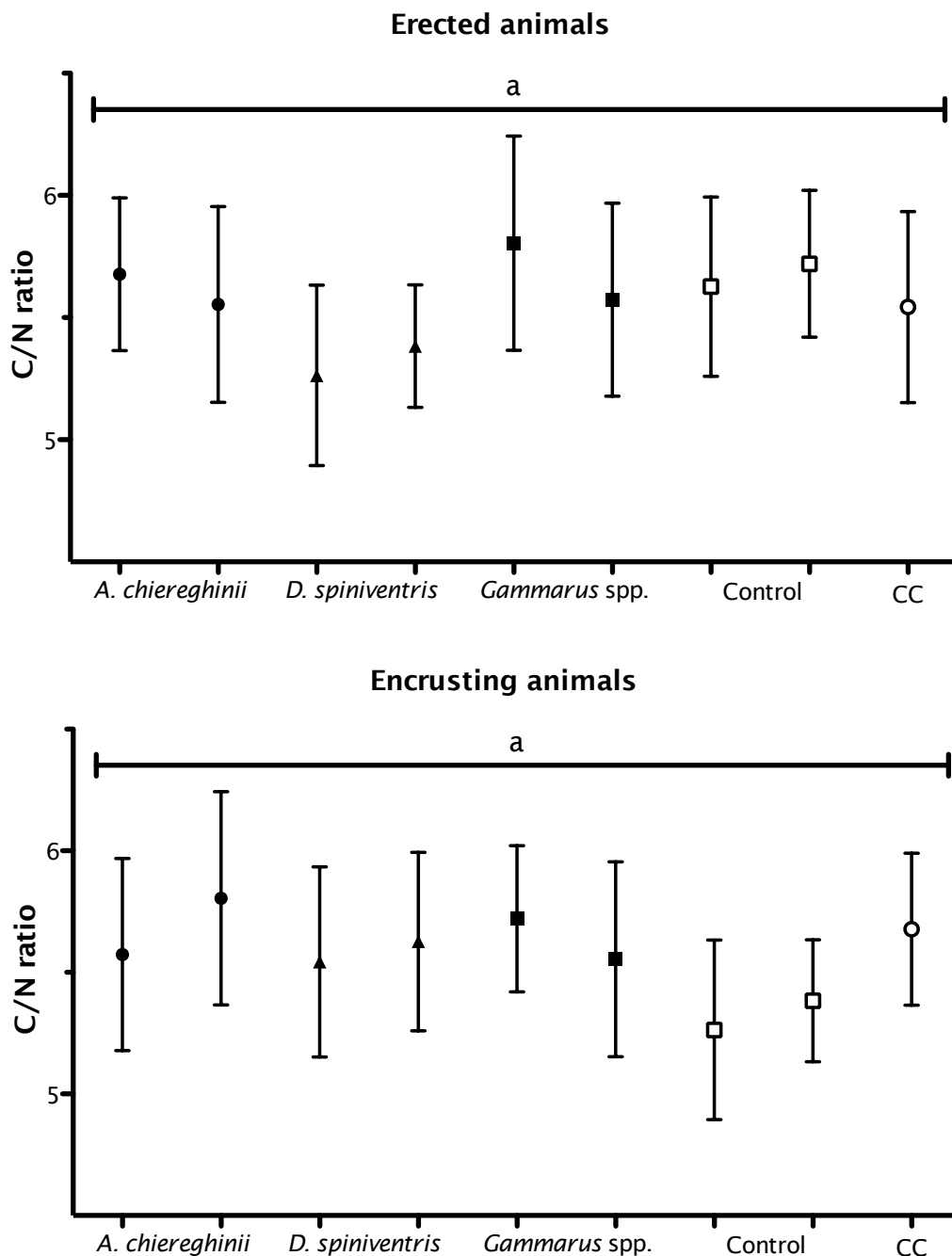
In algae as well as *P. oceanica* leaves, C contents were comparable from one treatment to another. However, the N content of vegetal tissues were higher when grazers are present, causing in turn a decrease in the C/N ratios.

As for biomasses (section III.2.A.), the two replicates of each treatment showed similar C/N ratios for all sampled items.

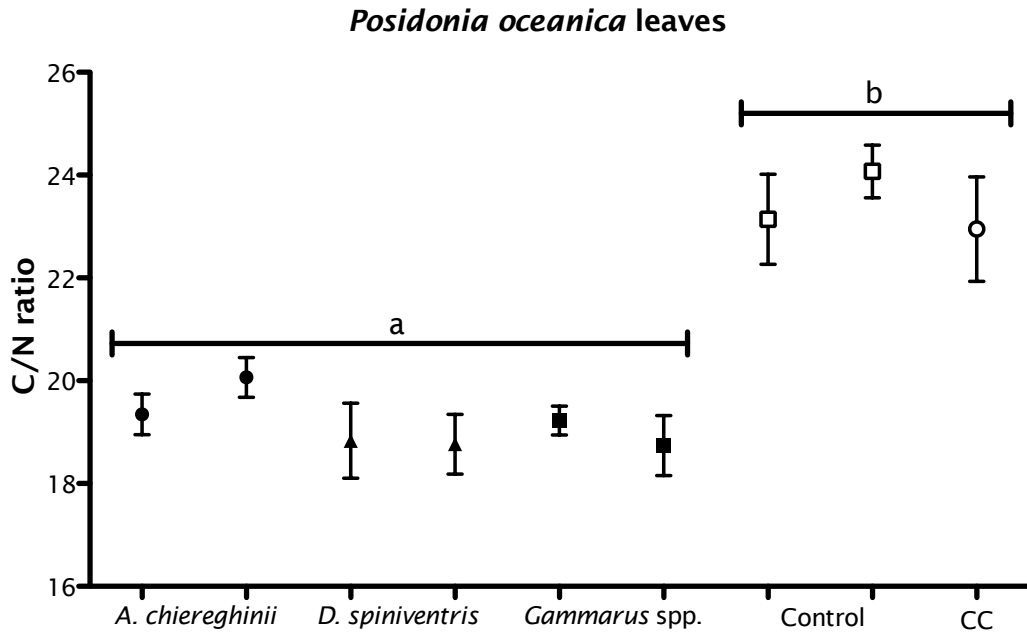


**Figure 5.14:** C/N ratios of erected (top) and crustose (bottom) algae at the end of the *in situ* grazing experiments. Different letters indicate different groups according to the Kruskal-Wallis 1-way analysis of variance followed by the Dunn's post-hoc multiple comparison procedure ( $p < 0.05$ ). Values are means, error bars are standard deviations. Black circles: *A. chieraghinii*, black triangles: *D. spiniventris*, black squares: *Gammarus* spp., white squares: control, white circle: double control (CC).





**Figure 5.15:** C/N ratios of erected (top) and crustose (bottom) animals at the end of the *in situ* grazing experiments. Different letters indicate different groups according to the Kruskal-Wallis 1-way analysis of variance followed by the Dunn's post-hoc multiple comparison procedure ( $p < 0.05$ ). Values are means, error bars are standard deviations. Black circles: *A. chiereghinii*, black triangles: *D. spiniventris*, black squares: *Gammarus* spp., white squares: control, white circle: double control (CC).

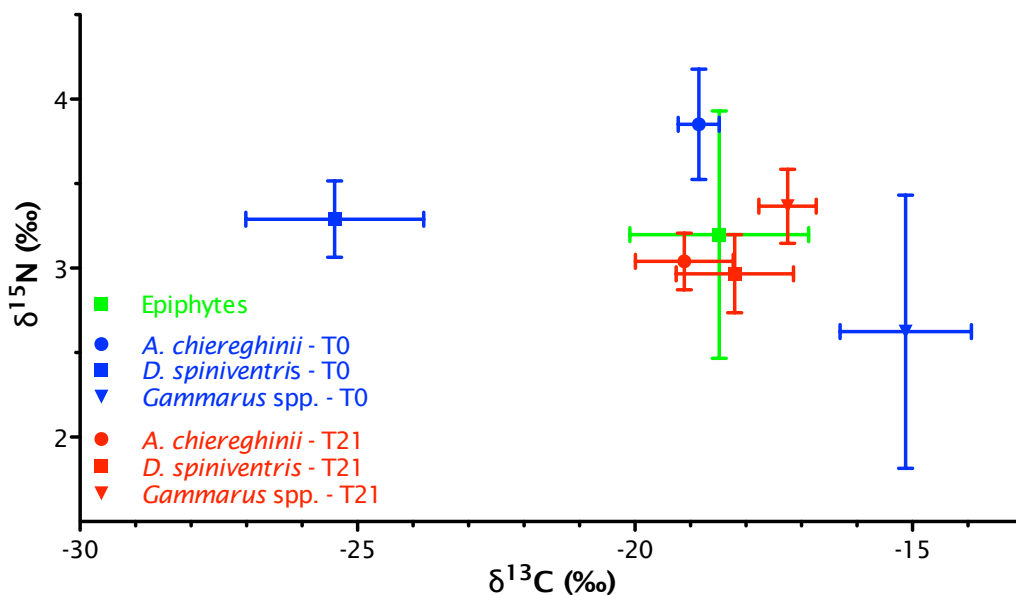


**Figure 5.16:** C/N ratios of *Posidonia oceanica* leaves at the end of the *in situ* grazing experiments. Different letters indicate different groups according to the Kruskal-Wallis 1-way analysis of variance followed by the Dunn's post-hoc multiple comparison procedure ( $p < 0.05$ ). Values are means, error bars are standard deviations. Black circles: *A. chiereghinii*, black triangles: *D. spiniventris*, black squares: *Gammarus* spp., white squares: control, white circle: double control (CC).

### III.2.C. Isotopic ratios of epiphytes and grazers

We measured the stable isotopes ratios of C and N in the 4 functional groups of epiphytes and the three taxa at the beginning ( $T_0$ ) and end ( $T_{21}$ ) of the *in situ* grazing experiment (cf. fig. 5.17). The signatures of all functional groups of epiphytes were similar at both  $T_0$  and  $T_{21}$  for  $\delta^{13}\text{C}$  and for  $\delta^{15}\text{N}$ , and we therefore used a global signature (means and standard deviations of all the measured values taken together). For amphipods, isotopic ratios were not statistically different in the two replicates of each treatment at  $T_{21}$ . The means and standard deviation were thus computed using values from the two replicates.

The  $\delta^{13}\text{C}$  of *Dexamine spiniventris* significantly shifted over the 21 days of the experiment (Mann-Whitney test,  $p < 0.001$ ). Initially very negative ( $-25.4 \pm 1.6$  ‰), it slide towards a value of  $-18.2 \pm 1.1$  ‰, statistically identical to the  $\delta^{13}\text{C}$  of epiphytes ( $-18.5 \pm 1.6$  ‰, Mann-Whitney test,  $p = 0.747$ ).  $\delta^{15}\text{N}$  values of this amphipod, on the other hand, were identical at the beginning and the end of the experiment, and both coincided with the  $\delta^{15}\text{N}$  of epiphytes.



**Fig. 5.17:**  $\delta^{13}\text{C}$  vs.  $\delta^{15}\text{N}$  biplot of epiphytes and amphipods at the beginning (blue symbols) and end (red symbols) of the *in situ* grazing experiment. Values are means and error bars are standard deviations.

The  $\delta^{13}\text{C}$  of *Gammarus* spp. at the beginning of the experiment was less negative than the one of epiphytes ( $-15.1 \pm 1.2$  ‰ vs.  $-18.5 \pm 1.6$  ‰, Mann-Whitney test,  $p = 0.034$ ). After 21 days,  $\delta^{13}\text{C}$  of *Gammarus* spp. reached values of  $-17.3 \pm 0.5$  ‰, and was merged with the one of epiphytes (Mann-Whitney test,  $p = 0.536$ ). As for *D. spiniventris*,  $\delta^{15}\text{N}$  of grazers at  $T_0$ , of grazers at  $T_{21}$  and of epiphytes were similar.

The  $\delta^{13}\text{C}$  of *Apherusa chiereghinii* already coincided with the one of the epiphytes at the beginning of the experiment, and this situation did not change over the 21 days of the experiment. The  $\delta^{15}\text{N}$  of *A. chiereghinii* was slightly lower at  $T_{21}$  than at  $T_0$  (Mann-Whitney test,  $p = 0.024$ ). However, these two values were statistically similar to the  $\delta^{15}\text{N}$  of epiphytes (Mann-Whitney tests,  $p > 0.05$  in each case).

At  $T_{21}$ , the mean  $\Delta^{13}\text{C}$  were  $-0.6$  ‰ for *A. chiereghinii*, for  $+0.3$  ‰ for *D. spiniventris* and  $+1.2$  ‰ for *Gammarus* spp. The mean  $\Delta^{15}\text{N}$  were  $+0.7$  ‰ for *A. chiereghinii*,  $+0.1$  ‰ for *D. spiniventris* and  $-0.6$  ‰ for *Gammarus* spp., respectively.

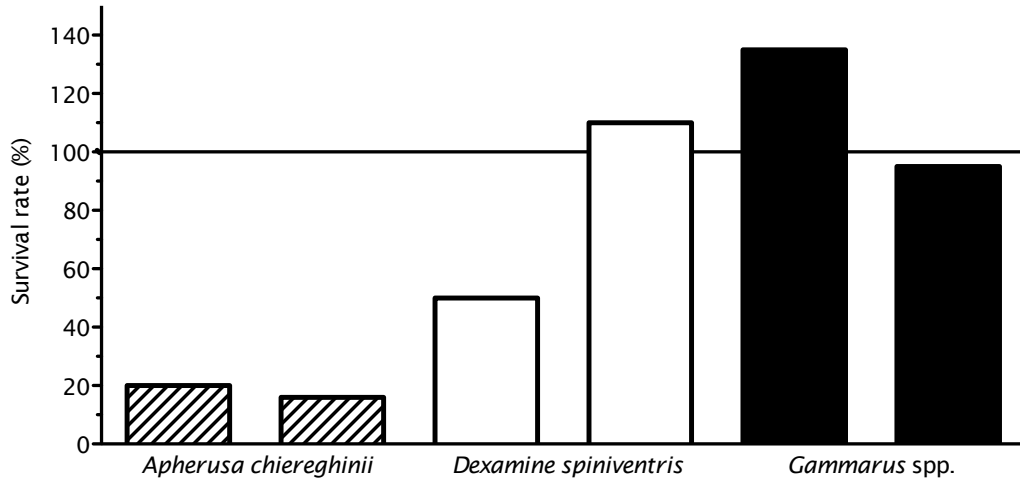
### III.2.D. Grazer survival, biomass & secondary production

All replicates, including the control treatments, were contaminated with non-amphipod (gastropods, polychaetes, copepods) grazers. This indicates that our defaunation step might not have been efficient enough. However, biomasses of these undesired grazers was always low, and was similar in each

## Functional role of amphipod grazing in epiphyte dynamics

treatment. We therefore hypothesized that their impact was negligible compared to the one of introduced amphipods.

The figures 5.18 gives the survival rates of amphipods during the *in situ* grazing experiment.



**Fig. 5.18:** Survival rates for the *in situ* grazing experiment, expressed in percentage of the initial effective. The solid black line indicates 100% of survival.

Survival rates for *A. chieraghinii* (hatched bars) were low. Only 20 % of the amphipods survived the experiment in each replicate. Survival rates were higher, but widely differed from one replicate to the other for *Dexamine spiniventris* (white bars). While in one iteration, half the amphipods died, in the other, survival was over 100 %, indicating an increase of grazer effective. It is also the case in one of the two replicates of *Gammarus* spp. (black bars), while in the other survival was just under 100 %

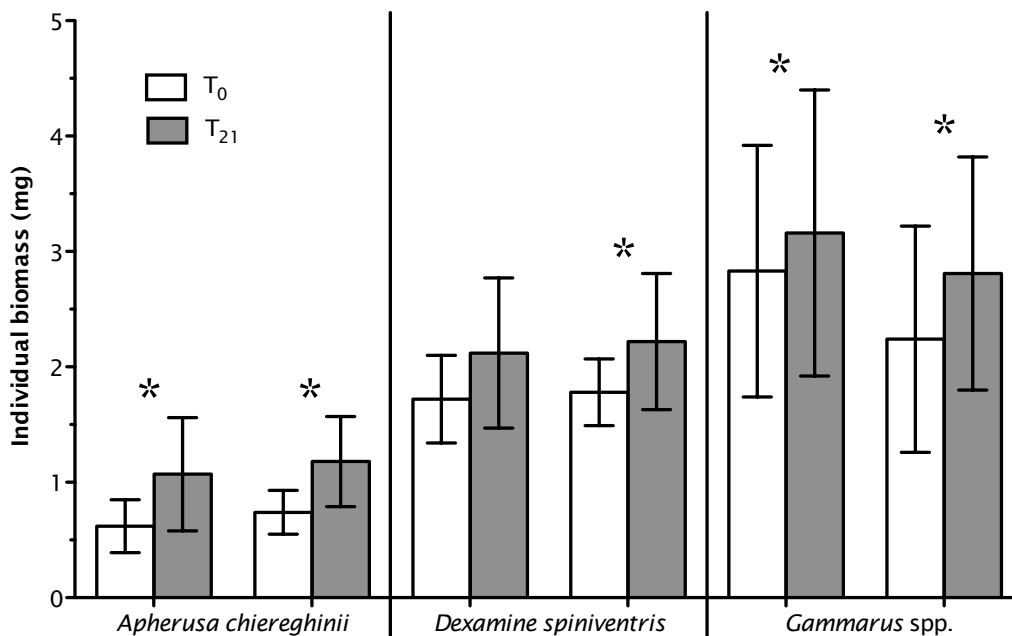
Table 5.II gives the initial and final grazer biomasses in each treatment, as well as, when applicable (*i.e.*, when the total biomass did actually increase) the net increase of grazer biomass and the secondary production (rate of increase of grazer biomass). Unsurprisingly, biomass of grazers decreased in the treatments where survival was low (the two *A. chieraghinii* and one of the *D. spiniventris* replicates).

In the three remaining treatments, it was possible to measure an increase of grazer biomass (secondary production). It is interesting to note that while two of the secondary production rates are relatively comparable (0.52 and 0.67 mg DM.d<sup>-1</sup>), the third one is nearly three times higher, emphasizing a potential high variability associated with this parameter. The same can be said of productivity rates (*i.e.*, production standardized by initial biomass of grazers responsible for this production).

Besides these total grazer biomass measurement, figure 5.19 displays the mean individual biomasses for each treatment at  $T_0$  and  $T_{21}$ .

**Table 5.II:** Secondary production of grazers. For each treatment, the table gives the total initial grazer biomass (in mg of dry mass), the total final grazer biomass (in mg of dry mass), the net biomass increase over the 21 days of the experiment (in mg of dry mass) and the net secondary production (in mg of dry mass per day).

Grazer	Initial biomass (mgDM)	Final biomass (mgDM)	Biomass increase (mgDM)	Production (mgDM.d <sup>-1</sup> )	Productivity rate (d <sup>-1</sup> )
<i>A. chieraghinii</i>	28.95	9.63	-	-	-
	31.02	8.52	-	-	-
<i>D. spiniventris</i>	34.44	21.20	-	-	-
	37.11	51.21	14.10	0.67	0.018
<i>Gammarus</i> spp.	51.52	85.39	33.87	1.61	0.031
	41.27	52.11	10.84	0.52	0.013



**Fig. 5.19:** Individual dry biomass of grazers in each treatment at the beginning (white bars) and the end (grey bars) of the *in situ* experiment. Values are means, error bars are standard deviations. Asterisks indicate a significant difference between T<sub>0</sub> and T<sub>21</sub> (Mann-Whitney test, p < 0.05).

In each replicate of each grazer treatment, a trend towards an increase of biomass over the 21 days of the experiment is visible. Despite relatively high variability, this increase is statistically significant for all the treatments but one of the replicates of *Dexamine spiniventris* (Mann-Whitney test, p < 0.05). In other terms, in 5 of the 6 treatments, amphipod growth was noticeable. This includes the *Apherusa chieraghinii* treatments, where total biomass showed an important decrease.

## **IV. Discussion**

### **IV.1. Methodological considerations**

#### **IV.1.A. *In vitro* vs. *in situ* experimental designs**

In order to ensure that our view of the studied processes was as adequate as possible, we chose to combine *in vitro* and *in situ* microcosms experiments. From a methodological point of view, each approach has pros and cons.

***In vitro* experiments** allowed us to work on a controlled environment, whose variables could be easily monitored. After initial set-up, it is fairly easy to perform sampling of epiphytes and/or grazers during the course of the experiment. *In vitro* experiments were therefore useful to delineate precise temporal trends. They also allow direct visual observations, and they are more suitable for controlled feeding experiments, since one can easily control which food items are readily available to grazers.

On the other hand, biomasses of erected epiphytes decreased even in control treatment, indicating a potential carrying capacity of our systems for these populations.

In addition, our experiments were biased by artificial nitrogen enrichment of producers that caused a deviation from the natural, oligotrophic conditions of Calvi Bay. Artificial nutrient enrichment of the water supplied by the installations of the STARESO has indeed been reported. This enrichment is notably strong for  $\text{NO}_3^-$ , as concentrations can be five times higher than those measured *in situ* (VERMEULEN, Pers. Comm.).

Another problem of the *in vitro* experiments was the low grazer survival rates that points out potential inadequacy of our systems. Several factors could explain this.

We used a flow-through system with constant supply of oxygen. Overdevelopment of harmful bacteria and/or hypoxia were therefore unlikely to happen, and can be discarded.

On the other hand, oversimplification of the habitat could have had deleterious effects. We aimed for a simple and straightforward experimental design, and used tanks containing only the necessary material (*i.e.* seagrass leaf mimics, epiphytes growing on them, and amphipod grazers). By doing so, we moved away from the natural habitat of the animals, which has a very complex tridimensional structure. Our design may not be suitable for sustaining populations of amphipods over a prolonged time period.

Another problem could have arisen from the low resource availability. Amphipods were apparently able to consume erected epiphytes, whose biomass decreased importantly over time, and was very low in the second half of the experiment. The amount of algae may therefore have been too low to match the nutritional requirements of amphipods, therefore limiting crustacean survival.

Cannibalism also likely took place. It is a very common phenomenon among gammarid amphipods (MACNEIL *et al.*, 1999). Moreover, evidence of higher cannibalism occurrence under low or nil alternative resource availability exists for other epiphyte-grazing amphipods (ANDERSSON *et al.*, 2009, for *Gammarus locusta*).

Even if we took great care while handling the amphipods, the collection and pre-experimental processing of amphipods inevitably induced direct (physical damage) and indirect (physiological stress) detrimental effects. These effects could have impaired amphipod survival as well, especially for the small *Apherusa chiereghinii* individuals.

The simplicity of experimental design was at the same time the most desirable characteristic and the greatest flaw of *in vitro* experiments. Simple designs allow clear, easily comprehensible effects. Nevertheless, it also caused discrepancies between artificial experimental environment and actual field conditions that question the representativeness of these effects.

***In situ* experiments**, since they took place in the field, allowed us to account for the potentially important effects of physiological integration among seagrass shoots that grow in the same meadows. They also allowed good matching between the environmental conditions of the microcosms and those of the surrounding area, and flows of dissolved and fine particular organic matters could be preserved. Experimental conditions were therefore far more representative of real conditions, and measured effects more robust and trustworthy (VALENTINE & DUFFY, 2006).

Grazer survival was much better *in situ* than *in vitro*. This supports the view that inadequate experimental design is at least partly responsible for the high *in vitro* mortality observed. Survival rates for *Apherusa chiereghinii* were nonetheless still low. This species may suffer more than the other two taxa from the collection process and pre-experimental handling. Amphipods from the genus *Apherusa* are indeed a small and delicate animals, whose fragility has been stressed by previous workers (KRAPP-SCHICKEL & SORBE, 2006).

Field microcosms however have their drawbacks. Contrary to a lot of intertidal seagrasses, *Posidonia oceanica* forms fully submerged meadows. All work (initial set-up, maintenance, sampling) therefore has to be done by scuba diving, implying higher logistics demands. Working with small, fast-moving animals underwater also hugely complicates potential sampling events during the course of the experiment. Opening the microcosms would more than likely be a source of contamination and/or experimental biases. Such designs should be restricted to cases where only initial and final states are of interest.

The design we used proved to be trouble-free to handle. However, it did not allow us to quantify the precise biomasses of seagrasses and epiphytes at the beginning of the experiment. This makes direct estimation of seagrass and/or epiphyte primary production impossible.

In addition, the defaunation step should be improved, as non-amphipod vagile invertebrates were present in the microcosms. Several authors proposed the

---

## Functional role of amphipod grazing in epiphyte dynamics

use of insecticides, such as carbaryl, as an efficient mean of defaunation (DUFFY & HAY, 2000 ; DOUGLASS *et al.*, 2007). However, from an environmental perspective, the use of such toxic compounds is more than questionable.

Overall, *in vitro* and *in situ* grazing experiments undoubtedly had their own specific advantages and disadvantages. Combining them may therefore be a good way to ensure that each type compensates for biases associated with the other type, and thus to have a clear view of trophic interactions. The fact that, despite specific biases, trends and effects are generally similar in the two types of experiments makes the insights drawn from our approach more reliable.

### IV.1.B. Adequacy of seagrass mimics for experimental purposes

We decided to use seagrass mimics leaves for the *in vitro* experiments because we wanted to offer the grazers living epiphytes, and nothing else (controlled feeding assay). Moreover, maintaining healthy *Posidonia oceanica* in simplified artificial systems can be problematic. However, the epiphytic cover that grew on actual and factice *P. oceanica* leaves were different.

The *Posidonia oceanica* shoots used for the *in situ* grazing experiment were covered with an epiphytic community that matched the general characteristics described in previous studies (VAN DER BEN, 1971 ; MAZZELLA *et al.*, 1989 ; CEBRIÁN *et al.*, 1999 ; LEPOINT *et al.*, 1999 ; JACQUEMART & DEMOULIN, 2006).

The seagrass mimics, on the other hand, were covered with considerable quantities of algae, but biomasses of epifauna were extremely low, and close to zero (always under 1% of the total epiphytic biomass). This situation differs considerably of the typical situation of natural seagrass leaves. In the Calvi bay, at a depth of 10 m and in late spring/early summer, animals typically account for 35 to 40 % of the total epiphytic biomass (LEPOINT *et al.*, 1999).

Moreover, before the beginning of the experiment, biomasses of erected algae (most values ranging from 40 to 50 mg of dry mass per mimic) were much greater than those of encrusting algae (typically comprised between 10 and 20 mg of dry mass per mimic). This situation is highly unusual, as encrusting epiphytes are generally more abundant (*e.g.* CEBRIÁN *et al.*, 1999). Even if erected epiphytes can be abundant under certain circumstances, such dominance is, to our knowledge, never described under natural conditions. Dominance of erected forms on our mimics might be linked with the important, anarchic development of huge filaments of *Ectocarpus silicosus*. Diversity and evenness seemed lower in the epiphytic communities of mimics than in those of real leaves.

While "opportunistic" epiphytes (*e.g.* Corallinaceae), that tend to colonize most submerged items in the area of interest, were well present on the mimics, the epiphytic cover from artificial leaves lacked some of the essential characteristics of the cover of real leaves. *Posidonia* leaves are notorious for bearing large amounts of the algae *Myrionema orbiculare* and the bryozoan



*Electra posidonae* that seem to grow only on seagrass leaves, and were indeed rare or absent from the mimics. These taxa are regarded as critical for structuring the epiphytic communities, as they readily settle on the leaves (right after the micro-epiphytes) and are easily covered by other epiphytes (secondary or upper order epiphytism) (JACQUEMART & DEMOULIN, 2006). The determinism of their installation on the leaves remains poorly known, but their scarcity on the mimics could have been responsible for the deep differences in the structure of the natural and artificial leaves.

PÊTE (2005) analyzed the composition of the early (0 to 10 days) epiphytic cover of *Posidonia oceanica* mimics identical to ours, at the same site. She found that epiphytic organisms were more abundant, but less diverse on the artificial leaves. She hypothesized that these differences could be explained by factors related to the host plant, notably secretion of antifouling phenolic compounds. These early differences could in turn explain the differences noted on our older seagrass mimics. On the other hand, for *Posidonia australis*, epiphytic distribution on artificial and real blades seems only influenced by the relative position along the leaf (distance to leaf basis), and not by interactions between the host plant and epiphytes (*i.e.*, no differences between natural and artificial leaves; HORNER, 1987).

Since our aim was to have a pool of similar seagrass mimics, we chose not to group them in "shoots" of 3-5 mimics, as it is in actual shoots, to avoid higher epiphytic development on the outer "leaves". This choice may also explain a part of the differences between the natural communities and the one we observed on our seagrass mimics. This view is supported by a recent study that used comparable *Posidonia oceanica* mimics grouped in artificial shoots and attached to an artificial rhizome. The epiphytic cover they obtained was apparently closer to the natural communities, and, although they were rare, included hydrozoans and bryozoans (*Lichenopora* sp.; GAMBI *et al.*, 2011)

The differences noted between the epiphytes from natural leaves and those from seagrass mimics raises the question of the representativeness of these epiphytes, and of the suitability of our artificial leaves as actual seagrass mimics. Differences have already been discussed. However, it is interesting to note that all algal species that were identified on seagrass mimics are also described as epiphytes from real *Posidonia oceanica* leaves in the study area (JACQUEMART & DEMOULIN, 2006). Since the number of taxa was lower on the mimics, they could be seen as "simplified" epiphytic communities that show resemblance to actual, field communities. Epiphytes collected on our mimics could therefore, to a certain extent, have an interest for some experimental purposes, but can hardly be seen as representative from the real communities from *P. oceanica* leaves.

The question of the suitability of these mimics remains open, as its precise assessment requires an extensive study of their colonization that is way beyond the scope of our study. The reader is nevertheless advised to keep in mind the important differences between epiphytes from the real and artificial seagrass leaves, and therefore between the *in situ* and *in vitro* experiments, while reading the next sections.

## **IV.2. Resource depletion: evolution of epiphytic biomasses**

While no effect on the total epiphytic biomass was seen, in all experiments, the presence of any of the 3 grazer taxa caused a reduction of the standing stocks of erected epiphytes. This was the case for algae but also, when they were present, animals. Interestingly, grazing of epiphytes from the leaves was also noted for *Dexamine spiniventris*, a species that does not seem to feed preferentially on this resource in actual, non-manipulated conditions (see chapter 4, section IV.4.C.). In most of the cases (all but *A. chiereghinii* under *in situ* conditions), this resource depletion was statistically significant, and trends were strong and clear.

Although they comparatively received less attention than other mesograzers from seagrass meadows (notably mollusks), consumption of epiphytic algae by amphipods is well documented. Significant depletion of erected algal biomass by amphipod grazers occurs in a number of temperate and subtropical seagrass systems. The most relevant studies are grouped in table 5.III.

Direct comparisons of effects or grazing rates are often complicated or irrelevant, due to large differences in experimental design (*in situ* vs. *in vitro*, exclusion vs. inclusion, etc.). In addition, estimation of epiphytic abundance can be done using different methods (biomass, coverage, dosing of chlorophyll a, etc.). Finally, grazer effects can be expressed under *per capita* (as a function of numerical abundance) or per biomass (expressed in wet mass, dry mass or ash-free dry mass) effects. Nevertheless, with consumption of 50 to 90 % of the erected algae (cf. table 5.I), our estimates are within the range of previous studies.

None of the grazers seemed to consume either crustose algae, or encrusting animals. This was even the case in situations where the biomass of erected epiphytes was very low, such the later stages of the *in vitro* experiment. This could be linked with the feeding mechanism of amphipods.

**Table 5.III:** Summary of essential studies documenting impact of amphipod grazing on seagrass epiphytes populations (adapted, modified and updated from JERNAKOFF *et al.*, 1996 ; VALENTINE & DUFFY, 2006). For each study, the table gives the concerned seagrass and the location of the meadow, the identity of amphipod grazers, a brief description of the observed effects and, when available, the estimated grazing rates (WM: wet mass, DM: dry mass, AFDM: ash-free dry mass). References: 1: ZIMMERMAN *et al.*, 1979; 2: HOWARD & SHORT, 1986; 3: CAINE, 1980; 4: NECKLES *et al.*, 1993; 5: DUFFY & HARVILICZ, 2001; 6: DUFFY *et al.*, 2001; 7: DUFFY *et al.*, 2003; 8: ANDERSSON *et al.*, 2009; 9: HOWARD, 1982; 10: JERNAKOFF & NIELSEN, 1997; 11: JERNAKOFF *et al.*, 1996; 12: This study; 13: PEDUZZI, 1987. This last reference concerns gastropods, but was nonetheless included, because it is, to our knowledge, the only quantitative study of tropho-functional interactions between epiphytes from leaves and mesograzers in *Posidonia oceanica*.

Seagrass (location)	Amphipod	Observed effect on epiphytes	Grazing rate	Ref.
<i>Halodule wrightii</i> <i>Syringodium filiforme</i> <i>Ruppia maritima</i> <i>Thalassia testudinum</i> (Florida, USA)	<i>Cymadusa compta</i> <i>Gammarus mucronatus</i> <i>Melita nitida</i> <i>Grandidierella bonnieroides</i>	Consumption of micro- and macro-epiphytes, that constituted 41 to 75 % of amphipod diet. Species-specific dietary preferences.	0.35 to 1.05 mgDM ingested per mgDM of grazer per day	1
<i>Halodule wrightii</i> (Florida, USA)	<i>Cymadusa compta</i> <i>Gammarus mucronatus</i> <i>Grandidierella bonnieroides</i>	Exclusion of grazers caused increased epiphytic biomass and higher leaf loss.	-	2
<i>Zostera marina</i> (Puget Sound, USA)	<i>Caprella laeviscula</i>	Exclusion of grazer caused a dramatic increase (+ 411 %) of periphyton.	-	3
<i>Zostera marina</i> (Chesapeake Bay, USA)	<i>Gammarus</i> sp. <i>Amphithoe</i> sp.	Under nutrient enrichment and in summer, removal of grazers caused epiphyte accumulation and had a negative effect on seagrass production.	-	4
<i>Zostera marina</i> (Chesapeake Bay, USA)	<i>Gammarus mucronatus</i> <i>Amphithoe longimana</i> <i>Cymadusa compta</i>	Amphithoids consumed more than 90 % of the epiphytic biomass. <i>G. mucronatus</i> had no overall impact on biomass. Species-specific differences in grazing influenced the structure of communities.	-	5
<i>Zostera marina</i> (Chesapeake Bay, USA)	<i>Gammarus mucronatus</i>	Amphipods consumed 2/3 of epiphytic standing stocks, and had a positive effect on seagrass biomass.	-	6
<i>Zostera marina</i> (Chesapeake Bay, USA)	<i>Gammarus mucronatus</i> <i>Dulichieilla appendiculata</i> <i>Cymadusa compta</i>	Amphipods grazed 75 to 100 % of macroalgae, and caused an increase in the biomass of tunicates and, in the case of <i>G. mucronatus</i> , of seagrass leaves	-	7

## Functional role of amphipod grazing in epiphyte dynamics

Seagrass (location)	Amphipod	Observed effect on epiphytes	Grazing rate	Ref.
<i>Zostera marina</i> (Sweden)	<i>Gammarus locusta</i>	Amphipods can consume important amounts of <i>Ulva</i> spp. and ectocarpales, but their positive effect on seagrass is limited by high predation pressure in the field.	0.3 to 5 mgDM ingested per amphipod per day	8
<i>Heterozostera tasmanica</i> (Victoria, Australia)	<i>Paradexamine churinga</i> <i>Tethygeneia nalgo</i>	Total removal of epiphytes and associated detritus by amphipods.	-	9
<i>Posidonia sinuosa</i> (Western Australia)	Mixed species of amphipods and isopods	Depletion of biomass or macroepiphytes and periphyton (44 % of biomass), influence on the species composition	-	10
<i>Posidonia sinuosa</i> (Western Australia)	<i>Tethygeneia nalgo</i> <i>Paradexamine churinga</i> <i>Hyale rubra</i> <i>Amphithoe</i> sp. (together)	Consumption of periphyton and macroepiphytes	Up to 1.727 mgAFDM ingested per mgAFDM of grazer per day	11
<i>Posidonia oceanica</i> (Calvi Bay, Corsica)	<i>Apherusa chierighinii</i> <i>Dexamine spiniventris</i> <i>Gammarus</i> spp.	Removal of erected epiphytic macroalgae (50 to 89 % of biomass) and erected epifauna (44 to 83 % of biomass). No effect on total epiphytic biomass.	0.018 to 0.03 mgDM ingested per gDM of leaf per mgDM of grazer per day	12
<i>Posidonia oceanica</i> (Gulf of Naples, Italia)	<b>Gastropods</b> <i>Gibbula umbilicaris</i> <i>Jujubinus striatus</i>	Consumption of macroepiphytes on epiphytised seagrass leaves	1.78 to 4.08 µg organic carbon ingested per mgWM grazer per day	13

As it has been mentioned earlier, typical feeding in gammarid amphipods (and in most peracarid crustaceans) involves an initial bite using the incisor process of the mandible that cut fragments, which are then triturated and crushed by the mandibular molar process. Food pieces are then gathered and brought to the mouth for ingestion (BELLAN-SANTINI, 1999). Encrusting morphotypes are not easily available for this type of feeding, and amphipods might therefore simply be unable to consume them.

At any rates, this preferential consumption of erected epiphytes has important implications for the role of amphipod grazers in *Posidonia oceanica* meadows. In the light of our results, they seem to be able to perform top-down control on populations of erected epiphytes, while they do not impact the crustose organisms. This selective grazing pressure may be an important process involved in the structuring of the epiphytic cover of *Posidonia oceanica* leaves. Discriminatory removal of certain taxa through grazing can indeed relieve the non-consumed species from competition for space, nutrients and/or light, and therefore allow their development and in turn modify the whole epiphytic community structure (JERNAKOFF *et al.*, 1996).

Consumption of sessile animals by amphipods, although apparently less generalized, has also already been recorded. Amphipod grazers from Atlantic American *Zostera marina* meadows eat bryozoans and tunicates. Moreover, they seem to consume the erected species, such as *Molgula manhattensis* but not the crustose ones, like *Botryllus schlosseri* (DUFFY & HARVILICZ, 2001 ; DOUGLASS *et al.*, 2007)

Biomasses of erected epiphytes were similar in the 3 grazed treatments (*i.e.* not statistically different) at the end of the *in situ* experiment. The treatments grazed by *A. chierighinii* showed a trend towards higher "raw" biomasses, but this trend fades when the comparison is performed using the standardized grazing rates (table 5.1). *In vitro*, the final biomasses of erected algae at the end of the experiment were also close in each grazed treatment, despite a single interspecific difference in set 1 (fig. 5.5).

Overall, no clear species-specific differences in grazing activity appear, suggesting a certain degree of functional redundancy among the studied taxa. However, species that have similar impacts in terms of energy flow and trophodynamics do not necessarily have similar functional roles. More subtle effects can occur, such as modification of epiphytic community structure and/or turnover (DUFFY & HARVILICZ, 2001 ; HAYS, 2005).

In our case, no obvious differences in the community structure (*i.e.*, very high/low abundance of one or several epiphytic species in one grazer treatment and not in others) were noted. However, since we did not perform a complete assessment of epiphytic community composition and diversity, we cannot exclude it.

### **IV.3. C/N ratios of epiphytes: implications of grazing activity for nutrient cycling**

During the *in vitro* experiments, C/N ratio of both functional groups of algae decreased more importantly in grazed than in control treatments. Similarly, in the *in situ* experiment the C/N ratios of erected and crustose algae as well as those of *Posidonia oceanica* leaves were lower in grazed treatments. In both experiments, there seems to be a generalized trend towards N enrichment of vegetal tissues when grazers are present.

The causes of this N enrichment could be multiple. It could simply be an indirect effect of epiphyte consumption. Since epiphytic biomass decreases through grazing, nitrogen availability is higher for the surviving organisms, leading to an apparent concentration effect. However, since N enrichment is also present in ungrazed groups (crustose algae & *P. oceanica* leaves), whose biomasses exceed by far those of erected algae *in situ*, it is more likely that other, non-exclusive phenomena occur concomitantly. Grazing activity itself may directly enhance N cycling by processes such as excretion (faecal pellets and  $\text{NH}_4^+$ ) and/or sloppy feeding.

This increase in N availability could be critical for primary production. NW Mediterranean is indeed a very oligotrophic zone, and plant growth can be limited by nutrient scarcity. This is especially true when light availability is high, *i.e.* at shallow depths and in late spring and summer.

Nutrient limitation of seagrass growth seems very common (HUGHES *et al.*, 2004). The growth of *P. oceanica* can indeed be enhanced by nutrient fertilization (ALCOVERRO *et al.*, 1997).

Epiflora (both crustose and erected) could be even more nutrient limited than its host plant, since their nutrient demand and uptake rates are higher (LEPOINT *et al.*, 2007). Epiphytic growth is indeed more important under higher nutrient loads (HOLMER *et al.*, 2003 ; JACQUEMART, 2009).

Through N enrichment, amphipod grazing could have a positive effect of production of both grazed (erected epiflora) and non-grazed (encrusting epiflora, seagrass) plant groups. This stresses the fact that, contrary to traditional views on the subject, grazing may not be a purely negative interaction. It may instead be a complex interaction, and its overall impact may be a balance between negative (resource depletion) and positive (production enhancement) effects.

Excretion of sessile invertebrates (*e.g.* bryozoans) can cause N enrichment in marine macrophytes on which they grow (HURD *et al.*, 1994). Similarly, slow-moving gastropod mesograzers, such as *Littorina littorea* or *Rissoa membranacea*, enhance N content of the *Zostera marina* epiphytes they feed on (JASCHINSKI & SOMMER, 2010).

However, the same authors found no effect on epiphytic C/N ratios for amphipods (*Gammarus oceanicus*) or isopods (*Idotea balthica*). They hypothesize that enrichment can only occur in the case of a tight association with the seagrass leaves, and that dispersal and dilution of waste products

limits the fertilization effect in the case of highly motile and free-swimming crustaceans.

Our results disagree with this hypothesis, emphasizing the differences between these two temperate seagrass systems. Contrasting impacts of grazing on plant N content may originate in structural and functional disparities between the two meadows (different depth extensions, epiphytic communities, seagrass size and growth rates, etc.)

Besides this, general N availability is different in the two systems, and could be an important factor. JASCHINSKI & SOMMER (2010) worked in *Zostera marina* meadows from the Kiel bight, an area well-known for high nutrient and plankton loads, and for eutrophication (PRADO-FIEDLER, 1990). In addition, they showed that artificially high nutrient supply suppressed the positive effects of gastropod grazers on epiphytic productivity.

On the other hand, the Mediterranean sea in general, and Calvi Bay in particular, are oligotrophic (LEPOINT *et al.*, 2004). As stated above, high affinities for N (important uptake rates) of producers from Mediterranean *P. oceanica* meadows may be linked with nutrient limitation. In this context, increase of nutrient supply through grazing could be more crucial than in Baltic *Z. marina* meadows, and therefore cause stronger, more marked effects.

Unlike vegetal groups, animal epiphytes (either crustose or erected) did not show any N enrichment during the *in situ* experiment. This could be explained by several phenomena. First, since amphipods are ammonotelic animals, a part of the nitrogen they excrete is under the form of inorganic  $\text{NH}_4^+$  that can be assimilated by plants. However, animals rely primarily on organic, particulate N, and are likely to be unable to use ammonium. Nitrogen availability may thus be lower for the epifauna than for the epiflora and the seagrass.

Second, while nutrients and/or light might limit production of autotrophic epiphytes in the area of study, heterotrophic epiphytes are more likely limited by available space. This view is supported by results showing that animal epiphytes are more abundant in deeper meadows (20 meters or more), where they are released of the competition with vegetal epiphytes that suffer from lower light availability (LEPOINT *et al.*, 1999). Since N is not as critical to epifauna than it is to epiflora, uptake rates may be lower, resulting in little or no N enrichment of animal epiphytes.

#### **IV.4. Assimilation of consumed epiphytic material**

Stable isotope ratios of C and N clearly show that amphipod grazers assimilated the *Posidonia oceanica* epiphytes they ingested during the experiments.

At the beginning of the experiments, *Gammarus* spp. was fairly  $^{13}\text{C}$ -enriched, and its  $\delta^{13}\text{C}$  was less negative than the one of epiphytes. This is consistent with our previous results (see chapter 4) that show that *Gammarus aequicauda* (by far the most numerically abundant species in our experiments) has a mixed diet, consisting mainly of epiphytic and/or drift algae, but with considerable contribution of seagrass-derived material (*P. oceanica* litter).

## Functional role of amphipod grazing in epiphyte dynamics

The observed  $\delta^{13}\text{C}$  shift indicates that *Gammarus* spp. fed strictly on epiphytes. This is not surprising for the *in vitro* experiment, where epiphytes were the only resource available to amphipods. However, it indicates that *in situ* consumption of living *Posidonia* leaves did not occur, an hypothesis supported by the absence of grazing marks on the seagrass leaves. This confirms that the part of the diet of *Gammarus aequicauda* that consists of seagrass organic matter (cf. chap. 4) probably originates from dead *Posidonia oceanica* material.

The initial  $\delta^{13}\text{C}$  of *Dexamine spiniventris* was very negative, as this species preferentially feed nearly exclusively on  $^{13}\text{C}$ -depleted rhizome epiphytes (see chapter 4 for further information). At the ends of the grazing experiments, its  $\delta^{13}\text{C}$  had shifted to match the one of epiphytes. This stresses the fact that even if it does not seem to consume them in natural conditions, *Dexamine spiniventris* is perfectly able to digest and assimilate organic matter derived from the photophilous epiphytes from the leaves. The apparent specialization observed in chapter 4 would therefore be linked with situational factors (*e.g.*, avoidance of competition) rather than physiological ones.

The initial  $\delta^{13}\text{C}$  of *Apherusa chierighinii* matched the ones of epiphytes in both experiments. It was not possible to measure it at the end of the *in vitro* experiment because of the absence of surviving individuals. It did not shift over the course of the *in situ* experiments. This indicates that assimilation of leaf epiphytes is probably already realized in the field. This is consistent with findings exposed in chapter 4, namely that *A. chierighinii* primarily relies on the epiphytes from the *P. oceanica* leaves and/or litter fragments.

Interestingly, fractionation factors for carbon ( $\Delta^{13}\text{C}$ ) and nitrogen ( $\Delta^{15}\text{N}$ ) were very low. While  $\Delta^{13}\text{C}$  is often low (MCCUTCHAN *et al.*, 2003), this situation is more surprising for  $\Delta^{15}\text{N}$ . Once again, this is consistent with results from the field study of chapter 4. Elements of discussion concerning isotopic fractionation factors in this chapter (section IV.3.B) apply here as well.

Our first set of *in vitro* grazing experiment could easily be seen as a controlled feeding assay similar to the ones used to experimentally measure fractionation factors (*e.g.* CRAWLEY *et al.*, 2007). Only one food item was readily available for the animals (epiphytes from the seagrass mimics) and environmental conditions (notably temperature) were monitored. We therefore used the fractionation factors computed at  $T_{28}$  of the experiment to perform isotopic mixing model runs (see chapter 4).

The second set of *in vitro* experiments involved artificially  $^{13}\text{C}$  and  $^{15}\text{N}$ -enriched epiphytes. The purpose of this labeling experiment was to study the assimilation kinetics more precisely, and ultimately to highlight putative inter-taxa differences in assimilation rates.

Measurements of assimilated quantities of both  $^{13}\text{C}$  and  $^{15}\text{N}$  showed an extremely important dispersion that render data interpretation complicated, and prevent us to delineate clear temporal trends. This high variability may be linked with important variabilities in the food intake and/or the digestive physiology of individuals.



However, it is important to keep in mind that the assemblages of amphipods used in this experiment were heterogeneous *per se*. While we put some effort in the selection of relatively similar size classes, amphipods inevitably differed in gender, in age class, in physiological status (*i.e.*, stage of the molt cycle) and, in the case of *Gammarus* spp., sometimes belonged to close, morphologically similar species. More homogeneous assemblages may have yielded less variable results. Unfortunately, selection of a sufficient number of "similar" individuals would have been logistically prohibitive, if not impossible.

Besides this, it is interesting to note that inter-treatment variation in kinetics of stable isotope ratios of epiphytes was different for C and N (fig. 5.9).

$\delta^{13}\text{C}$  of marked epiphytes (both encrusting and erected) decreased over time in control treatments, indicating a dilution of the initial isotopic labeling. This dilution increased when grazer were present (stronger decrease of  $\delta^{13}\text{C}$ ) for erected algae, while no effect was present for ungrazed encrusting algae. Grazing may enhance epiphytic turnover for C. Direct damage caused to epiphytic biomass by grazers may indeed cause an increased tissue synthesis activity to compensate for this loss. This view is supported by past work that suggest that grazing could keep epiphytic productivity high by maintaining short turnover times (JERNAKOFF *et al.*, 1996).

Alternatively, this effect could be caused by preferential grazing on actively growing plants (*i.e.*, epiphytes that had higher uptake rates during the labeling experiment, and were more labeled), leaving only the less active or senescent plants. This would result in apparent decrease in  $\delta^{13}\text{C}$ , due to changes in the epiphytic community.

On the other hand, the trend was the exact opposite for  $\delta^{15}\text{N}$ , and dilution of the initial labeling was less marked in grazed treatments, for both consumed (erected algae) and non-consumed (encrusting algae) epiphytes. These contrasting kinetics may be explained by differences in the affinities towards the two elements. While C is usually not a limiting nutrient for plant growth, we stated earlier that N can be, especially in the system we study. This potential N limitation is linked with very high uptake rates (LEPOINT *et al.*, 2007). This important affinity could cause immediate re-uptake of grazer-excreted  $^{15}\text{N}$  by the epiphytes, and grazer-enhanced nutrient cycling would paradoxically lead to a higher residence time of  $^{15}\text{N}$ . Concentration effect caused by lower epiphytic biomasses in the grazed treatments is also likely to occur.

#### **IV.5. Organic matter transfers and secondary production**

*In vitro* survival of amphipods was species-dependent, but always very poor. Causes of this high mortality have been discussed in section IV.1. *In situ* survival was better in all taxa, even if its mortality was still high for *Apherusa chiereghinii*. Population effectiveness even increased in one of the *D. spiniventris* treatments, as well as in one of those that contained *Gammarus* spp.

These low survival rates render secondary production estimates complicated in most of the experiments. Nevertheless, it was possible to measure a grazer biomass increase in 3 of the 6 treatments of the *in situ* experiment (table 5.2).

## Functional role of amphipod grazing in epiphyte dynamics

The net secondary production was highly variable from one treatment to another, therefore questioning the representativeness of our estimates.

Grazers are generally thought of as being key components of seagrass ecosystems, especially because they are an important trophic link between primary producers and upper rank consumers (JERNAKOFF *et al.*, 1996). Estimates of grazer secondary production are nevertheless rare in the literature. The logistical and technical complications associated with such measurements (notably initial grazer biomass estimation) undoubtedly explain this scarcity.

DUFFY & HARVILICZ (2001) and DUFFY *et al.* (2001) performed measurements of population growth on amphipod grazers from Atlantic *Zostera marina* meadows. They focused on numerical abundance rather than biomass increase.

Both studies report tremendous growth of amphipod grazers. DUFFY & HARVILICZ (2001) performed 4-week experiments and worked with two different grazer taxa. Amphithoids (a mixture of *Cymadusa compta* and *Amphithoe longimana* in undetermined proportions) were about 55 times more abundant at the end of the experiment (5500 % increase of the population effective). Population growth was lower, yet comparable, for *Gammarus mucronatus* (nearly 45-fold, *i.e.* 4500 % increase). DUFFY *et al.* (2001) found lower population growths (20-fold increase) for *Gammarus mucronatus* over the 6 weeks of their experiments.

In either case, these numbers have no common measure with the population growth that we measured during our *in situ* experiment. Our population growth rates were much lower, and the highest increase we measured was only 130 % (1.3-fold increase). Even if, as stated before, these two meadows differ in several critical aspects, these extreme differences are puzzling.

Besides the trends concerning community production, we found a generalized trend towards higher individual biomasses. In 5 of the 6 treatments, including the ones containing *A. chierighinii*, individual growth seemed to occur over the 21 days of the *in situ* experiment. It suggests that notwithstanding the negative population production (probably linked with low survival rates), secondary production of epiphyte-fed amphipods might be positive. However, this effect may be biased by inter-cohort cannibalism, and predation of large amphipods on the smaller individuals could cause artificially high final biomasses (DUFFY & HARVILICZ, 2001). We tried to plot distribution frequencies of size classes, to discriminate between actual growth of individuals (*i.e.*, final distribution similar to the initial one, but shifted towards big sizes) and modifications of population structure towards the highest size classes, but results were inconclusive (data not shown).

ANDERSSON *et al.* (2009) monitored individual growth of newly hatched *Gammarus locusta*, initially collected in a *Zostera marina* meadow, which grazed macroalgae *in vitro*. They found that growth was fast, and adult size was reached (*i.e.*, individual length increase became low) in 9 weeks.

Using our body length vs. dry mass relationship (see section II.2 of this chapter), these growth rates can be compared with ours, at least for *Gammarus* spp.

In our first replicate, mean initial individual biomass was 2.8 mg, roughly the biomass of *Gammarus locusta* after 6 weeks. 3 weeks later, individual of *Gammarus locusta* reached their adult biomass (3.7 mg), while our *Gammarus* spp. only reached a mean biomass of 3.2 mg.

In our second replicate, initial biomass was lower (2.2 mg) and comparable to the biomass of *Gammarus locusta* after 5 weeks. 3 weeks later, this value reached 3.2 mg, while it was only 2.8 mg in our experiment.

These apparently lower growth rates of Mediterranean amphipods are questioning, especially since water temperatures were higher (19-22°C in Corsican *P. oceanica* meadows vs. 13-18°C in Swedish *Z. marina* meadows).

A similar comparison is possible using data from Mediterranean *Gammarus aequicauda* (the dominant species in our *Gammarus* spp. pools) raised *in vitro* on a mixed diet (green algae and commercial fish food) at a constant temperature of 18°C (PRATO *et al.*, 2006). The initial size of our amphipod was comprised between the biomasses of their animals when they were aged 8 (2.2 mg DM) or 9 (3.8 mg DM) weeks. Three weeks later, expected individual biomasses would be comprised between 4.5 and 5.1 mg DM, much higher than the one we recorded in our experiment. While this comparison is obviously biased by the use of a more nutritive food, the growth of our amphipod grazers, and therefore their secondary production rates, seem limited. This limitation could come from resource availability or quality.

MAERNOUDT, (2010) indeed showed that growth of *Gammarus aequicauda* depended on the nutritional quality of the diet. When the diet of animals is stoichiometrically unbalanced (high C/N ratios), respiration rates of animals are high, to get rid of excess carbon. This high respiration causes loss of energy, therefore limiting individual growth.

Our results from chapter 4 show that *Gammarus aequicauda*, *Apherusa chierighinii* and, to a lesser extent, *Dexamine spiniventris* have a mixed diet, involving several food items including epiphytes from different compartments of the plant. In our experimental systems, those food items were not available, preventing diet mixing. As a result, animals may not have been able to fulfill their nutritional requirements, hence the limited growth.

Overall, few things are clear concerning secondary production of amphipods raised only on epiphytes from leaves of *Posidonia oceanica*. Grazer responses were typically low to nil, so that we can hardly discriminate between actual effects and experimental biases. Unfortunately, concerning this point, it seems more realistic to consider this work as a preliminary study.

#### **IV.6. Importance of amphipod grazers in *P. oceanica* meadows**

JONES *et al.* (1994) defined ecosystems engineers as "organisms that directly or indirectly modulate the availability of resources (other than themselves) to other species, by causing physical state changes in biotic or abiotic materials.

## Functional role of amphipod grazing in epiphyte dynamics

In so doing they modify, maintain and/or create habitats". He further makes the distinction between autogenic and allogenic engineers, the latter "changing their environment by transforming living or non-living materials from one physical state to another, via mechanical or other means". Later in the same article, he concedes that "physical engineering is not the only form of engineering that organisms carry out. Chemical and transport engineering are two obvious other forms that we consider will conceptually fit into the same general classification scheme".

In this context, several workers have classified mesograzers from seagrass meadows as allogenic ecosystem engineers (*e. g.* DUFFY & HARVILICZ, 2001 ; VALENTINE & DUFFY, 2006 ; JASCHINSKI & SOMMER, 2010). In our case, amphipod grazers exert selective top-down controls on epiphytic communities, and therefore have an influence on their abundance and structure (erected vs. crustose morphocenoses). By doing so, they modify the "landscape" of seagrass leaves, at a small spatial scale. Moreover, they are able to modulate the supply of nutrients available to other species in the meadow, at least to a local extent. They could therefore be seen as allogenic ecosystem engineers.

Their functional role could even be much more important, since they may be able to impact their seagrass host itself. As a matter of fact, feeding activity of amphipod mesograzers has two indirect, putatively positive effects on *Posidonia oceanica* production. First, through grazing, they release the seagrass from competition for nutrients and/or light with faster-growing erected epiphytes. Second, through excretion and/or sloppy feeding, they enhance nitrogen availability and residence time, which could in turn boost seagrass production.

Concerning the first point, VALENTINE & DUFFY (2006) state that this positive interaction between mesograzers and seagrasses represents a delicate balance. It can indeed turn antagonistic, as some mesograzers (notably idoteid isopods or amphithoid amphipods) readily graze directly on seagrass tissues when alternative food supplies are low. In the case of amphipod grazers from *Posidonia oceanica*, direct consumption of live seagrass material apparently does not occur, either in natural (cf. chapter 4) or artificial (cf. this chapter). The balance has therefore no reason to lean towards the dark side, and the interaction is unlikely to become negative.

Nutrient additions have contrasting effects in seagrass production. While additions in the sediment typically have a positive effect on seagrass growth, water column additions, such as the one likely occurring in our study, can have adverse effects (HUGHES *et al.*, 2004). Since epiphytes are able to use these nutrients more efficiently (higher uptake and growth rates) than the seagrass itself, they tend to outgrow the seagrass, and can lead to seagrass death in some situations (BOROWITZKA *et al.*, 2006)

HAYS (2005) accordingly suggested that nutrient enrichment could have negative effects on *Thalassia testudinum* growth. However, they showed that under top-down control of epiphytic growth by mesograzers, this effect is

reversed, and enhanced nutrient availability has a positive effect on seagrass production.

In the *P. oceanica* meadow of Calvi bay, low nutrient availability (oligotrophic zone) and constant grazing of fast-growing erected epiphytes by amphipods make such a positive effect on seagrass growth quite likely.

Direct measurements of the impact of amphipod grazing on seagrass growth *in situ* were not performed. Since initial seagrass biomass was unknown, our initial design was not adequate for such assays. Moreover, such experimental measurements are complicated by contradictory times of interest. Seagrass growth is slow, and should be recorded over several weeks or months to be considered representative, especially for *P. oceanica*. Amphipod grazers, on the other are short-lived, and hard to keep alive in artificial conditions, so that mortality over time periods exceeding a few weeks would probably be very high.

Anyhow, we have no actual evidence that amphipod grazing enhances *Posidonia oceanica* production. However, judging by the elements exposed in the previous paragraph, we have nothing but reasons to believe that feeding activity of mesograzers has an overall positive effect on seagrass growth. The interaction between *Posidonia oceanica* and amphipod grazers could therefore be seen as a facultative mutualistic relationship, where amphipods would keep biomasses of algal competitors at acceptable levels, while the seagrass would provide a substratum and a shelter from predation (VALENTINE & DUFFY, 2006).

Another challenging, yet crucial, aspect of the biology and mesograzers is the question of the regulation of their populations. The balance between top-down and bottom-up control of mesograzers takes a renewed importance in the context of recent anthropogenic modifications of meadow ecosystems (VALENTINE & DUFFY, 2006). Eutrophication, leading to excessive growth of epiphytes, is a major challenge that seagrass meadows face worldwide. If grazer population size are limited by food supply (bottom-up control), increased epiphytic biomass will lead to more important grazer populations, which will, to some extent, buffer the effect of over-fouling of seagrasses through epiphytic consumption.

However, if mesograzers population sizes are dictated by their predators (top-down control by small fishes & invertebrates), grazer density will not increase in relation with epiphytic biomass, and adverse effects of eutrophication could be even more severe. This effect would be even worse in meadows where over-harvesting of top predators (typically large-sized, commercially important fish) occurs. This decrease of top predators could release smaller fishes and invertebrates (*i.e.* mesograzers predators) from top-down control, and in turn have dramatic effects on mesograzer abundance, and therefore feeding activity.

## V. Conclusions & perspectives

Past work shows extensive evidence that 3-way interactions between seagrasses, the epiphytes that grow on their leaves and the organisms able to feed on epiphytes and/or the seagrass play a pivotal role in the functioning of all seagrass meadows (JERNAKOFF *et al.*, 1996 ; VALENTINE & DUFFY, 2006). Here, we tried to understand what part amphipod crustacean play in this seagrass-epiphyte-grazers system in Mediterranean *Posidonia oceanica* meadows. As most species of amphipods seem to rely (at least partly) on leaf epiphytes as a food source (see chapter 4), we aimed to quantify this trophic interaction, and to assess whether this feeding activity could have an influence on other ecosystem processes.

We characterized the trophic interaction between amphipod grazers and epiphytes from a triple point of view.

First, we showed that all amphipod taxa (*Apherusa chiereghinii*, *Dexamine spiniventris* and *Gammarus* spp.) consumed epiphytes, and by doing so, were able to impact the epiphytic communities quantitatively (resource depletion) and qualitatively. Qualitative modifications include structural changes (selective grazing of erected epiphytes only) and elemental composition alterations (higher N content in erected and encrusting epiphytes). All three amphipod taxa seemed to have similar impacts, suggesting a certain degree ecological redundancy. This ecological redundancy could however be lower in the field, due to taxon-specific dietary preferences (cf. chap. 4).

Second, we showed that amphipods were able to digest and assimilate organic part the epiphytes they consumed. All taxa showed assimilation, including *D. spiniventris*, which does not readily feeds on leaf epiphytes in the field.

A third logical step was to quantify the extent to which this consumed and assimilated epiphytic material was actually transferred to the next level, by monitoring grazer secondary production. Here, contrary to the two previous points, experiments were rather inconclusive, and experimental biases prevented us to calculate reliable production rates.

In most cases, results of *in vitro* and *in situ* experiments were in good agreement. This confirms that effects observed *in vitro* were not only artifacts due to our relatively simple experimental designs. More importantly, it points out the fact that these interactions have the potential to be realized in the field, under actual conditions.

Full understanding of grazer-epiphyte-seagrass interactions can only be achieved through holistic studies. Single-species grazing experiments such as ours are of course a necessary starting point. However, there is increasing evidence that biodiversity is a crucial factor in the functioning of most ecosystems, including seagrass meadows (CARDINALE *et al.*, 2006 ; DUFFY, 2009). The term "diversity" is hereby used in its widest acceptation, since it can be apprehended in different ways.

Specific diversity effect is widely acknowledged. Multi-specific assemblages of ecologically redundant grazers can have different and sometimes unexpected effects relative to monospecific populations, and inter-grazer interactions

(direct or indirect, facilitative or antagonistic) can modulate the impact of grazing on ecosystem functioning (*e.g.* DUFFY *et al.*, 2001 ; DUFFY *et al.*, 2003).

Functional diversity of grazers could also have an impact. For example, in *Posidonia oceanica* meadows gastropod mesograzers abundance and biomass is similar, or even greater than the one of amphipods. Since their life habits (sedentary, slow-moving vs. mobile, free-swimming) and feeding modes (scraping/browsing with a radula vs. biting with mandibles) are different, they likely have different effects on epiphytes from the leaves. Species of the genus *Gibulla* are indeed able to consume various encrusting items from the epiphytic cover of *P. oceanica* leaves (bacteria, diatoms and soft or calcareous algae; MAZZELLA & RUSSO, 1989)

Conjugated experiments involving these two functional guilds of grazers, in addition of being more closely related to actual field conditions, would undoubtedly provide interesting insights on the importance of grazing in *Posidonia* meadows.

Besides ecological control of their populations (top-down and bottom-up effects), that have been discussed earlier, environmental can modulate the density of mesograzers, and therefore indirectly their feeding activity. An example of this is hydrodynamics. Under important currents, grazers from *Zostera noltii* are less abundant, resulting in important accumulations of epiphytes on seagrass leaves (SCHANZ *et al.*, 2002). Those factors therefore also have to be taken into account when characterizing the trophic interactions.

When collecting data concerning ecosystem functioning processes, such as those we presented in this chapter, the ultimate goal of a researcher would be to place them in the wider frame of the functioning of the *Posidonia oceanica* meadow as an ecosystem. The grazing rates we calculated here could indeed be included in calculations of organic matter fluxes through the ecosystem, providing insightful estimates on how amphipod grazers could actually influence epiphyte growth in the field. However, caution should be taken when attempting such calculations. They indeed require robust and trustful estimates of biomasses of the end members of the direct interaction (epiphytes and grazers), which are, in the case of grazers, not readily available.

Moreover, since the grazer-epiphyte-seagrass system is a complex interplay of factors and feedback loops, it is subject to variation in response of various biotic or abiotic factors, making any attempt to generalization of trends invalid (JERNAKOFF *et al.*, 1996 ; BOROWITZKA *et al.*, 2006). Some of these sources of variation are well known and relatively predictable (*e.g.*, spatio-temporal variations), while other were recently discovered and still poorly understood. For example, genetic diversity of seagrasses clones can influence grazing impacts in *Zostera marina* meadows (HUGHES *et al.*, 2010).

Finally, our grazing estimates themselves should be critically analyzed. Even if they come from *in situ* experiments (therefore potentially excluding a number of experimental artifacts), they still represent drastic simplifications of an

## Functional role of amphipod grazing in epiphyte dynamics

extremely complicated food web. Factors such as interactions with other animals (competitors and/or predators), time spent in searching for food resources, and alternative food supplies, may lead to differences between experimentally measured feeding rates and actual, field-realized effects (RUESINK, 2000).

Untangling the elaborate interactions between seagrasses, epiphytes and mesograzers therefore seems to be an extremely complicated task, and requires further work on many aspects.

On the other hand, this chapter presented results that constitute, to our knowledge, the first direct, experimental evidence of the importance of amphipod grazers in the functioning of *Posidonia oceanica* meadows. For this reason, we like to see them as another step towards a better comprehension of this complex, yet critically pivotal, ecosystem.

## References

- ALCOVERRO T., ROMERO J., DUARTE C. M. & LOPEZ N. I. (1997): Spatial and temporal variations in nutrient limitation of seagrass *Posidonia oceanica* growth in the NW Mediterranean. *Mar. Ecol. Progr. Ser.*, **146**: 155-161.
- ANDERSSON S., PERSSON M., MOKSNES P.-O. & BADEN S. (2009): The role of the amphipod *Gammarus locusta* as a grazer on macroalgae in Swedish seagrass meadows. *Mar. Biol.*, **156** (5): 969-981.
- BELL J. D. & HARMELIN-VIVIEN M. L. (1983): Fish fauna of French mediterranean *Posidonia oceanica* seagrass meadows. 2. Feeding habits. *Tethys*, **11**: 1-14.
- BELLAN-SANTINI D. (1999): Ordre des Amphipodes (Amphipoda Latreille, 1816). in *Traité de Zoologie - Anatomie, Systématique, Biologie* (Pierre-P. Grassé). Tome VII, Fascicule III A : Crustacés Pécararides, FOREST J. (Ed.): 93-176.
- BIANDOLINO F. & PRATO E. (2006): A preliminary investigation of the lipids and fatty acids composition of *Gammarus aequicauda* (Crustacea: Amphipoda) and its main food source. *J. Mar. Biol. Ass. U.K.*, **86**: 345-348.
- BOLOGNA P. A. X. & HECK K. H. J. (1999): Macrofaunal associations with seagrass epiphytes - Relative importance of trophic and structural characteristics. *J. Exp. Mar. Biol. Ecol.*, **242**: 21-39.
- BOROWITZKA M. A., LAVERY P. & VAN KEULEN M. (2006): Epiphytes of seagrasses. in *Seagrasses : Biology, Ecology and Conservation*, LARKUM A. W. D., ORTH R. J. & DUARTE C. M. (Eds.): 441-461.
- BOROWITZKA M. A. & LETHBRIDGE R. C. (1989): Seagrass epiphytes. in *Biology of seagrasses - A treatise on the biology of seagrasses with special reference to the Australian region*, LARKUM A. W. D., MCCOMB A. J. & SHEPHERD S. A. (Eds.): 458-489.
- BORUM J. (1985): Development of epiphytic communities on eelgrass (*Zostera marina*) along a nutrient gradient in a Danish estuary. *Mar. Biol.*, **87** (2): 211-218.



- BUIA M. C., GAMBI M. C. & ZUPO V. (2000): Structure and functioning of mediterranean seagrass ecosystems: an overview. *Biol. Mar. Medit.*, **7**: 167-190.
- CAINE E. A. (1980): Ecology of two littoral species of caprellid amphipods (Crustacea) from Washington, USA. *Mar. Biol.*, **56** (4): 327-335.
- CARDINALE B. J., SRIVASTAVA D. S., EMMETT DUFFY J., WRIGHT J. P., DOWNING A. L., SANKARAN M. & JOUSEAU C. (2006): Effects of biodiversity on the functioning of trophic groups and ecosystems. *Nature*, **443** (7114): 989-992.
- CEBRIÁN J., ENRIQUEZ S., FORTES M., AGAWIN N., VERMAAT J. E. & DUARTE C. M. (1999): Epiphyte accrual on *Posidonia oceanica* (L.) Delile leaves: implications for light absorption. *Bot. Mar.*, **42**: 123-128.
- CRAWLEY K. R., HYNDES G. A. & VANDERKLIFT M. A. (2007): Variation among diets in discrimination of  $\delta^{13}\text{C}$  and  $\delta^{15}\text{N}$  in the amphipod *Allorchestes compressa*. *J. Exp. Mar. Biol. Ecol.*, **349** (2): 370-377.
- CRUZ-RIVERA E. & HAY M. E. (2000): The effects of diet mixing on consumer fitness: macroalgae, epiphytes, and animal matter as food for marine amphipods. *Oecologia*, **123** (2): 252-264.
- DOUGLASS J. G., DUFFY J. E., SPIVAK C. & RICHARDSON J. P. (2007): Nutrient versus consumer control of community structure in a Chesapeake Bay eelgrass habitat. *Mar. Ecol. Progr. Ser.*, **348**: 71-83.
- DUFFY J. E. (2009): Why biodiversity is important to the functioning of real-world ecosystems. *Front. Ecol. Environ.*, **7** (8): 437-444.
- DUFFY J. E. & HARVILICZ A. M. (2001): Species-specific impacts of grazing amphipods in an eelgrass-bed community. *Mar. Ecol. Progr. Ser.*, **223**: 201-211.
- DUFFY J. E. & HAY M. E. (2000): Strong impacts of grazing amphipods on the organization of a benthic community. *Ecol. Monogr.*, **70** (2): 237-263.
- DUFFY J. E., MACDONALD K. S., RHODE J. M. & PARKER J. D. (2001): Grazer diversity, functional redundancy, and productivity in seagrass beds: an experimental test. *Ecology*, **82** (9): 2417-2434.
- DUFFY J. E., RICHARDSON J. P. & CANUEL E. A. (2003): Grazer diversity effects on ecosystem functioning in seagrass beds. *Ecol. Lett.*, **6**: 637-645.
- GAMBI M. C., DONNARUMA L., LOMBARDI C. & COCITO S. (2011). *Posidonia oceanica* mimics as an experimental tool to study colonization of seagrass epiphytes. An example along a gradient of water acidification. *Proceedings of the 42nd Congresso della Societa Italiana di Biologia Marina*, Olbia, Italy.
- GAMBI M. C., LORENTI M., RUSSO G. F., SCIPIONE M. B. & ZUPO V. (1992): Depth and seasonal distribution of some groups of the vagile fauna of the *Posidonia oceanica* leaf stratum: Structural and trophic analyses. *P.S.Z.N. I: Mar. Ecol.*, **13** (1): 17-39.
- GLASBY T. M. (1999): Effects of shading on subtidal epibiotic assemblages. *J. Exp. Mar. Biol. Ecol.*, **234**: 275-290.

## Functional role of amphipod grazing in epiphyte dynamics

- HAYS C. G. (2005): Effect of nutrient availability, grazer assemblage and seagrass source population on the interaction between *Thalassia testudinum* (turtle grass) and its algal epiphytes. *J. Exp. Mar. Biol. Ecol.*, **314** (1): 53-68.
- HECK K. L. J. & ORTH R. J. (2006): Predation in seagrass beds. in *Seagrasses : Biology, Ecology and Conservation*, LARKUM A. W. D., ORTH R. J. & DUARTE C. M. (Eds.): 537-550.
- HOLMER M., PÉREZ M. & DUARTE C. M. (2003): Benthic primary producers--a neglected environmental problem in Mediterranean maricultures? *Mar. Poll. Bull.*, **46** (11): 1372-1376.
- HORNER S. M. J. (1987): Similarity of epiphyte biomass distribution on *Posidonia* and artificial seagrass leaves. *Aquat. Bot.*, **27** (2): 159-167.
- HOWARD R. K. (1982): Impact of feeding activities of epibenthic amphipods on surface-fouling of eelgrass blades. *Aquat. Bot.*, **14**: 91-97.
- HOWARD R. K. & SHORT F. T. (1986): Seagrass growth and survivorship under the influence of epiphyte grazers. *Aquat. Bot.*, **24** (3): 287-302.
- HUGHES A. R., BANDO K. J., RODRIGUEZ L. F. & WILLIAMS S. L. (2004): Relative effects of grazers and nutrients on seagrasses: a meta-analysis approach. *Mar. Ecol. Progr. Ser.*, **282**: 87-99.
- HUGHES A. R., BEST R. J. & STACHOWICZ J. J. (2010): Genotypic diversity and grazer identity interactively influence seagrass and grazer biomass. *Mar. Ecol. Progr. Ser.*, **403**: 43-51.
- HURD C. L., DURANTE K. M., CHIA F. S. & HARRISON P. J. (1994): Effect of bryozoan colonization on inorganic nitrogen acquisition by the kelps *Agarum fimbriatum* and *Macrocystis integrifolia*. *Mar. Biol.*, **121** (1): 167-173.
- JACQUEMART J. (2009): Etude de la communauté des macroalgues épiphytes de *Posidonia oceanica* (L.) Delile et comparaison avec celle de *Cystosera balearica* Sauv. - Approche expérimentale visant à élucider les effets de l'eutrophisation sur ces communautés. PhD in Sciences thesis, University of Liège, Liège, 393 pp.
- JACQUEMART J. & DEMOULIN V. (2006): Inventaire des macroalgues épiphytes des feuilles de *Posidonia oceanica* (L.) Delile dans la baie de la Revellata (Calvi, Corse). *Lejeunia*, **181**: 1-71.
- JASCHINSKI S. & SOMMER U. (2010): Positive effects of mesograzers on epiphytes in an eelgrass system. *Mar. Ecol. Progr. Ser.*, **401**: 77-85.
- JERNAKOFF P., BREARLEY A. & NIELSEN J. (1996): Factors affecting grazer-epiphytes interactions in temperate seagrass meadows. *Oceanogr. Mar. Bio. Ann. Rev.*, **34**: 109-162.
- JERNAKOFF P. & NIELSEN J. (1997): The relative importance of amphipod and gastropod grazers in *Posidonia sinuosa* meadows. *Aquat. Bot.*, **56** (3-4): 183-202.
- JONES C. G., LAWTON J. H. & SHACHAK M. (1994): Organisms as ecosystem engineers. *Oikos*, **69**: 373-386.

- KEVREKIDIS T. & KOUKOURAS A. (1989a): Life cycle and reproduction of *Gammarus aequicauda* (Crustacea, Amphipoda) in the Evros Delta (NE Greece). *Isr. J. Zool.*, **35** (3): 137-149.
- KEVREKIDIS T. & KOUKOURAS A. (1989b): Seasonal variation of abundance of *Gammarus aequicauda* (Crustacea, Amphipoda) in the Evros Delta (NE Greece). *Isr. J. Zool.*, **36** (3-4): 113-123.
- KIKUCHI T. (1980): Faunal relationships in temperate seagrass beds. in *Handbook of seagrass biology - An ecosystem perspective*, PHILLIPS R. C. & McROY C. P. (Eds.): 153-172.
- KLUMPP D. W., HOWARD R. K. & POLLARD D. A. (1989): Trophodynamics and nutritional ecology of seagrass communities. in *Biology of seagrasses - A treatise on the biology of seagrasses with special reference to the Australian region*, LARKUM A. W. D., MCCOMB A. J. & SHEPHERD S. A. (Eds.): 395-457.
- KRAPP-SCHICKEL T. & SORBE J.-C. (2006): *Apherusa delicata* n. sp., a new suprabenthic amphipod (Crustacea, Eusiroidea, Calliopiidae) from the northern Bay of Biscay, with a discussion of the genus. *Org. Divers. Evol.*, **6**: 57-65.
- LEBRETON B., RICHARD P., RADENAC G., BORDES M., BRÉRET M., ARNAUD C., MORNET F. & BLANCHARD G. F. (2009): Are epiphytes a significant component of intertidal *Zostera noltii* beds? . *Aquat. Bot.*, **91**: 82-90.
- LEPOINT G., GOBERT S., DAUBY P. & BOUQUEGNEAU J. M. (2004): Contributions of benthic and planktonic primary producers to nitrate and ammonium uptake fluxes in an nutrient-poor shallow coastal area (Corsica, NW Mediterranean). *J. Exp. Mar. Biol. Ecol.*, **302**: 107-122.
- LEPOINT G., HAVELANGE S., GOBERT S. & BOUQUEGNEAU J.-M. (1999): Fauna vs flora contribution to the leaf epiphytes biomass in a *Posidonia oceanica* seagrass bed (Revellata Bay, Corsica). *Hydrobiologia*, **394**: 63-67.
- LEPOINT G., JACQUEMART J., BOUQUEGNEAU J. M., DEMOULIN V. & GOBERT S. (2007): Field measurements of inorganic nitrogen uptake by epiflora components of the seagrass *Posidonia oceanica* (Monocotyledons, Posidoniaceae). *Journal of Phycology*, **4** (2): 208-218.
- LEPOINT G., NYSSSEN F., GOBERT S., DAUBY P. & BOUQUEGNEAU J.-M. (2000): Relative impact of a seagrass bed and its adjacent epilithic algal community in consumer diets. *Mar. Biol.*, **136**: 513-518.
- MACNEIL C., DICK J. T. A. & ELWOOD R. W. (1999): The dynamics of predation on *Gammarus* spp. (Crustacea: Amphipoda). *Biol. Rev.*, **74** (4): 375-395.
- MAERNOUDT G. (2010): Etude expérimentale de la relation entre le régime alimentaire et les performances physiologiques chez l'amphipode détritivore marin *Gammarus aequicauda*, dans la litière à *Posidonia oceanica*. Master in biology of organisms and ecology thesis, FUNDP Namur, Namur, 87 pp.
- MAZZELLA L., BUIA M. C., GAMBI M. C., LORENTI M., RUSSO G. F., SCIPIONE M. B. & ZUPO V. (1992): Plant-animal trophic relationships in the *Posidonia oceanica* ecosystem of the Mediterranean Sea: a review. in *Plant-Animal Interactions in the Marine Benthos*, JOHN D. M., HAWKINS S. J. & PRICE J. H. (Eds.): 165-187.
- MAZZELLA L. & OTT J. A. (1984): Seasonal changes in some features of *Posidonia oceanica* (L.) Delile leaves and epiphytes at different depths. in *International*

## Functional role of amphipod grazing in epiphyte dynamics

*Workshop on Posidonia oceanica Beds*, BOUDOURESQUE C. F., JEUDY DE GRISSAC A. & OLIVIER J. (Eds.): 119-127.

MAZZELLA L. & RUSSO G. F. (1989): Grazing effect of two *Gibbula* species (Mollusca, Archaeogastropoda) on the epiphytic community of *Posidonia oceanica* leaves. *Aquat. Bot.*, **35**: 353-373.

MAZZELLA L., SCIPIONE M. B. & BUIA M. C. (1989): Spatio-temporal distribution of Algal and Animal communities in a *Posidonia oceanica* meadow. *P.S.Z.N. I: Mar. Ecol.*, **10** (2): 107-129.

MCCUTCHAN J. H. J., LEWIS W. M. J., KENDALL C. & MCGRATH C. C. (2003): Variation in trophic shift for stable isotope ratios of carbon, nitrogen, and sulfur. *Oikos*, **102**: 378-390.

NECKLES H. A., WETZEL R. L. & ORTH R. J. (1993): Relative effects of nutrient enrichment and grazing on epiphyte-macrophyte (*Zostera marina* L.) dynamics. *Oecologia*, **93**: 285-295.

PEDUZZI P. (1987): Dietary preferences and carbon absorption by two marine gastropods, *Gibbula umbilicaris* (Linne) and *Jujubinus striatus* (Linne). *P.S.Z.N. I: Mar. Ecol.*, **8**: 359-370.

PÊTE D. (2005): Colonisation épiphyte de *Posidonia oceanica* (L.) Delile. Comparaison entre des feuilles artificielles et des feuilles naturelles. Master in Animal Biology thesis, University of Liège, Liège, 52 pp.

PINNEGAR J. K. & POLUNIN N. V. C. (2000): Contributions of stable-isotope data to elucidating food webs of Mediterranean rocky littoral fishes. *Oecologia*, **122** (3): 399-409.

PRADO-FIEDLER R. (1990): Atmospheric input of inorganic nitrogen species to the Kiel Bight. *Helgol. Mar. Res.*, **44** (1): 21-30.

PRATO E. & BIANCOLINO F. (2003): Seasonal changes in population of the amphipod *Gammarus aequicauda* (Martynov, 1931) *Medit. Mar. Sci.*, **4** (1): 49-56.

PRATO E., BIANCOLINO F. & SCARDICCHIO C. (2006): Postembryonic growth, development and reproduction of *Gammarus aequicauda* (Martynov, 1931) (Gammaridae) in laboratory culture. *Zool. Stud.*, **45** (4): 503-509.

PRATO E., BIANCOLINO F. & SCARDICCHIO C. (2008): Implications for toxicity test with amphipod *Gammarus aequicauda*: effects of temperature and salinity on life cycle. *Environ. Technol.*, **29** (12): 1349-1356.

ROMERO J., LEE K.-S., PÉREZ M., MATEO M. A. & ALCOVERRO T. (2006): Nutrient Dynamics in Seagrass Ecosystems. in *Seagrasses : Biology, Ecology and Conservation*, LARKUM A. W. D., ORTH R. J. & DUARTE C. M. (Eds.): 227-254.

RUESINK J. L. (2000): Intertidal mesograzers in field microcosms: linking laboratory feeding rates to community dynamics. *J. Exp. Mar. Biol. Ecol.*, **248** (2): 163-176.

SÁNCHEZ-JEREZ P., BARBERÁ-CEBRIÁN C. & RAMOS-ESPLÁ A. A. (1999): Comparison of the epifauna spatial distribution in *Posidonia oceanica*, *Cymodocea nodosa* and unvegetated bottoms: Importance of meadow edges. *Acta Oecol.*, **20** (4): 391-405.

- SCHANZ A., POLTE P. & ASMUS H. (2002): Cascading effects of hydrodynamics on an epiphyte-grazer system in intertidal seagrass beds of the Wadden Sea. *Mar. Biol.*, **141** (2): 287-297-297.
- SCIPIONE M. B., GAMBI M. C., LORENTI M., RUSSO G. F. & ZUPO V. (1996). Vagile fauna of the leaf stratum of *Posidonia oceanica* and *Cymodocea nodosa* in the Mediterranean Sea. *Seagrass Biology : Proceedings on an internaional workshop*, Rottnest Island, Western Australia.
- TRAUTMAN D. A. & BOROWITZKA M. A. (1999): Distribution of the epiphytic organisms on *Posidonia australis* and *P. sinuosa*, two seagrasses with differing leaf morphology. *Mar. Ecol. Progr. Ser.*, **179**: 215-229.
- VALENTINE J. F. & DUFFY J. E. (2006): The central role grazing in seagrass ecology. in *Seagrasses : Biology, Ecology and Conservation*, LARKUM A. W. D., ORTH R. J. & DUARTE C. M. (Eds.): 463-501.
- VAN DER BEN D. (1971): Les épiphytes des feuilles de *Posidonia oceanica* Delile sur les côtes françaises de la Méditerranée. *Mémoires de l'Institut Royal des Sciences Naturelles de Belgique*, **168**: 1-101.
- VAZQUEZ-LUIS M., SANCHEZ-JEREZ P. & BAYLE-SEMPERE J. T. (2009): Comparison between amphipod assemblages associated with *Caulerpa racemosa* var. *cylindracea* and those of other Mediterranean habitats on soft substrate. *Estuar. Coast. Shelf Sci.*, **84**: 161-170.
- VIZZINI S., SARÀ G., MICHENER R. H. & MAZZOLA A. (2002): The role and contribution of the seagrass *Posidonia oceanica* (L.) Delile organic matter for secondary consumers as revealed by carbon and nitrogen stable isotope analysis. *Acta Oecol.*, **23**: 277-285.
- WALKER B. H. (1992): Biodiversity and Ecological Redundancy. *Conservation Biology*, **6** (1): 18-23.
- ZIMMERMAN R., GIBSON R. & HARRINGTON J. (1979): Herbivory and detritivory among gammaridean amphipods from a Florida seagrass community. *Mar. Biol.*, **54**: 41-47.





# Chapter 6

## General discussion, conclusions and perspectives

Everything has an end, except the banana, which has two of them.

(Bambara saying)

The future is unwritten.

(Joe Strummer)





## **I. Importance of *Posidonia oceanica* as a host plant**

*Posidonia oceanica* is by far the most widespread seagrass species of the Mediterranean Sea. Its meadows cover a surface estimated to 40,000 km<sup>2</sup>. Production is highly variable, ranging from 150 to 3000 gDM.m<sup>-2</sup>.year<sup>-1</sup>. These estimates imply that, on average, 6.10<sup>12</sup> gDM to 120.10<sup>12</sup> gDM (*i.e.*, 6 to 120 millions of tons) of *P. oceanica* tissues are produced each year (CEBRIAN & DUARTE, 2001).

Aboveground living tissues of *Posidonia oceanica*, including leaves, therefore represent a widely available trophic resource. However, *P. oceanica* leaves have a poor nutritional quality (high C/N ratio, abundance of structural refractory carbohydrates, such as lignocellulose). In addition, they produce phenolic compounds (notably tannins) that seem to act at herbivore deterrents (VIZZINI, 2009).

For a long time, direct grazing on *P. oceanica* leaves has been considered very rare, and the aforementioned reasons were often used to explain this low grazing pressure. Classical views on the subject typically mention that herbivory is responsible for consumption of less than 10% of *Posidonia oceanica* aboveground production (PERGENT *et al.*, 1994 ; CEBRIAN *et al.*, 1996).

However, recent work brings increasing evidence that seagrass herbivory could have been largely underestimated due to inadequate methodology. It would not be that rare, but rather extremely variable in time and space (HECK & VALENTINE, 2006). In specific situations, it could reach values as high as 70% of net aboveground production, even in *P. oceanica* meadows (TOMAS *et al.*, 2005).

The identity of *Posidonia oceanica* herbivores has also been a point of debate. The main consumer is a fish macrograzer, the salema porgy, *Sarpa salpa*. Recent work suggests that this species seems to feed preferentially on most nutritious, younger leaves. It can therefore have a significant impact on seagrass production (VERGÉS *et al.*, 2011). This is in accordance with older studies showing that *Sarpa salpa* mostly relies on *Posidonia oceanica* leaves, with minor contributions of epiphytic and epilithic algae to the diet (HAVELANGE *et al.*, 1997). When feeding on fresh leaves, the soluble compounds (sugars and amino acids) are apparently assimilated preferentially to the structural carbohydrates (VELIMIROV, 1984).

Another macrograzer feeding on *Posidonia* leaves is the stony sea urchin, *Paracentrotus lividus*. This species has a more mixed diet than *Sarpa salpa*, and it apparently feeds preferentially on the older leaves. These are less nutritious than the young one, but are more palatable (less chemical defense) and covered in epiphytes, which are probably the main nitrogen source of the animals (VERGÉS *et al.*, 2011). Since it feeds on already senescent tissues, its impact on seagrass production is much weaker than the one of *Sarpa salpa*. In shallow Spanish meadows, *S. salpa* is responsible for the consumption of 70%

of the total grazed biomass, while *P. lividus* only contributes for the remaining 30% (PRADO *et al.*, 2007b).

Other organisms have been reported as occasionally feeding on *P. oceanica* leaves, to a much lesser extent. Some omnivorous decapods (*Pisa muscosa*, *Pisa nodipes*) occasionally ingest seagrass, but this source is likely rather anecdotal in their diet (MAZZELLA *et al.*, 1992 ; VIZZINI, 2009). Isopod mesograzers such as *Idotea balthica* and *Idotea hectica* can also ingest living seagrass leaves, but their main food source is probably epiphytes (LEPOINT *et al.*, 2000). The same can be said about the polychaete *Platynereis dumerilii* (GAMBI *et al.*, 2000).

Our results point out that none of the dominant species of amphipods associated to *P. oceanica* beds directly graze on their seagrass host. The extent of seagrass consumption by amphipod mesograzers has been studied in various meadows.

CARLIER *et al.* (2007) used stable isotopes to delineate trophic interactions in a Mediterranean lagoon containing *Zostera noltii* and *Ruppia cirrhosa* patches. *Gammarus aequicauda* did not seem to graze on living tissues of these phanerogams, preferring, like in our study, decaying vegetal material and algal epiphytes.

Outside the Mediterranean, eelgrass (*Z. marina*) meadows undoubtedly received the most attention. Some of the mesograzers (isopods and gastropods) from these ecosystems partly rely on seagrass material (*e.g.* DUFFY *et al.*, 2001 ; KHARLAMENKO *et al.*, 2001). In the case of amphipods, contrasting results are reported.

For example, FARLIN *et al.* (2010), using stable isotopes, showed that in Californian *Zostera marina* meadows, 4 of the 5 common, amphipod taxa fed on seagrass material. Reliance on eelgrass varied widely in each genus. It was moderate to high for *Erichthonius* sp. and *Caprella* sp. (40.2 % and 50.3 % of the diet, respectively). Moreover, eelgrass was the dominant food source for *Amphithoe* sp. (60.8 % of the diet) and the nearly exclusive food item of *Protohyale* sp. (94.8 % of the diet). Unfortunately, they only used stable isotopes of C and N, and were therefore not able to discriminate between live and detrital eelgrass material.

In Atlantic meadows of Chesapeake Bay, Amphithoids (*Cymadusa compta* and *Amphithoe longimana*) could graze them after algal epiphytes have been depleted (DUFFY & HARVILICZ, 2001 ; DUFFY *et al.*, 2001). Stable isotopes indeed brought evidence that eelgrass can be a important food source for *Cymadusa compta* (OLSEN *et al.*, 2011) and *Amphithoe longimana* (DOUGLASS *et al.*, 2011). In Alaskan meadows, *Amphithoe* sp. could partly rely on eelgrass carbon (MCCONNAUGHEY & MCROY, 1979).

In Ukrainian meadows of the Black Sea, the consumption of seagrass leaves was frequent for *Amphithoe ramondi*, whose gut contents contained 8 % of *Ruppia maritima* and 16 % of *Z. maritima*. In addition, seagrass were the main food item in the guts of *Gammarus locusta* (25 % of *R. maritima* and 43 % of *Z. maritima*) (GREZE, 1968).

Finally, in laboratory trials, *Gammarus oceanicus* from Danish *Zostera marina* meadows consumed seagrass leaves, but only when they were covered with epiphytes (HARRISON, 1977).

On the other hand, a notable number of studies report that amphipods do not seem to feed on eelgrass material. This is the case of various gammarids and of *Caprella alaskana* from Alaskan meadows (MCCONNAUGHEY & MCROY, 1979). In Chesapeake Bay, *Gammarus mucronatus* does not seem to graze seagrass leaves either (DUFFY & HARVILICZ, 2001 ; DUFFY *et al.*, 2001). Stable isotopes indeed revealed that neither *Caprella penantis* nor *Gammarus mucronatus* rely on eelgrass-derived organic matter (DOUGLASS *et al.*, 2011)

Stable isotopes and fatty acids markers showed that *Amphithoe rubricata* from German Baltic meadows did not consume seagrass (JASCHINSKI *et al.*, 2008). In Swedish *Z. marina* meadows, neither *Gammarus locusta* nor *Microdeutopus gryllotalpa* graze on seagrass tissues (JEPHSON *et al.*, 2008). In Ukrainian meadows, seagrass herbivory was nil for *Gammarellus carinatus*, and low for *Dexamine spinosa*, whose diet contained 3 % of *Ruppia maritima*, and 1.8 % of *Zostera marina* (GREZE, 1968).

In Japanese meadows, neither gammarids nor caprellids seemed to feed on *Zostera marina* (HOSHIKA *et al.*, 2006)

Other temperate meadows were also studied. In Australia, Gammarids *Paradexamine churinga* and *Tethygeneia nalgo* from *Heterozostera tasmanica* meadows apparently did not consume their seagrass host (HOWARD, 1982). Lysianassoid amphipods, however, seem to prey on *Halophile ovalis* seeds (ORTH *et al.*, 2007).

ZIMMERMAN *et al.* (1979) studied amphipods from shallow subtropical *Thalassia testudinum* and *Halodule wrightii* beds of Florida. None of the 4 studied species (*Cymadusa compta*, *Melita nitida*, *Gammarus mucronatus* and *Grandidierella bonnieroides*) seemed to feed on seagrass tissues. Similarly, HOWARD & SHORT (1986) showed that three of these species (*C. compta*, *G. mucronatus* and *G. bonnieroides*) avidly ate periphyton associated to *Halodule wrightii*, but did not consume seagrass tissues.

*A contrario*, in tropical *Syringodium isoetifolium* of Fiji islands, consumption of seagrass leaves by *Amphithoe* sp. was very common, and estimates, although they are probably overlooked, show that grazing could lead to the loss of up to 58% of seagrass production (MUKAI & IJIMA, 1995).

VONK *et al.* (2008) used stable isotopes of C and N to study the food web of polyspecific meadows (*Enhalus acoroides*, *Thalassia hemprichii*, *Cymodocea rotundata*, *Halodule uninervis* and *H. ovalis*) from southern Sulawesi (Indonesia), and showed that amphipods (mixed undetermined species) fed mostly on seagrass leaves.

Among the factors explaining these wide differences in amphipod preferences, the lack of alternative resources (macroalgae, detritus, microepiphytes, etc.) is the most commonly cited. In a lot of cases, amphipod mesograzers will not feed preferentially on seagrass leaves, but will consume them when availability of other items is low (VALENTINE & DUFFY, 2006). In addition, differences in

palatability and nutritional content can occur. Tropical seagrasses, for instance, are known to contain less fibers and structural compounds (KLUMPP *et al.*, 1989).

While trophic role of *Posidonia oceanica* itself was apparently limited, our results show that it supports an abundant and diverse community of amphipod crustaceans (cf. chapter 3). Previous work indeed clearly showed that amphipod diversity and abundance is much greater in *P. oceanica* meadows than in unvegetated sand areas (SÁNCHEZ-JEREZ *et al.*, 1999a ; VAZQUEZ-LUIS *et al.*, 2009). These authors correlate their findings with the complex tridimensional structure of the *Posidonia* meadows that would provide an adequate habitat to large populations of invertebrates.

*Posidonia oceanica* associated amphipod communities also appear to be more abundant and/or diverse than the ones found in other Mediterranean macrophytes from soft substrates, including *Cymodocea nodosa* (SCIPIONE *et al.*, 1996 ; SÁNCHEZ-JEREZ *et al.*, 1999a ; COMO *et al.*, 2008 ; VAZQUEZ-LUIS *et al.*, 2009 ; SCIPIONE & ZUPO, 2010), *Caulerpa prolifera* (VAZQUEZ-LUIS *et al.*, 2009), *Zostera marina* (SCIPIONE & ZUPO, 2010) and possibly the invasive *Caulerpa racemosa* (VAZQUEZ-LUIS *et al.*, 2009). Greater structural complexity of *P. oceanica* probably explains a part of the greater abundance and diversity of the amphipod community. Nevertheless, it is unlikely to be the only contributing phenomenon (ATTRILL *et al.*, 2000). Another important factor could be the abundance of epiphytes in *Posidonia oceanica* meadows.

## **II. The epiphyte/amphipod relationship: trophic and functional insights**

Epiphyte abundance has proven to be, alongside geographical position, the most useful variable to explain differences in the distribution and composition of amphipod assemblages associated to *P. oceanica* meadows (ZAKHAMA-SRAIEB *et al.*, 2011). Our results accordingly showed that the community of Calvi Bay was more abundant and diverse in June, when the epiphytic cover was the most developed of our three sampling seasons.

As stated in Chapter 1, the epiphytic community of *Posidonia oceanica* is among the most diverse and well structured of all seagrasses. This is explained by the important longevity of the leaves, which allows the settlement and growth of many epiphytic species (HEMMINGA & DUARTE, 2000). Biomass of epiphytes can reach 40 % of total foliar biomass, and the epiphytic cover shows an important taxonomic diversity (*e.g.* MAZZELLA *et al.*, 1989 ; BALATA *et al.*, 2007). In addition, rhizomes are also covered by important amounts of sciaphilous algae (PIAZZI *et al.*, 2002).

All these epiphytes increase the structural complexity of the habitat offered by the seagrass meadow. However, their primary relationship with the invertebrates is of trophic nature (BOLOGNA & HECK, 1999). Mesograzers are indeed known to feed mostly on micro and/or macro-epiphytes growing on

seagrass aboveground parts (see JERNAKOFF *et al.*, 1996 ; VALENTINE & DUFFY, 2006 for reviews).

Amphipods of *Posidonia oceanica* meadows seemed to be no exception to this statement. Our results show that the primary food source of all dominant species of the community were the macroalgae that grow on the seagrass. However, this statement is not incompatible with a significant amount of interspecific trophic diversity.

Amphipods indeed exhibited specific grazing patterns. Some species grazed on epiphytes growing on the leaves or on the litter fragments scattered among the shoots (*Apherusa chierighinii*, *Aora spinicornis*, *Gammarus aequicauda*). *Dexamine spiniventris*, on the other hand, seemed to specialize on epiphytes from rhizomes. The three remaining species were apparently generalists consuming epiphytes from all meadows compartments, either in comparable proportions (*Amphithoe helleri*, *Caprella acanthifera*) or with preference for epiflora of the rhizomes (*Gammarella fucicola*).

Moreover, 6 of the 7 species had a mixed diet. *Dexamine spiniventris* was the only species that seemed to feed mostly on a single resource (rhizome epiflora). All other dominant species seemed to rely on several food items. Diet mixing could be a way to cope with low nitrogen content of food sources. Most food items indeed had higher C/N ratios than the amphipod tissues. In this context, herbivore amphipods could select a mix of complementary plant items that balance their nutritional requirements. Growth of *Amphithoe valida*, *Cymadusa compta* and *Gammarus mucronatus* is indeed more important when they are fed on a mixture of algae (*Enteromorpha* spp., *Polysiphonia* spp., *Ectocarpus* spp., *Fucus vesiculosus*, *Sargassum filipendula*) than when they are fed each of these algae alone (CRUZ-RIVERA & HAY, 2000).

“Positional” grazing preferences and diet mixing can be linked with the vertical migrations of the amphipods. Movements of animals inside the meadow could allow exploitation of different resources at different periods of the day. For example, most species seem to spend the night in the foliar stratum, where they could eat epiphytes from the leaves, but live in the lower layers of the meadow during the day, and could therefore consume epiphytes from the rhizomes or litter fragments at this moment.

During our grazing experiments, amphipods only had access to the epiphytic cover of seagrass leaves (*in situ* experiments) or mimics (*in vitro* experiments). Diet mixing by consumption of other food items could therefore not be achieved. This could, alongside other factors, partly explain the low growth rates and/or the important mortality that we recorded.

Another common way to cope with poor-quality food is to use occasional carnivory to enhance protein uptake. CRUZ-RIVERA & HAY (2000) showed that a mixed animal/vegetal diet benefited *Gammarus mucronatus*, but had no effect on *Amphithoe valida* or *Cymadusa compta*.

In this study, gut contents examination showed that consumption of crustaceans and/or sessile invertebrates occurred in all dominant species, but

in small amounts. In addition, erected epifauna was readily consumed by *Apherusa chiereghinii*, *Dexamine spiniventris* and *Gammarus* spp. during *in situ* grazing experiments. However, trophic markers (stable isotopes, fatty acids) were not able to settle the question of the reliance of the amphipods on animal-derived organic matter. Animal epiphytes could be a significant food item, especially in deep meadows (> 20 m), where their relative abundance is much higher than in shallow beds (LEPOINT *et al.*, 1999)

The importance of the microorganisms, on the other hand, is rather clear. Although selective grazing of diatoms by certain amphipods from *P. oceanica* meadows is documented (SCIPIONE & MAZZELLA, 1992), diatoms were, in our case, very rare in the gut contents of all species. In addition, fatty acid analyses pointed out that they were not a significant food source in the diet of the studied amphipods. FA also pointed out that bacterial inputs were rare. Only *Gammarus aequicauda* showed presence of low amounts of bacterial FA, and they could come from symbionts rather actual food.

Microepiphytes and microphytobenthos were therefore anecdotal contributors to the diet of the amphipods from *Posidonia oceanica* meadows. This situation differs from other seagrass systems, where some amphipods strongly rely on diatoms or other unicellular organisms found in periphyton (*e.g.* ZIMMERMAN *et al.*, 1979 ; DOUGLASS *et al.*, 2011).

Consumption of diatoms by invertebrates from seagrass meadows is a fairly common phenomenon. In *Zostera noltii* meadows, benthic diatoms could even be the producers supporting most animal consumers (LEBRETON *et al.*, 2011). In *Posidonia oceanica* meadows, gastropod mesograzers (notably *Gibbula ardens* and *Gibbula umbilicaris*) do feed on the diatoms present on seagrass leaves (MAZZELLA & RUSSO, 1989). They can also be important items in the gut contents of isopods (*Idotea hectica*, *Synisoma appendiculata*; STURARO, 2005) and decapods (*e.g.* *Hippolyte inermis*; ZUPO, 2001).

In our case, however, amphipods seemed to prefer the widely available macroepiphytes. These taxon-specific dietary preferences support the view that an important trophic diversity between groups of mesograzers might exist, therefore reducing the overall ecological redundancy of the communities (MAZZELLA *et al.*, 1992 ; JERNAKOFF *et al.*, 1996 ; VALENTINE & DUFFY, 2006).

Besides this, grazing experiments showed that amphipods only feed on erected algae and animals, discarding the crustose morphotypes. By doing so, they are able to exert selective top-down control on epiphytic populations, and to act as ecosystem engineers.

The algal epiphytic cover of *Posidonia oceanica* leaves exhibits a strong seasonal variation. Epiphytic biomass is at its lowest in winter. Organisms start to grow during spring. The fast-growing erected brown algae typically dominate the community in spring and early summer (May/June). Crustose epiphytes, such as red coralline algae, are present all year round, but become more and more abundant as the epiphytic cover develops. They are the dominant organisms in late summer, when epiphytic coverage and specific

diversity are maximal (MAZZELLA *et al.*, 1989 ; CEBRIÁN *et al.*, 1999 ; LEPOINT *et al.*, 2000 ; JACQUEMART & DEMOULIN, 2006).

Since amphipods are particularly abundant in June (cf. chap. 3), they could play a part in the structuring of epiphytic communities. By consuming erected algae, they could limit their biomass, and release the crustose algae from competition. By doing so, they would participate in the balance between the two epiphytic morphotypes, and allow the epiphytic community to fully develop, and reach its maximal diversity.

In addition, the functional impact of amphipods is particularly important in the framework of coastal eutrophication. Under high nutrient supply, erected epiphytes can outgrow the seagrass, leading to deleterious effects. Grazers could be crucial in the control of this process. *In situ* and *in vitro* experiments indeed suggested that they could limit the negative impact of artificial nutrient enrichment in Calvi Bay (JACQUEMART, 2009).

Amphipods are of course not the only organisms capable of top-down control on epiphytes. Macrograzers, for example, are known to consume large amounts of epiphytes. This is especially true for the urchin *Paracentrotus lividus* that feeds on old *P. oceanica* leaves covered with epiphytes (VERGÉS *et al.*, 2011). Macrograzer feeding can indeed have important impacts on the epiphytic cover of *Posidonia oceanica* (PRADO *et al.*, 2007a). Since the individual biomass of these macrograzers is much more important than those of mesograzers, and their population densities can be very high, the overall effect on macrograzers on epiphytic assemblages could even be greater than the one caused by amphipods.

However, macrograzers typically bite off seagrass leaves chunks, and ingest them with the epiphytes they bear. This feeding mode is rather incompatible with selection of certain epiphytic groups, and it is more likely that the macrograzers are mostly responsible for quantitative effects (biomass depletion). In addition, they directly consume seagrass tissues, and therefore have adverse effects on seagrass production.

Amphipod grazing activity, on the other hand, causes quantitative and qualitative modifications of the epiphytic cover. By doing so, they can have a double positive effect on their seagrass host. First, they would help keep epiphytic communities balanced and epiphytic loads to a normal extent. Second, they could boost seagrass production by enhancing nitrogen cycling locally through excretion and sloppy feeding.

The association between *Posidonia oceanica* and amphipods could therefore be described as a non-essential case of mutualism. The seagrass host would provide a suitable, complex habitat and trophic resources under the form of epiphytes. The amphipods, in turn, would perform “maintenance” of the epiphytic cover, and would increase N availability to the host plant.

Overall, epiphytes clearly constitute a compartment (arguably several compartments) that is crucial for the dominant species of amphipods associated to *Posidonia oceanica* meadows. Epiphyte grazing is nevertheless

not the only trophic activity from amphipods that is likely to impact ecosystem functioning (cf. below).

### **III. The *P. oceanica* litter among the meadow: trophic vs. structural role**

The importance of herbivory in *Posidonia oceanica* meadows (discussed in section I of this chapter) is still debated, and no actual consensus between workers exists. The fact that a significant part of *P. oceanica* production is not consumed alive, but enters the food web under detrital form is nevertheless widely accepted. Estimates vary over a large interval, and values of 50 % to 90 % of total seagrass particulate production are reported (ROMERO *et al.*, 1992 ; PERGENT *et al.*, 1994 ; CEBRIAN *et al.*, 1996 ; MATEO & ROMERO, 1997 ; PERGENT *et al.*, 1997 ; CEBRIÁN *et al.*, 1999 ; CEBRIAN & DUARTE, 2001).

Most belowground detritus (dead roots and rhizomes) are generally not exported, and accumulate as refractory material within the meadow. They can represent 25 % to 35 % of seagrass production (MATEO & ROMERO, 1997 ; CEBRIAN & DUARTE, 2001).

Aboveground tissues such as leaves have different fates. After senescence and shedding, a large part of leaf detritus (typically 40 to 80 %) are exported to other ecosystems by current or waves. This detritus subsequently accumulates on sandy beaches (beach wrack, or “banquettes”) in unvegetated areas adjacent to the meadow (submerged phytodetritus accumulations, or SPA), or even in deeper areas (ROMERO *et al.*, 1992 ; MATEO *et al.*, 2003).

The remaining part of detritus accumulate in the meadow, where they decompose within a few months (MATEO & ROMERO, 1997). Chemical decomposition takes place mostly under the action of microorganisms (bacteria, fungi). However, detritivores invertebrates from meio-, meso- and macrofauna also play a part. By feeding on *P. oceanica* detritus (and on its associated microorganisms), they participate in the mechanical degradation (fragmentation) of detrital material. Increased fragmentation favors microorganism colonization and activity, there enhancing overall decomposition and the associated nutrient recycling. In addition, they are eaten by fishes and large invertebrates, and therefore transfer seagrass organic matter to higher trophic levels (VIZZINI, 2009).

In the meadow, psammivorous holothurians seem to be the main recyclers of seagrass detritus. They feed on surface sediment, and ingest and assimilate significant amounts of associated *P. oceanica* detritus (LEPOINT *et al.*, 2000 ; VIZZINI & MAZZOLA, 2004 ; VIZZINI, 2009).

In this study, we showed that three of the dominant species of the community (*Dexamine spiniventris*, *Gammarella fucicola* and *Gammarus aequicauda*) ingested modest amounts of seagrass vascular detritus (chapter 4, section IV.1).

In the case of the two former species, ingestion of litter was probably accidental, and likely occurred while feeding on epiphytes from litter



fragments (*G. fucicola*) or rhizomes (*G. fucicola*, *D. spiniventris*). Our results show that no assimilation of consumed *P. oceanica* detritus apparently took place. Their role in litter degradation is likely moderate, and limited to occasional physical fragmentation.

*G. aequicauda*, on the other hand, actually assimilated detritus. Stable isotopes mixing model estimates suggest that detritus is, alongside epiphytes from leaves and litter, a major food source, and that their diet is composed of 25 % to 50 % of detritus (chapter 4, section IV.4.G). This unique specialization could be linked with the presence of bacterial symbionts in the gut of this species, whose activity enhances digestion of refractory compounds (GENIN, 2007). *G. aequicauda* is also very abundant in SPA, where its diet is similar to, but even more litter-based than the one reported here (LEPOINT *et al.*, 2006 ; REMY, 2010) All these features show that *G. aequicauda* could be regarded as a potentially important litter recycler.

The functional role of *in situ* (*i.e.*, occurring directly in the meadow) litter recycling is poorly understood. However, since detrital pathway is very important in *P. oceanica* meadows, this activity could have significant local impacts. It could increase the residence time of seagrass-derived organic matter at its site of production, and enhance nutrient availability for the primary producers (seagrass and epiphytes). Alongside psammivorous holothurians, the amphipod *G. aequicauda* could play a part in these processes.

While *G. aequicauda* was the only amphipod directly exploiting litter for trophic purposes, most dominant species (all but *D. spiniventris*) were consistently found among litter fragments (see chap. 3). This compartment was apparently the preferred habitat of *Gammarella fucicola*, which was rarely found in the foliar stratum, but common in the litter at both day- and nighttime. Other species performed vertical migrations, and were found in both litter and foliar stratum at different periods.

The litter cover present among the meadow could therefore be an important microhabitat for amphipods. Its physical and chemical features (light and oxygen availability, tridimensional configuration, etc.) are different from those of the foliar stratum. The two zones can be regarded as distinct, yet directly contiguous and interconnected environments. Litter could therefore enhance the structural diversity of the habitat offered by *Posidonia oceanica* meadows to the amphipod community.

Moreover, at the periods where they live in the litter, dominant species (again, with the exception of *D. spiniventris*) probably graze on the macro-epiphytes that are present on litter fragments. They could not be discriminated from those growing on living leaves using either stable isotopes or fatty acids, and the relative contributions of these two food sources could therefore not be assessed precisely. Contribution of litter epiphytes could nonetheless be important, notably in the perspective of diet mixing (see section II of this chapter).

#### **IV. Determinants of amphipod communities in *P. oceanica* meadows of Calvi Bay**

In the preceding chapters, we mentioned a number of factors that can influence the size of amphipod communities. It would be interesting to summarize them to understand which ones could actually control the development of the studied taxocenosis.

As exposed in chapter 4, the trophic interactions depicted by our results seem to be temporally stable, and exhibit little seasonal variation. In addition, even if a certain amount trophic diversity, the main food source of all dominant species are epiphytic macroalgae. Since epiflora is subject to important biomass variations throughout the year (MAZZELLA *et al.*, 1989 ; LEPOINT *et al.*, 1999), trophic resource availability might be low in winter and early spring.

In this context, bottom-up control of amphipods could explain the lesser development of the community (lower density) that we recorded in March 07. Under artificial conditions, in our *in vitro* microcosms, monospecific populations of *Apherusa chierighinii*, *Dexamine spiniventris* and *Gammarus* spp. grazed on erected algae until total (or nearly total) resource depletion. However, in the field, such extreme grazing was not observed, and erected epiphytes standing stocks were present in all seasons (Pers. Obs.). This suggests that in the field, amphipod populations cannot reach a size where they can consume all present epiphytes. Bottom-up control alone is therefore not sufficient to explain amphipod abundance.

Horizontal direct or indirect interactions between mesograzers (amphipod or non-amphipod) could play a part. In particular, interspecific competition for habitat could occur when seagrass biomass is low, and litter scarce. This moment matches the one where epiphytic biomass is the lowest (winter/spring). Consequently, it is difficult to consider the relative importance of habitat vs. food limitations for amphipods of *P. oceanica* meadows. However, in both cases, nychthemeral vertical migrations could be important to ensure an optimal use of all available resources and limit competition (SÁNCHEZ-JEREZ *et al.*, 1999b).

Differences in life histories could also be a mechanism to limit interspecific competition. Amphipods show a wide diversity in reproductive cycles and periods that can be different according to the species and/or the environmental conditions. Some amphipods breed once a year, other twice a year (often at the beginning and the end of a single period). Other breed several times throughout the year, either continuously or only during a part of the year (*i.e.* when environmental conditions are favourable) (BELLAN-SANTINI, 1999). No data are, to our knowledge, available for amphipods living in *Posidonia oceanica* meadows. In a different Mediterranean ecosystem (Mar Piccolo lagoon, Southern Italy), *Gammarus aequicauda* seems to breed twice a year: once in spring, and once in autumn (PRATO & BIANDOLINO, 2003). This is however not a general case (*e.g.* KEVREKIDIS *et al.*, 2009).

Juveniles of *Apherusa* sp. (presumably *A. chiereghinii*) were present in November, March, and June (cf. chap. 3), and so were egg-bearing females (data not shown). This species could therefore breed several times a year, with a maximum at the end of the winter/early spring, since more juveniles are present in March.

Juveniles of the genus *Dexamine*, on the other hand, were only present in June. Their total absence in March and November suggest that reproduction could occur only once a year, in spring.

These discrepancies in reproductive events, although they must be confirmed and replaced in the wider context of life histories of animals, could be important for community structures. These two abundant species could indeed have maximal population effectives at two different times of the year, limiting the extent of interspecific competition for habitat and/or food.

Another factor possibly limiting the size of amphipod populations is top-down control. In *Posidonia oceanica* meadows, a number of small predators feed on small crustaceans. Those include fish (BELL & HARMELIN-VIVIEN, 1983 ; PINNEGAR & POLUNIN, 2000 ; STERGIOU & KARPOUZI, 2002) and possibly larger invertebrates, such as decapods (LEPOINT *et al.*, 2000 ; VIZZINI *et al.*, 2002).

The role of top-down in control of mesograzers population size has been proven in other seagrass system, such as *Zostera marina* (DUFFY *et al.*, 2005) and *Thalassia testudinum* (HECK *et al.*, 2000). Its importance is widely debated, but it could be a widespread phenomenon, common to most seagrass meadows (HECK & VALENTINE, 2006 ; HECK & VALENTINE, 2007). In *P. oceanica* meadows, experimental predator exclusion indeed seems to cause higher amphipod abundance (STURARO, Unpubl. data).

Overall, control of amphipod population size seems to be a complex and multifactorial problematic. It probably involves trophic interactions as well as habitat features, and more research is needed to understand it fully.

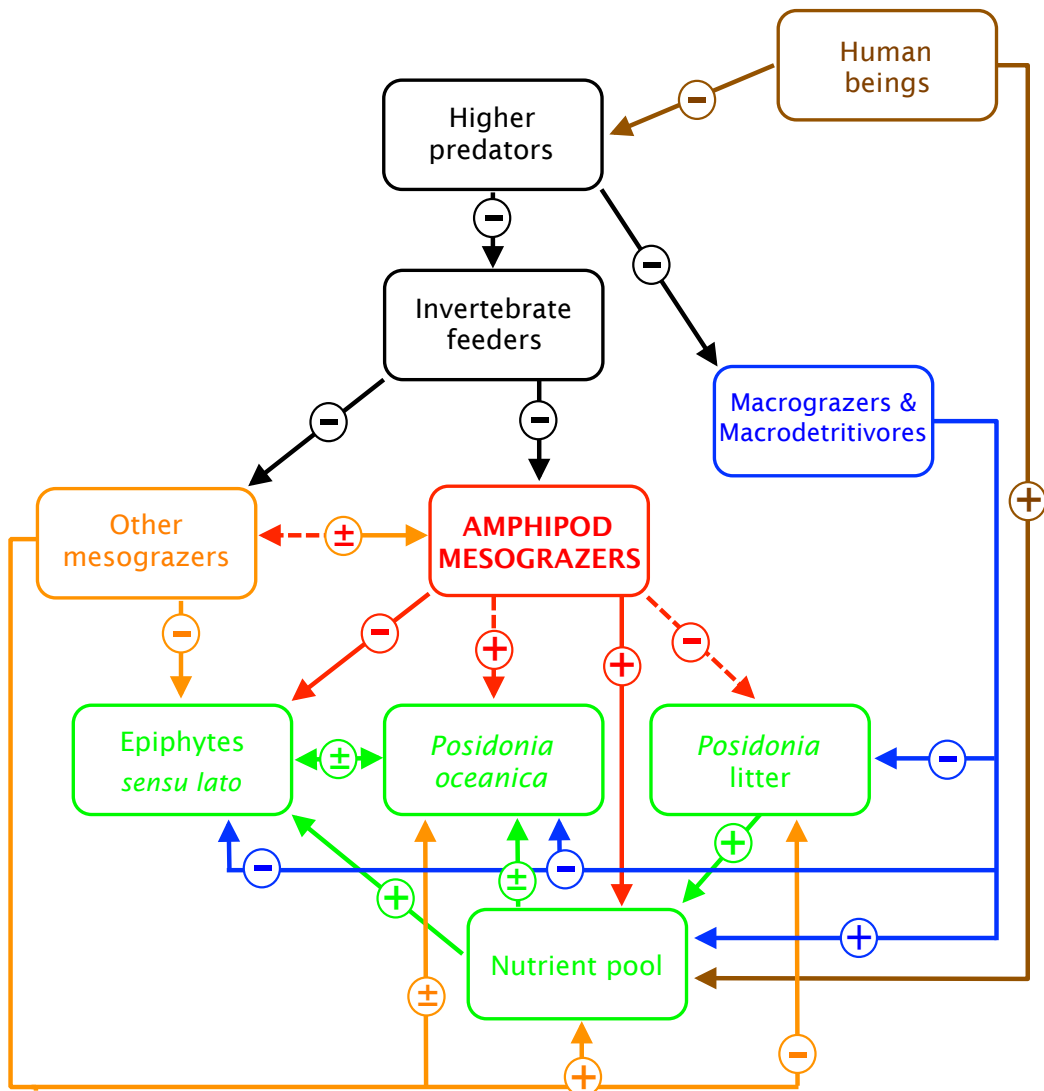
The intricacy of phenomena involved in this issue reflects the overall complexity of functional relationships in seagrass meadows in general, and in *P. oceanica* meadows in particular.

## **V. The place of amphipods in trophic and functional interactions of *Posidonia oceanica* meadows**

The most important interactions discussed in this chapter, or in the previous ones, are summarized on figure 6.1. Most of them are based on trophic processes, but it is not a general case

As mentioned earlier in this chapter, physical and chemical litter degradation causes nutrient recycling, and increases their availability for producers (in green on fig. 6.1). This explains the "+" sign associated to this interaction.

Increased nutrient inputs can have contrasted effects on seagrass production. Moderate enrichment in the water column, or nutrient fertilization in the



**Fig. 6.1:** Partial overview of functional interactions in Mediterranean *P. oceanica* meadows (After VALENTINE & DUFFY, 2006, modified). Interactions concerning amphipod mesograzers are in red. Solid red lines indicate interactions confirmed by our results, and dashed red lines indicate interactions suggested by our results and findings from other meadows. Other groups include primary producers and nutrients (in green), non-amphipod mesograzers (in orange), macrograzers and macrodetrivores (in blue), predators (in black) and humans (in brown). "+" signs designate positive interactions, "-" signs negative interactions and "±" signs ambivalent interactions that can be negative or positive depending on the situation.

sediment typically enhance seagrass production (*e.g.* ALCOVERRO *et al.*, 1997 ; HUGHES *et al.*, 2004). On the other hand, under high nutrient loads, epiphytes tend to outgrow the seagrass, reducing its production (BOROWITZKA *et al.*, 2006).

The overall effect of nutrient enrichment on epiphytic biomass is typically positive. Severe changes in the structure of the communities (specific diversity, relative dominance relationships) can occur (BOROWITZKA *et al.*, 2006 ; HECK & VALENTINE, 2006 ; JACQUEMART, 2009), but epiphytic production is typically enhanced by nutrient increase (BOROWITZKA *et al.*, 2006 ; HECK & VALENTINE, 2006).

As exposed in chapters 5, interactions between seagrass and epiphytes are usually balanced, and each end member can (to a certain extent) benefit of them. However, when epiphytic abundance becomes too high, it can have deleterious effects on the seagrass (JERNAKOFF *et al.*, 1996).

In this study, we showed that amphipod mesograzers (in red on fig. 6.1) feed on macroepiphytes (chapter 4), and that this trophic activity had an impact on epiphytic biomass and on nitrogen availability in the meadow (chapter 5). By providing nutrient to the seagrass and removing its erected epiphytes, amphipods likely enhance *P. oceanica* production. In addition, *Gammarus aequicauda*, which feeds partly on *Posidonia* litter, could play a part in its degradation. Direct and indirect horizontal interactions between amphipods, or between amphipods and other mesograzers, could also be important. They could be negative, as competition for habitat or food could occur under given environmental conditions. They could also be positive, as increased diversity of mesograzers assemblages can reduce the strength of top-down control (DUFFY *et al.*, 2005) or enhance secondary production (DUFFY *et al.*, 2003). The extent of functional or ecological redundancy between grazers is probably one of the key factors in the balance of positive vs. adverse effects.

Other mesograzers (in orange on fig. 6.1) include gastropods, polychaetes, isopods and arguably decapods. All the concepts discussed in the previous paragraph for amphipods may apply to them as well. A notable difference is that, contrary to amphipods, some other mesograzers consume living *P. oceanica* tissues (MAZZELLA *et al.*, 1992), explaining the "±" of this interaction. However, these animals mostly feed on epiphytes or other resources (GAMBI *et al.*, 2000 ; LEPOINT *et al.*, 2000 ; STURARO *et al.*, 2010). Their importance in seagrass grazing is therefore probably limited, and it is very unlikely that these organisms have an actual negative effect on seagrass biomass. Another indirect negative effect could nonetheless come physical degradation of the blade by mesograzers feeding on epiphytes (notably by gastropods with strong radulae).

Macrograzers (*Sarpa salpa*, *Paracentrotus lividus*) and macrodetritivores (*Holothuria* spp., some decapod crustaceans) are larger-sized animals directly consuming living or dead *Posidonia* material, as well as the epiphytes associated to it (blue interactions on fig. 6.1). Since their feeding modes and

consumption rates are different from those of mesograzers, their impacts on producers will likely be different as well (HECK & VALENTINE, 2006 ; VALENTINE & DUFFY, 2006). Their trophic activity could, like the one of mesograzers, enhance nutrient cycling. However, in some cases, this effect could also be reduced by dispersion of nutrients due to high mobility of consumers.

Predators (in black on figure 6.1) can have indirect effects on primary producers by influencing the density of grazers through top-down control. In *Posidonia oceanica* meadows, small fishes and/or large invertebrates feed on mesograzers. In addition, larger predators (typically benthic-feeding fishes) feed on these first-order predators, and could also consume macrograzers and macrodetritivores. Trophic cascades in marine coastal ecosystems are known to be strong, and action of predators could therefore be crucial in the functioning of the ecosystem (BORER *et al.*, 2005 ; VALENTINE & DUFFY, 2006).

Finally, anthropogenic impacts (in brown on figure 6.1) further complicate the interactions. They essentially take two forms: increase in nutrient loads in the water column through coastal eutrophication, and reduction of the stocks of large predators through commercial harvesting and/or habitat modification. As mentioned in chapter 5, these two effects are generally regarded as negative for the seagrasses (VALENTINE & DUFFY, 2006 and references therein). Important nutrient availability can indeed lead to over-development of epiphytes. In addition, harvesting of higher rank predators could allow the small, first-order predators densities to increase, leading to important depletion of mesograzers. These negative indirect effects likely aggravate “direct” adverse anthropogenic effects such as meadow destruction and seagrass habitat modification (DUARTE, 2002 ; BOUDOURESQUE *et al.*, 2006)

Figure 6.1 is only a partial overview of functional interactions occurring inside *P. oceanica* meadows. Several compartments and functional groups are omitted, and numerous interactions are not represented. It nonetheless captures the entanglement of networked functional relationships and influences typical of seagrass systems in general, and of *Posidonia oceanica* meadows in particular.

In this complex framework, our results indicate that amphipod mesograzers can interact with multiple compartments and animal groups. Since their feeding activities can influence their biotopes through several effects, they could be pivotal items in the functioning of *Posidonia oceanica* meadows as ecosystems.

## **VI. Further research: suggestions and perspectives**

Over the course of this work, the number of questions we raised is at least as great as the number of questions we answered. In this final part, we intend to summarize a few suggestions of research issues that should, in our opinion, be investigated in priority.

In chapter 3, we studied the structure of the communities of amphipods associated to *Posidonia oceanica* meadows. We showed that it was a complex and dynamic taxocenosis, and that combination of sampling methods was desirable to collect it in a complete and representative manner. Discrepancies between our study and literature data, as well as uncertainties in the described trends, indicated that more consistent work is necessary to fully understand the composition of these assemblages.

Our results show that the litter cover present among the shoots could be an important feature of the habitat offered by *Posidonia oceanica* meadows, and could play a central role in nychthemeral migration patterns. It would be interesting to understand how litter availability influences the abundance and diversity of amphipod assemblages. This could be done by studying the communities present in different area that are distinguished by abundance of litter, or alternatively by experimentally manipulating litter density.

Since amphipods could also graze on epiphytes present on litter fragments, it would also be interesting to evaluate the trophic and structural importance of litter. This could be assessed by studying colonization of unmodified litter patches versus patches where epiphytes were removed.

In chapter 4, we studied the feeding habits of the dominant species of the community. To have an accurate view of their trophic ecology, we combined a classical method (gut content examination) and two trophic markers (fatty acids and stable isotopes ratios of C and N).

This multidisciplinary approach proved to be efficient, as each method had specific strengths and made up for caveats associated with the others. Our results point out that a certain extent of interspecific diversity existed, and that most species had a mixed diet consisting mostly on macroepiphytes. However, the similarity of the producers (particularly epiphytic groups) and the sometimes important variation associated with the food sources limited the insights that could be drawn from our study. For example, it was difficult to discriminate epiflora and epifauna from leaves and litter fragments. Consumers could preferentially feed on one or several of these 4 sources, or even select specific epiphytic taxa inside these compartments. From the point of view of this study, they will have similar diets. Trophic diversity would nonetheless occur, at a finer level, and would be undetected.

Providing solutions to these issues will undoubtedly be challenging. Refining the sampling of food sources (*i.e.*, sampling the dominant taxa of epiphytic groups rather than the whole group itself) could help. Using additional trophic markers could also be useful, but the intrinsic similarity of some epiphytic groups could make a full discrimination impossible.

Besides this, our results suggest that of intraspecific and/or interindividual trophic diversity also exists and could, in some case, be far from negligible. Assessment of its extent requires robust datasets of individual measurements (cf. chapter 4), but could be rewarding, since intraspecific specialization could be a mechanism limiting competition for food.

In chapter 5, we tried to determine how the trophic activity of 3 of the dominant taxa studied in chapter 4 influenced dynamics of the epiphytic cover of the leaves, using *in vitro* and *in situ* grazing experiments. Our results show that these 3 taxa are capable of top-down control on erected epiflora and epifauna. All taxa apparently consumed similar amounts of epiphytes, suggesting a certain degree of functional redundancy. However, like for food habits, interspecific differences could exist at a finer level. It would be interesting to repeat the experiments and to focus on biomass of specific epiphytic taxa, or to assess the diversity and community structure of epiphytes under grazing pressure from different amphipods.

Our results also suggest that grazing activity of amphipods could increase seagrass production by releasing *Posidonia oceanica* from competition with erected epiphytes and enhancing nutrient cycling. However, this production increase has yet to be actually measured.

Our experimental *in situ* microcosms did not allow precise measurements of seagrass biomass at the beginning of the experiment. Even by modifying the microcosm design, direct measurements of biomass seem complex, since *Posidonia oceanica* poorly stands experimental manipulation (uprooting, etc.). Indirect measurements (*i.e.* measurements of seagrass biomass in different meadow patches) are another option, but they will likely be biased by the small-scale variability in this parameter. The most sensible approach could be direct measurement of foliar surface to estimate biomass of the studied shoots.

However, even with accurate biomass data, measuring the influence of mesograzers activity on seagrass production will be complicated by the inadequacy of time requirements. Growth of *Posidonia oceanica* is indeed slow, while mesograzers are short-lived, and hard to maintain alive for long periods in microcosms. Indirect, immediate estimations of seagrass production (photosynthetic activity measurement by fluorimetry, net oxygen production estimation, evaluation of carbon incorporation through labeling, etc.) should also be considered.

Besides epiphyte grazing, other trophic activities of amphipods could be important in the functioning of *Posidonia oceanica*. Assessing the impact of partial detritivores (mostly *Gammarus aequicauda*) on litter dynamics could be insightful, as the fragmentation they induce could influence litter abundance, and putatively nutrient cycling.

As mentioned earlier in this chapter, both bottom-up and top-down controls of amphipod abundance likely occur. In other words, sizes of amphipod populations are probably limited by epiphyte availability and by predation by fish and larger invertebrates. Determining whether one of these two mechanisms is predominant is a complicated task, implying extensive experimental work (*in situ* manipulations). However, in the framework of coastal eutrophication, this issue could be crucial in predicting the role of mesograzers in human-impacted seagrass meadows. It therefore deserves to receive attention.



Vertical interactions are not the only phenomena able to modulate functional role of mesograzers in seagrass ecosystems. Consistent evidence that horizontal relationships between amphipods, or between amphipods and other taxa can be important exists in other temperate systems, such as *Zostera marina* meadows (DUFFY *et al.*, 2001 ; DUFFY, 2002, 2003 ; DUFFY *et al.*, 2003 ; DUFFY *et al.*, 2005 ; DUFFY, 2009). In this context, it would be interesting to assess how specific diversity can modify the impact of amphipod grazing. This can be done by performing grazing experiments using polyspecific assemblages of apparently functionally redundant amphipods. Importance of functional diversity should also be considered, by working with assemblages of several grazers that have different feeding modes and/or preferences, and therefore putatively different impacts (amphipods vs. gastropods, for example).

Besides these topical suggestions, the biggest challenge is probably the generalization of our results. *Posidonia oceanica* meadows are complex and intricate ecosystems, and their heterogeneous nature causes important small-scale spatial variation. Larger scale variation also occurs, in relation to differences in biotic and abiotic factors. Even though our results suggest that trophic interactions could be stable throughout the year (see chapter 4), temporal variations could occur in a number of parameters, in response to seasonal changes of meadow features.

The trophic and functional interactions inside *Posidonia oceanica* meadows form a intricate interplay of relationships, which features numerous biological, chemical and physical control mechanisms and feedback loops. This complexity makes the system very sensitive to spatio-temporal variations, the situation described here, in Calvi Bay, at 10 m of depth, could be different in other locations and under different conditions. Understanding this likely important variation patterns is a key factor for the comprehension of *in situ* realization of the effects and relationships that we described in this study, and is therefore highly desirable.

## **References**

ALCOVERRO T., ROMERO J., DUARTE C. M. & LOPEZ N. I. (1997): Spatial and temporal variations in nutrient limitation of seagrass *Posidonia oceanica* growth in the NW Mediterranean. *Mar. Ecol. Progr. Ser.*, **146**: 155-161.

ATTRILL M. J., STRONG J. A. & ROWDEN A. A. (2000): Are macroinvertebrates communities influenced by seagrass structural complexity ? *Ecography*, **23**: 114-121.

BALATA D., NESTI U., PIAZZI L. & CINELLI F. (2007): Patterns of spatial variability of seagrass epiphytes in the north-west Mediterranean Sea. *Mar. Biol.*, **151** (6): 2025-2035.

BELL J. D. & HARMELIN-VIVIEN M. L. (1983): Fish fauna of French mediterranean *Posidonia oceanica* seagrass meadows. 2. Feeding habits. *Tethys*, **11**: 1-14.

- BELLAN-SANTINI D. (1999): Ordre des Amphipodes (Amphipoda Latreille, 1816). in *Traité de Zoologie - Anatomie, Systématique, Biologie* (Pierre-P. Grassé). Tome VII, Fascicule III A : Crustacés Pécararides, FOREST J. (Ed.): 93-176.
- BOLOGNA P. A. X. & HECK K. H. J. (1999): Macrofaunal associations with seagrass epiphytes - Relative importance of trophic and structural characteristics. *J. Exp. Mar. Biol. Ecol.*, **242**: 21-39.
- BORER E. T., SEABLOOM E. W., SHURIN J. B., ANDERSON K. E., BLANCHETTE C. A., BROITMAN B., COOPER S. D. & HALPERN B. S. (2005): What determines the strength of a trophic cascade? *Ecology*, **86** (2): 528-537.
- BOROWITZKA M. A., LAVERY P. & VAN KEULEN M. (2006): Epiphytes of seagrasses. in *Seagrasses : Biology, Ecology and Conservation*, LARKUM A. W. D., ORTH R. J. & DUARTE C. M. (Eds.): 441-461.
- BOUDOURESQUE C. F., BERNARD G., BONHOMME P., CHARBONNEL E., DIVIACCO G., MEINESZ A., PERGENT G., PERGENT-MARTINI C., RUITTON S. & TUNESI L. (2006): Préservation et conservation des herbiers à *Posidonia oceanica*. Ramoge, Marseille, 202 pp.
- CARLIER A., RIERA P., AMOUROUX J.-M., BODIQUO J.-Y., ESCOUBEYROU K., DESMALADES M., CAPARROS J. & GRÉMARE A. (2007): A seasonal survey of the food web in the Lapalme Lagoon (northwestern Mediterranean) assessed by carbon and nitrogen stable isotope analysis. *Estuar. Coast. Shelf Sci.*, **73** (1-2): 299-315.
- CEBRIAN J. & DUARTE C. (2001): Detrital stocks and dynamics of the seagrass *Posidonia oceanica* (L.) Delile in the Spanish Mediterranean. *Aquat. Bot.*, **70** (4): 295-309.
- CEBRIAN J., DUARTE C. M., MARBA N., ENRIQUEZ S., GALLEGOS M. & OLESEN B. (1996): Herbivory on *Posidonia oceanica*: magnitude and variability in the Spanish Mediterranean. *Mar. Ecol. Progr. Ser.*, **130**: 147-155.
- CEBRIÁN J., ENRIQUEZ S., FORTES M., AGAWIN N., VERMAAT J. E. & DUARTE C. M. (1999): Epiphyte accrual on *Posidonia oceanica* (L.) Delile leaves: implications for light absorption. *Bot. Mar.*, **42**: 123-128.
- COMO S., MAGNI P., BAROLI M., CASU D., DE FALCO G. & FLORIS A. (2008): Comparative analysis of macrofaunal species richness and composition in *Posidonia oceanica*, *Cymodocea nodosa* and leaf litter beds. *Mar. Biol.*, **153** (6): 1087-1101.
- CRUZ-RIVERA E. & HAY M. E. (2000): The effects of diet mixing on consumer fitness: macroalgae, epiphytes, and animal matter as food for marine amphipods. *Oecologia*, **123** (2): 252-264.
- DOUGLASS J. G., DUFFY J. E. & CANUEL E. A. (2011): Food Web Structure in a Chesapeake Bay Eelgrass Bed as Determined through Gut Contents and C-13 and N-15 Isotope Analysis. *Estuaries Coasts*, **34** (4): 701-711.
- DUARTE C. M. (2002): The future of seagrass meadows. *Environ. Conserv.*, **29** (2): 192-206.
- DUFFY J. E. (2002): Biodiversity and ecosystem function: the consumer connection. *Oikos*, **99** (2): 201-219.
- DUFFY J. E. (2003): Biodiversity loss, trophic skew and ecosystem functioning. *Ecol. Lett.*, **6** (8): 680-687.

- DUFFY J. E. (2009): Why biodiversity is important to the functioning of real-world ecosystems. *Front. Ecol. Environ.*, **7** (8): 437-444.
- DUFFY J. E. & HARVILICZ A. M. (2001): Species-specific impacts of grazing amphipods in an eelgrass-bed community. *Mar. Ecol. Progr. Ser.*, **223**: 201-211.
- DUFFY J. E., MACDONALD K. S., RHODE J. M. & PARKER J. D. (2001): Grazer diversity, functional redundancy, and productivity in seagrass beds: an experimental test. *Ecology*, **82** (9): 2417-2434.
- DUFFY J. E., RICHARDSON J. P. & CANUEL E. A. (2003): Grazer diversity effects on ecosystem functioning in seagrass beds. *Ecol. Lett.*, **6**: 637-645.
- DUFFY J. E., RICHARDSON J. P. & FRANCE K. E. (2005): Ecosystem consequences of diversity depend on food chain length in estuarine vegetation. *Ecol. Lett.*, **8** (3): 301-309.
- FARLIN J., LEWIS L., ANDERSON T. & LAI C. (2010): Functional diversity in amphipods revealed by stable isotopes in an eelgrass ecosystem. *Mar. Ecol. Progr. Ser.*, **420**: 277-281.
- GAMBI M. C., ZUPO V., BUIA M. C. & MAZZELLA L. (2000): Feeding ecology of *Platynereis dumerlii* (Audouin & Milne-Edwards) in the seagrass *Posidonia oceanica* system: the role of the epiphytic flora. *Ophelia*, **53** (3): 189-202.
- GENIN A. (2007): Approche pluridisciplinaire des stratégies alimentaires de quelques crustacés amphipodes inféodés à la litière de *Posidonia oceanica* (L.) Delile. Master in Animal Biology thesis, University of Liège, Liège, 49 pp.
- GREZE I. I. (1968): Feeding habits and food requirements of some amphipods in the Black Sea. *Mar. Biol.*, **1** (4): 316-321.
- HARRISON P. G. (1977): Decomposition of macrophyte detritus in seawater : effects of grazing by amphipods. *Oikos*, **28**: 165-169.
- HAVELANGE S., LEPOINT G., DAUBY P. & BOUQUEGNEAU J. M. (1997): Feeding of the Sparid Fish *Sarpa salpa* in a Seagrass Ecosystem: Diet and Carbon Flux. *P.S.Z.N. I: Mar. Ecol.*, **18** (4): 289-297.
- HECK J. K. L. & VALENTINE J. F. (2006): Plant-herbivore interactions in seagrass meadows. *J. Exp. Mar. Biol. Ecol.*, **330** (1): 420-436.
- HECK K. & VALENTINE J. (2007): The primacy of top-down effects in shallow benthic ecosystems. *Estuaries Coasts*, **30** (3): 371-381-381.
- HECK K. L., PENNOCK J. R., VALENTINE J. F., COEN L. D. & SKLENAR S. A. (2000): Effects of nutrient enrichment and small predator density on seagrass ecosystems: An experimental assessment. *Limnol. Oceanogr.*, **45** (5): 1041-1057.
- HEMMINGA M. A. & DUARTE C. M. (2000): Seagrass Ecology. Cambridge University Press, Cambridge, 298 pp.
- HOSHIKA A., SARKER M. J., ISHIDA S., MISHIMA Y. & TAKAI N. (2006): Food web analysis of an eelgrass (*Zostera marina* L.) meadow and neighbouring sites in Mitsukuchi Bay (Seto Inland Sea, Japan) using carbon and nitrogen stable isotope ratios. *Aquat. Bot.*, **85** (3): 191-197.
- HOWARD R. K. (1982): Impact of feeding activities of epibenthic amphipods on surface-fouling of eelgrass blades. *Aquat. Bot.*, **14**: 91-97.

HOWARD R. K. & SHORT F. T. (1986): Seagrass growth and survivorship under the influence of epiphyte grazers. *Aquat. Bot.*, **24** (3): 287-302.

HUGHES A. R., BANDO K. J., RODRIGUEZ L. F. & WILLIAMS S. L. (2004): Relative effects of grazers and nutrients on seagrasses: a meta-analysis approach. *Mar. Ecol. Progr. Ser.*, **282**: 87-99.

JACQUEMART J. (2009): Etude de la communauté des macroalgues épiphytes de *Posidonia oceanica* (L.) Delile et comparaison avec celle de *Cystosera balearica* Sauv. - Approche expérimentale visant à élucider les effets de l'eutrophisation sur ces communautés. PhD in Sciences thesis, University of Liège, Liège, 393 pp.

JACQUEMART J. & DEMOULIN V. (2006): Inventaire des macroalgues épiphytes des feuilles de *Posidonia oceanica* (L.) Delile dans la baie de la Revellata (Calvi, Corse). *Lejeunia*, **181**: 1-71.

JASCHINSKI S., BREPOHL D. C. & SOMMER U. (2008): Carbon sources and trophic structure in an eelgrass *Zostera marina* bed, based on stable isotope and fatty acid analyses. *Mar. Ecol. Progr. Ser.*, **358**: 103-114.

JEPHSON T., NYSTROM P., MOKSNES P. O. & BADEN S. P. (2008): Trophic interactions in *Zostera marina* beds along the Swedish coast. *Mar. Ecol. Progr. Ser.*, **369**: 63-76.

JERNAKOFF P., BREARLEY A. & NIELSEN J. (1996): Factors affecting grazer-epiphytes interactions in temperate seagrass meadows. *Oceanogr. Mar. Bio. Ann. Rev.*, **34**: 109-162.

KEVREKIDIS T., KOURAKOS G. & BOUBONARI T. (2009): Life History, Reproduction, Growth, Population Dynamics and Production of *Gammarus aequicauda* (Crustacea: Amphipoda) at Extremely Low Salinities in a Mediterranean Lagoon. *Int. Rev. Hydrobiol.*, **94** (3): 308-325.

KHARLAMENKO V. I., KIYASHKO S. I., IMBS A. B. & VYSHKVARTZEV D. I. (2001): Identification of food sources of invertebrates from the seagrass *Zostera marina* community using carbon and sulfur stable isotope ratio and fatty acid analyses. *Mar. Ecol. Progr. Ser.*, **220**: 103-117.

KLUMPP D. W., HOWARD R. K. & POLLARD D. A. (1989): Trophodynamics and nutritional ecology of seagrass communities. in *Biology of seagrasses - A treatise on the biology of seagrasses with special reference to the Australian region*, LARKUM A. W. D., MCCOMB A. J. & SHEPHERD S. A. (Eds.): 395-457.

LEBRETON B., RICHARD P., GALOIS R., RADENAC G., PFLÈGER C., GUILLOU G., MORNET F. & BLANCHARD G. F. (2011): Trophic importance of diatoms in an intertidal *Zostera noltii* seagrass bed: Evidence from stable isotope and fatty acid analyses. *Estuar. Coast. Shelf Sci.*, **92** (1): 140-153.

LEPOINT G., COX A. S., DAUBY P., POULICEK M. & GOBERT S. (2006): Food sources of two detritivore amphipods associated with the seagrass *Posidonia oceanica* leaf litter. *Mar. Biol. Res.*, **2** (5): 355-365.

LEPOINT G., HAVELANGE S., GOBERT S. & BOUQUEGNEAU J.-M. (1999): Fauna vs flora contribution to the leaf epiphytes biomass in a *Posidonia oceanica* seagrass bed (Revellata Bay, Corsica). *Hydrobiologia*, **394**: 63-67.

- LEPOINT G., NYSSSEN F., GOBERT S., DAUBY P. & BOUQUEGNEAU J.-M. (2000): Relative impact of a seagrass bed and its adjacent epilithic algal community in consumer diets. *Mar. Biol.*, **136**: 513-518.
- MATEO M. A. & ROMERO J. (1997): Detritus dynamics in the seagrass *Posidonia oceanica*: Elements for an ecosystem carbon and nutrient budget. *Mar. Ecol. Progr. Ser.*, **151** (1-3): 43-53.
- MATEO M. A., SANCHEZ-LIZASO J. L. & ROMERO J. (2003): *Posidonia oceanica* 'banquettes': a preliminary assessment of the relevance for meadow carbon and nutrients budget. *Estuar. Coast. Shelf Sci.*, **56** (1): 85-90.
- MAZZELLA L., BUIA M. C., GAMBI M. C., LORENTI M., RUSSO G. F., SCIPIONE M. B. & ZUPO V. (1992): Plant-animal trophic relationships in the *Posidonia oceanica* ecosystem of the Mediterranean Sea: a review. in *Plant-Animal Interactions in the Marine Benthos*, JOHN D. M., HAWKINS S. J. & PRICE J. H. (Eds.): 165-187.
- MAZZELLA L. & RUSSO G. F. (1989): Grazing effect of two *Gibbula* species (Mollusca, Archaeogastropoda) on the epiphytic community of *Posidonia oceanica* leaves. *Aquat. Bot.*, **35**: 353-373.
- MAZZELLA L., SCIPIONE M. B. & BUIA M. C. (1989): Spatio-temporal distribution of Algal and Animal communities in a *Posidonia oceanica* meadow. *P.S.Z.N. I: Mar. Ecol.*, **10** (2): 107-129.
- MCCONNAUGHEY T. & MCROY C. P. (1979): <sup>13</sup>C label identifies eelgrass (*Zostera marina*) carbon in an alaskan estuarine food web. *Mar. Biol.*, **53**: 263-269.
- MUKAI H. & IJIMA A. (1995): Grazing effects of a gammaridean Amphipoda, *Amphithoe* sp., on the seagrass, *Syringodium isoetifolium* and epiphytes in a tropical seagrass bed of Fiji. *Ecol. Res.*, **10** (3): 243-257.
- OLSEN Y. S., FOX S. E., TEICHBERG M., OTTER M. & VALIELA I. (2011): delta N-15 and delta C-13 reveal differences in carbon flow through estuarine benthic food webs in response to the relative availability of macroalgae and eelgrass. *Mar. Ecol. Progr. Ser.*, **421**: 83-96.
- ORTH R. J., KENDRICK G. A. & MARION S. R. (2007): *Posidonia australis* seed predation in seagrass habitats of Two Peoples Bay, Western Australia. *Aquat. Bot.*, **86** (1): 83-85.
- PERGENT G., RICO-RAIMONDINO V. & PERGENT-MARTINI C. (1997): Fate of primary production in *Posidonia oceanica* meadows of the Mediterranean. *Aquat. Bot.*, **59** (3-4): 307-321.
- PERGENT G., ROMERO J., PERGENT-MARTINI C., MATEO M.-A. & BOUDOURESQUE C.-F. (1994): Primary production, stocks and fluxes in the Mediterranean seagrass *Posidonia oceanica*. *Mar. Ecol. Progr. Ser.*, **106**: 139-146.
- PIAZZI L., BALATA D. & CINELLI F. (2002): Epiphytic macroalgal assemblages of *Posidonia oceanica* rhizomes in the western Mediterranean. *Eur. J. Phycol.*, **27**: 69-76.
- PINNEGAR J. K. & POLUNIN N. V. C. (2000): Contributions of stable-isotope data to elucidating food webs of Mediterranean rocky littoral fishes. *Oecologia*, **122** (3): 399-409.

- PRADO P., ALCOVERRO T., MARTINEZ-CREGO B., VERGES A., PEREZ M. & ROMERO J. (2007a): Macrograzers strongly influence patterns of epiphytic assemblages in seagrass meadows. *J. Exp. Mar. Biol. Ecol.*, **350** (1-2): 130-143.
- PRADO P., TOMAS F., ALCOVERRO T. & ROMERO J. (2007b): Extensive direct measurements of *Posidonia oceanica* defoliation confirm the importance of herbivory in temperate seagrass meadows. *Mar. Ecol. Progr. Ser.*, **340**: 63-71.
- PRATO E. & BIANCOLINO F. (2003): Seasonal changes in population of the amphipod *Gammarus aequicauda* (Martynov, 1931) *Medit. Mar. Sci.*, **4** (1): 49-56.
- REMY F. (2010): Structure trophique et diversité des macro-organismes associés aux litières de *Posidonia oceanica* (L.) Delile, dans la baie de Calvi en Corse. Master in Biology of Organisms and Ecology thesis, University of Liège, Liège, 54 pp.
- ROMERO J., PERGENT G., PERGENT-MARTINI C., MATEO M. A. & REGNIER C. (1992): The detritic compartment of a *Posidonia oceanica* meadow - Litter features, decomposition rates and mineral stocks. *P.S.Z.N. I: Mar. Ecol.*, **13** (1): 69-83.
- SÁNCHEZ-JEREZ P., BARBERÁ-CEBRIÁN C. & RAMOS-ESPLÁ A. A. (1999a): Comparison of the epifauna spatial distribution in *Posidonia oceanica*, *Cymodocea nodosa* and unvegetated bottoms: Importance of meadow edges. *Acta Oecol.*, **20** (4): 391-405.
- SÁNCHEZ-JEREZ P., BARBERÁ-CEBRIÁN C. & RAMOS-ESPLÁ A. A. (1999b): Daily vertical migrations in the epifauna associated with *Posidonia oceanica* meadows. *J. Mar. Biol. Ass. U.K.*, **79**: 971-977.
- SCIPIONE M. B., GAMBI M. C., LORENTI M., RUSSO G. F. & ZUPO V. (1996). Vagile fauna of the leaf stratum of *Posidonia oceanica* and *Cymodocea nodosa* in the Mediterranean Sea. *Seagrass Biology : Proceedings on an international workshop*, Rottnest Island, Western Australia.
- SCIPIONE M. B. & MAZZELLA L. (1992): Epiphytic community in the diet of crustacean amphipods of *Posidonia oceanica* leaf stratum. *Oebalia*, **suppl. 17**: 407-412.
- SCIPIONE M. B. & ZUPO V. (2010): Crustacean amphipods from the seagrasses *Zostera marina*, *Cymodocea nodosa* and *Posidonia oceanica* in the Adriatic Sea (Italy): a first comparison. *Zoologica baetica*, **21**: 15-32.
- STERGIOU K. & KARPOUZI V. S. (2002): Feeding habits and trophic levels of Mediterranean fish. *Rev. Fish Biol. Fisheries*, **11**: 217-254.
- STURARO N. (2005): Diversité trophique des Idoteidae associés à l'herbier et à la litière de *Posidonia oceanica* (L.) Delile. Master in Animal Biology thesis, University of Liège, Liège, 48 pp.
- STURARO N., CAUT S., GOBERT S., BOUQUEGNEAU J.-M. & LEPOINT G. (2010): Trophic diversity of idoteids (Crustacea, Isopoda) inhabiting the *Posidonia oceanica* litter. *Mar. Biol.*, **157** (2): 237-247.
- TOMAS F., TURON X. & ROMERO J. (2005): Seasonal and small-scale spatial variability of herbivory pressure on the temperate seagrass *Posidonia oceanica*. *Mar. Ecol. Progr. Ser.*, **301**: 95-107.

VALENTINE J. F. & DUFFY J. E. (2006): The central role grazing in seagrass ecology. in *Seagrasses : Biology, Ecology and Conservation*, LARKUM A. W. D., ORTH R. J. & DUARTE C. M. (Eds.): 463-501.

VAZQUEZ-LUIS M., SANCHEZ-JEREZ P. & BAYLE-SEMPERE J. T. (2009): Comparison between amphipod assemblages associated with *Caulerpa racemosa* var. *cylindracea* and those of other Mediterranean habitats on soft substrate. *Estuar. Coast. Shelf Sci.*, **84**: 161-170.

VELIMIROV B. (1984): Grazing of *Sarpa salpa* L. on *Posidonia oceanica* and utilization of soluble compounds. in *International Workshop on Posidonia oceanica beds*, BOUDOURESQUE C. F., JEUDY DE GRISSAC A. & OLIVIER J. (Eds.): 381-387.

VERGÉS A., ALCOVERRO T. & ROMERO J. (2011): Plant defences and the role of epibiosis in mediating within-plant feeding choices of seagrass consumers. *Oecologia*, **166** (2): 381-390.

VIZZINI S. (2009): Analysis of the trophic role of Mediterranean seagrasses in marine coastal ecosystems: a review. *Bot. Mar.*, **52** (5): 383-393.

VIZZINI S. & MAZZOLA A. (2004): Stable isotope evidence for the environmental impact of a land-based fish farm in the western Mediterranean. *Mar. Poll. Bull.*, **49**: 61-70.

VIZZINI S., SARÀ G., MICHENER R. H. & MAZZOLA A. (2002): The role and contribution of the seagrass *Posidonia oceanica* (L.) Delile organic matter for secondary consumers as revealed by carbon and nitrogen stable isotope analysis. *Acta Oecol.*, **23**: 277-285.

VONK J. A., CHRISTIANEN M. J. A. & STAPEL J. (2008): Redefining the trophic importance of seagrasses for fauna in tropical Indo-Pacific meadows. *Estuar. Coast. Shelf Sci.*, **79** (4): 653-660.

ZAKHAMA-SRAIEB R., SGHAIER Y. & CHARFI-CHEIKHROUHA F. (2011): Community structure of amphipods on shallow *Posidonia oceanica* meadows off Tunisian coasts. *Helgol. Mar. Res.*, **65** (2): 203-209.

ZIMMERMAN R., GIBSON R. & HARRINGTON J. (1979): Herbivory and detritivory among gammaridean amphipods from a Florida seagrass community. *Mar. Biol.*, **54**: 41-47.

ZUPO V. (2001): Influence of diet on sex differentiation of *Hippolyte inermis* Leach (Decapoda: Natantia) in the field. *Hydrobiologia*, **449** (1): 131-140.









# Take home message

- *Posidonia oceanica* meadows shelter an abundant, complex and diverse community of amphipod crustaceans. The density and the structure of this community vary widely at both day/night and seasonal scales. We suggest that the best way to sample the whole community is to combine several methods.
- All the dominant species of the community rely on epiphytic macroalgae for a large part of their diet. However, interspecific differences in dietary preferences (*e.g.* epiphytes from leaves and litter vs. epiphytes from rhizomes) exist. In addition, most species have a mixed diet, and feed on several items *in situ*.
- Amphipods can exert selective top-down control on erected epifauna and epiflora, but do not consume the crustose morphotypes. By doing so, they could influence epiphytic community structure and biomass-specific productivity. Grazing activity also increase nitrogen availability for producers. Through epiphyte removal and N enrichment, amphipods could boost seagrass production. Amphipods from *P. oceanica* meadows can therefore be seen as ecosystem engineers.
- The interactions between *Posidonia oceanica* and amphipods living in the meadows could be regarded as a facultative mutualistic association. The former provides habitat and, indirectly, food (epiphytes), while the latter performs "maintenance" of the epiphytic cover and provides nutrients. Amphipods could therefore be pivotal items in the trophic and functional relationships within *Posidonia oceanica* meadows.