



## PALAEOECOLOGICAL AND ICHNOLOGICAL SIGNIFICANCE OF MICROBORINGS IN QUATERNARY FORAMINIFERA

**Kurt Søren Svensson Nielsen, Jan Kresten Nielsen,  
and Richard Granville Bromley**

Kurt Søren Svensson Nielsen. Geological Institute, University of Copenhagen, Øster Voldgade 10, DK-1350 Copenhagen K, Denmark. [nk061259@geo.geol.ku.dk](mailto:nk061259@geo.geol.ku.dk)

Jan Kresten Nielsen. Geological Museum, University of Copenhagen, Øster Voldgade 5-7, DK-1350 Copenhagen K, Denmark. [bioerosion@yahoo.dk](mailto:bioerosion@yahoo.dk)

Richard Granville Bromley. Geological Institute, University of Copenhagen, Øster Voldgade 10, DK-1350 Copenhagen K, Denmark. [rullard@geo.geol.ku.dk](mailto:rullard@geo.geol.ku.dk)

### ABSTRACT

A large number of Quaternary foraminiferans, collected from several localities worldwide, show evidence of bioerosion in their tests. These bioerosion traces confirm that predation and parasitism of benthic foraminiferans are widespread phenomena in modern and fossil marine environments. Also, single borings related to different chambers in the tests of planktonic foraminiferans support the hypothesis that one or several unknown planktonic organisms prey on living foraminiferans. A healed boring observed on the test of a planktonic foraminiferan indicates that at least some planktonic foraminiferans survive the attack of the unknown predator.

The occurrence of one of the traces, *Fossichnus solus* *igen. et isp. nov.*, suggests that its distribution is controlled by environmental parameters. *Fossichnus solus* *isp. nov.* is distinguished by a single groove having a circular to oval outline and most likely represents an attachment structure. Alternatively, as *F. solus* *isp. nov.* forms part of a developmental sequence that may result in *Oichnus simplex*, it could be interpreted as an abandoned predation trace. Other bioerosion structures are recorded for the first time. A sieve-shaped boring is left in open nomenclature because of its rarity. A crescent-shaped hole and a groove-shaped hole are left in open nomenclature as *Oichnus* *aff. asperus* and *O. aff. paraboloides*, respectively.

*Fossichnus solus* *isp. nov.* is quite common within its temporal and geographical area of distribution. Therefore, this ichnospecies has a potential usefulness as a palaeoecological marker. However, the sieve-shaped boring, *Oichnus* *aff. asperus*, and *O. aff. paraboloides* all occur very rarely and therefore are of limited palaeoecological use at present.

**Copyright:** Palaeontological Association September 2003

**Submission:** 14 October 2002. Acceptance: 19 June 2003

**KEY WORDS:** Foraminifera, bioerosion, ichnotaxonomy, Pleistocene, ichnology

---

## INTRODUCTION

Previous studies of traces on foraminiferal tests have shown that a surprising variety can be observed in modern and fossil marine environments (e.g., Sliter 1971; Arnold et al. 1985; Hallock and Talge 1994). These observations led Nielsen (1998) to suggest that the majority of the traces may be interpreted as evidence of predation of the foraminiferans by several unknown predators, including benthic as well as planktonic organisms. Further studies have shown this pattern to be a global phenomenon in many recent and fossil marine environments (Nielsen 1999; Nielsen et al. 2002). A few of the observed traces may be host-species specific, being related to certain foraminiferans; for example the trace *Dipatulichnus rotundus* occurs only on the planktonic *Orbulina universa* (Nielsen and Nielsen 2001). However, detailed analyses of bioerosion traces and the relationship of these to modern faunas are needed before any conclusions can be drawn as to the trophic level of the foraminiferans as well as the identities of the tracemakers; this presents at least two major problems. The first problem is that, although foraminiferans are numerous and present in all marine environments, they are extremely small and difficult to observe in their natural habitat. The second problem is that very few modern studies of bioerosion traces employ ichnotaxonomy. In part, this may be due to the fact that it is not advisable, according to the International Code of Zoological Nomenclature (International Commission on Zoological Nomenclature 1999), to assign names on the basis of unfossilized material (see Nielsen and Nielsen 2001 for discussion). Until a satisfactory solution to this problem is found, we are restricted to naming and describing fossil traces. In our opinion, a name must be given to a new trace, regardless of the age of the trace. In particular, bioerosion traces on the foraminiferal test seem to be well suited for naming, since a majority of foraminiferal tests may be considered to become fossilized upon the death of the organism. Even though ichnotaxonomy may seem foreign to many researchers outside the ichnological community, the naming of bioerosion traces would certainly increase our present knowledge and ease

communication and exchange of results between different working groups, whether these be geologists or biologists.

This study has two major objectives. First, we define new ichnotaxa. Second, we would like to stress the potential usefulness of these ichnotaxa in the context of palaeoenvironmental studies. One of the ichnotaxa, *Fossichnus solus* igen. et isp. nov., is considered to be related only to benthic foraminiferans. It has been found only in Holocene temperate to arctic marine environments and in Pleistocene sediments on the Greek island of Rhodes in the Aegean Sea. The distribution seems to depend on environmental parameters.

## MATERIAL AND METHODS

The studied material consists of foraminiferal tests derived from various research projects (Table 1). The Faeroes samples were collected during expeditions under the BIOFAR programme (Nørrevang et al. 1994). The Galathea samples were collected during the Danish deep-sea expedition 1950-1952 (Bruun 1959), the West Greenland samples were collected from a transect in the Disko area (unpublished material) and the Gulf of Aqaba samples were collected by H.J. Hansen and others (Reiss and Hottinger 1984; Hottinger et al. 1993). Between 600 and 1500 foraminiferans from each of the 200 samples were examined with a scanning electron microscope for evidence of bioerosion.

The Pleistocene samples investigated were collected by KSSN on the Greek island of Rhodes. These samples were taken from a 40 m high section located at Tsambika beach. The section is interpreted as a transgressive marine sequence, referable to the Lindos Bay clay facies group of the Rhodes Formation (Hanken et al. 1996) and represents a steep inner to outer shelf environment of water depth between 200 and 1000 m. A preliminary interpretation of the foraminiferal data suggests that the bottom water was somewhat deficient in oxygen at the time of deposition.

Type material is housed in the Geological Museum, University of Copenhagen, using numbers with the prefix MGUH.

**Table 1.** List of studied samples from Pleistocene and Holocene localities. Adapted from Nielsen and Nielsen (2001).

Sample number	Position	Depth (m)	Age	Sample area	Project
P 53	36° N 28° E	-	Pleistocene	Rhodes	-
P 56	36° N 28° E	-	Pleistocene	Rhodes	-
P 135	36° N 28° E	-	Pleistocene	Rhodes	-
P 194	36° N 28° E	-	Pleistocene	Rhodes	-
G 196	29°55' S 31°20' E	425-430	Holocene	Off Durban	Galathea
G 289	11°06' N 80°05' E	127	Holocene	Off Tranquebar, SE India	Galathea
G 292	11°06' N 80°05' E	20	Holocene	Off Tranquebar, SE India	Galathea
G 404	05°09' N 106°47' E	63	Holocene	South China Sea	Galathea
G 471	10°26' S 107°52' E	2780	Holocene	Java trench	Galathea
G 547	30°00' S 153°32' E	139	Holocene	Brisbane River, Coral Sea	Galathea
G 550	31°27' S 153°33' E	4090	Holocene	Tasmania Sea	Galathea
G 555	37°21' S 138°44' E	875	Holocene	Great Australian Bight	Galathea
G 556	37°18' S 138° 43' E	795	Holocene	Great Australian Bight	Galathea
G 558	37°11' S 138°42' E	370	Holocene	Great Australian Bight	Galathea
G 759	37°41' S 138°41' E	180	Holocene	Great Australian Bight	Galathea
G 561	37°04' S 138°39' E	112	Holocene	Great Australian Bight	Galathea
G 743	07°27' N 79°37' W	600	Holocene	Gulf of Panama	Galathea
G 773	47°50' N 08°23' W	1680	Holocene	Gulf of Biscay	Galathea
E2a	68° N 55° W	190-200	Pleisto-Holocene	West Greenland	-
E3	68° N 55° W	190-200	Pleisto-Holocene	West Greenland	-
E4	68° N 55° W	190-200	Pleisto-Holocene	West Greenland	-
E5	68° N 55° W	190-200	Pleisto-Holocene	West Greenland	-
E6	68° N 55° W	190-200	Pleisto-Holocene	West Greenland	-
E7	68° N 55° W	190-200	Pleisto-Holocene	West Greenland	-
E8	68° N 55° W	190-200	Pleisto-Holocene	West Greenland	-
E10	68° N 55° W	190-200	Pleisto-Holocene	West Greenland	-
E11	68° N 55° W	190-200	Pleisto-Holocene	West Greenland	-
Barfeldt 12	15°09'33"N 19°05' W	-	Holocene	Atlantic Ocean	-
Hu-5187	28°00' N 34°30' E	87	Holocene	Gulf of Aqaba, Red Sea	-
Hr-4a	29°30' N 34°57' E	230	Holocene	Gulf of Aqaba, Red Sea	-
Tiran	27°54' N 34°28' E	1200	Holocene	Gulf of Aqaba, Red Sea	-
Nueba 1	-	>50	Holocene	Gulf of Aqaba, Red Sea	-
0793	60°41'02" N 09°21'04" W	197	Holocene	Faroe Islands	BIOFAR
0794	61°07'07" N 08°32'04" W	104	Holocene	Faroe Islands	BIOFAR
0795	61°12'00" N 08°32'04" W	127	Holocene	Faroe Islands	BIOFAR
0796	61°18' N 08°32' W	254	Holocene	Faroe Islands	BIOFAR

**SYSTEMATIC PALAEOLOGY**

**Ichnogenus FOSSICHNUS igen. nov.**

**Type Ichnospecies.** *Fossichnus solus* igen et isp. nov.

**Derivation of Name.** “Foss-” (Latin *fossa*), meaning ditch, trench and channel, referring to the concavity of the trace fossil. “-ichnus” (Greek *ikhnos*), refers to trace.

**Diagnosis.** Biogenic concavity characterized by a circular to oval groove. Outer border conforms with inner border, both sharp in outline. Parts of the groove may penetrate through the substrate. Situated in skeletal substrates.

***Fossichnus solus* isp. nov.**

**Figures 1-3**

**1993 boring; Shroba, (1993: 7h)**

**illustrated an unnamed boring similar to *F. solus*.**

**Derivation of Name.** “*solus*” (Latin), alone, refers to the presence of only one groove.

**Holotype.** MGUH 26767 (Figure 1B), a specimen in the test of a benthic foraminiferan (sample E10, Table 1).

**Type Locality and Age.** 68° N 55° W, 190-200 m water depth: Quaternary.

**Paratypes.** MGUH 26768 (Figure 1C), situated in the same test as the holotype. MGUH 26769 (Fig-

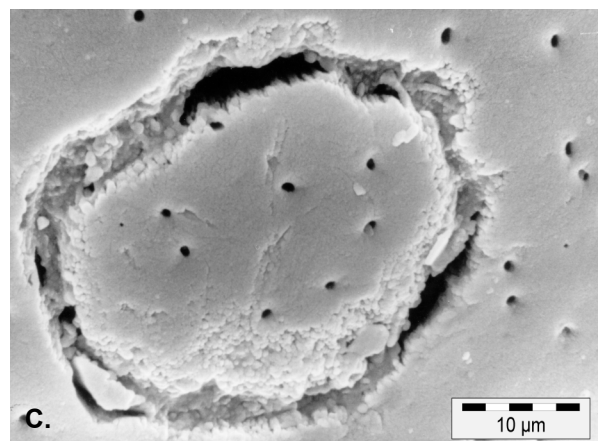
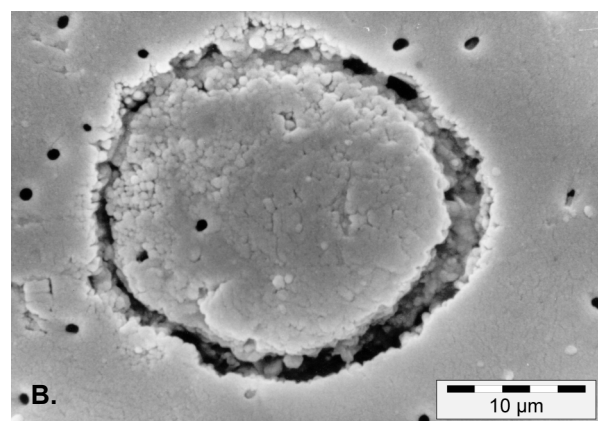
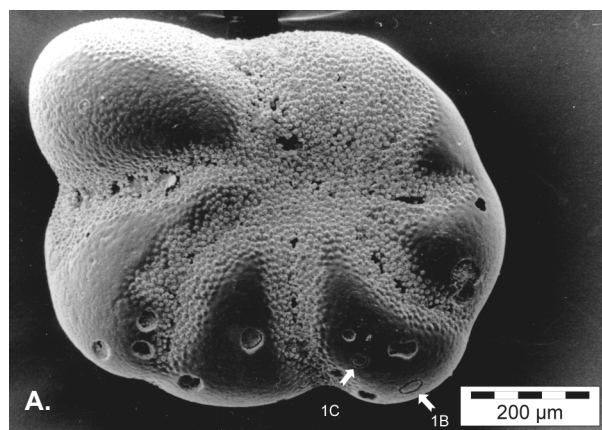
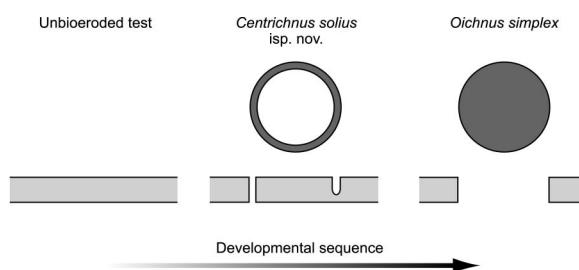

**Figure 1A.** *Fossichnus solus* isp. nov. **A.** Location of type specimens in a foraminiferal test (arrows). **B.** Close-up of specimen, MGUH 26767 holotype. **C.** Another specimen in the same test, MGUH 26768 paratype.

ure 3A), in the test of a benthic foraminiferan (sample E10, Table 1).

**Diagnosis.** As for the ichnogenus, by monotypy.

**Description.** Depth of the groove may vary in the same specimen. Where the groove penetrates the test its sides are parallel and perpendicular to the test surface. Substrate circumscribed by the groove may correspond in level with that immedi-



**Figure 2.** Outlines and cross-sections showing different stages of bioerosion. An intermediate stage is represented by *Fossichnus solus* isp. nov., whereas the end stage is a circular hole similar to *Oichnus simplex*. Not to scale.

ately outside the groove. In some cases, however, the circumscribed substrate surface has been diminished by partial etching. Margin of the groove has a granular texture. The external diameter of the bioerosion structure ranges from 13 to 30 µm, while the internal diameter ranges from 10 to 17 µm. Width of the groove is max. 4 µm. Multiple specimens of this trace fossil may occur in the same chamber of a foraminiferan. In such cases the trace fossils are apparently randomly distributed, but in some cases the density of the trace fossil is greatest in the adult chamber.

**Remarks.** Two kinds of problems arise with the ichnotaxonomic description of *Fossichnus solus*. Firstly, *F. solus* seems to be part of a developmental sequence, where the end member is *Oichnus simplex* (Figure 2). This interpretation is supported by the two overlapping *F. solus* shown in the aboral end of the test in Figure 3. Just above the aperture, in the same figure, an overlapping *F. solus* and an *O. simplex* are shown. It seems likely that the *O. simplex* started out as *F. solus* and later became *O. simplex* when the central field fell out. Whether this is a consequence of a physical process or whether *F. solus* should be considered an unfinished *O. simplex* is not known in all cases. As can be seen in the figures of *F. solus*, these structures partly penetrate the foraminiferal tests in many cases, which suggests that the transformation is part of a biological process. We cannot exclude that some of the observed *O. simplex* are not related to this biological process but the small size variation of the diameter between *O. simplex* and *F. solus* observed on the same test suggests these *O. simplex* are former *F. solus*. In this particular case, a re-definition of *O. simplex* will not solve the problem but would create taxonomic confusion. However, it makes little sense to consider two bioerosion structures belonging to the same sequence of formation as two different ichnospecies. The guidelines of the International Code of

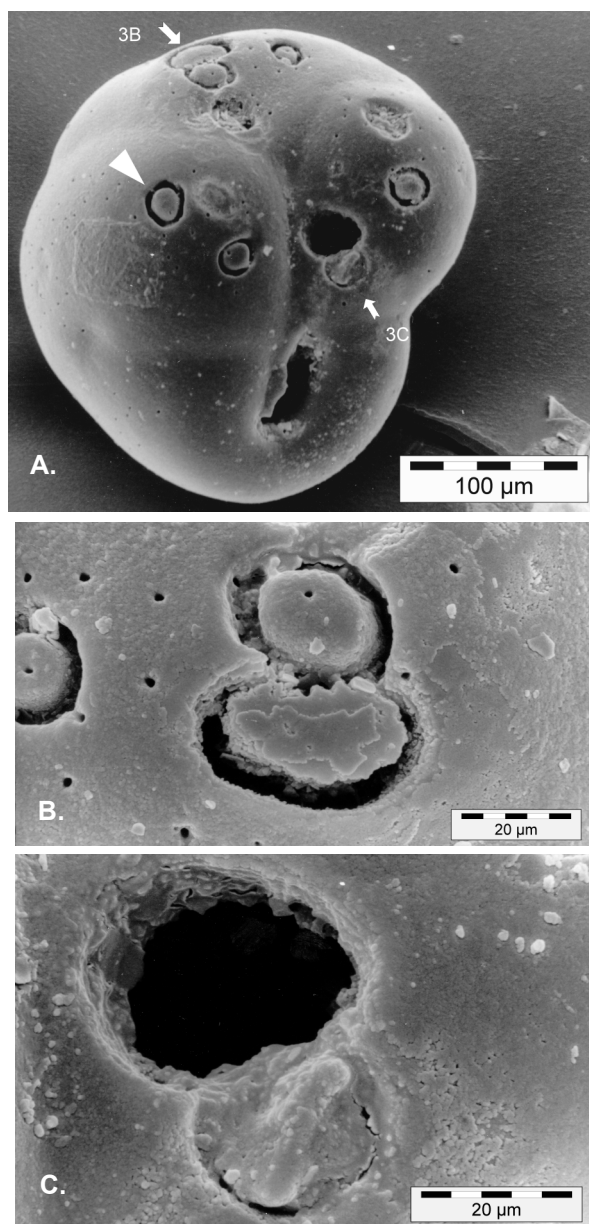

**Figure 3.** Distribution of *Fossichnus solus* and *Oichnus simplex* in foraminiferal tests, sample E 10. **A.** Intersected specimens of *F. solus* (arrows) situated in aboral end of test. Location of type specimen (triangle), MGUH 26769 paratype. **B-C.** Close-up of the intersected specimens.

Zoological Nomenclature contain no solution to the taxonomic problem regarding such sequences. But in our case, there are strong indications, viz. size, shape and position on foraminiferal test, suggesting that some *O. simplex* are former *F. solus*.

Secondly, does *Fossichnus solus* represent part of a more complex structure? Most observations of *F. solus* indicate that it is a random, repeated, solitary bioerosion structure. However, in the example shown in Figure 4, eight *F. solus* are

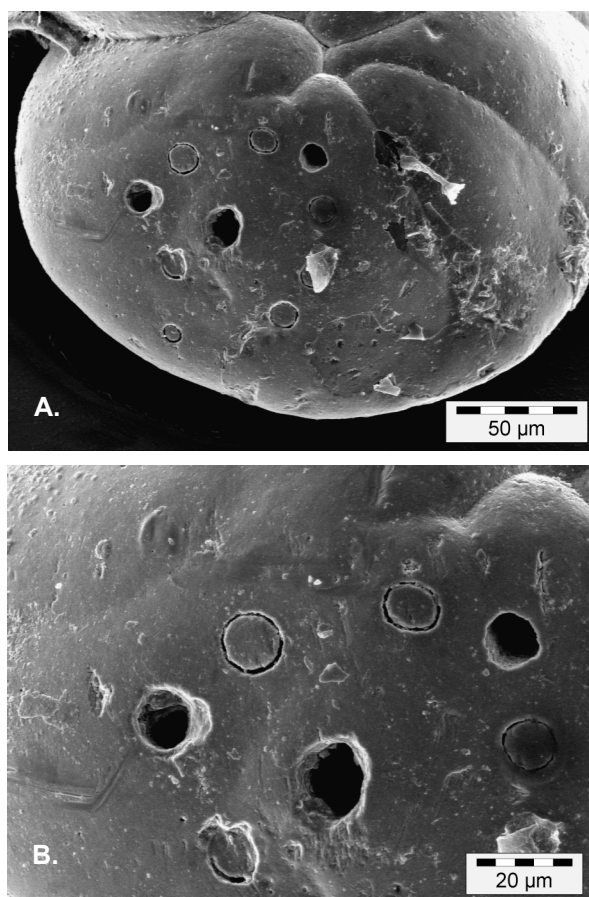

**Figure 4.** Non-random distribution of borings, sample P 56. **A.** Eight bioerosion structures similar to *F. solus* and *Oichnus simplex* encircling a central hole. **B.** Close-up of same.

arranged in a circular pattern around a main hole, which is slightly larger. Unlike many of the other *F. solus* observed, this pattern cannot be considered a random distribution. This distribution suggests that all of the bioerosion traces occurring on this test are part of a single event, in which case they should be considered one trace. If morphological features of the trace are to be the main taxonomic criterion in ichnotaxonomy then it should be named differently from *F. solus*.

In contrast to *Fossichnus*, the ichnogenus *Centrichnus* includes individual bioerosion structures characterized by multiple grooves. *Fossichnus solus* differs from *Centrichnus concentricus* Bromley and Martinell, 1991, as the latter has a central rounded pit surrounded by a flat shelf. Furthermore, this shelf may be patterned with concentric rings. In contrast to *F. solus*, *C. eccentricus* Bromley and Martinell, 1991 is a tear- or drop-shaped scar, which comprises a series of bow-shaped grooves (Bromley and Martinell 1991). *Oichnus excavatus* was defined by Donovan and Jagt (2002) as a circular to elliptical pit with a

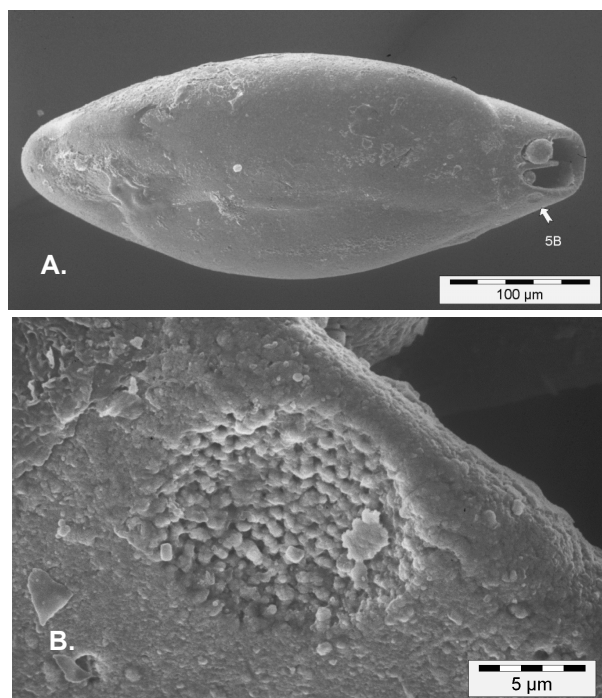
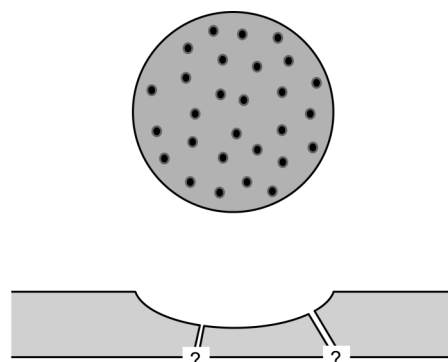

**Figure 5.** Sieve-shaped boring. **A.** Location of specimen in foraminiferal test (arrow). **B.** Close-up of sieve-shaped boring.

broad, high, raised central boss. As the aperture of *O. excavatus* is overhanging and the walls are concave, *O. excavatus* clearly differs from *Fossichnus solus* in morphology.

*Fossichnus solus* occurs abundantly in samples from Rhodes (samples P 56 and 194) and Greenland (samples E 2a, 5, 7, 9 and 10). Shroba (1993) illustrated an unnamed boring similar to *F. solus*. The boring was derived from temperate waters off Juan Island, Washington.

It is well known that gastropods of the family Cassidae and other predatory prosobranch families may prey on sea urchins (e.g., Hughes and Hughes 1971; Taylor et al. 1980; Hughes 1986; Lowry and Stoddart 1989). Cassid gastropods may form bioerosion structures that in an unfinished stage are similar to *F. solus*. For example, *Cassis tuberosa* feeds on regular echinoids by cutting a disc from their test. The resulting hole, which is formed by completing a roughly circular groove, is subcircular and has a rough edge (Hughes and Hughes 1971). The cassid *Galeodea echinophora* may prey on the infaunal spatangoid *Echinocardium cordatum*. This gastropod also cuts a disc out of the test, which it either pushes inward or displaces to one side (Hughes 1986). The holes, which show signs of acid etching, are indistinguishable from those made by *C. tuberosa*. Unfinished



**Figure 6.** Outline and cross-section of the sieve-shaped boring. Not to scale.

holes still holding a disc bear a close resemblance to *Fossichnus solus* isp. nov. However, their size is much larger than those observed in the foraminiferal tests.

**Stratigraphic Range.** Quarternary.

#### Sieve-shaped boring Figures 5-6

**Description.** The bioerosion structure is a pit having a circular outline and penetrated by two or more holes or pits, evenly distributed within the pit. Diameter and depth of the pit are 18 µm and 3 µm, respectively. The pit is perforated by minor structures. As we have chosen not to examine the internal surface of the substrate of the unique specimen, it is unknown whether the structures are indeed holes penetrating through the test. These holes are less than 1 µm in diameter. Each has a simple cylindrical form, oriented perpendicular to the surface of the major pit. The major pit has a granular appearance, because the holes are closely situated.

**Remarks.** The boring is characterized by a sieve-shaped texture. The substrate, i.e., the foraminiferal test, is assigned to *Quinqueloculina* of the family Miliolida. As specimens of Miliolida are non-laminar and imperforate (Haynes 1981; Hansen 1994), the sieve-shaped texture cannot be related to microstructural characteristics of the test.

The major pit of the sieve-shaped boring is similar to *O. paraboloides* Bromley, 1981 (see Nielsen and Nielsen 2001). But, the sieve-shaped boring consists of both a pit and tiny holes and clearly differs from previously known bioerosion structures. As the sieve-shaped boring has only been observed in a single benthic foraminiferan collected from Rhodes (sample P 194), it is left in open nomenclature.

**Stratigraphic Range.** Pleistocene.

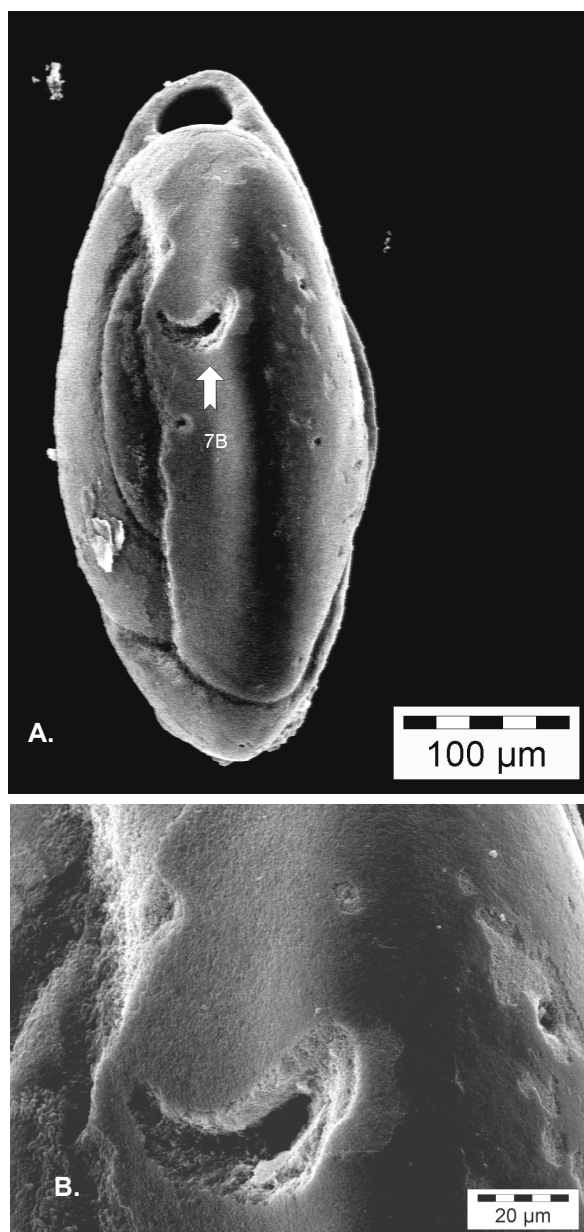
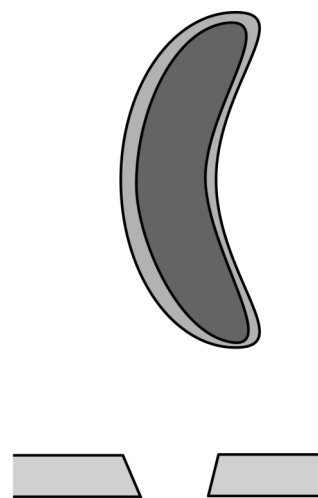

**Figure 7.** *Oichnus* aff. *asperus*. **A.** Location of specimen in foraminiferal test (arrow). **B.** Close-up of *Oichnus* aff. *O. asperus*.

**Ichnogenus OICHNUS Bromley, 1981**

**Type Ichnospecies.** *Oichnus simplex* Bromley, 1981, by original designation.

**Emended diagnosis.** Circular, subcircular, oval or rhomboidal solitary holes or pits of biogenic origin in hard substrates, commonly perpendicular to subperpendicular to substrate surface. The holes pass directly through substrate as a penetration, whereas the pits end within the substrate as a shallow to moderately deep depression or short subcylindrical pit, commonly with a depth:width ratio of 1, with or without a central boss (emended after Bro-



**Figure 8.** Outline and cross-section of *Oichnus* aff. *O. asperus*. Note that margin of the hole is obliquely oriented to the exterior test surface. Not to scale.

mley 1981; Nielsen and Nielsen 2001; Donovan and Jagt 2002; Donovan and Pickerill 2002).

**Remarks.** The original diagnosis was emended by Nielsen and Nielsen (2001) to include a greater variety of holes and pits and to cover the morphology of *Tremichnus* Brett, 1985, which they considered a junior synonym of *Oichnus*. Subsequently, a further emendation was provided by Donovan and Jagt (2002) in order to accommodate their *O. excavatus*. The above emended diagnosis is that of Donovan and Pickerill (2002) but excluding the word “excavation” (suggesting soft substrate). The word “solitary” has been added to emphasize the difference between *Oichnus* and *Dipatulichnus* Nielsen and Nielsen, 2001. The latter is characterized by holes in pairs.

***Oichnus* aff. *O. asperus*  
Figures 7-8**

**Description.** The structure is characterized by a crescent-shaped outline and occurs in a foraminiferal test. The external opening is equal to or slightly larger than the internal opening. Both openings are sharp in outline. Largest dimension, measured on the external opening, is 56 µm. Its smallest dimension is 24 µm. Margin of the hole is perpendicular to external test surface or converging slightly inward in a straight manner. The margin has a granular texture.

**Remarks.** The margin shows an etched relief, which probably was produced by the tracemaker. The substrate bears no other signs of etching. Only a single *Oichnus* aff. *O. asperus* has been

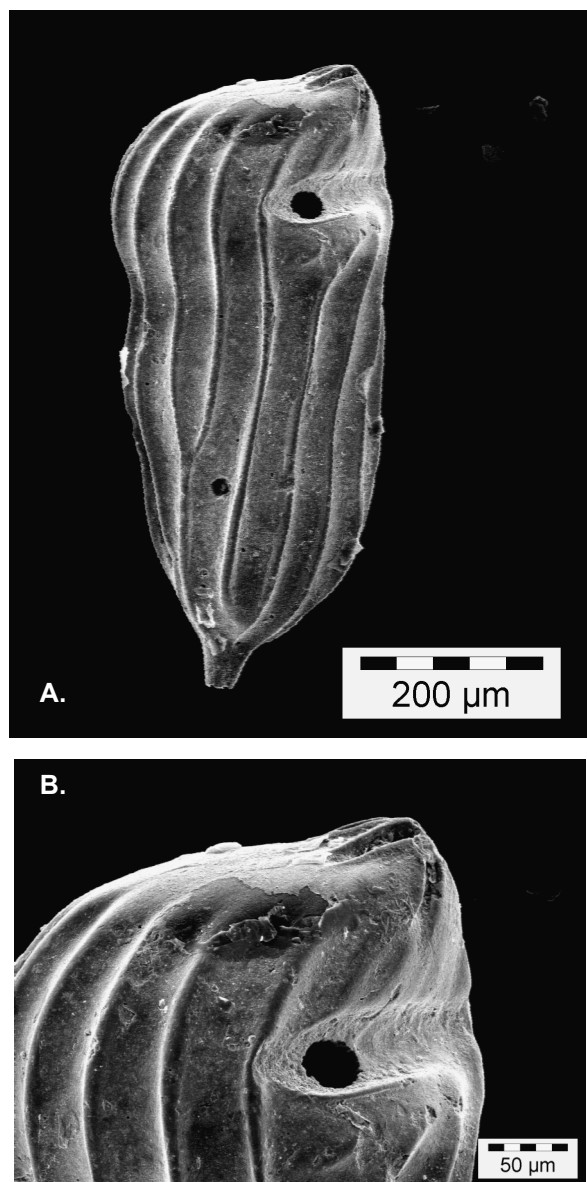
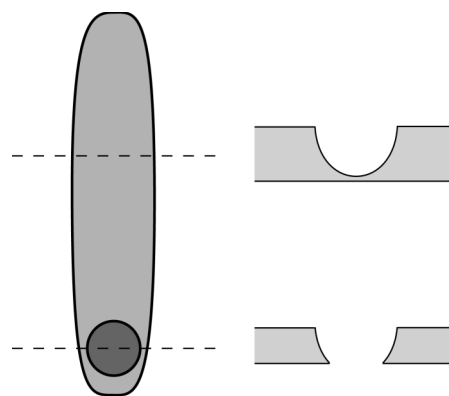

**Figure 9.** *Oichnus* aff. *P. paraboloides*, sample P 53. **A.** Location of specimen in foraminiferal test. **B.** Enlargement of borehole at upper right. Close-up of *Oichnus* aff. *O. paraboloides*.

observed in a benthic foraminiferan, collected at Rhodes (sample P 135).

*Oichnus* aff. *O. asperus* differs from known ichnospecies of *Oichnus* in its elongated and curved outline. The former bears closest resemblance with *O. asperus* Nielsen and Nielsen (2001), which is regular to irregular elongate-oval in outline. None of the specimens studied by Nielsen and Nielsen (2001) was curved. The boring thus is left in open nomenclature, following the nomenclatural guidelines by Bengtson (1988).

**Stratigraphic Range.** Pleistocene.



**Figure 10.** Outline and cross-section of *Oichnus* aff. *O. paraboloides*. Not to scale.

***Oichnus* aff. *O. paraboloides*  
Figures 9-10**

**Description.** *Oichnus* aff. *O. paraboloides* situated in skeletal substrate is characterized by a straight elongated groove with a sharp outline. A circular hole is situated within the groove close to one end. A distinctive feature is the elongate outline of the groove. Its length, width and depth are at their maximum 147, 47 and 38 µm, respectively. Bottom of the groove is even in level, although the substrate surface immediately outside the groove varies in level. The groove is parabolic in cross-section. Where the groove penetrates the foraminiferal test its sides are oblique or perpendicular to the test surface. Margin of the groove has a smooth texture. The transition from the groove to the inner opening is gradual and smooth. Diameter of the hole is 33 µm.

**Remarks.** The studied samples contain no similar structures. No evidence indicates that *Oichnus* aff. *O. paraboloides* could be an artifact related to sample collection and preparation. Thus, *O. aff. O. paraboloides* clearly is a biogenic structure. The smooth transition between the groove and the hole suggests that the trace fossil is not a composite structure, but that the same process formed the entire structure during one event. The shape and position of the hole probably have been influenced by the shape of the substrate. The only known specimen was obtained from sample P 53 collected at Rhodes.

The circular hole resembles ichnospecies of *Oichnus*; however, the groove is straight and elongate, which is not seen in any ichnospecies of *Oichnus* or other known trace fossils. *Oichnus* aff. *O. paraboloides* resembles *O. paraboloides* Bromley, 1981 that includes specimens of “*Oichnus* having a spherical paraboloid form, being truncated in those cases where the boring penetrates



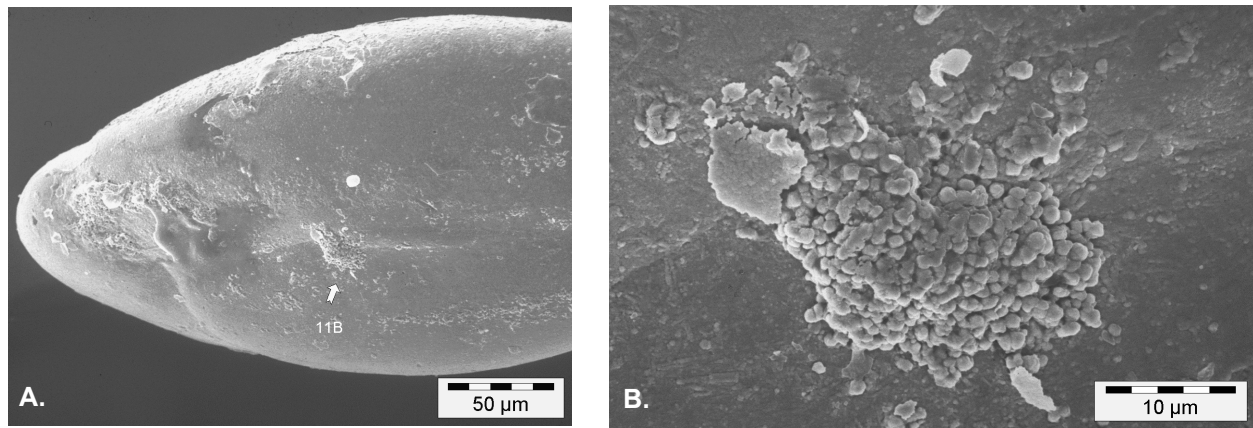

**Figure 11.** Aggregates of sediment grains situated at the aboral end of the foraminiferal test containing a sieve-shaped boring, sample P 194. **A.** Location of an aggregate (arrow). **B.** Close-up of aggregates.

right through the substrate” (Bromley 1981, p. 62). The former also resembles *O. ovalis* Bromley, 1993, which originally was characterized as an oval *Oichnus* tapering subparabolically from a larger external opening to a smaller inner one. The morphological variability of *O. aff. O. paraboloides* is unknown and may turn out to vary significantly, depending on the exterior and interior shape of the substrate. The boring thus is left in open nomenclature.

**Stratigraphic Range.** Pleistocene.

## DISCUSSION

### Tracemakers and Behaviour

The observed bioerosion structures raise several fundamental problems concerning the trace-making process: the supposed identity of the organisms responsible, the distribution of traces and the ichnotaxonomy of these traces. Few observations have been made concerning the identity of bioeroders of foraminiferal tests, which include invertebrates (Sliter 1971; Walker 1971; Mageau and Walker 1975; Hickman and Lipps 1983; Arnold et al. 1985; Gooday 1986; Langer et al. 1995) and other foraminiferans (Hallock and Talge 1994; Nielsen 2002). The morphological variation of these bioerosion traces (Nielsen and Nielsen 2001) and the new traces described herein suggests that a number of unknown organisms should be considered as tracemakers. The outline and regularity of the traces seem to exclude most marine bacteria, fungi and algae as likely trace producers of them (cf. Vogel et al. 1995; Glaub and Bundschuh 1997; Perry 1998).

If any relationship exists between size of the bioerosion traces and size of the trace-making organisms or their physiological features as sug-

gested by several authors (e.g., Taylor et al. 1980; Gibson and Watson 1989; Kowalewski 1993; Nebelsick and Kowalewski 1999), then many of the suggested organisms are simply too large to be likely candidates. The juveniles of these organisms may have the right size of body or physiological feature to be candidates but owing to the morphology of the bioerosion traces, these can probably be disregarded as well. The physiological feature used to produce the plug traces, *Fossichnus solus*, would need a morphology much like a hollow tube to produce such traces. *Fossichnus solus* may occur in groups as multiple specimens in the same foraminiferal test. As the trace apparently is an early stage of *Oichnus simplex*, which penetrates the test, the target may have been the cytoplasm of the foraminiferal test. However, most specimens of *F. solus* have not been transformed into *O. simplex*. As the way of penetration appears to have been inefficient, predatory behaviour is less likely. Instead, *F. solus* is more likely to be interpreted as an attachment scar formed by an unknown tracemaker.

As *Oichnus aff. O. asperus* and *Oichnus aff. O. paraboloides* provided the tracemakers with access to the interior of the foraminiferal tests, these trace fossils are best interpreted as predatory traces and may be categorized as praedichnia (Ekdale 1985). However, the physiological actions by which the trace fossils were formed remain unknown.

An organism having an attachment pedicle or pedicle-like feature could produce a trace like the sieve-shaped boring. However, we would like to suggest a second possibility, even though this is highly speculative. As can be seen in Figure 11, several aggregates of sediment grains are found attached to the aboral end of the foraminiferal test

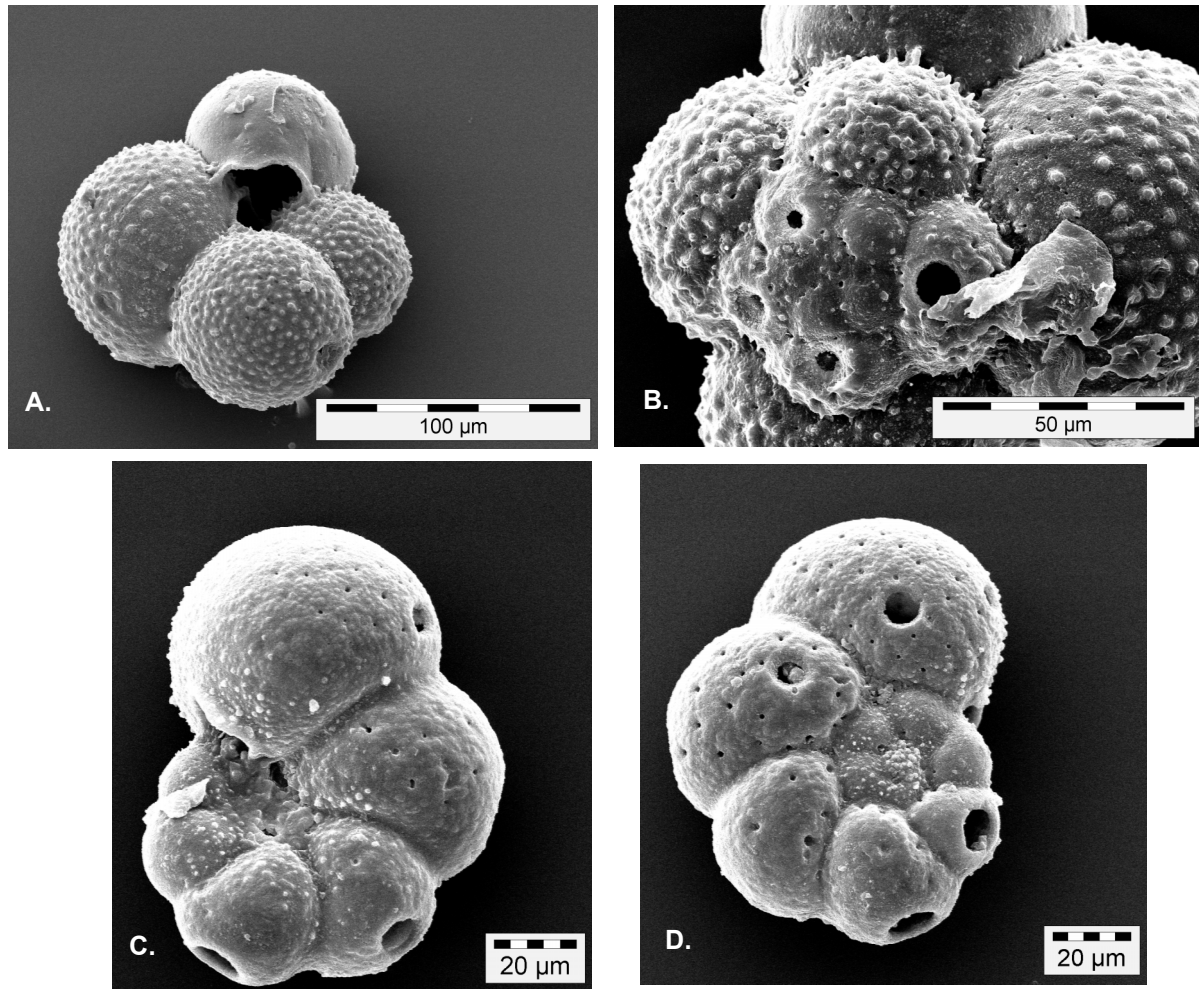
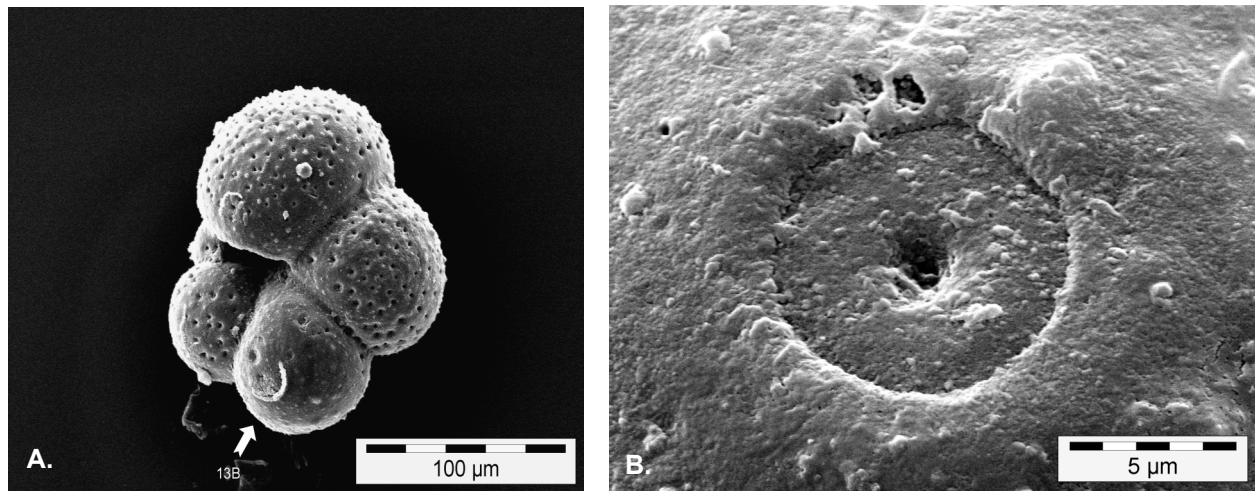

**Figure 12.** Repeated solitary borings in different test chambers of planktonic foraminiferans. **A-B.** Borings similar to *Oichnus paraboloides* in small chambers, sample P 56. **C-D.** A specimen of *O. simplex* situated separately in each chamber, sample P 194.

surfaces containing the sieve-shaped boring. These could be organic structures made by an arenaceous organism. Owing to the treatment of the specimen and because these structures have not been observed on any other foraminiferal test in the samples, it is unlikely that the grains represent non-organic structures. If this argument is correct, then a likely candidate as tracemaker could be this arenaceous organism. Most arenaceous organisms are found in the unicellular marine order of Foraminiferida. It has long been known that the foraminiferans have the ability to cause bioerosion for various reasons (Todd 1965; Banner 1971; Baumfalk et al. 1982; Plewes et al. 1993; Cedhagen 1994; Hallock and Talge 1994; Vénec-Peyré 1988, 1996; Collen 1998). Most of these species are calcareous but many arenaceous species live on the test of other marine species and at least one is known to be a predator (Cedhagen,

personal commun., 1999). This is of course speculation since we do not know whether the aggregates are indeed a species of Foraminifera. Further, it is not known for certain whether any connection exists between the sieve structure and the sediment aggregates. This conundrum could be resolved by careful removal of the aggregates from the test surfaces. However, as this process would probably destroy the specimen, we have been unwilling to do so.

The occurrence of repeated solitary borings in different chambers, as seen in Figure 12, on the test of smaller planktonic foraminiferans, seems to confirm that unknown predators prey on these while living. The sequences of circular borings have so far only been observed in planktonic species smaller than 350 µm. Since these only occur in smaller specimens of planktonic foraminiferans it seems to exclude scavenging and favours preda-



**Figure 13.** A possible repaired bioerosion trace in test of planktonic foraminiferan, sample P 135. **A.** Location of specimen in foraminiferal test (arrow). **B.** Close-up of trace.

tion as a likely explanation of these. The boring shown in Figure 13 may be interpreted as either a case of abandoned predation, a repair or an attachment structure. As no invertebrates were observed in the sample, this favours the two first interpretations. No etching structures are observed, which could imply that the trace is best interpreted as a repair structure.

#### Implications for Palaeoenvironmental Studies

Trace-fossil assemblages have been successfully defined for both soft and hard substrates to show the relationship between tracemakers and physical characters of the palaeoenvironments (e.g., Seilacher 1967; Vogel et al. 1995; Bromley 1996; Glaub and Bundschuh 1997). Studies of recent bioerosion of the foraminiferal test have shown that such a relationship can be demonstrated (Nielsen et al. 2002). However, until now, we have been unable to transfer these results to palaeoenvironments.

This is the first time that the relationship can be documented in a study of bioerosion of the foraminiferal test. The ichnospecies *Fossichnus solus* has only been observed in five out of 200 investigated samples. The age of the E-series is probably Holocene (see Nielsen and Nielsen 2001), whereas the samples from Rhodes, P 56 and 194, are Early to Middle Pleistocene. A preliminary interpretation of the foraminiferal fauna found in the two Pleistocene samples is that P 56 represents a very diverse, fully oxygenated fauna, deposited in water depth of more than 300 m. The foraminiferal fauna from sample P 194 represents a poorly diverse assemblage probably deposited in water

depth somewhat deeper than the P 56 fauna and during conditions when the bottom-water mass was somewhat deficient in oxygen. The occurrence of several species of temperate and subtropical planktonic foraminiferans seems to indicate that temperature and salinity would have been much like the present day conditions of deeper levels in the Aegean Sea.

The three samples of the E-series were obtained as box-samples from a water depth of 190 to 200 m. We have no information concerning the physical characteristics of the water mass, but the planktonic foraminiferans constitute a typical low diversity, cold-water fauna. The occurrence of *Fossichnus solus* in these two very different environments suggests that its distribution is controlled by water temperature and other parameters related to oceanography.

#### CONCLUSIONS

Four bioerosion structures from the Quaternary are described for the first time. Although the tracemakers are unknown, their behaviour forming the traces suggests attachment, predation and perhaps other ways of life. The most common trace, *Fossichnus solus*, has thus far only been observed in Pleisto-Holocene cold-water faunas of West Greenland and in the Pleistocene bathyal faunas of Rhodes. Because the trace fossil has not been observed in any recent subtropical to tropical samples investigated, this distribution seems to imply that water temperature may be the determining factor in the distribution of the trace.

## ACKNOWLEDGEMENTS

We are indebted to R. M. Kristensen (Zoological Museum, Copenhagen) and H. J. Hansen (Geological Institute, Copenhagen) for providing samples. We also thank two anonymous reviewers whose comments led to considerable improvement of the paper.

## REFERENCES

- Arnold, A. J., D'Escrivan, F. and Parker, W. C. 1985. Predation and avoidance responses in the foraminifera of the Galapagos hydrothermal mounds. *Journal of Foraminiferal Research*, 15: 38-42.
- Banner, F. T. 1971. A new genus of the Planorbulinidae. An endoparasite of another foraminifer. *Revista Española de Micropaleontología*, 3: 113-128.
- Baumfalk, Y. A., Fortuin, A. R. and Mok, R. P. 1982. *Talpinella cunicularia* n. gen., n. sp., a possible foraminiferal parasite of Late Cretaceous *Orbitoides*. *Journal of Foraminiferal Research*, 12: 185-196.
- Bengtson, P. 1988. Open nomenclature. *Palaeontology*, 31: 223-227.
- Brett, C. E. 1985. *Tremichnus*: a new ichnogenus of circular-parabolic pits in fossil echinoderm. *Journal of Paleontology*, 59: 625-635.
- Bromley, R. G. 1981. Concepts in ichnotaxonomy illustrated by small round holes in shells. *Acta Geológica Hispánica*, 16: 55-64.
- Bromley, R. G. 1993. Predation habits of octopus past and present and a new ichnospecies, *Oichnus ovalis*. *Bulletin of the Geological Society of Denmark*, 40: 167-173.
- Bromley, R. G. 1996. *Trace Fossils: Biology, Taphonomy and Applications* (second edition). Chapman & Hall, London.
- Bromley, R. G. and Martinell, J. 1991. *Centrichnus*, new ichnogenus for centrally patterned attachment scars on skeletal substrates. *Bulletin of the Geological Society of Denmark*, 38: 243-252.
- Bruun, A. F. 1959. General introduction to the reports and list of deep-sea stations, p. 7-48. In Bruun, A. F., Greve, S. and Spärck, R. (eds), *Galathea Report, Volume 1, Scientific Results of the Danish Deep-Sea Expedition round the World 1950-52*. Danish Science Press, Copenhagen.
- Cedhagen, T. 1994. Taxonomy and biology of *Hyrrokkin sarcophaga* gen. et sp. n., a parasitic foraminiferan (Rosalinidae). *Sarsia*, 79: 65-82.
- Collen, J. D. 1998. *Metarotaliella tuvaluensis* sp. nov. from Funafuti Atoll, western Pacific Ocean: relationship to miliolid foraminifera. *Journal of Foraminiferal Research*, 28: 66-75.
- Donovan, S. K. and Jagt, J. W. M. 2002. *Oichnus* Bromley borings in the irregular echinoid *Hemipneustes Agassiz* from the Type Maastrichtian (Upper Cretaceous, The Netherlands and Belgium). *Ichnos*, 9: 67-74.
- Donovan, S. K. and Pickerill, R. K. 2002. Pattern versus process or informative versus uninformative ichnotaxonomy: reply to Todd and Palmer. *Ichnos*, 9: 85-87.
- Ekdale, A. A. 1985. Paleoecology of the marine endobenthos. *Palaeogeography, Palaeoclimatology, Palaeoecology*, 50: 63-81.
- Gibson, M. A. and Watson, J. B. 1989. Predatory and non-predatory borings in echinoids from the upper Ocala Formation (Eocene), northcentral Florida USA. *Palaeogeography, Palaeoclimatology, Palaeoecology*, 71: 309-321.
- Glaub, I. and Bundschuh, M. 1997. Comparative study on Silurian and Jurassic/Lower Cretaceous microborings. *Courier Forschungsinstitut Senckenberg*, 201: 123-135.
- Gooday, A. J. 1986. Meiofaunal foraminiferans from the bathyal Porcupine Seabight (northeast Atlantic): size structure, standing stock, taxonomic composition, species diversity and vertical distribution in the sediment. *Deep-Sea Research*, 33A: 1345-73.
- Hallock, P. and Talge, H. K. 1994. A predatory foraminifer, *Floresina amphiphaga*, n. sp., from the Florida Keys. *Journal of Foraminiferal Research*, 24: 210-213.
- Hanken, N.-M., Bromley, R. G. and Miller, J. 1996. Pliocene Pleistocene sedimentation in coastal grabens, northeast Rhodes, Greece. *Geological Journal*, 31: 271-296.
- Hansen, H. J. 1994. Shell construction in modern calcareous Foraminifera, p. 57-71. In Sen Gupta, B. K. (ed.), *Modern Foraminifera*. Kluwer Academic Publishers, London.
- Haynes, J. R. 1981. *Foraminifera*. MacMillan Publishers Ltd, London.
- Hickman, C. S. and Lipps, J. H. 1983. Foraminiferivory: selective ingestion of foraminifera and test alterations produced by the neogastropod *Olivella*. *Journal of Foraminiferal Research*, 13: 108-114.
- Hottinger, L., Halicz, E. and Reiss, Z. 1993. *Recent Foraminiferida from the Gulf of Aqaba, Red Sea*. The Slovenian Academy of Sciences and Arts and the Swiss Academy of Natural Sciences, Ljubljana.
- Hughes, R. N. 1986. Laboratory observations on the feeding behaviour, reproduction and morphology of *Galeodea echinophora* (Gastropoda: Cassidae). *Zoological Journal of the Linnean Society*, 86, 355-365.
- Hughes, R. N. and Hughes, H. P. I. 1971. A study of the gastropod *Cassis tuberosa* (L.) preying upon sea urchins. *Journal of Experimental Marine Biology and Ecology*, 7: 305-314.
- International Commission on Zoological Nomenclature 1999. *International Code of Zoological Nomenclature* (fourth edition). International Trust for Zoological Nomenclature, London.
- Kowalewski, M. 1993. Morphometric analysis of predatory drillholes. *Palaeogeography, Palaeoclimatology, Palaeoecology*, 102: 69-88.

- Langer, M. R., Lipps, J. H. and Moreno, G. 1995. Predation on foraminifera by the dentaliid deep-sea scaphopod *Fissidentalium megathyris*. *Deep-Sea Research*, Part 1, 42: 849-857.
- Lowry, J. K. and Stoddart, H. E. 1989. The scopelocheirid genus *Aroui* (Crustacea: Amphipoda: Lysianassoidea) with notes on the association between scopelocheirid amphipods, cassid gastropods and spatangoid echinoids. *Records of the Australian Museum*, 41: 111-120.
- Mageau, C. M. and Walker, D. A. 1975. Alteration of foraminiferal tests due to ingestion by larger invertebrates. *Benthonics '75*, Dalhousie Univ. Halifax, N. S., Canada, p. 29.
- Nebelsick, J.H. and Kowalewski, M. 1999. Drilling predation on Recent clypeasteroid echinoids from the Red Sea. *Palaios*, 14: 127-144.
- Nielsen, J.K. 2002. Borings formed by Late Cretaceous endobiotic foraminifers within larger benthic foraminifers. *Acta Palaeontologica Polonica*, 47: 673-678.
- Nielsen, K.S.S. 1998. Micro-scale test penetration of the modern foraminifera, a global phenomenon?. *International Symposium of Foraminifera, Forams '98*, Proceedings of the Meeting and Abstracts with Programs, Sociedad Mexicana de Paleontología, Special Publication, p. 72-73.
- Nielsen, K.S.S. 1999. Foraminiferivory revisited: a preliminary investigation of holes in foraminifera. *Bulletin of the Geological Society of Denmark*, 45: 139-142.
- Nielsen, K.S.S. and Nielsen, J.K. 2001. Bioerosion in Pliocene to late Holocene tests of benthic and planktonic foraminiferans, with a revision of the ichnogenera *Oichnus* and *Tremichnus*. *Ichnos*, 8: 99-116.
- Nielsen, K.S.S., Collen, J. D., and Ferland, M. A. 2002. *Floresina*: A genus of predators, parasites or scavengers. *Journal of Foraminiferal Research*, 32: 93-95.
- Nørrevang, A., Josefson, A., Brattgard, T., Snelli, J. A. and Tendal, O. S. 1994. List of Biofar stations. *Sarsia*, 79: 165-180.
- Perry, C. T. 1998. Grain susceptibility to the effects of microboring: implications for the preservation of skeletal carbonates. *Sedimentology*, 45: 39-51.
- Plewes, C. R., Palmer, T. J. and Haynes, J. R. 1993. A boring foraminiferan from the Upper Jurassic of England and northern France. *Journal of Micropalaeontology*, 12: 83-89.
- Reiss, Z. and Hottinger, L. 1984. *The Gulf of Aqaba: Ecological Micropaleontology*. Ecological studies 50. Springer-Verlag, Berlin.
- Seilacher, A. 1967. Bathymetry of trace fossils. *Marine Geology*, 5: 413-428.
- Shroba, C. S. 1993. Taphonomic features of benthic foraminifera in a temperate setting: experimental and field observations on the role of abrasion, solution and microboring in the destruction of foraminiferal tests. *Palaios*, 8: 250-266.
- Sliter, W. V. 1971. Predation on benthic foraminifers. *Journal of Foraminiferal Research*, 1: 20-29.
- Taylor, J. D., Morris, N. J. and Taylor, C. N. 1980. Food specialization and the evolution of predatory prosobranch gastropods. *Palaeontology*, 23: 375-409.
- Todd, R. 1965. A new *Rosalinia* parasitic on a bivalve. *Deep-Sea Research*, 12: 831-837.
- Vénec-Peyré, M.-T. 1988. Two new species of bioeroding Trochamminidae (Foraminiferida) from French polynesia. *Journal of Foraminiferal Research*, 18: 1-5.
- Vénec-Peyré, M.-T. 1996. Bioeroding foraminifera: a review. *Marine Micropaleontology*, 28: 19-30.
- Vogel, K., Bundschuh, M., Glaub, I., Hofmann, K., Radtke, G. and Schmidt, H. 1995. Hard substrate ichnocoenoses and their relations to light intensity and marine bathymetry. *Neues Jahrbuch für Geologie und Palaeontologie, Abhandlungen*, 195: 49-61.
- Walker, D. A. 1971. Etching of the test surface of benthic foraminifers due to ingestion by the gastropod *Littorina littorea* Linné. *Canadian Journal of Earth Science*, 8: 1487-1491.