

## TRACING REINJECTED WATER BY SEISMIC MONITORING

Cemil Gurbuz<sup>1</sup>, Umran Serpen<sup>2</sup>, Tahir Ongur<sup>2</sup>, Niyazi Aksoy<sup>3</sup> and Cagri Dincer<sup>1</sup>

<sup>1</sup>Bogazici University, Kandilli Observatory, <sup>2</sup>Tahir Ongur Inc., 3, 9 Sept. University Vocational School.  
Arikoy Sitesi Macka Cad. No. 76.  
Istanbul, 34450, Turkey  
e-mail: umranserpen@gmail.com

### **ABSTRACT**

During the last 5 year period of the Dora I power plant power generation, full reinjection of disposal water has been carried out in Salavatli geothermal field, Turkey. Since reinjection returns as relatively colder water to the production area was a concern, a tracer test was conducted with no results. Therefore, it was decided to trace reinjected waste water by seismic monitoring. By observing microseismic activities it was hoped that orientation of reinjected brine paths would be identified.

A 9- station network of three-component digital seismometers at the Salavatlı, Köşk, Aydın, Turkey geothermal area was deployed in May 2010 in connection with tracing reinjected water by seismic monitoring project, with high-quality microearthquake (MEQ) recordings that are well suited to monitoring microearthquakes in the Salavatlı, Aydın geothermal area. We are currently using these data to investigate active processes within the geothermal reservoir by applying high-precision MEQ hypocenter location. A velocity model constructed from well – logs, receiver function and surface wave analysis of earthquakes and seismic reflection studies done in the region by Turkish Petroleum Company. MEQ are recorded for a period of 7 months and a dense seismic activity was observed in the west and north-west of AS-2 reinjection well.

First obtained results were very encouraging and the paths that reinjected brine has followed were started to appear. In order to have clear-cut results the project was extended for six more months. With the additional data recorded in the coming months the trends would be more clearly determined.

In this study, geoscientific information on Salavatli field is first introduced. Then, the reinjection operations conducted in the field so far are presented, and finally, after submitting information about

previous and actual monitoring operations, results are reported.

### **INTRODUCTION**

As of common knowledge, reinjection operations provide the following benefits: (1) pressure maintenance in the reservoir, (2) prevention of waste water contamination, and (3) enhancing heat recovery by heat mining. Not reinjecting or partly reinjecting in our country geothermal fields has resulted in pressure losses of reservoirs and in turn productivity losses of the wells, and contamination of most fertile soils of agricultural areas. As more geothermal fields are being operated soon, and actual operations are extended in some fields conducting or no-conducting reinjection operations with their pronounced resulting effects will become most important issue in Turkish geothermal industry in very near future.

Micro Earthquake (MEQ) data have been used as one of the tools for assessing permeability structures in geothermal fields, determine reservoir boundaries and to monitor the migration pattern of injection. This study describes migration pattern of the injection fluid.

The Salavatli geothermal area is the first seismically monitored geothermal area in Turkey. There are three reinjection and four production wells in the study area. This geothermal field is in operation since 1990. Some colored material mixed with the cold water during re-injection was not observed at the production well. We installed a micro-earthquake network to investigate flow direction of the injected water. High-quality digital three component seismograms can make also possible application of new generation of data-processing techniques to study the geothermal field. As a part of this study also a local seismic tomography will be conducted to get 3-D structure beneath the seismic network.

In this study, after a brief introduction of Salavatli geothermal field all reinjection history and our

experience for the last 5 years will be presented. Monitoring efforts of following reinjected waste brine pathways and the results will be reported.

### **GEOLOGICAL STRUCTURE OF SALAVATLI GEOTHERMAL FIELD**

Salavatlı Geothermal field is situated at middle of the Menderes Metamorphic Massive (MMM) and at the northern half of actual Büyük Menderes Graben. Büyük Menderes Graben is a geological structure where the geothermal systems are being encountered as most frequently in Turkey. Büyük Menderes Graben has several prospects which are suitable for the formation of geothermal resources. Most of these fields have developed at reservoirs with medium enthalpies, with 120-180°C temperatures. These temperatures are being raised through to the asymmetrical axis of the Graben and reach up to 240°C. The geothermal reservoirs have generally been developed at different lithological units of metamorphic basement. A typical characteristic of this Basement is the location of originally deep situated gneisses over the upper units of metamorphic as result of a regional overthrusting.

Salavatlı Field is situated at east of the Aydın City, in northern side of Menderes River. Büyük Menderes Graben is relatively wider and filled by thick young sediments. The alluvial plain is extending about 6.5 km at the north of river bed. Observable graben forming faults occurred only after this margin. There is a series of ENE-WSW or NW-SE gravity faults with falling blocks at south. Holocene aged terraces and Pliocene aged coarse clastics outcrop at stepped blocks which were separated with these faults.

Geological Map of the Field based on Karamanderesi (1994) and revised by us are being given in Fig.1. The Field is divided into two parts by main gravity faults as can be seen from this map. Metamorphic Basement and Miocene sedimentary units outcrop at north of this divide; while, only Pliocene and Quaternary deposits outcropping at south. Miocene units located as filling NW-SE oriented old grabens over the Metamorphic Basement at NW quarter of the area. But, the Pliocene deposits obviously are filling the ENE-WSW oriented young graben system.

Two wells had been previously drilled by MTA in the area as AS-1 and AS-2. These are located to cut two main young graben faults which were considered as dipping about 40° by Karamanderesi (1994). But, there is no sign to conclude that this target has been reached. Seven more wells have been drilled during the development phase of the field. Locations of these have been selected according to the low resistivity anomalies. These wells intersect Quaternary to Recent Alluvial deposits, Pliocene and

Miocene deposits, gneiss, micaschist, marble, quartzschist succession. Depth to the top of Metamorphic Basement vary between 316-1280 m, and this surface being deeper to south of the field (Fig .2).

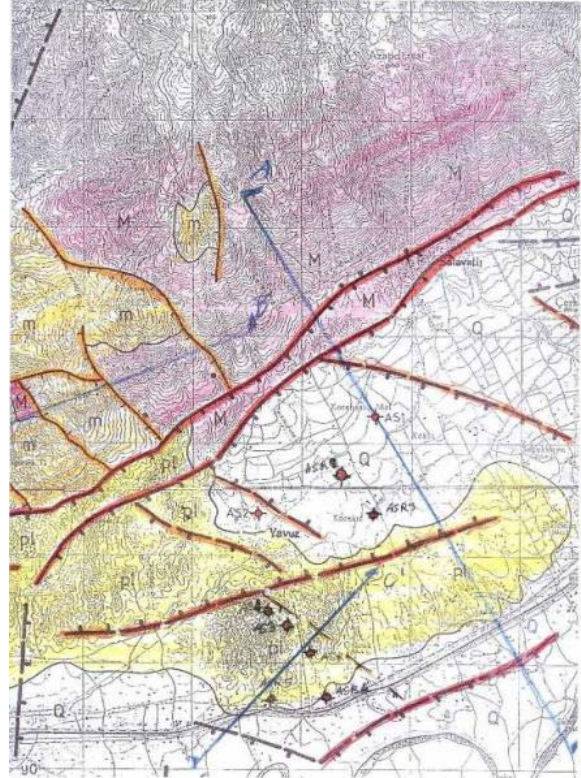

Figure 1: Geological Map of the Salavatlı Geothermal Area.

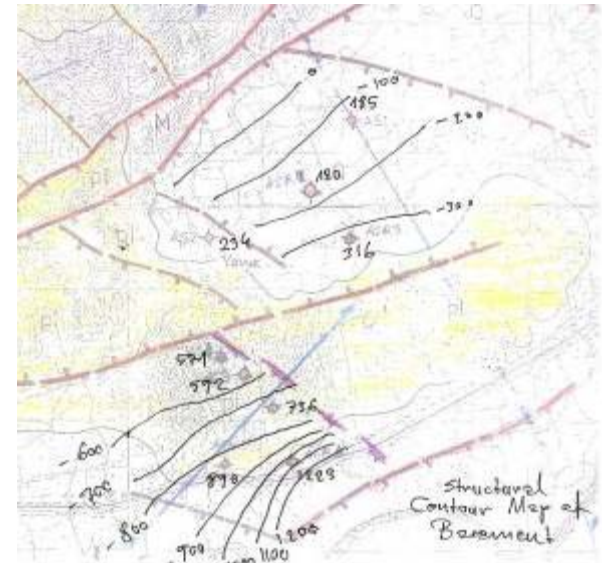

Figure 2: Structural Contour Map of Basement.

Gravity Bouguer contours show the existence of a knee of Metamorphic Basement as a Basement Rise

at north of Köşk between NE-SW and NW-SE oriented faults which are interpreted as products of tectonical processes since Miocene times. Thick Miocene deposits existed at SW of these boundaries or Pliocene deposits at SE and the Basement depths are quickly deepening to these directions. But, this deepening looks stepped near these faults and low at southern sectors. Gravity Second Derivative maps represent the covered structures more clearly. Some buried horsts and inner grabens exist in these sectors. These structures are not randomly distributed and look in accord with known Miocene and Pliocene structures. These structures make easy to draw some of the mapped faults at Geological Map. Interpreted faults have been shown by different colors according to their formation periods in Geological Map. First phase faults control the deposition of Miocene sediments (orange colored). These might be formed during the Miocene or Upper Miocene. These are NW-SE extending gravity faults. Five discrete fault lines could be mapped.

A second cluster of fault has developed between Metamorphic Basement and young deposits extending at ENE-WSW. These are shown by red lines at Map. Most typical two parallel of these are crossing from Salavatli and extending to North of Köşk. These are projection of the main fault at North of Menderes Graben in the surface. There are warm water springs, hydrothermal alterations and sulphur flowerings at these discontinuities. It is a product of extensional tectonics regime effective since Pliocene. Another fault cluster related to these systems is shown with red lines. These are drawn by interpretation especially of gravity second derivative anomalies. These are NW or SE dipping ENE-WSW oriented gravity faults that form the Menderes Graben, too. A set of ENE-WSW extending inner horsts and grabens were formed by these. Besides, these were imparted to some blocks by secondary NW-SE extending short faults.

Geophysical resistivity surveys brought reliable results (Şahin, 1985; and SUMET, 2010). Resistivity level maps show the distribution of large low resistivity anomalies in this area. These zones cover nearly 15 sq.km area. Areas with resistivities lower than 7 and 5 Ohmm's cover about 10 sq.km area, too. Very low resistivity area located especially at the hills between Yavuz Village and Menderes Plain and goes down to at least 1000-1200 m depths. This area is extending through to north of Köşk from Yavuz. A subsurface structural geological map based on the depth to resistive basement information gathered by last resistivity survey is being shown in Fig 3. This map also exposes the covered old Miocene gravity faults which can also be observed in the NW, outside of the field in northern neighboring hills. This structural pattern is being considered as important for the interpretation of reinjection and seismic

monitoring studies.

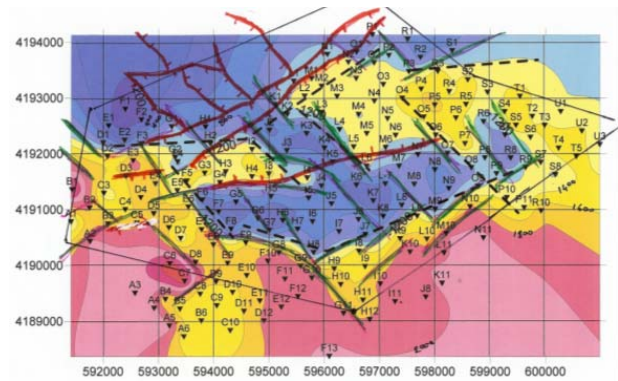

Figure 3: Structural Geology Map According to the Resistive Basement Depths.

There is a thick metamorphic rock sequence of micaschist, chlorite schist and quartzite alternation at bottom of stratigraphical column. There is also local marble unit up to a 1000 m thick with fillite and schist intercalations over this. There is an average 200 m thick gneiss slab at top of this metamorphic sequence. This slab is being interpreted as the fragmentation zone of the Başçayır Detachment Fault. It looks reasonable to consider that gneiss slab is being thicker first and then quickly disappear toward the south. Micaschist-quartzschist-calcschist alternation may be dominant in this direction and might gain secondary permeability where it is influenced by graben faults.

Thickness of the Tertiary deposits at Graben where the wells were drilled reach to more than 1000 m. There is a reddish colored Upper Miocene sandstone, conglomerate, mudstone sequence at bottom of Tertiary. A thick section of some silty marls and silty sandstones intercalated with gravely sandstones form main sequence of Miocene. Overlying Pliocene sandstone, siltstone and shale sequence has about 150 m thickness. This is covered by thicker Pleistocene sand and gravel deposits of terraces. Alluvium is very thin in the north while it is being thicker in the south of Highway.

Thickness of the young deposits has been estimated as more than >1500 m by processing gravity data. Basement rocks can be reached at very deep at middle of the Graben.

Old Miocene and recent graben forming fault systems provide channels for the infiltration of surface waters considerably deep levels and contact with high temperature rock medium. The recharge region must be the northern slopes where the metamorphic basement outcropped. Heated water already finds ascending channels especially along intersecting zones of different fault sets. The main geothermal reservoir is situated in the Metamorphic Basement.



Temperature logs of the completed wells and typical low resistivity zones are identified in this Basement. Productive zones at drilled wells are generally encountered in marbles or calcschists. But, some other limited permeability zones may also be encountered in gneiss or quartz rich micaschists. Some large loss of circulation fluids have occurred when the main fault zones had been intersected.

### **REINJECTION OPERATIONS IN SALAVATLI GEOTHERMAL FIELD**

Salavatli geothermal field is located in one of the most promising geothermal regions, namely on the northern flank of B. Menderes graben of Menderes Massif. The field was discovered after a regional resistivity survey conducted by MTA Institute of Turkey. Two wells were drilled in 1987 and 1988 to 1500 m and 962 m, with temperatures of 169.5°C and 172.5°C, respectively. Two more wells were also drilled in 2003 and 2005 to the depths 1300 and 1430 m for reinjection and stand by production, and both have encountered similar temperatures. The geothermal fluid contains an average of 1% of CO<sub>2</sub> by weight, which is more or less similar to that of other geothermal fields encountered in the Büyük Menderes region. An air cooled binary power plant with 7.35 MW<sub>e</sub> gross power was installed, and it has been generating power since May 2006.

Information so far provided by geophysical studies (resistivity and CSAMT), drilling and testing the wells indicated that the Salavatli geothermal field might be a giant structure. Recently, three more wells drilled (to approx. 1000 m) 5-8 km away from main area to the east in Sultanhisar section, found lower temperatures (two closer wells with 145°C and easternmost with 120°C) with relatively good permeability, confirming the extension of the field to the east as resistivity survey indicated (Fig. 4).

Salavatli is a big geothermal field with relatively moderate temperatures of 170°C and relatively high static wellhead pressures of 7 to 12 bar (Serpen and Tufekcioglu, 2003), and it is slightly overpressured as pressure measurements indicate. Relatively high CO<sub>2</sub> content also increase the reservoir pressure and consequently, create excess gradients. Reinjection operation for Dora I power plant was devised to take advantage of the brine pressure of at the outlet of the ORC (5 bar). Disposal water discharged from Dora I geothermal power plant has been reinjected at a rate of 550 t/h since May 2006.

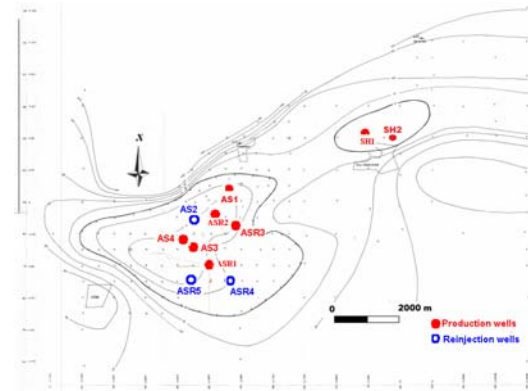

Figure 4: Location of production and reinjection wells.

As seen in Fig. 5, heat of geothermal water produced at around 170°C from AS-1 and ASR-2 production wells with a distance of 1.2 km from one to other is transferred in the binary power plant and disposal water at 80°C is reinjected into reinjection well (AS-2) that is 800 m away from nearest production well. The depth of reinjection in AS-2 well is around 980 m. As shown in Fig 6, three vertical inline pumps (one for standby) each having 185 kW power have been installed at the wellhead of AS-2 well to carry out the reinjection operation.

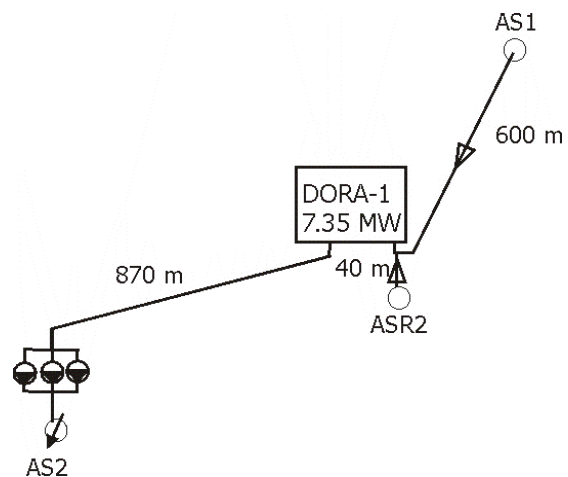

Figure 5: Reinjection scheme for Dora I power plant.

This successfully conducted reinjection operation has been carefully monitored by the resource management. During this 5 years operation period no change in the performance of neither reinjection nor production wells has been observed (see Fig. 7 and 8). Under normal circumstances, relatively cold reinjected disposal water is expected to move toward the area of two production wells (see Fig. 4) due to pressure gradient formed between production area and reinjection point. To follow the waste brine movement, estimate disposal water velocity, and model this process 100 kg of tracer (fluorecine) is pumped into reinjection well (AS-2), and two

production wells are utilized as observation ones. During these last four years, after tracer pumping into the reservoir no trace element has been detected in the observation wells. No tracer breakthrough is interpreted as they have been lost in a large fractured system. Earlier, the same tracer had been successfully used in three different geothermal reservoirs with temperatures of 110°C, 140°C and 210°C in Turkish geothermal fields, and tracer returns had been detected after short periods. In Salavatli operation, because of high rate reinjection a successful tracing test result with returns has been expected. No result in tracer testing has created a concern, such as a sudden cold water breakthrough. Failure in tracer testing has led the management to microseismic monitoring method for reinjection observation.

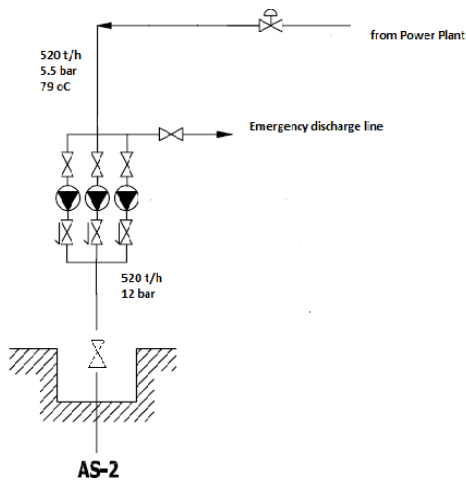

Figure 6: Reinjection in AS-2 well in Dora I power plant (Serpen and Aksoy, 2010).

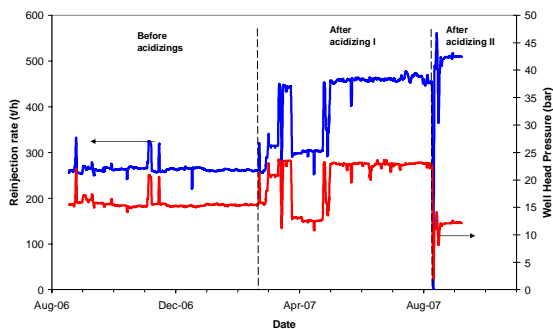

Figure 7: Reinjection history of AS-2 well in 2006-2007 period (Serpen and Aksoy, 2010).

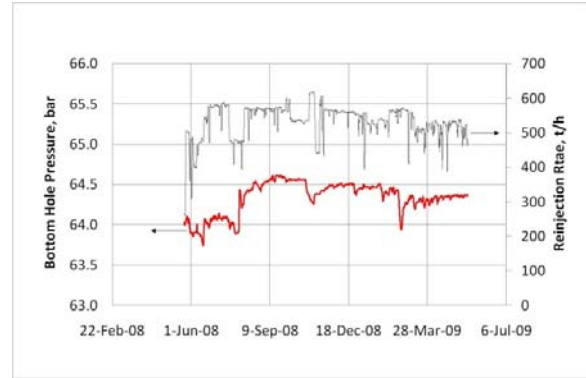

Figure 8: Reinjection history of AS-2 well in 2008-2009 period (Serpen and Aksoy, 2010).

On the other hand, at the southern part of the field another power plant, Dora II has started to operate 4 months ago in 2010. As seen in Fig. 4, two producing wells (AS-3 and AS-4) have been connected to the power plant, supplying 830 ton/h geothermal brine to the ORC. After transferring brine's heat to the ORC of Dora II plant, waste brine is reinjected into two reinjection wells, namely ASR-4 and ASR-5 at almost equal rates (Fig. 9). Since ASR-4 well is found at a fallen block its reinjection depth is very deep, at around 1900 m while pay zones of producing wells (AS-3 and AS-4) are around 1000 to 1200 m depth. On the other hand, the other reinjection well's injection level is around 1050 m. This well is closer to the producing wells and pay zones of these wells are also at the same elevation. Consequently, it was thought that ASR-5 well might have more potential to affect the producing wells. For this reason, tracer testing was conducted between ASR-5 reinjection well and AS-3-AS-4 producing wells. Hundred kg of tracer (fluorecine) is pumped into reinjection well (ASR-5) and two production wells (AS-3- AS-4) are utilized as observation ones. During the last four months, after tracer pumping into the reservoir, no trace element has been detected in the observation wells.

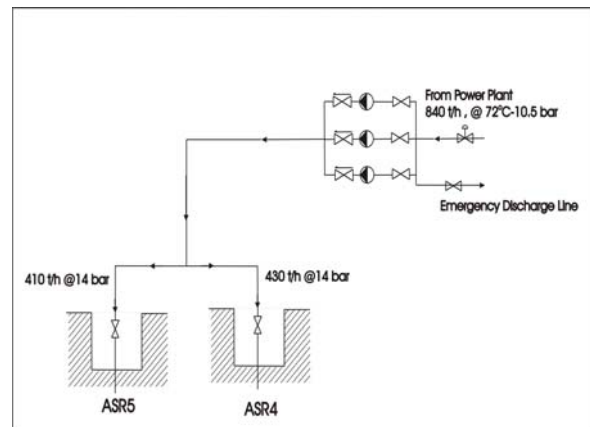

Figure 9: Reinjection scheme of Dora II plant.

## DATA ACQUISITION AND PROCESSING

### Installation

This study aims at monitoring seismic activity in the Salavatli geothermal field and locating reinjected water close to the AS-2 reinjection well. Data were collected in the Salavatli geothermal area from May 23 to October 15, 2010 using a temporary seismic network covering an area of 20 km<sup>2</sup>. The seismograph network comprised of 9 stations (Fig. 10). Seismic network was put in operation at two deployments using Güralp CMG 6T digital three component broadband instruments. The recording was continuous with a sample rate of 100 samples/s. Each seismic station consisted of a hard disk of 4 Gb memory, a GPS receiver, Solar panel and was powered by a 12 V battery. The first deployment phase consisted of 7 instruments. Pits were dug for the seismometers through loose surface cover in areas where outcropping rock was not available in situ. Seismometers were buried to a depth of 1 m at the first phase.

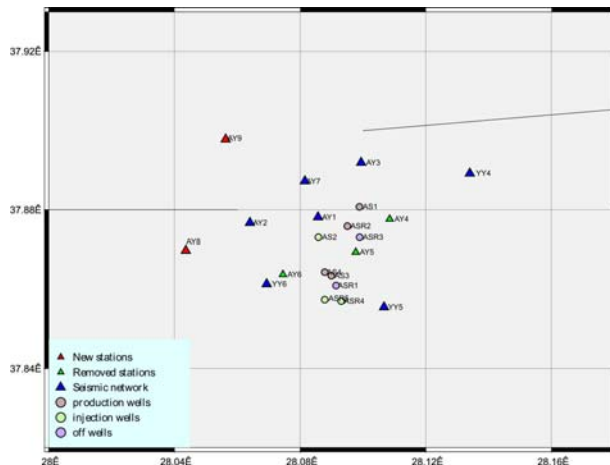

Figure 10: Location of seismic stations and geothermal wells.

Locations of three stations were changed to a new site in August 2010. During the second phase of the installation seismometers of the three sites and central station were buried to a depth of 1.5 m in order to reduce high noise level. There was a big improvement in the signal to noise ratio about tenfold (Fig.'s 11 and 12). Seismometers were placed far away from the main roads and factories and if possible as close to outcropping rocks in order to avoid noisy conditions and high attenuation associated with tuffs, soils, sediments and other soft surface deposits to achieve as high a signal-to-noise ratio as possible. A flat base was then constructed with cement for the instrument to be mounted upon. The number of stations was increased to 9 by adding

two new stations to the network in 15 October 2010 (Fig. 10). Originally the seismic network was planned according to the AS-2 re-injection well where migration pattern of the injected water was looked for. Later, size of the network was increased to cover all reinjection and production wells

### Data processing

Data used in this study was recorded by the temporary local seismic network. Data from the temporary local network was downloaded directly from the instrument onto an external hard disk and later transferred to a laptop computer and was displayed in the field in order to control performance of the instruments. This helped to obtain continuous data during the experiment. Every one hour data was written to a file and was extracted from external hard disk to PC computer with(gcf) format. This data was converted to sac from(gcf) format before transferring the data to SEISAN data analysis program.

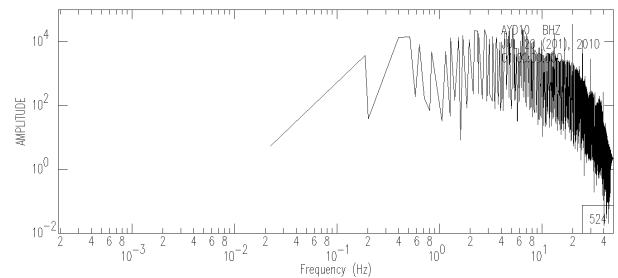

Figure 11: Noise spectrum of AYD01 station at July 20 2010, 01:00 hours.

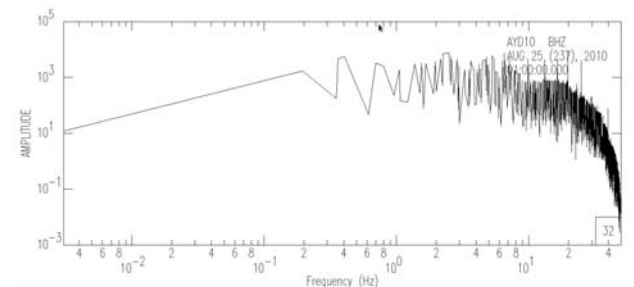

Figure 12: Noise spectrum of AYD01 station at August 25 2010, 01:00 hours.

### Velocity model

Crustal velocity model was constructed to locate the events. For velocity construction we used various sources. There are well logs from all the wells in the study area. Each geological unit with depth is given up to basement rock. Depth of basement varies between wells. It becomes deeper in the south towards the Mendere River. For crustal velocity model we need also P and S wave velocity information. Turkish Petroleum Company had done seismic reflection study in the region. There are

horizontal and vertical profiles crossing the study area. Information obtained from this study was used to estimate velocity of layers obtained from the well logs (Ciftci et al., 2010). This information is enough to get top part of the model up to 2 – 3 km depth. Below this depth, velocity structure are derived from surface wave dispersion analysis (Tezel et al., 2007), receiver function analysis (Tezel et al., 2010 ) and velocity model obtained from Velest program applied to the aftershocks of Denizli earthquakes near to the study area(S. Ozalbey, personal communication).

### Location of Earthquakes

Vertical component of all stations were displayed and local earthquakes were looked for. After selecting local earthquakes, picking of the arrival times was done using the SEISAN program (which has a series of interactive tools such as filtering and spectral frequency display of the waveforms) based on adequate signal-to-noise ratio irrespective of the frequency of the seismic arrival. Accuracy of observed arrival times depends mainly on: P and S – wave arrivals were read and located using HYPO71 program. Residuals were checked, and if they are greater than a certain predefined value, reading of seismograms was repeated. This value was selected:

- Accuracy of the station location;
- Sampling interval;
- Phase clarity or impulsiveness.

A total of 340 local events were picked from the array. Some high quality data with clear P and S phases were recorded and in such a case picking was easy (Fig.s 13 and 14). Noise characteristics of data were investigated and frequency band of signals were determined. In some cases, it was difficult to distinguish between the P and S phases from the background noise, thus a band pass filter (2 - 10 Hz) was used to filter the noisier events to improve the arrival time estimate.

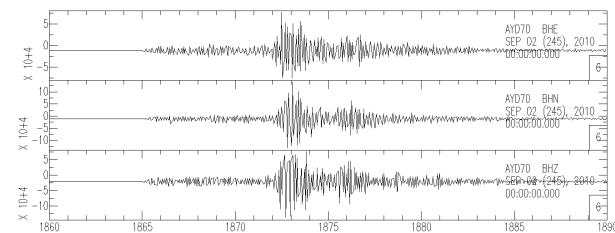

Figure 13: Local event recorded by three component broadband station at site AYD07.

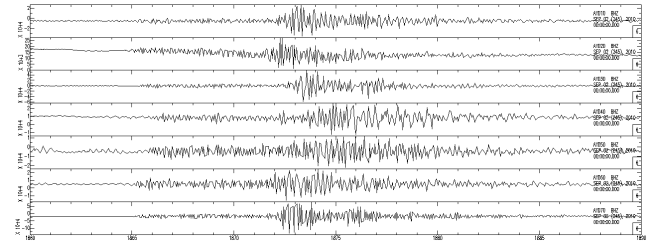

Figure 14: Same event recorded at seven stations (shown only vertical components).

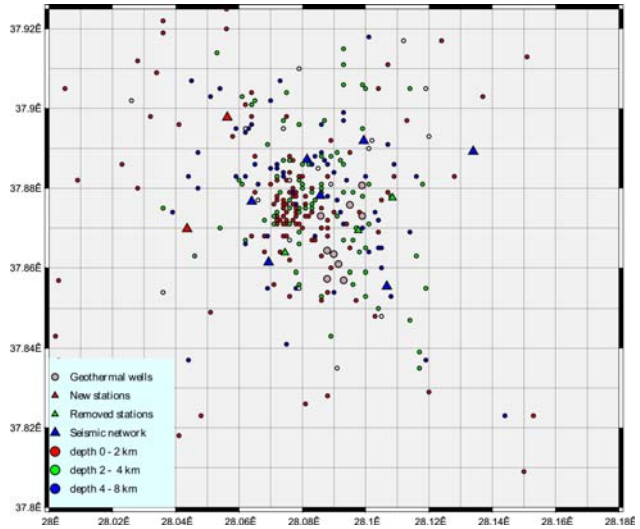

Figure 15: Location of 340 local events for a period of 4.5 months.

### DISCUSSION OF RESULTS

Micro seismicity can be related to the creation of the underground reservoir and the subsequent extraction of the geothermal energy associated with the development of production and injection wells. Induced seismicity resulted in conjunction with enlarged geothermal system reservoir development and subsequent extraction of heat from underground.

The seismicity map presented in this paper is in some ways similar to most maps produced by different scientists in various parts of the world (Fig. 15). There is cluster of events in the west and north-west of the AS-2 reinjection well. It could be concluded that the seismicity was due to contraction cracking associated with cooling and circulating reinjected water. When we plot only the events with good signal to noise ratio, we have found dense clustering in the same region (Fig. 16). In 27th of June 2010 reinjection from AS-2 well stopped and 2 days later restarted. Just after the reinjection period we observed earthquakes close to the well lasting four days (Fig. 17).



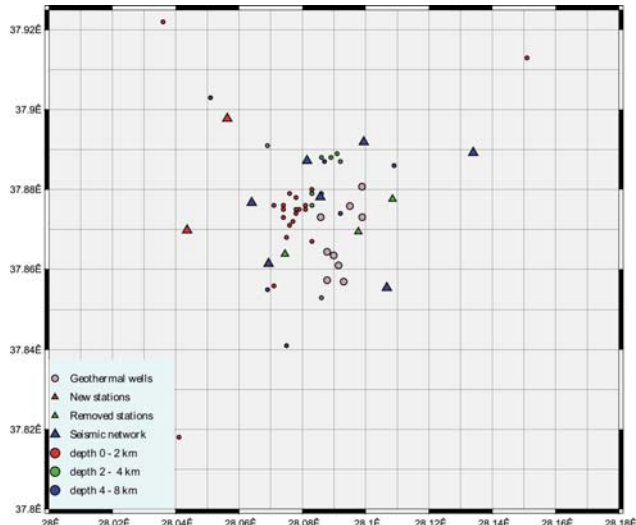

Figure 16: Location of events with high signal to noise ratio.

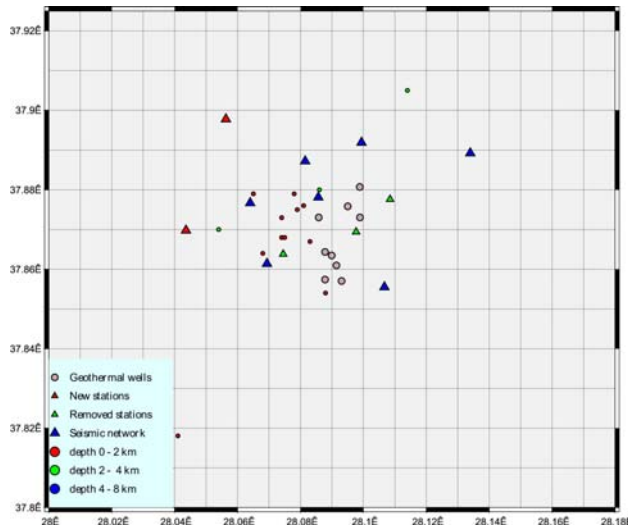

Figure 17: Events located two days after the start of reinjection at AS2 geothermal well.

To trace depths of earthquakes a cross-section in the east-west and north-east - south-west direction were taken and shown in Figure 18. Most of the earthquakes are accumulated at a depth range of 2 – 3 km. This indicates that reservoir might be extending to these depths or dense cold disposal water goes deeper sections of the system. The production wells are located in the east of the AS-2 reinjection well, and the injected water does not seem to flow towards the production wells. It may indicate that fractures may exist in the western and north – western part of the AS-2 re-injection well. Previously conducted interference test between AS-1 and AS-2 wells for 45 days had not indicated any clear connection.

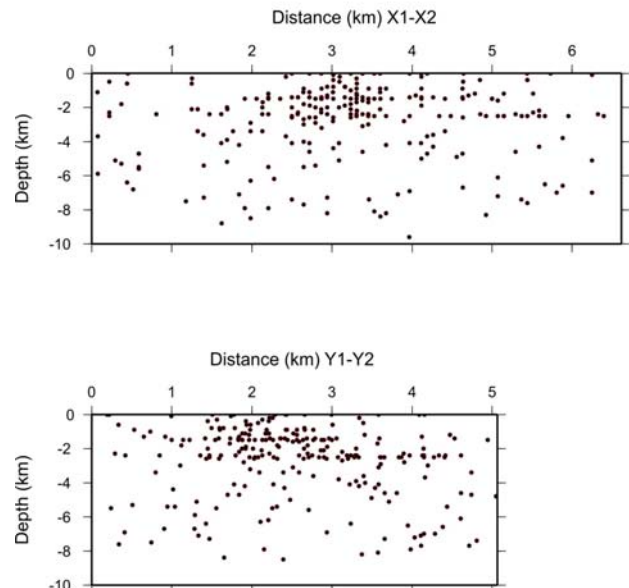
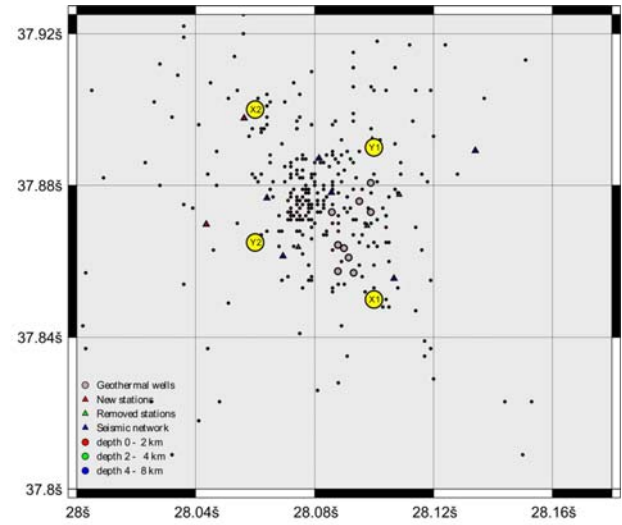

Figure 18: (a) location of all events between June 25 and 15th of October 2010. (b) Depth section of earthquakes obtained between X1 and X2 points, (c) Depth section of earthquakes obtained between Y1 and Y2 points.

## PRELIMINARY CONCLUSIONS

Preliminary results of the seismic monitoring of reinjection at northern part of Salavatli Geothermal Field shows some clear trends of the fluid motion. Most visible pattern is the western and northwestern distribution of the microseismic events. These have occurred especially at depth range of 0-2 km. Deeper seated foci's are regularly distributed in the region and look as mostly natural seismic background. On the other hand, shallower events took place around the reinjection location and especially at west and



northwest surroundings. But, these parts of the area consist of the hanging wall of the main structure, Aydın-Salavatlı Fault. According to the distribution pattern of triggered shallow seismic events, reinjected waste water seems to disperse towards outside of the geothermal system, looking to escape from main reservoir zone. This mechanism is considerable and must be interpreted with terms of the geothermal system.

Most obvious aspect is that the region where the reinjected cooler water seems to flow is the recharge area of the regional geothermal system. There must be distributed downflow of infiltrated water through to deeper and warmer rock medium. But, the heated and lighter fluid looks to upflow at southern side of the region by deeper reached central graben faults. These last faults are roughly E-W oriented Pliocene to actual graben forming faults while the fracture system that provide infiltration channels to the downflowing cooler water are the relicts of Miocene aged NW-SE oriented old graben forming stress medium.

It is obvious that the monitoring is at its preliminary phase. By monitoring the triggered events for longer period and collecting better and richer data, this interpretation might be subject to revision or proving.

### **ACKNOWLEDGEMENT**

The authors would like to thank Menderes Geothermal Directors for providing data and would also like to express special gratitude to its CEO, Muharrem Balat for supporting this study.

### **REFERENCES**

- Ciftci, G., Pamukcu, O., Coruh, C., Copur, S., Sozibilir, H., (2010). *Shallow and Deep Structure of a Supradetachment Basin Based on Geological, Conventional Deep Seismic Reflection Sections and Gravity Data in the Büyük Menderes Graben, Western Anatolia*. Survey Geophys, DOI 10.1007/s10712-010-9109-8.
- Erişen, B., Akkuş, I., Uygur, N. and Koçak, A., (1996). *Geothermal Inventory of Turkey*, MTA, Ankara.
- Karamandersi, I.H., Yakabağı, A., Çiçekli, K., Üstün, Z. and Çağlav, F., (1994). *Regional Evaluation Report of the Aydın-Sultanhisar-Salavatlı Geothermal Field and AS-1 and AS-2 Wells*, MTA report No. 9956, Izmir.
- Ozalbey, S. (2010). Personal communication.
- Serpen U. and Aksoy, N. Reinjection Problems in Overpressured Reservoirs. *Proceedings*,

*Thirtieth Workshop on Geothermal Reservoir Engineering Stanford University*, Stanford, California, January 31-February 2 (2005).

- Serpen, U., and Aksoy, N., (2010). *Reassessment of Reinjection in Salavatlı-Sultanhisar Field, Turkey*. Proceedings World Geothermal Congress 2010 Bali, Indonesia, 25-29 April 2010.
- Serpen, U. and Tüfekçioğlu, H., (2003). *Developments in Salavatlı Geothermal Field of Turkey*. Transactions of GRC 2003 Annual Meeting, Oct. 12-15, Morelia, Michoacan, Mexico.
- SUMET, (2010). Resistivity Surveying in Salavatlı Geothermal Field, Report to Menderes Geothermal, İzmir.
- Şahin, H., (1985). Resistivity surveying in Salavatlı-Sultanhisar area, MTA Report, Ankara.
- Tezel, T., Shibutanip, T., Kaypak, B., (2010). *Crustal structure variation in Western Turkey inferred from the receiver function analysis*, Tectonophysics, doi: 10.1016/j.tecto.2010.06.006.
- Tezel, T., Erduran, M., Alptekin, O., (2007). *Crustal shear wave velocity structure of Turkey by surface wave dispersion analysis*, Annals of Geophysics, 50, No 2, 177-190.