

10 cm 2-Way Speaker

110 W MAX.



Key Selling Point

- Twaron** Aramid fiber cone reproduces deep and bold bass & bold vocal sound and also expresses even the most subtle nuances.
- Open & Smooth™ sound concept delivers open staging & smooth transition of driver response to provide the ultimate in-car sound.
- Included brackets** provide for installation flexibility and wide coverage.

Speaker Technology

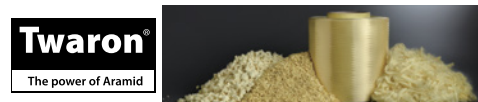
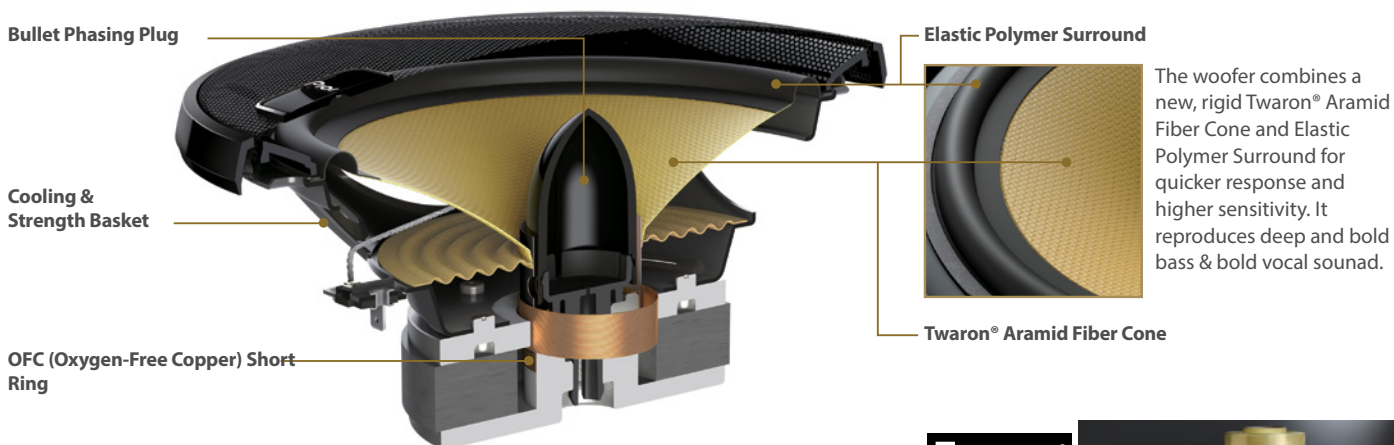

	<p>Open*</p> <p>Open staging and sound characteristics enhance the widening effect that extends way beyond the space between speakers.</p>
	<p>Smooth*</p> <p>With smooth transitions between mid-bass and tweeter frequency characteristics, sound from these speakers is not marred by crossover frequency dips.</p>

The new cone on the woofer of the Pioneer TS-D component offers a variety of improvements for optimal performance and phenomenal sound. The aramid fiber cone is constructed from Twaron® woven cloth that is hardened and shaped to produce a rigid and durable cone. The woofer offers stiffer dampening for quicker response. The woofer section of the TS-D component produces deep and bold bass & bold vocal sound.

* Twaron® is a registered trade mark of Teijin Aramid BV.

With the "Open & Smooth" sound of Pioneer D-Series Speakers out on the open road, the journey to more dramatic in-car audio sensations moves every passenger in its natural, dynamic flow.

A Superior Characteristic of D-Series: Smaller Dips for Wider Angles

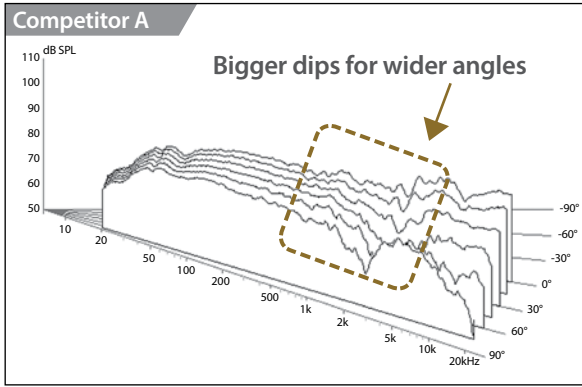
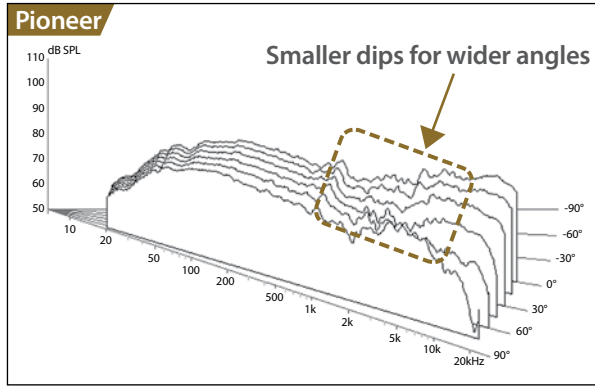

Unlike competitors' speakers, Pioneer D-Series speakers produce more natural sound without big gaps in the high-to-midrange frequency range for various angles.

Tweeter

Rear Chamber

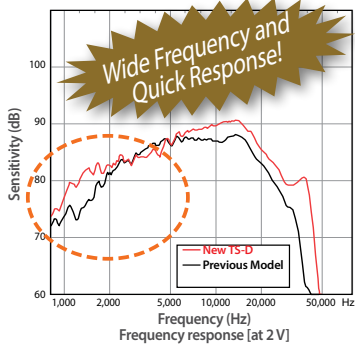

Light Weight Soft Dome Diaphragm

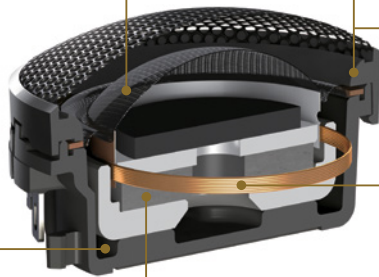

Optimized Flange Shape

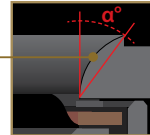

CCAW (Copper-Clad Aluminum) Voice Coil

Neodymium Magnet

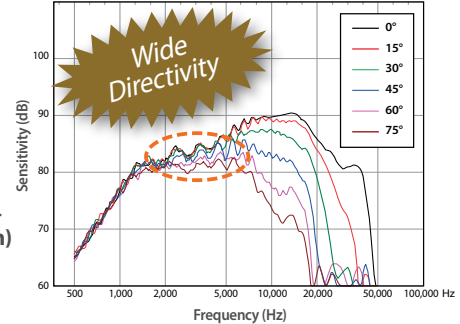

The flange is optimally shaped for wider directivity and reproduces steady sound.

The new D-Series components are capable of wider frequency sound and quicker response in playback than any models that preceded them.

Brackets (for TS-D1730C)

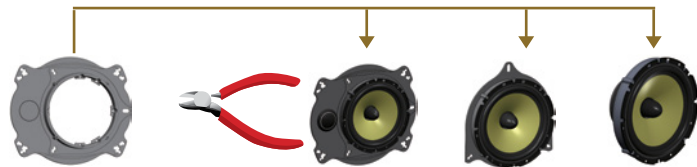

OEM-like multi-application

The included bracket can be cut as needed for flexible installation in various types of cars without having to cut vehicle doors.

23 Pole Tweeter

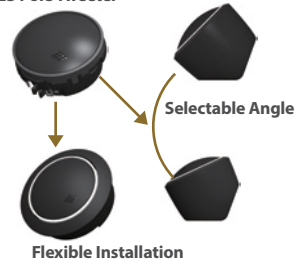

Main Specifications

Max input	Nominal Input	Frequency Response	Sensitivity	Impedance	Size	Tweeter size
110 W	25 W	40 Hz to 40 KHz	86 dB	4Ω	10 cm	18 mm

Dimension

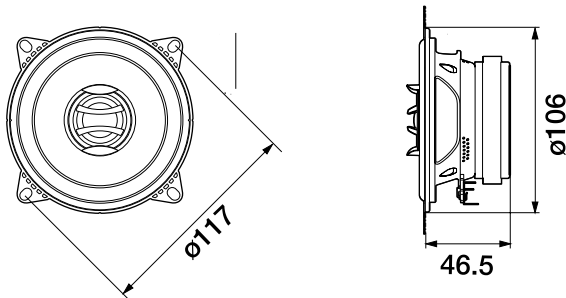

For more information please visit www.pioneer-mea.com

Year of Release: 2016

Pioneer, Gulf Free Zone Dubai, U.A.E.
Tel: +971 4 8815756, Fax 8816414
Email: support@pioneer-uae.com
www.pioneer-mea.com

Corporate web : www.pioneer.jp

Copyright Info: ©2016 Pioneer MEA. All Rights Reserved. Reproduction in whole or in part without written permission is prohibited. Design, Features and Specifications are subject to change without notice.

