



Scientific Excellence • Resource Protection & Conservation • Benefits for Canadians  
Excellence scientifique • Protection et conservation des ressources • Bénéfices aux Canadiens

# **A Collection of Amphipoda from the Southern Beaufort Sea**

M.A. Keast and M.J. Lawrence

Central and Arctic Region  
Department of Fisheries and Oceans  
Winnipeg, Manitoba R3T 2N6

July 1990

**Canadian Data Report of  
Fisheries and Aquatic Sciences  
No. 799**



Fisheries  
and Oceans

Pêches  
et Océans

Canada

Canadian Data Report of  
Fisheries and Aquatic Sciences 799

July 1990

A COLLECTION OF AMPHIPODA FROM THE SOUTHERN BEAUFORT SEA

Edited by

M.A. Keast and M.J. Lawrence

Central and Arctic Region  
Department of Fisheries and Oceans  
Winnipeg, Manitoba R3T 2N6

This is the 46th Data Report  
from the Central and Arctic Region, Winnipeg

## PREFACE

Production of this publication was funded by the Northern Oil and Gas Action Program (NOGAP) and the Department of Fisheries and Oceans (DFO), Central and Arctic Region. It is one of a series of manuals to the invertebrates of the southern Beaufort Sea region. This document is in part the result of work conducted under the terms of a Department of Supply and Services contract issued to Invertebrate Research Associates (DSS Contract No. FP43-4-N4981).

The scientific authority was M.J. Lawrence, Department of Fisheries and Oceans, Central and Arctic Region, 501 University Crescent, Winnipeg, Manitoba, R3T 2N6. This document constitutes NOGAP Report B2.15.

(c) Minister of Supply and Services Canada 1990

Cat. no. Fs 97-13/799E

ISSN 0706-6465

Correct citation for this publication is:

Keast, M.A., and M.J. Lawrence. (ed.) 1990. A collection of Amphipoda from the southern Beaufort Sea. Can. Data Rep. Fish. Aquat. Sci. 799: vi + 114 p.

## TABLE OF CONTENTS

	<u>Page</u>
ABSTRACT/RÉSUMÉ . . . . .	vi
INTRODUCTION . . . . .	1
SITE DESCRIPTION . . . . .	1
METHODS . . . . .	1
MAJOR IDENTIFYING CRITERIA . . . . .	2
SYSTEMATIC LIST . . . . .	4
KEY TO 2 SUBORDERS OF AMPHIPODA . . . . .	5
 HYPERIIDAE . . . . .	 6
<u>Hyperia</u> Latreille 1825 . . . . .	6
<u>Hyperia galba</u> (Montagu) 1813 . . . . .	6
<u>Hyperia medusarum</u> (Muller) 1776 . . . . .	6
<u>Hyperoche medusarum</u> (Krøyer) 1838 . . . . .	7
<u>Parathemisto</u> Boeck 1870 . . . . .	7
<u>Parathemisto abyssorum</u> Boeck 1870 . . . . .	8
<u>Parathemisto libellula</u> (Lichtenstein) 1822 . . . . .	8
 STENOTHOIDAE . . . . .	 9
<u>Metopa</u> Boeck 1870 . . . . .	9
<u>Metopa longirama</u> Dunbar 1942 . . . . .	9
 PODOCERIDAE . . . . .	 10
<u>Dyopedos porrectus</u> Bate 1857 . . . . .	10
 LYSIANASSIDAE . . . . .	 11
<u>Anonyx</u> Krøyer 1838 . . . . .	11
<u>Beockosimus affinis</u> (Hansen) 1887 . . . . .	11
<u>Onisimus glacialis</u> G.O. Sars 1900 . . . . .	11
<u>Onisimus litoralis</u> (Krøyer) 1845 . . . . .	12
<u>Onisimus nanseni</u> G.O. Sars 1900 . . . . .	12
<u>Orchomene minuta</u> (Krøyer) 1846 . . . . .	13
<u>Orchomene pinguis</u> (Boeck) 1861 . . . . .	13
 STEGOCEPHALIDAE . . . . .	 15
<u>Andaniella pectinata</u> G.O. Sars 1882 . . . . .	15
 SYNOPIIDAE . . . . .	 16
<u>Syrrhoe crenulata</u> Goes 1866 . . . . .	16
 OEDICEROTIDAE . . . . .	 17
<u>Acanthostepheia behringiensis</u> (Lockington) 1877 . . . . .	17
<u>Acanthostepheia malmgreni</u> (Goes 1866) . . . . .	17
<u>Aceroides latipes</u> G.O. Sars 1895 . . . . .	17
<u>Monoculodes Stimpson</u> 1853 . . . . .	18
<u>Monoculodes packardi</u> Boeck 1871 . . . . .	18
<u>Oediceros saginatus</u> Krøyer 1842 . . . . .	18
<u>Paroediceros lynceus</u> (M. Sars 1858) . . . . .	19
 COROPHIIDAE . . . . .	 20
<u>Lembos borealis</u> Myers 1976 . . . . .	20
<u>Protomedeia</u> Krøyer 1842 . . . . .	20
<u>Protomedeia fasciata</u> Krøyer 1842 . . . . .	20

	<u>Page</u>
EUSIRIDAE . . . . .	22
<u>Apherusa glacialis</u> (Hansen) 1887 . . . . .	22
<u>Apherusa megalops</u> G.O. Sars 1882 . . . . .	22
<u>Haliragoides inermis</u> G.O. Sars 1882 . . . . .	23
<u>Pontogeneia inermis</u> (Krøyer) 1838 . . . . .	23
PONTOPOREIIDAE . . . . .	24
<u>Pontoporeia affinis</u> Lindstrom 1855 . . . . .	24
<u>Pontoporeia femorata</u> Krøyer 1838 . . . . .	24
GAMMARIDAE . . . . .	25
<u>Gammaracanthus loricatus</u> Sabine) 1821 . . . . .	25
<u>Gammarus wilkitzkii</u> Birula 1897 . . . . .	25
<u>Weyprechtia heuglini</u> (Buchholz) 1874 . . . . .	26
GLOSSARY . . . . .	27
ACKNOWLEDGMENTS . . . . .	32
REFERENCES . . . . .	33

## LIST OF APPENDICES

<u>Appendix</u>	<u>Page</u>
1 VERIFICATION OF AMPHIPOD SPECIES . . . . .	110
2 EXTRANEOUS MATERIAL UTILIZED . . . . .	112
3 SPECIES COLLECTION SITE . . . . .	113

## LIST OF PLATES

<u>Plate</u>		<u>Page</u>
I	The basic hyperiid (modified from Bowman 1973) . . . . .	41
II	The basic gammaridean (modified from Barnard 1969) . . . . .	42
III-IV	<u>Hyperia galba</u> (Montagu) 1813 . . . . .	43-44
V-VI	<u>Hyperia medusarum</u> (Muller) 1776 . . . . .	45-46
VII-VIII	<u>Hyperoche medusarum</u> (Krøyer) 1838 . . . . .	47-48
IX-X	<u>Parathemisto abyssorum</u> Boeck 1870 . . . . .	49-50
XI-XII	<u>Parathemisto libellula</u> (Lichtenstein) 1822 . . . . .	51-52
XIII-XIV	<u>Metopa longirama</u> Dunbar 1942 . . . . .	53-54
XV-XVII	<u>Dyopedos porrectus</u> sp. Bate 1857 (modified from Sars 1895) . . . . .	55-57
XVIII-XIX	<u>Boeckosimus affinis</u> (Hansen) 1887 . . . . .	58-59
XX-XXI	<u>Onisimus glacialis</u> G.O. Sars 1900 . . . . .	60-61
XXII-XXIII	<u>Onisimus litoralis</u> (Krøyer) 1845 . . . . .	62-63
XXIV-XXV	<u>Onisimus nansenii</u> G.O. Sars 1900 . . . . .	64-65
XXVI-XXVII	<u>Orchomene minuta</u> (Krøyer) 1846 . . . . .	66-67

<u>Plate</u>		<u>Page</u>
XXVIII-XXIX	<u>Orchomene pinguis</u> (Boeck) 1861 . . . . .	68-69
XXX-XXXI	<u>Andaniella pectinata</u> G.O. Sars 1882 . . . . .	70-71
XXXII-XXXIV	<u>Syrrhoë crenulata</u> Goes 1866 . . . . .	72-74
XXXV-XXXVI	<u>Acanthostepheia behringiensis</u> (Lockington) 1877 . . . . .	75-76
XXXVII-XXXVIII	<u>Acanthostepheia malmgreni</u> (Goes) 1866 . . . . .	77-78
XXXIX-XL	<u>Aceroides latipes</u> G.O. Sars 1895 . . . . .	79-80
XLI-XLII	<u>Monoculodes packardi</u> Boeck 1871 . . . . .	81-82
XLIII-XLIV	<u>Oediceros saginatus</u> Krøyer 1842 . . . . .	83-84
XLV-XLVI	<u>Paroediceros lynceus</u> (M. Sars) 1858 . . . . .	85-86
XLVII-XLVIII	<u>Lembos borealis</u> Myers 1976 . . . . .	87-88
XLIX-L	<u>Protomedeia fasciata</u> Krøyer 1842 . . . . .	89-90
LI-LII	<u>Apherusa glacialis</u> (Hansen) 1887 . . . . .	91-92
LIII-LIV	<u>Apherusa megalops</u> G.O. Sars 1882 . . . . .	93-94
LV-LVI	<u>Haliragoides inermis</u> G.O. Sars 1882 (modified from Sars 1895) . . . . .	95-96
LVII-LVIII	<u>Pontogeneia inermis</u> (Krøyer) 1838 . . . . .	97-98
LIX-LX	<u>Pontoporeia affinis</u> Lindstrom 1855 . . . . .	99-100
LXI-LXII	<u>Pontoporeia femorata</u> Krøyer 1842 . . . . .	101-102
LXIII-LXIV	<u>Gammaracanthus loricatus</u> (Sabine) 1821 . . . . .	103-104
LXV-LXVI	<u>Gammarus wilkitzkii</u> Birula 1897. . . . .	105-106
LXVII-LXIX	<u>Weyprechtia heuglini</u> (Buchholz) 1874 . . . . .	107-109

## ABSTRACT

Keast, M.A., and M.J. Lawrence. (ed.) 1990. A collection of Amphipoda from the southern Beaufort Sea. Can. Data Rep. Fish. Aquat. Sci. 799: vi + 114 p.

This report provides descriptions, with drawings, of benthic and pelagic amphipods of two suborders (Hyperiidea and Gammaridea). The amphipods came from collections made by DFO in the coastal waters of the southern Beaufort Sea.

Key words: amphipoda; Hyperiidea; Gammaridea; pelagic; benthos; taxonomy; Beaufort Sea.

## RÉSUMÉ

Keast, M.A., and M.J. Lawrence. (ed.) 1990. A collection of Amphipoda from the southern Beaufort Sea. Can. Data Rep. Fish. Aquat. Sci. 799: vi + 114 p.

Ce rapport donne des descriptions, accompagnées de dessins, des amphipodes benthiques et pélagiques des deux sous-ordres (Hyperiidea et Gammaridea). Les amphipodes viennent des collections rassemblées par le MPO dans les eaux littorales de la partie sud de la mer de Beaufort.

Mots-clés: amphipoda; Hyperiidea; Gammaridea; pélagique; benthos; taxinomie; mer de Beaufort.

## INTRODUCTION

Amphipods collected between 1982 to 1986 from the southern Beaufort Sea are in this report. A glossary of terms used in the text is also included.

Identification of amphipods is difficult due to the diversity present within the taxon. More than 5500 species have been described and placed within over 100 families (Karaman and Barnard 1979; Barnes 1980). This is further complicated by complex changes in the systematics and nomenclature. This report follows the Barnard-Karaman nomenclature (Barnard 1964, 1969, 1972, 1973, 1974; Barnard and Karaman 1975, 1980, 1982; Karaman and Barnard 1979).

We emphasize that the species described in this report do not include all species that may be found in the southern Beaufort Sea.

## SITE DESCRIPTION

### SOUTHERN BEAUFORT SEA SHELF

Collections were made in the coastal area of the southern Beaufort Sea within Canadian boundaries lying to the south of 72°N latitude bound to the east by McKinley Bay (70°N, 131°W) and to the west by Herschel Island (69°N, 138°W), Yukon Territory. The bathymetry is characterized by a broad shallow continental shelf bordering the mainland coast with the shelf margin lying between the 100 and 200 m isobaths (Cornford et al. 1982). The shelf may be as far offshore as 150 km with depths of less than 10 m occurring up to 30 km offshore (Cornford et al. 1982). The shelf is discontinuous to the west off Herschel Island where the MacKenzie Trench has depths of 100 m or more within 35 km of the coastline. Eastward another trench extends from Kugmallit Bay to the margin of the shelf. This is most evident north of the Tuktoyaktuk Peninsula.

The Mackenzie River outflow introduces fresh sediment laden water into the Beaufort Sea, influencing the physical and chemical properties of the surface waters. The degree of intermixing of fresh and salt water is dependent on tides, currents, prevailing wind conditions, and the presence or absence of ice cover.

Lunar tides are generally less than 30 cm in the Beaufort Sea. There is a reduced intertidal zone and tidal currents are usually weak.

## METHODS

Most animals used for illustrative purposes were from collections made in the Beaufort Sea by Department of Fisheries and Oceans (DFO), Winnipeg, between 1984-1987. The exception is the species Pontogeneia inermis (Krøyer) 1838 for which a representative specimen from the Beaufort Sea was obtained from



invertebrate collections at DFO, Ste Anne de Bellevue, Quebec (courtesy of E. H. Grainger). Although a specimen of Haliragoides inermis G.O. Sars 1882 was obtained from the DFO surveys, the specimen was in too poor condition to draw. Copyright permission was obtained from the editor to include the illustration of H. inermis by G.O. Sars (1895). In addition, copyright permission was granted for the inclusion of Plate I (basic hyperiid) and Plate II (basic gammaridean).

The illustrations were prepared using a WILD M8 stereo microscope and a WILD M20 compound microscope each equipped with a camera lucida. The total body length was measured laterally from the anterior margin of the head to the posterior tip of the telson. The species descriptions were based on the specimen illustrated. All specimens utilized are stored in the Invertebrate Collections of DFO, Winnipeg.

#### MAJOR IDENTIFYING CRITERIA

Only two suborders, Gammaridea and Hyperiidea, are represented in this collection. The hyperiids are planktonic, most being oceanic in distribution. The gammarideans occur in the plankton although a greater number of species occur in the benthic environment.

The general body plan for the hyperiid and gammaridean amphipod is illustrated in Plates I and II, respectively. The body appears laterally compressed. In amphipods, due to the lack of a carapace, seven distinct pereonites are visible each with a pair of appendages varying in structure and size among species. Sessile compound eyes are typical in most gammarideans. In the Hyperiidea the eyes are large, covering most of the head. Antenna 1 consists of 3 peduncle segments and a flagellum of varying numbers of articles. The accessory flagellum, if present, is usually attached to the distal peduncle segment of antenna 1. The presence and number of articulations of the accessory flagellum is an important taxonomic character. Antenna 2 consists of 5 peduncle segments and a flagellum of varying number of articles. The amphipod appendage (7 pairs in total) consists of 7 segments, which may be referred to by name or number; coxa (1), basis (2), ischium (3), merus (4), carpus (5), propodus (6), and dactyl (7). Pereopods 1 and 2 are commonly referred to as gnathopods 1 and 2 respectively, modified for grasping and excavating, subsequently followed by pereopods 3 to 7. Pereopods 3 and 4 are flexed backwards while pereopods 5-7 flex forwards when viewing the animal laterally. The shape and size of the coxal plates is of taxonomic importance at certain familial levels. Paired pleopods located on each of the 3 pleonites are biramous, the rami being multisegmented and setose. Variations in the size and structure of pleopods are slight among species and are used to describe different generic and familial characteristics of the Phliantidae, Talitroidea, and some Corophiidae (Barnard 1969). The uropods, usually 3 pairs, consist of a peduncle and two rami, an endopod and exopod, which vary in structure. The uropods are modified posterior pleopods (Dahl 1977). The outer or inner ramus may be absent in some species. Uropod 3 may be reduced in size and structure, and is absent in some sedentary species. The telson is of taxonomic importance depending on whether it is cleft, entire, emarginate, and/or ornate.

Major ornamentation of the body includes the shape and size of the rostrum, differentiation of lateral head lobes, and cuspidation of the epimeral plates. Dorsal ornamentation, common among cold water gammarideans, occurs in the form of a sharp ridge or cusps on the pereonites and/or pleonites.

Male amphipods are distinguished by the presence of a pair of small penial structures, occasionally minutely setose, attached to pereonite 7 between the coxae. The penial structures are obscure, confused easily with the coxal gills. Ovigerous females can be readily identified by the presence of a ventral marsupium formed by four or five overlapping pairs of lamella attached to the inner margin of coxae 2 to 5 (may include coxa 6). The morphology, size of the lamella, and the type and quantity of setae which beset the lamella are variable and are an indication of the egg protection exhibited by the species (Leite et al. 1986). The sexes frequently exhibit external dimorphism. Males are generally larger in total body length. Structural differences are apparent when examining the gnathopods, the male appearing larger and more spinose and/or setulose, the antennae being longer, uropod 3 may be more setulose, and the eyes are generally larger when compared with the females of the same species (Barnard 1969). The larger gnathopods exhibited by males are believed to assist in precopulation (Barnard 1969; Bousfield 1973), however they may also be used against other males during antagonistic encounters (Borowsky 1984). Difficulty in keying amphipods, particularly the gammarids, is due partly in attempting to key isolated, immature specimens, combined with the occurrence of individual variation and sexual dimorphism in adults (Gosner 1971). The specific taxonomic characters for most species described within the manual are based on adults of both sexes.

## SYSTEMATIC LIST

PHYLUM ARTHROPODA  
 SUBPHYLUM CRUSTACEA  
 CLASS MALACOSTRACA  
 SUBCLASS EUMALACOSTRACA  
 SUPERORDER PERACARIDA  
 ORDER AMPHIPODA  
 SUBORDER GAMMARIDEA

## FAMILY COROPHIIDAE

Lembos borealis Myers 1976  
Protomedeia fasciata Krøyer 1842  
Protomedeia Krøyer<sup>1</sup> 1842

## FAMILY EUSIRIDAE

Apherusa glacialis (Hansen) 1887  
Apherusa (=Halirages) megalops G.O. Sars 1882  
Haliragoidea inermis G.O. Sars 1882  
Pontogeneia inermis (Krøyer) 1838

## FAMILY GAMMARIDAE

Gammaracanthus loricatus (Sabine) 1821  
Gammarus wilkitzkii Birula 1897  
Weyprechtia heuglini (Buchholz) 1874

## FAMILY PANTOPOREIIDAE

Pantoporeia affinis Lindstrom 1855  
Pantoporeia femorata Krøyer 1842

## FAMILY LYSIANASSIDAE

Anonyx (Krøyer)<sup>1</sup> 1838  
Boeckosumus affinis (Hansen) 1887  
Onisimus glacialis G.O. Sars 1900  
Onisimus litoralis (Krøyer) 1845  
Onisimus nanseni G.O. Sars 1900  
Orchomene minuta (Krøyer) 1846  
Orchomene pinguis (Boeck) 1861

---

<sup>1</sup>specimen could not be identified lower than genus

## FAMILY OEDICEROTIDAE

Acanthostephea behringiensis (Lockington) 1877  
Acanthostephea malmgreni (Goes) 1866  
Aceroides latipes G.O. Sars 1895  
Monoculodes Stimpson<sup>2,3</sup> 1853  
Monoculodes packardi Boeck 1871  
Oediceros saginatus Krøyer 1842  
Paroediceros lynceus (M. Sars) 1858

## FAMILY PODOCERIDAE

Dyopedos porrectus Bate 1857

## FAMILY STEGOCEPHALIDAE

Andaniella pectinata G.O. Sars 1882

## FAMILY STENOTHOIDAE

Metopa Boeck<sup>2,3</sup> 1871  
Metopa longirama Dunbar 1942

## FAMILY SYNOPIIDAE

Syrrhoe crenulata Goes 1866

## SUBORDER HYPERIIDEA

## FAMILY HYPERIIDAE

Hyperia Latreille<sup>3</sup> 1824  
Hyperia galba (Montagu) 1813  
Hyperia medusarum (Muller) 1776  
Hyperoche medusarum (Krøyer) 1838  
Parathemisto Boeck<sup>3,4</sup> 1870  
Parathemisto abyssorum Boeck 1870  
Parathemisto libellula (Lichtenstein) 1822

## KEY TO 2 SUBORDERS OF AMPHIPODA

Eyes large shielding >75% of head; coxae reduced. . . . . Hyperiidea  
(Plate I)

Eyes medium or small shielding <50% of head; coxae variable,  
usually large . . . . . Gammaridea  
(Plate II)

---

<sup>2</sup>may represent additional species - specimens from NOGAP surveys were assigned as Metopa sp. or Monoculodes sp. when in poor condition or immature; Grainger and Grohe (1975) also list Monoculodes sp. and Metopa sp., no reasons were given by the authors.

<sup>3</sup>specimen could not be identified lower than genus

<sup>4</sup>Mason Bay, N.W.T. only

## HYPERIIDAE

Hyperia Latreille 1825

Body smooth, few pigments; head broader than long; antenna 2 longer than antenna 1 for both sexes, male antennae longer than female; gnathopod 1 subchelate or barely chelate; gnathopod 2 chelate, carpus with spatulate lobe; pereopods 5-7 shorter than pereopods 3-4; coxal plates not fused to pereonites; uropod 3, inner ramus broad; telson entire.

References: Sars 1895; Stephensen 1942; Yashnov 1948; Tencati and Geiger 1968; Tencati 1970; Gosner 1971; Bowman 1973; Bowman and Gruner 1973.

Hyperia galba (Montagu) 1813

Plates III-IV

Female body short, stout, male slender; eye pigment narrow, reniform; female antennae small, subequal, male antennae longer; antenna 1, posterior margin setose; antenna 2 posterior and anterior margins minutely setose; gnathopods small and sparsely setose; gnathopod 1, carpus with slender lobe; gnathopod 2, carpus with slender lobe distally extending to middle of the propodus, propodus attenuated and finely serrated along posterior margin with several spines, dactyl small, slender; pereopods minutely setose; pereopods 3 and 4 longer than pereopods 5-7; pereopods 3 and 4, basis elongate, propodus elongate, spiniferous on posterior margin, dactyl small, slender; uropod 3 broad; telson entire, triangular, lacking spines or setae; female 8-14 mm, males smaller. Maximum size recorded for arctic specimen 20 mm (Sars 1895).

Occurrence: parasitic on Aurelia

Distribution: circumpolar; southern Beaufort Sea; North Atlantic and Pacific Oceans; Frobisher Bay; Barents Sea; Sea of Japan; southwest and east Greenland; Baltic Sea; northern and western Norway; White Sea; Spitsbergen; Franz Josef Land; Iceland.

References: Sars 1895; Norman 1900; von der Bruggen 1905; Stappers 1911; Shoemaker 1920, 1926, 1955; Stephensen 1923, 1931, 1933b, 1940, 1942, 1944; Schellenberg 1927; Jones 1948; Yashnov 1948; Bousfield 1951; Kielhorn 1952; Dunbar 1954, 1963; Forsman 1956; Grainger 1959, 1962; Shen 1966; Tencati and Geiger 1968; Tencati 1970; Gosner 1971; Shih et al. 1971; Bowman 1973; Shih and Laubitz 1978; Smidt 1979; Bradstreet 1982; Dittrich 1987.

Hyperia medusarum (Muller) 1776

Plates V-VI

Body stout; eye pigment large; female antennae small, subequal, male longer; gnathopods large and densely setose, spines lacking; gnathopod 1, carpus scarcely produced; gnathopod 2, carpus with distal process, propodus serrated on posterior margin; pereopods 3 and 4 with short bristles on posterior margin, spines lacking; uropods similar to H. galba; telson entire, triangular, lacking spines or setae; female 13-17 mm, male 11-13 mm.

Occurrence: parasitic on Cyanea Peron and Lesueur, occasionally on Aurelia Peron and Lesueur.

Distribution: North Atlantic and Pacific Oceans; southern Beaufort Sea; Pt. Barrow, Alaska; Bering Sea; western and northern Norway; White Sea; Spitsbergen; S.W. Greenland; western Ireland; Sea of Japan; Irminger Sea; North Sea; Iceland.

References: Goes 1866; Sars 1895; Stephensen 1923, 1931, 1940, 1942; Shoemaker 1926, 1955; Schellenberg 1927; Yashnov 1948; Bousfield 1951; Dunbar 1954, 1963; MacGinitie 1955; Grainger 1962, 1965; Shen 1966; Tencati 1970; Gosner 1971; Shih et al. 1971; Bowman 1973; Sanger 1974; Lorz and Percy 1975; Smidt 1979.

Hyperoche medusarum (Krøyer) 1838  
(=Hyperoche kroyeri Bovallius)

Plates VII-VIII

Female body short, swollen, male slender, compressed; head round; eye pigment oval; female antennae subequal, antenna 1 longer than antenna 2; male antennae equal, much longer; pereon arched; pleon slender; gnathopods minutely setose; gnathopods 1 and 2, carpus produced inferiorly to a compressed knife-like process, inner margins of carpus and propodus denticulate; gnathopod 1, dactyl denticulate proximally on posterior margin; gnathopod 2, dactyl smooth; pereopods 3 and 4 longer than pereopods 5-7, carpus distal posterior margin minutely denticulate, interspersed with several long setae, propodus elongate, denticulate on posterior margin; pereopods 5-7 sparingly setose, carpus and propodus elongate; epimeral plates acute at posterolateral angle; uropod 3, peduncle twice length of telson; telson entire, triangular, spineless; female 8-15 mm.

Occurrence: in association with ctenophores (Pleurobrachia bachei (Muller), Pleurobrachia pileus) (Muller) and the medusans (Cyanea capillata (Linnaeus) and Tima formosa L. Agassiz).

Distribution: circumpolar; southern Beaufort Sea; Arctic Ocean; Arctic Bay; Bering Sea; Strait of Georgia; Ungava Bay; Gulf of St. Lawrence; S.W. Greenland; Polar Basin; Iceland; Spitsbergen; White Sea; Barents Sea; Japan Sea.

References: Sars 1895; Stappers 1911; Shoemaker 1920, 1930; Stephensen 1923, 1931, 1933b, 1940, 1944; Schellenberg 1927; Dunbar 1942, 1954, 1963; Yashnov 1948; Bousfield 1951; MacGinitie 1955; Grainger 1959, 1962, 1965; Bowman et al. 1963; Shen 1966; Brusca 1970; Shih et al. 1971; Evans and Shearer 1972; Sanger 1974; Lorz and Percy 1975; Harbison et al. 1977; Madin and Harbison 1977; Shih and Laubitz 1978; Smidt 1979; Weslawski 1983b; Cahoon et al. 1986.

Parathemisto Boeck 1870

Body compressed, heavily pigmented; head oval to round; pereon and pleon well developed with large epimeral plates; female antennae subequal, male same as Hyperia; gnathopod 1 simple, carpus broad; gnathopod 2 subchelate, carpus with narrow lobe; pereopods 5-7 longer than pereopods 3 and 4; uropods more slender than Hyperia; telson entire.

References: Dunbar 1946, 1963, 1964; Bowman 1960; Bowman and Gruner 1973; Wing 1976.

Parathemisto abyssorum Boeck 1870  
 (= Parathemisto oblivia (Krøyer))  
 (Parathemisto = Themisto = Euthemisto)

Plates IX-X

Eyes oval, pigment black; female antenna 1, setose on posterior margin; male antennae longer; gnathopods, propodus shorter than carpus; gnathopod 1, carpus lacking distal process; gnathopod 2, carpus with narrow process extending to more than half the length of propodus, dactyl long, slender; pereopods 3 and 4 shorter than pereopods 5-7, carpus oblong with 5 slender setae on posterior margin; pereopods 5-7 similar, carpus and propodus elongate, setose, dactyl slender; telson entire, triangular; female 10-17 mm.

Distribution: southern Beaufort Sea; Pt. Barrow and Collinson Pt., Alaska; Canadian arctic archipelago; Hudson Strait; Labrador; Gulf of St. Lawrence; Strait of Belle Isle; Newfoundland; Ungava Bay; Davis Strait; Foxe Basin; Siberian Shelf; Franz Josef Land; south Greenland; Norway; British Isles; Iceland.

References: Sars 1895; Norman 1900; von der Bruggen 1905, 1906; Holmes 1910; Stappers 1911; Shoemaker 1920, 1930, 1955; Stephensen 1923, 1931, 1933b, 1940, 1942, 1944; Schellenberg 1927; Thorsteinson 1941; Jones 1948; Yashnov 1948; Bousfield 1951; Dunbar 1954, 1963, 1964; Barnard 1959; Bowman 1960; Grainger 1962, 1965; Shen 1966; Tencati and Geiger 1968; Tencati 1970; Shih et al. 1971; Bowman and Gruner 1973; Mohammed and Grainger 1974; Shih and Laubitz 1978; Weslawski 1983b.

Parathemisto libellula (Lichtenstein) 1822  
 (Parathemisto = Themisto = Euthemisto)

Plates XI-XII

Body slender, pigmented; pereon smooth; eyes large; antenna 1 with slightly curved setae on posterior margin; antenna 2, flagellum slender, falciform; gnathopods, propodus shorter in length than carpus; gnathopod 2, carpus produced inferiorly to a rounded lobe, extends to distal tip of propodus, propodus pyriform, dactyl small, falciform; pereopods 3 and 4, carpus ovate with series of elongated spines and setae on posterior margin, propodus elongate, dactyl small; pereopod 5 longest, basis with anterior margin setose, carpus and propodus elongate, anterior margin with setae and spines, dactyl flexuous and pectinate with dense tuft of fine spinules at base; uropod 2 shortest, uropod 3, rami subequal; telson entire, triangular, lacking spines or setae; male 19-21 mm.

Distribution: circumpolar; southern Beaufort Sea; Bering Sea; Spitsbergen; southwest and eastern Greenland; Norway; Ireland; southern Iceland; Bering Sea; Okhotsk Sea; Kara Sea; Eisfjord, Advenbay.

References: Goes 1866; Sars 1895, 1900; Norman 1900; von der Bruggen 1906; Stappers 1911; Shoemaker 1920, 1926, 1955; Stephensen 1923, 1931, 1933a,b, 1940, 1942, 1944; Schellenberg 1927; Dunbar 1946, 1954, 1963, 1964; Yashnov 1948; Bousfield 1951; MacGinitie 1955; Barnard 1959; Bowman 1960; Grainger 1962, 1965; Shen 1966; Tencati and Geiger 1968; Tencati 1970; Shih et al. 1971; Mohammed and Grainger 1974; Sanger 1974; Wing 1976; Shih and Laubitz 1978; Smidt 1979; Bradstreet 1982; Cross 1982; Weslawski 1983b.

## STENOTHOIDAE

Metopa Boeck 1870

Antennae elongate; no accessory flagellum; gnathopod 1 simple or weakly subchelate; gnathopod 2 usually subchelate; coxae 2 and 3 large; coxa 4 largest; pereopods 6 and 7, basis expanded distally; pereopod 6 longest; uropod 2, inner ramus longer than outer ramus; telson entire.

References: Sars 1895; Stephensen 1942; Shoemaker 1955; Gosner 1971; Bousfield 1973.

Metopa longirama Dunbar 1942

Plates XIII, XIV

Body smooth; eyes medium, round, composed of several ommatidia; head anterolateral angle acute; antennae long, slightly less than total body length; antenna 1 longer than antenna 2; coxa 1 shielded by coxa 2; coxa 2 small, narrow, similar to coxa 3; coxa 4 largest, triangular; coxa 5 shielded by coxa 4; coxae 6 and 7 reduced; coxa 7 rectangular; gnathopod 1 feeble, 1/2 size of gnathopod 2, merus setose and spiniferous on posterior margin; gnathopod 2 powerful, merus produced inferiorly with 2 spines, carpus produced inferiorly with 7 spines, propodus twice size carpus, palm spiniferous with 2 large spines proximally, dactyl falciform; pereopods elongate; pereopods 3 and 4 similar; pereopods 6 and 7, merus posterior margin serrated and spinose with a posterodistal lobe strongly developed; pereopod 5, merus posterior margin smooth with 1 medial seta and posterodistal lobe weakly developed; epimeral plate 3, posterior angle acute; uropod 3 shorter than uropods 1 and 2, uniramous, 2nd segment with 1 lateral spine; pleopods, rami elongate, setose; telson oblong, entire, spineless; male 2.9 mm.

Distribution: southern Beaufort Sea<sup>5</sup>; Clyde River, Baffin Island; Ungava Bay; Placentia Bay, Newfoundland.

References: Dunbar 1942, 1954; Fenwick and Steele 1983; Korczynski et al. 1989.

---

<sup>5</sup>findings represent an extended range distribution (Korczynski et al. 1989).



## PODOCERIDAE

Dyopedos porrectus Sp. Bate 1857  
(=Dulichia porrecta Sp. Bate)

Plates XV-XVII

Body smooth, female more slender than male; rostrum rudimentary; eyes large, prominent, pigment dark red; pereonite 1 shorter than others, pereonites 6 and 7 fused; antennae, peduncle segments elongate, posterior margin setose; antenna 1 equivalent to length or longer than the total body, 5 flagellar articles; antenna 2 shorter than antenna 1; accessory flagellum triarticulate; coxa 1 small, quadrate; coxa 2 larger in male than female, produced anteriorly to an acute angle, spinose only in male; coxae 3-7 reduced; female gnathopod 1, carpus longer than propodus which is narrow, oval; male gnathopod 1, carpus 1/2 length of propodus, dactyl short, setose; male gnathopod 2 subchelate, longer than gnathopod 1, basis long, slender, carpus small, longer than broad, propodus elongate, densely setose on palm, distal margin with long spine and with long finger-like process at posterior angle, dactyl large, setose; female gnathopod 2 as long as gnathopod 1; pereopods 3 and 4 feeble; pereopods 5-6 similar; pereopod 7 longest, sparingly setose; urosomes depressed; uropod 1, peduncle minutely spinulose on outer margin, inner ramus longer than outer, spinulose on inner margin; uropod 2 biramous; uropod 3 absent; telson entire, inflated with 2 ridges, ovate, spineless; male and female 5-7 mm.

Distribution: circumpolar; North Pacific Ocean; Arctic Ocean; Frobisher Bay; Gulf of St. Lawrence; Gulf of Maine; Cape Cod Bay; Bay of Fundy; North Sea; Denmark; Shetlands; Scotland; Great Britain; Iceland; Northern Norway to NW France; Skagerrak and Kattegat; Lofoten Islands; West Greenland; Finmark; Tromsø, Trondheim, Menai Straits.

References: Sars 1895; Stebbing 1906; Shoemaker 1920, 1926, 1955; Stephensen 1931, 1933b, 1940, 1942; Jones 1948; Gurjanova 1951; MacGinitie 1955; Bousfield 1973; Dahl 1977; Laubitz 1977.

## LYSIANASSIDAE

Anonyx Krøyer 1838

Head, interantennal lobe pronounced; eyes large, spatulate; antenna 2 longer than antenna 1; gnathopods weakly subchelate; pereopods 5-7 successively increasing in length; epimeral plate 3, posterior angle with a reflexed spine; uropod 2, proximal half of inner ramus notched; telson deeply cleft.

References: Sars 1895; Stephensen 1942; Shoemaker 1955; Barnard 1969; Gosner 1971; Bousfield 1973.

Boeckosimus affinis (Hansen) 1887

Plates XVIII-XIX

(=Onisimus affinis Hansen)  
(=Onisimus botkini Birula)

Body smooth; head, lateral angle rounded; eyes spatulate, pigment red; antenna 2 slightly longer than antenna 1; male antenna 1, 24-30 flagellar articles, female 19 flagellar articles; accessory flagellum triarticulate; male antenna 2, 30-38 flagellar articles, female 24 flagellar articles; coxa 1 expanded distally; coxae 2-4 elongate; coxae 5-7 reduced; gnathopod 1, propodus longer than carpus, slightly convex anteriorly, concave posteriorly, palm with row of small spines interspersed with several large spines, dactyl inner margin with 1 medial spine and finely serrated proximally; gnathopod 2, carpus and propodus densely setose; pereopods 3 and 4 feeble; pereopods 5-7, basis expanded, finely serrated on posterior margin; epimeral plate 3, posterior angle rounded; telson entire, slightly emarginate, 4 minute apical spines; female 10-12 mm.

Distribution: Tuktoyaktuk Harbour; Demarcation Pt., Point Barrow, Collinson Pt., Alaska; Kara Sea; Ungava Bay; Bering Strait; northeast Greenland; King William Island.

References: Shoemaker 1920, 1955; Gurjanova 1951; Dunbar 1954; MacGinitie 1955; Busdosh and Atlas 1975, 1977; Percy 1975; Busdosh et al. 1979; Robilliard and Busdosh 1980; Busdosh 1981; Atlas et al. 1982.

Onisimus glacialis G.O. Sars 1900

Plates XX-XXI

(=Pseudalibrotus glacialis Sars)

Body less robust than O. nanseni; pereon smooth; head with lateral lobes distinctly angular; eyes medium, oval; female antennae 1 and 2, 14 flagellar articles; accessory flagellum, 3 articles; coxa 1 broad, anterolateral angle rounded; coxa 5 bilobed; gnathopod 1, carpus obpyriform, propodus subtriangular, dactyl small, slender; gnathopod 2, propodus oblong, obliquely truncated distally, dactyl close to distal margin; pereopods 5-7 less robust than O. nanseni, basis expanded, finely serrated on posterior margin, the extent of the serration is dependent on the size of the animal and individual variability; urosome 1 slightly depressed dorsad; uropod 3, inner and outer ramus lacking marginal setae; epimeral plate 3, posterolateral angle acute; telson entire, length and width equal, 2 minute apical spines; female 11-13 mm.

Distribution: circumpolar; southern Beaufort Sea; Frobisher Bay; Davis Strait; east Greenland; Iceland; Franz Josef Fjord.

References: Sars 1900; Shoemaker 1920; Stephensen 1923, 1942, 1944; Schellenberg 1927; Dunbar 1954; Grainger 1962, 1965; Holmquist 1965; Tencati 1970; Shih et al. 1971; Mohammed and Grainger 1974; Bradstreet 1982; Bradstreet and Cross 1982; Cross 1982.

Onisimus litoralis (Krøyer) 1845  
(=Pseudalibrotus litoralis (Krøyer))

Plates XXII-XXIII

Body smooth; head lateral angle slightly produced; eyes medium, oval, pigment red; antenna 2 slightly longer than antenna 1; female antenna 1 with 14 flagellar articles; female antenna 2 with 16 flagellar articles, accessory flagellum with 5 articles; coxa 1 expanded distally; coxae 2-4 elongate; coxa 5 bilobed; coxae 6-7 reduced; gnathopod 1, comparison of basal and distal widths for propodus, for O. litoralis broader basally or distally, O. glacialis broader basally, O. nanseni widths equal (note: Variations also do occur within the species); gnathopod 1, dactyl large, falciform, inner margin with 1 small medial spine; gnathopod 2, propodus oblong, dactyl situated 1/3 from inner end of the oblique distal margin; pereopods 3 and 4 feeble; pereopods 5-7, basis expanded, coarsely serrated on posterior margin, (note: the extent of the serration is dependent on the size of the animal and individual variability); urosome 1 slightly depressed dorsad; uropods, rami shorter than basis; uropod 2, outer ramus with 3 spines (note: variability is pronounced among specimens), inner ramus with 2 spines; posterior margin of epimeral plate 3 concave in smaller specimens but convex in larger ones; telson entire, slightly emarginate, longer than broad, 2 apical spines; female 11-13 mm.

Distribution: Tuktoyaktuk Harbour; Collinson Pt., Alaska; Bernard Harbour; Jones Sound; James Bay; Hudson Bay; Ungava Bay; Labrador; Scoresby Sund area; east and west Greenland; Kara Sea; Northern Norway; Franz Josef Fjord; Jan Mayen Island; Finmark; Spitsbergen; Barents Sea; Iceland; Hornsund.

References: Sars 1895; Stebbing 1906; von der Bruggen 1906; Stappers 1911; Shoemaker 1920, 1926, 1955; Stephensen 1923, 1931, 1933b, 1940, 1942, 1944; Schellenberg 1927; Gurjanova 1951; Dunbar 1954; MacGinitie 1955; Holmquist 1965; Barnard 1969; Tencati 1970; Fernandez 1971; Busdosh et al. 1979; Weslawski 1980, 1983a,b.

Onisimus nanseni G.O. Sars 1900  
(=Pseudalibrotus nanseni Sars)

Plates XXIV-XXV

Body robust, pereon smooth; head with lateral lobes acute, eyes medium, oval; female antenna 1 with 17 flagellar articles; antenna 2 longer than antenna 1; female antenna 2 with 19 flagellar articles; accessory flagellum triarticulate; coxae 1-4 similar; coxae 5-7 reduced; gnathopod 1, propodus obliquely truncate on distal margin, dactyl inner margin finely serrated proximally; gnathopod 2, propodus broad, truncated distally, densely setose with a thick mat of bristles, dactyl located medially; pereopods 5-7, basis expanded, coarsely serrated on posterior margin, the extent of the serration is dependent on the size of the animal and individual variability; pereopod 7 slightly shorter in length than pereopod 5 or 6; urosome 1 with distinct

saddle-like depression dorsad; uropod 3 shorter in length than uropods 1 or 2; epimeral plate 3, posterolateral angle acute; telson entire, wider than long, emarginate with 2 apical setae; female 10-14 mm.

Distribution: southern Beaufort Sea; Ungava Bay; Labrador; E. Newfoundland; Gabriel Strait; Frobisher Bay; Ellesmere Island; M'Clure Strait; Queen Elizabeth Island; Point Barrow, Alaska; Davis Strait; Foxe Basin; east Greenland; Iceland; Kara Sea; Franz Josef Fjord.

References: Sars 1900; Shoemaker 1920; Stephensen 1923, 1933b, 1942, 1944; Schellenberg 1927; Dunbar 1954; Grainger 1962, 1965; Holmquist 1965; Tencati and Geiger 1968; Tencati 1970; Shih et al. 1971.

Orchomene minuta (Krøyer) 1846  
(=Orchomenella minuta (Krøyer))

Plates XXVI-XXVII

Body short, thick, broadly vaulted back; head with lateral angle produced (female right-angled; male acute); eyes oval, pigment bright red; antenna 1, peduncle segment 1 thick, larger than peduncle segments 2 and 3, flagellum equivalent in length to peduncle segments, 10 flagellar articles; accessory flagellum 4-5 articles; antenna 2 slightly longer than antenna 1, 10-12 flagellar articles; coxae 1-3 similar; coxa 4 lobe on posterior margin; coxae 5 and 6 bilobed, posterior lobe longer; coxa 7 reduced; gnathopod 1 short, propodus obliquely truncated distally; gnathopod 2 twice length of gnathopod 1, carpus bulbous, propodus bidentate distally with long setae, dactyl small, slender; pereopods short, dactyl small; pereopods 5-7, basis longer than remaining pereopodal segments; epimeral plate 3, posterolateral angle slightly produced; urosome 1 slight depression dorsad; uropod 3 inner ramus shorter than outer, spinose; telson cleft with 3 lateral and 1 apical spine; female 6-8 mm.

Distribution: southern Beaufort Sea; Arctic Ocean; Greenland; White Sea; Barents Sea; Franz Josef Land; SW Spitsbergen; Siberian Polar Sea; British Isles; Adriatic Sea.

References: Sars 1895; Shoemaker 1926, 1930; Stephensen 1931, 1942; Barnard 1969; Bousfield 1973; Kudryashov and Lenskaya 1978; Weslawski 1983a,b.

Orchomene pinguis (Boeck) 1861  
(=Orchomenella pinguis (Boeck))

Plates XXVIII-XXIX

Body robust; head posterolateral angle round; eyes reniform, pigment light red; antenna 1 shorter than antenna 2, peduncle segment 1 enlarged, peduncle segments 2 and 3 are reduced, narrow, 1st segment of flagellum large (especially in males), 12 flagellar articles; accessory flagellum 7 articles; antenna 2, 28 flagellar articles; coxa 1 expanded to a lobe on anterior margin; coxae 2 and 3 similar; coxa 4, projecting lobe at posterior margin; coxa 5 bilobed, lobes similar; coxa 6 rectangular; coxa 7 reduced; gnathopod 1, basis elongate, long setae on anterior margin; gnathopod 2, carpus larger than propodus, anterior margin with dense bristles, propodus rectangular, margins with dense bristles and setae, dactyl medial, small; pereopods 3 and 4, posterior margin setose; pereopods 5-7, basis shorter than remaining pereopodal segments, merus with projection at posterolateral angle; urosome 1 with transversal depression dorsad; epimeral plate 3 rounded at posterolateral

angle, posterior margin minutely denticulate; uropod 3, inner ramus shorter than outer, outer ramus with 8 long, plumose setae on inner margin; telson cleft, 3 lateral spines, 1 apical spine, and 1 apical seta; pleopods, rami with long plumose setae; male 9 mm, female smaller.

Distribution: southern Beaufort Sea; Hudson Bay to Cape Hatteras; Gulf of St. Lawrence; St. Andrews, New Brunswick; Norway; Siberian Polar Sea; West Spitsbergen; White Sea; Novaja Zemlya Island; Kara Sea.

References: Sars 1895; Shoemaker 1920, 1930; Stephensen 1931, 1933b, 1942; Barnard 1969; Bousfield 1973.

## STEGOCEPHALIDAE

Andaniella pectinata G.O. Sars 1882

Plates XXX-XXXI

Body stout, short; head, lateral angle rectangular; eyes absent; antenna 1 longer than antenna 2, peduncle segment 1 is twice length of peduncle segments 2 and 3 combined, flagellum short; accessory flagellum half the length of first flagellar article; antenna 2, peduncle segment 4 largest, flagellum short; coxa 1 tapers distally; coxae 2 and 3 elongate, truncated distally; coxa 4 largest, broad, rounded lobe on posterior margin; coxae 5-7 reduced; gnathopods 1 and 2 feeble, propodus elongate, setose on posterior margin, dactyl with 3 spines; pereopods sparingly setose, some devoid of any setae; pereopod 3 short; pereopods 5 and 6 similar; pereopod 6 longest; pereopod 7 shortest, basis oval, posterior margin smooth, deflexed lobe extends to middle of the merus; pereopods 5 and 6, basis elongate, merus spinous projection at posterior angle; epimeral plate 2 and 3 acute at posterolateral angle; uropod 3, peduncle longer than rami, outer ramus longer than inner; telson broad, entire and triangular, 1 spine on each lateral margin; female 2-4 mm.

Occurrence: semiparasitic in branchial cavity of Ascidacea (Molgula Forbes and Hanley) (Sars 1895).

Distribution: southern Beaufort Sea<sup>6</sup>; Newfoundland; east and west Greenland; White Sea; Spitsbergen; Franz Josef Land; Skagerrak; Iceland; west and north Norway.

References: Sars 1895; Stebbing 1906; Stephensen 1931, 1940, 1942, 1944; Barnard 1969; Korczynski et al. 1989.

---

<sup>6</sup>findings represent an extended range distribution (Korczynski et al. 1989).

## SYNOPIIDAE

Syrrhoe crenulata Goes 1866

Plates XXXII-XXXIV

Body slender; 7th pereonite and all pleonites crenulate on posterior margin; head length equivalent to 1st 3 pereonites combined, lateral angle acute; rostrum large, deflexed; eyes coalesced dorsally; antenna 1 shorter than antenna 2, anterior margins setose, up to 1/3 body length, antenna 1, 10 flagellar articles; accessory flagellum biarticulate; antenna 2, peduncle segments 4 and 5 elongate, flagellum 1/2 length of peduncle segments; coxae 1 and 2 narrow; coxa 3 distally expanded; coxa 4-7 small; coxae 5-7 bilobed, posterior lobe larger; gnathopods feeble, carpus elongate, setose on posterior margin; pereopods 3 and 4 short, similar; pereopods 5-7 successively increasing in length, basis expanded, coarsely serrated on posterior margin; pereopod 7, basis expanded to a deflexed lobe; epimeral plate 2 with recurved spine on posterolateral angle; epimeral plate 3 emarginate and coarsely serrated on posterior margin; uropod 3, inner ramus longer than outer, inner margins setose; telson cleft, elongate, bidentate; female 3-4 mm, male smaller.

Distribution: southern Beaufort Sea; NE America; Ungava Bay; Strait of Belle Isle; Bay of Fundy; Iceland; south Bear Island; Franz Josef Land; east and west Greenland; Spitsbergen; north and west Norway; White Sea; Iceland; Sea of Japan; Svalbard.

References: Goes 1866; Sars 1895; von der Bruggen 1906; Stebbing 1906; Stappers 1911; Shoemaker 1930; Stephensen 1931, 1933a,b, 1940, 1942, 1944; Dunbar 1954; Barnard 1969; Shih et al. 1971; Bousfield 1973; Weslawski 1983b.

## OEDICEROTIDAE

Acanthostepheia behringiensis (Lockington) 1877

Plates XXXV-XXXVI

Dorsal keel pronounced from pereonite 6 to include all pleonites (more evident on pleonites); head with lateral angle acutely produced; rostrum large, strongly deflexed; eyes medium, oval, pigment dark brown; male antenna 1, 22 flagellar articles; male antenna 2 longer than antenna 1, with 83 flagellar articles; coxae 1-4 quadrangular; coxae 5 and 6 bilobed with posterior lobe larger; coxa 7 rectangular; gnathopods powerful, equal, palm evenly rounded, posterior margin setose, carpus with rounded distal lobe, propodus oval, dactyl falciform; pereopods 3-6 slender, feeble, densely setose; pereopod 7 longest, spiniferous, basis expanded, dactyl long, setose, denticulate; epimeral plates, posterolateral angle broadly rounded; uropods slender, elongate, minutely setose; telson entire, quadrangular, slightly emarginate; spines absent; male 26-30 mm.

Distribution: southern Beaufort Sea; Point Barrow, Alaska; Bering Strait; White Sea; Barents Sea; Kara Sea; Franz Josef Fjord.

References: Stappers 1911; Stephensen 1942; Shoemaker 1955; Bousfield 1973.

Acanthostepheia malmgreni (Goes 1866)

Plates XXXVII-XXXVIII

Dorsal keel pronounced from 6th pereonite extending to include all pleonites (more evident on pleonites); head, lateral angle sharply produced; rostrum large; eyes large, reniform, pigment dark brown; antenna 2 longer than antenna 1; male antenna 1, 30 flagellar articles; male antenna 2, 142 flagellar articles; coxa 1 slightly produced anteriorly; coxae 2 and 3 quadrangular; coxae 5 and 6 bilobed; coxa 7 reduced; gnathopods powerful, equal, palm setose with a distal spine, carpus produced to a setiferous lobe, propodus oblong, dactyl large, falciform; pereopods 3-6 feeble, slender, densely setose; pereopod 7 longest, minutely setose, basis expanded, merus to the propodus elongate, dactyl long, falciform, denticulate; epimeral plates 1 and 2, posterolateral angle with 2 spinous projections, epimeral plate 3 with 1 spinous projection; uropods slender, elongate, minutely setose; telson entire, quadrangular, slightly emarginate, 1 pair lateral and 2 apical spines; male 31-33 mm.

Distribution: southern Beaufort Sea; Bering and Okhotsk Seas; Point Barrow, Alaska; Arctic Ocean; Hudson Bay; Strait of Belle Isle; Newfoundland; Ellesmere Island; north and east Greenland; Labrador; Franz Josef Fjord.

References: Stebbing 1906; Shoemaker 1920, 1955; Stephensen 1942, 1944; Barnard 1969; Shih et al. 1971; Bousfield 1973.

Aceroides latipes G.O. Sars 1895

Plates XXXIX-XL

Body smooth, slightly inflated; pereonites 1-6 narrow; head length equals first three pereonites; rostrum very small; eyes absent; female antenna 1 with 17 flagellar articles; female antenna 2 with 29 flagellar articles; coxae 1-6 reduced; coxa 7 laterally expanded; gnathopod 1, propodus obovate and longer than carpus; gnathopods 1 and 2, carpus distally produced to a rounded lobe;



pereopods 3 and 4 large, strong, merus with distal lobe, setose, carpus broad, small distal lobe, setose on posterior margin, propodus oval with apical setae, dactyl large, projects from posterolateral margin; pereopods 5 and 6 small, feeble; pereopod 7 longest, basis large, oval, beset with setae; uropods, rami slender, beset with few spinules; telson entire, quadrangular, 4 apical spines; female 8-10 mm.

Distribution: southern Beaufort Sea; Collinson Pt., Alaska; Ungava Bay; northern Norway; Spitsbergen; White Sea; Kara Sea; west Greenland.

References: Sars 1895; Stebbing 1906; Shoemaker 1920; Stephensen 1942; Dunbar 1954; Barnard 1969; Bousfield 1973.

Monoculodes Stimpson 1853

Body slender; rostrum sharp, deflexed; eyes contiguous, prominent on the base of the rostrum; antenna 2 longer than antenna 1; gnathopods stout, unequal in structure; gnathopod 2 larger than gnathopod 1; coxae 1-4 successively increasing in size; coxa 5 large, bilobed; pereopod 7 longest; telson entire.

References: Sars 1895; Stephensen 1942; Gosner 1971; Bousfield 1973.

Monoculodes packardi Boeck 1871

Plates XLI-XLII

Body smooth, slender, pellucid; head, posterolateral angle rounded; rostrum strong, slightly deflexed; eyes small, oval, pigment light red; antenna 1, peduncle segment 3 less than 1/2 length of peduncle segment 1, peduncle segments 1 and 2 elongate (2 longer than 1), 9 flagellar articles; antenna 2 longer than antenna 1, peduncle segment 5 slightly shorter than peduncle segment 4, setose, 16 flagellar articles; coxae setose on posterior margins; coxae 1-3 similar; coxa 4 posterior margin lobed; coxae 5 and 6 bilobed, lobes similar; coxa 7 reduced; gnathopod 1, carpus with distal lobe, apex rounded and setose; gnathopod 2, carpus with distal lobe extending to palm, apex pointed and setose; pereopods slender, dactyls falciform; pereopod 7 longest, basis broad, arcuate on posterior margin, setose; uropod 3, rami equal, spineless; telson quadrangular, entire, apically convex, 2 minute apical setae; female 7 mm.

Distribution: southern Beaufort Sea; Gulf of St. Lawrence; Newfoundland; west Greenland; British Isles; Norway; Jan Mayen Island; north and east Iceland; Denmark; Scotland.

References: Sars 1895; Stappers 1911; Shoemaker 1930; Stephensen 1942; Enequist 1949; Barnard 1969; Shih et al. 1971; Bousfield 1973; Moore 1984.

Oediceros saginatus Krøyer 1842

Plates XLIII-XLIV

Body smooth, pigmented, somewhat inflated; head, posterolateral angle rectangular; rostrum strong, deflexed; eyes oval, located at base of rostrum, pigment dark red; antenna 1 approximately 1/4 total body length, peduncle segments 1 and 2 equal in length, short, thick, peduncle segment 3 short, 15 flagellar articles; antenna 2 slightly longer than antenna 1, 27 flagellar

articles; coxa 1 rounded with anterior lobe; coxae 2-4 similar; coxae 5 and 6 bilobed, posterior lobe longer; coxa 7 rectangular, narrow; gnathopods similar, powerful, carpus with distal lobe, setose, propodus large, oval, palm with row of spines and setae, dactyl long and falciform; pereopods 3 and 4 short, stout; pereopods 5-6 similar; pereopod 7 longest, exceeds 1/2 total body length, basis obovate, posterior margin beset with plumose and straight setae; uropod 3, inner ramus longer than outer with 4 spines on inner margin; telson entire, rounded quadrangularly with 4 apical setae; female up to 20 mm.

Distribution: southern Beaufort Sea<sup>7</sup>; Arctic Ocean; east and west Greenland; Hudson Bay; Grand Banks; Ungava Bay; northeast Baffin Island; Iceland; Spitsbergen; Siberian Polar Sea; Barents Sea; north and west Norway; Svalbard.

References: Goes 1866; Sars 1895; Shoemaker 1926; Stephensen 1931, 1940, 1942, 1944; Dunbar 1954; Barnard 1969; Shih et al. 1971; Bousfield 1973; Korczyński et al. 1989).

Paroediceros lynceus (M. Sars 1858)

Plates XLV-XLVI

Body smooth, pleon with a very slight keel; rostrum rounded, rudimentary; head, lateral angle acute; eyes large, contiguous, prominent on base of rostrum; antenna 2 longer than antenna 1; female antenna 1 with 19 flagellar articles; female antenna 2 with 88 flagellar articles; coxa 1 rounded; coxae 2-4 quadrangular; coxa 5 bilobed; coxae 6 and 7 rectangular; gnathopods powerful; gnathopod 1, propodus elongate, dactyl falciform; gnathopod 2, propodus obovate, carpus distally produced to a setiferous lobe, dactyl falciform; pereopods slender; pereopods 3 and 4 shorter than pereopods 5-7; pereopods 3 and 4, basis narrow; pereopods 5 and 6, basis expanded; pereopod 7 longest, basis broad, posterior margin setose, ischium reduced, merus to propodus elongate, dactyl slender, setose; uropods slender; uropods 3, inner ramus with 2 spines; telson entire, quadrangular, 2 apical spines; male 21-23 mm.

Distribution: southern Beaufort Sea; Iceland; Kara Sea; Laptev Sea; Siberian Sea; Norway; Barents Sea; Greenland; Sea of Japan.

References: Sars 1895; von der Bruggen 1905, 1906; Stebbing 1906; Stappers 1911; Shoemaker 1920, 1926, 1930; Stephensen 1931, 1933b, 1940, 1942, 1944; Gosner 1971; Bousfield 1973; Weslawski 1980, 1983b.

---

<sup>7</sup>findings represent an extended range distribution (Korczyński et al. 1989).

## COROPHIIDAE

Lembos borealis Myers 1976

Plates XLVII-XLVIII

Body smooth; head, posterolateral angle truncated; eyes small, round, composed of 10-12 ommatidia; antenna 1 longer than antenna 2, 14 flagellar articles; accessory flagellum biarticulate; antenna 2, 6 flagellar articles; pereonites 2-5 each with a sternal process, well developed on pereonites 3 and 4; coxae small, reduced; gnathopods 1 and 2 similar, dactyl posterior margin denticulate and spinose; gnathopod 1, propodus posterior margin setose with 1 long medial spine; pereopods 3 and 4 similar; pereopod 5 shortest; pereopod 6, merus and propodus elongate, dactyl falciform; pereopod 7 longest; epimeral plates 2 and 3 smooth; uropod 1 longest, inner ramus slightly longer than outer; uropod 2 with 3 apical spines on each ramus; uropod 3, rami equal, elongate, inner ramus with 2 spines and 1 long seta apically, outer ramus with 2 apical and 2 pairs lateral spines; telson entire, triangular, 3 pairs lateral setae; female 4-5 mm, male slightly smaller.

Distribution: southern Beaufort Sea; Frobisher Bay; Jan Mayen Island; Kara Sea; NW Greenland.

References: Barnard 1969; Bousfield 1973; Myers 1976; Just 1980.

Protomedeia Krøyer 1842

Body slender; head, anterior lobe truncated; eyes small; antenna 1 longer than antenna 2; accessory flagellum present; female gnathopods slender and densely setose; gnathopod 2 larger than gnathopod 1, basis beset with long setae; coxal plates small; pereopods 3 and 4 densely setose; pereopods 5-7 successively increasing in length; uropod 3, rami spinose; telson entire.

References: Sars 1895; Shoemaker 1955; Bousfield 1973.

Protomedeia fasciata Krøyer 1842

Plates XLIX-L

Body smooth; eyes small, round; head, posterolateral angle slightly produced; antenna 1 longer than antenna 2, equivalent in length to 1/3 total body length, 15 flagellar articles; accessory flagellum triarticulate; antenna 2, peduncle segments thicker and more elongate than antenna 1; coxae small, reduced; coxae 5-7 bilobed, posterior lobe smaller; male gnathopod 1 smaller than gnathopod 2, densely setose on posterior margin; gnathopod 2, carpus expanded, oblong, propodus triangular; pereopod 5 shortest; pereopods 6 and 7, basis expanded with plumose setae on posterior margin; epimeral plates rounded; uropod 3 shortest, peduncle has 4 stout apical spines dorsad, inner ramus shorter than outer, inner ramus with 3 stout apical spines and 1 lateral spine, outer ramus with 3 stout and 1 long spine apically and 2 lateral spines; uropods 2 and 3 spiniferous; telson entire, 2 pairs lateral setae and 1 pair apical spines; male 8 mm, female smaller.

Distribution: southern Beaufort Sea; Ungava Bay; Gulf of St. Lawrence; Iceland; Bering Sea; Arctic Ocean; North Sea; British Isles; Okhotsk Sea; Northumberland Coast; Skagerrak; west and east Greenland; Denmark; Great Britain.

References: von der Bruggen 1905; Stebbing 1906; Shoemaker 1920, 1930, 1931; Stephensen 1940, 1942, 1944; Dunbar 1954; Barnard 1962, 1969; Bousfield 1973; Conlan 1983.

## EUSIRIDAE

Apherusa glacialis (Hansen) 1887

Plates LI-LII

Body slender; head excavate at base of antenna 2; eyes medium, round, pigment dark brown; antenna 1, peduncle segment 3 shorter in length than peduncle segments 1 or 2, 21 flagellar articles; antenna 2 longer than antenna 1, 29 flagellar articles; coxae 1-4 subquadrate; coxae 5-6 bilobed, posterior lobe larger; coxa 7 reduced; gnathopods similar, feeble, setose on posterior margin, carpus elongate, twice length of propodus; pereopods 3 and 4 similar, slender; pereopods 5-7 successively increasing in length, margins with bundles of 2-3 spines; epimeral plate 3, posterolateral angle rounded with several setae; uropods, rami elongate, setose; telson entire with 2 apical spines; female up to 6 mm.

Distribution: circumpolar; southern Beaufort Sea; Pt. Barrow, Alaska; Greenland; Spitsbergen; Franz Josef Fjord; Kara and Laptev Seas; Svalbard.

References: Stebbing 1906; Stappers 1911; Schellenberg 1927; Stephensen 1931, 1933a,b, 1942, 1944; Dunbar 1954; MacGinitie 1955; Shoemaker 1955; Barnard 1959, 1969; Grainger 1959, 1962; Tencati and Geiger 1968; Tencati 1970; Shih et al. 1971; Bousfield 1973; Kulikov 1980; Bradstreet 1982; Bradstreet and Cross 1982; Cross 1982; Weslawski 1983b.

Apherusa megalops G.O. Sars 1882  
(=Halirages megalops (Buchholz))

Plates LIII-LIV

Body slender with slight dorsal keel on pleonites; head lateral angle produced to a lobe; rostrum short, acute; eyes large, oval, pigment dark brown; antenna 1, peduncle segment 1 equals length of peduncle segments 2 and 3 combined, numerous flagellar articles; antenna 2 longer than antenna 1; coxae 1-3 similar; coxa 4 expanded; coxae 5 and 6 bilobed, posterior lobe larger; coxa 7 reduced; gnathopods small, propodus ovate, carpus triangular; pereopods slender, 5-7 successively increasing in length, basis ovate, posterior margin denticulate; epimeral plates 2 and 3 with reflexed spine at posterolateral angle; epimeral plate 3 excavated medially, posterior margin minutely denticulate; uropods 1 and 2, inner ramus minutely serrated; uropod 3, rami elongate, setose; telson entire, slightly emarginate, subtriangular, apex truncated with 2 apical spines; female up to 13 mm.

Distribution: southern Beaufort Sea; Jones Sound; Ungava Bay; Gabriel Strait; Gulf of St. Lawrence; Labrador Harbour; west Spitsbergen; Norway; east Greenland; Iceland; Franz Josef Fjord; Hudson Strait; Alaska; Kara Sea; Laptev Sea; Barents Sea; James Bay.

References: Sars 1895; von der Bruggen 1905; Stebbing 1906; Shoemaker 1920, 1926, 1930; Stephensen 1931, 1933b, 1942, 1944; Dunbar 1942, 1954; Shih et al. 1971; Bousfield 1973.

Haliragoides inermis G.O. Sars 1882  
(=Halirages inermis Sars)

Plates LV-LVI

Body narrow, smooth; head, anterolateral angle produced to a narrow, linguiform deflexed lobe, serrated on anterior margin; eyes large, oval, bright red; antenna 1 up to 1/2 total body length, peduncle segments short, decreasing in size distally, peduncle segments 1 and 2 with several acute lappets, 23 flagellar articles; antenna 2 longer than antenna 1, peduncle segment 1 broad, spinous projection posteriorly, peduncle segments 2 and 3 equal, flagellum composed of numerous articles; coxa 1 obliquely expanded, anterior margin produced; coxae 2-4 rounded quadrangularly; coxae 5 and 6 bilobed with posterior lobe larger; coxa 7 reduced; gnathopods 1 and 2 similar, carpus broadens distally with several transverse rows of setae, propodus shorter than carpus, ovate, palm with short setae, dactyl large, falciform; pereopods slender, margins with bundles of setae; pereopods 5-7 successively increasing in length; pereopod 7 longest, basis with posterior margin serrated and slightly sinuated; epimeral plates 2 and 3, posterolateral angle acute; uropods 1 and 2 slender; uropod 3 largest, peduncle elongate, rami lanceolate, inner ramus longer than outer, setose; telson entire, triangular, tridentate apically; female 14 mm.

Distribution: southern Beaufort Sea<sup>8</sup>; Gulf of St. Lawrence; Labrador; North of Faroe Island; west Norway; east Greenland; Barents Sea.

References: Sars 1895; Stebbing 1906; Shoemaker 1930; Stephensen 1931, 1933b, 1942, 1944; Barnard 1969; Bousfield 1973; Korczynski et al. 1989.

Pontogeneia inermis (Krøyer) 1838

Plates LVII-LVIII

Body slender, dorsally smooth; eyes large, broad, reniform, pigment light red; head, posterolateral margin excavated; rostrum very short, acute; female antenna 1, peduncle segment 3 produced distally to a small triangular lappet; male antenna 1, peduncle segments 2 and 3 calceolate on opposite margins; accessory flagellum lacking; coxae 1-3 rectangular; coxa 4 largest, posterior margin emarginate; coxa 5 bilobed; coxae 6-7 reduced; gnathopods 1 and 2 similar, weakly subchelate; gnathopod 2 slightly longer than gnathopod 1, both densely setose; pereopods slender, spiniferous; pereopods 5-7 successively increasing in length; pereopod 7, basis oval with posterior margin minutely serrated, setose; epimeral plate 3, posterolateral angle acute; uropods 1 and 2 slender, spiniferous; uropod 3, rami spiniferous and setose; telson cleft, lobe tapers distally, spineless; female 12-15 mm, males smaller.

Distribution: southern Beaufort Sea; Ungava Bay; North Pacific and Atlantic Oceans; Bering Sea; Gulf of St. Lawrence; Strait of Belle Isle; Gabriel Strait; Hudson Bay; Newfoundland; Bernard Harbour; Arctic Ocean; Sea of Japan; east Greenland; Norway; east Siberia.

References: Sars 1895; Stebbing 1906; Shoemaker 1920, 1926, 1930; Stephensen 1931, 1933b, 1942, 1944; Dunbar 1942, 1954; Barnard 1969; Shih et al. 1971; Bousfield 1973.

---

<sup>8</sup>findings represent an extended range distribution (Korczynski et al. 1989)

## PONTOPOREIIDAE (=HAUSTORIIDAE)

Pontoporeia affinis Lindstrom 1855

Plates LIX-LX

Body compressed; head, lateral angle rounded; eyes medium, reniform, pigment black; female antenna 1 with 22 flagellar articles, antenna 2 with 27 flagellar articles; antennae with plumose setae on posterior margin; accessory flagellum triarticulate; coxae 1-4 quadrangular; coxae 5-7 reduced; gnathopods feeble, densely setose; gnathopod 1, propodus oval; gnathopod 2, carpus elongate; pereopods 3 and 4 feeble, similar, setose; pereopods 5 and 6 similar; pereopod 6 longest; pereopod 7, basis expanded with long setae on posterior margin; urosome 1 lacking bifid cusp dorsad; uropods, rami with minute spines, 3 apical spines; telson small, broad, deeply cleft, each lobe with 4 apical spines; female 10-12 mm.

Distribution: southern Beaufort Sea; Prudhoe Bay, Alaska; Frobisher Bay; Ungava Bay; Gulf of St. Lawrence; Baltic Sea; Gulf of Riga, U.S.S.R.; Gulf of Finland; Kara Sea; Kattegat Sea; many freshwater lakes in Canada and United States; North Atlantic south to France; Sweden; Finland.

References: Sars 1895; Stebbing 1906; Shoemaker 1920; Johansen 1921; Adamstone 1928; Stephensen 1931, 1942; Larkin 1948; Segerstrale 1950, 1959, 1962, 1967, 1977, 1978; Dunbar 1954; Forsman 1956; Mulicki 1957; Bousfield 1958, 1973; Bagge et al. 1965; Barnard 1969; Shih et al. 1971; Jarvekulg 1973; Dadswell 1974; Kudryashov and Lenskaya 1978; Moore 1979; Robilliard and Busdosh 1980; Busdosh et al. 1982.

Pontoporeia femorata Krøyer 1838

Plates LXI-LXII

Body smooth, moderately compressed; eyes reniform, bright red pigment; antennae with plumose setae on posterior margin; female antenna 1 with 8 flagellar articles; female antenna 2 with 19 flagellar articles; accessory flagellum small, biarticulate; coxae 1-4 oblong; coxa 5 bilobed, anterior lobe larger; coxae 6 and 7 reduced, rectangular; gnathopods feeble, densely setose; pereopods densely setose; pereopod 6 longest; pereopod 7 shortest, basis expanded, larger than remaining pereopodal segments, with long setae on posterior margin; urosome 1 bifid cusp dorsad; telson broad, deeply cleft, each lobe with 1 large apical spine; female 6-8 mm.

Distribution: southern Beaufort Sea; Pt. Barrow, Prudhoe Bay, Alaska; Jones Sound; Baffin Island; Bernard Harbour; James Bay; Ungava Bay; Labrador; Baltic Sea; Gulf of Riga, U.S.S.R.; Gulf of Finland; northwest and north coast Estonia; Kara Sea; Laptev Sea; Sea of Japan; White Sea; Spitsbergen; east Greenland; Norway; Iceland.

References: Goes 1866; Sars 1895; von der Bruggen 1905, 1906; Stebbing 1906; Shoemaker 1920, 1926, 1955; Stephensen 1931, 1933b, 1940, 1942, 1944; Segerstrale 1950, 1967, 1978; Dunbar 1954; MacGinitie 1955; Forsman 1956; Mulicki 1957; Bagge et al. 1965; Barnard 1969; Gosner 1971; Shih et al. 1971; Bousfield 1973; Jarvekulg 1973; Robilliard and Busdosh 1980; Busdosh et al. 1982; Weslawski 1983b.

## GAMMARIDAE

Gammaracanthus loricatus (Sabine) 1821

Plates LXIII-LXIV

Body slender; dorsal keel pronounced from 5th pereonite extending to include all pleonites; head, lateral angle with a tuberculate projection; rostrum strong, deflexed; eyes small, oval, pigment black; male antenna 1 with 42 flagellar articles; accessory flagellum 4 articles; male antenna 2 with 15 flagellar articles; coxae 1-2 ovate; coxae 3-4 quadrangular; coxae 5 and 6 bilobed, anterior lobe larger; coxa 7 reduced; gnathopods 1 and 2 equal, powerful, carpus small, produced to a narrow setiferous lobe, more pronounced in gnathopod 2, propodus oval, large, palm setose, dactyl strong, falciform; pereopods 3 and 4 feeble, densely setose, slightly longer than gnathopods; pereopods 5-7 slender and elongate, bundles with spines; pereopod 6 longest; uropod 3, rami obovate, beset with long setae; telson small, broad, deeply cleft, each lobe with several lateral and medial spines; male 35-40 mm.

Distribution: circumpolar; southern Beaufort Sea; Collinson Pt., Pt. Barrow, Alaska; some freshwater lakes in North America; east and west Greenland; White Sea; Barents Sea; Franz Josef Fjord.

References: Sars 1895; Stebbing 1906; Shoemaker 1920, 1926, 1955; Stephensen 1931, 1933b, 1942, 1944; Dunbar 1954; MacGinitie 1955; Barnard 1959, 1969; Grainger 1962, 1965; Baker and Wong 1968; Tencati 1970; Shih et al. 1971; Dadswell 1974; Kudryashov and Lenskaya 1978; Bradstreet 1982.

Gammarus wilkitzkii Birula 1897

Plates LXV-LXVI

Body slender; head excavate above base of antenna 2, less acute at base of antenna 1; eyes small, reniform, pigment black; antennae 1 and 2 densely setose on posterior margin; male antenna 1 with 35 flagellar articles; accessory flagellum, 8-9 articles; male antenna 2 with 16 flagellar articles, peduncle segment 3 elongate; coxae 1-4 similar; coxae 5-7 bilobed; gnathopods 1 and 2 similar, powerful; gnathopod 1, propodus large triangular; male gnathopods 1 and 2, palm with spines; pereopods 5-7 similar, elongate, merus to propodus elongate with bundles of spines and setae on posterior and anterior margins; pereopod 4 shortest; pereopod 7 longest, slightly longer than pereopod 6; urosomes with bundles of spines and long straight setae dorsad; uropod 3, inner ramus shorter than outer, beset with spines and long plumose setae; telson deeply cleft, each lobe with 2 lateral and 3 apical spines, several setae; male 17-24 mm.

Distribution: circumpolar; southern Beaufort Sea; east Greenland; northern Iceland; northern Norway; Spitsbergen; Kara Sea; Laptev Sea.

References: Shoemaker 1920; Stephensen 1931, 1940, 1942, 1944; Dunbar 1954, 1964; Barnard 1959; Grainger 1959, 1962, 1965; Baker and Wong 1968; Tencati and Geiger 1968; Tencati 1970; Shih et al. 1971; Mohammed and Grainger 1974; Steele and Steele 1975; Kulikov 1980; Bradstreet 1982; Bradstreet and Cross 1982; Cross 1982; Weslawski 1983b.



Weyprechtia heuglini (Buchholz) 1874

Plates LXVII-LXIX

Body smooth; eyes medium, reniform; antenna 1 shorter than antenna 2; accessory flagellum 7 articles; antenna 1, 38 flagellar articles; antenna 2, 75 flagellar articles; coxae 1-3 uniform in shape; coxa 4 largest, arched with 2 sharp projections; coxae 5 and 6 excavated medially; coxa 7 small, rounded; gnathopods 1 and 2 feeble, densely setose on posterior margin, dactyl small, falciform, denticulate on posterior margin; pereopods 3 and 4 similar, elongate; pereopods 5-7 successively increasing in length, merus to propodus elongate, spiniferous on both margins; epimeral plates setose on ventral margin; epimeral plate 1 slightly produced at posterolateral angle; epimeral plate 2 acute at posterolateral margin; epimeral plate 3 excavated with 2 spinous projections; uropods 1-3 similar, rami denticulate and spiniferous; telson entire, 4 apical spines; female 36-38 mm.

Distribution: southern Beaufort Sea; Pt. Barrow, Alaska; Ellsmere Island; west Baffin Bay; Davis Strait; Bernard Harbour; Hudson Bay; Hornsund, Goes Bay, Netherlands; Eisfjord; Adventbay; Storfjord; Ginevrabay; Barents Sea; Kara and Laptev Seas; eastern Siberia.

References: Stebbing 1906; von der Bruggen 1906; Stephensen 1920, 1931, 1933b, 1942; Shoemaker 1926; Gurjanova 1951; Dunbar 1954; MacGinitie 1955; Barnard 1969.

## GLOSSARY

ACCESSORY FLAGELLUM	The secondary ramus of antenna 1, may be lacking or vestigial, attached medially to peduncle segment 3.
ACUMINATE	Tapering to a point.
ANTENNA ANTENNAE (pl.)	The paired segmented sensory organs, borne one on each side of the head.
APEX	That part of any joint or segment opposite the base by which it is attached.
APICAL	At, near or pertaining to the apex of any structure.
ARCUATE	Arched, curved like a bow.
ARTICLE	Separation, joint, or segment.
BASIS	The 2nd segment of a thoracic appendage.
BATHYAL	Relating to, or existing in the deep sea.
BENTHIC	Of or pertaining to the bottom of any permanent body of water.
BESET	To surround, hem in on all sides.
BIDENTATE	Having two teeth-like conical projections (of margin).
BIFID	Cleft or divided into two parts.
BIRAMOUS	Having two branches.
BRISTLE	A stiff, coarse hair or hair-like structure, usually short and blunt.
BULBOUS	Bulb-like; swollen to form a bulb.
CALCEOLUS	A small globular or plate-shaped sense organ on one or both antennae, found usually on the posterior edge of antenna 1 and anterior edge of antenna 2.
CARINA	Keel-like structure, not necessarily high or acute.
CARPUS	The 5th segment of a thoracic appendage.
CEPHALON	Anterior body region, consisting of head segment.
CHELA	A terminal pincer formed by an immovable and movable finger.
CHELATE	Having the form of a chela.

CLEFT	A fissure, slit or opening, e.g. telson may be cleft resulting in a bilobed structure.
COALESCED	United or grown together.
CONTIGUOUS	So near together as to touch.
COXA	Segment 1 of a thoracic appendage.
COXA PLATE	Expansion of coxa into a plate-like structure.
CRENATE	Scalloped with small, blunt, rounded teeth.
CRENULATE	Minutely or finely crenate.
CUSPIDATION	Ending in a sharp point.
DACTYL	The terminal segment (7th) of a thoracic appendage, usually claw-like in appearance.
DEFLEXED	Abruptly bent downward.
DENTICULATE	Having minute, tooth-like projections.
DIOECIOUS	Having the sexes separate.
DISTAL	Furthest from the body or point of attachment.
DORSAL	Of or belonging to the upper surface or back of any part.
EMARGINATE	Shallowly concave, as in the apex of an uncleft telson.
ENDOPOD	Inner branch or ramus of a biramous crustacean appendage.
ENTIRE	Not bilobed e.g. an uncleft telson.
EPIMERON, EPIMERAL PLATE	Ventrolateral expansion of pleonites 1-3.
EXCAVATE	Incised or emarginate, but more deeply.
EXOPOD	Outer branch or ramus of a biramous crustacean appendage.
FALCIFORM	Sickle-shaped, convexly curved.
FINGER	One of the terminal elements of a chela; dactyl is the movable finger, the immovable or fixed finger is the terminal extension of segment 6 (propodus).
FLAGELLUM	The usually multiarticulate, sometimes whiplike terminus of antennae 1 and 2; that portion beyond the peduncle segments.

FLEXUOUS	Almost zig-zag, without acute angles but more acute at angles than undulating.
FOLIACEOUS	Leaf-like.
FOSSORIAL	Adapted for digging, burrowing, or tunneling; pereopods are broad, and setose or spinose.
GNATHOPOD	Modified pereopods 1 and 2 for grasping, holding or/and excavating.
INCISED	Cut into, having a deeply notched margin.
INFERIORLY	Located beneath, below or behind.
INTERANTENNAL HEAD LOBE	Lateral head process between the antennal sinuses.
ISCHIUM	The 3rd segment of a thoracic appendage.
KEEL	A ridge or ridge-like process; a carina.
LAMELLA	Thin, plate-like structure.
LANCEOLATE	Pointed, lance-shaped.
LAPPET	A small fold or flap.
LINGUIFORM	Tongue-shaped.
MARSUPIUM	A brood pouch on the ventral surface of adult females which acts as a receptacle for holding eggs.
MERUS	The 4th segment of a thoracic appendage.
NOTCH	A v-shaped depression on a margin or surface.
OBLONG	Longer than broad, having the sides nearly parallel for most of the length.
OBPYRIFORM	Inversely pear-shape.
OBOVATE	Oval, broader distally.
OMMATIDIA	The visual elements which compose the compound eye.
ORNATE	Elaborately adorned.
OVIGEROUS	Carrying eggs; applies to the fertilized female.
PALM	The posterior surface or margin of segment 6 (propodus) of a pereopod on which the dactyl closes for prehension; may be marked by a change in the marginal slope or by presence of spine(s).

PECTINATE	Comb-like.
PEDUNCLE	The basal segment(s) of paired, usually biramous appendages, as in pleopods, uropods or antennae.
PELAGIC	Of or pertaining to the open sea.
PELLUCID	Clear, transparent.
PEREON	The 7 thoracic segments bearing gnathopods or pereopods.
PEREONITE	A single segment of the pereon.
PEREOPOD	A uniramous appendage of the pereon; composed of 7 segments varying in shape and size; in amphipods pereonites 3-7 each with one pair of pereopods.
PLEON	The first 3 segments of the abdomen each with paired pleopods.
PLEONITE	A segment of the pleon.
PLEOPOD	A biramous appendage of the abdomen.
PLUMOSE	Feather-like.
PREHENSILE	Fitted or adapted for grasping, holding, or seizing.
PROPODUS	The 6th segment of a thoracic appendage.
PROXIMAL	Nearest to body or point of attachment.
PYRIFORM	Pear-shaped.
RAMUS, pl. RAMI	A branch.
RENIFORM	Kidney-shaped.
ROSTRUM	The median process extending anteriorly from the head.
RUDIMENTARY	Undeveloped.
SEDENTARY	Not active; settled or remaining in one place.
SERRATE	Notched, having teeth like a saw-blade.
SESSILE	Describing any organ that does not possess a stalk where one might be expected.
SETA, pl. Setae	Slender hair-like structure.
SETULA, pl. Setulae	A small stiff bristle or seta.
SETOSE	Furnished with setae.

SPATULATE	Spoon-shaped.
SPINIFEROUS	In the form or shape of a spine.
SPINOUS	Beset with spines.
SPINULE	A small or minute spine.
STERNAL PROCESS	Finger-like projection from midsection of sternite.
STERNITE	The sclerotized ventral surface of a body segment.
STOUT	Strong, robust, bulky.
STYLIFORM	Slender, elongate in form, terminating in a point.
SUBCHELATE	A prehensile condition of the pereopod or gnathopod, less than fully chelate.
SUBEQUAL	Similar but not equal in size, form or other characters.
SUBQUADRATE	Not quite square.
SUBTRIANGULAR	Not quite triangular.
TELESCOPING	In reference to Family Lysianassidae; antenna 1, peduncle segments 2 and 3 scarcely indistinguishable, run together.
TELSON	Terminal portion of the abdomen.
TRANSVERSAL	Appearing broader than long; running across.
TRUNCATE	Blunt, appearance of sharply cut-off or broken-off either squarely or obliquely.
TUBERCULE	A little solid pimple or small button.
TUFT	A cluster of hairs growing closely together.
UROPOD	One of three pairs of terminal urosomal appendages, consisting of a peduncle and two rami in most instances.
UROSOME	The posterior three abdominal segments, which may or may not be fused, bearing the uropods and telson.
UROSOMITE	A segment of the urosome.
VAULTED	Arched.

## ACKNOWLEDGMENTS

We wish to thank Dr. Rita Korczynski for her work preparing the original draft upon which this guide is based. We thank M. Pidlubny and V. de Jong for the drawings that accompany the text. We wish to thank D. Chiperzak, G. Hopky, G. Lacho, and W.R. Sauvé for the collection of amphipods from the study site. Thanks are extended to M. Curtis and J.L. Barnard (Smithsonian Institution) for their assistance with the amphipod literature and for their review comments. Further thanks go to M. Curtis for verifications of a number of amphipod species and for his numerous suggestions which improved the quality of this report. Thank you to P. Flannagan for assistance with literature searches and to J. Schick and K. DeCaigny for typing the manuscript.

## REFERENCES

- ADAMSTONE, F.B. 1928. Relict amphipods of the genus Pontoporeia. Trans. Am. Microsc. Soc. 47: 366-371.
- ATLAS, R.M., M. BUSDOSH, E.J. KRICHEVSKY, and T. KANEKO. 1982. Bacterial populations associated with the arctic amphipod Boeckosimus affinis. Can. J. Microbiol. 28: 92-99.
- BAGGE, P., K. JUMPPANEN, E. LEPPAKOSKI, and P. TULKKI. 1965. Bottom fauna of the Finnish southwestern archipelago. Ann. Zool. Fenn. 2: 38-52.
- BAKER, J.H., and J.W. WONG. 1968. Paradoxostoma rostratum Sars (Ostracoda, Podocopida) as a commensal on the arctic gammarid amphipods Gammaracanthus loricatus (Sabine) and Gammarus wilkitzkii Birula. Crustaceana (Leiden) 14: 307-311.
- BARNARD, J.L. 1959. Epipelagic and under-ice Amphipoda of the central arctic basin. In Scientific Studies at Fletcher's Ice Island, T-3 1952-1953. V. Bushnell (ed.) Geophysical Research Papers. No. 63, Vol. 1: 115-152.
- BARNARD, J.L. 1962. Benthic marine Amphipoda of southern California: Families Aoridae, Photidae, Ischyroceridae, Corophiidae, Podoceridae. Pac. Nat. 3(1): 3-72.
- BARNARD, J.L. 1964. Revision of some families, genera, and species of gammaridean Amphipoda. Crustaceana (Leiden) 7: 49-74.
- BARNARD, J.L. 1969. The families and genera of marine Gammaridean Amphipoda. Bull. U.S. Natl Mus. 271: 535 p., 173 figs.
- BARNARD, J.L. 1972. A review of the family Synopiidae (=Tironidae), mainly distributed in the deep sea (Crustacea: Amphipoda). Smithson. Contrib. Zool. 124: 1-94.
- BARNARD, J.L. 1973. Revision of Corophiidae and related families (Amphipoda). Smithson. Contrib. Zool. 151: 1-27.
- BARNARD, J.L. 1974. Evolutionary patterns in gammaridean Amphipoda. Crustaceana (Leiden) 27(2): 137-146.
- BARNARD, J.L., and G.S. KARAMAN. 1975. The higher classification in amphipods. Crustaceana (Leiden) 28(3): 304-310.
- BARNARD, J.L., and G.S. KARAMAN. 1980. Classification of gammarid Amphipoda. Crustaceana Suppl. (Leiden) 6: 5-16.
- BARNARD, J.L., and G.S. KARAMAN. 1982. Classificatory revisions in gammaridean Amphipoda (Crustacea), Part 2. Proc. Biol. Soc. Wash. 95(1): 167-187.
- BARNES, R.D. 1980. Invertebrate zoology. 4th ed. W. B. Saunders Co., Philadelphia, PA. 1089 p.



- BOROWSKY, B. 1984. The use of the males' gnathopods during precopulation in some gammaridean amphipods. *Crustaceana* (Leiden) 47(3): 245-250.
- BOUSFIELD, E.L. 1951. Pelagic Amphipoda of the Belle Isle Strait region. *J. Fish. Res. Board Can.* 8(3): 134-163.
- BOUSFIELD, E.L. 1958. Fresh-water amphipod crustaceans of glaciated North America. *Can. Field-Nat.* 72(2): 55-113.
- BOUSFIELD, E.L. 1973. Shallow-water Gammaridean Amphipoda of New England. Cornell University Press, London. 312 p., 69 pls.
- BOWMAN, T.E. 1960. The pelagic amphipod genus Parathemisto (Hyperiidea: Hyperiidae) in the North Pacific and adjacent Arctic Ocean. *Proc. U.S. Natl Mus.* 112: 343-392.
- BOWMAN, T.E. 1973. Pelagic amphipods of the genus Hyperia and closely related genera (Hyperiidae, Hyperiidae). *Smithson. Contrib. Zool.* 136: 76 p.
- BOWMAN, T.E., and H-E. GRUNER. 1973. The families and genera of Hyperiidea (Crustacea: Amphipoda). *Smithson. Contrib. Zool.* 146: 64 p.
- BOWMAN, T.E., C.D. MEYERS, and S.D. HICKS. 1963. Notes on associations between hyperiid amphipods and medusae in Chesapeake and Narragansett Bays and the Niantic River. *Chesapeake Sci.* 4: 141-146.
- BRADSTREET, M.S.W. 1982. Pelagic feeding ecology of dovekies, Alle alle, in Lancaster Sound and western Baffin Bay. *Arctic* 35(1): 126-140.
- BRADSTREET, M.S.W., and W.E. CROSS. 1982. Trophic relationships at high arctic ice edges. *Arctic* 35(1): 1-12.
- BRUSCA, D.F. 1970. Notes on the association between Hyperoche medusarum A. Agassiz (Amphipoda, Hyperiidea) and the ctenophore, Pleurobrachia bachei (Muller). *Bull. South. Calif. Acad. Sci.* 69: 179-181.
- BUSDOSH, M. 1981. Long-term effects of the water soluble fraction of Prudhoe Bay crude oil on survival movement and food search success of the arctic amphipod Boeckosimus (=Onisimus) affinis. *Mar. Environ. Res.* 5: 167-180.
- BUSDOSH, M., and R.M. ATLAS. 1975. Response of two arctic amphipods, Gammarus zaddachi and Boeckosimus (Onisimus) affinis, to variations in temperature and salinity. *J. Fish. Res. Board Can.* 32: 2564-2568.
- BUSDOSH, M., and R.M. ATLAS. 1977. Toxicity of oil slicks to arctic amphipods. *Arctic* 30: 85-92.
- BUSDOSH, M., D. LAVIGNE, and G.A. ROBILLIARD. 1982. Habitat separation by the amphipods Pontoporeia affinis and P. femorata near Prudhoe Bay, Alaska. *Oikos* 39: 77-82.
- BUSDOSH, M., K. TARBOX, and G. ROBILLIARD. 1979. Attraction of amphipods by baited traps. Part IV. In P. Mangarells et al. *Environmental Studies of the Beaufort Sea, Winter 1979*. Woodward Clyde Consultants, San Diego.

- CAHOON, L.B., C.R. TRONZO, and J.C. HOWE. 1986. Notes on the occurrence of Hyperoche medusarum (Krøyer) (Amphipoda, Hyperiidae) with Ctenophora off North Carolina, USA. *Crustaceana* (Leiden) 51(1): 95-97.
- CONLAN, K.E. 1983. The amphipod superfamily Corophioidea in the northeastern Pacific Region 3. Family Isaeidae: Systematics and distributional ecology. *Natl Mus. Nat. Sci. (Ott.) Publ. Nat. Sci.* 4: 75 p.
- CORNFORD, A.B., D.D. LEMON, D.B. FISSEL, H. MELLING, B.D. SMILEY, R.H. HERLINVEAUX, and R.W. MacDONALD. 1982. Arctic data compilation and appraisal. Vol. 1. Beaufort Sea: physical oceanography, temperature, salinity, currents, and water levels. *Can. Data Rep. Hydrogr. Ocean Sci.* 5: 279 p.
- CROSS, W.E. 1982. Under-ice biota at the Pond Inlet ice edge and in adjacent fast ice areas during spring. *Arctic* 35(1): 13-27.
- DADSWELL, M.J. 1974. Distribution, ecology, and post-glacial dispersal of certain crustaceans and fishes in eastern North America. *Natl Mus. Nat. Sci. (Ott.) Publ. Zool.* 11: 110 p.
- DAHL, E. 1977. The amphipod functional model and its bearing upon systematics and phylogeny. *Zool. Scr.* 6: 221-228.
- DITTRICH, B. 1987. Post embryonic development of the parasitic amphipod Hyperia galba. *Helgol. Meeresunters.* 41: 217-232.
- DUNBAR, M.J. 1942. Marine macroplankton from the Canadian eastern arctic. *Can. J. Res. Sect. D. Zool. Sci.* 20(D): 33-46.
- DUNBAR, M.J. 1946. On Themisto libellula in Baffin Island coastal waters. *J. Fish. Res. Board Can.* 6: 419-434.
- DUNBAR, M.J. 1954. The amphipod crustacea of Ungava Bay, Canadian eastern Arctic. *J. Fish. Res. Board Can.* 11(6): 709-798.
- DUNBAR, M.J. 1963. Amphipoda. Sub-Order: Hyperiidea Family: Hyperiidae. *Cons. Int. Explor. Mer Zooplankton Sheet* 103: 2-4.
- DUNBAR, M.J. 1964. Euphausiids and pelagic amphipods. Distribution in North Atlantic and Arctic waters. *Serial Atlas Marine Environment Amer. Geogr. Soc. Folio* 6, 2 p., 8 pls.
- ENEQUIST, P. 1949. Studies on the soft-bottom amphipods of the Skagerrak. *Zool. Bidr. Upps.* 28: 297-492.
- EVANS, F., and M. SHEADER. 1972. Host species of the hyperiid amphipod Hyperoche medusarum (Krøyer) in the North Sea. *Crustaceana Suppl. (Leiden)* 3: 275-276.
- FENWICK, G.D., and D.H. STEELE. 1983. Amphipods of Placentia Bay, Newfoundland. *Memorial Univ. Newfoundland Occas. Pap. Biol.* 7: 1-22.
- FERNANDEZ, H.R. 1971. Studies on the visual receptors of two arctic amphipods. In *Biological oceanography of ice in marine systems*. Proc.

22nd Alaska Science Conference College, Alaska. Alaska Division, American Association for the Advancement of Science.

- FORSMAN, B. 1956. Notes on the invertebrate fauna of the Baltic. *Ark. Zool.* 9(17): 389-419.
- GOES, A. 1866. Crustacea amphipoda maris Spetsbergiam alluentis, cum speciebus aliis arcticis enumerat. *Ofversigt Kongl. Vetenskaps-Akad. Forhandl.*, 1865: 517-536, pls. 36-41.
- GOSNER, K.L. 1971. Guide to identification of marine and estuarine invertebrates. Cape Hatteras to Bay of Fundy. John Wiley and Sons Ltd., New York. 693 p.
- GRAINGER, E.H. 1959. The annual oceanographic cycle at Igloolik in the Canadian arctic. 1. The zooplankton and physical and chemical observations. *J. Fish. Res. Board Can.* 16(4): 453-501.
- GRAINGER, E.H. 1962. Zooplankton of Foxe Basin in the Canadian Arctic. *J. Fish. Res. Board Can.* 19(3): 377-400.
- GRAINGER, E.H. 1965. Zooplankton from the Arctic Ocean and adjacent Canadian waters. *J. Fish. Res. Board Can.* 22(2): 543-564.
- GRAINGER, E.H., and C. GROHE. 1975. Zooplankton data from the Beaufort Sea, 1951 to 1975. *Fish. Res. Board Can. Tech. Rep.* 591: 54 p.
- GURJANOVA, E.F. 1951. Amphipoda - Gammaridea of the seas of the USSR and adjoining waters. In *Opredelitel fauny i flory severnykh morei SSSR*. *Zool. Inst. Acad. Sci. USSR*. No. 41. 1029 p., 705 figs. (In Russian).
- GURJANOVA, E.F. 1962. Gammaridean Amphipoda of the northern part of the Pacific Ocean. In *Opredelitel fauny i flory severnykh morei SSSR*. *Zool. Inst. Acad. Sci. USSR*. No. 74. 440 p., 143 figs. (In Russian).
- HARBISON, G.R., D.C. BIGGS, and L.P. MADIN. 1977. The associations of Amphipoda Hyperiidea with gelatinous zooplankton II. Associations with Cnidaria, Ctenophora and Radiolaria 24: 465-488.
- HOLMES, S.J. 1910. Amphipod crustaceans of the expedition, p. 233-246. In *Harriman Alaska Series, Vol. X. Crustaceans*. Smithsonian Institution, Washington.
- HOLMQUIST, C. 1965. The amphipod genus Pseudalibrotus. *Z. Zool. Syst. Evolutionsforsch.* 3: 19-46.
- JARVEKULG, A. 1973. Distribution and ecology of local populations of benthic glacial relicts. *Oikos. Suppl.* 15: 91-97.
- JOHANSEN, F. 1921. Freshwater Crustacea from Canada. *Can. Field-Nat.* 35: 99-100.
- JONES, N.S. 1948. The ecology of the Amphipoda of the south of the Isle of Man. *J. Mar. Biol. Assoc. U.K.* 27: 400-439.

- JUST, J. 1980. Amphipoda (Crustacea) of the Thule area: northwest Greenland: faunistics and taxonomy. *Greenland Biosci.* 2: 61 p.
- KARAMAN, G.S., and J.L. BARNARD. 1979. Classificatory revisions in gammaridean Amphipoda (Crustacea), Part I. *Proc. Biol. Soc. Wash.* 92(1): 106-165.
- KIELHORN, W.V. 1952. The biology of the surface zone zooplankton of a boreo-arctic Atlantic Ocean area. *J. Fish. Res. Board Can.* 9(5): 223-264.
- KORCZYNSKI, R.E., M. LAWRENCE, and G. HOPKY. 1989. Range extensions of some peracaridan crustaceans in the Beaufort Sea. *Crustaceana (Leiden)* 56(2): 215-219.
- KUDRYASHOV, V.A., and S.A. LENSKEYA. 1978. Biogeographic structure of the intertidal amphipod fauna of the Chukotsk Coast, Bering Sea. *Nauchnye Soobshcheniya Instituta Biologii Morya. Dal'nevostochnyi Nauchnyi Tsentralnykh. Akademiya Nauk SSSR.* 3: 45-48. (In Russian)
- KULIKOV, A.S. 1980. K ekologii dvukh vidov gammarid (Amphipoda, Gammaridea) i mizidy (Mysidacea) v kriopelagicheskom biotsenoze tsentral'nogo Arkticheskogo basseina. (The ecology of two species of gammarids (Amphipoda, Gammaridea) and a mysid (Mysidacea) in the cryopelagic biocenosis of the central arctic basin) p. 111-118. In *Akad. Nauk SSSR, Biologiya tsentral'nogo arkticheskogo Basseina (Transl. by Can. Transl. Fish. Aquat. Sci. 4969. 1983).*
- LARKIN, P.A. 1948. Pontoporeia and Mysis in Athabaska, Great Bear and Great Slave Lakes. *Fish. Res. Board Can. Bull.* 88: 1-33.
- LAUBITZ, D.R. 1977. A revision of the genera Dulichia Krøyer and Paradulichia Boeck (Amphipoda, Podoceridae). *Can. J. Zool.* 55: 942-982.
- LEITE, F.P.P., Y. WAKABARA, and A.S. TARARAM. 1986. On the morphological variations in oostegites of gammaridean species (Amphipoda). *Crustaceana (Leiden)* 51(1): 77-94.
- LORZ, H.V., and W.G. PEARCY. 1975. Distribution of hyperiid amphipods off the Oregon Coast. *J. Fish. Res. Board Can.* 32: 1442-1447.
- MacGINITIE, G.E. 1955. Distribution and ecology of the marine invertebrates of Point Barrow, Alaska. *Smithson. Misc. Collect.* 128(9): 1-201.
- MADIN, L.P., and G.R. HARBISON. 1977. The associations of Amphipoda Hyperiidae with gelatinous zooplankton. I. Associations with Salpidae. *Deep-Sea Res.* 24: 449-463.
- MOHAMMED, A.A., and E.H. GRAINGER. 1974. Zooplankton data from the Canadian arctic archipelago, 1962. *Fish. Res. Board Can. Tech. Rep.* 460: 135 p.
- MOORE, J.W. 1979. Ecology of a subarctic population of Pontoporeia affinis Lindstrom (Amphipoda). *Crustaceana (Leiden)* 36(3): 267-276.
- MOORE, P.G. 1984. The amphipod Monoculodes gibbosus (Crustacea) in British waters. *J. Mar. Biol. Assoc. U.K.* 64: 271-278.

- MULICKI, Z. 1957. The ecology of the more important benthic invertebrates in the Baltic Sea. (Ekologia wazniejszych bezkregowcow dennych Baltyku). Prace Morskiego Instytutu Rybackiego W Gdyni 9: 313-379 (Transl. from Polish).
- MYERS, A.A. 1976. Studies on the genus Lembos Bate. IV. L. megacheir (Sars), L. borealis sp. nov., L. hirsutipes Stebbing, L. karamani sp. nov., L. setimerus sp. nov. Bull. Mus. Civ. Nat. Verona 3: 445-477.
- NORMAN, C. 1900. British Amphipoda of the tribe Hyperiidea and the families Orchestiidae and some Lysianassidae. Ann. Mag. Nat. Hist. Ser. 7(5): 126-144.
- PERCY, J.A. 1975. Ecological physiology of arctic marine invertebrates, temperature and salinity relationships of the amphipod Onisimus affinis H.J. Hansen. J. Exp. Mar. Biol. Ecol. 20: 99-117.
- ROBILLIARD, G.A., and M. BUSDOSH. 1980. Ecology of isopods and amphipods in the Beaufort Sea, Alaska. Am. Zool. 20(4): 76.
- SANGER, G.A. 1974. Pelagic amphipod crustaceans from the southeastern Bering Sea, June 1971. U.S. NOAA Tech. Rep. NMFS SSRF-680: 8 p.
- SARS, G.O. 1895. An account of the Crustacea of Norway: Amphipoda. Vol. 1. Alb. Cammermeyers, Christiania and Copenhagen. 711 p. + 240 pls., 8 suppl. pls.
- SARS, G.O. 1900. Amphipoda, p. 14-34. In Fridtjof Nansen (ed.) Crustacea: The Norwegian North Polar Exped., 1893-1896. Vol. 1 (5). Christiania and Copenhagen. 141 p.
- SCHELLENBERG, A. 1927. Amphipoda des nordischen Plankton. Nordisches Plankton 20: 589-722, figs. 1-104.
- SEGERSTRALE, S.G. 1950. The amphipods on the coast of Finland-some facts and problems. Commentat. Biol. Soc. Sci. Fenn. 10(14): 28 p.
- SEGERSTRALE, S.G. 1959. Synopsis of data on the crustaceans Gammarus locusta, Gammarus oceanicus, Pontoporeia affinis, and Corophium volutator (Amphipoda, Gammaridea). Commentat. Biol. Soc. Sci. Fenn. 20(5): 23 p.
- SEGERSTRALE, S.G. 1962. The immigration and prehistory of the glacial relicts of Eurasia and North America. A survey and discussion of modern views. Int. Rev. Gesamten Hydrobiol. 47(1): 1-25.
- SEGERSTRALE, S.G. 1967. Observations of summer-breeding in populations of the glacial relict Pontoporeia affinis Lindstr. (Crustacea Amphipoda) living at greater depths in the Baltic Sea, with notes on the reproduction of P. femorata Krøyer. J. Exp. Mar. Biol. Ecol. 1: 55-64.
- SEGERSTRALE, S.G. 1977. The taxonomic status and prehistory of the glacial relict Pontoporeia (Crustacea, Amphipoda) living in North American lakes. Commentat. Biol. Soc. Sci. Fenn. 89: 3-18.

- SEGERSTRALE, S.G. 1978. The negative correlation between the abundances of the amphipod Pontoporeia and the bivalve Macoma in Baltic waters and the factors involved. *Ann. Zool. Fenn.* 15: 143-145.
- SHEN, Y. 1966. The distribution and morphological variation of certain euphausiids and pelagic amphipods in tropical, northwest Atlantic, and Canadian Arctic waters. M. Sc. Thesis, McGill University, Marine Sciences Center, Montreal, Quebec. 69 p.
- SHIH, C.-T., A.J.G. FIGUEIRA, and E.H. GRAINGER. 1971. A synopsis of Canadian marine zooplankton. *Fish. Res. Board Can. Bull.* 176: 264 p.
- SHIH, C.-T., and D. LAUBITZ. 1978. Zooplankton distribution in the eastern Beaufort Sea and the northwest passage. *Astarte* 11(1): 45-54.
- SHOEMAKER, C.R. 1920. The amphipods of the Canadian arctic expedition, 1913-18, p. 3-29. In *Report of the Canadian Arctic Expedition. Vol. VII. Crustacea.* Thomas Mulvey, Ottawa.
- SHOEMAKER, C.R. 1926. Report on the marine amphipods collected in Hudson and James Bays, by Fritz Johansen in the summer of 1920. *Contrib. Can. Biol. Fish.* 3: 1-11.
- SHOEMAKER, C.R. 1930. The amphipods of the Cheticamp Expedition of 1917. *Contrib. Can. Biol. Fish.* 5(10): 221-359.
- SHOEMAKER, C.R. 1931. The stegocephalid and ampeliscid amphipod crustaceans of Newfoundland, Nova Scotia and New Brunswick in the United States National Museum. *Proc. U.S. Natl Mus.* 79 (2883): 1-18.
- SHOEMAKER, C.R. 1955. Amphipoda collected at the Arctic Laboratory, Office of Naval Research, Point Barrow, Alaska, by G.E. MacGinitie. *Smithson. Misc. Collect.* 128: 78 p.
- SMIDT, E.L.B. 1979. Annual cycles of primary production and of zooplankton at southwest Greenland. *Greenland Biosci.* 1: 3-53.
- STAPPERS, L. 1911. Crustacea Malacostraces. *Campagne Arctique de 1907.* C. Bullens (ed.) Duc d'Orleans, Bruxelles. 152 p. + pls.
- STEBBING, T.R.R. 1906. Amphipoda I. Gammaridea. *Das Tierreich* 21: 806 p.
- STEELE, D.H., and V.J. STEELE. 1975. The biology of Gammarus (Crustacea, Amphipoda) in the northwestern Atlantic. IX. Gammarus wilkitzkii Birula, Gammarus storerensis Reid, and Gammarus mucronatus Say. *Can. J. Zool.* 53: 1105-1109.
- STEPHENSON, K. 1923. Crustacea Malacostraca V. (Amphipoda I). *Danish Ingolf-Exped.* 3(8): 1-100, figs. 1-22.
- STEPHENSON, K. 1931. The Tanaidacea and Amphipoda of the Arctic. *Fauna Arctica* 5: 345-378.
- STEPHENSON, K. 1933a. Crustacea and Pycnogonida. *Medd. Gronl.* 104(15): 12 p. + 1 pl.

- STEPHENSEN, K. 1933b. The Godthaab Expedition 1928. Amphipoda. Medd. Gronl. 79(7): 2-88.
- STEPHENSEN, K. 1940. Marine Amphipoda. Vol. III. The Zoology of Iceland pt. 26: 1-111.
- STEPHENSEN, K. 1942. The Amphipoda of N. Norway and Spitsbergen with adjacent waters. Tromso Mus. Skr. Vol. 3. 527 p.
- STEPHENSEN, K. 1944. The zoology of east Greenland. Medd. Gronl. 121(14): 3-165.
- TENCATI, J.R. 1970. Amphipods of the central arctic. Univ. South. Calif. Tech. Rep. No. 2. 37 p.
- TENCATI, J.R., and S.R. GEIGER. 1968. Pelagic amphipods of the slope waters of northeast Greenland. J. Fish. Res. Board Can. 25(8): 1637-1650.
- THORSTEINSON, E. 1941. New or noteworthy amphipods from the North Pacific coast. Univ. Wash. Publ. Oceanogr. 4(2): 50-96.
- TORRE-BUEND, J.R., de la. (ed). 1962. A glossary of entomology. Brooklyn Entomological Society, Brooklyn, N.Y.
- VON DER BRUGGEN, E. 1905. Die amphipoden des Katharinahafens (Mumankuste) und seine Umgebungen. Travaux de la Societe Imperiale des Naturalistes de St. Petersbourg Comptes Rendus 36: 218-228.
- VON DER BRUGGEN, E. 1906. Zoologische Ergebnisse der Russischen Expeditionen nach Spitzbergen. Ann. Mus. Zool. Acad. Imper. Sci. (St. Petersburg) 11: 214-245.
- WESLAWSKI, J. 1980. Mass species of Amphipoda from Hornsund Fjord, Spitsbergen. ICES L5: 9 p.
- WESLAWSKI, J. 1983a. The macrophagic amphipods from Hornsund Fjord/sw Spitsbergen. Int. Counc. Explor. Sea Counc. Meetings. 8 p.
- WESLAWSKI, J. 1983b. Observations on the coastal Amphipoda of the Hornsund Fjord (Southwest Spitsbergen). Pol. Arch. Hydrobiol. 30(3): 199-207.
- WING, B.L. 1976. Ecology of Parathemisto libellula and P. pacifica (Amphipoda: Hyperiidea) in Alaskan coastal waters. Northwest Fisheries Center Auke Bay Fisheries Laboratory, Processed Report. 266 p.
- YASHNOV, V.A. 1948. Leptostraca, Mysidacea, Cumacea, Isopoda, Amphipoda, [Leptostraca, Mysidacea, Cumacea, Isopoda, Amphipoda], p.223-257. In Opredelitel' fauny i flory severnykh morei SSSR. (Transl. from Russian by Can. Transl. Fish. Aquat. Sci. 3880, 1976).

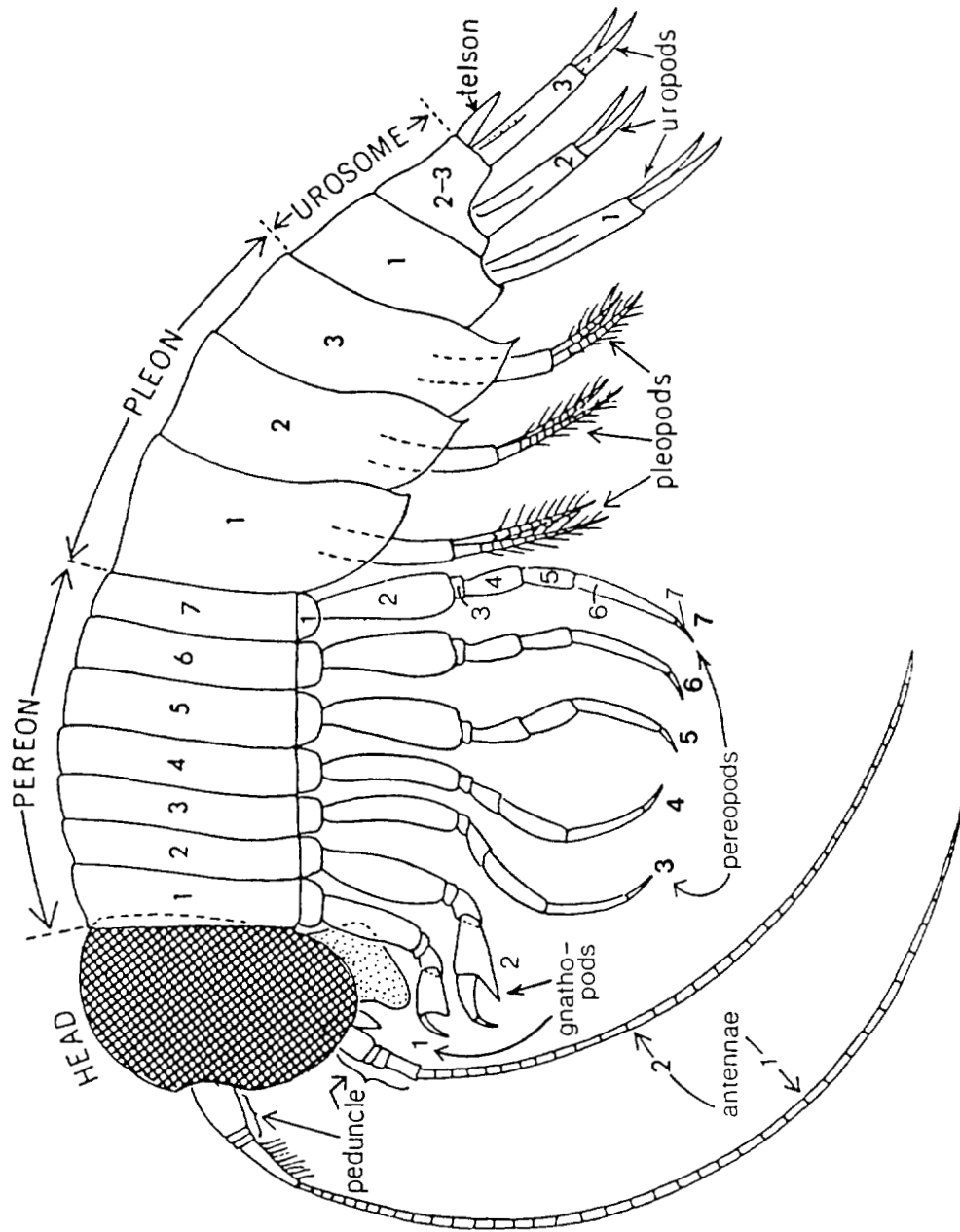

Basic hyperiid  
(modified from Bowman 1973)



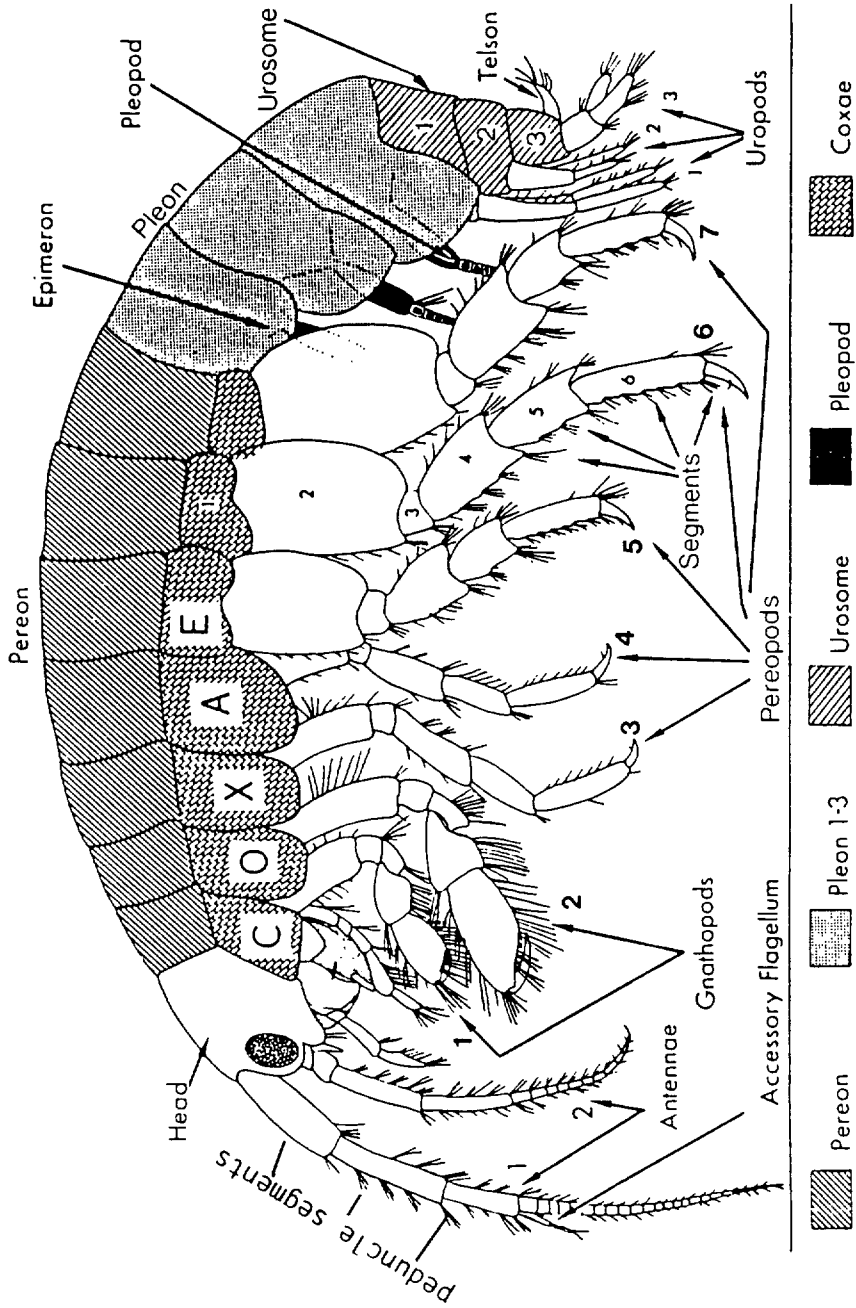

Basic gammaridean  
(modified from Barnard 1969)

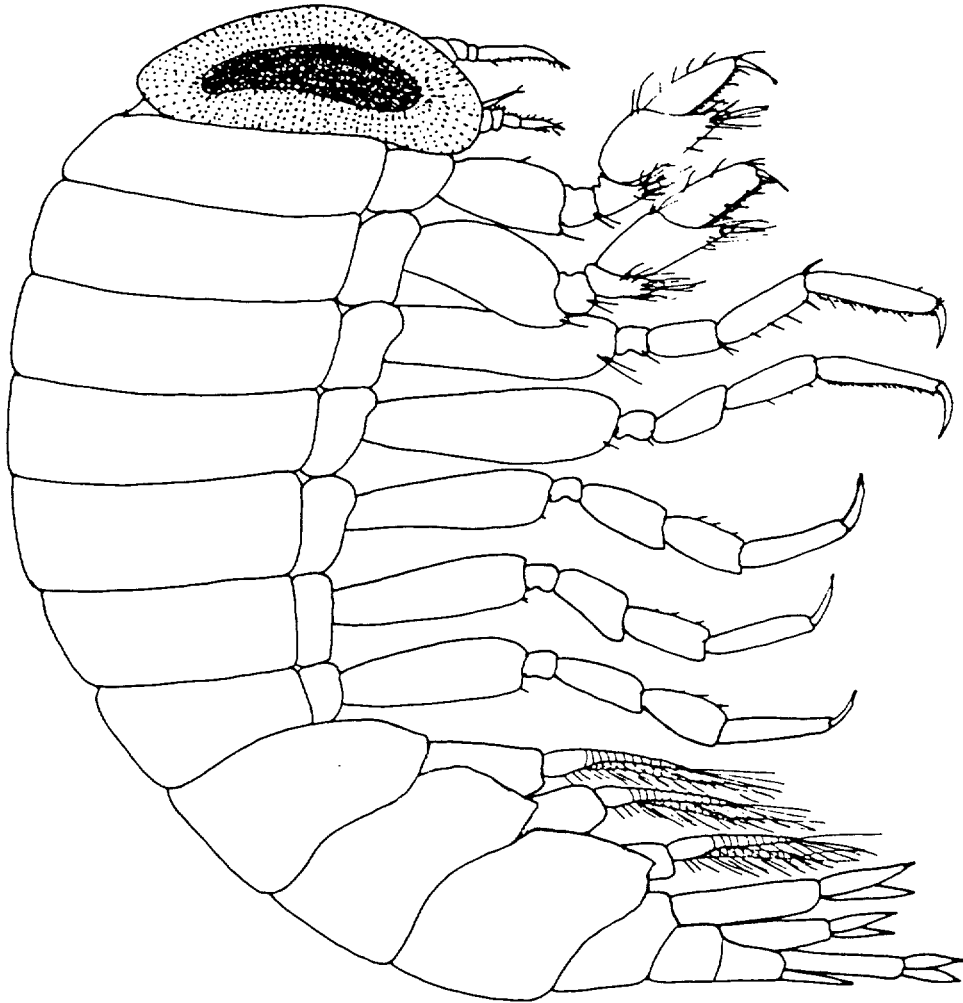

Hyperia galba Montagu 1813

TL = 8 mm ♀

HYPERIIDAE

PLATE IV

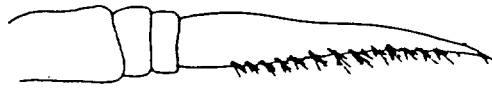

1.0 mm

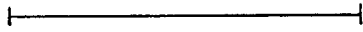

antenna 1



1.0 mm

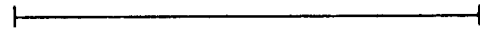

antenna 2

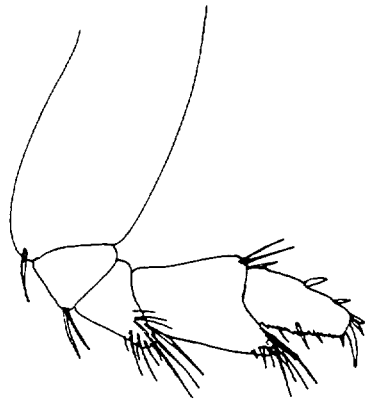

1.0 mm

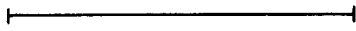

gnathopod 1

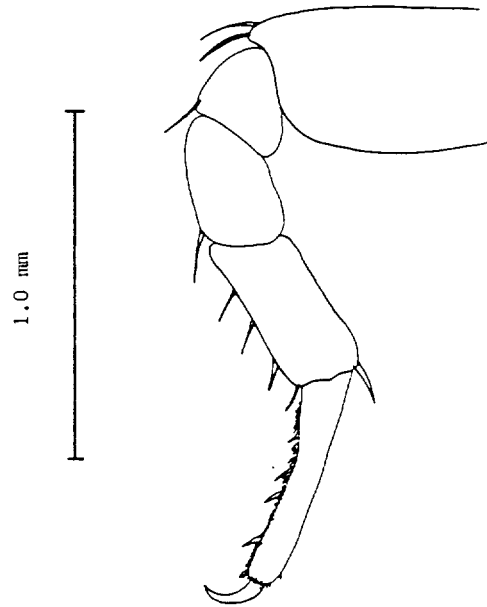

1.0 mm



pereopod 3

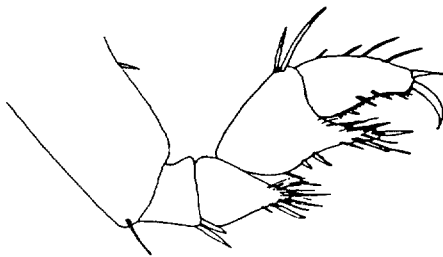

1.0 mm

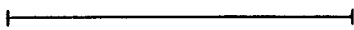

gnathopod 2

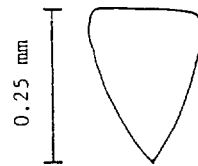

0.25 mm



telson

Hyperia galba Montagu 1813

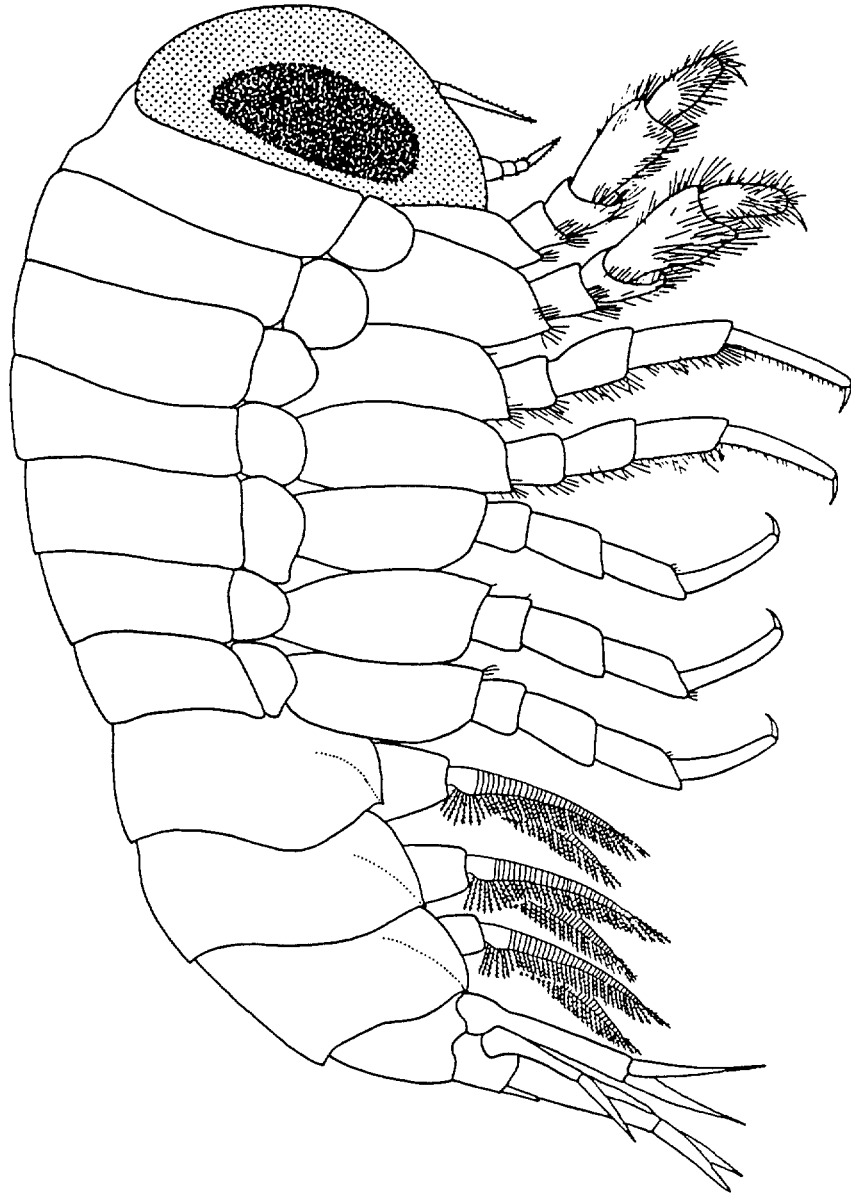

Hyperia medusarum (Muller) 1776

TL = 17.0 mm ♀

HYPERIIDAE

PLATE VI

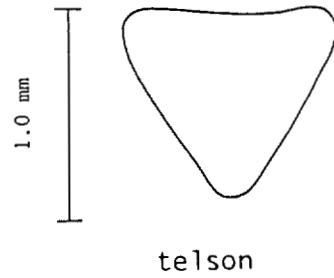
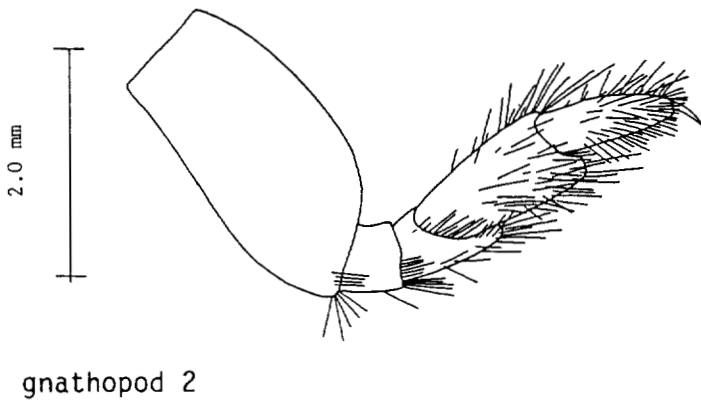
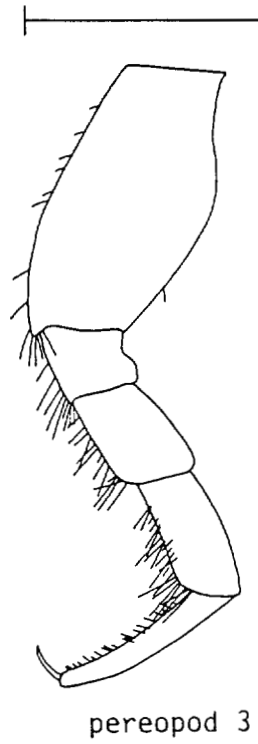
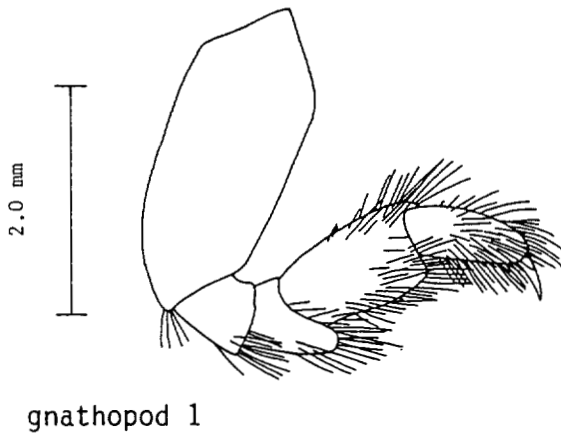
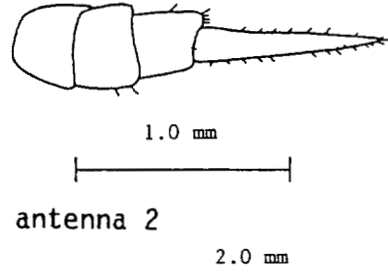
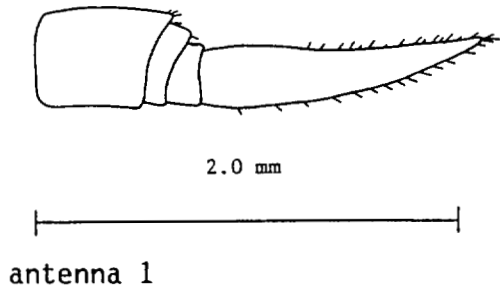

Hyperia medusarum (Muller) 1776

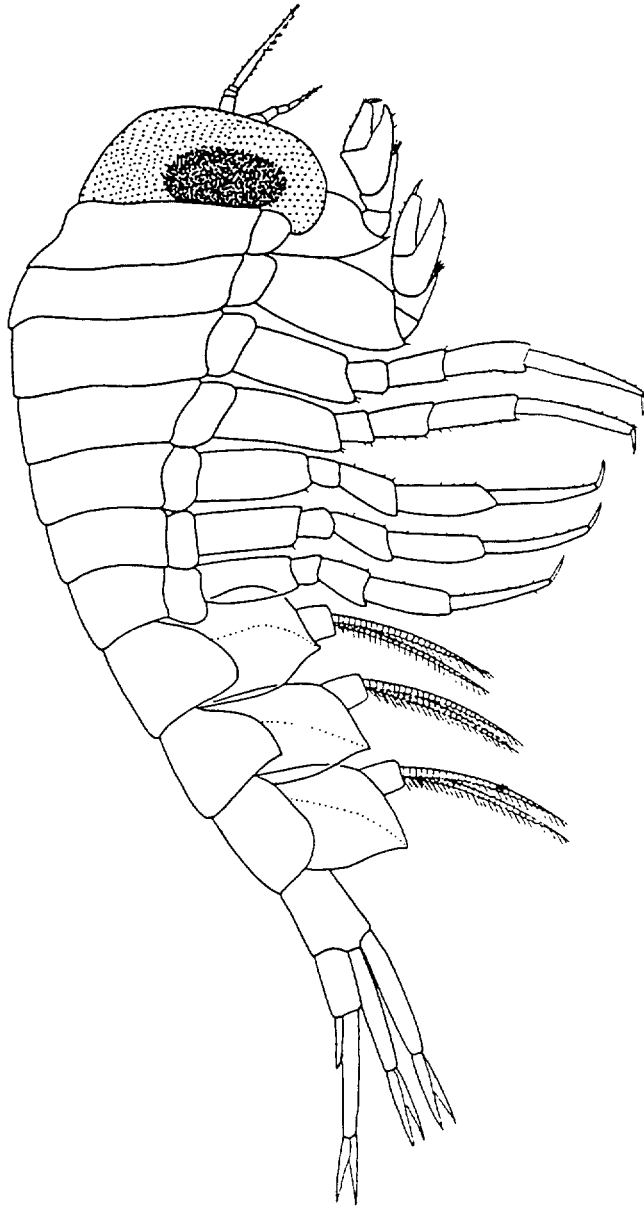

Hyperoche medusarum (Krøyer) 1838

TL = 8.2 mm ♀

HYPERIIDAE

PLATE VIII

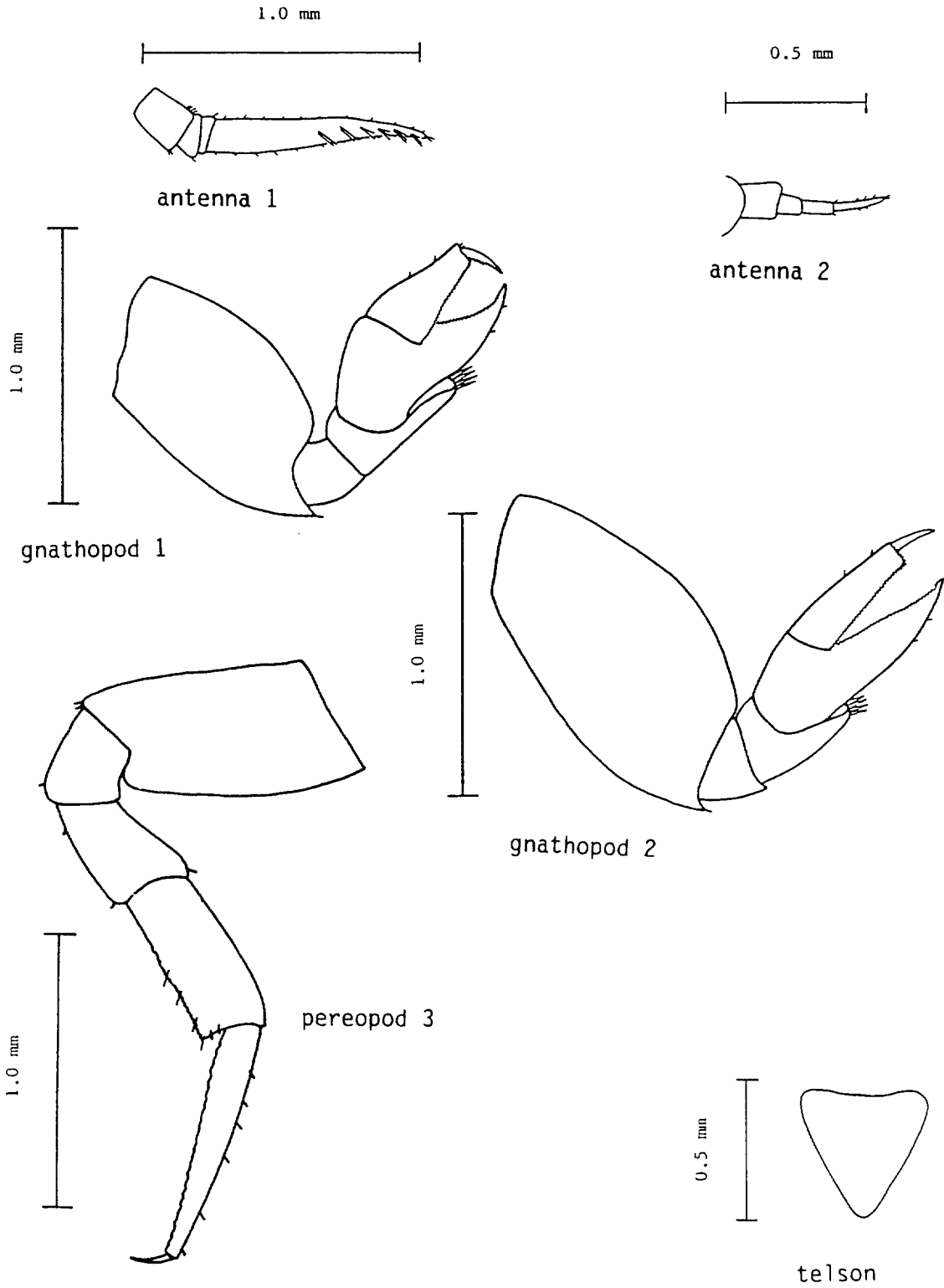

*Hyperoche medusarum* (Krøyer) 1838

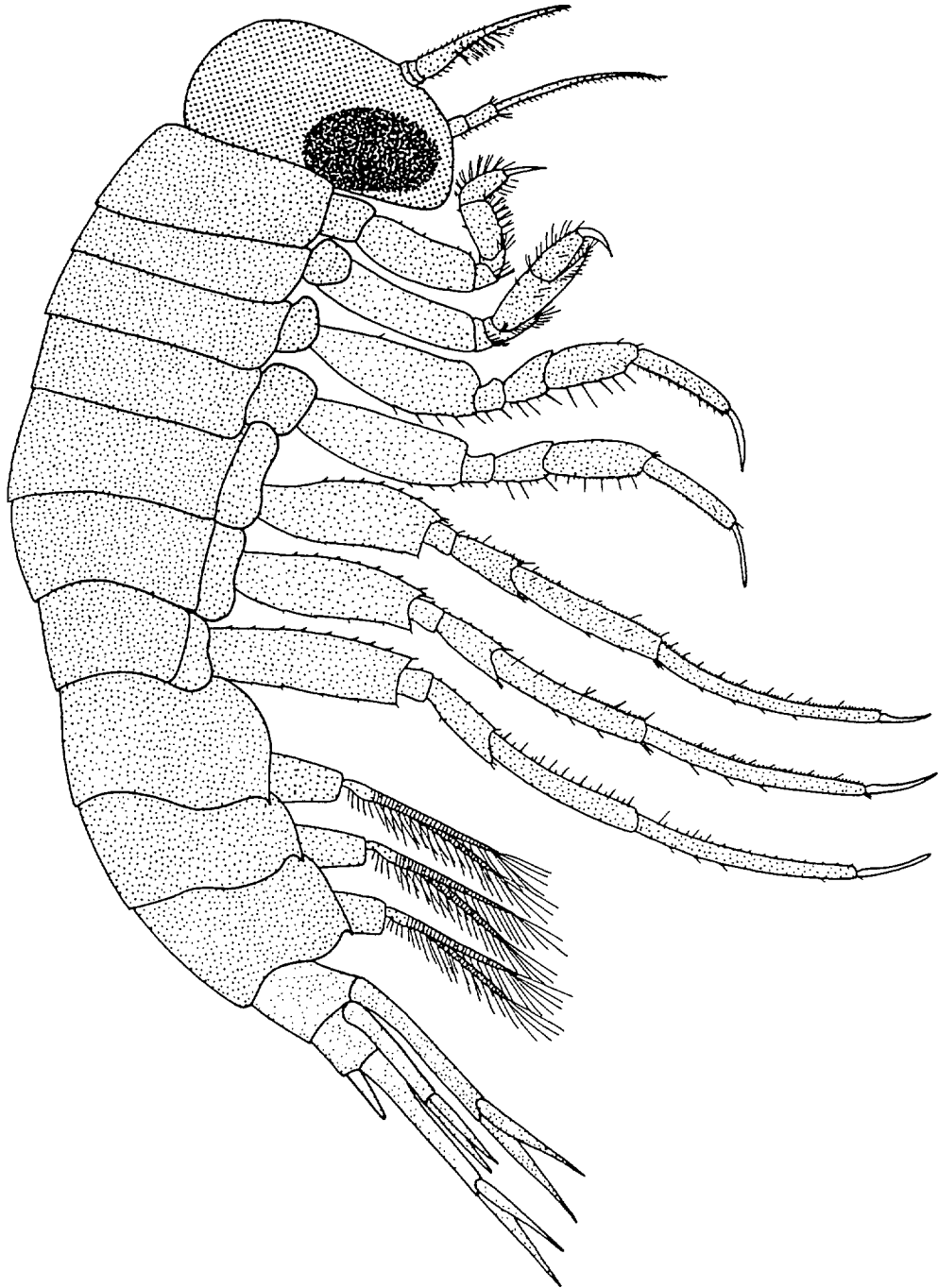

Parathemisto abyssorum Boeck 1870

TL = 10.1 mm ♀



HYPERIIDAE

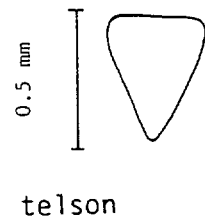
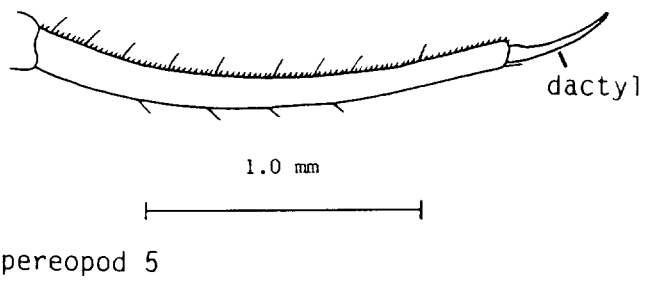
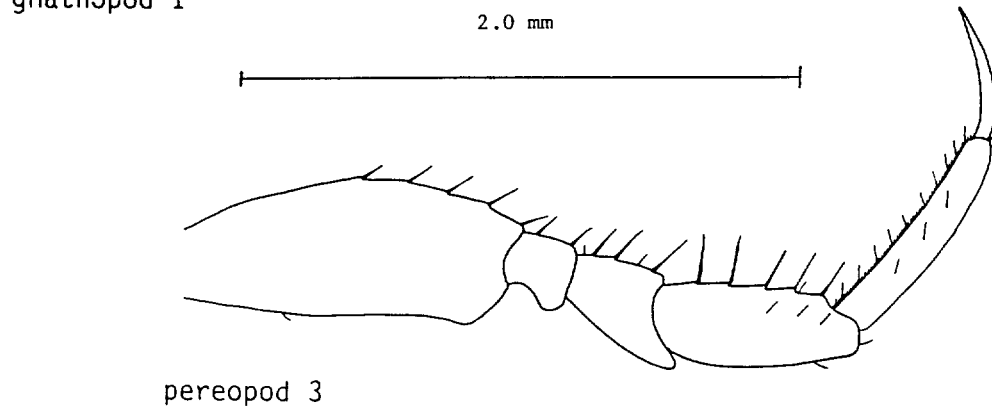
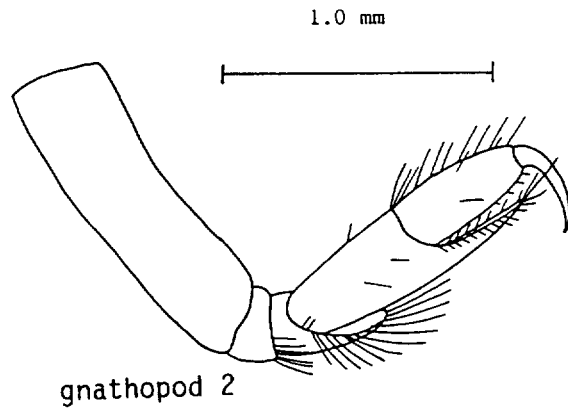
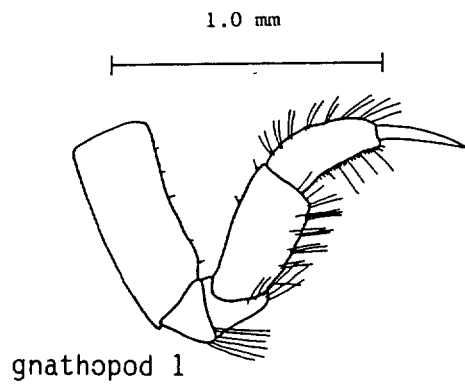
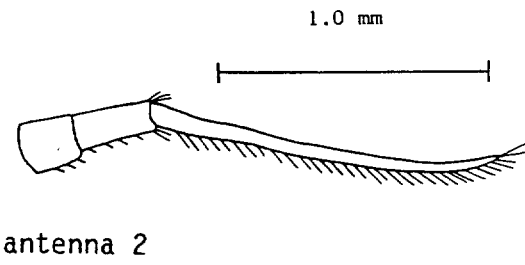
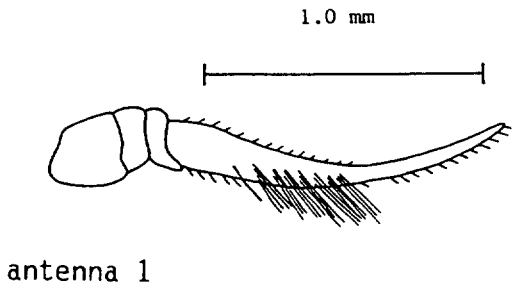

Parathemisto abyssorum Boeck 1870

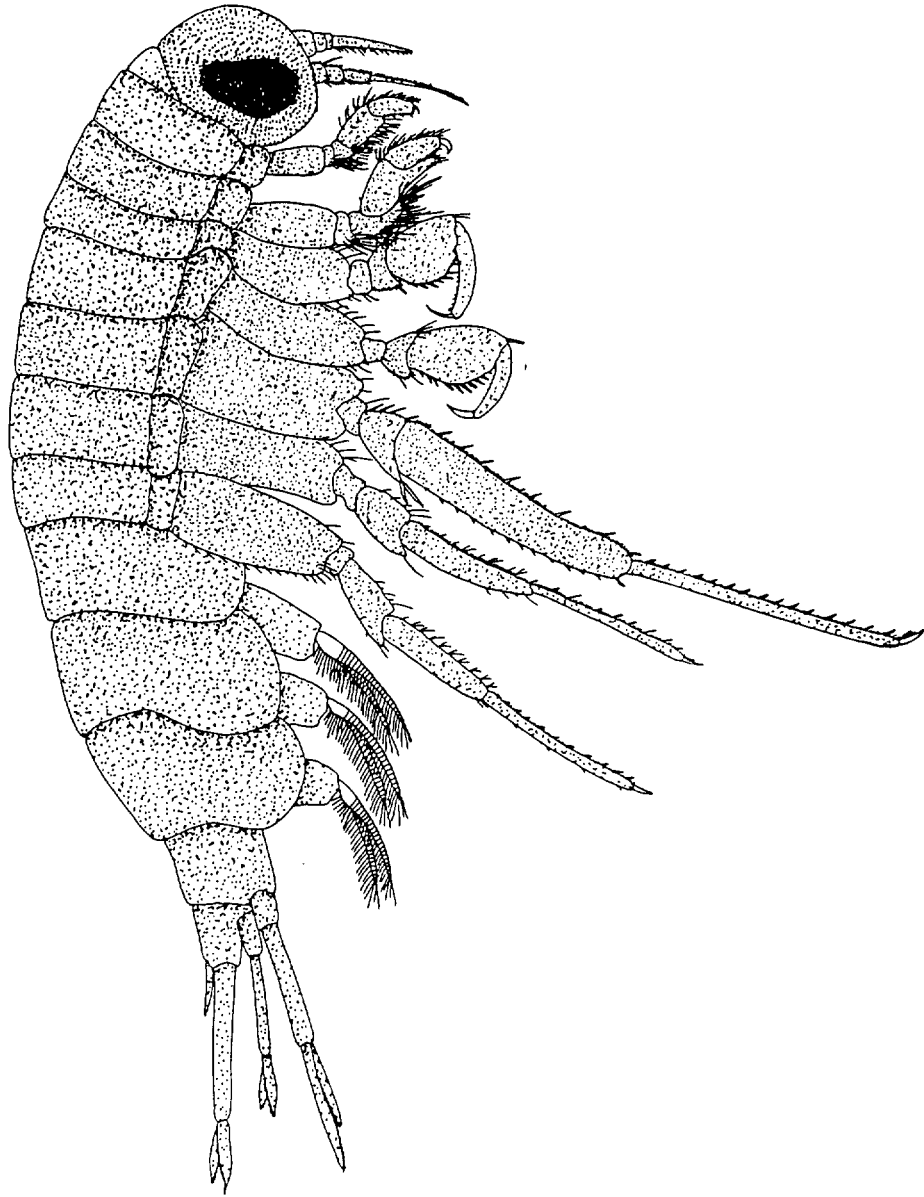

Parathemisto libellula (Lichtenstein) 1822

TL = 21 mm ♂

HYPERIIDAE

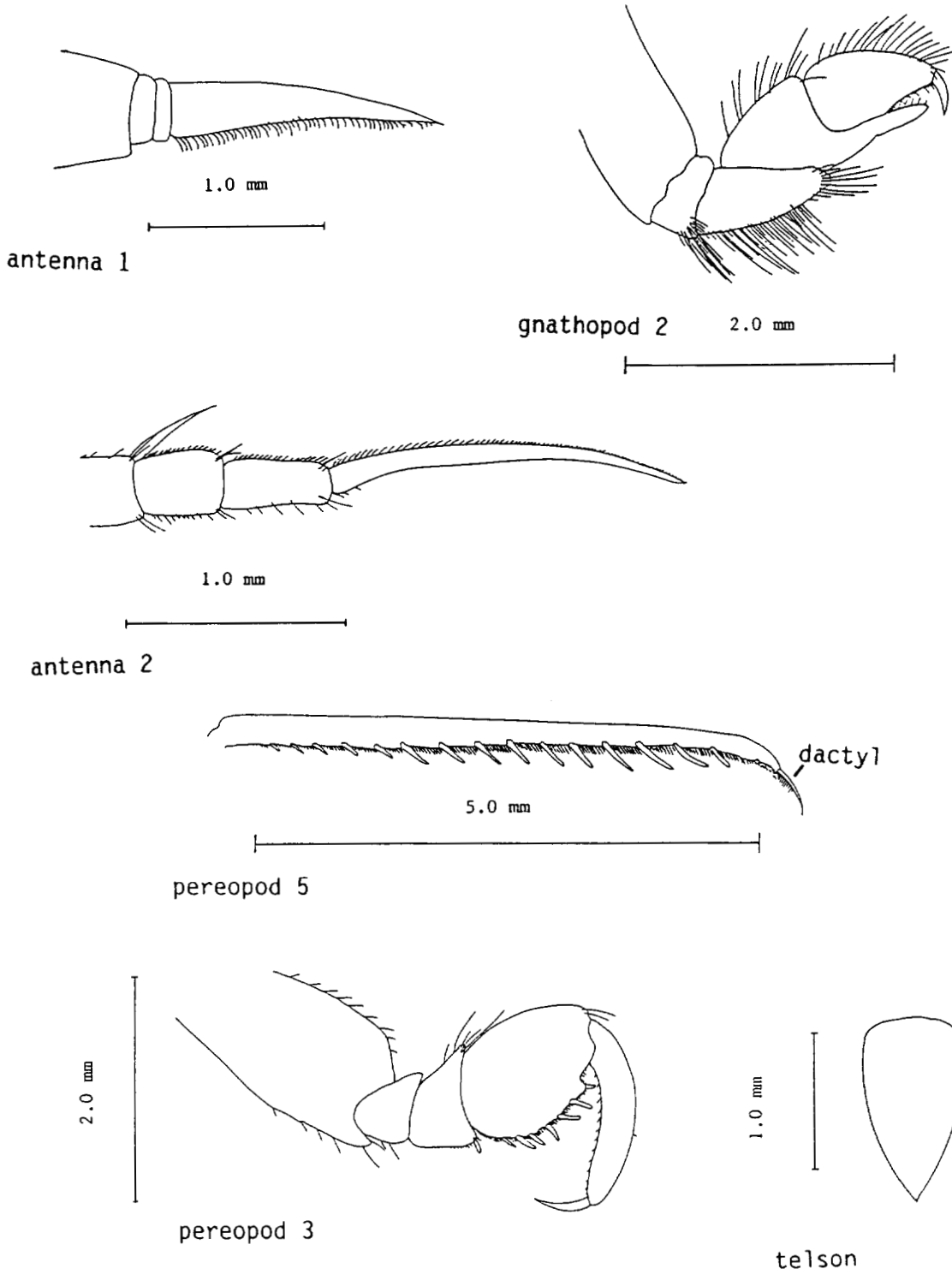

Parathemisto libellula (Lichtenstein) 1822

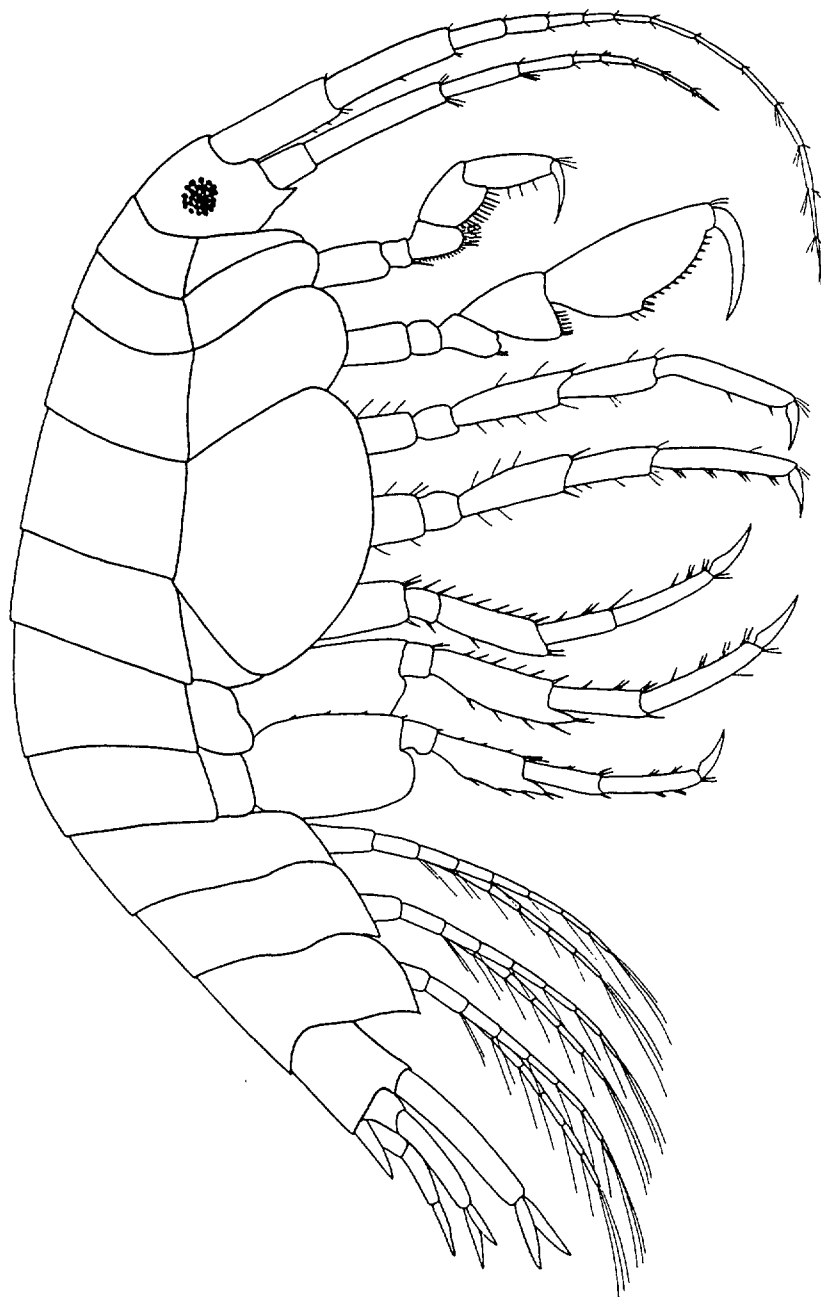

Metopa longirama Dunbar 1942

TL = 2.9 mm ♀

(gnathopod 2, pereopods 5 & 7, and epimeral plate 3  
after Korczynski et al. 1989)

STENOTHOIDAE

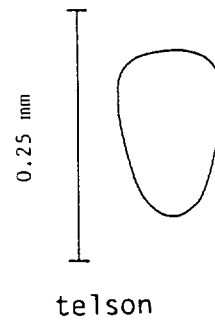
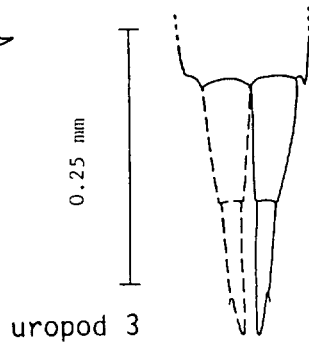
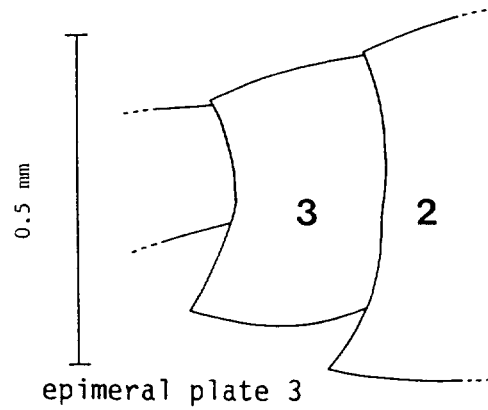
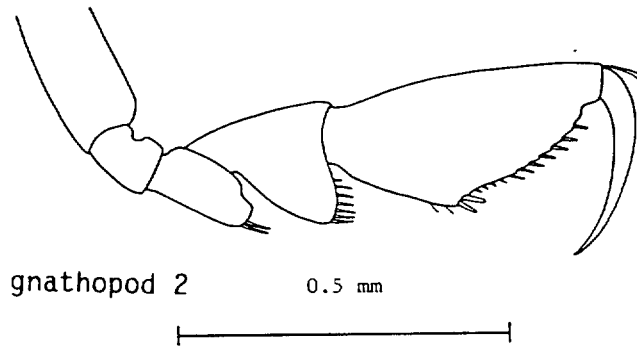
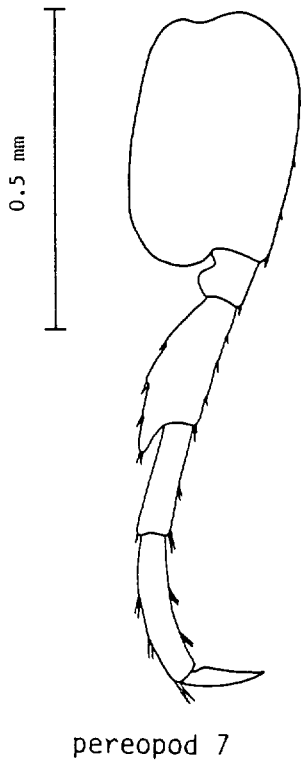
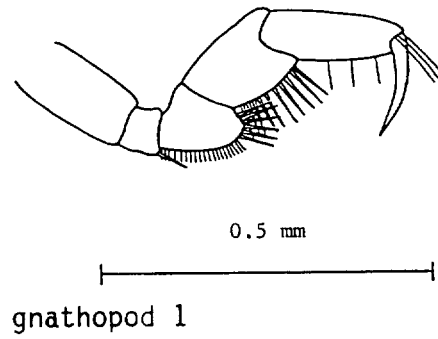
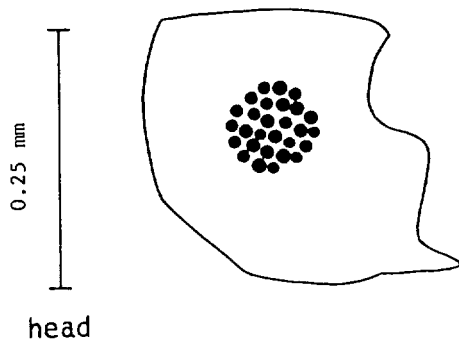

Metopa longirama Dunbar 1942

(gnathopod 2, pereopods 5 & 7, and epimeral plate 3  
after Kocczynski et al. 1989)

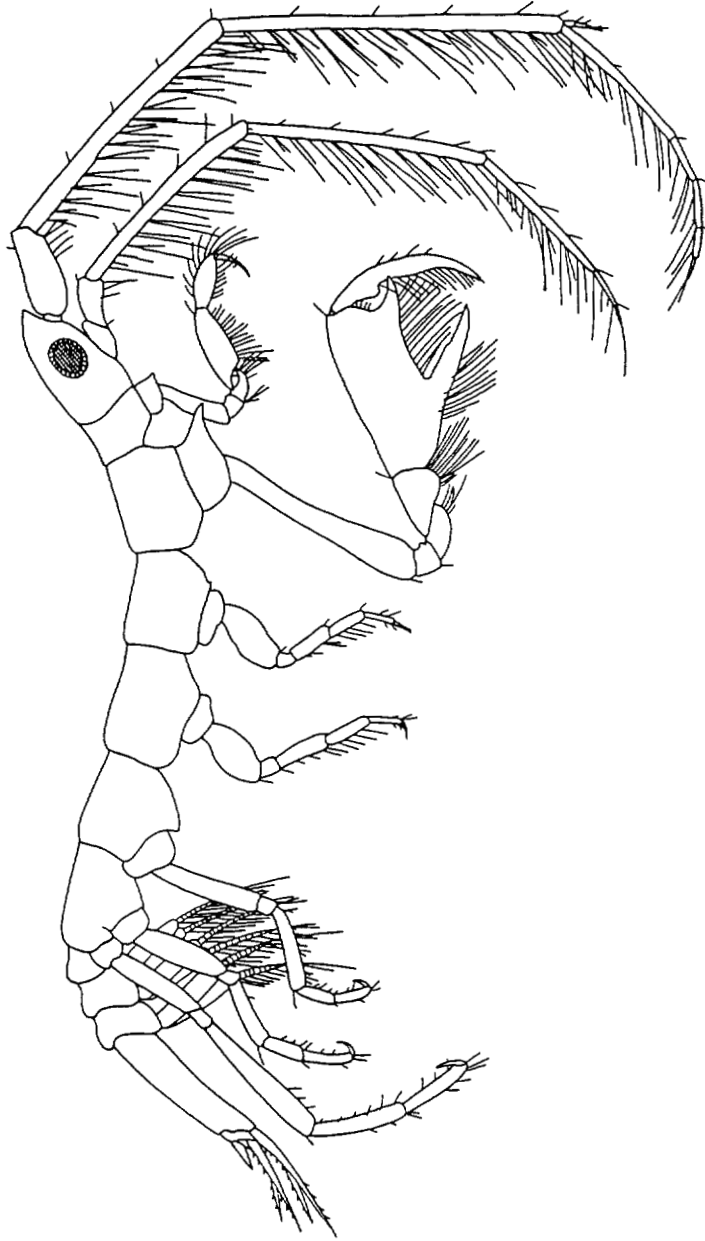

*Dyopodos porrectus* Sp. Bate 1857  
(modified from Sars 1895)

TL = 1.7 mm ♂

## PODOCERIDAE

## PLATE XVI

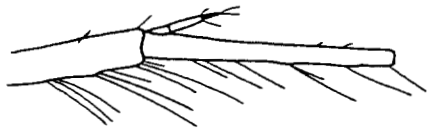
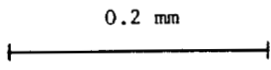

antenna 1

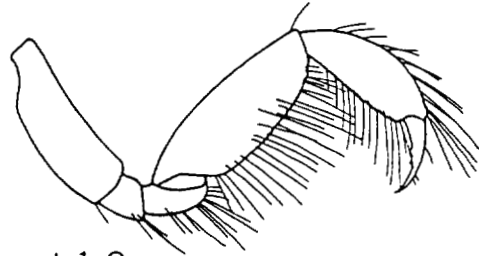
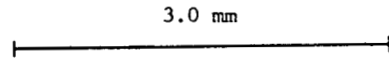

gnathopod 1 ♀

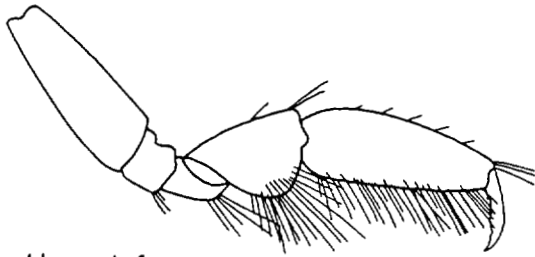
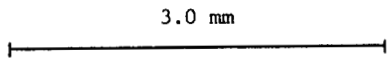

gnathopod 1 ♂

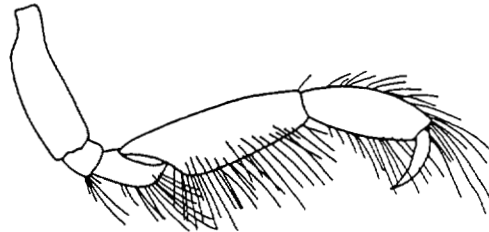
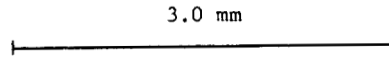

gnathopod 2 ♀

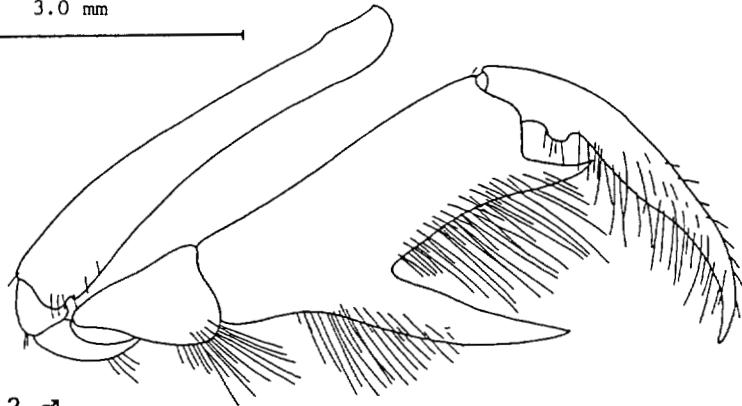
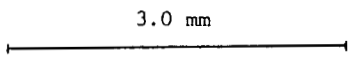

gnathopod 2 ♂

*Dyopodos porrectus* Sp. Bate 1857  
(modified from Sars 1895)

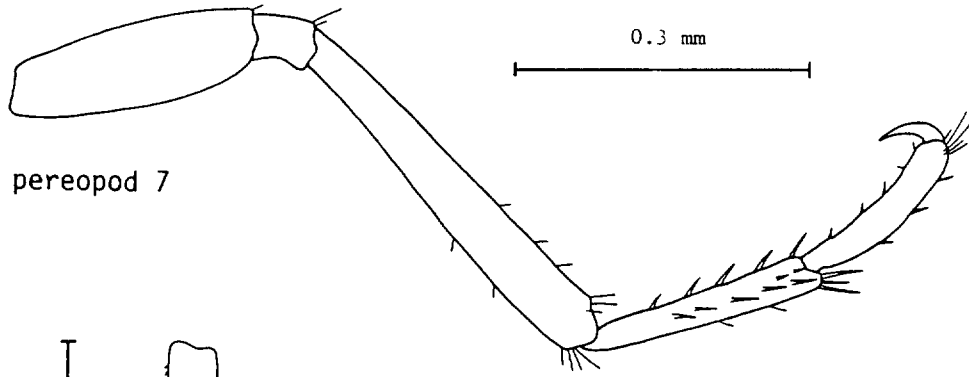

pereopod 7

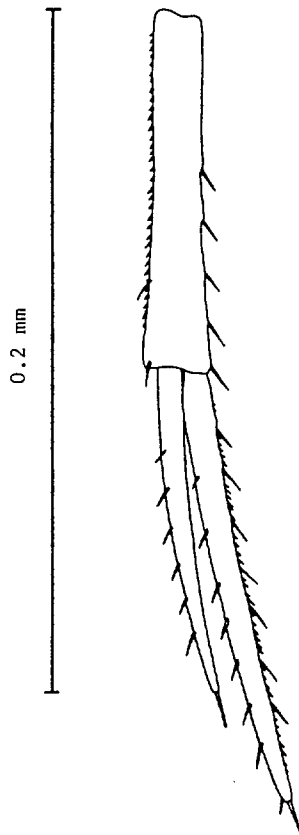

uropod 1

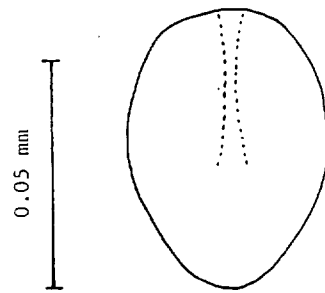

telson

*Dyopodos porrectus* Sp. Bate 1857  
(modified from Sars 1895)



LYSIANASSIDAE

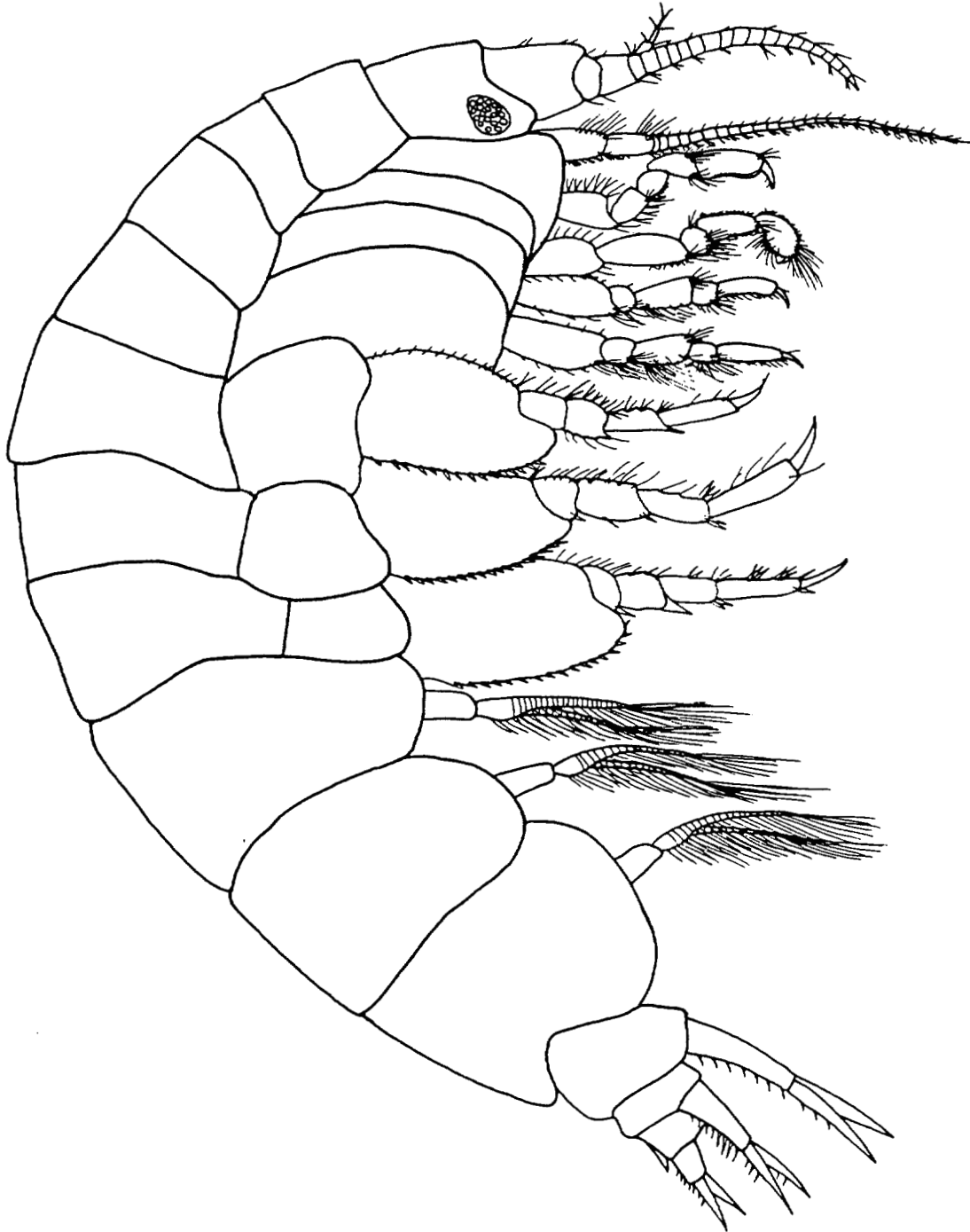

*Boeckosimus affinis* (Hansen) 1887

TL = 11.0 mm ♀

PLATE XIX

LYSIANASSIDAE

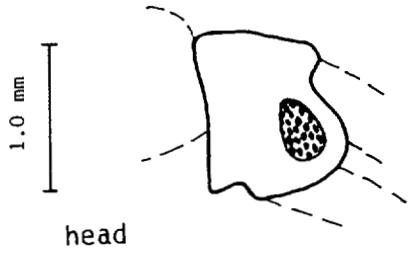

head

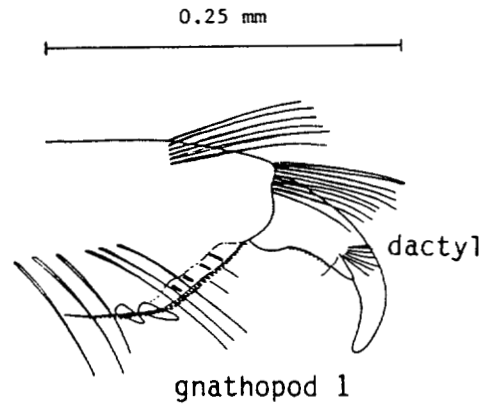

gnathopod 1

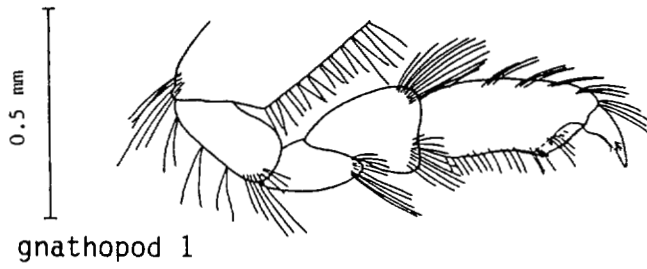

gnathopod 1

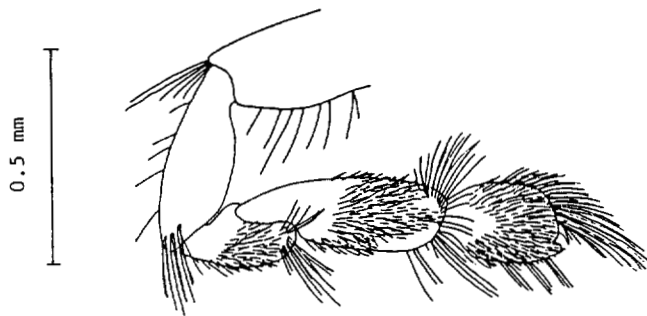

gnathopod 2

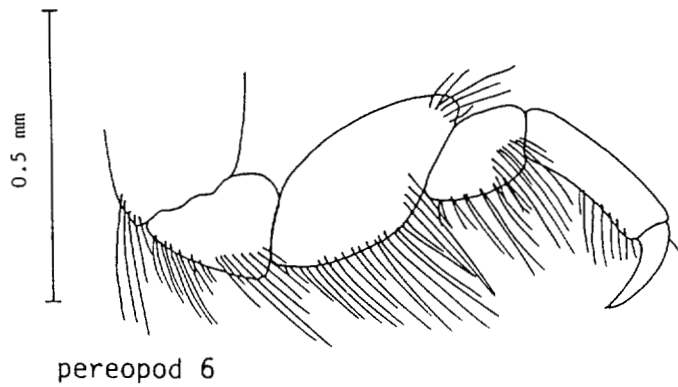

pereopod 6

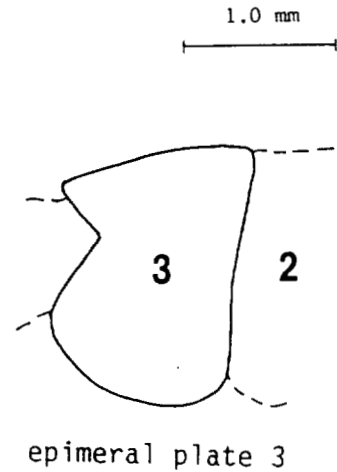

epimeral plate 3

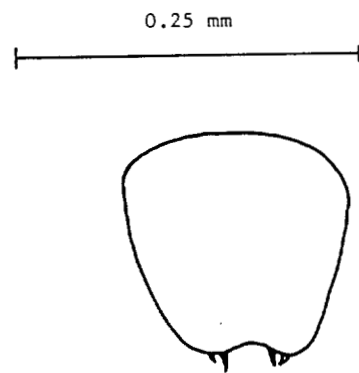

telson

Boeckosimus affinis (Hansen) 1887

LYSIANASSIDAE

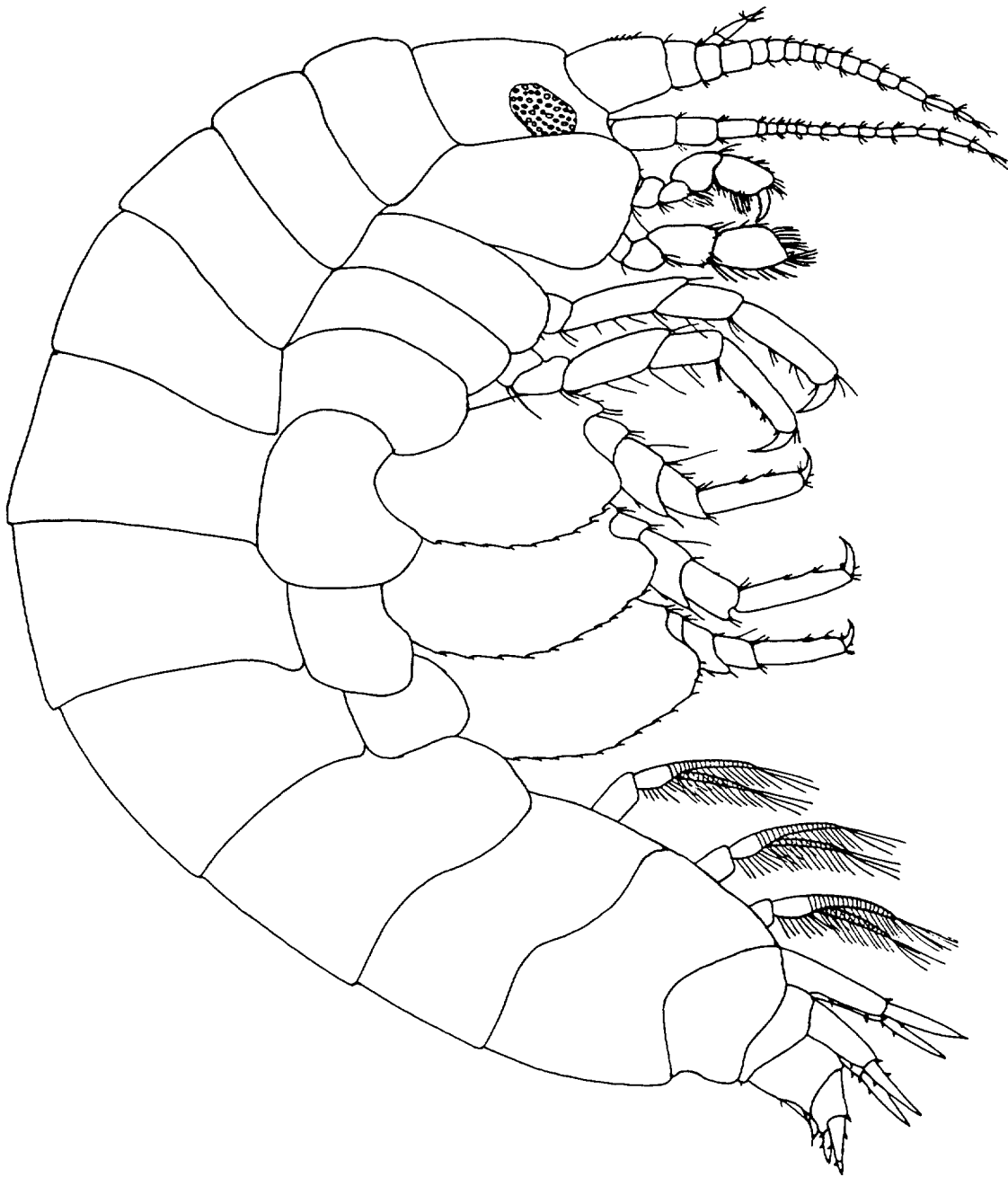

Onisimus glacialis G.O. Sars 1900

TL = 13.0 mm ♀

LYSIANASSIDAE

PLATE XXI

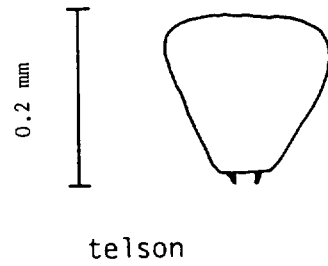
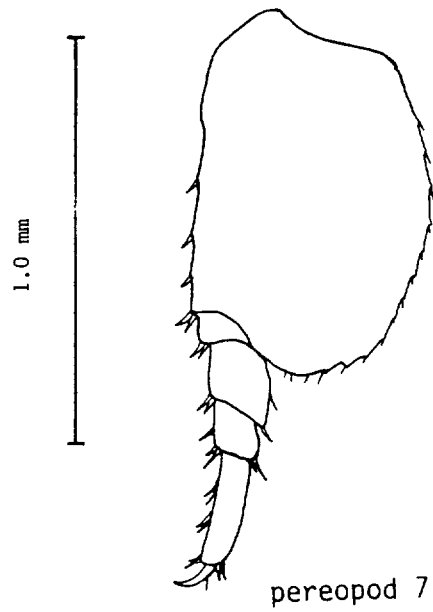
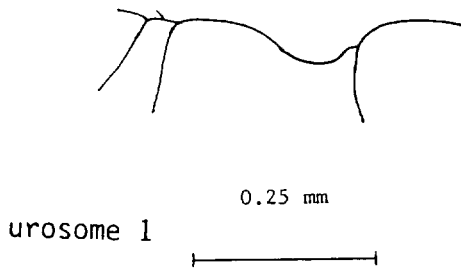
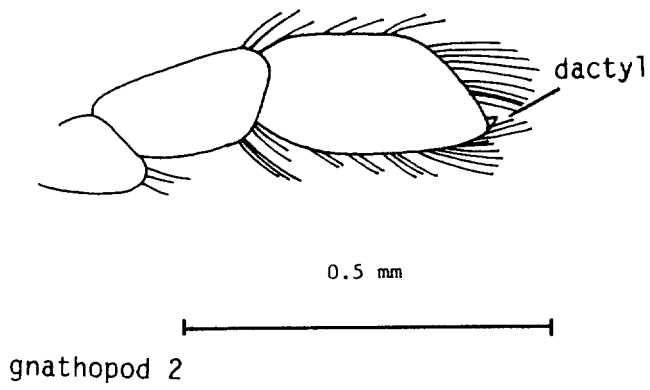
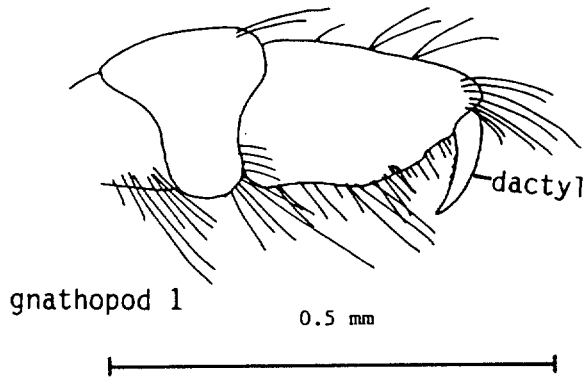

Onisimus glacialis G.O. Sars 1900

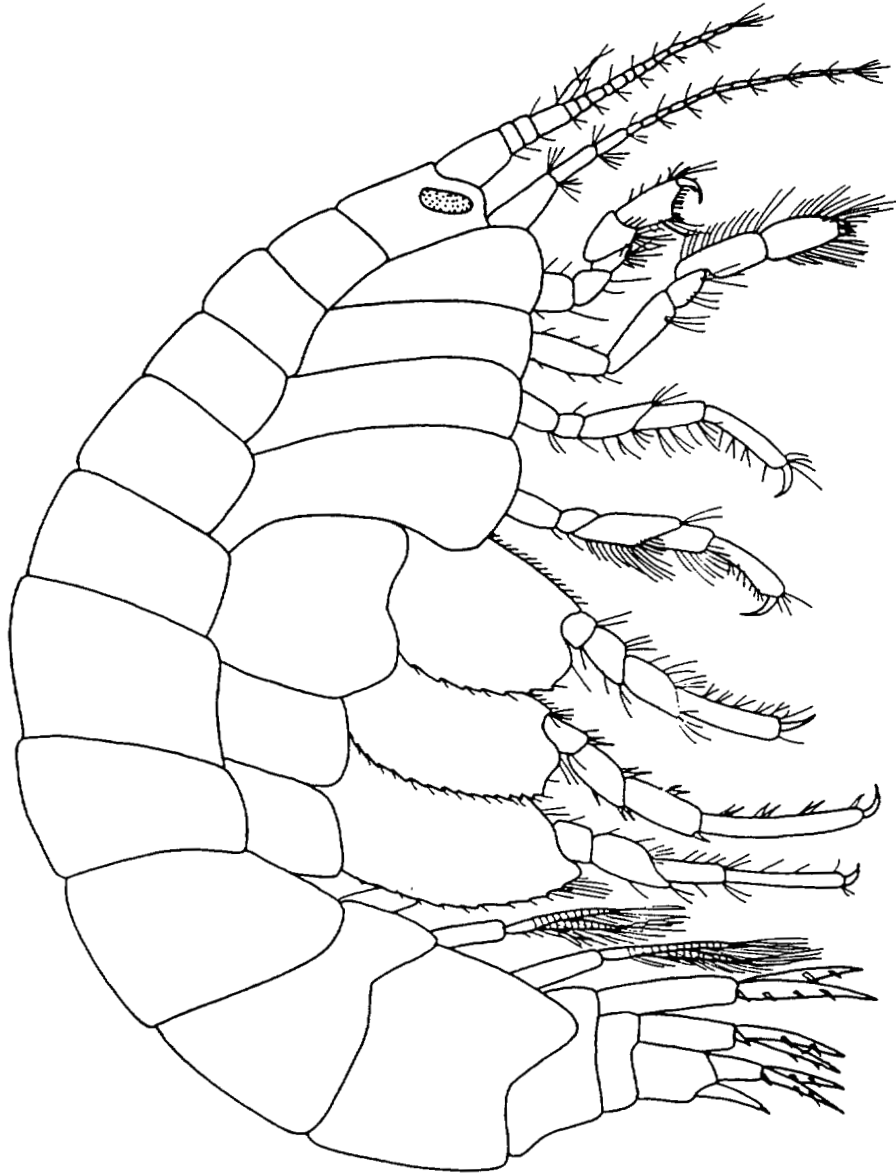

Onisimus litoralis (Krøyer) 1845

TL = 12.0 mm ♀

LYSIANASSIDAE

PLATE XXIII

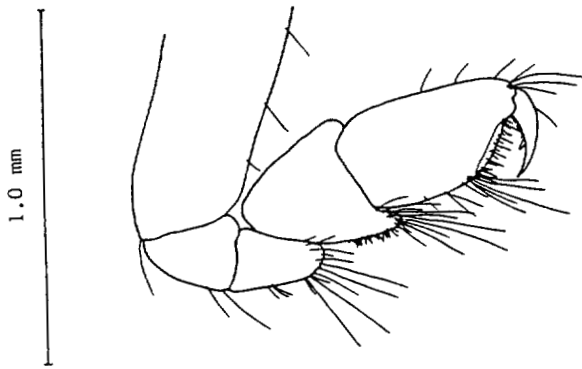

gnathopod 1

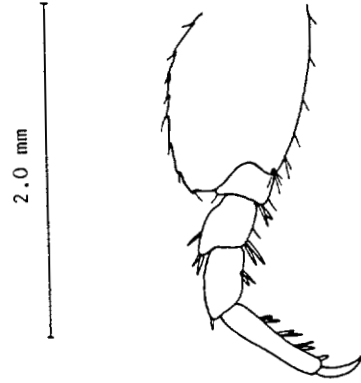

pereopod 6

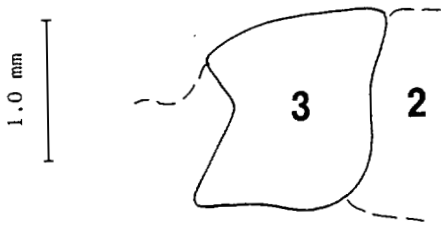

epimeral plate 3



urosome 1

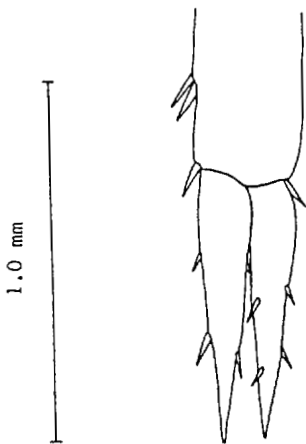

uropod 2

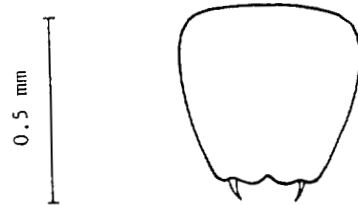

telson

Onisimus litoralis (Krøyer) 1845

## LYSIANASSIDAE

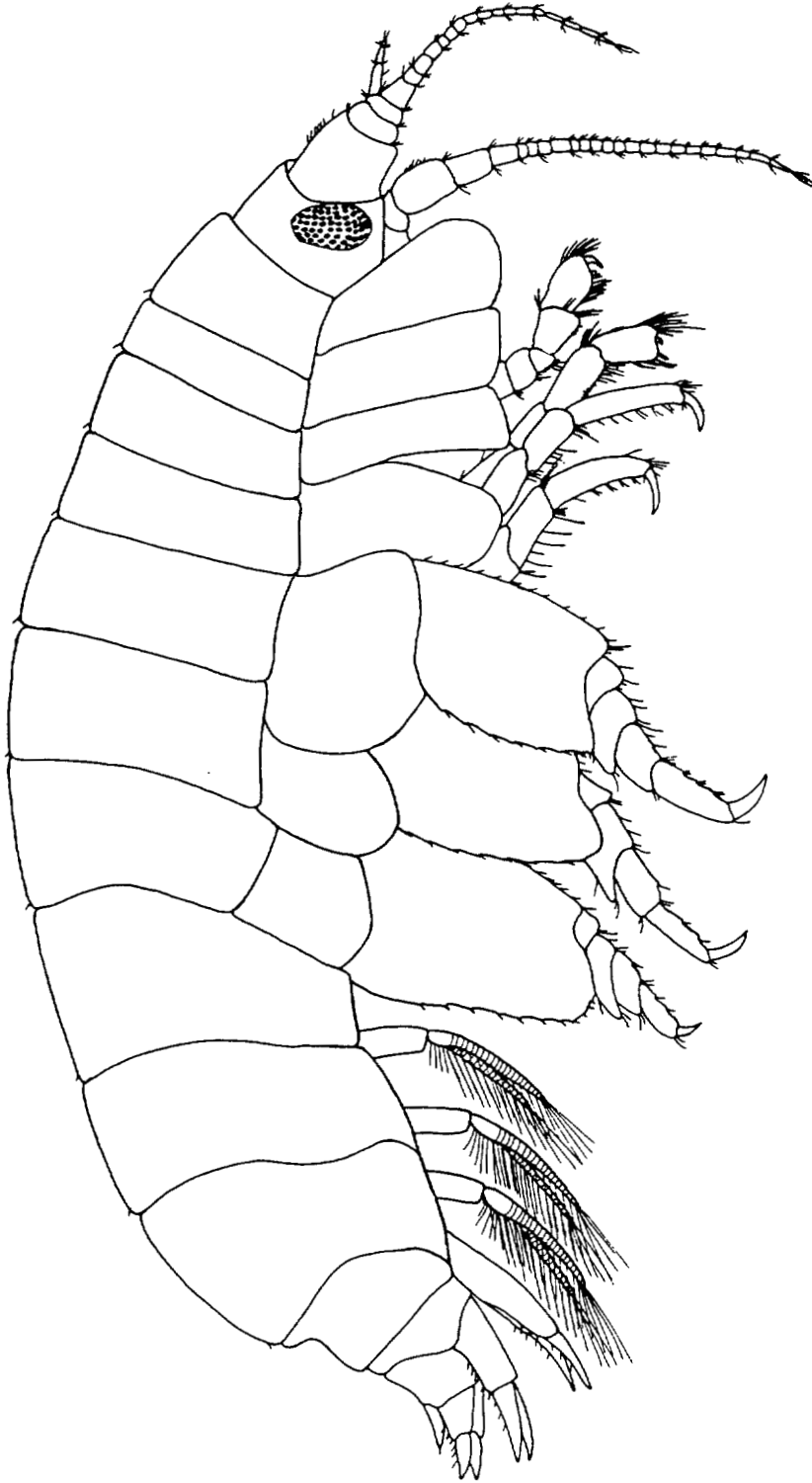

Onisimus nanseni G.O. Sars 1900

TL = 10.0 mm ♀

LYSIANASSIDAE

PLATE XXV

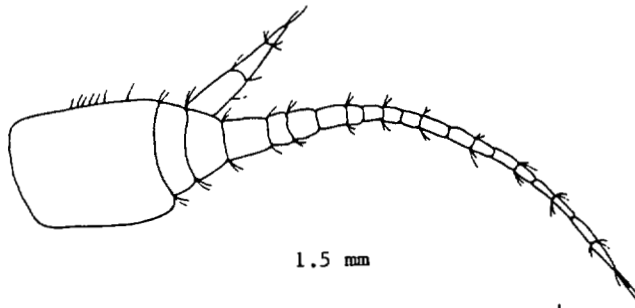

antenna 1

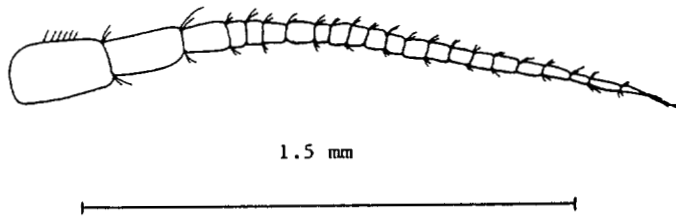

antenna 2

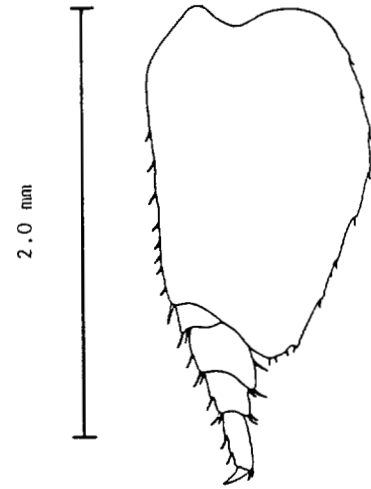

pereopod 7

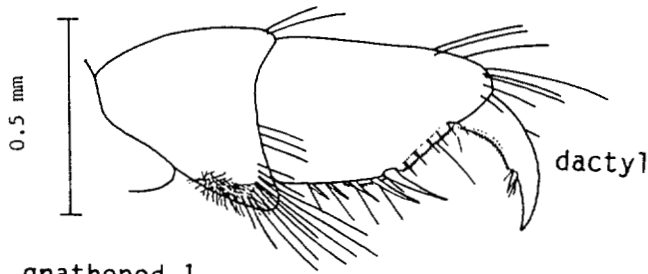

gnathopod 1

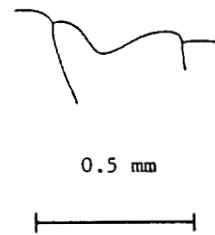

urosome 1

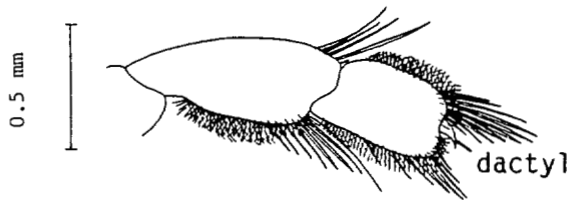

gnathopod 2

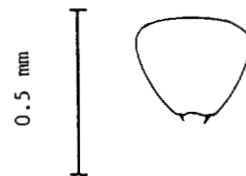

telson

Onisimus nanseni G.O. Sars 1900



LYSIANASSIDAE

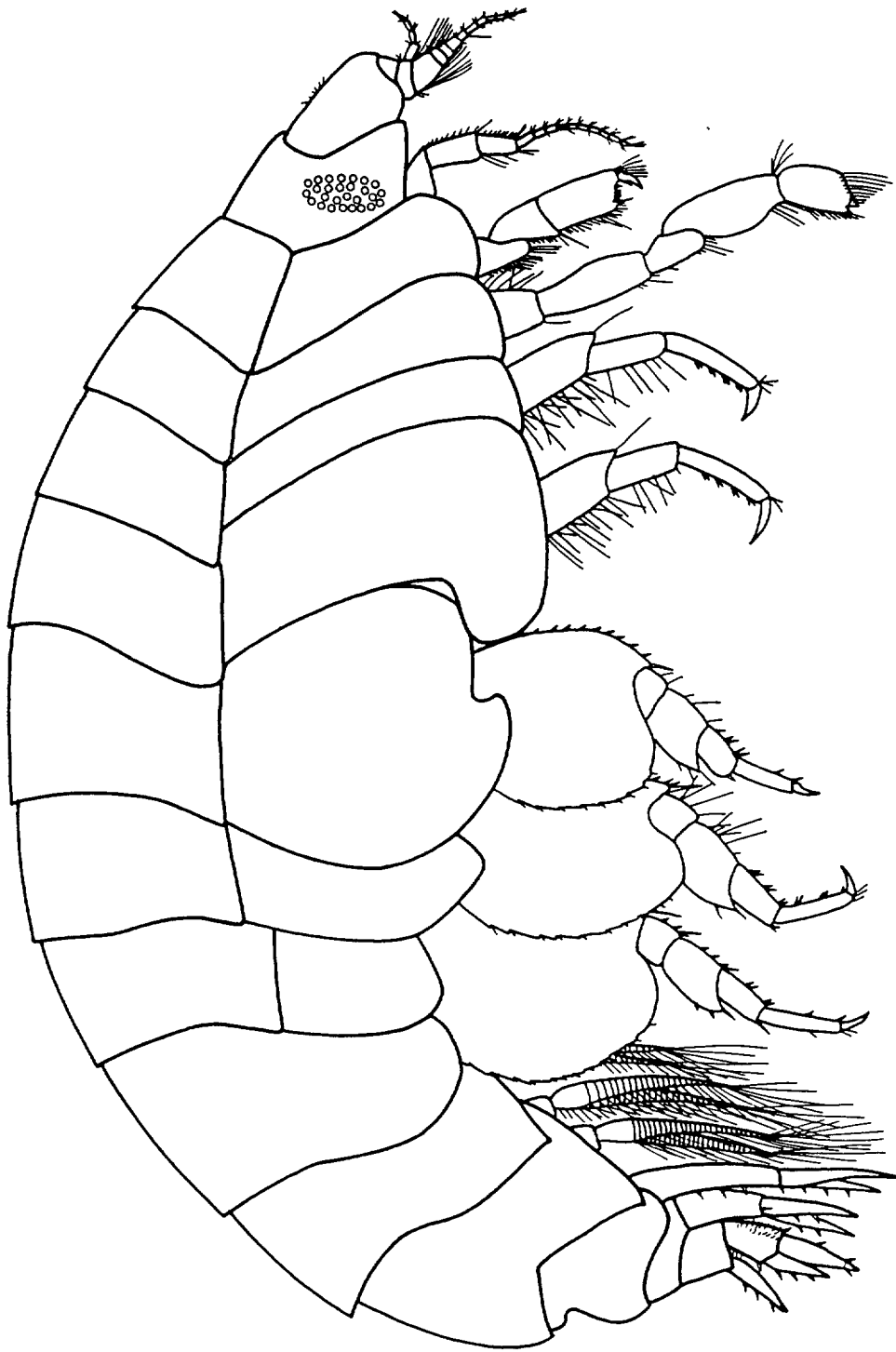

Orchomene minuta (Krøyer) 1846

TL = 7.4 mm ♀

LYSIANASSIDAE

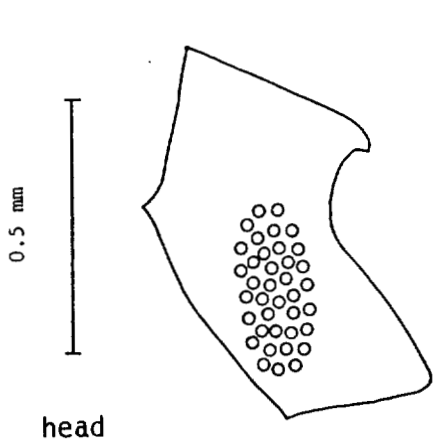

head

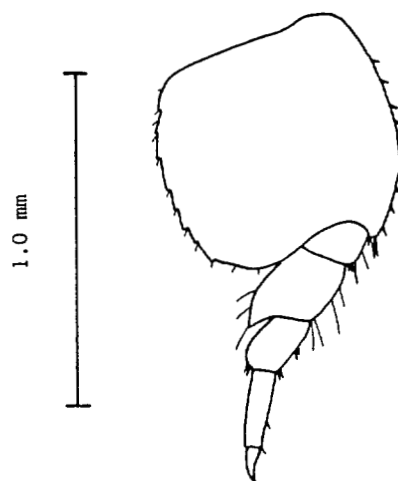

pereopod 5

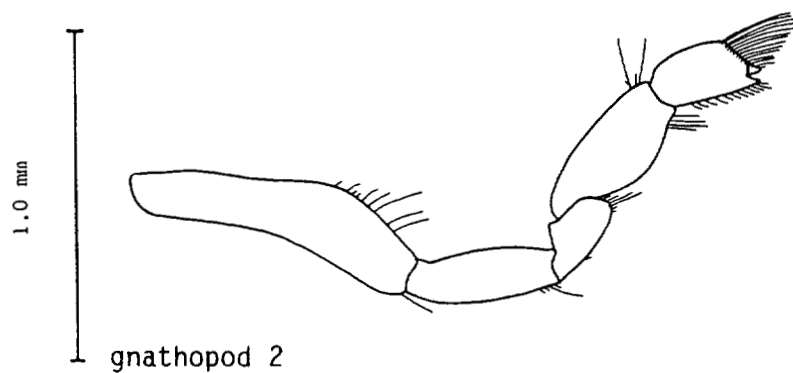

gnathopod 2

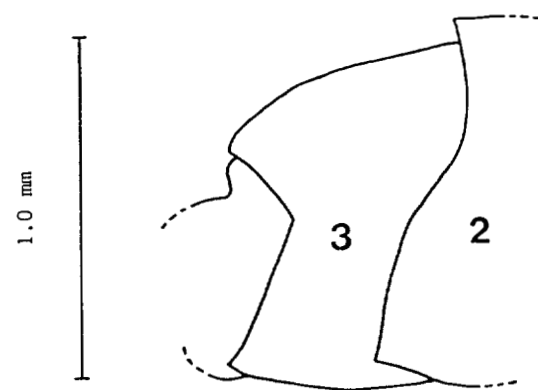

epimeral plate 3

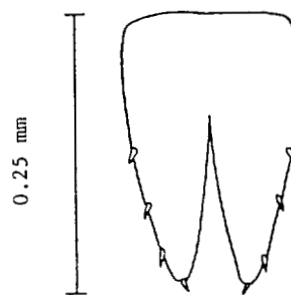

telson

*Orchomene minuta* (Krøyer) 1846

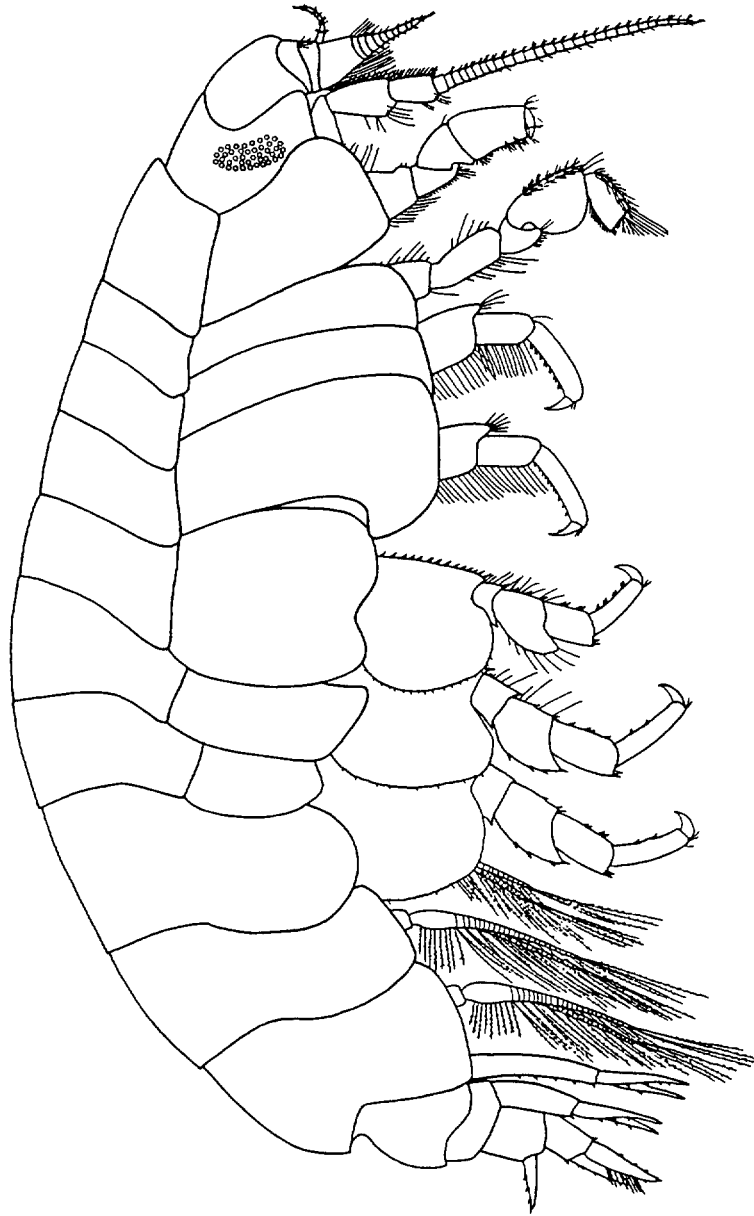

Orchomene pinguis (Boeck) 1861

TL = 9.0 mm ♂

LYSIANASSIDAE

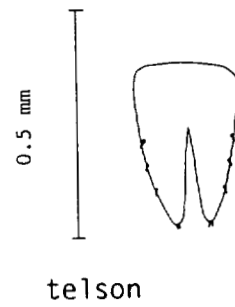
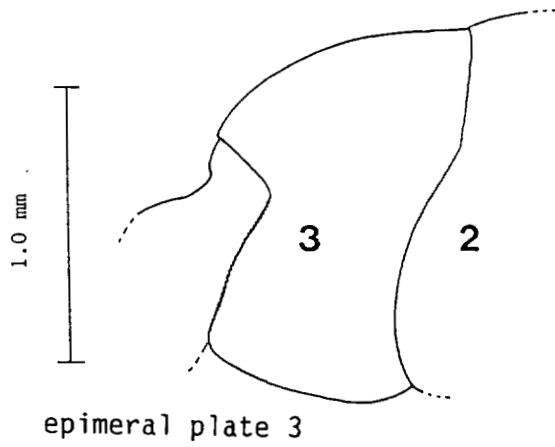
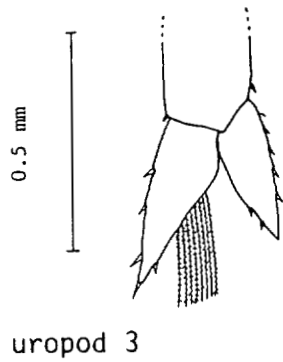
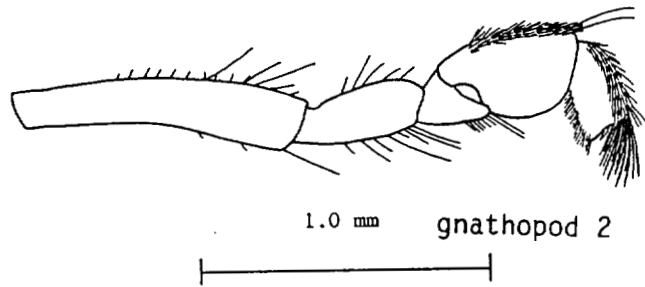
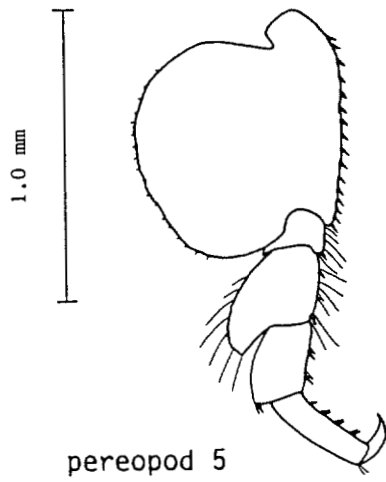
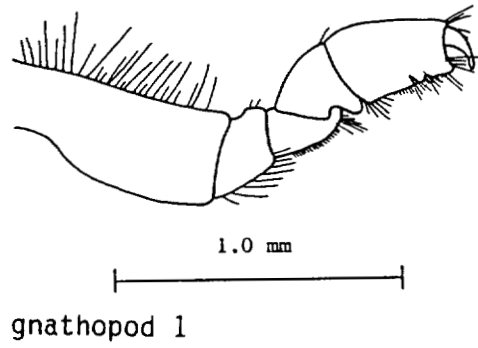
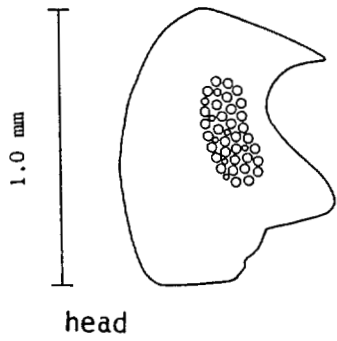

*Orchomene pinguis* (Boeck) 1861

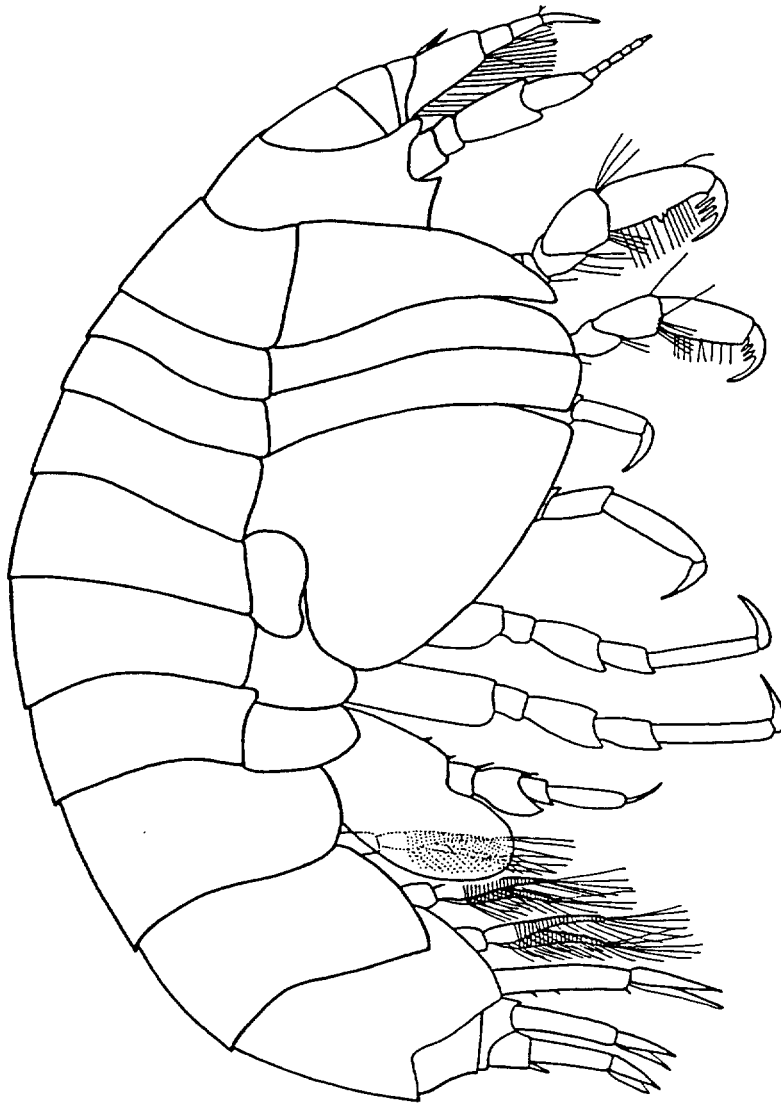

Andaniella pectinata G.O. Sars 1882

TL = 2.7 mm ♀

STEGOCEPHALIDAE

PLATE XXXI

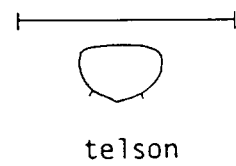
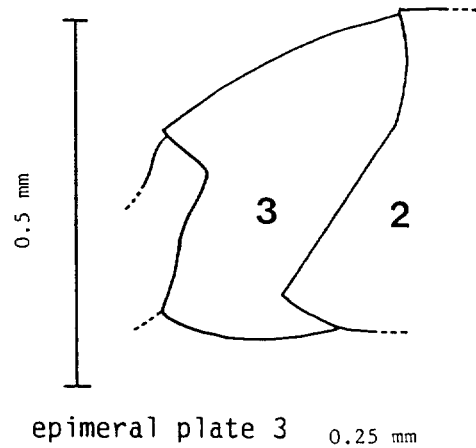
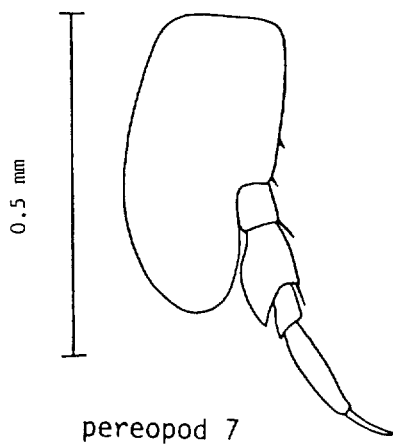
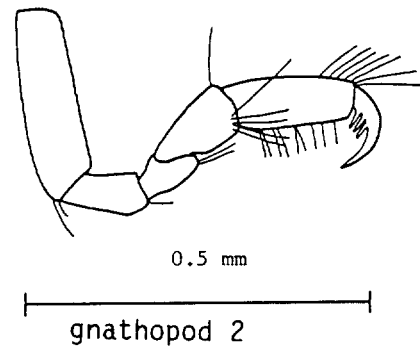
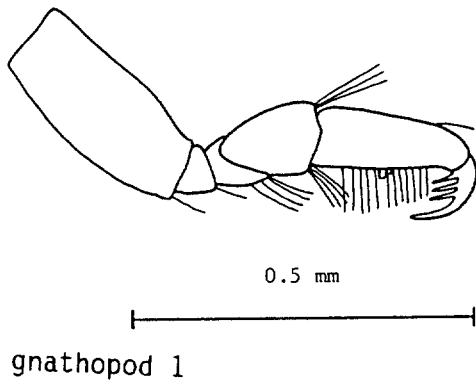
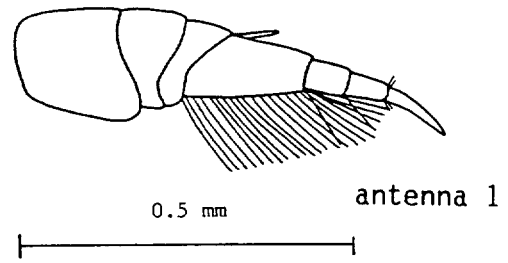
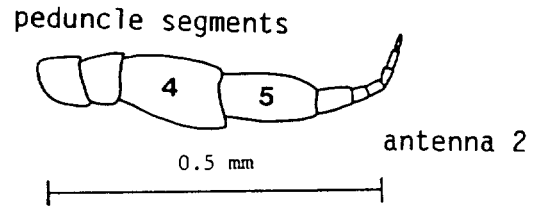
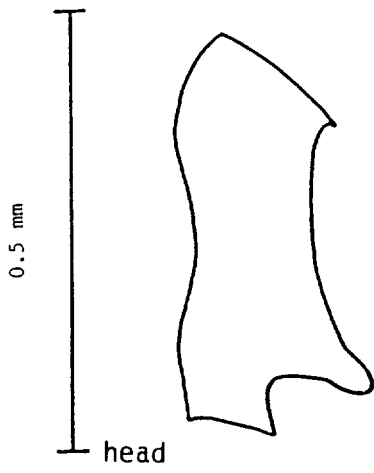

*Andaniella pectinata* G.O. Sars 1882

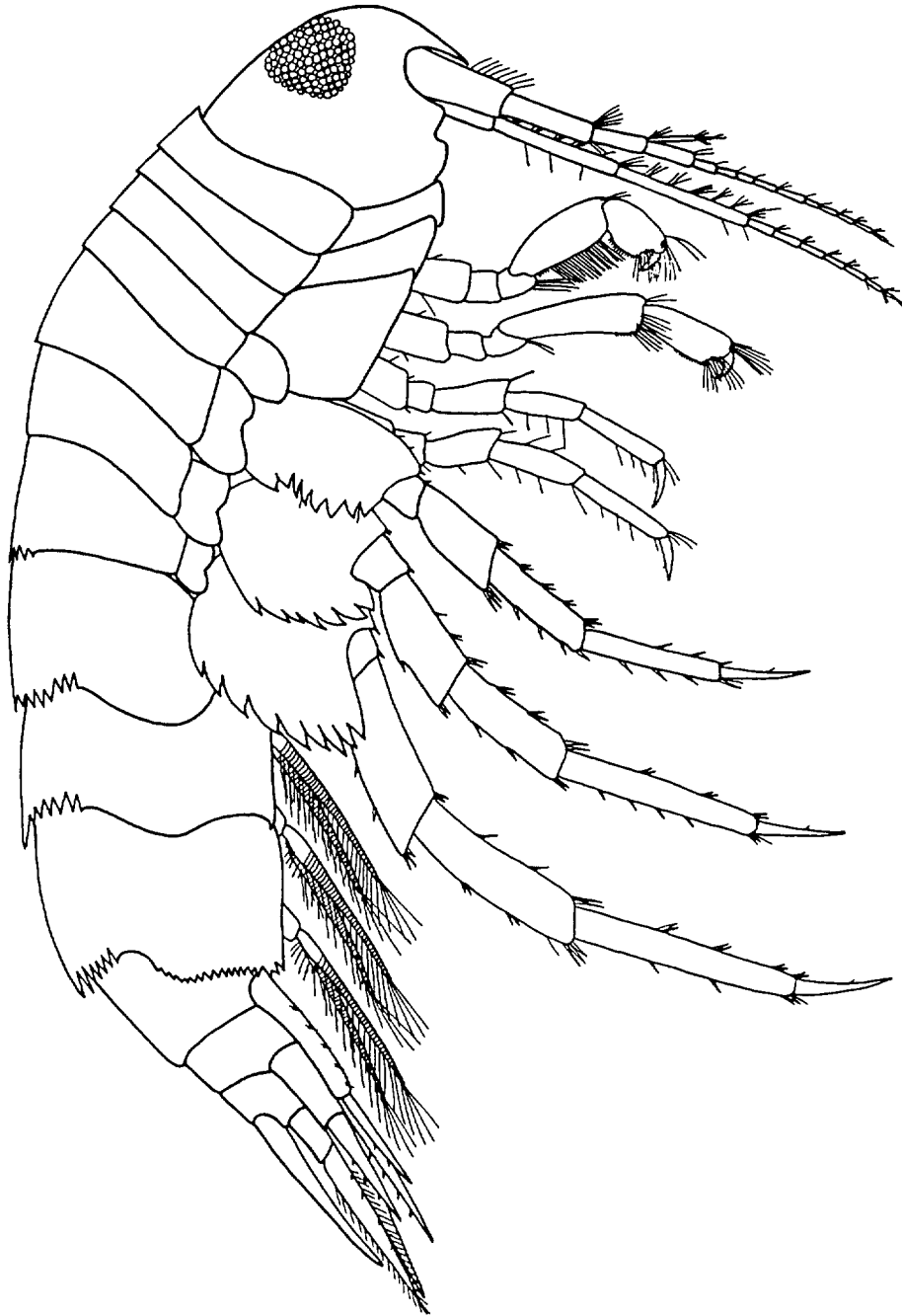

Syrrhoe crenulata Goes 1866

TL = 3.9 mm ♀

SYNOPIIDAE

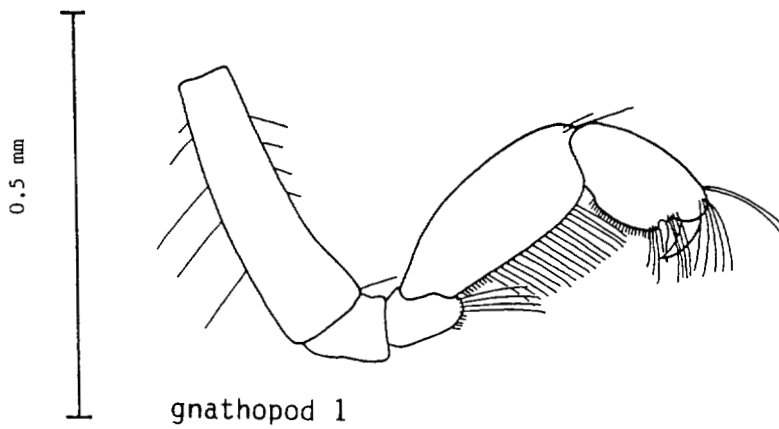
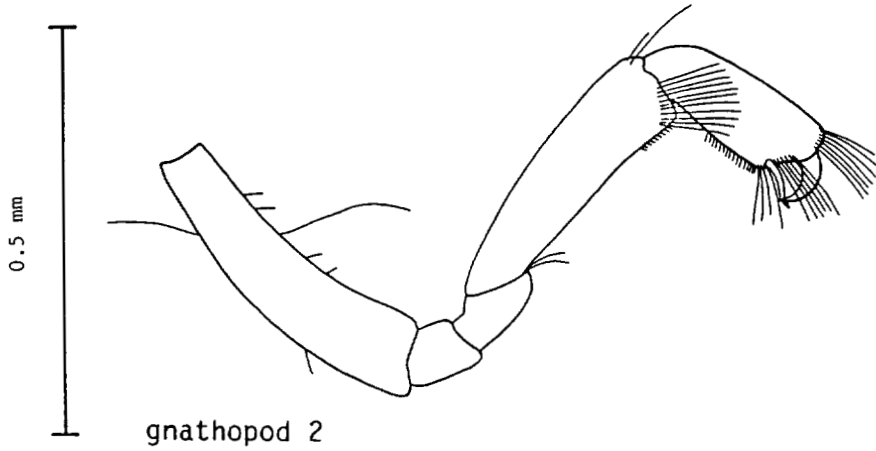
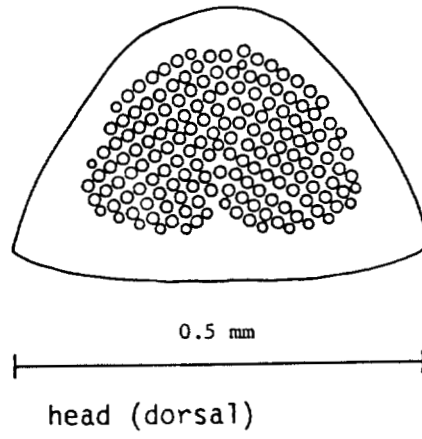
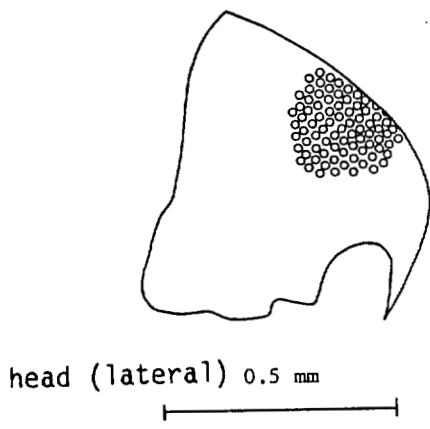

*Syrrhoe crenulata* Goes 1866



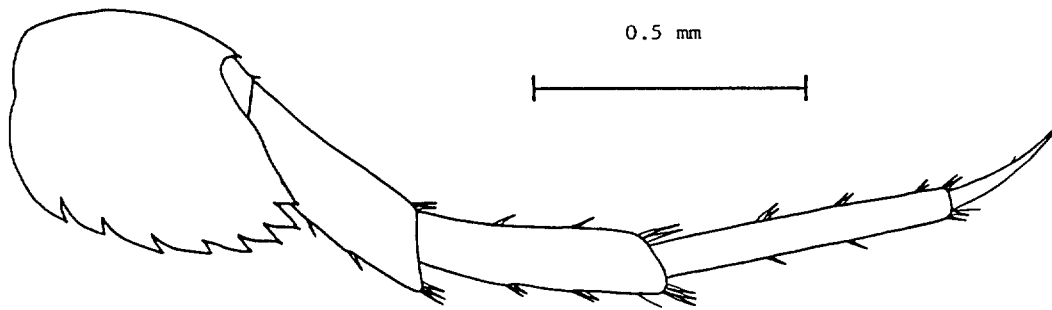

pereopod 7

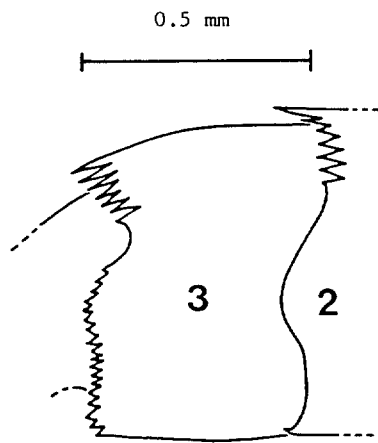

epimeral plate 3

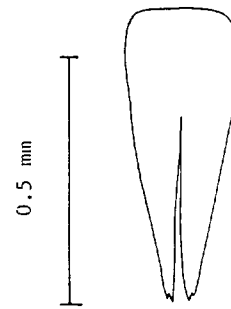

telson

Syrrhoe crenulata Goes 1866

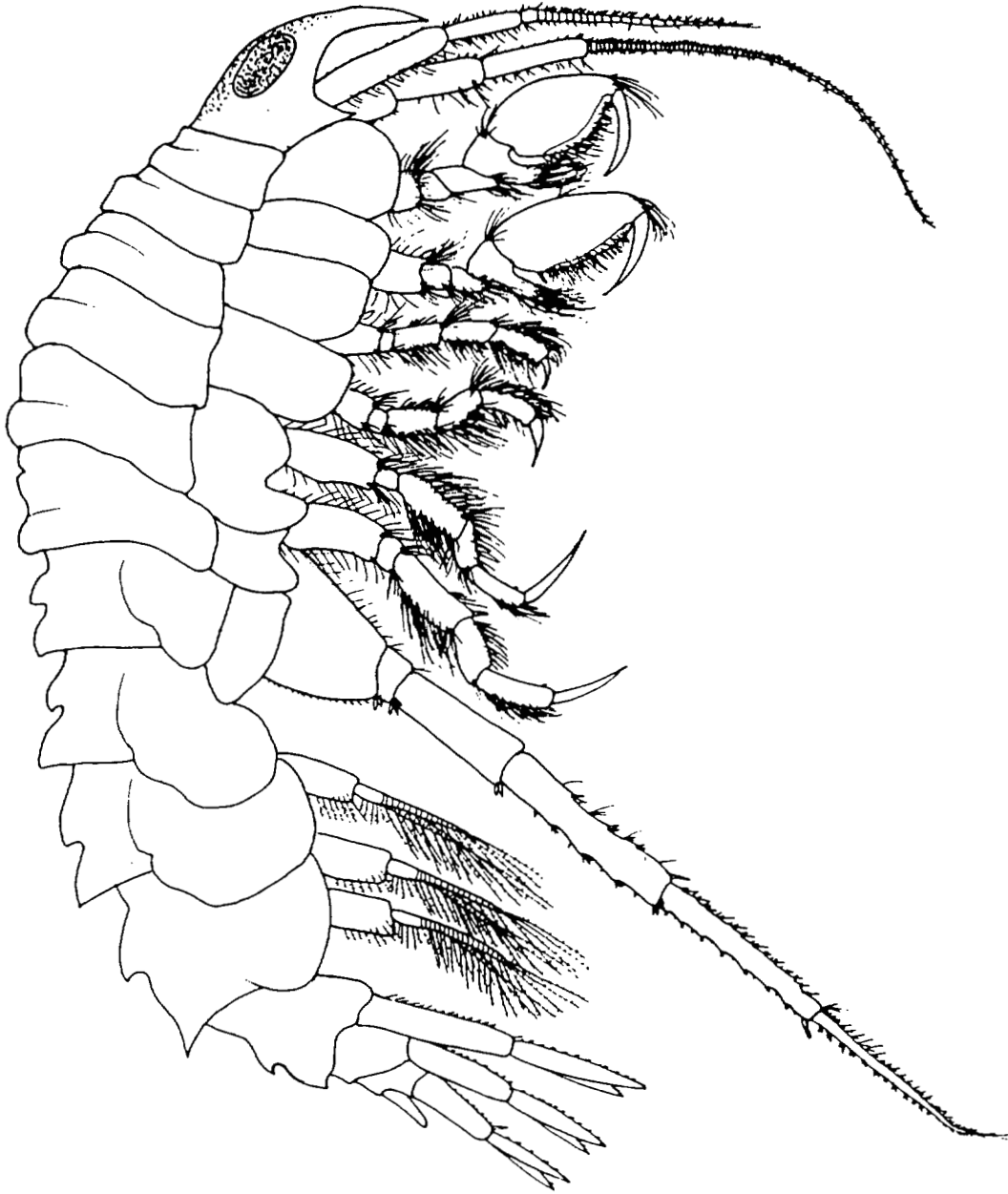

Acanthostepheia behringiensis (Lockington) 1877

TL = 26.0 mm ♂

## OEDICEROTIDAE



head

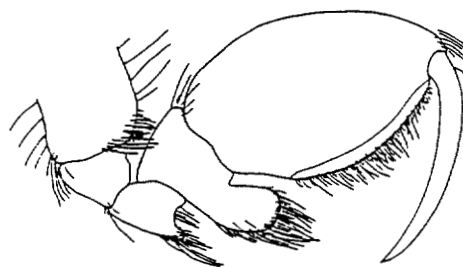

gnathopod 1

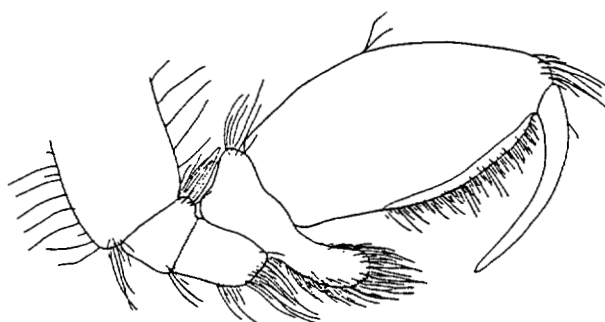

gnathopod 2

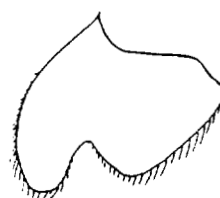

coxal plate 5

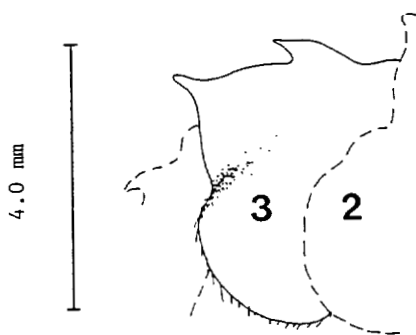

epimeral plate 3

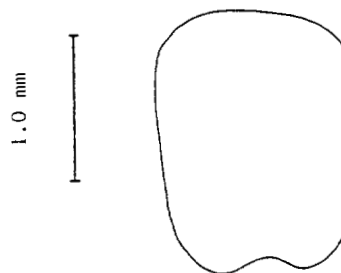

telson

Acanthostepheia behringiensis (Lockington) 1877

## OEDICEROTIDAE

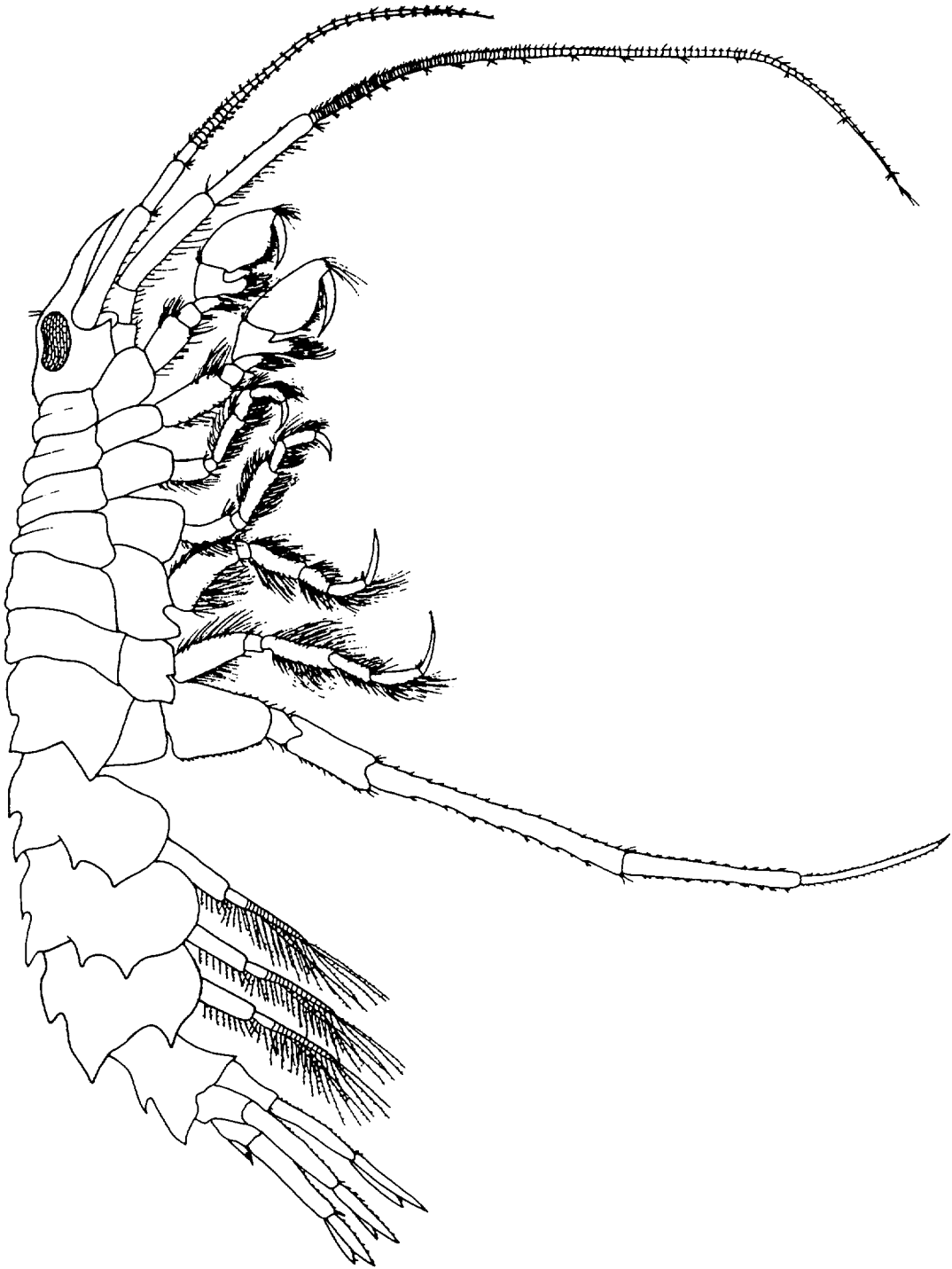

Acanthostepheia malmgreni (Goes) 1866

TL = 33.0 mm ♂

PLATE XXXVIII

OEDICEROTIDAE

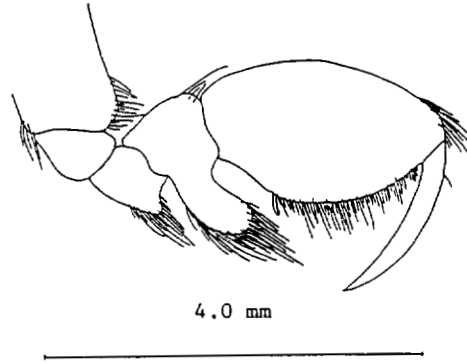
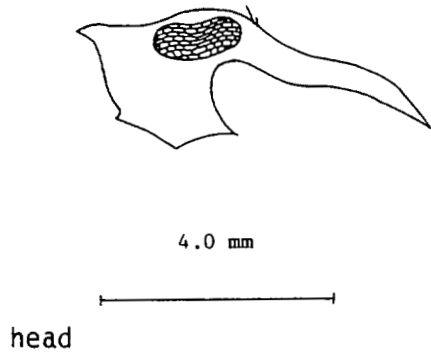

gnathopod 1

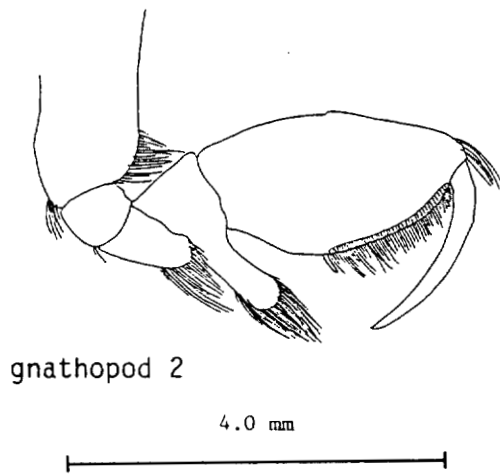

gnathopod 2

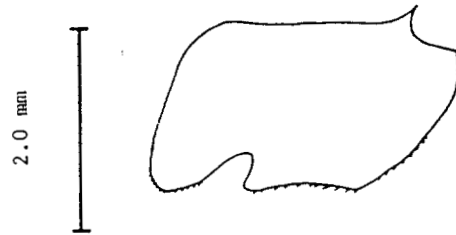

coxal plate 5

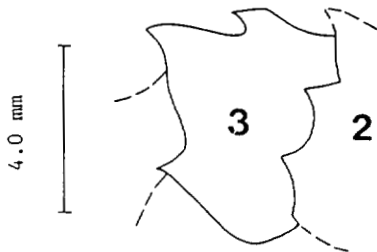

epimeral plate 3

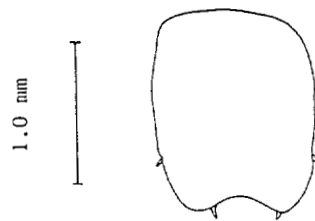

telson

Acanthostephea malmgreni (Goes) 1866

OEDICEROTIDAE

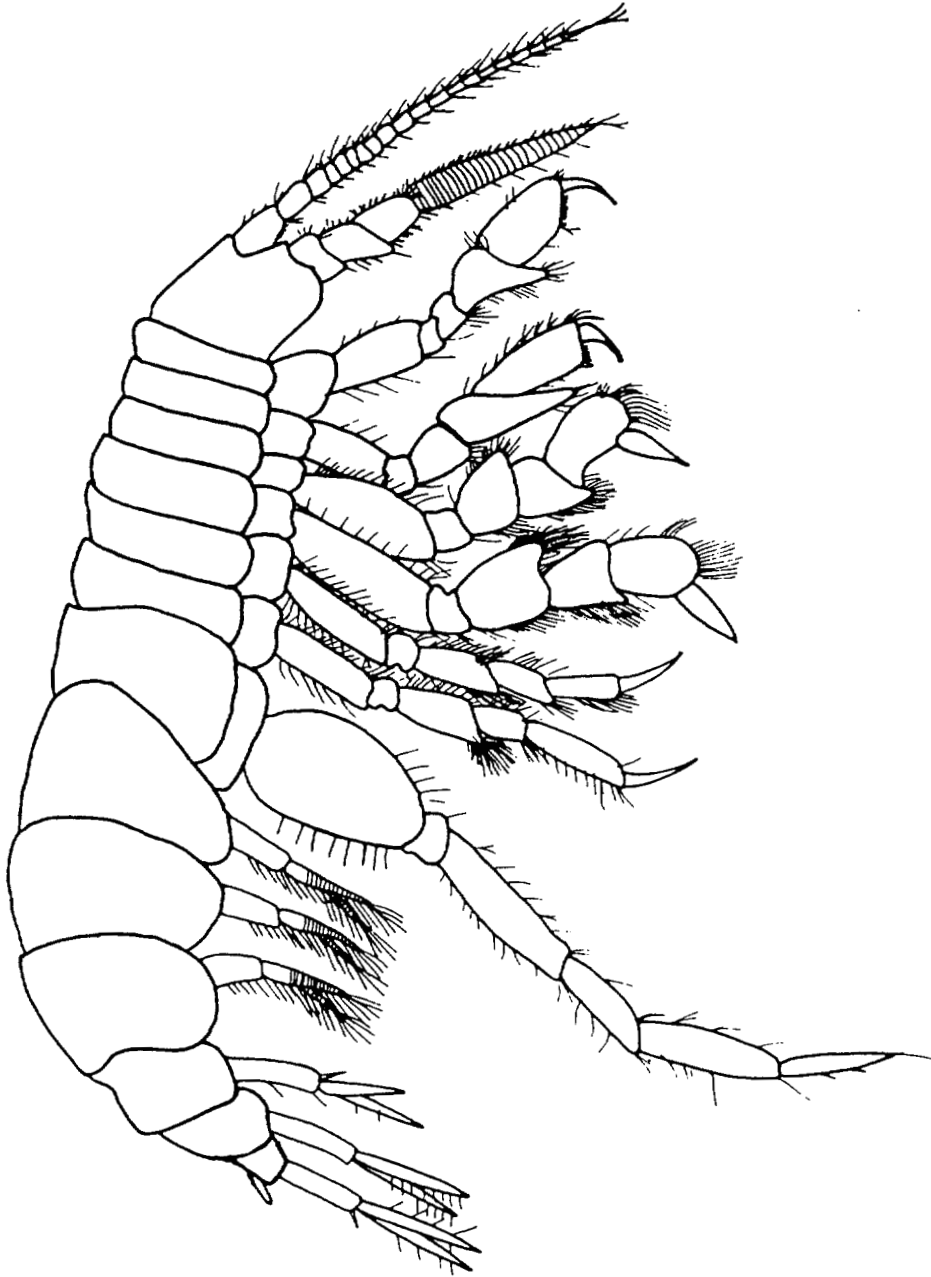

Aceroides latipes G.O. Sars 1895

TL = 7.0 mm ♀

OEDICEROTIDAE

PLATE XL

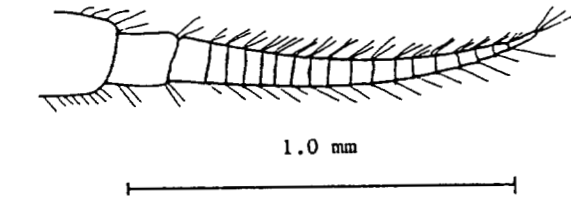

antenna 1

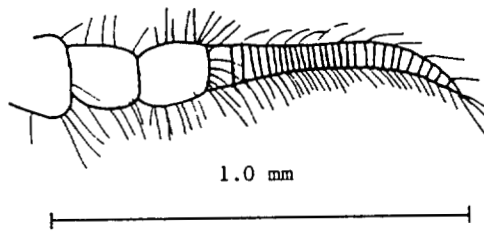

antenna 2

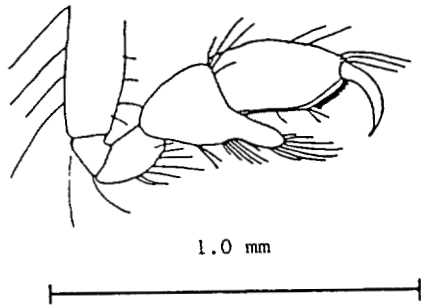

gnathopod 1

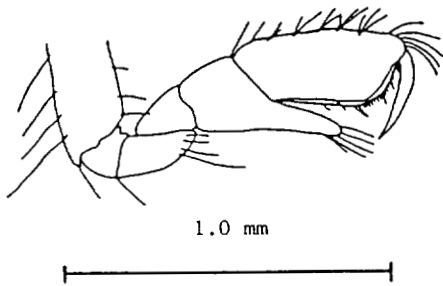

gnathopod 2

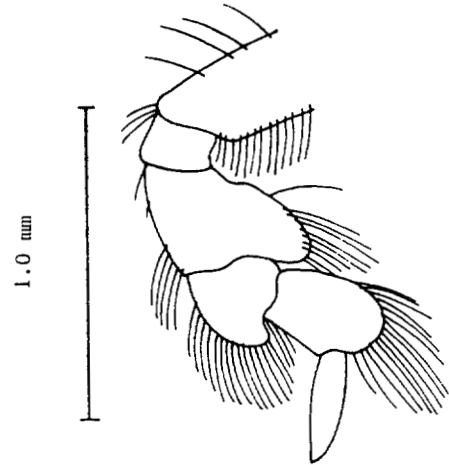

pereopod 6

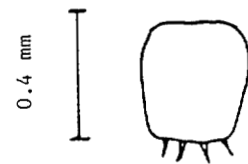
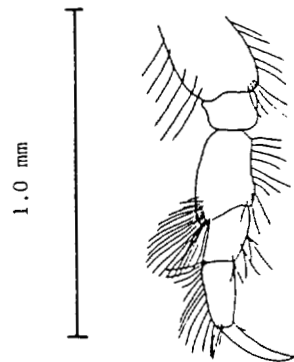

telson

Aceroides latipes G.O. Sars 1895

OEDICEROTIDAE

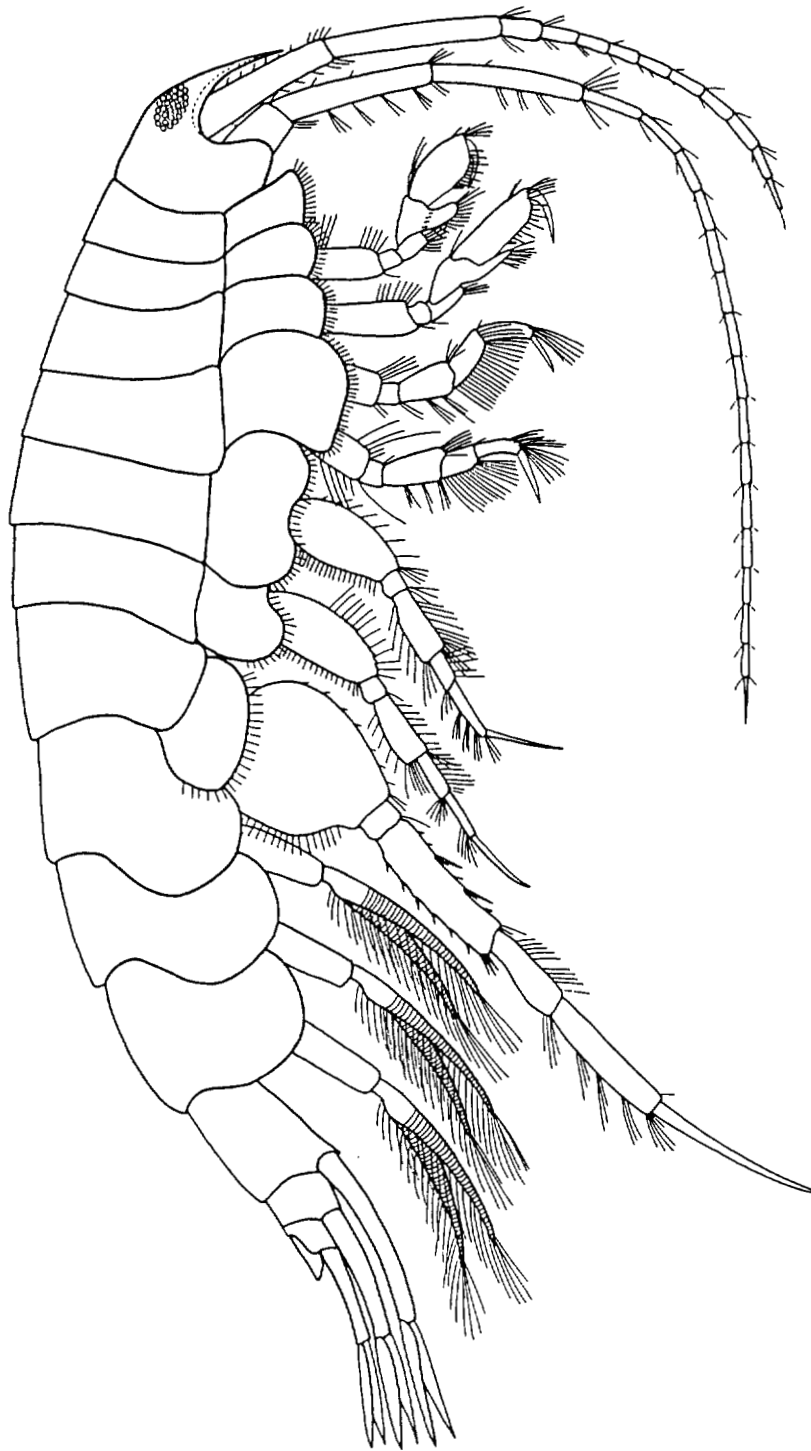

Monoculodes packardi Boeck 1871

TL = 6.7 mm ♀



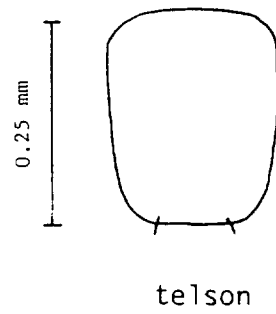
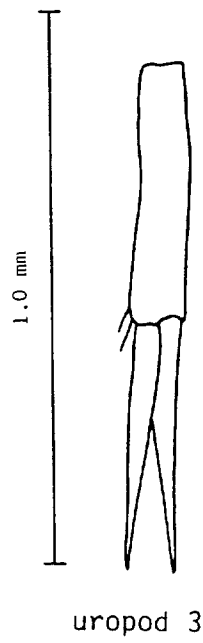
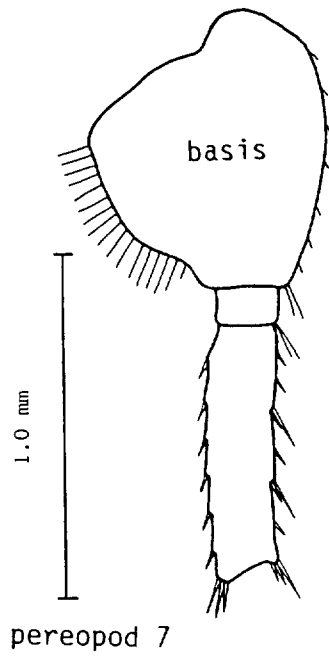
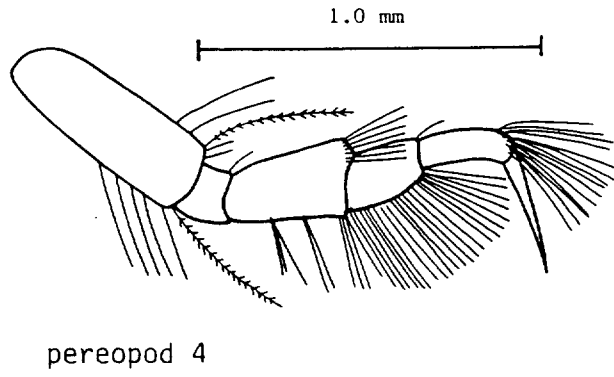
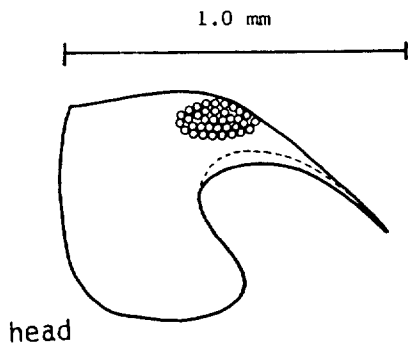

Monoculodes packardi Boeck 1871

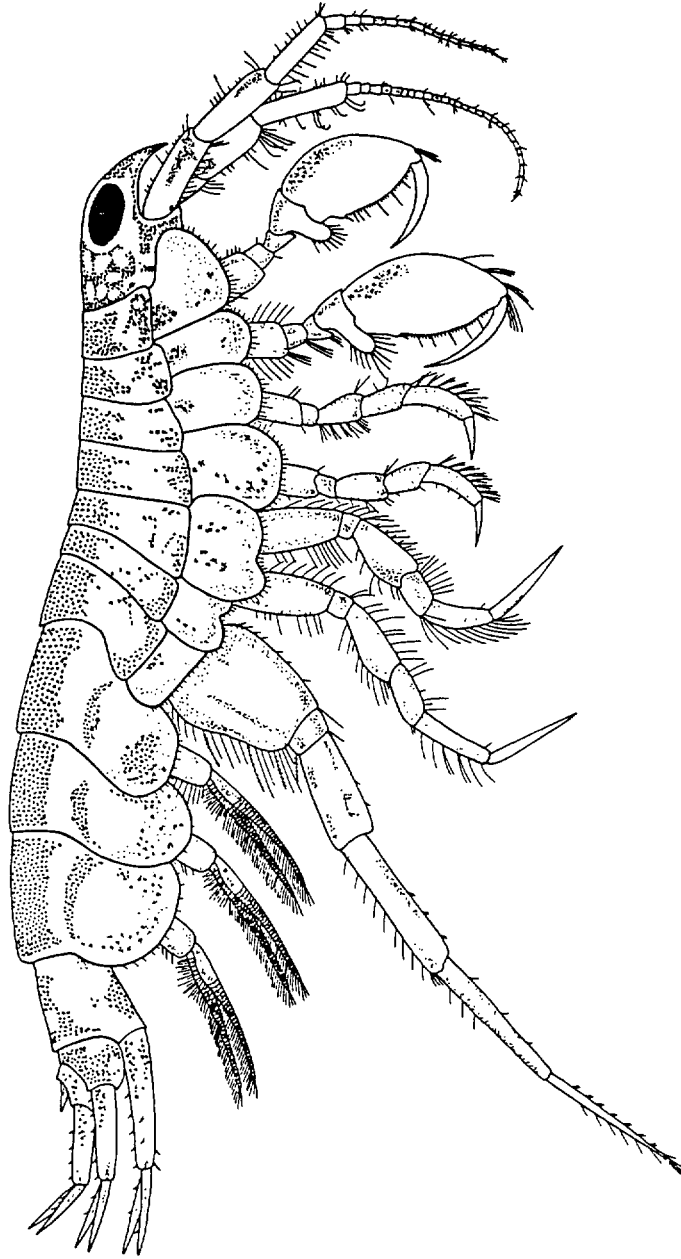

Oediceros saginatus Krøyer 1842

TL = 7.4 mm ♂

OEDICEROTIDAE

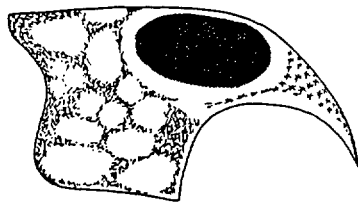

1.0 mm

head (lateral)

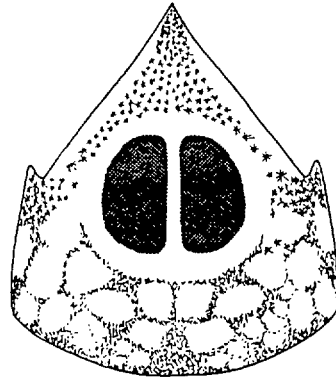

1.0 mm head (dorsal)

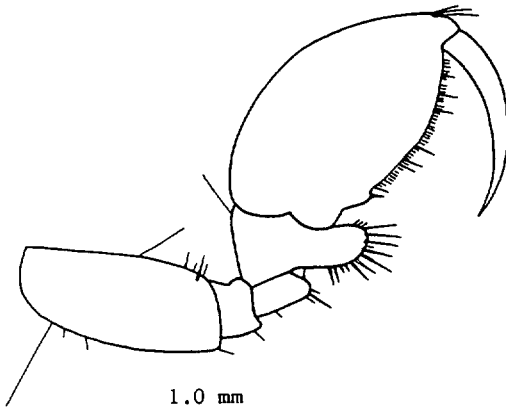

1.0 mm

gnathopod 1

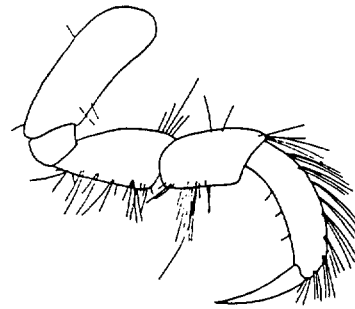

1.0 mm

pereopod 3

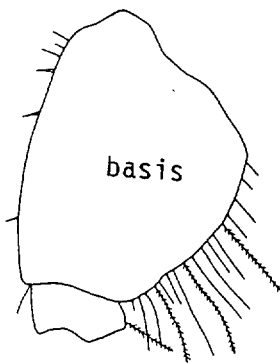

basis

1.0 mm

pereopod 7

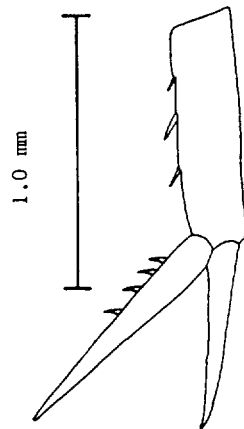

1.0 mm

uropod 3

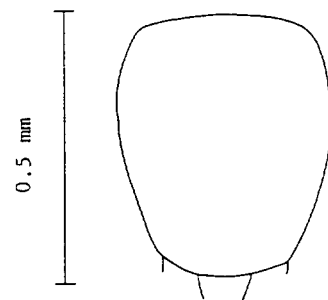

0.5 mm

telson

Oediceros saginatus Krøyer 1842

## OEDICEROTIDAE

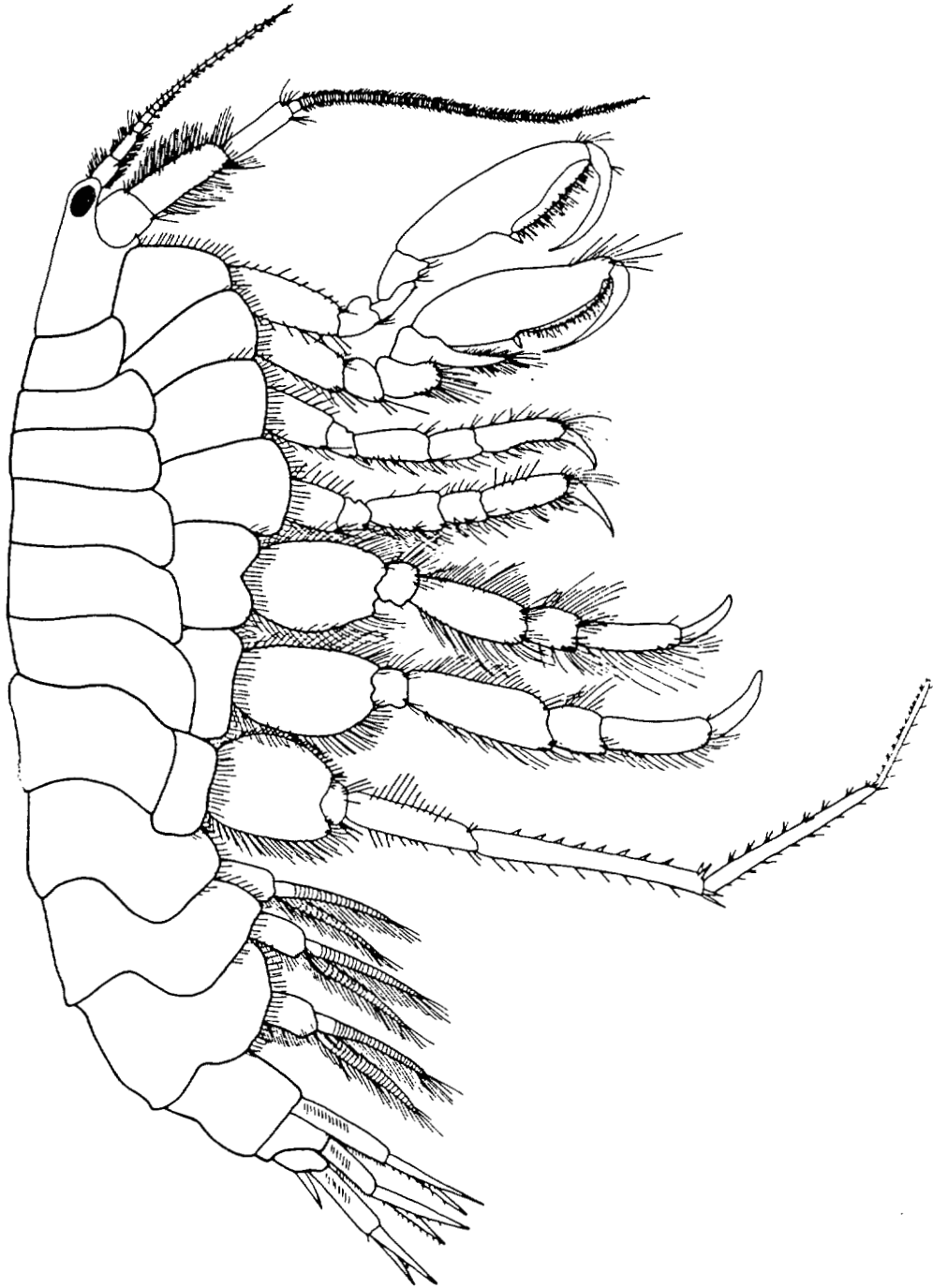

Paroediceros lynceus (M. Sars 1858)

TL = 22.0 mm ♂

OEDICEROTIDAE

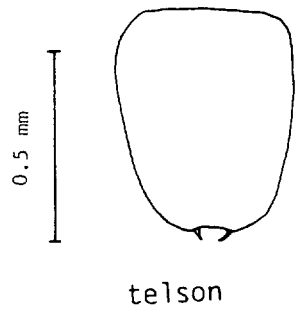
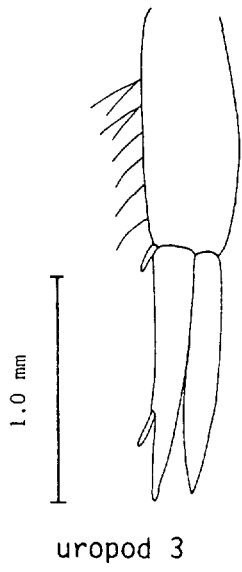
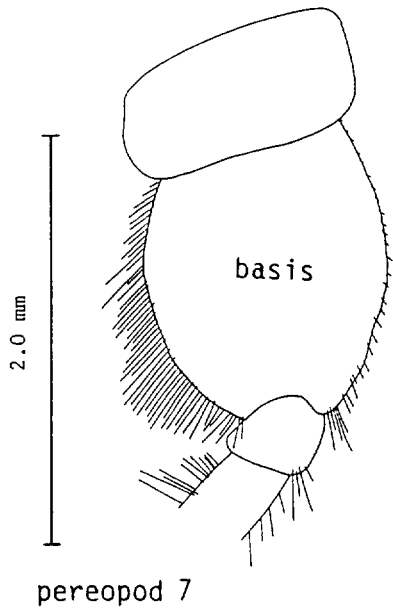
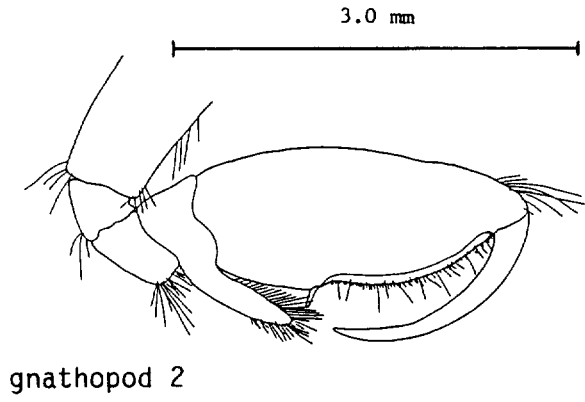
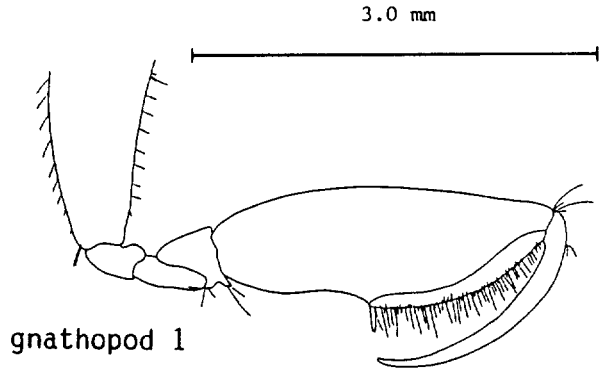
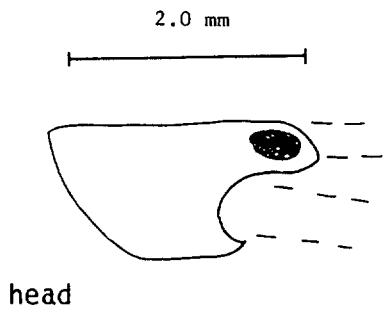

Paroediceros lynceus (M. Sars 1858)

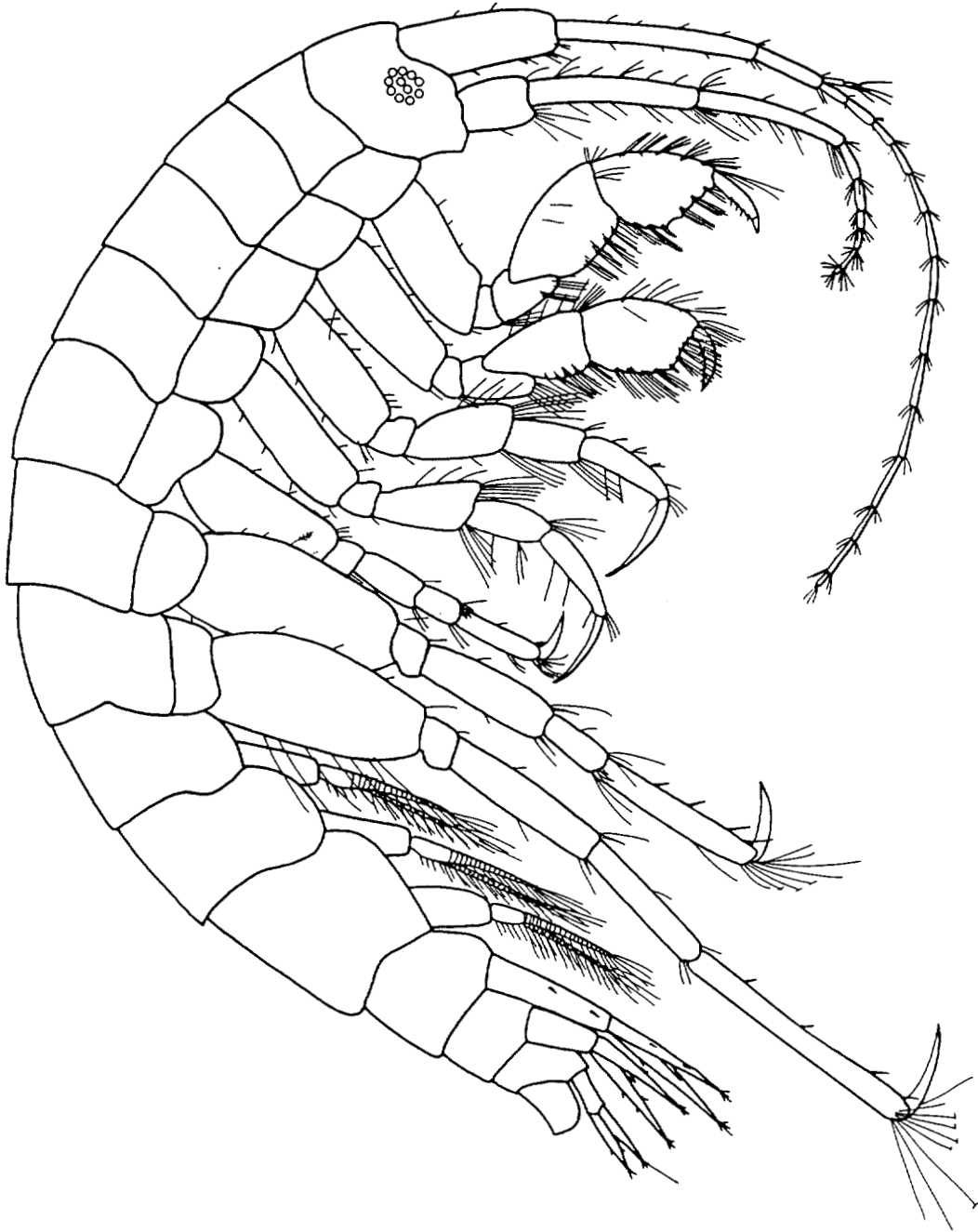

Lembos borealis Myers 1976

TL = 4.2 mm ♂

COROPHIIDAE

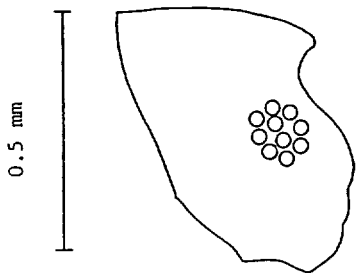

head

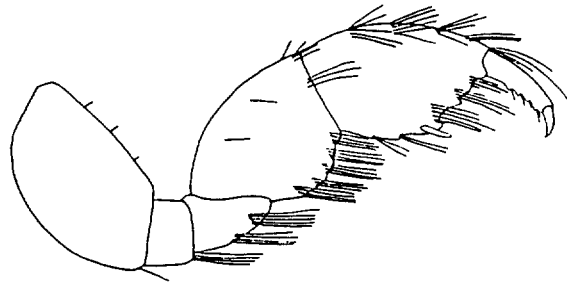

gnathopod 1

1.0 mm

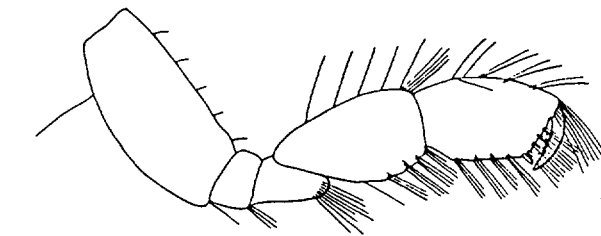

gnathopod 2

1.0 mm

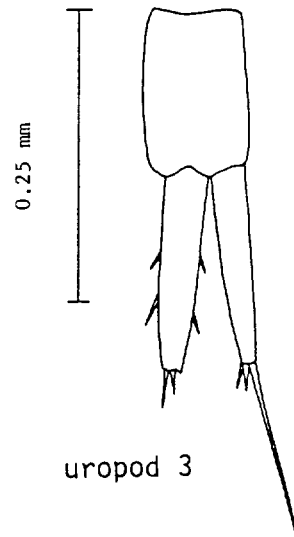

0.25 mm

uropod 3

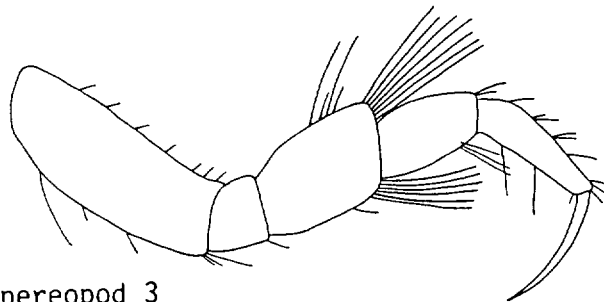

pereopod 3

1.0 mm

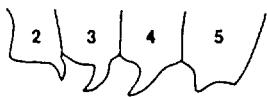

sternal process

1.0 mm

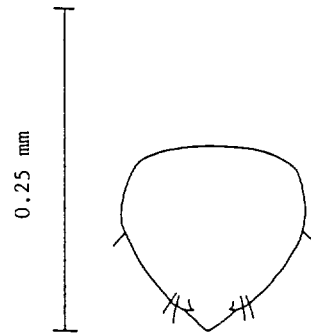

0.25 mm

telson

Lembos borealis Myers 1976

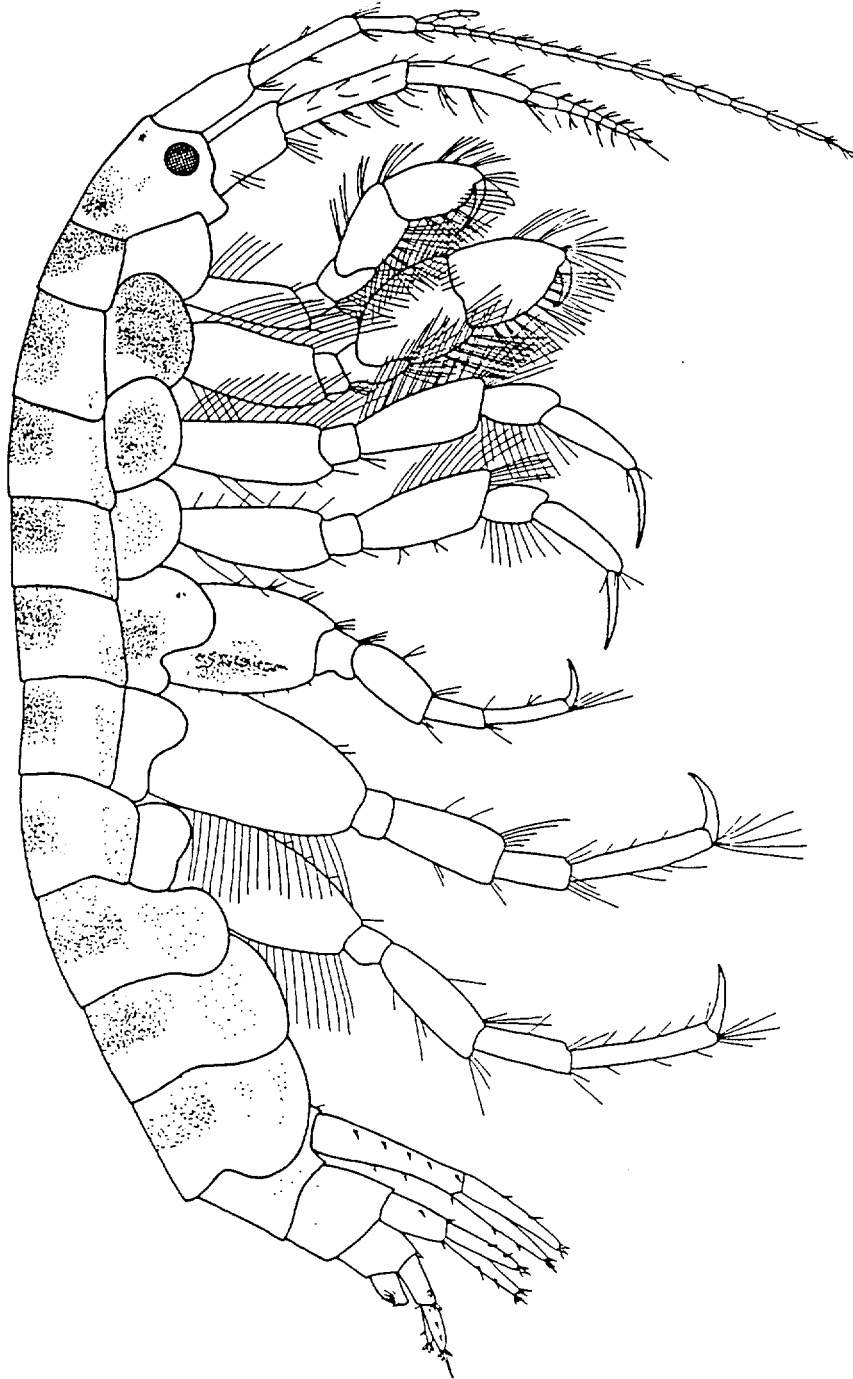

Protomeдея fasciata Krøyer 1842

TL = 4.4 mm ♂



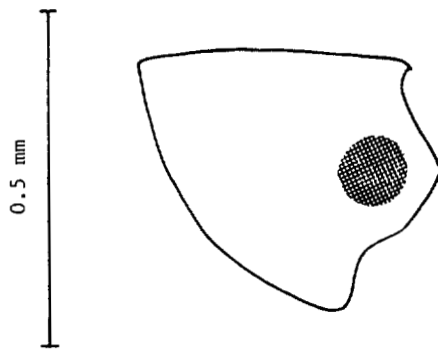

head

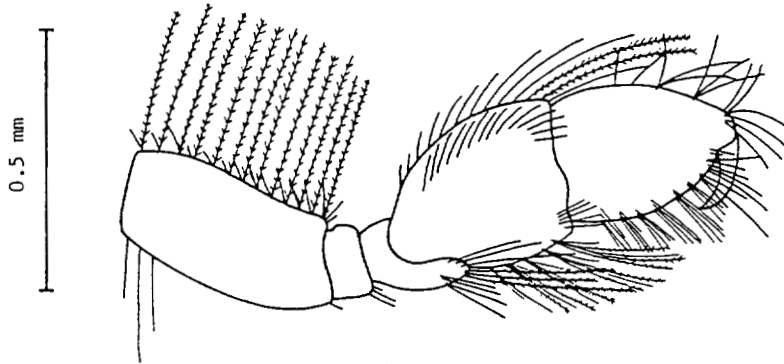

gnathopod 2

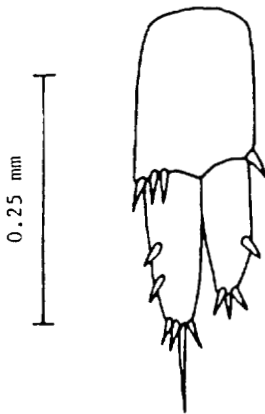

uropod 3

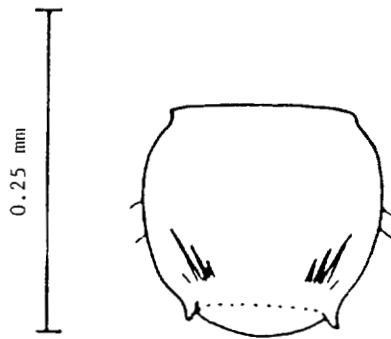

telson

Protomeдея fasciata Krøyer 1842

EUSIRIDAE

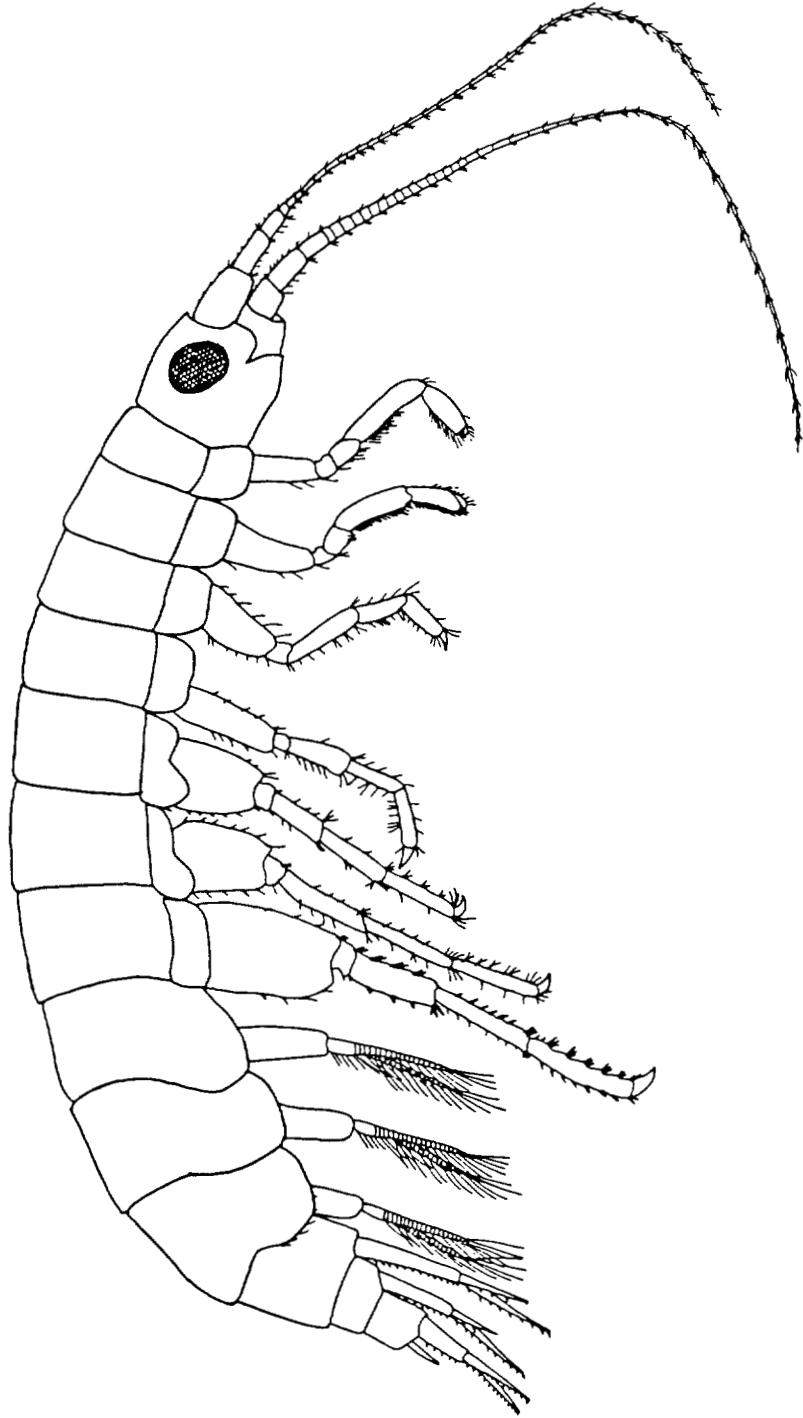

Apherusa glacialis (Hansen) 1887

TL = 4.0 mm ♀

EUSIRIDAE

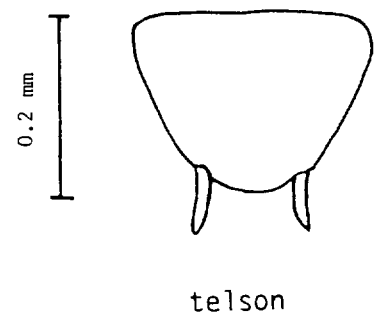
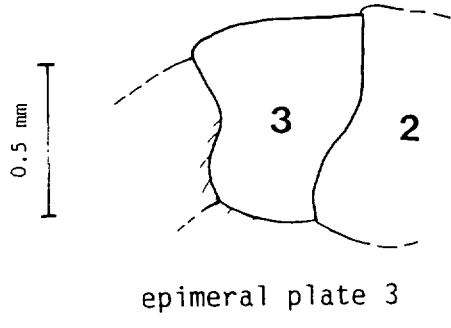
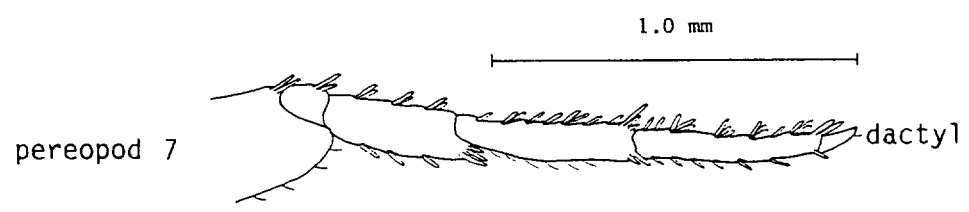
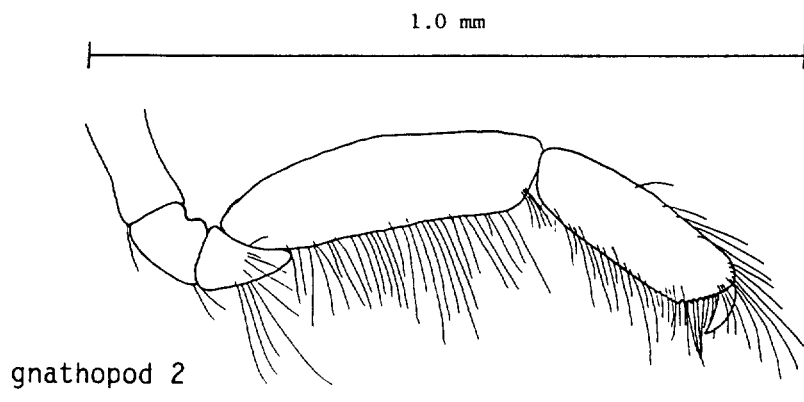
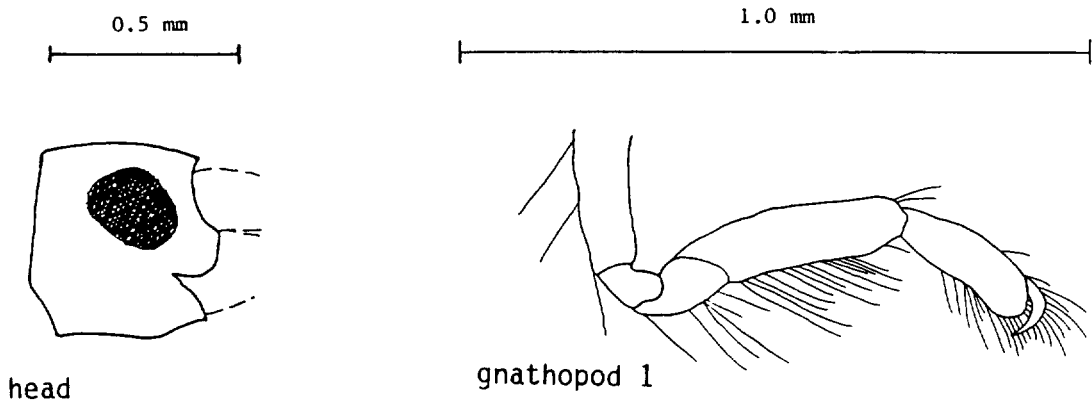

Apherusa glacialis (Hansen) 1887

EUSIRIDAE

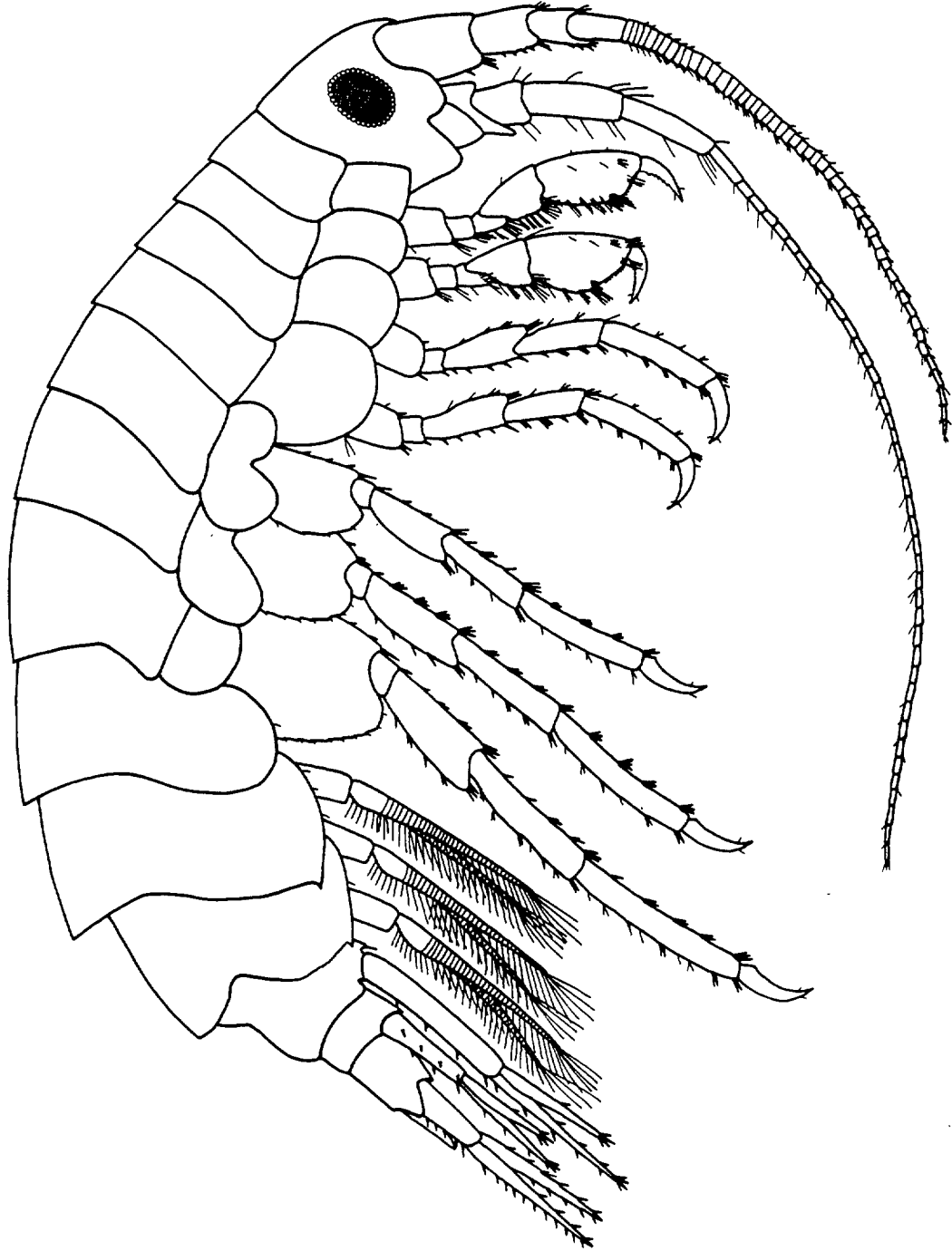

Apherusa megalops G.O. Sars 1882

TL = 6.0 mm ♀

EUSIRIDAE

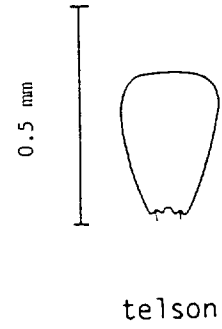
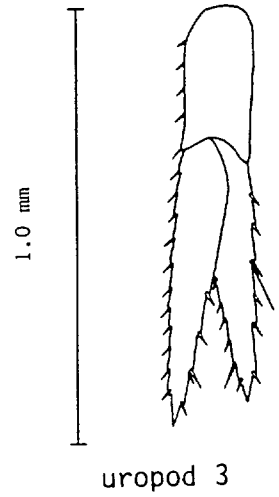
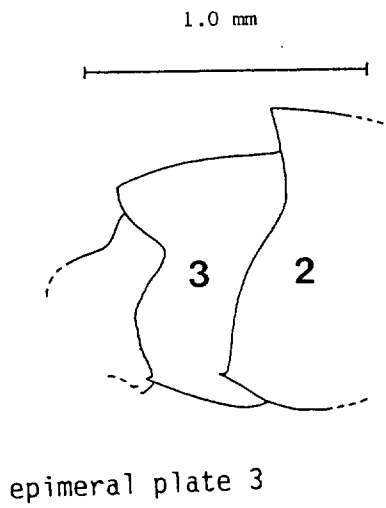
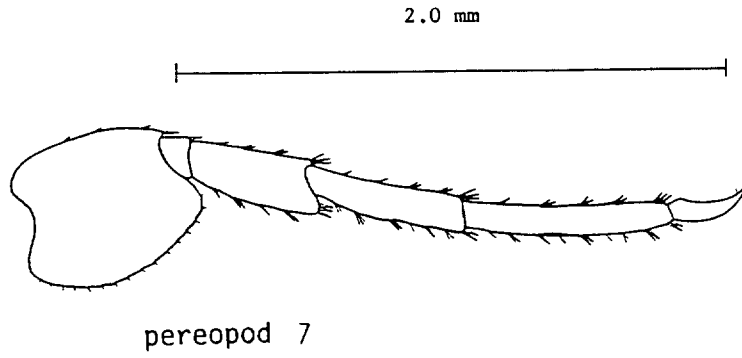
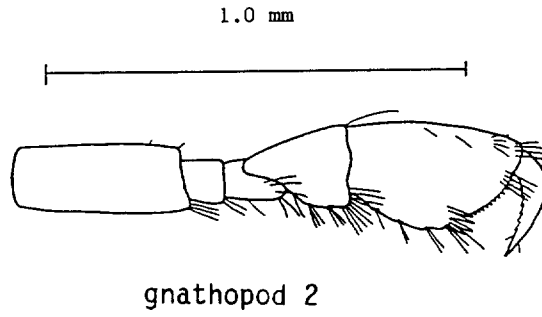
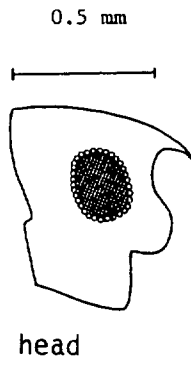

Apherusa megalops G.O. Sars 1882

EUSIRIDAE

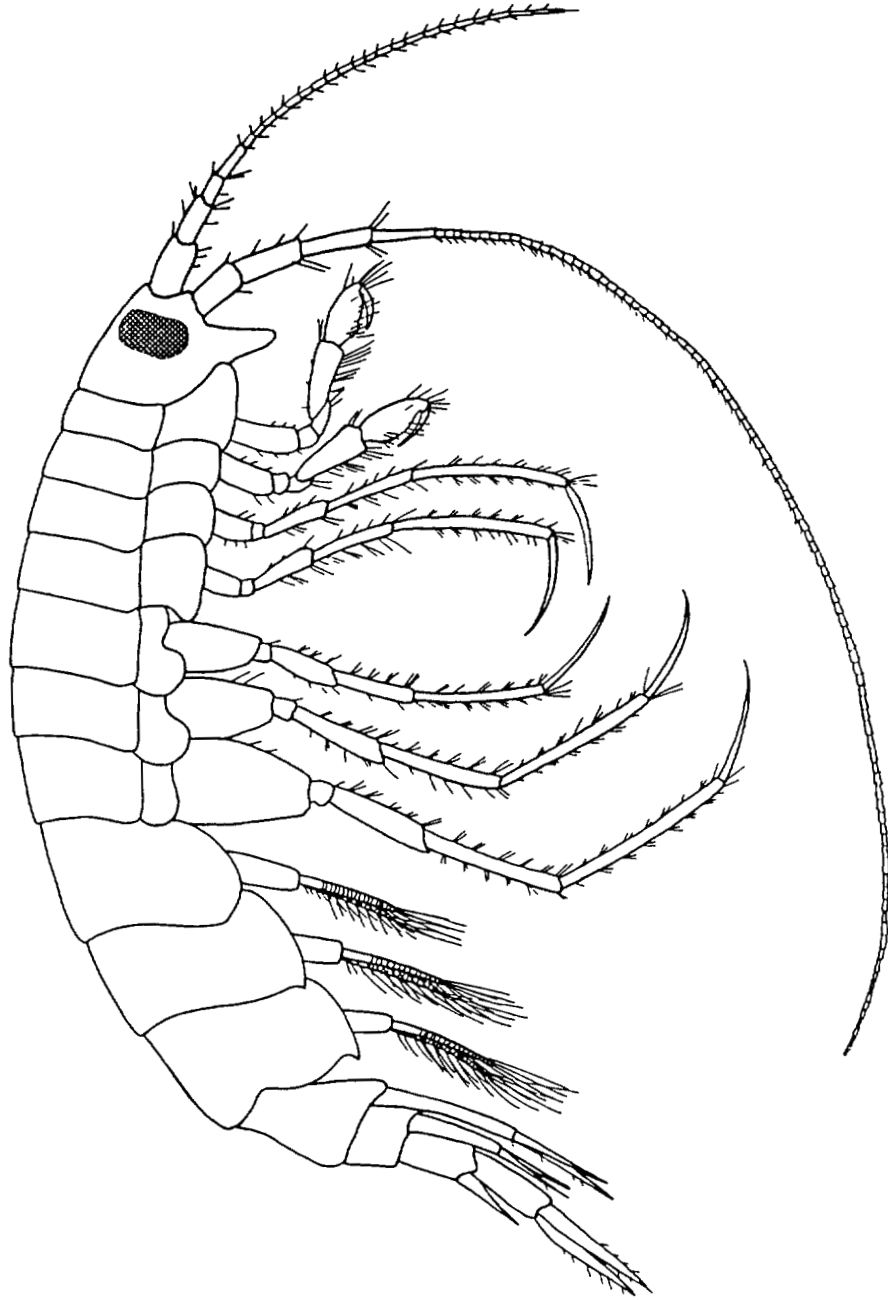

Haliragoides inermis G.O. Sars 1882  
(modified from Sars 1895)

TL = 10.0 mm ♂

## EUSIRIDAE

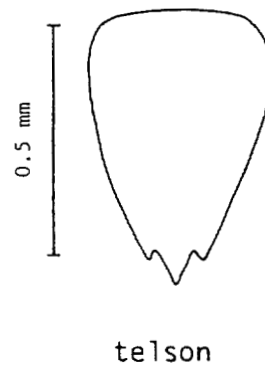
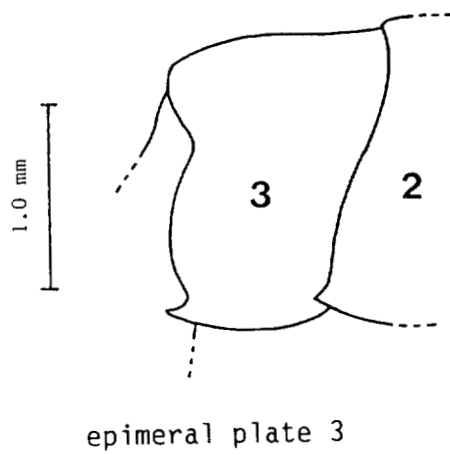
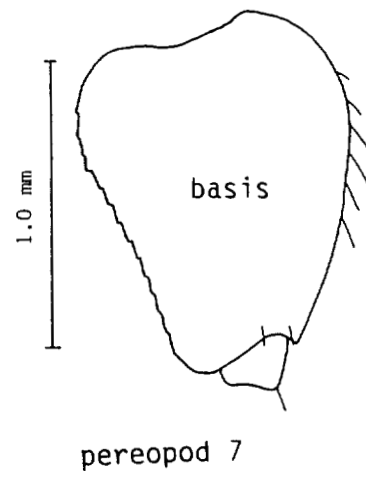
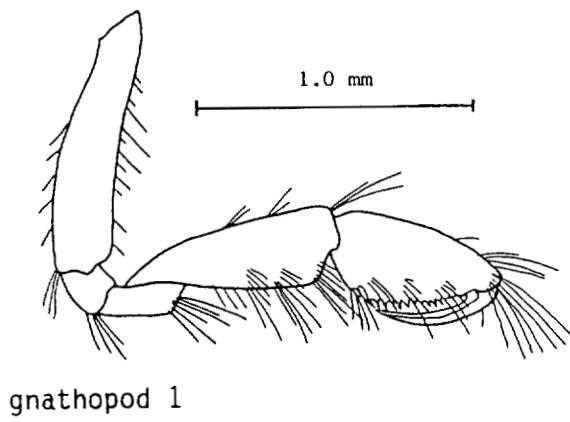
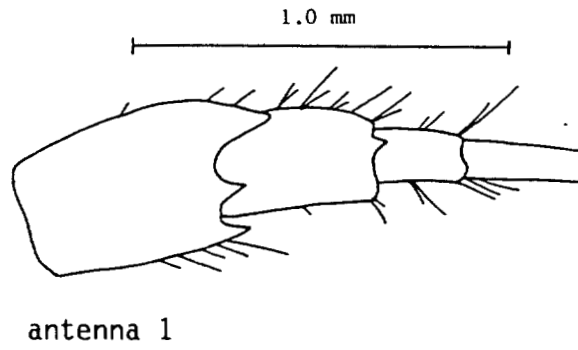
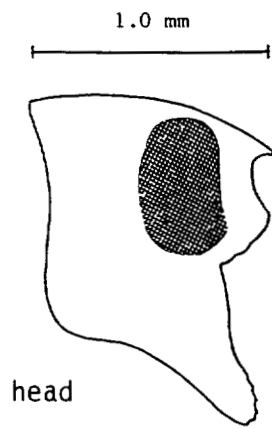

*Haliragoides inermis* G.O. Sars 1882  
(modified from Sars 1895)

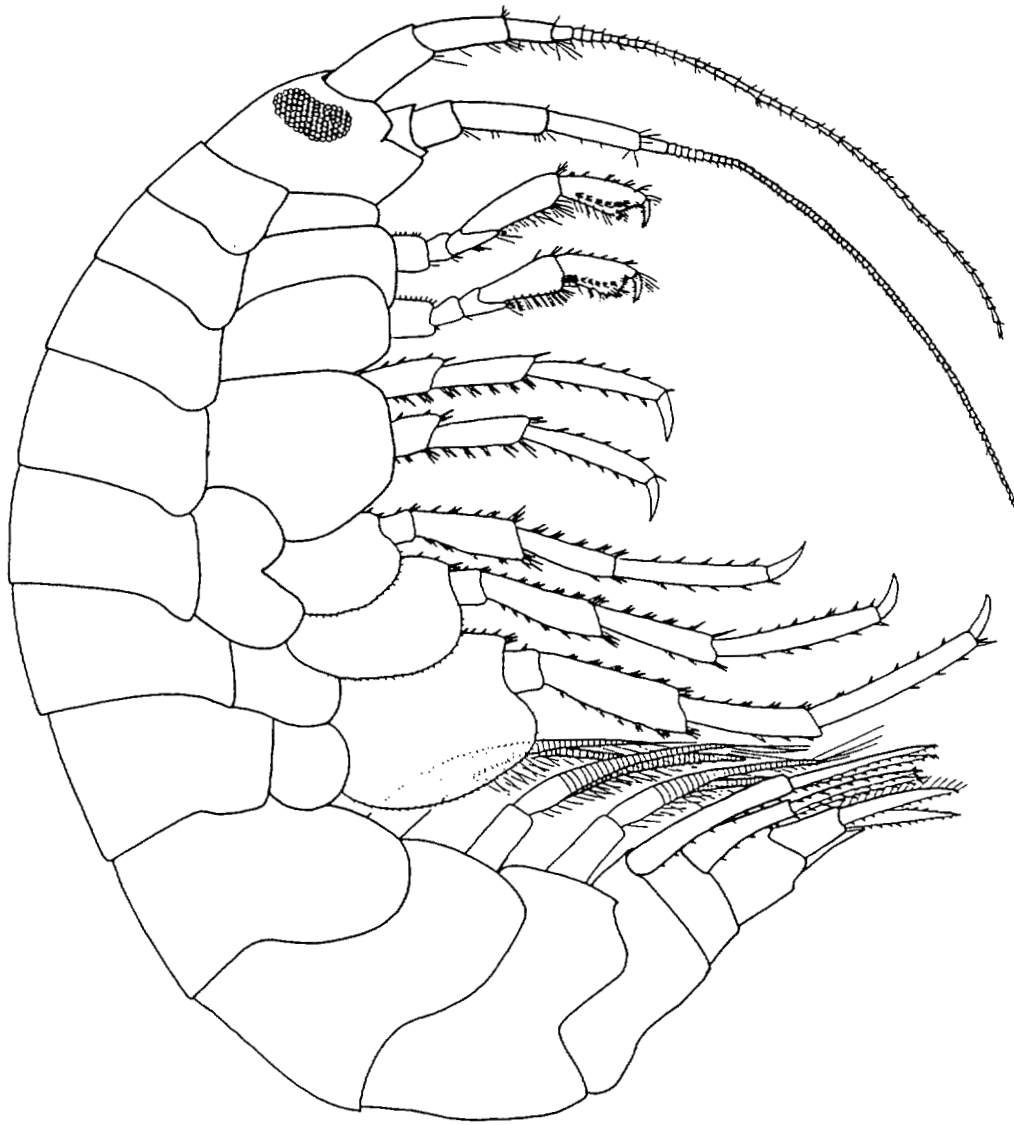

Pontogeneia inermis (Krøyer) 1838

TL = 15.3 mm ♀



EUSIRIDAE

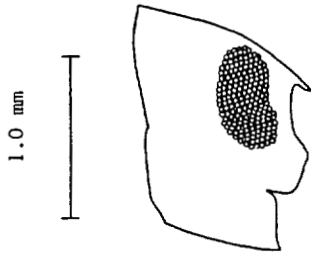

head

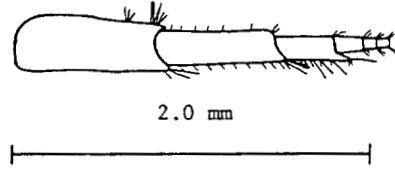

antenna 1

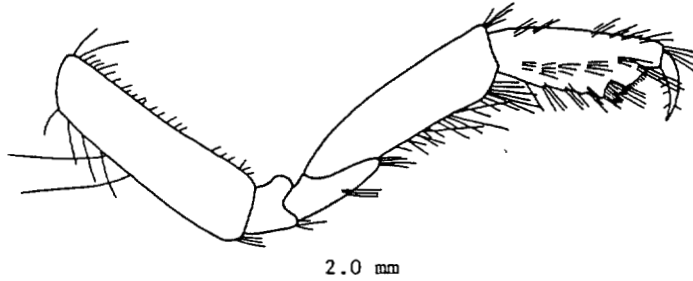

gnathopod 1

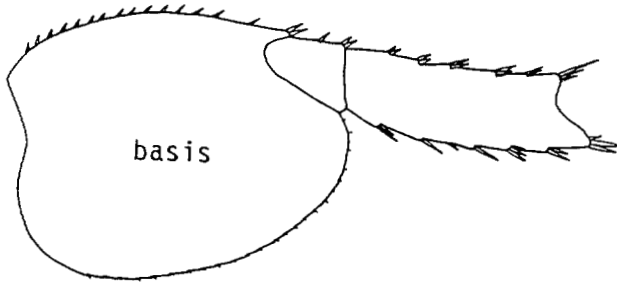

pereopod 7

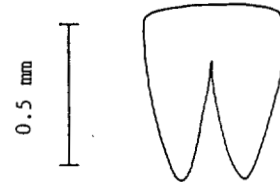

telson

Pontogeneia inermis (Krøyer) 1838

PONTOPOREIIDAE

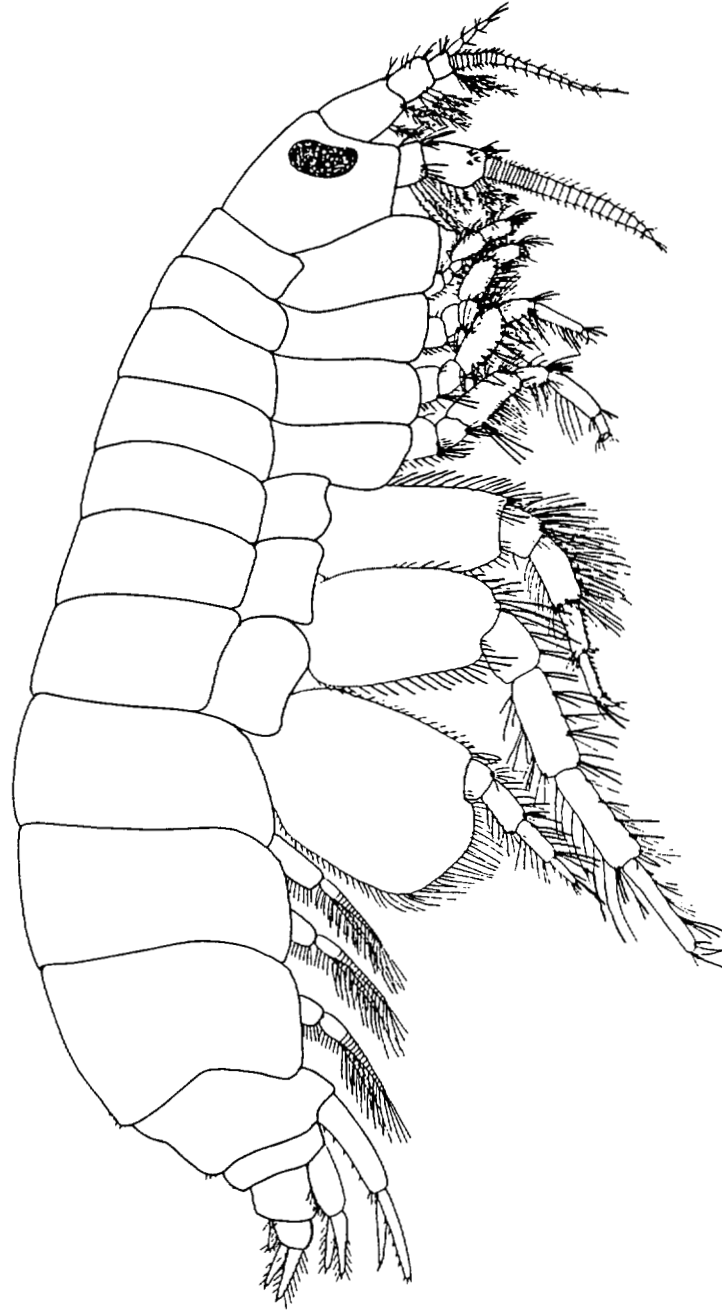

Pontoporeia affinis Lindstrom 1855

TL = 10.0 mm ♀

PONTOPOREIIDAE

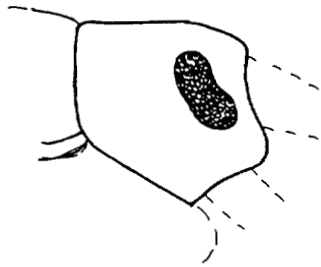

1.0 mm

head

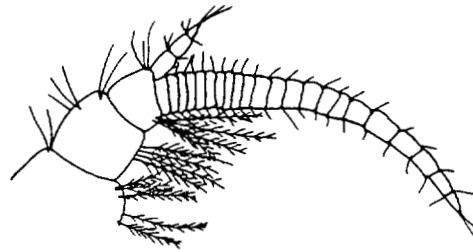

1.0 mm

antenna 1

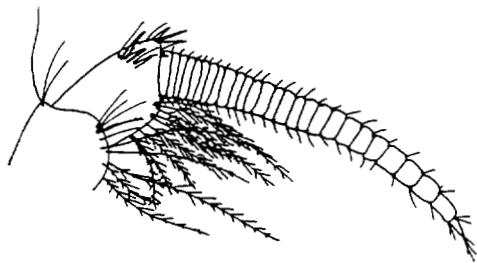

1.0 mm

antenna 2

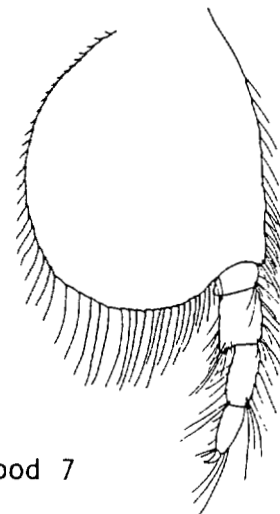

1.0 mm

pereopod 7

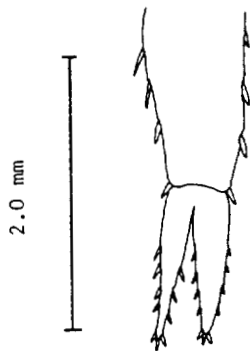

2.0 mm

uropod 2



2.0 mm

telson

Pontoporeia affinis Lindstrom 1855

## PONTOPOREIIDAE

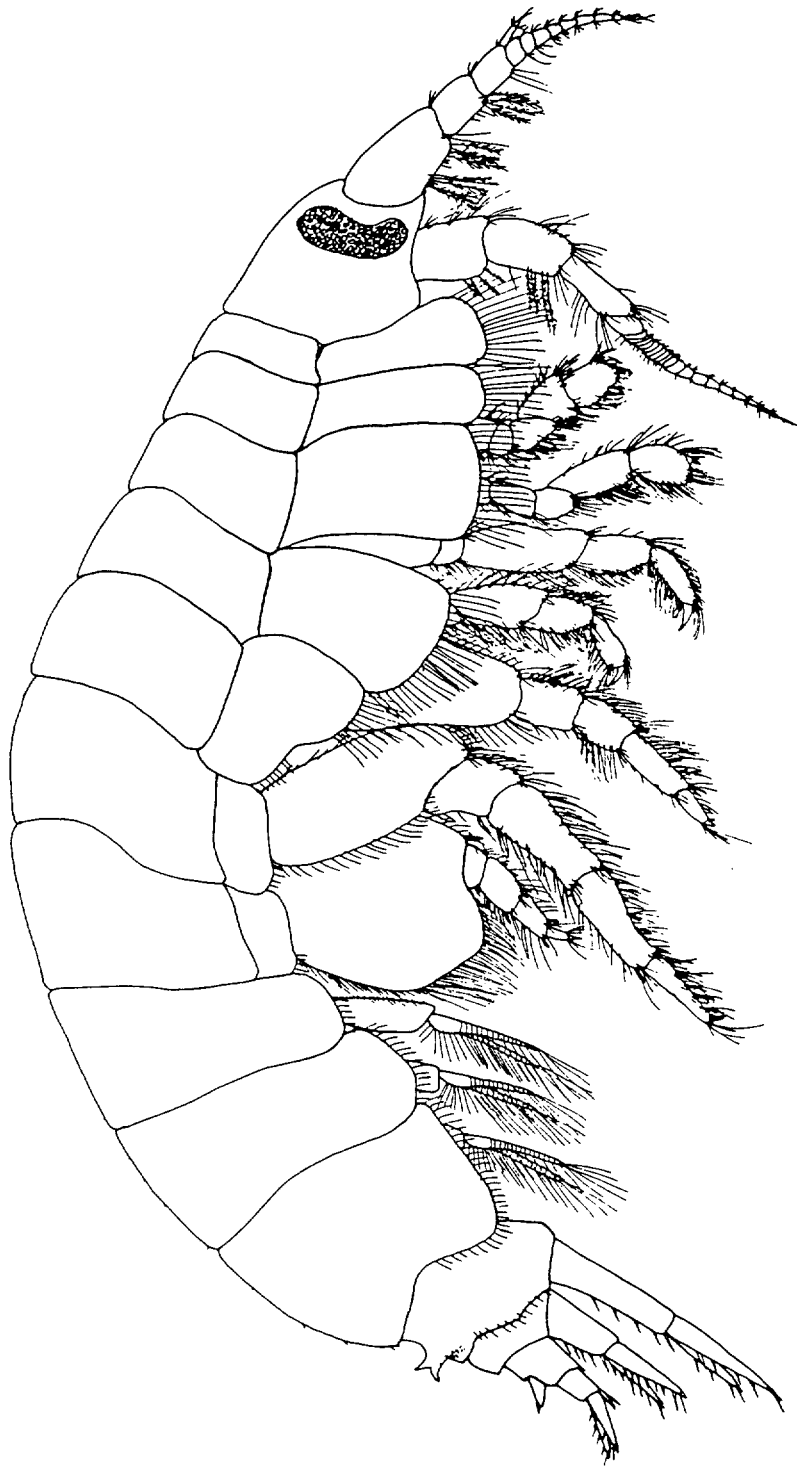

Pontoporeia femorata Krøyer 1842

TL = 6.0 mm ♀

PONTOPOREIIDAE

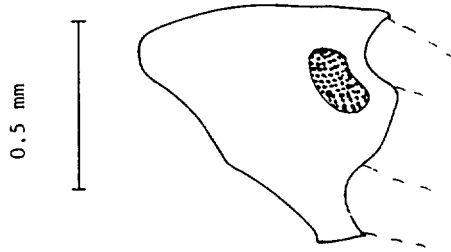

head

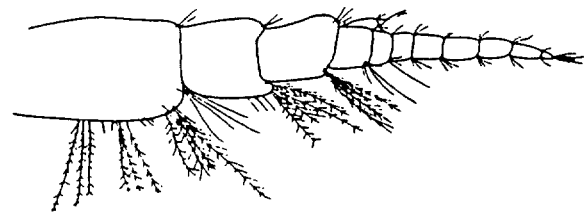

antenna 1

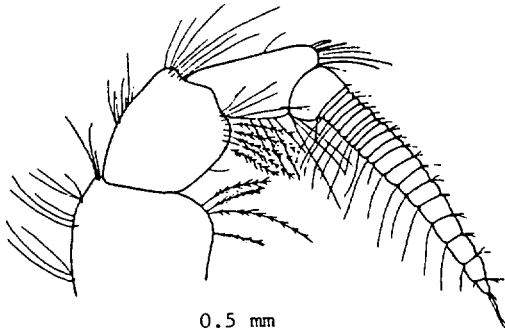

antenna 2

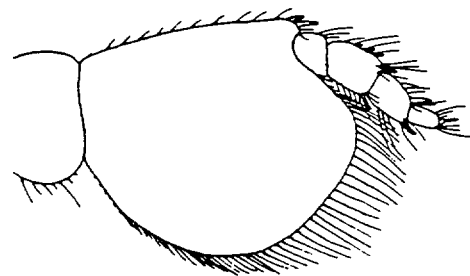

pereopod 7

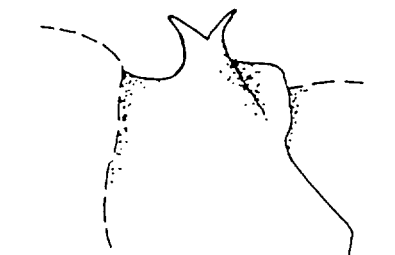

urosome 1

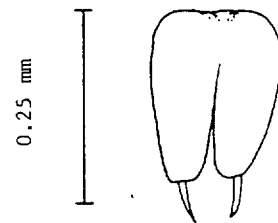

telson

Pontoporeia femorata Krøyer 1842

GAMMARIDAE

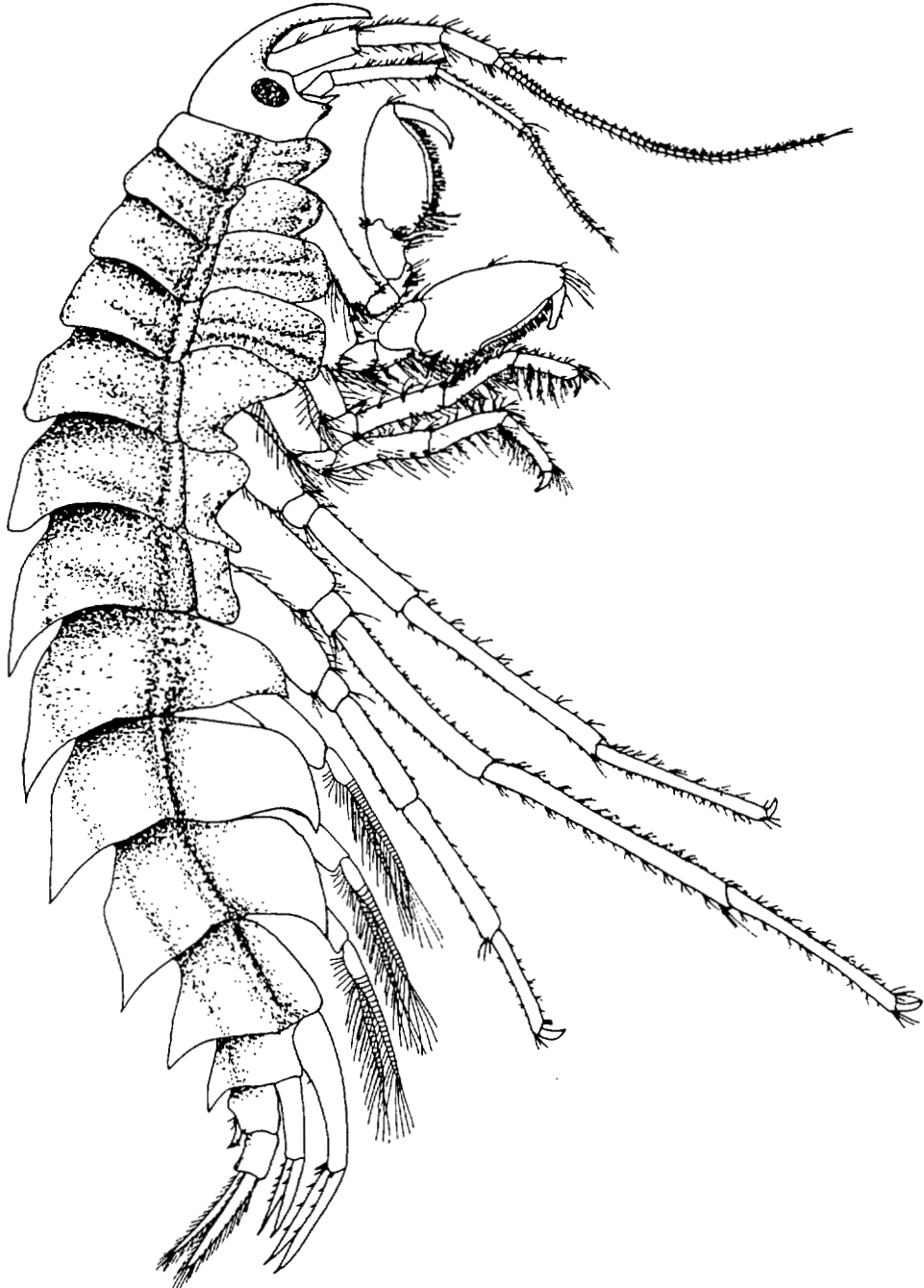

Gammaracanthus loricatus (Sabine) 1821

TL = 35.0 mm ♂

GAMMARIDAE

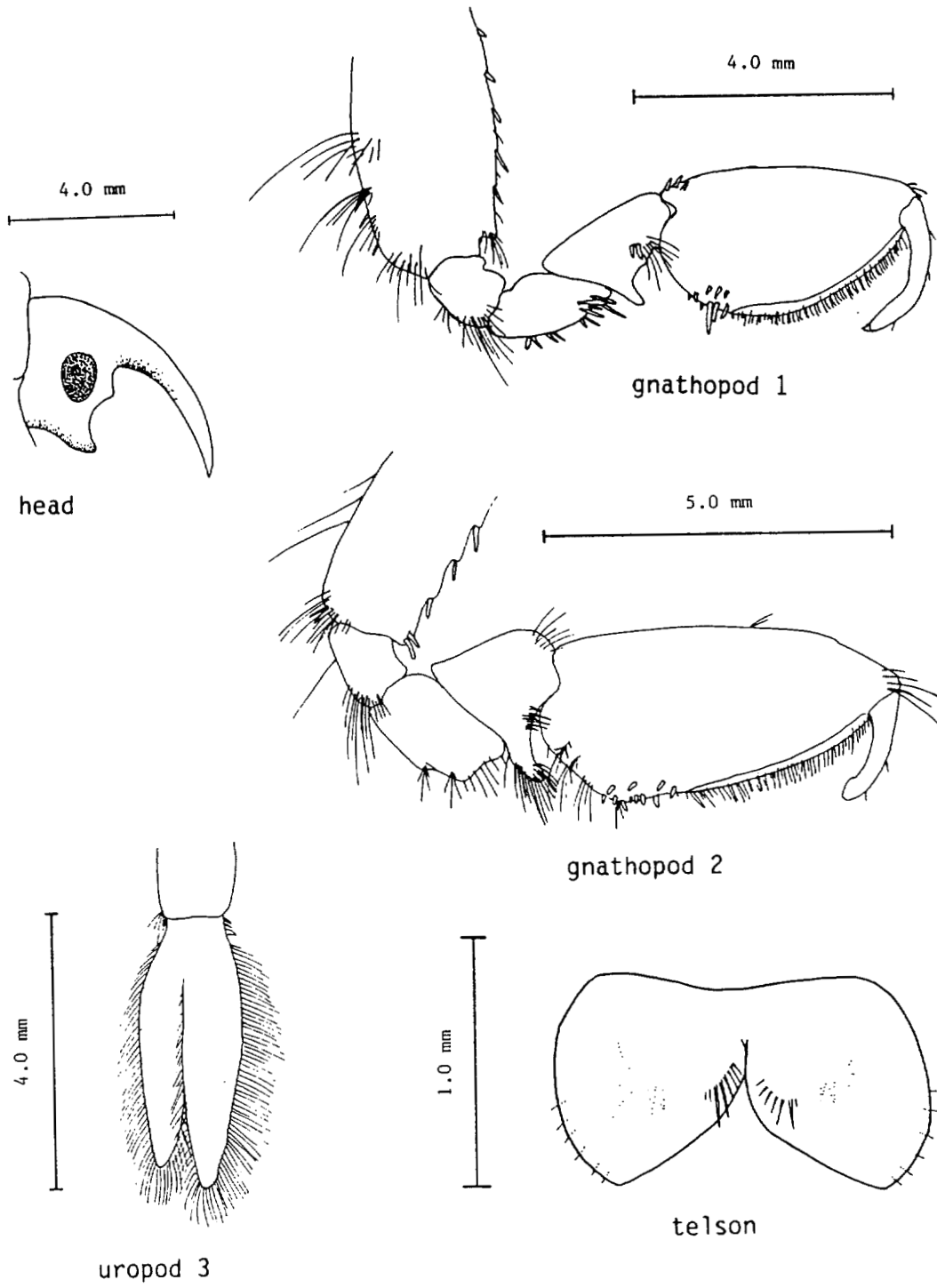

Gammaracanthus loricatus (Sabine) 1821

GAMMARIDAE

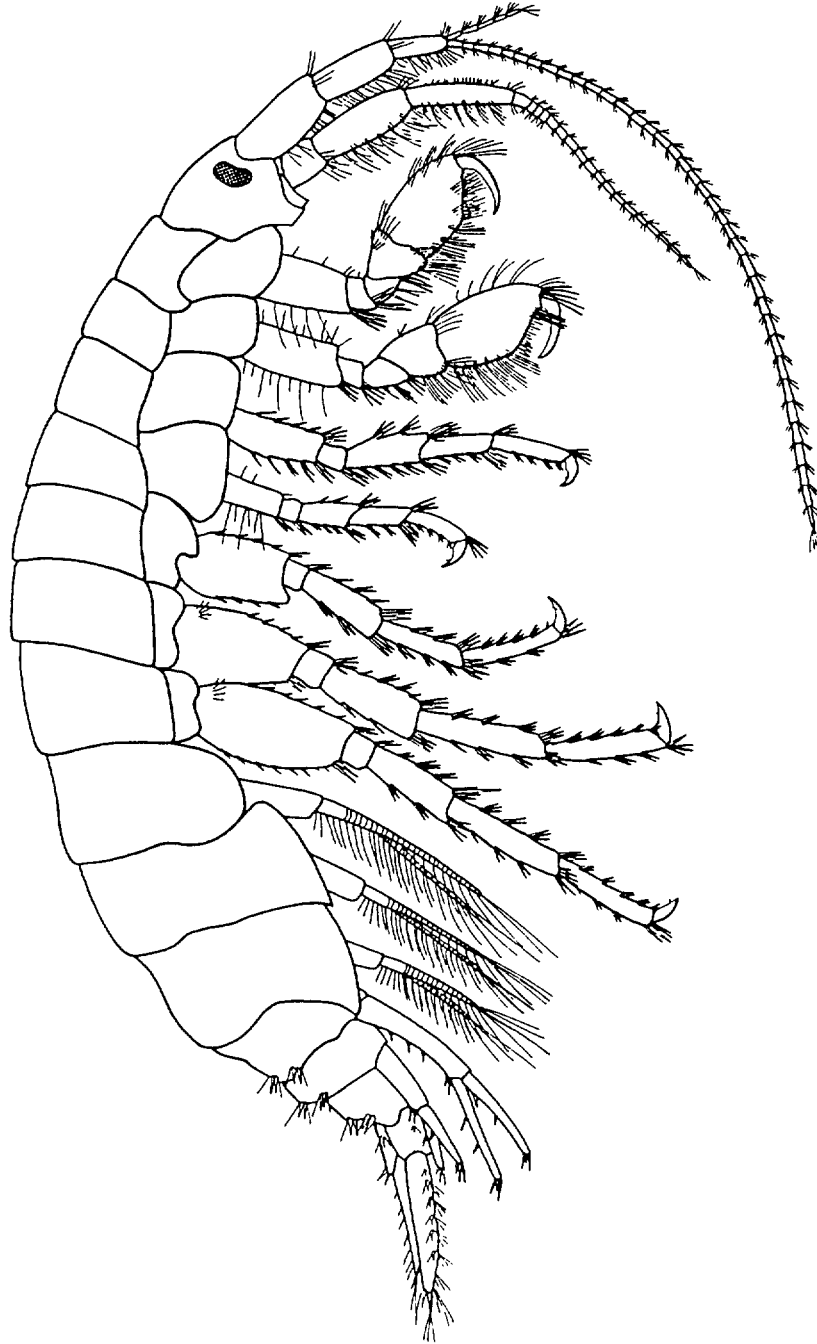

Gammarus wilkitzkii Birula 1897

TL = 17.0 mm ♂



GAMMARIDAE

PLATE LXVI

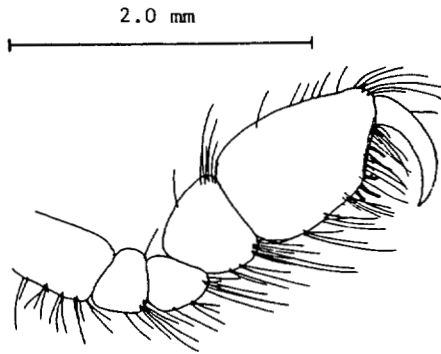

gnathopod 1

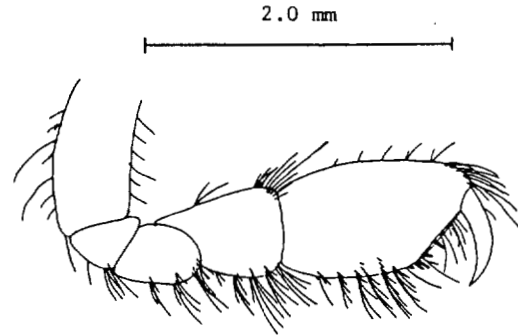

gnathopod 2

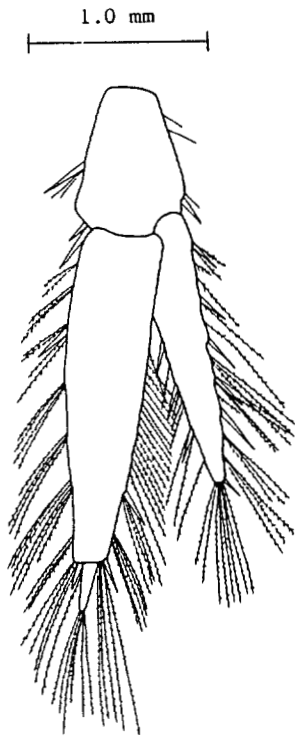

uropod 3

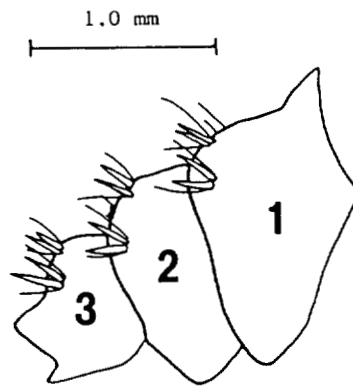

urosome

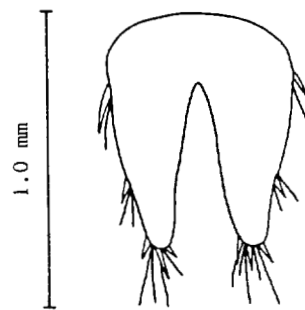

telson

Gammarus wilkitzkii Birula 1897

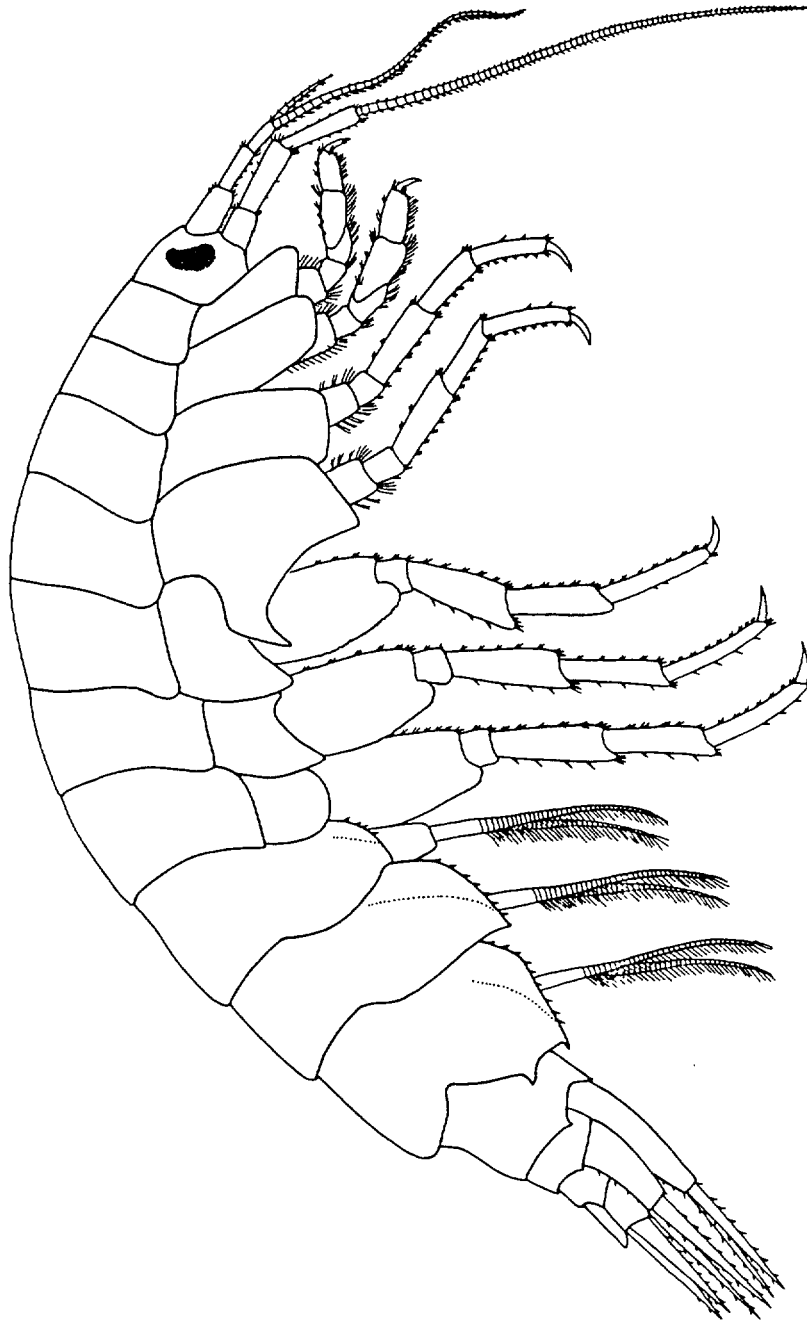

Weyprechtia heugling (Buchholz) 1874

TL = 36.4 mm ♀

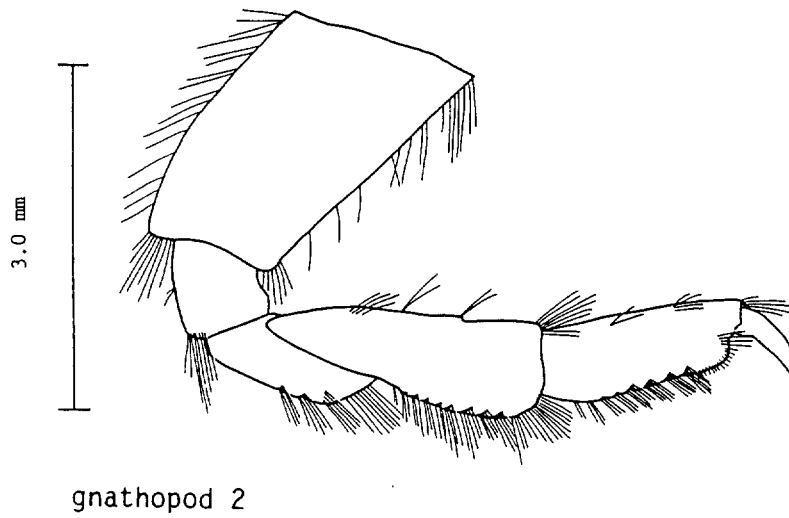
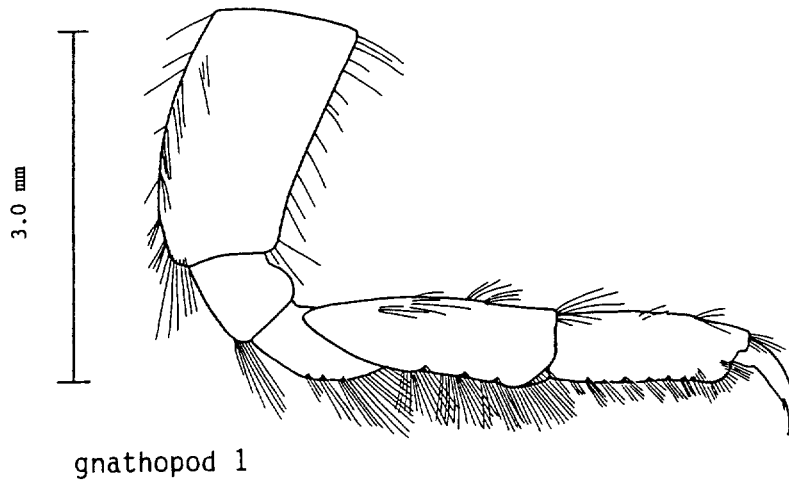

Weyprechtia heuglini (Buchholz) 1874

GAMMARIDAE

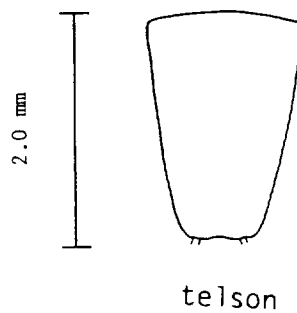
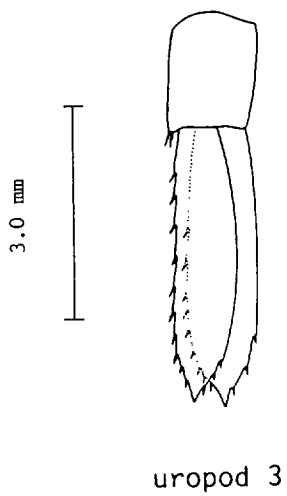
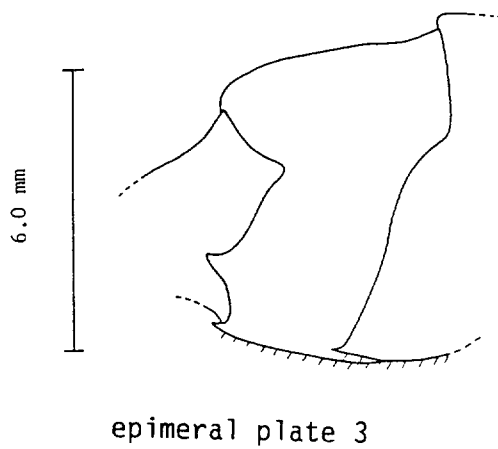
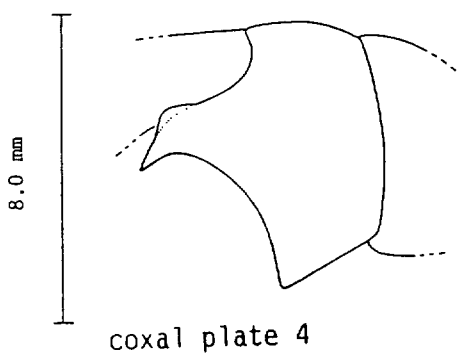
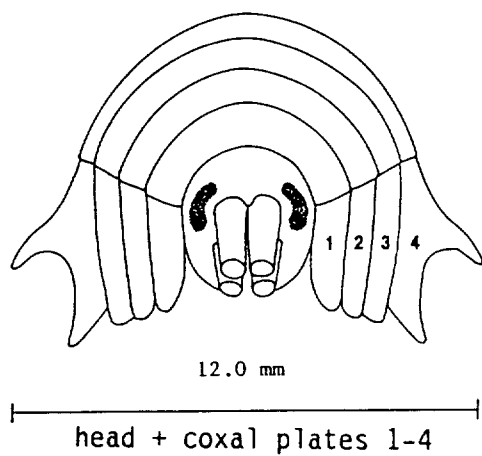

Weyprechtia heuglini (Buchholz) 1874

## APPENDIX 1

## VERIFICATION OF AMPHIPOD SPECIES

The following species of amphipods incorporated within the systematic list of the key were verified by the following persons:

1. Mrs. Norma Jarrett  
Department of Invertebrate Zoology  
National Museum of Natural Sciences  
National Museums of Canada, Ottawa, Ontario

Verified specimens obtained in samples processed by Invertebrate Research Associates, Winnipeg, for the Department of Fisheries and Oceans, Winnipeg.

Acanthostepheia malmgreni (Goes) 1866  
Aceroides latipes G.O. Sars 1895  
Andaniella pectinata G.O. Sars 1882  
Apherusa glacialis (Hansen) 1887  
Gammaracanthus loricatus (Sabine) 1821  
Haliragoides inermis G.O. Sars 1882  
Lembos borealis Myers  
Metopa longirama Dunbar 1942  
Monoculodes packardi Boeck 1871  
Oedicerus saginatus Krøyer 1842  
Onisimus glacialis G.O. Sars 1900  
Onisimus nansenii G.O. Sars 1900  
Orchomene minuta (Krøyer) 1846  
Orchomene pinguis (Boeck) 1861  
Pontoporeia affinis Lindstrom 1855  
Pontoporeia femorata Krøyer 1842  
Syrrhoe crenulata Goes 1866  
Weyprechtia heuglini (Buchholz) 1874

2. Martin Curtis, Freshwater Institute  
Fisheries and Oceans, Winnipeg, Manitoba

Gammarus wilkitzkii Birula  
Hyperia galba (Montagu) 1813  
Protomedea fasciata Krøyer 1842

3. E. H. Grainger and C. Grohe  
"Zooplankton Data from the Beaufort Sea 1951-1975"  
Fisheries and Marine Service  
Technical Report No. 591. 1975. 54 pp.  
Pontogeneia inermis (Krøyer) 1838<sup>9</sup>
4. Dr. Rita Korczynski, Invertebrate Research Associates  
Hyperoche medusarum (Muller) 1776

---

<sup>9</sup>species not obtained in samples processed by Invertebrate Research Associates for DFO, Winnipeg

## APPENDIX 2

## EXTRANEIOUS MATERIAL UTILIZED

The amphipod Pontogeneia inermis (Krøyer) 1838 used for illustrative purposes within the key was obtained from collections taken in the Beaufort Sea in 1979 (courtesy of E. H. Grainger). This was the only species which was not obtained from the NOGAP surveys.

Pontogeneia inermis, Beaufort Sea, STA. 79A, 10/8/79. 4D

APPENDIX 3  
SPECIES COLLECTION SITE

SPECIES	LATITUDE	LONGITUDE	COLLECTION DATE	REFERENCE* CODE
<u>Acanthostepheia behringiensis</u>	69 51.8	132 54.0	07/09/84	43-615-1
<u>Acanthostepheia malmgreni</u>	70 20	131 50.0	08/09/84	43-615-2
<u>Aceroides latipes</u>	69 26.0	132 59.0	25/08/82	43-616-1
<u>Andaniella pectinata</u>	69 46.4	138 34.8	06/08/85	43-668-1
<u>Apherusa glacialis</u>	70 06	131 00	09/09/84	43-619-1
<u>Apherusa megalops</u>	70 08.3	130 54.9	05/09/86	43-619-2
<u>Boeckosimus affinis</u>	69 26.0	132 59.0	25/08/82	43-624-1
<u>Dyopedos porrectus</u>	69 32.9	134 07.5	19/03/86	43-630-1
<u>Gammaracanthus toricatus</u>	69 16.9	138 20.2	26/08/85	43-633-1
<u>Gammarus wilkitzkii</u>	69 27.7	138 47.9	24/07/85	43-635-3
<u>Haliragoides inermis</u>	69 46.5	138 34.8	06/08/85	43-674-1
<u>Hyperia galba</u>	70 02	132 20	15/07/84	43-641-1
<u>Hyperia medusarum</u>	69 07.1	137 55.2	17/09/86	43-641-2
<u>Hyperoche medusarum</u>	69 48.5	134 24.6	10/08/86	43-671-1
<u>Lembos borealis</u>	69 46.5	138 34.8	06/08/85	43-643-2
<u>Metopa longirama</u>	69 16.15	138 16.6	26/07/85	43-645-2
<u>Monoculodes packardi</u>	69 23.6	138 44.5	24/09/85	43-647-3
<u>Oedicerus saginatus</u>	69 16.9	138 20.2	26/07/85	43-669-1
<u>Onisimus glacialis</u>	69 51.8	132 20	07/09/84	43-650-1
<u>Onisimus litoralis</u>	69 29.55	132 58	10/09/84	43-650-2
<u>Onisimus nansenii</u>	69 27.7	138 47.9	24/07/85	43-650-3
<u>Orchomene minuta</u>	69 28.45	138 48.75	25/07/85	43-666-2
<u>Orchomene pinquus</u>	69 28.45	138 48.75	25/07/85	43-666-1



SPECIES	LATITUDE	LONGITUDE	COLLECTION DATE	REFERENCE* CODE
<u>Parathemisto abyssorum</u>	69 58.1	134 36.3	11/08/85	43-653-1
<u>Parathemisto libellula</u>	70 17.3	131 53.5	15/07/84	43-653-2
<u>Paroediceros lynceus</u>	69 31.7	138 44.6	24/07/84	43-655-1
<u>Pontogeneia inermis</u>	N/A	N/A	10/08/79	N/A
<u>Pontoporeia affinis</u>	69 26.0	132 59.0	08/07/82	43-659-1
<u>Pontoporeia femorata</u>	69 25.1	132 58.25	26/07/84	43-659-2
<u>Protomedeia fasciata</u>	69 31.05	138 55.5	25/07/85	43-661-1
<u>Syrrhoe crenulata</u>	69 39.7	138 42.5	05/08/85	43-667-1
<u>Weyprechtia heuglini</u>	70 13	132 22	08/09/84	43-670-1

\* Reference code refers to the species identification number for specimens held in the reference collection at DFO, Winnipeg, Manitoba.