

Biology and Systematics
of *Greya* Busck and
Tetragma, new genus
(Lepidoptera: Prodoxidae)

DONALD R. DAVIS,
OLLE PELLMYR,
and
JOHN N. THOMPSON

SERIES PUBLICATIONS OF THE SMITHSONIAN INSTITUTION

Emphasis upon publication as a means of "diffusing knowledge" was expressed by the first Secretary of the Smithsonian. In his formal plan for the Institution, Joseph Henry outlined a program that included the following statement: "It is proposed to publish a series of reports, giving an account of the new discoveries in science, and of the changes made from year to year in all branches of knowledge." This theme of basic research has been adhered to through the years by thousands of titles issued in series publications under the Smithsonian imprint, commencing with *Smithsonian Contributions to Knowledge* in 1848 and continuing with the following active series:

Smithsonian Contributions to Anthropology
Smithsonian Contributions to Astrophysics
Smithsonian Contributions to Botany
Smithsonian Contributions to the Earth Sciences
Smithsonian Contributions to the Marine Sciences
Smithsonian Contributions to Paleobiology
Smithsonian Contributions to Zoology
Smithsonian Folklife Studies
Smithsonian Studies in Air and Space
Smithsonian Studies in History and Technology

In these series, the Institution publishes small papers and full-scale monographs that report the research and collections of its various museums and bureaux or of professional colleagues in the world of science and scholarship. The publications are distributed by mailing lists to libraries, universities, and similar institutions throughout the world.

Papers or monographs submitted for series publication are received by the Smithsonian Institution Press, subject to its own review for format and style, only through departments of the various Smithsonian museums or bureaux, where the manuscripts are given substantive review. Press requirements for manuscript and art preparation are outlined on the inside back cover.

Robert McC. Adams
Secretary
Smithsonian Institution

Biology and Systematics
of *Greya* Busck and
Tetragma, new genus
(Lepidoptera: Prodoxidae)

*Donald R. Davis, Olle Pellmyr,
and John N. Thompson*



SMITHSONIAN INSTITUTION PRESS

Washington, D.C.

1992

ABSTRACT

Davis, Donald R., Olle Pellmyr, and John N. Thompson. Biology and Systematics of *Greya* Busck and *Tetragma*, new genus (Lepidoptera: Prodoxidae). *Smithsonian Contributions to Zoology*, number 524, 88 pages, 375 figures, 7 maps, 1992.—*Greya* is a genus of particular biological interest, in that it is among the genera closest related to the yucca moths, which are widely quoted in discussions of coevolution. Both *Greya* and the new genus *Tetragma* share some morphological and behavioral traits with the yucca moths. In this paper, the general morphology, classification, distribution, and biology of the western North American genera *Greya* and *Tetragma* new genus, are reviewed, and a phylogeny is proposed. Sixteen species of *Greya* are recognized, including seven new species: *G. mitellae*, *G. obscura*, *G. enchrysa*, *G. variabilis*, *G. pectinifera*, *G. suffusca*, and *G. powelli*. *Greya piperella* is resurrected as a valid species. The new genus *Tetragma* is described, with the single, new species *T. gei*. Keys are provided for all species, and diagnostic characters of all taxa are illustrated by line drawings and photographs.

OFFICIAL PUBLICATION DATE is handstamped in a limited number of initial copies and is recorded in the Institution's annual report, *Smithsonian Year*. SERIES COVER DESIGN: The coral *Montastrea cavernosa* (Linnaeus).

Library of Congress Cataloging-in-Publication Data

Davis Donald R. (Donald Ray)

Biology and systematics of *Greya* Busck and *Tetragma*, new genus (Lepidoptera: Prodoxidae) / Donald R. Davis, Olle Pellmyr, and John N. Thompson.

p. cm.—(Smithsonian contributions to zoology ; no. 524)

Includes bibliographic references.

1. *Greya*. 2. *Tetragma*. I. Pellmyr, Olle. II. Thompson, John N. III. Title. IV. Series.

QL1.S54 no. 524 [QL561.P57] 591 s—dc20 [595.78'1] 91-28433

© The paper used in this publication meets the minimum requirements of the American National Standard for Permanence of Paper for Printed Library Materials Z39.48—1984.

Contents

	<i>Page</i>
Introduction	1
Abbreviations	1
Acknowledgments	2
Life History	2
Host Plants	2
Adult	3
Flight Period	3
Activity Pattern and Foraging	4
Courtship	4
Oviposition	4
Egg	5
Larva	5
Pupa	10
Natural Enemies	10
Larva	10
Adult	10
Egg and Pupa	10
Geographic Distribution	10
Phylogeny	13
Interrelationships between <i>Greya</i> and <i>Tetragma</i> Species	13
<i>Greya</i> and <i>Tetragma</i> in Relation to Other Prodoxid Genera	16
Key to the Genera of Prodoxidae	18
<i>Tetragma</i> Davis and Pellmyr, new genus	18
<i>Tetragma gei</i> Davis and Pellmyr, new species	19
Genus <i>Greya</i> Busck	24
Key to the Species of <i>Greya</i>	27
<i>Greya punctiferella</i> (Walsingham)	28
<i>Greya piperella</i> (Busck)	33
<i>Greya mitellae</i> Davis and Pellmyr, new species	36
<i>Greya obscura</i> Davis and Pellmyr, new species	39
<i>Greya obscurumaculata</i> (Braun)	40
<i>Greya sparsipunctella</i> (Walsingham)	43
<i>Greya politella</i> (Walsingham)	43
<i>Greya enchrysa</i> Davis and Pellmyr, new species	51
<i>Greya variabilis</i> Davis and Pellmyr, new species	56
<i>Greya pectinifera</i> Davis and Pellmyr, new species	58
<i>Greya variata</i> (Braun)	59
<i>Greya subalba</i> Braun	63
<i>Greya solenobiella</i> (Walsingham)	64
<i>Greya suffusca</i> Davis and Pellmyr, new species	66
<i>Greya reticulata</i> (Riley)	68
<i>Greya powelli</i> Davis and Pellmyr, new species	70
Literature Cited	72
Figures 251–375	74

Biology and Systematics of *Greya* Busck and *Tetragma* new genus (Lepidoptera: Prodoxidae)

Donald R. Davis, Olle Pellmyr,
and John N. Thompson

Introduction

The yucca-pollinating moths, *Tegeticula* and *Parategeticula*, are probably the best known group of non-ditrysian moths. Their status arises from the obligate pollination mutualism that has evolved between most species of these genera and their larval host plants (Riley, 1892a; Powell and Mackie, 1966; Davis, 1967; Powell, 1984). Female yucca moths collect pollen with specialized mouthparts prior to oviposition, then pollinate flowers while visiting them for oviposition. Thus, they insure a food source for their progeny, which feed on seeds or vegetative parts of the fruit.

In contrast to the yucca moths and associated Agavaceae-feeders, their probable sister group *Greya* has received far less attention. No known morphological synapomorphy delimits the Agavaceae-feeding genera from *Greya*, and it is likely that an understanding of the phylogeny, systematics, host associations, and interactions of this genus would shed light on the evolutionary origin of the yucca-yucca moth mutualism.

Although the first species now placed within *Greya* was described in 1880 (Walsingham, 1880), the genus was not recognized until 1903 (Busck, 1903). It has never been subject to a modern revision, and Davis (1983) brought together several taxa previously placed within other genera to list a total

Donald R. Davis, Department of Entomology, National Museum of Natural History, Smithsonian Institution, Washington, D.C. 20560.
Olle Pellmyr, Department of Biological Sciences, University of Cincinnati, Cincinnati, Ohio 45221 and Departments of Botany and Zoology, Washington State University, Pullman, Washington 99164.
John N. Thompson, Departments of Botany and Zoology, Washington State University, Pullman, Washington 99164.

Review Chairman: Ronald J. McGinley, National Museum of Natural History, Smithsonian Institution.

Reviewers: Ebbe S. Nielson, Division of Entomology, CSIRO, Canberra City, Australia; Jerry A. Powell, University of California, Berkeley, California; and David L. Wagner, University of Connecticut, Storrs, Connecticut.

of eight species. Eight new taxa are described in this report. With the exception of a recorded single flower visit (Taylor, 1965) nothing was known about the early instars or the biology of any member until oviposition in *G. subalba* was studied in the 1980's (Thompson, 1986, 1987). The onset of a large-scale study of the phylogeny and biology by two of the authors in 1987 has led to rapid growth of our knowledge in this respect, and much more material has also become available for systematic studies. Although more information is likely to become available to resolve certain issues (e.g., generic status of two species currently unclear), we have chosen to publish at this point to make the new names available. Although a member a different subfamily than *Greya*, the new genus *Tetragma* likewise is included to provide a name and to present important biological information. The systematic parts of this revision have been prepared by Davis and Pellmyr, while the biological information was brought together by Pellmyr and Thompson. In the biological sections, information without specific references to other works is based on unpublished data collected by the authors.

ABBREVIATIONS.—Abbreviations for the museums, institutions, and private collections where the material examined is deposited.

AMNH	American Museum of Natural History, New York, NY, USA
ANSP	Academy of Natural Sciences in Philadelphia, Philadelphia, PA, USA
BMNH	Collections of the former British Museum (Natural History), now renamed as the Natural History Museum, London, United Kingdom
CAS	California Academy of Sciences, San Francisco, CA, USA

CNC	Canadian National Collection, Ottawa, ON, Canada
CU	Cornell University, Ithaca, NY, USA
DLW	David L. Wagner, Storrs, CT, USA
LACM	Los Angeles County Museum, Los Angeles, CA, USA
MCZ	Museum of Comparative Zoology, Cambridge, MA, USA
OP	Olle Pellmyr, Cincinnati, OH, USA. All collections of <i>Greya</i> and <i>Tetragma</i> in collection OP are held jointly by OP and JNT, and will eventually be placed in USNM
RBCM	Royal British Columbia Museum, Victoria, BC, Canada
RL	Ron Leuschner, Manhattan Beach, CA, USA
UBCZ	University of British Columbia, Vancouver, BC, Canada
UCB	University of California at Berkeley, Berkeley, CA, USA
UI	University of Idaho, Moscow, ID, USA
USNM	Collections of the former United States National Museum, now deposited in the National Museum of Natural History, Smithsonian Institution, Washington, D.C., USA

United States Postal Service abbreviations for state and Canadian province names used are as follows.

AB	Alberta
AK	Alaska
BC	British Columbia
CA	California
CT	Connecticut
ID	Idaho
MA	Massachusetts
MT	Montana
NY	New York
OH	Ohio
ON	Ontario
OR	Oregon
PA	Pennsylvania
WA	Washington

Other abbreviations:

AFB	Slide number prefix for some slides made by Annette F. Braun
DRD	Slide number prefix for slides made by D.R. Davis

Botanical nomenclature in this work follows Kartesz and Kartesz (1980), except for *Lithophragma*, which follows Taylor (1965), and *Osmorhiza*, which follows Lowry and Jones (1984). Family affiliation and authors are given for all host plants in Table 1.

ACKNOWLEDGMENTS.—We thank the following institutions

and individuals for loans, gifts, or access to inspection of material in their charge or possession: Paul H. Arnaud Jr., CAS, San Francisco, CA, USA, M. Deane Bowers, MCZ, Cambridge, MA, USA, Sydney G. Cannings, UBCZ, Vancouver, BC, Canada, Julian P. Donahue, LACM, Los Angeles, CA, USA, Cris Guppy, RBCM, Victoria, BC, Canada, Fred Merickel, UI, Moscow, ID, USA, Ron Leuschner, Manhattan Beach, CA, USA, James G. Miller and Frederick Rindge, AMNH, New York, NY, USA, Jerry A. Powell, UCB, Berkeley, CA, USA, Gaden S. Robinson, BMNH, London, UK, David L. Wagner, Storrs, CT, USA, Donald Lafontaine and Jean-François Landry, CNC, Ottawa, ON, Canada, Donald Azuma, ANSP, Philadelphia, PA, USA, and John Franclemont, CU, Ithaca, NY, USA.

Pellmyr and Thompson wish in particular to thank the following persons for logistic help and information in the fieldwork: J.F. Gates Clarke (deceased), Nalini Nadkarni, Jerry A. Powell, Wayne F. Wehling, Nelsa and Buck Buckingham, Vern Oswald, Donald Frack II, David McMullen, Don Stratton and Helen Young, Susan Mazer, Paulette Bierzychudek, William F. Barr, and William J. Turner. Access to land for collecting was gracefully provided by the Nez Perce Tribe of Idaho (to JNT and OP), the Penticton Indian Band (to OP), and by Vincent Schultz. Boris Kovalev and Christer Löfstedt gave us access to an unpublished manuscript on a *Lampronia* pheromone. A. Zagulajev checked several Soviet collections for *Greya variabilis*. John Shepard, Cris Guppy, and Danny Shepley aided in tracking down some Canadian localities. James S. Farris performed phylogenetic analyses using Hennig86 on our data matrices. Parasitoid identifications were provided by Michael Sharkey, Robert Carlson, and Paul Marsh. The illustrations for this paper (except the cladograms) were prepared by Vichai Malikul, the late Andre Pizzini, and George Venable of the Smithsonian Institution. Photographic assistance was provided by Victor Krantz of the Smithsonian Photographic Laboratory and Susann Braden and Walt Brown of the Smithsonian Scanning Electron Microscope Laboratory. Some exploratory SEM work was done in the laboratory of the New York Botanical Garden; we especially thank Donald Brown for access to the microscope. Ebbe Nielsen, Jerry Powell, and David Wagner provided helpful comments on the manuscript. Funds for this research were provided through a postdoctoral grant from the Swedish Natural Sciences Research Council (OP), NSF grants DEB-7918492 and BSR-8219884 (JNT), NSF grant BSR-8817337 (JNT, OP, R.G. Harrison, and D.E. Soltis), a grant from the Hardman Foundation (JNT and OP), the Smithsonian Institution Research Opportunity Fund (DRD), and through personal funds.

Life History

HOST PLANTS

Known host records are given in Table 1. Eggs are either laid inside the ovary, in the ovary wall, in pedicels, petioles, or

TABLE 1.—Host plants for *Tetragma* and *Greya*. Each record includes family (R = Rosaceae, S = Saxifragaceae, U = Umbelliferae (Apiaceae)) and species of known host(s).

Moth species	Host species
<i>Tetragma gei</i> Davis and Pellmyr, new species	R: <i>Geum triflorum</i> Pursh
<i>Greya punctiferella</i> (Walsingham)	S: <i>Tiarella trifoliata</i> L. <i>Tolmiea menziesii</i> (Pursh) Torrey and Gray <i>Tellima grandiflora</i> (Pursh) Douglas
<i>Greya piperella</i> (Busck)	S: <i>Heuchera cylindrica</i> Douglas ex Hooker <i>H. micrantha</i> Douglas
<i>Greya mitellae</i> Davis and Pellmyr, new species	S: <i>Mitella stauropetala</i> Piper
<i>Greya obscura</i> Davis and Pellmyr, new species	S: <i>Lithophragma affine</i> Gray <i>L. cymbalaria</i> Torrey and Gray <i>L. heterophyllum</i> (Hooker and Arnold) Torrey and Gray <i>L. trifoliatum</i> Eastwood
<i>Greya obscuramaculata</i> (Braun)	Unknown
<i>Greya sparsipunctella</i> (Walsingham)	Unknown
<i>Greya politella</i> (Walsingham)	S: <i>Lithophragma affine</i> Gray <i>L. bolanderi</i> Gray <i>L. cymbalaria</i> Torrey and Gray <i>L. heterophyllum</i> (Hooker and Arnold) Torrey and Gray <i>L. parviflorum</i> (Hooker) Torrey and Gray <i>L. tenellum</i> Nuttall <i>Heuchera grossulariifolia</i> Rydberg (also introgressed with <i>H. cylindrica</i>)
<i>Greya enchrysa</i> Davis and Pellmyr, new species	S: <i>Heuchera cylindrica</i> Douglas ex Hooker <i>H. grossulariifolia</i> Rydberg (also introgressed with <i>H. cylindrica</i>)
<i>Greya variabilis</i> Davis and Pellmyr, new species	Unknown
<i>Greya pectinifera</i> Davis and Pellmyr, new species	Unknown
<i>Greya variata</i> (Braun)	Possibly on U: <i>Osmorhiza occidentalis</i> (Nuttall) Torrey
<i>Greya subalba</i> (Braun)	U: <i>Lomatium ambiguum</i> (Nuttall) Coulter and Rose <i>L. dissectum</i> (Nuttall ex Torrey and Gray) Mathias and Constance <i>L. grayi</i> (Coulter and Rose) Coulter and Rose <i>L. triternatum</i> (Pursh) Coulter and Rose <i>L. macrocarpum</i> (Nuttall) Coulter and Rose
<i>Greya solenobiella</i> (Walsingham)	U: <i>Yabea microcarpa</i> (Hooker and Arnold) Kozo-Poljansky
<i>Greya suffusca</i> Davis and Pellmyr, new species	U: <i>Osmorhiza brachypoda</i> Torrey
<i>Greya reticulata</i> (Riley)	U: <i>Osmorhiza chilensis</i> Hooker and Arnold
<i>Greya powelli</i> Davis and Pellmyr, new species	U: <i>Bowlesia incana</i> Ruiz and Pavon

peduncles, depending on species. It should be emphasized that all records refer to first-instar larvae. Larvae of all species studied leave the host tissue at the end of the first instar, and the subsequent fate is known for only two species.

Host specificity is very high in species with known hosts. Six *Greya* taxa are known to be associated with Umbelliferae; five of them appear to be species-specific, whereas the sixth is limited to part of a genus. The species that feed on members of Saxifragaceae vary between genus and species specificity. Only *G. politella* is recorded from two genera. So far, the record of *Heuchera* as a host is limited to populations along two rivers in Idaho.

Tetragma gei, new species, differs from *Greya* in that it feeds on a rosaceous host plant. Plesiomorphic genera, such as *Lampronia*, feed on Rosaceae and Grossulariaceae (Heath and Pelham-Clinton, 1976).

ADULT

FLIGHT PERIOD.—All species are univoltine. Most species oviposit in flowers or stems of a single host species, and their

phenology is constrained to match that of the host. For example, in *G. politella*, which oviposits in the flowers of *Lithophragma parviflorum* in SE Washington, adults are found for about two weeks in any one population. Because of altitudinal range and aspect differences, however, populations may vary widely in emergence date; in the Blue Mountains of Washington, populations within 10 km of each other emerge one month apart. In addition, broad geographic range of some species contributes to variation of emergence date; in southern California, *G. politella* may emerge in early February, whereas the same event happens in early July in the Canadian Rocky Mountains.

Both *Greya* and *Tetragma* probably evolved within the semiarid areas of western North America, which is reflected in their life cycle. Most taxa go through the adult stage in early spring-summer, before onset of the summer drought. In SE Washington, most species are found between April and early June. The few species that encounter moister regimes (e.g., *G. variabilis*, *G. pectinifera*, *G. punctiferella*) appear later in the season.

It is quite common to find several *Greya* species simultaneously in many habitats. We have observed (in Washington) as many as five species within an area less than 100 m² on the same day. Host specificity and utilization of different parts of shared hosts may play an important role in this high species packing. Most species can reach rather high density in their populations, with infestation frequency of host plants sometimes reaching and exceeding 25%. In some host plant populations, virtually all plants are infested in some years.

ACTIVITY PATTERN AND FORAGING.—All species are diurnal, although an occasional specimen has been caught in light traps (*G. mitellae* and *T. gei*). Although it is our impression that most species are active throughout the day, J.F. Gates Clarke (pers. comm.) observed that *G. variabilis* in the alpine region of the Queen Charlotte Islands were active primarily in the early morning hours, especially between 0800 and 0900 h. It has been recorded at other times of the day elsewhere. Most species also fly actively at dusk, but generally settle within an hour after sunset. For example, *G. enchrysa* is active during most of the day, but oviposition and mate search reaches a distinct peak for about one hour just after sunset. This may in part be due to lower wind velocities, to which the moths are very sensitive. When *G. enchrysa* and *G. piperella* coexist, the former is typically active for an additional hour after *G. piperella* has ceased flight.

Nectar foraging has been observed in seven species. *Greya politella* (Figure 1) and *G. enchrysa* (Figure 7) take nectar only of their larval hosts. Four other taxa nectar on their larval host and other species as well: *G. mitellae* has been observed feeding on *Mitella stauropetala* and on *Osmorhiza chilensis*, *G. obscura* on their local *Lithophragma* host and on *Dentaria californica*, *G. piperella* on *Heuchera cylindrica* and *Lithophragma parviflorum*, and *G. solenobiella* on *Lithophragma affine*, *L. parviflorum*, and *Plectritis macrocera* (Valerianaceae). *Greya pectinifera* and *G. variabilis*, for which the host plants are unknown, have been observed taking nectar on *Platanthera stricta* (Orchidaceae) (Patt, 1986; Patt et al., 1989, given as *Greya* sp.). It seems probable that more of the flower-ovipositing species will be found to take nectar. In contrast, *G. subalba* and *G. powelli* apparently do not take nectar at all; they have never been observed nectaring, and the haustellum of *G. subalba* is sometimes reduced.

Despite extensive observation, nectaring has never been observed in *Tetragma gei*. The relatively long haustellum would suggest that it may occur, but *Geum triflorum* flowers used for oviposition are past the stage of nectar production and their nectar would be very difficult to access even in the best of times because of its location deep inside the flower.

COURTSHIP.—Courtship and/or mating has been observed in six species.

There is behavioral evidence of a female pheromone in *G. politella*. A virgin female brought into the laboratory refused to oviposit for two days (in contrast to other females), and instead perched for hour-long periods with the abdomen raised, and

eighth segment and the ovipositor extended. When a male was introduced into the cage on the second day, mating followed immediately upon male wing-fanning. Males also pursue ovipositing, resting, or feeding females on flowers. Courtship includes rapid wing-fluttering and abdomen-bending. If the female flees to other flowers, the male may pursue her for several flowers. Such courtship almost always ends in rejection. Copulation occurs in the usual head-apart posture, with the male hanging below the female (Figure 4).

Courtship behavior is quite similar in both *G. obscura* and *G. enchrysa*, with males courting females as they rest on the host flowers. A mating pair of *G. obscura* was found at 0900 h at the base of a *Lithophragma* stem; a fresh pupal exuvia below may indicate that the female mated soon after eclosion. A mating pair of *G. enchrysa* was found resting on an inflorescence of *H. cylindrica* at 0920 h; the male also sat on the flowers.

In *G. subalba*, males fly among umbels of *Lomatium* spp. in search of females. Females spend much of their time on umbels throughout both the day and night, ovipositing during the day and resting during the night and cloudy or cool periods of the day. Both resting and ovipositing females are commonly harassed during the day by males attempting to mate with them.

In *G. mitellae*, males move quickly between flowering ramets, running up and down the inflorescences in search of mates. Either sex will be courted by males. The males are quite aggressive, and unwilling females flee immediately. Copulation has not been observed.

A female sex pheromone recently was isolated from abdominal tips of the prodoxid *Lampronia capitella* (B. Kovalev and C. Löfstedt, in litt.). This genus is closely related to *Greya*. The isolated substance, Z11-tetradecenyl acetate, proved highly attractive to males in field tests. This is evidently the first identification of a female sex pheromone in a non-ditrysian moth.

OVIPOSITION.—The oviposition of *G. subalba* has been described in detail (Thompson, 1987). The female positions herself head upward on an immature *Lomatium* schizocarp, piercing with the cutting ovipositor into the space between the schizocarp wall and the endosperm (Figures 5, 6). One or two eggs are usually laid per schizocarp. The average oviposition lasts for 162 seconds. Ovipositing females generally lay eggs in only a few schizocarps on each umbellet they visit, and exhibit a constant probability of leaving an umbellet after each egg is laid. Consequently, some umbellets receive more eggs than others. Females do not appear to choose schizocarps of particular sizes within umbellets (Thompson, 1987). Moreover, there is no indication that they avoid schizocarps that already contain eggs or larvae. Thompson (1987) suggested that selection may have favored females that distribute their eggs among umbellets in a way that maximizes unpredictability on larval dispersion to a searching parasitoid. Females of a braconid wasp, *Agathis thompsoni*, carefully search umbellets for *G. subalba* larvae and are the only known major enemies of the larvae while they are within the schizocarps (Thompson,

1986). The pattern of oviposition of *G. subalba* results in a broad distribution of larvae within and among plants. In a population of *L. dissectum* studied for three consecutive years, virtually all plants had between 10% and 65% of their seeds infested by *G. subalba* (Thompson, 1987).

The female of *G. powelli* oviposits into the ovary of *Bowlesia incana*, an umbellifer. Usually a single egg is laid into each ovary, which consists of a single ovule. Similar behavior is present in *G. solenobiella*, which oviposits into developing schizocarps of *Yabea microcarpa*. *Greya suffusca* oviposits into the developing seeds of *Osmorhiza brachypoda* at the suture between the ovaries (Figure 15), depositing an egg partly or wholly inside either of the ovaries. Similar behavior has been reported for *G. reticulata*, which oviposits into the developing schizocarps of *Osmorhiza chilensis* (J. Powell, unpubl. data). In all species that oviposit into umbellifer seeds, the female typically sits with her feet on the stylopodium, cutting into the schizocarp at a point determined by the length of the developing fruit. In the ovoid-fruited *Yabea*, this usually means a basal incision, while in the slender *Osmorhiza* most insertions appear near the middle.

We have extensive observations on oviposition behavior for *G. politella*, which oviposits on many species of *Lithophragma* and at least one *Heuchera* species. Females invariably take nectar on a flower before ovipositing into it (Figure 1). After nectaring, the abdomen is pushed down the floral hypanthium (Figures 2, 3). In some hosts, the ovipositor cuts through the nectariferous disk at the top of the ovary, and one or more eggs are laid inside the ovary. In other species, the ovipositor is inserted between the non-fused styles, and the eggs are laid inside the ovary. A female may fly elsewhere, return to the same flower, or visit other flowers on the same inflorescence for subsequent ovipositions.

Females of *G. mitellae* cut into the ovary wall of *Mitella stauropetala*, laying single eggs within the adnate calyx and ovary wall (Figures 117-119). They have also been observed to oviposit into pedicels and petioles. In *G. obscura*, females either cut through the ovary wall of *Lithophragma* from the outside, depositing one or several eggs inside the ovary wall, or place single eggs in the stem pith. In *G. punctiferella*, females cut into the ovary of *Tiarella trifoliata* and deposit an egg inside it; repeated observations of insertions into pedicels and peduncles suggest that eggs may be deposited in those parts as well (Figure 10). In one California population, females deposit their eggs into the ovary or calyx of *Tolmiea menziesii* and *Tellima grandiflora*. In *G. piperella*, moths walk down *Heuchera cylindrica* inflorescence stalks still in bud, depositing single eggs at intervals of 2-10 mm into the stem. We have seen up to 11 ovipositions in a row by a female. In one population, the host is *Heuchera micrantha*; the oviposition site is unknown. *Greya enchrysa* oviposits into flowers of *H. cylindrica* and *H. grossulariifolia* (Figure 8). The carpels of the host are not fused but merely appressed to each other, and the female sits atop, pushing her ovipositor down between the

edges to the center of the ovary, where a cluster of eggs (Figure 181) is deposited. Most ovipositions in *Greya* species last between 25 seconds and 10 minutes.

The female of *Tetragma gei* oviposits into the ovaries of partly developing ovules of *Geum triflorum* (Figures 11-14). Some flowers allow relatively easy access to ovules, while in others the moth may have to work very hard to reach the ovaries. In such cases, it may take the moth 20 to 30 minutes to reach it, and an oviposition of a single egg may take about 1 hour. In such cases, the female, who possesses the most elongate, telescoping abdomen of any known prodoxid (Figure 63), backs down into the flower so deep that the wings are folded over the body, with only the wingtips visible in profile (Figure 14).

There is no indication of an oviposition-detering pheromone in any species. In species such as *G. politella*, *G. enchrysa*, and *Tetragma gei*, the same female or another individual may oviposit in a structure seconds after a previous oviposition.

EGG

Little is known about egg biology. In *Greya subalba*, most eggs are laid in the middle third of the schizocarp as a consequence of the way in which females position themselves on schizocarps while ovipositing. In *G. politella*, eggs are laid in columns between the rows of ovules, and they hatch about 6-8 days later. Similar time periods are indicated in *G. piperella* and *Tetragma gei*. In *G. enchrysa*, the duration of the egg stage is 9-10 days.

LARVA

Biology of the first-instar larva is known in part for several species (Thompson, 1987, and unpubl. data), but we only know the penultimate and ultimate instar for *G. politella* and *G. obscura*. In *G. politella*, the larva emerges about one week after the host flower has shed its petals. One to several larvae may be found in the syncarpous capsule of *Lithophragma*. Individual seeds are excavated by the larvae, leaving seed coat fragments behind. The fully grown first-instar larva, which is about 2 mm long, leaves the capsule after about two weeks. Larvae exit by eating through the ovary wall or through the gradually opening capsule apex. The subsequent spring, penultimate (4th ?) and ultimate (5th ?) instar larvae feed on early leaf sheaths and flower buds, or most commonly on foliage. The last-instar larva folds part of a large leaf or an entire small one, and ties it below. It feeds inside this shelter, and pupates in a loose cocoon that is thickest near the caudal end.

Observations of just-hatched first-instar larvae of *G. obscura* in *L. affine* followed the patterns seen in *G. politella*. Last-instar larvae and pupae are found inside folded leaves of their host, in a fashion indistinguishable to us from that of *G. politella*. The cocoon is more uniform in its silk density than that of *G. politella*.



FIGURES 1-6.—1-4, *Greya politella* on *Lühophragma parviflorum*: 1, nectaring female; 2, 3, female ovipositing into flower; note elongated seventh segment cleared of scales in Figure 2; 4, in copula on host. 5, 6, *Greya subalba* ovipositing into developing seeds of *Lomatium dissectum*. Figures 1-4 from Granite Point, WA, 5, 6 from Rock Lake, WA (Figure 24).

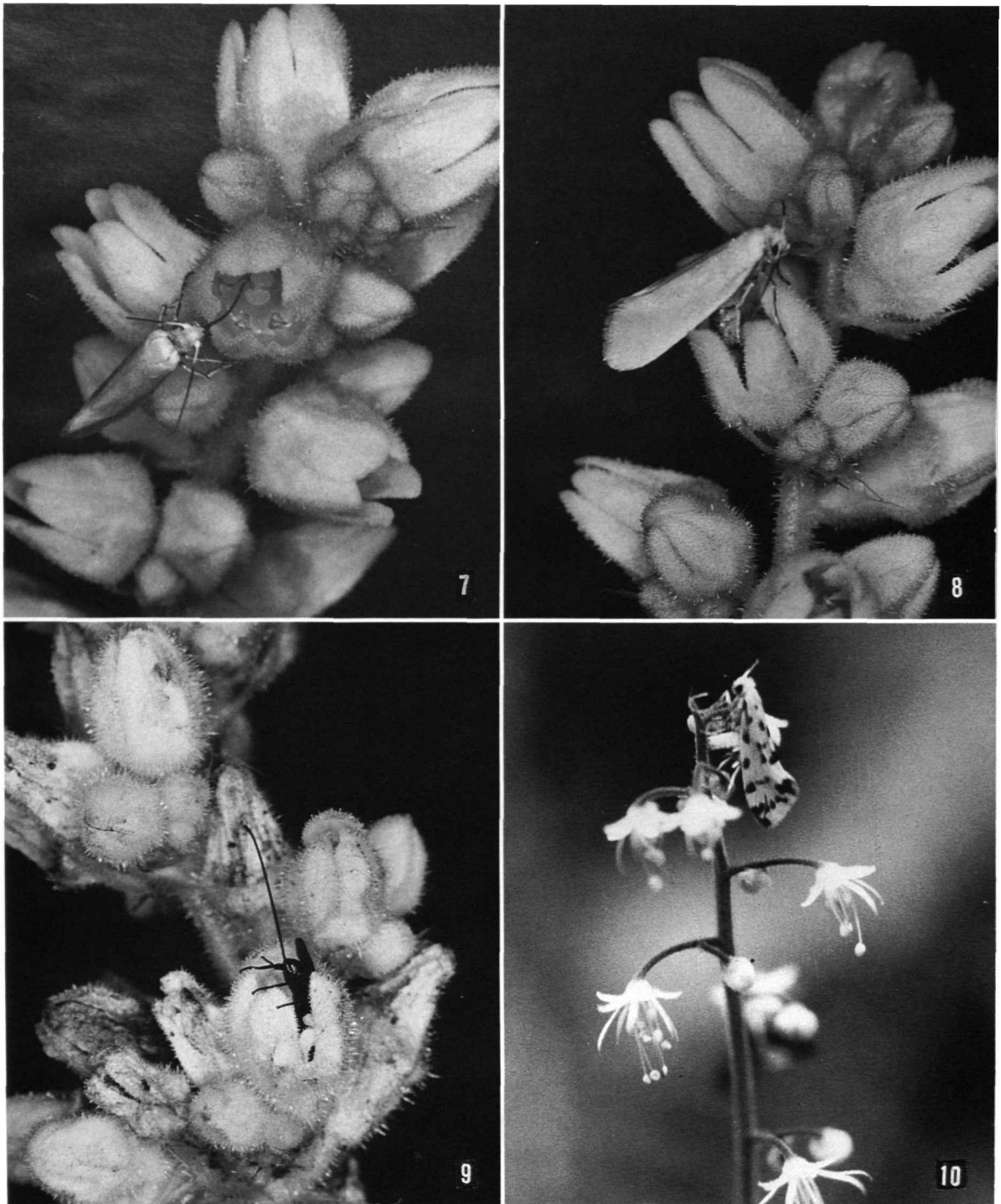

FIGURES 7-10.—7, 8, *Greya enchrysa* on *Heuchera cylindrica*: 7, nectaring female; 8, ovipositing female. 9, *Agathis* near *brevicornis*, a parasitoid of *G. enchrysa*, nectaring on flowers of *H. cylindrica*. 10, *Greya punctiferella* ovipositing into peduncle of *Tiarella trifoliata*. Figures 7-9 from E of Spalding, ID; 10 from Deer Lake trail in Olympic Mountains, WA.

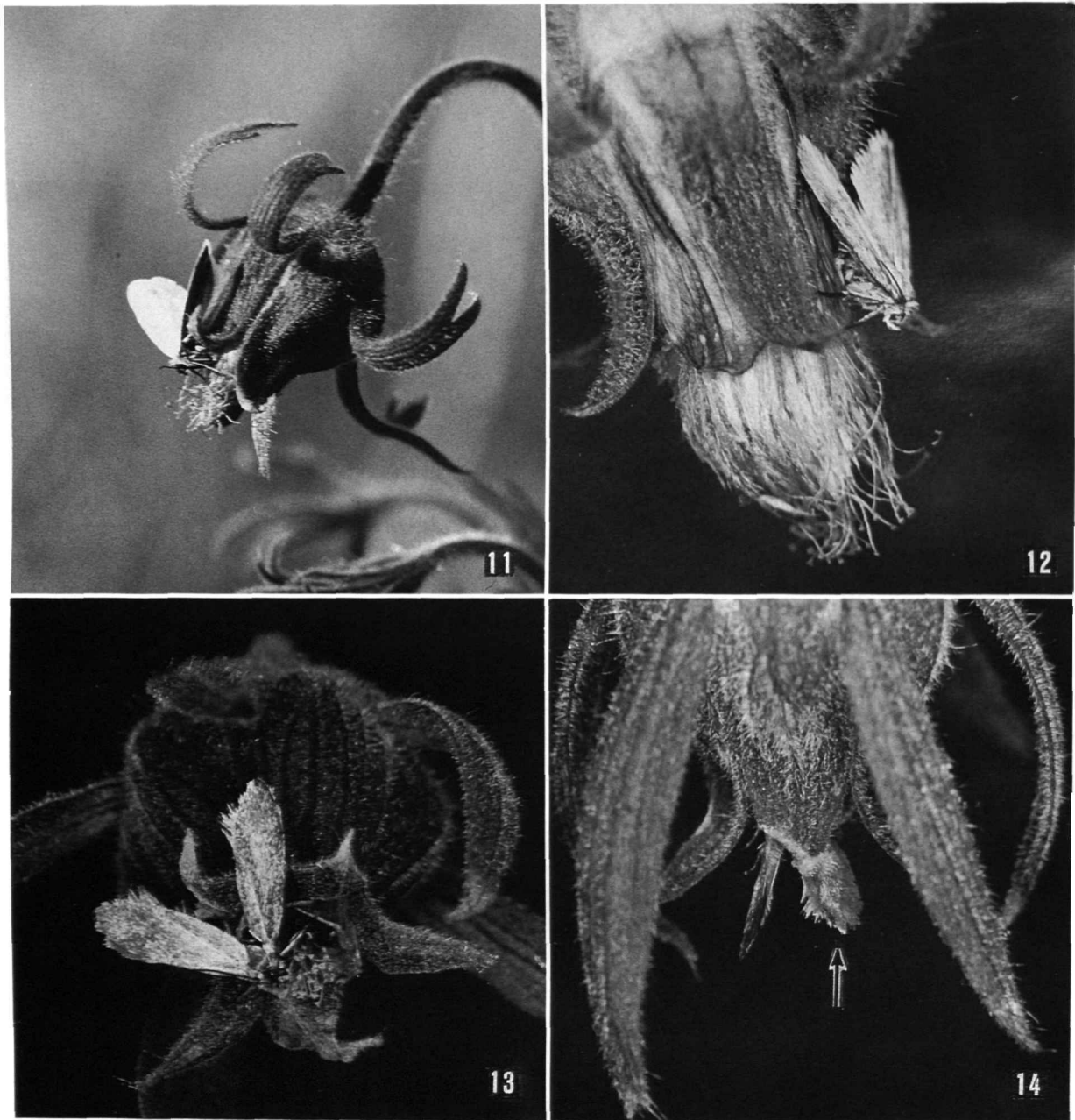

FIGURES 11-14.—*Tetragma gei* on *Geum triflorum*: stages of oviposition, backing down into the flower, which is past reproductive phase; in Figure 14, the moth has descended so far that only the wing tips (arrow) folded over back are visible in profile. All photos from N of Anatone, WA (Figure 19).

In *G. piperella*, first-instar larvae eat throughout the peduncle, consuming all meristematic tissue when a stem is heavily infested (Figure 16). The presence of exit holes in the basal 10 cm of old stems suggest that the larvae exit prior to pupation.

Larvae of *G. enchrysa* consume a subset of developing seeds

in capsules of *Heuchera cylindrica*. Full-grown first-instar larvae are often found in a cluster surrounded by a few silk threads basally in the capsule. Nothing is known about the further fate of these larvae.

In *G. subalba*, usually one or two larvae develop per seed (Thompson, 1987). A larva usually consumes only part of the



FIGURES 15-18.—15, *Greya suffusca* ovipositing into developing schizocarp of *Osmorhiza brachypoda*. 16, section of peduncle of *Heuchera cylindrica* completely excavated by over 20 first-instar larvae of *Greya piperella*; a single larva is visible on left near lower fourth of the photo. 17, 18, fragments of *Lithophragma parviflorum* with dried leaf containing cocoons and (17) extruding pupal exuviae of *G. politella*. Length of cocoon is ~6.5 mm. Figure 15 from type locality at Sequoia National Park, CA (Figure 29), Figure 16 from E of Spalding, ID, leaves in Figures 17 and 18 from Rattlesnake Grade Canyon and Granite Point, WA, respectively.

seed, leaving the embryo intact. Ellison (1986) found that larvae fed predominantly on the endosperm near the site at which the egg is laid, with most larvae feeding in the middle third of the schizocarp. At the end of the first instar, the larva bores out and drops to the ground. Its subsequent habits are unknown.

In some *Lomatium* populations, developing schizocarps are infested by both *G. subalba* and two species of weevil: *Smicronyx* sp. (*cinereus* group) and *Apion oedorhynchum* Le Conte (Ellison and Thompson, 1987). These weevils are capable of eating most or all of the endosperm within a seed and they may compete with *G. subalba* when population numbers are high. Oviposition by *A. oedorhynchum* causes the seed to form a gall. Ellison (1986) found that schizocarps in which both seeds were galled had fewer *G. subalba* eggs than non-galled seeds.

Wagner and Powell (1988) observed exiting first- or second-instar larvae of *G. reticulata* from *Osmorhiza chilensis* after inflorescences were brought into the laboratory.

Tetragma larvae eat their way through the ovule of *Geum triflorum*, exiting basally as a young larva (Figure 64). The habits of later instars are not known.

PUPA

The pupae of only *G. politella* and *G. obscura* are known within the two genera. In both species, the pupa rests in a thin cocoon on the underside of a slightly folded, fresh leaf of the host plant near the base of the stem (Figures 17, 18). Duration of the pupal stage appears to be about 5–14 days.

NATURAL ENEMIES

LARVA.—Parasitoid wasps are known to attack five or six species. *Agathis thompsoni* (Sharkey) (Braconidae: Agathidini) attacks *G. subalba* (Thompson, 1986, 1987; Sharkey, 1987) by probing *Lomatium* schizocarps in search of larvae. Thompson (1986) found no indication that *A. thompsoni* females could efficiently determine and respond to larval distribution. Females probe preferentially into large schizocarps but, nonetheless, do no better than chance in finding larvae among the schizocarps they probe. Females do not probe more schizocarps on umbellets with many rather than few larvae. While searching for larvae, *A. thompsoni* females walk slowly over the schizocarps, palpating the surface of the seed coat with their antennae. They generally visit one to several schizocarps on an umbellet before walking or flying onto a nearby umbellet. Adults appear to spend much of their time on *Lomatium* umbels, searching for larvae or resting during the day, and resting during the night. Parasitism levels are not known, but no moth populations studied to date lack the parasitoid.

Greya enchrysa is attacked by another species of *Agathis*, tentatively identified as near *brevicornis* (Muesebeck) (Figure

9; M. Sharkey, pers. comm.). The female, which has a 6–7 mm long ovipositor, probes through the slightly open capsule shortly after flowering. A female caught in association with *G. enchrysa* feeding on *H. grossulariifolia* had a distinctly shorter ovipositor.

Greya politella is attacked in SE Washington by an *Apanteles* species (Braconidae: Apantelinii). Female wasps search for eggs or larvae contained within the capsules of *L. parviflorum*, often probing repeatedly into individual capsules. Oviposition occurs a few days after flowering, at which point the *Greya* hosts are still eggs or recently hatched larvae. The parasitoid apparently kills the last-instar larva, and emerges from its cocoon. The ichneumonid *Diadegma* sp. 1 has been reared from last-instar larvae. The species has been seen searching on seed capsules of *L. parviflorum*, but oviposition has not been observed.

Greya mitellae is evidently attacked by the ichneumonid *Diadegma* sp. 2. Males of the parasitoid sought females on inflorescences near the end of flowering, and females oviposited into flowers past receptivity where ovipositor scars were present on the calyx and an egg was found in the ovary wall.

Greya punctiferella may be attacked by the ichneumonid *Diadegma* sp. 3; males were seen searching the inflorescences of *Tolmiea* for females in a fashion similar to that of *Diadegma* sp. 2 on *Mitella stauropetala*.

ADULT.—Adults of several flower-visiting species are commonly caught by thomisid spiders, including *Misumena vatia* (Clerck), *Tibellus oblongus* (Walck.), and *Xysticus* sp.; records exist for *G. politella*, *G. mitellae*, *G. obscura*, *G. enchrysa*, *G. subalba*, and *G. piperella*. In addition, *G. subalba* are often caught by web-building spiders near their host plant.

On one occasion, a dragonfly (Odonata, Anisoptera) was observed to search on and around *Heuchera cylindrica* for *G. enchrysa* and *G. piperella*, which were caught as they flew up.

EGG AND PUPA.—No enemies are known for these stages.

Geographic Distribution

Greya is largely limited to the semiarid and moist areas of western North America (Maps 2–7; Figures 19–30), although one species touches on the Palearctic region in Beringia. In contrast, the sister group of *Greya*, the Agavaceae-feeding prodoxids (Davis, 1967; Nielsen and Davis, 1985; Wagner and Powell, 1988) predominate in semiarid or arid regions of North and Central America. Recorded distributions of *Greya* suggest two current centers of diversity for the genus—one in California and one in eastern Washington—but this probably reflects collecting activity more than actual distribution. Intensive collecting of the genus has been done by J.A. Powell and collaborators in California, whereas OP and JNT have collected extensively (out of Pullman) in eastern Washington. Very little collecting has been done in Oregon since the type specimens of the genus were caught by Walsingham in 1871. Still, there is some evidence that several taxa are limited to



FIGURES 19-24.—19, type locality of *Tetragma gei*; 5 km N Anatone, WA; also present at site is *Greya subalba*. 20, rockface with *G. piperella* in Calaveras County, CA; the host, *Heuchera micrantha*, grows in crevices and on ledges; also present at site are *G. politella* and *G. obscura* on *Lithophragma affine* and *L. bolanderi*. 21, habitat of *G. politella* and *G. obscura* on *Lithophragma cymbalaria* near Alamo-Pintado Creek on Figueroa Mtn., Santa Barbara Co., CA. 22, habitat of *G. powelli* near Alamo-Pintado Creek on Figueroa Mtn., Santa Barbara Co., CA; males often perch on *Artemisia* (e.g., by trunk on left), while females remain on host plant in shade among shrubs; also present at site are *G. politella* and *G. obscura*. 23, 24, habitat of *G. politella* in northern part of its distribution and of *G. subalba*; Figure 23 from Kramer Reserve, WA, Figure 24 from Rock Lake, WA; at latter site, other prodoxids found include *G. enchrysa*, *G. piperella*, *Tetragma gei*, *Lampronia aenescens* (Walsingham), and *L. oregonella* (Walsingham).

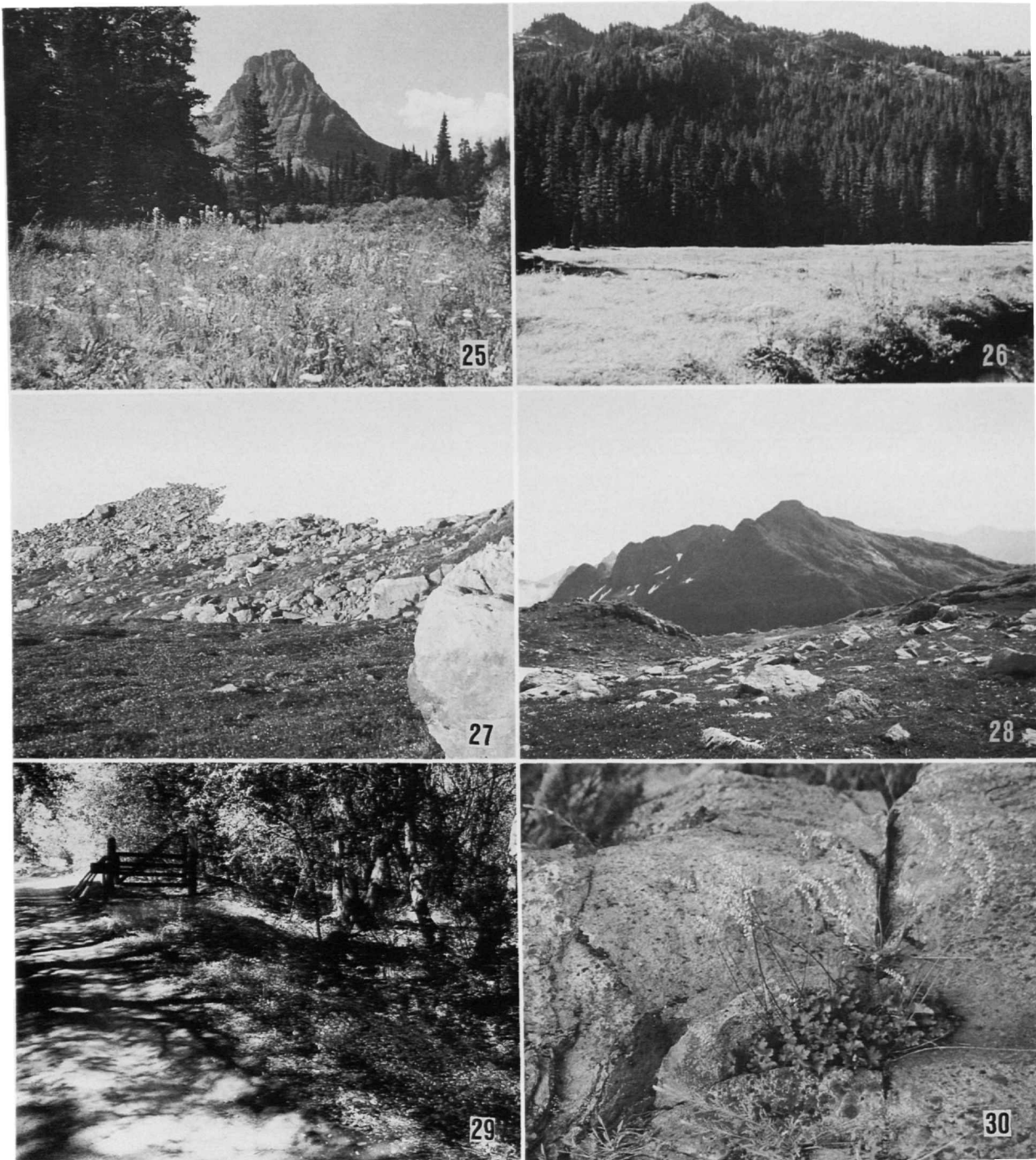

FIGURES 25-30.—25, type locality of *Greya variata*; south of Two Medicine Lake, Glacier National Park, MT; also present in meadow are *G. piperella*, *G. enchrysa*, and *G. subalba*. 26, type locality of *G. pectinifera*; Deer Lake area in Olympic Mtns., WA; *G. variabilis* is sympatric with it in open boggy areas. 27, 28, Queen Charlotte Islands, Graham Island above Dawson Inlet, at 2500 m. *Greya variabilis* very common in habitat just below snowline (upper part of Figure 27); in Figure 28, view downhill from site. 29, type locality of *G. suffusca*; Sequoia National Park boundary on South Fork Drive of Kaweah River, CA; moth was abundant in dense understory of *Osmorhiza brachypoda* on both sides of the road. 30, *Heuchera grossulariifolia*, possibly introgressed with *H. cylindrica*, E of Lowell, ID; host of *G. politella* and *G. enchrysa*, it grows on north and northwest facing rocks. Figures 27 and 28 by N.L. Clarke.

either the northern and southern ends of the distribution area of the genus. Several dry-habitat species are limited in distribution to the California coast, primarily between the San Francisco area and Los Angeles. Examples of this distribution pattern are *G. reticulata* and *G. powelli*. In contrast, several species occur only in drier areas farther north, such as *G. enchrysa*, *G. subalba*, and *G. variata*. *Greya politella* is the only widespread species limited to dry habitats; its range extends east to western Colorado, north to Alberta, and south to southern California. In the northern areas, several taxa inhabit moister habitats. Examples are *G. obscurumaculata*, *G. punctiferella*, *G. mitellae*, and *G. pectinifera*. The most aberrant distribution is found in *G. variabilis*, which inhabits moist coniferous forest and alpine habitats from NW Oregon, via the Queen Charlotte Islands and Alaska, to St. Lawrence Island in the Bering Strait. It is currently not known from, but likely to extend into, mainland Siberia.

Tetragma gei (Map 1; Figures 19, 24) is currently known only from a few localities, mostly in mid to high-altitude forb-rich meadow habitats. Extending from easternmost Washington into the Black Hills of South Dakota, it is the easternmost ranging taxon treated in this revision, yet it belongs to the same biotic region. The scattered records of the species suggest that it has been overlooked, and eventually may be found in many more places.

Phylogeny

INTERRELATIONSHIPS BETWEEN *Greya* AND *Tetragma* SPECIES

The characters listed below were used in the phylogenetic reconstruction of the two genera; all autapomorphies have been excluded, and *Lampronia* was used as outgroup. The matrix used is shown in Table 2. The cladograms were derived using PAUP 3.0 (developed by David Swofford). A most-parsimonious tree was derived, using the branch-and-bound algorithm in PAUP. Wagner parsimony was used for all traits except numbers 13, 14, 23, and 25, which were unordered (Camin-Sokal parsimony). In addition, we ran the analyses on Hennig86 (developed by James S. Farris) to test whether all unique topologies had been found. All results reported below from the PAUP analyses were corroborated using Hennig86. We used MacClade 2.1 (developed by Wayne P. and David R. Maddison) to test alternative topologies, particularly for higher-order branching patterns.

The following characters were used.

1. *Male larger than female*. Most other Lepidoptera either lack sex-based size dimorphism, or the female is the larger sex.

2. *Maxillary palpus 3-4-segmented*. Many prodoxids have a 5-segmented palpus, and it is the primitive state in Lepidoptera (Common, 1975). The character has probably evolved through loss of the fifth segment,

which is minute in the plesiomorphic state. This character has evolved independently at least twice among the prodoxids (present in *Prodoxoides*, *Tridentiforma*, some *Greya*, and *Parategeticula*).

3. *Interantennal suture convex in dorsal view (0), straight or concave (1), or absent (2)*. In the plesiomorphic condition, the suture is distinctly convex as viewed dorsally.

4. *Interantennal suture reduced to a series of parallel ridges*. While these ridges may be present also in other taxa, there is always a distinct, deeper suture line behind them.

5. *Vestiture of frons sparse*. The cuticula is clearly visible in the derived condition, while in the plesiomorphic condition the scales form a complete cover.

6. *Metasternal furca fused to secondary arms*. Metasternal furca are free in all primitive genera. Similar-type fusion is present also in Tischeriidae, one genus of Opostegidae, and some ditrysian families (Davis, 1989).

7. *Wing pattern sexually dimorphic*. Sexual dimorphism in wing pattern is considered absent in the primitive state.

8. *Zigzag wing pattern*. The zigzag pattern formed by dark blotches against a pale ground color is expressed to different degrees, particularly in the *solenobiella* group. The same zigzag pattern has evolved independently at least twice more in the family (in some *Lampronia* and *Prodoxus*).

9. *Ground color of forewing result of pointillistic mixing of fuscous and white scales*. In other taxa, the ground color is made up of uniform-colored scales or at least patches of uniform scales.

10. *Wing pattern made up of minute brown spots*.

11. *Cubitals convergent in hindwing*. In the primitive taxa, the cubital veins are parallel.

12. *Uncus deeply bilobed (0), shallowly bilobed (1), or more or less pointed, unilobed (2)*. In most *Lampronia*, the uncus is shallowly bilobed, thus this is considered the plesiomorphic state.

13. *Vinculum-saccus short (0), long (1), or very long (2)*. This character is linked to the length of the aedeagus. The character is treated as unordered.

14. *Number of cornuti*. Character coded by number of cornuti.

15. *Aedoeagus broad at posterior end*. No apparent broadening present in the plesiomorphic condition.

16. *Aedoeagus appears two-pronged at anterior end*. End of aedeagus is undivided in the plesiomorphic condition.

17. *Aedoeagus with two fin-like structures at apical end*. These structures are absent in other taxa.

18. *Basal costa on valva ends squarely against costal*

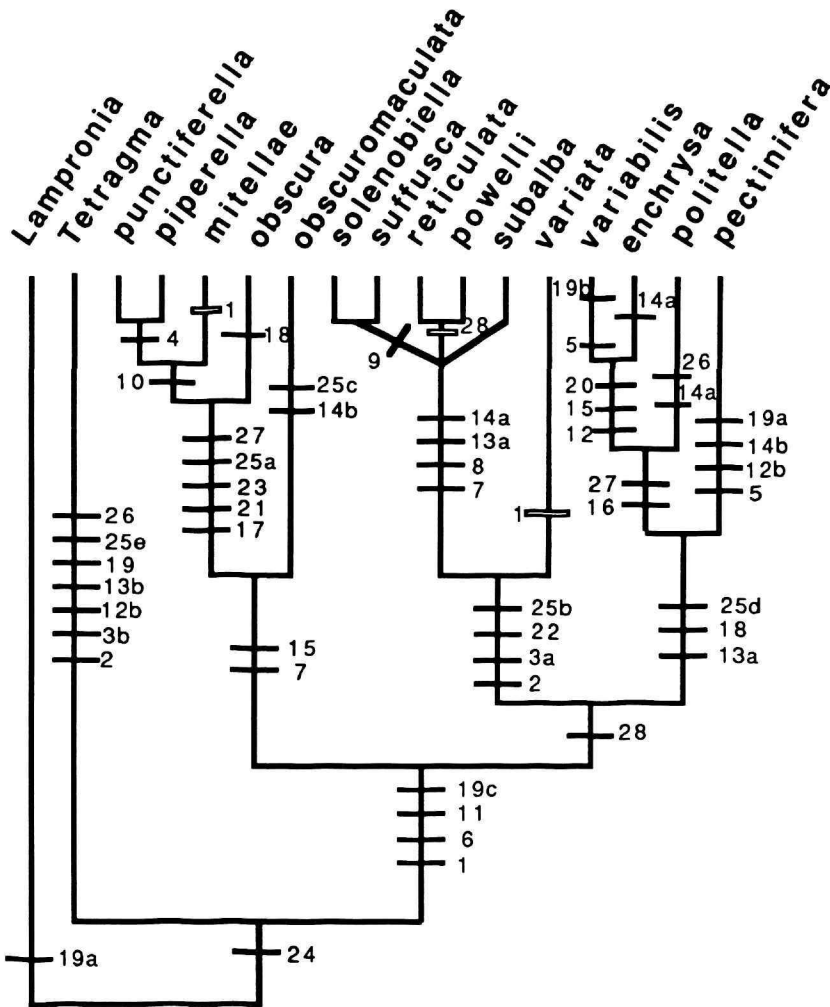

Figure 31.—Cladogram for *Greya* and *Tetragma* based on 28 informative characters. This single most-parsimonious cladogram was generated using the branch-and-bound algorithm (with the delayed-transformation option) in PAUP. *Lampronia* was used as designated outgroup. The tree required 57 steps, and had a consistency index of 0.67. *Greya sparsipunctella* was excluded because about half of the character states are unknown. Filled bars represent character changes, open bars reversals. For multistate characters, letters (a-e) after character number indicate states 1-5 in matrix.

tially become quite different as more data becomes available (see below).

We must stress that phylogenetic reconstruction of *Greya* is greatly impeded by apparent homoplasy of many derived traits (e.g., fusion of R_4 and R_5 , loss of signa, four-segmented maxillary palpi, scaly haustellum), and also by the relative paucity of synapomorphies to link species groups. For example, the three major groups that emerged can be moved around within the cladogram with only slight lengthening of the cladogram. Thus the phylogeny presented here should be considered as tentative. In an attempt to overcome many of

these obstacles, a project is under way utilizing mtDNA to obtain data to further determine the relationships among and within these genera (R.G. Harrison, J.N. Thompson, and O. Pellmyr, in prep.).

In the phylogeny, two groups doubtless constitute monophyletic entities. The *punctiferella* group, consisting of *G. punctiferella*, *G. piperella*, *G. mitellae*, and *G. obscura*, share four synapomorphies: fin-like structures at the apical end of the aedocagus, a heavily melanized pollex without externally visible suture between the spine and the cucullus, pollex near apex of valva, and numerous long sensilla on the caudal margin

of the seventh segment in the female. In addition, three of the members have spotted forewings, and the facies of the male genitalia is so similar that some species are difficult to differentiate on this basis.

The second, or *solenobiella* group, consists of *G. solenobiella*, *G. subalba*, *G. suffusca*, *G. powelli*, and *G. reticulata*. Autapomorphies for the group include either straight or concave interantennal suture, zigzag wing pattern of the female, and constriction of the cucullus beyond the pollex (the latter shared with *G. variata*). Again, the male genitalia are very similar among taxa. Female wing pattern shows gradual change from the all-white to hardly-discernibly patterned *G. subalba*, the rarely-white to distinctly patterned *G. solenobiella*, the brownish patterned *G. suffusca*, to the dark brown-and-white *G. reticulata* and *G. powelli*.

The sister-taxon status of *G. enchrysa* and *G. variabilis* is moderately robust. They share multifid pollex and deeply bilobed uncus. The squarely truncated end of the base of the costa of the valva, the broad caudal end of the aedocagus, and the sparse vestiture of the frons may suggest that these taxa together with *G. poliella* and *G. pectinifera* constitute a monophyletic group. The latter relationship is contradicted by the presence of a pectinifer and scaly haustellum in *G. pectinifera*: the pectinifer is usually present in the more primitive prodoxid genera, and the scaly haustellum is a family trait for Adelidae and a generic character of *Tridentiforma*. A strong argument against inclusion of *G. pectinifera* in, e.g., *Lampronia*, is the fused metafurcasternum, which is a synapomorphy of *Greya* and the Agavaceae-feeding genera. The resolution of the generic placement of *G. pectinifera* and *G. sparsipunctella*, and the relative positions of the groups and isolated taxa within the genus, will hopefully be better understood as molecular data become available.

Greya AND *Tetragma* IN RELATION TO OTHER PRODOXID GENERA

A phylogeny at the genus level for the family was proposed by Nielsen and Davis (1985). They listed two autapomorphies for *Greya*.

1. A prominent pollex on the ventral margin of the valva. In *Greya*, a digitate extension from the ventral margin of the cucullus is present, and it almost always bears one or more modified spines. It is believed to represent the most reduced state of the pectinifer. In fact, occasional specimens of *G. variabilis* show a rudimentary pectinifer of up to six scattered spines along the ventral margin. One species described here (*pectinifera*) displays the plesiomorphic state, a pectinifer instead of the pollex, and it is unclear whether it is a case of reversal. The only other Incurvarioidea with a pollex is Crinopterygidae (Petersen, 1978; Nielsen and Davis, 1985).

2. A long, narrow membranous zone on the inner surface of the valva.

In addition to these traits a third should be added.

3. Reversed size dimorphism between the sexes. Males of *Greya* are usually distinctly larger than females (see Figures 71 and 247 for two examples). Similar size dimorphism is known to occur sporadically in, e.g., Eucosmiinae, Pyralidae, and Adelidae, but not in Prodoxidae. An interesting secondary reversal to typical size dimorphism has occurred in *G. mitellae*, where males are much smaller than the females. The condition is unclear for *G. variata*, where the few individuals known show little size difference, and for *G. sparsipunctella*, where the male is unknown.

The phylogenetic position of the monobasic genus *Tetragma* is somewhat less certain. Autapomorphies are as follows.

1. No armature on ventral margin of valva.
2. Uncus simple and rather pointed. Uncus shallowly or deeply bilobed in all other genera.
3. Short and uniformly distributed vestiture on the antennae. In other genera, sensilla trichodea are more spindly, of varying length, and are more densely distributed at the base of each segment.
4. No erect sensilla chaetica on the flagellar segments.
5. Microtrichia lost dorsally on basal $3/4$ of forewing. These structures are present in most non-ditrysian moths, but partly or completely lost in nearly all Ditrysia (Davis, 1990).
6. Narrow anal fold containing a hairpencil on hindmargin of hindwing in male.
7. Extremely elongated seventh segment in the female. This segment is about as long as all anterior abdominal segments together.
8. Eighth abdominal segment telescoping in female.
9. Caudal margin of seventh abdominal segment in female without setae. In other genera, the segment has numerous hairs along the margin.

In addition, the taxon displays fusion of R_4 and R_5 in the forewing, four-segmented maxillary palpi, and reduced pilifers, but these characters have been lost repeatedly in related taxa and cannot be regarded as very reliable in phylogenetic reconstruction. To test whether *Tetragma* actually may be a specialized member of *Lampronia*, a matrix was drawn with five *Lampronia* species that represent most of the morphological diversity within the genus. Also included was *Greya*, and *Prodoxoides* was used as the outgroup. A 14-character matrix was used (Table 3). It was run in PAUP under a branch-and-bound most-parsimonious algorithm, with characters 1, 3, 7, 8, 9, 10, 11, and 13 run as unordered, and the remainder as

ordered. MacClade 2.1 was used to test alternative topologies. The following characters were used.

1. *Eye small or medium in size.* 0 = small, 1 = medium.

2. *Epicranial suture absent.* A more or less distinct sulcus is present in the primitive state.

3. *Flagellum with scales dorsally only on basal half (0), with some scales on each flagellomer (1), or completely scale-covered (2).* Complete scale coverage is present in adeliids and incurvariids, but it is unclear whether the trait is conserved or independently evolved in *Lampronia luzella*. The trait is treated as unordered.

4. *Maxillary palpus 4-segmented.* The palpus is 5-segmented in the primitive stage (Common, 1975), with the apical segment being very small.

5. *Haustellum short.* In the primitive state, the haustellum is typically longer than the labial palpus.

6. *Pilifers absent or at least much reduced.* In the primitive state, the pilifers cross, or almost so, in front of the haustellum.

7. *Forewing unicolorous, without markings.* In the other state, the wing may have several different colors and definitely has markings.

8. *Uncus shallowly bilobed (0), simple and broadly rounded (1), deeply bilobed (2), or simple and near-pointed (3).*

9. *Costa of valva with distinct notch.* A small notch may be present in the primitive state.

10. *Armature on caudal margin of valva a comb-like pectinifer (0), a cluster of basally fused spines (1), a single spine (pollex; 2), a pointed protrusion of cucullus (3), or completely without armature (4).*

11. *Number of cornuti.* Coded by their number.

12. *Ovipositor smooth.* The ovipositor is distinctly serrated in the plesiomorphic condition.

13. *Ovipositor slender and cutting (0), broad and bluntly truncated (1), or slender with arrow-shaped tip (2).*

14. *Signum with flat area or hole in center, with few rays.* The signum consists of a nodulate structure with more than 10 rays in the plesiomorphic condition.

The analysis yielded four topologically different most-parsimonious cladograms, each with 28 steps and a consistency index of 0.79 (Figures 32, 33). *Tetragma* is placed as sister group of *Lampronia* or as sister group of *Greya*, but never within *Lampronia*. Nielsen and Davis (1985) gave two synapomorphies for *Lampronia*: small eyes and a short proboscis. The former trait may be a synapomorphy for *Tetragma* + *Lampronia*. Based on the present evidence it seems warranted to give generic status to the taxon. Further analysis is much needed, though, as several topologies marginally longer could include *Tetragma* within *Lampronia*.

TABLE 3.—Data matrix for *Prodoxoides*, *Tetragma*, five *Lampronia* species, and *Greya*. The fourteen characters used are listed in the "Phylogeny" section. An asterisk (*) indicates a lack of information, a 9 indicates not applicable information.

Species	Character													
	1	5	10											
<i>Prodoxoides</i>	1	1	0	1	0	0	0	1	1	0	2	0	0	0
<i>Tetragma</i>	0	1	0	1	0	1	1	3	1	4	0	1	0	9
<i>Lampronia oregonella</i>	0	0	1	1	1	0	0	1	0	0	0	0	1	0
<i>Lampronia russatella</i>	0	0	1	1	1	0	0	2	0	0	2	0	1	0
<i>Lampronia capitella</i>	0	0	0	1	1	0	0	0	1	1	0	0	0	0
<i>Lampronia luzella</i>	0	*	2	1	1	*	0	2	0	3	1	0	0	1
<i>Lampronia aenescens</i>	0	0	0	1	1	1	1	1	0	1	2	0	2	1
<i>Greya</i>	1	0	0	0	0	0	0	1	1	2	2	1	0	0

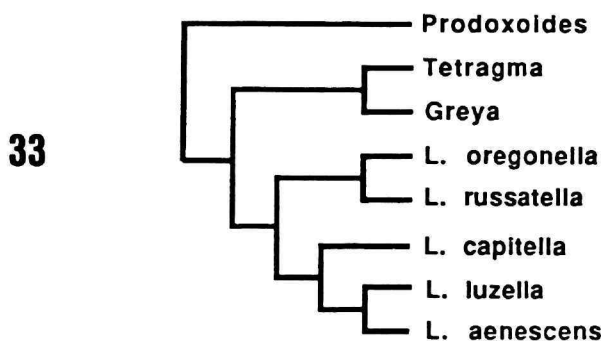
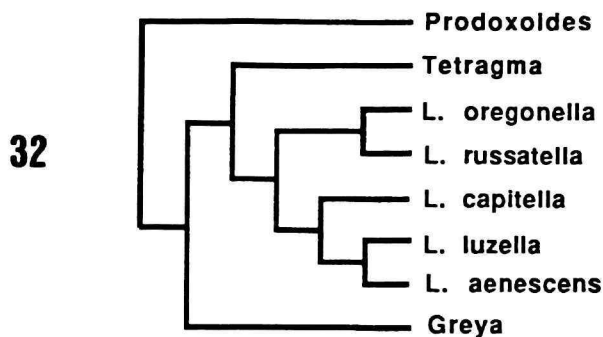

FIGURES 32, 33.—Two cladograms for *Prodoxoides*, *Tetragma*, *Greya*, and five *Lampronia* species. The latter were chosen so as to cover most of the morphological variation within the genus. These trees were generated using the branch-and-bound algorithm in PAUP. Fourteen characters (see Table 3) were used. Each tree required 28 steps, and had a consistency index of 0.79. Four trees were equally short, the two not shown here differing only in the relative positions within *Lampronia*. Note that *Tetragma* is isolated from *Lampronia* in all trees. Character evolution is not proposed in these cladograms, because the sparsity of characters makes even the topology tenuous. Character evolution schemes will be proposed as molecular data becomes available.

Key to the Genera of Prodoxidae

1. Furcal arms of metathoracic sternum free [Figure 43] (*Lamproniinae*) 2
Furcal arms of metathoracic sternum joined to secondary arms [Figure 45] (*Prodoxinae*) 5
2. Haustellum not exceeding length of maxillary palpus *Lampronia*
Haustellum 2-3 × the length of maxillary palpus 3
3. Base of haustellum scaled; male valva with pectinifer arranged in three well separated rows *Tridentiforma*
Haustellum naked; pectinifer absent or arranged in single row 4
4. Radius of forewing with all branches arising separate from discal cell; male with juxta asymmetrical, valva with pectinifer; female with moderately elongated seventh abdominal segment *Prodoxoides*
Radius with R₄ and R₅ stalked [Figure 40]; juxta symmetrical, valva without pectinifer, seventh abdominal segment greatly elongated [Figure 63] in female *Tetragma*, new genus
5. Haustellum more than twice the length of maxillary palpus *Greya*
Haustellum less than 1.5 × the length of maxillary palpus 6
6. Epiphysis and frenulum absent; labial palpus 2-segmented *Parategeticula*
Epiphysis and frenulum present; labial palpus 3-segmented 7
7. Apical (third) segment of labial palpus as long as second; fourth segment of maxillary palpus as long as third; haustellum less than length of maxillary palpus *Agavenema*
Apical (third) segment of labial palpus less than half the length of second; fourth segment of maxillary palpus twice the length of third; haustellum exceeding the length of maxillary palpus 8
8. Frons relatively narrow (interocular index more than 1.2); female with sclerotized, uncinat process from caudal apex of seventh abdominal tergum *Mesepiola*
Frons relatively broad (interocular index less than 1.0); female abdomen without uncinat process on seventh tergum 9
9. Male genitalia with ventral margin of valva deeply lobed and usually bearing a few to several short spines in a single cluster; maxillary palpus of female usually with an elongate tentacle arising from basal segment *Tegeticula*
Male genitalia with ventral margin of valva evenly curved; spines usually absent or, if present, scattered; maxillary palpus of female simple, without basal tentacle *Prodoxus*

Tetragma Davis and Pellmyr, new genus

TYPE SPECIES.—*Tetragma gei*, new species.

ADULT.—Small, slender bodied moths; wing expanse approximately 11–17 mm.

Head (Figures 34, 35): Vestiture rough. Eyes naked, rather small, interocular index¹ 0.67, eye index² 0.87. Epicranial suture and interantennal suture completely absent. Antenna short, 25–30-segmented, approximately 0.33–0.5 × the length of the forewing; scape with distinct pecten of 12–14 setae;

¹sensu Davis 1975:5: ratio between vertical eye diameter and interocular distance at point halfway between interantennal suture and anterior tentorial pits.

²sensu Powell 1973:8: ratio between vertical eye height and distance from shortest horizontal line between antennal sockets and ventral margin of clypeus.

flagellum densely pubescent with stubby sensilla trichodea; erect sensilla chaetica completely absent; sensilla coeloconica present with central sensillum short and stout and without encirclement of spines (Figures 49, 50). Pilifers reduced to 1–2 stout piliform setae (Figure 48). Maxillary palpus four-segmented, relatively short, less than length of haustellum or labial palpus; basal three segments subequal; apical segment (fourth) the longest, approximately 1.5 × length of third. Haustellum (Figure 35) 1.75 × length of labial palpus and 2.5 × length of maxillary palpus; legulae acute, apices slightly attenuated, straight (Figure 51). Labial palpus exceeding length of maxillary palpus, with basal two segments equal in length; apical segment the shortest, approximately 0.8 × the length of second; organ of vom Rath apical on third segment (Figures 52, 53).

Thorax: Primary furcal arms of the metathoracic furca separate from the secondary arms of the furcasternum (Figures 42, 43). Legs as in Figure 46. Epiphysis (Figures 61, 62) present, pectinate, arising from middle of prothoracic tibia and extending only part way to apex of segment; approximately 0.3 the length of tibia; epiphysal spines relatively broad and truncate. Forewing (Figure 40) relatively slender, greatest width $\sim 0.28\text{--}0.33 \times$ that of length, 12-veined; R_2 arising from outer third of accessory cell; R_4 and R_5 stalked approximately half their length; remainder of veins arising separate from cell; 1A and 2A divided about $1/3$ their length at base; male subcostal retinaculum a slender flap arising between costa and Sc and curling over base of Sc (Figures 54, 55); dorsal scales of discal cell variable in length with bi- or tridentate apices (Figure 58); windows between longitudinal ridges numerous and relatively large, their diameter ranging between $0.3\text{--}0.5 \times$ the distance between the ridges (Figure 59). Microtrichia densely scattered over all wing surfaces except largely absent over basal $3/4$ of dorsal forewing (Figures 58). Hindwing slender, greatest width $\sim 0.33 \times$ that of length, 8-veined; all veins separate except M_1 and M_2 which are occasionally connate; CuA_1 and CuA_2 diverging slightly from distal fourth of cell; base of medius forked within cell of both wings; hind margin of male with narrow anal fold (Figures 56, 57) containing a hairpencil.

Abdomen: Unmodified in male, without specialized appendages or hair tufts; seventh segment greatly elongated in female (Figure 63).

Male Genitalia: Uncus simple. Vinculum-saccus elongate, Y-shaped. Valva with sacculus well developed, broad; cucullus reduced, narrow, without pectinifer or pollex. Juxta with cephalic end gradually tapering to apex, acuminate; caudal end broad, subtruncate. Aedoeagus elongate, slender, without cornuti.

Female Genitalia: Ovipositor with apex compressed, acute. Ductus bursae elongate. Corpus bursae with a pair of stellate signa. Vagina reduced in size.

IMMATURE STAGES.—As described under the species.

ETYMOLOGY.—The four-segmented maxillary palpus, a character shared with some or all taxa of three other genera of Prodoxidae, has suggested the generic name of this taxon. It is derived from the Greek, tetra (four) and agma (fragment), and is treated as feminine.

DISCUSSION.—Although sharing certain similarities with *Greya* and *Lampronia*, *Tetragma* possesses sufficient differences from *Lampronia* to warrant separate generic status, as discussed in the phylogeny section. The separation from *Greya* is primarily based on the freely projecting metafurcal arms (Figures 42, 43), in contrast to the fused condition described for *Greya* and most Prodoxinae. Apparent autapomorphies for the genus are: uncus simple, cucullus without armature, absence of erect sensilla chaetica, organ of vom Rath apical on labial palpus, sensilla coeloconica reduced, and uniform cover of relatively flat sensilla trichodea on the antennae.

Tetragma superficially resembles some *Greya* with respect

to several morphological features of the head, particularly the reduced four-segmented maxillary palpi (found in most *Greya*) and the relatively long haustellum. The latter characteristic distinguishes *Tetragma* from *Lampronia*, another prodoxid genus sometimes with four-segmented maxillary palpi.

A special note is warranted in connection with vom Rath's organ on the labial palp. Part of the Lepidoptera groundplan (Kristensen, 1984), its function has been recorded as unknown in the systematic literature. Electrophysiological study has recently shown that the receptors in this organ (called "labial palp-pit receptors") show a strong, dose-dependent response to carbon dioxide (Bogner et al., 1986). The biological function of such a receptor is unclear.

Tetragma gei Davis and Pellmyr, new species

FIGURES 11–14, 19, 24, 34–35, 40, 42, 43,
48–70, 251, 293–297, 359; MAP 1

ADULT (Figure 251).—Wing expanse: σ^7 , 11–13.5 mm; q , 13.5–16.5 mm. Integument dark, nearly black.

Head: Grayish fuscous, with a few white hairs intermixed at lateral margins of occiput and lower margin of frons. Antenna $0.33\text{--}0.5 \times$ the length of the forewing, 25–30-segmented, with basal 6–8 segments covered dorsally with dark, fuscous scales. Maxillary palpus white. Labial palpus white at base, becoming gray at apex of second segment; apical segment mostly gray to dark fuscous.

Thorax: Dorsum brownish gray, becoming white caudally and along posterior margin of tegula. Venter mostly white; anterior legs grayish fuscous dorsally, white ventrally; metathoracic legs mostly white, lightly intermixed with pale fuscous dorsally. Forewing uniformly pale ochreous; basal third of costal margin fuscous; cilia mostly white. Hindwing gray, with a slight bronzy luster; cilia white. Forewing underside darker than that of the hindwing.

Abdomen (Figure 63): Gray dorsally, heavily suffused with white caudally; white ventrally. Female with seventh sternite greatly extended, nearly $5 \times$ length of sixth; eighth sternite uniformly and lightly pigmented.

Male Genitalia (Figures 293–297): Uncus reduced, terminating in a relatively simple, subacute apex. Vinculum-saccus elongate, nearly $2 \times$ length of valva. Valva with basal half expanded, gradually constricting to a narrow, slightly curved cucullus; pollex and pectinifer absent; instead with a scattered series of short, blunt spines along hind margin of valva, gradually becoming more concentrated and longer near apex of cucullus. Juxta flared at middle, gradually tapering anteriorly to acuminate apex; caudal half terminating in relatively broad, spinose, truncate apex. Aedoeagus slender, elongate; apical fourth of vesica minutely spinose.

Female Genitalia (Figure 359): Apex of ovipositor compressed, acute, symmetrical, and relatively smooth. Eighth and ninth segments elongate, slender; sternites essentially unpigmented. Ductus bursae elongate, approximately $1.5 \times$ the

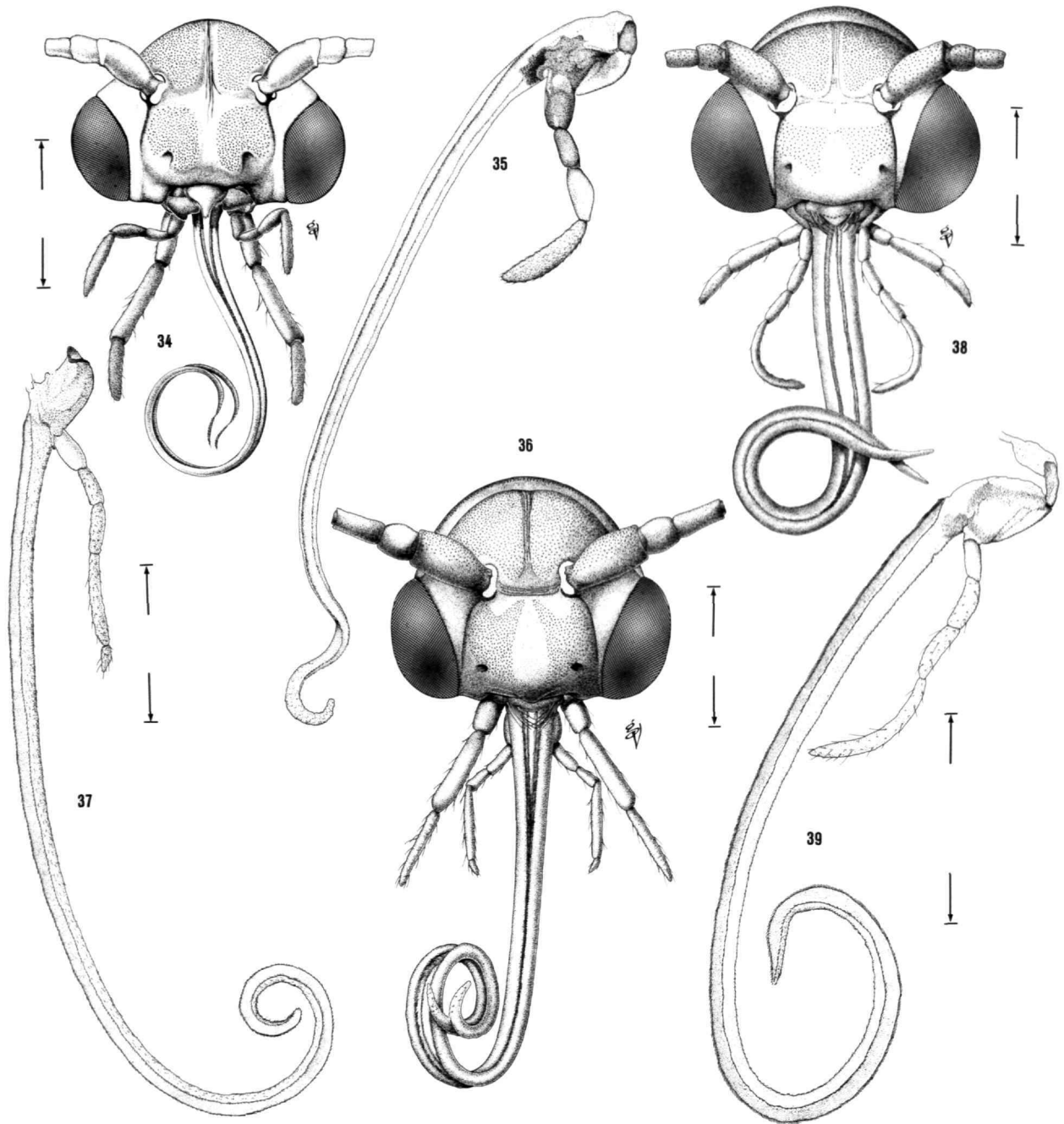

FIGURES 34-39.—Adult head morphology. *Tetragma gei*: 34, anterior view; 35, maxilla. *Greya punctiferella*: 36, anterior view; 37, maxilla. *Greya poliella*: 38, anterior view; 39, maxilla. (All scales = 0.5 mm).

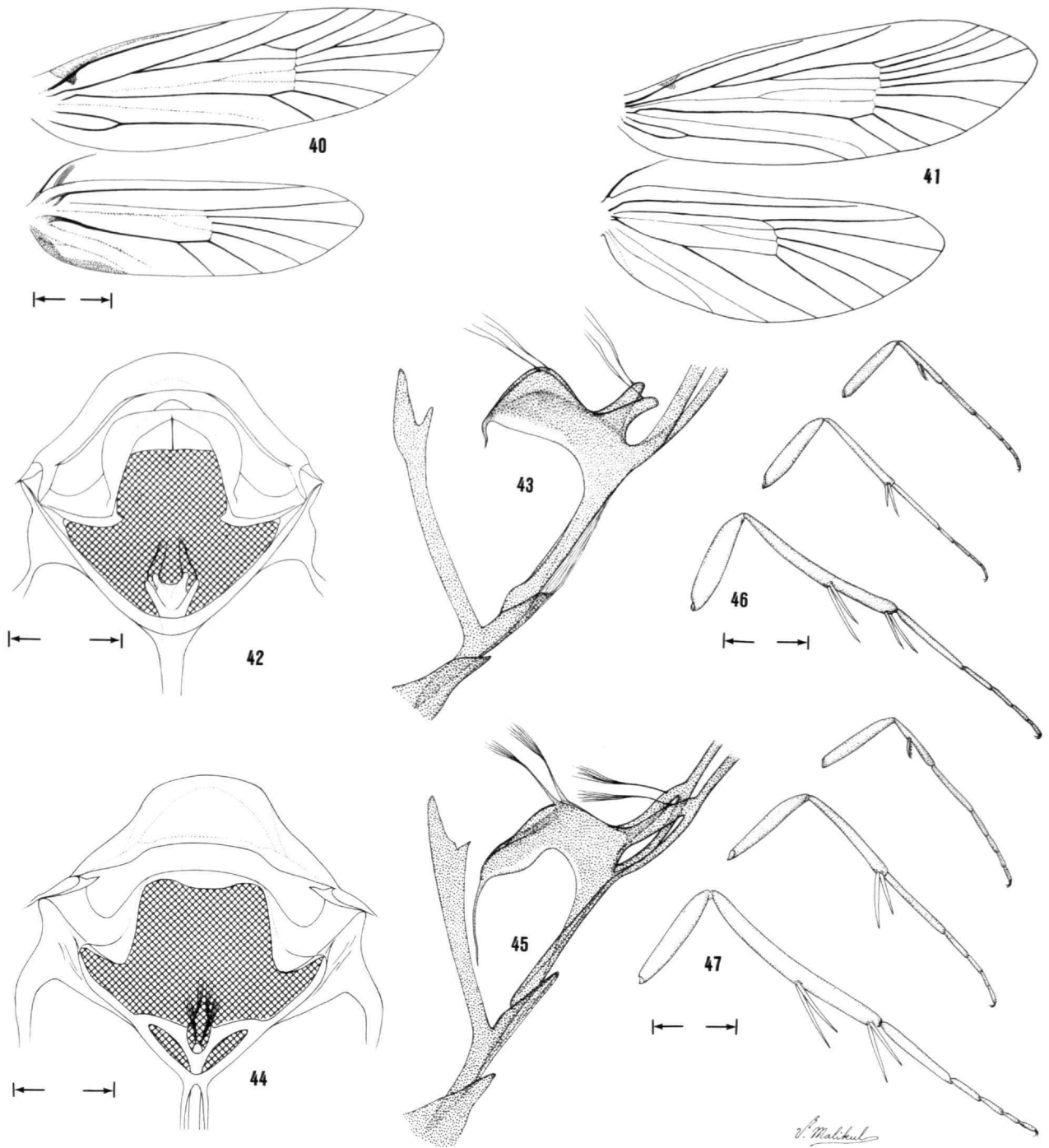

FIGURES 40-47.—Thoracic morphology. Wing venation: 40, *Tetragma gei*; 41, *Greya politella*. *Tetragma gei*: 42, metathorax, caudal view (0.3 mm); 43, lateral view of metafurcasternum. *Greya punctiferella*: 44, metathorax, caudal view (0.3 mm); 45, lateral view of metafurcasternum. Leg structure: 46, *Tetragma gei* (1 mm); 47, *Greya punctiferella* (1 mm). (Scale lengths in parentheses.)

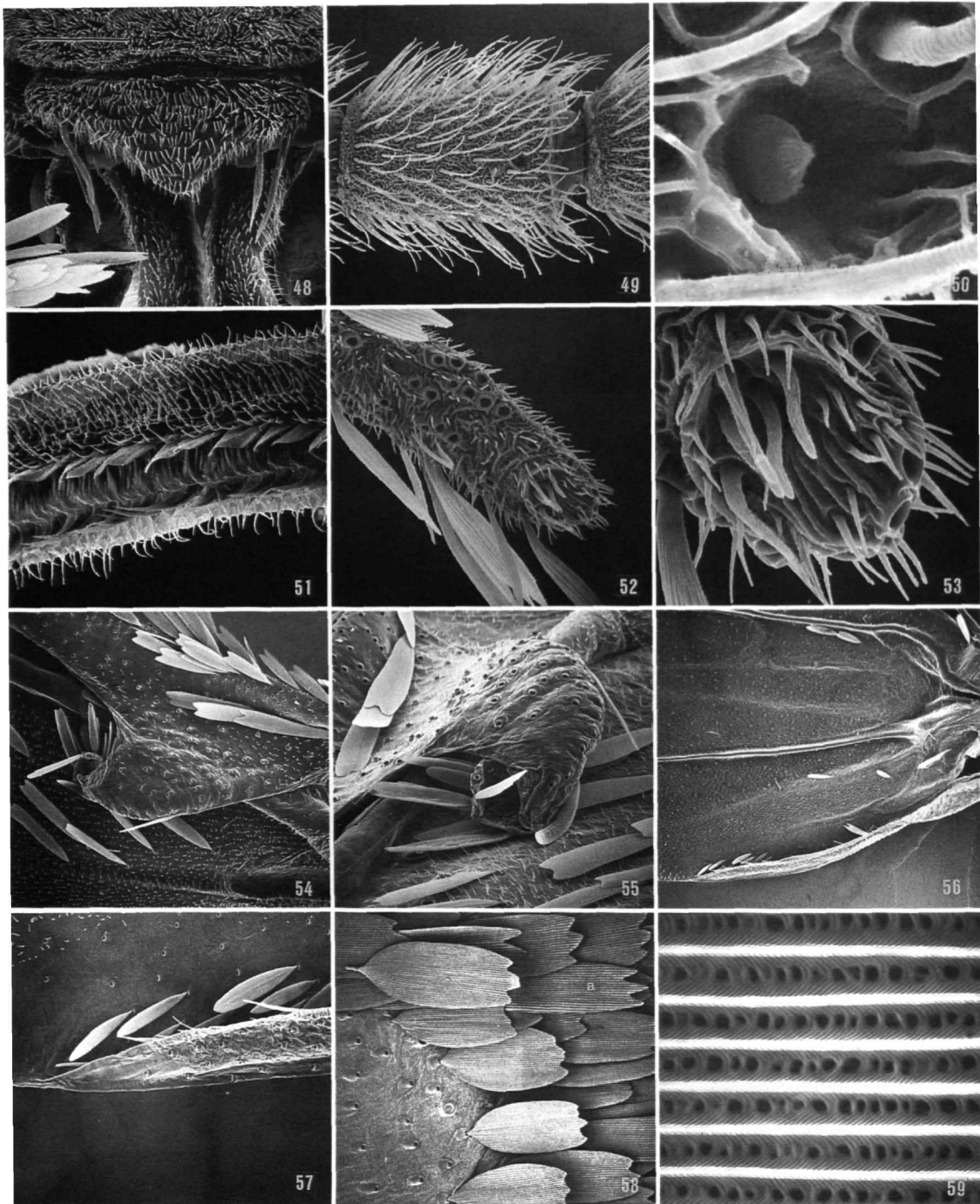

FIGURES 48-59.—*Tetragma gei*, adult morphology: 48, labrum (50 μm); 49, flagellomere near middle of antenna (43 μm); 50, detail of sensillum coeloconicum in Figure 49 (3 μm); 51, legulae bordering food channel of haustellum (23.1 μm); 52, apical segment of labial palpus (30 μm); 53, organ of vom Rath (apical sensory pit) of labial palpus (8.6 μm); 54, male retinaculum, ventral view (120 μm); 55, apical view of Figure 54 (60 μm); 56, ventral anal fold of male forewing (0.38 mm); 57, detail of anal fold showing apices of hair pencil (86 μm); 58, scales of dorsal forewing within discal cell, note absence of microtrichia (60 μm); 59, scale structure of scale "a" in Figure 58 (3 μm). (Scale lengths in parentheses; bar scale for all photographs given in Figure 48.)

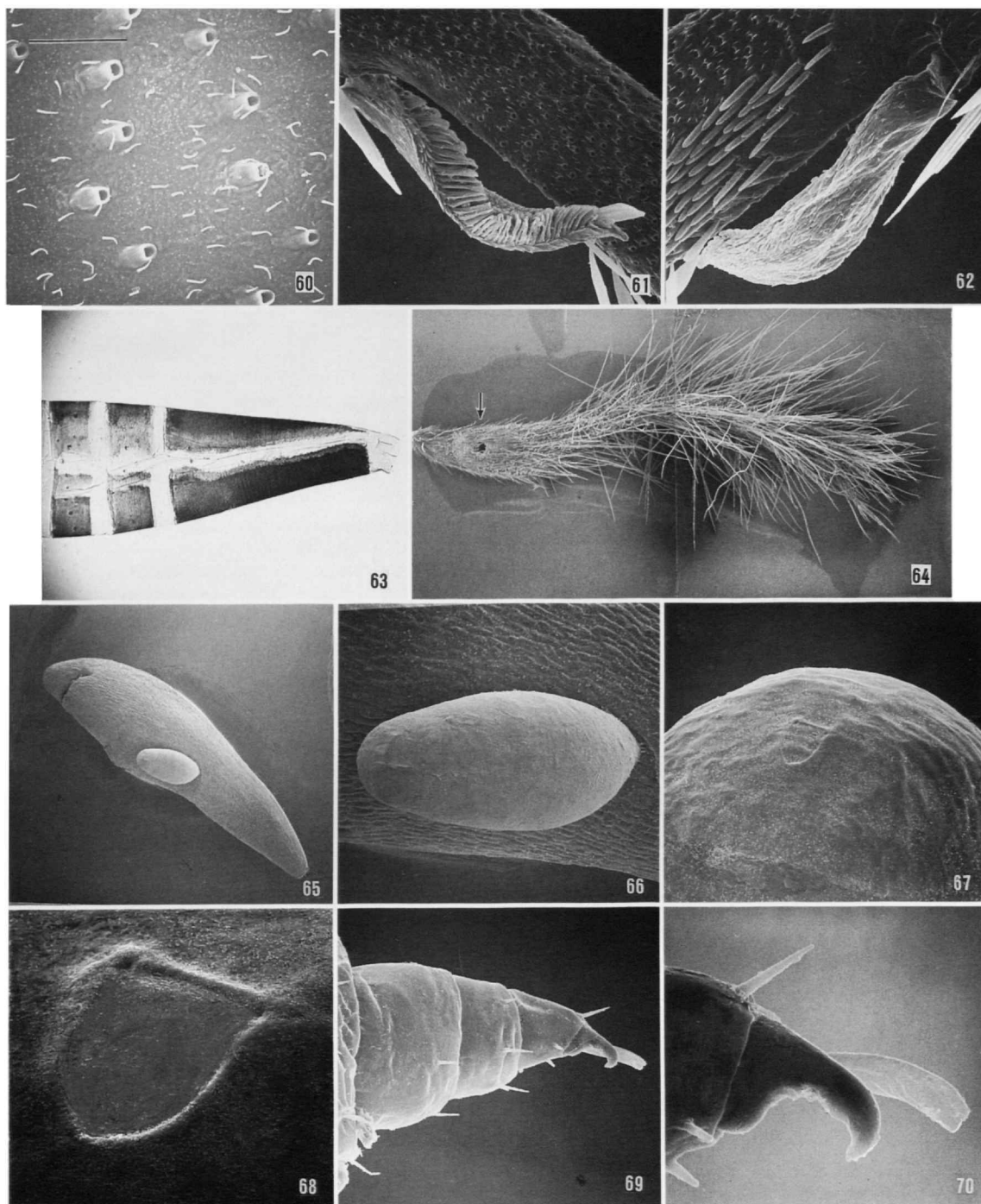

FIGURES 60-70.—*Tetragma gei*, morphology of adult and immatures: 60, microtrichia on dorsal forewing surface near apex (27 μm); 61, epiphysis, posterior view (60 μm); 62, epiphysis with associated tibial setae, posterior view (50 μm); 63, female abdominal segments 5-7; 64, single-seeded fruit of *Geum triflorum* showing larval exit hole of *T. gei* (1.5 mm); 65, developing seed of *Geum triflorum* (coat removed) with egg of *T. gei* attached (0.75 mm); 66, egg (176 μm); 67, micropylar end of egg (38 μm); 68, micropyle (10 μm); 69, prothoracic leg of first-instar larva (20 μm); 70, detail of pretarsus in Figure 69 (6 μm). (Scale lengths in parentheses; bar scale for all photographs given in Figure 60.)

length of posterior apophyses. Corpus bursae spherical, well differentiated from ductus. Signa paired, stellate, with 4–6 long slender rays.

EGG (Figures 65–68).—White, shape highly variable, molded by space between endosperm and ovary wall. Length 0.3–0.5 mm; width 0.2–0.4 mm. Chorion smooth. Micropylar end smooth with relatively reduced micropyle consisting of a single, variably quadrate ridge with 3–4 aeropyles typically in the inner angles of the ridge.

LARVA (Figures 69, 70).—This description is based on the first instar; no older larvae were available. Length of largest larva 1.6 mm; width 0.3 mm; maximum head diameter 0.25 mm. P1 laterad and caudad of AF2. L1 caudad and ventrad of A3. S1 below and nearer to stemma 3 than 2. Stemmata 3–5 well developed; 1–2, 6 less so, cornea relatively flat. Sensilla of antenna and maxilla as described for *Greya*. Mental setae greatly reduced. Pretarsus with elongate subapical, spatulate seta as in *Greya* (Figures 69, 70); claw more elongate, with more reduced axial spine. Prolegs similar to *Greya* but with callosities on A3–6 less evident. Anal combs of A10 with 4–6 spines.

PUPA.—Unknown.

HOLOTYPE.—3 mi [4.8 km] N Anatone, Asotin Co., Washington, ♂, 5 Jun 1970, J.F.G. Clarke; in the National Museum of Natural History, Smithsonian Institution.

PARATYPES.—UNITED STATES: IDAHO: *Latah Co.*: M.M. McCroskey Park, W end, along Skyline Drive, 1020 m: 3♂, 2 Jun 1989, O. Pellmyr (OP). *Nez Perce Co.*: 4 mi [6.4 km] SW Webb: 2♂, 8 Jun 1962, R.E. Stecker (USNM). SOUTH DAKOTA: *Lawrence Co.*: Stovehole Park, sec. 2 and 3, T. 2N, R. 1E: 2♂, 4–6 Jul 1965, R.W. Hodges, ♂ genitalia slide DRD 1208 (USNM). WASHINGTON: *Asotin Co.*: 3 mi [4.8 km] N Anatone: 20♂, 3♀, 6 Jun 1970, J.F.G. Clarke, ♂ genitalia slide 16047, wing slide 16051 (USNM); 1♂, 5 Jun 1970, J.F.G. Clarke (AMNH); 1♂, same data (CNC); 2♂, same data, (UCB). 5 km NE Anatone, along Hwy 129, 960 m: 7♂, 4♀, 31 May 1989, O. Pellmyr and J.N. Thompson (OP). 5 km SE Anatone, along Weissenfels Ridge Rd, 1100 m: 4♂, 1♀, 1 Jun 1989, O. Pellmyr (OP). *Garfield Co.*: 2.6 km SE Lower Granite Dam, along Wawawai Grade, 400 m: 10♂, 1♀, 17 May 1990, O. Pellmyr (OP); 2♀, 21 May 1990, O. Pellmyr (OP). *Whitman Co.*: 1.9 km SE upper end of Rock Lake, 625 m: 1♂, 27 May 1990, O. Pellmyr (OP). WYOMING: *Park Co.*: Yellowstone National Park, Pebble Creek Trail, 7900 ft [2370 m]: 1♀, 27 Jul 1979, R.E. Dietz IV (UCB). Yellowstone National Park, near eastern entrance: 1♂, 21 Jul 1982, R. Leuschner (RL).

Described from a total of 55 males and 12 females.

HOST.—*Geum triflorum* (Rosaceae).

FLIGHT PERIOD.—Late May to July.

DISTRIBUTION (Map 1).—This species is presently known only from a band ranging from the Black Hills of western South Dakota to the Columbia Plateau of southeastern Washington. Altitudinal range, 400–2500 m. Since the larval host was identified, we have found the moth in many populations of the

host. Future search around the host during the latter part of its flowering period may reveal a wider distribution than currently known.

HABITAT (Figures 19, 24).—Typical habitat for the species is forb-rich meadows, often at somewhat higher altitude, with plentiful *Geum triflorum*. The moths are active throughout the day. The two specimens from South Dakota, however, were collected at dusk and with a UV light trap, respectively.

ETYMOLOGY.—The specific epithet is the genitive form of the name of the plant genus *Geum*, a host record unique to *Tetragma* within the Prodoxidae.

DISCUSSION.—*Tetragma gei* is a relatively small, unicolorous, pale ochreous moth distinguishable from all other prodoxid species by the simple, subacute uncus, heavily setose but otherwise unarmed valva, the greatly lengthened seventh abdominal segment of the female, and the stalked condition of veins R₄ and R₅. Superficially, *T. gei* bears closest resemblance to *Greya subalba*, a species with which it is at least parapatric; the two may be easily separated by the above characteristics, and by the long, white cilia of *T. gei*. Two other characters, quite obvious in the field, is the dark head of *T. gei* (white in *G. subalba*), and that the fore- and hindwing undersides are of different color in *T. gei* but uniformly dark in *G. subalba*. Furthermore, in *Tetragma gei* the females are larger than the males, contrary to the unusual condition in most *Greya*. Thus, the size ranges of the respective sexes of these two species are approximately reversed.

The female of this species possesses the longest abdomen, in proportion to its overall size, of any known species of prodoxid. Most of this length is provided by a remarkable elongation of the seventh segment, which extends for nearly half of the length of the abdomen in repose. The telescoping eighth segment is similarly lengthened and together with the ovipositor provide a highly specialized mechanism for inserting eggs into the deeply recessed ovaries of *Geum triflorum*. A moth often spends 20–30 minutes probing with its telescoping abdomen, then pushing down into the flower, to reach an ovary. An incision is made in the ovary, usually near the top, and a single egg laid between the ovary wall and the endosperm. Retraction is likewise a slow process, and a complete oviposition can take about 1 hour. Occasionally, moths attack older infructescences, where the calyx lobes are reflexing, and the ovaries are more easily reached. Because the female backs all the way into the flower (Figures 11–14), the entire abdomen quickly loses all scales, and the dark integument becomes visible. This is another unique diagnostic trait for the species.

Genus *Greya* Busck

Greya Busck, 1903:194.—Kearfott in Smith, 1903:122.—Dietz, 1905:39, 92.—Busck, 1906:347.—Barnes and McDunnough, 1917:196.—Braun, 1924:238, 249.—Fletcher, 1929:101.—McDunnough, 1939:109.—Davis, 1978:10.—Frack, 1982:11.—Davis, 1983:4.—Nielsen and Davis, 1985:319.—Patt, 1986:41, 54, 55, 71–87, 90, 91, 93–96, 100, 101, 103.—Wagner and Powell, 1988:550.—Patt et al., 1989:1097.

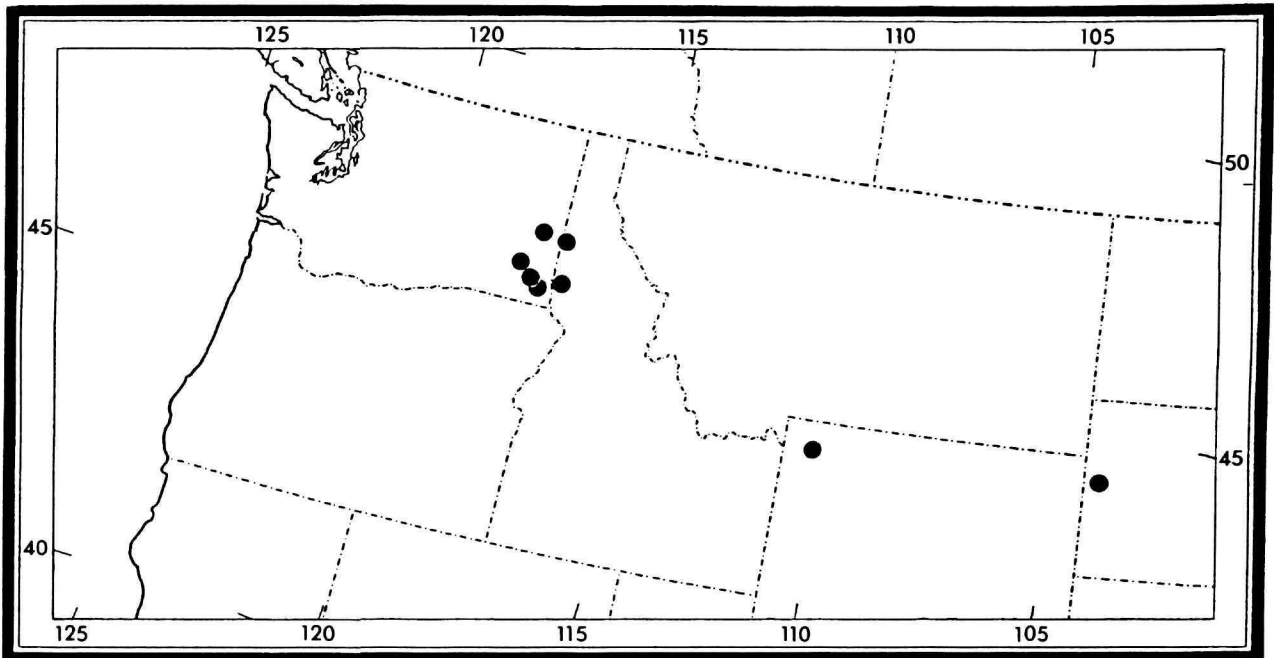
MAP 1.—Distribution of *Tetragma gei*.

Graya [sic].—Dietz, 1905:22. [Not *Graya* Bonaparte, 1856:841; *Graya* Buchecker, 1880: pl.1, no.4.]

Tetragreya Powell, 1985:84 [nomen nudum, based on an unpublished determination label].

TYPE SPECIES.—*Incurvaria punctiferella* Walsingham, 1888. Designated by Fletcher, 1929.

ADULT.—Small, slender bodied moths; wing expanse 7–27 mm.

Head (Figures 36–39): Vestiture completely rough, somewhat anteriorly pointed on vertex. Epicranial suture present. Interantennal suture present as simple suture or a row of more or less parallel ridges. Antenna simple, 27–39-segmented, approximately 0.35–0.70 × length of forewing; scape with pecten present, consisting of 10–14 setae; basal tenth to one-half of flagellum (3–18 segments; rarely 0) typically densely scaled dorsally, more so in female, densely pubescent over apical half and ventrally. Male pubescence usually longer than that of female. Most segments with 2–4 short erect sensilla chaetica medially on segments. Sensilla coeloconica present, with encircling spines. Ocelli absent. Compound eye relatively small to medium-size, interocular index approximately 0.7–0.8, eye index 0.95–1.05; microsetae minute, evenly but sparsely distributed over surface of eye. Mandible present, greatly reduced. Maxillary palpus elongate, slightly exceeding length of labial palpus, 3–5 segmented, folded in repose; fourth (penultimate) segment the longest; apical segment minute, less than 0.1 × as long as fourth. Pilifers

present, with 6–9 stout piliform setae (Figures 72, 123, 208). Haustellum (Figure 76) usually naked (basally scaled in *pectinifera*) well developed, usually over 3 × the length of maxillary palpus; legulae (Figures 76, 125) with greatly attenuated, strongly curved apices. Labial palpus three-segmented, somewhat shorter than maxillary palpus; organ of vom Rath arising near middle of apical segment.

Thorax: Primary arms of the metathoracic furca fused with the secondary arms of the furcasternum (Figures 44, 45). Foretibia (Figure 47) with pectinate epiphysis (Figures 86–89) arising from middle of tibia and extending 0.65 × the distance to apex; epiphysial spines relatively broad and truncate. Pretarsus with well developed arolium and pulvilli; unguitractor plate with 4–5 rows of scales (Figures 90–92). Forewing (Figure 41) relatively slender, greatest width ~0.3 × that of length, 11- or 12-veined; all veins arising separate from the discal cell; R_2 arising from apex of accessory cell approximate to R_3 ; R_4 and R_5 fused, stalked, or separate; CuA_2 variable in position, frequently arising close to CuA_1 at lower end of cell; accessory cell present; base of medius forked within discal cell. Male subcostal retinaculum a narrow flap arising near costal margin and curving over Sc (Figures 81, 82, 134). Dorsal scales of discal cell variable in length, mostly broad with tri- or quadridentate apices (Figures 132, 217); windows between longitudinal ridges often closed or minute; diameter less than 0.2–0.25 × the width between longitudinal ridges (Figures 85, 133, 218). Microtrichia densely scattered over all

wing surfaces. Hindwing relatively broad, greatest width $\sim 0.36 \times$ that of length, 8-veined; all veins separate; CuA_1 and CuA_2 converging slightly; base of medius forked within discal cell.

Abdomen: Unmodified, without specialized setal tufts or appendages. Seventh sternite of female moderately long, usually averaging approximately $2.5\text{--}3.5 \times$ length of sixth, with some species decidedly longer than others. Eighth segment lightly and uniformly pigmented, without darkly sclerotized areas laterally.

Male Genitalia: Uncus distinct, bilobed. Vinculum-saccus broad, V-shaped, approximately equalling valvae in length. Valva relatively simple, usually broad at base and narrowing to a rounded apex; ventral margin of cucullus typically with a single prominent, spinose process (i.e., pollex) or with a pectinifer containing numerous, small spines (in *G. pectinifera*). Juxta with anterior half narrow, attenuate; caudal half much broader, often with lateral margins sinuate; ventral surface of anellar membrane spinose or rough (Figure 122). Aedoeagus slender, elongate; cornuti present or absent; caudal end of vesica spinose or rugose.

Female Genitalia: Apex of ovipositor compressed, acute; an elongate, shallow, cloacal groove extends along underside of ovipositor apex (Figures 141, 244, 248) into which the alimentary canal and oviporus terminate (groove is probably developed in *Tetragma* and most if not all Prodoxidae). Vestibulum reduced in size, without noticeable sclerotization. Bursa copulatrix moderately long, slightly exceeding cephalic end of anterior apophyses when ovipositor is fully extended. Signa 0-2, if present, then of a stellate form.

IMMATURE STAGES.—The basic groundplan for prodoxids has been described by Davis (1987). The descriptions below are based on eggs of eight species (*subalba*, *politella*, *enchrysa*, *mitellae*, *punctiferella*, *piperella*, *solenobiella*, *powelli*), first-instar larvae of six species (*politella*, *enchrysa*, *piperella*, *Greya* sp., *subalba*, *obscura*), last-instar larvae of one species (*politella*), and pupae of two species (*politella*, *obscura*).

EGG.—White or yellowish white, or semi-transparent, pyriform, 0.25-0.5 mm in diameter. Without any surface texture, shape often molded by surrounding matter.

FIRST-INSTAR LARVA.—Length 1.1-2.65 mm; width 0.2-0.4 mm. Color white or yellowish white, with brown to dark brown head and pronotal plate; body cuticle rough, minutely spinose (Figures 93, 107, 184, 223).

Head: Maximum width 0.19-0.3 mm; round, prognathous, sometimes partly withdrawn into prothorax. Frontoclypeus relatively large, extending nearly to epicranial notch. AF1 and 2 arising close together above (caudad) middle of elongate adfrontal sclerite. Six stemmata present. P2 greatly reduced, similar in length to MD1-3. S3 minute, arising closer to MG1 than to S2. Antenna 3-segmented; second segment bearing 1 long and 2 short sensilla chaetica; apical segment bearing 1 sensillum basiconicum, 1 elongate sensillum chaeticum on a raised base (socle), and 1-2 shorter sensilla chaetica.

Mentum with a pair of minute setae ventrad to spinneret. Spinneret slender, exceeding length of labial palpus.

Thorax: Pronotal plate reduced, separate from SD1 and 2 (Figures 105, 234). Meso- and metanotal plates and pinacula not developed. Prespiracular series (L) trisetose. Prothoracic spiracle reduced in size (Figures 106, 235), ovoid with a broad marginal ring $0.25\text{--}0.35 \times$ diameter of spiracle in width. SV bisetose on prothorax, unisetose on meso- and metathorax. Legs well developed, coxae well separated (Figures 93, 107, 196); pretarsus with a single spatulate, subapical seta laterad to claw and surpassing it in length (Figures 108, 109, 153, 154, 197, 239); claw with a relatively well developed apical spine.

Abdomen: Pinacula undeveloped; anal plate moderately large, extending over most of tergum, bearing 3 pairs of setae. Prolegs on A3-6 and 10 reduced, without crochets and resembling ambulatory callosities (Figures 113, 114, 154, 155, 199, 200, 240, 243). All surfaces surrounding anal opening with numerous spinose combs consisting of rows with 3-11 spines each (Figures 116, 204).

LAST-INSTAR LARVA.—Length 5.6 mm; width 1.1 mm; maximum head width 0.52 mm. Frontoclypeus as in first instar. Chaetotaxy very similar to first instar. Mandible with 4 acute cusps. Labrum with 3 pairs of similar epipharyngeal setae. A3-6 reduced. Prolegs with relatively small crochets arranged in an indefinite biordinal circle; prolegs of A10 without crochets.

PUPA.—Length $\sim 5\text{--}6$ mm; width 1.6 mm. Color chestnut brown to brownish black. Vertex smoothly rounded. Antenna and forewing extending to approximate middle of A6. A single anterior row of 13-35 minute spines on terga of A2-8. Cremaster greatly reduced, essentially absent.

DISCUSSION.—The genus *Greya* has never been accurately defined, with the result that some of the species previously included within the group were misplaced. Busck (1903) proposed the generic name, in honor of Thomas de Grey, Lord Walsingham, and originally included three species previously described by Walsingham within the group (i.e., *G. humilis*, *G. punctiferella*, and *G. solenobiella*). We have found the latter two of these three insects to be congeneric and have retained *G. punctiferella*, the type of the genus as designated by Fletcher (1929), and *G. solenobiella* within *Greya*. The first taxon is now placed in the genus *Lampronia* (Davis, 1978; Nielsen and Davis, 1985).

The present members of the genus can be recognized by their relatively small eyes, long haustellum, and in males a single, prominent, acuminate process (or pollex) arising from the ventral margin of the cucullus (the latter replaced by a pectinifer in *G. pectinifera*, and partially in some individuals of *G. variabilis*). The pollex is usually trifid in two taxa (*G. variabilis* and *G. enchrysa*) and is rarely double in several taxa. The vein R_5 is sometimes missing, and if the palpus has five segments, the last is greatly reduced in size. The ovipositor appears smooth, but the serrate condition found in ancestral genera can be observed in a few species at very high

magnification. Perhaps the most unusual character is the reversed size dimorphism, with males larger than females; few other Lepidoptera show this condition. *Greya* demonstrates closest affinities to the Agavaceae-feeding prodoxine genera (Davis, 1967). *Greya* and the Agavaceae feeders form a monophyletic group based on the fused arms of the furcasterium (Nielsen and Davis, 1985). This group is probably the sister group of either *Tridentiforma* or *Lampronia* + *Tetragma*. Meanwhile, no synapomorphy except the host shift (and probably complete larval endophagy) has been recognized to distinguish the Agavaceae feeders from *Greya* (Wagner and Powell, 1988), and resolution of that group will have to await further data.

A special note is warranted in regard to larval morphology. Because of the inherent difficulties in locating late-instar larvae of *Greya* (as well as *Tetragma*), most larvae collected and examined represent only the first instar. Mature larvae of only one species, *G. politella*, were available. Comparison of the first and last instars of that species has shown the chaetotaxy

and sensillae to be the same or very similar. The primary difference noted is that crochets are acquired on the prolegs of abdominal segments three to six at some stage prior to the final larval instar. Furthermore, the first-instar larvae of all species studied in this complex, including *Tetragma*, have been found to agree closely. Minor differences in setal placement was noted between species, but intraspecific variation can not be ruled out at this point. Consequently, available evidence suggests that further information on mature larvae probably would not significantly alter the results of this study based largely on first-instar larvae.

Small, depressed, centrally located pits, similar to the ommatidial pores described in female adults of the psychid *Thyridopteryx ephemeraeformis* (Haworth) (Neal, 1986), were observed on the stemmata of certain *Greya* (Figures 163, 225). Because no openings (i.e., pores) were detected and also because their presence was observed to vary within the same instar of *G. politella*, these depressions may only represent an artifact of preservation.

Key to the Species of *Greya*

1. Forewing without pattern 2
Forewing with some pattern 9
2. Forewing ochreous to pale ochreous, wingspan 17–20 mm
. *G. enchrysa*, new species
Forewing not ochreous, smaller 3
3. Forewing brownish gray *G. politella*
Forewing pale gray or white 4
4. Forewing white or yellowish white 5
Forewing pale gray 6
5. Female with 7th abdominal segment relatively truncate, 2× or less length of A6;
R₄+R₅ fused in forewing *G. subalba*
Female with 7th abdominal segment more attenuated, 2.5–3× longer than A6,
longer than broad; R₄+R₅ separate in forewing *G. politella*
6. Forewing with R₄+R₅ stalked; valva with pollex situated immediately ventrad to
apex of cucullus [Figure 356] *G. powelli*, new species, male
Forewing with R₄+R₅ separate; pollex situated more basally 7
7. Pollex pointed, cucullus with rounded apex [Figure 352] *G. reticulata*, male
Pollex sharply pointed, cucullus with broadly tapering apex 8
8. Forewing usually 5.5–7 mm long; collected around *Yabea microcarpa*
. *G. solenobiella*, male
Forewing usually 7.5–9.5 mm long; collected around *Osmorhiza brachypoda* . . .
. *G. suffusca*, new species, male
9. Forewing pattern consisting of numerous transverse striae or small spots of fuscous
. 10
Forewing pattern not spotted, instead either fuscous or variously marked with either
well-defined or obscure streaks or bands 13
10. Forewing heavily marked with numerous short, transverse, fuscous striae [Figure
265] *G. sparsipunctella*
Forewing with numerous, small, scattered spots of fuscous [Figure 252–260] . . .
. 11
11. Forewing white or grayish white, spots distinct; cucullus as long as broad beyond

- pollex [Figure 303] *G. piperella*
 Forewing stramineous with or without light fuscous; cucullus as long as or longer than broad beyond pollex [Figure 299, 308] 12
12. Forewing stramineous, with patchy spots; cucullus longer than broad beyond cucullus *G. punctiferella*
 Ground color of forewing darker, light fuscous; male smaller, darker than female, cucullus as long as broad beyond pollex *G. mitellae*, new species
13. Ground color of wing golden to dark ochreous with a pale subterminal spot and/or narrow streak on costa (central Idaho) [Figure 268]
 *G. enchrysa*, new species
 Ground color darker, not golden or ochreous 14
14. Haustellum scaly at base; male with pectinifer on valva [Figure 332]
 *G. pectinifera*, new species
 Haustellum not scaly at base; male without pectinifer 15
15. Maxillary palpus five-segmented [Figure 37] 16
 Maxillary palpus with four or seldom three segments [Figure 39] 18
16. Forewing pattern indistinct, consisting of a few, faint white streaks on a predominantly grayish fuscous background [Figures 261, 262]
 *G. obscura*, new species
 Forewing pattern relatively distinct 17
17. Pattern consisting of pale streaks and patches on a dark background [Figures 269-276] *G. variabilis*, new species
 Pattern consisting of irregular transverse bands of fuscous, never as streaks; female fuscous on white bottom [Figures 263, 264] *G. obscuramaculata*
18. Forewing fuscous with two large, pale ochreous spots nearly traversing wing [Figure 278] *G. variata*
 Forewing with a pattern more complex than above 19
19. Forewing with faint zigzag pattern 20
 Forewing with distinct dark zigzag pattern 21
20. Forewing heavily dusted with brown, usually 6.5-8 mm long [Figures 285, 286] *G. suffusca*, new species, female
 Forewing light or seldom dusted with brown, usually 4.5-6 mm long [Figures 281-284] *G. solenobiella*, female
21. Forewing with R_4+R_5 either connate or stalked
 *G. powelli*, new species, female
 Forewing with R_4+R_5 separate *G. reticulata*, female

Greya punctiferella (Walsingham)

FIGURES 10, 36, 37, 44, 45, 47, 71-92,
 252-255, 298-301, 360; MAP 2

Incurvaria punctiferella Walsingham, 1888:145.—Riley in Smith, 1891:96, no. 5122.—Dyar, 1903 ("1902"):569, no. 6483.

Greya punctiferella (Walsingham)—Busck, 1903:194.—Kearfott in Smith, 1903:123, no. 7022.—Busck, 1904:775.—Dietz, 1905:37, 39, 40, 92.—Barnes and McDunnough, 1917:196, no. 8442.—Braun, 1921:20.—Blackmore, 1926:295.—McDunnough, 1939:109, no. 9810.—Davis, 1983:4.

Greya piperella (Busck)—Barnes and McDunnough, 1917:196, no. 8442 [as synonym of *Greya punctiferella* Walsingham].

Greya punctiferella speculella Blackmore, 1926:295.—McDunnough, 1939:109, no. 9810a.—Davis, 1983:4 [synonym of *Greya punctiferella* (Walsingham)].

ADULT (Figures 252-255).—Wing expanse: ♂, 16-19 mm; ♀, 12.5-16.5 mm.

Head (Figures 36, 37): Usually entirely white. Antenna 27-35-segmented, 0.4-0.55× the length of the forewing, with 6-16 basal segments white dorsally, apical remainder fuscous and pubescent. Maxillary and labial palpi mostly white, terminal segment of labial palpus sometimes suffused with light brown.

Thorax: Dorsum yellowish white; venter silvery white; tegula white with anterior margin fuscous. Legs usually completely stramineous; richly patterned specimens may have fuscous on anterior portions of all legs. Forewing pale stramineous, variously spotted with 15-25 small, brown spots (rarely wanting); spots often coalesce, forming streaks; they are arranged thus: a distinct apical spot or streak, often reaching a subterminal row through a narrow streak, nearly wanting in pale specimens; incomplete distal row of 1-4 spots occasionally present; subterminal row crossing the wing from near apex

to the large tornal spot, typically fusing with the latter, composed of 6–8 elongate spots that may merge into a band; occasionally a small spot present along termen above tornus; a diagonal row of 1–3 spots starting $\frac{2}{3}$ out on the costa, reaching halfway across the wing, and continued near the hindmargin as 1–4 often coalescing dots; a short row of 1–2 spots starts on costa and meets the previous row at right angle; a basal streak and occasionally a separate spot in the costal cell; 3 spots in a row basally in the lowest portion of the discal cell, with distance between the outer two $\frac{1}{4}$ – $\frac{1}{3}$ of distance between inner two; a single spot just above this row, slightly inside the central spot; two spots in cell between CuP and 1A+2A, one between CuP and CuA₂, and a large spot near hind margin below 1A+2A; basal sixth of edge of costa brown. Much variation exists, with spots very small in some individuals; an occasional specimen has spotting reduced to faint spots tornally and $\frac{3}{4}$ out on costa; occasional males have many spots coalescing to form a blotchy pattern. Cilia mostly stramineous, but brown extends to the edge tornally and subternally. Hindwing pale to median gray, somewhat paler than in *G. piperella*.

Abdomen: Stramineous with a light fuscous suffusion dorsally, white ventrally, often with a silvery luster.

Male Genitalia (Figures 298–301): Uncus superficially bilobed. Vinculum-saccus relatively short, less than length of valva. Valva moderately long, slender; pollex moderately developed, situated subapically at posterior angle to cucullus. Cucullus about 1.5× as long as broad beyond pollex. Juxta broadest at middle, gradually tapering anteriorly to acuminate apex; lateral margin sharply constricted beyond middle. Aedeagus without cornuti; caudal fifth of vesica minutely spinose.

Female Genitalia (Figure 360): Apex of ovipositor acute, relatively smooth, laterally compressed. Bursa copulatrix entirely membranous, signa absent.

EGG.—Pyriform, white, about 0.4 mm in diameter.

LARVA AND PUPA.—Unknown.

TYPES.—Lectotype, ♂ (*Greya punctiferella*, present designation): “Type; Rogue River, Josephine Co., Oregon, 7.V.1882, Wism. 90597, Walsingham Collection 1910-427, *Incurvaria punctiferella* Wism., U.S. Dr. Agr. Div. Ent. Ins. Life I, 145-6 (1888), Type ♂”; in the Natural History Museum, London. Holotype, ♂ (*Greya punctiferella speculella*); in the Canadian National Collection.

TYPE LOCALITIES.—Rogue River, Josephine Co., Oregon (*Incurvaria punctiferella*). Mt. Tzouhalem, near Duncan, British Columbia (*Greya punctiferella speculella*).

HOST.—*Tiarella trifoliata*, *Tolmiea menziesii*, and *Tellima grandiflora* (Saxifragaceae).

FLIGHT PERIOD.—April to mid-August.

DISTRIBUTION (Map 2).—This species ranges widely over much of the Pacific Northwest from southeastern Alaska through montane Western Canada, south to the coastal ranges and the Sierra Nevada of northern California. The blotchiness

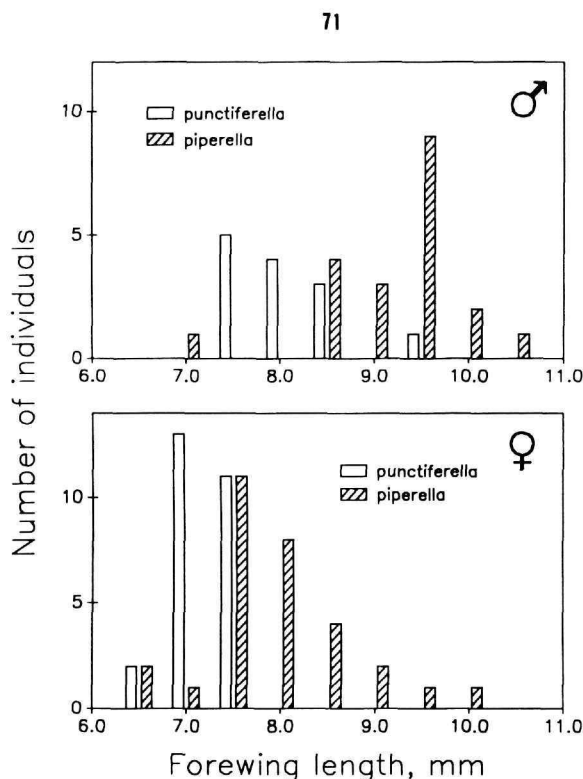

Figure 71.—Forewing length (wingbase to apex) in *Greya punctiferella* ($n = 39$) and *G. piperella* ($n = 50$), measured on all individuals in CNC, UBCZ, and OP before 1990. Mann-Whitney tests used to compare mean size for each sex between the species showed highly significant differences in both sexes; U_s -scores given are computed in accordance with Sokal and Rohlf (1981:434): ♂, $U_s = 359.5$, $Z = -3.666$, $P_{[20,30]} = 0.0005$; ♀, $U_s = 652$, $Z = -4.304$, $P_{[13,26]} = 0.0001$.

that characterizes males of Blackmore's variety *speculella* is most common in specimens from southern British Columbia. Altitudinal range, sea level to 1150 m.

HABITAT.—In understory of moist coniferous forests.

MATERIAL EXAMINED.—40 males, 78 females.

CANADA: BRITISH COLUMBIA: Specific locality unknown: 2♂, 2♀ (USNM). Duncan: 1♂, 1♀, 14 May (RBCM). Fitzgerald: 1♂, 28 May (UBCZ); 2♂, 1♀ (paratype, *Greya punctiferella speculella*), 4 Jun (USNM); 2♀, 5 Jun (USNM). Goldstream: 1♀, 15 May (RBCM); 1♀, 31 May (CNC); 1♀, 24 May (CNC); 4♀, 14–31 May (USNM). Mt. Newton: 1♂, 24 May (UBCZ). Mt. Tzouhalem: 1♂ (holotype, *Greya p. speculella*), 24 May (CNC); 2♂, 2♀, (paratype, *Greya p. speculella*), 24 May (USNM); 3♂, 2♀ (2♂ paratypes, 1♀ allotype, *Greya p. speculella*), 24 May (UBCZ). Prospect Lake: 1♂, 4♀, 10 May (USNM). Quamicham Lake, Vancouver Island: 1♀, 22 May (USNM); 1♀, 7 Jul (RBCM). Saanichton: 1♂, 3♀, 16 May (USNM); 1♀, 16 May (UBCZ); 1♀, 24 May (UBCZ). Victoria: 3♂, 10 May (USNM); 1♂, 10 May

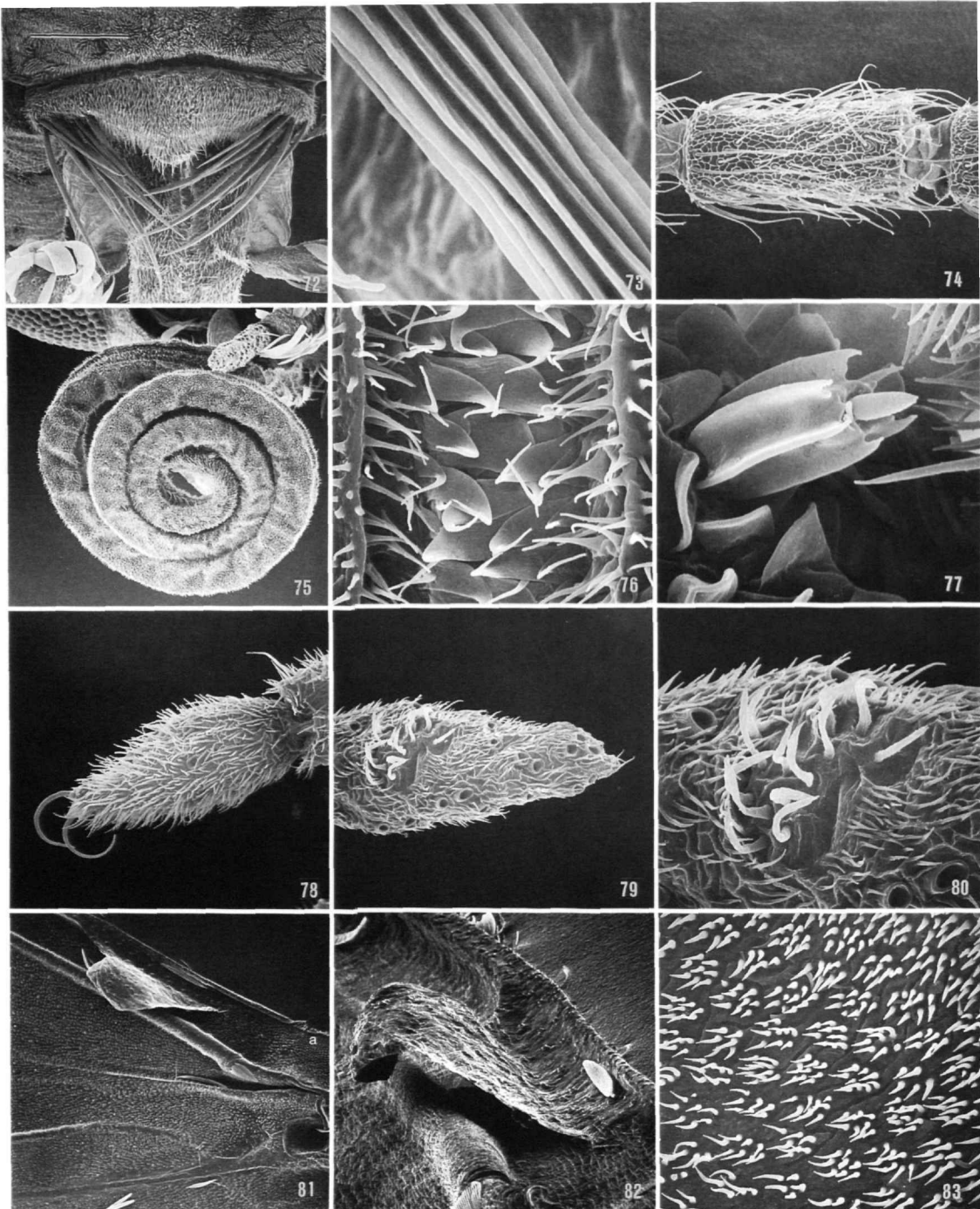

FIGURES 72-83.—*Greya punctiferella*, adult morphology: 72, labrum (67 μm); 73, detail of pilifer seta in Figure 72 (3 μm); 74, flagellomere near middle of antenna (50 μm); 75, haustellum, tightly coiled (120 μm); 76, detail of interlocking spines (legulae) of haustellum (7.5 μm); 77, sensillum styloconicum of haustellum with ribbed base (5 μm); 78, apical segment of maxillary palpus (25 μm); 79, apical segment of labial palpus with subapical organ of vom Rath (27 μm); 80, detail of organ of vom Rath in Figure 79 (12 μm); 81, male retinaculum, ventral view (250 μm); 82, basal view of Figure 81 (75 μm); 83, subhumeral microtrichia in Figure 81, "a" (15 μm). (Scale lengths in parentheses; bar scale for all photographs given in Figure 72.)

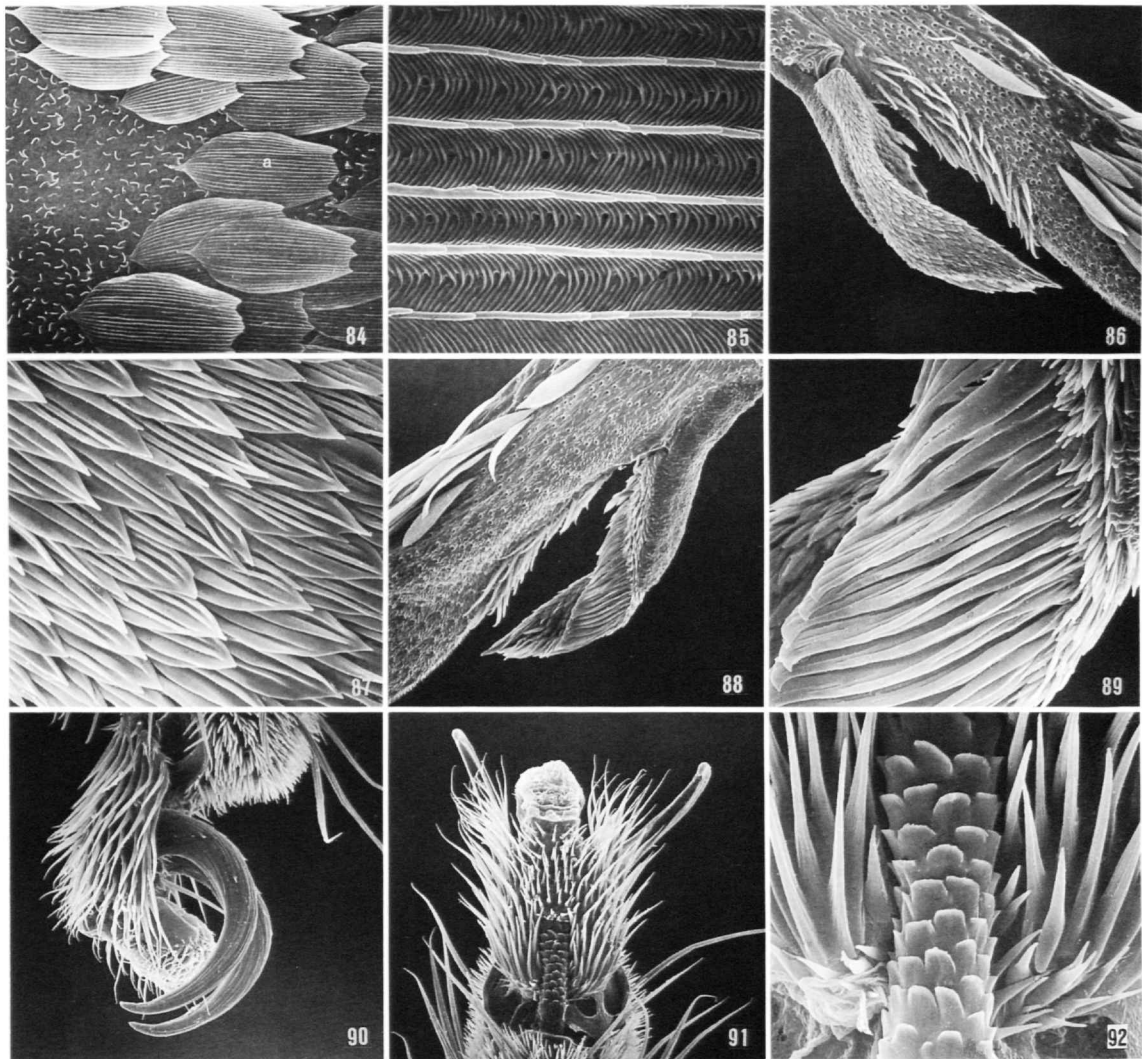

FIGURES 84–92.—*Greya punctiferella*, adult morphology: 84, scales of dorsal forewing within discal cell (60 μm); 85, detail of scale “a” in Figure 84 (3 μm); 86, epiphysis with associated tibial setae, posterior view (75 μm); 87, detail of imbricate spines of epiphysis in Figure 86 (10 μm); 88, epiphysis, anterior view (75 μm); 89, detail of epiphysial comb in Figure 88 (15 μm); 90, pretarsus of foreleg, lateral view (30 μm); 91, ventral view of Figure 90 (38 μm); 92, detail of unguitactor plate of Figure 91 (8.6 μm). (Scale lengths in parentheses; bar scale for all photographs given in Figure 84.)

(UBCZ); 1 σ , 12 May (CNC); 1 σ , 3 ϕ , 16 May (CNC); 1 σ , 8 Jun (CNC). Victoria, Mt. Douglas: 2 ϕ , 16 Jun (CNC).

UNITED STATES: ALASKA: *First Judicial Div.*: Yakutat: 1 σ , 21 Jun (USNM). CALIFORNIA: *Humboldt Co.*: 2 mi [3.2 km] W Briceland: 3 σ , 21 May (UCB). *Mendocino Co.*: Head of Dry Creek: 1 ϕ (paralectotype, *Incurvaria punctiferella*), 24 May (BMNH). 2.5 km NE Westport, 1.4–1.6 km up Branscomb Rd, 80–100 m: 1 σ , 1 ϕ , 31 May (OP); 3 σ , 13 ϕ , 1 Jun (OP). *Placer Co.*: Specific locality unknown: 2 ϕ , 20 Apr–1 May (USNM). *Sonoma Co.*: Bodega: 1 σ , 8 Apr (CNC). *Yuba Co.*: near Camptonville: 1 ϕ , 24 May (CAS). OREGON:

Jackson Co.: 1 mi [1.6 km] NE Mt. Ashland Ski Bowl, 1 ϕ , 14 Jul (UCB). *Josephine Co.*: Rogue River: 1 σ (lectotype, *Incurvaria punctiferella*), 5 May (BMNH); 2 σ , 5 ϕ (paralectotypes, *I. punctiferella*), 5 Jul (BMNH); 1 σ (paralectotype, *I. punctiferella*), 5 Jul (LACM); 1 ϕ (paralectotype, *I. punctiferella*), 7 Jul (USNM). WASHINGTON: *Clallam Co.*: Deer Lake trail in Olympic Mtns, 700–950 m: 2 σ , 8 ϕ , 15 Jul (OP); 1 ϕ , 17 Jul (OP); 1 σ , 8 ϕ , 18 Jul (OP). *Kitsap Co.*: Seattle: 1 σ , no date (USNM); 1 ϕ , 22 May (USNM) [discrepant information: county on Olympic peninsula, Seattle in King county]. *Pierce Co.*: Mt. Rainier: 1 σ , 2 Aug (CNC). Mt. Rainier, 2.5 km W Round Pass,

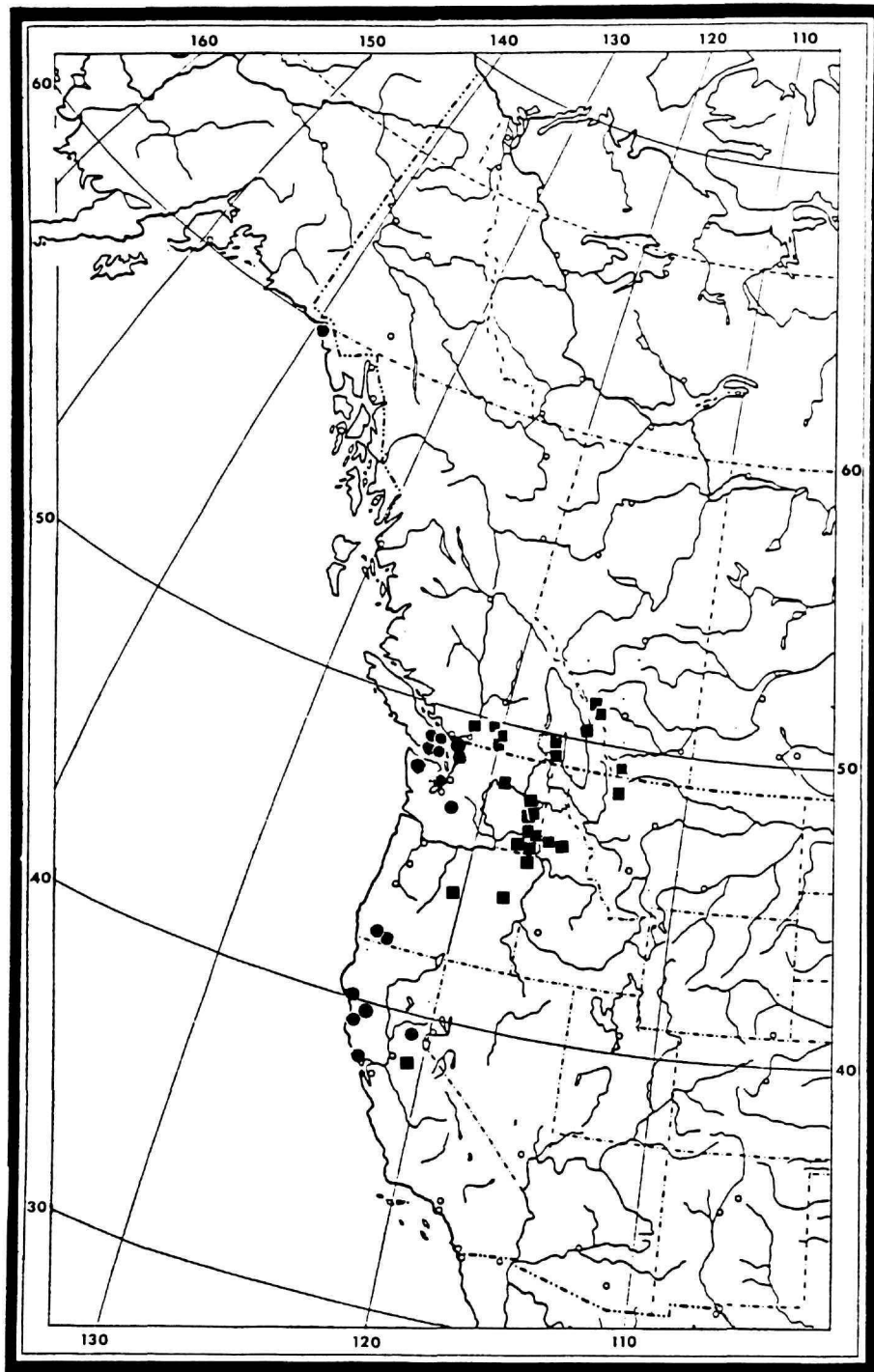

MAP 2.—Distribution of *Greya punctiferella* (●) and *G. piperella* (■).

1140 m: 1♀, 12 Jul (OP). *Whatcom Co.*: Bellingham: 1♀, 7 May (USNM).

DISCUSSION.—The *punctiferella* group is quite distinctive. *Greya punctiferella* is very similar to its sibling species *G. piperella*, but virtually always displays larger spots and a broad subterminal row of dots, in addition to the stramineous ground color of the moth. The absence of a terminal band, together with the prominent, broad subterminal band, may indicate that these rows are fused in this species. Most individuals are also smaller than *G. piperella* (Figure 71). In the male genitalia, the extended cucullus beyond the pollex is a stable character for distinguishing the two taxa. Also, the difference in host and behavioral differences in oviposition are quite distinctive for the two taxa. Although *G. sparsipunctella* approaches some specimens of *G. punctiferella* in maculation, the former exhibits a more barred pattern, and is considerably larger.

The population near Westport in northern coastal California is somewhat different from all others, in that a fair proportion of the moths partly or completely lack dark spots on their forewings, and it is the only known population where *Tolmiea* and *Tellima* serve as hosts. There is a slight difference in the relative length of the cucullus in the male genitalia, but few specimens from that single population are available, so any taxonomic considerations should await the availability of more material.

Greya punctiferella was originally described from an unspecified number of males and females collected by Lord Walsingham during May, 1871, from Mendocino County, California, and at Rogue River, in southern Oregon. The latter locality was misspelled "Rouge" River in the original citation, but it was correctly labelled "Rogue" on all the syntypes from that area. In his customary manner, Walsingham selected both a male and a female as types and labelled the remaining syntypes as paratypes. We examined a total of three male and seven female syntypes, and selected the male bearing Walsingham's type designation as lectotype.

Greya piperella (Busck)

FIGURES 16, 20, 24, 25, 71, 93–116,
256–258, 302–306, 361; MAP 2

Incurvaria piperella Busck, 1904:775.—Dietz, 1905: 37, 92.

Greya piperella (Busck).—Barnes and McDunnough, 1917:196, no. 8442 [as new synonym of *G. punctiferella* (Walsingham)].—Davis, 1983:4.

Lampronia piperella (Busck).—Braun, 1921:20.—Blackmore, 1926:295.—McDunnough, 1939:108, no. 9800.

ADULT (Figures 256–258).—Wing expanse: ♂, 16.5–21.5 mm; ♀, 16.5–21 mm.

Head: Entirely white. Antenna 0.4–0.5× the length of the forewing, 30–33-segmented, with 8–17 segments dorsally white from scales, apical remainder fuscous and pubescent. Maxillary palpus 5-segmented, labial palpus 3-segmented, both cream white.

Thorax: Dorsum white with slightly brownish fuscous

scales, especially caudally and laterally; venter silvery white; tegula cream white with some brown scales anteriorly. Fore- and midlegs brown dorsally, white ventrally; hind femur and tibia brown with some white scaling dorsally, tarsi mostly white, venter of entire leg white. Forewing white or cream white in females, rarely with stramineous tinge basally in specimens from the Alberta Rocky Mountains, with gray tinge in males, with pattern of fine spots on the forewing, these spots usually being less than half the diameter of the corresponding spots in *G. punctiferella*, and only rarely coalescing. The spots are arranged thus: a terminal row of 3–4 spots starting behind apex, occasionally missing, and a parallel subterminal row of 3–5 spots starting on the costa, reaching halfway across the wing; two separate or one fused tornal spot; a diagonal row of 4–6 spots starting $\frac{2}{3}$ out on the costa, crossing apex of the discal cell, and reaching hind margin slightly beyond the halfway mark; a short row of 2 spots (including a prominent costal spot) starts on costa and meets the previous row at right angle; 1–3 spots in the costal cell; 3 spots in a row basally in the lowest portion of the discal cell, with distance between the outer two about $\frac{2}{3}$ of the distance between inner two; two spots in the cell between CuP and 1A+2A, one between CuP and CuA₂, and 1–2 spots near hind margin below 1A+2A; apical spot missing; basal sixth of edge of costa brown; termen of ground color, sometimes with fuscous shadow basally, particularly supraternally; hindwing gray, darker than that of *G. punctiferella*. Some specimens collected in the Waterton Lakes area have very faint spots, and are partly wanting in the distal part of the forewing.

Abdomen: Fuscous dorsally (similar to hindwing), white on underside, with a slight fuscous suffusion on anterior margin of each segment.

Male Genitalia (Figures 302–306): Identical to those of *G. punctiferella*, except cucullus as long as it is broad beyond pollex. Arising from a more distal portion of the pollex, it sometimes makes the basal portion of the pollex asymmetrical.

Female Genitalia (Figure 361): No differences have been detected from the genitalia of *G. punctiferella*.

EGG.—Pyriform, white, about 0.5 × 0.25 mm in diameter.

FIRST-INSTAR LARVA (Figures 93–116).—Length of largest larva 2.65 mm; width 0.4 mm; maximum head width 0.3 mm. P1 laterad and slightly caudad of AF2. L1 caudad and ventrad of A3. S1 below and midway between stemmata 2 and 3. Stemmata 1–6 well developed. Sensilla of antennae (Figures 103, 104) and maxilla (Figures 101, 102) as illustrated. Chaetotaxy of A10 as illustrated (Figures 112–116); anal combs with 3–11 spines.

PUPA.—Unknown.

TYPE.—Lectotype, ♂ (present designation): "Pullman, Washington; Collector C.V. Piper; Type no. 7870, USNM; *Incurvaria piperella* Busck, type; ♂ genitalia on slide AB Fbr. 18, 1922; lectotype, ♂ *Incurvaria piperella* Busck, by D. Davis"; in the National Museum of Natural History, Smithsonian Institution.

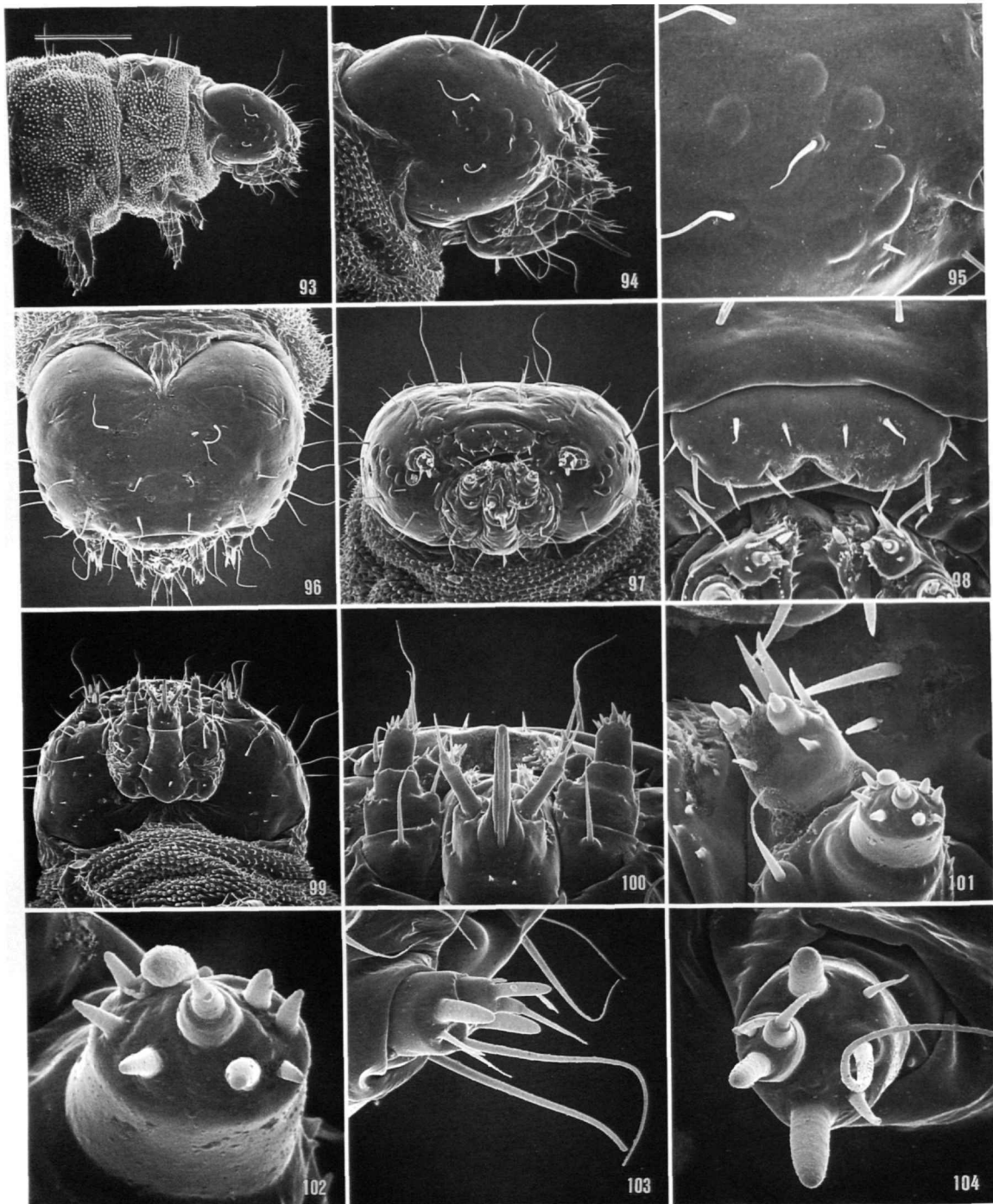

FIGURES 93-104.—*Greya piperella*, first-instar larva: 93, head and thoracic segments 1 and 2, lateral view (176 μm); 94, head, lateral view (75 μm); 95, stemmatal region of head (25 μm); 96, head, dorsal view (86 μm); 97, head, anterior view (86 μm); 98, labrum, dorsal view (25 μm); 99, head, ventral view (86 μm); 100, labium and maxillae, ventral view (25 μm); 101, detail of maxilla (10 μm); 102, sensilla of maxillary palpus (3.8 μm); 103, antenna, ventral view (15 μm); 104, antenna, apical view (8.6 μm). (Scale lengths in parentheses; bar scale for all photographs given in Figure 93.)

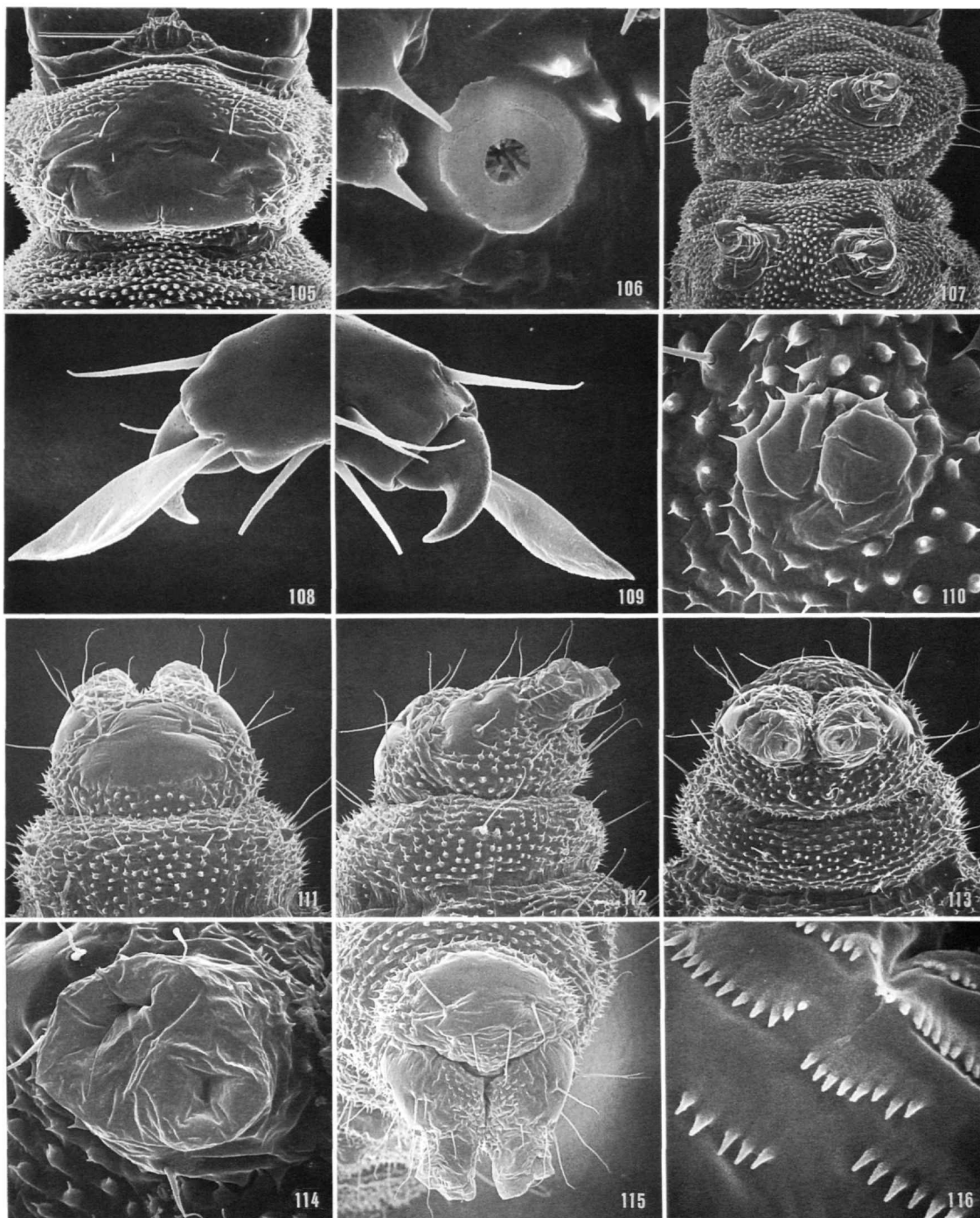

FIGURES 105-116.—*Greya piperella*, first-instar larva: 105, pronotum (86 μm); 106, prothoracic spiracle (5 μm); 107, thoracic segments 1 and 2, ventral view (100 μm); 108, prothoracic pretarsus, posterior view (8.6 μm); 109, anterior view of Figure 108 (8.6 μm); 110, proleg of third abdominal segment (17.6 μm); 111, abdominal segments 9 and 10, dorsal view (75 μm); 112, lateral view of Figure 111 (75 μm); 113, ventral view of Figure 111 (75 μm); 114, detail of proleg in Figure 113 (20 μm); 115, caudal view of Figure 111 (75 μm); 116, detail of anal combs in Figure 115 (4.3 μm). (Scale lengths in parentheses; bar scale for all photographs given in Figure 105.)

TYPE LOCALITY.—Pullman, Washington.

HOST.—In all known areas except California on peduncles of *Heuchera cylindrica* (Saxifragaceae). Eggs are laid about one week before flowers of the attacked stem open. The single known California population feeds on *H. micrantha*.

FLIGHT PERIOD.—May to mid-August.

DISTRIBUTION (Map 2).—Dry interior parts of southern British Columbia to central Oregon, reaching eastward to western Montana. An isolated population is known from central-interior California. Altitudinal range, 200–2300 m.

HABITAT (Figures 20, 24, 25).—The host, *H. cylindrica*, typically grows in crevices of rockfaces and outcrops. The moth is found in open country with such structures, and in grassy, dry, open *Pinus ponderosa* forest.

MATERIAL EXAMINED.—44 males, 63 females.

CANADA: ALBERTA: Banff, Cascade Mtn. Amphitheater, 7000 ft [2134 m]: 1♀, 27 Jul (USNM). Laggan [now named Lake Louise]: 2♀, 4 Jul (USNM). Laggan, near Agnes Lake 7000–7500 ft [2134–2287 m]: 1♀, 16–18 Jul (CNC). Lake Louise: 1♀, 21 Jul (CNC). Mt. Niblock: 1♀, 14 Aug (USNM). Waterton Lakes: 1♂, 12 Jul (ANSP); 1♂, 6♀, 20 Jun–12 Jul (CNC). Waterton Lakes Park: 1♂, 2♀, 3–10 Jun (CNC). BRITISH COLUMBIA: Aspen Grove: 1♂, 20 May (USNM). Lardeau: 4♂, 7 May (CNC); 2♂, 7 May (UBCZ). Paradise: 2♂, 14 Jul (CNC); 2♂, 1♀, 14 Jul (UBCZ). Paradise Valley, 8000 ft [2439 m]: 1♀, 24 Jul (USNM). Pentiction, Brent's Lake: 4♀, 30 May (CNC). Pentiction, Shingle Creek: 1♂, 1♀, 16 May (CNC). Salmon Arm: 1♀, 16 May (UBCZ); 1 paratype (no species label; abdomen lost), 16 May (UBCZ). Summerland: 3♀, 25–26 May (USNM).

UNITED STATES: CALIFORNIA: *Calaveras Co.*: S Fork Mokelumne River at Rte 26 crossing (3.3 km NE Glencoe), 600–625 m: 7♂, 1♀, 3 May (OP); 3♂, 2♀, 4 May (OP). IDAHO: *Clearwater Co.*: 3.2 km W Ahsahka, rd-mile 38.8 on Rte 12: 1♂, 7♀, 26 May (OP). *Nez Perce Co.*: 0.6–2.4 km ENE Spalding, 275 m: 2♀, 14 May (OP); 1♀, 4 Jun (OP). MONTANA: *Glacier Co.*: Glacier National Park: 1♀, 15 Jul (ANSP). Glacier National Park, Swiftcurrent Lake, 1450 m: 1♀, 9 Jul (OP). OREGON: *Crook Co.*: Rte 26 rd-mile 38.25, 11.9 rd-miles W Ochoco Summit: 1♂, 1♀, 2 Jun (OP). *Grant Co.*: Rte 7 NE Austin, rd-mile 3.4, 4.3 rd-miles SW Baker Co. line, 1300 m: 2♀, 3 Jun (OP). *Wallowa Co.*: Applegate Canyon on Rte 3, 930–970 m: 1♀, 3 Jun (OP). WASHINGTON: *Asotin Co.*: Rattlesnake Grade above Grande Ronde River, 785 m: 4♂, 2♀, 14 May (OP). *Columbia Co.*: Maloney Mtn. N of Patrick Grade, 1400 m: 3♀, 5 Jun (OP). *Garfield Co.*: 2 km SE Lower Granite Dam, 425 m: 2♀, 5 May (OP); 1♀, 6 May (OP); 1♀, 12 May (OP); 1♀, 21 May (OP). 2.6 km SE Lower Granite Dam, along Wawawai Grade, 400 m: 2♂, 2♀, 17 May (OP); 2♀, 21 May (OP). *Okanogan Co.*: Brewster: 2♂, 3 May (CNC). *Whitman Co.*: 3 km E Malden: 2♀, 27 May (OP). Pullman: 5♂, 1♀ (USNM). Kamiak Butte, 950 m: 4♂, 1♀, 6 Jun (OP). 1.7 km SE head of Rock Lake, 650 m: 2♀, 29 May (OP). 3 km N head of Rock Lake, along Hole-in-the-Ground Rd, 550 m: 1♀, 29 May (OP).

DISCUSSION.—This species was previously synonymized under *punctiferella* by Barnes and McDunnough (1917). This was based on very limited inland material, representing Busck's *piperella*; in light of the high variability in spottiness found in *punctiferella*, *piperella* was thought to fall within this range. Since then, much more material of *G. piperella* has become available, and major differences in biology have been documented. It is now evident that this is a sibling species. Apart from the morphological differences discussed under *G. punctiferella*, the utilization of a different host genus in combination with the very distinctive oviposition behavior provides strong evidence that *G. piperella* should be resurrected to species status. The difference in male genitalia and the typically larger size (Figure 71) serves to identify most specimens of this species.

Moths from the only known California population have a slightly yellow ground color (Figure 258) and the male has a narrower cucullus (Figure 306), compared to more northerly specimens. Material from additional populations should clarify whether this represents geographic variation or a sibling taxon. It is also noteworthy that the California population utilizes *Heuchera micrantha*. This species is common throughout the range of *G. piperella* and also farther west, but we have failed to find any other populations with moths.

A particular note is warranted in connection with the mapping of the specimens from Paradise [Valley], British Columbia. This site appears not to exist on maps under that name, but this name was used for one site by local lepidopterists. The specimens were collected by W.B. Anderson in 1923, and other collections from this trip were described in a note (Blackmore, 1924). Paradise was the name of a mining camp near Paradise mine (elevation 2150 m) in the Selkirk Range, about 30 km N of Invermere. It was the most accessible alpine site, and it was visited by many naturalists. We owe special gratitude to J. Shepard for this information on Paradise. It is gratifying to note that Paradise mine is a verified locality for *Heuchera cylindrica* (Calder and Savile, 1959), the host of *G. piperella*.

We have seen a single specimen in LACM, labelled "New Mexico" from the Cockerell collection. Because of the limited data associated with this specimen, plus the fact that the locality is far removed from its known range, this specimen has not been included with the established records. Since it is within the recorded range of the host genus, however, the possibility cannot be excluded that the species may exist somewhere in northern New Mexico.

Greya mitellae Davis and Pellmyr, new species

FIGURES 117–119, 259, 260, 307–310, 362; MAP 3

ADULT (Figures 259, 260).—Wing expanse: ♂, 10–13 mm; ♀, 11–15 mm.

Head: Frons stramineous in both sexes; vertex stramineous with some brown hairs in female, mostly yellowish brown

in male. Antenna pale stramineous, in female approximately 0.45× the length of the forewing, in male 0.55–0.6×, 26–32-segmented, both sexes with 15–16 segments dorsally scale-covered. Base of haustellum, and labial palpus, white, usually suffused with brown dorsally.

Thorax: Dorsum brown, with some stramineous admixed in female. Venter silvery stramineous in both sexes. Legs brownish gray dorsally and laterally, white ventrally. Forewing distinctly sexually dimorphic; female stramineous, male with brown to dark stramineous ground color and slight purple iridescence in fresh specimens; both sexes marked with numerous small, dark brown spots, usually somewhat fewer in the male than in the female. The spots are arranged thus: a small apical spot occasionally present; a terminal row of 4–5 sometimes coalescing spots almost reaching the tornal area, in male usually 1–3 faint spots; parallel subterminal row consisting of 2–5 spots; tornal spots 1–2, often coalescing; a diagonal row of 4–5 spots starting $\frac{2}{3}$ out on the costa, reaching across the wing; a short row of 1–2 spots starts on costa and meets the previous row at right angle; three separate spots in female, a spot, and a basal streak in male, in the costal field; 3 spots in a row basally in the lowest portion of the discal field, with distance between the outer two about the same as that of the inner two; two spots in field between CuP and 1A+2A, one between CuP and CuA₂, and a spot near hind margin below 1A+2A, and sometimes a small spot between CuP and 1A+2A; basal fifth of edge of costa brown. Ground color of male paler between subterminal and central rows near costa and in tornal area, giving rise to a sagittate outline when the moth is resting. Cilia brownish fuscous in inner portion, stramineous in outer half. Hindwing as dark as the abdomen, medium to dark gray with a brown touch.

Abdomen: Brown dorsally, stramineous ventrally in female, with a brown-silver color in male; male with a fringe of erect scales on hind margin of last tergite, and erect scale fringes dorsally on the valva.

Male Genitalia (Figures 307–310): Very similar to all other members of the *punctiferella* group, and without distinguishable characters from *G. piperella*. Uncus superficially bilobed. Vinculum-saccus relatively short, less than length of valva. Valva moderately long, slender; pollex moderately developed, situated subapically at posterior angle to cucullus. Cucullus as long as broad beyond pollex. Juxta broadest at middle, gradually tapering anteriorly to acuminate apex; lateral margin sharply constricted beyond middle. Aedocagus without cornuti; caudal fifth of vesica minutely spinose.

Female Genitalia (Figure 362): Apex of ovipositor acute, relatively smooth, laterally compressed. Bursa copulatrix entirely membranous, signa absent.

EGG (Figures 117–119).—Pyriform, white, about 0.45 × 0.20 mm.

LARVA AND PUPA.—Unknown.

HOLOTYPE.—Moscow Mtns. [near Moscow], Idaho, 4 June 1933, J.F.G. Clarke, ♂ genitalia slide USNM 18192; in the National Museum of Natural History, Smithsonian Institution.

PARATYPES.—UNITED STATES: **IDAHO:** *Benewah Co:* M.M. McCroskey Park, W part, along Skyline Drive, 1020–1050 m: 3♂, 3♀, 2 Jun 1989, O. Pellmyr (OP); 2♀, 6 Jun 1989, O. Pellmyr (OP). *Kootenai Co:* S Fork of Beauty Creek, near Lake Coeur d'Alene: 1♀, 3 Jun 1974, W.F. Barr (USNM); 5♂, 2♀, 28 May 1975, D.F. Veirs (UCB). Cottonwood Creek, 6 mi [9.6 km] NE Harrison: 2♂, 1♀, 29 May 1975, D.F. Veirs (UCB); 1♀, 18 May 1976, D.F. Veirs (UCB). *Latah Co:* same data as holotype: 1♀ (USNM). 1.3 mi [2.1 km] E Laird Park, 850 m: 2♂, 14 May 1962, W.F. Barr (USNM). 1.4 km SE Laird Park, 840 m: 11♂, 5♀, 12 May 1987, O. Pellmyr (OP). 1.4–2 km SE Laird Park, 840–900 m: 13♂, 4♀, 6 May 1990, O. Pellmyr (OP). 2–2.5 km SE Laird Park, 900 m: 1♂, 10 May 1988, O. Pellmyr (OP). 2.1 km NE Laird Park: 2♂, 2♀, 19 May 1990, O. Pellmyr (OP). 11 km ENE Moscow, 840 m: 1♂, 2♀, 18 May 1988, O. Pellmyr (OP); 10♂, 4♀, 21 May 1988, O.

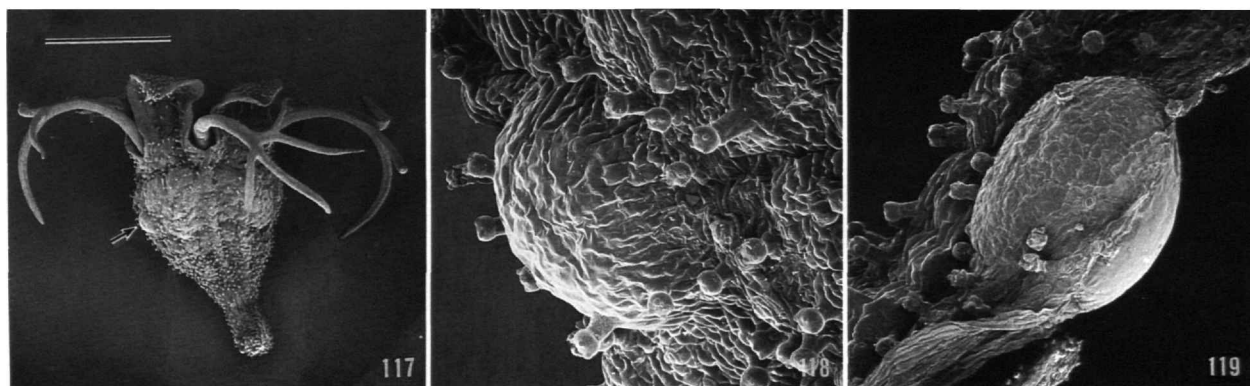

FIGURES 117–119.—*Greya mitellae*, egg: 117, flower of *Mitella stauropetala* with egg of *G. mitellae* (arrow) inserted below calyx epidermis (1.5 mm); 118, detail of inserted egg in Figure 117 (136 μ m); 119, broken calyx and ovary wall with inserted egg, with egg surface visible on inside (176 μ m). (Scale lengths in parentheses; bar scale for all photographs given in Figure 117).

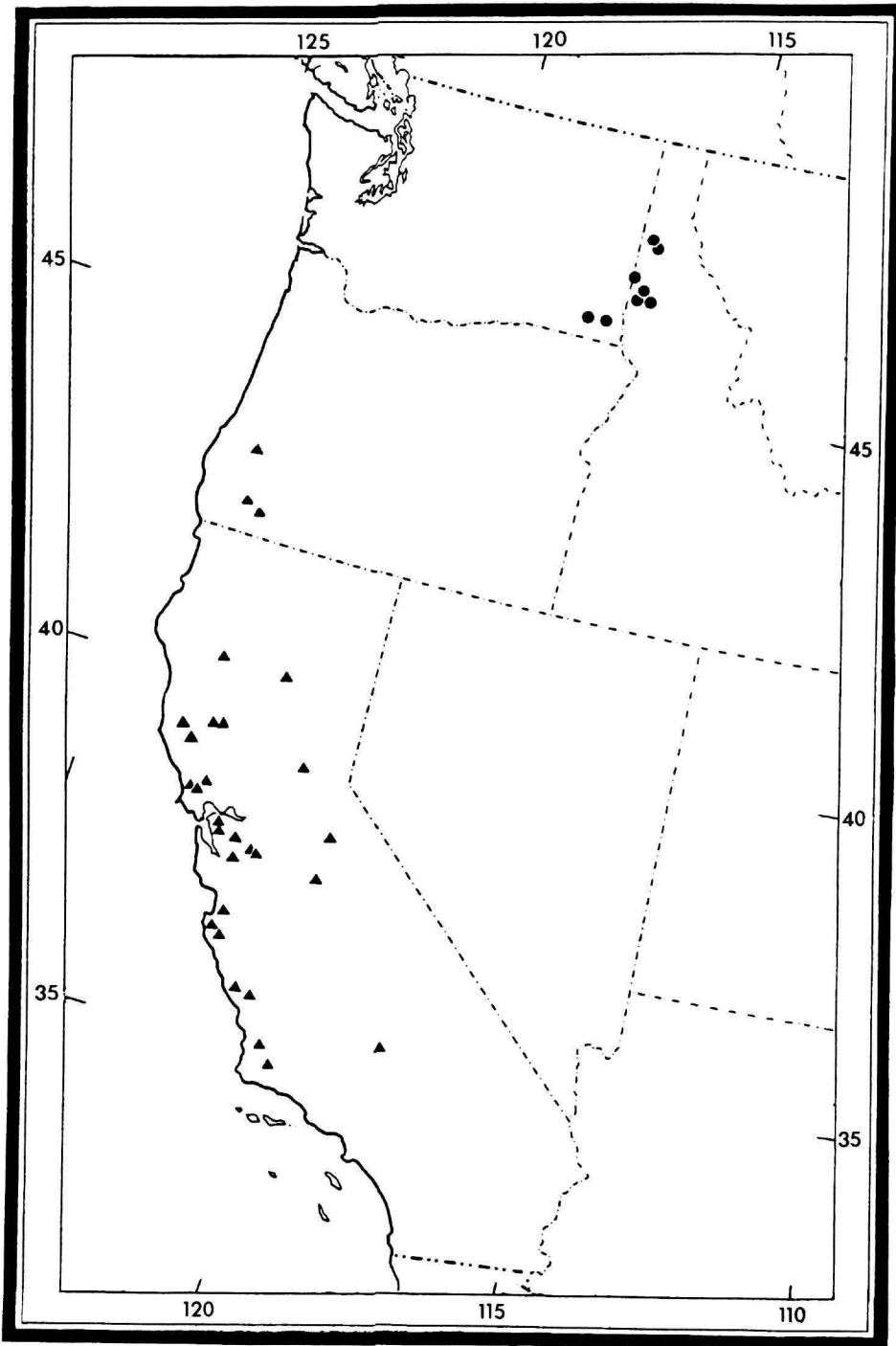

MAP 3.—Distribution of *Greya mitellae* (●) and *G. obscura* (▲).

Pellmyr (OP); 1♂, 4 Jun 1988, O. Pellmyr (OP); 3♂, 1♀, 25 May 1989, O. Pellmyr (OP). Moscow Mtns. [near Moscow]: 1♂, 6♀, 11 Jun 1958, H.C. Manis (USNM); same data, 5♀ (UT). Thatuna Hills [Moscow Mtns., near Moscow] 3200 ft [976 m]: 1♀, 4 Jun 1970, W.F. Barr (USNM). WASHINGTON: *Asotin Co.*: near Field Spring State Park, 1300 m: 3♂, 2♀, 16 May 1987, W.F. Wehling (OP). *Columbia Co.*: 1 km SE Gilbreath Spring in Blue Mtns., 960 m: 4♂, 2♀, 14 May 1988, O. Pellmyr (OP). All specimens in OP collected on *Mitella stauropetala*.

Described from a total of 63 males and 45 females.

HOST.—*Mitella stauropetala* (Saxifragaceae).

FLIGHT PERIOD.—Mid-May to mid-June.

DISTRIBUTION (Map 3).—Records to date show this species to be restricted to northwestern Idaho and the Blue Mountains of Washington. Wider distribution of the host suggests that the actual distribution could be more extensive. Altitudinal range, 800–1300 m.

HABITAT.—In relatively moist to moist coniferous or mixed forest. The host flowers more luxuriantly in light gaps, and moths may aggregate in such spots.

ETYMOLOGY.—The specific epithet is the genitive form of the name of the host genus, *Mitella*.

DISCUSSION.—This species can be easily distinguished from *G. punctiferella* and *G. piperella* by its darker color and smaller size. The species is remarkably uniform in coloration, and distinctly sexually dimorphic, in contrast to *G. punctiferella*. Still, the striking similarity in the genitalia is evidence of close relationship between the two species.

This species is further distinct in being the only member of *Greya* with a male smaller than the female, in having an equal number of flagellar segments in both sexes scale-clad, and in having appressed sensilla trichodea on the antenna. Biological studies of this species may yield insights into the origin of reversed size dimorphism in *Greya*.

Greya obscura Davis and Pellmyr, new species

FIGURES 21, 22, 261, 262, 311–314, 363; MAP 3

ADULT (Figures 261, 262).—Wing expanse: ♂, 14.5–19 mm; ♀, 10.5–15 mm.

Head: Light brown to gray, partly suffused with white in male, mostly dull white in female. Antenna 0.5–0.6× the length of the forewing, 29–34-segmented, with scape and basal 4 (♂) to 19 (♀) segments light brown to gray dorsally; remainder of flagellum dark, densely pubescent. Maxillary and labial palpi white, sometimes lightly suffused with gray, especially over apical segment of labial palpus.

Thorax: Dorsum gray to brown with tegulae and collar white. Venter white; legs light brown in male, mostly white in female. Forewing mostly gray to light brown in male, dark stramineous or with slight bronzy iridescence in female, suffused with white to whitish yellow, frequently forming a faint (♂) or more or less distinct (♀) pattern of markings over wing; maculation typically consists of rather short, narrow

streaks especially along veins extending obliquely from margin toward body; a distinct rhomboid pale toral or subtoral patch present in most specimens, forming a characteristic sagittate patch when moth is resting, sometimes extended as pale streak toward the wing base; cilia gray. Hindwing uniformly gray, approximately same shade or slightly darker than forewing.

Abdomen: Gray dorsally, white ventrally.

Male Genitalia (Figures 311–314): Uncus shallowly bilobed. Vinculum-saccus relatively short, less than length of valva. Valva relatively elongate, slender; pollex reduced to a short, stout spine situated at extreme hind angle of cucullus; no thicker spines in apical portion of the cucullus, in contrast to the other members of the *punctiferella* group. Juxta broadest at middle, gradually tapering anteriorly to an acute apex; lateral margins constricted caudally before broad posterior end. Aedocagus without cornuti; posterior fifth of vesica partially sclerotized.

Female Genitalia (Figure 363): Apex of ovipositor acute, relatively smooth. Corpus bursae without signa.

EGG.—Pyriform, white, 0.25–0.35 mm in diameter.

LARVA.—Unknown.

PUPA.—Nutbrown with dark brown eyes; exuviae in such poor condition that no differences could be distinguished from pupa of *G. politella*.

HOLOTYPE.—3 mi [4.8 km] N Bagby, Mariposa Co., California: ♂, 25 March 1965, J.A. Powell, in the collection of the University of California at Berkeley.

PARATYPES.—UNITED STATES: CALIFORNIA: *Alameda Co.*: Del Valle Lake: 1♀, 29 Apr 1974, J. Powell (UCB); 1♀, 12 Apr 1975, J. Powell (UCB); 6♂, 9♀, 30 Apr 1975, J. Powell (UCB). *Colusa Co.*: S Lodoga: 1♂, 8♀, 16 Apr 1961 (UCB); 1♀, 16 Apr (USNM). *Contra Costa Co.*: Russelmann Park, Mt. Diablo: 2♂, 1♀, 6–13 Apr 1962, J. Powell (UCB); 1♂, same data (USNM). Russell Tree Farm, 4 mi [6.4 km] NE Orinda: 1♂, 6 Mar 1970, P. Opler (UCB); 1♂, 11 Apr 1981, J. Powell (UCB). *Kern Co.*: Democrat Hot Springs on Kern River, 2000–2200 ft [600–660 m]: 17♂, 5 Apr 1975, R. Leuschner (RL); 1♂, 5 Apr 1975, R. Leuschner (LACM); 1♂, 2 May 1981, R. Leuschner (RL); 13♂, 31 Mar 1985, R. Leuschner (RL); 4♂, 28 Mar 1987, R. Leuschner (RL); 1♂, 1♀, 28 Mar 1987, R. Leuschner (LACM); 13♂, 12 Mar 1988, R. Leuschner (RL). Near Democrat Hot Springs, 2100 ft [630 m]: 2♂, 7 Apr 1974, R. Leuschner (RL). *Mariposa Co.*: 3 mi [4.8 km] N Bagby: 1♂, 25 Mar 1965, J. Powell (UCB); 1♂, same data (BMNH); 1♂, same data (USNM). *Mendocino Co.*: Hopland Field Stn, 1 km E HQ, 300 m: 1♀, 1 May 1990, O. Pellmyr and J.N. Thompson (OP). W Ukiah, mi 9.4 along Rte 253, 660 m: 1♂, 3♀, 1 May 1990, O. Pellmyr and J.N. Thompson (OP). *Monterey Co.*: Indians Rd, 2 mi [3.2 km] S Arroyo Seco Guard Station, 2500 ft [750 m]: 1♂, 3 May 1975, J. Powell (UCB). 1 mi [1.6 km] S Jamesburg, 2900 ft [870 m]: 1♀, 5 May 1975, Chemsak, Powell, and Szerlip (UCB); 1♂, 8 May 1975, Powell and Chemsak (UCB). 2.4 km SE Jamesburg, 960 m: 5♂, 8♀, 2 May 1988, O. Pellmyr (OP), 1♀, 4 May 1988, O. Pellmyr (OP); 2♂, 3 May 1989, O. Pellmyr (OP). *Napa Co.*: Monticello: 16♂, 31 Mar 1935, E. Johnston (CNC); 5♂, same

data (USNM). *Nevada Co*: 6 mi [9.6 km] SW Colfax: 6♂, 3♀, 18 Apr 1968, P. Opler (UCB). *San Benito Co*: 2 mi [3.2 km] W Jct. Cienega and Lime Kiln Rds: 1♂, 30 Mar 1963, D.C. Rentz and K.A. Hale (CAS). Limekiln Canyon, SW Paicines: 1♂, 5♀, 24 Apr 1968, J. Powell on *Lithophragma* (UCB); 2♀, same data (USNM); 1♂, 4♀, P. Opler (UCB); 3♀, 23 Apr 1969, J. Powell (UCB). Limekiln Road, 5 mi [8 km] SW Paicines: 1♂, 24 March 1966, J. Powell (UCB); 1♂, same data (USNM). *San Luis Obispo Co*: Nacimiento Dam: 2♂, 6♀, 14 Apr 1967, J. Powell on *Lithophragma* (UCB); 1♀, same data (USNM). *Santa Barbara Co*: Colson Canyon Rd 600 m from Tepusquet Rd, 310 m: 1♂, 3♀, 22 Mar 1989, O. Pellmyr and J.N. Thompson (OP). Colson Canyon Rd 3.2 km N Tepusquet Peak, 460 m: 1♂, 1♀, 22 Mar 1989, O. Pellmyr and J.N. Thompson (OP). Figueroa Mtn. Road at Alamo-Pintado Creek, 450–500 m: 1♂, 23 Mar 1989, O. Pellmyr and J.N. Thompson (OP); 1♀, 25 Mar 1989, O. Pellmyr and J.N. Thompson (OP); 4♀, 26 Mar 1989, O. Pellmyr and J.N. Thompson (OP); 2♂, 17 Mar 1990, O. Pellmyr and J.N. Thompson (OP); 3 pupae, 20 Mar 1990, 1♂ eclosed 26 Mar 1990, O. Pellmyr and J.N. Thompson (OP); 1♂, 22 Mar 1990, O. Pellmyr and J.N. Thompson (OP); 1♂, 23 Mar 1990, O. Pellmyr and J.N. Thompson (OP); 10♂, 10♀, 1 pupa, 24 Mar 1990, O. Pellmyr and J.N. Thompson (OP). *Santa Clara Co*: Mt. Hamilton: 4♂, 6 Apr 1974, E. Rogers (UCB). *Shasta Co*: Platina, 680 m: 2♂, 7♀, 29 Apr 1989, O. Pellmyr (OP). *Sonoma Co*: Petaluma: 2♂, 22 March 1940, E. Johnston (CNC). The Geysers: 2♂, 1–9 May 1935, E. Johnston (CNC). *Stanislaus Co*: Del Puerto Canyon, 1.8 km E Frank Raines Park, 300–325 m: 9♂, 9♀, 29 Mar 1989, O. Pellmyr and J.N. Thompson (OP). Del Puerto Canyon, 18 mi [28.8 km] W Patterson: 3♂, 10♀, 9 Apr 1967, P. Opler, on *Lithophragma* sp. (UCB); 1♂, 2♀, same data (USNM). Del Puerto Canyon, 20 mi [32 km] W Patterson: 2♂, 5 Mar 1963, J. Powell (UCB); 2♂, 1♀, 25 Mar 1969, J. Powell (UCB); 1♂, same data (USNM); 7♂, 21 Feb 1970, J. Powell (UCB); 2♂, 20♀, 9 Apr 1971, J. Doyen (UCB). Del Puerto Canyon, N fork of Del Puerto Creek, 900–1200 ft [300–400 m]: 2♂, 1♀, 9 Apr 1977, J. Powell (UCB); 1♀, 30 Apr 1975, J. Powell (UCB). *Tehama Co*: 200 m E Battle Creek Vista Point, 1000 m: 8♂, 2♀, 28 Apr 1989, O. Pellmyr (OP). *Tuolumne Co*: N fork of Tuolumne River, 3 mi [4.8 km] NE Tuolumne: 1♀, 1 May 1961, R.M. Brown (CAS). OREGON: Specific locality unknown: 1♀, 28 Jan 1880, Lord Walsingham (BMNH). *Douglas Co*: SE Winston on Clarks Branch Rd, 4.1 rd-miles [6.5 km] from Interstate 5: 1♂, 1♀, 2 May 1991, O. Pellmyr and J.N. Thompson (OP). *Josephine Co*: 2.65 rd-miles [4.24 km] W Merlin, Avery Gulch: 1♂, 2♀, 2 May 1991, O. Pellmyr and J.N. Thompson (OP). 2 mi [3.2 km] W Murphy on Southside Rd: 4♀, 3 May 1991, O. Pellmyr and J.N. Thompson (OP).

Described from a total of 179 males and 142 females.

HOST.—Probably several *Lithophragma* species (Saxifragaceae). Eggs have been found in *L. affine*, *L. cymbalaria*, and *L. heterophyllum* flowers and pedicels, and adults have also been collected in a pure population of *L. trifoliatum*.

FLIGHT PERIOD.—Latter part of March to early May.

DISTRIBUTION (Map 3).—This species occurs most commonly along the western Coastal Ranges of the United States from Douglas County in southwestern Oregon south to San Luis Obispo County in California. It has also been found more interiorly in Stanislaus, Shasta, and Mariposa Counties, California. Altitudinal range, 300–1000 m.

HABITAT (Figures 21, 22).—In grassy areas forming understory of open oak forest, with or without a shrub component. In coastal California, often in areas around live oak.

ETYMOLOGY.—Derived from the Latin *obscurus* (dark, indistinct), and named for the obscure markings on the somewhat glossy forewing, that especially characterize the male of the species.

DISCUSSION.—*Greya obscura* may be separated from most members of *Greya* by the indistinct, rather obscure markings of the forewing. In maculation, it sometimes may be difficult to distinguish male *G. obscura* from, e.g., *G. politella*, but maxillary palpal differences between these may be used if doubt arises. Also, the pale tornal patch at about 45°-angle to the edge, appearing as a sagittate mark on resting specimens, is quite distinctive. In addition to maculation, the reduced pollex, situated near the extreme distal edge of the valva, is a reliable diagnostic feature of this species.

One female specimen of *obscura* from the Stainton Collection, now in the Natural History Museum, London, bears the somewhat enigmatic label with a date "28.1.80." Since this cannot be the time it was captured, the date probably refers either to the date of publication of the name *Greya solenobiella* (under which the specimen was originally identified) or the date which Stainton received the specimen from Walsingham.

Greya obscuromaculata (Braun)

FIGURES 120–122, 263, 264, 315–318, 364; MAP 4

Lampronia obscuromaculata Braun, 1921:19.—McDunnough, 1939:109, no. 9804.

Greya obscuromaculata (Braun).—Davis, 1983:4.

Greya augustella Blackmore, 1926:294.—McDunnough, 1939:109, no. 9808.—Davis, 1983:4 [synonym of *obscuromaculata*].

ADULT (Figures 263, 264).—Wing expanse: ♂, 15–17 mm; ♀, 13–14.5 mm.

Head: White to pale ochreous. Antenna 0.4–0.6× the length of the forewing, 28–34-segmented, with scape and 7(♂) to 21(♀) basal scaly segments of flagellum pale ochreous; remainder of flagellum dark, densely pubescent. Maxillary palpus, haustellum, and labial palpus white to pale ochreous; apical segment of labial palpus tending to be more brown.

Thorax: Dorsum white to pale ochreous. Venter white; legs usually more brown. Forewing white to pale ochreous, irregularly marked with pale brown to dark fuscous; pattern distinctly sexually dimorphic, being darker and more well defined in female, giving it a checkerspot appearance; a broad, Y-shaped band present near apex of wing; an irregular, zigzag, sometimes Y-shaped transverse band across middle; an

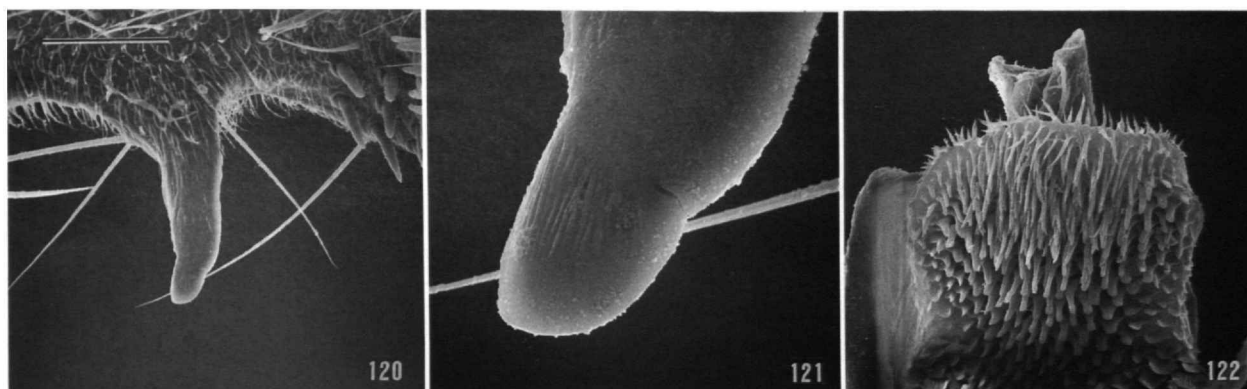

FIGURES 120–122.—*Greya obscuromaculata*, male genitalia: 120, pollex of valva (50 μ m); 121, detail of pollex showing broad, largely fused apical spine (10 μ m); 122, spinose anellar membrane of juxta, ventral view (60 μ m). (Scale lengths in parentheses; bar scale for all photographs given in Figure 120.)

elongate spot extending along costa from wing base and frequently joining with median band; an elongate spot bordering hind margin at base. Hindwing uniformly gray.

Abdomen: Pale fuscous to brown dorsally, ochreous to white ventrally.

Male Genitalia (Figures 120–122, 315–318): Uncus shallowly bilobed. Length of vinculum-saccus exceeding that of valva. Valva broad at base; inner surface of cucullus with numerous relatively elongate spines; pollex slender, elongate with a single, stout, blunt, mostly fused spine; in contrast to other taxa, the spine is only the top fifth or less of the pollex. Juxta broadest at middle, tapering anteriorly to form a slender, rodlike shaft. Aedeagus with a pair of short, stout, slightly curled cornuti; caudal fourth of vesica spinose.

Female Genitalia (Figure 364): Apex of ovipositor acute, relatively smooth. Ductus bursae with slightly thickened, pigmented walls at middle. A pair of stellate signa present, bearing 12–14 elongate rays.

IMMATURE STAGES.—Unknown.

TYPES.—Holotype σ (*Lampronia obscuromaculata* Braun); in the Academy of Natural Sciences, Philadelphia. Holotype σ (*Greya augustella* Blackmore); in the Canadian National Collection.

TYPE LOCALITIES.—Two Medicine Lake, Glacier National Park, Montana, “in dry meadow” (*Lampronia obscuromaculata* Braun). Quamichan Lake, near Duncan, British Columbia (*Greya augustella* Blackmore).

HOST.—Unknown.

FLIGHT PERIOD.—End of May through July.

DISTRIBUTION (Map 4).—Present records indicate this species to be restricted to southwestern Canada and the northwestern United States, from British Columbia south to Idaho. Altitudinal range, sea level to 1500 m.

HABITAT.—Usually in moist to somewhat moist coniferous forest with dense shrub understory and herbaceous layer. Dominant herbs include *Tiarella trifoliata* and *Osmorhiza chilensis*.

MATERIAL EXAMINED.—35 males and 11 females.

CANADA: ALBERTA: Waterton Lakes: 1 ϕ , 12 Jul (CNC). BRITISH COLUMBIA: Goldstream: 1 σ , 2 Jun (USNM). Quamichan Lake: 1 σ (holotype, *Greya augustella*), 26 May (CNC); 1 σ , (paratype, *Greya augustella*), 26 May (USNM); 1 σ , (paratype, *Greya augustella*), 26 May (UBCZ).

UNITED STATES: IDAHO: *Benewah Co.*: M.M. McCroskey Park, W end, along Skyline Drive, 1020–1050 m: 1 σ , 2 Jun (OP); 2 σ , 1 ϕ , 5 Jun (OP); 1 ϕ , 6 Jun (OP). *Latah Co.*: 1.2 km NE Laird Park, 800 m: 2 σ , 1 ϕ , 9 Jun (OP). 2.1 km NE Laird Park, 825 m: 1 σ , 9 Jun (OP). 6 mi [11 km] NE Moscow: 1 ϕ , 29 Jun (UCB). 11 km ENE Moscow, 840 m: 8 σ , 3 ϕ , 4 Jun (OP); 1 σ , 5 Jun (OP); 1 ϕ , 6 Jun (OP). Thathuna Hills [Moscow Mtns.], near Moscow 3200 ft [976 m]: 4 σ , 1 Jun (USNM); 1 ϕ , 4 Jun (USNM). MONTANA: *Glacier Co.*: Glacier National Park: 1 σ (holotype, *Lampronia obscuromaculata*) 16 Jul (ANSP); 1 σ , 24–31 Jul (ANSP). WASHINGTON: *Clallam Co.*: Deer Lake trail in Olympic Mtns., 700–950 m: 8 σ , 15 Jul (OP); 1 ϕ , 18 Jul (OP). *Whatcom Co.*: Skyline Ridge, 5000 ft [1524 m]: 2 σ , 29 Jul–1 Aug (USNM).

DISCUSSION.—The irregularly banded forewing pattern of this species usually distinguishes it from all other members of *Greya*. The only prodoxids that approach it in pattern are the female of *G. reticulata* and some forms of male *G. variabilis*. The elongate, bluntly spined pollex of the male valva and the prominently stellate signa of the female easily separate *G. obscuromaculata* from the latter two species. The minute spine on the pollex is unusual to the genus, and contributes to a suite of unique characters that makes the phylogenetic position of this species difficult to determine.

The male holotype of *augustella* has been found to be conspecific with *G. obscuromaculata*. In proposing his new species, *G. augustella*, Blackmore may not have been aware of Braun’s earlier description of *obscuromaculata*. In his original description, Blackmore was careful to compare *augustella* to *punctiferella*, but he made no reference to *obscuromaculata*.

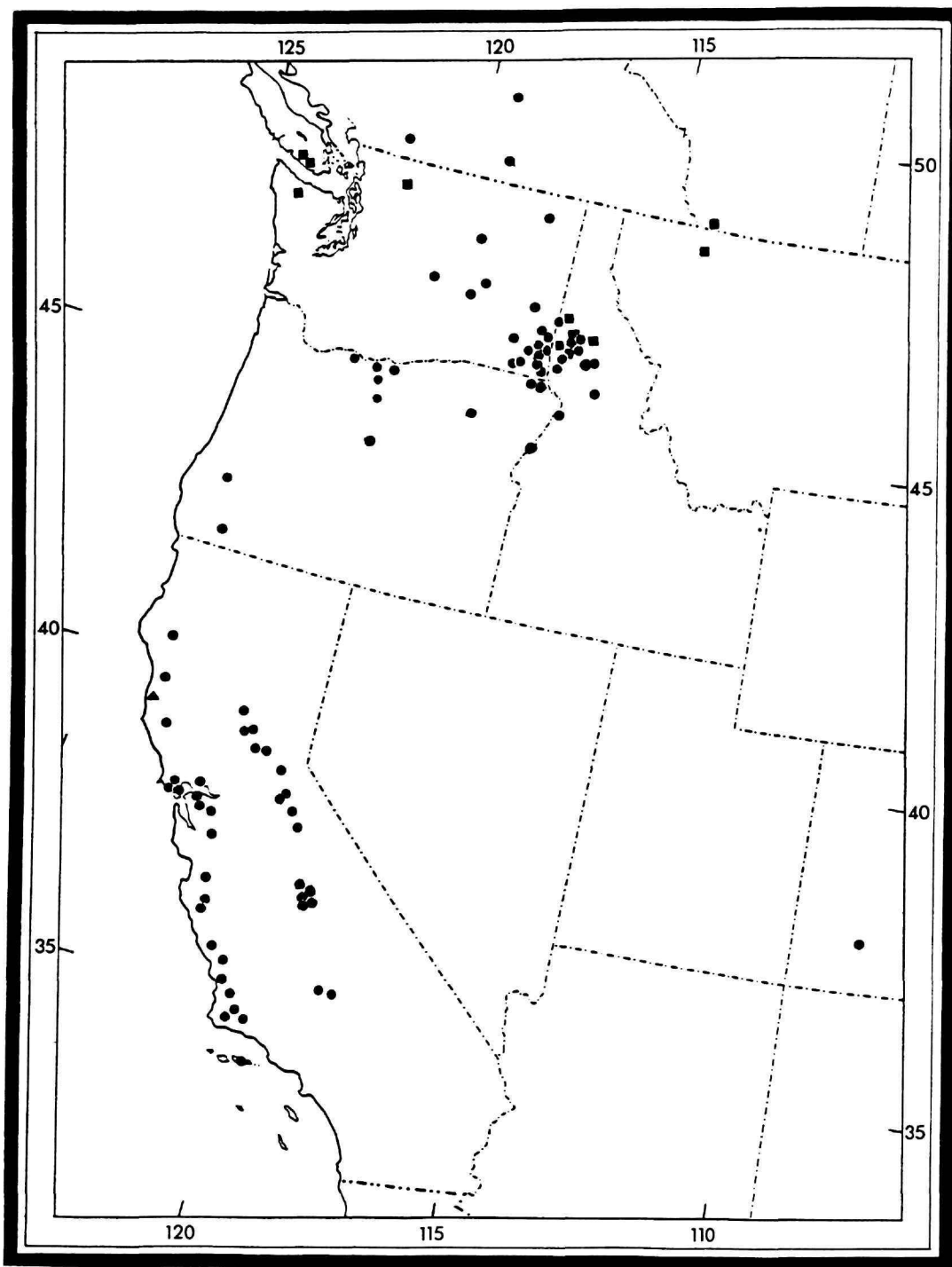

MAP 4.—Distribution of *Greya obscuromaculata* (■), *G. sparsipunctella* (▲), and *G. politella* (●).

Greya sparsipunctella (Walsingham)

FIGURES 265, 365; MAP 4

Tinea sparsipunctella Walsingham, 1907:227.—Barnes and McDunnough, 1917:193, no. 8262.—McDunnough, 1939:105, no. 9657.

Greya sparsipunctella (Walsingham).—Davis, 1983:4.

ADULT (Figure 265).—Wing expanse: ♀, 23–27 mm.

Head: White, face rough. Antenna approximately 0.5 × the length of forewing; scape, pedicel, and dorsum of basal third of flagellum white, not ringed; remainder of flagellum fuscous, densely pubescent. Maxillary and labial palpus white; third segment of labial palpus with brown suffusion, second segment with a few apical bristles.

Thorax: Dorsum white with brown suffusion along anterior margin of patagia. Venter white with suffusion of pale brown, especially on prothoracic and mesothoracic legs. Forewing white, heavily irrorated with brown fuscous spots; markings rather evenly scattered over wing but tend to coalesce to form short, narrow transverse bands, especially near termen; cilia white at base, outer half gray to pale fuscous. Hindwing gray fuscous; cilia gray, slightly irrorated with white.

Abdomen: Brown dorsally with slight admixture of white caudally, paler ventrally.

Male Genitalia: Unknown.

Female Genitalia (Figure 365).—Apex of ovipositor compressed, acute. A pair of stellate signa present; each with approximately 20–25 rays.

IMMATURE STAGES.—Unknown.

TYPE.—Holotype, ♀, no. 90947; in the Natural History Museum, London.

TYPE LOCALITY.—Mendocino Co., north of Mendocino (near the town), California.

HOST.—Unknown.

FLIGHT PERIOD.—Early June.

DISTRIBUTION (Map 4).—This species is known only from the type locality near Mendocino, California. The area is a coastal situation predominantly characterized by forests of pine and redwood. The route map of Lord Walsingham, compiled by Essig (1941), would suggest that the type locality was in the vicinity of the current Russian Gulch State Park. This site is located at sea level.

HABITAT.—Not known.

MATERIAL EXAMINED.—3 females.

UNITED STATES: CALIFORNIA: *Mendocino Co.*: N (near Mendocino: 1♀ (holotype), 3–5 Jun, 1♀ (paratype), 3–5 Jun (BMNH); 1♀ (paratype), 3–5 Jun (USNM).

DISCUSSION.—For nearly 70 years this species had been considered a member of the ditrysian family Tineidae. However, an examination of the female genitalia clearly revealed the correct family placement for this insect. No specimens have been collected since the discovery of the type series in 1871; consequently, the male is still unknown. The eventual discovery of this sex, however, should verify the generic assignment as now recognized. The greatly lengthened

haustellum and five segmented maxillary palpus suggests the affiliation of *sparsipunctella* to *Greya*. These traits appear also in *Mesepiola*, but *sparsipunctella* is most likely a diurnal species.

Greya sparsipunctella should be easily recognized by its size and unique pattern, which consists of narrow, bar-like spots randomly scattered over the forewing.

Greya politella (Walsingham)FIGURES 1–4, 17, 18, 20–24, 30, 38, 39,
123–180, 266, 319–322, 366; MAP 4

Incurvaria politella Walsingham, 1888:146.—Riley in Smith, 1891:96, no. 5121.—Dyar 1903 ("1902"):569, no. 6482.—Kearfott in Smith, 1903:122, no. 7018.—Busck, 1903:193.—Dietz, 1905:37, 38, 92.—Barnes and McDunnough, 1917:196, no. 8432.

Lampronia politella (Walsingham).—Braun, 1921:20; 1925:127.—McDunnough, 1939:109, no. 9802.—Taylor, 1965:37, 38.

Greya politella (Walsingham).—Davis, 1983:4.

Tetrageya politella (Walsingham).—Powell, 1985:84.

ADULT (Figure 266).—Wing expanse: ♂, 14–19 mm; ♀, 11.5–20 mm.

Head (Figures 38, 39): Light brownish gray to white. Antenna 0.4–0.55 × the length of the forewing, 30–36-segmented, with basal 7 (♂) to 16 (♀) segments covered dorsally with brownish gray to nearly white scales. Maxillary palpus usually brownish gray, occasionally white, 4- or 5-segmented. Labial palpus brownish gray with suffusion of white ventrally to almost totally white.

Thorax: Dark brownish gray or brownish gray, occasionally lightly irrorated with grayish white; collar white to light gray. Venter pale gray to white; legs usually brownish gray dorsally, white below. Forewing rather uniformly brownish gray, irrorated with a sparse scattering of somewhat indistinct grayish white scales, sometimes so heavily as to impart a pale bronzy iridescence; cilia brownish gray at base, becoming white toward tips. Hindwing gray, usually darker than forewing and without pale, bronzy luster.

Abdomen: Brownish gray dorsally, light gray to white underneath. Female with seventh abdominal segment considerably elongated, about 2–3 × longer than broad.

Male Genitalia (Figures 135–137, 319–322): Uncus rather broad, well set off from tegumen by constricted base; superficially bilobed. Vinculum-saccus Y-shaped, elongate, approximately 1.5 × length of valva. Valva with pollex enlarged, length more than 0.5 × width of cucullus; cucullus broadly rounded, not excavate. Pollex occasionally with a secondary spine originating basally or medially on major spine. Juxta broadest at middle, gradually tapering to acute apex anteriorly. Aedocagus with a single, large cornutus usually projecting at right angle from shaft.

Female Genitalia (Figures 138, 139, 141, 142, 366): Apex of ovipositor compressed, acute, smooth. Walls of anterior half of ductus bursae slightly rugose. Corpus bursae without signa.

EGG.—White, pyriform or oblong, molded by surrounding ovules, 0.35×0.2 mm. Chorion smooth. Micropyle reticulate, consisting of a roughly circular/angulate to triangular ridge, surrounded by a faint reticulation of ~5–6 cells. A nearly contiguous series of aeropyle openings around inner ridge.

FIRST-INSTAR LARVA (Figures 143–157).—Length 2.4 mm; width 0.4 mm; maximum width of head 0.3 mm. P1 laterad to AF2. L1 caudad to A3. S1 below and nearer to stemma 3. Stemmata 1–6 well developed. Sensilla of antenna as illustrated (Figures 150, 151), apical segment with 1–2 short sensilla chaetica. Sensilla of maxilla as illustrated (Figures 147, 148). Chaetotaxy of A10 as illustrated (Figures 156, 157); anal combs with 4–6 spines.

LAST-INSTAR LARVA (Figures 158–178).—Length of largest larva 5.6 mm; width 1.1 mm; maximum head width 0.52 mm. P1 arising laterad and slightly anterior to AF2. L1 caudad and ventrad to A3. Stemmata 1–6 well developed; stemma 6 with a central, minute pore (Figure 163). Mandible with 4 acute cusps; middle two cusps largest (Figure 178). Labrum with 3 pairs of similar epipharyngeal setae (Figures 176, 177). Chaetotaxy of head and body very similar to those of first-instar larvae. Leg and pretarsus (Figures 167, 168) similarly developed as in first-instar. All prolegs present on A3–6 but reduced, with relatively small crochets arranged in an indefinite biordinal circle (Figure 169); ~16–17 in outer circle and 5–11 in inner circle; proleg A10 without crochets (Figure 171).

PUPA (Figures 179, 180).—Length of largest pupa 5.4 mm; maximum width 1.6 mm. Dark brown to black. Vertex smoothly rounded. Antenna and forewing extending to approximate middle of A6. A single anterior row of minute spines of terga of A2–8 with the maximum number of ~35 spines on A5, decreasing in number anteriorly and posteriorly. Chaetotaxy as illustrated. Cremaster of A10 greatly reduced, with only a pair of minute rounded tubercles on tergum and a slightly larger pair on sternum.

TYPE.—Lectotype, ♂ (present designation): “Type; to Fort Dallas, Wasco Co., Oregon, 15–22.IV.1872, Wlsm. 90621; Walsingham Collection, 1910-427; *Incurvaria politella* Wlsm., U.S. Dp. Agr. Div. Ent., Ins. Life I, 146 (1888), Type ♂; lectotype ♂, by D. Davis.” In the Natural History Museum, London.

TYPE LOCALITY.—To Fort Dallas, Wasco Co., Oregon.

HOST.—First-instar larvae live on the seeds of several *Lithophragma* species (Saxifragaceae). Records exist for *L. parviflorum*, *L. tenellum*, *L. affine*, *L. heterophyllum*, *L. bolanderi*, and *L. cymbalaria*. Along the Clearwater and Lochsa rivers in central Idaho, observed populations feed on *Heuchera grossulariifolia* (sometimes introgressed with *H. cylindrica*) (Figure 30).

FLIGHT PERIOD.—Mid-March to early August.

DISTRIBUTION (Map 4).—This species occurs widely over Western North America, ranging along the Pacific Coast from British Columbia south to Santa Cruz Island and the southern

end of the Sierra Nevada, California, east to Idaho and western Colorado. Altitudinal range, sea level to ~3000 m.

HABITAT (Figures 20–24, 30).—In the southern part of its range, in grassy understory of open oak forest, often with *Ceanothus* and *Artemisia* (Figures 20–22). In the northern part (Figures 23, 24, 30), in open grassland, often in somewhat disturbed sites. Populations feeding on *L. tenellum* occur in sagebrush prairie. Northward also in mixed forest, in light gaps of relatively dry coniferous forest.

MATERIAL EXAMINED.—267 males and 316 females.

CANADA: BRITISH COLUMBIA: Chase: 1♀, 21 May (CNC). Penticton, Brent's Lake: 1♂, 30 May (CNC). 10 km W Penticton, Shingle Creek Rd, 700 m: 1♀, 31 May (OP). Pinantan Lake: 1♂, 18 May (CNC).

UNITED STATES: CALIFORNIA: no specific locality, no date: 2♂, (coll. H. Edwards; AMNH). *Alameda Co*: Lake Del Valle, 300–350 m: 1♂, 15 Mar (UCB); 2♀, 29 Apr (UCB); 6♂, 5♀, 30 Apr (UCB); 1♀, 1 May (OP); 2♂, 3♀, 3 May (UCB). *Butte Co*: Feather Falls, 615–715 m: 2♂, 2♀, 1 pupal exuviae and cocoon, 2 May (OP); 1♀, 8 May (OP). 11 km N Oroville, 360 m: 1♀, 5 May (OP). Oroville: 1♀, 9 Apr (CAS). 500 m E Richardson Springs, 200 m: 3♀, 28 Apr (OP). *Calaveras Co*: N Fork of Mokelumne River near Rte 26 crossing, 2.7 km NW West Point, 600–625 m: 2♂, 2♀, 3 May (OP). S Fork of Mokelumne River at Rte 26 crossing, 3.3 km NE Glencoe, 600–625 m: 1♂, 1♀, 3 May (OP). *Contra Costa Co*: Briones-Hampton Rd: 1♀, 1 Apr (UCB); 1♂, 1♀, 25 Mar (UCB). Russelmann Park, Mt. Diablo: 1♂, 6 Apr (UCB). *El Dorado Co*: 4 km E Auburn, 330 m: 3♂, 3♀, 2 May (OP). 10 mi [16 km] SW Pollock Pines: 3♂, 1♀, 28 May (UCB); 1♂, 28 May (USNM). *Kern Co*: Democrat Hot Springs on Kern River, 2200 ft [660 m]: 1♂, 1♀, 7 Apr (RL); 3♀, 15 Apr (RL); 1♀, 19 Apr (RL); 1♂, 25 Apr (RL); 1♂, 2♀, 2 May (RL); 1♂, 2 May (LACM). 1 mi [1.6 km] E Woody: 3♂, 1♀, 25 Apr–3 May (UCB). *Marin Co*: Alpine Lake: 1♂, 21 Apr (UCB). Alpine Lake, Lily Gulch, 230 m: 2♀, 29 Apr (OP). 2 mi [3.2 km] W Fairfax: 1♀, 21 Apr (UCB). Liberty Gulch, near Alpine Lake, 640–900 ft [190–270 m]: 7♂, 2♀, 21 Apr (UCB). 3 mi [4.8 km] NE Nicasio: 3♀, 28 Apr (USNM); 2♂, 4♀, 28 Apr (UCB). *Mendocino Co*: Hopland Field Station Headquarters, 900–1600 ft [270–480 m]: 1♂, 27 Apr (UCB). Pond area 0.6 mi [1 km] E Hopland Field Station Headquarters, 900–1600 ft [270–480 m]: 3♂, 11♀, 29 Apr (UCB). Northern California Coast Range Preserve, 0.5 mi [0.8 km] N Branscomb: 1♀, 25 May (UCB). Northern California Coast Range Preserve, 3 mi [4.8 km] N Branscomb, 420 m: 4♂, 6♀, 17 May (UCB). *Monterey Co*: 0.2 mi [0.3 km] SW Arroyo Seco Guard Station, 2500 ft [750 m]: 1♂, 1♀, 3 May (UCB). 1.5 mi [2.4 km] SW Arroyo Seco Guard Station, 1300 ft [390 m]: 2♂, 4♀, 3/7 May (UCB). Indian Guard Station 17 mi [27.2 km] NW Jolon, 2100 ft [630 m]: 6♂, 8♀, 9 May (UCB). *Nevada Co*: 6 mi [9.6 km] SW Colfax: 1♂, 18 Apr (UCB). 4 mi [6.4 km] S Rough and Ready: 3♀, 5 May (UCB). *Placer Co*: Colfax: 1♂, 1♀, May (ANSP); 1♂, 1♀, May (MCZ); 1♂, 2♀ (USNM). *San Benito*

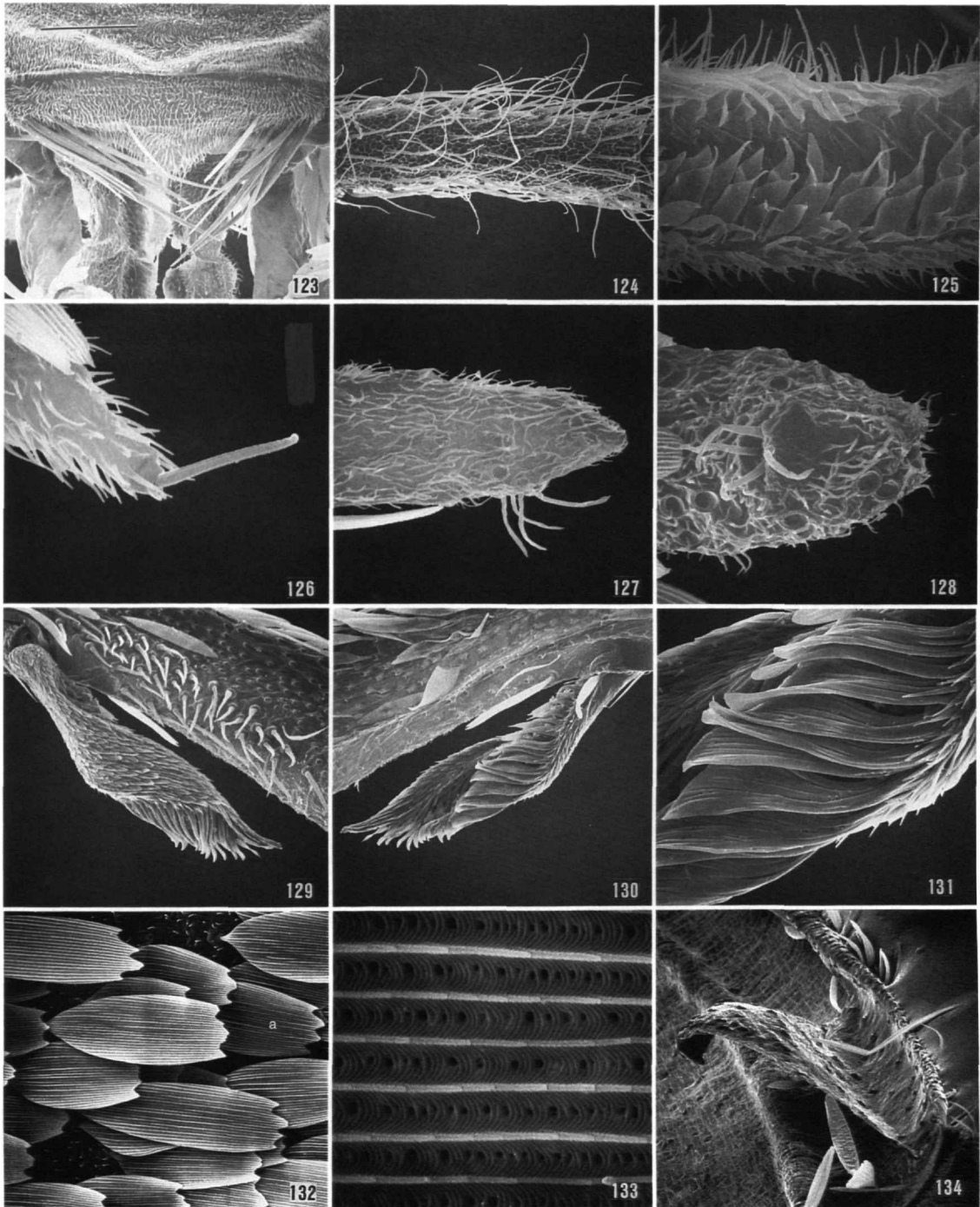

FIGURES 123–134.—*Greya politella*, adult morphology: 123, labrum (60 μm); 124, flagellomere near middle of antenna (50 μm); 125, legulae bordering channel of haustellum (13.6 μm); 126, apex of maxillary palpus (17.6 μm); 127, apex of labial palpus with subapical organ of vom Rath (17.6 μm); 128, detail of apex of labial palpus (12 μm); 129, epiphysis with associated tibial setae, posterior view (60 μm); 130, epiphysis, anterior view (60 μm); 131, detail of epiphysal comb (17.6 μm); 132, scales of dorsal surface of forewing within discal cell (60 μm); 133, detail of scale “a” in Figure 132 (3 μm); 134, male frenulum, basal view (75 μm). (Scale lengths in parentheses; bar scale for all photographs given in Figure 123.)

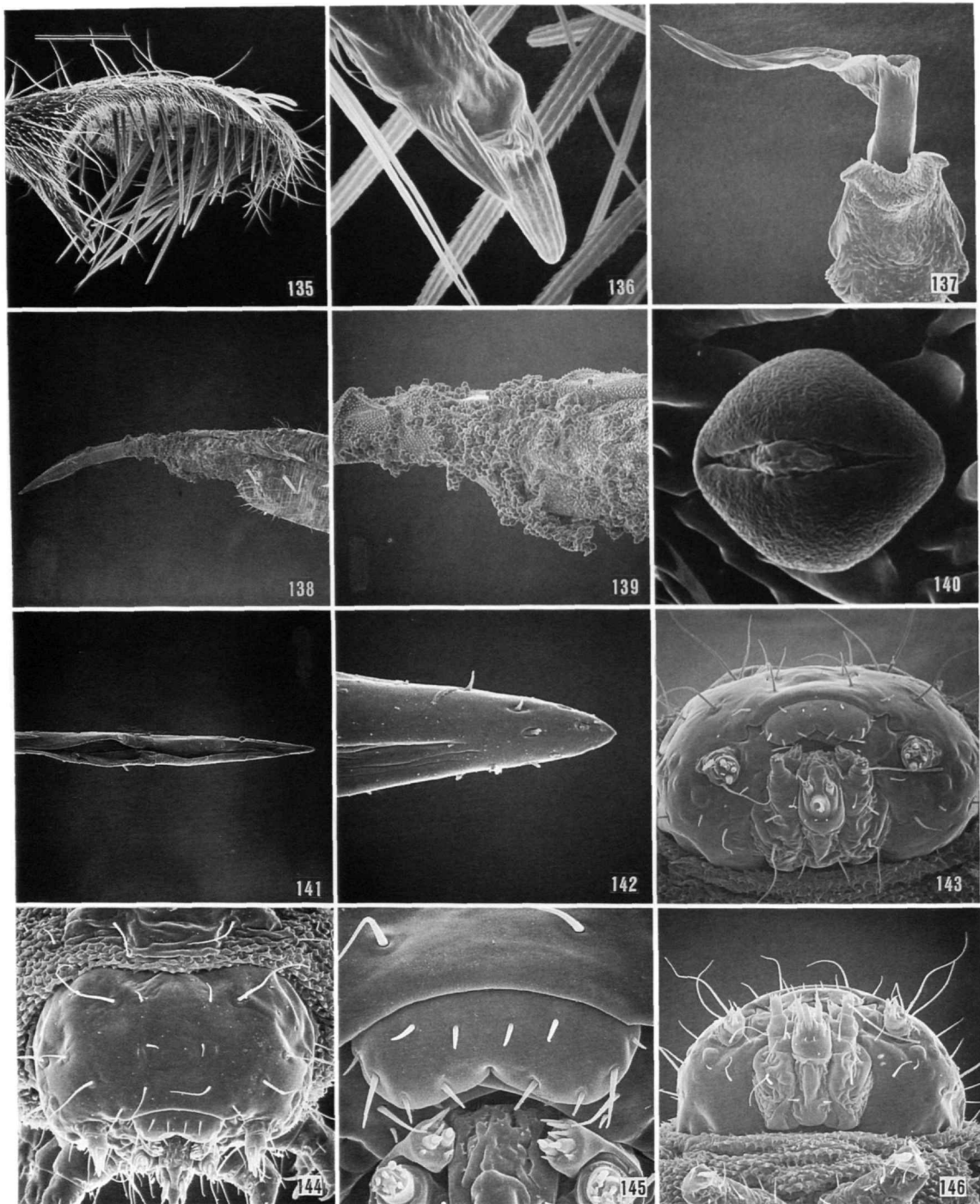

FIGURES 135-146.—*Greya politella*, adult and larval morphology: 135, apex of male valva showing elongate pollex (86 μm); 136, apex of pollex with two spines (10 μm); 137, apex of male aedeagus showing characteristic cornutus and moderately spinose anellar membrane, ventral view (120 μm); 138, caudal end of female ovipositor (0.5 mm); 139, pollen of *Lithophragma parviflorum* adhering to eighth abdominal segment of ovipositor (150 μm); 140, pollen grain of *Lithophragma parviflorum* (4.3 μm); 141, apex of ovipositor, ventral view, showing elongate cloacal groove (231 μm); 142, apex of ovipositor, lateral view (23.1 μm). First-instar larva: 143, head, anterior view (50 μm); 144, head, anterodorsal view (60 μm); 145, labrum (20 μm); 146, head, dorsal view (60 μm). (Scale lengths in parentheses; bar scale for all photographs given in Figure 135.)

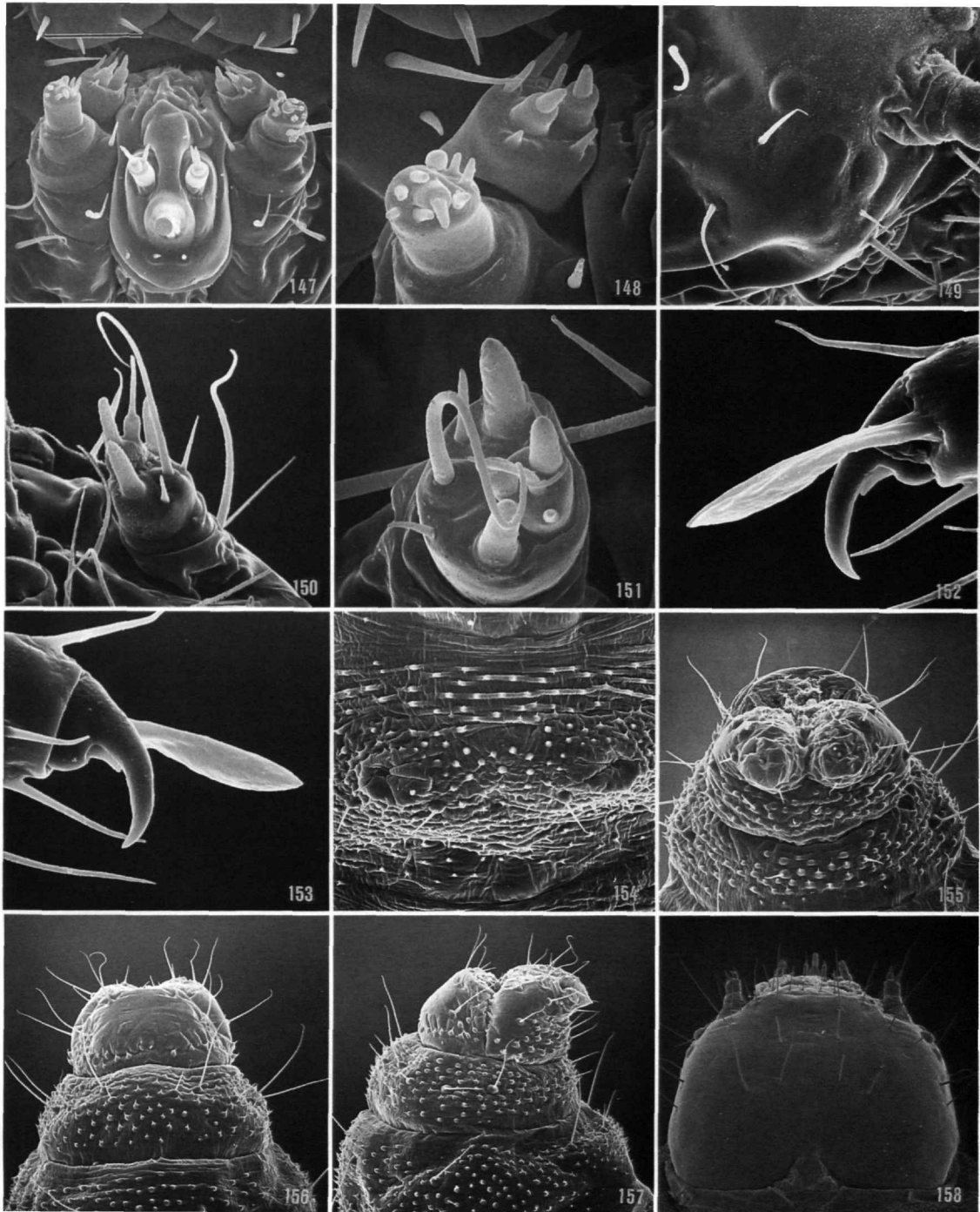

FIGURES 147-158.—*Greya politella*, first-instar larva: 147, maxilla and labium (20 μ m); 148, sensilla of maxilla (7.5 μ m); 149, stemmatal region of head (20 μ m); 150, antenna, ventral view (15 μ m); 151, antenna, apical view (7.5 μ m); 152, prethoracic pretarsus, caudal view (7.5 μ m); 153, anterior view of Figure 152 (7.5 μ m); 154, prolegs of third abdominal segment (43 μ m); 155, abdominal segments 9 and 10, ventral view (60 μ m); 156, dorsal view of Figure 155 (75 μ m); 157, lateral view of Figure 155 (86 μ m). Last-instar larva: 158, head, dorsal view (176 μ m). (Scale lengths in parentheses; bar scale for all photographs given in Figure 147.)

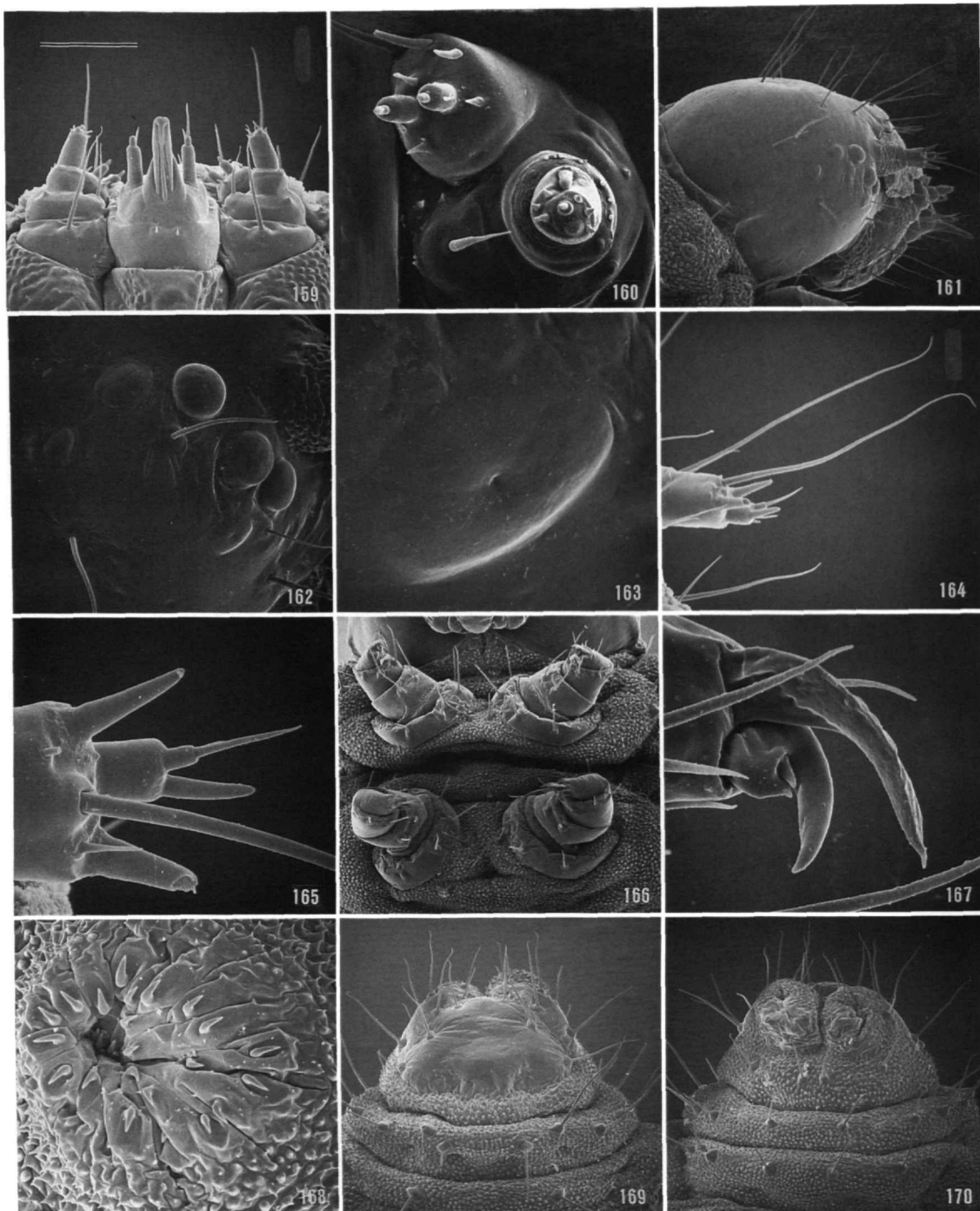

FIGURES 159–170.—*Greya politella*, last-instar larva: 159, labium and maxillae, ventral view (60 μm); 160, sensilla of maxilla (20 μm); 161, head, lateral view (150 μm); 162, stemmatal region of head (50 μm); 163, central depression in sixth stemma (8.6 μm); 164, antenna, ventral view (50 μm); 165, antenna, lateral view (17.6 μm); 166, ventral view of thoracic segments 1 and 2 (176 μm); 167, prothoracic pretarsus, posterior view (13.6 μm); 168, crochets of fourth abdominal segment (38 μm); 169, abdominal segments 9 and 10, dorsal view (176 μm); 170, ventral view of Figure 169 (176 μm). (Scale lengths in parentheses; bar scale for all photographs given in Figure 159.)

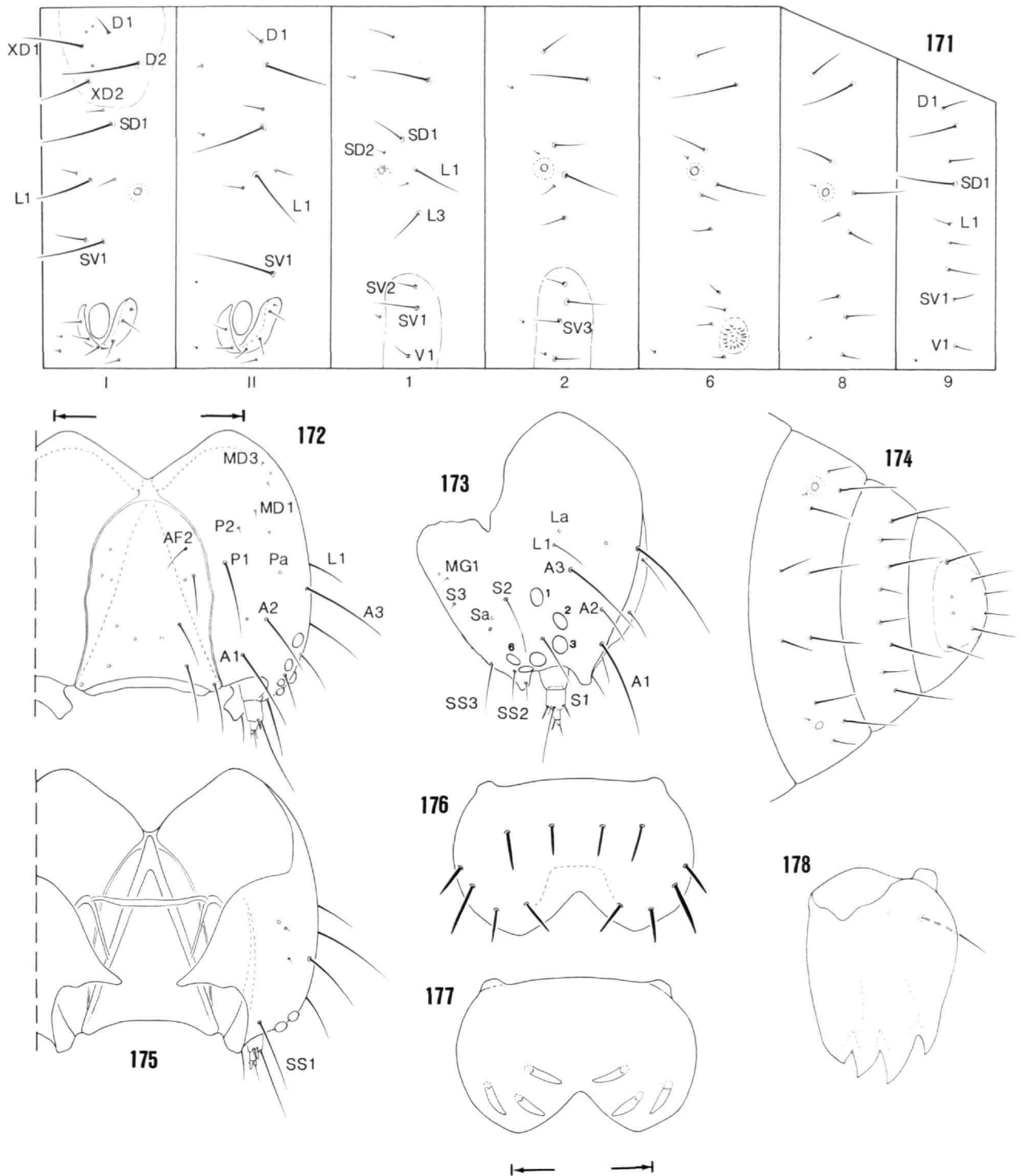

FIGURES 171-178.—*Greya politella*, chaetotaxy of last-instar larva: 171, lateral schematic of prothorax, mesothorax, and abdominal segments 1, 2, 6, 8, and 9; 172, dorsal view of head (0.5 mm); 173, lateral view; 174, dorsal view of abdominal segments 8-10; 175, head, ventral view; 176, labrum, dorsal view; 177, ventral view (0.1 mm); 178, mandible. (Scale lengths in parentheses.)

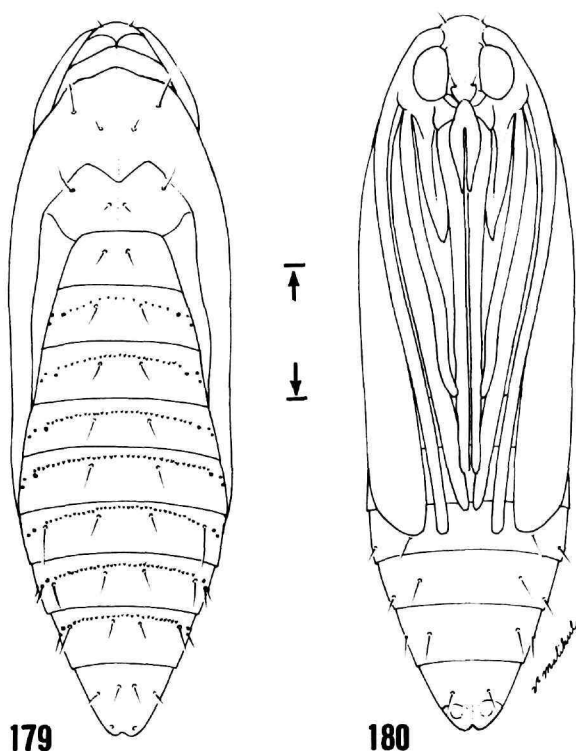

FIGURES 179, 180.—*Greya politella*, pupa: 179, dorsal view; 180, ventral view. (Scale = 1 mm.)

Co: 2 mi [3.22 km] W Jct. Cienega and Lime Kiln Rds: 2♂, 30 Mar (CAS). Limekiln Canyon, SW Paicines: 4♀, 24 Apr (UCB); 3♂, 23 Apr (UCB). *San Luis Obispo Co*: Nacimiento Dam: 2♂, 14 Apr (UCB). San Luis Obispo: 1♂, Mar (USNM). York Mtn., 8 mi [12.8 km] W Templeton: 1♂, 3♀, 27 Apr (UCB). *Santa Barbara Co*: Colson Canyon Rd, 300–460 m: 2♂, 4♀, 22 Mar (OP). Figueroa Mtn. Road at Alamo-Pintado Creek, 350–500 m: 1 pupa, 20 Mar (♂ eclosed 26 Mar) (OP); 1♂, 23 Mar (OP); 5♂, 8♀, 24 Mar (OP); 1 pupa, 24 Mar (♂ eclosed 31 Mar) (OP); 1♂, 26 Mar (OP); 4♀, 27 Mar (OP). Happy Canyon Rd, 375 m: 1♂, 26 Mar (OP). 6.5 km S Santa Ynez, Refugio Rd along Quiota Creek: 1♂, 21 Mar (OP). *Santa Cruz Island*: Canada de la Cuesta: 1♀, 15 Mar (USNM); 7♂, 8♀, 15 Mar (UCB). Canada del Puerto: 1♀, 16 Mar (USNM); 1♂, 1♀, 16 Mar (UCB). Eagle Canyon: 1♂, 16 Mar (USNM); 2♀, 16 Mar (UCB). Prisoner's Harbor: 1♂, 1♀, 16 Mar (USNM); 4♂, 14♀, 14–16 Mar (UCB). *Solano Co*: Green Valley, 9 mi [14.4 km] N Highway 40: 1♀, Apr (UCB). *Stanislaus Co*: Del Puerto Canyon, 18 mi [28.8 km] W Patterson: 1♂, 9 Apr (UCB). *Trinity Co*: 3.5 km NW Norse Butte, 1075 m: 1♂, 29 Apr (OP). *Tulare Co*: Ash Mtn. Headquarters, 1700 ft [510 m]: 3♂, 9♀, 28 Apr (UCB). Potwisha 0.3 mi [0.5 km] NE Ash Mtn. Headquarters: 1♂, 2♀, 4 May (UCB). Potwisha 3 mi [4.8 km] NE Ash Mtn.

Headquarters: 17♂, 3♀, 1 May, (UCB). Sequoia National Park, Generals Highway, 990 m: 1♂, 2♀, 29 Apr (OP). Sequoia National Park, Little Baldy: 1♀, 22 Jul (ANSP). S Fork Kaweah River, 10 mi [16 km] SE Three Rivers: 1♀, 29 Apr (UCB). S Fork Kaweah River, rd-mile 10.5, 850 m: 1♂, 29 Apr (OP). S Fork Camp, 13 mi [20.8] km SE Three Rivers, 3200–3600 ft [960–1080 m]: 1♀, 28 Apr (OP); 6♂, 1♀, 1 May (OP); 1♂, 2♀, 3 May (UCB). 10 mi [16 km] SE Three Rivers, 2800 ft [840 m]: 3♂, 2♀, 29 Apr (UCB). *Tuolumne Co*: 6 km NE Tuolumne, on Cottonwood Creek Rd., 750 m: 5♂, 4 May (OP). N fork of Tuolumne River, 3 mi [4.8 km] NE Tuolumne: 1♀, 13 May (CAS). 6 mi [9.6 km] S Mather: 1♀, 12 Jun (USNM); 1♂, 4♀, 12 Jun (UCB). *Yuba Co*: Sierra Foothills Station, 5 mi [8 km] N Smartville, 1300–1500 ft [390–450 m]: 5♀, 7 May (UCB). COLORADO: *San Juan Co*: Silverton: 2♂, 8♀, 8 Jul–7 Aug (USNM). IDAHO: *Benewah Co*: M.M. McCroskey Park, W part, along Skyline Drive, 1020–1050 m: 1♂, 2 Jun (OP); 1♂, 5 Jun (OP). *Clearwater Co*: 3.2 km W Ahsahka, rd-mile 38.8 on Rte 12, 290 m: 2♀, 26 May (OP). *Idaho Co*: Johnson's Bar [Hell's Canyon], Snake River; 2♂, 10 Apr (USNM). Lochsa River 2 km S Snowshoe Creek: 1♂, 15♀, 7 Jun (OP). *Latah Co*: 2.1 km NE Laird Park, 850 m: 2♂, 20 Apr (OP); 2♀, 15 May (OP); 2♂, 4♀, 16 May (OP). M.M. McCroskey Park, W end, along Skyline Drive, 1020–1050 m: 1♂, 2 Jun (OP). 11 km ENE Moscow, 840 m: 1♀, 25 May (OP). W Moscow Mtns, 980 m: 1♀, 21 May (OP). 1.5 km E Princeton: 1♀, 15 May (OP). 5 km NW Troy: 1♂, 5♀, 15 May (OP). *Nez Perce Co*: 1.5 km SSW Arrow, 275 m: 1♂, 20 Apr (OP). OREGON: Specific locality unknown: 1♂ (BMNH). *Crook Co*: Rte 26 rd-mile 38.25, 11.9 rd-mile W Ochoco Summit: 1♂, 2 Jun (OP). *Hood River Co*: Starvation Creek State Park: 1♀, 5 May (OP). *Jackson Co*: To Rogue River: 3♂ (paralectotypes), 4–6 May (BMNH). *Umatilla Co*: Applegate Canyon on Rte 3, 930–970 m: 1♀, 3 Jun (OP). Rte 395 S Ukiah, 7.4–14.4 km N confluence of Camas Creek and N Fork John Day River, 875–970 m: 1♀, 29 May (OP). *Wallowa Co*: 28 mi [44.8 km] SE Joseph, 5400 ft [1646 m]: 1♂, 20 Jun (USNM). 5 km NE Troy: 1♂, 23 Apr (OP). *Wasco Co*: Cow Canyon on Rte 97: 1♂, 4♀, 4 May (OP). NW McCall Reserve: 1♀, 5 May (OP). E Rowena on Mosier-Dallas Hwy: 1♀, 5 May (OP). S Dallas on Fivemile Rd, 1.4 mi [2 km] W jct Pleasant Ridge Rd: 11♂, 3♀, 5 May (OP). To Fort Dallas: 4♂, 1♀ (paralectotypes), 15–22 Apr (BMNH), 1♂ (paralectotype), 15–22 Apr (USNM). WASHINGTON: Specific locality unknown: Cow Creek Canyon: 1♂, 18 Apr (USNM). *Asotin Co*: 2 km W Clarkston, 250 m: 2♂, 20 Apr (OP). 2 km S Field Spring Park, 1000 m: 1♀, 12 Apr (OP). Rattlesnake Grade above Grande Ronde River, 600–675 m: 3♂, 3♀, 10 Apr (OP). Rattlesnake Grade above Grande Ronde River, 785 m: 3♂, 2♀, 14 May (OP). Rattlesnake Grade above Grande Ronde River, 800 m: 1♂, 17 Apr (OP). *Chelan Co*: Dryden: 1♀, 16 May (USNM). *Columbia Co*: 1 km SE Martin Spring in Blue Mtns, 1100 m: 1♂, 2♀, 5 May (OP); 1♂, 2♀, 20 Apr (OP). Tucannon Ranger Station, 800 m: 3♂, 9♀, 5 May (OP).

Ferry Co: Columbia Mtn., 6500 ft [1982 m]: 1♀, 23 Jul (USNM). *Garfield Co:* Wawawai Grade Rd 2.6 km SE Lower Granite Dam, 425 m: 1♂, 15 Apr (OP); 1♀, 21 Apr (OP); 1♂, 5 May (OP); 1♀, 6 May (OP). *Grant Co:* 3 km S Coulee City, 500 m: 12♂, 4♀, 23 Apr (OP); 2♀, 9 May (OP). Devil's Canyon near Ephrata, 450–600 m: 19♂, 8♀, 19 Apr (OP), 1♀, 23 Apr (OP); 1♀, 9 May (OP). Intersection of Pinto Rd and Rd 34, 4.6 km S Coulee City, 500 m: 2♂, 23 Apr (OP); 1♀, 9 May (OP). *Okanogan Co:* Brewster: 1♂, 3 May (USNM). *Whitman Co:* 600 m above Granite Point on Snake River, 220 m: 11 larvae and pupae, 15 Mar (eclosed 18–21 Mar) (OP); 2♀, 4 Apr (OP); 3♂, 3♀, 11 Apr (OP); 6♀, 13 Apr (OP). 1.3 km above Granite Point on Snake River, 220 m: 9 larvae and pupae, 9 Mar (eclosed 12–17 Mar) (OP); 1♂, 20 Mar (OP); 1♂, 30 Mar (OP); 2♂, 31 Mar (OP); 2♀, 1 Apr (OP); 4♀, 13 Apr (OP); 1♀, 21 Apr (OP); 1♀, 5 May (OP). 10.1 km above Granite Point on Snake River, 240 m: 5♂, 16♀, 13 Apr (OP). Kamiak Butte, 950 m: 2♂, 3♀, 17 May (OP); 1♂, 6 Jun (OP). Palouse Falls, 300 m: 1♂, 3 May (CU); 2♂, 3 May (USNM); 2♂, 6♀, 23 Apr (OP). Pullman, 750 m: 6♂, 24 Apr (USNM). Red Wolf Crossing, 250 m: 1♀, 31 Mar (OP). 1.7 km SE head of Rock Lake, 650 m: 2♀, 29 May (OP). Smoot Hill, 800–900 m: 1♂, 3♀, 4 May (OP); 1♂, 11 May (OP); 2♂, 17 May (OP). Snake River, opposite Clarkston, 250 m: 2♂, 3 Apr (USNM). Union Flat [near Pullman]: 1♂, 20 Apr (USNM). Wawawai Park, 210 m: 4♂, 6♀, 1 Apr (OP), 1 without abdomen, 6 Apr (OP).

DISCUSSION.—The immaculate, brownish gray forewing in both sexes of *G. politella* easily separates this species from all other members of the genus. Superficially, *G. politella* most resembles the adults of *Lampronia humilis*, but the two may be readily distinguished by several major differences in wing venation, genitalic characters, and overall size. *Lampronia humilis* is typically a smaller species with a wing expanse of 10 to 14 mm, it possesses only four radial veins in the forewing, and bears a prominent pectinifer on the valva of the male.

Specimens from Grant County, Washington (Okanogan Valley), are much whiter than elsewhere, and closely resemble *G. subalba*. Females are easily distinguished by the greatly elongated seventh abdominal segment, and both sexes also have more pointed wings. In contrast, specimens from Sequoia National Park in interior California and from Smoot Hill (Whitman Co.), Washington, are distinctly darker than the nominal form. In both cases, the habitat is moister than most other sites.

The type series of *politella* was found to consist of eight males and one female. One female, originally designated as a paratype of *politella* by Walsingham (1888), was found to be a misidentified specimen of *L. humilis*. Because Walsingham originally selected both a male and female as types for *politella*, his entire series has been considered as syntypes (even though most are labelled as paratypes), and a lectotype has been selected.

Although the flight period of *G. politella* extends over several months, it lasts for only a few weeks in any one

population. Consequently, the species undergoes only one generation per year. The apparent variation in seasonal activity is primarily due to the rather extensive distribution of the species, both in latitude and elevation.

Greya enchrysa Davis and Pellmyr, new species

FIGURES 7–9, 24, 25, 30, 181–207,
267, 268, 323–326, 367; MAP 5

ADULT (Figures 267, 268).—Wing expanse: ♂, 17–20 mm; ♀, 15.5–20 mm.

Head: Usually white, sometimes pale stramineous. Antenna 0.35–0.40 × the length of the forewing, 29–32-segmented, with basal 8–12 segments usually with white scales dorsally. Maxillary and labial palpi completely white.

Thorax: Dorsum white to ochreous, tegula usually entirely ochreous. Venter white. Anterior legs white ventrally, usually ochreous to light brown dorsally; metathoracic legs entirely white. Forewing uniformly pale ochreous, often with a pale golden luster, rarely white; cilia white. In some populations in central Idaho, forewing ochreous or dark ochreous with a pale subterminal patch and sometimes a slight costal patch near apex (Figure 268). Hindwing darker, gray.

Abdomen: Pale brown dorsally, white to pale ochreous ventrally.

Male Genitalia (Figures 205–207, 323–326): Uncus prominently bilobed, slightly constricted at base. Vinculum-saccus moderately long, approximately 1.5 × length of valva; anterior end relatively broad, bluntly rounded. Valva rather narrow; pollex sessile, consisting of a cluster of three (rarely four) elongate spines situated at outer third of ventral margin. Juxta flared at middle, tapering gradually to elongate, acuminate anterior end; caudal half relatively broad. Aedoeagus with a single large cornutus at caudal fourth; posterior margin asymmetrical, a flaplike extension projecting caudally from one side.

Female Genitalia (Figure 367): Apex of ovipositor compressed, bluntly rounded. Ductus bursae with minutely rugose, slightly thickened walls midway to corpus bursae. Signa absent.

EGG (Figures 181–183).—White, pyriform, about 0.4 mm in diameter. Chorion smooth. Micropyle reticulate, consisting of a well-defined central, oval to circular ridge, lined internally with numerous aeropylae and encircled by 6–8 slightly less defined cellular reticulations.

FIRST-INSTAR LARVA (Figures 184–204).—Length of largest larva 2.5 mm; width 0.38 mm; maximum width of head 0.3 mm. P1 laterad and slightly caudad of AF2. L1 moderate in length, directly caudad of A3. S1 below and midway between stemmata 2 and 3. Stemmata 2–6 well developed; stemma 1 greatly reduced (flattened), lens barely evident. Sensilla of antennae (Figures 189, 190) and maxilla (Figures 187, 188) as illustrated. Chaetotaxy of A10 as illustrated (Figures 200, 201, 203); anal combs with 4–9 spines (Figure 204).

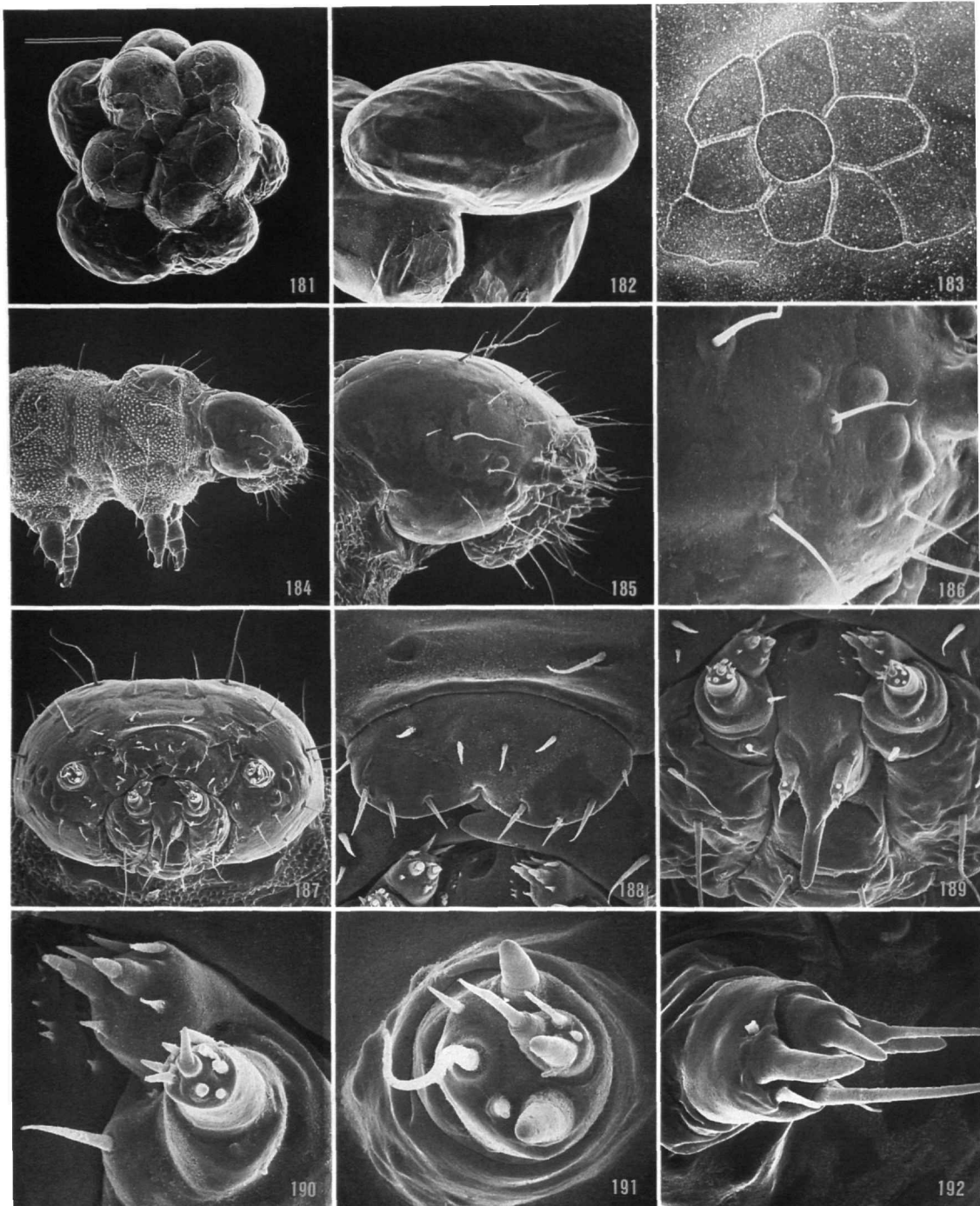

FIGURES 181-192.—*Greya enchrysa*, egg: 181, cluster of ~10 eggs, deposited by one female (0.27 mm); 182, detail of single egg (150 μ m); 183, micropyle (25 μ m). First-instar larva: 184, head and thoracic segments 1 and 2, lateral view (200 μ m); 185, head, lateral view (86 μ m); 186, stemmatal region of head (30 μ m); 187, head, anterior view (86 μ m); 188, labrum (27 μ m); 189, labium and maxillae (30 μ m); 190, sensilla of maxilla (10 μ m); 191, antenna, apical view (8.6 μ m); 192, antenna, dorsal view (10 μ m). (Scale lengths in parentheses; bar scale for all photographs given in Figure 181.)

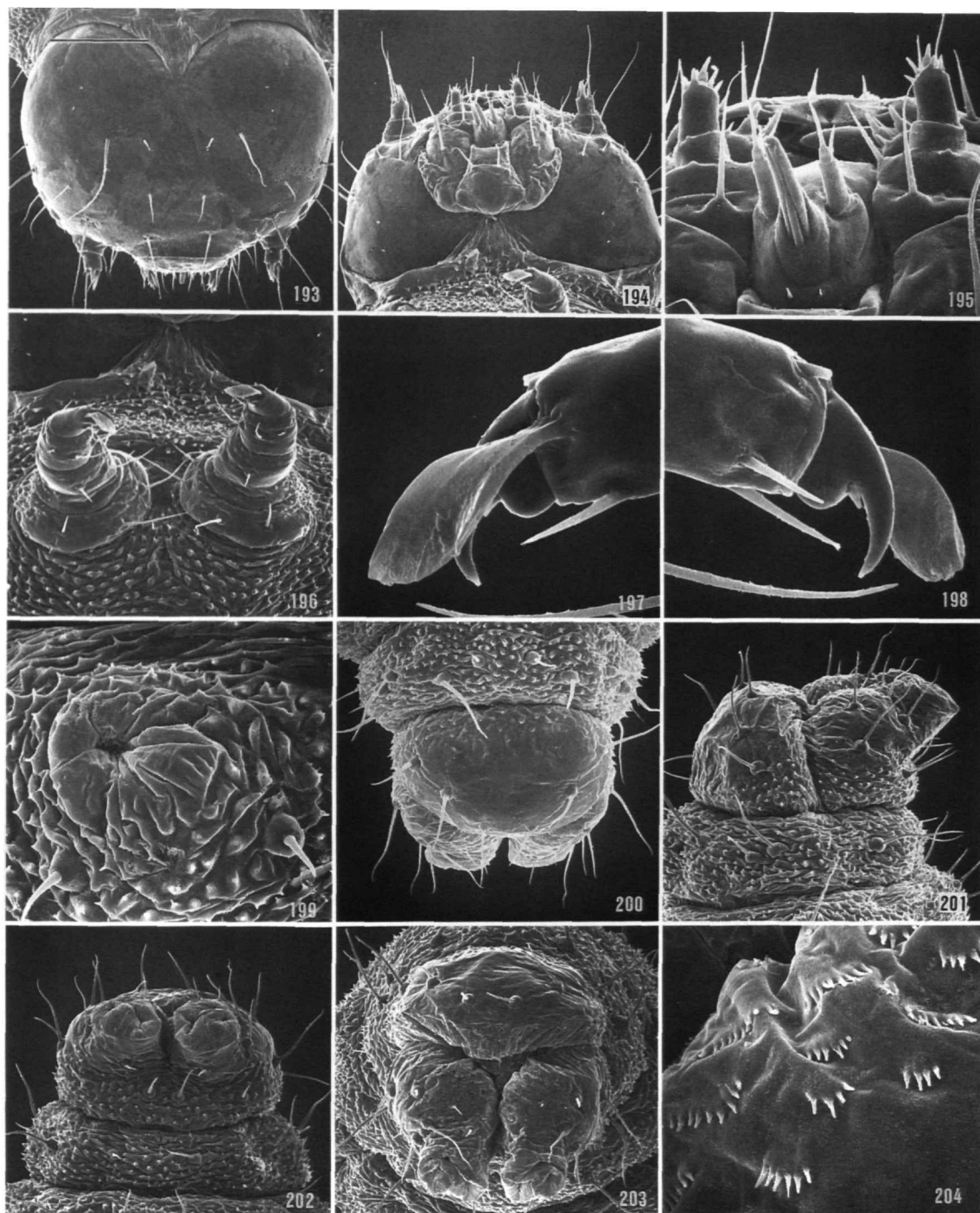

FIGURES 193–204.—*Greya enchrysa*, first-instar larva: 193, head, dorsal view (88 μm); 194, head, ventral view (86 μm); 195, labium and maxillae, ventral view (23.1 μm); 196, prothoracic legs (67 μm); 197, prothoracic pretarsus, posterior view (10 μm); 198, anterior view of Figure 197 (10 μm); 199, proleg of fourth abdominal segment (27 μm); 200, abdominal segments 9 and 10, dorsal view (86 μm); 201, lateral view of Figure 200 (86 μm); 202, ventral view of Figure 200 (86 μm); 203, caudal view of Figure 200 (86 μm); 204, detail of anal combs in Figure 203 (8.6 μm). (Scale lengths in parentheses; bar scale for all photographs given in Figure 143.)

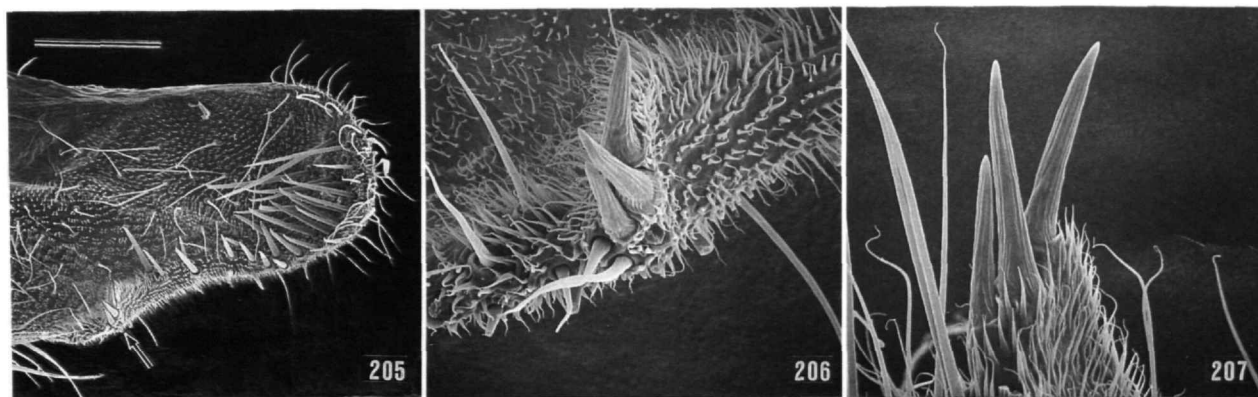

FIGURES 205-207.—*Greya enchrysa*, male genitalia: 205, apex of valva (120 µm); 206, detail of reduced pectinifer in Figure 205 (see arrow) (25 µm); 207, lateral view of Figure 206 (23.1 µm). (Scale lengths in parentheses; bar scale for all photographs given in Figure 205.)

PUPA.—Unknown.

HOLOTYPE.—Summerland, British Columbia, ♂, 26 May 1936, A.N. Gartrell; in the Canadian National Collection.

PARATYPES.—CANADA: ALBERTA: Waterton Lakes: 1♀, 20 Jun 1923, J. McDunnough (ANSP); 1♀, 19 Jun 1923, J. McDunnough, 1♀, 27 Jun 1923, J. McDunnough (CNC); 1♂, 2 Jul 1923, J. McDunnough (USNM). Waterton Lakes Park: 1♂, 2 Jul 1923, J. McDunnough (CNC). BRITISH COLUMBIA: Keremeos: 1♀, 18 Jun 1923, C. Garrett (CNC). Keremeos, Shingle Creek Road: 1♂, 8 Jun 1935, A.N. Gartrell (CNC). Oliver: 1♂, 22 May 1923, C. Garrett (CNC). Osoyoos: 1♂, 27 May 1938, G. Walley (CNC); 1♂, same data (USNM). Penticton: 1♂, 7 Jun 1933, J. McDunnough (CNC). Penticton, Brent's Lake: 6♂, 8♀, 30 May 1935, A.N. Gartrell (CNC); 2♀, same data (USNM). Penticton, Brent Lake, 600 m: 1♂, 1 Jun 1988, O. Pellmyr (OP). Penticton, Shingle Creek: 3♂, 5 Jun 1933, J. McDunnough (CNC); 1♀, same data (USNM); 1♀, 25 Jun 1935, A.N. Gartrell (CNC). 10 km W Penticton, Shingle Creek Road, 700 m: 5♂, 13♀, 31 May 1988, O. Pellmyr (OP). Summerland: 3♂, 2♀, 26 May 1936, A.N. Gartrell (CNC); 1♂, same data (USNM); 1♀, 3 Jun 1935, A.N. Gartrell (CNC); 1♀, 25 May 1935, A.N. Gartrell (USNM). Vaseaux Lake: 1♂, 21 May 1936, A.N. Gartrell (CNC).

UNITED STATES: IDAHO: *Clearwater Co.*: 3.2 km W Ahsahka, rd-mile 38.8 on Rte 12: 3♀, 26 May 1990, O. Pellmyr and J.N. Thompson (OP). *Idaho Co.*: Lochsa River 2 km S Snowshoe Creek: 2♀, 7 Jun 1989, O. Pellmyr (OP). *Lewis Co.*: 8 km NW Kamiyah, along Hwy 12, 350 m: 3♂, 4♀, 7 Jun 1989, O. Pellmyr (OP). *Nez Perce Co.*: 700 m W Lenore, 280 m: 1♂, 1♀, 25 May 1989, O. Pellmyr (OP). 1 km E Lenore, rd-mile 29 on Rte 12, 270 m: 1♀, 26 May 1990, O. Pellmyr and J.N. Thompson (OP). 600-2400 m ENE Spalding, 275 m: 3♀, 11 May 1989, O. Pellmyr and J.N. Thompson (OP); 1♂, 1♀, 13 May 1989, O. Pellmyr (OP); 2♂, 5♀, 23 May 1990, O. Pellmyr (OP); 1♀, 30 May 1989, O. Pellmyr (OP); 1♀, 4 Jun 1989, O. Pellmyr (OP). MONTANA: *Cascade Co.*: Little Belts Mtns, 1.6

km N Belt Creek Ranger Station, 1500 m: 1♂, 8 Jun 1989, O. Pellmyr (OP). *Glacier Co.*: Glacier National Park: 1♂, 15 Jul 1920, A. Braun (ANSP); 2♂, 21 Jul 1920, A. Braun (ANSP). OREGON: *Grant Co.*: Rte 395 S crossing Middle Fork John Day River, rd-mile 77.8, 880 m: 1♀, 29 May 1990, O. Pellmyr (OP). *Umatilla Co.*: Rte 395 S of Ukiah, 7.4(Fivemile Creek)-14.4 km N confluence of Camas Creek and N Fork John Day River, 875-970 m: 1♂, 5♀, O. Pellmyr (OP). *Wallowa Co.*: Applegate Canyon on Rte 3, 930-970 m: 2♀, 3 Jun 1990, O. Pellmyr (OP). WASHINGTON: *Asotin Co.*: 2 km W Clarkston, 250 m: 2♀, 11 May 1989, O. Pellmyr and J.N. Thompson (OP). Rattlesnake Grade above Grande Ronde River, 630 m: 2♂, 1♀, 14 May 1989, O. Pellmyr (OP). *Garfield Co.*: 500-1000 m SE Lower Granite Dam, 225 m: 2♀, 17 May 1990, O. Pellmyr (OP). 2 km SE Lower Granite Dam, 425 m: 1♂, 12 May 1989, O. Pellmyr (OP). 2.6 km SE Lower Granite Dam, along Wawawai Grade, 400 m: 17 May 1990, O. Pellmyr (OP). *Okanogan Co.*: 24 km E Tonasket, Rte 20, 975 m: 2♀, 1 Jun 1988, O. Pellmyr (OP). *Whitman Co.*: Kamiak Butte, 950 m: 1♀, 6 Jun 1988, O. Pellmyr (OP). 1.7 km SE head of Rock Lake, 650 m: 1♀, 29 May 1989 (OP).

Described from a total of 43 males and 72 females.

HOST.—*Heuchera cylindrica* and *H. grossulariifolia* and hybrids between these two taxa (Saxifragaceae) (Figure 30).

FLIGHT PERIOD.—Late May to early July.

DISTRIBUTION (Map 5).—Present records indicate this species to be restricted to southwestern Canada, east to Montana, and south at least to central Oregon. Altitudinal range, 250-1500 m.

HABITAT (Figures 24, 25, 30).—Rockfaces in open country, where the host is found growing in crevices and on ledges, or in open, grassy *Pinus ponderosa* forest. Often occurring together with *G. punctiferella*.

ETYMOLOGY.—The specific epithet is derived from the Greek *enchrysos* (golden), denoting the distinctive pale golden tinge that characterizes the forewing.

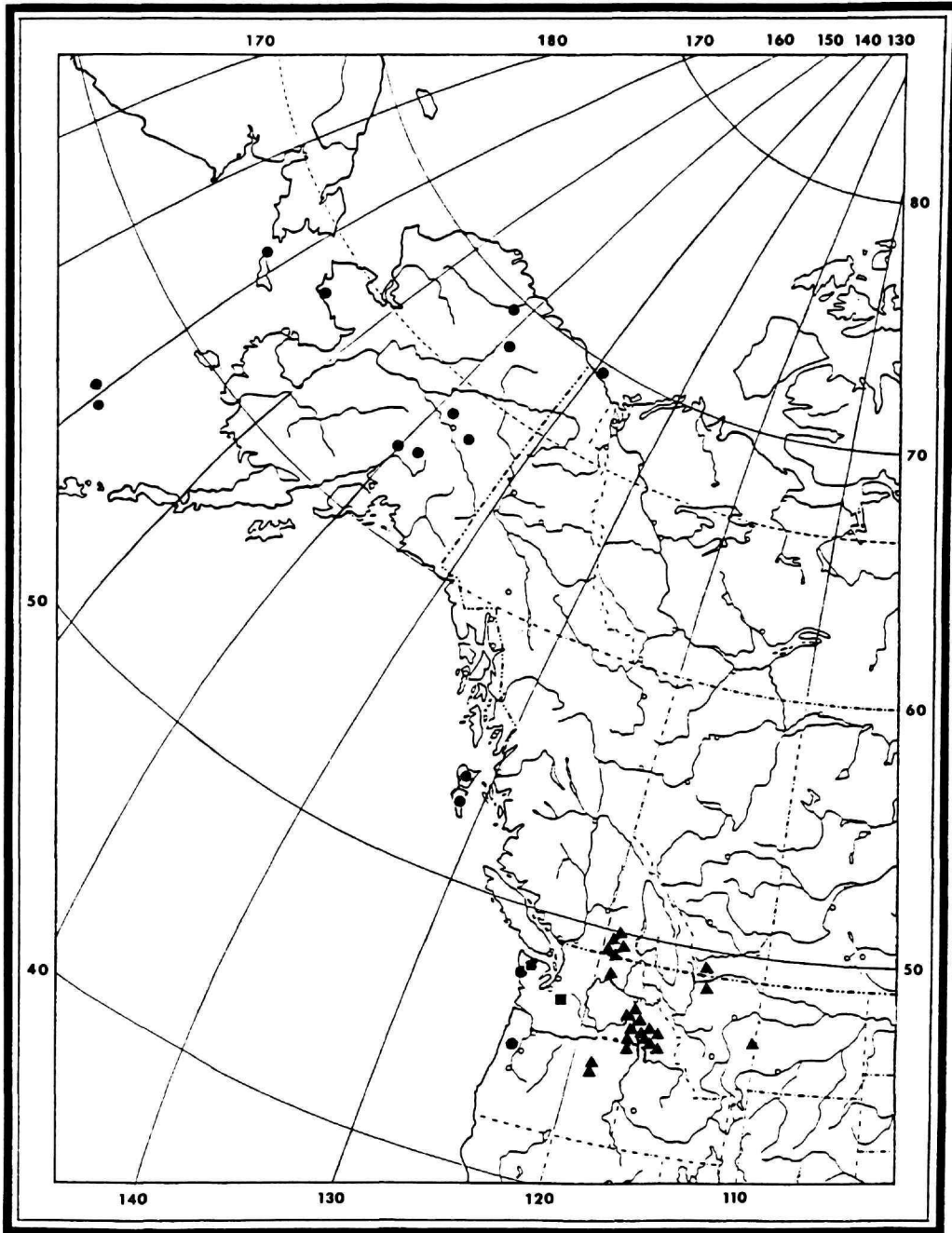

MAP 5.—Distribution of *Greya enchrysa* (▲), *G. variabilis* (●), and *G. pectinifera* (■).

DISCUSSION.—*Greya enchrysa* may be easily distinguished from all other members of *Greya* by its usually immaculate, pale, golden yellow forewings, which have suggested its specific name. All other known members of this genus exhibit a forewing pattern to some degree, or bright white coloration as in *G. subalba*. The male genitalia are unique for the family, especially in the subtruncate termination of the anterior end of the saccus and in the reduced pollex, which is situated rather remote from the apex of the cucullus. Although superficially similar to *Lampronia aenescens* (Walsingham), *G. enchrysa* may be distinguished from it by its relatively larger size and five-segmented maxillary palpi. The two species often coexist at sites, but *L. aenescens* is found in close proximity of *Rosa woodsii*, whereas *G. enchrysa* typically is found resting on its host.

***Greya variabilis* Davis and Pellmyr, new species**

FIGURES 26–28, 208–222, 269–276, 327–330, 368; MAP 5

ADULT (Figures 269–276).—Wing expanse: ♂, 13–18 mm; ♀, 12–16 mm.

Head: Pale ochreous with occasional suffusion of light fuscous. Antenna 0.4–0.5× the length of the forewing, with scape and pedicel pale ochreous, 30–34-segmented, mostly devoid of scales, sometimes lightly scaled on basal 7–8 segments, dark, densely pubescent. Maxillary palpus, haustellum, and labial palpus pale ochreous; apical segment of labial palpus frequently suffused with light fuscous.

Thorax: Dorsum variable, completely pale ochreous to fuscous with pale ochreous tegula. Venter pale ochreous, occasionally suffused with light fuscous, especially on dorsum of legs. Forewing with extremely variable maculation, usually of various shades of fuscous heavily marked with streaks and irregular spots of pale ochreous, which tend to anastomose; in rare instances forewing may be completely pale ochreous; cilia usually entirely pale ochreous, sometimes irrorated with fuscous. Hindwing uniformly pale ochreous to gray.

Abdomen: Pale brown to fuscous dorsally, light fuscous to ochreous ventrally.

Male Genitalia (Figures 220–222, 327–330): Uncus prominently bilobed. Length of vinculum-saccus approximately equal to that of valva. Valva moderately broad at base; pollex elongate, triangular, of variable development, usually capped by a cluster of 3 short spinose setae, sometimes reduced to a single seta; sometimes in addition a row of up to six short spines. Juxta broadest at middle with a slight constriction toward caudal end, gradually tapering to anterior end; dorsal surface spinose. Aedeagus with a prominent, angulate strip of vesicle projecting at right angles from apex; distal fifth of vesicle spinose.

Female Genitalia (Figures 219, 368): Apex of ovipositor acute, relatively smooth. Ductus bursae membranous, walls not thickened. Corpus bursae without signa.

IMMATURE STAGES.—Unknown.

HOLOTYPE.—British Columbia: Queen Charlotte Islands, Graham Island, Queen Charlotte Range, ridge above Takakia Lake, 3000 ft [900 m]: ♂, 30 Jul 1985, J.F.G. Clarke; in the National Museum of Natural History, Smithsonian Institution.

PARATYPES.—CANADA: BRITISH COLUMBIA: same data as holotype: 4♂, J.F.G. Clarke (USNM). Graham Island, Queen Charlotte Ranges, ridge W of Mt. Brown, 3100 ft [930 m]: 4♂, 27 Jul 1985, J.F.G. Clarke (USNM). Graham Island, SW of Dinan Bay, 2575 ft [775 m]: 1♀, 23 Jul 1987; 1♂, 24 Jul 1987, J.F.G. Clarke and N.L. duPre (USNM). Graham Island, 2 mi [3.2 km] NE Dawson Inlet, 8100 ft [2470 m]: 52♂, 3♀, 11–12 Jul 1988, J.F.G. Clarke and N.L. duPre (USNM). YUKON TERRITORY: Herschel Island: 1♀, 18 Jul 1930, O. Bryant (CAS).

UNITED STATES: ALASKA: *Second Judicial Div.*: Nome: 14♂, 6♀, 14 Jun 1959, D.P. Whillans (CNC); 2♂, 14 Jun 1951, D.P. Whillans (USNM). St. Lawrence Island, Gambell: 1♂, 22 Jul 1966; 1♂, 26 Jul 1966; 1♂, 27 Jul 1966; 3♂, 1♀, 28 Jul 1966; 1♂, 29 Jul 1966, all S.G. Sealy (AMNH); 1♂, 23 Jul 1966, S.G. Sealy (USNM). Umiat: 2♂, 2 and 10 Jul 1959, J. Martin (CNC); 5♂, 2♀, 22 Jul 1959, R. Madge (CNC); 1♂, 22 Jul 1959, R. Madge (USNM). *Third Judicial Div.*: Pribilof Islands: St. George Island: 10♂, 5♀, 21 Jul 1947, E.C. Johnston (CNC); 3♂, 1♀, 21 Jul 1947, E.C. Johnston (USNM). St. Paul Island: 2♂, 24 Jun 1940; 2♂, 24 Jun 1941; 1♂, 26 Jun 1940; 1♂, 29 Jun 1947; 4♂, 2 Jul 1939; 3♂, 1♀, 4 Jul 1939; 2♂, 7 Jul 1944; 2♂, 8 Jul 1941; 4♂, 13 Jul 1944; 1♂, 14 Jul 1939; 1♂, 28 Jul 1945, E.C. Johnston (CNC); 1♀, 24 Jun 1940; 1♂, 26 Jun 1940; 1♂, 29 Jun 1939; 1♂, 1♀, 29 Jun 1941; 2♂, 13 Jul 1944, E.C. Johnston (USNM). St. Paul Island, Zap. Cliffs: 1♂, 30 Jun 1954, R.E. Phillips (USNM). *Fourth Judicial Div.*: Brooks Range, Atigun Pass and below: 1♀, 7 Jun 1979, R. Leuschner (RL). 4 mi [6.4 km] N Cantwell, 2000–2200 ft [600–660 m]: 15♂, 1♀, 26–28 Jun 1979, P. Opler and J. Powell (UCB). Eagle Summit, 65 mi [104 km] SW Circle, 3800 ft [1140 m]: 23♂, 10♀, 2 Jul 1979, P. Opler and J. Powell (UCB); 1♂, 2♀, 2 Jul 1979, R. Leuschner (RL); 1♂, 2 Jul 1979, R. Leuschner (LACM). McKinley Park [Denali National Park]: 1♂, 21 Jun 1881, F.W. Moran (USNM). Murphy's Dome 20 mi [32 km] NW Fairbanks, 2600–2800 ft [780–840 m]: 1♂, 3♀, 1 Jul 1979, P. Opler and J. Powell (UCB). OREGON: *Tillamook Co.*: Boyer: 3♂, 2 Jul 1937 (USNM). WASHINGTON: *Clallam Co.*: Olympic National Park, Deer Lake drainage, 3550–3600 ft [1065–1080 m], on flowers of *Platanthera stricta*: 1♂, 14 Aug 1984, J.M. Patt (UCB); 2♂, 21 Aug 1984, J.M. Patt (UCB). Olympic National Park, trail to Deer Lake, 700–900 m: 1♂, 15 Jul 1988, O. Pellmyr (OP). Olympic National Park, edge of meadow ~400 m SE Deer Lake: 1♂, 12 Aug 1989, J.N. Thompson (OP).

Described from a total of 186 males and 40 females.

HOST.—Unknown.

FLIGHT PERIOD.—Late June to late July.

DISTRIBUTION (Map 5).—This species is widely distributed over Alaska, occurring as far north as Umiat (69°25'N lat.), westward to the Pribilof and St. Lawrence Islands, and as far

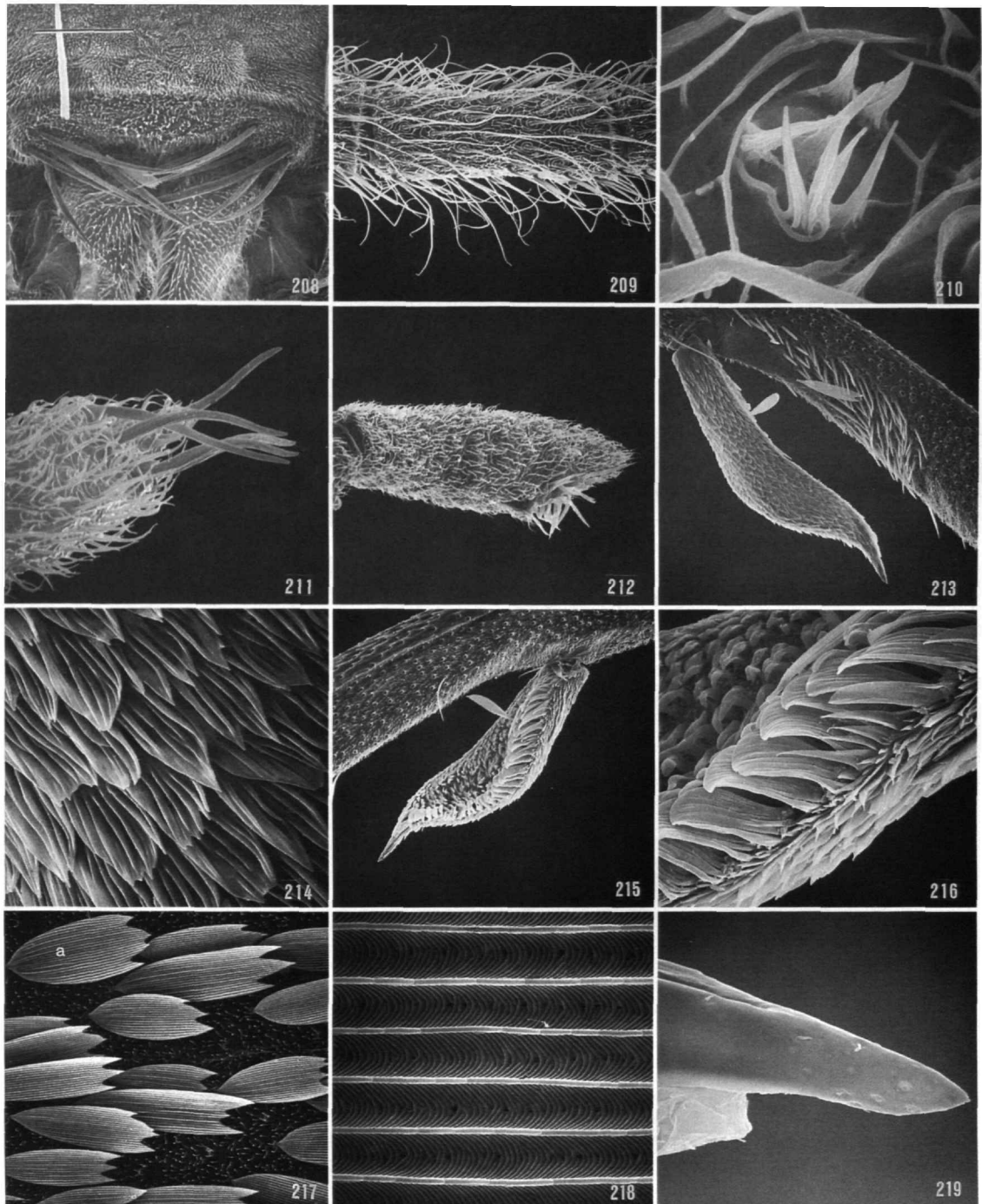

FIGURES 208–219.—*Greya variabilis*, adult morphology: 208, labrum (60 μm); 209, flagellomere near middle of antenna (60 μm); 210, sensillum coeloconicum from distal third of flagellomere (3.8 μm); 211, sensilla chaetica at apex of maxillary palpus (12 μm); 212, subapical organ of vom Rath on apical segment of labial palpus (38 μm); 213, epiphysis with associated tibial spines, posterior view (38 μm); 214, detail of imbricate spines in Figure 213 (8.6 μm); 215, epiphysis, anterior view (86 μm); 216, detail of epiphysial comb in Figure 215 (2 μm); 217, scales of dorsal surface of forewing within discal cell (60 μm); 218, detail of scale “a” in Figure 217 (3 μm); 219, apex of female ovipositor, lateral view (20 μm). (Scale lengths in parentheses; bar scale for all photographs given in Figure 208.)

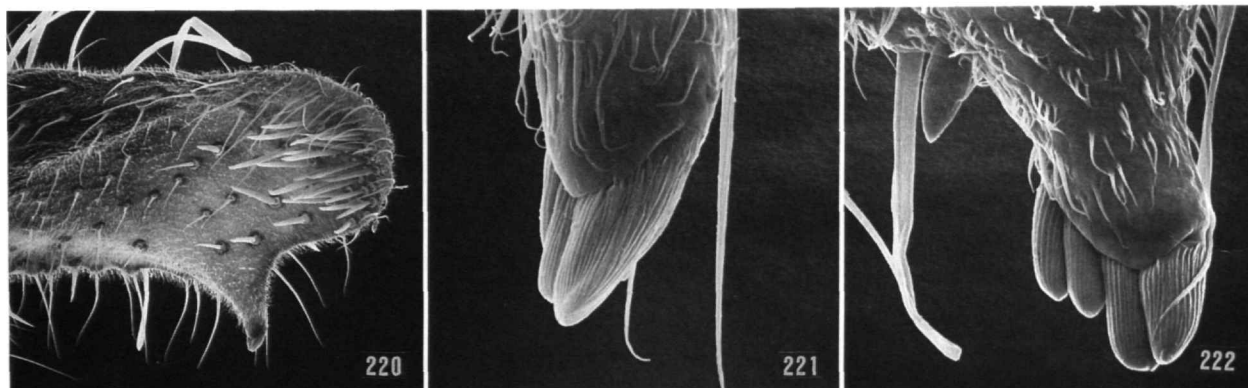

FIGURES 220–222.—*Greya variabilis*, male genitalia: 220, apex of valva (86 μ m); 221, apex of pollex in Figure 220 with three spines (10 μ m); 222, pollex with four apical and one subapical spine (15 μ m). (Scale lengths in parentheses; bar scale for all photographs given in Figure 220.)

south as Oregon. It is the most boreal of all the Nearctic Incurvarioidea, being one of only two species in this superfamily known to occur north of the Arctic Circle. Considering its broad dispersal, it is likely that *G. variabilis* also occurs in eastern Siberia. Dr. A. Zagulajev at our request checked the collections of Akademia NAUK in Moscow, Kiev, and Leningrad, for specimens from the Soviet Union but no specimens were found. Altitudinal range, sea level to 2500 m.

HABITAT (Figures 26–28).—Incompletely understood, but apparently quite varied. So far recorded from very moist coniferous forest (Olympic peninsula; Figure 26) and around outcrops in alpine meadows (Queen Charlotte Islands; Figures 27, 28), or even on tundra (Eagle Summit, Alaska).

ETYMOLOGY.—Derived from the Latin *variabilis* (changeable), this species is named for the extreme variability in wing pattern among populations.

DISCUSSION.—As its specific name suggests, this species demonstrates the greatest variation in maculation of all New World Prodoxidae. Forty specimens available for study were collected on the two major islands of the Pribilof group, St. George and St. Paul. Although these two islands are separated by less than 65 km of sea, a striking difference in maculation exists between the populations of *G. variabilis* on the two islands. With the exception of one male specimen, all the individuals from St. George were of a much paler, ochreous color than those from St. Paul, with one female being without any wing markings at all. The exceptional male (Figure 271) from St. George resembles those from St. Paul in possessing a dark wing pattern, contrastingly spotted with pale ochreous. It is, of course, possible that this specimen was mislabelled. The specimens from St. Paul, which were collected over a number of years, were mostly dark as shown in Figure 272, but some ranged as pale as Figure 269. The specimens from mainland Alaska exhibit patterns which ranged from heavily spotted to a paler form similar to the prevalent type existing on St. George. In contrast, the specimens from the Queen Charlotte Islands are relatively large and very distinctly patterned (Figures 273–

275). The three males examined from Boyer, Oregon, are badly rubbed, but large, oval spots of pale yellow are evident.

The large variation seen in this species may indicate the presence of several biological entities under this taxon. Because of the pronounced intra- and interpopulational variation of this species, paralleled also in some genitalic traits, and the absence of study material from several critical areas, proposal of additional names, even subspecific ones, would be both undesirable and unnecessary at this time.

Some of the specimens identified as *Greya* sp. by Patt (1986) refer to this species.

Greya pectinifera Davis and Pellmyr, new species

FIGURES 26, 277, 331–334, 369; MAP 5

ADULT (Figure 277).—Wing expanse: ♂, 14–16 mm, ♀, 13–14 mm.

Head: Pale ochreous. Antenna with about 31 segments, 0.6× the length of the forewing, with scape and basal fourth of flagellum sparsely covered with ochreous scales dorsally; remainder of antenna largely dark, naked, except for dense pubescence; sensory setae approximately 0.5 diameter of shaft. Maxillary palpus pale ochreous, dorsum of fourth segment more brown. Haustellum densely scaled on the basal half, ochreous. Labial palpus pale ochreous; second segment with 2–4 dark bristles arising from apex.

Thorax: Dorsum pale brown. Venter pale ochreous to white; legs pale ochreous with dorsal surfaces brown. Forewing brown, with a slight bronzy iridescence, heavily marked with 4 pale yellow areas as follows: a relatively small, narrow costal spot between basal third and middle; a large, irregular, triangular spot near apex of costa; a narrow, elongate spot bordering most of termen; and an elongate, relatively indistinct streak extending from base of wing along lower margin of discal cell to hind margin between veins CuA₁ and CuA₂. Hindwing uniformly gray.

Abdomen: Pale brown dorsally, pale ochreous ventrally.

Male Genitalia (Figures 331–334): Caudal margin of uncus slightly sinuate. Length of vinculum-saccus approximately equalling valva. Valva relatively narrow at base; distal half bearing an elongate pectinifer consisting of a single row of 40–45 slender spines bordering ventral margin of valva; inner surface of cucullus with a scattered series of short stout spines. Caudal half of juxta with lateral margins nearly parallel; dorsal surface heavily spinose. Aedoeagus with a pair of stout, short, curled cornuti at apex; caudal fourth of vesica densely spinose.

Female Genitalia (Figure 369): Apex of ovipositor acute, relatively smooth. Ductus bursae membranous, walls not thickened. Corpus bursae with two prominent signa with 20–35 rays each; the rays vary greatly in length.

IMMATURE STAGES.—Unknown.

HOLOTYPE.—Washington: Deer Lake drainage, Olympic National Park: ♀, Aug 1985. J.M. Patt, ♀ genitalia slide USNM 30692; in the National Museum of Natural History, Smithsonian Institution.

PARATYPES.—UNITED STATES: WASHINGTON: *Clallam Co.*: Olympic National Park, Deer Lake drainage, 3550–3600 ft [1065–1080 m], on flowers of *Platanthera stricta*: 1♀, 15 Aug 1984, J.M. Patt (UCB). Same data as holotype: 1♂, 3♀. *Pierce Co.*: Mt. Rainier, Round Pass, 3875 ft [1180 m]: 1♂, 18 Jul 1932, J.F.G. Clarke (USNM).

Described from a total of 2 males and 5 females.

HOST.—Unknown.

FLIGHT PERIOD.—July-early August.

DISTRIBUTION (Map 5).—Known only from the type locality in the Seven Lakes Basin of Olympic National Park, and from the southwestern section of Mount Rainier National Park, Washington. Altitudinal range, 1050–1200 m; both localities in the subalpine region.

HABITAT (Figure 26).—Most specimens have been collected during the daytime in moist meadows, bordered by fir and spruce.

ETYMOLOGY.—The specific epithet is derived from the Latin *pecten* (comb), and *fero* (carry), indicating the presence of a pectinifer in the male of this species.

DISCUSSION.—The generic placement of this species is somewhat uncertain, but until more specimens are available for study the present classification seems best. The male genitalia are atypical for *Greya* in possessing an elongate, many spined pectinifer, and the scaly haustellum is a trait shared with *Tridentiforma*.

The nectaring records of Patt (1986) and Patt et al. (1989), given as those of an undescribed species, refer in part to this species and in part to *G. variabilis*.

Greya variata (Braun)

FIGURES 223–243, 278, 335–338, 370; MAP 6

Lampronia variata Braun, 1921:20.—McDunnough, 1939:108 no. 9796.

Greya variata (Braun).—Davis, 1983:4.

ADULT (Figure 278).—Wing expanse: ♂, 11.5–13 mm; ♀, 11–13 mm.

Head: White, heavily suffused with light brown. Antenna 28–30-segmented, 0.6× the length of the forewing, dark, densely pubescent, basal fourth to one-half covered with brown scales. Maxillary palpus light brown; fourth (apical) segment approximately twice the length of third. Labial palpus white, variously suffused with brown.

Thorax: Dorsum brown fuscous. Venter white. Legs usually with ventral surfaces white and dorsal surfaces brownish fuscous. Forewing brownish fuscous with a slight bronzy iridescence; two large, elongate spots of pale ochreous extending from hind margin nearly to costal margin at basal third and apical third of wing; basal band sometimes complete; a much smaller, almost indistinct pale ochreous spot sometimes present near apex; cilia brownish fuscous. Hindwing brownish fuscous, only slightly paler than forewing.

Abdomen: Brownish fuscous dorsally, grayish white underneath.

Male Genitalia (Figures 335–338): Uncus superficially bilobed. Vinculum-saccus V-shaped, relatively short, less than length of valva. Valva broad from base to pollex; sharply constricted, appearing excavate beyond pollex; pollex prominent, curved slightly ventrad, terminating in a single, short, spinose seta. Cucullus relatively narrow, digitate. Juxta broadest at middle, gradually tapering to acute anterior and sharply constricted caudad beyond middle; lateral margin approximately parallel to caudal apex. Aedoeagus with one cornuti; caudal fifth of vesica rugose, not heavily spinose.

Female Genitalia (Figure 370): Apex of ovipositor compressed, acute, relatively smooth. Walls of caudal half of ductus bursae slightly rugose. A pair of stellate signa present, each with 10–16 relatively short, stocky rays; length of rays variable between pair with those of one signum usually distinctly shorter.

IMMATURE STAGES.—*Greya* larvae were extracted from *Osmorhiza occidentalis* seeds at the exact type locality, about two weeks after the flight period of *G. variata*. They may of course belong to an as yet unknown species, or represent a new host genus for the sympatric *G. subalba* (but stemmata differ from those of *G. subalba* from Washington). The most likely situation is that they belong to *G. variata*, however, and we describe them under that name below. Final identification must await confirmation through larvae from observed ovipositions.

EGG AND PUPA.—Unknown.

FIRST-INSTAR LARVA (Figures 223–243).—Length of largest larva 2.1 mm; width 0.32 mm; maximum head width 0.32 mm. P1 laterad and slightly caudad of AF2. L1 directly caudad of A3. S1 below and midway between stemmata 2 and 3. Stemmata 2–5 well developed, 1 and 6 less so; a central depression (pore ?) present on all stemmata (Figure 225). Sensilla of antenna (Figures 232, 233) and maxilla (Figures 228, 231) as illustrated. Apical spine of pretarsal claw –0.6–0.8× length of the claw (Figures 238, 239).

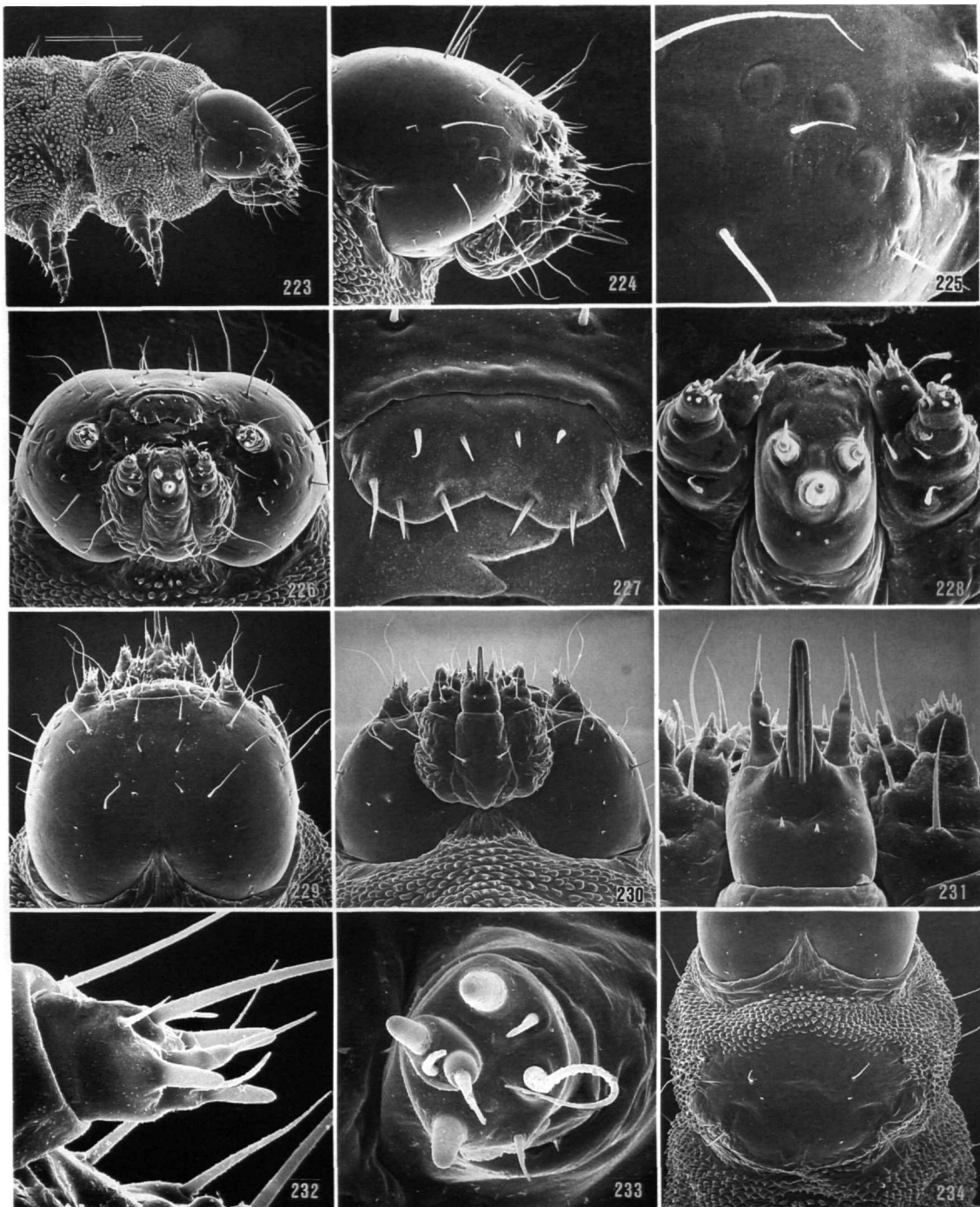

FIGURES 223–234.—*Greya* sp., ?*variata*, first-instar larva: 223, head and thoracic segments 1 and 2, lateral view (200 μm); 224, head, lateral view (86 μm); 225, stemmatal region of head (25 μm); 226, head, anterior view (86 μm); 227, labrum (23.1 μm); 228, labium and maxillae (27 μm); 229, head, dorsal view (100 μm); 230, head, ventral view (86 μm); 231, labium and maxillae, ventral view (23.1 μm); 232, antenna, dorsal view (12 μm); 233, antenna, apical view (8.6 μm); 234, pronotum (120 μm). (Scale lengths in parentheses; bar scale for all photographs given in Figure 223.)

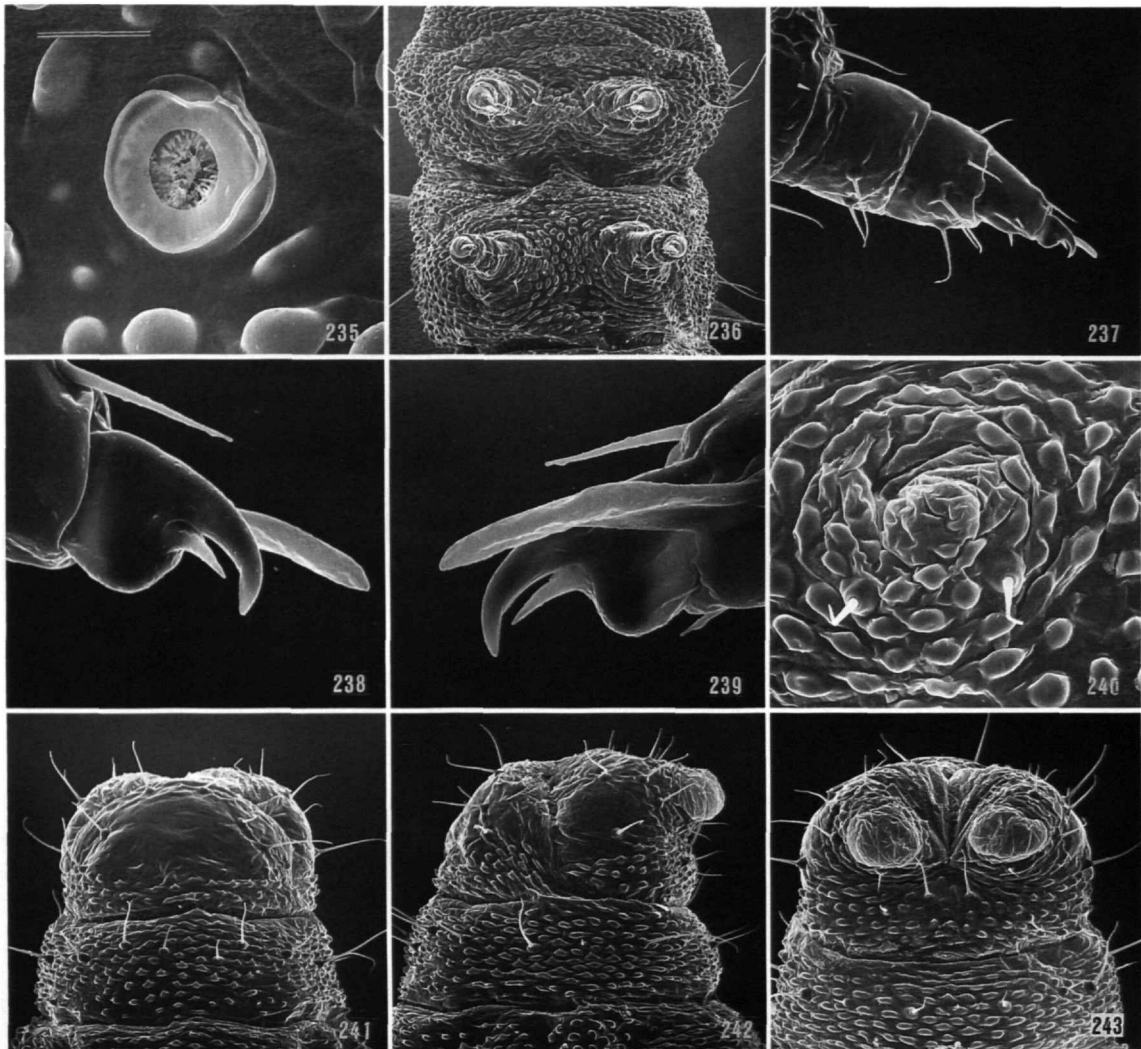

FIGURES 235-243.—*Greya* sp., ?*variata*, first-instar larva: 235, prothoracic spiracle (10 μ m); 236, legs of thoracic segments 1 and 2 (120 μ m); 237, prothoracic leg, anterior view (38 μ m); 238, pretarsus of Figure 237, anterior view (7.5 μ m); 239, pretarsus of Figure 237, posterior view (7.5 μ m); 240, proleg of sixth abdominal segment (25 μ m); 241, abdominal segments 9 and 10, dorsal view (86 μ m); 242, lateral view of Figure 241 (86 μ m); 243, ventral view of Figure 241 (75 μ m). (Scale lengths in parentheses; bar scale for all photographs given in Figure 235.)

Chaetotaxy of A10 as illustrated (Figures 241, 242); anal combs with 2-11 spines.

TYPE.—Holotype, σ^7 ; in the Academy of Natural Sciences, Philadelphia.

TYPE LOCALITY.—Two Medicine Lake, Glacier National Park, Montana, "in forest openings."

HOST.—Unknown, but possibly *Osmorhiza occidentalis* (Umbelliferae). Unidentified *Greya* larvae were extracted from developing seeds at the type locality in Glacier National Park, and adults of *G. variata* were found resting exclusively on this plant.

FLIGHT PERIOD.—Mid-June to mid-July.

DISTRIBUTION (Map 6).—Presently known only from the lower elevations of the Continental Divide of Glacier National Park (Montana) and the adjacent Waterton Lakes National Park (Alberta) of Canada. Altitudinal range, 1200-1400 m.

HABITAT.—Probably as shown in Figure 25.

MATERIAL EXAMINED.—9 males and 6 females.

CANADA: ALBERTA: Waterton Lakes: 1 ϕ , 25 Jun (ANSP); 2 σ^7 , 3 ϕ , 25 Jun-12 Jul (CNC); 3 σ^7 , 1 ϕ , 25 Jun-12 Jul (USNM). Waterton Lakes Park: 1 σ^7 , 18 Jun (CNC).

UNITED STATES: MONTANA: *Glacier Co.*: Glacier National Park: 1 σ^7 , 8 Jul (OP); 1 ϕ (paratype), 15 Jul (ANSP); 1 σ^7 (paratype), 15 Jul (USNM).

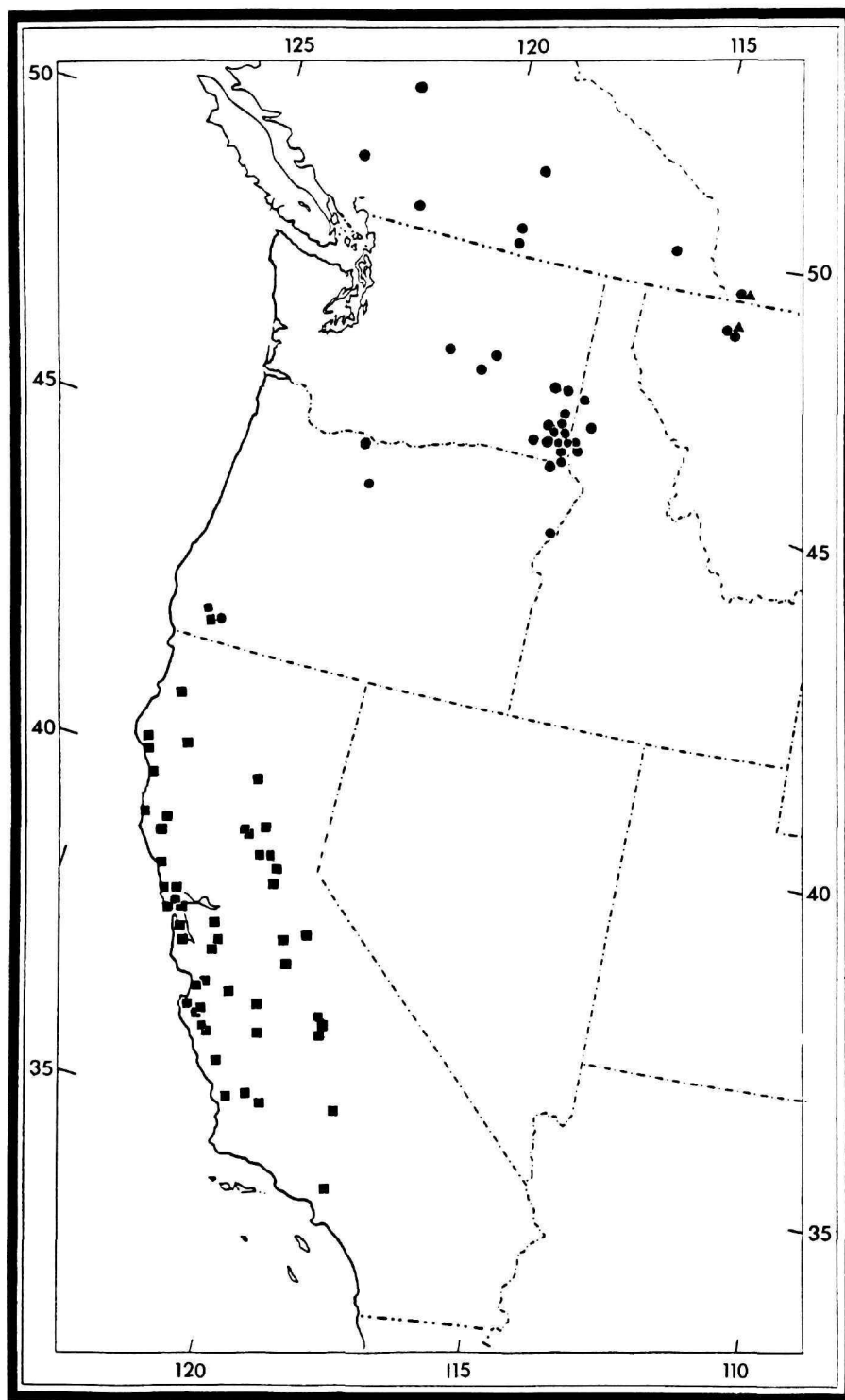

MAP 6.—Distribution of *Greya variata* (▲), *G. subalba* (●), and *G. solenobiella* (■).

DISCUSSION.—The distinctive forewing pattern of *G. variata*, which typically consists of two prominent, transverse spots, easily distinguishes this species from all other members of the family. Its placement within the genus is indicated by the presence of a prominent pollex arising from the ventral margin of the valva.

Greya subalba Braun

FIGURES 5, 6, 19, 23–25, 279, 280, 339–342, 371; MAP 6

Greya subalba Braun, 1921:21; 1924:238.—Blackmore, 1926:295, 296.—McDunnough, 1939:109, no. 9807.—Davis, 1983:4.—Thompson, 1986:351–358; 1987:311–318.—Sharkey, 1987:47, 48.

ADULT (Figures 279, 280).—Wing expanse: ♂, 13–16 mm; ♀, 11–13 mm.

Head: Vertex and frons white with suffusion of ochreous to light fuscous between antennae, especially in male. Antenna 0.55–0.65 × length of the forewing; 31–33-segmented, with 6 (♂) to 13 (♀) segments partly covered dorsally with white to yellowish white scales. Maxillary palpus white to pale ochreous, with all three or four segments short; fourth segment slightly longer than third if present. Labial palpus white, often with apical segment partially suffused with light fuscous.

Thorax: Dorsum white to pale yellowish white. Venter white. Legs white ventrally, heavily suffused with grayish fuscous dorsally; metathoracic legs mostly white. Forewing uniformly white (in male) to pale yellowish (in female). Hindwing light gray, slightly darker than forewing; cilia gray with white tips.

Abdomen: Pale brownish white to yellowish white dorsally; white ventrally.

Male Genitalia (Figures 339–342): Uncus superficially bilobed; base slightly constricted. Vinculum-saccus Y-shaped, elongate, approximately 2 × the length of valva. Valva broad to pollex, then abruptly narrowing to relatively small, rounded cucullus; pollex short, less than one third the width of valva at base of pollex, terminating in a single, short spinose seta. Juxta with anterior end long, acuminate, gradually flaring to broad caudal end. Aedeagus with a single, stout, sinuate cornutus at apex.

Female Genitalia (Figure 371): Apex of ovipositor compressed, acute, edges smooth, a pair of stellate signa present, approximately equal in size, with 9–11 rays of varying length.

EGG.—White, pyriform, ~0.5 mm long, 0.3 mm wide.

FIRST-INSTAR LARVA.—Length of largest larva 1.1 mm; width 0.2 mm; maximum head width 0.19 mm. P1 laterad and slightly caudad of AF2. L1 caudad and slightly ventrad to A3. All stemmata poorly developed with 4–6 being slightly more distinct. S1 reduced in length and arising midway below stemmata 2 and 3. Pretarsal claw with axial spine poorly developed, broadly rounded. Anal combs with 4–10 spines.

PUPA.—Unknown.

TYPE.—Holotype ♂; in the Academy of Natural Sciences, Philadelphia.

TYPE LOCALITY.—Two Medicine Lake, Glacier National Park, Montana, “in dry meadow.”

HOST.—Currently known to mine the seeds of five species of *Lomatium* (Umbelliferae): *L. grayi*, *L. dissectum*, *L. triter-natum*, *L. macrocarpum*, and *L. ambiguum* (Thompson 1986, 1987, and unpubl. data).

FLIGHT PERIOD.—Late April to mid-July, early September.

DISTRIBUTION (Map 6).—Present records indicate this species to be restricted to the northwestern United States and southwestern Canada, from southern Alberta and British Columbia south to Oregon. The Walsingham records from Rogue River may indicate a zone of sympatry with *G. solenobiella* in southern Oregon. Altitudinal range, 200–1650 m.

HABITAT (Figures 19, 23–25).—In dry forb-rich prairie habitat with *Lomatium*.

MATERIAL EXAMINED.—182 males and 106 females.

CANADA: ALBERTA: Waterton Lakes: 1♂, 3♀, 28 Jun–8 Jul (CNC); 1♀, 28 Jun (USNM). BRITISH COLUMBIA: Ft. Steele: 1♀, 23 May (UBCZ). Jesmond: 3♂, 1 Sep (CNC). Pinantan Lake: 2♀, 18 May (CNC). Summerland: 1♂, 26 May (CNC). Vaseaux Lake: 1♂, 21 May (CNC). Vernon: 1♂, 30 Apr (UBCZ).

UNITED STATES: IDAHO: *Benewah Co.*: M.M. McCroskey Park, W part, along Skyline Drive, 1020–1050 m: 2♂, 2 Jun (OP). *Latah Co.*: 1.5 km E Princeton: 1♂, 15 May (OP). *Nez Perce Co.*: 600–2400 m ENE Spalding, 275 m: 1♀, 14 May (OP). MONTANA: *Glacier Co.*: Glacier National Park: 1♀, 16 Jul (BMNH); 1♂, 2♀ (paratypes), 16–23 Jul (ANSP); 1♂, 1♀ (paratypes), 14–16 Jul (ANSP); 2♂, 1♀ (paratypes), 16 Jul (USNM). OREGON: *Jackson Co.*: To Rogue River: 1♂, 4–6 May (BMNH). *Wallowa Co.*: 28 mi [44.8 km] E Joseph, 5400 ft [1646 m]: 26♂, 18♀, 19–21 Jun (USNM). 5 km NE Troy, 425 m: 3♂, 23 Apr (OP). *Wasco Co.*: Cow Canyon on Rte 97: 2♂, 2♀, 4 May (OP). McCall Reserve NE Rowena: 1♀, 5 May (OP). WASHINGTON: *Asotin Co.*: 3 mi [4.8 km] N Anatone: 1♂, 1♀, 5 Jun (USNM). 5 km N Anatone, 960 m: 2♂, 10 May (OP). Grande Ronde River at Hwy 129 crossing, 400 m: 1♀, 23 Apr (OP). Montgomery Ridge, 900 m: 1♂, 3 May (OP). Rattlesnake Grade above Grande Ronde River, 600 m: 9♂, 5♀, 23 Apr (OP). Weissenfels Ridge, 1100 m: 1♂, 10 May (OP). *Chelan Co.*: Dryden: 1♀, 16 May (USNM). *Garfield Co.*: Wawawai Grade Rd 2.6 km SE Lower Granite Dam, 425 m: 1♂, 15 Apr (OP); 1♂, 9 May (OP); 6♂, 3♀, 6 May (OP); 1♂, 7 May (OP). Wawawai Grade Rd 2.7 km SE Lower Granite Dam, 550 m: 6♂, 3♀, 19 Apr (OP); 4♂, 2♀, 21 Apr (OP). *Grant Co.*: Devil's Canyon near Ephrata, 450–600 m: 2♂, 19 Apr (OP); 2♂, 2♀, 23 Apr (OP); 1♂, 1♀, 9 May (OP). Intersection of Pinto Rd and Rd 34, 4.6 km S Coulee City, 500 m: 1♂, 23 Apr (OP). *Whitman Co.*: Near Albion, Smoot Hill Biological Reserve, 900 m: 1♂, 2♀, 23 Mar–8 May (USNM); 3♀, 27 May (OP). Almota: 1♂, 26 Apr (USNM). 1.3 km above Granite Point on Snake River, 220 m: 2♂, 30 Mar (OP); 1♂, 4 Apr (OP); 4♂, 2♀, 10 Apr (OP); 18♂, 13 Apr (OP); 1♀, 16 Apr (OP); 1♂, 20 April (OP); 10♀, 21 April (OP); 3♂, 3♀, 24

Apr (UCB), 1♂, 2♀ 24 Apr (OP). 3.3 km above Granite Point on Snake River, 230 m: 2♂, 2♀, 13 Apr (OP). 10.1 km above Granite Point on Snake River, 240 m: 10♂, 2♀, 13 Apr (OP). Kramer Reserve SW Colton, 825 m: 1♂, 8 May (OP). 3 km E Malden, 625–650 m: 1♂, 27 May (OP). Pullman, 750 m: 25♂, 2♀, 10–31 May (USNM); 1♂, 9 May (OP); 1♂, 10 May (AMNH). Red Wolf Crossing, 250 m: 1♂, 31 Mar (OP). 1.7 km SE head of Rock Lake, 650 m: 5♂, 29 May (OP). Smoot Hill, 875–900 m: 1♀, 8 May (OP); 10♂, 10♀, 15 May (OP); 6♂, 12♀, 26 May (OP). Snake River, near Clarkston, 250 m: 2♂, 2 Apr (OP). Wawawai: 1♀, 4 May (USNM).

13 additional paratypes listed by Braun (1921) have not been found.

DISCUSSION.—*Greya subalba* is the least sexually dimorphic member of the *solenobiella* group, with only some females showing a trace of pattern. There is, however, a conspicuous difference in size, and the females are typically more yellow than the males. The genitalic characters of *G. subalba* are essentially inseparable from those of *G. solenobiella* and *G. reticulata*, but the former can usually be distinguished by the immaculate, uniform color of its forewing. *Greya subalba* is partially sympatric with *Tetragma gei*. They look quite similar, but *G. subalba* can be identified by its white head, and uniformly dark wing undersides.

The flight period for this species appears rather extended. The early September capture record from British Columbia is noticeably disjunct, and reflects either the northern locality or a labelling error; no other records exist after 23 July.

Greya solenobiella (Walsingham)

FIGURES 244–247, 281–284, 343–346, 372; MAP 6

Incurvaria solenobiella Walsingham, 1880:82; 1888:146.—Riley in Smith, 1891:96, no. 5124.—Dyar, 1903 ("1902"):569, no. 6485.

Greya solenobiella (Walsingham).—Busck, 1903:194.—Kearfott in Smith, 1903:123, no. 7023.—Dietz, 1905:39, 40, 92.—Barnes and McDunnough, 1917:196, no. 8441.—Braun, 1921:21.—McDunnough, 1939:109, no. 9809.—Davis, 1983:4.

ADULT (Figures 281–284).—Wing expanse: ♂, 11–18 mm; ♀, 9.5–14.5 mm.

Head: White to gray in male, usually white in female. Antenna 0.5–0.65 × the length of the forewing; 33–39-segmented, with basal 5 (♂) to 13 (♀) segments covered with white to gray scales dorsally. Maxillary palpus white to light gray; all four segments short and of approximately equal lengths; palpus rarely 3-segmented. Labial palpus with basal two segments mostly white; apical segment heavily suffused with gray to entirely grayish fuscous.

Thorax: Dorsum white to gray. Venter white to pale gray; legs white below, pale gray to fuscous dorsally. Forewing white, heavily irrorated with an almost equal amount of grayish fuscous; female generally more white; a faint pattern of white streaks usually evident as follows: a long, submarginal band, parallel to termen; a short, subapical band from costa directed

obliquely toward, but usually not touching, submarginal band; a subternal, sometimes triangular spot, at outer fourth of hind margin; a similar spot sometimes visible along basal third of hind margin; maculation generally more distinct in females, in some specimens appearing washed out and glazed; occasional males may completely lack wing pattern; cilia gray, intermixed with white in male, usually entirely white in female, in some individuals with a very narrow dark band at base along part of termen. Hindwing uniformly gray.

Abdomen: Uniformly gray to white, usually slightly lighter ventrally.

Male Genitalia (Figures 343–346): Very similar to other members of the *solenobiella* group. Uncus superficially bilobed. Vinculum-saccus Y-shaped, nearly 2 × length of valva, but variable in length. Valva broad to pollex, then abruptly narrowing to relatively small, rounded cucullus; pollex short, less than 1/3 the width of valva at base of pollex, terminating in a single, short, spinose seta. Rarely a double spine is present, or it may be lost on at least one valva. Apical spines on cucullus reaching pollex (or nearly so) as a narrow band. Juxta with anterior end long, acuminate, gradually flaring to broad, caudal third. Aedoeagus with a single, sinuate cornutus at apex.

Female Genitalia (Figures 244–246, 372): Apex of ovipositor compressed, subacute, minutely serrulate. A pair of stellate signa present, approximately equal in size, but sometimes one reduced; rays highly variable in size and number, usually 12–18 rays, although rarely reduced to as few as 2 or increased to more than 25.

EGG.—White, pyriform, 0.35–0.45 mm.

LARVA AND PUPA.—Unknown.

TYPE.—Lectotype, ♂ (present designation): "Type; Russian River, Sonoma Co., California, 19.V.1871, Wlsm. 90653; Walsingham Collection, 1910-427; ♂ genitalia slide 15217; *Incurvaria solenobiella* Wlsm., Pr. Z. Soc. Lond. 1880, 82–3, Type ♂; Lectotype ♂, *Incurvaria solenobiella* Wlsm., by D. Davis;" in the Natural History Museum, London.

TYPE LOCALITY.—Russian River near Fitch Mtn., ~3 km east of Healdsburg, Sonoma Co., California.

HOST.—*Yabea microcarpa* (Umbelliferae).

FLIGHT PERIOD.—Late March to end of May.

DISTRIBUTION (Map 6).—This species is largely restricted to the extreme west coast of the United States from Josephine County in southwestern Oregon south to Los Angeles County, California. Altitudinal range, sea level to 1500 m.

HABITAT.—Grassy areas in dry to moderately moist oak or mixed deciduous forest. Many known sites are located in the oak-pine transition zone.

MATERIAL EXAMINED.—235 males and 181 females.

UNITED STATES: CALIFORNIA: *Alameda Co.*: Del Valle Lake: 1♂, 3 May (UCB); 1♂, 29 Apr (UCB); 1♂, 30 Apr (UCB). *Butte Co.*: Chico, 1♂, 18 Apr (CAS). Feather Falls trail, 690–715 m: 1♂, 1♀, 2 May (OP). Pentz: 1♂, 5 Apr (CAS). *El Dorado Co.*: 4 km E Auburn, 300 m: 1♀, 2 May (OP). Cosumnes River at Somerset: 1♂, 24 May (UCB). *Fresno Co.*:



FIGURES 244–246.—*Greya solenobiella*, female genitalia: 244, apex of ovipositor, ventral view, showing elongate cloacal groove (43 μ m); 245, dorsolateral view of Figure 244 (23.1 μ m); 246, signum inside corpus bursae (20 μ m). (Scale lengths in parentheses; bar scale for all photographs given in Figure 244.)

Big Panoche Creek, on San Benito Co border: 1 σ , 2 ϕ , 21 Apr (UCB). Ciervo Hills 18 air-miles [28.8 km] SW Mendota: 6 σ , 21 Mar (UCB). 6 mi [9.6 km] S Coalingua: 1 ϕ , 30 Mar (UCB). *Humboldt Co*: 5 mi [8 km] NW Briceland: 1 σ , 1 ϕ , 20 May (UCB); 1 σ , 21 May (UCB). 0.5 mi [800 m] W Briceland: 3 σ , 6 ϕ , 10 May (UCB). 2 mi [3.2 km] W Briceland: 2 σ , 3 ϕ , 21 May (UCB). 1 mi [1.6 km] W Hoopa: 1 ϕ , 2 Jul (CAS). *Kern Co*: Democrat Hot Springs along Kern River, 2000 ft [600 m]: 1 σ , 22 Apr (RL). *Lake Co*: Mt. San Hedron: 2 σ , 27 Apr (CNC); 1 σ , 2 ϕ , 27 Apr (USNM). *Los Angeles Co*: Specific locality unknown: 1 σ , Mar (BMNH); 2 σ , Mar (USNM). *Marin Co*: Alpine Lake: 2 σ , 25 Apr (UCB). 2 mi [3.2 km] N Alpine Lake: 1 σ , 7 May (DLW). NE ridge above Bon Tempe Lake: 1 σ , 16 Apr (UCB). 2 mi [3.2 km] SW Fairfax, near Meadow Club: 1 σ , 17 Apr (CAS). 2 mi [3.2 km] W Fairfax: 1 σ , 21 Apr (UCB). Lily Gulch on Alpine Lake, 230 m: 3 σ , 26 Apr (OP). Lily Lake near Alpine Lake, 680–720 ft [200–215 m]: 1 ϕ , 15 Apr (UCB). W Novato: 10 σ , 5 ϕ , 5 Apr (CAS); 2 σ , 19 May (CAS). Vicinity of Phoenix Lake: 1 σ , 8 ϕ , 3 May (CAS). Ring Mtn. 1 mi [1.6 km] SE Corte Madera: 1 ϕ , 30 Apr (UCB). *Mariposa Co*: 3 mi [4.8 km] N Bagby: 1 σ , 25 Mar (UCB). *Mendocino Co*: Head of Dry Creek: 2 σ (paralectotypes), 24 May (BMNH); 1 σ , 1 ϕ (paralectotypes), 24 May (USNM). Mouth of Albion River [near Albion]: 2 σ (paralectotypes), 30–31 May (BMNH); 1 σ (paralectotype), 30–31 May (USNM). 1 mi [1.6 km] N Pierce: 1 ϕ , 20/23 May (UCB). W Ukiah, mile 9.4 along Rte 253, 660 m: 2 σ (OP). *Monterey Co*: Arroyo Seco: 1 σ , 2 ϕ , 15 Apr (UCB); 1 ϕ , 15 Apr (USNM). 1.5 mi [2.4 km] SW Arroyo Seco Guard Station, 1300 ft [390 m]: 1 σ , 3/7 May (UCB). Cachagua Creek 3 mi [4.8 km] SE Jamesburg: 1 ϕ , 4 May (UCB). Carmel: 3 ϕ , Apr (USNM). 1 air-mile [1.6 km] S Jamesburg, 2900 ft [870 m]: 2 σ , 12 ϕ , 5 May (UCB); 3 σ , 1 ϕ , 8 May (UCB). 2.4 km SE Jamesburg, 960 m: 8 σ , 5 ϕ , 2 May (OP); 8 σ , 4 ϕ , 3 May (OP). Paloma Creek, 4 air-miles [6.4 km] NE Arroyo Seco: 1 ϕ , 8 May (UCB). Wiley Ranch, 6 mi [9.6 km] W Greenfield, 1200 ft [360 m]: 1 ϕ , 2 May

(UCB). *Nevada Co*: 6 mi [9.6 km] SW Colfax: 8 σ , 2 ϕ , 18 Apr (UCB). *Placer Co*: Colfax: 9 σ , 8 ϕ , Apr (USNM). *San Benito Co*: 11 mi [17.6 km] W Gonzales: 1 σ , 1 ϕ , 15 Apr (CAS). 2 mi [3.2 km] W jct Cienega and Lime Kiln Roads: 1 σ , 30 Mar (CAS); 1 σ , 24 Apr (UCB). 5 mi [8 km] SW Paicines, Lime Kiln Road: 21 σ , 8 ϕ , 24 Mar (UCB); 4 σ , 24 Mar (USNM). Pinnacles National Monument: 1 σ , 9 Apr (CAS); 2 σ , 25 Apr (UCB). 9 mi [14.4 km] N Pinnacles: 1 σ , 3 ϕ , 15 Apr (CAS). *San Luis Obispo Co*: La Panza Camp, 12 mi [19.2 km] NE Pozo: 1 σ , 29 Apr (UCB). 3 mi [4.8 km] W Paso Robles: 28 Apr (UCB). Nacimiento Dam: 1 σ , 14 Apr (UCB); 2 σ , 2 ϕ , 14–30 Apr (UCB); 2 ϕ , 30 Apr (USNM). San Luis Obispo: 8 σ , 8 ϕ , Mar (USNM). *San Mateo Co*: Black Mtn. Road: 1 σ , 13 Apr (UCB). Redwood City: 1 ϕ , 9 Apr (CAS). San Bruno Mtns: 1 ϕ , 16 Apr (CAS). San Bruno Mtns, Buckeye Canyon: 1 ϕ , 29 Mar (CAS). San Bruno Mtns, Owl Canyon: 1 ϕ , 22 Mar (CAS). *Santa Barbara Co*: 40 mi [64 km] E Santa Maria, Miranda Pine Camp: 1 σ , 2 May (UCB). *Santa Clara Co*: Mt. Hamilton: 1 σ , 16 May (UCB). Mt. Hamilton, 1170 m: 1 σ , 1 ϕ , 27 Apr (OP); 1 σ , 1 ϕ , 1 May (OP); 1 ϕ , 3 May (OP). Mt. Hamilton Road: 1 σ , 23 Apr (CAS). *Shasta Co*: Platina, 680 m: 1 σ , 1 ϕ , 29 Apr (OP). *Sonoma Co*: Specific locality unknown: 8 σ , 3 ϕ , 10–25 May (USNM). Bodega: 7 ϕ , 3 May (CNC); 1 σ , 2 ϕ , 3 May (USNM). 1 mi [1.6 km] SE Bodega Bay: 3 σ , 4 May (DLW). Dry Creek: 1 σ (paralectotype), 20–21 May (BMNH). Fairfax: 3 ϕ , 23 May (USNM). Mark West Springs: 1 ϕ , 20 Apr (CAS). Russian River: 1 σ (lectotype), 2 σ , 2 ϕ (paralectotypes), 19 May (BMNH); 1 σ (paralectotype), 19 May (USNM). Two Rock: 1 ϕ , 26 April (USNM). *Stanislaus Co*: Del Puerto Canyon, 20 mi [32 km] W Patterson: 1 σ , 6 ϕ , 30 Apr (UCB). 2 ϕ , 30 Apr (USNM). Del Puerto Canyon, 22 mi [35.2 km] W Patterson: 19 σ , 10 ϕ , 27 Apr (UCB); 4 σ , 3 ϕ , 27 Apr (USNM). Del Puerto Canyon, N fork of Del Puerto Creek, 900–1200 ft [300–400 m]: 1 ϕ , 12 Apr (UCB). *Trinity Co*: 6 mi [9.6 km] SE Hayfork: 1 σ , 3 ϕ , 23 May (UCB). *Tulare Co*: 1 mi [1.6 km] NE Posey: 1 σ , 14 May (UCB); 1 σ , 14 May (USNM). 10 mi [16

km) SE Three Rivers, 2800 ft [840 m]: 1♂, 2♀, 29 Apr (UCB). S Fork Kaweah River, 10 mi [16 km] SE Three Rivers: 1♂, 29 Apr (UCB). Sequoia National Park, E South Fork campground, 1100 m: 3♂, 8♀, 2 May (OP). S Fork Drive Kaweah River near Sequoia National Park, mile 9.5, 850 m: 1♂, 28 Apr (OP); 1♂, 29 Apr (OP). South Fork Drive at Sequoia National Park boundary, 1000 m: 1♀, 28 Apr (OP); 8♂, 3♀, 1 May (OP). *Tuolumne Co*: Ackerson Meadows, 3 mi [4.8 km] S Mather, 4700 ft [1433 m]: 1♂, 11 Jun (UCB). 6 mi [9.6 km] S Mather: 1♂, 12 Jun (UCB). 1 mi [1.6 km] NW Soulsbyville: 5♂, 4♀, 1 May (UCB); 2♂, 1♀, 1 May (USNM); 9♂, 1♀, 1 May (CAS). Twain Harte, 4000 ft [1200 m]: 1♂, 30 May (CAS). OREGON: Specific locality unknown: 1♀ (BMNH). *Josephine Co*: 2.65 rd-miles [4.24 km] W Merlin, Avery Gulch: 5♂, 8♀, 2 May (OP). Rogue River: 2♂, 7 May (BMNH).

DISCUSSION.—Although the genitalic characters of this species closely resemble those of *G. subalba*, *G. reticulata*, and *G. powelli*, *G. solenobiella* usually can be identified by the pale gray color of its forewing variously streaked with white. Specimens from the northern part of the distribution area sometimes are more cream-colored than white. It is, however, often very difficult to distinguish it from the sibling species *G. suffusca*. They are most easily identified on behavioral differences. These, and certain diagnostic morphological features in these highly variable taxa, are given under the description of *G. suffusca*. The female form with washed-out, glazed-looking pattern (Figure 283) has only been found in *G. solenobiella*. Although not originally stated by Walsingham, the type series of *solenobiella* was found to consist of 11 males and 3 females. The type locality was reported by Walsingham (1880) as "near San Francisco, May 19th, 1871"; however, none of the above syntypes bear this locality information. A male and female from the Walsingham collection in the Natural History Museum, London, are both labelled "type" and were collected 19 May 1871, at an unspecified point along the Russian River in Sonoma County, north of San Francisco. Information in Walsingham's diary, including a map, indicate that he collected these specimens at Fitch's Mountain near the present Highway 101 crossing just south of Healdsburg (J.A. Powell, pers. comm.). The male has been selected as lectotype.

Greya suffusca Davis and Pellmyr, new species

FIGURES 15, 29, 247, 285, 286, 347–350, 373; MAP 7

ADULT (Figures 285, 286).—Wing expanse: ♂, 13–20 mm; ♀, 12.5–17.5 mm.

Head: Vertex white or slightly fuscous; frons more brown. Antenna 0.5–0.6× the length of the forewing, 31–34-segmented, with 4 (♂) to 14 (♀) basal segments with brown scales dorsally. Maxillary palpus 3-segmented, two basal segments mostly white; apical segment suffused with brownish gray, at least dorsally. Labial palpus 3-segmented, white in its entirety.

Thorax: Dorsum white and pale brown, venter white; legs white below, pale brown dorsally or white dorsally; forewing brown with heavy irroration of white scales; female generally darker and more patterned; pattern consists of pale streaks and patches as follows: a long submarginal band, parallel to termen; a shorter subapical band from costa directed obliquely toward, but usually not touching, submarginal band; a tornal or subtornal triangular spot in outer fourth of hind margin; maculation more distinct in females, and sometimes altogether absent in male, or only subtornal patch visible; cilia in both sexes with a basal fuscous band, the rest white in female, white or brown in male. Hindwing uniformly gray.

Abdomen: Uniformly brown or white, somewhat lighter ventrally.

Male Genitalia (Figures 347–350): Very similar to *G. solenobiella*; no character found to definitively separate the two species. Uncus superficially bilobed. Vinculum-saccus Y-shaped, nearly 2× length of valva, but variable in length. Valva broad to pollex, then abruptly narrowing to relatively small, rounded cucullus; pollex short, less than 1/3 the width of valva at base of pollex. Apical spines on cucullus reaching halfway or less from apex to pollex, tightly clustered near apex. Juxta with anterior end long, acuminate, gradually flaring to broad, caudal third. Aedoeagus with a single, sinuate cornutus at apex.

Female Genitalia (Figure 373): No consistent differences from those of *G. solenobiella*. Apex of ovipositor compressed, subacute, minutely serrulate. A pair of stellate signa present, approximately equal in size; rays highly variable in size and number, usually 5–8 rays, and rays occasionally reduced to short spikes.

EGG.—White, round, ~0.5 × 0.3 mm.

LARVA AND PUPA.—Unknown.

HOLOTYPE.—♂, "CA: Tulare Co. Sequoia National Park. E of South Fork campground, 1100 m, on or around *Osmorhiza brachypoda*, 1.v.1989 R29E T18S S24NW, Leg. Olle Pellmyr;" in the National Museum of Natural History, Smithsonian Institution.

PARATYPES.—UNITED STATES: CALIFORNIA: *Tulare Co*: Sequoia National Park, along Generals Hwy, 990 m: 2♂, 4♀, 29 Apr 1990, O. Pellmyr and J.N. Thompson (OP); Sequoia National Park, E South Fork campground, 1100 m: 10♂, 7♀, 1 May 1989, O. Pellmyr (OP); 4♂, 4♀, 2 May 1989, O. Pellmyr (OP). Sequoia National Park, boundary on South Fork Drive, 960 m: 3♀, 1 May 1989, O. Pellmyr (OP); 3♂, 2♀, 28 Apr 1990, O. Pellmyr and J.N. Thompson (OP); 1♂, 1♀, 29 Apr 1990, O. Pellmyr and J.N. Thompson (OP). S Fork Camp, 13 mi [20.8] km SE Three Rivers, 3200–3600 ft [960–1080 m]: 12♂, 3♀, 29 Apr 1979, J. Powell (UCB); 14♂, 6♀, 3 May 1979, J. Powell (UCB); 5♂, 4♀, 3 May 1979, J.T. Doyen (UCB); 7♂, 4♀, 3 May 1979, M.E. Buegler (UCB).

Described from a total of 59 males and 38 females.

HOST.—*Osmorhiza brachypoda* (Umbelliferae)

FLIGHT PERIOD.—Late April–early May.

DISTRIBUTION (Map 7).—So far known only from the type

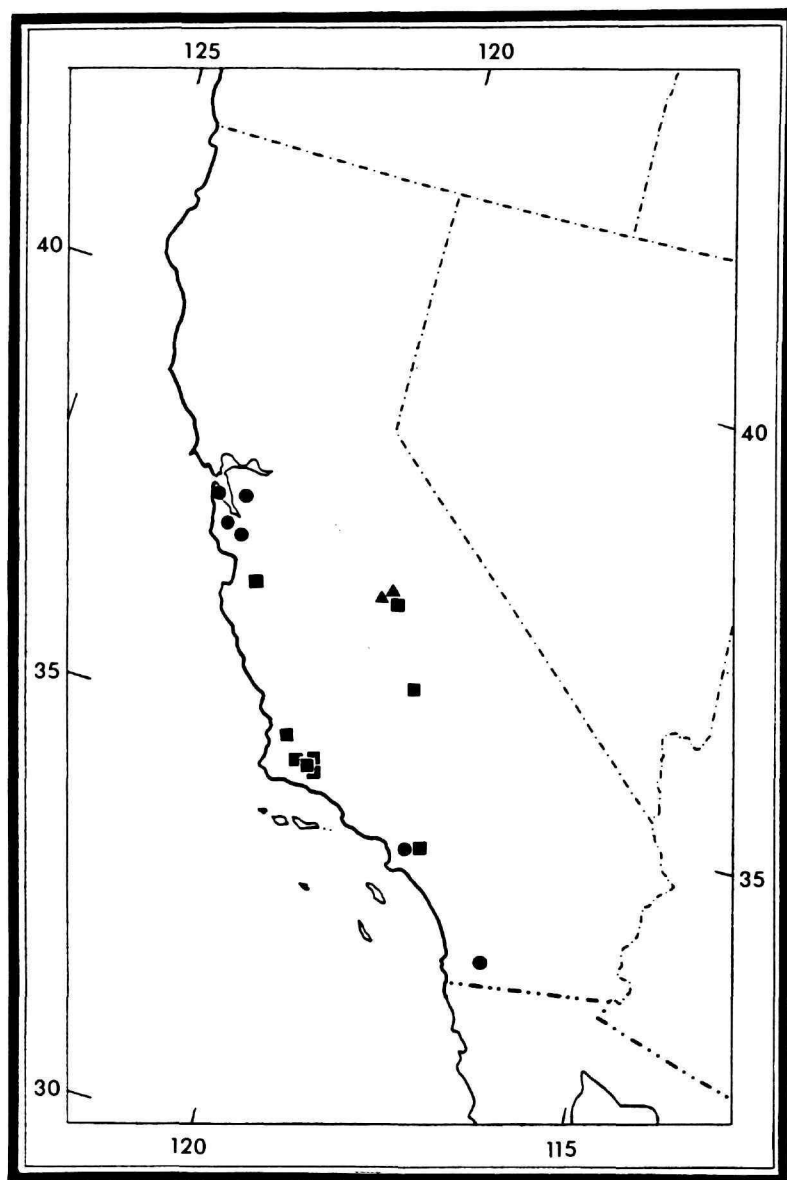

MAP 7.—Distribution of *Greya suffusca* (▲), *G. reticulata* (●), and *G. powelli* (■).

locality near the southwestern boundary of Sequoia National Park in the southern Sierra Nevada Mountains of California, and from a second site about 20 km away. Altitude range 950–1100 m.

HABITAT (Figure 29).—Oak forest with understory dominated by *O. brachypoda*, sometimes also with *Galium* sp., and *Toxicodendron diversilobum* Torrey and Gray (poison oak).

ETYMOLOGY.—The specific epithet is derived from the Greek *suffuscus*, to indicate the considerable suffusion of brown scales that distinguishes the species.

DISCUSSION.—*Greya suffusca* is very similar to *G. solenobiella*, and the males are especially difficult to tell apart. Because of the considerable variation in size and wing patterns, many individuals are difficult to identify. *Greya suffusca* is larger, with the mean forewing length typically about 2 mm longer than that of *G. solenobiella*; this difference is statistically highly significant (Figure 247). The dark band on the termen is typically broader, the female is darker, and usually more patterned. Occasionally females of *G. solenobiella* can also be richly patterned, but they are always

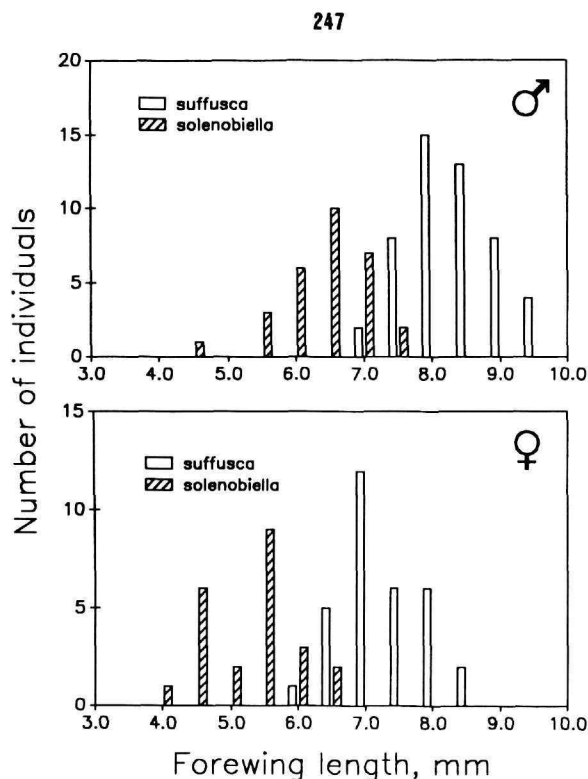

Figure 247.—Forewing length (wingbase to apex) in *Greya solenobiella* ($n = 35$) and *G. suffusca* ($n = 51$), measured on all individuals caught before 1990 of both species in OP, and also all of the latter in UCB (i.e., all known individuals of the species caught before 1990). Mann-Whitney tests used to compare mean size for each sex between the species showed highly significant differences in both sexes; U_s -scores given are computed in accordance with Sokal and Rohlf (1981:434): ♂, $U_s = 1479$, $Z = -7.211$, $P_{[51,29]} < 0.0001$; ♀, $U_s = 727.5$, $Z = -6.134$, $P_{[32,23]} < 0.0001$.

considerably smaller. No consistent differences were observed in the genitalia, but additional populations need to be discovered and studied before good morphological criteria can be identified for separating the two taxa.

Greya suffusca is both geographically and temporally sympatric with *G. solenobiella* but the two species usually may be separated by differences in microhabitat. At disturbed sites, or especially at habitat interfaces, the more vagrant males may fly side by side. A suite of behavioral traits, however, makes it relatively easy to distinguish females in the field. (1) Extreme host specificity: *G. solenobiella* females stay in patches of their inconspicuous host, *Yabea microcarpa*, and usually fly at the height of developing fruits, about 5–25 cm above ground. In contrast, *G. suffusca* stays within a few meters of *O. brachypoda*, and flies about 30–100 cm above ground, where young fruits are found. (2) Wing beat frequency: the distinctly smaller females of *G. solenobiella* have a relatively faster wing

beat, so that the individual strokes cannot be seen with the naked eye. In contrast, *G. suffusca* has a relatively slow wing beat, with individual strokes visible to the naked eye. Males of both species have even slower beats, appearing fluttery even when in full flight. (3) Escape behavior: scared females of *G. solenobiella* are prone to drop to the ground, rather than fly away, while *G. suffusca* females fly away. (4) Wing color: *G. solenobiella* appears almost white in flight, while the fuscous of *G. suffusca* renders it brownish gray in flight. This difference is particularly evident at low light levels.

Greya reticulata (Riley)

FIGURES 248–250, 287, 288, 351–354, 374; MAP 7

Prodoxus reticulatus Riley, 1892a:152; 1892b:99, 100; 1892c:374, 375; 1893a:48, 50; 1893b:308.—Dyar, 1903:103.—Barnes and McDunnough, 1917:197, no. 8464.—McDunnough, 1939:109, no. 9827.—Busck in McKelvey, 1947:184.—Davis, 1967:82, 84.

"*Prodoxus*" *reticulatus* Riley.—Davis, 1967:1, 3, 84.

Prodoxus reticulata [sic] Riley, 1892d:316.—Dyar, 1903 ["1902"]:576, no. 6568.—Kearfott in Smith, 1903:124, no. 7106.—Holland, 1905:440.

Lampronia reticulata (Riley).—Davis, 1967:1.

Greya reticulata (Riley).—Davis, 1983:4.—Wagner and Powell, 1988:550.

ADULT (Figures 287, 288).—Wing expanse: ♂, 12–15.5 mm; ♀, 9–14 mm.

Head: White to grayish white, occasionally with a few dark tipped hairs intermixed. Antenna 0.55–0.70 × the length of the forewing, 29–35-segmented, with basal 4 (♂) to 11 (♀) segments covered with white to grayish white scales dorsally. Maxillary palpus white, 3- or 4-segmented; fourth segment short, approximately same length as second. Labial palpus white, apical segment usually entirely or partially grayish fuscous.

Thorax: Dorsum white to light gray; costal half of tegula light fuscous. Venter white; pro- and mesothoracic legs white ventrally, brownish fuscous dorsally in male, brownish ochreous dorsally in female; tarsal segments faintly banded dorsally with brownish fuscous in female; metathoracic legs mostly white. Forewing with dimorphic pattern; maculation well defined in female, obscure in male. Female with ground color white to pale ochreous, heavily banded with brownish fuscous as follows: a marginal band extending from apex to CuA_2 ; two Y-shaped bands transversing forewing at middle and at outer fourth, their inner arms anastomosing at costal margin; outer Y-shaped band with base anastomosing with base of marginal band at CuA_2 ; an oblique band extending from base of costa outwards to basal fourth of hind margin. Male with ground color of forewing pale, whitish ochreous, heavily irrorated with brownish fuscous; banding obsolescent, indistinct, pale ochreous spots usually evident as follows: a small, subapical, oval spot near costa between R1 and R2; a subternal, triangular spot at outer fourth of hind margin between CuA_2 and 2A; a small spot sometimes visible at basal third of hind margin. Some individuals, particularly from the southern part

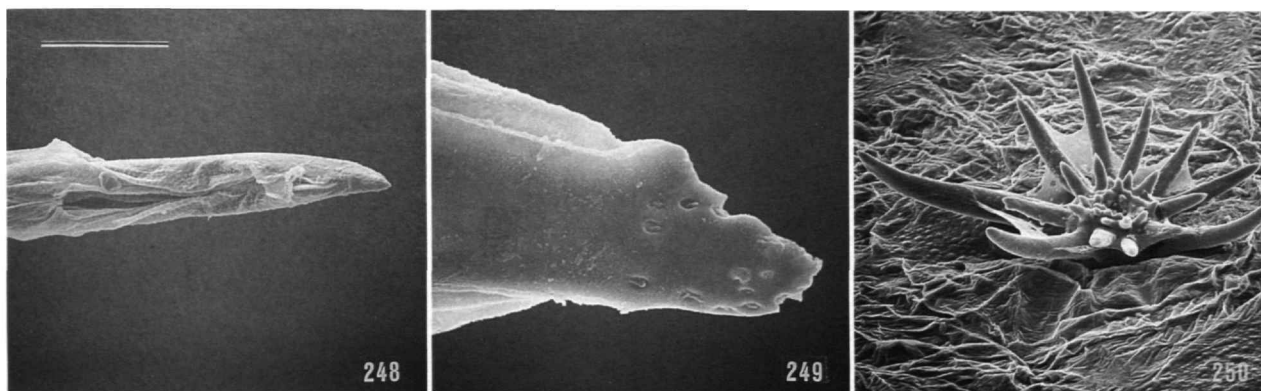

FIGURES 248–250.—*Greya reticulata*, female genitalia: 248, apex of ovipositor, ventral view, showing elongate cloacal groove (75 μm); 249, lateral view of Figure 248 (15 μm); 250, signum in corpus bursae (38 μm). (Scale lengths in parentheses; bar scale for all photographs given in Figure 248.)

of the distribution almost completely without pattern; cilia white in female, mostly white in male but with brown bases forming a thin marginal band. Hindwing uniformly gray, frequently darker in female than in male.

Abdomen: Pale to median gray dorsally, usually paler ventrally.

Male Genitalia (Figures 351–354): Similar to those of *G. subalba*. Uncus superficially bilobed. Vinculum-saccus Y-shaped, nearly 2 \times the length of valva. Valva broad to pollex, then abruptly narrowing to relatively small, rounded cucullus; pollex short, less than 0.3 \times the width of valva at origin of pollex, terminating in a single, short, spinose seta. Juxta with anterior end long, acuminate, gradually widening to broad caudal end. Aedoeagus with a single, sinuate cornutus at caudal apex.

Female Genitalia (Figures 248–250, 374): Apex of ovipositor compressed, subacute, minutely serrulate. Signa paired, usually stellate in form but greatly reduced in size and highly variable; rays short, varying in number from 2 to 7.

IMMATURE STAGES.—Unknown.

TYPE.—Lectotype, ♀ (present designation): “Mar.; Los Angeles Co., Cal.; *Prodoxus reticulatus* Riley; Type no. 424 USNM; Lectotype ♀, *Prodoxus reticulatus* Riley, by D. Davis;” in the National Museum of Natural History, Smithsonian Institution.

TYPE LOCALITY.—Los Angeles Co., California.

HOST.—*Osmorhiza chilensis* (Umbelliferae).

FLIGHT PERIOD.—Late March to late April.

DISTRIBUTION (Map 7).—Present records indicate this species to be restricted to the coastal ranges of west-central California from Alameda County south to Los Angeles County. Altitudinal range, ~100–500 m.

HABITAT.—In moist situations with *Osmorhiza chilensis* as understory in shrubby, well-shaded deciduous forest.

MATERIAL EXAMINED.—53 males and 32 females.

UNITED STATES: CALIFORNIA: *Alameda Co.*: Specific

locality unknown: 4♀, 12–26 Apr (ANSP); 4♀, 12–26 Apr (USNM). *Los Angeles Co.*: Specific locality unknown: 1♀ (lectotype), 2♀ (paralectotype), March (USNM); 6♂ (CAS); 1♂ (LACM). *San Diego Co.*: Cuyamaca State Park: 1♀, 23 May (UCB). *San Mateo Co.*: Corte de Madera Creek, vicinity of Portola: 1♀, 7 May (CAS). San Bruno Mtn.: 1♀, 21 Apr (UCB); 1♀, 26 Apr (DLW). *Santa Clara Co.*: 3 mi [4.8 km] W New Almaden: 21♂, 2♀, 28 Apr (UCB); 6♂, 2♀, 28 Apr (USNM). 3 mi [4.8 km] W New Almaden, Herbert Creek, 275 m: 12♂, 8♀, 20 Apr (UCB); 2♂, 4♀, 20 Apr (USNM); 5♂, 1♀, 26 Apr (OP).

DISCUSSION.—This species was originally described by C.V. Riley from three female specimens “taken by Mr. Koebele at Los Angeles, California, but without notes of habit” (Riley, 1892a:152). As lectotype, we have selected a specimen whose maculation is actually less clearly marked than either of the two remaining paralectotypes. The primary reason for this selection is that the proposed lectotype was the only syntype possessing an abdomen; furthermore, it had been selected (though unpublished) many years earlier as the type of this species and bore the unique type label, USNM no. 424.

Until recently, the male of this species was unknown. The discovery of this sex was significant in that it has shown that *G. reticulata* is one of the most sexually dimorphic members of the family, a feature which clearly distinguishes this species together with *G. powelli*. The females of *G. reticulata* bear great resemblance in maculation to certain yucca moths, particularly *Prodoxus coloradensis* Riley (where the sexes are similar). Thus, it is not surprising that *reticulata* was first described in the genus *Prodoxus* and was thought to be a yucca moth for over 70 years. Riley (1893a) further confused the issue by reporting a specimen of “*Prodoxus*” *reticulatus* collected from the flowers of *Yucca whipplei* at Arrow Springs, California. As pointed out in a revision of the yucca moths (Davis, 1967), the specimen which Riley referred to was most probably an example of *Prodoxus coloradensis*. On the basis of

morphology, Davis (1967) removed *reticulata* from the Prodoxinae and the genus *Prodoxus* and tentatively placed it in the genus *Lampronia* pending an anticipated revision of the Incurvarioidea. With the discovery of additional material, especially associated males, its proper relationships were easily determined (Davis, 1983).

Interestingly, Koebele had at least six male specimens in his possession (found by us as unidentified moths in CAS). He collected numerous prodoxids at the request of Riley (1892a), but apparently did not think of these males as potential yucca moths, and thus never sent them to Riley. They were likely part of Koebele's personal collection, which was retained in his home and eventually given to the California Academy of Sciences in 1926 by his widow, well after the 1906 fire that would have destroyed any previously deposited material (Essig, 1931).

The distinction between this species and *G. powelli* will be discussed under the latter species.

Greya powelli Davis and Pellmyr, new species

FIGURES 22, 289–292, 355–358, 375; MAP 7

ADULT (Figures 289–292).—Wing expanse: ♂, 9.5–12 mm; ♀, 7–8.5 mm.

Head: White with a slight admixture of brown hairs. Antenna 0.55–0.7 × the length of the forewing in the male, 0.5–0.55 × in the female, 28–35-segmented, with basal 5 (♂) to 15 (♀) segments with white to light brown scales dorsally. Maxillary palpus and base of haustellum white. Labial palpus white with apical segment mostly light brown; venter of second segment with a series of pale brown hairs clustered near apex.

Thorax: Dorsum white to pale ochreous; tegula heavily suffused with brown. Venter white. Pro- and mesothoracic legs white ventrally, brown dorsally; metathoracic legs entirely white to pale ochreous. Forewing strongly sexually dimorphic; maculation well defined in female, indistinct to absent in male. Male forewing with ground color white to pale ochreous, usually lightly suffused with a sparse scattering of light brown scales; banding obsolescent, if present at all, as follows: a subternal, triangular spot at outer third of hind margin, and a small spot near hind margin in basal part; costal margin mostly brown; basal third of cilia along termen brown, thus forming a narrow, brown marginal band, often broken into a row of dark spots; outer two-thirds of cilia white; outline of wing relatively slender with apex produced; veins R_4 and R_5 usually stalked or connate. Female forewing with ground color white, heavily banded with dark to rust as follows: a marginal band extending from slightly above apex to CuA_2 , with a small white spot at apex; two Y-shaped bands transversing forewing at middle and at outer fourth, their inner arms anastomosing at costal margin; outer Y-shaped band with base slightly but distinctly separated from apical band; outer branch of outer Y-band often

interrupted by rusty or white patch from fork to near costa; outer branch of inner Y-band with small rusty patch. Fringes dark in basal third or less along areas where dark wing band reaches termen, else white; at subternus, patch of all-dark fringe hairs. Hindwing in both sexes slender, typically paler than forewing; basal third of cilia bordering outer margin pale stramineous, outer two-thirds white.

Specimens from Sequoia National Park, California, have very different wing patterns, especially in the female. In the male (Figure 291), a larger proportion of rusty and brown scales render the male darker and typically a bit more patterned than those of coastal populations. In the female (Figure 292), the white spots are so much reduced as to render the ground color rusty or pale brown, resulting from a mixture of white, rusty, and brown scales; marginal band wholly lost; outer Y-shaped band with inner part of the Y lost, remainder reduced to a costal and a subternal spot; inner Y-shaped band without outer part of the Y, occasionally reduced to a basal spot on termen; outer spots lined with brown, sometimes expanded to a brown patch from costa to termen basal to broken white band; narrow brown streak on costa between outer band and apex; wing pattern otherwise as described for coastal populations. Head with only white hairs, and scales basally on antennae white.

Abdomen: Pale brown dorsally, white ventrally.

Male Genitalia (Figures 355–358): Similar to those of subalba. Uncus minutely bilobed. Vinculum-saccus V-shaped, approximately 1.5 × length of valva. Valva broad to pollex, abruptly terminating beyond pollex; cucullus shortened, less produced than in any other species of *Greya*; pollex terminating in a single, short spinose seta. Juxta with anterior half elongate, acuminate; gradually widening to broad, caudal half. Aedeagus with a single, large, somewhat sinuate cornutus at apex.

Female Genitalia (Figure 375): Apex of ovipositor compressed, subacute, minutely serrulate. Signa paired, stellate; rays 6–8 in number, variable in length.

EGG.—White, variable in shape from pyriform to spherical, 0.35 mm in length and 0.25–0.35 mm in diameter. Chorion moderately smooth, appearing finely striate under high magnification, sometimes with minute, scattered dark spots; micropyle not observed.

LARVA AND PUPA.—Unknown.

HOLOTYPE.—5 mi [8 km] SW Paicines, Lime Kiln Road, San Benito Co., California, ♂, 24 March 1966, J. Powell; ♂ genitalia on slide DRD 2446; in the collections of the University of California at Berkeley.

PARATYPES.—UNITED STATES: CALIFORNIA: *Kern Co.*: Along Kern River, 2200 ft [660 m]: 1♂, 12 Mar 1988, R. Leuschner (RL). Democrat Hot Springs, along Kern River, 2000 ft [600 m]: 3♂, 17 Apr 1977, R. Leuschner (RL). *Los Angeles Co.*: no specific locality: 2♀, "March," collection of Koebele (CAS). *San Benito Co.*: Same data as holotype: 3♂, wing slide DRD 2911 (UCB); 2♂, ♂ genitalia slide DRD

1319, wing slide USNM 16053 (USNM). 5 mi [8 km] SW Paicines, Lime Kiln Road: 1♀, 24 Mar 1966, J. Powell (UCB). *Santa Barbara Co*: Colson Canyon, 1 rd-mile from Tepusquet Canyon Road: 1♀, 13 Mar 1976, S. Miller (collection Scott Miller). Colson Canyon Road, 3.2 km NW Tepusquet Peak, 330 m: 3♂, 22 Mar 1989, O. Pellmyr and J.N. Thompson (OP). Figueroa Mtn. Road at Alamo-Pintado Creek crossing, 450 m: 2♂, 1♀, 23 Mar 1989, O. Pellmyr and J.N. Thompson (OP); 1♂, 1♀, 27 Mar 1989, O. Pellmyr and J.N. Thompson (OP). Figueroa Mtn. Road, 1.7 km E Midland School, 480–500 m: 1♂, 26 Mar 1989, O. Pellmyr and J.N. Thompson (OP). Happy Canyon Road, 3.2 km SE Goat Rock, 450 m: 7♂, 23 Mar 1989, O. Pellmyr and J.N. Thompson (OP). Happy Canyon Road, 3.1 km SSE Goat Rock, 375 m: 1♂, 3♀, 26 Mar 1989, O. Pellmyr and J.N. Thompson (OP); 1♂, 27 Mar 1989, O. Pellmyr and J.N. Thompson (OP). 9 km E Lake Cachuma, Lewis Canyon on Paradise Road: 1♂, 21 Mar 1990, O. Pellmyr and J.N. Thompson (OP). *Tulare Co*: Sequoia National Park, S Fork Drive on Kaweah River at 9.4 mile, 840 m: 4♂, 2♀, 29 Apr 1990, O. Pellmyr and J.N. Thompson (OP); Sequoia National Park, S Fork Drive on Kaweah River at 9.5 mile, 850 m: 2♂, 1♀, 28 Apr 1990, O. Pellmyr and J.N. Thompson (OP).

Described from a total of 33 males and 12 females.

HOST.—Developing seeds of *Bowlesia incana* (Umbelliferae).

FLIGHT PERIOD.—March–early May.

DISTRIBUTION (Map 7).—This species is known only from coastal sites between San Benito County and Los Angeles County, and from sites in the south-central Sierra Nevada of California. Altitudinal range, 300–850 m.

HABITAT (Figure 22).—In relatively dry to moderately moist grassy areas in open oak forest, particularly in the oak-digger pine transition zone. The hostplant often grows tucked under *Artemisia californica*, and these shrubs often serve as perch sites for males; the females generally stay within patches of the host.

ETYMOLOGY.—It is our privilege to name this species in honor of Dr. Jerry Powell of the University of California at Berkeley in recognition of the outstanding field work which he has conducted over the past decades on the Microlepidoptera of the state of California.

DISCUSSION.—*Greya powelli* is obviously a member of the *solenobiella* species group. The members of this group, which also contains *G. reticulata*, *G. suffusca*, and *G. subalba*, possess nearly identical genitalia. *Greya powelli* may be distinguished from the other members of this closely interrelated group by its small size, relatively slender wings, and by the connate or stalked condition of R_4 and R_5 in the forewing. The pale, relatively uniform color of the forewing of the male, with the darker terminal bands, is also diagnostic. In addition, the cucullus of the valva is less extended beyond the pollex than in any other species of *Greya*. The female can be distinguished from *G. reticulata* through the presence of rusty patches in the interrupted Y-bands, and the separation of the outer band and the Y-band. *Greya powelli* and *G. reticulata* may be sympatric, but occur largely in different habitats. Although the size range of the two species overlaps slightly, the wing outlines are distinctive with that of *G. powelli* being decidedly more slender.

As indicated in the description, specimens from Sequoia National Park have very different wing patterns, while the genitalia appear identical. This may represent a subspecific entity, or just local geographic variation. When material (especially females) becomes available from additional populations in the Sierra Nevada, the taxonomic status of these specimens can be decided.

Males typically predominate in field collections. This is because males tend to fly up when disturbed, whereas females drop from the vegetation and feign death. In fact, we have not seen females fly longer distances than a few centimeters. While ovipositing, a female normally oviposits into many ovaries on a ramet and then runs on the ground or on plant parts to other ramets of the clonal host.

Literature Cited

- Barnes, W., and J.H. McDunnough
1917. *Check List of the Lepidoptera of Boreal America*. 392 pages. Decatur, Illinois: Herald Press.
- Blackmore, E.H.
1924. Entomology. *British Columbia Provincial Museum Reports*, 1923:15-25, plate 5.
1926. Two New Greyas from British Columbia (Lepidoptera, Incurvariidae). *The Canadian Entomologist*, 58:294-296.
- Bogner, F., M. Boppré, K.-D. Ernst, and J. Boeckh
1986. CO₂ Sensitive Receptors on Labial Palps of *Rhodogastris* Moths (Lepidoptera: Arctiidae): Physiology, Fine Structure, and Central Projection. *Journal of Comparative Physiology, A*, 158:741-749.
- Bonaparte, C.
1856. Additions et corrections au coup de oeil sur l'Ordre des Pigeons, et a la partie correspondante du Conspectus Avium. *Compte Rendu de l'Academie des Sciences, Paris*, 43:833-841.
- Braun, A.F.
1921. Two Weeks Collecting in Glacier National Park. *Proceedings of the Academy of Natural Sciences, Philadelphia*, 73:1-23.
1924. The Frenulum and Its Retinaculum in the Lepidoptera. *Annals of the Entomological Society of America*, 17:234-257, plate 1, figures 1-9.
1925. New Canadian Microlepidoptera. *Canadian Entomologist*, 57: 124-127.
- Buchecker, H.
1880. *Systema entomologiae sistens Insectorum Classes, Genera, Species*. Part 6. München.
- Busck, A.
1903. Notes on Brackenridge Clemens' Types of Tineina. *Proceedings of the Entomological Society of Washington*, 5:181-220.
1904. Tineid Moths from British Columbia, with Descriptions of New Species. *Proceedings of the United States National Museum*, 37:745-778.
1906. On Dr. Wm. Dietz's Revision of the Tineidae. *Canadian Entomologist*, 38:345-348.
1947. Family Prodoxidae. In S.D. McKelvey, *Yuccas of the Southwestern United States*, part 2, pages 182-184. Jamaica Plain, Massachusetts: The Arnold Arboretum of Harvard University.
- Calder, J.A., and D.B.O. Savile
1959. Studies in the Saxifragaceae, I: The *Heuchera cylindrica* Complex In and Adjacent to British Columbia. *Brittonia*, 11:49-67.
- Common, I.F.B.
1975. Evolution and Classification of the Lepidoptera. *Annual Review of Entomology*, 20:193-203.
- Davis, D.R.
1967. A Revision of the Moths of the Subfamily Prodoxinae (Lepidoptera: Incurvariidae). *United States National Museum Bulletin*, 255:1-170, 155 figures, 17 maps.
1975. A Review of the West Indian Moths of the Family Psychidae with Descriptions of New Taxa and Immature Stages. *Smithsonian Contributions to Zoology*, 188:1-66, 206 figures.
1978. A Revision of the North American Moths of the Superfamily Eriocraniioidea with the Proposal of a New Family, Acanthopteroctetidae (Lepidoptera). *Smithsonian Contributions to Zoology*, 251:1-130, 344 figures, 3 tables, 6 maps.
1983. Incurvarioidea. In R.W. Hodges et al., *Check List of the Lepidoptera of America North of Mexico*, pages 3-4. London: E.W. Classey Ltd. and the Wedge Entomological Research Foundation.
1987. Prodoxidae, Incurvarioidea. In F.W. Stehr, editor, *Immature Insects*, pages 359-362. Dubuque, Iowa: Kendall/Hunt.
1989. Generic Revision of the Opostegidae, with a Synoptic Catalog of the World's Species (Lepidoptera: Nepticuloidea). *Smithsonian Contributions to Zoology*, 478:1-97, 320 figures, 1 map, 2 tables.
1990. Neotropical Lepidoptera XXIII: First Report of the Family Eriocottidae from the New World, with Descriptions of New Taxa. *Proceedings of the Entomological Society of Washington*, 92:1-35.
- Dietz, W.G.
1905. Revision of the Genera and Species of the Tineid Subfamilies Amydriinae and Tineinae Inhabiting North America. *Transactions of the American Entomological Society*, 31(1):1-95, 6 plates.
- Dyar, H.G.
1903 ("1902"). A List of North American Lepidoptera. *United States National Museum Bulletin*, 52: 723 pages.
1903. A Review of the North American Species of *Pronuba* and *Prodoxus*. *Journal of the New York Entomological Society*, 11:102-104.
- Ellison, R.L.
1986. Effects of the Seed Weevil *Smicronyx cinereus* on Seed Mass Mean, Variance, Germinability, and Growth in *Lomatium grayi* (Umbelliferae). Master's thesis, Washington State University, Pullman, Washington.
- Ellison, R.L., and J.N. Thompson
1987. Variation in Seed and Seedling Size: The Effects of Seed Herbivores on *Lomatium grayi* (Umbelliferae). *Oikos*, 49:269-280.
- Essig, E.O.
1931. *A History of Entomology*. vii + 1029 pages. New York: Hafner. [1965 facsimile of the original edition.]
1941. Itinerary of Lord Walsingham in California and Oregon, 1871-1872. *Pan-Pacific Entomologist*, 17:96-113.
- Fletcher, T.B.
1929. A List of the Generic Names Used for Microlepidoptera. *Memoirs of the Department of Agriculture in India, Entomological Series*, 11: ix + 246 pages.
- Frack, D.C., Jr.
1982. A Systematic Study of Prodoxine Moths (Adelidae:Prodoxinae) and Their Hosts (Agavaceae), with Descriptions of the Subfamilies of Adelidae (s.lat.). vii + 209 pages. Master's thesis, California State Polytechnic University, Pomona, California.
- Heath, J., and E.C. Pelham-Clinton
1976. Incurvariidae. In J. Heath, editor, *The Moths and Butterflies of Great Britain and Ireland, 1: Micropterigidae-Heliozelidae*, pages 277-300. Oxford: Blackwell Scientific Publications and Curwen Press.
- Holland, W.
1905. *The Moth Book*. xxiv + 479 pages, 48 color plates, 263 figures. New York: Doubleday, Page, and Co.
- Kartesz, J.T., and R. Kartesz
1980. *A Synonymized Checklist of the Vascular Flora of the United States, Canada, and Greenland, Vol. II: the Biota of North America*. xlviii + 500 pages. Chapel Hill: University of North Carolina Press.
- Kearfott, W.D.
1903. Tineidae. In J.B. Smith, *Check List of Lepidoptera of Boreal America*, pages 118-124. Philadelphia: American Entomological Society.
- Kristensen, N.P.
1984. Studies on the Morphology and Systematics of Primitive Lepidoptera (Insecta). *Steenstrupia*, 10:141-191, figures 1-33.

- Lowry II, P.P., and A.G. Jones
1984. Systematics of *Osmorhiza* Raf. (Apiaceae: Apioideae). *Annals of the Missouri Botanical Garden*, 71:1128-1171.
- McDunnough, J.
1939. Checklist of the Lepidoptera of Canada and the United States of America, part 2: Microlepidoptera. *Memoirs of the Southern California Academy of Sciences*, 2(1): 171 pages.
- Neal, J.W., Jr.
1986. Salient Vestiture and Morphological Characters of the Pharate Female Bagworm, *Thyridopteryx ephemeraeformis* (Lepidoptera: Psychidae). *Annals of the the Entomological Society of America*, 79:814-820.
- Nielsen, E.S., and D.R. Davis
1985. The First Southern Hemisphere Prodoxid and the Phylogeny of the Incurvarioidae (Lepidoptera). *Systematic Entomology*, 10:307-322.
- Patt, J.M.
1986. The Pollination Biology of *Platanthera stricta* Lindley (Orchidaceae) in Olympic National Park, Washington. vii + 115 pages. Master's thesis, University of Washington, Seattle, Washington.
- Patt, J.M., M.W. Merchant, D.R.E. Williams, and B.J.D. Meeuse
1989. Pollination Biology of *Platanthera stricta* (Orchidaceae) in Olympic National Park, Washington. *American Journal of Botany*, 76:1097-1106.
- Petersen, G.
1978. Zur systematischen Stellung der Gattung *Crinopteryx* PEYER-IMHOFF, 1871. *Beiträge zur Entomologie, Berlin*, 28:217-220.
- Powell, J.A.
1973. A Systematic Monograph of New World Ethmiid Moths (Lepidoptera: Gelechioidea). *Smithsonian Contributions to Zoology*, 120: 1-302, 294 figures, 22 plates, 68 maps.
1984. Biological Interrelationships of Moths and *Yucca Schottii*. *University of California Publications in Entomology*, 100:1-93.
1985. Faunal Affinities of the Channel Islands Lepidoptera: A Preliminary Overview. In A.S. Menke and D.R. Miller, *Entomology of the California Channel Islands*, pages 69-94. Santa Barbara, California: Santa Barbara Museum of Natural History.
- Powell, J.A., and R.A. Mackie
1966. Biological Interrelationships of Moths and *Yucca whipplei*. *University of California Publications in Entomology*, 42:1-59.
- Riley, C.V.
1891. Incurvariidae. In J.B. Smith, *List of the Lepidoptera of Boreal America*, page 96. Philadelphia: American Entomological Society.
- 1892a. The *Yucca* Moth and *Yucca* Pollination. *Missouri Botanical Garden, Third Annual Report*, pages 99-158, plates 34-43.
1892b. Some Interrelations of Plants and Insects. *Proceedings of the Biological Society of Washington*, 7:81-104, 16 figures.
1892c. Some Interrelations of Plants and Insects. *Insect Life*, 4:358-378, figures 57-75.
1892d. New Species of Prodoxidae. *Proceedings of the Entomological Society of Washington*, 2(3):312-319, figures 15-21.
1893a. Further Notes on *Yucca* Insects and *Yucca* Pollination. *Proceedings of the Biological Society of Washington*, 8:41-53, 1 plate.
1893b. Further Notes on *Yucca* Insects and *Yucca* Pollination. *Insect Life*, 5:300-310, 1 figure.
- Sharkey, M.
1987. *Agathis thompsoni* n.sp., a Nearctic Species of Agathidinae (Hymenoptera: Braconidae) Parasitic on *Greya subalba* (Braun) (Lepidoptera: Incurvariidae). *Proceedings of the Entomological Society of Washington*, 89:47-50.
- Sokal, R.R., and F.J. Rohlf
1981. *Biometry*. xviii + 859 pages. New York: W.H. Freeman and Co.
- Taylor, R.L.
1965. The Genus *Lithophragma* (Saxifragaceae). *University of California Publications in Botany*, 37:1-89, 21 plates.
- Thompson, J.N.
1986. Oviposition Behaviour and Searching Efficiency in a Natural Population of a Braconid Parasitoid. *Journal of Animal Ecology*, 55:351-360.
1987. Variance in Number of Eggs Per Patch: Oviposition Behaviour and Population Dispersion in a Seed Parasitic Moth. *Ecological Entomology*, 12:311-320.
- Wagner, D.L., and J.A. Powell
1988. A New *Prodoxus* from *Yucca baccata*: First Report of a Leaf-mining Prodoxine (Lepidoptera: Prodoxidae). *Annals of the Entomological Society of America*, 81:547-553.
- Walsingham, Lord (Thomas de Grey)
1880. On Some New and Little Known Species of Tineidae. *Proceedings of the Zoological Society of London*, pages 77-93, plates xi-xii.
1888. Steps Toward a Revision of Chambers' Index, with Notes and Descriptions of New Species. *Insect Life*, 1:145-150.
1907. Descriptions of New North American Tineid Moths, with a Generic Table of the Family Blastobasidae. *Proceedings of the United States National Museum*, 33:197-228.

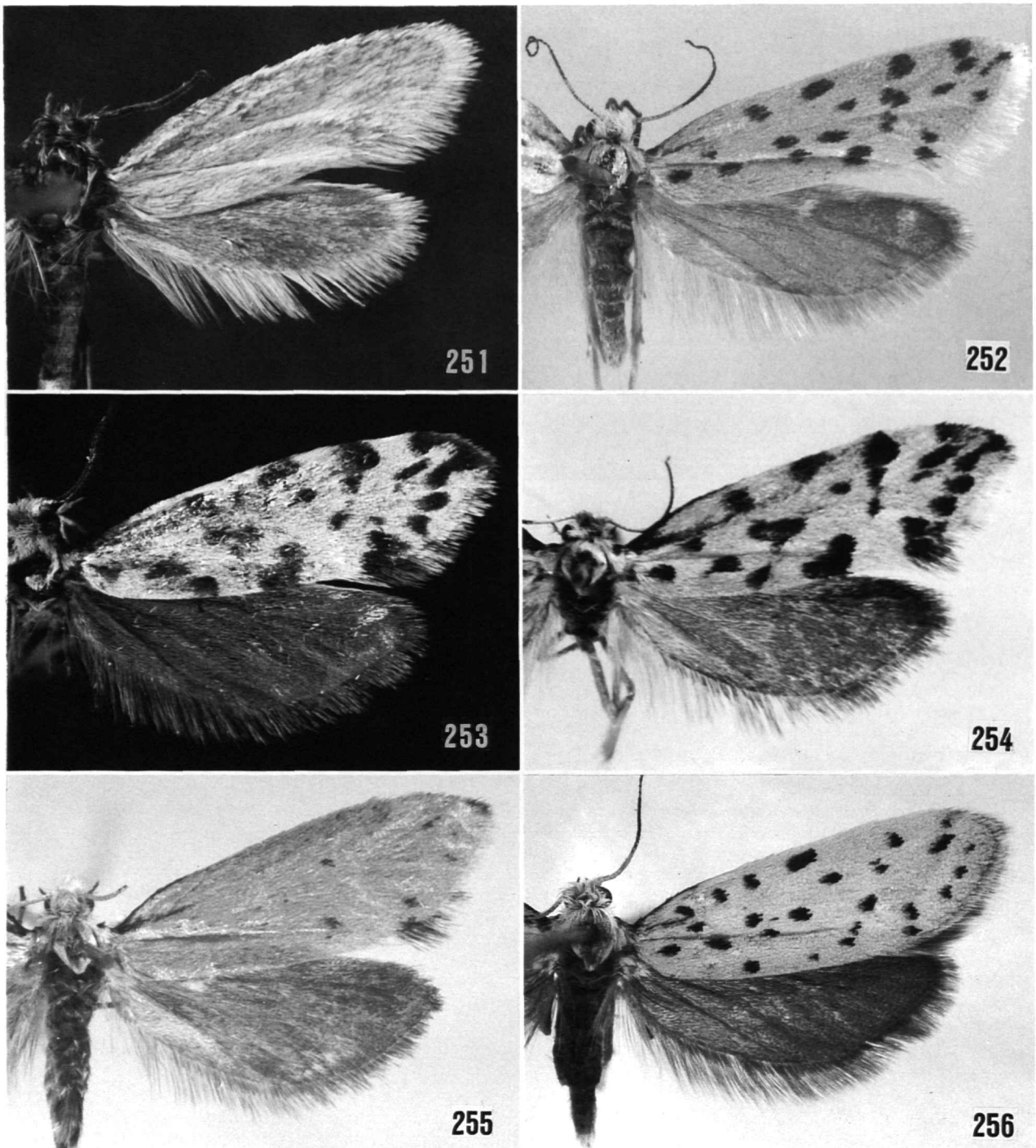

FIGURES 251–256.—Adult moths: 251, *Tetragma gei*, ♂, holotype, 4.8 km N Anatone, WA (5 mm); 252, *Greya punctiferella*, ♀, paralectotype, Rogue River, OR (6.6 mm); 253, *G. punctiferella*, (♂ holotype of *Greya punctiferella speculella*), Mt. Tzouhalem, near Duncan, BC (8 mm); 254, *G. punctiferella*, ♀ (note resemblance to Figure 253), 2.5 km W Round Pass, Mt. Rainier, WA (7.2 mm); 255, *G. punctiferella*, ♀, Deer Lake Trail, Olympic National Park, WA (7 mm); 256, *G. piperella*, ♀, 2.6 km SE Lower Granite Dam, Garfield Co., WA (7 mm). (Forewing length in parentheses.)

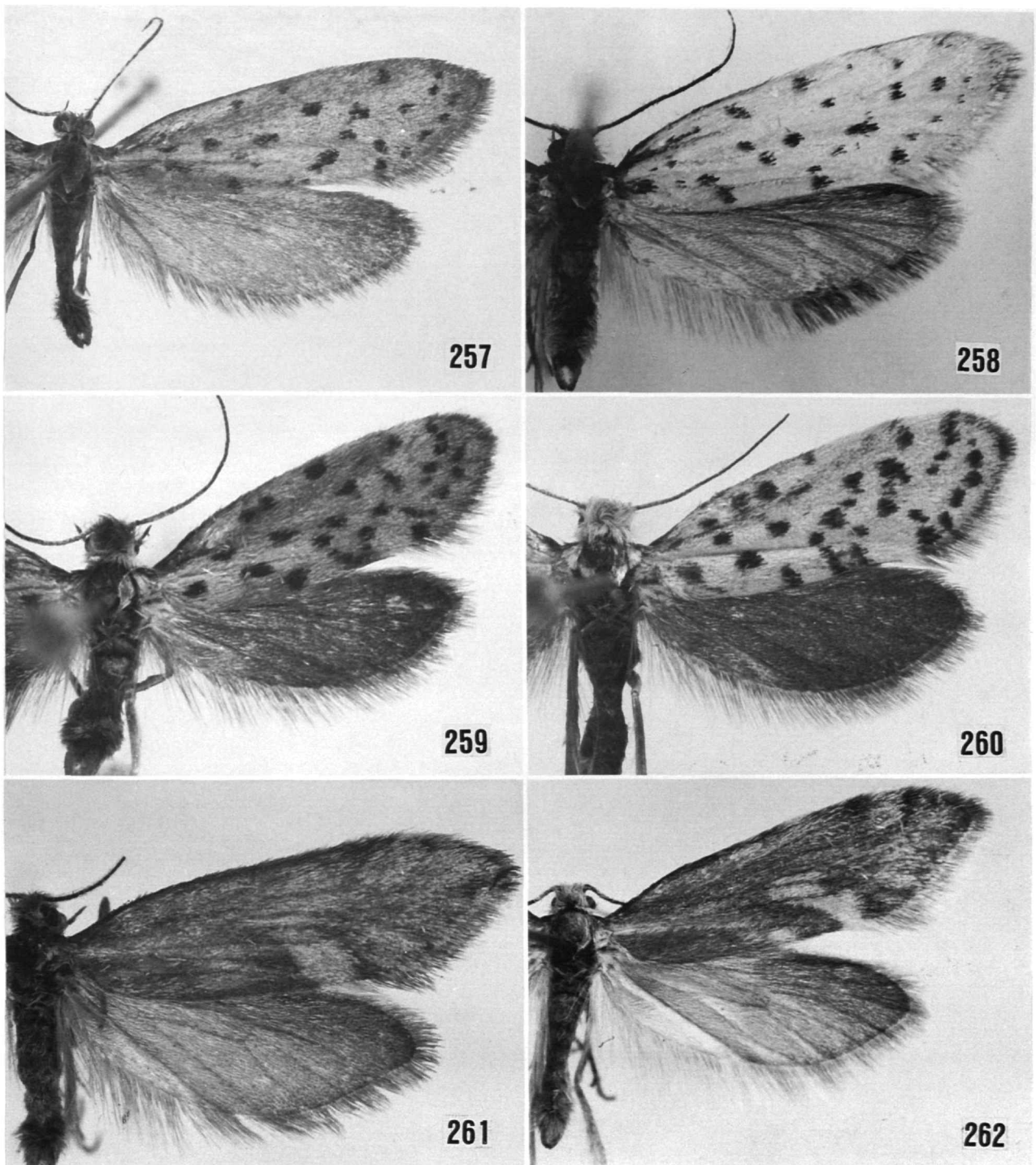

FIGURES 257-262.—Adult moths: 257, *Greya piperella*, ♂, above Grande Ronde River, Asotin Co., WA (9.5 mm); 258, *G. piperella*, ♂, 3.3 km NE Glencoe, Calaveras Co., CA (8.9 mm); 259, *G. mitellae*, ♂ paratype, 1.4 km SE Laird Park, ID (5.5 mm); 260, *G. mitellae*, ♀ paratype, 1.4 km SE Laird Park, ID (6.6 mm); 261, *G. obscura*, ♂ paratype, Monticello, CA (8.9 mm); 262, *G. obscura*, ♂ holotype, 4.8 km N Bagby, CA (7.3 mm). (Forewing length in parentheses.)

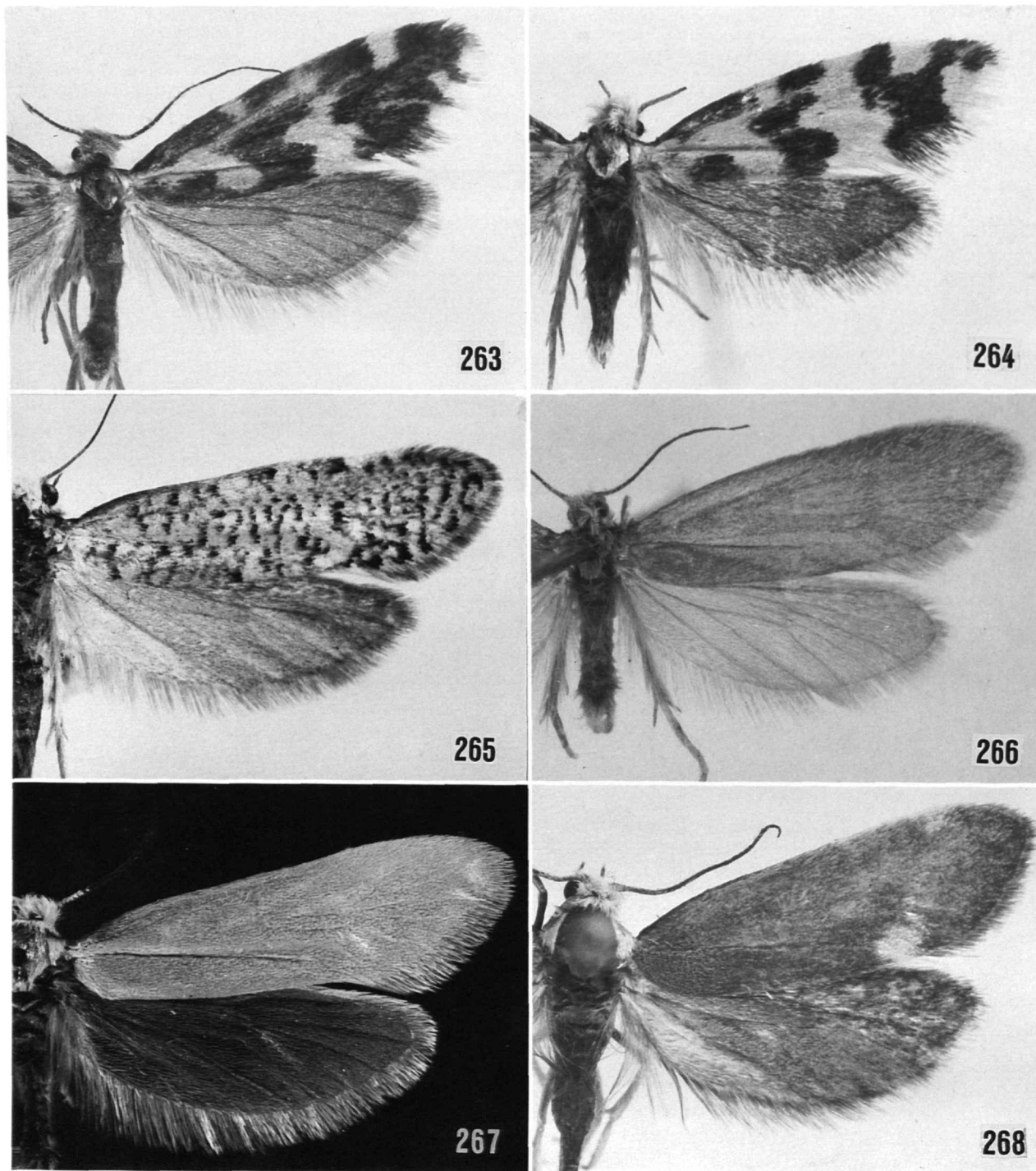

FIGURES 263–268.—Adult moths: 263, *Greya obscuromaculata*, ♂, Deer Lake trail, Olympic National Park, WA (7.1 mm); 264, *G. obscuromaculata*, ♀, Deer Lake trail, Olympic National Park, WA (6.1 mm); 265, *G. sparsipunctella*, ♀ holotype, N of Mendocino, CA (12 mm); 266, *G. politella*, ♂, Pullman, WA (8.7 mm); 267, *G. enchrysa*, ♂ paratype, Brent's Lake, Pentiction, BC (9 mm); 268, *G. enchrysa*, ♂ paratype, E Lowell, ID (8.5 mm). (Forewing length in parentheses.)

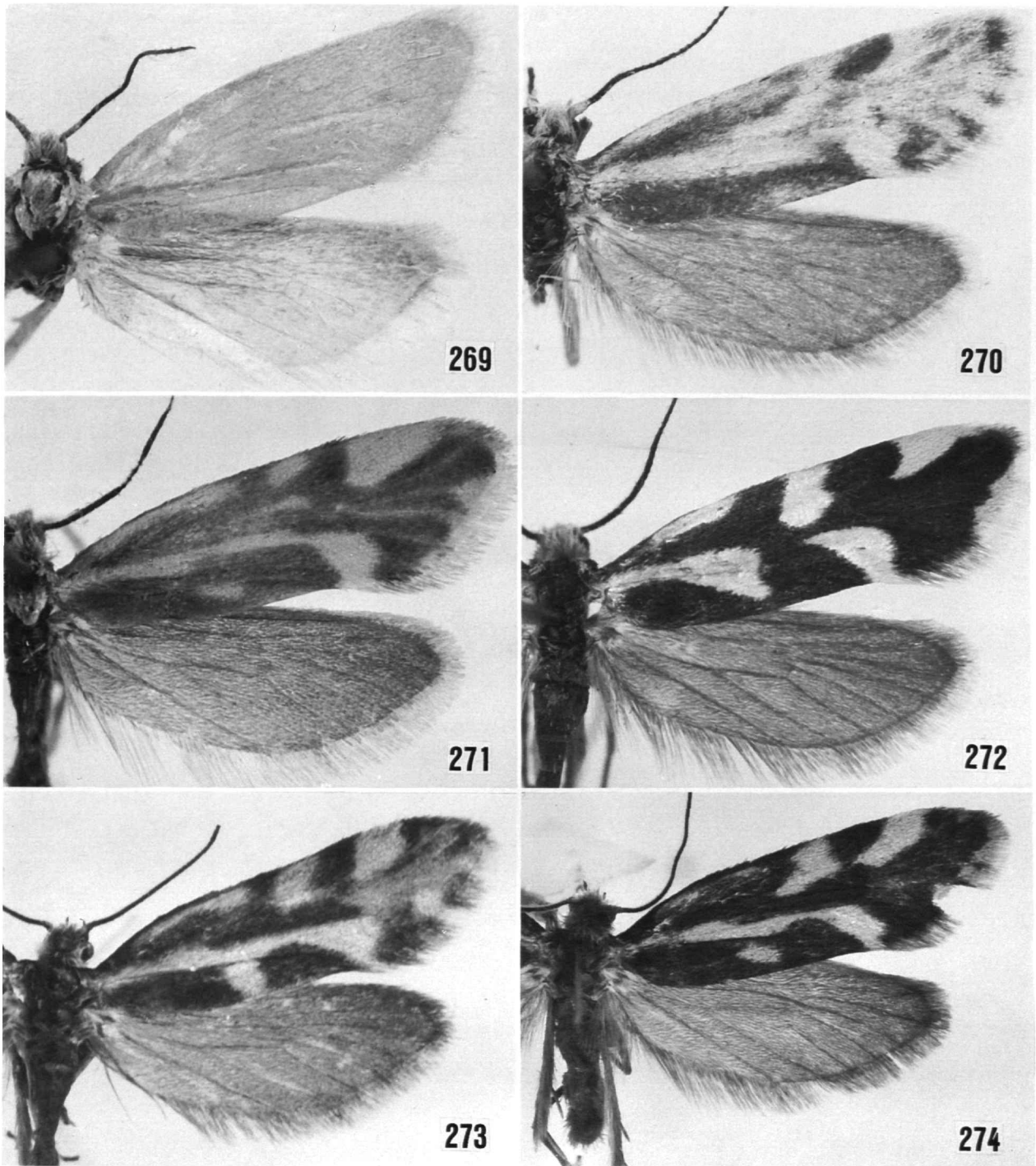

FIGURES 269–274.—*Greya variabilis*, adult moths: 269, ♂ paratype, St. George Island, Pribilof Islands, AK (5.8 mm); 270, ♂ paratype, St. Paul Island, Pribilof Islands, AK (7.4 mm); 271, ♂ paratype, St. George Island, Pribilof Islands, AK (6.6 mm); 272, ♂ paratype, St. Paul Island, Pribilof Islands, AK (7 mm); 273, ♂ paratype, Graham Island, Queen Charlotte Islands, BC (6.6 mm); 274, ♂ holotype, Moreshby Island, Queen Charlotte Islands, BC (7.2 mm). (Forewing length in parentheses.)

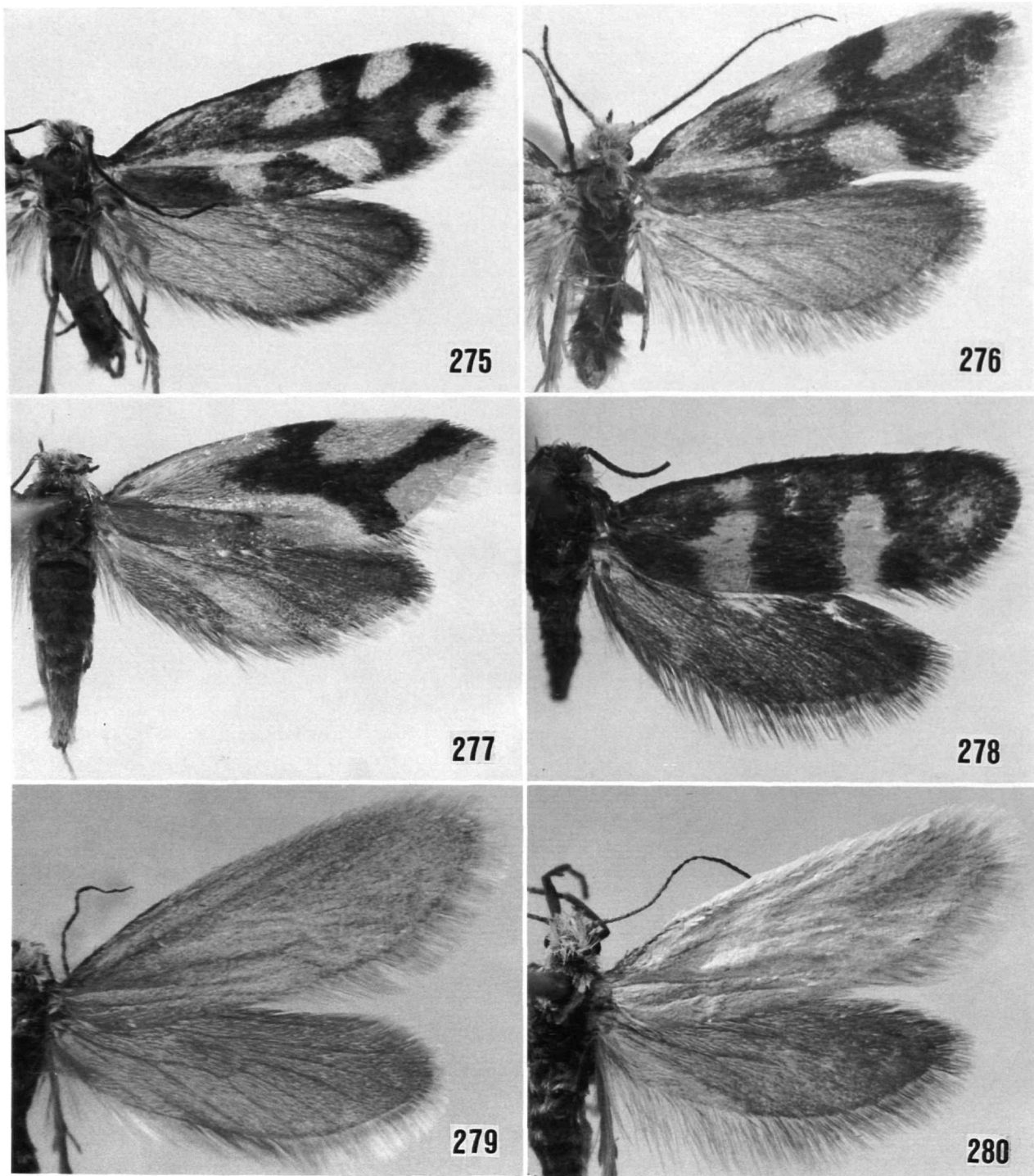

FIGURES 275-280.—Adult moths: 275, *Greya variabilis*, ♂ paratype, Graham Island, Queen Charlotte Islands, BC (7 mm); 276, *G. variabilis*, ♂ paratype, Deer Lake trail, Olympic National Park, WA (6.6 mm); 277, *G. pectinifera*, ♀ holotype, Deer Lake drainage, Olympic National Park, WA (7 mm); 278, *G. variata*, ♂, Waterton Lakes, AB (5.7 mm); 279, *G. subalba*, ♂, Pullman, WA (7.6 mm); 280, *G. subalba*, ♀, 44.8 km SE Joseph, WA (5.7 mm). (Forewing length in parentheses.)

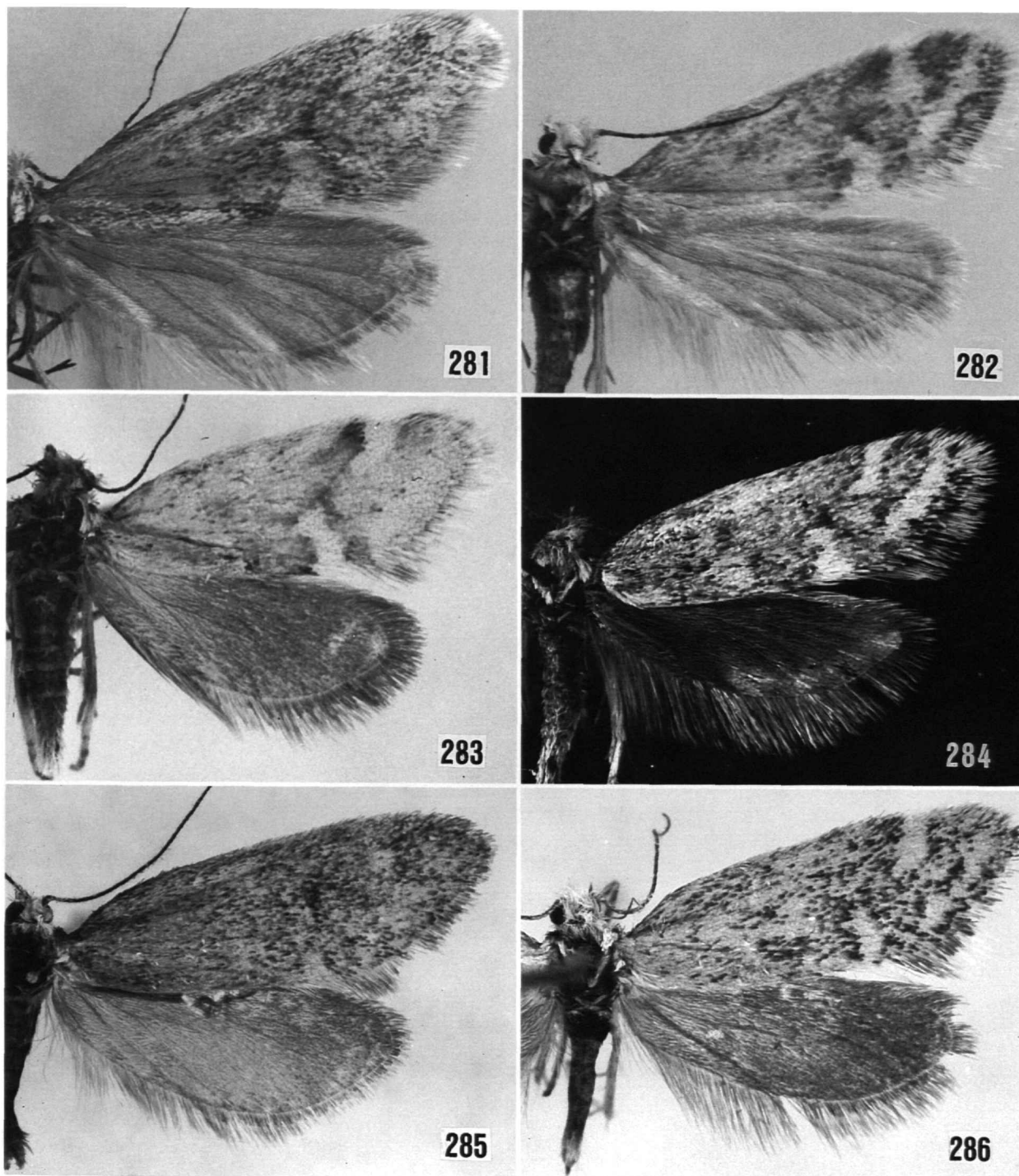

FIGURES 281–286.—Adult moths: 281, *Greya solenobiella*, ♂, 8 km SW Paicines, San Benito Co., CA (8 mm); 282, *G. solenobiella*, ♀, 8 km SW Paicines, San Benito Co., CA (5.8 mm); 283, *G. solenobiella*, ♀, 2.4 km SE Jamesburg, Monterey Co., CA (6.4 mm); 284, *G. solenobiella*, ♀, Del Puerto Canyon, Stanislaus Co., CA (5.9 mm); 285, *G. suffusca*, ♂ holotype, E South Fork campground, Sequoia National Park, CA (8.6 mm); 286, *G. suffusca*, ♀ paratype, E South Fork campground, Sequoia National Park, CA (6.5 mm). (Forewing length in parentheses.)

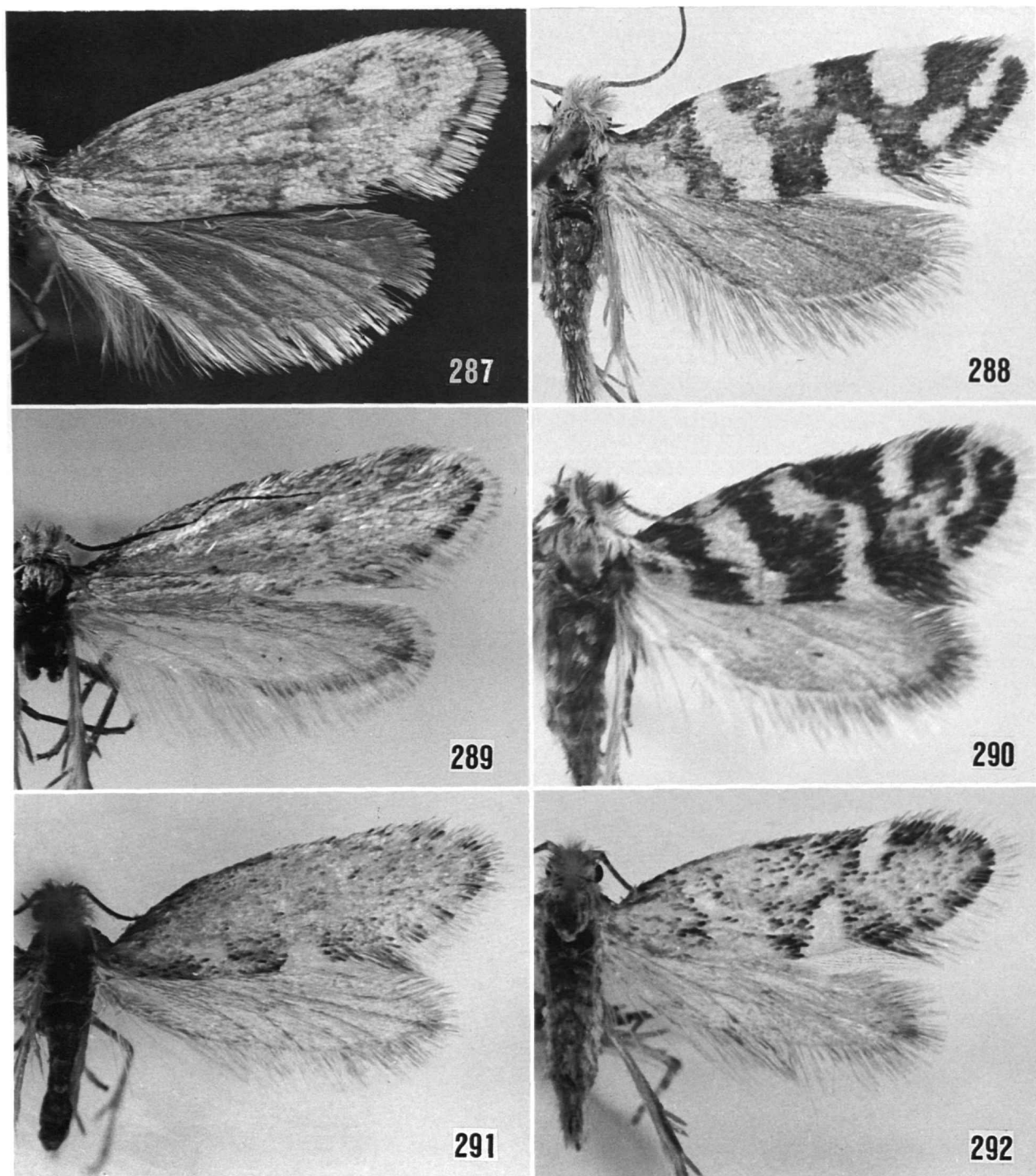

FIGURES 287-292.—Adult moths: 287, *Greya reticulata*, ♂, 4.8 km W New Almaden, Santa Clara Co., CA (6.5 mm); 288, *G. reticulata*, ♀, 4.8 km W New Almaden, Santa Clara Co., CA (5 mm); 289, *G. powelli*, ♂ paratype, 8 km SW Paicines, San Benito Co., CA (5.8 mm); 290, *G. powelli*, ♀, Happy Canyon, Santa Barbara Co., CA (4.5 mm); 291, *G. powelli*, ♂ paratype, South Fork Drive, Sequoia National Park, CA (5 mm); 292, *G. powelli*, ♀ paratype, South Fork Drive, Sequoia National Park, CA (5.3 mm). (Forewing length in parentheses.)

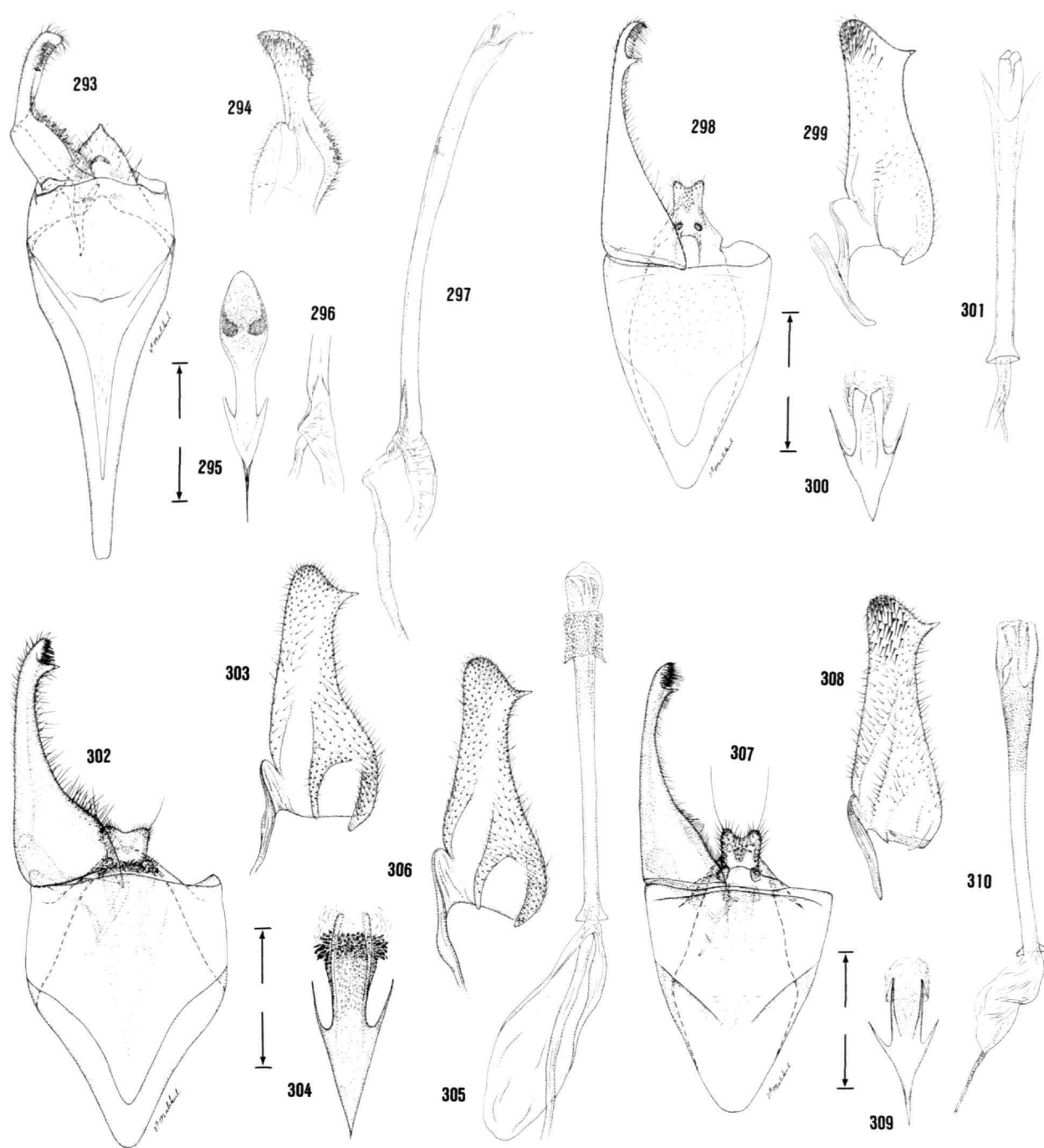

FIGURES 293-310.—Male genitalia. *Tetragma gei*: 293, ventral view; 294, valva, lateral view; 295, juxta, ventral view; 296, base of aedeagus, ventral view; 297, aedeagus, lateral view. *Greya punctiferella*: 298, ventral view; 299, valva, lateral view; 300, juxta, ventral view; 301, aedeagus, ventral view. *G. piperella*: 302, ventral view, from Pullman, WA; 303, valva, lateral view; 304, juxta, ventral view; 305, aedeagus, ventral view; 306, valva, lateral view, specimen from Calaveras Co., CA. *G. mitellae*: 307, ventral view; 308, valva, lateral view; 309, juxta, ventral view; 310, aedeagus, ventral view. (All scales = 0.5 mm.)

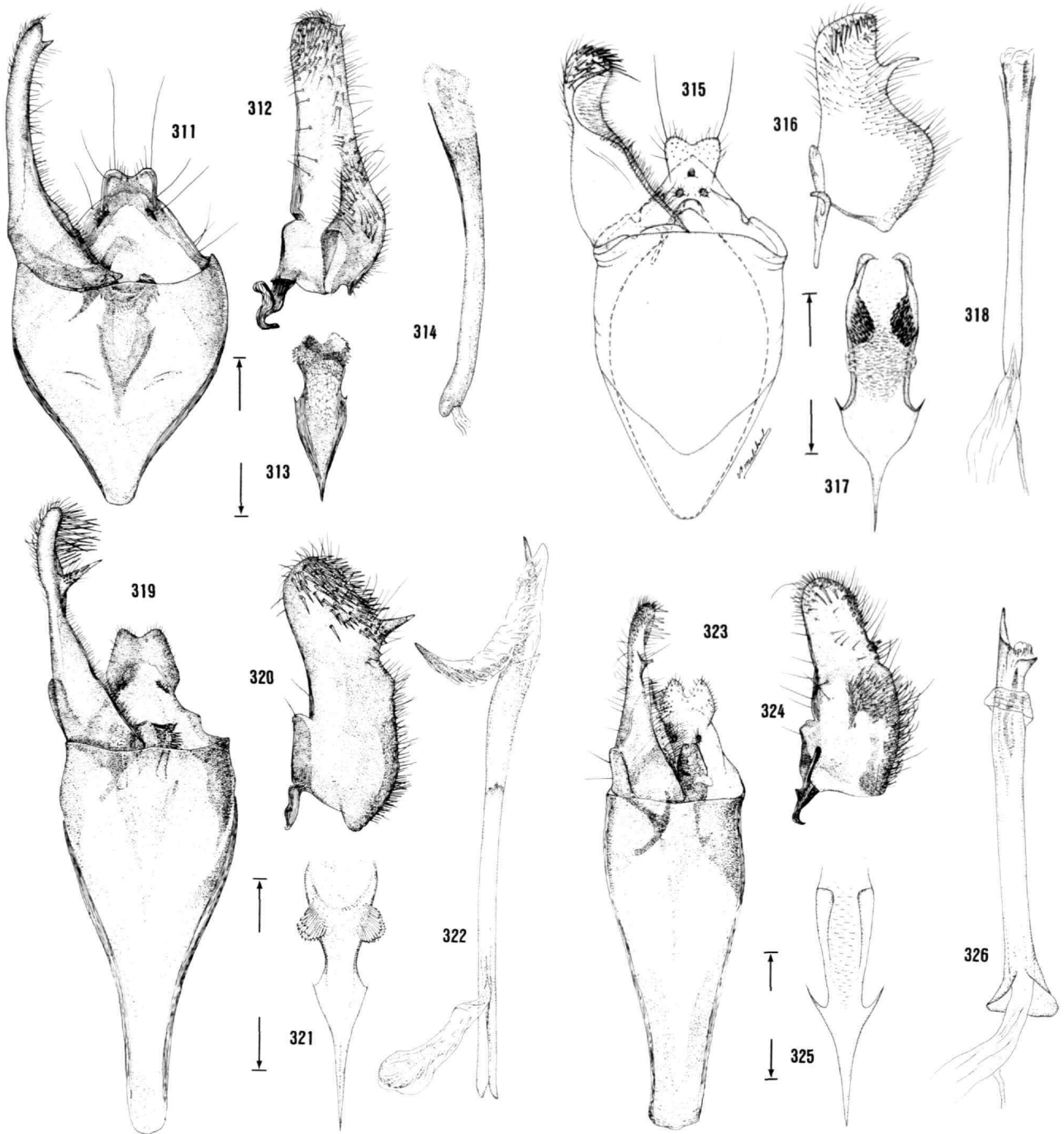

FIGURES 311-326.—Male genitalia. *Greya obscura*: 311, ventral view; 312, valva, lateral view; 313, juxta, ventral view; 314, aedoeagus, lateral view. *G. obscuromaculata*: 315, ventral view; 316, valva, lateral view; 317, juxta, ventral view; 318, aedoeagus, ventral view. *G. politella*: 319, ventral view; 320, valva, lateral view; 321, juxta, ventral view; 322, aedoeagus, ventral view. *G. enchrysa*: 323, aedoeagus, ventral view; 324, valva, lateral view; 325, juxta, ventral view; 326, aedoeagus, ventral view. (All scales = 0.5 mm.)

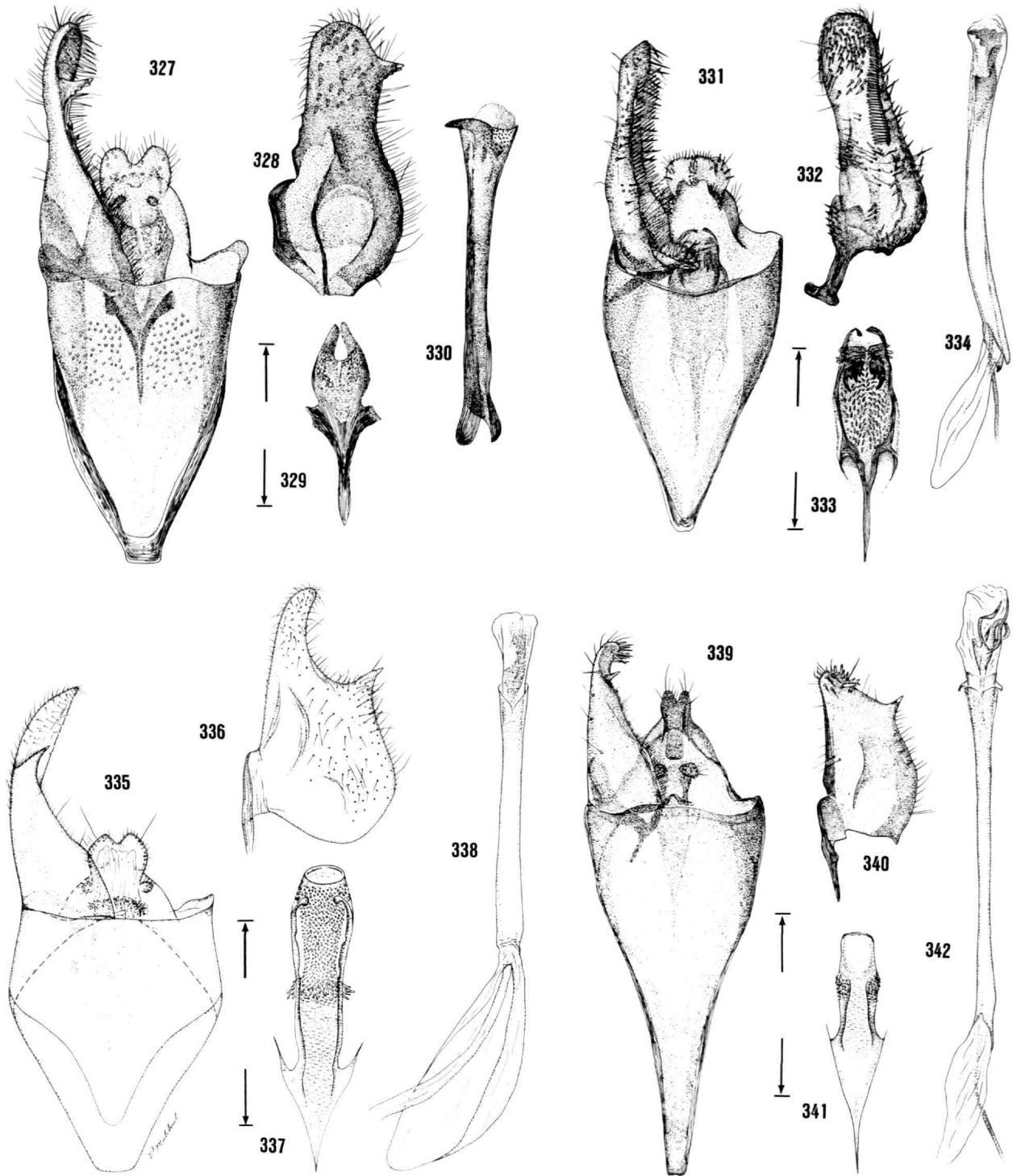

FIGURES 327-342.—Male genitalia. *Greya variabilis*: 327, ventral view; 328, valva, lateral view; 329, juxta, ventral view; 330, aedoeagus, lateroventral view. *G. pectinifera*: 331, ventral view; 332, valva, lateral view; 333, juxta, ventral view; 334, aedoeagus, lateral view. *G. variata*: 335, ventral view; 336, valva, lateral view; 337, juxta, ventral view; 338, aedoeagus, ventral view. *G. subalba*: 339, ventral view; 340, valva, lateral view; 341, juxta, ventral view; 342, aedoeagus, ventral view. (All scales = 0.5 mm.)

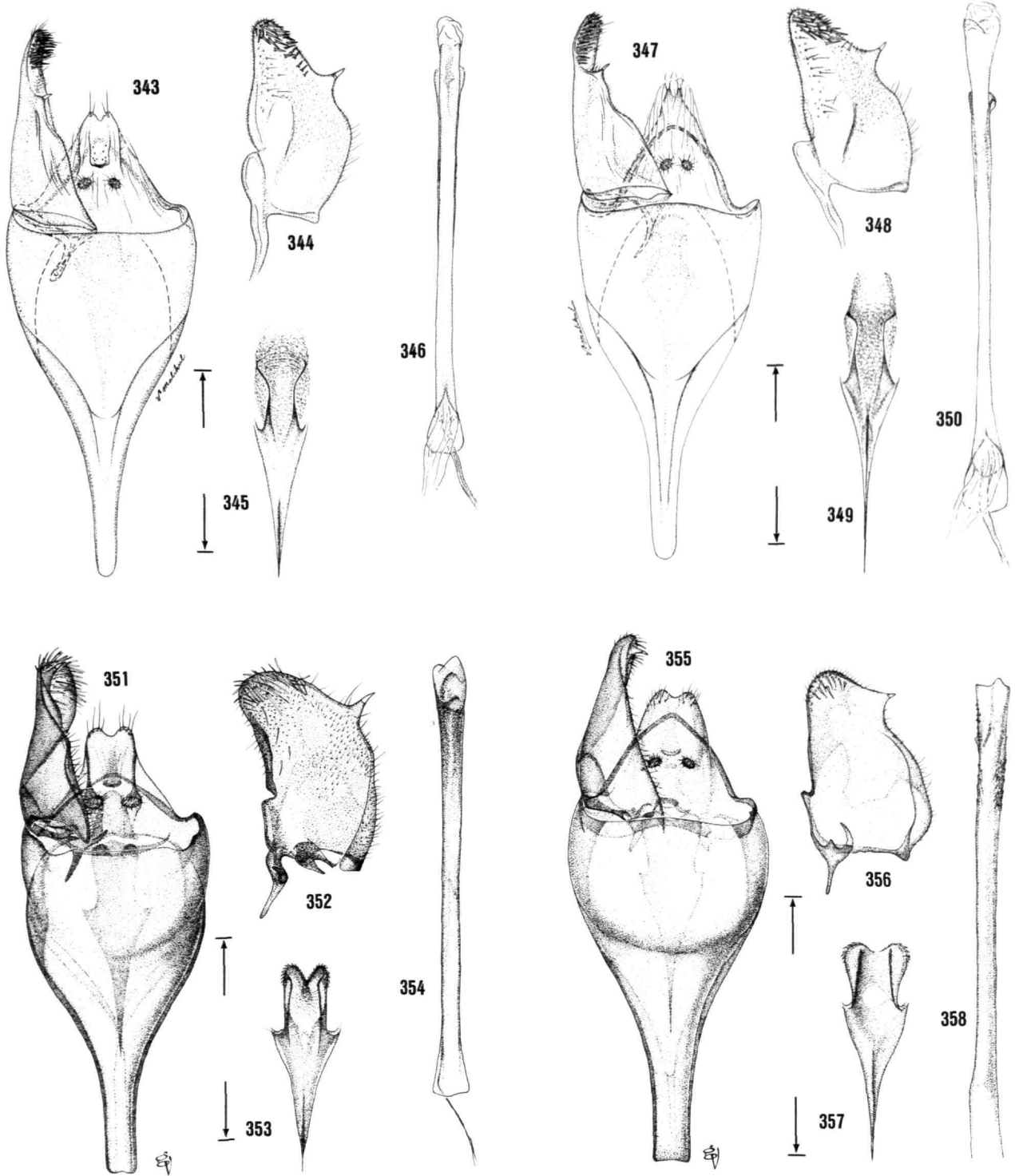

FIGURES 343-358.—Male genitalia. *Greya solenobiella*: 343, ventral view; 344, valva, lateral view; 345, juxta, ventral view; 346, aedoeagus, ventral view. *G. suffusca*: 347, ventral view; 348, valva, lateral view; 349, juxta, ventral view; 350, aedoeagus, ventral view. *G. reticulata*: 351, ventral view; 352, valva, lateral view; 353, juxta, ventral view; 354, aedoeagus, ventral view. *G. powelli*: 355, ventral view; 356, valva, lateral view; 357, juxta, ventral view; 358, aedoeagus, ventral view. (All scales = 0.5 mm.)

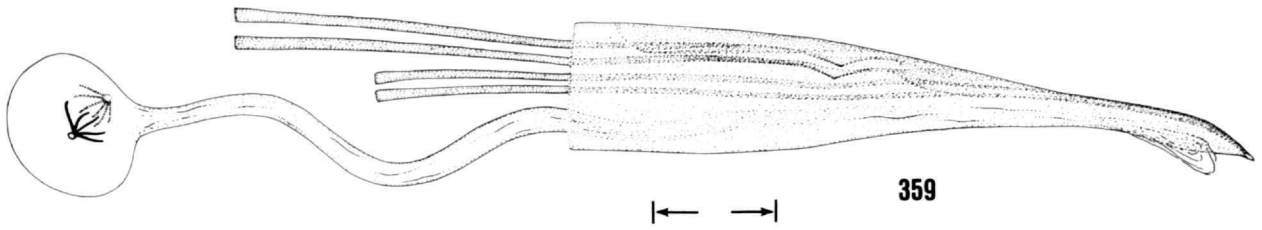

359

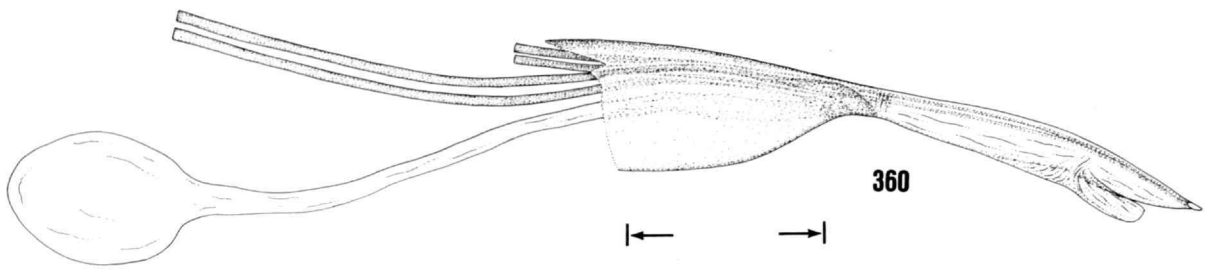

360

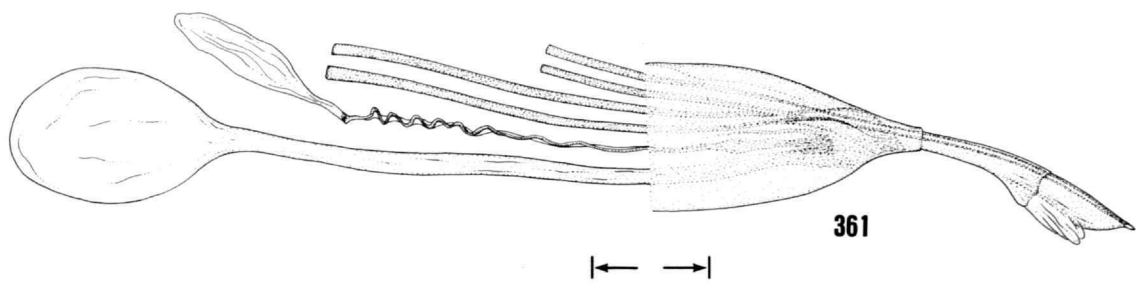

361

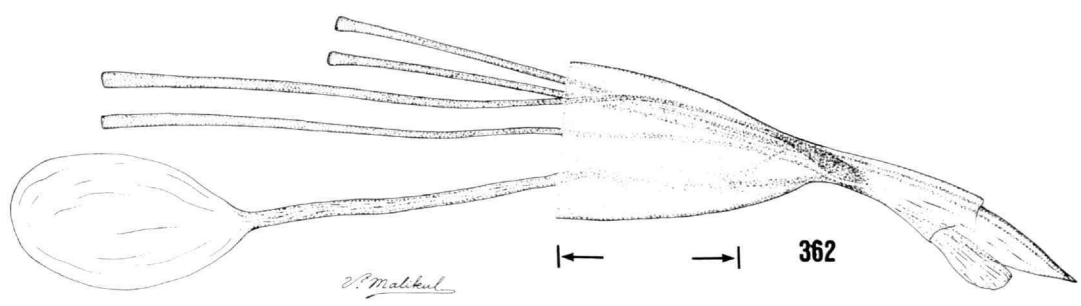

362

V. Malloch

FIGURES 359-362.—Female genitalia, lateral view: 359, *Tetragma gei*; 360, *Greya punctiferella*; 361, *G. piperella*; 362, *G. mitellae*. (All scales = 0.5 mm.)

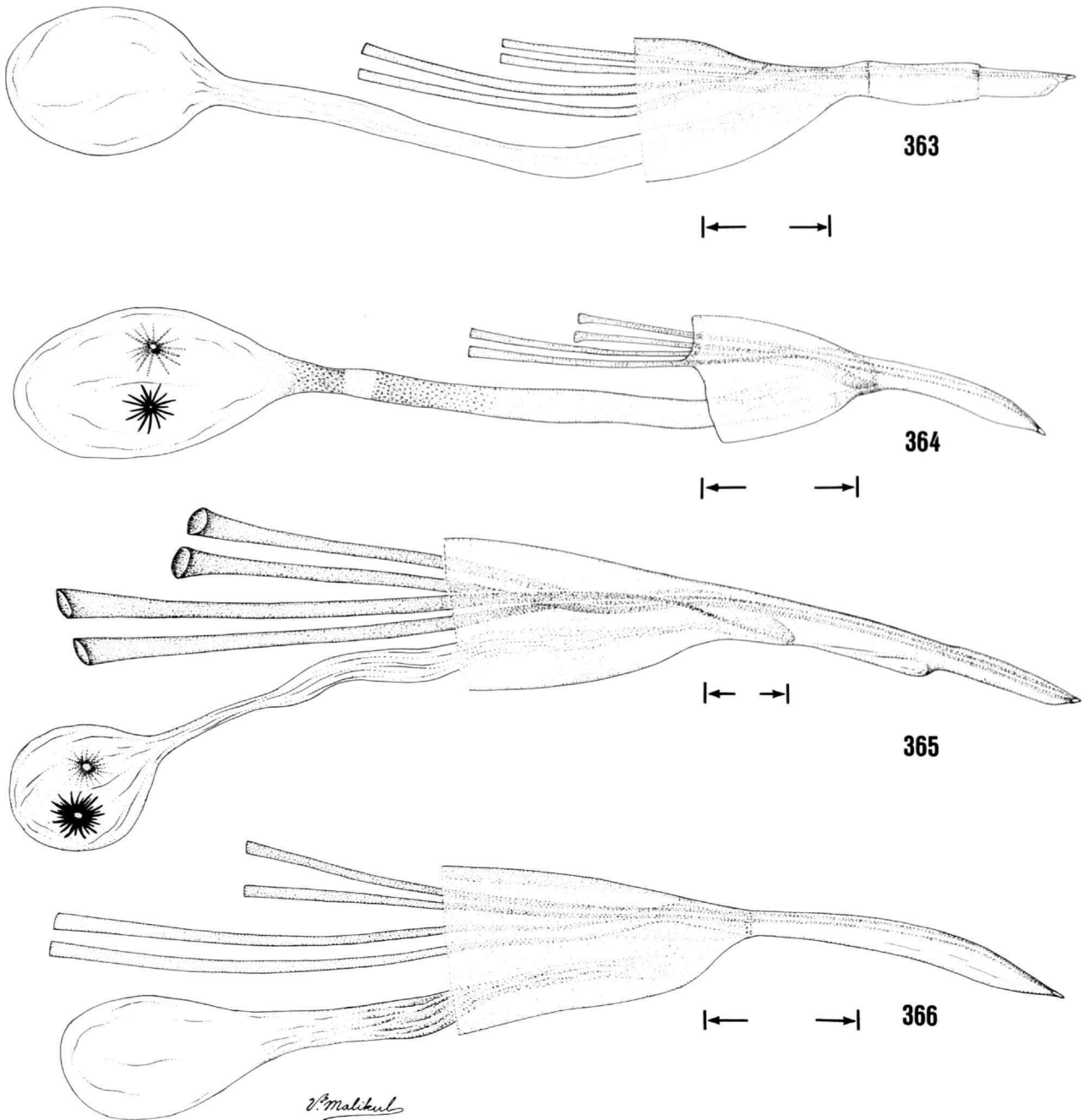

FIGURES 363-366.—Female genitalia, lateral view: 363, *Greya obscura*; 364, *G. obscuramaculata*; 365, *G. sparsipunctella*; 366, *G. politella*. (All scales = 0.5 mm.)

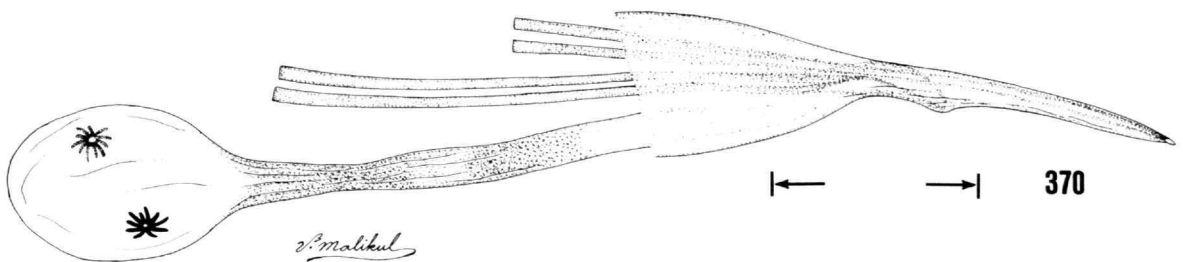
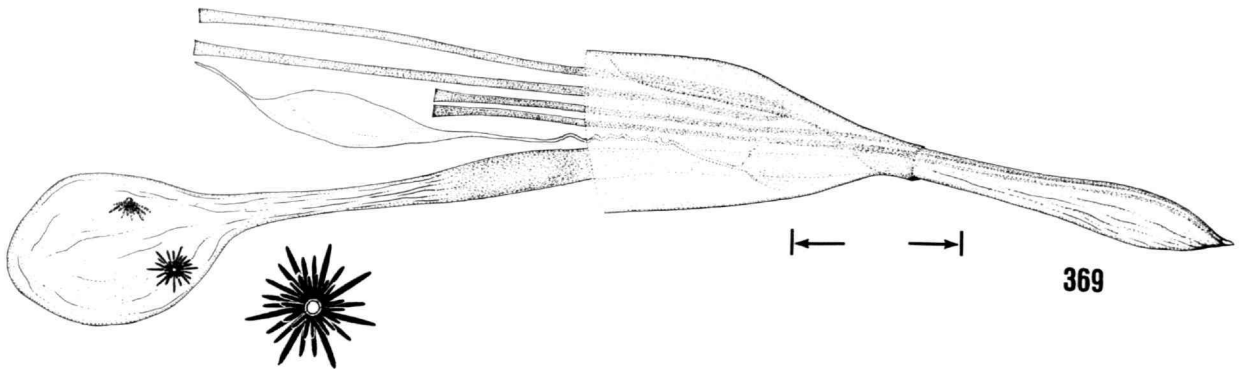
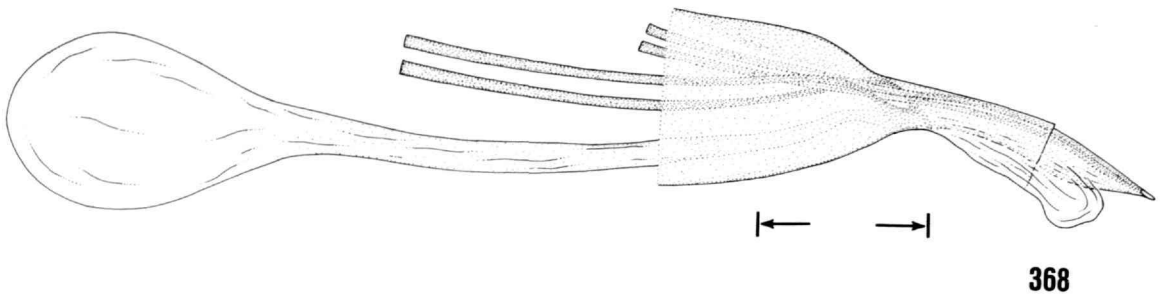
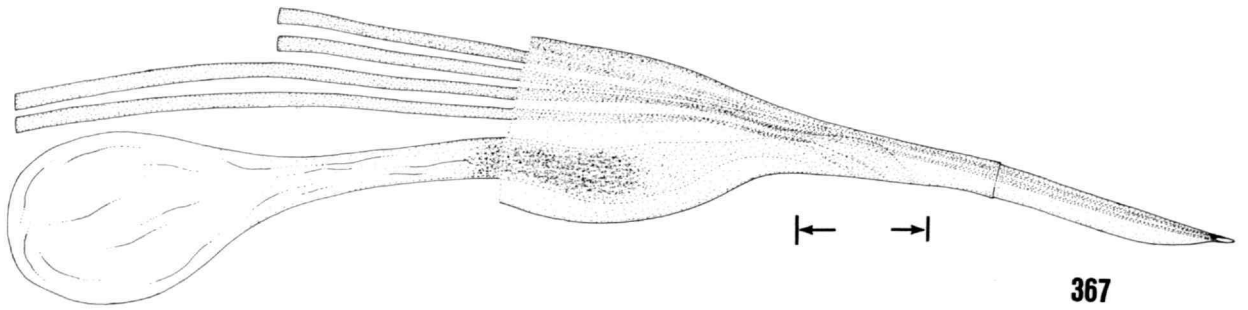

FIGURES 367-370.—Female genitalia, lateral view: 367, *Greya enchrysa*; 368, *G. variabilis*; 369, *G. pectinifera*, with enlarged view of signum; 370, *G. variata*. (All scales = 0.5 mm.)

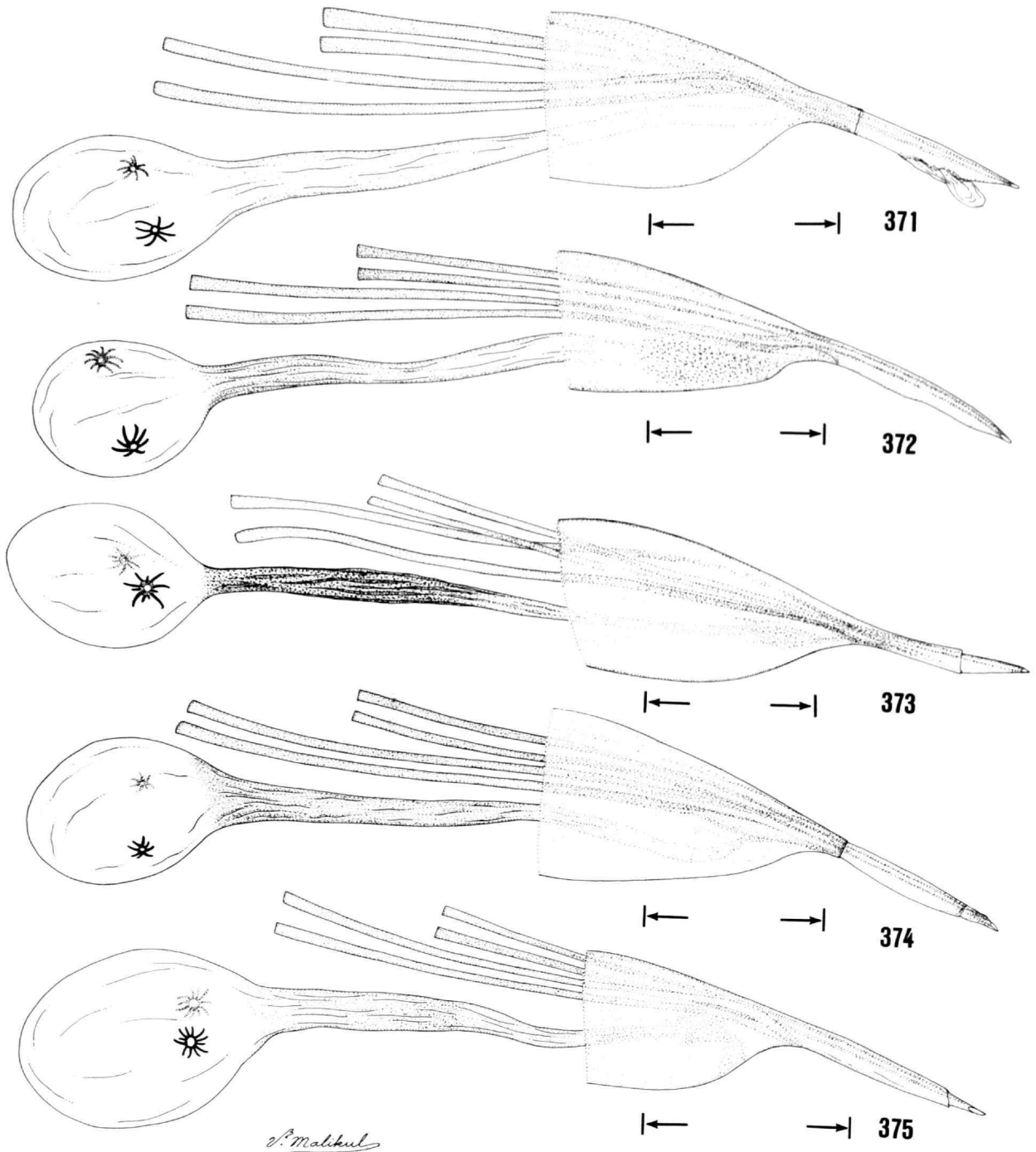

FIGURES 371-375.—Female genitalia, lateral view: 371, *Greya subalba*; 372, *G. solenobiella*; 373, *G. suffusca*; 374, *G. reticulata*; 375, *G. powelli*. (All scales = 0.5 mm.)

REQUIREMENTS FOR SMITHSONIAN SERIES PUBLICATION

Manuscripts intended for series publication receive substantive review (conducted by their originating Smithsonian museums or offices) and are submitted to the Smithsonian Institution Press with Form SI-36, which must show the approval of the appropriate authority designated by the sponsoring organizational unit. Requests for special treatment—use of color, foldouts, case-bound covers, etc.—require, on the same form, the added approval of the sponsoring authority.

Review of manuscripts and art by the Press for requirements of series format and style, completeness and clarity of copy, and arrangement of all material, as outlined below, will govern, within the judgment of the Press, acceptance or rejection of manuscripts and art.

Copy must be prepared on typewriter or word processor, double-spaced, on one side of standard white bond paper (not erasable), with 1¼" margins, submitted as ribbon copy (not carbon or xerox), in loose sheets (not stapled or bound), and accompanied by original art. Minimum acceptable length is 30 pages.

Front matter (preceding the text) should include: **title page** with only title and author and no other information, **abstract page** with author, title, series, etc., following the established format; table of **contents** with indents reflecting the hierarchy of heads in the paper; also, **foreword** and/or **preface**, if appropriate.

First page of text should carry the title and author at the top of the page; **second page** should have only the author's name and professional mailing address, to be used as an unnumbered footnote on the first page of printed text.

Center heads of whatever level should be typed with initial caps of major words, with extra space above and below the head, but no other preparation (such as all caps or underline, except for the underline necessary for generic and specific epithets). Run-in paragraph heads should use period/dashes or colons as necessary.

Tabulations within text (lists of data, often in parallel columns) can be typed on the text page where they occur, but they should not contain rules or numbered table captions.

Formal tables (numbered, with captions, boxheads, stubs, rules) should be submitted as carefully typed, double-spaced copy separate from the text; they will be typeset unless otherwise requested. If camera-copy use is anticipated, do not draw rules on manuscript copy.

Taxonomic keys in natural history papers should use the aligned-couplet form for zoology and may use the multi-level indent form for botany. If cross referencing is required between key and text, do not include page references within the key, but number the keyed-out taxa, using the same numbers with their corresponding heads in the text.

Synonymy in zoology must use the short form (taxon, author, year:page), with full reference at the end of the paper under "Literature Cited." For botany, the long form (taxon, author, abbreviated journal or book title, volume, page, year, with no reference in "Literature Cited") is optional.

Text-reference system (author, year:page used within the text, with full citation in "Literature Cited" at the end of the text) must be used in place of bibliographic footnotes in all Contributions Series and is strongly recommended in the Studies Series: "(Jones, 1910:122)" or "... Jones (1910:122)." If bibliographic

footnotes are required, use the short form (author, brief title, page) with the full citation in the bibliography.

Footnotes, when few in number, whether annotative or bibliographic, should be typed on separate sheets and inserted immediately after the text pages on which the references occur. Extensive notes must be gathered together and placed at the end of the text in a notes section.

Bibliography, depending upon use, is termed "Literature Cited," "References," or "Bibliography." Spell out titles of books, articles, journals, and monographic series. For book and article titles use sentence-style capitalization according to the rules of the language employed (exception: capitalize all major words in English). For journal and series titles, capitalize the initial word and all subsequent words except articles, conjunctions, and prepositions. Transliterate languages that use a non-Roman alphabet according to the Library of Congress system. Underline (for italics) titles of journals and series and titles of books that are not part of a series. Use the parentheses/colon system for volume (number): pagination: "10(2):5-9." For alignment and arrangement of elements, follow the format of recent publications in the series for which the manuscript is intended. Guidelines for preparing bibliography may be secured from Series Section, SI Press.

Legends for illustrations must be submitted at the end of the manuscript, with as many legends typed, double-spaced, to a page as convenient.

Illustrations must be submitted as original art (not copies) accompanying, but separate from, the manuscript. Guidelines for preparing art may be secured from Series Section, SI Press. All types of illustrations (photographs, line drawings, maps, etc.) may be intermixed throughout the printed text. They should be termed **Figures** and should be numbered consecutively as they will appear in the monograph. If several illustrations are treated as components of a single composite figure, they should be designated by lowercase italic letters on the illustration; also, in the legend and in text references the italic letters (underlined in copy) should be used: "Figure 9b." Illustrations that are intended to follow the printed text may be termed **Plates**, and any components should be similarly lettered and referenced: "Plate 9b." Keys to any symbols within an illustration should appear on the art rather than in the legend.

Some points of style: Do not use periods after such abbreviations as "mm, ft, USNM, NNE." Spell out numbers "one" through "nine" in expository text, but use digits in all other cases if possible. Use of the metric system of measurement is preferable; where use of the English system is unavoidable, supply metric equivalents in parentheses. Use the decimal system for precise measurements and relationships, common fractions for approximations. Use day/month/year sequence for dates: "9 April 1976." For months in tabular listings or data sections, use three-letter abbreviations with no periods: "Jan, Mar, Jun." etc. Omit space between initials of a personal name: "J.B. Jones."

Arrange and paginate sequentially every sheet of manuscript in the following order: (1) title page, (2) abstract, (3) contents, (4) foreword and/or preface, (5) text, (6) appendixes, (7) notes section, (8) glossary, (9) bibliography, (10) legends, (11) tables. Index copy may be submitted at page proof stage, but plans for an index should be indicated when manuscript is submitted.

