

A Review of the North American  
Freshwater Snail Genus  
*Fluminicola* (Hydrobiidae)

ROBERT HERSHLER  
and  
TERRENCE J. FREST

SMITHSONIAN CONTRIBUTIONS TO ZOOLOGY • NUMBER 583

## SERIES PUBLICATIONS OF THE SMITHSONIAN INSTITUTION

Emphasis upon publication as a means of "diffusing knowledge" was expressed by the first Secretary of the Smithsonian. In his formal plan for the institution, Joseph Henry outlined a program that included the following statement: "It is proposed to publish a series of reports, giving an account of the new discoveries in science, and of the changes made from year to year in all branches of knowledge." This theme of basic research has been adhered to through the years by thousands of titles issued in series publications under the Smithsonian imprint, commencing with *Smithsonian Contributions to Knowledge* in 1848 and continuing with the following active series:

*Smithsonian Contributions to Anthropology*  
*Smithsonian Contributions to Botany*  
*Smithsonian Contributions to the Earth Sciences*  
*Smithsonian Contributions to the Marine Sciences*  
*Smithsonian Contributions to Paleobiology*  
*Smithsonian Contributions to Zoology*  
*Smithsonian Folklife Studies*  
*Smithsonian Studies in Air and Space*  
*Smithsonian Studies in History and Technology*

In these series, the Institution publishes small papers and full-scale monographs that report the research and collections of its various museums and bureaux or of professional colleagues in the world of science and scholarship. The publications are distributed by mailing lists to libraries, universities, and similar institutions throughout the world.

Papers or monographs submitted for series publication are received by the Smithsonian Institution Press, subject to its own review for format and style, only through departments of the various Smithsonian museums or bureaux, where the manuscripts are given substantive review. Press requirements for manuscript and art preparation are outlined on the inside back cover.

I. Michael Heyman  
*Secretary*  
Smithsonian Institution

A Review of the North American  
Freshwater Snail Genus  
*Fluminicola* (Hydrobiidae)

*Robert Hershler  
and Terrence J. Frest*



SMITHSONIAN INSTITUTION PRESS

Washington, D.C.

1996

## ABSTRACT

Hershler, Robert, and Terrence J. Frest. A Review of the North American Freshwater Snail Genus *Fluminicola* (Hydrobiidae). *Smithsonian Contributions to Zoology*, number 583, 41 pages, 18 figures, 1996.—Species currently allocated to the northwestern North American genus *Fluminicola* Carpenter, 1864, comprise a morphologically diverse group that is shown to be paraphyletic based on a cladistic analysis of nominal species utilizing European *Lithoglyphus* Hartmann, 1821, and two eastern North American genera as outgroups. *Fluminicola* consists of a single, highly divergent species (*F. virens*) and a clade comprising all other congeners, which is defined by synapomorphic conditions of pedal ganglia and penis. Groups of species within the clade are united by derived modifications of shell protoconch microsculpture, operculum, central and lateral radular teeth, ctenidium, hypobranchial gland, penis, ovary, and female capsule gland.

A redefinition of *Fluminicola* in the wake of the above analysis cannot be provided until anatomical details of the type species (which may be extinct) are obtained. Nine Recent species currently are assigned to this group. These are *Fluminicola coloradensis*, distributed in the Green River basin; *F. dalli*, Pyramid Lake basin; *F. fuscus*, Snake-Columbia River basin; *F. minutissimus*, Snake River basin; *F. modoci*, Goose Lake basin; *F. nuttallianus*, Willamette River basin; *F. seminalis*, Sacramento and Pit river basins; *F. turbiniformis*, northwestern Great Basin; and *F. virens*, Willamette and lower Columbia river basins.

*Amnicola hindsii* Baird, 1863, *Fluminicola nuttalliana columbiana* Keep, 1887, and *Fluminicola columbiana* Pilsbry, 1899a, are junior synonyms of *F. fuscus* (Haldeman, 1841); *Lithoglyphus cumingii* Frauenfeld, 1863a, is a junior synonym of *F. seminalis* (Hinds, 1842); and *Paludina nuclea* Lea, 1838, is a junior synonym of *F. virens* (Lea, 1838). The genus-group taxon *Heathilla* Hannibal, 1912, is a synonym of *Fluminicola*.

OFFICIAL PUBLICATION DATE is handstamped in a limited number of initial copies and is recorded in the Institution's annual report, *Smithsonian Year*. SERIES COVER DESIGN: The coral *Montastrea cavernosa* (Linnaeus).

---

Library of Congress Cataloging-in-Publication Data

Hershler, Robert.

A review of the North American freshwater snail genus *Fluminicola* (Hydrobiidae) / Robert Hershler and Terrence J. Frest.

p. cm. — (Smithsonian contributions to zoology ; no. 583)

Includes bibliographical references (p.37).

1. *Fluminicola*. I. Frest, Terrence J. II. Title. III. Series.

QL1.S54 no. 583 [QL430.5.H9] 591 s—dc20 [594'.32] 96-15188

∞ The paper used in this publication meets the minimum requirements of the American National Standard for Permanence of Paper for Printed Library Materials Z39.48—1984.

# Contents

	<i>Page</i>
Introduction . . . . .	1
Materials and Methods . . . . .	2
Acknowledgments . . . . .	2
Character Descriptions . . . . .	2
Phylogenetic Reconstruction . . . . .	5
Superfamily RISSOIDEA Gray, 1847 . . . . .	6
Family HYDROBIIDAE Troschel, 1857 . . . . .	6
Subfamily LITHOGLYPHINAE Troschel, 1857 . . . . .	6
Genus <i>Flumicola</i> Carpenter, 1864 . . . . .	6
<i>Flumicola coloradensis</i> Morrison, 1940 . . . . .	8
<i>Flumicola dalli</i> (Call, 1884) . . . . .	9
<i>Flumicola fuscus</i> (Haldeman, 1841) . . . . .	10
<i>Flumicola minutissimus</i> Pilsbry, 1907 . . . . .	13
<i>Flumicola modoci</i> Hannibal, 1912 . . . . .	13
<i>Flumicola nuttallianus</i> (Lea, 1838) . . . . .	14
<i>Flumicola seminalis</i> (Hinds, 1842) . . . . .	15
<i>Flumicola turbiniformis</i> (Tryon, 1865) . . . . .	16
<i>Flumicola virens</i> (Lea, 1838) . . . . .	17
Appendix: Western American Fossil Species Described as or Allocated to <i>Flumicola</i> or <i>Lithoglyphus</i> . . . . .	20
Literature Cited . . . . .	37

## ABSTRACT

Hershler, Robert, and Terrence J. Frest. A Review of the North American Freshwater Snail Genus *Fluminicola* (Hydrobiidae). *Smithsonian Contributions to Zoology*, number 583, 41 pages, 18 figures, 1996.—Species currently allocated to the northwestern North American genus *Fluminicola* Carpenter, 1864, comprise a morphologically diverse group that is shown to be paraphyletic based on a cladistic analysis of nominal species utilizing European *Lithoglyphus* Hartmann, 1821, and two eastern North American genera as outgroups. *Fluminicola* consists of a single, highly divergent species (*F. virens*) and a clade comprising all other congeners, which is defined by synapomorphic conditions of pedal ganglia and penis. Groups of species within the clade are united by derived modifications of shell protoconch microsculpture, operculum, central and lateral radular teeth, ctenidium, hypobranchial gland, penis, ovary, and female capsule gland.

A redefinition of *Fluminicola* in the wake of the above analysis cannot be provided until anatomical details of the type species (which may be extinct) are obtained. Nine Recent species currently are assigned to this group. These are *Fluminicola coloradensis*, distributed in the Green River basin; *F. dalli*, Pyramid Lake basin; *F. fuscus*, Snake-Columbia River basin; *F. minutissimus*, Snake River basin; *F. modoci*, Goose Lake basin; *F. nuttallianus*, Willamette River basin; *F. seminalis*, Sacramento and Pit river basins; *F. turbiniformis*, northwestern Great Basin; and *F. virens*, Willamette and lower Columbia river basins.

*Amnicola hindsi* Baird, 1863, *Fluminicola nuttalliana columbiana* Keep, 1887, and *Fluminicola columbiana* Pilsbry, 1899a, are junior synonyms of *F. fuscus* (Haldeman, 1841); *Lithoglyphus cumingii* Frauenfeld, 1863a, is a junior synonym of *F. seminalis* (Hinds, 1842); and *Paludina nuclea* Lea, 1838, is a junior synonym of *F. virens* (Lea, 1838). The genus-group taxon *Heathilla* Hannibal, 1912, is a synonym of *Fluminicola*.

OFFICIAL PUBLICATION DATE is handstamped in a limited number of initial copies and is recorded in the Institution's annual report, *Smithsonian Year*. SERIES COVER DESIGN: The coral *Montastrea cavernosa* (Linnaeus).

---

Library of Congress Cataloging-in-Publication Data

Hershler, Robert.

A review of the North American freshwater snail genus *Fluminicola* (Hydrobiidae) / Robert Hershler and Terrence J. Frest.

p. cm. — (Smithsonian contributions to zoology ; no. 583)

Includes bibliographical references (p.37).

1. *Fluminicola*. I. Frest, Terrence J. II. Title. III. Series.

QL1.S54 no. 583 [QL430.5.H9] 591 s—dc20 [594'.32] 96-15188

∞ The paper used in this publication meets the minimum requirements of the American National Standard for Permanence of Paper for Printed Library Materials Z39.48—1984.

# Contents

	<i>Page</i>
Introduction . . . . .	1
Materials and Methods . . . . .	2
Acknowledgments . . . . .	2
Character Descriptions . . . . .	2
Phylogenetic Reconstruction . . . . .	5
Superfamily RISSOIDEA Gray, 1847 . . . . .	6
Family HYDROBIIDAE Troschel, 1857 . . . . .	6
Subfamily LITHOGLYPHINAE Troschel, 1857 . . . . .	6
Genus <i>Flumicola</i> Carpenter, 1864 . . . . .	6
<i>Flumicola coloradensis</i> Morrison, 1940 . . . . .	8
<i>Flumicola dalli</i> (Call, 1884) . . . . .	9
<i>Flumicola fuscus</i> (Haldeman, 1841) . . . . .	10
<i>Flumicola minutissimus</i> Pilsbry, 1907 . . . . .	13
<i>Flumicola modoci</i> Hannibal, 1912 . . . . .	13
<i>Flumicola nuttallianus</i> (Lea, 1838) . . . . .	14
<i>Flumicola seminalis</i> (Hinds, 1842) . . . . .	15
<i>Flumicola turbiniformis</i> (Tryon, 1865) . . . . .	16
<i>Flumicola virens</i> (Lea, 1838) . . . . .	17
Appendix: Western American Fossil Species Described as or Allocated to <i>Flumicola</i> or <i>Lithoglyphus</i> . . . . .	20
Literature Cited . . . . .	37





# A Review of the North American Freshwater Snail Genus *Fluminicola* (Hydrobiidae)

Robert Hershler  
and Terrence J. Frest

## Introduction

Hydrobiid snails of the genus *Fluminicola* Carpenter, 1864 (subfamily Lithoglyphinae), are among the more ubiquitous macroinvertebrates in large, lotic water bodies of northwestern North America. *Fluminicola* is a relatively small genus as measured by the number of nominal taxa now associated with the group, but malacologists have paid scant attention to these snails and their systematics is confused. In addition, virtually nothing is known about the morphology and biology of these animals.

Several species now allocated to *Fluminicola* were placed in *Lithoglyphus* Hartmann, 1821 (an otherwise European group), subsequent to their original description, and there is no modern consensus as to whether the North American genus merits distinction from the latter. Pilsbry (1935) stated that these genera differ in their penes and therefore did not advocate placement of North American species in *Lithoglyphus*. This opinion was shared by numerous subsequent workers (including Starobogatov, 1970; Burch, 1979, 1982; Thompson, 1984; Vaught, 1989; Banarescu, 1990, 1992). Taylor (1966a:131), however, found no "anatomical warrant" for the separation of the two genera and hence treated *Fluminicola* as a junior synonym of *Lithoglyphus*. He later reiterated this opinion (Taylor 1966b, 1981, 1985; Taylor and Smith, 1971), which has been accepted by at least two other workers (Clarke 1976, 1981; Beetle, 1989).

Additionally, the composition of *Fluminicola* has not been well clarified in the literature, and there are lingering problems

concerning the identity, taxonomic status, and limits of nominal forms. For instance, modern treatments of the small members of the genus have varied substantially: Taylor (1966a) placed *F. dalli* (Call, 1884) and *F. modoci* Hannibal, 1912, in synonymy with *F. turbiniformis* (Tryon, 1865), whereas Burch and Tottenham (1980) accepted *F. modoci* and *F. turbiniformis* as distinct (*F. dalli* is not treated in this work). In the only two papers (Stimpson, 1865b; Thompson, 1984) purporting to treat the morphology of the type species, *F. nuttallianus* (Lea, 1838), the exemplar material was not *F. nuttallianus* but was misidentified as this snail. Stimpson's early (1865b) study was based on specimens provided by Binney from an unspecified locality. The shell illustrated (Stimpson, 1865b, fig. 15) clearly is not *F. nuttallianus*, and, although we have not examined anatomical material for this (probably extinct) species, the figured penis (Stimpson, 1865b, fig. 16) is not similar to that of any snail we have studied from the historic range of this species in the Willamette River. Instead, it resembles penes of undescribed snails from the Klamath basin. In Thompson's (1984) recent review of the North American lithoglyphine genera, the three lots used to characterize *F. nuttallianus* are of undescribed species and *F. virens* (Lea, 1838).

Stabilization of the taxonomy of *Fluminicola* is especially desirable at this time because of the interest now being shown by land management agencies in the conservation of Pacific Northwest forest ecosystems within the range of the northern spotted owl, *Strix occidentalis caurina* (Merriam) (where many of these snails occur). One species, *F. fuscus* (Haldeman, 1841), has been a Federal Listing candidate since 1984 (USDI, 1984; as *Lithoglyphus columbianus* (Pilsbry)).

The purposes of this paper are to determine which nominal species of *Fluminicola* are recognizable and to assess the distinguishing features of these taxa. Based on a preliminary hypothesis that we propose for phylogenetic relationships within the genus, we conclude that although western American

---

Robert Hershler, Department of Invertebrate Zoology, NHB MRC 118, National Museum of Natural History, Smithsonian Institution, Washington, D.C. 20560. Terrence J. Frest, Deixis Consultants, 2517 NE 65th Street, Seattle, WA 98115.

lithoglyphines (traditionally allocated to *Fluminicola*) are distinct from European *Lithoglyphus*, they do not comprise a monophyletic group when eastern North American taxa are considered; instead, they represent two phylogenetically distinct clades. We cannot determine at this time which (if any) of these clades corresponds to *Fluminicola* as the anatomy of its type species is unknown (we have been unable to collect material for this presumably extinct animal). For the time being, we accept this group as a composite assemblage of western American lithoglyphines.

We hope that this paper will serve as a framework for future descriptive studies as many novelties in this group await the attention of systematists, and large geographic regions in the Northwest still have not been thoroughly surveyed for these animals. We acknowledge that our concept of nominal species of *Fluminicola* will likely change somewhat as additional anatomical material (for records based on dry shells) becomes available for study. The three groups of taxa most in need of scrutiny in this regard are the large snails from the coastal drainages of Oregon and Washington (often assigned to *F. nuttallianus* or *F. virens* in the literature or in museum collections); the small snails from the northwest Great Basin and adjacent regions in California and Oregon (assigned to *F. turbiniformis* by Taylor, 1966a, fig. 9); and the large snails from the northeastern Great Basin and portions of southern Idaho and southwestern Wyoming (assigned to *F. hindsii* [sic] (Baird) by Taylor, 1966a, fig. 14).

Recent nominal species of *Fluminicola* now assigned to *Pyrgulopsis* are not treated herein (for summary of these see Hershler, 1994). We also do not address fossil taxa associated with this genus (beyond their listing in the Appendix), given the difficulty in clarifying systematic relationships of hydrobiid snails solely on the basis of empty shells.

**MATERIALS AND METHODS.**—*Fluminicola* species were characterized based on examination of type and other dry museum material and on anatomical study of topotypes or other available specimens. Anatomical material used as exemplars to characterize species is listed at the end of the "Remarks" sections (other alcohol lots were examined more cursorily). Acronyms for institutional repositories of examined specimens are those of Leviton et al. (1985). Lots that include alcohol material are indicated in the "Material Examined" sections by asterisks. Anatomical study was of alcohol-preserved snails that had been relaxed with menthol crystals and fixed in dilute (4%) formalin. Methods of morphological study are those of Hershler (1994). The phylogenetic analysis was performed using HENNIG86 (Farris, 1988). Character-state evolution on the tree generated was studied using CLADOS (Nixon, 1992).

Because anatomical material was not available for the type species *F. coloradensis* Morrison, 1940, was used instead to illustrate details pertaining to the genus generally (the shells of these two species are closely similar). Type and nontype shells, shell protoconch, operculum, radula, penis, distal female genitalia, and geographic distribution are illustrated for each species.

**ACKNOWLEDGMENTS.**—We thank the following individuals (and their respective institutions) for lending material pertinent to this study: G. Rosenberg and D. Bardes (ANSP), F. Naggs and J. Freeman (BMNH), T. Gosliner and E. Kools (CAS), F.G. Thompson (FSM), K. Boss and T. Kausch (MCZ), and K. Edlinger and the late E. Wawra (NMW). We also thank the following individuals for the donation of specimens pertinent to this study and/or for assistance in the field: D. Clark (Portland General Electric, Oregon City), M. Haase (NMW), P. Hovingh (Salt Lake City, Utah), E. Johannes (Deixis Consultants, Seattle), D. Sada (Bishop, California), S. Welty (Dubois, Wyoming), and G. Vinyard (University of Nevada, Reno). We thank E. Coan (CAS), A. Kabat (Invertebrate Zoology, National Museum of Natural History, Smithsonian Institution (NMNH)), F. Naggs, and G. Steyskal (FSM) for their input pertaining to taxonomic, nomenclatural, or other problems in this genus. We also thank two anonymous reviewers for their comments on the manuscript.

Scanning electron micrographs were taken by Susanne Braden, Scanning Electron Microscopy Laboratory (NMNH), and prints of these were prepared by Victor Krantz and the staff of the Office of Printing and Photographic Services (NMNH). Victor Krantz photographed and prepared prints of shells. Maps and illustrations were prepared by M. Ryan (Invertebrate Zoology, NMNH) and S. Escher (Front Royal, Virginia).

Partial support for fieldwork and laboratory studies was provided by awards to the first author from the Smithsonian Institution Research Opportunities Fund and Scholarly Studies Program. The second author's California fieldwork in part was supported by the California Department of Fish and Game.

### Character Descriptions

A preliminary elucidation of phylogenetic relationships within *Fluminicola* was derived using a data set of 27 characters (56 character states) for the seven congeners for which anatomical material was available, plus three outgroups. We used as the prime outgroup (occupying basal positions on generated trees) the genus *Lithoglyphus* (as exemplified by its type species, *Paludina naticoides* Pfeiffer, 1828), to which *Fluminicola* has been most closely allied in the recent literature. Data for *L. naticoides* were obtained from the literature (as referenced below) and from study of a single lot of relaxed anatomical material (River March, Austria, USNM 883415). We used as additional outgroups the type species of the eastern North American lithoglyphine genera *Gillia* Stimpson, 1865a (*Melania atilis* Lea, 1841), and *Somatogyrus* Gill, 1863 (*Amnicola depressa* Tryon, 1864a). Data for these species were obtained from Thompson (1984) and from the study of available anatomical material (*G. atilis*, Lake Waccamaw, Columbus County, North Carolina, UF 27550; *S. depressus*, Cedar River, near Osage, Mitchell County, Iowa, USNM 883757). Character states found in the prime outgroup were treated as plesiomorphic (i.e., if also found in *Fluminicola*). Multistate characters were treated as unordered.

Characters are discussed below. Derived states are illustrated in association with the species description section unless otherwise stated.

**SHELL.**—Characters are protoconch microsculpture (character 1) and shell umbilicus (character 2).

Protoconchs are variable within *Fluminicola*, with sets of species having either of two conditions involving spiral microsculpture. Two small species (*F. dalli*, *F. turbiniformis*) have protoconchs sculptured with weakly developed spiral striae (state 1), whereas *Gillia*, *Somatogyrus*, and other *Fluminicola* have strong spiral lines (state 2). *Lithoglyphus*, by contrast, has a completely smooth protoconch (Falniowski, 1990, figs. 121, 122). In this analysis, we treat both of the conditions seen in *Fluminicola* as derived because the smooth protoconch of the outgroup also is considered primitive among hydrobiid snails generally (Falniowski, 1991). All *Fluminicola* species except *F. coloradensis* and *F. fuscus* share a derived condition in which the umbilical region often has a well-developed axial ridge; the outgroups and latter two species have a simple umbilical region.

**OPERCULUM.**—Characters are thickening of attachment-scar margin (character 3) and rim development along outer edge of operculum (character 4).

*Fluminicola modoci* and *F. seminalis* (Hinds, 1842) share a derived condition in which the scar margin is strongly thickened. The outgroups and all other species have a weak or unthickened attachment scar. A derived condition in which the outer edge of the operculum has a well-developed rim (state 1) is shared by *F. coloradensis* and *F. fuscus* (plus *Gillia* and *Somatogyrus*). Other species of *Fluminicola* and *Lithoglyphus* have a weakly developed rim (state 0) (or lack one entirely).

**CENTRAL RADULAR TEETH.**—Characters are dorsal indentation of tooth (character 5), width of central cusp (character 6), and number of basal cusps (character 7).

*Fluminicola coloradensis* and *F. fuscus* share a derived condition in which the dorsal edge of the central tooth is only slightly concave. The outgroups and other *Fluminicola* have a moderate to strong dorsal indentation. These same two species also share with *F. seminalis* a derived condition in which the central cusp is very broad. The outgroups and other *Fluminicola* have a narrow to medium-wide central cusp. *Fluminicola dalli* and *F. turbiniformis* share a derived condition in which only a single pair of basal cusps is present on the central tooth. The outgroups and other *Fluminicola* have at least two pairs of basal cusps.

**LATERAL RADULAR TEETH.**—Characters are width of central cusp (character 8) and tooth shaft length (character 9).

As with the central tooth, *F. coloradensis* and *F. fuscus* share a derived condition in which the central cusp is especially broad. The outgroups and other *Fluminicola* have a narrow to medium-wide central cusp. Five species (*F. dalli*, *F. modoci*, *F. seminalis*, *F. turbiniformis*, *F. virens*) plus *Gillia* and *Somatogyrus* have a derived condition in which the length of the lateral tooth shaft is greater than the height of the tooth face (state 1).

*Lithoglyphus* and other *Fluminicola* have a shaft that is shorter than the tooth face (state 0).

**MARGINAL RADULAR TEETH** (character 10).—Three species (*F. dalli*, *F. modoci*, *F. turbiniformis*) have a derived condition of numerous cusps (>20) on the inner marginal teeth, whereas the outgroups and other *Fluminicola* have no more than 17 cusps on this tooth.

**CEPHALIC TENTACLES.**—Characters are length of tentacles relative to snout (character 11) and dorsal pigmentation of tentacles (character 12).

Short, almost stubby tentacles (Figure 1A-D) represent a synapomorphy for the group consisting of *Fluminicola*, *Gillia*, and *Somatogyrus*. *Lithoglyphus*, by contrast, has tentacles that are much longer than the snout (Krause, 1949, fig. 4). All *Fluminicola* (plus *Somatogyrus*) except *F. virens* have a derived condition in which dorsal tentacle pigmentation is diffuse or uniform (not illustrated). *Lithoglyphus*, *Gillia*, and *F. virens* have a completely different pigment pattern consisting of an elongate, longitudinal band on each tentacle.

**CTENIDIUM.**—Characters are posterior extent of ctenidium relative to pericardium (character 13) and condition of faces of ctenidial filaments (character 14).

*Fluminicola dalli* and *F. turbiniformis* have a derived condition in which the ctenidium ends well anterior to the pericardium (see Ponder et al., 1993, fig. 2a for illustration of this state). In the outgroups and in other *Fluminicola*, the ctenidium overlaps the pericardium posteriorly (Figure 2). Three species (*F. dalli*, *F. seminalis*, *F. turbiniformis*) have a derived condition in which the faces of the ctenidial filaments are smooth (not illustrated). The outgroups and other *Fluminicola* have prominent pleats on the faces.

**HYPOBRANCHIAL GLAND** (character 15). *Fluminicola dalli* and *F. turbiniformis* have a derived condition in which the posterior portion of the hypobranchial gland is thin (not illustrated). The outgroups and other *Fluminicola* have a pronounced posterior swelling of the hypobranchial gland.

**CEPHALO-PEDAL GANGLIA.**—Characters are length of pedal commissure (character 16) and pigmentation of ganglia (character 17).

All *Fluminicola* except *F. virens* have derived conditions in which the pedal commissure is elongate relative to the width of the pedal ganglia (i.e., more than 50% of ganglion width), and in which all cephalo-pedal ganglia are pigmented (neither state illustrated). The outgroups and *F. virens* have a much shorter commissure and have unpigmented ganglia.

**TESTIS** (character 18).—A relatively small testis, which fills no more than 67% of the length of the visceral coil behind the stomach, is a derived condition shared by *Fluminicola* and *Somatogyrus* (not illustrated). *Lithoglyphus* and *Gillia*, by contrast, have an elongate testis that extends virtually to the apical tip of the animal. (The very small testis diagrammatically illustrated by Krause (1949, fig. 22) for *L. naticoides* is an error.)

**PENIS.**—Characters are penis shape (character 19) and folding of dorsal surface (character 20).

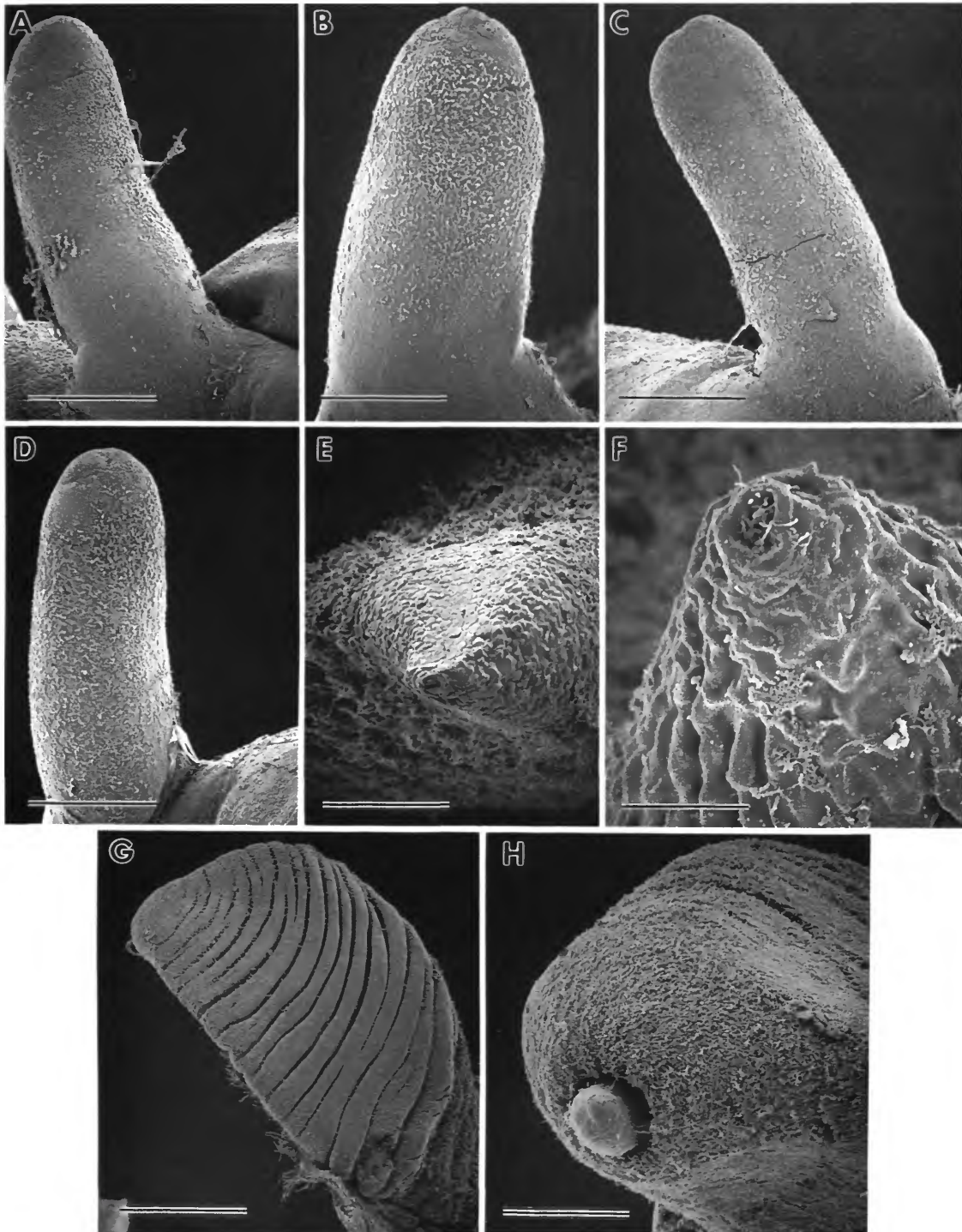

FIGURE 1.—Critical-point-dried tentacles and penes of *Fluminicola* species. A–D, tentacles, *F. coloradensis*, USNM 883493: A, left tentacle, dorsal surface (bar = 0.33 mm); B, left tentacle, ventral surface (bar = 0.33 mm); C, right tentacle, dorsal surface (bar = 0.33 mm); D, right tentacle, ventral surface (bar = 0.33 mm). E,F, penis, *F. coloradensis*, USNM 883493: E, distal penis (bar = 50 µm); F, distal tip (bar = 15 µm). G,H, penis, *F. virens*, USNM 883673: G, dorsal aspect (bar = 0.38 mm); H, distal tip (bar = 100 µm).

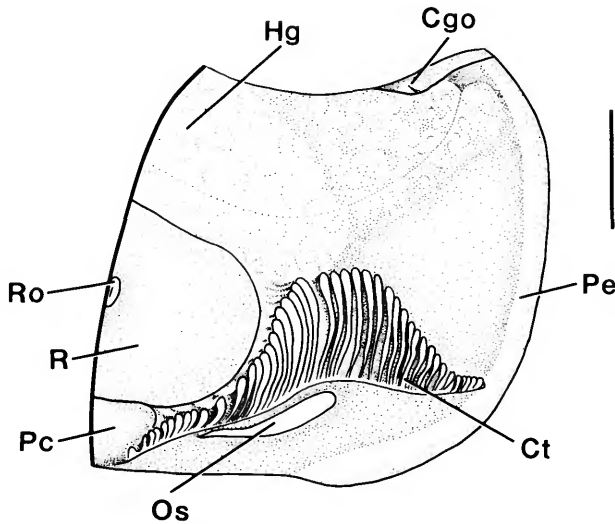

FIGURE 2.—Contents of pallial cavity of *Fluminicola coloradensis*, USNM 883493 (bar = 1.0 mm). Pallial roof has been separated from the head-foot. Note the large pallial portion of the renal organ and the ctenidium overlapping the pericardium posteriorly. The hypobranchial gland covers the rectum and capsule gland (except for its opening) and is swollen posteriorly (lighter stipple). (Cgo = capsule gland opening; Ct = ctenidium, Hg = hypobranchial gland, Os = osphradium, Pc = pericardium, Pe = pallial edge; R = renal organ; Ro = opening of renal organ.)

Penial shape is variable within *Fluminicola*. All but two species have a sickle-shaped penis that is a derived state (state 1); *F. dalli* has a uniquely elongate penis that also is derived (state 2). The outgroups (Bole, 1982, fig. 4; Thompson, 1984, fig. 51; Falniowski, 1987, fig. 31) and *F. virens* have a stout, broadly triangular penis that is nearly straight. A very weakly folded or smooth dorsal surface is a derived condition shared by most species of *Fluminicola*. The outgroups and three of the larger species (*F. coloradensis*, *F. fuscus*, *F. virens*) have a strongly folded surface.

**OVARY** (character 21).—A very small ovary, filling less than 25% of the length of the visceral coil behind the stomach, is a derived condition shared by *F. dalli* and *F. turbiniformis* (not illustrated). The outgroups and other *Fluminicola* have a much larger ovary that fills 33%–50% of the visceral coil behind the stomach.

**BURSAL DUCT**.—Characters are insertion of duct into bursa copulatrix (character 22) and length of duct (character 23).

Three species (*F. modoci*, *F. seminalis*, *F. virens*) have a derived condition in which the bursal duct inserts into or near the middle of the long axis of the bursa copulatrix. In the outgroups and in other *Fluminicola*, the duct inserts into the tip of the long axis of the bursa copulatrix. All *Fluminicola* (plus *Gillia*) except *F. coloradensis* and *F. virens* have a derived condition consisting of a short bursal duct (relative to length of bursa copulatrix). The latter two species as well as *Litho-*

*glyphus* and *Somatogyrus* have a relatively elongate bursal duct.

**SEMINAL RECEPTACLE** (character 24).—Three species (*F. modoci*, *F. seminalis*, *F. turbiniformis*) share a derived condition in which the seminal receptacle overlaps the bursa copulatrix. In the outgroups and in other *Fluminicola*, the seminal receptacle is anterior to the bursa copulatrix.

**GLANDULAR OVIDUCT**.—Characters are development of rectal furrow (character 25), shape of genital opening (character 26), and development of anterior vestibule (character 27).

Three species (*F. coloradensis*, *F. fuscus*, *F. seminalis*) share a derived condition consisting of a deep rectal furrow along the length of the glandular oviduct. In the outgroups and in other *Fluminicola*, the furrow is either very shallow or absent. *Fluminicola coloradensis* and *F. fuscus* share a slit-like genital opening and a well-developed anterior vestibule that are derived character states. The outgroups and other *Fluminicola* have a simple, pore-like genital opening and have a weakly developed or absent anterior vestibule.

### Phylogenetic Reconstruction

The small size of the data set permitted use of an exact method of calculating trees (the “ie” option of HENNIG86), which yielded two fully resolved and maximally parsimonious trees of 41 steps that have a consistency index of 0.70 and a retention index of 0.75. One of these trees is shown in Figure 3. The other tree was identical in topology except that the near-basal branches that terminate in *F. virens* and *Gillia altilis* were swapped.

Homoplasy and/or reversals are associated with 11 of the 27 characters. For eight characters (2, 6, 10, 14, 22–25), a single parallelism is involved; for one character (9), a single reversal is involved. Character 4 exhibits two reversals on the illustrated tree, but it has only a single reversal on the second tree. Character 18 is a synapomorphy on the illustrated tree, but it is reversed on the second tree.

The cladistic analysis reveals that the North American lithoglyphines that we studied are distinguished from European *Lithoglyphus* by two nonhomoplastic synapomorphies (protoconch with spiral microsculpture, short cephalic tentacles). Among the North American lithoglyphines, western American species (allocated to *Fluminicola*) do not comprise a monophyletic group. Note, however, that with the exception of *F. virens*, other members of *Fluminicola* do comprise a clade united by two nonhomoplastic synapomorphies (elongate pedal commissure, sickle-shaped or elongate penis).

Within this group of six species, *F. coloradensis* and *F. fuscus* comprise a basal clade united by four nonhomoplastic synapomorphies (weak dorsal indentation of central radular teeth, broad central cusp of lateral radular teeth, slit-like genital opening, well-developed anterior vestibule of capsule gland). The other four species are united by a single nonhomoplastic synapomorphy (a weakly folded or smooth dorsal penis). Within this group, *F. dalli* and *F. turbiniformis* comprise a

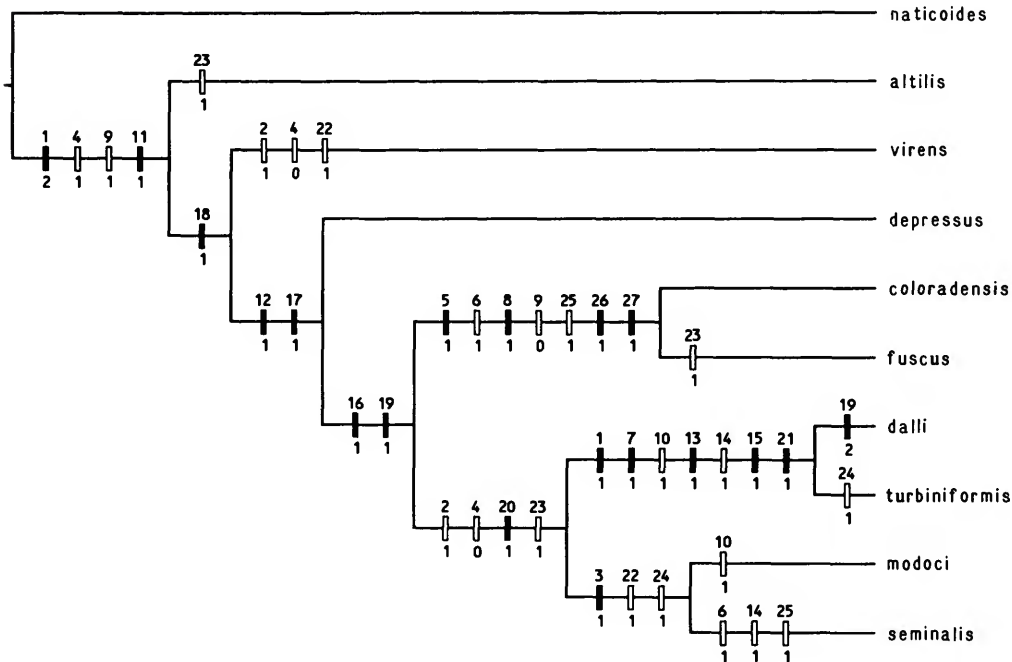

FIGURE 3.—Cladogram for *Fluminicola* species plus three outgroups (*Lithoglyphus naticoides*, *Gillia attilis*, and *Somatogyrus depressus*). White bars indicate character state transformations supporting nodes, with character number given above and state indicated below. Black bars indicate unreversed synapomorphies.

well-differentiated clade united by five nonhomoplastic synapomorphies (weak spiral lines on shell protoconch, single pair of basal cusps on central radular teeth, short ctenidium, thin posterior portion of hypobranchial gland, small ovary). *Fluminicola modoci* and *F. seminalis* comprise a second clade supported by a single nonhomoplastic synapomorphy (strongly thickened opercular attachment-scar margin).

#### Superfamily RISSOIDEA Gray, 1847

#### Family HYDROBIIDAE Troschel, 1857

#### Subfamily LITHOGLYPHINAE Troschel, 1857

#### Genus *Fluminicola* Carpenter, 1864

*Fluminicola* Carpenter, 1864:676 [type species: *Paludina nuttalliana* Lea, 1838; original designation.]

*Heathilla* Hannibal, 1912:186 [type species: *Paludina seminalis* Hinds, 1842; original designation.]

*Fluminicola* is a morphologically diverse assemblage of northwestern North American lithoglyphine snails that vary widely in size. This group, as currently constituted, is probably paraphyletic (see "Phylogenetic Reconstruction," above) and is not readily distinguishable from several eastern North American lithoglyphine genera, hence a diagnosis is not provided herein.

**DESCRIPTION.**—Shell usually globose to trochoid, rarely ovate- or narrow-conic; height 2.5–12.0 mm; whorls 3.5–5.0. Protoconch of 1.25–1.50 whorls; diameter 0.6–1.0 mm; microsculpture of numerous spiral striae. Teleoconch whorls convex or (rarely) nearly flat; whorls shouldered, sometimes with broad sutural shelf. Microsculpture of collabral growth lines and occasional weak spiral striae or scratches. Periostracum brown, green, tan, or red. Shell opaque-translucent, clear white, grey, or pink. Aperture usually large, ovate-lunate, rounded below, narrowed above. Outer lip prosocline, straight or weakly sinuate, usually thin. Parietal lip usually complete, variably thickened, adnate or slightly detached. Columellar lip usually thick; columellar swelling usually broad, often covering umbilical region. Umbilical region sometimes excavated, with adaxial ridge. Shell anomphalous or with small umbilicus.

Operculum ovate-ellipsoidal, amber, of thin to medium thickness, nearly flat, dorsal surface frilled, nucleus eccentric. Outer margin of operculum sometimes with obvious rim. Attachment-scar margin variably thickened. Callus nearly absent to strongly developed.

Radula with about 60–90 rows of teeth; ribbon elongate; central tooth width 30–100  $\mu$ m. Central tooth trapezoidal; dorsal edge weakly to strongly indented; lateral cusps 2–5; median cusp dagger or U-shaped, enlarged relative to laterals; basal cusps 1–3, originating from lateral angles or tooth face,

innermost cusp largest; basal tongue well developed, basal sockets usually well excavated; lateral angles thickened, inclined at about 45°–50°, not extending beyond base of tooth. Lateral tooth with flexed shaft; shaft as long as or longer than height of tooth face; dorsal edge of tooth convex to concave; cutting edge comprising 35%–60% of tooth width; tooth face usually taller than wide; shaft inclined about 30°–40°; basal tongue knob-like; central cusp U-shaped, lateral cusps 2–5. Inner marginal teeth with 7–27 cusps; outer marginal teeth with 6–29 cusps.

Epithelial body pigmentation usually well developed. Tentacles usually with pale to light patch surrounding eyes. Pallial roof and visceral coil usually black.

Snout squat; distal lobation pronounced. Tentacles short, parallel sided, and well ciliated (more so on ventral surfaces) but without well-defined tracts; eyelobes weakly developed. Foot narrowly ovate, anterior end convex, lateral wings well developed, posterior end rounded; anterior mucous gland of numerous similar-sized glands.

Ctenidium extending almost entire length of pallial cavity, often overlapping pericardium posteriorly; filaments about 16–40, well developed, broadly to narrowly triangular, usually pleated, apices on right, free edge usually concave. Osphradium usually narrow, about 30%–50% of ctenidium length, centered posterior to middle of ctenidial axis, anterior end simple or weakly hooked. Hypobranchial gland thin on pallial roof, thicker on rectum and genital ducts, often swollen proximally. Rectum nearly straight, broadly overlapping genital ducts, fecal pellets usually longitudinal; anus near pallial edge, slightly anterior to anterior end of capsule gland. Renal organ with 40%–60% of length in pallial roof, sometimes greatly swollen; renal gland horizontal, on left side of renal organ; renal opening small, usually white. Pericardium slightly bulging into pallial cavity. Buccal mass filling length of snout. Salivary glands simple, narrow, usually overlapping cerebral ganglia. Stomach about as long as style sac; posterior caecum absent. Cerebral and pedal commissures usually elongate (more than 50% of ganglia width); right pleural and supraesophageal ganglia abutting. Ganglia usually pigmented. Body spaces with relatively little connective tissue.

Testis more than 1.0 whorl, of multiple branches connected by narrow vas efferens and bearing grape-like clusters of lobes, usually overlapping posterior stomach chamber and filling about 50% of visceral coil behind stomach. Seminal vesicle of numerous coils, abutting stomach beneath anterior 25%–50% of testis. Prostate gland with about 33% of length in pallial roof, bean-shaped, oval in section, of complexly folded cells; vas deferens opening just in front of pallial wall near anterior end of gland. Vas deferens straight or slightly undulating, rarely coiled in pallial roof and neck. Penis of variable size, narrowly elongate to sickle-shaped, weakly curved to tightly coiled, unlobed, surface variably folded, usually gently tapering along basal and medial portions; distal portion either simply tapering or with subterminal constriction followed by

pointed tip or papilla. Dorsal penis usually moderately ciliated (rarely unciliated); cilia often dense near distal tip. Penial duct near center, muscular, of narrow to medium width, often undulating along most of length. Dorsal penis lightly to darkly pigmented along most of length; subepithelial pigment usually well developed along length of penial duct.

Females oviparous; egg capsules large, hemispherical (Stimpson's (1865b, fig. 17) early illustration of compound egg capsules was obviously based on pulmonate material). Ovary of compound lobes, 0.25–1.0 whorl, positioned behind posterior edge of stomach and filling up to 50% of visceral coil behind stomach. Coiled oviduct usually having inverted U-shape, positioned slightly behind pallial wall and anterior to bursa copulatrix; usually unpigmented, bound in connective tissue, surface of irregular appearance; posterior arm of primary coil often swollen with sperm; proximal portion usually with 1–2 small secondary twists or coils; distal portion short, straight. Coiled oviduct and bursal duct join slightly to well behind pallial wall; oviduct opening to albumen gland ventrally. Bursa copulatrix about 33%–67% of albumen gland length, ovate-pyiform, rarely globular, positioned on right side of albumen gland, part or most of length posterior to gland, long axis perpendicular to gland. Bursal duct short to elongate, narrow, deeply imbedded in albumen gland, issuing from ventral tip to near midpoint of long axis of organ. Seminal receptacle small, pouch-like, usually unpigmented; positioned on left side of albumen gland (although edge often partly or entirely overlapped by gland) near ventral edge, usually at or near posterior edge, anterior to or slightly overlapping bursa copulatrix; duct very short. Pallial gonoduct of complexly folded cells and with shallow to deep rectal furrow. About 17%–50% of albumen gland lying in front of posterior pallial wall. Capsule gland of 2 tissue sections (anterior section much shorter), usually narrower than albumen gland. Ventral channel sometimes with short anterior vestibule. Genital opening a pore or short slit, subterminal to terminal.

**DISTRIBUTION AND ECOLOGY.**—Northwestern North America, including portions of the northern Great Basin, Snake-Columbia River system, Sacramento River system, and Pacific coastal drainages (British Columbia, California, Idaho, Nevada, Oregon, Utah, Washington, Wyoming). Early Yellowstone River and South Dakota records (Henderson, 1935, 1936a) require confirmation.

*Fluminicola* are usually found in clear, cold waters with high dissolved oxygen content. Large species are typically found in streams, whereas smaller species are commonly found in either spring or stream environments. Many taxa are apparently lithophiles and graze on periphyton. Often, species in this genus appear to be community dominants, comprising most of the invertebrate biomass. *Fluminicola* are fairly intolerant of impounded waters and soft substrates as well as of nutrient-enhanced or lacustrine habitats. Although the free-flowing, oligotrophic waters where these animals thrive were once ubiquitous throughout the historic range of the genus, the genus

is apparently now extirpated from large areas (e.g., much of the Columbia and Snake river drainages and the Olympic Peninsula) owing to human-related activities. Note that only relatively small reaches of the Columbia River system remain free flowing.

**FOSSIL RECORD.**—Based on fossil species that may belong to this genus (Appendix), a Miocene (or earlier) origin is inferred. Taylor (1966b:160) observed that several Recent species are known from the Pliocene.

**SPECIES OF UNCERTAIN STATUS.**—Taylor (1975a) allocated *Bithynia perfecta* Frauenfeld, 1862 (Recent, Columbia, North America; see Frauenfeld, 1865, pl. IX: unnumbered fig.), and its subspecies *dubitata* (see Frauenfeld, 1865, pl. IX: unnumbered fig.) to *Lithoglyphus*, presumably on the assumption that the type localities referred to British Columbia. Type material for these taxa (MNW uncat.) do not closely resemble any North American material for *Fluminicola* that we have seen and, instead, they are more similar to South American *Potamolithus* Pilsbry in Pilsbry and Rush, 1896. We reserve further judgment of these taxa pending collection and study of anatomical material.

**REMARKS.**—Carpenter (1864:676) introduced *Fluminicola* in reference to an unpublished work of Stimpson (“*Fluminicola* [Stimpson, MS] *nutallii*”) and did not include a description. Nevertheless, his genus was validly described as he provided an indication by using the name in combination with an available species-group name (International Commission on Zoological Nomenclature (ICZN), Article 12b[5]). Authorship of this genus name has invariably been attributed in the literature to Stimpson (1865a:52–53), who provided a full description. Carpenter based the genus on the same type species as did Stimpson, and the concept of *Fluminicola* is not altered as a result of this authorship change.

Hannibal (1912) distinguished his subgenus *Heathilla* by its more globose shell, shorter spire, more rapid teleoconch expansion rate, and shallower sutures; he placed five species in this group (*F. columbiana*, *F. fusca*, *F. modoci*, *F. seminalis*, *F. virens*). This assemblage actually encompasses a much broader range of shell morphologies than implied above, and there is no justification for such a subgeneric grouping based on our phylogenetic hypothesis.

Yen (1944) distinguished fossil *Pilsbryus* (type species *Lithasia antiqua* Gabb, 1866; original designation) from *Fluminicola* (and *Lithoglyphus*) by its smaller, more depressed spire, retreating outer lip, thicker parietal and columellar lips, naticoid appearance, and thicker shell. Although Taylor (1966b) later placed *Pilsbryus* as a junior synonym of *Lithoglyphus* (including *Fluminicola*), we concur with Yen's assessment and accept the former as distinct.

Stimpson (1865b) placed *Fluminicola* in his broadly conceived subfamily Hydrobiinae. Tryon (1866), in a review of Stimpson's paper, instead advocated placement of the genus in the Lithoglyphinae, which has been accepted by most subsequent authors (including Fischer, 1883; Walker, 1918;

Taylor, 1966b; Burch 1978, 1979; Thompson, 1984; Vaught, 1989). Clessin (1880) erected the Fluminicolinae to accommodate *Fluminicola* and similar-shelled taxa (including *Lithoglyphus*). This taxon has been little used in the literature (but see Starobogatov, 1970) and is now considered equivalent to the Lithoglyphinae (Ponder and Warén, 1988). Thiele (1928, 1929) instead placed *Fluminicola* in the Amnicolinae, which was accepted by Wenz (1939).

Thompson (1984) reviewed the North American lithoglyphine genera and postulated a close relationship between *Fluminicola* and *Gillia* based on a phenetic analysis (Thompson, 1984, fig. 58, table 2). Characters linking these two genera were large size, narrowly umbilicate shell, penial papilla, large central cusps of central and lateral radular teeth, and vertical shaft of the lateral radular tooth. Note, however, that these features are not characteristic of most species now assigned to *Fluminicola*: e.g., only *F. virens* has a (eversible) penial papilla, and the shaft of the lateral tooth is flexed (not vertical) in all of these species.

#### *Fluminicola coloradensis* Morrison, 1940

*Fluminicola fusca*.—Binney, 1865:92 [in part].—Ingersoll, 1875:127 [in part].—Pilsbry, 1899a:123 [in part].—Orcutt 1901a:35 [in part].—Henderson, 1924:192 [in part].—Chamberlin and Jones, 1929:180 [in part].—Henderson, 1935:107 [in part]; 1936a:139 [in part].—Beetle, 1961:5.  
*Fluminicola coloradoense* Morrison, 1940:125 [in part; holotype: USNM 526631; type locality: Green River, Wyoming].—Taylor, 1966a:34, fig. 14 [as synonym of *L. hindsi*].—Rosewater, 1984:3.—Beetle, 1989:639 [as synonym of *L. hindsi*].

*Lithoglyphus hindsi* [sic].—Taylor, 1966a:34, fig. 14 [in part].

*Lithoglyphus coloradoensis*.—Taylor, 1975a:60.

*Fluminicola hindsi*.—Burch and Tottenham, 1980:102 [in part].

*Lithoglyphus hindsi*.—Taylor, 1985:306 [in part].—Beetle, 1989:639 [in part].

**DIAGNOSIS.**—Large with subglobose to broadly conical shell; penis of medium size, sickle-shaped.

A pigmented seminal receptacle (and occasionally a pigmented coiled oviduct) is unique to this species among members of the genus. *Fluminicola coloradensis* is further distinguished from sister taxon *F. fusca* by the grey white shell color, absence of either pronounced subsutural angulation or keel on body whorl, weaker operculum callus, frequent presence of third pair of basal cusps on central radular teeth, bulbous distal penis, longer bursal duct, and greater overlap of seminal receptacle by albumen gland.

**DESCRIPTION.**—Shell (Figures 4A, 5A–D) subglobose to broadly conical; height 6.5–10.8 mm; whorls 3.5–4.5. Protoconch (Figure 6A) of 1.5 whorls; diameter about 1.0 mm; microsculpture of numerous, sometimes anastomosing, strong spiral striae. Teleoconch whorls convex, shouldered, often with broad sutural shelf. Microsculpture of collabral growth lines and occasional weak spiral striae or scratches. Periostracum tan. Shell opaque, grey white. Aperture large, broadly lunate, narrowed above. Outer lip usually thick. Parietal lip complete, usually thick, adnate or rarely slightly detached. Columellar lip



thick, columellar swelling broad, often covering umbilical region. Shell anomphalous, cryptomphalous, or with small umbilicus.

Operculum (Figure 7A) of medium thickness; outer margin with obvious rim. Outer edge of attachment-scar margin slightly thickened, inner edge unthickened. Callus weak or absent.

Radula (Figure 8A-C) with about 65 rows of teeth; ribbon length 3.0 mm, ribbon width 0.3 mm; central tooth width 95  $\mu$ m. Central tooth with slight dorsal indentation; lateral cusps 2-3; median cusp broadly U-shaped, slightly broader and longer than laterals; basal cusps 2-3, narrow, originating near dorsal edge of lateral angles; basal tongue medium wide, basal sockets moderately excavated; lateral angles thickened. Lateral tooth with convex dorsal edge, very slightly indented centrally; dorsal edge about 50% of tooth width; lateral shaft shorter than height of tooth face; tooth face taller than wide; central cusp broadly U-shaped, lateral cusps 3 (sometimes 4 on outer side). Inner marginal teeth with 9-11 cusps; outer marginal teeth with 10-11 cusps.

Brown black pigment well developed on snout and tentacles (except for light patch around and slightly posterior to eyes). Head light grey, foot grey black and often dark along anterior and posterior edges. Pallial roof and visceral coil black.

Contents of pallial cavity shown in Figure 2. Ctenidium overlapping pericardium; filaments about 38, tall, pleated. Osphradium about 40% of ctenidium length. Hypobranchial gland swollen on proximal genital duct. Fecal pellets oblique, almost perpendicular. Renal organ greatly swollen; renal opening white. Salivary glands terminating anterior to cerebral ganglia. Stomach about as long as style sac. Ganglia pigmented.

Testis 1.5 whorls, overlapping posterior stomach chamber, filling more than 50%-67% of visceral coil behind stomach. Prostate gland with 33% of length in pallial roof. Vas deferens nearly straight in pallial roof and in neck. Penis (Figure 9A) of medium size, sickle-shaped, usually very tightly coiled, with strong folds along proximal 67% of length; base slightly narrowed; medial section gently tapering; bulbous distal section narrowing considerably to short, pointed tip (Figure 1E,F). Penial duct near center, of medium width, strongly undulating in basal and medial sections. Penis usually with dark epithelial pigment on proximal half of dorsal surface, rarely pale; black subepithelial pigment scattered along length of penial duct.

Ovary 1.0 whorl, abutting posterior edge of stomach, filling about 50% of visceral coil behind stomach. Distal female genitalia shown in Figure 10A. Coiled oviduct narrow, sometimes weakly pigmented; proximal portion usually with 1-2 small horizontal twists or coils; distal portion of primary coil sometimes containing sperm. Coiled oviduct and bursal duct join just behind pallial wall. Bursa copulatrix about 50% of albumen gland length, pyriform, about as long as wide, with central section decidedly narrowed, positioned largely posterior

to gland. Bursal duct about 67% of bursa length, originating slightly lateral to tip of organ. Seminal receptacle about 33% of bursa copulatrix length, lightly pigmented, positioned anterior to bursa copulatrix near posterior edge of albumen gland, partly or entirely overlapped by gland. Pallial gonoduct with deep rectal furrow. About 17% of albumen gland lying in front of posterior pallial wall. Capsule gland about as long and as wide as albumen gland. Ventral channel with anterior vestibule. Genital opening a subterminal slit fringed by small papilla.

DISTRIBUTION.—Upper Green River drainage, Wyoming (Figure 11). We have been unable to confirm the Emery County, Utah, record, which is well downflow from other Green River sites for the species and may represent drift material (shells in this lot are worn and were collected empty).

REMARKS.—Morrison (1940) described this species to accommodate snails not only from the Green River drainage but also from the Great Basin of Utah. Although shells of these two groups of populations are generally similar in form, a preliminary survey of available alcohol material revealed significant differences in penial morphology between them, suggesting that the Great Basin populations comprise one or more undescribed species. Pending further study of this problem, we have decided to restrict *F. coloradensis* to populations from the Green River. Anatomical data are from USNM 883493.

MATERIAL EXAMINED.—UTAH. Green River, UF 78511. Head of Green River, USNM 28103, USNM 120462. ?*Emery County*: Green River, Hideout, FMNH 178501.

WYOMING. ANSP 88598. Wyoming Territory, USNM 28538, USNM 170789. Green River, USNM 526631 (holotype), USNM 526576 (paratypes), USNM 159396, USNM 160394. Green River, Blacks Fork, Millersville, ANSP 27769. *Lincoln County*: Hams Fork, Green River, Bells Fish Cliff, USNM 526754. Green River, Smiths Fork, ANSP 27773. *Sublette County*: Green River at bridge, HWY 359, 12.8 km north of Place Cafe, USNM 883191\*. Green River, HWY 187-189 bridge, USNM 883493\*.

### *Fluminicola dalli* (Call, 1884)

*Amnicola dalli* Call, 1884:21,45-47, figs. 2, 3; pl. VI: figs. 4-6 [lectotype: MCZ 2087; type locality: small tributary to Pyramid Lake, near the north end, at Symons Ranch].—Call, 1886:2-4.—Orcutt 1901b:47.—Taylor, 1966a:24, fig. 9 [as synonym of *L. turbiniiformis*].—Johnson, 1975:142 [lectotype selection].

*Fluminicola seminalis dalli*.—Pilsbry, 1899a:123.—Walker, 1918:142. *Lithoglyphus dalli*.—Taylor, 1975a:71.

DIAGNOSIS.—Small with broadly conical shell; penis of medium size, nearly vermiform.

The broad osphradium, nearly vermiform penis, and absence of penial folds are unique to this species within the genus. *Fluminicola dalli* is further separable from sister taxon *F. turbiniiformis* by the weaker operculum callus, darker body pigmentation, larger penis, simply tapering distal penis, smaller

bursa copulatrix, greater overlap of albumen gland onto bursa copulatrix, more anteriorly positioned seminal receptacle, and greater overlap of albumen gland onto seminal receptacle.

**DESCRIPTION.**—Shell (Figures 4B, 5E-G) broadly conical, with low spire; height 2.1–3.4 mm; whorls 3.5–4.0. Protoconch (Figure 6B) of 1.25 whorls, diameter about 0.6 mm; microsculpture of weak, anastomosing spiral striae. Teleconch whorls of medium convexity, sometimes with very weak peripheral angulation; shoulders pronounced but narrow. Microsculpture of collabral growth lines and weak spiral striae. Periostracum light brown or green. Shell translucent, clear white. Aperture large, ovate, weakly angled above. Outer lip thin. Parietal lip complete, thick, broadly adnate to slightly detached. Columellar lip thick, columellar swelling broad. Shell shallowly perforate to broadly rimate; umbilical region sometimes narrowly excavated, with adaxial ridge.

Operculum (Figure 7B) thin; rim along outer margin very weak or absent. Attachment-scar margin slightly thickened along inner edge to nucleus; outer edge thickening very weak or absent. Callus moderately developed.

Radula (Figure 8D-F) with about 81 rows of teeth; ribbon length 1.2 mm, ribbon width 0.15 mm; central tooth width 38  $\mu$ m. Central tooth with pronounced dorsal indentation; lateral cusps 3–5; median cusp narrowly U-shaped, slightly broader and considerably longer than laterals; basal cusps 1 (rarely with faint suggestion of second cusp), broadly triangular, arising from tooth face near intersection with lateral angle; basal tongue medium wide, basal sockets moderately to strongly excavated; lateral angles thickened. Lateral tooth with slightly concave dorsal edge; dorsal edge about 35% of tooth width; lateral shaft considerably longer than height of tooth face; tooth face taller than wide; central cusp narrowly U-shaped, lateral cusps 2 or 3 (inner side) to 3 or 4 (outer side). Inner marginal teeth with 24–25 cusps; outer marginal teeth with 22 cusps.

Snout and head nearly colorless to medium grey. Tentacle pigment as for snout, with pale patch surrounding eyes. Foot pigment as for snout, darkest along anterior edge. Pallial roof and visceral coil black.

Ctenidium not overlapping pericardium; filaments 16, narrow, without pleats. Osphradium broad, about 30% of ctenidium length. Hypobranchial gland uniformly thin. Fecal pellets longitudinal. Renal organ not swollen; renal opening opaque. Salivary glands overlapping cerebral ganglia. Stomach slightly longer than style sac. Ganglia pigmented.

Testis 1.0 whorl, abutting posterior edge of stomach, filling slightly less than 50% of visceral coil behind stomach. Prostate gland small, narrow, with 30% of length in pallial roof. Vas deferens undulating in pallial roof, straight in neck. Penis (Figure 9B) of medium size, nearly vermiform, slightly curved, without folds; penis tapering gently throughout to simple distal tip. Penial duct slightly to right of midline, narrow, gently undulating in proximal 67%. Penis without epithelial pigment; subepithelial pigment restricted to distal 50%.

Ovary 0.25 whorl, positioned behind stomach, filling about 20% of visceral coil behind stomach. Distal female genitalia shown in Figure 10B. Coiled oviduct narrow to broad, unpigmented; proximal portion with vertical loop or small kink; distal portion of primary coil sometimes containing sperm. Coiled oviduct and bursal duct join well behind pallial wall. Bursa copulatrix about 36% of albumen gland length, ovate, wider than long, largely overlapped by gland. Bursal duct short (25% of bursa length), originating near tip of organ. Seminal receptacle about 33% of bursa copulatrix length, unpigmented, positioned slightly anterior to bursa copulatrix near posterior edge of albumen gland, entirely overlapped by gland. Pallial gonoduct with weak rectal furrow. About 22%–30% of albumen gland lying in front of posterior pallial wall. Capsule gland slightly shorter, narrower than albumen gland. Ventral channel without or (less commonly) with very short anterior vestibule. Genital opening a terminal pore.

**DISTRIBUTION.**—Thus far known only from type locality area, northern Pyramid Lake basin (Great Basin), Nevada (Figure 11).

**REMARKS.**—The type locality is in Washoe County. Inasmuch as Call distributed type material to several institutions and did not explicitly state that his figured specimen was a type, we treat MCZ 2087 as a lectotype selected by Johnson (1975), rather than as the identified holotype. Anatomical data are from USNM 874899 (near topotypes).

**MATERIAL EXAMINED.**—NEVADA. *Washoe County*: Small tributary to Pyramid Lake, near the north end, at Symons Ranch, MCZ 2087 (lectotype). Near north end of Pyramid Lake, MCZ 2088 (paralectotypes). Stream flowing into Pyramid Lake, USNM 31269. Stream, north end of Pyramid Lake, ANSP 27783, ANSP 92081, USNM 526835. Spring, 3.2 km west of Thunderbolt Bay (Pyramid Lake), USNM 874899\*, USNM 883467\*.

### *Fluminicola fuscus* (Haldeman, 1841)

*Anculosa fusca* Haldeman, 1841 [cover; type not located; type locality: Oregon].

*Leptoxis fusca*.—Haldeman, 1847:4, pl. 3: figs. 83, 84.—Adams and Adams, 1854:307.—Binney, 1859:11; 1860:10.—Brot, 1862:24.

*Anculotus fuscus*.—Reeve, 1860–1861:11 [as synonym of *A. nuttalli*].

*Amnicola hindsi* Baird, 1863:67 [lectotype: BMNH 1863.2.4.17A, selected herein; type locality: River Kootanie].—Carpenter, 1864:604.—Binney, 1865:90 [as synonym of *F. nuttalliana*].—Pilsbry, 1899a:123 [as synonym of *F. nuttalliana*].—Dall, 1905:119 [as synonym of *F. nuttalliana*].—Hannibal, 1912:187 [as synonym of *F. virens*].—Henderson, 1929:168 [as synonym of *F. nuttalliana*].

*Paludina hindsi*.—Carpenter, 1864:676 [as synonym of *F. nuttalli*].—Frauenfeld, 1864:613.

*Fluminicola fusca*.—Binney, 1865:92 [in part].—J.G. Cooper, 1867:30.—Tryon, 1870:66, pl. 17: fig. 19 [in part].—Call, 1884:21 [in part].—J.G. Cooper, 1888:240 [in part].—Pilsbry, 1899a:123 [in part].—Orcutt 1901a:35 [in part]; 1902?:61 [in part].—Hannibal, 1912:187 [in part].—Henderson, 1929:167 [as synonym of *F. columbiana*].—Morrison, 1940:125.—Baker, 1964:172.—Burch and Tottenham, 1980:102, fig. 141.—Turgeon et al., 1988:60.—Beetle, 1989:639 [as synonym of *L. hindsi*].

- Fluminicola hindsii* [sic].—Stimpson, 1865a:53; 1865b:54.—Hemphill, 1881:12.
- Fluminicola hindsii*.—J.G. Cooper, 1867:30.—Orcutt 1901a:35; 1902?:61.—Morrison, 1940:125.—Burch and Tottenham, 1980:102 [in part].—Turgeon et al., 1988:60.
- Fluminicola nuttalliana* var. *columbiana* Hemphill, 1881:12 [nomen nudum].
- Ammicola fusca*.—Grasset, 1884:91.
- Fluminicola nuttalliana columbiana* Keep, 1887:63 [ex Hemphill MS; type not located (see Coan, 1985); type locality: rivers of Oregon and Washington].—Coan, 1985:212.—Coan and Roth, 1987:327.
- Pomatiopsis fusca*.—Paetel, 1888:471.
- Fluminicola columbiana* Pilsbry, 1899a:125 [lectotype: ANSP 27767; type locality: Columbia River, near Wallula].—Hannibal, 1912:188.—Walker, 1918:141.—Morrison, 1940:125.—Baker, 1964:172 [lectotype selection].—Henderson, 1924:191; 1929:167–168 [in part]; 1936b:277.—Burch and Tottenham, 1980:102, fig. 145.—Turgeon et al., 1988:60.—Neitzel and Frest, 1989:7, fig. 1.—USDI, 1991:58819.—Neitzel and Frest, 1993:9, fig. 1.
- Fluminicola nuttalliana hindsii*.—La Rocque, 1953:270.
- Lithoglyphus columbianus*.—Taylor, 1966b:160; 1975a:60.—Clarke, 1976:18.—USDI, 1984:21673.
- Lithoglyphus hindsii* [sic].—Taylor, 1966a:34, fig. 14 [in part]; 1975a:96.
- Lithoglyphus fuscus*.—Taylor, 1975a:86.
- Lithoglyphus hindsii*.—Clarke, 1981:70 [as synonym of *L. virens*].

**DIAGNOSIS.**—Large with subglobular to trochoid shell having strong subsutural angulation or keel on body whorl; penis of medium size, sickle-shaped.

In addition to body whorl shape, the frequently incomplete parietal lip, pigmented salivary glands, and position of seminal receptacle entirely lateral to albumen gland are unique to *F. fuscus* within the genus.

**DESCRIPTION.**—Shell (Figures 4C,D, 12) subglobular to trochoid, apex often eroded; height 7.0–11.2 mm; whorls 4.0–4.5. Protoconch (Figure 6C) of 1.5 whorls; diameter about 1.0 mm; microsculpture of numerous strong spiral striae. Teleoconch whorls slightly convex, shouldered. Body whorl with subsutural angulation to well-developed, thick ledge; periphery well below middle of whorl, usually angulate, sometimes strongly so. Microsculpture of strong collabral growth lines. Periostracum tan, brown, or red. Shell opaque, usually pink. Aperture large, ovate, narrowly angled to pyriform above. Outer lip sometimes weakly sinuate (adapically advanced), usually thin. Parietal lip thin, often glaze-like, sometimes incomplete across body whorl, rarely thick and slightly detached. Columellar lip thick, columellar swelling broad, often covering umbilical region, sometimes slightly flared basally. Shell usually anomphalous, rarely with small umbilicus.

Operculum (Figure 7C) of medium thickness; outer margin with obvious rim. Outer edge of attachment-scar margin slightly thickened, inner edge slightly to moderately thickened. Callus well developed, crescent-like.

Radula (Figure 8G,I) with about 85 rows of teeth; ribbon length 3.2 mm, ribbon width 0.3 mm; central tooth width 81  $\mu$ m. Central tooth with slight dorsal indentation; lateral cusps 2–4; median cusp broadly U-shaped, slightly broader and longer than laterals; basal cusps 1–2, narrow, originating near

dorsal edge of lateral angles; basal tongue narrow, basal sockets weakly to moderately excavated; lateral angles broad, thickened. Lateral tooth with convex dorsal edge; dorsal edge about 50% of tooth width; lateral shaft slightly shorter than height of tooth face; tooth face taller than wide; central cusp U-shaped, lateral cusps 3 (sometimes 2 on inner side). Inner marginal teeth with 10–13 cusps; outer marginal teeth with 10–11 cusps.

Snout, including distal lips, dark purple brown; tentacles similarly pigmented except for pale circle around eyes. Head moderately pigmented; foot moderately to darkly pigmented. Pallial roof and visceral coil almost uniformly black; pallial edge black.

Ctenidium overlapping pericardium; filaments about 36, tall, strongly pleated. Osphradium about 45% of ctenidium length. Hypobranchial gland swollen on proximal genital ducts. Fecal pellets oblique. Renal organ rarely swollen; renal opening white. Salivary glands pigmented, overlapping cerebral ganglia. Stomach about as long as style sac. Ganglia pigmented.

Testis 2.0 whorls, overlapping posterior stomach chamber, filling 50%–67% of visceral coil behind stomach. Prostate gland with 33% of length in pallial roof. Vas deferens nearly straight in pallial roof and in neck. Penis (Figure 9C) of medium size, sickle-shaped, coiled, with strong folds along proximal 50%–67% of length; base slightly narrowed; medial section gently tapering; distal section narrowing slightly to medium-long, pointed tip. Penial duct near center, medium wide, strongly undulating in basal and medial sections. Penis usually with very dark epithelial pigment on proximal 50% of dorsal surface; black subepithelial pigment scattered along length of penial duct.

Ovary 0.75 whorl, abutting posterior edge of stomach, filling about 50% of visceral coil behind stomach. Distal female genitalia shown in Figure 10C. Coiled oviduct narrow; proximal portion with 1–2 small, horizontal to oblique twists or coils; distal portion of primary coil sometimes containing sperm. Coiled oviduct and bursal duct join just behind pallial wall. Bursa copulatrix 53%–63% of albumen gland length, pyriform, longer than wide, positioned largely posterior to gland. Bursal duct short (15%–25% of bursa length), originating slightly lateral to tip of organ. Seminal receptacle about 25% of length of bursa copulatrix, positioned just anterior to bursa copulatrix near posterior edge of albumen gland. Pallial gonoduct with deep rectal furrow. About 33% of albumen gland lying in front of posterior pallial wall. Capsule gland about as long and as wide as albumen gland. Ventral channel with anterior vestibule. Genital opening a very short, sub-terminal slit.

**DISTRIBUTION.**—Lower Snake River, Columbia River, and large tributaries (Figure 11).

**REMARKS.**—Haldeman described *F. fuscus* based on specimens from Thomas Nuttall, who presumably collected the snail when he journeyed along the lower Snake-Columbia River system in 1834 (Pennell, 1936). The two lots listed by Baker

(1964:172) as possible type material (ANSP 27772, ANSP 27774) are whitened, worn shells devoid of periostracum, which he admitted do not conform to the species as originally described and illustrated; there is no convincing evidence from associated labels that either lot represents type material (only one of these lots is from Oregon; the other lot is from Utah Lake). Despite the fact that Haldeman's types have not been found, his original description and subsequent illustrations (Haldeman, 1847) clearly identify his species as the large form with angulate body whorl that is (or at least was historically) widespread in the lower Snake-Columbia River system.

Baird (1863:67) gave the type locality for *A. hindsi* as "River Kootanie, and stream at the foot of the Rocky Mountains." A single lot (seven specimens) identified as this species in the British Museum (BMNH 1863.2.4.17, labelled "syntypes," Kootanie River) probably is from the original type series that Baird gave to that institution. As Baird did not figure any specimens along with his description, we herein select the only fully adult specimen (Figure 4D) as the lectotype. Baird's description mentioned the carinate nature of the body whorl, and both his types and shells from the nearby Wigwam River locality (the second locality that he listed for this species) closely conform to *F. fuscus*; hence, we treat *A. hindsi* as a subjective junior synonym of the former, despite its apparently disjunct occurrence in British Columbia.

Keep's (1887:63) minimal description of *F. nuttalliana columbiana* as being "more rounded [than *F. nuttalliana*], with a shorter spire" is relatively uninformative; however Pilsbry's (1899a:125) types and description of having "dark color, ... narrow but prominent shoulder of the last whorl, ... absence of callous on the inner lip" readily permits identification as *F. fuscus*. Pilsbry (1899a:125) gave the type locality for his species as "Columbia River, Washington, near Wallula and near mouth of Snake River; Snake River; near Weiser, Idaho," but original labels associated with his type series restrict the locality to the first mentioned site. Note that *F. columbiana* Pilsbry, 1899, is a junior homonym of *F. nuttalliana columbiana* Keep, 1887.

*Fluminicola fuscus* (or its synonyms) has been attributed by many authors to the Great Basin of Utah, middle or upper Snake River drainage, and other waters to the east (Tryon, 1870; Call, 1884; Pilsbry, 1899a; Orcutt, 1901a; Hannibal, 1912; Henderson and Daniels, 1917; Henderson, 1924, 1931, 1936a; Chamberlin and Jones, 1929; Jones, 1935, 1940; Woolstenhulme, 1942; Berry, 1948; Baily and Baily, 1951; Beetle, 1957; Rubin and Taylor, 1963; Branson, Sisk, and McCoy, 1966; Taylor 1966a, 1985; Taylor and Bright, 1987; Neitzel and Frest, 1989; Bowler and Frest, 1992; Frest and Bowler, 1993; Neitzel and Frest, 1993). As mentioned above, we believe that these populations comprise one or more undescribed species. Although we allocated lower Salmon River material to *F. fuscus*, populations found above the River of No Return do not closely conform to this animal and may be conspecific with undescribed snails living in the headwaters of the Snake River. Anatomical data are from USNM 883182.

MATERIAL EXAMINED.—Columbia River, USNM 27901.

BRITISH COLUMBIA. Kootanie [sic; Kootenai] River, BMNH 1863.2.4.17A (lectotype, *A. hindsi* Baird), BMNH 1863.2.4.17 (paralectotypes, *A. hindsi* Baird). Wigwam River, west slope of Rocky Mountains, BMNH 1863.2.4.16.

IDAHO. Snake River, near Weiser City, ANSP 62341. Salmon River, USNM 762527. *Idaho County*: Salmon River, 3–5 mi (4.8–8.0 km) east of Riggins, UF 47432 (mixed with *Fluminicola* sp.). Salmon River, 10.5 mi (16.9 km) east of Riggins, UF 47436 (mixed with *Fluminicola* sp.). Salmon River, 18 mi (28.9 km) north of Riggins, UF 47427 (mixed with *Fluminicola* sp.). Skookumchuck Creek, access across from US 95, Salmon River, river mi 57.9–58.3 (km 93.2–93.8), USNM 883520\*. Salmon River, river mi 83.6–83.8 (km 134.5–134.8), north of Riggins, USNM 883516\*. Spring Bar, Salmon River, river mi 97.0 (km 156.1), east of Riggins, USNM 883510\*. Salmon River, River of No Return, river mi 107.6 (km 173.1), USNM 883519\*. *Valley County*: Salmon River, 25 mi (40.2 km) east of Riggins, UF 47438 (mixed with *Fluminicola* sp.), UF 47439\* (mixed with *Fluminicola* sp.). *Washington County*: Snake River, Weiser, CAS 93885.

OREGON. USNM 47875. Columbia River, ANSP 122135. Portland, USNM 473990. Willamette River, UF 88656 (mixed with *Fluminicola* sp.), USNM 99303 (mixed with *F. virens*), USNM 854693. *Multnomah County*: CAS 93905. *Wallowa County*: Grande Ronde River, 0.5 mi (0.8 km) northeast of Troy, UF 46002\*, UF 46003 (mixed with *Fluminicola* sp.). Grande Ronde River, river mi 52.7 (km 84.8), USNM 883495\*. Mouth of Imnaha River, Hells Canyon, USNM 883515\*. *Wasco County*: Columbia River, The Dalles, CAS 93904, CAS 93786 (mixed with *Fluminicola* sp.).

WASHINGTON. ANSP 27763, CAS 93900. Columbia River, near mouth of Snake River, ANSP 62926. Snake River, ANSP 122133, ANSP 122136, CAS 93902. Spokane River, ANSP 122137. *Asotin County*: Grande Ronde River, 13.2 mi (21.2 km) northeast of Troy, UF 46007. Grande Ronde River, river mi 0.5 (km 0.8), near junction with Snake River, Hells Canyon, USNM 883499\*. Grande Ronde River, river mi 30.2 (km 48.6), USNM 883497\*. Grande Ronde River, river mi 36.4 (km 58.6), USNM 883509\*. Grande Ronde River, river mi 41.1 (km 66.1), USNM 883504\*. *Chelan County*: Mouth of Wenatchee River, USNM 130527. *Okanogan County*: Methow River, first bridge north of Pateros, USNM 883182\*. Methow River, WA 50, USNM 883637\*, USNM 883642\*. Okanogan River, river mi 14.0–14.3 (km 22.5–23.0), USNM 883639\*. Okanogan River, Rattlesnake Point, river mi 15.0–15.3 (km 24.1–24.6), USNM 883640\*. *Spokane County*: Spokane Falls, ANSP 73837, CAS 93884, CAS 93893, USNM 511023, USNM 511051. Spokane, ANSP 75779, USNM 128665. Little Spokane River, north of Spokane, USNM 380804. *Walla Walla County*: Columbia River, near Wallula, ANSP 27767 (lectotype, *F. columbiana* Pilsbry), ANSP 398349 (paralectotypes, *F. columbiana* Pilsbry), CAS 58880, CAS 58881. Columbia River, near mouth of Snake River, Wallula, CAS 93908. Snake River, near mouth, USNM 30588.

***Fluminicola minutissimus* Pilsbry, 1907**

*Fluminicola minutissima* Pilsbry, 1907:76 [lectotype: ANSP 94273; type locality: Price Valley, Weiser Canyon, Washington County, Idaho].—Pilsbry, 1908:133, pl. XI: fig. 4.—Hannibal, 1912:188.—Walker, 1918:142.—Henderson, 1924:192.—Baker, 1964:174 [lectotype selection].—Burch and Tottenham, 1980:102, fig. 147.—Turgeon et al., 1988:60. "*Fluminicola*" *minutissima*.—Taylor, 1975a:124.

**DIAGNOSIS.**—Small with globose shell; animal unknown. *Fluminicola minutissimus* is distinguished from other small congeners by its minute size, globose shell, and blunt spire.

**DESCRIPTION.**—Shell (Figure 4E) globose, with blunt spire; height about 1.5 mm; whorls 3.0. Protoconch (Figure 6D) of 1.5 whorls; diameter about 0.56 mm; microsculpture of numerous weak spiral striae. Teleoconch whorls convex, sometimes with narrow sutural shelf; whorls broadest below midpoint. Microsculpture of medium growth lines. Periostracum green to light brown. Shell transparent, clear white. Aperture large, nearly circular, slightly angled above. Outer lip prosocline, weakly sinuate, of medium thickness. Parietal lip complete, of medium thickness, broadly adnate. Columellar lip of medium thickness, columellar swelling moderate. Shell perforate; umbilical region narrowly excavated, with adaxial ridge.

**DISTRIBUTION.**—Thus far known only from the type locality, in the Snake River drainage (Figure 11).

**REMARKS.**—Pilsbry's type material, collected by Ashmun in 1904, comprises the only known specimens for this species. We have visited the type locality area on several occasions, and we were unable to locate this animal.

**MATERIAL EXAMINED.**—IDAHO. *Washington County*: Price Valley, Weiser Canyon, ANSP 94273 (lectotype), ANSP 398350 (paralectotypes).

***Fluminicola modoci* Hannibal, 1912**

*Ammicola micrococcus*.—Hannibal in Keep, 1911:314, pl. III: fig. 13. *Fluminicola modoci* Hannibal, 1912:187, pl. 8: fig. 30 [in part; lectotype: CAS 60798; type locality: Fletchers Spring, south end, Goose Lake, California].—Walker, 1918:142.—Taylor, 1966a:24, fig. 9 [as synonym of *L. turbiniformis*].—Taylor and Smith, 1971:312, figs. 16, 21 [lectotype designation; as synonym of *L. turbiniformis*].—Burch and Tottenham, 1980:102.—Taylor, 1981:153 [as synonym of *L. turbiniformis*].—Turgeon et al., 1988:60. *Lithoglyphus modoci*.—Taylor, 1975a:125.

**DIAGNOSIS.**—Small with broadly conical shell; penis large, sickle-shaped.

A pigmented renal opening is unique to *F. modoci* within the genus. *Fluminicola modoci* is further separable from the closely related *F. seminalis* by narrow central cusps on central and lateral teeth, more numerous cusps on marginal teeth, and pleated ctenidial filaments.

**DESCRIPTION.**—Shell (Figures 4F, 5H–J) broadly conical, usually with eroded spire; height 2.7–4.1 mm; whorls 3.5–3.75. Protoconch (Figure 6E) of 1.5 whorls, diameter about 0.65 mm; microsculpture of numerous, strong, anastomosing spiral striae. Teleoconch whorls convex; shoulders well developed but narrow. Microsculpture of strong collabral growth lines. Periostracum yellow green. Shell translucent,

clear white. Aperture large, broadly lunate, strongly angled above. Outer lip prosocline, weakly sinuate, thin. Parietal lip complete, thin, broadly adnate. Columellar lip thin, columellar swelling medium wide, sometimes covering umbilical region. Shell usually anomphalous, sometimes narrowly rimate; umbilical region sometimes narrowly excavated, with adaxial ridge.

Operculum (Figure 7D) of medium thickness; outer margin without obvious rim. Attachment-scar margin strongly thickened all around, although somewhat less so along outer edge. Callus well developed.

Radula (Figure 8J–L) with about 73 rows of teeth; ribbon length 1.1 mm, ribbon width 0.14 mm; central tooth width 42  $\mu$ m. Central tooth with pronounced dorsal indentation; lateral cusps 4–5; median cusp narrowly U-shaped, considerably broader and slightly longer than laterals; basal cusps 3, broadly triangular, originating from lateral angles, outermost sometimes weakly developed; basal tongue medium wide, basal sockets moderately excavated; lateral angles weakly thickened. Lateral tooth with flat or very slightly concave dorsal edge; dorsal edge about 40% of tooth width; lateral shaft slightly longer than height of tooth face; tooth face taller than wide; central cusp narrowly U-shaped, lateral cusps 3–4 (inner side) to 3–5 (outer side). Inner marginal teeth with 23–26 cusps; outer marginal teeth with 26–29 cusps.

Snout black; distal lips grey black, pale near edge. Head pale grey. Tentacles dark grey black, with pale to light grey patch around eyes. Foot dark grey black. Pallial roof and visceral coil black.

Ctenidium overlapping pericardium; filaments about 20, short, pleated. Osphradium about 32% of ctenidium length. Hypobranchial gland swollen on proximal genital duct. Fecal pellets longitudinal. Renal organ not swollen; renal opening pigmented. Salivary glands overlapping cerebral ganglia. Stomach longer than style sac. Ganglia pigmented.

Testis 1.0 whorl, overlapping posterior and portion of anterior stomach chambers, filling about 67% of visceral coil behind stomach chamber. Prostate gland with about 40% of length in pallial roof, fat. Vas deferens straight in pallial roof, with a few bends in neck. Penis (Figure 9D) large, medium wide, sickle-shaped, curved to tightly coiled, with a few weak folds along proximal inner curvature; penis tapering gently along entire length to pointed distal tip. Penial duct near center, narrow, straight or very weakly undulating. Penis pale or with light epithelial pigment on distal half; subepithelial pigment moderate along entire length of penis.

Ovary 0.5 whorl, positioned just behind posterior edge of stomach, filling about 33% of visceral coil behind stomach. Distal female genitalia shown in Figure 10D. Coiled oviduct narrow, unpigmented; proximal portion with small vertical coil; distal portion of primary coil with prominent bulge containing sperm. Coiled oviduct and bursal duct join well behind pallial wall. Bursa copulatrix about 55% of albumen gland length, ovate, wider than long, partly overlapped by albumen gland. Bursal duct very short (<16% of bursa length),

originating near middle of long axis of organ. Seminal receptacle small, 25%–33% of bursa copulatrix length, unpigmented, partly overlapping anterior bursa copulatrix near posterior edge of albumen gland, partly imbedded in gland. Pallial gonoduct with weak rectal furrow. About 33% of albumen gland lying in front of posterior pallial wall. Capsule gland shorter, narrower than albumen gland. Ventral channel with or without very short anterior vestibule. Genital opening a terminal pore.

**DISTRIBUTION.**—Thus far known only from the type locality area, along the southwest corner of Goose Lake (California) (Figure 11).

**REMARKS.**—As implied by Taylor and Smith (1971:312), Hannibal (1912:187) mixed material of two species when he described *F. modoci* (“elevated-conic, spire decidedly elevated”), as his figured “type” is a narrow, high-spined form (*Pyrgulopsis?*) that conflicts with the broader, typically decollate *Fluminicola* shells comprising the available type series (readily identifiable by original labels associated with Hannibal material transferred from Stanford University to the CAS; Taylor and Smith, 1971). Also note that in his description, Hannibal refers to an earlier illustration of *F. modoci* (in Keep, 1911, pl. III: fig. 13) that also conforms to its identity as a *Fluminicola*. It is evident that Hannibal used the wrong photograph as an illustration of *F. modoci*: note that he used this same photograph earlier (in Keep, 1911, pl. III: fig. 11) to depict *Pyrgulopsis longinqua*. We interpret Hannibal’s error as a *lapsus calami*, and thus accept his description of *F. modoci* as a *Fluminicola* (as opposed to treating *F. modoci* as an inadvertently described *Pyrgulopsis*, thus requiring a new name for the *Fluminicola*). The specimen identified as the holotype of *F. modoci* by Taylor and Smith (1971, figs. 16, 21) is not the shell Hannibal illustrated (although it appears to be that which he earlier illustrated as *Ammicola micrococcus* (in Keep, 1911)); hence, it cannot serve as the holotype (ICZN, Article 73a[iv]). In addition, the original labels associated with this specimen contain several different handwriting styles, and it is not clear whether Hannibal himself indicated that this specimen is the holotype. In our view, Taylor and Smith selected a lectotype for *F. modoci* (instead of identifying the holotype). We have not seen Hannibal’s material from the other two sites he originally listed, but one of us (Hershler) has visited these localities, which occur in the Great Basin southeast of Goose Lake basin, and found only *Pyrgulopsis*; hence, we are restricting *F. modoci* to the type locality area. This situation is complicated yet further in that several paratype lots are mixed with a second, smaller (undescribed) *Fluminicola* species having a squatter shell.

The type locality probably refers to unnamed springs at Fletcher Place along the southwest corner of Goose Lake, township (T) 45N, range (R) 13E, section (sec.) 18. We could not access this site owing to problems related to private ownership of this land, and for our anatomical study we instead used material (USNM 883468) from nearby springs (no more than 10 km distant) that also are along the southwest margin of Goose Lake.

**MATERIAL EXAMINED.**—CALIFORNIA. *Modoc County*: Fletchers Spring, south end, Goose Lake, CAS 60798 (lectotype, paralectotypes), CAS 60799 (paratypes), CAS 66545 (paratypes). Unnamed spring, Three Springs Ranch, Goose Lake basin, T 46N, R 13E, sec. 16, 21, USNM 883468\*, USNM 883469\*, USNM 883867\*, USNM 883868\*.

### *Fluminicola nuttallianus* (Lea, 1838)

- Paludina nuttalliana* Lea, 1838:101, pl. XXIII: fig. 89 [lectotype: USNM 121467, selected herein; type locality: Wahlamat (sic) (River), near its junction with the Columbia River].—Frauenfeld, 1864:630.—Hannibal, 1912:187 [as synonym of *F. virens*].
- Leptoxis nuttalliana* [sic].—Haldeman, 1847:6, pl. 5: fig. 156 [in part].—Brot, 1862:25 [in part].
- Leptoxis nuttalliana*.—Binney, 1859:12; 1860:11.
- Ammicola nuttalliana*.—W. Cooper, 1860:374.—Frauenfeld, 1863b:1029.—Grasset, 1884:92.
- Anculotus nuttallii* [sic].—Reeve, 1860–1861:[11; species 46] [in part].
- Fluminicola nuttallii* [sic].—Carpenter, 1864:676 [in part].
- Fluminicola nuttalliana*.—Carpenter, 1864:598.—Binney, 1865:89–91 [in part].—Stimpson, 1865a:53; 1865b:54.—J.G. Cooper, 1867:30.—Tryon, 1870:65, pl. 17: fig. 17 [in part].—Paetel, 1883:71.—Römer, 1891:66.—Pilsbry, 1899a:123 [in part].—Orcutt 1901a:35 [in part]; 1902:61 [in part].—Dall, 1905:119 [in part].—Walker, 1918:32.—Henderson, 1929:168 [in part].—Morrison, 1940:125.—La Rocque, 1953:270 [in part].—Burch and Tottenham, 1980:102, fig. 142.—Turgeon et al., 1988:61.
- Paludina nuttalliana* [sic].—Anonymous, 1866:272.
- Fluminicola nuttalli* [sic].—Schmeltz, 1874:103.—Hemphill, 1881:8.
- Fluminicola nuttalliana* [sic].—Wenz, 1939:576.
- Lithoglyphus nuttallianus*.—Taylor, 1975a:132.

**DIAGNOSIS.**—Large with broadly conical to globose shell; animal unknown.

The shell of this apparently extinct species closely resembles that of larger specimens of *F. coloradensis*, but it is thicker and has a narrower columellar swelling and more consistently reduced umbilicus.

**DESCRIPTION.**—Shell (Figure 13A) broadly conical to globose, with very short spire; height 8.5–10.0 mm; whorls 4.25–4.5. Protoconch (Figure 6F) of 1.5 whorls; diameter about 0.92 mm; microsculpture of numerous, strong, anastomosing spiral striae. Teleoconch whorls highly convex, with very broad, flattened sutural shelf; whorls broadest below midpoint. Microsculpture of collabral growth lines. Periostracum tan. Shell opaque, grey white. Aperture large, broadly lunate, rounded below, angled above. Outer lip strongly prosocline, thin. Parietal lip complete, thin, adnate. Columellar lip of medium thickness, columellar swelling narrow to moderate. Shell anomphalous or with small, chink-like umbilicus.

**DISTRIBUTION.**—Known with certainty only from the type locality area, near the mouth of the Willamette River (Figure 14). We have been unable to locate the Hartford, Oregon, site, although it may refer to Hanford, Washington, which is well upstream from the mouth of the Willamette, on the Columbia River.

**REMARKS.**—This species was incorrectly referred to as Lea

(1839) by Kabat and Hershler (1993). Identification of the three species of *Flumicola* that Lea named from the mouth of the Willamette River historically has posed difficulties. This is due to the brief and sometimes enigmatic original descriptions, uncertain status of type material, virtual destruction of *Flumicola* habitat in the type locality and vicinity as a result of the growth and development of the Portland metropolitan area in the past 150 years, and historic complexity of the *Flumicola* fauna in this river, which includes not only Lea's taxa and *F. fuscus*, but also two undescribed forms (a neritiform species rare in historical collections and probably extinct, and a large, convex-whorled form still common in the river, which has been confused with *F. nuttallianus*). Lea's description and illustration defined *F. nuttallianus* as a large, nearly globose form (the shell resembling that of *F. coloradensis*), which is rarely represented in historic collections from the region and is probably now extinct. A single lot of three shells (now labeled "Wahlamette [sic], Oregon") from the Lea collection in the National Museum of Natural History conforms to Lea's description and probably represents part of his type series (original labels are absent). All three specimens in this lot are somewhat smaller than the size he indicated for the species. Of these, one is juvenile and another is extremely worn; hence, we have selected the third specimen, an adult, as the lectotype (Figure 13A).

We recognize *F. nuttallianus* as distinct from a larger, more elongate, undescribed form from the Willamette River and distinct from one or more large, subglobose, round-whorled forms found elsewhere in western Washington and Oregon. Both of these forms have been frequently confused with *F. nuttallianus*. We similarly view the disjunct population in the Clearwater River (Idaho), referred to as *F. nuttallianus* by Taylor (1966a), as both undescribed and distinct from our concept of *F. nuttallianus*.

Valid records of *F. nuttallianus* are from a limited portion of the lower Willamette River, namely from the vicinity of Oregon City (at approximately river mi 20 (km 32.2)) to the historic mouth. This reach extends from Willamette Falls, at Oregon City, along the present Multnomah Channel to its junction with the Columbia River near St. Helens, Oregon. The Multnomah Channel was abandoned as the primary Willamette channel when the Willamette River shifted to approximately its present position after a major flood in 1890. On several occasions between 1991 and 1994 we searched for *Flumicola* in the vicinity of Willamette Falls and at both the Multnomah channel and the present course of the Willamette River downflow from Oregon City. This area is now highly industrialized. A lumber mill, locks, and a power plant have long been present at Willamette Falls. Sites surveyed above the falls have yielded *F. virens* and an undescribed species in this genus but have not yielded *F. nuttallianus*. All of the adjoining lower Columbia River is impounded, generally has soft substrates, and has few surviving colonies of *Flumicola*, none of which resembles *F. nuttallianus*. We consider it likely that this species is now extinct.

MATERIAL EXAMINED.—West Coast, ANSP 365331.

OREGON. UF 88670. Hartford (?), USNM 47874 (mixed with *Flumicola* sp.). Willamette (River), ANSP 27771. Wahlamette [sic], Oregon, USNM 121467 (lectotype), USNM 860648 (paralectotypes).

### *Flumicola seminalis* (Hinds, 1842)

*Paludina seminalis* Hinds, 1842:83–84 [type not located; type locality: Rio Sacramento, California].—Hinds, 1845:59, pl. XVI: fig. 22.—Haldeman, 1847:6 [as synonym of *L. nuttalliana*].—Carpenter, 1857:206, 211.—Brot, 1862:25 [as synonym of *L. nuttalliana*].—Carpenter, 1864:676 [as synonym of *F. nuttallii*].—Frauenfeld, 1864:645 [as synonym of *L. nuttalliana*].—Binney, 1865:89 [as synonym of *F. nuttalliana*].

*Melania seminalis*.—Lea, 1856:81.

*Bithinia seminalis*.—Carpenter, 1857:326.—Binney, 1859:13.

*Amnicola seminalis*.—W. Cooper, 1860:374.—Grasset, 1884:91.

*Lithoglyphus cumingii* Frauenfeld, 1863a:195 [lectotype: BMNH 1933047, selected herein; type locality: California]; 1865:530, pl. 11: unnumbered fig.—Walker, 1918:142 [as synonym of *F. seminalis*].—Taylor, 1975a:69.

*Flumicola seminalis*.—Carpenter, 1864:598.—Stimpson, 1865a:53; 1865b:54.—Pilsbry, 1899a:123 [in part]; 1899b:66.—Hannibal, 1912:187 [in part].—Walker, 1918:142 [in part].—Henderson, 1929:169 [in part].—Morrison, 1940:125.—Burch and Tottenham, 1980:102 [in part].—Turgeon et al., 1988:61.

*Melania (Paludina) seminalis*.—Carpenter, 1864:634.

*Paludina cumingii*.—Frauenfeld, 1864:595.

*Lithoglyphus cumingi* [sic].—Pilsbry, 1899a:123 [as synonym of *F. seminalis*].—Taylor, 1981:153.

*Flumicola seminis* [sic].—Wenz, 1939:576.

*Flumicola seminaris* [sic].—Wenz, 1939:576.

*Lithoglyphus seminalis*.—Taylor, 1966a:48; 1975a:172; 1981:153.

DIAGNOSIS.—Medium to large, with globose to broadly conical shell; penis large, sickle-shaped.

DESCRIPTION.—Shell (Figures 13B,C, 15A–F) globose to broadly conical, spire often eroded; height 5.8–8.0 mm; whorls 4.0–4.5. Protoconch (Figure 6G) of 1.5 whorls; diameter about 0.8 mm; microsculpture of numerous strong spiral striae. Teleoconch whorls convex, often highly so, weakly to strongly shouldered. Microsculpture of collabral growth lines, sometimes with fine spiral striae. Periostracum tan, brown, or light green. Shell opaque, clear white. Aperture large, lunate, slightly angled above. Outer lip thin. Parietal lip complete, thin, usually adnate, rarely slightly detached. Columellar lip thin, columellar swelling medium wide to broad. Shell usually anomphalous, sometimes with slit-like umbilicus; umbilical region sometimes narrowly excavated, with adaxial ridge.

Operculum (Figure 16A) of medium thickness; outer margin with weak rim. Outer edge of attachment-scar thickened, sometimes strongly so; inner edge slightly thickened. Callus weak to moderately thickened, small.

Radula (Figure 17A–C) with about 71 rows of teeth; ribbon length 2.2 mm, ribbon width 0.25 mm; central tooth width 70  $\mu$ m. Central tooth moderately indented dorsally; lateral cusps 4–5; median cusp broadly U-shaped, considerably broader and slightly longer than laterals; basal cusps 2–3, narrow, innermost arising from tooth face; basal tongue medium wide, basal sockets moderately excavated; lateral angles broad,

thickened. Lateral tooth with slightly concave dorsal edge; dorsal edge about 50% of tooth width; lateral shaft slightly longer than height of tooth face; face tooth face about as tall as wide; central cusp broadly U-shaped, lateral cusps 3–4. Inner marginal teeth with 15–17 cusps; outer marginal teeth with 18–21 cusps.

Snout and foot black; head pale grey; tentacles black except for pale circle surrounding eyes. Pallial roof and visceral coil black.

Ctenidium overlapping pericardium; filaments about 35, tall, without pleats. Osphradium about 40% of ctenidium length. Hypobranchial gland swollen over proximal genital ducts. Fecal pellets longitudinal. Renal organ swollen; renal opening opaque. Salivary glands overlapping cerebral ganglia. Stomach slightly longer than style sac. Ganglia pigmented.

Testis 1.5 whorls, overlapping posterior stomach chamber, filling 67% of visceral coil behind stomach. Prostate gland with 33% of length in pallial roof, elongate. Vas deferens slightly undulating in pallial roof, straight in neck. Penis (Figure 9E) large, curved, sickle-shaped, with weak folds along proximal half; penis gently tapering along entire length to pointed tip. Penial duct near outer edge, narrow, coiled along proximal 67% of length. Penis with grey black epithelial pigment on proximal 50%; black subepithelial pigment concentrated distally.

Ovary 0.5 whorl, abutting posterior edge of stomach, filling about 50% of visceral coil behind stomach. Distal female genitalia shown in Figure 18A. Coiled oviduct narrow, positioned about midway between pallial wall and anterior edge of bursa copulatrix, unpigmented; proximal portion with 2 small oblique-horizontal loops; distal section of primary coil overlapped by albumen gland, sometimes containing sperm. Coiled oviduct and bursal duct join well behind pallial wall. Bursa copulatrix about 50% of albumen gland length, pyriform, wider than long, positioned about 33% posterior to gland. Bursal duct extremely short, originating near middle of long axis of organ. Seminal receptacle about 25% of bursa copulatrix length, unpigmented, abutting anterior edge or slightly overlapping bursa copulatrix near posterior edge of albumen gland, partly imbedded in gland. Pallial gonoduct with deep rectal furrow. About 35% of albumen gland lying in front of posterior pallial wall. Capsule gland about as long as and slightly narrower than albumen gland. Ventral gland without vestibule. Genital opening a pore mounted on small terminal papilla.

**DISTRIBUTION.**—Sacramento River basin from near its mouth (historically), upstream into the Pit River, including large, spring-fed tributaries (Figure 14; modified from Taylor, 1981). The species is apparently now extinct in the main-stem Sacramento River.

**REMARKS.**—Hinds described *P. seminalis* based on specimens he collected during his voyage on the H.M.S. *Sulphur* by means of the consort ship *Starling*, which coursed up the Sacramento River in fall, 1837. The precise type locality is unknown, but it surely was from the lower portion of the Sacramento River as the ship did not penetrate more than 160

km upstream from the mouth (from original voyage accounts summarized in Pierce and Winslow, 1979). (Note that Taylor (1981) gave the type locality as Sacramento River below mouth of American River.) Hinds' type series has not been located, although specimens in the British Museum identified as this species (Sacramento River, uncataloged, H. Cuming coll.) may comprise part of such, as much of his collection was donated to that institution, either by himself or by private collectors, including Cuming (Keen, 1966). Two lots of single specimens identified as syntypes of *L. cumingii* (labeled "California") were located in the BMNH and NMW: the former specimen more closely resembles Frauenfeld's (1865) illustration of the species and thus we select this as the lectotype (Figure 13C). Frauenfeld's description and type material (i.e., medium-sized, globose or broadly conical shell with thin parietal lip) allow recognition of *L. cumingii* as a junior subjective synonym of *F. seminalis* as previously suggested in the literature.

Material from the San Joaquin River, Napa County, and Klamath basin has been assigned to this species either in museum collections or in the literature (Pilsbry, 1899a; Hanna, 1924; Henderson, 1929; Clench, 1940), but based on differences in shell features, we prefer to exclude these from *F. seminalis* for the time being. Anatomical data are from USNM 883465.

**MATERIAL EXAMINED.**—CALIFORNIA. BMNH 1933047 (lectotype, *L. cumingii* Frauenfeld), NMW uncat. Sacramento River, ANSP 27776, ANSP 27778, BMNH 1994109, BMNH 1994110, CAS 93865, UF 227630, USNM 11860, USNM 121465. *Shasta County*: ANSP 341358. Battle Creek, Battle Creek County Park (on Tehama County line), USNM 883465\*. McCloud River, USNM 883188\*. Lava Creek, Lava Springs Ranch, USNM 883180\*. Pit River, above Pit #1 foot bridge, USNM 883739\*. Big Lake, Ahjumawi Lava Springs State Park, USNM 883742\*. Rising River, bridge crossing on Redding–Alturas HWY, CAS 93863. Burney Falls (Burney Creek), CAS 93777, CAS 93862. Fall River, near Glenburn, CAS 93860. *Tehama County*: Sacramento River, near Red Bluffs, ANSP 122139.

### *Fluminicola turbiniformis* (Tryon, 1865)

*Ammicola turbiniformis* Tryon, 1865:219, pl. 22: fig. 5 [in part; lectotype: ANSP 27779; type locality: west side of Steens Mountains, Harney County, Oregon].—J.G. Cooper, 1867:30.—Tryon, 1870:56, pl. 17: fig. 6 [in part].—Grasset, 1884:91.—Pilsbry, 1899a:123 [as synonym of *F. seminalis*].—Orcutt, 1901b:48 [as synonym of *Ammicola protea* Gould, 1855].—Hannibal, 1912:187 [as synonym of *F. seminalis*].—Walker, 1918:142 [as synonym of *F. seminalis*].—Henderson, 1929:169 [as synonym of *F. seminalis*].

*Ammicola turtoniformis* [sic].—Paetel, 1888:444.

*Fluminicola turbiniformis*.—Baker, 1964:177 [lectotype selection].—Burch and Tottenham, 1980:102, fig. 152 [in part].—Turgeon et al., 1988:61.

*Lithoglyphus turbiniformis*.—Taylor, 1966a:24, fig. 9 [in part].—Taylor and Smith, 1971:312 [in part]; Taylor, 1975a:197; 1981:153 [in part]; 1985:309 [in part].

**DIAGNOSIS.**—Small with ovate- to narrow-conic shell; penis small, sickle-shaped.

The extremely small size of the penis (relative to head) in this species is unique among *Fluminicola* species.



DESCRIPTION.—Shell (Figures 5K,L, 13D) ovate- to narrow-conic; height 3.1–4.3 mm; whorls 3.5–4.0. Protoconch (Figure 6H) of 1.5 whorls, diameter about 0.7 mm; microsculpture of weak, anastomosing spiral striae. Teleoconch whorls highly convex; shoulders weak or absent. Microsculpture of collabral growth lines. Periostracum light green or brown. Shell transparent, clear white. Aperture of medium size, ovate, slightly angled above. Outer lip weakly sinuate, thin. Parietal lip complete, thick, usually slightly detached. Columellar lip thick, columellar swelling broad. Shell narrowly umbilicate; umbilical region often narrowly excavated with adaxial ridge.

Operculum (Figure 16B) thin; outer margin without obvious rim. Attachment-scar margin narrowly thickened along inner edge to nucleus; outer edge thickening weak or absent. Callus strongly developed.

Radula (Figure 17D–F) with about 83 rows of teeth; ribbon length 1.25 mm, ribbon width 17  $\mu$ m; central tooth width 46  $\mu$ m. Central tooth with moderate dorsal indentation; lateral cusps 4–5; median cusp narrowly U-shaped, slightly broader, considerably longer than laterals; basal cusps 1, elongate, originating from junction between tooth face and lateral angle; basal tongue medium wide, basal sockets moderately excavated; lateral angles thickened. Lateral tooth with straight to slightly concave dorsal edge; dorsal edge about 40% of tooth width; lateral shaft considerably longer than height of tooth face; tooth face slightly taller than wide; central cusp U-shaped, lateral cusps 2 (inner side) to 3 or 4 (outer side). Inner marginal teeth with 26 cusps; outer marginal teeth with 29 cusps.

Snout light medium grey; distal lips pale. Head pale to lightly pigmented. Tentacles pale to lightly pigmented, with small, dark internal pigment patch distal to eyes. Foot lightly to moderately pigmented. Pallial roof and visceral coil medium brown to black, although not uniformly pigmented.

Ctenidium not overlapping pericardium; filaments 17, short, without pleats. Osphradium about 30% of ctenidium length. Hypobranchial gland thin. Fecal pellets longitudinal. Renal organ slightly swollen; renal opening opaque. Salivary glands overlapping cerebral ganglia. Stomach slightly longer than style sac. Ganglia pigmented.

Testis 1.0 whorls, slightly overlapping posterior stomach chamber, filling slightly less than 50% of visceral coil behind stomach. Prostate gland with about 33% of length in pallial roof, fat. Vas deferens nearly straight in pallial roof and in neck. Penis (Figure 9F) small, flattened, narrow, tightly coiled, sickle-shaped, weakly folded along portion of proximal left side; base slightly swollen; medial section gently tapering; distal section with subterminal narrowing followed by elongate, pointed tip. Penial duct slightly to right of center, narrow, gently undulating in proximal 67% of length. Penis without epithelial pigment; dark internal pigment flanking penial duct.

Ovary 0.25 whorl, positioned slightly behind stomach, filling about 12% of visceral coil behind stomach. Distal female genitalia shown in Figure 18B. Coiled oviduct broad, unpigmented; proximal portion with small twist or oblique loop; distal portion of primary coil sometimes containing

sperm. Coiled oviduct and bursal duct join well behind pallial wall. Bursa copulatrix about 50%–70% of albumen gland length, ovate, wider than long, positioned largely posterior to albumen gland. Bursal duct very short, originating near tip of organ. Seminal receptacle 25%–33% of bursa copulatrix length, unpigmented, slightly overlapping bursa copulatrix near posterior edge of albumen gland, partly overlapped by gland. Rectal furrow in pallial gonoduct weak or absent. About 38%–50% of albumen gland lying in front of posterior pallial wall. Capsule gland slightly longer but narrower than albumen gland. Ventral channel without anterior vestibule. Genital opening a terminal pore.

DISTRIBUTION.—Thus far known only from the type locality area, in the northwestern Great Basin of Oregon (Figure 14).

REMARKS.—Tryon (1865:219) gave the type locality as “Crane Lake Valley, and Surprise Valley, N.E. California; and W. side of Stein’s [sic; Steens] Mountains, S. Oregon.” Original labels associated with the lectotype permit a more precise determination of the type locality, which Taylor (1985) identified as Catlow Valley. Tryon’s material from the other two sites does not closely resemble *F. turbiniformis* in shell features, and we have decided to restrict the species to the type locality area. Anatomical data are from USNM 883470 (near topotypes).

MATERIAL EXAMINED.—OREGON. *Harney County*: West side of Steens Mountains, ANSP 27779 (lectotype), ANSP 398352 (paralectotypes). Roaring Springs, Catlow Valley, USNM 883470\*.

### *Fluminicola virens* (Lea, 1838)

*Paludina virens* Lea, 1838:91, pl. XXIII: fig. 93 [lectotype: USNM 121431, selected herein; type locality: Wahlamat (sic) (River), near its junction with the Columbia River].—Frauenfeld, 1864:659.

*Paludina nuclea* Lea, 1838:91, pl. XXIII: fig. 103 [type not located; type locality: Wahlamat (sic) (River), near its junction with the Columbia River].—Haldeman, 1847:5 [as synonym of *L. virens*].—Carpenter, 1857:207, 297.—Brot, 1862:26 [as synonym of *L. virens*].—Frauenfeld, 1864:630 [as synonym of *P. virens*].—Binney, 1865:91 [as synonym of *F. virens*].—Pilsbry, 1899a:123 [as synonym of *F. virens*].—Dall, 1905:119 [as synonym of *F. virens*].—Hannibal, 1912:187 [as synonym of *F. virens*].—Henderson, 1929:169 [as synonym of *F. virens*].

*Leptoxis virens*.—Haldeman, 1847:5, pl. 5: figs. 147–150.—Binney, 1859:12; 1860:11.—Brot, 1862:26.

*Bithinia nuclea*.—Carpenter, 1857:326.—Binney, 1859:13.

*Vivipara nuclea*.—Binney, 1859:12 [as synonym of *L. virens*].

*Vivipara virens*.—Binney, 1859:13.

*Anculosa nuclea*.—Tryon, 1864b:104.

*Anculosa virens*.—Tryon, 1864b:104.

*Fluminicola nuclea*.—Stimpson, 1865a:53; 1865b:54.

*Fluminicola virens*.—Binney, 1865:91–92.—Stimpson, 1865a:53; 1865b:54.—J.G. Cooper, 1867:30.—Tryon, 1870:65, pl. 17: fig. 18 [in part].—Pilsbry, 1899a:122–123 [in part].—Orcutt, 1901a:35–36 [in part]; 1902?:61–62 [in part].—Dall, 1905:119 [in part].—Hannibal, 1912:187 [in part].—Henderson, 1929:169 [in part]; 1936b:277 [in part].—La Rocque, 1953:271 [in part].—Burch and Tottenham, 1980:102–103, fig. 145 [in part].—Turgeon et al., 1988:61.

*Lithoglyphus virens*.—Taylor, 1966b:160; 1975a:205.—Clarke, 1981:70 [in part].

*Lithoglyphus nucleus*.—Taylor, 1975a:131.

*Fluminicola nuttalliana*.—Thompson, 1984:140 [in part].

**DIAGNOSIS.**—Large with ovate- to narrow-conic shell; penis large, broadly triangular.

This species is phylogenetically distinct from the clade comprising all other species allocated to *Fluminicola*, and it is set apart by various unique features (within the genus), including unpigmented ganglia, short pedal commissure, vas deferens coiled on neck, broadly triangular penis, penis deeply folded along almost entire length, terminal papilla on penis, simple, posterior oblique coiled oviduct, absence of secondary storage of sperm in coiled oviduct, subglobular bursa copulatrix, extremely long bursal duct, and large seminal receptacle.

**DESCRIPTION.**—Shell (Figures 13E,F, 15G–N) ovate- to narrow-conic, usually with eroded spire; height 5.8–12.0 mm; whorls 4.5–5.0. Protoconch (Figure 6i) of 1.5 whorls, diameter about 0.85 mm; microsculpture of numerous strong spiral striae. Teleoconch whorls flat to slightly convex; shoulders very narrow or absent. Microsculpture of fine collabral growth lines. Periostracum light tan, yellow, or green. Shell opaque, grey white. Aperture of medium size, ovate, strongly angled above. Outer lip weakly sinuate, usually thick. Parietal lip complete, usually thick, broadly adnate, sometimes slightly expanded over body whorl. Columellar lip of medium thickness, columellar swelling narrow to medium wide. Shell usually anomphalous; umbilical region sometimes narrowly excavated, with adaxial ridge.

Operculum (Figure 16C) of medium thickness; outer margin with very weak rim. Attachment-scar margin slightly thickened, stronger along inner edge. Callus weak but with pronounced narrow thickening extending to outer side of nucleus.

Radula (Figure 17G–I) with about 78 rows of teeth; ribbon length 1.84 mm, ribbon width 0.2 mm; central tooth width 59  $\mu$ m. Central tooth with pronounced dorsal indentation; lateral cusps 4–5; median cusp narrowly U-shaped, slightly broader and longer than laterals; basal cusps 2–3, elongate; basal tongue medium wide, basal sockets strongly excavated; lateral angles slightly thickened. Lateral tooth with slightly concave dorsal edge; dorsal edge about 50% of tooth width; lateral shaft considerably longer than height of tooth face; tooth face about as tall as wide; central cusp narrowly U-shaped, lateral cusps 3 (inner side) or 4 (outer side). Inner marginal teeth with 13–14 cusps; outer marginal teeth with 15–16 cusps.

Snout grey black; distal lips pale. Tentacles with black, central, longitudinal band extending from eyes nearly to distal tip, otherwise pale except for internal grey pigment at base. Head grey. Foot pale to light grey. Pallial roof grey black. Visceral coil nearly colorless to medium grey.

Ctenidium overlapping pericardium; filaments about 39, tall, pleated. Osphradium almost 50% of ctenidium length. Hypobranchial gland swollen on proximal genital duct. Fecal pellets longitudinal. Renal organ swollen; renal opening white. Salivary glands overlapping cerebral ganglia. Stomach slightly longer than style sac. Pedal commissure less than 25% of ganglia width. Ganglia unpigmented.

Testis 1.5 whorls, overlapping posterior stomach chamber, filling 50%–67% of visceral coil behind stomach chamber. Prostate gland with 33% of length in pallial roof, fat. Vas deferens nearly straight in pallial roof, coiled in a series of tight loops in neck. Penis (Figure 9G) large, broad, flattened, slightly curved (but uncoiled), with strong folds along entire length except distal tip (Figure 1G); base slightly narrowed; medial section weakly tapering; distal section strongly tapering, with rounded tip bearing eversible papilla (Figure 1H). Penial duct central, narrow, tightly coiled in basal and medial sections. Penis without epithelial pigment; two broad, dark bands of black subepithelial pigment flanking penial duct.

Ovary 0.5 whorl, abutting posterior edge of stomach, filling about 50% of visceral coil behind stomach. Distal female genitalia shown in Figure 18C. Coiled oviduct narrow, posterior oblique, unpigmented; proximal portion rarely with small kink. Coiled oviduct and bursal duct join just behind pallial wall. Bursa copulatrix about 33% of albumen gland length, subglobular, about as long as wide, almost entirely overlapped by gland. Bursal duct as long as or slightly longer than bursa, originating from middle of long axis of organ. Seminal receptacle 40%–50% of bursa copulatrix length, positioned anterior to bursa copulatrix near middle of albumen gland, entirely overlapped by gland. Pallial gonoduct without rectal furrow. About 25% of albumen gland lying in front of posterior pallial wall. Capsule gland shorter, narrower than albumen gland. Ventral channel without anterior vestibule. Genital opening a subterminal pore.

**DISTRIBUTION.**—Willamette River (and large tributary streams), from Corvallis to its mouth, and the lower Columbia River below Portland (Figure 14).

**REMARKS.**—Like *F. nuttallianus*, both *P. virens* and *P. nuclea* were described from material provided by Nuttall. Two lots in the National Museum of Natural History collection identified as *P. virens* (now labeled “Wahlamette [sic], Oregon”) are Nuttall material from the Lea collection and probably represent the type series (original labels are not associated with these lots). One of these lots includes shells closely resembling Lea’s original figure of *P. virens*, and we have selected from these a lectotype (Figure 13E). Identification of Lea’s *P. virens* is made difficult by the fact that his description was based on decollate shells; nevertheless, his illustration permits recognition of this snail as the relatively tall, slightly convex-whorled species commonly found in the lower Willamette River.

Despite the fact that Lea compared *P. nuclea* to (*Campe-loma*) *decisa*, it is clear from his figure that this is the same species as *F. virens* (as concluded by many earlier workers), differing only in its less eroded spire and in having a remnant of black periostracum bordering the aperture. We have not been able to conclusively identify type material for *P. nuclea*, although possible syntypes conforming to Lea’s description may be a single lot from the National Museum of Natural History (labeled “Wahlamette [sic], Oregon,” I. Lea collection,

ex Nuttall, USNM 121432; specimens mixed with more typical *F. virens*) and a single specimen lot from the ANSP (Willamette River, ex I. Lea, ANSP 27765).

This species has been incorrectly ascribed to other drainages of western North America (e.g., Clarke, 1981; Beetle, 1989). Anatomical data are from USNM 883673 (near topotypes).

**MATERIAL EXAMINED.**—OREGON. Wahlamette [sic], USNM 121432, USNM 860649 (paralectotypes, *P. virens* Lea). Willamette River, ANSP 27755, ANSP 27756, ANSP 27765, USNM 28115, USNM 99303 (mixed with *F. fuscus*), USNM 121431 (lectotype, *P. virens* Lea). Portland, ANSP 27761 (mixed with *Fluminicola* sp.), ANSP 113137, USNM 473989, USNM uncat. (Lea 1379). Corvallis, USNM 531629. Clackamas River, CAS 93810. *Clackamas County*: Canal or flume from Tualatin River to Oswego Lake, ANSP 111291

(mixed with *Fluminicola* sp.). Willamette River, Oregon City, ANSP 73605, USNM 511059 (mixed with *Fluminicola* sp.). Oswego, USNM 511057 (mixed with *Fluminicola* sp.). Willamette River, Canby Ferry (north side), USNM 883673\*, USNM 883779\*. Willamette River, Bernert Landing (on Clackamas-Linn County line) (mixed with *Fluminicola* sp.), USNM 883670\*. Willamette River (south side), river mi 34.9 (km 56.2), Molalla State Park, USNM 883461. Willamette River (south side), river mi 40.9 (km 65.8), French Prairie State Park, USNM 883183\*, USNM 883692\*. *Linn County*: Willamette River, Albany, USNM 883676 (mixed with *Fluminicola* sp.). *Multnomah County*: Near Portland, CAS 93814.

WASHINGTON. *Cowlitz County*: Columbia River, Abernathy Point, just east of mouth of Abernathy Creek, USNM 883463\*, USNM 883693\*.

## Appendix

### Western American Fossil Species Described as or Allocated to *Fluminicola* or *Lithoglyphus*

(in alphabetical order by species name, with emendations of type localities and current generic assignments)

- Paludina abavia* Mayer, 1869:40, pl. X: fig. 13. Miocene, English Bay, Alaska; Miocene–Pliocene, Kenai Formation (Taylor, 1975a). Transferred to *Lithoglyphus* by Taylor (1975a).
- Lithasia antiqua* Gabb, 1866:13, pl. 2: fig. 22. Fresh-water Tertiary deposit on Snake River, Idaho Territory, on the road from Fort Boise to the Owyhee mining country; Late Pliocene–Early Pleistocene, Glens Ferry Formation, Canyon or Owyhee County, Idaho, near Walters Ferry, T 1S, R 2W, sec. 17 (Taylor, 1966a). Allocated to *Lithoglyphus* by Taylor (1966a; as synonym of *Natica(?) occidentalis* Hall, 1845).
- Lithoglyphus campbelli* Dall, 1924:115, pl. XXVI: fig. 1. Mouth of King Hill Creek near Glenn's Ferry, Snake River Canyon, Idaho, United States Geological Survey (USGS) Station 3486; Late Pliocene–Early Pleistocene, Glens Ferry Formation, USGS Cenozoic locality 21510: Elmore County, Idaho, T 5S, R 10E, NW<sup>1</sup>/<sub>4</sub> sec. 14 (Taylor, 1966a). Transferred to *Pliopholix* (Pliopholygidae) by Taylor (1966a).
- Fluminicola yatesiana inflata* Yen, 1950:186, pl. 1: figs. 5, 5a. Probably Pliocene, Truckee Formation, western Nevada, 2 mi (3.2 km) north of the triangle marking the position of the Desert Queen Mine, which lies in the northeastern corner of the Hot Springs Mountains; Pliocene, Truckee Formation (Taylor, 1975a). Transferred to "*Ammicola*" by Taylor (1975a).
- Fluminicola junturae* Taylor, 1963:38, figs. 8–10. Miocene, USGS locality 21173, Black Butte local fauna, Malheur County, Oregon; Pliocene, Juntura Formation (Taylor, 1975a). Transferred to *Lithoglyphus* by Taylor (1975a).
- Fluminicola kettlemanensis* Pilsbry, 1934:15 (Pilsbry, 1935, pl. 19: figs. 1–3). San Joaquin Formation outcrop; Kettleman Hills at Shell Oil Co. locality 2502, San Joaquin Formation immediately below the *Pecten coalingaensis* zone (Pilsbry, 1935); Pliocene, upper San Joaquin Formation, Kings County, California, T 22S, R 18E, near center sec. 26 (Taylor, 1966a). Transferred to *Lithoglyphus* by Taylor (1966a).
- Fluminicola malheurensis* Henderson and Rodeck, 1934:266–267, pl. 37: figs. 8a, 8b. Pliocene, about 16 mi (25.7 km) southwest of Vale, Malheur County, Oregon; Pliocene, Grassy Mountain Formation (Taylor, 1975a). Transferred to *Lithoglyphus* by Taylor (1975a).
- Natica(?) occidentalis* Hall, 1845:308, pl. 3: figs. 8, 8a. Longitude 115°, latitude 43°, in a gray siliceous limestone; Late Pliocene–Early Pleistocene, Glens Ferry Formation, Canyon or Owyhee County, Idaho, near Walters Ferry, T 1S, R 2W, sec. 17 (Taylor, 1966a). Transferred to *Lithoglyphus* by Taylor (1966a).
- Fluminicola percarinata* Pilsbry, 1934:16 (Pilsbry, 1935, pl. 19: figs. 8, 9). Lost Hills Oil Field (California), 445–520 ft (136–158 m); Lost Hills Oil Field in Universal Consolidated Well No. 44, at 445–520 ft (136–158 m) (Pilsbry, 1935); Pliocene, upper part of San Joaquin Formation, Kern County, California, T 26S, R 21E, sec. 32 (Taylor, 1966a). Transferred to *Savaginius* (= *Pyrgulopsis*; fide Hershler, 1994) by Taylor (1966a).
- Fluminicola perditicollis* Pilsbry, 1934:16 (Pilsbry, 1935, pl. 19: fig. 4). Lost Hills Oil Field (California), 455–650 ft (139–198 m); Lost Hills Oil Field in Universal Consolidated Well No. 44, sec. 32–26–21, at 455–650 ft (139–198 m) (Pilsbry, 1935); Pliocene, upper part of San Joaquin Formation, Kern County, California, T 26S, R 21E, sec. 32 (Taylor, 1966a). Transferred to *Savaginius* by Taylor (1966a).

- Fluminicola pilula* Pilsbry, 1934:15 (Pilsbry, 1935, pl. 19: figs. 11–13). Lost Hills Oil Field (California); San Joaquin Formation: Lost Hills Oil Field, Universal Consolidated Well No. 44, sec. 32-26-21, at 435–445 ft (133–136 m) (Pilsbry, 1935); Pliocene, upper part of San Joaquin Formation, Kern County, California, T 26S, R 21E, sec. 32 (Taylor, 1966a). Transferred to *Savaginius* by Taylor (1966a).
- Fluminicola protea* Yen, 1948:41, pl. 10: fig. 12. Paleocene, Montana: Locality 17, 300 ft (91 m) east from the southeast corner sec. 32, T 8S, R 46E, Powder River County, 100 ft (30 m) above base of Anderson clinker. Transferred to *Reesidella* (Bithyniidae) by Taylor (1975b).
- Fluminicola sanmateoensis* Glen, 1960:1208–1209, fig. 1e–g. CAS locality number 36724, California, San Mateo County, T 5S, R 5W, 300 yd (274 m) north, 45° west of the entrance (on Skyline Blvd.) to the Skyline Materials Plant No. 1; latest Pliocene–earliest Pleistocene, Santa Clara Formation (Taylor, 1966a). Transferred to *Lithoglyphus* by Taylor (1966a).
- Fluminicola siegfusi* Pilsbry, 1934:16 (Pilsbry, 1935, pl. 19: fig. 10). Lost Hills Oil Field (California); San Joaquin Formation: Lost Hills Oil Field, the Universal Consolidated Well No. 44, at 365–720 ft (111–219 m) (Pilsbry, 1935); Late Pliocene, upper part of San Joaquin Formation, Kern County, California, T 26S, R 21E, sec. 32 (Taylor, 1966a). Transferred to *Savaginius* by Taylor (1966a). Transferred to *Brannerillus* (Planorbidae?) by Taylor (1975a).
- Fluminicola spiralis* Pilsbry, 1934:16 (Pilsbry, 1935, pl. 19: figs. 14–19). Twenty-three mi (37 km) southeast of Hanford (California), 772–794 ft (235–242 m), and in the McKittrick Front Oil Field; Tulare Formation, Boston Land Co. “C” well, 772–792 ft (235–241 m), 23 mi (37 km) southeast of Hanford, sec. 27-19-18 (Pilsbry, 1935); Late Pliocene, upper part of Tulare Formation, within or immediately above Corcoran Clay member, Fresno County, California (Taylor, 1966a). Transferred to *Savaginius* by Taylor (1966a).
- Pilsbryus superbus* Yen, 1944:105, fig. 8. Pliocene, Idaho Formation, Hammett, Elmore County, Idaho; Late Pliocene–Early Pleistocene, Glens Ferry Formation, Elmore or Owyhee County, Idaho (Taylor, 1966a). Transferred to *Lithoglyphus* by Taylor (1966a).
- Pilsbryus antiquus utahensis* Yen, 1947:273, pl. 43: fig. 7. Pliocene, Salt Lake Formation, Cache/Box Elder Counties, Utah, T 13N, R 2W, sec. 15; Late Pliocene, Cache Valley Formation, Box Elder County, Utah, USGS locality 20093 (Taylor, 1966a). Transferred to *Lithoglyphus* by Taylor (1966a).
- Fluminicola yatesiana utahensis* Yen, 1947:273, pl. 43: fig. 6. Pliocene, Salt Lake Formation, Cache/Box Elder Counties, Utah, T 13N, R 2W, sec. 15; Late Pliocene, Cache Valley Formation, Box Elder County, Utah, USGS locality 20093 (Taylor, 1966a). Transferred to *Savaginius* by Taylor (1966a; as synonym of *Paludestrina nanna* Chamberlin and Berry, 1933).
- Fluminicola weaveri* Yen, 1944:105, fig. 6. Pliocene, Idaho Formation, Hammett, Elmore County, Idaho; Late Pliocene–Early Pleistocene, Glens Ferry Formation, Elmore or Owyhee County, Idaho (Taylor, 1966a). Transferred to *Lithoglyphus* by Taylor (1966a).
- Pyrgulopsis williamsi* Hannibal, 1912:189–190, pl. VIII: fig. 29. Martin and Dudley’s oil well, SE ¼ sec. 32, T 26S, R 21E, Lost Hills; Late Pliocene, upper part of Santa Clara Formation, Lost Hills Oil Field, Kern County, California (Taylor, 1966a). Transferred to *Savaginius* by Taylor (1966a).
- Amnicola yatesiana* J.G. Cooper, 1894:171, pl. XIV: fig. 10. Pliocene, Santa Clara lake beds, San José Mission, Santa Clara County; Late Pliocene, Santa Clara Formation, Alameda County, California, ridge of gravel and alluvium at Mission San Jose, probably in sec. 1, 2, 11, 12, T 5S, R 1W (Taylor, 1966a). Transferred to *Fluminicola* by Pilsbry (1935). Transferred to *Savaginius* by Taylor (1966a).

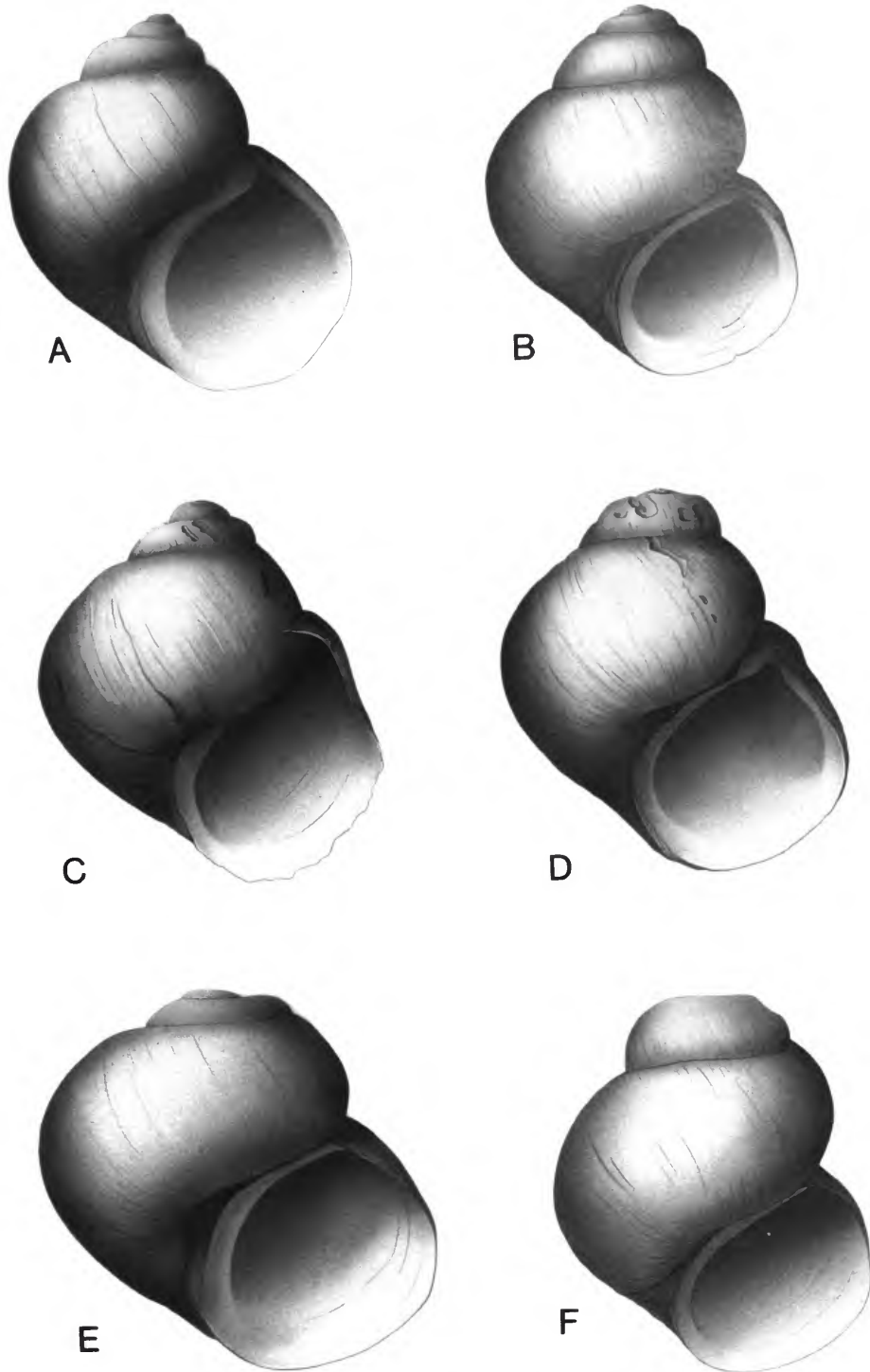

FIGURE 4.—Shells of type and other historically important material of *Fluminicola* species. A, *F. coloradensis*, holotype, USNM 526631 (shell height, 10.8 mm); B, *F. dalli*, lectotype, MCZ 2087 (3.1 mm); C, *F. columbiana* (= *F. fuscus*), lectotype, ANSP 27767 (8.0 mm); D, *Amnicola hindsi* (= *F. fuscus*), lectotype, BMNH 1863.2.4.17A (8.7 mm); E, *F. minutissimus*, lectotype, ANSP 94273 (1.5 mm); F, *F. modoci*, lectotype, CAS 60798 (4.1 mm).

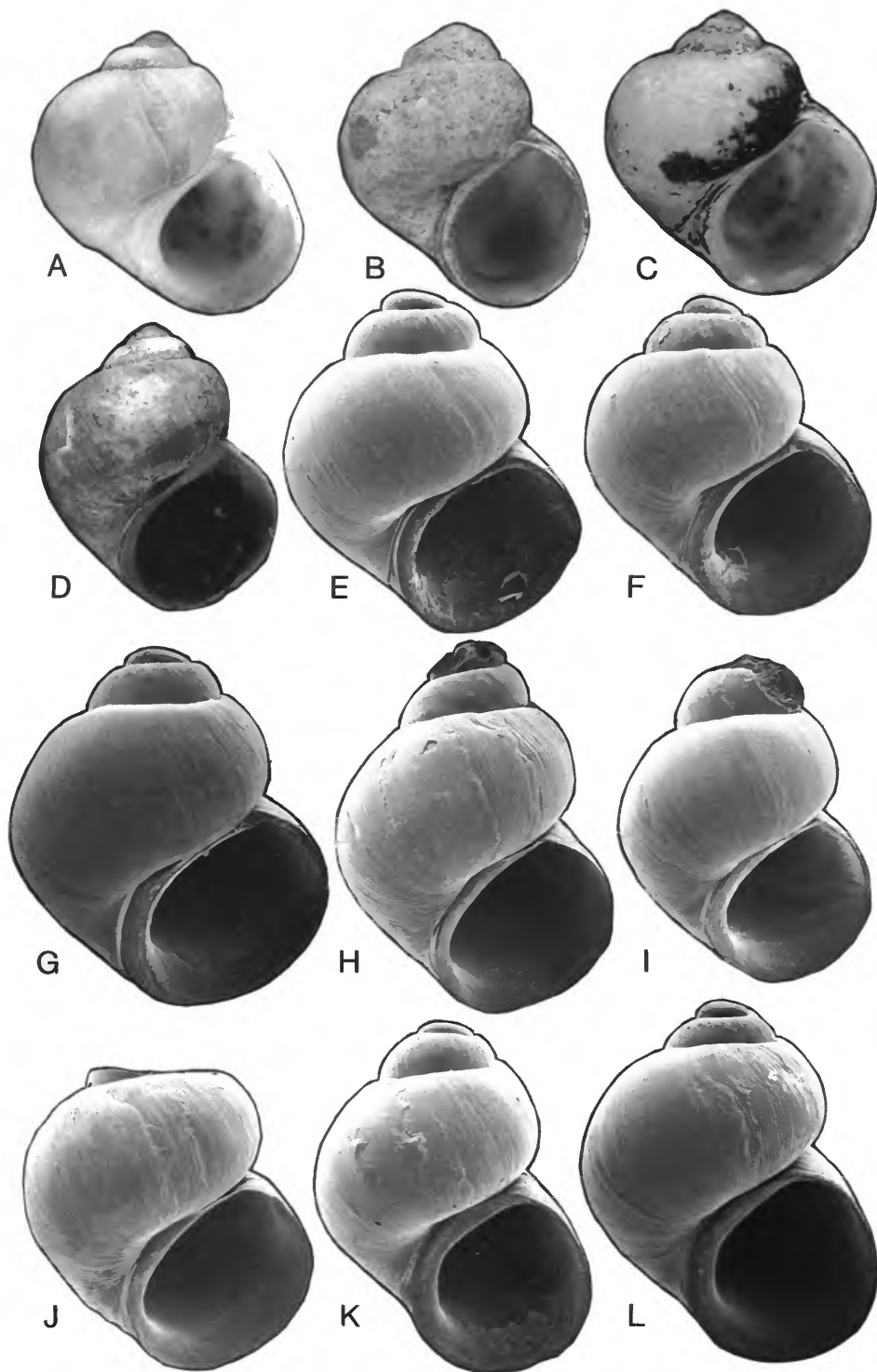

FIGURE 5.—Shells of *Fluminicola* species. A–D, *F. coloradensis*: A, USNM 160394 (shell height, 9.2 mm); B, USNM 883493 (8.7 mm); C, USNM 526754 (6.5 mm); D, USNM 28103 (9.3 mm). E–G, *F. dalli*, USNM 883467 (2.3 mm, 2.4 mm, 2.1 mm, respectively); H–J, *F. modoci*, USNM 883468 (3.2 mm, 2.9 mm, 2.7 mm, respectively); K,L, *F. turbiniformis*, USNM 883470 (3.1 mm, 3.2 mm, respectively).

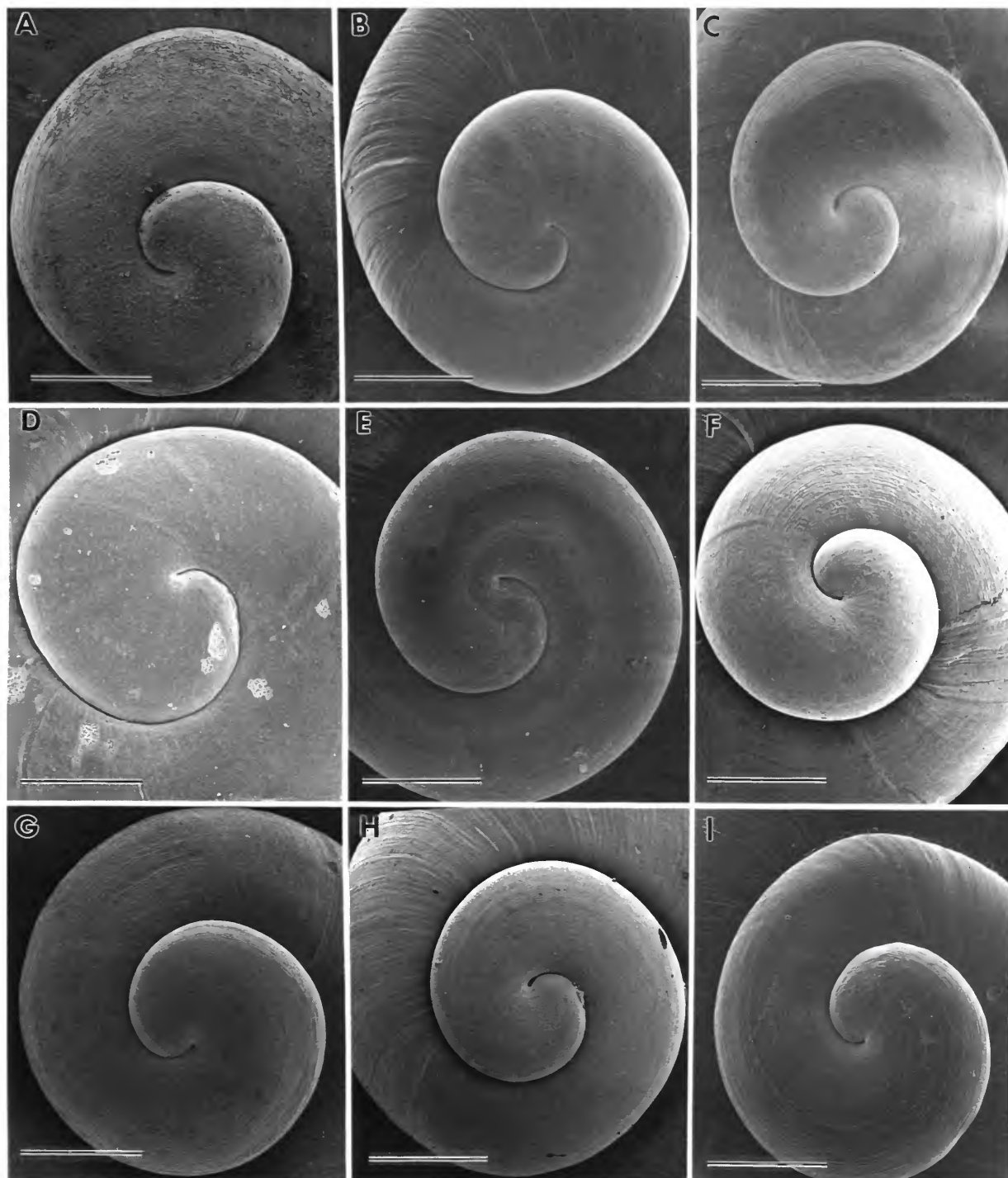

FIGURE 6.—Shell protoconchs of *Fluminicola* species. A, *F. coloradensis*, USNM 526576 (bar = 0.27 mm); B, *F. dalli*, USNM 526835 (bar = 231  $\mu$ m); C, *F. fuscus*, USNM 883495 (bar = 0.33 mm); D, *F. minutissimus*, ANSP 398350 (bar = 120  $\mu$ m); E, *F. modoci*, USNM 883468 (bar = 200  $\mu$ m); F, *F. nuttallianus*, USNM 47874 (bar = 0.33 mm); G, *F. seminalis*, USNM 883465 (bar = 231  $\mu$ m); H, *F. turbiniformis*, USNM 883470 (bar = 250  $\mu$ m); I, *F. virens*, USNM 883183 (bar = 0.27 mm).



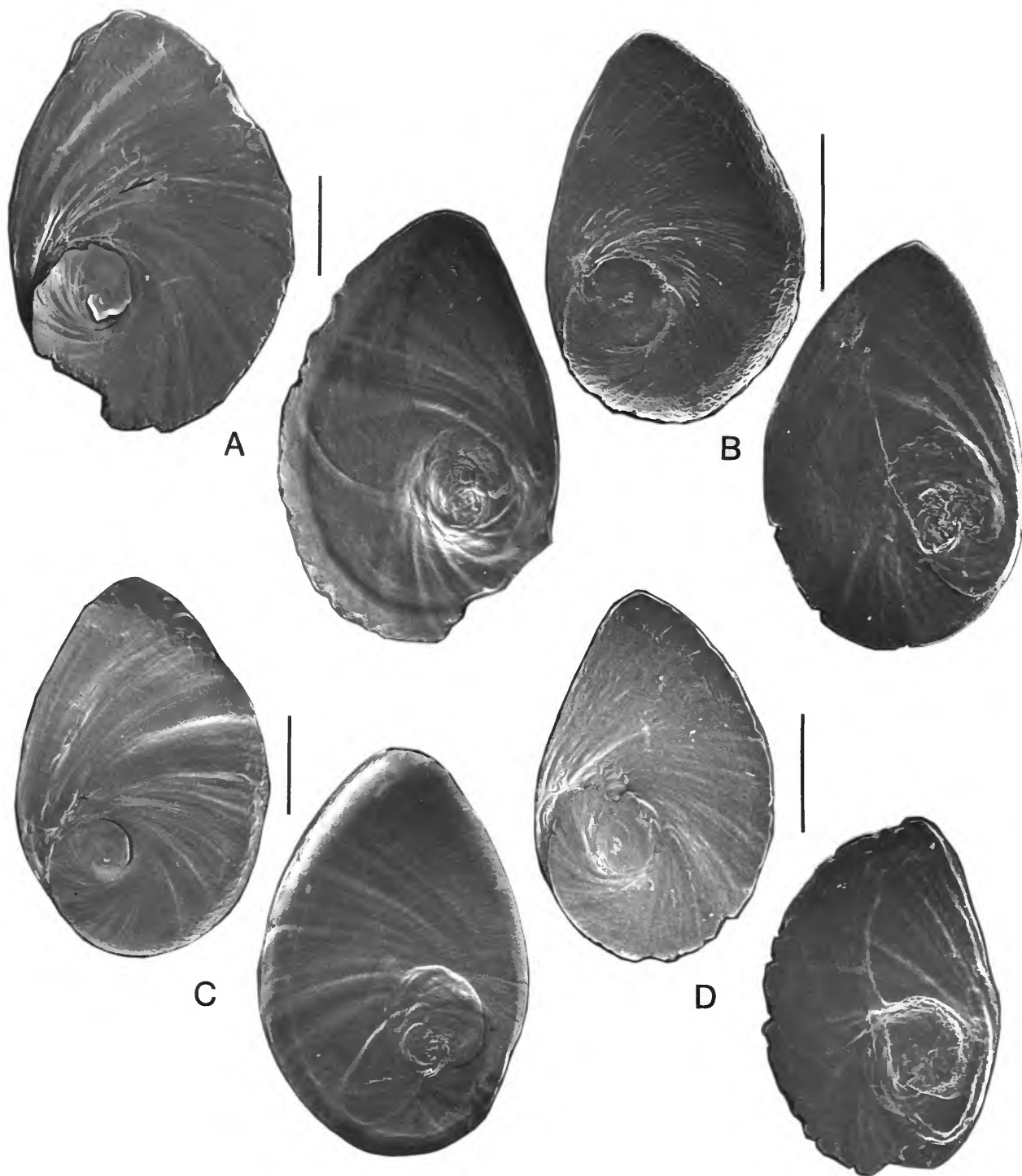

FIGURE 7.—Opercula of *Fluminicola* species. A, *F. coloradensis*, USNM 883493 (bar = 1.2 mm); B, *F. dalli*, USNM 874899 (bar = 0.38 mm); C, *F. fuscus*, USNM 883182 (bar = 1.2 mm); D, *F. modoci*, USNM 883468 (bar = 0.5 mm). Dorsal views to left, ventral views to right.

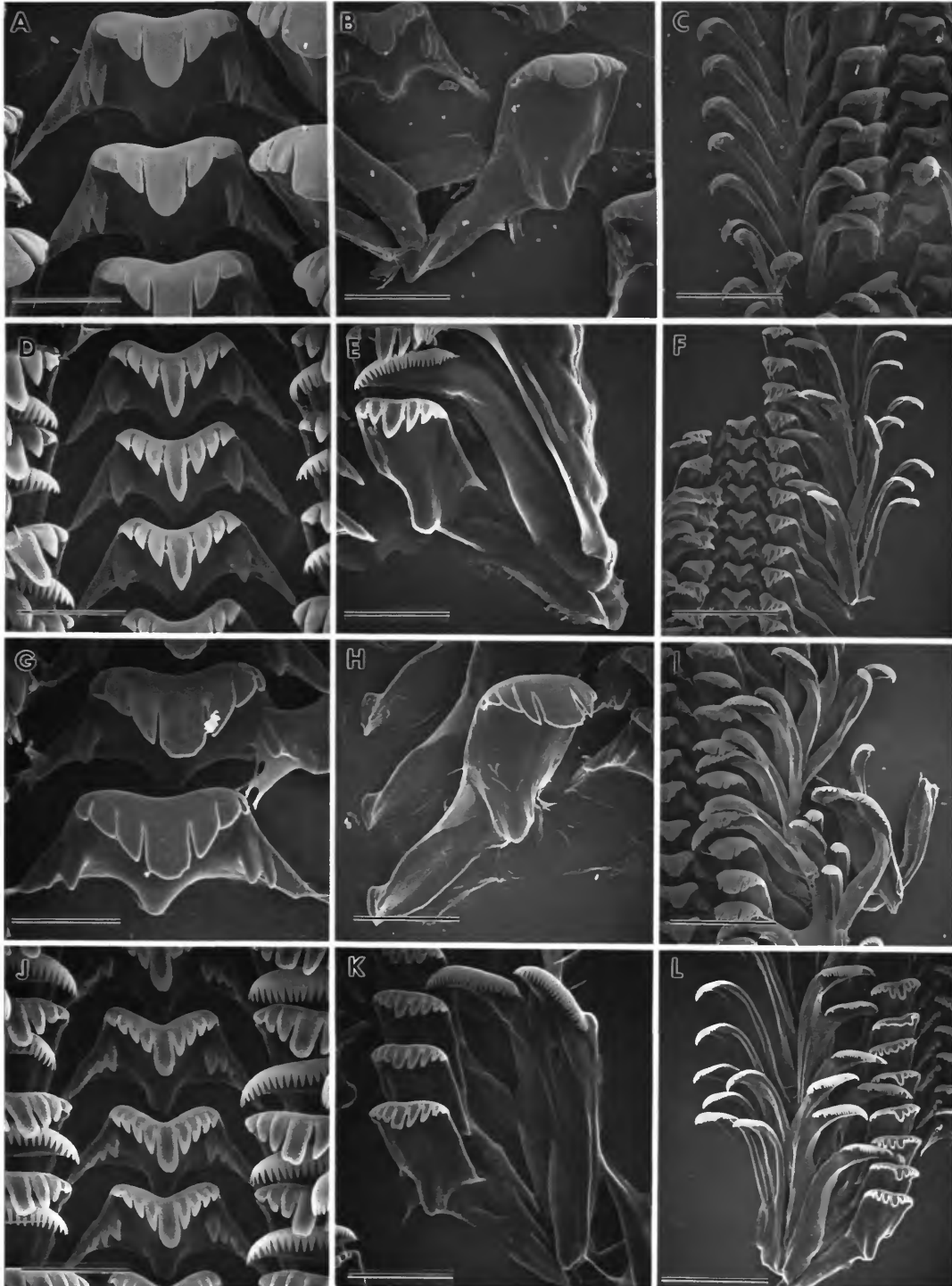

FIGURE 8.—Radulae of *Fluminicola* species. A–C, *F. coloradensis*, USNM 883493 (bars = 38  $\mu$ m, 60  $\mu$ m, 136  $\mu$ m, respectively); D–F, *F. dalli*, USNM 874899 (bars = 17.6  $\mu$ m, 20  $\mu$ m, 60  $\mu$ m, respectively); G–I, *F. fuscus*, USNM 883182 (bars = 30  $\mu$ m, 50  $\mu$ m, 120  $\mu$ m, respectively); J–L, *F. modoci*, USNM 883468 (bars = 20  $\mu$ m, 30  $\mu$ m, 50  $\mu$ m, respectively). Photographs show (from left to right) central teeth, lateral teeth, and general view of portion of radula ribbon.

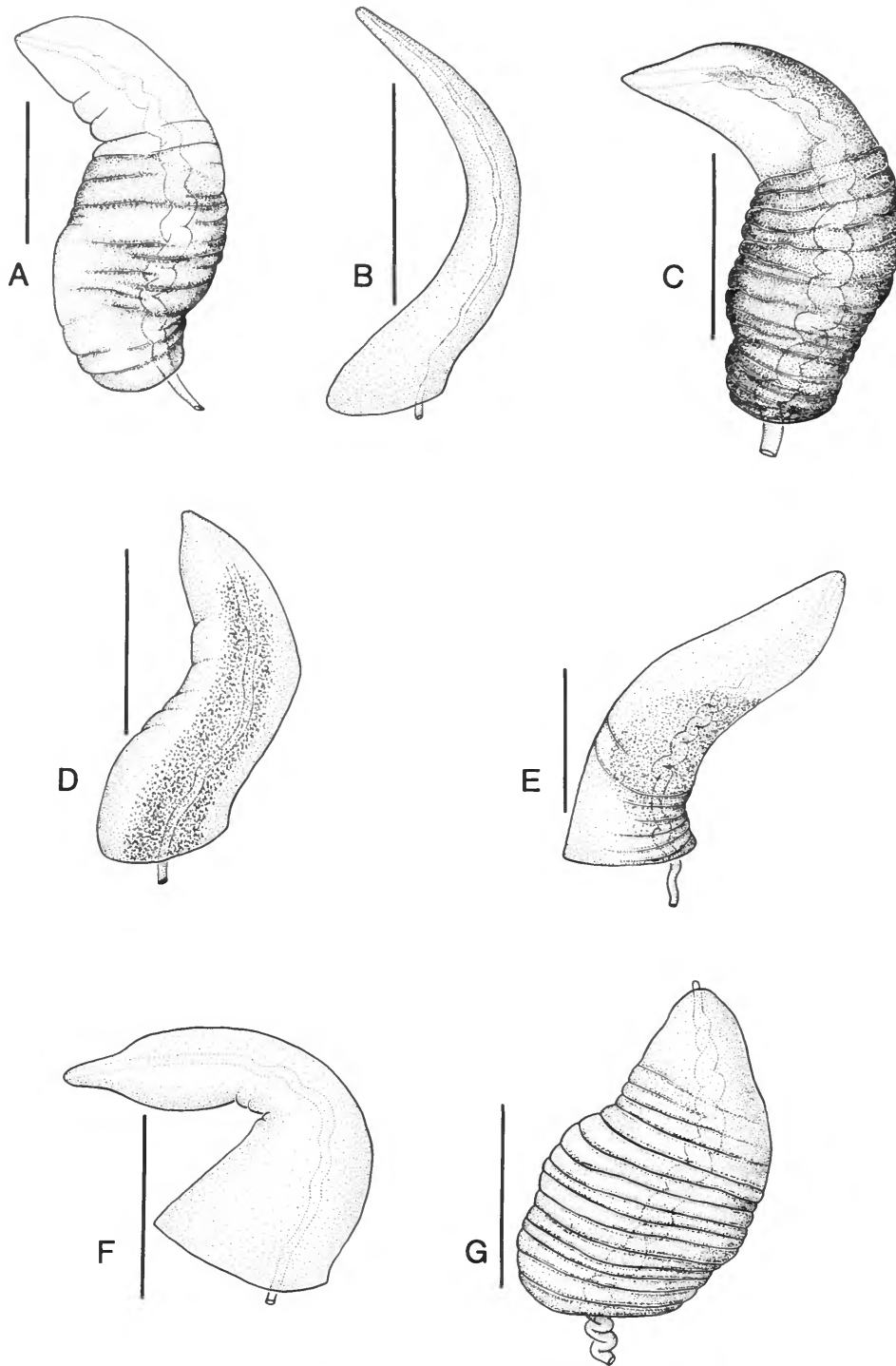

FIGURE 9.—Penes (dorsal views) of *Fluminicola* species. A, *F. coloradensis*, USNM 883493 (bar = 1 mm); B, *F. dalli*, USNM 874899 (bar = 0.50 mm); C, *F. fuscus*, USNM 883182 (bar = 1 mm); D, *F. modoci*, USNM 883468 (bar = 0.5 mm); E, *F. seminalis*, USNM 883465 (bar = 0.5 mm); F, *F. turbiniformis*, USNM 883470 (bar = 0.33 mm); G, *F. virens*, USNM 883673 (bar = 1 mm). The penial duct is indicated by dotted lines. Epithelial pigment is shown as dark stipple.

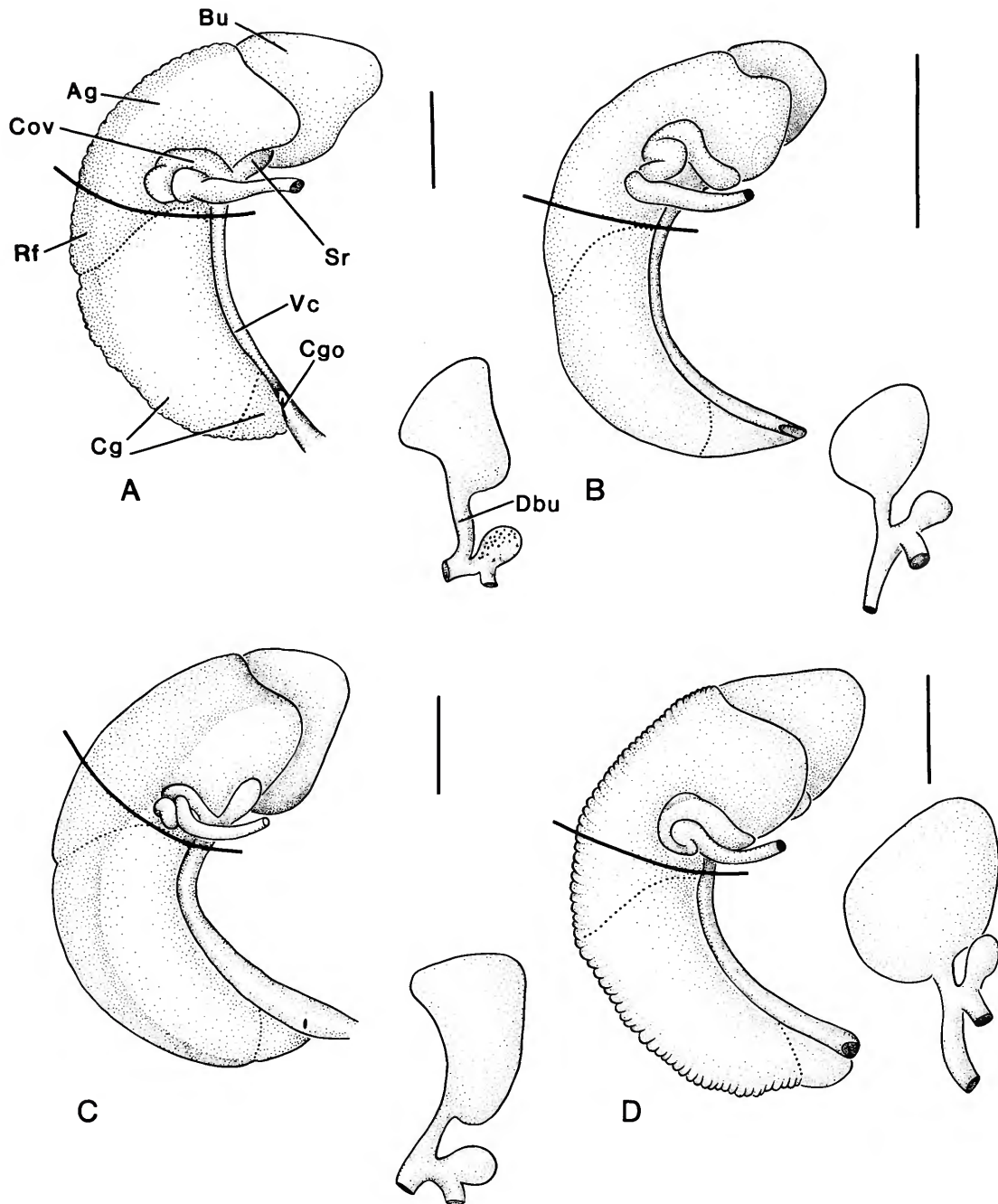

FIGURE 10.—Distal female genitalia (left side) of *Fluminicola* species. A, *F. coloradensis*, USNM 883493 (bar = 1 mm); B, *F. dalli*, USNM 874899 (bar = 0.5 mm); C, *F. fuscus*, USNM 883182 (bar = 1 mm); D, *F. modoci*, USNM 883468 (bar = 0.5 mm). (Ag = albumen gland, Bu = bursa copulatrix, Cg = capsule gland, Cgo = capsule gland opening, Cov = coiled oviduct, Dbu = bursal duct, Rf = rectal furrow, Sr = seminal receptacle, Vc = ventral channel.)

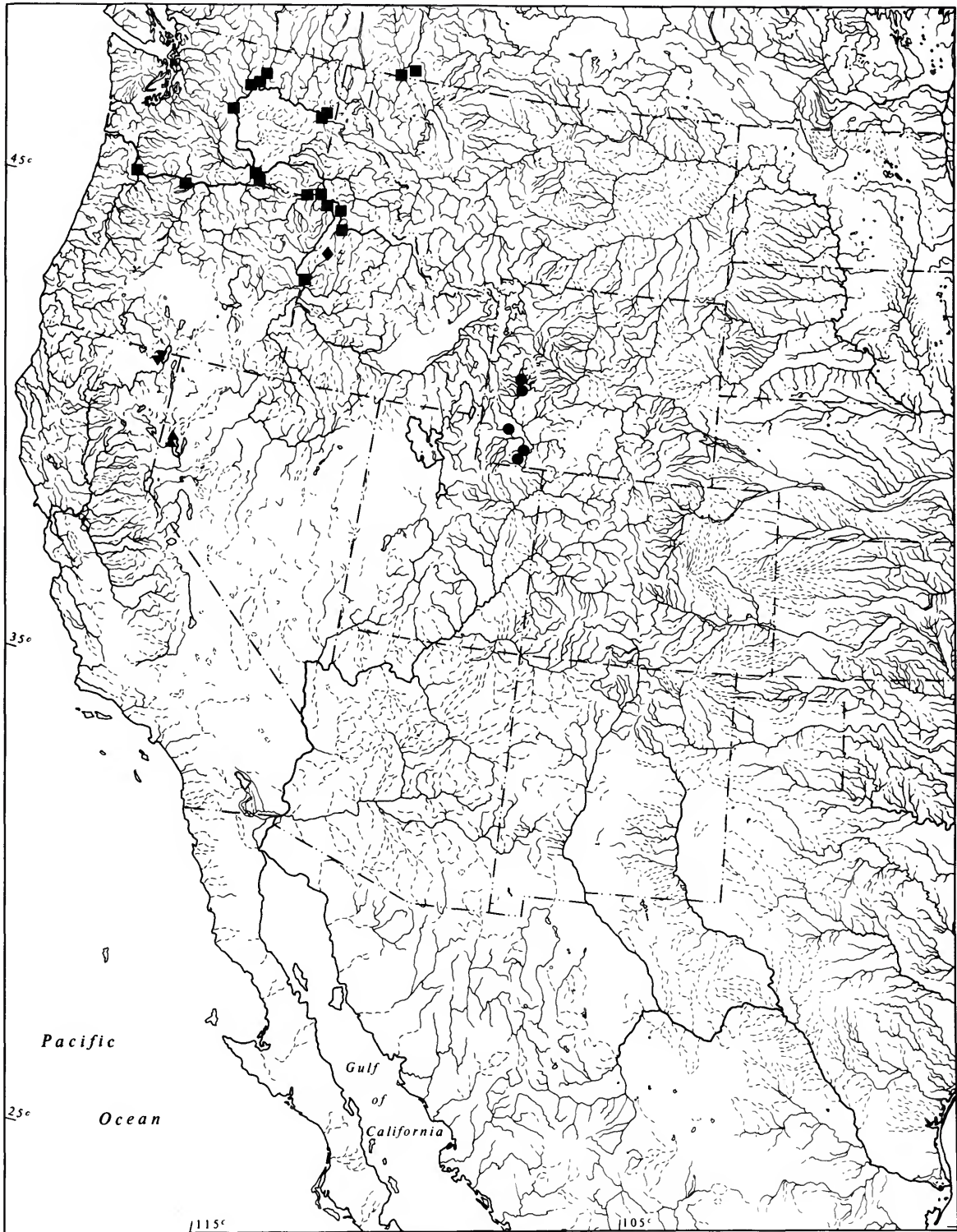

FIGURE 11.—Map showing distribution of *Fluminicola* species (● = *F. coloradensis*, ■ = *F. fuscus*, ▼ = *F. modoci*, ▲ = *F. dalli*, ◆ = *F. minutissimus*).

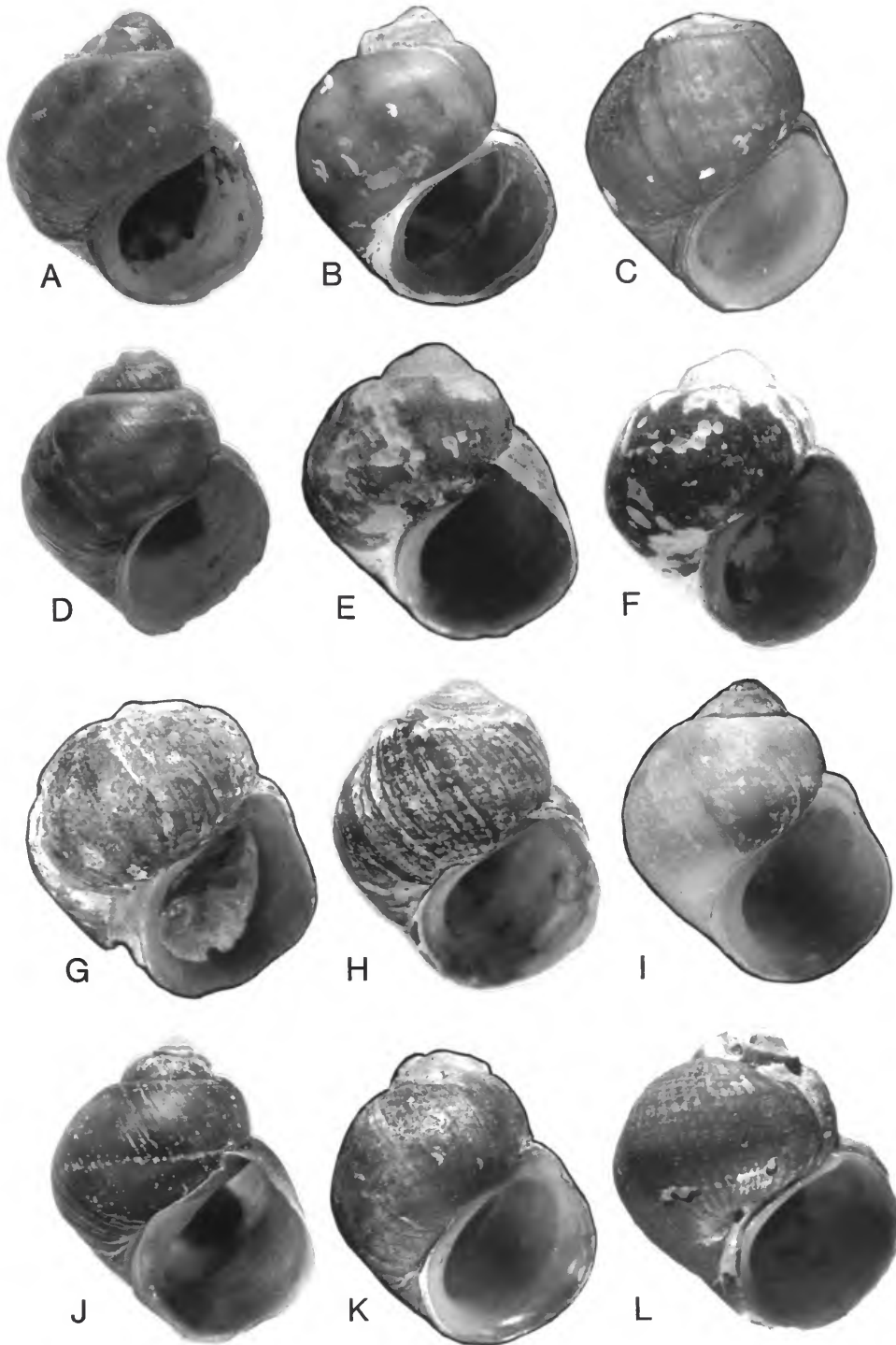

FIGURE 12.—Shells of *Fluminicola fuscus*. A, ANSP 62341 (shell height, 8.5 mm); B, USNM 883516 (7.3 mm); C, USNM 473390 (9.2 mm); D, USNM 854693 (9.3 mm); E, USNM 883515 (7.8 mm); F, USNM 380804 (7.7 mm); G, USNM 883499 (8.7 mm); H, USNM 130527 (11.2 mm); I, USNM 883182 (10.0 mm); J, USNM 883640 (10.0 mm); K, USNM 511051 (8.8 mm); L, BMNH 1863.2.4.16 (8.3 mm).

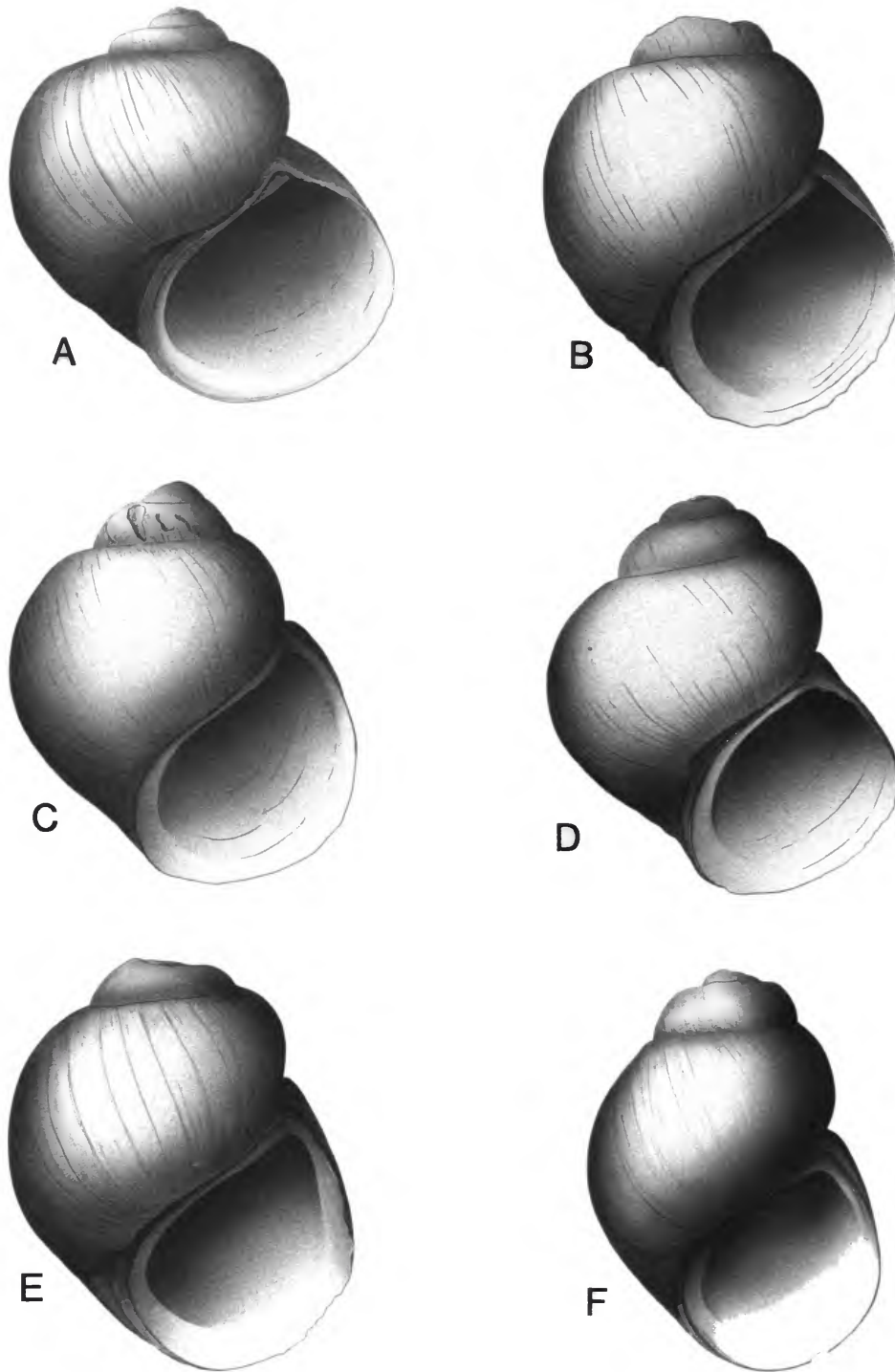

FIGURE 13.—Shells of type and other historically important material of *Flumicola* species. A, *F. nuttallianus*, lectotype, USNM 121467 (shell height, 8.8 mm); B, *F. seminalis*, possible syntype, BMNH 1994109 (7.7 mm); C, *Lithoglyphus cumingii* (= *F. seminalis*), lectotype, BMNH 1933047 (5.8 mm); D, *F. turbiniformis*, lectotype, ANSP 27779 (3.3 mm); E, *F. virens*, lectotype, USNM 121431 (7.5 mm); F, *Paludina nuclea* (= *F. virens*), possible syntype, ANSP 27765 (8.3 mm).

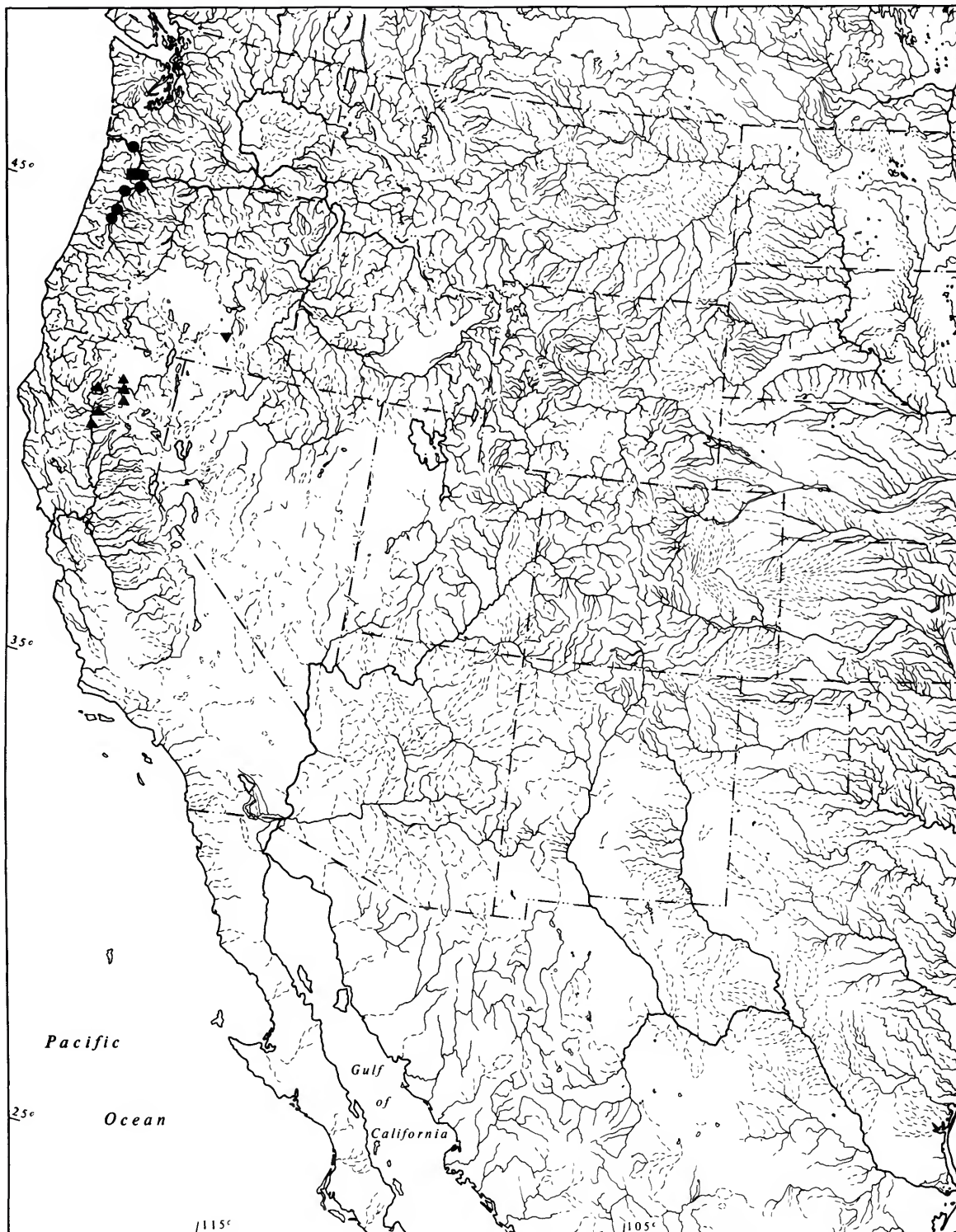

FIGURE 14.—Map showing distribution of *Fluminicola* species (■ = *F. nuttallianus*, ▼ = *F. turbiniformis*, ▲ = *F. seminalis*, ● = *F. virens*).



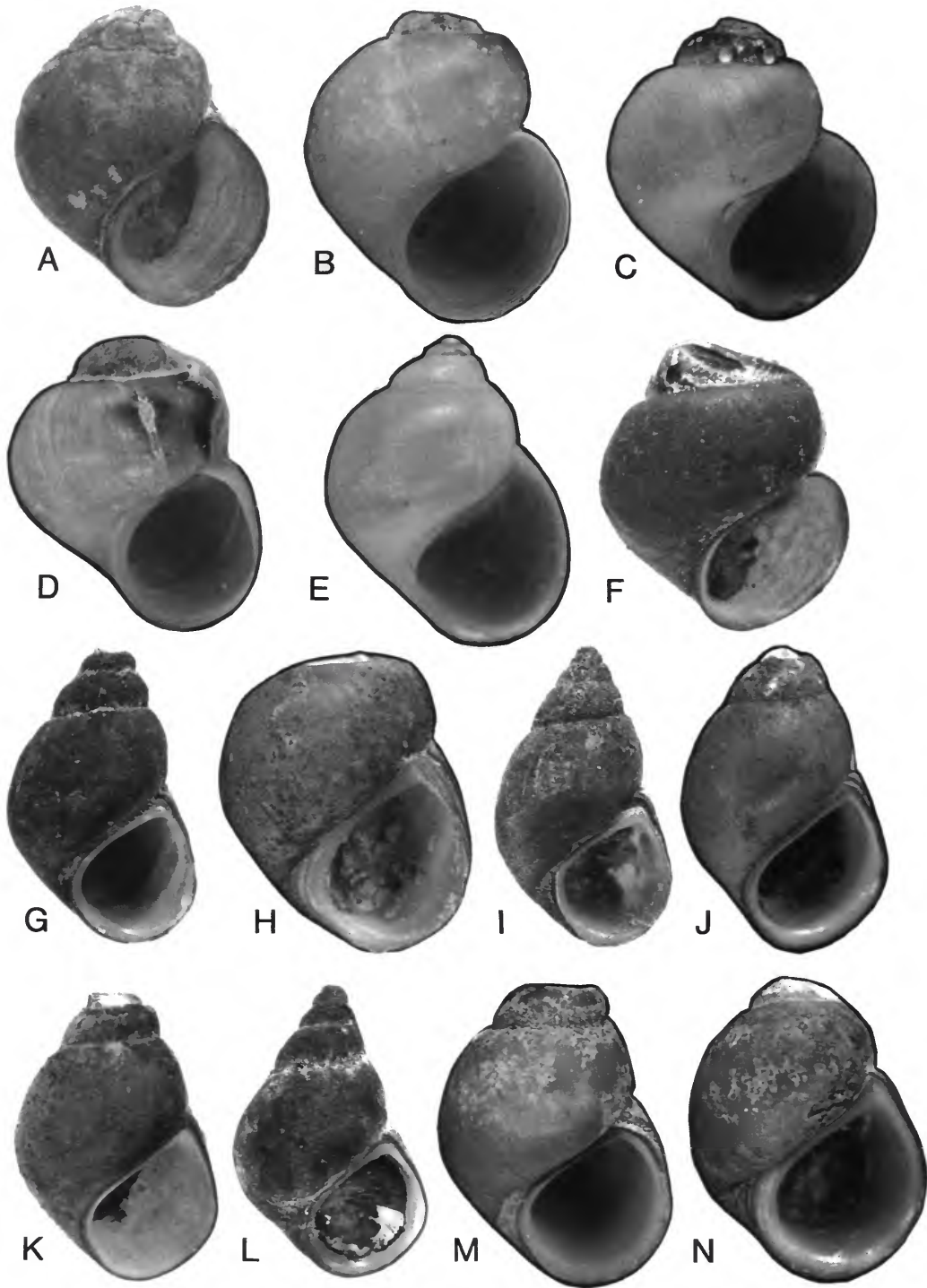

FIGURE 15.—Shells of *Fluminicola* species. A–F, *F. seminalis*: A, USNM 121465 (shell height, 8.0 mm); B, USNM 883465 (6.0 mm); C, USNM 883188 (6.0 mm); D, USNM 883180 (6.2 mm); E, USNM 883742 (6.5 mm); F, CAS 93862 (6.0 mm). G–N, *F. virens*: G, USNM 473989 (9.5 mm); H, CAS 93810 (5.8 mm); I, USNM 511057 (11.5 mm); J, USNM 511059 (10.3 mm); K, USNM 883673 (7.5 mm); L, USNM 883670 (10.3 mm); M, USNM 883676 (8.7 mm); N, USNM 883693 (7.7 mm).

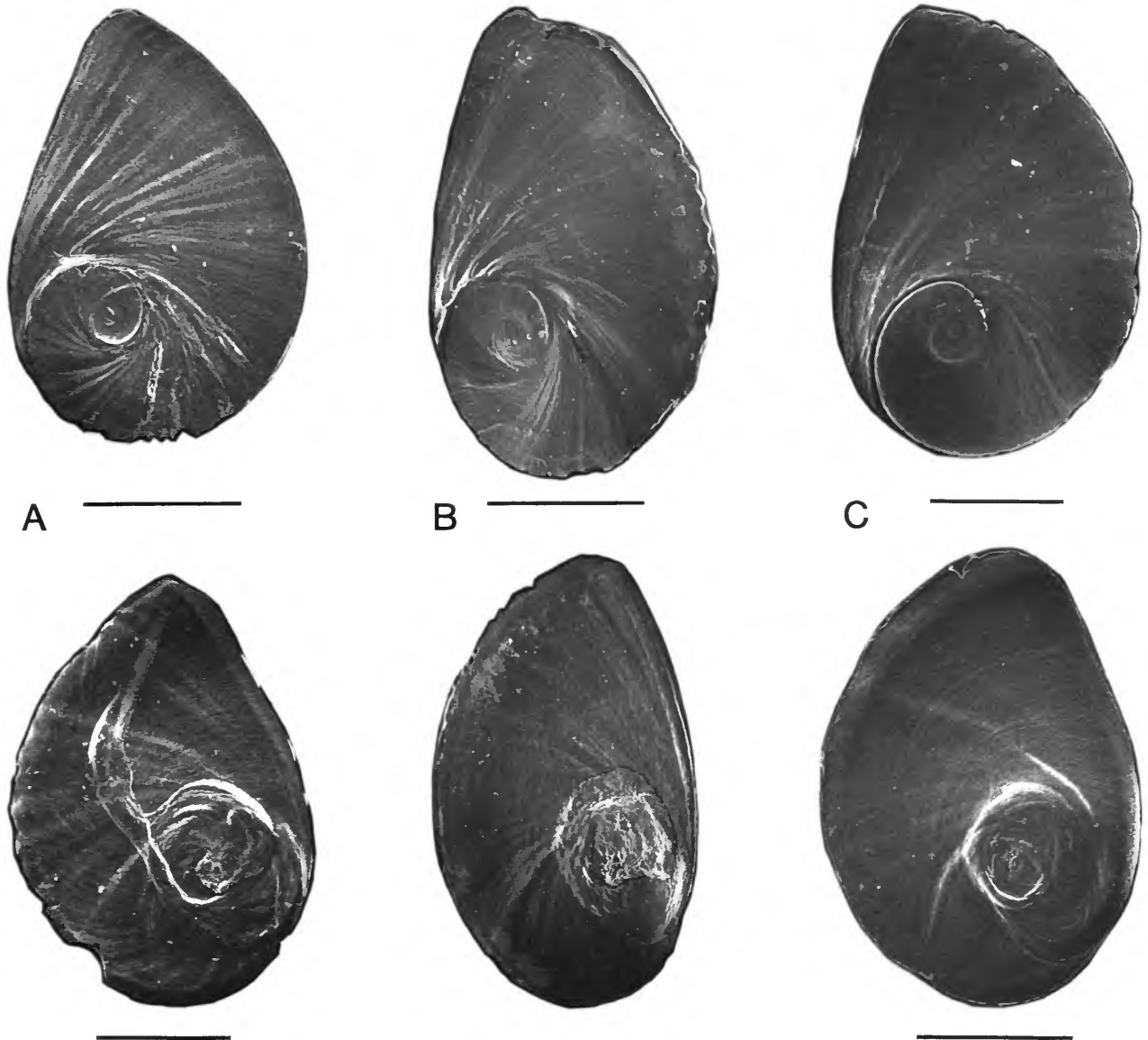

FIGURE 16.—Opercula of *Fluminicola* species. A, *F. seminalis*, USNM 883465 (bars = 0.86 mm (left), 1 mm (right)); B, *F. turbiniformis*, USNM 883470 (bar = 0.43 mm); C, *F. virens*, USNM 883673 (bars = 1 mm (left), 0.86 mm (right)). Dorsal views to left, ventral views to right.

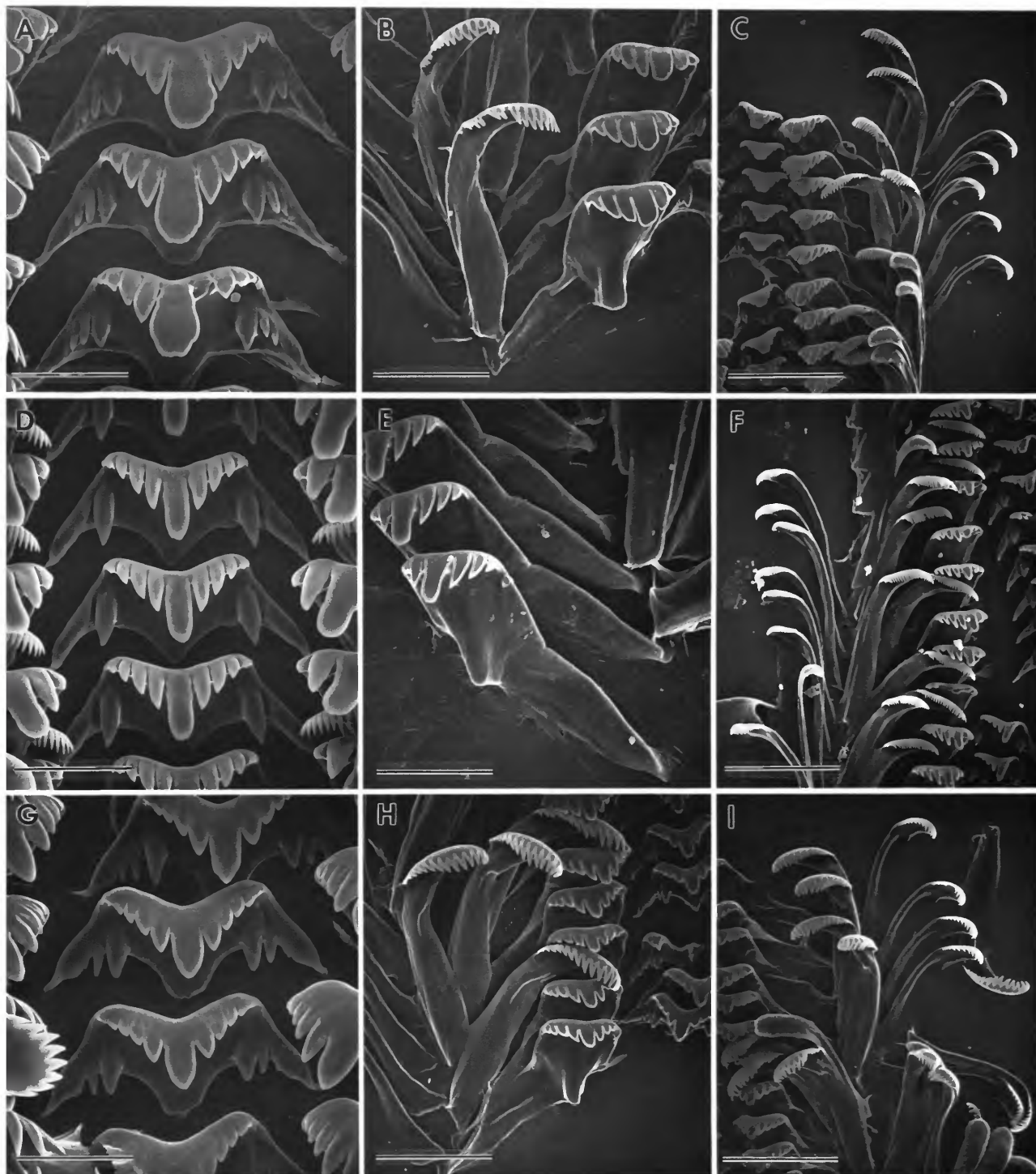

FIGURE 17.—Radulae of *Fluminicola* species. A–C, *F. seminalis*, USNM 883465 (bars = 27  $\mu$ m, 50  $\mu$ m, 100  $\mu$ m, respectively); D–F, *F. turbiniformis*, USNM 883470 (bars = 20  $\mu$ m, 27  $\mu$ m, 50  $\mu$ m, respectively); G–I, *F. virens*, USNM 883673 (bars = 25  $\mu$ m, 60  $\mu$ m, 86  $\mu$ m, respectively). Photographs show (from left to right) central teeth, lateral teeth, and general view of portion of radula ribbon.

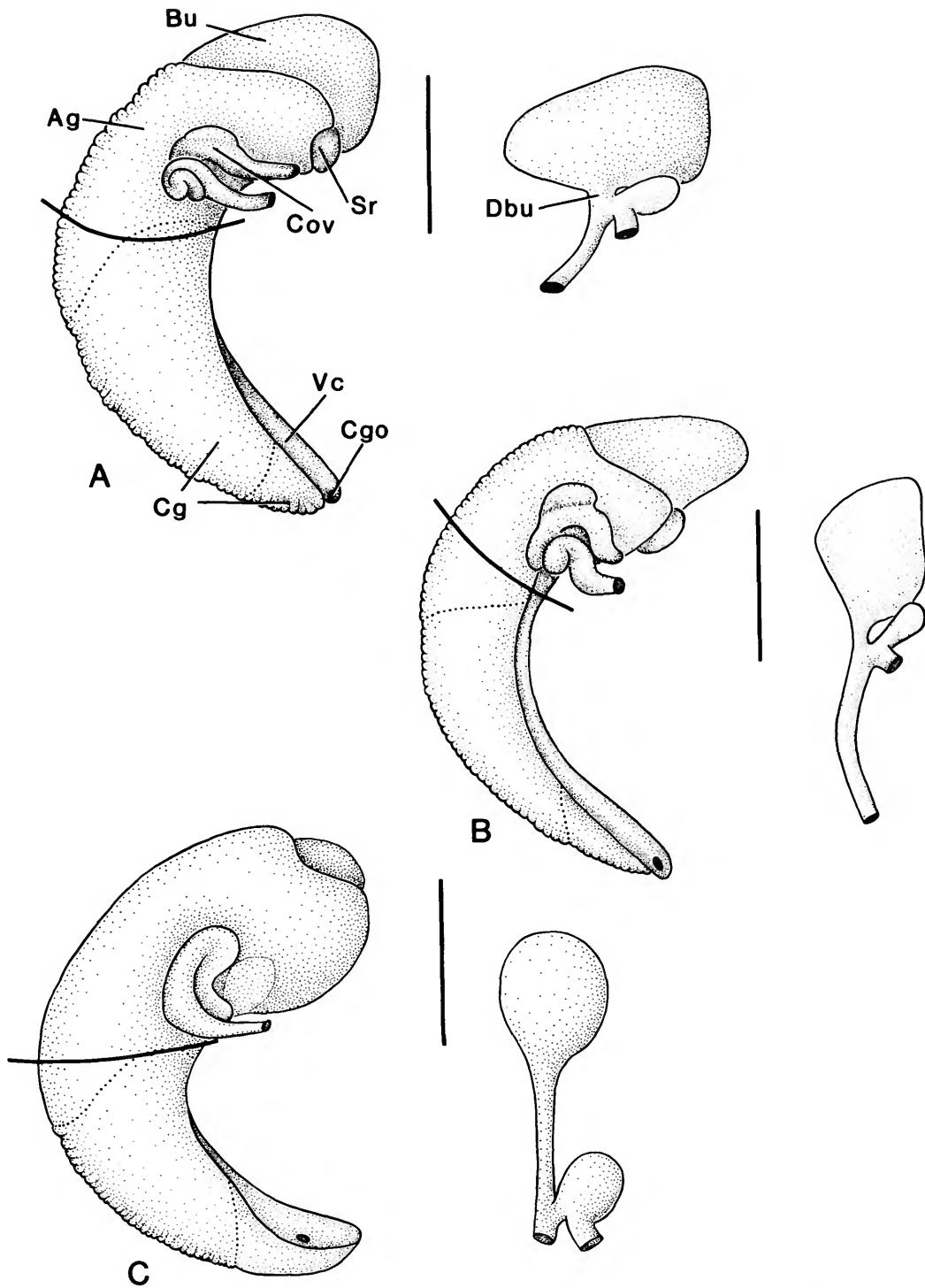

FIGURE 18.—Distal female genitalia (left side) of *Fluminicola* species. A, *F. seminalis*, USNM 883465 (bar = 1 mm); B, *F. turbiniformis*, USNM 883470 (bar = 0.5 mm); C, *F. virens*, USNM 883673 (bar = 1 mm). (Ag = albumen gland, Bu = bursa copulatrix, Cg = capsule gland, Cgo = capsule gland opening, Cov = coiled oviduct, Dbu = bursal duct, Sr = seminal receptacle, Vc = ventral channel.)

## Literature Cited

- Adams, H.A., and A.A. Adams  
1853–1854. *The Genera of Recent Mollusca Arranged According to Their Organization*. Volume 1 [of three], 484 pages. London: John Van Voorst.
- Anonymous  
1866. [Review of "Researches Upon the Hydrobiinae and Allied Forms; Chiefly Made Upon Materials in the Museum of the Smithsonian Institution" by W. Stimpson (1865).] *American Journal of Science*, 41:270–272.
- Baily, J.L., and R.I. Baily  
1951–1952. Further Observations on the Mollusca of the Relict Lakes in the Great Basin. *Nautilus*, 65:46–53, 85–93.
- Baird, W.  
1863. Descriptions of Some New Species of Shells, Collected at Vancouver Island and in British Columbia, by J.K. Lord, Esq., Naturalist to the British North-American Boundary Commission, in the Years 1858–1862. *Proceedings of the Zoological Society of London*, 31:66–70.
- Baker, H.B.  
1964. Type Land Snails in the Academy of Natural Sciences of Philadelphia, III: Limnophile and Thalassophile Pulmonata; IV: Land and Fresh-water Prosobranchia. *Proceedings of the Academy of Natural Sciences of Philadelphia*, 116:149–193.
- Banarescu, P.  
1990. General Distribution and Dispersal of Freshwater Animals. In *Zoogeography of Fresh Waters*, 1: 511 pages. Wiesbaden: AULA-Verlag.  
1992. Distribution and Dispersal of Freshwater Animals in North America and Eurasia. In *Zoogeography of Fresh Waters*, 2:519–1091. Wiesbaden: AULA-Verlag.
- Beetle, D.E.  
1957. The Mollusca of Teton County, Wyoming. *Nautilus*, 71:12–22.  
1961. A Checklist of Wyoming Recent Mollusca. *Sterkiana*, 3:1–9.  
1989. Checklist of Recent Mollusca of Wyoming, USA. *Great Basin Naturalist*, 49:637–645.
- Berry, E.G.  
1948 ("1947"). Snails Collected for the Schistosomiasis Investigations. *United States National Institute of Health Bulletin*, 189:55–69. [Date on title page is 1947; actually published in 1948.]
- Binney, W.G.  
1859. Catalogue of the Terrestrial and Fluvial Gasteropods Inhabiting the Continent of North America. Pages 1–15. [Issued as pamphlet under the head Smithsonian Miscellaneous Collections, First Edition, but not actually published in this series.]  
1860. Check List of the Shells of North America. Fluvial Gasteropoda. *Smithsonian Miscellaneous Collections*, 2(6):7–13.  
1865. Land and Fresh-water Shells of North America, III: Ampullariidae, Valvatidae, Viviparidae, Fresh-water Rissoidae, Cyclophoridae, Truncatellidae, Fresh-water Neritidae, Helicinidae. *Smithsonian Miscellaneous Collections*, 7:1–120.
- Bole, J.  
1982 ("1981"). Zur Problematik der Gattung *Lithoglyphus* Hartmann 1821 (Gastropoda: Lithoglyphidae). *Slovenska Akademija Znanosti In Umetnosti Academia Scientiarum et Artium Slovenica*, 33:157–169. [Date on title page is 1981; actually published in 1982.]
- Bowler, P.A., and T.J. Frest  
1992. The Non-native Snail Fauna of the Middle Snake River, Southern Idaho. *Proceedings of the Desert Fishes Council*, 23:28–44.
- Branson, B.A., M.E. Sisk, and C.J. McCoy  
1966. Observations on and Distribution of Some Western and Southwestern Mollusks. *Veliger*, 9:145–151.
- Brot, A.  
1862. *Catalogue Systématique des Espèces qui Composent la Famille des Mélianiens*. 72 pages. Geneva: Jules-Guillaume Fick.
- Burch, J.B.  
1978. An Outline of Classification of the Freshwater Gastropods of North America (North of Mexico). *Journal de Conchyliologie*, 115:3–9.  
1979. Some Corrections and Additional Comments on the Classification of Recent North American Freshwater Gastropods. *Journal de Conchyliologie*, 115:66–71.  
1982. North American Freshwater Snails; Identification Keys, Generic Synonymy, Supplemental Notes, Glossary, References, Index. *Walkerana*, 1:217–365.
- Burch, J.B., and J.L. Tottenham  
1980. North American Freshwater Snails; Species List, Ranges and Illustrations. *Walkerana*, 1:81–215.
- Call, R.E.  
1884. On the Quaternary and Recent Mollusca of the Great Basin with Descriptions of New Forms; Introduced by a Sketch of the Quaternary Lakes of the Great Basin by G.K. Gilbert. *United States Geological Survey Bulletin*, 11:1–66.  
1886. On Certain Recent, Quaternary and New Fresh-water Mollusca. *Proceedings of the Davenport Academy of Natural Science*, 5:1–8.
- Carpenter, P.P.  
1857. Report on the Present State of Our Knowledge with Regard to the Mollusca of the West Coast of North America. *Report of the British Association for the Advancement of Science*, 26:159–368.  
1864. Supplementary Report on the Present State of Our Knowledge with Regard to the Mollusca of the West Coast of North America. *Report of the British Association for the Advancement of Science*, 33:517–686.
- Chamberlin, R.V., and E. Berry  
1933. Mollusks of the Pliocene Deposits at Collinston, Utah. *Nautilus*, 47:25–29.
- Chamberlin, R.V., and D.T. Jones  
1929. A Descriptive Catalog of the Mollusca of Utah. *University of Utah Bulletin*, 19:1–203.
- Clarke, A.H.  
1976. Endangered Freshwater Mollusks of Northwestern North America. *Bulletin American Malacological Union*, 1976:18–19.  
1981. *The Freshwater Molluscs of Canada*. 446 pages. Ottawa: National Museums of Canada.
- Clench, W.J.  
1940. *Pyrgulopsis nevadensis* Stearns in Oregon. *Nautilus*, 53:137.
- Clessin, S.  
1880. Studien über die Familie der Paludinen. *Malakozoologische Blätter*, 2:161–196.
- Coan, E.  
1985. A Bibliography and List of Molluscan Names of Josiah Keep. *Veliger*, 28:211–215.
- Coan, E., and B. Roth  
1987. The Malacological Taxa of Henry Hemphill. *Veliger*, 29:322–339.
- Cooper, J.G.  
1867. *Geographical Catalogue of the Mollusca Found West of the Rocky Mountains between Latitudes 33° and 49° North*. 40 pages. San Francisco: Geological Survey of California.

1888. Catalogue of Californian Fossils. In *Seventh Annual Report of the State Mineralogist*, pages 221–308. Sacramento: State of California.
1894. On Some Pliocene Fresh Water Fossils of California. *Proceedings of the California Academy of Sciences*, 4:166–172.
- Cooper, W.
1860. Report upon the Mollusca Collected on the Survey. In *Reports of Explorations and Surveys, to Ascertain the Most Practicable ... Route for a Railroad from the Mississippi River to the Pacific Ocean, Made ... in 1853–55 ...*; 1: I.I. Stephens, editor, *Supplementary Report of Explorations for a Route ... near the Forty-seventh and Forty-ninth Parallels ... from St. Paul to Puget Sound, III: Zoological Report*, 6:369–386. Washington, D.C.: U.S. S. Exec. Doc. 56, volume 12, book 2, 36th Cong., 1st Sess.
- Dall, W.H.
1905. Land and Freshwater Mollusks. In C.H. Merriam, editor, *Alaska: Giving the Results of the Harriman Alaska Expedition, Carried Out with the Cooperation of the Washington Academy of Sciences*, 13:1–171. London: Washington Academy of Sciences.
1924. Discovery of a Balkan Fresh-water Fauna in the Idaho Formation of Snake River Valley, Idaho. *United States Geological Survey Professional Paper*, 132-G:109–115.
- Falniowski, A.
1987. Hydrobioidea of Poland (Prosobranchia: Gastropoda). *Folia Malacologica, Scientific Bulletins of Stanislaw ... Metallurgy (Cracow)*, 1(1096):1–122.
1990. Anatomical Characters and SEM Structure of Radula and Shell in the Species-Level Taxonomy of Freshwater Prosobranchs (Mollusca: Gastropoda: Prosobranchia): A Comparative Usefulness Study. *Folia Malacologica, Scientific Bulletins of Stanislaw ... Metallurgy (Cracow)*, 4(1276):53–142.
- 1991 (“1989”). Phylogenetic Implications of Shell SEM Outer and Inner Structures Within Hydrobioidea (Prosobranchia: Caenogastropoda): a Preliminary Report. *Proceedings of the Tenth International Malacological Congress (Tübingen)*, 2:529–533. [Date on title page is 1989; actually published in 1991.]
- Farris, J.S.
1988. HENNIG86, an Interactive Program for Phylogenetic Analysis, Ver. 1.5. Stony Brook, New York: J.S. Farris.
- Fischer, P.H.
- 1880–1887. Manuel de Conchyliologie et de Paléontologie Conchyliologique ou Histoire Naturelle des Mollusques Vivants et Fossiles suivi d'un Appendice sur les Brachiopodes par D.P. Oehlert. 1369 pages. Paris: F. Savy.
- Frauenfeld, G.R. von
1862. Versuch einer Aufzählung der Arten der Gattung *Bithynia* Lch. und *Nematura* Bns. *Verhandlungen der Zoologisch-Botanischen Gesellschaft in Wien*, 12:1145–1170.
- 1863a. Die Arten der Gattung *Lithoglyphus* Mhlf., *Paludinella* Pf., *Assimineae* Gray, in der Kaiserlichen und Cuming's Sammlung. *Verhandlungen der Zoologisch-Botanischen Gesellschaft in Wien*, 13:193–212.
- 1863b. Vorläufige Aufzählung der Arten der Gattungen *Hydrobia* Htm. und *Amnicola* Gld. Hldm. *Verhandlungen der Zoologisch-Botanischen Gesellschaft in Wien*, 13:1017–1032.
1864. Verzeichniss der Namen der Fossilen und Lebenden Arten der Gattung *Paludina* Lam. Nebst Jenen der Nächststehenden und Einreihung Derselben in die Verschiedenen Neueren Gattungen. *Verhandlungen der Zoologisch-Botanischen Gesellschaft in Wien*, 14:561–672.
1865. Zoologischen Miscellen. V. *Verhandlungen der Zoologisch-Botanischen Gesellschaft in Wien*, 15:525–536.
- Frest, T.J., and P.A. Bowler
1993. A Preliminary Checklist of the Aquatic and Terrestrial Mollusks of the Middle Snake River Sub-basin. *Proceedings of the Desert Fishes Council*, 24:53–58.
- Gabb, W.M.
1866. [Description of the] Tertiary Invertebrate Fossils. *Geological Survey of California, Paleontology*, 2:1–38.
- Gill, T.
1863. Systematic Arrangement of the Mollusks of the Family Viviparidae, and Others, Inhabiting the United States. *Proceedings of the Academy of Natural Sciences of Philadelphia*, 15:33–40.
- Glen, W.
1960. Pliocene Fresh-water Gastropods from San Mateo County, California. *Journal of Paleontology*, 34:1207–1209.
- Gould, A.A.
1855. New Species of Land and Fresh-water Shells from Western (N.) America. *Proceedings of the Boston Society of Natural History*, 5:127–130.
- Grasset, J.-P.-A.
1884. *Index Testaceorum Viventium quae in Collectione J.-P.-A. Grasset Extant*. 324 pages. Casablanca, Alger.
- Gray, J.E.
1847. A List of the Genera of Recent Mollusca, Their Synonyma and Types. *Proceedings of the Zoological Society of London*, 15: 129–219.
- Haldeman, S.
- 1840–1871. *A Monograph of the Limniades or Freshwater Univalve Shells of North America*. 231 pages. Philadelphia: J. Dobson.
1847. *G. Leptoxis*. *Leptoxe*. Rafinesque. In J.C. Chenu, *Illustrations Conchyliologiques*, pages 1–6. Paris: A. Franck.
- Hall, J.
1845. Descriptions of Organic Remains Collected by Captain J.C. Frémont, in the Geographical Survey of Oregon and North California. In J.C. Frémont, *Report of the Exploring Expedition to the Rocky Mountains in the Year 1842, and to Oregon and North California in the Years 1843–'44*, 4:304–310. Washington, D.C.: U.S. H. Exec. Doc. 166, 28th Cong., 2nd Sess.
- Hanna, G.D.
1924. Freshwater Mollusks of Eagle Lake, California. *Proceedings of the California Academy of Sciences*, 13:131–136.
- Hannibal, H.
1912. A Synopsis of the Recent and Tertiary Freshwater Mollusca of the Californian Province, Based upon an Ontogenetic Classification. *Proceedings of the Malacological Society of London*, 10:112–211.
- Hartmann, J.D.W.
1821. System der Erd- und Süßwasser-Gasteropoden Europa's. ... In Jacob Sturm, *Deutschlands Fauna in Abbildungen nach der Natur, mit Beschreibungen*, 6: *Die Würmer*, 5: 60 pages.
- Hemphill, H.
1881. *New Catalogue of the Shells of California and Adjacent States*. 12 pages. San Diego: Privately published.
- Henderson, J.
1924. Mollusca of Colorado, Utah, Montana, Idaho and Wyoming. *University of Colorado Studies*, 13:65–223.
1929. Non-marine Mollusca of Oregon and Washington. *University of Colorado Studies*, 17:47–190.
1931. The Problem of the Mollusca of Bear Lake and Utah Lake, Idaho-Utah. *Nautilus*, 44:109–113.
1935. *Margaritifera* and *Fluminicola* in Wyoming. *Nautilus*, 48:107.
- 1936a. Mollusca of Colorado, Utah, Montana, Idaho, and Wyoming—Supplement. *University of Colorado Studies*, 23:81–145.
- 1936b. The Non-marine Mollusca of Oregon and Washington—Supplement. *University of Colorado Studies*, 23:251–280.
- Henderson, J., and L.E. Daniels
1917. Hunting Mollusca in Utah and Idaho in 1916. *Proceedings of the Academy of Natural Sciences of Philadelphia*, 69:48–81.
- Henderson, J., and H.G. Rodeck
1934. New Species of Pliocene Mollusca from Eastern Oregon. *Journal of Paleontology*, 8:264–269.

- Hershler, R.  
1994. A Review of the North American Freshwater Snail Genus *Pyrgulopsis* (Hydrobiidae). *Smithsonian Contributions to Zoology*, 554: 115 pages.
- Hinds, R.B.  
1842. Descriptions of New Shells. *Annals and Magazine of Natural History*, 10:81–84.  
1845. Mollusca, 111. In R.B. Hinds, editor, *The Zoology of the Voyage of H.M.S. Sulphur Under the Command of Captain Sir Edward Belcher ... during ... 1836-1842 ... Edited and Supervised by R.B. Hinds*, pages 49–72. London: Smith, Elder and Co.
- International Commission on Zoological Nomenclature (ICZN)  
1985. International Code of Zoological Nomenclature. Third edition, xx + 338 pages. Berkeley and Los Angeles: University of California Press.
- Ingersoll, E.  
1875. Report on the Natural History of the United States Geological and Geographic Survey of the Territories, 1874. *Bulletin of the United States Geological and Geographical Survey of the Territories*, 2:121–142.
- Johnson, R.I.  
1975. R. Ellsworth Call with a Bibliography of His Works on Mollusks and a Catalogue of His Taxa. *Occasional Papers on Mollusks, Museum of Comparative Zoology, Harvard University*, 4:133–144.
- Jones, D.T.  
1935. Mollusks from Weber Canyon, Utah. *Proceedings of the Utah Academy of Sciences, Arts and Letters*, 12:227–228.  
1940. Recent Collections of Utah Mollusca, with Extralimital Records from Certain Utah Cabinets. *Proceedings of the Utah Academy of Sciences, Arts and Letters*, 17:33–45.
- Kabat, A.R., and R. Hershler  
1993. The Prosobranch Snail Family Hydrobiidae (Gastropoda: Rissooidea): Review of Classification and Supraspecific Taxa. *Smithsonian Contributions to Zoology*, 547: 94 pages.
- Keen, A.M.  
1966. West American Mollusk Types in the British Museum (Natural History), II: Species Described by R.B. Hinds. *Veliger*, 8:265–275.
- Keep, J.  
1887. *West Coast Shells: A Familiar Description of the Marine, Fresh Water, and Land Mollusks of the United States, Found West of the Rocky Mountains*. 230 pages. San Francisco: Bancroft Brothers and Co.  
1911 [1910]. *West Coast Shells (Revised Edition): A Description of the Principal Marine Mollusks Living on the West Coast of the United States, and of the Land Shells of the Adjacent Region; Also a Chapter on the Fresh-water Mollusks of the Pacific Slope by Harold Hannibal*. 346 pages. San Francisco: Whitaker and Ray-Wiggin.
- Krause, H.  
1949. Untersuchungen zur Anatomie und Ökologie von *Lithoglyphus naticoides* (C. Pfeiffer). *Archiv für Molluskenkunde*, 78:103–148.
- La Rocque, A.  
1953. Catalogue of the Recent Mollusca of Canada. *Bulletin, National Museum of Canada*, 129:1–406.
- Lea, I.  
1838. Description of New Freshwater and Land Shells. *Transactions of the American Philosophical Society*, 6:1–154.  
1841. New Fresh Water and Land Shells. *Proceedings of the American Philosophical Society*, 2:11–15.  
1856. Description of New Fresh Water Shells from California. *Proceedings of the Academy of Natural Sciences of Philadelphia*, 8:80–81.
- Leviton, A.E., R.H. Gibbs, Jr., E. Heal, and C.E. Dawson  
1985. Standards in Herpetology and Ichthyology, Part I: Standard Symbolic Codes for Institutional Resource Collections in Herpetology and Ichthyology. *Copeia*, 1985:802–832.
- Mayer, C.  
1869. Mollusca. In O. Heere, *Flora Fossilis Arctica; Flora fossilis Alaskana*, volume 2, part 4, pages 40–41.
- Merriam, C.H.  
1891. Results of a Biological Reconnaissance of Idaho, South of Latitude 45° and East of the Thirty-Eighth Meridian, Made during the Summer of 1890, with Annotated Lists of the Mammals and Birds, and Descriptions of New Species. *North American Fauna*, 5:1–117.
- Morrison, J.P.E.  
1940. A New Species of *Fluminicola* with Notes on “Colorado Desert” Shells, and on the Genus *Clappia*. *Nautilus*, 53:124–127.
- Neitzel, D.A., and T.J. Frest  
1989. Survey of Columbia River Basin Streams for Giant Columbia River Spire Snail *Fluminicola columbiana* and Great Columbia River Limpet *Fisherola nuttalli*. 34 pages + appendix. [Unpublished report prepared by Pacific Northwest Laboratory for the U.S. Department of Energy under Contract DE-AC06-76RLO 1830.]  
1993. Survey of Columbia River Basin Streams for Columbia Pebblesnail *Fluminicola columbiana* and Shortface Lanx *Fisherola nuttalli*. 29 pages + appendices. [Unpublished report prepared by Pacific Northwest Laboratory for the U.S. Department of Energy under Contract DE-AC06-76RLO 1830.]
- Nixon, K.C.  
1992. CLADOS Ver. 1.3. Cornell University, Ithaca, New York: K.C. Nixon, L.H. Bailey Hortorium.
- Orcutt, C.R.  
1901a. Shells of Western Lake and Stream. *West American Scientist*, 12:33–40.  
1901b. West American Mollusca. *West American Mollusca*, 1:45–52.  
1902? West American Mollusca. *West American Mollusca*, 1:61–68.
- Paetel, F.  
1883. *Catalog der Conchylien-Sammlung von F. Paetel*. 271 pages. Berlin: Gebrüder-Paetel.  
1888. *Vierte Neubearbeitung*. Volume 1, 639 pages. Berlin: Gebrüder-Paetel.
- Pennell, F.W.  
1936. Travels and Scientific Collections of Thomas Nuttall. *Bartonia*, 18:1–51.
- Pfeiffer, C.  
1828. *Naturgeschichte Deutscher Land-und Süßwasswer-Mollusken*. Volume 3, 84 pages. Weimar: C. Pfeiffer.
- Pierce, R.A., and J.H. Winslow, editors  
1979. *H.M.S. Sulphur on the Northwest and California Coasts, 1837 and 1839. The Accounts of Captain Edward Belcher and Midshipman Francis Guillemard Simpkinson*. 144 pages. Kingston, Ontario: Limestone Press.
- Pilsbry, H.A.  
1899a. Catalogue of the Amnicolidae of the Western United States. *Nautilus*, 12:121–127.  
1899b. Mollusks Collected by R.C. McGregor in Northern California. *Nautilus*, 13:64–67.  
1907. A New Species of *Fluminicola*. *Nautilus*, 21:75–76.  
1908. Notes on Plate XI. *Nautilus*, 21:133.  
1934. Pliocene Fresh-water Fossils of the Kettleman Hills and Neighboring Californian Oil Fields. *Nautilus*, 48:15–17.  
1935 (“1934”). Mollusks of the Fresh-water Pliocene Beds of the Kettleman Hills and Neighboring Oil Fields, California. *Proceedings of the Academy of Natural Sciences of Philadelphia*, 86: 541–570. [Date on title page is 1934; actually published in 1935.]
- Pilsbry, H.A., and W.H. Rush  
1896. List, with Notes, of Land and Fresh Water Shells Collected by Dr. Wm. R. Rush in Uruguay and Argentina. *Nautilus*, 10:76–81.
- Ponder, W.F., G.A. Clark, A.C. Miller, and A. Toluzzi  
1993. On a Major Radiation of Freshwater Snails in Tasmania and Eastern

- Victoria: A Preliminary Overview of the *Beddomeia* Group (Mollusca: Gastropoda: Hydrobiidae). *Invertebrate Taxonomy*, 5:501-750.
- Ponder, W.F., and A. Warén  
1988. Appendix: Classification of the Caenogastropoda and Heterostropha—A list of the Family-Group Names and Higher Taxa. In W.F. Ponder, editor, *Prosobranch Phylogeny. Malacological Review*, supplement, 4:288-326.
- Radoman, P.  
1983. Hydrobioidea a Superfamily of Prosobranchia (Gastropoda), I: Sistematics. *Serbian Academy of Sciences and Arts, Department of Sciences*, 57:1-256.
- Reeve, L.A.  
1860-1861. Monograph of the Genus *Anculotus*. In *Conchologia Iconica: Or, Illustrations of the Shells of Molluscous Animals*. Volume 12, 12 unnumbered pages, 6 plates. London: Reeve and Benham.
- Römer, A.  
1891. Catalog der Conchylien-Sammlung des Naturhistorischen Museums zu Wiesbaden. *Jahrbücher des Nassauischen Vereins für Naturkunde*, 44:17-207.
- Rosewater, J.  
1984. A Bibliography and List of the Taxa of Mollusca Introduced by Joseph P.E. Morrison (December 17, 1906-December 2, 1983). *Nautilus*, 98:1-9.
- Rubin, M., and D.W. Taylor  
1963. Radiocarbon Activity of Shells from Living Clams and Snails. *Science*, 141:637.
- Schmeltz, O.  
1874. Topographische und Zoologische Notizen [supplement]. In *Museum Godeffroy*. Catalog V, 215 pages. Hamburg: L. Friederichsen and Co.
- Starobogatov, Ya.I.  
1970. *Fauna molluskov i zoogeograficheskoe raionirovanie kontinental'nykh vodoemov zemnogo shara* [Fauna of Molluscs and Zoogeographical Separation into Districts of the Continental Water Reservoirs of the World]. 372 pages. Leningrad: Zoologicheskii Institut, Akademiia Nauk SSSR. [In Russian.]
- Stearns, R.E.C.  
1891. List of North American Land and Fresh-water Shells Received from the U.S. Department of Agriculture, with Notes and Comments Thereon. *Proceedings of the United States National Museum*, 14:95-106.  
1893. Report on the Land and Fresh-water Shells Collected in California and Nevada by the Death Valley Expedition, Including a Few Additional Species Obtained by Dr. C. Hart Merriam and Assistants in Parts of the Southwestern United States. *North American Fauna*, 7:269-283.
- Stimpson, W.  
1865a. Diagnoses of Newly Discovered Genera of Gasteropods, Belonging to the Sub-Fam. Hydrobiinae, of the Family Rissoidae. *American Journal of Conchology*, 1:52-54.  
1865b. Researches Upon the Hydrobiinae and Allied Forms; Chiefly Made Upon Materials in the Museum of the Smithsonian Institution. *Smithsonian Miscellaneous Collections*, 201:1-59.
- Taylor, D.W.  
1963. Mollusks of the Black Butte Local Fauna. *Transactions of the American Philosophical Society*, 53:35-41.  
1966a. Summary of North American Blancan Nonmarine Mollusks. *Malacologia*, 4:1-172.  
1966b. A Remarkable Snail Fauna from Coahuila, México. *Veliger*, 9:152-228.  
1975a. Index and Bibliography of Late Cenozoic Freshwater Mollusca of Western North America. *University of Michigan Museum of Zoology, Papers on Paleontology*, 10:1-384.  
1975b. Early Tertiary Mollusks from the Powder River Basin, Wyoming-Montana, and Adjacent Regions [edited by J. Hanley]. In *United States Geological Survey Open-File Report*, 75-331: 515 pages.  
1981. Freshwater Mollusks of California: A Distributional Checklist. *California Fish and Game*, 67:140-163.  
1985. Evolution of Freshwater Drainages and Molluscs in Western North America. In C.J. Smiley and A.J. Leviton, editors, *Late Cenozoic History of the Pacific Northwest*, pages 265-321. San Francisco: American Association for the Advancement of Science.
- Taylor, D.W., and R.C. Bright  
1987. Drainage History of the Bonneville Basin. In R.S. Kopp and R.E. Cohenour, editors, *Cenozoic Geology of Western Utah: Sites for Precious Metal and Hydrocarbon Accumulations. Utah Geological Association Publication*, 16:239-256.
- Taylor, D.W., and A.G. Smith  
1971. Harold Hannibal (1889-1965) with a Review of His Molluscan Research. *Veliger*, 13:303-315.
- Thiele, J.  
1928. Revision des Systems Hydrobiiden und Melaniiden. *Zoologische Jahrbücher*, 53:113-146.  
1929. *Handbuch der Systematischen Weichtierkunde*. Volume 1, part 1, 376 pages. Jena: Gustav Fischer.
- Thompson, F.G.  
1984. North American Freshwater Snail Genera of the Hydrobiid Subfamily Lithoglyphinae. *Malacologia*, 25:109-141.
- Troschel, F.H.  
1856-1863. *Das Gebiss der Schnecken zur Begründung einer natürlichen Classification*. Volume 1, 252 pages. Berlin: Nicolaische Verlagsbuchhandlung.
- Tryon, G.W.  
1864a. Notes on American Fresh Water Shells, with Descriptions of Two New Species. *Proceedings of the Academy of Natural Sciences of Philadelphia*, 15:451-452.  
1864b. Synonymy of the Species of Strepomatidae, a Family of Fluvialite Mollusca Inhabiting North America. *Proceedings of the Academy of Natural Sciences of Philadelphia*, 16:92-104.  
1865. Descriptions of New Species of *Ammicola*, *Pomatiopsis*, *Somatogyrus*, *Gabbia*, *Hydrobia*, and *Rissoa*. *American Journal of Conchology*, 1:219-222.  
1866. [Review of "Researches Upon the Hydrobiinae and Allied Forms, Chiefly Made Upon Materials in the Museum of the Smithsonian Institution" by W. Stimpson (1865).] *American Journal of Conchology*, 2:152-158.  
1870. *A Monograph of the Fresh-water Univalve Mollusca of the United States: Turbidae, Physadae*. Part 1, 82 pages. Philadelphia: [Conchological Section of] Academy of Natural Sciences of Philadelphia.  
1883. *Structural and Systematic Conchology: An Introduction to the Study of the Mollusca*. Volume 2, 430 pages. Philadelphia: Privately published.
- Turgeon, D.D., A.E. Bogan, E.V. Coan, W.K. Emerson, W.G. Lyons, W.L. Pratt, C.F.E. Roper, A. Scheltema, F.G. Thompson, and J.D. Williams  
1988. Common and Scientific Names of Aquatic Invertebrates from the United States and Canada: Mollusks. *American Fisheries Society Special Publication*, 16:1-277.
- United States Department of the Interior [USDJ]  
1984. Endangered and Threatened Wildlife and Plants; Review of Invertebrate Wildlife for Listing as Endangered or Threatened Species. *Federal Register*, 49:21664-21675.  
1991. Endangered and Threatened Wildlife and Plants; Animal Candidate Review for Listing as Endangered or Threatened Species, Proposed Rule. *Federal Register*, 56:58804-58836.



Vaught, K.C.

1989. *A Classification of the Living Mollusca*. 189 pages. Melbourne, Florida: American Malacologists, Inc.

Walker, B.

1918. A Synopsis of the Classification of the Fresh-water Mollusca of North America, North of Mexico, and a Catalogue of the More Recently Described Species, with Notes. *University of Michigan Museum of Zoology. Miscellaneous Publications*, 6: 213 pages.

Wenz, W.

- 1938-1944. Gastropoda, I: Allgemeiner Teil und Prosobranchia. In O.H. Schindewolf, editor, *Handbuch der Paläozoologie*, 6:1-1639. Berlin: Gebrüder Borntraeger.

Woolstenhulme, J.

1942. New Records of Mollusca. *Bulletin of the University of Utah*, 32(11):1-14.

Yen, T.-C.

1944. Notes on Fresh-water Mollusks of Idaho Formation at Hammett, Idaho. *Journal of Paleontology*, 18:101-108.
1947. Pliocene Fresh-water Mollusks from Northern Utah. *Journal of Paleontology*, 21:268-277.
- 1948 ("1947"). Paleocene Fresh-water Mollusks from Southern Montana. *United States Geological Survey Professional Paper*, 214-C:35-50. [Date on title page is 1947; actually published in 1948.]
1950. A Molluscan Fauna from the Type Section of the Truckee Formation. *American Journal of Science*, 248:180-193.



## REQUIREMENTS FOR SMITHSONIAN SERIES PUBLICATION

**Manuscripts** intended for series publication receive substantive review (conducted by their originating Smithsonian museums or offices) and are submitted to the Smithsonian Institution Press with Form SI-36, which must show the approval of the appropriate authority designated by the sponsoring organizational unit. Requests for special treatment—use of color, foldouts, case-bound covers, etc.—require, on the same form, the added approval of the sponsoring authority.

**Review** of manuscripts and art by the Press for requirements of series format and style, completeness and clarity of copy, and arrangement of all material, as outlined below, will govern, within the judgment of the Press, acceptance or rejection of manuscripts and art.

**Copy** must be prepared on typewriter or word processor, double-spaced, on one side of standard white bond paper (not erasable), with 1 1/4" margins, submitted as ribbon copy (not carbon or xerox), in loose sheets (not stapled or bound), and accompanied by original art. Minimum acceptable length is 30 pages.

**Front matter** (preceding the text) should include: **title** page with only title and author and no other information; **abstract** page with author, title, series, etc., following the established format; table of **contents** with indents reflecting the hierarchy of heads in the paper; also, **foreword** and/or **preface**, if appropriate.

**First page of text** should carry the title and author at the top of the page; **second page** should have only the author's name and professional mailing address, to be used as an unnumbered footnote on the first page of printed text.

**Center heads** of whatever level should be typed with initial caps of major words, with extra space above and below the head, but no other preparation (such as all caps or underline, except for the underline necessary for generic and specific epithets). Run-in paragraph heads should use period/dashes or colons as necessary.

**Tabulations** within text (lists of data, often in parallel columns) can be typed on the text page where they occur, but they should not contain rules or numbered table captions.

**Formal tables** (numbered, with captions, boxheads, stubs, rules) should be submitted as carefully typed, double-spaced copy separate from the text; they will be typeset unless otherwise requested. If camera-copy use is anticipated, do not draw rules on manuscript copy.

**Taxonomic keys** in natural history papers should use the aligned-couplet form for zoology and may use the multi-level indent form for botany. If cross referencing is required between key and text, do not include page references within the key, but number the keyed-out taxa, using the same numbers with their corresponding heads in the text.

**Synonymy** in zoology must use the short form (taxon, author, year:page), with full reference at the end of the paper under "Literature Cited." For botany, the long form (taxon, author, abbreviated journal or book title, volume, page, year, with no reference in "Literature Cited") is optional.

**Text-reference system** (author, year:page used within the text, with full citation in "Literature Cited" at the end of the text) must be used in place of bibliographic footnotes in all Contributions Series and is strongly recommended in the Studies Series: "(Jones, 1910:122)" or "...Jones (1910:122)." If bibliographic footnotes are

required, use the short form (author, brief title, page) with the full citation in the bibliography.

**Footnotes**, when few in number, whether annotative or bibliographic, should be typed on separate sheets and inserted immediately after the text pages on which the references occur. Extensive notes must be gathered together and placed at the end of the text in a notes section.

**Bibliography**, depending upon use, is termed "Literature Cited," "References," or "Bibliography." Spell out titles of books, articles, journals, and monographic series. For book and article titles use sentence-style capitalization according to the rules of the language employed (exception: capitalize all major words in English). For journal and series titles, capitalize the initial word and all subsequent words except articles, conjunctions, and prepositions. Transliterate languages that use a non-Roman alphabet according to the Library of Congress system. Underline (for italics) titles of journals and series and titles of books that are not part of a series. Use the parentheses/colon system for volume (number):pagination: "10(2):5-9." For alignment and arrangement of elements, follow the format of recent publications in the series for which the manuscript is intended. Guidelines for preparing bibliography may be secured from Series Section, SI Press.

**Legends** for illustrations must be submitted at the end of the manuscript, with as many legends typed, double-spaced, to a page as convenient.

**Illustrations** must be submitted as original art (not copies) accompanying, but separate from, the manuscript. Guidelines for preparing art may be secured from the Series Section, SI Press. All types of illustrations (photographs, line drawings, maps, etc.) may be intermixed throughout the printed text. They should be termed **Figures** and should be numbered consecutively as they will appear in the monograph. If several illustrations are treated as components of a single composite figure, they should be designated by lowercase italic letters on the illustration; also, in the legend and in text references the italic letters (underlined in copy) should be used: "Figure 9b." Illustrations that are intended to follow the printed text may be termed **Plates**, and any components should be similarly lettered and referenced: "Plate 9b." Keys to any symbols within an illustration should appear on the art rather than in the legend.

**Some points of style:** Do not use periods after such abbreviations as "mm, ft, USNM, NNE." Spell out numbers "one" through "nine" in expository text, but use digits in all other cases if possible. Use of the metric system of measurement is preferable; where use of the English system is unavoidable, supply metric equivalents in parentheses. Use the decimal system for precise measurements and relationships, common fractions for approximations. Use day/month/year sequence for dates: "9 April 1976." For months in tabular listings or data sections, use three-letter abbreviations with no periods: "Jan, Mar, Jun," etc. Omit space between initials of a personal name: "J.B. Jones."

**Arrange and paginate sequentially every sheet of manuscript** in the following order: (1) title page, (2) abstract, (3) contents, (4) foreword and/or preface, (5) text, (6) appendices, (7) notes section, (8) glossary, (9) bibliography, (10) legends, (11) tables. Index copy may be submitted at page proof stage, but plans for an index should be indicated when the manuscript is submitted.

